

DOCUMENT RESUME

ED 164 224

RC 011 064

TITLE Indian Education. Hearings Before the Subcommittee on Elementary, Secondary and Vocational Education of the Committee on Education and Labor, House of Representatives, 95th Congress, 1st Session (February 1 and 2, 1977).

INSTITUTION Congress of the U.S., Washington, D.C. House Committee on Education and Labor.

PUB DATE Feb 77

NOTE 356p.; Not available in hard copy due to small print size of original document

EDRS PRICE MF-\$0.83 Plus Postage. HC Not Available from EDRS.

DESCRIPTORS Agency Role; Boarding Schools; Community Schools; Day Schools; Educational Programs; *Elementary Secondary Education; Government Role; *Government School Relationship; *Hearings; Interviews; Power Structure; *Program Evaluation; *Program Improvement; Tables (Data); Tribes; Vocational Education

IDENTIFIERS *American Indian Education; *Bureau of Indian Affairs; Contract Schools; Federal Indian Relationship; Hopi (Tribe); Navajo (Tribe); Oglala Sioux (Tribe); Seneca (Tribe)

ABSTRACT

The Subcommittee focused its 1-2 February 1977 hearings on the educational activity of the Bureau of Indian Affairs (BIA), as the beginning of an effort to obtain an accurate picture of the current state of educational programs dealing with Indians and the development of ways to improve both the programs and their delivery. On 1 February a panel of officials from the BIA Central Office testified; on 2 February a panel of personnel from BIA field operations gave some insight into the conditions and problems of various local school levels. There were witnesses from the Phoenix Indian Boarding High School, the Seneca Indian Boarding School, the Hotevilla-Bacavi Community School, the Aberdeen (South Dakota) BIA Area Office, and the Navajo Area, representing Seneca, Hopi, Oglala Sioux, and Navajo tribal schools in particular and Indian schools in general. The Subcommittee majority staff's report of research and on-site inspections emphasized a need to grasp the diversity of the American Indian peoples and the need for them to more fully understand the workings of the federal government, while pointing out that the BIA suffers from a lack of leadership, a lack of information gathering and program monitoring capabilities, a plethora of administrative problems, and more time spent in self justification than in problem solving. (SB/BR)

 * Reproductions supplied by EDRS are the best that can be made *
 * from the original document. *

ED164224

KE

INDIAN EDUCATION

HEARINGS

BEFORE THE

SUBCOMMITTEE ON ELEMENTARY, SECONDARY
AND VOCATIONAL EDUCATION

OF THE

COMMITTEE ON EDUCATION AND LABOR
HOUSE OF REPRESENTATIVES

NINETY-FIFTH CONGRESS

FIRST SESSION

HEARINGS HELD IN WASHINGTON, D.C.

FEBRUARY 1, 2, 1977

Printed for the use of the Committee on Education and Labor

CARL D. PERKINS, *Chairman*

U. S. DEPARTMENT OF HEALTH,
EDUCATION & WELFARE
NATIONAL INSTITUTE OF
EDUCATION

THIS DOCUMENT HAS BEEN REPRODUCED EXACTLY AS RECEIVED FROM THE PERSON OR ORGANIZATION ORIGINATING IT. POINTS OF VIEW OR OPINIONS STATED DO NOT NECESSARILY REPRESENT OFFICIAL NATIONAL INSTITUTE OF EDUCATION POSITION OR POLICY.



U.S. GOVERNMENT PRINTING OFFICE

WASHINGTON : 1977

93-545 O

RC 01 1064



COMMITTEE ON EDUCATION AND LABOR

CARL D. PERKINS, Kentucky, *Chairman*

FRANK THOMPSON, Jr., New Jersey
JOHN H. DENT, Pennsylvania
JOHN BRADENAS, Indiana
AUGUSTUS F. HAWKINS, California
WILLIAM D. FORD, Michigan
PHILLIP BURTON, California
JOSEPH M. GAYDOS, Pennsylvania
WILLIAM "BILL" CLAY, Missouri
MARIO BIAGGI, New York
IKE ANDREWS, North Carolina
MICHAEL T. BLOUIN, Iowa
ROBERT J. CORNELL, Wisconsin
PAUL SIMON, Illinois
EDWARD P. BEARD, Rhode Island
LEO C. ZEFERETTI, New York
GEORGE MILLER, California
RONALD M. MOTT, Ohio
MICHAEL O. MYERS, Pennsylvania
AUSTIN J. MURPHY, Pennsylvania
JOSEPH A. LE FANTE, New Jersey
TED WEISS, New York
CEC HEFTEL, Hawaii
BALTASAR CORRADA, Puerto Rico
DALE E. KILDEE, Michigan

ALBERT H. QUIE, Minnesota
JOHN M. ASHBROOK, Ohio
JOHN N. ERLBORN, Illinois
RONALD A. SARASIN, Connecticut
JOHN BUCHANAN, Alabama
JAMES M. JEFFORDS, Vermont
LARRY PRESSLER, South Dakota
WILLIAM F. GOODLING, Pennsylvania
BUD SHUSTER, Pennsylvania
SHIRLEY N. PETTIS, California
CARL D. PURSELL, Michigan
MICKEY EDWARDS, Oklahoma

SUBCOMMITTEE ON ELEMENTARY, SECONDARY, AND VOCATIONAL EDUCATION

CARL D. PERKINS, Kentucky, *Chairman*

WILLIAM D. FORD, Michigan
IKE ANDREWS, North Carolina
MICHAEL T. BLOUIN, Iowa
PAUL SIMON, Illinois
LEO C. ZEFERETTI, New York
RONALD M. MOTT, Ohio
AUSTIN J. MURPHY, Pennsylvania
JOSEPH A. LE FANTE, New Jersey
TED WEISS, New York
CEC HEFTEL, Hawaii
BALTASAR CORRADA, Puerto Rico
DALE E. KILDEE, Michigan
GEORGE MILLER, California

ALBERT H. QUIE, Minnesota
JOHN BUCHANAN, Alabama
LARRY PRESSLER, South Dakota
WILLIAM F. GOODLING, Pennsylvania
SHIRLEY N. PETTIS, California
CARL D. PURSELL, Michigan

(II)

CONTENTS

	Page
Hearings held in Washington, D.C.:	
February 1, 1977-----	1
February 2, 1977-----	71
Statement of--	
Allen, Noah, Phoenix area, superintendent, Phoenix Indian Boarding High School-----	76
Bull, Harry Eagle, Aberdeen area office director, educational services-----	83
Butler, Raymond V., Acting Commissioner BIA: accompanied by Theodore Drenzke, Acting Deputy Commissioner, BIA; William C. Demmert, Director, Office of Indian Education; George Scott, Assistant to the Director, Office of Indian Education; William Benham, Director, Indian Education, Resource Center; John Wade, IERC, chief, Division of Education Assistance; John Carmody, IERC, chief, Division of School Facilities; Jose A. Zuni, director, Office of Administration; statement of Raymond Butler, Acting Commissioner, Bureau of Indian Affairs-----	8
Holman, Larry, Navajo area, education program administrator, Eastern Navajo Agency-----	161
Magnuson, Ernest, Navajo area office, supervisory education specialist-----	231
Masayesva, Vernon, Phoenix area, principal, Hotevilla Day School-----	254
McGilbary, Ray, Muskogee area, superintendent, Seneca Indian Boarding School-----	278
Prepared statements, letters, supplemental material, and so forth:	
Allen, Noah, Phoenix area, superintendent, Phoenix Indian Boarding High School, prepared statement-----	72
Butler, Raymond V., Acting Commissioner of Indian Affairs, statement of-----	9
Committee on Education and Labor, Indian Education, majority staff, prepared statement of-----	2
Holman, Larry D., Education Program Administrator, U.S. Department of the Interior, Bureau of Indian Affairs, Navajo area, Eastern Navajo Agency Branch of Education, prepared testimony of-----	91
Magnuson, Ernest L., supervisory education specialist, Navajo area office, prepared statement of-----	162
Masayesva, Vernon, principal, Hotevilla-Bacavi Community School, Hotevilla, Ariz., prepared statement by-----	236
McGilbary, Ray, superintendent, Seneca Indian School, Muskogee area office, a report-----	264
Powell, John M., acting legislative counsel, U.S. Department of the Interior, letter to Chairman Carl D. Perkins, dated February 18, 1977, with enclosures-----	57

APPENDIX

Holman, Larry, education programs administrator, Eastern Navajo Agency, Bureau of Indian Affairs, Crownpoint, N. Mex.:	
Letter from Chairman Blouin, advisory study group on Indian education, requesting information, dated April 6, 1977-----	296
Letter from Larry Holman, dated June 10, 1977, enclosing responses-----	297
Magnuson, Ernest, supervisory education specialist, Navajo Area Office, Bureau of Indian Affairs, Window Rock, Ariz.:	
Letter from Chairman Blouin, advisory study group on Indian Education, requesting information, dated April 6, 1977-----	300
Responses from Ernest Magnuson, regarding Indian affairs-----	301

	Page
Masayesva, Vernon, principal, Hotevilla Day School, Bureau of Indian Affairs, Keams Canyon, Ariz.:	
Letter from Chairman Blouin, advisory study group on Indian Education, dated April 7, 1977, requesting information-----	303
Letter from Masayesva, Vernon, dated June 1, 1977, responses to questions-----	303
McLaren, Glen D., chief, Division of Program Development and Implementation Bureau of Indian Affairs, Department of the Interior:	
Chart and narrative descriptions-----	307
U.S. Department of the Interior, memorandum to Commissioner of Indian Affairs, dated December 29, 1976-----	322
Chino, Wendell, president, Mescalero Apache Tribe, president, National Tribal Chairman Association, mailgram to Chairman Perkins, dated January 28, 1977-----	351

INDIAN EDUCATION

TUESDAY, FEBRUARY 1, 1977

HOUSE OF REPRESENTATIVES,
SUBCOMMITTEE ON ELEMENTARY, SECONDARY
AND VOCATIONAL EDUCATION OF THE
COMMITTEE ON EDUCATION AND LABOR,
Washington, D.C.

The subcommittee met, pursuant to notice, at 1:35 p.m., in room 2175, Rayburn House Office Building, Hon. Michael T. Blouin (chairman of the subcommittee) presiding.

Members present: Representatives Perkins, Blouin, Mottl, Heftel, Kildee, Quie, Buchanan, and Pressler.

Staff present: Alan Lovesee, counsel; Jack Jennings, counsel; Scherri Tucker, assistant clerk; Jeff McFarland, research assistant; Beatrice Clay, research assistant; Chris Cross, minority senior education consultant; Yvonne Franklin, minority staff investigator; and Dick Bragg, minority consultant.

Mr. BLOUIN: Without any objection from any 69 members, the committee and the minority staff have agreed the committee will meet without a minority member present.

Mr. Quie will be here momentarily. We are voting on the emergency natural gas legislation now.

The Subcommittee on Elementary, Secondary and Vocational Education is conducting oversight hearings today and tomorrow on Indian education. Beginning with the last Congress, the Committee on Education and Labor was charged with legislative responsibility for all Federal laws affecting Indian education. In discharging this responsibility, subcommittee staff has undertaken in-depth research and onsite inspections. A summary statement is available today and a complete report on these activities along with staff recommendations is being prepared for inclusion in the record.

[Material submitted by majority staff follows:]

(1)

PREPARED STATEMENT OF THE MAJORITY STAFF
COMMITTEE ON EDUCATION AND LABOR

INDIAN EDUCATION

The staff of the Subcommittee on Elementary, Secondary and Vocational Education undertakes research and investigative activities in response to the orders of the Subcommittee. Pursuant to the transfer of responsibility for programs dealing with Indian education to the Committee on Education and Labor and the subsequent assignment of oversight responsibility to this subcommittee, the staff began information gathering activities. They were intensified during the summer of 1976, with the commencement of on-site inspections by a staff member. Much of the effort of the staff has gone towards educating itself and others on the range of Federal programs dealing with Indian tribes or nations and the complex educational problems that exist.

To date, the subcommittee staff has spent seventy-three man days in the field and has visited seven Indian reservations. Since the thrust of this investigation has been the education of Indian groups, the staff concentrated on schools, though other installations were visited (i.e. Indian Health Service Clinics). A total of fifty-nine BIA schools were visited including thirty on-reservation boarding facilities, fifteen day schools, seven off-reservation boarding schools, and seven homeliving (peripheral) dormitories.

Eight public schools serving a majority or substantial Indian student population were visited. In an attempt to assess the scope of the impact of P.L. 93-638 (the Indian Self-Determination and Education

Assistance Reform Act), two contract schools were seen. Additionally, the staff has actively sought out the input, ideas, advice, and complaints of members of the Indian community, government agencies, and interested parties. Included in these groups were Central Office, Area Office, Agency Office, and school personnel of the Bureau of Indian Affairs, officials of the Department of the Interior, officials of the U.S. Office of Education, Members of the National Advisory Council on Indian Education, Members of the American Indian Policy Review Commission, Officials of tribal governments, local tribal officials, traditional tribal leaders, parents, school boards, teachers, students, Indian organizations, public school administrators, and officials of State Department of Education.

In anticipation of the full report, the following general observations have been prepared by the members of the majority staff of the Subcommittee on Elementary, Secondary, and Vocational Education. This statement is of preliminary staff findings and may not reflect the views of the Members of the Subcommittee.

First and foremost, the staff wishes to impress upon all the diversity and complexity of the Indian peoples. Geographical and historical distinctions are reflected in social, political, lingual, and educational differences between tribes and bands. In the past, these differences have sometimes been forgotten or ignored by those in charge of Federal programs. Many have regarded Indian education as too complex a problem, best left to others. Some have also felt that until "Indians" agree on programs, their wishes should be discounted. This view has led to a paternalistic attitude on the part of some, and has increased the frustration and bitterness on the part of Indian

peoples. The staff feels that the implementation of P.L. 93-638 and the trend towards increasing local control of education programs is a positive step towards changing these attitudes.

Along this same line of thought, the staff found that the misconception of the Indian peoples as constituting a single, homogeneous unit has been damaging to the formation of a policy to promote community control of schools. The potential for effective local control varies widely between and within areas, tribes, reservations, etc. The local Indian constituents often realize their limitations far better than those who have control of the programs. A failure by government officials to take into consideration these variations and allow Indian communities to proceed wisely increases frustration, anger, and fear on the part of Indian groups and may contribute to situations of program failure.

The majority staff has found that the failure of understanding is not only on the part of the Federal Government. Many Indian tribes and leaders do not adequately understand the makeup and procedure of the Federal Government and their relationship to it. Their responsibilities are often shunted aside in an effort to obtain temporary advantages and avoid accountability. This failure has added complexity to the definition of the special Federal-Indian relationship.

Since the Bureau of Indian Affairs has been the chief government instrument in fulfilling this special relationship, the Subcommittee majority staff gave special attention to its operations, and is prepared to make the following observations:

- (1) A major problem of the Bureau of Indian Affairs is lack of leadership. The positions of Commissioner and Director of Education

19

Programs have been subject to frequent change and the resulting instability has created an untenable situation. This pattern within the Central Office is often repeated in the field, creating an ever-widening leadership vacuum. The various Area Offices have been allowed to go their own way, without direction, or, in many cases, accountability. This has led to great variations in program performance, an overall lack of policy formation and frustration on the part of tribes and local BIA officials, who see inquiries and suggestions effectively ignored. Because of this leadership problem, the Bureau lacks a sense of mission. The staff hopes that the new Director of Education Programs, supported seriously by the Commissioner's Office, will be able to go far towards correcting this situation.

(2) The BIA suffers from a lack of information gathering and program monitoring capabilities. Information systems are directed toward aggregating dollar figures to submit to Congress and the justification of these amounts. Information which would be useful in the formulation of policy (i.e. administrative versus program costs, accurate student information, community make-ups, staff abilities and performance) is either non-existent or not available to those in policy-making positions. This situation is further complicated by the varying levels of cooperation within the divisions of Central Office and between the Central Office and field. This "failure to communicate" has made it extremely difficult for the Subcommittee staff to obtain needed information and may explain why some BIA decisions from the Central Office, Area or Agency level are difficult to effectuate in the schools and are sometimes ignored.

(3) The BIA has a plethora of problems (i.e. facilities maintenance and construction, personnel, budget control, etc.), which are administrative in nature. Along with these go various policy questions

(i.e. boarding schools, Indian self-determination, and community control). Coherent policies and specific operations procedures must be formulated to deal with all these problems and the formulation of these solutions must begin now. The majority staff of the Subcommittee endorses the finding of the staff of the Appropriations Committee that the Bureau has been too long governed by personalities, not procedures. The staff stresses that any policy formulations should occur through the system, with BIA constituent tribal input, and should not be formulated outside the system and subsequently imposed. Such impositions lead to resistance on the part of both field personnel and local tribes and will contribute to the problem, not its solution.

The Subcommittee staff wishes to stress that the foregoing is not meant to place "blame" on any party or parties. This statement and the report being prepared are reports on problems, not "report cards" on people.

(4) In the past, too much Bureau time has been spent in justification and excuse-making in anticipation of, or in response to, criticism. Not enough effort has gone into a true commitment to solve problems.

At this time, the Subcommittee staff wishes to state, for the record, that it was greatly impressed by the efforts of those individuals on the local and school levels to serve the needs of Indian students. In spite of plant, fiscal, and bureaucratic pressures, coupled with local conditions at times primitive, these individuals render service in the best traditions of any agency of the government. The staff wishes to express its gratitude for their aid and its respect for their efforts.

The staff of the Subcommittee also looked at those programs administered by the U.S. Office of Education (i.e. Elementary and Secondary Education Act title programs and the Indian Education Act of 1972). Monitoring in these programs is stronger. However, it should be pointed out that the Federal responsibility here is indirect and thus, such would be expected. The staff found a need for the Congress to assess several of these programs and determine their efficacy and need. Chief among these is a needed review of education for the handicapped, bilingual-bicultural programs, adult education programs, vocational education programs, and programs for advanced students. Also needed is a Congressional look at the relationship between the States and their Indian citizens. Attitudes vary widely between and within States as regards the right of Indian citizens to education and the quality that education should reach. In view of the level of Federal funds expended through the States each year on Indian education, an investigation of these attitudes is warranted and proper.

With regards to several programs, the majority staff is continuing its research and will make recommendations at a later date. Among these programs are early childhood development and community education programs. The majority staff hopes that interested parties will take the time to transmit their feelings to the Subcommittee.

In the future, the Subcommittee plans to conduct on-site inspections, hearings, and further investigations to enable the Committee on Education and Labor to aid in fashioning solutions to the problems within Indian education. The majority staff of the Subcommittee takes this opportunity to ask for the input of interested parties and assure them of all the reciprocal cooperation we can give.

Mr. BLOUIN. These present hearings will focus on the education activity of the Bureau of Indian Affairs. Since the Bureau of Indian Affairs has been the major Federal entity dealing with Indian nations and tribes the importance of its operation cannot be minimized.

These hearings will be the beginning of a subcommittee effort and as of this morning an effort that has been singled out to be on the normal subcommittee authorization process.

The committee has agreed to give the Indian education area the distinction of being handled by a special advisory study group chaired by myself and hopefully aided greatly by Congressman Quie who has almost singlehandedly for the last few months carried out an interest as a member of the committee.

But we will be beginning an effort in that capacity to obtain an accurate picture of the current state of educational programs dealing with Indians and the development of ways to improve both the programs and their delivery.

We wish at this time to welcome Mr. Ray Butler who is current Acting Commissioner for the Bureau. I would like to ask him to introduce those who are with him today.

PANEL PRESENTATION OF RAYMOND V. BUTLER, ACTING COMMISSIONER, BIA; THEODORE KRENZKE, ACTING DEPUTY COMMISSIONER, BIA; WILLIAM G. DEMMERT, DIRECTOR, OFFICE OF INDIAN EDUCATION PROGRAMS; GEORGE SCOTT, ASSISTANT TO THE DIRECTOR, OFFICE OF INDIAN EDUCATION PROGRAMS; WILLIAM BENHAM, DIRECTOR, INDIAN EDUCATION RESOURCES CENTER; JOHN WADE, IERC, CHIEF, DIVISION OF EDUCATIONAL ASSISTANCE; JOHN CARMODY, IERC, CHIEF, DIVISION OF SCHOOL FACILITIES; JOSE A. ZUNI, DIRECTOR, OFFICE OF ADMINISTRATION

STATEMENT OF RAYMOND V. BUTLER, ACTING COMMISSIONER, BUREAU OF INDIAN AFFAIRS

Mr. BUTLER. Thank you, Mr. Chairman.

On my immediate left is Dr. William Demmert, Director of the Office of Indian Education, Bureau of Indian Affairs.

To my far right is Mr. Jose Zuni, Director of the Administration of the Bureau of Indian Affairs.

And to my immediate right is Mr. Theodore Krenzke, Acting Deputy Commissioner.

Mr. BLOUIN. You can proceed, Mr. Butler, in any way you wish.

Mr. BUTLER. Thank you, Mr. Chairman.

At the indulgence of the Chair, we have an opening statement. At the Chair's wishes, could we submit that for the record and I will summarize the opening statement?

Mr. BLOUIN. Any way you wish, Mr. Butler. I think that will be fine if you prefer to insert and summarize. We will be happy to go that route.

[The statement of Raymond V. Butler follows.]

STATEMENT OF RAYMOND V. BUTLER, ACTING COMMISSIONER OF INDIAN AFFAIRS, BEFORE THE COMMITTEE ON EDUCATION AND LABOR, HOUSE OF REPRESENTATIVES.

Mr. Chairman:

It is a pleasure to appear before you today and testify regarding the Education program of the Bureau of Indian Affairs. The questions submitted to the Bureau by the Committee have been reviewed carefully. However, since they are comprehensive, extensive, and require long-range planning, your indulgence is requested to allow the detailed new policy answers to them be deferred for response by a new Commissioner.

From the tone of the questions submitted to the Bureau I sense a concern on the part of the Committee as to whether or not the Bureau has the plan or design necessary to respond adequately to the educational challenge placed upon it. While this is an understandable concern I would ask the Committee to be fully aware of the myriad of factors bearing on Indian education today. I would also urge

that you not overlook accomplishments which have occurred in Bureau schools in recent years, while being concerned with the admitted deficiencies in a number of areas which must be rectified.

Permit me to briefly focus on some of the complexities which exist in respect to the Bureau's education responsibilities. We have a general responsibility for Indian education with less than a third of Indian children attending Bureau schools. Those Indian children not in Federal schools attend public and tribal contract schools. Of those enrolled in BIA schools, many attend day schools spread in isolated communities from southern Florida to northern Alaska. These represent a wide variety of tribes, each with its own distinctive language, culture, economy, and history including that of its relationship with the U. S. Government. Nearly half the Bureau's students are in boarding schools away from their homes. While most of these in past times were there because of lack of schools in their home communities, this is no longer the case and this population now reflects primarily young people who have special needs which make it impossible to remain in their own homes and communities. It is not an easy group to educate. Furthermore, the whole process occurs within a funding process which is largely fragmented and even within the Federal establishment requires the local school administrator to be something of a grantsman in order to enable an individual school to obtain the advantage of all the potentially worthwhile funding sources available. We have found ourselves in just the last dozen years giving major attention to Indian education following a generation of neglect during World War II and the Termination era.

In the midst of renewed emphasis on Indian education, there has been a continuing turnover of leadership at the top in BIA education. While this is important, the normal day-to-day instructional program has continued unabated. While sustained leadership at the top is helpful and desired, it is noticed less at the school level than at the Commissioner's level.

Finally, this program is conducted within an intensive effort by the Bureau to make the concept of Indian Self-Determination truly meaningful --that on the basis of a government to government relationship each Indian tribe should have maximum opportunity to develop the educational program which most closely reflects their needs and desires.

In spite of the above, as well as many other diverse factors, much progress has occurred in the past and continues to be made at the community level. While there remains a crying need for improved facilities in many areas, the recently completed new school facilities are modern and complete. One may visit the campus of Sherman Institute at Riverside, California or the close-by Cherokee reservation in Cherokee, North Carolina to observe school plants reflecting some of the most up-to-date education concepts available in American education today. More needs to be done, but note should also be made of accomplishments.

Speaking of accomplishments, the administration of the USOE Title I program that is conducted within the Bureau of Indian Affairs schools is reputed to be one of the best in the entire United States. Recently



completed films depicting programs under Title I have won film awards in the movie industry.

It is important that there are more Indians seeking college educations than ever before. Scholarship assistance provided by the Congress through the BIA is one of the most important programs today. It has grown dramatically within the past decade and the BIA has continued to work with Indian college students toward improved funding for them. When compared to non-Indians, their needs are great, and the BIA is striving to make it possible for every aspiring Indian student desiring to attend the college of his choice.

There have been changes and improvements in the administration of assistance to Indian children enrolled in public schools. Within the past five years BIA has shifted control of the funds spent via the Johnson O'Malley authority to Indian people. This was in response to the evaluation of the administration of funds. Placing control of funds in the hands of Indian people is an important advancement in the administration of them.

While there is room for improvement the BIA now has better Bureauwide enrollment statistics than they ever have. The new computerized system is in the second year of implementation and it is estimated that its validity will achieve over 95% by the close of the school year 1977-78. In the weeks ahead we are going to implement reviews of schools in order to improve practices.

It is important to note that BIA Education has established a process for turning schools over to tribes. This process was modified in order

to conform to P.L. 93-638. It should be pointed out that the BIA started turning control of schools over to Indian tribes well before the passage of P.L. 93-638. In a sense, 93-638 strengthened the turn-over procedures regarding Tribal control of schools.

In another area of concern, the Bureau developed and implemented regulations governing the extention of procedural due process to students in BIA schools in relationship to expulsions, suspensions, and transfers. This was accomplished two years ago and has been evaluated annually. Before implementation of the program there were several law suits against the Bureau regarding such activities. Since the regulations, law suits have disappeared and problems have been settled administratively without resort to the courts.

There are other accomplishments that could be mentioned in order to make the point, but the above should suffice. With this in mind, I would like to comment on BIA Education programs and what would appear to me to be practical and reasonable directions to pursue.

There have been limited innovations in recent years in bilingual-bicultural education in the schooling of American Indian children. A review of the effectiveness of bilingual education (grades K - 3) indicates that when carried out in a rigorous and systematic manner, it is more effective than the traditional monolingual English approach. Obviously, the most potent cultural feature of human behavior is their language, but there are other non-language cultural features that should be part of the curriculum. This aspect of

curriculum change is aimed at improving the self-image of Indian children. Efforts to date in bilingual-bicultural education have been developmental whereas the objective should be to make bilingual-bicultural education a part of the regular curriculum.

There is great need for the Bureau of Indian Affairs to improve its early childhood education program as recommended in the recently completed early childhood education needs assessment conducted by Bank Street College. The recommendations concern three types of programs and also provide for the establishment of a National Center for the Education of Young Native American Children in order to plan, implement, and coordinate the recommended early childhood programs. The recommendations concern:

1. Programs for Children from Birth Through Age Four and Their Families
2. Programs for Children Aged Five Through Age Eight and Their Families
3. Training Programs for Teachers and Parents

It is emphasized that the design and implementation of these programs must take into account issues of comprehensiveness, continuity, and tribal control.

Comprehensiveness refers, first, to a broad definition of education as a process to promote overall growth--intellectual, emotional, and social --and not merely as a means for training children in literacy and vocational skills. Second, comprehensiveness means extending this definition to one in which the educational program is seen as a vehicle and medium for parent and family education, for delivering health, nutrition, psychological, and social services, and programs for handicapped children.

There has been progress made in recent years by the Bureau's participation in USOE programs in the education of the handicapped or special education. Throughout the years it has been my experience to observe the basic need for a sound Program in special education in the Bureau. This is especially important since so much has been said in research about the basic health problems of Indian children that in so many instances translate into special education needs.

There has been considerable concern expressed historically about BIA off-reservation boarding schools. The Senate asked for a cost study of them and this was conducted in the winter and spring of the school year 75-76. The outcome of this study is that the Bureau is making a concerted effort to update them in every respect. There is a draft of a program that has been developed that contains direct funding, limited size and comprehensive education services in support of specialized education. Meetings have been held with principals and superintendents and more are planned with the objective to improve the quality of education in BIA off-reservation boarding schools.

In another area of consideration it is important that the Bureau continue strong support in scholarships to individual students who seek college and university educations. This is particularly significant in times of self-determination when Indians are in great need of professionally run tribal programs. Regarding higher education, special types of programs in the professions such as forestry, lawyers, business administration, education, and medical specialities are also in great need. If Indians are to control their own services, it is imperative that they seek and receive

support from the BIA for both undergraduate and graduate degrees.

There has been much attention paid lately to construction and maintenance of school buildings as related to BIA Education programs.

The Bureau of Indian Affairs places high priority on developing a realistic process of prioritizing school construction needs. The objective of this thrust is to place school construction on a more solid footing, one that reflects educational need. This process will do much to provide information for decision-making purposes concerning school construction.

Regulations formalized about a year ago provided three years to phase out "basic support" for Indian children enrolled in public schools and changes the entire program to one providing "supplemental" aid only. There are a number of public schools located on or near reservations that cannot provide sufficient basic support due to inadequate state and federal programs. The only alternative is support from the BIA under regular program authority. Proposed regulations would provide basic support only when the state formula for assistance does not discriminate against public schools located on reservations. They would also provide basic support for public schools located near reservations when local efforts don't discriminate against schools located near an Indian reservation, serving substantial numbers of Indian children. Many tribes, members of Congress, state and local education personnel have been very concerned about the phase-out of basic support.

support from the BIA for both undergraduate and graduate degrees.

There has been much attention paid lately to construction and maintenance of school buildings as related to BIA Education programs. The Bureau of Indian Affairs places high priority on developing a realistic process of prioritizing school construction needs. The objective of this thrust is to place school construction on a more solid footing, one that reflects educational need. This process will do much to provide information for decision-making purposes concerning school construction.

Regulations formalized about a year ago provided three years to phase out "basic support" for Indian children enrolled in public schools and changes the entire program to one providing "supplemental" aid only. There are a number of public schools located on or near reservations that cannot provide sufficient basic support due to inadequate state and federal programs. The only alternative is support from the BIA under regular program authority. Proposed regulations would provide basic support only when the state formula for assistance does not discriminate against public schools located on reservations. They would also provide basic support for public schools located near reservations when local efforts don't discriminate against schools located near an Indian reservation, serving substantial numbers of Indian children. Many tribes, members of Congress, state and local education personnel have been very concerned about the phase-out of basic support.

The recently completed report on BIA Education that was made by the General Accounting Office (GAO) raised a pertinent point concerning management or education information in BIA. While progress has been made in recent years, a new and vigorous support of its improvement is needed. The Education budget is the largest one in BIA and there is a shortage of up-to-date valid education information. Plans are ready which will provide an up-to-date education information system, which was a point of criticism raised by GAO in its report.

Another aspect of the BIA Education programs that is receiving appropriate attention concerns the hiring, placing and training of teachers in Federal schools. There was a shift in the management of this important activity in the realignment of the Central Office in 1974. There have been serious problems since that but plans are underway to make the necessary corrections. A task force is nearing the end of its assignment and it is from this group that major recommendations for improvement will be taken.

It is my pleasure to appear before you and to offer my testimony.

Mr. BUTLER. Thank you, sir.

Let me explain to you, sir, that we have had a very rapid change in the Commissionership of the Bureau of Indian Affairs in the past recent months. Commissioner Reifel, who was a former distinguished Member of your House, asked me to share with you his regrets that he would not be here with you today.

On that basis, Mr. Chairman, I would hope that the committee would indulge in that I feel it would be somewhat presumptuous on our part to enter into very extensive policy areas of Indian education.

As a result of this, at this time a detailed response involving the policy issues sent to the Bureau of Indian Affairs by Chairman Perkins are not being provided because of this change in the Commissionerships at the present time.

Complexities of Indian education is by and large a result of the differences between tribes, culture, economy, the education, and the geography. It is probably impractical to have a uniform educational program within the Bureau because of the complexities as needs will vary dramatically.

Each Indian community will have differing wants and desires as well as needs. Differences, in our judgment, should be worked out within the policy enunciated for us by the Congress in the Self-Determination and Education Act.

Briefly, in some of the educational accomplishments, our new facilities are very modern and reflect current educational concepts. Mr. Chairman, it was my personal privilege to visit the new Cherokee school in North Carolina this past year. It is, indeed, a facility designed to provide a good educational program for the eastern Cherokee children.

Administration of title I in BIA is one of the best. More Indians than ever before are seeking higher education. And BIA is striving to stay up with this need in meeting the higher education requirements of our Indian children.

Administration of assistance to public schools has been greatly improved with the funds now being controlled by the Indian people of that given reservation:

The computerized student enrollment system has improved. The quality of enrollment and attendance has improved significantly. Turning over control of schools to tribes even before the passage of the Indian Self-Determination Act. It is our judgment that the Self-Determination Act will strengthen this process. Some of our suggestions and recommendations for improving Indian education, bilingual and bicultural education needs to be made a part of the basic core of curricula.

There is need to improve the early childhood education programs with a parent base, ages 0 to 4, a comprehensive program. All-reservation boarding schools are in great need of modernization. Higher education programs need to be improved with reference to specialized programs and professions—recent school construction priority systems that will add much to the administration of the program.

The recently completed General Accounting Office report speaks to a great need for improvement in the management information system in education and plans are moving forward to implement the GAO recommendation.

Mr. Chairman, I believe that concludes my summary remarks of the opening statement. Because of our impending situation and inasmuch as this is only my first day and a half in this position, if the Chair would please indulge, I would respectfully desire you to or permit members of the committee to direct their questions specifically to Dr. William Demmert, and if I have something to add to that, I will be delighted to share it with the committee.

Thank you, sir.

Mr. BLOUIN. Mr. Butler, I think I know how you feel about the day and a half. I have been there. You have a whole day up on me.

I hope you folks will understand the situation we find ourselves in. We have had an able staff, working, for the last few months in this area. I have not been anywhere near in-depth in this area as I should be. I hope to make up for some lost time over the next few weeks and I hope these hearings today and tomorrow will help us in that regard.

You can feel free to refer questions to anyone of the folks with you that you wish.

One comment. We may at some point in the next, my guess, half hour, have to break for a vote on the floor. There is one more vote pending. Barring that, we should be able to get through this fairly easily today without much interruption. Keep your fingers crossed.

In 1975, then Commissioner Thompson testified that a revision of the goals of the BIA Education Branch was completed and would soon be released. He said, and this is a quote, "This revision will provide the philosophical base for developing educational needs."

My question really has three parts. One, what is the current BIA education goal; second, how is it formulated and where is this found; and third, how has it been transmitted to the field in the form of specific operational goals?

Dr. DEMMERT. The goals and objectives we are currently working under are those that were established in the Bureau a few years back. We have a draft of some proposed recommendations that were forwarded this summer, and we are in the process since my administration—I just came to the Bureau this past summer—in looking at how to best identify goals and objectives in the Bureau of Indian Affairs. And, as we pointed out, in the GAO audit, we are looking toward having these established from the community level upward. We have not implemented new procedures yet and are still in the process of drafting recommendations for the new Commissioner when he or she comes in.

Mr. BLOUIN. Do you have an indication, Mr. Demmert, when those will be sent to the field and will there be procedures to carry them out?

Dr. DEMMERT. We anticipate having our recommendations finalized for review and comment to the field before the end of February. We usually like to give between 30 and 45 days for review and comment before we submit them to the Commissioner for action. We will probably hold fairly close to that schedule.

Mr. BLOUIN. By the end of February then you will be sending them out to the field—

Dr. DEMMERT. For review and comment.

Mr. BLOUIN. How long a period of time once they receive them follows before they go to the Commissioner?

Dr. DEMMERT. We prefer giving them between 30 and 45 days.

Mr. BLOUIN. You are talking about the middle of April?

Dr. DEMMERT. No; let me attempt to back up a bit. Once we develop them, using expert consultants both from within the Indian community and from the professions, we pull them together, send them out, and at that point, which in this case will be somewhere near the end of February, send them out to the Indian community for review and comment. Once we get those comments back in and make necessary and appropriate adjustments, they are sent to the Commissioner for immediate action as a recommendation. At that point they may either be accepted or rejected by the new Commissioner.

Mr. BLOUIN. Do you have any idea when they will be getting to the Commissioner? Are we talking about a couple weeks after the end of February?

Dr. DEMMERT. I would say near the end of March.

Mr. BLOUIN. Are the educational standards and procedures of all areas alike—testing, special education, personnel, and so on?

Dr. DEMMERT. No.

Mr. BLOUIN. Could you go into that a little bit in terms of how they differ?

Dr. DEMMERT. Let me confer just a second with a member of my staff.

Mr. BLOUIN. Sure.

Dr. DEMMERT. Let me ask Mr. Tom Hopkins of my staff who has played a role in the implementation of testing and standardization of activities in that area.

Mr. BLOUIN. Sure, feel free to.

Mr. HOPKINS. Congressmen, are you speaking specifically to testing?

Mr. BLOUIN. I think we are speaking of testing as compared to special education as compared to personnel, as compared to curriculum, et cetera, whatever else you get into. Generally, are there uniform standards and procedures in all of these educational areas?

Mr. HOPKINS. There is not a single set of standards in relationship to, well, what I would call a classical concept of education. The area offices, and you will be hearing them tomorrow, follow rather closely the State curriculums. As a matter of fact, it is a statutory obligation for the Bureau of Indian Affairs schools in the State of South Dakota to follow the State curriculum. So in that respect in South Dakota they follow the State curriculum.

In the Juneau area, there is a close relationship to the State Department of Education. They follow it there likewise. In past times, the Bureau of Indian Affairs has had what is called minimum essential goals which establish curriculum standards, if you will. They are really criteria. So I think the answer to that is that outside of what we have in the code of Federal regulations, then our standards are very much geared to those of the public schools with each area office in curriculum having the freedom to develop curriculums for the specialized needs of Indian children.

With regard to testing now, the Bureau of Indian Affairs does not have a single testing program. We have had, I do not know if you are familiar—

Mr. BLOUIN. Why is that? Why is there no uniformity in testing?

Mr. HOPKINS. Because of the differences among the people educationally, economically, and geographically.

Mr. BLOVIN. Would you care to go into that a little bit?

Mr. HOPKINS. Let's take Alaska, for instance. Mr. Demmert here is a Native Alaskan. In Alaska you have a set of circumstances there where I think you have tremendous dynamics in education, particularly in Native education. You have the State wanting actively, desiring to take over the control of education and working to do that. Among the people you have cultural diversity within Alaska. You have five basic cultural groups in Alaska.

Each of these will have a somewhat different—let's take language, for instance. You will have differences in language within the Eskimo people and Alaska. You will also have differences in geographic distances between people in there. You will have differences in terms of the economics of the people and, therefore, it is pretty difficult to standardize it.

If you go down into the continental United States and take the very large, the largest, the Navaho, you have a different set of circumstances there. All too frequently, the largest tribes, say the Navaho in this instance, people tend to think of Indian education in terms of the largest tribe. But there are about 40 to 45 percent of the Bureau of Indian Affairs total responsibility in this. And where we have some of the biggest differences they are in some of the very small tribes. Where you have several tribes in one particular area, I think the largest number of tribes probably would be in the Northwest—Oregon, Washington, and thereabouts.

Mr. BLOVIN. And each of these cultural groups, do they try to maintain some uniformity in standards?

Mr. HOPKINS. In education?

Mr. BLOVIN. In education within the various groups. For instance, from the public school system to the BIA to contract schools and so on. Is there a uniformity of standards among the various elements of education?

Mr. HOPKINS. We do not have the uniformity of standards but we have a fairly common offering. We have fairly common education that would, I think, relate strongly to what is called common school education in the Bureau of Indian Affairs. Our standards are primarily in terms of blood quantum, enrolling children in boarding schools, moving children across State lines. We have a set of regulations now in relation to procedural due process in Federal schools and contract schools. These are in themselves standards. Those are the types of standards we have. I am not sure I would recommend curriculum standards.

Mr. BLOVIN. I would like to get back into this in a couple of minutes. I would like to first recognize the chairman of the overall Education and Labor Committee as well as the Elementary, Secondary and Vocational Education Subcommittee.

Chairman PERKINS. I first want to compliment the distinguished Chairman of the Advisory Study Group on Indian Education because he was willing to assume the responsibility of a very complicated subject matter and especially in an area that has long been neglected insofar as Indian education is concerned throughout the Nation. And we think at long last with the assistance of Congressman Quie in the minority.

I want to say Congressman Quie has been out front in this legislation, I mean in connection with the Study that is going to eventually lead to legislation. I am proud of the fact that we are on our way and I hope the results on down the road will be worth all the effort that we are going to put into this. We are going to put considerable effort into it under the leadership of Congressman Blouin and Congressman Quie, and I certainly will be doing everything in my power to assist them.

Let me thank the distinguished gentleman from Iowa for recognizing me. I do want to state that Mr. Lovesee, an attorney, has been working on this matter for several months, he is there with Mr. Blouin, and Congressman Quie has had a consultant on this subject for several months, and I think this is the first time—I feel that it is the first time, to my knowledge—in 20 years that we have ever given this subject matter as serious consideration as we are presently giving the Indian education subject. It is my hope we will obtain good results.

I want to thank you, Mr. Blouin.

Mr. BLOUIN. Thank you. We hope to live up to your expectations.

I would like to yield to the ranking minority member of the Education and Labor Committee, Congressman Al Quie.

Mr. QUIE. Thank you, Mr. Blouin.

I appreciate that we are getting these hearings started. I also want to indicate my appreciation to Chairman Perkins for addressing first our staff and then the committee itself to the question of Indian education because in the last Congress, for the first time, we received sole jurisdiction over Indian education. Before that it had been split. In fact, the Education and Labor Committee came into it secondhand because the Senate had done the studies leading to the Indian Education Act.

It is about as complex a subject as we can run across, but also more of a responsibility, I think, than we have for the education of other children in the country because of the treaty relationships the Indians have with the Federal Government.

We cannot turn this over to the States as we have with the education of all other children under the Constitution, where the responsibility lies primarily in the States. I think this is not the case with Indian education.

We have seen some movements in the legislation here to give more responsibility to the tribes and to the parents in title I, the Johnson-O'Malley program, and in the vocational education amendments adopted in the last Congress. It is a trend that is continuing toward self-determination.

If we have more of a responsibility for providing adequate education to Indian children than we do with other children, it seems that we ought to know more about it.

Today, I do not feel on our committee that we have the kind of intimate knowledge that we ought to have. I am pleased with what Mr. Lovesee and Mr. Bragg did on the outside visits which they have conducted so far. I recognize there are other studies and it must be really discouraging to Indians to have everybody under the sun come out there and try to talk to them and find out what is happening. We do have a responsibility here, and we must have some firsthand information from our own staff.

We will be having a description of the staff trips and the findings they have made so far. We would like to progress into the future based on that plus the other studies that we have made.

Mr. QUIE. I would yield back to you so you can pursue the questions that you had begun before I came in and then pick up myself.

Mr. BLOUIN. Thank you, Mr. Quie.

I would like to get back into this area because I am fairly confused as to why there seems to be a lack of emphasis on uniformity at least even on the local level within various groups.

Have there been attempts made at trying to establish uniformity of standards over the last few years?

Dr. DEMMERT. As I pointed out, I have been in the Bureau for about 6 or 7 months. When you get too far back into its history, I have to defer to some of the members of my staff that have been there a lot longer. In this instance I would like to call on Mr. Benham to respond.

Mr. BENHAM. Mr. Chairman, committee members, my response is to the question, are there standards, let's say, within an area of jurisdiction, and the answer is, yes. Again, I will use the largest area, the Navaho area, as an illustration. There will be representatives here tomorrow. In the Navaho area, there are standards established that parallel the State course of study.

As the contracts are made with contract schools—a program that parallels or equals the State course of study is required. This is generally one of the provisions of the contract. There is a great deal of curriculum activity on the Navaho. Curriculum committees made up of teachers and parents are active and work for the improvement, say, of the language arts, or improvement of math or social studies, and other curriculum areas in the past, there has been an area testing program as well. You made that comment earlier. So, yes, there are these things.

Mr. BLOUIN. Who has the duty to monitor what happens in regard to maintaining these standards?

Mr. BENHAM. The immediate work and evaluation of the school, again I will use Navaho as an illustration, is carried on at the local agency in terms of help to schools, assistance is also given by the area office staff at the area office headquarters at Window Rock, Ariz.

At the same time, on special occasions, requests are made for help from the central office part of the organization, generally on particular kinds of circumstance or problems, such as total school evaluations and Bureauwide projects, and this goes on. Periodic visits and evaluations are made.

Mr. BLOUIN. Is there any effort above the local level all the way up to the national level made within the BIA to monitor and coordinate this effort?

Dr. DEMMERT. At the present time, the major effort to evaluate and to monitor comes from the central office in Albuquerque where Dr. Benham is the chief administrator to the director. But most of that at the present time comes from either the area office or the agency, and we do not do an awful lot of—in fact, I will defer to Dr. Benham to have him give an indication of just how much his office has been involved over the past couple years.

Mr. BENHAM. We have, Mr. Chairman, 80 reports that are essentially some phase of the evaluation process, some of them being a total school

evaluation where the program, both in the classroom, the dormitory, and curricula offerings. This total evaluation is developmental. Such evaluation involves the school staff in its totality as well as community members, as an endeavor to, let's say, philosophically to get a recognition of problems which obtain at a particular location on the part of the staff, on the part of the community through their involvement in the evaluation process.

Some of those are fairly recent vintage. As an illustration, the Flandreau School evaluation is in process now, as Mr. Harry Eagle Bull, whom I notice is here in the audience, can tell you. He is the head education man up there.

Mr. BLOUIN. You monitor and coordinate this at the national level?

Mr. BENHAM. In working with our director, Dr. Demmert. He is our director—in strict accordance with him.

Mr. BLOUIN. I understand that one of the reasons this subject is even brought up is that the staff has received numerous complaints of a lack of visits to the schools and reservations, unanswered mail and phone calls and personality clashes that apparently go on. I know much of that is probably a normal part of any structure that is probably totally unavoidable in many instances.

I guess my concern is that it is not more than anywhere else and there is really a flow of information, a working relationship up and down a line and a coordinated effort at the Federal level to understand what the standards are and make sure there is some uniformity of enforcement.

Dr. DEMMERT. Let me respond by pointing out that the normal process within the Bureau is to send materials through the area directors to the schools and that is the process we are continuing to use. But, in addition to that, to insure timely distribution, especially the recommendations we have been working on over the past few months, we also send them to the schools directly.

We have some 200 schools in the Bureau of Indian Affairs. We send them directly to national organizations, both tribal and professional—I am talking about Indian organizations—for distribution through their network, and we have, on occasion, sent them directly to the federally recognized tribes that we have on our list.

Mr. BENHAM. Mr. Chairman, may I add to Director Demmert's remarks, we endeavored to get at the practical research part of the endeavor in terms of the sharing of education through an education research bulletin which is made up of articles which describes the practices of practitioners in Federal schools primarily but also in the public schools as well. It is called the BIA Education Research Bulletin. This comes out about once every 2 months. This is the IERC bulletin which comes out when there is something significant to report. It generally is at least once each month. It has wide circulation. Its primary goal is the exchange of information. It does go to public schools and universities. It does go to other parochial and private schools in the endeavor. It is primarily for the Federal endeavor.

Mr. BLOUIN. Thank you. I would like to yield to Mr. Quie at this point.

Mr. QUIE. I would like to get into the whole question of how the Bureau is organized and how it operates. I am a little confused on how you direct things out of Washington here through the Commissioner and the Director of Indian education programs.

It seems to me somewhere or other Albuquerque gets involved. It sounds like you have two bosses, one here and one in Albuquerque. Can you straighten that out first?

Dr. DEMMERT. In terms of line of authority, authority to make decisions and implement policy, you, of course, have the Commissioner of Indian Affairs and then the Deputy Commissioner. For all matters in the Bureau, including education, let me relate specifically to education in this particular instance, and from the Commissioner and the Deputy Commissioner responsibility and line of authority goes directly to and from the area directors out in the field. In most cases they have an assistant area director for education and in most cases a staff position similar to mine in the central office.

Mr. QUIE. How many areas?

Mr. DEMMERT. Twelve area directors.

Mr. QUIE. In this case is Albuquerque considered one of those areas as well as a resource center?

Dr. DEMMERT. No; we then move into the organizational structure of the Director for Indian education programs which is the position I now hold. Under the Director, we have a planning office with a small staff and we have an executive office with a small staff and three divisions. A division for elementary and secondary education where the responsibility for making sure those responsibilities of the Director are carried out. We have a division of postsecondary education and then we have a division of the IERC, Albuquerque Indian Education Resource Center.

Their primary responsibility is being changed somewhat as a result of the recent reorganizing of my immediate office and their primary focus, we hope, will be on the development of a curriculum center for materials on Indian education, whether they are from the public, private, or Bureau sector. And then a primary responsibility to monitor and provide technical assistance on evaluation and research efforts. But ours is primarily a staff function, a staff function for the Deputy and for the Commissioner.

Mr. QUIE. Do you develop the policy on Indian education in your office, or is that policy developed in Albuquerque?

Dr. DEMMERT. Let me respond directly to what we have been doing in the past 6 months, if I might. What we have been doing in the past 6 months is to pull together recommendations in various areas like construction, like early childhood education, like bilingual education, like meeting handicapped needs of Indian children. Once we pull the recommendations together, we submit them to the field for review and comment. And that—

Mr. QUIE. By field, do you mean the 12 area offices?

Dr. DEMMERT. Not only the 12 area offices, but the members of the Indian community, national Indian organizations, both professional and tribal and anyone that is interested.

Mr. QUIE. Where did the recommendations come from?

Dr. DEMMERT. For those that I just mentioned, they were initiated by my office directly and either assigned to members of my immediate staff in the central office or on occasion to staff members of IERC. Construction was in part pulled together by members of the field staff. Meeting special education needs of Indian students is in part being developed by the field staff. Most of the others have been developed through the central office directly. But in all cases we are not formulat-

ing policy. We are pulling together recommendations for policy that the Commissioner and his line people will evaluate and accept or reject.

Mr. QUIE. It seems to me the recommendations came from you, yet you are pulling them together. Do you mean pulling them together from your staff?

Dr. DEMMERT. My staff and consultants that we use from the field. At that point, they will either become official policy or be rejected. If they become official policy, we then start the process for implementation and in some cases, that would include publication of rules and regulations in the Federal Register, changes in the manual, and the issuing of instructions or directions to the field.

Mr. QUIE. Is the division of elementary and secondary education now located with you?

Dr. DEMMERT. That is correct.

Mr. QUIE. Did it use to be under Albuquerque?

Dr. DEMMERT. In the past we did not have a division for elementary and secondary education or a division for postsecondary education. We have a division of internal and division of external services.

Mr. QUIE. Has this resulted in taking anything away from Albuquerque?

Dr. DEMMERT. Yes. In fact, it has resulted in some changes in positions as well as some changes in lines of authority and responsibility that are currently under the Director of Indian Education.

Mr. QUIE. On the whole area of development of budgets, do the 12 area offices submit their proposals to Albuquerque, they in turn review it and send it out to you, or now do they send it directly to you?

Dr. DEMMERT. We have two different efforts under the budget. One is through the band analysis. I will defer to Mr. Gorrell or Mr. Zuni to describe that. The other is the central office budget. The other is what I primarily have responsibility for as a director. That is pulled together in part by the staff both in the central office and in the field—education staff under my authority and responsibility. The band analysis process is much different.

Mr. QUIE. Let me just recap what you said. Anything having to do with your own staff you do here. Everything having to do with schools and area offices goes through Albuquerque?

Dr. DEMMERT. Through the 12 area offices including the area office in Albuquerque; that is correct?

Mr. QUIE. It sounds to me like Albuquerque is something more than an area office.

Dr. DEMMERT. There is an area office in Albuquerque and then there is—

Mr. QUIE. The resource center?

Dr. DEMMERT. They are two different operations completely.

Mr. QUIE. The resource center develops policy and develops budgets, does it not?

Dr. DEMMERT. Under the current operation the resource center assists me in developing budget recommendations as they affect programs or activities that are under the authority and responsibility of the director. In the past, when we may not have had a director, I am not sure what happened at that point. I would have to defer to Dr. Benham who has acted in acting capacity as director and as the lead person in the Albuquerque Resource Center.

Mr. QUIE. Normally I think a resource center is where the research, innovation, and development occurs, but is not a part of the reissuing of Federal money out to the schools, be they on or off the reservation. I understand that Albuquerque serves as a Federal management office that is an extension really of the Washington office.

Dr. DEMMERT. Let me ask Mr. Zuni to respond to the role at the various offices in Albuquerque.

Mr. ZUNI. Congressman, the Indian Education Resource Center in Albuquerque is a part of the central office of education. It is geographically removed from Washington. It is a staff arm of the Director of Indian Education, and in that capacity serves to help the Director of Indian Education to develop policy and do the necessary staff work with which to develop and carry out an Indian education program. I hope we are making this clear.

Also in Albuquerque we have a regional or field office which is separate and apart from the Indian Education Resource Center, so we would like to keep those two offices separate and apart, otherwise we will be confused.

To answer your question directly regarding the budget formulating process, Dr. Demmert mentioned the band analysis. It sounds like an archaic method. Really it is not. By this process we mean Indian participation on the development of budget priorities by reservations. The priorities are made at the reservation level and they are filtered up the Bureau hierarchy or the organization, the agency offices in the field, which there are approximately 80, into the area offices of which there are 12, and finally into the central office where they are consolidated into a Bureau-wide education budget.

Mr. QUIE. Do budget recommendations from all 12 go into that one Albuquerque office of the resource center before they come up to the director, or do the 12 offices send their budget recommendations directly?

Mr. ZUNI. They come directly into the central office.

Mr. QUIE. They then bypass the Albuquerque Resource Center.

Mr. ZUNI. It is not a bypass because the Indian Education Resource Center is a part of the central office in Washington. It is only geographically removed from Washington.

Mr. QUIE. Then since you are calling the resource center a part of the central office and, therefore, when you say the central office, you may mean Albuquerque or you may mean Washington?

Mr. ZUNI. This is correct.

Mr. QUIE. Which of those two locations, of the central office handles the budgeting?

Mr. ZUNI. It comes into the central office in Washington.

Mr. QUIE. So, in other words, the Albuquerque office does not play a part in the budgeting. The area office in Albuquerque does as do the other areas offices, but the resource center is not involved in the budgeting.

Mr. ZUNI. Yes, sir, but they do participate to some extent based on their experience.

Mr. DEMMERT. To be specific, the area of construction is where they play a major part, a necessary part.

Mr. GORRELL. I am Joseph Gorrell, assistant director for financial management and I, too, have people in Albuquerque who are part of

the central office, as well as here in the Washington area. We have our accounting management division in Albuquerque, people that do all of the finance work for the 12-area offices as well as the central office. If you define "budget" as including accounting management, we do that part of the BIA work in Albuquerque.

We do the budget planning, budget development work and the execution part here except for the accounting part.

Mr. QUIE. Do you have a flow chart of the various functions. Have you made those up so we could look at the flow chart, not just in the big boxes, but actually where each one of them runs with lines to each one where they move from one to the other?

Mr. GORRELL. We have an organizational chart which has been orally described by Dr. Demmert and Mr. Zuni, but we do not have it available. But I sure will be glad to provide for the record a flow chart for our budget process.

Mr. QUIE. I think that will be helpful. May I say to the staff, when we do meet could we have it on a big board so members could refer to it to see how it now flows.

Looking at the organization we came up with a criticism from one tribe that they were not getting enough money for construction. The tribe receives a large total budget from which they decide how much will go for education and how much will go for something else. Thus they may choose to use the money for something other than education. Is our understanding correct here? In the budget is there a specific allotment for education or is there some flexibility so they can decide out there whether it would be used for education, roads or whatever else it might be?

Mr. GORRELL. I am afraid, like all other parts of Indian education, the answer will be complex. We have to begin at the top. We get a planning number for a particular fiscal year, like fiscal year 1978 which we have a budget before the Congress now from the Department of the Interior.

That planning number is divided into three parts essentially. We have a banded part which goes down to the area offices and the agency offices for tribal consideration and tribal input and tribal prioritizing. We have a nonbanded part which is the part of the budget that is dealt with in the central office here in Washington.

The Commissioner's staff, people like Dr. Demmert, review and make proposals for particular activities in a fiscal year. Those activities are the nonbanded part. Essentially in our—let me get specific. In fiscal 1978, for example, the budget we will be testifying on later this month or next month, our banded part in operation of Indian programs is \$366.4 million. The education elements of that is \$185.3. The unbanded part of our operation of Indian programs is \$273.9 million. The education part of that is \$73.4 million.

As I say, the unbanded part is the part that the Commissioner's office, the central office deal with and set priorities on. Right now we have a very small amount of money that is in the banded part that is in construction. Construction items, because they are nonrecurring and because they vary because of need across Indian country, those priorities with some input are developed here in the Washington office or in the central office. I should say. Is that responsive to your question?

Mr. QUIE. Yes. On budgeting, how do you decide what then will be banded and what will be nonbanded?

Mr. GORRELL. We have a chart that shows element by element the items which are banded and those that are not essentially in a nutsell, banded items are those that get down to tribal level very quickly on in the essential services like school operations that go on and on year after year.

The criteria for unbanded or things like construction, both road construction, irrigation construction, and building and utilities construction to illustrate that point they are sort of what I call the non-recurring but important large chunks of money that are needed.

At the present time we have a questionnaire out in the field asking area offices, agency offices, and tribal leaders as much as we can to get their ideas of what should and what should not be banded.

It is not easy to—the criteria are less than crystal clear on what should be banded and what should be unbanded.

Mr. QUIE. To what extent does the tribe have input into the banded budget items and to what extent do they have input on the nonbanded budget items?

Mr. GORRELL. On the banded part we hope they have a great deal of input. The information we have pulled together as a result of the 1978 budget process indicates there was a fair amount of that. And I have a summarized table which I would be happy to make available to you or the staff here that summarizes that very well.

There are agency bands and there are area bands. There are some amounts of money that go to the area level where an area director, say, in Phoenix, will call in tribal leaders from around his area to come and discuss the prioritization of an exquisite sum of money.

At the agency level, the agency deals directly with tribal leaders and develops priorities within that amount of money for a particular agency. So there is a good bit of evidence that indicates there is a good bit of involvement, especially at the agency level, but also at the area level on banded amounts.

There is consultation and some of the other people here may be able to give you some better indication than myself, but the unbanded parts do not have that same amount of consultation and discussion. That is one of the reasons for our current questionnaire is to find out what that level of consultation and discussion should be.

Mr. QUIE. What percentage of the budget would be nonbanded outside of the tribal participation or discussion?

Mr. GORRELL. Roughly, now of our Federal funds it is about a 50-50 split. For example, in the 1978 budget justifications, the banded part is \$366.4 million and the unbanded in operation of Indian programs is 373.9. There is slightly more banded than nonbanded in the operation of Indian program, for example.

The trust funds are a little difficult. Overall, our current estimate before the Congress is \$1 billion, \$247 million. Of that \$846 million is unbanded. But I want to be quick to point out there are \$390 million of trust funds which are automatic amounts that really the Congress takes no annual action on.

Mr. QUIE. How has the budget been changing over the years?

Mr. GORRELL. It is about even. It is about 50-50.

Mr. QUIE. Is it staying there?

Mr. GORRELL. And it is staying there. It depends on whether you are a central office director or someone in the field as to which way the trend leads. But I would say about even.

Mr. QUIE. Does your auditing show to what extent the tribes are involved in the determination on how the money is to be spent?

Mr. GORRELL. Yes. I will just briefly go through on two or three items here. Tribal input to the 1978 band analysis and agencies. Pine Ridge, for example, in the Aberdeen area, tribe notified four times and meeting postponed but tribal director attended. Brief meeting with president. Priorities are those of newly elected tribal governing body. Tribe wants more time to provide more meaningful participation.

That is sort of an illustration of the kinds of—

Mr. QUIE. It sounds like they didn't have very much input there.

Mr. GORRELL. Two meetings with the council is another one. Two meetings at Shawnee, Crow, at least two meetings with council. The detail is not provided. It looks like you can say anywhere from two meetings, two to five meetings, is sort of a range of meetings between agency superintendents. Those are, of course, the formal recorded kinds of meetings. As a summary, this does not really reflect the day-by-day or other kinds of consultation. That is not possible in this kind of a summary.

Mr. QUIE. Has that been done for all of the banded—

Mr. GORRELL. Yes, sir.

Mr. QUIE. To what extent is there overlap between Mr. Zuni and yourself, Mr. Demmert, and to what extent do you meet to try to work those things out?

Dr. DEMMERT. Let me attempt to be specific. I think you will have to listen to both Mr. Zuni and myself.

Let's take personnel. When we want to hire someone, we develop position descriptions in my office and use one or another process in interacting with his office. That is, we develop them in isolation and submit them and then a substantial interaction takes place on occasion until we reach a mutually agreeable PD as we call it.

In the other instance, and what we have been doing in the past 3 or 4 months is, members of my staff sit down with members of his staff and we attempt to develop those together from an outline that my staff has put together.

Planning let's use planning for the new budget cycle with Mr. Gorrell's shop, which, by the way, is under Mr. Zuni's office. We use the same process. We develop the basic documents and then we sit down with Mr. Gorrell's shop, members of his office and work out any differences of opinion either in the language or in the final analysis some of the priorities. Once we reach a consensus, we forward them as part of our recommendation.

Mr. QUIE. Again doing it in isolation?

Dr. DEMMERT. In some instances, yes. It depends on the topic and the area. In some cases, let me be specific, say, higher education where we have had some issues develop lately, in looking at what needs to be done there, we sit down together and work through the process together.

In an instance we might be developing a preliminary budget. We would probably do most of the work ourselves initially and then sit down and work out any disagreements either in the format or in the amounts.

Mr. BUTLER. Mr. Quie, if I may. I am Ray Butler. Might I share with you in terms of the structure of the Bureau? There are basically four program divisions within the Bureau, the Division of Indian Education which Dr. Demmert and you folks have subject matter today; the Division of Indian Services; the Division of Resources Development and the Division of Trust Responsibilities. The fifth is that of Director Zuni's operation which is the Division of Administration which basically provides all of the support functions in the administrative area such as Mr. Gorrell's area, personnel areas, procurement and et cetera, for all of the other program activities within the Bureau.

So there is to some degree, as Dr. Demmert has pointed out, some overlap, but basically they are supplementary to each other.

Mr. QUIE. You talk about budget and personnel. We are not just talking about your shop and we are not just talking about area offices or the resource center in Albuquerque either. Are we not talking here all the way down to the personnel in the school?

Mr. BUTLER. That is correct. Not from the central office level all the way down to schools. See, the area offices under which you have the line authority of the area directors and superintendents, they also have their support staff or personnel. For example, a teacher at a local school at Pima, Ariz., personnel actions there would be through the superintendent's administrative officer into the personnel office of the Phoenix area office.

Mr. QUIE. Yet it all comes back to the final policy decisions, does it not, in the BIA?

Mr. BUTLER. Yes, relative to the area of policy, but not operationally.

Mr. QUIE. Relative to public education, wouldn't you say the BIA operates at least with an extensive administrative authority as the State department of education does?

Dr. DEMMERT. At least.

Mr. QUIE. The reason I say at least, it also assumes that some responsibility is left to the local school district. That means you do make some decisions eventually with the Commissioner, that traditionally is done in the State department of education and some decisions are made within the local school district office. In both of these instances, do you not have, what seems to me, overlapping or confusing lines of authority. At least to me it is more confusing than anything I see out in the States.

Dr. DEMMERT. Let me see if I can be specific.

Mr. QUIE. Let me also tell you what I am thinking so you might want to start folding this into your answer as well. You were over in the Office of Education before you came to BIA.

Dr. DEMMERT. That is correct.

Mr. QUIE. We have a Federal policy on education for the Indians, I would hope and assume, because we have a responsibility here that is like the responsibilities in the States, only more so. I can understand why we do not have Federal policy on public elementary and secondary schools, because that main responsibility is with the State. If the Federal Government is going to assume that responsibility for Indians as it should, I cannot think of anything that is going to be as positive an influence for Indians than if the education system worked well for them. How are you going to make it work when other education policies are tied into it.

Dr. DEMMERT. There are two or three parts to that. I am not sure I can keep them straight, but will attempt to do that.

In the first instance, you have a public school system with a school superintendent who has primary authority and responsibility for the operation of the activities of that school, including line authority over the teachers he can or she can hire and/or fire after they go through the proper procedure on the spot.

In the Bureau of Indian Affairs we have a little different process, as you pointed out. If you want to hire a teacher, we use a civil service system that other Federal agencies here in Washington, D.C. use. And that has proven to be fairly cumbersome and in the past few months we have been attempting to refine that and we are looking at ways to improve the system as we now operate it.

In public schools we have got a school board that develops policy as it affects the operation of that school and if you have a large school district, that district.

In the Bureau system most of that policy is set at the area or the national level and not at the local level. You are asking how in our judgment, at least in my judgment, personal opinion. If we are going to make substantial improvements in the Bureau system as we now know it, and every system needs to be improved, I feel that a substantial amount of the authority and responsibility for policy and the operations of that school need to be conducted at the community level by representatives from the tribe usually in the form of a school board and the school superintendent or the school principal. We do not have that in the Bureau system right now.

There were two other areas you mentioned. I would have to have someone remind me of what they were before I could respond.

Mr. QUIE. What I was asking about?

Dr. DEMMERT. Yes.

Mr. QUIE. The tying into HEW's programs.

Dr. DEMMERT. That is right, and a consistent policy.

Mr. QUIE. Let me back up a moment. Doesn't the Civil Service Commission in Washington set the rules for the hiring of teachers?

Dr. DEMMERT. In general that is correct. I would assume.

Mr. QUIE. But the teachers that are selected under the HEW programs come under whatever responsibility exists out in the States.

Dr. DEMMERT. In the public system you have schools following the criteria established by the State department of education. Where you have HEW, USOE programs, they usually do not have to follow those, if you are talking about a program outside the school. But if it is a program within the school, the same criteria is usually followed both in the process for selecting, hiring, firing, transferring teachers and in academic credentials.

So you do not have a national system. You usually have a system by State to a large degree carried out and tailored to meet the needs of the various communities within the public system. In the past most of the policies and the authority and responsibility for Indian education has rested in the Bureau, either the central office or the area offices, depending on what period of history we are talking about and how the authority was delegated by the Commissioner.

The existing information that we have received from professionals that I have used as expert consultants points out that programs that



have evidence of effectiveness throughout the country, whether they are in an OE program, a BIA program or a school or a community based and developed program or project, have some factors that are fairly consistent. One of them is a substantial amount of community interaction, support, and direction.

Another, of course, is the high quality of teachers that they are able to attract and train both in service and preservice programs.

In the Indian community we have a very diverse group with distinct cultures and if you were to look at many of the Indians represented in this room you will find each of us are very different to a very large degree.

In general, public schools at the community level have the authority and responsibility for inservice training. In the past in the Bureau, we have either done it by the area or through the national level, or we have not done it at all. I think these are the basic differences between the public system for the general population, versus the Federal system for the Bureau. We are looking into making some recommendations on that particular topic or on those subjects.

Mr. QUIE. I imagine Mr. Zuni's office plays an important role in the various things you are talking about.

Let me try out a specific case. Suppose a superintendent of a school needs to have a teacher because another teacher leaves. How does a superintendent go about it and how long does it take to do it?

Mr. ZUNI. Congressman, our operation in the Bureau is one that is of a decentralized operation. The authorities and responsibilities are redelegated out to the field, out to the area offices, so those officials exercise some of the authorities and responsibilities that are exercised here in the central office. Really, they are the people that are running the operations out there.

Mr. QUIE. Do Mr. Demmert and you have a counterpart out there?

Mr. ZUNI. Yes, this is correct. Mr. Butler referred to the Bureau's organization as having four wheels, the fifth wheel being my organized administration. I hope this does not carry a bad connotation. The administration really is the lubricant. It is a service organization designed to assist the Commission programs to do their jobs efficiently, effectively.

Second, it is to make sure the program people carry out the laws as intended by Congress, to carry out the other rules and regulations as established by the regulatory agencies, the Civil Service Commission, the GSA, the Federal procurement system and in this matter we act as the Governor, we act as the keeper of the rules to make sure the taxpayers' funds are spent effectively and efficiently. But we are a service organization basically. We do have a problem, as Mr. Demmert has pointed out, in recruitment of teachers and replacing teachers that have left the organization because of the bureaucratic rules and regulations that are required by the Civil Service Commission. And we are attempting to try and streamline with the permission of the Civil Service Commission to be able to have our people out in the field react much faster and more quickly so we can be able to have teachers in the classrooms. This is not easy. This is difficult, but we are trying to do this.

Mr. QUIE. Could you tell me step by step what the superintendent would go through and how long it would take him to replace the teacher?

Mr. BUTLER. The superintendent who would have a resignation of a school teacher, to be very specific, would go to his administrator or manager and say I lost a teacher. He would complete what we call a form 52 in a personnel system. That would be submitted to the respective area personnel office that covers that particular school who would obtain a certificate of eligible teachers within that particular category, let's assume physical education category, sociology, home economics and a particular grade level and qualifications.

Mr. QUIE. Are you in the area office now?

Mr. BUTLER. In the area office now, yes, sir. That certificate would then be sent to the superintendent and his administrative officer who in consultation with the particular head of the department for which the teacher was desired to be selected and they would make their selection of the choice of the individual there, contact that individual, ascertain their availability.

Admittedly, Congressman, sometimes in the education field, particularly the teachers, if this occurs during the middle of the year you may have a little lost time. I am not personally knowledgeable and I would ask Dr. Demmert to go into the availability. I think perhaps this process goes on and he selects a teacher of his choice, makes arrangements for the teacher to come onboard at such and such a date and he hires the teacher.

Dr. DEMMERT. One point of clarification in that. The superintendent or the principal makes the selection and then forwards the selected person to the personnel office, probably at the area office, for notification of the teacher and hiring.

One of the problems we have run into is that we select from a list, a national list that is updated annually and once the school year starts, you start going down that list and you will find that teachers have decided to stay or have found other jobs, and so you go down one complete list in the middle of the school year or at the beginning of the school. When somebody resigns, you have to go back to the Civil Service Commission or a new register and then come off that register and do the same thing. If you select someone through that process and they are not available, then you have to go through that process again. That then is one of the areas that causes a substantial amount of delay in hiring teachers that have resigned after me. The reason I say that is, the process starts in February and closes about May.

Mr. QUIE. For the next school year?

Mr. DEMMERT. For the next school year.

Mr. QUIE. Replacements, however, come off that national list?

Mr. DEMMERT. That is correct. We have looked into some steps or activities in the last couple of months that would help us out next year. We have moved the dates up a little.

In addition to that, we have talked about implementing a program that was tried in Alaska last year where once we went through the register the first time and we found no eligible candidates, authority was given in this case to Alaska to hire right off the street or hire in Alaska, they did not have to go to the national register.

Mr. QUIE. Was the person in the area office that carried out this process Mr. Zuni's counterpart or Mr. Demmert's counterpart?

Mr. BUTLER. It would be the personnel office that would handle the mechanics of it. That would be Mr. Zuni's counterpart in the area

Mr. QUIE. I do not know how you can ever make it work that way because you do not have anybody whose primary responsibility is education in charge. The movement in some of the States in teacher hiring is for teachers to comprise a majority of the board making the decision.

It seems to me the teachers do not have any voice in it at all. The superintendent is virtually out of it and you move it into an office that is not connected with Indian education directly. That would be sort of like letting the highway commission run the education department in the State or the board of county commissioners be the school board instead of the local school board.

Unless in education you put policy decisions in the hands of people who have made it their interest, either the lay people on the board or the administrative professionals or the teaching professionals. I do not see how you are ever going to make this thing work properly.

Mr. BUTLER. Congressman, if I may, I apologize perhaps on not communicating on this. I was referring to your superintendent or principal at the local school who establishes what he needs in that area educationally.

What I was referring to in terms of the functional responsibility of the area office in terms of the personnel office, they merely perform the paperwork to carry out, but they do not alter or change that. They are just doing the paperwork on it.

Mr. QUIE. Getting it off the national list?

Mr. BUTLER. Yes, sir, and providing it to the superintendent or principal of the school.

Mr. QUIE. You still have to pick people from a long ways away. We tried in the Teacher Corps to recruit and train nationally and let schools select teachers from a national roll. It was a dismal failure because if a person wanted to work with needy kids in Mississippi, he did not like it if he got transferred to Minnesota. They got away from that idea.

It would be better if it was set up so local people could do their own selecting, recruiting and training. It is also better financially when you move toward self-determination.

If a teacher is going to be a role model for a Sioux, it would seem to be better to have Sioux teachers teaching Sioux.

Mr. DEMMERT. In direct response to that there is authority in the Bureau under Indian preference to hire Indian applicants immediately. They do not have to go through the long process that non-Indian applicants have to go through.

One of the major areas of difficulty identified when I first came aboard, identified by assistant area directors for education and other educational personnel with whom I talked, was the process we use under the Civil Service System for hiring, transferring, and processing the paperwork for teachers. We have organized a task force in coordination with Mr. Zuni's shop to look at some specific recommendations on whether or not we can improve the system as it exists and as we have to operate under and whether or not we have to come forward with some legislative recommendations that would streamline the total process for the Bureau of Indian Affairs.

If you are interested in helping us improving education, I am sure that is an area you would want to take a very close look at.

Mr. QUIE. What kind of contracts are the teachers under?

Mr. DEMMERT. Another problem. They are not under contracts. They are under the Civil Service System and they can decide to quit today and give a weeks' notice or leave tomorrow. Nothing can be done about it. Under contract, of course, you have to stay through the school year usually or you are in breach of contract and you have got unprofessionalism involved in that as well as other kinds of things.

Mr. QUIE. Has the Bureau ever made any recommendations that we change that?

Dr. DEMMERT. I will not be able to respond to that directly.

Mr. HOPKINS. We have gone through various studies in the past using the Defense Department schools which had enabling legislation to get out from under civil service and make it more on a contract basis. These were not followed up on. It did not seem to be necessary at the time they were made in the Bureau of Indian Affairs.

Mr. QUIE. So the recommendation to Congress to change the law was not forthcoming?

Mr. HOPKINS. It never did come forth from the Bureau of Indian Affairs.

Mr. KILDEE. Just some questions on the question of management of the program. Mr. Zuni might want to answer these.

On all levels, including the local level, there must be high management standards in this program and any other program. What management standards have been set and what programs have you established to meet those management standards? Do you have, for example, some management training program or some internship programs, some seminars for those who are in positions of management? In other words, what standards have you set and what means have you taken to achieve those standards for management?

Mr. ZUNI. We have attempted to develop standards that will insure a high success of managerial performance in all of our programs. Unfortunately, we have not made as much progress as we would like to in this particular area.

I think the GAO report and the other reports covering the education program brings out some of the deficiencies that we have in this particular area. And Dr. Demmert and I have talked about this deficiency and we are very anxious to devote some of our energies in this area to make some very desirable improvements in the area.

Mr. KILDEE. If there is not as much progress as you would hope for, have you analyzed as to why there has not been that progress? Have you found a cause, or some solution? Do you have some people actively pursuing increasing the management standards and getting better management performance? Have you done anything specific beyond being aware of the problem?

Mr. ZUNI. Specifically, no. I think all of the discussions are in the conceptual stages. We have discussed this in the development and in the planning of our 1978 budget, and we are also discussing this, currently, in the development of our plans for the 1979 budget so that we can be able to allocate the necessary sources to bring improvement in this particular area.

Mr. KILDEE. In the 1972 report, these same problems are enunciated, too. Have there been specific steps taken since then? I really think it is essential that in any organization that is delivering services to people

management has to be as good as possible. Whenever there is any indication that management needs improvement that should be a top priority of discussion, planning with those who have responsibility to make sure that management is improved so the services are delivered in the best possible way.

I am anxious as a Member of the Congress to assist you in making sure that that management is the best possible. But we have to, I think, take specific steps to do that since there has been a rather long time lag here since the first report came out indicating there were some management problems.

Mr. ZUNI. The Bureau has taken the initiative in the last 9 months to develop an action plan to improve its personnel management program.

We have designed a very ambitious short- and long-range program designed to bring about the development of new employees, the training of employees, the development of standards and the establishment of measurements, the establishment of performance standards for our employees, the design, the development of information systems so we can be able to plan, be able to budget our requirements in order to be able to efficiently and effectively carry out our programs.

The personnel management action plan was approved only last month by the Commissioner, so we are now in the process of implementing this plan. It is rather ambitious. It will be time consuming and we will have to remain dedicated to the effort in order for it to pay off.

Mr. KILDEE. That is encouraging to me you have a development action plan. Could you submit that plan to this committee?

Mr. ZUNI. Yes, sir, we will.

Mr. KILDEE. Mr. Chairman, I would so request that that action plan be submitted to the committee.

Mr. BLOTIN. If there is no objection, we would ask that that be done, yes.

Mr. Heftel.

Mr. HEFTEL. Dr. Demmert, though I am the Congressman from Hawaii, I spent a good portion of my life in Arizona and went to school there, which takes us back a great number of years. And even then, there was a feeling that it would be far better if the young people were educated in public schools or at least in nonboarding facilities. And it appears that in all of these years we still have not made much progress toward getting away from the boarding school concept. Is that reasonably accurate, and how do you feel about it?

Dr. DEMMERT. In terms of boarding schools in the last few years, you are right, the number has remained fairly stable. But in terms of the kinds of students attending those boarding schools, there have been a substantial amount of changes. For example, I will let some of my statisticians correct me if I am wrong. Many of the boarding schools in the past educated kids from all over. And there were a substantial number of Navaho children attending off-reservation boarding schools.

In general, a majority of Navaho children now go to school on the Navaho reservation, either in boarding schools or in day schools where in some cases, they are bused long distances.

Off-reservation boarding schools that they vacated have picked up Indian students who have dropped out of public school, or have been

pushed out. They have picked up students who have been referred by the courts and including students for referred social or handicap reasons.

We are looking at the boarding school situation. We have developed some specific recommendations on what to do with boarding schools to correct some of the problems of the boarding school system as it now exists in the Bureau and that is out in the field for review and comment. We should be getting it back. We have gotten comments back and we will be pulling together a recommendation fairly soon for the Commissioner.

Mr. HEFTEL. Do you have any ongoing studies to see if your boarding school population is or will be going down if that is an objective and in fact, more important, do you feel moving out of the boarding school situation is an objective? And, if it is, what are you doing to assure this objective is being reviewed and perhaps being met in some degree year by year?

Dr. DEMMERT. There are three parts to the question. The first was— if I may collect my thoughts here for a minute—whether or not we have anything ongoing, a longitudinal study. The answer to that is "No." We have just completed a short-term evaluation of the off-reservation boarding schools.

In general, the reasons we have not embarked on more longitudinal-type studies is that they are fairly expensive and we have placed most of our resources in programs.

The second, what we are doing about boarding schools and whether or not they should continue. I can only give you some personal opinions in this area.

Mr. HEFTEL. That is really what I would like is your personal opinion.

Dr. DEMMERT. My personal opinion is that we will need to continue many of our boarding schools primarily because of distance involved and because of other factors that focus on parental finances, the home situation, broken homes in some cases, social referrals, court referrals, Indian dropouts.

My own impression is that we have got another 30 or 40 years before we take another look, and we need to continue boarding schools in some form or another. But if we continue them, we need to undertake a major effort to improve the system as it now exists in several ways.

I believe that the size of boarding schools needs to be reduced. We have got boarding schools that handle up to a thousand children. Most of the evidence I have looked at tells us we cannot do an effective job. If we want to build more schools closer to communities, we need to reduce the size of the boarding schools, but they need to continue.

In addition to that, we need to restructure, in my judgment, the kind of program we offer in the boarding school. They need to develop an identity of their own. In some cases we will need boarding schools that will focus on meeting the needs of handicapped children and, interestingly enough, we are working on a plan to diagnose children and to develop a center with Indian help. They got the money, we did not. But that is the group we need to coordinate this with. We need to

develop boarding schools that will focus on vocational education and needs of Indian students. We have a tremendous need in that area on reservations and a tremendous need to develop that skill.

We have gone, in my judgment, downhill in that area since the days that my father attended boarding schools.

In addition to that, we need to develop some boarding schools that will focus on academic achievement, college-preparatory-type schools. We really do not do that in the Federal system.

Mr. HEFTEL. You are familiar with the very large school, and I cannot tell you that it is still operating as it did in the 1940's and 1950's in the center or core of Phoenix.

Dr. DEMMERT. Albuquerque—Phoenix Boarding School.

Mr. HEFTEL. Yes. What is the size of the enrollment of that school?

Dr. DEMMERT. Let me ask the superintendent to stand up and give us that information. Dr. Noah Allen.

Mr. ALLEN. The enrollment fluctuates between 575 students and 675.

Mr. HEFTEL. Is that school in its location functional, in your judgment, as opposed to a smaller location adjacent to the reservation areas?

Mr. ALLEN. I do not think it is functional in its present location.

Mr. HEFTEL. You feel there are problems because of its location?

Mr. ALLEN. Very definitely.

Mr. HEFTEL. It always appeared that that was a very undesirable location for the schools, and this was not a judgment of Congress and educators, this was just a feeling as part of a community. And I guess it seems unfortunate that 25 years later obviously we are still dealing with the problem in that same form and do we need to take a look at that kind of real estate and put it to other use and take the funds and apply them to the establishment of boarding schools in the locations where they should be if they are going to be effective for the young people?

Mr. ALLEN. In my judgment, I think we definitely should if it is possible to do under the system.

Mr. HEFTEL. Thank you very much.

Thank you, gentlemen.

Dr. DEMMERT. Mr. Congressman, you asked one final question and that was trends.

Mr. HEFTEL. Yes.

Dr. DEMMERT. I will give a partial response and Dr. Benham has asked to complete that response.

From 1952 to about 1971, the trend for boarding schools was upward. The trend for day schools remained and continues to remain fairly stable. In the last 3 or 4 years the numbers of students in boarding schools has decreased and I think there are several factors for that. No hard evidence, but professional judgment and evaluation.

Mr. BENHAM. Mr. Chairman, Congressman Heftel, a little look has been taken in a 5-year period from 1969 to 1973, and the trend persists. And here are the developments for the service population of the Bureau of Indian Affairs.

For the Federal schools, the number of students served went from 51,976 to 50,199—a decrease of 1,777. Most of the change was in students served by boarding schools which dropped in numbers from 36,263 in 1969 to 33,672 in 1973. And I say the trend persists. This

is a decrease of 2,591 boarding students with the number of day school students increasing.

Another change in the Federal schools is the number of schools being operated under contract. In 1969 there was 1 school; 1973, 12; now there are 25 schools. Again, this is a trend that persists. The public schools also gained in enrollment. In 1969, 120,539 students were enrolled; 1973, 131,805, a gain of 11,266.

Then I think a part of this perhaps at some point should have the attention of the committee in terms of the broadened base of the concern because these figures reflect developments on the reservation for most of the people served by the Bureau of Indian Affairs.

First. They probably reflect that as roads are developed and economic opportunities increase, the need for boarding schools is lessened. Economic development has been the main instance in most of the tribal groups.

Second. It shows the public schools are increasing in enrollment likely in direct ratio to these improvements in economic conditions. Education, of course, does not exist in a vacuum. It is part of a larger socioeconomic picture. I have often thought on the Navaho that it would not be too much different 100 years from now unless you get a total which would eliminate the problems of poverty, poor health conditions, and socioeconomic development matters which affect achievement in school. I think you will find such total development of interest to most of the tribes.

Mr. BLOUIN. Excuse me, cannot some of that trend, though, be attributed to the BIA rules that require the children must go to the public schools if it is closer to the routes of the buses that are provided?

Mr. BENHAM. Yes, sir, but, again, I think this is illustrative of the trends of what is happening. I think you are seeing a decrease, I know you are seeing a decrease in boarding school enrollments, an increase in day school enrollments with a particular increase in public school enrollment.

Mr. BLOUIN. Maybe playing off what Mr. Heftel was getting at or trying to determine, is this a purposeful trend, intentional trend of the BIA to phase out of boarding schools or is this just a happenstance?

Mr. BENHAM. Hopefully, as the tribes endeavor to improve their total socioeconomic conditions, as they move into circumstances where youngsters do not have to go to boarding school and can stay at home, the situation that you describe will change. That is today, as people have a chance to work and have all the things that go with a regular paycheck, of course, the economic conditions equalize and then and it is only then I maintain that you have an equalization of what happens in the schools.

So the past policy has been, as people move to where they can go to public schools, unless there are extraordinary circumstances which pertain in a particular situation—they attend public schools.

Mr. BLOUIN. Is there a particular problem in Arizona and New Mexico in terms of this transfer of students because of that 874 equalization formula, the lack of profitability, if you will, to the public schools to assume the educational obligation?

Mr. BENHAM. At least in my experience in working in Arizona and New Mexico with the public schools, this was not a problem. How

steady the income was, whether they got 100 percent, 80 percent, so on, this was a factor.

No; this has not been a particular deterrent. Let me emphasize in terms of communities where the change is made, it is based on mutual readiness, the readiness first of the communities for the change.

Two: The readiness of the State to accept and a joining of the two kinds of interests. This has been the thing in the past. This has not been a forced sort of thing and so on. As economic opportunities have improved and as people have moved to centers of population youngsters do go into public schools by and large.

Mr. BLOUIN. Mr. Quie.

Mr. QUIE. In deciding to go to boarding schools or not, you set up some education and social criteria. To what extent do you abide by them?

Dr. DEMMERT. As you point out, we have set up some criteria in the Bureau manual. The degree to which that is really followed is difficult to evaluate. We had a session this morning going over that and reached the conclusion, I think, or a consensus that each of the areas sort of define and adjust their policy as circumstances or situations change and that national policy is not necessarily followed.

I am not so sure that it ought to be followed and we have come up with and will be coming forward with some specific recommendations for some change in that area.

I would like to add one other part in moving off the topic that Dr. Benham finished and the reason for the change. I think he is right in that economic change will have an impact on the number of students that attend Bureau day and public schools—no question about it in my mind.

In addition, we have had the policy to limit enrollment in the boarding schools and we have a third factor that has not been addressed and that is, a condition of some of our boarding schools that Indian students attend. In some cases you have conditions in boarding schools where I would not send my own children. In other cases, you have conditions where I would be very happy to send them. And where the conditions are bad parents are not inclined to encourage their children to attend or continue.

Mr. QUIE. It seems to me you should have a policy that can be followed. It ought to be available for everyone to read and to know. Last, if it is not acceptable, you should not send any money.

Dr. DEMMERT. We have nothing that calls an individual accountable from moving off or away from the policy. And you are talking about monitoring and evaluating that effort to a certain degree which was pointed out earlier, I think. We really do not have a major effort in.

But, in addition to that, I personally look at policy established nationally with a jaundiced eye. I would prefer to look at policy established by the individual communities and schools because they will be able to adjust and react to changing situations much faster as they affect the operation of that school.

But I recognize at the same time that there are certain national policies that need to be established and we are going to be attempting to work through the difference between the two, and where the guidelines of the fine line dividing the two ought to be.

We have not yet done that.

Mr. QUIE. That seems to me as something that is definitely necessary. Using the example again of the public schools, since the State pays for the transportation aid, they for the most part make the decision as to how far the student must live from school before bus service is provided.

If the school district wants to go a little further than that they are permitted to do so as long as they are within State requirements.

Let me ask you also about the possible variation in the attendance at boarding schools. The gentleman from Phoenix indicated there are about 100 fewer students in his school at different times than at others. I do not know if that is from year to year. What happens for teachers? If you lose 100 students, perhaps teachers are teaching fewer. How do you find teachers if there are more students than expected? We were talking about earlier a peculiar system.

Dr. DEMMERT. OK, I would like if I might again to use Dr. Allen as a specific example of what happens in that particular school and, I think, it will probably give us a good parallel of what happens in other schools.

Dr. Allen, is he still here? Would you like to tell us what happens when you have a large reduction and you still have teachers, or vice versa?

Mr. ALLEN. The teachers are still there, and we cannot do anything. If we have an increased enrollment, then we simply add the number of students to each class. Rather than the class being 25, it might be 35, throughout the 20 or 30 classes that we offer.

I want to talk more about that tomorrow.

Mr. QUIE. OK. So, in other words, that is left entirely to the local superintendent.

Dr. DEMMERT. No, that is not correct, the case in point. That is national policy established either by our personnel ceiling or by the Civil Service System, or by, in some cases, the process that we are forced to work under in transferring non-Indian teachers that serve in Bureau schools. In a local community, a foundation program in public school would cut their budget by a certain amount, if the number of students were reduced, automatically.

They are under a foundation program, and the formula for that budget in part reflects students and teachers. As students go down, the number of teachers go down, the school can and does release them immediately. They can do that locally. If the number of pupils goes up, the foundation program gives them more money and allows them more teachers.

They can hire them immediately, on the spot. It takes us longer to react in the Bureau system, and in some cases, as Dr. Allen pointed out, it is virtually impossible to react to the changing demand from year to year, a major problem.

Mr. HEFTEL. Doctor, you used a word, if I may.

Mr. QUIE. Go ahead.

Mr. HEFTEL. I did not realize you were not through.

Mr. QUIE. No. I still wanted to follow through on this.

Mr. HEFTEL. Surely. Go ahead.

Mr. QUIE. Again, Dr. Allen saying the school was not functional sounded to me like saying that you should not exist and I imagine,

what it also means is that the money expended there ought to be expended someplace else for the students, you know, if they are Hopi Indians, probably closer. Where does that thing break down? Usually a superintendent would be saying, "Keep me open, we are needed."

We indeed do not often hear superintendents say their school is not functionally sound. That does not fit at all. That means at least locally they are different from some of these other schools. They have got their Senator coming in for a big chunk of new money, and everybody else wants them because nobody else knows where to go. They at least are taking an interest in someone.

Something broke down in the system that you were unable to do, but where does the breakdown come?

Dr. DEMMERT. OK, my memory needs to be refreshed on exactly what Dr. Allen suggested.

Mr. QUIE. He does not suggest anything, he says it is not functional.

Dr. DEMMERT. I do not want to put words into Dr. Allen's mouth. But, Dr. Allen, correct me if I am wrong in my explanation of what I thought I heard you say.

I think Dr. Allen was saying that in some cases it might not be appropriate to have a boarding school in the middle of a fairly large city. To be specific, you have Albuquerque Indian School. A school that the Bureau, I understand, was thinking of closing down, but that the Pueblos contracted for, the all Indian Pueblo Council. And it is in the middle of a city.

They are talking about donating some land and moving that school to another part of either one of the Pueblos, or to a different part of Albuquerque, out of the way from the center of the city.

What, I think, I heard Dr. Allen saying was that the decision on whether some of the boarding schools that are needed, on whether or not they need to be continued in or rebuilt, to a large degree would have to depend on their location, whether in the middle of a city and a place that does not provide a good environment for the students, or whether or not they are on some campus away from the city that could provide a very good environment.

He probably also said that in some cases boarding schools are not needed.

Mr. QUIE. I did not hear him say that.

Dr. DEMMERT. But I did not hear him say that, that is correct, because he would be in direct conflict with what I just said.

Mr. QUIE. He is going to be able to tell his story tomorrow, and you people on the national scene probably would not be here.

Dr. DEMMERT. Well, I am planning on coming, listening at least, because I need to know just as much as you do, in some cases.

Mr. QUIE. All right. What I really want to know is where the breakdown comes, whether it is Congress not appropriating money, or whether it never gets to us, or is it Congress not passing an authorization. If it never gets to us, if somebody down there in the Department made the decision that we want to keep everything the way it was before, and keep that school in Phoenix instead of where it ought to be, where does the breakdown come?

Dr. DEMMERT. OK. I will have to give you a personal assessment of that, and you will probably get a different evaluation as you talk to different people, but as I pointed out I am fairly new to the Bureau,

and so I may look at it with a jaundiced or an unjaundiced eye, I am not sure.

But at least it is not one from a longtime Bureau employee, and that may be good, it may be bad, I do not know that either. But since I have been there, my feeling for an appropriate response to that question is that the Bureau has not been given an opportunity to really do some good, long-range planning or to participate in some good, long-range planning activities.

The complexities of the system, the different needs and desires of the Indian community, the different wishes of the administration, and the different wishes of the legislative branch of the Government, all have a tremendous influence on that process, and helping that process, I think, to break down.

One of the reasons I established a planning office as part of the reorganization of my immediate office, was I felt it was something that was necessary and it is something that needs to be funded, I think, if we are going to do a good job.

And we need advice and consultation of people from within, as well as advice and consultation of people without the system, as well as from the Indian community and the opportunity to pull those plans together.

Mr. QUIN. Well, another problem comes up from my point of view, without having an overall plan. You know what you are talking about and we can figure out what the plan appears to be, but when an individual Congressman comes in for a chunk of money for his boarding school, then we are in a bind because we have nothing to turn to at all as the agreed on overall strategy.

So let me ask you, you were in HEW and we had the Advisory Committee.

Dr. DEMMERT. National Advisory Council.

Mr. QUIN. What would you think of having the same Advisory Committee give advice on BIA education programs and the HEW programs, and have responsibility for evaluating the community recommendations on both programs?

Dr. DEMMERT. OK. The Indian Education Act of 1972 authorizes that committee to make recommendations to Congress on all aspects of Indian education which includes HEW, USOE, and the Bureau of Indian Affairs. They have not elected to date to make specific recommendations on the Bureau of Indian Affairs, for whatever reason.

But in the past few months we have talked to the chairman and the deputy commissioner about the possibility of providing some money from the Bureau that would offer them an opportunity to come up with some specific recommendations. The first step is to review some of those that we will be developing. They are interested, and we are in the process of providing some money that would allow them to do that.

I think it is a good idea.

Mr. QUIN. Good, because I think it would be the height of folly if we were to set up one advisory committee for BIA and one for HEW and then have to figure out the difference between the advisory committees.

We look a little green now, but I do not think we will do worse than our sister committee who had it before.

You mentioned contracts. Tell me a little bit about contract schools and how many schools contract.

Mr. BUTLER. About 22, Congressman.

Mr. QUIE. Twenty-two of the approximately 200, I think, you referred to contract.

Mr. BUTLER. They tell me it is up to 25 now.

Mr. QUIE. Now 25.

Mr. BUTLER. Right.

Mr. QUIE. What about the pattern of funding the contract schools?

Dr. DEMMERT. OK, the pattern of funding for contract schools. Contract schools spend most of their time, in fact, too much of their time, soliciting money to operate the system, that particular school and have very little time, in my judgment, to focus on program quality, although the programs that have been developed and the attitude toward those programs are very good.

They have to spend too much time on the road soliciting money. They get money from the Bureau of Indian Affairs, they get money from the Office of Education, title IV, through both part A and part B. They get money from private foundations to a lesser degree today than, I think, when Rough Rock started.

In addition to that, they get money for specific kinds of programs, bilingual, early childhood, although there are probably only two or three schools, that get money from that particular program and other programs that are offered by HEW.

Mr. QUIE. Do they tend to get add-on money?

Dr. DEMMERT. Add-on money?

Mr. QUIE. Yes, go to a committee of Congress and get some money.

Dr. DEMMERT. Let me ask. I do not have an answer for that, but I could ask Mr. Summont, who is the executive director of Coalition of Indian Controlled School Boards, and he probably has a ready answer for that.

Are you still here, Ace? OK. Ace is not here. I doubt that they get add-ons by school. We might get an add-on in the Bureau of Indian Affairs for contract schools in general.

I am told that we do get it school by school.

Mr. QUIE. That is my understanding from the staff.

Dr. DEMMERT. OK.

Mr. QUIE. Well, then what has this to do with the morale of the other schools? Anytime somebody can circumvent the whole system and go through a committee of Congress and get some extra money, they have a good thing going for them which they do not want to lose, but this is going to make everybody else unhappy. I would think.

Dr. DEMMERT. Yes, that is the system as it now exists.

Mr. QUIE. Yes.

Dr. DEMMERT. That is correct. I might point out as some of the recommendations we are making focus on a foundation system and a formula based on certain criteria, for both our Bureau schools and contract schools, on an equal basis, so that we would not pit one against the other, so that they are all handled fairly equitably.

We will be ready with those recommendations within a month.

Mr. QUIE. How many of those 25-contract schools are boarding and how many are not? Do you have any vague idea?

Dr. DEMMERT. Let me check that.

About 40 percent boarding.

Mr. QUIE. By the way, how many boarding schools are there of the approximately 200?

Dr. DEMMERT. OK, we have approximately 200 Bureau schools, and about 26 boarding schools and about 26 contract schools.

Mr. QUIE. Twenty-five contract schools, and about 40 percent of those are boarding?

Dr. DEMMERT. Are boarding, right.

Mr. QUIE. But how many boarding, out of the 200? Something over 70?

Dr. DEMMERT. Seventy-seven.

Mr. QUIE. Seventy-seven, is that it?

Dr. DEMMERT. Yes.

Mr. BUTLER. Of which, Congressman, the majority of those are on the Navaho.

Dr. DEMMERT. With at least a third of the student body on the Navaho.

Mr. BLOUIN. That is not an up-to-date figure, is it?

Mr. HOPKINS. 1975 fiscal year. It would vary probably one, the Albuquerque Indian School.

Mr. QUIE. It would vary one what?

Mr. HOPKINS. Vary one, probably 76, from that because of the Albuquerque Indian School.

Mr. QUIE. You mean that one is closed?

Dr. DEMMERT. No, that is taken over by the Pueblos, the all Pueblo Indian Council.

Mr. QUIE. OK. Then you drop from 77 down to 75, plus Albuquerque? Is that what you are saying?

Dr. DEMMERT. It would be 76 plus Albuquerque.

Mr. QUIE. I see. Do they have more direct communication with the Washington office than the other schools because of the fact that they are contracting?

Dr. DEMMERT. In general, they go through the area offices where we talk about Bureau funding. But we must recognize that they also get support from title IV, from the Office of Indian Education and OE and the contact there is direct. They submit a proposal to the Deputy Commissioner, that is reviewed, and if they are awarded a contract then the check goes from the Treasury to the school. In the Bureau system, the funds are distributed through the area office.

Mr. QUIE. Now, you indicated that you are going to come up with recommendations. What are you going to be doing with the formula within the month?

Dr. DEMMERT. We will have something fairly concrete. We are testing the models and recommendations. We are testing some models right now for both boarding and day operation, and we will be out in the field. We won't be able to test all of them, but as soon as we test a certain percentage of them we will begin working out a formula for each of the schools, and we should have some recommendations within a month.

Mr. QUIE. What I would be interested in is the whole formula idea. In the interest of education that each Indian student needs, we need to look at what is available in the other programs as well as some of

them under formulas and some of them not, in relation, also, to your proposals, your formula today, and the money.

Dr. DEMMERT. Yes; we do have a comparison of the two figures.

Mr. QUIE. How soon could you bring that to us in a form so that we could look at it and make some judgments on it ourselves?

Dr. DEMMERT. OK. Mr. Merrick tells me we are testing our recommendations within 30 days. After that is tested, yes, we will have something ready within 30 days.

Mr. QUIE. OK, because you are ready for testing you have got the material all ready.

Dr. DEMMERT. Most of the material, that is correct.

Mr. QUIE. So it is in a form we can look at. I would like to have you test it on us.

Dr. DEMMERT. All right, we might be able to have it sooner than that, then.

Mr. QUIE. I would like to see that. Judging from what decisions were made on formulas last year, I have a particular interest.

Dr. DEMMERT. Yes, sir, that is correct.

Mr. QUIE. To be the fairest possible.

Mr. BLOUIN. If you will notify us as soon as they are ready, we will be happy to get together with you again to go into that exact thing Mr. Quie is talking about.

Dr. DEMMERT. Yes, sir. May I clarify a point.

Mr. BLOUIN. Yes.

Dr. DEMMERT. Once we develop the models, the process that we use or we are planning on using is sending that out to each of the schools for review and comment, and I am sure they will look at that very closely. It is tied into student enrollment, it ties pupil-teacher ratio, it ties program, all together.

Mr. QUIE. Let me just raise one problem. I have seen them working with programs for years. If a person does not have a national overview they are most likely to be the ones that say, give me the most money. We faced this with the Elementary and Secondary Education Act. Everybody was glad to get more money, but if anything showed they would get less money they weren't very happy with it. What we did was to get everybody else to back off from their biased position and look at what is best for everybody in the country, and this committee was able to do it.

In fact, the chairman of the committee went to the floor with a formula that gave his State less money than the old formula. I mean, that shows to me that logic and fairness even overcomes what one looks at best for his own district.

That is why I would like to see us take a look at it.

Dr. DEMMERT. Be glad to do that.

Mr. QUIE. Mr. Heftel.

Mr. HEFTEL. My apologies to Mr. Quie, but the reason I started to ask the question as fast as I could was that it was a reaction to something you were in the process of saying, Doctor, in which you implied, if not stated unequivocally, that you were being forced to work under a system.

The manner in which you used the word "force" sounded as though you would not use the system that is imposed upon you if you were given an opportunity to develop a system which you thought was best.

I am wondering whether you did or did not really mean that you are forced to work under a system, and that you do not think that is the system under which you should be working.

Dr. DEMMERT. OK. I think my response to that would be we are not, I am not necessarily talking about either changing the system or moving out of a system. I am talking about adjustments within the system that will provide or help provide a better educational opportunity for each Indian student, and if it is within the existing system and we can make appropriate adjustments, I think that is probably the way we ought to go.

Mr. HEFTEL. Were you suggesting that there are major changes within the system that are necessary for it to be effective?

Dr. DEMMERT. In my personal opinion, yes. That does not reflect a departmental position.

Mr. HEFTEL. And the second question concerns employment of Indian and non-Indian, in terms of positions which are not filled unless an Indian is available for the position; and in which reclassification of positions occurs so that Indians can be made to qualify, but you do not, in fact, have qualified people in positions needed because you are limiting yourself to the hiring of the Indian versus the non-Indian?

Dr. DEMMERT. I would have to address that as it affects me directly, and point out a couple of things. One is that in the operation of my immediate office, we follow the Bureau policy of Indian preference. That means if there is an eligible Indian applicant who qualified for the job, that is who we would hire. If there is not an eligible Indian applicant, then I hire the best-qualified individual and have done that.

In the area of teachers, there are not enough Indian teachers to fill all of the vacancies that exist. In general, my impression would be that most of the Indian teachers are hired that are available, but that there are a lot of vacancies that are filled with non-Indians, both out of necessity and in some cases because members of that particular Indian community might choose a non-Indian over an Indian of another tribe.

Mr. HEFTEL. The specific reference I have is to a staff report which may or may not be accurate which indicates cases in which no Indian was qualified and the position was not filled or reclassification occurred, so that an Indian could be used for that position.

Dr. DEMMERT. May I confer with Mr. Zuni for a minute?

Mr. HEFTEL. Surely. My concern is the end result for the students and what adverse affect it may be having.

Mr. ZUNI. I am not familiar with the case you just mentioned, but it is entirely possible that management, local management might have decided to take this action. However, all management is cautioned that a position should not be downgraded just to make a job available for an Indian applicant.

Mr. HEFTEL. Now, let's assume that the staff is correct in saying this is happening. Is there a failure to properly monitor or communicate that policy to every facet and every level of management?

Mr. ZUNI. Yes; you would be correct, there is a breakdown in communication.

Mr. HEFTEL. Is this a problem that needs to be addressed?

Mr. ZUNI. Yes.

Mr. HEFTEL. How do you propose to address it? How are you addressing it, and to what extent are you aware of it?

Mr. ZUNI. As I mentioned earlier to Congressman Kildee, we have developed a personal management action and one of the key areas that we are going to be concerned with would be Indian preference, the need to communicate the policy with the field and make the field people knowledgeable about Indian policy, develop the procedures so that everyone can be knowledgeable in providing Indian preference uniformly, so that there will be uniformity throughout the Bureau.

Mr. HEFTEL. How long has this problem existed, to your knowledge?

Mr. ZUNI. The problem has existed since 1972 when an Indian preference became a major policy in the Bureau.

Mr. HEFTEL. So for about 4 to 5 years we have not perhaps been able to both communicate properly the policy and set up the system to assure that the best person available would be hired, if no Indian were available as opposed to not hiring at all, or changing the classification to hire an Indian versus a non-Indian?

Mr. ZUNI. Yes; this has been a problem for them as well.

Mr. HEFTEL. So we are dealing with a 5-year problem that we are still addressing and talking about, but not solving; is that correct?

Mr. ZUNI. Yes; and then Indian preference is a very touchy topic, Congressman. It has divided the Bureau, unfortunately, into two camps.

Mr. HEFTEL. May I ask a question at this point?

Mr. ZUNI. Yes.

Mr. HEFTEL. Let's go back to the beginning, to this, extent, where did the policy come from? Can we isolate that facet?

Mr. ZUNI. Yes; we can trace the policy back to a congressional act of 1934.

Mr. HEFTEL. It goes back to a congressional act?

Mr. ZUNI. Right.

Mr. HEFTEL. Has this ever been communicated and implemented, in fact, or has it just sat?

Mr. ZUNI. Yes; the Bureau has been in practice, has been implementing Indian preference since the passage of the act. However, there were several court decisions in 1972 that forced the Bureau to apply Indian preference across the board.

Initially, we were applying it only during initial appointment, or for initial appointments, but the court which was later supported by a Supreme Court decision, took the position that we were required to apply Indian preference across-the-board, except in training.

Mr. HEFTEL. Well, of course, the concern that I think we all would have is the failure to have qualified people as a result of the manner in which we are failing to carry out, or not carrying out properly, the concept of Indian preference.

I think that is the problem that we should be focusing on.

Mr. ZUNI. Really one way to solve that issue is to properly train and develop Indian employees so that they can be qualified for all the vacancies which will be vacant in the future.

Mr. HEFTEL. Now, that is an ideal, and certainly no one would challenge its desirability; namely, training and qualifying Indians for all of the positions needed. But until you reach that point, whenever it occurs, whether it is tomorrow or 10 years from tomorrow, do you

not have to hire non-Indians to assure the quality of education which you are going to provide?

Mr. ZUNI. Yes; and the system does provide for it. The policy does provide for it, and we are doing that.

Mr. HEFTEL. Well, my only concern is apparently a staff report which indicates in the field a breakdown in communications to the extent that positions are not filled, except by an Indian, or reclassification occurs so that an Indian can be hired, as opposed to concern for the quality of the person filling the position.

Mr. ZUNI. Well, I would not debate the finding of the staff. Now, this might be true in the particular instance that they have reported, but I would not agree that this is uniformly applied throughout the Bureau.

Mr. HEFTEL. But certainly there is not uniform application and interpretation?

Mr. ZUNI. This is correct.

Mr. HEFTEL. What do you anticipate is going to remedy that in terms of what you are doing now already and intend to do?

Mr. ZUNI. As you stated earlier, and I concurred, we need to have better communication regarding Indian policy, Indian preference policy, the development of procedures so that everyone that is administering the policy can be knowledgeable.

Mr. HEFTEL. And that has not as yet taken place?

Mr. ZUNI. We are in the process of addressing that issue.

Mr. HEFTEL. Dr. Demmert.

Mr. BLOUIN. Excuse me, could you bring the microphone a little closer to you so all the folks here can hear you? Thank you.

Mr. HEFTEL. Dr. Demmert, as the new Director, to what extent are you aware of the new policy, where it came from, how it has been communicated? Have you addressed yourself to it, sir?

Dr. DEMMERT. Yes; I am aware of the policy of Indian preference, we apply it, but we do not intend to circumvent it or use it as a crutch in any of the dealings that I have been involved with in education and I am not aware of any specific instances that that has happened.

Mr. HEFTEL. Could we have the staff report on this facet developed for presentation to Dr. Demmert, so that he would have the same material that the staff has, and so that he will be at least on an equal footing with all of us in terms of input because if he does not have the same information we have to either test it and tell us it is or isn't accurate, you are in the dark and we are communicating on two different levels.

Dr. DEMMERT. That is correct, and I would appreciate that opportunity.

Mr. HEFTEL. I think the staff should do this.

Mr. BLOUIN. It is my understanding that either today or tomorrow this information will be inserted in the record as part of the staff background, and as soon as it is ready it will be available to you and we would very definitely like your response to it.

Mr. HEFTEL. Thank you very much.

Dr. DEMMERT. Thank you.

Mr. BLOUIN. We have two or three areas that the staff, majority and minority side both, would like to touch on in questions to you, and I would like to yield to them at this time, in whatever order you would like to follow.

Mr. LOVESEE. Go ahead.

Mr. BRAGG. Thank you, Mr. Chairman. If I could just ask a couple of brief questions and get some answers, in view of the late hour.

With regard to the dormitory aides, and as we travel around the boarding schools we were told often it is difficult to get quality people to serve in those capacities because they are GS-4's and sometimes, I guess, 3's. Where is that level set, and tourage, is that a problem that that grade level presents to the people in the field in order to obtain the kind of people they need in that position?

Mr. ZUNI. I think Dr. Demmert can better address that problem.

Dr. DEMMERT. I was looking for some help, but I will give it a try. I would assume at this point that if we are using a GS-3 or 4 that that is the level, let me use the word, imposed on us, or that we have to work with. Under the civil service system that we operate under, we do not have the flexibility to identify grade level for a particular job description, although we do draft the job descriptions.

They are in line with standard procedures within the civil service system.

Mr. BRAGG. So that is set by Civil Service. Have you contested those, or do you have a procedure to question those?

Dr. DEMMERT. The process that we use, again from personal experience, is if I think I need a 5, and Civil Service says that that grade level is a 4, we use our personnel office or officer to help us defend our position and strengthen the job position.

We may win, and we do win a few. But we might just as easily lose the argument or the appeal.

Mr. BRAGG. Going to some things from the GAO report, BIA was criticized for the lack of monitoring of programs. Under the reorganization, how will the monitoring work, will there be sufficient staff? How many positions are you going to have in Washington, or how many in Albuquerque for monitoring of programs?

Dr. DEMMERT. OK, when you talk about the reorganization, I would first like to clarify what we mean by that. There are two kinds of reorganization that we are looking at in the Bureau. The one is the reorganization of my immediate office which, in effect, is assigning individuals to particular areas of responsibility or tasks that are already under the authority of the Director.

In that effort, we are talking about developing some educational professionals, experts in the area of elementary and secondary education and in postsecondary education, to work with schools and area offices in providing both technical assistance and in monitoring programs.

When we talk about evaluation and research, technical assistance and monitoring, we would look to the resource center and they would work through, in some cases, the area office and/or with schools directly. But in both cases it takes both personnel and fiscal resources to do that job effectively and appropriately.

Mr. BRAGG. Another thing that was mentioned in that report was what it referred to as a lack of attention to some special education needs. We have alluded to some of these. Could you give us some idea of your plans or assessments of some things like bilingual education, education for the handicapped, counseling program, these kinds of things, what kind of priorities they have in your current program?

DR. DEMMERT. We have focused on bilingual education and have in the field for review and comment a set of recommendations which primarily allow schools and communities to determine whether or not they are interested, and then would allow them to implement a program.

But, of course, in the long-range effort that is based on additional resources, either from the USOE or to the Bureau itself, the same is true for early childhood education, for meeting the educational needs of handicapped Indian children, and we have got the bilingual and the early childhood recommendations out in the field for review and comment now.

We do not have the handicapped recommendations ready. But we have been developing them in coordination with USOE and they have been working on them for several months and are near completion.

MR. BRAGG. One final question if I may, Mr. Chairman.

MR. ZUNI. would you comment on the criticism if the House Appropriations investigation report that the BIA does not have a "workable priority system for constructing schools," and that that \$500 million backlog which is thrown around from time to time is not really a defensible figure because the data is no longer available or is no longer current to back up that?

How is the school construction priority set, and by whom, and in what manner?

MR. ZUNI. Well, first of all, the \$500 million backlog is defensible. Unfortunately when we first used the figure we did not indicate that \$300 million of it was specifically for educational facilities; \$200 million of it is for other type of construction that is required by the other Bureau operations.

So when you add the two figures out, it comes out to a total construction backlog of \$500 million. Now, the priority system that the Bureau uses, and this is an area in which we think improvements can be made, and Dr. Demmert earlier mentioned that he is developing, currently developing a system, a better system for determining education construction priorities.

The current system that we are using is a criteria on which we replace buildings when an act of God occurs, fires, earthquakes, storms, that is the No. 1 priority. The second one is whenever facilities will endanger the health and the safety of children.

We use that as a criteria for replacing the building. The third criterion is the change in the structure of a building to better provide education to the youngsters. In other words, a major remodification of an existing building with which to carry out a desirable educational system.

Another criterion is whenever an educational facility does not exist near an Indian community.

Unfortunately, in the past we have been able to address only the first criterion because of the number of misfortunes we have had in the loss of some of our school facilities. Now, some people might think that we deliberately set fires to our school buildings so that we can replace them with new buildings. I will assure you that this is not the case.

MR. BRAGG. Mr. Zuni, just as a part of that question, from time to time I have heard people say we are No. 8 on the priority list, and

now we are No. 34, No. 16. What does that mean, and how is that list established? What is that priority list that they go from here, way down to here, and on what basis?

Mr. ZUNI. I think Dr. Demmert mentioned earlier in his testimony that there are too many hands in the pot, there are too many experts in Indian education, determining what the educational program should be. Let me mention a few of them. The tribal officials and, of course, they have a right to be involved.

The Indian parents, they have a right to be involved. The BIA bureaucrats, the Indian educators, certainly they have a right to be involved. Congressional committees, as this one, certainly have a right to be involved. Various other interest groups all become involved. National Indian organizations all become involved, and we have a competition among various tribal groups, we have regional competition.

Now, you put all of them all together and you can imagine the type of pulls and tugs that are brought to bear upon the Bureau in determining what the priorities should be, and maybe we are not strong enough to resist these type of pressures.

Maybe this is a shortcoming of our system. However, if this committee gives us money to build a new facility. I do not think we will sit here and argue against the committee.

Mr. BRAGG. Thank you.

Thank you, Mr. Chairman.

Mr. BLOTIN. Mr. Lovesee.

Mr. LOVESEE. Excuse me. I have one for Dr. Benham.

Dr. Benham, in 1975 you testified before this committee. I believe it was in March, and you testified at the time that you did not feel line authority for the central office of education over local schools would be a good idea, at least you did not feel it would be wise, and I am wondering if you are still of that opinion, and very briefly because we are under some time constraints, briefly could you give me an idea why?

Mr. BENHAM. Yes, sir. I will be happy to comment on that. My own experience as an educator working at a school at an area level and with the Bureau of Indian Affairs organization has been very good. The organization has proven effective. I have seen it as a way, in terms of leadership, to harness all the resources that are at your command in an area that can be brought to bear. As I see it, not to just improve that particular school but hopefully the total socioeconomic circumstances surrounding the schools, to get the roads built and maintained, to get the assistance of the social service person on educational programs, to get employment for parents—to improve conditions which affect the total life of the child and his achievement in school.

And the way that that generally has been done has been with staff authority at the central office level, in terms of the educational function rather than line authority. In the instances where I have seen education set aside or separated with line authority this tends to fragment it from the rest of the organization, and lessen the overall effectiveness of education and all other programs.

Again, that is my own personal observation.

Mr. LOVESEE. I realize that, but I thought it was one that should be on the public record.

Mr. BENHAM. Thank you.

Mr. LOVESEE. Dr. Demmert, you came over from being deputy commissioner of the USOE, Office of Indian Education, and I am wondering in view of that past history it would seem to me that you would be in kind of a unique position to set up lines of interdepartment communication within the two organizations on such things as sharing information, assessments, these kinds of things, perhaps arriving at common definition of terms on certain problems such as common definition of the term Indian with reference to Federal programs, something that the two agencies have been trying to get at for a long time.

Have you taken any steps to improve interdepartmental communication, and do you feel you can?

Dr. DEMMERT: At one point during the month of April, May, June, I would like to point out that there never was as much interaction or coordination between the two offices. During those particular months I was the director of education in the Bureau, and acting deputy commissioner in the Office of Indian Education.

After I moved from the acting deputy commissioner, back into my full-time job as the director in the Bureau system, we continued that interaction and coordination. And it is evident in both the recommendation for bilingual, bicultural education, in the recommendations that we are coming up with for handicapped, in the recommendations in early childhood education and, in fact, we worked with Public Law 815 people in some of the recommendations for our construction effort, including Department level personnel from HEW.

In addition to that, I sit on the FICE committee as the chairman of a subcommittee for Indian education. In that capacity we are looking at ways and means to both coordinate other agencies beside HEW and Interior, and look at ways for sensitizing members of those organizations about Indian needs.

The process we are planning as a focal point for that effort includes the FICE meeting we are pulling together in March. As we discussed, you are being invited, we are inviting OMB, we are inviting representatives who are actually participating in the effort from other departments and representation from the Indian community have been invited.

Mr. LOVESEE. Let me ask you another question, if I may, and then I have one more short one because I know we are under time constraints. We have had some input from various people. Do you feel that you can do the job in education, BIA, with the staff and the budget you have now?

And if you do not, when will Congress receive realistic figures and some justification for those realistic figures so that the job can get done?

Dr. DEMMERT. Unfortunately, you are asking a question that I do not think anyone really has an answer for because I can come forward with recommendations and facts and figures that will support what we believe is necessary and important. At the same time, Congress has limitations that are placed on the budget as well as the administration, and the administration process places a limit on the budget that we are allowed to recommend.

So the process limits, to a large degree, those recommendations, when you talk in terms of money and staff. We are in the process, we are actually, believe it or not, in the process of conducting a national needs assessment that will tie need to program cost.

That was started while I was a deputy commissioner in the Office of Education, and we spent a year pulling together the requirements for that. This past year we have spent in attempting to get that contract awarded. Since I have been in the Bureau, we have been negotiating to include a stratified sample for the Bureau of Indian Affairs.

When that is complete, it will give us a fairly comprehensive picture.

Mr. LOVESEE. Will that be turned over to this committee?

Dr. DEMMERT. My understanding is that this committee has already done some interacting with the Office of Indian Education and is interested, has identified particular areas of interest, and that you will be included.

Mr. LOVESEE. All right. And one last question, if I may, and very quickly, Mr. Zuni, the committee received word and has done a little factfinding in a particular case. I do not like to get into specifics, but we do have the individuals' interest at heart.

Are you aware of an individual by the name of Jack Carson from within the Horton Agency, and can you briefly describe the situation and what is being planned about that?

Mr. ZUNI. It will take me all day to cover all the details involved. Yes, I am familiar with the Carson case.

Mr. LOVESEE. Will you submit something for the record, please?

Mr. ZUNI. Yes, I will.

Mr. LOVESEE. Thank you.

[Material submitted for inclusion in the record follows:]



United States Department of the Interior

OFFICE OF THE SECRETARY
WASHINGTON, D.C. 20240

BY SPECIAL MESSENGER

FEB 14 1977

Honorable Carl D. Perkins
Chairman, Committee on
Education and Labor
House of Representatives
Washington, D. C. 20515

Dear Mr. Chairman:

Enclosed is the transcript of the hearings held before the Committee on Education, Subcommittee on Elementary, Secondary and Vocational Education, on Tuesday, February 1, 1977, on "Indian Education."

We have reviewed the transcript and corrected the remarks of the Departmental witnesses. During the hearing, the Subcommittee requested a flow chart of the Bureau of Indian Affairs (BIA) budget process (at page 28 of the transcript). The BIA is currently preparing such a chart, and we will provide it to the Committee as soon as it is available. Further, at the hearing, Congressman Quie requested a copy of recommendations concerning a system of direct funding to local BIA schools from the Central Office, which are presently being developed by the BIA (at page 77). It is our understanding from the BIA that the recommendations will be developed by them within the next few weeks. We will be pleased to provide them under separate cover at that time.

The Subcommittee also requested information concerning the case of Mr. Jack Carson of the BIA's Horton Agency, Horton, Kansas. We are enclosing a letter dated January 11, 1977, from Richard R. Hite, Deputy Assistant Secretary of the Interior, to Congressman Lloyd Meeds concerning Mr. Carson. We are also providing a copy of the complaint filed by Mr. Carson's Attorney on October 26, 1976, in Carson v. Simon, Civil No. 76-170-C 5, United States District Court for the District of Kansas, and a copy of the answer filed in that case on January 26, 1977, by the United States Attorney for the District of Kansas.

Sincerely yours,

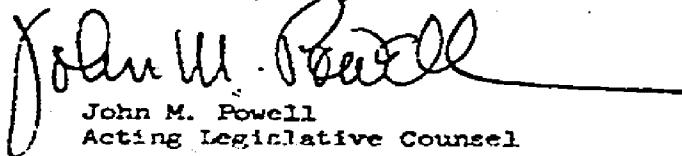

John M. Powell
Acting Legislative Counsel

Enclosures





United States Department of the Interior

OFFICE OF THE SECRETARY
WASHINGTON, D.C. 20240

JAN 11 1977

Dear Mr. Needs:

Your letter of November 24, 1976, addresses the problems Mr. Jack Carson Superintendent, Horton Agency, has encountered in the Bureau of Indian Affairs. Horton Agency is a multi-tribe agency serving four separate tribes in Kansas and Southeast Nebraska. Although Mr. Carson's differences with the Kickapoo Tribe began in early 1974, he was not removed from his position as Superintendent until April 1975 after a physical take-over of the agency office by militants of the Kickapoo tribe and sympathizers from the American Indian Movement.

In the opinion of the Area Director and the Commissioner of Indian Affairs, there was danger to the Superintendent and his family, as well as to other BIA employees and there was a serious threat of destruction of government records and property. The differences between the Kickapoo Tribe and Superintendent Carson continue. The Sac and Fox, Potawatomi and Iowa Tribes have, however, petitioned for his return as their Superintendent.

Long standing Federal statutes and recent court orders mandate that Indian preference eligibles have first consideration for all vacancies within the BIA, this includes lateral reassignments and even changes to lower grade, as well as initial appointments, reinstatements, transfers and promotions. For this reason, it has not been possible for the Bureau to laterally reassign Mr. Carson. On November 16, we offered him a lateral reassignment to a position of Trust Services Specialist, GS-13, in the Washington, D. C. Office of the Bureau, a vacancy for which there were no Indian candidates. On November 30, Mr. Carson declined this offer of reassignment.

Mr. Carson has indicated to us and to others, including the Civil Service Commission, that he prefers to leave the BIA if he cannot return to his position at Horton. We have a Departmental Career Placement Program designed to assist employees in Mr. Carson's situation, but he has not furnished the necessary documentation for us to give him priority consideration for placement. This documentation has been requested by telephone and in writing.

We sincerely regret that the formal appeal filed by the attorney for the tribes in February 1975 was not answered in writing. The attorney and the tribal representatives were verbally advised that the provisions of 25 CFR 2.2, are not applicable to personnel matters for which there are other statutory provisions for appeal. A written response to the appeal is being prepared.

cc:S: U/S: ESM: CL: ES: FSA-Denver

Although three of the tribes have petitioned for his return, Mr. Carson has been a controversial figure in that he did identify with factions rather than maintaining a good working relationship with all the tribes served by the agency. Returning him to duty as Superintendent would create new controversy, and would, we believe, be a disservice to the four tribes through fostering continuing inter-tribal dissension.

For your information, a chronology of major events concerning the situation at Horton and Mr. Carson is attached. Our efforts to find a solution to this very serious problem have been redoubled. As soon as we are able to take final action to reassign Mr. Carson within BIA or to place him with another agency, your office will be advised.

Sincerely yours,

(Signature) Hitt

~~Deputy Assistant~~ Secretary of the Interior

Honorable Lloyd Meeds
Chairman, Indian Affairs Subcommittee
Committee on Interior and Insular Affairs
House of Representatives
Washington, D. C. 20515

CHRONOLOGY -- Horton Agency, Kansas, and Jack Carson

- Early 1974 - much internal dissension within Kickapoo Tribe of Kansas, that tribe requested removal of Superintendent Jack Carson
- June 1974 - two-man fact finding team went to Horton to investigate problems including allegations against Supt Carson. Team found no substantive reasons to recommend adverse action against Carson
- Sept 1974 - Charles James appointed Area Director, Anadarko. Problems of Kickapoo Tribe continued with much attention from Area Office, BIA and Office of the Solicitor - tribal constitution involved
- Feb 1975 - Kickapoo militants with outside sympathizers physically took over Horton Agency office. Area Director James decided Supt Carson should be reassigned to protect employees and property. Militants agreed to allow him to remain until certain work was completed. James offered Carson detail to Anadarko Area - Carson preferred assignment outside Anadarko Area
- June 1975 - Carson detailed to Department's Missouri Basin Region office in Kansas City, Mo. With approval of Civil Service Commission this detail extended until March 20, 1976. Efforts to place Carson were being coordinated in office of the Deputy Asst Secretary for Management
- Dec 1975 - offer made to Carson of position, Staff Assistant, GS-13, Office of Manpower Training & Youth Activities, Denver - BIA to furnish employment ceiling to Office of the Secy.
- Mar 1976 - Carson declined above offer in writing - efforts continuing in Office of Asst Secretary to place him - contacts made with Small Business Adm for a position in SBA's office in Kansas City - position classified at GS-12. Carson declined to take a demotion BIA Personnel Office by teletype asked all Area offices to advise us of GS-13 vacancies for which they had no Indian candidates. CSC refused to extend Carson detail or to approve another detail within the year - Carson placed on administrative leave
- Oct 1976 - Carson detailed to Real Property division of Anadarko Area Office to complete assignments at Horton Agency with tribes other than Kickapoo
- 11-14-76 - Letter to Carson offers lateral reassignment to Trust Services Specialist, GS-13, BIA, Washington, D. C.
- 11-30-76 - Carson declined offer of reassignment to position in Washington

IN THE UNITED STATES DISTRICT COURT
FOR THE DISTRICT OF KANSAS

JACK CARSON,

Plaintiff,

-vs-

RALPH SIMON, AMOS G. GOSLIN, CLIFFORD O.
STEVE CADUE, CHARLES JAMES and MORRIS
THOMPSON,

Defendants.

Case No. 76-170-C5

COMPLAINT

Comes now the plaintiff and for his petition states and alleges:

1. That he is and has been during all the times relevant hereto the Superintendent of the Horton Agency of the Bureau of Indian Affairs, Department of Interior of the United States of America, and has been in government service twenty-one years.
2. That the defendants Ralph Simon, Amos G. Goslin and Clifford O. Steve Cadue are members of the Kickapoo Tribe of Kansas.
3. That the defendant Morris Thompson has been during all times relevant hereto Commissioner of the Bureau of Indian Affairs of the United States Department of Interior.
4. That the defendant Charles James has been during part of the times relevant hereto Area Director of the Bureau of Indian Affairs and the supervisor of plaintiff.
5. That all the defendants in this action are Indians and plaintiff is a white man.
6. This Court has jurisdiction under the Civil Rights Act of 1964, as amended, to wit: 42 U.S.C. §1983.
7. Defendants through a series of agreements and acts have conspired to have plaintiff removed from his duties and office as Superintendent of the Horton Agency of the Bureau of Indian Affairs.

FILED

8. Commencing in April and May, 1974, the defendants Ralph Simon, Clifford O. Steve Cadue and Amos C. Goslin met and agreed to intimidate and threaten plaintiff in order to remove him from his office of Superintendent of the Horton Agency of the Bureau of Indian Affairs.

9. Defendants Simon, Cadue and Goslin subsequently met and conspired with the defendant Norris Thompson in furtherance of their scheme to remove plaintiff from his office and place of confidence of the United States.

10. June 14, 1974, Defendant Ralph Simon and Amos Goslin threatened to physically take over the Horton Agency if plaintiff was not removed from his office at place of confidence of the United States.

11. In furtherance of defendants' conspiracy, on June 16, 1974, defendant Simon libeled plaintiff by stating to newspapers "This man is saying that Indians are ignorant savages. He is mocking us as a people by mocking our elected leadership."

12. That on November 4, 1974, defendant Goslin in furtherance of said conspiracy and intent to intimidate plaintiff, sent a telegram to defendant Charles James requesting an investigation of plaintiff for conspiracy.

13. On November 6, 1974, defendants Cadue and Goslin accompanied by a television cameraman and reporter, demanded of plaintiff that he be removed from his office in order to further intimidate plaintiff.

14. On January 8, 1975, defendant Goslin mailed libelious and slanderous newsletters to Kickapoo tribal members concerning plaintiff in furtherance of their, the defendants, scheme.

15. On January 30, 1975, defendant James met and conspired with defendants Cadue and Goslin for the removal of plaintiff from his place of confidence as Superintendent of the Horton Agency.

16. On January 30, 1975, defendant James announced to the Press that plaintiff would be removed as Superintendent of the Horton Indian Agency effective March 30, 1975, in furtherance of the conspiracy of defendants Cadue, Simon, Goslin, Thompson and James.

17. February 3 to 6, 1975, defendant James traveled to Washington, D. C. and

and conspired with defendant Morris Thompson to remove plaintiff from his office in order to appease and join defendants Goslin, Simon and Cadue in their intimidation and threats toward plaintiff in order to prevent him from holding his office and discharging his duties.

18. In furtherance of their common scheme and conspiracy, defendant Thompson had falsely advised Indian leaders friendly to plaintiff that he would not be in Washington at the time defendant James and he met to conspire against the plaintiff.

19. On February 12, 1975, defendant Morris Thompson in furtherance of the conspiracy advised defendant James that he concurred with the removal of plaintiff from his duties as Superintendent.

20. On February 13, 1975, defendant James in furtherance of the conspiracy attended a meeting with defendants Simon, Goslin and Cadue and stated plaintiff would not have any influence over Pottawatomie programs in his new assignment in Anadarko. Further, he stated, "I can assure you that I can take care of and handle any vessels in my own henhouse." Said comments being made toward plaintiff in furtherance of defendants conspiracy to have plaintiff removed from his duties.

21. On or about April 9, 1975, defendant Amos Goslin, Simon and James, to further their scheme, conspired and agreed to allow a delegation of Indians lead by defendant Simon to illegally occupy the Indian Agency offices at Horton, Kansas.

22. Defendant Amos Goslin and defendants illegally falsely imprisoned plaintiff and told him he and his staff could not leave the office building which was under the control and jurisdiction of plaintiff.

23. Defendant Goslin, while holding plaintiff a prisoner, told plaintiff he and his delegation could not leave the office until their demands were met. Defendants Goslin and Simon told plaintiff they did not want him to lock up the building until defendant James arrived even though plaintiff told them they would have to leave the building by 5:00 P.M. that date.

24. After defendant James arrived at the occupied offices after 5:00 P.M. that evening, he was told by defendant Goslin they would end the occupation if defendant James would agree to remove plaintiff immediately as Agency Superintendent.



25. Defendant James acknowledged at that time that he and defendant Coclin had met the day before and discussed the illegal action planned for April 9, 1975.

26. On April 10, 1975, in furtherance of defendants' conspiracy, defendant James relieved plaintiff of his duties as Agency Superintendent.

27. Defendant Thompson in furtherance of defendants' conspiracy, assigned plaintiff to Kansas City, Missouri, on temporary assignment until March 19, 1976. Since that time, plaintiff has remained at his home with no duties to perform, but drawing his full salary from the Bureau of Indian Affairs.

28. That as a result of the unlawful conduct of defendants, plaintiff has suffered indignity, embarrassment, nervousness, fright, humiliation and insult and is entitled to actual and punitive damages.

29. Defendants have conspired to destroy plaintiff's career in the government service because he is a white man and they are Indians.

30. On October 6, 1976, defendant Cadue still continuing said conspiracy, told plaintiff's new supervisor that replaced defendant James, that under no circumstances would he or his tribe accept plaintiff as agency Superintendent. At this time, tribal leaders of approximately five-sixths of the Indians at the Borron agency demanded plaintiff's reinstatement.

31. Because of current rulings of the Courts, plaintiff cannot be assigned to another position in the Bureau of Indian Affairs on a permanent basis if there is an Indian with minimum qualifications available to hold the position. This discrimination against plaintiff has been condoned by the Courts and is legal under the doctrine of Indian preference. Plaintiff has had his career in the Bureau of Indian Affairs destroyed and damaged by the defendants who are all Indians.

WHEREFORE, plaintiff prays for judgment against defendants and each of them, jointly and severally, as follows:

- (1) For actual and punitive damages in such amount as that upon proof at trial shall indicate as justifiable;
- (2) The costs of this action, including reasonable attorney fees;
- (3) Such further relief as the Court may feel appropriate in law and equity;

- (4) Plaintiff demands jury trial;
- (5) Plaintiff designates Topeka, Kansas, as the place of trial.

TILTON AND DILLON

By Robert E. Tilton
Robert E. Tilton
310 Columbian Title Building
820 Quincy
Topeka, Kansas 66612
913-233-9865
Attorney for Plaintiff

IN THE UNITED STATES DISTRICT COURT
FOR THE DISTRICT OF KANSAS

JACK CARSON,

Plaintiff,

vs.

RALPH SIMON, AMOS G. COSLIN,
CLIFFORD O. STEVE CADUE,
CHARLES JAMES and MORRIS THOMPSON,

Defendants.

No. 76-170-C5

A N S W E R

The defendant, Charles James, for his answer to the complaint of the plaintiff filed herein, alleges and states as follows:

1. This defendant admits paragraphs 1 through 6, inclusive, of the said complaint.
2. Defendant James specifically denies the allegations of paragraph 7.
3. Defendant James is without knowledge or information sufficient to form a belief as to the truth of the allegations contained in paragraph 8 of the complaint.
4. The defendant James is without knowledge or information sufficient to form a belief as to the truth of the allegations contained in paragraphs 9, 10, 11, 12, 13 and 14 of the complaint.
5. Defendant James is not aware that the alleged meeting of January 30, 1975 between defendant James and other named defendants ever took place as alleged in paragraph 15 of the complaint, but states specifically that if such meeting did occur, it did not involve any conspiracy on the part of the defendant, James.
6. This answering defendant again denies that there was any conspiracy on his part as alleged in paragraph 16 of the

complaint, but admits that the defendant James did announce on or about January 30, 1975 that the plaintiff was to be assigned to the Anadarko, Oklahoma Area Office of the Bureau of Indian Affairs.

7. This answering defendant specifically denies the allegations in paragraphs 17, 18 and 19 of the complaint.

8. Again denying the complicity of the defendant James in any conspiracy whatsoever, this answering defendant states that he is without knowledge or information sufficient to form a belief as to the truth of the allegations contained in paragraph 20 of the complaint.

9. This answering defendant is without knowledge or information sufficient to form a belief as to the truth of the allegations contained in paragraphs 21, 22, 23 and 24 of the complaint.

10. Defendant James specifically denies the allegations in paragraph 25 of the complaint.

11. This answering defendant again specifically denies any conspiracy on his part as alleged in paragraph 26 of the complaint, but admits that on or about April 10, 1975, the defendant James did advise the plaintiff that he (plaintiff) was temporarily relieved of his duties as Agency Superintendent at the Horton, Kansas Agency of the Bureau of Indian Affairs and that the plaintiff was to report for duty at the Anadarko Area Office not later than April 15, 1975.

12. This answering defendant again denies any conspiracy on his part as alleged in paragraph 27 of the complaint, but admits that by telegram on or about June 9, 1975, the defendant Thompson instructed the defendant James to detail the plaintiff to temporary duty with the office of the Staff Assistant to the Secretary, Missouri Basin Region, Kansas City, Missouri, effective June 16, 1975 and that this duty assignment ended on March 19, 1976, after which plaintiff, by orders of the defendant Thompson

was placed on administrative leave. This answering defendant further states that since October 1976, plaintiff has been on temporary assignment with the Anadarko Area Office.

13. This answering defendant specifically denies the allegations of paragraph 28 of the complaint.

14. This answering defendant again denies any conspiracy on his part as alleged in paragraph 29 of the complaint, but admits that the plaintiff is a white man and that the defendants James and Thompson are Indians.

15. This answering defendant again denies any conspiracy on his part and states that he is without knowledge or information sufficient to form a belief as to the truth of the remaining allegations contained in paragraph 30 of the complaint.

16. This answering defendant submits that paragraph 31 of the complaint consists of legal argument, and does not contain averments of fact to which an answer is required and requests that said paragraph be stricken from the complaint.

The defendant James hereby specifically denies all of the allegations of the complaint not hereinbefore otherwise answered, and having fully answered, this defendant prays that this action be dismissed and that the Court grant such other and further relief as may be appropriate.

/s/ E. Edward Johnson
 E. EDWARD JOHNSON
 United States Attorney
 District of Kansas
 Post Office Box 1537
 Topeka, Kansas 66601
 Attorney for Defendant,
 Charles James

CERTIFICATE OF MAILING

I hereby certify that on the 26th day of January 1977, I mailed a copy of the foregoing Answer, postage prepaid, to:

Robert E. Tilton
 Attorney at Law
 310 Columbian Title Building
 820 Quincy Street
 Topeka, Kansas 66612
 Attorney for Plaintiff

/s/ E. Edward Johnson
 E. EDWARD JOHNSON
 United States Attorney

Mr. BUTLER. Excuse me, Mr. Chairman. If I may, relative to the Jack Carson case, we are now in court litigation, and I would like to respectfully request the Chair's permission before we submit it to you for the clearance of our legal advisors as to anything relative to that.

It is not that we would not give it to you, we are in court.

Mr. BLOTTIN. I think that is probably a fair request. It is my understanding that there is some clearance on the part of Mr. Carson's already been given, but go ahead and check it out and, I think, from a legal aspect that is probably a smart move.

Mr. BUTLER. Thank you, sir.

Mr. BLOTTIN. Thank you.

Before the record is officially closed, there will be other questions probably submitted by the staff, and it is our intention to keep the record open until answers and information requested is received.

Also, the statement that I referred to in my opening remarks is now available and, I think, copies are available from the staff at the conclusion of this hearing.

With no other questions pending, the hearing will be adjourned until 9:30 tomorrow morning.

Thank you.

[Whereupon, at 4:25 p.m. the hearing was adjourned, to reconvene at 9:30 a.m., Wednesday, February 2, 1977.]

INDIAN EDUCATION

WEDNESDAY, FEBRUARY 2, 1977

HOUSE OF REPRESENTATIVES,
SUBCOMMITTEE ON ELEMENTARY, SECONDARY
AND VOCATIONAL EDUCATION OF THE
COMMITTEE ON EDUCATION AND LABOR
Washington, D.C.

The subcommittee met, pursuant to notice, at 9:40 a.m. in room 2175, Rayburn House Office Building, Hon. Michael Blouin presiding.

Members present: Representatives Blouin, Simon, Mottl, Murphy, Le Fante, Corrada, Kildee, Quie, and Pressler.

Staff present: Alan Lovesee, counsel, Special Advisory Study Group in Indian Education; Jeff MacFarland, research assistant, Special Advisory Study Group on Indian Education; Scherri Tucker, assistant clerk, Special Advisory Study Group on Indiana Education; Beatrice Clay, staff assistant; Jack Jennings, counsel; Christopher Cross, senior education advisor; Richard Bragg, consultant; and Yvonne Franklin, minority staff investigator.

Mr. BLOUIN. Good morning. Today is the second day of hearings by the newly created Advisory Study Group on Indian Education.

The witnesses at today's hearing are personnel of the Bureau of Indian Affairs, the Federal agency bearing the primary responsibility for fulfilling Federal policy in dealing with Indian tribes and nations.

The chairman wishes to take note of the attendance and interest of those members who attended yesterday afternoon's hearing. I was very pleased and hope that this is an indication of the attention the committee is focusing on this issue.

Today we have a panel of personnel from the field operations of BIA who will try to give us some insight into the conditions and problems at the local school level that they are most familiar with.

Let me first introduce the panel: Dr. Noah Allen, who I think was our voice from the audience yesterday; Mr. Harry Eagle Bull at the end; Mr. Larry Holman; Mr. Ernest Magnuson; Mr. Vernon Masayeva; and Mr. Ray McGilbarry.

I think it was agreed that we will proceed with the witnesses in alphabetical order and then hold our questions until you have all completed your statements.

Those of you who have statements that you would like to read have the option of summarizing and inserting your complete text into the hearing minutes or reading it as you wish.

I think Dr. Allen would be first.

[The prepared testimony of Dr. Noah Allen follows.]

(71)

Page 70 blank

75

Testimony Presented to the Congress of the United States on Bureau of Indian Affairs
Off-Reservation Boarding School Issues, February 2, 1977 by Dr. Noah Allen,
Superintendent, Phoenix Indian High School, Phoenix, Arizona

There is a great need for the Bureau to clearly define the public that off-reservation boarding schools should serve. I recommend that all Indian young people who can prove 1/4 degree Indian blood from a Federally recognized tribe be eligible for boarding school admission. Neither academic, social nor economic factors should be considered for admission. The administration of this policy should be uniformly followed Bureau wide.

There is a great need for the role of BIA boarding schools to be defined. I would strongly recommend that BIA boarding schools be divided into two very clear and concise areas of responsibility: one serving the academic and social remedial needs of students and the other serving the needs of other students who do not have extreme academic, psychological or sociological problems.

The Bureau of Indian Affairs is many millions of dollars behind in meeting school construction needs. It is obvious to administrators in the field that there is a need for perhaps as many as a dozen secondary schools in various parts of the country, but especially on the Papago and Hopi reservations. These two particular reservations have no secondary schools. Therefore, all high school students must be sent many miles away from home to attend school.

In order to accomplish some of the above suggested objectives, there is a very definite need for re-organization of the Bureau's Administrative system. To best deliver the educational services expected of Bureau schools, and in order to save dollars to implement new and innovative programs, the responsibility for the administration of boarding schools should lie with a duly elected school board with real authority and power. This school board in turn should develop the necessary policies dictated by its constituents. These policies should then be administered by the Superintendent of that school. I see very little need for an education component

at the area office level. The School Board, Superintendent and the school should in fact be regulated by the State and the accrediting organizations throughout the country. The Central Office's function should be along the lines of the State Department of public instruction.

The funding of Bureau schools should be dictated by the programs as reflected by the Board of Education and the Superintendent directly to the Central Office. The point of departure in developing the budget should be a zero based concept. We are all aware that schools in different parts of the country serving the same number of students may well have varying fixed costs, due to climate, isolation, age of buildings and step level of personnel. These fixed costs at various schools should be the base of zero funding. The general operational costs could well be equated on the basis of enrollment--preferably Average Daily Membership of the previous year.

The Federal funding of off-reservation boarding schools over the last several years has enabled those schools to maintain the status quo, but has not allowed for the development of new, progressive and innovative programs. The boarding school situation is not typical. The necessity for around-the-clock supervision, special instruction and much counseling dictates a very high per pupil cost. It would be well for the Congress to consider these unusual circumstances and conditions when funding Bureau of Indian Affairs Boarding schools.

It is an accepted fact in education that high quality educational services will be delivered with quality instructors in the classroom. Conversely, with the most beautiful and expensive school plants and with unlimited financial resources, good educational experiences can never be delivered with inferior teachers. One of the great problems in Bureau education today is the cumbersome, inadequate and inefficient personnel system used to staff boarding schools. I strongly recommend that a system be developed outside of the Civil Service system or as a satellite or affiliate to the Civil Service system to meet the unique personnel needs of education within the

Bureau of Indian Affairs. I would suggest that this system provide the individual schools with recruiting and hiring authority. I would suggest that this system provide a means whereby a teacher who could not teach could be separated from the school. Moreover, I would strongly recommend that this system not provide for tenure unless three years of satisfactory service had been demonstrated. This system should not provide for "personnel ceilings". The number of staff should be dictated by the programmatic needs of the students and on the dollars available within the budget.

There are some real limitations to the GSA system of purchasing needed supplies. Often times three bids are required to purchase textbooks, even though the desired book is published by only one publisher. Many times it takes up to a year to get certain items purchased through GSA. More often than not, the product is inferior in quality. It is impossible to exchange items due to the distances involved. I would recommend that the Bureau purchasing system be modified to allow open market purchasing with three bids as well as the option to buy through the General Services Administration.

A number of problems have developed with the Title programs in the boarding schools--not the least being the divisiveness created by the separate funds and separate regulations. I would strongly recommend that Title monies be a part of the boarding school's budget and be administered through the normal system to provide for the special needs of the Title target groups. The responsibility for accountability should rest with the school.

Travel Moratoriums--the dictation from Congress on the amount of money that an agency can spend for travel may serve a very useful purpose in most agencies of the government, but to the schools in the Bureau of Indian Affairs, it creates havoc in programs and in the ability of the school to meet the educational needs of its students. Student travel to and from the schools, athletic team travel, staff training program travel, student recreational travel, field trips, security patrol are considered travel under the definition of the Travel Moratorium. Therefore, Indian young people

are penalized programmatically in an unjustifiable manner, due to these periodic travel bans. I strongly recommend that the institution make the determination of what percentage of its allocated budget be spent for travel--not the Congress or the President.

For a hundred years, more or less, there have been off-reservation boarding schools for Indian young people. Students from ages 5 thru 25 have been sent many miles away from home for their education. They have been physically removed from the influence of their parents. It is my estimation that many of the dilemmas evident in the Indian world today are related to the disassociation and separation of parents and children. I recommend that the Congress look very carefully at the possibility of providing the resources to allow parental visits to the school as well as an improved communication system between parents and their children. This should be done through either PL 93-638 grants to the tribe or additional appropriations to the schools so that a system to maintain a close relationship between child and parents can be developed.

We will continue to be limited in what we can do for Indian young people until the Congress provides legislation to remove the Bureau schools from the chains inherent in the Civil Service System, General Service Administrations, and the "Shot Gun" approach of the federal government to meeting Indian needs as well as the archaic and cumbersome administrative systems of the Bureau and the absences of parents deciding what it is their children need.

I am urging this Committee to carefully deliberate on modifying the old ways so that the modern Indian will have a chance to find his rightful place in this society with a chance to be successful.

**STATEMENT OF NOAH ALLEN, PHOENIX AREA, SUPERINTENDENT,
PHOENIX INDIAN BOARDING HIGH SCHOOL**

Dr. ALLEN. Thank you very much. Distinguished Congressmen, aides, and guests, we from the Indian world want you to fully realize how much we appreciate your concern and interest in education for Indian young people.

I want to especially thank the committee for inviting the people at the table from the field to come in and share with you our views of the problems as we see them on the front line. I especially want to thank Alan Lovesee and Yvonne Franklin for taking time to come out to the field and visit with us and learn about some of our problems firsthand.

Now, I am going to take the liberty, if you don't mind, to qualify myself to some extent at least as a witness. I grew up in Oklahoma. My father was Indian; my mother was non-Indian. I started attending boarding schools when I was in the seventh grade and then spent approximately 7 years in public high schools, 15 years at the college level as an instructor, and for the last 6 years I have been in administration in the Bureau of Indian Affairs boarding schools.

All of my brothers and sisters and my father attended boarding schools, so I think I know a little bit about what happens historically.

The first thing I want to say is that I thank God for boarding schools. I think that without boarding schools many of us—certainly three that I know of sitting at this table—would have probably been in a jail somewhere today rather than sitting here. So they serve a very useful and important function, and Indian people would not like to see them dissolved or watered down in any fashion.

In preparing my testimony, I assumed that the committee was knowledgeable to some extent about the problems in the field. After listening to testimony yesterday, I have some doubts. Perhaps I—I as a matter of fact have stated the problem as I see it in the field and a possible solution. I hope that you will feel free to ask questions at the conclusion of my prepared statement, so that I can elaborate on those points.

Now, for some of my statements. The first thing that I would like to mention is that there is a great need for the Bureau to clearly define the public that off-reservation boarding schools should serve.

I recommend that all Indian young people who can prove one-quarter degree Indian blood from a federally recognized tribe be eligible for boarding school admission. And I am sure that you are aware that that is a radical departure from the criteria for boarding school admission at the present time. Neither academic, social, nor economic factors should be considered for admission. The administration of this policy should be uniformly followed throughout the Bureau.

No. 2, there is a great need for the role of BIA boarding schools to be defined. I would strongly recommend that BIA boarding schools be divided into two very clear and concise areas of responsibility: One serving the academic and social remedial needs of students and the other serving the needs of other students who do not have extreme academic, psychological, or sociological problems.

The Bureau of Indian Affairs is many millions of dollars behind in meeting school construction needs. It is obvious to administrators

in the field that there is a need for perhaps as many as a dozen secondary schools in various parts of the country, but especially on the Papago and Hopi Reservations down in my neighborhood. These two particular reservations have no secondary schools. Therefore, all high school students must be sent many miles away from home to attend school.

Now, in order to accomplish some of the above suggested objectives, there is a very definite need for reorganization of the Bureau's administrative system. To best deliver the educational services expected of Bureau schools and in order to save dollars to implement new and innovative programs, the responsibility for the administration of boarding schools should lie with a duly elected school board with real authority and power. Now, I want to emphasize that. I feel very strongly that boarding schools should function very much the same as other schools in this country, meaning, that the parents should have a definite input into what young people receive. And this is not the case today.

It seems to me that duly elected school boards with real power will do a great deal to allow parents to have a voice in what happens to their young people.

Mr. QUIE. Dr. Allen, since those who read the transcript will probably know even less than we do—and we hope to know more when this is over—would you tell us how it presently operates?

Dr. ALLEN. Fine; be glad to do that. At the present time—Let me take my own area, the Phoenix area, for example, which covers Arizona, Nevada, Utah, and California. We have an intertribal school board, whereby the tribal council appoints members to the intertribal school board. And they meet pretty much on a monthly basis at the various schools throughout the Phoenix area, meaning specifically Inter-Mountain; Stewart; Sherman, Riverside, Calif.; and the Phoenix Indian School at Phoenix, Ariz.; Theodore Roosevelt Junior High School on the White Mountain Apache Reservation; and Santa Rosa Boarding School down on the Papago Reservation. They meet on a monthly rotating basis at these schools.

My point is that they do not have any authority. They are strictly advisory. The second point that I would make is that, even though the Federal Government's relation with Indian tribes supposedly is from government to government, I have a little trouble with that and I guess I ought to say so right now.

The government in the United States—the State government, for example—has very little to do with what happens in the local public school, and I feel that the Indian tribes of this country should have that same right, that the tribal government should not run the schools, but rather the people should dictate to the school board, a duly elected school board, what they want to happen in the school systems.

I have a little trouble with the tribal governments appointing the representatives to the school board and I have even more trouble living with the fact that these school boards do not have any authority or power in that they are strictly advisory.

I am recommending that the people be allowed to elect members of the school board and, furthermore, I would add that each school should have a school board and not an intertribal school board that represents all schools in an area.

This school board in turn should develop the necessary policies dictated by its constituents. These policies should then be administered by the superintendent of that school.

I see very little need for an education component at the area office level. Now, I hope that you will follow the points that I am attempting to make very closely because I think they are significant. I am not going to elaborate unless you ask, but this is significant. If we don't have an area office education component—

Mr. BLOUN. It might not be a bad idea, Doctor, to just assume that we are asking you to elaborate as you go through your points.

Dr. ALLEN. All right. I will do the best that I can, but, if I don't get through, let me know and let me take another cut at it.

Mr. BLOUN. You bet we will.

Dr. ALLEN. Fine; I fully realize that what is said in these hearings is public knowledge and that there will probably be some repercussions from some of the comments that we will make, but I don't have to work for the Bureau.

Mr. QUIE. Repercussions from whom? From the Bureau or from the people back home?

Dr. ALLEN. I am thinking strictly of the Bureau.

Mr. QUIE. OK.

Dr. ALLEN. In my judgment, the services that we get from the education components in area offices do not merit their existence, and I will explain that in a little more detail later in my testimony, but suffice it to say at this point that the technical and logistical help and support that we get at the boarding school level does not merit the great outlay in personnel and money and that this could better be done with direct responsibility to the central office. And I will explain that in a little more detail down the road.

The school board, superintendent, and the school should in fact be regulated by the State and the accrediting organizations throughout the country, meaning specifically that I personally don't see a need for Bureau schools to be regulated in any fashion different from the public schools. And at the present time the public school systems are regulated by the State department of public instruction and by the accrediting organizations like North Central, for example.

Mr. QUIE. Could I ask a question? In that case, in many of the States, all of the decisionmaking will be done by individuals who have no Indian blood and probably no understanding of Indians, except some with an animosity toward Indians. This is what comes off the top of my head when you suggest that.

In New Mexico and Arizona, you have such a large percentage of Indians in the populations of the States that I think it would be different there, but, using South Dakota as an example—Is there somebody here from Aberdeen? I don't know if this would work out for us to do, but I like to take these points as we go along because we do have exceptionally good testimony from which we can build legislation.

Could the gentleman here from Aberdeen, Mr. Eagle Bull—Could you react to how that suggestion would work in South Dakota?

Mr. EAGLE BULL. If I may ask Dr. Allen to correct me, the way I understood what he was saying is that we would build the school boards at each of our schools with the same power as far as authority as the State school boards? Am I right on that?

Dr. ALLEN. No; that is not my intention. My intention is to say that a school board should be elected by the constituents that that school serves and that that school board would be responsible for developing policy under which that school will operate and that it will be the responsibility of that superintendent to administer that policy.

Mr. QUIE. And, as I understood what you said, the central office of BIA would still function as a State department of education. However, when it comes to the regulations—that would be accrediting and other regulations—on certification?

Dr. ALLEN. Right.

Mr. QUIE. Of the superintendent and the school board. That would come from the States. It leaves me a little unclear as to where the central office functions as a State department stop and where the State then can move in, which doesn't have responsibility, and where that would apply. Now, I can understand it if it meant what we were talking about yesterday, the teacher licensure or the teacher certification in the State would be governed by State licensure laws, which I guess are in five States, or State accreditation of teachers, as most of the other States have, if that is what you are talking about.

Dr. ALLEN. Let me see if I can explain that, Congressman. At the present time, the boarding schools, as far as I know, are in fact regulated and abide by the same State requirements and regulations for graduation as any other school does, so this would not be an addition. For example, at Phoenix Indian School, we have to have certain—students must meet certain requirements in order to get a diploma from the State of Arizona.

Mr. QUIE. So—

Mr. BLOUIN. You are talking about the standards that have to be met to be an accredited school, to receive an accredited diploma, and so on down the line?

Dr. ALLEN. Definitely.

Mr. BLOUIN. It would vary, depending on the standards within that State?

Dr. ALLEN. Very definitely.

Mr. BLOUIN. You are not suggesting that it all be turned over to the State department of public instruction?

Dr. ALLEN. Oh, no, I am sorry; I didn't make that clear.

Mr. BLOUIN. Thank you. I think that is where the confusion came from.

Dr. ALLEN. I can understand where it might be. I will go on. Please stop me at any point.

The funding of Bureau schools should be dictated by the programs as reflected by the board of education and superintendent directly to the central office in Washington. The point of departure, at least in my mind, in developing the budget should be what I call a zero-based concept.

We are all aware that schools in different parts of the country serving the same number of students may well have varying fixed costs due to climate, isolation, age of buildings, and the step level of personnel. And I can well emphasize that point because at Phoenix Indian School the average age of our teachers is about 60. So the cost of our personnel is way up here, whereas maybe at Santa Rosa Boarding School it may well be lower, they may be on the first, second, or third step

of their GS classification, where ours for the most part are at the top of the classification.

Mr. QUIE. Do you have mandatory retirement at 65?

Dr. ALLEN. No, 70.

Mr. QUIE. I see. That is how the average can be 64. I was thinking that you could wait 2 years and it would be over with, but you have to wait 7.

Dr. ALLEN. These fixed costs at various schools should be the base of what I am calling zero funding. They should be the base, the fixed costs that you can't do anything about whether you have 575 or 625 students.

The general operational costs could well be equated on the basis of enrollment, preferably average daily membership of the previous year.

Mr. QUIE. Let me ask you this. That hundred variation—

Dr. ALLEN. Right.

Mr. QUIE. Was that within the year? At any time within the year, you may have a variation of 100?

Mr. ALLEN. Let me give you specific figures. Our high enrollment at Phoenix Indian School this year was 644 students and right now the enrollment is 585 students. I suspect by the end of the school year it may be 560 or possibly even 550, but there is very little we can do to change the number of personnel, you know, in a year.

This dropout is due to a multitude of causes: Getting in trouble, flunking out, parents deciding to send them to a public school. After age 16, they can drop out of school. A number of things that really are outside of the control, I think, of the boarding schools.

Mr. QUIE. That would work for you where you have a declining enrollment. What would happen if you had a growing enrollment and you use the average daily or average membership of the previous year?

Dr. ALLEN. We think that the difference in buying food—that this would be the only real variable—the difference in buying food would not be significant. We can feed, you know, 700 students for about what we can feed 675 or 650. Now, if the variation were more than that, it would be an important factor.

I will go on. That Federal funding of off-reservation boarding schools over the last several years has enabled those schools to maintain the status quo, but has not allowed for the development of new, progressive, nor innovative programs.

The boarding school situation is not typical, and I want to emphasize that. The necessity for around-the-clock supervision, special instruction, and the amount of counseling required dictates a very high per pupil cost. It would be well for the Congress to consider these unusual circumstances and conditions when funding Bureau of Indian Affairs boarding schools.

It is an accepted fact in education that high quality educational services will be delivered with quality instructors in the classrooms. Conversely, with the most beautiful and expensive school plants and with unlimited financial resources, good educational experiences can never be delivered with inferior teachers.

One of the great problems in Bureau education today is the cumbersome, inadequate, and inefficient personnel system used to staff boarding schools. I strongly recommend that a system be developed outside

the Civil Service System or as a satellite or affiliate to the civil service system to meet the unique personnel needs of education within the Bureau of Indian Affairs.

I would suggest that such a system provide the individual schools with recruiting and hiring authority. No one knows better the type of individual that I need to do a job than I do. Certainly not classification in the area office and certainly not classification at the Washington area.

I would suggest that this system provide a means whereby a teacher who could not teach could be separated from the school. And this is nearly impossible at the present time under the civil service system.

Moreover, I would strongly recommend that this system not provide for tenure unless 3 years of satisfactory service has been demonstrated. And right now it is 1 year.

This system should not provide for personnel ceilings in any shape or form. The number of staff should be dictated by the programmatic needs of the students and on the dollars available within the budget.

There are some real limitations to the GSA, General Services Administration, system of purchasing needed supplies and equipment. Often-times three bids are required to purchase textbooks, even though the textbook is published by only one publisher.

Many times it takes up to 1 year to get certain items purchased through GSA. More often than not, the product is inferior in quality, or, I could add, not exactly what you ordered in the first place. It is impossible to exchange items due to the distances involved.

Now, I would recommend that the Bureau purchasing system be modified to allow open market purchasing with three bids, but maintain the option of buying through GSA if it is to the school's advantage. And I think that is the way 93-638 permits tribes to purchase at the present time.

A number of problems have developed with the title programs in the boarding schools, not the least being the divisiveness created by the separate funds and separate regulations. I would strongly recommend that title money's be a part of the boarding school's budget and be administered through the normal system to provide for the special needs of the title target groups. The responsibility for accountability should rest with the school, and not an area office component for Federal programs.

As to travel moratoriums, the dictation from Congress or OMB or the President—I am not certain where this comes from—on the amount that an agency can spend for travel may serve a very useful purpose in most agencies of the Government, but, to the schools in the Bureau of Indian Affairs, it creates havoc in programs and in the ability of the school to meet the educational needs of its students.

Student travel to and from the schools, athletic team travel, staff training travel, student recreational travel, field trips, security patrol are all considered "travel" under the definition of the travel moratorium. Therefore, Indian young people are penalized programmatically in an unjustifiable manner due to these periodic travel bans.

I strongly recommend that the institution make the determination of what percentage of its allocated budget be spent for school travel, not the Congress or the President or OMB.

For 100 years, more or less, there have been off-reservation boarding schools for Indian young people. Students from ages 5 through 25

have been sent away many miles from home for their education. They have been physically removed from the influence of their parents.

It is my estimation that many of the dilemmas evident in the Indian world today are related to the disassociation and separation of parents and children.

I recommend that the Congress look very carefully at the possibility of providing the resources to allow parental visits to the school as well as the development of improved communication system between parents and their children. This should be done through either Public Law 93-638 grants to the tribe or additional appropriations to the schools so that a system to maintain a close relationship between the child and parents can be developed.

I would like to think back to the time when I was in the seventh grade going to Yuchi Mission Boarding School at Sapulpa, Okla. Children were so happy to see their parents that one little friend of mine who was standing there saw an old pickup truck drive up and he said: "Oh, boy, my parents are here." He ran out and jumped in the truck, and it wasn't his parents. It was someone else who had a similar car.

But they are so elated to see their parents after an absence of 3, 4, 5, or 6 months that they see things sometimes. They see things that really don't exist. So I have very strong feelings about that.

We will continue—and I am talking about the boarding schools—we will continue to be limited in what we can do for Indian young people until the Congress provides legislation to remove the Bureau schools from the chains inherent in the civil service system, the General Services Administration, and the "shotgun" approach of the Federal Government to meeting Indian needs, as well as the archaic and cumbersome administrative systems of the Bureau and the complete absence of parents deciding what is their children need.

I am urging this committee to carefully deliberate on modifying the old ways so that the modern Indian will have a chance to find his rightful place in this society with some chance to be successful.

Mr. PRESSLER. Mr. Chairman, could I get a question in here? I know there is—maybe this is better for Mr. Harry Eagle Bull—but I know there is a dormitory on the Rosebud Reservation. You were talking about the dormitory situation. How well does that program function? And do Indian parents have substantial input in the programs?

Mr. EAGLE BULL. That operation is strictly a dormitory operation. The students attend the public school. The operations, I think you will find, I am sure, in the presentations that fellow members of this panel will make, are very similar to some of the concerns Dr. Allen has pointed out in all of the areas that he has touched on. We do have the same problems that he mentioned in the area of staffing, although in that particular instance, the dormitory—it is not as great, since the turnover is not as great as we find in our schools with teachers.

But basically the same concerns he has voiced I think will hold true in all of our dormitories.

Mr. PRESSLER. Thank you.

Mr. BLOVIN. Do any members of the committee have any clarification questions on Dr. Allen's statement?

Mr. QUIE. I have one, Dr. Allen, would you consider your school as an off-reservation school?

Dr. ALLEN. Yes; I certainly would. We have students from northern California, from Nebraska, Iowa, Michigan. We have had students from Mississippi. So, yes, I would.

Mr. QUIE. Thank you.

Mr. BLOTTN. Thank you, Dr. Allen.

The next on the list is Mr. Harry Eagle Bull. I understand that you do not have a prepared statement, but that you may have some comments you would like to make.

**STATEMENT OF HARRY EAGLE BULL, ABERDEEN AREA OFFICE
DIRECTOR, EDUCATIONAL SERVICES**

Mr. EAGLE BULL. Yes, I do, Mr. Chairman. Mr. Chairman, members of the committee, and staff, guests, and fellow panel members, on behalf of the tribes, students, Indian communities, non-Indian communities, education and supportive staff of the Aberdeen area, I wish to take this opportunity to thank the committee for having the opportunity to appear before you. And my special thanks to Mr. Bragg for his visit to our area last year. We are looking forward to and would welcome future visits by members of this committee and staff.

I feel that I had best give a little background on myself because I think it plays a very important role in how I see myself as an employee of the Bureau of Indian Affairs and a fellow Indian to those we are serving.

BIA has been very instrumental in my entire life. I am a product of a BIA school, grades 1 through 12. I am also a product—and, without the help of the BIA's higher education program, a college education would have been a little bit hard for me to come by.

Since getting my degree, I have been involved in the Bureau of Indian Affairs as a teacher and—

Mr. QUIE. Could you tell us where that school was that you attended?

Mr. EAGLE BULL. Pine Ridge. I am a member of the Oglala Sioux Tribe and attended grades 1 through 12 at Pine Ridge.

Upon graduation from college with a teaching degree, I did teach about 6 years at one of our Bureau schools and then did move into the area office where I worked in the area of higher education. I have been in my current position just a little over a year and a half. So I do have a very deep feeling for some of the problems that were expressed yesterday and some of the things you will hear today.

I can recall my days as a student in our school system. I was not fully aware of some of the things that I am sure our teachers at that time or our administrators at that time were probably experiencing. Unfortunately, some of these are the same things we are experiencing today.

I do have a deep feeling for the system we are in and the services that we are to be delivering. Therefore, I was very much interested in yesterday's hearings and do appreciate the opportunity yesterday to listen to the session and witness what I do believe is the sincerity and interest of the committee members in the area of Indian education.

Personally and as an employee of the Bureau, I would be very willing to work in any way possible to help the committee hopefully to try to

overcome some of these concerns that were voiced yesterday and concerns that we will be facing from here on out.

We, as you are all aware, do have many problems, but I think many of the problems we do have are problems that every school system in the country will be facing or is facing. We are unique in one way because of the Federal relationships we have with the tribes and the Government.

However, I do feel and want to express that we have many positive things going for us in the Bureau and in our school systems. I appreciate the committee's concern in hopes of building on these positives and working together to overcome our shortcomings in the betterment of Indian education, which, in turn, will lead to the betterment of our people.

I do hope that my presence here will in some way benefit our programs. I do not have any other concerns that I will express at this time, but I am open for questions from the committee at your convenience and will answer to the best of my knowledge and my experience.

Thank you, Mr. Chairman.

Mr. BLOUIN. Thank you, Mr. Eagle Bull. One quick question. Do you share the same concern as Dr. Allen about making waves or facing possible repercussions as a result of things you may or may not say today?

Mr. EAGLE BULL. Well, I guess I have got the same feeling Dr. Allen has, and I think you will get the same response from other members who are sitting here and who will sit in this chair in a few years. I know that there may be some repercussions, but I also feel that there is employment elsewhere and I am not really too concerned about that at this point, if it leads to the betterment of what we are going for.

Mr. BLOUIN. Thank you for your straightforwardness on that. If this panel has any bearing on it at all, there won't be any repercussions in that kind of a sense.

Mr. Pressler.

Mr. PRESSLER. Mr. Chairman, let me say I am very proud to have Mr. Harry Eagle Bull here testifying from my area of the country. This is one of the great problems we face in South Dakota, and I must say that I get a large amount of staff work in problems in this area, and we appreciate your efforts.

I want to ask a few questions here. First of all, how are the parent committees in the Aberdeen area getting along with the school superintendents in regard to signoff authority on the program?

Mr. EAGLE BULL. I think, Mr. Pressler, that will vary. I know this isn't a very specific answer, but it will vary from parent committee to parent committee. There has been a great concern in a couple of our school districts on the regulations of Public Law 93-638 as far as the signoff authority that it does give to the parent advisory committees.

We have had some problems in that area, as a result, this has resulted in the slowness of developing contracts to carry out these programs. And I would like to attribute that to this being the first year we entered into that type of arrangement under Public Law 93-638.

We are this month and from here on out will be working with the same school systems, the same parent advisory groups, hoping to get them together on the programs for next fall. But, it is a concern of ours and we are trying to overcome it, but again it will vary from com-

mittee—new committee members coming on, school boards, and so on.

Mr. PRESSLER. Sure. Now, that 93-638—the impact of that on your area—did you have meetings in the area to explain this law? And what was the reaction?

Mr. EAGLE BULL. We had meetings in the area office and more meetings out at each of the agencies. We had meetings that varied in attendance where Public Law 638 staff went out and explained the entire act. We had staff members of the area office go out and meet with individual schools, individual school boards, parent groups, in an attempt to inform them of the regulations.

So we have had a number of meetings and we have ongoing meetings. It seems like a good part of our day is spent in the JOM area, so it is not an issue that we can let go for even 1 week and stay on top of it.

Mr. PRESSLER. How does the civil service prospect impact on your hiring of teachers in the South Dakota area? Does it pose any special problems for you?

Mr. EAGLE BULL. It is one of the most difficult problems that we have faced, and one that I have faced personally. It is unbelievable in the length of time we tend to spend in trying to hire a teacher.

I will give you an example. Yesterday there was a member of our central office staff who gave a rundown on how one might go about hiring a teacher. The process is there. I think we can live with the process if the results could come back to us faster.

Let me just clarify what I am saying, Mr. Pressler. The time element is the big factor. We may have a teacher vacancy and it may take us anywhere from 30 days to 3 to 4 months to fill that vacancy under the system we must now go through, and this is a big problem.

As Mr. Quie mentioned yesterday, what would happen if a superintendent finds he is short one teacher? Well, the explanation was given as far as the process, but the important thing that has caused us problems is the time element that it does oftentimes take. It varies depending on when the vacancy occurs.

If the vacancy were to occur in the month of August, through the system we have, it is quite a lengthy process in filling that.

Mr. PRESSLER. I am told you advertised for some principal positions and you had no applicants. Is that right?

Mr. EAGLE BULL. We have had in the past some problems in filling vacancies in the administration of our schools, principals and teacher supervisors. We have had instances where we had to advertise two to three times before we can get anyone qualified to apply for these.

Now, I have a personal feeling on that in the contacts that I had when I was working in higher education, if I might just elaborate on that, I think it would give the committee a feeling of what I am trying to express.

It seems like you go out and talk to people and we hear all of the things we should be doing as a Bureau or all the bad things we are doing, and we don't have the positive side brought out enough. And, as a result, I think, if I may use the term, it is scaring off some of the qualified people who could fill those positions.

To step in and take over a principalship or a teacher supervisor position, because of what they have heard, they don't really want to come to work for the BIA. That is a personal viewpoint, but I really think

that has something to do with the lack of people wanting to apply for those positions.

Mr. PRESSLER. Now, very briefly, could you discuss the joint community schools? Pine Ridge would be a good example. Give us your opinion on how this system seems to work.

Mr. EAGLE BULL. Are you referring to the cooperative school agreements?

Mr. PRESSLER. That is right.

Mr. EAGLE BULL. We have a number of cooperative school agreements in our area. I think we have approximately 16 of our schools that are what we would call cooperative schools. This is a joint effort between the Bureau of Indian Affairs, represented by that local agency, and the local public school district, where they have joined together through a cooperative agreement and are operating the school financially and staffwise.

One thing I would like to point out that has been a big benefit to our operations is that area where the public schools do hire a number of teachers and it does make it a lot faster when they replace their staff and so on. So we do feel that the cooperative agreements are very beneficial to our total programs.

Mr. PRESSLER. OK. One quick, final question. Do many of the children in your area have Sioux or Lakota as their first language? And what kinds of bilingual programs do you have? Are they title VII, title I, or does BIA money go into programs in the day schools?

Mr. EAGLE BULL. We have a title VII program at one of our schools which is now a contract school for the first year. It went into contract last October. That is Loneman School at Pine Ridge.

Now, I think you will find that the bilingual needs will vary greatly from one area to another. For example, in my area the bilingual is there, the request is there, but it is mainly in the area of cultural classes, teaching it as an extension and the continuance of the Indian culture.

Because of the lack of request from the schools for bilingual, in order for them to go on with the regular program—I think it would be safe to say in our area that bilingual requests and needs are expressed mainly through the cultural classes that are in our schools.

Mr. PRESSLER. Thank you very much, Harry.

Mr. QUIE. Mr. Blouin, I will wait with my questions on the whole operation until the end, except that I would just like to get one understanding.

You have heard us talking yesterday with people in the Washington office here. Dr. Allen is out at the school and you are director of educational services in an area office. Could you just tell us who your boss is and how you relate to Albuquerque and to the Washington office?

Mr. EAGLE BULL. I would be glad to do that.

Mr. QUIE. Thank you.

Mr. EAGLE BULL. The structure that we operate under in the Aberdeen area—and I think it is similar in other areas—is that my position as director of educational services is an area office position located in the area office. My immediate supervisor is the area director. The channel or chain of command up to the central office would be through my area director, my immediate supervisor, up to the Commissioner's office.

Now, going the other way, we in turn would contact the superintendent of an agency and go to his particular staff member—my counterpart at the agency level, you might say, in the program area.

So our relationship is one or—

Mr. QUIE. When you say "agency"—

Mr. EAGLE BULL. The agency is—for example, Pine Ridge is one of our agencies. We have 13 agencies in our area. And we, in turn, would make contact through what we call education programs administrator at the agency, who has the responsibility for the educational program on the entire reservation area.

Mr. QUIE. In other words, you have no direct contact with Dr. Demmert? You go to your director, who is the Commissioner's counterpart out there in your area, who then contacts the Commissioner, and then that goes down through—

Mr. EAGLE BULL. That is why I mentioned that that is the channel that is set up, but we have contact directly with staff of Dr. Demmert upon request from the field, so it is one that is open in that area.

Mr. BLOUIN. Maybe as a followup on that same point, what kind of contact do you generally run into that is initiated from the national office to you?

Mr. EAGLE BULL. I think one of the biggest things that we have been working with over the past year, far as a national concern and level, is the implementation of 93-638 which brought on a number of things that the Bureau is now responsible for.

I could cite one example. The previously private schools, that now, through Public Law 93-638—the Bureau does have the obligation to assist in those schools, and this is one area that is national in scope, yet is very much a concern in our area because of the number of these schools that we do have.

They touched on some of the items yesterday a little in the presentation of, for example, the school construction guidelines, the bilingual question. So it is a matter of information we get transmitted for input, for comments, and so on, from the central office.

Mr. BLOUIN. Is there a regular ongoing flow of information from the top down to you seeking an understanding of the kinds of problems you are facing daily?

Mr. EAGLE BULL. Well, I guess we could say not daily. I would like to think that some of the concerns we do get are those that come up to our office, but we don't have the immediate answer.

I will continue to refer back to the teacher recruitment problem because it is a problem that we just don't have the immediate answer to. We tell the superintendent and the principals we have made the request of the Civil Service, that we are waiting for Civil Service and so on, but that is not going to get a teacher in the classroom.

Mr. BLOUIN. Dr. Allen?

Dr. ALLEN. Yes, Mr. Chairman. I think it is important that this committee understand conversely what Harry was saying. For example, the superintendent at Flandreau Indian School, if he has a problem or an issue, must go directly to the area director and not Harry, who really, you know, is in charge of education in that area. Then in turn the area director would go to Harry and say: "Well, you work on that." Now, is that correct?

Mr. EAGLE BULL. That is true.

Dr. ALLEN. That is the way it is in our area too.

Mr. BLOUIN. Is that a functional process?

Mr. EAGLE BULL. Yes, it is.

Mr. BLOUIN. Does it work?

Mr. EAGLE BULL. Well, it works probably as far as getting the superintendent's concerns into the area office, but I do agree with Dr. Allen. In cases like that, it may work better in the reverse. It keeps us on top of the issues when they are a problem. I think.

Mr. QUIE. I would say this is a problem that we are running into in other parts of the Government, in education as well. Also, for instance, we ran into it, in rehabilitation, HEW wanted to have everything under the control of the regional director, so in education they have to go through the regional director for rehab. So the local school board members, used to working with individuals that they knew, then found administrative overburden.

So I think it may be something that the Secretary of HEW likes or maybe something that the Commissioner of BIA likes too. But when it comes to the needs of the tribes or the students or the administrator of the school, I myself think it doesn't work very well.

That is no criticism of BIA itself, just the way the Federal Government operates.

To get this clear, let me ask you this again. When do you go to Jon Wade out in Albuquerque without going through your supervisors, and what things would you go to Bill Demmert directly about without going through your supervisors?

Mr. EAGLE BULL. OK. The practice we follow in our area—and it is a practice that we follow to keep the area director's office and his staff informed—is, on these issues that we must come either to IERC or to Dr. Demmert's staff—we do discuss these with the area director and usually then make our calls. If he feels he should be in on the call, he gets on the call or he will ask us to take care of it. So we do call members of Dr. Demmert's staff and IERC on concerns that we have.

Mr. QUIE. Could you differentiate for me a couple of the concerns that you would—

Mr. EAGLE BULL. Fine. We would go to IERC in the area of title I concerns. We would go to them in the school construction area.

Mr. QUIE. When you say "title I," you are talking about—

Mr. EAGLE BULL. ESEA. And we will go to them on the student enrollment system in their research and evaluation section. That is when we would contact IERC.

Mr. QUIE. Then which ones would you take to Demmert?

Mr. EAGLE BULL. We would come to the central office on concerns that are voiced to us through tribal resolution and maybe in the area of a matter dealing with higher education. It may be in the area of a matter of a tribe interested in retaining its school or its school board. And these are matters that I guess we can say there are no set policies that would give us guidance on how we handle this as far as what is the national policy. We may have a method in the area office on how we would handle it in an area office, but it may not be a national concern.

Mr. QUIE. That is helpful.

Mr. BLOUIN. Mr. Simon?

Mr. SIMON. You mentioned earlier that it takes a lengthy period of time to work through Civil Service. If you have a teacher who resigns tomorrow just suddenly—and these things happen—and you have to go through Civil Service, what do you mean by a lengthy time? How long is it going to take you to get that teacher?

Mr. EAGLE BULL. OK. Let us say we have a teacher who leaves our system tomorrow. We get a call that we need an English teacher at this particular school. What will happen is that the agency must initiate action. I will go over this for your benefit as far as the terms. The agency will initiate a form 52, which is action to recruit to fill that position. This will come into our area personnel office.

When this form is received, we in turn in the area office will go down to Albuquerque and request a certificate of eligibles. From that, we will get back a list of names that Civil Service in Albuquerque will have available for that particular position and at that particular grade level at which it was advertised.

Now, that process in itself is no problem. The problem comes from the length of time between the time that that request leaves the area office and the time we do get a cert back from Albuquerque giving us a list of names to contact.

An example is that it will vary—If this teacher were to leave now, chances are we wouldn't get that position filled until school is out. It will vary from as long as 3 months from the time we would get the cert back from Albuquerque giving us the list of names. That in itself is part of the problem.

The other part of the problem is that, if, for example, we get five names on the list, we will then go out and inquire about those individuals to see if they are available for employment. And that late in the year, 9 times out of 10 they are already teaching somewhere, and it doesn't give us anyone to pick from. So that is another big problem.

It will vary from the time the vacancy occurs, but it is no surprise to us to wait 3 months anymore.

Mr. SIMON. OK. One other, if I may ask a sweeping question to both you and Dr. Allen. As you view Indian education, say, over a period of 10 years or 20 years, has there been a marked improvement?

I realize, you know, we have not made the progress we should. What do you see as you view the big picture from a perspective of 10 or 20 years?

Mr. EAGLE BULL. I do believe we have come a long way in the past 10 years, but I also feel we do have things standing in our way, that, unless these things are taken care of, our progress may not move as fast as we would like and certainly not as fast as the Indian people who want education to move for their betterment.

I think we can point to a number of things to show we have come a long way: The increase in our high school graduates, the increase in the number of students entering college. These are two areas that we can point to.

It is rather difficult to really evaluate the effectiveness of any educational program only on the final product—there are so many factors entering into the operation including that the final product may not bloom until years later after he leaves the school.

So it is rather difficult, I think, to judge progress on a 1-year term, looking at a student for 1 year, but I do personally think that we have come a long way, and I say that as a former student of our system and an employee of it.

Again, we do have some shortcomings that I hope we can all work together and eliminate these or correct them to help us out.

Dr. ALLEN. Congressman Simon, I would want to agree with Harry's evaluation of the progress that we have made, but I think to really answer that question will depend on this committee and what Congress does to improve some of the real problems.

For example, the dilemma that we find ourselves in in hiring staff. I think the Congress not only has to find a way by providing necessary legislation to eliminate these bottlenecks of hiring logistics, parental involvement, and supporting Dr. Demmert's proposal for reorganization within the organizational component of the Bureau of Indian Affairs.

If we don't have that kind of help from Congress, then we are not going to be successful and we are not going to progress the way we should over the next 10 years.

Mr. SIMON. Thank you. I have no further questions, Mr. Chairman.

Mr. BLOUIN. Thank you. Do any of the other members have any clarification questions before we move on to the panel?

Thank you, Mr. Corrada?

Mr. CORRADA. I would like to ask a question. Perhaps you might have addressed yourself to this question before I arrived here, but yesterday we had a general overview of your problems. Could you state briefly which are in your mind the most critical problems in terms of needed reform in the area of Indian education? Again, I repeat perhaps—I know that you have been discussing all these things, but I have just arrived and I would like you, if you could, just to summarize the main thrust of what you feel ought to be done by Congress, by ourselves, in terms of improving Indian education. If you could summarize that.

Mr. EAGLE BULL. OK, I think one of the areas that this committee and Congress can be very effective in is in the area of making the supportive services easier to get, easier for the system to operate under. By "supportive services," there are many areas, whether it be in the area of personnel, teacher recruitment, whether it be in the area of maintenance of the facilities.

I agree with Dr. Allen that, in order for the education system to operate and make the headway, we would like to see—there are a lot of things standing in the way that do make it difficult that need correcting.

If this committee could do only one thing, I would think that my presence here and the trip would be worthwhile, and that would be in the area of the teacher recruitment problem. I think that would go a long way—because it is rather difficult to sit and judge a school or a school system and say: "Well, maybe if we had a teacher in that classroom last semester or last year"—so I think this is an area that, if in itself it can be handled and made easier, it would be a big help to us.

Mr. CORRADA. Thank you.

Mr. BLOUIN. Thank you.

The next person on our panel, Mr. Larry Holman from the Navaho area, has joint testimony—is that correct—with Mr. Magnuson.

Mr. HOLMAN. Yes, some of our concerns will be similar.

Mr. BLOUIN. If you would prefer, you could proceed together. Or do you each have comments separately? You have submitted a 100-page statement for the record. We would sincerely hope you would drastically summarize that. [Laughter.]

[Testimony submitted by Larry D. Holman follows:]

OVERSIGHT HEARINGS ON INDIAN EDUCATION**TESTIMONY****PRESENTED TO**

**CONGRESS OF THE UNITED STATES
HOUSE OF REPRESENTATIVES
COMMITTEE ON EDUCATION AND LABOR
SUB-COMMITTEE ON ELEMENTARY, SECONDARY,
AND VOCATIONAL EDUCATION**

PREPARED BY

**UNITED STATES DEPARTMENT OF THE INTERIOR
BUREAU OF INDIAN AFFAIRS
NAVAJO AREA
EASTERN NAVAJO AGENCY
BRANCH OF EDUCATION
LARRY C. HOLMAN
EDUCATION PROGRAM ADMINISTRATOR**

February 2, 1977

92

TABLE OF CONTENTS

	Page
Introduction	2
Locale	7
Overview	9
Instructional Services	11
A. Curriculum	11
B. Career Education	17
C. Kindergarten	20
D. Secondary Education	21
E. Special Education	22
F. Summer Programs	26
Home Living	26
A. Dormitory Operations	26
B. Cultural Awareness	27
C. Counseling	28
D. Enrichment and Extracurricular Activities	28
Food Services	30
Personnel/Training	31
Transportation Needs	32
Plant Maintenance Services	34
Facilities	35
Community Involvement	43
Conclusion	47
Appendix	49

INTRODUCTION

On behalf of the Navajo students and communities being served by the Eastern Navajo Agency's Branch of Education, I wish to thank this committee for giving me the opportunity to testify before you.

We, at the local field level, who have the final responsibility for carrying out the plans and programs mandated by Congress appreciate this chance to be heard directly. What follows, which is from this local perspective only, is my appraisal of the current status of Navajo education as acquired through administrative experience and personal involvement with the communities and people served by the Eastern Navajo Agency. It is not my intention, nor is it within my capacity, to speak for others outside this delineation.

We have worked, extremely hard, at improving our educational program. However, much remains to be accomplished. For this, your interest and legislative leadership is urgently needed. Our students, for a variety of reasons (among them cultural, linguistic and economic), have special needs. These must be addressed in a manner beyond our current capacity to deliver if the Navajo student is to become a productive and contributing citizen to the same degree as other segments of our society.

The educational process is a primary method for realizing self-sufficiency. It is toward this end that I would like to call your attention to several problems which, if remediated, will help achieve this goal. I will list them now and they will be dealt with in more detail later.

The Special Education needs of your Navajo students are not totally being met at present. Currently, all our students are at least two years academically retarded and consequently are in need of specialized educational services. Due to a lack of regular program funding for the services, the schools develop projects which have been funded since 1967 through the Office of Education, H.E.W., under Public Laws 89-10 and 93-380. While this is, of course, a great help, it is our feeling that we are by law required to provide these services and that funding should be included in the Bureau of Indian Affairs annual budget.

All of our facilities were designed and constructed around the concept of one teacher for every thirty students on a suburban public school model, in the case of dormitories on open bay models, with no consideration of the special educational needs of our students. Also, some facilities are over thirty years old, and all facilities have been deteriorating physically as a result of a lack of adequate maintenance funds.

Our plant maintenance personnel estimate that at least forty million dollars is needed to bring our facilities up to a standard level of maintenance. Subject funds could only be expanded at the rate of fifteen million dollars a year. I have also been informed that another major reason for deteriorating facilities is that Navajo Area has been funded at the lowest square foot for maintenance for any Bureau of Indian Affairs area in the last five fiscal years.

Enrollment has declined since the facilities were constructed on the above referenced criteria. Thus, in some cases, we do have space available for special education programs, but no funds are available for renovation or additional construction. Our facilities management personnel stated that Education has submitted sixty-eight million dollars in facilities improvement projects for school plants. This Fiscal Year 1977, we have received only one hundred and two thousand for alterations and improvements.

It has always been the policy of the Bureau of Indian Affairs to provide educational services to Navajo children as close to their homes as possible. We are no longer sending students to off-reservation boarding schools, except in special isolated cases. We have in some cases increased grade levels at community schools and we have established and/or extended bus routes to provide day school services.

However, some students, parents, and community leaders are expressing a desire to maintain dormitory services when criteria exists, such as: family size is large in relation to income, running water and electricity is non-existent in the family home, and bus service over unimproved roads of over thirty miles one way is impossible. Current Bureau of Indian Affairs policy requires day school attendance if the student can be reached by a bus regardless of the circumstances. Local Tribal governing body resolutions are submitted in the appendix that address the continuation of boarding schools.

Our dormitory operations are understaffed in that the current staffing criteria, based on funding patterns, authorize the employment of one instructional aide for every twelve students. A boarding school operation is responsible for twenty-four hour a day, seven days a week supervision of students. Thus, the actual adult-student ratio is one to thirty-two during the evening hours from 5:30 to 11:00 p.m. We recommend a staffing criteria of one aide for every eight students which would provide closer physical and personal supervision.

Over the years, the Bureau has received criticism concerning its residential dormitory program. As with all criticism of a program as large as the Bureau's some is justified and some is not. It is true the Bureau operates a majority of its dormitories that are of a barracks construction.

Facilities remodeling and new construction money is needed for improvement. It is true that in some cases instructional aides have less education than the students, but educational programs currently available are reversing this trend, and funding is needed to provide further training to increase the professional expertise of our dormitory aides. Two years ago we attacked the walk-away and AWOL problem by starting a Behavior Modification Program whereby contracts were established between students and school personnel. The contract states that as the result of no walk-aways/AWOLS and improved attendance in school the entire student body (those not in violation) would be taken on an experience educational field trip to a locale which would be the choice of the majority of the students. This program has reduced the attendance problems by one-half and the walk-away problems by 52 per cent, and costs \$30,000 a year. However, for total success, we feel an additional one hundred and seventy thousand dollars is needed.

Our School Bus Transportation equipment is provided by General Services Administration through a monthly rental mileage charge. Current replacement mileage established by GSA is 80,000 miles. Due to the extensive amount of unimproved roads our buses must traverse, no bus is safe after 50,000 miles. These buses spend a great deal of time in distant shops, as far away as one hundred twenty-eight miles, for repairs that usually take more than one week to complete.

In the early 1960's, the Bureau changed its educational thrust to provide an opportunity for all Navajo students to receive a college preparatory academic background. The problem with this philosophy is that a college preparatory curriculum was all that was being emphasized, and the Bureau phased out some very worthwhile vocational agriculture and industrial arts programs. In my opinion, the concept that all students will aspire to a college degree is unrealistic for Navajo Education, as well as the national student body. Thus, in our Agency, we have embarked on a Career Education Program for grades kindergarten through twelve. But, we do not have adequate funds to provide a total dual tract curriculum for our secondary students. I have read where your chairman, the Honorable Carl Perkins, has introduced a revised version of the Elementary and Secondary Career Education Act, which could mean two hundred seventy-five million dollars for school districts over the next five years. If our Bureau schools are not considered in this legislation, then legislation needs to be enacted to require and fund Career Education for all Indian students.

LOCALE

The Eastern Navajo Agency is in northwestern New Mexico. While it is one of the five agencies under the Navajo Area, it is not part of the Navajo Reservation, but adjacent to it. Headquartered in Crownpoint, which is sixty miles northeast of Gallup, the agency is made up of checkerboard land.

That is, the ownership of the land parcels within it are in many hands: Bureau of Indian Affairs, other federal administrative divisions, Navajo Tribe, individual Indian allotments, railroad, and non-Indian holdings. Also, the Agency has jurisdiction over two separate "pocket" reservations apart from its continuous boundaries: Alamo (28 miles northwest of Magdalena, New Mexico) and Canoncito (30 miles west of Albuquerque). The Agency encompasses over 3,200,000 acres, including 1,251 miles of unimproved roads and 200 miles of paved roads.

The area is flanked by mountains and characterized by broad open valleys, mesas, and deeply incised drainage features transected by the Continental Divide. The altitude of the area ranges from 5,000 to 8,000 feet above sea level and the mountain crest from 8,000 to 11,000 feet.

The climate is mostly semi-arid. Annual precipitation averages between 8 to 10 inches per year. Water is scarce. Vegetation is sparse, especially grass, due to overgrazing. However, with the completion of the Navajo Irrigation Project, the northern section of the Agency will become productive for crops. The land is rich in minerals, especially uranium and coal.

Just a few years ago, there were less than 100 miles of paved road within the agency proper and now the figure is approaching 200 miles. However, transportation is still a major problem. Road conditions play havoc with school programs and budgets. Attendance falls as roads become impassable due to inclement weather and the equipment breaks down due to the extremely rough terrain regardless of the weather.

A sense of community within this region usually encompasses a vast area of land where pockets of people live in relative isolation. There are no villages, with the exception of Crownpoint, and thus for the majority of Navajos the school and Chapter House (government and social units of the Navajo Tribe) become the foci of community life. Our schools distribute the mail, conduct community activities, serve as the primary communication link with the outside, render medical attention on a first aid basis, and, in general, performs duties outside the spectrum of most public schools. Unemployment is over five times the National average, hence the school functions also as the primary employer in most communities.

OVERVIEW

We have administrative responsibility for twenty (20) education programs for grades kindergarten through twelve (12) level. The types of programs are as follows: 12 elementary boarding schools,

4 elementary day schools, 2 bordertown dorm programs, 1 boarding high school and 1 contract elementary school. This school year our total average enrollment is 3,931 students: 2,623 boarding, 956 day and 352 bordertown students.

Our total operational budget from direct BIA funds is \$10,301,864 representing an average cost per pupil of \$2,621. The funding for a day student is \$1,582; a bordertown dorm student, \$1,870; an elementary boarding student, \$2,877; and a secondary student at Wingate High School, \$3,331. Funding received from Health, Education and Welfare through the BIA from Public Law 93-380, Title I, is \$1,331,911 representing a cost per pupil of \$339.00.

Our employment in all job classifications is 826 positions for BIA funded programs. Our Title I employment ceiling is 132 positions. Of all 958 positions, 627 are all enrolled members of the Navajo Tribe, fifteen per cent (15%) are other Indians, and twenty-three per cent (23%) are non-Indians. Fifty-one of approximately 110 professionals are Indian.

The students of our schools are, first of all, children. Like all children, they come in all shapes, sizes and temperments. Secondly, these students are Navajo. Sixty-three per cent of our students come to school at the age of five or six speaking and understanding too little English to compete with English-speaking peers.

Most have been raised traditionally, under different concepts of behavior, discipline and competition. Our programs in the schools must take all these factors into consideration.

INSTRUCTIONAL SERVICES

a. Curriculum:

The number one goal and mission of this educational program is:

To provide a quality educational program that is consistent in identifying and meeting the instructional and social needs of the Navajo children that the Navajo Nation has entrusted to us.

We believe a quality education is one that provides each child with the minimum tools necessary to succeed in life. These tools are:

The ability to read, to compute, to understand the basic laws of science, to know the outline of man's history, to appreciate the arts, and above all, to reason; to draw conclusions on the basis of one's knowledge.

To help achieve the above, this agency has developed the Minimum Grade Standards (MGS). The MGS instrument gives our program direction, continuity, and purpose. This instrument is a sequenced series of behavioral objectives which are a composite of what our teachers consider to be the basic skills and understandings needed at each grade

level for the majority of students to progress at a reasonable and satisfactory rate.

These standards are not meant to limit any teacher, supplant any program, nor curtail creativity. It blends individual teacher effort with the total academic program which has been devised to meet the special needs of Navajo students instead of duplicating available commercial programs and products.

Assessment instruments (MGS Criterion-Referenced Tests) are also used to evaluate student progress according to a mastery, review, or reteaching scale. Both the MGS and the MGS/CR Tests were developed locally by teachers experienced in Navajo Education. These tests are revised and upgraded annually to keep them relevant and viable.

Thus our curriculum revolves around the Minimum Grade Standards (MGS) in grades kindergarten through eighth. The secondary curriculum is also upgraded on a regular basis and fused with course outlines.

Rather than describe the total curriculum (an abbreviated outline follows) reference will be made to those highlights which emphasize this agency's effort to merge program with student needs.

Curriculum Outlines - Major Areas (Career Education Integrated Throughout)

	<u>ELEMENTARY (MGS)</u>	<u>SECONDARY - Courses</u>
Language Arts:	NALAP - Primary DISTAR - Primary CTE - Primary Various other programs	Remedial Developmental Electives
Social Studies:	Navajo Area Guidelines Condie Units Consumer Education Field Trips (\$ permitting) Teacher Prepared Units Various Supplementals	Introductory World & American History Geography & Economics Government & Anthropology Modern Indian Ethnology World Civilizations
Mathematics:	Navajo Area Guidelines DISTAR SRA - Math Learning Systems Kits & Games (individualized)	Workshop I & II (Remedial) Freshmen Algebra I & II Trigonometry & Geometry Consumer Education Math
Science:	Piloting Navajo Area Guide Xerox (A Process Approach) Various Supplementals	Introductory Biology & Chemistry Agriculture I & II
Industrial Arts:	7th & 8th McKnights World of Construction & Manufacturing	Introductory drafting, electricity, woodworking, metal, automotive, building education & driver education

Curriculum Outlines - Major Areas (Career Education Integrated Throughout)

<u>ELEMENTARY (MGS)</u>	<u>SECONDARY - Courses</u>
Home Economics: 7th & 8th Food preparation, sewing, consumer education, family & home	Food preparation, sewing, marriage & family, consumer education, home management, clothing & homemaking
Health & Safety: plus Red Cross First Aid (usual programs): Program, Alcohol & Drug, Abuse Prevention Unit, & VD Prevention Unit for all 6th-8th grades Diso Program-primary	Complete program with electives
Physical Education: AAU Fitness Program	Complete program with electives, internurals, & varsity sports
Art: Teacher developed	Business Education: Typing, general clerical, data processing, bookkeeping, accounting, banking, & shorthand
Music: Teacher developed; two schools have a staffed program	
Special Education: Details on page 10	Cultural Arts: Eight courses including music & band

EXPLANATORY NOTES:Language Arts

NALAP (Navajo Area Language Arts Project). This ESL program has been developed around 14 linguistic and pedagogical premises, sequencing the grammatical structures of the English language based upon the particular language needs of Navajo children. Its major approach is a structural-sequential one with an ultimate goal of internalization of English. It is based on the specific language and conceptual needs of Navajo children in the setting in which they must use the language. Thus far it has been developed for the primary grades, but may be adapted for use at other levels.

DISTAR-Published by SRA (Scientific Research Associates). These materials are a programmed system of language, reading and arithmetic involving fast paced presentations, student responses and immediate feedback. This is a no-nonsense, straight forward program designed to teach children to use certain basic concepts and to talk about them in standard English. DISTAR is not specifically an ESL program. Teacher instructions are very explicit and the program keeps track of itself. The language part focuses on concept development, their analyses and relationships. Reading is basically decoding. Assessment is a continuous component of the program.

CITE (Consultants In Total Education) This program was developed by Dr. Robert D. Wilson under a Title I grant. Wilson was also an advisor to NALAP.

The plans by which the learning of a second language is accomplished are four strategies: resources, objectives, presentation (in 3 stages-reveal, renew and relate) and systematization (sequencing, review, and bilingualism). It emphasizes strategies for learning to read and is systematic in presenting the many distinctive features of written language. It too is a encoding and decoding approach like DISTAR, but is also like NALAP in that it is linguistic in orientation, based on the specific language and conceptual needs of Navajo children.

Social Studies

CONDIE MATERIALS - This program was developed several years ago by Dr. LeRoy Condie of UNM, funded by a Title I grant. Nine elementary and 4 secondary units were produced. These have been the best received social studies materials by our teachers. Each unit inquires into separate aspects of contemporary, historic, or prehistoric Navajo life. The units will take about 4 to 8 weeks of the instructional year. Unit kits include everything the teacher needs to implement the unit (manuals, student books, charts, and audio-visual aids). The teacher manuals are prescriptive in nature and include daily lesson plans. It is basically a teaching unit rather than a resource unit.

KALTSOUNIS- (Navajo Area Social Studies Curriculum Development Project)

Dr. Theodore Kaltsounis, University of Washington, was the chief advisor to the Area Committee which developed this program. This too is divided into units. The objectives of each unit consist of 3 categories: understandings or knowledge, attitudes, and skills. The content of each unit has been converted into a series of problems. Basically, these are resource units which the teacher must develop on their own. Area has suggested that the Condie materials be used first and the remainder of the year spent on this latest social studies program.

Lake Valley Navajo School operates a bilingual-bicultural educational program where initial instruction is in Navajo as the child matures (starting about second grade). English language instruction is gradually phased into the program. This is still in the experimental stage, and final results are not yet available. The Lake Valley program is funded by PL 93-380, Title VII.

b. Career Education .

In order to refocus our educational program so that what is taught in the classroom has a clear, demonstrable meaning and bearing on our students, this Agency's commitment to career education has established three objectives:

- 1) Elementary - to develop an awareness of life roles (occupational, family, citizen, consumership, & leisure) and of the world after formal education ends.
- 2) Junior High - to stimulate occupational interest, provide exploratory prevocational experiences, and provide an environment which makes instruction more meaningful to the student.
- 3) Senior High - to provide specialized training for a specific occupation or a grouping of closely related occupations, and, to stimulate interdepartmental/Community cooperation through the unifying relationship of career education with all subject areas.

An implementation plan was submitted to each school for guidance in organizing the methods required to achieve the objectives set forth. These methods were adopted in accordance with two fundamental guidelines:

- 1) Career education must be integrated throughout the entire instructional program, not merely a curricular addition. This integration of a career education plan is flexible toward local adaptations uniquely appropriate for each individual community, school, and staff situation.

- 2) Attaining student competencies in the mastery of the traditional subject areas would continue to be the keystones of instruction. But the instructional process in teaching these disciplines now incorporates the principles of preparing students for various roles of a learner, citizen, consumer, family member, and wage earner, which provides realistic goals for mastering the skills in the subject areas.

The junior high career education program is, in our opinion, truly outstanding. A variety of hands-on career exploration activities are offered utilizing the Singer Vocational materials, industrial arts and home economics classes, and other similar programs. Grades kindergarten through six are involved to varying degrees in career awareness and value clarification programs using a variety of materials such as the DUSO kits. The high school is in the process of revamping its vocational courses into career education courses and expanding its career exploration offerings. More funding is needed at the high school level for equipment, materials, and facilities renovation. The estimated cost for equipment and materials is \$190,000 additional, and \$340,000 for additional facilities.

Of significant importance is a grant the Board of Education received from the Four Corners Regional Commission of \$50,000 to

provide supplies and materials to an Agriculture Awareness curriculum for grades first through twelfth at both Wingate High School and Wingate Elementary School. This curriculum has been in full operation since the 1974-75 School Year. The purpose of adding agriculture to the curriculum is to provide students with marketable job skills in agriculture, so that they may assume a contributing role to the Navajo Tribe's Irrigation Project north of Bisti, New Mexico.

Additional funding is needed to fully develop a comprehensive and integrated program at the elementary/junior high level. This funding would be used to hire coordinators to be located at the schools with junior high students with the prime responsibility to establish resource centers, develop materials, and lend expertise to the programs in the satellite or feeder schools. Presently, our schools have done nearly all that could be expected of them in career education without the assistance and resources of field coordinators to extend and improve the program.

c. Kindergarten

There are presently twelve (12) BIA kindergartens in operation within the Agency. These are located at Jones Ranch Community School, Chi ch'il tah Community School, Bread Springs Community School, Mariano Lake Community School, Lake Valley Navajo School,

Dzilth Na O Dith Hle Community School, Pueblo Pintado Community School, Ojo Encino Community School, Camencito Community School, Alamo Community School, Baca Boarding School, and Torreon Community School.

These kindergarten programs at all schools have certain similar characteristics: they are day school operations and have a low pupil-personnel ratio (each unit is staffed with a teacher, a Navajo-speaking aide, and a bus driver). Four of these programs are staffed with Navajo students.

It is hoped that in the near future our request for new construction of kindergarten classrooms and teacherages for Huerfano, Ojo Encino, Baca and Dzilh Na O Dith Hle will be forthcoming.

d. Secondary Education

The Eastern Navajo Agency operates one high school, Wingate High School, Home of the Bears.

Wingate High School is fully accredited by the New Mexico State Department of Education and the North Central Accrediting Association for secondary schools. The school offers a four year academic program leading to high school diploma for graduates.

At present the curriculum is geared for academic preparation for graduates to enter the university or college of their choice. However, a comprehensive career education program is being integrated throughout the curriculum.

The curriculum consists of language arts, mathematics, science, social studies, (including a course in Navajo Tribal Government and Understanding Basic Navajo Law) cultural arts, industrial arts, health and physical education, US Army ROTC, home economics, and business education.

The school fields each year teams in football, basketball, track, and wrestling. Another popular activity at the school is the Rodeo Club. Each year this club sponsors an Inter-High School Rodeo Championship.

e. Special Education

Currently, all our students are at least two years academically retarded and, consequently, are in need of specialized educational services. Due to a lack of regular program funds for these services, the schools develop projects which are funded through the Office of Education, HEW, under P. L. 94-380.

This Fiscal Year 1977, Title I of PL 93-380, provides for supplemental education programs in 18 schools. Programs in the elementary schools concentrate in general on language development and reading. This includes hiring bilingual aides for lower elementary classes, providing reading laboratories for older students, and providing new and different materials for the students' use. We also are operating five (5) special education programs for the mentally retarded and four (4) schools are operating programs for the learning disabled.

Additionally, many children either are receiving no services at all, are receiving regular class services only, or are being sent off reservation or out of state to receive specialized services. The Bureau of Indian Affairs would more adequately serve these students at present facilities, but no funds are available. The estimated cost for a gradual assumption of responsibility follows:

FY -78	\$ 952,900
FY -79	\$3,056,350 including \$1,470,000 for housing staff
FY - 80	\$5,986,950 including \$1,290,000 for housing and \$2,300,000 for renovation of facilities
FY -81	\$3,077,150 including \$360,000 for housing
FY-82	\$3,364,450 including \$270,000 for housing
Future years:	\$3,054,450 to sustain

The main thrust of PL 93-380, Title I, is to alleviate and remediate learning deficiencies among deprived children. The Bureau of Indian Affairs has always had the responsibility to provide this kind of program since in this area the majority of Indians can be identified, in comparison with middle America, as being deprived due to poverty, isolation, and a language difference.

Use of supplementary funds, such as Title I, while legal, still circumvents the duty of the Bureau of Indian Affairs to provide such services. This was recognized by the General Accounting Office (GAO) in its report to Congress "Opportunity to Improve Indian Education in Schools Operated by the Bureau of Indian Affairs." To quote from that report:

"One of the key issues in this report is that, although BIA has known for years that Indian Children in BIA Schools require some form of special or compensatory education, its education program has not been designed to fully meet these needs. BIA has not established a systematic means of determining the special and compensatory needs of its students." (From Chapter 4 of the report)

One of the six recommendations of GAO to the Secretary of the Interior stated:

"Develop a comprehensive educational program which is designed specifically to overcome the factors which impede progress in meeting the goal (of achieving parity with national norms by 1976) and which is flexible enough to meet the needs of students in all BIA operated schools."

(From chapter 3 of the report).

Clearly, this refers to the regular program, not the supplementary PL 93-380, Title I program, which has served to somewhat make the regular program comprehensive.

Attention needs to be focused on one factor effecting our educational program: the BIA's policy (which is written into the treaty of 1868) of thirty students to a teacher. Most public schools are attempting to lower this ratio and it is inconceivable that our schools, with second language learners, would adhere to this policy. Our students need much more attention and practice than a 30-1 ratio affords. Also, it would benefit the students to have a Navajo-speaking aide in each classroom. If we are to improve student achievement so that it equals national norms, a policy to reduce the existing ratio needs to be developed with the necessary funds appropriated to implement the policy. We suggest the following guidelines:

Primary	- 15 to 1, with an aide
Intermediates	- 18 to 1, with an aide
Junior High	- 20 to 1, with an aide
Senior High	- 22 to 1, with an aide

f. Summer Programs

During Fiscal Year 1976, the emphasis in summer programs was on enrichment. Through a grant to the Health and Physical Education Department at the University of New Mexico, a summer program of Navajo games and crafts, library, archery, dancing, and swimming is presently in operation in schools at Crownpoint, Pueblo Pintado, Dziłth Na O Dith Hle and Magdalena. In addition, Wingate High School offers a regular academic summer program for students to make up credits necessary for graduation.

During the summer of 1977, the agency will sponsor a Youth Conservation Corp Camp for thirty students at Wingate High School.

HOMELIVING

a. Dormitory Operations

Dormitory programs are operating successfully with the constraints of existing staffing patterns. There is a need for more Instructional Aides to supervise students and to plan activities.

An increase is proposed from the present one to sixteen ratio on a twenty-four hour basis to a one to ten ratio during the one eight hour activity shift.

Wingate High School offers an Honor Dorm Program. Students of high standing in all respects are jointly recommended and nominated for admission into this dorm by teachers, counselors, instructional aids and supervisors. Any student is eligible to apply. The purpose of the Honor Dorm is to provide students opportunity to make decisions affecting both himself and his peers. Students have the opportunity to develop ability for growth in the areas of civic responsibility, participation, group planning, and honesty.

b. Cultural Awareness

Most cultural awareness concepts are developed through dormitory activities. However, the social studies curriculum at all levels includes units on Indian heritage/history, Navajo history and government, and other similar activities. Also, the high school offers credit for Navajo weaving, silversmithing, other native arts and crafts, Navajo Law and Navajo History.

The dormitories also take part in school, agency and area-wide pow-wows, the Navajo Tribal Fair, the Indian Pavilion activities at the New Mexico State Fair, and the Miss Eastern Navajo and Miss Navajo pageants. Parents, chapter members, and community leaders frequently visit both classrooms and dormitories to visit the students and encourage their best efforts toward getting a sound education.

c. Counseling

Counseling, especially social or adjustment counseling, is a critical need in a boarding situation. Further training is needed, however, for both counselors and their supervisors. In addition, a program to train Navajo-speaking counselors is needed.

d. Enrichment and Extracurricular Activities

Chief among those activities which result in positive learning are first-hand experiences gained through field trips. Such trips may range from short walking tours to trips of several days duration to a metropolitan area. Trips are always planned with specific objectives in mind. School students take trips to Los Angeles, Albuquerque, Denver, Farmington, Gallup, Las Cruces, Santa Fe, and Phoenix.

Perhaps the most popular of all extracurricular activities has been involvement in Pow-Wows. Students are trained and dressed in traditional ways for various type dances. Dance groups from the various schools meet in several regional and area Pow-Wows. In these competitions, our school teams took four of a possible six prizes in the Annual Navajo Area Pow-Wow in Both 1972 and 1973. In 1974, 1975, and 1976, students took three of the six places at the Navajo Area Pow-Wow.

Elementary students were involved in a variety of sports activities at both the junior high and pee-wee levels. Basketball is especially popular. Older elementary students participated in Navajo Area Softball and flag football leagues.

A scouting program is found in many of our schools. At present, there are 7 Cub Scout packs, 6 Boy Scouts troops, and 3 Explorer posts which are functioning. The Girl Scouts program has a comparable number of organized groups.

Other student organizations include art, science, and photo clubs. Mother Earth Days and Johnny Horizon Clean Up Campaigns were observed at all schools with students and employees collecting and disposing of vast quantities of litter around schools and along roads.

While Johnny Horizon is a national effort, Mother Earth Days is a local endeavor initiated by the Eastern Navajo Council and the Agency Superintendent.

However, we feel that our student activity programs of recreation, educational field trips, behavior modification programs, and sports are not adequately funded. For example, last year's Behavior Modification Program reduced student absenteeism without authorized leave by 5370 at an expenditure of only about \$10,000 per student. We feel to adequately maintain a comprehensive behavioral modification program which will reduce absenteeism, student absence, improve school attendance and increase personal responsibility for behavior, we would need an additional one hundred and seventy thousand dollars.

FOOD SERVICES

Our Food Services Program provides all boarding students with three meals a day and, in some cases, a night-time snack. Day students receive a full breakfast, a noon meal and an afternoon snack. As well as operating the aforementioned cafeteria-style dining program, we also offer instructional dining (family-style dining) and occasional buffets. The food service operation is one area we can be proud of. Our students are well fed by a master menu that is adjusted annually based on student inquiries as to likes and dislikes.

PERSONNEL/STAFFING TRAINING

Eastern Navajo Agency does stress staff development during the school year and the summer months. Cooks and food service workers receive monthly training sessions covering such topics as kitchen safety, food handling techniques, and special food preparation. Training is provided through the Bureau of Indian Affairs, Navajo Area, for all supervisors in various areas such as adverse actions, basic supervision, supervisory management and management development. Clerks have been eligible for various kinds of skill improvement courses. All personnel have been eligible for such training as firefighting techniques and the EEO Program. Over 80% of the education staff have taken, or are presently taking, training to improve their skills utilizing educational leave or government training plans.

The most outstanding accomplishment in staff development, however, has been in teacher training courses for our education and instructional aides. Three different programs have been established for those individuals who wish to become teachers. The established goal of Eastern Navajo Agency Education is to develop and place Navajo teachers in the classroom. In order to do this, the Agency has nominated a number of Navajo Aides in the Navajo Tribal Division of Education's program for teacher training funded by the Tribes PL 92-318. Teacher aides are also enrolled in the Summer Linguistics Conference at Northern Arizona University sponsored by Navajo Area to develop their skills in teaching English as a second language.

In addition, Eastern Navajo Agency Education Office persuaded the Gallup Branch of the University of New Mexico to offer courses at Crownpoint leading to an Associate of Arts Degree in education. Over one hundred Navajo employees are currently enrolled.

Random surveys of guidance staff, both professional and paraprofessional, show a need for further training in learning disabilities, individual differences, and guidance lesson planning. Other areas which need training include behavior modification, counseling techniques for paraprofessionals, testing, student banking activities for students, career awareness and human relations.

TRANSPORTATION NEEDS

The major need, and a very critical one, is better equipment. Currently, many vehicles, especially buses and vans, spend as much time in the shop for repairs as they do in service. Consideration should be given to replacing vehicles every two years used on the reservation unimproved roads regardless of mileage.

Under no conditions should buses be allowed to operate on unimproved roads more than fifty thousand miles. Current replacement mileage established by General Services Administration is eighty thousand miles.

Any bus approaching this mileage is totally unsafe for transportation of students. We realize that a change in expected mileage would result in an increased cost, but we feel that this increase would be more than offset by the increased safety of almost one thousand day students.

Another major problem is travel limitations imposed, I believe, by OMB, and the Department of the Interior, which currently apply to student transportation (school buses) as well as employee travel. While we fully support the limitation in terms of employees' travel and have effected a thirty-two (32%) percent reduction in this area, we cannot reduce student travel expenditures without reducing the educational opportunities. The only vehicles exempt from these restrictions are those utilized for transportation of things (e.g., pickups). It seems hauling equipment and supplies is more important than the daily transportation of students to school and transportation of students on experience field trips. We have requested that student transportation be exempted from travel restrictions, but to date, we have not received a response. I would further like to note that we have to provide transportation for students to receive medical care at Public Health Service Hospitals that are located in Gallup, Crownpoint, and Shiprock, New Mexico. These are a considerable distance from some of our schools.

PLANT MAINTENANCE SERVICES

The apparent underlying basis of problems between Education and Plant Management is the reorganization over the years whereby Plant Management employees are no longer responsible to Education for assignment of duties. Therefore, it seems that Plant Management employees feel no personal responsibility for the condition of buildings or the welfare of children. Custodial services are limited at best and totally non-existent at worst. Our large schools with full-time janitor positions find that the janitors refuse to clean certain rooms or buildings, as our principals can not direct their work and janitorial services at small schools are non-existent.

Routine maintenance is hampered by a limitation imposed on field Plant Management Personnel by Area of a maximum of four hours per project. This eliminates many relatively minor repairs, and with the present backlog of work orders, these minor repairs become major repairs before the work crew arrives.

Major alteration and improvement projects are backlogged by approximately fifteen years. This, we are informed, resulted from the Navajo Area receiving less than its share of MA&I funds per capita or per square foot. The only possible way to improve the situation is to increase the funding to its fair portion.

The only way to eliminate the backlog would probably be a special Congressional appropriation.

FACILITIES: REHABILITATION AND NEW CONSTRUCTION

Of the twelve (12) elementary boarding schools, only one plant is considered physically adequate by present modern standards. Four (4) plants are semi-adequate, requiring expansion and modernization. The remaining eight (8) boarding schools are substandard, old, lacking in adequate space and expensive to maintain. One bordertown dorm is only minimally adequate, and one is adequate for the present time.. The four (4) day schools, being of more recent construction, are the best schools in the Agency, but need to be enlarged to allow for expansion of educational programs.

The following presents a summary of the most pressing needs in this regard. It has been submitted as part of the Branch of Education's Annual Program Plan from 1972 to 1976 although the need is current. Each construction, Expansion or Renovation Request was submitted after full consultation with each respective Board of Education. Each subject request should be recognized as an ideal program for that community in terms of facilities. Each school location is listed in terms of the priority of immediate need established by the Agency School Board:

Wingate Elementary: 750 students - Boarding School

Total new facilities are needed. Is presently in the construction program of the Bureau for design money.

Alamo: 60 students - Day School.

Is currently in Bureau's request for design money

Construct School - (K - 6th, 200 students)

Academic Building - (8) classrooms, offices, library, etc.

Multi-purpose room

Kitchen and dining facilities

Plant Management Work Center

Construct 26 housing units (3 bedroom)

Torrion: 120 students - Boarding School

Will be converted to day school by September 1977.

Construct school building - (12) classrooms, (2) K-1st, second through 8th grade, offices, library, and media center.

Construct multi-purpose building for 500 people.

Construct kitchen and dining room

Construct all weather playground

Construct 30 housing units (3 bedroom).

Canoncito: 125 Students - Boarding School

A. Creation of sub-agency: Administration building and staff housing of 25, maintenance shop for plant Management and roads.

B. Renovation of school:

Construct multi-purpose room for 500

Construct (6) housing units - (3 bedrooms)

Construct (8) new classrooms

Wingate High School: 750 students - Boarding School

Construct student union building

Construct girls gymnasium

Construct one large, 40 X 60, vocational building

Construct one large, 40 X 60, agriculture science program building

Construct one 60 X 100, auto mechanics building

Construct one 60 X 60 body and fender building

Construct one 40 X 40 welding shop

Construct one 40 X 60 machine shop building

Construct one baseball field

Construct one softball field

Renovate mdeco grounds.

Borrogo Pass: 150 students - Day School

Construct academic building for Grades K through 6th, offices, library, and media center

Construct multi-purpose building for 500 people

Borrogo Pass: 150 students - Day School

Construct kitchen and dining room

Construct all weather playground

Construct 30 housing units (3 bedroom)

Iberfano: 150 students - bordertown dormitory

Construct multi-purpose building for 500 people

Renovate kitchen and dining room

Build new boys dormitory - 75 students

Construct all weather playground and athletic field

Construct (10) housing units (3 bedroom)

Pueblo Pintado: 180 students - Boarding School

A. Expansion for a junior high school

Construct (10) new classrooms, library, media center

Construct dorm for 300 students

Renovate and construct additional kitchen and dining room

Facilities to include family style dining area for 50

Renovate and expand present gym to install bleachers for 500
plus air conditioning

Construct all weather playground and athletic field

Construct (50) housing units (3 bedroom)

B. Construct high school for 500 students: new high school

facility outline contained in FY-74 - A. P. P.

25 classrooms

Administrative Offices

5 Vocational classrooms

1 Auditorium 600 capacity

2 gyms - one with seating capacity for 800

1 student canteen capacity for 500 including dance floor

5 - 100 pupil dormitories with individual study areas

1 complete athletic compound to include track, football, and baseball

Kitchen and dining area for 500 pupils

Library and media center

45 housing units (3 and 4 bedroom)

Crowpoint: 650 students - Boarding School

Construct 2 softball fields and 1 football field

Renovate (1) wing of Tsozil Hall to provide a student union

Construct (3) parking areas

Construct Parent-Child Education Center, including gym, pool, auditorium, classrooms, and vocational shops

Renovate playground - landscape campus

Renovate dining room for more storage

Renovate dormitories for individual rooms with (4) students to a room

Chi Chil Tah: 130 students - Boarding School

Renovate facilities

Construct Multi-purpose room

Construct (4) housing units (3 bedrooms)

Renovate dining room

Construct new dormitory or renovate present one

Mariano Lake: 150 students - Boarding School

Construct (5) classrooms (3 additional and 2 replacements)

include office space and restrooms, library and lounge

Build garage for government vehicles

Renovate kitchen for 300 students

Construct dormitory for 90 students

Construct all weather playground and athletic field

Construct multi-purpose room for 500 adults

Dlo'ay azhi: 168 students - Boarding School

Construct new kitchen and dining room facilities

Construct multi-purpose room for 500 people

Construct dormitory for 168 students

Construct library and media center

Construct all weather playground

Construct housing units 30 (3 bedrooms)

Baca: 60 students - Boarding School

- Construct new facility for 80 students, kindergarten - 2nd grade
- Construct academic building
- Construct dormitory for 80 students
- Construct multi-purpose room for 200 students to include gym and family education center.
- Construct dining facility
- Construct 5 housing units (3 bedroom)

Lake Valley: 135 students - Boarding School

- Construct (1) additional classroom
- Construct diagnostic center
- Construct (12) housing units (3 bedroom)
- Construct vocational building for community education program
- Construct recreation center of baseball field and paved oval track

Breed Springs: 80 students - Day School

- Convert to boarding school for 140 students (Community Request)
- Construct (3) new classrooms
- Construct (1) dorm for 80 students
- Construct (1) Dining room for 140 students
- Construct (3) housing units (3 bedroom)
- Construct (1) multi-purpose room - 300 capacity

Jones Ranch: 70 students - Day School

Construct library and media center

Construct (2) classroom

Construct all weather playground and tennis court

Construct multi-purpose parent child educational center and gym

Ojo Encino: 80 students - Day School

Construct kindergarten building

Construct (3) classrooms for 4th, 5th, and 6th grades

Construct dormitory to house 100 students (Community request)

Construct multi-purpose room

Construct (19) housing units (3 bedroom)

Drill new well

Renovate kitchen and dining room for 175 pupils

Construct multi-purpose family education center

Construct outdoor baseball, basketball, & track facilities

Standing Rock: 50 students - Boarding School

Renovate present classrooms (2)

Construct multi-purpose room

Magdalena: - 246 students - Bordertown Dormitory

No expansion planned

Construct chain-link fences around campus

Expand present gym to include auditorium and stage

Dzilth Na O Dith Hle: 325 students - Boarding and Day School

No new construction programs currently needed

It should be noted that a complete high school is being requested at Pueblo-Pintado for the region northeast of Crownpoint. This request is supported by the Eastern Navajo Council, the elected representation of the Agency's Navajo people. This facility would provide secondary education for 500 students who now must spend several hours daily commuting to public schools over unimproved roads. At times, commuting hours last well into the night when roads are in muddy status.

Kindergarten construction is a separate appropriation, consequently our requests are handled separately. Current requests in priority are for new kindergarten units at Huerfano Bordertown Dorm, Baca Boarding School, Ojo Encino Day School, and Dzilth Na O Dith Hle Community School.

COMMUNITY INVOLVEMENT

In the past several years a lot of emphasis has been placed on "parent involvement", "Self-Determination", and several other programs with various catchy titles. One does not really understand what these catchy titles are supposed to mean in terms of designing programs in our Agency.

From the grass roots level - the community school to the Agency level, the Navajo people are having a say in every aspect of the education program.

Every school has a school board and, as of to date, every board but one has been able to make the decision on who their principal is. All our boards are consulted on personnel hiring for positions at their respective schools.

What does an Eastern Navajo School Board do? Its membership reviews the school's budget once it is received; recommends and approves where and how various allocations are spent; assists, by recommendation, the principal in selecting non-professional staff members for vacant jobs; actively participates in planning future programs, rebuilding, renovation, etc.; works with school people on special projects such as Title I and various funds from outside organizations; helps plan adult education and summer programs; assists with discipline and attendance problems, quality effort by individuals, poor roads, and after hours use of facilities.

On a regular daily basis, more parents visit schools than did five years ago just to say "hello" or to visit their child's classroom or dormitory. Our community schools are the center of the community being the main source for employment, the post office, sometimes the only telephone center, for evening activities, and emergency transportation for medical services.

The Eastern Navajo Council, representing all of the Agency's Navajo Communities, have been in the forefront of the people's fight against budgetary cuts and restrictions and employment "freezes." Both of these factors severely restrict efficient operation of the education program.

The Council's Education Committee has accepted the responsibility of assisting and working with the Agency Education Office in its functions. The overall operational budget is reviewed, discussed and allocated in a cooperative manner. Budget cuts, who and what they affect, priorities in hiring in "freeze" conditions, priorities in renovation and building construction requests, - all are set with the advice and consent of the Education Committee.

The Borrego Pass Community School Board contracted entirely for the educational services the community receives in the amount of one hundred eighty three thousand one hundred forty-eight, in BIA dollars. This year a special grant from Public Law 92-318 of around forty-six thousand five hundred dollars was also awarded the board and its 115 students. Funding has also been received under the bilingual education act.

The Wingate High School Board contracted approximately two hundred twenty thousand four hundred four dollars in Title I funds for their school this past year. The Lake Valley Navajo School Board contracts for forty-eight thousand eight hundred twelve dollars in Title VII Bilingual Bicultural education.

Our school boards and their local principals have also received support from benevolent organization for sponsorship of enrolled children in the amount of onehundred twenty seven thousand seven hundred fifty-two dollars. These organizations are "Children, Incorporated," "Save The Children Fund", and "World Changers".

All in all, Eastern Navajo people are not only making themselves more visible at/and in Eastern Navajo's schools, but they are making themselves heard. More importantly, the people are being listened to - a big step in the right direction!

141



CONCLUSION

In conclusion, I would like to emphasize that I have addressed only those problems which might require Congressional action. We have other problems, but these are internal and it is hoped they can be resolved upon the permanent appointments of competent individuals in various vacant line authority positions now in the Bureau of Indian Affairs and Navajo Area.

I would also like to take this opportunity to express gratitude to this distinguished committee for demonstrating the beginnings of a sincere interest in improving Navajo Education. In my ten and one-half years with the Bureau I have never experienced any contact, outside of Navajo Area, with the personages that determine program and policy. Majority Consultant, Mr. Lovesee and Minority Consultant, Mr. Bragg came to the Navajo Reservation and sincerely demonstrated an effort to arrive at conclusions based on fact. They did not gather data by phone or idle conversation with top officials, but by actually traveling the roads, visiting the schools, sleeping in the dorms, talking to students and staff from the entire spectrum of our organizational structure.

It is also my opinion, that this committee should be aware that extra funding for additional personnel, equipment and instructional material will not be a panacea for improvement of Navajo Indian Education, unless, specific measurable objectives are developed for the accountability of funds. Further, I would recommend that no funds be appropriated unless they are specifically earmarked for the remediation of specific deficiencies the committee has recognized as creditable.

All our efforts should be together with only one paramount objective in mind, one which none of us should lose sight of, "The academic achievement of the Navajo child will be equal to if not superior to the academic achievement levels recognized as the national norm."

APPENDIX

- A. Resolution of the Navajo Tribal Council - CAU-43-61
"Adopting Navajo Education Policy"
- B. Resolution of the Eastern Navajo Council
The Navajo Tribe ENC-JAN-72-3
"Requesting that the Boarding Schools Under the Bureau of Indian Affairs be Continued Indefinitely"
- C. Resolution of the Navajo Area School Board Association NASBA-03-75
"Requesting That the Navajo Tribal Council Rescind Resolution CAU-43-61 and that The Education Committee Develop a New Education Policy"
- D. Resolution of the Eastern Navajo Council
The Navajo Tribe of Indians ENC-MAR-75-16
"Requesting Revocation of Tribal Council Resolution CAU-43-61"
- E. Resolution of the Eastern Navajo Agency School Board
"Requesting that The Navajo Tribal Council Rescind Resolution CAU-43-61 and develop a new Policy Based on the Principle That for Navajo Parents can Decide to Which School They Send Their Children"
- F. Resolution of the Shiprock Agency School Board
"Requesting Revocation of Navajo Tribal Council Resolution CAU-43-61"
- G. Resolution of the Chinle Agency School Board
"Recommending that The Navajo Tribal Council Rescind the 1961 Education Policy Resolution and Support the Rights of The Navajo People to Send their Children to the School of Their Choice"
- H. Resolution of The Education Committee of the Navajo Tribal Council
"Supporting the Plan to Relieve the Overcrowded Public Schools by Increasing the Opportunities for Navajo Students to Attend the Under Utilized B. I. A. Schools on The Navajo Reservation"
- I. Resolution of the Navajo Tribal Council CJN-40-75
"Providing that The Education Committee of The Navajo Tribal Council be Authorized to Prevent the Impending Loss of B. I. A. Schools Due to Declining Enrollment, and Providing that The Education Committee Develop a Comprehensive Navajo Education Policy for Approval by the Navajo Tribal Council"
- J. Resolution of the Canoncito Navajo Chapter
"Demanding that The Bureau of Indian Affairs Do all it can to Continue the Operation of the Canoncito Community School Dormitory for the Remainder of the 1976-77 School Year to serve the Navajo Children in Canoncito"
- K. Resolution of the Education Committee of the Navajo Tribal Council
"Recommending to the B. I. A., Education Division, a Continuation of Dormitory Operation at Canoncito through the School Year 1976-1977"

- L. Resolution of the Eastern Navajo Council
The Navajo Tribe ENC-JAN-77-1
"Requesting the Revision of Tribal Council Resolution CAU-43-61
Adopting Navajo Education Policy"
- M. Map of Agency
- N. Location by miles of schools from Agency Office
- O. School Bus Routes and Mileage
- P. Grades by School and Number of children

RESOLUTION OF THE
NAVAJO TRIBAL COUNCIL

Adopting Navajo Education Policy

WHEREAS:

1. Great progress has been made in improving educational opportunities for Navajo people in the past ten years.

2. However, many areas need improvement and it is appropriate that the Navajo Tribal Council consider over all policy objectives with the Bureau of Indian Affairs for the future development of education opportunities for Navajo people.

NOW THEREFORE BE IT RESOLVED THAT:

1. The attached Exhibit entitled "Navajo Education Policy Statement" is hereby adopted by the Navajo Tribal Council as the Education Policy of the Navajo Tribe.

2. The Navajo Tribal Council urgently requests the Congress of the United States and responsible officials of the Department of the Interior to use their best efforts to implement the aims and objectives of the Navajo Education Policy, through appropriation and administrative action.

CERTIFICATION

I hereby certify that the foregoing resolution was duly considered by the Navajo Tribal Council at a duly called meeting at Window Rock, Arizona, at which a quorum was present and that same was passed by a vote of 58 in favor and 0 opposed, this 29th day of August, 1961.

Scott Director
Vice Chairman
Navajo Tribal Council

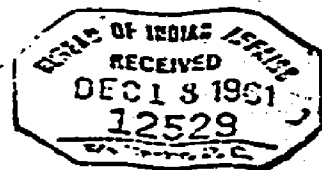

JOINT BUREAU OF INDIAN AFFAIRS-NAVAJO TRIBAL COUNCIL
Navajo Education Policy Statement

Under Congressional authorities and Departmental direction it shall be the policy of the Bureau of Indian Affairs and the Navajo Tribe to attack simultaneously the education problems of Navajos on all fronts and at all levels, from beginning grades through adult programs, by laying the problems before the public, the Congress, and by working in cooperation with the State, local and public school officials, and other Federal agencies in providing the type of education opportunities that best meet the needs of the Navajo people.

The ultimate education objective is educational competency for all Navajo people so that they may participate in the local community, State, and national life equally with other citizens. Therefore, the Bureau of Indian Affairs and the Navajo Tribe shall plan educational programs in terms of specific needs of the Navajo people and seek funds from the Congress to carry out each program.

I. Policy objectives. It shall be the policy

1. To provide educational opportunities for Navajo children on the reservation from beginners through grade twelve in order that all children may be near their parents. This is the basis for developing an educational system on the Navajo Reservation in keeping with the pattern of public education in the United States.
2. To develop, when there is mutual readiness, educational opportunities in public schools for Navajo children at all grade levels in order that Navajo youth may have the opportunity to participate in public school educational programs on an equal basis with other citizens.
3. To use present off-reservation education facilities for Navajo youth as long as the need exists.
4. To provide through State and other resources educational opportunities for mentally and physically handicapped Navajo children (blind, deaf, spastic, etc.)
5. To encourage Navajo high school graduates to utilize fully existing facilities and programs in pursuit of further education and/or training in keeping with their individual interests and capabilities.
6. To provide adult education instruction in close cooperation with local community groups.

II. Implementation of policy objectives:

1. Navajo students will attend schools on the reservation.

(a) In public schools wherever they are already available. Additional public school opportunities will be developed on the reservation as public school officials and the Navajo people are mutually prepared.

(b) In Federal day schools wherever population will support a day operation. The value attached to home living with school attendance on a day basis remains a primary objective of tribal and Bureau education policy.

(c) Existing boarding schools will be expanded on the reservation at the nearest locations to the parents to care for the remainder who cannot be accommodated in day facilities. As roads are developed students who can be reached will attend on a day basis. When a boarding facility can serve all children within the area on a day basis the boarding facility will be converted to day operation.

2. Conditions under which Navajo students may attend Off-reservation schools.

(a) Navajo students who are up to grade may attend public schools wherever public schools have been made available for them within the States of their residence. The Bureau will assure dormitory care make suitable contract arrangements for instruction in the public schools.

(b) Navajo children 13 years of age or older who are retarded two or more grades may continue to attend off-reservation Federal schools to receive special vocational instruction as long as the need exists.

(c) Navajo students 13 years of age or older who cannot be accommodated in on reservation schools will continue to attend off-reservation schools.

3. Education beyond high school level.

(a) Post high school courses in Haskell and Chilocco will continue to be available to Navajos.

(b) Vocational training under Public Law 959 will be available to qualified Navajo applicants.

(c) Qualified Navajo students will be encouraged to make the fullest use of all scholarship assistance - tribal scholarships, Bureau and private scholarships - to further their education in colleges and universities, and technical and trade schools.

4. **Adult education.** Lack of early opportunities for education makes it imperative that many appropriate courses be provided for Navajo adults to insure their educational progress. The Bureau of Indian Affairs and the Navajo Tribe will work with all agencies providing adult instruction to plan and develop adult education programs in closest possible keeping with requests initiated by the local community.

5. **Special education.** In cooperation with responsible agencies the greatest care will be exercised to identify the handicapped Navajo students.

(a) For such handicapped students whose needs can be met in a modified school environment, arrangements will be made (in cooperation with responsible agencies) to provide adequate instruction in existing schools.

(b) The extreme cases that cannot be provided for in a modified school situation and thus require institutional care shall be provided for in appropriate State and private institutions.

Summary

The Bureau of Indian Affairs and the Navajo Tribe agree to work in full cooperation in developing plans that will carry out all phases of the foregoing policy objectives.

Chairman, Navajo Tribal Council

Commissioner, Bureau of Indian Affairs

MAR - 5 1952

ENC-JAN-72-3
(January 15, 1972)

Resolution of the Eastern-Navajo Council

The Navajo Tribe of Indians

Subject: Requesting that the Boarding Schools Under the Bureau of Indian Affairs be Continued Indefinitely

WHEREAS:

1. From time to time, the Navajo People at the "grass-roots" level hear and read about proposals about elimination of the boarding school system under the Bureau of Indian Affairs, replacing the boarding school system with day schools so the students can attend schools from their homes, and
2. The statements made and being made by Congressional legislators, educators, administrators, and students for the elimination of the boarding schools are not truly representative of the Navajo people and the school children, and it is the desire of the Eastern Navajo Council that the Navajo people be given an opportunity to submit their viewpoints and statements about how they feel about the boarding school system and to make known their position, and
3. It is very desirable that the Navajo parents and Navajo leaders make known their feelings and opinions about the boarding school system and to submit resolutions, petitions, suggestions and recommendations from their respective chapters, communities, and local schools to the Navajo Tribal Administration, concerned Congressional delegations, and educational administrations, and
4. It is very desirable that the Navajo Tribal Administration and its newly established Division of Education hear the feeling of the Navajo parents and the Navajo leadership about the future of the boarding school system, and
5. Before the educational programs on the Navajo Indian Reservation become partially or totally day schools, there are several very important factors and conditions that need to be considered for alleviation on the same basis before a total day school program can be established. Some of the factors and conditions are: bad road conditions for school buses; economic and social conditions at home; unemployment; lack of employment on the Reservation, and so on.

NOW THEREFORE BE IT RESOLVED THAT:

1. The Eastern Navajo Council hereby takes a firm stand for the continuation of the boarding school system under the Bureau of Indian Affairs for an indefinite period.

2. The Eastern Navajo Council hereby requests that the boarding school system be continued as long as several conditions and factors remain which are to be considered in deferring continued need; factors, like bad road conditions for school buses; economic and social conditions at homes for school children; high rate of unemployment; and the like.
3. The Eastern Navajo Council requests the local chapters, communities, and local school boards to discuss the future of the boarding school system, if the people want to have boarding schools, and submit their feelings and comments to the Navajo Tribal Administration, Congressional legislators, educational administrators, and so on.
4. The Eastern Navajo Council hereby instructs the President of the said Council to transmit copies of this resolution to the Navajo Tribal Administration, concerned Congressional legislators, educational administrators, and other concerned parties requesting them to hear the feelings and attitudes of the Navajo parents the "grass-roots" Navajo leadership.

CERTIFICATION -

I HEREBY CERTIFY THAT THE FOREGOING RESOLUTION was duly considered and moved for adoption by Tom Rafael (District 16), seconded by Clarence Warner (Mariano Lake), thoroughly discussed and adopted by a vote of 79 in favor, none opposing, at a regularly called meeting of the Eastern Navajo Council at Crownpoint, New Mexico, on January 15, 1972.

 Ernest C. Becenti, President
 Eastern Navajo Council

RESOLUTION
OF THE
NAVAJO AREA SCHOOL BOARD ASSOCIATION

Requesting that the Navajo Tribal Council rescind resolution CAU-43-61 and that the Education Committee develop a new Education Policy.

WHEREAS:

1. The Navajo Tribal Council in 1961 passed a resolution adopting a Navajo Education Policy; and,

2. This policy and its present implementation is having the effect of overcrowding public schools while bureau schools are receiving fewer and fewer students every year; and,

3. The Navajo people do not wish bureau schools to be phased out and demand that they have a voice concerning the type of school to which they send their children; and,

4. The Eastern Navajo Council and Agency School Board Conference, the Shiprock Agency Board, the Chinle Agency School Board Conference, and several chapters and local school boards have passed resolutions favoring the development of a new policy governing reservation enrollment.

NOW THEREFORE BE IT RESOLVED:

1. That the Navajo Tribal Council rescind its 1961 Resolution No. CAU-43-61, adopting a Navajo Education policy and that a new policy be developed by the Navajo Tribal Education Committee working closely with the Navajo Area School Board Association for consideration by the Navajo Tribal Council; and,

2. This policy should provide the Navajo people with a means to ensure the continuation of the bureau and the public education systems in accordance with the Treaty of 1868, the historical relationship between the Navajo people and the federal government since that time, and the fact that Indian people are full citizens of the states in which they reside; and,

3. Any policy developed should seek to coordinate bureau, state, and tribal education activities in such a way to eliminate wasting of funds, and maximize educational opportunities for Navajo children.

C E R T I F I C A T I O N

I certify that the foregoing resolution was considered at a duly called meeting of the Navajo Area School Board Association on the 30th day of April, 1975, was moved for passage by Frank Hannah and, seconded by George Hubbard, and was passed by a vote of 164 in favor and 0 opposed.

Edward T. Begay, President
NASBA

ENC-MAR-75-16
(March 15, 1975)

Resolution of the Eastern Navajo Council

The Navajo Tribe of Indians

Subject: Requesting Revocation of Tribal Council Resolution CAU-43-61

WHEREAS:

1. The President of the United States and the Congress of the United States have expressed concern that the Indian people have the right of self-determination, and
2. Great progress has been made in involving Navajo parents in the education process at various public and Bureau of Indian Affairs schools in the Eastern Navajo Agency through local school boards and parent advisory councils, and
3. Navajo parents in various communities are expressing a preference for non-public schools.

NOW THEREFORE BE IT RESOLVED THAT:

1. The Eastern Navajo Council hereby requests the revocation of the Navajo Tribal Council Resolution CAU-43-61, Adopting Navajo Education Policy, of 1961.
2. The Eastern Navajo Council does hereby further requests the passage of an alternate resolution and policy establishing local self-determination for local communities allowing the respective communities to determine the type of education management system they desire to meet their student needs.
3. The Eastern Navajo Council hereby directs the President of said Council to transmit copies of this resolution to the Chairman of the Navajo Tribal Council, Chairman, Navajo Tribal Education Committee; Director, Navajo Division of Education; Assistant Area Director (Education), Bureau of Indian Affairs; and Area Director, Bureau of Indian Affairs.

CERTIFICATION

I HEREBY CERTIFY THAT THE FOREGOING RESOLUTION was duly considered and moved for adoption by Dennie House (Smith Lake), seconded by Clarence Warner (Mariano Lake), thoroughly discussed and adopted by a vote of 54 in favor, none opposing at a regularly called meeting of the Eastern Navajo Council held at Crownpoint Chapter, Crownpoint, New Mexico on the 15th day of March, 1975.

Ernest C. Bennett, President
Eastern Navajo Council

Resolution of the Eastern Navajo Agency

School Board - NASBA

The Navajo Tribe of Indians

Subject: Requesting that the Navajo Tribal Council rescind Resolution CAU - 43 - 61 and develop a new policy based on the principle that for Navajo parents can decide to which school they send their children.

WHEREAS:

1. The Navajo Tribal Council passed a resolution (CAU-43-61) on August 29, 1961, which favors attendance of Navajo students in public schools and
2. This resolution and the bureau's enrollment criteria are causing severe over crowding in many reservation public schools while bureau school enrollment is severely declining, and
3. The Navajo people do not wish to see the bureau's educational program phased out and do not prefer the public school system to the bureau system.
4. The federal government's policy of self-determination requires that a new tribal policy be developed based on the principle of free choice.

NOW THEREFORE BE IT RESOLVED THAT:

1. That the Navajo Tribal Council reconsider and rescind the 1961 resolution adopting Navajo Education Policy, and
2. That a new tribal education policy statement be developed by the tribal education committee utilizing extensive input from the Navajo people, adhering to the policy that Navajo parents be able to choose the type of school, BIA or public that their children attend.

CERTIFICATION

I HEREBY CERTIFY THAT THE FOREGOING RESOLUTION was duly considered and moved for adoption by Lincoln Perry, seconded, Augustine Sandoval, thoroughly discussed and adopted by a vote of 50 in favor, none opposing, at a regularly called meeting of Eastern Navajo Agency School Board on the 9th day of April 1975 at Crownpoint, New Mexico.

Frank Hannah
 Frank Hannah, Vice President
 Eastern Navajo Agency, NASBA

RESOLUTION OF SHIPROCK AGENCY SCHOOL BOARD

Requesting Revocation of Navajo Tribal Council Resolution CAI-43-61.

WHEREAS:

1. The Treaty of 1963 between the Navajo people and United States Government stipulates that the United States shall provide a teacher for every thirty (30) children which to this day is binding, and
2. The Navajo people in our chapter areas withdrew sizable land for the Bureau of Indian Affairs to construct schools and further committed their children to attend these schools, and
3. Due to the present school attendance policy of the Bureau of Indian Affairs and Navajo Tribe which gives preference to the State Public schools, many Navajo parents do not have a choice but to force their youngsters to attend public schools which are overcrowded and their physical facilities are far from adequate, and
4. The Navajo youngsters have no choices but to meet the public school buses early in the morning, travel excessive distances in overcrowded buses, and return home late in the evening while the nearest bureau schools are not being occupied to the optimal capacity, and
5. Since the inception of Navajo Tribal educational goal which provides for a maximum involvement of Navajo parents in the educational process of their children, the local school boards, Agency school board, and Parent Advisory Council have made great stride and progress toward the realization of this goal; thereby it is the desire of Navajo parents and Tribal leaders to continue this effort.

NOW THEREFORE BE IT RESOLVED THAT:

1. The Shiprock Agency School Board hereby requests to have the Navajo Tribal Council revoke its resolution CAI-43-61, and
2. The Shiprock Agency School Board does hereby further the passage of an alternate resolution and policy establishing local self-determination for local communities allowing the respective communities to determine the type of educational management system they desire to meet their student needs, and

3. The Shiprock Agency School Board hereby directs the President of NASBA Executive Board to transmit copies of this resolution to the Chairman, Navajo Tribe; Chairman, Navajo Education Committee; Director, Navajo Division of Education; Assistant Area Director (Education), Bureau of Indian Affairs; and Area Director, Bureau of Indian Affairs.

CERTIFICATION

I HEREBY CERTIFY THAT THE FOREGOING RESOLUTION was duly considered by the Shiprock Agency School Board at a duly called meeting at Shiprock, Navajo Nation, New Mexico, at which a quorum was present and that same was passed by a vote of six (6) in favor and zero (0) opposed, this 17th day of April, 1975.

President
Shiprock Agency School Board

RESOLUTION

Resolution of the Chinle Agency School Board Conference recommending that the Navajo Tribal Council rescind the 1961 Education Policy Resolution and support the rights of the Navajo people to send their children to the school of their choice. Whereas:

1. The Tribal Council approved a policy statement in a resolution (CAU-43-61) of August 29, 1961; and,
2. This policy is presently resulting in equal educational opportunity being denied to public school students due to overcrowding and long bus routes over roads unfit for that purpose; and,
3. Bureau enrollments are severely declining due to this policy, causing much vacant space in bureau schools; and,
4. The Naalini Chapter, and School Board, Cottonwood Day School Board, Tselani Chapter and Low Mountain School Board have passed resolutions favoring free choice for Navajo parents in sending their children to whichever school they prefer; and,
5. The Navajo people do not favor public schools over BIA schools, but, rather, desire that Navajo parents have the right to send their children to the school of their choice.

Now Therefore be it Resolved:

1. That the Navajo Tribal Council rescind its 1961 resolution adopting Navajo Education Policy and that a new policy be prepared which is in accordance with the policy of self-determination; and that this policy specify that Navajo parents have the right to send their children to whatever school, (BIA or public) they choose.

CERTIFICATION

I certify that the foregoing resolution was duly considered at a conference of the Chinle Agency on April 8, 1975 at which a quorum was present and was passed unanimously.

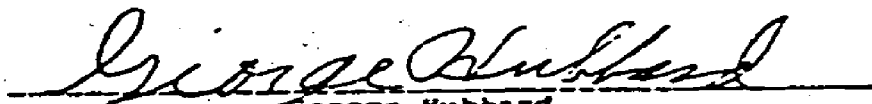
 George Hubbard
 Agency President, NASBA

RESOLUTION OF THE
EDUCATION COMMITTEE OF THE
NAVAJO TRIBAL COUNCIL

Supporting the plan to relieve the overcrowded Public Schools by increasing the opportunities for Navajo students to attend the under utilized B.I.A. Schools on the Navajo Reservation.

WHEREAS:

1. It is the desire of the Navajo people, as expressed by numerous resolutions of their local school boards, Chapters, and a recent reservation-wide school board conference to strengthen Bureau of Indian Affairs schools which are a valuable treaty asset to the Navajo people, and are the only economic activity based in many Navajo communities, and
2. Approximately 5,700 empty classroom seats are presently available in these schools and these seats could be used immediately to relieve the unsatisfactory conditions in the Reservation Public schools, which include overcrowded classrooms, long, tiring and unproductive school bus rides, and excessively high pupil-to-teacher ratios.

NOW THEREFORE BE IT RESOLVED THAT:

1. The Education Committee of the Navajo Tribal Council hereby endorses the plan to increase enrollment at B.I.A. schools by offering greater opportunities for Navajo parents to utilize them as day schools, and also supports the attached request written by Council Member, Dr. Annie D. Wauneka, to provide bus service and road maintenance to these B.I.A. schools, and
2. This committee further supports the resolution of the agency-wide conference of the Navajo Area School Board Association (NASBA) which is attached to this resolution, and the resolutions of those local boards and Chapters which request changes in the enrollment criteria to permit greater freedom of choice for Navajo parents in the selection of the schools to which they send their children, and
3. This committee requests that Dr. Wauneka, and other appropriate persons, submit this resolution with the attachments hereto, to any government officials who may be able to favorably implement these provisions, including members of Congress and Congressional hearings.

Certification

I hereby do certify that the above resolution was duly considered at a meeting held at Window Rock, Arizona, on May 8, 1975, at which a quorum was

present, and was passed by a vote 5 in favor 0 opposing.

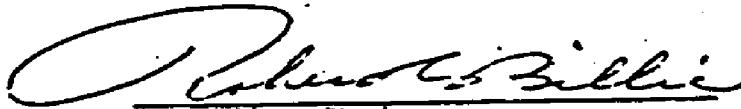

Presiding Chairman
The Education Committee of the
Navajo Tribal Council

CJN-40-75

Class "C" Resolution
No BIA Action Required.RESOLUTION OF THE
NAVAJO TRIBAL COUNCIL

Providing that the Education Committee of the Navajo Tribal Council be Authorized to Prevent the Impending Loss of BIA Schools Due to Declining Enrollment, and Providing that the Education Committee Develop a Comprehensive Navajo Educational Policy for Approval by the Navajo Tribal Council

WHEREAS:

1. The Education Committee of the Navajo Tribal Council has reviewed numerous resolutions from local school boards, chapters and agency councils requesting that BIA education be strengthened; and
2. The Education Committee of the Navajo Tribal Council is also very concerned with overcrowding in Reservation public schools, and with the long school bus rides which tire the Navajo students and consume excessive amounts of their time and seeks means to provide relief for these problems; and
3. The desires and attainable objectives of the Navajo people in education must be expressed in an understandable policy statement in order to consistently and effectively advance Navajo education, prevent the loss of BIA schools, and overcome present conflicts over policy.

NOW THEREFORE BE IT RESOLVED THAT:

The Education Committee of the Navajo Tribal Council in cooperation with the Navajo Area Office of the Bureau of Indian Affairs, the State Boards of Education for New Mexico, Arizona and Utah, the Navajo Division of Education, and the Navajo Area School Board Association, is directed to prepare a comprehensive Navajo Education Policy Statement for consideration by the subsequent session of the Navajo Tribal Council.

CERTIFICATION

I hereby certify that the foregoing resolution was duly considered by the Navajo Tribal Council at a duly called meeting at Window Rock, Navajo Nation (Arizona), at which a quorum was present and that same was passed by a vote of 54 in favor and 0 opposed, this 19th day of June, 1975.

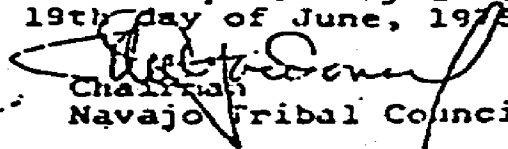
Chairman
Navajo Tribal Council

RESOLUTION OF THE CANONCITO NAVAJO CHAPTER

Demanding That the Bureau of Indian Affairs Do all It Can To Continue the Operation of the Canoncito Community School Dormitory for the Remainder of the 1976-77 School Year to serve the Navajo Children in Canoncito.

WHEREAS:

1. The Bureau of Indian Affairs has made a decision to close the school dormitory in Canoncito, effective January 28, 1977, without prior consultation with the Community, and
2. A community meeting was held in Canoncito on November 23, 1976 to discuss the above issue wherein a stand was made to demand continued operation of the dormitory because of the following reasons:
 - A. Lack of utilities and other modern facilities at home create a hardship on the children attending school.
 - B. Poverty existing in the family prevents children from enjoying a home environment comparable to other children of the so called "middle class".
 - C. The poor road conditions are not conducive to safe and sound bus rides to and from school on a daily basis.
 - D. Many families have become dependent upon the dormitory living for their children, and an abrupt cut off would create Social, Economics, and Health Problems.
 - E. In order to meet some of the special needs of the Navajo children dormitory living is necessary.

3. The Canoncito Community is very concerned about the Bureau's hasty decision to close the dormitory without the actual involvement of the community, which it had vowed to practice.
4. Hereby attached is a petition, signed by the Canoncito Chapter, for continuation of said Dormitory and support of their resolution.

NOW THEREFORE BE IT RESOLVED THAT:

The Canoncito Chapter demands that the Bureau of Indian Affairs do all it can to continue the operation of the Canoncito Community School Dormitory for the remainder of the 1976-77 school year to serve the Navajo children in Canoncito.

CERTIFICATION

We hereby certify that the foregoing resolution was duly considered and thoroughly discussed by the Canoncito Chapter at a duly called meeting at which a quorum was present and that same was passed by a vote of 36 in favor and 0 opposed this 23 of November, 1976.

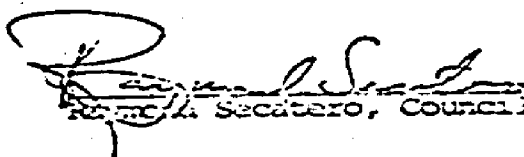
Ramon Sandoval, Councilman

Joe M. Sandoval, Chapter President

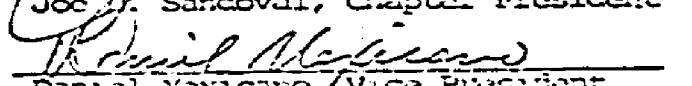
Daniel Mexicano, Vice President

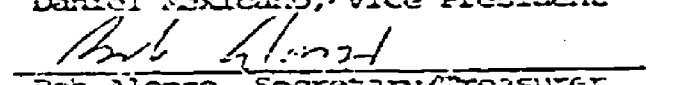
Bob Alonzo, Secretary/Treasurer

RESOLUTION OF THE
EDUCATION COMMITTEE OF THE
NAVAJO TRIBAL COUNCIL

Recommending to the BIA, Education Division, a Continuation of Dormitory Operation at Canoncito Through the School Year 1976-1977.

WHEREAS:

1. By Navajo Tribal Council Resolution, the Education Committee of the Navajo Tribal Council is the official recognized Committee on education matters in the Navajo area; and,
2. The Bureau of Indian Affairs, Navajo Area, has proposed to close the school dormitory at Canoncito effective January 28, 1977; and,
3. A resolution has been passed by the Canoncito Chapter and local School Board requesting that the BIA do whatever is necessary to continue the operation of the dormitory through the School Year 1976-1977; and,
4. Dormitory living is needed for certain Navajo students.

NOW THEREFORE BE IT RESOLVED THAT:

1. The Education Committee of the Navajo Tribal Council recommend that BIA honor the request of the Canoncito School Board and the Chapter in continuing the school's dormitory operation through the School Year 1976-1977; and,
2. The Navajo Area, BIA, do whatever is necessary to continue the dormitory operations at Canoncito.

C E R T I F I C A T I O N

This foregoing Resolution was duly considered by the Navajo Education Committee of the Navajo Tribal Council at a duly called meeting and that same was passed by a vote of 5 in favor and 0 opposed, this 15 day of Dec., 1976.

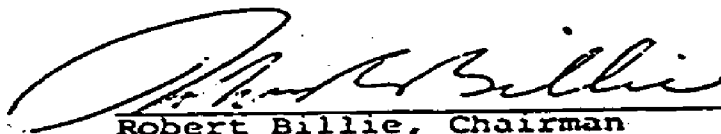

Robert Billie, Chairman
Navajo Education Committee
of the Navajo Tribal Council

ENC-JAR-77-01
(January 15, 1977)

*Resolution of the Eastern Navajo Council,
The Navajo Tribe of Indians*

Subject: *Requesting the Revision of Tribal Council Resolution
CAU-43-61, Adopting Navajo Education Policy*

WHEREAS:

1. *The President and Congress of the United States have expressed concern that the Indian people have the right of self-determination, and*
2. *Great progress has been made in involving Navajo parents in the Education process at various public and Bureau of Indian Affairs Schools in the Eastern Navajo Agency through local school boards and parent advisory councils, and*
3. *Navajo parents in various communities are expressing a preference for non-public schools, and*
4. *Navajo parents in various communities such as Cononcito are expressing a preference for boarding facilities rather than day school facilities.*

NOW THEREFORE BE IT RESOLVED THAT:

1. *The Eastern Navajo Council hereby requests the revision of the Navajo Tribal Council Resolution CAU-43-61, Adopting Navajo Education Policy, to permit local communities to determine the type of education management system they desire to meet their students' needs.*
2. *The Eastern Navajo Council further requests that adverse housing conditions, such as lack of running water or electricity or heating, should be considered as criteria for boarding school placement, as well as large family size in relation to income.*
3. *The Eastern Navajo Council hereby directs the President of said Council to transmit copies of this resolution to the Chairman, Navajo Tribal Council; Chairman, Navajo Tribal Education Committee; Director, Navajo Division of Education; Assistant Area Director (Education), Bureau of Indian Affairs; and Area Director, Bureau of Indian Affairs.*

CERTIFICATION

I HEREBY CERTIFY THAT THE FOREGOING RESOLUTION was duly considered and moved for adoption by Ford Y. Begay (Pinedale) seconded by Charlie Toledo (Torreon), thoroughly discussed and adopted by a vote of 86 in favor, 0 opposing at a regularly called meeting of the Eastern Navajo Council held at Crownpoint Chapter, Crownpoint, New Mexico on the 15th day of January, 1977.

Earnest C. Becenti
Earnest C. Becenti, President
Eastern Navajo Council

STATEMENT OF LARRY HOLMAN, NAVAHO AREA, EDUCATION PROGRAM ADMINISTRATOR, EASTERN NAVAHO AGENCY

Mr. HOLMAN. Thank you. Mr. Chairman, distinguished members, staff, on behalf of the Navaho students and communities being served by the Eastern Navaho Agency's Branch of Education, I would wish to thank this committee for giving me the opportunity to testify.

We at the local field level who have the final responsibility for carrying out the plans and programs mandated by Congress appreciate this chance to be heard directly.

My report for the record is from the local perspective only. It is my appraisal of the court status of Navaho education as acquired through administrative experience and personal involvement with the communities and people served by the Eastern Navaho Agency. It is not my intention nor is it within my capacity to speak for others.

We have worked extremely hard at improving our educational program. However, much remains to be accomplished. For this, your interest and legislative leadership is urgently needed. Our students for a variety of reasons—among them, cultural, linguistic, and economic—have special needs. These must be addressed in a manner beyond our current capacity to deliver if the Navaho student is to become a productive and contributing citizen to the same degree as other segments of our society.

I would also like to take this opportunity to express gratitude to this distinguished committee for demonstrating the beginnings of a sincere interest in Indian education.

The majority consultant, Mr. Lovesee, and minority consultant, Mr. Bragg, came to the Navaho Reservation, and sincerely demonstrated an effort to arrive at conclusions based on fact. They did not gather data by phone or out of conversations with top officials, but by actual traveling the roads, visiting the schools, sleeping in the dorms, talking to the students and staff, including the entire spectrum of our organizational structure.

It is also my opinion that this committee should be aware that extra funding for additional personnel, equipment, and instructional material will not be a panacea for improvement of Navaho Indian education, unless specific measurable objectives are developed for accountability of funds.

Further, I would recommend that no funds be appropriated unless they are earmarked for the remediation of specific deficiencies the committee has recognized as credible.

All of our efforts should be together with one objective, and that is raising the academic achievement of an Indian child to that that is recognized as the national norm.

Thank you.

Mr. QUIE. Are you talking about all of the programs for education?

Mr. HOLMAN. Just Navaho.

Mr. QUIE. I am talking about all the programs that go to the Navaho—

Mr. HOLMAN. Just the Bureau's programs.

Mr. QUIE. You are talking about Bureau programs.

Mr. HOLMAN. Yes, sir.

Mr. BLOUIN. Thank you. Mr. Magnuson?

[Prepared statement by Ernest L. Magnuson follows:]

S T A T E M E N T

by

Ernest L. Magnuson

for

Oversight Hearings

House of Representatives

Committee of Education and Labor

INTRODUCTION

The Navajo Reservation stretches across a geographical area comparable in size to the state of West Virginia. It embraces 25,000 square miles of desert and mountainous terrain. It extends from northwestern New Mexico, across Arizona and north into the state of Utah.

Recent census reports indicate that there are approximately 146,296 Navajos. Of that number approximately 54,200 are of school age.

These students attend either public schools, private mission schools or schools operated by the Bureau of Indian Affairs. In addition, three schools are contracted to Navajo communities.

Due to its vastness, the Navajo Reservation is divided into five agencies, each of which is responsible for the education of the students who reside within its boundaries.

The Navajo people are predominantly native speakers of the Navajo Indian language. Many remain monolingual speakers of Navajo. Approximately 75% of the Navajo, six years, entering school do not speak English.

I feel a real privilege in being able to deliver this statement of the role, progress and concerns of we who work on the Navajo Reservation.

The role of the Bureau schools on the Navajo Reservation is to serve those students who cannot attend a public school on a day-basis because a public school is not available or for social reasons. The following is the enrollment criteria taken from 62 IAM 2.5.2:

.2 Eligibility for Admission. Children otherwise eligible who meet one or more of the criteria listed below may be admitted to Federal Boarding Schools:

A. Education Criteria.

- (1) Those for whom a public or Federal day school is not available. Walking distance to school or bus transportation is defined as one mile for elementary children and 1-1/2 miles for high school.
- (2) Those who need special vocational or preparatory courses, not available to them locally, to fit them for gainful employment. Eligibility under this criterion is limited to students of high school grades 9 through 12.
- (3) Those retarded scholastically three or more years or those having pronounced bilingual difficulties, for whom no provision is made in available schools.

B. Social Criteria.

- (1) Those who are rejected or neglected for whom no suitable plan can be made.
- (2) Those who belong to large families with no suitable home and whose separation from each other is undesirable.
- (3) Those whose behavior problems are too difficult for solution by their families or through existing community facilities and who can benefit from the controlled environment of a boarding school without harming other children.
- (4) Those whose health or proper care is jeopardized by illness of other members of the household.

Further, a joint Navajo Tribal Council Education Policy Statement was agreed to in 1961 (CAU-43-61, attached as Exhibit #1) which supports the enrollment criteria stated above and encourages cooperative efforts on the part of all concerned to develop education opportunities that best meet the needs of the Navajo people.

Since that date, the entire Reservation has been incorporated into public school districts which by law are charged with serving those students living within their district areas (Reservation map attached as Exhibit #2). However, since a large number of families still live beyond the mile and one-half walking distance, the Bureau boarding schools serve them or those families as defined under the social enrollment criteria. In some areas of the reservation, the Bureau also serves students on a day-basis also because they cannot be served by the public school within whose district they reside.

On January 14, 1977, our enrollment was 17,896 Navajo children and youth (K-12, approximate ages 5 to 20) are being served in forty-three (43) boarding schools, ten (10) day schools, eight (8) bordertown and Reservation dormitories, three (3) high schools and our three contract schools have an additional enrollment of 895 students. Summary of enrollment attached (Exhibit #3).

Enrollment in Bureau schools has declined over the past few years because of families moving from the more isolated areas to urban areas within the Reservation for greater employment opportunities. The following will illustrate this change:

NAVAJO AREA ENROLLMENT IN BIA SCHOOLS

1970	20,003
1971	20,903
1972	20,532
1973	18,958
1974	18,581
1975	17,478
1976	16,977
1/1977	17,896

During these same years, the public school enrollment has grown as follows:

1970	23,787
1971	25,725
1972	28,039
1973	27,779
1974	26,928
1975	30,277
1976	27,463
1/1977	29,611.

The growth in public school enrollment has been dramatic and this has created multiple problems with overcrowding of facilities and lengthy bus routes over less than adequate roads. There are bus routes of over 60 miles, one way, which can create hardships for the students. We have attempted (and I believe with some success in working with the Navajo Division of Education and the public schools) to reduce the length of time a student would have to ride a bus. The Navajo Division of Education has suggested 30 miles and we have suggested no longer than 45 minutes, one way, and we plan to hold joint meetings with public school officials to promote this plan.

A study titled "Report on Chinle School District", December 1975, and published by the Bureau of Educational Research and Services, College of Education, Arizona State University, speaks to this problem more fully in Section 7, page 68 and 69 as follows:

"the fact that the majority of students live in remote areas and must be transported causes the transportation department to be the backbone of the Chinle School District. High Absenteeism may be caused in part by the fact that many students are on the school bus as long as two and one-half hours each day going to and from school.

Another existing problem is the many dirt roads which are poorly maintained".

During these past three years, I have noted that more and more prominent Navajos are concerned with the decreased enrollment in Bureau schools and are asking for a change in policy. They suggest that the Navajo family have a choice in which type of school they enroll their children whether Bureau or public. This idea would create problems for all schools in developing education plans since the number of students would be uncertain. We feel that the best approach is a cooperative effort defining more clearly areas of service.

We expect that the Navajo Tribal Council will discuss this enrollment criteria for boarding schools during their winter session and they may call for a revision of CAU-43-61 which would also require a change in the Bureau Manual as they concern boarding school enrollment. (Attached Exhibits 4-8 show how strongly the Navajo people feel about this subject.)

Curriculum development was started in the Navajo Area nine years ago with the specific goal of developing curricular guidelines based on the needs of the Navajo students in Bureau schools. To accomplish this task, three factors were considered: (1) the needs of the students;

(2) the needs of the students' adult society; and (3) the nature of the discipline (subject) itself.

The Area Office felt that the first two (i.e., the needs of the students and their adult society) had to be determined by the Navajo people themselves - the students, parents, and Tribal leaders- along with the teachers and school personnel involved in the day-by-day instructional process. Therefore, curriculum committees in the various disciplines were organized at various levels - local, or school, agency, and Area. These committees were assigned the task of researching and documenting the needs of the students and his adult society to serve as a basis for culturally relevant curricula.

For the third factor (i.e., the nature of the discipline itself), the "expert(s)" in the subject area was relied on to provide the expertise needed to develop the curriculum based upon the pre-established needs with additional input from Bureau personnel. The "expert" at times was a consultant from a university, however, Navajo Area personnel with specific skills frequently served as the "expert". Whenever the expertise needed was available within the Bureau, the savings to the government was large.

The curriculum development process briefly described above has been long and is still not completed. But this office feels it has been the right approach, for it has attempted to seriously consider the needs of the learners and their society and to actively involve as many people as possible. And this curricular process still represents the current philosophy and thinking of the Navajo Area Office.

1. Navajo Area Curriculum Development Project: Language Arts.

The first part of the language arts curriculum developed is an activities book, providing specific instructional strategies, activities, and games for teaching universal language arts skills. The book contains an outline of skills divided into four major areas: listening, speaking, reading and writing. This outline was developed from the needs assessment conducted by the curriculum committees for language arts. The book contains over 600 activities for teaching the skills listed in the outline. The suggested activities were provided, for the most part, by classroom teachers in Bureau schools who found these activities to be successful in teaching Navajo children. This book is available to all teachers today as a resource guide.

2. NALAP (Navajo Area Language Arts Project).

NALAP is the acronym for the Navajo Area Language Arts Project started in the summer of 1971 in response to an urgent request from teachers for teachable materials which have a linguistically sound base for Navajo learners. NALAP is an outgrowth of a workshop conducted by the Branch of Curriculum and Instruction at Northern Arizona University to evaluate the Navajo Area Language Arts Curriculum Guidelines which were developed to meet the universal needs of children in the language arts areas. This evaluation indicated the critical need of additional guidelines in language arts to meet, more efficiently and effectively, the needs of second language learners. Therefore, the main objective of the Project is to develop a sequence of the grammatical structures of the English language based upon the particular language needs of Navajo children.

The project committee is composed of education specialists and teachers employed by the Bureau of Indian Affairs in the Navajo Area. These people were selected on the basis of their theoretical knowledge of linguistics and their classroom experience teaching Navajo children. During the initial stages of the Project, the committee consulted with Dr. Gina Harvey, Northern Arizona University; Dr. William Slager, University of Utah; and Dr. Robert Wilson, University of California at Los Angeles. Assistance from these linguists as well as other resource people, continues to be available as needed.

During the school years 1971-1974, numerous classroom teachers, on a voluntary basis, piloted the NALAP materials. The first two NALAP books are partially the result of the effort of these teachers who willingly field-tested the NALAP materials and provided the Project Committee with on-going feedback and evaluation.

The first volume, NALAP Book 1, published in 1973, contains ten units of eighty-six (86) structural objectives, providing instructional materials for the first year to the first year and a half of English language learning. The sequenced objectives in Book 1 serve as prerequisites for the objectives in Book 2.

NALAP Book 2 contains ten units of ninety-six (96) objectives, providing instructional material for one to one and a half years of English language learning beyond Book 1.

At the present time, NALAP Book 3 is being written and will be ready for school year 1977-78.

It is the desire of the Project Committee to eventually extend the sequence of objectives to provide an instructional program for all the elementary years.

Criterion-referenced tests for the NALAP materials are being developed. An oral production test for Book 1 has been completed. Diagnostic tests for Book 1 have been drafted and will be field-tested in March 1977. Plans are being made for tests for Book 2.

3. C.I.T.E. (Consultants in Total Education).

C.I.T.E. is the acronym for a language arts program developed by a corporation known as Consultants in Total Education. The program was started in 1968 as an outgrowth of a workshop to orient Navajo Area teachers to TESL (Teaching English as a Second Language) methodology. The author of the program was Dr. Robert Wilson and his CITE staff in California. Several Navajo Area teachers provided valuable input during the piloting stage. Their contributions were incorporated into the revision.

The C.I.T.E. program covers four levels, kindergarten through third grade. At the first level the program is a total one, involving the entire instructional day. At the next three levels, the program provides an instructional base for all the language arts - listening, speaking, reading, and writing. Criterion-referenced tests have been/are being developed for the program.

C.I.T.E. like NALAP, is an ESL program based upon the language needs of Navajo learners. The major differences between the two programs are:

- (1) CITE is total language arts while NALAP requires additional materials for reading and writing

- (2) CITE is more prescriptive and comprehensive, that is, it provides very specific information to the teacher about conducting each individual lesson.

This office feels there is a definite need for both programs, NALAP and CITE, due to different learning and teaching styles of the students and teachers. At the present time, it is policy that NALAP and/or CITE be used in all Bureau schools within the Navajo Area as the basis for English instruction. Other programs and books may be used (and are encouraged) as supplementary and enrichment materials.

At the levels where specific ESL materials have not been developed as of yet (e.g., middle grades and junior high) this office has published a list of ESL programs which may be purchased and used. It is strongly advocated that ESL materials, along with appropriate methods and strategies be used at all grade levels.

4. Linguistics Conferences.

An integral part of our language arts curriculum is a training program sponsored by the Area Office to educate all the teachers in ESL (English as a Second Language) methodology. Since the majority of our teachers come to us with no background in ESL, this office feels it is imperative to require our teachers to acquire this training. We fully realize that just because a person speaks English as a first language he/she is not necessarily qualified to teach English as a second language. Therefore, it has been policy since December 1974 that all teachers will earn six semester hours in linguistics and related courses such as: TESL, transformational grammar and socio-linguistics.

For the past five summers, this office has sponsored Linguistics Conferences at Northern Arizona University at which time participants could obtain the required credit. During 1976, an additional conference was held at the University of New Mexico. These universities have co-operated with us in designing courses to meet the specific needs of our teachers on the Navajo Reservation. Bureau employees are hand-picked by this office to serve as teaching interns to work with the professors in conducting small group sessions. These persons are invaluable to the learning process for they are able to reinforce, extend and expand the lectures and help apply the information to Bureau classrooms.

A Linguistics Conference for this summer, 1977, is being finalized now. It is hoped this training can be continued in future years and required of all new teachers as they enter government service.

B. Social Studies.

The social studies curriculum guidelines was the first one to be fully developed. It was written by Dr. Theodore Kaltsounis and his staff at the University of Washington. Julia Moore, a Navajo teacher in the Bureau, worked with the staff of writers, as a consultant. In addition, the writers relied upon input from Bureau teachers during the field-testing phase.

The curriculum is organized into two guides, one containing units for grades kindergarten through four and the second for grades five through eight. At each grade level there are a series of units based upon a central theme, such as family, school, community, contributions of Indian societies, the Navajo Tribe, etc.

9/2
piece?

The social studies curriculum is concerned with human relationships; that is, the instruction within the classroom promotes the Navajo child's understanding of how he interacts with the members of his nuclear and extended families; his peers and the teachers within the school; the members of the communities located in the Navajo Nation; and persons in the larger, pluralistic American society. All the units in this curriculum deal with such human interaction. Throughout the units the child studies the Navajo culture first because it is the one with which he is most familiar. Other remote cultures and settings are used to develop the social science generalizations around which the units are developed.

The objectives for each unit consist of three categories: understandings, or knowledge; attitudes; and skills. The content of each unit has been converted into a series of problems. For each problem there are many activities representative of the day-to-day classroom instruction carried out by the teacher. These activities can be selected and modified by the teacher in light of the characteristics of the pupils. As the children pursue the activities, they will arrive at their own answers to the unit problems. These answers can lead to the formulation of relationships that represent the objectives of the unit. Leading the child to solve problems is an important aspect of the curriculum.

This curriculum will be revised during the summer of 1977. The revision committee will look again at the over-all scope and sequence, add additional units, up-date the materials and resources list, provide suggestions for integration with other curriculum guidelines, and revise the already existing criterion-referenced test.

In addition to this social studies program, the Navajo Area sponsored a program of Navajo-based teaching units for social studies. These units were developed under the direction of Dr. LeRoy Condie of the University of New Mexico with input from Bureau teachers. One unit has been developed for each grade level, kindergarten through eighth, and four at the high school level. It is recommended that these units be taught at the beginning of each year followed by the units in the Navajo Area social studies guide.

C. Mathematics.

The mathematics guidelines in its present form was completed in 1975 under the direction of Dr. Richard Gibbs and Mr. Harry Rosenberg of Ft. Lewis College, Durango, Colorado. The writing was done by Bureau teachers during the summer of 1974 and 1975 at Fort Lewis College.

The math guidelines consists of 147 objectives arranged in an ungraded sequence. For each objective, several activities are provided to help the teacher in teaching that skill. Other aids for the teacher include a list of objectives by reference area, a glossary, a cross-reference, and directions for use.

The basic purpose of the guidelines is to develop first an understanding of arithmetic and then develop skill in its use. Conceptualization is an integral part of a child's understanding. Thus, conceptualization (or understanding) and skill must develop together. Often, understanding is deemphasized and skill is over-emphasized because skill is easier to measure. In the guidelines, however, heavy emphasis is placed on the development of understanding. This does not mean that drill is sacrificed, only that it follows understanding.

Throughout the guidelines the child is first given experiences related to a concept, then he begins to realize and verbalize the concept involved. Only when this is accomplished is a written format and the skills associated with the concept introduced. For example, in the guidelines, the child is given experiences with sets, discussing various likes and differences between sets that will, in the end, develop his quantitative sense. Only then is the idea of number introduced. This number becomes a way of talking about something the child already senses conceptually.

Pre- and post-tests have been developed and are included in the guidelines. The results of the pre-test help the teacher place the child in the curriculum according to need.

D. Science.

The science curriculum in its present format was completed in 1975. It was finalized by a committee of Bureau teachers with Dr. Eddie Sage of Northern Arizona University serving as consultant.

The science guidelines in two volumes have been developed around seven key strands: air and weather, living things, machines, earth's surface and water, electricity and magnetism, solar system and beyond, and sound, heat and light. Each strand is developed without grade level automatics, developing from the easier concepts to the more difficult ones and approximating the maturational development of learners and increasing difficulty of facts and knowledge within a strand.

Within the development for each strand is a listing of concepts paralleled with appropriate performance outcomes for the learners. Suggested activities, resources and materials, and vocabulary are listed in each strand.

The guidelines specifically point out to the teacher that respect for Navajo traditions, feelings and beliefs is mandatory. The crucial thing is to "know" the learners so that misunderstandings will not result from what is taught.

At the present time the science guidelines are being evaluated by Dr. Lynn Glass of the University of Iowa. His assignment is to critique the curriculum in light of present-day science education. Criterion-referenced tests have not been developed as of yet.

E. Health and Physical Education.

The health and physical education curriculum was completed in 1973 under the direction of the Branch of Curriculum and Instruction of the Navajo Area Office, Division of Education. The writers were all Bureau employees on the Navajo Reservation. Indian Health Service personnel served as resource people.

The guidelines are arranged into several broad areas concerning health, safety and physical education. Within each area are listed specific objectives with parallel skills, concepts and activities and related materials and resources. The guide also contains pre-and post-tests.

In connection with the health curriculum this office recommends the following:

- (1) use of the Health Education Guide prepared by the Lankenau Hospital in Philadelphia, and
- (2) use of the American Red Cross course in "Basic First Aid" at the sixth and eighth grade levels in all schools.

F. Fine Arts.

The Art guidebook was completed in 1970 under the direction of the

Branch of Curriculum & Instruction of the Navajo Area Division of Education. The contributors were members of the Area Art Curriculum Committee consisting of Bureau teachers and education specialists in art.

Rather than attempting to develop an art curriculum, the committee decided to develop a guide or resource book on "how-to-do-it" outline for those on the Navajo Reservation who deal with children. The book is a comprehensive guide providing helpful information regarding a wide range of topics, such as: art appreciation, recipes, various media, recommended art activities by instructional levels and developmental age levels of children's art.

A curriculum for music has not been finalized as of this time. Committees have functioned and completed preliminary work; however, the final curriculum to be used in all Navajo Area schools has not been approved. It is hoped that the curriculum will be completed within the next year.

G. Guidance.

The guidance curriculum has been divided into two major volumes, one for elementary and one for high school. Both guidelines were developed under the direction of the Branch of Curriculum and Instruction of the Navajo Area Division of Education. The writers are all Bureau employees who have worked/are working in dormitory programs on the Navajo Reservation.

The elementary guidelines were developed based upon ten broad goals, such as: self-image, decision making, cultures, etc. Within each of these ten goals, suggested activities are provided for each area of the dormitory operations: homeliving, counseling and student activities. The guide also contains suggestions for implementation and administration of the guidance program, sample position descriptions, and guidance forms and suggested

resources.

The high school guidelines were developed based upon twelve broad goals such as: value systems, careers, multi-cultural adjustments, etc. Within these twelve goals, objectives and activities are provided for the areas of curriculum and adult involvement. The guide also contains suggestions for implementation and administration of the guidance program and suggested resources.

Counseling services for Navajo students must be strengthened to meet the educational and social objectives set forth by the Bureau and the Navajo Tribal expectations. Qualifications for counselors are below the standards established by the American Personnel and Guidance Association. More training of a professional nature must be provided to the counselors already in the schools. The administering and interpretation of test results is one of the weaknesses for our present counselors. One area of concern which the Navajo Area Office would like to assist counselors to function better in is in the various techniques of counseling itself. Most of the counselors are trained and tied to one theory and/or technique of counseling and find that in working with a large number of children, some children do not respond to this particular technique. Counselors need to be trained in a variety of techniques to meet the needs of more students. The counselors are minimally involved in the placement process. Much needs to be done in helping counselors and teachers work together for the common good of the students.

Recently counseling responsibilities were given back to staff members who also administer the dormitories. This has reduced the numbers of counselors who are truly neutral and at the most appropriate position to be effective counselors. While these administrative counselors are in a position to effect changes necessary to solve problems, there is a reluctance on the part of students to bring their problems to these persons because they are viewed as authoritative figures in the line of school administration.

Extra-curricular activities include recreation programs, trips, sports, educational trips and social events. Transportation problems, (lack of vehicles and travel restrictions), limit many of these activity programs. There is a need for additional personnel in the schools to carry out the many and varied activities that students need and want in a situation where they spend most of the year. Navajo Area has consciously tried to expand the recreation program in all schools. In the past, emphasis has been placed almost totally on the academic area of the school. In the past year the Area has been able to add a few new positions to assist in the recreation program in several schools. The goal is to have a full complement of staff within the near future to implement a recreation/activities program for ALL students in the Navajo Area schools.

Many of the dormitories in the Navajo Area are becoming run down and in a state of disrepair. Lack of funds is the reason most often given for this condition. Many dormitories no longer have curtains up at the windows; supplies for decorating the dormitories have been cut drastically and children do not have the necessary night clothes to provide a good

institutional living condition. The number of students who run away, who get hurt, who get into trouble of one kind or another indicates that there is a lack of supervision. More homeliving staff are needed to provide the 24-hour, 7-day coverage that is required. Much of the supervision involves trying to keep track of the children. There is not enough time and staff to plan the necessary activities that should be inherent in the homeliving program. One great area of accomplishment has been lowering of the ratio of 1/16 to 1/12 which will increase the aide/student ratio from 1/64.5 to 1/52.8 on the floor coverage in the dormitory on any tour of "duty". This has been a tremendous asset to the homeliving program. More activities are possible. The aides have more time to give individual attention to the students. Taking into account the out of class, waking time, each student could receive a maximum of 8.2 minutes of individual attention per day. This is not a reality as the instructional aides also have to supervise at least 51.2 other students when a student comes to them to talk about a problem or anything for that matter. Many feel that this inability to provide individual attention is the basis for homesickness, frustration, and other personal problems with the students. Most dormitory activities are done in large groups and students feel a loss of identity.

H. Career Education.

The implementation of a vocational program has been very limited due to the lack of funding since priorities have been to provide the student with a basic skills program. A comprehensive vocational program for the students being served is imperative because of:

the number of students dropping out of school due to a program that is not relevant for the student not college-bound

b. the numerous students needing alternative to a traditional academic program

c. the need to comply with the P.L. 94-142 in providing the best program possible for students with special needs to help them to be able to have a skill for a job security.

Presently the following vocational programs operating in Navajo Area high schools are as follows:

building and trades
small engines
food service
diversified education
clerical training.

Other vocational programs are taught only on a limited basis.

Vocational Agriculture and related programs are necessary because of the gigantic irrigation project located in the northeastern part of the Reservation. Due to the short growing season within the academic year, the practical application of agriculture education is almost impossible without hydroponic plants.

Business education includes typing, shorthand and bookkeeping.

But to remain current with the technology of today students need to be taught the key punch computer skills and be provided transcriber experience.

Child care learning centers are limited by the space when complying to the state regulations. The age of the child served in the center is limited and the learner is handicapped by not having practical experience with all ages of children. The construction program in one of the schools is a minor repair center only because of space.

Yet other programs cannot be instigated because of the lack of equipment and space. The Navajo Tribe, community and students have requested several vocational programs be offered. Auto mechanics and body and fender education have been requested but \$400,000 is needed for buildings and \$75,000 for equipment.

Graphic arts and related disciplines are areas the Navajo students will be able to do well. To put in such a program would cost \$200,000.

In addition to the present Navajo high schools we are recommending a vocational high school be established at Shiprock. The proposal states this school will be established for the purpose of providing vocations that will meet the job demands required in the Four-Corners Area caused by the rapid influx of industry in that particular area. The status of this program is contingent on the approval of the Central Office.

It is impossible to have a job for all students graduating from high school, therefore, it is necessary to help the student find a job off the reservation. The student seeking a job off the reservation gets urban-shock! When the Navajo Area high schools are able to have a program that will provide basic skills in the above-mentioned vocations, then the student is placed in an urban setting, an extension of the high school.

Funds given the employer would provide the students with a salary so they could learn to pay rent, food and other routine expenses.

The vocational program will be less effective unless Career Awareness and career exploration is provided in the elementary schools. Therefore, a career awareness (K-6) and a career exploration (7-8) has to be made an integral part of the curriculum.

Budget:

Career Awareness (K-6)	\$ 50,000
Career Exploration (7-8)	800,000
Vocational Education including space and equipment	900,000

OVERVIEW OF THE ELEMENTARY
AND SECONDARY EDUCATION ACT (ESEA) PROGRAMS

Public Law 93-380 has as its basic purpose the extension and amendments of the Elementary and Secondary Education Act of 1965. The titles, which the Bureau of Indian Affairs is eligible to receive funding for are:

TITLE I, whose purpose and intent is to provide financial assistance to schools serving areas with children from low income families. It is meant to expand and improve educational programs which contribute to meeting the special education needs of educationally deprived children. It is the largest of the title efforts to improve the academic achievement of children attending Bureau of Indian Affairs schools.

The Navajo Area Title I budget for FY'77 is \$7,030,035 funding a total of 60 projects. Basic services provided are in the subject areas of Language Arts, Reading, Math, Social Studies and Special Education. A more detailed description of the types of services offered is provided in Appendix A.

Although project and component success vary from school to school, the average overall achievement gain for children receiving Title I services is one months gain per one months participation in a service. Appendix B is offered providing a detailed evaluation for each type of service for individual Navajo Area schools. It is felt this academic achievement is significant when compared to the average gain of .47 for the population-at-large.

Perhaps the biggest problem with the Title I program is based on the lack of funding in the regular 3100 program. Because 3100 funding is limited, Title funds are being used to provide types of services, i.e., bi-lingual education, special education, that should be funded with regular funds. If 3100 programs were adequately funded, Title I monies could then be used to fund truly supplementary educational programs.

TITLE IV ESEA

Title IV of the Elementary and Secondary Education Act combines several of the titles formerly included in the Act.

Part B is intended for:

- (a) the acquisition of school library resources, textbooks, and other printed material;
- (b) the acquisition of instructional equipment;
- (c) testing, guidance and counseling of students.

Part C is intended for innovative approaches for:

- (a) strengthening teaching the academic subjects;
- (b) strengthening values held by various Indian cultures and merging these values in the value system held by the school;
- (c) developing programs for school dropout and/or potential dropouts;
- (d) developing health education programs;
- (e) developing special education programs.

Seventy-three eight hundred thirty-one dollars (\$73,831)

provides funding for five Title IV-C projects.

Funding for these titles is provided to the Bureau of Indian Affairs after the United States Office of Education has approved an annual program plan for the implementation of Title IV proposals. Allocation of funds are made in accordance with the provisions of this plan.

This Title program provides relatively little funding when compared to the Title I programs. It is successful in that it

provides needed materials, supplies and services to schools based on a truly supplemental plan.

Any problems related to this title operation are identical to those found with the Title I/3100 program relationship.

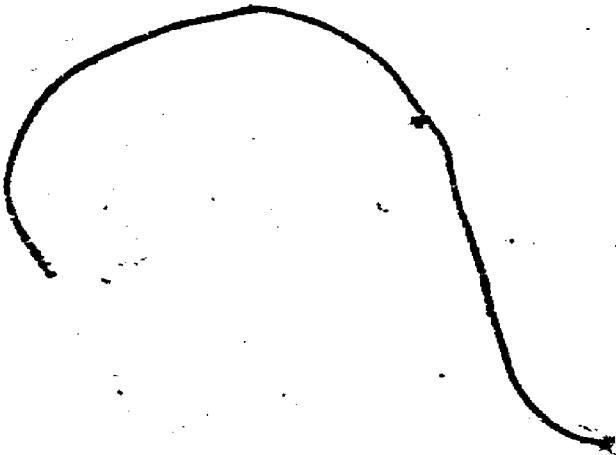

TITLE VI-B ESEA

Title VI, Part B, of PL 89-10 amended by PL 93-380 provides supplemental funds to be used in improving services to physically and mentally handicapped children. The particular Title has made available a very limited amount of funds to the Bureau of Indian Affairs and has been distributed to IEAs by competitive proposal submission. This has been an unsatisfactory method of distribution, but of little concern because of the limited funds available. The passage of PL 94-142 by Congress in November 1975, however, has placed a new emphasis on the manner in which the Bureau administers funds from this source.

PL 94-142 places mandatory compliance requirements on Local Education Agencies to service all handicapped individuals emphasizing an even greater need for Areas and LEAs to have knowledge of the specific level of funds which are available to them from all funding sources including Title VI-B/94-142.

FY'77 finds \$68,625 in services from this source.

Weaknesses

Line item appropriation must be made to the base program and earmarked for specific purposes in order that Title VI-B/94-142 can be truly supplemental.

It is recommended that the United States Office of Education cease allowing competitive approval of projects and insist that states and the BIA make distribution on the basis of identified need or on a per capita basis.

SPECIAL EDUCATION

Passage of PL 94-142, Education of all Handicapped Act, was indeed a necessity. States, in order to comply with this Congressional mandate can increase the tax base to provide funding for this purpose.

The Bureau of Indian Affairs has no such option. Presently, the Navajo Area funds special education from Titles I and IV-B. Current funding approximates \$1.2 million from Title I and \$68,625 from IV-B.

A study conducted in December 1974 (Sileo, Ramey) revealed:

Table I - Frequency of Students

(Column A) Indicates the estimated number of students presently enrolled in school who exhibit one or more of the exceptionalities enumerated below.

(Column B) Indicates the number of students residing in school attendance areas and not enrolled in school who exhibit one or more of the exceptionalities enumerated below.

(Column C) Indicates the number of students in school who are presently enrolled in special education services designed to meet their specific needs.

	<u>A</u>	<u>B</u>	<u>C</u>
1. Deaf	<u>10</u>	<u>63</u>	<u>9</u>
2. Hard of Hearing	<u>413</u>	<u>161</u>	<u>36</u>
3. Blind	<u>1</u>	<u>23</u>	<u>1</u>
4. Partially Sighted	<u>347</u>	<u>95</u>	<u>12</u>
5. Crippled or Orthopedically Handicapped	<u>93</u>	<u>107</u>	<u>19</u>

	<u>A</u>	<u>B</u>	<u>C</u>
6. Special Health Problems	<u>198</u>	<u>176</u>	<u>47</u>
7. Educable Mentally Handicapped	<u>253</u>	<u>160</u>	<u>171</u>
8. Trainable Mentally Handicapped	<u>50</u>	<u>217</u>	<u>26</u>
9. Emotionally Disturbed	<u>181</u>	<u>87</u>	<u>89</u>
10. Socially Maladjusted	<u>339</u>	<u>159</u>	<u>108</u>
11. Gifted	<u>241</u>	<u>108</u>	<u>7</u>
12. Slow Learner	<u>1,449</u>	<u>812</u>	<u>777</u>
13. Aphasia and Other Communication Disorders	<u>49</u>	<u>49</u>	<u>7</u>
14. Culturally and Educationally Disadvantaged	<u>8,065</u>	<u>2,947</u>	<u>3,105</u>
15. Specific Learning Disability	<u>897</u>	<u>717</u>	<u>423</u>
Totals:	<u>12,586</u>	<u>5,881</u>	<u>4,337</u>

From this, it is apparent that 13,810 children are suspected as needing special help and for whom no program currently exists.

National data reveal the population to exhibit the following exceptionalities:

	<u>Percentage</u>
1. Deaf)	<u>.075</u>
2. Hard of Hearing)	<u>6.5</u>
3. Blind)	<u>_____</u>
4. Partially Sighted)	<u>.1</u>
5. Crippled or Orthopedically Handicapped)	<u>1.5</u>
6. Special Health Problems)	<u>_____</u>

7. Educable Mentally Handicapped)	<u>2.3</u>
8. Trainable Mentally Handicapped)	_____
9. Emotionally Disturbed	<u>2.0</u>
10. Aphasia and Other Communication Disorders	<u>3.5</u>
11. Specific Learning Disability	<u>3.0</u>
12. Multi-handicapped	<u>.06</u>

The Navajo Otitis* media project revealed children as having up to twelve (12) times the national incidence of diseases of the ear.

Applying national data to the school-age population for whom the Navajo Area of the Bureau of Indian Affairs has responsibility, the following is realized:

Number needing service
(based on population of 58,696)

1. Deaf)	<u>3,375</u>
2. Hard of Hearing)	_____
3. Blind)	_____
4. Partially Sighted)	<u>587</u>
5. Crippled or Orthopedically Handicapped)	_____
6. Special Health Problems)	_____
7. Educable Mentally Handicapped)	<u>1,350</u>
8. Trainable Mentally Handicapped)	_____
9. Emotionally Disturbed	<u>1,174</u>
10. Aphasia and Other Communication Disorders	<u>2,054</u>
11. Specific Learning Disability	<u>1,761</u>
	<u>11,182</u>

*Navajo Otitis Media Project, Indian Health Service, Gallup Indian Medical Center, Gallup, New Mexico, 1975

Revealed in the above references study was a grave need for training of professional personnel relative to (1) general information relative to each discipline.

The types of special education programs now (school year 1976/77) serving special education students are shown in Table 4 by Agencies of the Navajo Area. Forty-five schools reported; but some schools failed to report on individual items in this section. Other schools have more than one type of special education program in operation now.

Table 4
December 1976

Agency	Number Schools	Resource Room (1)	Speech Therapy (2)	Self-contained Room (3)	Emotionally Disturbed (4)	Gifted (5)	Other (6)
Chinle	7	4	-	2	1	-	2
Eastern Navajo	16	8	-	1	-	1	6
Ft. Defiance	4	4	-	1	-	-	-
Shiprock	9	3	1	1	-	-	2
Western Navajo	9	3	2	3	-	-	4
Total	45	22	3	8	1	1	14

The number of exceptional children now being served by special education programs is shown by Agency and category in Table 5. The number of schools in the Agency reporting under this category is shown under N column.

Table 5
December 1976

Agency	N	Hard of Hearing	Retarded	Speech Difficulties	Vision Difficulties	Gifted	Emotionally Disturbed	Crippled	Learning Disabled	TOTAL
	(1)	(2)	(3)	(4)	(5)	(6)	(7)	(8)		
Chinle	4	-	15	-	387	-	-	-	31	433
Eastern Navajo	14	30	42	14	331	76	3	13	123	632
Ft. Defiance	3	23	31	5	44	2	4	5	268	382
Shiprock	5	2	23	18	10	5	19	1	87	165
Western Navajo	7	2	27	32	17	1	25	5	530	639
Total	33	57	138	69	789	84	51	24	1,039	2,251

In response to the educational level of children being served through special education programs, approximately one-half of the reporting schools supplied the number of students along with the grade level. The other one-half supplied only the grade levels taught in the particular school. The following gives a summary of the number of schools by grade levels in all 55 Navajo BIA reservation schools. It should be noted that a majority of these schools also have ungraded or special programs. The number of schools with these programs are shown by the letter S in the Table 6.

Table 6

<u>Grade Levels</u>	<u>No. of Schools</u>
K -S	1
K-1	1
K-3	3
K-3-S	11
K-4-S	3
K-5-S	4
K-6	2
K-6-S	4
K-7	2
K-8	2
K-8-S	9
1-2-S	2
1-5	1
1-5-S	1
1-8-S	6
7-9	1
9-12	2
	<u>55</u>

A further breakdown of the number of schools serving students in each grade category is shown in Table 7.

Table 7

<u>Grade Categories</u>	<u>No. of Schools</u>
Kindergartens	42
Grade 1	51
2	49
3	47
4	34
5	31
6	23
7	20
8	18
9-12	2
Special or Ungraded	40

Based on the survey answers provided, 49 separate special education programs are now being provided Navajo students in the 45 schools reporting. It is estimated that the non-reporting schools have an additional 4 programs or computed total of 53 special education programs in the Navajo Area Bureau school system. It should be kept in mind that some schools have more than one program while others have none.

Funding Sources for Special Education

In the Navajo Area, special education projects are funded almost exclusively from Title I funds. Only two projects are funded from special education funds provided through Title VI ESEA and two other projects through Title IV. Regular school support funds account for some other projects. Table 8 reflects the Title I funded special projects along with the grade span of students being served as funds were programmed. The contract schools* at Rough Rock and Rock Point are included in the table.

Table 8

<u>Agency</u>	<u>School</u>	<u>Title</u>	<u>Amount</u>	<u>Grade Span</u>	<u>No. of Target Children</u>
Chinle	Low Mountain	I	\$ 23,332	1-3	15
	Pinon	I	23,524	1-4	15
	Cottonwood	I	16,908	1-7	16
	*Rock Point	I	9,328	2-5	10
	*Rough Rock	I	21,224	K-5	55
			\$ 94,316	K-7	111
Eastern Navajo	Mariano Lake	I	\$ 16,821	K-3	18
	Crownpoint	I	68,122	Ung	23
	Wingate High	I	32,840	9-12	48
	Dzilth-na-o-dith-hle	I	17,775	K-6	21
			\$ 135,558	K-12	110
Ft. Defiance	Chuska	I	\$ 22,574	3-6	15
	Greasewood	I	43,302	K-8	80
	Tohatchi	I	19,252	1-5	25
	Toyel	I	16,376	1-8	55
			\$ 101,504	K-8	175

201

<u>Agency</u>	<u>School</u>	<u>Title</u>	<u>Amount</u>	<u>Grade Span</u>	<u>No. of Target Children</u>
Shiprock	Nenahnezad Sanostee	I	\$ 19,991	1-6	25
		I	44,195	1-4	39
			\$ 64,186	1-6	64
Western Navajo	Dennehotso	I	\$ 19,522	1-5	20
	Kaibeto	I	45,285	K-8	60
	Kayenta	I	23,812	2-5	15
	Leupp	I	50,508	Ung	15
	Red Lake	I	22,432	Ung	20
	Shonto	I	33,307	K-8	35
	Tuba City Boarding	I	88,978	K-8	57
			\$ 283,874	K-8	222

The Title IV projects are:

Chuska/Tohatchi (for gifted children) \$ 29,000 (30 students)

Area-wide (diagnostic and pre-
scriptive service) 10,659 (50 students)
80 students

The Title VI projects are:

Area-wide (trainable and
mentally handicapped) \$ 61,700 (16 students)

Chuska (speech therapy),
program pending 29,797 (70 students)
86 students

Another Title I project is being funded to a contract unit at the Chuska School in the amount of \$30,000 involving 50 mentally and physically handicapped children.

Also, an additional Title IV-C project (search and find the severely retarded and physically handicapped children) has been approved as an area-wide project in the amount of \$50,000.

Special Education Staff

Of the 45 schools reporting the number of special education teachers and teacher aides (paraprofessionals) now employed is shown in Table 9 by agencies.

Table 9

<u>Agency</u>	<u>N-Teachers</u>	<u>N-Aides</u>
Chinle	2	3
Eastern Navajo	9	13
Ft. Defiance	3	3
Shiprock	4	5
Western Navajo	<u>10</u>	<u>13</u>
	28	37

Vacant positions were reported by three schools. There are obviously others based on the comments forwarded with questionnaires from individual schools.

203

Comments

The comments made by school personnel are paraphrased in the following:

Chinle Agency

- (Cottonwood) Other means learning disabilities;
- (Low Mountain) Other means learning disabilities; Special Education teacher position vacant; aide not appointed until teacher arrives;
- (Pinon) Resource room for learning disabled; 15 students not being served; request in for teacher;

Eastern Agency

- (Bread Springs) No funds, space or personnel for special education programs; Teachers handle best they know how;
- (Chi-Chil-Tah) Still waiting for building set up for resource room;
- (Crownpoint) Other is an opportunity program;
- (Dlo-ay-azhi) Other is regular program;
- (Mariano Lake) No teacher with aide operating; Other means learning disabilities; and teacher requested in March, 1976;
- (Wingate Elementary) Other is mainstream program; no additional funds used for Special Education; all students in school have special education needs because of lack of ability to communicate fully in English;
- (Wingate High) There are 244 students out of school for unknown reasons;
- (Canoncito) Any child who is suspected of exceptional learning problem should be brought to this school's attention; action would be taken to supply need; so far, only one sent to Aneth;
- (Lake Valley) Other means Remedial Reading Lab (Learning Disabilities); one student sent to "school for me" at Chuska;

- (Ojo Encino) Assessment still in progress by USPHS;
- (Pueblo Pintado) Assessment still in progress by USPHS;

Ft. Defiance

- (Kinlichee) Learning disabled is duplicated count; PHS gathering information on out of school;
- (Toyei) Will have resource room if teacher can be found;

Shiprock

- (Aneth) Special Education room changed to prevocational;
- (Cove) Some parents refusing special education services for children;
- (Nenahnezad) Some students fit in more than one category;
- (Sanostee) Other is Learning Disabilities - 2 classrooms;
- (Shiprock) Other is Trainable Mentally Handicapped;
- (Teecnospos) Teacher position not filled;
- (Toadlena) We have no special education program; 4 or 5 slowest children that we now have are mainstreamed through regular classroom instruction and two of them go to a resource room for one hour per day for language arts;

Western Navajo

- (Chilchinbeto) Other is Title I, Language Arts, Reading;

- (Kaibeto) Other is Special Reading)
- (Kayenta) Self contained room for Language Arts; Reading and Math; Other is Learning Disabled; Other is also Title III - \$6,823; Library IV - \$2,333, Dropout Prevention - \$1,000;
- (Leupp) Self contained room for Mentally Retarded; Other is Reading; One vacancy for Special Education teacher;
- (Navajo Mountain) Gifted served by regular program;
- (Rocky Ridge) Funding - 3100 (regular school funds) - the amount unknown at this date;
- (Tuba City Boarding Elementary) Self contained room for Educationally Handicapped, Emotionally Disturbed (combination);
- (Tuba City High School) Learning disabled includes Language, Culture difficulties and Reading Handicaps; Gifted program scheduled to start 2nd semester (January, 1977) through Public School.

Table 10

Number of known exceptional students (in all categories) for whom no special education program has been implemented. Very few schools would hazard a guess on this question. Principals were asked to project the number both IN or OUT of school. Responses are shown in the table. N is for the number of schools in the agency that reported.

<u>Agency</u>	<u>N</u>	<u>In School</u>	<u>Out of School</u>
Chinle	2	60	-
Eastern Navajo	6	755*	67
Ft. Defiance	3	87	47
Shiprock	3	65	5
Western Navajo	5	480**	93
	19	1,447	212

*650 of this number reported by Wingate Elementary.

**420 of this number reported by Tuba City High.

Similarly, the number of students suspected as having a handicap (and are not being served) was requested. Again, very few schools would hazard a guess. Responses are shown in Table 11. Failure to respond again points out the severe need for child-find activities and adequate diagnostic and prescriptive services.

Table 11

<u>Agency</u>	<u>N</u>	<u>In School</u>	<u>Out of School</u>
Chinle	2	62	27
Eastern Navajo	6	60	33
Ft. Defiance		162	100
Shiprock	3	33	19
Western Navajo	5	96	77
	19	413	256

Problems Relative to Special Education

No line item is included in the base appropriation for the Bureau of Indian Affairs budget.

Children in many, if not most, instances have not been identified.

Identified children have, in most cases not been properly diagnosed nor have prescriptions been prepared reflecting individual education plans.

Budget for Adequate Program

Search and Find - 2 years	estimate 1,000,000
Diagnoses and prescriptions - 2 years	2,000,000
Renovation of facilities (ramps, handrails, etc.)	estimate 3,000,000
Living quarters, professional (80%) 320 units @ 45,000	11,520,000
Living quarters, paraprofessional (40%) 268 units @ 45,000	12,060,000
Training of all staff	350,000

PersonnelTMB

N=Estimate 675

Academic 1:10 professional - 68	958,596
1:10 paraprofessional - 68	565,488
Homeliving 4:10 paraprofessional - 272	2,261,952
Sheltered Workshop:	
1:100 administrator - 7	119,392
5:100 vocational/workshop professionals - 34	479,298
1:100 diagnostician - 7	119,392

1:100 nurses - 7	17,056
20:100 homeliving paraprofessionals - 135	1,122,660
1:100 professional homeliving - 7	17,056
materials, supplies, equipment @ \$675 per capita	472,500

EMH (resource concept)

N=Est. 675

Academic 1:15 professional - 45	634,365
1:15 paraprofessional - 45	374,220
Homeliving 1:30 paraprofessional - 23	213,969
materials, supplies, equipment @ \$500 per capita	337,500

Hard of Hearing (resource concept)

N=3,375

materials, supplies, equipment @ \$300 per capita	1,012,500
--	-----------

Partially Sighted (resource concept)

N=587

materials, supplies, equipment @ \$300 per capita	176,100
--	---------

Orthopedically Handicapped (resource concept)

N=881

materials, supplies, equipment estimated at \$250 per capita	220,250
---	---------

Itinerate Therapist 1:100 - 9

153,504

Speech Impaired

N=2,054

1:70 therapist - 29

494,624

materials, supplies, equipment @ \$100 per capita	205,400
--	---------

205,400

Specific Learning Disabled (resource concept)

N=1,761

1:70 professional - 25	352,425
2:70 paraprofessional - 50	415,800
materials, supplies, equipment @ \$300 per capita	528,300

Emotionally Disturbed (self-contained/resource)

N=1,174

1:15 professional - 78	1,099,566
1:15 paraprofessional - 78	648,648
1:60 psychological - 20	176,100
materials, supplies, equipment @ \$150 per capita	176,100
	<hr/> \$43,106,661

EARLY CHILDHOOD EDUCATION

Based on United States Census percentages Indian children age 0-1 constitute .070% of 5-18 population;

Age 1-2 constitute .065%
 2-3 constitute .066%
 3-4 constitute .066%
 4-5 constitute .070%

Using U. S. Census percentages, the computed number of Navajo children by age groups would be:

0-1 yr.	(.070% of 58,696)	-	4,108
1-2	(.065%)	-	3,815
2-3	(.066%)	-	3,873
3-4	(.066%)	-	3,873
4-5	(.070%)	-	4,108
Total (Ages 0-5)			19,777

Realizing the fact that children acquire one-half of all they will ever know by age four and realizing that parents are the most effective teachers (positive and negative), the importance of early childhood education is obvious.

If a comprehensive early childhood education program is to be implemented it is felt that the following options must be available:

School programs of young children and parents, a vital component of which must be parental education. Parents and young children would attend school on a day basis.

Cluster programs in which itinerate teachers work with parents and young children coming from homes located close together and/or in individual homes.

Community (Chapter) Centers which function as day-care opportunities which require the parent(s) to assist professionals for specific periods of time per day/week.

BUDGET

School Programs, Ages 3-5

1:20 professional - English, 394 @	5,554,218
1:20 professional - Navajo, 394 @	5,554,218
2:20 paraprofessional, 788 @	6,553,008
auditory, visual, kinesthetic	868,010
materials, supplies, equipment @ \$110	
per capita	
classroom facilities @ \$40,000	2,600,000
living quarters (professional 80%)	25,200,000
living quarters (paraprofessionals 40%)	12,600,000
transportation, 394 @	200,000

Cluster Programs, Ages 0-3 (one-half)

N=5,898

1:15 professional - Navajo, 393 @	5,540,121
auditory, visual, kinesthetic	648,780
materials, supplies, equipment @ \$110	
per capita	
transportation, 933 @ \$4,000	1,572,000

Community (Chapter) Centers, Ages 0-3 (one-half)

N=5,898

1:20 professional - English, 295@	4,158,615
1:20 professional - Navajo, 295 @	4,158,615
1:20 paraprofessional, 295@	2,453,220
auditory, visual, kinesthetic	648,780
materials, supplies, equipment @ 110	
per capita	
living quarters (professional 80%)	18,880,000
transportation, 295 @ \$4,000 per center	1,180,000
	<u>\$98,369,585</u>

TITLE VII ESEA
BILINGUAL EDUCATION

Projects under this Title are funded by the United States Office of Education on a competitive basis. Total funding received for FY'77 is \$265,148.

It should be noted that 84% of Navajo children meet the criteria for eligibility for funding with approximately 8% actually receiving services.

Weaknesses

Competitive project approval should be eliminated with per capita being used.

Introduction

The Congress, in amending the Elementary and Secondary Education Act through P.L. 93-380, mandated an assessment of the bilingual education needs of Indian children enrolled in schools operated or funded by the Department of the Interior. The study that followed showed that 84% of all Navajo children in the Area schools were in need of bilingual education under the definition of need given in the law.

An Indian child with a bilingual education need is a child with limited English speaking ability who comes from a home where the Indian (or Native) language is the dominant language spoken.

In effect, the bilingual section of this study begins where the national study ended. The local dimensions to this (and the other needs assessments included) are explored. What methods or models are being used locally to implement bilingual education, assuming funds, staff and space are available? These are typical of the questions to which the study is addressed. The assumption is made that the school boards are best in position to speak for parents.

Space requirements are especially acute if special education and early childhood education needs of Navajo children are going to be met. Special focus is given to this area of the survey.

Survey Objectives

The objectives of the survey were:

- (1) To ascertain bilingual education models presently being followed in the schools;
- (2) To ascertain the model schools would prefer to follow given funds and staff to implement;
- (3) To secure a signed commitment of the kind of bilingual education program, if any, the school board would prefer.

Survey Design and Contacts

The primary approach involved meeting each school principal in person and providing same with an easy-to-complete questionnaire. Each principal was met on the occasion of the regular principals' meetings at each of the five Agencies in the Navajo Area. Follow-up telephone contacts were made to the principals who were late in responding or who had questions about the survey.

The contract schools at Rough Rock, Rock Point and Borrego Pass were forwarded questionnaires with the request that they participate.

Space requirement data was developed with the School Principals in a single meeting in Gallup, January 6, 1977.

The needs assessments are reported separately by the five agencies with summary totals following.

Responses to Questionnaire

The overall number of schools responding to the questionnaire was very good. Out of the 55 BIA operated schools, 45 responded (or 82%). Some questionnaires were not fully completed. Some schools confused the survey with an earlier tabulation made by the Navajo Area of the number of bilingual children that could be counted for ESEA Title VII purposes. None of the three Tribal contract schools (Borrego Pass, Rock Rock, and Rock Point) responded. The Federal dormitories were not included in the study as the children all attend the public schools where the dormitories are located.

The number of schools responding to the questionnaire is shown as follows by each Agency in the Navajo Area.

Agency	No. of Schools	Number Responding
Chinle	7	7
Eastern	17	16
Ft. Defiance	11	4
Shiprock	9	9
Tuba City	11	9
Total	55	45

BILINGUAL EDUCATION

The models used in this survey were developed by Navajo Area personnel as best representing the various approaches that might be used in a bilingual education program. The models can be described briefly as follows (fuller explanation of models is given in the Appendix):

- Models:
- (1) Uses both oral Navajo and oral English in grades K-6 presented by teachers and aides.
 - (1a) Uses Navajo until competency in English is achieved.
 - (2) Uses Navajo and English to teach skills of literacy in both languages.
 - (3) Uses Navajo to obtain literacy in Navajo, then changes to English in order to obtain coordinate bilingualism.
 - (4) Emphasizes Navajo during the first year with English being introduced more each year until the two languages receive approximately equal emphasis.

Survey Findings

Table 1 depicts the bilingual education models now being followed in the Navajo Area Schools responding to the survey questionnaire. The "did not respond" column in the table refers only to the number of schools that did not respond to the particular question. The "none" column means that none of the models shown are being followed.

Table 1

Agency-Total	No. of Schools	MODELS						Did Not Respond
		1	1a	2	3	4	None	
Chinle	7	6	1					
Eastern	16	13		1			1	1
Ft. Defiance	4	4						
Shiprock	9	5	1		1		1	1
Tuba City	9	9						
TOTAL	45	37	2	1	1		2	2

The bilingual education model that the schools would prefer to follow if given the funds and staff to implement is shown in Table 2. Again, 6 of the schools did not respond to the question. Based on their comments, these schools are undecided as to which model, if any, they would prefer. It is noted that 5 schools do not desire to follow any of the models shown.

Table 2

Agency-Total	No. of Schools	MODELS						Did Not Respond
		1	1a	2	3	4	None	
Chinle	7	3	1	1		2		
Eastern	16	7		5	1		1	2
Ft. Defiance	4			1		1	2	
Shiprock	9	3	3				1	2
Tuba City	9	3				3	1	2
TOTAL	45	16	4	7	1	6	5	6

In Table 3, the requests of the school boards are tabulated in terms of the models proposed by the Navajo Area for bilingual education. The school boards were given the opportunity also to check and sign the statement, "The School Board does not want bilingual education". Five of the school boards checked "none" of the models desired. Three of these schools (Pinon, Crownpoint and Beclabito) indicated that no bilingual is wanted at their school. The two other schools (Wingate Elementary and Wingate High) want only a modified program (to use teacher aides for concept explanation when needed).

The school boards at 5 other schools are undecided as to what type of bilingual program is desired. They want to study the matter further before reaching a decision.

Table 3

Agency-Total	No. of Schools	MODELS					None Desired	Undecided
		1	1a	2	3	4		
Chinle	7	2		2		1	1	1
Eastern	16	9		2		2	3	1
Ft. Defiance	4		1	2				1
Shiprock	9	1	2	1		2	1	1
Tuba City	9	5		2		1		1
TOTAL	45	17	3	9		6	5	5

BILINGUAL EDUCATION

In Navajo education, bilingual education will be defined as providing classroom instruction in two languages: 1) Navajo which is the learner's first or home language, and 2) English which is the learner's second or school language. Implicit in this definition is an appreciation for and, where possible, incorporation of the cultural heritage of the learners in the instructional program.

Several bilingual models, with variations of each one, are possible for implementation in Navajo Area schools. Four major models with variations are discussed in this document.

Model 1

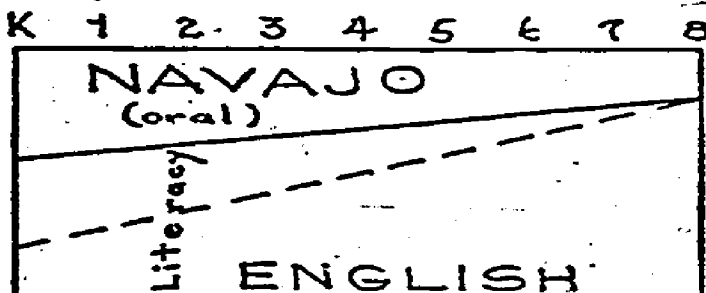

This model is the one most frequently found in BIA schools today. Navajo is used as a medium of instruction at the kindergarten level along with English. The amount of Navajo used is determined by whether a Navajo-speaking person is in the classroom—a teacher, a training instructor, an education aide, and/or a bus driver. The amount of English used for instruction is increased each year as the learner progresses through school. In the elementary years (K-6), over ninety percent (+90%) of the classes have the services of a bilingual teacher and/or aide; however, in the middle grades (4-6) in departmentalized schools and upper levels (7-12), many classes do not have either one. The amount of Navajo used for teaching is, therefore, contingent upon the availability of a bilingual person.

In this model, Navajo instruction is only oral. There is no attempt made to teach the learners to read and write Navajo. Literacy in English is started at the second to third year in school when the teacher feels the child is ready to read, both experientially and linguistically.

Model 1-A

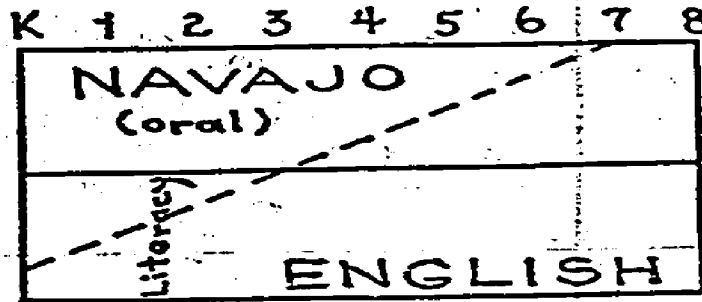

This model shows two major variations of Model 1. Both languages are used for instruction with literacy only occurring in English.

The solid black line illustrates a maintenance bilingual program which aims at orally reinforcing and maintaining both languages, even after the learner has gained proficiency in English.

The disconnected line illustrates a transitional bilingual program which uses Navajo as the medium of instruction until competency is achieved in English at which time there is a transition to instruction entirely in the second language.

Model 2

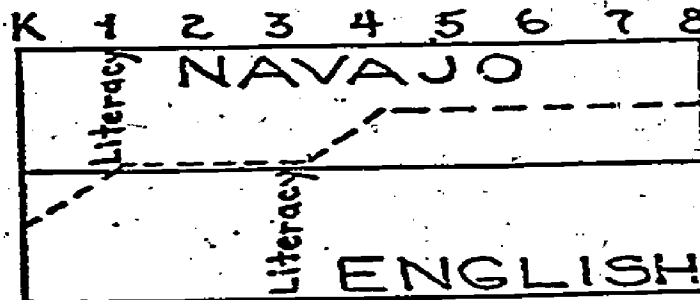

This model is one of the most popular models found in the world today. It is a maintenance bilingual program which teaches the skills of literacy in both languages.

Navajo, along with English, is used as a medium of instruction from the first year in school. Although the learner's first language may be used more initially, in the middle grades instruction may be greater in the second language. Literacy is first acquired in Navajo during the second year while reading and writing in English is introduced around the third or fourth year.

Programs designed after this model have as a goal "coordinate bilingualism". Instruction is provided in both languages without mixing the two or using the translation process. The objective is to help the learner become equally proficient in both languages, being equipped to think independently in Navajo and English without the need for translation. The learner, as he develops competency in both languages, ultimately acquires the ability of "code-switching", that is switching from one language to the other at will in accordance with appropriate contexts. This person is known as an "integrated" bilingual.

The disconnected line illustrates the bilingual program found at Rock Point Community School. Instruction in the first year is about two-thirds Navajo. During the remaining years at the primary level, instruction in both languages is about equal. In the middle and upper grades, instruction in English increases to about three-fourths of the academic day. The goal at Rock Point is to help the learners become coordinate bilinguals with equal competency and independent thinking skills in both languages.

Model 3

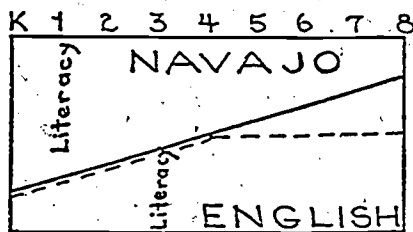

This model is related to the preceding one in that literacy is acquired in Navajo first and then in English, one to three years later. It is usually a maintenance program with the aim of coordinate bilingualism. It may be a transitional model if the use of the first language is eventually phased out.

The solid black line illustrates a maintenance program which begins in the first year with most of the instruction in Navajo. English is introduced that year more like a foreign language than a second language. In each succeeding year, English is increased and Navajo decreased for instructional purposes until at the end of elementary school, the majority of instruction is in English.

This model is the basic design for the bilingual-bicultural programs at Sanostee and Toadlena schools in the Shiprock Agency and at Rough Rock Demonstration School. According to the disconnected line, instruction in Navajo is emphasized (80-90% instructional time) during the first year with the use of English increasing each year at the primary level. From about the third grade (fourth year) on, instruction in both languages receives equal instructional time or English receives more emphasis than Navajo.

Model 4

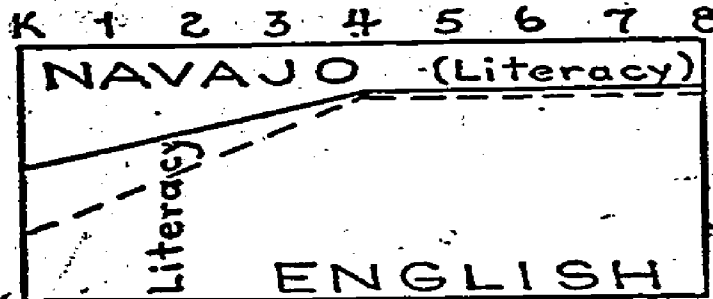

This model is one which has been proposed as a viable, realistic model for Navajo Area schools. It is a maintenance program which suggests that the skills of literacy be taught first in English, but only when the learner is ready experientially and linguistically.

The solid and disconnected lines illustrate that instruction in the first year be 50-75% in Navajo with English instruction being increased throughout the primary level at a rapid rate. Throughout the middle and upper grades, Navajo is maintained orally through Navajo studies and language instruction.

This model also suggests that literacy skills in Navajo may be taught in the middle and upper levels (4-8). It is felt that students at these levels would find the task of reading and writing their native language both motivating and challenging.

BUDGET

Bilingual paraprofessionals, 520 classrooms	4,324,320
Bilingual literacy professionals, 48 classrooms	676,656
Regional (5) materials development centers @ \$200,000	1,000,000
Quarters, paraprofessionals @ 40%	8,320,000
Quarters, professional @ 80%	1,520,000
	<u>\$15,840,976</u>

Contract Schools in Arizona.

The Navajo Area, Bureau of Indian Affairs, has contracts with Rock Point Community School and the Rough Rock School Board, Inc., to provide educational services to Indian children in their respective areas.

These contracts have three funding sources: Education, Facility Management and Contract Support.

<u>Rock Point</u>		<u>Rough Rock</u>
\$149,133.00	Contract Support	\$ 326,050.00
616,550.00	Education	1,070,700.00
<u>50,318.00</u>	Facility Management.	<u>136,894.00</u>
\$816,001.00	TOTAL	\$1,533,644.00
<u>14,793.00</u>	Modifications	<u>54,000.00</u>
\$830,794.00	Present Total as of	\$1,587,644.00
	01/28/77	

Both of these schools receive funds under other JOM Title programs but this information is not available in this office.

The enrollments are: Rock Point - 340, kindergarten through grade 7; Rough Rock - 443, kindergarten through high school.

There have been four major problems this school year: (1) The evaluation contract has not been finalized for the evaluation of these programs, (2) Rock Point Contract Support. It was late December before the indirect cost agreement was finalized. This has caused some delay because all invoices have to be resubmitted to agree with the new budget. (3) Rock Point has been experiencing problems with the three-day "turn-around" time and Letter of Credit Drawdowns.

(4) The Industrial Arts Program at Rough Rock has been experiencing problems because of the crowded conditions. Although there has been no accidents, the safety officer believes this crowded space has the potential for a serious fire.

Facility Management and the Contracting Office are trying to locate a metal building to relieve this situation. The school is rescheduling classes to separate woodworking and welding.

In spite of these problems, the Area Office has established a good rapport with these schools and their controlling boards; with this climate of cooperation, we are looking forward to a successful year.

JOM.

Prior to the enactment of Public Law 93-638, the Navajo Area Office contracted directly with the states, districts and Indian corporations for Johnson O'Malley services to eligible Indian students. On January 30, 1976, the Area Office received a letter from the Navajo Tribe expressing their intent to contract to administer the total JO'M program for the Navajo Area. The Navajo Tribe's Division of Education obtained a tribal resolution on June 2, 1976 and a contract was negotiated, with an effective date of August 1, 1976. Since that time the Area's involvement in the JO'M program has changed substantially. The Area is now concerned primarily with technical assistance, training, monitoring, and evaluations through the contracting officer's representative's responsibilities. Incidental duties include enrollment verification and equipment inventory. Copies of the compliance reports and enrollment data are attached.

Now that we have worked under PL 93-632 for a year, we have found three areas that need clarification or revision. These problem areas include:

(1) Difficulties in Tribal contracting for JO'M administration. To contract for this administration, the regulations require that a tribal organization comply with all the requirements in Part 273 and Part 271. This imposes an added burden on tribal organizations that is not imposed on states, school districts or Indian corporations. This Area recommends that tribes be allowed to contract for JO'M administration (a Bureau program) under Part 271 and to subcontract with states, school districts and Indian corporations under Part 273.

(2) Administration funds. All JO'M monies are program funds; they are allocated on a per capita basis and intended to provide services to students at the local level. Local Indian Education Committees have the final say on how this money will be spent. To obtain funds for administration, tribal organizations must appeal to the local Indian Education Committees; this puts the administrators in the unenviable position of "taking money from our children". There really should be a better way to fund tribal administration of JO'M programs.

This Area recommends that the possibility of setting aside administrative funds be investigated.

(3) Distribution formula. This Area recommends a straight per capita allocation formula be used to distribute JO'M funds to eligible Indian students. A copy of the Area's letter on the formula is attached.

THE NAVAJO AREA FOOD SERVICE PROGRAM

1. **PURPOSE:** The centralized feeding program was established to: provide better nutritionally balanced meals and to take advantage of lower costs due to the consolidation of all purchases at one location.
2. **HISTORY:** The food program was begun in the former Gallup Area in 1956 for the school year 1956-57.

Formerly all menus were made by the kitchen personnel and forwarded to Agency Education Specialists for review and approval. The menus were generally changed at the school to take advantage of food on hand and did not always meet all nutritional standards and dietary requirements.

Many schools operated dairy farms and planted large gardens. During the summer, school personnel spent much of their time canning food for winter use. Many schools would have a large stock of certain items while other schools were overstocked with other items.

The Navajo Area Food Service Staff presently consists of John G. Orr, Area Food Service Officer, and two Education Specialists, Carmen R. Burch, and Barbara A. Roberts, and one vacancy. Gladys C. Tisi, is the Secretary-Typist.

3. OPERATION OF THE PRESENT FOOD SERVICE PROGRAM:

- A. **Master Menu:** A master menu is prepared for each type of school as follows:
 1. Boarding School.
 2. Day School Students at Boarding School.
 3. Dormitory.
 4. Day School with Full Breakfast.
 5. Day School Without Snacks.
 6. High School.

These menus are made for a four week period and are repeated nine times during the school year of thirty-six weeks. Allowances indicated are for 100 students for each menu.

The menus are prepared by the three Education Specialists, Home Economics, in the Navajo Area Office. In addition, cooks and students from various schools on the Navajo, have offered suggestions for changes in the menus.

Careful attention is paid to the basic four Food Groups which are as follows: Milk Group; Meat Group; Vegetable-Fruit Group; and the Bread-Cereal Group. Special attention is given to nutritional requirements; color; texture; flavor; and student preference. If the menus were checked for calories the Boarding School menu would be about 26-2700 calories per day.

Recipes used are taken from: Training Manual United States Army TM-10-412; United States Air Force 146-3 and Quantity Recipe file Quantity Recipes for Type A School Lunches, United States Department of Agriculture.

4. When new items are added to these menus the nutritive value of that item is checked against Menu Planning Guide for Type A School Lunch Program, Department of Agriculture.
5. The completed menus are checked against the Daily Dietary Allowances, Food Nutritional Board National Academy of Sciences National Research Council.
6. A recapitulation sheet is made for each menu which indicate quantities of food needed each day, each week, and total requirement, for four weeks.

In addition each school is allowed food for two parties per month and are given cookies, cake, and punch. These items are issued to the school one month in advance. Schools are also authorized 5-pounds of pop corn per month for each 100 students.

- B. The surplus commodity program of the Department of Agriculture, Dallas, Texas has been of considerable assistance in serving a more nutritious menu since the following items are furnished free. The following list varies from time to time but the items marked with an * have been available for most of the years of this program.

Ground Beef, Butter*, Lard or Lard Substitute*, Peanut Butter*, Flour*, Cornmeal*, Rice*, Powdered Milk*, Rolled Wheat*, Bulger*, Rolled Oats*, Pinto Beans*.

The total value for the above items has varied from \$150,000 to \$325,000 per annum depending upon the quantity and the items available.

- C. Milk Subsidy Program: The Navajo Area Food Service Program has been very fortunate in receiving 5½ cents for each half pint of fresh whole milk served from the Milk Subsidy Program, Department of Agriculture.
- D. Funds: The Navajo Area Food Service Program is funded from Education Funds. Approximately \$1.48 per student per day or \$370 annually for Boarding School Students and \$1.52 per student per day for High School Students, \$380. \$1.15 cents per student per day or \$207 per annum for Day School Students. The amount received is based on the authorized enrollment as established by the Assistant Area Director (Education), of each of the Areas served by the food program.

The funds allocated are used for the cost of the Food Service Office, Gallup Supply Center, cost of freight for shipping of food to the school and the cost of food purchased for the program. The cost of food preparation and kitchen facilities are not paid out of food service funds.

The overhead cost for school year 1975-76 will be about 10-¹/₂%. Funds available to the food program will be approximately \$6,500,000. Cost of Bread, Milk and Ice Cream for the year will be approximately \$1,443,615. Over 1¹/₂ million pounds of beef are purchased annually by Procurement Section, Branch of Property and Supply.

The estimated authorized enrollment for school year 1976-77 for all schools will be in excess of 22,000 students including Hopi, Albuquerque, and Contract feeding.

Many workshops are also served such as Teacher Orientation, Summer Schools, and Community Development Seminars. No additional funds are made for programs.

- E. **Training:** Training of school kitchen personnel is the most important function secondary only to making of good, well balanced, nutritional menus. This Branch has been fortunate in obtaining resource people for workshops. Assistance has been obtained from United States Public Health Service, New Mexico State Sanitation, National Dairy Council, National Wheat Board, Extension Service of State Universities at New Mexico, Colorado, Utah, and Arizona, United States Department of Agriculture, Dallas, Texas, Nation Livestock Meat Board as well as Bureau of Indian Affairs Personnel.
1. The Branch of Food Service publishes a food service pamphlet: "Food Topics" by which information and assistance is furnished to all locations under the Food Service Program and each area in the Bureau of Indian Affairs. This information is also distributed, on request, to other Government Agencies.
 2. Food Service training is accomplished by workshops. Training is given in all phases of the food service operation as well as menu preparation. The workshops have resulted in considerable improvement in these operations. It is very important for all food service personnel to not only understand the "how" of accomplishing their jobs but also the "why".
 - (a) Sanitarians from Environmental Health, United States Public Health Service at Albuquerque and Window Rock have been outstanding in their assistance and the result has been a considerable improvement in sanitation in school kitchens. However, sanitation is a continuing problem and must be checked at all times. Each time the workshops have been held, the attendance was more than anticipated. The support given by resource personnel has been outstanding.
 - (b) Area Food Service workshops were started in 1956. Except on a very few occasions they are held annually.
- F. Staff visits are made to each school for the purpose of assisting in the Food Service Program which includes, Food Storage, Food preparation, serving, safety, and sanitation.

1. Food Service Check List: A food service check list was devised as the result of many school visits, study of the staff visits reports and a review of sanitation reports by sanitarians from United States Public Health Service on visits to the schools.

C. Instructional Dining Room: Most of the schools have an additional dining room referred to as the instructional dining room. This room is of sufficient size for one or two classrooms of thirty each. The students with the teacher's guidance are responsible for the setting of the tables with napkins, silverware, table cloth and centerpieces. The teacher and the students eat the meal family style and the students are permitted to invite an additional guest.

The goals of the Food Service Branch are as follows:

1. Provide up to date training in food preparation for food service personnel.
2. To serve nutritious and well balanced meals to Indian children, including some of their native foods.
3. To introduce new food items to Indian children attending Bureau of Indian Affairs schools.

Special Concerns.

Facility Management. We have been concerned for the past few years with the gradual deterioration of our school facilities. Our contacts with Facility Management indicate that the funding level is such that they cannot do the work necessary to keep up. In fact they state that their backlog of Repair and Maintenance projects has reached 40 million today and grows at a rate of six to seven million per year. In order to catch up they need 15 million additional funds for the next two years and then they could work on the ten million backlog.

In the area of Major Alterations and Improvements, they have a backlog of 68 million. These projects include streets, sidewalks, lighting, sewer ponds and OSHA projects. We are including with this statement (Exhibit) a copy of a letter written discussing the fact that very important project features were eliminated from the Grey Hills High School project. The elimination of the features contributed to the overall funding difficulties which Facility Management is experiencing.

Indian Preference. This writer has no problem with the Indian Preference in regard to hiring or promotions provided the applicant has the qualifications. However, management throughout the Bureau is having problems since non-Indians cannot be laterally transferred even when this would serve the best interests of the Government. Indian preference has made it impossible to reassign teachers or principals from one school to another. Positions must be advertised; then, if there are no Indian applicants, a reassignment

can be made. The Navajo Area needs the authority to make necessary reassignments in a timely manner.

Roads. Roads maintenance and additional funding for roads is a dire need on the Navajo Reservation. It is estimated that 2,500 miles of roads used daily as bus routes for BIA schools, ONEO Headstart, and public schools are non-system roads. When we use the term non-system roads, it means that these roads are not funded for maintenance. Since these roads are important to our educational program some funding should be made available on a year to year basis. A study by Earle V. Miller, Engineer, estimated that three million dollars would be needed annually for these roads.

In closing this report, I would again like to thank the Committee for this opportunity and to acknowledge the difficult problem you have in developing legislation that will assist our Indian citizens. This problem is more complex than most people imagine because the needs of each Reservation are similar but yet so different. The vast Navajo Reservation is a good example of this in that the Navajo child needs experiences of which they have been deprived because of isolation. The world of work, as the dominant society knows it, for the most part is unknown. This means that we have to stress vocational courses, where they learn a saleable skill or trade, in our schools and in this way we make education relevant.

To make education relevant to the Navajo, a program is needed which preserves his traditional values and thus his identity while providing him with the skills, knowledge and understanding necessary to cope with the complexities of a multicultural society. Furthermore, the Navajo must be educationally equipped in social and technical skills/ knowledge to make a practical contribution to society and thereby maintain a high standard of living for himself and his family.

**STATEMENT OF ERNEST MAGNUSON, NAVAHO AREA OFFICE,
SUPERVISORY EDUCATION SPECIALIST**

Mr. MAGNUSON. Thank you, Mr. Chairman, members of the committee. I also want to express my appreciation for the opportunity to be here, and I want to thank again, Mr. Lovesee, Mr. Bragg, and Miss Franklin. We were really impressed by the work that they did. They arrived with open minds, wanting only to learn, and Alan has the constitution of a horse. He was able to—

[Laughter.]

Mr. MAGNUSON [continuing]. Not only ride all of those rough roads and drink all of the different kinds of water, but spend nights in the dormitory with the kids. And we really appreciated that.

We felt that for the first time probably that things were going to happen, and I hope we can help things happen. I think it is very important that we assist you to see our problems and identify those problems out in the field, because there are hundreds of dedicated employees out there only waiting for the additional resources in order to do the best possible job on behalf of the students they serve.

Now, on the Navaho area, the area that Alan bounced across, it is a large area, 25,000 square miles. It is approximately 146,000 people who live there. We have a school-age population of 54,000, and we have separated that area into 5 agencies to better serve the Indian people.

I think we have to acknowledge the difficult problem that faces the committee in trying to develop legislation that will assist the Indian citizen. This problem is more complex than most people would imagine because the needs of each reservation, although similar, are so different.

Our Navaho Reservation is a good example of that, where the Navaho Tribe, because of isolation, needs a larger program, if you will, in order to become educated so that he can get along in the multicultural world in which he has to get along. And we have to make that education program relevant, and this is difficult because of isolation. So whatever we can do today to help you, we are grateful for that opportunity.

Thank you, Mr. Chairman.

Mr. BLOUIN. Thank you. Do any of the members have any clarification questions? Mr. Kildee?

Mr. KILDEE. For my own background, I am new on the committee, and I would like to ask you this. What is the philosophy and practice in your schools on the bilingual, bicultural aspects of Indian education? Do you have a stated philosophy, something that you have thought about? Is that carried out into practice?

Mr. MAGNUSON. On the Navaho, we have been very interested in this for a number of years. We have tried to get the resources together to have a bilingual, bicultural program for the first four grades. We have not been successful because we need additional training for our people and additional funding. The idea that, if you find a native teacher who speaks the language—that they can teach a bicultural, bilingual program, is not true. You have to have specific training. So this is something that is going to have to be developed. But we hope to do more in this area.

We have had for years in the lower grades both—If there is an anglo teacher or a native teacher, we have an aide who does speak and work

with the children in Navaho. But this is a program that we want to expand, sir. It is a good thing because it helps the children keep their identity and does wonders for their personalities.

Mr. KILDEE. In the State of Michigan, we have a bilingual program for anyone who has a bilingual blessing. Some look upon bilingualism as a problem. I think it is a blessing to be bilingual. But we have special dollars set aside for that and we appropriate that to school districts, mandating bilingual education for all school districts, whether it be Spanish or Arabic or various languages. And the State provides extra dollars for those bilingual programs to make sure—because there is extra cost and personnel cost and material cost.

Has the Federal Government, has the Congress, recognized the need for extra dollars to carry this out adequately, if they have done anything?

Mr. MAGNUSON. There is funding through title VII for this, but I am not sure it is adequate.

Mr. KILDEE. OK.

Mr. QUIE. Mr. Chairman. To get a little understanding on your position now, Mr. Holman, your superintendent is Dr. Allen's superintendent, but you have on-reservation schools rather than off-reservation schools, plural instead of singular as in the case of Dr. Allen; is that correct?

Mr. HOLMAN. That is correct. I administer 20 schools.

Mr. QUIE. Are you physically located at one of the schools or is there an administrative unit separate from all the schools?

Mr. HOLMAN. An administrative unit separate from the schools. It is located at an agency office, agency headquarters office.

Mr. QUIE. And you have an advisory committee?

Mr. HOLMAN. Yes, sir. We have an agency school board which oversees 20 schools, as well as each school having an advisory school board. From that body of 20 boards, there has been elected an agency board.

Mr. QUIE. So each of the individual local school boards elects a person to that agency board of just 20 members?

Mr. HOLMAN. That is correct.

Mr. QUIE. OK. And, Mr. Magnuson, you are the counterpart of Mr. Eagle Bull?

Mr. MAGNUSON. That position is vacant at this time. Assistant director for education is vacant. I have acted in it. My present capacity is that of supervisory education specialist. I am in the area office. I work with the five agencies in whichever way possible in order to help them with their education programs.

Mr. QUIE. OK. Now, when you deal with the Bureau, do you go through Mr. Magnuson for everything, or, under the new reorganization, do you as superintendent go directly to either Mr. Demmert or Mr. Wade without having to go through the area office?

Mr. HOLMAN. If I were going to be contacting Mr. Demmert, I would be going through the area office. Now, as far as the Indian Education Resources Center, I have direct contact with them.

Mr. BLOUIN. How long has that assistant directorship been vacant?

Mr. MAGNUSON. About 4 years, sir.

Mr. BLOUIN. About 4 years?

Mr. MAGNUSON. Yes, sir.

Mr. BLOUIN. No interest?

Mr. MAGNUSON. I think there is interest.

Mr. BLOUIN. What is the problem?

Mr. MAGNUSON. I don't know what the problem is. There has been no selection made as yet.

Mr. BLOUIN. Have there ever been requests from the local level that that slot be filled?

Mr. MAGNUSON. Yes; that job was advertised and there were a number of candidates. Unfortunately, at Navaho, we have not had an area director. We have had acting area directors for the past year. A new area director has just been appointed who will take office on Monday, Mr. Dodge. I am certain he will take the steps necessary to rectify that very soon. But it has been vacant for 4 years.

Mr. BLOUIN. In your opinion, where has the problem rested in terms of the 4-year vacancy? Who has the responsibility for filling that slot?

Mr. MAGNUSON. The area director.

Mr. BLOUIN. And the previous area director did not see fit to fill it for one reason or another?

Mr. MAGNUSON. Right. That is correct.

Mr. BLOUIN. Is that rather prevalent, to your knowledge, across the country?

Mr. MAGNUSON. I don't think so, sir.

Mr. BLOUIN. OK.

Mr. QUIE. Can we get a word from the Washington office? Can you tell us? I know you have been in your position for a short time as well. Could you cast any light on it?

Dr. DEMMERT. Let me just speculate a little bit without knowing the details of why the area director would not have hired that individual.

Mr. BLOUIN. Or any individual.

Dr. DEMMERT. In the first place, as it was pointed out, there have been acting area directors and they have not seen fit to address the political issue of who the assistant area director for education on the Navaho ought to be. I am speculating.

Mr. BLOUIN. That takes care of 1 year. [Laughter.]

Dr. DEMMERT. Right. I would also—how long has the position been vacant? Four years? If we have had acting area directors for the last 4 years, I would assume that each of the acting directors would look at it in the same light.

I do know that individuals have talked to me about the position from the Navaho, and there are individuals that are interested, qualified individuals, and I am hoping that, as a result of the recent appointment of an area director on the Navaho, that steps will be taken to fill that position.

Mr. BLOUIN. Is there any kind of a BIA policy on length of vacancies that are considered tolerable?

Dr. DEMMERT. Let me defer to Mr. Zuni. He would be more familiar with personnel policies and civil service requirements in that area.

Mr. BLOUIN. Maybe, Mr. Zuni, you could explain if there is a policy at BIA with regard to filling vacancies at the administrative level. Is there any kind of checkpoint?

Mr. ZUNI. Mr. Chairman, we encourage our field administrators to fill all their vacancies as quickly as possible.

Mr. BLOUIN. How do you do that? What kind of encouragement?

Mr. ZUNI. Usually, the Commissioner takes the initiative to let his

area directors know that he is interested in filling these key positions. When Mr. Dodge, the new area director, was appointed last week, we had a session in my office. The directions given to him by me were to fill all of his vacancies.

Mr. BLOUIN. What about the last 4 years? I think that is commendable for the future. Are you notified when a vacancy exists? Are you aware of this?

Mr. ZUNI. We are aware. Yes.

Mr. BLOUIN. For the last 4 years, in this particular slot, what have you done? What have you people done to try to fill it?

Mr. ZUNI. Apparently we did not have enough clout to convince the area director to fill this particular position.

Mr. BLOUIN. Who hires the area director?

Mr. ZUNI. The Commissioner does.

Mr. BLOUIN. Who is he responsible to?

Mr. ZUNI. To the Commissioner.

Mr. BLOUIN. The Commissioner for 4 years has seen fit not to exert his authority to direct that person to fill that vacancy?

Mr. ZUNI. That is the conclusion—

Mr. BLOUIN. For one reason or another.

Mr. ZUNI. Yes.

Mr. QUIE. What are the politics involved?

Mr. ZUNI. The politics involved are that there are some—several Navaho candidates that are vying for this particular position, and some of the people out there—the area director in this instance, the previous area director, was afraid to bite the bullet.

Mr. QUIE. Is Mr. Magnuson not qualified because he—he may be Indian for all I know or Norwegian like me. I shouldn't think a person with a name like Magnuson would be an Indian. Am I correct on that?

Mr. MAGNUSON. I would be qualified; yes, sir. I am sure that they will want to select an Indian candidate.

Mr. BLOUIN. Mr. Zuni, how many other vacancies like this exist around the country?

Mr. ZUNI. We have a number of key vacancies throughout the country, but I think the worst situation has been on the Navaho. We have four assistant area directorships that have been vacant for some time.

Mr. BLOUIN. Can you supply to this committee the number of vacancies over the last, let us say, 4 years that have developed across the Nation and the length of time it has taken to fill those?

Mr. ZUNI. Yes, sir.

Mr. BLOUIN. We would appreciate that. Mr. Holman, has this vacancy harmed your ability to function, and, as a result, has it had a negative effect on the educational quality or the delivery of educational services to the students?

Mr. HOLMAN. Within eastern Navaho, I would say it has not had an effect. But I don't get any direction either. I have just been primarily let alone to run the school system as best I see fit. So it hasn't had—

Mr. BLOUIN. Is it unfair for me to assume then that, in your opinion, that assistant slot isn't even needed?

Mr. HOLMAN. Well, I wouldn't assume that. I do think it is needed to give some overall directives, especially in the area of curriculum on the Navaho.

Mr. BLOUIN. But its absence for 4 years hasn't harmed you?

Mr. HOLMAN. No.

Mr. BLOUIN. I think that is pretty good credence for its not being needed. Thank you.

Mr. HOLMAN. Let me elaborate further on that. I do think the function itself is needed to set overall objectives and policies. There are five agencies out there. I am only from one of them. Coordination is needed so that all five of the agencies can be singing the same song, doing the same job.

Mr. BLOUIN. And that has not been the case for the past 4 years of the vacancy?

Mr. HOLMAN. I think the vacancy has contributed to a lack of coordination.

Mr. BLOUIN. It has harmed the coordination?

Mr. HOLMAN. You might say that.

Mr. BLOUIN. Thank you. [Laughter.]

Any other questions?

I think our next person alphabetically is Mr. Vernon Masayesva from the Phoenix area, the principal at the Hotevilla Day School.

[Statement prepared by Vernon Masayesva follows:]

Statement by
Vernon Masayesva
Principal
Hotevilla-Bacavi Community School
Hotevilla, Arizona

before the

Subcommittee on
Elementary, Secondary and Vocational Education
of the
Committee on Labor and Education
U.S. House of Representatives
Congress of the United States
Washington, D.C. 20515

PART I
GENERAL CHARACTERISTICS OF HOPIS

Mr. Chairman, and Members of the Sub-Committee:

I welcome and appreciate this opportunity to appear before this distinguished Sub-Committee to provide testimony for and in behalf of the Hopi children whose wants, needs, and aspirations are very important to me.

I am a member of the Hopi Indian Tribe whose Reservation is located on a dry-arid desertland in northeastern Arizona. The Hopis, formerly known as the Moqui Indians, are descendants of the prehistoric Indians whose dwellings are scattered through-out the entire southwest. Always having been peaceful people, they have inhabited the southwest for over a thousand years. The village of Oraibi is the oldest continuously inhabited community in the United States.

The present reservation was included in the territory of the Spanish province from 1540 to about 1821, after which for 25 years it was part of the province of Mexico. The territory was acquired by the United States at the consumation of the Treaty of Guadalupe Hidalgo in February 1848.

The Hopi Indian Reservation was established by Executive Order on December 16, 1882. It consisted of 2,472,095 acres. The 8,000 Hopis, however, do not enjoy exclusive use of the Reservation, having been confined to a small portion of the Reservation called District #6. For many years, the Hopis have been struggling to regain the

Executive Order Reservation. The continuing dispute with Navajos, whose vast reservation completely surrounds Hopiland, is now in the hands of the U.S. judicial system.

The present-day Hopis live in twelve villages. Each village is autonomous and has its own system of government. A few villages still retain the traditional system of government, while the rest of the villages have adopted modern democratic system. The hereditary chiefs functions as heads of traditional communities, while the more modern communities are governed by popularly elected Board of Directors and village Governors. Nine villages send representatives to the Hopi Tribal Council, which is the official governing body for the Hopi Tribe.

The Hopis have historically been agricultural people. Throughout many centuries they have perfected a method of dry, arid environment where the average annual precipitation is less than ten inches. A few elderly Hopis still rely on dry-farming for subsistence. A majority of the Hopis, however, now make their living making excellent crafts, working for federal and tribal government, and ranching. More and more Hopis are establishing private businesses. The Hopis are industrious, energetic and capable, but because of the scarcity of jobs, approximately 50% of the people, are unemployed.

Religion is an important aspect of the Hopi way of life. Most Hopi parents live and utilize their religion or some aspect of it on a daily basis. Most are involved in ceremonies throughout the year. These ceremonies teach peace and good will, and have been

handed down through the centuries from their ancestors.

EDUCATION ON THE HOPI RESERVATION

Education on the Hopi Reservation involves many programs which provide comprehensive educational services from early childhood through adulthood. The majority of these educational services are directed by four entities, the Bureau of Indian Affairs, the Hopi Tribe, Public School District #25 and the Mennonite Mission School.

The Bureau of Indian Affairs has primary responsibility for education on the Hopi Reservation and maintains a program from kindergarten through post-graduate education. The main effort of the Bureau of Indian Affairs' educational program involves the six reservation Bureau of Indian Affairs schools which enrolls nine hundred sixty-five (965) students in grades K-8. Five of the Bureau of Indian Affairs Day schools are located in the major Hopi villages stretching from Polacca to Moencopi, Arizona, a distance of seventy-three (73) miles. The sixth school is an amalgamated boarding day and public school located in Keams Canyon and operates cooperatively with Public School District #25. Information regarding enrollment, budget, per pupil expenditure and pupil/teacher ratio for the six schools can be found in Appendix A.

The Bureau of Indian Affairs, Branch of Education, is the largest employer on the reservation employing seventh-three (73) professional staff members of which thirty-two (32), or forty-four (44%) are Indians. The one hundred and one (101) clerical, motor vehicle

operators/custodians, cooks and educational aids positions are completely Indian staffed.

The Bureau of Indian Affairs Agency Education Office directs the program of the six elementary schools, coordinates the off-reservation placement of Hopi high schools students in Winslow and Phoenix, Arizona; Riverside, California; Carson City, Nevada and Brigham City, Utah. The office also coordinates the Higher Education Grant Program which assisted one hundred ninety-two (192) Hopi college students with grants totaling \$406,791 during 1976 fiscal year. This averages out at slightly more than two thousand dollars (\$2,000.00) per student.

The Hopi Tribe has been actively involved in provide educational services for over seven years and has recently completed the structuring of their Tribal Education Department. The Hopi Tribe is very involved in Early Childhood Programs, Career Education and Special Education. In Early Childhood Education the Hopi Tribe sponsors a Home/School Program for parents and pre-school children; a Headstart Program for children age 3 and 4 and a Follow-Through Project for pupils in four Bureau of Indian Affairs schools in grades Kindergarten through Third. The Career Education Programs is a health professions development project assisting in the preparation of Hopi elementary, high school and college students for health and medical professions in cooperation with the Bureau of Indian Affairs. The Hopi Tribe also maintains a special education facility. The Hopi Center for Human Services, which provides services for exceptional children on a day and boarding basis.

A third entity providing educational services is School District #25 located at Keams Canyon, Arizona. Public School students attend Keams Canyon Boarding School and the one hundred sixty-two (162) pupils are a part of the cooperative amalgamation of Bureau of Indian Affairs and Public School. The school district also provides off-reservation high school busing, on a daily basis, to Ganado, Arizona, a round trip of ninety (90) miles; Holbrook, Arizona, a round trip of one hundred thirty (130) miles and to Winslow, Arizona, a round trip of one hundred seventy (170) miles per day. A total of one hundred sixty-six (166) students are bused daily to these off-reservation high schools.

The Hopi Mission School located at Oraibi, Arizona is the fourth organization providing educational services to Hopi students. The school is funded through the General Conference of the Mennonite Church and operates under a local board. The school presently enrolls sixty (60) students in grades Kindergarten through eighth.

Hopi people value education and demonstrate their support by participating in school organizations and fund-raising activities. School attendance is strongly encouraged and accounts for the near perfect attendance records at all the Hopi day schools. Student drop-out problems in elementary schools is uncommon, and the local schools are not victimized by acts of vandalism and other serious disciplinary problems.

The Hopis also enjoy the distinction of having the largest

proportionate number of college graduates among the Indian tribes in United States. Approximately ~~25~~¹⁹⁷ Hopi students are presently enrolled in colleges and universities around the country. This is a commendable achievement record for a tribe who did not have access to formal education until 1902 when the first day school was established at New Oraibi.

PART II
ADMINISTERING A BIA DAY SCHOOL

Before I speak about the problems and frustrations faced by the BIA day school principals, let me first introduce myself and the school I administer. I hold the distinction of being the first Hopi Indian to be appointed to a principalship. I was appointed in 1970 to be the principal at Hotevilla Day School, known now as Hotevilla Bacavi Community School by the parents. HBCS is one of the smaller schools with student population of 110 in grades Kindergarten through grades six. It is located between the villages of Hotevilla, considered to be a traditional community by many people, and Bacavi, which is a modern Hopi community. I was born in Hotevilla and raised in both villages. My mother Zetta Masayesva is from Hotevilla; my father Victor Masayesva from Bacavi. I attended and graduated from Hotevilla Day School in 1956.

I supervise a staff of 17 teachers, instructional aides, janitors and cooks. 63% of the professional teaching staff is Hopi; all the aides, cooks and janitors are Hopis.

The Hopi staff and I enjoy a unique relationship with the students which is uncommon anywhere in the United States. For example, I am either a father, brother, uncle or nephew to all the students in my school. It is not unusual for me to address a kindergarten boy as my father. This unique relationship evolves

from special kinship systems in Hopi society where the nuclear family and the extended nuclear family is further reinforced and extended by the clanship system. The web of relationships is very confusing to non-Hopis but is easily understood by the children.

As principals, we are given grave responsibilities to provide the type of educational experiences necessary to prepare Hopi children to become productive members of their society. We receive children in our schools during their most impressionable ages, and we determine to some degree how the children think; act, communicate, and what they value. It is imperative therefore, that parents be involved in determining the type of educational experience most appropriate for the Hopi children. Yet our efforts are often hampered by a myriad of confusing federal policies, rules/regulations, and procedures, many of which appear to us, to be confusing, contradictory, irrelevant, and in general not conducive to the development and delivery^{of} relevant and meaningful educational opportunities for the children.

Let me cite several examples beginning with parental involvement. Within the last few years, the Bureau of Indian Affairs has strongly advocated the involvement of parents in the operation of educational programs. My colleagues and I responded by creating local parent advisory councils for all the day schools. Recently I was made aware of a federal policy which in essence prohibits us from involving parents. This particular policy, which can be found

in "3. U.S.C. 665(b)", states explicitly, that no employee of the United States government shall accept voluntary services for the United States in excess of that authorized by law. Since we do not know what voluntary services are authorized by law, the Principal operates in a bind. A clarification of this policy would be appreciated.

Let us turn to teacher recruitment. It is an accepted fact among educators that a key resource in any educational program is the teacher. The failure, success, and quality of any program is determined to a large extent by the scope of experience, skill, and dedication a teacher brings into the classroom. Yet, in our system, a principal has no authority over any aspect of the recruitment process. Authority for recruiting and hiring is shared by the U.S. Civil Service Commission and, in our instance, the Phoenix Area Office. Principals are involved only when PAO prepares a list of available candidates for the schools; at that point the principal makes his selection from the roster. In the selection process, Indians and veterans have preference over other candidates even though they might have superior qualifications.

All BIA day schools operate under an employment ceiling. This means we cannot establish additional positions even if we have sufficient funds to finance the positions. Consequently, we cannot realistically expand school programs and implement new projects to meet special educational needs of the children.

The limitation on new positions can also have a bearing on the

school's decision to apply for special federal funding such as bilingual education funds. I feel that unless the employment ceiling is lifted, we are going to have difficulty complying with future programs mandated for Indians.

Procurement is another matter, which though not a major problem, can and does frustrate school operations at times. Most of our school supplies come from GSA catalogues and companies on contract with the federal government. We are authorized to purchase from companies outside these two sources, but only as a last resort. It has been my experience that what a teacher orders and receives from GSA source is more suitable for office use. Nevertheless, we cannot purchase from "open-market" sources when the item requested by the teacher is included in GSA catalogue. We are also required to purchase items in standard packages; thus if a teacher wants one box of paper clips, we have to buy a hundred boxes.

Travel moratorium is another government mandate which has effected school operations. Because of the moratorium, we cannot finance student field trips and off-reservation training for the employees from the school's operating budget. Consequently, the field trips are financed by monies raised by students.

The principals are held responsible for translating government policies and mandates into viable programs. Often, the mandates are issued without adequate guidelines and resources for proper and effective implementation. Take for example the BIA policy on Indian education which states that students are to be taught how

to read and write in the English language and the language of the home. Since Hopi is not a written language it is difficult for us to comply with this policy in its entirety. Another example is the Students Rights and Responsibilities which we are required to develop and teach along with law-related courses to elementary and kindergarten children. ESEA Title I is another program which requires local education agencies to involve parents in the highly technical process of planning, implementing, and evaluating of Title I projects. Title I program prescribes how parents are to be organized, but does not adequately explain how and to what extent, parents are to be involved in areas of implementing and evaluating.

Summary: The BIA principals are given overwhelming responsibilities but not the requisite authority to carry out the responsibilities effectively. A BIA principal has no authority over many factors which determines the quality and ~~efficiency~~^{efficacy} of educational services required by Hopi children. Factors such as recruitment, procurement, employment ceilings, etc. lies outside the control of the school principal. In effect what we see is not one central source of authority, but authority dispersed among many federal agencies which ultimately effects our responsibility to provide good educational program for the Hopi people.

PART III
EDUCATIONAL NEEDS

The needs identified and discussed below is based on my personal opinion and does not necessarily reflect the thinking of my colleagues and superiors.

Learning, Research and Resources Development Center.

When the BIA introduced its formal educational system to the Hopis, several village leaders refused to accept the alien institution. They considered the schools to be an intrusion and a threat to the survival of Hopi culture. These leaders refused to enroll children and were consequently imprisoned in federal penitentiaries.

The policy of the BIA at the time was to use schools for the purpose of civilizing the Hopi children; harsh disciplinary measures were inflicted on children to induce them to think, act, and talk like the white man. Those children boarded in schools hundreds of miles from home were not permitted to return home for several years.

All this has changed. The BIA policy now mandates parental involvement in all major decision making processes at local level. Children are free to express themselves in their own language; corporal punishment is outlawed in BIA schools and local school administrators are under increasing pressure to make school curriculum more relevant.

The community attitude toward schooling have also changed. Schools are no longer seen as a threat, but as a salvation for survival. Instead of operating outside cultural confines, schools are now an integral part of Hopi society. Yet, the basic curriculum, teaching methods, and organizational structures of schools remains essentially unchanged. Certainly, there have been modifications; some schools have even experimented with open-classroom, learning centers, discovery approach to learning, etc. In essence however, we are running white man's schools. Basic curriculum in our school are no different from what you see in a majority of public schools in the country.

I feel that the environment created by ^{the} change in BIA policies and community acceptance of schools is noⁿ conducive to transforming the role of BIA day schools so that they truly become Hopi institutions.

The task of transforming schools, however, is not going to be easy. It would be unrealistic to put this grave responsibility on the school principal. What I feel is needed is a permanent institution, adequately staffed and permanently housed, whose major responsibility will be to study and translate basic Hopi philosophy and educational needs into viable programs, and provide necessary support services (curriculum development and teacher training) to implement the programs.

Hopi High School

The Hopi Tribe is the only major tribe in the United States that is without secondary school facilities on the reservation, a facility that is today commonplace and a basic part of the education system in almost every community in this country. Hopi high school students are having to contend with severe constraints in order to be able to attend any high school at all. All high school students must leave home and go beyond the borders of Hopi Reservation in order to attain this basic educational privilege. Our students are scattered in federal high school located in Arizona, California, and Nevada 300 to 700 miles from home or a daily bus ride ~~of~~ 140 miles.

The impact of lack of high school on Hopi families is severe: nuclear and extended Hopi families are rapidly disintegrating because the high school age students are away during the most impressionable ages. The religious organizations whose survival depends on the participation of its youth is also on the decline as more and more Hopi youngsters find it inconvenient to participate.

Those students who find themselves unable to attend high schools and those who are expelled or suspended from schools find themselves with nothing to do on the reservation and consequently find themselves permanently out of school.

The lack of high school can also effect the decision of teachers to either accept or reject an elementary teaching job on Hopi Reservation. Hopis such as my self must eventually face the

the possibility of moving off the Reservation so that our children can attend public schools without having to be boarded or commuted unreasonable distances.

Because of the gravity of the high school situation I sincerely hope that his distinguished Committee will provide an opportunity for members of my tribe to provide testimony on this matter.

School Facilities

Hotevilla Bacavi Community School enjoyed the distinction at one time of being the only school with a comprehensive fine arts program for children and adults. I regret to say that this fine program has not been curtailed due to the unsafe and unsanitary condition of the art facility. HBCS has also had to curtail shop and home economic classes for similar reasons.

Children are presently subject to unsanitary eating conditions caused by lack of dining facilities. Students are presently fed in the school symnasium. The unsanitary condition is created when children are fed in ~~in~~ gym immediately following gym classes. The problem is aggravated during the winter months when heating system kicks up and circulates fine particles of dust. This dust often seeps into the food preparation area which adjoins the gym.

HBCS however, is very fortunate compared to Moencopi and Polacca Day School which have no multipurpose rooms, and operate school programs in dilapidated classrooms.

Community School Concept

A community school concept is based on the premise that communities can receive maximum use out of their school facilities by extending operational hours beyond the regular school day. Another premise is, that it is not reasonable to expect parents to participate actively in the decision-making processes of the school until they become comfortable in a school environment. One way to bring this about is to offer a wide range of activities such as sewing, arts and crafts activities, movies, programs, recreation activities, etc. to entice parents to frequent school visits as often as possible.

This concept makes special sense on Indian Reservations which have no YMCAs, bowling alleys, movie theaters, swimming pools, city parks and recreations, etc. to meet the recreational and enrichment needs of the Indian communities. On the Hopi Reservation problems of vandalism, drunkenness, and other types of destruction ^{brought resulting from} boredom of having nothing to do. The problems become especially acute during summer months when all the high school students return home from boarding schools.

It therefore borders on the ridiculous when federal day school facilities lay empty and dormant during the summer months. When it can be centers of youth and adult activities. The BIA has a policy which allows schools to be used for community activities and we do grant permission to colleges to hold extension classes in our classrooms, but this type of activities meet a handful

of community needs; what is needed is a well-planned, organized and administered community school program.

It is regrettable that BIA day schools are not eligible for funding under the Community Education Act passed by Congress last year.

This concludes my testimony. I appreciate the opportunity to appear before this Committee. I realize the problems and needs expressed in this statement is brief and sketchy, so if additional information is needed I will be pleased to prepare necessary information.

Thank you.

**STATEMENT OF VERNON MASAYESVA, PHOENIX AREA, PRINCIPAL,
HOTEVILLA DAY SCHOOL**

Mr. MASAYESVA. Mr. Chairman and members of the committee, I appreciate this opportunity to appear before you on behalf of the Hopi children whose needs, aspirations, wants have always been very, very important to me. So I am very appreciative of this opportunity to appear before this committee, and also I am quite nervous about this situation. This is my first time here.

I am a member of the Hopi Tribe. Our reservation is located in Arizona, in northeastern Arizona, right in the middle of the vast Navaho Reservation.

There are approximately 8,000 Hopis living on about 600,000 acres of Hopi Reservation District 6. The tribe presently is in litigation of another portion of their reservation:

The Hopi Reservation, I believe, is among the last reservations introduced to formal education. We did not have a day school system until about the early 1900's, so, compared to other tribes, our experience with formal education has been relatively short.

However, the Hopis have accomplished a commendable task; within that very short span of time they have been successful in encouraging their children to complete their secondary education, and go to higher education. As a matter of fact, today the Hopis have the largest proportionate number of college graduates, and we are very proud of that and presently have around 200 students enrolled in various universities throughout the country.

The attendance rates in our elementary schools—we have six elementary schools on the reservation—averages anywhere from 96 to 98 percent, which is probably the highest in the country.

This is evidence of how supportive Hopis are of their educational system.

Mr. QUIE. Are you going to go into secondary schools?

Mr. MASAYESVA. We don't have secondary schools, however, I would like to mention that later on in my statement.

The Hopis live in 12 communities, and there are distinct differences among these communities even within this tiny little reservation. No two communities are the same. They each have their own forms of government. They have their own religious organizations. They are autonomous communities even though they are all part of the Hopi Reservation. Dialects vary from one community to another.

In the midst of all these communities lives another tribe of people called the Tewas, and they speak a completely different Indian language.

Some communities are still governed by the hereditary chiefs. Others have resorted to a more modern democratic form of government, and they are governed by boards of directors and village governors. So the communities are not the same in any sense.

There are 6-day schools operating on the reservation. We have two junior high schools. Another school operated by the Mennonite Mission and another—a junior high school run jointly by the public school and the Bureau of Indian Affairs.

The problems, the administrative problems, that we have to contend with are those exact things that Mr. Allen has already elaborated upon, so I will try to go into other areas.

The principals, such as myself, are the most visible representatives of the Government. We are faced with people every day, with parents, with community and tribal leaders. Consequently, we are expected to be thoroughly versed in every Government rule, regulation, mandate.

Everything that goes wrong in our schools, we are held responsible for it, which is to say at the least, very unfair because, as you probably sense by now, we have little authority.

We have this incredible responsibility to provide relevant, useful, productive educational experiences for the Indian children, but we are given little authority to determine these things. The many factors that were mentioned in this hearing—recruitment, procurement, employment ceilings, travel moratoriums—these are factors outside the control of the principal.

So, those of us from the field level looking up—we see contradictory policies, contradictory mandates, confusing guidelines, and in some instances, policies, that are irrelevant to the operation of the school program for children.

This is what I see as a principal. Let me give you an example of a contradictory Government mandate. Within the last few years, the Bureau of Indian Affairs has strongly encouraged the involvement of parents in the decisionmaking process of the school. We all support this. It is long overdue, and my colleagues and I have responded to this policy by establishing advisory committees in our day schools. As a matter of fact, Hotevilla has the distinction of having the first organization of this type on the reservation.

So we are doing everything in our power, what little we have, to try to encourage this kind of thing. Yet, there is a policy on the books right now which states quite specifically that no employee of the U.S. Government shall accept voluntary services. So, in essence, we are trying to operate contradictory policies. This is one example of it.

The other example is the mandate on schools to establish student rights and responsibilities and to develop law-related courses for the students. Now, how do you develop a law-related course for a kindergarten student, for example? The guidelines given to us are applicable mainly to high schools, but I suppose we are expected to develop all of these materials for elementary grades.

I think this is an instance where I think we are given insufficient guidelines and insufficient resources to carry out our responsibilities.

Mr. BLOTIN. Excuse me. Could I make sure I am understanding what you are saying? Even though you have no secondary schools in your area at all, you are forced to implement secondary school standards into your system?

Mr. MASAYESVA. Well, the guidelines we receive are more applicable to establishing such a program in high school. We are not required to use this, but that is the only resource that we received.

Mr. BLOTIN. You use those resources or use nothing?

Mr. MASAYESVA. Here is a guideline or here is an idea of how to do it. And we are supposed to take our cue from it and develop a program for elementary students.

Mr. BLOTIN. Are they adaptable programs? Are they things for the most part that can be adapted to the elementary grades?

Mr. MASAYESVA. They are adaptable to a sixth grade student more so than to a kindergarten student. That is when you start having some problems.

Mr. BLOUIN. Can you give me some examples? You mentioned the law. I can probably think of lots of ways of—very simple examples that could be spun off from that even for the early grades, but what are some examples of programs?

Mr. MASAYESVA. What we do is that we go ahead and carry on the duties in the classroom that are done every day, like the concept of sharing, of being responsible, and I believe these are probably sufficient at that level.

Mr. BLOUIN. At all grade levels? You have no problem with those.

Mr. MASAYESVA. No.

Mr. BLOUIN. What are some that you would have problems with specifically in adapting?

Mr. MASAYESVA. Student rights, and student codes of conduct.

Mr. BLOUIN. In the early grades?

Mr. MASAYESVA. Yes. We are required to have a due process system in our elementary grades so that, if a child feels denied of a certain right or if his right is violated, then we have to go through a due process procedure and having hearings for a kindergarten student.

Mr. BLOUIN. Thank you.

Mr. MASAYESVA. As I mentioned earlier, I would like to elaborate on some other things that were not touched upon here. Mr. Allen has touched on these factors and the problems with the recruitment, the delays, the position classifications.

I would like to touch on the area that sort of concerns me as a Hopi administrator, because I think it is a serious one. Like I said, the Hopi have a commendable achievement in areas of education, but, when it was first introduced to the Hopis, it was resisted by several leaders, and, consequently, these leaders were imprisoned in Federal penitentiaries because they saw formal education as a destructive system. That is, as an intrusion that is intended to destroy the culture of the Hopis.

Consequently, these people just refused to send their children to these schools, and, consequently, were imprisoned.

The Government policy at the time was also to do precisely what the chiefs were aware of. They used harsh disciplinary measures to entice Hopi children to think, act, and talk like the white man, and contained them in boarding schools without any visiting privileges. They would be kept in these boarding schools for several years.

Of course, all this has changed. Things are different. The BIA government—the policy in our schools is that the children are free to express themselves in any language or in their own language if they choose. There are no reprimands.

The parents are strongly encouraged to play a part in the decision-making process of the day schools. The community has accepted the institution as one of their own, and this is where I think the problem comes in.

We, who operate the government schools, I don't really think quite recognize that we are no longer operating outside the cultural confines of the Hopi communities, but that we are now a part of the process.

Hopi schools are now an important and permanent institution in the Hopi society, but, you walk into any of our schools and you will see a curriculum that you would see in the majority of our public school

systems anywhere. There is nothing unique or distinct about the curriculum. There is nothing to suggest that this is a Hopi school. So the curricula are the same as you would find anywhere else.

I think there is a need to define the role of schools in a community that is undergoing rapid change, from a traditional society to a modern one.

Mr. Q. Mr. Kildee would like to ask a question.

Mr. KILDEE. You mentioned that it is difficult to distinguish a Hopi school curriculum from a regular school. What type of programs do you think you need in the Hopi school to really carry out your educational function for the Hopi people? What programs are needed there?

Mr. MASAYESVA. I think we need the kinds of programs that build on the immediate experiences of the children, that will extend their knowledge beginning from what they already know. I think we need the kind of learning experiences that will focus more on the important skill of learning to learn, rather than rote learning and memorization of skills.

I think we need to extend the program so that the children can use this to understand their own society and the kinds of problems that they are facing. This is not a very easy thing to accomplish.

Mr. KILDEE. Do you have a curriculum committee? If you were to sit down and write a curriculum for a Hopi school, is there such a document now as to what that curriculum would be and what the goals of the school would be, what the curriculum would be to lead to those goals? Is there any such document now or any material on that?

Mr. MASAYESVA. The advisory committee has a philosophy which is, I think, relevant. It begins with the statement that we are a transitional society and therefore the role of the school should be more appropriate to that kind of a society, rather than a stable kind of a community, that there ought to be more kinds of programs going in our curriculum so that the kids can be taught to learn.

Our goal should be: How can these children better appreciate and have a deeper insight into their own culture? How can they partake of the more modern ways of looking at things without losing the old ways. A pairing of the old Hopi philosophy with the new is a pretty sophisticated process and it is unreasonable to expect the BIA principals to really get into this kind of a thing, considering all of their other responsibilities that they have and the lack of resources.

You know, it is very hard to do anything innovative if you don't control teachers. It is hard to bring in more staff if you have employment ceilings.

Mr. KILDEE. But, if there is not clarity as to the purpose of a school, be it any school, then we are going to have a real difficult time developing curricula. Now, for the European migrants who came to this country, we look back and we see some things that probably should not have happened. Half my ancestry came from Germany, the other half from Ireland. The part that came from Germany—they were treated in the same way the Indians were treated. When they spoke German in school, they were reprimanded for that. We look back now and say that that was wrong, that we live in a community or country that is a mosaic rather than a melting pot.

If the goal of Indian education is just transitional and not a program of maintaining Indian culture, it would seem to me that, if the goal is

transitional, that implies that the Indian culture is somewhat inferior and something to be overcome, and I don't agree with that.

I think that the Indian culture is part of that mosaic and that the goal of the school has to be to recognize that. Now, there are many options. A Hopi may have a variety of options. He may decide to accept more and more of the non-Hopi culture, but he really or she really should have those options available and not have them forced upon one, I would think.

I look back to my ancestors, and some of them—my mother tells stories where they were actually reprimanded and cured of their Germanness, and I hope that the goal of the Indian school is not to cure one of something that is not a disease, but something that is something beautiful, being an Indian.

I think that we really have to sit down and ask ourselves: What is the goal of the Indian school? Then, how does the curriculum fit that goal?

That is a statement more than a question. I really believe that strongly, and anyone involved in Indian education has to really ask himself regularly: What is our goal and what are we doing to achieve that goal?

Mr. MASAYESVA. As a matter of fact, in my prepared statement, that is precisely one of the areas that I mentioned as being a critical need. I think what we need is to establish an institution on our reservation which will bring people together, to expound very seriously upon what it is that the goal of our educational program ought to be. This has never been done. There has never been an organization that the goal of our educational program ought to be. This has never been done. There has never been an organization that brought all of the resources within the community together into a serious effort to come up with a viable definition of what the educational philosophy, goal, and objectives ought to be.

The other concern I would like to mention is the need for our schools to expand their role to include more community school programs, where we can offer enrichment, recreational activities, on a planned basis for the entire community.

The need for these kinds of activities becomes especially critical during the summer months when all the school students are home from boarding schools. There is nothing for them to do on the reservation; so they resort to drunkenness, vandalism, and other kinds of destructive behavior, strictly out of boredom.

At the same time, the day schools are not staffed to provide year-round programs for the communities. As a matter of fact, summertime is the only time our staff can go away to further their education, and it is not fair to expect the teachers to operate summer programs.

Consequently, the Federal facilities lay empty and dormant, when they could be centers of activities for the entire community. The Bureau does have this policy. They have the mechanism already set up, making it possible for us to service the community outside of our primary responsibilities.

I think there is a need for schools to function more as community schools because there are no bowling alleys on the reservation, there are no movie theaters, there are no city parks and recreation programs.

As a matter of fact, there is no youth program of any kind that I know of on the reservation.

I think we have to take that responsibility to provide some meaningful and enjoyable kinds of experiences for these youngsters so that we can reduce anti-social behavior that becomes pretty prevalent during the summer months.

Another problem that I see is something that is partially perpetuated by the fact that Hopi Reservation is the only major reservation in the United States that does not have secondary school facilities, something that you take for granted, but which we don't have.

Consequently, the Hopi parent endures a lot of hardship in either having the kids away from home for 9 months during their most impressionable ages or, if a parent wishes to keep the child—and more and more parents are now leaning toward this way—of sending their children to city public schools. I believe the closest high school is in Winslow which is a round trip of about 140 to 160 miles.

You can imagine the kinds of privileges that are denied to these youngsters when they cannot participate in extracurricular activities, when they have to be at a bus stop at a certain time because if they miss the bus by 5 minutes they missed the whole school day.

Also, the fact that the parents are left out of school activities. Many parents love to be part of the school. So they feel pretty bad if they cannot assist the school, the public school, in raising money and activities of this kind.

The thing which bothers me greatly is that boarding schools are taking responsibility away from parents; a responsibility to raise children. They have been doing this for so long that parents are actually happy to see their kids go back to boarding schools because, when they come home, they bring new ideas, strange concepts, differing values, and it is too much for Hopi families to handle.

Another reason it is hard is because of the kind of social structure that Hopis live under. In my school, I have a unique relationship with all of my students. Probably you wouldn't see this kind of a relationship anywhere else in this country.

I am either a father, an uncle, a nephew, a son, to every single student in my school. It is not uncommon for me to address a little kindergarten student as my father.

This is a unique nuclear and extended family structure, that binds us very closely into one family.

This kind of society has its benefits. One is that the nuclear family, the mother and the father, particularly the father—don't have the sole responsibility for raising their children. It is shared among different institutions. Different institutions play a different role in helping these children grow up to be Hopis.

The problem comes when you expose this type of community to rapid change that we have talked about. One thing that happens is that the nuclear family slowly deteriorates. The supporting institutions no longer play the support role, so eventually what you have is parents assuming total responsibility for raising their children. This is new to the Hopis. This is the first time in Hopi history that this has happened.

Many parents have not accepted this. Consequently, they look around for institutions to be the substitute uncle, for example, because in Hopi the maternal uncle is the disciplinarian.

A lot of parents look over their experience and see a BIA day school as an authoritarian school. That is from their experience when they went to boarding school and how they were subjected to harsh disciplinary measures. Today a lot of parents see the day school as a substitute uncle, and they come to us and say: "Can you tell this to my child? My child has done something wrong. I want you to punish him."

I think they see the same kind of thing with the boarding schools. That is why you see a lot of relieved parents when buses take the kids away to boarding schools.

It is a problem the parents are just prolonging. They are dealing with the symptoms. It is like taking an aspirin. At least they won't have to worry about it for 3 months.

These are the problems associated with a lack of secondary facilities; the slow disintegration of the social structure of the Hopis.

Hopis are also very religious people. They have several major religious ceremonies, which are required for young Hopis to participate in. Since ceremonies take place mainly during winter months when schools are in session, it becomes difficult and inconvenient for our students who are in boarding schools to participate in any of these activities.

So the religious organizations are subjected to a slow disintegration process. This is happening at the community of Hotevilla. For example the last ceremony called the Wuchim ceremony, is a ceremony which makes the young Hopi a man, was performed at Hotevilla 2 years ago.

I think the pressures on boarding school children can become quite incredible. I don't think we realize what pressures they get under. A student who is suspended from a boarding school, for example, there is nothing for him to do on the reservation. So that student might wind up permanently dropping out of school.

I feel there is an urgent need for a secondary school facility on Hopi reservation.

Other things that it affects is recruiting teachers. Last year I had a chance to recruit a teacher who had a tremendous background in areas of bilingual education. Her first question was: "Is there a high school for my kids to go to?" I said: "No, there isn't at the present time." She said: "Well, I will have to refuse the job."

Many of us Hopis are forced to make decisions of having to move away from home so that our children can have the benefit of a secondary education. I would sincerely hope that this committee will provide an opportunity for members of my tribe to testify on this matter further, because it is such a crucial, crucial need on the reservation.

I would just like to conclude with a statement that is a philosophy among the Hopis. It is a simple, but a very, very beautiful one. It says that a plant grows best on its own plot of earth, but water has to be brought to it.

I do thank the committee for this opportunity to testify.

Mr. BLOTIN: Thank you very much. Do any of the members have additional questions? Mr. Le Fante?

Mr. LE FANTE: I noticed throughout yesterday's hearings and most of this morning many of you have made reference to regulations and

guidelines from the various agencies. Since I was brought up a Northwestern boy and since this is my freshman term. I am going to ask you to please try to understand right now that I am just probing a little bit.

Where do the regulations and guidelines come from? Is it from the various agencies? Is it from the administrators? Is it from those responsible for running the schools? Is it from the Federal Government? Is it from the U.S. Congress? Where do they come from? Why and how do they exist? Can anyone answer that?

[No response.]

Mr. LE FANTE. There have been reference made not only this morning, but quite a few times yesterday to regulations and guidelines. My point and the reason I am bringing up the question is that I am concerned about the very clearcut and definite understanding of a regulation or guidelines versus the laws as passed by the U.S. Congress.

If there are regulations and guidelines that hamper and hinder your operation, I would like to know where they are coming from, if not from the U.S. Congress. If anyone can answer, I would appreciate it.

Dr. DEMMERT. If no one at the table will respond, I can respond in part and point out that, in the Bureau, there are guidelines in what we call the Bureau manual. In some cases, some of those have been published in what we call the Federal Register, and the Federal Register is the formal process for providing rules and regulations that provide information that allows the implementation of laws that are passed by Congress.

Mr. LE FANTE. Who interprets them?

Dr. DEMMERT. Usually the general counsel, the legal counsel, to the agencies that submit those rules and regulations to the Federal Register. And they have the force of law. And the Congress in the past couple of years has set up a system whereby they have a review of those rules and regulations before they become final, but that is just recent.

There are quite a few rules and regulations on the books that have had the review of the agencies, in some cases Office of Management and Budget, and in all cases a comment period for the public.

It is a very complex set, and the Bureau, depending on the programs that it participates in, has different sets of rules and regulations that it has to follow. For example, for the title VII bilingual projects that we get from the Office of Education, we follow their rules and regulations. For the food programs that the Bureau kids participate in in public school—by "Bureau kids," I mean children of federally recognized tribes who attend public schools—we follow the rules and regulations of the USDA. For programs that we participate in from— for any of the projects that we participate in, we have different sets of rules and regs, and that is a complex—and they provide complex problems for local schools to work with.

I think some of those problems have been very clearly identified today and some of them were touched on yesterday.

Mr. LE FANTE. Most laws are brought about as a result of needs. It seems that from the time the legislation is introduced until it is finally passed, and through until the enforcement of the act, you may never recognize the original intent of the legislation. I think that may be the case in many situations.

I heard of at least three or four such situations yesterday and today. Many of you said that the regulations prohibit you from doing this and the guidelines prohibit you from doing that. Apparently, what you are really saying is that it is the wrong thing to be doing, and, if you weren't under such strict control, you probably could correct the situation. That is how I interpret that.

Have any of you as administrators or members of these various agencies participated in setting down regulations or guidelines? What has been the extent of your participation?

DR. DEMMERT. I have personally, yes. Especially in my last job, where I was responsible for implementing a new program passed by Congress, title IV of the Indian Education Act of 1972, and I am now in the process of looking at the rules and regulations in the Bureau of Indian Affairs to see what needs to be revised or to see what needs to be pulled together and adjusted or amended.

As I pointed out yesterday in my testimony, my own personal bias is that we allow many of those, whenever possible, not only to be initiated at the community level, but to give them a substantial amount of discretion to adjust them according to the various needs of the different communities.

MR. LE FANTE. Thank you. Did I hear Dr. Allen testify that the average age of the teaching staff or personnel is 64 in that district?

DR. ALLEN. Somewhere between 62 and 64.

MR. LE FANTE. Sixty-four. To your knowledge, have they been there many years? Do they follow an antiquated system? Do they take continuing education courses to update themselves? Is there any requirement to do so?

DR. ALLEN. I think one of the problems lies in the fact that it is very difficult to teach old dogs new tricks. They want to function as boarding schools functioned when my father attended boarding schools. We are in a new time.

MR. LE FANTE. Agreed. Do you think if we were successful in recruiting younger staff, younger teachers, who are more modern and have a grip on the problem, that it would help the situation?

DR. ALLEN. Well, it would certainly help the situation, but I do not equate age with good or bad.

MR. LE FANTE. Neither do we equate dollars with quality.

DR. ALLEN. Right, exactly. But I would think that, if we had the option in the boarding schools of hiring staff that met our particular needs when we needed them and when we wanted them, rather than waiting from 3 months to 12 months to get that staff person on board, it would certainly help.

I am a firm believer that, everything else being equal, that we need Indian people to work with Indian children. And I hope that you understand that everything else being equal, because we have some of the very finest non-Indian teachers in our school. Just because you are one or the other really doesn't make that much difference. It is your ability to communicate, to teach, that really makes a difference.

MR. LE FANTE. There are very unique problems existing there, and it is very difficult for one who is not familiar with it, such as myself, to comprehend. I guess the philosophy and upbringing have a lot to do with it. The area I come from is strictly provincial. What we try to do is to provide a mixture. For example, one of the parochial

schools is in the Italian-American neighborhood. We try to put someone other than an Italian-American in that school to instruct. By doing that, we mix cultures.

The bilingual education system in the Northeast is working fantastically. We have it in our State, and it is working fantastically, in that bilingual education is in more direct contact with the needs of the student. The student in turn is going home and educating the rest of the family, because they understand and comprehend.

So I think your problems are unique, but and I mean this sincerely, Mr. Chairman—I personally have very strong convictions about regulations and guidelines when I see the intent of the U.S. Congress not being carried out in so many respects and in so many ways and in so many actions. Many times when the guidelines and regulations are written by counsel or whoever else is involved, the original sponsor of the bill is not even contacted. Sometimes I begin to wonder if they even know the intent of the bill. Do they know why it exists and what reason prompted it to be enacted? I don't think so.

So this is probably an area to which we can direct ourselves. It would help these gentlemen. Thank you.

Mr. BLOTTIN. I think you make a very good point. I think, as I understand it, it is not just the intent of the law, but the age of the law and the gray hairs that are accumulating around the Bureau mission and the guidelines that stem from that mission. It is my understanding that we are talking about guidelines that are some 20 years old or older and have not been updated since. And it is hard to visualize those kinds of guidelines being relevant to today in any useful sense.

I doubt if any group of people in any school district under the normal process anywhere in the country would have stood still for 20 years while the guidelines developed gray hairs all over the top.

I am very hopeful that part of our success will be directed in that area. I have put it in those terms because we have got every desire and every intention of succeeding in this area over the next year or year and a half in making what we hope to be some very major changes and some useful strides forward for Indian education.

The last person on our panel is Mr. Ray McGilbarry, the superintendent of Seneca Indian Boarding School.

[Statement submitted by Ray McGilbarry follows:]

BUREAU OF INDIAN AFFAIRS**OKLAHOMA REPORT****TO****HOUSE COMMITTEE ON EDUCATION AND LABOR****February 2, 1977**

**By: Ray McGilbary, Superintendent
Seneca Indian School
Muskogee Area Office**

OKLAHOMA

CHOCTAW TRIBE WORD - MEANING RED PEOPLE

STATEHOOD 1907

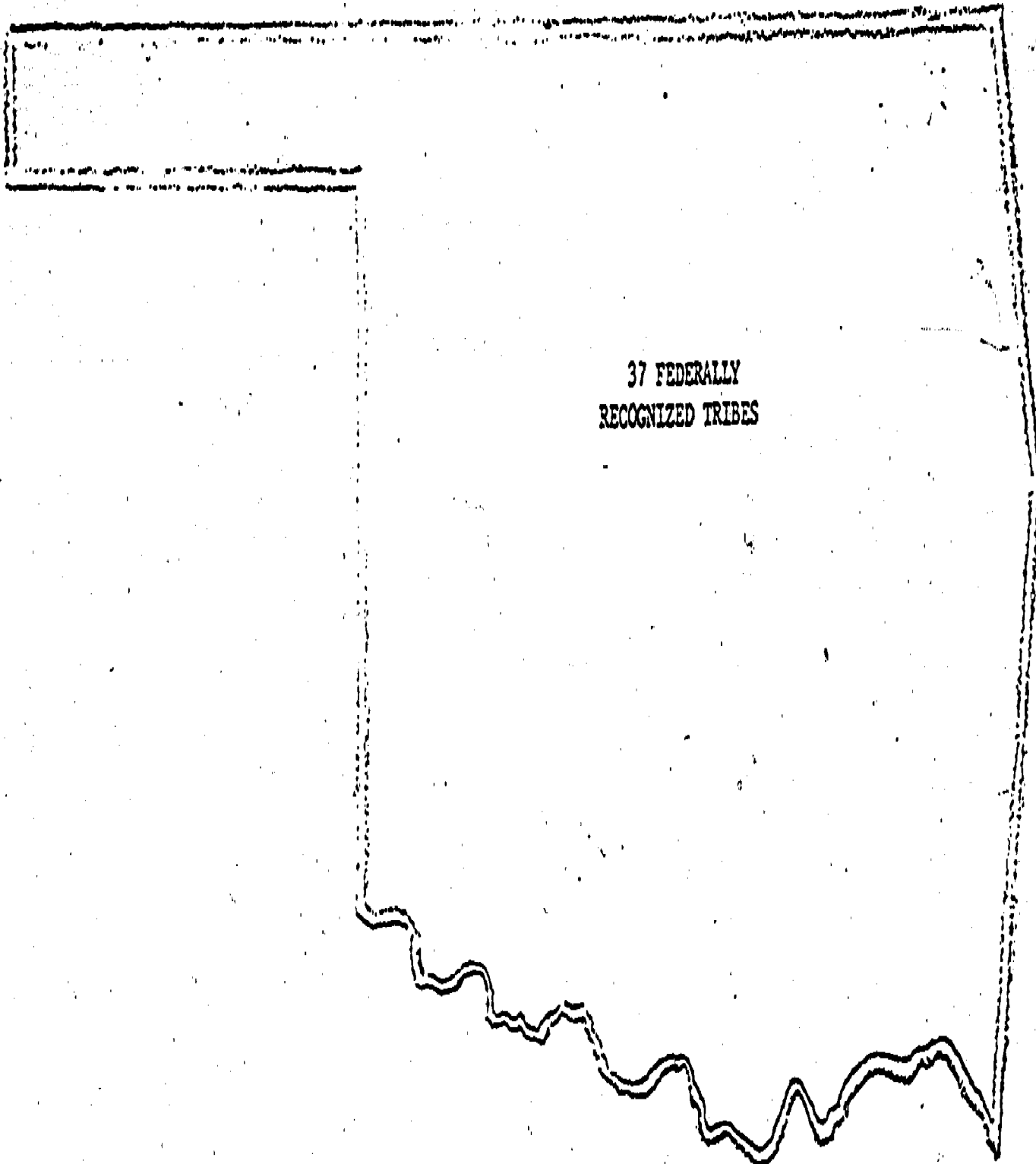

37 FEDERALLY
RECOGNIZED TRIBES

265

269

ONE RESERVATION IN THE STATE OF OKLAHOMA

OSAGE TRIBE

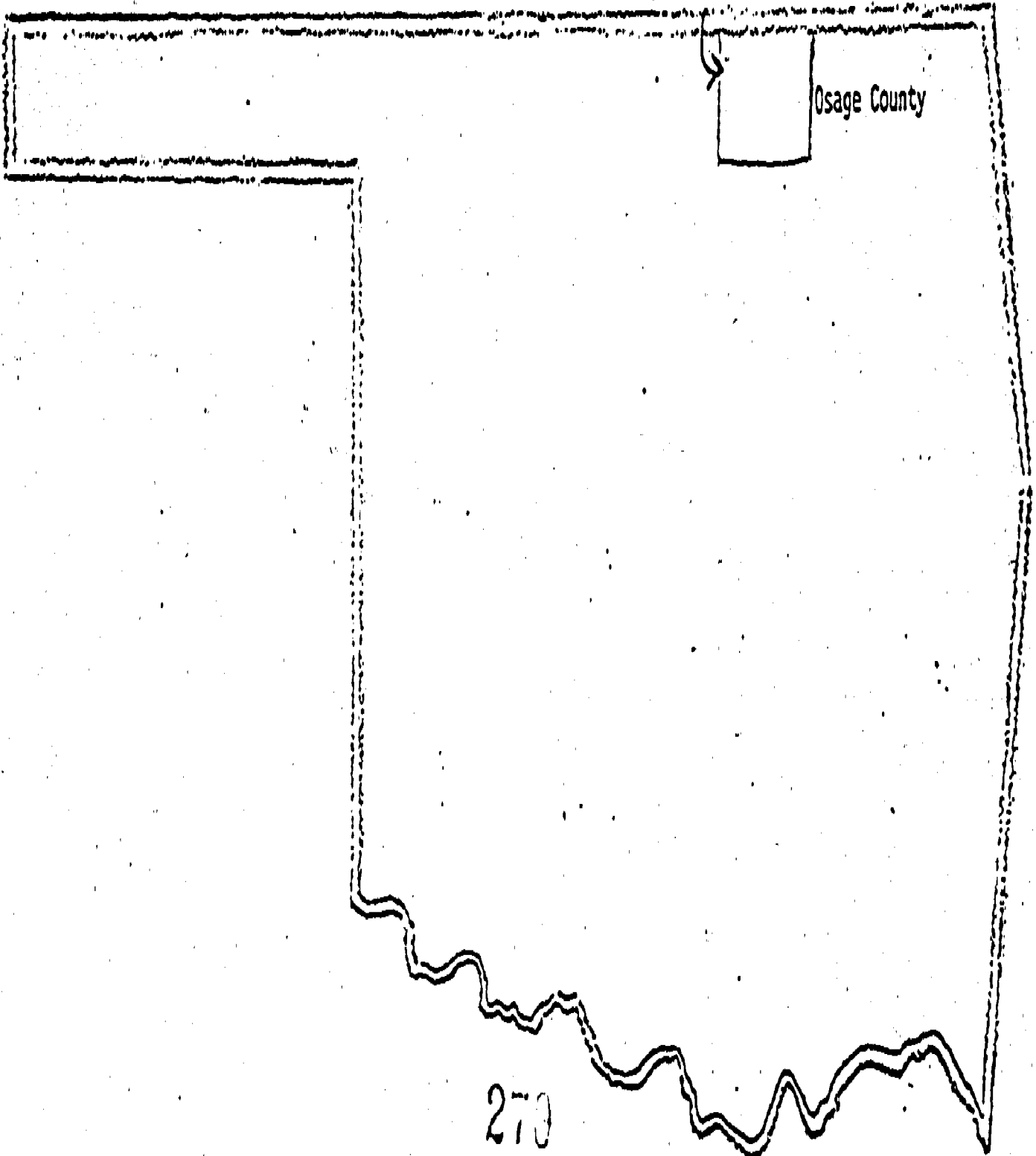

Osage County

270

Chillico Indian School

Seneca Indian School

Sequoyah Indian School

Concho Indian School

Eufaula Dormitory

Riverside Indian School

Jones Academy

Fort-Sill Indian School

Carter Seminary

267

271

OTHER STATES STUDENTS COME FROM WHO ATTEND OKLAHOMA BOARDING SCHOOLS

SENECA INDIAN SCHOOL

New York
 Florida
 Texas
 Kansas
 Arkansas
 Missouri
 Illinois

SEQUOYAH

Florida
 North Carolina
 New York
 Kansas
 Nebraska
 Texas
 Arizona
 S. Dakota
 Washington State

Eufaula Dormitory

Texas
 California
 Wyoming
 Illinois
 New York

JONES ACADEMY

Texas
 Mississippi
 Virginia

Carter Seminary

Texas

CONCHO BOARDING SCHOOL

Kansas
 Texas
 New York
 Arkansas
 Virginia
 Arizona

CHILOCCO BOARDING SCHOOL

North Dakota	Minnesota
South Dakota	Mississippi
Nebraska	Florida
New Mexico	Washington State
Arizona	New York
Colorado	Illinois
Texas	Kansas
Wyoming	
Montana	

FORT SILL BOARDING SCHOOL

Washington State	N. Dakota
Indiana	S. Dakota
Oregon	Nebraska
Illinois	Kansas
California	Texas
Arizona	New York
Missouri	
Colorado	
New Mexico	
Idaho	
Wyoming	
Iowa	
Montana	

RIVERSIDE BOARDING SCHOOL

Arizona
 California
 New Mexico
 Washington State
 Montana
 Wyoming
 Minnesota
 N. Dakota
 Iowa
 Utah
 Colorado
 Idaho

There are 37 federally recognized Indian Tribes in Oklahoma. We have one reservation in Oklahoma which is the Osage Tribe reservation. Rest of the tribes do not have boundaries or designated reservations. We live in all communities in the State of Oklahoma.

There are 45,489 American Indians under twenty one years of age in the State of Oklahoma and all school age children do have access to public schools. You may think at this moment - why do you have boarding school?

Federal Boarding School Systems in Oklahoma serve Indian students of Oklahoma and from other states. Today, the main tool of my presentation will be the student profile to inform you of today's student character. This profile will reflect all boarding schools in Oklahoma. We have 9 facilities composed of:

Six full service facilities -

Seneca Indian School, Muskogee Area	Established	1872
Sequoyah Indian School, Muskogee Area	"	1872
Fort Sill, Anadarko Area	"	1871
Riverside, Anadarko Area	"	1871
Concho, Anadarko Area	"	1871
Chilocco, Anadarko Area	"	1884

Three Dormitory Operations - Academic Program Off-campus - Home-living in Dormitory

Eufaula Dormitory	Established	1882
Jones Academy	"	1891
Carter Seminary	"	1847

Before I get into the profile - I want to explain levels of Indian students in the state of Oklahoma.

1. Home to school and school to home daily life.
2. Dormitory to school and school to dormitory 3 facilities.
3. Full service boarding school on campus.

FILES: Review Profile

These are the characteristics of our students in the federal boarding schools in Oklahoma. The students are "pushouts" from their communities. Public school declares some of them not eligible to be in their school in cases of too much truancy.

The fact that students are drop-outs from Public schools have delinquent behavioral pattern and their parents have social and emotional problems. The parents inflict the same problem on the children. In time, the child does not interact in the public school system. Boarding school is the answer to help each student to adjust for socially, intellectually, and spiritual well being. We succeed with some and some we are not so successful.

This is our clientele today: What can we do to help from the present operating level.

1. Recognize and provide funds for programs or activities which helps the student to achieve self-worthiness. A program that reaches out into the community to get the parents and guardians interested in their children's education. Parents and guardians supporting the school will enhance the students to be more responsible individuals.
2. Need technical assistance in:
 - a. School psychologist
 - b. Social Rehabilitation services and Activities which teaches students

to be responsible as an individual. Trained dormitory personnel to be para-professionals in counseling.

c. Counselors

d. School Nurse on campus.

3. Facilities: Replace old buildings in existence and have adequate facilities. Cherokee Hall at Sequoyah High School has been condemned more than two times. Dormitories at Seneca Indian School are inadequate. Jones Academy needs multi-purpose facility for on campus activities. Carter Seminary needs a separate feeding facility. Presently, they eat their meals in the gymnasium. Request and plans have been submitted to proper branches.

4. P.L. 93 - 638 provides opportunity for Indian involvement. Indian people now have an opportunity to participate in decision making for the welfare of Indian people. The authority always has been from the top down to tell us what our needs are. Now, we can express our needs from the people to the top. The needs can be expressed through O-based budget for accountability of the cost. ~~When combined with presentation.~~

The following information is based on data taken from students records enrolled at Seneca Indian School, 1975-76 school year.

Enrollment Criteria:

3.4% academic reasons

10.6% parental choice

86.0% social referrals

52% social referrals primarily due to the family : sion.

14% social referrals due to financial problems.

33% social referrals due to broken homes.

37.4% of the students come from homes where the mother is the head of the household.

53.9% of the students come from homes where the father is the head of the household.

8.9% of the students come from homes where someone other than their parent is the head of the household.

Parent's education level: (home student lived in just prior to enrollment)

Average grade level for both parents:	7.9
Average grade level for father:	7.6
Average grade level for mother:	8.1

Significant Negative Student Behavior:

- a. Truancy: 20.8%
- b. Public School drop-out: 38%
- c. Delinquency: 21%
- d. Transfers from other schools: 29%

Court referrals due to family or student causes: 6.9%

Students with emotional or psychological needs: 87%

30% are students from broken homes due to divorce.

17% are students that have lost one or both parents through death

16% are students from homes where the parents are separated.

One student out of 187 students is here because of physical abuse in the home.

21% are students with : ests.

25.8% of the parents last year in school was between the 8th and 12th grades.

50.6% of the parents last year in school was between the 1st and 8th grades.

64% of the parents are poverty level and below.

18.2% of the students will be 15 years old or older by the end of the school year. (normal age for completing the 8th grade is 14)

Data compiled by Mary E. White, Social Worker Aide

Ray M. Gilbary
Ray McGilbary
Superintendent

As of January 31, 1977 Seneca Indian School has enrolled 131 students for school year 1976-77. The following information is based on data taken from these student's applications and other records.

- 83% are enrolled due to social reasons.
 - 15% are enrolled because of parental choice. (No apparent academic or social reason. The parent prefers boarding school placement.)
 - 2% are enrolled because of academic reasons.
1. 15% of the enrollment are court referrals due to family or student causes.
 2. Head of household student lived in just prior to enrollment:
 - 38.9% mother head of household.
 - 34.4% father head of household.
 - 26.7% other than parent head of household. (grandparent, stepfather, aunt, sister.)
 3. 6.9% are in the custody of Department of Institutions, Social and Rehabilitative Services.
 4. 33.6% of the students are from broken homes due to divorce.
 5. 10.7% are students from homes where the parents are separated.
 6. 14.5% are students that have lost one or both parents through death.
 7. 23.7% of the students have been involved in law violations, court actions or conflicts with school personnel.
 8. 15% of the students will be 15 years or older by the end of the school year. (Normal age for completing the 8th grade is 14)

BUDGET 1977 - MUSKOGEE AREA

	<u>3100</u>	<u>3500</u>
SENECA INDIAN SCHOOL (TITLE PROGRAMS \$89,033)	772,933	228,200
SEQUOYAH HIGH SCHOOL (TITLE PROGRAMS \$82,922)	1,358,200	832,100
EUFAULA DORMITORY	340,174	85,000
JONES ACADEMY	634,700	190,700
CARTER SEMINARY	376,100	104,600
MUSKOGEE AREA EDUCATION OFFICE	<u>256,200</u>	
SUB TOTAL-----	3,738,307	1,440,600

BUDGET 1977 - ANADARKO AREA

	<u>3100</u>	<u>3500</u>
FORT SILL INDIAN SCHOOL SPECIAL EDUCATION	1,162,228 5,000	343,624
RIVERSIDE INDIAN SCHOOL SPECIAL EDUCATION	1,522,873 5,000	342,800
CONCHO INDIAN SCHOOL	1,192,177	403,011
CHILOCCO INDIAN SCHOOL	1,627,922	746,005
ANADARKO AREA EDUCATION OFFICE	<u>256,000</u>	
SUB TOTAL-----	5,771,200	835,440
GRAND TOTAL-----	9,509,507	276,040

Seneca Indian School Per-Pupil Cost Based on 131 Students as of January 31, 1977

<u>Account</u>	<u>Services</u>	<u>Alloted</u>	<u>Per Pupil</u>
1161	Direct Instruction	205,000	1,564.00
1164	Pupil Services	39,000	297.00
1165	Home-living	229,000	1,748.00
1166	Student Activity	19,200	146.00
1167	Food Service	105,900	808.00
1168	Pupil Transportation	10,800	82.00
1190	General Operations	72,000	549.00
1191	Indian Policy Group	3,000	

SENECA INDIAN SCHOOL

Muskogee Area

Wyandotte, Oklahoma 74370

PHILOSOPHY OF EDUCATION

PREAMBLE:

To realize more fully the promises and possibilities of democracy as a way of life, we shall provide a program which meets the needs of all students intellectually, socially, physically, and emotionally. These are our primary objectives. We shall achieve these objectives by:

1. Providing opportunities to promote emotional stability.
2. Providing wholesome environment that is conducive to the maximum physical and social growth.
3. Providing opportunities for healthful living at all times.
4. Providing opportunities for intellectual growth in understanding and mastery of those skills and abilities needed in life situation.
5. Providing opportunities for the development of each child to the maximum of his capacity, interests, and aptitudes.
6. Providing opportunities for development and understanding of Tribal Culture.
7. Providing opportunities for the Advisory School Board to counsel and advise on the program.
8. Providing opportunities to use local community leaders as resource people.
9. Providing opportunities for development and understanding and an appreciation of the democratic way of living.
10. Provide opportunities for public relations and involvement in community affairs.

STATEMENT OF RAY MCGILBARRY, MUSKOGEE AREA, SUPERINTENDENT, SENECA INDIAN BOARDING SCHOOL

Mr. MCGILBARRY. Thank you. I want to thank you and the committee members for this opportunity. I am representing the State of Oklahoma in my presentation.

I would like to ask you to turn to the copies that I have submitted to the committee, and we will go through this. I have been given information from the other areas that I am speaking on their behalf.

The map of Oklahoma, which is a Choctaw word meaning "red people"—there are 37 federally recognized tribes.

On the next one there, there is one reservation in the State of Oklahoma. We have talked about reservations here, by the other panel members. In Oklahoma, we just have one county that is designated a reservation.

The 1970 census says 98,468 Indian people, 3.8 percent of the total population.

Let us go to the next map there, showing the schools on whose behalf I am speaking: Chilocco, Seneca, Sequoyah, Eufala, Jones, Carter, Fort Sill, Riverside, and Concho.

Then following that is the Muskogee area, which takes care of the east half of Oklahoma, and the Anadarko Area. You see the 1976-77 enrollment as of January 31. Seneca is an elementary school, 131. Sequoyah is a high school, secondary, 290. Eufala is a dormitory facility. Their students go to public school. Jones Academy has 186. They are a dormitory and their students go to public school. Carter Seminary, a total of 910 students.

Anadarko Area—Fort Sill—as you can see there, 225. Riverside, 241. Concho, 301. Chilocco, 361. They are all full facility boarding schools. They have a school on campus. Their enrollment is 1,098. So the total for the State of Oklahoma is 2,008.

I would like to go on to the next page, where the students come from who attend Oklahoma boarding schools. At Seneca, we have seven States represented. At Sequoyah, about nine States. As you can see down the line there, Fort Sill Boarding School has the most from different States, from Washington State to New York to Montana and so on. So I want you to be aware that many students come from these States.

I would like to go into my text, my presentation here, at this time. There are 37 federally recognized Indian tribes in Oklahoma. We have one reservation, which is the Osage Tribe. The rest of the tribes do not have boundaries or designated reservations. We live in all communities in the State of Oklahoma.

There are 45,389 American Indians under 21 years of age, and all school age children do have access to public schools. You may think at this moment: Why do you have boarding schools? The Federal boarding school systems of Oklahoma serve Indian students of Oklahoma and from other States.

Today, my main tool of presentation will be the student profile to inform you of today's student character. This profile will reflect on all boarding schools in Oklahoma.

We have three dormitory facilities and we have six full service academic on campus facilities that I have mentioned. And, as you can

see as to when they were established, from 1871 to 1884, the full-service facilities, and the three dormitories—there was one established in 1847. Carter Seminary.

Mr. BLOUIN. That is not the age of the facility. It is the establishment of the school itself, is it not?

Mr. MCGILBARRY. Yes.

Mr. BLOUIN. Have the facilities themselves been updated?

Mr. MCGILBARRY. To some extent. To some extent.

Mr. BLOUIN. Could you—

Mr. MCGILBARRY. We have—well, not that far back, but there are some that we consider that far back in some sense.

Mr. BLOUIN. What is the average age of the typical facility you are using?

Mr. MCGILBARRY. I have at my school—the two dormitories were built in 1938, and our dining room and kitchen were built in 1927. I think most of the schools have been updated in the 1920's and 1930's.

Mr. BLOUIN. Nothing to speak of since then?

Mr. MCGILBARRY. Not too much, and that is what they were speaking about yesterday, the backlog of buildings, building programs.

Before I get into the profile, I want to explain the levels of Indian students in the State of Oklahoma. Level I, you are at. I understand regular home to school and school to home and daily life is a normal operation in this day and time. Now, we have level II dormitory set ups, dormitory to school and school to dormitory, and we have three facilities. Then we have level III the full-service boarding school on campus.

I would like to review the profile. My main presentation today is following page 3. Would you please turn to the document following page 3.

This data is taken from the students' records enrolled at Seneca Indian School in the 1975-76 school year. These are the reasons why some of them came to school. Academic reasons, 3.4 percent. They were behind for various reasons. Parental choice, 10.6. We have a strong alumni feeling about that Seneca Indian School. Some of them preferred to send their children there. Then 86 percent are social referrals. Fifty-two percent social referrals are primarily due to the family situation. Fourteen percent due to financial problems. Thirty-three percent to broken homes. Thirty-seven percent where mother is the head of the family. Fifty-three where the father is the head of the household. Students, 8.9 percent come from homes where someone other than their parent is head of the household.

Parental education level for both parents is 7.9. For father, 7.6. For mother, 8.1.

Significant negative student behavior. Truancy, 20 percent. Public school dropout, 38 percent. Delinquency, 21 percent. Transfers from other schools, 29 percent.

Mr. QUIE. Could you stop a minute? When you go through that A through D, there may be overlap?

Mr. MCGILBARRY. Yes, sir.

Mr. QUIE. OK, second, when you talk about social referrals, who refers on that? You give all these breakdowns.

Mr. MCGILBARRY. We have social agencies in our Bureau system, branch of social services, who have representatives in the communities in the States who have direct contact with the families. Not only do

they work with students about schools, but they will work with the families, the whole family structure, and employment, and assist them in some way.

Mr. QUIE. Do the parents agree in all those 86 percent of the cases that you call social referrals?

Mr. MCGILBARRY. Sir?

Mr. QUIE. Did the parents agree in all of those social referrals?

Mr. MCGILBARRY. Oh, yes.

Mr. QUIE. Thank you.

Mr. MCGILBARRY. Students with emotional or psychological needs in my school in 1975-76 is 87 percent. Thirty percent are students from broken homes due to divorce. Seventeen percent have lost one or both parents through death. Sixteen percent from homes where the parents are separated. And 1 student out of 187 that were enrolled that year is abused in the home.

I think this next one here—21 percent of the students from first grade through eighth grade had a prior arrest record.

On the next page, 25 percent of the parents' last year in school were between 8th and 12th grades. Fifty percent of the parents last year in school were between first and eighth grades. Sixty-four percent of the parents are at a poverty level and below. Eighteen percent of the students will be 15 years or older by the end of the school year.

I would like to go on further to the next page, to bring you up to date as of January 31 of this year. We have 83 percent enrolled due to social reasons and 15 percent enrolled because of parental choice and 2 percent enrolled because of academic reasons, and 15 percent of enrollment—that has increased this year—are court referrals due to family or student causes.

Head of the household student lived in just prior to enrollment: 39 percent, mother head of household; 34 percent, father head of household; and 26 percent, other than parent head of household—grandparents, step-father, aunt, and sister. Six percent are in custody of Department of Institutional, Social, and Rehabilitation Services. That is welfare. Thirty-three percent are from broken homes; 10 percent where parents are separated; and then 14 percent where students have lost one or both parents through death. Twenty-three percent of the students have been involved in law violations, court actions, or conflicts with school personnel. Fifteen percent of the students will be 15 years or older by the end of this school year.

I would like to go back to page 2, Mr. Chairman and committee members.

Mr. QUIE. Could I ask one question? On your 87 percent with emotional or psychological needs, what kind of criteria was placed on that? In one way, we all have some emotions. In the other way, there are the emotionally disturbed and the handicapped. I assume you are not talking about all of us and you are not talking about the educationally handicapped. What benchmark do you use on emotional or psychological needs?

Mr. MCGILBARRY. We are basing it on these overlapping causes of why they are enrolled in the boarding school. The type of students that we have here—they are hyperactive and their sense of self-worthiness is gone. They are pushed out of their communities. I think

I would like to answer your question in my text here. I was about to get into it.

These are the characteristics of our students in Federal boarding schools in Oklahoma. The students are pushouts from their communities. Public schools declare some of them not eligible to be in their schools in cases of too much truancy.

The fact that the students are dropouts from public schools, have delinquent behavioral patterns, and their parents have social and emotional problems. The parents inflict the same problems on the children. In time, the child does not interact in the public school system.

Boarding school is the answer to help each student to adjust to social, intellectual, and spiritual well-being. We succeed with some, and with some we are not successful. This is our clientele today.

What can we do to help from the present operating level? Recognize and provide funds for programs or activities which help the student to achieve self-worthiness, a program that reaches out into the community to get the parents and guardians interested in their children's education.

Parents and guardians supporting the school will enhance the students to be more responsible individuals. We need technical assistance in school psychologists, social rehabilitation services, and activities which teach students to be responsible as individuals. Train dormitory personnel to be professionals and counselors. We need counselors and school nurses on campus. Along with that, we need to upgrade our facilities, replace old buildings. For example, the Cherokee Hall at Sequoyah has been condemned several times, but we are still using it. And the dormitories at Seneca Indian School are inadequate. Jones Academy needs a multipurpose facility for on-campus activities. Carter Seminary needs a separate feeding facility. Presently they eat their meals in the gymnasium.

These requests—requests and plans have been submitted to the proper branches.

In closing here, Public Law 638 provides opportunity for Indian involvement. Indian people now have an opportunity to participate in decisionmaking for the welfare of Indian people.

The authority has always been from the top down, to tell us what our needs are, and now we can express our needs from the people to the top. And this has to be done through a prudent zero-based budget for accountability of spending money.

Mr. QUIE. Can you tell me, Mr. McGilbarry, what grades we are talking about now in the Seneca School?

Mr. MCGILBARRY. One through eight.

Mr. QUIE. Let us see. Have we got a listing? They come not only from Oklahoma, but from New York, Florida, Texas, Kansas, Arkansas, Missouri, and Illinois?

Mr. MCGILBARRY. Yes, sir.

Mr. QUIE. What percentage of the students—131 students, is that correct, as of this time?

Mr. MCGILBARRY. I have four students from New York, seven students from Florida, and one from Texas, and two from Kansas, and two from Arkansas, and Missouri and Illinois, one.

Mr. QUIE. Would that be the case in the other schools too? A small percent?

Mr. MCGILBARRY. Some schools would have a higher percent. I think 18 percent in one school. I think that was at Riverside or Chilocco.

Mr. QUIE. Would the ones who come from other States tend to have more severe problems than the ones from Oklahoma?

Mr. MCGILBARRY. It varies. Some do and some even from Oklahoma have severe problems. It all depends on the case study through the social services. Like my school, I do not take felony cases, and there are felony cases among students of that age that I just don't accept.

Speaking on behalf of Oklahoma and the boarding school setup, we are providing services to children that just can't hack it in public school or in their home community, so we are in need of a new dimension of—how do you work with people with problems, with many problems on campus at the same time? And we need in-service training of some type to deal with this problem.

I think my presentation is almost the opposite of the whole presentation here. They are talking about getting into the society and I am talking about students that can't hack it in the society, and we are trying to get them readjusted to participate in the society.

Mr. QUIE. You are talking about one through eight. You know, if those figures were from a secondary school system, I would not be quite as surprised. These are pretty severe problems.

Mr. MCGILBARRY. I have talked with other school people about their schools, and they said that sounds like their schools when I quoted my student profile.

Mr. QUIE. Would you call yourself then both an on-reservation and off-reservation boarding school?

Mr. MCGILBARRY. We are considered off-reservation.

Mr. QUIE. Any of those other schools that are listed here considered—

Mr. MCGILBARRY. They are all off-reservation boarding schools.

Mr. QUIE. Some of them may live nearby, but they are still called off-reservation boarding schools?

Mr. MCGILBARRY. Pardon me?

Mr. QUIE. Do some of them live fairly close, some of the Oklahoma students?

Mr. MCGILBARRY. Yes; they live—we are on the eastern side. Most of our enrollment are Cherokees, which are nearby.

Mr. QUIE. If somebody from another State wants to come to one of those schools for any of those reasons, do you refuse them for any other reason than that they are convicted of felonies?

Mr. MCGILBARRY. No; we review the case history of the student and we review with the social worker, like the four kids from New York. We will have a study about them before we make our decision, and, if they are, if I can say it this way, salvageable, we will say: "Yes, send them on and we will try to help them."

Mr. QUIE. How do they happen to come from New York? That is a long way away. Because of the name "Seneca"?

Mr. MCGILBARRY. I guess so. There are some relatives there in that area of Seneca that are—you know, some move from New York to Seneca, near Seneca Indian School.

Mr. QUIE. Many of the Oklanoma Indians in that area are Cherokee?

Mr. MCGILBARRY. Oklahoma Indians?

Mr. QUIE. In your school.

Mr. MCGILBARRY. Oh, yes; it is about 90 percent of our enrollment is Oklahoma Indians.

Mr. QUIE. Ninety percent are Cherokee. And I don't see any from North Carolina coming in here.

Mr. MCGILBARRY. No, sir, Concho may have them. I don't know if Concho—I am the elementary school on the eastern half of Oklahoma, and Concho Boarding School is the elementary school for the western half of Oklahoma.

Mr. QUIE. In your dealings with the office of the Bureau—and we heard a little bit here on how that relationship operates—do you deal directly through your area office? Could you give me a picture of when you want to reach anybody at a higher level than yourself?

Mr. MCGILBARRY. My position level of superintendent—my next line of authority is the education program administrator. His title is assistant area director of education. And his superior is the area director. All my communication is directly to assistant area director of education. It is not to the area director, then to assistant area director, like some cases. Mine is directly to the assistant area director.

Mr. QUIE. Back to the problem of the severe emotional difficulties and other social problems that exist, what can be done to, in some way, tie in with the parents? What strikes me is that, even though it seems like there is a need for boarding schools, within that need one ought to be involving the parents more, because the parents fulfill a role that nobody else can fulfill.

Dr. Allen mentioned that some, interestingly, in the kibbutz in Israel now—that is one of the significant things I have noticed of late, that they are really putting pressure on parents to come and visit more often.

I believe, if I recall what Dr. Demmert was suggesting in some plans of his, it was even letting some of the school people in the earliest grades, if I recall it correctly—correct me if it is incorrect—actually provide someone to go to the home so that initial training could actually occur in the home, and I suppose that is in preschool, not more than the first three grades anyway. Have you looked at that at all as a possibility as the superintendent of schools?

Mr. MCGILBARRY. I am planning to submit a title IV, section B, of parental involvement with the students, to come to school and even stay on the campus with us. And, if we can get that relationship established, where the student feels worthwhile, I would like to pursue that if the project is approved, to pay them mileage to get to the school. Like I said, 64 percent are at the poverty level or below, and, yes, we are looking to get parents up to our school and be involved.

Mr. QUIE. Any of the others? Mr. Masayeva, what have you done? You have the day schools. What have you done to tie the parents in a little bit more? It seems to me it is much easier for you. Perhaps we could learn something from the way you do it with your day school.

Mr. MASAYEVA. Well, I was fortunate to receive quite a bit of training in administration of community schools. I was one of the fellows under the Charles Stewart Mott Foundation, and I have had the privilege of participating in a wide range of community service-type

activities during my internship in Flint, Mich. So, when I became principal, I, you know, brought this philosophy to the school with me. My predecessor had a PAC organization to raise money for Christmas presents, but that was the extent of the involvement. So, the way I did it was—the community school is based on the premise that, before you can really get the parents involved in the real serious, major decisionmaking processes, you should just make them feel comfortable being in the school, because most of them have never been inside the school even since they left when they were students in elementary school. One way to do this is to offer them activities, some useful kinds of activities that they can all be involved in.

So, we have opened up the gym for afternoon basketball, evening recreation for adults. We even worked out a system where, since it is the hardest to get the fathers into the school—we ran an evening recreation where the kid has to bring the father, to be admitted into the gym. And this brought a lot of fathers. Later on, they sort of took over the gym.

We have had movies. We asked the county library extension office to set up a little library in one of our classrooms. We offered cake decorating classes. We got such incredible involvement that, when we were doing one of our fine arts programs, a ceramics project, we held it in what used to be a generating room for the facility. There was a generator in there. Before they brought power onto the reservation, we had generators. So it was a generator room which was abandoned, so we took over that little facility and we were holding classes. And the community said: "There is that old condemned BIA building. Why don't we fix that up?" So the community got together and developed it into an art studio. It was strictly voluntary labor. They developed it into an art facility, which later was used to extend the fine arts classes in my school.

Unfortunately, last year we had to abandon that whole project because it was declared unsafe, and we were not permitted to use the facility any more. Consequently, that whole facility has now been shut down.

But this was the way I did it. You know, I held just a lot of activities for the parents to get them into the school and just to be comfortable being in the school, to make them develop that sense of their school, that this is their facility. And that was my technique.

MR. QUIE. I am trying to get some information on how we ought to proceed with legislation. Suppose that we believed this was a good concept, that here you have Dr. Demmert suggesting something along this line, the superintendent of schools—the principal at least—talking about it here. Should we have a line item for parental involvement? Should we have something with project grants like title IV? Or should we just make certain that the authorization permits you to use the money you are going to get anyway for this good idea and let you make the decision?

What I want to ask you is this. If you got enough power and authority by way of bringing that about locally, so, if the money is available out there, you will set that as a higher priority than something else—

MR. MASAYESVA. Mr. Quie, 2 years ago, I wanted to make this a permanent part of my facility, part of my program. As a matter of fact, the Bureau policy as it now exists states quite specifically that

you can use existing staff to meet the educational needs of the community, but first you have to meet the primary responsibility of educating elementary children.

So we have that authority, that we can assign staff members to maybe teach GED, and this is what I was doing, and pay them compensatory time or overtime. But it gets to be quite a drain on your staff, and this is what I found, unless someone—If it is going to be done right, you have to have a person in full time planning and coordinating this entire range of activities, particularly when it gets to the summer part where you know you would like to have a very comprehensive program for the entire community.

We did at one time ask for a summer program fund, which was given to us, but it was given so late that, by the time we received all of our equipment, it was time to start school again.

So it would be nice if it were part of our regular budget, and not another program coming in with its own mandates and guidelines and procedures, but if it could be just part of the operating budget, so we don't have to be meeting someone else's requirements again.

Now, presently there is an act passed by Congress last year which provides for community school activities. Unfortunately, the BIA day schools are not eligible for these funds from the Community Education Act. We brought this—I brought this up at one of the hearings, but it was too late for amendments to be made.

I understand we are also not eligible for title IV of the Indian Education Act. As Bureau schools, we aren't. So the services that we really need to bring about the community school type of activities—I think the resources are there, but we are shut off from it.

Mr. QUIE. We are talking about—Really, community schools are one thing. Bringing the whole education program to the parents so they are involved more is really a little something different.

Could I ask the three superintendents if you could just quickly respond?

Dr. ALLEN. Congressman Quie, in my judgment, if we do not have line item money to spend to get parents involved, we will not—it will not happen, because historically we have not received enough money to do the kinds of things we want with our children, so, if we lump it all today, I would be concerned about it never happening. If it came as a line item, I think that would make it certain that it happened.

Mr. QUIE. What about the other two?

Mr. MCGILBARRY. I feel the same way. Many of our parents live so far away that they just can't afford to come to our schools, and the only way we can get them there is to give them some gasoline money to get there.

I would support that, that we make a line item for that particular—

Mr. QUIE. How about you, Mr. Holman?

Mr. HOLMAN. I am in concurrence that there should be a line item for community education programs.

Mr. QUIE. Let us hear from Mr. Eagle Bull and Mr. Magarson.

Mr. EAGLE BULL. I would agree for this reason, that in that way it is not as apt to bring additional regulations and rules and guidelines that we would have to adhere to to carry out the program. If they come to us as a line item and we have freedom to use it in that way in our

own regular budget, as a Bureau budget, so that we don't have another program coming in.

Mr. QUIE. You would have another program if you had a line item.

Mr. EAGLE BULL. I mean, if it is going to come in in our regular 3100 budget, for example, for education, I think it will, as far as our area is concerned—If that would come into our program, regular program, that would be left up to the agencies to decide if they want to use it that way. I am sure that is what will happen to it, insofar as the agency operations are concerned, but in no way would that stop at the area office. It would be a decision they would have to make at the agency.

Mr. QUIE. Mr. Magnuson.

Mr. MAGNUSON. I do agree that it should be a line item also because, if we are going to do it, we would have to have earmarked money, like our summer program funds that come now. We use that for summer. It is a line item. We use it for summer programs. And this is the way I would like to see it come, Mr. Quie.

Mr. QUIE. I would like to hear from Bill Demmert on that one.

Dr. DEMMERT. I would agree with Dr. Allen's original statement that, if it is lumped in, other priorities will take precedence. And, if this is the kind of priority that you receive a line item budget for, the chances for it appearing are good, but, in order to assure those chances, you have to go one step further, and that is to give the superintendents and the principals the authority and responsibility for the money.

Mr. QUIE. Let me switch to another subject. We didn't get into it yesterday: The distribution of the money. Some of you, I guess, have heard my name attached to some ideas on formalized JOM, so you know I am concerned about it. I am concerned about this all through the distribution of Federal moneys. Formulas have to be fair and equitable. I gather that Jon Wade from Albuquerque has something to do with that, and I would like to get some response from you. You haven't been called on before, have you? Not when I was present anyway. Could I get you to respond? I would like to get a little better idea of what happens.

Mr. WADE. Are we talking about a school operation formula for Bureau schools?

Mr. QUIE. I am talking right now JOM, and I would like to get into Bureau schools, but I'll take Bureau schools first and then go to JOM.

Mr. WADE. The gentlemen here would be more interested in the school operations budget formula for their schools. I think. I would say, if it is all right with you, let us get into that first. Or do you want to go to JOM and then get back to that?

Mr. QUIE. I would like to start out—because JOM has not been thrown in. JOM money, you know, is Federal money used for reservation kids to go to public schools.

Mr. BLOVIN. Why don't you move up to the table near a microphone. It might be easier for all of us, including the poor lady who is trying to follow this conversation.

Mr. WADE. Do you want to talk about JOM formula? OK. The regulations that govern the Johnson/O'Malley program talk about funds being distributed on a substantially equal basis, based upon two

things: the number of students to be served and the cost of education in the State.

The problem to the Bureau is: How do we consider the cost of education in the State? How does that fit into the formula for the distribution of funds?

For the first time, that formula or those words were used in the distribution of the fiscal year 1976 allocation. At that time, a decision was made that the way we were to consider the cost of education in the State was a strict—a very strict and literal interpretation of the cost of education in the State, and, as a result, the amount of money per student varied greatly depending on what State you lived in.

For instance, everything was based on the lowest State, which in this case was Mississippi. The range of dollars per student ranged from a low of, for example, \$1 per student in Mississippi to a high of about \$2.75 per student in Alaska.

That was the relationship percentagewise of the difference in the cost of education from the State of Alaska to the State of Mississippi.

In December 1975, there was a meeting held in Albuquerque of JOM contractors, area people who were involved in the Johnson-O'Malley program, and we discussed this particular formula. As I say, that was one that was decided for us.

There was criticism at that time that that particular formula made the rich get richer and the poor get poorer. In other words, kids who lived in low-cost States obviously got less money than kids who lived in the high-cost States.

So, at that particular meeting, a decision was made that, for next year, for fiscal year 1977, we should recommend that, for any State whose cost was below the national average, the national average would be used. For any State above the national average, they would get credit for that percent they were above the national average.

In doing that, every State below the national average got \$1. For about six States above the national average, their range ran up to a high of about \$1.78, again in the State of Alaska.

That was in direct relationship to those States' cost of education as compared to the national average. So that is where we are today. The fiscal year 1977 distribution was made based on that formula. In the meantime, we had a conversation in which the formula was discussed and a suggestion was made that we try out a different formula, that was done, and that formula coincided with the formula for the distribution of title I ESEA funds among the States.

That distribution was worked out during the summer, this past summer. There was a commitment to try it on the different States, the different contractors, the different Indian tribes, across the country.

Responses were received. A decision was made to stick with the original BIA formula, the one that was adopted or had been agreed to previously. I believe there has been a more recent commitment to you to try again, and, as a result, our three formula options that have been developed and the one that is to be considered have been sent to the field with, hopefully, an adequate explanation of each formula option. Responses are to be returned to Dr. Demmert sometime this month.

Based on those responses, the formula will be, as I understand it, written in the Federal Register for review and comment and will become a part of the regulations governing the program.

I have, since those three options went out—I have had contact with several of the areas. One of the areas, the Navaho area office, in consultation with the Navaho Tribe, is suggesting a fourth option, and that fourth option is a strict per capita distribution, except with a 25-percent increase for the State of Alaska. That corresponds to Federal service cost-of-living increases for employees who would go to the State of Alaska.

So, the Navaho area is suggesting that option as one to be considered, a straight per capita with a 25-percent increase for Alaska.

Mr. QUIE. Is that going out for review as well?

Mr. WADE. I don't believe so. I told them if they feel strongly about it to send it to Dr. Demmert and he can decide whether or not he wants to make it a part of the other three formula options.

Mr. QUIE. On the ESEA title I formula, we came to the conclusion that it would not be fair for the State who was down at the lowest to receive just that amount, because, if you are going to improve education in a low-cost State, those costs would be greater than just taking the average cost of education. By the same token, with the highest cost States, a lot of their costs don't reflect on quality of education. New York is the best example of that, where they have a retirement program which is the biggest factor, bigger than in any other State. I guess you could retire around \$20,000 after 20 years or something of that nature. You know, that reflects on the whole cost of education. That is cranked into the program.

Now, it may not be \$20,000 anymore. It may be higher than that, the way things are changing.

For that reason, we went to an 80-percent figure—if you were below the 80 percent of the national average, you were brought up to that. If you were above 120 percent of the national average, you stayed at that.

Then the question came up as to Alaska. We decided to go with 120 percent, even though Alaska might have some other causes for higher costs.

As you have looked at Alaska, how do you think the formula should apply? We are trying to look at it from the national perspective.

Mr. WADE. Like you said yesterday, we at the national level have to look at the total picture and shouldn't be quite so provincial. I think those were your words, sir. Watch this bureaucratic shuffle. [Laughter.]

As you look at the leading factors, you range in option A, the one that was used in fiscal year 1976—the range is from \$1 per student to \$3.04 per student. And the question I would ask is: Is that a fair difference in the cost of delivering special educational services to Indian children among those States? I think that is a little great.

The next one—what about the next option? There the range is from \$1 per student to \$1.78 per student. Question: Is that fair? Is that a fair difference as we look at the program nationwide?

Factor C or option C—The range is from \$1 per student to \$1.50 per student, a narrowing of the difference between the money provided per student.

The Navaho option would be from \$1 to \$1.25 per student, and I think we are going to have to take a good hard look at either one of those options and say: What is the most fair in the distribution? What best reflects the cost of education in those States? I haven't been

to Alaska recently, so I would be hard pressed to say whether the B or C option would be best or even whether the Navaho option would be the best, but I think we have to think about what is the most fair and what represents—the best difference in considering the cost of education in the States.

Is \$0.78 reflective of that difference? Or is \$0.50 more reflective? My personal bias at this time is for option C.

Mr. BLOUIN. Who ultimately has to decide which formula is fair?

Mr. WADE. Dr. Demmert, I believe, is going to take that responsibility after he consults with or after the responses are returned on these three formula options as have been explained. They are out in the field now, and they will be returned to Dr. Demmert, and I believe he will make that decision, unless he wants to buck it up to the Commissioner.

Mr. BLOUIN. Could you supply this panel with the information that is out in the field and what they are analyzing, so that we might be able to—

Mr. WADE. You bet.

Mr. BLOUIN [continuing]. Do the same kind of reviewing?

Mr. QUIE. Let me take one other question on JOM then before we get down to the BIA money. I was under the impression for a period of time JOM was for special needs of Indian students—and let me say that you ought to be using JOM money only for these special needs and not for any basic support. You indicated that JOM money ought to be used to increase achievement, improve the achievement.

When I got out to South Dakota, I found that they did have a special plight, at least in the Sisseton group out there, that they actually lost money as the school lost money. The Indian kids lost the benefit of the education program, and it seemed at least for a period of time they needed some basic support. Have you looked at that, Jon?

Mr. WADE. Yes, sir.

Mr. QUIE. May we have an indication from the rest of you as well.

Mr. WADE. I have been dealing with this problem for about 12 years. I started out in 1965 as a State Director of Indian Education for the State of South Dakota, and I am quite intimately familiar with the problem, not only in South Dakota, but throughout the Aberdeen area and now recently throughout the Nation.

The problem started that prior to 638 or the regulations that were adopted in fiscal year 1976, the regulations governing the program in talking about the basic support said that it was allowable under special and exceptional circumstances. Those were about the words. Nobody bothered to define those terms.

As a result, I, as the State Director of Indian Education, in administering the program, or after I moved to the area office in administering the program—it is pretty much my judgment as to what constituted “special and exceptional circumstances” in these schools.

There was evidence around the country that people disagreed with not only my interpretation of what these circumstances were, but what other area offices and other State directors or contractors—how they defined it.

As a result, there were charges of misuse, some substantiated. The Bureau opted to get out of the program and, in the regulations formulated as a result of 93-638, the Bureau opted to have a phaseout.

In fact, in our report to the Congress that was delivered, I think, a year ago October, the report recommended that the Bureau get out of the basic support business.

Well, as soon as we did that, it became very evident that there were public schools around the country that had great needs and that, in most of the criticism of the report or the program, it was depicted as a white/Indian fight, that non-Indians were ripping off Indians in the operation of these schools.

Well, it turns out that the majority of these schools are close to 100 percent Indian enrollment, 90 percent and so forth. A goodly number of these schools also have Indian school boards. So it isn't and wasn't a white/Indian confrontation and that, when we started to phase out the basic support program, we are in fact hurting the education of a substantial number of Indian children.

I have continued to preach this over the past several years. It is now getting some recognition, and I think we are at a position now that it has been recognized that there are between 25 and 30 school districts, public school districts, nationwide who have a need—who are educating substantial numbers of Indian children located on reservations and that they do have a problem, not because of their own, but because of the nature in which public schools are financed in this country.

Without assistance, they are in great difficulty. Now, as we talk about basic support, the first thing we have to do is establish a standard, a standard that we in the Government are willing to support. Is this the quality or quantity of education that we want for these children?

If left to each individual LEA—and I think we have done that—we get into great discrepancies in measures of need. But I think we in the Federal system have to establish what standard we are willing to support and then look at what each one of these school districts can do on their own and then see whether or not we are willing to make up the difference.

But, first, we have to establish what standard. I have some feelings about whether or not the Bureau in itself can do that. I would have recommended that a national committee of people, membership of five to nine people, be appointed from all walks of life, but who are knowledgeable in school finance, accreditation, standards, and so forth, to represent public school State Departments of Education, tribes, and these people can be found who would establish that criteria, that standard, that we are going to support, and that applications come from the various public schools around the country to this committee, that they make recommendations to the Commissioner on the level of support for each one of these schools.

At this point, I don't particularly care where the program is located in the Federal Government, whether it is located in the Bureau of Indian Affairs or in USOE, just so USOE has an adequate staff to assist in this effort.

I think there are some advantages to having it located in the USOE as opposed to the Bureau of Indian Affairs. They are that too often we have experienced when it has been in the Bureau and a level of need has been identified with a public school—for one reason or another, even when the money is available, the money has not gone to that public school.

That would not happen if it were in HEW, where they could make direct grants.

Mr. QUIE. Mr. Holman, when you made that comment that there ought to be an inclusion—the way I understood it, it was that it ought to be used in the remediation or for all the BIA money—and I may have misunderstood you on that. The way I thought the people have been talking about BIA money is that there ought to be some goal to be achieved, so there would be an increase in achievement, and that is what GAO's study was based on versus 1972 and now, that Indian children were going to reach the average of the Nation as a goal to be achieved.

Would you think it would be right if BIA money were used primarily on basic needs of the school that has a goal of improving achievement, but also have categorical programs alongside it for special remediation that students would have because of handicaps or other disadvantages and others we talked about a little bit earlier, working with the parents so that the parents would be involved?

I would just like to have you clear up for me what your thinking was when you made this comment.

Mr. HOLMAN. Yes; that is exactly what I think the Bureau should do. The school should be required to identify the basic education program. It should get higher administrative approval, and then the money should be line itemed for that program at that school to accomplish objective *a*.

Now, this would include your special ed programs that you referred to, but it ought to be basically in the Bureau budget. Right now we have to acquire moneys for special education programs from ESEA because we are considered a 51st State. This really ought to be in the Bureau's main budget items. We shouldn't have to go outside for money. We should have a program of our own developed, and we have to justify it.

Does that answer your question?

Mr. QUIE. Yes; good enough for now. To do this—let me ask John Wade: How do you think we could best monitor what is happening here? You have to have a monitoring system if this is going to be done.

Mr. WADE. The Bureau of Indian Affairs in our ESEA programs that I have responsibility for—we have a monitoring procedure established for the monitoring of our title I programs, in particular.

Mr. QUIE. Title I of ESEA?

Mr. WADE. Right; as 51st State we get a substantial amount of dollars for that program. The monitoring procedure as established there is very good. USOE, I think, will back us up. We have a very good system for operating that particular program. It has been nationally recognized. That system is transferrable to any Bureau program that the Bureau opts to operate, whether it is land operations or road programs or the basic program in education. I would recommend to anybody who wants to monitor a program from the central office level to adopt the monitoring techniques that we have established in title I to monitor area office operations or school operations at the local level.

Mr. QUIE. You are suggesting using what you have in place for title I for the total of the BIA program?

Mr. WADE. I am saying that model could be adapted, and it wouldn't take a large staff to do it.

Mr. QUIE. What would you be talking about in an increase in staff in order to do that?

Mr. WADE. A dozen people.

Mr. QUIE. That is all?

Mr. WADE. We are doing it now with three people, and the technique is basically like this. Area offices have the responsibility for monitoring every project once every year. Area office has a staff that we fund to do that, and it varies from one to three to three to four people, depending upon the size of the area. That is over 200-some projects a year.

We have a staff of three or four professional people who monitor the area office to insure that they are doing their job properly, and we then select sites that our central office—central office people also go out to make sure that what they have said in their area monitoring is correct.

Mr. QUIE. Let me ask two people, Mr. Eagle Bull and Mr. Magnuson, how you react now to what Jon Wade has said, because I imagine what he would do would go through your offices, if I am correct on that.

Mr. EAGLE BULL. Like Jon mentioned, his office does monitor the area office. His office does monitor our office. That in turn monitors in our area the 39 projects under title I ESEA moneys. Jon mentioned the size of the staff that it would take to do that. What it would mean to our office is that we would have to realine some of the duties of our staff in the area office to carry out similarly what title I staff is doing to the projects in our area.

So I think it is workable. It will be a realinement of some duties, but it is not out of the realm of possibility.

Mr. QUIE. Mr. Magnuson?

Mr. MAGNUSON. Yes, I agree. On Navaho, we have a staff that works with the schools in monitoring. We have developed over the years—not completely, but we have been working on a curriculum fitted to the Navaho students. So we monitor to insure that the schools are using this curriculum, these curriculum guides.

We can go a step further. One of the things—if you are going to get a job done, you have to have accountability or monitoring, so I am sure that this can be done. I am sure, if we had a set of standards and goals established—now, I think the goals have to be established for each area. I don't think we can have a national goal for Indian education. Our schools are in different situations. Our schools are not the same. We don't have the same students as Mr. McGilbarry has been talking about. Our students are different.

So this was the point that I wanted to make earlier, that we have to take a look at each situation, each tribe, and then work toward establishing goals, work toward establishing accountability, monitor to assure that accountability, and I don't see any problem.

Mr. QUIE. Using criteria reference testing enables one to do that rather than standardized testing that we have been doing so much in the past.

Mr. MAGNUSON. Right; and we have been working on developing this type of test in our area. We haven't completed it. We are still using the metropolitan SRA. But this is a goal that we have.

Mr. QUITE. Jon?

Mr. WADE. Yes; a very vital component of our monitoring activities I overlooked was the role that the office of audit investigation of the Department of the Interior plays. Most of our monitoring is program monitoring. The office of audit investigation does the fiscal auditing for us, and they have a schedule of auditing every one of our projects at least once every 3 years. That is the fiscal audit, and they provide a very meaningful service to us. In that way, our people can devote themselves to the program audits.

Mr. QUITE. The last question I want to get into is the distribution of money, BIA money. I wanted to run through the Johnson-O'Malley because at least we are struggling with an adequate formula, a more equitable formula. When you talk about the banding and the nonbanding and how this BIA money goes, it is the most confusing thing and I can't understand how any of the school superintendents can look at that and say: "Well, this is fair or unfair."

I mean, it shouldn't be that the people who have responsibility for the programs look at the national picture and say "what we are getting isn't fair."

Now, Jon, do you want to start? Do you have any suggestions as to how we could develop a formula so that the money could get out to the schools as they needed it? As Mr. Holman indicated, it is better that you get the money you need out of that one fund, rather than having to go to other agencies and put together all the categories aids and develop grantsmanship in order to get it. That is what Mr. McGilbarry is going to have to have, good grantsmanship, in order to get that title IV money. It is all right to go and get some money that way, but, if you are going to run a good program, you had better know you are getting the money for it the most fair and equitable way.

Mr. WADE. I don't work directly with it, but I have been around it for a goodly number of years, and I do know that the Bureau has tried to establish a system over the past half dozen years of equalizing the funding of our programs, particularly basic school operation.

Generally speaking, that runs into a roadblock because in any formula some people are going to lose, and those people who have advocated a formula distribution have not been powerful enough within the Bureau to get it done.

I might leave it there and let these people who are at the front line talk about how it works now with the banded programs.

Mr. QUITE. Dr. Allen?

Mr. ALLEN. Yes, I have to say something about that, mainly because this is what is happening right now. Education in the field is fighting the priorities established by the tribes, who in turn put pressure on the area director for resources. They have more clout with the area director than we do as superintendents, because the budget goes to the area right now and the area director makes the decisions as to what goes to education and what goes to other things within that area.

In order to overcome that, I see a great need for direct funding to the schools from the central office and not through the area office.

Mr. QUITE. First you have to start out with having money earmarked for education and it can't be used for other purposes, so that you don't have to compete. I will tell you, in Buffalo, N.Y., if they did that, they would have a hard time keeping education money away from snow re-

moval right now. And that seems to me what you are running into in the educational programs.

Mr. MAGNUSON. Here again, each area is different. I am learning something about the other area. Although I have been in this outfit for 26 years, I have learned something today. On Navaho we approached it differently. The area office had to build a zero-based budget, and we met with our board of directors, who are the school superintendents, one from each agency. They are our board of directors in a sense informally.

The area office education staff had to prove that whatever they were going to do was necessary. We built in so much for travel, so much for consultants, so much for program, and then every penny of the money besides that was sent out on a per capita basis, and we came up with a weighted formula which allowed—and we used the factor of 1 for a boarding student, we used a factor of 55 percent of that 1 for a day student, we used 1.25 for a high school student, and we used 0.65—we have some dormitories. We used a factor of 0.65 for dormitory students. Then we have one special school where we had a factor of 1.17.

The Navaho Tribe in banding—we did not lose any education money. In fact, we got a little additional in banding. But every penny of that money was distributed on a per capita basis, based on enrollment on a given day.

It is not as sophisticated as we would like. We felt that the day students were—they needed a little bit more. We have to do something with that factor because the enrollment or the schools in which they are enrolled are usually smaller, so they didn't carry as much money with them, you see.

But this is the way we did it, and I think that it is a good way.

Mr. QUIE. Do you have any contract schools?

Mr. MAGNUSON. Yes, sir. We have three contract schools.

Mr. QUIE. Do they get extra money over the others?

Mr. MAGNUSON. Yes.

Mr. QUIE. How do the others feel about it?

Mr. MAGNUSON. They didn't like it very much, but that is the way it is.

Mr. QUIE. Let us go to Mr. Holman, if we could, and then Mr. Eagle Bull.

Mr. HOLMAN. The factor system Mr. Magnuson was explaining we utilized this year. Now, about how we get our money to factor out—I don't know whether there is any formula attached to it or anything like that. That is something I would be interested in, that these moneys be specifically earmarked for specifically identifiable education programs.

We have one contract school in our agency, and they do not get any extra money over the rest of the schools because the local tribal governing body has seen to that. They get the same per capita as the rest of the schools.

Mr. QUIE. Mr. Eagle Bull.

Mr. EAGLE BULL. I kind of feel like Ernie here. It seems like we learn more about ourselves when we get together on some of these issues. I think our area differs a little bit from what Dr. Allen was explaining.

The agency band analysis—for example, when an agency sends theirs in, it does not get changed at the area office level. When it leaves the superintendent's office, there are no other changes made to it from the time it leaves there—from the time it is submitted through the Bureau's budget channels through the Department of the Interior and so on.

The area office does have its own band analysis for its operation, the operation of the area office programs; namely, salaries, personnel services. The problem we have in that type of thing is that we have two off-reservation boarding schools, and their budget is in the area office band, and, as a result, we don't have what I heard just a few minutes ago, that the tribal input and the tribal power being setting these priorities.

So these two schools in our case are in the area office band and serve two areas besides the Aberdeen area. And this causes some concern. It causes a few problems where we do set the area office band, but, without direct tribal involvement, it doesn't have the same impact that an agency band has coming up that has had tribal involvement.

So, as far as the agency band analysis, once the amounts are determined, the priorities set, we don't change those at the area level.

Mr. QUIE. Could I just get a quick response from Mr. McGilbarry?

Mr. MCGILBARRY. It is similar to what he is saying in our area, except at the area office. You get a memorandum saying that your money is thus and so for this year and you are to operate within this amount. So it is similar to Mr. Eagle Bull's situation, except for the area office.

Mr. QUIE. What is your reaction to what Dr. Allen has indicated?

Mr. MCGILBARRY. About—

Mr. QUIE. Separate funding.

Mr. MCGILBARRY. I like that because you know where you are and over. It can get into long-range planning. As it is now, it seems like we just plan from year to year to year, and, if we know we have got the money, that it is a line item directly for our needs, we can have more effective programs.

Mr. QUIE. Mr. Masayesva?

Mr. MASAYESVA. I like this idea of direct funding. It gets us away from having to compete with tribal priorities, which is the way it is in our area right now.

Mr. QUIE. OK. Thank you.

Mr. WADE. Sir, could I just add one thing? I am an educator, I have been in the outfit for many, many years, about 38, and I think it is important that we realize that education on a reservation does not exist in a vacuum, as was mentioned yesterday.

Also, the legal responsibility that we in the Bureau of Indian Affairs have to Indians is a government-to-government relationship. Even as much as I as an educator would like to have dealings with educators and kids, we must continue to recognize that that is the relationship, legally, so far—and it was pointed out very clearly in Public Law 93-638. It declares that the intent of the Federal Government is that our relationship will be with tribes.

So we have to be very careful in talking about education separate from that relationship, whether it is in the funding aspect or whatever. I just want to make the committee aware of that, that, as much

as we would like to, we still have that legal responsibility to deal with tribes, and it is important for us to consider in this whole complex issue with Indian education.

Mr. QUIN. Is there anything that would prohibit us from providing the education money separately?

Mr. WADE. A policy change on the part of the Congress as declared by Public Law 93-638.

Mr. BLOUIN. Yes, sir.

Mr. MCGILBARRY. Mr. Chairman, before we close here, I have, I think, a problem that is similar to the rest of the panel members here, and I would like to mention this as a matter of record.

When we have boarding school students under our charge and when we are in need of emergency medical help, when you are away from your school, we are directed to take our patients to—the patient to the nearest Indian hospital. Sometimes we can't do that.

Our area director has directed us that, if it is necessary, we should take them to the nearest local hospital, and we have done that. But we have a confrontation of who is going to pay the bill.

So I would like to ask the committee to consider some type of a health insurance for each student, because the higher education students do have health insurance and they can get services anywhere.

For the safety and welfare of the students, I would like for some kind of a floating fund, if we can, to pay for the services of the hospitals nearby.

I just wanted to mention that because sometimes they are on field trips and, if someone gets hurt, we want to be sure that the children receive adequate medical help.

Thank you.

Mr. BLOUIN. Thank you very much. I would like to thank all of you on the panel. We have had an excellent learning experience this morning. Obviously those of us on the committee have, and it seems like you have amongst each other.

We would like to keep the record open, if there is no objection. The staff has some questions that they would like to specifically submit by name to each of you to give you an opportunity to respond in writing. We just didn't have time to get to them today. We will keep the record open, with no objection, for that purpose.

This concludes our 2-day hearings on Indian education. I might just add that it doesn't conclude anything but the end of the very beginning of what we hope will be a very successful and long overdue venture into Indian education and the role the BIA has in it and the updating and upgrading of the quality of education for Indian people all over the country.

Thank you for coming and thank you for your cooperation.

[Whereupon, at 1:04 p.m., the subcommittee adjourned.]

APRIL 6, 1977.

Mr. LARRY HOLMAN.

Education Programs Administrator, Eastern Navaho Agency, Bureau of Indian Affairs, Crownpoint, N. Mex.

DEAR MR. HOLMAN: We are writing to ask you to answer for the record several questions which we were unable to ask you during your appearance before the Subcommittee on Elementary, Secondary and Vocational Education on February 3, 1977. Attached to this letter is a list of those questions.

We would appreciate a prompt response so that the questions and your answers can be incorporated into the printed hearing record.

If you have any questions, please feel free to contact the staff of the Advisory Study Group on Indian Education.

Warmest personal regards,
Sincerely,

MICHAEL T. BLOUIN,

Chairman, Advisory Study Group on Indian Education.

Enclosure.

(1) What is the purpose and responsibility of boarding schools within your Agency and what problems are encountered in fulfilling these aspects?

(2) Why has BIA attendance on Navajo fallen off over the past few years?

(3) Are "Title" programs working? How have they influenced the education in your Agency?

(4) How much stance or advice on policy or program questions do you receive from BIA Central Office, either in Washington, D.C. or IERC in Albuquerque?

(5) In view of decreasing enrollment within Bureau schools on Navajo, what is being done to utilize or maintain the empty facilities?

(6) In the past, several bodies have urged the Bureau to turn over, to other groups, vacant facilities. What policy, if any, has the Bureau undertaken to cooperate with the public schools, tribes or others in the use of the underutilized buildings within your Agency?

(7) Do the current BIA standards and policies regarding dormitory attendants create local school problems?

(8) What, in your opinion, has been the reaction of local tribal leadership to 93-638, the Indian Self-Determination and Education Assistance Act?

(9) How could you prioritize the educational needs within your Agency?

—U.S. DEPARTMENT OF THE INTERIOR,

BUREAU OF INDIAN AFFAIRS.

Crownpoint, N. Mex., June 10, 1977.

HON. MICHAEL T. BLOUIN,

Chairman, Advisory Study Group on Indian Education, Committee on Education and Labor, Congress of the United States, House of Representatives, Rayburn House Office Building, Washington, D.C.

DEAR MR. BLOUIN: As per your request, submitted herewith are my personal responses to the questions you submitted relative to the oversight hearings conducted before the Subcommittee on Elementary, Secondary and Vocational Education on February 2, 1977.

Question 1. What is the purpose and responsibility of boarding schools within your Agency and what problems are encountered in fulfilling these aspects?

Answer. The purpose of boarding schools within our agency is to provide an elementary, middle and secondary educational program for Navajo youth, ages 6-21, who reside more than one mile from a public or BIA school bus route and who have special needs, academic or social, that are not being met in their present school.

The responsibilities of boarding schools, I believe, are tremendous in that those of us who hold accountable positions in the education program are considered in loco parentis for these students through the daily operation of boarding schools. Thus, we must provide services not normally found in public education programs.

Some of these services are: Providing student opportunities to participate in a wide range of evening activities; nutritious meals; training in personal hygiene and maintenance thereof; development of acceptable social behavior; maintenance of individual student health; and providing opportunities to observe various career fields.

One specific problem encountered in totally fulfilling our responsibilities is lack of funds to acquire and train adequate dormitory staff. We have funding to hire one instructional aide for every sixteen students, but the reality of operating a twenty-four-hour, seven-day-a-week program is that we have on the average of one aide on duty at a minimum for every thirty-two students during the evening hours of 5:30 p.m. to 10:00 p.m. At other times it is one aide on duty for every fifty to seventy students. Also, our instructional aides and the other dormitory personnel all too often enter their jobs with little or no training, knowledge, or

skill in the professional child guidance one should have to provide for total fulfillment of all aspects of a group homeliving environment.

Another problem is the design and condition of the majority of our facilities. They are poorly designed, the academic buildings not allowing for space to implement special academic programs for the remediation of learning deficiencies, and dormitories consisting of open bay wings that provide little or no personal privacy. Some of the facilities were constructed during the thirties and forties, and they do not even come close to meeting current space utilization standards. Maintenance of our facilities has been very poor, and the lack of authority for education personnel to establish maintenance priorities is also a problem. Restrictions on the utilization of available funds also creates problems; e.g., we plan extensive behavior modification student awareness field trips and are then subjected to travel "freeze" or required to allocate only set dollar amounts for all travel costs. Student transportation, especially buses and vans, is a major problem throughout the agency. Due to the excessive mileage these vehicles travel over unimproved and infrequently graded dirt roads, these vehicles deteriorate rapidly. Currently, the GSA replacement standard is 80,000 miles. We feel that no bus or van is safe after 50,000 miles of these roads and that the replacement standard should be lowered. Optionally, we feel that the buses and vans should be replaced every two (2) years, regardless of mileage. While we realize that either change would result in increased transportation costs, we feel that any cost increase would be more than offset by the increased safety of our students.

Question 2. Why has BIA attendance on Navajo fallen off over the past few years?

Answer. The BIA as a whole has actively pursued a policy that Indian children should attend school as close to home as possible and that said school should be a public school. Thus, the Navajo area has actively encouraged and assisted in the establishment of public schools on the reservation. As public schools have become available, our enrollment policy requires Navajo students that can be accommodated by a bus route, regardless of how long in miles, condition of roads, and time consumed, attend the public schools. Also, as with the national trend, the birth rate has fallen somewhat among the Navajo people, and since the majority of the current generation are products of a 12th grade education and beyond, more young Navajo families are locating or relocating close to the peripheral reservation towns or to sites of economic development in order to obtain jobs.

Question 3. Are "Title" programs working? How have they influenced the education in your agency?

Answer. A cut and dried answer is impossible to give due to the nature of the "Title" programs. First, and most importantly, on an individual student basis (that is "target" students) the answer would be yes in the majority of cases. However, administratively, the answer would be qualified. It takes huge amounts of time to write a proposal and implement it with all the reports, forms and monitoring systems which go with the acceptance of "Title" monies. This can only be accomplished at the expense of the regular program in terms of time and expenditure of effort beyond what is reasonable, if we equate both "Title" and regular programs in relation to their size, scope and budget. Nevertheless, since the needs met, though not totally, by "Title" programs are real, we have no choice presently but to use whatever it takes in excess of the regular program in order to obtain the services they provide. You could say we are working at making the "Title" programs work because, in our present circumstances, we must, in order to provide for the needs of our students.

Title programs have influenced the education in our Agency wrongly, because they allow the Bureau to ignore funding as a line item in such areas as special education and second language learning. Therefore, we cannot plan programming except on a year-to-year basis with the accompanying and often distracting fluctuations in "Title" regulations and monies as interpreted and allocated by and to the Bureau. Further, "Title" programs are appropriated with final allotments which stipulate that no more than one-third of the student body can be defined as "target" students at just \$336.00 per student, when in fact all our students should qualify. However, let me add that without "Title" programs our regular funding could never do the job, given the present budget. Our Agency does what it should and must with regard to "Title" programs, but we could do more if provided the means to do so from our regular funding sources.

Question 4. How much assistance or advice on policy or program questions do you receive from BIA Central Office, either in Washington, D.C., or IERC in Albuquerque?

Answer. None. However, I have received answers, upon request, to school construction procedural questions from the Division of School Facilities within IERC.

Question 5. In view of decreasing enrollment with Bureau schools on Navajo, what is being done to utilize or maintain the empty facilities?

Answer. We have only one vacant facility in our agency, which was a boarding school for a maximum of fifty students. The school was constructed in the early thirties and consists of one stone and log building that served as a dormitory/kitchen combination and two metal quonset huts for classrooms. We are currently processing the administrative procedures to give the facilities to the local Navajo Community for whatever program they can fund.

I would like to emphasize that when our schools were constructed, they were designed around the concept of one teacher for every thirty students, on suburban public school models then in existence, with no consideration of the Special Education needs of our students. Thus, as our enrollment has decreased, on the criteria of one classroom for every thirty students, extra classroom space is currently being utilized by our Title funded projects. In regards to dormitory space that is no longer occupied, we have in our Agency utilized this space by converting the space for utilization as an Industrial Arts Class, Employment Assistance Career Development Center, Public School Classrooms and Honor Dorm Programs.

Question 6. In the past, several bodies have urged the Bureau to turn over, to other groups, vacant facilities. What policy, if any, has the Bureau undertaken to cooperate with the public schools, tribe or others in the use of underutilized buildings within your Agency?

Answer. In our Agency one dormitory wing has been converted to classrooms for utilization by a near by public school and no problems were encountered. As I previously mentioned, we are in the process of turning over the old Whitehorse Lake facility to the local community. The policy I have been informed of is that if we no longer have a need for a facility, then said facility can be utilized by another federal agency, such as Public Health Service, the local public school, or the Tribe. There are in existence specific regulations, in our property manual, that outline regulatory requirements for transferring ownership or leasing a facility. This past year in our Agency this situation was sort of the other way around, in that we purchased a public school portable classroom facility that was surplus to their needs for additional classrooms at Torreon Community School.

Question 7. Do the current BIA standards and policies regarding dormitory attendance create local school problems?

Answer. Yes, they do, in that some of our communities do not accept the Bureau policy of "when possible the student will go to a day school." The Navajo people in our Agency strongly feel that boarding schools are still needed. In fact, some of the communities in our Agency that have day schools are requesting the construction of boarding facilities. The various reasons for this, that have been expressed to me by the Navajo Leadership in our Agency, are as follows:

Economic.—Large families, low income, no utilities at home, substandard housing.

Attendance.—Have problems getting their child to attend on a day basis regularly.

Discipline.—Have problems getting their child to obey at home.

Poor Roads.—Impassable in heavy snow and spring than resulting in missed days.

Long Public School Bus Routes.—Some public school bus routes are two to two and one-half hours long during the best of weather conditions.

Adequate Health Care.—Children have accessible transportation for receiving health care, and dormitory staff provide day-to-day medication when prescribed. Child receiving a balanced diet, child has access to adequate facilities to maintain personal hygiene, and the child's clothing is cared for.

Dissatisfaction with some public schools.—Feel they have no real opportunities to bring about change. Public school boards not interested in welfare of Navajo children; they only extended their bus routes for purpose of getting more money, not for the purpose of providing an education program that recognizes the educational needs of their children.

Question 8. What, in your opinion, has been the reaction of local tribal leadership to 93-638, the Indian Self-Determination and Education Assistance Act?

Answer. Again, my opinion can only be expressed in terms of what I have heard the local Navajo leadership express. Their comments are as follows:

Careful consideration before any action, which results from a distrust of policy that has come from Washington in the past. Their immediate needs never seem to be recognized and acted upon with haste.

The Navajo people fear that P.L. 93-638 is another U.S. Government attempt at termination.

In some instances, local Navajos do not trust their own tribal government to assume control of programs they are receiving direct services from.

Some efforts at contracting have received criticism for ineffective management. The local people do not wish to have the same problems in their communities and the resultant embarrassment.

Our local communities wish to remain autonomous by determining their own future destiny based on Federal Government, State, Tribal and local resources available. If the provisions in P.L. 93-638 are accepted, then the local community wishes to decide and not allow anyone else to decide for them.

Question: 9. How would you prioritize the educational needs within your Agency?

Answers: Our educational needs are difficult to prioritize as they inter-relate in that one need will contribute to the success of fulfilling another need. However, in my opinion, our most critical needs, in priority order, are as follows:

(a) Adequate funding to allow for the design and implementation of specialized educational services that will totally meet the special education needs of Navajo students. Some of these supplemental program needs are identified in my narrative statement presented for the record.

(b) The rehabilitation, remodeling, and/or new construction in part or whole of certain facilities which would provide facilities that are conducive to allowing for implementation of special or supplemental education program services.

(c) The re-design or design of administrative regulations which would allow for all Federal appropriations for direct educational services for Indian children to be in line item appropriations under the responsibility of the Bureau of Indian Affairs. This would also allow for the maintenance of only one administrative system for accountability.

If I have not adequately responded to the aforementioned question, then please feel free to establish contact.

I would also like to take this opportunity to personally thank you for the concern you, the committee membership, and the committee staff have demonstrated in the interest of improving educational services for the Navajo people.

Respectfully yours,

L. HOLMAN, School Superintendent.

APRIL 5, 1977.

Mr. ERNEST MAGNUSON,
Supervisory Education Specialist, Navaho Area Office, Bureau of Indian Affairs,
Window Rock, Ariz.

DEAR MR. MAGNUSON: We are writing to ask you to answer for the record several questions which we were unable to ask you during your appearance before the Subcommittee on Elementary, Secondary, and Vocational Education on February 2, 1977. Attached to this letter is a list of those questions.

We would appreciate a prompt response so that the questions and your answers can be incorporated in to the printed hearing record.

If you have any questions, please feel free to contact the staff of the Advisory Study Group on Indian Education.

Warmest personal regards,

Sincerely,

MICHAEL T. BLOUIN,

Chairman, Advisory Study Group on Indian Education.

Enclosure.

(1) What do you, on an area level, see as the major role of the BIA in Indian Education?

(2) What is the policy of your area with respect to encouragement of Navajo students to attend public versus BIA schools?

(3) What is the role of the Advisory School Board in the administration of Navajo area schools?

(4) What has been the effect, if any, in the restriction of travel funds within the Navajo area?

(5) How can BIA and public school systems better cooperate to serve Navajo students?

(6) Has a comprehensive needs assessment ever been conducted on Navajo? If so, when, and what were the results? If not, is one being planned? When will it be conducted?

(7) What has been the effect of the Bureau's current Indian preference policy on Navajo education? Within your area, what is the policy as regards Indian preference and how is this policy translated into action?

(8) In your opinion, why has the policy of placing Navajo students in the public school not resulted in a more rapid assimilation into the dominant society?

(9) Do you have any concerns regarding the practices used by public school districts in your area in obtaining higher levels of Federal monies, (i.e. 874, JOM, etc.)? Would you detail these practices, please?

ERNEST MAGNUSON'S REPLIES TO QUESTIONS SUBMITTED

Question 1. What do you, on an area level, see as the major role of the BIA in Indian Education?

Answer. The major purpose of the Bureau of Indian Affairs involvement in education is to provide educational opportunities to Indian children who for social, economic, and/or isolation reasons cannot attend public schools. It is the responsibility of Area Office to assure a quality education for every Navajo child by providing leadership assistance and support to the agencies and schools in the areas of program development and implementation, setting common policies and direction.

Question 2. What is the policy of your area with respect to encouragement of Navajo students to attend public versus BIA schools?

Answer. The role of the Bureau schools on the Navajo Reservation is to serve those students who cannot attend a public school on a day-basis because public school is not available or for social reasons. The following is the enrollment criteria taken from 62 IAM 2.5.2:

2 Eligibility for Admission. Children otherwise eligible who meet one or more of the criteria listed below may be admitted to Federal Boarding Schools:

A. Education Criteria.

(1) Those for whom a public or Federal day school is not available. Walking distance to school or bus transportation is defined as one mile for elementary children and 1½ miles for high school.

(2) Those who need special vocational or preparatory courses, not available to them locally, to fit them for gainful employment. Eligibility under this criterion is limited to students of high school grades 9 through 12.

(3) Those retarded scholastically three or more years or those having pronounced bilingual difficulties, for whom no provision is made in available schools.

B. Social Criteria.

(1) Those who are rejected or neglected for whom no suitable plan can be made.

(2) Those who belong to large families with no suitable home and whose separation from each other is undesirable.

(3) Those whose behavior problems are too difficult for solution by their families or through existing community facilities and who can benefit from the controlled environment of a boarding school without harming other children.

(4) Those whose health or proper care is jeopardized by illness of other members of the household.

Question 3. What is the role of the Advisory School Board in the administration of Navajo area schools?

Answer. The Advisory School Boards are advisory, as the name implies. However, they do have a great deal of input into the local educational program, in curriculum offering development and implementation. They do recommend individuals for employment; they do not select. The school boards serve as arbitrators on occasions between school management, employees and the community. They also are able to have great influence on policy development because they represent the parents and students enrolled.

Question 4. What has been the effect, if any, in the restriction of travel funds within the Navajo area?

Answer. I do not disagree with the idea that the travel of employees should be restricted. I do, however, feel that to include student travel within the travel restrictions impedes the education program and that action should be taken by your committee to make that change.

Question 5. How can BIA and public school systems better cooperate to serve Navajo students?

Answer. A. Because of the size and density on the Navajo Reservation, it is often difficult for individuals at the Area or state level to make intelligent decisions for schools in remote parts of the reservation. Personnel at the local level should be involved in decision-making for their area and their recommendations should be respected. After all they are on the line where the action is.

B. A coordinated curriculum between the Bureau and the public school system would offer the greatest benefit to Navajo students. Navajo families are now more mobile and students often transfer back and forth with little or no continuity in learning.

C. The Bureau and the school districts need less competition and more cooperation in student placement. The primary consideration should be: which environment best meets the needs of each individual student?

This type of placement can only take place through close cooperation at the local level and continual reevaluation as circumstances and needs change.

Question 6. Has a comprehensive needs assessment ever been conducted on Navajo? If so, when, and what were the results? If not, is one being planned? When will it be conducted?

Answer. Yes, several assessments have been conducted since the late 60's. The first, and most significant, was a curriculum needs assessment. This was done by nine committees who gathered information concerning the curriculum needs of Navajo students in the nine disciplines of instruction. The needs were compiled in 1967. These needs formed the basis for the development of Navajo Area Curriculum Guidelines in these disciplines.

Needs assessments of pupil performance were conducted at all schools on a yearly basis from 1971-74. The last compiled results was published by Navajo Area in 1974.

Continuous assessments are made bi-annually by the administration of the SRA and MAT achievement tests.

A needs assessment is being planned for the 1977-78 school year to be conducted by each Agency in all Navajo schools.

Question 7. What has been the effect of the Bureau's current Indian preference policy on Navajo education? Within your area, what is the policy as regards Indian preference and how is this policy translated into action?

Answer. Morale among all employees is very low. The Indian Preference policies have created divisions between Indian and non-Indian employees. Non-Indians have been frustrated in attempts to move into vacancies within the Bureau, and most have been unable to move to other agencies within the Federal Government. The out-placement program (DCPA) by the Interior Department has been almost totally ineffective.

It is the policy in Navajo Area to fill all vacancies and promotions with Indian applicants. Non-Indians are not considered if one or more Indians apply.

Question 8. In your opinion, why has the policy of placing Navajo students in the public school not resulted in a more rapid assimilation into the dominant society?

Answer. A major reason that Navajo students have not assimilated into the dominant society to a greater degree is that an effective model is not available or is extremely limited. Public schools on the Navajo Reservation are made up of approximately 90% Navajo students. Therefore, Navajo language and culture predominate the public school system. Anglo values and language are modeled mainly by the teaching staff much as it is in the federal schools. There is a minimum of peer interaction with members of the non-Navajo society. Furthermore, Navajo young people often have a negative experience with the dominant or anglo society because they are either actually discriminated against or fear discrimination in towns and communities surrounding the Reservation. Employment opportunities are sometimes limited to Indian people. There have been instances where Indian students have experienced discrimination in public schools in bordertowns. Participation in the social life of the community is somewhat limited. Therefore, Indians have a tendency to socialize with a small group of peers.

Question 9. Do you have any concerns regarding the practices used by public school districts in your area in obtaining higher levels of Federal monies, (i.e. S74, JOM, etc.)? Would you detail these practices, please?

Answer. A. Because of past practices in the use of JOM funds many school districts still want JOM funds with no accountability for programs, equipment or monies.

B. Programs written into proposals are often deleted or diluted after a contract is signed.

C. When problems arise during contract negotiations or concerning contract compliance, some districts use the press to threaten and attempt to coerce the Bureau or the prime contractor to accept the districts terms, right or wrong.

APRIL 7, 1977.

Mr. VERNON MASAYESVA,
Hotevilla Day School, Bureau of Indian Affairs,
Keams Canyon, Ariz.

DEAR MR. MASAYESVA: We are writing to ask you to answer for the record several questions which we were unable to ask you during your appearance before the Subcommittee on Elementary, Secondary, and Vocational Education on February 2, 1977. Attached to this letter is a list of those questions.

We would appreciate a prompt response so that the questions and your answers can be incorporated into the printed hearing record.

If you have any questions, please feel free to contact the staff of the Advisory Study Group on Indian Education.

Warmest personal regards,
Sincerely,

MICHAEL T. BLOUIN,
Chairman, Advisory Study Group on Indian Education.

Enclosure.

(1) Under what programs are inapplicable secondary school standards being applied to the students at Hotevilla? What would be your suggested remedy?

(2) What kind of support structures or curricula, relevant to the changing nature of Hopi society, can be encouraged by the Federal government within schools under its control?

HOTEVILLA BACAVI COMMUNITY SCHOOLS,
Hotevilla, Ariz., June 1, 1977.

MICHAEL T. BLOUIN,
Chairman, Advisory Study Group on Indian Education,
Rayburn House Office Bldg., Washington, D.C.

DEAR MR. BLOUIN: Thank you for the opportunity to elaborate on the two questions submitted to me in your letter of April 7, 1977. I am very sorry that I was not able to respond earlier. I did not receive the letter until I returned from various school trips in May.

In response to your first question concerning inapplicability of secondary school standards being applied to students at Hotevilla, I would like to say that inapplicability concerns the student rights and responsibilities, particularly as it is applied to kindergarten and lower elementary students.

I am enclosing for the record a copy of the HBCS Code which defines student rights, responsibilities, and due process. The code is identical to the student codes used by elementary schools on the Hopi Reservation and is based on a model code developed for BIA high school boarding schools.

I feel that a model needs to be developed expressly for elementary school students; a code which provides same student rights and privileges but written in such a way that it is more comprehensible to our elementary students, and the parents.

In response to the second question concerning relevant curricula for changing Hopi society, I would like to enter for the record, the school philosophy recently adopted by the HBCS Advisory Committee for Hotevilla Bacavi Community School and the subsequent proposal to implement a pilot project (using 4th grade) based on the philosophy.

Thank you very much for the opportunity to testify in behalf of the Hopi children and parents.

Sincerely,

VERNON MASAYESVA,
Principal, Hotevilla Bacavi Community School.

RATIONAL

In order for a school to be truly relevant for a child, we feel that the educational program should be one that is locally initiated and controlled. MBCS has established a statement of philosophy and a set of goals for its students. In order to further carry out the intentions of the philosophy, we feel that a curriculum in line with that philosophy be established.

In an honest attempt to build a program upon our philosophy, we feel that such a situation be free as much as possible from outside sources. In order to carry out truly locally controlled program, we should be free as much as we can from outside restrictions and legislations.

ORGANIZATION

In line with the above reasons, MBCS wishes to implement a three-year pilot project which would be free of Title I funding. The core of the program will be the Man: A Course of Study social studies program. This course has been adapted and further supplemented for several years here at HBCS. Three major areas of the program will serve as focuses for each of three years. MACOS is being used because of its broad appeal, flexibility and it fully complements HBCS Goals and Philosophy. This course has already been used in a smaller setting. That of the Social-and-Life Science Course for this school.

BEHAVIORAL GOALS

The Behavioral goals for students will follow the list of Goals as established by HBCS.

A. Achievement

- (1) The learner should recognize that task are functional to goals.
- (2) The learner should be comfortable in setting his own goals.
- (3) The learner should be able to set his own tasks (which are sequential factors of a goal).
- (4) The learner should be able to measure his own accomplishment at any time with reference to his goals.

B. Self-image

- (1) The learner should have an accurate knowledge of what he wants.
- (2) The learner should have accurate knowledge of what he can do.
- (3) The learner should have an accurate knowledge of what other people think he can do.

C. Group activity

The learner should have the ability to work within a task group. Specifically, he should be aware of the differences in attitudes and goals of the other persons in the group. He should be able to use these differences for mutual benefit.

D. Natural environment

The learner should be able to ask these questions in any situation:

- (1) What factors of the natural environment determine me?
- (2) Over what factors can I exercise some choice?

Organization of the curriculum will consist of:

A. Conceptual Approach: The facts will be on the Major Concept of Adaptation. Beneath this will be several pairs of Operative Concepts which are used to approach the Major Concept. The Operative Concepts consist of: (1) Structure-Function, (2) Cause-Effects, (3) Conflict-Cooperation (or Opposing Forces).

B. Content Areas: The above concepts will be used to study a different content area each year. As the curriculum is now structured, the content areas will be as follows: 4th Grade—Natural World; 5th Grade—Cultures Around the World; 6th Grade—Comparative Study of Eskimo-Hopi.

Due to the nature of the program, the content areas enable the students to explore many of the academic areas, such as: Biology, Geology, Physics, etc. as well as art areas such as Painting, Ceramics, Creative writing, Literature, etc.

A large part of the procedure for students will be that of investigation and experimentation. In this way, all of their reading, writing, and math skills will be utilized and refined. In order to study in the content areas, the student will learn and be able to use the following "thinking skills."

1. Observation—to gather information by attentive listening, or reading something.
2. Classifying: Match related obvious relationships.
3. Comparing and contrasting: Find important similarities and differences in ideas, places, objects, etc.
4. Generalizing: Describe relationships that apply to a wide range of ideas, objects, etc.
5. Synthesizing: Devise a way to demonstrate a general relationship.

6. Prediction : Using selected forms and generalizations to forecast something.
 7. Testing Predictions : Find a way to test a prediction and if possible carry out the experiment.
 8. Evaluation : Making a judgment about how valid a prediction is.
- C. Academic skills : Regular textbooks will be used to teach basic skills in reading, math and language.

OVERVIEW

As one can see, academic skills are not ignored but rather presented in such a way as to immediately and constantly use. Perhaps the biggest change in this type of program is that of moving away from schools as a place where you "store knowledge" but as a place where the child learns to "know how to approach tasks and resolve questions or problems."

HOTEVILLA BACAVI COMMUNITY SCHOOL

"A Flower grows best in its own plot of earth . . ."

STATEMENT OF PHILOSOPHY

Hopi Society, like many traditional societies throughout the world is experiencing a rapid transition from the old ways to the modern technological society. For our society, which has recently been introduced to the complex technological scene, the change is profound and confusing. As a result, many of our traditional social institutions, such as the family and religion are beginning to weaken and lose their functions as cohesive and stabilizing mechanism in our society.

Modern technology has brought us many tangible benefits; because of it, we live a long and healthy life. However, it has also caused us to lose touch with our history and heritage, and it is causing us to rely more and more on a man-made world and less on the earth which makes our life possible.

In view of the changes, problems, and uncertainties of the future, we are relying on our school to help our society by providing our children with proper skills so that they will function successfully and productively within their own culture and in the cultures of mankind throughout the world.

We believe that for our children to live a full, meaningful happy, and productive life, they must become aware and proud of who they are; they must develop necessary skills, talents, and attitude to contribute to betterment of the Hopi Society; and they must develop sensitivities to enjoy and appreciate things of the earth which makes our lives complete.

Guidelines for Program Development:

Curriculum development

1. HBCS shall provide a balanced curriculum to foster the intellectual, social, emotional and physical development of every student.
2. It is our experience that a Hopi child learns most effectively by observing and then personally applying the skills. A Hopi proverb "you learn by doing, not by watching", is applicable to effective teaching. For this reason the curriculum at HBCS shall be based on active, experiential approach to learning.
3. Curriculum shall offer opportunities for children to use the language they know best in learning skills and concepts. If Hopi is the first and only language that a child knows, a program shall be designed to provide a planned transition to English language.

Instruction

1. The rapid accumulation of knowledge caused by modern technology has become so vast and overwhelming that it has made memorization of fact and information obsolete. Teaching should therefore foster processes of thinking and learning so that children can learn to use information and skills to further understanding and knowledge.
2. Whenever applicable and appropriate, teachers shall use the familiar experiences and background of the children as a base for teaching and extending skills and concepts. Effort shall be made to base lessons on events, objects, or setting familiar to Hopi children.
3. Opportunities shall be provided for non-Hopi staff to learn about the language of the Hopi, their ways of learning and looking at the world, and whatever information is necessary to help improve teaching.

School-community relations

1. Parent shall be kept fully informed about the progress and problems of school which directly effects their children.
2. The Principal will require all teachers to make a minimum of one visit to the homes of the children. If a parent wishes to meet with the teacher at the school, arrangements mutually agreeable to both parties, will be made to accommodate the parent-teacher conference.
3. HBCS will maintain an "open-door" policy so that interested parents may visit the classrooms anytime during the school day.
4. HBCS shall continue to offer its facilities and resources to community for enrichment, adult education, and recreation purposes. Furthermore, the Principal will continue to seek the establishment of a Community School Director, so that planned use of school facilities and resources will be realized.

U.S. DEPARTMENT OF THE INTERIOR,
BUREAU OF INDIAN AFFAIRS,
Washington, D.C., February 18, 1977.

Copies of this material have been submitted to the House Committee on Education and Labor in further response to their request for additional BIA budgeting data.

GLEN D. McLAREN,
Chief, Division of Program Development and Implementation.
Attachments.

ACTIONS TO BE TAKEN IN THE DEVELOPMENT OF A
BUDGET FOR THE BUREAU OF INDIAN AFFAIRS

1. DEVELOP WORKSHOP MATERIALS (11/1-3/1)

Visual and textual workshop aids are prepared to assist the Areas and Agencies in conducting programming and budgeting workshops. This material is non-technical in nature, suitable for indoctrinating Tribal leaders and BIA staff members into the Federal fiscal process.

The workshops and the presentation materials are not intended to replace program and budget guidelines and instructions. Instructions for the development of local programs and budgets will be formulated later in the cycle and will be issued independently of the workshop materials prior to the start of work on the Bands and the program plans.

2. TARGET PLANNING ALLOWANCE TO DEPARTMENT FROM OMB (2/1)

OMB makes a determination as to what the Federal government can reasonably expect the national income for the budget year will be. As representatives of the President, and with his guidance, they establish national priorities and spending limits as general guidelines.

Within the limits of the national income and priorities, OMB makes a rough allowance to each Department. This is the basic figure that will be used for planning purposes by each Department and Bureau.

A letter, sent to each Secretary by OMB, includes special instructions on policy matters, staffing and operating procedures. The letter also includes instructions on developing Indian programs and how to provide information on those programs to the Bureau.

The letter directs each Department to collect data on proposed funding for Indians from each of its Bureaus, assemble the information and provide it to the Department of the Interior.

3. TENTATIVE ALLOCATIONS TO AREAS/AGENCIES FROM CENTRAL OFFICE (2/15)

Tentative budget allocations for the Budget Year are provided by the Central Office for each program activity to the Agency level. These tentative allocations are based on the President's budget for the current year and become the funding level base from which the planning year Bands and program plans are developed.

4. **NON-BAND INSTRUCTIONS TO AREAS/AGENCIES FROM CENTRAL OFFICE (2/28)**

Guidelines for developing programs for non-Banded activities are completed and forwarded to the field. The guidelines are designed to give more field level input into the budget process beyond the Banded program by including consideration of the non-Banded activities at the Agency/Tribal level.

5. **AREA PROGRAM AND BUDGET OFFICERS WORKSHOP (3/2)**

On or about this date, a national meeting with all Area Program and Budget Officers is held to formally introduce the workshop presentation materials and to review plans for the development of the Budget and Program Plans for the next Fiscal Year.

This is the formal start of the new Budget and Program cycle for the Area Offices.

6. **TARGET PLANNING ALLOWANCE TO BUREAU FROM DEPARTMENT (4/1)**

The Department of the Interior provides the Bureau with a Target Planning Allowance and includes any special instructions on policy matters, staffing or operating procedures. Anticipated funding levels that will be available are identified on a Bureau by Bureau basis by the Department. This allowance is an early estimate based on National priorities and the objectives of the Administration. It provides a reasonable guideline as to the limits within which the BIA programs will be developed. The Band Analysis of priorities will be used to adjust the programs for each Tribe within the limits established by the Target Planning Allowance.

Also included are instructions on the Program Strategy Paper format and on developing Indian programs and how to submit estimates.

7. **NON-BAND INPUT PROVIDED TO CENTRAL OFFICE FROM FIELD (4/10)**

Contributions from Agency and Area Office levels on the development of the non-banded portion of the Bureau programs forwarded to the Central Office.

8. **WORKSHOPS CONDUCTED BY AREAS/AGENCIES (4/15-4/30)**

Workshops are conducted by the Area Program Officers utilizing workshop data provided by the Central Office. Each Area has the flexibility to introduce and substitute presentation materials considered more suitable to meet distinctive local needs. These Area workshops are held to provide all Tribal officials and interested BIA employees the opportunity to become more familiar with the BIA Budget and Program process

and with the Federal fiscal process and to introduce new procedures and concepts in the cycle.

At the option of each Area, these workshops may be conducted by Agency personnel.

9. BAND GUIDELINES COMPLETED (5/1)

Revisions to that portion of the guidelines dealing with the preparation of the Band Analysis are completed and forwarded to Areas/Agencies. Instructions include schedules for completion of the Bands as well as Tribal input requirements.

10. DEVELOP LOCAL BANDS (5/1-6/15)

Using the tentative budget allocations from the previous Fiscal Year as a base, Band Analyses and narrative descriptions for the Budget Year are developed for each Agency and Area Office within the limits established by the Department Target Planning Allowance. The Bands are developed with the assistance and support of the Tribal leaders and they identify the priority levels for each program within each Agency as expressed by the Tribal leaders. Information provided with the Bands includes some material not part of the banding process such as Irrigation O&M and JOM.

11. PROVIDE BANDED AND NON-BANDED TARGET PLANNING ALLOWANCES TO AREAS BY LOCATION (5/15)

Central Office provides the Banded and Non-Banded portion to the Target Planning Allowance to Area Offices indicating by installation (and Activity for the Non-Banded) funding levels for the planning year.

12. BUREAU PROGRAM STRATEGY PAPER TO DEPARTMENT (5/15)

The Program Strategy Paper identifies the aggregate program priorities of the Bureau and is submitted to the Department for the concurrence of the Secretary of the Interior. Major new thrusts of the Bureau are identified.

13. PROVIDE BANDED AND NON-BANDED TARGET PLANNING ALLOWANCES TO AGENCIES (5/30)

Area Offices distribute the Banded and Non-Banded portion of the Target Planning Allowance to the Agency level for the planning year.



14. AGENCIES DEVELOP AGENCY PROGRAM PLANS WITH TRIBES (5/30-6/30)

Meetings are held with each Tribal Council to review Target Planning Allowances. In close cooperation with the Tribe, a program plan for each Agency is developed using the Target Planning Allowances for the Planning year and the Budget year justification data.

15. AREA DEVELOPS AREA OFFICE PROGRAM PLANS WITH TRIBES (5/30-6/30)

Meetings are held with representatives of tribal leadership in each Area to review Area Target Planning Allowances. In close cooperation with the Tribal representatives, a program plan for each Area Office is developed using the Target Planning Allowances for the planning year and the Budget year justification data.

16. PREPARE SECRETARIAL ISSUE PAPER (6/1-7/15)

Using information from Tribes, Agencies and the Central Office, potential BIA issues are identified. Based, in part, on the data in the program strategy papers submitted by the various Bureaus in the Department, the Secretarial Issue Papers are developed in the Department. Issues are defined as problems that require special solutions through new programs or a significant change in direction or emphasis.

17. BANDS RETURNED TO CENTRAL OFFICE (7/1)

Agency and Area Offices forward their completed Band Analyses to the Central Office. These Bands, developed with the assistance of the Tribal leaders, reflect local priorities and will be used to develop Bureauwide program requirements in the form of a consolidated Band.

18. PROGRAM PLANS TO CENTRAL OFFICE (7/15)

Completed Area, Agency and Central Office data forms are returned to the Data Center in Albuquerque to be inserted into the PPE data system. Tentative programs for the Budget year are also updated to the Financial System.

19. UPDATE PPE SYSTEM WITH PROGRAM PLANS (7/15-8/15)

The PPE data system is updated with the funding, staffing and work accomplishment data developed in the Agency, Area Office and Central Office program plans for the Budget and Planning years.

20. PLANNING ALLOWANCE TO BUREAU FROM DEPARTMENT (8/1)

Using the Target Planning Allowance as a guideline, the Secretarial staff makes tentative allocations to each Bureau in the Department. Each Bureau now has a rough but fairly accurate figure that they can use for planning purposes.

21. EACH DEPARTMENT PROVIDES INTERIOR WITH INDIAN PROGRAMS (9/1)

Based upon instructions provided in OMB letters which accompanied the Target Planning Allowances, each Department collects data on proposed funding for Indians from each of its Bureaus, assembles the information and provides it to the Department of the Interior. Funding includes amounts in the Budget Estimate, and total needs of Indians for each Bureau.

22. ESTIMATES TO OMB (9/15)

The Secretary's Office, after negotiating with the Commissioner's staff, submits the Bureau's Budget Estimates to the OMB. The Estimates were prepared using the individual program plans plus consolidations of the data forms from the PPE data system.

The OMB, which is directly responsible to the President, reviews the Bureau's plan to be sure it is in line with the President's budget for the total Federal Service. At this point, a great amount of communication between the Offices of the Commissioner, the Secretary and the OMB is generated.

Ordinarily, adjustments are necessary and the Bureau's Budget Estimate is returned by the OMB to the Department, and subsequently, to the Bureau for more negotiations between the Department and the Bureau and for final updating and justifications.

23. PROPOSED FUNDING LEVEL FOR INDIAN PROGRAMS TO INDIANS (10/1)

Transmit to Area and Agency Offices information on funding by Bureau and by activity for the Indian programs designed to benefit Indians within each Area and Agency service area.

24. PROPOSED FUNDING LEVEL REVIEWED BY INDIANS (10/8-10/22)

Each Agency Superintendent and each Area Director reviews and discusses with the Tribes in their service area the proposed funding levels for each Federal Bureau.

25. HEARINGS WITH OMB (10/15-11/15)

Sometime during October and November, OMB conducts hearings on the Department and BIA budgets. Representatives from the Department and BIA are in attendance and, this provides an early review of the Budget prior to inclusion in the President's budget and prior to Congressional hearings.

26. INDIAN REACTION TO PROPOSED BUDGET TO CENTRAL OFFICE (10/30)

Each Agency Superintendent and each Area Director submits to the BIA Central Office any comments, protests or other reactions from the Indians in their service-area to the proposed budget including any differences in total needs for any Bureau program.

27. ALLOWANCES FROM OMB (11/6-11/15)

After review of the Department and BIA budgets, the OMB provides further guidance and instructions in the form of a passback. Based on the hearings and on other considerations, revised figures are provided and the BIA budget is adjusted accordingly.

28. PRESIDENT SUBMITS CURRENT SERVICES BUDGET TO CONGRESS (11/10)

The President (OMB) is required to submit to Congress a current services budget by this date. The budget provides estimates of the financing needed to carry on existing programs for the next fiscal year at the same level as the current fiscal year. Data includes needs by Agency, functional categories, and major programs. The purpose of this action is to give Congress detailed information with which to begin analysis and preparation of the budget for the upcoming fiscal year.

29. APPEALS AND BUDGET PRINTING PROCESS (11/15-12/15)

After the Bureaus have received their share of the OMB allowance, they may appeal to the Department for a larger share or for a general or specific redistribution of their share. These appeals are based on what each Bureau feels they need to effectively operate their programs and they are guided to a large extent by the data and priorities that have been developed in the Agency and Area program plans.

30. OMB ALLOWANCES (12/8-12/15)

OMB provides updated allowance figures which are a refinement of the planning allowance figures provided earlier in the cycle. The revised figures are based, in part, on the hearings that OMB has been conducting with the various Bureaus and Departments and on more current estimates of the anticipated national income and priorities for the planning year.

31. PREPARE BUDGET JUSTIFICATIONS (12/15-1/1)

To help Congress in its deliberations over each Department and Bureau budget, justifications and support data down to the program level are developed and submitted for each Bureau and Department. These justifications are based upon the Budget Estimates submitted in October and subsequent OMB hearings.

32. JUSTIFICATIONS TO CONGRESS (1/1)

Program justifications, developed in support of program plans, are provided to Congress to assist in making judgment on programs and budgets.

33. EACH DEPARTMENT PROVIDES INTERIOR WITH INDIAN PROGRAMS IN PRESIDENT'S BUDGET (1/1)

This is follow-up data provided on September 1. Each Department will collect data on funding for Indians from each of its Bureaus for the President's Budget and transmit it to the Department of the Interior.

34. PRESIDENT'S BUDGET TO CONGRESS (1/15)

Based on the Budget Estimates, the OMB recommends levels of funding for the Bureau to the President. The President's staff reviews the Bureau's Budget Estimates and related documents as well as recommendations appended by the Secretary's Office and the OMB, and after reaching a decision as to a recommended funding level, the President makes a formal presentation of his Budget to Congress fifteen days after Congress convenes. Even though the Budget process for this cycle has been under way for over a year, this is the first public exposure of the Budget.

35. INDIAN PROGRAMS IN PRESIDENT'S BUDGET DISTRIBUTED TO FIELD (1/15)

Information is provided to each Area and Agency Office on funding by Bureau, by activity for the Indian programs designed to benefit Indians within each Area or Agency service area.

36. HOUSE AND SENATE APPROPRIATIONS HEARINGS (2/15-4/1)

Although House hearings are usually held first and are closely followed by the Senate hearings, either body may start the hearings. Differences between the House and Senate are worked out in committee meetings before the Budget Bills are passed.

Tribes appear before the Appropriation Subcommittees of the Congress to express their views on the President's Budget and indicate changes they desire to meet their needs and for circumstances that may have changed in the past few months or as they differ from the proposed Budget. Several subcommittees may be involved.

37. CONGRESSIONAL COMMITTEES, RECOMMENDATIONS TO BUDGET COMMITTEES (3/15)

House and Senate Budget Committees have been created to review the current and anticipated financial situation and needs of the nation as a whole. It is the responsibility of all standing committees of the House and Senate to make recommendations on the overall budget plans to the House and Senate Budget Committees. These plans are based on the national needs and resources as the committees see them and they provide the Budget Committees with an early and comprehensive indication of committee spending plans for the next fiscal year.

38. CONGRESSIONAL BUDGET OFFICE REPORTS TO BUDGET COMMITTEES (4/1)

A Congressional Budget Office has been established with primary responsibility to the House and Senate Budget Committees. This office serves as a central coordinating point between the two Budget committees and helps to resolve any differences that may arise between them. It also helps to define the general limits and directions the National budget will take. The Congressional Budget Office is required to submit an annual report to the Budget Committees on or before April 1 on fiscal policy and national priorities for the next fiscal year. The report discusses alternative budget levels in the aggregate, as well as for each major functional category of the budget.

39. BUDGET COMMITTEES REPORT FIRST CONCURRENT BUDGET RESOLUTION TO CONGRESS (4/15)

After the Budget Committees reach an agreement, the first concurrent resolution on the budget is delivered to Congress for consideration. This report is really a target and deals with broad functional allocations, issues of fiscal policy and budget priorities. It does not make recommendations on programs, Agencies, appropriation projects or spending considerations at that level.

More than any other document, the First Concurrent Budget Resolution determines the shape of things to come. It is here that priorities are set by Congress and are later reaffirmed in the Second Concurrent Budget Resolution.

40. FLOOR ACTION ON MONEY BILLS (5/15-9/12)

Congress takes floor action on all individual spending and revenue measures, completing action by September 12. Appropriations Committees must have completed mark-ups, i.e., made spending decisions, on all appropriations bills before any can be brought up for floor action.

41. CONGRESS COMPLETES ACTION ON FIRST CONCURRENT BUDGET RESOLUTION (5/15)

The first budget resolution presented by the Budget Committees has been before Congress for one month. After review and deliberation by the Congress, the resolution is revised as necessary and is adopted by this date. This resolution outlines, in broad terms, the general limits and goals of the budget. It covers the level of total budget authority and outlays, new budget authority and estimated outlays by functional category surplus or deficit, revenues, and public debt and its appropriate limit.

This is only a tentative budget and will be revised when better figures are available, usually by September 15, when the second budget resolution will be passed.

42. LEGISLATIVE COMMITTEES REPORT ON AUTHORIZING LEGISLATION (5/15)

On the same date that Congress passes the first budget resolution, the legislative committees complete their reports on the scope and type of legislation that will be required in order to reach the goals outlined in the proposed budget.

P.L. 93-344 specifies that authorizing legislation providing new budget authority is subject to point of order unless reported out by 5/15, and identifies certain exceptions. It requires appropriations committees to make continuing studies of existing spending authority and propose modifications.

43. AGENCY AND AREA PROGRAM PLANS UPDATED (6/15-6/30)

Based on the tentative allocations developed from the President's Budget, Area and Agency program plans are revised.

44. FINANCIAL PROGRAMS UPDATED (6/30)

Based on updated Agency and Area Program Plans developed from the President's Budget, all Financial Program are updated.

45. CONGRESS PASSES MONEY BILLS (9/7)

The seventh day after Labor Day is the deadline for completing congressional action on all regular budget authority and entitlement bills providing new obligations and spending authority. Delay in completing action on this legislation would force Congress into continued reliance on so-called "Continuing Resolutions."

46. CONGRESS COMPLETES ACTION ON SECOND CONCURRENT BUDGET RESOLUTION (9/15)

The second budget resolution, based on update budget figures developed by the Budget Committees is approved by Congress and serves as a later guide for Congressional actions. This new resolution is a reaffirmation of the priorities set by Congress in the First Concurrent Budget Resolution and represents a firm budget. It includes actions on entitlement and could direct changes in revenues or spending to reach the appropriate surplus or deficit.

P.L. 93-344 does not set a deadline for reporting on the Second Resolution and the date for this action will probably vary from year to year, depending on when action is completed on the various spending bills.

47. CONGRESS COMPLETES ACTION ON RECONCILIATION BILL (9/25)

Congress completes action on reconciliation bill implementing the second concurrent resolution. This congressional action is necessary to reflect directives in the second concurrent resolution.

P.L. 93-344 provides procedures for a "Reconciliation Process" (which is necessary when changes need to be made by committees) to be completed by this date and prohibits congressional adjournment before completion of necessary actions.

48. FISCAL YEAR BEGINS (10/1)

With the completion of reconciliation actions, the new fiscal year begins October 1. This recent change in the start of the fiscal year from July 1 to October 1 was designed to give Congress an additional three months in the budget cycle for decision making and deliberation on the budget.

49. DISTRIBUTION OF FUNDS TO AREAS (10/15-1/1)

Allotments of appropriated funds are sent to the Area Directors. Allotment documents will have attached, however, instructions concerning the distribution of funds by element/component and locations to the Agency level.

Also included are instructions concerning clearances required before funds can be changed between elements and locations.

Financial plans are updated to reflect these new figures.

50. AREA AND AGENCY FINANCIAL PLANS UPDATED (10/15-1/1)

Area and Agency plans are updated to reflect figures provided in the appropriated fund distribution.

51. PERIODIC REVIEW OF PROGRAM PLAN PROGRESS (12/1-10/1)

As the Fiscal Year advances, periodic checks and reports will be made as to the status of funds expended and the work accomplishments experienced to date. These figures will be available to individual tribes to help keep them advised on the progress of their program plan.

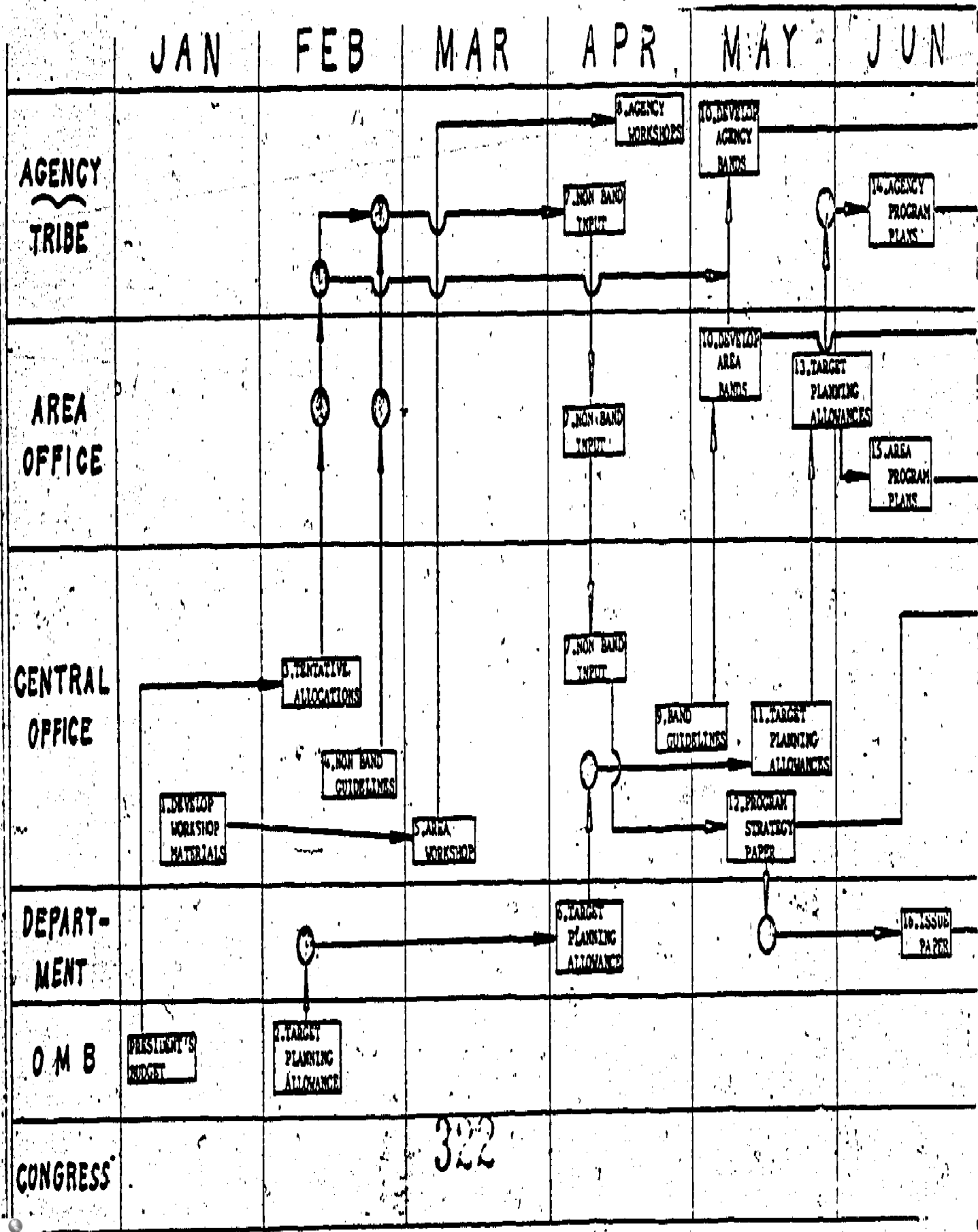

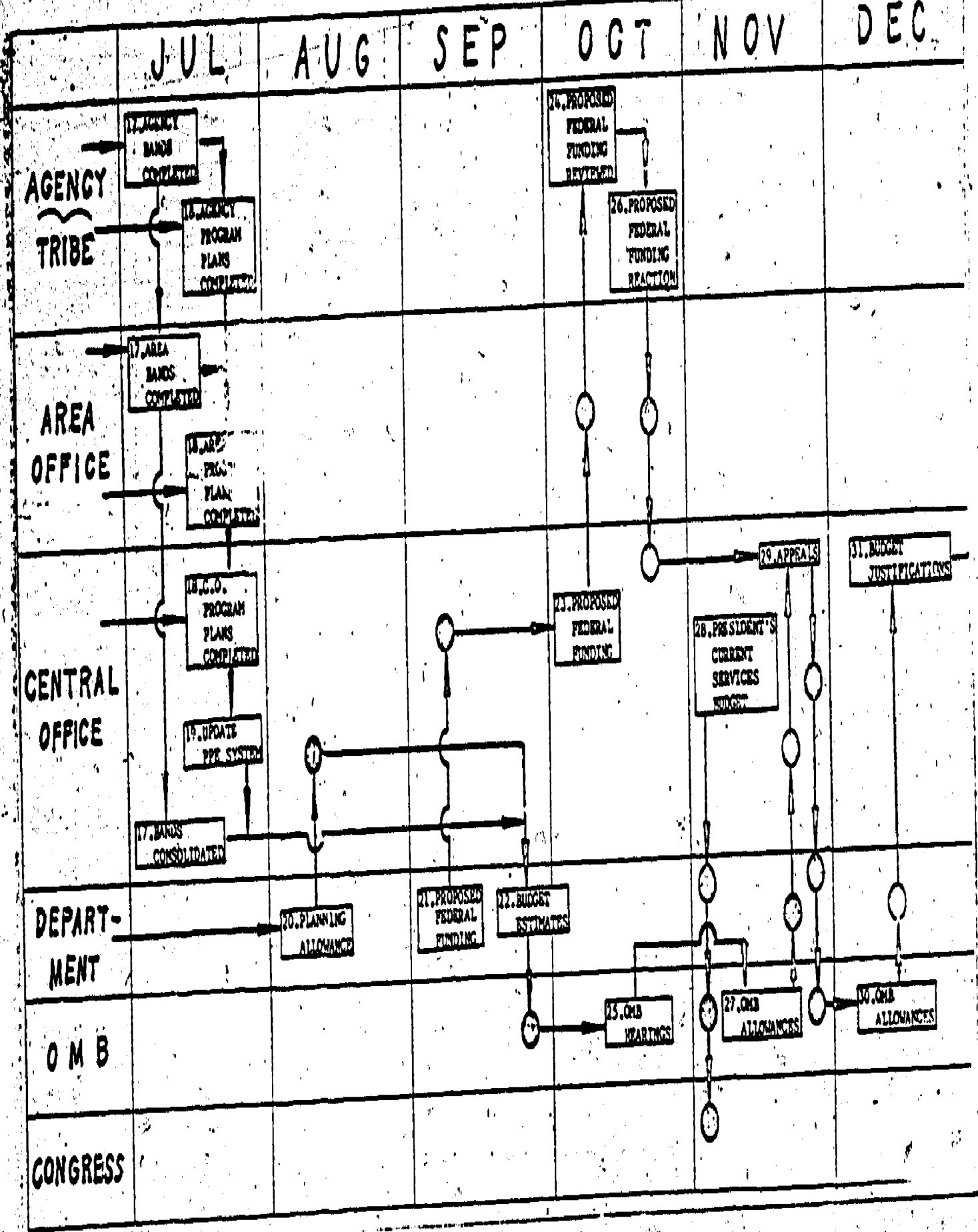

319

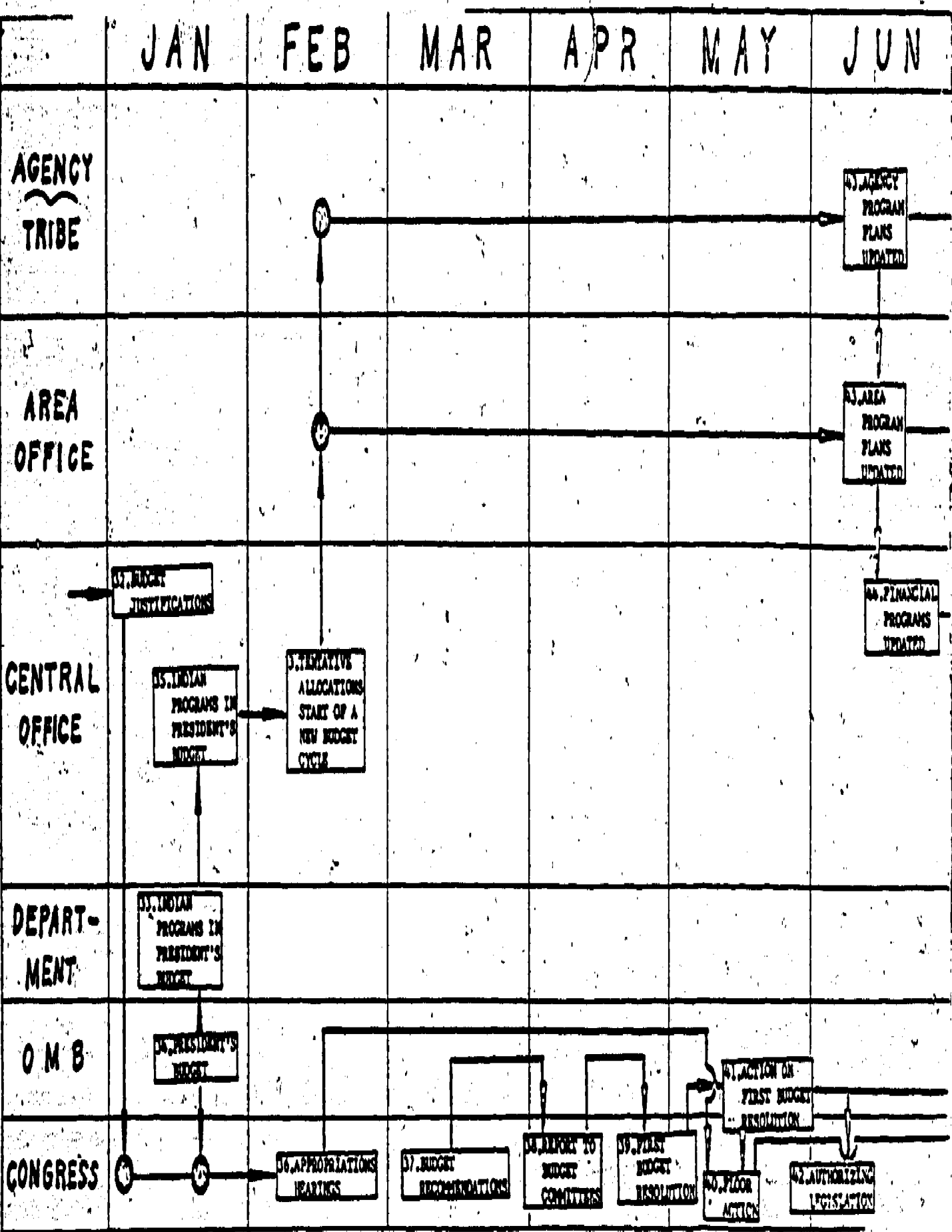

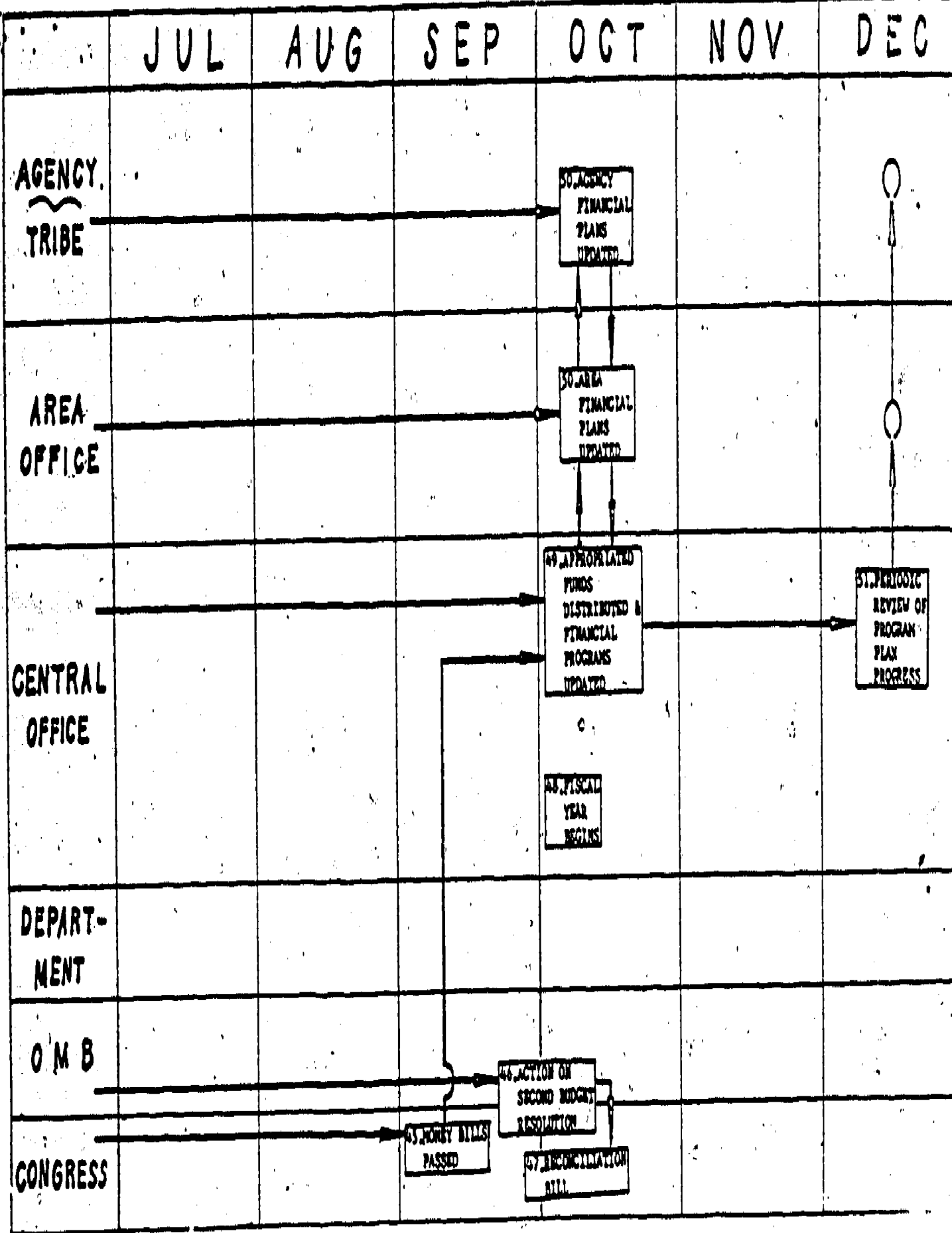

Department of the Interior

HUMAN AFFAIRS

D. C. 20245

5

December 29, 1976

Action Plan for Personnel Management

for approval, I want to take the perspective which I consider of specifics of the document itself.

process of developing the Action Plan change for personnel management in the problem. While it may only be the thing has been made and the corner has fronted, discussed, and developed a standing personnel management problems, or building a new and more useful tools for managing the Bureau's human

pend upon the continuation of this problem ownership by management.

process has also clearly indicated the personnel management and general (internal) are embarking upon a constellation of personnel management issues and recognized to (and apparently being. Review Commission — and which, I realistic improvement thrust than ves are greatly needed in related staffing standards and allocation, ed work methods, and communications.

ion Plan indicates, these management but the impetus for their full created action must come from top management is right. A concerted effort made on plans for presentation in the next

to Serve America!

226

3. The continuation of the personnel management improvement effort, and the undertaking of similarly needed efforts in any other areas of general management, will continue to be open to a degree of uncertainty, doubt and skepticism due to the absence within the Bureau of an institutional focus for internal management. A line, alter ego, career Deputy/Associate Commissioner position must be established and filled so that the direction of the Bureau -- as an organization -- receives that systematic and continuous leadership needed to ensure that BIA truly constitutes an effective and efficient instrument for accomplishing program missions and objectives, and not an institution wasting time and resources in less-than-effective management of itself.

4. As mentioned, this Action Plan may serve as an "answer" to any questions concerning what the Bureau is doing about the personnel management part of the "Management Study." It also constitutes the major part of a needed Bureau response to Civil Service Commission and Departmental concerns expressed in evaluation reports and elsewhere. Both the Commission and the Department's Office of Personnel Management are being asked to play significant "participant" roles in helping to implement various steps, and their continued assistance and guidance should and will be sought.

As many of the Bureau managers expressed themselves in Phoenix earlier this month, "We've talked and discussed enough -- Let's start doing." I totally agree. There has been more than enough writing and planning and verbalizing; now it is time to act. The ultimate victim of inaction and unfaced problems in personnel management are the Indian people whom the Bureau is to serve. They have waited long enough for us to move forward.

It has been a privilege to work with the Bureau in developing the Action Plan. It represents an even larger challenge to be asked to assist in making it a reality.

Paul L. ...

cc: Acting Deputy Commissioner
BIA Personnel Management Task Group members
Chief Personnel Officer

BUREAU OF INDIAN AFFAIRS

ACTION PLAN FOR

PERSONNEL MANAGEMENT IMPROVEMENT

APPROVED:

Commissioner of Indian Affairs

Date:

June 3 1977

BUREAU OF INDIAN AFFAIRS
ACTION PLAN FOR
PERSONNEL MANAGEMENT IMPROVEMENT

Objective and Scope of Plan

This plan addresses long-standing problems of human resource management in the Bureau of Indian Affairs. Its objective is to develop and change various concepts, policies, programs and procedures so that personnel management in the Bureau becomes a primary contributor towards program accomplishment rather than constituting a problem in itself.

The roles and responsibilities of both management and the personnel function are addressed, as are the programmatic and operating tasks within that function. The plan does not presume to cover every conceivable aspect or problem area. Rather, it concentrates on those personnel management actions considered of fundamental significance at this time so that the Bureau thereby will be provided with a base for a fully acceptable program in all respects.

Background to the Need for Improvement

During FY 1976, the necessity for a major improvement effort in personnel management in the Bureau was spotlighted by a number of evaluations made by the Civil Service Commission, the Department's Office of Personnel Management, and the Bureau itself. The March 25, 1976, Agreement between the Commissioner and the Assistant Secretary for Management detailed many specific initiatives and commitments for both the Bureau and the Department, primarily in the areas of position classification as well as the staffing and organizational placement of the Division of Personnel Management. A project manager was called for and designated, "to coordinate and direct" the improvement efforts through the development and implementation of an Action Plan.

The steps outlined in the March 25 Agreement have been taken, with significant and continuing effects on the quality of position classification and the capability of the Division of Personnel Management. The recommended Action Plan submitted by the Project Manager on September 7, 1976, analyzed the effects on personnel management in the Bureau of the dramatic events in Indian affairs of the past 8-10 years, and emphasized the developments and improvements needed in the:

- Leadership role in the Bureau for general (internal) management
- Evaluation and communication functions in the Bureau

- Conception of personnel management by managers and personnel staffs
- Orientation and development of managers and supervisors
- Management and operation of the personnel function itself
- Specific personnel management areas of
 - Policy development and issuance
 - Manpower planning
 - Recruitment
 - Indian intake and development
 - Qualification standards and determinations
 - Career development
 - Position management/classification

Method of Development

The primary basis for the Project Manager's recommended Action Plan of September 7 was an analysis of the 136 individual problem identification/solution discussions held with managers and personnel officials throughout the Bureau in June-August. Many important aspects of personnel management — such as performance evaluation, equal employment opportunity, labor-management relations, and employee services — were purposely not directly included in the recommended plan in order to (1) Concentrate on those problem areas which the discussions reflected as the most basic and pressing, and thus (2) Provide a foundation without which further meaningful development in these other areas was considered unrealistic.

During the following 3½ month period, management of the Bureau:

- Distributed widely and reviewed the recommended Action Plan
- Committed itself to adopt a BIA Action Plan by December 31
- Held two 2-day Director's meetings (Denver, October 28-29; Phoenix, December 8-9) to discuss the plan, agree to its specific content, and adopt an "immediate priority" framework for implementation.

Based on extensive individual and group discussions within the Division of Personnel Management and on contacts with Area Directors, the specific no-later-than (NLT) dates and the leader/participant names appearing on the Action Plan Step pages were agreed upon.

Steps to be Accomplished

Accomplishment of the specific actions included in this plan will result in the following initial improvements:

A. Personnel Function (PF 1-5)

1. Establishing a work objectives/work planning system within the Division of Personnel Management featuring communication and coordination across Branch lines, periodic review of progress being made toward meeting objectives, and continuing expansion and updating of the work plans.
2. Developing more meaningful statements of the role of each Branch and of the personnel function as a whole, constituting a part of the needed conceptual change regarding personnel management in the Bureau.
3. Providing the mechanism for Bureauwide coordination within the personnel function through sharing of work plans, the "head role" concept, and periodic meetings on Bureauwide problem topics—thus avoiding wasteful duplication of effort and establishing a meaningful team mode for problem solving.
4. Improving personnel operations by providing immediate assistance to the Central Office and Albuquerque Field servicing operations, conducting technical assistance visits to selected Area personnel offices, and initiating a schedule of studies to improve operational methods and techniques Bureauwide.
5. Establishing a planned evaluation program within the function.

B. Staffing and Manpower (HR 1-5, 8-10)

1. Obtaining the resources needed to produce a set of numerical estimates of Bureau manpower needs for immediate use in developing recruitment and staffing plans, and to install a forecasting system providing periodic manpower information to management for action purposes.
2. Obtaining the resources needed to develop a positive recruitment system for the Bureau including a centralized inventory of Indian skills nationwide, and a centralized listing of Indian Affairs jobs available.
3. Developing the budget and ceiling justifications for an Indian intake-and-development program in the Bureau; as well as the application requirements, publicity means, screening procedures, and selection methods.
4. Establishing a task force to develop a work plan for growing more Indian candidates for technical/specialist positions (e.g. engineers, foresters, etc.)
5. Issuing policy guidelines on the application of Indian preference in relation to restructuring and readvertizing positions.
6. Issuing appropriate qualification standards material for six major types of positions including Area Director and Superintendent.

*from formulated
in this context?*

7. Issuing policy guidelines regarding the use of general acceptability considerations and selective placement factors in determining eligibility and qualifications for specific vacancies.
8. Conducting training sessions Bureauwide in the use of Handbook X-118 for making qualification determinations.
9. Developing a work plan to improve the use of promotion panels, assessment forms and ranking procedures.
10. Reissuing updated policy guidelines for tribal consultation on personnel selections.

C. Training and Development (HR 12 and G 5)

*... the fact
is how to
...
personnel people
... how to deal with them.*

1. Developing and conducting role clarification and problem-solving communication workshops on personnel management, for managers/supervisors and personnel staffs.
2. Obtaining the resources needed to develop an orientation course for managers to general management principles, Federal government management policies, Bureau policies and programs, and Indian tribal government and culture; and conducting sessions Bureauwide.
3. Obtaining the resources needed to develop career guidelines/pathways for major types of management positions.

D. Position Management and Classification (HR 11A-D)

1. Issuing policy letter on coordinated budget/management analysis/personnel procedures to be followed Bureauwide regarding proposed organizational changes and new positions/upgradings.
2. Issuing revised Manual chapter on position management and classification policies.
3. Preparing work plan for developing several manpower/staffing standards.
4. Issuing policy guidelines on coordinated roles of budget and personnel functions in employment ceiling operations.
5. Conducting supervisory/managerial training in position management and the Factor Evaluation System.
6. Providing continuing assistance in position management/classification to personnel offices.
7. Conducting a Bureauwide position management/classification conference.

8. Issuing position classification guidelines for eight major types of positions including Superintendent and Tribal Operations Officer.
9. Preparing work plan for designing a career system for law enforcement positions.
10. Issuing policy statement on construction rates for Wage Grade positions.

Commitment of Resources

The manpower resources directly committed to implementing this plan include a significant part of the total capability available in the Division of Personnel Management, participation in four specific tasks by selected individuals in Area offices, the use on a temporary project/product basis of outside-BIA resources for four tasks, and the continued assignment of the Project Manager as both coordinator/director and specific task performer.

The no-later-than (NLT) dates listed on the Action Plan Step pages are the most realistic ones possible at this time. As already indicated, the Action Plan in no way covers all problems in personnel management nor represents the total work performed in the function. The realities of the daily "press of business" and new "priority" demands have been taken into account as far as possible in committing resources and setting deadlines in the plan. A system of monthly progress review/plan update meetings will be used to provide management with status reports and make appropriate plan revisions.

Additional Issues Considered

During the review period of the September 7 recommended Action Plan, the additional steps included in the plan were discussed and settled as follows:

- A work group has been formed to prepare two issue papers for the Commissioner covering the topics addressed in HR 6 and 7, i.e., reassignment of non-Indians in relation to Indian preference, and outplacement/legislative assistance for non-Indians. Depending upon the decisions on these issues, one or both may become future parts of the Action Plan.
- The establishment of a career, line Deputy/Associate Commissioner (Management) position, to provide an effective institutional focus for internal management, was agreed upon. The next step is for Bureau top management to submit a specific written package/proposal to the Departmental Executive Manpower Resources Board, *what type of interdepartmental interfacing to Education Programs Dir.*
- It was agreed that the development of standards for evaluating operating program effectiveness and to serve as the basis for an ongoing program evaluation activity in the Bureau was a responsibility of the Commissioner's Office, which should be carried out. Central Office and Area Directors have been requested to submit preliminary information and suggestions for use in commencing work in this area.

*Part of the field
input on the
understanding*

- It was agreed that the providing of leadership in organizational structure matters, the development of manpower/staffing standards, and the systematic study and improvement of work methods are responsibilities of the Central Office, which should be carried out. This Action Plan includes the issuance of a policy letter on procedures to be followed in organizational matters, and the preparation of a work plan for the development of several "pilot" manpower/staffing standards based on preliminary information and suggestions requested from Central Office and Area Directors. Similar information and suggestions have been solicited regarding needed work method studies.
- It was agreed that to a very large extent improvements in the Bureau's communication management style will depend upon the behavior of and example set by the Commissioner. Many methods and techniques can be used to develop a teamwork atmosphere of cooperation and coordination.

Any of the above issues, depending upon future developments and decisions, may become parts of an expanded Action Plan.

ACTION PLAN STEP: PF 1 & 2 Restate the role of ... and establish a planning work objectives system within it.

Responsible official: Marc Herschler, Chief, Branch of Personnel Management Evaluation

Date: 12/31/77

Element	Time (NWS)		Leader	Participants
	Planned	Actual		
1. Schedule, select site of, and prepare agenda for first Personnel Division 2-3 day off-site Communication meeting for problem identification, inter-functional coordination, and work objectives building.	1/16/77		Marc Herschler	Doug Rabel Paul Lorentzen
2. Hold Personnel Division off-site meeting with Director of Administration, Chief Personnel Officer, Asst. Chief, and 7 Branch Chiefs in attendance--resulting in list of operational problems and possible ways of solving them.	1/24-26		Paul Lorentzen (facilitator)	
3. Prepare individual Branch work objectives and work plans including resources needed (monetary, travel, space, etc.)	1/31/77		Marc Herschler	Each Branch Chief
4. Prepare individual Branch revised statements of function and revised statement of function for Division.	2/28/77		Marc Herschler	Each Branch Chief
5. Develop the ongoing Personnel Division planning/work objectives system providing for periodic Communication meetings; measurement of program progress, appropriate revision of work objectives and plans, etc.	3/31/77		Marc Herschler	

331



ACTION PLAN STEP: PF 3 Provide Bureau-wide coordination within personnel function

Responsible official: Marc Herschler, Chief, Branch of Personnel Management Evaluation

Date: 12/31/75

Elements	Time (XLS)		Leader	Participants Involved
	Planned	Actual		
1. Establish and implement concept of "lead roles" in specific areas of the personnel function, by Area Office, based on offices' interests and concerns (see PF 4) and to avoid duplication of efforts.	3/31/77		Marc Herschler	Other Personnel Division Branch Chiefs
2. Establish a communication network within personnel function by (a) sharing all Personnel Division work plans with Area Personnel Offices; (b) Through "lead role" concept, informing Area Offices of major developments throughout Bureau in all functional areas; and (c) Using normal telephone contacts for keeping abreast of problem identification and resolution.	4/30/77		Marc Herschler	Other Personnel Division Branch Chiefs
3. Prepare for and conduct periodic personnel officer meetings during 1977 on specific functional topics (with those functional chiefs attending), using "lead role" concept to develop agendas.	4/30/77		Marc Herschler	Other Personnel Division Branch Chiefs
	8/31/77			
	12/31/77			

00
00
00

336

ACTION PLAN STEP: PF 4 Improve operations and work methods within personnel function

Version: 1

Responsible official: Marc Herschler, Chief, Branch of Personnel Management Evaluation

Date: 12/31/75

Elements	Time (NL)		Leader	Participants/Comments
	Planned	Actual		
1. Assist Branch of Personnel Services, C.O., in (a) Responding to and taking actions on the CSC evaluation report;	7/15/77		Marc Herschler	Chief, Branch of Personnel Services
(b) Identifying work areas/methods in need of improvement, and developing a plan for accomplishing same.	7/31/77		Marc Herschler	Chief, Branch of Personnel Services
2. Obtain list from Area Offices of (a) improved operational methods/techniques each is using, and (b) operational problem/concern areas in need of improvement.	7/31/77		Marc Herschler	
3. Develop work plan for conducting improved operational methods/techniques studies and instituting such improvements Bureau-wide.	2/28/77 and on-going		Marc Herschler	Branch of PME Staff members
4. Conduct technical assistance visits to Albuquerque Field Personnel Office and Muskogee Area Personnel Office. (see HR 11C)	4/30/77		Marc Herschler	Other Division personnel as assigned
5. Coordinate timing of assistance by other Branches to Area Offices (e.g. continuing Classification and Staffing/Manpower visits to Aberdeen - see HR 11C)	Ongoing		Marc Herschler	Other Personnel Division Branch chiefs

CS
CS
CS



ACTION PLAN STEP: PF 5 Conduct a personnel management evaluation program

Responsible official: Marc Herschler, Chief, Branch of Personnel Management Evaluation

12/31/75

<u>Elements</u>	<u>Time (M/D)</u>		<u>Leader</u>	<u>Participant resources</u>
	<u>Planned</u>	<u>Actual</u>		
1. Develop schedule of 3 - 4 PNE's to be conducted during 1977--considering possibility that some may become more oriented towards assistance visits than strictly evaluations.	1/31/77		Marc Herschler	Other Personnel Division Branch Chiefs
2. Conduct PNE's	ongoing		Marc Herschler	Branch of PNE staff members and other Division members as assigned; Area Personnel Office Staff as assigned

333

334

ACTION PLAN STEP: HRI Develop and start operating a manpower forecasting system.

Responsible official: Pattie L. Fulgham, Chief, Branch of Staffing and Manpower

<u>Elements</u>	<u>Time (NET)</u>		<u>Leader</u>	<u>Participant resources</u>
	<u>Planned</u>	<u>Actual</u>		
1. Recruit and hire from another agency (on one-year reimbursable detail) a project leader to (a) produce "immediate ballpark" numerical estimates for Indian intake-and-development program, and (b) design and install ongoing system.	1/31/77		Pattie Fulgham	Louis D. Bayhille, Jr. Paul Lorentzen AFN CSC
2. Obtain information on anticipated program trends/levels the next 2-3 years.	2/28/77		Project Leader	Financial Mgmt. Specialist Designated Area and C.O. Managers
3. Determine specific occupational fields/types of positions "significant."	3/15/77		Project Leader	
4. Obtain available statistics from computer regarding past projected attrition rates in these occupational fields.	3/31/77		Project Leader	Employee Data and Compensation personnel
5. Produce "ballpark" numerical estimates of manpower needs by "significant" occupational fields.	4/30/77		Project Leader	
6. Design method for capturing periodic program information	6/30/77		Project Leader	To be determined later
7. Revise/expand computer base/capability.	8/31/77		Project Leader	"
8. Install operational manpower forecasting system.	10/31/77		Project Leader	"
9. Monitor system performance.	12/31/77 and ongoing		Project Leader	"

335

ACTION PLAN STEP: HR2 Develop and start operating a centralized skills inventory/Indian Affairs - jobs-available system involving pro-active, outreach recruitment.

Responsible official:

Pattie I. Fulgham, Chief, Branch of Staffing and Manpower

Elements	Time (NLT)		Leader	Participant(s)
	Planned	Actual		
1. Recruit and hire from another agency (on one-year reimbursable detail) a project leader to develop (a) a Bureau positive recruitment system, (b) a centralized Indian Affairs jobs available listing, and (c) a centralized Indian skills inventory.	1/31/77		Pattie Fulgham	Louis D. Bayhille, Jr. Paul Lorentzen APX CSC
2. Determine occupational fields to be concentrated upon.	2/28/77		Project Leader	
3. Prepare specific work plans for (a), (b), and (c) above.	3/31/77		Project Leader	
4. Determine additional staff (numbers and kinds) needed to accomplish work plans, recruit and hire on reimbursable detail basis.	4/30/77		Project Leader	

340

336

ACTION PLAN STEP: HR3 Develop and operate an Indian intake-and-development program.

Responsible official: Pattie L. Fulgham, Chief, Branch of Staffing and Manpower

Keep copy in file

<u>Element</u>	<u>Time (M/D)</u>		<u>Leader</u>	<u>Participant resources</u>
	<u>Planned</u>	<u>Actual</u>		
1. Obtain from Area Offices complete inventory of Indian participants in present training/development programs, by occupational field and grade level (including Cooperative Education, Bridge to Professional, Field Management Development Training, and Management Under-study Programs).	2/28/77		Paul Lorentzen	Empl. Development Specs.
2. Develop guidelines for improved Bureauwide utilization and coordination of these programs during the "interim" (i.e., through October 1978).	3/31/77		Paul Lorentzen	Mercedes Lewis and Empl. Development Specs.
3. Based on numerical estimates of manpower needs in "significant" occupational fields (resulting from HRI), determine estimated first-year cost of Indian intake-and-development program for budget and ceiling justifications.	4/30/77		Paul Lorentzen	Financial Mgmt. Spec.
4. Develop basic requirements for program entrance.	6/30/77		Paul Lorentzen	Mercedes Lewis
5. Develop program publicity and contact network for locating candidates.	9/30/77		Paul Lorentzen	Project Leader of HR2
6. Develop application, screening, and selection procedures	12/30/77		Paul Lorentzen	Mercedes Lewis
7. Develop work plan for bringing on board first intake "class" by October 1978.	12/30/77		Paul Lorentzen	Mercedes Lewis and Empl. Development Specs.

387

341

APPROXIMATE STEP: HR 4 Take steps to grow Indian candidates for technical/specialist positions (i.e. engineers, foresters, etc.)

Version: :

Responsible officials: Patrick L. Fulginiti, Chief, Branch of Staffing & Manpower

Date: 12/31/77

Elements	Time (MLT)		Leader	Participant resources
	Planned	Actual		
1. Establish field task force of managers, to meet for a week in Central Office in April, to develop a work plan together with the C.O. Directorates concerned (Admin., Education, Tribal Resources, and Trust Responsibilities)	4/31/77		Mercedes Lewis	Central Office Directorates representatives Field task force members: Richard Drapeaux, Deputy A.D., Aberdeen Dan Sahnant, Educ. Program Admin., Anadarko Alonso Sjang, Chief, Indian Serv., Billings Charles Toyabo, Comm. Serv. Officer, Serran Robert Walker, Financial Officer, Albuquerque Otto Karl Weaver, Chief, Land Oper., Navajo

342

388

ACTION PLAN STEP: HR5 Issue policy guidelines on application of Indian preference (restructuring and re-advertising positions).

Version:

Date: 12/1/77

Responsible official: Patti L. Fulghina, Chief, Branch of Staffing and Manpower

<u>Elements</u>	<u>Time (NLT)</u>		<u>Leader</u>	<u>Participant/Resource</u>
	<u>Planned</u>	<u>Actual</u>		
1. Prepare and issue guidelines in the form of a "spotlighted" expansion and explanation of the "Area of Consideration" and "Job Redesign" paragraphs of 46 BLAM 335, Promotion and Internal Placement.	2/01/77		Marlee Benecke	

343

330

ACTING PLAN STP: HR 8 Develop qualification standards/guidelines for major types of positions

Version: 1

Responsible official: Parris Fulgham, Chief, Branch of Staffing & Manpower

Date: 12/31/76

Elements	Time (NLT)		Leader	Participant resources
	Planned	Actual		
1. Determine whether X-118 qualification standards are suitable as is for the following Bureau positions:				
GS-1715 Vocational Development Specialist	1/31/77		Mercedes Lewis	
GS-950 Tribal Operations Officer (coordinated time-wise with Classification's decision re series)	2/28/77		Joyce Branch	
If not in either case, develop appropriate qualification material in consultation with CSC.				
2. Develop draft qualification standards for the following positions:				
GS-083 Policeman (excepted standard)	2/28/77		Dennis Ravilla, Staffing Spec., Aberdeen	
GS-301 Area Director (single-agency standard)	2/28/77		William Finala, Area Director, Sacramento	
GS-340 Superintendent " " " (coordinated info-wise with Classification's guideline)	2/28/77		Doyce Waldrip, Acting AD, Portland	
GS-1101 Housing Development Officer (single-agency standard; coordinated time-wise with Classification's guideline)	2/28/77		Richard Slater, Pers. Officer, Albuquerque	
3. Obtain comments on above draft standards from appropriate Central Office program officials	3/15/77		Joyce Branch	
4. Make informal contacts on drafts with Dept. and CSC	3/31/77		"	
5. Send drafts to Areas, unions and tribes for comment	3/31/77		"	
6. Receive comments back in Central Office	5/31/77		"	
7. Revise as necessary; send final standards to Dept./CSC	6/15/77		"	
8. Obtain Dept./CSC approval	7/15/77		"	
9. Solicit recommendations from Areas for any additional qualification standards needed	7/31/77		"	

344

340

ACTION PLAN STEP: HR 9 Improve procedures for determining eligibility and qualifications for specific vacancies

Responsible official: Pattie Fulgham, Chief, Branch of Staffing and Manpower

Version: 1
Date: 12/31/76

Elements	Time (NLT)		Leader	Participant resources
	Planned	Actual		
1. Prepare and issue policy guidelines on general acceptability considerations and selective placement factors--in the form of a revision of the "Qualification Determination of Applicants for Positions in BIA" memo and an expansion of the "Determining Basic Eligibility" paragraph of 44 BIA 335, Promotion and Internal Placement--to be used in announcing and filling vacancies.	2/28/77		Joyce Branch	
2. Develop training program in how to use Handbook X-118 in making qualification determinations.	3/31/77		Joyce Branch	
3. Identify and select 8-10 instructors (staffing specialists).	4/30/77		Pattie Fulgham	
4. Train instructors by conducting a pilot session in Central Office.	5/31/77		Joyce Branch	
5. Develop schedule of Bureau-wide training sessions and use of the instructors.	5/31/77		Joyce Branch	
6. Monitor and evaluate several sessions.	6/30/77		Joyce Branch	
7. Obtain recommendations from Areas on revision/improvements needed in use of promotion panels, assessment forms and ranking procedures in 44 BIA 335.	7/31/77		Marlee Benecke	
8. Develop work plan to accomplish above revisions/improvements.			Marlee Benecke	

341

345

ACTION PLAN STEP: HR 10 Reissue updated policy guidelines for tribal consultation on personnel selections

Version: 1

Responsible officials: Patricia Fulgham, Chief, Branch of Staffing & Manpower

Date: 12/31/76

<u>Elements</u>	<u>Time (NL2)</u>		<u>Leader</u>	<u>Participant resources</u>
	<u>Planned</u>	<u>Actual</u>		
1. Draft guidelines statement	2/15/77		Joyce Branch	
2. Have draft reviewed by Central Office management and revise/refine with the help of field task force	3/1/77		Joyce Branch	James Canan, AD, or) Bill Anson Baker, Supt.) Lings Emmett Cameron, Admin. Officer, Minneapolis Ed McCabe, Supt., Navajo
3. Send resulting draft guidelines to Areas, unions, and tribes for comment	3/15/77		"	
4. Receive comments back in Central Office	5/15/77		"	
5. Prepare and issue final guidelines	6/30/77		"	

343

342

ACTION PLAN STEP: HR 11A Establish improved policies and procedures for position management and organizational structure
 Responsible official: James DeFrance, Chief, Branch of Classification

Version: 1
 Date: 12/31/76

<u>Elements</u>	<u>Time (NLT)</u>		<u>Leader</u>	<u>Participant resources</u>
	<u>Planned</u>	<u>Actual</u>		
1. Draft policy letter containing "front-end" submission and analysis procedures to be followed Bureauwide on (a) proposed organizational changes and (b) proposed new position/upgrading -- involving coordinated review by budget, management analysis and personnel functions; types of justification documents needed, etc.	1/15/77		James DeFrance	
2. Obtain C.O. review and comments on draft	1/31/77		"	
3. Obtain comments from Area Directors	2/28/77		"	
4. Issue final policy letter, and start operating accordingly	3/15/77		"	
5. Prepare and issue revised BIAM chapter covering position management and classification policies (e.g. use of evaluation statements, cyclic audit operations, etc.)	3/15/77		Gene Adams	

348



ACTION PLAN STEP: HR 118 Develop initial manpower/staffing standards, and improved employment ceiling-operational procedures

Version: 1

Responsible official: James DeFrance, Chief, Branch of Classification

Date: 12/31/76

<u>Elements</u>	<u>Time (MLT)</u>		<u>Leader</u>	<u>Participant Resources</u>
	<u>Planned</u>	<u>Actual</u>		
1. Review submissions from Area Offices re manpower/staffing standards needed (Attachment 3 of Phoenix meeting report)	1/31/77		Bill Furlong	HR&E
2. Based thereon, prepare work plan for developing several pilot manpower/staffing standard projects, including the GS-200 field	2/28/77		"	HR&E
3. Prepare and issue policy guidelines on coordination between Budget and Personnel functions in employment ceiling operations and on using the flexibilities of the system	6/30/77		"	Financial Mgmt.

343

344

ACTION PLAN STEP: HR 11C Continue to provide technical assistance in position classification/management to the field

Version: 1

Responsible official: James DeFrance, Chief, Branch of Classification

Date: 12/31/76

<u>Elements</u>	<u>Time (KLT)</u>		<u>Leader</u>	<u>Participant resources</u>
	<u>Planned</u>	<u>Actual</u>		
1. Conduct model supervisory training for managers and supervisors in Central Office, in position management and Factor Evaluation System (FES); and make course content available to Area Offices	1/11/77		Gene Adams	Douglas Rabel
2. Provide continuing assistance to Aberdeen Personnel Office (every other month) (see PF 4)	2/28/77 A ongoing		Gene Adams	
3. Help selected Area Offices with position classification operations, e.g. Billings and Phoenix (see PF 4)	3/31/77 A ongoing			Branch staff members
4. Participate in technical assistance visits to Albuquerque Field Personnel Office and Muskogee Area P.O. (see PF 4)	4/30/77			Branch staff members
5. Prepare for and conduct Bureauwide position management/classification conference (review effectiveness of guidelines and procedures, facilitate interchange of ideas on position management operations in Area Offices, identify further work areas for policy and technical assistance, etc.) (see PF 3)	5/31/77		James DeFrance	Branch staff members

345

ACTION PLAN STEP: HR 110 Conduct and complete various position classification and wage administration studies and projects

Responsible official: James DeFrance, Chief, Branch of Classification

Version: 1

Date: 12/31/76

Elements	Time (XLT)		Leader	Participant resources
	Planned	Actual		
1. Vocational Development Specialist GS-1715: Issue position classification guideline firming up use of GS-1715 series and providing grade level/position management guidance	1/31/77		Bill Furlong	
2. Educational Aids & Technicians GS-1702: Issue position classification guideline providing grade level guidance for non-supervisory positions, and standard p.d.'s.	2/28/77		Frank DeKona Gene Platt	<i>Gene Adams</i>
3. Wage Grade jobs: Review policies and procedures related to construction rates, and issue policy statement	2/28/77		Wanda Byram	
4. Tribal Operations Officer GS-301/950: Coordinate with qualification standards study (HR 8) re use of GS-950 series, and issue position classification guidelines	2/28/77 3/15/77		Bill Furlong & Frank DeKona	
5. Housing Development Officer GS-1101: Prepare rationale for use of GS-1101 series, and guidelines for classification by cross-referencing other standards -- then coordinate with qualification standard project (HR-8) for 7/15/77 issuance	3/15/77 7/15/77		Gene Adams	
6. Road Engineer GS-810: Continue study to determine if Bureau of Public Roads' classification guideline is applicable to BIA positions and, if so, issue same as Bureau guideline. (If not, develop schedule for guideline project, and conduct same)	3/31/77		Gene Adams	
7. Law Enforcement positions: Prepare detailed work plan for designing a career system covering guards, policemen, detectives, and criminal investigators -- including grade level distinctions and relationships with other law enforcement bodies (i.e. FBI, State and tribal enforcement bodies)	3/31/77		Gene Adams	

346

350

ACTION PLAN STEP: HR 11D (continued)

Version:

Responsible official:

Date:

<u>Elements</u>	<u>Time (KLT)</u>		<u>Leader</u>	<u>Participant resources</u>
	<u>Planned</u>	<u>Actual</u>		
8. Social Workers GS-185: Prepare and issue position classification guideline summarizing grade level distinctions	3/31/77		Kurt Stende	
9. Teachers GS-1710: Prepare and issue restatement of classification guidelines re GS-9 journeyman level vs GS-11 non-supervisory positions, including model p.d.'s.	4/30/77		Bill Furlong & Gene Platt	<i>In this case?</i>
10. Superintendent GS-340: Continue to prepare guideline for classifying positions: Send redraft, based on field comments, out to field Obtain field comments back in Central Office Issue final guideline	3/31/77 5/15/77 6/30/77		Frank DeKona	Branch staff members

347

ACTION PLAN STEP: M-12 Develop and conduct communication workshops on personnel management

Version: 1

Responsible official: Douglas Rabel, Chief, Branch of Employee Development

Date: 12/31/76

<u>Elements</u>	<u>Time (MLT)</u>		<u>Leader</u>	<u>Participant resources</u>
	<u>Planned</u>	<u>Actual</u>		
1. Develop workshop format and prepare initial draft of workshop guide	1/31/77		Doug Rabel	Dick Gubbins & Judy Zundel Irene Fischer Paul Lorentzen
2. Refine format and guide with help of "outside" resource	2/28/77		Doug Rabel	Training Officer, Bureau of Reclamation
3. Finalize format and guide with help of 3 Area resource persons	3/31/77		Doug Rabel	Don Ross, Billings Ed Renneau, Portland C.L. Henson, Sacramento
4. Identify and select 10 facilitators from within Bureau	3/31/77		Doug Rabel	Same as (1) above
5. Train facilitators by conducting a pilot workshop	4/30/77		Paul Lorentzen	Paul Vaniman, APH, as "critiquer"
6. Develop initial schedule of workshops and use of facilitators	4/30/77		Doug Rabel	10 trained facilitators
7. Monitor and evaluate several workshops	5/31/77 & ongoing		Doug Rabel	Branch staff members

352

348

Responsible official: Douglas Rabel, Chief, Branch of Employee Development

Date: 12/31/76

<u>Element</u>	<u>Time (M:)</u>		<u>Leader</u>	<u>Participant resources</u>
	<u>Planned</u>	<u>Actual</u>		
1. Identify and select an outside resource person/organization to develop course format and content	1/31/77		Doug Rabel	Paul Lorentzen
2. Effect contract with same	2/28/77		Doug Rabel	Financial Management
3. Obtain product from same	5/31/77		Doug Rabel	Contractor
4. Identify instructors and get them trained	6/30/77		Doug Rabel	Contractor
5. Develop schedule of orientation sessions and use of instructors	6/30/77		Doug Rabel	Instructors
6. Monitor and evaluate several sessions	7/31/77 & ongoing		Doug Rabel	

349



ACTION PLAN STEP: 6.5B Develop career guidelines/pathways for major types of management positions

Version: 1

Responsible official: Pattie Fulgham, Chief, Branch of Staffing and Manpower

Date: 12/31/76

<u>Elements</u>	<u>Time (NET)</u>		<u>Leader</u>	<u>Participant resources</u>
	<u>Planned</u>	<u>Actual</u>		
<p>1. Recruit and hire from another agency (on reimbursable detail) a project leader. Work plan to include:</p> <ul style="list-style-type: none"> - Determining specific types of management positions (e.g. Area Director, Superintendent, etc.) which will be dealt with - Obtaining data on career pathways which present incumbents of these positions have followed - Developing draft career guidelines/pathways - Sending drafts to appropriate managers and obtaining comments - Revising as necessary with help of manager task force and issue in final 	7/31/77		Pattie Fulgham	Louis Bayhille Paul Lorentzen APM CSC

354

350

Consent Camera copy

MESCALERO TRIBAL OFFICE ET
PO BOX 176
MESCALERO NM 88340



Mailgram
western union



2-043431E028 01/28/77 ICS IPMBNGZ CSP HSHC
5050718895 MGM TDBN MESCALERO NM 138 01-28 0435P EST

CONGRESSMAN CARL D PERKINS
CHAIRMAN OF THE COMMITTEE ON EDUCATION AND
LABOR
2181 RAYBURN HOUSE OFFICE BLDG
WASHINGTON DC 20515

REGARDING OVERSIGHT HEARING YOUR COMMITTEE HOLDING ON INDIAN EDUCATION
FEBRUARY FIRST, REQUEST YOU REGISTER OUR OPPOSITION TO DOCTOR DENKERTS
PROPOSED REORGANISATION, ALSO REQUEST YOU CALL B I A TO MAKE AVAILABLE
TO TRIBE, THE STUDY ON WHICH IT WAS BASED. MY CONCERNS ARE NUMBER ONE
THIS REORGANISATION IS PROCEEDING WITHOUT INVOLVEMENT OF LEGITIMATE
LEADERSHIP OF TRIBAL GOVERNMENT; NUMBER TWO IT WILL RESULT IN A SERIOUS
EROSION OF TRIBAL GOVERNMENTAL AUTHORITY BECAUSE IT PERMITS DIRECT
FUNDING AND LINE SUPERVISION OF EDUCATION PROGRAM FROM WASHINGTON TO
LOCAL SCHOOL ORGANISATIONS, BYPASSING TRIBAL GOVERNMENT; AND NUMBER
THREE IF THIS APPROACH IS TAKEN WITH INDIAN EDUCATION, OTHER B I A
PROGRAMS WILL NO DOUBT SOON FOLLOW THE SAME PATTERN.

REQUEST YOU ASSURE THAT TRIBAL GOVERNMENT HAVE INPUT INTO SUCH MAJOR
CHANGES.

MENDELL CHINO PRESIDENT
MESCALERO APACHE TRIBE
PRESIDENT NATIONAL TRIBAL CHAIRMAN
ASSOCIATION
PO BOX 176
MESCALERO NM 88340

16135 EST

MGMCOMP MGM

February 1, 1977

Mr. Wendell Chino
President
National Tribal Chairman Association
Mescalero Apache Tribe
P.O. Box 176
Mescalero, New Mexico 88340

Dear Mr. Chino:

Thank you very much for sending me your recent mailgram expressing your opposition to the reorganization of education programs in the Bureau of Indian Affairs.

Since the Committee is beginning general oversight hearings today on Federal programs to improve the education available to Indian children and adults, I appreciate knowing of your views. If you have no objection, I would like to make that mailgram a part of the hearing record.

Thank you again.

Sincerely,

Carl D. Perkins
Chairman

CDP:Jp