

TeraStation User Manual



Americas: www.buffaloamericas.com

Europe: www.buffalo-technology.com

Asia Pacific: www.buffalo-asia.com

Contents

Chapter 1 Diagrams and Layout.....7

TeraNavigator Setup.....7

Diagrams and Layout..... 12

Auto Power Mode..... 14

Chapter 2 Using your TeraStation 15

Opening a Shared Folder..... 15

Opening a Shared Folder from a Second PC 15

Adding Additional TeraStations..... 17

Opening Settings 17

Chapter 3 Changing RAID Modes..... 22

RAID Arrays..... 22

Using JBOD 23

Using RAID 5 with 4 Hard Drives..... 24

Using RAID 5 with 3 Hard Drives..... 26

Using RAID 10..... 28

Using RAID 1 30

Using RAID 0..... 32

Configuring a Hot Spare 34

Drive Failures..... 36

<u>Chapter 4 Adding an External Hard Drive</u>	37
Connect an External Drive.....	37
Formatting the External Drive	38
Set Access Restrictions on the External Drive.....	39
<u>Chapter 5 Removing External Hard Drives.....</u>	40
Dismounting with the Function Button	40
Dismounting from Settings.....	40
<u>Chapter 6 Backup</u>	42
Back Up from your Windows PC	42
Back Up from the TeraStation	42
Configure Destination for Backup.....	42
Backup Folders.....	43
Backing Up to Another TeraStation on the Local Network.....	44
Backing Up to a TeraStation on Another Network which Is Connected by a VPN.....	44
Configuring a Backup Job	45
Backup Restrictions	47
If a Scheduled Backup Fails (I54)	47
Using TeraStation Batch Backup	48
Replication.....	48
Replication Folders	50
Configuring Replication	51
Replication to a TeraStation on a Different Network	52
Time Machine	54
Restoring Backup Data	59

<u>Chapter 7 Configuring Access Restrictions</u>	60
Adding a Shared Folder	60
Technical Restrictions.....	62
Adding Users	63
Adding Groups	65
Access Restrictions.....	66
Setting Access Restrictions for Users/Groups.....	66
Access Restrictions on NT Domain.....	69
Access Restrictions on Active Directory	70
Restrictions When Administrating in Active Directory Domain	71
Access Restrictions through Delegate Authority to External SMB Server	72
Restrictions When Administrating Delegate Authority Option	74
<u>Chapter 8 Managing your TeraStation.....</u>	75
Name, Date and Time	75
RAID Scanning.....	76
Disk Check	77
Encrypt Hard Drives on the TeraStation	79
Formatting Drives	79
Email Notification	80
UPS Settings	83
Beep Alerts	84
LCD Display Settings.....	85
Changing the Admin Username and Password	86
Erase Data on the TeraStation Completely.....	87

Initialization	87
Restore Factory Defaults	87
Initialization from Settings	88
Changing the IP Address	89
Network	90
Jumbo Frames	90
Port Trunking.....	91
Configuring Port Trunking	92
Update the TeraStation's Firmware	92
Online Update	92
Update by Downloading File from Buffalo Website.....	92

Chapter 9 Extensions **93**

Using WebAccess.....	93
What is WebAccess?	93
Direct Copy	93
Eye-Fi Connected	95
Print Server	96
Setting up a printer on Windows 8, Windows 7 or Windows Vista	98
Setting Up a Printer on Windows XP	100
Setting Up a Printer on Windows 2000	101
Sleep Timer	103
Disk Quotas	105
Disk space quotas for users.....	105
Disk space quotas for groups.....	108
TeraSearch	113
Offline Files.....	114

DFS (Distributed File System)	117
FTP Server	119
To access the TeraStation with an FTP client.....	121
Accessing the TeraStation with an Anonymous User:.....	121
Accessing from a NFS Client	122
Encrypting Data Transmission	124
Encrypting Data from Settings	124
Encrypting FTP Transfer Data	125
SSL Key.....	125
Wake-on-LAN	125
Web Server.....	126
MySQL Server	127
SNMP	128
<u>Chapter 10 NAS Navigator2.....</u>	<u>129</u>
Windows	129
Mac OS	131
<u>Chapter 11 Software</u>	<u>133</u>
NAS Navigator2.....	133
File Security Tool	133
NS-SHFT	133
EXT3 Reader	134
<u>Chapter 12 List of Items in Settings</u>	<u>135</u>
Common Items (Left Side of the Screen)	135

Shared Folders.....	135
Users/Groups	138
Network	140
System.....	144
Extensions	157

Chapter 13 Appendix **160**

Assign as Network Drive (Windows).....	160
Mount as a Network Drive (Mac OS)	160
Specifications	162
Factory Defaults	163
Software.....	163
Info Folder	164
Troubleshooting.....	164
Data Backup	166
GPL Information	166
Compliance Information.....	166

Chapter 1 Diagrams and Layout

TeraNavigator Setup

To configure your TeraStation, insert the TeraNavigator CD into a Windows computer on the network and follow the directions, or use the following procedure.

1 Connect cables

TS-XL, TS-XEL

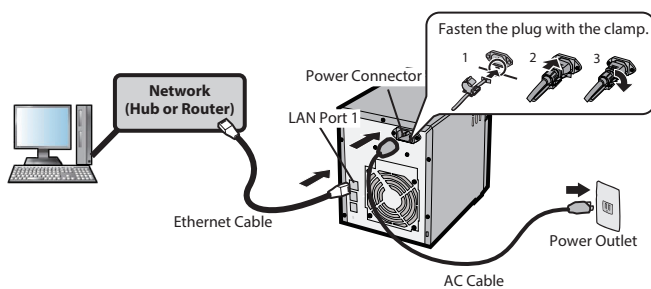

TS-WXL

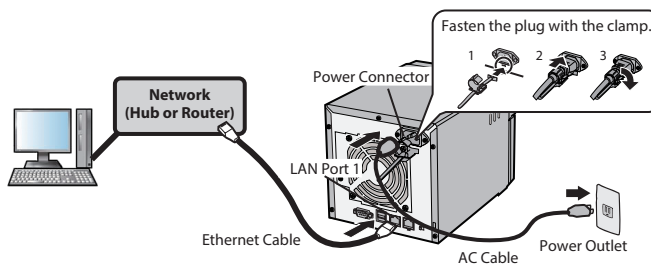

TS-RXL

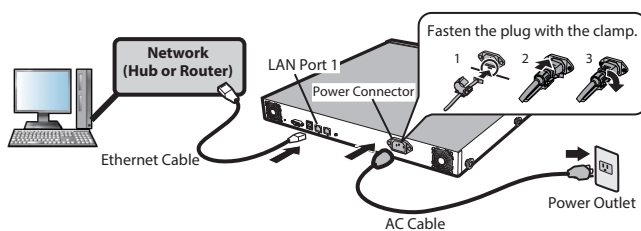

Note: Use LAN port 1 for initial setup. After setup, you may connect a second cable to LAN port 2. If used, configure the IP address of LAN port 2 at *Network - Setting - IP Address Settings* in Settings or NAS Navigator2.

2 Hold down the power button on the TeraStation for three seconds to turn it on.

3 Wait until the green power LED changes from flashing to lit. In the TS-RXL TeraStations, the LED is not illuminated. Continue to Step 4.

4 Insert the TeraNavigator software CD into your computer. The TeraNavigator wizard will launch. Click *Begin Installation*. Step through the wizard to connect cables and install software.

If the wizard doesn't open automatically, navigate to the TeraNavigator CD and double-click the  icon (TSNavi.exe).



Notes:

- If you are using Windows 8, Windows 7, or Windows Vista, the autoplay screen may appear. Click *Run TSNavi.exe*.
- If "Do you want to allow the following program to make changes to this computer ?" is displayed in Windows 8 or Windows 7, click *Yes*.
- If "A program needs your permission to continue" is displayed in Windows Vista, click *Continue*.
- For Mac OS, open the CD and double-click the TeraNavigator icon.
- Disable your antivirus software or firewall before continuing. The TeraNavigator software may not install properly if antivirus or firewall is enabled. Re-enable antivirus and firewall after setup.

5 When "Finish" is displayed, initiate NAS Navigator2 by clicking Launch NAS Navigator2. Alternately, you can click *Next* to display more information about the power mode switch, which can turn the TeraStation on and off automatically.

- 6 Right-click your TeraStation's icon, and choose *Properties - IP Address*. For Mac OS, hold the control key, click the TeraStation icon, then click *Configure - IP Address*.

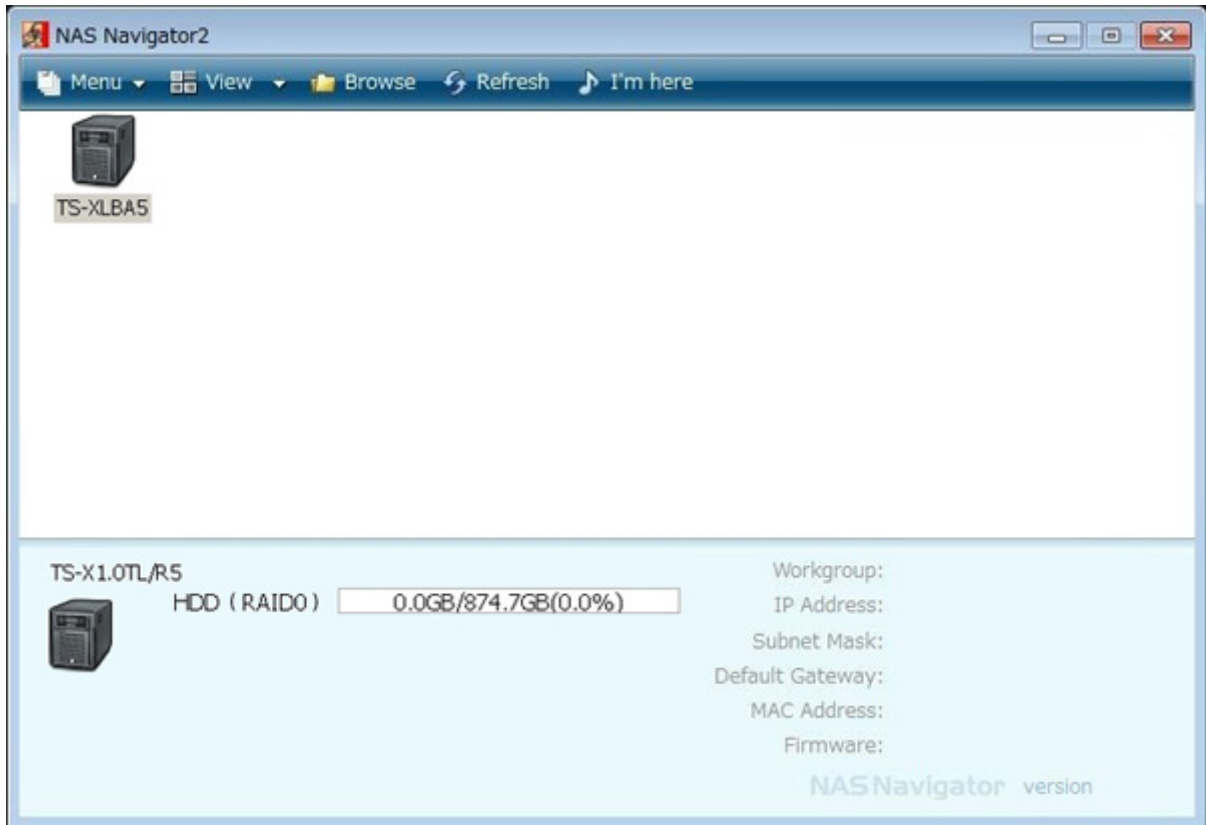

- 7 Enter the desired IP address, subnet mask, and default gateway. Click *OK*.

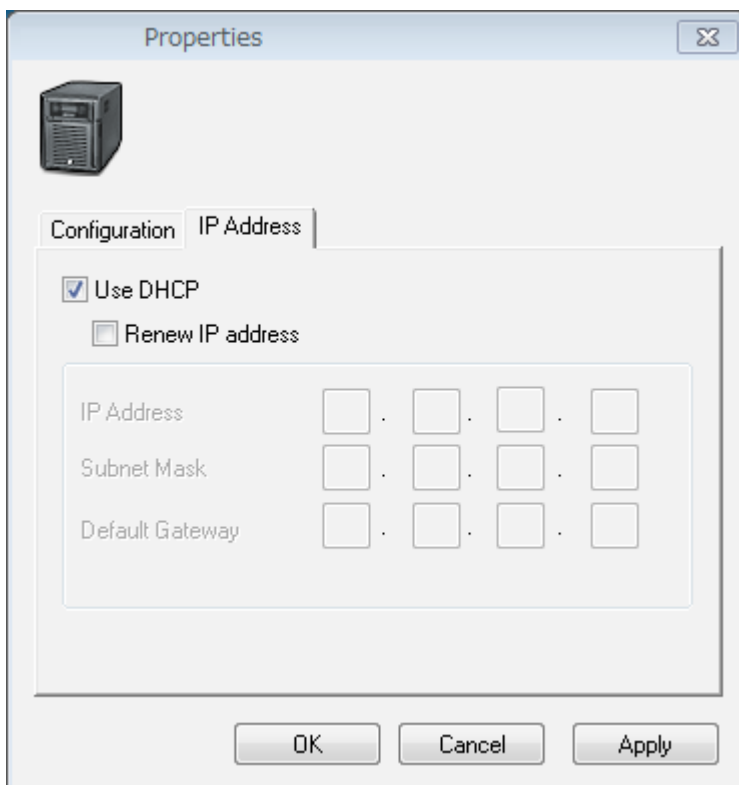

Notes:

- If you don't know how to configure these settings, click *Use DHCP* to check the box. For Mac OS, click *Use DHCP*.

- If you are prompted to enter the administrator's password, enter the TeraStation's password (it is set to "password" by factory default).

8 Right-click the TeraStation icon in NAS Navigator2 and choose *Settings*. For Mac OS, hold the control key, click the TeraStation icon, and click *Settings*.

Note: Settings requires Firefox 1.5 or later, Internet Explorer 6.0 Service Pack 2 or later, or Safari 3 or later.

9 Enter the administrator name and password, and click *Login*.

Notes:

- The following settings are set by factory default.
Username: admin
Password: password
- The default language for Settings is English. To change the display language, click *System - Settings - Language - Modify Settings*, select *Display Language*, and click *Save*.

10 Click *System - Settings - Date and Time*.

11 Click *Modify Settings*.

12 To manually configure the date and time, click *Manual* for "Date/Time Source" and adjust date, time, and time zone. Click *Save*.

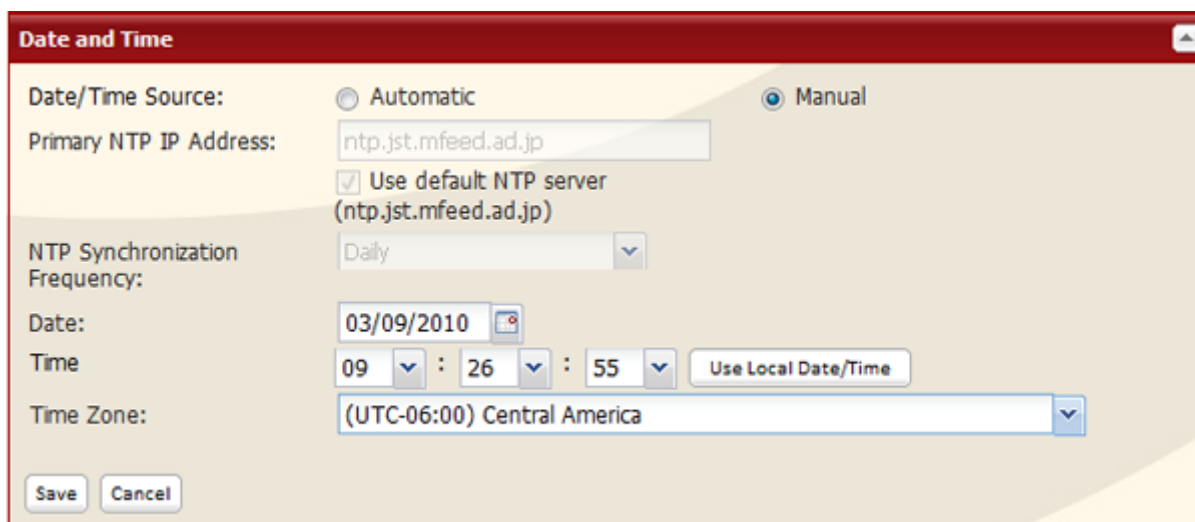

Notes:

- Click *Use Local Date/Time* to use your computer's time (or time zone) for the TeraStation's time.
- By default, the TeraStation will attempt to use an NTP server to set the time.
- NTP may not be usable in some network environments.
- Read the terms of use for Internet Multifeed Co. at www.jst.mfeed.ad.jp. Internet Multifeed Co. is the group that manages the NTP server at www.jst.mfeed.ad.jp. Internet Multifeed Co. is not responsible for any loss or damages caused by this service.
- Buffalo is not responsible for any loss or damage caused by using of this service, stopping the service, or missing service.
- If your TeraStation fails to automatically obtain the time from the NTP server, verify the settings for the DNS server address of the TeraStation. You must set a primary DNS server address to specify an NTP server by hostname. Otherwise you will have to specify the DNS server by IP address. You can change the DNS server settings at *Network - Settings - IP Address Settings* in Settings.

13 The following settings changes are recommended.

Change Your Administrator Password

We recommend that you change the default password to a secure password.

- (1) Click *Users/Groups - Local Users* in Settings.
 - (2) Select *admin* from the user list and click *Edit User*.
 - (3) Enter a new password (twice) and click *Save*.
- Your administrator password is now changed.

Configure RAID Scan

RAID scan checks your RAID 1, 5 or 10 arrays for problems and automatically fixes any errors it can. To configure:

- (1) Click *System - Storage - RAID Scanning - Modify Settings*.
- (2) Click *Enable for RAID Scanning*.
- (3) Select the schedule to perform RAID scan.

Note: With "Immediate" checked, RAID scan will run immediately.

- (4) Click *Save*.

You have completed the settings for RAID scan.

14 Double-click your TeraStation's icon.

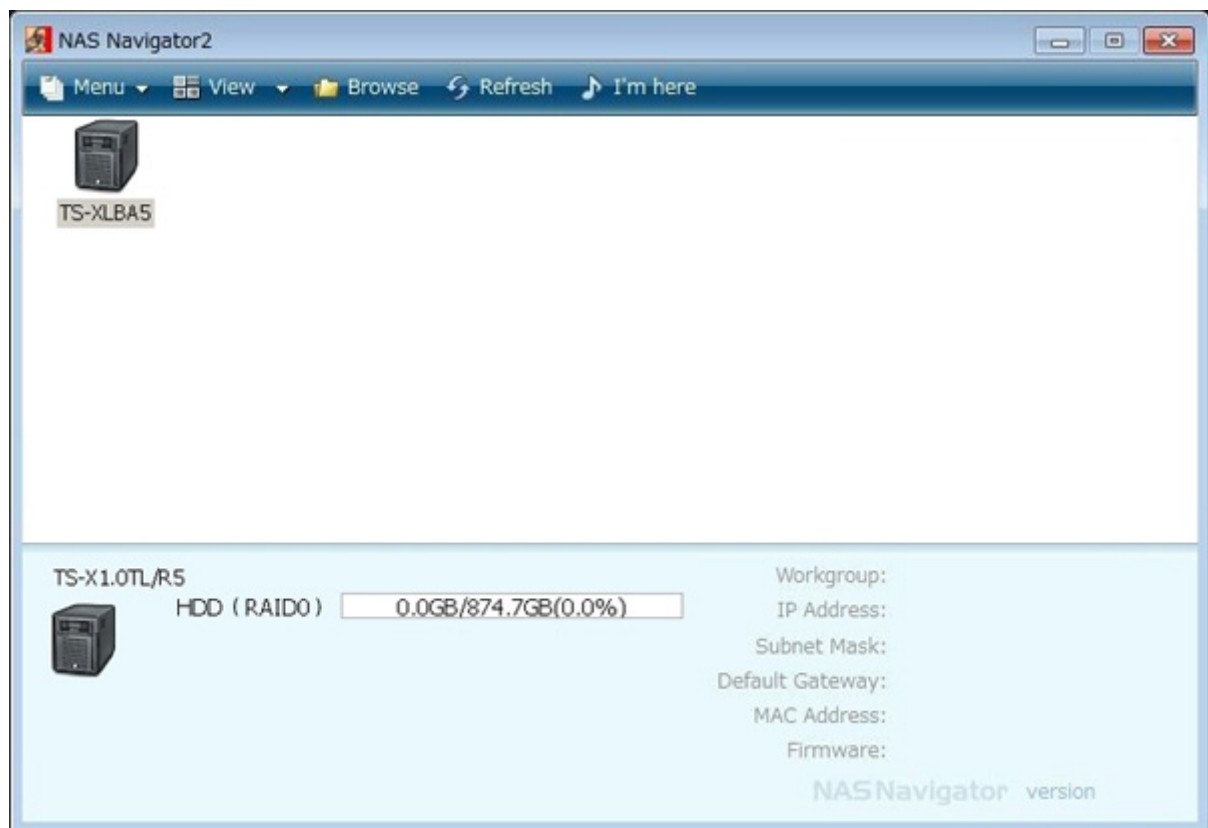

15 The TeraStation's shared folders are displayed.

Note: For Mac OS, TeraStation is mounted as a drive icon on the desktop, or displayed in the sidebar of the Finder.

Setup is now complete. You can now use the TeraStation's shared folders to save files just like other hard drives.

Note: Keep the TeraStation updated with the latest firmware. You can download the latest firmware from the Buffalo website. The currently installed firmware version is displayed on the main screen of NAS Navigator2.

Diagrams and Layout

TS-XL, TS-XEL

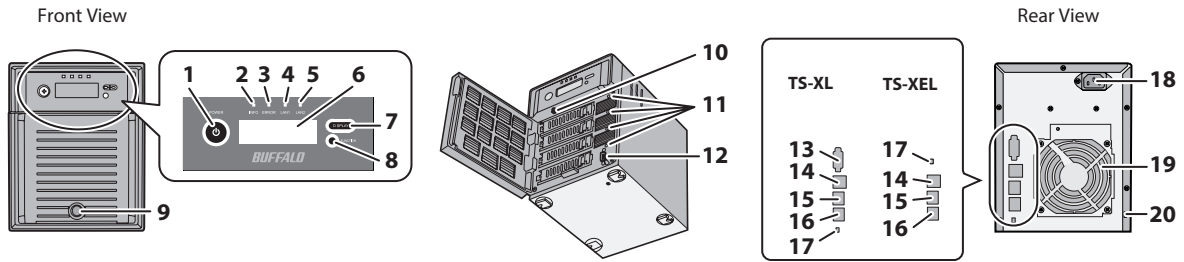

TS-WXL

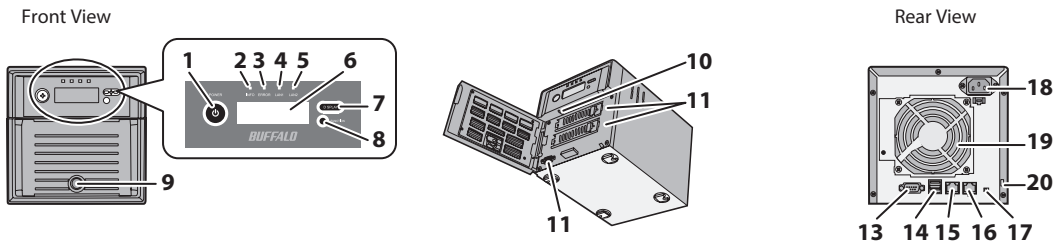

TS-RXL

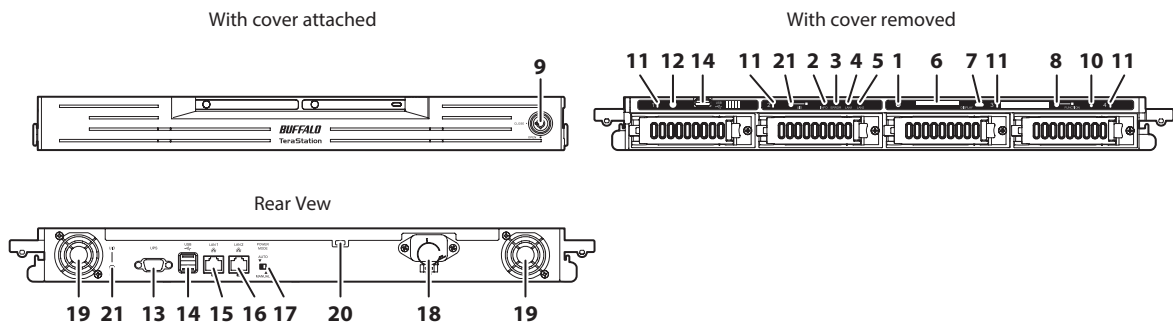

1 Power Button

Power On and Off: Press and hold the power button for 3 seconds until it beeps.

Note: To power on, connect the AC cable and wait for 10 seconds. Then press the power button.

2 Info LED

If there is a message about the current status, the amber info LED is illuminated. Check the LCD display for current status.

3 Error LED

The red error LED is illuminated when an error occurs. Check the LCD display for more information.

4 LAN1 LED

When the LAN port 1 is connected to a network, it is illuminated in green (the light next to the LAN port 1 will be illuminated as well).

5 LAN2 LED

When the LAN port 2 is connected to a network, it is illuminated in green (the light next to the LAN port 2 will be illuminated as well).

6 LCD Display

Displays the status of the TeraStation.

7 Display Button

Switches between the different display modes. This button stops beeping.

8 Function Button

Use this button to perform the following operations:

- Direct Copy
- Removal of USB devices
- Rebuild RAID after replacing hard drives

9 Drive Lock

Open the front panel with the key to replace hard drives or press the reset button.

10 Reset Button

With the TeraStation powered on, hold down this button until it beeps (about 5 seconds) to reset the TeraStation's IP address and password to the factory defaults. The password will not be reset if this functionality has been disabled from within Settings.

Note: To access the TS-RXL series' reset button, insert the tip of an unfolded paper clip.

11 Status LEDs 1 - 4

LEDs 1 through 4 will be illuminated in green when the corresponding hard drives are accessed. If an error occurs on a hard drive, the corresponding LED will be illuminated or flash in red or amber.

12 Factory Use Only

TS-XEL TeraStations do not have this port.

13 UPS Port

Connect a UPS (Uninterruptible Power Supply). TS-XEL TeraStations do not have this port.

14 USB Connector (USB 2.0/1.1 Series A)

Compatible Buffalo USB hard drives, USB flash drives, and digital cameras can be connected. USB hubs are not supported.

15 LAN Port 1

Connect to a router, hub, or switch on your Ethernet network.

16 LAN Port 2

Use this second Ethernet port for redundancy or backup. For backup, a second TeraStation may be connected directly.

17 Power Mode Switch

Switches between "AUTO" and "MANUAL" power modes.

18 Power Connector

Use the included AC cable to connect to an UPS, surge protector, or outlet.

19 Fan

Do not block the fan when installing the unit.

20 Anti-Theft Security Slot

You can also secure it using an off-the-shelf wire lock.

21 UID Button

The blue LED next to the UID button will be illuminated or turned off every time you push this button on the front or back.

Auto Power Mode

The TeraStation can be configured to automatically turn on and off with your computer. To use this feature, install NAS Navigator2 on your computer and then set the power mode switch on the back of your TeraStation to "AUTO".

<TS-XHL, TS-XL>

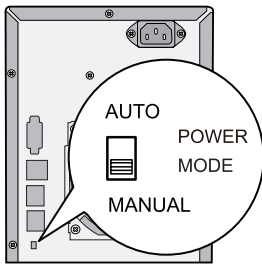

<TS-XEL>

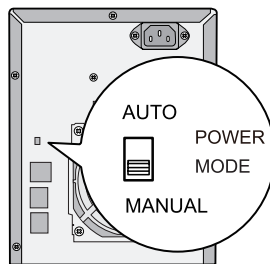

<TS-WXL>

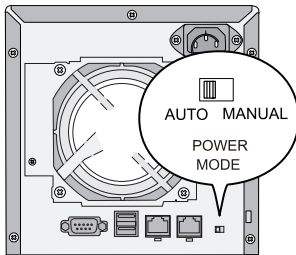

<TS-RXL>

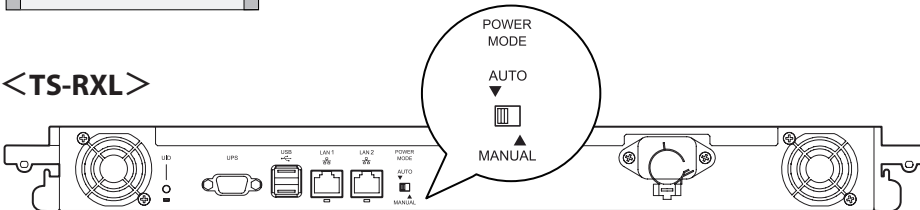

Manual (default):

In this position, the power button on the front of the TeraStation turns it on and off. It is not affected by the power state of connected computers.

Auto:



In this position, if all connected computers are turned off, the TeraStation will turn off too. If a connected computer is powered on, the TeraStation will power on too.

Notes:

- After you turn off your computer, it may take several minutes for the TeraStation to shut down.
- When the power mode switch is changed from Auto to Manual or vice-versa, it takes about five minutes for the change to take effect.
- Power on the TeraStation before moving the switch to the Auto position.
- Auto Power Mode doesn't work if port trunking is enabled or if NasNavi detection is disabled.
- Install NAS Navigator2 on all computers that will be accessing the TeraStation before switching to Auto Power Mode.
- Some networks may not support the Auto Power Mode. If there are persistent issues with the network, use Manual Power Mode for safety.

Chapter 2 Using your TeraStation

Opening a Shared Folder

- 1 Double-click the  icon on the desktop. NAS Navigator2 will start. For Mac OS, click the  icon in the Dock.
- 2 Double-click the TeraStation icon.

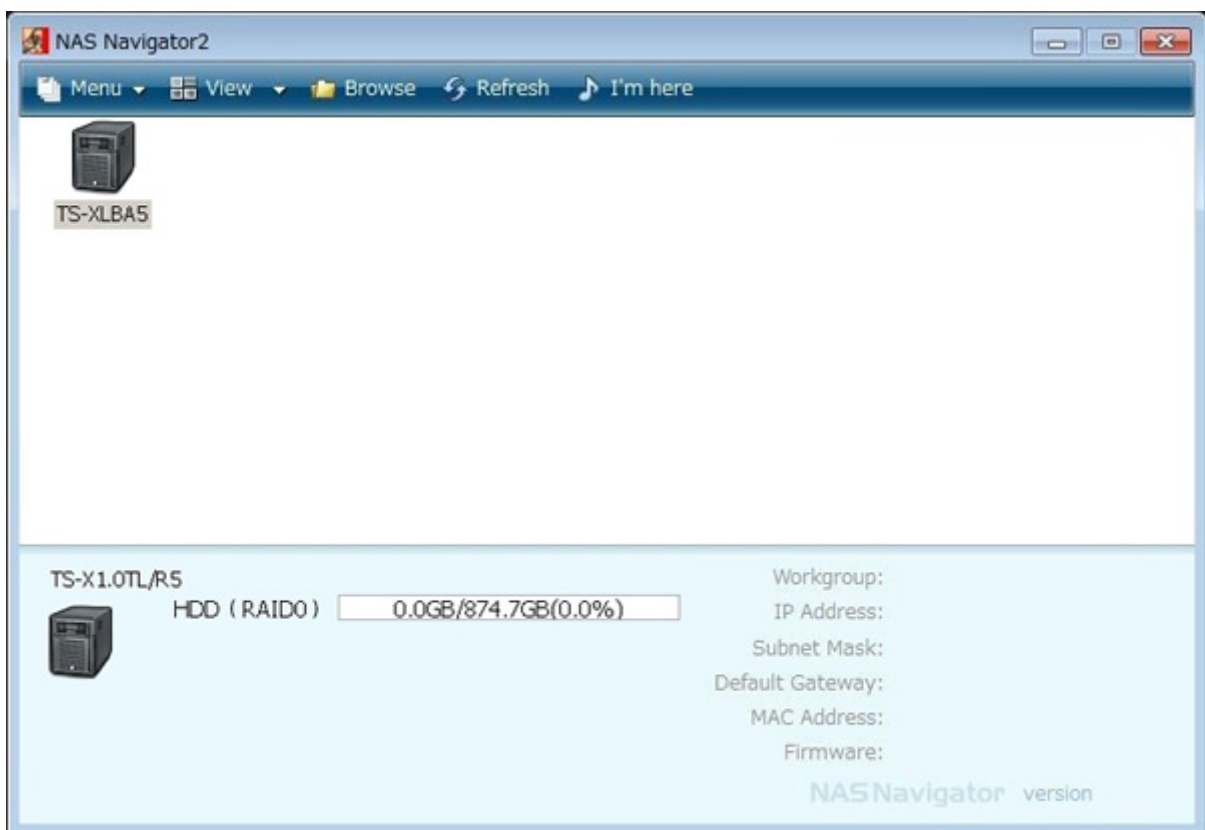

Note: When you access a shared folder from a Windows PC, you may be asked to enter a username and password. In such a case, enter "guest" for the username and the password is blank.

- 3 The TeraStation's shared folders are displayed.

Note: With a Mac, the TeraStation is mounted as a drive icon on the desktop, and displayed in the sidebar of the Finder.

You can now use the TeraStation's shared folders to save files just like other hard drives.

Opening a Shared Folder from a Second PC

Once you've connected the first computer to the TeraStation, you don't have to run the setup program again to connect additional computers. Just install NAS Navigator2 on each additional computer and use it to open the TeraStation's shared folder as necessary.

1 Insert the TeraNavigator CD into your computer. TeraNavigator will launch.

Notes:

- For Windows 8, Windows 7, or Windows Vista, click *Run TSNavi.exe* when the auto-play screen is displayed.
- If "A program needs your permission to continue" is displayed, click *Continue*.
- For Mac OS, double-click the TeraNavigator icon in the utility CD.



2 Click *Install NAS Navigator2*.

If this screen doesn't open, open the CD and double-click the  icon (TSNavi.exe).



3 Step through the wizard to install NAS Navigator2.

4 After NAS Navigator2 is installed, click the  in the right top right corner of the window to close the installer. Then, use NAS Navigator2 to open the TeraStation's shared folder.

5 Double-click the  icon on the desktop. NAS Navigator2 will start. For Mac OS, click the  icon in the Dock.

6 Double-click the TeraStation icon.

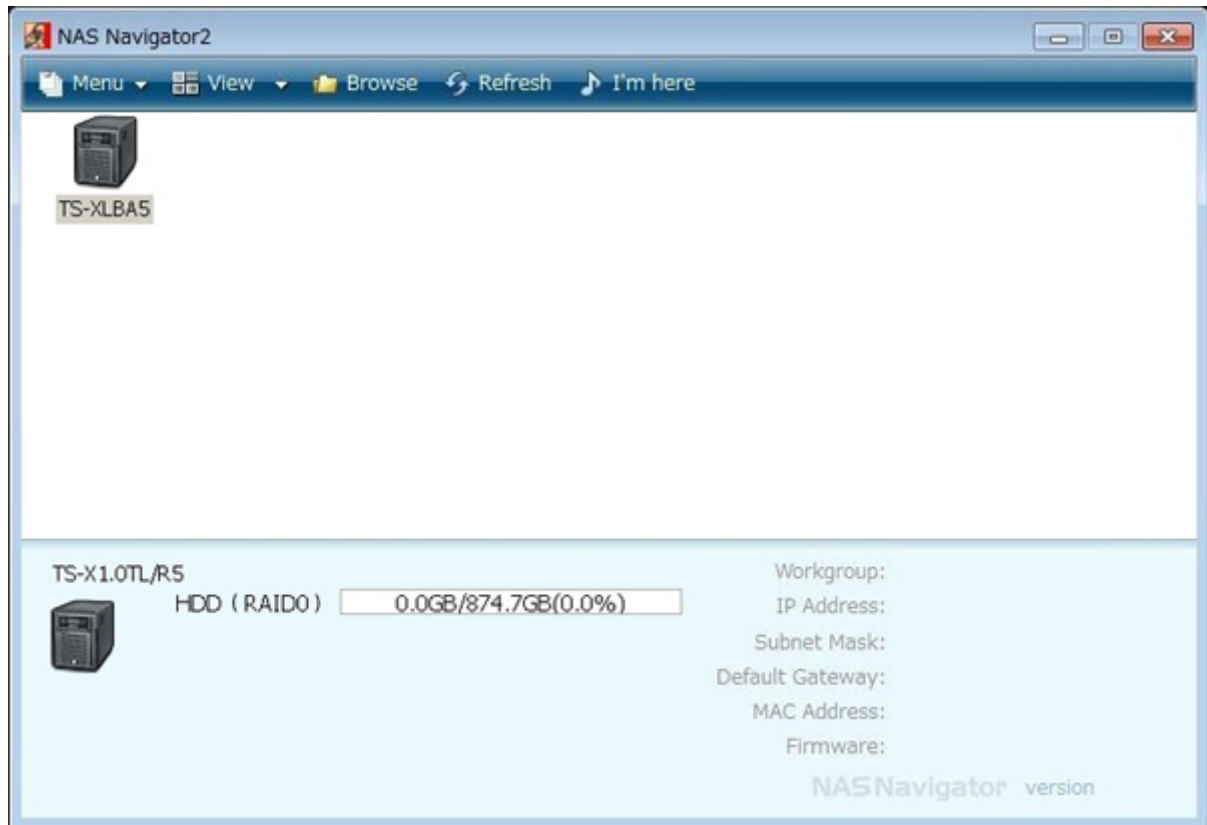

Note: When you access a shared folder from a Windows PC, you may be asked to enter a username and password. In such a case, enter "guest" for the username and the password is blank.

7 The TeraStation's shared folders are displayed.

Note: With a Mac, the TeraStation is mounted as a drive icon on the desktop, and displayed in the sidebar of the Finder.



You can now use the TeraStation's shared folders to save files just like other hard drives.

Adding Additional TeraStations

Run the TeraNavigator installation program from the CD for each TeraStation that you add to the network. You cannot set up multiple TeraStations at the same time.

Opening Settings

To configure your TeraStation, use Settings from a browser on a computer connected to the same network.

1 Double-click the  icon on the desktop. NAS Navigator2 will start. For Mac OS, click the  icon in the Dock.

- 2** Right-click the TeraStation icon (on Mac OS, click the icon while holding down the control key) and select *Settings* from the menu.

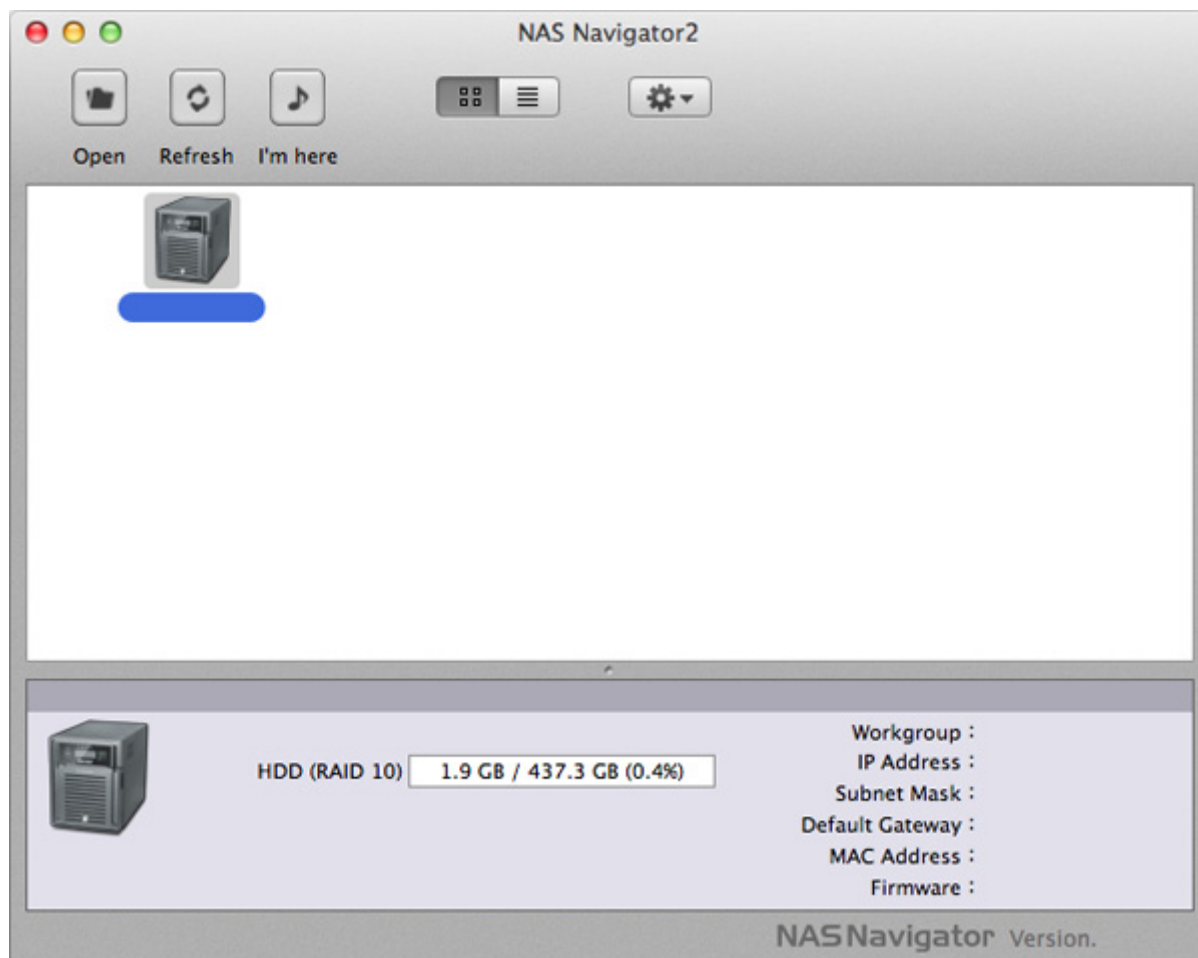

Notes:

- If multiple TeraStations and TeraStations are connected to the network, multiple icons will be displayed. Click the correct TeraStation.
- Record the TeraStation's IP address from the bottom right of the NAS Navigator2 window.

- 3** Enter your username and password, and click *Login*. Initially, use the default username and password:

- Username: admin
- Password: password

After you log in, change the password for security.

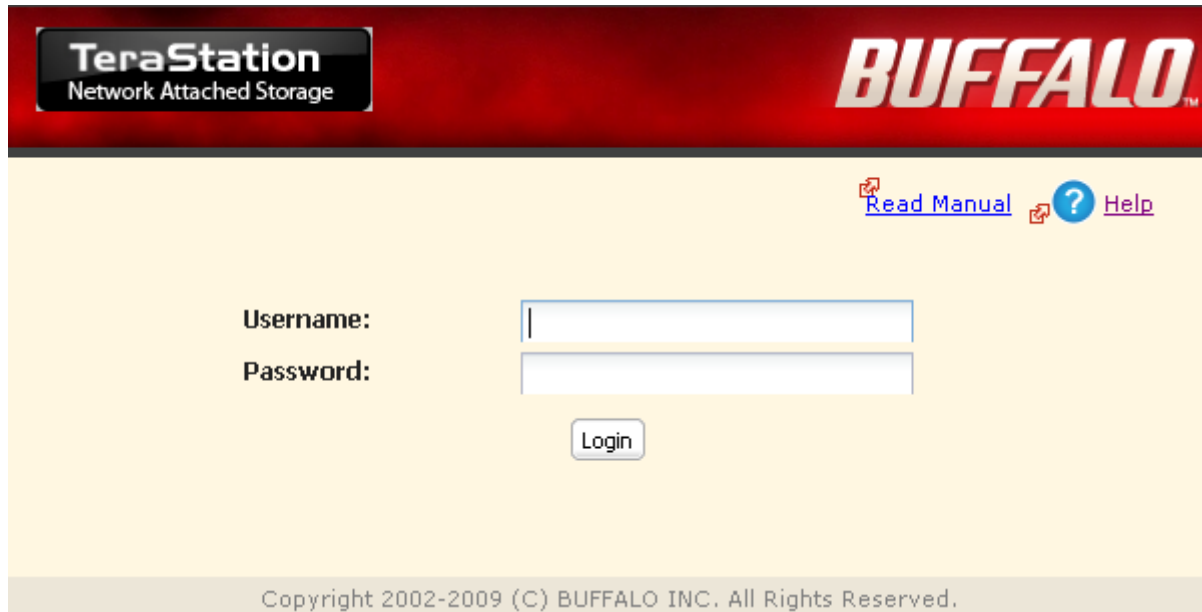

Note: To login as a guest, type "guest" for the Username, leave the password blank, and click OK. Guests can check the TeraStation's name, IP address, workgroup, and disk status. Regular users can change their login passwords as well as check the TeraStation name, IP Address, workgroup, and disk status. Administrator user, "admin" by default, can configure all options.

4 This is Settings. This page displays the TeraStation's current status, including name, IP address, workgroup, and hard disk settings.

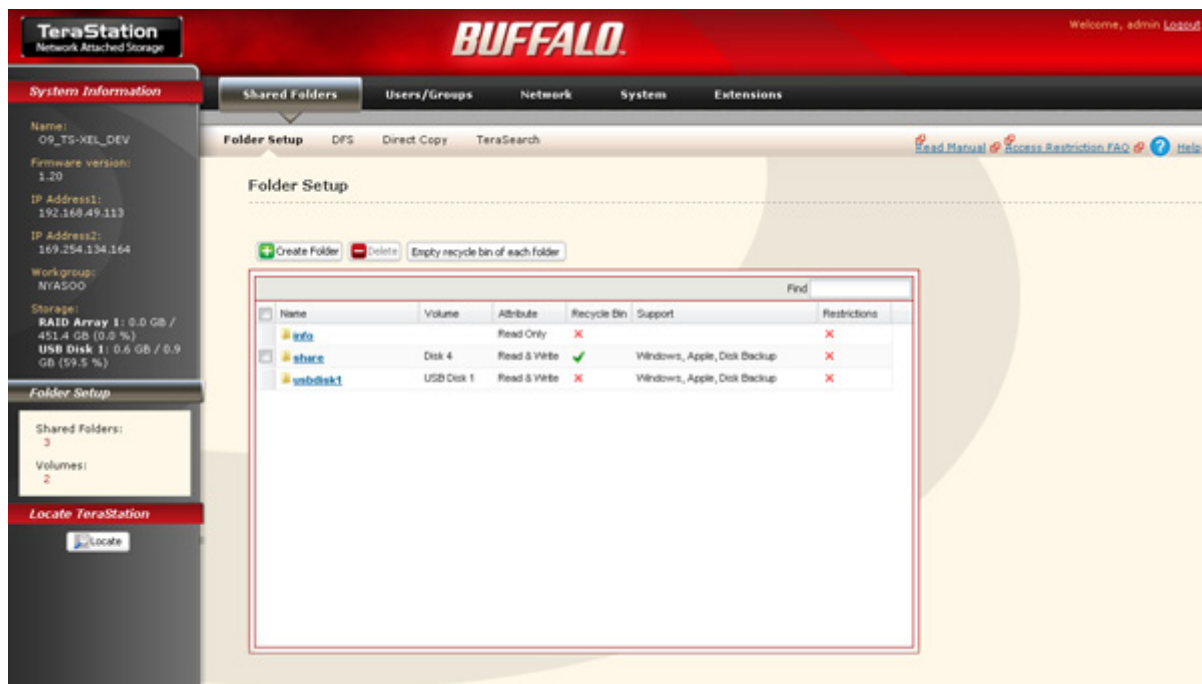

Notes:

- Settings supports Firefox 1.5 or later, Internet Explorer 6.0 with SP2 or later, and Safari 3 or later. It may not display properly in other browsers.
- Settings may not display correctly in Internet Explorer due to your browser security settings. If this happens, navigate to Tools - Internet Options - Security on Internet Explorer, and set the security settings to Local intranet.

Settings is organized by tabs across the top. The following tabs are available.

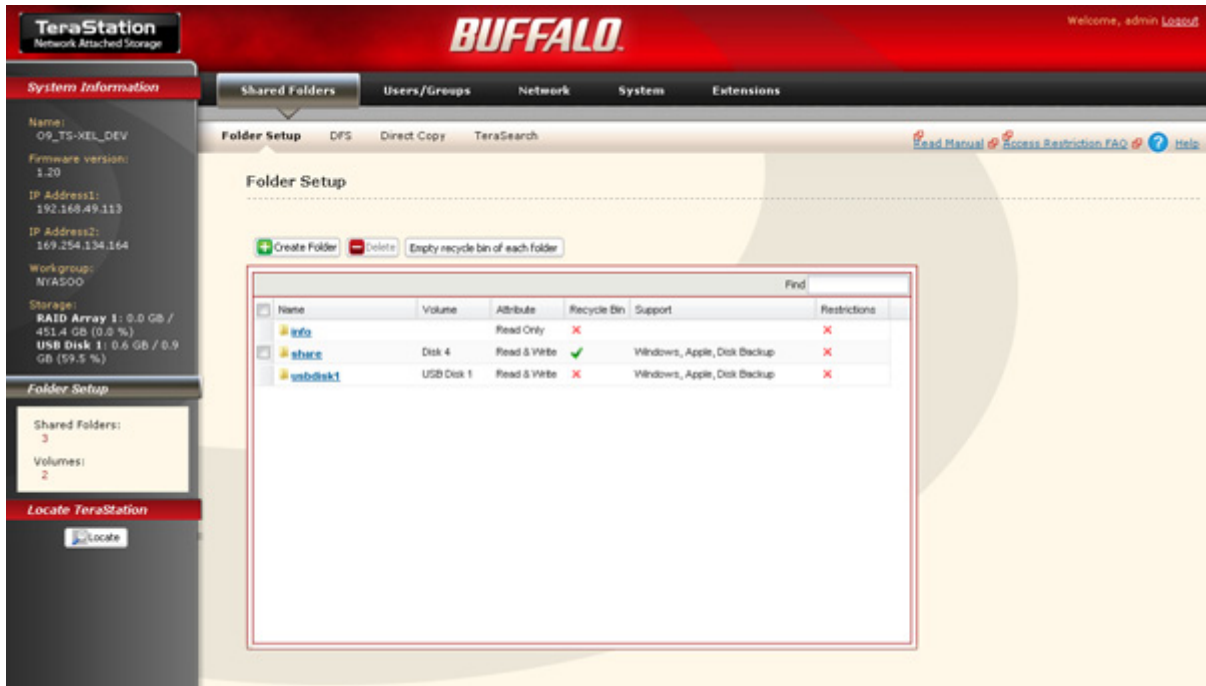

- **Shared Folders**
Add or delete shared folders; configure access restrictions, Direct Copy, DFS and TeraSearch.
- **Users/Groups**
Add, delete, and configure users and groups.
- **Network**
Configure network, workgroup, and NFS settings.
- **System**
Configure name, date and time, RAID setup, RAID scanning, check disk, format disk, backup, replication, email notification, sleep timer, UPS settings, restore and erase.
- **Extensions**
Configure WebAccess, Print Server, Time Machine, and Web Service Support.

Notes:

- To open Settings from a different computer, refer to Quick Setup Guide and install NAS Navigator2. After the installation, follow chapter 2, or, you may enter the IP address of TeraStation on a web browser.
- You may also open Settings by typing the IP address that you wrote down in step 2 into the address field of your browser. Press the Enter key and bookmark this page in your browser so that you can return to it easily.
- With OS X 10.4 or later, you can open Settings from within Safari with Bonjour.
 - (1) Launch Safari.
 - (2) Select *View - Show Bookmarks Bar* from Safari's menu.
 - (3) Select *Bonjour* from the left-side menu, then click your TeraStation in the bookmark list.



- (4) Enter your username and password. Click *Login*.

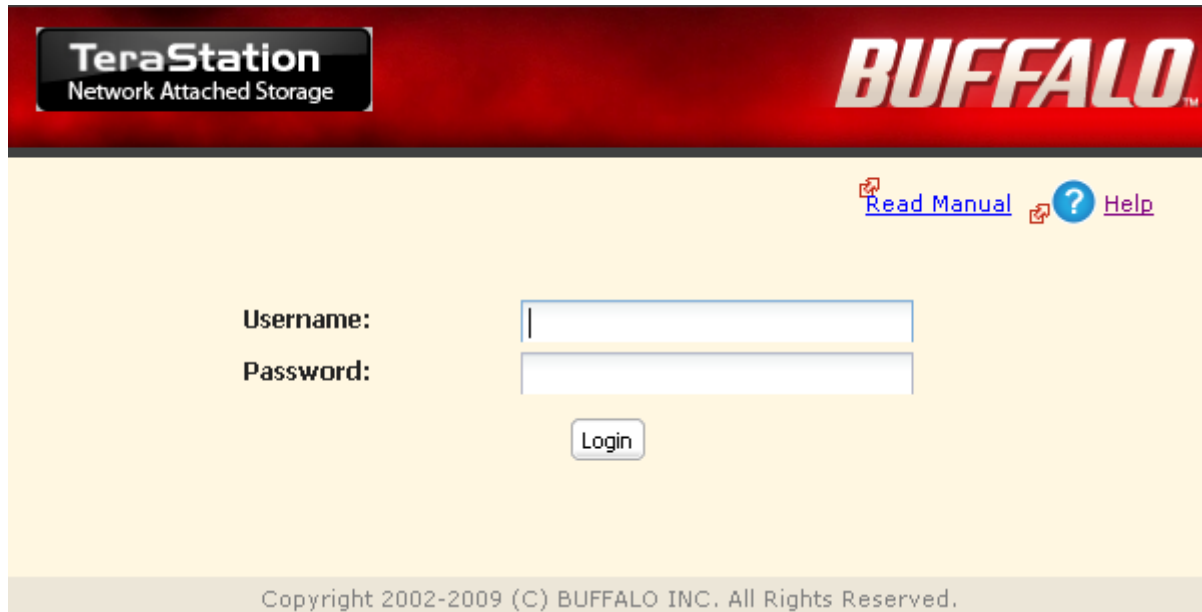

Note: To log in as a guest, type "guest" as the username and leave the password blank.

- (1) Settings opens.

The TeraStation's name, IP address and disk information are displayed on the left.

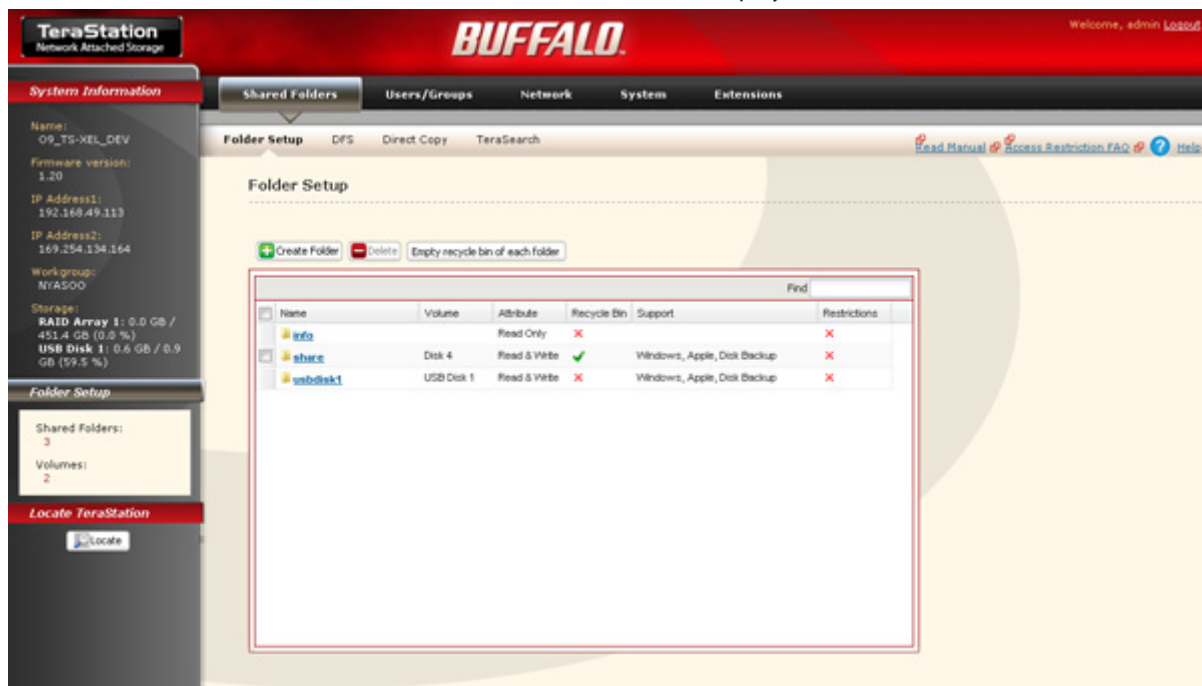

Chapter 3 Changing RAID Modes

RAID Arrays

TS-XL, TS-XEL and TS-RXL series TeraStations default to RAID 5 (4 hard drives), TS-WXL/R1 series default to RAID 1, and TS-WXL/1D series default to JBOD. The characteristics of each type of RAID are described below. If you change the RAID mode, all of the data on the hard drive is deleted. Always back up any important data before changing the RAID mode.

Note: In this document, the term "Recovery" means reverting the TeraStation back to the state prior to the drive error or RAID mode change. It does not refer to reading data from failed hard drives.

RAID 5 with 4 hard drives (default for TS-XL, TS-XEL and TS-RXL)

Note: TS-WXL/R1 and TS-WXL/1D TeraStations don't support this mode, as they don't have 4 hard drives.

Arranges 4 hard drives in one array. Parity is generated during writes, so access speeds will be slower than other RAID modes. Total usable space is the sum of the 3 drives. If one of the drives fails, you can recover data on the array by replacing the damaged drive. However, data cannot be recovered if 2 or more drives become damaged.

RAID 5 with 3 hard drives

Note: TS-WXL/R1 and TS-WXL/1D TeraStations don't support this mode, as they don't have 3 hard drives.

Arranges 3 hard drives in one array. Parity is generated during writes, so access speeds will be slower than other RAID modes. Total usable space is the sum of 2 drives. A fourth drive may be configured as a hot spare that will automatically replace a drive if it fails. If one of the drives fails, you can recover data on the array by replacing the damaged drive. However, data cannot be recovered if 2 or more drives become damaged.

RAID 10

Note: TS-WXL/R1 and TS-WXL/1D TeraStations don't support this mode, as they don't have 4 hard drives

Arranges 4 hard drives in one array, with 2 stripes of mirrored drives. Total usable space is the sum of 2 hard drives. Data is written quickly and access speed is faster than other RAID modes (except for RAID 0). Since data is written into 2 hard drives at the same time, even if one of the drives fails, data can still be recovered by replacing the damaged drive (data cannot be recovered if both drives become damaged).

RAID 1 (default for TS-WXL/R1)

Arranges 2 hard drives in one array. You can set up to 2 arrays on TS-XL, TS-XEL, and TS-RXL series. Total usable space is 1 hard drive's space for each array. Data is written to 2 hard drives at once. If a drive fails, data can be recovered by replacing the damaged drive (data cannot be recovered if both drives in the array become damaged).

You can create an array and designate another drive as a hot spare (which automatically replaces a failed drive) for TS-XL and TS-RXL TeraStation models. You can also use 2 drives to create a RAID 1 array, use another drive as a hot spare, and use another as a regular drive, all at once.

RAID 0

This is the fastest RAID mode, but if any of the drives fails, data cannot be recovered.

JBOD (default for TS-WXL/1D)

This mode uses the hard drives inside the TeraStation as individual hard disks. It is sometimes referred to as JBOD. The disk space you can use is the total space of all hard drives in the TeraStation. If a hard disk is damaged, you cannot recover data from that drive.

Note: During a recovery, the TeraStation's front LED display shows "RAID ARRAY* Resyncing" and file transfer speeds are slower than usual until the RAID array is rebuilt.

Using JBOD

- 1 Click *System - Storage - RAID Array* in Settings.

The screenshot shows the 'Storage' settings page. At the top, there are tabs for 'Shared Folders', 'Users/Groups', 'Network', 'System', and 'Extensions'. Under 'System', there are sub-tabs for 'Settings', 'Storage', 'Backup', 'Maintenance', 'Power Management', and 'Restore/Erase'. The 'Storage' section is active, showing a 'Disks' table and a 'RAID Array' table.

Disk	Status	Encrypted	Unit Name	Unit Capacity	Amount Used	% U
Array 1	-	×	-	458,524,800 KB	856 KB	
Disk 1	Array 1	×	WD2500AAKS-00B3A	-	-	
Disk 2	Array 1	×	WD2500AAKS-00B3A	-	-	
Disk 3	Array 1	×	WD2500AAKS-00B3A	-	-	
Disk 4	Array 1	×	WD2500AAKS-00B3A	-	-	
USB Disk 1	-	×	USB Disk	1,018,752 KB	340,912 KB	

Name	RAID Mode	Status	Total Capacity	Amount Used	Percent Used	File
Array 1	RAID10	Normal	458,524,800 KB	856 KB	0.00 %	XFS
Array 2	Not Configured					

- 2 Select the array you want to configure.

This is a close-up of the 'RAID Array' table. The 'Array 1' row is highlighted in red, indicating it is selected. The table shows the RAID mode as RAID10, status as Normal, total capacity as 458,524,800 KB, amount used as 856 KB, and percent used as 0.00%. Array 2 is listed as 'Not Configured'.

Name	RAID Mode	Status	Total Capacity	Amount Used	Percent Used	File
Array 1	RAID10	Normal	458,524,800 KB	856 KB	0.00 %	XFS
Array 2	Not Configured					

- 3 Click *Delete RAID Array*.

- 4 When the RAID array operation window opens, click *Apply*.
- 5 The "Confirm Operation" screen will appear. Enter the number shown in the confirmation number field within 60 seconds, and click *Apply*.
- 6 Follow the instructions displayed on the screen.

You have now set up JBOD.

Confirm Operation Screen

When you perform any of the following tasks, a "Confirm Operation" screen is displayed . To continue, enter the confirmation number within 60 seconds and click *Apply*.

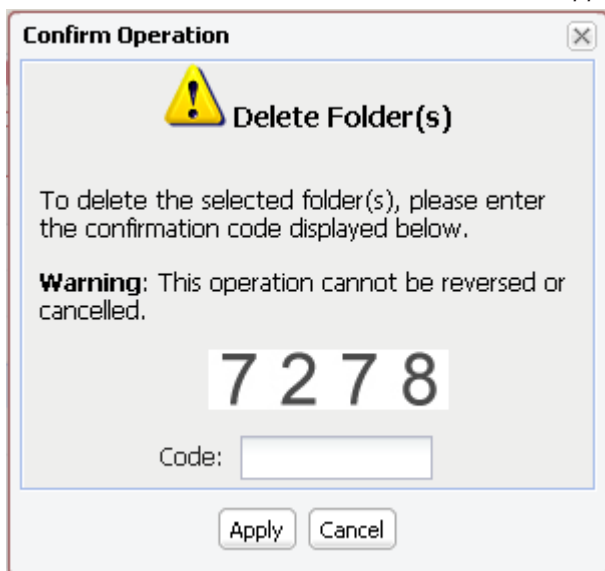

- Changing structures of RAID array (create/delete)
- Delete folder
- Restore factory defaults
- Format TeraStation
- Empty recycle bin of each folder
- Format array or drive
- Remove drive
- Rebuild RAID array
- Configure hot spare
- Configure JBOD

Using RAID 5 with 4 Hard Drives

- 1 Change system to JBOD.

2 Click *System - Storage - RAID Array* in Settings.

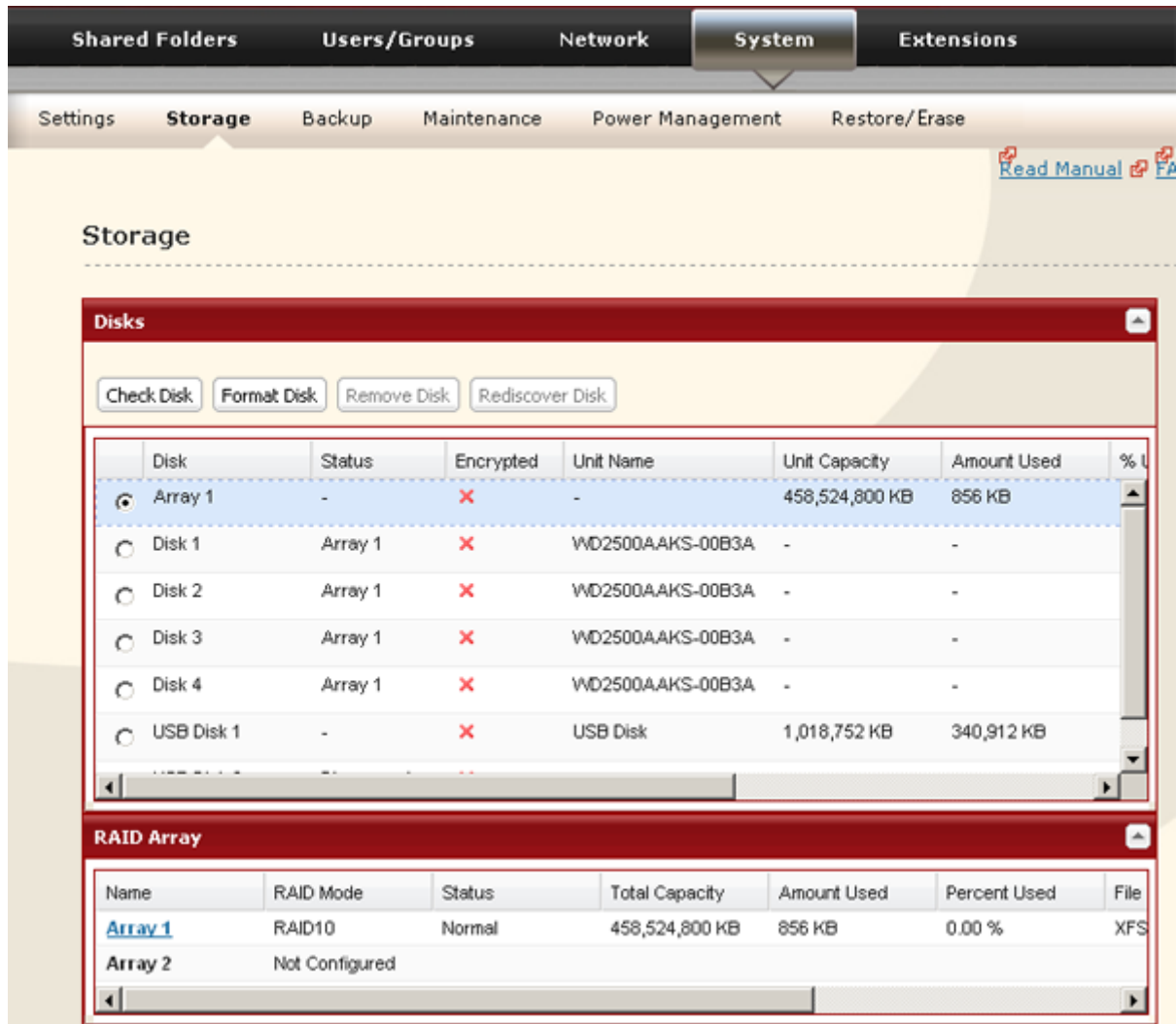

3 Click the array you want to configure.

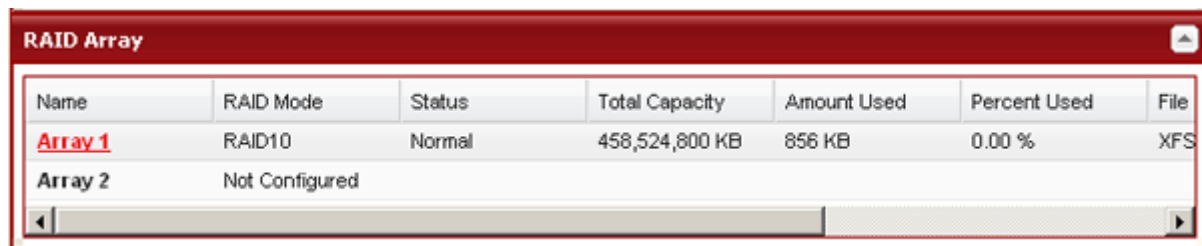

4 Select hard drives (all 4 of them) to use in RAID 5.

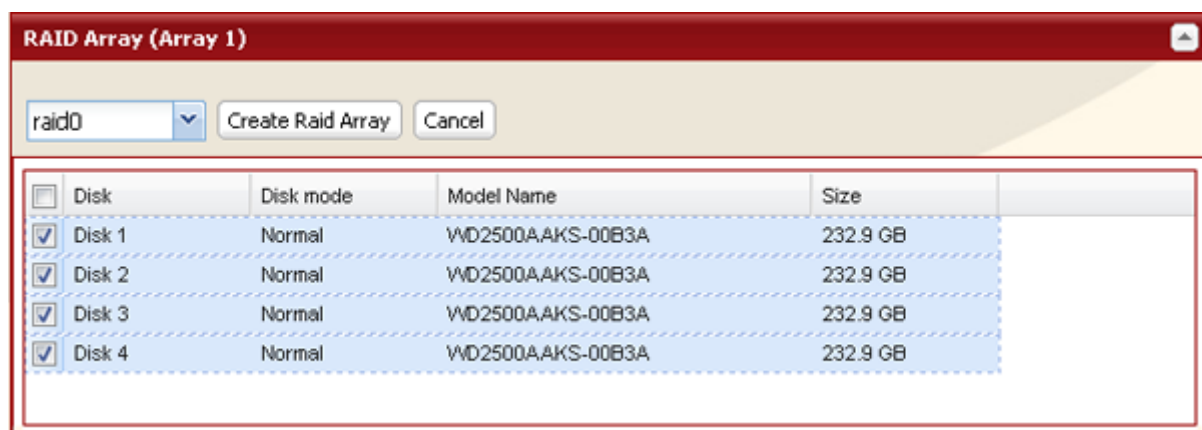

5 Select RAID 5 and click *Create Raid Array*.

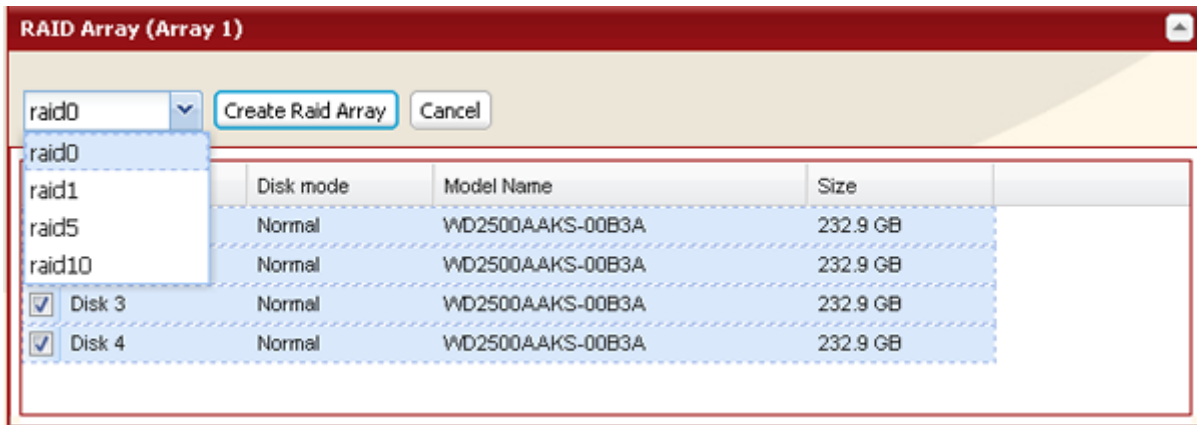

Note: After the RAID array is changed, the TeraStation will perform a RAID check that will take about 5 hours per TB. File transfers will be slower during this period. While the "RAID ARRAY x Resyncing" message is displayed on the LCD display, do not turn off the TeraStation. If you turn it off, the RAID check will start over.

6 The "Confirm Operation" screen will open. Enter the number shown in the confirmation number field within 60 seconds, and click *Apply*.

7 Follow the instructions displayed on the screen.

You have now set up a RAID 5 array. Refer to the "Adding a Shared Folder" section in chapter 7 to create a shared folder.

Using RAID 5 with 3 Hard Drives

1 Change system to JBOD.

2 Click *System - Storage - RAID Array* in Settings.

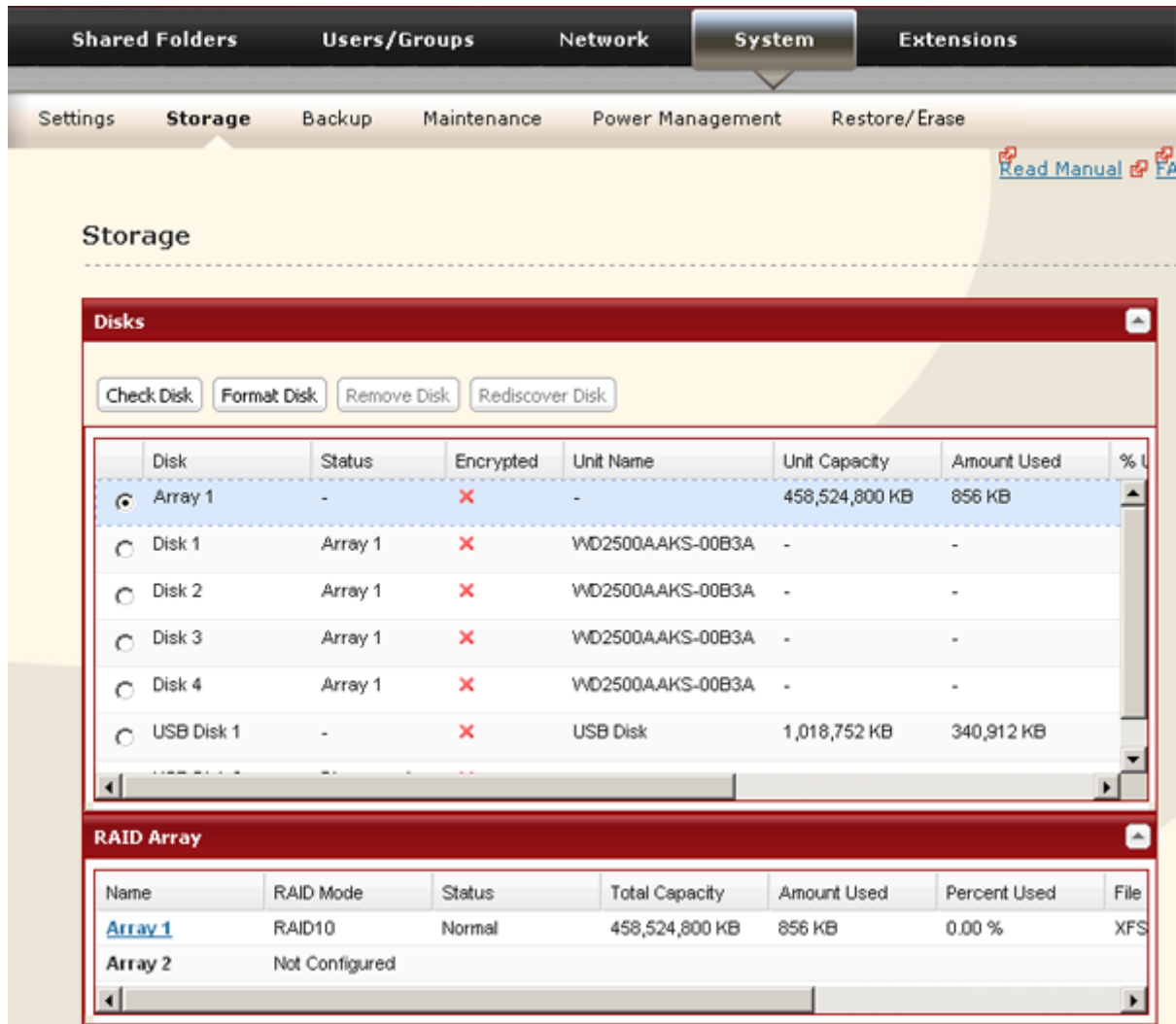

3 Click the array you want to configure.

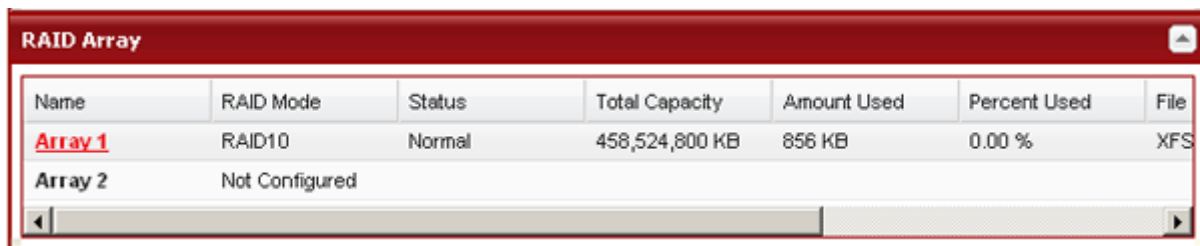

4 Select hard drives (3 of them) to use in RAID 5.

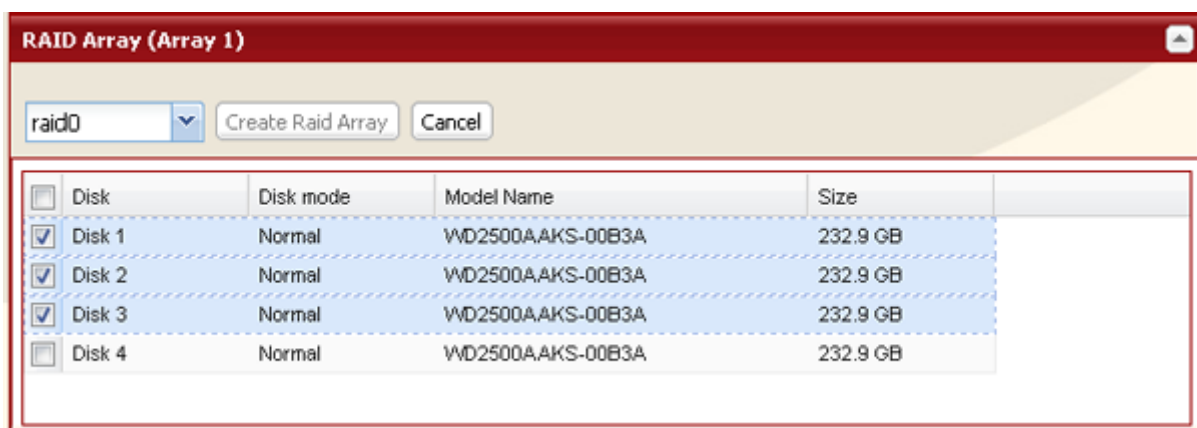

5 Select *RAID 5* and click *Create Raid Array*.

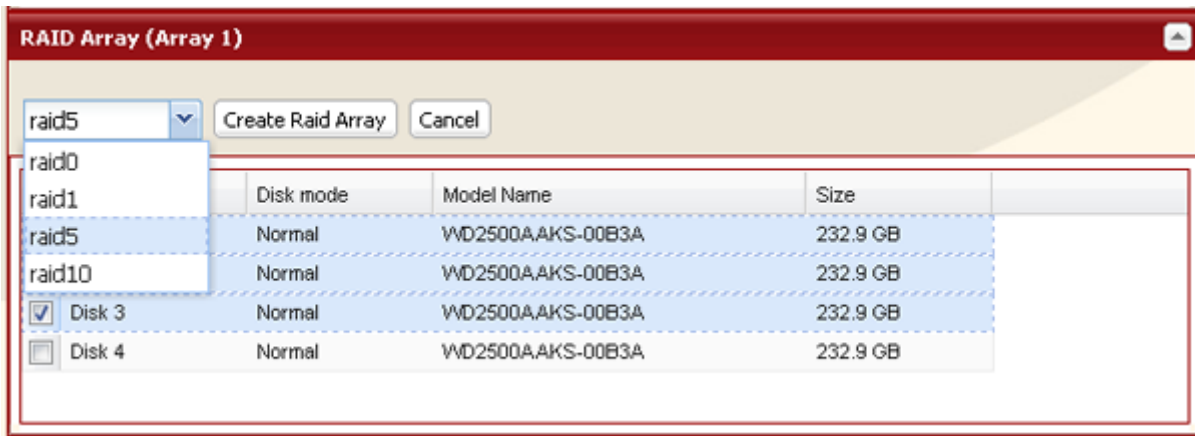

Note: After the RAID array is changed, the TeraStation will perform a RAID check that will take about 5 hours per TB. File transfers will be slower during this period. While the "RAID ARRAY x Resyncing" message is displayed on the LCD display, do not turn off the TeraStation. If you turn it off, the RAID check will start over.

6 The "Confirm Operation" screen will open. Enter the number shown in the confirmation number field within 60 seconds, and click *Apply*.

7 Follow the instructions displayed on the screen.

You have now set up a RAID 5 array. Refer to the "Configuring a Hot Spare" section to configure a hot spare with the remaining drive. Refer to the "Adding a Shared Folder" section in chapter 7 to create a shared folder.

Using RAID 10

1 Change system to JBOD.

2 Click *System - Storage - RAID Array* in Settings.

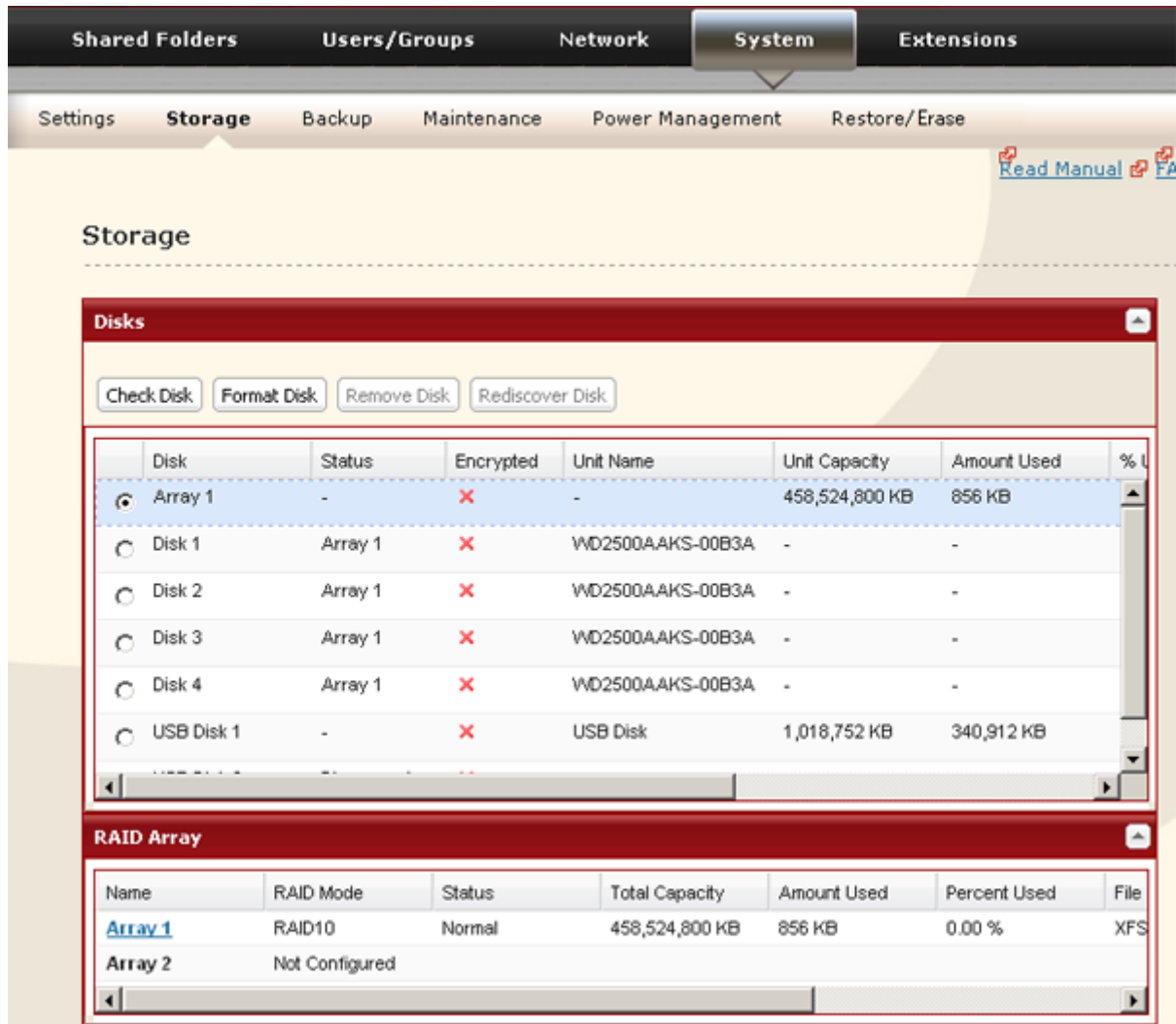

3 Click the array you want to configure.

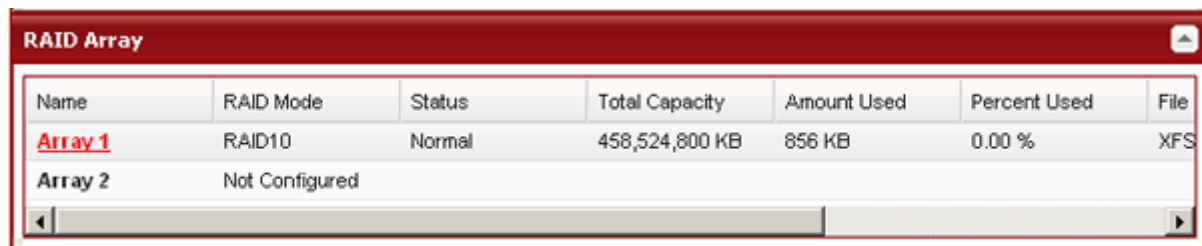

4 Select hard drives (all 4 of them) to use in RAID 10.

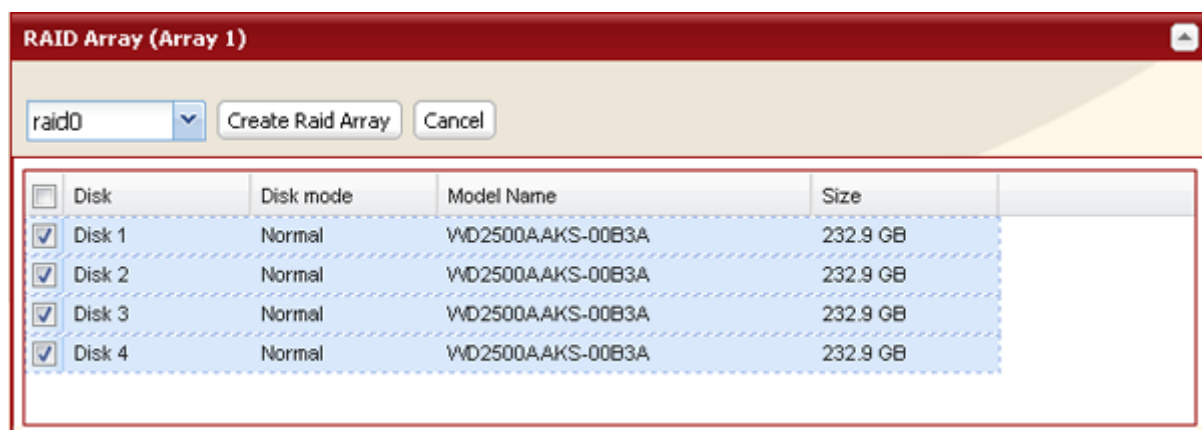

5 Select *RAID 10* and click *Create Raid Array*.

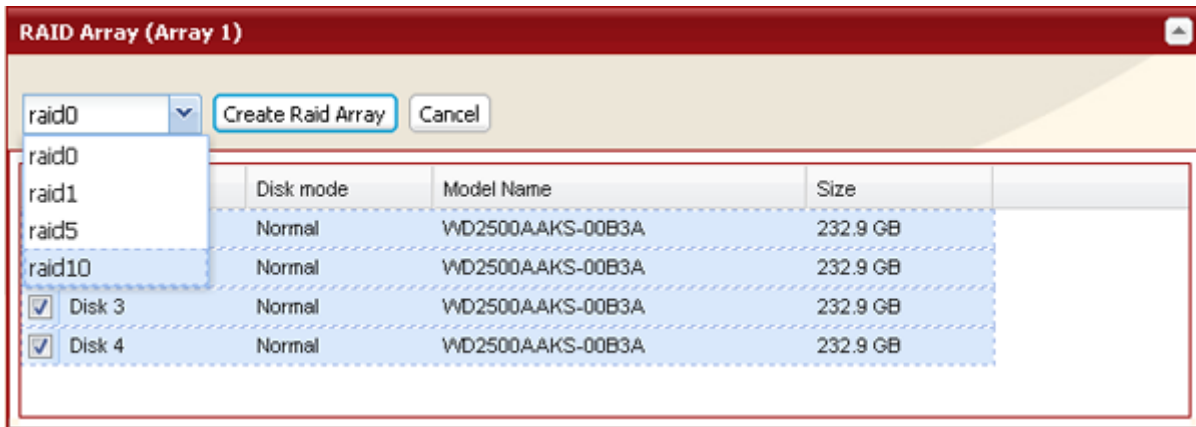

Note: After the RAID array is changed, the TeraStation will perform a RAID check that will take about 5 hours per TB. File transfers will be slower during this period. While the "RAID ARRAY x Resyncing" message is displayed on the LCD display, do not turn off the TeraStation. If you turn it off, the RAID check will start over.

6 The "Confirm Operation" screen will open. Enter the number shown in the confirmation number field within 60 seconds, and click *Apply*.

7 Follow the instructions displayed on the screen.

You have now set up a RAID 10 array. Refer to the "Adding a Shared Folder" section in chapter 7 to create a shared folder.

Using RAID 1

1 Change system to JBOD.

2 Click *System - Storage - RAID Array* in Settings.

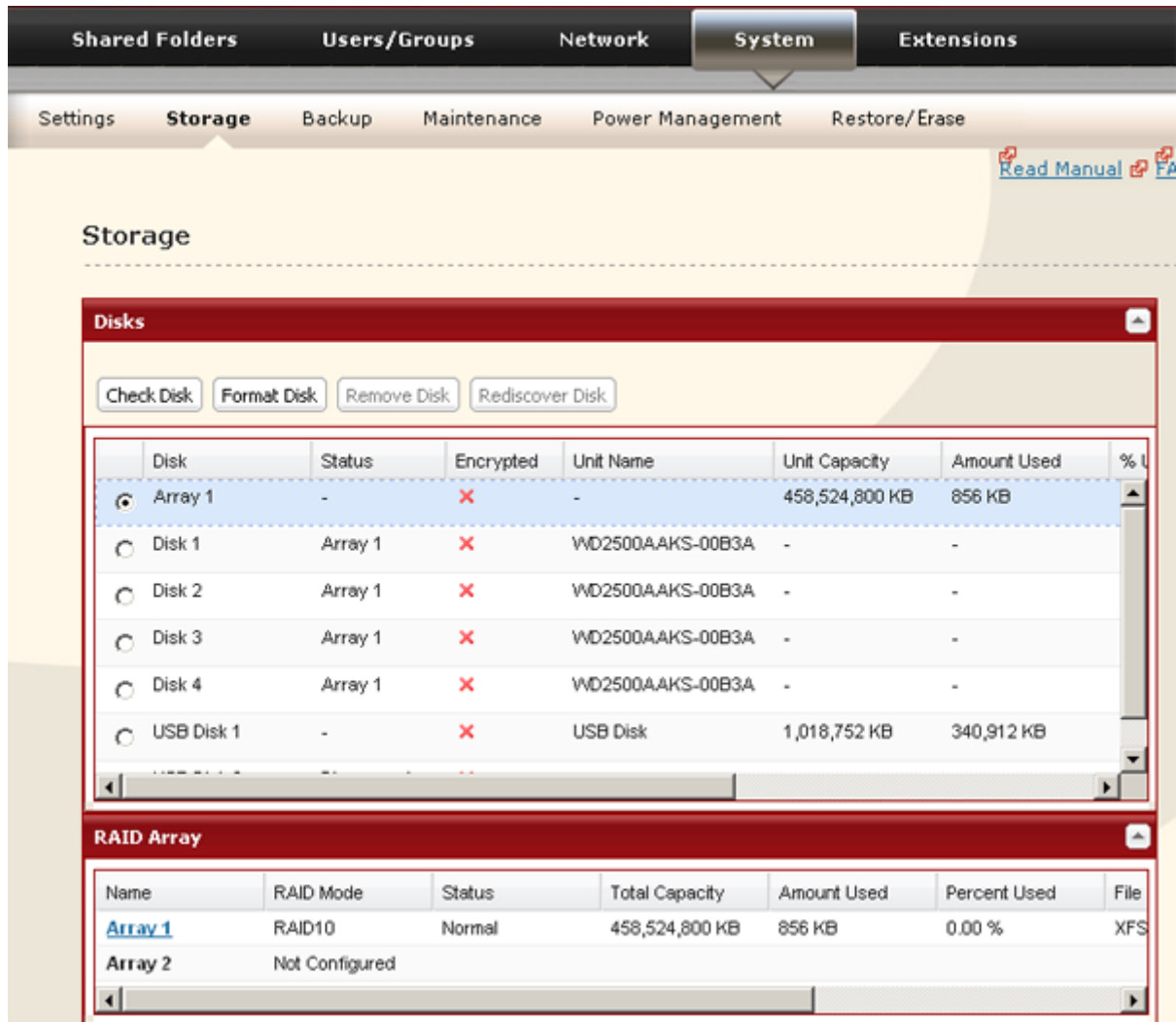

3 Click the array you want to configure.

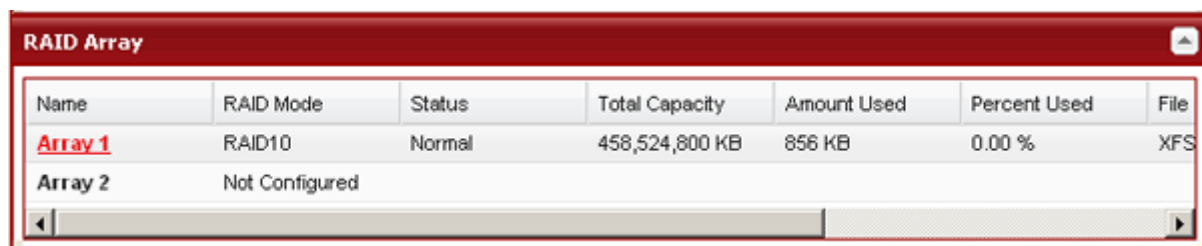

4 Click hard drives (drives 1 and 2, or drives 3 and 4) in RAID 1.

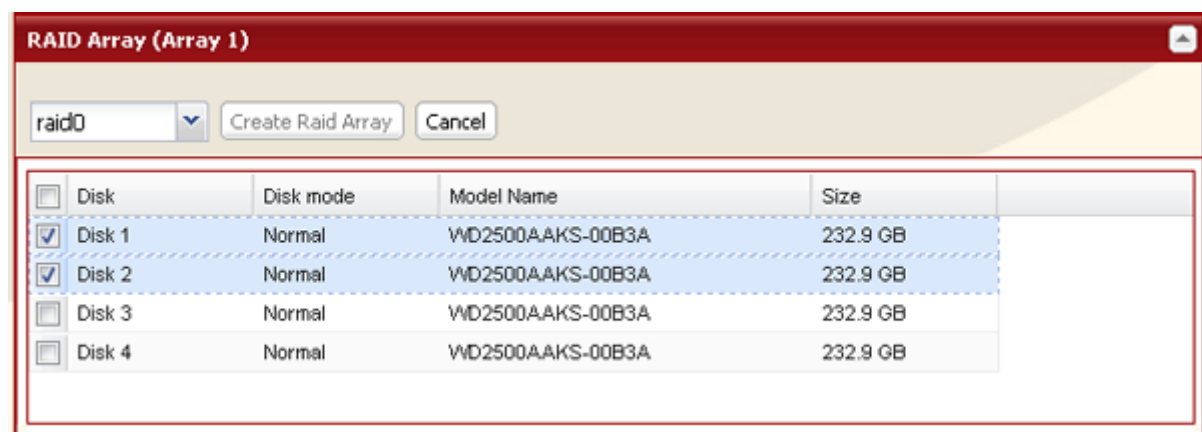

5 Select *RAID 1* and click *Create Raid Array*.

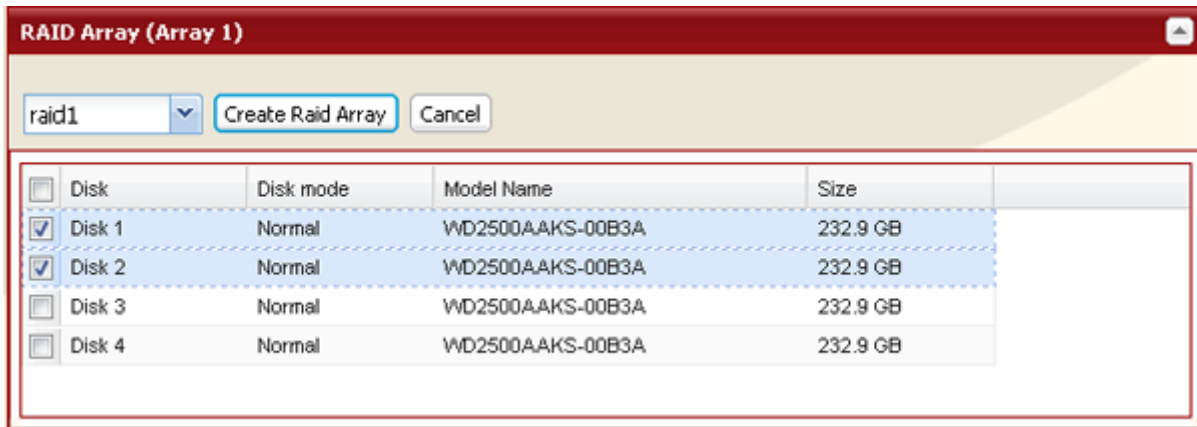

Note: After the RAID array is changed, the TeraStation will perform a RAID check that will take about 5 hours per TB. File transfers will be slower during this period. While the "RAID ARRAY x Resyncing" message is displayed on the LCD display, do not turn off the TeraStation. If you turn it off, the RAID check will start over.

6 The "Confirm Operation" screen will open. Enter the number shown in the confirmation number field within 60 seconds, and click *Apply*.

7 Follow the instructions displayed on the screen.

You have set up a RAID 1 array. Repeat the steps to create a second RAID 1 array with the other two drives, or refer to the "Configuring a Hot Spare" section to configure a hot spare with one of the remaining drives. Refer to the "Adding a Shared Folder" section in chapter 7 to create a shared folder.

Using RAID 0

1 Change system to JBOD.

2 Click *System - Storage - RAID Array* in Settings.

The screenshot shows the 'System' settings page with the 'Storage' sub-section selected. The 'Disks' section contains a table of disks and a 'RAID Array' section with a table of RAID arrays.

Disk	Status	Encrypted	Unit Name	Unit Capacity	Amount Used	% U
Array 1	-	✗	-	458,524,800 KB	856 KB	
Disk 1	Array 1	✗	WD2500AAKS-00B3A	-	-	
Disk 2	Array 1	✗	WD2500AAKS-00B3A	-	-	
Disk 3	Array 1	✗	WD2500AAKS-00B3A	-	-	
Disk 4	Array 1	✗	WD2500AAKS-00B3A	-	-	
USB Disk 1	-	✗	USB Disk	1,018,752 KB	340,912 KB	

Name	RAID Mode	Status	Total Capacity	Amount Used	Percent Used	File
Array 1	RAID10	Normal	458,524,800 KB	856 KB	0.00 %	XFS
Array 2	Not Configured					

3 Click the array you want to configure.

This is a close-up of the 'RAID Array' table from the previous screenshot. The 'Array 1' entry is highlighted in red.

Name	RAID Mode	Status	Total Capacity	Amount Used	Percent Used	File
Array 1	RAID10	Normal	458,524,800 KB	856 KB	0.00 %	XFS
Array 2	Not Configured					

4 Select all available hard drives.

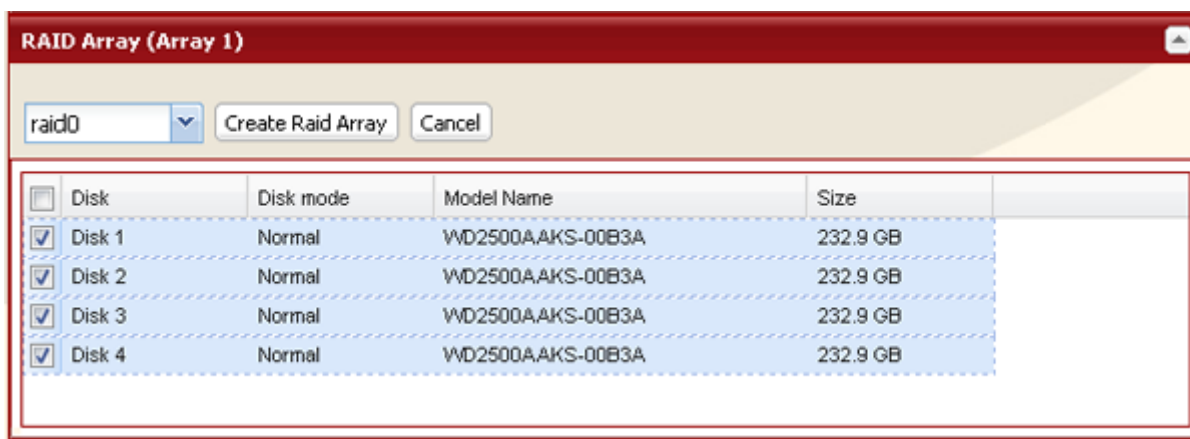

5 Select *RAID 0* and click *Create Raid Array*.

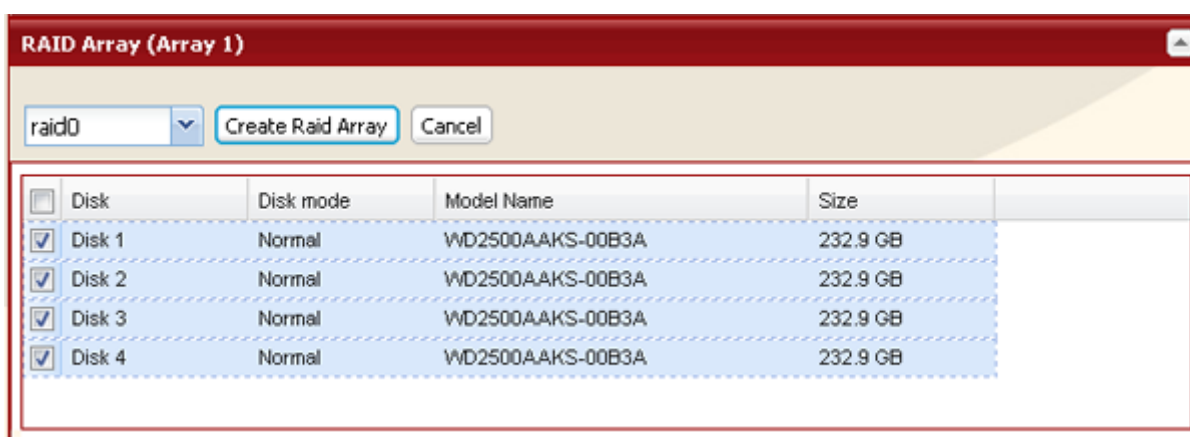

6 The "Confirm Operation" screen will open. Enter the number shown in the confirmation number field within 60 seconds, then click *Apply*.

7 Follow the instructions displayed on the screen.

You have set up a RAID 0 array. Refer to the "Adding a Shared Folder" section in chapter 7 to create a shared folder.

Configuring a Hot Spare

If you have 3 drives in a RAID 5 array, or 2 drives in a RAID 1 array, then you can configure another drive as a hot spare. If one of the drives in the array fails, the TeraStation will switch over to the hot spare immediately.

1 Click *System - Storage - RAID Array* in Settings.

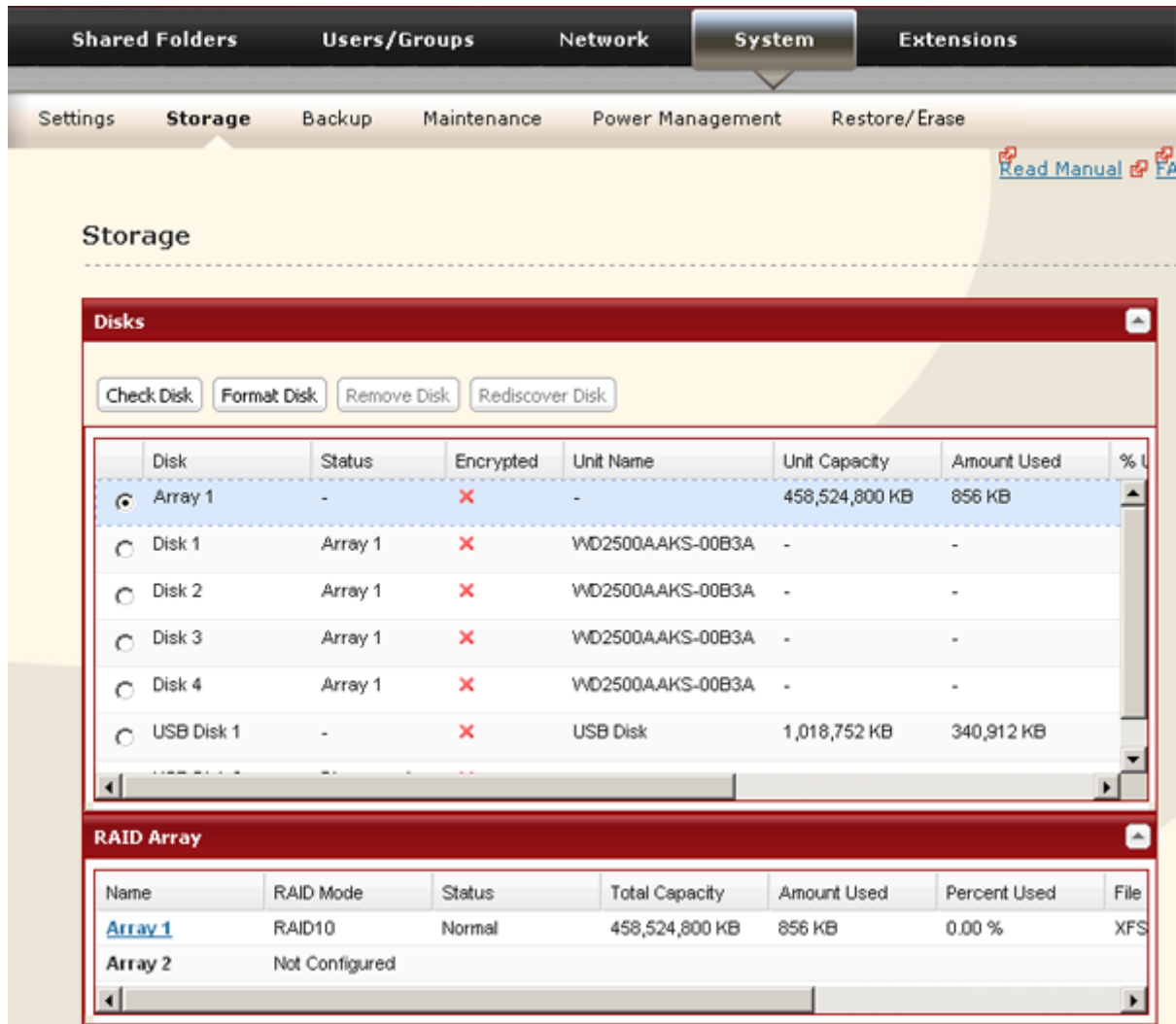

2 Click the array you want to configure.

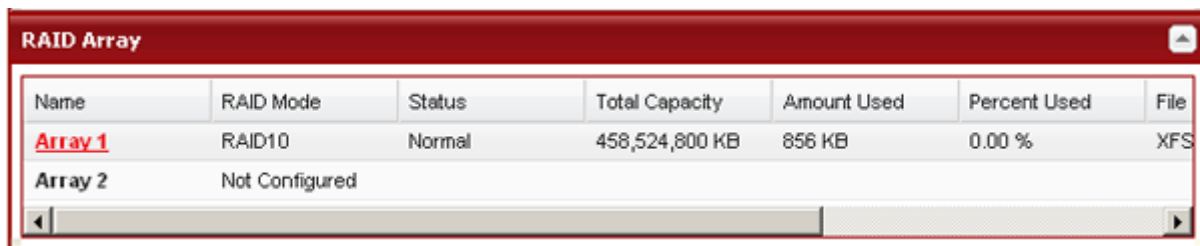

3 Click *Set* to a spare drive.

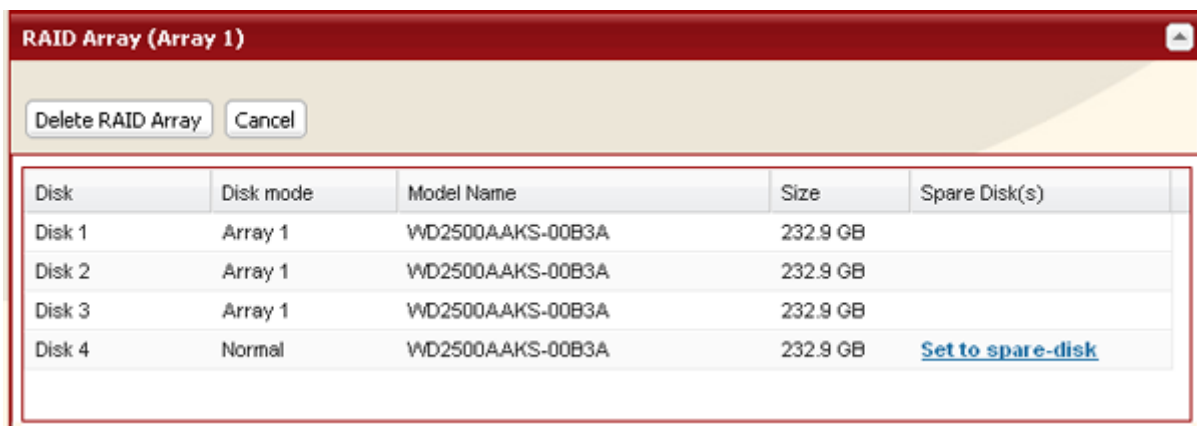

Note: If a hot spare is configured, click *Set* to normal disk to change the hot spare to a normal disk.

4 The "Confirm Operation" screen will open. Enter the number shown in the confirmation number field within 60 seconds and click *Apply*.

5 Follow the instructions displayed on the screen.

You have now configured a hot spare.

Notes: All data in the hot spare drive will be deleted when it is configured as a hot spare and again when it changes over from a spare to a drive in the array.

Drive Failures

If a drive in the TeraStation fails, open the front cover and check the status LED lights. If a drive's status LED is lit or flashing red, it is malfunctioning and needs to be replaced. For replacement, use Buffalo OP-HD series drives of the same size.

For more information on drive removal, installation, and rebuilding RAID arrays, refer to the "Hard Drive Replacement Procedure" document available from the link provided in the TeraNavigator CD. You can also download the document from the Buffalo website.

Chapter 4 Adding an External Hard Drive

Connect an External Drive

Your TeraStation includes 2 USB connectors (3 if it's a TS-RXL). You can connect a Buffalo external hard drive to it for backup or extra storage.

Connect the external drive as shown below. If the hard drive is already formatted, it will be detected automatically. If it is not formatted, format it from within Settings.

One external hard drive may be connected to each USB port on the TeraStation. USB hubs are not supported.

Warning! Do not unplug the drive from the TeraStation without dismounting it first. Refer to the "Removing External Hard Drives" chapter for directions on dismounting a connected drive.

TS-XL, TS-XEL

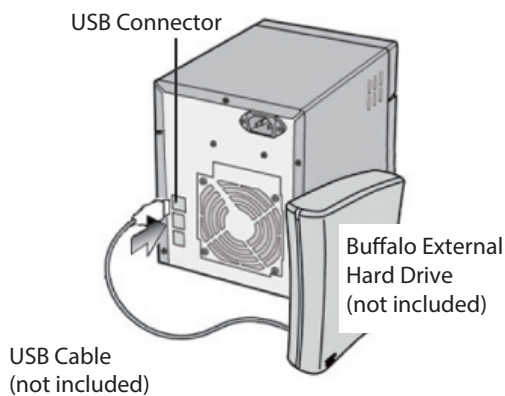

TS-WXL

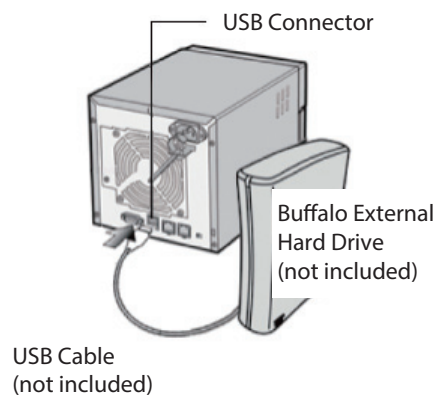

TS-RXL

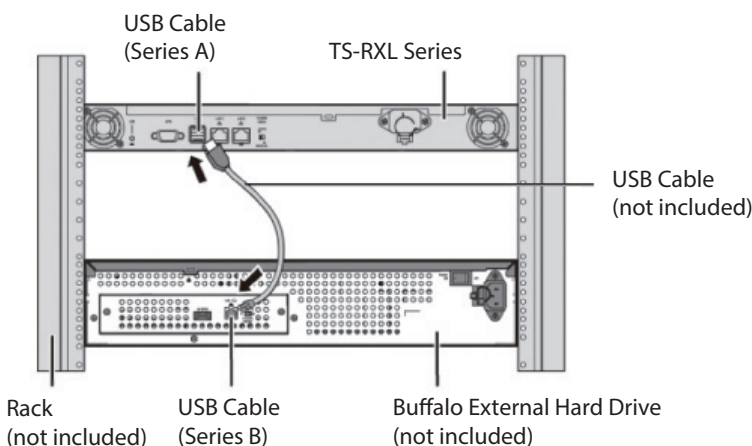

A third hard drive can be connected to the USB connector on the front panel of the TS-RXL TeraStation if the front panel is removed.

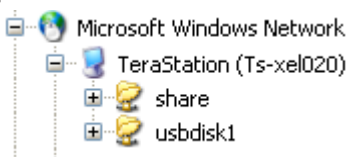

If the drive properly connected, "usbdiskX" is added to the TeraStation's shares on the network, where X is the # of the drive.

Note: Files that are automatically created by Mac OS cannot be backed up to a FAT32 drive because they contain characters that are not allowed in FAT32.

Formatting the External Drive

- A format deletes all data from a hard drive. Be careful! Back up any important data on a drive before formatting it. It will take a several minutes to format a drive.
- Shared folders cannot be accessed during formatting.
- Do not turn off or disconnect power to the TeraStation while formatting a hard drive.
- If power mode switch is set to auto, then the TeraStation will turn off when the format is finished.
- To erase all data on a disk, choose *System - Restore/Erase*.

1 In Settings, navigate to *System - Storage - Disks*.

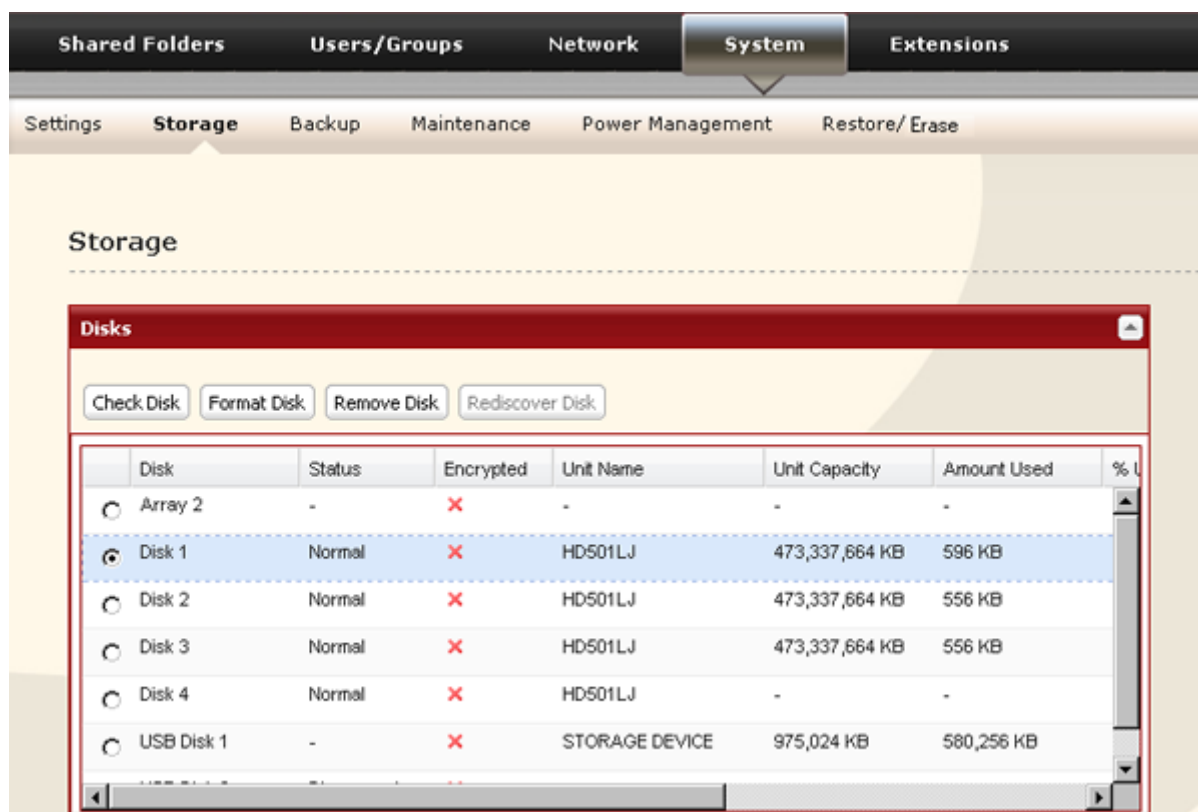

2 Select the drive to format. Make sure that you have the right drive! Click *Format Disk*.

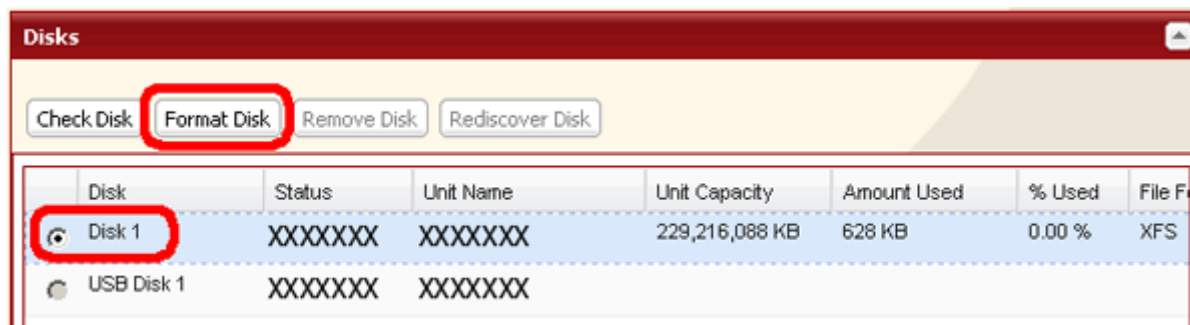

- 3** Select a file system and click *Format*.

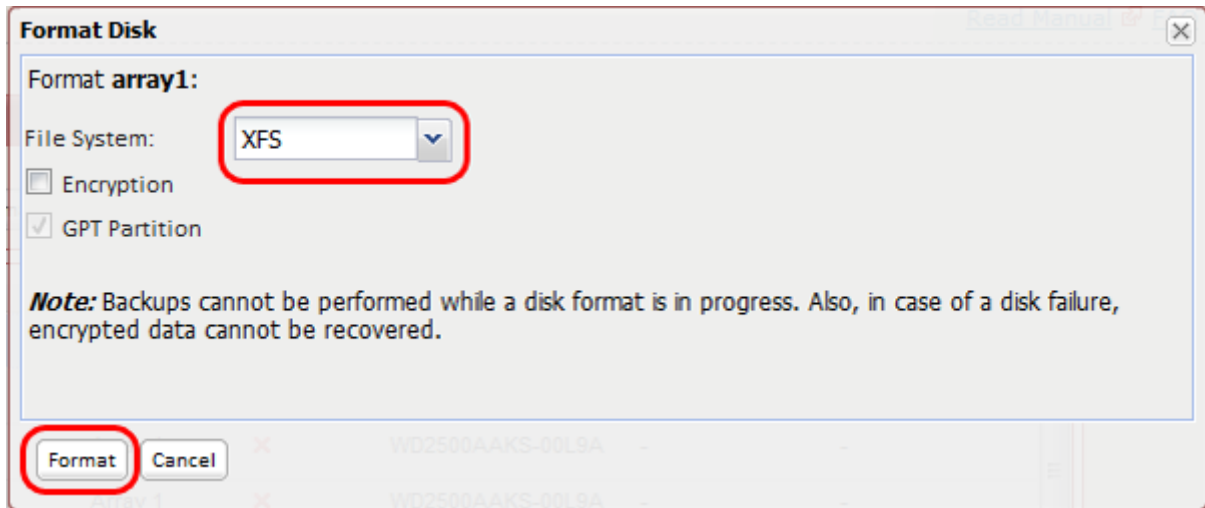

Note: Refer to the "System" section in chapter 12 for more on format type.

- 4** The "Confirm Operation" screen will open. Type the displayed number into the confirmation number field within 60 seconds, then click *Apply*.

- 5** Follow the instructions displayed on the screen.

Notes:

- The time needed to format a hard drive will vary (a few seconds to a few minutes) depending on the drive's size and format type.
- The info LED on the front of the TeraStation will flash during formatting. The TeraStation's shared folders cannot be accessed until the disk format is complete.
- If the hard drive is connected to the USB connector, partitions will be recreated.

Set Access Restrictions on the External Drive

You can set the access restrictions on the new drive. Use the procedure on the "Access Restrictions" section in chapter 7 to set the access restrictions.

Note: Even if a shared folder is not visible, you can still format the drive, run a disk check, and back up to the new drive.

Restrictions

- The TeraStation supports many types of USB devices including USB storage devices, card readers, digital cameras, and USB printers. Devices that are not supported include USB hubs, card readers that recognize multiple card types, and USB mice and keyboards.
- You can connect up to 2 hard drives to a TeraStation via its USB connectors (3 for a TS-RXL). Only Buffalo drives are supported.
 - The TeraStation may not recognize a hard drive whose power mode is set to auto. Set the power mode to manual for drives connected to the TeraStation.
 - Direct Copy doesn't work with the HD-DU2 series DriveStation unless it has been reformatted.
 - The TeraStation can supply bus power to a single external drive only. For multiple drives, or if you experience power problems, connect an AC adapter to each hard drive.
- Only the primary partition of the hard drive connected via USB connector will be recognized. Secondary and other partitions will not be recognized.

Chapter 5 Removing External Hard Drives

If the TeraStation is on, always dismount external hard drives before disconnecting them. You may dismount drives with the function button or from within Settings. If the TeraStation is turned off, dismounting is not necessary.

Dismounting with the Function Button

To dismount a USB drive, press and hold the function button for 7 seconds. The function button will be illuminated in blue (The LED next to the function button will be illuminated in blue on the TS-RXL). After the light in the function button goes out, you can safely remove your USB device.

TS-XL, TS-XEL

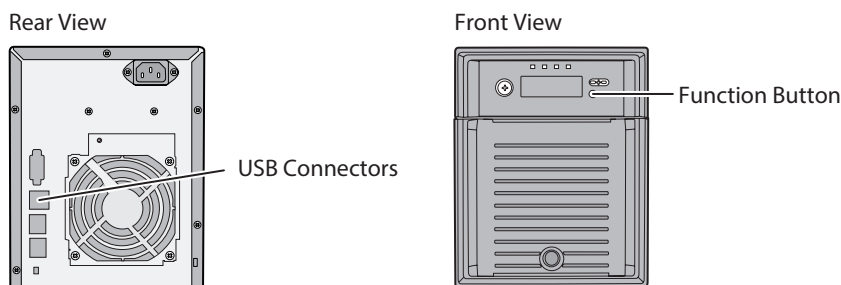

TS-WXL

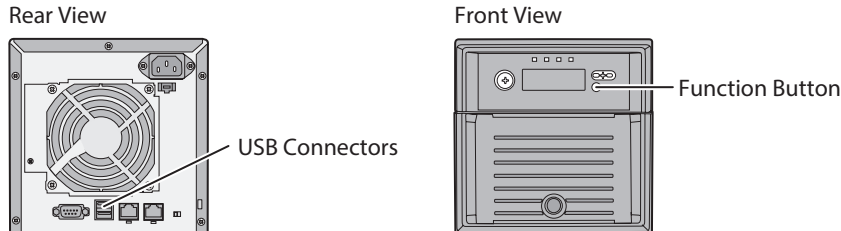

TS-RXL

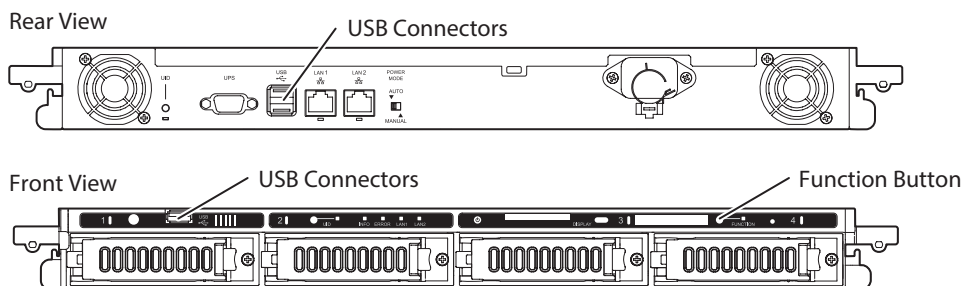

Note: View with the front cover open

Note: Wait 3 minutes before reconnecting a dismounted USB drive. It may not be recognized if you attempt to connect it immediately.

Dismounting from Settings

Alternately, you can dismount an external drive from within Settings.

1 In Settings, click *System - Storage - Disks*.

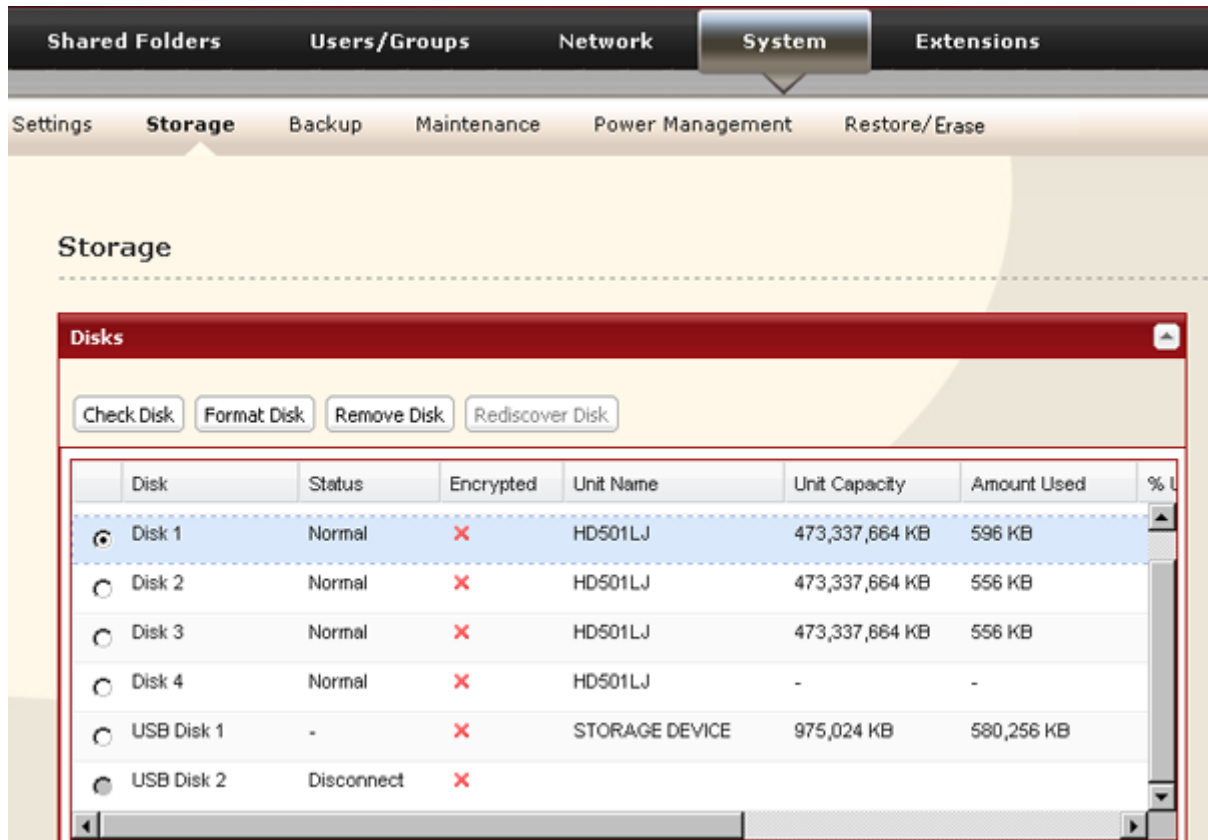

2 Select the USB drive. Click *Remove Disk*.

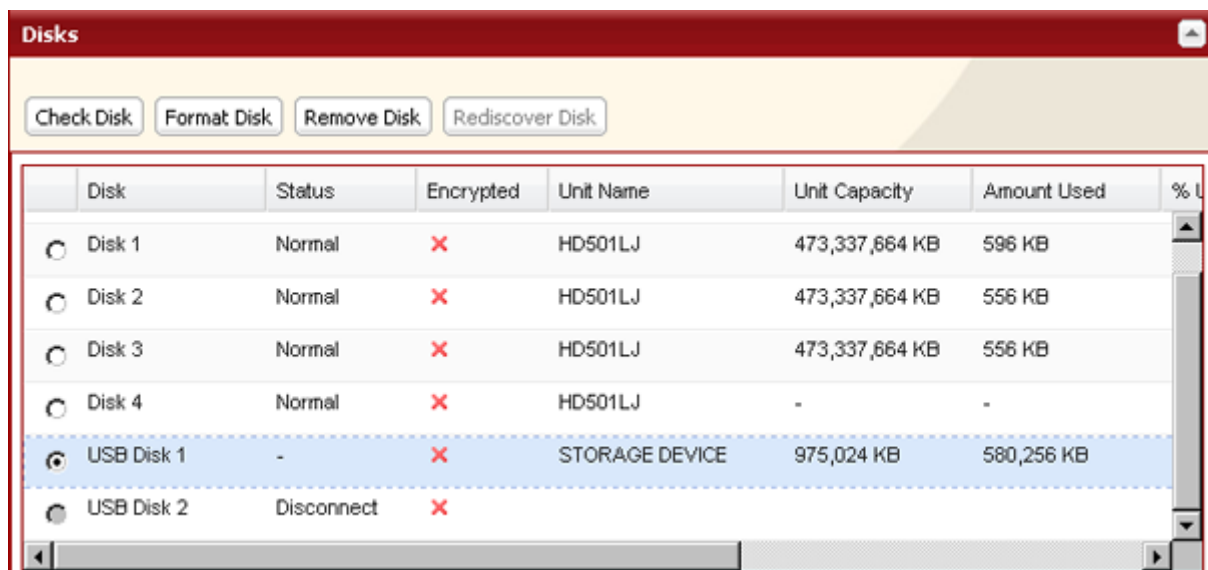

When the "Confirm Operation" screen opens, enter the confirmation number within 60 seconds and click *Apply*.

3 The function button will flash blue (on the TS-RXL, the LED next to the function button will flash). Remove the USB device within 30 seconds.

Note: After 30 seconds, the drive will be remounted. If this happens, perform another dismount before removing it.

The USB drive may now be safely disconnected.

Chapter 6 Backup

Back Up from your Windows PC

To back up data from your PC to the TeraStation, use the backup program, included with your TeraStation. The backup software can be installed from your TeraNavigator CD.

Back Up from the TeraStation

You can back up folders on the TeraStation to any of the following destinations:

- Another TeraStation
- A different folder on the same TeraStation
- A USB hard drive connected to the TeraStation

Configure Destination for Backup

Before backing up to a TeraStation, configure a folder on the TeraStation as a backup destination.

1 In Settings, click *Shared Folders - Folder Setup*.

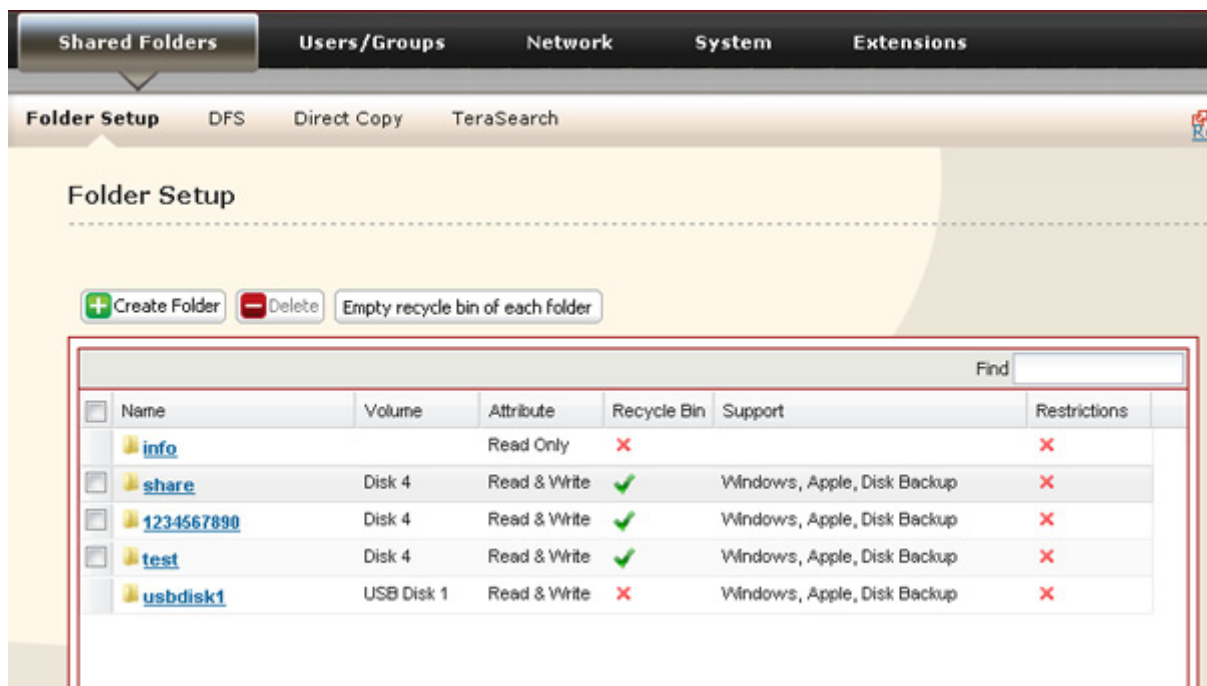

2 Choose the folder you want to set as a backup destination.

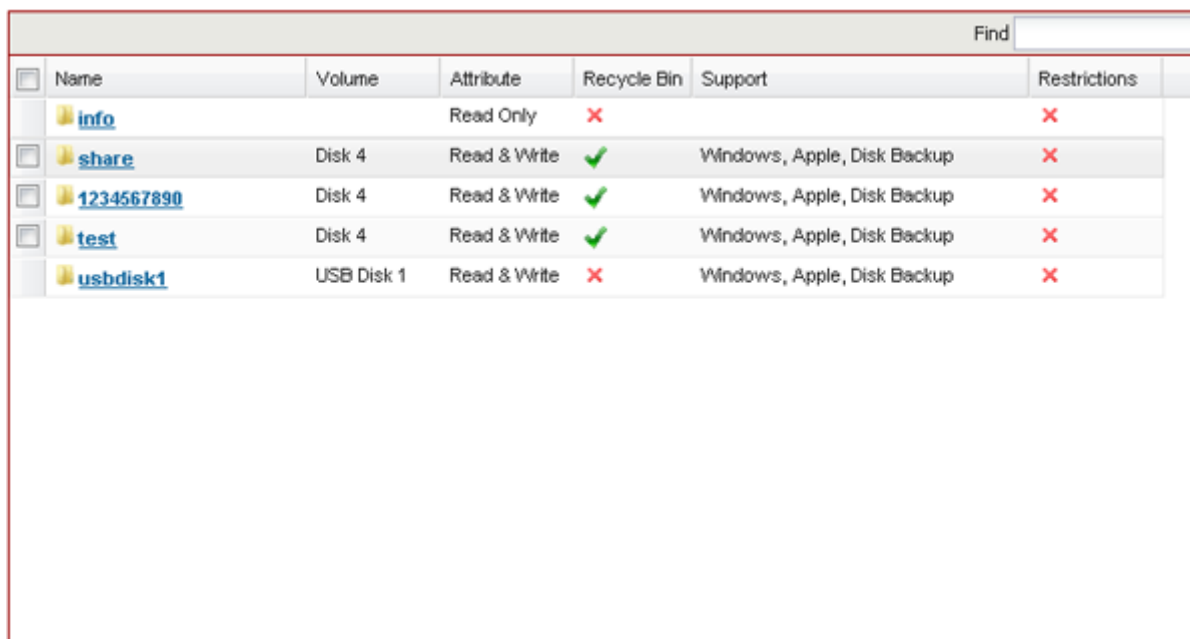

Name	Volume	Attribute	Recycle Bin	Support	Restrictions
info		Read Only	✗		✗
share	Disk 4	Read & Write	✓	Windows, Apple, Disk Backup	✗
1234567890	Disk 4	Read & Write	✓	Windows, Apple, Disk Backup	✗
test	Disk 4	Read & Write	✓	Windows, Apple, Disk Backup	✗
usbdisk1	USB Disk 1	Read & Write	✗	Windows, Apple, Disk Backup	✗

3 Check "Disk Backup" from "Shared Folder Support".

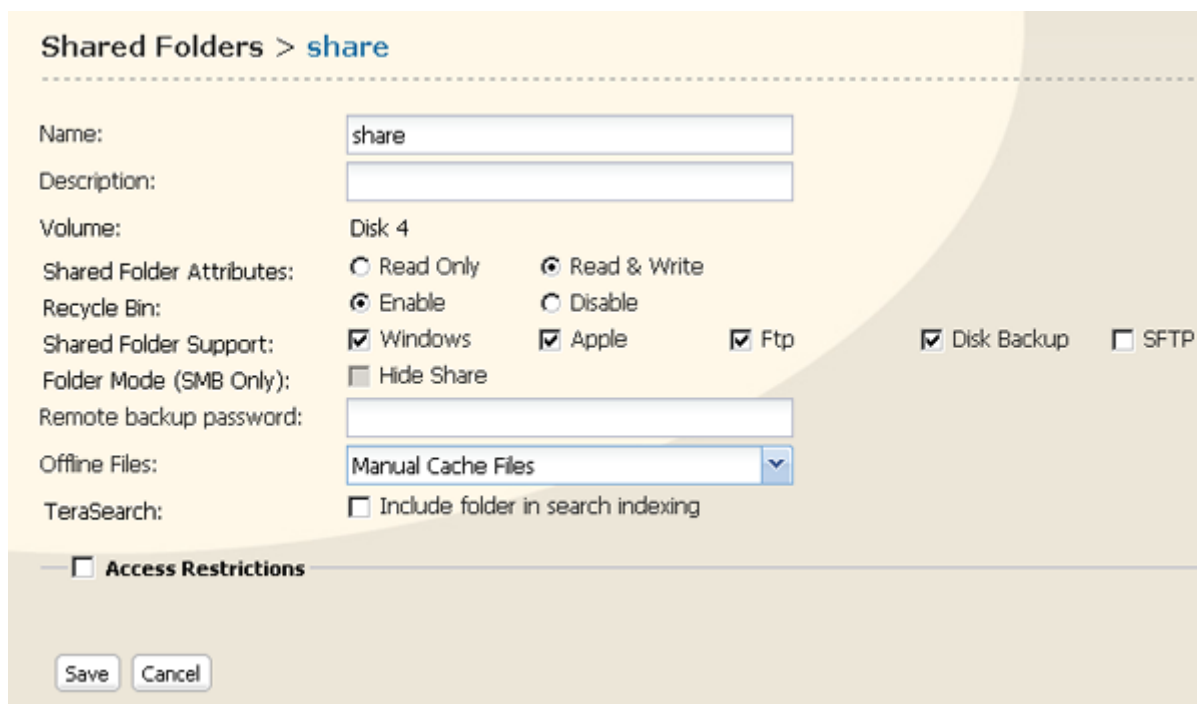

Shared Folders > share

Name: share

Description:

Volume: Disk 4

Shared Folder Attributes: Read Only Read & Write

Recycle Bin: Enable Disable

Shared Folder Support: Windows Apple Ftp Disk Backup SFTP

Folder Mode (SMB Only): Hide Share

Remote backup password:

Offline Files: Manual Cache Files

TeraSearch: Include folder in search indexing

Access Restrictions

Save Cancel

Note: To configure a password for backup jobs to this share, enter it in the "Remote backup password" field. If you do not want to set a password, do not enter anything.

4 Click Save at the bottom of the screen.

Backup Folders

Folders that can be selected as the source and destination for backups are described below.

Normal, Overwrite-Append, and Overwrite-Differential Backups

Folders that can be selected as the backup sources:

- Shared folders on the TeraStation from which backup is configured (except for the "info" folder). This includes USB drives.

- Shared folders on another TeraStation or LinkStation on the same network subnet (not including USB drives).*
- Shared folders of TeraStations or LinkStations whose IP addresses were entered manually at *System - Backup - View NAS Devices* in the TeraStation's settings (not including USB drives).*

Folders that can be selected as destinations for backup:

- Shared folders on the TeraStation where the backup job is configured (except for the "info" folder). This includes USB drives.*
- Shared folders on another TeraStation or LinkStation on the same network subnet (not including USB drives).*
- Shared folders of TeraStations or LinkStations whose IP addresses were entered manually at *System - Backup - View NAS Devices* in the TeraStation's settings. *

* In *Shared Folders - Shared Folder Support*, select "Disk Backup". Subfolders within the main shared folder are not backed up.

Backing Up to Another TeraStation on the Local Network

If the target TeraStation is configured with a password for backup, you can find it on the network by searching for the password.

- 1** In the target TeraStation's settings, navigate to *System - Backup*.
- 2** Under "Search for Backup Destination by Password", click *Modify Settings*.
- 3** Enter a password and click *Save*.

Now, you can easily find this target TeraStation when configuring backup jobs on a source TeraStation.

Backing Up to a TeraStation on Another Network which Is Connected by a VPN

You can back up to a TeraStation on another network as long as the two networks are connected by a VPN. Follow the procedure below to enter IP address of the target TeraStation.

- 1** In the source TeraStation's settings, click *System - Backup - View NAS Devices*.

- Under "Off Subnet TeraStation", enter the IP address of the target TeraStation in the "New IP Address" field, and click *Add*.

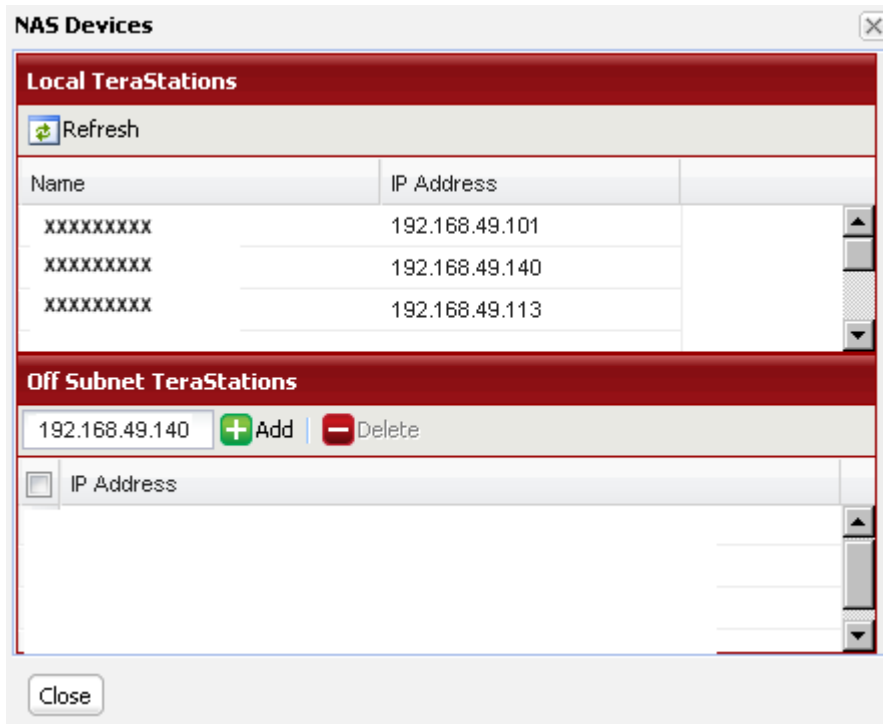

If you meet the following conditions, then you don't have to configure the settings described above:

- No backup password is set for the target TeraStation.
- The source and target TeraStations are on the same network.
- No TeraStation from outside the subnet, or connected by a VPN, is used. Instead, configure a backup job.

Note: To back up data between TeraStations or LinkStations on a network using jumbo frames, make sure that both devices are configured to use identical (or similar) Ethernet frame sizes. If Ethernet frame sizes of these are significantly different, the backup job may not be properly performed. In such a case, select the default frame size (1518 bytes).

Configuring a Backup Job

- To create a backup job, navigate to *System - Backup - Backup Jobs Setup - Create New Job* in the source TeraStation's settings.

Note: Up to 8 backup jobs can be configured.

- Select backup settings such as date and time to run.

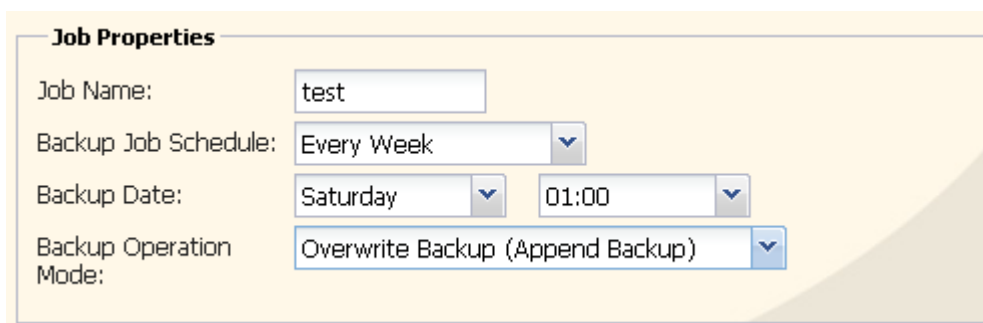

The following types of backup job may be selected:

Normal Backup

All files in the source will be backed up to the destination.

Overwrite Backup (Append Backup)

The first time the backup job runs is just like a normal backup. Each subsequent backup job will add all new files created in the backup source to the backup destination. If files have been removed from the backup source, they will remain unchanged in the backup destination. Over time, the backup destination size will become larger than the backup source.

Overwrite Backup (Differential Backup)

The first time the backup job runs is just like a normal backup. Each subsequent backup job will add all new files created in the backup source to the backup destination, but all files removed from the backup source will be deleted in the backup destination. The backup source and backup destination will always remain the same size.

3 Click *Backup Folders - Add*.

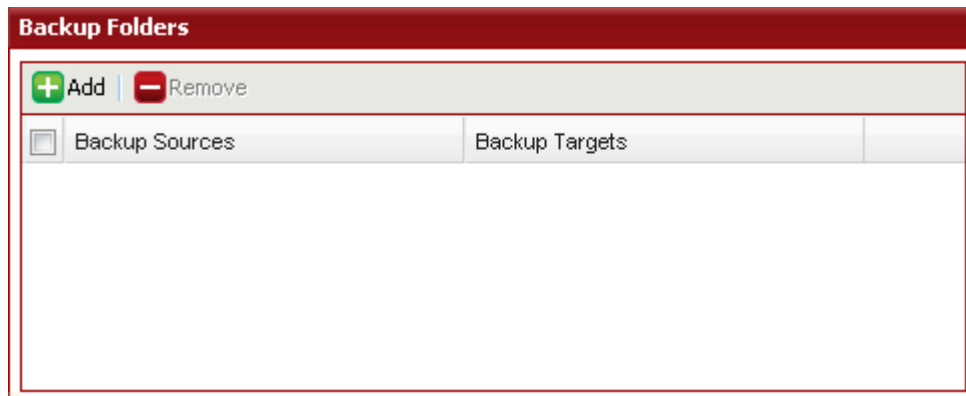

4 Select backup sources and backup targets folders. Click *Add*.

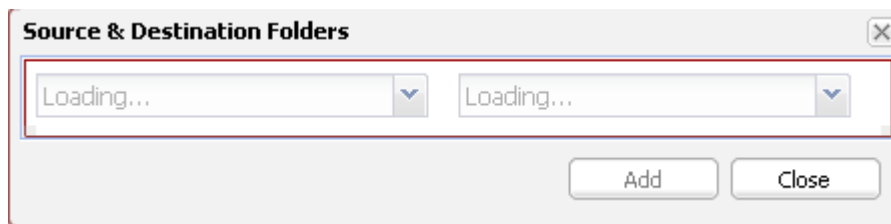

5 Click *Apply*.

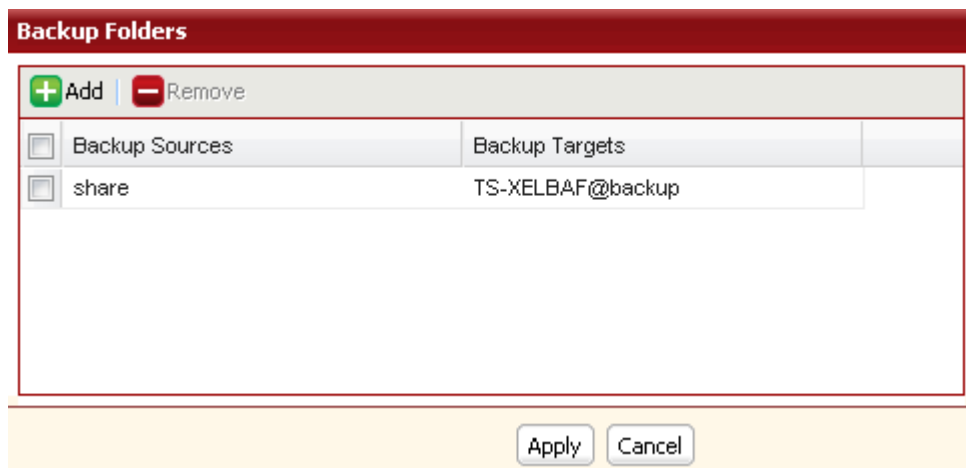

6 The backup job is added to the list of backup jobs.

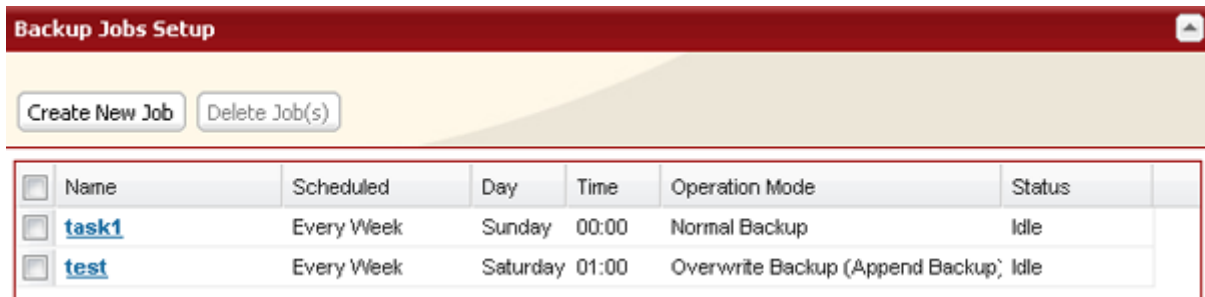

Notes:

- You can register up to the second level of subfolders. However, folders with more than 80 bytes (UTF-8) in their names cannot be selected.
- Before they can be selected as backup target folders, folders on other TeraStations must be configured as backup destinations.
- Hard drives formatted with FAT32 or FAT16 may come with some limitations if connected to the TeraStation. The following limitations may apply. For best results, use XFS or EXT3 formatted drives instead.
 - Files larger than 2 GB cannot be backed up to a FAT16 drive, and files larger than 4 GB cannot be backed up to a FAT32 drive. Errors will occur and the backup operation may stop before finishing.
 - If the data being backed up contains files from Mac OS such as ".DS_Store", the file names may include characters that cannot be written to FAT16 or FAT32 drives. This will cause errors and the backup operation may stop before finishing.
- Note the following if using Auto Power Mode* during backups.
 - If the TeraStation is in standby mode, it will power on automatically 15 minutes before a backup starts.
 - If the TeraStation is switched to standby mode immediately before a scheduled backup, the backup may not be performed.

* Refer to the "Auto Power Mode" section in chapter 1 for more information on Auto Power Mode.

Backup Restrictions

- If you are using overwrite-differential backup to back up to a external USB drive formatted with FAT32, it may overwrite even if there are no differences in the data. If the second of the date when the file was created is an odd number, data is overwritten regardless of any differences in the data.
- To back up data between TeraStations or LinkStations on a network using jumbo frames, make sure that both devices are configured to use identical (or similar) Ethernet frame sizes. If Ethernet frame sizes of these are significantly different, the backup job may not be properly performed. In such a case, select the default frame size (1518 bytes).
- Backing up files or folders with multibyte characters in their names may cause log files to output incorrectly.
- If you change RAID settings or reformat a drive, you must redo all backup settings for the drive. If another TeraStation tries to use the drive as a backup destination without redoing the backup job, an error message will be displayed.
- If the firmware for the backup source and/or backup target is not the latest version, occasionally shared folders with names that are 20 bytes or more cannot be selected. In some cases, this problem may be fixed by downloading the latest firmware version for your TeraStation from the Buffalo website.

If a Scheduled Backup Fails (I54)

Check the startup state, network status, shared folder settings for the backup source and target folders on the backup source and target LinkStation and/or TeraStation.

Checking the Startup State

- Check that the backup source and target LinkStation and/or TeraStation are not being shut down during the scheduled backup.
- If the sleep timer is enabled for the backup source or target LinkStation or TeraStation, disable the timer and try rerunning the backup. If the backup failed, the backup target may not have been recognized properly. Check the network and USB connections at the backup target. If the backup succeeded, there may have been a problem with the sleep timer setting. Correct the sleep timer settings or disable the sleep timer.

Note: If either the backup source or target LinkStation or TeraStation is in standby when a scheduled backup job begins, the backup job will fail.

Checking the Network Status

Check whether the backup source and target LinkStation and/or TeraStation can be found using *System - Backup - View NAS Devices*. If it cannot be found, check the network settings of the backup source and target LinkStation and/or TeraStation. Also check whether any network cables are disconnected.

Checking the Shared Folder Settings

Confirm that *Disk Backup* is checked for "Shared Folder Support" in the shared folder settings of the backup source and target LinkStation and/or TeraStation.

Using TeraStation Batch Backup

Batch backup allows backup of shared folders from multiple TeraStations to a single TeraStation. Configure this as described in step 3 on the "Configure Destination for Backup" section. To configure a TeraStation to be the backup destination, make the settings as described on the "Configure Destination for Backup" and "Configuring a Backup Job" sections.

Notes:

In the cases below, a TeraStation cannot be selected as the backup source as described in step 4 on the "Configuring a Backup Job" section. If this happens, change the settings as described on the "Backing Up to Another TeraStation on the Local Network" or "Backing Up to a TeraStation on Another Network which is Connected by a VPN" sections.

- If a password has been set for a TeraStation designated as a backup source.
- If the source TeraStation and the backup destination TeraStation are not on the same subnet.

Batch Backup of TeraStations

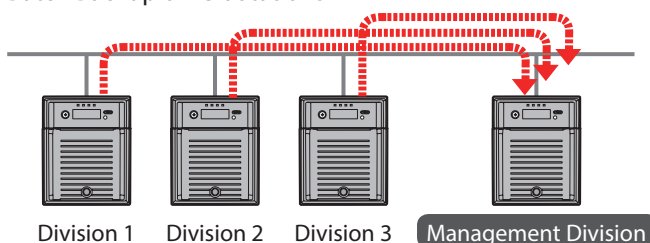

Replication

Replication is when you copy all data from one TeraStation onto another TeraStation. This allows you to easily create another backup unit should your main TeraStation ever fail, thus adding another layer of protection for your data. To initiate replication, simply connect a second TeraStation to your main TeraStation. You can plug in an Ethernet cable

into the LAN port on each unit to link them together. Refer to the "Configuring Replication" section for instructions on how to configure replication settings for each TeraStation.

Normal Operation (Replication State)

Each TeraStation unit has two LAN ports. One can be used to connect to the network, and the other to another TeraStation. When the two units are linked, data on the main TeraStation is fully duplicated on the second TeraStation on a file-by-file basis. Whenever a file is created or deleted on the main TeraStation, the second TeraStation will automatically receive the same update.

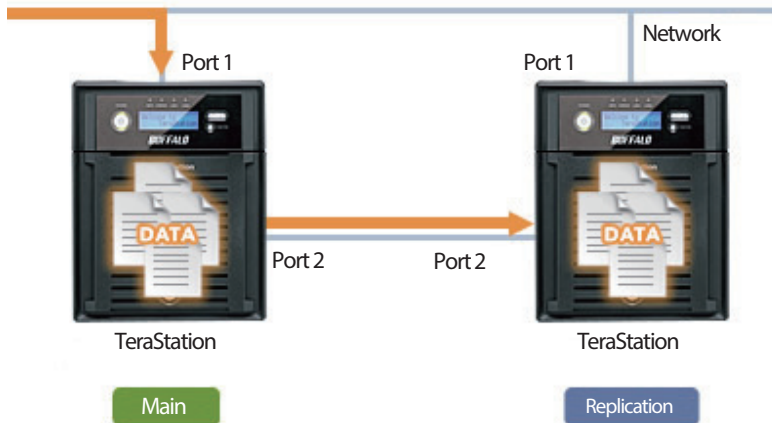

Note: Replication can also be specified for individual shared folders, and a maximum of 64 shared folders can be specified.

If the Main TeraStation Fails

Replication only copies data between two TeraStation units, but not settings. If your main TeraStation fails, you may configure the second unit via Settings to enable it as your main unit.

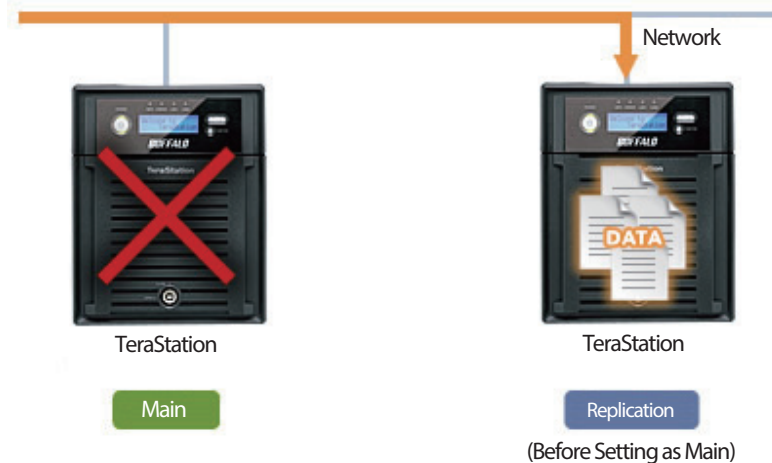

Rebuilding Replication

After the failed unit is repaired, reconnect the two TeraStation units via the LAN ports to initiate replication again with the repaired unit as the new backup.

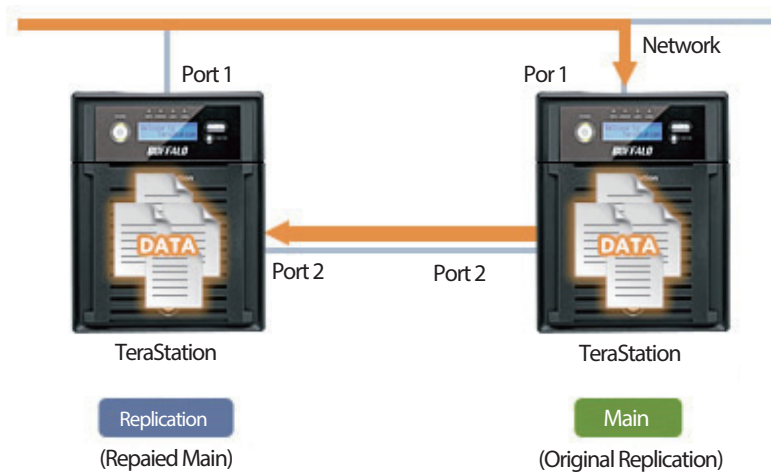

Notes:

- Only data written by SMB and CIFS (Windows) and AFP, NFS, SFTP, FTP, and FTPS (Apple) can be mirrored by replication.
- Replication transfers files asynchronously. It may take time to transfer files depending on the network environment or status of the TeraStation.
- Replication will retry file transfers if they fail due to a temporary disconnection in the network. If the retry fails, an error will occur. The error LED on the front of the TeraStation will glow red and an alarm will sound. To repair, fix the network problem, then navigate to *System - Backup - Replication* and choose *Resynchronize* in Settings.
- System performance may become slow when accessing a folder that was set as the replication source.
- Do not set multiple replication targets for one replication source. Multiple transfer processes for replication will run, and system performance will be adversely affected.
- A large number of files cannot be continuously written to the replication source folder over a long period of time.
- Do not replicate a share that is the target of Time Machine backups by Mac OS.
- Cascading is not possible in replication – i.e. files transferred to the replication target cannot be further replicated to another location.
- System performance may be degraded if Mac OS writes to the replication source folder with an AFP connection. If this occurs, connect via SMB for better performance.
- When replicating to a USB drive, a folder which has the same name as the backup source will be created on the USB drive. If the same folder name already exists on the USB drive, any files in that folder will be deleted.
- Hard drives formatted with FAT32 or FAT16 may come with some limitations if connected to the TeraStation. The following limitations may apply. For best results, use XFS or EXT3 formatted drives instead.
 - Files larger than 2 GB cannot be backed up to a FAT16 drive, and files larger than 4 GB cannot be backed up to a FAT32 drive. Errors will occur and replication may stop before finishing.
 - If the data being backed up contains files from Mac OS such as ".DS_Store", the file names may include characters that cannot be written to FAT16 or FAT32 drives. This will cause errors and the replication may stop before finishing.
- If NFS is used in kernel mode, files or folders written by NFS are not transmitted to the replication destination. To change NFS from kernel mode to user mode, select *Network - NFS - NFS Service* in Settings.
- If the firmware for the replication source and/or replication target is not the latest version, occasionally shared folders with names that are 20 bytes or more cannot be selected. In some cases, this problem may be fixed by downloading the latest firmware version for your TeraStation from the Buffalo website.

Replication Folders

Folders that be selected as the source and destination for replication are described below.

Folders that can be selected as the replication sources:

- Shared folders on the TeraStation from which replication is configured (except for the "info" folder). This includes USB drives.

Folders that can be selected as destinations for replication:

- Shared folders on the TeraStation where the replication job is configured (except for the "info" folder). This includes USB drives.*
- Shared folders on another TeraStation or LinkStation on the same network subnet (not including USB drives).**
- Shared folders of TeraStations or LinkStations whose IP addresses were entered manually at *System - Backup - View NAS Devices* in the TeraStation's settings.**

* In *Shared Folders - Shared Folder Support*, select *Disk Backup*. Subfolders within the main shared folder will not be backed up.

** Shared folders with passwords configured in *Shared Folders - Remote backup password* cannot be selected as destinations for replication.

Configuring Replication

Configure replication as described below.

- 1 In the source TeraStation's settings, click *System - Backup - Replication*.

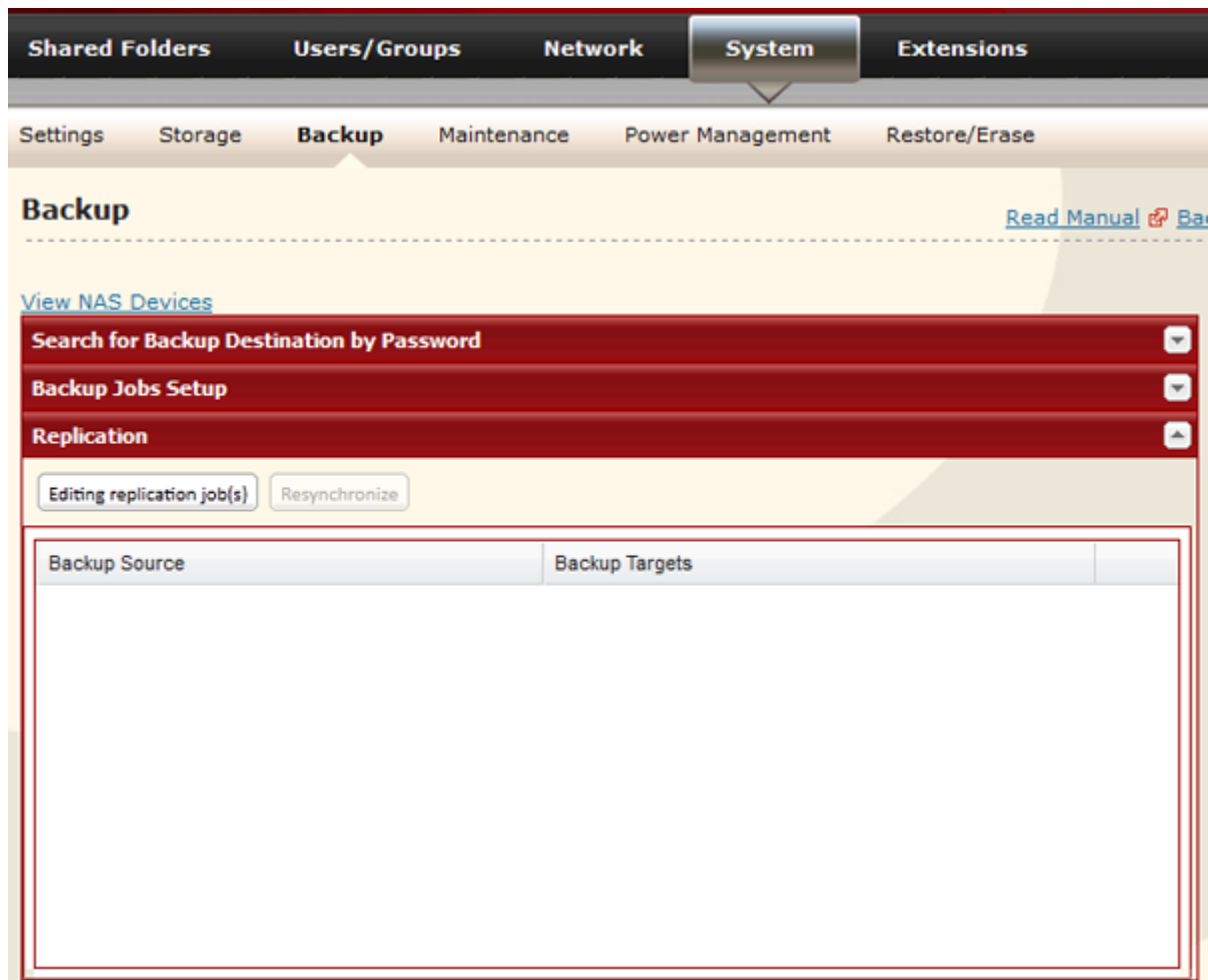

- 2 Click *Editing replication job(s)*.

3 Click *Add*.

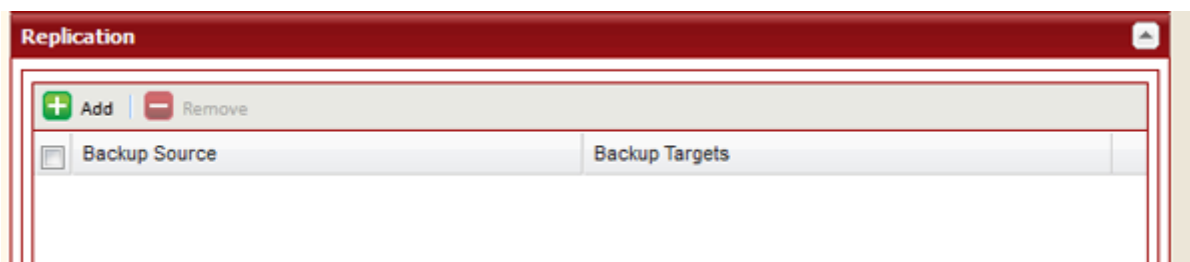

4 Select replication source folder for backup source and replication target folder for backup target. Click *Add*, then *Close*.

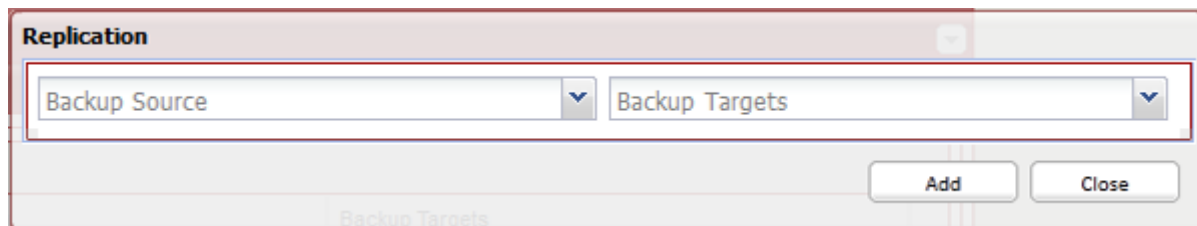

5 Click *Save*.

6 Read the alert message carefully and click *OK*.

Replication is configured.

Replication to a TeraStation on a Different Network

If your target TeraStation is on a different network or subnet, you may still configure replication as described above, but you must first add the target TeraStation to your list of off-subnet TeraStations as described below.

1 In the source TeraStation's settings, navigate to *System - Backup - View NAS Devices*.

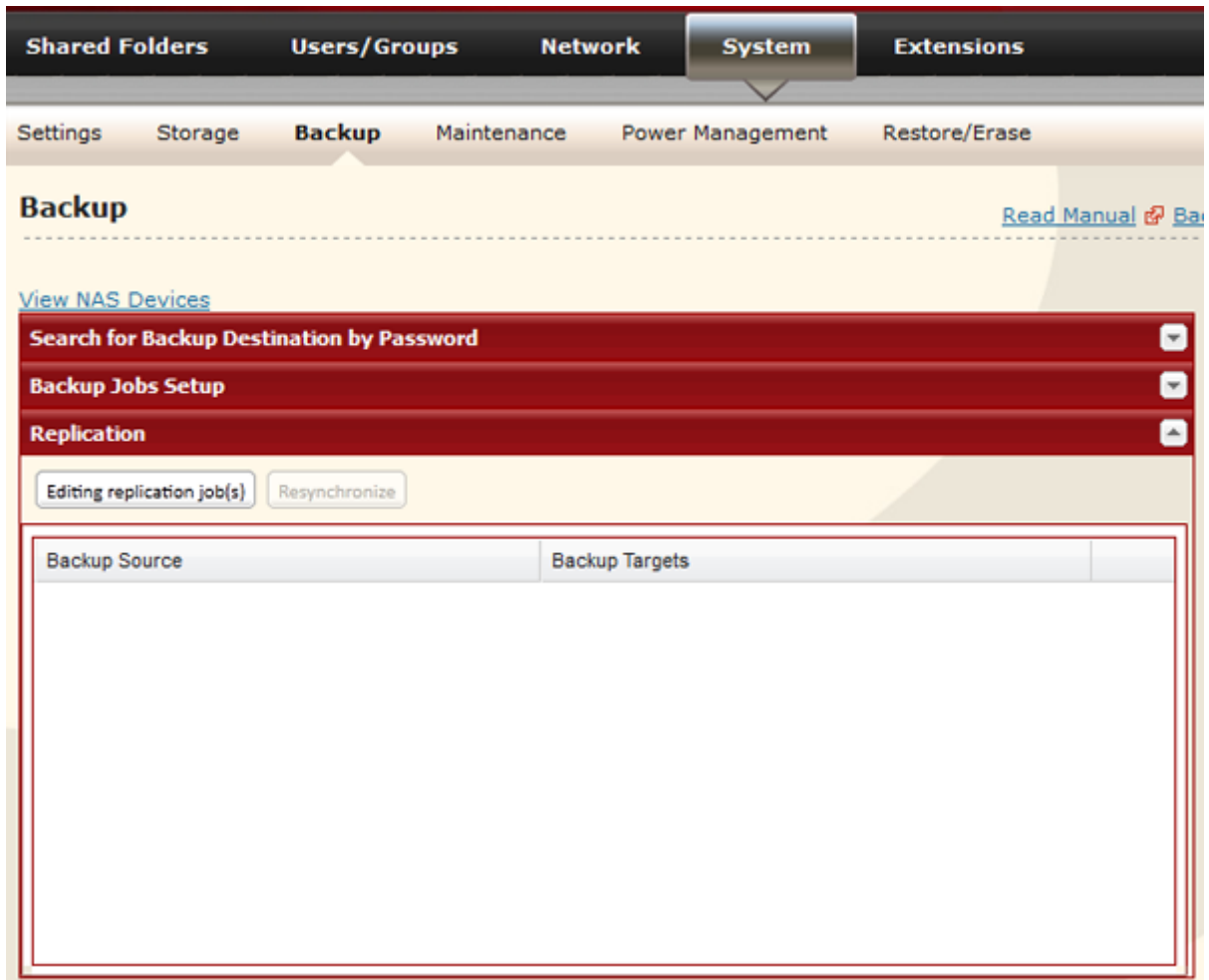

2 Under "Off Subnet TeraStations", enter the target TeraStation's IP address in the "New IP Address" field and click *Add*.

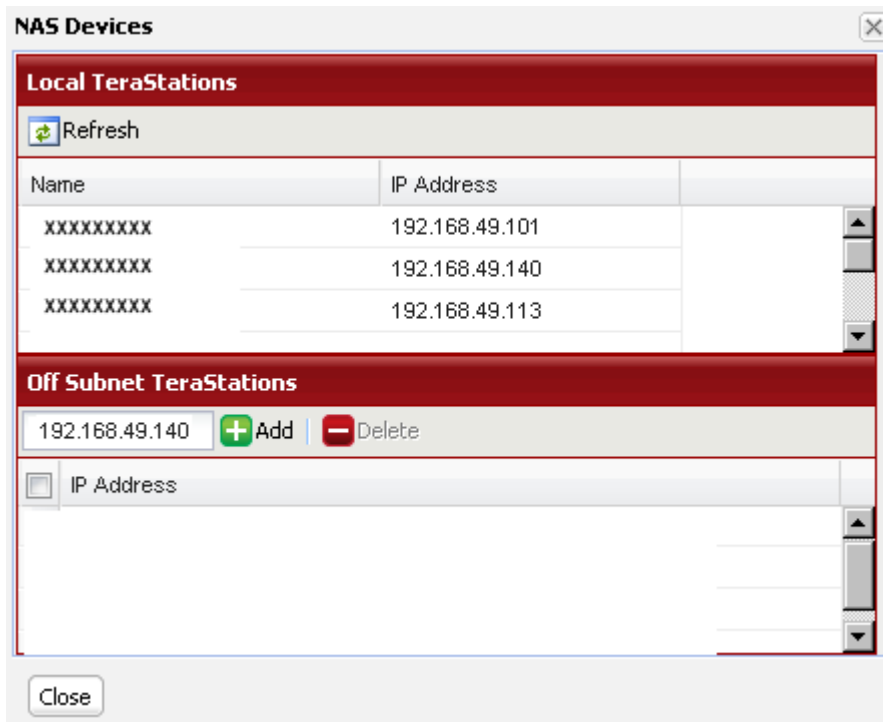

Note: If the target TeraStation is behind a router, enter the router's WAN side IP address. You will need to map ports 873, 22938, and 22939 to the target TeraStation in the router for this to work correctly.

3 Click *Close*.

You can now configure replication as described in the previous section.

Time Machine

Time Machine is a backup program included with OS X 10.5 or later. To use it with the TeraStation, configure the TeraStation as described below.

1 In Settings, navigate to *Network - Settings - Network Services* and click *AFP*.



2 Select *Enable* and click *Save*.



Note: Settings for both LAN Port 1 and 2 are the same (ports cannot be configured separately).

3 Navigate to *Shared Folders - Folder Setup*. Choose a shared folder to configure as a backup destination for Time Machine.

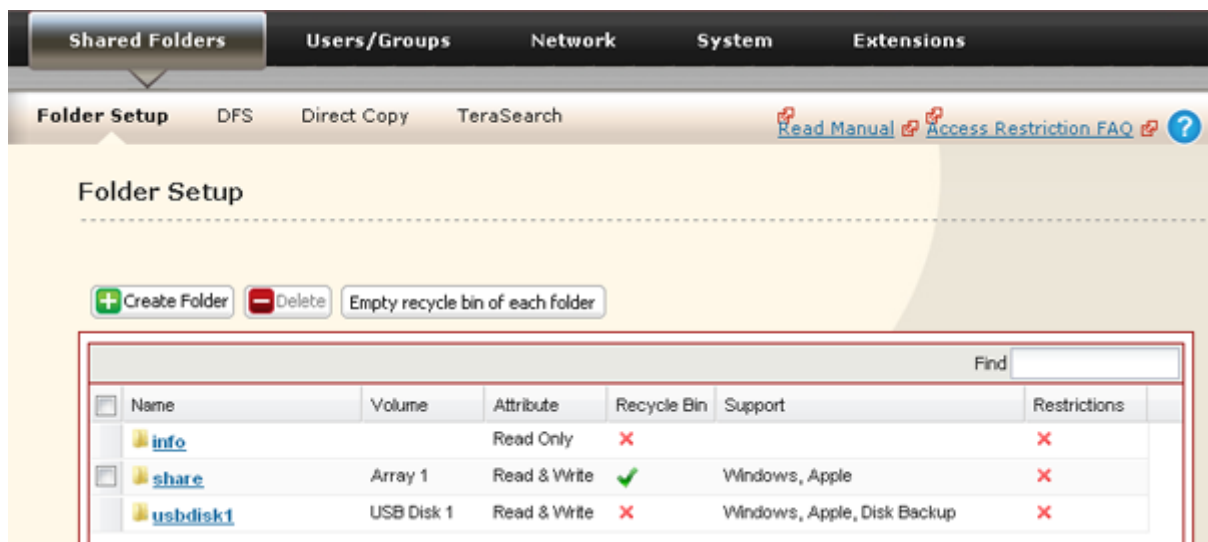

4 Check *Apple* under "Shared Folder Support". Click *Save*.

Shared Folders > share

Name: share

Description:

Volume: Array 1

Shared Folder Attributes: Read Only Read & Write

Recycle Bin: Enable Disable

Shared Folder Support: Windows Apple Ftp Disk Backup SFTP

Folder Mode (SMB Only): Hide Share

Remote backup password:

Offline Files: Disable Offline Files

TeraSearch: Include folder in search indexing

Access Restrictions

Save Cancel

5 Navigate to *Extensions - Time Machine* and click *Modify Settings*.

Time Machine

Time Machine: Enabled

Target Folder: share

Modify Settings

6 Select *Enable* and the shared folder that you set in step 3. Click *Save*.

Time Machine

Time Machine: Enable Disable

Target Folder: share

Save Cancel

7 From the Apple menu, select *System Preferences*.

8 Click *Time Machine*.

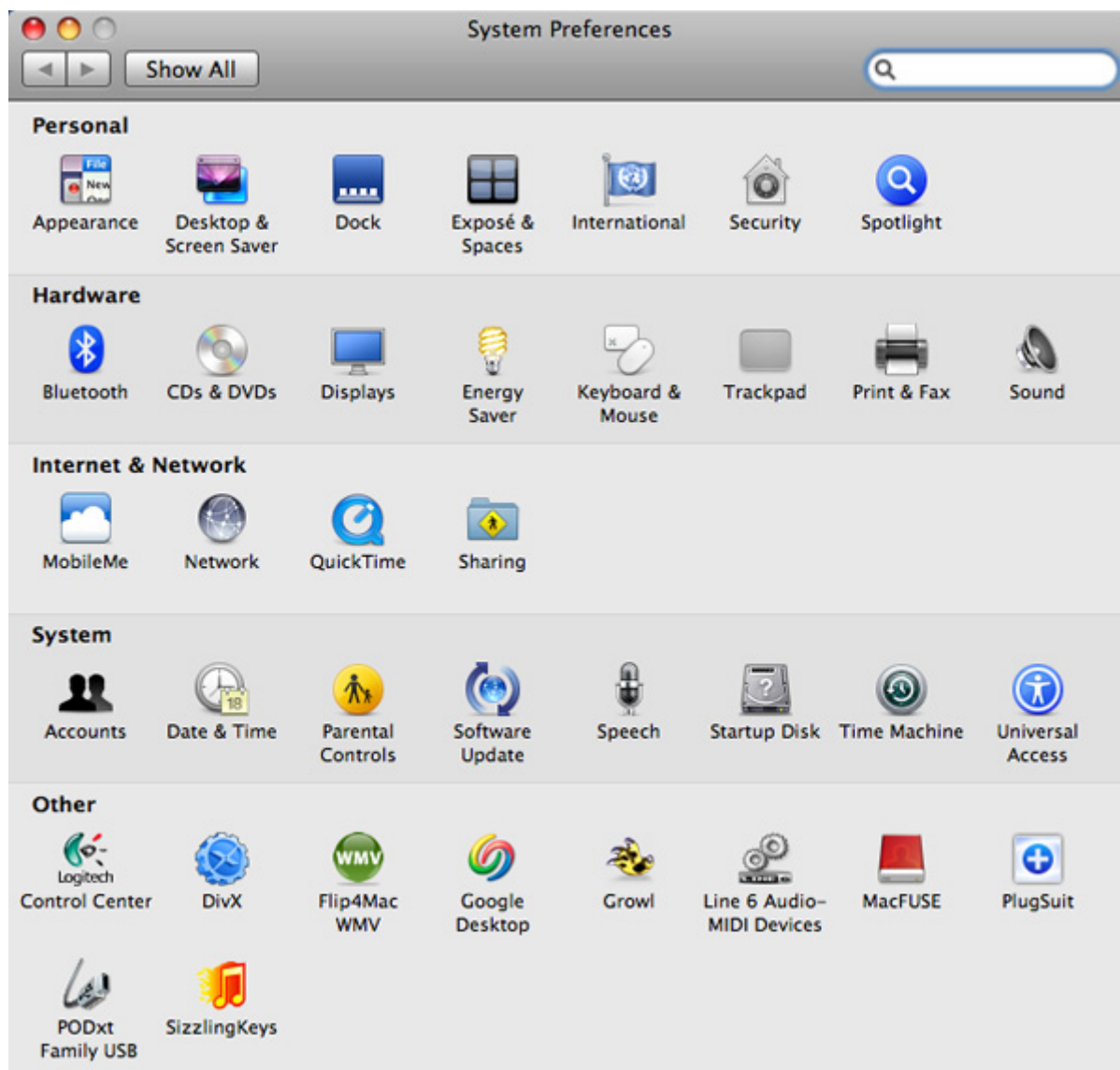

9 Click *Choose Backup Disk*.



10 Select TeraStation, and click *Use for Backup*.

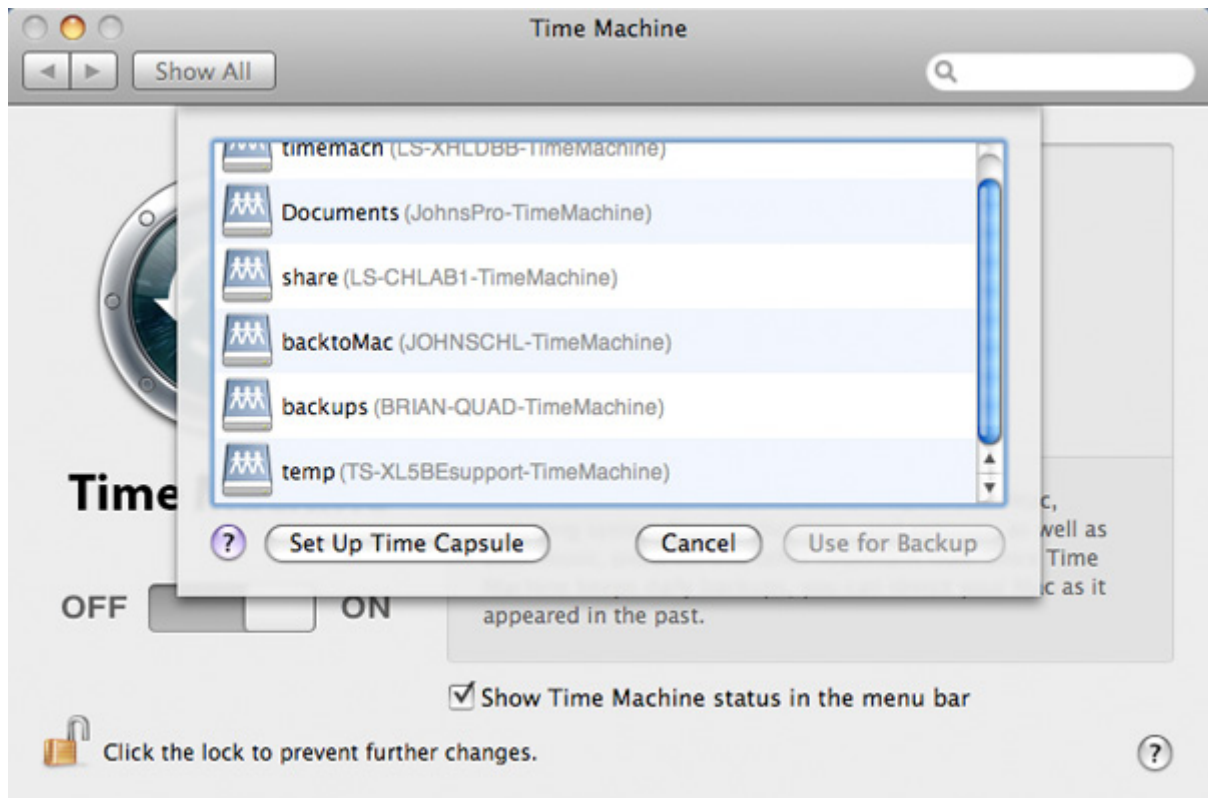

- 11** Enter a username and password with the rights to access the shared folder of the TeraStation, and click *Connect*.

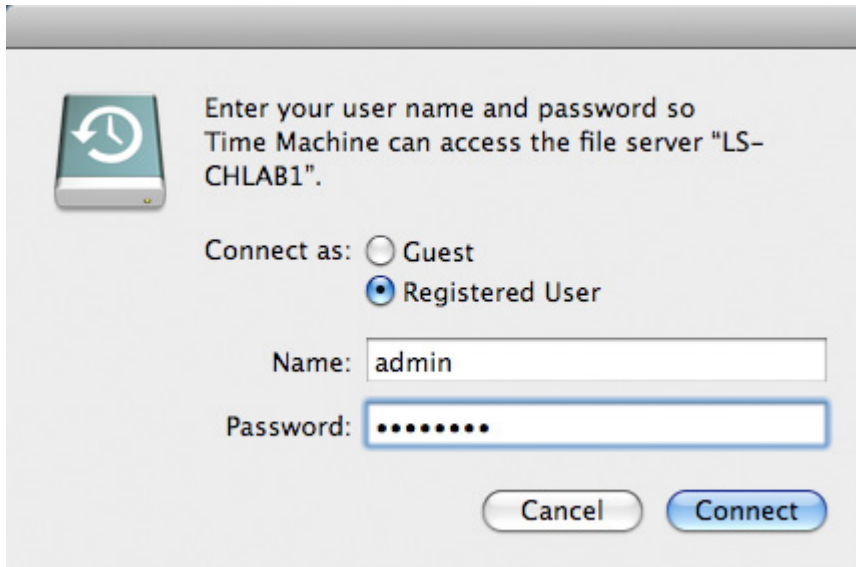

Note: If the backup target folder on the TeraStation does not have access restrictions configured, type "admin" for the username and "password" for the password.

- 12** Ensure that Time Machine is set to "on". A backup job will start in 120 seconds, and you can still use your Mac as usual while Time Machine runs in the background. For more information on using Time Machine, refer to your Mac's help guide on Time Machine.



Your TeraStation is now configured for use with Time Machine.

Restoring Backup Data

For computer data backed up by a backup program

Consult your backup program's documentation or help files for information on the restoration procedure.

For computer data backed up by a TeraStation backup program such as batch backup or replication

Data backed up by TeraStation backup programs is copied to a destination folder on the TeraStation. No compression or encryption is performed on this data, so you can use Explorer or other tools to simply copy the backup data back to the original folder.

For computer data backed up by Mac OS Time Machine

Use Time Machine to restore your data. For more information on using Time Machine, see the Mac OS help.

Chapter 7 Configuring Access Restrictions

TeraStation allows you to set permissions for users or groups to access specific shared folders. Four types of Access Restrictions are available:

- Access Restrictions for Users and/or Groups on the TeraStation
Follow the procedure on the "Access Restrictions" section to configure.
- Access Restrictions on NT Domain
Follow the procedure on the "Access Restrictions on NT Domain" section to configure.
- Access Restrictions on Active Directory
Follow the procedure on the "Access Restrictions on Active Directory Domain" section to configure.

Notes:

- This chapter describes the procedure to use Active Directory with Windows 2000 Server, Windows Server 2003, and Windows Server 2008.
- Depending on the security settings, the TeraStation may not be able to join, or may be able to join but may not be authenticated by a domain. In such a case, it is recommended to restrict access by delegating authority.
- Access Restrictions through delegate authority to external SMB server
Follow the procedure on the "Access Restrictions on through Delegate Authority to External SMB Server" section to configure.

Notes:

- Access restrictions on the TeraStation are configured for shared folders in the root folder. Subfolders inherit their permissions from their parent folder and may not be configured separately.
- Permissions on the TeraStation are configured from within Settings. Changing TeraStation permissions on the fly from within Windows or Mac OS is not supported.

Adding a Shared Folder

1 In Settings, click *Shared Folders - Folder Setup*. Click *Create Folder*.

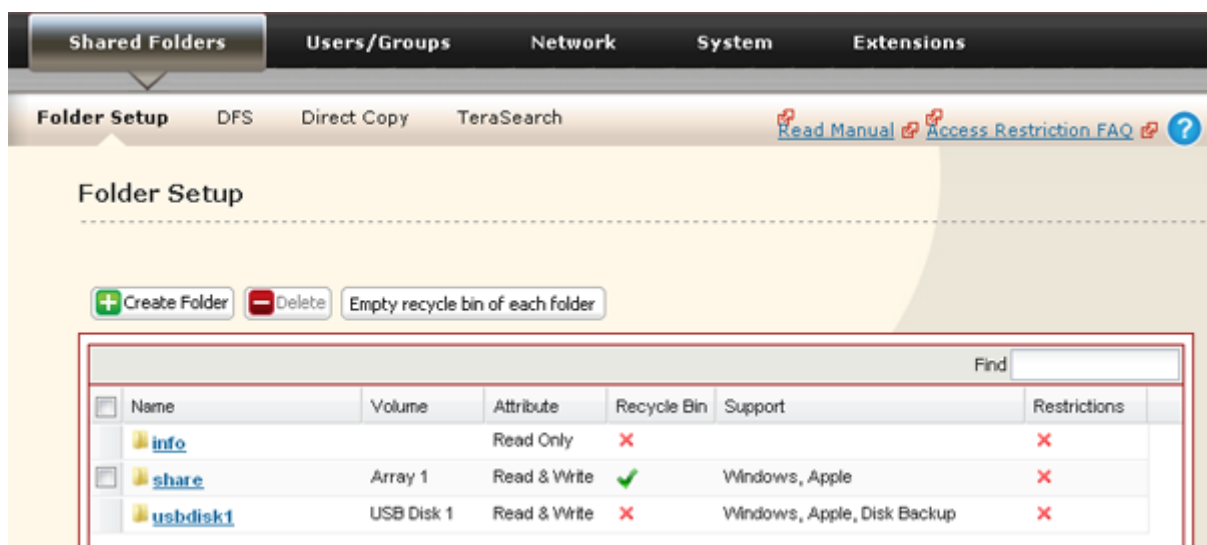

2 Configure the desired settings for the new folder. Click *Save*.

Shared Folders > New Folder [Read Manual](#) [Access Restr](#)

Copy Settings From: (Optional) ▾

Name:

Description:

Volume: Array 1 ▾

Shared Folder Attributes: Read Only Read & Write

Recycle Bin: Enable Disable

Shared Folder Support: Windows Apple Ftp Disk Backup SFTP

Folder Mode (SMB Only): Hide Share

Remote backup password:

Offline Files: Disable Offline Files ▾

TeraSearch: Include folder in search indexing

Access Restrictions

Notes:

- Shared folder names can contain up to 27 bytes(UTF-8). Alphanumeric characters, multibyte characters, hyphens (-), and underscores (_) may be used. Do not use a symbol as the first character.
- Shared folder descriptions can contain up to 75 bytes(UTF-8). Alphanumeric characters, multibyte characters, hyphens (-), underscores (_), and spaces may be used. Do not use a symbol as the first character.
- You may create up to 400 shared folders on the TeraStation.

You have created a new shared folder.

Recycle Bin

Each shared folder on the TeraStation that is connected by SMB may have the recycle bin enabled or disabled from within Settings. If enabled, deleted data from a shared folder will be temporarily moved to a trashbox subfolder. To recover deleted data, open the trashbox folder and move files.

Note: To delete all files in the recycle bin, click *Shared Folders - Folder Setup - Empty* recycle bin of each folder in Settings.

Read Only Shares

A folder may be configured as read-only by selecting *Read Only* from "Shared Folder Attributes".

Note: The default setting is read & write. A shared folder whose attribute is set to Read Only is read-only for all users, even if they are assigned write permissions on the share. When a shared folder is configured to read only, the message "(Read Only)" is added to the description of that share folder.

Hide Share

In Settings, click *Shared Folders* and select *Hide Share* on *Folder Mode (SMB Only)*. Click *Save*.

To open a hidden folder, click *Start - Search programs and files* and enter \\TeraStation name\Shared folder name\$\
for the name.

Example: If the TeraStation name is "TS-XX001" and the shared folder name is "share", then enter "\\TS-XX001\share\$" to open it.

Note: FTP, SFTP, and Mac AFP folders cannot be hidden.

Technical Restrictions

- Windows does not support some characters that Mac OS and the TeraStation allow. So, if you create a filename on a Mac with any of the following characters, it will not display correctly on a Windows computer. With OS X 10.2 or later, you may have to connect to the TeraStation via AFP in order to display or copy any of the following characters: ? / ¥ = + < > ; : " , | *
- Do not use any of the following words as a username or group name: root, bin, daemon, sys, adm, tty, disk, lp, sync, shutdown, halt, operator, nobody, mail, news, uucp, ftp, kmem, utmp, shadow, users, nogroup, all, none, hdusers, admin, guest, man, www, sshd, administrator, ftpuser, apache, mysql.
- Do not use any of the following words as a shared folder name: info, spool, usbdisk1, usbdisk2, usbdisk3, usbdisk4, lost+found, global, printers, homes, lp, auth, ram, disk1, disk2, disk3, disk4, array1, array2.
- When using multibyte characters (such as Japanese), make folder and file names with 80 bytes or less. Total path length is limited to 1024 bytes. You may not be able to copy a folder or file whose name is more than 80 bytes characters long, or whose pathname is more than 1024 bytes total.
- You cannot set hidden or read-only attributes to folders or files on a TeraStation from Windows. To set an attribute for a share on the TeraStation, use Settings. In *Shared Folders - Folder Setup*, click the shared folder you want to configure. Select *Read Only* or *Read & Write* from "Shared Folder Attributes", and *Hide Share* from "Folder Mode (SMB Only)".
- If local characters aren't displayed properly in a shared folder or Workgroup name, use alphabetical character.
- If you access a shared folder from a Mac, information files for Mac may be automatically generated. Do not delete these files from a Windows computer. Otherwise, you may no longer access folders from Mac.
- A volume name mounted by Finder from OS X 10.3.9 may be corrupted when connected via SMB. File names and data should be fine.
- On OS X 10.5 - 10.5.6, you cannot search by Spotlight while connected via AFP. In such a case, use SMB connection or use OS X 10.5.7 or later.
- TeraStation belongs to the default zone specified by an AppleShare Server. You cannot specify a zone.
- Date and Time stamp information stored on a TeraStation's hard disk or a USB hard disk connected to the TeraStation may be updated by an attached OS, and its accuracy cannot be guaranteed.
- If you display size of hard drives through Settings, it will show a larger value than that shown by Windows' drive properties.
- If you change a TeraStation's settings or add a USB hard drive while transferring files, the file transfer may be aborted.
- Copying files to TeraStation is protected by the Journaling File System. However, if power is suddenly disconnected in the middle of a file copy, the following events may occur:
 - Data configured (TeraStation, user or group names) may be lost.
 - The copied file may be incomplete and it may not be deleted. In such a case, restart TeraStation and delete the file, and try copying the file again.
- Although you format TeraStation's hard disk, "Percent Used" or "Amount Used" in Settings will not show 0 (zero). This is because some space is used for the system.
- Set the TeraStation's username and password the same as the user's username and password for logging into the Windows network. If they are different, you may not be able to access share folders with access restrictions.
- Click *Shared Folders - Folder Setup - Empty recycle bin of each folder* in Settings to delete all of the contents of the "Recycle Bin" folder in the shared folder.
- Do not set the same network address for LAN port 1 and LAN port 2, or data transmission may be unstable. If this happens, initialize the TeraStation with the reset button.

- If you want to access a different network from the TeraStation, use LAN port 1. LAN port 2 cannot access beyond the TeraStation User Manual 51 local subnet as it doesn't have a default gateway.
Examples: You cannot use email notification (cannot find the email server), or you cannot find a TeraStation by IP address to configure as a backup destination.
To resolve, place the TeraStation on the same subnet as the device that you are trying to connect to via LAN port 2.

Adding Users

1 Click *Users/Groups - Local Users - Create User*.

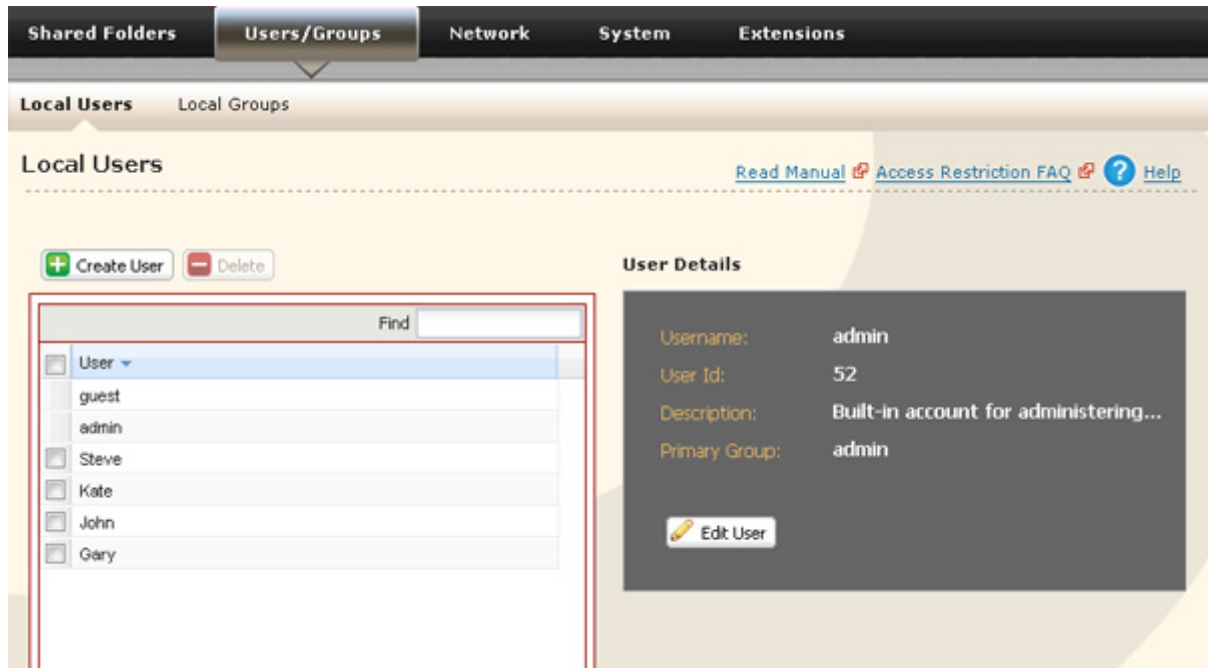

2 Enter the username, description, and password. Click *Save*.

The screenshot shows the 'Local Users > New User' form. The form contains the following fields and controls:

- Username:
- User Id:
- Description:
- Password:
- Confirm Password:
- Primary Group: (dropdown menu)
- User Quota: Enable
- Soft Limit (GB):
- Hard Limit (GB):

At the bottom of the form, there are 'Save' and 'Cancel' buttons.

Notes:

- Usernames can contain up to 20 bytes(UTF-8). Do not use multibyte characters. Alphanumeric characters, hyphens (-), underscores (_), periods (.), !, #, &, @, \$, *, ^, % may be used. Do not use a symbol as the first character.
- User descriptions can contain up to 75 bytes(UTF-8). Alphanumeric characters, multibyte characters, hyphens (-), underscores(_), and spaces may be used. Do not use a symbol and space as the first character.
- You may register up to 300 local users with the TeraStation.
- Passwords can contain up to 20 bytes(UTF-8). Do not use multibyte characters. Alphanumeric character and the following characters may be use: - _ @ ! # \$ % & ' () * + , . / ; < > = ? ^ { } | ~ Do not use a symbol except -(hyphen) as the first character.
- Set the TeraStation's username and password the same as the user's username and password for logging into the Windows network. If they are different, the user may not be able to access shared folders with access restrictions.
- Repetitive deletions and additions of users may cause the quota feature to not work properly. Even though the data is copied by the backup function of the TeraStation, the quota feature may not work properly if a user ID/group ID is duplicated. In such a case, use a username/group name of an unused user ID or group ID.
- To assign quotas for users, check *Enable* for "User Quota" and enter a limit in GB. Refer to the "Disk Quotas" section in chapter 9.
- If the user ID is left blank, a user ID will be automatically assigned. When using the quota feature, use numbers between 1000 and 1999 to set a group ID manually. Make sure that user ID are unique.
- For Windows 8, use a local username instead of your Windows Live ID.

Importing Users

To import many users at once, enter the following information in the "Input CSV format data" field on *Users/Groups - Local Users* on Settings, and click *Import*.

Format of the user information: username (required), password (required), and description (optional)

Example:

username1, password1, description1

username2, password2, description2

username3, password3, description3

.....

Notes:

- It may take about 1 hour depending on the number of users you import. Note that you cannot use Settings while the system is busy.
- Use commas as separators. Do not use spaces before or after the commas.
- If a line is incorrectly formatted, then the user in that line will not be registered.
- If a username is already registered on the TeraStation, that user will be overwritten.
- Commas should not be used in usernames, passwords, or user descriptions.

Adding Groups

1 Click *Users/Groups - Local Groups* in Settings. Click *Create Group*.

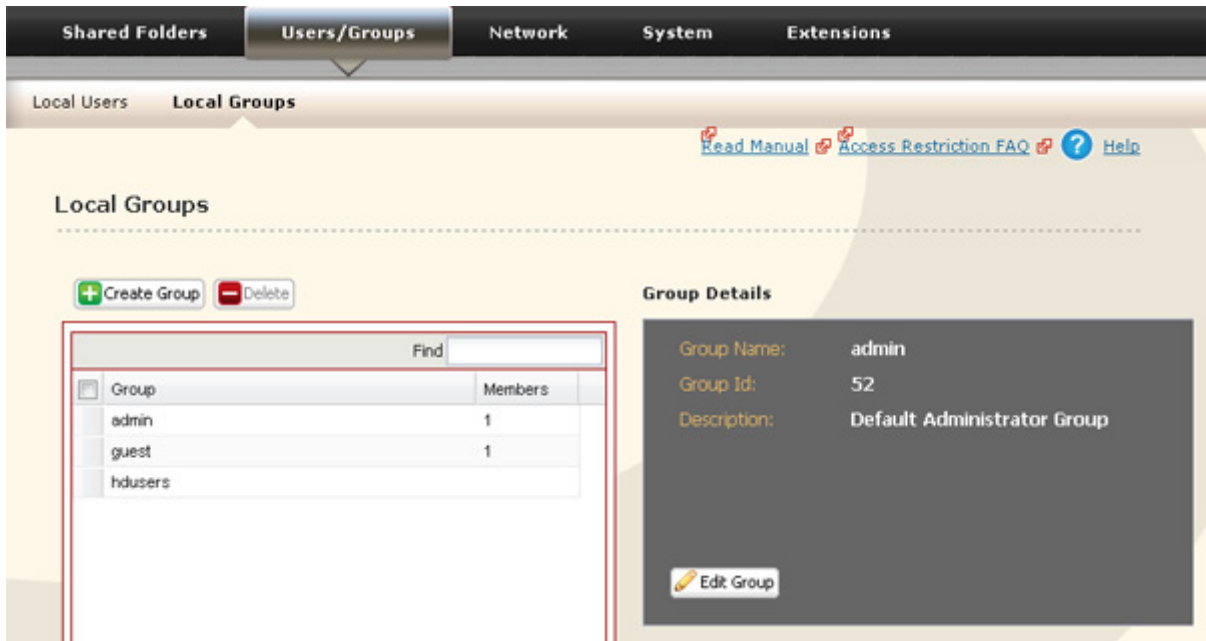

2 Enter group name and description. Select users who join a group, click *Add*. Click *Save*.

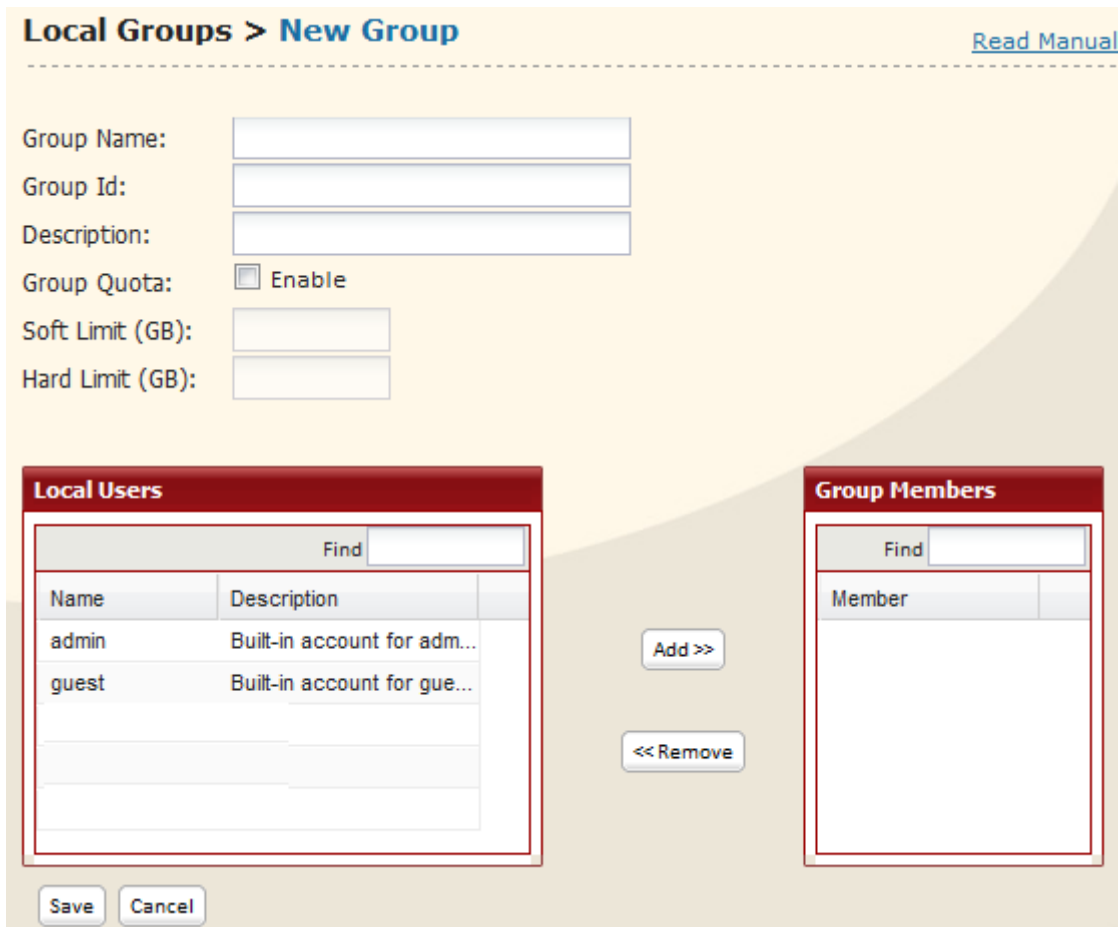

Notes:

- Group names can contain up to 20 bytes(UTF-8). Do not use multibyte characters. Alphanumeric characters, hyphens (-), underscores (_), and periods (.) may be used. Do not use a symbol as the first character.

- Group descriptions can contain up to 75 bytes(UTF-8). Alphanumeric characters, multibyte characters, hyphens, underscores (_), and spaces may be used. Do not use space as the first character.
- You may register up to 300 groups with the TeraStation.
- Repetitive deletions and additions of groups may cause the quota feature to not work properly. Even though the data is copied by the backup function of the TeraStation, the quota feature may not work properly if a user ID/group ID is duplicated. In such a case, use a username/group name of an unused user ID or group ID.
- If the group ID is left blank, a group ID will be automatically assigned. When using the quota feature, use numbers between 1000 and 1999 to set a group ID manually. Make sure that a user ID does not duplicate to other users.
- To set a quota for a group, check *Enable* for "Group Quota", and enter the maximum disk space allotted in GB. Refer to the "Disk Quotas" section in chapter 9.

Access Restrictions

Setting Access Restrictions for Users/Groups

The TeraStation allows you to specify which groups and users can access specific shared folders.

- 1 Register users and groups to the TeraStation as described in the previous sections.
- 2 In Settings, click *Shared Folders - Folder Setup*. Click the shared folder you want to set access restrictions for.

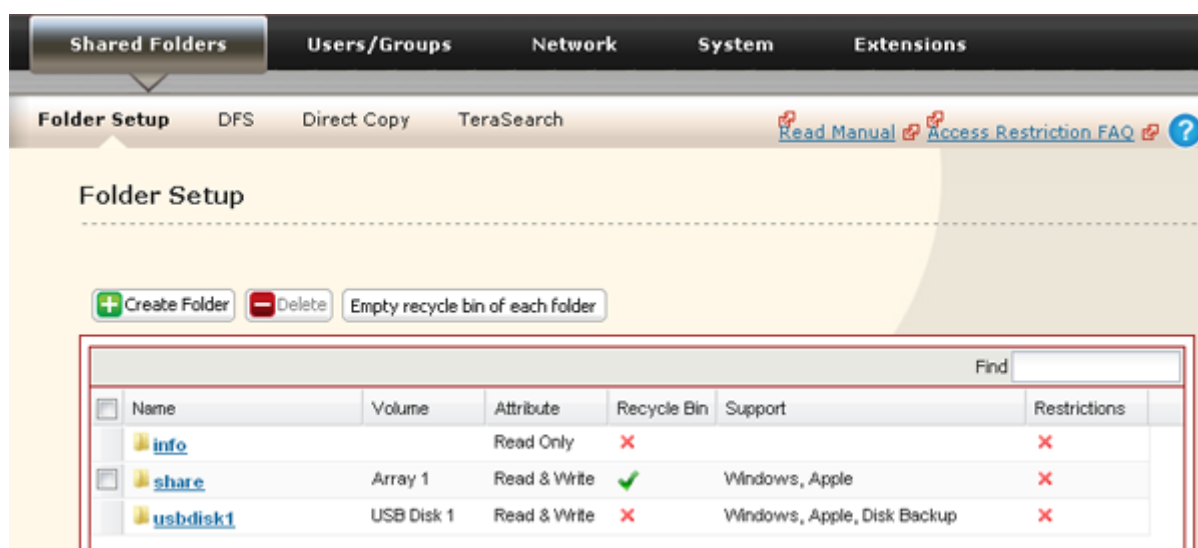

3 Click *Access Restrictions*.

Shared Folders > share

Name:

Description:

Volume: Array 1

Shared Folder Attributes: Read Only Read & Write

Recycle Bin: Enable Disable

Shared Folder Support: Windows Apple Ftp Disk Backup SFTP

Folder Mode (SMB Only): Hide Share

Remote backup password:

Offline Files: ▼

TeraSearch: Include folder in search indexing

Access Restrictions

4 Click *Add*.

Local Users [Close]

Find

- Local Users ▲
- admin
- guest
- john

Note: The procedure described here shows an example of how to set the access restrictions for local users. To set the access restrictions on local groups bases, click *Local Groups - Add*.

5 Check users or groups that you want to allow to access to the share. Click *Add*.

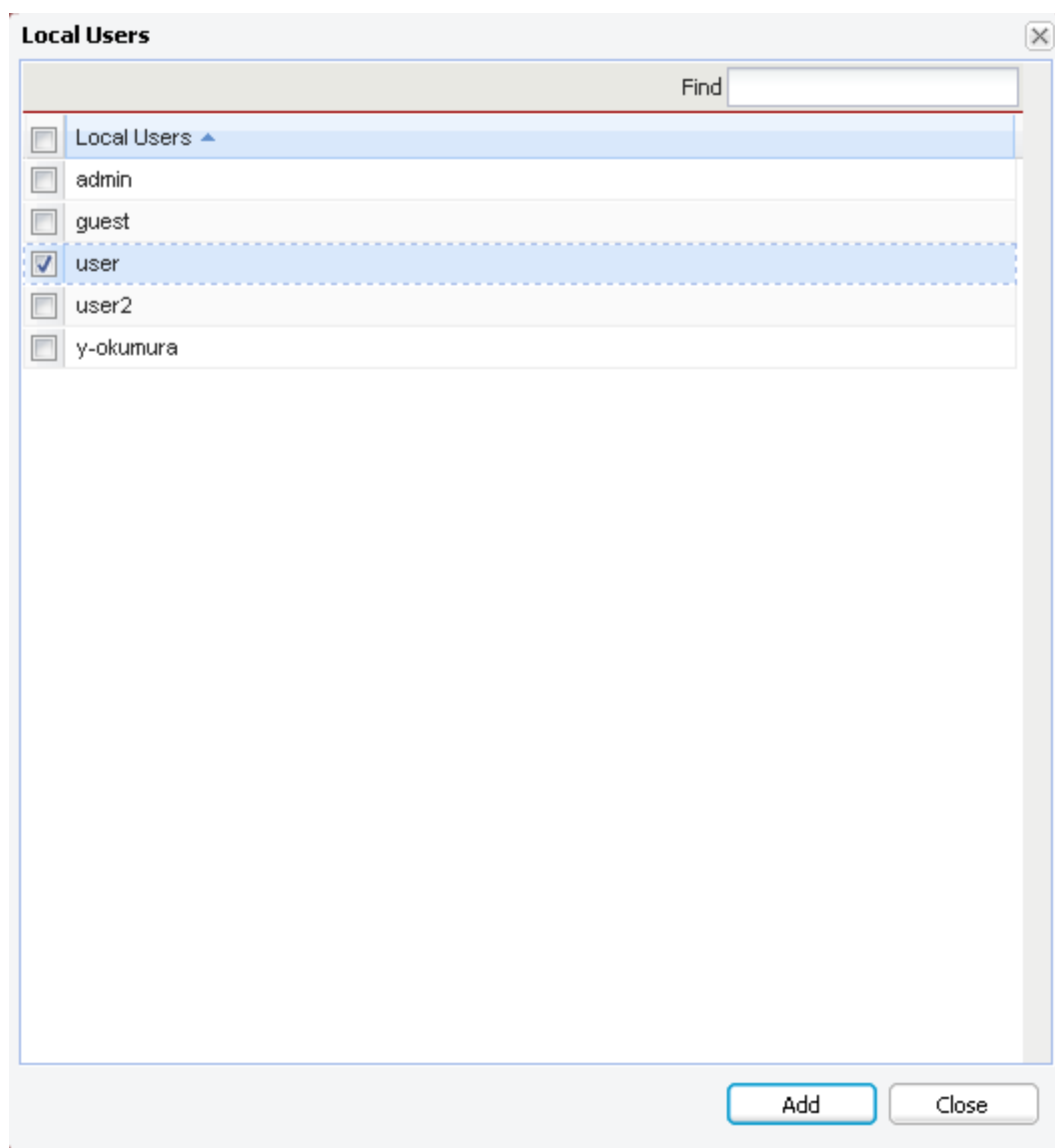

6 Select the level of privilege for the user or group you added.

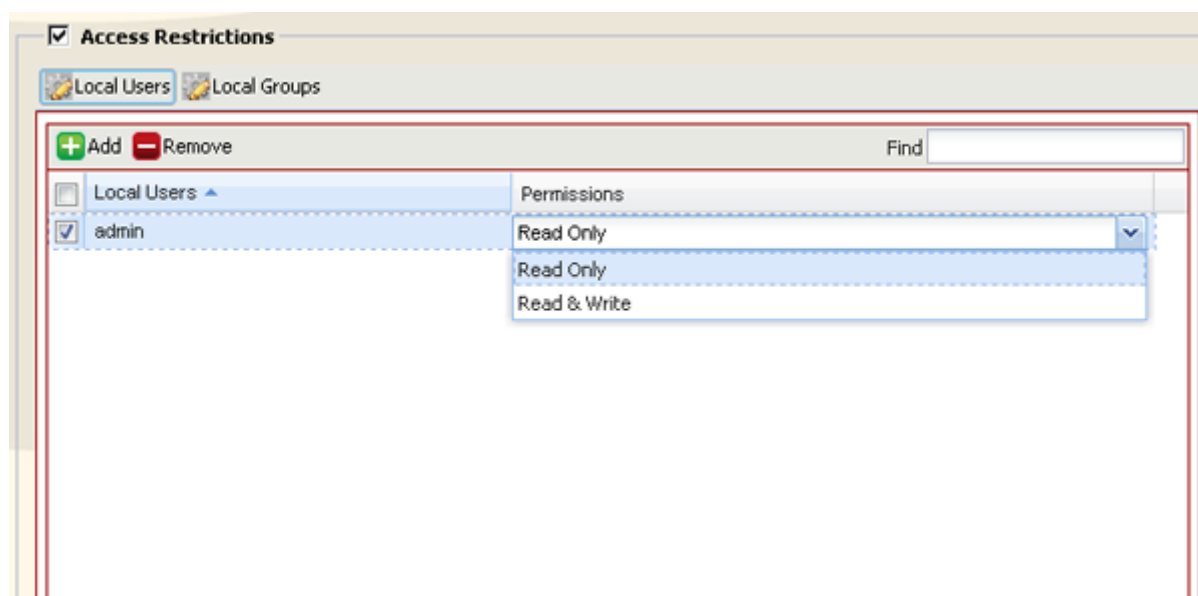

7 Click *Save*.

You have completed configuring access restrictions.

Notes:

- If you log on from a Microsoft Network Domain, you can set the access restrictions with the usernames/group names which are registered on the domain.
- If a specific user is assigned both read only and read & write, they will have read only" access. The most restrictive access is always used.

Access Restrictions on NT Domain

The TeraStation can download users, groups, and passwords from an NT domain server. This procedure is recommended for system administrators only.

1 Create an account on the domain controller for the TeraStation.

Note: If there is an option to "Accept accounts for computers with Windows 2000 or earlier", then select it.

2 Click *Network - Workgroup/Domain - Modify Settings* in Settings.

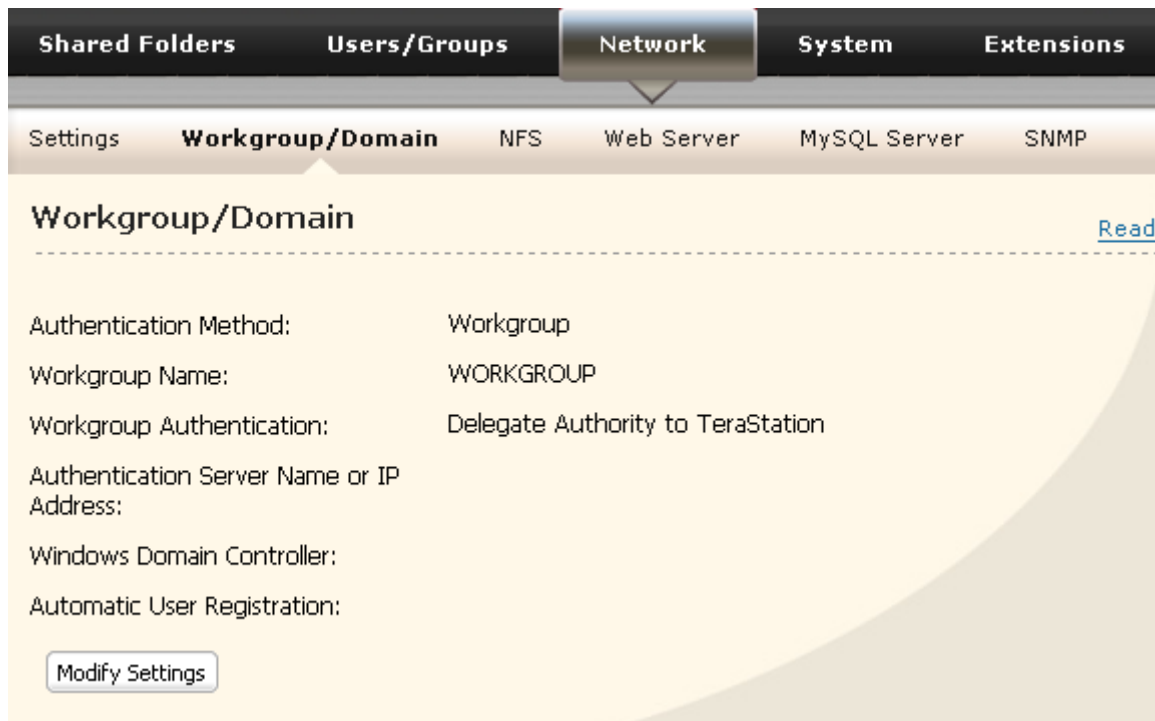

- 3** Select *NT Domain* and enter NT domain name, NT domain controller name, administrator name, administrator password, and WINS server IP address (optional). Click *Save*.

Workgroup/Domain [Read Ma](#)

Authentication Method Workgroup NT Domain Active Directory

NT Domain Name:

NT Domain Controller Name:

Administrator Name:

Administrator Password:

WINS Server IP Address:

- 4** Follow the instructions in the previous section to add access restrictions to the domain.

Notes:

- You can enter up to 23 bytes(UTF-8) for NT domain name. Alphanumeric characters, multibyte characters, hyphens (-), underscores (_), and periods (.) may be used. Do not use a symbol as the first character.
- You can enter up to 63 bytes(UTF-8) for NT domain controller name. Do not use multibyte characters. Alphanumeric characters, hyphens (-), and underscores (_) may be used. Do not use a symbol as the first character.

Notes:

- If you change the TeraStation's name, you will no longer be able to use domain users and groups or access restrictions. Rejoin the domain.
- If a domain username contains more than 20 bytes, the TeraStation truncates it to 20 bytes.
- The TeraStation only downloads the first 1000 users or the first 1000 groups from a domain controller.
- If you operate TeraStation as a member server of NT Domain or Active Directory domain, you cannot connect as a guest user via AFP.
- When you change the user or group settings on the domain controller, these changes may not take effects immediately on TeraStation. If you need to reflect changes on the domain controller immediately, reboot TeraStation.
- If your TeraStation is a member server in NT Domain or Active Directory domain and you change the Authentication Method to *Workgroup* in *Network - Workgroup/Domain - Modify Settings* on Settings, the computer account on the domain controller will not be deleted automatically.
- If it has joined a domain network, you cannot connect to the TeraStation via FTP.

Access Restrictions on Active Directory

The TeraStation can download users, groups, and passwords from an Active Directory domain server. This procedure is recommended for system administrators only.

1 Click *Network - Workgroup/Domain - Modify Settings* in Settings.

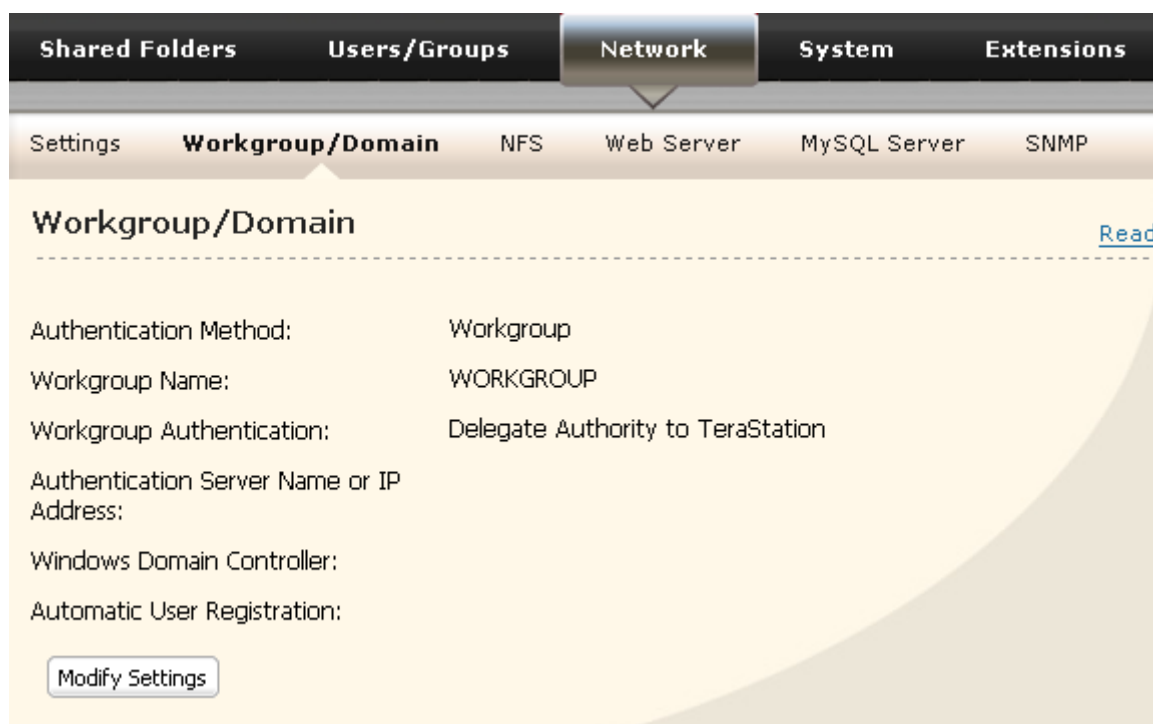

2 Select *Active Directory* and enter Active Directory domain name (NetBIOS name), Active Directory domain name (DNS/Realm name), Active Directory domain controller name, administrator name, administrator password, and WINS server IP address (optional). Click *Save*.

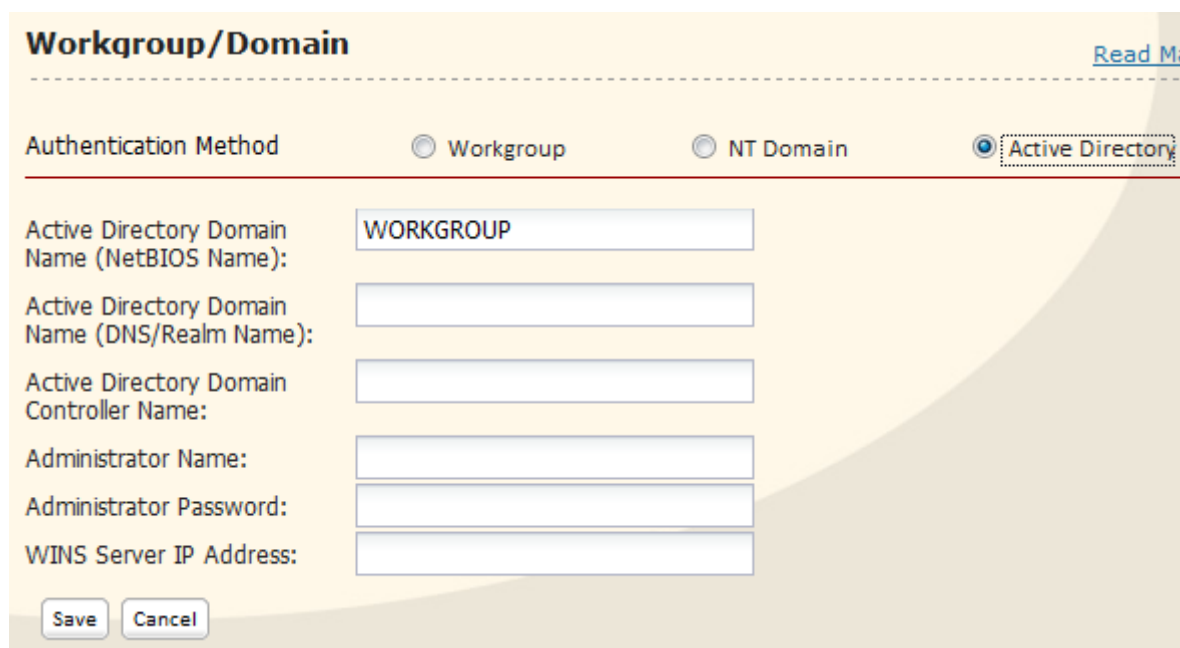

3 Follow the instructions in chapter 7 to add access restrictions to domain users or groups.

You have completed the settings for this feature.

Restrictions When Administrating in Active Directory Domain

- When you have the TeraStation joined to an Active Directory domain, you must specify the DNS server which can resolve names for Active Directory domain.
- After building an Active Directory domain, the administrator's password which is needed to join the Active Directory domain must be changed at least once, or joining the Active Directory domain will fail.

- Active Directory domain's DNS name and NetBIOS name must be identical.
- If there are more than 5 minutes differences between the TeraStation's clock and the domain controller's clock, joining the domain or authenticating domain user or group may fail.

Access Restrictions through Delegate Authority to External SMB Server

To permit access to the TeraStation by administrating all user accounts and passwords together using a delegate server, follow procedures below. This is recommended for network administrators only.

Notes:

For Windows 8, Windows 7, Windows Vista, Windows Server 2003, or Windows Server 2008 Users:

When setting Access Restrictions via external SMB Server, you need to change the security setting in Windows.

You can download the File Sharing Security Level Change Tool from the Buffalo website.

Open the File Sharing Security Level Change Tool, then select *Change security level* to change the security level (when changing back again, select *Recover default security level*).

During the initial setup, the message, "Change security level. Will you continue?" is displayed. Click *Yes* and follow the instructions on the screen to restart your PC .

Note: Clicking *Yes* on the message which is displayed when applying changing external SMB server settings will convert all local users registered on the TeraStation to external SMB server users. You must set the local user password again after resetting the external SMB server.

1 In Settings, click *Network - Workgroup/Domain - Modify Settings*.

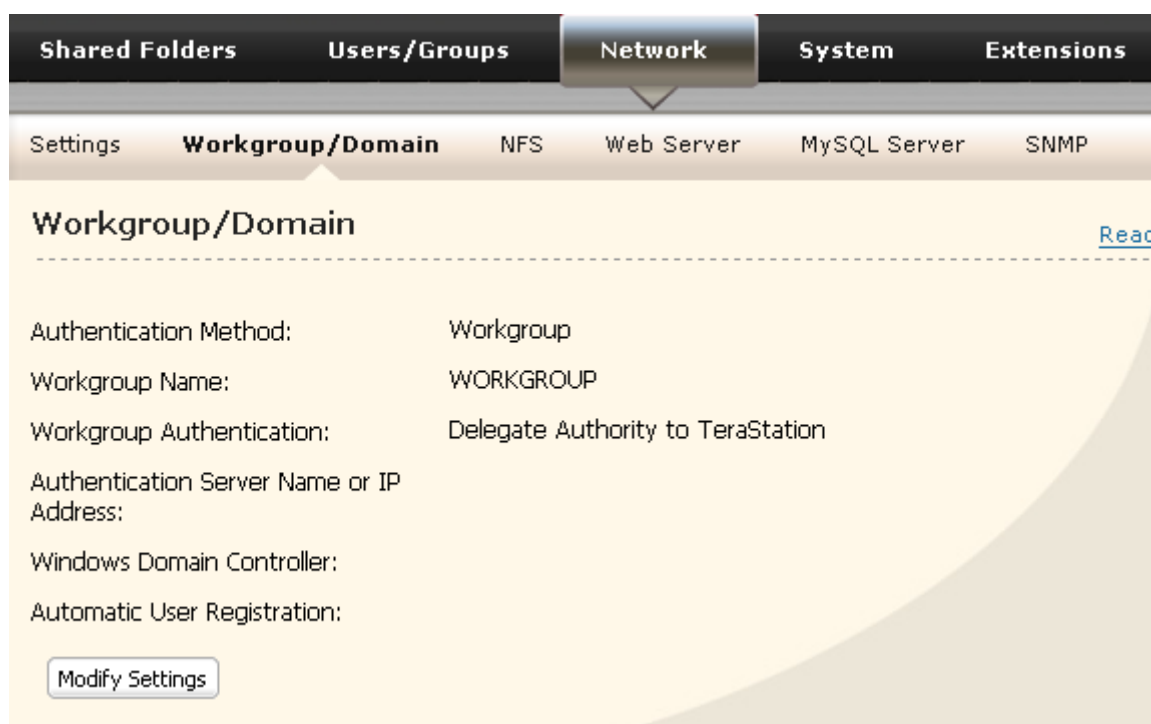

2 Select *Workgroup - Delegate Authority to External SMB Server*.

Workgroup/Domain

Authentication Method Workgroup NT Domain Active Directory

Workgroup Name:

WINS Server IP Address:

For Workgroup Authentication

Delegate Authority to LinkStation
 Delegate Authority to External SMB Server

Note: Even if you will use this unit in a domain environment, select *Workgroup*.

3 Click *Automatic User Registration*. Check *Enable Authentication Shared Folder*. If using Windows domain controller, check *Use Windows Domain Controller as Authentication Server*. Enter authentication server name or IP address and an authentication share folder name in "Enable Authentication Shared Folder" field. Click *Save*.

For Workgroup Authentication

Delegate Authority to LinkStation
 Delegate Authority to External SMB Server

Authentication Server Name or IP Address:

Use Windows Domain Controller as Authentication Server
 Automatic User Registration

Enable Authentication Shared Folder

Note: If you will be connecting using AFP and FTP, entering an IP address for the authentication server is recommended.

Notes:

- Match the Workgroup name of this product and the Windows domain controller's domain name if you would like to specify the Windows domain controller as an external authentication server.
- You can enter up to 23 bytes(UTF-8) for workgroup name. Alphanumeric characters, multibyte characters, hyphens (-), underscores(_), and periods (.) may be used. Do not use a symbol as the first character.

4 An authentication shared folder is created on the TeraStation. When a user who is registered to the specified external server opens the authentication shared folder, it will be automatically registered as a TeraStation user (you can directly register users).

Notes:

- A user who is automatically registered will belong to the "hdusers" group. They can be set to belong to any group from the group settings.
- Access restrictions to shared folders can be set for the username obtained.
- Username registered will be displayed when clicking *Users/Groups - External Users*. To delete a user that automatically registered, select the user and click *Delete External Users*.

- When connecting using AFP and FTP, always use an IP address. Authentication may fail if a server name is used.
- Enter the IP address when specifying a server in a different subnet.
- AFP and FTP connections do not allow obtaining user information by delegating authority to external SMB server.
- Automatic user registration may not work with OS X 10.8 (or later) the first time. If this occurs, try rebooting the TeraStation and access the authentication shared folder again.

5 Follow the instructions in chapter 7 to add access restrictions to external users or groups.

You have completed the settings for the authentication server.

Note: If settings for delegating authority to the external SMB server are changed, you may need to restart your computer before accessing shared folders via SMB connection.

Restrictions When Administrating Delegate Authority Option

- If you cannot access the TeraStation while logged into Windows using the account information registered to the authentication server, you cannot access shared folders on the TeraStation or set access restrictions.
- If you use the delegate authority option, you cannot connect as a guest user via AFP.
- If you use the delegate authority option, you cannot connect as a anonymous user via FTP.

Chapter 8 Managing your TeraStation

Name, Date and Time

Configure the TeraStation's hostname, date, or time as follows:

- 1 In Settings, navigate to *Modify Settings* in *System - Settings - Name*.

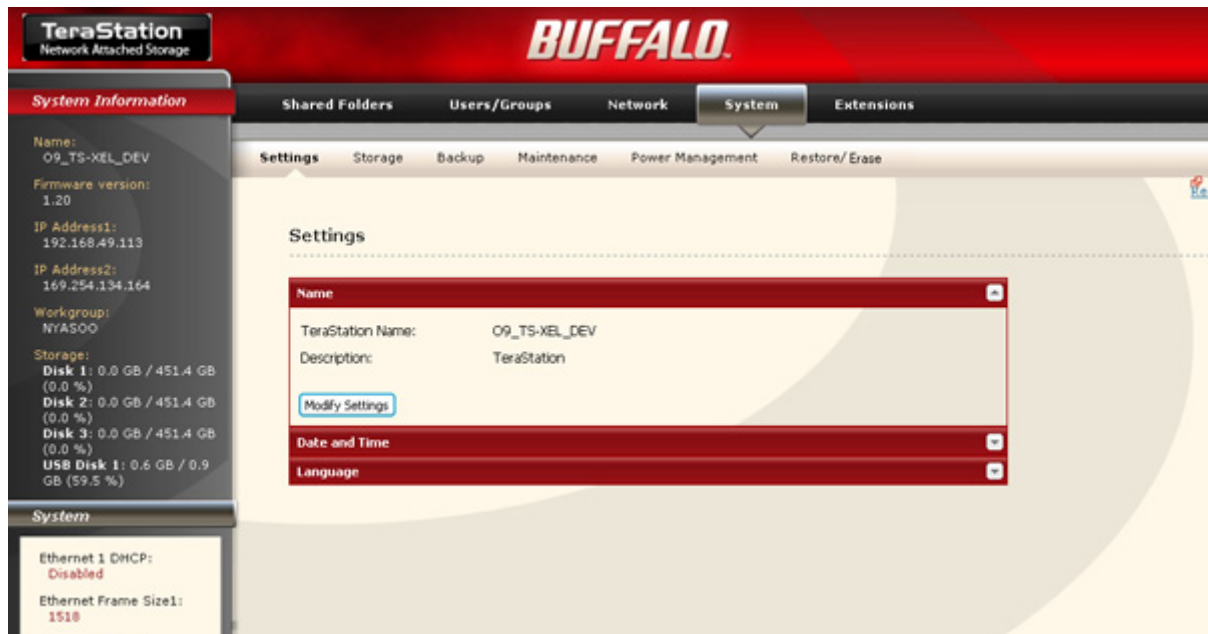

- 2 Enter TeraStation name and description and click *Save*.

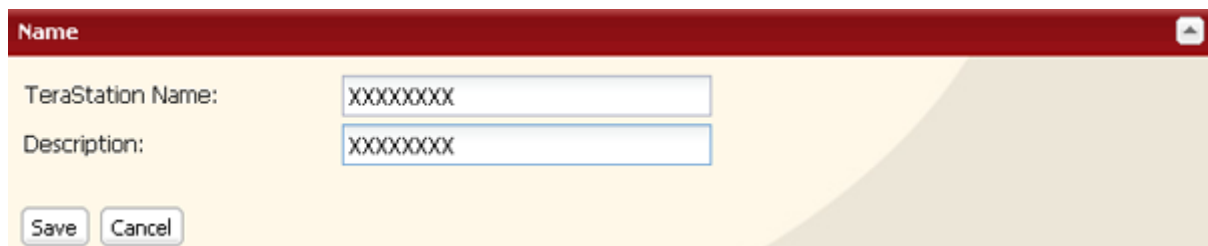

3 In Settings, navigate to *Modify Settings* in *System - Settings - Date and Time*.



4 Select date and time, then click *Save*.

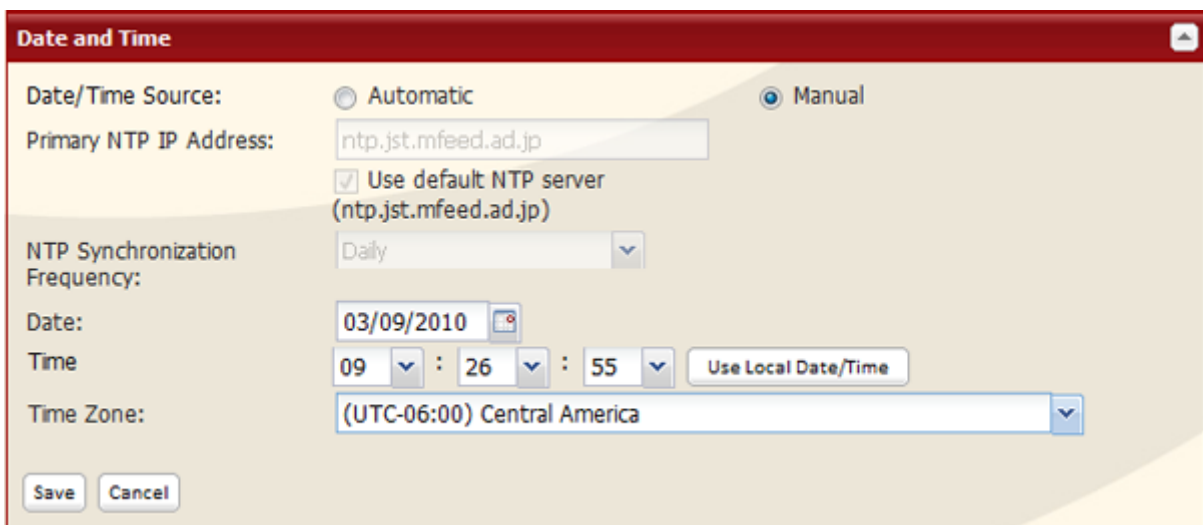

Click *Use Local Date/Time* to use your computer's time settings for the TeraStation. By default, the TeraStation adjusts its clock automatically by using an NTP server.

NTP

NTP may not be usable in some networks.

The default NTP server (ntp.jst.mfeed.ad.jp) belongs to Internet Multi Feed Inc. For more information, visit www.jst.mfeed.ad.jp.

Use NTP at your own risk. Buffalo is not responsible for any loss or damage caused by using of this service, stopping the service, or missing service.

You've completed hostname and time settings for the TeraStation.

Note: The TeraStation's internal clock may run at a slightly different speed from other clocks on you network, and over a long period of time your network devices may show different times. If clocks on your network vary by more than 5 minutes it may cause unexpected behavior. For best results, keep all clocks on the network set to the same time by adjusting them regularly, or use an NTP server to correct them all automatically.

RAID Scanning

RAID scanning allows regular scans of your RAID arrays to be configured to run automatically. Errors will be fixed as they are found if possible.

For best results, schedule regular RAID scans if you use RAID arrays in your TeraStation.

1 In Settings, click *System - Storage - RAID Scanning - Modify Settings*.

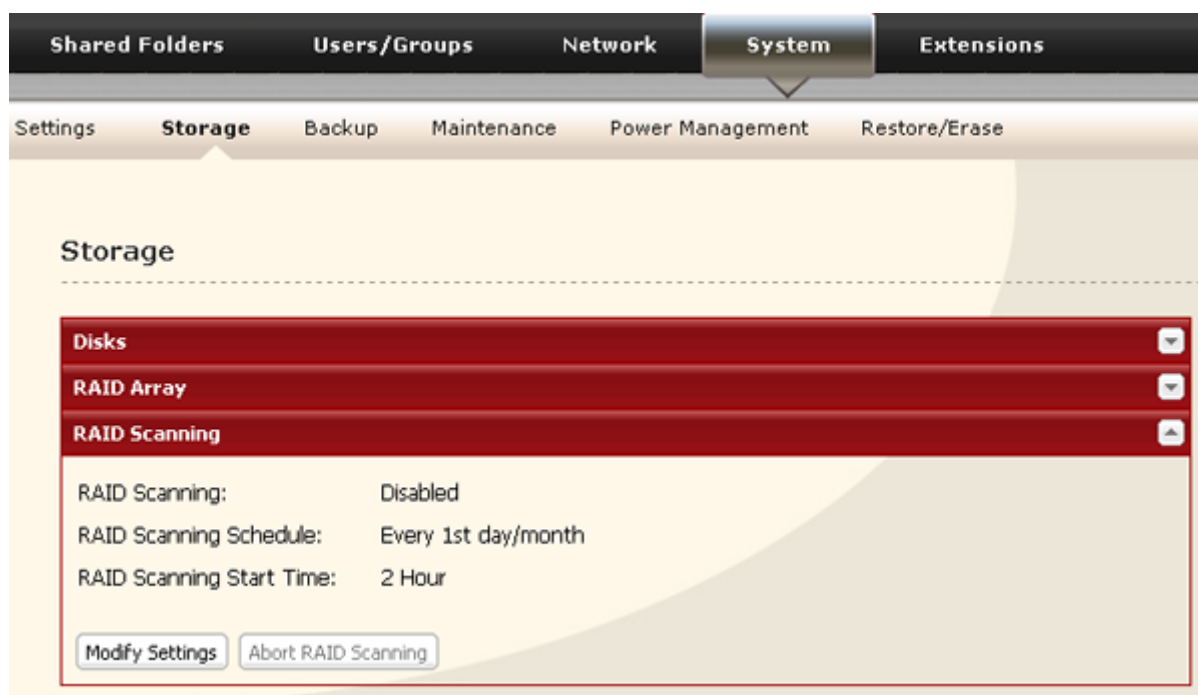

2 Click *Enable*. Select your desired schedule for scanning schedule, then click *Save*.

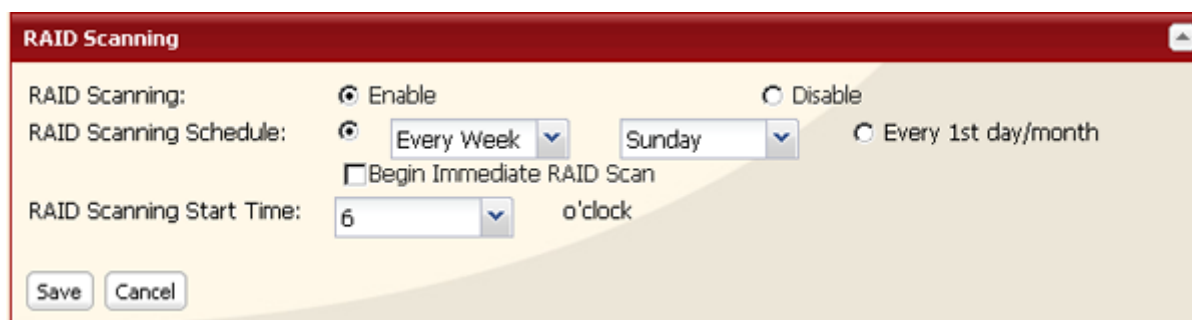

Notes:

- Select *Shut Down* to have the TeraStation shut down automatically when an error is detected.
- If *Begin Immediate RAID Scan* is selected, then a RAID scan will begin immediately.
- To stop a RAID scan, click *Abort RAID Scanning*.

You have configured RAID scan.

Disk Check

A disk check tests the data on a drive in the TeraStation or connected via USB. Errors are fixed automatically. A disk check may run for more than ten hours. Shared folders cannot be accessed during the disk check. Do not turn off power to the TeraStation during the disk check.

If the power mode switch is set to auto, then the TeraStation will turn off when the disk check is finished.

Run a disk check as follows:

1 In Settings, navigate to *System - Storage - Disks*.

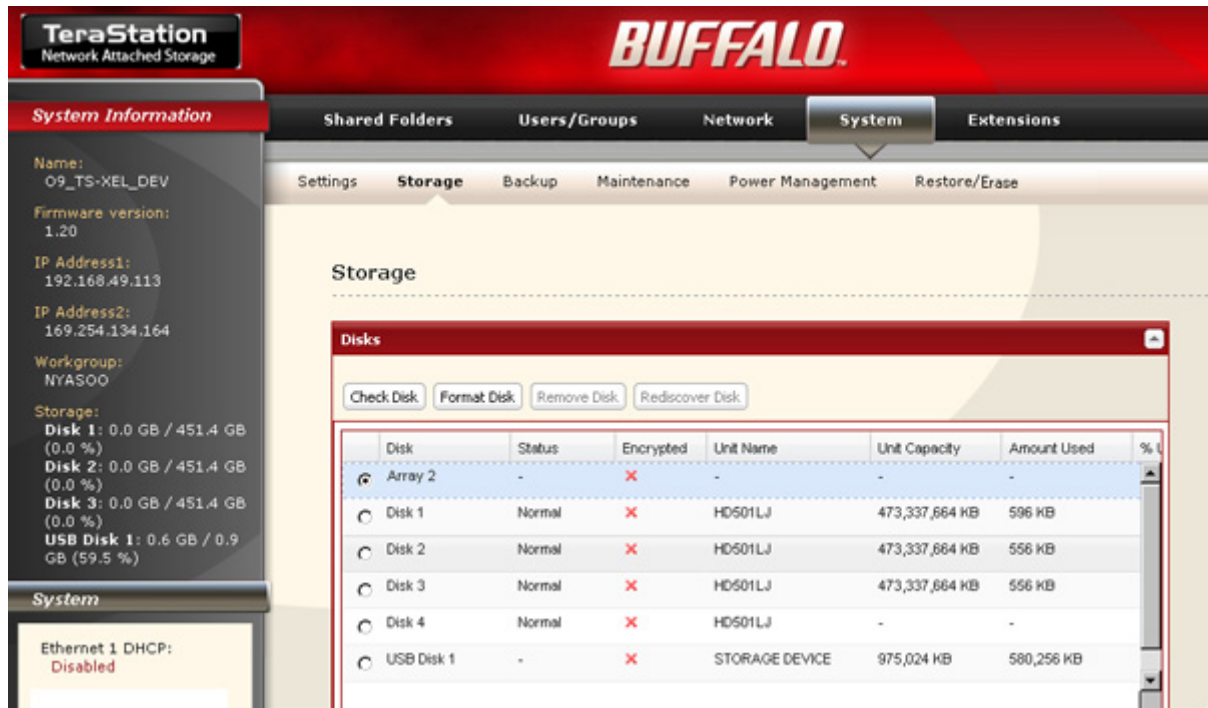

2 Select the hard drive to test and click *Check Disk*.

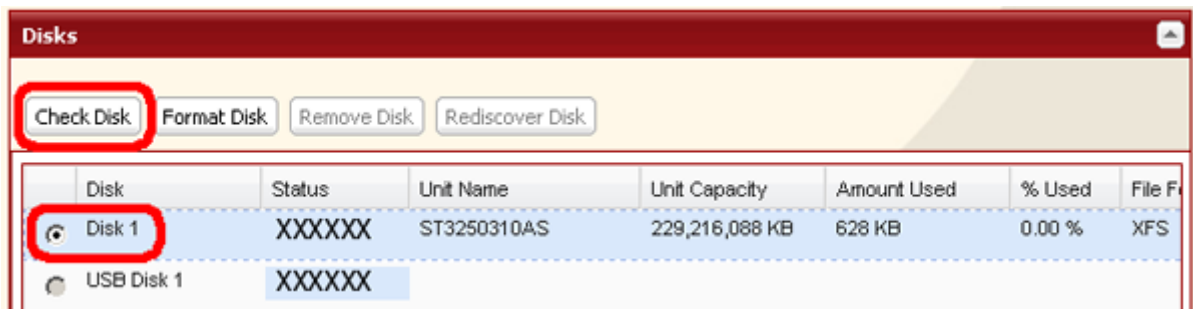

3 Click *Check*.

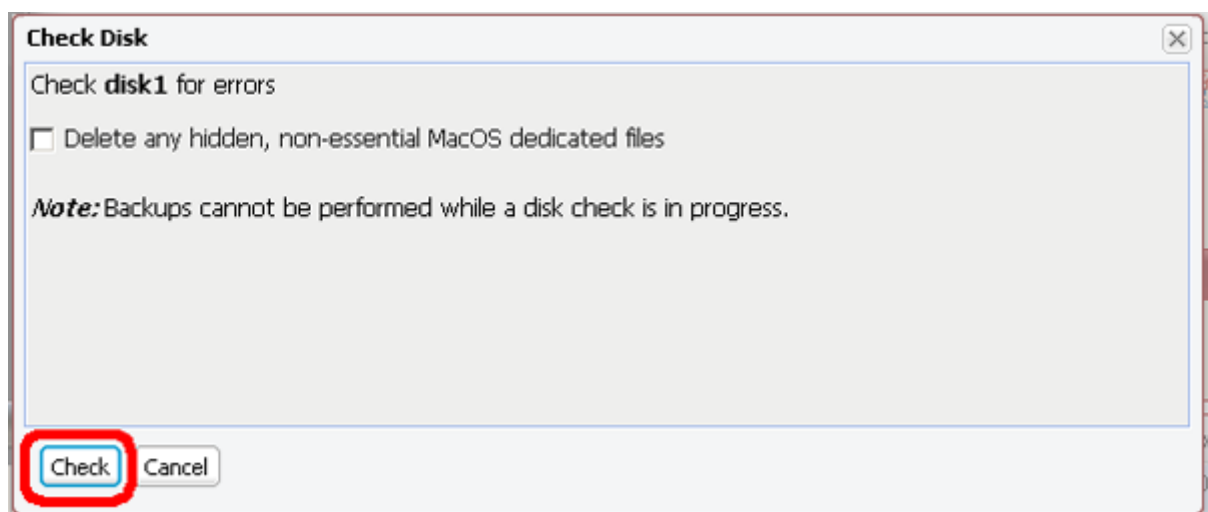

The status LED on the front of the TeraStation will flash during the disk check. The TeraStation's shared folders cannot be accessed until the disk check is complete.

Note: If a power outage disconnects the TeraStation in the middle of a disk check, then you may not be able to access shares on the TeraStation from Mac OS. This is because the database created by Mac OS is damaged. To

resolve, navigate to *System - Storage - Check Disk* and check Delete any hidden, non-essential Mac OS dedicated files. Rerun the disk check when done.

Encrypt Hard Drives on the TeraStation

If encryption is selected during a reformat of a drive or array, it will be encrypted with 128 bit AES. The drive or array will then be only readable from that specific TeraStation. To unencrypt the hard drive, uncheck Encrypt and format it again.

Notes:

- Performance will be slower if an array or drive is encrypted.
- USB drives cannot be encrypted.
- Data recovery services will probably not be able to recover data from an encrypted drive or array.

Formatting Drives

Notes:

- Formatting deletes all data from a hard drive. Be careful! Back up any important data on a drive before formatting it. It will take a several minutes to format a hard drive.
- Shared folders cannot be accessed during formatting.
- Do not turn off the power switch or disconnect power while formatting a hard drive.
- If the power mode switch is set to auto, then the TeraStation will turn off when the format is finished.
- To erase all data on a disk, choose *System - Restore/Erase* instead of formatting.

1 In Settings, navigate to *System - Storage - Disks*.

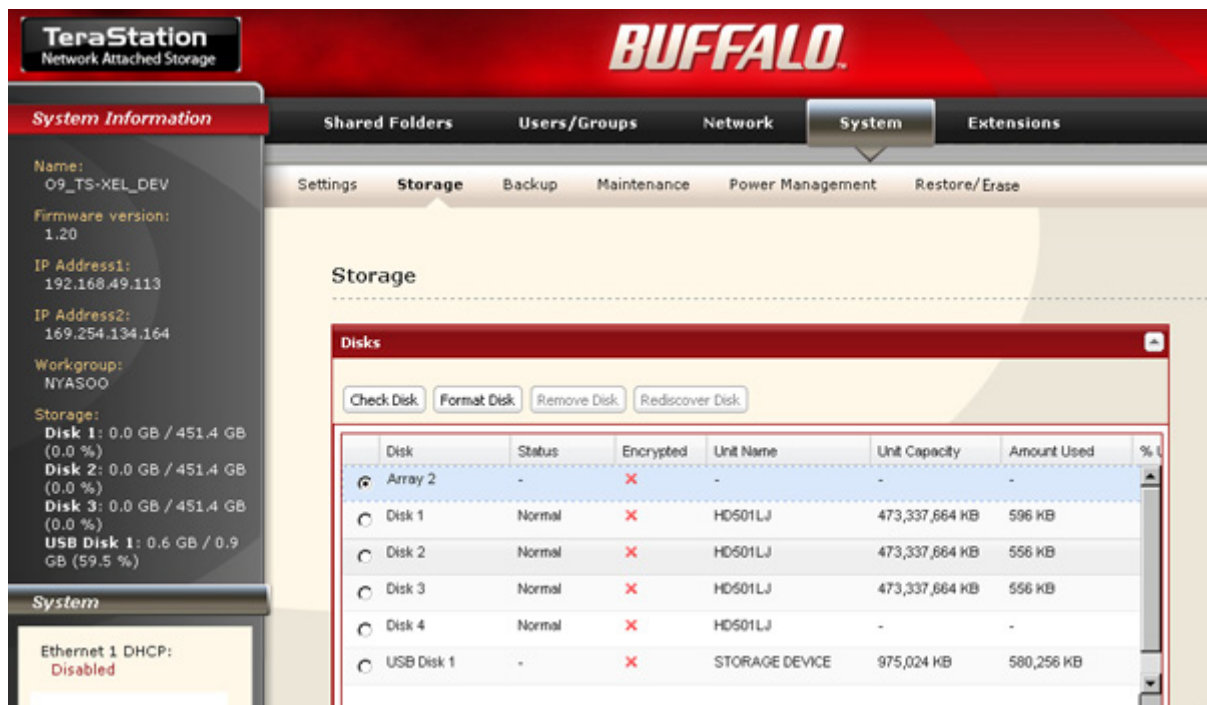

2 Select the drive to format and click *Format Disk*.

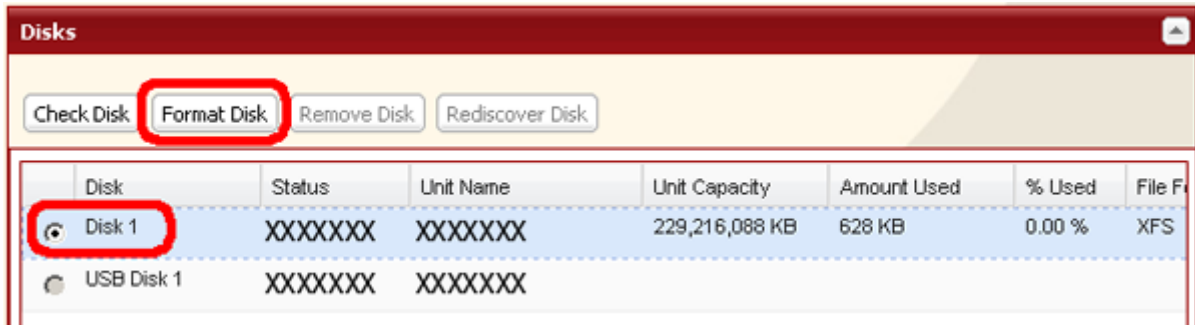

3 Select a file system and click *Format*.

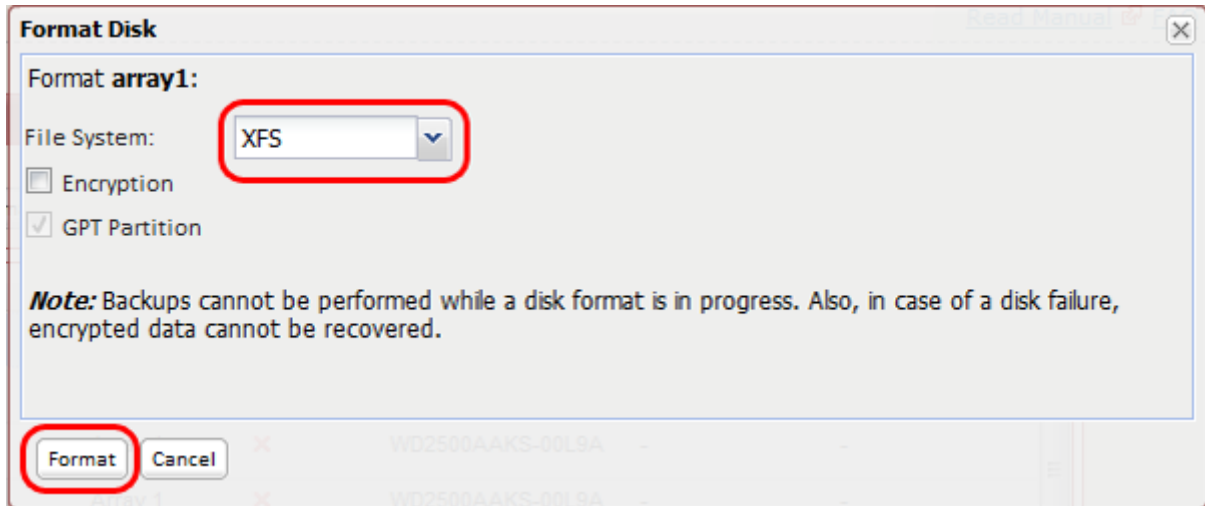

Notes:

- If you check *Encryption*, the drive will be encrypted with 128 bit AES. It will be normally accessible in the TeraStation, but if removed, it will not be accessible from other devices. If encryption is enabled, data recovery services will not be able to recover data from a damaged disk. To unencrypt the drive, uncheck *Encryption* and format it again.
- Refer to the "System" section in chapter 12 for more on format type.

4 The "Confirm Operation" screen will open. Enter the confirmation number into the confirmation number field within 60 seconds, then click *Apply*.

5 Follow the instructions displayed on the screen.

Notes:

- The time needed to format a hard drive varies based on the hard drive's size and format types (a few seconds to several minutes).
- The info LED on the front of the TeraStation will flash during formatting. The TeraStation's shared folders cannot be accessed until the disk format is complete.
- If the hard drive is an external USB drive, its partitions will be recreated.

Email Notification

Your TeraStation can send you daily email reports. It can also send you an email when settings are changed or an error occurs.

The following contents will be sent via email.

- Sends the status of hard drives at specified time
- Changes to RAID configuration

- Fan error alert
- Hard drive replacement alert
- Notifies when backup jobs are completed
- RAID error alert
- Hard drive read error alert
- Notification of Quota changes or limits

1 In Settings, navigate to *System - Maintenance*.

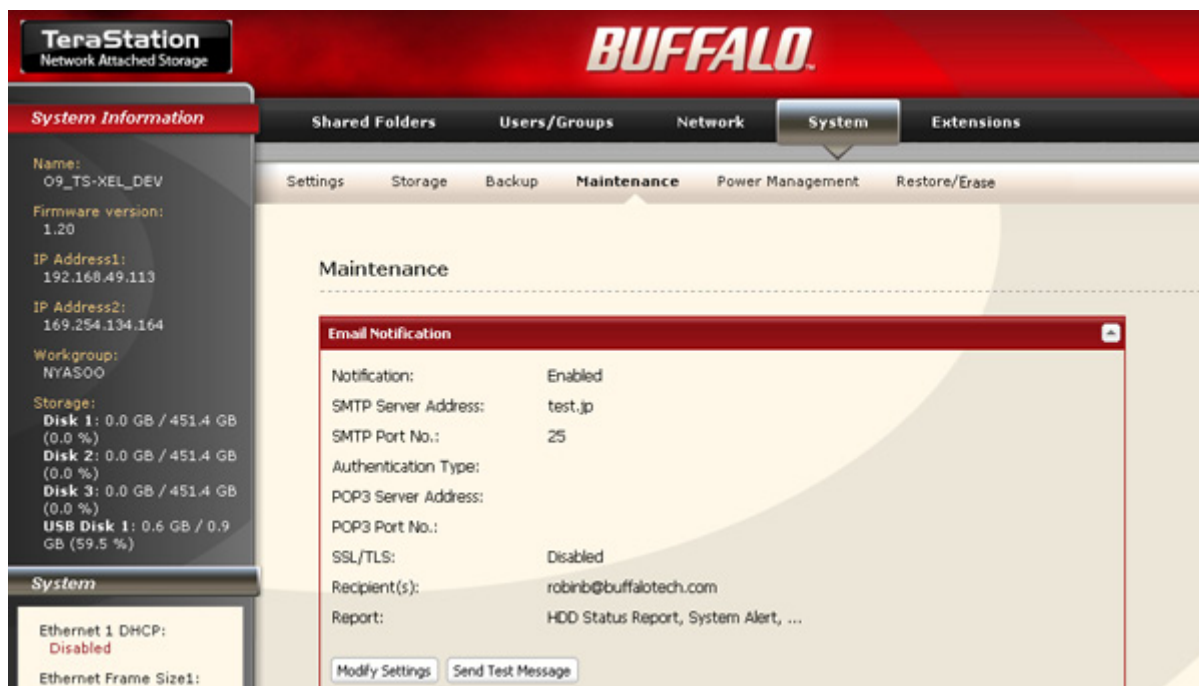

2 Click *Modify Settings* in "Email Notification".

- 3** Click *Enable* to the right of "Notification" and enter SMTP server address, SMTP port number. If using POP before SMTP, enter POP3 server address and POP3 port number. Select authentication type from *Disabled*, *POP before SMTP*, *LOGIN(SMTP-AUTH)*, or *CRAM-MD5(SMTP-AUTH/CRAM-MD5)*.

Email Notification

Notification: Enable Disable

SMTP Server Address:

SMTP Port No.:

Authentication Type:

POP3 Server Address:

POP3 Port No.:

SSL/TLS:

Username:

Password:

Subject:

Recipient(s):

Recipient(s)

Report: HDD Status Report o'clock
 Fan Failure
 Disk Error
 Backup Complete
 Quota Report
 System Alert

- 4** Select *SSL* or *TLS* to use a secured connection, enter username and password, and enter subject for notification email. Enter an email address in "New Email Address" field, then click *Add*. Emails can be sent to up to 5 addresses.

- 5** Select conditions for emails to be sent.

- *HDD Status Report*: Sends the condition of the hard drives at the specified time.
 - *Fan Failure*: Sends when the fan error is recognized.
 - *Disk Error*: Sends when an hard drive error is recognized
 - *Backup Complete*: Sends when the backup is complete.
 - *Quota Report*: Sends when the quota space limitation is exceeded at the time which is specified on HDD status report.
 - *System Alert*: Sends when system is rebooted or shut down, or RAID configuration is changed.
- If you have selected *HDD Status Report* for sending condition, select time to send.

- 6** Click *Save*.

7 Click *Send Test Message* to send a test message.

Notification:	Enabled
SMTP Server Address:	test.jp
SMTP Port No.:	25
Authentication Type:	
POP3 Server Address:	
POP3 Port No.:	
SSL/TLS:	Disabled
Recipient(s):	robinb@buffalotech.com
Report:	HDD Status Report, System Alert, ...

Notes:

The following examples show notification emails for each selection:

- The content of the mail which include the periodical report when *HDD Status Report* is selected
TeraStation Status Report: Periodical Report: Information
TeraStation Information
TeraStation Name: TS-xxxxx
Time Stamp: 2009/03/23 00:00:01
IP Address: 172.16.37.62
Configuration Screen: <http://172.16.37.62/>
Continuous operating time: 13:51:57
- The content of mail which is sent periodically when *Disk Error* is selected
TeraStation Status Report: DISK Error
Notification: Failure: Fail to mount a disk
DISK Error Notification
The error occurred on HDD.
The erroneous disk drive: Disk 1
Disk could not be mounted.
- The content of mail which is sent periodically when *Fan Failure* is selected
TeraStation Status Report: FAN
Error Notification: Failure: FAN stopped.
FAN Error Notification
The FAN has stopped.
The internal temperature is now over the threshold. Shut down the system.
System temperature: 52 °C

UPS Settings

An UPS (Uninterruptible Power Supply) can protect the TeraStation from power outages and brownouts. To use the TeraStation with a UPS, proceed as follows:

- 1** Plug the power cable of the UPS to a wall socket.
- 2** Connect the AC cable of the TeraStation to the UPS.
- 3** Connect the UPS to the TeraStation with a USB or serial connection.

Note: TS-XEL series TeraStations do not have UPS Port.

- 4** Turn on the UPS, then the TeraStation.

5 In Settings, click *System - Power Management - UPS Settings*.

6 Click *Modify Settings*.

7 Configure the desired settings. If your TeraStation is connected directly to the UPS, select *synchronize with UPS connected to this TeraStation*. To have the UPS shut down multiple TeraStations on the same network, select *synchronize with UPS connected to other TeraStation on the network* and enter the IP address of the TeraStation that is connected directly to the UPS in the field below. Click *Save*.

UPS Settings

Synchronization with UPS: synchronize with UPS connected to this TeraStation
 synchronize with UPS connected to other TeraStation on the network
 do not synchronize with UPS

synchronized source
TeraStation IP Address:

UPS Connection Type:

TeraStation behavior When Power failure:
 Shutdown TeraStation after Minutes of Power Failure
 Shutdown TeraStation when UPS Reports 'Battery Low' status.

UPS Behavior After TeraStation has shut down:
 Alive
 Turn Off

UPS Recovery function:
 Enable
 Disable

Notes:

- If the UPS has shut down the TeraStation because of a power outage, make sure that power has been restored before restarting the TeraStation. If the TeraStation is restarted after a shutdown, but power is not available, then the UPS will not shut down the TeraStation a second time even if its battery is running low.
- If the TeraStation is set to use UPS recovery, then the UPS will restart the TeraStation when normal power is restored.

Beep Alerts

You can set the TeraStation to beep when certain errors occur.

1 In Settings, select *System - Maintenance - Alert Sound Settings - Modify Settings*.

- 2 Select the conditions to beep the alert from Overheating, Disk Error, Fan Error, or UPS power Error. Click *Save*.



You've now configured alerts.

LCD Display Settings

You may configure the LEDs and LCD display on the front of the TeraStation here.

- 1 In Settings, select *System - Maintenance - Front Panel Settings - Modify Settings*.
- 2 Configure the desired settings for LCD and LED. Click *Save*.

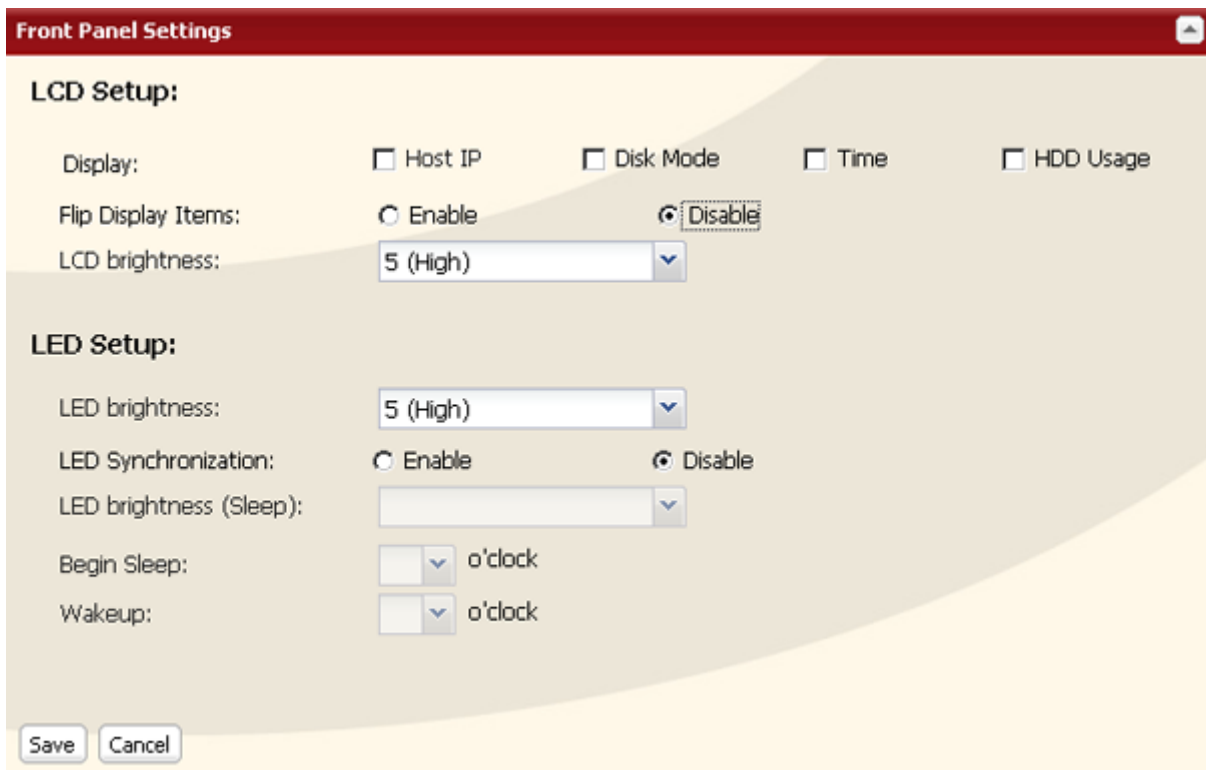

You have completed the settings for the display panel.

Changing the Admin Username and Password

1 In Settings, select *Users/Groups - Local Users*.

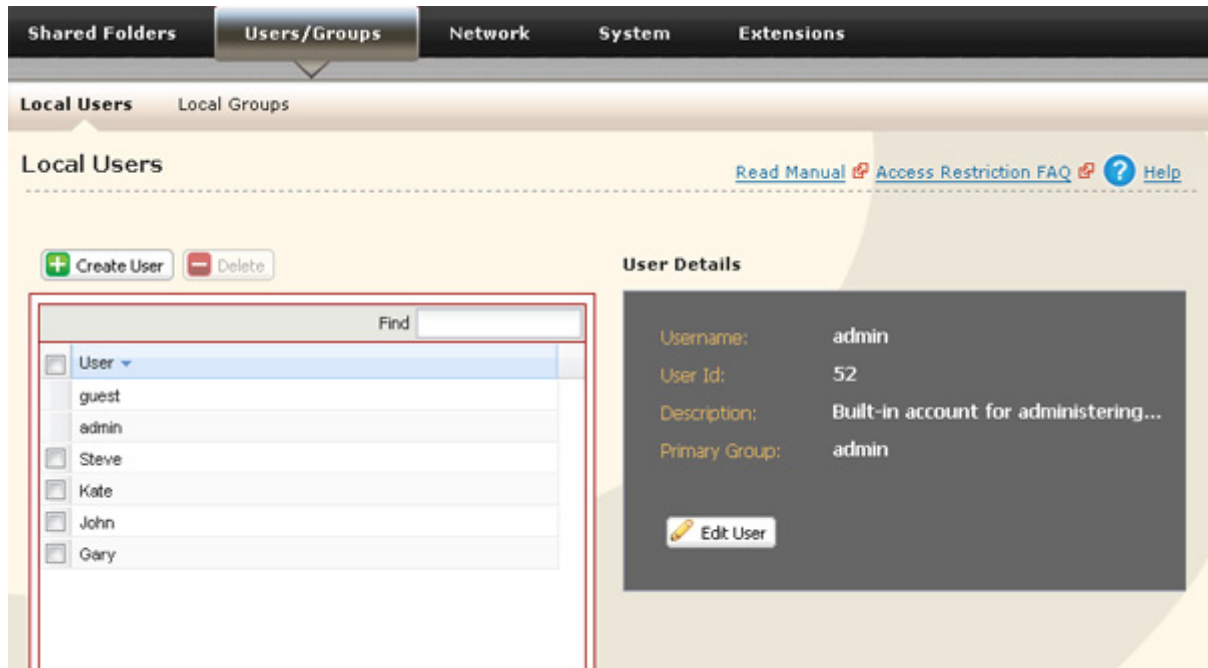

2 Click *admin* from the user list. Click *Edit User*.

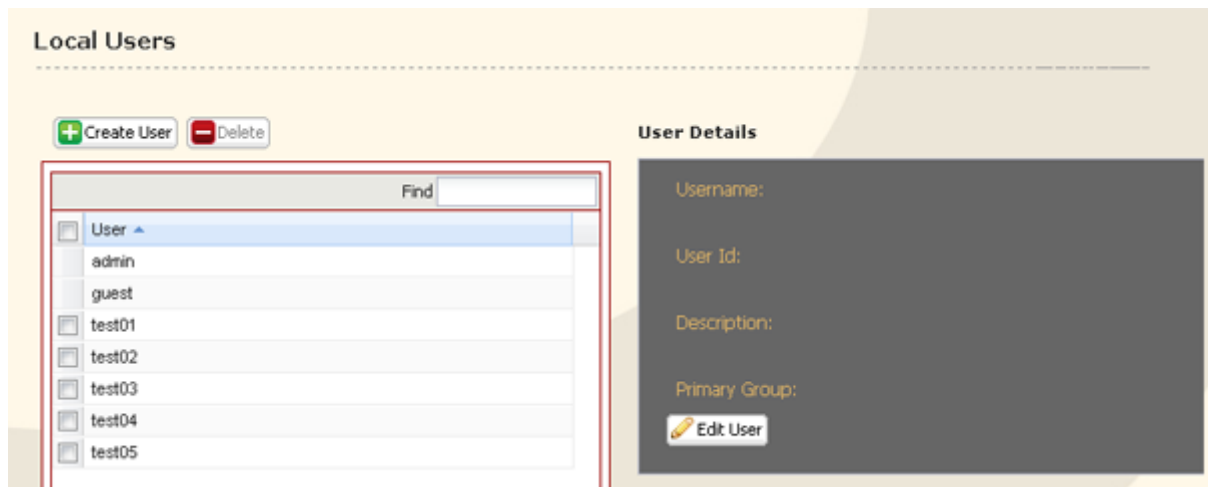

3 Enter username and password. Click *Save*.

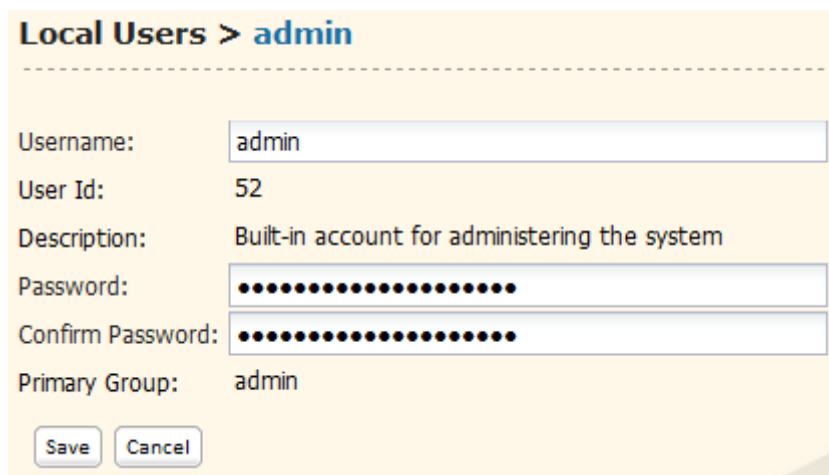

You've now changed the admin password.

Notes:

- Usernames can contain up to 20 bytes(UTF-8). Do not use multibyte characters. Alphanumeric characters, hyphens (-), underscores (_), periods (.), !, #, &, @, \$, *, ^, % may be used. Do not use a symbol as the first character.
- Passwords can contain up to 20 bytes(UTF-8). Do not use multibyte characters. Alphanumeric character and the following characters may be use: - _ @ ! # \$ % & ' () * + , . / ; < > = ? ^ { } | ~ Do not use a symbol except a hyphen (-) as the first character.
- You cannot assign access restrictions to the "admin" account, or use it for WebAccess.

Erase Data on the TeraStation Completely

Data on the hard drive is not completely erased by just performing "Delete" or "Format". If you want to completely delete data from a TeraStation that you are going to donate, give away, or send in for repairs, do the following.

1 In Settings, select *System - Restore/Erase - Erase*.

2 Click *Erase*.

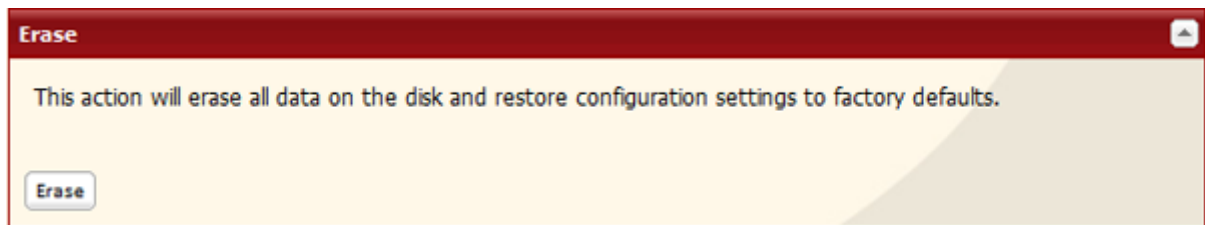

3 The "Confirm Operation" screen will open. Enter the number from the confirmation number field within 60 seconds, then click *Apply*.

4 Follow the instructions displayed on the screen.

Notes:

- This will erase all data on the TeraStation and replace it with zeros. When the process is complete, the TeraStation will be configured as follows:
 - Hard drives in JBOD
 - Shared folders (share 1 - 4 on TS-XL, TS-XEL, and TS-RXL; share 1 and 2 on TS-WXL) on each drive
 - All settings to factory defaults
 - All logs deleted
 - All data deleted
- If you remove a drive and then erase all data on the TeraStation, the LCD display will show the error "HDx Error E22 HDx Can't Mount" where x is the hard drive you removed. You can still use the TeraStation.

Initialization

Restore Factory Defaults

To reset the TeraStation to its factory default settings, power on the unit and hold down the reset button for five seconds.

Location of the reset button varies according to model. You will need to open or remove the drive door to access it. A key for the drive door is included in your TeraStation package.

TS-XL, TS-XEL

Reset Button

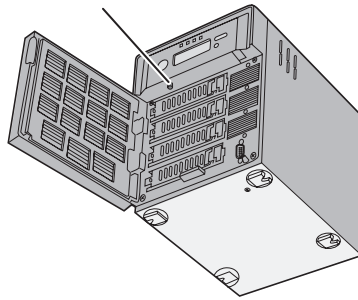

TS-WXL

Reset Button

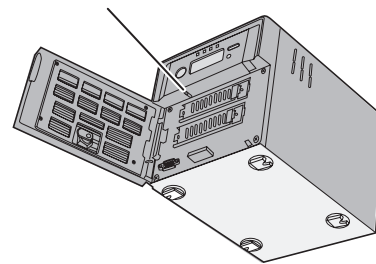

TS-RXL

Reset Button

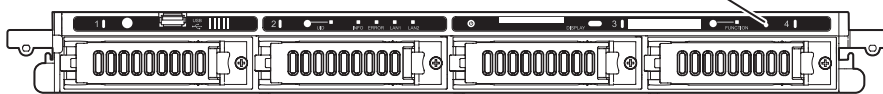

Note: View with the front cover open

To reset the TeraStation to its factory default settings, power on the unit and hold down the reset button for five seconds.

Notes:

- Normally, holding down the reset button initializes settings for IP address, Ethernet frame size, admin username and password, SSL key, port trunking (default is off), and network services except AFP and FTP. The ability to reset the admin username and password may be turned off in Settings. You can also initialize settings from within Settings.
- To disable resetting the admin password from the initialization button, navigate to *System - Restore/Eraser - Restore Factory Defaults - Modify Settings* and select *Keep current admin password*. Click *Save*.
- If you disable resetting the admin password from the reset button, you can no longer configure the TeraStation if you forget the password. Write down your password and keep it in a safe place.

Initialization from Settings

In Settings, you can initialize the following settings, including things that are not initialized from the reset button. TeraStation name, description, NTP settings, workgroup settings, network services, file sharing settings, shared folders settings, USB drive settings, RAID scan, sleep timer, upon restore, restrictions on shared folders, user settings, users and groups, notification settings, synchronization with UPS, backup settings, admin username, admin password, network settings (such as IP address, subnet mask etc.), Time Machine, WebAccess, DFS, Direct Copy, NFS, TeraSearch, alert sound settings, front panel settings, RAID array failure settings, language, syslog, print server, web server, MySQL server, SNMP, antivirus scan

1 In Settings, navigate to *System - Restore/Eraser - Restore Factory Defaults*.

2 Click *Restore TeraStation*.

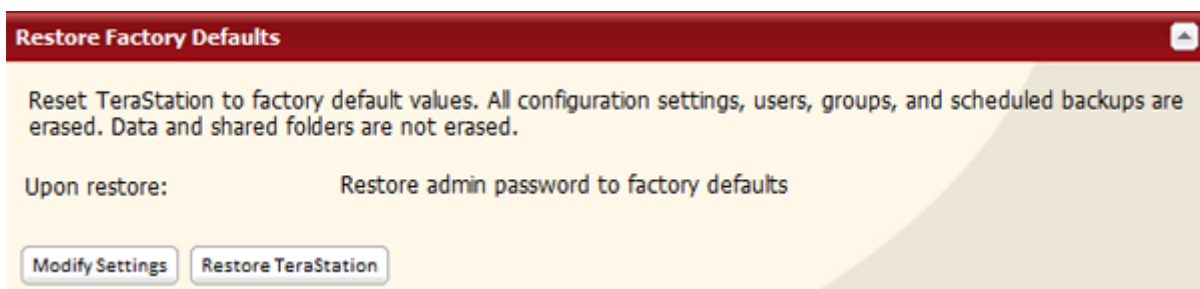



- 3 The "Confirm Operation" screen will open. Enter the number from the confirmation number field within 60 seconds, then click *Apply*.
- 4 Follow the instructions displayed on the screen.

Notes:

- To disable resetting the admin password from the reset button, navigate to *System - Restore/Erase - Restore Factory Defaults - Modify Settings* and select *Keep current admin password*. Click *Save*.
- If you disable resetting the admin password from the reset button, you can no longer configure the TeraStation if you forget the password. Write down your password and keep it in a safe place.

Changing the IP Address

Normally, the TeraStation's IP address is set automatically from a DHCP server on your network. If you prefer, you can set it manually. To change the TeraStation's IP address settings, your computer should be connected to the same router (subnet) as the TeraStation and should be running NAS Navigator2 (included on your TeraNavigator CD).

- 1 Double-click the  icon on the desktop. NAS Navigator2 will start. For Mac OS, click the  icon in the Dock.
- 2 For a PC, right-click your TeraStation and choose *Properties - IP Address*. For a Mac, hold the control key and click your TeraStation's icon, then choose *Configure - IP Address*.
- 3 Uncheck *Use DHCP*. Enter the desired IP address and subnet mask. Click *OK* or *Apply* if you're using a Mac.

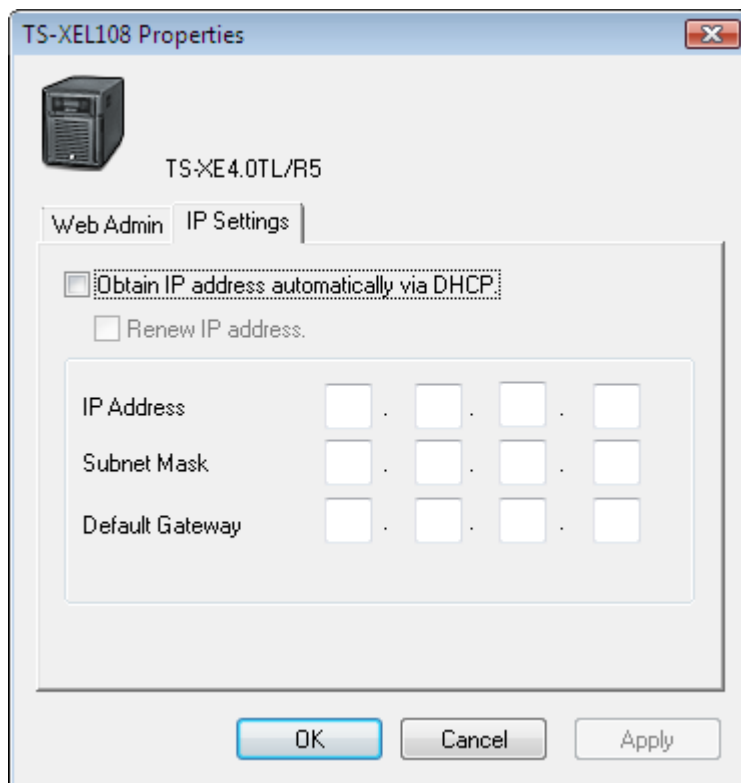

You've configured a static IP address for the TeraStation. To return to using DHCP, reopen the network properties screen and recheck Use DHCP.

Network

Jumbo Frames





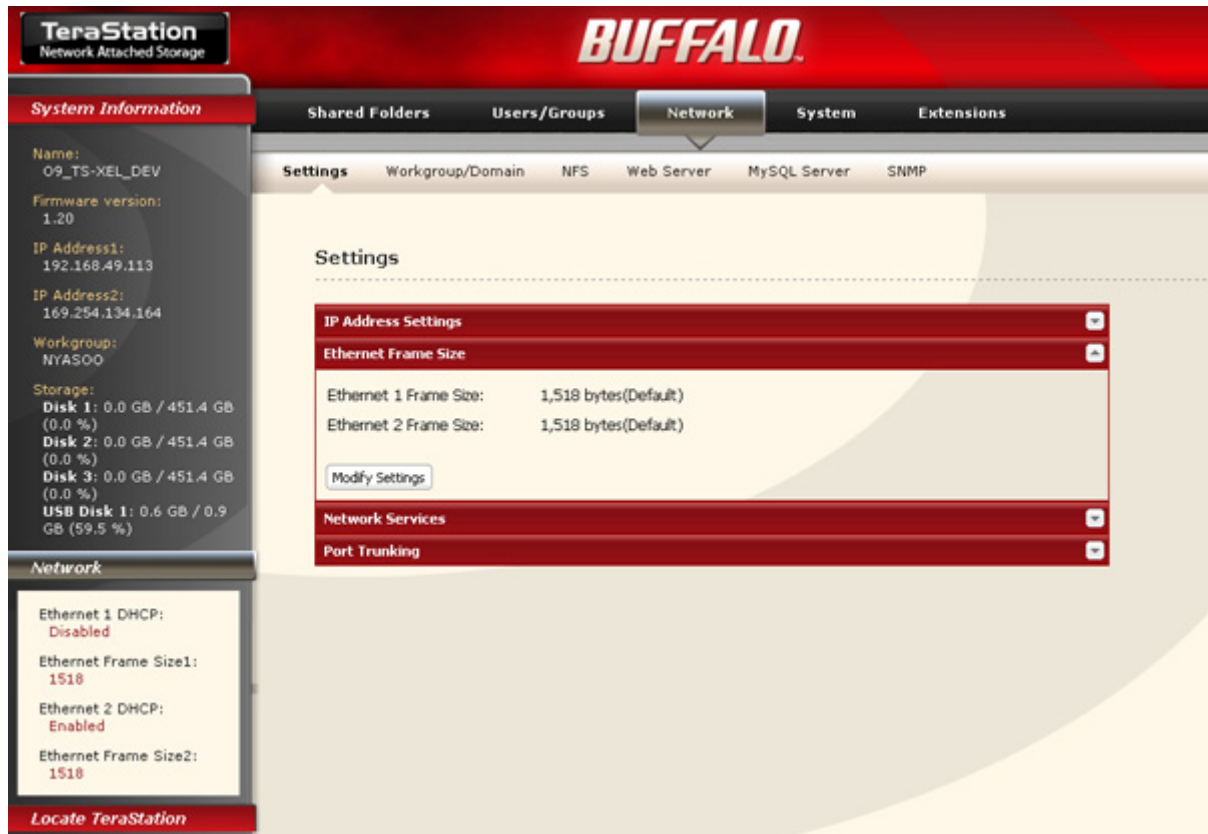



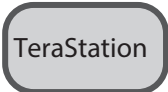
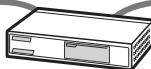
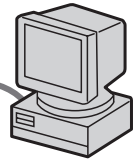

If your other network devices support it, you may be able to increase network performance with jumbo frames.

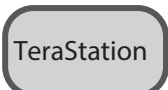
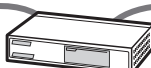
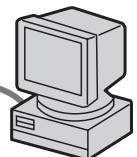
- 1 In Settings, navigate to *Network - Settings - Modify Settings* in "Ethernet Frame Size".

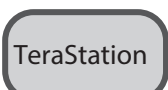
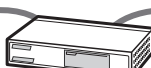
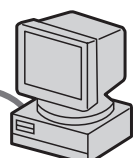

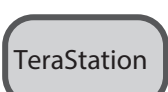
- 2 Select *Ethernet Frame Size* and click *Save*.

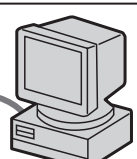

Connection			Transmission	
				Transfer data in jumbo frames.
				Transfer data not using jumbo frames.
				Transfer data not using jumbo frames.
				Any data cannot be transferred.

Notes:

- To benefit from using jumbo frames in the TeraStation, your router, switch, or hub should support jumbo frames.
- To use jumbo frames (4102, 7422, or 9694 bytes), your computer's NICs and all switches, hubs, and routers on the transmission route need to support jumbo frames. If any device on the route doesn't support jumbo frames, use standard transmission (1518 bytes) instead.
- If you are using jumbo frames and back up data from a LinkStation or TeraStation to another LinkStation or TeraStation, set the Ethernet frame sizes of the LinkStations or TeraStations to the same settings (or the closest available). If the Ethernet frame sizes are significantly different, the backup job may fail. If you have problems with backup jobs, select the default frame size (1518 bytes).

Port Trunking

You may use two separate LAN connections for redundancy, speed, and reliability.

Note: To use port trunking, your hub or switch must support it.

The following port trunking modes are available:

- *Off*: Port trunking is not used.
- *Round-robin policy**: Sets a round-robin policy for fault tolerance and load balancing.
- *Active-backup policy*: Sets an active-backup policy for fault tolerance.
- *XOR policy**:

Sets an XOR (exclusive-or) policy for fault tolerance and load balancing.

- *Broadcast policy:*

Sets a broadcast policy for fault tolerance.

- *Dynamic link aggregation**:*

Sets an IEEE 802.3ad dynamic link aggregation policy.

- *Adaptive transmit load balancing (TLB):*

Sets a Transmit Load Balancing (TLB) policy for fault tolerance and load balancing

* Your switch must support this. Configure the two ports on the switch in advance. Refer to your switch's manual for instructions on configuring it.

** Your switch must support this. Enable LACP (Link Aggregation Control Protocol) in the switch in advance. Refer to your switch's manual for instructions on configuring it.

Important:

After configuring Port Trunking in Settings, reboot the TeraStation by holding down the power button until it shuts down, then restarting it.

Configuring Port Trunking

To configure port trunking,

- 1** Connect LAN port 1 on the TeraStation to a port on the switch. Do not connect LAN port 2 yet.
- 2** In Settings, navigate to *Network - Settings - Port Trunking*.
- 3** Under "Port Trunking", click *Modify Settings*.



- 4** Connect LAN port 2 on the TeraStation to the switch.
- 5** Hold down the TeraStation's power button for 3 seconds to turn it off. Press it again to restart the TeraStation.

Port Trunking is now configured.

Update the TeraStation's Firmware

Online Update

If a new firmware is available, the message "A new version of the firmware has been released. The current firmware can be updated to the latest version." is displayed when the TeraStation boots.

To update the firmware, open the TeraStation's settings and navigate to *System - Maintenance - Firmware Installation - Check for Update* to check the change log, then *Install Update* to update to the latest firmware.

Note: Update notification will display "I52" on the LCD and a message on the login screen when an update is available. To disable update notification, click *Disable* notification of updates.

Update by Downloading File from Buffalo Website

You can also update the TeraStation's firmware manually. Visit the Buffalo website to download the latest TeraStation firmware updater. Double-click the file you downloaded to unzip it. The unzipped folder will include the program to update your TeraStation's firmware.

Chapter 9 Extensions

Using WebAccess

What is WebAccess?

WebAccess lets you access files on your TeraStation through the Internet. Access restrictions can be set for folders that are shared, and automatic router settings by UPnP and redirect functionality from the BuffaloNAS.com server (similar to dynamic DNS) make configuration easy.

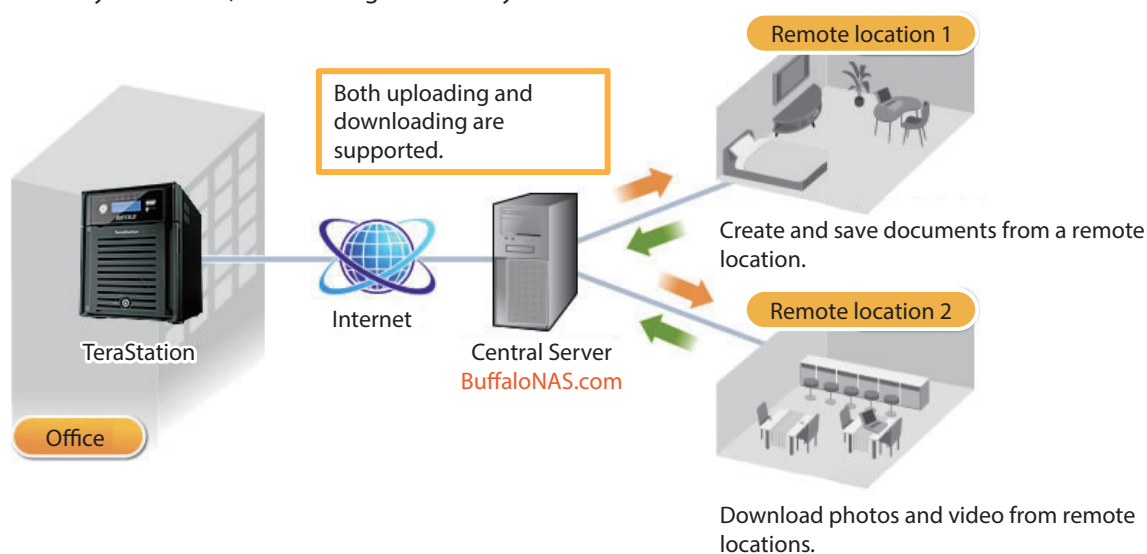

Note: Care should be taken with configuration of WebAccess. Certain settings can make the files in the shared folder available to anyone on the Internet without any access restrictions.

Use compatibility mode to use WebAccess with Windows 8.

For more information on WebAccess, visit <http://buffalonas.com/manual/setup/en/>

Direct Copy

Direct Copy automatically copies movie, music, and images directly to the TeraStation from a USB device.

You can connect many types of USB devices to the TeraStation, including USB hard drives, USB flash drives, single-card card readers, digital cameras, and USB printers. USB hubs, mice, keyboards, and card readers that support 2 or more cards are not supported:

1 Connect to a USB device (USB flash/digital camera/hard disk/card reader) to the TeraStation.

TS-XL, TS-XEL

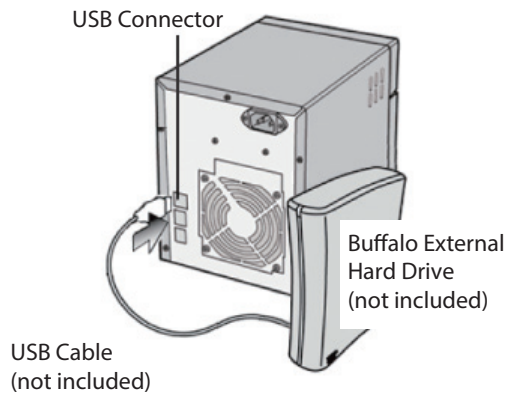

TS-WXL

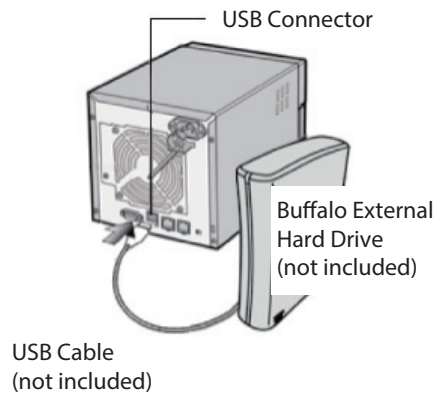

TS-RXL

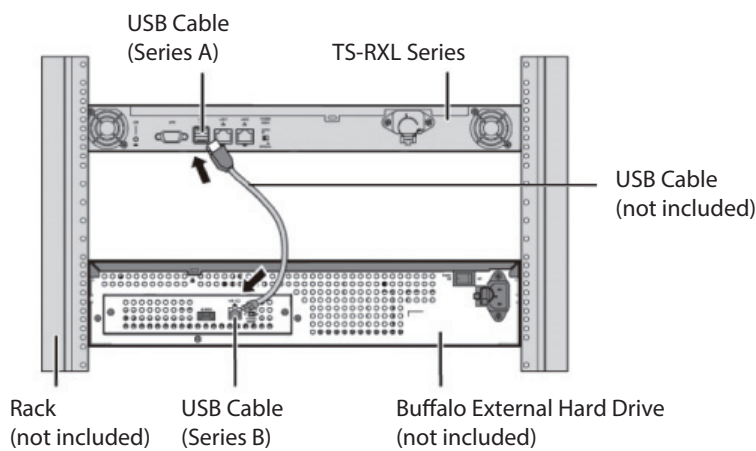

Notes:

- After the USB device is recognized, the function button is lit in blue for 60 seconds. After the function button is lit in blue, you can access the USB device.
- If an unsupported USB memory device is connected to the TeraStation, then the function button will not light up in blue, and the device will not be mounted.

2 While the function button is blue, press it to automatically copy data from the USB device to the Direct Copy folder on the TeraStation. The function button will flash blue during the copy. Push the function button again to abort the copy.

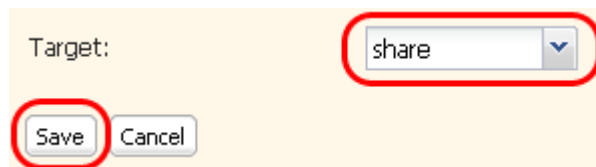

Files are copied to the folder:

<Direct Copy folder>/pictures/yyyymmdd

yyyy: year copied

mm: month copied

dd: date copied

You may change the destination shared folder for Direct Copy in *Shared Folders - Direct Copy - Modify Settings* in Settings. Subsequent Direct Copy folders are created at:

<Direct Copy folder>/pictures/yyyymmdd/n

yyyy: year copied

mm: month copied

dd: date copied

n: 1st time n=0, 2nd time n=1, 3rd time=2 etc.

For USB mass storage class USB devices, files with following extensions will be copied.

avi, divx, asf, mpg, mpe, m1v, vob, mts, m2ts, m2t, mpeg, mpeg2, vdr, spts, tp, ts, 3gp, mov, m4v, wmv, dvr-ms, xvid, mp4, jpg, jpeg, gif, png, tif, tiff, yuv, bmp, mp3, mpa, wma, aac, apl, ac3, lpcm, pcm, wav, m3u, m4a, m4b, aif, aiff, flac, ogg, mp2, mp1

For digital cameras and other devices that don't follow the USB mass storage Class standard, all files on the device will be copied.

3 When the access LED of the USB device goes off, the copy is finished. Dismount the USB device before unplugging it.

To dismount the USB device if the TeraStation is on, hold in the function button for 6 seconds. The blue LED will go out, and the USB device is dismounted. You may now unplug it safely.

If you turn off the TeraStation, the USB device is already dismounted, and you can remove it safely.

Eye-Fi Connected

Eye-Fi connected can transfer images from a digital camera with an Eye-Fi card (available from Eye-Fi) to your TeraStation over the Internet.

The following things are required to use Eye-Fi connected:

- Wireless LAN access point
- SD card or SDHC-compatible digital camera
- Computer with USB port and Internet connection
- Eye-Fi card

1 If using the Eye-Fi card for the first time, connect the Eye-Fi card to the computer beforehand to make the initial settings.

Note: For the mounting procedure, driver installation procedure, and removal procedure, refer to the manual supplied with the Eye-Fi card.

2 Remove the Eye-Fi card from the computer and insert it into your digital camera.

3 In Settings, navigate to *Extensions - Web Service Support - Eye-Fi connected*.

4 Click *Enable*.



5 Enter the Email and Password that was set in step 1. Click *Log in*.



- 6 The name of the card or device that was set in *Eye-Fi connected - Cards/Devices Settings* in step 1 is displayed. Click the name of the card or device whose data will be transferred to the TeraStation.
- 7 Select *Enable* and a Destination, then click *Save*.



Images that are saved on the card will be copied to the TeraStation automatically.

Notes:

- Video files are not copied to the TeraStation.
- Only JPEG images are copied.
- In step 7, if the TeraStation is not set as the destination, images will not be transferred to the TeraStation.
- After a picture is taken, it may take some time for it to be transferred to the TeraStation.
- A USB drive connected to the TeraStation cannot be specified as the target folder.
- If a subfolder to the main shared folder is specified as the destination, the subfolder name must be in single-byte alphanumeric characters. Subfolders with names in multibyte characters cannot be used.
- When the TeraStation firmware is updated, the destination is initialized. Reset the destination before using Eye-Fi.
- Photos will be transferred to the destination share even if it is set to read-only.

Print Server

TeraStation is equipped with a USB connector on the back. You can connect a USB printer to the TeraStation as shown below.

TS-XL, TS-XEL

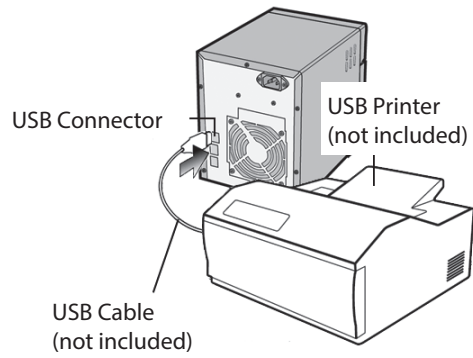

TS-WXL

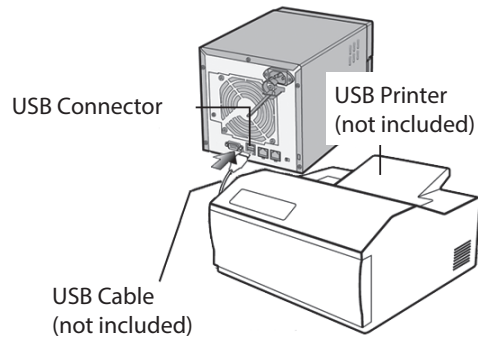

TS-RXL

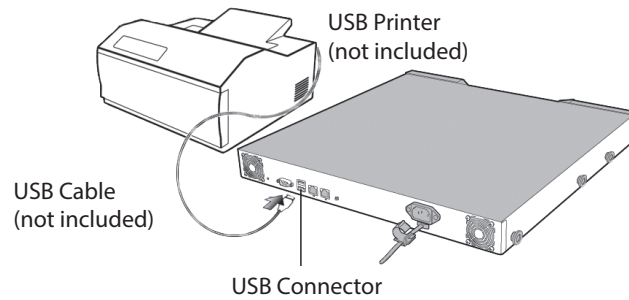

Notes:

- Only one printer can be connected to the TeraStation.
- The TeraStation does not support 2-way communication. For example, it cannot tell you the amount of ink left.
- Multi-function printers are not supported.
- Printers which only support 2-way communication or WPS (Windows Printing System) are not supported.
- Mac OS cannot print to a printer connected to the TeraStation.

Setting up a printer on Windows 8, Windows 7 or Windows Vista

1 In Settings, navigate to *Extensions - PrintServer* and click *Modify Settings*.

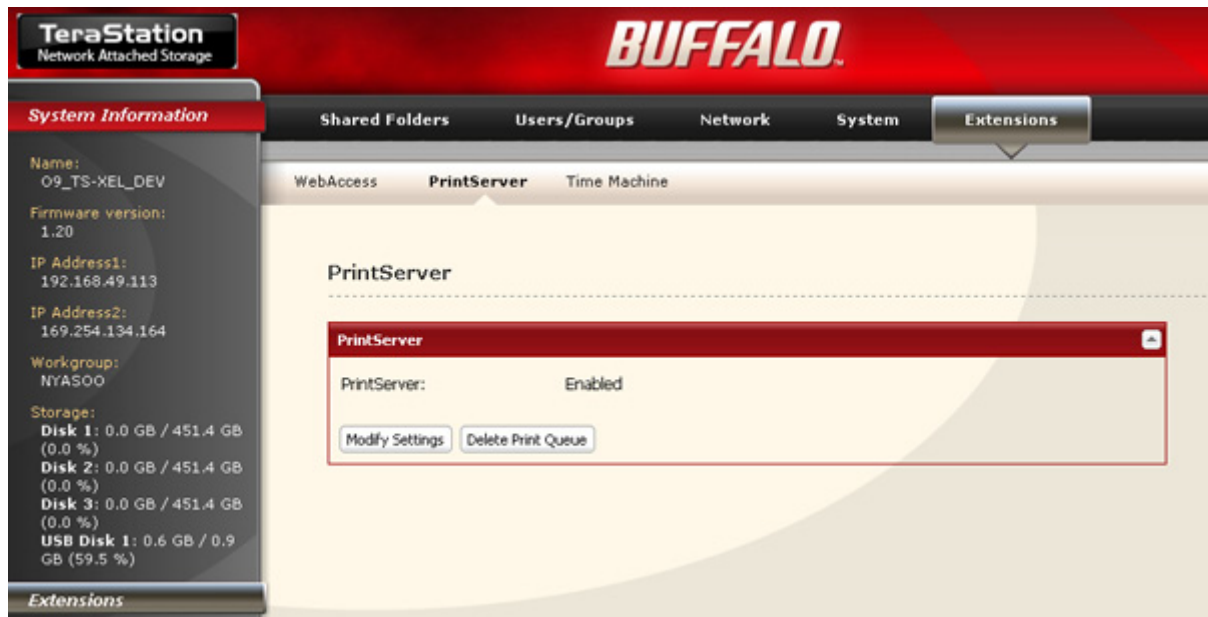

2 Select *Enable* and click *Save*.



3 Refer to your printer's manual installation instructions. You may need to install the printer driver from a software disk.

4 Click *Start - Network*. On Windows 8, click *Network* in *File Explorer*.

5 Double-click the TeraStation's server name.

6 Double-click the TeraStation's printer icon ("LP").

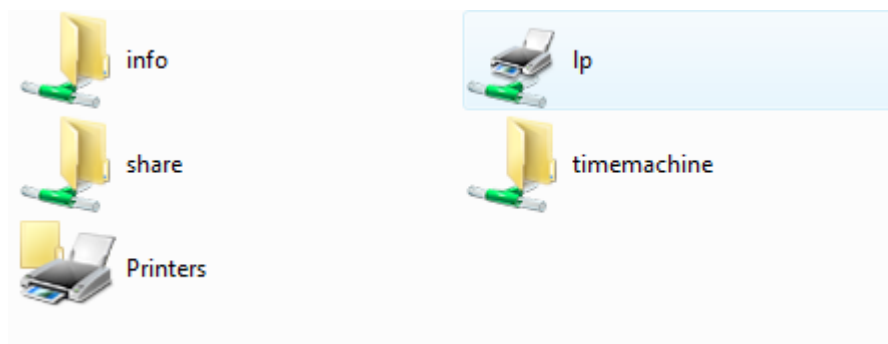

7 Click OK.

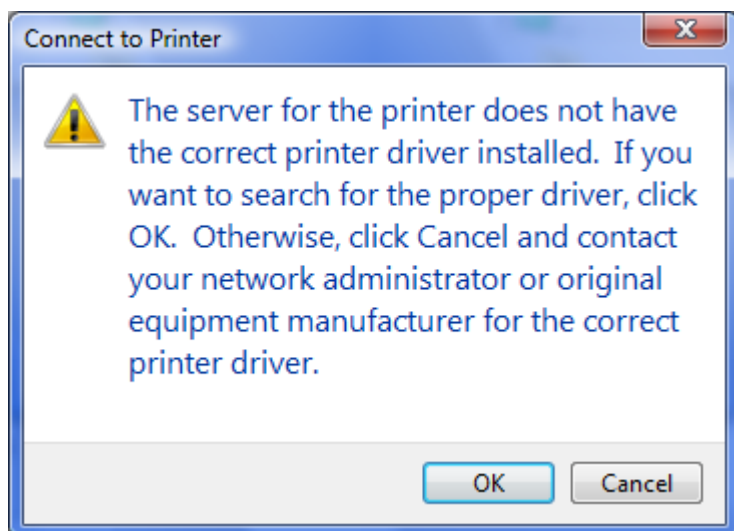

8 Select your printer. Choose the manufacturer on the left and the model on the right. If your printer is not listed, click *Have Disk* and follow the printer manufacturer's directions for installation. Click *OK*.

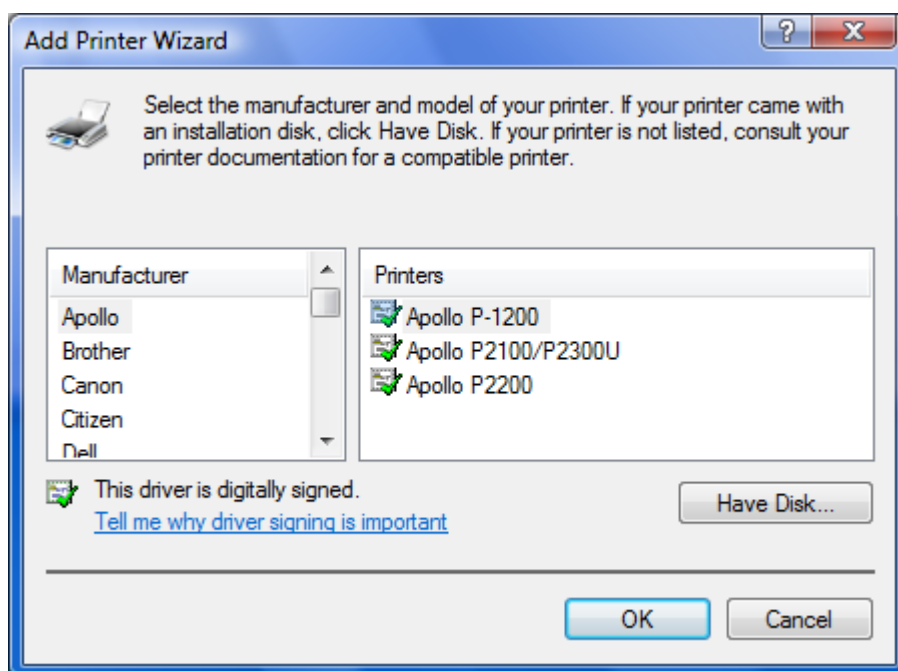

You have added a printer.

Setting Up a Printer on Windows XP

1 In Settings, navigate to *Extensions - PrintServer* and click *Modify Settings*.



2 Choose *Enable* and click *Save*.



3 Refer to your printer's manual installation instructions. You may need to install the printer driver from a software disk.

4 Click *Start - Control Panel*.

5 Click *Network and Internet Connections* icon.

6 Double-click *My Network Places - View workgroup computers - (Name of the TeraStation Server name)* in this order.

7 Double-click the TeraStation's printer icon ("lp").



8 If "The printer driver to your computer will be automatically installed. (...) Would you like to continue?" is displayed, click *Yes*.

- 9 Select your printer. Choose the manufacturer on the left and the model on the right. If your printer is not listed, click *Have Disk* and follow the printer manufacturer's directions for installation. Click *OK*.

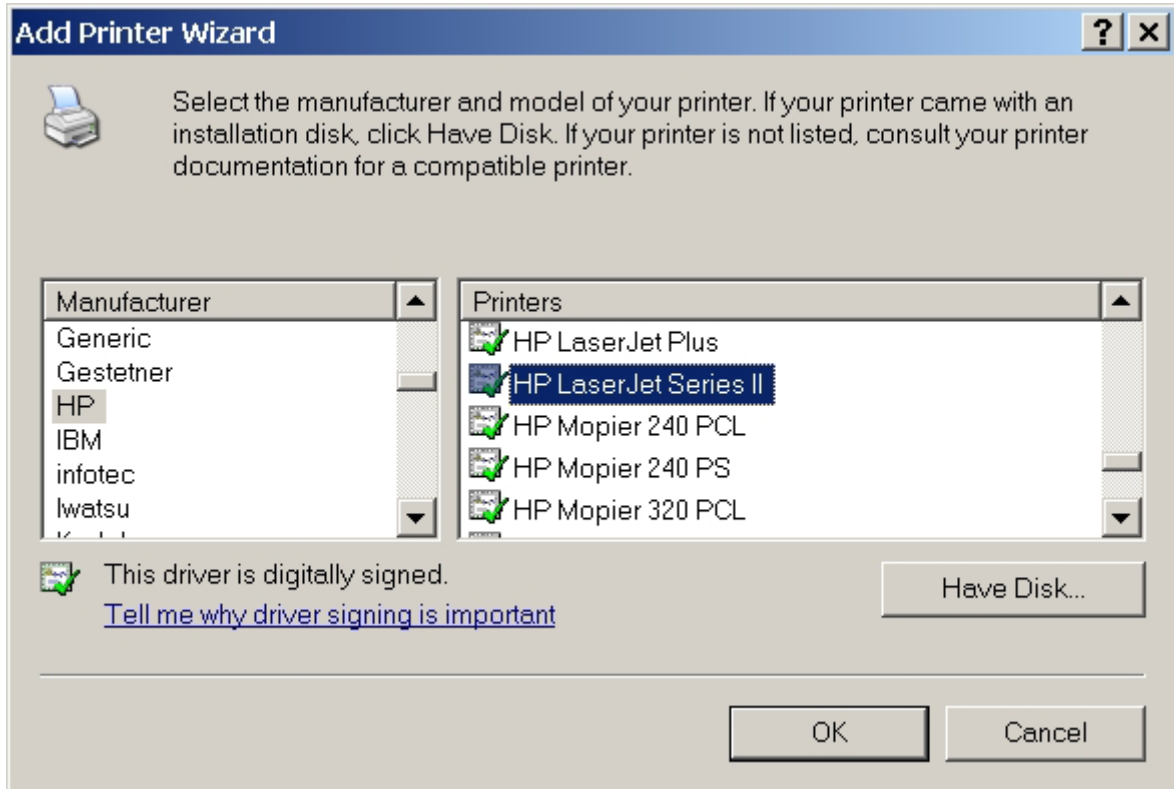

You have added a printer.

Setting Up a Printer on Windows 2000

- 1 In Settings, navigate to *Extensions - PrintServer* and click *Modify Settings*.



- 2 Click *Enable*, then *Save*.

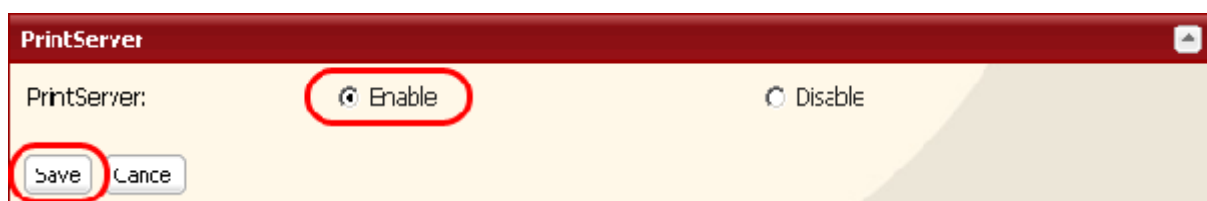

- 3** Refer to your printer's manual to install the printer driver.
- 4** Double-click *My Network Places* - *Entire Network* - (the TeraStation Server Name).
* On Windows NT 4.0, this is *Network*.
- 5** Double-click the TeraStation's printer icon ("lp").



- 6** Click *OK*.

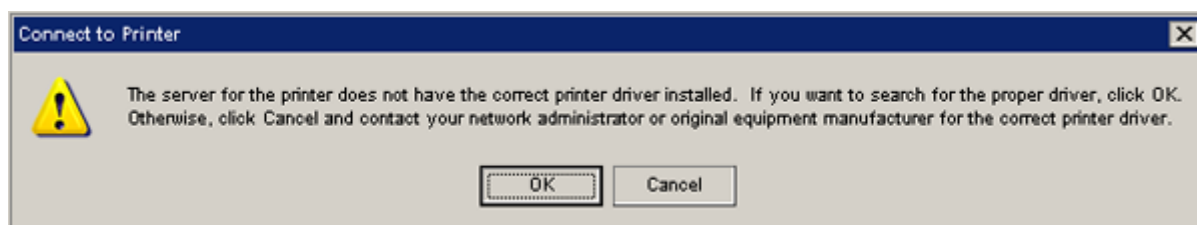

- 7** Click *Yes*.

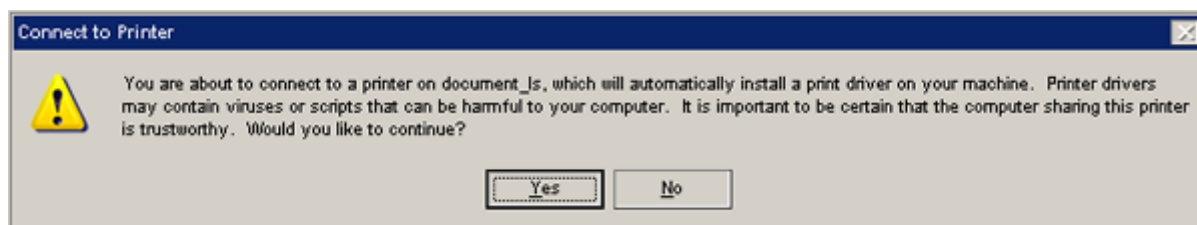

- 8** Select your printer. Choose the manufacturer on the left and the model on the right. If your printer is not listed, click *Have Disk* and follow the printer manufacturer's directions for installation. Click *OK*.

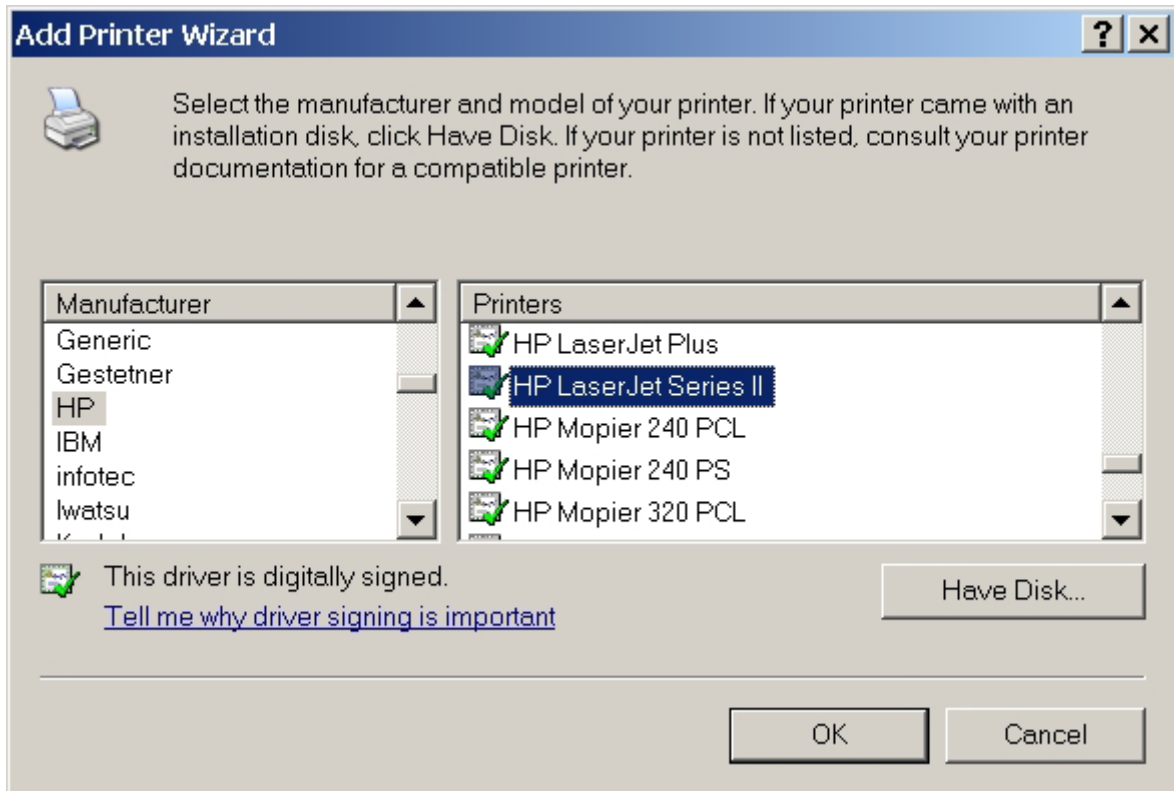

You have added a printer.

Sleep Timer

Sleep timer will automatically turn your TeraStation on and off at specific times to save energy. In sleep mode, the TeraStation's hard drives, display panel, and LED lights are turned off. To use sleep timer, set your TeraStation's power mode switch to manual. Sleep timer is not usable when the power mode switch is set to auto.

- 1** In Settings, navigate to *System - Power Management - Sleep Timer*.
- 2** Click *Modify Settings*.
- 3** Specify "Timer Interval", "Wake up at", and "Begin Sleep at". You can set up to 3 timers. "Wake up at" times may be set from 0:00 to 23:45. "Begin Sleep at" times may be set from 0:00 to 27:45. If "Begin Sleep at" is set to 24:00 or later, then "Wake up at" can be set from 4:00 to 23:45. 24:00 is equivalent to 0:00 of the next day, and 27:00 is

equivalent to 3:00 of the next day. "Wake up at" times should be earlier in the day than "Begin Sleep at" times. Do not set the same time for both "Wake up at" and "Begin Sleep at". Click *Save* when done.

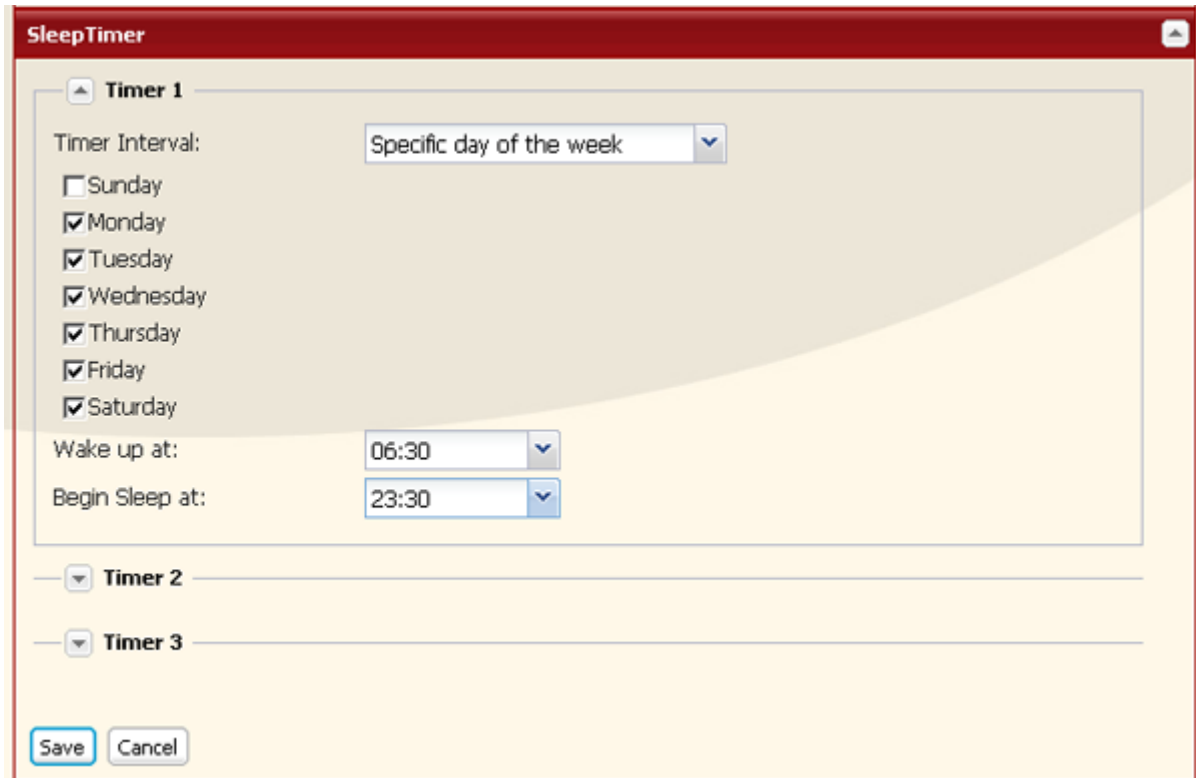

Notes:

- To exit sleep mode, hold in the power button on the TeraStation for about 3 seconds. The unit will power on.
- The TeraStation will not go into sleep mode while performing check disk, disk format, or backup, or if a backup is scheduled within 5 minutes of the current time.
- If multiple sleep timers conflict, the longest interval time is used. Here are some examples of multiple timers:
 - (e.g.1) It is at 10:00 Wednesday with the TeraStation powered on:
 Timer 1 *Everyday* 12:00 - 24:00
 Timer 2 *Disable*
 Timer 3 *Disable*
 -> Nothing happens at 12:00 and the unit enters sleep mode at 24:00
 - (e.g.2) It is at 10:00 Wednesday with the TeraStation powered on:
 Timer 1 *Everyday* 9:00 - 18:00
 Timer 2 *Specific day of the week - Wednesday* 10:00 - 20:00
 Timer 3 *Disable*
 -> Except on Wednesdays, the unit powers on at 9:00 and moves to sleep mode at 18:00.
 -> On Wednesdays, it enters sleep mode at 20:00.
 - (e.g.3) It is at 10:00 Wednesday with the TeraStation powered on:
 Timer 1 *Everyday* 9:00 - 18:00
 Timer 2 *Specific day of the week - Wednesday* 10:00 - 25:00
 Timer 3 *Disable*
 -> Except on Wednesdays, the unit powers on at 9:00 and moves to sleep mode at 18:00.
 -> On Wednesdays, it enters sleep mode at 1:00 of the next day.
 - (e.g.4) It is at 10:00 Wednesday with the TeraStation powered on:
 Timer 1 *Everyday* 9:00 - 18:00
 Timer 2 *Specific day of the week - Wednesday* 07:30 - 22:00
 Timer 3 *Disable*
 -> Except on Wednesdays, the unit powers on at 9:00 and enters sleep mode at 18:00.
 -> On Wednesdays, the unit powers on at 7:30 and enters sleep mode at 22:00.

Disk Quotas

Notes:

- When using quotas, disable the recycle bin or empty the trash folder. The limited space includes the space used for trash.
- Quotas apply per drive or per array. If a quota is set to 1 GB, each array or drive can use maximum of 1 GB.
- Quotas can't be set for external USB hard drives connected to the TeraStation, only internal drives.

Disk space quotas for users

To limit the space of shared folders that each user can use, follow the procedure below.

- 1 In Settings, navigate to *Users/Groups - Local Users*. Click *Create User*.

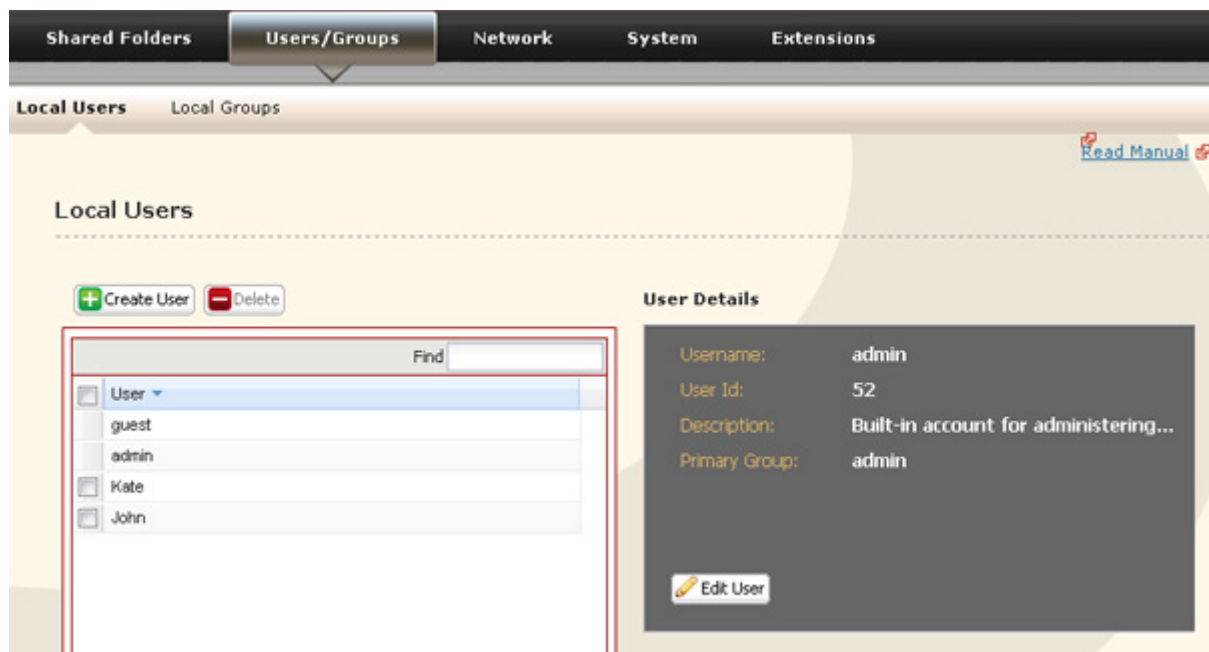

- 2** Enter username, user ID, password, and description. Check *Enable* for "User Quota". Enter the maximum space this user is allowed for the hard limit. If a soft limit is entered, the user will receive a warning when the soft limit is reached. The soft limit should be smaller than the hard limit. Click *Save*.

Local Users > New User

Username:

User Id:

Description:

Password:

Confirm Password:

Primary Group:

User Quota: Enable

Soft Limit (GB):

Hard Limit (GB):

Note: User IDs may be between 1000 and 1999. Do not duplicate user IDs.

Notes:

- Username and password must be the same one that the user logs into Windows with. If these values are different, shared folders with access restrictions cannot be accessed.
- Deleting or adding users repeatedly may cause quotas to not work properly.

- 3** Select *Shared Folders - Folder Setup* and click *Create Folder*.

- 4** Configure the desired settings. Click *Access Restrictions*.

Shared Folders > New Folder

Copy Settings From:

Name:

Description:

Volume:

Shared Folder Attributes: Read Only Read & Write

Recycle Bin: Enable Disable

Shared Folder Support: Windows Apple Ftp Disk Backup SFTP

Folder Mode (SMB Only): Hide Share

Remote backup password:

Offline Files:

TeraSearch: Include folder in search indexing

Access Restrictions

5 Click *Add*.

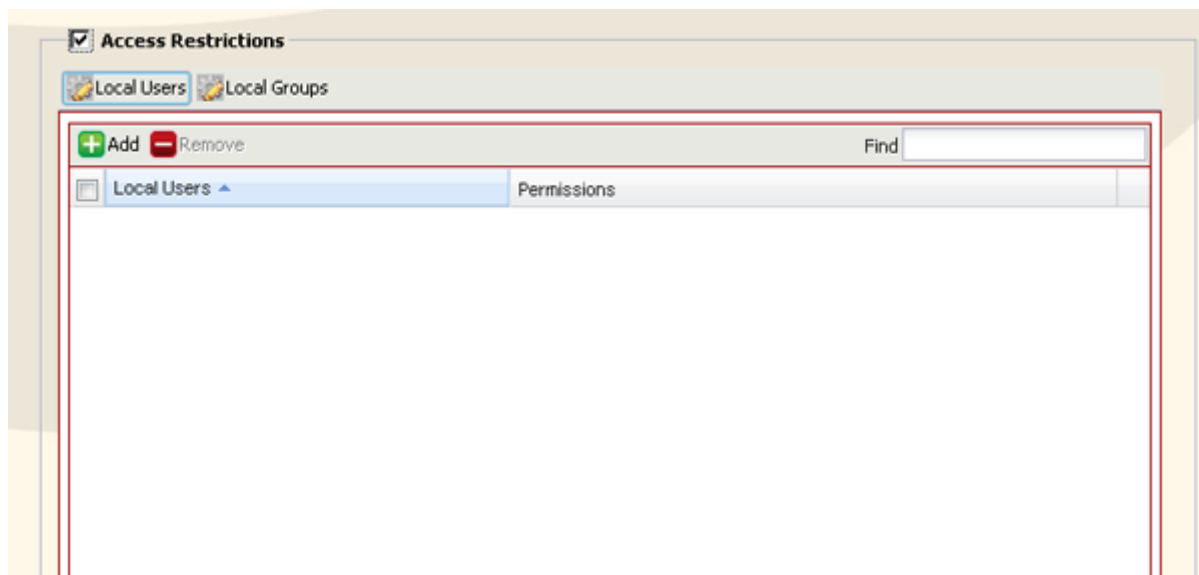

6 Check the user you created in step 2. Click *Add*.

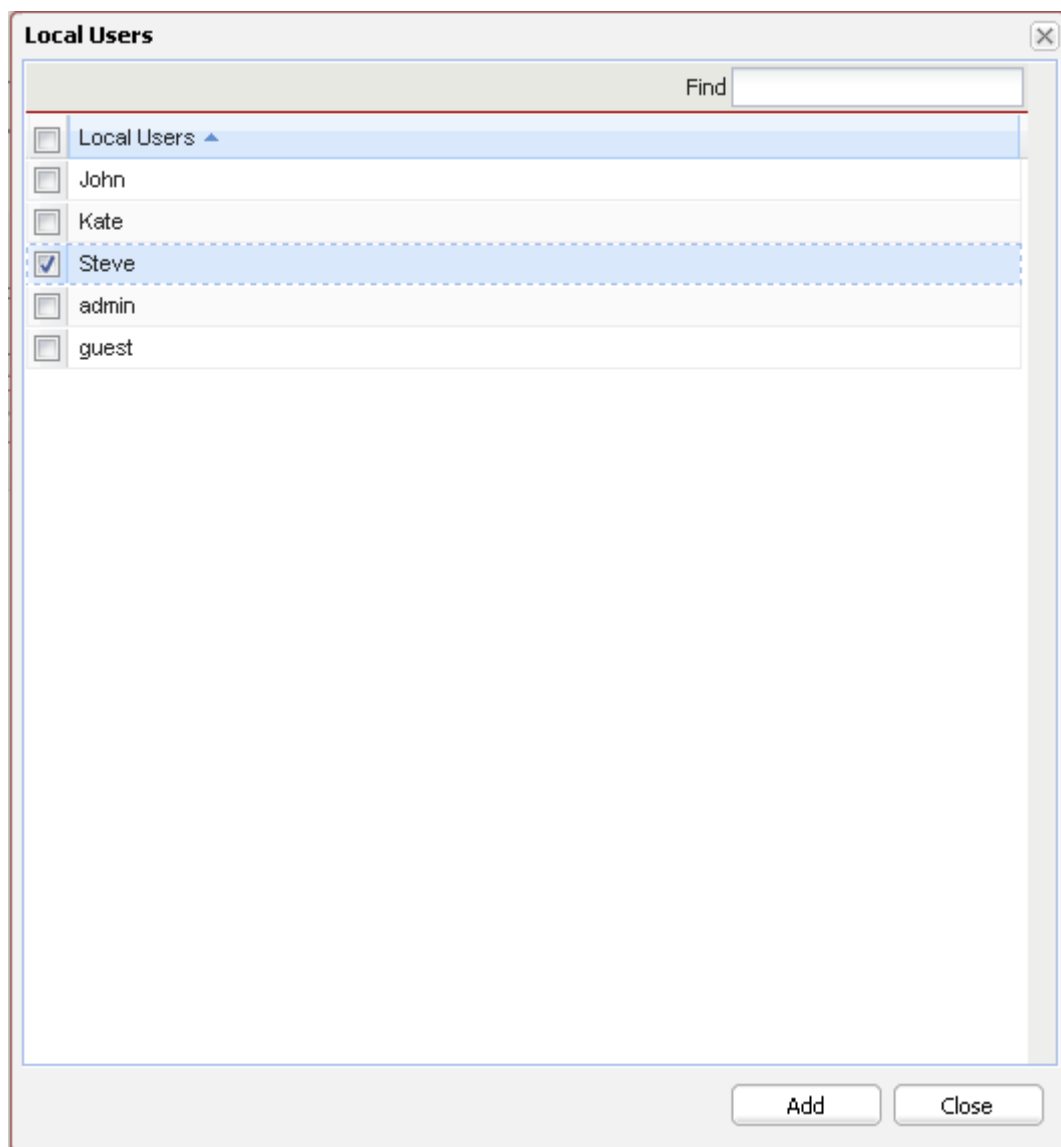

7 Select level of access privileges for the user you added from *Read Only* or *Read & Write*.

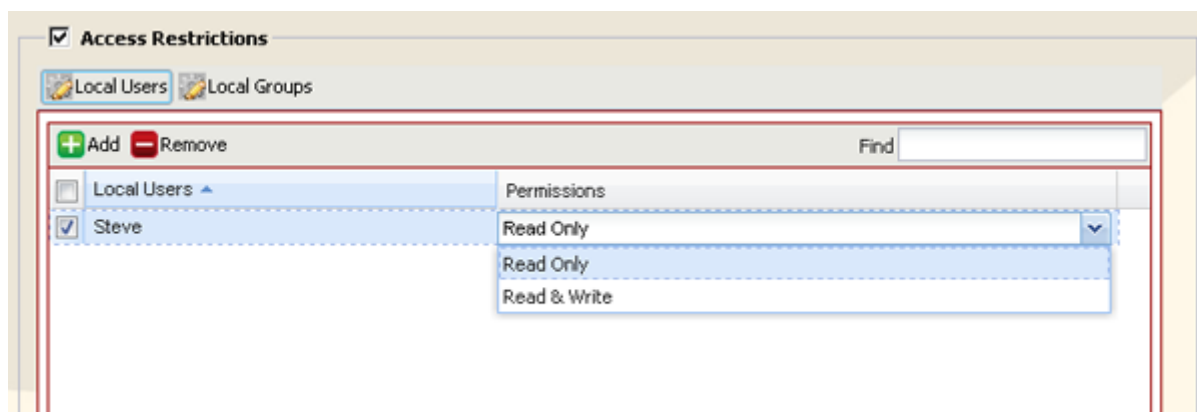

8 Click *Save*.

9 You've configured a disk quota.

Disk space quotas for groups

To limit the space of shared folders that each group can use, follow the procedure below.

1 In Settings, select *Users/Groups - Local Users*. Click *Create User*.

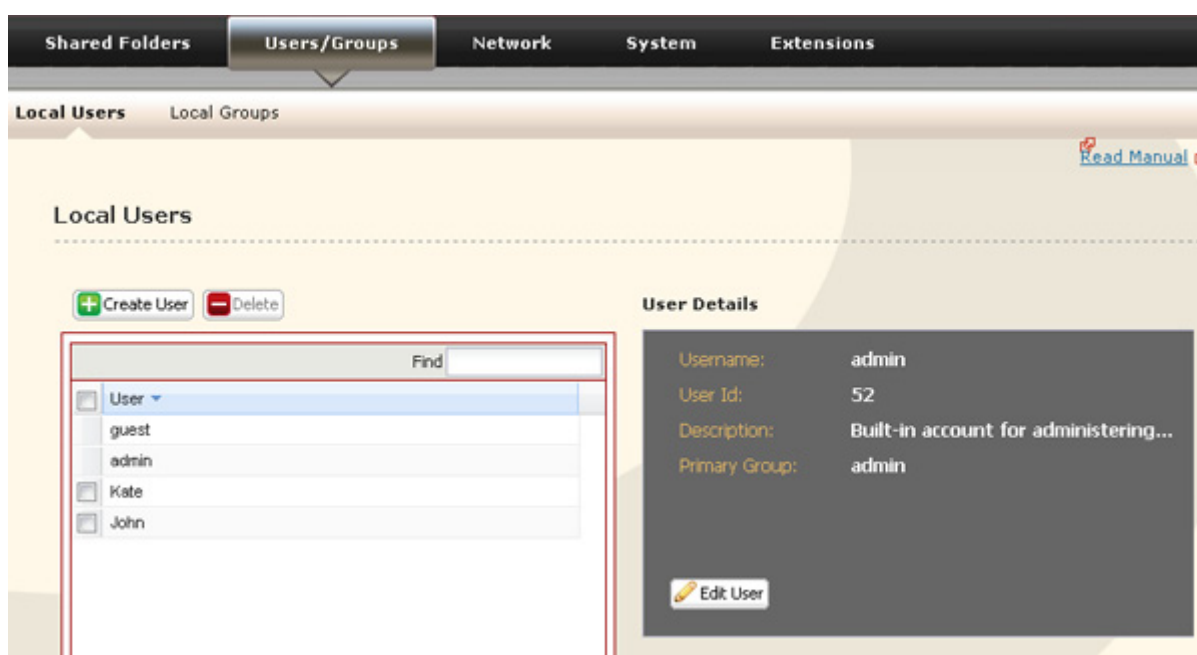

2 Enter username, user ID, password, and description. Click Save.

Local Users > New User

Username:

User Id:

Description:

Password:

Confirm Password:

Primary Group:

User Quota: Enable

Soft Limit (GB):

Hard Limit (GB):

Note: User IDs may be between 1000 and 1999. Do not duplicate user IDs.

Notes:

- Usernames and passwords should be the same ones that the users log in to Windows with.
- If two different quotas apply, such a user quota and a group quota, the smaller quota is applied.

3 Select *Users/Groups - Local Groups*. Click *Create Group*.

Shared Folders | **Users/Groups** | Network | System | Extensions

Local Users | **Local Groups** [Read Manual](#)

Local Groups

Group	Members
admin	1
guest	1
hdusers	4

Group Details

Group Name: hdusers
Group Id: 100
Description: Default System Group

- 4 Enter group name, group ID, and description. Click *Enable* for "Group Quota". Enter the total space that the group can use in the hard limit field. Select users from step 2 in local users, then click *Add* for each. Click *Save*.

Local Groups > New Group

Group Name:

Group Id:

Description:

Group Quota: Enable

Soft Limit (GB):

Hard Limit (GB):

Local Users

Name	Description
admin	Built-in account for admini
guest	Built-in account for guest
Gary	
John	
Kate	

Group Members

Member

Add >>

<< Remove

Save Cancel

Note: The group ID may be any number from 1000 and 1999. Do not duplicate group IDs.

Note: Deleting and adding groups repeatedly may cause quotas to not work properly.

- 5 Click *Users/Groups - Local Users*. Select a user from step 2, and click *Edit User*.

Shared Folders **Users/Groups** Network System Extensions

Local Users Local Groups [Read Manual](#)

Local Users

+ Create User - Delete

User
<input type="checkbox"/> guest
<input type="checkbox"/> admin
<input type="checkbox"/> Steve
<input type="checkbox"/> Kate
<input type="checkbox"/> John
<input checked="" type="checkbox"/> Gary

User Details

Username: Gary

User Id: 1003

Description:

Primary Group: hdusers

Edit User

- 6 Select the group created in step 4 for primary group and click *Save*.

Local Users > Gary

Username: Gary

User Id: 1003

Description:

Password:

Confirm Password:

Primary Group: GroupA

User Quota: Enable

Soft Limit (GB): 0

Hard Limit (GB): 0

Save Cancel

- 7 Click *Shared Folders - Folder Setup*.

- 8 Click *Create Folder*.

- 9 Configure the desired settings. Click *Access Restrictions*.

Shared Folders > New Folder

Copy Settings From: (Optional)

Name:

Description:

Volume: Array 1

Shared Folder Attributes: Read Only Read & Write

Recycle Bin: Enable Disable

Shared Folder Support: Windows Apple Ftp Disk Backup SFTP

Folder Mode (SMB Only): Hide Share

Remote backup password:

Offline Files: Disable Offline Files

TeraSearch: Include folder in search indexing

Access Restrictions

Save Cancel

10 Click *Local Groups*. Click *Add*.

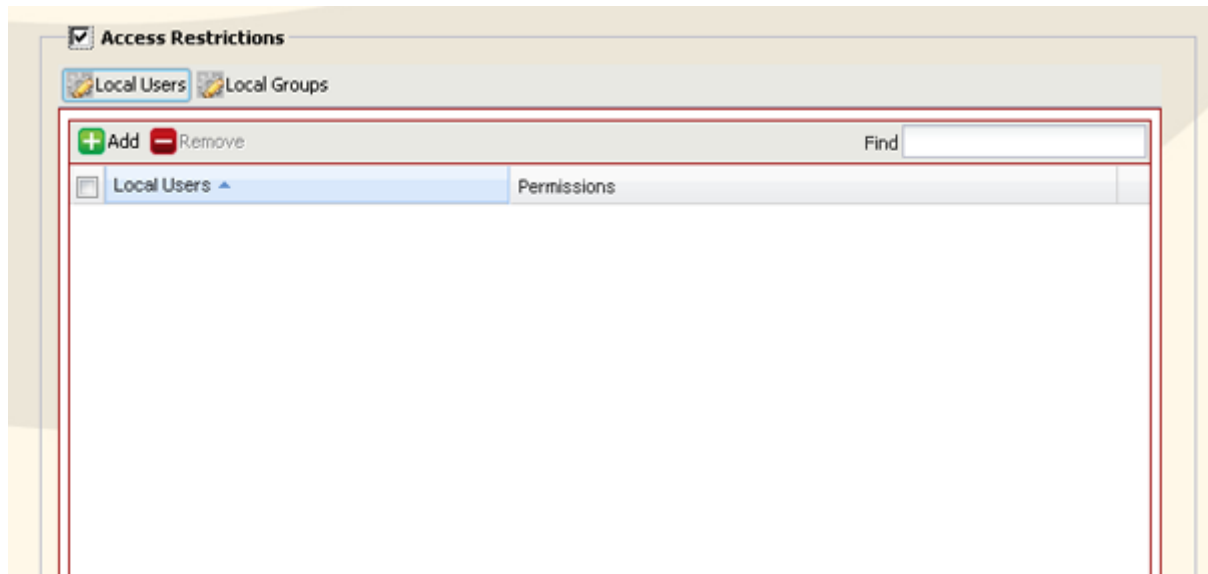

11 Check the group you created step 4. Click *Add*.

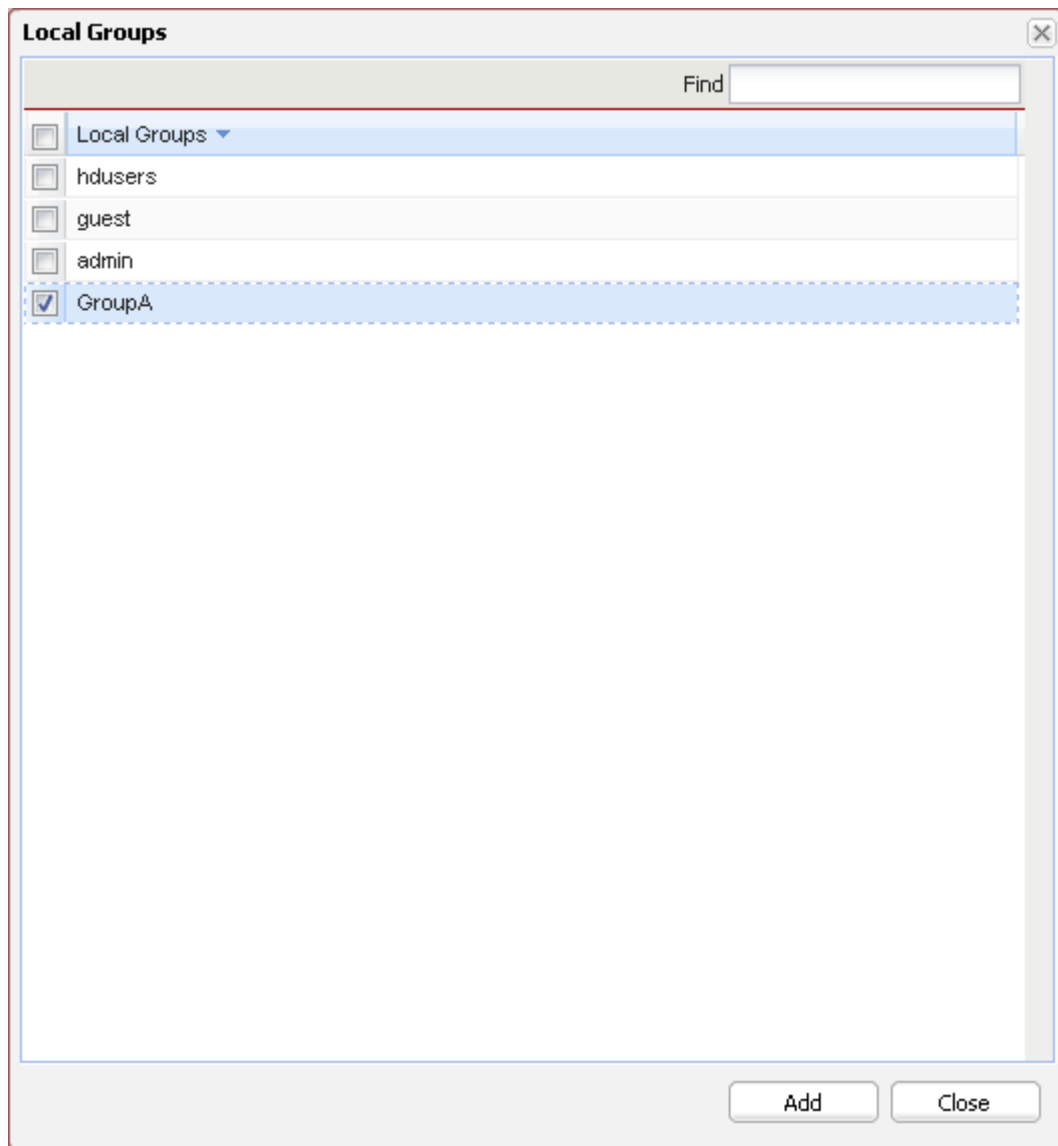

12 Select level of access privileges for group you added from *Read Only* or *Read & Write*.

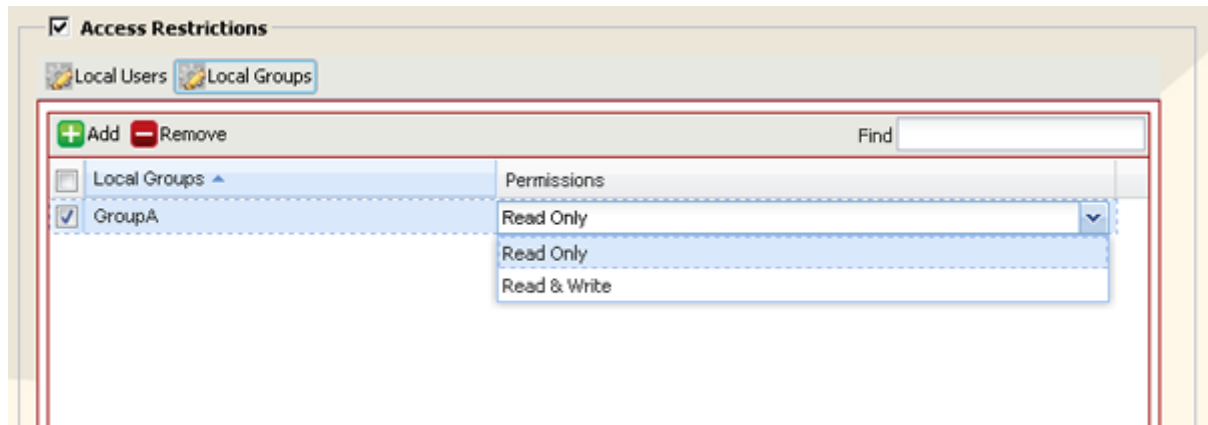

13 Click *Save*.

You have configured a group quota.

TeraSearch

Enable TeraSearch to allow text searches for strings (such as from a text file or data) on the TeraStation.

1 In Settings, select *Shared Folders - Folder Setup*.

2 Click the shared folder to create an index for.

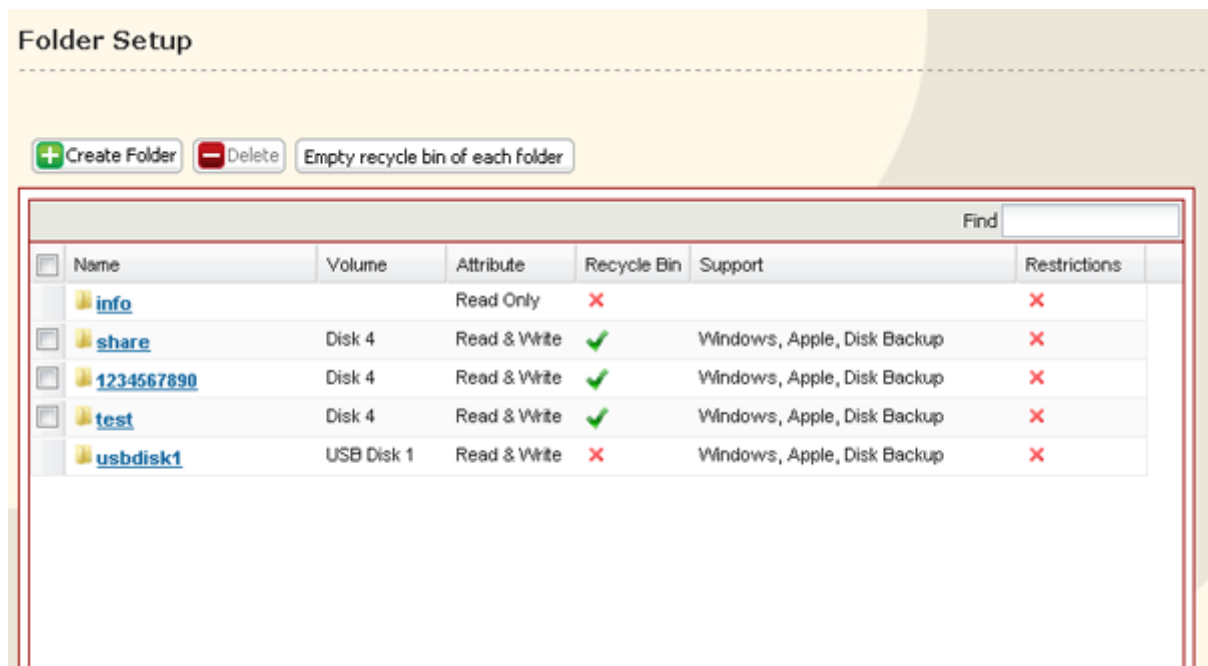

- 3** Click *Include folder in search indexing* for TeraSearch. Click *Save*.

The screenshot shows the 'Shared Folders > share' configuration window. The fields are as follows:

- Name: share
- Description: (empty)
- Volume: Disk 4
- Shared Folder Attributes: Read Only, Read & Write
- Recycle Bin: Enable, Disable
- Shared Folder Support: Windows, Apple, Ftp, Disk Backup, SFTP
- Folder Mode (SMB Only): Hide Share
- Remote backup password: (empty)
- Offline Files: Disable Offline Files (dropdown)
- TeraSearch: Include folder in search indexing

At the bottom, there is an 'Access Restrictions' section with a checkbox, and 'Save' and 'Cancel' buttons.

- 4** Click *Shared Folders - TeraSearch* on Settings.

- 5** Click *Modify Settings*.

- 6** Select *Enable*, and click *Save*.

Note: If you want to update the index regularly, click *Modify Settings* and specify a Time to update the index for "Update Index at".

- 7** Click *Update Index*.

- 8** Open and display the following URL in an Internet browser.

http://(IP address of TeraStation) :3000/

Tip: You can get the IP address of your TeraStation from its front panel LCD display, or from NAS Navigator2.

- 9** Enter a username and password from an account on the TeraStation and click *Login*. For example, the guest account, with blank password, will work.

- 10** Enter a keyword to search for. If you check *Enhanced Search*, you can also specify filename, owner, update date/ time, and size to search for.

- 11** Click *Search*.

Your search results are now displayed.

Offline Files

Your PC can access files from the TeraStation even when it's not connected to the network if offline files are enabled. Offline files are updated and saved on the computer when it's online. Offline files work with Windows 2000, Windows XP Professional, Windows Vista, Windows 7, and Windows 8. Windows Me and XP Home Edition are not supported.

Configure your PC to use files offline as follows:

- 1** In Settings, select *Shared Folders - Folder Setup*.

2 Select a folder to be available offline. Double-click the folder's name.

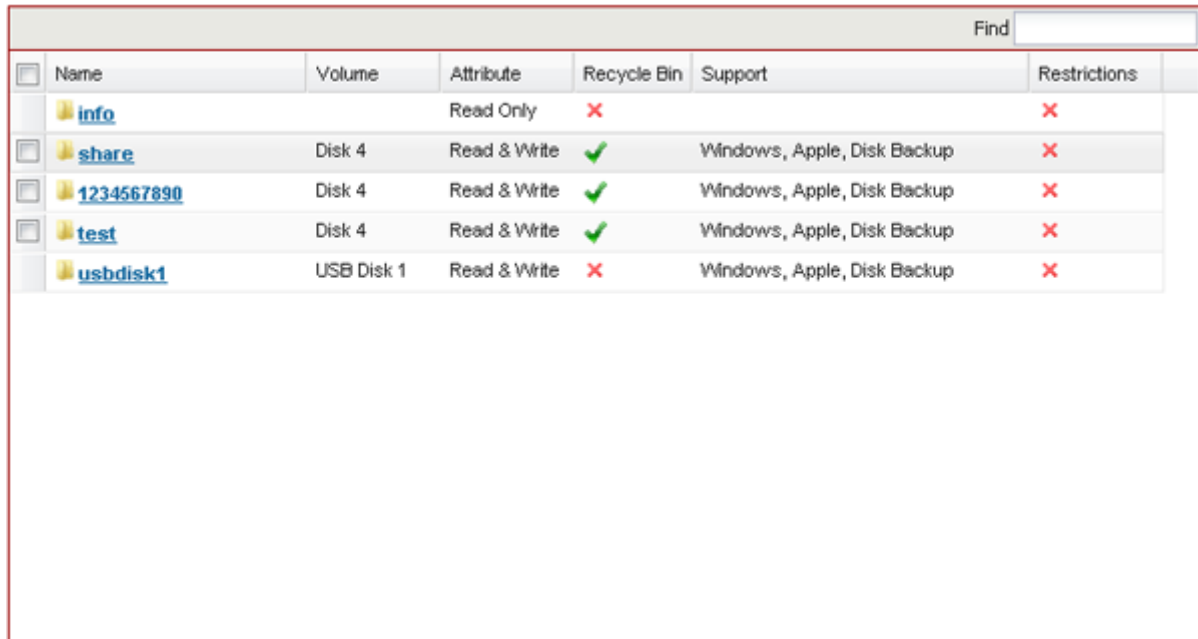

Name	Volume	Attribute	Recycle Bin	Support	Restrictions
info		Read Only	✗		✗
share	Disk 4	Read & Write	✓	Windows, Apple, Disk Backup	✗
1234567890	Disk 4	Read & Write	✓	Windows, Apple, Disk Backup	✗
test	Disk 4	Read & Write	✓	Windows, Apple, Disk Backup	✗
usbdisk1	USB Disk 1	Read & Write	✗	Windows, Apple, Disk Backup	✗

From the "Offline Files" dropdown, select *Manual Cache Files*, *Automatic Cache Files* or *Automatic Cache Programs and Files*.

Manual Cache Files - Manually select the files to be available offline.

Automatic Cache Files - Opened files are cached locally and may be used offline. Old files that cannot be synchronized will be deleted automatically and replaced by new ones.

Automatic Cache Programs and Files - Opened files are cached locally and may be used offline. Old files and network applications that cannot be synchronized will be deleted automatically and replaced with new ones.

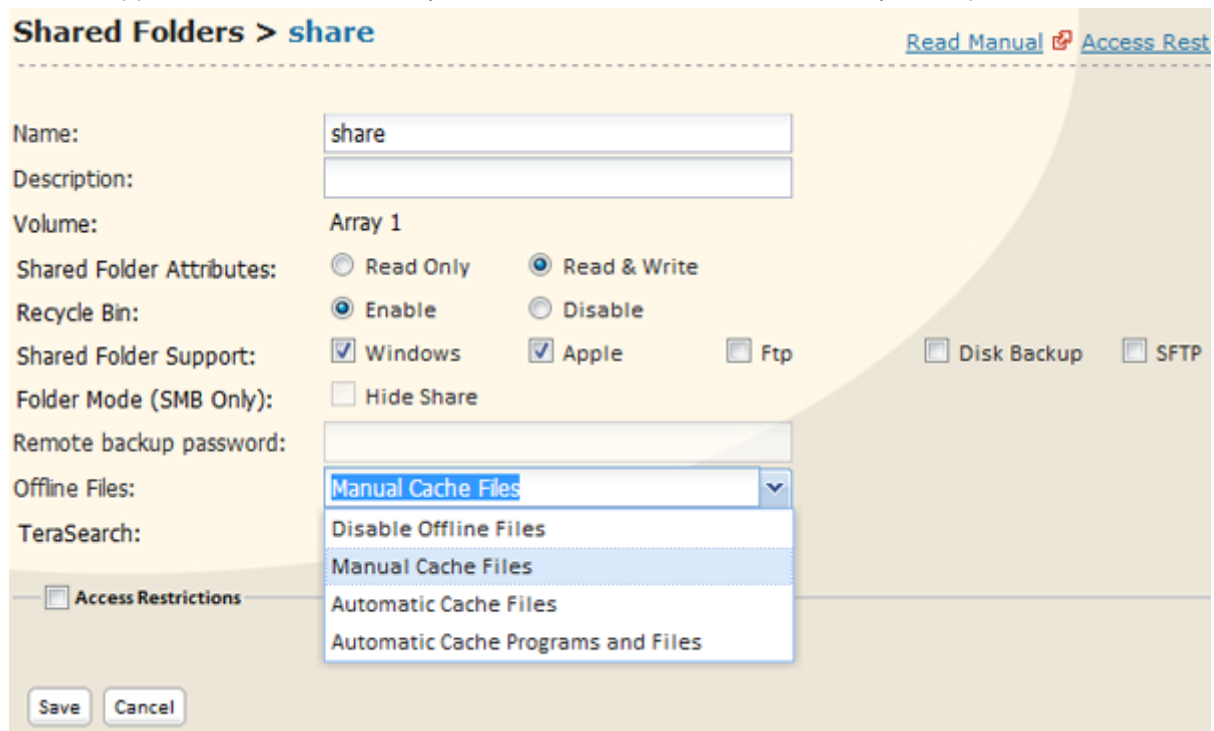

If you're running Windows 8 or Windows 7, skip steps 4 & 5 and move to step 6.

3 Open Windows folder. Select *Folder Options* from the Tool menu.

Note: Select *Control Panel - Folder Options* in Windows 2000 Server.

4 Click *Offline Files* tab. Click *Enable Offline Files*. Click *OK*.

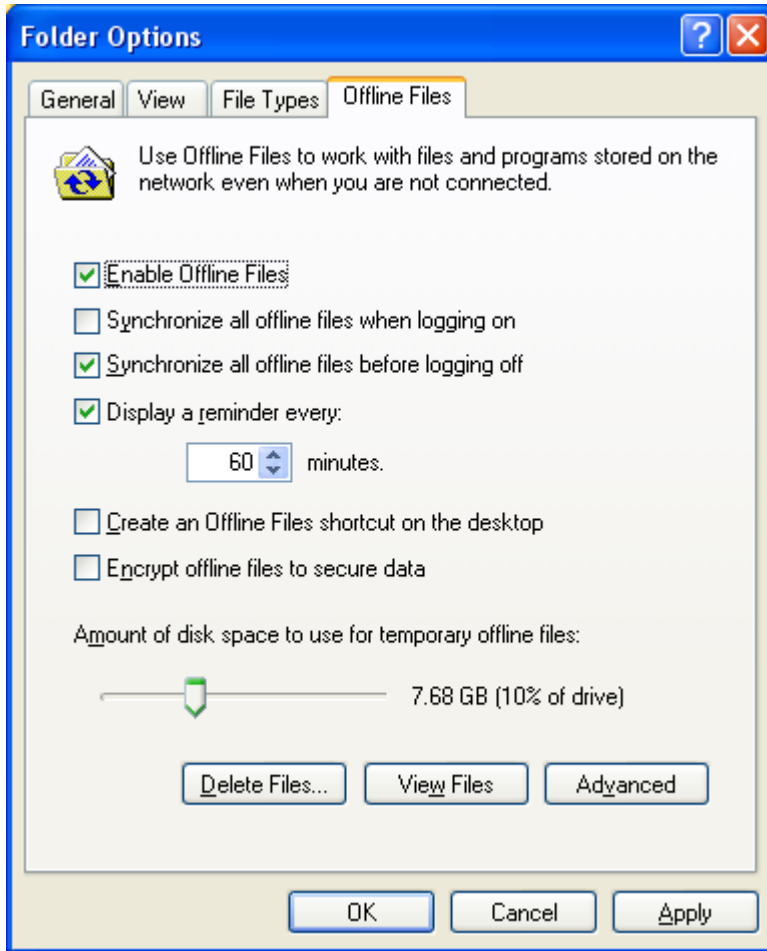

Note: If "Fast User Switching" in Windows XP is enabled, the screen above will not be displayed. In such a case, open User Accounts in the Control Panel and uncheck "Use Fast User Switching".

5 Right-click the icon of the shared folder on the TeraStation you have set the offline feature for. Click *Make Available Offline*.

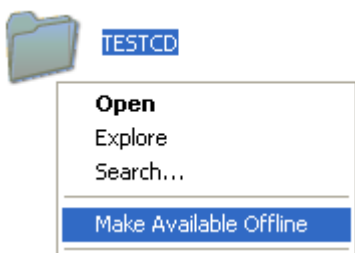

6 When the offline file wizard opens, follow the instructions on the screen to configure. For more information, refer to the Windows help file.

7 After configuration, your offline files and folders display as below (from Windows XP).



8 After the synchronization is complete, you can open offline files even after disconnecting from the network that the TeraStation is on. Offline files can be accessed through the UNC to the original location.

Note: If offline files are available, the icon is displayed in the systray.

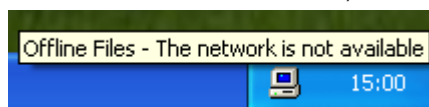

*** Editing Offline Files**

Offline files can be edited or deleted just like regular files. Differences between data in different locations will be resolved by re-synchronization when the network connection is re-established.

*** Synchronizing Offline Files**

Offline files are automatically synchronized when you log on or off the network.

*** Version Conflicts**

Conflicts occur when the offline and original files are both modified differently before they are re-synchronized. If conflicts occur, the following wizard opens. Step through the wizard to resolve the conflicts.

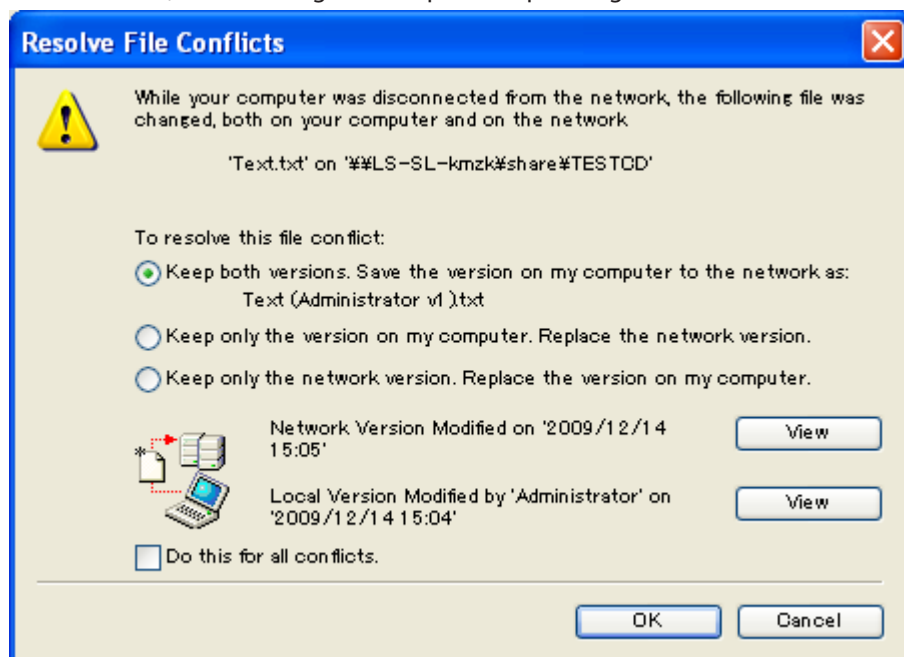

You've configured offline files.

DFS (Distributed File System)

Distributed File System (or DFS) combines shares on the network server together into one tree.

In the following example, when the client computer addresses //tera/share/backup, it's actually looking at files located at //pc_srv/backup. This is transparent to the user of the client computer. If the TeraStation is configured to address multiple DFS shares, then shares on other devices could be addressed as native shares on the TeraStation. For example, //tera/share/share might actually address data located at //link/share.

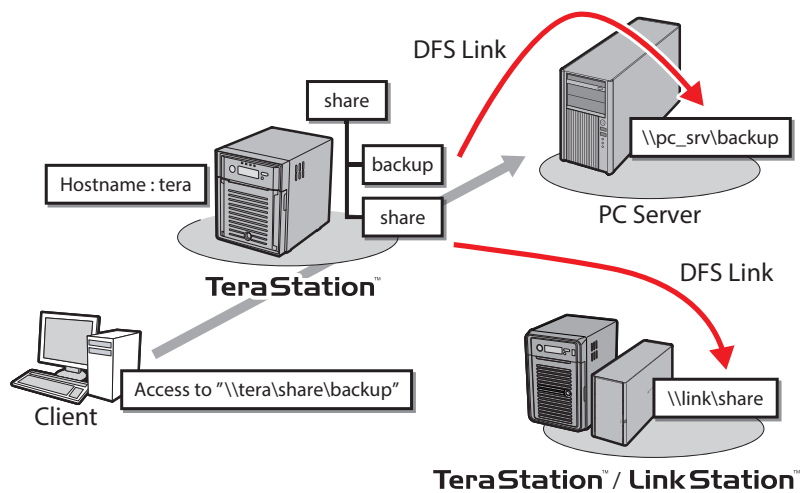

Notes:

- Buffalo does not support using DFS with Mac OS.
- Windows 2000 and Windows Server 2003 cannot properly address DFS link destinations that have access restrictions on one or more folders.
- DFS only works with SMB connections. AFP and FTP connections are not supported.
- Access restrictions configured on DFS link destinations are applied to the shared folder link. Access restrictions on the DFS root or DFS links are not visible.

Set up DFS as described below:

- 1** In Settings, select *Shared Folders - DFS*.
- 2** Under "DFS Service", click *Modify Settings*. Click *Enable* and choose whether to allow multiple DFS links, or just one.



No allows just one DFS link to be addressed.
 Yes allows up to 8 DFS link destinations to be used.

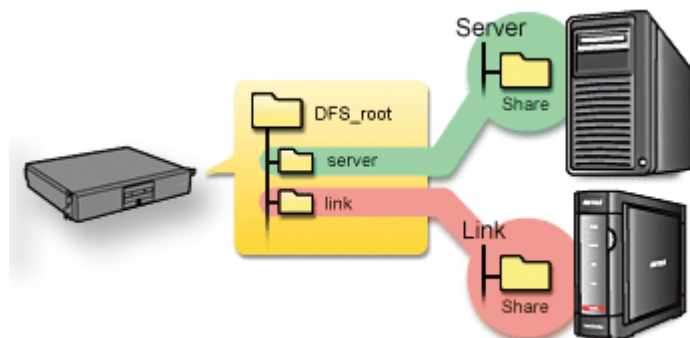

Enter the DFS root folder name, then click *Save*.

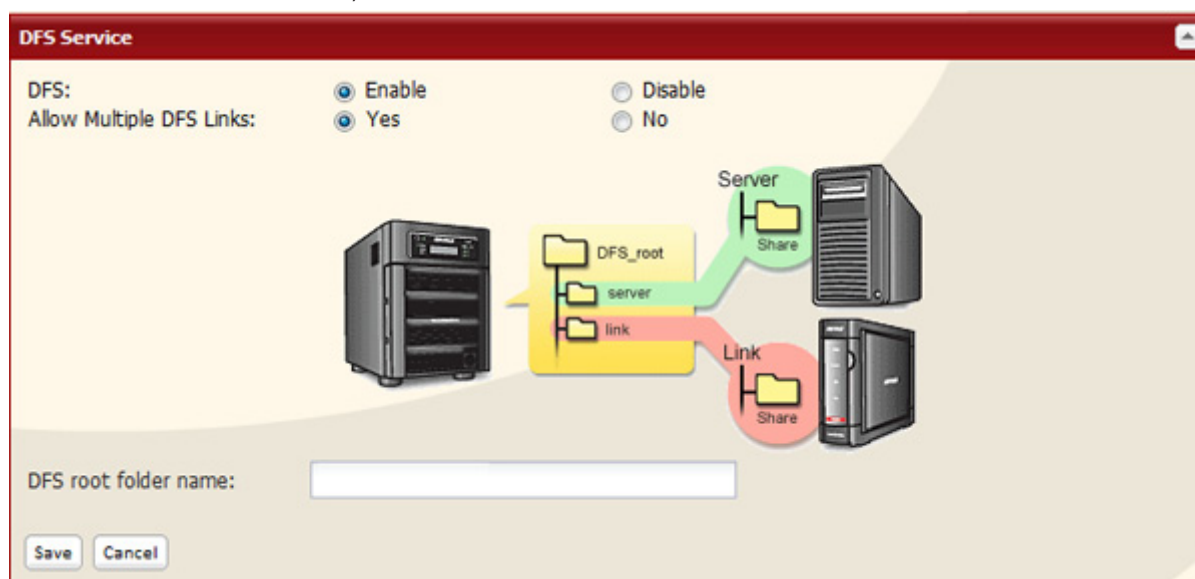

3 Under *DFS Links*, click *Add Link*.

Enter link name, destination hostname, and destination folder. Click *Save*.



Note: The following machines can be DFS link destinations:

- TeraStations
- Windows PC with SMB (Mac OS and Linux are not supported)

DFS has been configured.

FTP Server

By default, the TeraStation's shares are only accessible by users connected to the same network or router as the TeraStation. The optional FTP server allows users to access the TeraStation from outside of the local network. You may enable it as follows.

1 In Settings, navigate to *Network - Settings - Network Services* and click *FTP*.

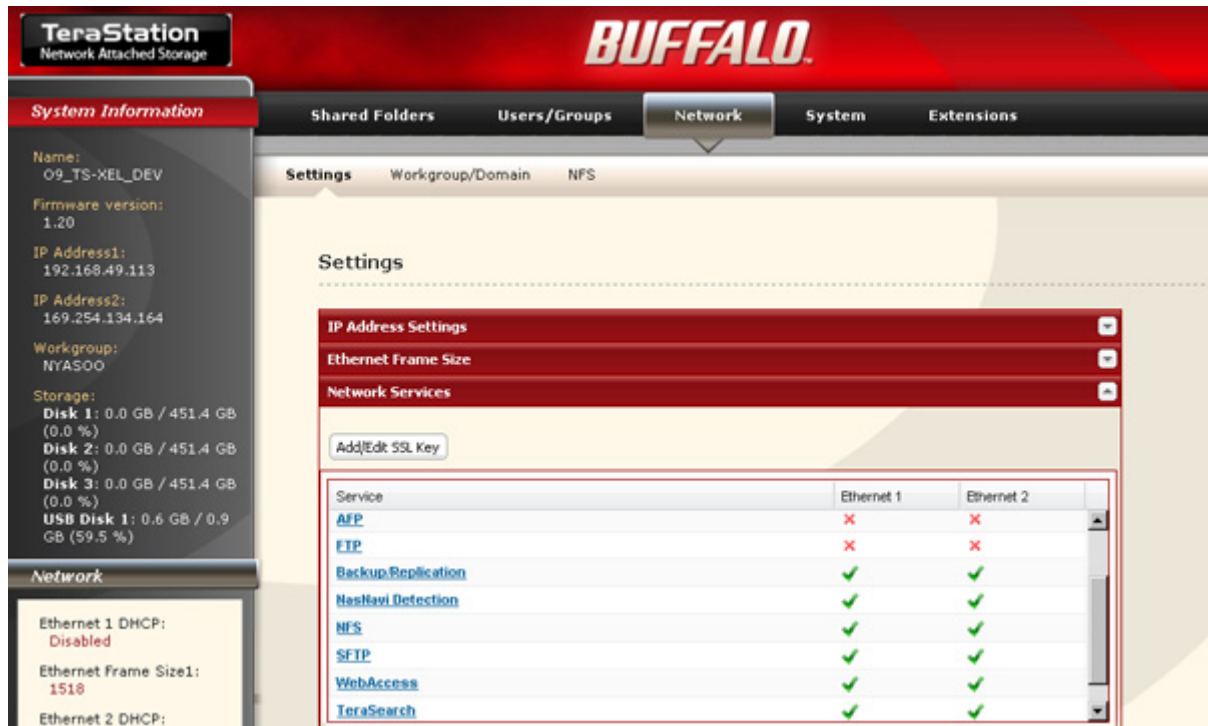

2 Select *Enable*. Click *Save*.



3 Click *Shared Folders - Folder Setup*.

4 Click the folder to enable remote FTP access on.

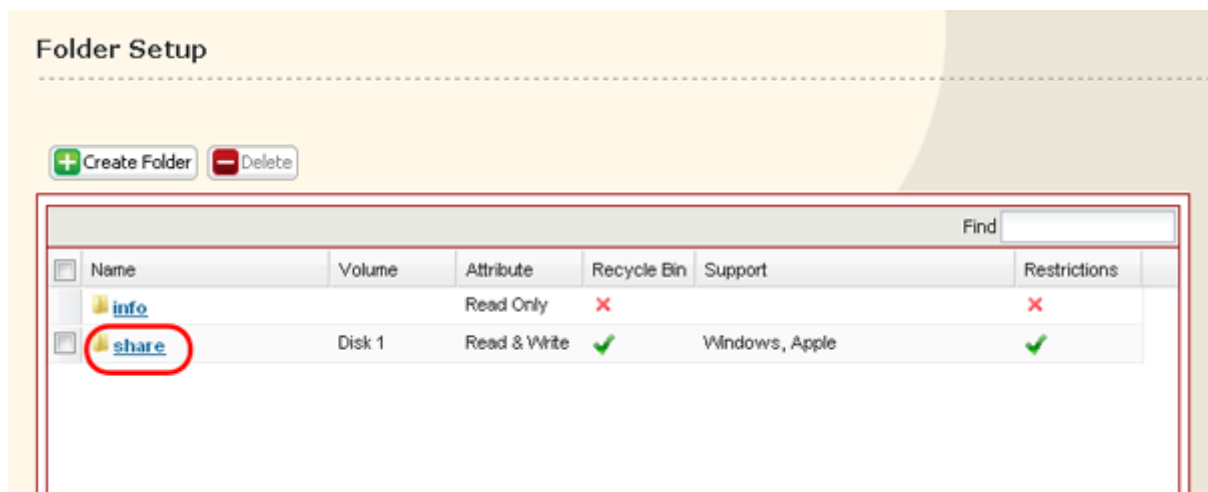

5 Select whether the shared folder is to be *Read Only* or *Read & Write*. Check *Ftp*. Click *Save*.

Shared Folders > share

Name: share

Description: TeraStation folder

Volume: Disk 4

Shared Folder Attributes: Read Only Read & Write

Recycle Bin: Enable Disable

Shared Folder Support: Windows Apple Ftp Disk Backup SFTP

Folder Mode (SMB Only): Hide Share

Remote backup password:

Offline Files: Disable Offline Files

TeraSearch: Include folder in search indexing

Access Restrictions

Save Cancel

The folder is now configured for FTP access. Do not forget to give read (or write) permissions for the FTP share to any users that will be accessing the share remotely. Folder permissions can only be changed from Settings. Changing them remotely with FTP client software is not supported.

To access the TeraStation with an FTP client

Configure your FTP client software with the following settings:

- Host Name IP address of the TeraStation.
- Username Username registered on the TeraStation
- Password Password registered to the TeraStation
- Port 21

Example ftp://192.168.11.150/

- You cannot write by FTP if the shared folder is set to read-only on the TeraStation.
- Access restrictions are applied based on the settings in the TeraStation. The restrictions aren't displayed for users without permissions for the share.
- To access your FTP share from outside of your network, you may need to configure your router and firewall. Consult your router documentation for more information.
- Shared folders appear as follows when connected by FTP:
 - disk1 share
 - usbdisk1
- The internal hard drive of the TeraStation is displayed as disk1, and a USB hard drive (optional) will be displayed as usbdisk1.
- "usbdisk1" is not displayed when the USB hard drive is not connected or access is restricted.

Accessing the TeraStation with an Anonymous User:

To allow anonymous access to your FTP share, disable access restrictions on the FTP share. Configure your FTP client as follows:

- Host Name IP address of the TeraStation
- Username anonymous
- Password any set of characters
- Port 21

Example ftp://192.168.11.150/

- To make your FTP share available from outside your network, you will need to configure your router and firewall. Consult your router's documentation for information on how to allow FTP traffic.
- If the TeraStation joins a domain, anonymous users cannot access it.
- Folders created or copied via an AFP connection may not be deleted from the AFP connection. This is because an automatically generated ".AppleDouble" folder begins with a dot. To delete these files, use an SMB connection.
- Do not exceed 250 bytes for a file/folder name including directory path when you are creating it by using an FTP connection. Otherwise, you cannot view or delete it in Explorer or other applications.

Accessing from a NFS Client

Use the following procedure configure the TeraStation for access from UNIX with NFS.

Note: This section is for information only. Unix and NFS are not supported by Buffalo. If you choose to configure your TeraStation this way, it does not void your warranty, but you are on your own for tech support.

Use the following procedure to configure the TeraStation for access with NFS.

Note: (US purchasers only) Buffalo's customer support will help configure the NFS settings on your TeraStation, and will support VMware and Windows clients but will not provide support for configuring your Linux or other UNIX clients. There are many types of UNIX and the procedures for configuring NFS with them will vary considerably. For help configuring your Netware, Linux, or other UNIX clients for NFS support, consult each client's own documentation and support.

1 In Settings, select *Network - NFS - NFS Service*, and click *Modify Settings*.

2 Click *Enable*, then *Save*.

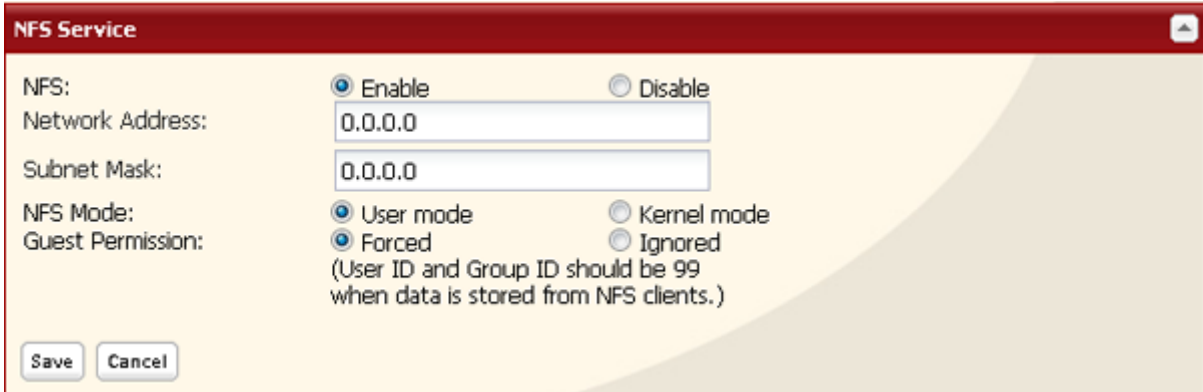

Notes:

- If you use a public folder of the TeraStation set by NFS as a hard drive for VMware ESX/ESXi, it is required to set *NFS Mode* to *Kernel mode* in order to use it (It is set to *User mode* by default).
- To set access restrictions by IP addresses, specify a network address and subnet mask from the screen above.
(e.g.) To allow access from a client with the IP address 192.168.11.xxx:
Network Address: 192.168.11.0
Subnet Mask: 255.255.255.0
xxx can be 1 to 254. Enter 0 (zero) for the Network Address.
(e.g.) To allow access from a client with the IP address 192.168.xxx.xxx:
Network Address: 192.168.0.0
Subnet Mask: 255.255.0.0
xxx can be 1 to 254. Enter 0 (zero) for the Network Address.

3 Click *NFS Folders Setup*.

4 Choose a shared folder.



5 Write down the NFS public path. Click *Enable*, then *Save*.

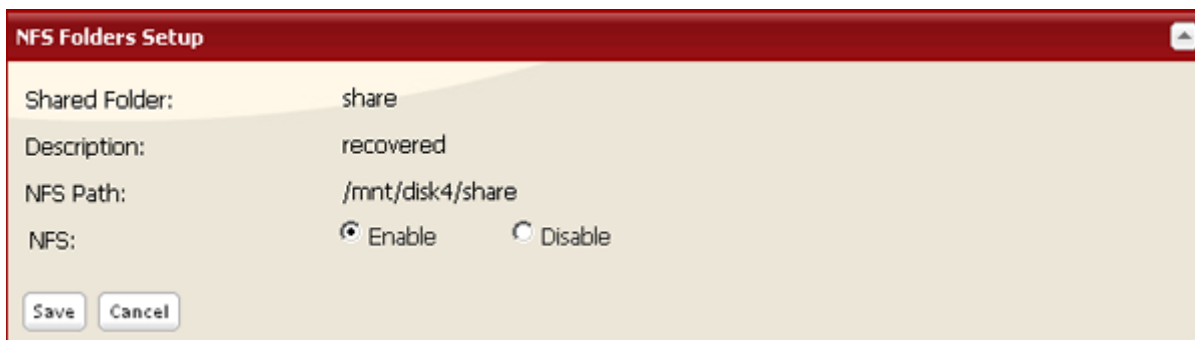

6 Click *NFS Client Setup*.

7 Click *Add Client*.

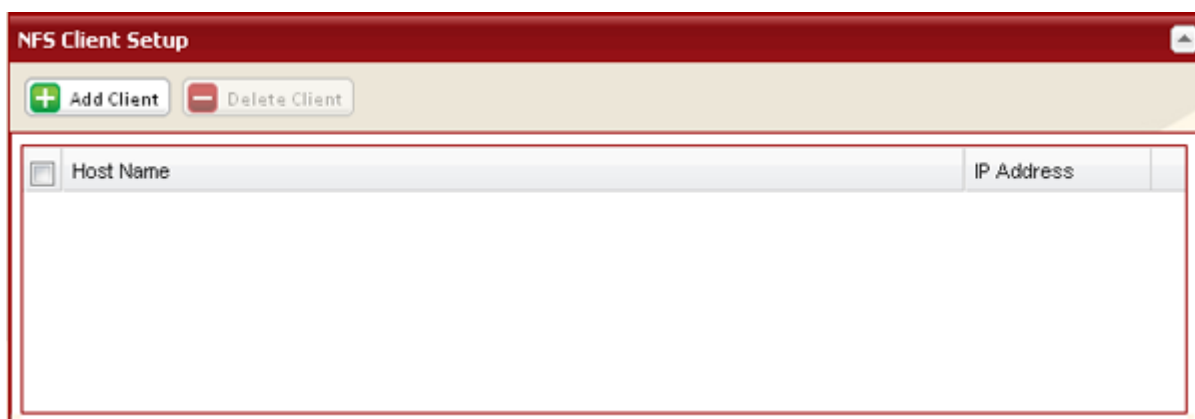

8 Enter target hostname and IP address of the NFS UNIX client. Click *Save*.



9 The IP address and the hostname of the client are added.



Notes:

- To remove, check the box next to the hostname and click *Delete Client*.
- You may be able to connect via NFS from a computer that is not registered as a client.

10 Examples of commands to access a folder on the TeraStation from the NFS client:

From Linux:

```
mount -t nfs <IP Address>:<NFS public path for the TeraStation><the mounting point on the local computer>  
(e.g.) mkdir /mnt/tsx1
```

```
mount -t nfs 192.168.11.10:/mnt/array1/share /mnt/tsx1
```

In this example, TeraStation's IP address is "192.168.11.10", NFS publishing path is "/mnt/array1/share", and a mount point on the local computer is "/mnt/tsx1".

From Windows Services for Unix 3.5:

```
mount <IP Address>:<NFS publishing path for the TeraStation> <a network drive's letter (an error occurs if not available)>
```

```
(e.g.) mount 192.168.11.10:/mnt/array1/share z:
```

In this example, TeraStation's IP address is "192.168.11.10", NFS publishing path is "/mnt/array1/share", and a network drive letter is "z".

From Solaris10:

```
mount -<F nfs IP Address>:<NFS publishing path for the TeraStation><the mounting point on the local computer>
```

```
(e.g.) mkdir /mnt/tsx1
```

```
mount -F nfs 192.168.11.10:/mnt/array1/share /mnt/tsx1
```

In this example, TeraStation's IP address is "192.168.11.10", NFS publishing path is "/mnt/array1/share", and a mount point on the local computer is "/mnt/tsx1".

Notes:

- When using simultaneously with Windows file sharing, setting the character encoding to UTF-8 will display Japanese file names normally even over an SMB connection (this is not possible in Windows Service for Unix).
- The same uid and gid cannot be set for user management on the TeraStation and for users on NFS clients.

You've completed the steps to access the TeraStation via NFS.

Encrypting Data Transmission

Encrypting Data from Settings

Access "https://<TeraStation's IP address>" instead of "http://..." to encrypt all data from Settings.

Note:

Your computer may display "there is a problem with this site's security", but you may ignore this message and work normally.

Encrypting FTP Transfer Data

First, in Settings, navigate to Shared Folder Support - Ftp. Check the box by each shared folder to encrypt data transfers. Enable SSL security in your FTP client to encrypt login passwords and files by using SSL/TLS for FTP communication.

Examples: In FileZilla's settings, select *FTP over TLS (explicit encryption)* for the server type. For Smart FTP, select *FTP over SSL explicit* in the settings.

Notes:

- Encryption processes may seriously reduce data transfer speeds. Your transfers may be as much as 10 times slower when using encryption.
- Depending on your computer's security settings, the message "there is a problem with this site's security" may be displayed, but you may ignore this message and work normally.

SSL Key

Note: This procedure is described for network administrators and advanced users. Do not try to configure this unless you know exactly what you're doing.

You may use encrypted keys such as https and FTPS for settings operations and FTP connections.

SSL (Secure Socket Layer) is a public key encryption method. SSL operation is managed by 2 files:

(1) server.crt (SSL Certificate)

TeraStation will send this certificate to other computers, which will use it as a key for encryption. The TeraStation will then receive encrypted data and use the server.key (SSL Key) to decrypt them.

This key includes Server Certificate on SSL, and your PC may decide if the certificate can be trusted or not. Your computer may display the message "There is a problem with the site's security certificate."

(2) server.key (SSL Key)

This is used to decrypt data encrypted by the server certificate.

Note: Prepare the decrypted passphrase for the server.key (SSL Key).

Updating SSL Key

To update a server certificate and a private key for SSL, follow the procedure below.

(1) In Settings, navigate to *Network - Settings - Network Services - Add/Edit SSL Key*.

(2) Register server.key for "SSL Key" and server.crt for "SSL Certificate", then click *Import*.

Note: Save SSL key files (server.key and server.crt) on the root of drive C. They should not be saved in a folder or path whose name includes multi-byte or special characters.

You've updated the SSL key.

Notes:

- The SSL key should not be password protected.
- If Settings isn't accessible after updating, initialize the TeraStation.
- Updating the firmware will initialize an SSL key.

Wake-on-LAN

The TeraStation supports Wake-on-LAN, which allows it to be turned on remotely.

Before using Wake-on-LAN, enable it as described below.

- 1** In Settings, navigate to *Network - Settings - IP Address Settings*. Click *Modify Settings*.

2 Click *Enable* for *Wake on LAN*. Click *Save*.

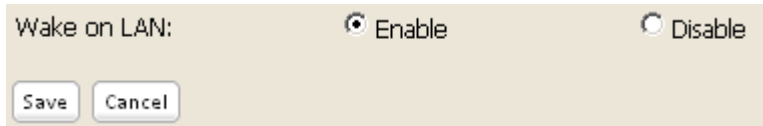

Wake-on-LAN is now enabled. As long as it is connected to power and the network, you can turn on the TeraStation remotely. To turn the TeraStation on remotely, send a Wake-on-LAN packet to the TeraStation on UDP port 2304.

Notes:

- TS-XEL series TeraStations do not support Wake-on-LAN.
- After receiving the Wake-on-LAN packet, the TeraStation may take approximately five minutes to be ready to use.
- After power is restored from a power outage, wait five minutes before sending a Wake-on-LAN packet to the TeraStation.
- To use Wake-on-LAN, you'll need Wake-on-LAN software. The TeraStation does not include Wake-on-LAN software.
- The TeraStation does not support using Wake-on-LAN and port trunking at the same time. You may use either feature, but not both at the same time.
- On the local network, Wake-on-LAN packets may be sent to port 2304 on either of the TeraStation's LAN ports. If the TeraStation is connected to a Buffalo wireless router configured for remote access, then it may be turned on from outside the local network (from the WAN side). To use this feature, the Buffalo router must be connected to LAN port 1 only on the TeraStation. The TeraStation does not support remote WAN-side Wake-on-LAN if LAN port 2 is connected to the router.

Web Server

The TeraStation can be used as a web server. In addition to html files, images, and JavaScript, the TeraStation also allows installation of Perl script and PHP script files. The TeraStation's web server is for advanced users only. Do not enable it unless you know what you're doing.

1 In Settings, navigate to *Network - Settings - IP Address Settings*. Click *Modify Settings*.

2 Select *Enable* for web server. Choose an external port (81 is the default) and a folder for the web server. Click *Save*.

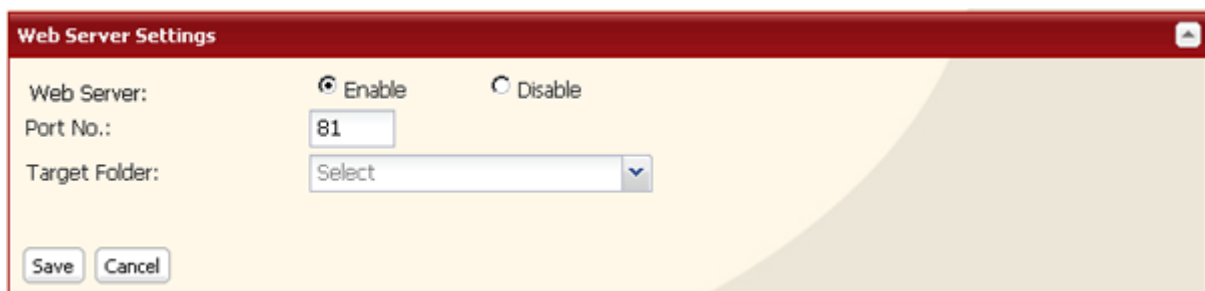

- 3 Edit the php.ini file to change the PHP language interpreter settings.

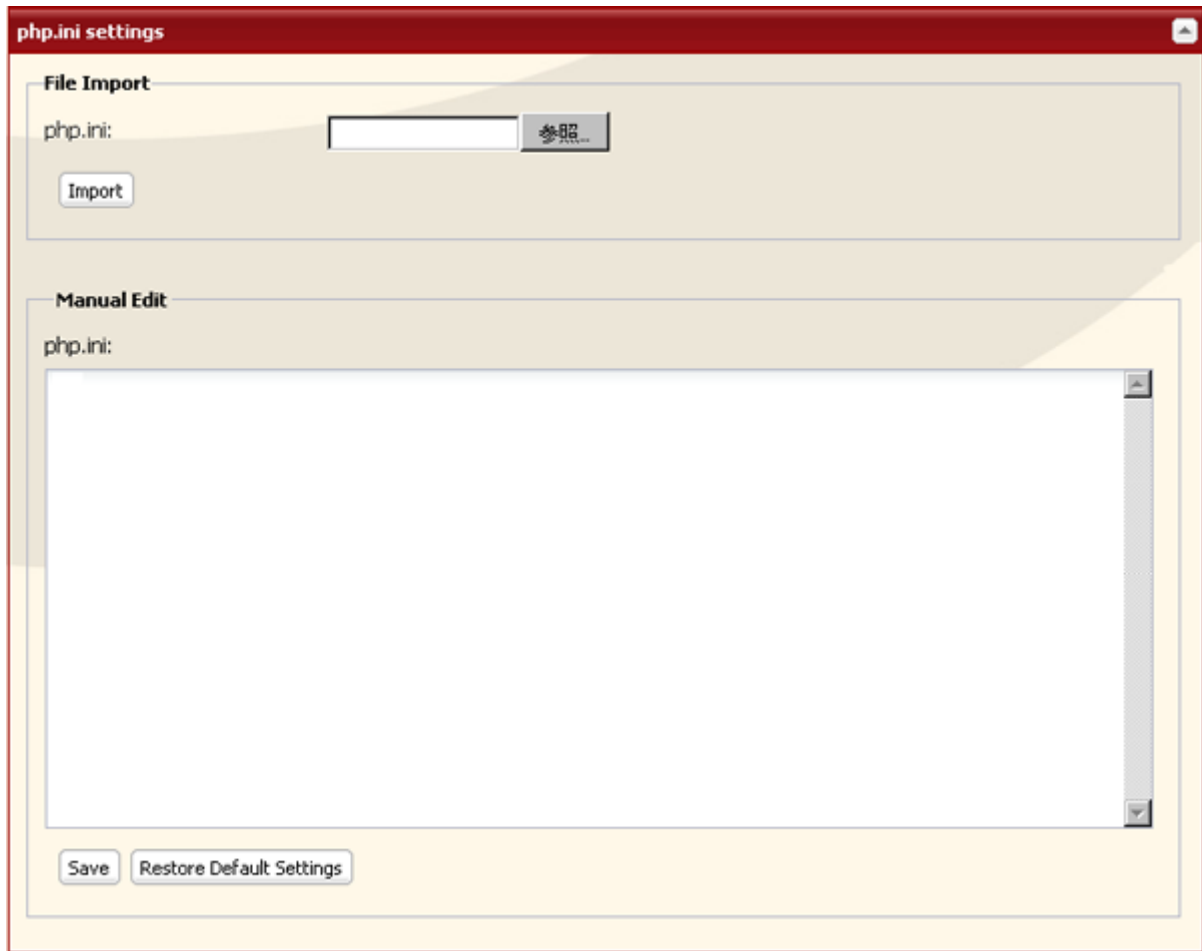

Note:

The web server uses version 1.4.23 of lighttpd, version 5.8.8 of Perl, and version 5.2.10 of PHP.

The Web server is now configured.

MySQL Server

The TeraStation can be used as a MySQL server. A MySQL database may be installed and linked with the web server. The TeraStation's MySQL server is for advanced users only. Do not enable it unless you know what you're doing.

- 1 In Settings, navigate to *Network – MySQL Server*. Click *Modify Settings*.
- 2 Select *Enable* for MySQL Server, choose a port number and data folder, then click *Save*.

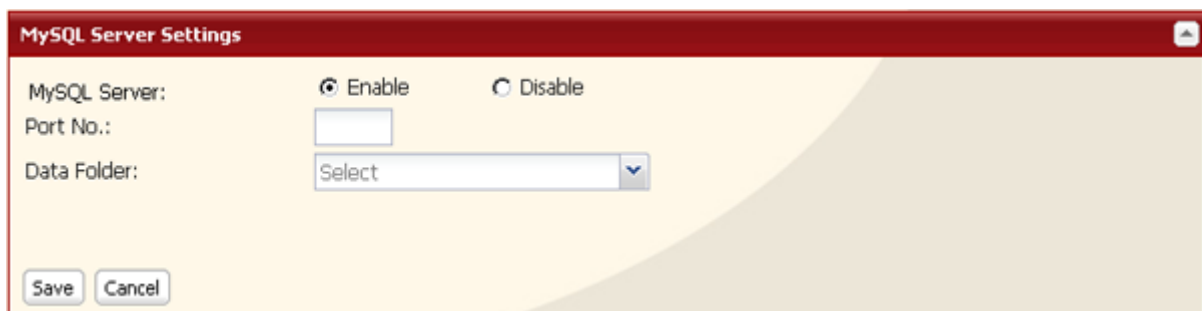

Note:

The TeraStation uses version 5.0.70 of MySQL server and version 3.2.2 of PhpMyAdmin.

The MySQL server is now configured.

SNMP

If SNMP is enabled, you can browse your TeraStation from SNMP-compatible network management software. SNMP network management is for advanced users only. Do not enable it unless you know what you're doing.

- 1 In Settings, navigate to *Network - SNMP*. Click *Modify Settings*.
- 2 Select *Enable* for *SNMP Settings*, configure desired settings, and click *Save*.

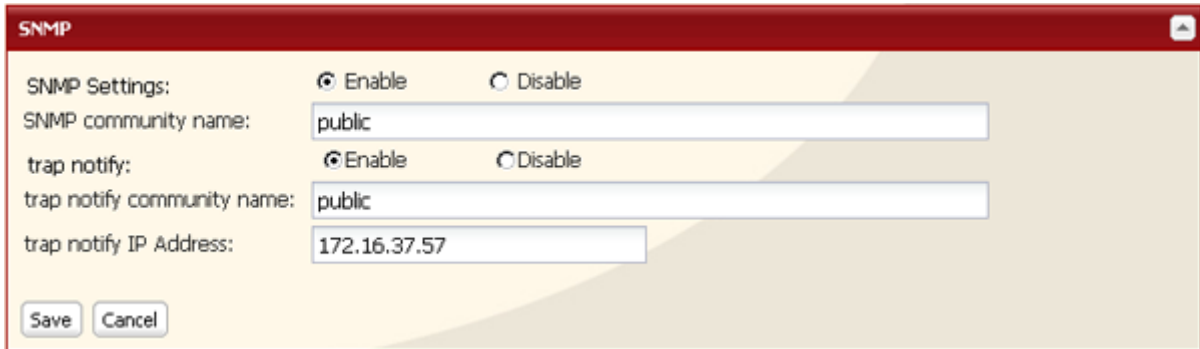

The screenshot shows a dialog box titled "SNMP" with a red header bar. It contains the following configuration options:

- SNMP Settings:** Enable Disable
- SNMP community name:**
- trap notify:** Enable Disable
- trap notify community name:**
- trap notify IP Address:**

At the bottom left, there are two buttons: "Save" and "Cancel".

Note: The specific MIB (management information base) file for Buffalo is available from the Buffalo website. SNMP is now configured.

Chapter 10 NAS Navigator2

NAS Navigator2 is a utility program that makes it simple to display Settings, change its IP address, or check its hard drive.

Windows

If you set up the TeraStation with the TeraNavigator CD, NAS Navigator2 was installed and configured to run automatically in the system tray at startup.



Double-click the  icon on the desktop to start NAS Navigator2.

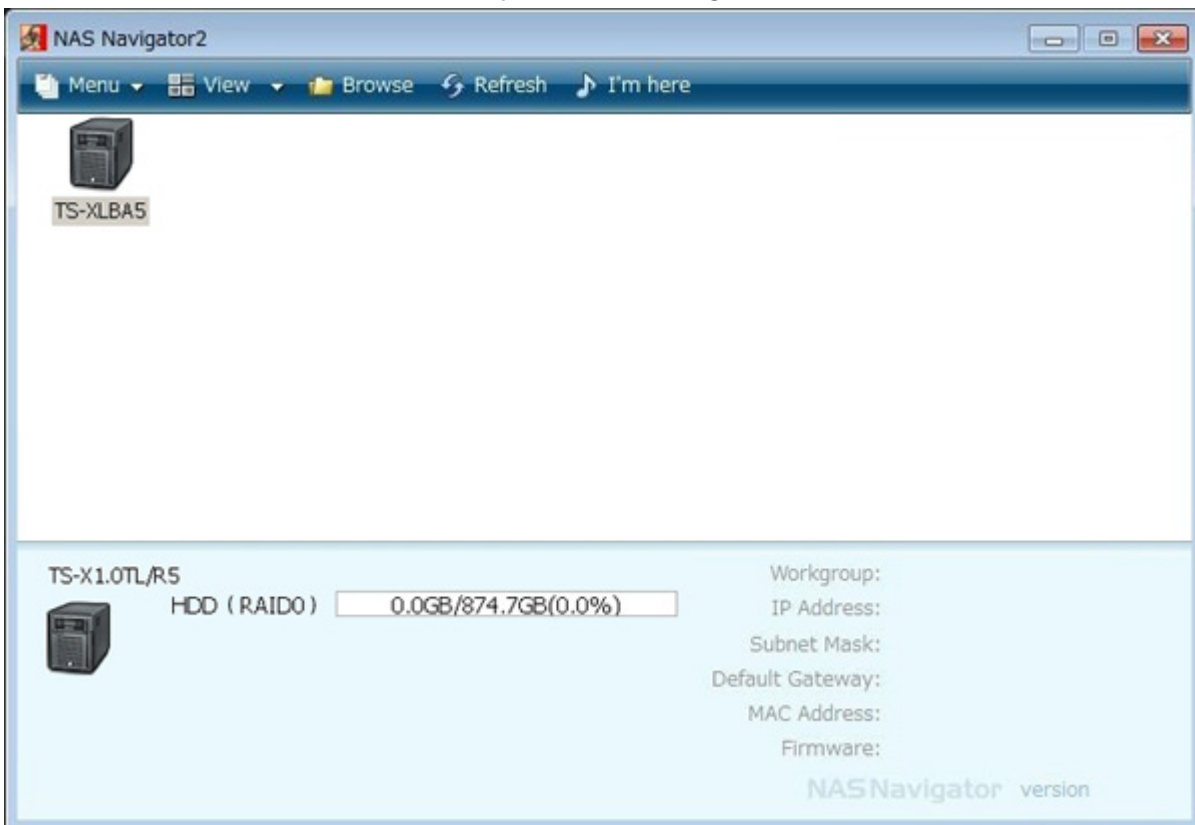

Clicking a TeraStation's icon will display its total capacity, capacity being used, workgroup, IP address, subnet mask, default gateway, MAC address, and firmware version.

Name	Descriptions	
Menu	Map Share*	Assigns the searched TeraStation's shared folder as a network drive.
	Disconnect Share*	Unmaps the network drive.
	Map All Remote Shares to Drive Letters	Assigns the all TeraStation's shared folders found as a network drive.
	Create Desktop Shortcut*	Creates the shortcut icon to searched TeraStation's shared folder (share).
	Launch NAS Navigator2 on startup	Launches NAS Navigator2 when Windows is booted.
	Display Errors	Displays an error message on NAS Navigator2 icon in the task tray when an error occurs.
	Properties*	Opens the selected TeraStation's Properties window.
	Close	Closes NAS Navigator2 window.
View	View	Icon: Displays icon for ease. Details: Displays name, product name, workgroup, IP address, subnet mask, and default gateway.
	Sort by	Selects the sort order from following to display when multiple TeraStations are found: Hostname, product name, workgroup, IP address, subnet mask, and default gateway
Browse*	Opens the displayed shared folder on the TeraStation.	
Refresh	Searches the TeraStation again.	
I'm here*	Ring a tone from the TeraStation when click it (This option is disabled if the product does not support this feature).	

*Click your TeraStation's icon to display these options.

When NAS Navigator2 is minimized, right-click the NAS Navigator2 icon in the task tray for the following options:

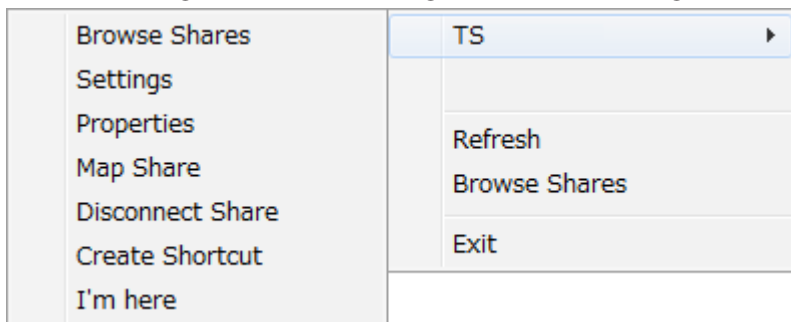

Menu Item	Descriptions	
TeraStation Name	Browse Shares	Opens a shared folder on the TeraStation.
	Settings	Opens the selected TeraStation's settings.
	Properties	Opens the selected TeraStation's Properties window.
	Map Share	Assigns the searched TeraStation's shared folder as a network drive.
	Disconnect Share	Unmaps the network drive.
	Create Shortcut	Creates the shortcut icon to the searched TeraStation's shared folder (share).
	I'm here	Rings a tone from the TeraStation (This option is disabled if the product does not support this feature).
Refresh	Refreshes list of NAS devices.	
Browse Shares	Displays NAS Navigator2 window.	
Exit	Exits NAS Navigator2.	

The following tasks may be performed from the TeraStation's Properties window.

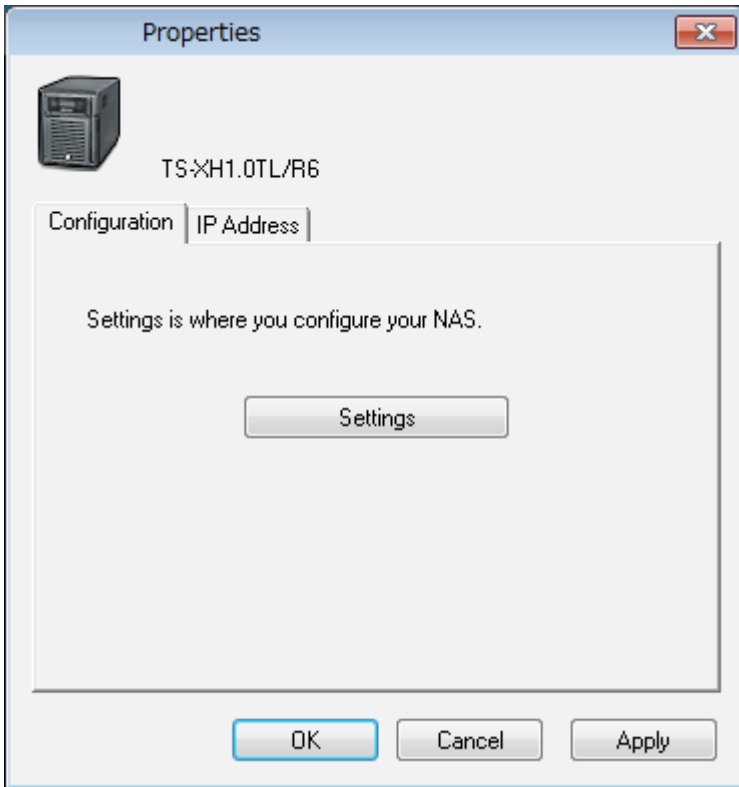

Menu Item	Description
Configuration	Click Settings to display Settings.
IP Address	Insert the check mark in Use DHCP to assign IP address from DHCP server automatically. If there is no DHCP server in the network, you cannot use this function. If you insert the check mark into Renew IP address, it will obtain an IP address from DHCP server again. You can manually enter IP address, subnet mask and default gateway.

Mac OS

If you installed the TeraStation with the TeraNavigator CD, NAS Navigator2 was installed automatically. To launch it,

click the  icon in the Dock.

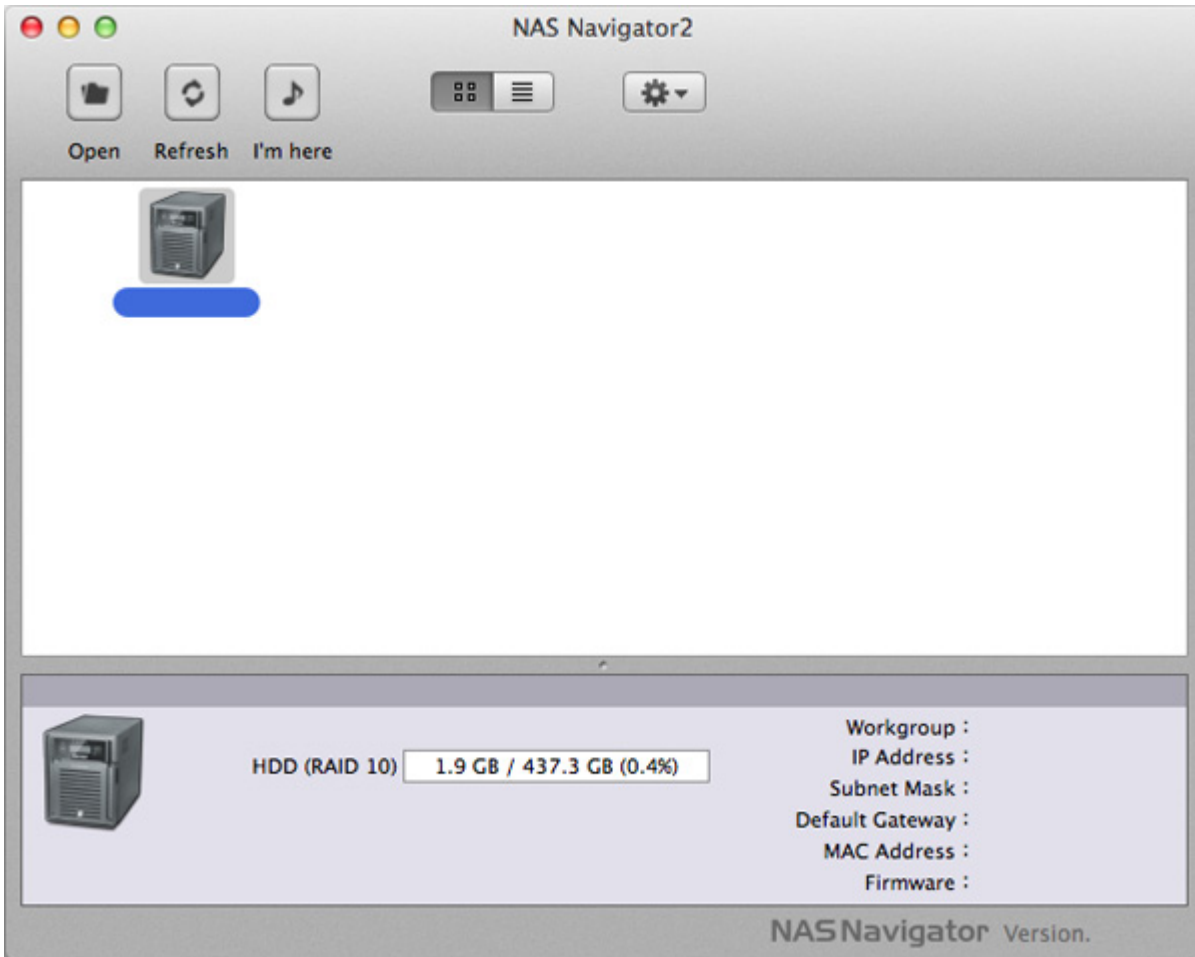

Click a TeraStation's icon to display its total capacity, used capacity, workgroup, IP address, subnet mask, default gateway, MAC address, and firmware version. Double-click to open a share on the TeraStation.

Menu Item		Descriptions
Open		Opens a shared folder on the TeraStation.
Refresh		Searches the TeraStation again.
I'm here		Ring a tone from the TeraStation when click it (This option is disabled if the product does not support this feature).
Menu displayed when click TeraStation Icon while pressing the control Key	Open Folder	Opens a shared folder on the TeraStation.
	Settings	Opens the selected settings.
	Configure	Displays the screen to open Settings or change an IP address.
	I'm here	Ring a tone from the TeraStation when click it (This option is disabled if the product does not support this feature).
	View Options	Sets the orders of icon sizes, label positions, and icons.

Chapter 11 Software

NAS Navigator2

NAS Navigator2 client software is described in chapter 10.

File Security Tool

Before using the TeraStation with Windows 8, Windows 7, Windows Vista, Windows Server 2003, or Windows Server 2008, you will need to change the security settings to allow access to NAS devices. The File Security Tool makes these changes for you automatically during installation from the TeraNavigator CD, or you may run it manually as described below.

Notes:

- This will be installed only on Windows 8, Windows 7, Windows Vista, and Windows Server 2003, or Windows Server 2008.
- During the initial setup, the message, "Change security level. Will you continue?" is displayed. Click *Yes* and follow the instructions on the screen to restart your PC.

1 Click *Start - BUFFALO - File Security Tool - File Security Tool*. The File Security Tool will launch.

Note: When "A program needs your permission to continue" is displayed, click *Continue*.

2 Select *Change security level*, then click *Change*.

3 The message, "Change security level. Will you continue?" is displayed; click *Yes*.

4 The message, "Will you restart your computer?" is displayed; click *Yes*. Your PC will reboot.

You have changed the security settings.

Note: To reset security settings to their factory defaults, use the following procedure.

- (1) Click *Start - BUFFALO - File Security Tool - File Security Tool*.
When "A program needs your permission to continue" is displayed, click *Continue*.
 - (2) Select *Recover default security level*.
 - (3) Click *Change*.
- Security settings are now restored to their default settings.

NS-SHFT

This software stores your TeraStation's configuration settings as a file on your computer. You may use it to restore settings on the TeraStation, or copy the settings to a different TeraStation of the same model. After installation, read the help files at *(All) Programs - BUFFALO - NS-SHFT - Manual (PDF)* for instructions on how to use it. For Windows 8, right-click NS-SHFT and select *Open file location*. Double-click *Manual (PDF)*.

Notes:

- NS-SHFT doesn't work with Windows Server 2003, Windows Server 2008, Windows 2000 Server, or Mac OS.
- NS-SHFT does not save data to the TeraStation.

- If NS-SHFT displays the message "Failed" after saving configuration data, then your configuration has not been saved. In such a case, save the configuration again.

EXT3 Reader

The best format for external USB hard drives attached to the TeraStation is EXT3, a native Linux format, but this format is not normally supported by Windows. The EXT3 Reader software allows you to ready files from an EXT3 hard drive directly connected to your Windows PC.

To use EXT3 Reader.

- 1** Dismount the EXT3-formatted USB hard disk from your TeraStation. Unplug it, then connect it to your Windows PC.

Notes:

- USB hard drive that includes TurboUSB support will work fine with EXT3 Reader. Disable TurboUSB before using EXT3 reader, because the two programs do not always play well together.
- EXT3 only recognizes the primary partition on the USB hard drive.
- Before connecting the EXT3 hard drive to your PC, it must be properly dismounted from the TeraStation.
- EXT3 volumes created on GUID partitions (GPT) cannot be read by Windows 2000 or Windows XP.

- 2** Select *Start - (All) Programs - EXT3 Reader - EXT3 Reader*, and launch EXT3 Reader. For Windows 8, click the *EXT3 Reader*.

- 3** Click *Enable*.

- 4** Right-click on the icon () in the task tray and select USB mass storage device in the displayed menu. When the message "you can now safely remove hardware" appears, unplug the drive.

- 5** After a few seconds, reconnect the USB hard drive to your PC.

- 6** You can now read data from the hard drive normally. Note that you can only read data, not write, edit, or delete it.

EXT3 Reader is now working on your PC.

To remove the hard drive while disabling the EXT3 reader, use the following procedure.

If you remove it while it is enabled, use only step 3 (step 1, 2 and 4 are not required to be performed).

- 7** Select *Start - (All) Programs - EXT3 Reader - EXT3 Reader*, and launch EXT3 Reader.

- 8** Click *Disable*.

- 9** Right-click on the icon () in the task tray, and select USB mass storage device in the displayed menu. If the message "you can now safely remove hardware", remove it.

- 10** Restart Windows.

You have disconnected the EXT3 drive from your PC.

Chapter 12 List of Items in Settings

The following options can be set from Settings.

Common Items (Left Side of the Screen)

Common Items (displayed on the left side of the screen)	
Name	Displays the TeraStation's name.
Firmware Version	Displays TeraStation's firmware version number.
IP Address	Displays the IP addresses of the TeraStation's LAN ports 1 and 2.
Workgroup	Displays workgroups on the TeraStation.
Storage	Displays total space and used space of internal hard drives.
Shared Folders Users/Groups Network	When <i>Shared Folders</i> is selected, the number of shared folders and the number of disks are displayed. When <i>Users/ Groups</i> is selected, the number of users and the number of groups are displayed. When <i>Network</i> is selected, enabling or disabling DHCP and Ethernet frame size are displayed.
Locate	Causes the TeraStation to beep.
Logout (displayed on the upper right of the screen)	Log out from Settings.

Shared Folders

Shared Folders		
Folder Setup	Folder Setup	Click <i>Create Folder</i> to add a new shared folder. Click the shared folder name to edit the shared folder's information. Select the shared folder and click <i>Delete</i> to delete the shared folder. * Enter a letter in the <i>Refresh</i> field to see folders that start with that letter. Click an item on the list to select the folder name. * Click <i>Empty recycle bin of each folder</i> to delete the data in the recycle bins.
Folder Setup - New Folder * Displayed when clicking Create Folder on the shared folder configuration screen.	Copy Settings From	Select the shared folder you want to copy settings from.
	Name	Enter a share folder's name. * You can enter up to 27 bytes(UTF-8). * Alphanumeric characters, multi-byte characters, hyphens (-), and underscores (_) may be used. * Do not use a symbol as the first character.

<p>Folder Setup - New Folder</p> <p>* Displayed when clicking Create Folder on the shared folder configuration screen.</p>	Description	<p>Enter a description for the shared folder</p> <p>* You can enter up to 75 bytes(UTF-8).</p> <p>* Alphanumeric characters, multi-byte characters, hyphens (-), underscores (_), and spaces may be used.</p> <p>* Do not use a symbol as the first character.</p>
	Volume	Select where to create a share folder.
	Shared Folder Attributes	Shared folders may be read-only or writable.
	Recycle Bin	<p>If deleting files in the selected shared folder or "usbdisk", the trashbox folder is automatically created in the shared folder and files will be moved into this folder.</p> <p>* Directory information will also be sustained in the trashbox.</p> <p>* One trashbox folder can be set per shared folder on the TeraStation and per connected USB hard drive.</p> <p>* The USB hard drives must be formatted as EXT3, XFS or FAT32 in order to use trashbox. Files in NTFS or HFS+ formats cannot be deleted.</p> <p>* You cannot use this feature while connecting via AFP.</p> <p>* You cannot use this feature while connecting via FTP.</p>
	Shared Folder Support	<p>Select which operating systems and features the share will support.</p> <ul style="list-style-type: none"> • <i>Shared Folder Support</i>: Descriptions • <i>Windows</i>: Allow or reject connection via SMB from Windows PC or Mac OS. • <i>Apple</i>: Allow or reject the connection via Appletalk (AFP) from Mac OS. • <i>Ftp</i>: Set to allow/disallow to manipulate folders via FTP. <p>Note: It is required to configure to use FTP in <i>Network - Settings - Network Services</i> beforehand.</p> <ul style="list-style-type: none"> • <i>Disk Backup</i>: Set to enable/disable to use as a backup destination. • <i>SFTP</i>: Select when connecting by SFTP. <p>If you uncheck <i>Windows</i>, <i>Apple</i>, <i>Ftp</i>, and <i>SFTP</i> and only check <i>Disk Backup</i>, only TeraStation's backup programs will be able to see the share. If you want to be able to access TeraStation's backup folders from a computer, check the <i>Windows</i> option.</p>
Folder Mode (SMB Only)	<p>If you choose <i>Hide Share</i>, the configured shared folder will be invisible.</p> <p>To open a hidden folder, click <i>Start - Search programs and files</i> and enter \\TeraStation name\Shared folder name\$ for the name. Example: If the TeraStation name is "TS-XX001" and the shared folder name is "share", then enter "\\TS-XX001\share\$" to open it. FTP, SFTP, and Mac AFP folders cannot be hidden.</p>	

Folder Setup - New Folder * Displayed when clicking Create Folder on the shared folder configuration screen.	Remote backup password	When you back up data from other TeraStation to this unit via network, you can set up the password so that this unit is mistakenly selected as a backup destination. * You can enter up to 8 bytes(UTF-8) including alphanumeric characters, hyphens (-), and underscores (_). * You cannot use a hyphen (-) for the first letter.
	Offline Files	Options: <i>Disable Offline Files</i> : Disables offline file. <i>Manual Cache Files</i> : Enables offline files. You need to select the files to use offline yourself. <i>Automatic Cache Files</i> : Enables offline files. Open files are cached locally and may be used offline. Old files that cannot be synchronized are replaced by newer files or deleted automatically. <i>Automatic Cache Programs and Files</i> : Enables offline files. Opened files are cached locally and may be used offline. Old files and network applications that cannot be synchronized are replaced by newer files or deleted automatically.
	TeraSearch	To create an index for TeraSearch, check <i>Include folder in search indexing</i> and click <i>Save</i> .
Access Restrictions Click Access Restrictions on "New Folder" to view this option.	Access Restrictions	Enable access restrictions. Click <i>Add</i> and select the user or group name which are allowed to access, then click <i>Add</i> . To remove access, select the username and group, then click <i>Disconnect</i> . If using FTP/FTPS/SFTP connection, access restrictions can be set per user.
DFS Service Click <i>Modify Settings</i> to change settings.	DFS	Select to <i>Enable</i> or <i>Disable</i> for Distributed File System (DFS).
	Allow Multiple DFS Links	Enable to allow multiple DFS connections.
	DFS root folder name	Enter the displayed SMB name of the DFS root folder. * You cannot use a name which has already used. * You can enter up to 27 bytes (UTF-8). * Alphanumeric characters, multi-byte characters, hyphens (-), and underscores (_) may be used. * Do not use a number or symbol as the first character.
DFS Links	Add Link	Enter link name, destination hostname, and destination folder. If it is possible to resolve the name in SMB, use the UNC hostname. Otherwise, enter the IP address.
	Remove Link	Delete selected DFS link.
Direct Copy Click <i>Modify Settings</i> to change settings.	Target	Change the shared folders as a Direct Copy destination.
TeraSearch Click <i>Modify Settings</i> to change settings.	TeraSearch	Select <i>Enable</i> to use TeraSearch. Specify the time to update the index in "Update Index at" option. To update the index immediately, click <i>Update Index</i> .

Users/Groups

Users/Groups - Local Users		
Local Users	Local Users	<p>Displays username, user ID, description, and primary group. To create a new user, click <i>Create User</i>. To edit the user, select the username and click <i>Edit User</i>. To delete the user, select the user and click <i>Delete</i>. If you have selected <i>Delegate Authority to External SMB Server</i>, you can convert the user you registered at the TeraStation to the external SMB server certificated user when you clicking <i>Convert the local users to the external user</i>. Selecting <i>guest</i> and then clicking <i>Enable</i> or <i>Disable</i> will let you configure "guest" to be enabled or disabled.</p> <ul style="list-style-type: none"> * Enter a letter in the "Refresh" field, the choice of the username with the first letter matching with the letter will be displayed. Click one of the users listed, and the folder name is selected. * The users "admin" and "guest" have already set in the factory default. You cannot delete them. The "guest" can be disabled. * If you are joining the network as a domain, domain user list is also displayed on the above screen. * "Input CSV format data" will let you obtain user information (in CSV) at once.
Local Users - New User To display, click <i>Create User</i> on the user screen.	Username	<p>Enter the username you register to the TeraStation</p> <ul style="list-style-type: none"> * You can enter up to 20 bytes (UTF-8). Do not use multi-byte characters. * Alphanumeric characters, hyphens (-), underscores (_), periods (.), !, #, &, @, \$, *, ^, % may be used. * Do not use a symbol as the first character.
	User Id	<p>If a user ID is left blank, a user ID will be automatically assigned. When using the quota feature, use numbers between 1000 and 1999 to set a group ID manually. Make sure that a user ID does not duplicate to other users.</p>
	Description	<p>Set the description of a username.</p> <ul style="list-style-type: none"> * You can enter up to 75 bytes (UTF-8). * Alphanumeric characters, multi-byte characters, hyphens (-), underscores (_), and spaces may be used. * Do not use a symbol and space as the first character. * Additional users will automatically belong to the "hdusers" group. You can change the group from group settings.
	Password	<p>Enter the password needed to access the TeraStation.</p> <ul style="list-style-type: none"> * You can enter up to 20 bytes (UTF-8). Do not use multi-byte characters. * Alphanumeric character and the following characters may be use. - _ @ ! # \$ % & ' () * + , . / ; < > = ? ^ { } ~ * Do not use a symbol except underscore (_) as the first character. * You can enter up to 14 bytes alphanumeric character (UTF-8) if you are using Windows 98SE/98/95. You can enter up to 8 bytes alphanumeric characters (UTF-8) if you are using Mac OS. Otherwise, you will not able to access shared folders.
	Confirm Password	<p>Enter the password for confirmation.</p>
	Primary Group	<p>When the user belongs to the multiple groups, select which group is the main for that user. If the space usage is limited by the quota feature for the group, the limitation of the usage of the group selected is applied</p>
	User Quota	<p>To use a quota to restrict the space which is available for a user, click <i>Enable</i>.</p>
	Soft Limit (GB)	<p>Set the space which if exceeded will trigger an email notification.</p>

Users/Groups - Local Users		
Local Users - New User To display, click <i>Create User</i> on the user screen.	Hard Limit (GB)	Set space to be available to use (in GB). * Quotas only restrict the available hard drive space. This feature does not provide quotas per user; it should be managed by individual users. To verify the owner, open the new window and click <i>Owner</i> tab by selecting <i>Security</i> tab on Properties screen for each file or folder and click <i>Advanced Settings</i> . (The steps to check the owner may vary according to your OS. The example above is for Windows XP).
Domain Users	Domain Users	The list of domain users is displayed when it joins NT domain or Active Directory.
Domain Groups	Domain Groups	The list of domain groups is displayed when it joins NT domain or Active Directory.
External Users	External Users	<i>Delegate Authority to External SMB Server</i> and <i>Automatic User Registration</i> from <i>Network - Workgroup/Domain</i> for <i>Workgroup Authentication</i> are selected and user is automatically registered, the list of user who is automatically registered is displayed. To delete a user that automatically registered, that user and click <i>Delete External Users</i> .
Users/Groups - Local Groups		
Local Groups	Local Groups	Displays group name, group ID, and description. To create a new group, click <i>Create Group</i> . Select a group name and click <i>Edit Group</i> to display "Edit Group Information" screen. To delete the group, select the group and click <i>Delete</i> . * Enter a letter in the "Refresh" field, the choice of the group name with the first letter matching with the letter will be displayed. Click one of the shared folder listed, and the group name is selected.

Local Groups - New Group To display, click <i>Create Group</i> on the Group screen.	Group Name	Set the name of the group. * You can enter up to 20 bytes (UTF-8). Do not use multi-byte characters. * Alphanumeric characters, hyphens (-), underscores (_), and periods (.) may be used. * Do not use a symbol as the first character.
	Group Id	If group ID is left blank, a group ID will be automatically assigned. When using the quota feature, use numbers between 1000 and 1999 to set a group ID manually. Make sure that the group ID does not duplicate to other groups.
	Description	Set the description of the group. * You can enter up to 75 bytes(UTF-8). * Alphanumeric characters, multi-byte characters, hyphens (-), underscores (_), and spaces may be used. * Do not use space as the first character.
	Group Quota	To use a quota to restrict the space which is available for a group, click <i>Enable</i> .
	Soft Limit (GB)	Set the space which if exceeded will trigger email notification.
	Hard Limit (GB)	Set space to be available for use (in GB). * Quota feature only restricts the available hard drive space. This feature does not show the space that each group is currently using; It should be managed by individual group. To verify the owner, open the new window and click <i>Owner</i> tab by selecting <i>Security</i> tab on "Properties" screen for each file or folder and click <i>Advance Settings</i> . (The steps to check the owner may vary depending on OS. The example above shows for Windows XP).
Local Users/Group Members	Local Users	Select a username which have belong to the group and click <i>Add</i> . This will add the selected as group members. * You cannot let domain users that are obtained from the domain controller belong to any group.
	Group Members	Displays users who are registered to a group. Select user group register and click <i>Disconnect</i> to unregister from the group.

Network

Network		
IP Address Settings Click <i>Modify Settings</i> to change settings. * The LAN cable connected to LAN Port 2 should be set for Ethernet 2.	DHCP	If enabled, DHCP will configure your IP settings automatically. A DHCP server on the network is required for use.
	Primary IP Address	If DHCP is disabled, you can enter an IP address manually.
	Subnet Mask	Set a subnet mask.
	Default Gateway Address	Specify the IP address for a default gateway..
	Primary DNS Server	Specify an IP address of the primary DNS server.
	Secondary DNS Server	Specify an IP address of the secondary DNS server.
	Wake on LAN	Select <i>Enable</i> or <i>Disable</i> for "Wake on LAN". * TS-XEL series TeraStations do not support Wake on LAN.

Network		
<p>Ethernet Frame Size Click <i>Modify Settings</i> to change settings. * The LAN cable connected to LAN port 2 should be set for Ethernet 2.</p>	<p>Ethernet Frame Size</p>	<p>You can improve transmission efficiency by changing the maximum size of data that can be sent at a time.</p> <ul style="list-style-type: none"> • <i>1518 bytes (Default)</i>: It is set to 1518 bytes at default. • <i>4102 bytes (Jumbo Frame)</i>: Transfer at 4102 bytes. • <i>7422 bytes (Jumbo Frame)</i>: Transfer at 7422 bytes. • <i>9694 bytes (Jumbo Frame)</i>: Transfer at 9694 bytes.
<p>Network Services</p>	<p>Network Services</p>	<p><i>HTTP</i>: It is set to <i>Enable</i> by default. * You cannot open Settings from a network for which <i>Disable</i> is selected. <i>HTTPS</i>: It is set to <i>Enable</i> by default. * You cannot open Settings through SSL from a network for which <i>Disable</i> is selected. <i>SMB</i>: It is set to <i>Enable</i> by default. * You cannot access the TeraStation via SMB from a network where <i>Disable</i> is selected. <i>AFP</i>: It is set to <i>Enable</i> by default. * You cannot connect TeraStation via AFP from a Mac even if you add <i>AFP</i> in the shared folder settings. <i>FTP</i>: It is set to <i>Disable</i> by default. * You cannot connect to the TeraStation via FTP from a Mac, even if you add <i>FTP</i> to the shared folder settings. To use FTP, change this setting to <i>Enable</i>. <i>Backup/Replication</i>: It is set to <i>Enable</i> by default. * You cannot use the TeraStation as a backup destination from a network connected for which <i>Disable</i> is selected. <i>NasNavi Detection</i>: It is set to <i>Enable</i> by default. * If disabled, NAS Navigator2 will not be able to detect the TeraStation. * NAS Navigator2 detection should be enabled to update firmware, use auto power management, or use NS-SHFT. <i>NFS</i>: It is set to <i>Enable</i> by default. * You cannot access the TeraStation from NFS clients if <i>Disable</i> is selected. <i>SFTP</i>: It is set to <i>Enable</i> by default. * You cannot access the TeraStation via SFTP if <i>Disable</i> is selected. <i>WebAccess</i>: It is set to <i>Enable</i> by default. * You cannot access the TeraStation via WebAccess feature if <i>Disable</i> is selected. <i>TeraSearch</i>: It is set to <i>Enable</i> by default. * You cannot use the TeraSearch if <i>Disable</i> is selected. <i>Power Interlock</i>: It is set to <i>Enable</i> by default. * You cannot use the auto power management if <i>Disable</i> is selected. * If Ethernet 1 and 2 are both disabled, and the power mode switch is set to auto, the TeraStation will not turn on. Move the power mode switch to manual to allow the TeraStation to power on again.</p>
	<p>Add/Edit SSL Key</p>	<p>Set when updating SSL server certification and the private key.</p>

Network		
<p>Port Trunking Click <i>Modify Settings</i> to change settings.</p>	<p>Port Trunking</p>	<p>Enable port trunking to use two Ethernet connections to the TeraStation. The following configurations are available:</p> <ul style="list-style-type: none"> • <i>Off</i>: Do not use port trunking. • <i>Round-robin policy</i>: Sets a round-robin policy for fault tolerance and load balancing. • <i>Active-backup policy</i>: Sets an active-backup policy for fault tolerance. • <i>XOR policy</i>: Sets an XOR (exclusive-or) policy for fault tolerance and load balancing. • <i>Broadcast policy</i>: Sets a broadcast policy for fault tolerance. • <i>Dynamic link aggregation</i>: Sets an IEEE 802.3ad dynamic link aggregation policy. • <i>Adaptive transmit load balancing (TLB)</i>: Sets a Transmit Load Balancing (TLB) policy for fault tolerance and load balancing.
<p>Workgroup/Domain Click <i>Modify Settings</i> to change settings.</p>	<p>Authentication Method</p>	<p>Select the method to join the network (<i>Workgroup</i>, <i>NT Domain</i>, or <i>Active Directory</i>). <i>Workgroup</i> is the default. Networking knowledge is required to configure other methods. Consult your network administrator for details.</p>
	<p>Workgroup Name</p>	<p>To join a workgroup, enter the name of your workgroup. * You can enter up to 23 bytes (UTF-8). * Alphanumeric characters, multi-byte characters, hyphens (-), underscores (_), and periods (.) may be used. * Do not use a symbol as the first character.</p>
	<p>WINS Server IP Address</p>	<p>Enter the IP address of your WINS server to use WINS server.</p>
	<p>NT Domain Name</p>	<p>Enter NT domain name to use NT domain as the method to join the network. * You can enter up to 23 bytes (UTF-8). * Alphanumeric characters, multi-byte characters, hyphens (-), underscores (_), and periods (.) may be used. * Do not use a symbol as the first character.</p>
	<p>NT Domain Controller Name</p>	<p>Enter NT domain controller name to use NT domain as a method to join the network. Register the computer account which has the same name as the TeraStation to the domain controller. * You can enter up to 63 bytes (UTF-8). Do not use multi-byte characters. * Alphanumeric characters, hyphens (-), and underscores (_) may be used. * Do not use a symbol as the first character.</p>
	<p>Active Directory Domain Name (NetBIOS Name)</p>	<p>Enter Active Directory domain name (NetBIOS name) to use Active Directory as a method to join the network. * You can enter up to 23 bytes (UTF-8). * Alphanumeric characters, multi-byte characters, hyphens (-), underscores (_), and periods (.) may be used. * Do not use a symbol as the first character.</p>
	<p>Active Directory Domain Name (DNS/Realm Name)</p>	<p>Enter Active Directory domain name (DNS/realm name) when selecting <i>Active Directory</i> as a method to join the network. * You can enter up to 255 bytes (UTF-8). Do not use multi-byte characters. * Alphanumeric characters, hyphens (-), underscores (_), and periods (.) may be used.</p>

Network		
Workgroup/Domain Click <i>Modify Settings</i> to change settings.	Administrator Password	<p>Enter Administrator Password.</p> <ul style="list-style-type: none"> * This must be entered if <i>NT Domain</i> or <i>Active Directory</i> is selected for authentication method. * You can enter up to 256 bytes (UTF-8). Do not use multi-byte characters. * Alphanumeric characters, hyphens (-), and underscores (_) may be used. * Do not use a symbol as the first character.
	Active Directory Domain Controller Name	<p>Enter Active Directory domain controller name to use Active Directory.</p> <ul style="list-style-type: none"> * You can enter up to 63 bytes (UTF-8). Do not use multi-byte characters. * Alphanumeric characters, hyphens (-), and underscores (_) may be used. * Do not use a symbol as the first character.
	Administrator Name	<p>Enter the administrator account username for administrator name.</p> <ul style="list-style-type: none"> * This must be entered if <i>NT Domain</i> or <i>Active Directory</i> is selected for authentication method. * You can enter up to 256 bytes (UTF-8). Do not use multi-byte characters. * Alphanumeric characters, hyphens (-), underscores (_), and periods (.) may be used. * Do not use a symbol as the first character.
Workgroup/Domain	For Workgroup Authentication	<p>Select to access the TeraStation from a workgroup network.</p> <p><i>Delegate Authority to TeraStation</i> (recommended) Only users that are registered in the TeraStation can access it. Local users' usernames and passwords must match the usernames and passwords of their Windows logins.</p> <p><i>Delegate Authority to External SMB Server</i> Access to the TeraStation is controlled by an authentication server. Microsoft networking knowledge is required to configure this. Consult your network administrator for details.</p> <p><i>Use Windows Domain Controller as Authentication Server</i> Users are verified by a domain controller, but the TeraStation does not join the domain. * If you specify the Windows domain controller as an external SMB authentication server, the workgroup name of the TeraStation and the domain name of the Windows domain controller must match.</p> <p><i>Automatic User Registration</i> Select to add users allowed by the authentication server to the TeraStation's authenticated user list. Example: Use automatic registration for a while to add users, then disable to limit users to those who accessed the shared folder during the authentication registration process.</p> <p><i>Enable Authentication Shared Folder</i> Use the folder as an authentication test folder that can be accessed by users registered to the authentication server.</p>

Network		
Workgroup/Domain	Authentication Server Name or IP Address	<p>When <i>Delegate Authority to External SMB Server</i> is selected for authentication method, specify the external server to be used for user authentication by its name or IP address.</p> <ul style="list-style-type: none"> * When connecting via AFP, FTP, FTPS, or SFTP, always use an IP address. The server name may not work. * Always use the IP address when specifying a server that is not in the same subnet of the network as the TeraStation.
	Enable Authentication Shared Folder	<p>When selecting <i>Delegate Authority to External SMB Server</i>, <i>Automatic User Registration</i>, and <i>Enable Authentication Shared Folder</i>, specify the folder name for the authentication shared folder. It can register users automatically when they open the folder.</p> <ul style="list-style-type: none"> * You cannot create more than 2 shared folders for the authentication shared folder. * A user who is automatically registered will belong to the "hdusers" group. * Do not use preexisting shared folders for the authentication shared folder. Specify a new folder name. * You can enter up to 27 bytes (UTF-8). * Alphanumeric characters, multi-byte characters, hyphens (-), and underscores (_) may be used. * Do not use a symbol as the first character. * AFP, FTP, FTPS, and SFTP connections don't support obtaining user information by delegating authority to external SMB server.
NFS	NFS Service Click <i>Modify Settings</i> to change settings.	<p>Enable to access shared folders with NFS (Network File System). Enter a remote network address for network address, and remote subnet mask for subnet mask to restrict access.</p> <p>Select <i>User mode</i> or <i>Kernel mode</i> for NFS mode. To use the replication feature, select <i>User mode</i>. If using for VM-ware ESX/ESXi, select <i>Kernel mode</i>.</p> <p>If you select <i>Forced for Guest Permission</i>, the user ID and group ID will be 99 when data is stored from NFS clients. This setting is recommended for use with other file sharing services such as SMB. Using <i>Ignored</i> is recommended only for NFS clients with no other services.</p>
	NFS Folders Setup	Click the folder for remote access via NFS. The NFS path for the folder you clicked is displayed. When accessing from an NFS client, enable NFS.
	NFS Client Setup	<i>Add Client</i> adds an NFS client. To add a client, enter the IP address and hostname of NFS client. To delete a client, select it and click <i>Delete Client</i> .

System

System - Settings		
Name Click <i>Modify Settings</i> to change settings.	TeraStation Name	<p>Enter a name to identify the TeraStation on the network.</p> <ul style="list-style-type: none"> * You can enter up to 15 bytes (UTF-8). Do not use multi-byte characters. * Alphanumeric characters, hyphens (-), and underscores (_) may be used. * Do not use a symbol as the first character.

System - Settings		
Name Click <i>Modify Settings</i> to change settings.	Description	Enter a description of the TeraStation (optional) to describe it on the network. * You can enter up to 75 bytes (UTF-8). * Alphanumeric characters, multi-byte characters, hyphens (-), underscores (_), and spaces may be used. * Do not use space as the first character. * Only Windows computers display the description.
Date and Time Click <i>Modify Settings</i> to change settings.	Date/Time Source	Select <i>Automatic</i> to use NTP to adjust the TeraStation's time automatically. Select <i>Manual</i> to set the time manually.
	Primary NTP IP Address	Enter the DNS name or IP address of the NTP server. Example: ntp.jst.mfeed.ad.jp or 192.168.11.123 To specify ntp.jst.mfeed.ad.jp as the NTP server, check <i>Use default NTP server</i> .
	NTP Synchronization Frequency	Select how often to access the NTP server and correct the time from <i>Daily</i> , <i>Weekly</i> , or <i>Every 3 hours</i> . *If you access the NTP server through a proxy server, access may fail in some networks.
	Time Zone	Specify the time zone.
	Date	Displays year, month and date. Enter numbers to change these values.
	Time	Displays time. Enter numbers to change the time. * To match the time to your PC, click <i>Use Local Date/Time</i> . * If the TeraStation's internal clock settings are more than 5 minutes different from other devices on your network, you may experience access problems. For best results, configure all devices on your network to correct their time settings automatically from an NTP server.
Language Click <i>Modify Settings</i> to change settings.	Display Language	Select the language to be displayed.
	Windows Client Language	Select the language to be used in the Windows client.

System - Storage		
Disks	Check Disk	<p>Checks hard drives for errors and problems, both internal drives and attached USB drives. Time required for a disk check will depend on the size of the drive. Large drives may take several hours.</p> <ul style="list-style-type: none"> * You cannot run a disk check while a backup job is scheduled. * During a disk check, all file sharing services stop. <p>If the TeraStation disconnected abnormally from power while connected to a Mac, the Mac database may be damaged and your connection lost. If this happens, select <i>Delete any hidden, non-essential MacOS dedicated files</i> and run a disk check. All of the files listed below will be deleted (including sub directories) and you may be able to connect again.</p> <ul style="list-style-type: none"> • AppleDB • .AppleDesktop • .AppleDouble • TheVolumeSettingsFolder • Network Trash Folder <ul style="list-style-type: none"> * Make sure the TeraStation is not selected as a backup destination of other TeraStations before running a disk check. * You cannot run Disk Check for the following types of drives. <ul style="list-style-type: none"> • USB hard drive formatted in NTFS • USB hard drive formatted in HFS+ * If you have a FAT32 USB hard drive larger than 1 TB, the disk check will take a very long time. For best results with such a drive, connect it to a Windows PC and run a disk check from within Windows.
Disks	Format Disk	<p>Format the additional hard disk installed to the TeraStation and the USB connector. Data will be completely erased if the disk is formatted. Use extra caution not to loose your important data. The time required to format a disk will vary depending on the space to be used (a few minutes).</p> <p>You cannot format a disk when you have set up a backup job.</p> <p>Warning: Do not format a drive if the TeraStation is configured as a backup device for another TeraStation.</p> <p>Format type</p> <p>TeraStation can format or recognize the multiple format types*.</p> <p>GPT partitions (64-bit) are recommended for connected USB hard drives of 2.2 TB or larger. Other types of partitions will not address the full size of larger drives. GPT partitions are supported by Windows 8, Windows 7, Windows Vista, Windows Server 2003 SP1 or later, Windows Server 2008, OS X 10.4 or later, and Buffalo TeraStation and LinkStations (e.g. TS-XL, TS-XEL, TS-WXL, LS-XHL, and LS-CHL series). Note that other operating systems (including Windows XP) may not detect GPT partitions correctly. To read hard drives larger than 2.2 TB from Windows XP, either use a proprietary GPT solution, or use multiple partitions smaller than 2.2 TB.</p>
Disks	Remove Disk	To remove a hard disk, select the disk you want to disconnect and click <i>Remove Disk</i> .
	Rediscover Disk	After performing the procedure to remove the hard drive, taking it off physically, and replacing to another hard drive, click here to have the TeraStation recognize a drive again without restarting the unit.

System - Storage		
RAID Array	RAID Array	<p>This is displayed when clicking the name on the RAID array screen. If you have not set RAID, you can select from <i>RAID 5</i>, <i>RAID 1</i>, <i>RAID 10</i>, and <i>RAID 0</i> for TS-XL and TS-XEL series TeraStations, <i>RAID 1</i> and <i>RAID 0</i> for TS-WXL series TeraStations. If you do not select from any of the above, the unit is used as a normal mode (4 hard drives).</p> <p>RAID mode: Displays the hard drives that consist of RAID. To configure RAID, check the hard drives you are going to use, select RAID mode, and click <i>Create Raid Array</i>.</p> <ul style="list-style-type: none"> • To configure (build) RAID 1, click 2 drives you are going to use and insert check marks. • To configure (build) RAID 10 and RAID 0, click all drives and insert check marks. <p>* TS-WXL series TeraStations cannot be set to RAID 10.</p> <ul style="list-style-type: none"> • To configure (build) RAID 5, click all drives or 3 drives you are going to use and insert check marks. <p>* TS-WXL series TeraStations cannot be set to RAID 5</p> <ul style="list-style-type: none"> • When delete RAID composition, click <i>Delete RAID Array</i>. * Changing or deleting RAID settings will erase all data in the hard drive. Back up your important data before performing any operations described above. * If you have a hard drive in the normal mode while building RAID 5 (3 hard drives) or RAID 1, it can be set as a spare by clicking <i>Set to spare-disk</i>. If it has already set to a spare drive, click <i>Set to normal disk</i> to set it to the hard drive in JBOD. * <i>Set to spare-disk</i> will not be displayed on TS-WXL series TeraStations.
RAID Array	RAID Array Error Detection Response	When there is an error on the RAID array, the system will be shut down automatically to protect data (This feature is only for RAID 1, 5 or 10. This does not work while in JBOD or RAID 0). The default setting is <i>Not shut down</i> .
	RAID Array check speed	Select the speed of the RAID scanning from the following <ul style="list-style-type: none"> • <i>High</i>: 10 hours per 1 TB RAID Array • <i>Normal Mode</i>: 20 hours per 1 TB RAID Array • <i>Low</i>: 100 hours per 1 TB RAID Array

System - Storage		
<p>RAID Scanning: Click <i>Modify Settings</i> to change settings.</p>	<p>RAID Scanning</p>	<p>RAID scan is the feature to read check for all sectors in the data area of hard drives which build RAID 1, 5 and 10. An error possible to repaired* (bad sectors) which is found during check will be automatically repaired. Also an error possible to repaired* which is found during standard file operations will be automatically repaired regardless of performing RAID scan or not.</p> <ul style="list-style-type: none"> • Recoverable errors*: Read error in the data area which are build in RAID 1, 5, or 10 (including RAID 1 system area) • Unrecoverable errors: Write error, RAID management area error, drive partition information area error, and drive recognition failure, etc. <p>If many errors possible to repair *(bad cluster) are found in one of the hard drives which build RAID, that drive will be removed and the system will automatically move to degrade mode. Data are not protected in the degrade mode, it is strongly recommended to immediately replace the erroneous hard drive. When running RAID Scanning in the first time, it is strongly recommended to backup data on the TeraStation in advance.</p> <p><i>RAID Scanning</i>: Set whether using RAID Scanning or not.</p> <p><i>RAID Scanning Schedule</i>: Select the schedule to perform RAID Scanning.</p> <ul style="list-style-type: none"> • <i>Every Week</i>, and from <i>Sunday</i> to <i>Saturday</i> • <i>1st</i>, and from <i>Sunday</i> to <i>Saturday</i> • <i>2nd</i>, and from <i>Sunday</i> to <i>Saturday</i> • <i>3rd</i>, and from <i>Sunday</i> to <i>Saturday</i> • <i>4th</i>, and from <i>Sunday</i> to <i>Saturday</i> • <i>1st, 3rd</i>, and from <i>Sunday</i> to <i>Saturday</i> • <i>2nd, 4th</i>, and from <i>Sunday</i> to <i>Saturday</i> • <i>Every 1st day/month</i> <p>Select <i>Begin Immediate RAID Scan</i> and click <i>Save</i> to immediately run the maintenance.</p> <p><i>RAID Scanning Start Time</i>: Select time to start RAID Scanning from 0 to 23 o'clock.</p> <p>* To stop RAID Scanning, click <i>Abort RAID Scanning</i>.</p>

* Following format types are supported by the TeraStation:

Format type	Descriptions
<p>EXT3 (USB hard drive only)</p>	<p>It is recommended when you may reconnect to TeraStation and use it.</p> <ul style="list-style-type: none"> • Supports both read and write. • Supports Journaling File System. • Takes for a long time to format (a several minutes or more). • Less space is available than XFS after formatted. • More files in 1 folder, slower the access space. <p>* Use EXT3 Reader included in this package when reading data directly connected to your PC.</p>

Format type	Descriptions	
XFS (USB hard drive/ TeraStation internal hard drive)	<p>This format is recommended when you use the additionally installed hard disk at the TeraStation.</p> <ul style="list-style-type: none"> • Supports both read and write. • Supports Journaling File System. • More space is available than XFS after formatted. • Access speed will not degrade even though more files in 1 folder. <p>This is not supported by legacy TeraStation (such as HD-LAN, HD-HLAN, HD-HLWG, HD-HGLAN Series).</p> <p>* You cannot read data by directly connecting a PC.</p>	
FAT32 (USB hard drive only)	<p>We recommend this format type when you want to connect the hard drive to your PC to view data in it.</p> <p>You can still connect the hard drive to Windows PC in case that the TeraStation fails.</p> <ul style="list-style-type: none"> • Supports both read and write. • Cannot copy, backup, or replicate data with more than 4 GB per file. • Cannot use some characters which are used in Mac OS such as .: 	
NTFS (USB hard drive only)	<p>Cannot format from Settings. It is Read-Only. Be able to use to connect to Windows 8, Windows 7, Windows Vista, Windows XP, or Windows 2000, or Windows Server 2003 or Windows Servers 2008.</p> <ul style="list-style-type: none"> • Read-only (not writable during backup or replication either). 	
HFS+ (USB hard drive only)	<p>Cannot format from Settings. Read-Only.</p> <p>Can be used to connect to OS X 10.3.9 or later.</p> <ul style="list-style-type: none"> • Read-only (not writable during backup or replication either). 	
System - Backup		
View NAS Devices	Local TeraStations	<p>Displays the list of the LinkStations and TeraStations* on the network.</p> <p>Click <i>Refresh</i> to update the list with the latest information.</p> <p>* Caution: Only the LinkStations and TeraStations which support backup via the network will be displayed.</p>
	Off Subnet TeraStations	<p>To add a LinkStation or TeraStation which is not on the list, or is on another network, enter its IP address and click <i>Add</i>. To remove a LinkStation or TeraStation from the list, select it and click <i>Delete</i>.</p> <p>* Caution: Only the LinkStations and TeraStations which support backup via the network can be registered.</p>

System - Backup		
<p>Search for Backup Destination by Password Click <i>Modify Settings</i> to change settings</p>	<p>Password to Search</p>	<p>Enter this password when you want to specify the shared folders on another TeraStation via the network as a backup destination. Enter the password to search for Backup which is set for the shared folders of another TeraStation. If you do not enter it, you cannot backup to the shared folders for which the authentication password has been set.</p> <p>* Only enter a single password for "Search for Backup Destination by Password".</p> <p>* The shared folder with different Remote backup password cannot be set as a backup destination as well.</p> <p>* Searching backup destination shared folder by entering "Search for Backup Destination by Password" is only available for TeraStation other than the backup source.</p> <p>Steps for Setup</p> <ol style="list-style-type: none"> 1 On Settings of the backup destination, set remote backup password for each shared folder. 2 Set the same password for remote backup password of a shared folder you want to display as a backup destination as "Search for Backup Destination by Password" when you configure backup for the backup source TeraStation. 3 Configure backup at the TeraStation which is the backup source. Select the shared folders of the backup destination from followings.* <ul style="list-style-type: none"> • Shared folders in the TeraStation which is the backup source. • The USB hard drive connected to the TeraStation which is the backup source. • A shared folder for which "Remote backup password" is not set in the TeraStation which is the backup destination. • A shared folder whose "Search for Backup Destination by Password" matches "Remote backup password" of the TeraStation which is the backup destination. <p>* "Backup" must be enabled as a remote backup destination when setting up the shared folder.</p>

System - Backup		
Search for Backup Destination by Password Click <i>Modify Settings</i> to change settings	Password to Search	<p>Example of Configuration on the TeraStation (Backup Destination)</p> <ul style="list-style-type: none"> • Shared folder name is "share1" and the remote backup password is "111". • Shared folder name is "share2" and the remote backup password is "222". • Shared folder name is "share_free" and the remote backup password is not entered. <p>Example of Configuration on the TeraStation (Backup Source)</p> <ul style="list-style-type: none"> • If the backup destination shared folder which is displayed when settings "111" to "Search for Backup Destination by Password" for the backup source TeraStation, "share1" and "share_free" will be shown but "share2" will not be shown. • The backup destination shared folder which is displayed when setting "222" to "Search for Backup Destination by Password" for the backup source TeraStation, "share2" and "share_free" will be shown but "share1" will not be shown. • A shared folder as a backup destination displayed when the password is not set, "share_free" will be shown but "share1" and "share2" will not be shown.
Backup Jobs Setup	Backup Jobs Setup	<p>Click <i>Create New Job</i> to set up to 8 backup timers. "Backup Configuration" screen will be displayed when clicking <i>Job Name</i>. Backup data saved on the TeraStation to the USB external hard drive or another LinkStation or TeraStation at the specified time.</p> <p>* If you choose the USB hard drive in order to utilize this backup feature, USB drive must be formatted in FAT32, XFS or EXT3. (Format type for a USB hard drive can be displayed on Settings, <i>System - Storage</i>.)</p> <p>* If a USB drive is formatted in FAT32, the maximum file size to be able to backup is 4 GB.</p> <p>* Never unplug LAN cable connected to the TeraStation or USB hard drive during backup.</p> <p>* Do not initialize the TeraStation, format, run disk check, backup settings, and, add, edit or delete shared folder and user group/user during backup. Otherwise, it may halt in error.</p> <p>* Normally, if there is an error during a scheduled backup (Every day/Every Week), that backup job will not run again. You will need to create a new backup job. However, if you select <i>Ignore Errors and Proceed with Backup</i>, then backup jobs will continue to run as scheduled, even after an error.</p>
Backup Jobs Setup Click <i>Create New Job</i> to display this option in the Backup Configuration Screen.	Job Name	Enter a name for the backup job.
	Backup Job Schedule	Select schedule to run backup from <i>Not Scheduled, Immediate, Every Day, Every Week, 1st, 2nd, 3rd, 4th, 1st, 3rd, 2nd, 4th</i> or <i>Every 1st day/month</i> .
	Backup Date	Select the day or time to run the backup job.

System - Backup		
<p>Backup Jobs Setup Click <i>Create New Job</i> to display this option in the Backup Configuration Screen.</p>	<p>Backup Operation Mode</p>	<p>Select the backup operation mode from the following choice.</p> <ul style="list-style-type: none"> • <i>Normal Backup</i> • <i>Overwrite Backup (Append Backup)</i> • <i>Overwrite Backup (Differential Backup)</i> <p>* If you select <i>Overwrite Backup (Differential Backup)</i>, any files which do not exist in the source will be deleted without showing the confirmation screen for deletion. Be careful not to delete the necessary data.</p> <p>* All operation mode other than normal backup will overwrite all of the data to the backup destination. Be careful not to delete the necessary data.</p> <p>* Do not perform any file operations (such as rename or delete a file) in the backup sources during the backup. If you do so, the backup job may halt with error. In such a case, after the error is completed, try to perform the backup again.</p> <p>Following table shows the behavior during each operation mode. The behavior will make a big difference whether or not selecting <i>Create Target Folder for Backup</i> in <i>Backup Options</i>:</p> <p>The example here uses "/target" as backup destination folder.</p> <ul style="list-style-type: none"> • If the data is backup to the USB hard drive, the "target" below will be displayed as "usbdisk*". The character * expresses 1 - 2 (number). • If the data is backup to the TeraStation, the "target" below the shared folder name of the backup source will be displayed. • Backup Log is created under following name within the backup source folder. backuplog (backup task number)_(backup starting time).txt Example: If the date the backup is started on March 27, 2004, 19:55, "backuplog1_200403271955.txt" is created. <p>* If the backup mode is set to <i>Overwrite Backup (Differential Backup)</i>, data in the backup destination may be deleted depending on the backup settings.</p> <p><i>Normal Backup</i>: Copy all files without overwriting previous backed up data every time.</p> <p>If you back up the "/share" folder, the folder tree in the backup destination will be "/target/(date and time*1)/share". If you back up the "/share/folder" folder, the folder tree in the backup destination will be "/target/(date and time*1)/folder".</p>

System - Backup		
<p>Backup Jobs Setup Click <i>Create New Job</i> to display this option in the Backup Configuration Screen.</p>	<p>Backup Operation Mode</p>	<p><i>Overwrite Backup (Append Backup)</i>: Only copy and overwrite the files with changes based on the file size and time stamp.*2 If you configure to create a folder which can identify backup source and back up the "/share" folder, the folder tree in the backup destination will be "/target/_backups/share". In case you back up the "/share/folder" folder, it will be "/target/_backups/folder". If you configure not to create a folder which can identify backup source and backup the "/share" folder, the folder tree in the backup source will be "/target". In case you back up the "/share/folder" folder, it will be "/target".</p> <p><i>Overwrite Backup (Differential Backup)</i>: Only copy and overwrite the files with changes based on the file size and time stamp.*2 If you configure to create a folder which can identify backup source and back up the "/share" folder, the folder tree in the backup destination will be "/target/_backups/share". In case you back up the "/share/folder" folder, it will be "/target/_backups/folder".*3 If you configure not to create a folder which can identify backup source and backup the "/share" folder, the folder tree in the backup source will be "/target". In case you back up the "/share/folder" folder, it will be "/target/_backups/folder".*3</p> <p>*1 The format of the folder is <i>yyyymmddhhmm</i> by using the backup starting time. For example, if the starting time is March 27, 2004, 19:55, the folder name is displayed as "200403271955". *2 "Time Stamp" here is not the time information that can be verified Windows Mac, but the time information managed by TeraStation. *3 If there is the difference in the shared folders that is above the backup folder, files will not be deleted.</p>
	<p>Backup Options</p>	<ul style="list-style-type: none"> • <i>Create Target Folder for Backup</i>: The options you have selected on the Backup Operation Mode will make a big differences on behavior. Refer to the table described in the Operation Mode. • <i>Create Backup Log File</i>: Create the backup log file. • <i>Use Encrypted Transfer Method</i>: Select whether having data to be transferred encrypted or not when backup data. * The throughput is degraded if the encryption is enabled. * Do not select this option when the backup destination is a USB hard drive. • <i>Use Compressed Transfer Method</i>: Select whether having data to be transferred compressed or not when backup data. * If running a backup job via the network, the compressed transfer may improve the transfer speed when the network bandwidth is narrow (this does not mean that data is archived into 1 file and backed up). * Do not select this option when the backup destination is a USB hard drive. • <i>Ignore backup failure and continue backup job on schedule</i>: The next backup will be performed even though the last backup is halt in error. • <i>Exclude trash boxes from backup target</i>: Exclude the data in the trash boxes to backup. • <i>Complete Backup</i> : Overwrite the files which have not changed.

System - Backup		
Backup Folders	Backup Folders	<p>Select the backup source and the shared folder on the backup destination folders, and click <i>Add</i>.</p> <p>You can select following folder as a shared folder on the backup destination.</p> <ul style="list-style-type: none"> • Shared folders on the LinkStation and TeraStation displayed in "View NAS Devices". • usbdisk1 and usbdisk2 connected to the backup source of the TeraStation <p>* Do not specify the backup source folder which include Japanese katakana in the folder name. The backup job will halt if any of these characters are included.</p>
Replication	Replication	<p>Click <i>Add</i> to display the screen to select a shared folder which is a replication source and another LinkStation and TeraStation which is a replication destination. Data saved on the replication source are automatically written to the shared folder of the replication destination.</p> <p>To delete the settings, select replication settings and click <i>Delete</i>. Click <i>Resynchronize</i> to overwrite (differential) data in replication source to replication destination folder.</p>

System - Maintenance		
<p>Email Notification</p> <p>Click <i>Modify Settings</i> to change settings.</p> <p>Click <i>Send Test Message</i> to send a test email to the email address which has been set.</p>	Notification	Select whether using email notification feature or not.
	SMTP Server Address	Enter SMTP server address (email server address).
	SMTP Port No.	<p>Enter SMTP port number</p> <p>* The standard port number (25) is used if not specified. Also, user authentication method is set to <i>Disable</i> or <i>POP before SMTP</i>, the standard port number (25) is used regardless of the number you entered in this field.</p>
	Authentication Type	Select authentication type from <i>POP before SMTP</i> , <i>LOGIN(SMTP-AUTH)</i> , and <i>CRAM-MD5(SMTP-AUTH/CRAM-MD5)</i> .
	POP3 Server Address	Enter POP3 server address (email server address).
	POP3 Port No.	<p>Enter POP3 port number</p> <p>* The standard port number (110) is used if not specified.</p>
	SSL/TLS	When <i>LOGIN(SMTP-AUTH)</i> and <i>CRAM-MD5(SMTP-AUTH/CRAM-MD5)</i> are selected for authentication type, specify either using <i>SSL</i> or <i>TLS</i> .
	Username	Enter a username that will be used for authentication.
	Password	Enter a password that will be used to verify.
	Subject	<p>Specify the subject of the email to be sent.</p> <p>* Do not use multi-byte characters. It may cause the character corruption.</p>
Recipient(s)	<p>Enter the email address of the receiver, and click <i>Add</i>.</p> <p>* You can register up to 5 email addresses as receivers.</p>	

System - Maintenance		
<p>Email Notification</p> <p>Click <i>Modify Settings</i> to change settings.</p> <p>Click <i>Send Test Message</i> to send a test email to the email address which has been set.</p>	Report	<p>Select the contents to send in the email notification.</p> <ul style="list-style-type: none"> • <i>HDD Status Report</i>: Sends the condition of the hard drives at the specified time on "HDD Status Report". • <i>System Alert</i>: Sends when system is rebooted or shut down, or RAID configuration is changed. • <i>Disk Error</i>: Sends when an hard drive error is recognized. • <i>Fan Failure</i>: Sends when the fan error is recognized. • <i>Backup Complete</i>: Sends when the backup is complete. • <i>Quota Report</i>: Sends when the quota space limitation is exceeded at the time which is specified on HDD status report.
<p>Syslog</p> <p>Click <i>Modify Settings</i> to change settings.</p>	Syslog	<p>Select <i>Enabled</i> for syslog transfer and select <i>Save</i> to transmit the system log.</p> <p>To view a log, select <i>System Log</i>, <i>File Log (SMB)</i>, <i>FTP Log</i> for "Logs To Transfer". You can transmit the log by entering the IP address of the syslog server in "Syslog Server IP Address" field when you select <i>System Log</i>, <i>File Log (SMB)</i>.</p> <p>*<i>FTP Log</i> does not support to output a log to the syslog server.</p> <p><i>Store Files Locally</i>: To store logs on the TeraStation, select <i>Enable</i> for "Store Files Locally". Select one of the TeraStation's shared folders as the target folder. A subfolder called "system_log" will be created in that folder, and logs will be saved to that subfolder.</p> <p>*If you select <i>File Log (SMB)</i> or <i>FTP Log</i>, only file operations from internal hard drives will be logged. File operations from USB drives will not be logged.</p> <p>Note: All logs are encoded in UTF-8 format. To show them correctly, change the software encoding to "UTF-8".</p>
<p>Alert Sound Settings</p> <p>Click <i>Modify Settings</i> to change settings.</p>	Alert Sound Settings	<p>Select the conditions that trigger alert beeps from <i>Overheating</i>, <i>Disk Error</i>, <i>Fan Error</i>, and <i>UPS power Error</i>.</p>
<p>Front Panel Settings</p> <p>Click <i>Modify Settings</i> to change settings.</p>	Display	<p>Select items to display on LCD display at the front of the TeraStation from <i>Host IP</i>, <i>Disk Mode</i>, <i>Time</i> and <i>HDD Usage</i>.</p>
	Flip Display Items	<p>Set if automatically switching the item to display on the LCD or not.</p>
	LCD brightness	<p>Adjust backlight brightness of the LCD display in 5 levels.</p>
	LED brightness	<p>Adjust the brightness at the front of the TeraStation in 5 levels.</p>
	LED Synchronization	<p>Select whether using the feature to change the LED brightness synchronized with time. For example, you can change the brightness on day time and night time.</p>
	LED brightness (Sleep)	<p>Adjust the brightness of LED in 4 levels while in dark.</p>
	Begin Sleep	<p>Set the time (0 to 23 o'clock) to darken LED brightness. This can be set in every 00 minute at 1 hour interval.</p>
	Wakeup	<p>Set the time (0 to 23 o'clock) to change LED brightness back to the normal setting. This can be set in every 00 minute at 1 hour interval.</p>
Restart TeraStation	Restart TeraStation	<p>Click <i>Restart</i> to reboot the TeraStation.</p> <p>* To avoid damaging your data, make sure that you are not working on with any data before shutting down the TeraStation.</p>
Shutdown TeraStation	Shutdown TeraStation	<p>Click <i>Shut Down</i> to turn off the TeraStation.</p> <p>* You cannot turn on the power of the TeraStation from Settings. Press the power switch on the TeraStation to turn it on.</p> <p>* To avoid damaging your data, make sure that you are not working on with any data before shutting down the TeraStation.</p>

System - Maintenance		
Firmware Installation		<p>Clicking <i>Check For Update</i> will check for the latest firmware version. If the installed firmware version is not the latest, click <i>Install Update</i> to update the firmware.</p> <p>Update notification will display "I52" on the LCD and a message on the login screen when an update is available. To disable update notification, click <i>Disable notification of updates</i>.</p>
System - Power Management		
UPS Settings Click <i>Modify Settings</i> to change settings.	Synchronization with UPS	<p><i>synchronize with UPS connected to this TeraStation</i>: Select to synchronize the TeraStation with a UPS that is directly connected.</p> <p><i>synchronize with UPS connected to other TeraStation on the network</i>: Select to synchronize the TeraStation with a UPS that is connected to a different TeraStation on the same network.</p> <p><i>do not synchronize with UPS</i>: Select if synchronizing to a UPS is not desired.</p>
	Synchronized source TeraStation IP Address	If <i>synchronize with UPS connected to other TeraStation on the network</i> is selected, enter the IP address of the TeraStation that is directly connected to the UPS.
	UPS Connection Type	<p>Select a connection method with UPS.</p> <p>* <i>USB Port (APC Style)</i> or <i>USB Port (OMRON Style)</i> can be set only when you are using USB type UPS manufactured by APC.</p> <p>* The items to select will vary depending on a UPS model number and a cable. Refer to Buffalo's website (www.buffaloamericas.com) for details.</p>
	TeraStation behavior When Power failure	<p>Allows you to set the time until shutdown when the power failure continues.</p> <p>Or, you can set to <i>Shutdown TeraStation when UPS Reports 'Battery Low' status</i>.</p> <p>* "Low Battery" shutdown is only supported with UPSs that are connected to the TeraStation via USB.</p>
	UPS Behavior After TeraStation has shut down	Specifies whether shutting down UPS or not after shutting down the TeraStation.
	UPS Recovery function	Reboot the TeraStation Automatically after recovering supply from AC power to UPS.
Sleep Timer Click <i>Modify Settings</i> to change settings.	Timer Interval	<p>Select Timer Interval from <i>Disable</i>, <i>Everyday</i>, or <i>Specific day of the week</i> for Sleep Timer.</p> <p>If selecting <i>Specific day of the week</i>, specify the day by tick the box for that day.</p> <p>Timer can be set up to 3 (1-3).</p>
	Wake up at	Specify a wake-up time for the TeraStation to recover from sleep mode and resume its normal state. Times from 0:00 to 23:45 are allowed.
	Begin Sleep at	<p>Specify a time for the TeraStation to move from its normal functionality to a standby state (sleep mode). Times from 0:00 to 27:45 are allowed.</p> <p>* Note: The wake-up time must be later than the beginning time.</p>

System - Restore/Erase		
Restore Factory Defaults	Upon restore Click <i>Modify Settings</i> to change settings.	Select whether or not you would like to initialize the administrator's password for the TeraStation when initializing the unit (press and hold the initialization switch you can find when opening the front cover for about 5 seconds) . * You may no longer be able to configure TeraStation if you forget the password if selecting <i>Keep current admin password</i> . Never forget the password.
	Restore TeraStation	Following settings are initialized when clicking <i>Restore TeraStation</i> . TeraStation name, description, NTP settings, workgroup settings, network services, file sharing settings, shared folder settings, USB drive settings, RAID scanning, sleep timer, upon restore, access restrictions, user settings, users and groups, email notification, synchronization with UPS, backup settings, administrator name, administrator password, network settings (such as IP address, subnet mask etc.), Time Machine, WebAccess, DFS, Direct Copy, NFS, TeraSearch, alert sound settings, front panel settings, RAID array failure settings, language, syslog, print server, web server, MySQL server, SNMP, antivirus scan
Erase	Erase	Clicking <i>Erase</i> will erase data on the drives on the TeraStation completely. * Data erased cannot be recovered. * You cannot change the configuration of the TeraStation while erasing data.

Extensions

Extensions - WebAccess		
WebAccess	WebAccess Settings	Click shared folder name to Edit. Folder information on the TeraStation which will be published with WebAccess is displayed in name and description. In WebAccess settings, following access restrictions can be selected. <ul style="list-style-type: none"> • <i>Disable</i>: Does not publish shared folders. • <i>Allow Anonymous</i>: Anyone can access (view) shared folders. • <i>Allow All Groups / Users</i>: Allow to access (or view) only groups or uses registered to the TeraStation. • <i>Use Inherited Folder Permissions</i>: Use same permissions as set on the shared folder screen. If access restrictions are not set in the shared folder screen, this option is not displayed.
WebAccess Service Click <i>Easy WebAccess Settings</i> to change settings.	WebAccess Service	<i>WebAccess Service</i> : Configure if using WebAccess or not. <i>BuffaloNAS.com Name</i> : Enter a name for your account with WebAccess. <ul style="list-style-type: none"> • Write this name down in a safe place. You will need it to use WebAccess. • If your TeraStation is left disconnected from the Internet for 60 days or more, your BuffaloNAS name and account may be deleted from the BuffaloNAS.com server.

Extensions - WebAccess		
<p>WebAccess Service</p> <p>Click <i>Advanced WebAccess Settings</i> to change settings.</p>	<p>WebAccess Service</p>	<p><i>WebAccess Service:</i> Configure if using WebAccess or not.</p> <p><i>HTTPS/SSL Encryption:</i> Configure if encrypting your data transfers with SSL.</p> <p><i>Use BuffaloNAS.com:</i> Configure if using BuffaloNAS.com server.</p> <p><i>BuffaloNAS.com Name:</i> Enter a name for your account with WebAccess.</p> <ul style="list-style-type: none"> • Write this name down in a safe place. You will need it to use WebAccess. • If your TeraStation is left disconnected from the Internet for 60 days or more, your BuffaloNAS name and account may be deleted from the BuffaloNAS.com server. <p><i>BuffaloNAS.com Key:</i> Choose a password (optional) to enter a name for your account with WebAccess.</p> <p><i>DNS Hostname:</i> Use of BuffaloNAS.com is recommended for most users, but you may specify a different DNS service by entering its hostname.</p> <p><i>Auto-Configure Firewall (UPnP):</i> If your router supports UPnP, selecting <i>Enable</i> for Auto-Configure Firewall (UPnP) is recommended. UPnP must be enabled in the router for this to work.</p> <p><i>External Port:</i> To configure the firewall manually without using UPnP, enter a port number. In the router's settings, forward this external port number to an internal port on your TeraStation on your local network.</p> <p><i>NAS Internal Port:</i> Enter internal port number for your TeraStation on your network.</p> <p><i>Exclusive session:</i> If <i>Exclusive session</i> is enabled, a user account cannot be used to log multiple computers in to WebAccess simultaneously. Only the last login will be active.</p> <p><i>Session expiration time (minute):</i> Enter a time in minutes (1 - 120) before inactive users are logged out of WebAccess, or select <i>Unlimited</i>. If "Exclusive session" is enabled, <i>Unlimited</i> may not be selected.</p>
Extensions - PrintServer		
<p>PrinterServer</p> <p>Click <i>Modify Settings</i> to change settings.</p>	<p>PrinterServer</p>	<p>Select whether or not using print server for Windows. Click <i>Delete Print Queue</i> to delete a printer job.</p>
Extensions - Time Machine		
<p>Time Machine</p> <p>Click <i>Modify Settings</i> to change settings.</p>	<p>Time Machine</p>	<p>Select <i>Enable</i> when using Time Machine on OS X 10.5 or later to specify the TeraStation as a backup destination. Select a shared folder as a backup destination in Target Folder.</p>

Extensions - Web Service Support		
<p>Web Service Support Click <i>Modify Settings</i> to change settings.</p>	<p>Eye-Fi connected</p>	<p><i>Enable:</i> Enables the Eye-Fi connected.</p> <p><i>Email:</i> Enter the email address registered in the Eye-Fi card initial settings.</p> <p><i>Password:</i> Enter the password registered in the Eye-Fi card initial settings.</p> <p><i>Log in:</i> This opens the cards or devices setting screen.</p> <p><i>Disable:</i> Disables the Eye-Fi connected.</p>

Chapter 13 Appendix

Assign as Network Drive (Windows)

You can easily map the TeraStation's shared folder as a network drive by using NAS Navigator2 included in the package.



1 Double-click the  icon on the desktop to start NAS Navigator2.

Right-click TeraStation's icon and click *Map Share*.

2 TeraStation's network drive icon should be added into Computer or My Computer. You can use this network drive just like other hard disks.

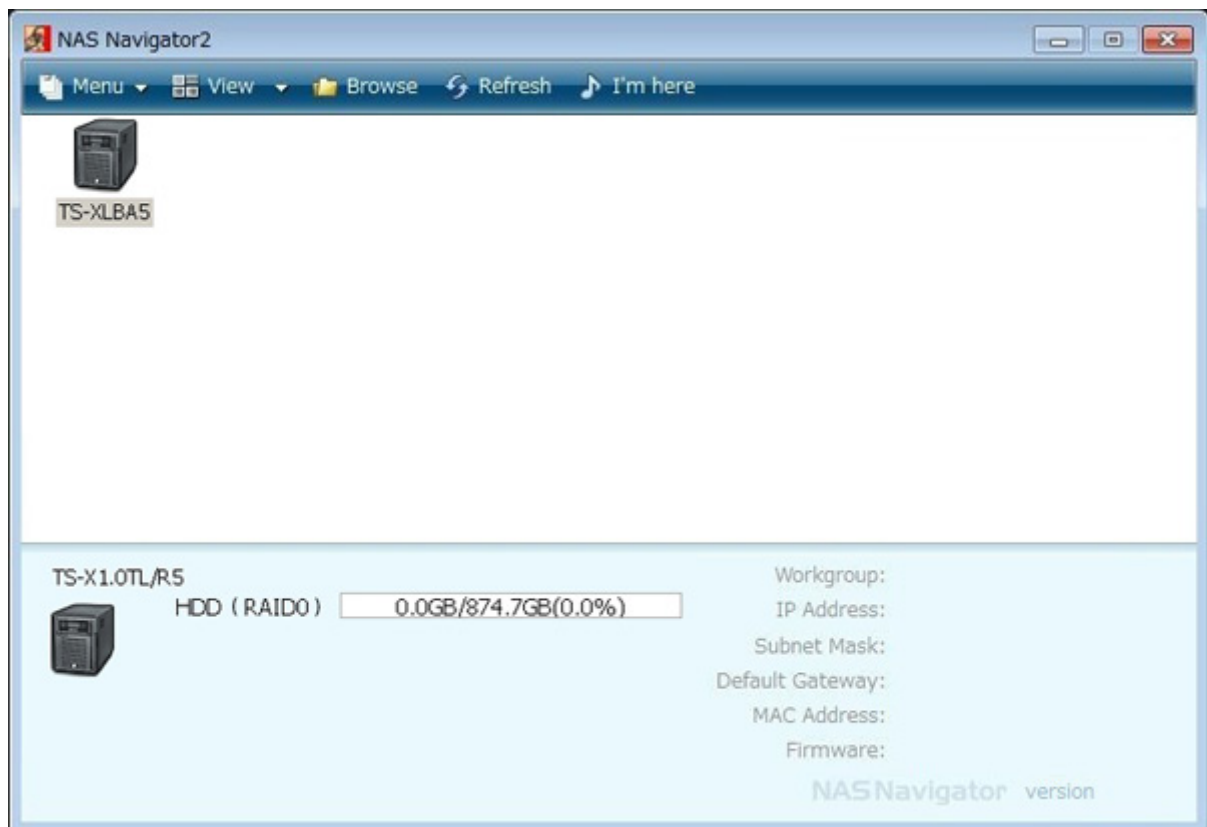

Note: If TeraStation is not connected to the network or is off at the time your computer is booted, "The network path could not be found. The connection was not established" is displayed.

If you want to assign a folder other than the shared folder as a network drive manually using the function built into your OS, refer to operation system's help file.

Mount as a Network Drive (Mac OS)

You can easily map the TeraStation's shared folder as a network drive by using NAS Navigator2 included in the package on OS X 10.3.9 or later.



- 1 Double-click the  icon in the Dock to start NAS Navigator2.
- 2 Click TeraStation's icon while holding on control key button, and select *Open Folder*.

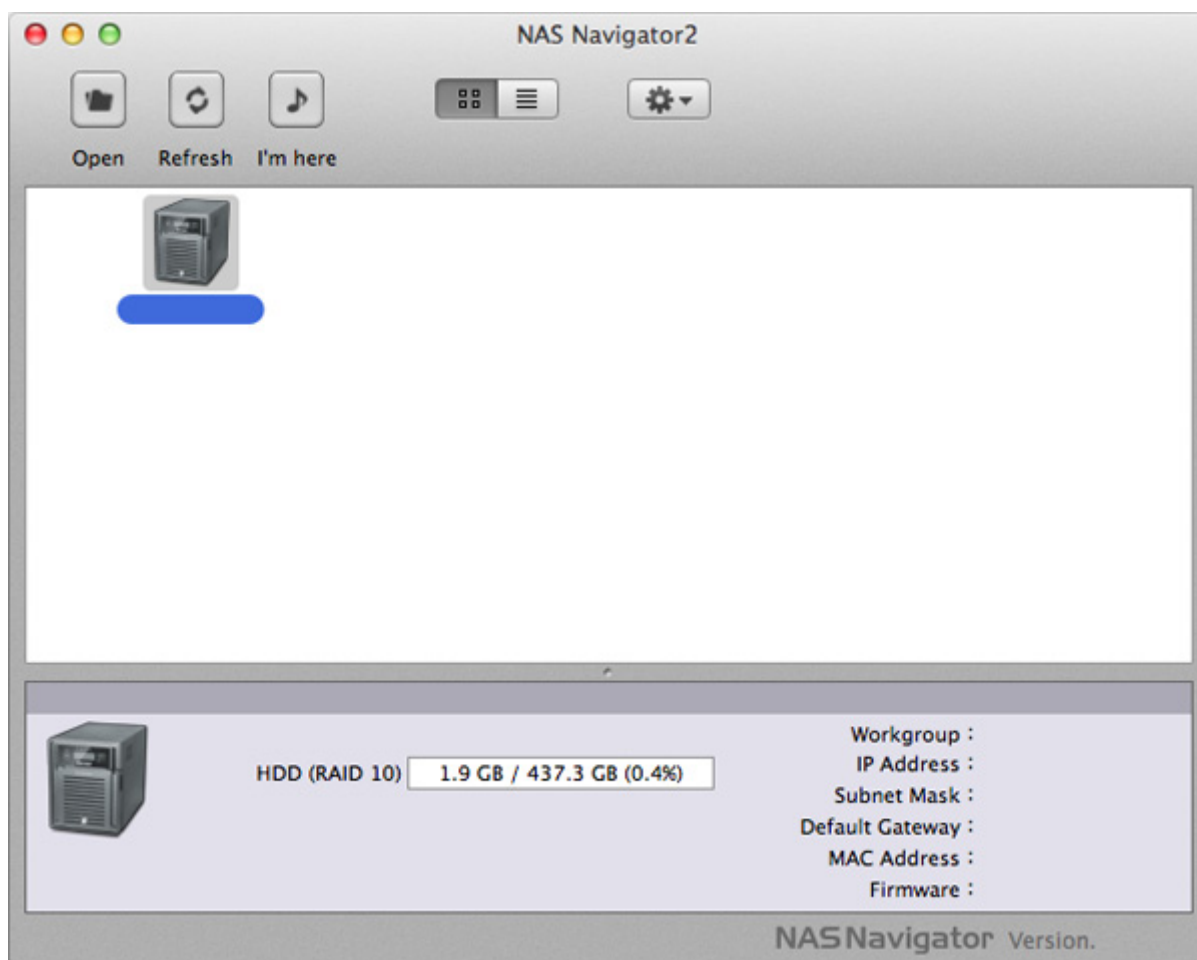

- 3 Select a shared folder name you want to mount, and click *OK*.



- 4 The following icon will be displayed on the desktop after it is mounted.



Notes:

- The displayed characters are the shared folder name. The characters vary depending on the folder name being configured.
- It may be displayed in the sidebar of the Finder on OS X 10.5 or later.
- To unmount, drag and drop the icon to the trashbox.

Now you have mapped the network drive. If you want to assign a folder other than the shared folder as a network drive manually using the function built into your OS, refer to operation system's help file.

Specifications

Check the Buffalo website for information about the latest products or compatible models.

LAN Port	Interface	IEEE 802.3ab (1000BASE-T), IEEE 802.3u (100BASE-TX), IEEE 802.3 (10BASE-T)
	Transfer Speed	1000 Mbps full duplex (auto-negotiation), 100 Mbps full duplex/half duplex (auto-negotiation) 10 Mbps full duplex/half duplex (auto-negotiation)
	Number of Ports	2 ports (supports auto-MDIX)
	Connector Type	RJ-45 8-pin
	Access Method	CSMA/CD
	Protocol	TCP/IP
	File Sharing	SMB/CIFS, AFP, FTP, FTPS, SFTP, NFS
	Jumbo Frame	1518, 4102, 7422, and 9,694 bytes modes are supported. (including 14 bytes of the header and 4 bytes of FCS)
USB Port	Interface	USB Standard Revision 2.0
	Data Transfer Speed	480 Mbps (Logical value) Maximum
	Connector	TS-XL, TS-XEL, TS-WXL : USB 2.0 port (Series A) x 2 TS-RXL : USB 2.0 port (Series A) x 3 Note: Compatible USB devices include printers, USB UPS devices, and Buffalo USB hard drives
UPS Port	Interface	UPS Port (D-SUB 9 pin (Male)) x 1
	Compatible UPS	UPS manufactured by Omron or APC.
Internal Hard Drive	Configured to RAID 5 mode (4 hard drives) for TS-XL, TS-XEL and TS-RXL at the factory default. Configured to RAID 1 mode for TS-WXL/R1. Configured to JBOD for TS-WXL/1D. Note: If the hard drives in the TeraStation are malfunctioned, replace with the hard drive OP-HD Series (with the same capacity as the malfunctioned hard drive) manufactured by Buffalo which is sold separately. Refer to the Buffalo website for details.	
Power / Power Consumption	TS-XL, TS-XEL : AC100-240V 50/60 Hz / approx. 60 W (average) TS-WXL/R1: AC100-240V 50/60 Hz / approx. 40 W (average) TS-WXL/1D: AC100-240V 50/60 Hz / approx. 30 W (average) TS-RXL: AC100-240V 50/60 Hz / approx. 110 W (Average)	
External size/ Weight	TS-XL, TS-XEL: W170×H215×D230 mm (excluding protruding parts) / approx. 8 kg TS-WXL/R1: W170×H170×D230 mm (excluding protruding parts) / approx. 4.5 kg TS-WXL/1D: W170×H170×D230 mm (excluding protruding parts) / approx. 3.6 kg TS-RXL: W430×H44.3×D420 mm (excluding protruding parts) / approx. 9 kg (main unit only)	
Operating Environment	Temperature 5 - 35 °C, Humidity 20 - 80% (no condensation)	

Compatible Computer	Windows and Mac computers with Ethernet interface. The TeraStation requires an Ethernet connection with your computer for operation. It cannot be connected via USB.
Supported OS	Windows 8*, Windows 7*, Vista*, Windows XP*, Windows 2000, Windows XP MCE 2005, Windows XP MCE 2004, Windows Server 2008, Windows Server 2008 R2, Windows Server 2003, Windows Server 2003 R2, Windows 2000 Server OS X 10.7, 10.6, 10.5, 10.4, 10.3.9 Note: Supports both 32-bit and 64-bit versions.

Factory Defaults

The following settings are factory defaults for the TeraStation.

Username	admin
Password	password
Shared Folders	"share" (for both Windows and Macintosh computers). The recycle bin is set to Enabled on "share" by default.
DHCP Client	Normally, the TeraStation will get its IP address automatically from a DHCP server on the network. If no DHCP server is available, then an IP address will be assigned as follows: IP Address: 169.254.xxx.xxx (xxx is assigned randomly when booting the TeraStation). Subnet Mask: 255.255.0.0
Registered Group	The TeraStation has 3 default groups: "hdusers", "admin" and "guest". You cannot edit or delete them.
Microsoft Network Group Setting	WORKGROUP
Ethernet Frame Size	1518 bytes
AFP	Enabled
FTP	Disabled
NTP	Automatic
PrintServer	Enabled
WebAccess	Disabled
Time Machine	Disabled
TeraSearch	Disabled
RAID Mode	TS-XL, TS-XEL, TS-RXL: RAID 5 with 4 hard drives TS-WXL/R1: RAID 1 TS-WXL/1D: JBOD

Note: To restore factory defaults, refer to the "Initialization" section in chapter 8.

Software

You can install following software applications and the manual by using TeraNavigator CD which comes with the TeraStation. Select and install software from the selection screen which is displayed during setup (Or click Option in TeraNavigator and follow the instruction on the screen to install software).

BUFFALO NAS Navigator2

You need NAS Navigator2 in order to display Settings or search for the TeraStation from the network. It is always installed when you setup by clicking Begin Installation on TeraNavigator.

Note: When using power management with PC, you need to install NAS Navigator2 on all computers connected within the same network as the TeraStation.

File Sharing Security Level Change Tool

For Windows 8, Windows 7, Vista, Windows Server 2003 or Windows Server 2008 Users. When setting access restrictions via delegate authority to external SMB server, you need to change the security settings in Windows.

NS-SHFT

This software allows to recover the TeraStation's configuration information when necessary which is saved to a configuration file (nas_config file) on the computer via the network.

Adobe Reader

Manuals for this product include PDF files. You need to install Adobe Reader to your computer in order to read PDF files. Install Adobe Reader if you haven't installed it yet. Refer to the Adobe Reader help for instructions how to use it.

EXT3 Reader

Read USB hard drive on Windows which is formatted in EXT3 on TeraStation.

Note: To delete the software installed, click *Options - Delete Software* in TeraNavigator. Follow the instructions displayed on the screen.

Info Folder

In the folder called "info" on the internal hard disk of the TeraStation, Install programs such as the manual, NAS Navigator2, or Easy Backup are included. When you want to read the manual on your computer in the network, install the utilities when you want.

info - English

- manual - manual.pdf: Display TeraStation PDF manuals.
- NASNavi2 - Inst.exe: Install NAS Navigator2. Refer to TeraStation Setup Guide for the instructions how to use it.
- Imcmchg - Inst.exe: Install File Security Tool. Refer to TeraStation Setup Guide for the instructions how to use it.
- nascfgsr - nascfgsr_ins.exe: Install NS-SHFT. Refer to "How to use NS-SHFT (a PDF file)" for the instructions to use it.
- nascfgsr - nascfgsr.pdf: Provide the instructions of how to use NS-SHFT (a PDF file). To read PDF file, Adobe Reader must be installed.
- EXT3 - instEXT3.exe: Install EXT3 Reader.

Troubleshooting

If You Cannot Setup:

The following list contains the typical symptoms and causes when TeraStation cannot be found on NAS Navigator2 or you cannot display Settings.

Cause 1 Cables are not connected properly.

The hard drive is not physically connected or may have the bad connection. Reconnect the AC cable and the LAN cable and restart your computer and the TeraStation.

Cause 2 The firewall is enabled, or software running in the background is installed.

Disable the firewall or uninstall software which enables the firewall, and try to search for the TeraStation again.

Cause 3. Both wireless and Ethernet adapter are enabled.

Disable any adapters other than the LAN adapter to connect to the TeraStation.

Cause 4 The defective LAN cable or the connection is not stable.

Change a port on the hub to connect or replace the LAN cable.

Cause 5 Your LAN board, card, or adapter is malfunctioning.

Replace a LAN board, card, or adapter.

Cause 6. The LAN board you are using or the transfer mode of the hub is not set.

Change the LAN board, or change the transfer mode to 10M half-duplex or 100M half-duplex. Some LAN boards and hubs may not be connected to the network properly if the transfer mode is set to Auto Negotiation.

Cause 7 There is a network bridge.

If any network bridge which is not used, delete them.

Cause 8 You are searching from a different network.

You cannot search for the TeraStation over network segments. Connect the TeraStation to the same segment as the computer you use for search.

Cause 9 TCP/IP does not work properly.

Reinstall the LAN Adapter's driver.

If Shared folders on the TeraStation would not suddenly open:

If you map shared folders on the TeraStation as a network drive, you may suddenly not be able to access TeraStation when the IP address or Workgroup is changed. In such a case, follow the instructions on the front of this sheet and open the shared folder on the TeraStation by using NAS Navigator2.

Note: On Mac OS, TeraStation is mounted as a drive icon on the desktop, or displayed in the sidebar on the Finder. If the problem still persists after you tried the procedures described above on Mac OS, select *System - Storage - Disks - Check Disk - Delete any hidden, non-essential Mac OS dedicated files* on Settings, and click *Check*.

If a shared folder does not open even though NAS Navigator2 recognizes the TeraStation

If power outage occurred or the AC cable is unplugged while the TeraStation is on, the TeraStation's firmware may be corrupted and shared folders may not open (You can search for folders on NAS Navigator2 but they do not open).

Note: In such a case, TeraStation Name displayed on NAS Navigator2 or Settings is displayed as TS-XL-EM*** (the example of TS-XL Series)*** expresses last 3 digits of the TeraStation's MAC address. In such a case, download the latest firmware from the Buffalo website and update it.

Data Backup

While using the TeraStation, you may lose your important data due to sudden accidents, hard disk failure, or accidental misoperation. It is important to backup your data to recover data or minimize losses in such a case. Use Mass Storage class hard disk manufactured by Buffalo (such as TeraStation/LinkStation and a USB external hard disk) as Backup Targets.

GPL Information

The source code for Buffalo products that use GPL code is available at <http://opensource.buffalo.jp/>.

Compliance Information

For Customers in the United States

FCC Warning

This equipment has been tested and found to comply with the limits for a Class A digital device, pursuant to Part 15 of the FCC Rules. These limits are designed to provide reasonable protection against harmful interference when the equipment is operated in a commercial environment. This equipment generates, uses, and can radiate radio frequency energy and, if not installed and used in accordance with the instruction manual, may cause harmful interference to radio communications. Operation of this equipment in a residential area is likely to cause harmful interference in which case the user will be required to correct the interference at his own expense.

For Customers in Europe

EU Declaration of Conformity

This is a Class A product. In a domestic environment, this product may cause radio interference, in which case the user may be required to take adequate measures.

Environmental Information

- The equipment that you have purchased required the extraction and use of natural resources for its production.
- The equipment may contain hazardous substances that could impact health and the environment.
- In order to avoid the dissemination of those substances in our environment and to diminish the load on natural resources, we encourage you to use the appropriate take-back systems.
- The take-back systems will reuse or recycle most of the materials of your end of life equipment appropriately.
- The crossed-out wheeled bin symbol invites you to use those systems.
- If you need more information on the collection, reuse and recycling systems, please contact your local or regional waste administration.



한국에서 구입 고객

KC

기종별	사 용 자 안 내 문
A급 기기 (업무용 정보통신기기)	이 기기는 업무용(A급) 전자파적합기기로서 판매자 또는 사용자는 이 점을 주의하시기 바라며, 가정외의 지역에서 사용하는 것을 목적으로 합니다.

面向中国用户

CCC

声明:

此为A级产品，在生活环境中，该产品可能会造成无线电干扰。在这种情况下，可能需要用户对其干扰采取切实可行的措施。

提供給台灣的客戶

BSMI

警告使用者：

這是甲類的資訊產品，在居住的環境中使用時，可能會造成射頻干擾，在這種情況下，使用者會被要求採取某些適當的對策。