

CIRCUIT DIAGRAM

FCC ID. No.: JJ6IRD2102S

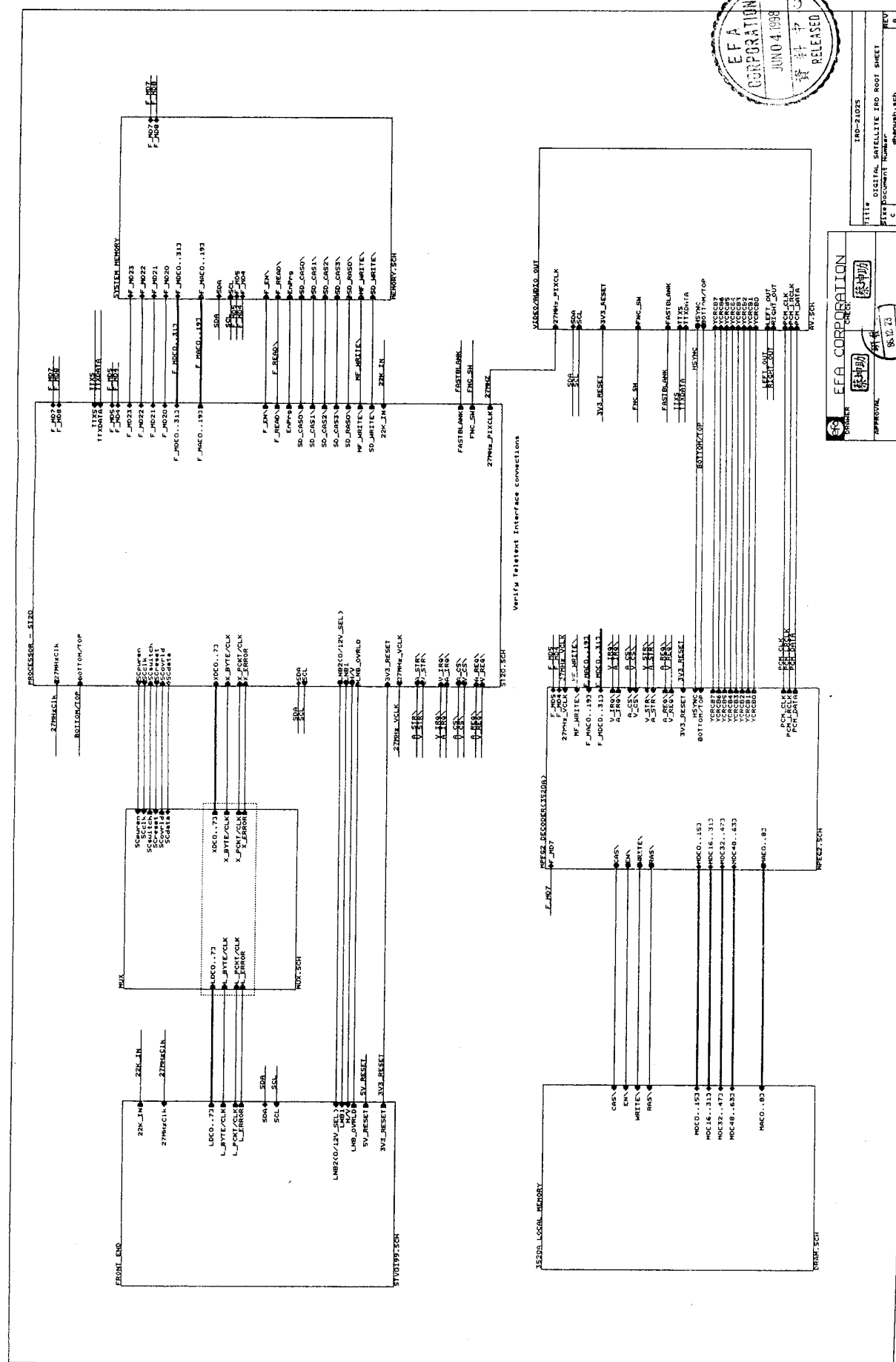

EFA CORPORATION	
11111 DIGITAL SIGNALS INP ROOT SHEET	
EFA DOCUMENT NUMBER: 488448A-424	
REV	REV
C	REV
DATE: DECEMBER 22, 1977/2847	

EFA CORPORATION	
11111 DIGITAL SIGNALS INP ROOT SHEET	
EFA DOCUMENT NUMBER: 488448A-424	
REV	REV
C	REV
DATE: DECEMBER 22, 1977/2847	

DO NOT COPY

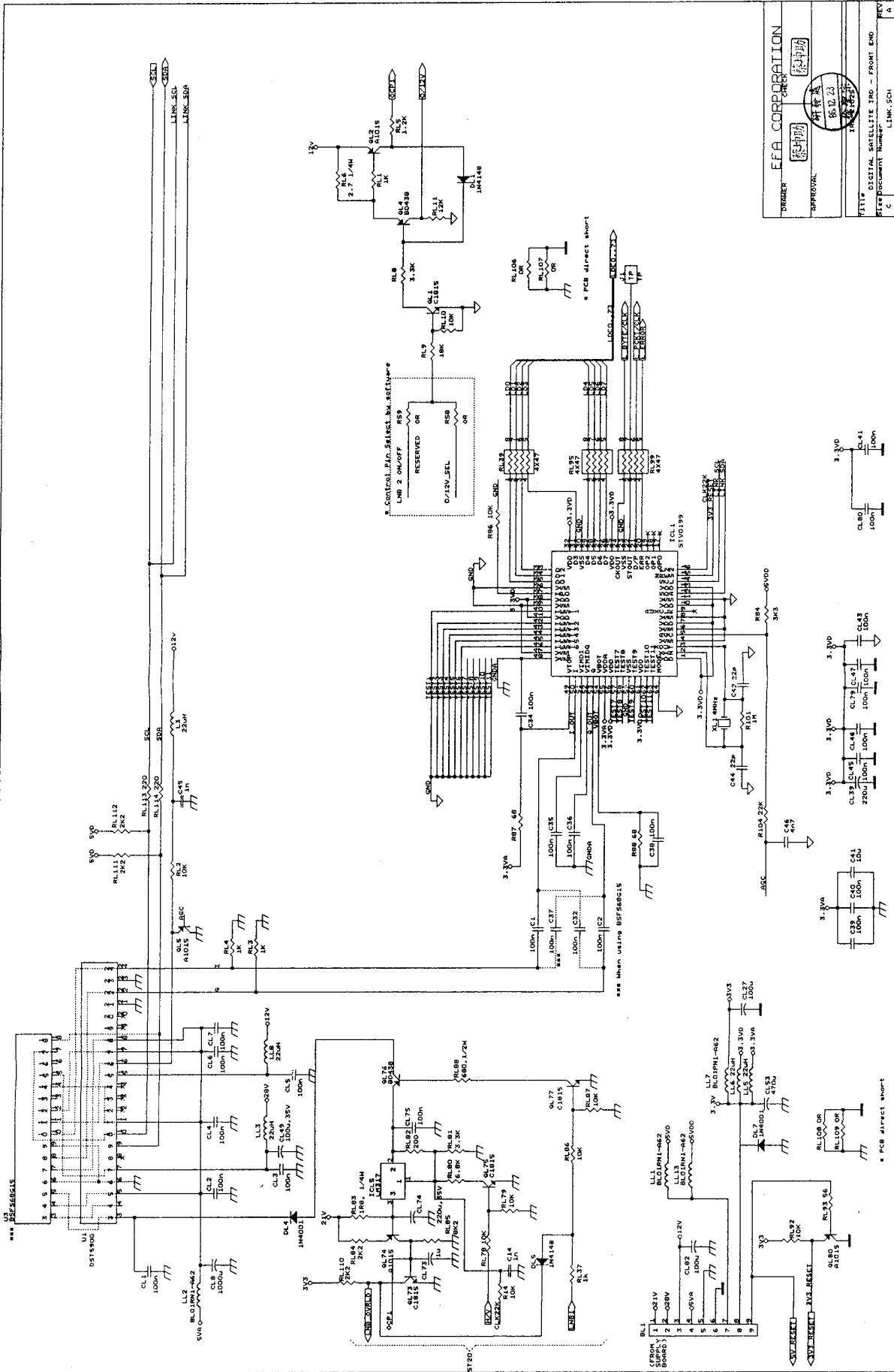

ORDER: EFA CORPORATION
 APPROVAL: [Signature]
 DATE: 8/10/83
 FILE: 830103
 DRAWN: [Signature]
 CHECKED: [Signature]
 DIGITAL SATELLITE TRD - FRONT END
 C: [Signature]
 DOCUMENT NUMBER: LINK_SEL
 SHEET: 2 OF 3

DO NOT COPY

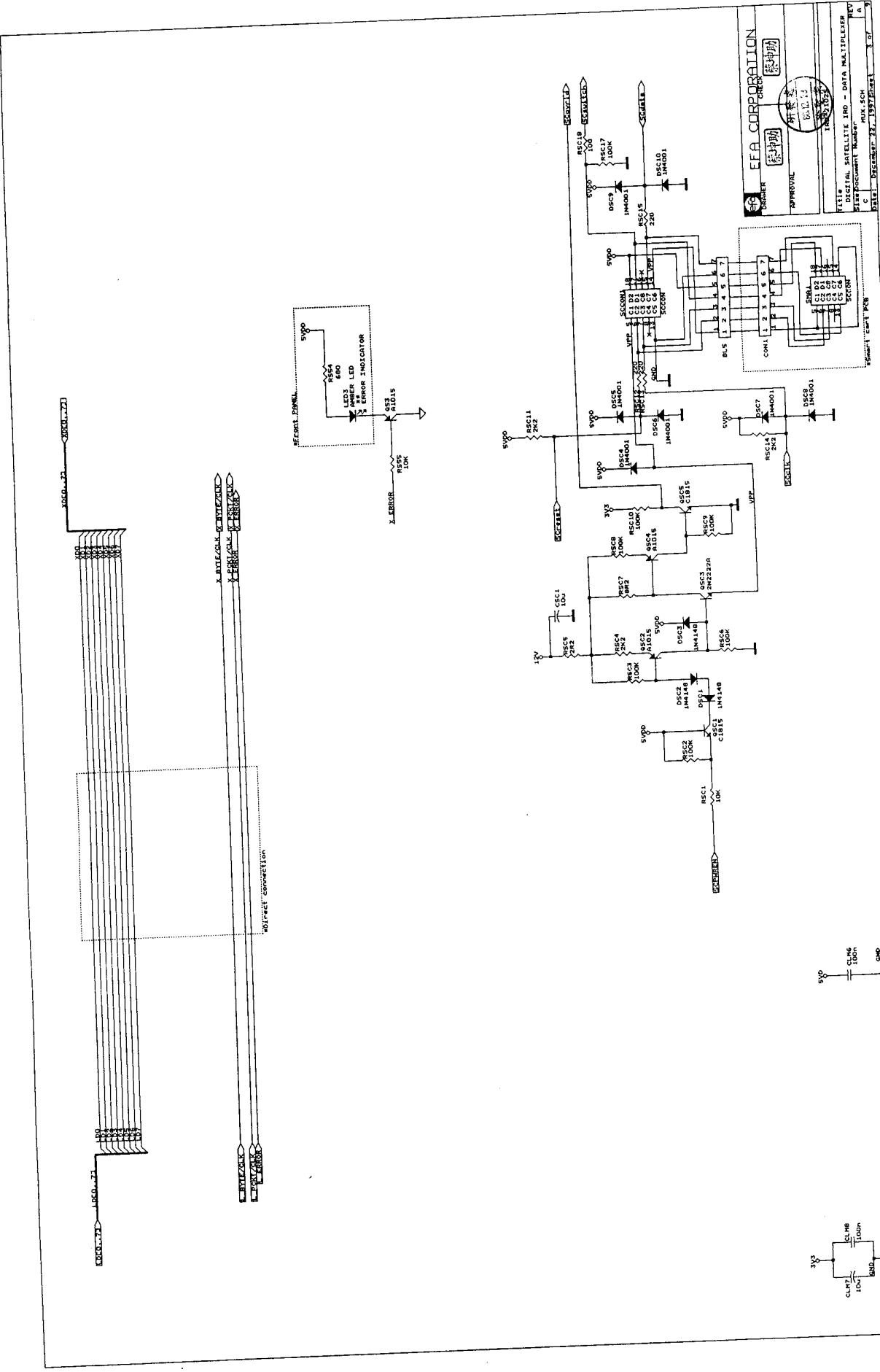

DO NOT COPY

EFA CORPORATION
 APPROVAL
 APPROVED BY: [Signature]
 DATE: [Date]
 REV: [Revision]
 SIZE: [Size]
 FILE: [File]
 SHEET: [Sheet] OF [Total]

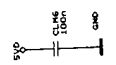

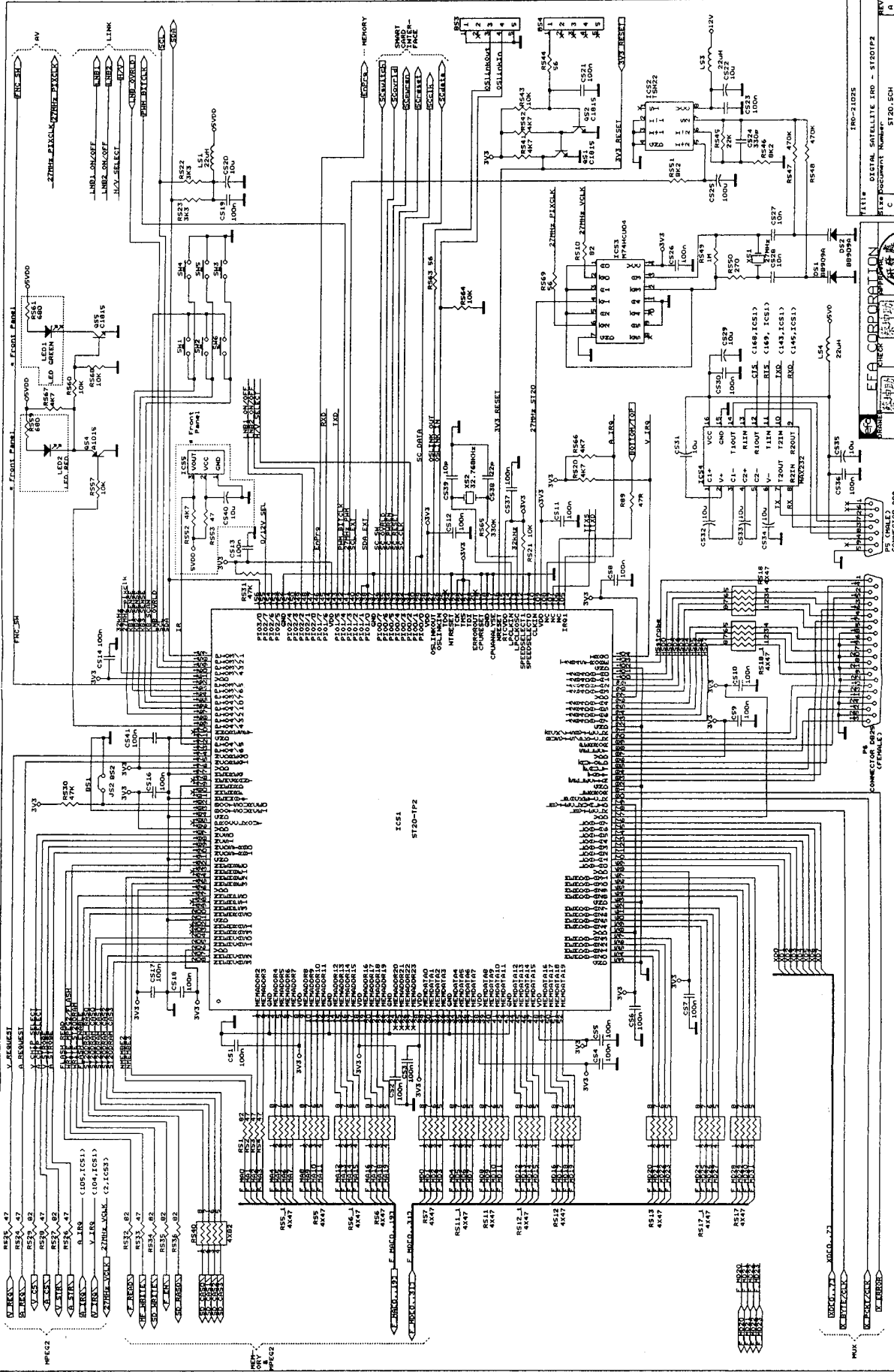

DO NOT COPY

FILE# DIGITAL SATELLITE IRD - 5720P1P2
 REV# REV# DOCUMENT NUMBER# 5720_SCH
 C. DATE# REVISION# 3. 1997.08.01 1 OF 1

EF&A CORPORATION
 研華公司
 研華資訊
 研華資訊
 研華資訊

CONNECTION DIB
 PS (CHOLE)
 PS CONNECTOR DIB

CONNECTION DIB
 PS (CHOLE)
 PS CONNECTOR DIB

CONNECTION DIB
 PS (CHOLE)
 PS CONNECTOR DIB

CONNECTION DIB
 PS (CHOLE)
 PS CONNECTOR DIB

CONNECTION DIB
 PS (CHOLE)
 PS CONNECTOR DIB

CONNECTION DIB
 PS (CHOLE)
 PS CONNECTOR DIB

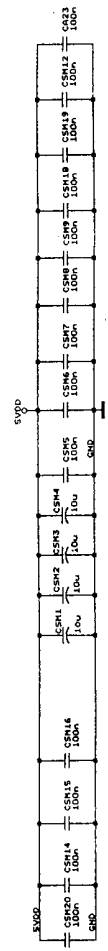
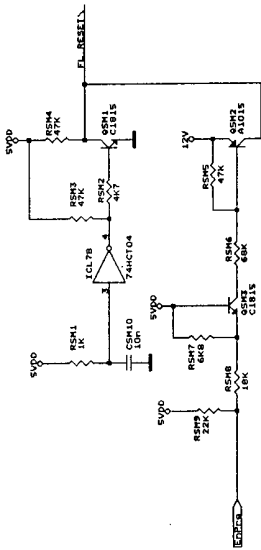
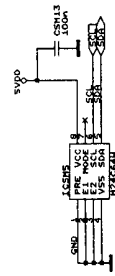
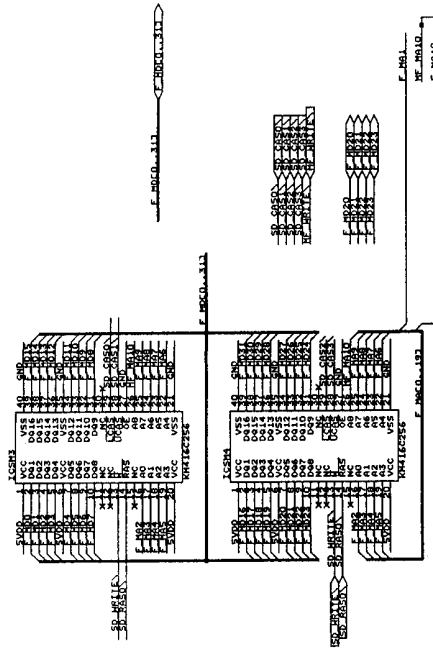
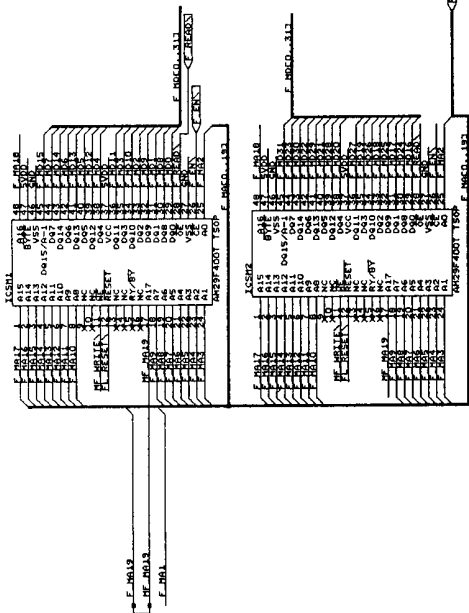

EEA CORPORATION
 DRAWING: []
 APPROVAL: []
 DATE: 86.12.23
 DIGITAL I/O Ref. Design
 REV 14
 5 OF 5

DO NOT COPY

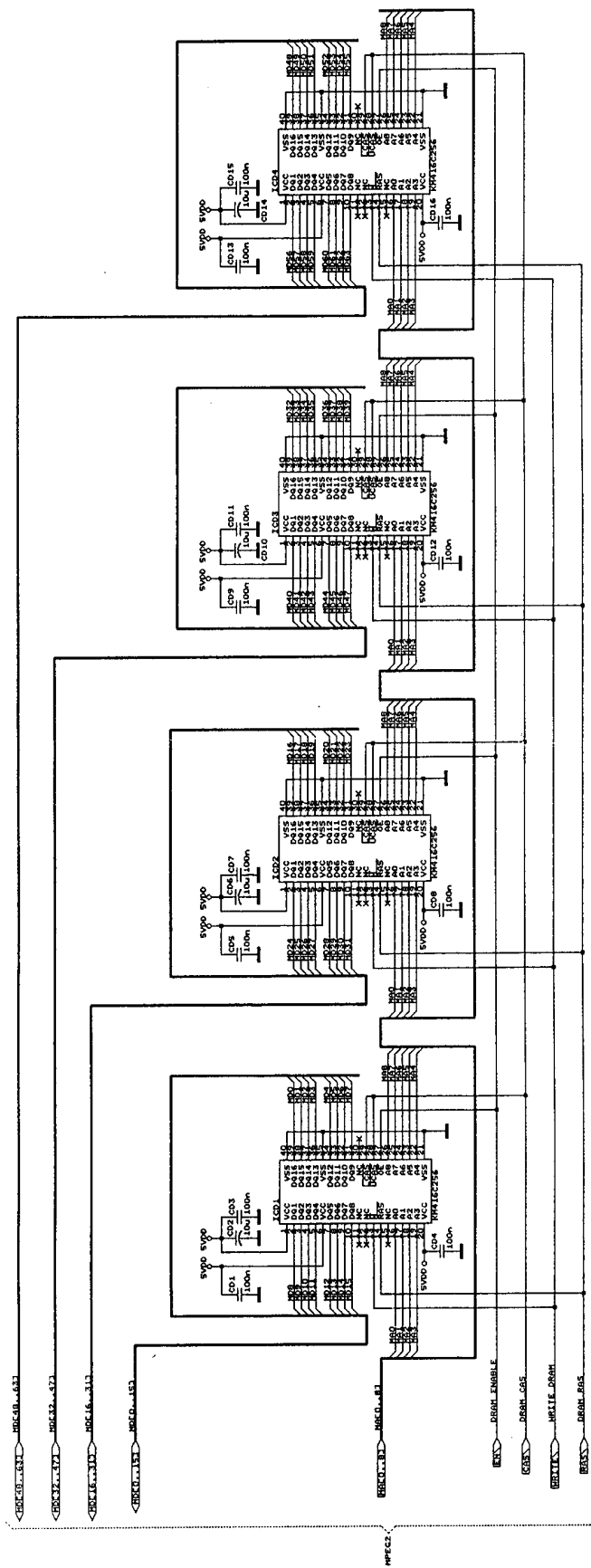

	EFA CORPORATION	DRIVER
DRIVER	蔡坤成	蔡坤成
APPROVAL	蔡坤成	蔡坤成
REV 4	REV 4	REV 4
DATE 2001-12-28	DATE 2001-12-28	DATE 2001-12-28
TYPE	DIGITAL SATELLITE IRD - MPF02 DRAM	TYPE
SIZE	Document Number	SIZE
DATE	2001-12-28	DATE

DO NOT COPY

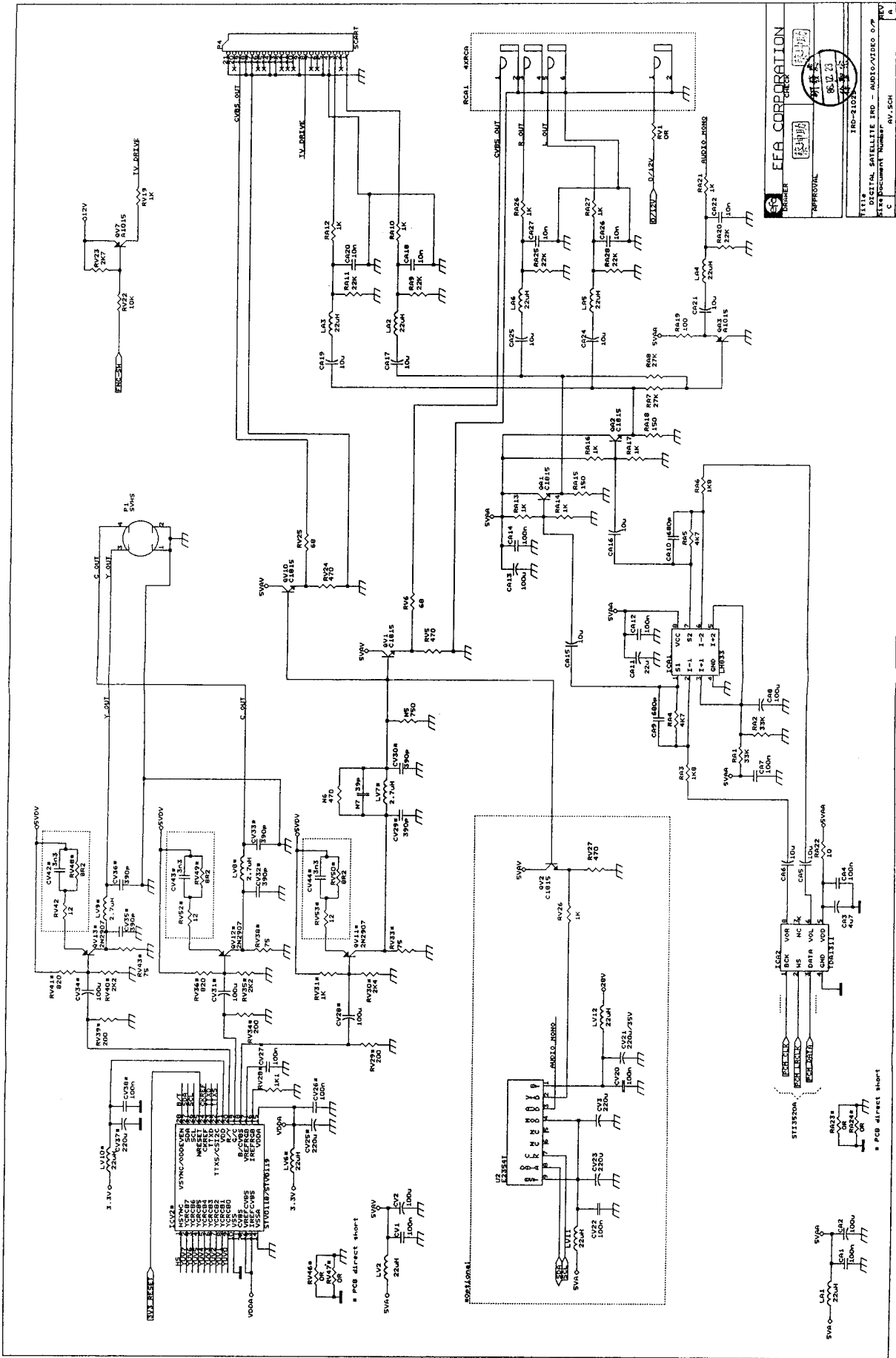

EFA CORPORATION

DESIGNED BY: [Signature]

APPROVAL: [Signature]

DATE: DECEMBER 23, 1977

IRD-2102N

TITLE: OPTICAL SATELLITE IMP - AUDIO/VIDEO S/P

SCALE: AS SHOWN

C: [Signature]

REV: [Signature]

DO NOT COPY

* PCB direct short

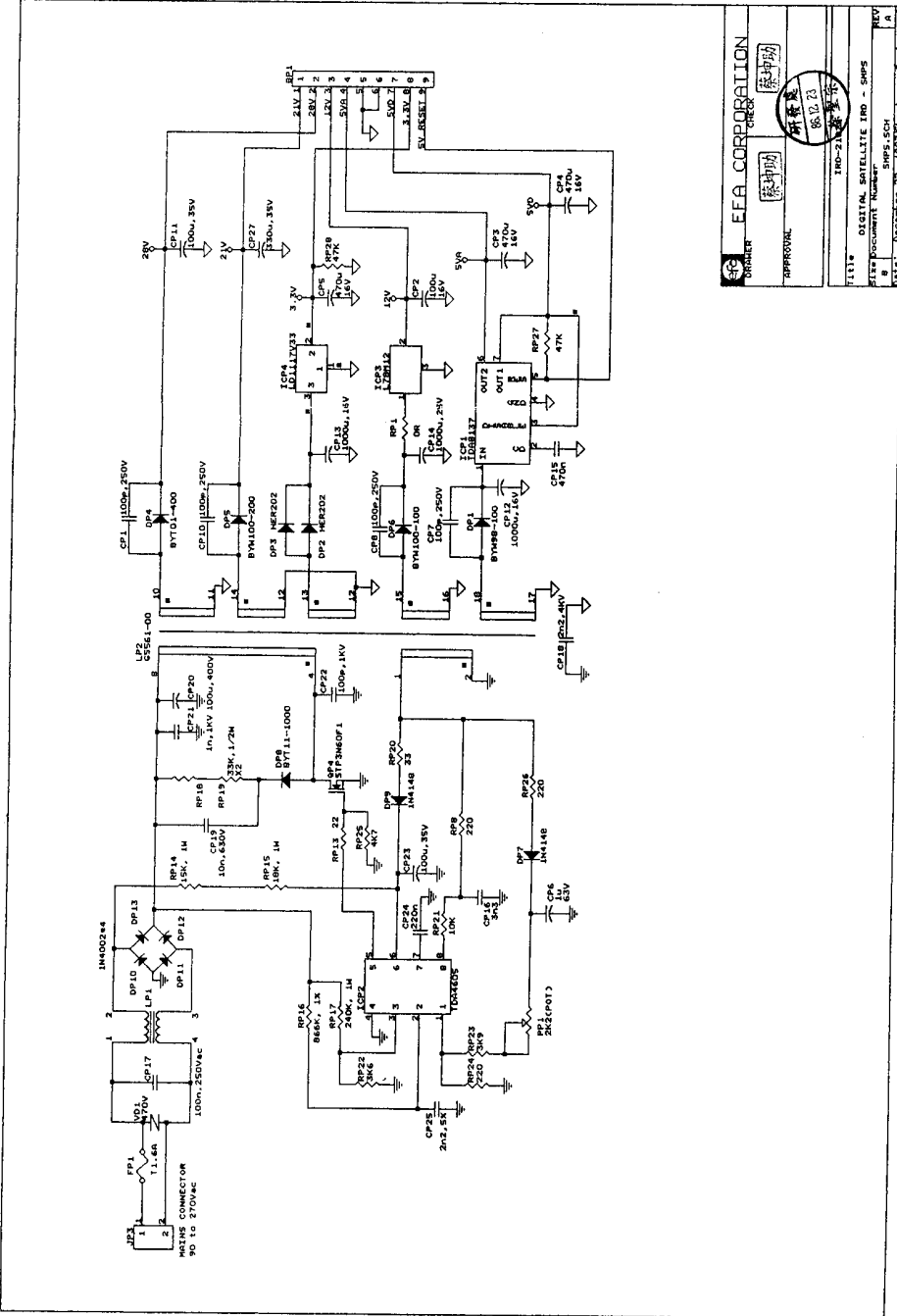

EFA CORPORATION
 DRAWN: (蔡坤明)
 APPROVAL: (蔡坤明)
 180-21
 TITLE: GEOSAT SATELLITE IRO - SWPS
 SHEET NUMBER: SWPS.SCH
 DATE: DECEMBER 22, 1977
 9 OF 9

DO NOT COPY

FCC APPLICATION FOR CERTIFICATION

FOR

EFA CO.

NO.3, TZU-CHIANG 4TH ROAD, CHUNGLI INDUSTRIAL ZONE,
TAOYUAN HSIEN, TAIWAN, R.O.C.

FCC ID.:JJ6IRD2102S

June, 1998

Submitted to:

Federal Communications Commission
EQUIPMENT APPROVAL SERVICES
P.O. BOX 358315
Pittsburgh, PA 15251-3315

LIST OF EXHIBITS

Form 731

Title Page

List of Exhibits

Letter of Authorization

Exhibit A - Technical Report, Diagram

Exhibit B - Photographs

Exhibit C - Measurement Report

Exhibit D - Equipment ID Label

Exhibit E - User's Manual