

Overview

HPE ProLiant DL380 Generation9 (Gen9)

The HPE ProLiant DL380 Gen9 Server delivers the best performance and expandability in the Hewlett Packard Enterprise 2P rack portfolio. Reliability, serviceability and near continuous availability, backed by a comprehensive warranty, make it ideal for any environment. Deploy the data center standard.

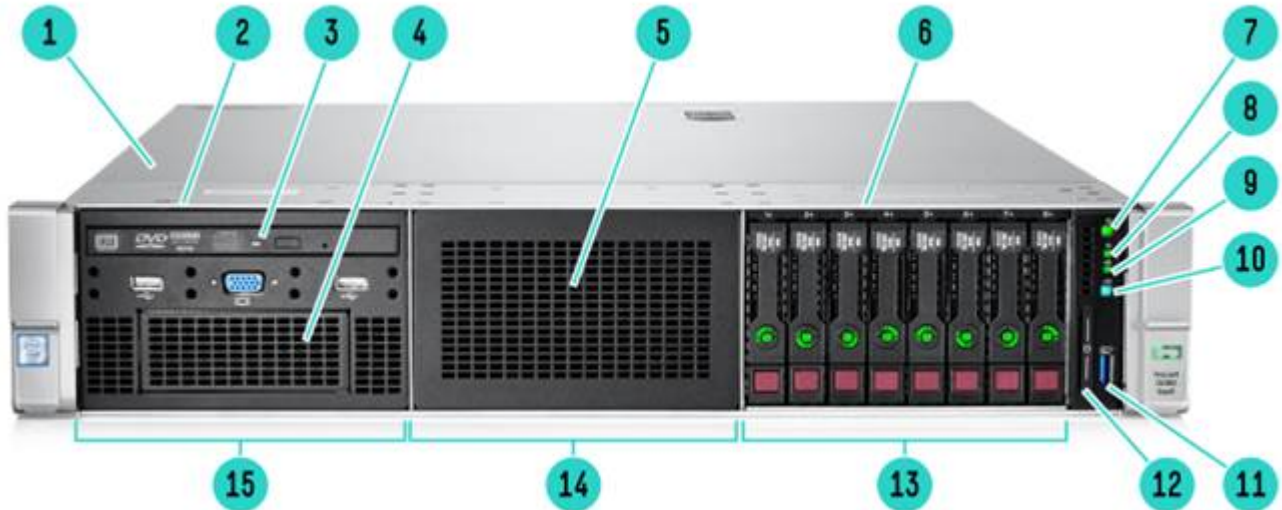

Front View - 8SFF Chassis with Optional Universal Media Bay shown

- | | |
|---|--|
| 1. Quick removal access panel | 2. Universal Media bay. 2 USB 2.0 and VGA standard (8SFF bay optional) |
| 3. Optional Optical drive. Requires Universal Media bay | 4. Optional 2 SFF HDD, blank shown. Requires Universal Media bay |
| 5. Drive Bay 2. Blank shown, 8SFF or 6NVMe optional | 6. 8 SFF Drive Cage Bay |
| 7. Power On/Standby button and system power LED button | 8. Health LED |
| 9. NIC status | 10. UID button |
| 11. USB 3.0 | 12. Serial label pull tag |
| 13. Bay 3 | 14. Bay 2 |
| 15. Bay 1 | |

Overview

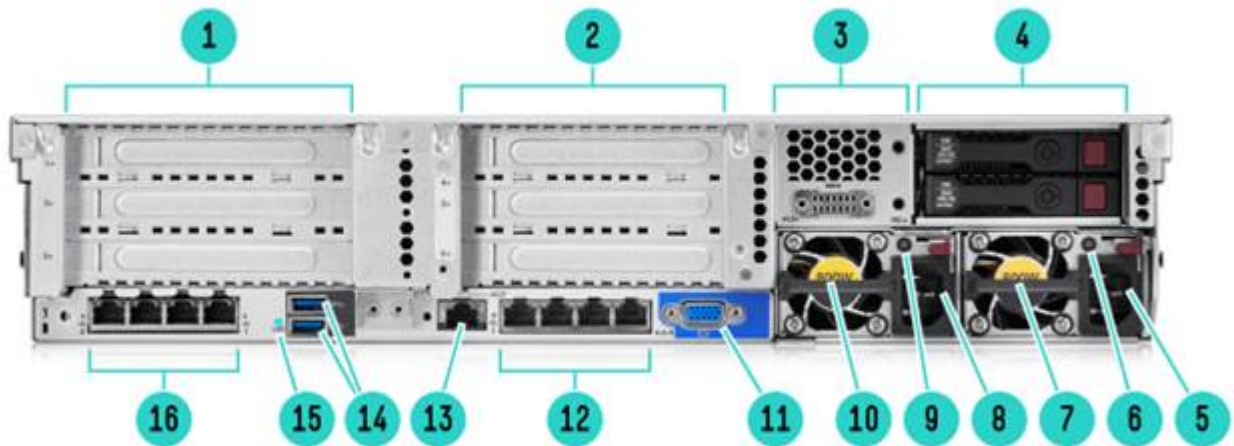

Rear View

1. PCI Slots (Slots 1-3 top to bottom, riser shipped standard)
2. PCI Slots (Slots 4-6 top to bottom, requires second riser card, and second processor)
3. Optional serial port
4. Optional rear 2 SFF HDD (supported in 24 SFF or 12 LFF front end)
5. Power supply Power connection
6. Power supply Power LED
7. HPE Flexible Slot Power Supply bay 1 (800w shown)
8. Power supply Power connection
9. Power supply Power LED
10. HPE Flexible Slot Power Supply bay 2 (800w shown)
NOTE: Optional Battery Back up option.
11. VGA connector
12. Embedded 4x1GbE Network Adapter
13. Dedicated iLO connector
14. USB 3.0 connectors (2)
15. Unit ID LED
16. Optional FlexibleLOM ports (Shown: 4x1GbE)

Overview

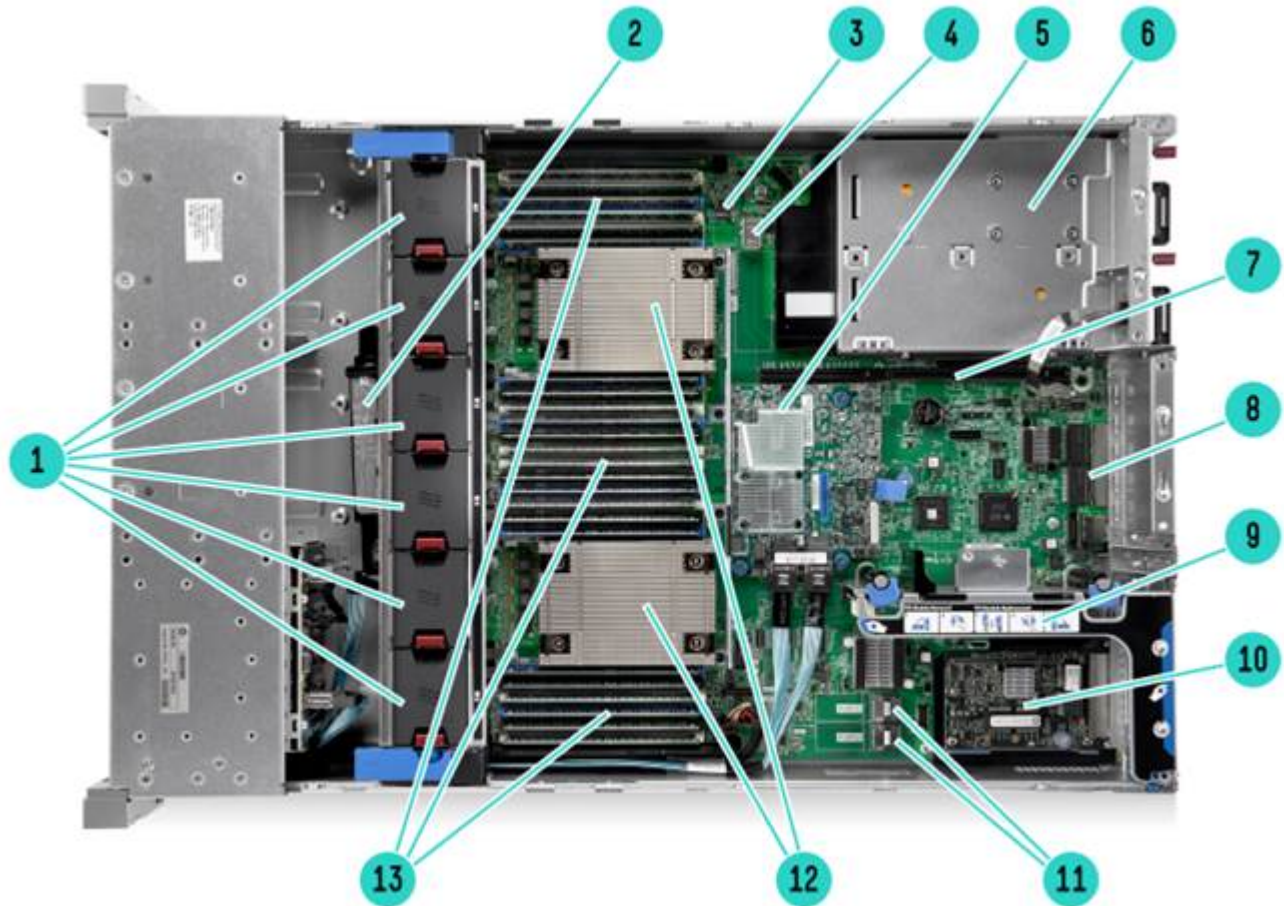

Internal View

1. Fan cage shown with 6 standard Hot-plug fans (High Performance fans optional)
2. Optional HPE Smart Storage Battery
3. MicroSD card slot
NOTE: Optional Dual MicroSD.
4. Internal USB 3.0 connector (2)
5. Optional HPE Flexible Smart Array or Smart HBA (H240ar shown)
6. (Under) Hot Plug redundant HPE Flexible Slot Power supplies
NOTE: Optional Micro UPS Battery Back up option.
7. Connection for second (optional) riser (Required second CPU)
8. Embedded 4x1Gbe NIC
9. Primary PCIe riser, standard (Optional double wide GPU riser)
10. Optional FlexibleLOM slot
11. X4 SATA ports (1 and 2)
12. 2 Processors, heatsink showing, with HPE Smart Socket Guide
13. DDR4 DIMM slots. Shown fully populated in 24 slots (12 per processor)

What's New

- New NVIDIA GPU
- New higher capacity LFF and SSD drives

Standard Features

NOTE: For more information regarding Intel Xeon processors, please see the following <http://www.intel.com/xeon>.

Processor	Model	CPU frequency	Cores	L3 Cache	Power	QPI	DDR4 Hz
Up to two of the following depending on model	E5-2699v3	2.3GHz	18	45MB	145W	9.6GT/s	2133
	E5-2698v3	2.3GHz	16	40MB	135W	9.6GT/s	2133
	E5-2697v3	2.6GHz	14	35MB	145W	9.6GT/s	2133
	E5-2695v3	2.3GHz	14	35MB	120W	9.6GT/s	2133
	E5-2690v3	2.6GHz	12	30MB	135W	9.6GT/s	2133
	E5-2687Wv3	3.1GHz	10	25MB	160W	9.6GT/s	2133
	E5-2683v3	2.0GHz	14	35MB	120W	9.6GT/s	2133
	E5-2680v3	2.5GHz	12	30MB	120W	9.6GT/s	2133
	E5-2670v3	2.3GHz	12	30MB	120W	9.6GT/s	2133
	E5-2667v3	3.2GHz	8	20MB	135W	9.6GT/s	2133
	E5-2660v3	2.6GHz	10	25MB	105W	9.6GT/s	2133
	E5-2650v3	2.3GHz	10	25MB	105W	9.6GT/s	2133
	E5-2650Lv3	1.8GHz	12	30MB	65W	9.6GT/s	2133
	E5-2643v3	3.4GHz	6	20MB	135W	9.6GT/s	2133
	E5-2640v3	2.6GHz	8	20MB	90W	8.0GT/s	1866
	E5-2637v3	3.5GHz	4	15MB	135W	9.6GT/s	2133
	E5-2630v3	2.4GHz	8	20MB	85W	8.0GT/s	1866
	E5-2630Lv3	1.8GHz	8	20MB	55W	8.0GT/s	1866
	E5-2623v3	3.0GHz	4	10MB	105W	8.0GT/s	1866
	E5-2620v3	2.4GHz	6	15MB	85W	8.0GT/s	1866
	E5-2609v3	1.9GHz	6	15MB	85W	6.4GT/s	1600
	E5-2603v3	1.6GHz	6	15MB	85W	6.4GT/s	1600
	E5-2699v4	2.2GHz	22	55MB	145W	9.6GT/s	2400
	E5-2698v4	2.2GHz	20	50MB	135W	9.6GT/s	2400
	E5-2697v4	2.3GHz	18	45MB	145W	9.6GT/s	2400
	E5-2697Av4	2.6GHz	16	40MB	145W	9.6GT/s	2400
	E5-2695v4	2.1GHz	18	45MB	120W	9.6GT/s	2400
	E5-2690v4	2.6GHz	14	35MB	135W	9.6GT/s	2400
	E5-2687Wv4	3.0GHz	12	30MB	160W	9.6GT/s	2400
	E5-2683v4	2.1GHz	16	40MB	120W	9.6GT/s	2400
	E5-2680v4	2.4GHz	14	35MB	120W	9.6GT/s	2400
	E5-2667v4	3.2GHz	8	25MB	135W	9.6GT/s	2400
	E5-2660v4	2.0GHz	14	35MB	105W	9.6GT/s	2400
	E5-2650v4	2.2GHz	12	30MB	105W	9.6GT/s	2400
	E5-2650Lv4	1.7GHz	14	35MB	65W	9.6GT/s	2400
	E5-2643v4	3.4GHz	6	20MB	135W	9.6GT/s	2400
	E5-2640v4	2.4GHz	10	25MB	90W	8.0GT/s	2133
	E5-2637v4	3.5GHz	4	15MB	135W	9.6GT/s	2400
	E5-2630v4	2.2GHz	10	25MB	85W	8.0GT/s	2133
	E5-2630Lv4	1.8GHz	10	25MB	55W	8.0GT/s	2133
E5-2623v4	2.6GHz	4	10MB	85W	8.0GT/s	2133	
E5-2620v4	2.1GHz	8	20MB	85W	8.0GT/s	2133	
E5-2609v4	1.7GHz	8	20MB	85W	6.4GT/s	1866	
E5-2603v4	1.7GHz	6	15MB	85W	6.4GT/s	1866	

Standard Features

E5-2699Av4	2.4GHz	22	55MB	145W	9.6GT/s	2400
------------	--------	----	------	------	---------	------

NOTE: All processors above 120W use a high efficiency Heatsink. Doublewide PCIe cards are only supported with this Heatsink. For processors with a standard Heatsink that require double wide PCIe cards, the Graphics Enablement kit option is also required (719082-B21).

NOTE: Mixing of E5-2600v3 and E5-2600v4 processors is not supported.

NOTE: Field upgrade from E5-2600v3 to E5-2600v4 is supported.

NOTE: All processors support Hyper-Threading except E5-2609 v4/v3 and E5-2603 v4/v3.

Chipset Intel® C610 Series Chipset
Intel® E5-2600v3 Processor Family
Intel® E5-2600v4 Processor Family

NOTE: For more information regarding Intel® chipsets, please see the following URL:
<http://www.intel.com/products/server/chipsets/>

On System Management Chipset HPE iLO (Firmware HPE iLO4 2.0) 4GB NAND

NOTE: Read and learn more in the [iLO QuickSpecs](#).

Memory Type:
One of the following depending on model HPE SmartMemory
DDR4 Registered (RDIMM), Load Reduced (LRDIMM) or Persistent Memory (NVDIMM)

DIMM Slots Available	24	(12 DIMM slots per processor, 4 channels per processor, 3 DIMMs per channel)
Maximum Capacity (LRDIMM)	3TB	(24 x 128GB LRDIMM @2400MHz)*
Maximum Capacity (RDIMM)	768GB	(24 x 32GB RDIMM @2400MHz)
Maximum Capacity (NVDIMM)	128GB	(16 x 8GB NVDIMM)*

NVDIMM support only with the E5-2600v4 processors, and RDIMMs only

- Note mixing of 2133 and 2400MHz memory is not supported
- Note mixing of RDIMM and LRDIMM memory is not supported
- Note the 128GB LRDIMM may not be mixed with other DIMM capacities/types

Memory Protection Advanced ECC Advanced ECC uses single device data correction to detect and correct single and all multibit error that occurs within a single DRAM chip.

Online Spare Memory online spare mode detects a rank that is degrading and switches operation to the spare rank.

Expansion Slots

Primary Riser (Standard)	Expansion Slots #	Technology	Bus Width	Connector Width	Bus Number	Form Factor	Notes
	1	PCIe 3.0	X8	X16	7	Full-height, half-length slot	Proc 1

Standard Features

2	PCIe 3.0	X8	X16	10	Full-height, half-length slot	Proc 1
3	PCIe 3.0	X8	X8	13	Half length/full height	Proc 1

NOTE: Bus Width Indicates the number of physical electrical lanes running to the connector.

NOTE: All slots support PCIe cards to 150W or more depending on card, but an additional Power Cord Option is required (PN 669777-B21). See Option Section below for offering.

NOTE: Double wide PCIe cards are only supported in risers with the Processors leveraging the High Performance Heatsink. For Processors requiring double wide GPU support please order the GPU enablement kit (719082-B21).

Slot 2 PCIe Riser (Optional 3-slot) 719073-B21	Expansion Slots #	Technology	Bus Width	Connector Width	Bus Number	Form Factor	Notes
	4	PCIe 3.0	X16	X16	16	Full-height, full-length slot	Proc 2
	5	PCIe 3.0	X16	X16	20	Full-height, full-length slot	Proc 2
	6	PCIe 3.0	X8	X8	23	Full-height, half-length slot	Proc 2

NOTE: Bus Width Indicates the number of physical electrical lanes running to the connector.

NOTE: When populating the second optional riser slot, the second processor must be installed.

NOTE: All slots support PCIe cards to 150W or more depending on card but an additional Power Cord Option is required (PN 669777-B21). See Option Section below for offering.

NOTE: Double wide PCIe cards are only supported in risers with the Processors leveraging the High Performance Heatsink. For Processors requiring double wide GPU support please order the GPU enablement kit (719082-B21).

Slot 1 PCIe Riser (Optional 2-slot) 719076-B21	Expansion Slots #	Technology	Bus Width	Connector Width	Bus Number	Form Factor	Notes
	2	PCIe 3.0	X16	X16	0x05	Full-height, full-length slot	Proc 1
	3	PCIe 3.0	X8	X8	0x08	Full-height, half-length slot	Proc 1

NOTE: Bus Width Indicates the number of physical electrical lanes running to the connector.

NOTE: This will replace the standard primary riser and supports double wide cards.

NOTE: All slots support PCIe cards to 150W or more depending on card, but an additional Power Cord Option is required (PN 669777-B21). See Option Section below for offering.

NOTE: Double wide PCIe cards are only supported in risers with the Processors leveraging the High Performance Heatsink. For Processors requiring double wide GPU support please order the GPU enablement kit (719082-B21).

Standard Features

Storage Controller

One of the following depending on model

Entry Models	HPE Dynamic Smart Array B140i Controller
	NOTE: The embedded B140i controller will operate in UEFI only mode. For legacy support an additional controller will be needed, and for CTO orders please also select the Legacy mode settings part, 758959-B22.
	NOTE: The B140i defaults to AHCI off the chipset. Smart array needs to be enables on the SATA only models if required.
	NOTE: The B140i will not operate in Legacy mode.
Base Models	HPE Dynamic Smart Array B140i Controller HPE Flexible Smart Array P440ar/2G FIO Controller HPE Flexible Smart Array P840/4G FIO Controller HPE Smart Array P840ar/2G Controller
Performance Models	HPE Dynamic Smart Array B140i Controller HPE Flexible Smart Array P440ar/2GB

Internal Storage Devices

One of the following depending on model

Optical Drive	Ships standard in Performance Models Optional: DVD-ROM, DVD-RW
Hard Drives	None ship standard
Hard Drive Bays	8 SFF with optional Universal Media Bay, 8 SFF bay or 6 NVME drive options 24 SFF plus optional 2 SFF drives rear 12 LFF plus optional 3 LFF drives rear NOTE: The 3 LFF rear drives will consume space for the secondary riser. NOTE: The 12 LFF chassis also supports 2 SFF rear which allows for the second riser. NOTE: The 6 NVMe drive option can only be leveraged in the SFF chassis and replaces Bay 2. 4 LFF drive bays total NOTE: The Universal Media Bay (724865-B21) not available with the LFF chassis or the 24SFF front end, and can only be populated in Bay1. NOTE: The 8SFF can be upgraded with a drive cage to 16 or 24 SFF with field upgrades. For optimal upgrade Bay2 should be populated second, with Bay 3 the last to be populated for a field upgrade to 24 SFF. NOTE: The 4LFF chassis cannot be upgraded to 12LFF in the field. NOTE: All Pre-configured Chassis come with an embedded 10-Port SATA controller. Optional HPE Flexible Smart Array and Smart SAS HBA Controllers can be added.

Maximum Internal Storage

	CAPACITY	CONFIGURATION
Hot Plug SFF SAS	52.0TB	24+2 x 2TB (with optional rear SFF drive cage)
Hot Plug SFF SATA	52.0TB	24+2 x 2TB (with optional SFF drive cage)
Hot Plug LFF SAS	180.0TB	12+3 x 12TB (with optional rear LFF drive cage)
Hot Plug LFF SATA	180.0TB	12+3 x 12TB (with optional rear LFF drive cage)

Standard Features

Hot Plug SFF SAS SSD	397.8TB	24+2 x 15.3TB (with optional rear SFF drive cage)
Hot Plug SFF SATA SSD	99.84TB	24+2 x 3.84TB (with optional rear SFF drive cage)
Hot Plug LFF SATA SSD	57.6B	12+3 x 3.84TB (with optional rear LFF drive cage)
Hot Plug SFF NVMe PCIe SSD	12TB NVMe + 36TB SFF	6x2TB NVMe plus 36TB with 18 SFF (Bay 1, bay 3 and optional rear drive support)

Power Supply

HPE 500W Flex Slot Platinum Hot Plug Power Supply

NOTE: Available in 94% efficiency.

HPE 800W Flex Slot Platinum Hot Plug Power Supply

NOTE: Available in 94% and 96% efficiency.

NOTE: Also available in -48VDC and 227VAC/380VDC power inputs.

HPE 1400W Flex Slot Platinum Plus Hot Plug Power Supply

NOTE: Available in 94% efficiency.

HPE Flexible Slot (Flex Slot) Power Supplies share a common electrical and physical design that allows for hot plug, tool-less installation into HPE ProLiant Gen9 Performance Servers. Flex Slot power supplies are certified for high-efficiency operation and offer multiple power output options, allowing users to "right-size" a power supply for specific server configurations. This flexibility helps to reduce power waste, lower overall energy costs, and avoid "trapped" power capacity in the data center.

All pre-configured servers ship with a standard 6-foot IEC C-13/C-14 jumper cord (A0K02A). This jumper cord is also included with each standard AC power supply option kit. If a different power cord is required, please check the [ProLiant Power Cables](#) web page.

To review the power requirements for your selected system, please use the HPE Power Advisor Tool located at <http://www.hpe.com/info/hppoweradvisor>.

Power specifications and technical content for all HPE Server power supplies can be found at <http://www.hpe.com/info/proliant/powersupply>.

System Fans

One of the following depending on model

Non-redundant

2P model

NOTE: 1P models typically ship with 4 standard fans. The second processor option kit contains 2 additional fans.

NOTE: The 12LFF and 24SFF chassis ship with 6 High Performance fans as standard.

NOTE: High Performance Fan Kit is available to meet ambient temperature environments.

NOTE: High Performance Fan Kit is required for Passive GPU support.

NOTE: The 8SFF Bay1 kit (719067-B21) will ship with 6 High efficiency fans.

Redundant

6 fans

Interfaces

Serial

Optional

Video

2 (1 front, optional via Universal Media Bay, 724865-B21), 1 back not active simultaneously

FlexibleLOM Network Ports

4 x 1Gb ports shipping standard with optional FlexibleLOM

Standard Features

HPE iLO Remote Management Network Port 1 Gb Dedicated

Micro SD Slot 1 Micro SD

NOTE: The Micro SD slot is not a hot-pluggable device. Customers should not attempt to plug an SD card into the SD slot while the server is powered.

USB 3.0 Up to 5 total: 1 front, 2 rear, 2 internal (secure), 2 optional USB 2.0 front via Universal Media Bay

SID (Systems Insight Display) Optional

NOTE: Not shipping as standard. Available as a CTO option or as a field upgrade (768900-B21).

Operating Systems and Virtualization Software Support for ProLiant Servers

Microsoft Windows Server

Canonical Ubuntu

Red Hat Enterprise Linux (RHEL)

SUSE Linux Enterprise Server (SLES)

Oracle Solaris

VMware

Citrix XenServer

ClearOS

NOTE: ClearOS allows you to build a fully functional server that is just right for you at no upfront cost. It is available via CTO preload, Intelligent Provisioning or via download. For more information on ClearOS, please visit <http://www.hpe.com/servers/clearos>.

NOTE: For more information on Hewlett Packard Enterprise Certified and Supported ProLiant Servers for OS and Virtualization Software and latest listing of software drivers available for your server, please visit our Support Matrix at: <http://www.hpe.com/info/ossupport> and our [driver download page](#).

Upgradeability

Upgradeable to 2 processors (36 Cores)

NOTE: Processor upgrade available from Intel® Xeon® Processors E5-2600v3. Please contact Hewlett Packard Enterprise Technology Sales (<http://www.hpe.com/support>), your local Hewlett Packard Enterprise Re-seller.

Up to 24 DIMM slots available for higher Memory capacity

FlexibleLOM connector for 1 Gigabit or 10 Gigabit networking options

HPE Flexible Smart Array or Smart HBA Controllers

Embedded 10-Port SATA, B140i as standard

Optional 3 slot riser (x16, x16, x8), or 2 slot primary riser (x16, x8)

NOTE: To take advantage of the additional 3 PCI slot upgrade, the second processor must be installed.

Redundant Power Supply

Optical Drive supported via Universal Media Bay

Standard Features

NOTE: The Universal Media bay provides front VGA and 2xUSB 2.0, plus ability to add 2SFF and Optical.

NOTE: Universal Media bay is only available with 8 or 8+8SFF chassis & can be populated in Bay1 only.

HPE Legacy Mode (FIO only, 758959-B22)

NOTE: UEFI is the default mode for CTO and BTO SKUs. Can change default to legacy via CTO.

Industry Standard Compliance

ACPI 2.0b Compliant

PCIe 3.0 Compliant

PXE Support

WOL Support

Microsoft® Logo certifications

USB 3.0 Support

USB 2.0 Support

NOTE: This support is on the optional Universal Media Bay.

Energy Star

ASHRAE A3/A4

NOTE: The DL380 Gen9 is now one of the first HPE ProLiant Gen9 Servers with Extended Ambient Support up to 45 C for data center infrastructures designed for better energy efficiency such as but not limited to fresh air cooling.

For additional technical thermal details regarding ambient temperatures, humidity and features support please visit: <http://www.hpe.com/servers/ashrae>.

UEFI (Unified Extensible Firmware Interface Forum)

NOTE: UEFI is the default for the DL380 Gen9. Legacy model can be selected in the field or as a CTO option (758959-B22).

Graphics

Integrated Matrox G200eH2 video standard with 16MB of Video RAM

- 1280 x 1024 (32 bpp)
- 1920 x 1200 (16 bpp)

HPE iLO 4 On System Management Memory

- 16 MB Flash
- 256 MB DDR3 with ECC (112 MB after ECC and video)

HPE Server UEFI/Legacy ROM

Unified Extensible Firmware Interface (UEFI) is an industry standard that provides better manageability and more secured configuration than the legacy ROM while interacting with your server at boot time. HPE ProLiant Gen9 platform defaults to UEFI and can be factory or field configured for Legacy BIOS Boot Mode.

NOTE: The UEFI System Utilities function is analogous to the HPE ROM-Based Setup Utility (RBSU) of legacy BIOS. For more information, please visit <http://www.hpe.com/servers/uefi>.

UEFI enables numerous new capabilities specific to HPE ProLiant servers such as:

- Secure Boot
- Operating system specific functionality
- Support for > 2.2 TB (using GPT) boot drives

Standard Features

- USB 3.0 Stack
- Embedded UEFI Shell
- Mass Configuration Deployment Tool using RESTful API for iLO 4
- PXE boot support for IPv6 networks
- Boot support for option cards that only support a UEFI option ROM
- Network Stack configurations

NOTE: For UEFI Boot Mode, boot environment and OS image installations should be configured properly to support UEFI.

NOTE: UEFI FIO Setting (758959-B22) can be selected to configure the system in Legacy mode in the factory for your HPE ProLiant Gen9 Server.

Form Factor

One of the following depending on model

2U Rack form factor

8 SFF & 24SFF Drive Bay Version:

3.44 x 17.54 x 26.75 in (8.73 x 44.55 x 67.94 cm)

4 LFF & 12LFF Drive Bay Version:

3.44 x 17.54 x 28.75 in (8.73 x 44.55 x 73.02 cm)

NOTE: Dimensions without bezel.

Embedded Management

HPE Integrated Lights-Out (HPE iLO)

Monitor your servers for ongoing management, service alerting, reporting and remote management with HPE iLO. Learn more at <http://www.hpe.com/info/ilo>.

UEFI

Configure and boot your servers securely with industry standard Unified Extensible Firmware Interface (UEFI). Learn more at <http://www.hpe.com/servers/uefi>.

RESTful API

RESTful API for iLO 4 is Redfish 1.0 conformance for simplified server management such as configuration and maintenance tasks based on modern industry standards. Learn more at <http://www.hpe.com/info/restfulapi>.

Intelligent Provisioning

Hassle free server and OS provisioning for 1 or few servers with Intelligent Provisioning. Learn more at <http://www.hpe.com/servers/intelligentprovisioning>.

Embedded Remote Support

The Hewlett Packard **Enterprise** embedded remote support, when used with Insight Online direct connect or HPE Insight Remote Support, allows HPE ProLiant servers to transmit hardware events directly to Hewlett Packard Enterprise or a Hewlett Packard Enterprise Authorized Partner for automated phone home support. Learn more at <http://www.hpe.com/info/insightonline/explore>.

Server utilities

Smart Update

Optimize firmware and driver updates with Smart Update solutions including Smart Update Manager (SUM) and Service Pack for ProLiant (SPP). Learn more at <http://www.hpe.com/servers/smartupdatemanager>.

Standard Features

HPE Systems Insight Manager (HPE SIM)	HPE SIM allows you to monitor the health of your HPE ProLiant Servers and HPE Integrity Servers, and also provides you with basic support for non-HPE servers. HPE SIM also integrates with Smart Update Manager to provide quick and seamless firmware updates. Learn more at http://www.hpe.com/servers/hpsim .
Scripting Tool Kit and Windows PowerShell	Provision 1 to many servers using your own scripts to discover and deploy them with Scripting Tool Kit (STK) for Windows and Linux or Scripting Tools for Windows PowerShell. Learn more at http://www.hpe.com/servers/proliant/stk or http://www.hpe.com/servers/powershell .
RESTful Interface Tool	RESTful Interface tool is a scripting tool to provision using RESTful API for iLO 4 to discover and deploy servers at scale. Learn more at http://www.hpe.com/info/resttool .
HPE iLO Mobile Application	Enables the ability to access, deploy, and manage your server anytime from anywhere from select smartphones and mobile devices. For additional information please visit: http://www.hpe.com/info/ilo/mobileapp .
HPE Insight Online	HPE Insight Online, available at no additional cost as part of your Hewlett Packard Enterprise warranty or contractual support agreement with Hewlett Packard Enterprise, is a personalized dashboard for simplified tracking of IT operations and support information from anywhere, anytime. Learn more at http://www.hpe.com/info/insightonline/explore .

Security

Power-on password
Serial interface control
Administrator's password
UEFI
iLO 4 (Integrated Lights-Out 4) has 12 customizable user accounts and SSL encryption
Integrated Lights-Out can be disabled via a Global Setting
iLO Advanced supports directory services integration
TPM 1.2

Warranty

This product is covered by a global limited warranty and supported by HPE Services and a worldwide network of HPE Authorized Channel Partners resellers. Hardware diagnostic support and repair is available for three years from date of purchase. Support for software and initial setup is available for 90 days from date of purchase. Enhancements to warranty services are available through HPE Pointnext operational services or customized service agreements. Hard drives have either a one year or three year warranty; refer to the specific hard drive QuickSpecs for details.

NOTE: Server Warranty includes 3-Year Parts, 3-Year Labor, 3-Year Onsite support with next business day response. Warranty repairs may be accomplished through the use of Customer

Standard Features

Self Repair (CSR) parts. These parts fall into two categories: 1) Mandatory CSR parts are designed for easy replacement. A travel and labor charge will result when customers decline to replace a Mandatory CSR part; 2) Optional CSR parts are also designed for easy replacement but may involve added complexity. Customers may choose to have Hewlett Packard Enterprise replace Optional CSR parts at no charge. Additional information regarding worldwide limited warranty and technical support is available at:

<http://h17007.www1.hp.com/us/en/enterprise/servers/warranty/>.

Optional Features

Embedded Management	iLO Advanced	HPE iLO Advanced licenses offer smart remote functionality without compromise, for all HPE ProLiant servers. The license includes the full integrated remote console, virtual keyboard, video, and mouse (KVM), multi-user collaboration, console record and replay, and GUI-based and scripted virtual media and virtual folders. You can also activate the enhanced security and power management functionality. Learn more about HPE iLO Advanced at http://www.hpe.com/servers/iloadvanced .
Server Management	HPE Insight Control	HPE Insight Control, lets you deploy, migrate, monitor, remote control, and optimize your IT infrastructure through a single, simple management console. For more information, see http://www.hpe.com/info/insightcontrol .
	HPE Insight Cluster Management Utility (CMU)	HPE Insight Cluster Management Utility is a HyperScale management framework that includes software for the centralized provisioning, management and monitoring of nodes and infrastructure. Learn more at http://www.hpe.com/info/cmu .
Rack and Power Infrastructure	HPE Rack and Power Infrastructure products and services create highly efficient and intelligent solutions for existing or new IT data centers. HPE Rack and Power infrastructure solutions - rack infrastructure, power protection and management, performance optimized data centers (PODs) - are the foundation you are looking for to help secure your long-term IT success. These products are designed to help you react to changes in the industry. They deliver efficient, easy-to-use capabilities to manage, monitor, deploy and provision infrastructure from entry to enterprise. As an industry leader, Hewlett Packard Enterprise is uniquely positioned to address the key concerns of power, cooling, cable management and system access. Learn more at HPE Rack and Power Infrastructure .	
High Performance Clusters	HPE Cluster Platforms are specifically engineered, factory-integrated large-scale ProLiant clusters optimized for High Performance Computing, with a choice of servers, networks and software. Operating system options include specially priced offerings for Red Hat Enterprise Linux and SUSE Linux Enterprise Server, as well as Microsoft Windows HPEC Server. A Cluster Platform Configurator simplifies ordering. https://www.hpe.com/us/en/solutions/hpc-high-performance-computing/hpc-software.html . NOTE: High Performance Computing (HPC) interconnect technologies are available for this server as part of the HPE Cluster Platform portfolio. These high-speed InfiniBand and Gigabit interconnects are fully supported by Hewlett Packard Enterprise when integrated within a Hewlett Packard Enterprise cluster. Flexible, validated solutions can be defined with the help of configuration tools. https://www.hpe.com/info/hpc/solutions .	
HPC Interconnects	NOTE: High Performance Computing (HPC) interconnect technologies are available for this server under the HPE Cluster Platform product portfolio. These high-speed interconnects are fully supported by Hewlett Packard Enterprise when they are part of these configure to order clusters. Solutions can be defined with a lot of flexibility with the help of configuration tools. https://www.hpe.com/info/hpc/solutions .	

Optional Features

Storage Software

Whether you need to solve a specific data protection, archiving, or storage command and control challenge, or deliver on strategic consolidation, compliance, or continuity initiatives, look no further than Hewlett Packard Enterprise storage software. Our storage software helps you reduce costs, simplify storage infrastructure, protect vital assets and respond faster to business opportunities.

Storage software that gets the job done:

- **Data Protection and Recovery Software**

Whether you're a large enterprise or a smaller business, Hewlett Packard Enterprise data protection and recovery software will cost-effectively protect you against disaster and ensure business continuity.

- **Data Archive and Migration Software**

Hewlett Packard Enterprise storage software enables you to comply with data retention and retrieval requirements, improve application performance, and reduce costs by efficiently migrating infrequently accessed or less valuable data to lower cost storage.

- **Storage Resource Management Software (SRM)**

Hewlett Packard Enterprise storage resource management software reduces operational costs and provides the command and control foundation you need to efficiently manage and visualize your physical and virtual environments.

- **Data Replication Software**

Hewlett Packard Enterprise offers array-based and host-based replication software for use in disaster recovery, testing, application development and reporting.

- **Storage Device Management Software**

Maximize your investment in Hewlett Packard Enterprise storage and networking with software that enables hardware-specific configuration, performance tuning and connectivity management.

- **HPE StoreVirtual VSA**

Enable highly available and clustered storage in your HPE ProLiant servers with virtualized storage: Add StoreVirtual VSA to multiple servers, manage it as a single pool of shared storage capacity, and scale it to match your evolving needs. To simplify deployment, HPE offers StoreVirtual Ready Nodes, pre-defined reference configurations for converged vSphere and Hyper-V virtualization solutions. You also have the option to install free 1TB-capacity StoreVirtual VSA software during server setup within Intelligent Provisioning. HPE ProLiant Gen9 servers include a 3-year limited license for this HPE software-defined storage at no extra cost. More information, instructional videos, and free management software are available at <http://www.hpe.com/storage/storevirtual>.

NOTE: For more information about Storage Software including QuickSpecs, please see: <https://www.hpe.com/us/en/storage/software-defined.html>.

ClearOS

HPE and ClearCenter will help you lower the cost of building on-premise solutions without sacrificing security and ease of use. HPE ProLiant servers with ClearOS give you a simple, secure, and affordable operating system with an intuitive web based graphical user interface that provides a cloud-like experience on-premise, and an Application Marketplace with over 100 apps and growing. Whether you're starting out or scaling, you decide what applications you need and pay as you grow.

NOTE: For more information on ClearOS, please visit <http://www.hpe.com/servers/clearos>.

Optional Features

One Config Simple (SCE)

SCE is a guided self-service tool to help sales and non-technical people provide customers with initial configurations in 3 to 5 minutes. You may then send the configuration on for configuration help, or use in your existing ordering processes. If you require "custom" rack configuration or configuration for products not available in SCE, please contact Hewlett Packard Enterprise Customer Business Center or an Authorized Partner for assistance. <http://ocs.ext.hpe.com/>.

Service and Support

HPE Support Services

HPE Technology Services delivers confidence, reduces risk and helps customers realize agility and stability. Connect to Hewlett Packard Enterprise to help prevent problems and solve issues faster. HPE Support Services enable you to choose the right service level, length of coverage and response time as you purchase your new server, giving you full entitlement to the support for need for your IT and business.

Connect your devices

Unlock all of the benefits of your technology investment by connecting your products to Hewlett Packard Enterprise. Achieve up to 77%¹ reduction in down time, near 100%² diagnostic accuracy and a single consolidated view of your environment. By connecting, you will receive 24x7 monitoring, pre-failure alerts, automatic call logging, and automatic parts dispatch. HPE Proactive Care Service and HPE Datacenter Care Service customers will also benefit from proactive activities to help prevent issues and increase optimization. All of these benefits are already available to you with your server storage and networking products, securely connected to Hewlett Packard Enterprise support.
1- IDC 2 - HPE CSC reports 2014 - 2015

Recommended Support

Standard: HPE Proactive Care* with 24x7 coverage, three year Support Service
HPE Proactive Care gives customers an enhanced call experience. When your products are connected to Hewlett Packard Enterprise, Proactive Care helps prevent problems and maintains IT stability by utilizing personalized proactive reports with recommendations and advice. This service combines three years proactive reporting and advice with our 24x7 coverage, four hour hardware response time when there is a problem. This service also includes collaborative software support for Independent Software Vendors (ISVs), (Red Hat, VMWare, Microsoft, etc.) running on your HPE servers.
<https://www.hpe.com/h20195/v2/GetPDF.aspx/4AA3-8855ENW.pdf>

Optimized HPE Proactive Care* with 6 hour call-to-repair commitment, three year Support Service

HPE Proactive Care gives customers an enhanced call experience. When your products are connected to Hewlett Packard Enterprise, Proactive Care helps prevent problems and maintains IT stability by utilizing personalized proactive reports with recommendations and advice. This service combines three years' proactive reporting and advice with our highest level of hardware support - Hewlett Packard Enterprise 24x7, six hour hardware call-to-repair. Hewlett Packard Enterprise is the only leading manufacturer who makes this level of coverage available as a standard service offering for your most valuable servers. This service also includes collaborative software support for Independent Software Vendors (ISVs), (Red Hat, VMWare, Microsoft, etc.) running on your HPE servers.
<https://www.hpe.com/h20195/v2/GetPDF.aspx/4AA3-8855ENW.pdf>

Parts and Materials

Hewlett Packard Enterprise will provide Hewlett Packard Enterprise-supported replacement parts and materials necessary to maintain the covered hardware product in operating condition, including parts and materials for available and recommended engineering improvements.

Parts and components that have reached their maximum supported lifetime and/or the maximum usage limitations as set forth in the manufacturer's operating manual, product QuickSpecs, or the technical product data sheet will not be provided, repaired, or replaced as part of these services.

The defective media retention service feature option applies only to Disk or eligible SSD/Flash Drives replaced by Hewlett Packard Enterprise due to malfunction.

Service and Support

Related Services HPE Server Hardware Installation

Provides for the basic hardware installation of Hewlett Packard Enterprise branded servers, storage devices and networking options to assist you in bringing your new hardware into operation in a timely and professional manner.

<https://www.hpe.com/h20195/V2/GetPDF.aspx/5981-9356EN.pdf>

HPE Installation and Startup Service

Provides for the installation and startup of Hewlett Packard Enterprise technology including BladeSystems, C-Class enclosure, HPE ProLiant c-Class and Integrity server blades, storage blades, SAN switch blades, HPE Virtual Connect modules (Ethernet and Fibre Channel), Ethernet network interconnects, and InfiniBand, as well as the installation of one supported operating system type (Windows® or Linux).

HPE Technology Services Support Credits

Offer flexible services and technical skills to meet your changing IT demands. With a menu of service that is tailored to suit your needs, you get additional resources and specialist skills to help you maintain peak performance of your IT. Offered as annual credits, you can plan your budgets while proactively responding to your dynamic business.

HPE Education Services

Keep your IT staff trained making sure they have the right skills to deliver on your business outcomes. Book on a class today and learn how to get the most from your technology investment. <http://www.hpe.com/ww/learn>

HPE Support Center

The HPE Support Center is a personalized online support portal with access to information, tools and experts to support Hewlett Packard Enterprise business products. Submit support cases online, chat with Hewlett Packard Enterprise experts, access support resources or collaborate with peers.

Learn more <http://www.hpe.com/support/hpesc>

The Hewlett Packard Enterprise Support Center Mobile App* allows you to resolve issues yourself or quickly connect to an agent for live support. Now, you can get access to personalized IT support anywhere, anytime.

HPE Insight Remote Support and HPE Support Center are available at no additional cost with a Hewlett Packard Enterprise warranty, HPE Support Service or Hewlett Packard Enterprise contractual support agreement.

*HPE Support Center Mobile App is subject to local availability.

For more information: <http://www.hpe.com/services>

Pre-configured Models

	Entry Models			Base Models				
[SKU Number]	766342-B21	752686-B21	826681-B21	752688-B21	752687-B21	826682-B21	826683-B21	848774
Model Name	HPE ProLiant DL380 Gen9 E5-2609v3 1P 8GB-R B140i 4LFF SATA 500W PS Entry Server	HPE ProLiant DL380 Gen9 E5-2609v3 1P 8GB-R B140i 8SFF SATA 500W PS Entry Server	HPE ProLiant DL380 Gen9 E5-2609v4 1P 8GB-R B140i 8SFF 500W PS Entry Server	HPE ProLiant DL380 Gen9 E5-2620v3 2.4GHz 6-core 1P 16GB-R P840/4GB 12LFF 2x800W PS Base Server	HPE ProLiant DL380 Gen9 E5-2620v3 1P 16GB-R P440ar 8SFF 500W PS Base Server	HPE ProLiant DL380 Gen9 E5-2620v4 1P 16GB-R P440ar 8SFF 500W PS Base Server	HPE ProLiant DL380 Gen9 E5-2620v4 1P 16GB-R P440ar 2x800W PS Base Server	HPE ProLiant DL380 Gen9 E5-2630v4 16GB P440 8SFF 500W PS Base Server
Processor	Intel® Xeon® E5-2609v3		Intel® Xeon® E5-2609v4	Intel® Xeon® E5-2620v3		Intel® Xeon® E5-2620v4		Intel® Xeon® E5-2630v4
Number of Processors	One							
Memory	8GB (1x8GB Registered DIMMs, 2133 MHz) NOTE: With the E5-2609v3 this memory DIMM will only operate at 1600MHz.		8GB (1x8GB Registered DIMMs, 2400 MHz) NOTE: With the E5-2609v4 this memory DIMM will only operate at 1866MHz.	16GB (1x16GB Registered DIMMs, 2133 MHz) NOTE: With the E5-2620v3 this memory DIMM will only operate at 1866MHz.		16GB (1x16GB Registered DIMMs, 2400 MHz) NOTE: With the E5-2620v4 this memory DIMM will only operate at 2133MHz.		16GB (1x16GB Registered DIMMs, 2400 MHz) NOTE: With the E5-2630v4 this memory DIMM will only operate at 2133MHz.
Network Controller	HPE Embedded 1Gb Ethernet 4-port 331i Adapter, plus optional HPE FlexibleLOM or stand up c							
Storage Controller	HPE Dynamic Smart Array B140i, plus optional HPE Flexible Smart Array or Smart HBA controller NOTE: Default is AHCI off chipset, Smart Array needs to be enabled on SATA model.			HPE Flexible Smart Array P840/4G Controller	HPE Flexible Smart Array P440ar/2GB	HPE Flexible Smart Array P840ar/2G Controller	HPE Flexible Smart Array P440ar/	
Hard Drive	None ship standard			None ship standard; includes 10 LFF hard drive blanks	None ship standard			
Internal Storage	4 LFF HDD Bays	8 SFF HDD Bays (upgradable to 24)		12 LFF HDD Bays	8 SFF HDD Bays (upgradable to 24)		12 LFF HDD Bays	8 SFF HDD Bays (upgradable to 24)

QuickSpecs

HPE ProLiant DL380 Generation9 (Gen9)

Pre-configured Models

Optical Drive Bay	Not Available	Optional Universal Media Bay (724865-B21)	Not Available	Optional Universal Media Bay (724865-B21)	Not Available	Optional Universal Media Bay (724865-B21)
Optical Drive	Optional via HPE Mobile USB DVDRW Drive (701498-B21)	Optional DVD-ROM (726536-B21) or DVD-RW (726537-B21) via the Universal Media Bay (724865-B21)	Optional via HPE Mobile USB DVDRW Drive (701498-B21)	Optional DVD-ROM (726536-B21) or DVD-RW (726537-B21) via the Universal Media Bay (724865-B21)	Optional via HPE Mobile USB DVDRW Drive (701498-B21)	Optional DVD-ROM (726536-B21) or DVD-RW (726537-B21) via the Universal Media Bay (724865-B21)
PCI-Express Slots	3 PCIe slots (+3 PCI slots available with upgrade option, second processor required)					
Power Supply	(1) HPE 500W Flex Slot Platinum Power Supply	(2) HPE 800W Flex Slot Platinum Power Supply	(1) HPE 500W Flex Slot Platinum Power Supply	(2) HPE 800W Flex Slot Platinum Power Supply	(1) HPE 500W Flex Slot Platinum Power Supply	(2) HPE 800W Flex Slot Platinum Power Supply
Fans	4 hot plug fans, redundant	6 hot plug high performance fans, redundant	4 hot plug fans, redundant	6 hot plug high performance fans, redundant	4 hot plug fans, redundant	6 hot plug high performance fans, redundant
Management	iLO Management (standard), Intelligent Provisioning (standard), iLO Advanced (optional), Insight Control (optional), HPE OneView (optional)					
Form Factor	Rack (2U), HPE Easy Install Rails	Rack (2U), HPE Easy Install Rails with CMA				Rack (2U), HPE Easy Install Rails
Warranty	Server Warranty includes 3-Year Parts, 3-Year Labor, 3-Year Onsite support with next business day response					

	Performance Models			High Performance Models	
[SKU Number]	752689-B21	826684-B21	852432-B21	803860-B21	803861-B21
Model Name	HPE ProLiant DL380 Gen9 E5-2650v3 2P 32GB-R P440ar 8SFF 2x10Gb 2x800W Perf Server	HPE ProLiant DL380 Gen9 E5-2650v4 2P 32GB-R P440ar 8SFF 2x10Gb 2x800W Perf Server	HPE ProLiant DL380 Gen9 E5-2660v4 2P 64GB-R P440ar 8SFF 2x10Gb 2x800W Perf Server	HPE ProLiant DL380 Gen9 E5-2690v3 2P 32GB-R P440ar 8SFF 2x10Gb 2x800W High Perf Server	HPE ProLiant DL380 Gen9 E5-2690v3 2P 32GB-R P440ar 8SFF 2x10Gb 2x800W OneView Server
Processor	Intel® Xeon® E5-2650v3	Intel® Xeon® E5-2650v4	Intel® Xeon® E5-2660v4	Intel® Xeon® E5-2690v3	
Number of Processors	Two				

Pre-configured Models

Memory	32GB (2x16GB Registered DIMMs, 2133 MHz)	32GB (2x16GB Registered DIMMs, 2400 MHz)	64GB (4x16GB Registered DIMMs, 2400 MHz)	32GB (2x16GB Registered DIMMs, 2133 MHz)
Network Controller	HPE Embedded 4x1Gb, plus 2x10Gb-T FlexibleLOM		HPE Embedded 4x1Gb, plus 2x10Gb SFP+ FlexibleLOM	HPE Embedded 4x1Gb, plus 2x10Gb-T FlexibleLOM
Storage Controller	HPE Flexible Smart Array P440ar/2GB			
Hard Drive	None ship standard			
Internal Storage	8 SFF HDD Bays (upgradable to 24)			
Optical Drive Bay	Optional Universal Media Bay (724865-B21)	Universal Media Bay (724865-B21)		
Optical Drive	HPE Half-Height SATA DVD-RW Optical Drive			
PCI-Express Slots	6 PCIe slots (includes second riser slot upgrade option)	6 PCIe 3.0 slots	6 PCIe slots (includes second riser slot upgrade option)	
Power Supply	(2) HPE 800W Flex Slot Platinum Power Supply			
Fans	6 hot plug fans, redundant			
Management	iLO Management (standard), Intelligent Provisioning (standard), iLO Advanced (standard), HPE OneView (optional)		iLO Management (standard), Intelligent Provisioning (standard), iLO Advanced (standard), HPE OneView (Standard)	
Energy Star	Meets Energy Star requirements			
Form Factor	Rack (2U), HPE Easy Install Rails with CMA			
Warranty	Server Warranty includes 3-Year Parts, 3-Year Labor, 3-Year Onsite support with next business day response			

NOTE: UEFI is the standard default for all Predefined models.

Country Code Key

xx1 = B21

Worldwide

NOTE: The -B21 WW SKU is to be ordered in all countries other than Japan or PRC.

xx1 = 291

Japan

xx1 = AA1

PRC

Configuration Information - Factory Integrated Models

This section lists some of the steps required to configure a Factory Integrated Model. To ensure only valid configurations are ordered, Hewlett Packard Enterprise recommends the use of an HPE approved configurator. Contact your local sales representative for information on configurable product offerings and requirements.

1. Factory Integrated Models must start with a CTO Server.
2. FIO indicates that this option is only available as a factory installable option.
3. All Factory Integrated Models will be populated with sufficient hard drive blanks based on the number of initial hard drives ordered with the server.
4. Some options may not be integrated at the factory. Contact your local sales representative for additional information.

Step 1: Base Configuration (choose one of the following configurable models)

[Chassis]	HPE ProLiant DL380 Gen9 8SFF Configure-to-order Server	HPE ProLiant DL380 Gen9 NVMe 6 Solid State Drive Express Bay Configure-to-order Server	HPE ProLiant DL380 Gen9 24SFF Configure-to-order Server	HPE ProLiant DL380 Gen9 4LFF Configure-to-order Server	HPE ProLiant DL380 Gen9 12LFF Configure-to-order Server
SKU Number	719064-B21	810393-B21	767032-B21	767033-B21	719061-B21
Processor	2 (optional) x HPE Smart Socket Guide				
DIMM Slots	24 DIMM slots for RDIMM, LRDIMM DDR4 Memory				
Storage Controller	HPE Dynamic Smart Array B140i, plus optional HPE Flexible Smart Array or Smart HBA controller				
PCIe	3 PCIe slots (+3 PCI slots available with upgrade option, second processor required)				
Drive Cage	8SFF Hot Plug (+8SFF and Universal Media Bay Optional)	8SFF +6NVMe Hot Plug (+8SFF or Universal Media Bay Optional)	24SFF Hot Plug	4LFF Hot Plug	12LFF Hot Plug
Network Controller	HPE Embedded 1Gb Ethernet 4-port 331i Adapter, plus optional HPE FlexibleLOM or stand up card	HPE Embedded 1Gb Ethernet 4-port 331i Adapter	HPE Embedded 1Gb Ethernet 4-port 331i Adapter, plus optional HPE FlexibleLOM or stand up card		
Fans	4 hot plug fans, redundant	6 hot plug high performance fans, redundant		4 hot plug fans, redundant	6 hot plug high performance fans, redundant
Management	iLO Management (standard), Intelligent Provisioning (standard)				
USB	1 front, 2 internal, 2 rear	1 front, 1 internal, 2 rear	1 front, 2 internal, 2 rear	No front USB support	
Ears	HPE Quick Release Ears				

NOTE: With the NVMe chassis (810393-B21) there are limitations on GPU support.

NOTE: The NVMe chassis (810393-B21) ships with the standard x8 Risers supporting 6xNVMe drives.

Configuration Information - Factory Integrated Models

Step 2: Choose Required Options (only one of the following from each list unless otherwise noted)

HPE Processors Select one or two processors from Core Options-Processor section below.

- If one processor is desired, select one xxxxxx-L21
- If two processors are desired, select one xxxxxx-L21 and one xxxxxx-B21.
- Up to 2 processors supported. Mixing different processor models is not supported.
- DDR4 speed is the maximum memory speed of the processor. Actual memory speed depend on the quantity and type of DIMMs installed.

For the Intel® C600 Chipset E5-2600 Series, the letter preceding the model number indicates Product Line (E3, E5, E7); 2600x v#, 2 = number of CPUs in a Node, 6 is socket/segment designation, 00 = Processor SKU, x = L for low power SKUs and v# (not yet designated) = number.

HPE Memory Select one or more memory from Core Options-Memory section below.

- UDIMM, RDIMM, and LRDIMM are all distinct memory technologies and cannot be mixed within a server.
- HPE memory options from previous generation servers are not qualified or warrantec Hewlett Packard Enterprise Gen9 systems. HPE SmartMemory is required to realize memory performance improvements and enhanced functionality listed in this document Gen9.
- If only one processor is installed, only half of the total DIMM slots are available. When populating with two processors all DIMM slots are available.
- Depending on the memory configuration and processor model, the memory speed may be at 2400MHz, 2133MHz, 1866MHz or 1600MHz. Please see Memory Population Table and the Online Memory Configuration Tool at:
<http://www.hpe.com/servers/ddr4memoryconfig>.

HPE Power Supplies Select one or more power supplies from Core Options-Power Supplies section below.

- Prior to selecting a power supply option, it is highly recommended that you review your server configuration in the HPE Power Advisor tool to determine the right size power supply for your server configuration. The HPE Power Advisor is located at:
<http://www.hpe.com/info/hppoweradvisor>.
- Mixing of power supplies in the same server is not supported. All power supplies must be of the same input voltage, output rating, and efficiency rating. If non-matching power supplies are installed, you may receive an error message and/or experience operational issues with your server.

Step 3: Choose Additional Factory Integratable Options

HPE Unique Options Select one or more Unique options from Core Options section below.

- This section may contain FIO options, please see the Unique options section below.
- FIO indicates that this option is only available as a factory installable option.

HPE I/O Expansion Options Select one or more Riser Kit options from Core Options section below.

- To take advantage of the additional PCI slot upgrade, the second processor must be installed.
- This section may contain FIO options, please see HPE I/O Expansion Options section below.

Configuration Information - Factory Integrated Models

- FIO indicates that this option is only available as a factory installable option.

HPE Drives

Select one or more drives from Core Options-HPE Drives section below.

- The components of a storage subsystem (e.g. the drive, the HBA/controller, firmware and the server backplane) should operate at the same data transfer rate or the system bandwidth will be negotiated down to an acceptable level for all components.
- Hard drives have either a one year or three year warranty; refer to the specific hard drive QuickSpecs for details.
- The HPE ProLiant Gen9 Smart Storage solutions are equipped with re-designed Smart Form Factor (SFF 2.5 in) and Large Form Factor (LFF 3.5 in) hot plug carriers for HPE Qualified Hard Drives and Solid State Drives. These new carriers provide status and activity indicators as well as caution indicators for "Do Not Remove."

HPE FlexibleLOM

Select a FlexibleLOM from Core Options-Networking section below.

- Only one FlexibleLOM can be added to the server. These options are upgradeable and can be changed from the original configuration after the server is shipped.
- For 10Gb adapters, a minimum of two Gigabytes (2 GB) of server memory is required for each adapter.
- Please see the QuickSpecs for Technical Specifications and additional information: <http://www.hpe.com/servers/ProLiantNICs>.

HPE Networking

Select a standup NIC adapter from Core Options-Networking section below.

- Please see the QuickSpecs for Technical Specifications and additional information: <http://www.hpe.com/servers/ProLiantNICs>.
- These options are upgradeable and can be changed from the original configuration after the server is shipped.
- For 10Gb adapters, a minimum of two Gigabytes (2 GB) of server memory is required for each adapter.

HPE Storage Controllers

Select one or more Storage options from Additional Options section below.

- The embedded B140i controller will operate in UEFI only mode. For legacy support an additional controller will be needed, and for CTO orders please also select the Legacy mode settings part, 758959-B22.
- This section may contain FIO options, please see HPE Storage Controllers section below.
- FIO indicates that this option is only available as a factory installable option.

HPE Graphics Options

Select one or more graphics adapter from Additional Options section below.

- Please see the HPE Power Advisor for estimated power consumption of your individual system configuration prior to installing GPUs. The HPE Power Advisor is located at: <http://www.hpe.com/info/hppoweradvisor>.
- This section may contain FIO options, please see HPE Computation & Graphics Accelerators section below.

HPE Cooling Options

Select one or more Fan Kits from Core Options section below.

- This section may contain FIO options, please see HPE Cooling Options section below.
- FIO indicates that this option is only available as a factory installable option.

HPE Rail Kits

Select one type of rail kit from Additional Options section below.

- Please take a moment to review the installation documentation that comes with the server to help you with the installation of your Gen9 server.
- To assist in the installation of the server into the rack, an optional installation tool is available by contacting your local services representative (p/n 695539-001).
- See Hewlett Packard Enterprise Rack Options in Additional Options section of this QuickSpecs.

Configuration Information - Factory Integrated Models

QuickSpecs for more rack kit choices.

CAUTION: Hewlett Packard Enterprise recommends that a minimum of two people are required for all Rack Server installations. Please refer to your installation instructions for proper tools and number of people to use for any installation.

Core Options

NOTE: Some options may not be integrated at the factory. To ensure only valid configurations are ordered, Hewlett Packard Enterprise recommends the use of an HPE approved configurator. Contact your local sales representative for additional information.

HPE Unique Options	HP DL380 Gen9 NVMe 6 Solid State Drive Express Bay Enablement Kit	774741-B21
	NOTE: This option provides support for up to 6NVMe drives, and can only be populated in BAY2 in SFF chassis only, can be used with Bay1 and Bay 3 populated. NOTE: The HPE DL380 Gen9 High Performance Fan Kit is required for NVMe support (719079-B21). NOTE: The PCIe card in this enablement kit can only be populated in slot2 (primary) or slot 5 (secondary). NOTE: For true x16 support with this option a secondary riser (719073-B21) is needed (second processor required). NOTE: Kit includes Mylar film for Universal Media Bay (724865-B21) support to ensure optimal airflow. NOTE: For NVME CTO support, please use the NVME chassis (810393-B21), this kit is for field upgrades only. NOTE: There are limitations on GPU support with the NVMe bay installed.	
	HP DL380 Gen9 Universal Media Bay Kit	724865-B21
	NOTE: The HPE DL380 Gen9 Universal Media bay provides front VGA and 2xUSB 2.0; plus support for 2xSFF front drives (724864-B21) and ODD support (No included); and can only be located in Bay1 in either an 8SFF or 8+8SFF front end.	
	HP DL380 Gen9 Graphics Enablement Kit	719082-B21
	NOTE: This kit includes alternative 2 heatsinks plus6 cables to enable GPU support. Other limitations apply, see Graphic section for more details. NOTE: We support up to 2 Double wide and 3 single wide Graphics cards, limitations apply. NOTE: Double Wide GPUs will occupy slots 2 and 5 and will leave only 2 slots left open. NOTE: There are limitations on GPU support with the NVMe bay installed.	
	HP DL380 Gen9 High Performance Fan Kit	719079-B21
	NOTE: This kit is required for specific Ambient temperature environments, more details here: http://www.hpe.com/servers/ashrae . NOTE: This kit is also required to support Passive GPUs. NOTE: This kit provides max cooling for your Server.	
	HP DL380 Gen9 2SFF Front/Rear SAS/SATA Kit	724864-B21
	NOTE: For 2SFF front the Universal Media Bay (724865-B21) is required. NOTE: 2SFF in the rear is only supported with a 24SFF (CTO chassis or field upgraded) or 12LFF (719061-B21) front end. NOTE: Rear drives will not support higher than 160W CPUs and other special/unique CPUs.	
	HP DL380 Gen9 3LFF Rear SAS/SATA Kit	768856-B21

Core Options

NOTE: This is only supported in the 12LFF chassis (CTO: 719061-B21 or BTO skus).

NOTE: 3LFF rear drives will consume the 2nd riser expansion slot.

NOTE: Rear drives will not support higher than 160W CPUs and other special/unique CPUs.

HP DL380 Gen9 Primary 2 Slot GPU Ready Riser Kit 719076-B21

Slot1: 1x Gen3 x16 FH/FL, 1xGen3 x8 FH/HL.

NOTE: This replaces the standard Primary riser in slot1.

HPE DL380 Gen9 Secondary 3 Slot GPU Ready Riser Kit 719073-B21

Slot2: 2xGen3 x16 FH/FL, 1xGen3 x8 FH/HL.

HPE DL380 Gen9 8SFF Bay1 Cage/Backplane Kit 719067-B21

NOTE: To add an additional 8SFF drive cage in Bay1.

NOTE: To get to 16SFF total please populate bay 2 with 768857-B21 (from an 8SFF starting point).

NOTE: This ships with 6 High Efficiency Fans.

NOTE: Selecting this option does not allow you to select the Universal Media Bay.

HP DL380 Gen9 Additional 8SFF Bay2 Cage/Backplane Kit 768857-B21

NOTE: To add an additional 8SFF drive cage in Bay 2. This is the optimal solution to upgrade to 16SFF total and allows the flexibility to add the Universal Media Bay (724865-B21) for 2 additional SFF or Optical.

HP 12Gb SAS Expander Card with Cables for DL380 Gen9 727250-B21

NOTE: SAS expander to enable 24SFF field upgrade.

NOTE: Primary population in slot2 or 3 of the Primary Riser.

HP DL380 Gen9 Systems Insight Display Kit 768900-B21

NOTE: The Systems Insight Display no longer ships as standard but is available as a Factory Integrated or field upgrade option.

HPE Legacy FIO Mode Setting 758959-B22

NOTE: UEFI is the default, this FIO part can be used for CTO to enable Legacy mode.

HP DL380 Gen9 Rear Serial Port and Enablement Kit 768896-B21

HPE DL380 Gen9 P440ar/H240ar Riser 2 SAS Expander Kit 844115-B21

NOTE: Cable kit required to support the SAS Expander (727250-B21) in the secondary riser (719073-B21) with the P840ar or P440ar.

HPE Processors E5-2600v4 series Processors

HPE DL380 Gen9 Intel® Xeon® E5-2650Lv4 (1.7GHz/14-core/35MB/65W) FIO Processor Kit 817941-L21

HPE DL380 Gen9 Intel® Xeon® E5-2650Lv4 (1.7GHz/14-core/35MB/65W) Processor Kit 817941-B21

HPE DL380 Gen9 Intel® Xeon® E5-2630Lv4 (1.8GHz/10-core/25MB/55W) FIO Processor Kit 817931-L21

HPE DL380 Gen9 Intel® Xeon® E5-2630Lv4 (1.8GHz/10-core/25MB/55W) Processor Kit 817931-B21

HPE DL380 Gen9 Intel® Xeon® E5-2609v4 (1.7GHz/8-core/20MB/85W) FIO Processor Kit 817925-L21

NOTE: This processor does not support Hyper-Threading.

Core Options

HPE DL380 Gen9 Intel® Xeon® E5-2609v4 (1.7GHz/8-core/20MB/85W) Processor Kit	817925-B21
NOTE: This processor does not support Hyper-Threading.	
HPE DL380 Gen9 Intel® Xeon® E5-2603v4 (1.7GHz/6-core/15MB/85W) FIO Processor Kit	817923-L21
NOTE: This processor does not support Hyper-Threading.	
HPE DL380 Gen9 Intel® Xeon® E5-2603v4 (1.7GHz/6-core/15MB/85W) Processor Kit	817923-B21
NOTE: This processor does not support Hyper-Threading.	
HPE DL380 Gen9 Intel® Xeon® E5-2643v4 (3.4GHz/6-core/20MB/135W) FIO Processor Kit	817939-L21
NOTE: Ships with a High Performance Heatsink.	
HPE DL380 Gen9 Intel® Xeon® E5-2637v4 (3.5GHz/4-core/15MB/135W) FIO Processor Kit	817935-L21
NOTE: Ships with a High Performance Heatsink.	
HPE DL380 Gen9 Intel® Xeon® E5-2637v4 (3.5GHz/4-core/15MB/135W) Processor Kit	817935-B21
NOTE: Ships with a High Performance Heatsink.	
HPE DL380 Gen9 Intel® Xeon® E5-2623v4 (2.6GHz/4-core/10MB/85W) FIO Processor Kit	817929-L21
HPE DL380 Gen9 Intel® Xeon® E5-2623v4 (2.6GHz/4-core/10MB/85W) Processor Kit	817929-B21
HPE DL380 Gen9 Intel® Xeon® E5-2620v4 (2.1GHz/8-core/20MB/85W) FIO Processor Kit	817927-L21
HPE DL380 Gen9 Intel® Xeon® E5-2620v4 (2.1GHz/8-core/20MB/85W) Processor Kit	817927-B21
HPE DL380 Gen9 Intel® Xeon® E5-2643v4 (3.4GHz/6-core/20MB/135W) Processor Kit	817939-B21
HPE DL380 Gen9 Intel® Xeon® E5-2687Wv4 (3.0GHz/12-core/30MB/160W) FIO Processor Kit	817957-L21
NOTE: Ships with a High Performance Heatsink.	
HPE DL380 Gen9 Intel® Xeon® E5-2687Wv4 (3.0GHz/12-core/30MB/160W) Processor Kit	817957-B21
NOTE: Ships with a High Performance Heatsink.	
HPE DL380 Gen9 Intel® Xeon® E5-2699v4 (2.2GHz/22-core/55MB/145W) FIO Processor Kit	817967-L21
NOTE: Ships with a High Performance Heatsink.	
HPE DL380 Gen9 Intel® Xeon® E5-2699v4 (2.2GHz/22-core/55MB/145W) Processor Kit	817967-B21
NOTE: Ships with a High Performance Heatsink.	
HPE DL380 Gen9 Intel® Xeon® E5-2698v4 (2.2GHz/20-core/50MB/135W) FIO Processor Kit	817965-L21
NOTE: Ships with a High Performance Heatsink.	
HPE DL380 Gen9 Intel® Xeon® E5-2698v4 (2.2GHz/20-core/50MB/135W) Processor Kit	817965-B21
NOTE: Ships with a High Performance Heatsink.	

Core Options

HPE DL380 Gen9 Intel® Xeon® E5-2697v4 (2.3GHz/18-core/45MB/145W) FIO Processor Kit	817963-L21
NOTE: Ships with a High Performance Heatsink.	
HPE DL380 Gen9 Intel® Xeon® E5-2697v4 (2.3GHz/18-core/45MB/145W) Processor Kit	817963-B21
NOTE: Ships with a High Performance Heatsink.	
HPE DL380 Gen9 Intel® Xeon® E5-2697Av4 (2.6GHz/16-core/40MB/145W) FIO Processor Kit	817955-L21
NOTE: Ships with a High Performance Heatsink.	
HPE DL380 Gen9 Intel® Xeon® E5-2697Av4 (2.6GHz/16-core/40MB/145W) Processor Kit	817955-B21
NOTE: Ships with a High Performance Heatsink.	
HPE DL380 Gen9 Intel® Xeon® E5-2695v4 (2.1GHz/18-core/45MB/120W) FIO Processor Kit	817961-L21
NOTE: Ships with a High Performance Heatsink.	
HPE DL380 Gen9 Intel® Xeon® E5-2695v4 (2.1GHz/18-core/45MB/120W) Processor Kit	817961-B21
NOTE: Ships with a High Performance Heatsink.	
HPE DL380 Gen9 Intel® Xeon® E5-2690v4 (2.6GHz/14-core/35MB/135W) FIO Processor Kit	817959-L21
NOTE: Ships with a High Performance Heatsink.	
HPE DL380 Gen9 Intel® Xeon® E5-2690v4 (2.6GHz/14-core/35MB/135W) Processor Kit	817959-B21
NOTE: Ships with a High Performance Heatsink.	
HPE DL380 Gen9 Intel® Xeon® E5-2683v4 (2.1GHz/16-core/40MB/120W) FIO Processor Kit	817953-L21
NOTE: Ships with a High Performance Heatsink.	
HPE DL380 Gen9 Intel® Xeon® E5-2683v4 (2.1GHz/16-core/40MB/120W) Processor Kit	817953-B21
NOTE: Ships with a High Performance Heatsink.	
HPE DL380 Gen9 Intel® Xeon® E5-2680v4 (2.4GHz/14-core/35MB/120W) FIO Processor Kit	817951-L21
NOTE: Ships with a High Performance Heatsink.	
HPE DL380 Gen9 Intel® Xeon® E5-2680v4 (2.4GHz/14-core/35MB/120W) Processor Kit	817951-B21
NOTE: Ships with a High Performance Heatsink.	
HPE DL380 Gen9 Intel® Xeon® E5-2660v4 (2.0GHz/14-core/35MB/105W) FIO Processor Kit	817945-L21
NOTE: Ships with a High Performance Heatsink.	
HPE DL380 Gen9 Intel® Xeon® E5-2660v4 (2.0GHz/14-core/35MB/105W) Processor Kit	817945-B21
NOTE: Ships with a High Performance Heatsink.	
HPE DL380 Gen9 Intel® Xeon® E5-2650v4 (2.2GHz/12-core/30MB/105W) FIO Processor Kit	817943-L21
NOTE: Ships with a High Performance Heatsink.	
HPE DL380 Gen9 Intel® Xeon® E5-2650v4 (2.2GHz/12-core/30MB/105W) Processor Kit	817943-B21
NOTE: Ships with a High Performance Heatsink.	
HPE DL380 Gen9 Intel® Xeon® E5-2640v4 (2.4GHz/10-core/25MB/90W) FIO Processor Kit	817937-L21

Core Options

HPE DL380 Gen9 Intel® Xeon® E5-2640v4 (2.4GHz/10-core/25MB/90W) Processor Kit	817937-B21
HPE DL380 Gen9 Intel® Xeon® E5-2667v4 (3.2GHz/8-core/25MB/135W) FIO Processor Kit	817947-L21
NOTE: Ships with a High Performance Heatsink.	
HPE DL380 Gen9 Intel® Xeon® E5-2667v4 (3.2GHz/8-core/25MB/135W) Processor Kit	817947-B21
NOTE: Ships with a High Performance Heatsink.	
HPE DL380 Gen9 Intel® Xeon® E5-2630v4 (2.2GHz/10-core/25MB/85W) Processor Kit	817933-B21
HPE DL380 Gen9 Intel® Xeon® E5-2630v4 (2.2GHz/10-core/25MB/85W) FIO Processor Kit	817933-L21
HPE DL380 Gen9 Intel® Xeon® E5-2699Av4 (2.4GHz/22-core/55MB/145W) Processor Kit	871026-B21
HPE DL380 Gen9 Intel® Xeon® E5-2699Av4 (2.4GHz/22-core/55MB/145W) FIO Processor Kit	871026-L21
E5-2600v3 series Processors	
HPE DL380 Gen9 Intel® Xeon® E5-2609v3 (1.9GHz/6-core/15MB/85W) FIO Processor Kit	719052-L21
NOTE: This processor does not support Hyper-Threading.	
HPE DL380 Gen9 Intel® Xeon® E5-2609v3 (1.9GHz/6-core/15MB/85W) Processor Kit	719052-B21
NOTE: This processor does not support Hyper-Threading.	
HPE DL380 Gen9 Intel® Xeon® E5-2603v3 (1.6GHz/6-core/15MB/85W) FIO Processor Kit	719053-L21
NOTE: This processor does not support Hyper-Threading.	
HPE DL380 Gen9 Intel® Xeon® E5-2603v3 (1.6GHz/6-core/15MB/85W) Processor Kit	719053-B21
NOTE: This processor does not support Hyper-Threading.	
HPE DL380 Gen9 Intel® Xeon® E5-2630Lv3 (1.8GHz/8-core/20MB/55W) FIO Processor Kit	719060-L21
HPE DL380 Gen9 Intel® Xeon® E5-2630Lv3 (1.8GHz/8-core/20MB/55W) Processor Kit	719060-B21
HPE DL380 Gen9 Intel® Xeon® E5-2640v3 (2.6GHz/8-core/20MB/90W) FIO Processor Kit	719049-L21
HPE DL380 Gen9 Intel® Xeon® E5-2640v3 (2.6GHz/8-core/20MB/90W) Processor Kit	719049-B21
HPE DL380 Gen9 Intel® Xeon® E5-2637v3 (3.5GHz/4-core/15MB/135W) FIO Processor Kit	719058-L21
NOTE: Ships with a High Performance Heatsink.	
HPE DL380 Gen9 Intel® Xeon® E5-2637v3 (3.5GHz/4-core/15MB/135W) Processor Kit	719058-B21
NOTE: Ships with a High Performance Heatsink.	
HPE DL380 Gen9 Intel® Xeon® E5-2630v3 (2.4GHz/8-core/20MB/85W) FIO Processor Kit	719050-L21
HPE DL380 Gen9 Intel® Xeon® E5-2630v3 (2.4GHz/8-core/20MB/85W) Processor Kit	719050-B21

Core Options

HPE DL380 Gen9 Intel® Xeon® E5-2623v3 (3GHz/4-core/10MB/105W) FIO Processor Kit	779556-L21
HPE DL380 Gen9 Intel® Xeon® E5-2623v3 (3GHz/4-core/10MB/105W) Processor Kit	779556-B21
HPE DL380 Gen9 Intel® Xeon® E5-2620v3 (2.4GHz/6-core/15MB/85W) FIO Processor Kit	719051-L21
HPE DL380 Gen9 Intel® Xeon® E5-2620v3 (2.4GHz/6-core/15MB/85W) Processor Kit	719051-B21
HPE DL380 Gen9 Intel® Xeon® E5-2687Wv3 (3.1GHz/10-core/25MB/160W) FIO Processor Kit	762768-L21
NOTE: Ships with a High Performance Heatsink.	
NOTE: This processor is not supported in a 12LFF or 24SFF Chassis + Rear drive.	
HPE DL380 Gen9 Intel® Xeon® E5-2687Wv3 (3.1GHz/10-core/25MB/160W) Processor Kit	762768-B21
NOTE: Ships with a High Performance Heatsink.	
NOTE: This processor is not supported in a 12LFF or 24SFF Chassis + Rear drive.	
HPE DL380 Gen9 Intel® Xeon® E5-2699v3 (2.3GHz/18-core/45MB/145W) FIO Processor Kit	781915-L21
NOTE: Ships with a High Performance Heatsink.	
HPE DL380 Gen9 Intel® Xeon® E5-2699v3 (2.3GHz/18-core/45MB/145W) Processor Kit	781915-B21
NOTE: Ships with a High Performance Heatsink.	
HPE DL380 Gen9 Intel® Xeon® E5-2698v3 (2.3GHz/16-core/40MB/135W) FIO Processor Kit	781913-L21
NOTE: Ships with a High Performance Heatsink.	
HPE DL380 Gen9 Intel® Xeon® E5-2698v3 (2.3GHz/16-core/40MB/135W) Processor Kit	781913-B21
NOTE: Ships with a High Performance Heatsink.	
HPE DL380 Gen9 Intel® Xeon® E5-2697v3 (2.6GHz/14-core/35MB/145W) FIO Processor Kit	719054-L21
NOTE: Ships with a High Performance Heatsink.	
HPE DL380 Gen9 Intel® Xeon® E5-2697v3 (2.6GHz/14-core/35MB/145W) Processor Kit	719054-B21
NOTE: Ships with a High Performance Heatsink.	
HPE DL380 Gen9 Intel® Xeon® E5-2695v3 (2.3GHz/14-core/35MB/120W) FIO Processor Kit	762760-L21
NOTE: Ships with a High Performance Heatsink.	
HPE DL380 Gen9 Intel® Xeon® E5-2695v3 (2.3GHz/14-core/35MB/120W) Processor Kit	762760-B21
NOTE: Ships with a High Performance Heatsink.	
HPE DL380 Gen9 Intel® Xeon® E5-2690v3 (2.6GHz/12-core/30MB/135W) FIO Processor Kit	719044-L21
NOTE: Ships with a High Performance Heatsink.	
HPE DL380 Gen9 Intel® Xeon® E5-2690v3 (2.6GHz/12-core/30MB/135W) Processor Kit	719044-B21
NOTE: Ships with a High Performance Heatsink.	

Core Options

HPE DL380 Gen9 Intel® Xeon® E5-2683v3 (2GHz/14-core/35MB/120W) FIO Processor Kit	719055-L21
NOTE: Ships with a High Performance Heatsink.	
HPE DL380 Gen9 Intel® Xeon® E5-2683v3 (2GHz/14-core/35MB/120W) Processor Kit	719055-B21
NOTE: Ships with a High Performance Heatsink.	
HPE DL380 Gen9 Intel® Xeon® E5-2680v3 (2.5GHz/12-core/30MB/120W) FIO Processor Kit	762766-L21
NOTE: Ships with a High Performance Heatsink.	
HPE DL380 Gen9 Intel® Xeon® E5-2680v3 (2.5GHz/12-core/30MB/120W) Processor Kit	762766-B21
NOTE: Ships with a High Performance Heatsink.	
HP DL380 Gen9 Intel® Xeon® E5-2670v3 (2.3GHz/12-core/30MB/120W) FIO Processor Kit	719046-L21
NOTE: Ships with a High Performance Heatsink.	
HPE DL380 Gen9 Intel® Xeon® E5-2670v3 (2.3GHz/12-core/30MB/120W) Processor Kit	719046-B21
NOTE: Ships with a High Performance Heatsink.	
HPE DL380 Gen9 Intel® Xeon® E5-2660v3 (2.6GHz/10-core/25MB/105W) FIO Processor Kit	762764-L21
HPE DL380 Gen9 Intel® Xeon® E5-2660v3 (2.6GHz/10-core/25MB/105W) Processor Kit	762764-B21
HPE DL380 Gen9 Intel® Xeon® E5-2650Lv3 (1.8GHz/12-core/30MB/65W) FIO Processor Kit	719059-L21
HPE DL380 Gen9 Intel® Xeon® E5-2650Lv3 (1.8GHz/12-core/30MB/65W) Processor Kit	719059-B21
HPE DL380 Gen9 Intel® Xeon® E5-2650v3 (2.3GHz/10-core/25MB/105W) FIO Processor Kit	719048-L21
HPE DL380 Gen9 Intel® Xeon® E5-2650v3 (2.3GHz/10-core/25MB/105W) Processor Kit	719048-B21
HPE DL380 Gen9 Intel® Xeon® E5-2667v3 (3.2GHz/8-core/20MB/135W) FIO Processor Kit	719056-L21
NOTE: Ships with a High Performance Heatsink.	
HPE DL380 Gen9 Intel® Xeon® E5-2667v3 (3.2GHz/8-core/20MB/135W) Processor Kit	719056-B21
NOTE: Ships with a High Performance Heatsink.	
HPE DL380 Gen9 Intel® Xeon® E5-2643v3 (3.4GHz/6-core/20MB/135W) FIO Processor Kit	719057-L21
NOTE: Ships with a High Performance Heatsink.	
HPE DL380 Gen9 Intel® Xeon® E5-2643v3 (3.4GHz/6-core/20MB/135W) Processor Kit	719057-B21
NOTE: Ships with a High Performance Heatsink.	
NOTE: FIO indicates factory integrated option via CTO.	
NOTE: Up to 2 processors supported. Performance and Energy Star Model configurations include two processors.	
NOTE: HT indicates that the processor model supports Intel® Hyper-Threading Technology.	
NOTE: Turbo2: Intel® Turbo Boost Technology 2.0 provides more computing power when	

Core Options

you need it with performance that adapts to spikes in your workload and delivers more performance upside than the previous generation turbo technology.

NOTE: DDR4 speed is the maximum memory speed of the processor. Actual memory speed may depend on the quantity and type of DIMMs installed.

NOTE: The xxxxxx-L21 is the first processor shipped, the xxxxxx-B21 is the 2nd processor and ships with 2 additional FANs for factory or field installation.

NOTE: Double wide PCIe cards are only supported in risers with the Processors leveraging the High Performance Heatsink. For Processors requiring double wide GPU support please order the GPU enablement kit (719082-B21).

NOTE: Mixing of E5-2600v3 and E5-2600v4 Processors is not supported.

NOTE: Field upgrade from E5-2600v3 to E5-2600v4 is supported.

HPE Memory

Registered DIMMs (RDIMMs) for E5-2600v3 Series

NOTE: The following memory is supported by the E5-2600v3 series Processors.

HP 4GB (1x4GB) Single Rank x8 DDR4-2133 CAS-15-15-15 Registered Memory Kit	726717-B21
HP 8GB (1x8GB) Single Rank x4 DDR4-2133 CAS-15-15-15 Registered Memory Kit	726718-B21
HP 8GB (1x8GB) Dual Rank x8 DDR4-2133 CAS-15-15-15 Registered Memory Kit	759934-B21
HP 16GB (1x16GB) Dual Rank x4 DDR4-2133 CAS-15-15-15 Registered Memory Kit	726719-B21
HP 32GB (1x32GB) Dual Rank x4 DDR4-2133 CAS-15-15-15 Registered Memory Kit	728629-B21

NOTE: Depending on Processor selected this memory will run at 1600, 1866 or 2133MHz.

NOTE: Mixing of DIMM types is not supported.

NOTE: Mixing of 2133 and 2400MHz DIMMs is not supported.

Load Reduced DIMMs (LRDIMMs) for E5-2600v3 Series

NOTE: The following memory is supported by the E5-2600v3 series Processors.

HP 16GB (1x16GB) Dual Rank x4 DDR4-2133 CAS-15-15-15 Load Reduced Memory Kit	726720-B21
HP 32GB (1x32GB) Quad Rank x4 DDR4-2133 CAS-15-15-15 Load Reduced Memory Kit	726722-B21
HP 64GB (1x64GB) Quad Rank x4 DDR4-2133 CAS-15-15-15 Load Reduced Memory Kit	726724-B21

NOTE: Depending on Processor selected this memory will run at 1600, 1866 or 2133MHz.

NOTE: Mixing of DIMM types is not supported.**NOTE:** Mixing of 2133 and 2400MHz DIMMs is not supported.

Registered DIMMs (RDIMMs) for E5-2600v4 Series

NOTE: The following memory is supported by the E5-2600v4 series Processor only.

HP 8GB (1x8GB) Single Rank x8 DDR4-2400 CAS-17-17-17 Registered Memory Kit	805347-B21
HP 16GB (1x16GB) Single Rank x4 DDR4-2400 CAS-17-17-17 Registered Memory Kit	805349-B21

Core Options

HPE 16GB (1x16GB) Dual Rank x4 DDR4-2400 CAS-17-17-17 Registered Memory Kit 836220-B21

HP 32GB (1x32GB) Dual Rank x4 DDR4-2400 CAS-17-17-17 Registered Memory Kit 805351-B21

NOTE: Depending on Processor selected this memory will run at 1866, 2133 or 2400MHz.

NOTE: Mixing of DIMM types is not supported.

NOTE: Mixing of 2133 and 2400MHz DIMMs is not supported.

Load Reduced DIMMs (LRDIMMs) for E5-2600v4 Series

NOTE: The following memory is supported by the E5-2600v4 series Processor only.

HPE 32GB (1x32GB) Dual Rank x4 DDR4-2400 CAS-17-17-17 Load Reduced Memory Kit 805353-B21

HPE 64GB (1x64GB) Quad Rank x4 DDR4-2400 CAS-17-17-17 Load Reduced Memory Kit 805358-B21

HPE 128GB (1x128GB) Octal Rank x4 DDR4-2400 CAS-20-18-18 Load Reduced Memory Kit 809208-B21

NOTE: Depending on Processor selected this memory will run at 1866, 2133 or 2400MHz.

NOTE: These LRDIMMs do not support NVDIMMs.

NOTE: Mixing of DIMM types is not supported.

NOTE: Mixing of 2133 and 2400MHz DIMMs is not supported.

NOTE: Mixing the 128GB LRDIMM with other capacities is not supported.

HPE Persistent Memory (NVDIMM)

NOTE: The following memory is supported by the E5-2600v4 series Processor only.

HPE 8GB NVDIMM Single Rank x4 DDR4-2133 Module 782692-B21

NOTE: NVDIMMs are only supported with E5-2600v4 processors, excluding field upgrades from E5-2600v3 to E5-2600v4.

NOTE: A maximum of 16 NVDIMMs supported.

NOTE: Can only be mixed with RDIMMs.

NOTE: Depending on Processor selected this memory will run at 2133MHz maximum.

HPE Optical Drives

HPE 9.5mm SATA DVD-ROM JackBlack Gen9 Optical Drive 726536-B21

NOTE: The Universal Media Bay (724865-B21) is required for this option.

HPE 9.5mm SATA DVD-RW JackBlack G9 Optical Drive 726537-B21

NOTE: The Universal Media Bay (724865-B21) is required for this option.

HPE Mobile USB Non Leaded System DVD RW Drive 701498-B21

NOTE: This is only supported on USB 3.0 ports.

HPE Drives

SAS Hot Plug SFF (2.5-inch) Enterprise (ENT) Drives

HPE 2.4TB SAS 12G Enterprise 10K SFF (2.5in) SC 3yr Wty 512e Digitally Signed Firmware HDD 881457-B21

HPE 1.8TB SAS 12G Enterprise 10K SFF (2.5in) SC 3yr Wty 512e Digitally Signed Firmware HDD 872481-B21

HPE 1.8TB SAS 12G Enterprise 10K SFF (2.5in) SC 3yr Wty 512e HDD 791034-B21

Core Options

HPE 1.2TB SAS 12G Enterprise 10K SFF (2.5in) SC 3yr Wty Digitally Signed Firmware HDD	872479-B21
HPE 1.2TB SAS 12G Enterprise 10K SFF (2.5in) SC 3yr Wty HDD	781518-B21
HPE 900GB SAS 12G Enterprise 15K SFF (2.5in) SC 3yr Wty Digitally Signed Firmware HDD	870759-B21
HPE 900GB SAS 12G Enterprise 15K SFF (2.5in) SC 3yr Wty 512e Digitally Signed Firmware HDD	870765-B21
HPE 900GB SAS 12G Enterprise 10K SFF (2.5in) SC 3yr Wty HDD	785069-B21
HPE 600GB SAS 12G Enterprise 15K SFF (2.5in) SC 3yr Wty Digitally Signed Firmware HDD	870757-B21
HPE 600GB SAS 12G Enterprise 15K SFF (2.5in) SC 3yr Wty 512e Digitally Signed Firmware HDD	870763-B21
HPE 600GB SAS 12G Enterprise 10K SFF (2.5in) SC 3yr Wty Digitally Signed Firmware HDD	872477-B21
HPE 600GB SAS 12G Enterprise 15K SFF (2.5in) SC 3yr Wty 512e HDD	748387-B21
HPE 600GB SAS 12G Enterprise 15K SFF (2.5in) SC 3yr Wty HDD	759212-B21
HPE 600GB SAS 12G Enterprise 10K SFF (2.5in) SC 3yr Wty HDD	781516-B21
HPE 450GB SAS 12G Enterprise 15K SFF (2.5in) SC 3yr Wty HDD	759210-B21
HPE 300GB SAS 12G Enterprise 15K SFF (2.5in) SC 3yr Wty Digitally Signed Firmware HDD	870753-B21
HPE 300GB SAS 12G Enterprise 10K SFF (2.5in) SC 3yr Wty Digitally Signed Firmware HDD	872475-B21
HPE 300GB SAS 12G Enterprise 15K SFF (2.5in) SC 3yr Wty HDD	759208-B21
HPE 300GB SAS 12G Enterprise 10K SFF (2.5in) SC 3yr Wty HDD	785067-B21
SAS Hot Plug SFF (2.5-inch) Midline (MDL) Drives	
HPE 2TB SAS 12G Midline 7.2K SFF (2.5in) SC 1yr Wty 512e HDD	765466-B21
HPE 1TB SAS 12G Midline 7.2K SFF (2.5in) SC 1yr Wty 512e Digitally Signed Firmware HDD	765464-B21
HPE 1TB SAS 12G Midline 7.2K SFF (2.5in) SC 1yr Wty Digitally Signed Firmware HDD	832514-B21
12G SAS Hot Plug LFF (3.5-inch) Enterprise (ENT) Drives	
HPE 600GB SAS 12G Enterprise 15K LFF (3.5in) SC 3yr Wty HDD	765424-B21
HPE 450GB SAS 12G Enterprise 15K LFF (3.5in) SCC 3yr Wty HDD	737394-B21
HPE 300GB SAS 12G Enterprise 15K LFF (3.5in) SCC 3yr Wty HDD	737261-B21
12G SAS Hot Plug LFF (3.5-inch) SC Midline Hard Drives - 1yr Warranty	
HPE 10TB SAS 12G Midline 7.2K LFF (3.5in) SC 1yr Wty Helium 512e Digitally Signed Firmware HDD	857644-B21
HPE 8TB SAS 12G Midline 7.2K LFF (3.5in) SC 1yr Wty Helium 512e Digitally Signed Firmware HDD	861590-B21
HPE 8TB SAS 12G Midline 7.2K LFF (3.5in) SC 1yr Wty 512e Digitally Signed Firmware HDD	819201-B21
HPE 6TB SAS 12G Midline 7.2K LFF (3.5in) SC 1yr Wty Digitally Signed Firmware HDD	846514-B21
HPE 6TB SAS 12G Midline 7.2K LFF (3.5in) SC 1yr Wty 512e HDD	861754-B21
HPE 4TB SAS 12G Midline 7.2K LFF (3.5in) SC 1yr Wty Digitally Signed Firmware HDD	872487-B21

Core Options

HPE 4TB SAS 12G Midline 7.2K LFF (3.5in) SC 1yr Wty Digitally Signed Firmware HDD	872487-B21
HPE 4TB SAS 12G Midline 7.2K LFF (3.5in) SC 1yr Wty HDD	818367-B21
HPE 4TB SAS 12G Midline 7.2K LFF (3.5in) SC 1yr Wty 512e HDD	861756-B21
HPE 3TB SAS 12G Midline 7.2K LFF (3.5in) SC 1yr Wty Digitally Signed Firmware HDD	846528-B21
HPE 2TB SAS 12G Midline 7.2K LFF (3.5in) SC 1yr Wty Digitally Signed Firmware HDD	872485-B21
HPE 2TB SAS 12G Midline 7.2K LFF (3.5in) SC 1yr Wty Digitally Signed Firmware HDD	872485-B21
HPE 2TB SAS 12G Midline 7.2K LFF (3.5in) SC 1yr Wty HDD	818365-B21
HPE 1TB SAS 12G Midline 7.2K LFF (3.5in) SC 1yr Wty Digitally Signed Firmware HDD	846524-B21
SATA Hot Plug SFF (2.5-inch) Midline (MDL) Drives	
HPE 2TB SATA 6G Midline 7.2K SFF (2.5in) SC 1yr Wty 512e Digitally Signed Firmware HDD	765455-B21
HPE 1TB SATA 6G Midline 7.2K SFF (2.5in) SC 1yr Wty 512e Digitally Signed Firmware HDD	765453-B21
HPE 1TB SATA 6G Midline 7.2K SFF (2.5in) SC 1yr Wty Digitally Signed Firmware HDD	655710-B21
SATA Hot Plug LFF (3.5-inch) Midline (MDL) Drives	
HPE 12TB SATA 6G Midline 7.2K LFF (3.5in) SC 1yr Wty Helium 512e Digitally Signed Firmware HDD	881785-B21
HPE 10TB SATA 6G Midline 7.2K LFF (3.5in) SC 1yr Wty Helium 512e Digitally Signed Firmware HDD	857648-B21
HPE 8TB SATA 6G Midline 7.2K LFF (3.5in) SC 1yr Wty Helium 512e Digitally Signed Firmware HDD	861594-B21
HPE 8TB SATA 6G Midline 7.2K LFF (3.5in) SC 1yr Wty 512e Digitally Signed Firmware HDD	819203-B21
HPE 6TB SATA 6G Midline 7.2K LFF (3.5in) SC 1yr Wty 512e Digitally Signed Firmware HDD	861750-B21
HPE 6TB SATA 6G Midline 7.2K LFF (3.5in) SC 1yr Wty Digitally Signed Firmware HDD	846510-B21
HPE 6TB SATA 6G Midline 7.2K LFF (3.5in) SC 1yr Wty 512e HDD	861750-B21
HPE 4TB SATA 6G Midline 7.2K LFF (3.5in) SC 1yr Wty Digitally Signed Firmware HDD	872491-B21
HPE 4TB SATA 6G Midline 7.2K LFF (3.5in) SC 1yr Wty Digitally Signed Firmware HDD	872491-B21
HPE 4TB SATA 6G Midline 7.2K LFF (3.5in) SC 1yr Wty HDD	861678-B21
HPE 4TB SATA 6G Midline 7.2K LFF (3.5in) SC 1yr Wty 512e HDD	861752-B21
HP 4TB 6G SATA 7.2K rpm LFF (3.5-inch) SC 512e Performance 1yr Warranty Hard Drives	793665-B21
HPE 3TB SATA 6G Midline 7.2K LFF (3.5in) SC 1yr Wty Digitally Signed Firmware HDD	861693-B21
HPE 2TB SATA 6G Midline 7.2K LFF (3.5in) SC 1yr Wty Digitally Signed Firmware HDD	872489-B21
HPE 2TB SATA 6G Midline 7.2K LFF (3.5in) SC 1yr Wty Digitally Signed Firmware HDD	872489-B21

Core Options

HPE 2TB SATA 6G Midline 7.2K LFF (3.5in) SC 1yr Wty HDD	861676-B21
HPE 1TB SATA 6G Midline 7.2K LFF (3.5in) SC 1yr Wty HDD	861691-B21

SSD Selection

To streamline the configuration process for HPE ProLiant Gen9 servers and to provide the best product availability, HPE recommends SSDs from the list located here: <http://www.hpe.com/products/recommend>.

12G SAS Mixed Use Hot Plug SFF (2.5-inch) Solid State Drives

HPE 3.2TB SAS 12G Mixed Use SFF (2.5in) SC 3yr Wty Digitally Signed Firmware SSD	873367-B21
HPE 3.2TB SAS 12G Mixed Use SFF (2.5in) SC 3yr Wty Digitally Signed Firmware SSD	872386-B21
HPE 1.6TB SAS 12G Mixed Use SFF (2.5in) SC 3yr Wty Digitally Signed Firmware SSD	873365-B21
HPE 1.6TB SAS 12G Mixed Use SFF (2.5in) SC 3yr Wty Digitally Signed Firmware SSD	872382-B21
HPE 1.6TB SAS 12G Mixed Use SFF (2.5in) SC 3yr Wty SSD	822563-B21
HPE 800GB SAS 12G Mixed Use SFF (2.5in) SC 3yr Wty Digitally Signed Firmware SSD	873363-B21
HPE 800GB SAS 12G Mixed Use SFF (2.5in) SC 3yr Wty Digitally Signed Firmware SSD	872376-B21
HPE 800GB SAS 12G Mixed Use SFF (2.5in) SC 3yr Wty SSD	822559-B21
HPE 400GB SAS 12G Mixed Use SFF (2.5in) SC 3yr Wty Digitally Signed Firmware SSD	873359-B21
HPE 400GB SAS 12G Mixed Use SFF (2.5in) SC 3yr Wty Digitally Signed Firmware SSD	872374-B21
HPE 400GB SAS 12G Mixed Use SFF (2.5in) SC 3yr Wty SSD	822555-B21

12G SAS Hot Plug RI-3 SFF (2.5-inch) SC Solid State Drives

HPE 15.3TB SAS 12G Read Intensive SFF (2.5in) SC 3yr Wty Digitally Signed Firmware SSD	870148-B21
HPE 7.68TB SAS 12G Read Intensive SFF (2.5in) SC 3yr Wty Digitally Signed Firmware SSD	870144-B21
HPE 3.84TB SAS 12G Read Intensive SFF (2.5in) SC 3yr Wty Digitally Signed Firmware SSD	872394-B21
HPE 3.84TB SAS 12G Read Intensive SFF (2.5in) SC 3yr Wty Digitally Signed Firmware SSD	875330-B21
HPE 1.92TB SAS 12G Read Intensive SFF (2.5in) SC 3yr Wty Digitally Signed Firmware SSD	872392-B21
HPE 1.92TB SAS 12G Read Intensive SFF (2.5in) SC 3yr Wty Digitally Signed Firmware SSD	875326-B21
HPE 960GB SAS 12G Read Intensive SFF (2.5in) SC 3yr Wty Digitally Signed Firmware SSD	872390-B21
HPE 960GB SAS 12G Read Intensive SFF (2.5in) SC 3yr Wty Digitally Signed Firmware SSD	875313-B21
HPE 480GB SAS 12G Read Intensive SFF (2.5in) SC 3yr Wty Digitally Signed Firmware SSD	875311-B21

12G SAS Hot Plug MU-3 SFF (3.5-inch) SC Solid State Drives

HPE 800GB SAS 12G Mixed Use LFF (3.5in) SCC 3yr Wty Digitally Signed Firmware SSD	872378-B21
---	------------

Core Options

12G SAS Hot Plug SFF (2.5-inch) Write Intensive Solid State Drives

HPE 1.6TB SAS 12G Write Intensive SFF (2.5in) SC 3yr Wty Digitally Signed Firmware SSD	873357-B21
HPE 800GB SAS 12G Write Intensive SFF (2.5in) SC 3yr Wty Digitally Signed Firmware SSD	873355-B21
HPE 400GB SAS 12G Write Intensive SFF (2.5in) SC 3yr Wty Digitally Signed Firmware SSD	873351-B21

6G SATA Hot Plug SFF (2.5-inch) SC Read Intensive Solid State Drives

HPE 3.84TB SATA 6G Read Intensive SFF (2.5in) SC 3yr Wty Digitally Signed Firmware SSD	877764-B21
HPE 3.8TB SATA 6G Read Intensive SFF (2.5in) SC 3yr Wty Digitally Signed Firmware SSD	868830-B21
HPE 1.92TB SATA 6G Read Intensive SFF (2.5in) SC 3yr Wty Digitally Signed Firmware SSD	877758-B21
HPE 1.92TB SATA 6G Read Intensive SFF (2.5in) SC 3yr Wty Digitally Signed Firmware SSD	868826-B21
HPE 1.92TB SATA 6G Read Intensive SFF (2.5in) SC 3yr Wty Digitally Signed Firmware SSD	871770-B21
HPE 1.92TB SATA 6G Read Intensive SFF (2.5in) SC 3yr Wty Digitally Signed Firmware SSD	875513-B21
HPE 1.6TB SATA 6G Read Intensive SFF (2.5in) SC 3yr Wty Digitally Signed Firmware SSD	869386-B21
HPE 960GB SATA 6G Read Intensive SFF (2.5in) SC 3yr Wty Digitally Signed Firmware SSD	877752-B21
HPE 960GB SATA 6G Read Intensive SFF (2.5in) SC 3yr Wty Digitally Signed Firmware SSD	869384-B21
HPE 960GB SATA 6G Read Intensive SFF (2.5in) SC 3yr Wty Digitally Signed Firmware SSD	868822-B21
HPE 960GB SATA 6G Read Intensive SFF (2.5in) SC 3yr Wty Digitally Signed Firmware SSD	875511-B21
HPE 960GB SATA 6G Read Intensive SFF (2.5in) SC 3yr Wty SSD	871768-B21
HPE 480GB SATA 6G Read Intensive SFF (2.5in) SC 3yr Wty Digitally Signed Firmware SSD	877746-B21
HPE 480GB SATA 6G Read Intensive SFF (2.5in) SC 3yr Wty Digitally Signed Firmware SSD	869378-B21
HPE 480GB SATA 6G Read Intensive SFF (2.5in) SC 3yr Wty Digitally Signed Firmware SSD	868818-B21
HPE 480GB SATA 6G Read Intensive SFF (2.5in) SC 3yr Wty Digitally Signed Firmware SSD	875509-B21
HPE 240GB SATA 6G Read Intensive SFF (2.5in) SC 3yr Wty Digitally Signed Firmware SSD	877740-B21
HPE 240GB 6G SATA Read Intensive SFF (2.5-inch) SC DS SSD	868814-B21
HPE 240GB SATA 6G Read Intensive SFF (2.5in) SC 3yr Wty Digitally Signed Firmware SSD	869376-B21
HPE 240GB SATA 6G Read Intensive SFF (2.5in) SC 3yr Wty Digitally Signed Firmware SSD	875503-B21
HPE 150GB SATA 6G Read Intensive SFF (2.5in) SC 3yr Wty Digitally Signed Firmware SSD	869374-B21

Read Intensive - 6G SATA - M.2 - Solid State Drives

Core Options

HPE 960GB SATA 6G Read Intensive M.2 2280 3yr Wty Digitally Signed Firmware SSD	875500-B21
HPE 480GB SATA 6G Read Intensive M.2 2280 3yr Wty Digitally Signed Firmware SSD	875319-B21
HPE 480GB SATA 6G Read Intensive M.2 2280 3yr Wty Digitally Signed Firmware SSD	875498-B21
HPE 150GB SATA 6G Read Intensive M.2 2280 3yr Wty Digitally Signed Firmware SSD	875317-B21
6G SATA Hot Plug SFF (2.5-inch) SC Write Intensive Solid State Drives	
HPE 1.6TB 6G SATA Write Intensive-2 SFF 2.5-in SC 3yr Wty Digitally Signed Firmware SSD	872363-B21
HPE 800GB 6G SATA Write Intensive-2 SFF 2.5-in SC 3yr Wty Digitally Signed Firmware SSD	872359-B21
HPE 400GB 6G SATA Write Intensive-2 SFF 2.5-in SC 3yr Wty Digitally Signed Firmware SSD	872355-B21
6G SATA Hot Plug SFF (2.5-inch) SC Mixed Use Solid State Drives	
HPE 1.92TB SATA 6G Mixed Use SFF (2.5in) SC 3yr Wty Digitally Signed Firmware SSD	877788-B21
HPE 1.92TB SATA 6G Mixed Use SFF (2.5in) SC 3yr Wty Digitally Signed Firmware SSD	872352-B21
HPE 1.92TB SATA 6G Mixed Use SFF (2.5in) SC 3yr Wty Digitally Signed Firmware SSD	875478-B21
HPE 1.6TB SATA 6G Mixed Use SFF (2.5in) SC 3yr Wty SSD	804631-B21
HPE 960GB SATA 6G Mixed Use SFF (2.5in) SC 3yr Wty Digitally Signed Firmware SSD	877782-B21
HPE 960GB SATA 6G Mixed Use SFF (2.5in) SC 3yr Wty Digitally Signed Firmware SSD	872348-B21
HPE 960GB SATA 6G Mixed Use SFF (2.5in) SC 3yr Wty Digitally Signed Firmware SSD	875474-B21
HPE 480GB SATA 6G Mixed Use SFF (2.5in) SC 3yr Wty Digitally Signed Firmware SSD	877776-B21
HPE 480GB SATA 6G Mixed Use SFF (2.5in) SC 3yr Wty Digitally Signed Firmware SSD	872344-B21
HPE 480GB SATA 6G Mixed Use SFF (2.5in) SC 3yr Wty Digitally Signed Firmware SSD	875470-B21
HPE 240GB SATA 6G Mixed Use SFF (2.5in) SC 3yr Wty Digitally Signed Firmware SSD	880295-B21
HPE 240GB SATA 6G Mixed Use SFF (2.5in) SC 3yr Wty Digitally Signed Firmware SSD	875483-B21
Mixed Use - 6G SATA - M.2 - Solid State Drives	
HPE 960GB SATA 6G Mixed Use M.2 2280 3yr Wty Digitally Signed Firmware SSD	875492-B21
HPE 480GB SATA 6G Mixed Use M.2 2280 3yr Wty Digitally Signed Firmware SSD	875490-B21
HPE 240GB SATA 6G Mixed Use M.2 2280 3yr Wty Digitally Signed Firmware SSD	875488-B21
6G SATA Hot Plug LFF (3.5-inch) SC Read Intensive Solid State Drives	

Core Options

HPE 1.92TB SATA 6G Read Intensive LFF (3.5in) SCC 3yr Wty Digitally Signed Firmware SSD	877760-B21
HPE 1.6TB SATA 6G Read Intensive LFF (3.5in) SCC 3yr Wty Digitally Signed Firmware SSD	869388-B21
HPE 960GB SATA 6G Read Intensive LFF (3.5in) SCC 3yr Wty Digitally Signed Firmware SSD	877754-B21
HPE 480GB SATA 6G Read Intensive LFF (3.5in) SCC 3yr Wty Digitally Signed Firmware SSD	877748-B21
HPE 480GB SATA 6G Read Intensive LFF (3.5in) SCC 3yr Wty Digitally Signed Firmware SSD	869380-B21
6G SATA Hot Plug LFF (3.5-inch) SC Write Intensive Solid State Drives	
HPE 1.6TB 6G SATA Write Intensive-2 LFF 2.5-in SC 3yr Wty Digitally Signed Firmware SSD	872365-B21
HPE 800GB 6G SATA Write Intensive-2 LFF 2.5-in SC 3yr Wty Digitally Signed Firmware SSD	872361-B21
HPE 400GB 6G SATA Write Intensive-2 LFF 2.5-in SC 3yr Wty Digitally Signed Firmware SSD	872357-B21
6G SATA Hot Plug LFF (3.5-inch) SC Mixed Use Solid State Drives	
HPE 1.92TB SATA 6G Mixed Use LFF (3.5in) SCC 3yr Wty Digitally Signed Firmware SSD	877790-B21
HPE 1.92TB SATA 6G Mixed Use LFF (3.5in) SCC 3yr Wty Digitally Signed Firmware SSD	875480-B21
HPE 1.6TB SATA 6G Mixed Use LFF (3.5in) SCC 3yr Wty SSD	804634-B21
HPE 960GB SATA 6G Mixed Use LFF (3.5in) SCC 3yr Wty Digitally Signed Firmware SSD	877784-B21
HPE 960GB SATA 6G Mixed Use LFF (3.5in) SCC 3yr Wty Digitally Signed Firmware SSD	875476-B21
HPE 960GB SATA 6G Mixed Use LFF (3.5in) SCC 3yr Wty Digitally Signed Firmware SSD	872350-B21
HPE 480GB SATA 6G Mixed Use LFF (3.5in) SCC 3yr Wty Digitally Signed Firmware SSD	875472-B21
HPE 480GB SATA 6G Mixed Use LFF (3.5in) SCC 3yr Wty Digitally Signed Firmware SSD	872346-B21
HPE NVMe PCIe Read Intensive SFF (2.5 inch) Solid State Drives	
HPE 2TB NVMe x4 Lanes Read Intensive SFF (2.5in) SCN 3yr Wty SSD	764908-B21
HPE 1.92TB NVMe x4 Lanes Read Intensive SFF (2.5in) SCN 3yr Wty Digitally Signed Firmware SSD	875591-B21
HPE 1.2TB NVMe x4 Lanes Read Intensive SFF (2.5in) SCN 3yr Wty SSD	764906-B21
HPE 960GB NVMe x4 Lanes Read Intensive SFF (2.5in) SCN 3yr Wty Digitally Signed Firmware SSD	875589-B21
HPE 480GB NVMe x4 Lanes Read Intensive SFF (2.5in) SCN 3yr Wty Digitally Signed Firmware SSD	875587-B21
HPE 400GB NVMe x4 Lanes Read Intensive SFF (2.5in) SCN 3yr Wty SSD	764904-B21
NOTE: With NVMe support only 1xDouble Wide Graphics card is supported.	
HPE NVMe PCIe Mixed Use SFF (2.5 inch) Solid State Drives	
HPE 2TB NVMe x4 Lanes Mixed Use SFF (2.5in) SCN 3yr Wty SSD	765044-B21
HPE 1.6TB NVMe x4 Lanes Mixed Use SFF (2.5in) SCN 3yr Wty Digitally Signed Firmware SSD	875597-B21

Core Options

HPE 1.6TB NVMe x4 Lanes Mixed Use SFF (2.5in) SCN 3yr Wty SSD	765038-B21
HPE 800GB NVMe x4 Lanes Mixed Use SFF (2.5in) SCN 3yr Wty Digitally Signed Firmware SSD	875595-B21
HPE 800GB NVMe x4 Lanes Mixed Use SFF (2.5in) SCN 3yr Wty SSD	765036-B21
HPE 400GB NVMe x4 Lanes Mixed Use SFF (2.5in) SCN 3yr Wty Digitally Signed Firmware SSD	875593-B21
HPE 400GB NVMe x4 Lanes Mixed Use SFF (2.5in) SCN 3yr Wty SSD	765034-B21

NOTE: With NVMe support only 1xDouble Wide Graphics card is supported.

HPE NVMe PCIe Write Intensive SFF (2.5-inch) Solid State Drives

HPE 2TB NVMe x4 Lanes Write Intensive SFF(2.5in) SCN 3yr Wty SSD	764894-B21
HPE 1.6TB NVMe x4 Lanes Write Intensive SFF (2.5in) SCN 3yr Wty SSD	764892-B21
HPE 800GB NVMe x4 Lanes Write Intensive SFF (2.5in) SCN 3yr Wty SSD	736939-B21
HPE 400GB NVMe x4 Lanes Write Intensive SFF (2.5in) SCN 3yr Wty SSD	736936-B21

NOTE: The NVMe CTO chassis (810393-B21) or the NVMe Express Bay Enablement kit (774741-B21) are required to support these drives.

NOTE: HPE has qualified the NVMe drive portfolio using the Operating System inbox drivers, full detail on the [HPE Solid State Drive QuickSpecs](#).

NOTE: With NVMe support only 1xDouble Wide Graphics card is supported.

M.2 SSD

HPE 340GB SATA 6G Read Intensive 3yr Wty Dual M.2 Kit	835565-B21
HPE 340GB SATA 6G Read Intensive 3yr Wty M.2 Kit	835563-B21
HPE Universal SATA HHHL 3yr Wty M.2 Kit	878783-B21

NOTE: M.2 drives go in PCIe slots and use B140i SATA controller only.

NOTE: M.2 supports Software RAID only.

NOTE: No HPE Flexible Smart Array supported.

Hard Drive Blank Kits

HPE Large Form Factor Hard Drive Blank Kit	666986-B21
HPE Small Form Factor Hard Drive Blank Kit	666987-B21

Hard Drive Kits

HP DL380 Gen9 NVMe 6 Solid State Drive Express Bay Enablement Kit	774741-B21
---	------------

NOTE: This option provides support for up to 6NVMe drives, and can only be populated in BAY2 in SFF chassis only, can be used with Bay1 and Bay 3 populated.

NOTE: The HPE DL380 Gen9 High Performance Fan Kit is required for NVMe support (719079-B21).

NOTE: The PCIe card in this enablement kit can only be populated in slot2 (primary) or slot 5 (secondary).

NOTE: For true x16 support with this option a secondary riser (719073-B21) is needed (second processor required).

NOTE: Kit includes Mylar film for Universal Media Bay (724865-B21) support to ensure optimal airflow.

HPE DL380 Gen9 8SFF Bay1 Cage/Backplane Kit	719067-B21
HP DL380 Gen9 Additional 8SFF Bay2 Cage/Backplane Kit	768857-B21
HP DL380 Gen9 2SFF Front/Rear SAS/SATA Kit	724864-B21
HP DL380 Gen9 3LFF Rear SAS/SATA Kit	768856-B21

Core Options

NOTE: For a complete list of the drive, controller and cable options please check the compatibility matrix:

<https://www.hpe.com/h20195/V2/GetDocument.aspx?docname=4AA5-4154ENW&cc=us&lc=en>.

Media Bay Kits

HP DL380 Gen9 Universal Media Bay Kit 724865-B21

NOTE: The Universal Media Bay offers front VGA and 2xUSB 2.0, plus ability to add optional Optical drive, and 2SFF.

NOTE: This is only compatible with the 8SFF or 8+8 SFF front end configurations and can only be populated in Bay1.

HPE Networking

1 Gigabit Ethernet adapters

HPE Ethernet 1Gb 4-port 331T Adapter	647594-B21
HPE Ethernet 1Gb 2-port 332T Adapter	615732-B21
HPE Ethernet 1Gb 2-port 361T Adapter	652497-B21
HPE Ethernet 1Gb 4-port 366T Adapter	811546-B21

10 Gigabit Ethernet adapters

HPE Ethernet 10Gb 2-port 530SFP Adapter	652503-B21
HPE Ethernet 10Gb 2-port 530T Adapter	656596-B21
HPE Ethernet 10Gb 2-port 546SFP+ Adapter	779793-B21
HPE Ethernet 10Gb 2-port 557SFP+ Adapter	788995-B21
HPE Ethernet 10Gb 2-port 560SFP+ Adapter	665249-B21
HPE Ethernet 10Gb 2-port 561T Adapter	716591-B21
HPE Ethernet 10Gb 2-port 562SFP+ Adapter	727055-B21
HPE Ethernet 10Gb 2-port 570SFP+ Adapter	718904-B21

NOTE: The DL380 Gen9 chassis ships with 4x1Gb Embedded.

NOTE: A minimum of two Gigabytes (2 GB) of server memory is required per each adapter.

NOTE: Direct Attach Cable (DAC) for copper environments or fiber transceivers and cables for fiber-optic environments must be purchased separately. Please see the related NIC QuickSpecs for Technical Specifications and additional information:

<http://www.hpe.com/servers/ProLiantNICs>.

25 Gigabit Ethernet adapters

HPE Ethernet 4x25Gb 1-port 620QSFP28 Adapter	817762-B21
HPE Ethernet 10/25Gb 2-port 640SFP28 Adapter	817753-B21

FlexibleLOM Adapters

HPE Ethernet 1Gb 4-port 331FLR Adapter	629135-B22
HPE Ethernet 1Gb 4-port 366FLR Adapter	665240-B21
HPE FlexFabric 10Gb 2-port 533FLR-T Adapter	700759-B21
HPE FlexFabric 10Gb 2-port 534FLR-SFP+ Adapter	700751-B21
HPE FlexFabric 10Gb 4-port 536FLR-T Adapter	764302-B21
HPE Ethernet 10Gb 2-port 546FLR-SFP+ Adapter	779799-B21
HPE FlexFabric 10Gb 2-port 556FLR-T Adapter	794525-B21
HPE FlexFabric 10Gb 2-port 556FLR-SFP+ Adapter	727060-B21
HPE Ethernet 10Gb 2-port 560FLR-SFP+ Adapter	665243-B21

Core Options

HPE Ethernet 10Gb 2-port 561FLR-T Adapter	700699-B21
HPE Ethernet 10Gb 2-port 562FLR-SFP+ Adapter	727054-B21
HPE Ethernet 10/25Gb 2-port 640FLR-SFP28 Adapter	817749-B21

NOTE: The DL380 Gen9 chassis ships with 4x1Gb Embedded.

NOTE: Only one FlexibleLOM can be added to the server. These options are upgradeable and can be changed from the original configuration after the server is shipped.

NOTE: Direct Attach Cable (DAC) for copper environments or fiber transceivers and cables for fiber-optic environments must be purchased separately. Please see the related NIC QuickSpecs for Technical Specifications and additional information:

<http://www.hpe.com/servers/ProLiantNICs>.

HPE InfiniBand

NOTE: The RHEL6.5 driver is not part of SPP, but may be downloaded here: <http://h20565.www2.hpe.com/portal/site/hpsc/>.

HPE InfiniBand FDR/Ethernet 10Gb/40Gb 2-port 544+QSFP Adapter	764284-B21
HPE InfiniBand FDR/Ethernet 10Gb/40Gb 2-port 544+FLR-QSFP Adapter	764285-B21
HPE InfiniBand QDR/Ethernet 10Gb 2-port 544+FLR-QSFP Adapter	764286-B21
HPE 100Gb 1-port OP101 QSFP28 x16 PCIe Gen3 with Intel® Omni-Path Architecture Adapter	829335-B21
HPE 100Gb 1-port OP101 QSFP28 x8 PCIe Gen3 with Intel® Omni-Path Architecture Adapter	829334-B21
HPE InfiniBand EDR 100Gb 1-port 841QSFP28 Adapter	872725-B21
HPE InfiniBand EDR/Ethernet 100Gb 1-port 840QSFP28 Adapter	825110-B21
HPE InfiniBand EDR/Ethernet 100Gb 2-port 840QSFP28 Adapter	825111-B21

HPE I/O Expansion Options

HP DL380 Gen9 Primary 2 Slot GPU Ready Riser Kit	719076-B21
--	------------

NOTE: This is for slot 1 and supports double wide GPGPUs.

NOTE: For Graphics cards please also order the DL380 Gen9 Graphics Enablement kit, 719082-B21.

Slot1: 1xGen3 x16 FH/FL, 1xGen3 x8 FH/HL.

NOTE: Double wide PCIe cards are only supported in risers with the Processors leveraging the High Performance Heatsink. For Processors requiring double wide GPU support please order the GPU enablement kit (719082-B21).

HPE DL380 Gen9 Secondary 3 Slot GPU Ready Riser Kit	719073-B21
---	------------

NOTE: This is for slot 2 and supports double wide GPGPUs.

NOTE: For Graphics cards please also order the DL380 Gen9 Graphics Enablement kit, 719082-B21

Slot2: 2xGen3 x16 FH/FL, 1xGen3 x8 FH/HL.

NOTE: Double wide PCIe cards are only supported in risers with the Processors leveraging the High Performance Heatsink. For Processors requiring double wide GPU support please order the GPU enablement kit (719082-B21).

HPE Power Supplies

HPE Flex Slot Platinum Hot-plug Power supplies

HPE 500W Flex Slot Platinum Hot Plug Power Supply Kit	720478-B21
---	------------

Core Options

NOTE: Flex Slot Platinum power supplies support power efficiency of up to 94%.

HPE 800W Flex Slot Titanium Hot Plug Power Supply Kit 720482-B21

NOTE: Flex Slot Titanium power supplies support power efficiency of up to 96%.

HPE 800W Flex Slot Platinum Hot Plug Power Supply Kit 720479-B21

NOTE: Flex Slot Platinum power supplies support power efficiency of up to 94%.

HPE 800W Flex Slot Universal Hot Plug Power Supply Kit 720484-B21

NOTE: Flex Slot universal power supplies support power efficiency of up to 94% and support both 277VAC/380VDC power inputs.

HPE 800W Flex Slot -48VDC Hot Plug Power Supply Kit 720480-B21

NOTE: Flex Slot -48VDC power supplies support power efficiency of up to 94%.

HPE 1400W Flex Slot Platinum Plus Hot Plug Power Supply Kit 720620-B21

NOTE: Flex Slot Platinum Plus power supplies support power efficiency of up to 94%.

NOTE: All power supplies must be of the same input voltage, output rating, and efficiency rating. If non-matching power supplies are installed, you may receive an error message and/or experience operational issues with your server.

NOTE: Mixing different power supplies in the same server may limit or disable some power supply features including support for power redundancy. To ensure access to all available features, all power supplies within the same server should have the same output and efficiency ratings

NOTE: Prior to selecting a power supply option, it is highly recommended that you review your server configuration in the HPE Power Advisor tool to determine the right size power supply for your server configuration. The HPE Power Advisor is located at: <http://www.hpe.com/info/hppoweradvisor>.

NOTE: Support for HPE Power Discovery Services is included with the 1400W Flex Slot option. Power specifications and technical content for all HPE Server power supplies can be found at <http://www.hpe.com/info/proliant/powersupply>.

NOTE: Maximum of 2 Flex Slot PS per platform.

HPE Computation and Graphics Accelerators HP DL380 Gen9 Graphics Enablement Kit 719082-B21

NOTE: This GPU enablement kit includes 2 Heatsinks and 8 cables to enable double wide GPUs to be supported.

NOTE: For doublewide GPU support you are required to have at least 1x1400W Power Supply (720620-B21), per card for cards over 150W. Cards 150W or under can use 800W Power Supplies; however check the power usage via the HPE Power Advisor Tool located at <http://www.hpe.com/info/hppoweradvisor>.

NOTE: There are limitations on the chassis and processor supported when adding Graphics accelerators.

NOTE: Passive cards will require the addition of the High Performance Fan Kit (719079-B21).

NOTE: We support up to 2 Double wide and 3 single wide Graphics cards, limitations apply.

NOTE: This kit support up to 2 double wide Graphics cards.

NOTE: Double Wide GPUs will occupy slots 2 and 5 and will leave only 2

Core Options

slots left open.

NOTE: There are limitations on GPU support (1x double wide) with the NVMe bay installed.

NOTE: All Accelerators are restricted to less than 1024GB for system host memory, with the exception of the Tesla P100, AMD and Intel cards.

NOTE: This kit includes PCIe GPU Retention Brackets that need to be installed on the air baffle to support FL cards.

NOTE: Not required for M2000.

NVIDIA Tesla K40C 12GB Computational Accelerator

753960-B21

NOTE: This is supported in all chassis.

NOTE: The Primary GPU riser (719076-B21) is required to support this in slot1.

NOTE: The secondary GPU riser (719073-B21) is required to support this in slot2 (2nd processor required).

NOTE: For doublewide GPU support you are required to have at least 1x1400W Power Supply (720620-B21), per card.

NOTE: Double-wide cards require the addition of the High Performance Fan Kit (719079-B21).

NOTE: Only supported with E5-2600v3 processors.

HP NVIDIA Tesla K80 Dual GPU PCIe Computational Accelerator

J0G95A

NOTE: For doublewide GPU support you are required to have at least 1x1400W Power Supply (720620-B21), per card.

NOTE: This card only runs at PCIeGen2 speeds.

NOTE: The Primary GPU riser (719076-B21) is required to support this in slot1.

NOTE: The secondary GPU riser (719073-B21) is required to support this in slot2 (2nd processor required).

NOTE: PCIe accelerators are not supported in conjunction with this card.

NOTE: This card will require the addition of the High Performance Fan Kit (719079-B21).

NOTE: Max cooling setting required to support in RSBUs.

NOTE: There are limitations operating this card with operative environment temperature limitations: 24SFF chassis to 30°C and 12LFF chassis to <25°C

HPE NVIDIA Tesla M4 4GB Computational Accelerator

P9U90A

NOTE: Maximum of 3 cards supported per server.

NOTE: This is supported in all chassis.

NOTE: The Primary GPU riser (719076-B21) is required to support this in slot1.

NOTE: The secondary GPU riser (719073-B21) is required to support this in slot2 (2nd processor required).

NOTE: 1x 1400W PS recommended, but this card will work with 1x800W PS (Per GPU). However check the power usage via the HPE Power Advisor Tool located at <http://www.hpe.com/info/hppoweradvisor>.

NOTE: No GPU enablement kit is required for this option.

NOTE: Only supported with E5-2600v4 processors.

NVIDIA Tesla M10 Quad GPU Module

Q0J62A

NOTE: This is supported in all chassis, however with the following limitations: 4LFF supported to 35C, 8SFF supported to 35C, 12LFF

Core Options

supported to 30C, 16SFF+Universal Media bay supported to 35C, 16SFF+NVMe cage supported to 35C and 24SFF+2SFF supported to 35C.

NOTE: The Primary GPU riser (719076-B21) is required to support this in slot1.

NOTE: The secondary GPU riser (719073-B21) is required to support this in slot2 (2nd processor required).

NOTE: For doublewide GPU support you are required to have at least 1x1400W Power Supply (720620-B21), per card.

NOTE: Double-wide cards require the addition of the High Performance Fan Kit (719079-B21).

NOTE: Only supported with E5-2600v4 processors.

HPE NVIDIA Tesla M40 24GB Computational Accelerator

P8Y46A

NOTE: Maximum 2 supported with both risers, support for 2 cards requires the 1400W Power Supply (720620-B21) to be selected.

NOTE: Double-wide cards require the addition of the High Performance Fan Kit (719079-B21).

NOTE: The Primary GPU riser (719076-B21) is required to support this in slot1.

NOTE: The secondary GPU riser (719073-B21) is required to support this in slot2 (2nd processor required).

NOTE: Only supported with E5-2600v4 processors.

NOTE: There are limitations operating this card with operative environment temperature limitations: 24SFF chassis to 30^oC and 12LFF chassis to 25^oC

HPE NVIDIA Tesla M60 Reverse Air Flow Dual GPU PCIe Graphics Accelerator

M3X67A

NOTE: Maximum 2 supported with both risers, support for 2 cards requires the 1400W Power Supply (720620-B21) to be selected.

NOTE: Double-wide cards require the addition of the High Performance Fan Kit (719079-B21).

NOTE: This card only runs at PCIeGen2 speeds.

NOTE: The Primary GPU riser (719076-B21) is required to support this in slot1.

NOTE: The secondary GPU riser (719073-B21) is required to support this in slot2 (2nd processor required).

NOTE: There are limitations operating this card with a 160W processor with operative environment temperature limitations: 8SFF to 35^oC, 16 SFF to 25^oC and 24SFF/12LFF to 20^oC

NOTE: Additional Grid 2.0 Licensing from NVIDIA is required.

HPE NVIDIA Tesla P4 8GB Computational Accelerator

Q0V79A

NOTE: Maximum of 3 cards supported per server.

NOTE: This is supported in all chassis.

NOTE: The Primary GPU riser (719076-B21) is required to support this in slot1.

NOTE: The secondary GPU riser (719073-B21) is required to support this in slot2 (2nd processor required).

NOTE: 1x 1400W PS recommended, but this card will work with 1x800W PS (Per GPU). However check the power usage via the HPE Power Advisor Tool located at <http://www.hpe.com/info/hppoweradvisor>.

NOTE: No GPU enablement kit is required for this option.

NOTE: Only supported with E5-2600v4 processors.

Core Options

HPE NVIDIA Tesla P40 24GB Computational Accelerator	Q0V80A
NOTE: There are chassis limitations with this card: 4LFF supported to 35C, 8SFF supported to 35C, 12LFF supported to 25C , 16SFF+Universal Media bay supported to 30C, 16SFF+NVMe cage supported to 30C and 24SFF+2SFF supported to 30C.	
NOTE: For doublewide GPU support you are required to have at least 1x1400W Power Supply (720620-B21), per card.	
NOTE: The Primary GPU riser (719076-B21) is required to support this in slot1.	
NOTE: The secondary GPU riser (719073-B21) is required to support this in slot2 (2nd processor required).	
NOTE: There are limitations on the chassis and processor supported when adding Graphics accelerators.	
NOTE: This card will require the addition of the High Performance Fan Kit (719079-B21).	
NOTE: This card is supported on the E5-2600v4 series processors only.	
HPE NVIDIA Tesla P100 PCIe 16GB Computational Accelerator	Q0E21A
NOTE: There are chassis limitations with this card: 4LFF supported to 25C, 8SFF supported to 30C, 12LFF not supported, 16SFF+Universal Media bay supported to 30C, 16SFF+NVMe cage supported to 30C and 24SFF+2SFF supported to 20C.	
NOTE: For doublewide GPU support you are required to have at least 1x1400W Power Supply (720620-B21), per card.	
NOTE: The Primary GPU riser (719076-B21) is required to support this in slot1.	
NOTE: The secondary GPU riser (719073-B21) is required to support this in slot2 (2nd processor required).	
NOTE: There are limitations on the chassis and processor supported when adding Graphics accelerators.	
NOTE: This card will require the addition of the High Performance Fan Kit (719079-B21).	
NOTE: This card is supported on the E5-2600v4 series processors only.	
HPE NVIDIA Tesla P100 PCIe 12GB Computational Accelerator	Q2S42A
NOTE: There are chassis limitations with this card: 4LFF supported to 25C, 8SFF supported to 30C, 12LFF not supported, 16SFF+Universal Media bay supported to 30C, 16SFF+NVMe cage supported to 30C and 24SFF+2SFF supported to 20C.	
NOTE: For doublewide GPU support you are required to have at least 1x1400W Power Supply (720620-B21), per card.	
NOTE: The Primary GPU riser (719076-B21) is required to support this in slot1.	
NOTE: The secondary GPU riser (719073-B21) is required to support this in slot2 (2nd processor required).	
NOTE: There are limitations on the chassis and processor supported when adding Graphics accelerators.	
NOTE: This card will require the addition of the High Performance Fan Kit (719079-B21).	
NOTE: This card is supported on the E5-2600v4 series processors only.	
HPE NVIDIA Quadro P2000 Graphics Accelerator	Q0V77A
NOTE: Only supported with E5-2600v4 processors.	

Core Options

NOTE: This is supported in all chassis.

NOTE: Support with this card limited to 35C for all chassis permutations.

NOTE: The Primary GPU riser (719076-B21) is required to support this in slot1.

NOTE: The secondary GPU riser (719073-B21) is required to support this in slot2 (2nd processor required).

NOTE: 1x 1400W PS recommended, but this card will work with 1x800W PS (Per GPU). However check the power usage via the HPE Power Advisor Tool located at <http://www.hpe.com/info/hppoweradvisor>.

HPE NVIDIA Quadro P4000 Graphics Accelerator

Q0V78A

NOTE: Only supported with E5-2600v4 processors.

NOTE: This is supported in all chassis.

NOTE: Support with this card limited to 35C for all chassis permutations.

NOTE: The Primary GPU riser (719076-B21) is required to support this in slot1.

NOTE: The secondary GPU riser (719073-B21) is required to support this in slot2 (2nd processor required).

NOTE: 1x 1400W PS recommended, but this card will work with 1x800W PS (Per GPU). However check the power usage via the HPE Power Advisor Tool located at <http://www.hpe.com/info/hppoweradvisor>.

HPE NVIDIA Quadro P6000 Graphics Accelerator

Q0V76A

NOTE: There are chassis limitations with this card: 4LFF supported to 25C, 8SFF supported to 30C, 12LFF not supported, 16SFF+Universal Media bay supported to 30C, 16SFF+NVMe cage supported to 20C and 24SFF+2SFF supported to 20C.

NOTE: For doublewide GPU support you are required to have at least 1x1400W Power Supply (720620-B21), per card.

NOTE: The Primary GPU riser (719076-B21) is required to support this in slot1.

NOTE: The secondary GPU riser (719073-B21) is required to support this in slot2 (2nd processor required).

NOTE: There are limitations on the chassis and processor supported when adding Graphics accelerators.

NOTE: This card will require the addition of the High Performance Fan Kit (719079-B21).

NOTE: This card is supported on the E5-2600v4 series processors only.

HPE NVIDIA Quadro M2000 Graphics Accelerator

P8Y48A

NOTE: Maximum of 3 cards supported per server.

NOTE: This is supported in all chassis.

NOTE: The Primary GPU riser (719076-B21) is required to support this in slot1.

NOTE: The secondary GPU riser (719073-B21) is required to support this in slot2 (2nd processor required).

NOTE: Only supported with E5-2600v4 processors.

NOTE: 1x 1400W PS recommended, but this card will work with 1x800W PS (Per GPU). However check the power usage via the HPE Power Advisor Tool located at <http://www.hpe.com/info/hppoweradvisor>.

NOTE: No GPU enablement kit is required for this option.

HPE NVIDIA Quadro M4000 Graphics Accelerator

M9X58A

NOTE: Only supported with E5-2600v4 processors.

Core Options

NOTE: This is supported in all chassis.

NOTE: The Primary GPU riser (719076-B21) is required to support this in slot1.

NOTE: The secondary GPU riser (719073-B21) is required to support this in slot2 (2nd processor required).

NOTE: 1x 1400W PS recommended, but this card will work with 1x800W PS (Per GPU). However check the power usage via the HPE Power Advisor Tool located at <http://www.hpe.com/info/hppoweradvisor>.

HP NVIDIA Quadro M5000 Graphics Accelerator

M9R60A

NOTE: Only supported with E5-2600v4 processors.

NOTE: This is supported in all chassis.

NOTE: The Primary GPU riser (719076-B21) is required to support this in slot1.

NOTE: The secondary GPU riser (719073-B21) is required to support this in slot2 (2nd processor required).

NOTE: 1x 1400W PS recommended, but this card will work with 1x800W PS (Per GPU). However check the power usage via the HPE Power Advisor Tool located at <http://www.hpe.com/info/hppoweradvisor>.

NOTE: Double-wide cards require the addition of the High Performance Fan Kit (719079-B21).

HPE NVIDIA Quadro M6000 24GB Graphics Accelerator

P8Y47A

NOTE: Maximum 2 supported with both risers, support for 2 cards requires the 1400W Power Supply (720620-B21) to be selected.

NOTE: Double-wide cards require the addition of the High Performance Fan Kit (719079-B21).

NOTE: The Primary GPU riser (719076-B21) is required to support this in slot1.

NOTE: The secondary GPU riser (719073-B21) is required to support this in slot2 (2nd processor required).

NOTE: Only supported with E5-2600v4 processors.

HP AMD FirePro S9150 Accelerator Kit

J0H11A

NOTE: For doublewide GPU support you are required to have at least 1x1400W Power Supply (720620-B21), per card.

NOTE: The Primary GPU riser (719076-B21) is required to support this in slot1.

NOTE: The secondary GPU riser (719073-B21) is required to support this in slot2 (2nd processor required).

NOTE: There are limitations on the chassis and processor supported when adding Graphics accelerators.

NOTE: This card will require the addition of the High Performance Fan Kit (719079-B21).

NOTE: This card is supported on the E5-2600v3 series processors only.

NOTE: 12LFF support is restricted to 30C Server Ambient only.

HPE AMD FirePro S7150x2 Accelerator Kit

M3X68A

NOTE: For doublewide GPU support you are required to have at least 1x1400W Power Supply (720620-B21), per card.

NOTE: The Primary GPU riser (719076-B21) is required to support this in slot1.

NOTE: The secondary GPU riser (719073-B21) is required to support this in slot2 (2nd processor required).

Core Options

NOTE: There are limitations on the chassis and processor supported when adding Graphics accelerators.

NOTE: This card will require the addition of the High Performance Fan Kit (719079-B21).

NOTE: This card is supported on the E5-2600v4 series processors only.

NOTE: This card only runs at PCIeGen2 speeds.

NOTE: There are limitations operating this card with operative environment temperature limitations: 12LFF chassis to 30°C

HPE 150W PCI-E Power Cable Kit

669777-B21

NOTE: This cable is required for the K1, K4200, K5200, M5000 and W7100 cards.

NOTE: Each DL380 Gen9 server will accommodate up to three single-width or two double width PCIe cards for Computational Graphics support. Note that 11.25" is the max length for a card to also allow for cabling. This applies to primary slots 1 & 2 or secondary slots 4 & 5.

NOTE: The NVIDIA Tesla, GRID and Quadro modules are supported only on 64-bit versions of Linux and Windows operating systems as well as on Virtual Machine client operating systems. The supported bare metal operating systems are RHEL6, SLES 11 and Windows Server 2012 R2.

NOTE: There are limitations on fan types, setting, and chassis support by card.

NOTE: Mixing of GPUs is not supported.

NOTE: All NVIDIA, Intel and AMD cards limit configurations to having less than 1TB memory installed.

NOTE: Double Wide GPUs will occupy slots 2 and 5 and will leave only 2 slots left open.

NOTE: There are limitations on GPU support with the NVMe bay installed.

HPE Cooling Options

HP DL380 Gen9 High Performance Fan Kit

719079-B21

NOTE: High Performance Fan kit consists of 6 fans, these will need to replace all the standard Fans in the unit, and fill all 6-Fan cages.

NOTE: The 12LFF and 24SFF chassis (including field upgrades to 24SFF) will already include 6 High Performance Fan kits.

NOTE: The High Performance Fan Kit is needed to support certain Passive GPGPU (Graphics cards) configurations; or ASHRAE operating environments.

NOTE: For elevated ambient temperature support please see:

<http://www.hpe.com/servers/ashrae>

Additional Options

NOTE: Some options may not be integrated at the factory. To ensure only valid configurations are ordered, Hewlett Packard Enterprise recommends the use of an HPE approved configurator. Contact your local sales representative for additional information.

HPE Insight Software	HPE Insight Control	
	HPE Insight Control including 1yr 24x7 Technical Support and Updates 1-server LTU	C6N27A
	HPE Insight Control including 1yr 24x7 TSU E-LTU	C6N28ABE
	HPE Insight Control Upgrade from iLO Advanced including 1yr 24x7 Support E-LTU	C6N38ABE
<p>NOTE: Electronic and Flexible-Quantity licenses can be used to purchase multiple licenses with a single activation key.</p> <p>NOTE: Customer will receive a license entitlement certificate. The license entitlement certificate must be redeemed online or via fax in order to obtain the license activation key(s). Includes one year of 24 x 7 HPE Software Technical Support and Update Service.</p> <p>NOTE: Licenses ship without media. The HPE Insight Control Media Kit can be ordered separately, or can be downloaded at: https://www.hpe.com/info/insightmanagement</p> <p>NOTE: For additional license options please see the HPE Insight Control QuickSpecs.</p> <p>NOTE: For additional license options please see the QuickSpecs at: https://www.hpe.com/h20195/v2/GetHTML.aspx?docname=c04123391</p>		
	HPE Insight Control including 1yr 24x7 Support ProLiant ML/DL/BL-bundle Single Server FIO LTU	C6N36A

Embedded Management	HPE iLO Advanced	
	HPE iLO Advanced including 1yr 24x7 Technical Support and Updates 1-server LTU	512485-B21
	HPE iLO Advanced including 3yr 24x7 Tech Support and Updates 1-server LTU	BD505A
	HPE iLO Advanced including 1yr 24x7 Technical Support and Updates E-LTU	E6U59ABE
	HPE iLO Advanced including 3yr 24x7 Technical Support and Updates E-LTU	E6U64ABE

HPE Converged Infrastructure Management Software	HPE OneView Advanced (with HPE iLO Advanced)	
	HPE OneView including 3yr 24x7 Support Physical 1-server LTU	E5Y34A
	HPE OneView including 3yr 24x7 Support Flexible Quantity E-LTU	E5Y35AAE
	HPE OneView for ProLiant DL Server including 3yr 24x7 Support FIO Bundle Physical 1-server LTU	E5Y43A
	HPE OneView Advanced (without HPE iLO Advanced)	
	HPE OneView w/o iLO including 3yr 24x7 Support 1-server LTU	P8B24A
	HPE OneView w/o iLO including 3yr 24x7 Support Flexible Quantity E-LTU	P8B26AAE
	HPE OneView w/o iLO including 3yr 24x7 Support 1-server FIO LTU	P8B31A
	HPE OneView Physical Media Kit LTU	E5Y37A
	NOTE: Full licenses of HPE OneView Advanced also provide the right-	

Additional Options

to-use HPE Insight Control without additional charge.

NOTE: Server provisioning (via 'HPE Insight Control server provisioning') is licensed as part of HPE OneView Advanced and provides multi-server OS and driver provisioning. Media kit #BD883A can be ordered for a physical copy of this software (USB flash drive).

NOTE: Licenses ship without media. The HPE OneView Media Kit can be ordered separately, or can be downloaded at:

<http://www.hpe.com/info/hpeoneview>.

High Performance Clusters

HPE Cluster Management Utility

HPE Insight Cluster Management Utility 1yr 24x7 Flexible LTU QL803B

HPE Insight Cluster Management Utility 3yr 24x7 Flexible LTU BD476A

NOTE: These part numbers can be used to purchase one certificate for multiple licenses and support with a single activation key. Each license is for one node (server). Customer will receive a printed end user license agreement and license entitlement certificate via physical shipment. The license entitlement certificate must be redeemed online in order to obtain a license key. Customer also will receive a support agreement.

HPE Insight Cluster Management Utility Media BD477A

NOTE: For additional license kits please see the [HPE Insight Cluster Management Utility QuickSpecs](#).

HPE PCIe Workload Accelerator Options

Light Endurance (LE) PCIe Workload Accelerators

HPE 5.2TB FH/HL Light Endurance (LE) PCIe Workload Accelerator 775672-B21

NVME PCIe Workload Accelerators

HPE 6.4TB Read Intensive-2 FH/HL PCIe Workload Accelerator 831739-B21

HPE 6.4TB PCIe x8 Lanes Mixed Use HHHL 3yr Wty Digitally Signed Firmware Card 877829-B21

HPE 4TB PCIe x4 RI HH DS Card 877831-B21

HPE 3.2TB Read Intensive-2 HH/HL PCIe Workload Accelerator 831737-B21

HPE 3.2TB PCIe x8 Lanes Mixed Use HHHL 3yr Wty Digitally Signed Firmware Card 877827-B21

HPE 2.0TB NVMe Mixed Use HH/HL PCIe Workload Accelerator 803204-B21

HPE 1.6TB Read Intensive-2 HH/HL PCIe Workload Accelerator 831735-B21

HPE 1.6TB NVMe Write Intensive HH/HL PCIe Workload Accelerator 803197-B21

HPE 1.6TB PCIe x8 Lanes Mixed Use HHHL 3yr Wty Digitally Signed Firmware Card 877825-B21

HPE 1.6TB NVMe Mixed Use HH/HL PCIe Workload Accelerator 803202-B21

HPE 1.3TB Read Intensive-2 HH/HL PCIe Workload Accelerator 831733-B21

HPE 800GB NVMe Write Intensive HH/HL PCIe Workload Accelerator 803195-B21

HPE 800GB NVMe Mixed Use HH/HL PCIe Workload Accelerator 803200-B21

HPE Security

HPE 2U Security Bezel Kit 666988-B21

HPE Trusted Platform Module 2.0 Kit 745823-B21

NOTE: If the TPM Module (488069-B21) is installed, then there is no support for TPM 2.0.

Additional Options

NOTE: This is supported on both the E5-2600v3 and E5-2600v4 processors.

NOTE: HPE Trusted Platform Module 2.0 Option works with Gen9 servers with UEFI Mode not Legacy Mode. It is not compatible with HPE ProLiant Gen8 servers or earlier generation variants.

NOTE: HPE Gen9 servers purchased earlier may need the latest firmware update to be compatible with the TPM 2.0 Option.

NOTE: HPE server systems can have a TPM module (of any type) installed only once. It cannot be replaced with any other TPM module.

HPE Trusted Platform Module Option

488069-B21

NOTE: The HPE Trusted Platform Module Option (488069-B21) is the TPM 1.2 version. Compatible server platforms include Gen8 and Gen9 servers.

NOTE: HPE server systems can have a TPM module (of any type) installed only once. It cannot be replaced with any other TPM module.

HPE Storage Controllers

SAS Controllers

HPE Flexible Smart Array Controllers

HPE Smart Array P440ar/2GB FBWC 12Gb 2-ports Int SAS Controller 726736-B21

NOTE: Provides support for up to 8 internal SAS/SATA drives without using a PCIe slot.

NOTE: Includes the HPE Smart Storage Battery.

HP Smart Array P440ar/2GB FBWC 12Gb 2-ports Int FIO SAS Controller 749974-B21

NOTE: Provides support for up to 8 internal SAS/SATA drives without using a PCIe slot.

NOTE: Includes the HPE Smart Storage Battery.

NOTE: FIO indicates factory integrated option via CTO.

HPE Smart Array P840ar/2GB FBWC 12Gb 2-port Internal SAS Controller 843199-B21

NOTE: Provides support for up to 16 internal SAS/SATA drives without using a PCIe slot.

NOTE: Includes the HPE Smart Storage Battery.

HPE Smart Array Controllers

HPE Smart Array P440/4GB FBWC 12Gb 1-port Int SAS Controller 726821-B21

NOTE: Provides support for up to 8 internal SAS/SATA drives.

HPE Smart Array P840/4GB FBWC 12Gb 2-ports Int SAS Controller 726897-B21

HPE Smart Array P841/4GB FBWC 12Gb 4-ports Ext SAS Controller 726903-B21

HPE Smart Array P441/4GB FBWC 12Gb 2-ports Ext SAS Controller 726825-B21

HP Smart Array P440/4GB FBWC 12Gb 1-port Int FIO SAS Controller 761872-B21

NOTE: Provides support for up to 8 internal SAS/SATA drives.

NOTE: Includes the HPE Smart Storage Battery.

NOTE: FIO indicates factory integrated option via CTO.

HP Smart Array P840/4GB FBWC 12Gb 2-ports Int FIO SAS Controller 761874-B21

NOTE: Includes the HPE Smart Storage Battery.

NOTE: When ordering controllers, please reference the HPE Cable Options below for the required cable.

NOTE: FIO indicates factory integrated option via CTO.

HPE Smart Host Bus Adapters

Additional Options

HPE H241 12Gb 2-ports Ext Smart Host Bus Adapter	726911-B21
HPE H240 12Gb 2-ports Int Smart Host Bus Adapter	726907-B21
HPE H240ar 12Gb 2-ports Int Smart Host Bus Adapter	726757-B21

NOTE: Provides support for up to 8 internal SAS/SATA drives without using a PCIe slot.

HP H240ar 12Gb 2-ports Int FIO Smart Host Bus Adapter	749976-B21
---	------------

NOTE: Provides support for up to 8 internal SAS/SATA drives without using a PCIe slot.

NOTE: FIO indicates factory integrated option via CTO.

HPE Cable Options

HP DL380 Gen9 12LFF Rear 2SFF or 3LFF P840/440 SAS Cable Kit	783007-B21
--	------------

NOTE: 12LFF port 3 to 2SFF or 3LFF to P440/840 PCIe.

HP DL380 Gen9 2SFF Front SAS x4 Cable Kit	783008-B21
---	------------

NOTE: For front mount 2SFF to H240/P440ar, H240 or embedded B140i SATA.

HP DL380 Gen9 8SFF SAS Cable Kit	783009-B21
----------------------------------	------------

NOTE: 8/16/24 SFF to P840/440 bay 3.

HP DL380 Gen9 2SFF x8 Front Cable Kit	785989-B21
---------------------------------------	------------

NOTE: For front/rear mount 2SFF to P440/840 PCIe).

HP DL380 Gen9 12LFF SAS Cable Kit	785991-B21
-----------------------------------	------------

NOTE: For 12LFF to P440/840 PCIe cables- ports 1/2/3.

HPE DL380 SFF Smart Array HBA H200/P400 Series SAS Cable Kit	786092-B21
--	------------

NOTE: 8/16/24SFF to 240/440ar, H240 PCIe or embedded B140i SATA.

HP DL380 Gen9 12LFF Smart HBA H240 SAS Cable Kit	786215-B21
--	------------

NOTE: For 12LFF ports 1&2 to H240/P440ar, H240 or embedded B140i SATA.

NOTE: For details on cabling options, additional information available [here](#):

Cabling Matrix

Optional Software

HPE Smart Array SR Secure Encryption (Data at Rest Encryption/per Server Entitlement) E-LTU	Q2F26AAE
---	----------

HPE Smart Array SR SmartCache (Single Key/Single Server) LTU	D7S26A
--	--------

HPE Smart Array SR SmartCache (Single Key/Multiple Servers) LTU	D7S27A
---	--------

HPE Smart Array SR SmartCache (Single Key/Multiple Servers) E-LTU	D7S27AAE
---	----------

NOTE: HPE SmartCache is supported when one of the supported Smart Array Controllers is installed in the server.

NOTE: HPE SmartCache comes standard (no licensing is required) if the HPE Smart Array P840 Controller is installed in the server.

Optional Upgrades

HP 96W Smart Storage Battery with 145mm Cable for DL/ML/SL Servers	727258-B21
--	------------

NOTE: Provides backup power for multiple HPE Smart Array controllers or other devices (up to 16).

NOTE: Ships as standard with some HPE Flexible Smart Array Controllers.

Additional Options

HPE Tape Backup

NOTE: For the complete range of tape drives, autoloaders, libraries and media see: <http://www.hpe.com/storage/storeever>. For hardware and software compatibility of Hewlett Packard Enterprise tape backup products <http://www.hpe.com/storage/BURACompatibility>.

Tape Drives

HPE StoreEver LTO-7 Ultrium 15000 External Tape Drive	BB874A
HPE StoreEver 1/8 G2 LTO-6 Ultrium 6250 Fibre Channel Tape Autoloader	C0H19A
HPE StoreEver LTO-6 Ultrium 6250 Tape Drive in a 1U Rack Mount Kit	C0L99A
HPE StoreEver LTO-6 Ultrium 6250 External Tape Drive	EH970A
HPE StoreEver LTO-5 Ultrium 3000 SAS Tape Drive in a 1U Rack Mount Kit	EJ014B
HPE StoreEver LTO-5 Ultrium 3000 SAS External Tape Drive	EH958B
HPE StoreEver LTO-4 Ultrium 1760 SAS (1) in a 1U Rack Mount Kit	EH946C
HPE StoreEver LTO-4 Ultrium 1760 SAS External Tape Drive	EH920B
HPE StoreEver 1U SAS Rack Mount Kit	AE459B

HPE Tape Storage Systems

HPE StoreEver MSL6480

HPE StoreEver MSL6480 Scaleable Expansion Module	QU626A
--	--------

NOTE: Please see the [HPE StoreEver MSL6480 Tape Library QuickSpecs](#) for Technical Specifications and additional information).

HPE StoreEver MSL6480 Scalable Base Module	QU625A
HPE StoreEver MSL2024 0-drive Tape Library	AK379A
HPE StoreEver MSL4048 0-drive Tape Library	AK381A

HPE Disk Backup

HPE RDX Removable Disk Backup System

HPE RDX 4TB USB 3.0 External Disk Backup System	Q2R33A
HPE RDX+ 3TB USB 3.0 External Disk Backup System	P9L72A
HPE RDX 3TB USB 3.0 Internal Disk Backup System	P9L71A
HPE RDX 2TB USB3.0 External Disk Backup System	E7X53B
HP RDX+ 1TB External Backup System	B7B69B
HP RDX+ 500GB External Backup System	B7B66B
HPE RDX+ External Docking System	C8S07B
HPE D3700 Enclosure	QW967A
HPE D3600 Enclosure	QW968A

NOTE: For the complete range of RDX drives and media see: <https://www.hpe.com/us/en/product-catalog/storage/disk-based-backup-systems.html>. For hardware and software compatibility of Hewlett Packard Enterprise disk backup products see: <http://www.hpe.com/storage/spock>.

HPE Storage Options

NOTE: For the complete listing of Fibre Channel Host Bus Adapters for Windows 2000, Windows Server 2003 and Linux, please see: <https://www.hpe.com/us/en/product-catalog/storage/storage-adapters.html>.
Emulex Fibre Channel HBAs

Additional Options

HPE 81E 8Gb 1-port PCIe Fibre Channel Host Bus Adapter	AJ762B
HPE 82E 8Gb 2-port PCIe Fibre Channel Host Bus Adapter	AJ763B
HPE StoreFabric 84E 4-port 8Gb Fibre Channel Host Bus Adapter	E7Y63A
HPE StoreFabric SN1200E 16Gb Single Port Fibre Channel Host Bus Adapter	Q0L13A
HPE StoreFabric SN1200E 16Gb Dual Port Fibre Channel Host Bus Adapter	Q0L14A
HPE StoreFabric SN1600E 32Gb Single Port Fibre Channel Host Bus Adapter	Q0L11A
HPE StoreFabric SN1600E 32Gb Dual Port Fibre Channel Host Bus Adapter	Q0L12A
HPE StoreFabric SN1100E 16Gb Single Port Fibre Channel Host Bus Adapter	C8R38A
HPE StoreFabric SN1100E 16Gb Dual Port Fibre Channel Host Bus Adapter	C8R39A
HPE StoreFabric SN1100E 4-port 16Gb Fibre Channel Host Bus Adapter	P9D99A
QLogic Fibre Channel HBAs	
HPE 81Q 8Gb 1-port PCIe Fibre Channel Host Bus Adapter	AK344A
HPE 82Q 8Gb 2-port PCIe Fibre Channel Host Bus Adapter	AJ764A
HPE StoreFabric 84Q 4-port 8Gb Fibre Channel Host Bus Adapter	P9D91A
HPE StoreFabric SN1000Q 16GB 1-port PCIe Fibre Channel Host Bus Adapter	QW971A
HPE StoreFabric SN1100Q 16Gb Single Port Fibre Channel Host Bus Adapter	P9D93A
HPE StoreFabric SN1000Q 16GB 2-port PCIe Fibre Channel Host Bus Adapter	QW972A
HPE StoreFabric SN1100Q 16Gb Dual Port Fibre Channel Host Bus Adapter	P9D94A
HPE StoreFabric SN1600Q 32Gb Single Port Fibre Channel Host Bus Adapter	P9M75A
HPE StoreFabric SN1600Q 32Gb Dual Port Fibre Channel Host Bus Adapter	P9M76A
Converged Network Adapter	
HPE StoreFabric CN1100R Dual Port Converged Network Adapter	QW990A
HPE StoreFabric CN1100R 10GBASE-T Dual Port Converged Network Adapter	N3U52A
HPE StoreFabric CN1200E 10Gb Converged Network Adapter	E7Y06A
HPE StoreFabric CN1200E 10GBASE-T Dual Port Converged Network Adapter	N3U51A

HPE Data Center Racks

HPE Advanced Series Racks

HPE 48U 600mm x 1075mm Advanced Pallet Rack	H6J87A
HPE 48U 600mm x 1075mm Advanced Shock Rack	H6J88A
HPE 42U 600mm x 1075mm Advanced Pallet Rack	H6J65A
HPE 42U 600mm x 1075mm Advanced Shock Rack	H6J66A
HPE 42U 600mm x 1200mm Advanced Pallet Rack	H6J67A
HPE 42U 600mm x 1200mm Advanced Shock Rack	H6J68A

Additional Options

HPE 36U 600mm x 1075mm Advanced Pallet Rack	H6J77A
HPE 36U 600mm x 1075mm Advanced Shock Rack	H6J78A
HPE 22U 600mm x 1075mm Advanced Pallet Rack	H6J83A
HPE 22U 600mm x 1075mm Advanced Shock Rack	H6J84A
HPE 14U 600mm x 1075mm Advanced Shock Rack	H6J82A

NOTE: Please see the [HPE Advanced Series Racks QuickSpecs](#) for information on additional racks options and rack specifications.

HPE Enterprise Series Racks

HP 47U 600mm x 1075mm Enterprise Pallet Rack	BW911A
HP 47U 600mm x 1075mm Enterprise Shock Rack	BW912A
HP 47U 600mm x 1200mm Enterprise Pallet Rack	BW913A
HP 47U 600mm x 1200mm Enterprise Shock Rack	BW914A
HPE 42U 600mm x 1075mm Enterprise Pallet Rack	BW903A
HP 42U 600mm x 1075mm Enterprise Shock Rack	BW904A
HP 42U 600mm x 1200mm Enterprise Pallet Rack	BW907A
HP 42U 600mm x 1200mm Enterprise Shock Rack	BW908A
HP 42U 800mm x 1075mm Enterprise Pallet Rack	BW917A
HP 42U 800mm x 1075mm Enterprise Shock Rack	BW918A

NOTE: Please see the [HPE Enterprise Series Racks QuickSpecs](#) for information on additional racks options and rack specifications.

HPE Power Distribution Units (PDUs)

HPE Basic Power Distribution Units (PDU)

HPE 800VA - 277V Input / 230V Output NA Rack Mount Transformer	H3X09A
--	--------

NOTE: Please see the [HPE Basic Power Distribution Units \(PDU\) QuickSpecs](#)

for information on additional options and product specifications.

HPE Metered Power Distribution Units (PDU)

HPE Metered 4.9kVA/L6-30P 24A/208V Outlets (12) C13/Horizontal NA/JP PDU	D9N44A
HPE Metered 3.6kVA/60320 C20 Detachable 16A/230V Outlets (16) C13/Vertical WW PDU	D9N45A
HPE Metered 4.9kVA/L6-30P 24A/208V Outlets (20) C13 (4) C19/Vertical NA/JP PDU	D9N47A
HPE Metered 7.3kVA/60309 32A 3-wire/230V Outlets (20) C13 (4) C19/Vertical INTL PDU	D9N48A
HPE Metered 3Ph 8.6kVA/L15-30P 24A/208V Outlets (18) C13 (3) C19/Vertical NA/JP PDU	D9N51A
HPE Metered 3Ph 8.6kVA/L21-30P 24A/120-208V Outlets (18) C13 (3) C19 (3) 5-20R/Vertical NA/JP PDU	D9N53A
HPE Metered 3Ph 11kVA/60309 5-wire 16A/230V Outlets (18) C13 (3) C19/Vertical INTL PDU	D9N55A
HPE Metered 7.3kVA/60309 32A 3-wire/230V Outlet (32) C13 (4) C19/Vertical INTL PDU	D9N50A
HPE Metered 3Ph 11kVA/60309 5-wire 16A/230V Outlets (30) C13 (3) C19/Vertical INTL PDU	D9N57A

Additional Options

HPE Metered 3Ph 14.4kVA/CS8365C 40A/208V Outlets (12) C13 (12) C19/Vertical NA/JP PDU	D9N58A
HPE Metered 3Ph 16.6kVA/60309 32A-30A 5-wire 24A/230V Outlets (30) C13 (3) C19/Vertical NA/JP PDU	D9N61A
HPE Metered 3Ph 16.6kVA/60309 32A-30A 5-wire 24A/230V Outlets (12) C13 (12) C19/Vertical NA/JP PDU	D9N62A
HPE Metered 3Ph 17.3kVA/60309 60A 4-wire 48A/208V Outlets (24) C13 (3) C19/Vertical NA/JP PDU	D9N54A
HPE Metered 3Ph 17.3kVA/60309 60A 4-wire 48A/208V Outlets (12) C13 (12) C19/Vertical NA/JP PDU	D9N59A
HPE Metered 3Ph 17.3kVA/60309 60A 4-wire 48A/208V Outlets (12) C13 (12) C19/Vertical NA/JP PDU	G9Z07A
HPE Metered 3Ph 19.9kVA/L22-30P 24A/277V Outlets (30) RF-203P-HP/Vertical NA PDU	D9N63A
HPE Metered 3Ph 22kVA/60309 5-wire 32A/230V Outlet (30) C13 (3) C19/Vertical INTL PDU	D9N56A
HPE Metered 3Ph 22kVA/60309 5-wire 32A/230V Outlets (12) C13 (12) C19/Vertical INTL PDU	D9N60A
HPE Metered 3Ph 22kVA/60309 5-wire WT 32A/230V Outlets (12) C13 (12) C19/Vertical INTL PDU	G9Z08A
HP Environmental Sensor for Remote Monitored and Managed PDUs	E2D53A
NOTE: Please see the HPE Metered Power Distribution Units (PDU) QuickSpecs for information on additional options and product specifications.	
HPE Intelligent Power Distribution Unit (PDU)	
HPE Intelligent Modular 4.9kVA/L6-30P 24A/208V Outlets (6) C19/Horizontal NA/JP PDU	AF520A
HPE Intelligent Modular 8.3kVA/CS8265C 40A/208V Outlets (6) C19/Horizontal NA/JP PDU	AF521A
HPE Intelligent Modular 3Ph 8.6kVA/L15-30P 24A/208V Outlets (6) C19/Horizontal NA/JP PDU	AF522A
HPE Intelligent Modular 3Ph 17.3kVA/60309 60A 4-wire 48A/208V (6) C19/Horizontal NA/JP PDU	AF523A
HPE Intelligent Modular 3Ph 17.3kVA/60309 30A 5-wire 24A/240V (6) C19/Horizontal NA/JP PDU	AF901A
HPE Intelligent Modular 7.3kVA/60309 3-wire 32A/230V Outlets (6) C19/Horizontal INTL PDU	AF525A
HPE Intelligent Modular 3Ph 11kVA/60309 5-wire 16A/230V Outlets (6) C19/Horizontal INTL PDU	AF526A
HPE Intelligent Modular 3Ph 22kVA/60309 5-wire 32A/230V Outlets (6) C19/Horizontal INTL PDU	AF527A
HPE Intelligent Modular 3Ph 17.3kVA/IEC 60309 60A 4-wire 48A/208V (12) C19/Horizontal NA/JP PDU	AF535A
HPE Intelligent Modular 3Ph 22kVA/60309 5-wire 32A/230V Outlets (12) C19/Horizontal INTL PDU	AF538A
HPE Intelligent Modular 4.9kVA/L6-30P 24A/208V Outlets (20) C13 (6) C19/Horizontal NA/JP PDU	AF531A
HPE Intelligent Modular 3Ph 8.6kVA/L15-30P 24A/208V Outlets (20) C13 (6) C19/Horizontal NA/JP PDU	AF532A

Additional Options

HPE Intelligent Modular 3Ph 14.4kVA/CS8365C 40A/208V Outlets (6) C19/Horizontal NA/JP PDU AF533A

HPE Intelligent Modular 7.3kVA/60309 3-wire 32A/230V Outlets (6) C19/Horizontal INTL PDU Kit AF534A

HPE 5xC13 Intelligent PDU Extension Bar G2 Kit AF547A

HPE 5xC13 Outlets Power and UID LEDs Pair Standard Extension Bar AF528A

NOTE: Please see the [HPE Intelligent Power Distribution Unit \(PDU\) QuickSpecs](#)

for information on additional options and product specifications.

HPE Metered and Switched Power Distribution Units (PDU)

HPE Metered Switched 2.8kVA/L5-30P 24A/120V Outlets (24) 5-20R /Vertical NA/JP PDU H8B48A

HPE Metered Switched 3.6kVA/60320 C20 Detachable 16A/230V Outlets (7) C13 (1) C19/Vertical WW PDU H8B49A

HPE Metered Switched 4.9kVA/L6-30P 24A/208V Outlets (20) C13 (4) C19/Vertical NA/JP PDU H8B50A

HPE Metered Switched 7.3kVA/60309 3-wire 32A/230V Outlets (20) C13 (4) C19/Vertical INTL PDU H8B51A

HPE Metered Switched 3Ph 8.6kVA/L15-30P 24A/208V Outlets (18) C13 (6) C19/Vertical NA/JP PDU H8B52A

HPE Metered Switched 3Ph 8.6kVA/L21-30P 24A/208V Outlets (20)C13 (3)C19 (1)5-20R/Vertical NA/JP PDU H8B53A

HPE Metered Switched 3Ph 11kVA/60309 5-wire 16A/230V Outlets (21) C13 (3) C19/Vertical INTL PDU H8B54A

HPE Metered Switched 3Ph 14.4kVA/CS8365C 40A/208V Outlets (12) C13 (12) C19/Vertical NA/JP PDU H8B55A

HPE Metered Switched 3Ph 17.3kVA/60309 4-wire 48A/208V Outlets (12) C13 (12) C19/Vertical NA/JP PDU H8B56A

NOTE: Please see the [HPE Metered and Switched Power Distribution Units \(PDU\) QuickSpecs](#) for information on additional options and product specifications.

NOTE: To learn more, please visit the [HPE Uninterruptible Power Systems \(UPS\) web page](#)

HPE Rack Mount Consoles, KVM Switches, and Keyboards

HPE Location Discovery Services

HPE 42U Location Discovery Kit BW946A

HPE 47U Location Discovery Kit BW947A

HP DL380 Gen9 Location Discovery Services Ear Kit 768884-B21

HPE Location Discovery Services LCD8500 Kit TL052A

NOTE: Please see the [HPE Location Discovery Services QuickSpecs](#) for information on additional options and product specifications.

HPE Rack Mount Consoles

HP LCD8500 1U US Rackmount Console Kit AF630A

HP LCD8500 1U UK Rackmount Console Kit AF631A

HP LCD8500 1U DE Rackmount Console Kit AF632A

HP LCD8500 1U FR Rackmount Console Kit AF633A

Additional Options

HP LCD8500 1U JP Rackmount Console Kit	AF642A
HP LCD8500 1U RU Rackmount Console Kit	AF643A
HP LCD8500 1U INTL Rackmount Console Kit	AF644A
HP LCD8500 1U US TAA Rackmount Console Kit	AF645A

HPE KVM Switches

HP 0x1x8 G3 KVM Console Switch	AF651A
HP 0x2x16 G3 KVM Console Switch	AF652A
HP TAA 0x2x16 G3 KVM Console Switch	AF653A
HP USB Remote Access Key for G3 KVM Console Switches	AF650A
HP KVM Console USB Interface Adapter	AF628A
HP 0x2x16 KVM Server Console Switch G2 with Virtual Media CAC Software	AF618A
HP 0x2x32 KVM Server Console Switch G2 with Virtual Media CAC Software	AF619A
HP KVM Console USB 2.0 Virtual Media CAC Interface Adapter	AF629A
HP 1x4 USB/PS2 KVM Console Switch	AF611A
HP 1x1Ex8 KVM IP Console Switch G2 with Virtual Media CAC Software	AF620A
HP 2x1Ex16 KVM IP Console Switch G2 with Virtual Media CAC Software	AF621A
HP 4x1Ex32 KVM IP Console Switch G2 with Virtual Media CAC Software	AF622A

NOTE: To learn more, please visit the [HPE KVM Switches web page](#).

HPE USB Keyboard and Mouse

HPE USB US Keyboard/Mouse Kit	631341-B21
HPE USB UK Keyboard/Mouse Kit	631344-B21
HPE USB FR Keyboard/Mouse Kit	631346-B21
HPE USB ES Keyboard/Mouse Kit	631348-B21
HPE USB DE Keyboard/Mouse Kit	631358-B21
HPE USB JP Keyboard/Mouse Kit	631360-B21
HPE USB IT Keyboard/Mouse Kit	631362-B21
HPE USB CN Keyboard/Mouse Kit	631364-B21
HPE USB AE Keyboard/Mouse Kit	638212-B21
HPE USB RU Keyboard/Mouse Kit	638214-B21
HPE USB IN Keyboard/Mouse Kit	672097-D63
HPE USB AP/INTL Keyboard/Mouse Kit	672097-373
HPE USB INTL Keyboard/Mouse Kit	672097-B33
HPE USB PT Keyboard/Mouse Kit	672097-133
HPE USB TR Keyboard/Mouse Kit	672097-143
HPE USB CZ Keyboard/Mouse Kit	672097-223
HPE USB FI Keyboard/Mouse Kit	672097-353
HPE USB SE Keyboard/Mouse Kit	672097-103
HPE USB CH Keyboard/Mouse Kit	672097-113
HPE USB KR Keyboard/Mouse Kit	672097-KD3

Rail Kits

NOTE: Gen9 rail kits have changed significantly from prior generation rail kits. Please take a moment to review the installation documentation that comes with the server to help you with the installation of your Gen9 server.

Additional Options

NOTE: Rail kits are optional for DL380 Gen9 and are no longer included standard with the server. Customers have the option to purchase their server without a rail kit.

NOTE: Ball bearing and Easy Install rail kits contain telescoping rails which allow for in-rack serviceability.

NOTE: To assist in the installation of the server into the rack an optional installation tool is available by contacting your local services representative (p/n 695539-001).

CAUTION: Hewlett Packard Enterprise recommends that a minimum of two people are required for all Rack Server installations. Please refer to your installation instructions for proper tools and number of people to use for any installation.

HP 2U Small Form Factor Easy Install Rail Kit 733660-B21

NOTE: Does not include CMA (733664-B21).

HP 2U Large Form Factor Easy Install Rail Kit 733662-B21

NOTE: Does not include CMA (733664-B21).

HP 2U Cable Management Arm for Easy Install Rail Kit 733664-B21

HPE 2U Small Form Factor Ball Bearing Rail Kit 720863-B21

NOTE: Does not include CMA (720865-B21).

HPE 2U Large Form Factor Ball Bearing Rail Kit 720864-B21

NOTE: Does not include CMA (720865-B21).

HPE 2U Cable Management Arm for Ball Bearing Rail Kit 720865-B21

HPE Other Options

HPE Rack LED Light Kit BW939A

HP Kit LCD 1.83m Latch Display Port Cable G7T29A

HPE Uninterruptible Power Systems (UPS) HPE DirectFlow Three Phase UPS

Power Systems (UPS)

Power Unit (1U UPS)

HPE R12000 DirectFlow - 1U Rackmount Uninterruptible Power System G9Y75A

HPE R12000 DirectFlow - POD 1U Rackmount Uninterruptible Power System AF478A

HPE RP12000/3 12000VA Three Phase INTL 6U Rackmount Uninterruptible Power System AF437A

Input/Output Module Options for 1U UPS

HPE 32A 400-415 Volt Three Phase INTL R12000 DirectFlow UPS IEC309 Input/Output Module AF488A

HPE 30A 400-415 Volt Three Phase NA R10000 DirectFlow UPS IEC309 Input/Output Module AF489A

HPE 32A 380 Volt Three Phase China R12000 DirectFlow UPS Unterminated Input/Output Module AF490A

HPE 30A 480 Volt Three Phase NA R12000 DirectFlow UPS L22-30 Input/Output Module AF491A

HPE 30A 480 Volt Three Phase NA R12000 DirectFlow UPS IEC309 Input/Output Module AF492A

HPE 30A 400-415 Volt Three Phase NA R12000 DirectFlow UPS IEC309 Input/Output Module G9Y76A

HPE DirectFlow UPS Management Card AF493A

Power Unit (2U UPS)

HPE R18000 DirectFlow - 2U Rackmount Uninterruptible Power System AF479A

Input/Output Module Options for 2U UPS

Additional Options

HPE 32A 400-415 Volt Three Phase INTL R18000 DirectFlow UPS IEC309 Input/Output Module	AF483A
HPE 30A 380 Volt Three Phase China R18000 DirectFlow UPS Unterminated Input/Output Module	AF485A
HPE 30A 480 Volt Three Phase NA R18000 DirectFlow UPS IEC309 Input/Output Module	AF486A
HPE 30A 480 Volt Three Phase NA R18000 DirectFlow UPS IEC309 Input/Output Module	AF487A
HPE 30A 400 Volt Three Phase NA R18000 DirectFlow UPS IEC309 Input/Output Module	D9Q02A
HPE 30A 400-415V Three Phase NA R18000 DirectFlow UPS 1:1 IEC309 Input/Output Module	AF484A

NOTE: All Input/Output Modules support dual output outlets except the AF484A.

Battery Pack Options

HPE DirectFlow UPS - 1U Rackmount Lithium-ion Battery Pack	AF480A
HPE DirectFlow UPS - 3U Rackmount VRLA Battery Pack	AF482A
HPE WW DirectFlow Secondary Battery Cable	AF497A

NOTE: Please see the [HPE DirectFlow Three Phase Uninterruptible Power System QuickSpecs](#) for information on additional options and product specifications.

HPE Tower UPS

HPE T750 G4 UPS Models

HPE T750 G4 NA/JP Uninterruptible Power System	J2P85A
HPE T750 G4 INTL Uninterruptible Power System	J2P88A

HPE T1000 G4 UPS Models

HPE T1000 G4 NA/JP Uninterruptible Power System	J2P86A
HPE T1000 G4 INTL Uninterruptible Power System	J2P89A

HPE T1500 G4 UPS Models

HPE T1500 G4 NA/JP Uninterruptible Power System	J2P87A
HPE T1500 G4 INTL Uninterruptible Power System	J2P90A

HPE Rack-mountable UPS

HPE R/T2200 G4 UPS Models

HPE R/T2200 G4 NA/JP Uninterruptible Power System	J2R00A
---	--------

HPE R/T3000 G4 UPS Models

HPE R/T3000 G4 Low Voltage NA/JP Uninterruptible Power System	J2R01A
HPE R/T3000 G4 High Voltage NA/JP Uninterruptible Power System	J2R02A
HPE R/T3000 G4 High Voltage INTL Uninterruptible Power System	J2R04A

R1500 G4 Models

HPE R1500 G4 NA Uninterruptible Power System	J2Q99A
HPE R1500 G4 JP/TWN Uninterruptible Power System	J2R05A
HPE R1500 G4 INTL Uninterruptible Power System	J2R03A

R7000 Uninterruptible Power System (UPS)

HPE R7000 4U 50A High Voltage NA/JP Uninterruptible Power System	AF462A
HPE R7000 4U IEC-32A High Voltage INTL Uninterruptible Power System	AF463A

R5000 Uninterruptible Power System (UPS)

Additional Options

HPE R5000 3U L630 High Voltage NA/JP Uninterruptible Power System	AF460A
HPE R5000 3U IEC309-32A High Voltage INTL Uninterruptible Power System	AF461A

NOTE: Please see the [HPE Line Interactive Single Phase UPS QuickSpecs](#) for information on additional options and product specifications.

HPE UPS Options

HPE R/T2200 G4 Extended Runtime Module	J2R09A
HPE R/T3000 G4 Extended Runtime Module	J2R10A
HPE 2U Rack/Tower UPS Shipping Kit	L4Q11A

NOTE: To learn more, please visit the [HPE Uninterruptible Power Systems \(UPS\) web page](#).

HPE USB and SD Options

HPE Enterprise Mainstream Flash Media Kits for Memory Cards

HPE 32GB microSD Mainstream Flash Media Kit	700139-B21
HPE 8GB microSD Enterprise Mainstream Flash Media Kit	726116-B21
HPE 8GB USB Enterprise Mainstream Flash Media Drive Key Kit	737953-B21
HPE Dual 8GB microSD Enterprise Midline USB Kit	741279-B21

HPE Support Services

Installation & Start-up Services

HPE Install ProLiant DL38x(p) Service	U4554E
HPE Installation and Startup DL38x(p) Service	U4555E

Proactive Care

HPE 3 year Proactive Care 24x7 DL380 Gen9 w/IC Service	U5HW1E
HPE 3 year Proactive Care 24x7 with DMR DL380 Gen9 w/IC Service	U5HW2E
HPE 3 year Proactive Care 24x7 with CDMR DL380 Gen9 w/IC Service	U5HW3E
HPE 3 year Proactive Care Call to Repair DL380 Gen9 w/IC Service	U5HX0E
HPE 3 year Proactive Care Call to Repair 24x7 with DMR DL380 Gen9 w/IC Service	U5HX1E
HPE 3 year Proactive Care Call to Repair with CDMR DL380 Gen9 w/IC Service	U5HX2E
HPE 3 year Proactive Care 24x7 DL380 Gen9 Service	U7AE8E
HPE 3 year Proactive Care 24x7 with DMR DL380 Gen9 Service	U7AE9E
HPE 3 year Proactive Care 24x7 with CDMR DL380 Gen9 Service	U7AF0E
HPE 3 year Proactive Care Call to Repair DL380 Gen9 Service	U7AF4E
HPE 3 year Proactive Care Call to Repair 24x7 with DMR DL380 Gen9 Service	U7AF5E
HPE 3 year Proactive Care Call to Repair with CDMR DL380 Gen9 Service	U7AF6E

Memory

Memory Population guidelines

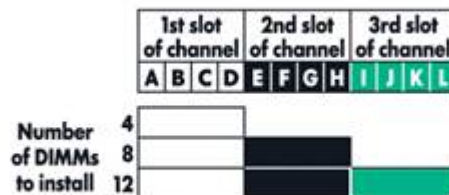
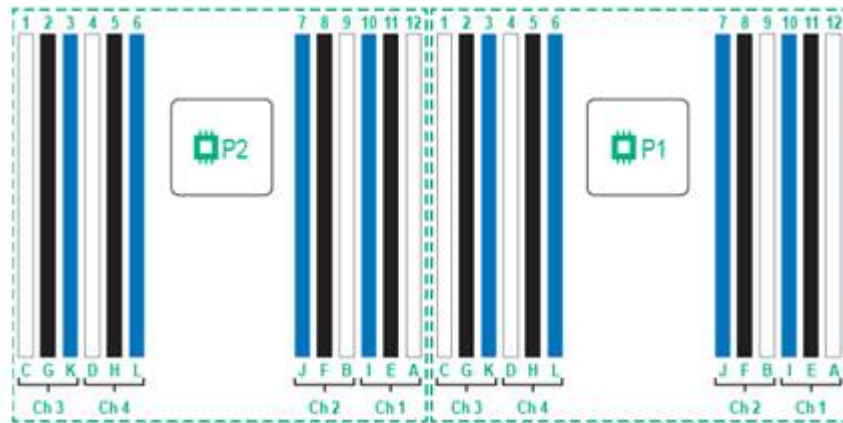

General Memory Population Rules and Guidelines:

- White DIMM slots denote the first slot of a channel. For 1 DPC (DIMM per channel) populate white slots only.
- A minimum of one DIMM is required per server.
- Install DIMMs only if the corresponding processor is installed.
- If only one processor is installed in a two processor system, only half of the DIMM slots are available.
- To maximize performance, it is recommended to balance the total memory capacity between all installed processors and to load the channels similarly whenever possible.
- When two processors are installed, balance the DIMMs across the two processors.
- Populate DIMMs from heaviest load (quad-rank) to lightest load (single-rank) within a channel. Heaviest load (DIMM with most ranks) within a channel goes furthest from the processor.
- Do not mix RDIMMs or LRDIMMs.
- LRDIMMs are supported up to 3 DIMMs per channel.
- DIMMs of different speeds may be mixed in any order; the server will select a common optimal speed.
- The maximum memory speed is a function of the memory type, memory configuration, and processor model.
- The maximum memory capacity is a function of the memory type and number of installed processors.
- HPE memory from previous generation servers is not compatible with the DL380 Gen9 Server. Certain HPE SmartMemory features such as memory authentication and enhanced performance may not be supported.
- To realize the performance memory capabilities listed in this document, HPE SmartMemory is required. For additional information, please see the HPE SmartMemory QuickSpecs at: <https://www.hpe.com/h20195/v2/GetHTML.aspx?docname=c04111535>.

Memory

- . For memory population rules and additional memory guidelines, please see the DL380 Gen9 user guide at <http://www.hpe.com/support>.
- . There are four (4) Memory channels per processor; eight (8) channels per 2 processor server.
- . There are three (3) DIMM slots for each memory channel; twenty four (24) total slots for 2 processor server.
- . Memory channels1 and 3 consists of the three (3) DIMMs that are furthest from the processor.
- . Memory channel 2 and 4 consists of the three (3) DIMMs that are closest to the processor.

Intel Gen9 Supported Memory Bandwidth for HPE ProLiant Gen9 Intel® Xeon® E5-2600v3 Series Processor Family

Memory Bandwidth and Capacity								
[DIMM Type]	Registered DIMMs (RDIMMs)					Load Reduced (LRDIMMs)		
HPE SKU P/N	726717-B21	726718-B21	759934-B21	726719-B21	728629-B21	726720-B21	726722-B21	726724-B21
DIMM Rank	Single Rank	Single Rank	Dual Rank	Dual Rank	Dual Rank	Dual Rank	Quad Rank	Quad Rank
DIMM Capacity	4GB	8GB	8GB	16GB	32GB	16GB	32GB	64GB
Voltage	Std Voltage 1.2V	Std Voltage 1.2V	Std Voltage 1.2V	Std Voltage 1.2V	Std Voltage 1.2V	Std Voltage 1.2V	Std Voltage 1.2V	Std Voltage 1.2V
DRAM Depth [bit]	512M	1G	512M	1G	1G	2G	2G	2G
DRAM Width [bit]	x8	x4	x8	x4	x4	x4	x4	x4
DRAM Density	4Gb	4Gb	4Gb	4Gb	4Gb	8Gb	8Gb	8Gb
CAS Latency	15-15-15	15-15-15	15-15-15	15-15-15	15-15-15	15-15-15	15-15-15	15-15-15
DIMM Native Speed (MT/s)	2133	2133	2133	2133	2133	2133	2133	2133
SLOTS THAT CAN BE POPULATED								
24 slot servers	24	24	24	24	24	24	24	24
MAXIMUM CAPACITY (GB)								
	96	192	192	384	768	384	768	1536
POPULATED DIMM SPEED (MT/s)								
1 DIMM Per Channel	2133	2133	2133	2133	2133	2133	2133	2133
2 DIMM Per Channel	2133	2133	2133	2133	2133	2133	2133	2133
3 DIMM Per Channel	1600	1600	1600	1600	1600	1866	1866	1866

Memory

Intel Gen9 Supported Memory Bandwidth for HPE ProLiant Gen9 Intel® Xeon® E5-2600v4 Series Processor Family

Memory Bandwidth and Capacity							
[DIMM Type]	Registered DIMMs (RDIMMs)				Load Reduced (LRDIMMs)		
HPE SKU P/N	805347-B21	805349-B21	836220-B21	805351-B21	805353-B21	805358-B21	809208-B21
DIMM Rank	Single Rank	Single Rank	Dual Rank	Dual Rank	Dual Rank	Quad Rank	Octal Rank
DIMM Capacity	8GB	16GB	16GB	32GB	32GB	64GB	128GB
Voltage	Std Voltage 1.2V	Std Voltage 1.2V	Std Voltage 1.2V	Std Voltage 1.2V	Std Voltage 1.2V	Std Voltage 1.2V	Std Voltage 1.2V
DRAM Depth [bit]	1G	2G	1G	2G	2G	2G	2G
DRAM Width [bit]	x8	x4	x4	x4	x4	x4	x4
DRAM Density	8Gb	8Gb	4Gb	8Gb	8Gb	8Gb	8Gb
CAS Latency	17-17-17	17-17-17	17-17-17	17-17-17	17-17-17	17-17-17	20-18-18
DIMM Native Speed (MT/s)	2400	2400	2400	2400	2400	2400	2400
SLOTS THAT CAN BE POPULATED							
24 slot servers	24	24	24	24	24	24	24
MAXIMUM CAPACITY (GB)							
	192	384	384	768	768	1536	3072
POPULATED DIMM SPEED (MT/s)							
1 DIMM Per Channel	2400	2400	2400	2400	2400	2400	2400
2 DIMM Per Channel	2133	2133	2400	2400	2400	2400	2400
3 DIMM Per Channel	1866	1866	1866	1866	2400	2400	2400

NOTE: Mixing the 128GB LRDIMM with other capacities is not supported.

Memory

Memory Speed by Processor Model	Processor Models	Supported Memory Speeds
	E5-2609v3, E5-2603v3	1600MT/s
	E5-2630Lv3, E5-2640v3, E5-2630v3, E5-2623v3, E5-2620v3	1866MT/s
	E5-2637v3, E5-2687Wv3, E5-2699v3, E5-2698v3, E5-2697v3, E5-2695v3, E5-2690v3, E5-2683v3, E5-2680v3, E5-2670v3, E5-2660v3, E5-2650Lv3, E5-2650v3, E5-2667v3, E5-2643v3	2133MT/s
	E5-2609v4, E5-2603v4	1866MT/s
	E5-2630Lv4, E5-2623v4, E5-2620v4, E5-2640v4, E5-2630v4	2133MT/s
	E5-2650Lv4, E5-2643v4, E5-2637v4, E5-2687Wv4, E5-2699v4, E5-2698v4, E5-2697v4, E5-2697Av4, E5-2695v4, E5-2690v4, E5-2683v4, E5-2680v4, E5-2660v4, E5-2650v4, E5-2667v4, E5-2699Av4	2400MT/s

Standard and Maximum Memory Capacity (Pre-configured Models)	Pre Configured Models	Standard Memory	Maximum Memory Plus Optional Memory	Standard Memory Replaced with Optional Memory
	E5-2690v3, E5-2650v3	32GB (2x16GB)	736GB (22x32GB, 2x16GB)	1536GB (24x64GB)
	E5-2660v4	64GB (4x16GB)	704GB (20x32GB, 4x16GB)	3072GB (24x128GB)
	E5-2650v4	32GB (2x16GB)	736GB (22x32GB, 2x16GB)	3072GB (24x128GB)
	E5-2630v4, E5-2620v4	16GB (1x16GB)	752GB (23x32GB, 1x16GB)	3072GB (24x128GB)
	E5-2620v3	16GB (1x16GB)	752GB (23x32GB, 1x16GB)	1536GB (24x64GB)
	E5-2609v4	8GB (1x8GB)	744GB (23x32GB, 1x8GB)	3072GB (24x128GB)
	E5-2609v3	8GB (1x8GB)	744GB (23x32GB, 1x8GB)	1536GB (24x64GB)

DDR4 memory options part number decoder

NOTE: Capacity references are rounded to the common gigabyte (GB) values.

- 4GB = 4,096MB
- 8GB = 8,192MB
- 16GB = 16,384MB
- 32GB = 32,768MB
- 64GB = 65,536MB
- 128GB = 13,072MB

Memory

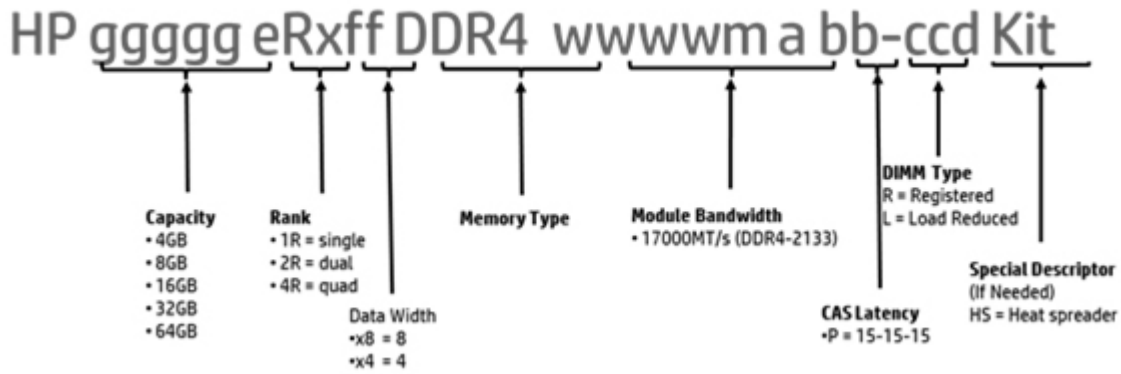

Storage

4 LFF hot-plug drive model

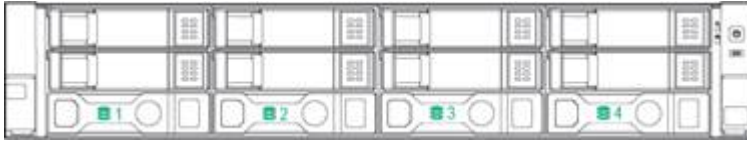

- 1-4 4 x LFF SATA/SAS/SSD Hot Pluggable Hard Drive Bays

12 LFF + 3 rear LFF hot-plug drive model

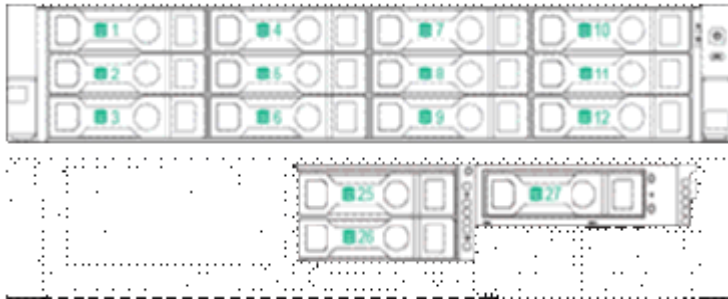

- 1-12 12 x LFF SATA/SAS/SSD Hot Pluggable Hard Drive Bays
- 25-27 3 x LFF SATA/SAS/SSD Hot Pluggable Rear Hard Drive Bays

12 LFF + 2 rear SFF hot-plug drive model

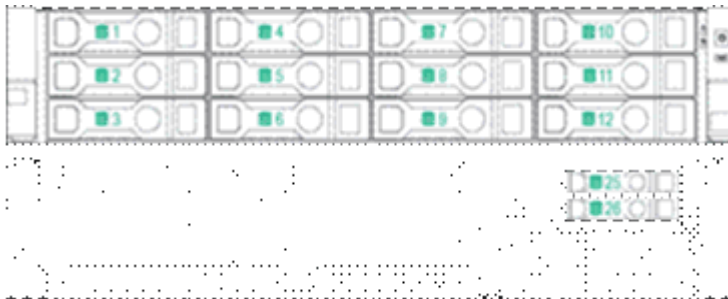

- 1-12 12 x LFF SATA/SAS/SDD Hot Pluggable Hard Drive Bays
- 25-26 2 x SFF SATA/SAS/SSD Hot Pluggable Rear Hard Drive Bays

8 SFF (+2 SFF) hot-plug drive model with Universal Media Bay

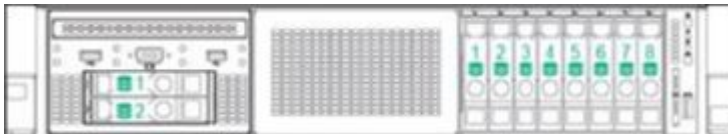

- 1-8 8 x SFF SATA/SAS/SDD Hot Pluggable Hard drive bays
- 1-2 2 x SFF SATA/SAS/SSD Hot Pluggable Hard Drive Bays

16 SFF (+2 SFF) hot-plug drive model with Universal Media Bay



- 9-24 16 x SFF SATA/SAS/SDD Hot Pluggable Hard drive bays
- 1-2 2 x SFF SATA/SAS/SSD Hot Pluggable Hard Drive Bays

Storage

24 SFF + rear 2 SFF hot-plug drive model



1-24 24 x SFF SATA/SAS/SDD Hot Pluggable Hard drive bays

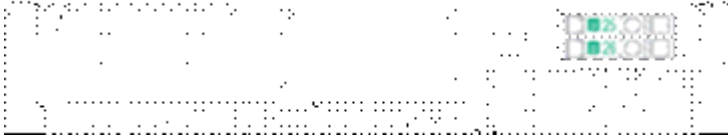

25-26 2 x SFF SATA/SAS/SSD Hot Pluggable Rear Hard Drive Bays

NOTE: Drives behind the SAS expander will be labeled continuous, drives behind a controller will be numbered 1-8.

NOTE: With a SAS Expander and rear drive support the 2SFF rear will be labeled 25 & 26, for 3LFF they will be numbered 25-27.

Technical Specifications

System Unit	Dimensions	SFF Drives: 3.44 x 17.54 x 26.75 in (8.73 x 44.55 x 67.94 cm) LFF Drives: 3.44 x 17.54 x 28.75 in (8.73 x 44.55 x 73.02 cm)
	Weight (approximate)	Minimum: 32.6 lb (14.759 kg) (Minimum - 8SFF chassis with 1xSFF HDD and 7 HDD blanks, 1x processor, 1x power supply (plus blank), 1x Flexible Smart Array, 1x Riser installed) Maximum: 51.5 lb (23.6 kg) (Maximum - 12 LFF hard drives (No rear drives), 2x processors, 2x power supplies, 1x Flexible Smart Array, 2x Risers installed)
	Input Requirements (per power supply)	Rated Line Voltage 100 to 120 VAC 200 to 240 VAC
	BTU Rating	Maximum For 800W Power Supply: 3207 BTU/hr (at 100 VAC), 3071 BTU/hr (at 200 VAC), 3112 BTU/hr (at 240 VAC) for China Only For 500W Power Supply: 1979 BTU/hr (at 100 VAC), 1911 BTU/hr (at 200 VAC), 1965 BTU/hr (at 240 VAC) for China Only
	Power Supply Output (per power supply)	Rated Steady-State Power For 1400W Power Supply: 1400W (at 240 VAC), 1400W (at 240 VAC) For 800W Power Supply: 800W (at 100 VAC), 800W (at 240 VAC), 800W (at 240 VAC) input for China only For 500W Power Supply: 500W (at 100 VAC), 500W (at 240 VAC), 500W (at 240 VAC) input for China only Maximum Peak Power For 1400W Power Supply: 1400W (at 200 to 240 1VAC), 1400W (at 240 VAC) input for China only For 800W Power Supply: 800W (at 100 to 127 VAC), 800W (at 200 to 240 1VAC), 800W (at 240 VAC) input for China only For 500W Power Supply: 500W (at 100 to 127 VAC), 500W (at 200 to 240 VAC), 500W (at 240 VAC) input for China only
	System Inlet Temperature	Standard Operating Support 10° to 35°C (50° to 95°F) at sea level with an altitude derating of 1.0°C per every 305 m (1.8°F per every 1000 ft) above sea level to a maximum of 3050 m (10,000 ft), no direct sustained sunlight. Maximum rate of change is 20°C/hr (36°F/hr). The upper limit and rate of change may be limited by the

Technical Specifications

		<p>type and number of options installed. System performance during standard operating support may be reduced if operating with a fan fault or above 30°C (86°F).</p>
	Extended Ambient Operating Support	<p>For approved hardware configurations, the supported system inlet range is extended to be: 5° to 10°C (41° to 50°F) and 35° to 40°C (95° to 104°F) at sea level with an altitude derating of 1.0°C per every 175 m (1.8°F per every 574 ft) above 900 m (2953 ft) to a maximum of 3050 m (10,000 ft). The approved hardware configurations for this system are listed at the URL: http://www.hpe.com/servers/ashrae</p>
		<p>For approved hardware configurations, the supported system inlet range is extended to be: 40° to 45°C (104° to 113°F) at sea level with an altitude derating of 1.0°C per every 125 m (1.8°F per every 410 ft) above 900 m (2953 ft) to a maximum of 3050 m (10,000 ft). The approved hardware configurations for this system are listed at the URL: http://www.hpe.com/servers/ashrae</p>
		<p>System performance may be reduced if operating in the extended ambient operating range or with a fan fault.</p>
Relative Humidity	Non-operating	-30° to 60°C (-22° to 140°F). Maximum rate of change is 20°C/hr (36°F/hr).
	Operating	Minimum to be the higher (more moisture) of -12°C (10.4°F) dew point or 8% relative humidity. Maximum to be the lower (less moisture) of 24°C (75.2°F) dew point or 90% relative humidity.
(non-condensing)	Non-operating	5 to 95% relative humidity (Rh), 38.7°C (101.7°F) maximum wet bulb temperature, non-condensing.
Altitude	Operating	3050 m (10,000 ft). This value may be limited by the type and number of options installed. Maximum allowable altitude change rate is 457 m/min (1500 ft/min).
	Non-operating	9144 m (30,000 ft). Maximum allowable altitude change rate is 457 m/min (1500 ft/min).
Acoustic Noise		Listed are the declared A-Weighted sound power levels (LWAd) and declared average bystander position A-Weighted sound pressure levels (LpAm) when the product is operating in a 23°C ambient environment. Noise emissions were measured in accordance with ISO 7779 (ECMA 74) and declared in accordance with ISO 9296 (ECMA 109).

Technical Specifications

Idle

LWAd	4.0 B Entry LFF
	4.1 B Entry
	4.2 B Base
	5.7 B Base LFF
	4.3 B Perf
LpAm	23 dBA Entry LFF
	24 dBA Entry
	24 dBA Base
	39 dBA Base LFF
	25 dBA Perf

Operating

LWAd	4.3 B Entry LFF
	4.6 B Entry
	4.8 B Base
	5.9 B Base LFF
	5.6 B Perf
LpAm	25 dBA Entry LFF
	29 dBA Entry
	30 dBA Base
	31 dBA Base LFF
	39 dBA Perf

NOTE: The Listed sound levels apply to standard shipping configurations (Entry LFF, Entry, Base, Base LFF and Performance models) additional options may result in increased sound levels. The Base LFF model leverages our High Efficiency Fans, other models are shipping with standard fan options.

Emissions Classification (EMC)

FCC Rating	Class A
Normative Standards	CISPR 22; EN55022; EN55024; FCC CFR 47, Pt 15; ICES-003; CNS13438; GB9254; K22;K24; EN 61000-3-2; EN 61000-3-3; EN 60950-1; IEC 60950-1

NOTE: Product conformance to cited product specifications is based on sample (type) testing, evaluation, or assessment. This product or family of products is eligible to bear the appropriate compliance logos and statements.

NOTE: The Listed sound levels apply to standard shipping configurations. Additional options may result in increased sound levels.

HPE Dynamic Smart Array B140i Controller	Number of PCI links	Four
	PCI link rate	4Gb/s
	Storage protocol support	SATA
	SAS/SATA peak data transfer rate	6Gb/s

Technical Specifications

Number of SAS/SATA links	10 links
SAS/SATA connectivity	2x4 connectors; 2x1 connectors
Expander support	No
Drives supported (max)	Up to 10 Internal Drives
RAID support	0, 1, 10, 5 SATA
Software management	HPE SSA, SMH, SIM
Warranty	Server warranty
HPE Secure Encryption license	Not Supported
HPE SmartCache License	Not Supported
HPE Smart Storage Administrator	Supported

HPE Ethernet 1Gb 4-port 331i Adapter	Network Interface	10Base-T/100Base-TX/1000Base-TX	
	Compatibility	IEEE 802.3 10Base-T IEEE 802.3ab 1000Base-T IEEE 802.3u 100Base-TX	
	Data Transfer Method	PCI Express, two lanes (x2)	
	Controller	BCM5719	
	Network Transfer Rate	10Base-T (Half-Duplex)	10 Mb/s per port, 40 Mb/s combined
		10Base-T (Full-Duplex)	20 Mb/s per port, 80 Mb/s combined
		100Base-TX (Half-Duplex)	100 Mb/s per port, 400 Mb/s combined
		100Base-TX (Full-Duplex)	200 Mb/s per port, 800 Mb/s combined
		1000Base-TX (Half and Full-Duplex)	1000 Mb/s per port, 4000 Mb/s combined
	Connector	1000Base-TX (Full-Duplex)	2000 Mb/s per port, 8000 Mb/s combined
Cable Support		Four RJ-45	
		10 Base-T Categories 3, 4 or 5 UTP; up to 328 ft (100 m)	
		10/100/1000 Base-TX Category 5 or higher UTP; up to 328 ft (100 m)	

Environment-friendly Products and Approach	End-of-life Management and Recycling	Hewlett Packard Enterprise offers end-of-life product return, trade-in, and recycling programs, in many geographic areas, for our products. Products returned to Hewlett Packard Enterprise will be recycled, recovered or disposed of in a responsible manner.
---	---	---

<http://www.hpe.com/recycle>

The EU WEEE directive (2002/95/EC) requires manufacturers to

Technical Specifications

provide treatment information for each product type for use by treatment facilities. This information (product disassembly instructions) is posted on the Hewlett Packard Enterprise web site. These instructions may be used by recyclers and other WEEE treatment facilities as well as Hewlett Packard Enterprise OEM customers who integrate and re-sell Hewlett Packard Enterprise equipment.

<http://www.hpe.com/recycle>

Summary of Changes

Date	Version History	Action	Description of Change
4-Dec-2017	From Version 34 to 35	Added	Added new higher capacity LFF and SSD drives.
		Changed	Maximum Internal Storage and Additional Options were revised.
		Removed	Obsolete SKUs were removed from the QuickSpecs.
25-Sep-2017	From Version 33 to 34	Added	Added new Solid State Drives offering to the HPE Drives section. Added new PCIe Accelerators options. Added new InfiniBand option.
		Changed	Core Options and Additional Options were revised.
		Removed	Obsolete SKUs were removed from the QuickSpecs.
7-Aug-2017	From Version 32 to 33	Added	Added new Solid State Drives offering to the HPE Drives section.
11-Jul-2017	From Version 31 to 32	Added	Added new NVIDIA Tesla GPUs.
		Changed	HPE Power Supplies section was revised.
5-Jun-2017	From Version 30 to 31	Added	Added new Solid State Drives offering to the HPE Drives section. Added new GPU option.
8-May-2017	From Version 29 to 30	Added	Support for ClearOS was added under Operating Systems and Virtualization Software Support for ProLiant Servers and Optional Features sections. Added new HPE Computation and Graphics Accelerators options.
		Changed	HPE Unique Options section was revised.
		Removed	Obsolete SKUs were removed from the QuickSpecs.
3-Apr-2017	From Version 28 to 29	Changed	Smart Buy models section was revised for the NA version only.
27-Mar-2017	From Version 27 to 28	Added	Added new Hard Drives and new HPE Networking option.
		Changed	Base Configuration, HPE Unique Options, HPE Computation and Graphics Accelerators, and HPE Storage Options were revised.
17-Feb-2017	From Version 26 to 27	Changed	HPE Memory section under Core Options was revised.
13-Feb-2017	From Version 25 to 26	Added	Added new HDD and SSD offering to HPE Drives section.
		Changed	Processors and Memory under Standard Features were revised. Storage Software, HPE Unique Options, HPE Processors, and HPE Memory were revised.

Summary of Changes

16-Dec-2016	From Version 24 to 25	Added	Availability note was added to the HPE Drives section.
		Changed	Overview, Storage Software, and HPE Computation and Graphics Accelerators were revised.
28-Nov-2016	From Version 23 to 24	Added	Added new NVIDIA Tesla M10 and P100 cards new Virtualization and High-End General Compute GPU offering. Added new LFF HDDs up to 10TB capacity now bring the DL380 max storage capacity to 150TB SAS. Added new Fiber Channel HBA's up to 32Gb. Added new E5-2699Av4 processor.
		Changed	Processors, Memory, Maximum Internal Storage, HPE Drives, HPE Computation and Graphics Accelerators, and HPE Storage Options were revised.
		Removed	Obsolete SKUs were removed from the QuickSpecs.
28-Oct-2016	From Version 22 to 23	Removed	Obsolete Hard Drives were removed from the QuickSpecs.
26-Sep-2016	From Version 21 to 22	Added	Added new NVIDIA Tesla M4/M40 GPUs and new 10TB LFF hard drives offering.
		Changed	Memory, Maximum Internal Storage, HPE Computation and Graphics Accelerators, and HPE Storage Options were revised.
		Removed	Obsolete SKUs were removed from the QuickSpecs.
19-Aug-2016	From Version 20 to 21	Changed	Smart Buy models section was revised for the NA version only.
15-Aug-2016	From Version 19 to 20	Added	Added new options to HPE Networking, HPE Infiniband, HPE Computation and Graphics Accelerators, HPE Disk Backup, and HPE Storage Options.
		Changed	HPE Unique Options was revised.
		Removed	Obsolete SKUs were removed from the QuickSpecs.
8-Jul-2016	From Version 18 to 19	Changed	Smart Buy models section was revised for the NA version only.
6-Jun-2016	From Version 17 to 18	Added	Added new 25GbE networking options, OneView 3.0, and new NVIDIA Quadro GPU options.
		Changed	Pre-configured Models, HPE Memory, HPE Drives, HPE Computation and Graphics Accelerators, HPE Disk Backup, and HPE Storage Options were updated.
29-Apr-2016	From Version 16 to 17	Changed	E5-2600v4 Series Smart Buy Models table was updated in the NA version only.

Summary of Changes

1-Apr-2016	From Version 15 to 16	Changed	What's New section was updated. Standard Features/Memory and HPE Memory sections were revised.
31-Mar-2016	From Version 14 to 15	Added	Added new Smart Memory DDR4 2400MHz, Intel Xeon E5-2600v4 processor support, new Flexible Smart Array P840ar controller, new graphic options, new HPE Trusted Platform Module (TPM) 2.0, new HDD offering.
		Changed	Embedded Management, Service and Support, Preconfigured Models, HPE Security, and Memory sections were revised.
		Removed	Obsolete SKUs were removed from the QuickSpecs.
16-Feb-2016	From Version 13 to 14	Added	New HDD offering was added to HPE Drives.
		Changed	HPE Computation and Graphics Accelerators, HPE Data Center Racks, and HPE Power Distribution Units (PDUs) were revised.
		Removed	Obsolete SKUs were removed from the QuickSpecs.
17-Dec-2015	From Version 12 to 13	Changed	Smart Buy models section was revised in the NA version only.
1-Dec-2015	From Version 11 to 12	Added	New HDD offering was added to HPE Drives. New options added to Graphics Options, HPE PCIe Workload Accelerator Options, and HPE Tape Backup.
		Changed	On System Management Chipset, Maximum Internal Storage, Embedded Management, and Server utilities were revised. Product images were updated.
		Removed	Obsolete SKUs were removed from the QuickSpecs.
28-Sep-2015	From Version 10 to 11	Added	Added new 6Gb SATA Solid State Drives. Added new HPE OneView management software.
		Changed	Maximum Internal Storage was revised.
		Removed	Obsolete SKUs were removed from the QuickSpecs.
17-Aug-2015	From Version 9 to 10	Added	Added new Solid State Drives offering. Added new graphic options.
		Changed	What's New changed to: New support for NVMe PCIe SSDs New Graphic card options Service and Support section was updated.

Summary of Changes

			Maximun Internal Storage and Core Options were revised.
		Removed	Obsolete SKUs were removed from the QuickSpecs.
1-Jun-2015	From Version 8 to 9	Added	New larger capacity HDDs (up to 8TB LFF), Max capacity 120TB were added. New higher capacity memory (64GB), Max capacity 1.5TB was added. New Networking options were added. Optional Software added to HPE Storage Controllers.
		Changed	Updated max HDD and memory capacity due to new options added. HPE SmartCache Software, HPE Disk Backup System, HPE Uninterruptible Power Systems (UPS) were updated.
30-Mar-2015	From Version 7 to 8	Added	New Hard Drives offering. Optical Software added to HPE Storage Controllers. Added new HPE Pointnext operational services. Added new HPE PCIe Workload Accelerator Options.
		Changed	What's New, Standard Features, Unique Options, Power Supplies, HPE Storage Controllers, HPE Disk Storage Systems, and Technical Specifications were revised.
		Removed	Removed obsolete HPE Pointnext operational services.
17-Feb-2015	From Version 6 to 7	Added	Added Smart Buy Models to the NA version only.
9-Feb-2015	From Version 5 to 6	Added	What's new section was added. Added new HDD offering, new computational Graphics options, and new G4 UPS models.
		Changed	HPE Drives, HPE Computation and Graphics Accelerators, HPE Tape Backup, HPE Disk Backup, HPE Rack Mount, Consoles, KVM Switches, and Keyboards, and HPE Uninterruptible Power Systems (UPS) sections were revised.
1-Dec-2014	From Version 4 to 5	Changed	Changes made throughout the entire QuickSpecs.
13-Oct-2014	From Version 3 to 4	Changed	Corrected inconsistencies between Product Bulletin and Concentra versions.
13-Oct-2014	From Version 2 to 3	Added	6G SATA Enterprise Value G1 Solid State Drives were added to Core Option section.

Summary of Changes

			HPE PCIe Workload Accelerator Options, HPE USB and SD options, and HPE Pointnext operational services were added to the Additional Options section.
		Changed	Standard Features, Optional Features, Pre-Configured Models, Configuration Information - Factory Integrated Models, Core Options, Additional Options, and Memory sections were revised.
19-Sep-2014	From Version 1 to 2	Changed	Changes were made throughout the QuickSpecs.

