

Overview

HPE ProLiant DL580 Generation9 (Gen9)

The HPE ProLiant DL580 Gen9 Server is the Hewlett Packard Enterprise four socket (4S) enterprise standard x86 server offering commanding performance, rock-solid reliability and availability, and compelling consolidation and virtualization efficiencies.

Supporting Intel® Xeon® E7-4800/8800 v4/v3 processors, the HPE DL580 Gen9 offers enhanced processor performance, up to 6 TBs of memory, greater IO bandwidth (9 PCIe Gen3.0 slots), and 12 Gb/s of SAS speeds. HPE ProLiant DL580 Gen9 has security and data protection features for system resiliency that your business can depend on. All, making it ideal for mission-critical enterprise, business intelligence, and database applications.

Whether needed for highly virtualized or cloud based deployments, with intelligence and simplicity of automated management with HPE OneView and HPE iLO 4 your business can achieve agile and lower cost infrastructure management.

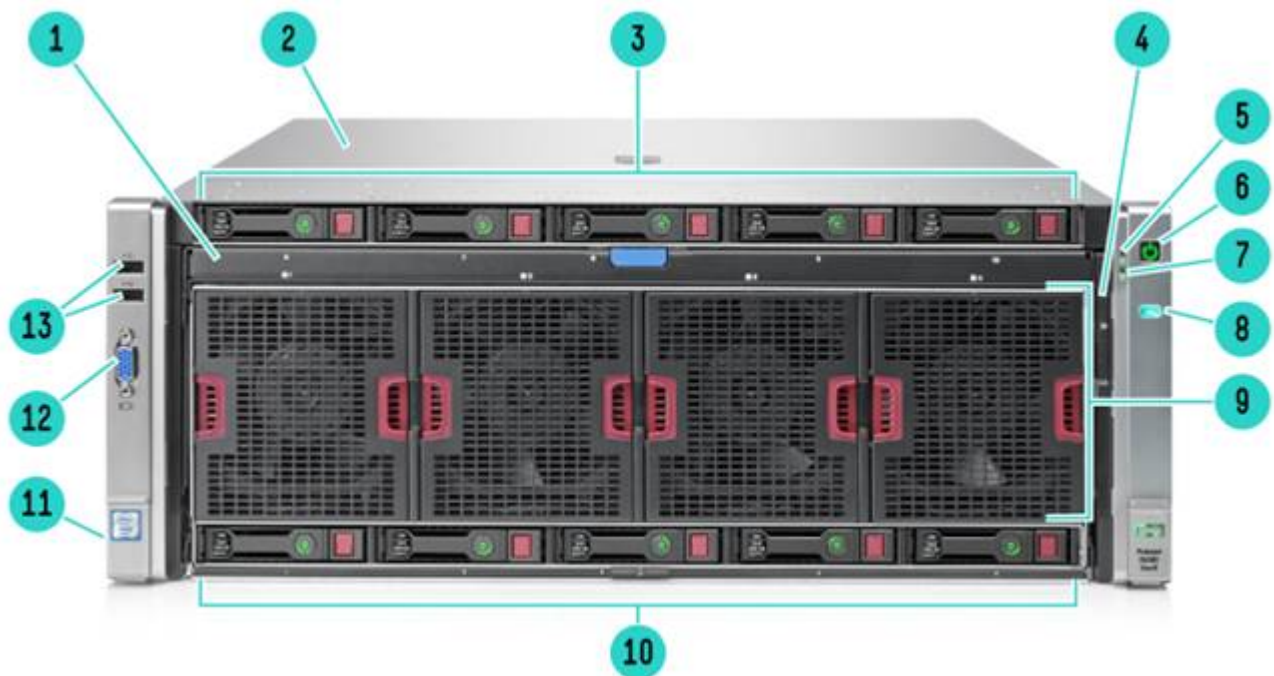

Front View

1. CPU Memory Drawer Handle
2. Quick removal access panel
3. Drive bays 6-10
NOTE: Drives installed in these bays require the optional SAS backplane and cables.
NOTE: Optional NVMe drives are only supported in Drive bays 6-10.
4. Systems Insight Display
5. Health Status LED
6. Power On/Standby button and system power LED button
7. NIC status LED
8. UID button
9. Fans 1-4
10. Drive bays 1-5
11. Discovery services connectors
12. Video connector
13. USB connectors (2)

Overview

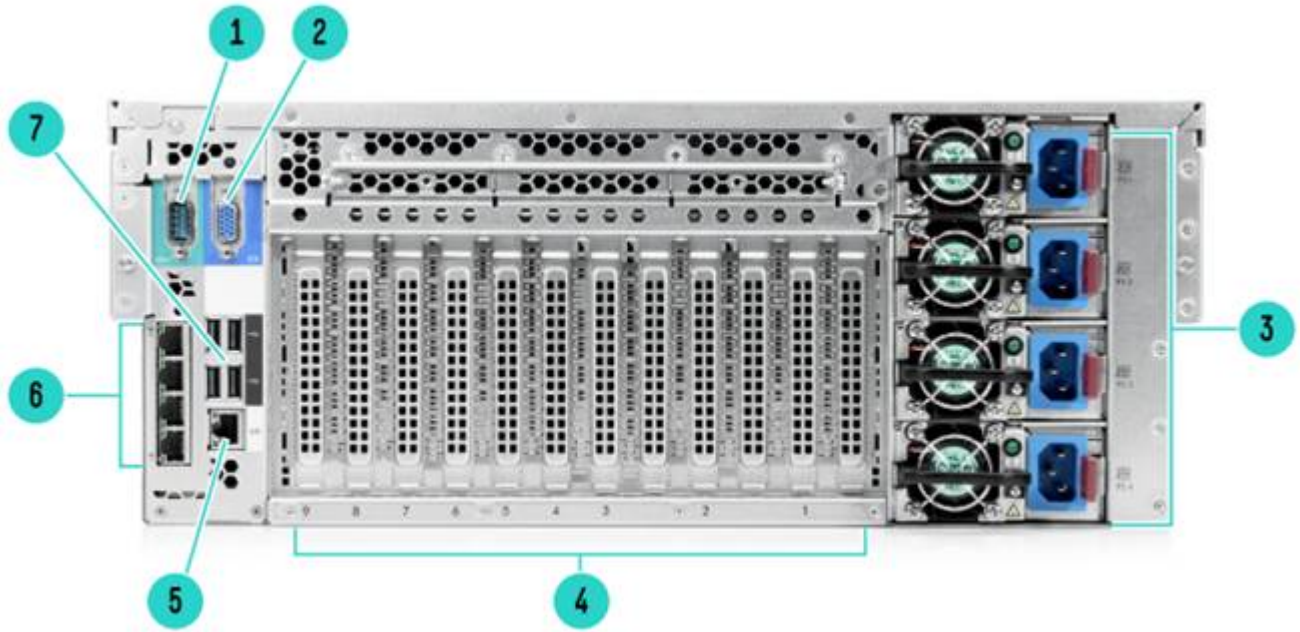

Rear View

- 1. Serial connector
- 3. Power Supplies 1-4
- 5. Dedicated iLO connector
- 7. USB connectors (4)

- 2. Video connector
- 4. PCI expansion slots 1-9
- 6. FlexibleLOM ports 1-4

NOTE: Port configuration is dependent on the installed FlexibleLOM and may differ from what is shown in the illustration.

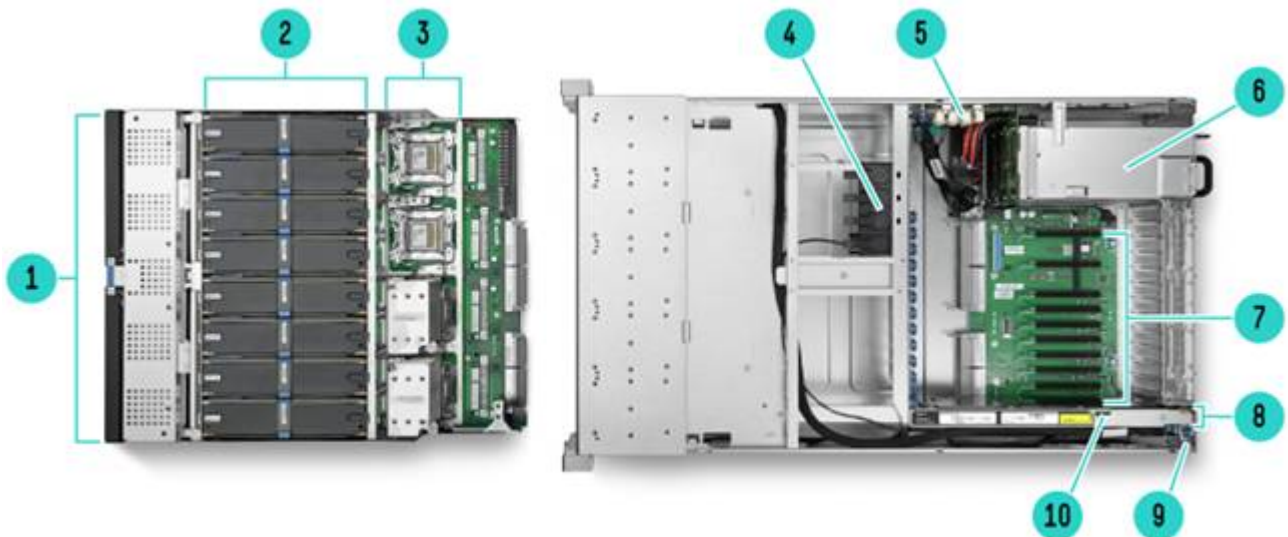

Internal View

Overview

1. CPU Memory Drawer
2. Memory Cartridges 1-8
3. Processors 1-4
4. FBWC capacitor slots 1-4
5. I/O Card Auxiliary Power Connectors
6. Power Supplies
7. PCI expansion slots 1-9
8. FlexibleLOM connector
9. SPI board (houses iLO chip, FBWC, microSD slot, 2x USB slots, TPM, top SAS backplane connector)
10. MicroSD Slot

What's New

- New Fiber Channel HBA's up to 32GB
- HPE NVIDIA Quadro M6000 24GB GPU
- HPE NVIDIA Tesla M60 RAF Dual GPU Module
- HPE Dual 8GB microSD USB Kit for redundancy in boot environments
- New 100Gb Omnipath networking card

Standard Features

NOTE: For more information regarding Intel Xeon processors, please see the following <http://www.intel.com/xeon>.

Processor	Model	CPU frequency	Cores	L3 Cache	Power	QPI	DDR4 Hz
One or more of the following depending on model	E7-8893v3	3.2GHz	4	45MB	140W	9.6GT/s	1866
	E7-8891v3	2.8GHz	10	45MB	165W	9.6GT/s	1866
	E7-8890v3	2.5GHz	18	45MB	165W	9.6GT/s	1866
	E7-8880v3	2.3GHz	18	45MB	150W	9.6GT/s	1866
	E7-8880Lv3	2.0GHz	18	45MB	115W	9.6GT/s	1866
	E7-8870v3	2.1GHz	18	45MB	140W	9.6GT/s	1866
	E7-8867v3	2.5GHz	16	45MB	165W	9.6GT/s	1866
	E7-8860v3	2.2GHz	16	40MB	140W	9.6GT/s	1866
	E7-4850v3	2.2GHz	14	35MB	115W	8.0GT/s	1866
	E7-4830v3	2.1GHz	12	30MB	115W	8.0GT/s	1866
	E7-4820v3	1.9GHz	10	25MB	115W	6.4GT/s	1866
	E7-4809v3	2.0GHz	8	20MB	115W	6.4GT/s	1866
	E7-8893v4	3.2GHz	4	60MB	140W	9.6GT/s	1866
	E7-8891v4	2.8GHz	10	60MB	165W	9.6GT/s	1866
	E7-8890v4	2.2GHz	24	60MB	165W	9.6GT/s	1866
	E7-8880v4	2.2GHz	22	55MB	150W	9.6GT/s	1866
	E7-8870v4	2.1GHz	20	50MB	140W	9.6GT/s	1866
	E7-8867v4	2.4GHz	18	45MB	165W	9.6GT/s	1866
	E7-8860v4	2.2GHz	18	45MB	140W	9.6GT/s	1866
	E7-4850v4	2.1GHz	16	40MB	115W	8.0GT/s	1866
	E7-4830v4	2.0GHz	14	35MB	115W	8.0GT/s	1866
	E7-4820v4	2.0GHz	10	25MB	115W	6.4GT/s	1866
	E7-4809v4	2.1GHz	8	20MB	115W	6.4GT/s	1866

Chipset

Intel® C602J Chipset

Intel® Xeon® E7-4800/8800v3 Processor Family

Intel® Xeon® E7-4800/8800v4 Processor Family

NOTE: For more information regarding Intel® chipsets, please see the following URL: <http://www.intel.com/products/server/chipsets/>

On System Management Chipset

HPE iLO (Firmware HPE iLO4 2.0) 4GB NAND

NOTE: Read and learn more in the [iLO QuickSpecs](#).

Standard Features

Memory

One of the following depending on model

Type:

HPE SmartMemory

DDR4 Registered (RDIMM) and Quad Rank Load Reduced (LRDIMM)

DIMM Slots 96

Available

Maximum Capacity 6TB (96 x 64GB)

NOTE: Hewlett Packard Enterprise memory from previous generation servers are not qualified or warranted with this HPE ProLiant Server. HPE SmartMemory is required to realize the memory performance improvements and enhanced functionality listed in this document for Gen9. For additional information, please see the [HPE SmartMemory QuickSpecs](#).

NOTE: LRDIMM and RDIMM are distinct memory technologies and cannot be mixed within a server.

NOTE: Depending on the memory configuration and processor model, the memory speed may run at 1866MHz, 1600MHz, or 1333MHz. Please see Memory Population Table below or the Online Memory Configuration Tool at: [HPE Server Memory Configurator](#).

Network Controller

FlexibleLOM

HPE ProLiant Gen9 servers offer a new flexible network technology - FlexibleLOMs, which offers customers a choice of 1Gb, 10Gb, or 10Gb base-T Ethernet or converged networking in their embedded adapter:

HPE Ethernet 1Gb 4-port 331FLR FIO Adapter

HPE Ethernet 1Gb 4-port 366FLR FIO Adapter

HPE FlexFabric 10Gb 2-port 533FLR-T FIO Adapter

HPE FlexFabric 10Gb 2-port 534FLR-SFP+ FIO Adapter

HPE Ethernet 10Gb 2-port 546FLR-SFP+ FIO Adapter

HPE FlexFabric 10Gb 2-port 556FLR-SFP+FIO Adapter

HPE FlexFabric 10Gb 2-port 556FLR-T FIO Adapter

HPE Ethernet 10Gb 2-port 560FLR-SFP+ FIO Adapter

HPE Ethernet 10Gb 2-port 561FLR-T FIO Adapter

HPE Ethernet 10Gb 2-port 562FLR-SFP+FIO Adapter

NOTE: For additional details see the Networking Section of this document.

NOTE: Wake-on-LAN feature is not supported on the DL580 Gen9 with FlexibleLOMs.

Standard Features

Expansion Slots

Primary Riser (Standard)	Expansion Slots #	Technology	Bus Width	Connector Width	Bus Number	Form Factor	Notes
	1	PCIe 3.0	x16	x16	C0/03/0	Full length/full height	Proc 4
	2	PCIe 3.0	x16	x16	C0/02/0	Full length/full height	Proc 4
	3	PCIe 3.0	x16	x16	80/03/0	Full length/full height	Proc 3
	4	PCIe 3.0	x8	x16	80/02/0	Full length/full height	Proc 3
	5	PCIe 3.0	x8	x16	80/02/1	Full length/full height	Proc 3
	6	PCIe 3.0	x16	x16	40/03/0	Full length/full height	Proc 2
	7	PCIe 3.0	x8	x16	40/02/0	Full length/full height	Proc 2
	8	PCIe 3.0	x8	x16	40/02/1	Full length/full height	Proc 2
	9	PCIe 3.0	x16	x16	00/03/0	Full length/full height	Proc 1

NOTE: PCIe slot availability is dependent on the number of processors installed.

NOTE: Inserting cards with PCI bridges may alter the actual bus assignment number.

NOTE: Slots are enumerated differently based on OS. MS OS's enumerate from lowest to highest Device ID by bus (starting with the lowest bus).

NOTE: Bus Width Indicates the number of physical electrical lanes running to the connector.

NOTE: When populating the second optional riser slot, the second processor must be installed.

NOTE: All slots support PCIe cards to 150W or more depending on card but an additional Power Cord Option is required (PN 669777-B21). See Option Section below for offering.

NOTE: Double wide PCIe cards are only supported in risers with the Processors leveraging the High Performance Heatsink. For Processors requiring double wide GPU support please order the GPU enablement kit (719082-B21).

NOTE: Up to 9 slots supported; all full-length/full-height. Standard: 4 PCI-E 3.0 x8, 5 PCI-E 3.0 x16.

Standard Features

Internal Storage Devices One of the following depending on model	Hard Disk Drive Backplane	Internal SAS lower and upper backplanes support up to ten SFF hard disk drives or solid state drives or Express Bays (NVMe drives)
	Diskette Drive	None
	Optional Optical Drive	External
	Hard Drives	None ship standard

NOTE: For Factory Integrated models, five (5) lower drive bays ship standard and five (5) upper drive bays can be ordered separately with a drive backplane kits. For Pre-configured models, please refer to the pre-configured models section below.

Maximum Internal Storage		CAPACITY	CONFIGURATION
	Hot Plug SFF SAS	20TB	10 x 2.0TB
	Hot Plug SFF SAS SSD	38.4TB	10 x 3.84TB
	Hot Plug SFF SATA SSD	38.4TB	10 x 3.84TB
	Hot Plug SFF NVMe PCIe SSD	8TB	5 x 1.6TB

NOTE: Optional support for 5 NVMe SSDs or 5 SFF drives are also available.

Power Supply One of the following depending on model	HPE 1500W Common Slot Platinum Plus Hot Plug Power Supply
	HPE 1500W Common Slot 48VDC Hot Plug Power Supply
	HPE 1200W Common Slot Platinum Plus Hot Plug Power Supply

NOTE: 1500W power supply supports high line voltage only.

NOTE: A minimum of two (2) power supplies are required. Four (4) 1500W power supplies offers N+N redundancy for highly loaded configurations.

Prior to making a power supply selection it is highly recommended that the HPE Power Advisor is run to determine the right size power supply for your server configuration. The HPE Power Advisor is located at: <http://www.hpe.com/info/hppoweradvisor>.

The Hewlett Packard Enterprise Common Slot (CS) power supplies allow for commonality of power supplies across a wide range of ProLiant and Integrity servers, as well as HPE Storage solutions, and are designed to provide the highest power supply efficiency without degrading system performance. Hewlett Packard Enterprise CS power supplies are tested by the Electric Power Research Institute (EPRI) and certified through the ECOS 80 Plus power supply program. HPE CS power supply options provide efficiency ratings of up to 94% (80 Plus Platinum) and are available. All Hewlett Packard Enterprise Common Slot power sources are UL, CE Mark Compliant, hot-plug and support redundant configurations.

HPE CS Platinum Plus power supplies are required when enabling HPE's Intelligent Power Discovery (IPD) solution. IPD is the first technology to create an automated, energy-aware network between IT systems and facilities. This allows your company to reclaim millions of dollars in wasted power capacity and downtime costs across data centers. For more information on the Hewlett Packard Enterprise IPD solution, go to [**HPE Intelligent Power Distribution Units**](#).

Standard Features

NOTE: Mixing of power supplies in the same server is not supported. All power supplies must be of the same output and efficiency rating. If non-matched power supplies are inserted you will get errors and operation will fail.

Required Cabling

Server Power Cords

Server ships with high-voltage server to PDU power cord.

NOTE: If customers require a local power cord, they can check the power cord matrix for the appropriate county specific SKU. Please see the following power cord matrix for details: <http://www.hp.com/go/powercordmatrix>

System Fans

One of the following depending on model

Non-redundant

4 Hot Plug Fans (eight rotors with N+1 redundancy)

Redundant

Interfaces

Serial	1 back
Video	1 front; 1 back
FlexibleLOM Network Ports	Selection of FlexibleLOM options
iLO 4 Remote Management	1 x 1Gbe dedicated
Micro SD Slot	1 internal
USB 2.0 Ports	8 total: 2 front; 4 back; 2 internal

NOTE: Dual microSD USB option kit also available (741279-B21).

Operating Systems and Virtualization Software

Support for ProLiant Servers

[Microsoft Windows Server](#)

[Red Hat Enterprise Linux \(RHEL\)](#)

[SUSE Linux Enterprise Server \(SLES\)](#)

[VMware](#)

[CentOS](#)

[Oracle Linux](#)

NOTE: For more information on Hewlett Packard Enterprise Certified and Supported ProLiant Servers for OS and Virtualization Software and latest listing of software drivers available for your server, please visit our Support Matrix at:

<http://www.hp.com/go/ossupport> and our driver download page

<http://h20565.www2.hp.com/hpsc/swd/public/readIndex?sp4ts.oid=8090151>.

Standard Features

Upgradeability	Upgradeable to 4 processors Up to 96 DDR4 DIMM slots 9 PCIe Gen3 expansion slots NOTE: PCIe slot availability is dependent on the number of processors installed. Please refer to the "Expansion Slots" section for more details. 10 SFF internal HDD/SSD SAS drive bays or 5 SFF Internal Express Bays + 5 SFF Internal HDD/SSD drive bays NOTE: Five drive bays come standard. An optional five SAS drive or five Express backplane kit with five drive bays can be ordered for ten drives. 5 NVMe SSD drive bays 4 redundant hot-plug power supplies
-----------------------	--

Industry Standard Compliance	ACPI 2.0. Compliant PCIe 2.0 Compliant PXE Support WOL Support NOTE: Not supported with FlexLOMs on DL580 Gen9. Physical Address Extension (PAE) Support Microsoft® Logo certifications USB 2.0 Support ASHRAE A3/A4 NOTE: For additional technical thermal details regarding ambient temperatures, humidity and features support please visit: http://www.hpe.com/servers/ashrae .
-------------------------------------	--

Graphics	Integrated Matrox G200 video standard <ul style="list-style-type: none">• 16 MB Flash• 256 MB DDR 3 with ECC (112 MB after ECC and video) HPE iLO 4 On System Management Memory <ul style="list-style-type: none">• 16 MB Flash• 256 MB DDR 3 with ECC (112 MB after ECC and video)
-----------------	---

Standard Features

HPE Server UEFI/Legacy ROM

Unified Extensible Firmware Interface (UEFI) is an industry standard that provides better manageability and more secured configuration than the legacy ROM while interacting with your server at boot time. HPE ProLiant Gen9 platform defaults to UEFI and can be factory or field configured for Legacy BIOS Boot Mode.

NOTE: The UEFI System Utilities function is analogous to the HPE ROM-Based Setup Utility (RBSU) of legacy BIOS. For more information, please visit <http://www.hpe.com/servers/uefi>.

UEFI enables numerous new capabilities specific to HPE ProLiant servers such as:

- Secure Boot
- Operating system specific functionality
- Support for > 2.2 TB (using GPT) boot drives
- USB 3.0 Stack
- Embedded UEFI Shell
- Mass Configuration Deployment Tool using RESTful API for iLO 4
- PXE boot support for IPv6 networks
- Boot support for option cards that only support a UEFI option ROM
- Network Stack configurations

NOTE: For UEFI Boot Mode, boot environment and OS image installations should be configured properly to support UEFI.

NOTE: UEFI FIO Setting (758959-B22) can be selected to configure the system in Legacy mode in the factory for your HPE ProLiant Gen9 Server.

Form Factor 4U rack

Embedded Management

HPE Integrated Lights-Out (HPE iLO)

Monitor your servers for ongoing management, service alerting, reporting and remote management with HPE iLO. Learn more at <http://www.hpe.com/info/ilo>.

UEFI

Configure and boot your servers securely with industry standard Unified Extensible Firmware Interface (UEFI). Learn more at <http://www.hpe.com/servers/uefi>.

RESTful API

RESTful API for iLO 4 is Redfish 1.0 conformance for simplified server management such as configuration and maintenance tasks based on modern industry standards. Learn more at <http://www.hpe.com/info/restfulapi>.

Intelligent Provisioning

Hassle free server and OS provisioning for 1 or few servers with Intelligent Provisioning. Learn more at <http://www.hpe.com/servers/intelligentprovisioning>.

Embedded Remote Support

The Hewlett Packard Enterprise embedded remote support, when used with Insight Online direct connect or HPE Insight Remote Support, allows HPE ProLiant servers to transmit hardware events directly to Hewlett Packard Enterprise or a Hewlett Packard Enterprise Authorized Partner for automated phone home support. Learn more at

Standard Features

<http://www.hpe.com/info/insightonline/explore>.

Server utilities	Smart Update	Optimize firmware and driver updates with Smart Update solutions including Smart Update Manager (SUM) and Service Pack for ProLiant (SPP). Learn more at http://www.hpe.com/servers/smartupdatemanager .
	HPE Systems Insight Manager (HPE SIM)	HPE SIM allows you to monitor the health of your HPE ProLiant Servers and HPE Integrity Servers, and also provides you with basic support for non-HPE servers. HPE SIM also integrates with Smart Update Manager to provide quick and seamless firmware updates. Learn more at http://www.hpe.com/servers/hpsim .
	Scripting Tool Kit and Windows PowerShell	Provision 1 to many servers using your own scripts to discover and deploy them with Scripting Tool Kit (STK) for Windows and Linux or Scripting Tools for Windows PowerShell. Learn more at http://www.hpe.com/servers/proliant/stk or http://www.hpe.com/servers/powershell .
	RESTful Interface Tool	RESTful Interface tool is a scripting tool to provision using RESTful API for iLO 4 to discover and deploy servers at scale. Learn more at http://www.hpe.com/info/resttool .
	HPE iLO Mobile Application	Enables the ability to access, deploy, and manage your server anytime from anywhere from select smartphones and mobile devices. For additional information please visit: http://www.hpe.com/info/ilo/mobileapp .
	HPE Insight Online	HPE Insight Online, available at no additional cost as part of your Hewlett Packard Enterprise warranty or contractual support agreement with Hewlett Packard Enterprise, is a personalized dashboard for simplified tracking of IT operations and support information from anywhere, anytime. Learn more at http://www.hpe.com/info/insightonline/explore .

Standard Features

Security

- Power-on password
- Keyboard password
- External USB port enable/disable
- Network Server Mode
- Serial interface control
- Administrator's password
- Trusted Platform Module (TPM)
- TPM 2.0

NOTE: HPE Trusted Platform Module 2.0 Option (745823-B21) works with Gen9 servers with UEFI Mode not Legacy Mode. It is not compatible with HP ProLiant Gen8 servers or earlier generation variants. HPE Gen9 servers purchased earlier may need the latest firmware update to be compatible with the TPM 2.0 Option. The earlier HPE Trusted Platform Module Option (488069-B21) is the TPM 1.2 version, which is also available however TPM 2.0 has newer technology standards incorporated. The TPM 1.2 compatible server platforms include Gen8 and Gen9 servers. HPE server systems can have a TPM module (of any type) installed only once. It cannot be replaced with any other TPM module.

- Intel® Secure Key
- HPE Secure Encryption (Smart Array Controller)
- HPE Advanced Data Guard (Smart Array Controller)

Warranty

This product is covered by a global limited warranty and supported by HPE Services and a worldwide network of HPE Authorized Channel Partners resellers. Hardware diagnostic support and repair is available for three years from date of purchase. Support for software and initial setup is available for 90 days from date of purchase. Enhancements to warranty services are available through HPE Care Pack services or customized service agreements. Hard drives have either a one year or three year warranty; refer to the specific hard drive QuickSpecs for details.

NOTE: Server Warranty includes 3-Year Parts, 3-Year Labor, 3-Year Onsite support with next business day response. Warranty repairs may be accomplished through the use of Customer Self Repair (CSR) parts. These parts fall into two categories: 1) Mandatory CSR parts are designed for easy replacement. A travel and labor charge will result when customers decline to replace a Mandatory CSR part; 2) Optional CSR parts are also designed for easy replacement but may involve added complexity. Customers may choose to have HPE replace Optional CSR parts at no charge. Additional information regarding worldwide limited warranty and technical support is available at: <http://h17007.www1.hp.com/us/en/enterprise/servers/warranty/>.

Optional Features

Embedded Management	iLO Advanced	HPE iLO Advanced licenses offer smart remote functionality without compromise, for all HPE ProLiant servers. The license includes the full integrated remote console, virtual keyboard, video, and mouse (KVM), multi-user collaboration, console record and replay, and GUI-based and scripted virtual media and virtual folders. You can also activate the enhanced security and power management functionality. Learn more about HPE iLO Advanced at http://www.hpe.com/servers/iloadvanced .
Server Management	HPE Insight Control	HPE Insight Control, lets you deploy, migrate, monitor, remote control, and optimize your IT infrastructure through a single, simple management console. For more information, see http://www.hpe.com/info/insightcontrol .
	HPE Insight Cluster Management Utility (CMU)	HPE Insight Cluster Management Utility is a HyperScale management framework that includes software for the centralized provisioning, management and monitoring of nodes and infrastructure. Learn more at http://www.hpe.com/info/cmu .
Rack and Power Infrastructure	HPE Rack and Power Infrastructure products and services create highly efficient and intelligent solutions for existing or new IT data centers. HPE Rack and Power infrastructure solutions - rack infrastructure, power protection and management, performance optimized data centers (PODs) - are the foundation you are looking for to help secure your long-term IT success. These products are designed to help you react to changes in the industry. They deliver efficient, easy-to-use capabilities to manage, monitor, deploy and provision infrastructure from entry to enterprise. As an industry leader, Hewlett Packard Enterprise is uniquely positioned to address the key concerns of power, cooling, cable management and system access. Learn more at HPE Rack and Power Infrastructure .	

Optional Features

High Performance Clusters

HPE Cluster Platforms HPE Cluster Platforms are specifically engineered, factory-integrated large-scale ProLiant clusters optimized for High Performance Computing, with a choice of servers, networks and software. Operating system options include specially priced offerings for Red Hat Enterprise Linux and SUSE Linux Enterprise Server, as well as Microsoft Windows HPEC Server. A Cluster Platform Configurator simplifies ordering. <http://www.hp.com/go/clusters>.

HPE HPEC Interconnects High Performance Computing (HPC) interconnect technologies are available for this server as part of the HPE Cluster Platform portfolio. These high-speed InfiniBand and Gigabit interconnects are fully supported by Hewlett Packard Enterprise when integrated within a Hewlett Packard Enterprise cluster. Flexible, validated solutions can be defined with the help of configuration tools. <http://www.hp.com/techservers/clusters/ucp/index.html>.

HPE Insight Cluster Management Utility HPE Insight Cluster Management Utility (CMU) is a Hewlett Packard licensed and supported suite of tools that are used for lifecycle management of hyperscale clusters of Linux ProLiant systems. CMU includes software for the centralized provisioning, management and monitoring of nodes. CMU makes the administration of clusters user friendly, efficient, and effective. <http://www.hp.com/go/cmu>.

HPC Interconnects

NOTE: High Performance Computing (HPC) interconnect technologies are available for this server under the HPE Cluster Platform product portfolio. These high-speed interconnects are fully supported by Hewlett Packard Enterprise when they are part of these configure to order clusters. Solutions can be defined with a lot of flexibility with the help of configuration tools. Please visit the following URL to configure HPEC Clusters with InfiniBand Interconnects:

<http://www.hp.com/techservers/clusters/ucp/index.html>.

Storage Software

Whether you need to solve a specific data protection, archiving, or storage command and control challenge, or deliver on strategic consolidation, compliance, or continuity initiatives, look no further than Hewlett Packard Enterprise storage software. Our storage software helps you reduce costs, simplify storage infrastructure, protect vital assets and respond faster to business opportunities.

Storage software that gets the job done:

- **Data Protection and Recovery Software**
Whether you're a large enterprise or a smaller business, Hewlett Packard Enterprise data protection and recovery software will cost-effectively protect you against disaster and ensure business continuity.
- **Data Archive and Migration Software**
Hewlett Packard Enterprise storage software enables you to comply with data retention and retrieval requirements, improve application performance, and reduce costs by efficiently migrating infrequently accessed or less valuable data to lower cost storage.
- **Storage Resource Management Software (SRM)**
Hewlett Packard Enterprise storage resource management software reduces operational costs and provides the command and control foundation you need to

Optional Features

efficiently manage and visualize your physical and virtual environments.

- **Data Replication Software**

Hewlett Packard Enterprise offers array-based and host-based replication software for use in disaster recovery, testing, application development and reporting.

- **Storage Device Management Software**

Maximize your investment in Hewlett Packard Enterprise storage and networking with software that enables hardware-specific configuration, performance tuning and connectivity management.

- **HPE StoreVirtual VSA**

With HPE StoreVirtual VSA you can use the power of virtualization to create a virtual array within your host server. Manage it as a single pool of shared storage capacity, and scale it to match your evolving needs. HPE ProLiant Gen9 servers include a 3-year limited license for HPE StoreVirtual VSA software with 1TB of capacity at no extra cost. Simply select to install HPE StoreVirtual VSA software during server setup within Intelligent Provisioning. More information, instructional videos, and free console management software are available at

<http://www.hp.com/go/vsa1TB>.

NOTE: For more information about Storage Software including QuickSpecs, please see:

<http://www.hp.com/go/storage/software>.

Solutions

Factory Express Portfolio for Servers and Storage

HPE Factory Express offers configuration, customization, integration and deployment services for Hewlett Packard Enterprise servers and storage products. Customers can choose how their factory solutions are built, tested, integrated, shipped and deployed.

Factory Express offers service packages for simple configuration, racking, installation, complex configuration and design services as well as individual factory services, such as image loading, asset tagging, and custom packaging. Hewlett Packard Enterprise products supported through Factory Express include a wide array of servers and storage: HPE Integrity, HPE ProLiant, HPE ProLiant Server Blades, HPE BladeSystem, HPE 9000 servers as well as the MSAxxxx, VA7xxx, EVA, XP, rackable tape libraries and configurable network switches.

For more information on Factory Express services for your specific server model please contact your sales representative or go to: <http://www.hp.com/go/factory-express>.

One Config Simple (SCE)

SCE is a guided self-service tool to help sales and non-technical people provide customers with initial configurations in 3 to 5 minutes. You may then send the configuration on for configuration help, or use in your existing ordering processes. If you require "custom" rack configuration or configuration for products not available in SCE, please contact Hewlett Packard Enterprise Customer Business Center or an Authorized Partner for assistance. <http://ocs.ext.hpe.com/>.

Service and Support

HPE Support Services

HPE Technology Services delivers confidence, reduces risk and helps customers realize agility and stability. Connect to Hewlett Packard Enterprise to help prevent problems and solve issues faster. HPE Support Services enable you to choose the right service level, length of coverage and response time as you purchase your new server, giving you full entitlement to the support for need for your IT and business.

Connect your devices

Unlock all of the benefits of your technology investment by connecting your products to Hewlett Packard Enterprise. Achieve up to 77%¹ reduction in down time, near 100%² diagnostic accuracy and a single consolidated view of your environment. By connecting, you will receive 24x7 monitoring, pre-failure alerts, automatic call logging, and automatic parts dispatch. HPE Proactive Care Service and HPE Datacenter Care Service customers will also benefit from proactive activities to help prevent issues and increase optimization. All of these benefits are already available to you with your server storage and networking products, securely connected to Hewlett Packard Enterprise support.
1- IDC 2 - HP CSC reports 2014 - 2015

Recommended Support

Standard: HPE Proactive Care* with 24x7 coverage, three year Support Service
HPE Proactive Care gives customers an enhanced call experience. When your products are connected to Hewlett Packard Enterprise, Proactive Care helps prevent problems and maintains IT stability by utilizing personalized proactive reports with recommendations and advice. This service combines three years proactive reporting and advice with our 24x7 coverage, four hour hardware response time when there is a problem. This service also includes collaborative software support for Independent Software Vendors (ISVs), (Red Hat, VMWare, Microsoft, etc.) running on your HPE servers.
<https://www.hpe.com/h20195/v2/GetPDF.aspx/4AA3-8855ENW.pdf>

Optimized HPE Proactive Care* with 6 hour call-to-repair commitment, three year Support Service

HPE Proactive Care gives customers an enhanced call experience. When your products are connected to Hewlett Packard Enterprise, Proactive Care helps prevent problems and maintains IT stability by utilizing personalized proactive reports with recommendations and advice. This service combines three years' proactive reporting and advice with our highest level of hardware support - Hewlett Packard Enterprise 24x7, six hour hardware call-to-repair. Hewlett Packard Enterprise is the only leading manufacturer who makes this level of coverage available as a standard service offering for your most valuable servers. This service also includes collaborative software support for Independent Software Vendors (ISVs), (Red Hat, VMWare, Microsoft, etc.) running on your HPE servers.
<https://www.hpe.com/h20195/v2/GetPDF.aspx/4AA3-8855ENW.pdf>

Parts and Materials

Hewlett Packard Enterprise will provide Hewlett Packard Enterprise-supported replacement parts and materials necessary to maintain the covered hardware product in operating condition, including parts and materials for available and recommended engineering improvements.

Parts and components that have reached their maximum supported lifetime and/or the maximum usage limitations as set forth in the manufacturer's operating manual, product QuickSpecs, or the technical product data sheet will not be provided, repaired, or replaced as part of these services.

The defective media retention service feature option applies only to Disk or eligible SSD/Flash Drives replaced by Hewlett Packard Enterprise due to malfunction.

Service and Support

Related Services HPE Server Hardware Installation

Provides for the basic hardware installation of Hewlett Packard Enterprise branded servers, storage devices and networking options to assist you in bringing your new hardware into operation in a timely and professional manner.

<https://www.hpe.com/h20195/V2/GetPDF.aspx/5981-9356EN.pdf>

HPE Installation and Startup Service

Provides for the installation and startup of Hewlett Packard Enterprise technology including BladeSystems, C-Class enclosure, HPE ProLiant c-Class and Integrity server blades, storage blades, SAN switch blades, HPE Virtual Connect modules (Ethernet and Fibre Channel), Ethernet network interconnects, and InfiniBand, as well as the installation of one supported operating system type (Windows® or Linux).

HPE Technology Services Support Credits

Offer flexible services and technical skills to meet your changing IT demands. With a menu of service that is tailored to suit your needs, you get additional resources and specialist skills to help you maintain peak performance of your IT. Offered as annual credits, you can plan your budgets while proactively responding to your dynamic business.

HPE Education Services

Keep your IT staff trained making sure they have the right skills to deliver on your business outcomes. Book on a class today and learn how to get the most from your technology investment. <http://www.hpe.com/ww/learn>

HPE Support Center

The HPE Support Center is a personalized online support portal with access to information, tools and experts to support Hewlett Packard Enterprise business products. Submit support cases online, chat with Hewlett Packard Enterprise experts, access support resources or collaborate with peers.

Learn more <http://www.hpe.com/support/hpesc>

The Hewlett Packard Enterprise Support Center Mobile App* allows you to resolve issues yourself or quickly connect to an agent for live support. Now, you can get access to personalized IT support anywhere, anytime.

HPE Insight Remote Support and HPE Support Center are available at no additional cost with a Hewlett Packard Enterprise warranty, HPE Support Service or Hewlett Packard Enterprise contractual support agreement.

*HPE Support Center Mobile App is subject to local availability.

For more information: <http://www.hpe.com/services>

Pre-configured Models

	High Performance Models				Database Models	
[SKU Number]	816815-B21	816816-B21	793312-B21	793310-B21	816814-B21	793314-B21
Model Name	HPE ProLiant DL580 Gen9 E7-8890v4 4P 256GB-R P830i/4G 534FLR-SFP 1500W RPS Server	HPE ProLiant DL580 Gen9 E7-4850v4 4P 128GB-R P830i/4G 534FLR-SFP 1200W RPS Server	HPE ProLiant DL580 Gen9 E7-8890v3 4P 256GB-R P830i/4G 534FLR-SFP+ 1500W RPS Server	HPE ProLiant DL580 Gen9 E7-4850v3 4P 128GB-R P830i/4G 534FLR-SFP+ 1200W RPS Server	HPE ProLiant DL580 Gen9 E7-8893v4 4P 256GB-R P830i/4G 534FLR-SFP 1500W RPS Server	HPE ProLiant DL580 Gen9 E7-8893v3 4P 256GB-R P830i/4G 534FLR-SFP+ 1500W RPS Server
Processor	Intel® Xeon® E7-8890v4	Intel® Xeon® E7-4850v4	Intel® Xeon® E7-8890v3	Intel® Xeon® E7-4850v3	Intel® Xeon® E7-8893v4	Intel® Xeon® E7-8893v3
Number of Processors	Four					
Memory	256GB (16x16GB DIMMs) PC4-2400P-R DIMMs (DDR4) installed in (8) Memory Cartridges	128GB (8x16GB DIMMs) PC4-2400P-R DIMMs (DDR4) installed in (4) Memory Cartridges	256GB (16x16GB DIMMs) PC4-2133P-R DIMMs (DDR4) installed in (8) Memory Cartridges	128GB (8x16GB DIMMs) PC4-2133P-R DIMMs (DDR4) installed in (4) Memory Cartridges	256GB (16x16GB DIMMs) PC4-2400P-R DIMMs (DDR4) installed in (8) Memory Cartridges	256GB (16x16GB DIMMs) PC4-2133P-R DIMMs (DDR4) installed in (8) Memory Cartridges
Network Controller	HPE FlexFabric 10Gb 2P 534FLR-SFP+ Adapter					
Storage Controller	HPE Smart Array P830i/4GB FBWC 12Gbps SAS controller					
Hard Drive	5 SFF HDD/SSD drive bays. No drives ship standard.					
Optical Drive	None					
PCI-Express Slots	9 PCIe Gen3.0 I/O Expansion slots (5x16 slots, 4x8 slots)					
Power Supply	(4) HPE 1500W Common Slot Platinum Plus Hot Plug Power Supplies	(4) HPE 1200W Common Slot Platinum Plus Hot Plug Power Supplies	(4) HPE 1500W Common Slot Platinum Plus Hot Plug Power Supplies	(4) HPE 1200W Common Slot Platinum Plus Hot Plug Power Supplies	(4) HPE 1500W Common Slot Platinum Plus Hot Plug Power Supplies	
Fans	4 hot plug fans (eight rotors with N+1 redundancy)					
Management	iLO Management (standard), Intelligent Provisioning (standard), iLO Advanced (optional), Insight Control (optional), HPE OneView (optional)					
Form Factor	Rack (4U), rail kit and cable management arm are included					
Warranty	Server Warranty includes 3-Year Parts, 3-Year Labor, 3-Year Onsite support with next business day response					

Pre-configured Models

	Base Models	
[SKU Number]	816817-B21	793308-B21
Model Name	HPE ProLiant DL580 Gen9 E7-4809v4 2P 64GB-R P830i/2G 331FLR-SFP 1200W RPS Server	HPE ProLiant DL580 Gen9 E7-4809v3 2P 64GB-R P830i/2G 331FLR-SFP+ 1200W RPS Server
Processor	Intel® Xeon® E7-4809v4	Intel® Xeon® E7-4809v3
Number of Processors	Two	
Memory	64GB (4x16GB DIMMs) PC4-2400P-R DIMMs (DDR4) installed in (2) Memory Cartridges	64GB (4x16GB DIMMs) PC4-2133P-R DIMMs (DDR4) installed in (2) Memory Cartridges
Network Controller	HPE Ethernet 1Gb 4P 331FLR Adapter	
Storage Controller	HPE Smart Array P830i/2GB FBWC 12Gbps SAS controller	
Hard Drive	5 SFF HDD/SSD drive bays. No drives ship standard.	
Optical Drive	None	
PCI-Express Slots	9 PCIe Gen3.0 I/O Expansion slots (5x16 slots, 4x8 slots)	
Power Supply	(2) HPE 1200W Common Slot Platinum Plus Hot Plug Power Supplies	
Fans	4 Hot Plug Fans (eight rotors with N+1 redundancy)	
Management	iLO Management (standard), Intelligent Provisioning (standard), iLO Advanced (optional), Insight Control (optional), HPE OneView (optional)	
Form Factor	Rack (4U), rail kit and cable management arm are included	
Warranty	Server Warranty includes 3-Year Parts, 3-Year Labor, 3-Year Onsite support with next business day response	

NOTE: For the Standard Features shipped in the "Factory Integrated Models," please see the "Configuration Information - Factory Integrated Models" section.

NOTE: Pre-configured models ship with the configurations below. Options can be selected from the Core or Additional options section of this QuickSpecs.

NOTE: HPE does not allow factory integration of options into pre-configured models. Any additional options purchased will be shipped separately.

NOTE: If you desire a custom configuration please see "Configuration Information - Factory Integrated Models" section of this QuickSpecs.

NOTE: Not all models are available in all regions. Check with your local country HPE offices for availability.

Country Code	xx1 = B21	Worldwide
Key	xx1 = 291	Japan
	xx1 = AA1	PRC

Configuration Information - Factory Integrated Models

This section lists some of the steps required to configure a Factory Integrated Model. To ensure only valid configurations are ordered, Hewlett Packard Enterprise recommends the use of an HPE approved configurator. Contact your local sales representative for information on configurable product offerings and requirements.

1. Factory Integrated Models must start with a CTO Server.
2. FIO indicates that this option is only available as a factory installable option.
3. All Factory Integrated Models will be populated with sufficient hard drive blanks based on the number of initial hard drives ordered with the server.
4. Some options may not be integrated at the factory. Contact your local sales representative for additional information.

Step 1: Base Configuration (choose one of the following configurable models)

[Chassis]	HPE ProLiant DL580 Gen9 Configure-to-order Server
SKU Number	793161-B21
Processor	4U Server Chassis with front-accessible processor and memory drawer
Storage Controller	Embedded HPE Smart Array 12G P830i Controller
PCIe	9 PCIe Gen3.0 I/O Expansion slots (5x16 slots, 4x8 slots)
Drive Cage	5 Hot-plug SAS/SATA SFF SSD or HDD Bays (Lower)
Fans	4 hot plug fans (eight rotors with N+1 redundancy), front accessible
Management	iLO Management (standard), Intelligent Provisioning (standard)
USB	8 USB 2.0 ports (2 front, 4 rear, 2 internal)

(Base Configuration Continued)

Intel® 602J Chipset

(2) video ports (1 front, 1 rear)

(1) microSD card slot

(1) Trusted Platform Module (TPM) connector

BIOS Legacy mode (field configurable) or Unified Extensible Firmware Interface (UEFI) mode (default)

Rack rails and cable management arm

NOTE: PCIe slot availability is dependent on the number of processors installed. Please refer to the "Expansion slots" section for more details.

NOTE: A minimum of two processors are required. The system may have three or four processors installed.

NOTE: A minimum of two memory cartridges are required (one per processor).

NOTE: A minimum of two memory DIMMs are required per cartridge (minimum of four DIMMs per server).

NOTE: A minimum of two power supplies are required.

Configuration Information - Factory Integrated Models

Step 2: Choose Required Options (only one of the following from each list unless otherwise noted)

HPE Processors Select two, three or four processors from Core Options-Processor section below.

- If two processors are desired, select one xxxxxx-L21 and one xxxxxx-B21.
- If three or four processors are desired, select additional xxxxxx-B21.
- Up to 4 processors supported. Mixing different processor models is not supported.
- DDR4 speed is the maximum memory speed of the processor. Actual memory speed may depend on the quantity and type of DIMMs installed.

HPE Memory Depending on the memory configuration and processor model, the memory speed may run at 1866MHz, 1600MHz or 1333MHz. Please see Memory Population Table or the Online Memory Configuration Tool at: <http://www.hpe.com/go/ddr4config>.

HPE Power Supplies Select two or four power supplies from Core Options-Power Supplies section below.

Step 3: Choose Additional Factory Integratable Options

HPE Unique Options Select one or more Unique options from Core Options section below.

- This section may contain FIO options, please see the Unique options section below.
- FIO indicates that this option is only available as a factory installable option.

HPE Drives The HPE ProLiant Gen9 Smart Storage solutions are equipped with re-designed Small Form Factor (SFF 2.5 in) hot plug carriers for HPE Qualified Hard Drives and Solid State Drives. These new carriers provide status and activity indicators as well as caution indicators for "Do Not Remove."

HPE FlexibleLOM Select a FlexibleLOM from Core Options-Networking section below.

- Only one FlexibleLOM can be added to the server. These options are upgradeable and can be changed from the original configuration after the server is shipped.
- For 10Gb adapters, a minimum of two Gigabytes (2 GB) of server memory is required per each adapter.
- Please see the QuickSpecs for Technical Specifications and additional information: <http://www.hpe.com/go/ProLiantNICs>.

HPE Networking Select a standup NIC adapter from Core Options-Networking section below.

- Please see the QuickSpecs for Technical Specifications and additional information: <http://www.hpe.com/go/ProLiantNICs>.
- These options are upgradeable and can be changed from the original configuration after the server is shipped.
- For 10Gb adapters, a minimum of two Gigabytes (2 GB) of server memory is required per each adapter.

HPE Storage Controllers Select one or more Storage options from Additional Options section below.

- This section may contain FIO options, please see HPE Storage Controllers section below.
- FIO indicates that this option is only available as a factory installable option.

HPE Graphics Select one or more graphics adapter from Additional Options section below.

Configuration Information - Factory Integrated Models

Options

- Please see the HPE Power Advisor for estimated power consumption of your individual system configuration prior to installing GPUs. The HPE Power Advisor is located at: <http://www.hpe.com/go/hpepoweradvisor>.
- This section may contain FIO options, please see HPE Computation & Graphics Accelerators section below.

HPE Rail Kits

Select one type of rail kit from Additional Options section below.

- Please take a moment to review the installation documentation that comes with the server to help you with the installation of your Gen9 server.
- To assist in the installation of the server into the rack, an optional installation tool is available by contacting your local services representative (p/n 695539-001).
- See Hewlett Packard Enterprise Rack Options in Additional Options section of this QuickSpecs for more rack kit choices.

CAUTION: Hewlett Packard Enterprise recommends that a minimum of two people are required for all Rack Server installations. Please refer to your installation instructions for proper tools and number of people to use for any installation.

Core Options

NOTE: Some options may not be integrated at the factory. To ensure only valid configurations are ordered, Hewlett Packard Enterprise recommends the use of an HPE approved configurator. Contact your local sales representative for additional information.

HPE Processors E7-8800v4 series Processors

HPE DL580 Gen9 Intel® Xeon® E7-8893v4 (3.2GHz/4-core/60MB/140W) Processor Kit	816661-B21
HPE DL580 Gen9 Intel® Xeon® E7-8893v4 (3.2GHz/4-core/60MB/140W) FIO Processor Kit	816661-L21
HPE DL580 Gen9 Intel® Xeon® E7-8891v4 (2.8GHz/10-core/60MB/165W) Processor Kit	816659-B21
HPE DL580 Gen9 Intel® Xeon® E7-8891v4 (2.8GHz/10-core/60MB/165W) FIO Processor Kit	816659-L21
HPE DL580 Gen9 Intel® Xeon® E7-8860v4 (2.2GHz/18-core/45MB/140W) Processor Kit	816649-B21
HPE DL580 Gen9 Intel® Xeon® E7-8860v4 (2.2GHz/18-core/45MB/140W) FIO Processor Kit	816649-L21
HPE DL580 Gen9 Intel® Xeon® E7-8867v4 (2.4GHz/18-core/45MB/165W) Processor Kit	816665-B21
HPE DL580 Gen9 Intel® Xeon® E7-8867v4 (2.4GHz/18-core/45MB/165W) FIO Processor Kit	816665-L21
HPE DL580 Gen9 Intel® Xeon® E7-8870v4 (2.1GHz/20-core/50MB/140W) Processor Kit	816647-B21
HPE DL580 Gen9 Intel® Xeon® E7-8870v4 (2.1GHz/20-core/50MB/140W) FIO Processor Kit	816647-L21
HPE DL580 Gen9 Intel® Xeon® E7-8880v4 (2.2GHz/22-core/55MB/150W) Processor Kit	816645-B21
HPE DL580 Gen9 Intel® Xeon® E7-8880v4 (2.2GHz/22-core/55MB/150W) FIO Processor Kit	816645-L21
HPE DL580 Gen9 Intel® Xeon® E7-8890v4 (2.2GHz/24-core/60MB/165W) Processor Kit	816643-B21
HPE DL580 Gen9 Intel® Xeon® E7-8890v4 (2.2GHz/24-core/60MB/165W) FIO Processor Kit	816643-L21

E7-8800v3 series Processors

HPE DL580 Gen9 Intel® Xeon® E7-8890v3 (2.5GHz/18-core/45MB/165W) Processor Kit	788317-B21
HPE DL580 Gen9 Intel® Xeon® E7-8890v3 (2.5GHz/18-core/45MB/165W) FIO Processor Kit	788317-L21
HPE DL580 Gen9 Intel® Xeon® E7-8880v3 (2.3GHz/18-core/45MB/150W) Processor Kit	788319-B21
HPE DL580 Gen9 Intel® Xeon® E7-8880v3 (2.3GHz/18-core/45MB/150W) FIO Processor Kit	788319-L21
HPE DL580 Gen9 Intel® Xeon® E7-8870v3 (2.1GHz/18-core/45MB/140W) Processor Kit	788321-B21
HPE DL580 Gen9 Intel® Xeon® E7-8870v3 (2.1GHz/18-core/45MB/140W) FIO Processor Kit	788321-L21
HPE DL580 Gen9 Intel® Xeon® E7-8860v3 (2.2GHz/16-core/40MB/140W) Processor Kit	788323-B21

Core Options

HPE DL580 Gen9 Intel® Xeon® E7-8860v3 (2.2GHz/16-core/40MB/140W) FIO Processor Kit	788323-L21
HPE DL580 Gen9 Intel® Xeon® E7-8891v3 (2.8GHz/10-core/45MB/165W) Processor Kit	788333-B21
HPE DL580 Gen9 Intel® Xeon® E7-8891v3 (2.8GHz/10-core/45MB/165W) FIO Processor Kit	788333-L21
HPE DL580 Gen9 Intel® Xeon® E7-8893v3 (3.2GHz/4-core/45MB/140W) Processor Kit	788335-B21
HPE DL580 Gen9 Intel® Xeon® E7-8893v3 (3.2GHz/4-core/45MB/140W) FIO Processor Kit	788335-L21
HPE DL580 Gen9 Intel® Xeon® E7-8880Lv3 (2.0GHz/18-core/45MB/115W) Processor Kit	788337-B21
HPE DL580 Gen9 Intel® Xeon® E7-8880Lv3 (2.0GHz/18-core/45MB/115W) FIO Processor Kit	788337-L21
HPE DL580 Gen9 Intel® Xeon® E7-8867v3 (2.5GHz/16-core/45MB/165W) Processor Kit	788339-B21
HPE DL580 Gen9 Intel® Xeon® E7-8867v3 (2.5GHz/16-core/45MB/165W) FIO Processor Kit	788339-L21
E7-4800v4 series Processors	
HPE DL580 Gen9 Intel® Xeon® E7-4809v4 (2.1GHz/8-core/20MB/115W) Processor Kit	816657-B21
HPE DL580 Gen9 Intel® Xeon® E7-4809v4 (2.1GHz/8-core/20MB/115W) FIO Processor Kit	816657-L21
HPE DL580 Gen9 Intel® Xeon® E7-4820v4 (2.0GHz/10-core/25MB/115W) Processor Kit	816655-B21
HPE DL580 Gen9 Intel® Xeon® E7-4820v4 (2.0GHz/10-core/25MB/115W) FIO Processor Kit	816655-L21
HPE DL580 Gen9 Intel® Xeon® E7-4830v4 (2.0GHz/14-core/35MB/115W) Processor Kit	816653-B21
HPE DL580 Gen9 Intel® Xeon® E7-4830v4 (2.0GHz/14-core/35MB/115W) FIO Processor Kit	816653-L21
HPE DL580 Gen9 Intel® Xeon® E7-4850v4 (2.1GHz/16-core/40MB/115W) Processor Kit	816651-B21
HPE DL580 Gen9 Intel® Xeon® E7-4850v4 (2.1GHz/16-core/40MB/115W) FIO Processor Kit	816651-L21
E7-4800v3 series Processors	
HPE DL580 Gen9 Intel® Xeon® E7-4850v3 (2.2GHz/14-core/35MB/115W) Processor Kit	788325-B21
HPE DL580 Gen9 Intel® Xeon® E7-4850v3 (2.2GHz/14-core/35MB/115W) FIO Processor Kit	788325-L21
HPE DL580 Gen9 Intel® Xeon® E7-4830v3 (2.1GHz/12-core/30MB/115W) Processor Kit	788327-B21
HPE DL580 Gen9 Intel® Xeon® E7-4830v3 (2.1GHz/12-core/30MB/115W) FIO Processor Kit	788327-L21
HPE DL580 Gen9 Intel® Xeon® E7-4820v3 (1.9GHz/10-core/25MB/115W) Processor Kit	788329-B21
HPE DL580 Gen9 Intel® Xeon® E7-4820v3 (1.9GHz/10-core/25MB/115W) FIO Processor Kit	788329-L21

Core Options

HPE DL580 Gen9 Intel® Xeon® E7-4809v3 (2.0GHz/8-core/20MB/115W) Processor Kit	788331-B21
HPE DL580 Gen9 Intel® Xeon® E7-4809v3 (2.0GHz/8-core/20MB/115W) FIO Processor Kit	788331-L21

Memory Selection

To streamline the configuration process for HPE ProLiant Gen9 servers and to provide the best product availability, HPE recommends memory from the list located here:

<http://www.hpe.com/products/recommend>.

Best product availability is limited to US, Canada, and Latin America at this time.

HPE Memory

NOTE: Hewlett Packard Enterprise memory from previous generation servers is not qualified or warranted with this HPE ProLiant Server. HPE SmartMemory is required to realize the memory performance improvements and enhanced functionality listed in this document for Gen9. For additional information, please see the [HPE SmartMemory QuickSpecs](#).

NOTE: LRDIMM and RDIMM are distinct memory technologies and cannot be mixed within a server.

NOTE: Depending on the memory configuration and processor model, the memory speed may run at 1866MHz, 1600MHz, or 1333MHz. Please see Memory Population Table below or the Online Memory Configuration Tool at: <http://www.hp.com/go/ddr4config>.

Registered DIMMs (RDIMMs)

HP 8GB (1x8GB) Single Rank x4 DDR4-2133 CAS-15-15-15 Registered Memory Kit	726718-B21
HP 16GB (1x16GB) Dual Rank x4 DDR4-2133 CAS-15-15-15 Registered Memory Kit	726719-B21
HP 32GB (1x32GB) Dual Rank x4 DDR4-2133 CAS-15-15-15 Registered Memory Kit	728629-B21
HP 8GB (1x8GB) Single Rank x8 DDR4-2400 CAS-17-17-17 Registered Memory Kit	805347-B21
HP 16GB (1x16GB) Single Rank x4 DDR4-2400 CAS-17-17-17 Registered Memory Kit	805349-B21
HPE 16GB (1x16GB) Dual Rank x4 DDR4-2400 CAS-17-17-17 Registered Memory Kit	836220-B21
HP 32GB (1x32GB) Dual Rank x4 DDR4-2400 CAS-17-17-17 Registered Memory Kit	805351-B21

Load Reduced DIMMs (LRDIMMs)

HP 32GB (1x32GB) Quad Rank x4 DDR4-2133 CAS-15-15-15 Load Reduced Memory Kit	726722-B21
HP 64GB (1x64GB) Quad Rank x4 DDR4-2133 CAS-15-15-15 Load Reduced Memory Kit	726724-B21
HPE 64GB (1x64GB) Quad Rank x4 DDR4-2400 CAS-17-17-17 Load Reduced Memory Kit	805358-B21

Memory Expansion Options

HPE DL580 Gen9 12 DDR4 DIMM Slots Memory Cartridge	788360-B21
--	------------

NOTE: Up to Eight (8) memory cartridges are supported for 96 DIMM slots.

NOTE: A minimum of two memory cartridges are required (one per processor).

Core Options

NOTE: A minimum of two memory DIMMs are required per cartridge (minimum of four DIMMs per server).

HPE Optical Drives	HP Mobile USB Non Leaded System DVD RW Drive	701498-B21
---------------------------	--	------------

HPE Drives

NOTE: The components of a storage subsystem (e.g. the drive, the HBA/controller, firmware, and the server backplane) should operate at the same data transfer rate or the system bandwidth will be negotiated down to an acceptable level for all components.

NOTE: Hard drives have either a one year or three year warranty; refer to the specific hard drive QuickSpecs for details.

12G SAS Value Endurance Hot Plug SFF (2.5-inch) Enterprise Value Solid State

HP 1.6TB 12G SAS Value Endurance SFF 2.5-in SC Enterprise Value 3yr Wty Solid State Drive	762263-B21
---	------------

HP 800GB 12G SAS Value Endurance SFF 2.5-in SC Enterprise Value 3yr Wty Solid State Drive	762261-B21
---	------------

12G SAS Hot Plug SFF (2.5-inch) Midline Drives

HPE 1TB 12G SAS 7.2K rpm SFF (2.5in) SC Midline 1yr Warranty Hard Drive	832514-B21
---	------------

12G SAS Hot Plug SFF (2.5-inch) Enterprise Drives

HPE 1.2TB SAS 12G Enterprise 10K SFF (2.5in) SC 3yr Wty Digitally Signed Firmware HDD	872479-B21
---	------------

HP 1.2TB 12G SAS 10K rpm SFF (2.5-inch) SC Enterprise 3yr Warranty Hard Drive	781518-B21
---	------------

HPE 900GB SAS 12G Enterprise 15K SFF (2.5in) SC 3yr Wty DS Digitally Signed Firmware HDD	870759-B21
--	------------

HP 900GB 12G SAS 10K rpm SFF (2.5-inch) SC Enterprise 3yr Warranty Hard Drive	785069-B21
---	------------

HPE 600GB SAS 12G Enterprise 10K SFF (2.5in) SC 3yr Wty Digitally Signed Firmware HDD	872477-B21
---	------------

HPE 600GB SAS 12G Enterprise 15K SFF (2.5in) SC 3yr Wty Digitally Signed Firmware HDD	870757-B21
---	------------

HP 600GB 12G SAS 10K rpm SFF (2.5-inch) SC Enterprise 3yr Warranty Hard Drive	781516-B21
---	------------

HP 600GB 12G SAS 15K rpm SFF (2.5-inch) SC Enterprise 3yr Warranty Hard Drive	759212-B21
---	------------

HP 450GB 12G SAS 15K rpm SFF (2.5-inch) SC Enterprise 3yr Warranty Hard Drive	759210-B21
---	------------

HPE 300GB SAS 12G Enterprise 10K SFF (2.5in) SC 3yr Wty Digitally Signed Firmware HDD	872475-B21
---	------------

HPE 300GB SAS 12G Enterprise 15K SFF (2.5in) SC 3yr Wty Digitally Signed Firmware HDD	870753-B21
---	------------

HP 300GB 12G SAS 10K rpm SFF (2.5-inch) SC Enterprise 3yr Warranty Hard Drive	785067-B21
---	------------

Core Options

HP 300GB 12G SAS 15K rpm SFF (2.5-inch) SC Enterprise 3yr Warranty Hard Drive 759208-B21

12G SAS Hot Plug SFF (2.5-inch) SC 512e Drives

HP 2TB 12G SAS 7.2K rpm SFF (2.5-inch) SC 512e 1yr Warranty Hard Drive 765466-B21

HPE 1.8TB SAS 12G Enterprise 10K SFF (2.5in) SC 3yr Wty 512e Digitally Signed Firmware HDD 872481-B21

HP 1.8TB 12G SAS 10K rpm SFF (2.5-inch) SC Enterprise 512e 3yr Warranty Hard Drive 791034-B21

HP 1TB 12G SAS 7.2K rpm SFF (2.5-inch) SC 512e 1yr Warranty Hard Drive 765464-B21

HPE 900GB SAS 12G Enterprise 15K SFF (2.5in) SC 3yr Wty 512e Digitally Signed Firmware HDD 870765-B21

HPE 600GB SAS 12G Enterprise 15K SFF (2.5in) SC 3yr Wty 512e Digitally Signed Firmware HDD 870763-B21

HP 600GB 12G SAS 15K rpm SFF (2.5-inch) SC 512e Enterprise 3yr Warranty Hard Drive 748387-B21

SSD Selection

To streamline the configuration process for HPE ProLiant Gen9 servers and to provide the best product availability, HPE recommends SSDs from the list located here: <http://www.hpe.com/products/recommend>. Best product availability is limited to US, Canada, and Latin America at this time.

To further assist with configuration, HPE also offers an SSD Selector Tool located here: <http://ssd.hpe.com>.

12G SAS Mixed Use Hot Plug SFF (2.5-inch) Solid State Drives

HPE 3.2TB 12G SAS Mixed Use-3 SFF 2.5-in SC 3yr Wty Solid State Drive 822567-B21

HPE 1.6TB 12G SAS Mixed Use-1 SFF (2.5in) SC 3yr Wty Solid State Drive 846436-B21

HPE 800GB 12G SAS Mixed Use-1 SFF (2.5in) SC 3yr Wty Solid State Drive 846434-B21

12G SAS Hot Plug SFF (2.5-inch) SC Write Intensive Solid State Drives

HPE 1.6TB 12G SAS Write Intensive-1 SFF (2.5in) SC 3yr Wty Solid State Drive 846432-B21

HPE 800GB 12G SAS Write Intensive-1 SFF (2.5in) SC 3yr Wty Solid State Drive 846430-B21

HP 800GB 12G SAS Write Intensive SFF 2.5-in SC 3yr Wty Solid State Drive 802586-B21

HP 400GB 12G SAS Write Intensive SFF 2.5-in SC 3yr Wty Solid State Drive 802582-B21

HP 200GB 12G SAS Write Intensive SFF 2.5-in SC 3yr Wty Solid State Drive 802578-B21

12G SAS Read Intensive Hot Plug SFF (2.5-inch) Solid State Drives

HPE 3.84TB 12G SAS Read Intensive-3 SFF 2.5-in SC 3yr Wty Solid State Drive 816576-B21

Core Options

HP 1.92TB 12G SAS Read Intensive SFF 2.5-in SC 3yr Wty Solid State Drive	802891-B21
HPE 1.6TB SATA 6G Read Intensive SFF (2.5in) SC 3yr Wty Digitally Signed Firmware SSD	869386-B21
HPE 960GB SATA 6G Read Intensive SFF (2.5in) SC 3yr Wty Digitally Signed Firmware SSD	869384-B21
HPE 480GB SATA 6G Read Intensive SFF (2.5in) SC 3yr Wty Digitally Signed Firmware SSD	869378-B21
HPE 240GB SATA 6G Read Intensive SFF (2.5in) SC 3yr Wty Digitally Signed Firmware SSD	869376-B21
HPE 150GB SATA 6G Read Intensive SFF (2.5in) SC 3yr Wty Digitally Signed Firmware SSD	869374-B21
12G SAS Hot Plug SFF (2.5-inch) Enterprise Mainstream Solid State Drives	
HP 1.6TB 12G SAS Mainstream Endurance SFF 2.5-in ENT Mainstream SC 3yr Wty H2 Solid State Drive	779176-B21
HP 800GB 12G SAS Mainstream Endurance SFF 2.5-in ENT Mainstream SC 3yr Wty H2 Solid State Drive	779172-B21
HP 400GB 12G SAS Mainstream Endurance SFF 2.5-in ENT Mainstream SC 3yr Wty H2 Solid State Drive	779168-B21
HP 200GB 12G SAS Mainstream Endurance SFF 2.5-in ENT Mainstream SC 3yr Wty H2 Solid State Drive	779164-B21
6G SAS Hot Plug with SmartDrive SFF (2.5-inch) Enterprise Drives	
HP 1.2TB 6G SAS 10K rpm SFF (2.5-inch) SC Dual Port Enterprise 3yr Warranty Hard Drive	718162-B21
HP 900GB 6G SAS 10K rpm SFF (2.5-inch) SC Enterprise 3yr Warranty Hard Drive	652589-B21
HP 600GB 6G SAS 10K rpm SFF (2.5-inch) SC Enterprise 3yr Warranty Hard Drive	652583-B21
HP 450GB 6G SAS 10K rpm SFF (2.5-inch) SC Enterprise 3yr Warranty Hard Drive	652572-B21
HP 300GB 6G SAS 10K rpm SFF (2.5-inch) SC Enterprise 3yr Warranty Hard Drive	652564-B21
HP 300GB 6G SAS 15K rpm SFF (2.5-inch) SC Enterprise 3yr Warranty Hard Drive	652611-B21
HP 146GB 6G SAS 15K rpm SFF (2.5-inch) SC Enterprise 3yr Warranty Hard Drive	652605-B21
6G SAS Hot Plug SmartDrive SFF (2.5-inch) Midline Drives	
HP 1TB 6G SAS 7.2K rpm SFF (2.5-inch) SC Midline 1yr Warranty Hard Drive	652749-B21
6G SATA Value Endurance Hot Plug SFF (2.5-inch) SC Enterprise Value M1 Solid State Drives	
HP 800GB 6G SATA Value Endurance SFF 2.5-in SC Enterprise Value 3yr Wty M1 Solid State Drive	764929-B21
HP 480GB 6G SATA Value Endurance SFF 2.5-in SC Enterprise Value 3yr Wty M1 Solid State Drive	764927-B21
HP 240GB 6G SATA Value Endurance SFF 2.5-in SC Enterprise Value 3yr Wty M1 Solid State Drive	764925-B21

Core Options

HP 120GB 6G SATA Value Endurance SFF 2.5-in SC Enterprise Value 3yr Wty M1 Solid State Drive	764923-B21
6G SATA Hot Plug SFF (2.5-inch) SC Mixed Use Solid State Drives	
HP 1.92TB 6G SATA Mixed Use-3 SFF 2.5-in SC 3yr Wty Solid State Drive	817011-B21
HPE 1.92TB SATA 6G Mixed Use SFF (2.5in) SC 3yr Wty Digitally Signed Firmware SSD	872352-B21
HP 1.6TB 6G SATA Mixed Use-2 SFF 2.5-in SC 3yr Wty Solid State Drive	804631-B21
HP 960GB 6G SATA Mixed Use-3 SFF 2.5-in SC 3yr Wty Solid State Drive	816995-B21
HPE 960GB SATA 6G Mixed Use SFF (2.5in) SC 3yr Wty Digitally Signed Firmware SSD	872348-B21
HP 800GB 6G SATA Mixed Use-2 SFF 2.5-in SC 3yr Wty Solid State Drive	804625-B21
HP 480GB 6G SATA Mixed Use-3 SFF 2.5-in SC 3yr Wty Solid State Drive	816985-B21
HP 480GB 6G SATA Mixed Use-2 SFF 2.5-in SC 3yr Wty Solid State Drive	832414-B21
HPE 480GB SATA 6G Mixed Use SFF (2.5in) SC 3yr Wty Digitally Signed Firmware SSD	872344-B21
HP 200GB 6G SATA Mixed Use-2 SFF 2.5-in SC 3yr Wty Solid State Drive	804613-B21
6G SATA Hot Plug SFF (2.5-inch) SC Write Intensive Solid State Drives	
HPE 1.6TB SATA 6G WI SFF SC DS SSD	872363-B21
HP 1.2TB 6G SATA Write Intensive-2 SFF 2.5-in SC 3yr Wty Solid State Drive	804677-B21
HP 800GB 6G SATA Write Intensive-2 SFF 2.5-in SC 3yr Wty Solid State Drive	804671-B21
HPE 800GB SATA 6G WI SFF SC DS SSD	872359-B21
HP 400GB 6G SATA Write Intensive-2 SFF 2.5-in SC 3yr Wty Solid State Drive	804665-B21
HPE 400GB SATA 6G WI SFF SC DS SSD	872355-B21
HP 200GB 6G SATA Write Intensive-2 SFF 2.5-in SC 3yr Wty Solid State Drive	804639-B21
6G SATA Hot Plug SFF (2.5-inch) SC Read Intensive Solid State Drives	
HP 3.84TB 6G SATA Read Intensive-3 SFF 2.5-in SC 3yr Wty Solid State Drive	816929-B21
HP 1.6TB 6G SATA Read Intensive-2 SFF 2.5-in SC 3yr Wty Solid State Drive	804605-B21
HP 800GB 6G SATA Read Intensive-2 SFF 2.5-in SC 3yr Wty Solid State Drive	804599-B21
HP 480GB 6G SATA Read Intensive-2 SFF 2.5-in SC 3yr Wty Solid State Drive	804593-B21
HP 240GB 6G SATA Read Intensive-2 SFF 2.5-in SC 3yr Wty Solid State Drive	804587-B21
HP 120GB 6G SATA Read Intensive-2 SFF 2.5-in SC 3yr Wty Solid State Drive	804581-B21
HP 80GB 6G SATA Read Intensive-2 SFF 2.5-in SC 3yr Wty Solid State Drive	804575-B21
HPE 960GB 6G SATA Read Intensive SFF (2.5in) SC 1yr Warranty Solid State Drive	871768-B21
HPE 1.92TB 6G SATA Read Intensive SFF (2.5in) SC 1yr Warranty Solid State Drive	871770-B21

Core Options

HPE NVMe PCIe Mixed Use SFF (2.5 inch) Solid State Drives

HP 1.6TB NVMe PCIe Mixed Use SFF 2.5-in SC2 3yr Wty Solid State Drive 765038-B21

HP 800GB NVMe PCIe Mixed Use SFF 2.5-in SC2 3yr Wty Solid State Drive 765036-B21

HP 400GB NVMe PCIe Mixed Use SFF 2.5-in SC2 3yr Wty Solid State Drive 765034-B21

HPE NVMe PCIe Write Intensive SFF (2.5-inch) Solid State Drives

HP 1.6TB NVMe PCIe Write Intensive SFF 2.5-in SC2 3yr Wty Solid State Drive 764892-B21

HP 800GB NVMe PCIe Write Intensive SFF 2.5-in SC2 3yr Wty Solid State Drive 736939-B21

HP 400GB NVMe PCIe Write Intensive SFF 2.5-in SC2 3yr Wty Solid State Drive 736936-B21

HPE NVMe PCIe Read Intensive SFF (2.5 inch) Solid State Drives

HP 1.2TB NVMe PCIe Read Intensive SFF 2.5-in SC2 3yr Wty Solid State Drive 764906-B21

HP 400GB NVMe PCIe Read Intensive SFF 2.5-in SC2 3yr Wty Solid State Drive 764904-B21

NOTE: To support NVMe PCIe SSDs you need to select the SSD Express Bay Kit (788359-B21), maximum of 5 drives supported.

NOTE: Hewlett Packard Enterprise has qualified the NVMe drive portfolio using the Operating System inbox drivers. For full details please see the Solid State Drive QuickSpecs:

<https://www.hpe.com/h20195/v2/GetHTML.aspx?docname=c04154378>.

Hard Drive Kits

HPE DL580 Gen9 NVMe 5 Solid State Drive Express Bay Enablement Kit 788359-B21

HP ProLiant DL580 5 Small Form Factor Drive Backplane Cage Kit 739405-B21

HP Small Form Factor Hard Drive Blank Kit 666987-B21

HPE Networking 1 Gigabit Ethernet adapters

HPE Ethernet 1Gb 4-port 331T Adapter 647594-B21

HPE Ethernet 1Gb 2-port 332T Adapter 615732-B21

HPE Ethernet 1Gb 2-port 361T Adapter 652497-B21

HPE Ethernet 1Gb 4-port 366T Adapter 811546-B21

10 Gigabit Ethernet adapters

HP Ethernet 10Gb 2-port 530SFP Adapter 652503-B21

HPE Ethernet 10Gb 2-port 530T Adapter 656596-B21

HPE Ethernet 10Gb 2-port 546SFP+ Adapter 779793-B21

HPE Ethernet 10Gb 2-port 557SFP+ Adapter 788995-B21

HPE Ethernet 10Gb 2-port 560SFP+ Adapter 665249-B21

HPE Ethernet 10Gb 2-port 561T Adapter 716591-B21

HPE Ethernet 10Gb 2-port 562SFP+ Adapter 727055-B21

NOTE: A minimum of two Gigabytes (2 GB) of server memory is required per each adapter.

Core Options

FlexibleLOM Adapters

HPE Ethernet 1Gb 4-port 331FLR FIO Adapter	684208-B21
HPE Ethernet 1Gb 4-port 366FLR FIO Adapter	684217-B21
HP FlexFabric 10Gb 2-port 533FLR-T FIO Adapter	700760-B21
HPE FlexFabric 10Gb 2-port 534FLR-SFP+ FIO Adapter	700752-B21
HPE FlexFabric 10Gb 4-port 536FLR-T Adapter	764302-B21
HPE FlexFabric 10Gb 4-port 536FLR-T FIO Adapter	764303-B21
HPE Ethernet 10Gb 2-port 546FLR-SFP+ Adapter	779799-B21
HPE Ethernet 10Gb 2-port 546FLR-SFP+ FIO Adapter	779800-B21
HPE FlexFabric 10Gb 2-port 556FLR-T Adapter	794525-B21
HPE FlexFabric 10Gb 2-port 556FLR-T FIO Adapter	794526-B21
HPE FlexFabric 10Gb 2-port 556FLR-SFP+ Adapter	727060-B21
HPE FlexFabric 10Gb 2-port 556FLR-SFP+ FIO Adapter	732456-B21
HPE Ethernet 10Gb 2-port 560FLR-SFP+ Adapter	665243-B21
HPE Ethernet 10Gb 2-port 560FLR-SFP+ FIO Adapter	684218-B21
HPE Ethernet 10Gb 2-port 561FLR-T Adapter	700699-B21
HP Ethernet 10Gb 2-port 561FLR-T FIO Adapter	700700-B21
HPE Ethernet 10Gb 2-port 562FLR-SFP+ Adapter	727054-B21
HP Ethernet 10Gb 2-port 562FLR-SFP+ FIO Adapter	789006-B21

NOTE: Wake-On-LAN not supported with FlexibleLOMs on DL580 Gen9.

NOTE: Please see the QuickSpecs for Technical Specifications and additional information: <http://www.hp.com/go/ProLiantNICs>.

25 Gigabit Ethernet adapters

HPE Ethernet 10/25Gb 2-port 640FLR-SFP28 Adapter	817749-B21
HPE Ethernet 10/25Gb 2-port 640FLR-SFP28 FIO Adapter	817750-B21
HPE Ethernet 10/25Gb 2-port 640SFP28 Adapter	817753-B21
HPE Ethernet 4x25Gb 1-port 620QSFP28 Adapter	817762-B21

HPE InfiniBand	HP InfiniBand FDR 2-port 545QSFP Adapter	702211-B21
	NOTE: Legacy and UEFI modes are supported.	
	HP InfiniBand FDR/Ethernet 10Gb/40Gb 2-port 544+QSFP Adapter	764284-B21
	NOTE: UEFI and Legacy modes are supported with Ethernet and InfiniBand functionality.	
	HP InfiniBand FDR/Ethernet 10Gb/40Gb 2-port 544+FLR-QSFP Adapter	764285-B21
	NOTE: UEFI and Legacy modes are supported with Ethernet and InfiniBand functionality.	
	HP InfiniBand QDR/Ethernet 10Gb 2-port 544+FLR-QSFP Adapter	764286-B21
	HPE 100Gb 1-port OP101 QSFP28 x16 PCIe Gen3 with Intel® Omni-Path Architecture Adapter	829335-B21
	HPE 100Gb 1-port OP101 QSFP28 x8 PCIe Gen3 with Intel® Omni-Path Architecture Adapter	829334-B21
	HPE InfiniBand EDR/Ethernet 100Gb 1-port 840QSFP28 Adapter	825110-B21
	HPE InfiniBand EDR/Ethernet 100Gb 2-port 840QSFP28 Adapter	825111-B21

Core Options

HPE Power Supplies

HPE Common Slot Platinum Plus Power Supply Kits

HPE 1500W Common Slot Platinum Plus Power Supply Kit	684532-B21
HPE 1500W Common Slot 48VDC Hot Plug Power Supply Kit	746708-B21
HPE 1200W Common Slot Platinum Hot Plug Power Supply Kit	748287-B21
HPE 1200W Common Slot Platinum Plus Hot Plug Power Supply Kit	656364-B21

NOTE: 94% efficiency with support for HPE Power Discovery Services.

NOTE: Prior to making a power supply selection it is highly recommended that the HPE Power Advisor is run to determine the right size power supply for your server configuration. The HPE Power Advisor is located at:

<http://www.hpe.com/info/hppoweradvisor>.

NOTE: Minimum of two (2) power supplies are required.

NOTE: All power supplies in a server should match. Mixing Power Supplies is not supported.

NOTE: Option Kits contain the specified power supply and a PDU IEC cable.

NOTE: 1500W Power Supplies only support High Line Voltage.

NOTE: HPE ProLiant servers ship with an IEC-IEC power cord used for rack mounting with Power Distribution Units (PDUs). For a full list of optional Hewlett Packard Enterprise power cords please go to <http://www.hp.com/products/powercords>.

HPE Computation and Graphics Accelerators

NVIDIA Tesla K40C 12GB Computational Accelerator

753960-B21

NOTE: Up to 4 cards are supported on the DL580 Gen9. Supporting multiple number of cards on the DL580 Gen9 blocks some active IO cards as follows due to space constraints:

For 2P config: Max of 2 double-wide cards are supported on slot 6 and slot 9 (slot 8 is blocked).

For 3P config: Max of 3 double-wide cards are supported on slot 3, slot 6 and slot 9 (slot 5 and slot 8 are blocked).

For 4P config: Max of 4 double wide cards are supported on Slot 1, Slot 3, Slot 6 and Slot 9 (slot 5 and slot 8 are blocked).

NOTE: HPE DL580/DL585/DL980 Power Cable Kit (631660-B21) is required for Graphics cards. Each cable kit has two 8-pin connectors (one 150W and other 225W) and can support up to two cards. For three cards, two cable kits are required. For 4 cards, 2 cable kits are required. The cards pull up to 75W of power from the IO slot and the rest from the auxiliary power connectors.

NOTE: Supported at Gen2 speeds.

HP NVIDIA Quadro M6000 Graphics Accelerator

J0G92A

NOTE: Only four M6000 graphic cards are supported on DL580 Gen9.

NOTE: If any HPE ProLiant server is configured with an NVIDIA Graphics Processor Unit (GPU), it must have less than 1 TB of server host memory. If the memory equals or exceeds 1 TB, the GPU options will not function properly due to a memory addressing design limitation with the NVIDIA GPU. See [HPE Service Advisory](#) for more details.

NOTE: The DL580 Gen9 supports six auxiliary power connectors.

HPE NVIDIA Tesla M60 Reverse Air Flow Dual GPU PCIe Graphics Accelerator

M3X67A

NOTE: Up to 4 cards are supported on the DL580 Gen9. Supporting multiple number of cards on the DL580 Gen9 blocks some active IO

Core Options

cards as follows due to space constraints:

For 2P config: Max of 2 double-wide cards are supported on slot 6 and slot 9 (slot 8 is blocked).

For 3P config: Max of 3 double-wide cards are supported on slot 3, slot 6 and slot 9 (slot 5 and slot 8 are blocked).

For 4P config: Max of 4 double wide cards are supported on Slot 1, Slot 3, Slot 6 and Slot 9 (slot 5 and slot 8 are blocked).

NOTE: HPE DL580Gen9 M60 Reverse Air Flow Cable Kit (869724-B21) is required for Graphics cards.

HPE DL580 Gen9 M60 Reverse Air Flow Cable Kit

869724-B21

HPE NVIDIA Quadro M6000 24GB Graphics Accelerator

P8Y47A

NOTE: Only four M6000 graphic cards are supported on DL580 Gen9.

NOTE: If any HPE ProLiant server is configured with an NVIDIA Graphics Processor Unit (GPU), it must have less than 1 TB of server host memory. If the memory equals or exceeds 1 TB, the GPU options will not function properly due to a memory addressing design limitation with the NVIDIA GPU. See [HPE Service Advisory](#) for more details.

NOTE: The DL580 Gen9 supports six auxiliary power connectors.

Additional Options

NOTE: Some options may not be integrated at the factory. To ensure only valid configurations are ordered, Hewlett Packard Enterprise recommends the use of an HPE approved configurator. Contact your local sales representative for additional information.

HPE Insight Software	HPE Insight Control	
	HPE Insight Control including 1yr 24x7 Technical Support and Updates 1-server LTU	C6N27A
	HPE Insight Control including 1yr 24x7 TSU E-LTU	C6N28ABE
	HPE Insight Management Media Kit	C6N31A
	NOTE: Electronic and Flexible-Quantity licenses can be used to purchase multiple licenses with a single activation key.	
	NOTE: Customer will receive a license entitlement certificate. The license entitlement certificate must be redeemed online or via fax in order to obtain the license activation key(s). Includes one year of 24 x 7 HPE Software Technical Support and Update Service.	
	NOTE: Licenses ship without media. The HPE Insight Control Media Kit can be ordered separately, or can be downloaded at: http://www.hp.com/go/insightupdates	
	NOTE: For additional license options please see the HPE Insight Control QuickSpecs .	
	HPE Insight Control including 1yr 24x7 Support ProLiant ML/DL/BL-bundle Single Server FIO LTU	C6N36A
	HPE Insight Control including 1yr 24x7 Support ProLiant ML/DL/BL-bundle FIO E-LTU	C6N36ABE

HPE Converged Infrastructure Management Software	HPE OneView Advanced (with HPE iLO Advanced)	
	HPE OneView including 3yr 24x7 Support Physical 1-server LTU	E5Y34A
	HPE OneView including 3yr 24x7 Support Flexible Quantity E-LTU	E5Y35AAE
	HPE OneView for ProLiant DL Server including 3yr 24x7 Support FIO Bundle Physical 1-server LTU	E5Y43A
	HPE OneView Advanced (without HPE iLO Advanced)	
	HPE OneView w/o iLO including 3yr 24x7 Support 1-server LTU	P8B24A
	HPE OneView w/o iLO including 3yr 24x7 Support Flexible Quantity E-LTU	P8B26AAE
	HPE OneView w/o iLO including 3yr 24x7 Support 1-server FIO LTU	P8B31A
	HPE OneView Physical Media Kit LTU	E5Y37A
	HPE Operations Analytics for HPE OneView LTU	K8G29A
	HPE Operations Analytics for HPE OneView E-LTU	K8G29AAE
	NOTE: Full licenses of HPE OneView Advanced also provide the right-to-use HPE Insight Control without additional charge.	
	NOTE: Server provisioning (via 'HPE Insight Control server provisioning') is licensed as part of HPE OneView Advanced and provides multi-server OS and driver provisioning. Media kit #BD883A can be ordered for a physical copy of this software (USB flash drive).	
	NOTE: Licenses ship without media. The HPE OneView Media Kit can be ordered separately, or can be downloaded at: http://www.hp.com/go/oneview .	
NOTE: Electronic and Flexible-Quantity licenses can be used to purchase multiple licenses with a single activation key.		

Additional Options

NOTE: Please see the [HPE OneView QuickSpecs](#) for Technical Specifications and additional information.

HPE iLO Advanced License	HPE iLO Advanced	
	HPE iLO Advanced including 3yr 24x7 Technical Support and Updates E-LTU	E6U64ABE
	HPE iLO Advanced including 1yr 24x7 Technical Support and Updates E-LTU	E6U59ABE
	HPE iLO Advanced including 3yr 24x7 Tech Support and Updates 1-server LTU	BD505A
	HPE iLO Advanced including 1yr 24x7 Technical Support and Updates 1-server LTU	512485-B21

HPE PCIe Workload Accelerator Options	Light Endurance (LE) PCIe Workload Accelerators	
	HPE 5.2TB FH/HL Light Endurance (LE) PCIe Workload Accelerator	775672-B21
	HPE 2.6TB HH/HL Light Endurance (LE) PCIe Workload Accelerator	775670-B21
	HPE 1.3TB HH/HL Light Endurance (LE) PCIe Workload Accelerator	775668-B21
	HPE 1.0TB HH/HL Light Endurance (LE) PCIe Workload Accelerator	775666-B21
	HPE Read Intensive PCIe Workload Accelerator	
	HPE 6.4TB Read Intensive-2 FH/HL PCIe Workload Accelerator	831739-B21
	HPE 3.2TB Read Intensive-2 HH/HL PCIe Workload Accelerator	831737-B21
	HPE 1.6TB Read Intensive-2 HH/HL PCIe Workload Accelerator	831735-B21
	HPE 1.3TB Read Intensive-2 HH/HL PCIe Workload Accelerator	831733-B21
	NVMe PCIe Workload Accelerators	
	HPE 2.0TB NVMe Mixed Use HH/HL PCIe Workload Accelerator	803204-B21
	HPE 1.6TB NVMe Mixed Use HH/HL PCIe Workload Accelerator	803202-B21
	HPE 1.6TB NVMe Write Intensive HH/HL PCIe Workload Accelerator	803197-B21
	HPE 800GB NVMe Mixed Use HH/HL PCIe Workload Accelerator	803200-B21
	HPE 800GB NVMe Write Intensive HH/HL PCIe Workload Accelerator	803195-B21

NOTE: Both Legacy and UEFI BIOS modes are supported. Please see the [HPE PCIe Workload Accelerators for ProLiant Servers QuickSpecs](#) for Technical Specifications and additional information.

Additional Options

HPE Security	<p>HP Trusted Platform Module 2.0 Kit 745823-B21</p> <p>NOTE: HPE Trusted Platform Module 2.0 Option (745823-B21) works with Gen9 servers with UEFI Mode not Legacy Mode. It is not compatible with HPE ProLiant Gen8 servers or earlier generation variants. HPE Gen9 servers purchased earlier may need the latest firmware update to be compatible with the TPM 2.0 Option. The earlier HPE Trusted Platform Module Option (488069-B21) is the TPM 1.2 version, which is also available however TPM 2.0 has newer technology standards incorporated. The TPM 1.2 compatible server platforms include Gen8 and Gen9 servers. HPE server systems can have a TPM module (of any type) installed only once. It cannot be replaced with any other TPM module.</p>
---------------------	---

HPE Storage Controllers

SAS Controllers

HPE Smart Array Controllers

HPE Smart Array P430/2GB FBWC 12Gb 1-port Int SAS Controller 698529-B21

HPE Smart Array P430/4GB FBWC 12Gb 1-port Int SAS Controller 698530-B21

NOTE: Please see the [HPE Smart Array P430 Controller QuickSpecs](#) for Technical Specifications and additional information.

HPE Smart Array P431/2GB FBWC 12Gb 2-ports Ext SAS Controller 698531-B21

HPE Smart Array P431/4GB FBWC 12Gb 2-ports Ext SAS Controller 698532-B21

NOTE: Please see the [HPE Smart Array P431 Controller QuickSpecs](#) for Technical Specifications and additional information.

HPE Smart Array P830/4GB FBWC 12Gb 2-ports Int SAS Controller 698533-B21

NOTE: Please see the [HPE Smart Array P830 Controller QuickSpecs](#) for Technical Specifications and additional information.

HP Smart Array 2GB 24in FIO Flashback Write Cache 758836-B21

HP 4GB Flash Backed Write Cache FIO Kit for P-series Smart Array Controllers 698537-B21

NOTE: A maximum of 4 HPE Smart Array Controllers (including embedded controller) can be installed.

HPE Smart Host Bus Adapters

HPE H240 12Gb 2-ports Int Smart Host Bus Adapter 726907-B21

NOTE: Please see the [HPE H240 Smart Host Bus Adapter QuickSpecs](#) for Technical Specifications and additional information.

HPE H241 12Gb 2-ports Ext Smart Host Bus Adapter 726911-B21

NOTE: Please see the [HPE H241 Smart Host Bus Adapter QuickSpecs](#) for Technical Specifications and additional information.

HP H240 12Gb 2-ports Int FIO Smart Host Bus Adapter 761873-B21

NOTE: For more information about HPE SmartCache, go to: <http://www.hp.com/go/smartcache>

NOTE: Both Legacy and UEFI modes are supported.

Optional Upgrades

HP DL580 PCIe Stand-up SAS Controller Upper Drive Backplane Cable Kit 748916-B21

HPE DL580 Gen9 H240 Card Upper SAS Backplane Cable Kit 805356-B21

Additional Options

HPE Tape Backup

NOTE: For the complete range of tape drives, autoloaders, libraries and media see: <http://www.hp.com/go/tape>. For hardware and software compatibility of HPE tape backup products see: <http://www.hp.com/storage/SPOCK> and <http://www.hp.com/go/ebs>

NOTE: For Internal drives to be connected to DL servers please make sure that you order rack mount kits as well.

HPE StoreEver LTO-4 Ultrium 1760 SAS (1) in a 1U Rack Mount Kit	EH946C
HPE StoreEver LTO-7 Ultrium 15000 External Tape Drive	BB874A
HPE StoreEver LTO-7 Ultrium 15000 Internal Tape Drive	BB873A
HPE StoreEver LTO-6 Ultrium 6650 SAS External Tape Drive	EH964A
HPE StoreEver LTO-6 Ultrium 6250 Tape Drive in a 1U Rack Mount Kit	C0L99A
HPE StoreEver LTO-6 Ultrium 6250 External Tape Drive	EH970A
HPE StoreEver LTO-5 Ultrium 3000 SAS Tape Drive in a 1U Rack Mount Kit	EJ014B
HPE StoreEver LTO-5 Ultrium 3000 SAS External Tape Drive	EH958B
HPE StoreEver LTO-5 Ultrium 3280 SAS External Tape Drive	EH900B
HPE StoreEver LTO-4 Ultrium 1760 SAS External Tape Drive	EH920B
HPE StoreEver LTO-3 Ultrium 920 SAS External Tape Drive	EH848B
HPE StoreEver 1U SAS Rack Mount Kit	AE459B
HPE DAT Autoloader	
HPE StoreEver 1/8 G2 LTO-6 Ultrium 6250 Fibre Channel Tape Autoloader	C0H19A
HPE StoreEver 1/8 G2 LTO-7 Ultrium 15000 FC Tape Autoloader	N7P34A
HPE StoreEver 1/8 G2 LTO-7 Ultrium 15000 SAS Tape Autoloader	N7P35A
HPE MSL2024 Tape Library	
HPE StoreEver MSL2024 0-drive Tape Library	AK379A
HPE MSL4048 Tape Library	
HPE StoreEver MSL4048 0-drive Tape Library	AK381A
HPE StoreEver MSL6480	
HPE StoreEver MSL6480 Scalable Base Module	QU625A
HPE StoreEver MSL6480 Scaleable Expansion Module	QU626A

NOTE: Please see the [HPE StoreEver MSL6480 Tape Library QuickSpecs](#) for Technical Specifications and additional information.

Additional Options

HPE Disk Backup	HPE D3700 Enclosure	QW967A
	HPE D3600 Enclosure	QW968A
	HPE StoreOnce 3100 8TB System	BB913A
	HPE StoreOnce 3540 24TB System	BB914A
	HPE StoreOnce 5100 48TB System	BB915A
	HPE StoreOnce 3520 12TB System	BB922A
	HPE RDX 3TB USB 3.0 Internal Disk Backup System	P9L71A
	HPE RDX+ 3TB USB 3.0 External Disk Backup System	P9L72A

NOTE: For the complete range of RDX drives and media see:

<http://www.hp.com/go/rdx>. For hardware and software compatibility of Hewlett Packard Enterprise disk backup products see:

<http://www.hp.com/storage/SPOCK>.

NOTE: For internal drives to be connected to DL servers please make sure that you order rack mount kit as well.

HPE Storage Options

HPE Converged Network Adapters

HPE StoreFabric CN1100R 10GBASE-T Dual Port Converged Network Adapter	N3U52A
HPE StoreFabric CN1100R Dual Port Converged Network Adapter	QW990A
NOTE: FCOE boot from SAN is not supported with VMWare.	
HPE StoreFabric CN1200E 10GBASE-T Dual Port Converged Network Adapter	N3U51A
HPE StoreFabric CN1200E 10Gb Converged Network Adapter	E7Y06A

NOTE: Both UEFI and Legacy mode are supported.

QLogic Fibre Channel HBAs

HPE 81Q 8Gb 1-port PCIe Fibre Channel Host Bus Adapter	AK344A
HPE 82Q 8Gb 2-port PCIe Fibre Channel Host Bus Adapter	AJ764A
HPE StoreFabric 84Q 4-port 8Gb Fibre Channel Host Bus Adapter	P9D91A
HPE StoreFabric SN1000Q 16Gb 1-port PCIe Fibre Channel Host Bus Adapter	QW971A
HPE StoreFabric SN1100Q 16Gb Single Port Fibre Channel Host Bus Adapter	P9D93A
HPE StoreFabric SN1000Q 16Gb 2-port PCIe Fibre Channel Host Bus Adapter	QW972A
HPE StoreFabric SN1100Q 16Gb Dual Port Fibre Channel Host Bus Adapter	P9D94A
HPE StoreFabric SN1600Q 32Gb Single Port Fibre Channel Host Bus Adapter	P9M75A
HPE StoreFabric SN1600Q 32Gb Dual Port Fibre Channel Host Bus Adapter	P9M76A

Emulex Fibre Channel HBAs

HPE 81E 8Gb 1-port PCIe Fibre Channel Host Bus Adapter	AJ762B
HPE 82E 8Gb 2-port PCIe Fibre Channel Host Bus Adapter	AJ763B
HPE StoreFabric 84E 4-port 8Gb Fibre Channel Host Bus Adapter	E7Y63A
HPE StoreFabric SN1100E 16Gb Single Port Fibre Channel Host Bus Adapter	C8R38A

Additional Options

HPE StoreFabric SN1100E 16Gb Dual Port Fibre Channel Host Bus Adapter	C8R39A
HPE StoreFabric SN1100E 4-port 16Gb Fibre Channel Host Bus Adapter	P9D99A
HPE StoreFabric SN1600E 32Gb Single Port Fibre Channel Host Bus Adapter	Q0L11A
HPE StoreFabric SN1600E 32Gb Dual Port Fibre Channel Host Bus Adapter	Q0L12A
HPE StoreFabric SN1200E 16Gb Single Port Fibre Channel Host Bus Adapter	Q0L13A
HPE StoreFabric SN1200E 16Gb Dual Port Fibre Channel Host Bus Adapter	Q0L14A

HPE Disk Storage Systems

Disk Enclosures

HP D6000 Dual I/O Module Disk Enclosure	QQ695A
HP D6000 w/35 4TB 6G SAS 7.2K LFF Dual Port MDL HDD 140TB Bundle	E7W30A
HP D6000 w/70 4TB 6G SAS 7.2K LFF Dual Port MDL HDD 280TB Bundle	E7W31A
HP D6000 w/35 2TB 6G SAS 7.2K LFF Dual port MDL HDD 70TB Bundle	QQ697A
HP D6000 w/70 2TB 6G SAS 7.2K LFF Dual port MDL HDD 140TB Bundle	QQ698A
HP D6000 w/35 3TB 6G SAS 7.2K LFF Dual port MDL HDD 105TB Bundle	QQ699A
HP D6000 w/70 3TB 6G SAS 7.2K LFF Dual port MDL HDD 210TB Bundle	QQ700A
HPE D6000 w/70 8TB 12G SAS 7.2K LFF (3.5in) Dual Port MDL HDD 560TB Bundle	M0T59A
HPE D6000 w/35 8TB 12G SAS 7.2K LFF (3.5in) Dual Port MDL HDD 280TB Bundle	M0T58A

NOTE: Please see the [HPE D6000 Disk Enclosure QuickSpecs](#) for Technical Specifications and additional information.

HPE Data Center Racks

HPE Advanced Series Racks

HPE 48U 600mm x 1075mm Advanced Pallet Rack	H6J87A
HPE 48U 600mm x 1075mm Advanced Shock Rack	H6J88A
HPE 42U 600mm x 1075mm Advanced Pallet Rack	H6J65A
HPE 42U 600mm x 1075mm Advanced Shock Rack	H6J66A
HPE 42U 600mm x 1200mm Advanced Pallet Rack	H6J67A
HPE 42U 600mm x 1200mm Advanced Shock Rack	H6J68A
HPE 36U 600mm x 1075mm Advanced Pallet Rack	H6J77A
HPE 36U 600mm x 1075mm Advanced Shock Rack	H6J78A
HPE 22U 600mm x 1075mm Advanced Pallet Rack	H6J83A
HPE 22U 600mm x 1075mm Advanced Shock Rack	H6J84A
HPE 14U 600mm x 1075mm Advanced Shock Rack	H6J82A

NOTE: Please see the [HPE Advanced Series Racks QuickSpecs](#) for information on additional racks options and rack specifications.

HPE Enterprise Series Racks

Additional Options

HP 47U 600mm x 1075mm Enterprise Pallet Rack	BW911A
HP 47U 600mm x 1075mm Enterprise Shock Rack	BW912A
HP 47U 600mm x 1200mm Enterprise Pallet Rack	BW913A
HP 47U 600mm x 1200mm Enterprise Shock Rack	BW914A
HPE 42U 600mm x 1075mm Enterprise Pallet Rack	BW903A
HP 42U 600mm x 1075mm Enterprise Shock Rack	BW904A
HP 42U 600mm x 1200mm Enterprise Pallet Rack	BW907A
HP 42U 600mm x 1200mm Enterprise Shock Rack	BW908A
HP 36U 600mm x 1075mm Enterprise Pallet Rack	BW895A
HP 36U 600mm x 1075mm Enterprise Shock Rack	BW896A
HP 42U 800mm x 1075mm Enterprise Pallet Rack	BW917A
HP 42U 800mm x 1075mm Enterprise Shock Rack	BW918A

NOTE: Please see the [HPE Enterprise Series Racks QuickSpecs](#) for information on additional racks options and rack specifications.

HPE Value Series Rack

HP 42U 600mm x 1075mm Standard Pallet Rack	AF046A
--	--------

NOTE: Please see the [HPE Standard Series Racks QuickSpecs](#) for information on additional racks options and rack specifications.

HPE Power Distribution Units (PDUs)

HPE Basic Power Distribution Units (PDU)

HPE Basic 1.9kVA/L5-20P 16A/120V Outlets (12) 5-20R/Horizontal NA/JP PDU	H5M54A
HPE Basic 3.6kVA/60320 C20 Detachable 16A/230V Outlets (12) C13/Horizontal WW PDU	H5M56A
HPE Basic 2.8kVA/L5-30P 24A/120V Outlets (18) 5-20R/Vertical NA/JP PDU	H5M55A
HPE Basic 4.9kVA/60320 C20 Detachable 16A/230V Outlets (20) C13/Vertical WW PDU	H5M57A
HPE Basic 4.9kVA/L6-30P 24A/208V Outlets (20) C13/Vertical NA/JP PDU	H5M58A
HPE Basic 7.3kVA/60309 5-wire 32A/230V Outlets (20) C13/Vertical INTL PDU	H5M68A
HPE Basic 3Ph 8.6kVA/L15-30P 24A/208V Outlets (18) C13/Vertical NA/JP PDU	H5M61A
HPE Basic 4.9kVA/L6-30P 24A/208V Outlets (24) C13 (6) C19/Vertical NA/JP PDU	H5M59A
HPE Basic 7.3kVA/60309 3-wire 32A/230V Outlets (24) C13 (6) C19/Vertical INTL PDU	H5M70A
HPE Basic 8.3kVA/CS8265C 40A/208V Outlets (30) C13 (6) C19/Vertical NA PDU	H5M60A
HPE Basic 11kVA/60309 63A 3-wire 48A/230V Outlets (30) C13 (6) C19/Vertical INTL PDU	H5M71A
HPE Basic 9.2kVA/50A Terminal Block 40A/230V Outlets (30) C13 (6) C19/Vertical WW PDU	H5M75A

Additional Options

HPE Basic 3Ph 5.7kVA/ L21-20P 16A/120-208V Outlets (24) C13 (3) 5-20R/Vertical NA/JP PDU	H5M63A
HPE Basic 3Ph 8.6kVA/L21-30P 24A/120-208V Outlets (24) C13 (3) C19 (3) 5-20R/Vertical NA/JP PDU	H5M64A
HPE Basic 3Ph 8.6kVA/L15-30P 24A/208V Outlets (24) C13 (6) C19/Vertical NA/JP PDU	H5M62A
HPE Basic 3Ph 11kVA/60309 5-wire 16A/230V Outlets (24) C13 (6) C19/Vertical INTL PDU	H5M72A
HPE Basic 3Ph 11kVA/60309 5-wire 16A/230V Outlets (36) C13 (6) C19/Vertical INTL PDU	H5M73A
HPE Basic 3Ph 11kVA/60309 16A/240V Outlets (36) C13 (6) C19/Vertical NA PDU	H5M67A
HPE Basic Modular 2.8kVA/L5-30P 24A/120V Outlets (4) C19/Horizontal NA/JP PDU	252663-D71
HPE Basic Modular 4.9kVA/L6-30P 24A/208V Outlets (4) C19/Horizontal NA/JP Core Only PDU	252663-D74
HPE Basic Modular 8.3kVA/CS8265C 40A/208V Outlets (4) C19/Horizontal NA/JP PDU	252663-D75
HPE Basic Modular 7.3kVA/60309 3-wire 32A/230V Outlets (4) C19/Horizontal INTL Core Only PDU	252663-B33
HPE Basic Modular 9.2kVA/60309 63A 3-wire 40A/230V Outlets (4) C19/Horizontal INTL PDU	252663-B34
HPE Basic Modular 3Ph 8.6kVA/L15-30P 24A/208V Outlets (6) C19/Horizontal NA/JP PDU	AF512A
HPE Basic Modular 3Ph 11kVA/60309 5-wire 16A/230V Outlets (6) C19/Horizontal INTL PDU	AF513A
HPE Basic Modular 3Ph 14.4kVA/CS8365C 40A/208V Outlets (6) C19/Horizontal NA/JP PDU	AF519A
HPE Basic Modular 3Ph 17.3kVA/60309 60A 4-wire 48A/208V Outlets (6) C19/Horizontal NA/JP PDU	AF511A
HPE Basic Modular 3Ph 22kVA/60309 5-wire 32A/230V Outlets (6) C19/Horizontal INTL PDU	AF518A
HP 800VA - 277V Input / 230V Output NA Rack Mount Transformer	H3X09A
NOTE: Please see the HPE Basic Power Distribution Units (PDU) QuickSpecs for information on additional options and product specifications.	
HPE Metered Power Distribution Units (PDU)	
HPE Metered 2.8kVA/L5-30P 24A/120V Outlets (12) 5-20R/Horizontal NA/JP PDU	D9N43A
HPE Metered 3.6kVA/60320 C20 Detachable 16A/230V Outlets (12) C13/Horizontal WW PDU	D9N46A
HPE Metered 4.9kVA/L6-30P 24A/208V Outlets (12) C13/Horizontal NA/JP PDU	D9N44A
HPE Metered 3.6kVA/60320 C20 Detachable 16A/230V Outlets (16) C13/Vertical WW PDU	D9N45A
HPE Metered 4.9kVA/L6-30P 24A/208V Outlets (12) C13/Vertical NA/JP PDU	G9Z05A
HPE Metered 7.3kVA/60309 3-wire 32A/230V Outlets (12) C13/Vertical INTL PDU	G9Z06A

Additional Options

HPE Metered 4.9kVA/L6-30P 24A/208V Outlets (20) C13 (4) C19/Vertical NA/JP PDU	D9N47A
HPE Metered 7.3kVA/60309 32A 3-wire/230V Outlets (20) C13 (4) C19/Vertical INTL PDU	D9N48A
HPE Metered 3Ph 8.6kVA/L15-30P 24A/208V Outlets (18) C13 (3) C19/Vertical NA/JP PDU	D9N51A
HPE Metered 3Ph 8.6kVA/L21-30P 24A/120-208V Outlets (18) C13 (3) C19 (3) 5-20R/Vertical NA/JP PDU	D9N53A
HPE Metered 3Ph 11kVA/60309 5-wire 16A/230V Outlets (18) C13 (3) C19/Vertical INTL PDU	D9N55A
HPE Metered 8.3kVA/CS8265C 40A/208V Outlets (30) C13 (3) C19/Vertical NA PDU	D9N49A
HPE Metered 7.3kVA/60309 32A 3-wire/230V Outlet (32) C13 (4) C19/Vertical INTL PDU	D9N50A
HPE Metered 3Ph 11kVA/60309 5-wire 16A/230V Outlets (30) C13 (3) C19/Vertical INTL PDU	D9N57A
HPE Metered 3Ph 14.4kVA/CS8365C 40A/208V Outlets (12) C13 (12) C19/Vertical NA/JP PDU	D9N58A
HPE Metered 3Ph 16.6kVA/60309 32A-30A 5-wire 24A/230V Outlets (30) C13 (3) C19/Vertical NA/JP PDU	D9N61A
HPE Metered 3Ph 16.6kVA/60309 32A-30A 5-wire 24A/230V Outlets (12) C13 (12) C19/Vertical NA/JP PDU	D9N62A
HPE Metered 3Ph 17.3kVA/60309 60A 4-wire 48A/208V Outlets (24) C13 (3) C19/Vertical NA/JP PDU	D9N54A
HPE Metered 3Ph 17.3kVA/60309 60A 4-wire 48A/208V Outlets (12) C13 (12) C19/Vertical NA/JP PDU	D9N59A
HPE Metered 3Ph 17.3kVA/60309 60A 4-wire 48A/208V Outlets (12) C13 (12) C19/Vertical NA/JP PDU	G9Z07A
HPE Metered 3Ph 19.9kVA/L22-30P 24A/277V Outlets (30) RF-203P-HP/Vertical NA PDU	D9N63A
HPE Metered 3Ph 22kVA/60309 5-wire 32A/230V Outlet (30) C13 (3) C19/Vertical INTL PDU	D9N56A
HPE Metered 3Ph 22kVA/60309 5-wire 32A/230V Outlets (12) C13 (12) C19/Vertical INTL PDU	D9N60A
HPE Metered 3Ph 22kVA/60309 5-wire WT 32A/230V Outlets (12) C13 (12) C19/Vertical INTL PDU	G9Z08A
HP Environmental Sensor for Remote Monitored and Managed PDUs	E2D53A
NOTE: Please see the HPE Metered Power Distribution Units (PDU) QuickSpecs for information on additional options and product specifications.	
HPE Intelligent Power Distribution Unit (PDU)	
HPE Intelligent Modular 4.9kVA/L6-30P 24A/208V Outlets (6) C19/Horizontal NA/JP PDU	AF520A
HPE Intelligent Modular 8.3kVA/CS8265C 40A/208V Outlets (6) C19/Horizontal NA/JP PDU	AF521A
HPE Intelligent Modular 3Ph 8.6kVA/L15-30P 24A/208V Outlets (6) C19/Horizontal NA/JP PDU	AF522A
HPE Intelligent Modular 3Ph 17.3kVA/60309 60A 4-wire 48A/208V (6) C19/Horizontal NA/JP PDU	AF523A

Additional Options

HPE Intelligent Modular 3Ph 17.3kVA/60309 30A 5-wire 24A/240V (6) C19/Horizontal NA/JP PDU	AF901A
HPE Intelligent Modular 7.3kVA/60309 3-wire 32A/230V Outlets (6) C19/Horizontal INTL PDU	AF525A
HPE Intelligent Modular 3Ph 11kVA/60309 5-wire 16A/230V Outlets (6) C19/Horizontal INTL PDU	AF526A
HPE Intelligent Modular 3Ph 22kVA/60309 5-wire 32A/230V Outlets (6) C19/Horizontal INTL PDU	AF527A
HPE Intelligent Modular 3Ph 17.3kVA/IEC 60309 60A 4-wire 48A/208V (12) C19/Horizontal NA/JP PDU	AF535A
HPE Intelligent Modular 3Ph 22kVA/60309 5-wire 32A/230V Outlets (12) C19/Horizontal INTL PDU	AF538A
HPE Intelligent Modular 4.9kVA/L6-30P 24A/208V Outlets (20) C13 (6) C19/Horizontal NA/JP PDU	AF531A
HPE Intelligent Modular 3Ph 8.6kVA/L15-30P 24A/208V Outlets (20) C13 (6) C19/Horizontal NA/JP PDU	AF532A
HPE Intelligent Modular 3Ph 14.4kVA/CS8365C 40A/208V Outlets (6) C19/Horizontal NA/JP PDU	AF533A
HPE Intelligent Modular 7.3kVA/60309 3-wire 32A/230V Outlets (6) C19/Horizontal INTL PDU Kit	AF534A
HP 5xC13 Intelligent PDU Extension Bar G2 Kit	AF547A
HP 5xC13 Outlets Power and UID LEDs Pair Standard Extension Bar	AF528A

NOTE: Please see the [HPE Intelligent Power Distribution Unit \(PDU\) QuickSpecs](#) for information on additional options and product specifications.

HPE Metered and Switched Power Distribution Units (PDU)

HPE Metered Switched 2.8kVA/L5-30P 24A/120V Outlets (24) 5-20R /Vertical NA/JP PDU	H8B48A
HPE Metered Switched 3.6kVA/60320 C20 Detachable 16A/230V Outlets (7) C13 (1) C19/Vertical WW PDU	H8B49A
HPE Metered Switched 4.9kVA/L6-30P 24A/208V Outlets (20) C13 (4) C19/Vertical NA/JP PDU	H8B50A
HPE Metered Switched 7.3kVA/60309 3-wire 32A/230V Outlets (20) C13 (4) C19/Vertical INTL PDU	H8B51A
HPE Metered Switched 3Ph 8.6kVA/L15-30P 24A/208V Outlets (18) C13 (6) C19/Vertical NA/JP PDU	H8B52A
HPE Metered Switched 3Ph 8.6kVA/L21-30P 24A/208V Outlets (20)C13 (3)C19 (1)5-20R/Vertical NA/JP PDU	H8B53A
HPE Metered Switched 3Ph 11kVA/60309 5-wire 16A/230V Outlets (21) C13 (3) C19/Vertical INTL PDU	H8B54A
HPE Metered Switched 3Ph 14.4kVA/CS8365C 40A/208V Outlets (12) C13 (12) C19/Vertical NA/JP PDU	H8B55A
HPE Metered Switched 3Ph 17.3kVA/60309 4-wire 48A/208V Outlets (12) C13 (12) C19/Vertical NA/JP PDU	H8B56A

NOTE: Please see the [HPE Metered and Switched Power Distribution Units \(PDU\) QuickSpecs](#) for information on additional options and product specifications.

NOTE: To learn more, please visit the [HPE Uninterruptible Power Systems \(UPS\) web page](#).

Additional Options

HPE Rack Mount Consoles, KVM Switches, and Keyboards	HPE Location Discovery Services	
	HPE Location Discovery Services LCD8500 Kit	TL052A
	NOTE: Please see the HPE Location Discovery Services QuickSpecs for information on additional options and product specifications.	
	HPE Rack Mount Consoles	
	HP LCD8500 1U US Rackmount Console Kit	AF630A
	HP LCD8500 1U UK Rackmount Console Kit	AF631A
	HP LCD8500 1U DE Rackmount Console Kit	AF632A
	HP LCD8500 1U FR Rackmount Console Kit	AF633A
	HP LCD8500 1U JP Rackmount Console Kit	AF642A
	HP LCD8500 1U RU Rackmount Console Kit	AF643A
	HP LCD8500 1U INTL Rackmount Console Kit	AF644A
	HP LCD8500 1U US TAA Rackmount Console Kit	AF645A
	NOTE: Please see the HPE LCD8500 Console Kit QuickSpecs for information on additional options and product specifications.	
	HPE KVM Switches	
	HP 0x1x8 G3 KVM Console Switch	AF651A
	HP 0x2x16 G3 KVM Console Switch	AF652A
	HP TAA 0x2x16 G3 KVM Console Switch	AF653A
	HP USB Remote Access Key for G3 KVM Console Switches	AF650A
	HP KVM Console USB Interface Adapter	AF628A
	HP 0x2x16 KVM Server Console Switch G2 with Virtual Media CAC Software	AF618A
	HP 0x2x32 KVM Server Console Switch G2 with Virtual Media CAC Software	AF619A
	HP KVM Console USB 2.0 Virtual Media CAC Interface Adapter	AF629A
	HP 1x4 USB/PS2 KVM Console Switch	AF611A
	HP 1x1Ex8 KVM IP Console Switch G2 with Virtual Media CAC Software	AF620A
	HP 2x1Ex16 KVM IP Console Switch G2 with Virtual Media CAC Software	AF621A
	HP 4x1Ex32 KVM IP Console Switch G2 with Virtual Media CAC Software	AF622A
	HPE KVM Console USB/Display Port Interface Adapter	AF654A
	HPE KVM Console USB 8-pack Interface Adapter	AF655A
	NOTE: To learn more, please visit the HPE KVM Switches web page.	
	HPE USB Keyboard and Mouse	
	HP USB BFR with PVC Free US Keyboard/Mouse Kit	631341-B21
	HP USB BFR with PVC Free UK Keyboard/Mouse Kit	631344-B21
	HP USB BFR with PVC Free FR Keyboard/Mouse Kit	631346-B21
	HP USB BFR with PVC Free ES Keyboard/Mouse Kit	631348-B21
	HP USB BFR with PVC Free DE Keyboard/Mouse Kit	631358-B21
	HP USB BFR with PVC Free JP Keyboard/Mouse Kit	631360-B21
	HP USB BFR with PVC Free IT Keyboard/Mouse Kit	631362-B21
	HP USB BFR with PVC Free CN Keyboard/Mouse Kit	631364-B21

Additional Options

HP USB BFR with PVC Free AE Keyboard/Mouse Kit	638212-B21
HP USB BFR with PVC Free RU Keyboard/Mouse Kit	638214-B21
HP USB BFR with PVC Free IN Keyboard/Mouse Kit	672097-D63
HP USB BFR with PVC Free AP-Intl Keyboard/Mouse Kit	672097-373
HP USB BFR with PVC Free Intl Keyboard/Mouse Kit	672097-B33
HP USB BFR with PVC Free PT Keyboard/Mouse Kit	672097-133
HP USB BFR with PVC Free TR Keyboard/Mouse Kit	672097-143
HP USB BFR with PVC Free CZ Keyboard/Mouse Kit	672097-223
HP USB BFR with PVC Free FI Keyboard/Mouse Kit	672097-353
HP USB BFR with PVC Free SE Keyboard/Mouse Kit	672097-103
HP USB BFR with PVC Free CH Keyboard/Mouse Kit	672097-113
HP USB BFR with PVC Free KR Keyboard/Mouse Kit	672097-KD3

NOTE: Please see the [HPE USB Keyboard and Mouse QuickSpecs](#) for information on additional options and product specifications.

HPE Other Options

HPE Rack LED Light Kit	BW939A
HP Kit LCD 1.83m Latch Display Port Cable	G7T29A
HP ConvergedSystem Door Branding Kit	TK815A
HP ConvergedSystem Rack Light Kit	TK816A
HP ConvergedSystem Rack Side Panel 1075mm Kit	TK817A

HPE Uninterruptible Power Systems (UPS)

HPE DirectFlow Three Phase UPS

Power Unit (1U UPS)

HPE R12000 DirectFlow - 1U Rackmount Uninterruptible Power System	G9Y75A
HPE R12000 DirectFlow - POD 1U Rackmount Uninterruptible Power System	AF478A
HPE RP12000/3 12000VA Three Phase INTL 6U Rackmount Uninterruptible Power System	AF437A

Input/Output Module Options for 1U UPS

HPE 32A 400-415 Volt Three Phase INTL R12000 DirectFlow UPS IEC309 Input/Output Module	AF488A
HPE 30A 400-415 Volt Three Phase NA R10000 DirectFlow UPS IEC309 Input/Output Module	AF489A
HPE 32A 380 Volt Three Phase China R12000 DirectFlow UPS Unterminated Input/Output Module	AF490A
HPE 30A 480 Volt Three Phase NA R12000 DirectFlow UPS L22-30 Input/Output Module	AF491A
HPE 30A 480 Volt Three Phase NA R12000 DirectFlow UPS IEC309 Input/Output Module	AF492A
HPE 30A 400-415 Volt Three Phase NA R12000 DirectFlow UPS IEC309 Input/Output Module	G9Y76A
HPE DirectFlow UPS Management Card	AF493A

Power Unit (2U UPS)

HPE R18000 DirectFlow - 2U Rackmount Uninterruptible Power System	AF479A
---	--------

Additional Options

Input/Output Module Options for 2U UPS

HPE 32A 400-415 Volt Three Phase INTL R18000 DirectFlow UPS IEC309 Input/Output Module	AF483A
HPE 30A 380 Volt Three Phase China R18000 DirectFlow UPS Unterminated Input/Output Module	AF485A
HPE 30A 480 Volt Three Phase NA R18000 DirectFlow UPS IEC309 Input/Output Module	AF486A
HPE 30A 480 Volt Three Phase NA R18000 DirectFlow UPS IEC309 Input/Output Module	AF487A
HPE 30A 400 Volt Three Phase NA R18000 DirectFlow UPS IEC309 Input/Output Module	D9Q02A
HPE 30A 400-415V Three Phase NA R18000 DirectFlow UPS 1:1 IEC309 Input/Output Module	AF484A

NOTE: All Input/Output Modules support dual output outlets except the AF484A.

Battery Pack Options

HPE DirectFlow UPS - 1U Rackmount Lithium-ion Battery Pack	AF480A
HPE DirectFlow UPS - 3U Rackmount VRLA Battery Pack	AF482A
HPE WW DirectFlow Secondary Battery Cable	AF497A

NOTE: Please see the [HPE DirectFlow Three Phase Uninterruptible Power System QuickSpecs](#) for information on additional options and product specifications.

HPE Tower UPS

HPE T750 G4 UPS Models

HPE T750 G4 NA/JP Uninterruptible Power System	J2P85A
HPE T750 G4 INTL Uninterruptible Power System	J2P88A

HPE T1000 G4 UPS Models

HPE T1000 G4 NA/JP Uninterruptible Power System	J2P86A
HPE T1000 G4 INTL Uninterruptible Power System	J2P89A

HPE T1500 G4 UPS Models

HPE T1500 G4 NA/JP Uninterruptible Power System	J2P87A
HPE T1500 G4 INTL Uninterruptible Power System	J2P90A

HPE Rack-mountable UPS

HPE R/T2200 G4 UPS Models

HPE R/T2200 G4 NA/JP Uninterruptible Power System	J2R00A
---	--------

HPE R/T3000 G4 UPS Models

HPE R/T3000 G4 Low Voltage NA/JP Uninterruptible Power System	J2R01A
HPE R/T3000 G4 High Voltage NA/JP Uninterruptible Power System	J2R02A
HPE R/T3000 G4 High Voltage INTL Uninterruptible Power System	J2R04A

R1500 G4 Models

HPE R1500 G4 NA Uninterruptible Power System	J2Q99A
HPE R1500 G4 JP/TWN Uninterruptible Power System	J2R05A
HPE R1500 G4 INTL Uninterruptible Power System	J2R03A

R7000 Uninterruptible Power System (UPS)

HPE R7000 4U 50A High Voltage NA/JP Uninterruptible Power System	AF462A
--	--------

Additional Options

HPE R7000 4U IEC-32A High Voltage INTL Uninterruptible Power System	AF463A
---	--------

R5000 Uninterruptible Power System (UPS)

HPE R5000 3U L630 High Voltage NA/JP Uninterruptible Power System	AF460A
---	--------

HPE R5000 3U IEC309-32A High Voltage INTL Uninterruptible Power System	AF461A
--	--------

NOTE: Please see the [HPE Line Interactive Single Phase UPS QuickSpecs](#) for information on additional options and product specifications.

HPE UPS Options

HPE R/T2200 G4 Extended Runtime Module	J2R09A
--	--------

HPE R/T3000 G4 Extended Runtime Module	J2R10A
--	--------

HPE 2U Rack/Tower UPS Shipping Kit	L4Q11A
------------------------------------	--------

NOTE: To learn more, please visit the [HPE Uninterruptible Power Systems \(UPS\) web page](#)

HPE USB and SD HPE Enterprise Mainstream Flash Media Kits for Memory Cards Options

HPE 32GB microSD Mainstream Flash Media Kit	700139-B21
---	------------

HPE 8GB microSD Enterprise Mainstream Flash Media Kit	726116-B21
---	------------

HP 8GB USB Enterprise Mainstream Flash Media Drive Key Kit	737953-B21
--	------------

HP Dual 8GB microSD Enterprise Midline USB Kit	741279-B21
--	------------

Memory

HPE SmartMemory

New HPE SmartMemory now provides additional protection for your servers. With HPE Authentication it can verify that you have true Hewlett Packard Enterprise Qualified Memory in your HPE ProLiant Gen9 server. With HPE SmartMemory, your new HPE ProLiant server can take advantage of additional Gen9 enhancements in performance, durability and future manageability support through HPE Active Health System.

For detailed memory configuration rules and guidelines, please use the Online DDR4 Memory Configuration Tool: <http://www.hp.com/go/ddr4config>.

Memory Subsystem Architecture

As shown in the figure below, memory cartridge to processor association as follows:

- Memory cartridges installed without a corresponding processor are not utilized:
 - Processor 1 corresponds to memory cartridges 1 and 2.
 - Processor 2 corresponds to memory cartridges 3 and 4.
 - Processor 3 corresponds to memory cartridges 5 and 6.
 - Processor 4 corresponds to memory cartridges 7 and 8.

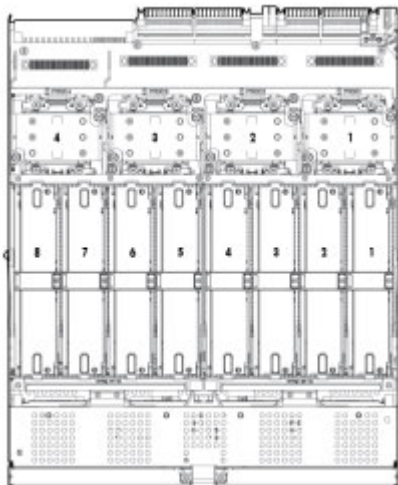

The server can operate in independent channel mode (performance) or combined channel mode (lockstep). Lockstep mode improves the system reliability and availability. If running with RDIMM (built with x4 DRAM devices), the system can survive the complete failure of two DRAM devices (DDDC). Running in independent mode, the server can only survive the complete failure of a single DRAM device (SDDC).

Memory performance depends on selected processor and whether the system is configured for independent channel mode (performance mode) or lockstep mode (RAS mode).

Memory

Memory Population guidelines

Each memory cartridge contains 12 DIMM slots as shown in figure below:

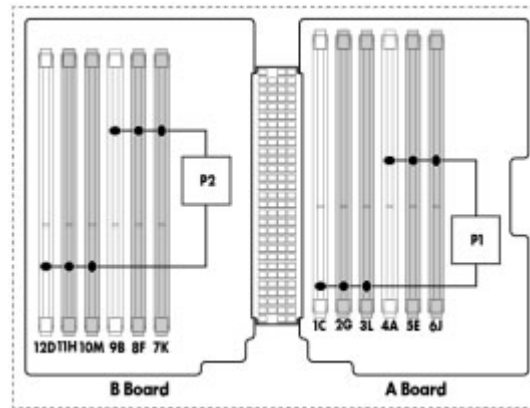

General Memory Population Rules and Guidelines:

- . To maximize performance, install two memory cartridges per processor and balance the total memory capacity between all installed processors.
- . When multiple processors are installed, HPE recommends installing the DIMMs in sequential alphabetical order: 4A, 9B, 1C, 12D, and so on.
- . LRDIMMs support higher densities than single- and dual-rank RDIMMs, and higher speeds than quad-rank RDIMMs. This support enables you to install more high capacity DIMMs, resulting in higher system capacities and higher bandwidth.
- . Do not mix LRDIMMs with any other DIMM type (RDIMM, LVDIMM).
- . RDIMM population is limited to a maximum of eight logical ranks per channel. Therefore, only two quad rank RDIMMs are supported per channel. If there are more than eight physical ranks per channel, LRDIMMs rank multiplication provides support for three DIMMs per channel.
- . **Performance or Independent Mode:** In this mode each DDR4 channel works independently and the SMI2 channel operates at twice the DDR4 speed (3200 MT/s max).
- . **Lockstep mode:** In this mode, the memory controller operates two DDR4 channels behind one memory buffer as single channel and the SMI2 channel operates at the DDR4 transfer rate (1866 MT/s max).

NOTE: UDIMMs are not supported. This server does not support mixing LRDIMMs, RDIMMs, or UDIMMs. Attempting to mix any combination of these DIMMs can cause the server to halt during BIOS initialization. For detailed memory configuration rules and guidelines, use the Online DDR4 Memory Configuration Tool on the HPE website (<http://www.hp.com/go/ddr3memory-configurator>).

Intel Gen9 Supported Memory Bandwidth for HPE ProLiant Gen9 Intel® Xeon® E7-4800v3/v4 Series Processor Family - running in 1:1 "Lockstep"? mode

Memory

Memory Bandwidth and Capacity

[DIMM Type]	Registered DIMMs (RDIMMs)			Load Reduced (LRDIMMs)	
HPE SKU P/N	726718-B21	726719-B21	728629-B21	726722-B21	726724-B21
DIMM Rank	Single Rank	Dual Rank	Dual Rank	Quad Rank	Quad Rank
DIMM Capacity	8GB	16GB	32GB	32GB	64GB
Voltage	Std Voltage 1.2V	Std Voltage 1.2V	Std Voltage 1.2V	Std Voltage 1.2V	Std Voltage 1.2V
DIMM Native Speed (MT/s)	2133	2133	2133	2133	2133

SLOTS THAT CAN BE POPULATED

96 slot servers	96	96	96	96	96
-----------------	----	----	----	----	----

MAXIMUM CAPACITY (GB)

	768	1536	3072	3072	6144
--	-----	------	------	------	------

POPULATED DIMM SPEED (MT/s)

1 DIMM Per Channel	1866	1866	1866	1866	1866
2 DIMM Per Channel	1866	1866	1866	1866	1866
3 DIMM Per Channel	1600	1333	1333	1600	1600

NOTE: The values shown in the table above are for Lockstep Mode. For Performance Mode (running in 2:1), the values are identical except Populated DIMM Speed MT/s is 1600 for 1 DIMM per Channel and 2 DIMM per Channel.

Intel Gen9 Supported Memory Bandwidth for HPE ProLiant Gen9 Intel® Xeon® E7-8800v3/v4 Series Processor Family - running in 1:1 "Lockstep" mode.

Memory Bandwidth and Capacity

[DIMM Type]	Registered DIMMs (RDIMMs)				Load Reduced (LRDIMMs)
HPE SKU P/N	805347-B21	805349-B21	836220-B21	805351-B21	805358-B21
DIMM Rank	Single Rank	Single Rank	Dual Rank	Dual Rank	Quad Rank
DIMM Capacity	8GB	16GB	16GB	32GB	64GB
Voltage	Std Voltage 1.2V	Std Voltage 1.2V	Std Voltage 1.2V	Std Voltage 1.2V	Std Voltage 1.2V
DRAM Depth [bit]	1G	1G	2G	2G	2G
DRAM Width [bit]	x8	x4	x4	x4	x4
DRAM Density	8Gb	8Gb	4Gb	8Gb	8Gb
CAS Latency	17-17-17	17-17-17	17-17-17	17-17-17	17-17-17
DIMM Native Speed (MT/s)	2400	2400	2400	2400	2400

SLOTS THAT CAN BE POPULATED

Memory

96 slot servers	96	96	96	96	96
MAXIMUM CAPACITY (GB)					
	768	1536	1536	3072	6144
POPULATED DIMM SPEED (MT/s)					
1 DIMM Per Channel	1866	1866	1866	1866	1866
2 DIMM Per Channel	1866	1866	1866	1866	1866
3 DIMM Per Channel	1600	1600	1333	1333	1600

NOTE: The values shown in the table above are for Lockstep Mode. For Performance Mode (running in 2:1), the values are identical except Populated DIMM Speed MT/s is 1600 for 1 DIMM per Channel and 2 DIMM per Channel.

DIMM slot and configuration diagram

The memory subsystem in this server is divided into channels. Each processor supports eight channels, and each channel supports three DIMM slots, as shown in the table below. White DIMM slots denote the first slot of a channel (Ch 4A, Ch 9B, Ch 1C, Ch 12D...).

CPU 1			CPU 2		
	Slot #	Population order	Slot #	Population order	
Chnl 3	1	C	1	C	Chnl3
	2	G	2	G	
	3	L	3	L	
CPU 1			CPU 2		
	Slot #	Population order	Slot #	Population order	
Chnl 1	4	A	4	A	Chnl 1
	5	E	5	E	
	6	J	6	J	
CPU 1			CPU 2		
	Slot #	Population order	Slot #	Population order	
Chnl 2	7	K	7	K	Chnl 2
	8	F	8	F	
	9	B	9	B	
CPU 1			CPU 2		
	Slot #	Population order	Slot #	Population order	
Chnl 4	10	M	10	M	Chnl 4
	11	H	11	H	
	12	D	12	D	

Memory

Memory Speed by Processor Model	Processor Models	Supported Memory Speeds
	E7-4809v4, E7-4820v4, E7-4830v4, E7-4850v4, E7-4850v3, E7-4830v3, E7-4820v3, E7-4809v3	1600MT/s
	E7-8893v4, E7-8891v4, E7-8860v4, E7-8867v4, E7-8870v4, E7-8880v4, E7-8890v4, E7-8890v3, E7-8880v3, E7-8870v3, E7-8860v3, E7-8891v3, E7-8893v3, E7-8880Lv3, E7-8867v3	1333/1600/1866MT/s

Standard and Maximum Memory Capacity (Pre-configured Models)	Pre Configured Models	Standard Memory	Maximum Memory Plus Optional Memory	Standard Memory Replaced with Optional Memory
	E7-8893v4, E7-8893v3, E7-8890v4, E7-8890v3	256GB (16x16GB)	2816GB (80x32GB, 16x16GB)	6144GB (96x64GB)
	E7-4850v4, E7-4850v3	128GB (8x16GB)	2944GB (88x32GB, 8x16GB)	6144GB (96x64GB)
	E7-4809v4, E7-4809v3	64GB (4x16GB)	3008GB (92x32GB, 4x16GB)	6144GB (96x64GB)

DDR4 memory options part number decoder

NOTE: Capacity references are rounded to the common gigabyte (GB) values.

- 2GB = 2,048MB
- 4GB = 4,096MB
- 8GB = 8,192MB
- 16GB = 16,384MB
- 32GB = 32,768MB
- 64GB = 65,536MB

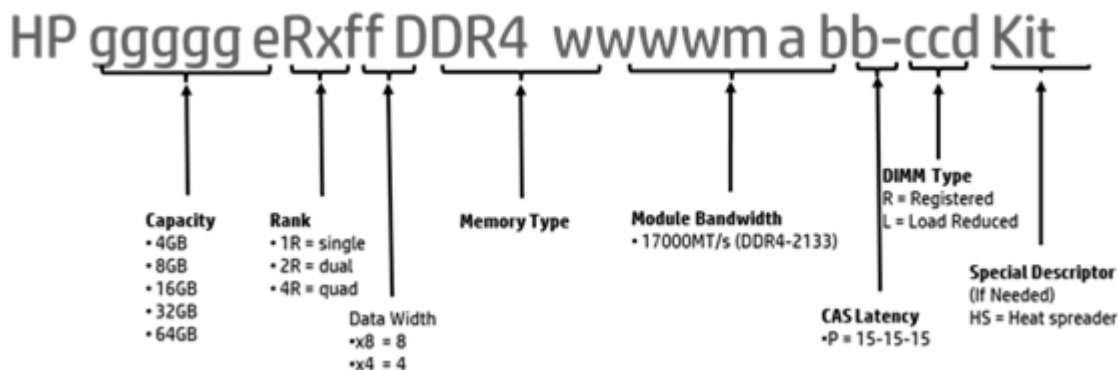

Storage

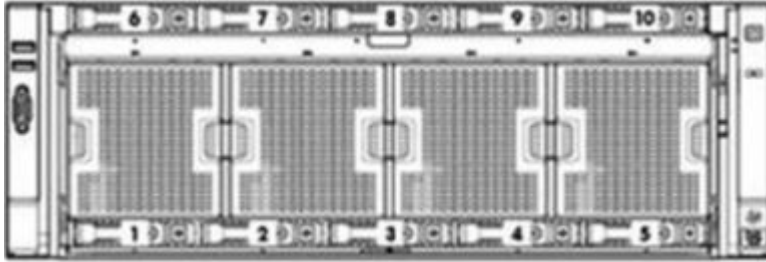

1-10 Ten (10) SFF Hot-plug HDD/SSD drive bays

NOTE: Drives installed in bays 6-10 require the optional SAS backplane kit.

NOTE: Optional NVMe drives are only supported in Drive bays 6-10.

Maximum Storage Capacity

NOTE: Optional support for 5 NVMe PCIe SSDs or 5 SFF drives are also available.

Hot Plug SFF SAS	20 TB (10 x 2.0 TB)
Hot Plug SFF SAS SSD	19.2 TB (10 x 1.92 TB)
Hot Plug SFF SATA SSD	38.4 TB (10 x 3.84 TB)
Hot Plug SFF NVMe PCIe SSD	8 TB (5 x 1.6 TB)

Technical Specifications

System Unit	Dimensions (H x W x D) (with bezel)	6.88" x 17.48" x 29" (17.5cm x 44.4cm x 73.6cm)	
Weight (approximate)	Weight (approximate)	Maximum: (all hard drives, power supplies, DIMMs and processors installed)	116.56 lb (52.87 kg)
		Minimum: (one hard drive, two power supplies, four DIMMs, and two processors installed)	70.94 lb (32.18 kg)
Input Requirements (per power supply)	Input Requirements (per power supply)	Rated Line Voltage	100 - 120 VAC (1200W PS only) 200 - 240 VAC (1200W & 1500W PS)
		Rated Input Current	9.2A (100 VAC), 6.6A (200 VAC) - 1200W PS8.3A (200 VAC) - 1500W PS
		Rated Input Frequency	50 to 60 Hz
		Rated Input Power	1000 W (120 VAC), 1320 W (230VAC)- 1200W PS 1652 W (at 230 VAC) - 1500W PS
BTU Rating	BTU Rating	Maximum	3408 BTU/hr (120 VAC), 4500 BTU/hr (at 230 VAC) - 1200W PS5637 BTU/hr (230 VAC) - 1500W PSVAC), 3112 BTU/hr (at 240 VAC) for China Only
Power Supply Output (per power supply)	Power Supply Output (per power supply)	Rated Steady- State Power	800 W (100 VAC low line),900 W (120 VAC low line), 1200W (200 - 240 VAC) for 1200W PS
		Maximum Peak Power	1500W (200 - 240V) for 1500W PS1400W (at 240 VAC) input for China only
			NOTE: To review typical system power ratings use the HPE Power Advisor which is available online located at url: http://www.hp.com/go/proliant-energy-efficient or http://www.hpe.com/info/hppoweradvisor .
System Inlet Temperature	System Inlet Temperature	Standard Operating Support	10° to 35°C (50° to 95°F) at sea level with an altitude derating of 1.0°C per every 305 m (1.8°F per every 1000 ft) above sea level to a maximum of 3050 m (10,000 ft), no direct sustained sunlight. Maximum rate of change is 20°C/hr (36°F/hr). The upper limit and rate of change may be limited by the type and number of options installed. System performance during standard operating support may be reduced if operating with a fan fault or above 30°C (86°F).
		Extended Ambient	

Technical Specifications

	Operating Support	supported system inlet range is extended to be: 5° to 10°C (41° to 50°F) and 35° to 40°C (95° to 104°F) at sea level with an altitude derating of 1.0°C per every 175 m (1.8°F per every 574 ft) above 900 m (2953 ft) to a maximum of 3050 m (10,000 ft). The approved hardware configurations for this system are listed at the URL: http://www.hpe.com/servers/ashrae
		For approved hardware configurations, the supported system inlet range is extended to be: 40° to 45°C (104° to 113°F) at sea level with an altitude derating of 1.0°C per every 125 m (1.8°F per every 410 ft) above 900 m (2953 ft) to a maximum of 3050 m (10,000 ft). The approved hardware configurations for this system are listed at the URL: http://www.hpe.com/servers/ashrae
		System performance may be reduced if operating in the extended ambient operating range or with a fan fault.
Relative Humidity (non-condensing)	Non-operating	-30° to 60°C (-22° to 140°F). Maximum rate of change is 20°C/hr (36°F/hr).
	Operating	10% to 90% relative humidity (Rh), 28°C (82.4°F) maximum wet bulb temperature, non-condensing.
	Non-operating	5 to 95% relative humidity (Rh), 38.7°C (101.7°F) maximum wet bulb temperature, non-condensing.
Altitude	Operating	3048 m (10,000 ft). This value may be limited by the type and number of options installed. Maximum allowable altitude change rate is 457 m/min (1500 ft/min).
	Non-operating	9144 m (30,000 ft). Maximum allowable altitude change rate is 457 m/min (1500 ft/min).
Acoustic Noise	Listed are the declared A-Weighted sound power levels (LWAd) and declared average bystander position A-Weighted sound pressure levels (LpAm) when the product is operating in a 23°C ambient environment. Noise emissions were measured in accordance with ISO 7779 (ECMA 74) and declared in accordance with ISO 9296 (ECMA 109).	
	Idle	
	LWAd	6.8 B
	LpAm	51.2
	Operating	
	LWAd	6.9 B
	LpAm	51.2
Emissions	FCC Rating	Class A

Technical Specifications

Classification (EMC)	Normative Standards	CISPR 22; EN55022; EN55024; FCC CFR 47, Pt 15; ICES-003; CNS13438; GB9254; K22;K24; EN 61000-3-2; EN 61000-3-3; EN 60950-1; IEC 60950-1
-----------------------------	---------------------	---

NOTE: Product conformance to cited product specifications is based on sample (type) testing, evaluation, or assessment. This product or family of products is eligible to bear the appropriate compliance logos and statements.

HPE Smart Array P830i	Disk Drive and Enclosure Interface - Transfer rate	12Gb/s SAS, 6Gb/s SAS & SATA
	SAS Connectors	2 internal x8 Mini-SAS double-wide internal
	Cache Memory Speed	DDR3L 1866 MT/s with 72-bit wide bus
	Speed	12Gb/s per physical link
	Cache Memory	FBWC cache is required. 2 GB is included with BTO models. For CTO, 2 GB or 4 GB FBWC cache is required.
	Host Memory Addressing	64-bit, supporting greater than 4GB server memory space
	RAID Support	RAID 6, 60 (Advanced Data Guarding) RAID 5, 50 (Distributed Data Guarding) RAID 1, 10 (Drive Mirroring), RAID 1 ADM, 10 ADM (Advanced Data Mirroring) RAID 0 (Striping)

HPE Ethernet 1Gb 4-port 331FLR Adapter	Network Interface Compatibility	10Base-T/100Base-TX/1000Base-TX
		IEEE 802.3 10Base-T
		IEEE 802.3ab 1000Base-T
		IEEE 802.3u 100Base-TX
		IEEE 802.3x
		IEEE 802.3ad 1000Base-TX
		IEEE 802.3az
		IEEE 1588
	Data Transfer Method Controller	PCI-Express 2.0 x4 BCM5719
	Network Transfer Rate	10Base-T (Full-Duplex) 20 Mb/s 100Base-TX (Full-Duplex) 200 Mb/s 1000Base-TX (Full-Duplex) 2000 Mb/s
Connector	Four RJ-45	
Cable Support	10 Base-T Categories 3, 4 or 5 UTP; up to 328 ft (100 m)	

Technical Specifications

100 Base-TX	Category 5 or higher UTP; up to 328 ft (100 m)
1000 Base-TX	Category 5 or higher UTP; up to 328 ft (100 m)

HPE FlexFabric 10Gb 2-port 534FLR-SFP+ Adapter	Network Interface	IEEE 802.3 SFP+ (SX, SR & LR)
	Compatibility	IEEE 802.3

Environment-friendly Products and Approach

End-of-life Management and Recycling

Hewlett Packard Enterprise offers end-of-life product return, trade-in, and recycling programs, in many geographic areas, for our products. Products returned to Hewlett Packard Enterprise will be recycled, recovered or disposed of in a responsible manner.

<http://www.hpe.com/recycle>

The EU WEEE directive (2002/95/EC) requires manufacturers to provide treatment information for each product type for use by treatment facilities. This information (product disassembly instructions) is posted on the Hewlett Packard Enterprise web site. These instructions may be used by recyclers and other WEEE treatment facilities as well as Hewlett Packard Enterprise OEM customers who integrate and re-sell Hewlett Packard Enterprise equipment.

<http://www.hpe.com/recycle>

Summary of Changes

Date	Version History	Action	Description of Change
27-Mar-2017	From Version 17 to 18	Changed	HPE Storage Options section was revised.
		Removed	Secondary Riser was removed from Expansion Slots.
17-Feb-2017	From Version 16 to 17	Changed	HPE Memory section under Core Options was revised.
13-Feb-2017	From Version 15 to 16	Added	Added new HDD and SSD offering to the HPE Drives section.
28-Nov-2016	From Version 14 to 15	Added	Added new Hard Disk Drives and GPU options. Added new New 100Gb Omnipath networking card.
		Changed	HPE Computation and Graphics Accelerators, HPE Tape Backup
		Removed	Obsolete SKUs were removed from the QuickSpecs.
28-Oct-2016	From Version 13 to 14	Removed	Obsolete Hard Drives were removed from the QuickSpecs.
26-Sep-2016	From Version 12 to 13	Changed	HPE Converged Infrastructure Management Software was revised. Smart Buy models section was updated for the NA version.
15-Aug-2016	From version 11 to 12	Added	Added new InfiniBand and Storage options.
		Changed	Pre-configured Models and Memory were revised.
6-Jun-2016	From Version 10 to 11	Added	Added new Processors, Memory, HPE Drives, and HPE Disk Backup options.
		Changed	HPE Processors, Chipset, Upgradeability, Graphics, Pre-configured Models, Configuration Information - Factory Integrated Models, HPE Memory, HPE Computation and Graphics Accelerators, and Storage sections were revised.
8-Apr-2016	From Version 9 to 10	Changed	HPE Processors section was revised.
31-Mar-2016	From Version 8 to 9	Added	Added new controllers, new HDD offering, new networking adapters, new security TPM module, and new transceiver.
		Changed	Network Controller, Embedded Management, Security, Service and Support, Pre-configured Models, and Storage Options sections were revised.
		Removed	Obsolete SKUs were removed from the QuickSpecs.
16-Feb-2016	From Version 7 to 8	Added	New HDD offering was added to HPE Drives.
		Changed	Operating Systems and Virtualization Software Support for ProLiant Servers, Pre-configured Models, Configuration Information - Factory Integrated Models, HPE Power Distribution Units (PDUs), and

Summary of Changes

			Technical Specifications were revised.
		Removed	Obsolete SKUs were removed from the QuickSpecs.
17-Dec-2015	From Version 6 to 7	Added	Smart Buy models were added to the NA version.
1-Dec-2015	From Version 5 to 6	Added	New SSD offering was added to HPE Drives. New options added to HPE Infiniband, HPE PCIe Workload Accelerator Options, and HPE Tape Backup.
		Changed	On System Management Chipset, Maximum Internal Storage, Embedded Management, Server Utilities,
		Removed	Obsolete SKUs were removed from the QuickSpecs.
9-Oct-2015	From Version 4 to 5	Changed	Memory, Maximum Internal Storage, HPE USB and SD Options, Storage, and Dimensions in Technical Specifications were revised.
2-Oct-2015	From Version 3 to 4	Changed	HPE Memory section was revised.
28-Sep-2015	From Version 2 to 3	Added	Added new 6Gb SATA Solid State Drives. Added new HPE OneView management software.
		Changed	Maximum Internal Storage, Interfaces, and HPE Memory were revised.
		Removed	Obsolete SKUs were removed from the QuickSpecs.
17-Aug-2015	From Version 1 to 2	Added	New Hard Drives offering was added to Core Options.
		Changed	Upgradeability and FlexibleLOM under Standard Features were revised. HPE Memory, HP Networking, and HPE Graphic Options under Core Options were revised. Memory section was revised.



Summary of Changes



[Sign up for updates](#)

© Copyright 2017 Hewlett Packard Enterprise Development LP. The information contained herein is subject to change without notice. The only warranties for Hewlett Packard Enterprise products and services are set forth in the express warranty statements accompanying such products and services. Nothing herein should be construed as constituting an additional warranty. Hewlett Packard Enterprise shall not be liable for technical or editorial errors or omissions contained herein.

Intel® and Xeon® are registered trademarks of Intel Corporation in the U.S. and other countries.

Microsoft®, Windows®, and Windows Server® are U.S. registered trademarks of the Microsoft group of companies.

For hard drives, 1GB = 1 billion bytes. Actual formatted capacity is less

c04601208 - 15187 - Worldwide - V18 - 27-March-2017

