



Installation, Operation, and Maintenance

Trane Rental Services

Air Handling Units



⚠ SAFETY WARNING

Only qualified personnel should install and service the equipment. The installation, starting up, and servicing of heating, ventilating, and air-conditioning equipment can be hazardous and requires specific knowledge and training. Improperly installed, adjusted or altered equipment by an unqualified person could result in death or serious injury. When working on the equipment, observe all precautions in the literature and on the tags, stickers, and labels that are attached to the equipment.



Introduction

Read this manual thoroughly before operating or servicing this unit.

Warnings, Cautions, and Notices

Safety advisories appear throughout this manual as required. Your personal safety and the proper operation of this machine depend upon the strict observance of these precautions.

The three types of advisories are defined as follows:

- ⚠ WARNING** Indicates a potentially hazardous situation which, if not avoided, could result in death or serious injury.
- ⚠ CAUTION** Indicates a potentially hazardous situation which, if not avoided, could result in minor or moderate injury. It could also be used to alert against unsafe practices.
- NOTICE** Indicates a situation that could result in equipment or property-damage only accidents.

Important Environmental Concerns

Scientific research has shown that certain man-made chemicals can affect the earth's naturally occurring stratospheric ozone layer when released to the atmosphere. In particular, several of the identified chemicals that may affect the ozone layer are refrigerants that contain Chlorine, Fluorine and Carbon (CFCs) and those containing Hydrogen, Chlorine, Fluorine and Carbon (HCFCs). Not all refrigerants containing these compounds have the same potential impact to the environment. Trane advocates the responsible handling of all refrigerants.

Important Responsible Refrigerant Practices

Trane believes that responsible refrigerant practices are important to the environment, our customers, and the air conditioning industry. All technicians who handle refrigerants must be certified according to local rules. For the USA, the Federal Clean Air Act (Section 608) sets forth the requirements for handling, reclaiming, recovering and recycling of certain refrigerants and the equipment that is used in these service procedures. In addition, some states or municipalities may have additional requirements that must also be adhered to for responsible management of refrigerants. Know the applicable laws and follow them.

⚠ WARNING

Proper Field Wiring and Grounding Required!

Failure to follow code could result in death or serious injury. All field wiring **MUST** be performed by qualified personnel. Improperly installed and grounded field wiring poses **FIRE** and **ELECTROCUTION** hazards. To avoid these hazards, you **MUST** follow requirements for field wiring installation and grounding as described in **NEC** and your local/state/national electrical codes.

⚠ WARNING

Personal Protective Equipment (PPE) Required!

Failure to wear proper PPE for the job being undertaken could result in death or serious injury. Technicians, in order to protect themselves from potential electrical, mechanical, and chemical hazards, **MUST** follow precautions in this manual and on the tags, stickers, and labels, as well as the instructions below:

- Before installing/servicing this unit, technicians **MUST** put on all PPE required for the work being undertaken (Examples; cut resistant gloves/sleeves, butyl gloves, safety glasses, hard hat/bump cap, fall protection, electrical PPE and arc flash clothing). **ALWAYS** refer to appropriate Safety Data Sheets (SDS) and OSHA guidelines for proper PPE.
- When working with or around hazardous chemicals, **ALWAYS** refer to the appropriate SDS and OSHA/GHS (Global Harmonized System of Classification and Labeling of Chemicals) guidelines for information on allowable personal exposure levels, proper respiratory protection and handling instructions.
- If there is a risk of energized electrical contact, arc, or flash, technicians **MUST** put on all PPE in accordance with OSHA, NFPA 70E, or other country-specific requirements for arc flash protection, **PRIOR** to servicing the unit. **NEVER PERFORM ANY SWITCHING, DISCONNECTING, OR VOLTAGE TESTING WITHOUT PROPER ELECTRICAL PPE AND ARC FLASH CLOTHING. ENSURE ELECTRICAL METERS AND EQUIPMENT ARE PROPERLY RATED FOR INTENDED VOLTAGE.**

⚠ WARNING**Follow EHS Policies!**

Failure to follow instructions below could result in death or serious injury.

- All Trane personnel must follow the company's Environmental, Health and Safety (EHS) policies when performing work such as hot work, electrical, fall protection, lockout/tagout, refrigerant handling, etc. Where local regulations are more stringent than these policies, those regulations supersede these policies.
- Non-Trane personnel should always follow local regulations.

Copyright

This document and the information in it are the property of Trane, and may not be used or reproduced in whole or in part without written permission. Trane reserves the right to revise this publication at any time, and to make changes to its content without obligation to notify any person of such revision or change.

Trademarks

All trademarks referenced in this document are the trademarks of their respective owners.

Revision History

Added Important information in RSAU0025F1, RSAU0050F1, and RSAU0062F1 section in General Information chapter.



Table of Contents

Overview	5	RSAU0025, 50, 62 F1 and F2 Series	43
General Information	6	RSCC0030 AHU	43
Application Considerations - Air Handler Units	8	Rigging Guidelines	45
Freeze Protection	8	General Lifting Considerations	45
RSAU0010F0-F1 AHU	9	Installation and Start-Up Guidelines	47
RSAU0010F2 - AHU	12	Installation	47
RSAU0025F1 AHU	14	Start-Up	47
RSAU0025F2 AHU	17	RSAU0010F0/F1	47
RSAU0050F1 AHU	20	RSAU0010F2	47
RSAU0050F2 AHU	23	RSAU0025, 50, and 62 F1 Series	48
RSAU0062F1 AHU	26	RSAU0025, 50, and 62 F2 Series	48
RSAU0062F2 AHU	29	RSCC0030F0	48
RSCC0030F0 AHU	32	Maintenance Checklist	49
Electrical Information	35	Decommissioning Guidelines	50
RSAU0010F0-F1 Style AHUs	35	RSAU0010F0/F1	50
RSAU0010F2 Style AHUs	35	RSAU0010F2	50
RSAU0025-50-62 F1 Style AHUs	35	RSAU0025, 50 and 62 F1 Series	50
RSAU0025-50-62 F2 Style AHUs	35	RSAU0025, 50 and 62 F2 Series	51
RSCC0030F0 Style AHUs	36	RSCC0030F0	51
Piping Connection Configuration	37	Recommended Shutdown	51
RSAU0010F0 - F2	37		
RSAU0025F1	37		
RSAU0050F1	37		
RSAU0062F1	38		
RSAU0025-50-62F2	39		
RSCC0030F0	39		
Duct Connection Configuration	41		
RSAU0010F0 - F2	41		
RSAU0025F1	41		
RSAU0050F1	41		
RSAU0062F1	41		
RSAU0025F2	42		
RSAU0050F2	42		
RSAU0062F2	42		
RSCC0030F0	42		
Controls Information	43		
RSAU0010 F0/F1/F2 Series	43		



Overview

This manual covers the air handling units (AHU) available to rent from Trane Rental Services for temporary cooling solutions. This includes AHU technical information, start-up information, and unit maintenance. Information contained in this manual is provided to ensure the safe installation and operation of the equipment and its surroundings.

The information provided is to be used as a reference for each AHU to aid in determining unit size, power requirements, or lifting requirements.

Contact Trane Rental Services for availability of equipment (including ancillary items: pumps, flexible hose, flexible duct) prior to proceeding with securing the rental equipment.

If additional information is required, contact Trane Rental Services.

Table 1. Units affected

Unit	Description
RSAU0010F0XX ^(a)	5,000 CFM AHU with cooling only
RSAU0010F1XX ^(a)	5,000 CFM AHU with cooling only
RSAU0010F2XX ^(a)	5,000 CFM AHU with cooling only
RSAU0025F1XX ^(a)	10,000 CFM AHU with cooling and hot water
RSAU0025F2XX ^(a)	10,000 CFM AHU with cooling only
RSAU0050F1XX ^(a)	20,000 CFM AHU with cooling and hot water
RSAU0050F2XX ^(a)	20,000 CFM AHU with cooling only
RSAU0062F1XX ^(a)	25,000 CFM AHU with cooling and hot water
RSAU0062F2XX ^(a)	25,000 CFM AHU with cooling only
RSCC0030F0XX ^(a)	18,000 CFM AHU with cooling only

(a) Represents the unique inventory number.

⚠ WARNING

Live Electrical Components!

Failure to follow all electrical safety precautions when exposed to live electrical components could result in death or serious injury.

When it is necessary to work with live electrical components, have a qualified licensed electrician or other individual who has been properly trained in handling live electrical components perform these tasks.



General Information

These rental air handling units are custom Trane air handlers modified for use as rental units. The majority of the modifications are related to framing for rigging purposes, connection of chilled water piping, and temporary duct connection.

RSAU0010F0 - F1

Units contain hydronic water coils that can be utilized for cooling or hot water applications, but the coils cannot be used with steam because they will be damaged. Each model has been selected for use with 100% outside air without return air duct connections.

The air handlers have unit mounted variable frequency drives (VFDs) with a potentiometer to adjust airflow (CFM) settings on the drive located inside each unit's control panel.

RSAU0010F2

Units have chilled water-cooling coils which can be used for hot water and not for steam applications. Each unit has input/output 16 series cam type power cable receptacles to allow daisy-chaining supply voltage conductors to other air handler models of the same type in series.

The air handlers have unit mounted variable frequency drives (VFDs) with bypass to allow the fan to run at full speed in an event the VFD is damaged. A potentiometer is utilized to adjust airflow (CFM) settings locally on the drive located inside each unit's control panel.

RSAU0025F1, RSAU0050F1, and RSAU0062F1

Units contain both chilled water and hot water coils for year-round operation. Each unit has been selected for use with 100% outside air, but include return plenums and dampers to allow for 100% return air.

A Trane TR2 variable frequency drive (VFD) is included to control the fan motor. The VFD is controlled with a potentiometer dial. For additional information on the unit controls see ["Controls Information," p. 43.](#)

Figure 1. RSAU0010

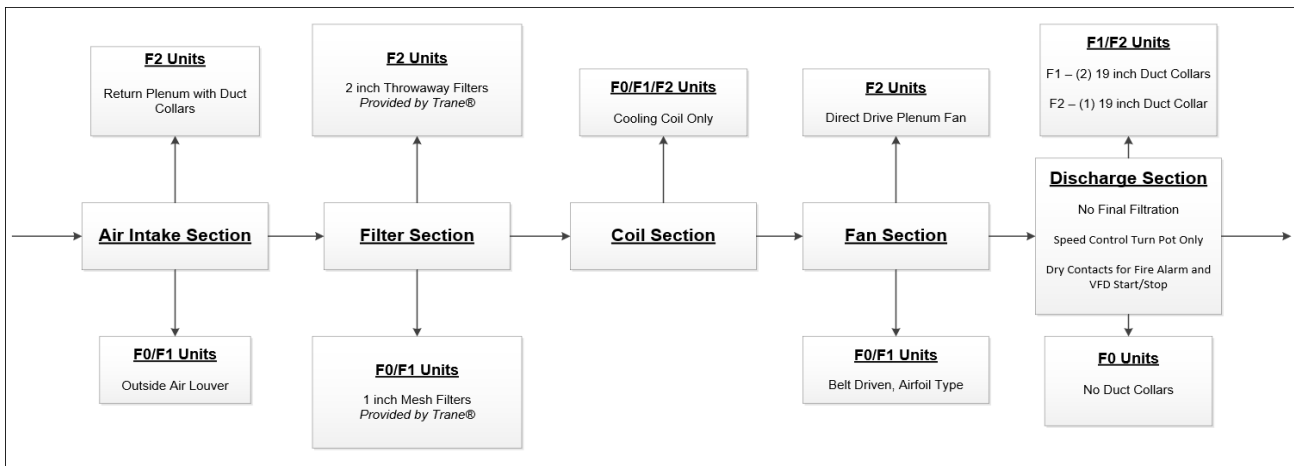

Important: Due to the configuration of the return air duct connections, these units must ship with the return air connections facing towards the rear of the trailer.

RSAU0025F2, RSAU0050F2, and RSAU0062F2

Each unit contains a single water coil that can be used for hot water or chilled water operation. Each unit has been selected for use with 100% outside air. Return connections and dampers allow for 100% return air.

Two Trane TR200 variable frequency drives (VFD) are included to control the dual plenum fans. Both VFDs receive input from a single potentiometer dial for fan speed. For additional information on the unit controls, see ["Controls Information," p. 43.](#)

RSCC0030F0

Units contain hydronic chilled water-cooling coils with 4-inch Victaulic manifolds that must be installed in the field outside each unit cabinet. Each unit model has been selected for use with 100% outside air with four discharge air ducts and six return air duct connections. Two units are capable of being stacked at a time. All units have input/out 16 series cam type power cable receptacles to allow daisy-chaining supply voltage conductors to other air handler models of the same type in series.

Air handlers have four, unit mounted TR150 variable frequency drives (VFDs) with bypass to allow the fan(s) to run at full speed in an event the VFD is damaged. Each supply fan airflow (CFM) can be adjusted utilizing the VFD speed potentiometer dial mounted on the outside of the top control panel located on the width side of each AHU.

Order of AHU Sections in Direction of Airflow

The figures below illustrate the general construction of all Trane Rental Air Handling Units.

Figure 2. RSAU0025, RSAU0050, and RSAU0062

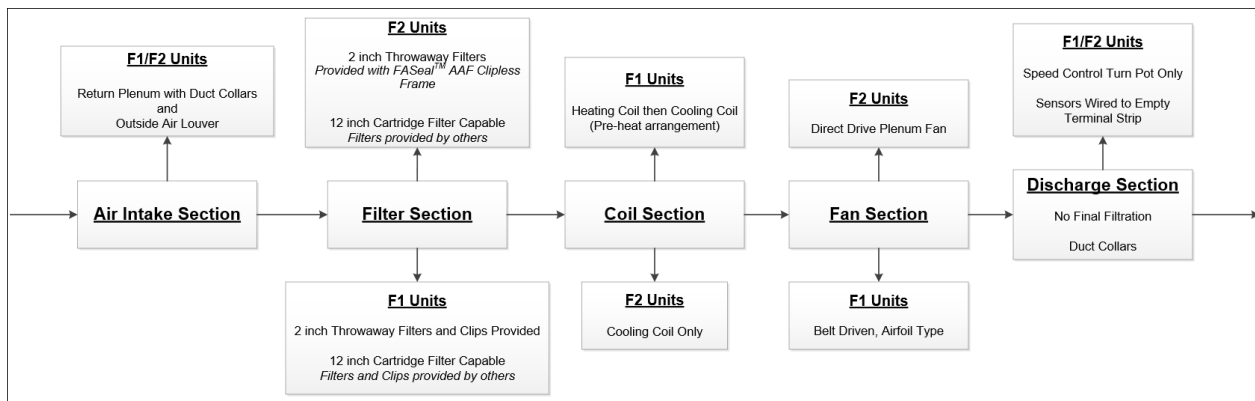
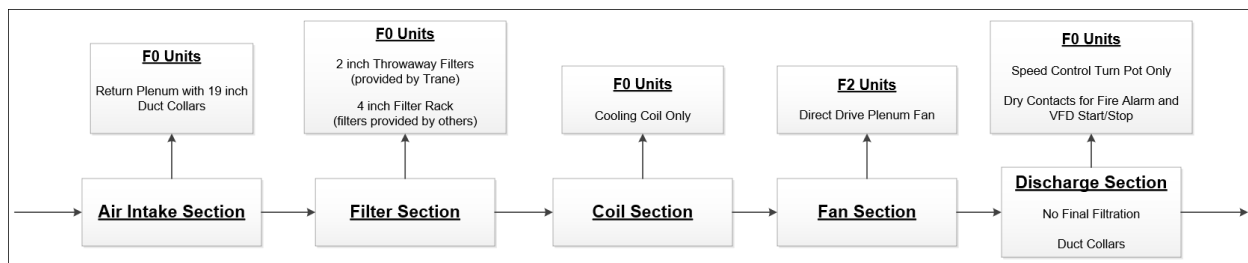

Figure 3. RSCC0030





Application Considerations - Air Handler Units

Freeze Protection

In ambient temperatures 32°F (0°C) and below freezing, it is recommended that a non-freezing, low temperature, corrosion inhibiting, heat transfer fluid be added to the chilled water system. The solution must be strong enough to provide protection against ice formation at the lowest anticipated fluid temperature. As a result of low fluid temperature below 40°F (4°C), glycol or other antifreeze solution may be utilized for hydronic systems. Contact Trane Rental Services engineering for more information on glycol percentage recommendations.

In addition to using glycol, it is highly recommended that all exposed pipe external to equipment enclosures be heat traced and insulated. Follow the recommended guidelines by the heat tracing manufacturer.

NOTICE

Coil Freeze-Up!

Failure to follow instruction below could result in equipment damage.

Drain and vent coils when not in use. Trane recommends glycol protection in all possible freezing applications. Use a glycol approved for use with commercial cooling and heating systems and copper tube coils.



RSAU0010F0-F1 AHU

Table 2. General data

Labels	Value
Model Number	3,200
Water Connection Size	2.5 in. Victaulic
Ambient Operating Conditions ^(a)	25°F – 100°F
Supply Motor(s)	5 hp
OCP Device	Circuit Breaker
Number of Electrical Circuits	1
Discharge Configuration	Horizontal
Flex Duct Connection Size	19 in. round
Number of Discharge Air Connections F0 Models	0
Number of Discharge Air Connections F1 Models	2
Max External Static Pressure @ Nominal CFM	1.47 in.
Number of Return Air Connectors	0
Filter (Quantity and size) ^(b)	(1) 27.5 in. x 29.5 in.
Nominal Airflow (cfm)	5,000
Min/Max Airflow (cfm) ^(c)	3,125/5,000

Note: Selection is required for actual AHU performance.

- (a) For ambient conditions below 40°F, glycol is recommended.
- (b) Unit provided with standard mesh filter. Filter rack will not accept any other type of filter.
- (c) Min/Max airflow is dependent upon external static pressure requirement. Contact Trane Rental Services for specific airflow and static pressure information.

Table 3. Electrical data

Labels	Value
Voltage	460V 3-phase
Frequency	60 Hz
Electrical Cable Supplied	50 ft. - #8/4 AWG
Minimum Circuit Ampacity (MCA)	10 amps
Maximum Overcurrent Protection (MOP)	30 amps

Note: For additional electrical information, contact Trane Rental Services.

Table 4. Performance data

Labels	Value
Airflow (CFM)	5,000
Cooling Coil	
Entering Air DB/WB Temp (°F)	90/73
Leaving Air DB/WB Temp (°F)	55.8/55.6
Fluid Flow (GPM)	35
Entering Water Temp (°F)	44
Leaving Water Temp (°F)	58.7
Coil Water Pressure Drop (ft H ₂ O)	23.9
Sensible Capacity (MBh)	166.2
Total Capacity (MBh)	258

Table 4. Performance data (continued)

Labels	Value
Coil Face Area (ft ²)	4.9
Coil Rows	8

Table 5. Water flow rates

	Minimum	Maximum
CW Coil Flow (GPM)	25	45
CW Coil Pressure Drop (ft H ₂ O)	16.2	25.4

Note: Maximum water side pressure is 150 psi (2.31 ft H₂O = 1 psi).

Table 6. Dimensions and weights

	F0 Models	F1 Models
Length	7 ft 4 in.	5 ft 8 in.
Width	2 ft 8 in.	2 ft 9 in.
Height without Casters	6 ft 5 in.	4 ft 9 in.
Weight	1,500 lb	1,300 lb

Features

- Discharge can be configured for one or two duct connections.
- Variable Frequency Drive (VFD) with potentiometer.
- Suitable for chilled and hot water applications.
- Condensate pump with alarm.
- Permanent, cleanable filter.
- Forklift pockets and caster wheels.

Figure 4. RSAU0010F0-F1 fan curve

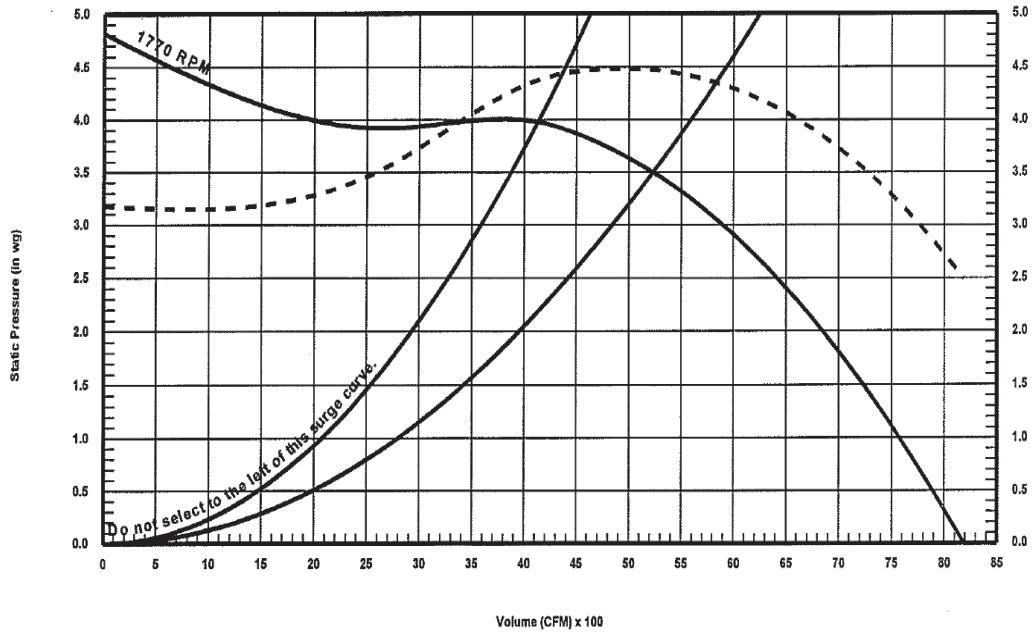

Figure 5. RSAU0010F0 side view



Figure 6. RSAU0010F0 supply and return view



Figure 7. RSAU0010F1 (2 supply style AHU)



Figure 8. RSAU0010F1 (2 supply style AHU)





RSAU0010F2 - AHU

Table 7. General data

Label	Value
Water Connection Size/Type	2.5 in. Victaulic
Ambient Operating Conditions	0°F – 115°F ^(a)
Number of Electrical Circuits	1

(a) Glycol may be required for ambient operation below 40°F.

Table 8. Electrical data - circuit breaker style disconnect

Label	Value
Voltage	460V 3 Phase
Frequency	60 Hz
Wire Connection Type	Series 16 Cam Type Only
SCCR	5,000 A
Minimum Circuit Ampacity (MCA)	15 A
Maximum Overcurrent Protection (MOP)	25 A
Motor FLA	11.6 A

Table 9. Airflow data

Label	Value
Supply Motor	10 HP
Nominal CFM	5,000
Min/Max CFM	3,500 – 5,000
Max External Static Pressure @ Nominal CFM	5.8 in.
Supply Air Connection Qty/Size	(1) 20 in.
Return Air Connection Qty/Size	(1) 20 in.
MERV-8 Throwaway Filters	(1) 16 in. x25 in. x 2 in. and (2) 20 in. x25 in. x 2 in.
450' Max Supply/Return Duct Run	@ 3,500 CFM
600' Max Supply/Return Duct Run	@ 5,000 CFM

Table 10. Installed/Operating clearances

Label	Value
Sides	36 in.
Ends (Supply/Return)	48 in.
Top	No requirements

Table 11. Cooling coil

Label	Value
Entering Air DB/WB Temp (°F)	95/80
Leaving Air DB/WB Temp (°F)	59.9/59.2
Fluid Flow (GPM)	84
Coil Water Pressure Drop (ft H ₂ O)	7.78
Entering Water Temp (°F)	44
Leaving Water Temp (°F)	53.4
Sensible Capacity (MBh)	191.4
Total Capacity (MBh)	394.5
Coil Face Area (ft ²)	7.26
Coil Rows	8
Air Pressure Drop through Unit (in H ₂ O)	1.37

Table 12. Water flow rates

	Minimum	Maximum
Cooling Coil Flow (GPM)	20	150
Cooling Coil Fluid Pressure Drop (ft H ₂ O)	0.53	23.4

Note: Maximum water side pressure is 150 psi (2.31' H₂O = 1 psi).

Table 13. Dimension and weights

Label	Value
Length	7 ft – 6.5 in.
Width	2 ft – 11.375 in.
Height without Casters	6 ft – 0 in.
Height with Casters	6 ft – 8.25 in.
Shipping Weight	2,000 lb
Fork Pocket Dimensions	9.75 in.x 3.5 in.
Center to Center Distance of Fork Pockets	40 in.

Note: Lifting Device: Forklift or Crane.

Features

- Blower VFD with across the line bypass and speed adjustment potentiometer.
- Integrated condensate pump.
- Phase and under/over voltage protection.
- Forklift pockets and caster wheels.
- Hinged service access.
- Series 16 cam type electrical connections.

For additional electrical information, contact Trane Rental Services.

Note: All features and specifications are subject to change without notice or liability.

Figure 9. RSAU0010F2 fan curve

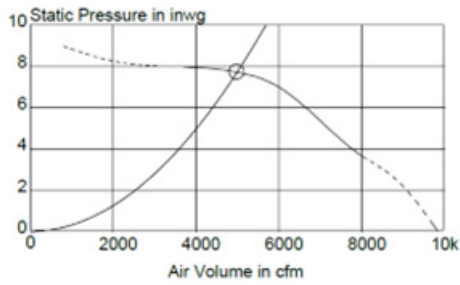

Table 14. Airflow data

Air Volume	5,000 cfm
Static Pressure	7.70 in. wg
Velocity Pressure	0.52 in. wg
Total Pressure	8.22 in. wg
Outer Velocity	14.84 m/s

Table 15. RSAU0010F2 fan sound data

Hz	63	125	250	500	1k	2k	4k	8k	Overall	
Lwi (Lin.)	82	83	85	91	83	79	79	75	94	dB
Lwi (A)	56	68	76	88	83	80	80	74	90	dB (A)
Lpi (A)	49	61	69	81	75	73	73	67	83	dB (A)

Notes:

- Sound data is for the inlet side.
- Sound pressure level 1m, room conditions.



Figure 10. RSAU0010F2 unit drawing

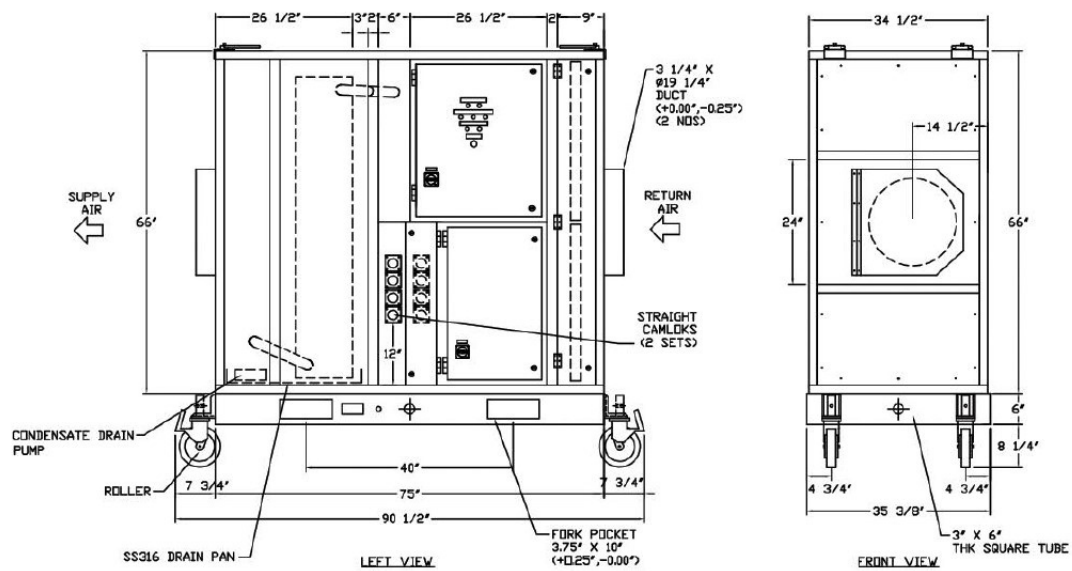



RSAU0025F1 AHU

Table 16. General data

Label	Value
Model Number	TCCB
Water Connection Size	2.5 in. Victaulic
Ambient Operating Conditions ^(a)	14°F – 104°F
Supply Motor	25 hp
Fused Disconnect	Yes
Number of Electrical Circuits	1
Discharge Configuration	Horizontal
Flex Duct Connection Size	19 in. round
Number of Discharge Air Connections	2
Max External Static Pressure @ Nominal CFM	6.0 in.
Number of Return Air Connectors	3
Filter Rack (Qty and size) ^(b)	(4) 24 in. x 24 in., (2) 24 in. x 12 in.
Nominal Airflow (cfm)	10,000
Min/Max Airflow (cfm) ^(c)	5,500/11,250

Note: Selection is required for actual AHU performance.

- (a) For ambient conditions below 40°F, glycol is recommended.
- (b) Unit provided with standard 2 in filters. Filter rack will accept up to 95% efficient MERV 14 filters.
- (c) Min/Max airflow is dependent upon external static pressure requirement. Contact Trane Rental Services for specific airflow and static pressure information.

Table 17. Electrical data

Labels	Value
Voltage	460V 3-phase
Frequency	60 Hz
Lug(s) can accept wire up to	#3 AWG wire
Minimum Circuit Ampacity (MCA)	44 amps
Maximum Overcurrent Protection (MOP)	70 amps

Notes:

- Provided with 50 ft of 4 conductor, 8 awg multicable
- For additional electrical information, contact Trane Rental Services.

Table 18. Performance data

Labels	Value
CFM	10,000
Air Pressure Drop through Unit (in H ₂ O)	2.8
Cooling Coil	
Entering Air DB/WB Temp (°F)	84/77
Leaving Air DB/WB Temp (°F)	55/54.9
GPM	155
Entering Water Temp (°F)	45
Leaving Water Temp (°F)	55
Coil Water Pressure Drop (ft H ₂ O)	8.53
Sensible Capacity (MBh)	323.9

Table 18. Performance data (continued)

Labels	Value
Total Capacity (MBh)	778.8
Coil Face Area (sq. ft)	19.9
Coil Rows	8
Heating Coil	
Entering Air DB/WB Temp (°F)	45
Leaving Air DB/WB Temp (°F)	78
GPM	36
Entering Water Temp (°F)	180
Leaving Water Temp (°F)	160
Coil Water Pressure Drop (ft H ₂ O)	2.38
Total Capacity (MBh)	357.89
Coil Face Area (sq. ft)	19.9
Coil Rows	1

Table 19. Water flow rates

	Minimum	Maximum
CW Coil Flow (GPM)	70	200
CW Coil Pressure Drop (ft H ₂ O)	2.14	13.66
HW Coil Flow (GPM)	10	125
HW Coil Pressure Drop (ft H ₂ O)	0.2	28.07

Table 20. Dimensions and weights

Labels	Value
Length	19 ft 0 in.
Width	6 ft 11 in.
Height	7 ft 6 in.
Weight	8,350 lb

Notes:

- Width includes permanently mounted piping manifold.
- Lifting Device: Fork Lift or Crane.

Figure 11. RSAU0025F1 fan curve

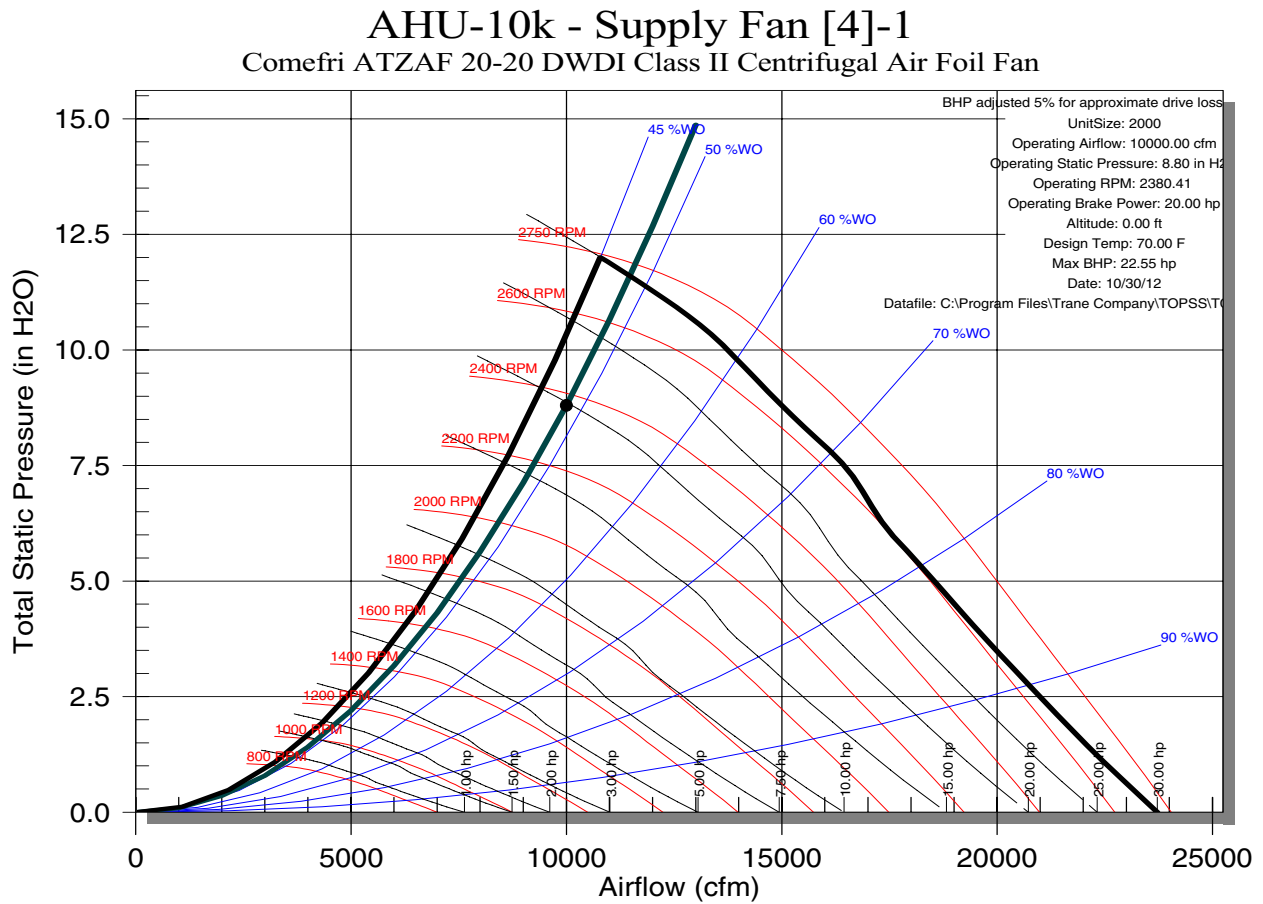

Figure 12. RSAU0025F1 submittal

RSAU0025F1XX

Trane Rental Services Air Handling Unit

Mechanical Specifications:

- Cold/Hot Water Connections: 2.5" Victaulic
- Coil Drains/Vents: 3/8" NPT w/ Ball Valves
- P-Trap: 1.5" PVC
- Duct: 19" Round Nominal
- Electrical Connector: 60A Fused Disconnect (NEMA 4)
- Fork Pockets: 6" x 10"
- Fan: 20" Class II @ 2380 RPM (Belt Driven)
- Nominal Fan Operating Point: 10,000cfm @ 6" ESP
- Fan Draws through coils
- Hot Water Coil: 5W, 1-Row
- Cold Water Coil: WD 6-Row
- Filters: 2" throwaway provided, fits up to 12" Cartridge MERV-13
- Sizes: (2) 24" x 12", (4) 24" x 24"

Shipping Weight: 8,353 lbs
Operating Weight: 8,653 lbs

Electrical Specifications:

- Voltage: 460V 3-Phase
- MCA: 44A
- MOP: 70A
- Motor HP: 25hp, FLA 30A
- VFD (Trane TRZ) Speed Controlled by Digital Potentiometer in Externally Mounted Enclosure

Control: Field Must provide DDC Controller, available points are provided to simplify wiring for convenience

Available Paints:

- White Filter Socks
- Discharge Air Temperature
- Low Limit (Leaving Air)
- Air Flow Meter
- Discharge Air Temp Sensor

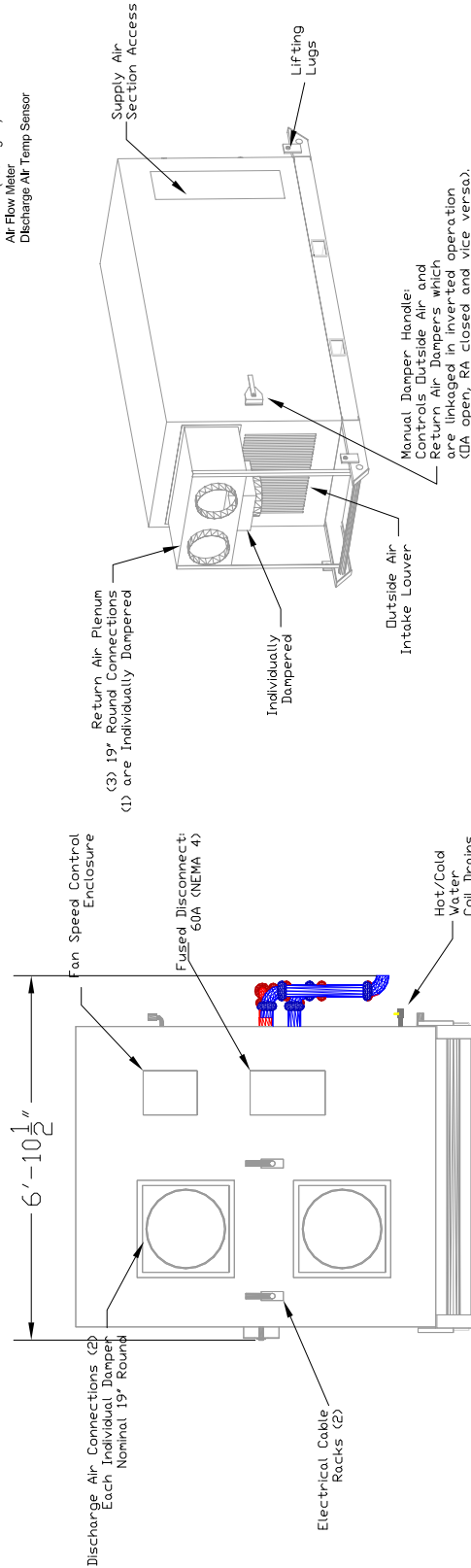
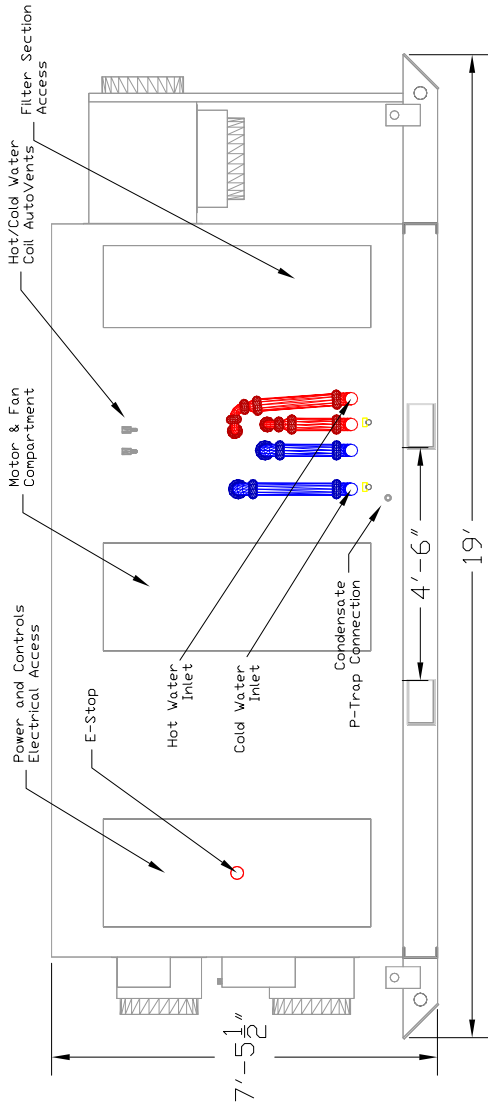



RSAU0025F2 AHU

Table 21. General data

Label	Description
Model Number	TCPA
Water Connection Size	2.5 in. Victaulic
Ambient Operating Conditions ^(a)	14°F – 104°F
Supply Motor(s)	(2) 15 hp
OCP Device	Circuit Breaker
Number of Electrical Circuits	1
Discharge Configuration	Horizontal
Flex Duct Connection Size	19 in. round
Number of Discharge Air Connections	2
Max External Static Pressure @ Nominal CFM	6.0 in.
Number of Return Air Connectors	3
Filter Rack (Qty. and size) ^(b)	(4) 24 in. x 24 in., (2) 24 in. x 12 in.
Nominal Airflow (cfm)	10,000
Min/Max Airflow (cfm) ^(c)	1,700/11,200

Note: Selection is required for actual AHU performance.

- (a) For ambient conditions below 40°F, glycol is recommended.
- (b) Unit provided with standard 2 in filters. Filter rack will accept up to 95% efficient MERV 14 filters.
- (c) Min/Max airflow is dependent upon external static pressure requirement. Contact Trane Rental Services for specific airflow and static pressure information.

Table 22. Electrical data

Label	Description
Voltage	460V 3-phase
Frequency	60 Hz
Electrical Connection Type	Cam Type Only
SCCR	65K
Minimum Circuit Ampacity (MCA)	54 amps
Maximum Overcurrent Protection (MOP)	70 amps

Note: For additional electrical information, contact Trane Rental Services.

Table 23. Performance data

Labels	Description
Airflow (CFM)	10,000
Air Pressure Drop through Unit (in H ₂ O)	3.63
Cooling Coil	
Entering Air DB/WB Temp (°F)	84/77
Leaving Air DB/WB Temp (°F)	50.4/50.4
Fluid Flow GPM	146.65
Entering Water Temp (°F)	44
Leaving Water Temp (°F)	56
Coil Water Pressure Drop (ft H ₂ O)	11.54
Sensible Capacity (MBh)	363.8

Table 23. Performance data (continued)

Labels	Description
Total Capacity (MBh)	883
Coil Face Area (sq. ft)	20
Coil Rows	10

Table 24. Water flow rates

	Minimum	Maximum
CW Coil Flow (GPM)	30	292
CW Coil Pressure Drop (ft H ₂ O)	0.62	41.5

Note: Lifting Device: Fork Lift or Crane.

Table 25. Dimensions and weights

Label	Value
Length	18 ft 0 in.
Width	6 ft 10 in.
Height	7 ft 6 in.
Weight	8,700 lb

Note: Lifting Device: Fork Lift or Crane.



Figure 13. RSAU0025F2 fan information

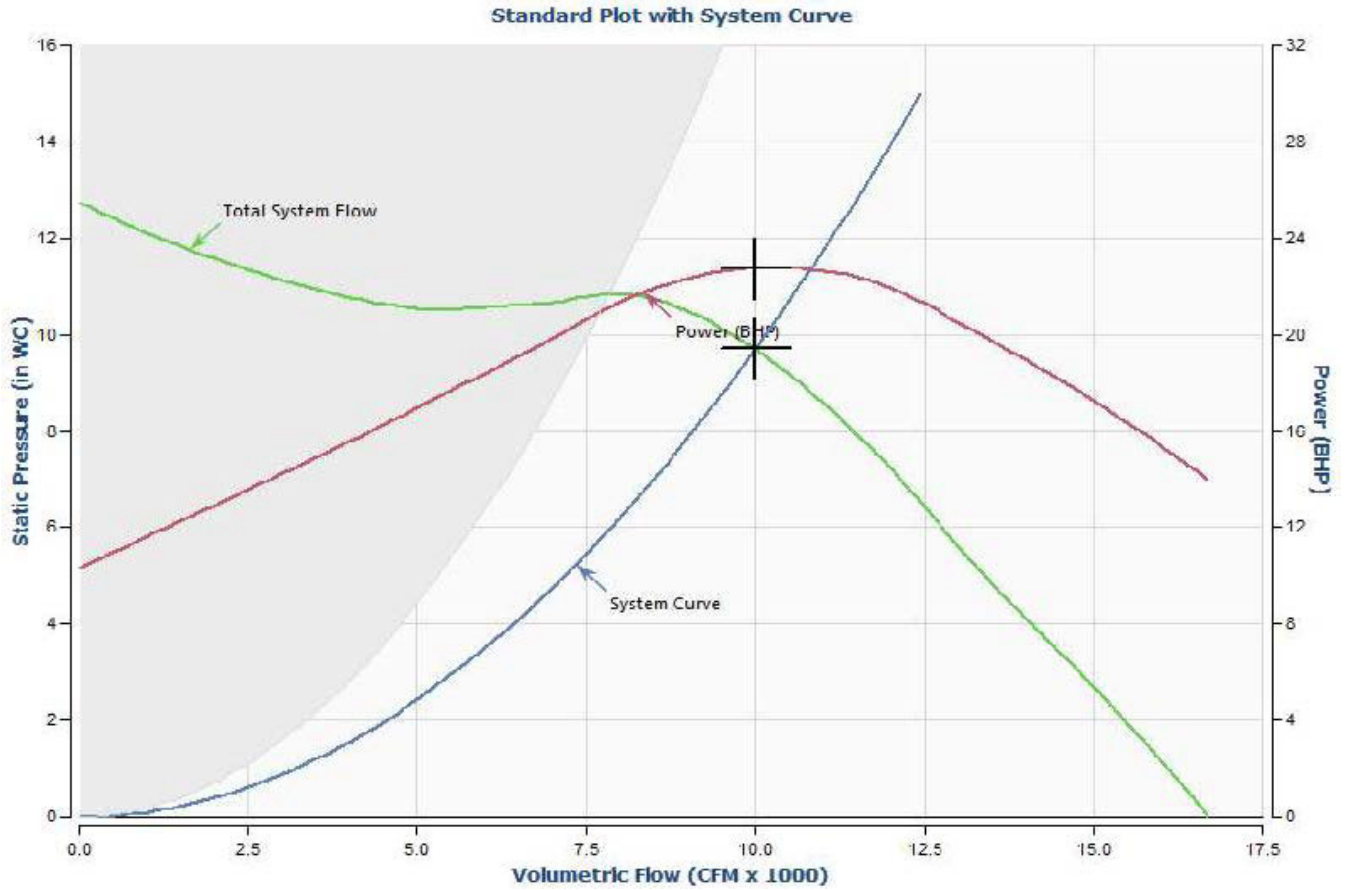

Label	Value
Size/Model	165MK2/EPLFN
Volumetric Flow (CFM)	10,000
SP (in WC)	9.7
Class	III
Speed (RPM)	3,560
Max Speed	4,000 RPM @ 70°F
Power (BHP)	22.76
Outlet Vel (FPM)	2,456
Density (lb/ft ³)	0.075

Note: Adjusted for (2) fans operating in parallel.

Sound Power	Octave Bands	1	2	3	4	5	6	7	8	LwA ^(a)	dBA ^(b)
	Inlet dB	91	91	93	101	95	88	87	89		
	Outlet dB	92	92	96	102	98	93	88	84		

(a) The overall (single value) fan sound power level in dB re. 10⁻¹² Watts, 'A' weighted.

(b) Estimated sound pressure level (re:0.0002 microbar) based on a single ducted installation at 5 ft, using a directivity factor of 1.

Figure 14. RSAU0025F2 submittal

- Mechanical Specifications
- Cold Water Connections : 2.5" Victaulic
 - Coil Drains/Vents : 1/2" w/ Ball Valves
 - P-Trap : 1.5" Schedule 80 PVC
 - Duct : 19" Round Nominal
 - Electrical Connection : Cam-Type w/ Nema 4 Breaker Style Disconnect
- Fan : Dual DDP 16.5" Class III @ 3560 RPM
 Nominal Fan Operating Point : 10,000 CFM @ 6" ESP
 Fan Draws through Coils
 Cold Water Coil : 58W46x60-12-10-F-Z-L 10-Row
- Filters : 2" Throwaway Merv 7 Provided, fits up to 12" Single Header Merv 13-14 Filter
 Sizes : (4) 24"x24", (2) 24" x12"
- Shipping Weight : 8700 lbs
 Operating Weight : 8950 lbs
- Electrical Specifications
- Voltage : 460V 3-Phase
 - MCA : 54 Amps
 - MOP : 70 Amps
 - SCCR : 65k
- Motors : (2) 15 HP @ 17.5 FLA
 VFD : (2) Trane TR200 Operated by Digital Potentiometer located in exterior controls cabinet
- Controls : Field Must Provide DDC Controller
- Available Points :
- Dirty Filter Switch
 - Entering & Discharge Air Temp
 - LIT Alarm Status Relay
 - Air Flow Meter
 - Discharge Air Temp

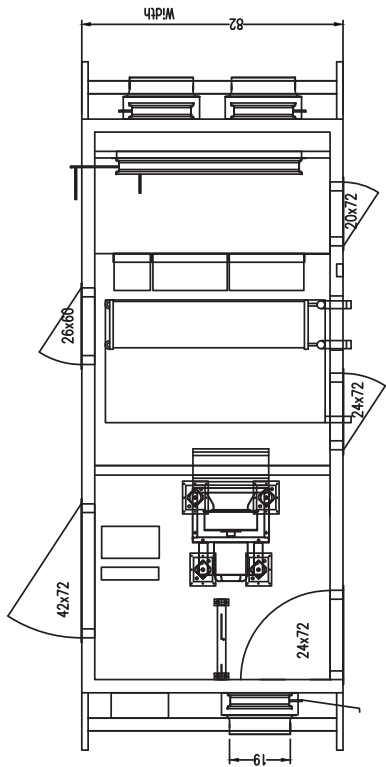

4 Plan View

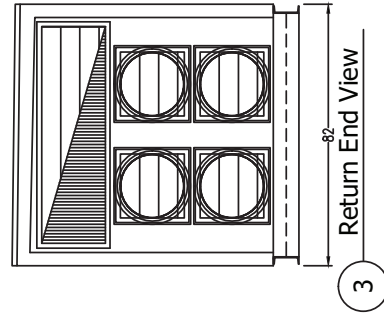

3 Return End View

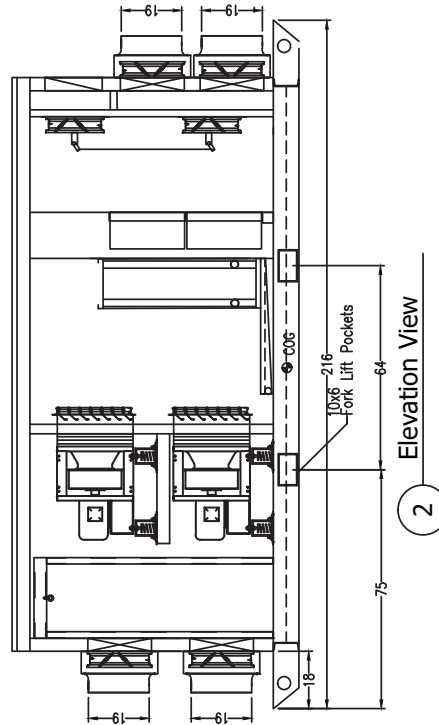

2 Elevation View

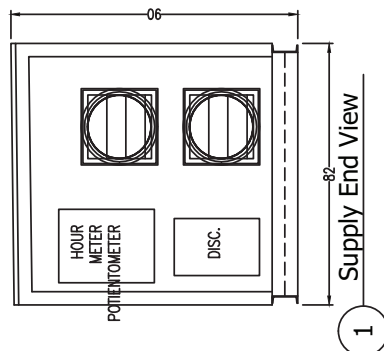

1 Supply End View



RSAU0050F1 AHU

Table 26. General data

Label	Value
Model Number	TCCB
Supply and Return Water Connection Sizes (inches)	2.5 in. Victaulic
Ambient Operating Conditions ^(a)	14°F – 104°F
Supply Motor	50 Hp
Fused Disconnect	Yes
Number of Electrical Circuits	1
Discharge Air Configuration	Horizontal
Flex Duct Connection Size	19 in round
Number of Discharge Air Connections	4
Number of Return Air Connections	5
Max External Static Pressure @ Nominal CFM	6.3 in.
Filters (Quantity and size) ^(b)	(9) 24 in. x 24 in. and (3) 24 in. x 12 in.
Nominal Airflow (cfm)	20,000
Min/Max Airflow (cfm) ^(c)	8,500/22,250

Note: Selection is required for actual AHU performance.

- (a) For ambient conditions below 40°F, glycol is recommended.
- (b) Unit provided with standard 2 in filters. Filter rack will accept up to 95% efficient MERV 14 filters.
- (c) Min/Max airflow is dependent upon external static pressure requirement. Contact Trane Rental Services for specific airflow and static pressure information.

Table 27. Electrical data

Label	Value
Voltage	460V 3-phase
Frequency	60 Hz
Lug(s) can accept wire up to	250 MCM
Minimum Circuit Ampacity (MCA)	83 amps
Maximum Overcurrent Protection (MOP)	125 amps

- Notes:**
- Provided with 50 ft of 4 conductor, 4 awg multicable.
 - For additional electrical information, contact Trane Rental Services.

Table 28. Performance data

Labels	Value
CFM	20,000
Air Pressure Drop through Unit (in H ₂ O)	2.81
Cooling Coil	
Entering Air DB/WB Temp (°F)	84/77
Leaving Air DB/WB Temp (°F)	55/54.9
GPM	310
Entering Water Temp (°F)	45
Leaving Water Temp (°F)	55
Coil Water Pressure Drop (ft H ₂ O)	14.29

Table 28. Performance data (continued)

Labels	Value
Sensible Capacity (MBh)	647.8
Total Capacity (MBh)	1,557.6
Coil Face Area (sq. ft)	40.6
Coil Rows	8
Heating Coil	
Entering Air DB/WB Temp (°F)	45
Leaving Air DB/WB Temp (°F)	78
GPM	38.5
Entering Water Temp (°F)	180
Leaving Water Temp (°F)	160
Coil Water Pressure Drop (ft H ₂ O)	3.56
Total Capacity (MBh)	715.77
Coil Face Area (sqft)	40.6
Coil Rows	1

Table 29. Water flow rates

	Minimum	Maximum
CW Coil Flow (GPM)	100	350
CW Coil Pressure Drop (ft H ₂ O)	2.03	17.82
HW Coil Flow (GPM)	20	185
HW Coil Pressure Drop (ft H ₂ O)	0.31	22.71

Table 30. Dimensions and weights

Labels	Value
Length	21 ft 7 in.
Width ^(a)	8 ft 6 in.
Height	9 ft 1 in.
Weight	11,600 lb

Note: Lifting Device: Fork Lift or Crane.

- (a) Width includes permanently mounted piping manifold.

Figure 15. RSAU0050F1 fan curve

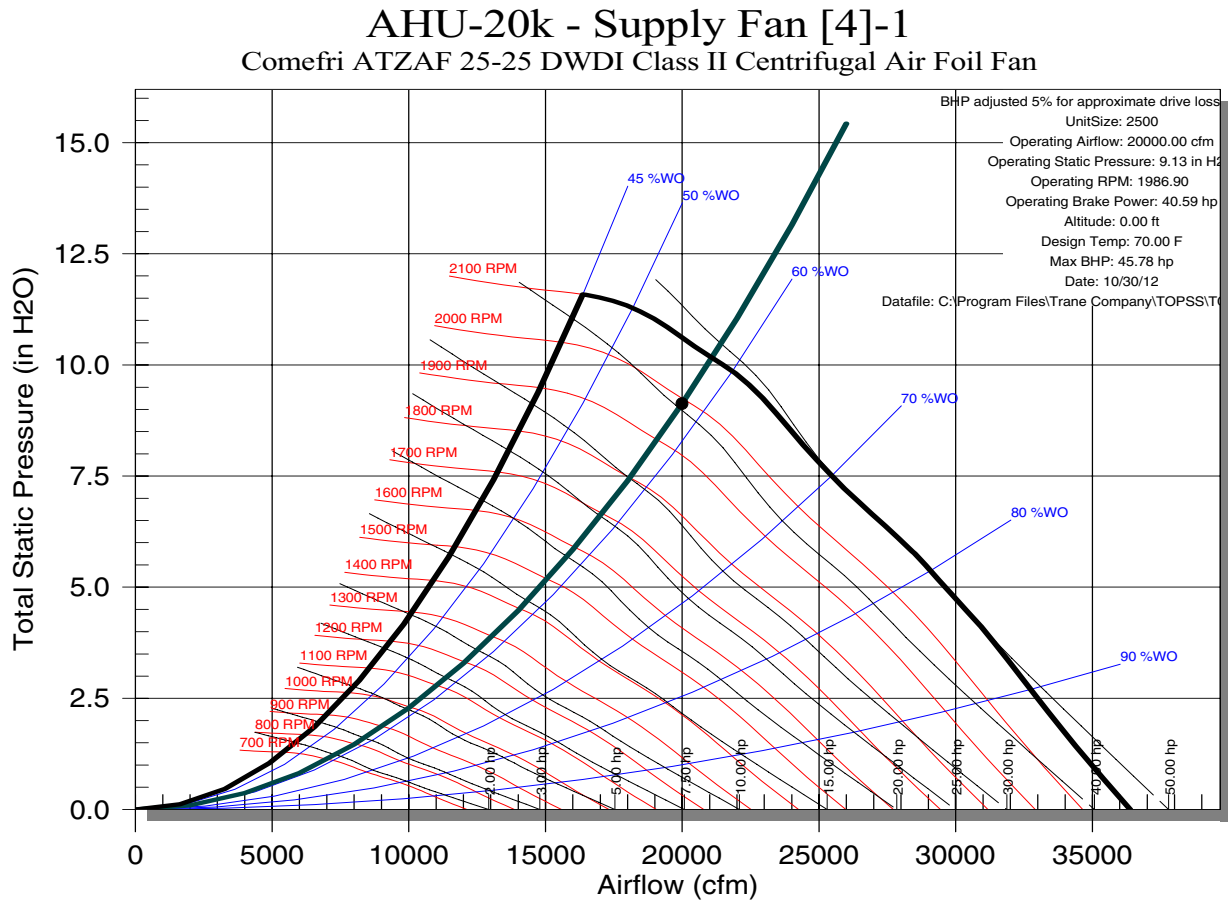

RSAU0050F1 AHU

Figure 16. RSAU0050F1 submittal

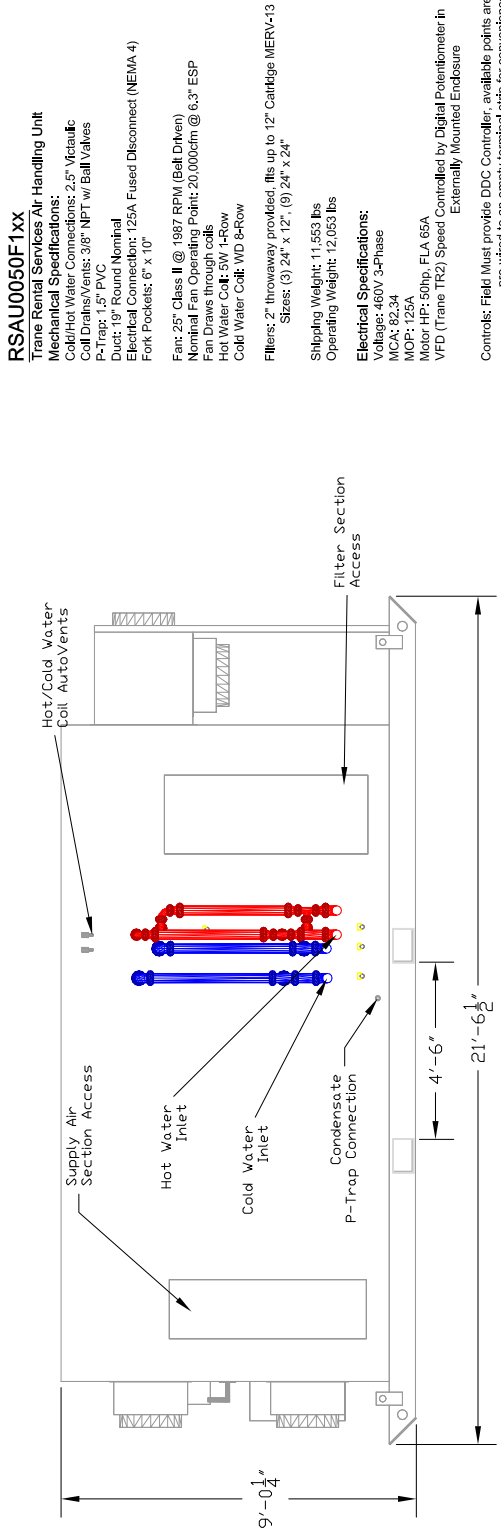

RSAU0050F1xx

- Trane Rental Services Air Handling Unit
- Mechanical Specifications:
 - Coil/Water Connections: 2.5" Vertical
 - Coil Drains/Vents: 3/8" NPT w/ Ball Valves
 - P-Fan: 1.5" PVC
 - Duct: 19" Round Nominal
 - Electrical Connection: 125A Fused Disconnect (NEMA 4)
 - Fork Pockets: 6" x 10"
- Fan: 25" Class II @ 1987 RPM (Belt Driven)
- Nominal Fan Operating Point: 20,000cfm @ 6.3" ESP
- Fan Draws through coils
- Hot Water Coil: 5W 1-Row
- Cold Water Coil: WD 8-Row
- Filters: 2" throwaway provided, fits up to 12" Cantridge MERV-13
- Sizes: (3) 24" x 12", (9) 24" x 24"
- Shipping Weight: 11,553 lbs
- Operating Weight: 12,053 lbs
- Electrical Specifications:
 - Voltage: 480V 3-Phase
 - MCA: 82.34
 - MOP: 125A
 - Motor HP: 50hp, FLA 65A
 - VFD (Trane TR2) Speed Controlled by Digital Potentiometer in Externally Mounted Enclosure
- Controls: Field Must provide DDC Controller, available points are pre-wired to an empty terminal strip for convenience
- Available Points:
 - Dirty Filter Switch
 - Entering Air Temperature
 - Low Limit (Leaving Air)
 - Air Flow Meter
 - Discharge Air Temp Sensor

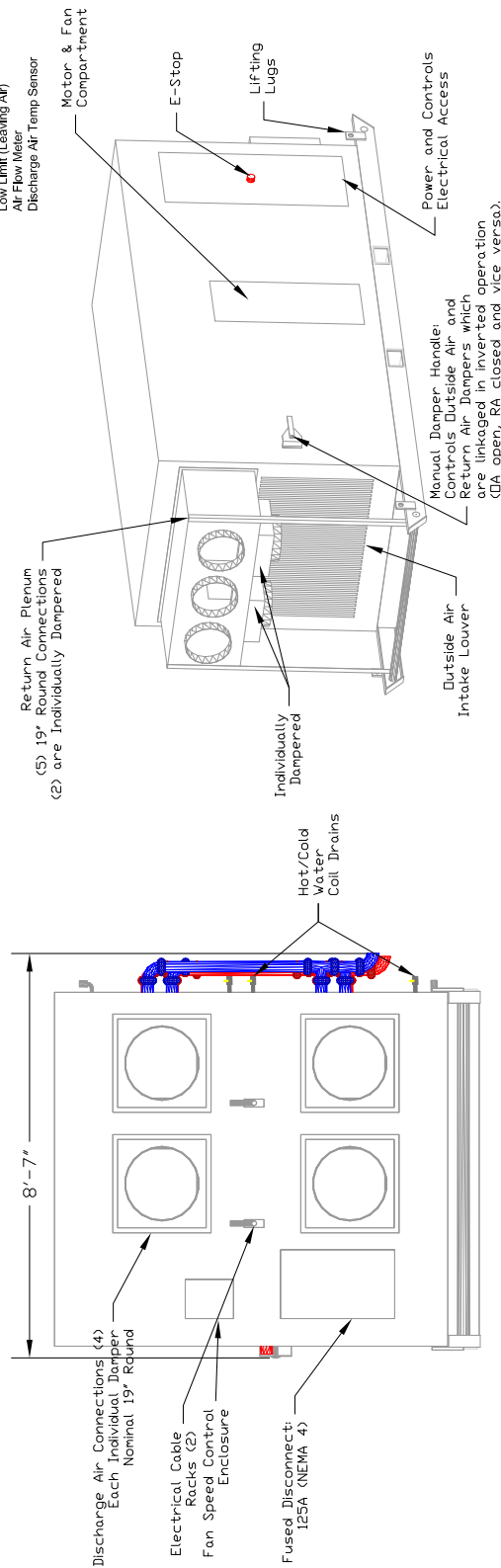



RSAU0050F2 AHU

Table 31. General data

Label	Value
Model Number	TCPA
Water Connection Size	4 in. Victaulic
Ambient Operating Conditions ^(a)	14°F – 104°F
Supply Motor(s)	(2) 25 hp
OCP Device	Circuit Breaker
Number of Electrical Circuits	1
Discharge Configuration	Horizontal
Flex Duct Connection Size	19 in. round
Number of Discharge Air Connections	4
Max External Static Pressure @ Nominal CFM	6.0 in.
Number of Return Air Connectors	6
Filter Rack (Qty. and size) ^(b)	(9) 24 in. x 24 in. and (3) 24 in. x 12 in.
Nominal Airflow (cfm)	20,000
Min/Max Airflow (cfm) ^(c)	4,500/20,800

Note: Selection is required for actual AHU performance.

- (a) For ambient conditions below 40°F, glycol is recommended.
- (b) Unit provided with standard 2 in filters. Filter rack will accept up to 95% efficient MERV 14 filters.
- (c) 3 Min/Max airflow is dependent upon external static pressure requirement. Contact Trane Rental Services for specific airflow and static pressure information.

Table 32. Electrical data

Label	Value
Voltage	460V 3-phase
Frequency	60 Hz
Electrical Connection Type	Cam Type Only
SCCR	65K
Minimum Circuit Ampacity (MCA)	86.25 amps
Maximum Overcurrent Protection (MOP)	110 amps

Note: For additional electrical information, contact Trane Rental Services.

Table 33. Performance data

Label	Description
Airflow (CFM)	20,000
Air Pressure Drop through Unit (in H ₂ O)	3.42
Cooling Coil	
Entering Air DB/WB Temp (°F)	84/77
Leaving Air DB/WB Temp (°F)	50.6/50.4
Fluid Flow GPM	292.08
Entering Water Temp (°F)	44
Leaving Water Temp (°F)	56
Coil Water Pressure Drop (ft H ₂ O)	11.23

Table 33. Performance data (continued)

Label	Description
Sensible Capacity (MBh)	724.4
Total Capacity (MBh)	1,757.8
Coil Face Area (sq. ft)	40.4
Coil Rows	10

Table 34. Water flow rates

	Minimum	Maximum
CW Coil Flow (GPM)	75	620
CW Coil Pressure Drop (ft H ₂ O)	0.88	46.41

Table 35. Dimensions and weights

Label	Value
Length	19 ft 0 in.
Width	8 ft 0 in.
Height	8 ft 6 in.
Weight	10,500 lb

Note: Lifting Device: Fork Lift or Crane.



Figure 17. RSAU0050F2 fan information

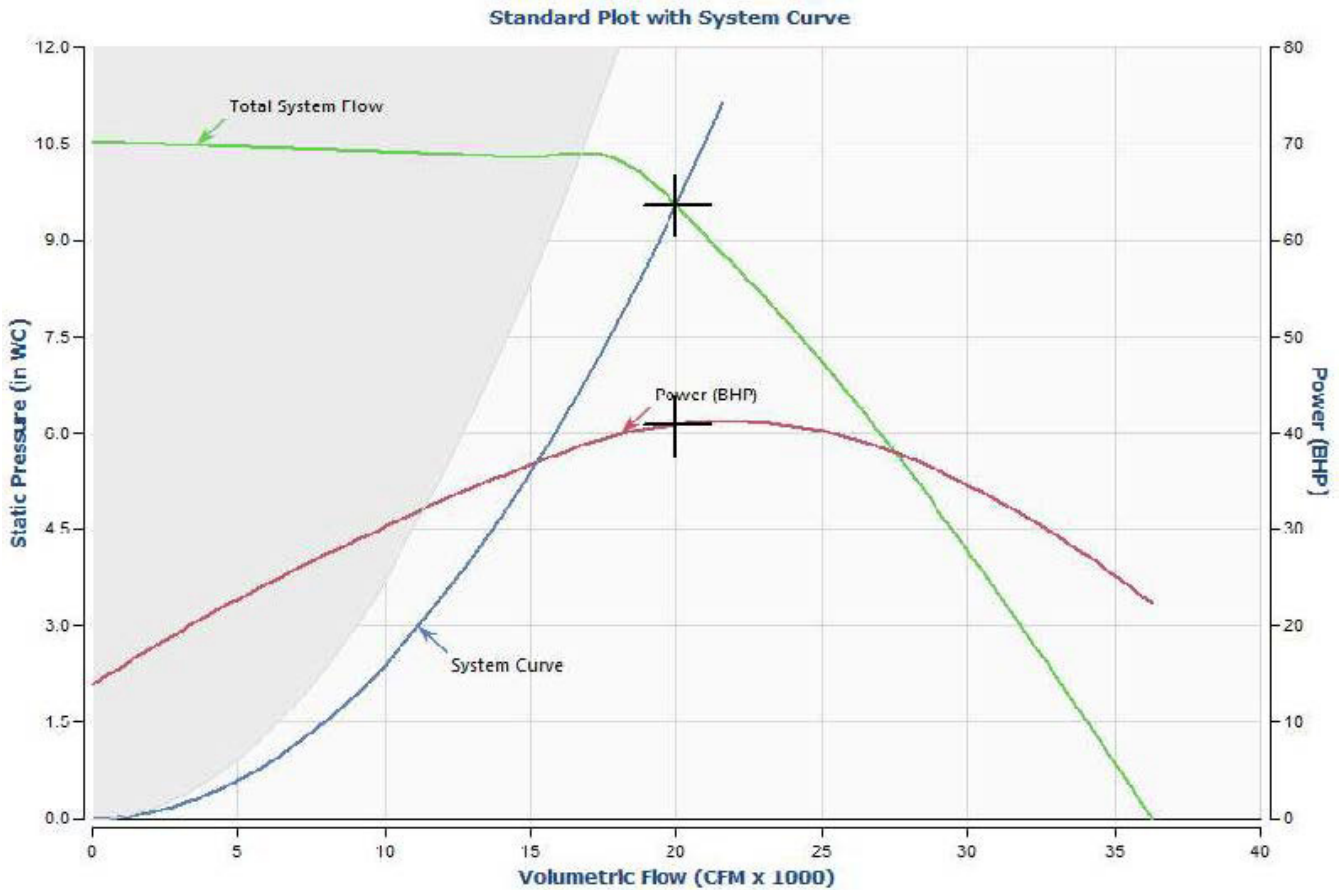

Label	Value
Size/Model	222MK2/EPLFN
Volumetric Flow (CFM)	20,000
SP (in WC)	9.55
Class	III
Speed (RPM)	2574
Max Speed	3,090 RPM @ 70°F
Power (BHP)	40.88
Outlet Vel (FPM)	2,606
Density (lb/ft ³)	0.075

Note: Adjusted for (2) fans operating in parallel.

Sound Power	Octave Bands	1	2	3	4	5	6	7	8	LwA ^(a)	dBA ^(b)
	Inlet dB	89	89	104	102	88	84	80	78	101	86
	Outlet dB	95	95	103	102	95	91	88	86	102	88

(a) The overall (single value) fan sound power level in dB re. 10⁻¹² Watts, 'A' weighted.

(b) Estimated sound pressure level (re:0.0002 microbar) based on a single ducted installation at 5 ft, using a directivity factor of 1.

Figure 18. RSAU0050F2 submittal

Mechanical Specifications
 Cold Water Connections : 4" Victaulic
 Coils Drains/Vents : 1/2" w/ Ball Valves
 P-Trap : 1.5" Schedule 80 PVC
 Duct : 19" Round Nominal
 Electrical Connection : Cam-Type w/ Nema 4 Breaker Style Disconnect

Fan : Dual DDP 22.25" Class III @ 2674 RPM
 Nominal Fan Operating Point : 20,000 CFM @ 6" ESP
 Fan Draws through Coils
 Cold Water Coil : 58W76.5x76-12-10-F-Z-L 10-Row
 Filters : 2" Throwaway Merv 7 Provided, fits up to 12" Single Header Merv 13-14 Filter
 Sizes : (9) 24"x24", (3) 24" x12"

Shipping Weight : 10500 lbs
 Operating Weight : 11010 lbs

Electrical Specifications
 Voltage : 480V 3-Phase
 MCA : 86.25 Amps
 MOP : 110 Amps
 SCOR : 65k

Motors : (2) 25 HP @ 30 FLA
 VFD : (2) Trane TR200 Operated by Digital Potentiometer located in exterior controls cabinet

Controls : Field Must Provide DDC Controller

Available Points :
 • Dirty Filter Switch
 • Entering & Discharge Air Temp
 • LLT Alarm Status Relay
 • Air Flow Meter
 • Discharge Air Temp

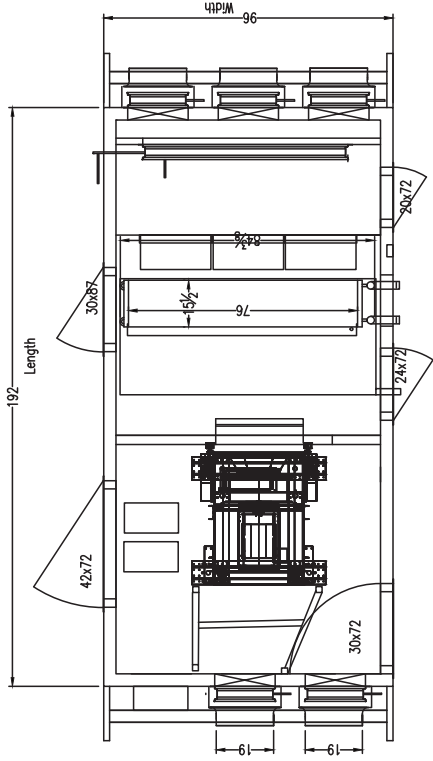

4 Plan View

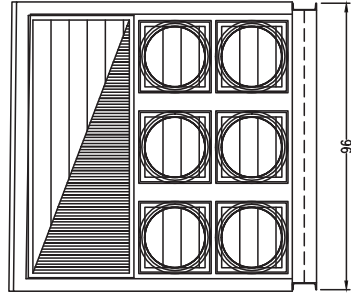

3 Return End View

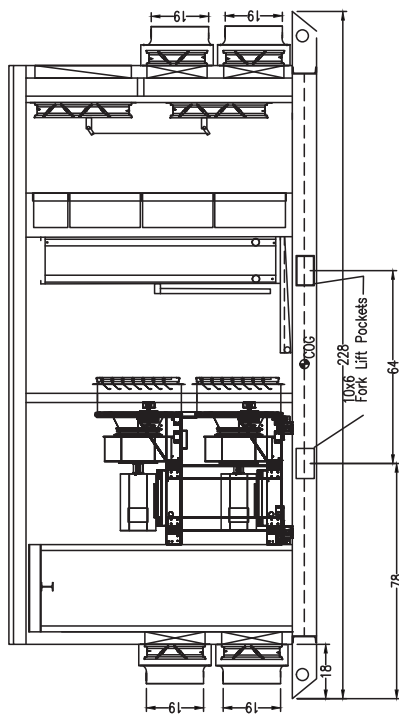

2 Elevation View

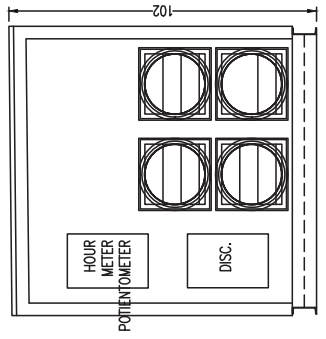

1 Supply End View



RSAU0062F1 AHU

Table 36. General data

Label	Value
Model Number	TCCB
Water Connection Size	4 in. Victaulic
Ambient Operating Conditions ^(a)	14°F – 104°F
Supply Motor	50 Hp
Fused Disconnect	Yes
Number of Electrical Circuits	1
Discharge Configuration	Horizontal
Flex Duct Connection Size	19 in. round
Number of Discharge Air Connections	4
Max External Static Pressure @ Nominal CFM	5.72 in.
Number of Return Air Connections	5
Filter Rack (Qty and size) ^(b)	(12) 24 in. x 24 in. and (4) 12 in. x 24 in.
Nominal Airflow (cfm)	25,000
Min/Max Airflow (cfm) ^(c)	11,000/27,500

Note: Selection is required for actual AHU performance.

- (a) For ambient conditions below 40°F, glycol is recommended.
- (b) Unit provided with standard 2 in filters. Filter rack will accept up to 95% efficient MERV 14 filters.
- (c) Min/Max airflow is dependent upon external static pressure requirement. Contact Trane Rental Services for specific airflow and static pressure information.

Table 37. Electrical data

Label	Value
Voltage	460V 3-phase
Frequency	60 Hz
Lug(s) can accept wire up to	250 MCM
Minimum Circuit Ampacity (MCA)	83 amps
Maximum Overcurrent Protection (MOP)	125 amps

Notes:

- For additional electrical information, contact Trane Rental Services.
- Provided with 50 ft of 4 conductor, 4 awg multicable.

Table 38. Performance data

Label	Value
CFM	25,000
Air Pressure Drop through Unit (in H ₂ O)	3.28
Cooling Coil	
Entering Air DB/WB Temp (°F)	84/77
Leaving Air DB/WB Temp (°F)	50/49.9
GPM	378
Entering Water Temp (°F)	44
Leaving Water Temp (°F)	56
Coil Water Pressure Drop (ft H ₂ O)	11.78

Table 38. Performance data (continued)

Label	Value
Sensible Capacity (MBh)	949.3
Total Capacity (MBh)	2,274.6
Coil Face Area (sqft)	50
Coil Rows	10
Heating Coil	
Entering Air DB/WB Temp (°F)	45
Leaving Air DB/WB Temp (°F)	78
GPM	44.7
Entering Water Temp (°F)	180
Leaving Water Temp (°F)	160
Coil Water Pressure Drop (ft H ₂ O)	3.56
Total Capacity (MBh)	894.72
Coil Face Area (sq. ft)	40.6
Coil Rows	1

Table 39. Water flow rates

	Minimum	Maximum
CW Coil Flow (GPM)	125	500
CW Coil Pressure Drop (ft H ₂ O)	1.88	19.48
HW Coil Flow (GPM)	30	200
HW Coil Pressure Drop (ft H ₂ O)	0.55	21.77

Table 40. Dimensions and weights

Labels	Value
Length	22 ft 9 in.
Width ^(a)	8 ft 6 in.
Height	9 ft 10.5 in.
Weight	15,100 lb

Note: Lifting Device: Fork Lift or Crane.

- (a) Width does not include field installed piping manifold.

Figure 19. RSAU0062F1 fan curve

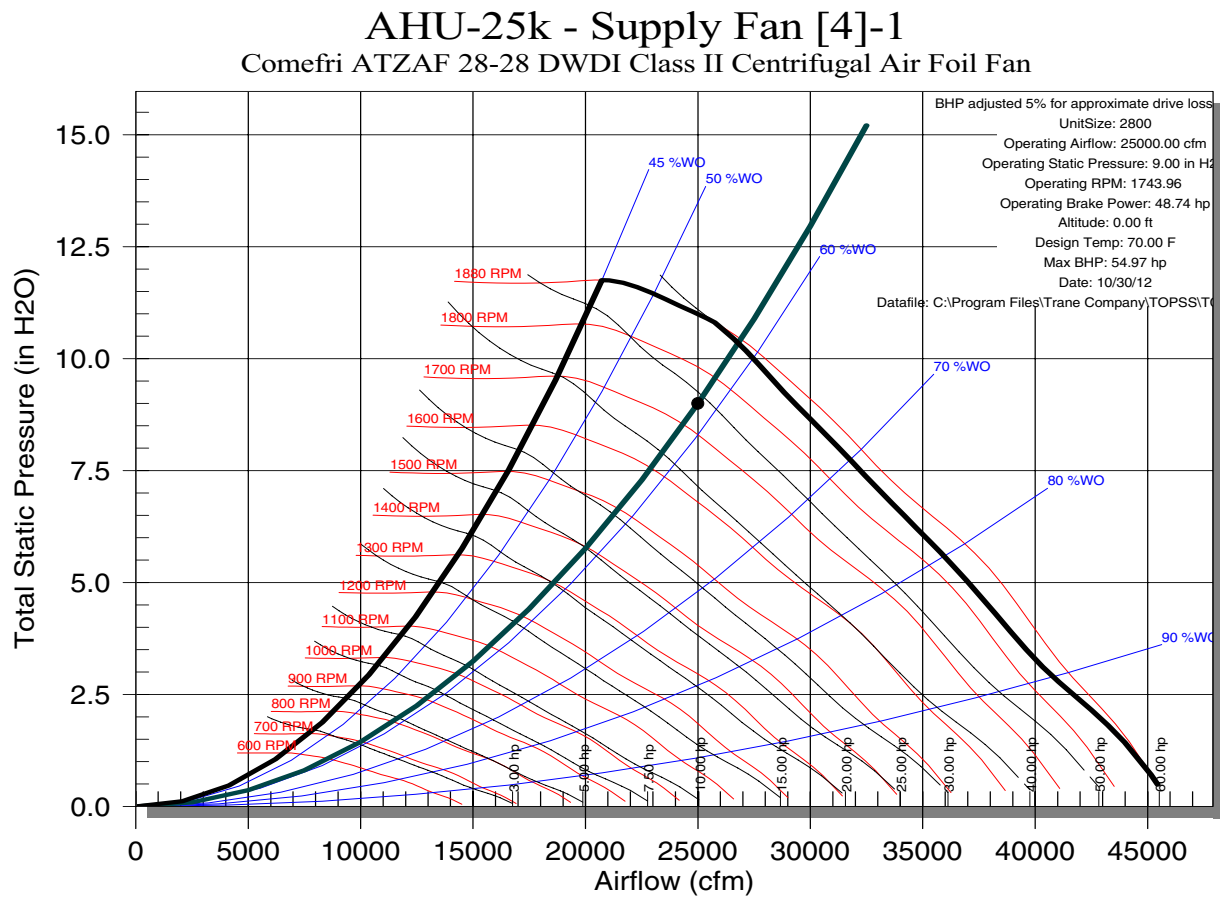

RSAU0062F1 AHU

Figure 20. RSAU0062F1 submittal

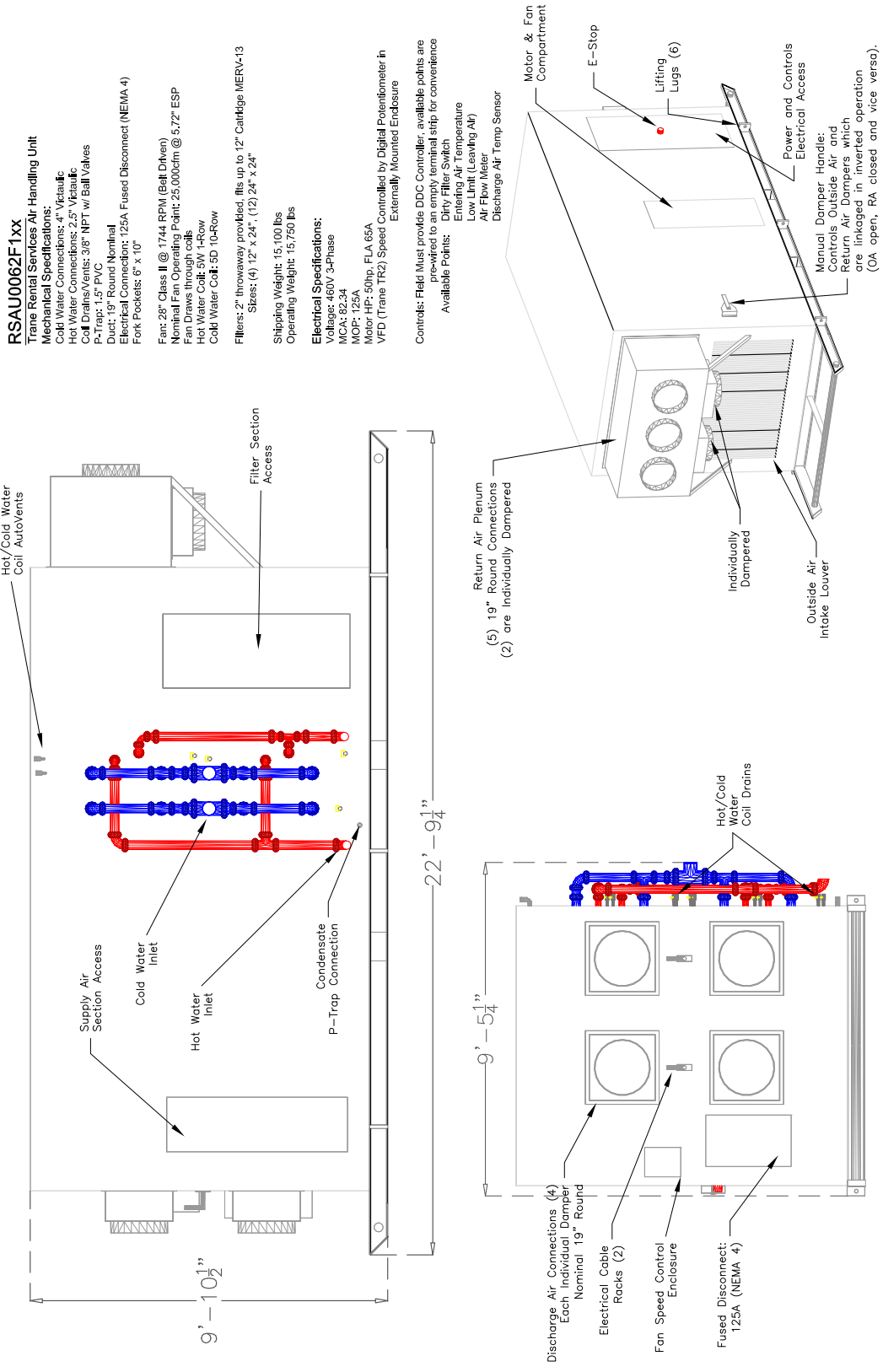



RSAU0062F2 AHU

Table 41. General data

Label	Value
Model Number	TCPA
Water Connection Size	4 in. Victaulic
Ambient Operating Conditions ^(a)	14°F – 104°F
Supply Motor(s)	(2) 30 hp
OCP Device	Circuit Breaker
Number of Electrical Circuits	1
Discharge Configuration	Horizontal
Flex Duct Connection Size	19 in. round
Number of Discharge Air Connections	6
Max External Static Pressure @ Nominal CFM	6.0 in.
Number of Return Air Connectors	6
Filter Rack ^(b) (Qty. and size)	(12) 24 in. x 24 in. and (4) 24 in. x 12 in.
Nominal Airflow (cfm)	25,000
Min/Max Airflow ^(c) (cfm)	5,600/26,000

Note: Selection is required for actual AHU performance.

- (a) For ambient conditions below 40°F, glycol is recommended.
- (b) Unit provided with standard 2 in filters. Filter rack will accept up to 95% efficient MERV 14 filters.
- (c) Min/Max airflow is dependent upon external static pressure requirement. Contact Trane Rental Services for specific airflow and static pressure information.

Table 42. Electrical data

Label	Value
Voltage	460V 3-phase
Frequency	60 Hz
Electrical Connection Type	Cam Type Only
SCCR	65K
Minimum Circuit Ampacity (MCA)	101.25 amps
Maximum Overcurrent Protection (MOP)	125 amps

Note: For additional electrical information, contact Trane Rental Services.

Table 43. Performance data

Label	Value
CFM	25,000
Air Pressure Drop through Unit (in H ₂ O)	3.28
Cooling Coil	
Entering Air DB/WB Temp (°F)	84/77
Leaving Air DB/WB Temp (°F)	49.6/49.6
GPM	374.92
Entering Water Temp (°F)	44
Leaving Water Temp (°F)	56
Coil Water Pressure Drop (ft H ₂ O)	24.56
Sensible Capacity (MBh)	931.3

Table 43. Performance data (continued)

Label	Value
Total Capacity (MBh)	2,254.7
Coil Face Area (sq. ft)	49.6
Coil Rows	10

Table 44. Water flow rates

	Minimum	Maximum
CW Coil Flow (GPM)	60	555
CW Coil Pressure Drop (ft H ₂ O)	0.86	50.97

Table 45. Dimensions and weights

Label	Value
Length	19 ft 0 in.
Width	8 ft 6 in.
Height	9 ft 9 in.
Weight	12,100 lb

Note: Lifting Device: Fork Lift or Crane.





RSAU0062F2 AHU

Figure 21. RSAU0062F2 fan information

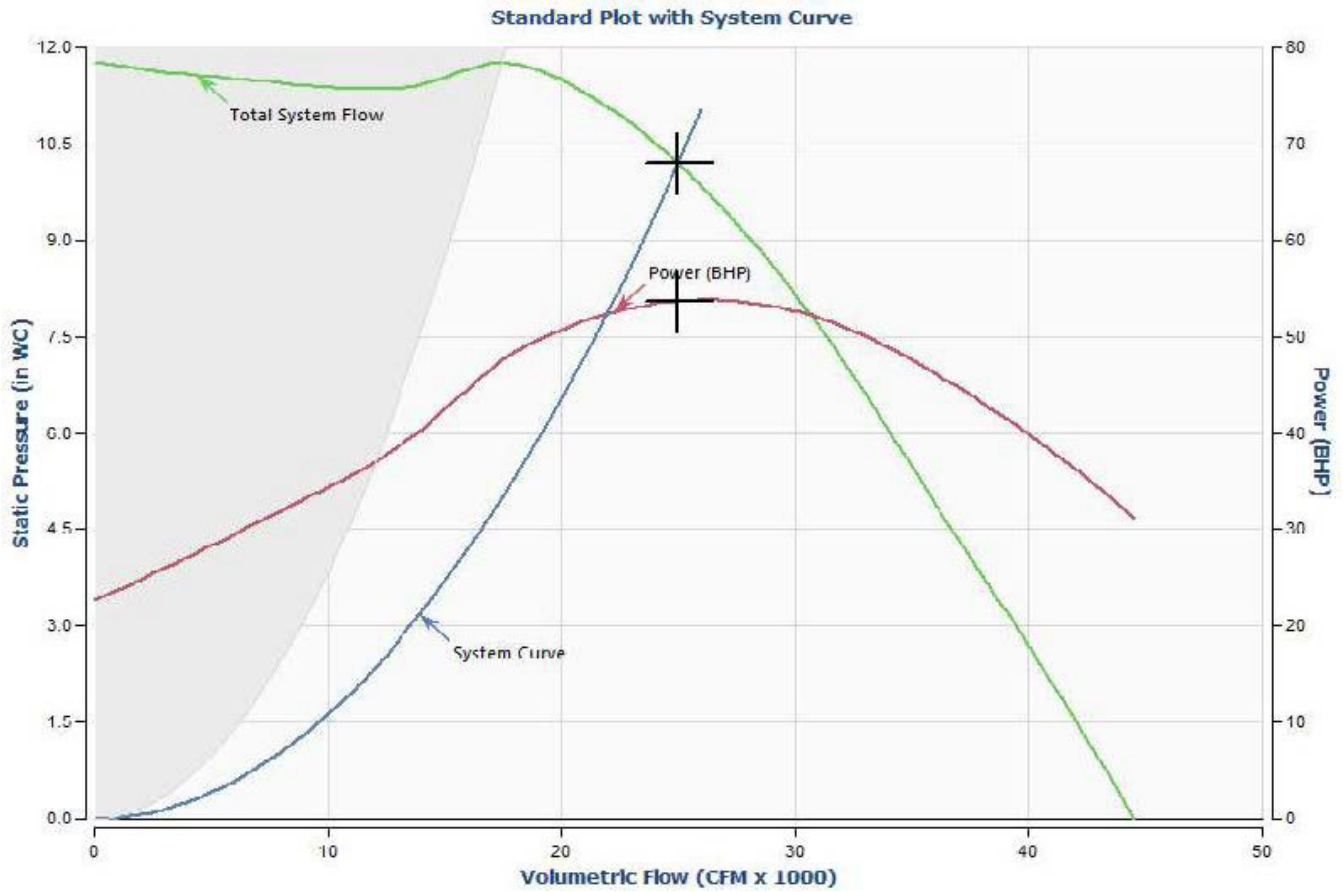

Label	Value
Size/Model	245MK2/EPLFN
Volumetric Flow (CFM)	25,000
SP (in WC)	10.2
Class	III
Speed (RPM)	2427
Max Speed	2806 RPM @ 70°F
Power (BHP)	53.66
Outlet Vel (FPM)	2,682
Density (lb/ft ³)	0.075

Note: Adjusted for (2) fans operating in parallel.

Sound Power	Octave Bands	1	2	3	4	5	6	7	8	LwA ^(a)	dBA ^(b)
	Inlet dB	91	91	107	103	89	88	87	82	103	88
	Outlet dB	98	98	102	101	97	94	91	87	103	88

(a) The overall (single value) fan sound power level in dB re. 10-12 Watts, 'A' weighted.

(b) Estimated sound pressure level (re:0.0002 microbar) based on a single ducted installation at 5 ft, using a directivity factor of 1.

Figure 22. RSAU0062F2 submittal

- Mechanical Specifications
- Cold Water Connections : 4" Victaulic
 - Coil Drains/Vents : 1/2" w/ Ball Valves
 - P-Trap : 1.5" Schedule 80 PVC
 - Duct : 19" Round Nominal
 - Electrical Connection : Cam-Type w/ Nema 4 Breaker Style Disconnect
- Fan : Dual DDP 24.5" Class III @ 2480 RPM
 Nominal Fan Operating Point : 25,000 CFM @ 6" ESP
 Fan Drives through Coils
 Cold Water Coil : 38W91.5x78-12-10-F-Z-L 10-Row
- Filters : 2" Throwaway Merv 7 Provided
 Fits up to 12" Single Header Merv 13-14 Filter
 Sizes : (12) 24"x24", (4) 24"x12"
- Shipping Weight : 12100 lbs
 Operating Weight : 12730 lbs
- Electrical Specifications
- Voltage : 460V 3-Phase
 - MCA : 101.25 Amps
 - MOP : 125 Amps
 - SCCR : 65k
 - Motors : (2) 30 HP @ 38 FLA
 - VFD : (2) Trane TR200 Operated by Digital Potentiometer located in exterior controls cabinet
- Controls : Field Must Provide DDC Controller
- Available Points :
- Dirty Filter Switch
 - Entering & Discharge Air Temp
 - LIT Alarm Status Relay
 - Air Flow Meter
 - Discharge Air Temp

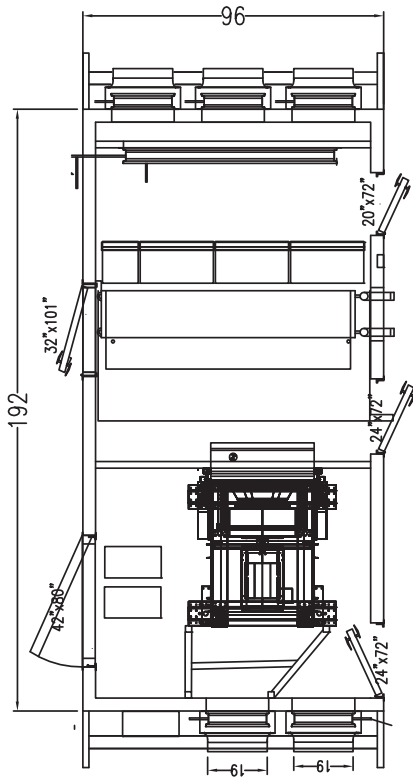

Plan View

4

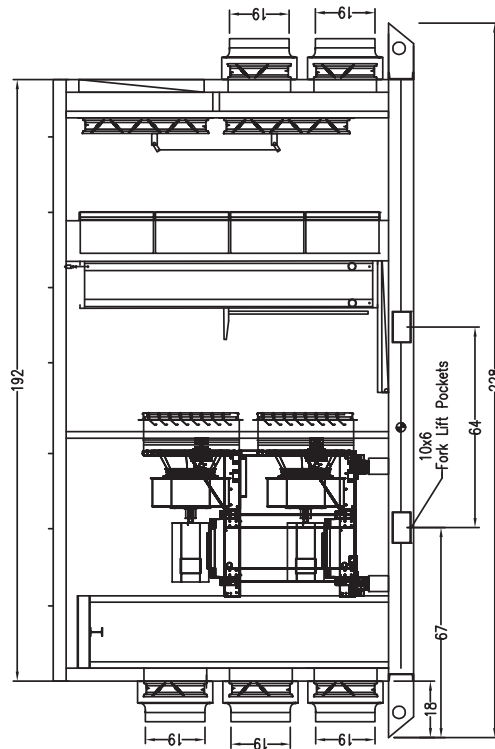

Elevation View

2

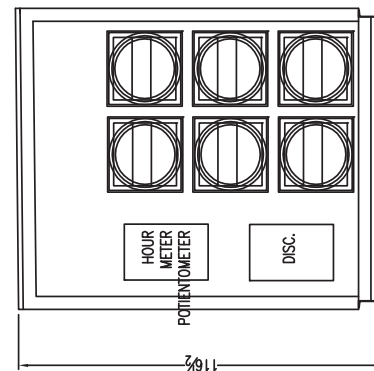

Supply End View

1

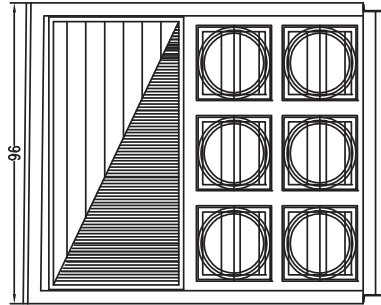

Return End View

3



RSCC0030F0 AHU

Table 46. General data

Label	Value
Ambient Operating Conditions ^(a)	14°F – 104°F

(a) For ambient conditions below 40°F, glycol is recommended.

Table 47. Electrical data

Label	Value
Voltage	460V 3-Phase
Frequency	60 Hz
Number of Electrical Circuits	1
SCCR	5,000A
OCP Device	Circuit Breaker
Supply Motor(s) (Qty/HP/FLA)	4/10 HP/11.6 A each
Wire Connection Type	Series 16 Cam Type Only
Minimum Circuit Ampacity (MCA)	62.76 A
Maximum Overcurrent Protection (MOP)	70 A

Note: Series 16 pin style cam type connections on incoming power with daisy chain capable series 16 receptacle style cam type connections on outgoing power.

Table 48. Air side performance data

Label	Value
Nominal Airflow (CFM)	18,000
Min/Max Airflow (CFM) ^(a)	5,740/18,300
Max External Static Pressure @ Nominal CFM	3.98 in.
Air Pressure Drop through Unit (in. H ₂ O)	3.27
Discharge Configuration	Horizontal
Flex Duct Connection Size (in.)	19 Round
Number of Discharge Air Connections	4
Number of Return Air Connections	6
Filter Rack (Qty and Size) ^(b)	(3) 12 in. x 24 in.
	(2) 16 in. x 20 in.
	(6) 20 in. x 24 in.

(a) Min/Max airflow is dependent upon external static pressure requirement. Contact Trane Rental Services for specific airflow and static pressure information

(b) Unit provided with standard Merv 7 (2 in. filters), can accept 2 in. or 4 in. filters.

Table 49. Cooling coil performance data

Label	Value
Entering Air DB/WB Temp (°F)	95/80
Leaving Air DB/WB Temp (°F)	51/50.9
Fluid Flow (GPM)	366.19
Entering Water Temp (°F)	44
Leaving Water Temp (°F)	54
Coil Water Pressure Drop (ft. H ₂ O)	18.6
Sensible Capacity (MBh)	884.9

Table 49. Cooling coil performance data (continued)

Label	Value
Total Capacity (MBh)	1,837.5
Coil Face Area (Ft ²)	28.7
Coil Rows	10
Water Connection Size	4 in. Victaulic

Table 50. Water flow rates

	Minimum	Maximum
Coil Flow (GPM)	61.5	418
Coil Pressure Drop (ft. H ₂ O)	0.69	23.95

Note: Maximum water side pressure is 150 psi (2.31 ft H₂O = 1 psi).

Table 51. Dimension and weights

Label	Value
Length	15 ft – 1 in.
Shipping Width	8 ft – 6 in.
Operating Width with chilled water manifold	9 ft – 6 in.
Height	7 ft – 6 in.
Shipping Weight	8,730 lb
Operating Weight	9,055 lb
Fork Pocket Dimensions	9.5 in. x 6 in.
Center to Center Distance of Fork Pockets	42 in.

Note: Lifting Device: Forklift or Crane.

Table 52. Operating clearances

Label	Value
Sides	48 in.
End (Control Panel/Supply)	48 in.
End (Return)	36 in.
Top	N/A

Figure 23. RSCC0030F0 supply fan curve

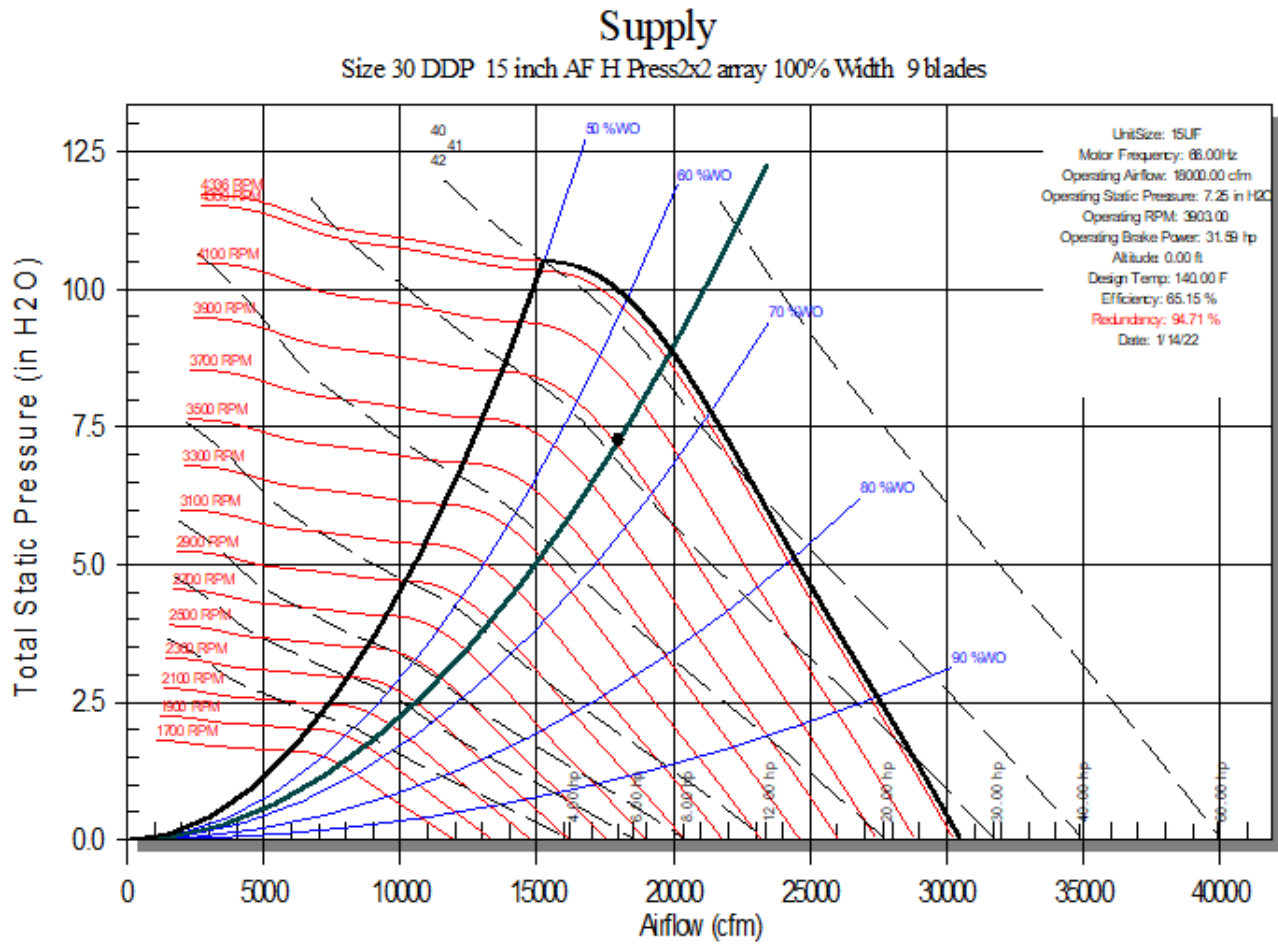



RSCC0030F0 AHU

Figure 24. RSCC0030F0 submittal

RSCC0030F0XX

Trane Rental Services Air Handling Unit
 Mechanical Specifications: 4. Visculite when using Trane provided manifolds
 Coil Inlets/Vents 3/4" NPT w/ Ball Valves
 P-Trap 1" Galvanized Steel
 Back Room Noise
 Fan Power 6" A, 9.5" x 3' 6" Center to Center
 Fan Coil 10" Class J BHP
 Fan Power 18,000 CFM @ 3.98" ESP
 Fan Inlets through Coils
 Max Operating Temp/Draw Through: IDAF
 Cold Water Coil 3/4" Pipe
 Filters: 2" Standard Merv 7, Provided
 1" Standard Merv 7, and a 4" Filter Rack
 (C) 12 in. x 24 in.
 (D) 16 in. x 24 in.
 (E) 20 in. x 24 in.
 Shipping Weight: 9,189 lbs
 Operating Weight
 Electrical Specifications:
 Voltage: 208V, 3-Phase
 MCA: 88.76 Amps
 MOP: 70 Amps
 Breaker: 100 Amps
 Unit Power Connections: Series 16 Can Type Pin Connections
 (C) Power (L1, L2, L3), (D) Ground
 (E) Fan
 (F) Trane TR125 - Speed Controlled by Externally Mounted Digital Potentiometer
 Controls: Dry Contacts For Fire Alarm and VFD Start/Stop

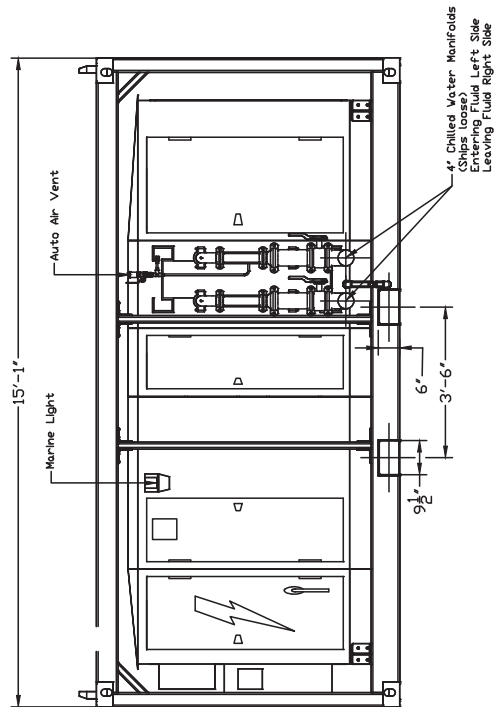
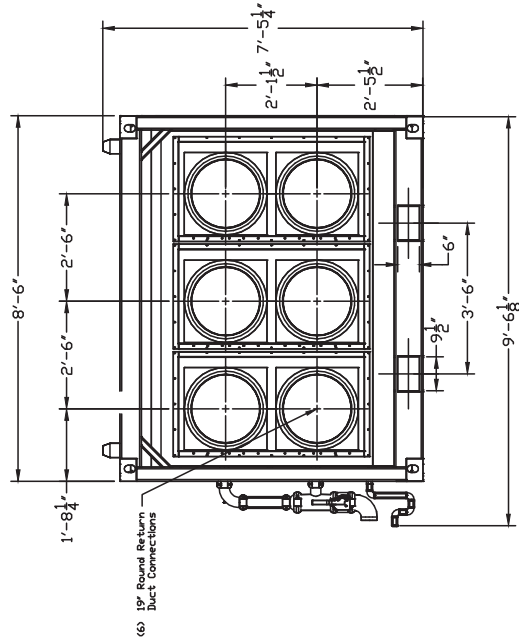
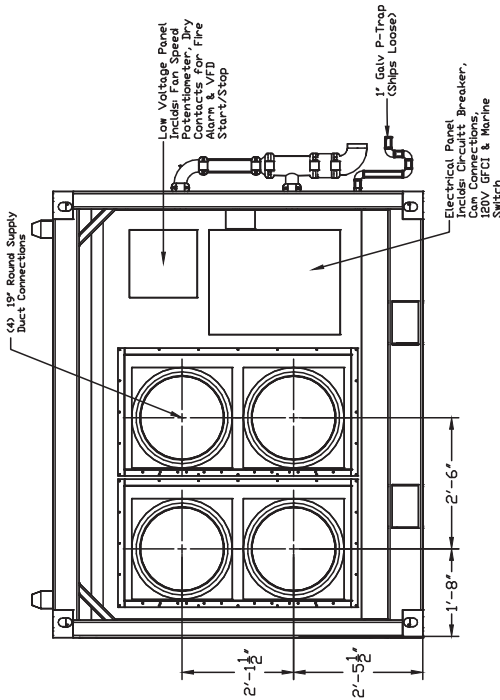



Electrical Information

RSAU0010F0-F1 Style AHUs

Each AHU has a main circuit breaker disconnect switch for over-current protection mounted external to F0 models and internal to F1 models that are rated for outdoors. The 5,000 cfm F0-F1 model units have unit mounted 50 feet long # 8/4 AWG electrical cables. See [Figure 25](#).

Figure 25. Unit mounted pigtail power cable - F1 Model



RSAU0010F2 Style AHUs

Each AHU has a main circuit breaker disconnect switch for over-current protection mounted internal to each unit in an outdoor rated access door panel (see [Figure 26](#)).

Figure 26. Internally mounted circuit breaker



The RSAU0010F2 style AHU has a removable disconnect handle that ships unattached inside each unit externally to allow enough clearance to fit through a standard doorway (see [Figure 27](#)).

Figure 27. Removable disconnect handle



The 5,000 cfm F2 model units have two sets of Series 16 cam type power supply receptacles. One set shall be utilized for

incoming power supply and the second set to accommodate daisy-chaining power (see [Figure 28](#)) supply connections to same style F2 model air handlers.

Figure 28. Input/Output cam type receptacles



RSAU0025-50-62 F1 Style AHUs

Each AHU has an external fused disconnect ([Figure 29](#)). In addition to the external fused disconnect, each unit has a circuit breaker inside the control cabinet ([Figure 30](#)).

Each 10,000 cfm unit is provided with a minimum of 50-feet of #8/4 600 volt electrical cable connected to the external fused disconnect. Each 20,000 cfm and 25,000 cfm unit is provided with a minimum of 50 feet of #4/4 600 volt electrical cable connected to the external fused disconnect.

RSAU0025-50-62 F2 Style AHUs

Each AHU has an externally mounted Nema 4 main disconnect provided with internal circuit breaker ([Figure 31](#)). In addition to the externally mounted circuit breaker, each VFD has its own drive disconnect switch inside the drive cabinet in order to isolate the drives if needed ([Figure 32](#)).

Each F2 style AHU is setup to accept Series 16 cam type receptacles only and does not have an option for hard wired connections ([Figure 33](#)).

Figure 29. Fused disconnect



Figure 30. Internal circuit breaker

Figure 31. Externally mounted disconnect with circuit breaker

Figure 32. Drive mounted disconnects

Figure 33. Series 16 cam type electrical connections

RSCC0030F0 Style AHUs

Each AHU has a main circuit breaker disconnect switch externally mounted in a NEMA 4 enclosure for over-current protection to each unit (see [Figure 34](#)).

Figure 34. Externally mounted circuit breaker

Each unit has two sets of Series 16 cam type power supply receptacles. One set shall be utilized for incoming power supply and the second set to accommodate daisy-chaining power (see [Figure 35](#)) supply connections to same style model air handlers.

Figure 35. Input/Output cam type receptacles



Piping Connection Configuration

RSAU0010F0 - F2

5000 cfm air handler models have one supply and one return water line connections with 2.5-inch Victaulic connections used with Trane Rental Services 2.5-inch standard water hose.

Figure 36. RSAU0010F0 - Victaulic water lines



Figure 37. RSAU0010F1 - Victaulic water lines

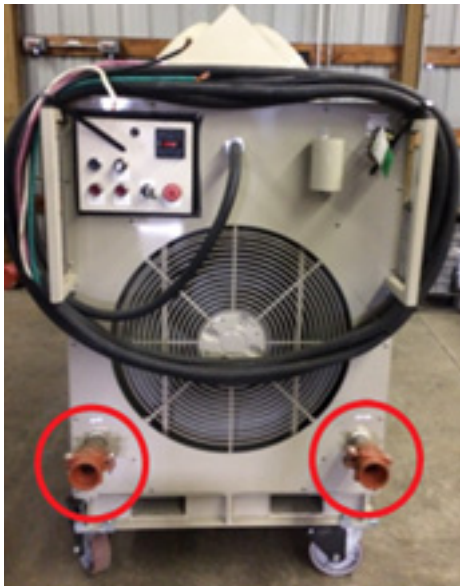

Figure 38. RSAU0010F0 - Victaulic water lines



RSAU0025F1

- Piping manifolds have been added to bring water connections to a more convenient elevation.
- There are two separate manifolds for the chilled and hot water coils. For identification, the hot water piping has been painted red.

RSAU0050F1

- To provide a single chilled water connection point and a single hot water connection point for each 20,000 cfm air handling unit, a piping manifold has been made to connect each of the unit's chilled water and hot water coils.
- Each 20,000 cfm unit has a manifold permanently installed on the unit for easy piping connection (Figure 39).
- For identification purposes, the chilled water piping has been painted grey and the hot water piping has been painted red.

Figure 39. RSAU0050F1 piping manifold



RSAU0062F1

- Multiple coils need to be manifolded together in order to connect with a single water connection.
- The unit is supplied with manifolds for both the hot and cold water coils.
- Due to shipping restrictions, these manifolds ship loose in the discharge section of the unit and must be field installed.
- Due to variances in header locations, the cooling coil manifolds are not interchangeable.
- Each is labeled with two, four letter codes.
- The first four letters (F1AO, for example) correspond to the last four letters of the AHU's identifying stencil.
- The second set of four letters designates where the piece should be installed on that unit. For example, TLFT indicates it should be installed in the upper left position. The labels are painted onto each pipe in the cooling coil manifolds. See [Figure 40](#).

Table 53. Bill of material for RSAU0062F1 unit piping manifold

Chilled Water Manifolds	
Quantity	Description of items
30	2.5 in. Coupling
4	2.5 in. Elbow
4	2.5 in. Tee
4	2.5 in. x 4 in. Reducer
2	4 in. Tee
4	4 in. Couplings
8	2.5 in. pipes of 3.25-in. nominal length
2	2.5 in. pipes of 16-in. nominal length
2	2.5 in. pipes of 15-in. nominal length
2	2.5 in. pipes of 3.5-in. nominal length
Hot Water Manifolds	
Quantity	Description of items
4	1.5 in. Elbow
8	1.5 in. Coupling
4	1.5 in. x 2.5 in. Reducer
4	2.5 in. Elbow
2	2.5 in. Tee
14	2.5 in. Coupling
2	2.5 in. pipes of 19-in. nominal length
2	2.5 in. pipes of 43-in. nominal length
1	2.5 in. pipe of 20-in. nominal length
1	2.5 in. pipe of 9-in. nominal length

Figure 40. New 25k manifold callout

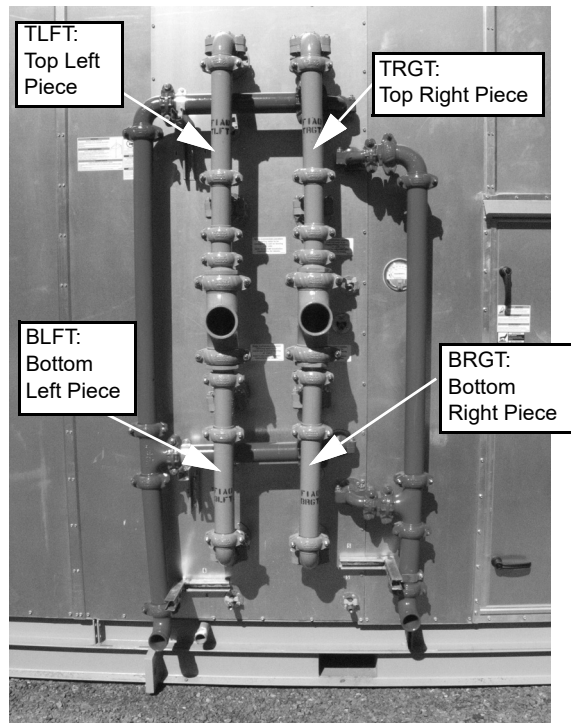

RSAU0025-50-62F2

All F2 Style AHU cooling coils are configured with a single inlet and single outlet Victaulic water connection, reference [Figure 41](#).

Figure 41. RSAU0062F2 Coil Connection - Chilled water inlet shown in blue, chilled water outlet shown in red.

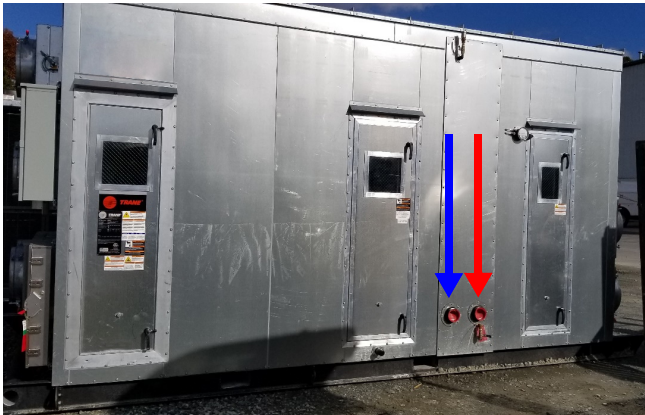

RSCC0030F0

All RSCC0030 style air handler models ship with manifold assemblies that must be field installed to join two chilled water cooling coils in to one common hard-pipe header. To accommodate one 4-inch Victaulic supply and return waterline connection. Reference [Figure 42](#) and [Figure 43](#) manifold assembly for more details.

Figure 42. RSCC0030F0 - Manifold coil connections



Piping Connection Configuration

Figure 43. RSCC0030F0 - Manifold assembly

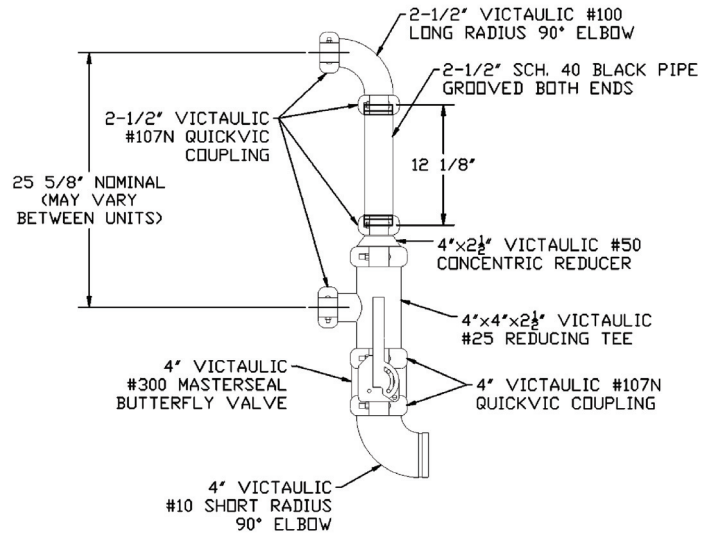

Table 54. Parts list - Chilled water manifold piping kit

Pipe and Hose	
Quantity	Description of Items
2	4 in. Dia x 12 - 1/8-in. Sch. 40 Black Pipe(s) - Grooved Both Ends
Couplings, Flanges, and Elbows	
Quantity	Description of Items
2	2.5-in. No.100 Victaulic Long Radius 90° Elbow(s)
8	2.5-in.107N or 107V Victaulic Coupling(s)
2	4 in. x 2.5-in. No.50 Victaulic Concentric Reducer(s)
2	4 in. x 4 in. x 2.5-in. No.25 Victaulic Reducing Tee(s)
2	4-in. No.300 Victaulic Lever Operated Butterfly Valve(s)
2	4-in. No.10 Victaulic Short Radius 90° Elbow(s)
6	4-in. 107N or 107V Victaulic Coupling(s)



Duct Connection Configuration

RSAU0010F0 - F2

- RSAU0010F0 units have no discharge air duct connections.
- RSAU0010F1 units have two, 19-inch diameter discharge air duct connections.
- Both models do not have any return air duct connections and are designed for either 100% outside air or drawing air into the unit directly from the conditioned space.

RSAU0025F1

- Each unit has two, 19-inch diameter discharge air connections and three, 19-inch diameter return air connections.
- All of the discharge air connections and one of the return air connections have manual dampers to control airflow.
- The connections will accept one, 20-inch diameter flexible duct.
- In addition to the return duct connections, units have a louver panel for 100% outside air operation that may be used instead of the return air duct connections.
- A handle on the side of the unit (Figure 45) controls the linked dampers: 100% outside air, 100% return air, or a combination of the two.

RSAU0050F1

- Each unit has four, 19-inch diameter discharge air connections and five, 19-inch diameter return air connections (Figure 44).
- All four discharge air connections and two of the return air connections have manual dampers to control airflow.
- The connections were made to accept one, 20-inch diameter flexible duct.
- In addition to the return duct connections, these units have a louver panel for 100% outside air operation that may be used instead of the return air duct connections.
- A handle on the side of the unit (Figure 45) controls the linked dampers: 100% outside air, 100% return air, or combination of the two.

Figure 44. RSAU0050F1 and RSAU0062F1 return air connections

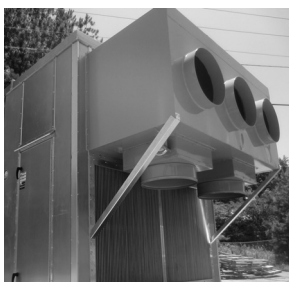

Figure 45. Handle to control linked dampers



RSAU0062F1

- Each unit has four, 19-inch diameter discharge air connections and five, 19 inch diameter return air connections (Figure 41, p. 39).
- All four of the discharge air connections and two of the return air connections have manual dampers to control airflow.
- The connections were made to accept one, 20-inch diameter flexible duct.
- In addition to the return duct connections, these units have a louver panel for 100% outside air operation that may be used instead of the return air duct connections.
- A handle on the side of the unit (Figure 45) controls the linked dampers: 100% outside air, 100% return air, or a combination of the two.

Reference Trane Rental Services Standard and High Temperature Flex Duct engineering bulletin, CHS-PRB004*-EN, for further information.

Duct Connection Configuration

RSAU0025F2

- Each unit has two, 19-inch diameter discharge air connections and four, 19-inch diameter return air connections.
- All of the discharge air connections and all the return air connections have manual dampers to control airflow.
- The connections were made to accept one, 20-inch diameter flexible duct.
- In addition to the return duct connections, these units have a louver panel for 100% outside air operation to use instead of the return air duct connections.
- A handle on the side of the unit (Figure 45) controls the linked dampers: 100% outside air, 100% return air, or a combination of the two.

RSAU0050F2

- Each unit has four, 19-inch diameter discharge air connections and six, 19-inch diameter return air connections.
- All four of the discharge air connections and all of the return air connections have manual dampers to control airflow.
- The connections were made to accept one, 20-inch diameter flexible duct.
- In addition to the return duct connections, these units have a louver panel for 100% outside air operation that may be used instead of the return air duct connections.
- The handle (Figure 45) installed on the side of each unit must be utilized to allow 100% outside or return airflow to enter the unit.

RSAU0062F2

- Each unit has six, 19-inch diameter discharge air connections and six, 19-inch diameter return air connections.
- All of the discharge air connections and all of the return air connections have manual dampers to control airflow.
- The connections were made to accept one, 20-inch diameter flexible duct.
- In addition to the return duct connections, these units have a louver panel for 100% outside air operation that may be used instead of the return air duct connections.
- A handle on the side of the unit (Figure 45) controls the linked dampers: 100% outside air, 100% return air, or a combination of the two.

RSCC0030F0

- Each unit has four, 19-inch diameter discharge air connections and six, 19-inch diameter return air connections.
- These design sequence models do not have any manual dampers for restricting the airflow and do not have outside air louvers. Refer to Figure 46 for the supply air discharge and Figure 47 for the return air duct connection locations.

Figure 46. Discharge air flex duct connections



Figure 47. Return air flex duct connections





Controls Information

RSAU0010 F0/F1/F2 Series

Rental AHUs (5,000 cfm) are equipped with a single VFD mounted inside the machine to control the speed of the fan. A unit mounted potentiometer is used to manually increase or decrease the speed of the fan. Refer to [Table 55, p. 44](#) for available points on these machines.

RSAU0025, 50, 62 F1 and F2 Series

Rental AHUs (10,000, 20,000, and 25,000 cfm) with the F1 and F2 designator are equipped with either a single or dual Trane TR200 VFDs ([Figure 48](#)) mounted in a control cabinet inside the unit. The VFDs are controlled by using a single digital potentiometer ([Figure 49](#)) that is located in a weatherproof box mounted on the exterior of the unit, just above the disconnect. The digital potentiometer is used to manually increase or decrease the fan speed of the unit. For adjustment purposes, the number 0000 on the digital potentiometer represents the minimum fan setting 20 Hz, while 1000 represents 100% nominal airflow. Refer to [Table 55, p. 44](#) for available points on these machines.

Figure 48. Trane TR200 VFD



Figure 49. Digital potentiometer



RSCC0030 AHU

Rental AHUs (18,000 cfm) are equipped with four Trane TR150 VFDs ([Figure 38, p. 37](#)) mounted in a control cabinet inside the unit. The VFDs are controlled by using a single digital potentiometer ([Figure 39, p. 38](#)) located on the outside of the main unit control panel. The control panel is mounted on the exterior of the machine just above the disconnect. Use the digital potentiometer to manually increase or decrease the fan speed of the unit. Refer to [Table 55, p. 44](#).

Figure 50. Trane TR150 VFDs



Figure 51. Speed adjustment potentiometer





Controls Information

Table 55. Rental AHU controls input/output points

Features		RSAU0010F0	RSAU0010F1	RSAU0010F2	RSAU0025F1	RSAU0025F2
Default Fan Speed Control		Turnpot	Turnpot	Turnpot	Turnpot	Turnpot
Fan Control and Feedback	BACnet®				x	x
	MODBUS®			x	x	x
	Hardwired Start/Stop	x	x	x	x	x
	Hardwired Speed Ref.	x	x	x	0-10VDC, 4-20mA	0-10VDC, 4-20mA
	Programmable Outputs (Binary + Analog)				x	x
	VFD Bypass			x		x
Sensor Outputs	Low-Limit Alarm				x	x
	Clogged Filter Switch				x	x
	Return Air Temp Sensor				10K thermister	10K thermister
	Supply Air Temp Sensor				10K thermister	10K thermister
	Differential Pressure Transducer				4-20mA	0-10VDC, 4-20mA
	Condensate Overflow	x	x	x		
Features		RSAU0050F1	RSAU0050F2	RSAU0062F1	RSAU0062F2	RSCC0030F0
Default Fan Speed Control		Turnpot	Turnpot	Turnpot	Turnpot	Turnpot
Fan Control and Feedback	BACnet®	x	x	x	x	x
	MODBUS®	x	x	x	x	x
	Hardwired Start/Stop	x	x	x	x	x
	Hardwired Speed Ref.	0-10VDC, 4-20mA	0-10VDC, 4-20mA	0-10VDC, 4-20mA	0-10VDC, 4-20mA	x
	Programmable Outputs (Binary + Analog)	x	x	x	x	x
	VFD Bypass		x		x	x
Sensor Outputs	Low-Limit Alarm	x	x	x	x	
	Clogged Filter Switch	x	x	x	x	
	Return Air Temp Sensor	10K thermister	10K thermister	10K thermister	10K thermister	
	Supply Air Temp Sensor	10K thermister	10K thermister	10K thermister	10K thermister	
	Differential Pressure Transducer	4-20mA	0-10VDC, 4-20mA	4-20mA	0-10VDC, 4-20mA	
	Condensate Overflow					

Note: Rental AHUs ship with turn potentiometer for simplified fan speed control and are not equipped with unit controllers. Contact Trane if more advanced controls integrations are desired.



Rigging Guidelines

General Lifting Considerations

⚠ WARNING

Risk of Unit Dropping!

Failure to follow instructions below could result in death or serious injury, and equipment damage. Inspect the suspension and/or support system to ensure all fasteners are tight and the unit is secure before working underneath the unit.

⚠ WARNING

Improper Unit Lift!

Failure to properly lift unit could result in unit dropping and possibly crushing operator/technician which could result in death or serious injury, and equipment or property-only damage. Test lift unit approximately 24 inches (61 cm) to verify proper center of gravity lift point. To avoid dropping of unit, reposition lifting point if unit is not level.

⚠ WARNING

Heavy Objects!

Failure to properly lift unit could result in death or serious injury or possible equipment or property-only damage. Use a forklift/crane of suitable capacity to move the unit.

NOTICE

Equipment Damage!

Premature skid removal could result in equipment damage.

Keep skid in place until unit is ready to set. Do not move the unit or subassembly without the skid in place as shipped from the factory.

Each AHU has forklift pockets and either an overhead lifting frame or base mounted lifting lugs (Figure 52). Before unit lifting, refer to pages 9-31 for unit dimensions and weights. Test the unit for proper balance before lifting.

- Lift sections using all lifting lugs or fork pockets provided.
- When hoisting the unit into position, use the proper rigging method, such as straps, slings, spreader bars, or lifting lugs for protection and safety.
- Make the loop of the sling parallel to the direction of airflow whenever possible.
- Each cable used to lift the unit must be capable of supporting the entire weight of the unit.
- Never lift units in windy conditions. Personnel should be positioned overhead and, on the ground, to guide the crane operator in positioning the sections.

Figure 52. RSCC0030F0 unit



Figure 53. RSCC0030F0 rigging detail

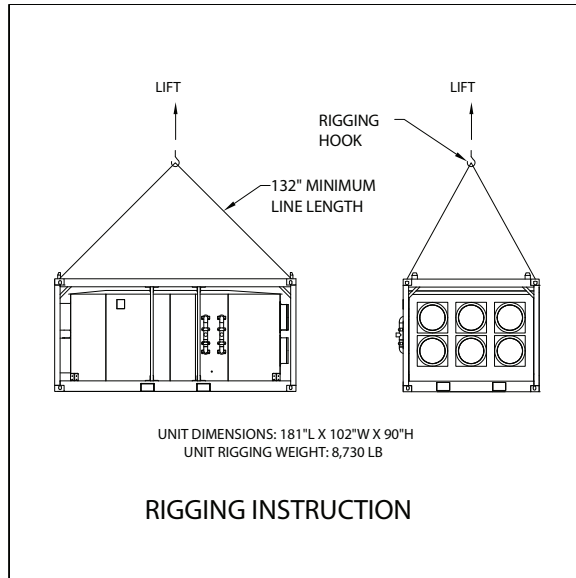
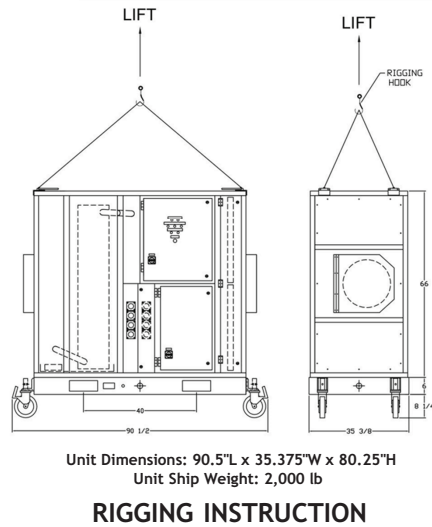

Figure 54. RSAU0010F2 rigging detail





Installation and Start-Up Guidelines

In addition to the start-up guidelines below, refer to start-up information in the *Climate Changer Custom Air Handlers Installation, Operation, and Maintenance Manual* CLCH-SVX010*-EN for RSAU0025, 50 and 62 Series AHUs and CLCH-SVX07*-EN for RSCC0030 Series AHUs.

⚠ WARNING

Hazardous Voltage w/Capacitors!

Failure to disconnect power and discharge capacitors before servicing could result in death or serious injury. Disconnect all electric power, including remote disconnects and discharge all motor start/run capacitors before servicing. Follow proper lockout/tagout procedures to ensure the power cannot be inadvertently energized. For variable frequency drives or other energy storing components provided by Trane or others, refer to the appropriate manufacturer's literature for allowable waiting periods for discharge of capacitors. Verify with a CAT III or IV voltmeter rated per NFPA 70E that all capacitors have discharged.

Installation

1. Install piping manifold supplied with unit (if applicable) and ensure all temporary piping is properly secured. See ["Piping Connection Configuration," p. 37.](#)
2. Install the p-trap supplied with unit. The unit p-trap is located inside the machine in a bin mounted to the filter access door.

Notes:

- RSAU0010F0-F1 utilize condensate pumps and do not have p-traps.
- RSAU0010F2 has built-in p-traps and do not need the p-trap field installed.
- RSAU0010F2 units can utilize gravity feed p-trap or built-in condensate pump.

Determine whether condensate pump will be used and connect condensate drain piping accordingly.

3. Close all coil drains and open the valves and fill the system with fluid, checking for leaks. Bleed all air out of water system using field installed valves at high points in the system.
4. Install temporary supply ductwork and open manual dampers (if equipped).
5. For AHUs with return duct connections, install temporary return air ductwork.
 - It is recommended that the number of return ducts exceeds the number of supply ducts by at least one where available. For example, if four supply ducts are used, five return ducts are recommended.
 - For RSAU0025, 50, and 62 models, the return section consists of two separate louvers. One louver allows access to fresh air and the other louver is used in conjunction with return air.

- A single damper adjustment handle on the outside of the unit operate the dampers for both return and fresh air louvers. Closing the return air louver will open the fresh air louver and vice versa.
 - Connect return ductwork to the duct connections without dampers first, then connect any additional return ducts on the bottom side of the plenum to the duct connectors with dampers.
6. Confirm the power supply is de-energized and connect electrical cable from the rental unit to the building power supply. See ["Electrical Information," p. 35](#) for additional details on electrical connection types.

Start-Up

RSAU0010F0/F1

1. Confirm all personnel are in a safe location and all doors on AHU are closed and panels secured.
2. Energize power to the unit at the main power supply.
3. Energize unit disconnect switch.
4. Pull the emergency stop button.
5. Turn on/off switch on the outside of the starter panel to the On position.
6. Set blower speed by using the airflow adjustment potentiometer. Turn it clockwise to increase fan speed and counterclockwise to decrease fan speed.

RSAU0010F2

1. Confirm all personnel are in a safe location and all doors on AHU are closed and panels secured.
2. Energize power to the unit at the main power supply.
3. Energize unit circuit breaker (3CB) and confirm control power pushbutton light (1PL) is on.
4. Confirm proper phasing at rental unit.
5. Turn on airflow switch (1SW).
6. Open control electrical panel and turn blower switch (2SW) to required operating mode (VFD or bypass).
7. If using the on-board condensate pump to remove condensate from the machine, turn pump switch on.
8. Set blower speed by using the airflow adjustment potentiometer. Turn it clockwise to increase fan speed and counterclockwise to decrease fan speed.



Installation and Start-Up Guidelines

RSAU0025, 50, and 62 F1 Series

1. Open VFD access door and confirm VFD disconnect switch (if equipped) is in the On position.
2. Confirm all personnel are in a safe location and all doors on AHU are closed and panels secured.
3. Energize power to the unit at the main power supply.
4. Energize unit disconnect.

Note: *If equipped, confirm the red e-stop button located on the exterior of the VFD cabinet door is disengaged. If engaged, the fan will not run.*

5. Set blower speed by using the airflow adjustment potentiometer, located in the low voltage controls cabinet on the outside end of the AHU located near the unit disconnect. Turn it clockwise to increase fan speed and counterclockwise to decrease fan speed.

Notes:

- *If AHU has a Trane TR200 VFD, operation mode must be set to **hand** mode for the potentiometer to control fan speed. Confirm mode at VFD faceplate.*
- *If AHU has a Trane TR150 VFD, operation mode must be set to **auto** mode for the potentiometer to control fan speed. Confirm mode at VFD faceplate.*

RSAU0025, 50, and 62 F2 Series

1. Open VFD access door and confirm VFD disconnect switches are in the **on** position.
2. Select the operating mode (drive or bypass) on each drive selector switch.

Note: *Both drives must be run in the same mode to prevent surging. It is recommended to run in Drive position for optimal performance.*

3. Confirm all personnel are in a safe location and all doors on AHU are closed and panels secured.
4. Energize power to the unit at the main power supply.

Notes: *Using color coded cams connections as a guide, units should be phased as follows:*

- *Black - A,*
- *Red - B,*
- *Blue - C phases.*

5. Confirm proper phasing at unit prior to energizing unit disconnect.
6. Energize unit circuit breaker (1DSC1).
7. Set blower speed by using the airflow adjustment potentiometer (SF1-2 potentiometer), located in the low voltage controls cabinet on the outside end of the AHU located near the unit disconnect. Turn it clockwise to increase fan speed and counterclockwise to decrease fan speed.

Note: *Trane TR200 VFDs, must be in Auto for the potentiometer to control fan speed. Confirm mode at VFD faceplate.*

RSCC0030F0

1. Confirm all personnel are in a safe location and all doors on AHU are closed and panels secured.
2. Energize power to the unit at the main power supply.
3. Confirm proper phasing at unit prior to energizing unit disconnect.
4. Energize unit circuit breaker (4CB1).
5. Confirm proper phasing at unit prior to energizing unit disconnect.
6. Set unit fan switch (5S5) to the **hand** position. This switch is located on the outside of the low voltage control cabinet and will light up when turned on.
7. Open control cabinet and turn Fan 1, Fan 2, Fan 3 and Fan 4 switches (5S1, 5S2, 5S3, and 5S4) to **run** position to start the VFDs/Fans.

Note: *All fans must be in the same mode Run or Bypass to prevent surging. It is recommended to operate fans in Run mode for optimal performance.*

8. Set blower speed by using the airflow adjustment potentiometer (5R1). Turn it clockwise to increase fan speed and counterclockwise to decrease fan speed.



Maintenance Checklist

Notes: Refer to the *Custom Climate Changer Installation, Operation, and Maintenance Manual CLCH-SVX010*-EN*.

- Carefully inspect lifting lugs for cracks or deformation.
- Check operation of manual supply and return dampers; also check condition of return plenum and supply/return duct collars for AHU models that have them.
- Verify p-trap, filter clips and air filters are present in the filter compartment. Replace filters as necessary.
- Carefully inspect coils, drains and vent valves, air bleeders and manifolds/hoses for damage.
- Check fan belts for signs of wear and replace as necessary for applicable AHU belt-driven models.
- Check fan motor/shaft bearings and grease as necessary (use Polyrex EM grease).
- Check fans for proper rotation and for excessive bearing noise.
- With fans running, verify proper operation of Magnahelic gauge.
- Monitor differential pressure across the unit filters using the pressure gauge mounted on the outside of the filter access door and change the filters, as necessary.
- **Electrical - No Power Applied:** Tighten all accessible electrical connections. Repair/replace any burned, damaged, or loose wires.
- **Electrical - No Power Applied:** Check Camlock connectors for signs of burning or damage.



Decommissioning Guidelines

Reference the following guidelines for decommissioning rental AHUs prior to their return at the end of a rental job. Contact Trane Rental Services for any additional information.

In conditions below freezing ambient temperatures, flush coil with antifreeze solution to ensure residual fluid cannot freeze. Contact Trane Rental Services if assistance is needed.

Notify Trane Rental Services if unit needs repair or has damage.

NOTICE

Freezing Damage!

Failure to take the outlined precautions may result in equipment damage for which customer will be liable. Trane Rental AHU units are prone to freeze damage caused by cold ambient temperatures. In addition to the guidelines below, refer to the Trane Rental Services Freeze Protection Policy referenced in the rental agreement.

⚠ WARNING

Hazardous Voltage w/Capacitors!

Failure to disconnect power and discharge capacitors before servicing could result in death or serious injury. Disconnect all electric power, including remote disconnects and discharge all motor start/run capacitors before servicing. Follow proper lockout/tagout procedures to ensure the power cannot be inadvertently energized. For variable frequency drives or other energy storing components provided by Trane or others, refer to the appropriate manufacturer's literature for allowable waiting periods for discharge of capacitors. Verify with a CAT III or IV voltmeter rated per NFPA 70E that all capacitors have discharged.

RSAU0010F0/F1

1. Turn **on/off** switch on the outside of the starter panel **off**.
2. Allow fan to fully stop prior to opening any unit access doors.
3. De-energize unit disconnect switch.
4. De-energize power to the unit at the main power supply.
5. Open all coil drains.
 - Confirm the machine is level or tilted toward the water connections.
 - Open all drains and vents, confirm fluid is draining freely. Check drain for restrictions if necessary.
 - Collect and dispose of drained fluid in accordance with applicable environmental laws and regulations.
 - Leave unit drains open until there is no more fluid coming out. This could take up to an hour or more. Do not relocate or release the unit for shipment until unit draining is complete.

6. Remove all external piping/ hoses, and duct work. Pack accessories in the associated compartments and bins.

RSAU0010F2

1. Turn airflow switch (1SW) on the outside of the starter panel **off**.
2. Allow fan to fully stop prior to opening any unit access doors.
3. De-energize unit circuit breaker (3CB).
4. De-energize power to the unit at the main power supply.
5. Open all unit drain valves.
 - Confirm the machine is level or tilted toward the water connections.
 - Open all drains and vents, confirm fluid is draining freely. Check drain for restrictions if necessary.
 - Collect and dispose of drained fluid in accordance with applicable environmental laws and regulations.
 - Leave unit drains open until there is no more fluid coming out. This could take up to an hour or more. Do not relocate or release the unit for shipment until unit draining is complete.
6. Remove all external piping/ hoses, and duct work. Pack accessories in the associated compartments and bins.
7. Close all duct doors and confirm all access doors are properly closed.

RSAU0025, 50 and 62 F1 Series

1. Turn airflow adjustment potentiometer all the way down and allow fan to reach minimum speed.
2. De-energize unit disconnect switch.
3. De-energize power to the unit at the main power supply.
4. Open all unit drain valves.
 - Confirm the machine is either level or tilted toward the water connections.
 - Open all drains and vents, confirm fluid is draining freely. Check drain for restrictions if necessary.
 - Collect and dispose of drained fluid in accordance with applicable environmental laws and regulations.
 - Leave unit drains open until there is no more fluid coming out. This could take up to an hour or more. Do not relocate or release the unit for shipment until unit draining is complete.
5. Remove all external piping/ hoses, and duct work. Pack accessories in the associated compartments and bins.

Note: *RSAU0062 AHU manifolds must be removed and stored in filter cabinet prior to shipment.*
6. Close all duct dampers and confirm all access doors are properly closed.

RSAU0025, 50 and 62 F2 Series

1. Turn airflow adjustment potentiometer all the way down and allow fan to reach minimum speed.
2. De-energize unit disconnect switch.
3. De-energize power to the unit at the main power supply.
4. Open all unit drain valves.
 - Confirm the machine is either level or tilted toward the water connections.
 - Open all drains and vents, confirm fluid is draining freely. Check drain for restrictions if necessary.
 - Collect and dispose of drained fluid in accordance with applicable environmental laws and regulations.
 - Leave unit drains open until there is no more fluid coming out. This could take up to an hour or more. Do not relocate or release the unit for shipment until unit draining is complete.
5. Remove all external piping/ hoses, and duct work. Pack accessories in the associated compartments and bins.
6. Close all duct dampers and confirm all access doors are properly closed.

RSCC0030F0

1. Set unit fan switch (5S5) to **off**.
2. Allow fans to fully stop prior to opening any unit access doors.
3. De-energize unit circuit breaker (4CB1).
4. De-energize power to the unit at the main power supply.
5. Open all unit drain valves.
 - Confirm the machine is either level or tilted toward the water connections.
 - Open all drains and vents, confirm fluid is draining freely. Check drain for restrictions if necessary.
 - Collect and dispose of drained fluid in accordance with applicable environmental laws and regulations.
 - Leave unit drains open until there is no more fluid coming out. This could take up to an hour or more. Do not relocate or release the unit for shipment until unit draining is complete.
6. Remove all external piping/ hoses, and duct work. Pack accessories in their associated compartments and bins.

Note: *AHU manifolds must be removed and stored in filter cabinet prior to shipment.*
7. Close all duct doors and confirm all access doors are properly closed.

Recommended Shutdown

1. In extreme cold conditions, flush coil with antifreeze solution to ensure residual fluid cannot freeze. Contact Trane Rental Services if assistance is needed.
2. Remove all temporary ductwork and close manual dampers or doors.
3. Disconnect electrical cable supplied with the unit from the power supply.
4. Confirm all access doors are properly closed.
5. Return additional hose, fittings, or cable (if furnished by Trane Rental Services) to appropriate containers for return shipment.
6. Notify Trane Rental Services if unit needs repair or has damage.

Trane - by Trane Technologies (NYSE: TT), a global climate innovator - creates comfortable, energy efficient indoor environments for commercial and residential applications. For more information, please visit trane.com or tranetechnologies.com.

Trane has a policy of continuous product and product data improvement and reserves the right to change design and specifications without notice. We are committed to using environmentally conscious print practices.