

Issue 302a USA/CANADA/MEXICO

THE WORLD'S LARGEST RANGE OF POWERSPORT BRAKES



EBC[®]
BRAKES

Brake pads, rotors, braided stainless brake lines, clutches and much more, with four manufacturing plants in the UK and USA producing over 10 million components each year.

www.ebcbrakes.com

Welcome to 2021 and the latest EBC Catalog with, as always, all the new brakes and clutches you need for your customers.

With nearly 40 years in the USA motorcycle market, we can only thank again our thousands of loyal dealers for their support through the years. Carrying EBC as an alternative product line to genuine parts continues to make good commercial sense, saves inventory dollars, increases hit rate on sales and offers a truly long-term solution to stocking aftermarket parts.

EBC also represents a sound investment as products do not perish or age, and with the help of your distributor and the stock rotation programs that many of them offer you, you don't get left with a bunch of old mis-matched inventory which could easily happen with other "New kid on the block" brands.

2019 saw a change in the way that we produce and distribute our catalogs. This catalog includes only the NEW products added to our range since the publication of the 2020 edition. This update-only catalog is designed to supplement the 2020 Issue 302 edition; we will publish a full catalogue in 2021 which will be entitled Issue 303. An up to date full catalogue will always be available on our website on the catalogs page.

Once again **THANK YOU DEALERS** and have a great 2021 selling season.



CATALOG COPYRIGHT

This catalog forms a copyright under US law.

This includes, but is not limited to, the series of brake pad, brake shoe, clutch and brake rotor design numbers with or without the prefixes FA, EPFA, GPFAX, MXS, SXR or suffixes R, HH, X, SV.

These design numbers prefixes and suffixes form the toils of many years of work and set EBC products apart and are easily distinguished from other manufacturers brands or numbers.

Any copying, imitation, in full or in part, by any third party, will result in prosecution to the fullest extent of US law.

Also included within this catalog are registered or applied for individual trademarks, such as:

- EBC
- Double-H
- Pro-lite
- SD-System
- Dirt Racer
- Street Racer
- DRC
- DRCF
- SRC
- SRK
- SV Series
- VLD Series
- VR Series
- UTVX
- SXR

All of the above are active trademarks and/or brands used by EBC Brakes licencees.

CONTENTS

PAD & SHOE APPLICATIONS

US Built Motorcycles (Harley-Davidson®, ATK, Bombardier/BRP, Buell, Can-Am, EBR, Indian, Motus, Polaris, Victory, Zero Electric Motorcycles).....	2-45
Rotor Designs and Dimensions for US Built Motorcycles	46-65
Japanese Bikes (Honda, Kawasaki, Suzuki, Yamaha)	68-165
Non-Japanese Bikes (Adly, AJP, Altamotors, Aprilia, Arch, Arctic Cat (ATV), Arctic Cat (Side x Side), Argo, Bajaj, Benelli, Bennche (ATV), Bennche (UTV Side x Side), Beta, BMW, Bultaco, Cagiva, CF Moto (ATV), CF Moto (Side x Side), Cobra (Moto), Coleman Powersports, CPI, CSC, CZ/Jawa, Daelim, Derbi, Dinli, Ducati, Energica, E-Ton, Gas-Gas, Gas-Gas (Pierer), Gogoro (Electric Scooter), Hisun (ATV), Hisun (Side x Side), Husaberg, Husqvarna, Hyosung, Italjet, John Deere (ATV & Side x Side), Kioti/Mechron, KTM, Kymco (Street), Kymco (ATV), Kymco (Side x Side), Laverda, LEM, Lifan, Maico/M-Star, Malaguti, Massimo (ATV), Massimo (Side x Side), Montesa, Moto-Guzzi, MV (Agusta), MZ/MUZ, Norton, Ohvale, Peugeot, Piaggio, Polini, Qlink, Royal Enfield, Sachs, Scorpa, SDG, Sherco, SYM, TGB/Peirspeed, Thumpstar, TM, Tomos, Triumph (Meriden), Triumph (Hinckley), U.M. (United Motors), Unison, Vertemati, Vespa, VOR)	166-277
Recommended 2021 Dealer Inventory	278-279
Road Racing Applications/ Pads for Aftermarket Calipers.....	280-284
Brake Lines.....	285-297

BRAKE
APPLICATIONS

BUYER'S GUIDE - BRAKE PADS

Buyer's Guide Brake Pad.....	298-391
------------------------------	---------

BUYERS GUIDE
BRAKE PADS

BUYER'S GUIDE - BRAKE SHOES

Buyer's Guide Brake Shoes	392-412
---------------------------------	---------

BUYERS GUIDE
BRAKE SHOES

BUYER'S GUIDE - BRAKE ROTORS

Buyer's Guide Brake Rotors - Streetbikes.....	413-480
Buyer's Guide Brake Rotors - Dirtbikes/ATV/UTV	481-524

ROTORS
BUYERS GUIDE

CLUTCH APPLICATIONS

Japanese Bikes.....	525-553
Non-Japanese Bikes	554-570

CLUTCH
APPLICATIONS

BUYER'S GUIDE - CLUTCHES

Buyer's Guide - CK Clutch Kits	571-593
Buyer's Guide - DRC/DRCF Clutch Kits	594-602
Buyer's Guide - SRC/SRK Clutch Kits	603-610

CLUTCH
BUYERS GUIDE

ACCESSORY PAGES

Carburettor Jets - Pilot Jets	611-613
Carburettor Jets - Main Jets	614-615
Brake Fluid & Caliper Lube.....	615

ACCESSORY
PAGES

COPYRIGHT NOTICE: The part numbers, illustrations and listings in this publication are the copyright of EBC Brakes and any reproduction in part or whole or similarity, without advance authority in writing is contrary to international law and copyright holders will enforce vigorously. Vehicle manufacturers names and model numbers are indicated for cross reference purposes only. All products in this catalogue are manufactured by EBC Brakes and are not original equipment parts.

MOTORCYCLE BRAKE PADS

Aramid Fiber Organic FA Series Pads

“X” Pads

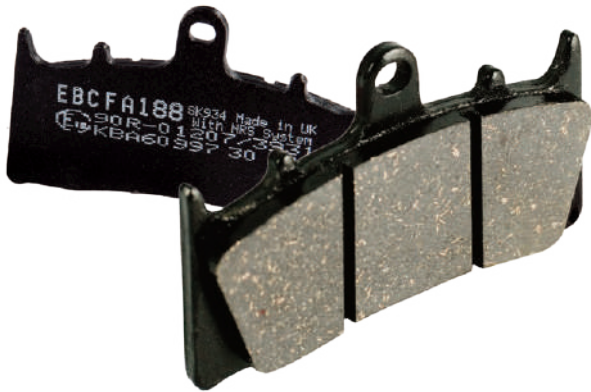

FA series organic brake pads will deliver fingertip stopping power and superb brake feel and control, the preferred choice for many sportbike riders. This compound has low disc attack characteristics and gives medium lifetime.

“X” series moto-x sport and enduro pads, cool running based pad compound for sport use in moto-x and ATV applications. For mud, sand or wet conditions requiring longer life, use our sintered range below.

Double-H™ Pads

MXS Series Pads

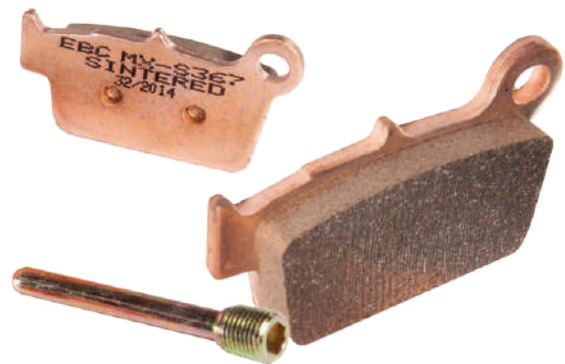
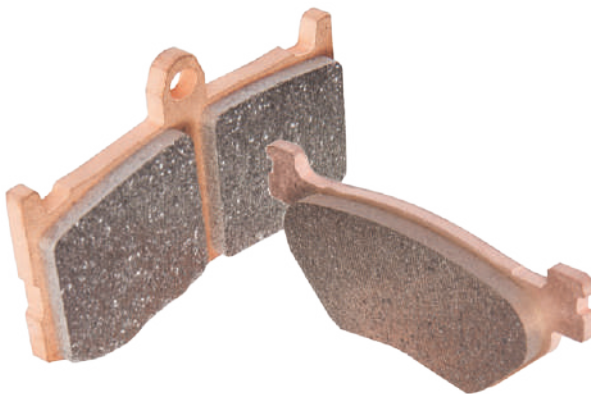

FA series with HH suffix, EBC’s American-made ultra high friction Double-H™ sintered copper alloy brake pads for maximum stopping power and lifetime. With stainless steel radiator plates to reduce heat transfer and double compact for wider pads.

“MXS” moto-x race pads, ultra high friction American-made sintered copper alloy with diamond ground surface finish for fast brake-in. With external hex drive slider pins, these pads are suitable for all fast moto-x riding.

“R” Series Pads

SV Pads

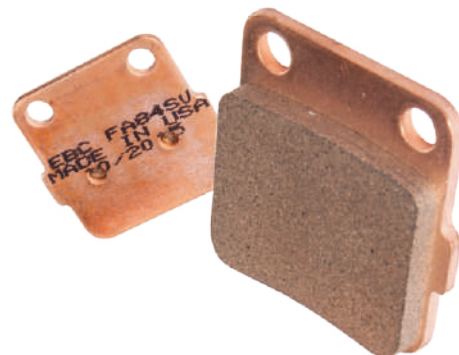

“R” series American-made sintered copper alloy ATV and Moto-X replacement pads for sport and utility off road riding.

“SV” series severe duty ATV pads, high density copper alloy for longest possible life in utility applications on ATV, especially in wet, mud, dust and dirt conditions.

MOTORCYCLE BRAKE PADS

EPFA Trackday Pads

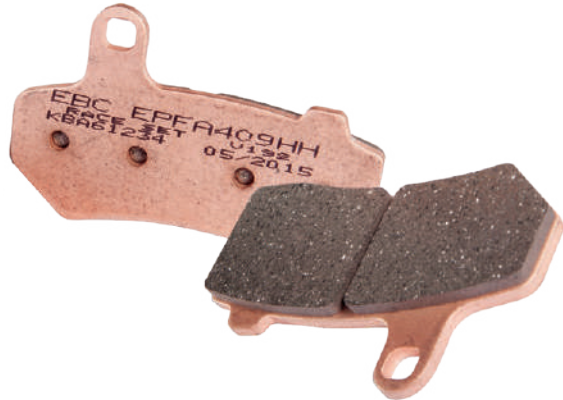

EPFA trackday pads give long life in street use with improved fade resistance and heat cycling plus improved noise characteristics, making this a great pad for heavy streetbikes and cruisers as well as faster superbikes. Great for intermittent track use.

GPFX Race Series Pads

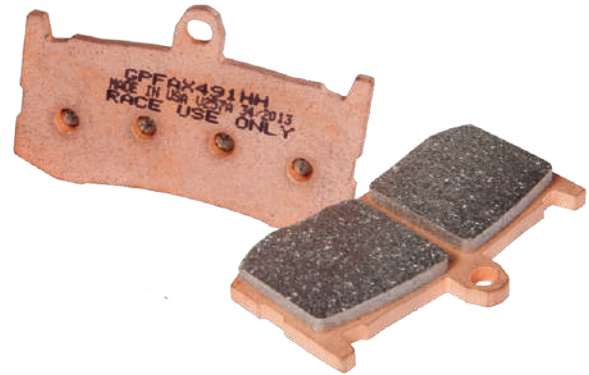

GPFX vacuum sintered ultra-high friction race pads are for sportbike asphalt racing and have been refined over the years to deliver one of the best brake race materials ever made. See page xii for full details.

SFA Organic Scooter Pads



A superb general replacement pad for urban use on scooter mopeds, mopeds and mopeds. Made using aramid fibers, these pads give above average lifetime, reduced rotor wear characteristics and offer great value for money.

SFA-HH Sintered Scooter Pads

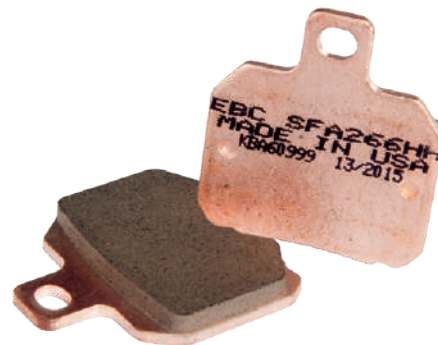

These American-made sintered scooter pads are long lasting with high performance HH rated stopping power for perfect braking - wet or dry. The HH pads target the faster and heavier scooter market and work well with stainless steel brake discs.

MOTORCYCLE BRAKE ROTORS

X and XC Series Sportbike Rotors

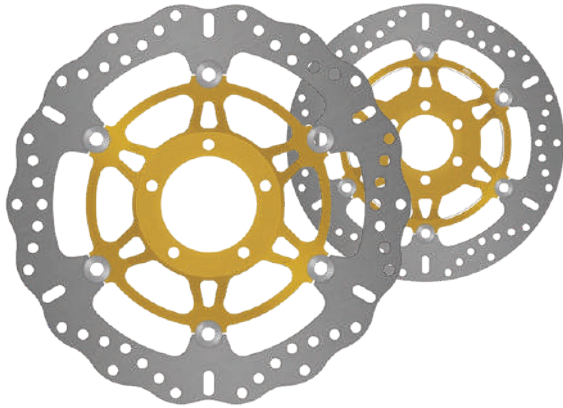

X and XC series rotors feature mill hard stainless steel high friction rotor blades for maximum brake effect and are direct size for size replacements for OEM rotors. These lightweight rotors feature our patented SD system square drive button system.

VMD Classic Style Rotors

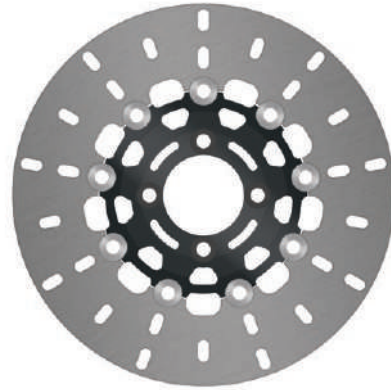

These lightweight, black anodised vintage rotors are new to our range. The vintage fitment benefits from billet aluminum construction; lightweight, less unsprung weight enables better handling and stopping power. Perfect for the Café racer scene.

Sportbike VR Series Rotors

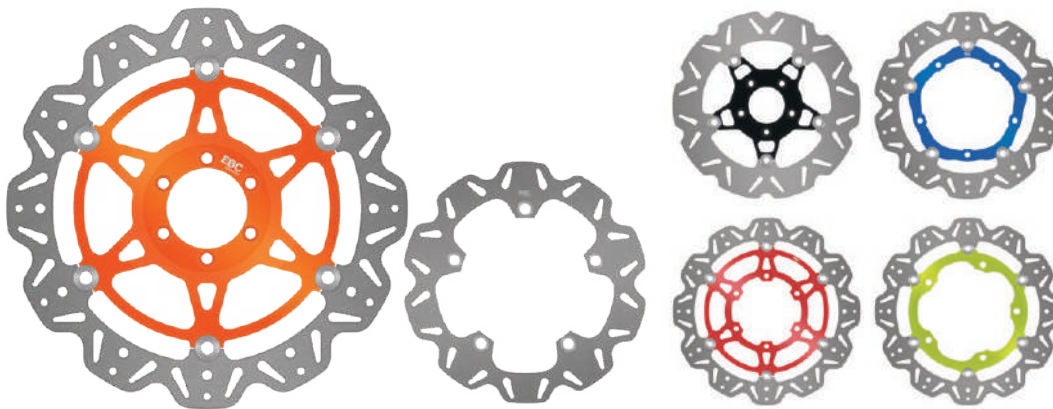

Vee profile lightweight rotors with alloy hubs and ground stainless steel rotor blades for fast street bikes. Choose from black or colored hub options as shown above. To order prefix with VR and suffix with chosen color BLK, RED, BLU, GRN, GLD. For rear rotors just the VR number.

Custom Finish VR Series Rotors

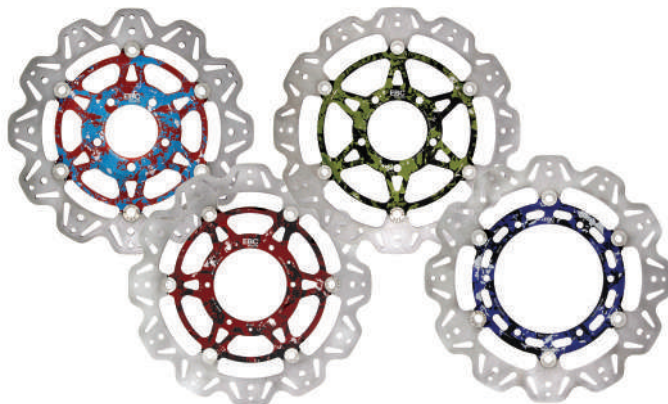

Special edition splatter anodised custom finish is applied to the center hubs of our VR series rotors by hand. The coating has the same resilience as other EBC rotor finishes but with a radical and unique aesthetic. Color options available: Light Blue, Red & White; Red, White & Black; Green, White & Black; Dark Blue, White & Black.

Supermoto Brake Rotor

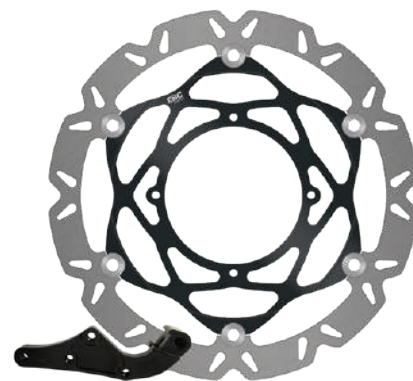

SMX rotor with vee design contoured rotor, 320mm rotor upgrade kits complete with relocation bracket.

MOTORCYCLE BRAKE ROTORS

MD Series Stainless Scooter Rotors



Made from mill hard rolled steel, these rotors are machined to match the original units, mechanically de-stressed to avoid rotor distortion, surface finished for precise smoothness and then zinc coated to prevent corrosion or rusting.

VR Series Stainless Scooter Rotors



Made in the UK using German mill rolled heat treated and precision ground stainless steel, the new VR series stainless profiled scooter sport rotors are the lightest and best looking on the market and can be used with any type of brake pad.

UTVX Rotors for ATV/Quad/4x4



These rotors look great and give an improved brake performance. Made in our British manufacturing facility using durable, tough German mill rolled stainless steel, heat treated & diamond ground to give great braking for less than OEM prices.

CX Extreme Off Road Rotors

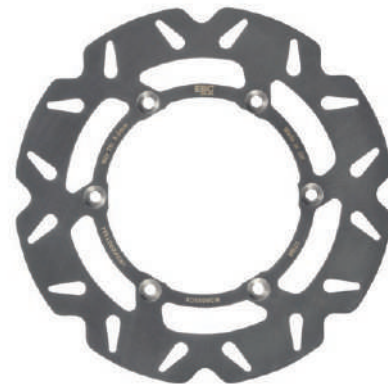

CX Extreme self-cleaning lightweight stainless rotors are a size-for-size replacement/upgrade for front and rear fitment on all modern motocross machines.

Oversize MX Rotors

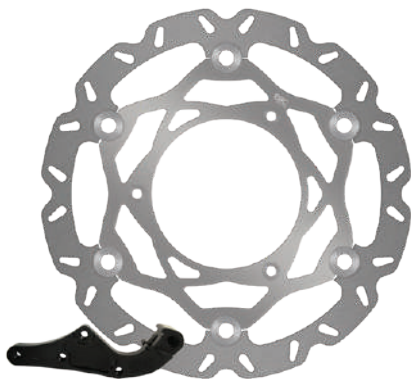

250 or 280mm motocross oversize rotor kit complete with billet aluminum relocation brackets for improved brake power and control with vee design rotor.

Rear Brake Rotors

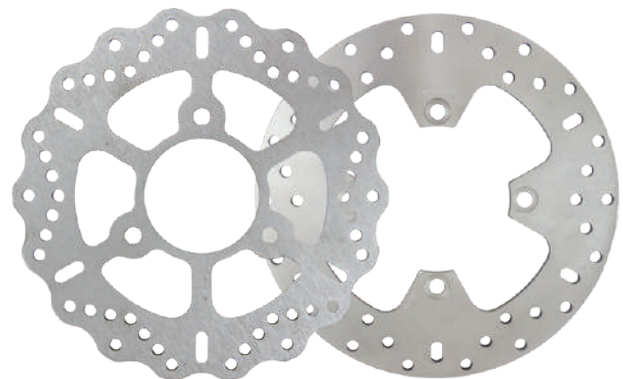

Made from stainless steel and available in full circle or contoured profile, suitable for performance street use or racing with new lightweight hole pattern construction.

MOTORCYCLE CLUTCH OPTIONS

CK/CKF Series Clutch Kits

DRC/DRCF Series Clutch Kits



CK complete engine sets of stack height controlled friction plates feature the EBC Brakes' unique alloy particle impregnated clutch facings that prevent burn up or slippage. CKF carbon fiber impregnated kits for ATV and moto-x use are built to last longer, grip and feel better than cork kits.

DRC is the ultimate clutch rebuild kit for your ATV and Moto-X machine. The DRCF kit swaps the stock type cork friction plates for a set of severe duty carbon fiber lined friction plates for better heat and wear abilities.

SRC/SRK Series Clutch Kits

CSK Coil & Diaphragm Clutch Kits



SRC is an aramid fiber lined plate set with heavy duty clutch springs (diaphragm type springs included where required). Ideal for heavy sport bikes, faster riders and production based race use. SRK series includes a full engine set of aramid lined friction plates with clutch springs and steel separator plates.

CSK sets include either coiled springs or diaphragm springs where appropriate. Coil springs are spiral wound with 4 to 8 pieces per set, made from heat treated high carbon steel delivering the right tension for your bike. Diaphragm springs are dish shaped flat steel pressure rings.

Clutch Removal Tools



NOW MADE IN STAINLESS STEEL

Made in the UK by EBC Brakes, these laser cut clutch tools make clutch removal, loosening of the drive shaft bolts and re-tightening a breeze, without any fear of damage to your expensive clutch basket. Tools can be extended to create more leverage if required with any simple workshop tool or tube. EBC Brakes produce a clutch tool for almost every clutch plate design known.

SXS Products from EBC BRAKES

The longest lasting, highest performing aftermarket pads and rotors for the SxS industry yet ...

All EBC Brakes pads for SxS fitments, both sintered and carbon X pads, are made with beefed-up pad thickness and DO NOT REQUIRE or accommodate the fitting of noise shims, offering even more available pad life for this tough application.

UTVX DISCS

- Lightweight • Profiled
- UK made • Heat treated stainless steel

NEW SXR PADS

- Vacuum sintered • Maximum grip
- Race performance • Longest wear life

SXR sintered pads are MADE IN THE USA using vacuum furnace sintering to deliver a refined and much longer lasting material blend.

SPORT CARBON TT PADS

also available for fast, dry riding using ENHANCED LIFE MATERIAL and enhanced pad thickness.

All parts are in stock at your favourite EBC Brakes distributor NOW for immediate delivery.

GO FAST STOP FAST

STEP UP FROM STOCK

Choose from our carbon graphite X pads, high-friction SXR Race Pads or severe duty SV Series pads.

Add these to our new stainless-steel UTVX Rotors for a great set of brakes to suit all of your riding styles.



Boost brake response even further with EBC Brakes' British-made Stainless Steel Braided Brake Lines.























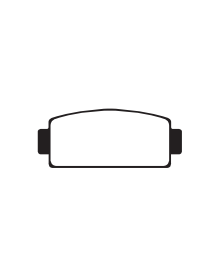







EBC
BRAKES

The World's No. 1 Name in Brakes www.ebcbrakes.com



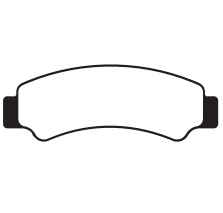







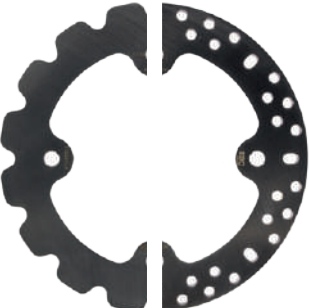

Part #	Make/Model	Year	Pad Position	UPC	Matching UTVX Rotor	
					Front	Rear
SXR135HH	CAN AM			5050953856174		
	Commander 800 R/XT/DPS/1000 STD/DPS/LTD/X/XT/XT-P Maverick 1000 STD/XRS	11-15 13	Front Right & Rear Front Left		UTVX6366 UTVX6370	UTVX6366 UTVX6370
SXR159HH	POLARIS			5050953856198		
	570 Sportsman	11-15	Front		UTVX6202	UTVX6275
	RZR 570	12-13	Rear		UTVX6312	UTVX6275
	600/700/800 Sportsman 4 x 4	02-13	Front		UTVX6202	MD6201D
	700/800 Sportsman EFI/X 2	07-14	Front		UTVX6202	UTVX6275
	Ranger	99	Front		MD6149D	TBA
	PPS/PTV 4 x 4/Series 10		Front		UTVX6202	MD6200D
	PPS/PTV 6 x 6/Series 10 PPS LUH 6 x 6	02	Front		MD6149D	MD6170D
SXR165HH	CAN AM			5050953856235		
	Commander 800 R/XT/DPS	11-15	Front Left		UTVX6366	UTVX6366
	Commander 1000 STD/DPS/LTD/X/XT/XT-P Maverick 1000 STD/XRS	11-15 13	Front Left Front Left		UTVX6366 UTVX6366	UTVX6366 UTVX6370
SXR307HH	BOMBARDIER			5050953856259		
	Outlander 300 HO/400/400 Max HO	03-06	Front Left		UTVX6222	UTVX6223
	Outlander 650 HO Efi 4 x 4/HO Efi XT 4 x 4	06	Front Left		UTVX6222	UTVX6223
	Outlander Max 650 HO Efi 4 x 4 HO Efi XT 4 x 4	06	Front Left		UTVX6222	UTVX6223
	Outlander 800 (All models)	06	Front Left		UTVX6222	UTVX6223
	Traxter (4 x 4)/XL (4 x 4)/XT (4 x 4)	01-04	Front Left		MD6229D	MD6230D
	Traxter Autoshift	01-05	Front Left		MD6225D	MD6224D
	Traxter Footshift	01	Front Left		MD6229D	MD6230D
	Quest 500 (4 x 4)	02-04	Front Left		MD6224D	MD6225D
	Traxter Max	03-05	Front Left		MD6245D	MD6225D
	Quest 500/650 (2 x 4)/650 (4 x 4)/650 XT (4 x 4)	02-04	Front Left		MD6224D	MD6225D
	Quest Max 650	03-	Front Left		MD6224D	MD6225D
	DS 650/650 Baja/X	00-06	Front Left		MD6171D	MD6172D
	Traxter Max 650/XL/Quest Max/STD/XT	04-05	Front Left		MD6245D	MD6225D
	CAN AM					
	Maverick 1000 STD/XRS	13	Rear Left & Rear		UTVX6366	UTVX6370
	Outlander 400/500/650/800/Max 400/500/650/800	07-15	Front Left & Rear		UTVX6222	UTVX6223
	Renegade 500/800	07-12	Front Left & Rear		UTVX6223	UTVX6223
	DS 650 X (3B7A/B)	07	Front Left & Rear		MD6171D	MD6172D
	Renegade 800	08-11	Front Left & Rear		TBA	TBA
	Buck/Trail Buck 500/650 EX/EXT	04-08	Rear Left		MD6245D	MD6225D
	Commander 1000 R EFI	18-19	Rear Left		UTVX6411	UTVX6366
	Commander Max 1000 - DPS/XT/LTD	14-15	Rear Left		TBA	UTVX6370
	Maverick 1000 - STD/XRS/XRS/XDS - DPS/XMR/XXC	14-15	Rear Left		UTVX6411	UTVX6370
Maverick Max 1000 Std/1000 - XRS/XDS - DPS	14-17	Rear Left		UTVX6411	UTVX6370	
SXR317HH	BOMBARDIER			5050953856273		
	Outlander 300 HO/400/400 Max HO	03-06	Front Right		UTVX6222	UTVX6223
	Outlander 650 HO Efi 4 x 4/HO Efi XT 4 x 4	06	Front Right		UTVX6222	UTVX6223
	Outlander Max 650 HO Efi 4 x 4 HO Efi XT 4 x 4	06	Front Right		UTVX6222	UTVX6223
	Outlander 800 (All models)	06	Front Right		UTVX6222	UTVX6223
	Traxter (4 x 4)/XL (4 x 4)/XT (4 x 4)	01-04	Front Right		MD6229D	MD6230D
	Traxter Autoshift	01-05	Front Right		MD6225D	MD6224D
	Traxter Footshift	01	Front Right		MD6229D	MD6230D
	Quest 500 (4 x 4)	02-04	Front Right		MD6224D	MD6225D
	Traxter Max	03-05	Front Right		MD6245D	MD6225D
	Quest 500/650 (2 x 4)/650 (4 x 4)/650 XT (4 x 4)	02-04	Front Right		MD6224D	MD6225D
	Quest Max 650	03-	Front Right		MD6224D	MD6225D
	DS 650/650 Baja/X	00-06	Front Right		MD6171D	MD6172D
	Traxter Max 650/XL/Quest Max/STD/XT	04-05	Front Right		MD6245D	MD6225D
	CAN AM					
	Maverick 1000 STD/XRS	13	Rear Right		UTVX6366	UTVX6370
	Outlander 400/500/650/800/Max 400/500/650/800	07-15	Front Right & Rear		UTVX6222	UTVX6223
	Renegade 500/800	07-12	Front Right & Rear		UTVX6223	UTVX6223
	DS 650 X (3B7A/B)	07	Front Right & Rear		MD6171D	MD6172D
	Renegade 800	08-11	Front Right & Rear		TBA	TBA
	Buck/Trail Buck 500/650 EX/EXT	04-08	Front Right & Rear Right		MD6245D	MD6225D
	Commander 1000 R EFI	18-19	Rear Right		UTVX6411	UTVX6366
	Commander Max 1000 - DPS/XT/LTD	14-15	Rear Right		TBA	UTVX6370
	Maverick 1000 - STD/XRS/XRS/XDS - DPS/XMR/XXC	14-15	Rear Right		UTVX6411	UTVX6370
Maverick Max 1000 Std/1000 - XRS/XDS - DPS	14-17	Rear Right		UTVX6411	UTVX6370	
SXR354HH	POLARIS			5050953856297		
	570 Sportsman Ace/Ace Euro	15-20	Rear		UTVX6202	UTVX6275
800 Ranger Crew	10-14	Rear		UTVX6338	UTVX6275	
SXR395HH	ARCTIC CAT			5050953856334		
	550 H1 EFI Prowler/650 H1 Prowler/650 Prowler 4 x 4/M4	07-09	Front		UTVX6271	N/A
	HDX 500 LTD Prowler/Prowler/XT Prowler	14	Front		UTVX6271	N/A
	XT 550/550 Prowler/650 H1 Prowler	06-14	Front		UTVX6271	N/A
	HDX 700 Prowler/LTD Prowler/Trail	11-14	Front		UTVX6271	UTVX6173
	Wildcat Trail 700 XT inc LTD	15-19	Front		UTVX6384	UTVX6384
	XTX 700 H1 EFI/LE Prowler/700 Prowler	08-14	Front		UTVX6271	N/A
	1000 H2 Mudpro EFI	10	Front		UTVX6173	UTVX6173
	1000 Mudpro	10-13	Front		UTVX6271	UTVX6271
	1000 TRV Cruiser/TRV H2 EFI/H2 EFI Cruiser	09-11	Front		UTVX6173	UTVX6173
	Thundercat 1000 H2/H2 LE	08-10	Front		UTVX6173	UTVX6173
	Wildcat 1000 GT	11-12	Front		UTVX6271	UTVX6173
	Wildcat 1000 GT/LTD/X-LTD/X-LTD-EPS	13-16	Front		TBA	TBA
	Wildcat X 1000/X-SE-EPS 1000	14-16	Front		TBA	UTVX6383
XTZ 1000 Prowler	10-14	Front		UTVX6271	UTVX6173	
SXR452HH	POLARIS			5050953856358		
	500 Ranger (4 x 4 EFI)/(Carb) 2 x 4/Ranger Crew	08-13	Front		UTVX6202	UTVX6275
	500 Ranger (EFI) 4 x 4 H.O.	09-11	Front		UTVX6338	UTVX6275
	RGR 570, Full Size (R06)	16	Front		UTVX6202	UTVX6275
	700 Ranger Crew (EFI) 4 x 4/6 x 4 EFI/XP 4 x 4	08-09	Front		UTVX6202	UTVX6275
	700 Ranger 4 x 4 EFI	09	Front		UTVX6338	UTVX6275
	800 Ranger/EFI/XP/Crew	10-14	Front		UTVX6338	UTVX6275
	800 Ranger 6 x 6	10-17	Front & Rear		UTVX6338	UTVX6275
	RZR-4 800 EPS	12	Front		UTVX6338	UTVX6275
	Ranger EV (Electric)	10-15	Front		UTVX6202	UTVX6275

Part #	Make/Model	Year	Pad Position	UPC	Matching UTVX Rotor	
					Front	Rear
SXR452HH	POLARIS (Contd)			5050953856358		
	900 D Crew Ranger Diesel/Crew Ranger Diesel	11-14	Front		UTVX6338	UTVX6275
	900 (Ranger XP 900)	15-19	Front		UTVX6338	UTVX6275
	900 (Ranger XP 900)	13-14	Front		UTVX6338	UTVX6374
	Ranger Crew 900 All Options (R07)	16-19	Front & Rear		UTVX6338	UTVX6275
	1000 General EPS (2 Seat)	16	Front		UTVX6338	UTVX6338
	1000 General EPS PS MD (R09, R13, 2 Seat)	17-20	Front		UTVX6408	UTVX6408
	1000 General 4 EPS PS XP DLX (R01, R14, R18, 4 Seat)	17-20	Front		UTVX6338	UTVX6408
	1000 Ranger Diesel Crew	15	Front		UTVX6338	UTVX6275
	RZR XP 1000 (R11 EU/MD, R12, R14)	16-17	Front		UTVX6380	UTVX6380
Brutus HD HDPTO (R03)	13-17	Front		UTVX6338	UTVX6275	
SXR456HH	POLARIS			5050953856372		
	RZR 570/RZR 800 (Inc EPS Models)	08-14	Front		UTVX6312	UTVX6275
RZR 570 S/EU/MD (R05)	14-19	Front		UTVX6338	UTVX6275	
SXR610HH	ARCTIC CAT			5050953856396		
Wildcat 4X/4X-LTD/4/4 LTD 1000	13-16	Front			UTVX6384	UTVX6384
SXR642HH	CAN AM			5050953856419		
	Commander 1000 R EFI	18-19	Front Left		UTVX6411	UTVX6366
	Commander Max 1000 - DPS/XT/LTD	14-15	Front Left		TBA	UTVX6370
	Maverick 1000 - STD/XRS/XRS/XDS - DPS/XMR/XXC	14-15	Front Left		UTVX6411	UTVX6370
Maverick Max 1000 Std/1000 - XRS/XDS - DPS	14-17	Front Left		UTVX6411	UTVX6370	
SXR645HH	CAN AM			5050953856433		
	Commander 1000 R EFI	18-19	Front Right		UTVX6411	UTVX6366
	Commander Max 1000 - DPS/XT/LTD	14-15	Front Right		TBA	UTVX6370
	Maverick 1000 - STD/XRS/XRS/XDS - DPS/XMR/XXC	14-15	Front Right		UTVX6411	UTVX6370
Maverick Max 1000 - Std/1000 - XRS/XDS - DPS	14-17	Front Right		UTVX6411	UTVX6370	
SXR651HH	CF MOTO (Side x Side)					
	1000 Z-Force	17-19	Rear		TBA	TBA
SXR656HH	POLARIS			5050953856457		
	570 Sportsman Ace/Ace Euro	15-20	Front		UTVX6202	UTVX6275
	570 Ranger Crew EFI	14-15	Front		UTVX6202	UTVX6275
	RGR 570, Full Size (R12/R06/R03)	17-20	Front		UTVX6202	UTVX6275
	RGR CRW 570 FS (R08/R05/R03)	16-20	Front		UTVX6202	UTVX6275
	RGR 570 EPS CRW MD (R04)/EFI CRW (R10/R03/R02)	17-20	Front		UTVX6202	UTVX6275
	RGR EV MD (R02)/EV LION (R08/R03)/EV (R12/R03/R02)	16-19	Front		UTVX6202	TBA
	RGR 800 6X6 MD Poland (R02)	17-20	Front		UTVX6202	TBA
	RGR CRW 900 XP 6P SP (R10)/900 EPS (R03)/6P SP (R14)	17-19	Front		UTVX6338	TBA
	Ranger 902D EU Tractor R07	19-20	Front		UTVX6380	UTVX6338
	RZR XP 1000 S4 R02	18-20	Front		UTVX6380	UTVX6338
	900 Ranger Crew	10-15	Front		UTVX6338	UTVX6275
	1000 Ranger Diesel EU (R12)	15-20	Front		UTVX6338	UTVX6275
	RGR CRW 1000 XP PS MD (R08)/PS All Options (R32/R09)	17-18	Front		UTVX6338	UTVX6275
	RGR CRW 1000 XP 6P, PS, NB, MD (R08)/PS (R10)	17-20	Front		UTVX6338	UTVX6275
	RGR 1000 D Poland (R07)/D EU (R14) D Crew (R16)	17-18	Front		UTVX6338	UTVX6275
	Ranger Crew 1000 (R04, R06, R08, R11)	18-20	Front		UTVX6338	UTVX6275
	Ranger 1000 XP PS Crew Inc EU, EPS, HD, MD (R03, R09, R13, R20)	18-20	Front		UTVX6338	UTVX6275
	Ranger 1000 XP PS NSTR, Crew Mud (R15, R17, R18)	18-20	Front		UTVX6338	UTVX6275
	RGR 1000D (R17/R13)	17-18	Front		UTVX6338	UTVX6275
	MIL RZR2 XP MV 1000 TD (R01/R04)/TD NELO (R01)	17-18	Front		TBA	TBA
	RZR XP 900 (Inc EPS Models)/4 XP 900 All Options Inc Military/4 900 (R05)	11-17	Front		UTVX6338	MD6374D
	RZR 4 900 (R05, R12)	16-18	Front		UTVX6338	TBA
	RZR XP 1000 R35	12-19	Front		UTVX6380	UTVX6380
	RZR RS1/XP 4 1000/4 1000 MD	16-20	Front & Rear		UTVX6380	UTVX6380
	RZR XP/XP 4 Turbo/Turbo 4	16-20	Rear		UTVX6397	UTVX6397
	RZR XP Turbo/Latin/MD/S/Tractor/Turbo S/XP4 Turbo/Turbo Intl/Turbo MD	17-20	Rear		UTVX6380	UTVX6397
	SXR657HH	POLARIS			5050953856471	
RZR/RZR-S 900 (50"/60" All Options)		15-20	Front		UTVX6338	UTVX6338
RZR 1000 60" PS EU/Tractor/Zug (R01, R06, R07, R09)	17-20	Front		UTVX6338	UTVX6338	
SXR676HH	YAMAHA			5050953856495		
	YZZ 1000 R All Models	16-17	Front		UTVX6395	UTVX6395
SXR677HH	YAMAHA			5050953856518		
	YZZ 1000 R All Models	16-17	Rear		UTVX6395	UTVX6395
SXR680HH	POLARIS			5050953856532		
	RZR XP/XP 4 Turbo/Turbo 4	16-20	Front		UTVX6397	UTVX6397
RZR XP/XP4	17-20	Front		UTVX6380	UTVX6397	
SXR682HH	CAN AM			5050953856556		
	Defender 500cc/799cc/Max/976cc	16-19	Front Left		UTVX6396	UTVX6396
	Maverick Trail 800cc/1000cc EFI	18	Front Left		UTVX6396	UTVX6412
Maverick X3/X3 Max	17-18	Front Left		UTVX6411	UTVX6412	
SXR683HH	CAN AM			5050953856570		
	Defender 500cc/799cc/Max/976cc	16-19	Front Right		UTVX6396	UTVX6396
	Maverick Trail 800cc/1000cc EFI	18	Front Right		UTVX6396	UTVX6412
Maverick X3/X3 Max	17-18	Front Right		UTVX6411	UTVX6412	
SXR684HH	CAN AM			5050953856594		
	Defender 799cc/976cc	16-19	Rear Left		UTVX6396	UTVX6396
SXR685HH	CAN AM			5050953856617		
	Defender 799cc/976cc	16-19	Rear Right		UTVX6396	UTVX6396
SXR701HH	HONDA			5050953856631		
	Pioneer 1000 SXS (2/4 seat)	16-18	Front Left		UTVX6410	UTVX6410
SXS Talon 1000 R	19-20	Front Left		UTVX6397	UTVX6425	
SXR702HH	HONDA			5050953856655		
	Pioneer 1000 SXS (2/4 seat)	16-18	Front Right		UTVX6410	UTVX6410
SXS Talon 1000 R	19-20	Front Right		UTVX6397	UTVX6425	
SXR703HH	HONDA			5050953856679		
	Pioneer 1000 SXS (2/4 seat)	16-18	Rear Left		UTVX6410	UTVX6410
SXS Talon 1000 R	19-20	Rear Left		UTVX6397	UTVX6425	
SXR704HH	HONDA			5050953856693		
	Pioneer 1000 SXS (2/4 seat)	16-18	Rear Right		UTVX6410	UTVX6410
SXS Talon 1000 R	19-20	Rear Right		UTVX6397	UTVX6425	
SXR726HH	CF MOTO (Side x Side)					
	1000 Z-Force	17-19	Front		TBA	TBA
SXR728HH	POLARIS			5050953868986		
	RZR XP4 Turbo S/XP Turbo S Velocity	19-20	Front		UTVX6380	UTVX6397

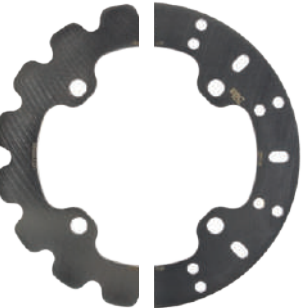
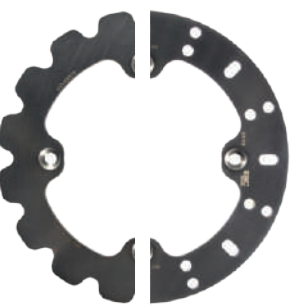
				
SXR135HH - 77.3/96.7mm wide	SXR159HH - 97mm wide	SXR165HH - 77.3/96.7mm wide	SXR307HH - 82/62mm wide	SXR317HH - 82/62mm wide
				
SXR354HH - 97mm wide	SXR395HH - 95mm wide	SXR452HH - 121mm wide	SXR456HH - 97.1mm wide	SXR610HH - 135.6mm wide
				
SXR642HH - 104/88mm wide	SXR645HH - 104/88mm wide	SXR651HH - 72.73mm wide	SXR656HH - 121mm wide	SXR657HH - 98mm wide
				
SXR676HH - 113.8mm wide	SXR677HH - 104mm wide	SXR680HH - 158mm wide	SXR682HH - 117.35/95.2mm wide	SXR683HH - 117.35/95.2mm wide
				
SXR684HH - 101.5/83.05mm wide	SXR685HH - 101.5/83.05mm wide	SXR701HH - 115.1mm wide	SXR702HH - 115.1mm wide	SXR703HH - 81.8mm wide
				
SXR704HH - 81.8mm wide	SXR726HH - 101.5mm wide	SXR728HH - 163.6mm wide		

X

Part numbers, prefixes, suffixes, photos and illustrations shown in this catalog are trademarks and/or copyrights of EBC Brakes or the trademark owner A C Freeman Investments Ltd and use without express written permission of the owners is punishable by law.

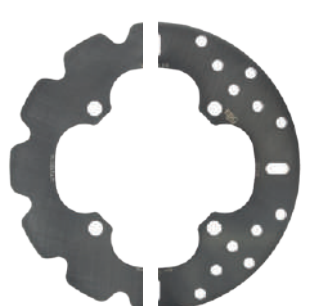
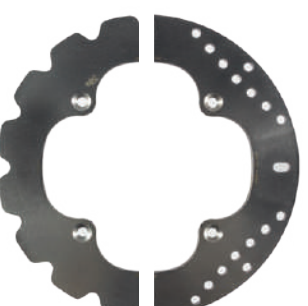
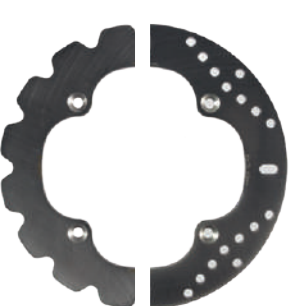
			
UTVX6173 / MD6173 202mm/7.95"	UTVX6202 / MD6202 228mm/8.98"	UTVX6271 / MD6271 252mm/9.92"	UTVX6275 / MD6275 218mm/8.58"
			
UTVX6312 / MD6312 235mm/9.25"	UTVX6338 / MD6338 220mm/8.93"	UTVX6366 / MD6366 215mm/8.46"	UTVX6370 / MD6370 215mm/8.46"
			
UTVX6374 / MD6374 218mm/8.58"	UTVX6380 / MD6380 245mm/9.64"	UTVX6384 / MD6384 252mm/9.92"	UTVX6395 / MD6395 245mm/9.64"
			
UTVX6408 / MD6408 227mm/8.94"	UTVX6410 / MD6410 210mm/8.27"	UTVX6411 / MD6411 260mm/10.23"	UTVX6412 / MD6412 247.5mm/9.74"

GP FAX Full Race Pads

PART #	BRIEF FITMENT
GP FAX16HH	ISR CALIPERS 22-030 (2 Piston Rear)/22-033 (2 Piston HD)
GP FAX95HH	DUCATI 748 Biposto 95-98, 851 Superbike Biposto 89-92, 916 (Biposto) 94-96, 916 Sienna 94-98
GP FAX197HH	HONDA NSF 100 R 06 / KAWASAKI EX 400 17-20
GP FAX244HH	BREMBO CALIPERS / DUCATI 748 99-02, 848 08-15, 916 97-98, 996 99-01, 998 02-03
GP FAX263HH	AP LOCKHEED CALIPERS / PFM CALIPERS Six piston superbike caliper
GP FAX295HH	BREMBO CALIPERS
GP FAX296HH	HONDA CBR 600 99-04 / KAWASAKI ZX6R (ZX 636 E) 636cc 13-17
GP FAX347HH	HONDA RS125 (Radial Caliper) 04-07, NSF250 R (Moto3) 12-13 / KAWASAKI Z900 17-20 / MORIWAKI MD250H 08-13 / YAMAHA TZ250 (Radial Caliper) 02-10
GP FAX379HH	KAWASAKI ZX 6R 18-20 / SUZUKI GSX-R 600 04-05, GSX-R 750 04-05, GSXR 1000 04-11
GP FAX380HH	YAMAHA YZF-R6 05-19, YZF-R198-19
GP FAX390HH	HONDA CBR 600 RR 05-17, VFR 800 F 14-15, CB 1000 R 10-16, CBR 1000 RR 04-16
GP FAX417/4HH	KAWASAKI ZX6R 07-12, Z 1000 07-08, ZG 1400 08-16, ZX14 Ninja ZX 1400 06-11, ZX14 R 12-17
GP FAX435/4HH	AP LOCKHEED CALIPERS
GP FAX442/4HH	YAMAHA YZ-R1 07-14
GP FAX447HH	BREMBO CALIPERS / HONDA CBR 1000 RR SP 14-20, RC 213 V-S 15-17 / KAWASAKI ZX10 R/RR Ninja ABS 16-20, Ninja 15-20 / SUZUKI GSX-R 600/750/1000 11-20, GSX-S 1000 16-20, GSX 1000 19-20 / BMW HP4 (1000cc) 13-14 / DUCATI 848 10-13, Desmosedici RR 08, 1098 07-09, Panigale V4 20, 1198 09-11, 1199 Panigale 12-15, 1299 Panigale 18-19, TRIUMPH Street Triple 675 18-19, Bonneville Street Scrambler 18-20
GP FAX491HH	TRIUMPH Daytona 675 09-17
GP FAX604/4HH	BMW S 1000 RR 10-17
GP FAX611HH	BREMBO CALIPERS
GP FAX630HH	BREMBO CALIPERS
GP FAX646HH	BREMBO CALIPERS
GP FAX662HH	YAMAHA MT03 & YZ-F R3
GP FAX663HH	YAMAHA YZ-F R3 15-20
GP FAX673HH	BREMBO CALIPERS
GP FAX700HH	HONDA CBR 600/1000 RR 18-20
GP FAX724HH	BMW S 1000 18-20, R1250 GS 18-20, R 1250 RT 18-20

BURNISH & SNUB STOPS

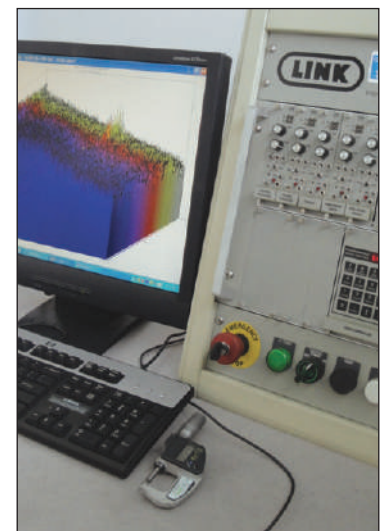
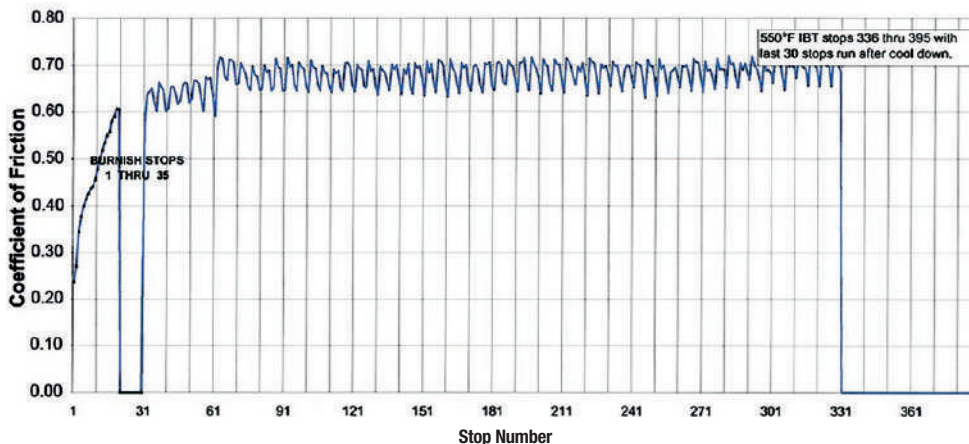

These pads bed in fast and deliver extremely high friction linear performance in track use. GP FAX pads are high friction but highly stable in stop. This means pads are powerful and predictable time after time when the brake is applied in race use. The “in-stop” friction fall off is almost zero and can hardly be noticed at the lever, meaning the brakes offer superb control. The EBC dyno is set to duplicate race conditions at the Road America race track and represents a true simulation of race brake demand. The number of race teams using GP FAX grows annually and for 2021 the exact same formulation developed through 2019 is used again.

EBC pads are developed in our own laboratory and tested using this race track simulator dynamometer to guarantee perfection before being thoroughly field tested on dozens of race teams.



Catalog - Issue 302a

**AMERICAN, EUROPEAN, ASIAN AND
BRITISH BUILT MACHINES**

FRONT: AMERICAN PRODUCED MOTORCYCLES

APPLICATIONS

BRAKE

* This symbol indicates a rotor made of billet steel, and should be only used with EBC FA Kevlar® Organic or Vee pads.

		FRONT						
		PADS	PADS	PADS	PADS	FRONT ROTOR OPTIONS		
		FA	V	HH/R	EPFA	DESIGN NO.		
		Kevlar Organic Pads	Semi-Sintered V-Pads™	Double-HT™ USA-Made Sintered Pads	Premium Low Noise Street Sintered Pads	See Buyers Guide for rotor style & finish options. Part nos for ordering & sizing.		
SUFFIX OR PREFIX PAD MATERIALS AND DESCRIPTION								
YEAR								
HARLEY DAVIDSON® TRUCK								
F-150 Pick Up Truck Special Edition	00-04	DP61259				GD7130	1	
HARLEY-DAVIDSON® ELECTRIC								
LiveWire	18-21			FA630HH*	EPFA630HH*		2	
HARLEY-DAVIDSON® SPORTSTER								
XL, XLH, XLCH, XLS, XLX	54-78						3	
XLH, XLCH Rivet Type	73-77	FA26					4	
79-81 Twin front caliper	79-81	FA71*	FA71V*				5	
82-83 Twin Girling caliper	82-83	FA71*	FA71V*				6	
84-Early 87 Girling caliper	84-87	FA94	FA94V	FA94HH		002	7	
Late 87-99	87-99	FA94	FA94V	FA94HH		002	8	
XL 50 50th Anniversary Sportster <i>Enlarge rotor available – see buyer's guide</i>	07	FA381	FA381V	FA381HH	EPFA381HH	001	9	
XLH 883 Sportster <i>Enlarge rotor available – see buyer's guide</i>	00-03	FA400	FA400V	FA400HH	EPFA400HH	001	10	
XLH 883 R Sportster Flat Track <i>Enlarge rotor available – see buyer's guide</i>	00-03	FA400	FA400V	FA400HH	EPFA400HH	001	11	
XL 883 Sportster Hugger <i>Enlarge rotor available – see buyer's guide</i>	00-03	FA400	FA400V	FA400HH	EPFA400HH	001	12	
XL 53c Sportster Custom (883cc) <i>Enlarge rotor available – see buyer's guide</i>	00-03	FA400	FA400V	FA400HH	EPFA400HH	001	13	
XL 883 Sportster Standard <i>Enlarge rotor available – see buyer's guide</i>	04-08	FA381	FA381V	FA381HH	EPFA381HH	001	14	
XL 883 C Sportster Custom <i>Enlarge rotor available – see buyer's guide</i>	04-10	FA381	FA381V	FA381HH	EPFA381HH	001	15	
XL 883 L Low <i>Enlarge rotor available – see buyer's guide</i>	04-10	FA381	FA381V	FA381HH	EPFA381HH	001	16	
XL 883 L Superlow <i>Enlarge rotor available – see buyer's guide</i>	11-13	FA381	FA381V	FA381HH	EPFA381HH	001	17	
XL 883 L Superlow Cast Wheel	14-20	FA640	FA640V	FA640HH	EPFA640HH	015	18	
XL 883 N Iron <i>Enlarge rotor available – see buyer's guide</i>	09-10	FA381	FA381V	FA381HH	EPFA381HH	001	19	
XL 883 N Iron Cast Wheel <i>Enlarge rotor available – see buyer's guide</i>	11-13	FA381	FA381V	FA381HH	EPFA381HH	001	20	
XL 883 N Iron Cast Wheel	14-18	FA640	FA640V	FA640HH	EPFA640HH	015	21	
XL 883 N Iron	16-21	FA640	FA640V	FA640HH	EPFA640HH	MD530	22	
XL 883 R 100th Anniversary Edition <i>Enlarge rotor available – see buyer's guide</i>	03	FA400*	FA400V*	FA400HH*	EPFA400HH*	001	23	
XL 883 R Sportster R <i>Enlarge rotor available – see buyer's guide</i>	05-13	FA381*	FA381V*	FA381HH*	EPFA381HH*	001	24	
XL 883 R Roadster <i>Enlarge rotor available – see buyer's guide</i>	10	FA381*	FA381V*	FA381HH*	EPFA381HH*	001	25	
XL 883 R Roadster Cast Wheel <i>Enlarge rotor available – see buyer's guide</i>	11-13	FA381*	FA381V*	FA381HH*	EPFA381HH*	001	26	
XL 883 R Roadster Cast Wheel	14-15	FA640	FA640V	FA640HH	EPFA640HH	015	27	
XL 1200 C Sportster Custom <i>Enlarge rotor available – see buyer's guide</i>	00-03	FA400	FA400V	FA400HH	EPFA400HH	001	28	
XL 1200 S Sportster Sport <i>Enlarge rotor available – see buyer's guide</i>	00-03	FA400*	FA400V*	FA400HH*	EPFA400HH*	001	29	
XL 1200 R Sportster Roadster <i>Enlarge rotor available – see buyer's guide</i>	04-08	FA381*	FA381V*	FA381HH*	EPFA381HH*	001	30	
XL 1200 C Sportster Custom <i>Enlarge rotor available – see buyer's guide</i>	04-10	FA381	FA381V	FA381HH	EPFA381HH*	001	31	
XL 1200 C Sportster Custom Cast & Spoke Wheel <i>Enlarge rotor available – see buyer's guide</i>	11-13	FA381	FA381V	FA381HH	EPFA381HH*	001	32	
XL 1200 C Custom Spoke Wheel	14-21	FA640	FA640V	FA640HH	EPFA640HH	015	33	
XL 1200 CX Roadster	16-21	FA640*	FA640V*	FA640HH*	EPFA640HH*	015	34	
XL 1200 L Sportster Low Spoke Wheel <i>Enlarge rotor available – see buyer's guide</i>	07-11	FA381	FA381V	FA381HH	EPFA381HH	001	35	
XL 1200 L Sportster Low Cast Wheel <i>Enlarge rotor available – see buyer's guide</i>	07-11	FA381	FA381V	FA381HH	EPFA381HH	001	36	
XL 1200 N Nightster Spoke Wheel <i>Enlarge rotor available – see buyer's guide</i>	08-12	FA381	FA381V	FA381HH	EPFA381HH	001	37	
XL 1200 T Superlow	14-21	FA640	FA640V	FA640HH	EPFA640HH	015	38	
XL 1200 V Seventy Two <i>Enlarge rotor available – see buyer's guide</i>	12-13	FA381	FA381V	FA381HH	EPFA381HH	001	39	
XL 1200 V Seventy Two	14-16	FA640	FA640V	FA640HH	EPFA640HH	015	40	
XL 1200 X Forty Eight <i>Enlarge rotor available – see buyer's guide</i>	10-13	FA381	FA381V	FA381HH	EPFA381HH	001	41	
XL 1200 X Forty Eight	14-21	FA640	FA640V	FA640HH	EPFA640HH	015	42	
XR 1200	08-10			FA296HH*	EPFA296HH*	012	43	
XR 1200 X	10-12			FA296HH*	EPFA296HH*	012	44	
RH 1250 S Sportster S	21-22		FA630V	FA630HH			45	
							46	
							47	
							48	
							49	
							50	
							51	
							52	
							53	
							54	
							55	

* symbol after part# = 2 pieces required i.e. 2 pad sets or 2 rotors (twin rotor models)

REAR: AMERICAN PRODUCED MOTORCYCLES

Line #	SUFFIX OR PREFIX PAD MATERIALS AND DESCRIPTION	YEAR	REAR				
			PADS	PADS	PADS	PADS	REAR ROTOR OPTIONS
			FA Kevlar Organic Pads	V Semi-Sintered V-Pads™	HH/R Double-H™ USA-Made Sintered Pads	EPFA Premium Low Noise Street Sintered Pads	DESIGN NO. <small>See Buyers Guide for rotor style & finish options. Part nos for ordering & sizing.</small>
	HARLEY DAVIDSON® TRUCK						
1	F-150 Pick Up Truck Special Edition	00-04	DP61633				GD7154
2							
3	HARLEY-DAVIDSON® ELECTRIC						
4	LiveWire	18-21	FA266		FA266HH	EPFA266HH	
5							
6	HARLEY-DAVIDSON® SPORTSTER						
7	XL, XLH, XLCH, XLS, XLX	54-78					
8	XLH, XLCH Rivet Type	73-77	FA72	FA72V			
9	79-81 Twin front caliper	79-81	FA72	FA72V			
10	82-83 Twin Girling caliper	82-83	FA78	FA78V			
11	84-Early 87 Girling caliper	84-87	FA78	FA78V	FA78HH		
12	Late 87-99	87-99	FA200	FA200V	FA200HH	EPFA200HH	004
13	XL 50 50th Anniversary Sportster	07	FA387	FA387V	FA387HH	EPFA387HH	003
14	XLH 883 Sportster	00-03	FA400	FA400V	FA400HH	EPFA400HH	003
15	XLH 883 R Sportster Flat Track	00-03	FA400	FA400V	FA400HH	EPFA400HH	003
16	XL 883 Sportster Hugger	00-03	FA400	FA400V	FA400HH	EPFA400HH	003
17	XL 53c Sportster Custom (883cc)	00-03	FA400	FA400V	FA400HH	EPFA400HH	003
18	XL 883 Sportster Standard	04-08	FA387	FA387V	FA387HH	EPFA387HH	003
19	XL 883 C Sportster Custom	04-10	FA387	FA387V	FA387HH	EPFA387HH	003
20	XL 883 L Low	04-10	FA387	FA387V	FA387HH	EPFA387HH	003
21	XL 883 L Superlow	11-13	FA387	FA387V	FA387HH	EPFA387HH	013
22	XL 883 L Superlow Cast Wheel	14-20	FA254	FA254V	FA254HH	EPFA254HH	013
23	XL 883 N Iron	09-10	FA387	FA387V	FA387HH	EPFA387HH	003
24	XL 883 N Iron Cast Wheel	11-13	FA387	FA387V	FA387HH	EPFA387HH	013
25	XL 883 N Iron Cast Wheel	14-18	FA254	FA254V	FA254HH	EPFA254HH	013
26	XL 883 N Iron	16-21	FA254	FA254V	FA254HH	EPFA254HH	013
27	XL 883 R 100th Anniversary Edition	03	FA400	FA400V	FA400HH	EPFA400HH	003
28	XL 883 R Sportster R	05-13	FA387	FA387V	FA387HH	EPFA387HH	003
29	XL 883 R Roadster	10	FA387	FA387V	FA387HH	EPFA387HH	003
30	XL 883 R Roadster Cast Wheel	11-13	FA387	FA387V	FA387HH	EPFA387HH	013
31	XL 883 R Roadster Cast Wheel	14-15	FA254	FA254V	FA254HH	EPFA254HH	013
32	XL 1200 C Sportster Custom	00-03	FA400	FA400V	FA400HH	EPFA400HH	003
33	XL 1200 S Sportster Sport	00-03	FA400	FA400V	FA400HH	EPFA400HH	003
34	XL 1200 R Sportster Roadster	04-08	FA387	FA387V	FA387HH	EPFA387HH	003
35	XL 1200 C Sportster Custom	04-10	FA387	FA387V	FA387HH	EPFA387HH	003
36	XL 1200 C Sportster Custom Cast & Spoke Wheel	11-13	FA387	FA387V	FA387HH	EPFA387HH	003
37	XL 1200 C Custom Spoke Wheel	14-21	FA254	FA254V	FA254HH	EPFA254HH	013
38	XL 1200 CX Roadster	16-21	FA254	FA254V	FA254HH	EPFA254HH	013
39	XL 1200 L Sportster Low Spoke Wheel	07-11	FA387	FA387V	FA387HH	EPFA387HH	003
40	XL 1200 L Sportster Low Cast Wheel	07-11	FA387	FA387V	FA387HH	EPFA387HH	013
41	XL 1200 N Nightster Spoke Wheel	08-12	FA387	FA387V	FA387HH	EPFA387HH	003
42	XL 1200 T Superlow	14-21	FA254	FA254V	FA254HH	EPFA254HH	013
43	XL 1200 V Seventy Two	12-13	FA387	FA387V	FA387HH	EPFA387HH	003
44	XL 1200 V Seventy Two	14-16	FA254	FA254V	FA254HH	EPFA254HH	013
45	XL 1200 X Forty Eight	10-13	FA387	FA387V	FA387HH	EPFA387HH	003
46	XL 1200 X Forty Eight	14-21	FA254	FA254V	FA254HH	EPFA254HH	013
47	XR 1200	08-10	FA387	FA387V	FA387HH	EPFA387HH	013
48	XR 1200 X	10-12	FA387	FA387V	FA387HH	EPFA387HH	013
49	RH 1250 S Sportster S	21-22	TBC	TBC	TBC		
50							
51							
52							
53							
54							
55							

* symbol after part# = 2 pieces required i.e. 2 pad sets or 2 rotors (twin rotor models)

Part numbers, prefixes, suffixes, photos and illustrations shown in this catalog are trademarks and/or copyrights of EBC Brakes or the trademark owner A C Freeman Investments Ltd and use without express written permission of the owners is punishable by law.

All names & numbers are for reference purposes only. ® Registered trademarks of Harley—Davidson® Motor Corp or Buell.
NOTE: — Some models may have a second rotor fitted as an optional extra. Please double check with your customer exactly which side the front rotor is fitted and if twin rotor or single.

Ⓢ This symbol indicates a rotor made of billet steel, and should be only used with EBC FA Kevlar® Organic or Vee pads.

**BRAKE
APPLICATIONS**

FRONT: AMERICAN PRODUCED MOTORCYCLES

APPLICATIONS

BRAKE

★ This symbol indicates a rotor made of billet steel, and should be only used with EBC FA Kevlar® Organic or Vee pads.

			FRONT					
			PADS	PADS	PADS	PADS	FRONT ROTOR OPTIONS	
			FA	V	HH/R	EPFA	DESIGN NO.	
SUFFIX OR PREFIX PAD MATERIALS AND DESCRIPTION			Kevlar Organic Pads	Semi-Sintered V-Pads™	Double-HT™ USA-Made Sintered Pads	Premium Low Noise Street Sintered Pads	See Buyers Guide for rotor style & finish options. Part nos for ordering & sizing.	Line #
HARLEY-DAVIDSON® STREET								
XG 500 Street 494cc	14-15		FA643	FA643V	FA643HH		MD531	1
XG 500 Street 300mm Discs	16-21		FA209/2	FA209/2V	FA209/2HH		022	2
XG 750 Street 749cc	14-15		FA643	FA643V	FA643HH		MD531	3
XG 750 Street 300mm Discs	16-21		FA209/2	FA209/2V	FA209/2HH		022	4
XG 750 Street Rod 300mm Discs	17-21		FA209/2	FA209/2V	FA209/2HH		022	5
HARLEY-DAVIDSON® DYNA								
FX, FXE Rivet type	73-77		FA26					8
FX, FXE, FXS Late 78-83	78-83		FA71	FA71V				9
FX, FXE, FXS	84-86		FA94*	FA94V*	FA94HH*	EPFA94HH*	002	10
FXWG, FXSB	83		FA71	FA71V				11
FL, FLH	49-71							12
FL, FLH	58-62							13
FL, FLH Banana caliper	72-84		FA24/2	FA24/2V				14
FL, FLH Banana caliper	72-80		FA24/2	FA24/2V				15
FL, FLH	81-84		FA24/2	FA24/2V				16
FXD/L/WG, FXR/S/T/D/LR	82-83		FA71	FA71V				17
FXD/L/WG, FXR/S/T/D/R	84-Early 87		FA94*	FA94V*	FA94HH*	EPFA94HH*	002	18
FXD/L/WG, FXR/S/T/D, FXLR <i>Oversize rotor available – see buyer's guide</i>	Late 87-99		FA94*	FA94V*	FA94HH*	EPFA94HH*	002	19
FLD Switchback	12-16			FA457V	FA457HH	EPFA457HH	007	20
FXD Super Glide <i>Oversize rotor available – see buyer's guide</i>	00-03		FA400	FA400V	FA400HH	EPFA400HH	001	21
FXD Super Glide Cast Wheel <i>Oversize rotor available – see buyer's guide</i>	08-10			FA457V	FA457HH	EPFA457HH	007	22
FXDF Fat Bob Cast Wheel <i>Oversize rotor available – see buyer's guide</i>	08-17			FA457V*	FA457HH*	EPFA457HH*	009	23
FXDX Super Glide Sport <i>Oversize rotor available – see buyer's guide</i>	00-03		FA400*	FA400V*	FA400HH*	EPFA400HH*	001	24
FXDL Low Rider <i>Oversize rotor available – see buyer's guide</i>	00-03		FA400*	FA400V*	FA400HH*	EPFA400HH*	001	25
FXDWG Wide Glide <i>Oversize rotor available – see buyer's guide</i>	00-03		FA400*	FA400V*	FA400HH*	EPFA400HH*	001	26
FXDWG Wide Glide Spoke Wheel <i>Oversize rotor available – see buyer's guide</i>	08			FA457V	FA457HH	EPFA457HH	009	27
FXDS-CON Dyna Convertible <i>Oversize rotor available – see buyer's guide</i>	00-02		FA400*	FA400V*	FA400HH*	EPFA400HH*	001	28
FXDXT Superglide T-Sport <i>Oversize rotor available – see buyer's guide</i>	01-03		FA400*	FA400V*	FA400HH*	EPFA400HH*	001	29
FXDi Super Glide 1450 <i>Oversize rotor available – see buyer's guide</i>	04-05		FA400	FA400V	FA400HH	EPFA400HH	001	30
FXDi 35 35th Anniversary Super Glide Spoke Wheel <i>Oversize rotor available – see buyer's guide</i>	06		FA400	FA400V	FA400HH	EPFA400HH	009	31
FXDXi Super Glide Sport <i>Oversize rotor available – see buyer's guide</i>	04-05		FA400*	FA400V*	FA400HH*	EPFA400HH*	001	32
FXDLi Low Rider 1450 <i>Oversize rotor available – see buyer's guide</i>	04-05		FA400	FA400V	FA400HH	EPFA400HH	001	33
FXDLi Dyna Low Rider Spoke Wheel <i>Oversize rotor available – see buyer's guide</i>	06		FA400	FA400V	FA400HH	EPFA400HH	009	34
FXDWGi Wide Glide 1450 <i>Oversize rotor available – see buyer's guide</i>	04-05		FA400	FA400V	FA400HH	EPFA400HH	001	35
FXDWGi Dyna Wide Glide Spoke Wheel <i>Oversize rotor available – see buyer's guide</i>	06-07		FA400	FA400V	FA400HH	EPFA400HH	009	36
FXDWG Dyna Wide Glide Spoke Wheel <i>Oversize rotor available – see buyer's guide</i>	08-20			FA457V	FA457HH	EPFA457HH	009	37
FXDC/FXDCi Super Glide Custom <i>Oversize rotor available – see buyer's guide</i>	05		FA400	FA400V	FA400HH	EPFA400HH	001	38
FXDCi Dyna Superglide Custom Spoke Wheel <i>Oversize rotor available – see buyer's guide</i>	06-07		FA400	FA400V	FA400HH	EPFA400HH	009	39
FXDC Super Glide Custom Spoke Wheel <i>Oversize rotor available – see buyer's guide</i>	08-14			FA457V	FA457HH	EPFA457HH	009	40
FXDBi Street Bob Spoke Wheel <i>Oversize rotor available – see buyer's guide</i>	06-07		FA400	FA400V	FA400HH	EPFA400HH	009	41
FXDB Street Bob Spoke Wheel	08-21			FA457V	FA457HH	EPFA457HH	009	42
FXDBC Street Bob LTD	16			FA457V*	FA457HH*	EPFA457HH*	009	43
FXDi Super Glide Cast Wheel <i>Oversize rotor available – see buyer's guide</i>	06-07		FA400	FA400V	FA400HH	EPFA400HH	007	44
FXDLi Low Rider Cast Wheel	06-07		FA400	FA400V	FA400HH	EPFA400HH	007	45
FXDLi Low Rider Spoke Wheel <i>Oversize rotor available – see buyer's guide</i>	06-07		FA400	FA400V	FA400HH	EPFA400HH	009	46
FXDL Low Rider Cast Wheel	08-13			FA457V	FA457HH	EPFA457HH	007	47
FXDL Low Rider Spoke Wheel <i>Oversize rotor available – see buyer's guide</i>	08-09			FA457V	FA457HH	EPFA457HH	009	48
FXDL Low Rider Cast Wheel <i>Oversize rotor available – see buyer's guide</i>	14-17			FA457V*	FA457HH*	EPFA457HH*	007	49
FXDL Low Rider Spoke Wheel <i>Oversize rotor available – see buyer's guide</i>	14-17			FA457V*	FA457HH*	EPFA457HH*	009	50
FXDCi Superglide Custom Cast Wheel <i>Oversize rotor available – see buyer's guide</i>	06		FA400	FA400V	FA400HH	EPFA400HH	007	51
								52
								53
								54
								55

* symbol after part# = 2 pieces required i.e. 2 pad sets or 2 rotors (twin rotor models)

REAR: AMERICAN PRODUCED MOTORCYCLES

Line #	SUFFIX OR PREFIX PAD MATERIALS AND DESCRIPTION	YEAR	REAR				
			PADS	PADS	PADS	PADS	REAR ROTOR OPTIONS
			FA	V	HH/R	EPFA	DESIGN NO.
HARLEY-DAVIDSON® STREET							
1	XG 500 Street 494cc	14-15		FA643V	FA643HH		MD532
2	XG 500 Street 300mm Discs	16-21		FA181V	FA181HH		023
3	XG 750 Street 749cc	14-15		FA643V	FA643HH		MD532
4	XG 750 Street 300mm Discs	16-21		FA181V	FA181HH		023
5	XG 750 Street Rod 300mm Discs	17-21		FA181V	FA181HH		023
HARLEY-DAVIDSON® DYNA							
8	FX, FXE Rivet type	73-77	FA24/2	FA24/2V			
9	FX, FXE, FXS Late 78-83	78-83	FA24/2	FA24/2V			
10	FX, FXE, FXS	84-86	FA78	FA78V	FA78HH		
11	FXWG, FXSB	83	FA78	FA78V	FA78HH		
12	FL, FLH	49-71					
13	FL, FLH	58-62					
14	FL, FLH Banana caliper	72-84	FA24/2	FA24/2V			
15	FL, FLH Banana caliper	72-80	FA24/2	FA24/2V			
16	FL, FLH	81-84	FA79	FA79V			
17	FXD/L/WG, FXR/S/T/D/LR	82-83	FA78	FA78V	FA78HH		
18	FXD/L/WG, FXR/S/T/D/R	84-Early 87	FA78	FA78V	FA78HH		
19	FXD/L/WG, FXR/S/T/D, FXLR	Late 87-99	FA200	FA200V	FA200HH	EPFA200HH	004
20	FLD Switchback	12-16		FA458V	FA458HH	EPFA458HH	003
21	FXD Super Glide	00-03	FA400	FA400V	FA400HH	EPFA400HH	003
22	FXD Super Glide Cast Wheel	08-10		FA458V	FA458HH	EPFA458HH	003
23	FXDF Fat Bob Cast Wheel	08-17		FA458V	FA458HH	EPFA458HH	003
24	FXDX Super Glide Sport	00-03	FA400	FA400V	FA400HH	EPFA400HH	003
25	FXDL Low Rider	00-03	FA400	FA400V	FA400HH	EPFA400HH	003
26	FXDWG Wide Glide	00-03	FA400	FA400V	FA400HH	EPFA400HH	003
27	FXDWG Wide Glide Spoke Wheel	08		FA458V	FA458HH	EPFA458HH	003
28	FXDS-CON Dyna Convertible	00-02	FA400	FA400V	FA400HH	EPFA400HH	003
29	FXDXT Superglide T-Sport	01-03	FA400	FA400V	FA400HH	EPFA400HH	003
30	FXDi Super Glide 1450	04-05	FA400	FA400V	FA400HH	EPFA400HH	003
31	FXDi 35 35th Anniversary Super Glide Spoke Wheel	06	FA400	FA400V	FA400HH	EPFA400HH	003
32	FXDXi Super Glide Sport	04-05	FA400	FA400V	FA400HH	EPFA400HH	003
33	FXDLi Low Rider 1450	04-05	FA400	FA400V	FA400HH	EPFA400HH	003
34	FXDLi Dyna Low Rider Spoke Wheel	06	FA400	FA400V	FA400HH	EPFA400HH	003
35	FXDWGi Wide Glide 1450	04-05	FA400	FA400V	FA400HH	EPFA400HH	003
36	FXDWGi Dyna Wide Glide Spoke Wheel	06-07	FA400	FA400V	FA400HH	EPFA400HH	003
37	FXDWG Dyna Wide Glide Spoke Wheel	08-20		FA458V	FA458HH	EPFA458HH	003
38	FXDC/FXDCi Super Glide Custom	05	FA400	FA400V	FA400HH	EPFA400HH	003
39	FXDCi Dyna Superglide Custom Spoke Wheel	06-07	FA400	FA400V	FA400HH	EPFA400HH	003
40	FXDC Super Glide Custom Spoke Wheel	08-14		FA458V	FA458HH	EPFA458HH	003
41	FXDBi Street Bob Spoke Wheel	06-07	FA400	FA400V	FA400HH	EPFA400HH	003
42	FXDB Street Bob Spoke Wheel	08-21		FA458V	FA458HH	EPFA458HH	003
43	FXDBC Street Bob LTD	16		FA458V	FA458HH	EPFA458HH	003
44	FXDi Super Glide Cast Wheel	06-07	FA400	FA400V	FA400HH	EPFA400HH	003
45	FXDLi Low Rider Cast Wheel	06-07	FA400	FA400V	FA400HH	EPFA400HH	003
46	FXDLi Low Rider Spoke Wheel	06-07	FA400	FA400V	FA400HH	EPFA400HH	003
47	FXDL Low Rider Cast Wheel	08-13		FA458V	FA458HH	EPFA458HH	003
48	FXDL Low Rider Spoke Wheel	08-09		FA458V	FA458HH	EPFA458HH	003
49	FXDL Low Rider Cast Wheel	14-17		FA458V	FA458HH	EPFA458HH	003
50	FXDL Low Rider Spoke Wheel	14-17		FA458V	FA458HH	EPFA458HH	003
51	FXDCi Superglide Custom Cast Wheel	06	FA400	FA400V	FA400HH	EPFA400HH	003
52							
53							
54							
55							

* symbol after part# = 2 pieces required i.e. 2 pad sets or 2 rotors (twin rotor models)

Part numbers, prefixes, suffixes, photos and illustrations shown in this catalog are trademarks and/or copyrights of EBC Brakes or the trademark owner A C Freeman Investments Ltd and use without express written permission of the owners is punishable by law.

All names & numbers are for reference purposes only. ® Registered trademarks of Harley—Davidson® Motor Corp or Buell.
NOTE: — Some models may have a second rotor fitted as an optional extra. Please double check with your customer exactly which side the front rotor is fitted and if twin rotor or single.

Ⓢ This symbol indicates a rotor made of billet steel, and should be only used with EBC FA Kevlar® Organic or Vee pads.

**BRAKE
APPLICATIONS**

FRONT: AMERICAN PRODUCED MOTORCYCLES

APPLICATIONS

BRAKE

⚡ This symbol indicates a rotor made of billet steel, and should be only used with EBC FA Kevlar® Organic or Vee pads.

HARLEY-DAVIDSON® SOFTAIL

SUFFIX OR PREFIX PAD MATERIALS AND DESCRIPTION	YEAR	FRONT					FRONT ROTOR OPTIONS DESIGN NO.	Line #
		PADS	PADS	PADS	PADS			
		FA Kevlar Organic Pads	V Semi-Sintered V-Pads™	HH/R Double-HT™ USA-Made Sintered Pads	EPFA Premium Low Noise Street Sintered Pads	See Buyers Guide for rotor style & finish options. Part nos for ordering & sizing.		
FXST/B/C/S, FLST/C/F/S/N <i>Overize rotor available – see buyer's guide</i>	84-Early 87	FA94	FA94V	FA94HH	EPFA94HH	002	1	
FXST/B/C/S, FLST/C/F/S/N	Late 87-99	FA94	FA94V	FA94HH	EPFA94HH	002	2	
FXST/FXSTi Softail Standard	00-05	FA400	FA400V	FA400HH	EPFA400HH	001	3	
FXSTB/FXSTBi Night Train <i>Overize rotor available – see buyer's guide</i>	00-05	FA400	FA400V	FA400HH	EPFA400HH	001	4	
FXSTD/FXSTD Softail Deuce/i	00-07	FA400	FA400V	FA400HH	EPFA400HH	001	5	
FXSTS/FXSTSi Softail Springer	00-05	FA94	FA94V	FA94HH	EPFA94HH	002	6	
FLSTF/FLSTFi Fat Boy	00-06	FA400	FA400V	FA400HH	EPFA400HH	001	7	
FLSTFi Fat Boy 15th Anniversary Edition <i>Overize rotor available – see buyer's guide</i>	05	FA400	FA400V	FA400HH	EPFA400HH	001	8	
FLSTF/FLSTFi Fat Boy <i>Overize rotor available – see buyer's guide</i>	07	FA400	FA400V	FA400HH	EPFA400HH	001	9	
FLSTF Fat Boy <i>Overize rotor available – see buyer's guide</i>	08-14		FA457V	FA457HH	EPFA457HH	001	10	
FLSTF Fat Boy <i>Overize rotor available – see buyer's guide</i>	15-17			FA296HH	EPFA296HH	MD530	11	
FLFB Fat Boy <i>Overize rotor available – see buyer's guide</i>	18			FA296HH	EPFA296HH	MD530	12	
FLSTFB Fat Boy LO <i>Overize rotor available – see buyer's guide</i>	10-14		FA457V	FA457HH	EPFA457HH	001	13	
FLSTFB Fat Boy LO <i>Overize rotor available – see buyer's guide</i>	15-17			FA296HH	EPFA296HH	MD530	14	
FLBFS Fat Boy 114 <i>Overize rotor available – see buyer's guide</i>	18-22			FA296HH	EPFA296HH	MD530	15	
FLBFS Fat Boy 114 Anniversary	18			FA296HH	EPFA296HH	MD530	16	
FLSTCi/FLSTC Heritage Classic/i <i>Overize rotor available – see buyer's guide</i>	00-07	FA400	FA400V	FA400HH	EPFA400HH	001	17	
FLSTS Heritage Springer <i>Overize rotor available – see buyer's guide</i>	00-03	FA94	FA94V	FA94HH	EPFA94HH	001	18	
FLSTNi/FLSTNi Softail Deluxe <i>Overize rotor available – see buyer's guide</i>	05-07	FA400	FA400V	FA400HH	EPFA400HH	001	19	
FLSTSC/FLSTSCi Springer Classic <i>Overize rotor available – see buyer's guide</i>	05-07	FA94	FA94V	FA94HH	EPFA94HH	001	20	
FLST/FLSTi Heritage Softail <i>Overize rotor available – see buyer's guide</i>	06	FA400	FA400V	FA400HH	EPFA400HH	001	21	
FLSTSB Softail Cross Bones <i>Overize rotor available – see buyer's guide</i>	08-11	FA94	FA94V	FA94HH	EPFA94HH	001	22	
FXST/FXSTi Softail Standard <i>Overize rotor available – see buyer's guide</i>	06-07	FA400	FA400V	FA400HH	EPFA400HH	001	23	
FXST Softail Standard	08-14		FA457V	FA457HH	EPFA457HH	001	24	
FXST Softail Standard	15			FA296HH	EPFA296HH	015	25	
FXST Softail Standard	19-22			FA296HH	EPFA296HH	015	26	
FXSTB/FXSTBi Night Train Softail	06-07	FA400	FA400V	FA400HH	EPFA400HH	001	27	
FXSTB Night Train Spoke Wheel	08-09		FA457V	FA457HH	EPFA457HH	001	28	
FXSTC Softail Custom <i>Overize rotor available – see buyer's guide</i>	07	FA400	FA400V	FA400HH	EPFA400HH	001	29	
FXSTC Softail Custom Spoke Wheel	08-10		FA457V	FA457HH	EPFA457HH	001	30	
FLSTSC/FLSTSCi Springer Softail Classic <i>Overize rotor available – see buyer's guide</i>	06-07	FA94	FA94V	FA94HH	EPFA94HH	001	31	
FLSTC Heritage Softail Classic	07	FA400	FA400V	FA400HH	EPFA400HH	001	32	
FLSTC Heritage Softail Classic	08-14		FA457V	FA457HH	EPFA457HH	001	33	
FLSTC Heritage Softail Classic <i>Overize rotor available – see buyer's guide</i>	15-17			FA296HH	EPFA296HH	015	34	
FLHC Heritage Classic <i>Overize rotor available – see buyer's guide</i>	18-20			FA296HH	EPFA296HH	015	35	
FLHCS Heritage Classic 114 <i>Overize rotor available – see buyer's guide</i>	18-22			FA296HH	EPFA296HH	015	36	
FLHCS Heritage Classic 114 Anniversary <i>Overize rotor available – see buyer's guide</i>	18-20			FA296HH	EPFA296HH	015	37	
FLSTN Softail Deluxe Spoke Wheel	08-14		FA457V	FA457HH	EPFA457HH	001	38	
FLSTN Softail Deluxe	15-17			FA296HH	EPFA296HH	015	39	
FLS Softail Slim	12-14		FA457V	FA457HH	EPFA457HH	001	40	
FLS Softail Slim	15-17			FA296HH	EPFA296HH	015	41	
FLSL Softail Slim	18-20			FA296HH	EPFA296HH	015	42	
FXCW Rocker Cast Wheel	08-09		FA457V	FA457HH	EPFA457HH	001	43	
FXCWC Rocker C Cast Wheel	08-11		FA457V	FA457HH	EPFA457HH	001	44	
FXS Blackline	11-13		FA457V	FA457HH	EPFA457HH	001	45	
FXSB Breakout	13-14		FA457V	FA457HH	EPFA457HH	001	46	
FXSB Breakout	15-17			FA296HH	EPFA296HH	MD530	47	
FXBR Breakout	18-20			FA296HH	EPFA296HH	MD530	48	
FXBRS Breakout 114	18-21			FA296HH	EPFA296HH	MD530	49	
FXBRS Breakout 114 Anniversary	18-20			FA296HH	EPFA296HH	MD530	50	
FLDE Deluxe	18-20			FA296HH	EPFA296HH	015	51	
FXBB Street Bob	18-21			FA296HH	EPFA296HH	015	52	
FXFB Fat Bob	18-20			FA296HH	EPFA296HH	MD530	53	
FXBS Fat Boy	18-21			FA296HH	EPFA296HH	MD530	54	
FXLRS Low Rider S <i>Overize rotor available – see buyer's guide</i>	18-22			FA296HH	EPFA296HH	0155	55	

* symbol after part# = 2 pieces required i.e. 2 pad sets or 2 rotors (twin rotor models)

REAR: AMERICAN PRODUCED MOTORCYCLES

Line #	SUFFIX OR PREFIX PAD MATERIALS AND DESCRIPTION	YEAR	REAR				
			PADS	PADS	PADS	PADS	REAR ROTOR OPTIONS
			FA	V	HH/R	EPFA	DESIGN NO.
	HARLEY-DAVIDSON® SOFTAIL		Kevlar Organic Pads	Semi-Sintered V-Pads™	Double-H™ USA-Made Sintered Pads	Premium Low Noise Street Sintered Pads	See Buyers Guide for rotor style & finish options. Part nos for ordering & sizing.
1	FXST/B/C/S, FLST/C/F/S/N	84-Early 87	FA78	FA78V	FA78HH		
2	FXST/B/C/S, FLST/C/F/S/N	Late 87-99	FA200	FA200V	FA200HH	EPFA200HH	004
3	FXST/FXSTi Softail Standard	00-05	FA400	FA400V	FA400HH	EPFA400HH	003
4	FXSTB/FXSTBi Night Train	00-05	FA400	FA400V	FA400HH	EPFA400HH	003
5	FXSTDI/FXSTD Softail Deuce/i	00-07	FA400	FA400V	FA400HH	EPFA400HH	003
6	FXSTS/FXSTSi Softail Springer	00-05	FA400	FA400V	FA400HH	EPFA400HH	003
7	FLSTF/FLSTFi Fat Boy	00-06	FA400	FA400V	FA400HH	EPFA400HH	003
8	FLSTFi Fat Boy 15th Anniversary Edition	05	FA400	FA400V	FA400HH	EPFA400HH	003
9	FLSTF/FLSTFi Fat Boy	07	FA434	FA434V	FA434HH	EPFA434HH	003
10	FLSTF Fat Boy	08-14		FA458V	FA458HH	EPFA458HH	003
11	FLSTF Fat Boy	15-17		FA458V	FA458HH	EPFA458HH	003
12	FLFB Fat Boy	18		FA710V	FA710HH	EPFA710HH	016
13	FLSTFB Fat Boy LO	10-14		FA458V	FA458HH	EPFA458HH	003
14	FLSTFB Fat Boy LO	15-17		FA458V	FA458HH	EPFA458HH	003
15	FLFBS Fat Boy 114	18-21		FA710V	FA710HH	EPFA710HH	016
16	FLFBS Fat Boy 114 Anniversary	18		FA710V	FA710HH	EPFA710HH	016
17	FLSTCi/FLSTC Heritage Classic/i	00-07	FA400	FA400V	FA400HH	EPFA400HH	003
18	FLSTS Heritage Springer	00-03	FA400	FA400V	FA400HH	EPFA400HH	003
19	FLSTN/FLSTNi Softail Deluxe	05-07	FA400	FA400V	FA400HH	EPFA400HH	003
20	FLSTSC/FLSTSCi Springer Classic	05-07	FA400	FA400V	FA400HH	EPFA400HH	003
21	FLST/FLSTi Heritage Softail	06	FA400	FA400V	FA400HH	EPFA400HH	003
22	FLSTSB Softail Cross Bones	08-11		FA458V	FA458HH	EPFA458HH	003
23	FXST/FXSTi Softail Standard	06-07	FA434	FA434V	FA434HH	EPFA434HH	003
24	FXST Softail Standard	08-14		FA458V	FA458HH	EPFA458HH	003
25	FXST Softail Standard	15		FA458V	FA458HH	EPFA458HH	003
26	FXST Softail Standard	19-22		FA710V	FA710HH	EPFA710HH	003
27	FXSTB/FXSTBi Night Train Softail	06-07	FA434	FA434V	FA434HH	EPFA434HH	003
28	FXSTB Night Train Spoke Wheel	08-09		FA458V	FA458HH	EPFA458HH	003
29	FXSTC Softail Custom	07	FA434	FA434V	FA434HH	EPFA434HH	003
30	FXSTC Softail Custom Spoke Wheel	08-10		FA458V	FA458HH	EPFA458HH	003
31	FLSTSC/FLSTSCi Springer Softail Classic	06-07	FA400	FA400V	FA400HH	EPFA400HH	003
32	FLSTC Heritage Softail Classic	07	FA400	FA400V	FA400HH	EPFA400HH	003
33	FLSTC Heritage Softail Classic	08-14		FA458V	FA458HH	EPFA458HH	003
34	FLSTC Heritage Softail Classic	15-17		FA458V	FA458HH	EPFA458HH	003
35	FLHC Heritage Classic	18-20		FA710V	FA710HH	EPFA710HH	003
36	FLHCS Heritage Classic 114	18-21		FA710V	FA710HH	EPFA710HH	003
37	FLHCS Heritage Classic 114 Anniversary	18-20		FA710V	FA710HH	EPFA710HH	003
38	FLSTN Softail Deluxe Spoke Wheel	08-14		FA458V	FA458HH	EPFA458HH	003
39	FLSTN Softail Deluxe	15-17		FA458V	FA458HH	EPFA458HH	003
40	FLS Softail Slim	12-14		FA458V	FA458HH	EPFA458HH	003
41	FLS Softail Slim	15-17		FA458V	FA458HH	EPFA458HH	003
42	FLSL Softail Slim	18-20		FA710V	FA710HH	EPFA710HH	003
43	FXCW Rocker Cast Wheel	08-09		FA458V	FA458HH	EPFA458HH	003
44	FXCWC Rocker C Cast Wheel	08-11		FA458V	FA458HH	EPFA458HH	003
45	FXS Blackline	11-13		FA458V	FA458HH	EPFA458HH	003
46	FXSB Breakout	13-14		FA458V	FA458HH	EPFA458HH	003
47	FXSB Breakout	15-17		FA458V	FA458HH	EPFA458HH	016
48	FXBR Breakout	18-20		FA710V	FA710HH	EPFA710HH	016
49	FXBRS Breakout 114	18-21		FA710V	FA710HH	EPFA710HH	016
50	FXBRS Breakout 114 Anniversary	18-20		FA710V	FA710HH	EPFA710HH	016
51	FLDE Deluxe	18-20		FA710V	FA710HH	EPFA710HH	016
52	FXBB Street Bob	18-21		FA710V	FA710HH	EPFA710HH	016
53	FXFB Fat Bob	18-20		FA710V	FA710HH	EPFA710HH	016
54	FXBS Fat Boy	18-21		FA710V	FA710HH	EPFA710HH	016
55	FXLRS Low Rider S	18-21		FA710V	FA710HH	EPFA710HH	016

* symbol after part# = 2 pieces required i.e. 2 pad sets or 2 rotors (twin rotor models)

Part numbers, prefixes, suffixes, photos and illustrations shown in this catalog are trademarks and/or copyrights of EBC Brakes or the trademark owner A C Freeman Investments Ltd and use without express written permission of the owners is punishable by law.

All names & numbers are for reference purposes only. ® Registered trademarks of Harley—Davidson® Motor Corp or Buell.
NOTE: — Some models may have a second rotor fitted as an optional extra. Please double check with your customer exactly which side the front rotor is fitted and if twin rotor or single.

Ⓢ This symbol indicates a rotor made of billet steel, and should be only used with EBC FA Kevlar® Organic or Vee pads.

BRAKE APPLICATIONS

FRONT: AMERICAN PRODUCED MOTORCYCLES

APPLICATIONS

BRAKE

★ This symbol indicates a rotor made of billet steel, and should be only used with EBC FA Kevlar® Organic or Vee pads.

		FRONT					Line #	
		PADS	PADS	PADS	PADS	FRONT ROTOR OPTIONS		
		FA	V	HH/R	EPFA	DESIGN NO.		
SUFFIX OR PREFIX PAD MATERIALS AND DESCRIPTION		Kevlar Organic Pads	Semi-Sintered V-Pads™	Double-HT™ USA-Made Sintered Pads	Premium Low Noise Street Sintered Pads	See Buyers Guide for rotor style & finish options. Part nos for ordering & sizing.		
HARLEY-DAVIDSON®	SOFTAIL	YEAR						
FXDR 114	Oversize rotor available – see buyer's guide	18-21			FA296HH	EPFA296HH	MD530BLK	1
HARLEY-DAVIDSON® S SERIES								2
FLSB Sport Glide 1745		18-22			FA296HH	EPFA296HH	015	3
FLSS Softail Slim S	Oversize rotor available – see buyer's guide	16-20			FA296HH	EPFA296HH		4
FLSTFBS Fat Boy S		16-18			FA296HH	EPFA296HH		5
FXDLS Dyna Low Rider S	Oversize rotor available – see buyer's guide	17		FA457V*	FA457HH*	EPFA457HH*	007	6
HARLEY-DAVIDSON® TOURING								7
FLT, FLHT, FLHTCI	UltraGlide®/ElectraGlide®/ElectraGlide Classic®/Ultra Classic®	80-83		FA72V*				8
FLT, FLHT, FLHTCI	UltraGlide®/ElectraGlide®/ElectraGlide Classic®/Ultra Classic®	84-85	FA94*	FA94V*	FA94HH*	EPFA94HH*		9
FLT, FLHT, FLHTCI	UltraGlide®/ElectraGlide®/ElectraGlide Classic®/Ultra Classic®	86-99	FA94*	FA94V*	FA94HH*	EPFA94HH*	002	10
FLHR, FLHRCi Road King®, Road King Classic®	Oversize rotor available – see buyer's guide	94-99	FA94*	FA94V*	FA94HH*	EPFA94HH*	002	11
FLHRi/FLHR Road King	Oversize rotor available – see buyer's guide	00-07	FA400*	FA400V*	FA400HH*	EPFA400HH*	001	12
FLHRCi Road King Classic		00-07	FA400*	FA400V*	FA400HH*	EPFA400HH*	001	13
FLHR Road King Spoke Wheel		08-16	FA409*	FA409V*	FA409HH*	EPFA409HH*	010	14
FLHR Road King Cast Wheel	Oversize rotor available – see buyer's guide	15-21	FA409*	FA409V*	FA409HH*	EPFA409HH*	017	15
FLHRC Road King Classic	Oversize rotor available – see buyer's guide	08-20	FA409*	FA409V*	FA409HH*	EPFA409HH*	010	16
FLHT/FLHTi Electra Glide Standard		00-07	FA400*	FA400V*	FA400HH*	EPFA400HH*	001	17
FLTR/FLTR-i Road Glide		00-07	FA400*	FA400V*	FA400HH*	EPFA400HH*	001	18
FLTR Road Glide Road Glide	Oversize rotor available – see buyer's guide	08-09	FA409*	FA409V*	FA409HH*	EPFA409HH*	010	19
FLTRX Road Glide	Oversize rotor available – see buyer's guide	15-20	FA409*	FA409V*	FA409HH*	EPFA409HH*	017	20
FLTRX Road Glide Limited	Oversize rotor available – see buyer's guide	15-20	FA409*	FA409V*	FA409HH*	EPFA409HH*	017	21
FLTRX Road Glide Custom		10-12	FA409*	FA409V*	FA409HH*	EPFA409HH*	010	22
FLTRXS Road Glide Special	Oversize rotor available – see buyer's guide	15-20	FA409*	FA409V*	FA409HH*	EPFA409HH*	017	23
FLTRXSE CVO Road Glide	Oversize rotor available – see buyer's guide	21	FA409*	FA409V*	FA409HH*	EPFA409HH*	017	24
FLTRU Road Glide Ultra	Oversize rotor available – see buyer's guide	11-12	FA409*	FA409V*	FA409HH*	EPFA409HH*	010	25
FLTRU Road Glide Ultra		16-20	FA409*	FA409V*	FA409HH*	EPFA409HH*	017	26
FLHTCU-i Electra Glide Ultra Classic		00-07	FA400*	FA400V*	FA400HH*	EPFA400HH*	001	27
FLHRS/FLHRSi Road King Custom	Oversize rotor available – see buyer's guide	04-07	FA400*	FA400V*	FA400HH*	EPFA400HH*	001	28
FLHTC/FLHTCi Electra Glide Classic	Oversize rotor available – see buyer's guide	04-07	FA400*	FA400V*	FA400HH*	EPFA400HH*	001	29
FLHTC Electra Glide Classic		08-12	FA409*	FA409V*	FA409HH*	EPFA409HH*	010	30
FLHTCU Ultra Classic Electra Glide		08-13	FA409*	FA409V*	FA409HH*	EPFA409HH*	010	31
FLHTCU Ultra Classic Electra Glide	Oversize rotor available – see buyer's guide	14-20	FA409*	FA409V*	FA409HH*	EPFA409HH*	017	32
FLHTCUL Ultra Classic Electra Glide Low	Oversize rotor available – see buyer's guide	15-16	FA409*	FA409V*	FA409HH*	EPFA409HH*	017	33
FLHT Electra Glide Standard	Oversize rotor available – see buyer's guide	08-10	FA409*	FA409V*	FA409HH*	EPFA409HH*	010	34
FLHTK Electra Glide Ultra LTD	Oversize rotor available – see buyer's guide	10-13	FA409*	FA409V*	FA409HH*	EPFA409HH*	010	35
FLHTK Electra Glide Ultra LTD	Oversize rotor available – see buyer's guide	15-21	FA409*	FA409V*	FA409HH*	EPFA409HH*	017	36
FLHTKL Electra Glide Ultra LTD Low	Oversize rotor available – see buyer's guide	15-20	FA409*	FA409V*	FA409HH*	EPFA409HH*	017	37
FLHTKSE CVO Limited	Oversize rotor available – see buyer's guide	21	FA409*	FA409V*	FA409HH*	EPFA409HH*	017	38
FLHX/FLHXi Street Glide	Oversize rotor available – see buyer's guide	06-07	FA400*	FA400V*	FA400HH*	EPFA400HH*	001	39
FLHX Street Glide	Oversize rotor available – see buyer's guide	08-13	FA409*	FA409V*	FA409HH*	EPFA409HH*	010	40
FLHX Street Glide	Oversize rotor available – see buyer's guide	14-21	FA409*	FA409V*	FA409HH*	EPFA409HH*	017	41
FLHXS Street Glide Special		15-21	FA409*	FA409V*	FA409HH*	EPFA409HH*	017	42
FLHXSE CVO Street Glide		21	FA409*	FA409V*	FA409HH*	EPFA409HH*	017	43
Pan American Adventure		20-21			FA630HH*	EPFA630HH*		44
HARLEY-DAVIDSON® TRIKE								45
FLHTCUTG Tri Glide Ultra Classic Trike		09-13		FA409V*	FA409HH*	EPFA409HH*	010	46
FLHXXX Street Glide Trike		10-11		FA409V*	FA409HH*	EPFA409HH*	010	47
FLRT Freewheeler Trike		15-21	FA638*	FA638V*	FA638HH*		018	48
FLHTCUTG Tri Glide Ultra Trike		14-21	FA638*	FA638V*	FA638HH*		018	49
FLHTCUTGSE CVO Tri Glide		21	FA638*	FA638V*	FA638HH*	EPFA638HH*	018	50
								51
								52
								53
								54
								55

* symbol after part# = 2 pieces required i.e. 2 pad sets or 2 rotors (twin rotor models)

REAR: AMERICAN PRODUCED MOTORCYCLES

Line #	SUFFIX OR PREFIX PAD MATERIALS AND DESCRIPTION	YEAR	REAR				
			PADS	PADS	PADS	PADS	REAR ROTOR OPTIONS
			FA Kevlar Organic Pads	V Semi-Sintered V-Pads™	HH/R Double-H™ USA-Made Sintered Pads	EPFA Premium Low Noise Street Sintered Pads	DESIGN NO. <small>See Buyers Guide for rotor style & finish options. Part nos for ordering & sizing.</small>
HARLEY-DAVIDSON® SOFTAIL							
1	FXDR 114	18-21		FA387V	FA387HH	EPFA387HH	
HARLEY-DAVIDSON® S SERIES							
4	FLSB Sport Glide 1745	18-20		FA710V	FA710HH	EPFA710HH	016
5	FLSS Softail Slim S	16-20		FA458V	FA458HH	EPFA458HH	
6	FLSTFBS Fat Boy S	16-18		FA458V	FA458HH	EPFA458HH	
7	FXDLS Dyna Low Rider S	17		FA458V	FA458HH	EPFA458HH	003
HARLEY-DAVIDSON® TOURING							
10	FLT, FLHT, FLHTCi Ultraglide®, Electraglide®, Electraglide Classic®/Ultra Classic®	80-83	FA79	FA79V			
11	FLT, FLHT, FLHTCi Ultraglide®, Electraglide®, Electraglide Classic®/Ultra Classic®	84-1985	FA79	FA79V			
12	FLT, FLHT, FLHTCi Ultraglide®, Electraglide®, Electraglide Classic®/Ultra Classic®	86-99	FA201	FA201V	FA201HH		MD509SR ⚡
13	FLHR, FLHRCi Road King®, Road King Classic®	94-99	FA201	FA201V	FA201HH		MD509SR ⚡
14	FLHRCi Road King Classic	00-07	FA400	FA400V	FA400HH	EPFA400HH	003
15	FLHRCi Road King Classic	00-07	FA400	FA400V	FA400HH	EPFA400HH	003
16	FLHR Road King Spoke Wheel	08-16	FA409	FA409V	FA409HH	EPFA409HH	011 ⚡
17	FLHR Road King Cast Wheel	15-21	FA409	FA409V	FA409HH	EPFA409HH	011 ⚡
18	FLHRC Road King Classic	08-20	FA409	FA409V	FA409HH	EPFA409HH	011 ⚡
19	FLHT/FLHTi Electra Glide Standard	00-07	FA400	FA400V	FA400HH	EPFA400HH	003
20	FLTR/FLTR-i Road Glide	00-07	FA400	FA400V	FA400HH	EPFA400HH	003
21	FLTR Road Glide Road Glide	08-09	FA409	FA409V	FA409HH	EPFA409HH	011 ⚡
22	FLTRX Road Glide	15-20	FA409	FA409V	FA409HH	EPFA409HH	011 ⚡
23	FLTRX Road Glide Limited	15-20	FA409	FA409V	FA409HH	EPFA409HH	011 ⚡
24	FLTRX Road Glide Custom	10-12	FA409	FA409V	FA409HH	EPFA409HH	011 ⚡
25	FLTRXS Road Glide Special	15-20	FA409	FA409V	FA409HH	EPFA409HH	011 ⚡
26	FLTRXSE CVO Road Glide	21	FA409	FA409V	FA409HH	EPFA409HH	011 ⚡
27	FLTRU Road Glide Ultra	11-12	FA409	FA409V	FA409HH	EPFA409HH	011 ⚡
28	FLTRU Road Glide Ultra	16-20	FA409	FA409V	FA409HH	EPFA409HH	011 ⚡
29	FLHTCU-i Electra Glide Ultra Classic	00-07	FA400	FA400V	FA400HH	EPFA400HH	003
30	FLHRS/FLHRSi Road King Custom	04-07	FA400	FA400V	FA400HH	EPFA400HH	003
31	FLHTC/FLHTCi Electra Glide Classic	04-07	FA400	FA400V	FA400HH	EPFA400HH	003
32	FLHTC Electra Glide Classic	08-12	FA409	FA409V	FA409HH	EPFA409HH	011 ⚡
33	FLHTCU Ultra Classic Electra Glide	08-13	FA409	FA409V	FA409HH	EPFA409HH	011 ⚡
34	FLHTCU Ultra Classic Electra Glide	14-20	FA409	FA409V	FA409HH	EPFA409HH	011 ⚡
35	FLHTCUL Ultra Classic Electra Glide Low	15-16	FA409	FA409V	FA409HH	EPFA409HH	011 ⚡
36	FLHT Electra Glide Standard	08-10	FA409	FA409V	FA409HH	EPFA409HH	011 ⚡
37	FLHTK Electra Glide Ultra LTD	10-13	FA409	FA409V	FA409HH	EPFA409HH	011 ⚡
38	FLHTK Electra Glide Ultra LTD	15-21	FA409	FA409V	FA409HH	EPFA409HH	011 ⚡
39	FLHTKL Electra Glide Ultra LTD Low	15-20	FA409	FA409V	FA409HH	EPFA409HH	011 ⚡
40	FLHTKSE CVO Limited	21	FA409	FA409V	FA409HH	EPFA409HH	011 ⚡
41	FLHX/FLHXi Street Glide	06-07	FA400	FA400V	FA400HH	EPFA400HH	003
42	FLHX Street Glide	08-13	FA409	FA409V	FA409HH	EPFA409HH	011 ⚡
43	FLHX Street Glide	14-21	FA409	FA409V	FA409HH	EPFA409HH	011 ⚡
44	FLHXS Street Glide Special	15-21	FA409	FA409V	FA409HH	EPFA409HH	011 ⚡
45	FLHXSE CVO Street Glide	21	FA409	FA409V	FA409HH	EPFA409HH	011 ⚡
46	Pan American Adventure	20-21	FA213	FA213V	FA213HH		
HARLEY-DAVIDSON® TRIKE							
49	FLHTCUTG Tri Glide Ultra Classic Trike	09-13		FA605/4V ▲	FA605/4HH ▲		MD540
50	FLHXXX Street Glide Trike	10-11		FA605/4V ▲	FA605/4HH ▲		MD540
51	FLRT Freewheeler Trike	15-21	FA641/4 ▲	FA641/4V ▲	FA641/4HH ▲		MD538
52	FLHTCUTG Tri Glide Ultra Trike	14-21	FA641/4 ▲	FA641/4V ▲	FA641/4HH ▲		MD538
53	FLHTCUTGSE CVO Tri Glide	21	FA631*	FA631V*	FA631HH*		MD538
54	▲ PADS ARE SOLD IN AXLE SETS – 4 PADS PER SET						

* symbol after part# = 2 pieces required i.e. 2 pad sets or 2 rotors (twin rotor models)

Part numbers, prefixes, suffixes, photos and illustrations shown in this catalog are trademarks and/or copyrights of EBC Brakes or the trademark owner A C Freeman Investments Ltd and use without express written permission of the owners is punishable by law.

All names & numbers are for reference purposes only. ® Registered trademarks of Harley—Davidson® Motor Corp or Buell. NOTE: — Some models may have a second rotor fitted as an optional extra. Please double check with your customer exactly which side the front rotor is fitted and if twin rotor or single.

⚡ This symbol indicates a rotor made of billet steel, and should be only used with EBC FA Kevlar® Organic or Vee pads.

BRAKE APPLICATIONS

FRONT: AMERICAN PRODUCED MOTORCYCLES

APPLICATIONS

BRAKE

★ This symbol indicates a rotor made of billet steel, and should be only used with EBC FA Kevlar® Organic or Vee pads.

HARLEY-DAVIDSON® V-ROD

SUFFIX OR PREFIX PAD MATERIALS AND DESCRIPTION	YEAR	FRONT				FRONT ROTOR OPTIONS	Line #
		PADS	PADS	PADS	PADS	DESIGN NO.	
		FA	V	HH/R	EPFA	See Buyers Guide for rotor style & finish options. Part nos for ordering & sizing.	
V-Rod Hayes Caliper	02-05	FA400*	FA400V*	FA400HH*	EPFA400HH*	006	1
V-Rod Brembo Caliper	06	FA409*	FA409V*	FA409HH*	EPFA409HH*	007	2
VRSCAW V-Rod	07	FA409*	FA409V*	FA409HH*	EPFA409HH*	007	3
VRSCAW V-Rod Spoke Wheel	08-09	FA409*	FA409V*	FA409HH*	EPFA409HH*	009	4
VRSCR Street Rod	06-07	FA409*	FA409V*	FA409HH*	EPFA409HH*	007	5
VRSCD Night Rod Cast Wheel	06-08	FA409*	FA409V*	FA409HH*	EPFA409HH*	007	6
VRSCDX Night Rod Special Cast Wheel	07-17	FA409*	FA409V*	FA409HH*	EPFA409HH*	007	7
VRSC 10th Anniversary V Rod	12	FA409*	FA409V*	FA409HH*	EPFA409HH*	007	8
VRSCX V-Rod <i>Oversize rotor available – see buyer's guide</i>	07	FA409*	FA409V*	FA409HH*	EPFA409HH*	009	9
VRSCF V-Rod Muscle <i>Oversize rotor available – see buyer's guide</i>	09-17	FA409*	FA409V*	FA409HH*	EPFA409HH*	007	10

ATK

50 MXLQ	03	TBA					13
50 MXN/TN	03	TBA					14
50 MXA	03	TBA					15
50 MXE/MXLO	03	TBA					16
125 (2 Stroke Enduro)	03	FA181X		FA181R		TBA	17
124 (4 Stroke Enduro)	03	TBA					18
250/260 (2 Stroke Enduro)	03	FA181X		FA181R		N/A	19
250 (2T)	04	FA181X		FA181R		MD6032D	20
GT 250 R V-Twin Sport	11	FA86*		FA86HH*		MD690*	21
GV 250 V-Twin Cruiser	11	FA86		FA86HH		N/A	22
370 (2T)	04	FA181X		FA181R		MD6032D	23
450 MX	05	TBA					24
450 MX	07	FA181X		FA181R		N/A	25
450 XC	05	TBA					26
450 XC	07	FA181X		FA181R		N/A	27
450 Enduro	05	TBA					28
450 Enduro	07	FA181X		FA181R		N/A	29
450 Motard	05	TBA					30
450 Motard	07	FA95		FA95HH		N/A	31
500 Enduro	03	FA181X		FA181R		N/A	32
500/600 Super Motard	02-03	FA95		FA95HH		N/A	33
500 (2T)	04	FA181X		FA181R		MD6032D	34
560	84-85	FA47X				N/A	35
560	86	FA47X				N/A	36
560	87-88	FA47X				N/A	37
560 & other models	89-91	FA126X		FA126R		N/A	38
All models	92	FA126X				N/A	39
All models	93-96	FA135X		FA135R		N/A	40
All models	97-99	FA181X		FA181R		N/A	41
600 DTM Dirt Track Motard	03	FA95		FA95HH		N/A	42
605 Enduro	03	FA181X		FA181R		N/A	43
620 Intimidator (2T)	04	FA181X		FA181R		MD6032D	44
650 GT R V-Twin Sport	11	FA86*		FA86HH*		MD690*	45
650 GV V-Twin Cruiser	11	FA86*		FA86HH*		MD691*	46
700 Intimidator (2T)	04	FA181X		FA181R		MD6032D	47
700 Intimidator	05	TBA					48

BOMBARDIER/BRP (SEE CAN-AM FOR 07 MODELS)

DS 50 (2 stroke)	02-06	346*		346G*			51
Quest 50	03-04	346*		346G*			52
DS 90 (2 stroke/4 stroke)	02-06	346*		346G*			53
Quest 90 (2 stroke/4 stroke)	03-04	346*		346G*			54
Rally 200 (7550/7551/7552/7553)	03-04	FA83X*		FA83R*		MD6220D*	55

* symbol after part# = 2 pieces required i.e. 2 pad sets or 2 rotors (twin rotor models)

REAR: AMERICAN PRODUCED MOTORCYCLES

Line #	SUFFIX OR PREFIX PAD MATERIALS AND DESCRIPTION	YEAR	REAR				
			PADS	PADS	PADS	PADS	REAR ROTOR OPTIONS
			FA	V	HH/R	EPFA	DESIGN NO.
	HARLEY-DAVIDSON® V-ROD		Kevlar Organic Pads	Semi-Sintered V-Pads™	Double-H™ USA-Made Sintered Pads	Premium Low Noise Street Sintered Pads	See Buyers Guide for rotor style & finish options. Part nos for ordering & sizing.
1	V-Rod Hayes Caliper	02-05	FA400	FA400V	FA400HH	EPFA400HH	MD515
2	V-Rod Brembo Caliper	06	FA409	FA409V	FA409HH	EPFA409HH	008
3	VRSCAW V-Rod	07	FA409	FA409V	FA409HH	EPFA409HH	008
4	VRSCAW V-Rod Spoke Wheel	08-09	FA409	FA409V	FA409HH	EPFA409HH	008
5	VRSCR Street Rod	06-07	FA409	FA409V	FA409HH	EPFA409HH	008
6	VRSCD Night Rod Cast Wheel	06-08	FA409	FA409V	FA409HH	EPFA409HH	008
7	VRSCDX Night Rod Special Cast Wheel	07-17	FA409	FA409V	FA409HH	EPFA409HH	008
8	VRSC 10th Anniversary V Rod	12	FA409	FA409V	FA409HH	EPFA409HH	008
9	VRSCX V-Rod	07	FA409	FA409V	FA409HH	EPFA409HH	008
10	VRSCF V-Rod Muscle	09-17	FA409	FA409V	FA409HH	EPFA409HH	014 ⚙
11							
12	ATK						
13	0 MXLQ	03	TBA				
14	50 MXN/TN	03	TBA				
15	50 MXA	03	TBA				
16	50 MXE/MXLO	03	TBA				
17	125 (2 Stroke Enduro)	03	FA208X		FA208R		TBA
18	124 (4 Stroke Enduro)	03	N/A		TBA		N/A
19	250/260 (2 Stroke Enduro)	03	FA208X		FA208R		N/A
20	250 (2T)	04	FA208X		FA208R		MD6035D
21	GT 250 R V-Twin Sport	11	FA86		FA86HH		MD689
22	GV 250 V-Twin Cruiser	11	606		606G		
23	370 (2T)	04	FA208X		FA208R		MD6035D
24	450 MX	05	TBA		TBA		TBA
25	450 MX	07	FA208X		FA208R		N/A
26	450 XC	05	TBA		TBA		TBA
27	450 XC	07	FA208X		FA208R		N/A
28	450 Enduro	05	TBA		TBA		TBA
29	450 Enduro	07	FA208X		FA208R		N/A
30	450 Motard	05	TBA		TBA		TBA
31	450 Motard	07	FA131X		FA131R		N/A
32	500 Enduro	03	FA208X		FA208R		N/A
33	500/600 Super Motard	02-03	FA208X		FA208R		
34	500 (2T)	04	FA208X		FA208R		MD6035D
35	560	84-85			814G		
36	560	86			N/A		
37	560	87-88	FA115X		FA115R		
38	560 & other models	89-91	FA116				
39	All models	92	FA47X		FA47R		
40	All models	93-96	FA135X		FA135R		
41	All models	97-99	FA208X		FA208R		
42	600 DTM Dirt Track Motard	03	FA208X		FA208R		
43	605 Enduro	03	FA208X		FA208R		
44	620 Intimidator (2T)	04	FA208X		FA208R		MD6035D
45	650 GT R V-Twin Sport	11	FA86		FA86HH		MD689
46	650 GV V-Twin Cruiser	11	FA86		FA86HH		
47	700 Intimidator (2T)	04	FA208X		FA208R		MD6035D
48	700 Intimidator	05	TBA		TBA		
49							
50	BOMBARDIER/BRP (SEE CAN-AM FOR 07 MODELS)						
51	DS 50 (2 stroke)	02-06	330		330G		
52	Quest 50	03-04	330		330G		
53	DS 90 (2 stroke/4 stroke)	02-06	330		330G		
54	Quest 90 (2 stroke/4 stroke)	03-04	330		330G		
55	Rally 200 (7550/7551/7552/7553)	03-04	N/A				MD6221D

* symbol after part# = 2 pieces required i.e. 2 pad sets or 2 rotors (twin rotor models)

Part numbers, prefixes, suffixes, photos and illustrations shown in this catalog are trademarks and/or copyrights of EBC Brakes or the trademark owner A C Freeman Investments Ltd and use without express written permission of the owners is punishable by law.

All names & numbers are for reference purposes only. ® Registered trademarks of Harley—Davidson® Motor Corp or Buell.

NOTE: — Some models may have a second rotor fitted as an optional extra. Please double check with your customer exactly which side the front rotor is fitted and if twin rotor or single.

⚙ This symbol indicates a rotor made of billet steel, and should be only used with EBC FA Kevlar® Organic or Vee pads.

**BRAKE
APPLICATIONS**

FRONT: AMERICAN PRODUCED MOTORCYCLES

APPLICATIONS

BRAKE

* This symbol indicates a rotor made of billet steel, and should be only used with EBC FA Kevlar® Organic or Vee pads.

BOMBARDIER/BRP (SEE CAN-AM FOR 07 MODELS)

SUFFIX OR PREFIX
PAD MATERIALS AND DESCRIPTION

YEAR

FRONT

PADS

PADS

PADS

PADS

FRONT ROTOR
OPTIONS

FA

V

HH/R

EPFA

DESIGN NO.

Kevlar
Organic
Pads

Semi-Sintered
V-Pads™

Double-HT™
USA-Made
Sintered Pads

Premium Low
Noise Street
Sintered Pads

See Buyers Guide for
rotor style & finish
options. Part nos for
ordering & sizing.

Line #

Rally 200		05-07	FA83X*		FA83R*		MD6220D*	1
DS 250		06	FA377X*	FA377V*	FA377R*		MD6283D*	2
Outlander 330 HO	Left	04-05	FA307X		SXR307HH		MD6222D	3
	Right		FA317X		SXR317HH		MD6222D	4
Outlander 400 (7535/7716)	Left	03-04	FA307X		SXR307HH		MD6222D	5
	Right		FA317X		SXR317HH		MD6222D	6
Outlander 400 Max HO	Left	03-06	FA307X		SXR307HH		MD6222D	7
	Right		FA317X		SXR317HH		MD6222D	8
Outlander 650 HO Efi 4 x 4/HO Efi XT 4 x 4	Left	06	FA307X		SXR307HH		MD6222D	9
	Right		FA317X		SXR317HH		MD6222D	10
Outlander Max 650 HO Efi 4 x 4 HO Efi XT 4 x 4	Left	06	FA307X		SXR307HH		MD6222D	11
	Right		FA317X		SXR317HH		MD6222D	12
Outlander 800 (All models)	Left	06	FA307X		SXR307HH		MD6222D	13
	Right		FA317X		SXR317HH		MD6222D	14
Traxter (4 x 4)		99-00	FA266*		FA266R*		MD6229D	15
Traxter (4 x 4)	Left	01	FA307X		SXR307HH		MD6229D	16
	Right		FA317X		SXR317HH		MD6229D	17
Traxter XL (4 x 4)		01	FA266*		FA266R		MD6229D	18
Traxter XL (4 x 4)	Left	01-04	FA307X		SXR307HH		MD6229D	19
	Right		FA317X		SXR317HH		MD6229D	20
Traxter XT (4 x 4) (Model types 7423/7424)			FA266		FA266R*		MD6229D	21
Traxter XT (4 x 4) (Model types 7446/7452/7467/7468/7472/7481/7493/7494)	Left	01	FA307X		SXR307HH		MD6229D	22
	Right		FA317X		SXR317HH		MD6229D	23
Traxter Autoshift (Model types 7431/7432/7433/7434)		01	FA266*		FA266R*		MD6229D*	24
Traxter Autoshift (Model types 7453/7454/7461/7462/7469/7470/7471/7475/7480/7495/7496/7497/7560/7561/7562/7563/7564/7566/7567/7568/7569/7570/7595/7596/7597/7598/7599)	Left	01-05	FA307X		SXR307HH		MD6225D	26
Right	FA317X			SXR317HH		MD6225D	27	
Traxter Footshift (Model types 7439/7440/7441/7442)		01	FA266*		FA266R		MD6229D*	28
Traxter Footshift (Model types 7473/7474)	Left	01	FA307X		SXR307HH		MD6229D	29
	Right		FA317X		SXR317HH		MD6229D	30
Quest 500 (4 x 4) (Model types 7478/7515/7525/7539/7540/7546/7547/7583/7584/7713/7724/7725/7731)	Left	02-04	FA307X		SXR307HH		MD6224D	31
	Right		FA317X		SXR317HH		MD6224D	32
Traxter Max	Left	03-05	FA307X		SXR307HH		MD6245D	33
	Right		FA317X		SXR317HH		MD6245D	34
Quest 500 (2 x 4) (Model types 7541/7542/7548/7549/7585/7586/7714/7726)	Left	02	FA307X		SXR307HH		MD6224D	35
	Right		FA317X		SXR317HH		MD6224D	36
Quest 650 (2 x 4) (Model type 7582)	Left	02	FA307X		SXR307HH		MD6224D	37
	Right		FA317X		SXR317HH		MD6224D	38
Quest 650 (4 x 4) (Model types 7443/7445/7516/7517/7523/7536/7537/7543/7544/7580/7581/7730)	Left	02-04	FA307X		SXR307HH		MD6224D	39
	Right		FA317X		SXR317HH		MD6224D	40
Quest 650 XT (4 x 4) (Model types 7522/7523/7534/7545/7715/7727/7728)	Left	02	FA307X		SXR307HH		MD6224D	41
	Right		FA317X		SXR317HH		MD6224D	42
Quest Max 650	Left	03-	FA307X		SXR307HH		MD6224D	43
	Right		FA317X		SXR317HH		MD6224D	44
DS 650 (Model types 7404/7409/7463/7482/7518/7519/7587/7588 - 7483)	Left	00-05	FA307X		SXR307HH		MD6171D	45
	Right		FA317X		SXR317HH		MD6171D	46
DS 650 Baja/X	Left	01-06	FA307X		SXR307HH		MD6171D	47
	Right		FA317X		SXR317HH		MD6171D	48
Traxter Max 650	Left	04-05	FA307X		SXR307HH		MD6245D	49
	Right		FA317X		SXR317HH		MD6245D	50
Sarasota 1000 Side x Side		05	N/A				51	
Traxter XL (7920/7921)	Left	04	FA307X		SXR307HH		MD6245D	52
	Right		FA317X		SXR317HH		MD6245D	53
Quest Max/STD/XT	Left	04-05	FA307X		SXR307HH		MD6245D	54
	Right		FA317X		SXR317HH		MD6245D	55

* symbol after part# = 2 pieces required i.e. 2 pad sets or 2 rotors (twin rotor models)

REAR: AMERICAN PRODUCED MOTORCYCLES

Line #	BOMBARDIER/BRP (SEE CAN-AM FOR 07 MODELS)	SUFFIX OR PREFIX PAD MATERIALS AND DESCRIPTION	YEAR	REAR				
				PADS	PADS	PADS	PADS	REAR ROTOR OPTIONS
				FA Kevlar Organic Pads	V Semi-Sintered V-Pads™	HH/R Double-H™ USA-Made Sintered Pads	EPFA Premium Low Noise Street Sintered Pads	DESIGN NO. See Buyers Guide for rotor style & finish options. Part nos for ordering & sizing.
1	Rally 200	05-07	FA165/2X		FA165/2R		MD6285D	
2	DS 250	06	FA377X		FA377R		MD6282D	
3	Outlander 330 HO	04-05	FA307X		FA307R		MD6223D	
4								
5	Outlander 400 (7535/7716)	03-04	FA307X		FA307R		MD6223D	
6								
7	Outlander 400 Max HO	03-06	FA307X		FA307R		MD6223D	
8								
9	Outlander 650 HO Efi 4 x 4/HO Efi XT 4 x 4	06	FA307X		FA307R		MD6223D	
10								
11	Outlander Max 650 HO Efi 4 x 4 HO Efi XT 4 x 4	06	FA307X		FA307R		MD6223D	
12								
13	Outlander 800 (All models)	06	FA307X		FA307R		MD6223D	
14								
15	Traxter (4 x 4)	99-00	FA266		FA266R		MD6230D	
16	Traxter (4 x 4)	01	FA307X		FA307R		MD6230D	
17								
18	Traxter XL (4 x 4)	01	FA266		FA266R		MD6230D	
19	Traxter XL (4 x 4)	01-04	FA317X		FA317R		MD6230D	
20								
21	Traxter XT (4 x 4) (Model types 7423/7424)		FA266		FA266R		MD6230D	
22	Traxter XT (4 x 4) (Model types 7446/7452/7467/7468/7472/7481/7493/7494)	01	FA317X		FA317R		MD6230D	
23								
24	Traxter Autoshift (Model types 7431/7432/7433/7434)	01	FA266		FA266R		MD6230D	
25	Traxter Autoshift (Model types 7453/7454/7461/7462/7469/7470/7471/7475/7480/7495/7496/7497/7560/ 7561/7562/7563/7564/7566/7567/7568/7569/7570/7595/7596/7597/7598/7599)	01-05	FA317X		FA317R		MD6224D	
26								
27								
28	Traxter Footshift (Model types 7439/7440/7441/7442)	01	FA266		FA266R		MD6230D	
29	Traxter Footshift (Model types 7473/7474)	01	FA317X		FA317R		MD6230D	
30								
31	Quest 500 (4 x 4) (Model types 7478/7515/7525/7539/7540/7546/7547/7583/7584/7713/7724/7725/7731)	02-04	FA317X		FA317R		MD6225D	
32								
33	Traxter Max	03-05	FA317X		FA317R		MD6225D	
34								
35	Quest 500 (2 x 4) (Model types 7541/7542/7548/7549/7585/7586/7714/7726)	02	FA317X		FA317R		MD6225D	
36								
37	Quest 650 (2 x 4) (Model type 7582)	02	FA317X		FA317R		MD6225D	
38								
39	Quest 650 (4 x 4) (Model types 7443/7445/7516/7517/7523/7536/7537/7543/7544/7580/7581/7730)	02-04	FA317X		FA317R		MD6225D	
40								
41	Quest 650 XT (4 x 4) (Model types 7522/7523/7534/7545/7715/7727/7728)	02	FA317X		FA317R		MD6225D	
42								
43	Quest Max 650	03-	FA317X		FA317R		MD6225D	
44								
45	DS 650 (Model types 7404/7409/7463/7482/7518/7519/7587/7588 - 7483)	00-05	FA307X		FA307R		MD6172D	
46								
47	DS 650 Baja/X	01-06	FA307X		FA307R		MD6172D	
48								
49	Traxter Max 650	04-05	FA317X		FA317R		MD6225D	
50								
51	Sarasota 1000 Side x Side	05	N/A					
52	Traxter XL (7920/7921)	04	FA317X		FA317R		MD6225D	
53								
54	Quest Max/STD/XT	04-05	FA317X		FA317R		MD6225D	
55								

* symbol after part# = 2 pieces required i.e. 2 pad sets or 2 rotors (twin rotor models)

Part numbers, prefixes, suffixes, photos and illustrations shown in this catalog are trademarks and/or copyrights of EBC Brakes or the trademark owner A C Freeman Investments Ltd and use without express written permission of the owners is punishable by law.

BRAKE
 APPLICATIONS

All names & numbers are for reference purposes only. ® Registered trademarks of Harley—Davidson® Motor Corp or Buell.
NOTE: — Some models may have a second rotor fitted as an optional extra. Please double check with your customer exactly which side the front rotor is fitted and if twin rotor or single.

Ⓢ This symbol indicates a rotor made of billet steel, and should be only used with EBC FA Kevlar® Organic or Vee pads.

FRONT: AMERICAN PRODUCED MOTORCYCLES

APPLICATIONS

BRAKE

⚡ This symbol indicates a rotor made of billet steel, and should be only used with EBC FA Kevlar® Organic or Vee pads.

BUELL		SUFFIX OR PREFIX PAD MATERIALS AND DESCRIPTION	YEAR	FRONT				FRONT ROTOR OPTIONS DESIGN NO. <small>See Buyers Guide for rotor style & finish options. Part nos for ordering & sizing.</small>	Line #
				PADS	PADS	PADS	PADS		
				FA	V	HH/R	EPFA		
M2 Cyclone (Disc has Countersunk bolt holes)			94-97	FA210	FA210V			MD719RS	1
S1 Lightning (Disc has Countersunk bolt holes)			94-97	FA210	FA210V			MD719RS	2
S2 Thunderbolt (Disc has Countersunk bolt holes)			94-97	FA210	FA210V			MD719RS	3
BS3 Thunderbolt (Disc has Countersunk bolt holes)			94-97	FA210	FA210V			MD719RS	4
M2 Cyclone (Disc has Countersunk bolt holes)			98-00	FA424		FA424HH		MD719RS	5
S1 Lightning (Disc has Countersunk bolt holes)			98-00	FA424		FA424HH		MD719RS	6
S1 White Lightning (Disc has Countersunk bolt holes)			98-00	FA424		FA424HH		MD719RS	7
S3 Thunderbolt (Disc has Countersunk bolt holes)			98-00	FA424		FA424HH		MD719RS	8
S3T Thunderbolt (Disc has Countersunk bolt holes)			98-00	FA424		FA424HH		MD719RS	9
X1 Lightning (Disc has Countersunk bolt holes)			98-00	FA424		FA424HH		MD719RS	10
M2 Cyclone (Disc has Counterbored bolt holes)			00-05	FA424		FA424HH		MD734RS	11
X1 Lightning (Disc has Counterbored bolt holes)			00-05	FA424		FA424HH		MD734RS	12
Blast			00-07	FA196	FA196V	FA196HH		MD737	13
Firebolt XB9R			02-07			FA345HH		MD735RS	14
XB9S Lightning			03-04			FA345HH		MD735RS	15
XB9SX Lightning City X			05-09			FA345HH		MD735RS	16
XB9SX Lightning			08-10			FA345HH		MD735RS	17
XB12 S Lightning			04-08			FA345HH		MD735RS	18
XB12 X Ulysses			06-10			FA345HH		MD735RS	19
XB12 XT Ulysses			08-10			FA345HH		MD735RS	20
XB12 SCG Lightning			06-08			FA345HH		MD735RS	21
XB12 Ss Lightning Long			06-08			FA345HH		MD735RS	22
XB12 Ss Lightning			09-10			FA454/HH		MD735RS	23
XB12 STT Lightning			08			FA345HH		MD735RS	24
XB12 SCG Lightning			09-10			FA454/4HH		MD735RS	25
XB12 R Firebolt			04-08			FA345HH		MD735RS	26
XB12 R Firebolt			09-10			FA454/4HH		MD735RS	27
1125 R			08-10			FA454/4HH		MD735RS	28
1125 CR			09-10			FA454/4HH		MD735RS	29
CAN AM (ATV)									
DS 70 (2 x 4) Mini 4T			08-15	346*		346G*			32
DS 90 (2 x 4) 4T			06-15	346*		346G*			33
DS 90 X (2 x 4) 4T			08-15	FA83X*		FA83R*		MD6335D*	34
Rally 200 (4A7A/B/C/D/E/F)			05-07	FA83X*		FA83R*		MD6220D*	35
DS 250 (3J7A/B/C)			06-15	FA377X*	FA377V*	FA377R*		MD6283D*	36
Outlander 400 (4 x 4 STD) (2D7A/B/C/D/E/F/G/H)	Left		07-14	FA307X		SXR307HH		MD6222D	37
	Right			FA317X		SXR317HH		MD6222D	38
Outlander 400 (XT 4 x 4) (2E7A/B/C/D/E/F)	Left		07-14	FA307X		SXR307HH		MD6222D	39
	Right			FA317X		SXR317HH		MD6222D	40
Outlander Max 400 (STD 4 x 4) (2F7B/C/D/E/F/G/H/J)	Left		07-14	FA307X		SXR307HH		MD6222D	41
	Right			FA317X		SXR317HH		MD6222D	42
Outlander Max 400 (XT 4 x 4) (2G7A/B/C/D/E)	Left		06-13	FA307X		SXR307HH		MD6222D	43
	Right			FA317X		SXR317HH		MD6222D	44
Outlander 400 EFI STD international	Left		15	FA307X		SXR307HH		MD6222D	45
	Right			FA317X		SXR317HH		MD6222D	46
DS 450 (2 x 4/EFI) road model with Hand brake			08-15			FA468R*			47
DS 450 X (2 x 4/EFI) road model with Hand brake			08-09			FA468R*			48
DS 450 Offroad model without hand brake			09-15			FA468R*			49
Outlander 450 EFI, MAX and T3	Left		18-19	FA618X		FA618R		MD6370D	50
	Right			FA617X		FA618R			51
Outlander 6x6 Max and T3	Left		19	FA618X		FA618R		MD6370D	52
	Right			FA617X					53
Outlander L 450 EFI	Left		15	FA618X		FA618R		MD6370D	54
	Right			FA617X					55

* symbol after part# = 2 pieces required i.e. 2 pad sets or 2 rotors (twin rotor models)

REAR: AMERICAN PRODUCED MOTORCYCLES

Line #	BUELL	SUFFIX OR PREFIX PAD MATERIALS AND DESCRIPTION	YEAR	REAR				
				PADS	PADS	PADS	PADS	REAR ROTOR OPTIONS
				FA Kevlar Organic Pads	V Semi-Sintered V-Pads™	HH/R Double-H™ USA-Made Sintered Pads	EPFA Premium Low Noise Street Sintered Pads	DESIGN NO. See Buyers Guide for rotor style & finish options. Part nos for ordering & sizing.
1	M2 Cyclone (Disc has Countersunk bolt holes)	94-97	FA251				MD511	
2	1 Lightning (Disc has Countersunk bolt holes)	94-97	FA251				MD511	
3	S2 Thunderbolt (Disc has Countersunk bolt holes)	94-97	FA251				MD511	
4	BS3 Thunderbolt (Disc has Countersunk bolt holes)	94-97	FA251				MD511	
5	M2 Cyclone (Disc has Countersunk bolt holes)	98-00	FA140		FA140HH		MD511	
6	S1 Lightning (Disc has Countersunk bolt holes)	FA140			FA140HH		MD511	
7	S1 White Lightning (Disc has Countersunk bolt holes)	98-00	FA140		FA140HH		MD511	
8	S3 Thunderbolt (Disc has Countersunk bolt holes)	98-00	FA140		FA140HH		MD511	
9	S3T Thunderbolt (Disc has Countersunk bolt holes)	98-00	FA140		FA140HH		MD511	
10	X1 Lightning (Disc has Countersunk bolt holes)	98-00	FA140		FA140HH		MD511	
11	M2 Cyclone (Disc has Counterbored bolt holes)	00-05	FA140		FA140HH		MD511	
12	X1 Lightning (Disc has Counterbored bolt holes)	00-05	FA140		FA140HH		MD511	
13	Blast	00-07	FA140		FA140HH		MD738	
14	Firebolt XB9R	02-07	FA140		FA140HH		MD522	
15	XB9S Lightning	03-04	FA140		FA140HH		MD522	
16	XB9SX Lightning City X	05-09	FA140		FA140HH		MD522	
17	XB9SX Lightning	08-10	FA140		FA140HH		MD522	
18	XB12 S Lightning	04-08	FA140		FA140HH		MD522	
19	XB12 X Ulysses	06-10	FA140		FA140HH		MD522	
20	XB12 XT Ulysses	08-10	FA140		FA140HH		MD522	
21	XB12 SCG Lightning	06-08	FA140		FA140HH		MD522	
22	XB12 Ss Lightning Long	06-08	FA140		FA140HH		MD522	
23	XB12 Ss Lightning	09-10	FA140		FA140HH		MD522	
24	XB12 STT Lightning	08	FA140		FA140HH		MD522	
25	XB12 SCG Lightning	09-10	FA140		FA140HH		MD522	
26	XB12 R Firebolt	04-08	FA140		FA140HH		MD522	
27	XB12 R Firebolt	09-10	FA140		FA140HH		MD522	
28	1125 R	08-10			FA460HH		N/A	
29	1125 CR	09-10			FA460HH		N/A	
30								
31	CAN AM (ATV)							
32	DS 70 (2 x 4) Mini 4T	08-15	307		307G			
33	DS 90 (2 x 4) 4T	06-15	307		307G			
34	DS 90 X (2 x 4) 4T	08-15	FA83X		FA83R		MD6334D	
35	Rally 200 (4A7A/B/C/D/E/F)	05-07	FA307X		FA307R		MD6285D	
36	DS 250 (3J7A/B/C)	06-15	FA377X		FA377R		MD6282D	
37	Outlander 400 (4 x 4 STD) (2D7A/B/C/D/E/F/G/H)	07-14	FA307X		FA307R		MD6223D	
38								
39	Outlander 400 (XT 4 x 4) (2E7A/B/C/D/E/F)	07-14	FA307X		FA307R		MD6223D	
40								
41	Outlander Max 400 (STD 4 x 4) (2F7B/C/D/E/F/G/H/J)	07-14	FA307X		FA307R		MD6223D	
42								
43	Outlander Max 400 (XT 4 x 4) (2G7A/B/C/D/E)	06-13	FA307X		FA307R		MD6223D	
44								
45	Outlander 400 EFI STD international	15	FA307X		FA307R		MD6223D	
46								
47	DS 450 (2 x 4/EFI) road model with Hand brake	08-15			FA398R			
48	DS 450 X (2 x 4/EFI) road model with Hand brake	08-09			FA398R			
49	DS 450 Offroad model without hand brake	09-15			FA398R		MD6021D	
50	Outlander 450 EFI, MAX and T3	18-19	FA618X		FA618R		MD6370D	
51								
52	Outlander 6x6 Max and T3	19	FA618X		FA618R		MD6370D	
53								
54	Outlander L 450 EFI	15						
55								

* symbol after part# = 2 pieces required i.e. 2 pad sets or 2 rotors (twin rotor models)

Part numbers, prefixes, suffixes, photos and illustrations shown in this catalog are trademarks and/or copyrights of EBC Brakes or the trademark owner A C Freeman Investments Ltd and use without express written permission of the owners is punishable by law.

All names & numbers are for reference purposes only. ® Registered trademarks of Harley—Davidson® Motor Corp or Buell.
NOTE: — Some models may have a second rotor fitted as an optional extra. Please double check with your customer exactly which side the front rotor is fitted and if twin rotor or single.

Ⓢ This symbol indicates a rotor made of billet steel, and should be only used with EBC FA Kevlar® Organic or Vee pads.

**BRAKE
APPLICATIONS**

FRONT: AMERICAN PRODUCED MOTORCYCLES

APPLICATIONS

BRAKE

✪ This symbol indicates a rotor made of billet steel, and should be only used with EBC FA Kevlar® Organic or Vee pads.

CAN-AM (ATV)			FRONT					Line #
			PADS		PADS		FRONT ROTOR OPTIONS	
			FA	V	HH/R	EPFA	DESIGN NO.	
SUFFIX OR PREFIX	PAD MATERIALS AND DESCRIPTION	YEAR	Kevlar Organic Pads	Semi-Sintered V-Pads™	Double-HT™ USA-Made Sintered Pads	Premium Low Noise Street Sintered Pads	See Buyers Guide for rotor style & finish options. Part nos for ordering & sizing.	
	Left	15	FA618X		FA618R		MD6370D	1
	Right		FA617X					2
	Left	07-12	FA307X		SXR307HH		MD6222D	3
	Right		FA317X		SXR317HH			4
	Left	07-12	FA307X		SXR307HH		MD6222D	5
	Right		FA317X		SXR317HH		MD6222D	6
	Left	07-12	FA307X		SXR307HH		MD6222D	7
	Right		FA317X		SXR317HH		MD6222D	8
	Left	07-12	FA307X		SXR307HH		MD6222D	9
	Right		FA317X		SXR317HH		MD6222D	10
	Left	13-15	FA618X				MD6370D	11
	Right		FA617X				MD6370D	12
	Left	13-14	FA618X				MD6370D	13
	Right		FA617X				MD6370D	14
	Left	15	FA618X				MD6370D	15
	Right		FA617X				MD6370D	16
	Left	15	FA618X				MD6370D	17
	Right		FA617X				MD6370D	18
	Left	07-08	FA307X		SXR307HH		MD6223D	19
	Right		FA317X		SXR317HH		MD6223D	20
	Left	09-12	FA307X		SXR307HH		MD6223D	21
	Right		FA317X		SXR317HH		MD6223D	22
	Left	12-15	FA618X		FA618R		MD6370D	23
	Right		FA617X		FA617R		MD6370D	24
	Left	17	FA618X		FA618R		MD6370D	25
	Right		FA617X		FA617R		MD6370D	26
	Left	18	FA618X		FA618R		MD6370D	27
	Right		FA617X		FA617R		MD6370D	28
	Left	18-19	FA618X		FA618R		MD6370D	29
	Right		FA617X		FA617R		MD6370D	30
	Left	19	FA618X		FA618R		MD6370D	31
	Right		FA617X		FA617R		MD6370D	32
	Left	07	FA307X		SXR307HH		MD6171D	33
	Right		FA317X		SXR317HH		MD6171D	34
	Left	07-12	FA307X		SXR307HH		MD6222D	35
	Right		FA317X		SXR317HH		MD6222D	36
	Left	07-12	FA307X		SXR307HH		MD6222D	37
	Right		FA317X		SXR317HH		MD6222D	38
	Left	07-12	FA307X		SXR307HH		MD6222D	39
	Right		FA317X		SXR317HH		MD6222D	40
	Left	07-12	FA307X		SXR307HH		MD6222D	41
	Right		FA317X		SXR317HH		MD6222D	42
	Left	13-15	FA618X		FA618R		MD6370D	43
	Right		FA617X		FA617R		MD6370D	44
	Left	15	FA618X		FA618R		MD6370D	45
	Right		FA617X		FA617R		MD6370D	46
	Left	12	FA307X		SXR307HH		MD6222D	47
	Right		FA317X		SXR317HH		MD6222D	48
	Left	13	FA618X		FA618R		MD6370D	49
	Right		FA617X		FA617R		MD6370D	50
	Left	17	FA618X		FA618R		MD6370D	51
	Right		FA617X		FA617R		MD6370D	52
	Left	18	FA618X		FA618R		MD6370D	53
	Right		FA617X		FA617R		MD6370D	54
								55

* symbol after part# = 2 pieces required i.e. 2 pad sets or 2 rotors (twin rotor models)

REAR: AMERICAN PRODUCED MOTORCYCLES

Line #	CAN-AM (ATV)	SUFFIX OR PREFIX PAD MATERIALS AND DESCRIPTION	YEAR	REAR				
				PADS	PADS	PADS	PADS	REAR ROTOR OPTIONS
				FA Kevlar Organic Pads	V Semi-Sintered V-Pads™	HH/R Double-H™ USA-Made Sintered Pads	EPFA Premium Low Noise Street Sintered Pads	DESIGN NO. See Buyers Guide for rotor style & finish options. Part nos for ordering & sizing.
1	Outlander L 450 Max EFI		15					
2								
3	Outlander 500 (STD 4 x 4) (2T7A/B/C/D)		07-12	FA307X		FA307R		MD6223D
4								
5	Outlander 500 (XT 4 x 4) (2U7A/B/C/D)		07-12	FA307X		FA307R		MD6223D
6								
7	Outlander Max 500 (STD 4 x 4) (2W7A/B/C)		07-12	FA307X		FA307R		MD6223D
8								
9	Outlander Max 500 (XT 4 x 4) (2X7A/B/C)		07-12	FA307X		FA307R		MD6223D
10								
11	Outlander 500 4 X 4 (STD/DPS/XT)		13-15					
12								
13	Outlander Max 500 4 X 4 (STD/DPS/XT)		13-14					
14								
15	Outlander 500 L EFI		15					
16								
17	Outlander Max 500 L Efi		15					
18								
19	Renegade 500 (4 x 4/EFI)		07-08	FA307X		FA307R		MD6223D
20								
21	Renegade 500 (4 x 4/EFI)		09-12	FA307X		FA307R		MD6223D
22								
23	Renegade 500 STD/EFI		12-15	FA618X		FA618R		MD6370D
24								
25	Outlander 570 Max Pro		17	FA618X		FA618R		MD6370D
26								
27	Outlander 570 T3 EFI inc (3FJD)		18	FA618X		FA618R		MD6370D
28								
29	Outlander 570 Max EFI T3 Pro inc DPS XT		18-19	FA618X		FA618R		MD6370D
30								
31	Renegade 570 EFI T3		19	FA618X		FA618R		MD6370D
32								
33	DS 650 X (3B7A/B)		07	FA307X		FA618R		MD6172D
34								
35	(ATV) Outlander 650 (4 x 4 STD) (2N7A/B/C/D/E/F/G/H)		07-12	FA307X		FA307R		MD6223D
36								
37	Outlander 650 (XT 4 x 4) (2P7A/B/C/D/E/F)		07-12	FA307X		FA307R		MD6223D
38								
39	Outlander Max 650 (STD 4 x 4) (2R7A/B/C/D/E/F/G/H/J/K)		07-12	FA307X		FA307R		MD6223D
40								
41	Outlander Max 650 (XT 4 x 4) (2S7A/B/C/D/E/F)		07-12	FA307X		FA307R		MD6223D
42								
43	Outlander 650 4x 4		13-15					
44								
45	Outlander 650 Mmr		15					
46								
47	Outlander Max 650 X-TP		12	FA307X		FA307R		MD6223D
48								
49	Outlander Max 650 4 x 4 (STD/DPS/XT)		13					
50								
51	Outlander 650 Max Pro		17	FA618X		FA618R		MD6370D
52								
53	Outlander 650 T3 EFI		18	FA618X		FA618R		MD6370D
54								
55								

* symbol after part# = 2 pieces required i.e. 2 pad sets or 2 rotors (twin rotor models)

Part numbers, prefixes, suffixes, photos and illustrations shown in this catalog are trademarks and/or copyrights of EBC Brakes or the trademark owner A C Freeman Investments Ltd and use without express written permission of the owners is punishable by law.

All names & numbers are for reference purposes only. ® Registered trademarks of Harley—Davidson® Motor Corp or Buell.

NOTE: — Some models may have a second rotor fitted as an optional extra. Please double check with your customer exactly which side the front rotor is fitted and if twin rotor or single.

Ⓢ This symbol indicates a rotor made of billet steel, and should be only used with EBC FA Kevlar® Organic or Vee pads.

**BRAKE
APPLICATIONS**

FRONT: AMERICAN PRODUCED MOTORCYCLES

APPLICATIONS

BRAKE

* This symbol indicates a rotor made of billet steel, and should be only used with EBC FA Kevlar® Organic or Vee pads.

CAN-AM (ATV)				FRONT					Line #		
				SUFFIX OR PREFIX		PADS	PADS	PADS		PADS	FRONT ROTOR OPTIONS
				PAD MATERIALS AND DESCRIPTION		FA	V	HH/R		EPFA	DESIGN NO.
			YEAR	Kevlar Organic Pads	Semi-Sintered V-Pads™	Double-HT™ USA-Made Sintered Pads	Premium Low Noise Street Sintered Pads	See Buyers Guide for rotor style & finish options. Part nos for ordering & sizing.			
Outlander 650 Max EFI T3 Pro inc DPS XT	Left		18-19	FA618X		FA618R		MD6370D	1		
	Right			FA617X		FA617R		MD6370D	2		
Outlander 650 Max 6x6 EFI T3	Left		19	FA618X		FA618R		MD6370D	3		
	Right			FA617X		FA617R		MD6370D	4		
Renegade 650 EFI T3	Left		19	FA618X		FA618R		MD6370D	5		
	Right			FA617X		FA617R		MD6370D	6		
Outlander 800 (STD 4 x 4) (2H7A/B/C/D/E/F/G/H)	Left		07-08	FA307X		SXR307HH		MD6222D	7		
	Right			FA317X		SXR317HH		MD6222D	8		
Outlander 800 (XT 4 x 4) (2J7A/B/C/D/E/F)	Left		07-08	FA307X		SXR307HH		MD6222D	9		
	Right			FA317X		SXR317HH		MD6222D	10		
Outlander 800 R EFI	Left		09	FA307X		SXR307HH		MD6222D	11		
	Right			FA317X		SXR317HH		MD6222D	12		
Outlander 800 R XT	Left		09-10	FA307X		SXR307HH		MD6222D	13		
	Right			FA317X		SXR317HH		MD6222D	14		
Outlander 800 R STD	Left		12-15	FA618X		FA618R		MD6370D	15		
	Right			FA617X		FA617R		MD6370D	16		
Outlander 800 R 4 X 4 (STD/DPS/XT/XT-P)	Left		14	FA618X		FA618R		MD6370D	17		
	Right			FA617X		FA617R		MD6370D	18		
Outlander Max 800 R EFI	Left		09-12	FA307X		SXR307HH		MD6222D	19		
	Right			FA317X		SXR317HH		MD6222D	20		
Outlander Max 800 R XT			09-12	FA307X		FA307R		MD6222D	21		
Outlander Max 800 R 4 X 4 (STD/XT/XT-P)	Left		13	FA618X		FA618R		MD6370D	22		
	Right			FA617X		FA617R		MD6370D	23		
Outlander 800 R XT	Left		12-13	FA618X		FA618R		MD6370D	24		
	Right			FA617X		FA617R		MD6370D	25		
Outlander 800 R Mmr	Left		15	FA618X		FA618R		MD6370D	26		
	Right			FA617X		FA617R		MD6370D	27		
Outlander Max 800 (Ltd 4 x 4) (2M7A/B/C)	Left		07-12	FA307X		SXR307HH		MD6222D	28		
	Right			FA317X		SXR317HH		MD6222D	29		
Outlander Max 800 (STD 4 x 4) (2K7A/B/C/D/E/F/G/H/J)	Left		07-12	FA307X		SXR307HH		MD6222D	30		
	Right			FA317X		SXR317HH		MD6222D	31		
Outlander Max 800 (XT 4 x 4) (2L7A/B/C/D/E/F)	Left		07-08	FA307X		SXR307HH		MD6222D	32		
	Right			FA317X		SXR317HH		MD6222D	33		
Outlander 800 R Xmr	Left		11-12	FA307X		SXR307HH		MD6222D	34		
	Right			FA317X		SXR317HH		MD6222D	35		
Outlander 800 R XXC	Left		11	FA307X		SXR307HH		MD6222D	36		
	Right			FA317X		SXR317HH		MD6222D	37		
Outlander Max 800 R X-TP	Left		12	FA307X		SXR307HH		MD6222D	38		
	Right			FA317X		SXR317HH		MD6222D	39		
Renegade 800 X (4 x 4/EFI)	Left		08	FA307X		SXR307HH		TBA	40		
	Right			FA317X		SXR317HH		TBA	41		
Renegade 800 (4 x 4/EFI)	Left		07-08	FA307X		SXR307HH		TBA	42		
	Right			FA317X		SXR317HH		TBA	43		
Renegade 800 R EFI	Left		09-11	FA307X		SXR307HH		TBA	44		
	Right			FA317X		SXR317HH		TBA	45		
Renegade 800 R STD EFI	Left		12-15	FA618X				MD6370D	46		
	Right			FA617X				MD6370D	47		
Renegade 800 R X	Left		09-10	FA307X		SXR307HH		MD6223D	48		
	Right			FA317X		SXR317HH		MD6223D	49		
Renegade 800 R XXC	Left		11	FA307X		SXR307HH		MD6223D	50		
	Right			FA317X		SXR317HH		MD6223D	51		
Renegade 800 R XXC	Left		12-14	FA618X				MD6370D	52		
	Right			FA617X				MD6370D	53		
Outlander 850 EFI	Left		18	FA618X				MD6370D	54		
	Right			FA617X				MD6370D	55		

* symbol after part# = 2 pieces required i.e. 2 pad sets or 2 rotors (twin rotor models)

REAR: AMERICAN PRODUCED MOTORCYCLES

Line #	CAN-AM (ATV)	SUFFIX OR PREFIX PAD MATERIALS AND DESCRIPTION	YEAR	REAR				
				PADS	PADS	PADS	PADS	REAR ROTOR OPTIONS
				FA Kevlar Organic Pads	V Semi-Sintered V-Pads™	HH/R Double-H™ USA-Made Sintered Pads	EPFA Premium Low Noise Street Sintered Pads	DESIGN NO. See Buyers Guide for rotor style & finish options. Part nos for ordering & sizing.
1	Outlander 650 Max EFI T3 Pro inc DPS XT	18-19	FA618X		FA618R		MD6370D	
2								
3	Outlander 650 Max 6x6 EFI T3	19	FA618X		FA618R		MD6370D	
4								
5	Renegade 650 EFI T3	19	FA618X		FA618R		MD6370D	
6								
7	Outlander 800 (STD 4 x 4) (2H7A/B/C/D/E/F/G/H)	07-08	FA307X		FA307R		MD6223D	
8								
9	Outlander 800 (XT 4 x 4) (2J7A/B/C/D/E/F)	07-08	FA307X		FA307R		MD6223D	
10								
11	Outlander 800 R EFI	09	FA307X		FA307R		MD6223D	
12								
13	Outlander 800 R XT	09-10	FA307X		FA307R		MD6223D	
14								
15	Outlander 800 R STD	12-15						
16								
17	Outlander 800 R 4 X 4 (STD/DPS/XT/XT-P)	14						
18								
19	Outlander Max 800 R EFI	09-12	FA307X		FA307R		MD6223D	
20								
21	Outlander Max 800 R XT	09-12	FA307X		FA307R		MD6223D	
22	Outlander Max 800 R 4 X 4 (STD/XT/XT-P)	13						
23								
24	Outlander 800 R XT	12-13						
25								
26	Outlander 800 R Mmr	15						
27								
28	Outlander Max 800 (Ltd 4 x 4) (2M7A/B/C)	07-12	FA307X		FA307R		MD6223D	
29								
30	Outlander Max 800 (STD 4 x 4) (2K7A/B/C/D/E/F/G/H/J)	07-12	FA307X		FA307R		MD6223D	
31								
32	Outlander Max 800 (XT 4 x 4) (2L7A/B/C/D/E/F)	07-08	FA307X		FA307R		MD6223D	
33								
34	Outlander 800 R Xmr	11-12	FA307X		FA307R		MD6223D	
35								
36	Outlander 800 R XXC	11	FA307X		FA307R		MD6223D	
37								
38	Outlander Max 800 R X-TP	12	FA307X		FA307R		MD6223D	
39								
40	Renegade 800 X (4 x 4/EFI)	08	FA307X		FA307R		TBA	
41								
42	Renegade 800 (4 x 4/EFI)	07-08	FA307X		FA307R		TBA	
43								
44	Renegade 800 R EFI	09-11	FA307X		FA307R		TBA	
45								
46	Renegade 800 R STD EFI	12-15	FA618X		FA618R		MD6370D	
47								
48	Renegade 800 R X	09-10	FA307X		FA307R		MD6223D	
49								
50	Renegade 800 R XXC	11	FA307X		FA307R		MD6223D	
51								
52	Renegade 800 R XXC	12-14	FA618X		FA618R		MD6370D	
53								
54	Outlander 850 EFI	18	FA618X		FA618R		MD6370D	
55								

* symbol after part# = 2 pieces required i.e. 2 pad sets or 2 rotors (twin rotor models)

Part numbers, prefixes, suffixes, photos and illustrations shown in this catalog are trademarks and/or copyrights of EBC Brakes or the trademark owner A C Freeman Investments Ltd and use without express written permission of the owners is punishable by law.

All names & numbers are for reference purposes only. ® Registered trademarks of Harley—Davidson® Motor Corp or Buell.

NOTE: — Some models may have a second rotor fitted as an optional extra. Please double check with your customer exactly which side the front rotor is fitted and if twin rotor or single.

☞ This symbol indicates a rotor made of billet steel, and should be only used with EBC FA Kevlar® Organic or Vee pads.

**BRAKE
APPLICATIONS**

FRONT: AMERICAN PRODUCED MOTORCYCLES

APPLICATIONS

BRAKE

⚡ This symbol indicates a rotor made of billet steel, and should be only used with EBC FA Kevlar® Organic or Vee pads.

			FRONT					Line #
			PADS	PADS	PADS	PADS	FRONT ROTOR OPTIONS	
			FA	V	HH/R	EPFA	DESIGN NO.	
SUFFIX OR PREFIX PAD MATERIALS AND DESCRIPTION			Kevlar Organic Pads	Semi-Sintered V-Pads™	Double-HT™ USA-Made Sintered Pads	Premium Low Noise Street Sintered Pads	See Buyers Guide for rotor style & finish options. Part nos for ordering & sizing.	
CAN-AM (ATV)	YEAR							
Outlander 850 Max	Left	17	FA618X				MD6370D	1
	Right		FA617X				MD6370D	2
Renegade 850 EFI	Left	19	FA618X				MD6370D	3
	Right		FA617X				MD6370D	4
Outlander 1000 STD	Left	12	FA618X		FA618R		MD6370D	5
	Right		FA617X		FA617R		MD6370D	6
Outlander 1000 XT	Left	12	FA618X		FA618R		MD6370D	7
	Right		FA617X		FA617R		MD6370D	8
Outlander 1000 4 x 4 (DPS/XT/XT-P)	Left	13	FA618X		FA618R		MD6370D	9
	Right		FA617X		FA617R		MD6370D	10
Outlander 1000 4 x 4 (LTD)	Left	13	FA618X		FA618R		MD6370D	11
	Right		FA617X		FA617R		MD6370D	12
Outlander 1000 4 x 4 (Xmr)	Left	13	FA618X		FA618R		MD6370D	13
	Right		FA617X		FA617R		MD6370D	14
Outlander Max 1000 4 x 4 (DPS/XT/XT-P)	Left	13	FA618X		FA618R		MD6370D	15
	Right		FA617X		FA617R		MD6370D	16
Outlander 1000 Max EFI T3 L and R	Left	17-19	FA618X		FA618R		MD6370D	17
	Right		FA617X		FA617R		MD6370D	18
Outlander 1000 EFI T3 and R	Left	17-19	FA618X		FA618R		MD6370D	19
	Right		FA617X		FA617R		MD6370D	20
Outlander 1000 6x6 EFI T3	Left	18-19	FA618X		FA618R		MD6370D	21
	Right		FA617X		FA617R		MD6370D	22
Renegade 1000 EFI T3 and R	Left	19	FA618X		FA618R		MD6370D	23
	Right		FA617X		FA617R		MD6370D	24
Outlander 6 x 6 XT	Left	14-15	FA618X		FA618R		MD6370D	25
	Right		FA617X		FA617R		MD6370D	26
Renegade 1000 STD EFI	Left	12-14	FA618X		FA618R		MD6370D	27
	Right		FA617X		FA617R		MD6370D	28
Renegade 1000 XXC	Left	12-14	FA618X		FA618R		MD6370D	29
	Right		FA617X		FA617R		MD6370D	30
CAN AM SIDE X SIDE								31
Commander Electric 9KW		13-15			FA468R*		MD6222D*	33
Commander 800 (XT/DPS)	Left	11-15	FA165X		SXR165HH		MD6366D	34
	Right		FA135X		SXR135HH		MD6366D	35
Commander 800 Single rear right disc brake	Left	11	FA165X		SXR165HH		MD6366D	36
	Right		FA135X		SXR135HH		MD6366D	37
Commander 800 Single rear right disc brake	Left	12-15	FA165X		SXR165HH		MD6366D	38
	Right		FA135X		SXR135HH		MD6366D	39
Commander 800 Supplement-IS Market /Locking rear Diff		13-14			FA398R*		MD6222D*	40
Commander 800 R (STD)	Left	11-15	FA165X		SXR165HH		MD6366D	41
	Right		FA135X		SXR135HH		MD6366D	42
Commander 800 R XT	Left	11-14	FA165X		SXR165HH		MD6366D	43
	Right		FA135X		SXR135HH		MD6366D	44
Commander 1000 EFI	Left	18-19	FA642X		SXR642HH		MD6411D	45
	Right		FA645X		SXR645HH		MD6411D	46
Defender 500cc HD5	Left	17-19	FA682X		SXR682HH		MD6396D	47
	Right		FA683X		SXR683HH		MD6396D	48
Defender 799cc	Left	16	FA682X		SXR682HH		MD6396D	49
	Right		FA683X		SXR683HH		MD6396D	50
Defender 799cc DPS	Left	16	FA682X		SXR682HH		MD6396D	51
	Right		FA683X		SXR683HH		MD6396D	52
Defender 799cc XT	Left	16	FA682X		SXR682HH		MD6396D	53
	Right		FA683X		SXR683HH		MD6396D	54
								55

* symbol after part# = 2 pieces required i.e. 2 pad sets or 2 rotors (twin rotor models)

REAR: AMERICAN PRODUCED MOTORCYCLES

Line #	CAN-AM (ATV)	SUFFIX OR PREFIX PAD MATERIALS AND DESCRIPTION	YEAR	REAR				
				PADS	PADS	PADS	PADS	REAR ROTOR OPTIONS
				FA Kevlar Organic Pads	V Semi-Sintered V-Pads™	HH/R Double-H™ USA-Made Sintered Pads	EPFA Premium Low Noise Street Sintered Pads	DESIGN NO. See Buyers Guide for rotor style & finish options. Part nos for ordering & sizing.
1	Outlander 850 Max		17	FA618X		FA618R		MD6370D
2								
3	Renegade 850 EFI		19	FA618X		FA618R		MD6370D
4								
5	Outlander 1000 STD		12					
6								
7	Outlander 1000 XT		12					
8								
9	Outlander 1000 4 x 4 (DPS/XT/XT-P)		13					
10								
11	Outlander 1000 4 x 4 (LTD)		13					
12								
13	Outlander 1000 4 x 4 (Xmr)		13					
14								
15	Outlander Max 1000 4 x 4 (DPS/XT/XT-P)		13					
16								
17	Outlander 1000 Max EFI T3 L and R		17-19	FA618X		FA618R		MD6370D
18								
19	Outlander 1000 EFI T3 and R		17-19	FA618X		FA618R		MD6370D
20								
21	Outlander 1000 6x6 EFI T3		18-19	FA618X		FA618R		MD6370D
22								
23	Renegade 1000 EFI T3 and R		19	FA618X		FA618R		MD6370D
24								
25	Outlander 6 x 6 XT		14-15	FA618X		FA618R		MD6370D
26								
27	Renegade 1000 STD EFI		12-14	FA618X		FA618R		MD6370D
28								
29	Renegade 1000 XXC		12-14	FA618X		FA618R		MD6370D
30								
31								
32	CAN AM SIDE X SIDE							
33	Commander Electric 9KW		13-15	N/A				
34	Commander 800 (XT/DPS)		11-15	FA135X		FA135R		MD6366D
35								
36	Commander 800 Single rear right disc brake		11					
37								
38	Commander 800 Single rear right disc brake		12-15					
39								
40	Commander 800 Supplement-IS Market /Locking rear Diff		13-14	N/A				
41	Commander 800 R (STD)		11-15	FA135X		FA135R		MD6366D
42								
43	Commander 800 R XT		11-14	FA135X		FA135R		MD6366D
44								
45	Commander 1000 EFI		18-19	FA135X		FA135R		MD6366D
46								
47	Defender 500cc HD5		17-19					
48								
49	Defender 799cc		16	FA684X		FA684R		MD6396D
50								
51	Defender 799cc DPS		16	FA684X		FA684R		MD6396D
52								
53	Defender 799cc XT		16	FA684X		FA684R		MD6396D
54								
55								

* symbol after part# = 2 pieces required i.e. 2 pad sets or 2 rotors (twin rotor models)

Part numbers, prefixes, suffixes, photos and illustrations shown in this catalog are trademarks and/or copyrights of EBC Brakes or the trademark owner A C Freeman Investments Ltd and use without express written permission of the owners is punishable by law.

All names & numbers are for reference purposes only. ® Registered trademarks of Harley—Davidson® Motor Corp or Buell.
NOTE: — Some models may have a second rotor fitted as an optional extra. Please double check with your customer exactly which side the front rotor is fitted and if twin rotor or single.

Ⓢ This symbol indicates a rotor made of billet steel, and should be only used with EBC FA Kevlar® Organic or Vee pads.

**BRAKE
APPLICATIONS**

FRONT: AMERICAN PRODUCED MOTORCYCLES

APPLICATIONS

BRAKE

* This symbol indicates a rotor made of billet steel, and should be only used with EBC FA Kevlar® Organic or Vee pads.

CAN-AM (SIDE X SIDE)			FRONT					FRONT ROTOR OPTIONS	Line #
			PADS	PADS	PADS	PADS	DESIGN NO.		
			FA	V	HH/R	EPFA			
SUFFIX OR PREFIX	PAD MATERIALS AND DESCRIPTION	YEAR	Kevlar Organic Pads	Semi-Sintered V-Pads™	Double-HT™ USA-Made Sintered Pads	Premium Low Noise Street Sintered Pads	See Buyers Guide for rotor style & finish options. Part nos for ordering & sizing.		
Defender 799cc XT Cab	Left	16	FA682X		SXR682HH		MD6396D	1	
	Right		FA683X		SXR683HH		MD6396D	2	
Defender Max	Left	17	FA682X		SXR682HH		MD6396D	3	
	Right		FA683X		SXR683HH		MD6396D	4	
Defender 799cc HD8	Left	17-19	FA682X		SXR682HH		MD6396D	5	
	Right		FA683X		SXR683HH		MD6396D	6	
Defender Max 799cc HD8	Left	18-19	FA682X		SXR682HH		MD6396D	7	
	Right		FA683X		SXR683HH		MD6396D	8	
Defender 976cc HD10	Left	17-19	FA682X		SXR682HH		MD6396D	9	
	Right		FA683X		SXR683HH		MD6396D	10	
Defender Max 976cc Max HD10 inc XMR	Left	18-19	FA682X		SXR682HH		MD6396D	11	
	Right		FA683X		SXR683HH		MD6396D	12	
Defender T	Left	17	FA682X		SXR682HH		MD6396D	13	
	Right		FA683X		SXR683HH		MD6396D	14	
Commander 1000 STD	Left	11-15	FA165X		SXR165HH		MD6366D	15	
	Right		FA135X		SXR135HH		MD6366D	16	
Commander 1000 Single rear right disc brake	Left	11	FA165X		SXR165HH		MD6366D	17	
	Right		FA135X		SXR135HH		MD6366D	18	
Commander 1000 Single rear right disc brake	Left	12-17	FA165X		SXR165HH		MD6366D	19	
	Right		FA135X		SXR135HH		MD6366D	20	
Commander 1000 Supplement-IS Market /Locking rear Diff		13-15			FA398R*		MD6222D*	21	
Commander 1000 (DPS)	Left	13-15	FA165X		SXR165HH		MD6366D	22	
	Right		FA135X		SXR135HH		MD6366D	23	
Commander 1000 LTD Single rear right disc brake	Left	12-14	FA165X		SXR165HH		MD6366D	24	
	Right		FA135X		SXR135HH		MD6366D	25	
Commander 1000 X	Left	11-13	FA165X		SXR165HH		MD6366D	26	
	Right		FA135X		SXR135HH		MD6366D	27	
Commander 1000 XT	Left	11-15	FA165X		SXR165HH		MD6366D	28	
	Right		FA135X		SXR135HH		MD6366D	29	
Commander 1000 XT-P	Left	14-15	FA165X		SXR165HH		MD6366D	30	
	Right		FA135X		SXR135HH		MD6366D	31	
Commander Max 1000 DPS/XT	Left	14	FA165X		SXR165HH		MD6366D	32	
	Right		FA135X		SXR135HH		MD6366D	33	
Commander Max 1000 DPS/XT	Left	15	FA642X		SXR642HH		MD6411D	34	
	Right		FA645X		SXR645HH		MD6411D	35	
Commander Max 1000 LTD	Left	15-17	FA642X		SXR642HH		MD6411D	36	
	Right		FA645X		SXR645HH		MD6411D	37	
Defender 976cc	Left	16	FA682X		SXR682HH		MD6396D	38	
	Right		FA683X		SXR683HH		MD6396D	39	
Defender 976cc DPS	Left	16	FA682X		SXR682HH		MD6396D	40	
	Right		FA683X		SXR683HH		MD6396D	41	
Defender 976cc XT	Left	16	FA682X		SXR682HH		MD6396D	42	
	Right		FA683X		SXR683HH		MD6396D	43	
Defender 976cc XT Cab	Left	16	FA682X		SXR682HH		MD6396D	44	
	Right		FA683X		SXR683HH		MD6396D	45	
Maverick 1000 Std	Left	13	FA165X		SXR165HH		MD6366D	46	
	Right		FA135X		SXR135HH		MD6366D	47	
Maverick 1000 XRS	Left	13	FA165X		SXR165HH		MD6366D	48	
	Right		FA135X		SXR135HH		MD6366D	49	
Maverick 1000 STD/XRS/XRS – DPS	Left	14-16	FA165X		SXR165HH		MD6411D	50	
	Right		FA135X		SXR135HH		MD6411D	51	
Maverick 1000 STD/XRS/XRS – DPS	Left	15	FA642X		SXR642HH		MD6411D	52	
	Right		FA645X		SXR645HH		MD6411D	53	
Maverick 1000 XDS – DPS	Left	15	FA642X		SXR642HH		MD6411D	54	
	Right		FA645X		SXR645HH		MD6411D	55	

* symbol after part# = 2 pieces required i.e. 2 pad sets or 2 rotors (twin rotor models)

REAR: AMERICAN PRODUCED MOTORCYCLES

Line #	CAN-AM (SIDE X SIDE)	SUFFIX OR PREFIX PAD MATERIALS AND DESCRIPTION	YEAR	REAR				
				PADS	PADS	PADS	PADS	REAR ROTOR OPTIONS
				FA Kevlar Organic Pads	V Semi-Sintered V-Pads™	HH/R Double-H™ USA-Made Sintered Pads	EPFA Premium Low Noise Street Sintered Pads	DESIGN NO. See Buyers Guide for rotor style & finish options. Part nos for ordering & sizing.
1	Defender 799cc XT Cab		16	FA684X		FA684R		MD6396D
2								
3	Defender Max		17	FA682X		FA682R		MD6396D
4								
5	Defender 799cc HD8		17-19	FA684X		FA684R		MD6396D
6								
7	Defender Max 799cc HD8		18-19	FA684X		FA684R		MD6396D
8								
9	Defender 976cc HD10		17-19	FA684X		FA684R		MD6396D
10								
11	Defender Max 976cc Max HD10 inc XMR		18-19	FA684X		FA684R		MD6396D
12								
13	Defender T		17	FA684X		FA684R		MD6396D
14								
15	Commander 1000 STD		11-15	FA135X		FA135R		MD6366D
16								
17	Commander 1000 Single rear right disc brake		11					
18								
19	Commander 1000 Single rear right disc brake		12-17					
20								
21	Commander 1000 Supplement-IS Market /Locking rear Diff		13-15					
22	Commander 1000 (DPS)		13-15	FA135X		FA135R		MD6366D
23								
24	Commander 1000 LTD Single rear right disc brake		12-14					
25								
26	Commander 1000 X		11-13	FA135X		FA135R		MD6366D
27								
28	Commander 1000 XT		11-15	FA135X		FA135R		MD6366D
29								
30	Commander 1000 XT-P		14-15	FA135X		FA135R		MD6366D
31								
32	Commander Max 1000 DPS/XT		14	FA307X		FA307R		MD6370D
33								
34	Commander Max 1000 DPS/XT		15	FA307X		FA307R		MD6370D
35								
36	Commander Max 1000 LTD		15-17	FA307X		FA307R		MD6370D
37								
38	Defender 976cc		16	FA684X		FA684R		MD6396D
39								
40	Defender 976cc DPS		16	FA684X		FA684R		MD6396D
41								
42	Defender 976cc XT		16	FA684X		FA684R		MD6396D
43								
44	Defender 976cc XT Cab		16	FA684X		FA684R		MD6396D
45								
46	Maverick 1000 Std		13	FA307X		FA307R		MD6370D
47								
48	Maverick 1000 XRS		13	FA307X		FA307R		MD6370D
49								
50	Maverick 1000 STD/XRS/XRS – DPS		14-16	FA307X		FA307R		MD6370D
51								
52	Maverick 1000 STD/XRS/XRS – DPS		15	FA307X		FA307R		MD6370D
53								
54	Maverick 1000 XDS – DPS		15	FA307X		FA307R		MD6370D
55								

* symbol after part# = 2 pieces required i.e. 2 pad sets or 2 rotors (twin rotor models)

Part numbers, prefixes, suffixes, photos and illustrations shown in this catalog are trademarks and/or copyrights of EBC Brakes or the trademark owner A C Freeman Investments Ltd and use without express written permission of the owners is punishable by law.

All names & numbers are for reference purposes only. ® Registered trademarks of Harley—Davidson® Motor Corp or Buell.

NOTE: — Some models may have a second rotor fitted as an optional extra. Please double check with your customer exactly which side the front rotor is fitted and if twin rotor or single.

Ⓢ This symbol indicates a rotor made of billet steel, and should be only used with EBC FA Kevlar® Organic or Vee pads.

**BRAKE
APPLICATIONS**

FRONT: AMERICAN PRODUCED MOTORCYCLES

APPLICATIONS

BRAKE

⚡ This symbol indicates a rotor made of billet steel, and should be only used with EBC FA Kevlar® Organic or Vee pads.

				FRONT					Line #
				PADS	PADS	PADS	PADS	FRONT ROTOR OPTIONS	
				FA	V	HH/R	EPFA	DESIGN NO.	
SUFFIX OR PREFIX PAD MATERIALS AND DESCRIPTION				Kevlar Organic Pads	Semi-Sintered V-Pads™	Double-HT™ USA-Made Sintered Pads	Premium Low Noise Street Sintered Pads	See Buyers Guide for rotor style & finish options. Part nos for ordering & sizing.	
CAN-AM (SIDE X SIDE)				YEAR					
Maverick 1000 XMR	Left	14-15	FA642X			SXR642HH		MD6411D	1
	Right		FA645X			SXR645HH		MD6411D	2
Maverick 1000 XXC	Left	14-16	FA165X			SXR165HH		MD6411D	3
	Right		FA135X			SXR135HH		MD6411D	4
Maverick Max 1000 Std, XRS	Left	14-15	FA642X			SXR642HH		MD6411D	5
	Right		FA645X			SXR645HH		MD6411D	6
Maverick Max 1000 XDS – DPS	Left	15-16	FA642X			SXR642HH		MD6411D	7
	Right		FA645X			SXR645HH		MD6411D	8
Maverick Max 1000 XRS – DPS	Left	14-15	FA642X			SXR642HH		MD6411D	9
	Right		FA645X			SXR645HH		MD6411D	10
Maverick Max 1000 Max	Left	16-17	FA642X			SXR642HH		MD6411D	11
	Right		FA645X			SXR645HH		MD6411D	12
Maverick Trail 800cc Trail EFI	Left	18	FA682X			SXR682HH		MD6396D	13
	Right		FA683X			SXR683HH		MD6396D	14
Maverick Trail 1000cc Trail EFI	Left	18	FA682X			SXR682HH		MD6396D	15
	Right		FA683X			SXR683HH		MD6396D	16
Maverick X3	Left	17	FA682X			SXR682HH		MD6411D	17
	Right		FA683X			SXR683HH		MD6411D	18
Maverick X3 Max	Left	17	FA682X			SXR682HH		MD6411D	19
	Right		FA683X			SXR683HH		MD6411D	20
Maverick X3 Turbo	Left	18	FA682X			SXR682HH		MD6411D	21
	Right		FA683X			SXR683HH		MD6411D	22
Maverick X3 Max Turbo	Left	18	FA682X			SXR682HH		MD6411D	23
	Right		FA683X			SXR683HH		MD6411D	24
Maverick X3 Turbo R	Left	18	FA682X			SXR682HH		MD6411D	25
	Right		FA683X			SXR683HH		MD6411D	26
Maverick X3 Max Turbo R	Left	18	FA682X			SXR682HH		MD6411D	27
	Right		FA683X			SXR683HH		MD6411D	28
Traxter T	Left	17	FA682X			FA682R		MD6396D	29
	Right		FA683X			FA683R		MD6396D	30
Traxter HD5 Single rear right disc brake	Left	17-19	FA682X			FA682R		MD6396D	31
	Right		FA683X			FA683R		MD6396D	32
Traxter HD8	Left	17-19	FA682X			FA682R		MD6396D	33
	Right		FA683X			FA683R		MD6396D	34
Traxter HD10	Left	17-19	FA682X			FA682R		MD6396D	35
	Right		FA683X			FA683R		MD6396D	36
Traxter HD10 Max	Left	17-19	FA682X			FA682R		MD6396D	37
	Right		FA683X			FA683R		MD6396D	38
Traxter T HD5	Left	18-19	FA682X			FA682R		MD6396D	39
	Right		FA683X			FA683R		MD6396D	40
Traxter T HD8	Left	18-19	FA682X			FA682R		MD6396D	41
	Right		FA683X			FA683R		MD6396D	42
Traxter T HD10	Left	18-19	FA682X			FA682R		MD6396D	43
	Right		FA683X			FA683R		MD6396D	44
CAN AM (RYKER)									
Ryker 600 Ace	Left	18-21	FA165X			SXR165HH			47
	Right		FA135X			SXR135HH			48
Ryker 900 Ace	Left	18-21	FA165X			SXR165HH			49
	Right		FA135X			SXR135HH			50
CAN AM (SPYDER)									
RS SE5	Left	08-09	FA474		FA474V			MD801	52
	Right		FA474		FA474V			MD801	53
RS SM5	Left	08-09	FA474		FA474V			MD801	54
	Right		FA474		FA474V			MD801	55

* symbol after part# = 2 pieces required i.e. 2 pad sets or 2 rotors (twin rotor models)

REAR: AMERICAN PRODUCED MOTORCYCLES

Line #	CAN-AM (SIDE X SIDE)	SUFFIX OR PREFIX PAD MATERIALS AND DESCRIPTION	YEAR	REAR				
				PADS	PADS	PADS	PADS	REAR ROTOR OPTIONS
				FA Kevlar Organic Pads	V Semi-Sintered V-Pads™	HH/R Double-H™ USA-Made Sintered Pads	EPFA Premium Low Noise Street Sintered Pads	DESIGN NO. See Buyers Guide for rotor style & finish options. Part nos for ordering & sizing.
1	Maverick 1000 XMR		14-15	FA307X		FA307R		MD6370D
2								
3	Maverick 1000 XXC		14-16	FA307X		FA307R		MD6370D
4								
5	Maverick Max 1000 Std, XRS		14-15	FA307X		FA307R		MD6370D
6								
7	Maverick Max 1000 XDS – DPS		15-16	FA307X		FA307R		MD6370D
8								
9	Maverick Max 1000 XRS – DPS		14-15	FA307X		FA307R		MD6370D
10								
11	Maverick Max 1000 Max		16-17	FA307X		FA307R		MD6370D
12								
13	Maverick Trail 800cc Trail EFI		18	FA682X		FA682R		MD6412D
14								
15	Maverick Trail 1000cc Trail EFI		18	FA682X		FA682R		MD6412D
16								
17	Maverick X3		17	FA682X		FA682R		MD6412D
18								
19	Maverick X3 Max		17	FA682X		FA682R		MD6412D
20								
21	Maverick X3 Turbo		18	FA682X		FA682R		MD6412D
22								
23	Maverick X3 Max Turbo		18	FA682X		FA682R		MD6412D
24								
25	Maverick X3 Turbo R		18	FA682X		FA682R		MD6412D
26								
27	Maverick X3 Max Turbo R		18	FA682X		FA682R		MD6412D
28								
29	Traxter T		17	FA684X		FA684R		MD6396D
30								
31	Traxter HD5 Single rear right disc brake		17-19					
32								
33	Traxter HD8		17-19	FA684X		FA684R		MD6396D
34								
35	Traxter HD10		17-19	FA684X		FA684R		MD6396D
36								
37	Traxter HD10 Max		17-19	FA682X		FA682R		MD6396D
38								
39	Traxter T HD5		18-19	FA682X		FA682R		MD6396D
40								
41	Traxter T HD8		18-19	FA682X		FA682R		MD6396D
42								
43	Traxter T HD10		18-19	FA682X		A682R		MD6396D
44								
45	CAN AM (RYKER)							
46								
47	Ryker 600 Ace		18-21	FA317X		FA317R		
48								
49	Ryker 900 Ace		18-21	FA317X		FA317R		
50								
51	CAN AM (SPYDER)							
52	RS SE5		08-09	FA473				MD802
53								
54	RS SM5		08-09	FA473				MD802
55								

* symbol after part# = 2 pieces required i.e. 2 pad sets or 2 rotors (twin rotor models)

Part numbers, prefixes, suffixes, photos and illustrations shown in this catalog are trademarks and/or copyrights of EBC Brakes or the trademark owner A C Freeman Investments Ltd and use without express written permission of the owners is punishable by law.

BRAKE
APPLICATIONS

All names & numbers are for reference purposes only. ® Registered trademarks of Harley—Davidson® Motor Corp or Buell.
NOTE: — Some models may have a second rotor fitted as an optional extra. Please double check with your customer exactly which side the front rotor is fitted and if twin rotor or single.

Ⓢ This symbol indicates a rotor made of billet steel, and should be only used with EBC FA Kevlar® Organic or Vee pads.

FRONT: AMERICAN PRODUCED MOTORCYCLES

APPLICATIONS

BRAKE

⚡ This symbol indicates a rotor made of billet steel, and should be only used with EBC FA Kevlar® Organic or Vee pads.

			FRONT					Line #
			PADS	PADS	PADS	PADS	FRONT ROTOR OPTIONS	
			FA	V	HH/R	EPFA	DESIGN NO.	
SUFFIX OR PREFIX PAD MATERIALS AND DESCRIPTION			Kevlar Organic Pads	Semi-Sintered V-Pads™	Double-HT™ USA-Made Sintered Pads	Premium Low Noise Street Sintered Pads	See Buyers Guide for rotor style & finish options. Part nos for ordering & sizing.	
CAN-AM (SPYDER)								
YEAR								
RS Phantom Black	Left	09	FA474	FA474V			MD801	1
	Right		FA474	FA474V			MD801	2
RT		10-12	FA474*	FA474V*			MD801*	3
RT LTD		10-12	FA474*	FA474V*			MD801*	4
RT-S		10-12	FA474*	FA474V*			MD801*	5
RS		10-12	FA474*	FA474V*			MD801*	6
RS-S		10-12	FA474*	FA474V*			MD801*	7
RS (Brembo Caliper)		13-16		FA630V*	FA630HH*		MD853*	8
RS-S (Brembo Caliper)		13-16		FA630V*	FA630HH*		MD853*	9
RT (3 Cyl Eng/ 6 Speed)		13-21		FA630V*	FA630HH*		MD853*	10
RT LTD (3 Cyl Eng/ 6 Speed)		13-21		FA630V*	FA630HH*		MD853*	11
RT-S (3 Cyl Eng/ 6 Speed)		13-15		FA630V*	FA630HH*		MD853*	12
RT-S (Special Series)		16-17		FA630V*	FA630HH*		MD853*	13
ST (Brembo Calipers)		13-16		FA630V*	FA630HH*		MD853*	14
ST LTD (Brembo Calipers)		13-15		FA630V*	FA630HH*		MD853*	15
ST-S (Brembo Calipers)		13-16		FA630V*	FA630HH*		MD853*	16
F3 (SE6/SM6)		15-21		FA630V*	FA630HH*		MD853*	17
F3 LTD		16-21		FA630V*	FA630HH*		MD853*	18
F3-S (SE6/SM6)		15-21		FA630V*	FA630HH*		MD853*	19
F3-S (Special Series)		16-21		FA630V*	FA630HH*		MD853*	20
F3-S Daytona 500		17		FA630V*	FA630HH*		MD853*	21
F3-T		16-21		FA630V*	FA630HH*		MD853*	22
EBR								
1190 RS (Sport)		14-15			FA454/4HH		MD735RS	25
1190 RX (Sport)		14-15			FA454/4HH		MD735RS	26
1190 SX (Naked)		14-15			FA454/4HH		MD735RS	27
INDIAN								
Chief All models Chief/Deluxe/Springfield/Road Master/Vintage		02-08	FA216/3	FA216/3V	FA216/3HH		N/A	30
Spirit All models Deluxe/Springfield/Roadblaster		02-08	FA216/3	FA216/3V	FA216/3HH		N/A	31
Scout All models Scout/Deluxe/Springfield		02-08	FA216/3	FA216/3V	FA216/3HH		N/A	32
Chief Blackhawk (Brembo calipers)		11	FA95*	FA95V*	FA95HH*		MD535*	33
Chief Blackhawk Dark (Brembo calipers)		11	FA95*	FA95V*	FA95HH*		MD535*	34
Chief		22			FA347HH			35
Chief Dark Horse		22			FA347HH			36
Chief Bobber		22			FA347HH			37
Chief Bobber Dark Horse		22			FA347HH			38
Super Chief		22			FA347HH			39
Super Chief Limited		22			FA347HH			40
Chief Classic (Brembo calipers)		11-13	FA95*	FA95V*	FA95HH*		MD535*	41
Chief Standard (Brembo calipers)		09-11	FA95*	FA95V*	FA95HH*		MD535*	42
Chief Deluxe (Brembo calipers)		09	FA95*	FA95V*	FA95HH*		MD535*	43
Chief Roadmaster (Brembo calipers)		09-11	FA95*	FA95V*	FA95HH*		MD535*	44
Chief Vintage (Brembo calipers)		09-13	FA95*	FA95V*	FA95HH*		MD535*	45
Bomber (Brembo calipers)		10-11	FA95*	FA95V*	FA95HH*		MD535*	46
Dark Horse (Brembo calipers)		10-13	FA95*	FA95V*	FA95HH*		MD535*	47
Chief Classic (Nissin calipers)		14-17			FA347HH*		TBA	48
Chief Dark Horse (Nissin calipers)		16-21			FA347HH*		TBA	49
Chief Vintage (Nissin calipers)		14-21			FA347HH*		TBA	50
Chieftain		14-21			FA347HH*		TBA	51
Chieftain Dark Horse (Nissin Calipers/Cast Wheels)		14-21			FA347HH*		TBA	52
Chieftain Limited (Nissin Calipers/Cast Wheels)		14-21			FA347HH*		TBA	53
Chieftain Elite (Nissin Calipers/Cast Wheels)		14-21			FA347HH*		TBA	54
Challenger 1800		20-21			FA630HH*			55

* symbol after part# = 2 pieces required i.e. 2 pad sets or 2 rotors (twin rotor models)

REAR: AMERICAN PRODUCED MOTORCYCLES

Line #	CAN-AM (SPYDER)	SUFFIX OR PREFIX PAD MATERIALS AND DESCRIPTION	YEAR	REAR				
				PADS	PADS	PADS	PADS	REAR ROTOR OPTIONS
				FA Kevlar Organic Pads	V Semi-Sintered V-Pads™	HH/R Double-H™ USA-Made Sintered Pads	EPFA Premium Low Noise Street Sintered Pads	DESIGN NO. See Buyers Guide for rotor style & finish options. Part nos for ordering & sizing.
1	RS Phantom Black		09	FA473				MD802
2								
3	RT		10-12	FA473				MD802
4	RT LTD		10-12	FA473				MD802
5	RT-S		10-12	FA473				MD802
6	RS		10-12	FA473				MD802
7	RS-S		10-12	FA473				MD802
8	RS (Brembo Caliper)		13-16			FA631HH		MD854
9	RS-S (Brembo Caliper)		13-16			FA631HH		MD854
10	RT (3 Cyl Eng/ 6 Speed)		13-21			FA631HH		MD854
11	RT LTD (3 Cyl Eng/ 6 Speed)		13-21			FA631HH		MD854
12	RT-S (3 Cyl Eng/ 6 Speed)		13-15			FA631HH		MD854
13	RT-S (Special Series)		16-17			FA631HH		MD854
14	ST (Brembo Calipers)		13-16			FA631HH		MD854
15	ST LTD (Brembo Calipers)		13-15			FA631HH		MD854
16	ST-S (Brembo Calipers)		13-16			FA631HH		MD854
17	F3 (SE6/SM6)		15-21			FA631HH		MD854
18	F3 LTD		16-21			FA631HH		MD854
19	F3-S (SE6/SM6)		15-21			FA631HH		MD854
20	F3-S (Special Series)		16-21			FA631HH		MD854
21	F3-S Daytona 500		17			FA631HH		MD854
22	F3-T		16-21			FA631HH		MD854
23								
24	EBR							
25	1190 RS (Sport)		14-15			FA460HH		N/A
26	1190 RX (Sport)		14-15			FA460HH		N/A
27	1190 SX (Naked)		14-15			FA460HH		N/A
28								
29	INDIAN							
30	Chief All models Chief/Deluxe/Springfield/Road Master/Vintage		02-08	FA216/3		FA216/3HH		
31	Spirit All models Deluxe/Springfield/Roadblaster		02-08	FA216/3		FA216/3HH		
32	Scout All models Scout/Deluxe/Springfield		02-08	FA216/3		FA216/3HH		
33	Chief Blackhawk (Brembo calipers)		11	N/A		FA696HH		MD535
34	Chief Blackhawk Dark (Brembo calipers)		11	N/A		FA696HH		MD535
35	Chief		22	FA196		FA196HH		
36	Chief Dark Horse		22	FA196		FA196HH		
37	Chief Bobber		22	FA196		FA196HH		
38	Chief Bobber Dark Horse		22	FA196		FA196HH		
39	Super Chief		22	FA196		FA196HH		
40	Super Chief Limited		22	FA196		FA196HH		
41	Chief Classic (Brembo calipers)		11-13	N/A		FA696HH		MD535
42	Chief Standard (Brembo calipers)		09-11	N/A		FA696HH		MD535
43	Chief Deluxe (Brembo calipers)		09	N/A		FA696HH		MD535
44	Chief Roadmaster (Brembo calipers)		09-11	N/A		FA696HH		MD535
45	Chief Vintage (Brembo calipers)		09-13	N/A		FA696HH		MD535
46	Bomber (Brembo calipers)		10-11	N/A		FA696HH		MD535
47	Dark Horse (Brembo calipers)		10-13	N/A		FA696HH		MD535
48	Chief Classic (Nissin calipers)		14-17	FA196		FA196HH		
49	Chief Dark Horse (Nissin calipers)		16-21	FA196		FA196HH		MD887BLK
50	Chief Vintage (Nissin calipers)		14-21	FA196		FA196HH		MD887BLK
51	Chieftain 14-21		FA196			FA196HH		MD887BLK
52	Chieftain Dark Horse (Nissin Calipers/Cast Wheels)		14-21	FA196		FA196HH		MD887BLK
53	Chieftain Elite (Nissin Calipers/Cast Wheels)		14-21	FA196		FA196HH		MD887BLK
54	Chieftain Elite (Nissin Calipers/Cast Wheels)		14-21	FA196		FA196HH		MD887BLK
55	Challenger 1800		20-21	FA196		FA196HH		

* symbol after part# = 2 pieces required i.e. 2 pad sets or 2 rotors (twin rotor models)

Part numbers, prefixes, suffixes, photos and illustrations shown in this catalog are trademarks and/or copyrights of EBC Brakes or the trademark owner A C Freeman Investments Ltd and use without express written permission of the owners is punishable by law.

All names & numbers are for reference purposes only. ® Registered trademarks of Harley—Davidson® Motor Corp or Buell.
NOTE: — Some models may have a second rotor fitted as an optional extra. Please double check with your customer exactly which side the front rotor is fitted and if twin rotor or single.

☞ This symbol indicates a rotor made of billet steel, and should be only used with EBC FA Kevlar® Organic or Vee pads.

**BRAKE
APPLICATIONS**

FRONT: AMERICAN PRODUCED MOTORCYCLES

APPLICATIONS

BRAKE

★ This symbol indicates a rotor made of billet steel, and should be only used with EBC FA Kevlar® Organic or Vee pads.

INDIAN	SUFFIX OR PREFIX PAD MATERIALS AND DESCRIPTION	YEAR	FRONT				FRONT ROTOR OPTIONS DESIGN NO. <small>See Buyers Guide for rotor style & finish options. Part nos for ordering & sizing.</small>	Line #
			PADS	PADS	PADS	PADS		
			FA Kevlar Organic Pads	V Semi-Sintered V-Pads™	HH/R Double-HT™ USA-Made Sintered Pads	EPFA Premium Low Noise Street Sintered Pads		
Challenger 1800 Dark Horse (Brembo calipers/cast wheels)		20-21					1	
Challenger 1800 Limited (Brembo calipers/cast wheels)		20-21					2	
Roadmaster (Nissin Calipers/Cast Wheels)		15-21			FA347HH*	TBA	3	
Roadmaster Dark Horse (Nissin Calipers/Cast Wheels)		15-21			FA347HH*	TBA	4	
Roadmaster Limited (Nissin Calipers/Cast Wheels)		15-21			FA347HH*	TBA	5	
Roadmaster Dark Horse Jack Daniel's Edition (Nissin Calipers/Cast Wheels)		21			FA347HH*	TBA	6	
Roadmaster Elite (Nissin Calipers/Cast Wheels)		15-21			FA347HH*	TBA	7	
Scout (Toso Calipers/Cast Wheels)		15-16	FA672	FA672V	FA672HH	MD534	8	
Scout		17-21	FA209/2	FA209/2V	FA209/2HH	MD534	9	
Scout Sixty		17-21	FA209/2	FA209/2V	FA209/2HH	MD534	10	
Scout Sixty (Toso Calipers/Cast Wheels)		16	FA672	FA672V	FA672HH	MD534	11	
Scout Bobber Scout Bobber		19-21	FA209/2	FA209/2V	FA209/2HH		12	
Scout Bobber Twenty Scout Bobber Twenty		19-21	FA209/2	FA209/2V	FA209/2HH		13	
Scout Bobber Sixty Scout Bobber Sixty		21	FA209/2	FA209/2V	FA209/2HH		14	
Springfield		16-21			FA347HH*	TBA	15	
Springfield Dark Horse		19-21			FA347HH*	TBA	16	
FTR 1200		18-21			FA630HH*		17	
FTR 1200 S		19-21			FA630HH*		18	
FTR 1200 S Race Replica		19-20			FA630HH*		19	
FTR 1200 Rally		20-21			FA630HH*		20	
							21	
							22	
MOTUS								
MST-01		12-13			FA322/4HH*	TBA	23	
MST		14-17	FA244*		FA244HH*	TBA	24	
MSTR-01		12-13			FA322/4HH*	TBA	25	
MSTR		14-17			FA447HH*	TBA	26	
							27	
							28	
POLARIS (ATV)								
Outlaw 50		08-18	338*		338G*		29	
Predator 50 (2 stroke)		04-07	338*		338G*		30	
Scrambler 50 (3 Wheeler)		85-86	503*		503G		31	
Scrambler 50		01-03	338*		338G*		32	
Outlaw 90		07-16	338*		338G*		33	
Predator 90		03-06	338*		338G*		34	
Scrambler 90 X		01-03	338*		338G*		35	
Sportsman 90		01-16	338*		338G*		36	
Outlaw 110		16-18	338*		338G*		37	
Phoenix 200 (AA/AB Model/Rear Drum Model)		05	FA159X*		FA159R*	MD6219D*	38	
Phoenix 200 (AC/AD Model and Following/Rear Drum Model)		06-09	FA83X*		FA83R*	MD6274D*	39	
Phoenix 200 (Rear Drum Model)		10-14			FA490R*	MD6274D*	40	
Phoenix 200 Quadricycle Model (EA/EB/Rear disc model)		05	FA159X*		FA159R*	MD6219D*	41	
Phoenix 200 Quadricycle Model (EC/ED Models/Rear disc model)		05-09	FA83X*		FA83R*	MD6274D*	42	
Phoenix 200 Quadricycle Model (Rear disc model)		10			FA490R*	MD6274D*	43	
Sawtooth 200 (Rear Drum Model)		06-07	FA83X*		FA83R*	MD6274D*	44	
Sawtooth 200 Quadricycle (Rear Disc Model)		06	FA83X*		FA83R*	MD6274D*	45	
Sawtooth 200 Quadricycle (Rear Disc Model)		08	FA83X*		FA83R*	MD6274D*	46	
250 2 x 4 / 4 x 4		90	FA159X*		FA159R*	MD6149D*	47	
250 2 x 4 / 4 x 4		93	FA159X*		FA159R*	MD6150D*	48	
250 Cyclone X		87	503*		503G*		49	
Big Boss 250 4 x 6		89-90	FA159X*		FA159R*	MD6147D*	50	
Big Boss 250 4 x 6 Middle Axle Brake		89-90	FA159X		FA159R	MD6149D*	51	
Big Boss 250 4 x 6		91-92	FA159X*		FA159R*	MD6150D*	52	
Big Boss 250 4 x 6 Middle Axle Brake		91-92	FA159X		FA159R	MD6149D*	53	
Big Boss 250 6 x 6		91	FA159X*		FA159R*	MD6149D*	54	
Big Boss 250 6 x 6 Middle Axle Brake		91	FA159X		FA159R	MD6149D*	55	

* symbol after part# = 2 pieces required i.e. 2 pad sets or 2 rotors (twin rotor models)

REAR: AMERICAN PRODUCED MOTORCYCLES

Line #	INDIAN	SUFFIX OR PREFIX PAD MATERIALS AND DESCRIPTION	YEAR	REAR				
				PADS	PADS	PADS	PADS	REAR ROTOR OPTIONS
				FA	V	HH/R	EPFA	DESIGN NO.
				Kevlar Organic Pads	Semi-Sintered V-Pads™	Double-H™ USA-Made Sintered Pads	Premium Low Noise Street Sintered Pads	See Buyers Guide for rotor style & finish options. Part nos for ordering & sizing.
1	Challenger 1800 Dark Horse (Brembo calipers/cast wheels)	20-21	FA196		FA196HH			
2	Challenger 1800 Limited (Brembo calipers/cast wheels)	20-21	FA196		FA196HH			
3	Roadmaster (Nissin Calipers/Cast Wheels)	15-21	FA196		FA196HH			MD887BLK
4	Roadmaster Dark Horse (Nissin Calipers/Cast Wheels)	15-21	FA196		FA196HH			MD887BLK
5	Roadmaster Limited (Nissin Calipers/Cast Wheels)	15-21	FA196		FA196HH			MD887BLK
6	Roadmaster Dark Horse Jack Daniel's Edition (Nissin Calipers/Cast Wheels)	21	FA196		FA196HH			MD887BLK
7	Roadmaster Elite (Nissin Calipers/Cast Wheels)	15-21	FA196		FA196HH			MD887BLK
8	Scout (Toso Calipers/Cast Wheels)	15-16	FA377X					MD534
9	Scout	17-21	FA213		FA213HH			MD534
10	Scout Sixty	17-21	FA213		FA213HH			MD534
11	Scout Sixty (Toso Calipers/Cast Wheels)	16	FA377X					MD534
12	Scout Bobber Scout Bobber	19-21	FA213		FA213HH			MD534
13	Scout Bobber Twenty Scout Bobber Twenty	19-21	FA213		FA213HH			
14	Scout Bobber Sixty Scout Bobber Sixty	21	FA213		FA213HH			
15	Springfield	16-21	FA196		FA196HH			MD887BLK
16	Springfield Dark Horse	19-21	FA196		FA196HH			MD887BLK
17	FTR 1200	18-21						MD8007
18	FTR 1200 S	19-21						MD8007
19	FTR 1200 S Race Replica	19-20						MD8007
20	FTR 1200 Rally	20-21						MD8007
21								
22	MOTUS							
23	MST-01	12-13	FA266					TBA
24	MST	14-17	FA266					TBA
25	MSTR-01	12-13	FA266					TBA
26	MSTR	14-17	FA266					TBA
27								
28	POLARIS (ATV)							
29	Outlaw 50	08-18	307		307G			
30	Predator 50 (2 stroke)	04-07	307		307G			
31	Scrambler 50 (3 Wheeler)	85-86	FA40					N/A
32	Scrambler 50	01-03	307		307G			
33	Outlaw 90	07-16	307		307G			
34	Predator 90	03-06	307		307G			
35	Scrambler 90 X	01-03	307		307G			
36	Sportsman 90	01-16	307		307G			
37	Outlaw 110	16-18	307		307G			
38	Phoenix 200 (AA/AB Model/Rear Drum Model)	05	306		306G			
39	Phoenix 200 (AC/AD Model and Following/Rear Drum Model)	06-09	306		306G			
40	Phoenix 200 (Rear Drum Model)	10-14	306		306G			
41	Phoenix 200 Quadricycle Model (EA/EB/Rear disc model)	05	FA67X		FA67R			MD6311D
42	Phoenix 200 Quadricycle Model (EC/ED Models/Rear disc model)	05-09	FA67X		FA67R			MD6311D
43	Phoenix 200 Quadricycle Model (Rear disc model)	10	FA67X		FA67R			MD6311D
44	Sawtooth 200 (Rear Drum Model)	06-07	306		306G			
45	Sawtooth 200 Quadricycle (Rear Disc Model)	06	FA67X		FA67R			MD6311D
46	Sawtooth 200 Quadricycle (Rear Disc Model)	08	FA67X		FA67R			MD6311D
47	250 2 x 4 / 4 x 4	90	FA232X		FA232R			N/A
48	250 2 x 4 / 4 x 4	93	FA232X		FA232R			N/A
49	250 Cyclone X	87	FA40					N/A
50	Big Boss 250 4 x 6	89-90	FA232X		FA232R			N/A
51	Big Boss 250 4 x 6 Middle Axle Brake	89-90						
52	Big Boss 250 4 x 6	91-92	FA232X		FA232R			N/A
53	Big Boss 250 4 x 6 Middle Axle Brake	91-92						
54	Big Boss 250 6 x 6	91	FA232X		FA232R			N/A
55	Big Boss 250 6 x 6 Middle Axle Brake	91						

* symbol after part# = 2 pieces required i.e. 2 pad sets or 2 rotors (twin rotor models)

Part numbers, prefixes, suffixes, photos and illustrations shown in this catalog are trademarks and/or copyrights of EBC Brakes or the trademark owner A C Freeman Investments Ltd and use without express written permission of the owners is punishable by law.

All names & numbers are for reference purposes only. ® Registered trademarks of Harley—Davidson® Motor Corp or Buell.
NOTE: — Some models may have a second rotor fitted as an optional extra. Please double check with your customer exactly which side the front rotor is fitted and if twin rotor or single.

☞ This symbol indicates a rotor made of billet steel, and should be only used with EBC FA Kevlar® Organic or Vee pads.

**BRAKE
APPLICATIONS**

FRONT: AMERICAN PRODUCED MOTORCYCLES

APPLICATIONS

BRAKE

✪ This symbol indicates a rotor made of billet steel, and should be only used with EBC FA Kevlar® Organic or Vee pads.

POLARIS (ATV)

SUFFIX OR PREFIX PAD MATERIALS AND DESCRIPTION	YEAR	FRONT				FRONT ROTOR OPTIONS	Line #
		PADS	PADS	PADS	PADS	DESIGN NO.	
		FA Kevlar Organic Pads	V Semi-Sintered V-Pads™	HH/R Double-HT™ USA-Made Sintered Pads	EPFA Premium Low Noise Street Sintered Pads	See Buyers Guide for rotor style & finish options. Part nos for ordering & sizing.	
Big Boss 250 6 x 6	92-93	FA159X*		FA159R*		MD6150D*	1
Big Boss 250 6 x 6 Middle Axle Brake	92-93	FA159X		FA159R		MD6149D*	2
Trail Blazer 250	90	FA159X*		FA159R*		MD6147D*	3
Trail Blazer 250	91-93	FA159X*		FA159R*		MD6150D*	4
Trail Blazer 250	94-98	FA159X*		FA159R*		MD6150D*	5
Trail Blazer 250	99-00	FA159X*		FA159R*		MD6155D*	6
Trail Blazer 250 (Freedom)	01-04	FA159X*		FA159R*		MD6155D*	7
Trail Blazer 250	05-06	FA159X*		FA159R*		MD6262D*	8
Trail Boss 250 2 x 4	85-87	503*		503C*			9
Trail Boss 250	88-90	FA159X*		FA159R*		MD6147D*	10
Trail Boss 250	91-99	FA159X*		FA159R*		MD6150D*	11
Trail Boss 250 4 x 4	87	FA54X*		FA54R*		MD6147D*	12
Trail Boss 250 2 x 4/4 x 4	88-89	FA159X*		FA159R*		MD6147D*	13
Trail Boss 250 2 x 4/4 x 4	91-92	FA159X*		FA159R*		MD6150D*	14
Xplorer 250 (4 x 4)		FA159X*		FA159R*		MD6155D*	15
300 2 x 4 / 4 x 4	94-95	FA159X*		FA159R*		MD6150D*	16
Big Boss 300 6 x 6	94	FA159X*		FA159R*		MD6150D*	17
Big Boss 300 6 x 6 Middle Axle Brake	94	FA159X*		FA159R*		MD6149D*	18
Hawkeye 300 2 x 4	06	FA395X*		FA395R*		MD6272D*	19
Hawkeye 300 2 x 4	08-09	FA159X*		FA159R*		MD6272D*	20
Hawkeye 300 4 x 4	06	FA395X*		FA395R*		MD6272D*	21
Hawkeye 300 2 x 4/4 x 4	07	FA159X*		FA159R*		MD6272D*	22
Sportsman 300 (4 x 4)	08-10	FA159X*		FA159R*		MD6272D*	23
Xplorer 300 4 x 4	96-00	FA159X*		FA159R*		MD6150D*	24
Xpress 300/400 L	96-97	FA159X*		FA159R*		MD6150D*	25
Xpress 300 2 x 4	98-00	FA159X*		FA159R*		MD6150D*	26
Hawkeye 325 2 x 4	15	FA159X*		FA159R*		MD6202D*	27
Magnum 325 (4 x 4) (2 x 4)		FA159X*		FA159R*		MD6155D*	28
Magnum 325 2 x 4/4 x 4 Moose	01	FA159X*		FA159R*		MD6155D*	29
Magnum 325 (2 x 4) HDS	02	FA159X*		FA159R*		MD6155D*	30
Magnum 325 4 x 4 (A02CD32AA/AB/AC)	02	FA159X*		FA159R*		MD6155D*	31
Magnum 325 4 x 4 HDS (A02CD32FB)	02	FA159X*		FA159R*		MD6202D*	32
Sportsman 325 Ace	14	FA656X*		FA656R*		MD6202D*	33
Sportsman 325 Ace EFI	15	FA656X*		FA656R*		MD6202D*	34
Sportsman 325 Ace Euro	14-15	FA656X*		FA656R*		MD6202D*	35
Sportsman 325 Ace HD	15	FA656X*		FA656R*		MD6202D*	36
Trail Boss 325		FA159X*		FA159R*		MD6155D*	37
Trail Boss 325	01-02	FA159X*		FA159R*		MD6155D*	38
Xpedition 325		FA159X*		FA159R*		MD6155D*	39
Xpedition 325	02	FA159X*		FA159R*		MD6155D*	40
330 ATP (4 x 4)	04-05	FA159X*		FA159R*		MD6202D*	41
Magnum 330 (2 x 4/HDS)	03-06	FA159X*		FA159R*		MD6149D*	42
Magnum 330 (4 x 4/HDS)	03-04	FA159X*		FA159R*		MD6202D*	43
Trail Boss 330	03-04	FA159X*		FA159R*		MD6155D*	44
Trail Boss 330	05-09	FA159X*		FA159R*		MD6262D*	45
Trail Boss 330	10-13	FA159X*		FA159R*		MD6202D*	46
Trail Blazer 330	08-09	FA159X*		FA159R*		MD6262D*	47
Trail Blazer 330	10-13	FA159X*		FA159R*		MD6202D*	48
Sportsman 335 4 x 4	99-00	FA159X*		FA159R*		MD6150D*	49
Sportsman 335 /Worker 4 x 4	99-00	FA159X*		FA159R*		MD6149D*	50
350 L 2 x 4	90	FA159X*		FA159R*		MD6150D*	51
350 L 4 x 4	90	FA159X*		FA159R*		MD6149D*	52
350 L 4 x 4	93	FA159X*		FA159R*		MD6150D*	53
Big Boss 350 L	93	FA159X*		FA159R*		MD6149D*	54
Big Boss 350 L Middle Axle Brake	93	FA159X*		FA159R*		MD6149D*	55

* symbol after part# = 2 pieces required i.e. 2 pad sets or 2 rotors (twin rotor models)

REAR: AMERICAN PRODUCED MOTORCYCLES

Line #	POLARIS (ATV)	SUFFIX OR PREFIX PAD MATERIALS AND DESCRIPTION	YEAR	REAR				
				PADS	PADS	PADS	PADS	REAR ROTOR OPTIONS
				FA	V	HH/R	EPFA	DESIGN NO.
				Kevlar Organic Pads	Semi-Sintered V-Pads™	Double-H™ USA-Made Sintered Pads	Premium Low Noise Street Sintered Pads	See Buyers Guide for rotor style & finish options. Part nos for ordering & sizing.
1	Big Boss 250 6 x 6		92-93	FA232X		FA232R		N/A
2	Big Boss 250 6 x 6 Middle Axle Brake		92-93					
3	Trail Blazer 250		90	FA232X		FA232R		N/A
4	Trail Blazer 250		91-93	FA232X		FA232R		N/A
5	Trail Blazer 250		94-98	FA232X		FA232R		N/A
6	Trail Blazer 250		99-00	FA270X		FA270R		MD6156D
7	Trail Blazer 250 (Freedom)		01-04	FA270X		FA270R		MD6156D
8	Trail Blazer 250		05-06	N/A		FA314R		MD6256D
9	Trail Boss 250 2 x 4		85-87	FA40				N/A
10	Trail Boss 250		88-90	FA232X		FA232R		N/A
11	Trail Boss 250		91-99	FA232X		FA232R		N/A
12	Trail Boss 250 4 x 4		87	FA232X		FA232R		N/A
13	Trail Boss 250 2 x 4/4 x 4		88-89	FA232X		FA232R		N/A
14	Trail Boss 250 2 x 4/4 x 4		91-92	FA232X		FA232R		N/A
15	Xplorer 250 (4 x 4)			FA270X		FA270R		N/A
16	300 2 x 4 / 4 x 4		94-95	FA232X		FA232R		N/A
17	Big Boss 300 6 x 6		94	FA232X		FA232R		N/A
18	Big Boss 300 6 x 6 Middle Axle Brake		94					
19	Hawkeye 300 2 x 4		06	FA395X		FA395R		MD6273D
20	Hawkeye 300 2 x 4		08-09	FA159X		FA159R		MD6273D
21	Hawkeye 300 4 x 4		06	FA395X		FA395R		MD6273D
22	Hawkeye 300 2 x 4/4 x 4		07	FA159X		FA159R		MD6273D
23	Sportsman 300 (4 x 4)		08-10	FA159X		FA159R		MD6273D
24	Xplorer 300 4 x 4		96-00	FA232X		FA232R		N/A
25	Xpress 300/400 L		96-97	FA232X		FA232R		N/A
26	Xpress 300 2 x 4		98-00	FA232X		FA232R		N/A
27	Hawkeye 325 2 x 4		15	FA475X		FA475R		MD6275D
28	Magnum 325 (4 x 4) (2 x 4)			FA270X		FA270R		MD6156D
29	Magnum 325 2 x 4/4 x 4 Moose		01	FA270X		FA270R		MD6156D
30	Magnum 325 (2 x 4) HDS		02	N/A		FA314R		MD6200D
31	Magnum 325 4 x 4 (A02CD32AA/AB/AC)		02	N/A		FA314R		MD6200D
32	Magnum 325 4 x 4 HDS (A02CD32FB)		02	N/A		FA314R		MD6200D
33	Sportsman 325 Ace		14			FA354R		MD6275D
34	Sportsman 325 Ace EFi		15			FA354R		MD6275D
35	Sportsman 325 Ace Euro		14-15			FA354R		MD6275D
36	Sportsman 325 Ace HD		15			FA354R		MD6275D
37	Trail Boss 325			FA270X		FA270R		MD6156D
38	Trail Boss 325		01-02	FA270X		FA270R		MD6156D
39	Xpedition 325			FA270X		FA270R		MD6156D
40	Xpedition 325		02	N/A		FA314R		MD6200D
41	330 ATP (4 x 4)		04-05	FA159X		FA159R		MD6200D
42	Magnum 330 (2 x 4/HDS)		03-06	N/A		FA314R		MD6200D
43	Magnum 330 (4 x 4/HDS)		03-04	N/A		FA314R		MD6200D
44	Trail Boss 330		03-04	FA270X		FA270R		MD6156D
45	Trail Boss 330		05-09	N/A		FA314R		MD6256D
46	Trail Boss 330		10-13	N/A		FA314R		MD6256D
47	Trail Blazer 330		08-09	N/A		FA314R		MD6256D
48	Trail Blazer 330		10-13	N/A		FA314R		MD6256D
49	Sportsman 335 4 x 4		99-00	FA270X		FA270R		N/A
50	Sportsman 335 /Worker 4 x 4		99-00	FA270X		FA270R		N/A
51	350 L 2 x 4		90	FA232X		FA232R		N/A
52	350 L 4 x 4		90	FA232X		FA232R		N/A
53	350 L 4 x 4		93	FA232X		FA232R		N/A
54	Big Boss 350 L		93	FA232X		FA232R		N/A
55	Big Boss 350 L Middle Axle Brake		93					

* symbol after part# = 2 pieces required i.e. 2 pad sets or 2 rotors (twin rotor models)

Part numbers, prefixes, suffixes, photos and illustrations shown in this catalog are trademarks and/or copyrights of EBC Brakes or the trademark owner A C Freeman Investments Ltd and use without express written permission of the owners is punishable by law.

All names & numbers are for reference purposes only. ® Registered trademarks of Harley—Davidson® Motor Corp or Buell.
NOTE: — Some models may have a second rotor fitted as an optional extra. Please double check with your customer exactly which side the front rotor is fitted and if twin rotor or single.

Ⓢ This symbol indicates a rotor made of billet steel, and should be only used with EBC FA Kevlar® Organic or Vee pads.

**BRAKE
APPLICATIONS**

FRONT: AMERICAN PRODUCED MOTORCYCLES

APPLICATIONS

BRAKE

⚡ This symbol indicates a rotor made of billet steel, and should be only used with EBC FA Kevlar® Organic or Vee pads.

POLARIS (ATV)	SUFFIX OR PREFIX PAD MATERIALS AND DESCRIPTION	YEAR	FRONT				FRONT ROTOR OPTIONS DESIGN NO. <small>See Buyers Guide for rotor style & finish options. Part nos for ordering & sizing.</small>	Line #
			PADS	PADS	PADS	PADS		
			FA Kevlar Organic Pads	V Semi-Sintered V-Pads™	HH/R Double-HT™ USA-Made Sintered Pads	EPFA Premium Low Noise Street Sintered Pads		
Sportsman 350 4 x 4		93	FA159X*		FA159R*		MD6149D*	1
Trail Boss 350 L 2 x 4		91-93	FA159X*		FA159R*		MD6150D*	2
Trail Boss 350 L 4 x 4		91	FA159X*		FA159R*		MD6149D*	3
400 L 2 x 4		94-95	FA159X*		FA159R*		MD6150D*	4
400 L 4 x 4		94	FA159X*		FA159R*		MD6149D*	5
Big Boss 400 L 6 x 6		94-95	FA159X*		FA159R*		MD6149D*	6
Big Boss 400 L 6 x 6 Middle Axle Brake		94-95	FA159X*		FA159R*		MD6149D*	7
Big Boss 400 L 6 x 6		96	FA159X*		FA159R*		MD6149D*	8
Big Boss 400 L 6 x 6 Middle Axle Brake		96			FA273R*		MD6153D	9
Big Boss 400 L 6 x 6		97	FA159X*		FA159R*		MD6149D*	10
Big Boss 400 L 6 x 6 Middle Axle Brake		97	FA159X*		FA159R*		MD6149D*	11
Hawkeye 400 H.O. 2 x 4		13-14	FA159X*		FA159R*		MD6202D*	12
Scrambler 400 L 4 x 4		95-97	FA159X*		FA159R*		MD6150D*	13
Scrambler 400 (2 x 4/4 x 4)			FA159X*		FA159R*		MD6155D*	14
Scrambler 400 4 x 4		98-02	FA159X*		FA159R*		MD6155D*	15
Scrambler 400 2 x 4		02	FA159X*		FA159R*		MD6155D*	16
Sport 400 L		94-98	FA159X*		FA159R*		MD6150D*	17
Sport 400		99-00	FA159X*		FA159R*		MD6150D*	18
Sportsman 400 L 4 x 4		94-97	FA159X*		FA159R*		MD6149D*	19
Sportsman 400		01-02	FA159X*		FA159R*		MD6149D*	20
Sportsman 400		03	FA159X*		FA159R*		MD6149D*	21
Sportsman 400 (Code CH42AA/AE/AG)		04	FA159X*		FA159R*		MD6149D*	22
Sportsman 400 (Code CH42AQ/AR/AS/AT/AV)		04	FA159X*		FA159R*		MD6202D*	23
Sportsman 400 HO 4 x 4		08-10	FA159X*		FA159R*		MD6272D*	24
Sportsman 400 HO 4 x 4		11-14	FA159X*		FA159R*		MD6202D*	25
Trail Blazer 400		03	FA159X*		FA159R*		MD6155D*	26
Xplorer 400 L 4 x 4		95-98	FA159X*		FA159R*		MD6149D*	27
Xplorer 400 L 4 x 4		99-00	FA159X*		FA159R*		MD6149D*	28
Xplorer 400 4 x 4		01-02	FA159X*		FA159R*		MD6155D*	29
Xplorer 400		01-02	FA159X*		FA159R*		MD6149D*	30
Magnum 425 2 x 4		95-98	FA159X*		FA159R*		MD6150D*	31
Magnum 425 4 x 4		95-98	FA159X*		FA159R*		MD6149D*	32
Magnum 425 6 x 6		96	FA159X*		FA159R*		MD6149D*	33
Magnum 425 6 x 6 Middle Axle Brake		96			FA273R*		MD6153D*	34
Magnum 425 6 x 6		97	FA159X*		FA159R*		MD6149D*	35
Magnum 425 6 x 6 Middle Axle Brake		97	FA159X*		FA159R*		MD6149D*	36
Xpedition 425 (4 x 4)			FA159X*		FA159R*		MD6149D*	37
Outlaw 450 S		08	FA456X*		FA456R*		MD6219D*	38
Outlaw 450 MXR		09-10	FA456X*		FA456R*		MD6219D*	39
Sportsman 450		06	FA159X*		FA159R*		MD6202D*	40
Sportsman 450		07	FA159X*		FA159R*		MD6202D*	41
455cc Diesel 4 x 4 EBS		99-00	FA159X*		FA159R*		MD6149D*	42
455cc Diesel		01	FA159X*		FA159R*		MD6149D*	43
500 ATP HO (4 x 4)		04-05	FA159X*		FA159R*		MD6202D*	44
500 ATV Pro 4 x 4 PPS		02	FA159X*		FA159R*		MD6202D*	45
Big Boss 500 6 x 6		98-99	FA159X*		FA159R*		MD6149D*	46
Big Boss 500 6 x 6 Middle Axle Brake		98-99	FA159X*		FA159R*		MD6149D*	47
Magnum 500 (4 x 4)		99-00	FA159X*		FA159R*		MD6149D*	48
Magnum 500		01	FA159X*		FA159R*		MD6149D*	49
Magnum 500 (2 x 39906 x 4 HDS)		02	FA159X*		FA159R*		MD6149D*	50
Magnum 500 4 x 4 HDS		02-03	FA159X*		FA159R*		MD6202D*	51
Outlaw		06-07	FA159X*		FA159R*		MD6219D*	52
Predator 500/TLD		03-07	FA159X*		FA159R*		MD6219D*	53
Scrambler 500 2 x 4		01-02	FA159X*		FA159R*		MD6155D*	54
Scrambler 500 2 x 4		07-08	FA159X*		FA159R*		MD6262D*	55

* symbol after part# = 2 pieces required i.e. 2 pad sets or 2 rotors (twin rotor models)

REAR: AMERICAN PRODUCED MOTORCYCLES

Line #	POLARIS (ATV)	SUFFIX OR PREFIX PAD MATERIALS AND DESCRIPTION	YEAR	REAR				
				PADS	PADS	PADS	PADS	REAR ROTOR OPTIONS
				FA	V	HH/R	EPFA	DESIGN NO.
				Kevlar Organic Pads	Semi-Sintered V-Pads™	Double-H™ USA-Made Sintered Pads	Premium Low Noise Street Sintered Pads	See Buyers Guide for rotor style & finish options. Part nos for ordering & sizing.
1	Sportsman 350 4 x 4		93	FA232X		FA232R		N/A
2	Trail Boss 350 L 2 x 4		91-93	FA232X		FA232R		N/A
3	Trail Boss 350 L 4 x 4		91	FA232X		FA232R		N/A
4	400 L 2 x 4		94-95	FA232X		FA232R		N/A
5	400 L 4 x 4		94	FA232X		FA232R		N/A
6	Big Boss 400 L 6 x 6		94-95	FA232X		FA232R		N/A
7	Big Boss 400 L 6 x 6 Middle Axle Brake		94-95					
8	Big Boss 400 L 6 x 6		96	FA232X		FA232R		N/A
9	Big Boss 400 L 6 x 6 Middle Axle Brake		96					
10	Big Boss 400 L 6 x 6		97	FA232X		FA232R		N/A
11	Big Boss 400 L 6 x 6 Middle Axle Brake		97					
12	Hawkeye 400 H.O. 2 x 4		13-14	FA475X		FA475R		MD6274D
13	Scrambler 400 L 4 x 4		95-97	FA232X		FA232R		N/A
14	Scrambler 400 (2 x 4/4 x 4)			FA270X		FA270R		MD6156D
15	Scrambler 400 4 x 4		98-02	FA270X		FA270R		MD6156D
16	Scrambler 400 2 x 4		02	FA270X		FA270R		MD6156D
17	Sport 400 L		94-98	FA232X		FA232R		N/A
18	Sport 400		99-00	FA270X		FA270R		MD6156D
19	Sportsman 400 L 4 x 4		94-97	FA232X		FA232R		N/A
20	Sportsman 400		01-02	FA270X		FA270R		N/A
21	Sportsman 400		03	N/A		FA314R		MD6201D
22	Sportsman 400 (Code CH42AA/AE/AG)		04	N/A		FA314R		MD6201D
23	Sportsman 400 (Code CH42AQ/AR/AS/AT/AV)		04	N/A		FA314R		MD6201D
24	Sportsman 400 HO 4 x 4		08-10	FA159X		FA159R		MD6273D
25	Sportsman 400 HO 4 x 4		11-14	FA475X		FA475R		MD6275D
26	Trail Blazer 400		03	FA270X		FA270R		MD6156D
27	Xplorer 400 L 4 x 4		95-98	FA232X		FA232R		N/A
28	Xplorer 400 L 4 x 4		99-00	FA270X		FA270R		MD6169D
29	Xplorer 400 4 x 4		01-02	FA270X		FA270R		MD6156D
30	Xplorer 400		01-02	FA270X		FA270R		MD6169D
31	Magnum 425 2 x 4		95-98	FA232X		FA232R		N/A
32	Magnum 425 4 x 4		95-98	FA232X		FA232R		N/A
33	Magnum 425 6 x 6		96	FA232X		FA232R		N/A
34	Magnum 425 6 x 6 Middle Axle Brake		96					
35	Magnum 425 6 x 6		97	FA232X		FA232R		N/A
36	Magnum 425 6 x 6 Middle Axle Brake		97					
37	Xpedition 425 (4 x 4)			FA270X		FA270R		MD6156D
38	Outlaw 450 S		08	FA159X		FA159R		MD6218D
39	Outlaw 450 MXR		09-10	FA159X		FA159R		MD6290D
40	Sportsman 450		06	N/A		FA314R		MD6201D
41	Sportsman 450		07	N/A		FA314R		MD6275D
42	455cc Diesel 4 x 4 EBS		99-00	FA270X		FA270R		N/A
43	455cc Diesel		01	FA270X		FA270R		N/A
44	500 ATP HO (4 x 4)		04-05	FA159X		FA159R		MD6200D
45	500 ATV Pro 4 x 4 PPS		02	N/A		FA314R		MD6200D
46	Big Boss 500 6 x 6		98-99	FA232X		FA232R		N/A
47	Big Boss 500 6 x 6 Middle Axle Brake		98-99					
48	Magnum 500 (4 x 4)		99-00	FA270X		FA270R		MD6156D
49	Magnum 500		01	FA270X		FA270R		MD6156D
50	Magnum 500 (2 x 39906 x 4 HDS)		02	N/A		FA314R		MD6200D
51	Magnum 500 4 x 4 HDS		02-03	N/A		FA314R		MD6200D
52	Outlaw		06-07	FA159X		FA159R		MD6290D
53	Predator 500/TLD		03-07	FA159X		FA159R		MD6218D
54	Scrambler 500 2 x 4		01-02	FA270X		FA270R		MD6156D
55	Scrambler 500 2 x 4		07-08	N/A		FA314R		MD6256D

* symbol after part# = 2 pieces required i.e. 2 pad sets or 2 rotors (twin rotor models)

Part numbers, prefixes, suffixes, photos and illustrations shown in this catalog are trademarks and/or copyrights of EBC Brakes or the trademark owner A C Freeman Investments Ltd and use without express written permission of the owners is punishable by law.

All names & numbers are for reference purposes only. ® Registered trademarks of Harley—Davidson® Motor Corp or Buell.

NOTE: — Some models may have a second rotor fitted as an optional extra. Please double check with your customer exactly which side the front rotor is fitted and if twin rotor or single.

Ⓢ This symbol indicates a rotor made of billet steel, and should be only used with EBC FA Kevlar® Organic or Vee pads.

BRAKE
APPLICATIONS

FRONT: AMERICAN PRODUCED MOTORCYCLES

APPLICATIONS

BRAKE

⚡ This symbol indicates a rotor made of billet steel, and should be only used with EBC FA Kevlar® Organic or Vee pads.

POLARIS (ATV)

SUFFIX OR PREFIX PAD MATERIALS AND DESCRIPTION	YEAR	FRONT				FRONT ROTOR OPTIONS	Line #
		PADS	PADS	PADS	PADS	DESIGN NO.	
		FA Kevlar Organic Pads	V Semi-Sintered V-Pads™	HH/R Double-HT™ USA-Made Sintered Pads	EPFA Premium Low Noise Street Sintered Pads	See Buyers Guide for rotor style & finish options. Part nos for ordering & sizing.	
Scrambler 500 4 x 4	97	FA159X*		FA159R*		MD6150D*	1
Scrambler 500 4 x 4	98-04	FA159X*		FA159R*		MD6155D*	2
Scrambler 500 4 x 4	05-09	FA159X*		FA159R*		MD6155D*	3
Scrambler 500 4 x 4	10-12	FA159X*		FA159R*		MD6202D*	4
Sportsman 500 4 x 4	96	FA159X*		FA159R*		MD6149D*	5
Sportsman 500 4 x 4	97	FA159X*		FA159R*		MD6149D*	6
Sportsman 500 /Worker 4 x 4 EBS/500 RSE	98-02	FA159X*		FA159R*		MD6149D*	7
Sportsman 500 HO/EFI Demand Drive	03-04	FA159X*		FA159R*		MD6149D*	8
Sportsman 500 EFI/HO	04-06	FA159X*		FA159R*		MD6202D*	9
Sportsman 500 EFI/HO	07-08	FA159X*		FA159R*		MD6202D*	10
Sportsman 500 HO (Built up to 15/12/08)	08	FA159X*		FA159R*		MD6202D*	11
Sportsman 500 HO (Built from 16/12/08)	09-13	FA159X*		FA159R*		MD6202D*	12
Sportsman 500 X2	06-08	FA159X*		FA159R*		MD6202D*	13
Sportsman 500 6 x 6	00-08	FA159X*		FA159R*		MD6149D*	14
Sportsman 500 X 2 EFI	07-09	FA159X*		FA159R*		MD6202D*	15
Sportsman 500 Forest	12	FA159X*		FA159R*		MD6202D*	16
Sportsman 500 Touring H.O.	08-11	FA159X*		FA159R*		MD6202D*	17
Sportsman 500 Touring H.O.	11-13	FA159X*		FA159R*		MD6202D*	18
Sportsman 500 EFI Quad H.O.	08-11	FA159X*		FA159R*		MD6202D*	19
Sportsman 500 XP	09	FA475X*		FA475R*		MD6339D*	20
Xplorer 4 x 4	97	FA159X*		FA159R*		MD6149D*	21
Xplorer S	08-10	FA456X*		FA456R*		MD6219D*	22
Outlaw IRS	08-11	FA456X*		FA456R*		MD6219D*	23
Sportsman 550	11-13	FA475X*		FA475R*		MD6339D*	24
Sportsman 550 EPS	10-14	FA475X*		FA475R*		MD6339D*	25
Sportsman 550 Forest	10-12	FA475X*		FA475R*		MD6339D*	26
Sportsman 550 XP EPS	09-11	FA475X*		FA475R*		MD6339D*	27
Sportsman 550 X2	10-14	FA475X*		FA475R*		MD6339D*	28
Sportsman 550 Touring EPS	10-14	FA475X*		FA475R*		MD6339D*	29
Sportsman 570 Ace	15-18	FA656X*		SXR656HH*		MD6202D*	30
Sportsman 570 Ace Euro	15-18	FA656X*		SXR656HH*		MD6202D*	31
Sportsman 570 Efi (Inc EPS Models)	11-21	FA159X*		SXR159HH*		MD6202D*	32
Sportsman 570 EFI X2	15-21	FA159X*		SXR159HH*		MD6202D*	33
Sportsman 570 Forest Tracker Efi/EPS	15	FA159X*		SXR159HH*		MD6202D*	34
Sportsman 570 Touring EFI	14-21	FA159X*		SXR159HH*		MD6202D*	35
Sportsman 570 Touring Tractor Efi EPS	16-21	FA159X*		SXR159HH*		MD6202D*	36
Sportsman 570 6X6	17-21	FA159X*		SXR159HH*		MD6202D*	37
Sportsman 570 6X6 Tractor	17-21	FA159X*		SXR159HH*		MD6202D*	38
Sportsman 600 4 x 4	03-05	FA159X*		SXR159HH*		MD6202D*	39
Sportsman 700 (4 x 4)/EFI	02-06	FA159X*		SXR159HH*		MD6202D*	40
Sportsman 700 MV	05-06	FA159X*		SXR159HH*		MD6202D*	41
Sportsman 700 EFI	07	FA159X*		SXR159HH*		MD6202D*	42
Sportsman 700 X 2	08	FA159X*		SXR159HH*		MD6202D*	43
Sportsman 800 EFI	05-06	FA159X*		SXR159HH*		MD6202D*	44
Sportsman 800 EFI (Built up to 15/12/08)	08	FA159X*		SXR159HH*		MD6202D*	45
Sportsman 800 EFI (Built up after 16/12/08)	09	FA159X*		SXR159HH*		MD6202D*	46
Sportsman 800 EFI	10-13	FA159X*		SXR159HH*		MD6202D*	47
Sportsman 800 X 2 EFI	07-09	FA159X*		SXR159HH*		MD6202D*	48
Sportsman 800 EFI Intl/HO	07-11	FA159X*		SXR159HH*		MD6202D*	49
Sportsman 800	12-14	FA475X*				MD6339D*	50
Sportsman 800 Forest	12	FA475X*				MD6339D*	51
Sportsman 800 Touring/EFI	08-09	FA159X*		SXR159HH*		MD6202D*	52
Sportsman 800 Big Boss/EFI 6 x 6/EFI	09-14	FA159X*		SXR159HH*		MD6202D*	53
Forest 850	15	FA475X*				MD6339D*	54
Scrambler 850	15	FA475X*				MD6339D*	55

* symbol after part# = 2 pieces required i.e. 2 pad sets or 2 rotors (twin rotor models)

REAR: AMERICAN PRODUCED MOTORCYCLES

Line #	POLARIS (ATV)	SUFFIX OR PREFIX PAD MATERIALS AND DESCRIPTION	YEAR	REAR				
				PADS	PADS	PADS	PADS	REAR ROTOR OPTIONS
				FA	V	HH/R	EPFA	DESIGN NO.
				Kevlar Organic Pads	Semi-Sintered V-Pads™	Double-H™ USA-Made Sintered Pads	Premium Low Noise Street Sintered Pads	See Buyers Guide for rotor style & finish options. Part nos for ordering & sizing.
1	Scrambler 500 4 x 4		97	FA232X		FA232R		N/A
2	Scrambler 500 4 x 4		98-04	FA270X		FA270R		MD6156D
3	Scrambler 500 4 x 4		05-09	N/A		FA314R		MD6256D
4	Scrambler 500 4 x 4		10-12	N/A		FA314R		MD6256D
5	Sportsman 500 4 x 4		96	FA232X		FA232R		MD6201D
6	Sportsman 500 4 x 4		97	FA232X		FA232R		MD6154D
7	Sportsman 500 /Worker 4 x 4 EBS/500 RSE		98-02	FA270X		FA270R		N/A
8	Sportsman 500 HO/EFI Demand Drive		03-04	N/A		FA314R		MD6201D
9	Sportsman 500 EFI/HO		04-06			FA314R		MD6201D
10	Sportsman 500 EFI/HO		07-08	N/A		FA314R		MD6275D
11	Sportsman 500 HO (Built up to 15/12/08)		08	N/A		FA314R		MD6275D
12	Sportsman 500 HO (Built from 16/12/08)		09-13	FA475X		FA475R		MD6275D
13	Sportsman 500 X2		06-08	N/A		FA314R		MD6275D
14	Sportsman 500 6 x 6		00-08	N/A		FA313R		MD6170D
15	Sportsman 500 X 2 EFI		07-09	FA159X		FA159R		MD6275D
16	Sportsman 500 Forest		12	N/A		FA314R		MD6275D
17	Sportsman 500 Touring H.O.		08-11	FA159X		FA159R		MD6275D
18	Sportsman 500 Touring H.O.		11-13			FA354R		MD6275D
19	Sportsman 500 EFI Quad H.O.		08-1	N/A		FA314R		MD6275D
20	Sportsman 500 XP		09	FA475X		FA475R		MD6339D
21	Xplorer 4 x 4		97	FA232X		FA232R		N/A
22	Xplorer S		08-10	FA159X		FA159R		MD6218D
23	Outlaw IRS		08-11	FA159X		FA159R		MD6290D
24	Sportsman 550		11-13	FA475X		FA475R		MD6339D
25	Sportsman 550 EPS		10-14	FA475X		FA475R		MD6339D
26	Sportsman 550 Forest		10-12	FA475X		FA475R		MD6339D
27	Sportsman 550 XP EPS		09-11	FA475X		FA475R		MD6339D
28	Sportsman 550 X2		10-14	FA475X		FA475R		MD6339D
29	Sportsman 550 Touring EPS		10-14	FA475X		FA475R		MD6339D
30	Sportsman 570 Ace		15-18			FA354R		MD6275D
31	Sportsman 570 Ace Euro		15-18			FA354R		MD6275D
32	Sportsman 570 Efi (Inc EPS Models)		11-21	FA475X		FA475R		MD6275D
33	Sportsman 570 EFI X2		15-21	FA475X		FA475R		MD6275D
34	Sportsman 570 Forest Tracker Efi/EPS		15	FA475X		FA475R		MD6275D
35	Sportsman 570 Touring EFI		14-21	FA475X		FA475R		MD6275D
36	Sportsman 570 Touring Tractor Efi EPS		16-21	FA475X		FA475R		MD6275D
37	Sportsman 570 6X6		17-21	FA475X		FA475R		MD6275D
38	Sportsman 570 6X6 Tractor		17-21	FA475X		FA475R		MD6275D
39	Sportsman 600 4 x 4		03-05	N/A		FA314R		MD6201D
40	Sportsman 700 (4 x 4)/EFI		02-06	N/A		FA314R		MD6201D
41	Sportsman 700 MV		05-06	N/A		FA314R		MD6201D
42	Sportsman 700 EFI		07	N/A		FA314R		MD6275D
43	Sportsman 700 X 2		08	FA159X		FA159R		MD6275D
44	Sportsman 800 EFI		05-06	N/A		FA314R		MD6201D
45	Sportsman 800 EFI (Built up to 15/12/08)		N/A			FA314R		MD6275D
46	Sportsman 800 EFI (Built up after 16/12/08)		N/A			FA314R		MD6275D
47	Sportsman 800 EFI		N/A			FA475R		MD6275D
48	Sportsman 800 X 2 EFI			FA159X		FA159R		MD6275D
49	Sportsman 800 EFI Int'l/HO		N/A			FA314R		MD6275D
50	Sportsman 800		12-14	FA475X		FA475R		MD6339D
51	Sportsman 800 Forest		12	FA475X		FA475R		MD6339D
52	Sportsman 800 Touring/EFI		08-09	FA159X		FA159R		MD6275D
53	Sportsman 800 Big Boss/EFI 6 x 6/EFI		09-14			FA314R		MD6275D
54	Forest 850		15	FA475X		FA475R		MD6339D
55	Scrambler 850		15	FA475X		FA475R		MD6339D

* symbol after part# = 2 pieces required i.e. 2 pad sets or 2 rotors (twin rotor models)

Part numbers, prefixes, suffixes, photos and illustrations shown in this catalog are trademarks and/or copyrights of EBC Brakes or the trademark owner A C Freeman Investments Ltd and use without express written permission of the owners is punishable by law.

All names & numbers are for reference purposes only. ® Registered trademarks of Harley—Davidson® Motor Corp or Buell.
NOTE: — Some models may have a second rotor fitted as an optional extra. Please double check with your customer exactly which side the front rotor is fitted and if twin rotor or single.

Ⓢ This symbol indicates a rotor made of billet steel, and should be only used with EBC FA Kevlar® Organic or Vee pads.

**BRAKE
APPLICATIONS**

FRONT: AMERICAN PRODUCED MOTORCYCLES

APPLICATIONS

BRAKE

⚡ This symbol indicates a rotor made of billet steel, and should be only used with EBC FA Kevlar® Organic or Vee pads.

		FRONT					Line #
		PADS	PADS	PADS	PADS	FRONT ROTOR OPTIONS	
		FA	V	HH/R	EPFA	DESIGN NO.	
SUFFIX OR PREFIX PAD MATERIALS AND DESCRIPTION		Kevlar Organic Pads	Semi-Sintered V-Pads™	Double-HT™ USA-Made Sintered Pads	Premium Low Noise Street Sintered Pads	See Buyers Guide for rotor style & finish options. Part nos for ordering & sizing.	
POLARIS (ATV)							
YEAR							
Sportsman 850 Touring EPS	10-13	FA475X*				MD6339D*	1
Sportsman 850 Touring H.O. EPS	13-15	FA475X*				MD6339D*	2
Sportsman 850 Forest	12	FA475X*		FA475R*		MD6339D*	3
Scrambler 850 XP H.O.	13-15	FA475X*		FA475R*		MD6339D*	4
Sportsman 850 XP	09-13	FA475X*		FA475R*		MD6339D*	5
Sportsman 850 XP EPS	09-13	FA475X*		FA475R*		MD6339D*	6
Sportsman 850 XP H.O. EPS	13-15	FA475X*		FA475R*		MD6339D*	7
Forest 1000	15	FA475X*		FA475R*		MD6339D*	8
Scrambler 1000	15	FA475X*		FA475R*		MD6339D*	9
Scrambler 1000 XP	15	FA475X*		FA475R*		MD6339D*	10
Scrambler 1000 XP	15-21	FA475X*		FA475R*		MD6339D*	11
Sportsman 1000 MD/XP	15-19	FA475X*		FA475R*		MD6339D*	12
Sportsman 1000 XP-S 55"	20-21	FA475X*		FA475R*		MD6338D*	13
Sportsman 1000 XP Tractor	16-21	FA475X*		FA475R*		MD6338D*	14
Sportsman 1000 Touring XP	15-20	FA475X*		FA475R*		MD6339D*	15
Sportsman 1000 MD/XP	16-21	FA475X*		FA475R*		MD6339D*	16
Sportsman 1000 High Lifter	19	FA475X*		FA475R*		MD6339D*	17
							18
							19
POLARIS ACE							
570 (R08) All models A17DAA57A5/A7	17-20			FA354R*		MD6202D*	20
570 EFI EURO (R09) A17DAA57F5	17-20			FA354R*		MD6202D*	21
							22
							23
POLARIS GENERAL (SIDE X SIDE)							
1000 General EPS (2 Seat)	16-20	FA452X*		SXR452HH*		MD6338D*	24
1000 General EPS (2 Seat)	17-20	FA452X*		SXR452HH*		MD6408D*	25
1000 General 4 EPS (4 Seat)	17-20	FA452X*		SXR452HH*		MD6338D*	26
							27
							28
POLARIS RANGER (COMMERCIAL)							
Brutus HD HDPTO (R03)	13-17	FA452X*		SXR452HH*		MD6338D*	29
							30
							31
POLARIS RANGER (SIDE X SIDE)							
325 Ranger ETX	15-16			FA354R*		MD6202D*	32
400 Ranger (All Models)	10-14			FA354R*		MD6202D*	33
499 Ranger (All Models)	17			FA354R*		MD6202D*	34
SXS 500 Ranger (2 x 4/4 x 4)	06-07			FA354R*		MD6202D*	35
SXS 500 Ranger (4 x 4 EFI)	06-07			FA354R*		MD6202D*	36
SXS 500 Ranger (4 x 4 EFI)	08-10	FA452X*		SXR452HH*		MD6202D*	37
SXS 500 Ranger (4 x 4 EFI)	11-13			FA354R		MD6202D*	38
SXS 500 Ranger (Carb) 2 x 4	08-09	FA452X*		SXR452HH*		MD6202D*	39
SXS 500 Ranger (EFI) 4 x 4 H.O.	09-11	FA452X*		SXR452HH*		MD6338D*	40
SXS 500 Ranger Crew	11-13	FA452X*		SXR452HH*		MD6202D*	41
SXS 500 Ranger Series 10 6 x 6						MD6202D*	42
SXS 500 Ranger 500 2WDHDPE ETX	17-20					MD6202D*	43
SXS 500 Ranger 500 R21MAA50BJ7	21-22					MD6202D*	44
Ranger 99 models	99	FA159X*		SXR159HH*		MD6149D*	45
Ranger Series 10						MD6202D*	46
Ranger 2 x 4 / 4 x 4	04-05					MD6202D*	47
Ranger Series 11						MD6202D*	48
Ranger 6 x 6	04-05					MD6202D*	49
Ranger TM	04-05					MD6202D*	50
Ranger TM	06					MD6202D*	51
Ranger XP	05					MD6202D*	52
570 Ranger EFI	14-20					MD6202D*	53
570 Ranger Crew EFI	14-15	FA656X*		SXR656HH*		MD6202D*	54
SXS Ranger 570 R16MA57A1/4/A9/L1	16					MD6202D*	55

* symbol after part# = 2 pieces required i.e. 2 pad sets or 2 rotors (twin rotor models)

REAR: AMERICAN PRODUCED MOTORCYCLES

Line #	POLARIS (ATV)	SUFFIX OR PREFIX PAD MATERIALS AND DESCRIPTION	YEAR	REAR				
				PADS	PADS	PADS	PADS	REAR ROTOR OPTIONS
				FA	V	HH/R	EPFA	DESIGN NO.
				Kevlar Organic Pads	Semi-Sintered V-Pads™	Double-H™ USA-Made Sintered Pads	Premium Low Noise Street Sintered Pads	See Buyers Guide for rotor style & finish options. Part nos for ordering & sizing.
1	Sportsman 850 Touring EPS		10-13	FA475X		FA475R		MD6339D
2	Sportsman 850 Touring H.O. EPS		13-15	FA475X		FA475R		MD6339D
3	Sportsman 850 Forest		12	FA475X		FA475R		MD6339D
4	Scrambler 850 XP H.O.		13-15	FA475X		FA475R		MD6339D
5	Sportsman 850 XP		09-13	FA475X		FA475R		MD6339D
6	Sportsman 850 XP EPS		09-13	FA475X		FA475R		MD6339D
7	Sportsman 850 XP H.O. EPS		13-15	FA475X		FA475R		MD6339D
8	Forest 1000		15	FA475X		FA475R		MD6339D
9	Scrambler 1000		15	FA475X		FA475R		MD6339D
10	Scrambler 1000 XP		15	FA475X		FA475R		MD6339D
11	Scrambler 1000 XP		15-21	FA456X		FA456R		MD6339D
12	Sportsman 1000 MD/XP		15-19	FA475X		FA475R		MD6339D
13	Sportsman 1000 XP-S 55"		20-21	FA456X		FA456R		MD6338D
14	Sportsman 1000 XP Tractor		16-21	FA475X		FA475R		MD6338D
15	Sportsman 1000 Touring XP		15-20	FA475X		FA475R		MD6339D
16	Sportsman 1000 MD/XP		16-21	FA475X		FA475R		MD6339D
17	Sportsman 1000 High Lifter		19	FA475X		FA475R		MD6339D
18								
19	POLARIS ACE							
20	570 (R08) All models A17DAA57A5/A7		17-20			FA354R		MD6201D
21	570 EFI EURO (R09) A17DAA57F5		17-20			FA354R		MD6201D
22								
23	POLARIS GENERAL (SIDE X SIDE)							
24	1000 General EPS (2 Seat)		16-20	FA456X		FA456R		MD6338D
25	1000 General EPS (2 Seat)		17-20	FA456X		FA456R		MD6408D
26	1000 General 4 EPS (4 Seat)		17-20	FA456X		FA456R		MD6408D
27								
28	POLARIS RANGER (COMMERCIAL)							
29	Brutus HD HDPTO (R03)		13-17	FA354R				MD6275D
30								
31	POLARIS RANGER (SIDE X SIDE)							
32	325 Ranger ETX		15-16	N/A		FA354R		MD6275D
33	400 Ranger (All Models)		10-14	N/A		FA354R		MD6275D
34	499 Ranger (All Models)		17	N/A		FA354R		MD6201D
35	SXS 500 Ranger (2 x 4/4 x 4)		06-07	N/A		FA354R		MD6275D
36	SXS 500 Ranger (4 x 4 EFI)		06-07	N/A		FA354R		MD6275D
37	SXS 500 Ranger (4 x 4 EFI)		08-10	N/A		FA354R		MD6275D
38	SXS 500 Ranger (4 x 4 EFI)		11-13	N/A		FA354R		MD6275D
39	SXS 500 Ranger (Carb) 2 x 4		08-09	N/A		FA354R		MD6275D
40	SXS 500 Ranger (EFI) 4 x 4 H.O.		09-11	N/A		FA354R		MD6275D
41	SXS 500 Ranger Crew		11-13	N/A		FA354R		MD6275D
42	SXS 500 Ranger Series 10 6 x 6			N/A		FA354R		MD6201D
43	SXS 500 Ranger 500 2WDHDPE ETX		17-20	N/A		FA354R		MD6201D
44	SXS 500 Ranger 500 R21MAA50BJ7		21-22	N/A		FA354R		MD6201D
45	Ranger 99 models		99	N/A		FA273R		N/A
46	Ranger Series 10			N/A		FA354R		MD6201D
47	Ranger 2 x 4 / 4 x 4		04-05	N/A		FA354R		MD6201D
48	Ranger Series 11			N/A		FA354R		MD6201D
49	Ranger 6 x 6		04-05	N/A		FA354R		MD6201D
50	Ranger TM		04-05	N/A		FA354R		MD6201D
51	Ranger TM		06	N/A		FA354R		MD6275D
52	Ranger XP		05	N/A		FA354R		MD6201D
53	570 Ranger EFI		14-20			FA354R		MD6275D
54	570 Ranger Crew EFI		14-15			FA354R		MD6275D
55	SXS Ranger 570 R16MA57A1/4/A9/L1		16			FA354R		MD6275D

* symbol after part# = 2 pieces required i.e. 2 pad sets or 2 rotors (twin rotor models)

Part numbers, prefixes, suffixes, photos and illustrations shown in this catalog are trademarks and/or copyrights of EBC Brakes or the trademark owner A C Freeman Investments Ltd and use without express written permission of the owners is punishable by law.

All names & numbers are for reference purposes only. ® Registered trademarks of Harley—Davidson® Motor Corp or Buell.
NOTE: — Some models may have a second rotor fitted as an optional extra. Please double check with your customer exactly which side the front rotor is fitted and if twin rotor or single.

Ⓢ This symbol indicates a rotor made of billet steel, and should be only used with EBC FA Kevlar® Organic or Vee pads.

**BRAKE
APPLICATIONS**

FRONT: AMERICAN PRODUCED MOTORCYCLES

APPLICATIONS

BRAKE

* This symbol indicates a rotor made of billet steel, and should be only used with EBC FA Kevlar® Organic or Vee pads.

POLARIS RANGER (SIDE X SIDE)

SUFFIX OR PREFIX PAD MATERIALS AND DESCRIPTION	YEAR	FRONT				FRONT ROTOR OPTIONS DESIGN NO. <small>See Buyers Guide for rotor style & finish options. Part nos for ordering & sizing.</small>	Line #
		PADS	PADS	PADS	PADS		
		FA Kevlar Organic Pads	V Semi-Sintered V-Pads™	HH/R Double-HT™ USA-Made Sintered Pads	EPFA Premium Low Noise Street Sintered Pads		
Ranger 570, (R12)	17-20					MD6202D*	1
Ranger 570 R18RCA57A1/A4/B4/B1 FULL SIZE (R06)	18-20					MD6202D*	2
Ranger 570 R19RCA57A1/A4/B1/B4 Full Size (R03)	19-20			FA354R*		MD6202D*	3
SXS Ranger 570 Full Size R21CCA57A1/A7	21-22	FA656X*		SXR656HH*		MD6202D*	4
Ranger Crew 570FS R17RDA57A1/B1 (R08)	17-20	FA656X*		SXR656HH*		MD6202D*	5
Ranger Crew 570 FS R18RDA57A1/B1 (R05)	16-20	FA656X*		SXR656HH*		MD6202D*	6
Ranger Crew 570 FS R19RDA57A1/B1 (R03)	19-20	FA656X*		SXR656HH*		MD6202D*	7
RGR 570 EPS Crew MD R18RNE57NV (R04)	18-20	FA656X*		SXR656HH*		MD6202D*	8
RGR 570 EFI Crew R17RNA57A1/A9/EAM/ENM R10)	17-20	FA656X*		SXR656HH*		MD6202D*	9
RGR 570 Crew R18RNA57B1/B9/EBV (R03)	18-20	FA656X*		SXR656HH*		MD6202D*	10
RGR 570 Crew R19RNA57B1/B9/EBX (R02)	16-20	FA656X*		SXR656HH*		MD6202D*	11
700 Ranger 6 x 6 EFi	06-09					MD6202D*	12
700 Ranger XP 4 x 4	06					MD6202D*	13
700 Ranger 4 x 4 EFi/LE	07					MD6202D*	14
700 Ranger 4 x 4 EFi	09	FA452X*		SXR452HH*		MD6338D*	15
700 Ranger Crew (EFi) 4 x 4	09	FA452X*		SXR452HH*		MD6202D*	16
700 Ranger 6 x 4 EFi	08	FA452X*		SXR452HH*		MD6202D*	17
700 Ranger XP 4 x 4	08	FA452X*		SXR452HH*		MD6202D*	18
Ranger EV (Electric)	10-15	FA452X*		SXR452HH*		MD6202D*	19
Ranger EV MD R18RMAE4N8 (R02)	18-19	FA656X*		SXR656HH*		MD6202D*	20
Ranger EV LIION R17RMAL4G9 (R08)	16-18	FA656X*		SXR656HH*		MD6202D*	21
Ranger EV LIION R18RMAL4G9 (R03)	16-18	FA656X*		SXR656HH*		MD6202D*	22
Ranger EV R17RMAE4G8/G9/N8/MAE4H8 (R12)	16-17	FA656X*		SXR656HH*		MD6202D*	23
Ranger EV R18RMAE4G8/G9 (R03)	16-18	FA656X*		SXR656HH*		MD6202D*	24
800 Ranger	10-12	FA452X*		SXR452HH*		MD6338D*	25
800 Ranger EFi	13-14	FA452X*		SXR452HH*		MD6338D*	26
800 Ranger Mid Size	13-14					MD6202D*	27
800 Ranger XP	10-12	FA452X*		SXR452HH*		MD6338D*	28
800 Ranger 6 x 6	10-17	FA452X*		SXR452HH*		MD6338D*	29
800 Ranger Crew	10-14	FA452X*		SXR452HH*		MD6338D*	30
RGR 800 6X6 R17RAA76NA MD Poland (R02)	17-20	FA656X*		SXR656HH*		MD6202D*	31
900 Ranger Crew	10-15	FA656X*		SXR656HH*		MD6338D*	32
900 D Crew Ranger Diesel	13-14	FA452X*		SXR452HH*		MD6338D*	33
900 D Ranger Diesel	11-14	FA452X*		SXR452HH*		MD6338D*	34
900 (Ranger XP 900)	13-14	FA452X*		SXR452HH*		MD6338D*	35
900 Ranger XP 900 (R27)	15-19	FA452X*		SXR452HH*		MD6338D*	36
900 R18RVA87A1/B1/E87A9/B9	16-19	FA452X*		SXR452HH*		MD6338D*	37
Ranger Crew 900XP 6P SP R18RVA87A1/B1/E87A9/B9 (R10)	18	FA656X*		SXR656HH*		MD6338D*	38
Ranger Crew 900 EPS R19RVA87A1/B1/EA9/AH/B9/BH (R03)	19	FA656X*		SXR656HH*		MD6338D*	39
Ranger Crew 900 6P SP R17RVA87A1/B1/E87A9/B9 (R14)	17	FA656X*		SXR656HH*		MD6338D*	40
Ranger 902D EU Tractor R07	19-20	FA656X*		SXR656HH*		MD6380D*	41
1000 Ranger Diesel	15-20	FA656X*		SXR656HH*		MD6338D*	42
1000 Ranger Diesel Crew	15	FA452X*		SXR452HH*		MD6338D*	43
Ranger Crew 1000XP PS MD R18RVE99NX (R08)	18	FA656X*		SXR656HH*		MD6338D*	44
Ranger Crew 1000XP PS R17RV_99 ALL OPTIONS (R32)	17	FA656X*		SXR656HH*		MD6338D*	45
Ranger Crew 000XP PS R18RV_99 ALL OPTIONS (R09)	18	FA656X*		SXR656HH*		MD6338D*	46
Ranger Crew 1000XP 6P,PS,NB,MD (R08) R17RVE99NY	17	FA656X*		SXR656HH*		MD6338D*	47
Ranger Crew 1000 PS R18RVU99AS (R10)	18-20	FA656X*		SXR656HH*		MD6338D*	48
Ranger 1000 Diesel Poland R18RTED1F1/SD1C1 (R07)	17-18	FA656X*		SXR656HH*		MD6338D*	49
Ranger 1000 Diesel EU R17RTED1F1/SD1C1 (R14)	17	FA656X*		SXR656HH*		MD6338D*	50
Ranger 1000 Diesel Crew R17RVAD1A1 (R16)	17-18	FA656X*		SXR656HH*		MD6338D*	51
Ranger Crew 1000 49/50S Factory choice (,R04, R06 R08, R11,)	18-20	FA656X*		SXR656HH*		MD6338D*	52
Ranger 1000XP PS Crew Inc EU, EPS, HD, MD (R03, R09, R13, R20)	18-20	FA656X*		SXR656HH*		MD6338D*	53
Ranger 1000XP PS NSTR, Crew Mud (R02,R15,R17,R18)	18-20	FA656X*		SXR656HH*		MD6338D*	54
Ranger 1000 Diesel R17RTAD1A1/ED1N1 (R17)	17	FA656X*		SXR656HH*		MD6338D*	55

* symbol after part# = 2 pieces required i.e. 2 pad sets or 2 rotors (twin rotor models)

REAR: AMERICAN PRODUCED MOTORCYCLES

Line #	POLARIS RANGER (SIDE X SIDE)	YEAR	REAR					
			PADS				REAR ROTOR OPTIONS	
			FA	V	HH/R	EPFA	DESIGN NO.	
			SUFFIX OR PREFIX PAD MATERIALS AND DESCRIPTION	Kevlar Organic Pads	Semi-Sintered V-Pads™	Double-H™ USA-Made Sintered Pads	Premium Low Noise Street Sintered Pads	See Buyers Guide for rotor style & finish options. Part nos for ordering & sizing.
1	Ranger 570, (R12)	17-20				FA354R		MD6275D
2	Ranger 570 R18RCA57A1/A4/B4/B1 FULL SIZE (R06)	18-20				FA354R		MD6275D
3	Ranger 570 R19RCA57A1/A4/B1/B4 Full Size (R03)	19-20				FA354R		MD6275D
4	SXS Ranger 570 Full Size R21CCA57A1/A7	21-22	FA656X			FA656R		MD6275D
5	Ranger Crew 570FS R17RDA57A1/B1 (R08)	17-20	FA656X			FA656R		MD6275D
6	Ranger Crew 570 FS R18RDA57A1/B1 (R05)	16-20	FA656X			FA656R		MD6275D
7	Ranger Crew 570 FS R19RDA57A1/B1 (R03)	19-20	FA656X			FA656R		MD6275D
8	RGR 570 EPS Crew MD R18RNE57NV (R04)	18-20	FA656X			FA656R		MD6275D
9	RGR 570 EFI Crew R17RNA57A1/A9/EAM/ENM R10)	17-20	FA656X			FA656R		MD6275D
10	RGR 570 Crew R18RNA57B1/B9/EBV (R03)	18-20	FA656X			FA656R		MD6275D
11	RGR 570 Crew R19RNA57B1/B9/EBX (R02)	16-20	FA656X			FA656R		MD6275D
12	700 Ranger 6 x 6 EFI	06-09	N/A			FA354R		MD6275D
13	700 Ranger XP 4 x 4	06	N/A			FA354R		MD6275D
14	700 Ranger 4 x 4 EFI/LE	07	N/A			FA354R		MD6275D
15	700 Ranger 4 x 4 EFI	09	N/A			FA354R		MD6275D
16	700 Ranger Crew (EFI) 4 x 4	09	FA452X			FA452R		MD6275D
17	700 Ranger 6 x 4 EFI	08	N/A			FA354R		MD6275D
18	700 Ranger XP 4 x 4	08	N/A			FA354R		MD6275D
19	700 Ranger XP 4 x 4	08	N/A			FA354R		MD6275D
20	Ranger EV (Electric)	10-15	FA656X			FA656R		
21	Ranger EV MD R18RMAE4N8 (R02)	18-19	FA656X			FA656R		
22	Ranger EV LIION R17RMAL4G9 (R08)	16-18	FA656X			FA656R		
23	Ranger EV R17RMAE4G8/G9/N8/MAE4H8 (R12)	16-17	FA656X			FA656R		
24	Ranger EV R18RMAE4G8/G9 (R03)	16-18	FA656X			FA656R		
25	800 Ranger	10-12	N/A			FA354R		MD6275D
26	800 Ranger EFI	13-14	N/A			FA354R		MD6275D
27	800 Ranger Mid Size	13-14	N/A			FA354R		MD6275D
28	800 Ranger XP	10-12	FA452X			FA452R		MD6275D
29	800 Ranger 6 x 6	10-17	FA452X			FA452R		MD6275D
30	800 Ranger Crew	10-14				FA354R		MD6275D
31	RGR 800 6X6 R17RAA76NA MD Poland (R02)	17-20						
32	900 Ranger Crew	10-15	FA452X			FA452R		MD6275D
33	900 D Crew Ranger Diesel	13-14	FA452X			FA452R		MD6275D
34	900 D Ranger Diesel	11-14	N/A			FA354R		MD6275D
35	900 (Ranger XP 900)	13-14	N/A			FA354R		MD6374D
36	900 Ranger XP 900 (R27)	15-19				FA354R		MD6275D
37	900 R18RVA87A1/B1/E87A9/B9	16-19	FA452X			FA452R		MD6275D
38	Ranger Crew 900XP 6P SP R18RVA87A1/B1/E87A9/B9 (R10)	18						
39	Ranger Crew 900 EPS R19RVA87A1/B1/EA9/AH/B9/BH (R03)	19						
40	Ranger Crew 900 6P SP R17RVA87A1/B1/E87A9/B9 (R14)	17						
41	Ranger 902D EU Tractor R07	19-20	FA456X			FA456R		MD6338D
42	1000 Ranger Diesel	15-20	N/A			FA354R		MD6275D
43	1000 Ranger Diesel Crew	15				FA354R		MD6275D
44	Ranger Crew 1000XP PS MD R18RVE99NX (R08)	18	FA452X			FA452R		MD6275D
45	Ranger Crew 1000XP PS R17RV_99 ALL OPTIONS (R32)	17	FA452X			FA452R		MD6275D
46	Ranger Crew 000XP PS R18RV_99 ALL OPTIONS (R09)	18	FA452X			FA452R		MD6275D
47	Ranger Crew 1000XP 6P,PS,NB,MD (R08) R17RVE99NY	17	FA452X			FA452R		MD6275D
48	Ranger Crew 1000 PS R18RVU99AS (R10)	18-20	FA452X			FA452R		MD6275D
49	Ranger 1000 Diesel Poland R18RTED1F1/SD1C1 (R07)	17-18	FA452X			FA452R		MD6275D
50	Ranger 1000 Diesel EU R17RTED1F1/SD1C1 (R14)	17	FA656X					MD6275D
51	Ranger 1000 Diesel Crew R17RVAD1A1 (R16)	17-18	FA656X					MD6275D
52	Ranger Crew 1000 49/50S Factory choice (,R04, R06 R08, R11,)	18-20				FA456R		MD6275D
53	Ranger 1000XP PS Crew Inc EU,EPS, HD,MD (R03, R09,R13, R20)	18-20	FA456X			FA456R		MD6275D
54	Ranger 1000XP PS NSTR, Crew Mud (R02,R15,R17,R18)	18-20	FA456X			FA456R		MD6275D
55	Ranger 1000 Diesel R17RTAD1A1/ED1N1 (R17)	17	FA656X					MD6275D

* symbol after part# = 2 pieces required i.e. 2 pad sets or 2 rotors (twin rotor models)

Part numbers, prefixes, suffixes, photos and illustrations shown in this catalog are trademarks and/or copyrights of EBC Brakes or the trademark owner A C Freeman Investments Ltd and use without express written permission of the owners is punishable by law.

All names & numbers are for reference purposes only. ® Registered trademarks of Harley—Davidson® Motor Corp or Buell.
NOTE: — Some models may have a second rotor fitted as an optional extra. Please double check with your customer exactly which side the front rotor is fitted and if twin rotor or single.

Ⓢ This symbol indicates a rotor made of billet steel, and should be only used with EBC FA Kevlar® Organic or Vee pads.

BRAKE APPLICATIONS

FRONT: AMERICAN PRODUCED MOTORCYCLES

APPLICATIONS

BRAKE

* This symbol indicates a rotor made of billet steel, and should be only used with EBC FA Kevlar® Organic or Vee pads.

		FRONT					Line #
		PADS	PADS	PADS	PADS	FRONT ROTOR OPTIONS	
		FA	V	HH/R	EPFA	DESIGN NO.	
SUFFIX OR PREFIX PAD MATERIALS AND DESCRIPTION		Kevlar Organic Pads	Semi-Sintered V-Pads™	Double-HT™ USA-Made Sintered Pads	Premium Low Noise Street Sintered Pads	See Buyers Guide for rotor style & finish options. Part nos for ordering & sizing.	
POLARIS RANGER (SIDE X SIDE)							
YEAR							
	Ranger 1000 Diesel R18RTAD1B1/ED1N1 (R13)	FA656X*		SXR656HH*		MD6338D*	1
	PPS/PTV 4 x 4/Series 10	FA159X*		SXR159HH*		MD6202D*	2
	PPS/PTV 6 x 6/Series 10	FA159X*		SXR159HH*		MD6149D*	3
	PPS/UTV 2 x 4 Series 10			FA354R*		MD6202D*	4
	PPS/UTV 4 x 6 Series 10			FA354R*		MD6202D*	5
	PPS/UTV 1500 2 x 4 Series 11			FA354R*		MD6202D*	6
	PPS LUH 6 x 6	FA159X*		SXR159HH*		MD6149D*	7
	PPS/Series 11 2 x 4/4 x 4			FA354R*		MD6202D*	8
	PPS/Series 11 6 x 6			FA354R*		MD6202D*	9
	Ranger (Various Models 05-16) Handbrake Pads						10
POLARIS RZR (SIDE X SIDE)							
	Military RZR2 XP MV 1000 Turbo Diesel (R01) M17VDED1MA/EX	FA656X*		SXR656HH*			11
	Military RZR2 XP MV 1000 Turbo Diesel NELO (R01) M18VDED1MN	FA656X*		SXR656HH*			12
	Military RZR4 XP MV 1000 Turbo Diesel (R04) M17VFED1MA/EX	FA656X*		SXR656HH*			13
	RZR 170			FA490R*		MD6353D*	14
	RZR 570	FA456X*		SXR456HH*		MD6312D*	15
	RZR 570	FA456X*		SXR456HH*		MD6338D*	16
	RZR 570	FA456X*		SXR456HH*		MD6338D*	17
	RZR 800 (Inc EPS Models)	FA456X*		SXR456HH*		MD6312D*	18
	RZR-4 800 EPS	FA452X*		SXR452HH*		MD6338D*	19
	RZR 900 (50" Inch All Options)	FA657X*		SXR657HH*		MD6338D*	20
	RZR-S 900 (60" Inch All Options)	FA657X*		SXR657HH*		MD6338D*	21
	RZR 900 XP (Inc EPS Models)	FA656X*		SXR656HH*		MD6338D*	22
	RZR 900 4 XP All Options Inc Military	FA656X*		SXR656HH*		MD6338D*	23
	RZR 4 900 Z17VCE87AB/AK/AM (R05)	FA656X*		SXR656HH*		MD6338D*	24
	RZR 4 900 Z18VCE87BK/BU/BR/LU (R05 R12)	FA656X*		SXR656HH*		MD6338D*	25
	RZR 1000 60 Inch PS EU/Tractor/Zug (R01,R06,R07,R09) (60" Inch All Options)	FA657X*		SXR657HH*		MD6338D*	26
	RZR 1000 XP	FA452X*		SXR452HH*		MD6380D*	27
	RZR 1000 XP	FA656X*		SXR656HH*		MD6380D*	28
	RZR 1000 Z19VCE99AM	FA656X*		SXR656HH*		MD6380D*	29
	RZR XP Turbo			SXR680HH*		MD6397D*	30
	RZR XP 4 Turbo			SXR680HH*		MD6397D*	31
	RZR RS1 RS1	FA656X*		SXR656HH*		MD6380D*	32
	RZR Turbo 4 Turbo 4	FA680X*		SXR680HH*		MD6397D*	33
	RZR 1000 XP 4	FA656X*		SXR656HH*		MD6380D*	34
	RZR 1000 XP 4	FA656X*		SXR656HH*		MD6380D*	35
	RZR 1000 XP 4	FA656X*		SXR656HH*		MD6380D*	36
	RZR 1000 XP 4 MD	FA656X*		SXR656HH*		MD6380D*	37
	RZR 1000 XP 4 MD	FA656X*		SXR656HH*		MD6380D*	38
	RZR Pro XP Turbo (Z20A_92 & Z21RAC)	FA680X*		SXR680HH*		MD6380D*	39
	RZR XP Turbo	FA680X*		SXR680HH*		MD6380D*	40
	RZR XP Turbo Latin	FA680X*		SXR680HH*		MD6380D*	41
	RZR XP Turbo MD	FA680X*		SXR680HH*		MD6380D*	42
	RZR XP Turbo S	FA680X*		SXR680HH*		MD6380D*	43
	RZR XP Turbo Tractor	FA680X*		SXR680HH*		MD6380D*	44
	RZR XP4 Turbo	FA680X*		SXR680HH*		MD6380D*	45
	RZR XP4 Turbo Intl	FA680X*		SXR680HH*		MD6380D*	46
	RZR XP4 Turbo MD	FA680X*		SXR680HH*		MD6380D*	47
	RZR XP4 Turbo S			SXR728HH*		MD6380D*	48
	RZR XP Turbo S Velocity			SXR728HH*		MD6380D*	49
							50
							51
							52
							53
							54
							55

* symbol after part# = 2 pieces required i.e. 2 pad sets or 2 rotors (twin rotor models)

REAR: AMERICAN PRODUCED MOTORCYCLES

Line #	SUFFIX OR PREFIX PAD MATERIALS AND DESCRIPTION	YEAR	REAR				
			PADS	PADS	PADS	PADS	REAR ROTOR OPTIONS
			FA Kevlar Organic Pads	V Semi-Sintered V-Pads™	HH/R Double-H™ USA-Made Sintered Pads	EPFA Premium Low Noise Street Sintered Pads	DESIGN NO. See Buyers Guide for rotor style & finish options. Part nos for ordering & sizing.
POLARIS RANGER (SIDE X SIDE)							
1	Ranger 1000 Diesel R18RTAD1B1/ED1N1 (R13)	18	FA656X				MD6275D
2	PPS/PTV 4 x 4/Series 10		N/A		FA314R		MD6200D
3	PPS/PTV 6 x 6/Series 10		N/A		FA313R		MD6200D
4	PPS/UTV 2 x 4 Series 10		N/A		FA354R		MD6201D
5	PPS/UTV 4 x 6 Series 10		N/A		FA354R		MD6201D
6	PPS/UTV 1500 2 x 4 Series 11		N/A		FA354R		MD6201D
7	PPS LUH 6 x 6	02	N/A		FA313R		MD6170D
8	PPS/Series 11 2 x 4/4 x 4		N/A		FA354R		MD6201D
9	PPS/Series 11 6 x 6		N/A		FA354R		MD6201D
10	Ranger (Various Models 05-16) Handbrake Pads	05-16	FA659X		FA659R		
POLARIS RZR (SIDE X SIDE)							
13	Military RZR2 XP MV 1000 Turbo Diesel (R01) M17VDED1MA/EX	17	FA656X		FA656R		
14	Military RZR2 XP MV 1000 Turbo Diesel NELO (R01) M18VDED1MN	18	FA656X		FA656R		
15	Military RZR4 XP MV 1000 Turbo Diesel (R04) M17VFED1MA/EX	17	FA656X		FA656R		
16	RZR 170	09-15	N/A		FA489R		MD6344D
17	RZR 570	12-13	FA159X		FA159R		MD6275D
18	RZR 570	14-19	FA456X		FA456R		MD6275D
19	RZR 570	20-21	FA475X		FA475R		MD6275D
20	RZR 800 (Inc EPS Models)	08-14	FA159X		FA159R		MD6275D
21	RZR-4 800 EPS	12	N/A		FA354R		MD6275D
22	RZR 900 (50" Inch All Options)	15-20	FA456X		FA456R		MD6338D
23	RZR-S 900 (60" Inch All Options)	15-20	FA456X		FA456R		MD6338D
24	RZR 900 XP (Inc EPS Models)	11-14			FA354R		MD6374D
25	RZR 900 4 XP All Options Inc Military	12-16	FA656X		FA656R		MD6374D
26	RZR 4 900 Z17VCE87AB/AK/AM (R05)	17	FA656X		FA656R		MD6374D
27	RZR 4 900 Z18VCE87BK/BU/BR/LU (R05 R12)	16-18	FA456X		FA456R		
28	RZR 1000 60 Inch PS EU/Tractor/Zug (R01,R06,R07,R09) (60" Inch All Options)	17-20	FA456X		FA456R		MD6338D
29	RZR 1000 XP	16-17	FA452X		FA452R		MD6380D
30	RZR 1000 XP	12-19	FA656X		FA656R		MD6380D
31	RZR 1000 Z19VCE99AM	18-20	FA456X		FA456R		MD6338D
32	RZR XP Turbo	16	FA656X		FA656R		MD6397D
33	RZR XP 4 Turbo	16	FA656X		FA656R		MD6397D
34	RZR RS1 RS1	18-20	FA656X		FA656R		MD6380D
35	RZR Turbo 4 Turbo 4	19-20	FA656X		FA656R		MD6397D
36	RZR 1000 XP 4	19-20	FA656X		FA656R		MD6380D
37	RZR 1000 XP 4	18	FA656X		FA656R		MD6380D
38	RZR 1000 XP 4	16-17	FA656X		FA656R		MD6380D
39	RZR 1000 XP 4 MD	17	FA656X		FA656R		MD6380D
40	RZR 1000 XP 4 MD	18-19	FA656X		FA656R		MD6380D
41	RZR Pro XP Turbo (Z20A_92 & Z21RAC)	20-21	FA656X		FA656R		MD6397D
42	RZR XP Turbo	17-20	FA656X		FA656R		MD6397D
43	RZR XP Turbo Latin	18	FA656X		FA656R		MD6397D
44	RZR XP Turbo MD	17-18	FA656X		FA656R		MD6397D
45	RZR XP Turbo S	18-20	FA656X		FA656R		MD6397D
46	RZR XP Turbo Tractor	17-18	FA656X		FA656R		MD6397D
47	RZR XP4 Turbo	17-20	FA656X		FA656R		MD6397D
48	RZR XP4 Turbo Intl	17	FA656X		FA656R		MD6397D
49	RZR XP4 Turbo MD	18-20	FA656X		FA656R		MD6397D
50	RZR XP4 Turbo S	19-20	FA656X		FA656R		MD6397D
51	RZR XP Turbo S Velocity	19-20					MD6397D
52							
53							
54							
55							

* symbol after part# = 2 pieces required i.e. 2 pad sets or 2 rotors (twin rotor models)

Part numbers, prefixes, suffixes, photos and illustrations shown in this catalog are trademarks and/or copyrights of EBC Brakes or the trademark owner A C Freeman Investments Ltd and use without express written permission of the owners is punishable by law.

All names & numbers are for reference purposes only. ® Registered trademarks of Harley—Davidson® Motor Corp or Buell.
NOTE: — Some models may have a second rotor fitted as an optional extra. Please double check with your customer exactly which side the front rotor is fitted and if twin rotor or single.

Ⓢ This symbol indicates a rotor made of billet steel, and should be only used with EBC FA Kevlar® Organic or Vee pads.

**BRAKE
APPLICATIONS**

FRONT: AMERICAN PRODUCED MOTORCYCLES

APPLICATIONS

BRAKE

★ This symbol indicates a rotor made of billet steel, and should be only used with EBC FA Kevlar® Organic or Vee pads.

		FRONT					
		PADS	PADS	PADS	PADS	FRONT ROTOR OPTIONS	
		FA	V	HH/R	EPFA	DESIGN NO.	
SUFFIX OR PREFIX PAD MATERIALS AND DESCRIPTION		Kevlar Organic Pads	Semi-Sintered V-Pads™	Double-HT™ USA-Made Sintered Pads	Premium Low Noise Street Sintered Pads	See Buyers Guide for rotor style & finish options. Part nos for ordering & sizing.	Line #
POLARIS (SLINGSHOT)							
	YEAR						
Slingshot Base (Front pads sold as an axle set of 4 pads)	15-17					MD533*	1
Slingshot S (Front pads sold as an axle set of 4 pads)	18					MD533*	2
Slingshot SL (Front pads sold as an axle set of 4 pads)	15-18					MD533*	3
Slingshot SL LE (Front pads sold as an axle set of 4 pads)	15-18					MD533*	4
Slingshot SLR (Front pads sold as an axle set of 4 pads)	17-18						5
							6
							7
VICTORY							
V92C Standard Cruiser	98-00	FA244	FA244V	FA244HH		MD727*	8
V92C Standard Cruiser	01-02	FA244	FA244V	FA244HH			9
V92DH Deluxe Cruiser	01-02	FA244	FA244V	FA244HH			10
V92SC Sport Cruiser	00	FA244*	FA244V*	FA244HH		MD727*	11
V92SC Sport Cruiser	01	FA244	FA244V	FA244HH			12
V92SC Special Edition	00	FA244	FA244V	FA244HH			13
V92TC Touring Cruiser	03-06	FA244*	FA244V*	FA244HH			14
Broadwalk	13-15			FA347HH			15
Cross Country	10-17			FA347HH			16
Cross Country 8 Ball	15-16			FA347HH			17
Cross Country Touring	13-17			FA347HH			18
Cross Country Cory Ness Victory	11-12			FA347HH			19
Cross Roads	10-12			FA347HH			20
Cross Roads Classic	13-14			FA347HH			21
Cross Roads 8 Ball	14-15			FA347HH			22
Empulse TT	16	FA244*	FA244V*	FA244HH			23
Gunner	15-17			FA347HH			24
Hammer	05-07	FA244*	FA244V*	FA244HH		MD678*	25
Hammer	08-11			FA347HH			26
Hammer 8 Ball	10-15			FA347HH			27
Hammer 8 Ball	16			FA347HH			28
Hammer S	07	FA244*	FA244V*	FA244HH		MD678*	29
Hammer S	08-17			FA347HH			30
Hard Ball	12-13			FA347HH			31
High Ball	12-17			FA347HH			32
Jackpot	07-10			FA347HH		MD678	33
Jackpot	11-16			FA347HH			34
Jackpot Cory Ness	08-10			FA347HH			35
Judge	13-17			FA347HH			36
King Pin	04-07	FA244	FA244V	FA244HH		MD678	37
King Pin	08-12			FA347HH			38
King Pin Tour	04-07	FA244	FA244V	FA244HH		MD678	39
King Pin Tour	08-09			FA347HH			40
King Pin 8 Ball	08-11			FA347HH			41
King Pin Low	09			FA347HH			42
Magnum	15-17			FA347HH			43
Magnum X-1	15-17			FA347HH			44
Ness Signature Series	05-07	FA244	FA244V	FA244HH		MD678	45
Octane 1200cc	17	FA209/2	FA209/2V	FA209/2HH		MD534	46
Vegas	03-07	FA244	FA244V	FA244HH		MD678	47
Vegas	08-12			FA347HH		MD678	48
Vegas	16-17			FA347HH		MD678	49
Vegas 8 Ball	05-07	FA244	FA244V	FA244HH		MD678	50
Vegas 8 Ball	08-10			FA347HH		MD678	51
Vegas 8 Ball	11-17			FA347HH		MD678	52
Vegas Jackpot	06-07	FA244	FA244V	FA244HH		MD678	53
Vegas Jackpot	08-12			FA347HH		MD678	54
Vegas Jackpot	13-14			FA347HH			55

* symbol after part# = 2 pieces required i.e. 2 pad sets or 2 rotors (twin rotor models)

REAR: AMERICAN PRODUCED MOTORCYCLES

Line #	POLARIS (SLINGSHOT)	SUFFIX OR PREFIX PAD MATERIALS AND DESCRIPTION	YEAR	REAR				
				PADS	PADS	PADS	PADS	REAR ROTOR OPTIONS
				FA	V	HH/R	EPFA	DESIGN NO.
				Kevlar Organic Pads	Semi-Sintered V-Pads™	Double-H™ USA-Made Sintered Pads	Premium Low Noise Street Sintered Pads	See Buyers Guide for rotor style & finish options. Part nos for ordering & sizing.
1	Slingshot Base (Front pads sold as an axle set of 4 pads)		15-17	FA670				MD533
2	Slingshot S (Front pads sold as an axle set of 4 pads)		18					MD533
3	Slingshot SL (Front pads sold as an axle set of 4 pads)		15-18	FA670				MD533
4	Slingshot SL LE (Front pads sold as an axle set of 4 pads)		15-18					MD533
5	Slingshot SLR (Front pads sold as an axle set of 4 pads)		17-18	TBA				TBA
6								
7	VICTORY							
8	V92C Standard Cruiser		98-00	FA209/2		FA209/2HH		MD727
9	V92C Standard Cruiser		01-02	FA209/2		FA209/2HH		
10	V92DH Deluxe Cruiser		01-0	FA209/2		FA209/2HH		
11	V92SC Sport Cruiser		00	FA209/2		FA209/2HH		MD727
12	V92SC Sport Cruiser		01	FA209/2		FA209/2HH		
13	V92SC Special Edition		00	FA209/2		FA209/2HH		MD727
14	V92TC Touring Cruiser		03-06	FA209/2		FA209/2HH		
15	Broadwalk		13-15	FA196		FA196HH		
16	Cross Country		10-17	FA196		FA196HH		
17	Cross Country 8 Ball		15-16	FA196		FA196HH		
18	Cross Country Touring		13-17	FA196		FA196HH		
19	Cross Country Cory Ness Victory		11-12	FA196		FA196HH		
20	Cross Roads		10-12	FA196		FA196HH		
21	Cross Roads Classic		13-14	FA196		FA196HH		
22	Cross Roads 8 Ball		14-15	FA196		FA196HH		
23	Empulse TT		16	FA266		FA266HH		
24	Gunner		15-17	FA196		FA196HH		
25	Hammer		05-07	FA209/2		FA209/2HH		MD678
26	Hammer		08-11	FA196		FA196HH		
27	Hammer 8 Ball		10-15	FA196		FA196HH		
28	Hammer 8 Ball		16	FA196		FA196HH		
29	Hammer S		07	FA209/2		FA209/2HH		MD678
30	Hammer S		08-17	FA196		FA196HH		
31	Hard Ball		12-13	FA196		FA196HH		
32	High Ball		12-17	FA196		FA196HH		
33	Jackpot		07-10	FA196		FA196HH		MD678
34	Jackpot		11-16	FA196		FA196HH		
35	Jackpot Cory Ness		08-10	FA196		FA196HH		
36	Judge		13-17	FA196		FA196HH		
37	King Pin		04-07	FA209/2		FA209/2HH		MD678
38	King Pin		08-12	FA196		FA196HH		
39	King Pin Tour		04-07	FA209/2		FA209/2HH		MD678
40	King Pin Tour		08-09	FA196		FA196HH		
41	King Pin 8 Ball		08-11	FA196		FA196HH		
42	King Pin Low		09	FA196		FA196HH		
43	Magnum		15-17	FA196		FA196HH		
44	Magnum X-1		15-17	FA196		FA196HH		
45	Ness Signature Series		05-07	FA209/2		FA209/2HH		MD678
46	Octane 1200cc		17	FA213		FA213HH		MD534
47	Vegas		03-07	FA209/2		FA209/2HH		MD678
48	Vegas		08-12	FA196		FA196HH		MD678
49	Vegas		16-17	FA196		FA196HH		MD678
50	Vegas 8 Ball		05-07	FA209/2		FA209/2HH		MD678
51	Vegas 8 Ball		08-10	FA196		FA196HH		MD678
52	Vegas 8 Ball		11-17	FA196		FA196HH		MD678
53	Vegas Jackpot		06-07	FA209/2		FA209/2HH		MD678
54	Vegas Jackpot		13-14	FA196		FA196HH		MD678
55	Vegas Jackpot		13-14	FA196		FA196HH		MD678

* symbol after part# = 2 pieces required i.e. 2 pad sets or 2 rotors (twin rotor models)

Part numbers, prefixes, suffixes, photos and illustrations shown in this catalog are trademarks and/or copyrights of EBC Brakes or the trademark owner A C Freeman Investments Ltd and use without express written permission of the owners is punishable by law.

All names & numbers are for reference purposes only. ® Registered trademarks of Harley—Davidson® Motor Corp or Buell.

NOTE: — Some models may have a second rotor fitted as an optional extra. Please double check with your customer exactly which side the front rotor is fitted and if twin rotor or single.

Ⓢ This symbol indicates a rotor made of billet steel, and should be only used with EBC FA Kevlar® Organic or Vee pads.

**BRAKE
APPLICATIONS**

FRONT: AMERICAN PRODUCED MOTORCYCLES

APPLICATIONS

BRAKE

✪ This symbol indicates a rotor made of billet steel, and should be only used with EBC FA Kevlar® Organic or Vee pads.

VICTORY	SUFFIX OR PREFIX PAD MATERIALS AND DESCRIPTION	YEAR	FRONT				FRONT ROTOR OPTIONS DESIGN NO. <small>See Buyers Guide for rotor style & finish options. Part nos for ordering & sizing.</small>	Line #
			PADS	PADS	PADS	PADS		
			FA Kevlar Organic Pads	V Semi-Sintered V-Pads™	HH/R Double-HT™ USA-Made Sintered Pads	EPFA Premium Low Noise Street Sintered Pads		
Vegas Zach Ness		11			FA347HH		MD678	1
Vegas Low		08-09			FA347HH		MD678	2
Vision 8 Ball		10-11			FA261HH			3
Vision Street		08-09			FA261HH			4
Vision Tour all models		08-15			FA261HH			5
Arlen Ness Victory Vision		10-12			FA261HH			6
								7
								8
ZERO								
DS ZF13.0 J.Juan Front & Rear Calipers		16-19	FA209/2		FA209/2HH			9
Zero DS ZF6.0/ZF9.0 2 Pin Fixing Front Pad		10-12	FA264		FA264HH			10
Zero DS ZF8.5/ZF11.4 Nissin Front & Rear Calipers		13	FA185X		FA185R			11
Zero DS ZF8.5/ZF11.4 Nissin Front/J.Juan Rear Calipers		14	FA185X		FA185R			12
Zero DS ZF9.4/ZF12.5 J.Juan Front & Rear Calipers		15	FA209/2		FA209/2HH			13
Zero DS II ZF14.4		19-21	FA209/2		FA209/2HH			14
Zero DS II ZF7.2		19-21	FA209/2		FA209/2HH			15
Zero DSR ZF13.0 J.Juan Front & Rear Calipers		17-19	FA209/2		FA209/2HH			16
Zero DSR ZF14.4.0		19-21	FA209/2		FA209/2HH			17
Zero DSR Black Forest		19-21	FA209/2		FA209/2HH			18
Zero FXZF2.8/ZF5.7 J.Juan Front & Rear Calipers		15	FA181X		FA181R			19
Zero FXZF2.8/ZF5.7 Nissin Front & Rear Calipers		13	FA185X		FA185R			20
Zero FXZF2.8/ZF5.7 Nissin Front/J.Juan Rear Calipers		14	FA185X		FA185R			21
Zero FX ZF3.3/ZF6.5		16-21	FA209/2		FA209/2HH			22
Zero FXS ZF3.3/6ZF.5		17-21	FA209/2		FA209/2HH			23
Zero MX 2 Pin Fixing Front Pad		10-12	FA264		FA264HH			24
Zero MX ZF2.8/ZF5.7 Nissin Front & Rear Calipers		13	FA185X		FA185R			25
Zero S ZF14.4		19-21	FA209/2		FA209/2HH			26
Zero S ZF6.0 2 Pin Fixing Front Pad		10-12	FA264		FA264HH			27
Zero S ZF7.2		19-21	FA209/2		FA209/2HH			28
Zero S ZF8.5/11.4 Nissin Front & Rear Calipers		13	FA185X		FA185R			29
Zero S ZF8.5/11.4 Nissin Front/J.Juan Rear Calipers		14	FA185X		FA185R			30
Zero S ZF9.4/ZF12.5 J.Juan Front & Rear Calipers		15	FA209/2		FA209/2HH			31
Zero S ZF9.8/ZF13.0 J.Juan Front & Rear Calipers		16-19	FA209/2		FA209/2HH			32
Zero SR ZF11.4 Nissin Front/J.Juan Rear Calipers		14	FA185X		FA185R			33
Zero SR ZF12.5 J.Juan Front & Rear Calipers		15	FA209/2		FA209/2HH			34
Zero SR ZF13.0 J.Juan Front & Rear Calipers		16-19	FA209/2		FA209/2HH			35
Zero X 2 Pin Fixing Front Pad		10-12	FA264		FA264HH			36
Zero XU 2 Pin Fixing Front Pad		10-12	FA264		FA264HH			37
Zero XU ZF2.8/ZF5.7 Nissin Front & Rear Calipers		13	FA185X		FA185R			38
Zero SR/F ZF14.4 kWh Electric		19-21	FA244*	FA244V*	FA244HH*		MD669X*	39
Zero SR/S ZF14.4kWh Electric		19-21	FA244*	FA244V*	FA244HH*		MD669X*	40
								41
								42
								43
								44
								45
								46
								47
								48
								49
								50
								51
								52
								53
								54
								55

* symbol after part# = 2 pieces required i.e. 2 pad sets or 2 rotors (twin rotor models)

REAR: AMERICAN PRODUCED MOTORCYCLES

Line #	VICTORY	SUFFIX OR PREFIX PAD MATERIALS AND DESCRIPTION	YEAR	REAR				
				PADS	PADS	PADS	PADS	REAR ROTOR OPTIONS
				FA Kevlar Organic Pads	V Semi-Sintered V-Pads™	HH/R Double-H™ USA-Made Sintered Pads	EPFA Premium Low Noise Street Sintered Pads	DESIGN NO. See Buyers Guide for rotor style & finish options. Part nos for ordering & sizing.
1	Vegas Zach Ness		11	FA196		FA196HH		MD678
2	Vegas Low		08-09	FA196		FA196HH		MD678
3	Vision 8 Ball		10-11	FA196		FA196HH		
4	Vision Street		08-09	FA196		FA196HH		
5	Vision Tour all models		08-15	FA196		FA196HH		
6	Arlen Ness Victory Vision		10-12	FA196		FA196HH		
7								
8	ZERO							
9	DS ZF13.0 J.Juan Front & Rear Calipers		16-19	FA213		FA213HH		
10	Zero DS ZF6.0/ZF9.0 2 Pin Fixing Front Pad		10-12	FA83X		FA83HH		
11	Zero DS ZF8.5/ZF11.4 Nissin Front & Rear Calipers		13	FA367X		FA367R		
12	Zero DS ZF8.5/ZF11.4 Nissin Front/J.Juan Rear Calipers		14	FA208X		FA208R		
13	Zero DS ZF9.4/ZF12.5 J.Juan Front & Rear Calipers			FA213		FA213HH		
14	Zero DS II ZF14.4		19-21	FA213		FA213HH		
15	Zero DS II ZF7.2		19-21	FA213		FA213HH		
16	Zero DSR ZF13.0 J.Juan Front & Rear Calipers		17-19	FA213		FA213HH		
17	Zero DSR ZF14.4.0		19-21	FA213		FA213HH		
18	Zero DSR Black Forest		19-21	FA213		FA213HH		
19	Zero FXZF2.8/ZF5.7 J.Juan Front & Rear Calipers		15	FA208X		FA208R		
20	Zero FXZF2.8/ZF5.7 Nissin Front & Rear Calipers		13	FA367X		FA367R		
21	Zero FX ZF3.3/ZF6.5		16-21	FA208X		FA208R		
22	Zero FXS ZF3.3/6ZF.5		17-21	FA213		FA213HH		
23	Zero FXS ZF3.3/6ZF.5		17-21	FA213		FA213HH		
24	Zero MX 2 Pin Fixing Front Pad		10-12	FA83X		FA83HH		
25	Zero MX ZF2.8/ZF5.7 Nissin Front & Rear Calipers		13	FA367X		FA367R		
26	Zero S ZF14.4		19-21	FA213		FA213HH		
27	Zero S ZF6.0 2 Pin Fixing Front Pad		10-12	FA83X		FA83HH		
28	Zero S ZF7.2		19-21	FA213		FA213HH		
29	Zero S ZF8.5/11.4 Nissin Front & Rear Calipers		13	FA367X		FA367R		
30	Zero S ZF8.5/11.4 Nissin Front/J.Juan Rear Calipers		14	FA208X		FA208R		
31	Zero S ZF9.4/ZF12.5 J.Juan Front & Rear Calipers		15	FA213		FA213HH		
32	Zero S ZF9.8/ZF13.0 J.Juan Front & Rear Calipers		16-19	FA213		FA213HH		
33	Zero SR ZF11.4 Nissin Front/J.Juan Rear Calipers		14	FA208X		FA208R		
34	Zero SR ZF12.5 J.Juan Front & Rear Calipers		15	FA213		FA213HH		
35	Zero SR ZF13.0 J.Juan Front & Rear Calipers		16-19	FA213		FA213HH		
36	Zero X 2 Pin Fixing Front Pad		10-12	FA83X		FA83HH		
37	Zero XU 2 Pin Fixing Front Pad		10-12	FA83X		FA83HH		
38	Zero XU ZF2.8/ZF5.7 Nissin Front & Rear Calipers		13	FA367X		FA367R		
39	Zero SR/F ZF14.4 kWh Electric		19-21					
40	Zero SR/S ZF14.4kWh Electric		19-21					
41								
42								
43								
44								
45								
46								
47								
48								
49								
50								
51								
52								
53								
54								
55								

* symbol after part# = 2 pieces required i.e. 2 pad sets or 2 rotors (twin rotor models)

Part numbers, prefixes, suffixes, photos and illustrations shown in this catalog are trademarks and/or copyrights of EBC Brakes or the trademark owner A C Freeman Investments Ltd and use without express written permission of the owners is punishable by law.

BRAKE
APPLICATIONS

All names & numbers are for reference purposes only. ® Registered trademarks of Harley—Davidson® Motor Corp or Buell.

NOTE: — Some models may have a second rotor fitted as an optional extra. Please double check with your customer exactly which side the front rotor is fitted and if twin rotor or single.

Ⓢ This symbol indicates a rotor made of billet steel, and should be only used with EBC FA Kevlar® Organic or Vee pads.

DISC GROUP NO. 001 - FRONT. CHOOSE YOUR PREFERRED STYLE:

Type	Solid	OD	11.5" / 290mm
Color /Finish	Natural	Thickness	0.196" / 5mm
Bobbins	None	Bore	2.22" / 56.4mm

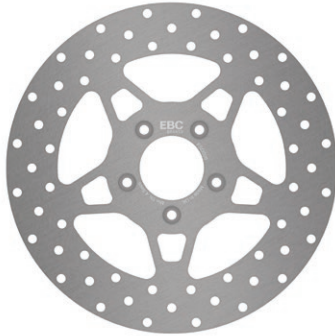

FSD008
Fits EBC Pads: 94, 381, 400, 457

Type	Solid	OD	11.5" / 290mm
Color /Finish	Natural	Thickness	0.196" / 5mm
Bobbins	None	Bore	2.22" / 56.4mm



VR009
Fits EBC Pads: 94, 381, 400, 457

Type	Floating	OD	11.5" / 290mm
Color /Finish	Polished	Thickness	0.196" / 5mm
Bobbins	5	Bore	2.22" / 56.4mm

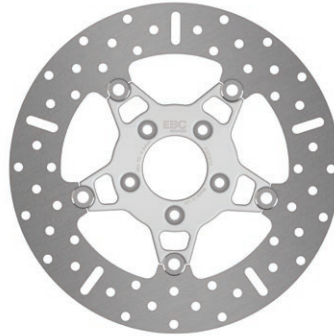

FSD010
Fits EBC Pads: 94, 381, 400, 457

Type	Floating	OD	11.5" / 290mm
Color /Finish	Black	Thickness	0.196" / 5mm
Bobbins	5	Bore	2.22" / 56.4mm



FSD010BLK
Fits EBC Pads: 94, 381, 400, 457

Type	Floating	OD	11.5" / 290mm
Color /Finish	Black	Thickness	0.196" / 5mm
Bobbins	5	Bore	2.22" / 56.4mm



VR010BLK
Fits EBC Pads: 94, 381, 400, 457

Type	Floating	OD	11.5" / 290mm
Color /Finish	Polished	Thickness	0.196" / 5mm
Bobbins	5	Bore	2.22" / 56.4mm

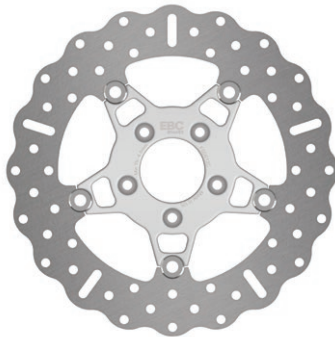

FSD012C
Fits EBC Pads: 94, 381, 400, 457

Type	Floating	OD	11.5" / 290mm
Color /Finish	Black	Thickness	0.196" / 5mm
Bobbins	5	Bore	2.22" / 56.4mm



FSD012CBLK
Fits EBC Pads: 94, 381, 400, 457

Type	Floating	OD	11.5" / 290mm
Color /Finish	Polished	Thickness	0.196" / 5mm
Bobbins	10	Bore	2.22" / 56.4mm

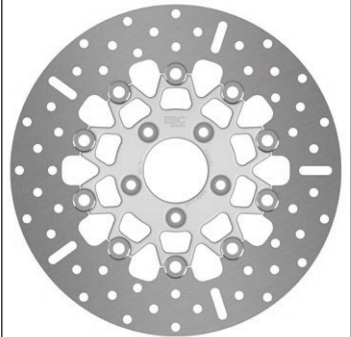

FSD023
Fits EBC Pads: 94, 381, 400, 457

Type	Floating	OD	11.5" / 290mm
Color /Finish	Black	Thickness	0.196" / 5mm
Bobbins	10	Bore	2.22" / 56.4mm

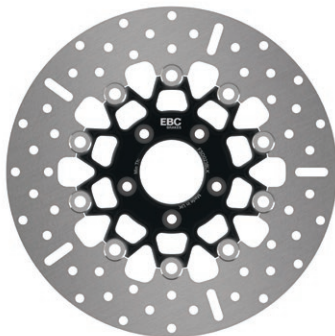

FSD023BLK
Fits EBC Pads: 94, 381, 400, 457

Type	Floating	OD	11.5" / 290mm
Color /Finish	Black	Thickness	0.196" / 5mm
Bobbins	10	Bore	2.22" / 56.4mm



VR023BLK
Fits EBC Pads: 94, 381, 400, 457

Type	Floating	OD	11.5" / 290mm
Color /Finish	Polished	Thickness	0.196" / 5mm
Bobbins	10	Bore	2.22" / 56.4mm

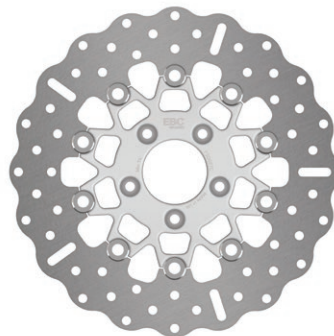

FSD027C
Fits EBC Pads: 94, 381, 400, 457

Type	Floating	OD	11.5" / 290mm
Color /Finish	Black	Thickness	0.196" / 5mm
Bobbins	10	Bore	2.22" / 56.4mm

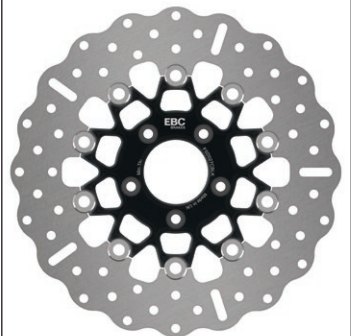

FSD027CBLK
Fits EBC Pads: 94, 381, 400, 457

DISC GROUP NO. 001 - FRONT. CHOOSE YOUR PREFERRED STYLE:

Type	Floating	OD	14" / 355mm
Color /Finish	Black	Thickness	0.196" / 5mm
Bobbins	5	Bore	2.22" / 56.4mm

OVERSIZE ROTOR OPTION



OSMD004-14BLK
Fits EBC Pads: 94, 381, 400, 457



BRK701 BRK702
Supplied with relocation bracket & hardware

Type	Floating	OD	15" / 381mm
Color /Finish	Black	Thickness	0.196" / 5mm
Bobbins	5	Bore	2.22" / 56.4mm

OVERSIZE ROTOR OPTION

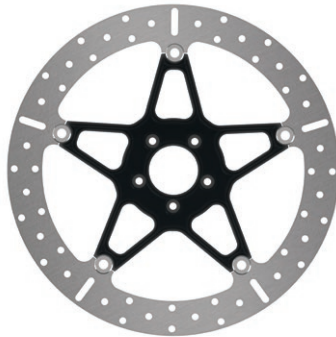

OSMD004-15BLK
Fits EBC Pads: 94, 381, 400, 457



BRK709 BRK710
Supplied with relocation bracket & hardware

Type	Floating	OD	15" / 381mm
Color /Finish	Black	Thickness	0.236" / 6mm
Bobbins	5	Bore	2.22" / 56.4mm

OVERSIZE ROTOR OPTION

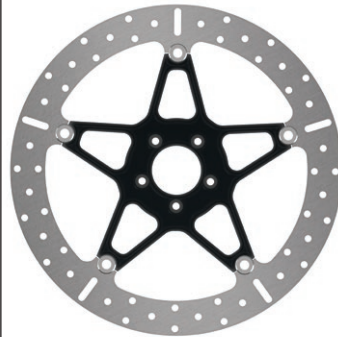

OSMD004-15/6BLK
Fits EBC Pads: 94, 381, 400, 457



BRK709 BRK710
Supplied with relocation bracket & hardware

Type	Floating	OD	14" / 355mm
Color /Finish	Black	Thickness	0.196" / 5mm
Bobbins	5	Bore	2.22" / 56.4mm

OVERSIZE ROTOR OPTION

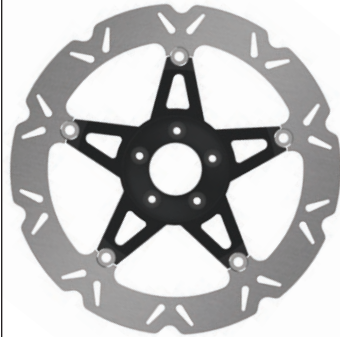

OSVR004-14BLK
Fits EBC Pads: 94, 381, 400, 457



BRK701 BRK702
Supplied with relocation bracket & hardware

Type	Floating	OD	15" / 381mm
Color /Finish	Black	Thickness	0.196" / 5mm
Bobbins	5	Bore	2.22" / 56.4mm

OVERSIZE ROTOR OPTION



OSVR004-15BLK
Fits EBC Pads: 94, 381, 400, 457



BRK709 BRK710
Supplied with relocation bracket & hardware

Type	Floating	OD	15" / 381mm
Color /Finish	Black	Thickness	0.236" / 6mm
Bobbins	5	Bore	2.22" / 56.4mm

OVERSIZE ROTOR OPTION



OSVR004-15/6BLK
Fits EBC Pads: 94, 381, 400, 457



BRK709 BRK710
Supplied with relocation bracket & hardware

Increased stopping power, feel and control with the EBC FULLY floating oversize range. These kits bolt directly onto your bike using the stock caliper and also deliver the advantages of a floating rotor over solid designs.

DISC GROUP NO. 002 - FRONT. CHOOSE YOUR PREFERRED STYLE:

Type	Solid	OD	11.5" / 290mm
Color /Finish	Natural	Thickness	0.196" / 5mm
Bobbins	None	Bore	1.99" / 50.6mm

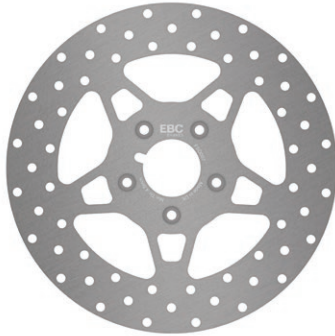

FSD007
Fits EBC Pads: 94, 216/3

Type	Solid	OD	11.5" / 290mm
Color /Finish	Natural	Thickness	0.196" / 5mm
Bobbins	None	Bore	1.99" / 50.6mm



VR007
Fits EBC Pads: 94, 216/3

Type	Floating	OD	11.5" / 290mm
Color /Finish	Polished	Thickness	0.196" / 5mm
Bobbins	5	Bore	1.99" / 50.6mm

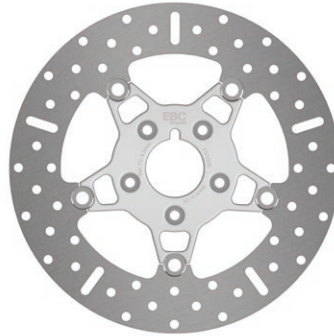

FSD009
Fits EBC Pads: 94, 216/3

Type	Floating	OD	11.5" / 290mm
Color /Finish	Black	Thickness	0.196" / 5mm
Bobbins	5	Bore	1.99" / 50.6mm

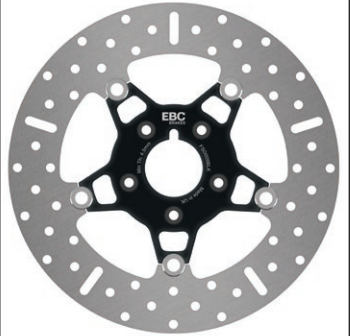

FSD009BLK
Fits EBC Pads: 94, 216/3

Type	Floating	OD	11.5" / 290mm
Color /Finish	Polished	Thickness	0.196" / 5mm
Bobbins	5	Bore	1.99" / 50.6mm

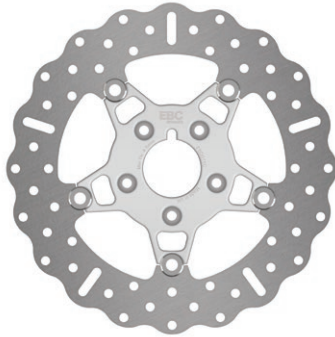

FSD011C
Fits EBC Pads: 94, 216/3

Type	Floating	OD	11.5" / 290mm
Color /Finish	Black	Thickness	0.196" / 5mm
Bobbins	5	Bore	1.99" / 50.6mm



FSD011CBLK
Fits EBC Pads: 94, 216/3

Type	Floating	OD	11.5" / 290mm
Color /Finish	Black	Thickness	0.196" / 5mm
Bobbins	5	Bore	1.99" / 50.6mm



VR011BLK
Fits EBC Pads: 94, 216/3

Type	Floating	OD	11.5" / 290mm
Color /Finish	Polished	Thickness	0.196" / 5mm
Bobbins	10	Bore	1.99" / 50.6mm

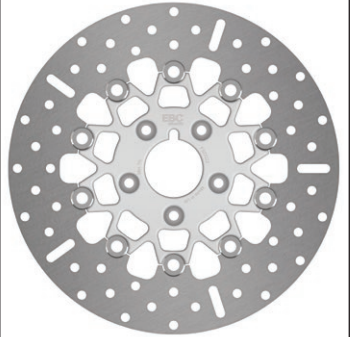

FSD022
Fits EBC Pads: 94, 216/3

Type	Floating	OD	11.5" / 290mm
Color /Finish	Black	Thickness	0.196" / 5mm
Bobbins	10	Bore	1.99" / 50.6mm

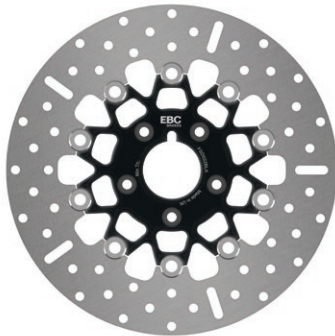

FSD022BLK
Fits EBC Pads: 94, 216/3

Type	Floating	OD	11.5" / 290mm
Color /Finish	Polished	Thickness	0.196" / 5mm
Bobbins	10	Bore	1.99" / 50.6mm

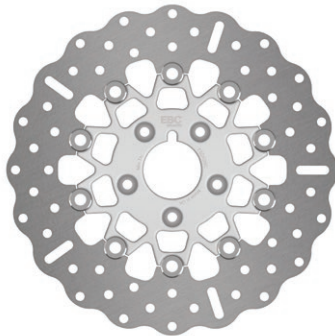

FSD026C
Fits EBC Pads: 94, 216/3

Type	Floating	OD	11.5" / 290mm
Color /Finish	Black	Thickness	0.196" / 5mm
Bobbins	10	Bore	1.99" / 50.6mm

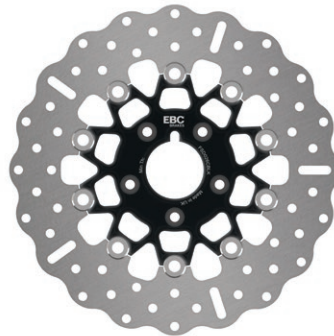

FSD026CBLK
Fits EBC Pads: 94, 216/3

DISC GROUP NO. 003 - REAR. CHOOSE YOUR PREFERRED STYLE:

Type	Solid	OD	11.5" / 290mm
Color /Finish	Natural	Thickness	0.236" / 6mm
Bobbins	None	Bore	2.22" / 56.4mm

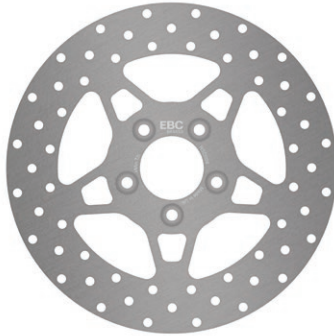

RSD008
Fits EBC Pads: 387, 400, 434, 458, 710

Type	Solid	OD	11.5" / 290mm
Color /Finish	Natural	Thickness	0.236" / 6mm
Bobbins	None	Bore	2.22" / 56.4mm



VR008
Fits EBC Pads: 387, 400, 434, 458, 710

Type	Floating	OD	11.5" / 290mm
Color /Finish	Polished	Thickness	0.236" / 6mm
Bobbins	10	Bore	2.22" / 56.4mm

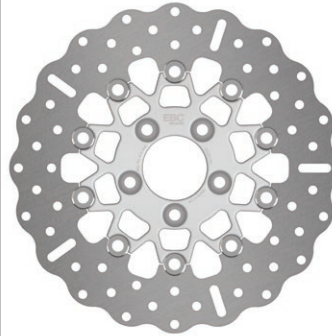

RSD018C
Fits EBC Pads: 387, 400, 434, 458, 710

Type	Floating	OD	11.5" / 290mm
Color /Finish	Black	Thickness	0.236" / 6mm
Bobbins	10	Bore	2.22" / 56.4mm

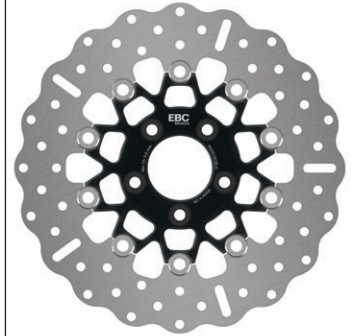

RSD018CBLK
Fits EBC Pads: 387, 400, 434, 458, 710

Type	Floating	OD	11.5" / 290mm
Color /Finish	Polished	Thickness	0.236" / 6mm
Bobbins	10	Bore	2.22" / 56.4mm

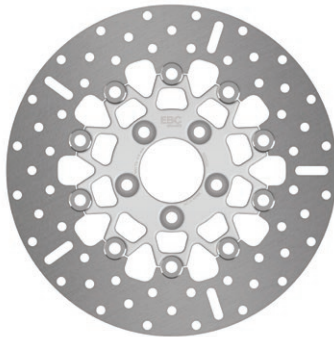

RSD020
Fits EBC Pads: 387, 400, 434, 458, 710

Type	Floating	OD	11.5" / 290mm
Color /Finish	Black	Thickness	0.236" / 6mm
Bobbins	10	Bore	2.22" / 56.4mm

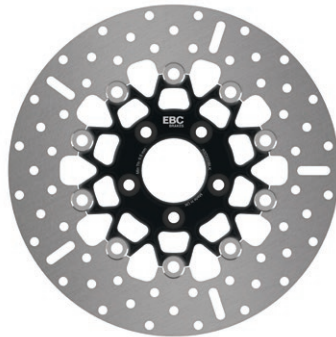

RSD020BLK
Fits EBC Pads: 387, 400, 434, 458, 710

Type	Floating	OD	11.5" / 290mm
Color /Finish	Black	Thickness	0.236" / 6mm
Bobbins	10	Bore	2.22" / 56.4mm



VR020BLK
Fits EBC Pads: 387, 400, 434, 458, 710

DISC GROUP NO. 004 - REAR. CHOOSE YOUR PREFERRED STYLE:

Type	Solid	OD	11.5" / 290mm
Color /Finish	Natural	Thickness	0.236" / 6mm
Bobbins	None	Bore	1.99" / 50.6mm

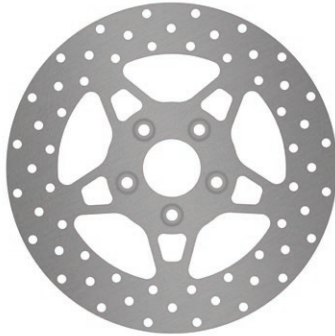

RSD007
Fits EBC Pads: 200, 216/3

Type	Solid	OD	11.5" / 290mm
Color /Finish	Natural	Thickness	0.275" / 7mm
Bobbins	None	Bore	1.99" / 50.6mm

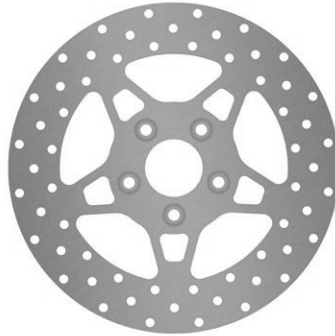

RSD007A
Fits EBC Pads: 200, 216/3

Type	Floating	OD	11.5" / 290mm
Color /Finish	Black	Thickness	0.236" / 6mm
Bobbins	10	Bore	1.99" / 50.6mm

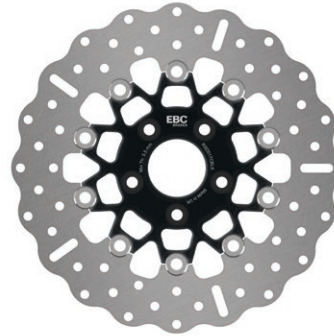

RSD017CBLK
Fits EBC Pads: 200, 216/3

Type	Floating	OD	11.5" / 290mm
Color /Finish	Polished	Thickness	0.236" / 6mm
Bobbins	10	Bore	1.99" / 50.6mm

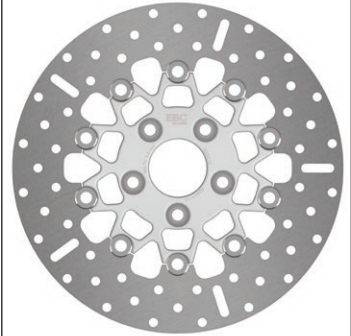

RSD019
Fits EBC Pads: 200, 216/3

Type	Floating	OD	11.5" / 290mm
Color /Finish	Polished	Thickness	0.236" / 6mm
Bobbins	10	Bore	1.99" / 50.6mm

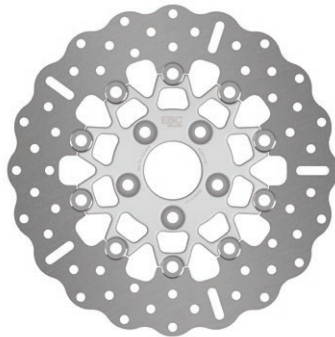

RSD019C
Fits EBC Pads: 200, 216/3

Type	Floating	OD	11.5" / 290mm
Color /Finish	Black	Thickness	0.236" / 6mm
Bobbins	10	Bore	1.99" / 50.6mm

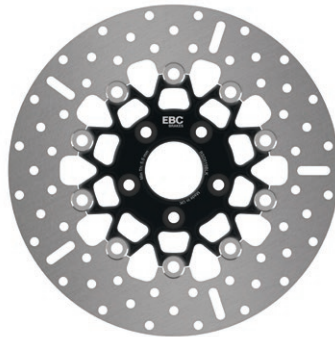

RSD019BLK
Fits EBC Pads: 200, 216/3

Type	Floating	OD	11.5" / 290mm
Color /Finish	Black	Thickness	0.236" / 6mm
Bobbins	10	Bore	1.99" / 50.6mm



VR019BLK
Fits EBC Pads: 200, 216/3

DISC GROUP NO. 005 - FRONT. CHOOSE YOUR PREFERRED STYLE:

Type	Solid	OD	9.44" / 240mm
Color /Finish	Natural	Thickness	0.196" / 5mm
Bobbins	None	Bore	4.13" / 105mm

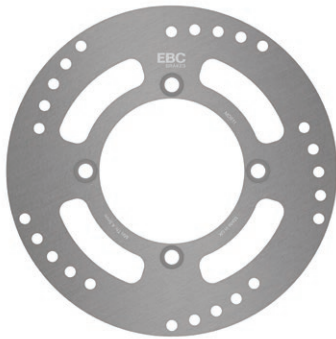

MD511
Fits EBC Pads: 140, 251

DISC GROUP NO. 006 - FRONT/REAR. CHOOSE YOUR PREFERRED STYLE:

Type	Solid	OD	11.5" / 290mm
Color /Finish	Natural	Thickness	0.196" / 5mm
Bobbins	None	Bore	6.77" / 172mm

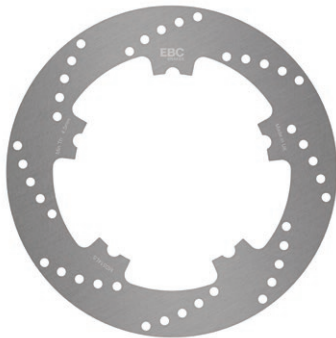

MD514LS
Fits EBC Pads: 400

Type	Solid	OD	11.5" / 290mm
Color /Finish	Natural	Thickness	0.196" / 5mm
Bobbins	None	Bore	6.77" / 172mm

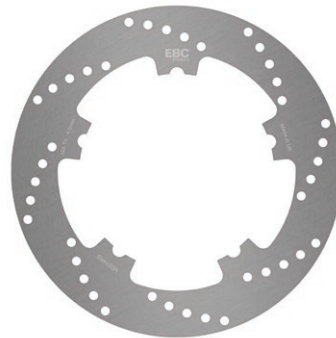

MD514RS
Fits EBC Pads: 400

Type	Solid	OD	11.5" / 290mm
Color /Finish	Natural	Thickness	0.196" / 5mm
Bobbins	None	Bore	6.77" / 172mm



VR514
Fits EBC Pads: 400

DISC GROUP NO. 007 - FRONT. CHOOSE YOUR PREFERRED STYLE:

APPLICATIONS

BRAKE

Type	Solid	OD	11.8" / 300mm
Color /Finish	Natural	Thickness	0.196" / 5mm
Bobbins	None	Bore	6.7" / 171mm

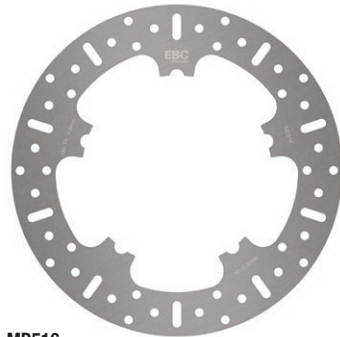

MD516
Fits EBC Pads: 400, 409, 457

Type	Solid	OD	11.8" / 300mm
Color /Finish	Natural	Thickness	0.196" / 5mm
Bobbins	None	Bore	6.7" / 171mm

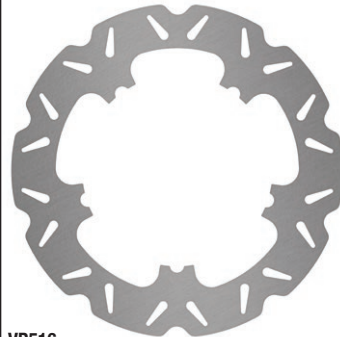

VR516
Fits EBC Pads: 400, 409, 457

Type	Floating	OD	11.8" / 300mm
Color /Finish	Polished	Thickness	0.196" / 5mm
Bobbins	5	Bore	6.7" / 171mm

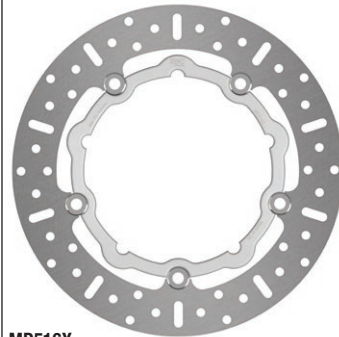

MD516X
Fits EBC Pads: 400, 409, 457

Type	Floating	OD	11.8" / 300mm
Color /Finish	Black	Thickness	0.196" / 5mm
Bobbins	5	Bore	6.7" / 171mm

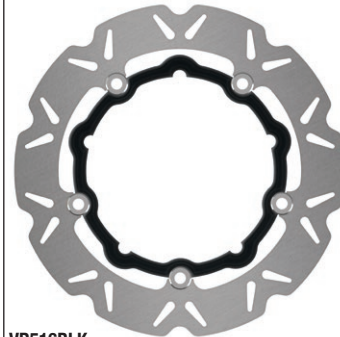

VR516BLK
Fits EBC Pads: 400, 409, 457

Type	Floating	OD	14" / 355mm
Color /Finish	Polished	Thickness	0.196" / 5mm
Bobbins	5	Bore	6.7" / 171mm

OVERSIZE ROTOR OPTION

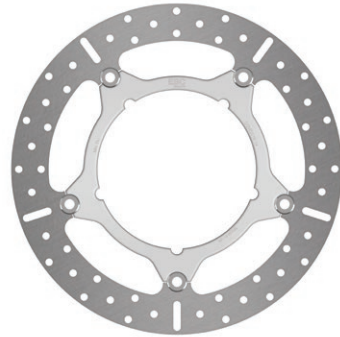

OSMD516-14
Fits EBC Pads: 400, 409, 457

Type	Floating	OD	14" / 355mm
Color /Finish	Black	Thickness	0.196" / 5mm
Bobbins	5	Bore	6.7" / 171mm

OVERSIZE ROTOR OPTION

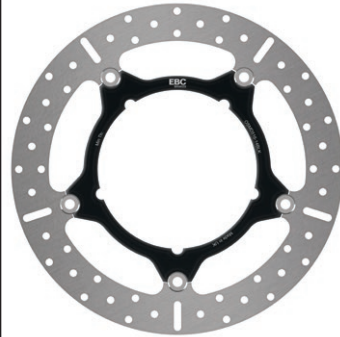

OSMD516-14BLK
Fits EBC Pads: 400, 409, 457

Type	Floating	OD	14" / 355mm
Color /Finish	Black	Thickness	0.196" / 5mm
Bobbins	5	Bore	6.7" / 171mm

OVERSIZE ROTOR OPTION

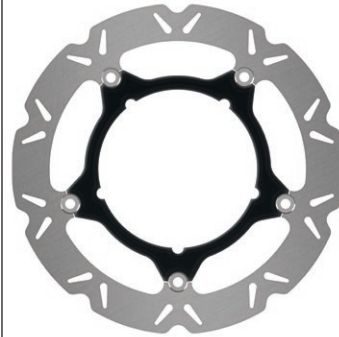

OSVR516-14
Fits EBC Pads: 400, 409, 457

Type	Floating	OD	15" / 381mm
Color /Finish	Polished	Thickness	0.196" / 5mm
Bobbins	5	Bore	6.7" / 171mm

OVERSIZE ROTOR OPTION

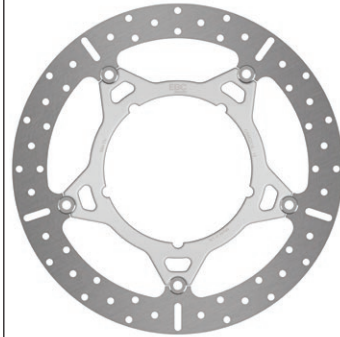

OSMD516-15
Fits EBC Pads: 400, 409, 457



Supplied with relocation bracket & hardware
BRK703 **BRK704**



Supplied with relocation bracket & hardware
BRK703 **BRK704**



Supplied with relocation bracket & hardware
BRK703 **BRK704**

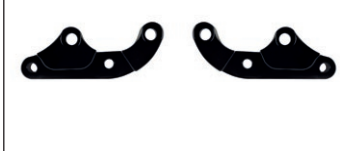

Supplied with relocation bracket & hardware
BRK707 **BRK708**

Type	Floating	OD	15" / 381mm
Color /Finish	Black	Thickness	0.196" / 5mm
Bobbins	5	Bore	6.7" / 171mm

OVERSIZE ROTOR OPTION

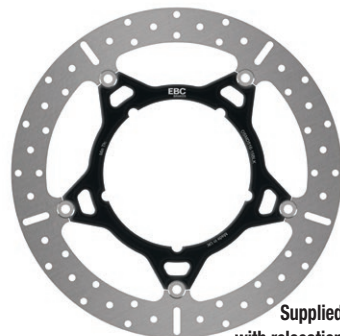

OSMD516-15BLK
Fits EBC Pads: 400, 409, 457
BRK707 **BRK708**

Type	Floating	OD	15" / 381mm
Color /Finish	Black	Thickness	0.196" / 5mm
Bobbins	5	Bore	6.7" / 171mm

OVERSIZE ROTOR OPTION

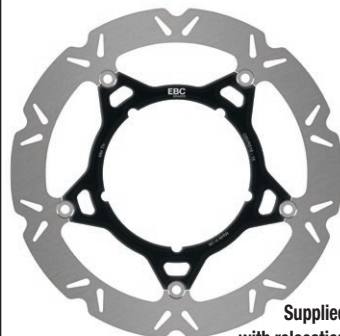

OSVR516-15
Fits EBC Pads: 400, 409, 457
BRK707 **BRK708**

Increased stopping power, feel and control with the EBC FULLY floating oversize range. These kits bolt directly onto your bike using the stock caliper and also deliver the advantages of a floating rotor over solid designs.



DISC GROUP NO. 008 - REAR. CHOOSE YOUR PREFERRED STYLE:

Type	Solid	OD	11.8" / 300mm
Color /Finish	Natural	Thickness	0.275" / 7mm
Bobbins	None	Bore	4" / 101.6mm

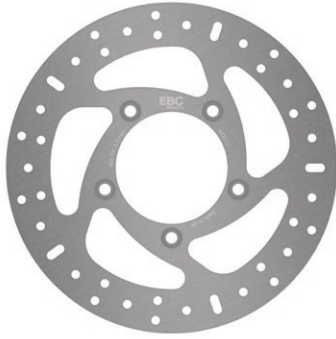

MD517
Fits EBC Pads: 409

Type	Solid	OD	11.8" / 300mm
Color /Finish	Natural	Thickness	0.196" / 5mm
Bobbins	None	Bore	4" / 101.6mm

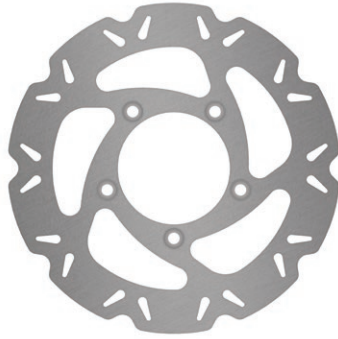

VR517
Fits EBC Pads: 409

Type	Floating	OD	11.8" / 300mm
Color /Finish	Black	Thickness	0.196" / 5mm
Bobbins	9	Bore	4" / 101.6mm

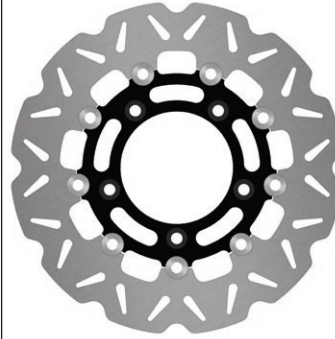

VR517BLK
Fits EBC Pads: 409

DISC GROUP NO. 009 - FRONT. CHOOSE YOUR PREFERRED STYLE:

Type	Solid	OD	11.8" / 300mm
Color /Finish	Natural	Thickness	0.196" / 5mm
Bobbins	None	Bore	2.22" / 56.4mm



VR518
Fits EBC Pads: 400, 409, 457

Type	Floating	OD	11.8" / 300mm
Color /Finish	Polished	Thickness	0.196" / 5mm
Bobbins	5	Bore	2.22" / 56.4mm

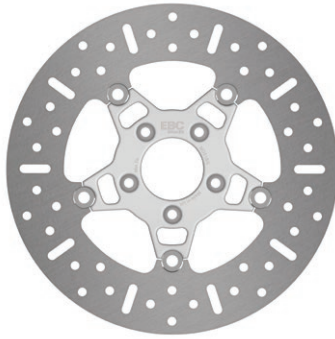

MD518/5
Fits EBC Pads: 400, 409, 457

Type	Floating	OD	11.8" / 300mm
Color /Finish	Black	Thickness	0.196" / 5mm
Bobbins	5	Bore	2.22" / 56.4mm



MD518/5BLK
Fits EBC Pads: 400, 409, 457

Type	Floating	OD	11.8" / 300mm
Color /Finish	Polished	Thickness	0.196" / 5mm
Bobbins	10	Bore	2.22" / 56.4mm

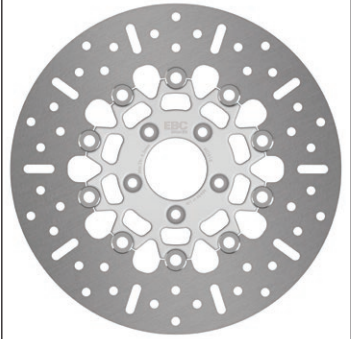

MD518
Fits EBC Pads: 400, 409, 457

Type	Floating	OD	11.8" / 300mm
Color /Finish	Black	Thickness	0.196" / 5mm
Bobbins	10	Bore	2.22" / 56.4mm

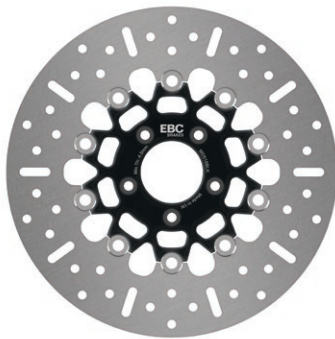

MD518BLK
Fits EBC Pads: 400, 409, 457

Type	Floating	OD	11.8" / 300mm
Color /Finish	Black	Thickness	0.196" / 5mm
Bobbins	10	Bore	2.22" / 56.4mm

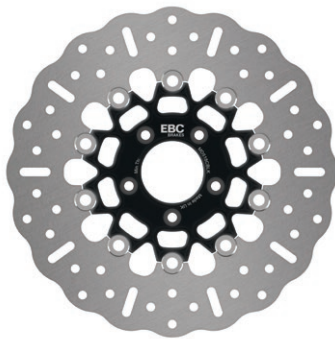

MD518CBLK
Fits EBC Pads: 400, 409, 457

Type	Floating	OD	11.8" / 300mm
Color /Finish	Black	Thickness	0.196" / 5mm
Bobbins	10	Bore	2.22" / 56.4mm



VR518BLK
Fits EBC Pads: 400, 409, 457

Type	Floating	OD	14" / 355mm
Color /Finish	Polished	Thickness	0.196" / 5mm
Bobbins	5	Bore	2.22" / 56.4mm

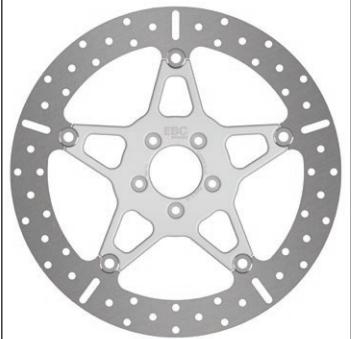

OSMD518-14
Fits EBC Pads: 400, 409, 457
Supplied with relocation bracket & hardware
BRK701



Type	Floating	OD	14" / 355mm
Color /Finish	Black	Thickness	0.196" / 5mm
Bobbins	5	Bore	2.22" / 56.4mm

OVERSIZE ROTOR OPTION

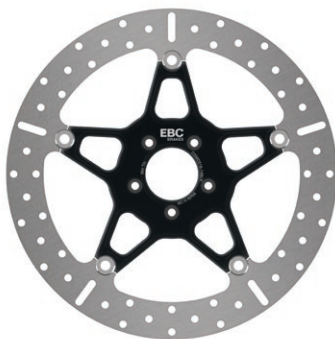

OSMD518-14BLK
Fits EBC Pads: 400, 409, 457
Supplied with relocation bracket & hardware
BRK701



Increased stopping power, feel and control with the EBC FULLY floating oversize range. These kits bolt directly onto your bike using the stock caliper and also deliver the advantages of a floating rotor over solid designs.

DISC GROUP NO. 010 - FRONT. CHOOSE YOUR PREFERRED STYLE:

Type	Solid	OD	11.8" / 300mm
Color /Finish	Natural	Thickness	0.196" / 5mm
Bobbins	None	Bore	2.22" / 56.4mm



VR520
Fits EBC Pads: 409

Type	Floating	OD	11.8" / 300mm
Color /Finish	Polished	Thickness	0.196" / 5mm
Bobbins	5	Bore	2.22" / 56.4mm

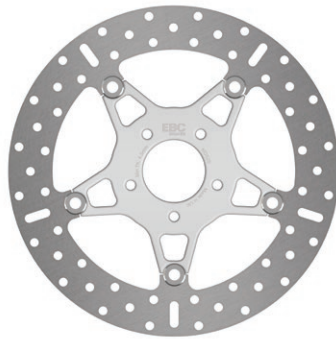

MD520
Fits EBC Pads: 409

Type	Floating	OD	11.8" / 300mm
Color /Finish	Black	Thickness	0.196" / 5mm
Bobbins	5	Bore	2.22" / 56.4mm



VR520BLK
Fits EBC Pads: 409

Type	Solid	OD	11.81" / 300mm
Color /Finish	Natural	Thickness	0.196" / 5mm
Bobbins	None	Bore	2.22" / 56.4mm

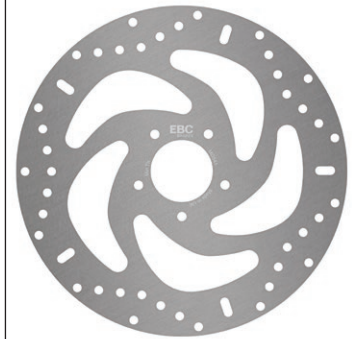

MD541
Fits EBC Pads: 409

DISC GROUP NO. 011 - REAR. CHOOSE YOUR PREFERRED STYLE:

Type	Solid	OD	11.8" / 300mm
Color /Finish	Natural	Thickness	0.275" / 7mm
Bobbins	None	Bore	2.22" / 56.4mm



VR521
Fits EBC Pads: 409

Type	Floating	OD	11.8" / 300mm
Color /Finish	Polished	Thickness	0.275" / 7mm
Bobbins	10	Bore	2.22" / 56.4mm

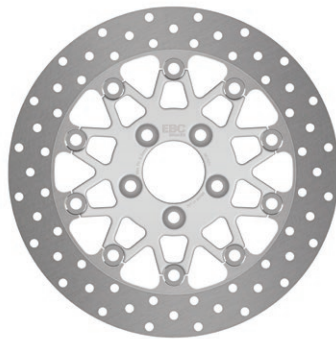

MD521
Fits EBC Pads: 409

Type	Floating	OD	11.8" / 300mm
Color /Finish	Black	Thickness	0.275" / 7mm
Bobbins	10	Bore	2.22" / 56.4mm

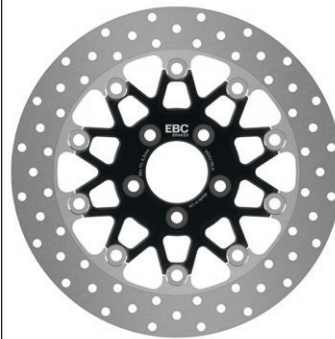

MD521BLK
Fits EBC Pads: 409

Type	Floating	OD	11.8" / 300mm
Color /Finish	Polished	Thickness	0.275" / 7mm
Bobbins	10	Bore	2.22" / 56.4mm

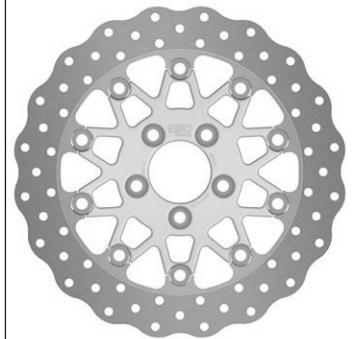

MD521C
Fits EBC Pads: 409

Type	Floating	OD	11.8" / 300mm
Color /Finish	Black	Thickness	0.275" / 7mm
Bobbins	10	Bore	2.22" / 56.4mm



VR521BLK
Fits EBC Pads: 409

DISC GROUP NO. 012 - FRONT. CHOOSE YOUR PREFERRED STYLE:

Type	Solid	OD	11.4" / 290mm
Color /Finish	Natural	Thickness	0.2" / 5.2mm
Bobbins	None	Bore	2.22" / 56.4mm



MD523
Fits EBC Pads: 296

Type	Floating	OD	11.4" / 290mm
Color /Finish	Polished	Thickness	0.2" / 5.2mm
Bobbins	5	Bore	2.22" / 56.4mm

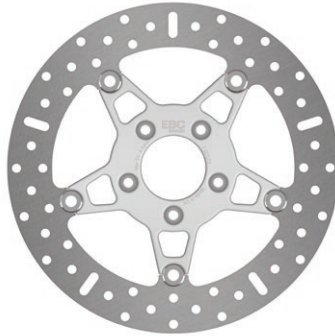

FSD523
Fits EBC Pads: 296

Type	Floating	OD	11.4" / 290mm
Color /Finish	Gold	Thickness	0.2" / 5.2mm
Bobbins	5	Bore	2.22" / 56.4mm



MD523X
Fits EBC Pads: 296

Type	Floating	OD	11.4" / 290mm
Color /Finish	Black	Thickness	0.2" / 5.2mm
Bobbins	5	Bore	2.22" / 56.4mm



VR523BLK
Fits EBC Pads: 296

DISC GROUP NO. 013 - REAR. CHOOSE YOUR PREFERRED STYLE:

Type	Solid	OD	10.23" / 260mm
Color /Finish	Natural	Thickness	0.275" / 7mm
Bobbins	None	Bore	2.22" / 56.4mm



MD524
Fits EBC Pads: 254, 387

Type	Floating	OD	10.23" / 260mm
Color /Finish	Polished	Thickness	0.275" / 7mm
Bobbins	10	Bore	2.22" / 56.4mm

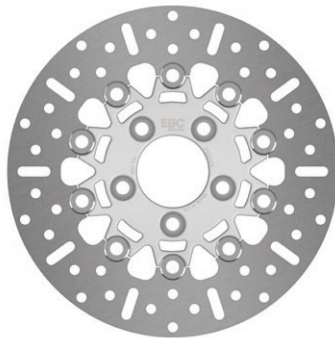

RSD524
Fits EBC Pads: 254, 387

Type	Floating	OD	10.23" / 260mm
Color /Finish	Gold	Thickness	0.275" / 7mm
Bobbins	10	Bore	2.22" / 56.4mm

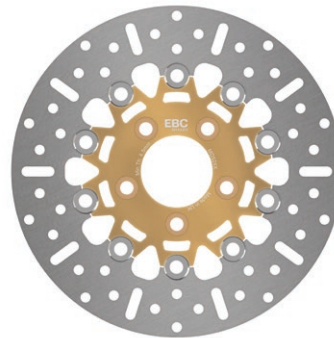

MD524X
Fits EBC Pads: 254, 387

Type	Floating	OD	10.23" / 260mm
Color /Finish	Black	Thickness	0.275" / 7mm
Bobbins	10	Bore	2.22" / 56.4mm



VR524BLK
Fits EBC Pads: 254, 387

DISC GROUP NO. 014 - REAR. CHOOSE YOUR PREFERRED STYLE:

Type	Floating	OD	11.8" / 300mm
Color /Finish	Polished	Thickness	0.275" / 7mm
Bobbins	9	Bore	4" / 101.4mm

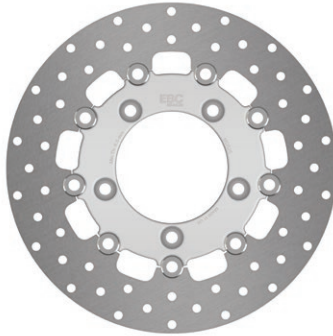

MD525
Fits EBC Pads: 409

Type	Floating	OD	11.8" / 300mm
Color /Finish	Black	Thickness	0.275" / 7mm
Bobbins	9	Bore	4" / 101.4mm

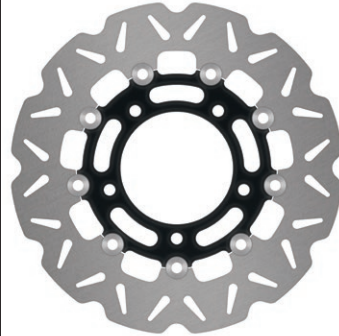

VR525BLK
Fits EBC Pads: 409

DISC GROUP NO. 015 - FRONT. CHOOSE YOUR PREFERRED STYLE:

Type	Solid	OD	11.8" / 300mm
Color /Finish	Natural	Thickness	0.196" / 5mm
Bobbins	None	Bore	2.22" / 56.4mm

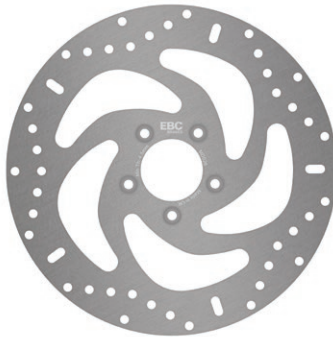

MD526
Fits EBC Pads: 296, 640

Type	Solid	OD	11.8" / 300mm
Color /Finish	Natural	Thickness	0.196" / 5mm
Bobbins	None	Bore	2.22" / 56.4mm



VR526
Fits EBC Pads: 296, 640

Type	Floating	OD	11.8" / 300mm
Color /Finish	Polished	Thickness	0.196" / 5mm
Bobbins	5	Bore	2.22" / 56.4mm

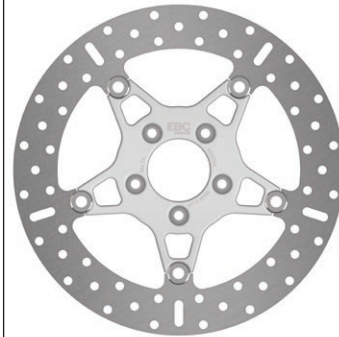

MD526X
Fits EBC Pads: 296, 640

Type	Floating	OD	11.8" / 300mm
Color /Finish	Black	Thickness	0.196" / 5mm
Bobbins	5	Bore	2.22" / 56.4mm



MD526XBLK
Fits EBC Pads: 296, 640

Type	Floating	OD	11.8" / 300mm
Color /Finish	Black	Thickness	0.196" / 5mm
Bobbins	5	Bore	2.22" / 56.4mm



VR526BLK
Fits EBC Pads: 296, 640

DISC GROUP NO. 016 - REAR. CHOOSE YOUR PREFERRED STYLE:

Type	Solid	OD	11.4" / 290mm
Color /Finish	Natural	Thickness	0.236" / 6mm
Bobbins	None	Bore	2.22" / 56.4mm



VR528
Fits EBC Pads: 458, 710

Type	Floating	OD	11.4" / 290mm
Color /Finish	Polished	Thickness	0.236" / 6mm
Bobbins	10	Bore	2.22" / 56.4mm

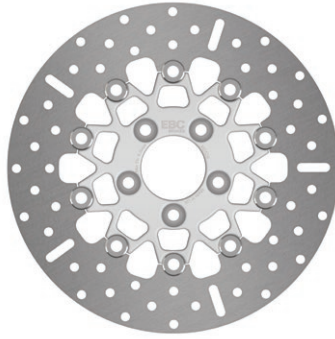

MD528
Fits EBC Pads: 458, 710

Type	Floating	OD	11.4" / 290mm
Color /Finish	Polished	Thickness	0.236" / 6mm
Bobbins	10	Bore	2.22" / 56.4mm

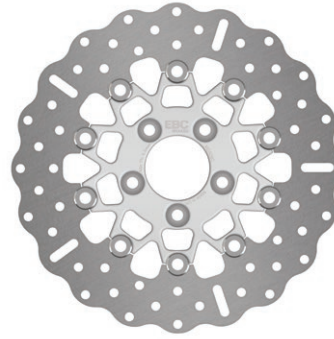

MD528C
Fits EBC Pads: 458, 710

Type	Floating	OD	11.4" / 290mm
Color /Finish	Black	Thickness	0.236" / 6mm
Bobbins	10	Bore	2.22" / 56.4mm



VR528BLK
Fits EBC Pads: 458, 710

DISC GROUP NO. 017 - FRONT. CHOOSE YOUR PREFERRED STYLE:

Type	Solid	OD	11.8" / 300mm
Color /Finish	Natural	Thickness	0.196" / 5mm
Bobbins	None	Bore	5.48" / 139.2mm

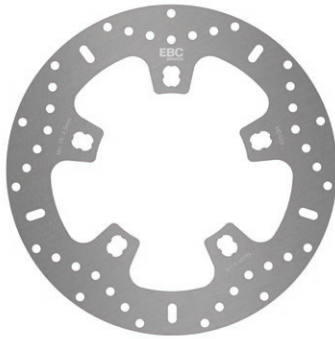

MD529
Fits EBC Pads: 409

Type	Solid	OD	11.8" / 300mm
Color /Finish	Natural	Thickness	0.196" / 5mm
Bobbins	None	Bore	5.48" / 139.2mm

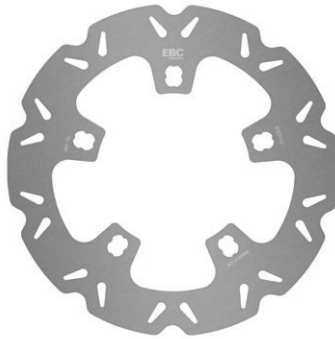

VR529
Fits EBC Pads: 409

Type	Solid	OD	14" / 355mm
Color /Finish	Natural	Thickness	0.196" / 5mm
Bobbins	None	Bore	5.48" / 139.2mm

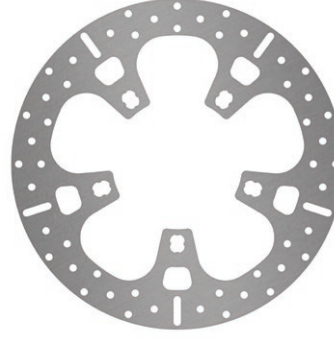

OSMD529-14
Fits EBC Pads: 409
Supplied with relocation bracket & hardware
BRK701



Type	Solid	OD	14" / 355mm
Color /Finish	Natural	Thickness	0.196" / 5mm
Bobbins	None	Bore	5.48" / 139.2mm

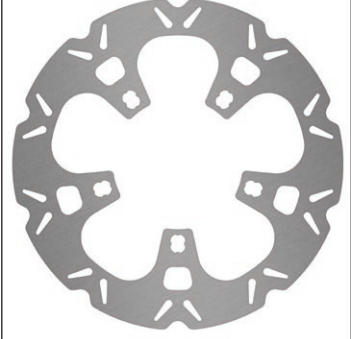

OSVR529-14
Fits EBC Pads: 409
Supplied with relocation bracket & hardware
BRK701



DISC GROUP NO. 018 - FRONT. CHOOSE YOUR PREFERRED STYLE:

Type	Solid	OD	11.8" / 300mm
Color /Finish	Natural	Thickness	0.196" / 5mm
Bobbins	None	Bore	2.22" / 56.4mm



VR530
Fits EBC Pads: 296, 638, 640

Type	Floating	OD	11.8" / 300mm
Color /Finish	Polished	Thickness	0.196" / 5mm
Bobbins	5	Bore	2.22" / 56.4mm

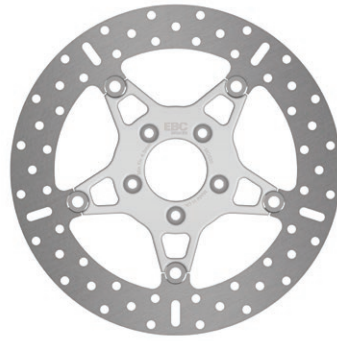

MD530
Fits EBC Pads: 296, 638, 640

Type	Floating	OD	11.8" / 300mm
Color /Finish	Black	Thickness	0.196" / 5mm
Bobbins	5	Bore	2.22" / 56.4mm



MD530BLK
Fits EBC Pads: 296, 638, 640

Type	Floating	OD	11.8" / 300mm
Color /Finish	Black	Thickness	0.196" / 5mm
Bobbins	5	Bore	2.22" / 56.4mm



VR530BLK
Fits EBC Pads: 296, 638, 640

DISC GROUP NO. 019 - FRONT/REAR. CHOOSE YOUR PREFERRED STYLE:

Type	Solid	OD	11.77" / 299mm
Color /Finish	Black	Thickness	0.82" / 21mm
Bobbins	None	Bore	2.67" / 68mm



MD533
Fits EBC Pads: 669/4, 670

Type	Solid	OD	11.77" / 299mm
Color /Finish	Black	Thickness	0.82" / 21mm
Bobbins	None	Bore	2.67" / 68mm



MD533BSDF
Fits EBC Pads: 669/4, 670

Type	Solid	OD	11.77" / 299mm
Color /Finish	Black	Thickness	0.82" / 21mm
Bobbins	None	Bore	2.67" / 68mm



MD533BSDR
Fits EBC Pads: 669/4, 670

DISC GROUP NO. 020 - FRONT/REAR. CHOOSE YOUR PREFERRED STYLE:

Type	Solid	OD	11.73" / 298mm
Color /Finish	Natural	Thickness	0.196" / 5mm
Bobbins	None	Bore	2.52" / 64.2mm

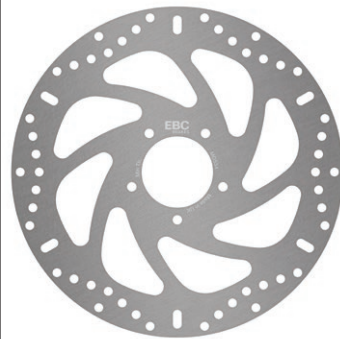

MD534
Fits EBC Pads: 209/2, 213, 377, 672

Type	Floating	OD	11.73" / 298mm
Color /Finish	Gold	Thickness	0.196" / 5mm
Bobbins	10	Bore	2.52" / 64.2mm

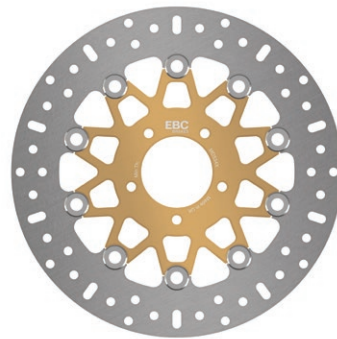

MD534X
Fits EBC Pads: 209/2, 213, 377, 672

Type	Floating	OD	11.73" / 298mm
Color /Finish	Black	Thickness	0.196" / 5mm
Bobbins	10	Bore	2.52" / 64.2mm

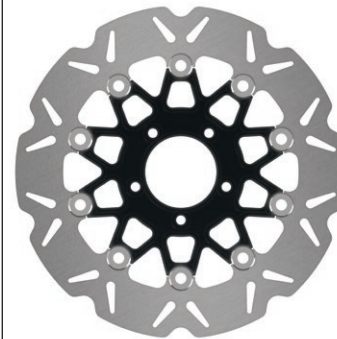

VR534BLK
Fits EBC Pads: 209/2, 213, 377, 672

DISC GROUP NO. 021 - FRONT/REAR. CHOOSE YOUR PREFERRED STYLE:

Type	Floating	OD	11.5" / 292mm
Color /Finish	Polished	Thickness	0.196" / 5mm
Bobbins	5	Bore	2.22" / 56.4mm

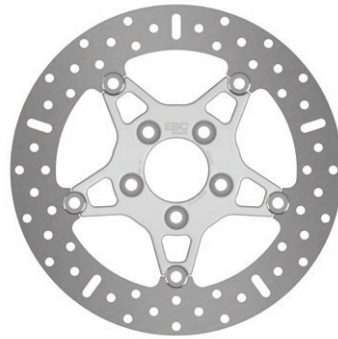

MD535
Fits EBC Pads: 95, 696

Type	Floating	OD	11.5" / 292mm
Color /Finish	Black	Thickness	0.196" / 5mm
Bobbins	5	Bore	2.22" / 56.4mm



MD535BLK
Fits EBC Pads: 95, 696

Type	Floating	OD	11.5" / 292mm
Color /Finish	Black	Thickness	0.196" / 5mm
Bobbins	5	Bore	2.22" / 56.4mm



VR535BLK
Fits EBC Pads: 95, 696

DISC GROUP NO. 022 - FRONT. CHOOSE YOUR PREFERRED STYLE:

Type	Solid	OD	11.8" / 300mm
Color /Finish	Natural	Thickness	0.236" / 6mm
Bobbins	None	Bore	2.22" / 56.4mm



MD536
Fits EBC Pads: 209/2

Type	Solid	OD	11.8" / 300mm
Color /Finish	Natural	Thickness	0.236" / 6mm
Bobbins	None	Bore	2.22" / 56.4mm



VR536
Fits EBC Pads: 209/2

Type	Floating	OD	11.8" / 300mm
Color /Finish	Polished	Thickness	0.236" / 6mm
Bobbins	5	Bore	2.22" / 56.4mm

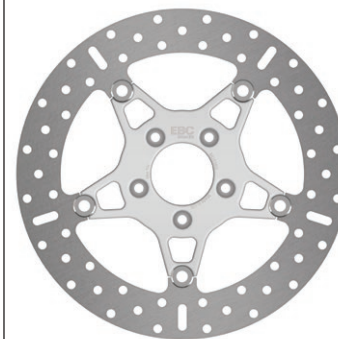

MD536X
Fits EBC Pads: 209/2

Type	Floating	OD	11.8" / 300mm
Color /Finish	Black	Thickness	0.236" / 6mm
Bobbins	5	Bore	2.22" / 56.4mm

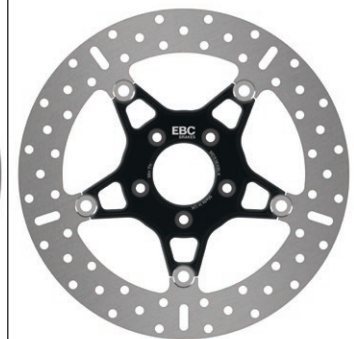

MD536XBLK
Fits EBC Pads: 209/2

DISC GROUP NO. 023 - REAR. CHOOSE YOUR PREFERRED STYLE:

Type	Solid	OD	11.8" / 300mm
Color /Finish	Natural	Thickness	0.236" / 6mm
Bobbins	None	Bore	2.22" / 56.4mm



MD537
Fits EBC Pads: 181

Type	Solid	OD	11.8" / 300mm
Color /Finish	Natural	Thickness	0.236" / 6mm
Bobbins	None	Bore	2.22" / 56.4mm



VR537
Fits EBC Pads: 181

Type	Floating	OD	11.8" / 300mm
Color /Finish	Polished	Thickness	0.236" / 6mm
Bobbins	5	Bore	2.22" / 56.4mm

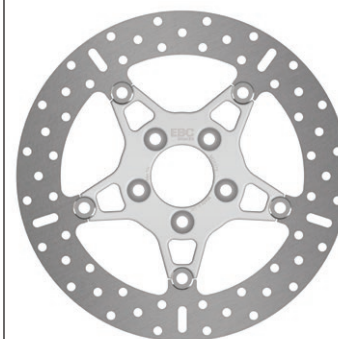

MD537X
Fits EBC Pads: 181

Type	Floating	OD	11.8" / 300mm
Color /Finish	Black	Thickness	0.236" / 6mm
Bobbins	5	Bore	2.22" / 56.4mm

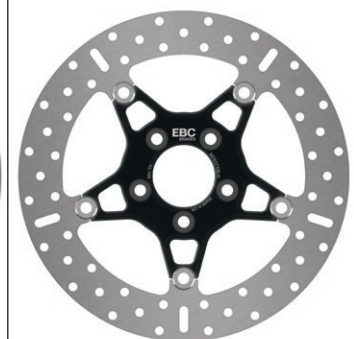

MD537XBLK
Fits EBC Pads: 181

DISC GROUP NO. 024 - FRONT/REAR. CHOOSE YOUR PREFERRED STYLE:

Type	Floating	OD	11.77" / 299mm
Color /Finish	Natural	Thickness	0.196" / 5mm
Bobbins	10	Bore	2.52" / 64.2mm

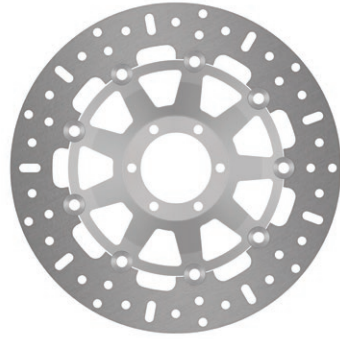

MD678
Fits EBC Pads: 196, 209/2, 244, 347

Type	Floating	OD	11.77" / 299mm
Color /Finish	Black	Thickness	0.196" / 5mm
Bobbins	10	Bore	2.52" / 64.2mm

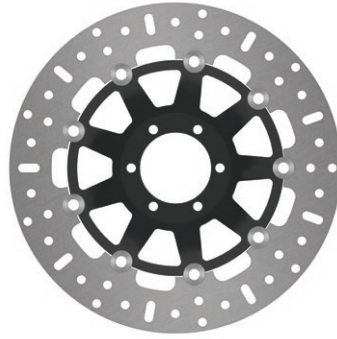

MD678BLK
Fits EBC Pads: 196, 209/2, 244, 347

Type	Floating	OD	11.77" / 299mm
Color /Finish	Black	Thickness	0.196" / 5mm
Bobbins	10	Bore	2.52" / 64.2mm

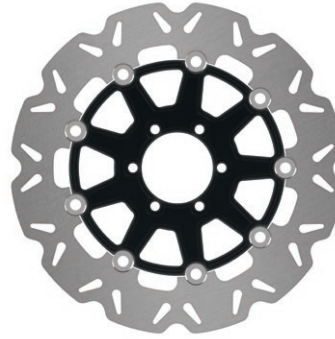

VR678BLK
Fits EBC Pads: 196, 209/2, 244, 347

DISC GROUP NO. 025 - REAR. CHOOSE YOUR PREFERRED STYLE:

Type	Floating	OD	11.77" / 299mm
Color /Finish	Black	Thickness	0.275" / 7mm
Bobbins	9	Bore	2.527" / 64.2mm

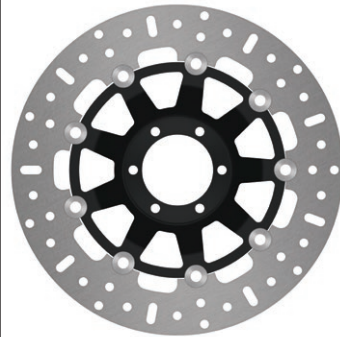

MD887BLK
Fits EBC Pads: 196

Type	Floating	OD	11.77" / 299mm
Color /Finish	Black	Thickness	0.275" / 7mm
Bobbins	9	Bore	2.527" / 64.2mm



VR887BLK
Fits EBC Pads: 196

DISC GROUP NO. 026 - FRONT/REAR. CHOOSE YOUR PREFERRED STYLE:

Type	Floating	OD	11.77" / 299mm
Color /Finish	Natural	Thickness	0.196" / 5mm
Bobbins	9	Bore	1.99" / 50.6mm

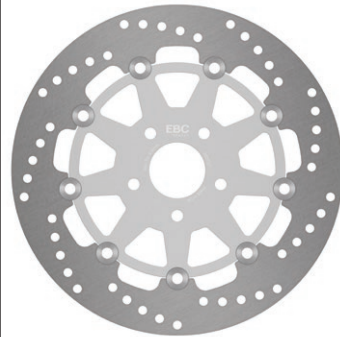

MD727
Fits EBC Pads: 209/2, 244

Type	Floating	OD	11.77" / 299mm
Color /Finish	Black	Thickness	0.196" / 5mm
Bobbins	9	Bore	1.99" / 50.6mm

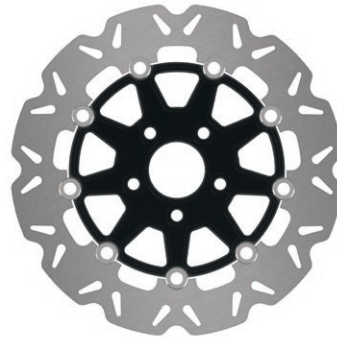

VR727BLK
Fits EBC Pads: 209/2, 244

DISC GROUP NO. 027 - FRONT. CHOOSE YOUR PREFERRED STYLE:

Type	Solid	OD	9.84" / 250mm
Color /Finish	Natural	Thickness	0.236" / 6mm
Bobbins	None	Bore	2.606" / 66.2mm

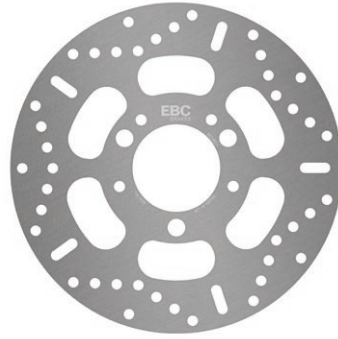

MD801
Fits EBC Pads: 474

Type	Solid	OD	9.84" / 250mm
Color /Finish	Natural	Thickness	0.236" / 6mm
Bobbins	None	Bore	2.606" / 66.2mm



VR801
Fits EBC Pads: 474

DISC GROUP NO. 028 - REAR. CHOOSE YOUR PREFERRED STYLE:

Type	Solid	OD	9.84" / 250mm
Color /Finish	Natural	Thickness	0.236" / 6mm
Bobbins	None	Bore	2.606" / 66.2mm



MD802
Fits EBC Pads: 473

Type	Solid	OD	9.84" / 250mm
Color /Finish	Natural	Thickness	0.236" / 6mm
Bobbins	None	Bore	2.606" / 66.2mm



VR802
Fits EBC Pads: 473

DISC GROUP NO. 029 - FRONT. CHOOSE YOUR PREFERRED STYLE:

Type	Solid	OD	10.6" / 270mm
Color /Finish	Natural	Thickness	0.275" / 7mm
Bobbins	None	Bore	2.46" / 62.6mm

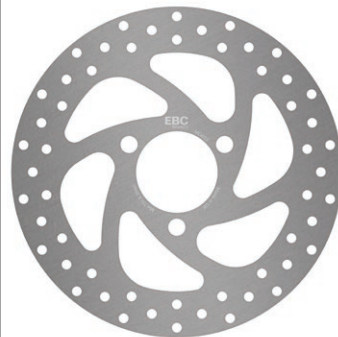

MD853
Fits EBC Pads: 630

Type	Solid	OD	10.6" / 270mm
Color /Finish	Natural	Thickness	0.275" / 7mm
Bobbins	None	Bore	2.46" / 62.6mm

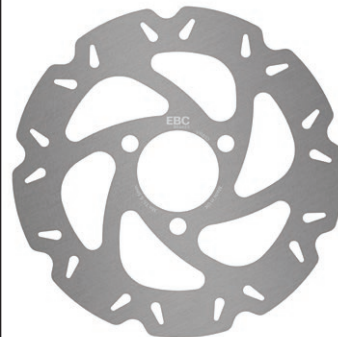

VR853
Fits EBC Pads: 630

DISC GROUP NO. 030 - REAR. CHOOSE YOUR PREFERRED STYLE:

Type	Solid	OD	10.6" / 270mm
Color /Finish	Natural	Thickness	0.275" / 7mm
Bobbins	None	Bore	2.46" / 62.6mm

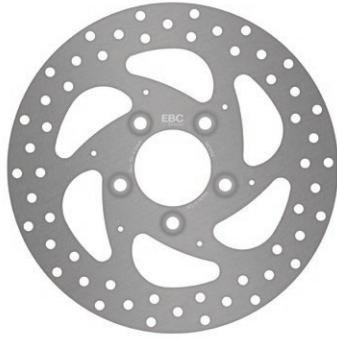

MD854
Fits EBC Pads: 631

Type	Solid	OD	10.6" / 270mm
Color /Finish	Natural	Thickness	0.275" / 7mm
Bobbins	None	Bore	2.46" / 62.6mm



VR854
Fits EBC Pads: 631

DISC GROUP NO. 031 - FRONT. CHOOSE YOUR PREFERRED STYLE:

Type	Solid	OD	12.59" / 320mm
Color /Finish	Natural	Thickness	0.196" / 5mm
Bobbins	None	Bore	8.86" / 225mm

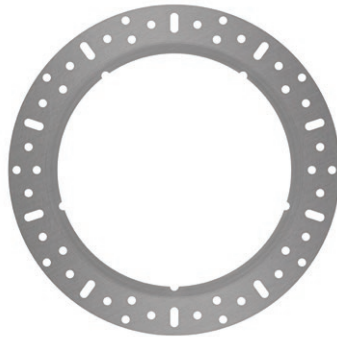

MD737
Fits EBC Pads: 196

Type	Solid	OD	12.59" / 320mm
Color /Finish	Natural	Thickness	0.196" / 5mm
Bobbins	None	Bore	8.86" / 225mm

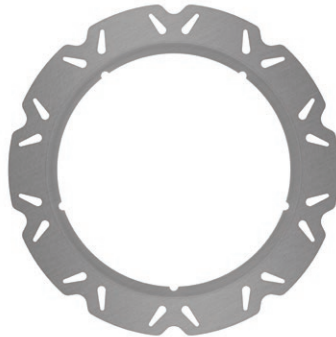

VR737
Fits EBC Pads: 196

DISC GROUP NO. 032 - REAR. CHOOSE YOUR PREFERRED STYLE:

Type	Solid	OD	8.66" / 220mm
Color /Finish	Natural	Thickness	0.196" / 5mm
Bobbins	None	Bore	1.99" / 50.6mm



MD738
Fits EBC Pads: 140

Type	Solid	OD	8.66" / 220mm
Color /Finish	Natural	Thickness	0.196" / 5mm
Bobbins	None	Bore	1.99" / 50.6mm



VR738
Fits EBC Pads: 140

MD509SR

Type	Solid	OD	10.67" / 271mm
Color /Finish	Natural	Thickness	0.3" / 7mm
Bobbins	None	Bore	4" / 101.8mm



MD509SR
Fits EBC Pads: 201

MD515

Type	Solid	OD	11.5" / 292mm
Color /Finish	Natural	Thickness	0.23" / 5.8mm
Bobbins	None	Bore	4" / 101.4mm

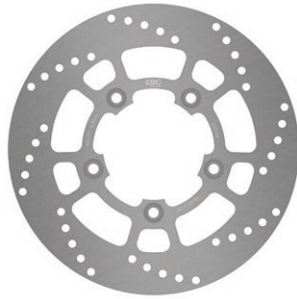

MD515
Fits EBC Pads: 400

MD522

Type	Solid	OD	9.44" / 240mm
Color /Finish	Natural	Thickness	0.196" / 5mm
Bobbins	None	Bore	2.77" / 70.6mm

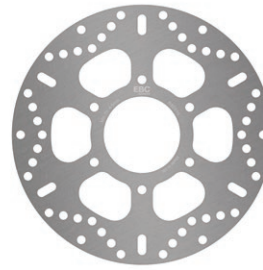

MD522
Fits EBC Pads: 140

MD531

Type	Solid	OD	11.41" / 290mm
Color /Finish	Natural	Thickness	0.2" / 5.2mm
Bobbins	None	Bore	2.22" / 56.4mm



MD531
Fits EBC Pads: 643

MD532

Type	Solid	OD	10.23" / 260mm
Color /Finish	Natural	Thickness	0.2" / 5.6mm
Bobbins	None	Bore	2.22" / 56.4mm



MD532
Fits EBC Pads: 643

MD538

Type	Solid	OD	10.67" / 270.5mm
Color /Finish	Black	Thickness	0.25" / 6.35mm
Bobbins	None	Bore	4.31" / 109.5mm

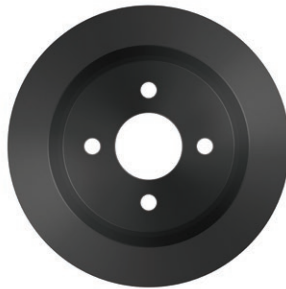

MD538
Fits EBC Pads: 641/4

MD540

Type	Solid	OD	8.97" / 228mm
Color /Finish	Black	Thickness	0.248" / 6.3mm
Bobbins	None	Bore	6.783" / 172.3mm



MD540
Fits EBC Pads: 605/4

MD689

Type	Solid	OD	9.05" / 230mm
Color /Finish	Natural	Thickness	0.177" / 4.5mm
Bobbins	None	Bore	3.433" / 87.2mm

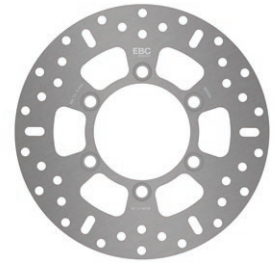

MD689
Fits EBC Pads: 86

MD690

Type	Floating	OD	11.77" / 299mm
Color /Finish	Gold	Thickness	0.157" / 4mm
Bobbins	9	Bore	2.527" / 64.2mm

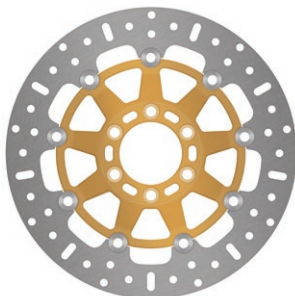

MD690
Fits EBC Pads: 86

MD690C

Type	Floating	OD	11.77" / 299mm
Color /Finish	Gold	Thickness	0.157" / 4mm
Bobbins	9	Bore	2.527" / 64.2mm

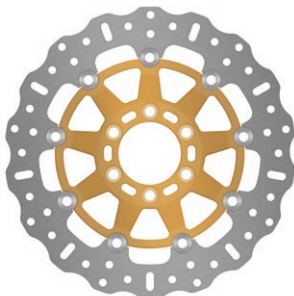

MD690C
Fits EBC Pads: 86

MD691

Type	Floating	OD	11.81" / 300mm
Color /Finish	Gold	Thickness	0.157" / 4mm
Bobbins	6	Bore	5.126" / 130.2mm

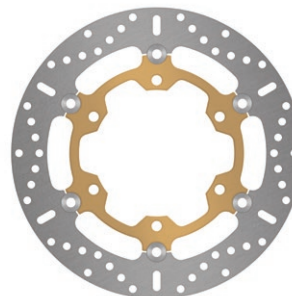

MD691
Fits EBC Pads: 86

MD719RS

Type	Floating	OD	13.38" / 340mm
Color /Finish	Natural	Thickness	0.196" / 5mm
Bobbins	9	Bore	2.385" / 60.6mm

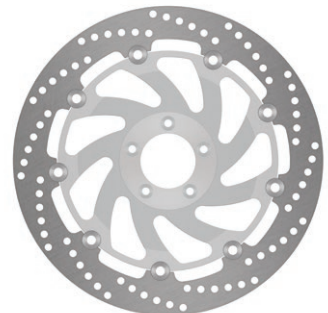

MD719RS
Fits EBC Pads: 210, 424

MD734RS

Type	Floating	OD	13.38" / 340mm
Color /Finish	Natural	Thickness	0.196" / 5mm
Bobbins	9	Bore	2.385" / 60.6mm

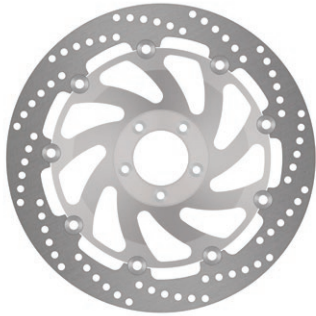

MD734RS
Fits EBC Pads: 424

MD735RS

Type	Solid	OD	14.76" / 375mm
Color /Finish	Natural	Thickness	0.196" / 5mm
Bobbins	None	Bore	12" / 307mm

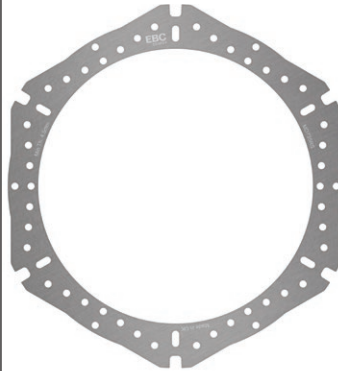

MD735RS
Fits EBC Pads: 345, 454/4

MD803

Type	Solid	OD	12.6" / 320mm
Color /Finish	Natural	Thickness	0.177" / 4.5mm
Bobbins	None	Bore	7.106" / 180.5mm

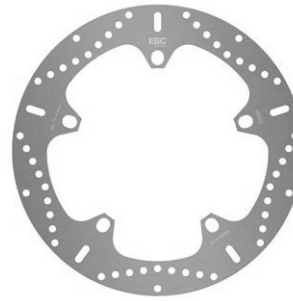

MD803
Fits EBC Pads: 630

MD890BLK

Type	Floating	OD	11.77" / 299mm
Color /Finish	Black	Thickness	0.196" / 5mm
Bobbins	10	Bore	2.527" / 64.2mm

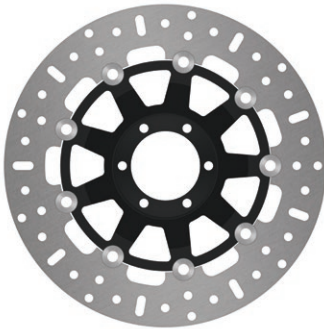

MD890BLK
Fits EBC Pads: 196, 261, 347

VR890BLK

Type	Floating	OD	11.77" / 299mm
Color /Finish	Black	Thickness	0.196" / 5mm
Bobbins	10	Bore	2.527" / 64.2mm

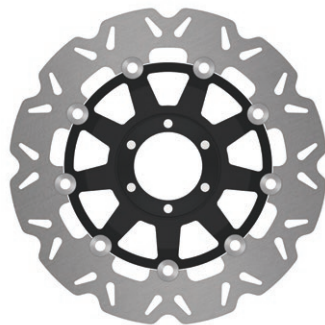

VR890BLK
Fits EBC Pads: 196, 261, 347

MD8007

Type	Solid	OD	10.24" / 260mm
Color /Finish	Natural	Thickness	0.196" / 5mm
Bobbins	None	Bore	4.63" / 117.6mm

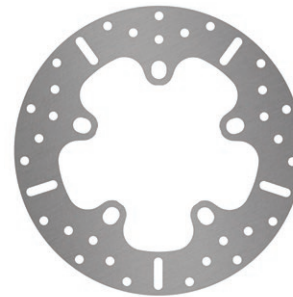

MD8007
Fits EBC Pads: FA266

MD1187C

Type	Solid	OD	12.6" / 320mm
Color /Finish	Natural	Thickness	0.196" / 5mm
Bobbins	None	Bore	8.35" / 212.2mm

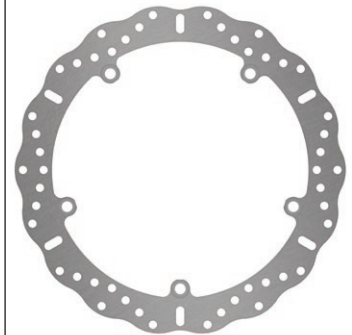

MD1187C
Fits EBC Pads: 209/2

MD6435C

Type	Solid	OD	9.44" / 240mm
Color /Finish	Natural	Thickness	0.157" / 4mm
Bobbins	None	Bore	4.141" / 105.2mm

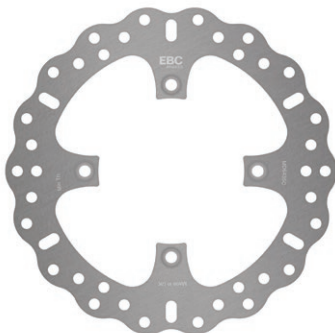

MD6435C
Fits EBC Pads: 83, 181, 185, 208, 209/2, 213, 264, 367

BRAKE APPLICATION SECTION
Brake pads, shoes and rotors for
European and Asian Motorcycles and ATVs

FRONT: HONDA



HONDA



DISC PAD CHOICES - FRONT

BRAKE ROTOR CHOICES - FRONT

											Line #
CHF 50/50 P/S Metropolitan	02-11	333									1
CRF 50 F	04-21	301	N/A								2
Dream 50 R CBR (AR02)	04	FA197	FA197HH				TBC				3
MB5	82	FA54	FA54HH				N/A				4
MR 50 K Elsinore	74-75	301	N/A								5
NA 50 Express II	79-81	301									6
NB 50/NB 50 M Aero 50	83-87	301									7
NC 50 Express	77-80	301									8
NC 50 Express	81-83	301									9
NCH 50 Metropolitan	13-21	333									10
NN 50 MD Gyro	84	301									11
NPS 50 Ruckus/NPS 50 S	03-21	333									12
NQ 50 D/NQ 50 Spree/Spree Special	84-87	301									13
NS 50 F	90	303									14
NSR 50 R (RS50) Mini 50	04	FA197	FA197HH				TBC				15
NU 50/NU 50 M Urban Express	82-83	333									16
NX 50 M Express SR	81-82	301									17
P 50		301									18
PA 50	78-81	301									19
PA 50	82-83	301									20
QA 50 K		303									21
SA 50 Elite LX/SR	88-93	301									22
SA 50 Elite SR/SA 50 P Elite S	94-01	333									23
SB 50/SB 50 P Elite/Elite ES	88-90	301									24
SE 50/SE 50 P Elite/Elite 50 S	87-88	301									25
TG 50/TG 50 M Gyro S	85-86	301									26
XR 50 R	00-03	301	N/A								27
Z 50 R	80-99	301	N/A								28
Z 50 RD	86	301	N/A								29
ZB 50	88	303	303G								30
CR 60 R	83-84	333	333G								31
ATC 70	79-85	NONE	NONE								32
C70 Passport	80-83	303									33
CRF 70 F	04-14	333	333G								34
CT 70 Trail	77-82	303	303G								35
CT 70 Trail	91-94	303	303G								36
SL 70 / K1	70-73	303	303G								37
TRX 70 Fourtrax	86-87	346*	346G*								38
XR 70 R	97-03	333	333G								39
XL 75	77/79	304	304G								40
XL 75	78	303	303G								41
CH 80 Elite	85-07	303									42
CR 80 R	80-81	304	304G								43
CR 80 R	82	304	304G								44
CR 80 R	83-84	333	333G								45
CR 80 R	85	333	333G								46
CR 80 R	86-91	FA84X	FA84R			MXS84	MD6004D				47
CR 80 R	92-95	FA84X	FA84R			MXS84	MD6004D				48
CR 80 R/RB Expert	96-02	FA84X	FA84R			MXS84	MD6058D			MD6058C	49
CRF 80 F	04-14	333	333G								50
NH 80 MD Aero	83-84	303									51
NH 80 Aero	85	303									52
XL 80 S	80-85	304	304G								53
XR 80	79-84	304	304G								54
XR 80 R	85-04	333	333G								55
CR 85 R/RB	03-07	FA84X	FA84R			MXS84	MD6058D			MD6058C	56

FRONT

APPLICATIONS
BRAKE

* This symbol indicates a rotor made of billet steel, and should be only used with EBC FA Kevlar® Organic or Vee pads.
 † SAFETY NOTICE - With vehicles primarily designed for off highway use such as quads now being used on the highway, we would recommend the use of X or MXS pads for highway use and ONLY using the R and SV higher density / harder pad series for off road riding.

*-2 Sets Required. † For Vee disc colours add RED, BLU, GRN, GLD, ORG suffix to part number. **SAFETY WARNING:- DO NOT USE HH PADS ON REAR UNLESS ALSO USED ON FRONT TO AVOID BRAKE IMBALANCE**

FRONT: HONDA Cont'd

REAR: HONDA

Line #	BRAKE ROTOR CHOICES - FRONT						DISC PAD CHOICES - REAR					BRAKE ROTOR CHOICES - REAR					
	CC Custom Rotor	CX Extreme® /Vee-Rotor	OS Series Oversize 250/280mm Rotor Kit	OSX Series Oversize 280mm Rotor Kit	Relocating Bracket for Oversize Rotor	SMX Series Oversize 320mm Rotor Kit	Relocating Bracket for 320mm Rotor		Sintered/HH Pads/ Grooved Shoes	SV Series Severe Duty Pads	EPFA Sintered Fast Road/ Track Pads	Specialty Pads SXR/ VEE/MXS Race	Standard Rotor	Vintage Rotor / UTV Oversize Brake Kit	Contour Profile Rotor	CX Extreme® /Vee-Rotor	
1								333									
2								301									
3								FA131X					TBC				
4								304									
5								301									
6								302									
7								302									
8								301									
9								302									
10								304									
11								301									
12								333									
13								301									
14								304									
15								FA131X					TBC				
16								302									
17								302									
18								N/A									
19								322									
20								301									
21								303									
22								302									
23								333									
24								301									
25								302									
26								301									
27								301									
28								301									
29								301									
30								303	303G								
31								333	333G								
32								310	310G								
33								303									
34								333	333G								
35								303	303G								
36								303	303G								
37								303	303G								
38								330	330G								
39								333	333G								
40								304	304G								
41								303	303G								
42								333									
43								304	304G								
44								333	333G								
45								333	333G								
46								338	338G								
47								338	338G								
48								FA131X	FA131R			MXS131	MD6005D		MD6005C		
49		MD6058CX	OS6058C	OSX6058	BRK026			FA131X	FA131R			MXS131	MD6005D		MD6005C	MD6005CX	
50								333	333G								
51								302									
52								333									
53								304	304G								
54								304	304G								
55								333	333G								
56		MD6058CX	OS6058C	OSX6058	BRK026			FA131X	FA131R				MXS131	MD6005D		MD6005C	MD6005CX

REAR

BRAKE APPLICATIONS

⚠ This symbol indicates a rotor made of billet steel, and should be only used with EBC FA Kevlar® Organic or Vee pads.
 SAFETY NOTICE - With vehicles primarily designed for off highway use such as quads now being used on the highway, we would recommend the use of X or MXS pads for highway use and ONLY using the R and SV higher density / harder pad series for off road riding.

*-2 Sets Required. † For Vee disc colours add RED, BLU, GRN, GLD, ORG suffix to part number. **SAFETY WARNING:** DO NOT USE HH PADS ON REAR UNLESS ALSO USED ON FRONT TO AVOID BRAKE IMBALANCE

FRONT: HONDA



HONDA



DISC PAD CHOICES - FRONT

BRAKE ROTOR CHOICES - FRONT

											Line #
EZ 90 Cub	91-96	303	303G								1
TRX 90 Fourtrax/Sportrax	93-06	303*	303G*								2
TRX 90 EX	07-08	303*	303G*								3
TRX 90 X	09-21	303*	303G*								4
CRF 100 F	04-14	333	333G								5
NSF 100 R	06	FA197	FA197HH		EPFA197HH	GPFAX197HH					6
NSF 100 R (Note - CF=new floating conversion available)	06										7
SL 100 K	70-74	303	303G								8
XL 100 (Up to F # 1020001)	74	303	303G								9
XL 100 (From F # 1020001)	74	304	304G								10
XL 100 K	75	304	304G								11
XL 100	76	304	304G								12
XL 100	77-78	303	303G								13
XL 100 S	79-85	304	304G								14
XR 100	81-84	304	304G								15
XR 100 R	85-04	333	333G								16
ATC 110	79-85	NONE	NONE								17
CRF 110 R	13-21	333	333G								18
CT 110 Trail	80-86	303	303G								19
NHX 110 Elite	10-11	SFA323	SFA323HH				MD931D				20
ATC 125 M	84-87	303	303G								21
Super Cub C 125 (ABS)	18-20	SFA708									22
Super Cub C 125 (ABS) 007	18-20	SFA708									23
CB 125 F	15-21	FA679	FA679HH								24
CB 125 S	79-82	304									25
CB 125 S	84-85	330									26
CB 125 TT	90	FA124/2	FA124/2HH				N/A				27
CB 125 R	19-20	FA679	FA679HH				N/A				28
CBR 125 R (6 Bolt Front Disc / Canada)	04-10	FA375	FA375HH				MD644				29
CBR 125 RWB/RC (5 Bolt Front Disc / Canada)	11-13	FA375	FA375HH				MD1166RS				30
CG 125 (CA/KS/KSE) Drum Front Brake	01-06	352									31
CG 125 (ES) Disc Front Brake	01-04	FA54	FA54R				N/A				32
CH 125 Elite	84	303									33
CL 125 A (Scrambler Twin)	65	306	306G								34
CL 125 S (Single)	67-74	303	303G								35
CL 125 S1 (Single) up to frame # 1120001	67-74	303	303G								36
CL 125 S1 (Single) from frame # 1120002	67-74	304	304G								37
CR 125 M Elsinore	73-78	304	304G								38
CR 125 R Elsinore	79-81	324	324G								39
CR 125 R	82	330	330G								40
CR 125 R	83	331	331G								41
CR 125 R	84-85	FA92X	FA92R				MD6087D				42
CR 125 R	86	FA92X	FA92R				MD6087D				43
CR 125 R	87-88	FA125X	FA125R				MD6087D				44
CR 125 R	89	FA125X	FA125R				MD6008D				45
CR 125 R	90-91	FA125X	FA125R				MD6003D				46
CR 125 R	92-94	FA125X	FA125R				MD6001D				47
CR 125 R	95-97	FA185X	FA185R		EPFA185HH	GPFAX185HH	MXS185	MD6037D		MD6001C	48
CR 125 R	98-01	FA185X	FA185R		EPFA185HH	GPFAX185HH	MXS185	MD6037D		MD6037C	49
CR 125 R	02-03	FA185X	FA185R		EPFA185HH	GPFAX185HH	MXS185	MD6037D		MD6037C	50
CR 125 R	04-07	FA185X	FA185R		EPFA185HH	GPFAX185HH	MXS185	MD6037D		MD6037C	51
CRF 125 F (17/14" Small Wheels)	14-21	FA185X	FA185R		EPFA185HH	GPFAX185HH	MXS185	MD6390D		MD6390C	52
CRF 125 FB (19/16" Big Wheels)	14-21	FA185X	FA185R		EPFA185HH	GPFAX185HH	MXS185	MD6390D		MD6390C	53
CRG 125 (Mexico)	09-10	TBC					TBC				54
CT 125	77	304	304G								55
Elite 125 (Mexico)	09-10	TBC					TBC				56

FRONT

APPLIATIONS
SAFETY NOTICE - With vehicles primarily designed for off highway use such as quads now being used on the highway, we would recommend the use of X or MXS pads for highway use and ONLY using the R and SV higher density / harder pad series for off road riding.

*** This symbol indicates a rotor made of billet steel, and should be only used with EBC FA Kevlar® Organic or Vee pads.**

*-2 Sets Required. † For Vee disc colours add RED, BLU, GRN, GLD, ORG suffix to part number. **SAFETY WARNING:- DO NOT USE HH PADS ON REAR UNLESS ALSO USED ON FRONT TO AVOID BRAKE IMBALANCE**

FRONT: HONDA Cont'd

REAR: HONDA

BRAKE ROTOR CHOICES - FRONT

DISC PAD CHOICES - REAR

BRAKE ROTOR CHOICES - REAR

Line #

CC Custom Rotor	CX Extreme® /Vee-Rotor	OS Series Oversize 250/280mm Rotor Kit	OSX Series Oversize 280mm Rotor Kit	Relocating Bracket for Oversize Rotor	SMX Series Oversize 320mm Rotor Kit	Relocating Bracket for 320mm Rotor		Sintered/HH Pads/ Grooved Shoes	SV Series Severe Duty Pads	EPFA Sintered Fast Road/ Track Pads	Specialty Pads SXR/ VEE/MXS Race	Standard Rotor	Vintage Rotor / UTV Oversize Brake Kit	Contour Profile Rotor	CX Extreme® /Vee-Rotor
1								303	303G						
2								306	306G						
3								306	306G						
4								306	306G						
5								333	333G						
6							FA131X			EPFA131HH				MD1170C	
7															
8								303	303G						
9								303	303G						
10								304	304G						
11								304	304G						
12								304	304G						
13								303	303G						
14								304	304G						
15								304	304G						
16								333	333G						
17								306	306G						
18								333	333G						
19								303	303G						
20								352							
21								306	306G						
22								352							
23								352							
24							FA629	FA629HH							
25								304							
26								303							
27								310							
28							FA629	FA629HH							
29							FA343	FA343HH				MD1151			
30							FA629	FA629HH				MD1151			
31								352							
32								352							
33								303							
34								307	307G						
35								303	303G						
36								303	303G						
37								304	304G						
38								304	304G						
39								330	330G						
40								330	330G						
41								331	331G						
42								331	331G						
43								344	344G						
44							FA131X	FA131R			MXS131	MD6009D			
45							FA131X	FA131R			MXS131	MD6002D			
46							FA131X	FA131R			MXS131	MD6002D			
47	MD6001CX	OS6001EC	OSX6001E	BRK004	N/A	N/A	FA131X	FA131R			MXS131	MD6002D			MD6002CX
48	MD6037CX	OS6037C	OSX6037	BRK008	SMX6037	BRK009	FA131X	FA131R			MXS131	MD6002D			MD6002CX
49	MD6037CX	OS6037C	OSX6037	BRK008	SMX6037	BRK009	FA131X	FA131R			MXS131	MD6002D			MD6002CX
50	MD6037CX	OS6037C	OSX6037	BRK008	SMX6037	BRK009	FA346X	FA346R		EPFA346HH	MXS346	MD6191D		MD6124C	MD6124CX
51	MD6037CX	OS6437C	OSX6437	BRK005	SMX6437	BRK006	FA346X	FA346R		EPFA346HH	MXS346	MD6191D		MD6191C	MD6191CX
52								333	333G						
53								333	333G						
54								TBC							
55								304	304G						
56								TBC							

REAR

BRAKE APPLICATIONS

⚠ This symbol indicates a rotor made of billet steel, and should be only used with EBC FA Kevlar® Organic or Vee pads.
 SAFETY NOTICE - With vehicles primarily designed for off highway use such as quads now being used on the highway, we would recommend the use of X or MXS pads for highway use and ONLY using the R and SV higher density / harder pad series for off road riding.

*-2 Sets Required. † For Vee disc colours add RED, BLU, GRN, GLD, ORG suffix to part number. **SAFETY WARNING:- DO NOT USE HH PADS ON REAR UNLESS ALSO USED ON FRONT TO AVOID BRAKE IMBALANCE**

FRONT: HONDA



HONDA



DISC PAD CHOICES - FRONT

BRAKE ROTOR CHOICES - FRONT

											Line #
MT 125 / K1 Elsinore	74-77	304	304G								1
MSX 125 GROM (Non ABS)	13-20	FA375	FA375HH				MD1183				2
MSX 125 GROM (ABS)	18-21	FA375	FA375HH				MD1191			MD1191C	3
MSX 125 GROM (When Fitted With Brembo Single Pin Aftermarket Calipers)		FA266	FA266HH			FA266V					4
Monkey 125	18-21	FA375									5
NH 125 Aero	84	303									6
NX 125	88-90	350	N/A								7
NXR 125 (JC30)	03-08	352	N/A								8
PCX 125 (WW 125 EX2A)	11	SFA603	SFA603HH				MD9134D				9
PCX 125 (ABS Model)	18-21	SFA693	SFA693HH								10
SL 125 K	71-73	303	303G								11
SS 125 A (Supersport 125)	65	306									12
TL 125 K	71-75	304	304G								13
TL 125 S	76	304	304G								14
TRX 125 Fourtrax	85-88	303*	303G*								15
XL 125 K/76	74-76	304	304G								16
XL 125	77-78	303	303G								17
XL 125 S	79-84	304	304G								18
XL 125 S	85	330	330G								19
ADV 150	21	SFA693	SFA693HH								20
CRF 150 F	03-20	FA185X	FA185R			MXS185	MD6317D			MD6317C	21
CRF 150 R	07-21	FA84X	FA84R			MXS84	MD6314D			MD6314C	22
CRF 150 RB Expert	18-21	FA84X	FA84R			MXS84	MD6314D			MD6314C	23
CH 150/150 D Elite/Elite Deluxe	85-87	303									24
NXR 150 (KD02)	03-05	352	N/A								25
NXR 150 (KD03) Front Disc Model	06-08	FA185X	FA185R			MXS185	N/A				26
NXR 150 (KD03) Front Drum Model	06-08	352	N/A								27
PCX 150 (WW150)	13-20	SFA603	SFA603HH				MD9134D				28
PCX 150 (ABS Model)	18-21	SFA693	SFA693HH							MD9177C	29
SH 150i	10-11	SFA323	SFA323HH				MD970D				30
CD 175	67-68	306									31
CD 175 K	69-71	306									32
CL 175/175 K	68-72	308									33
MR 175 Elsinore	75-77	304	304G								34
SL 175 K	72-73	309	N/A								35
XL 175 K	73-75	312	312G								36
XL 175	76-78	312	312G								37
ATC 185	80	303	303G								38
ATC 185 S	81-83	303	303G								39
XL 185 S	79-83	304	304G								40
XR 185	79	304	304G								41
ATC 200	81-83	303	303G								42
ATC 200 E Big Red	82-83	303	303G								43
ATC 200 ES Big Red	84	303	303G								44
ATC 200 M	84-85	303	303G								45
ATC 200 S	84-86	303	303G								46
ATC 200 X	83-85	FA84X	FA84R	FA84SV			MD6059D				47
ATC 200 X	86-87	FA84X	FA84R	FA84SV			MD6059D				48
CM 200 T Twinstar	80-82	312									49
TLR 200 Reflex	86-87	304	304G								50
TR 200 Fatcat	86-87	304	304G								51
TRX 200 Fourtrax	84	339*	339G*								52
TRX 200 SX Fourtrax	86-88	345*	345G*								53
TRX 200 Fourtrax	90-91	345*	345G*								54
TRX 200 D Type II Fourtrax	91-97	345*	345G*								55

*-2 Sets Required. † For Vee disc colours add RED, BLU, GRN, GLD, ORG suffix to part number. **SAFETY WARNING:- DO NOT USE HH PADS ON REAR UNLESS ALSO USED ON FRONT TO AVOID BRAKE IMBALANCE**

⚠ This symbol indicates a rotor made of billet steel, and should be only used with EBC FA Kevlar® Organic or Vee pads.

SAFETY NOTICE - With vehicles primarily designed for off highway use such as quads now being used on the highway, we would recommend the use of X or MXS pads for highway use and ONLY using the R and SV higher density / harder pad series for off road riding.

FRONT: HONDA Cont'd

REAR: HONDA

Line # 1
2
3
4
5
6
7
8
9
10
11
12
13
14
15
16
17
18
19
20
21
22
23
24
25
26
27
28
29
30
31
32
33
34
35
36
37
38
39
40
41
42
43
44
45
46
47
48
49
50
51
52
53
54
55
56

BRAKE ROTOR CHOICES - FRONT							DISC PAD CHOICES - REAR					BRAKE ROTOR CHOICES - REAR			
CC Custom Rotor	CX Extreme® /Vee-Rotor	OS Series Oversize 250/280mm Rotor Kit	OSX Series Oversize 280mm Rotor Kit	Relocating Bracket for Oversize Rotor	SMX Series Oversize 320mm Rotor Kit	Relocating Bracket for 320mm Rotor		Sintered/HH Pads/ Grooved Shoes	SV Series Severe Duty Pads	EPFA Sintered Fast Road/ Track Pads	Specialty Pads SXR/ VEE/MXS Race	Standard Rotor	Vintage Rotor / UTV Oversize Brake Kit	Contour Profile Rotor	CX Extreme® /Vee-Rotor
							304	304G							
	VR1183		OSX1183	BRK037			FA629	FA629HH				MD1184		MD1184C	VR1184
	VR1191			BRK048			FA629	FA629HH				MD1184		MD1184C	VR1184
							FA266	FA266HH			FA266V				
							FA629								
							303								
							304	304G							
							304	304G							
							352								
							352								
							304	304G							
							307								
							304	304G							
							304	304G							
							306	306G							
							304	304G							
							303	303G							
							304	304G							
							304	304G							
							352								
		OS6317C	OSX6317	BRK008	SMX6317	BRK009	304	304G							
	MD6314CX	OS6314C	OSX6314	BRK026	N/A	N/A	FA346X	FA346R			MXS346	MD6316D		MD6316C	MD6316CX
	MD6314CX	OS6314C	OSX6314	BRK026	N/A	N/A	FA346X	FA346R			MXS346	MD6316D		MD6316C	MD6316CX
							303								
							304	304G							
							304	304G							
							304	304G							
							352								
							352								
							307								
							307								
							309								
							304	304G							
							309								
							310	310G							
							310	310G							
							306	306G							
							306	306G							
							304	304G							
							304	304G							
							306	306G							
							306	306G							
							306	306G							
							306	306G							
							306	306G							
							306	306G							
							306	306G							
							N/A	FA84/2R				MD6059D			
							FA84X	FA84R	FA84SV			MD6059D			
							310								
							333	333G							
							304	304G							
							306	306G							
							306	306G							
							306	306G							
							306	306G							
							306	306G							

REAR

BRAKE APPLICATIONS

⚠ This symbol indicates a rotor made of billet steel, and should be only used with EBC FA Kevlar® Organic or Vee pads.
 SAFETY NOTICE - With vehicles primarily designed for off highway use such as quads now being used on the highway, we would recommend the use of X or MXS pads for highway use and ONLY using the R and SV higher density / harder pad series for off road riding.

*-2 Sets Required. † For Vee disc colours add RED, BLU, GRN, GLD, ORG suffix to part number. **SAFETY WARNING:** DO NOT USE HH PADS ON REAR UNLESS ALSO USED ON FRONT TO AVOID BRAKE IMBALANCE

FRONT: HONDA



HONDA



DISC PAD CHOICES - FRONT

BRAKE ROTOR CHOICES - FRONT

											Line #
XL 200 R	83-84	304	304G								1
XR 200 R	80-84	304	304G								2
XR 200 R Pro Link	81-83	304	304G								3
XR 200 R	84-02	304	304G								4
CRF 230 F AC	03-20	FA185X	FA185R	EPFA185HH		MXS185	MD6001D			MD6001C	5
CRF 230 L	08-11	FA185X	FA185R	EPFA185HH		MXS185	MD6001D			MD6001C	6
CRF 230 M	09-11	FA185X	FA185R	EPFA185HH		MXS185	MD6001D			MD6001C	7
ATC 250 R	81	FA54X	FA54R	FA54SV			MD6060D				8
ATC 250 R	82	FA54X	FA54R	FA54SV			MD6060D				9
ATC 250 R	83-84	FA84X	FA84R	FA84SV			MD6059D				10
ATC 250 R	85-86	FA92X	FA92R				MD6059D				11
ATC 250 ES Big Red	85-87	306	306G								12
ATC 250 SX	85-87	306	306G								13
CB 250 N/T		FA45					MD1036LS		VMD1036		14
CB 250 Nighthawk	91-08	312									15
CBR 250 R (Non ABS Model)	11-14	FA226	FA226HH	EPFA226HH			MD1180X				16
CBR 250 RA (ABS Model)	11-14	FA388	FA388HH	EPFA388HH			MD1180X				17
CH 250 Elite	85-86	330									18
CH 250 Elite	87-90	330									19
CM 250 C Custom	82-83	312									20
CM 250 T		FA45					MD1036LS		VMD1036		21
CMX 250 C/CD Rebel	85-87	FA86	FA86HH				MD1030				22
CMX 250 C Rebel	96/97/99-14	FA228	FA228HH				MD1030				23
CMX 250 C2	99-00	FA228					MD1030				24
CMX 250 X	15	FA228					MD1030				25
CN 250 Helix	86-87	FA69	FA69HH				MD908D				26
CN 250 Helix	92-93	FA69/2					MD908D				27
CN 250 Helix	94-01/05-07	SFA142	SFA142HH				MD908D				28
CR 250 M Elsinore	73-76	312	312G								29
CR 250 R Elsinore	78-80	324	324G								30
CR 250 R Elsinore	81	327	327G								31
CR 250 R	82	328	328G								32
CR 250 R	83	328	328G								33
CR 250 R	84-85	FA92X	FA92R				MD6087D				34
CR 250 R	86	FA92X	FA92R				MD6087D				35
CR 250 R	87-88	FA125X	FA125R			MXS125	MD6087D				36
CR 250 R	89	FA125X	FA125R			MXS125	MD6008D				37
CR 250 R	90-91	FA125X	FA125R			MXS125	MD6003D				38
CR 250 R	92-94	FA125X	FA125R			MXS125	MD6001D			MD6001C	39
CR 250 R	95-96	FA185X	FA185R	EPFA185HH		MXS185	MD6037D			MD6037C	40
CR 250 R	97-01	FA185X	FA185R	EPFA185HH		MXS185	MD6037D			MD6037C	41
CR 250 R	02-03	FA185X	FA185R	EPFA185HH		MXS185	MD6037D			MD6037C	42
CR 250 R	04-07	FA185X	FA185R	EPFA185HH		MXS185	MD6037D			MD6037C	43
CRF 250 L (Non ABS)	13-21	FA465X	FA465R			MXS465				MD6372C	44
CRF 250 LA (ABS)	19-21	FA465X	FA465R			MXS465				MD6372C	45
CRF 250 Rally (Non ABS)	19-21	FA465X	FA465R			MXS465				MD6409C	46
CRF 250 Rally (ABS)	19-21	FA465X	FA465R			MXS465				MD6409C	47
CRF 250 R (240mm F/Disc)	04-14	FA185X	FA185R	EPFA185HH		MXS185	MD6037D			MD6037C	48
CRF 250 R AC (F-disc 260mm, R-disc 240mm)	15-22	FA185X	FA185R	EPFA185HH		MXS185				MD6389C	49
CRF 250 RX (F-disc 260mm R-disc 240mm, 18" rear wheel)	19-22	FA185X	FA185R	EPFA185HH		MXS185				MD6389C	50
CRF 250 X	04-16	FA185X	FA185R	EPFA185HH		MXS185	MD6037D			MD6037C	51
FL 250 Odyssey	77-84	N/A	N/A								53
FL 250 Odyssey Handbrake	77-84										54
MR 250 Elsinore	76	311	311G								55
MT 250 K/76	74-76	311	311G								56

APPLIATIONS
BRAKE
 * This symbol indicates a rotor made of billet steel, and should be only used with EBC FA Kevlar® Organic or Vee pads.
 † For Vee disc colours add RED, BLU, GRN, GLD, ORG suffix to part number. **SAFETY WARNING:- DO NOT USE HH PADS ON REAR UNLESS ALSO USED ON FRONT TO AVOID BRAKE IMBALANCE**
 SAFETY NOTICE - With vehicles primarily designed for off highway use such as quads now being used on the highway, we would recommend the use of X or MXS pads for highway use and ONLY using the R and SV higher density / harder pad series for off road riding.

FRONT: HONDA Cont'd

REAR: HONDA

Line #

BRAKE ROTOR CHOICES - FRONT							DISC PAD CHOICES - REAR					BRAKE ROTOR CHOICES - REAR			
CC Custom Rotor	CX Extreme® /Vee-Rotor	OS Series Oversize 250/280mm Rotor Kit	OSX Series Oversize 280mm Rotor Kit	Relocating Bracket for Oversize Rotor	SMX Series Oversize 320mm Rotor Kit	Relocating Bracket for 320mm Rotor		Sintered/HH Pads/ Grooved Shoes	SV Series Severe Duty Pads	EPFA Sintered Fast Road/ Track Pads	Specialty Pads SXR/ VEE/MXS Race	Standard Rotor	Vintage Rotor / UTV Oversize Brake Kit	Contour Profile Rotor	CX Extreme® /Vee-Rotor
1							304	304G							
2							304	304G							
3							304	304G							
4							304	304G							
5		MD6001CX	OS6001C	OSX6001	BRK008	SMX6001	BRK009	304	304G						
6		MD6001CX	OS6001C	OSX6001	BRK008	SMX6001	BRK009	FA131X	FA131R		MXS131	MD6013D		MD6013C	MD6013CX
7		MD6001CX	OS6001C	OSX6001	BRK008	SMX6001	BRK009	FA131X	FA131R		MXS131	MD6013D		MD6013C	MD6013CX
8							306	306G							
9							N/A	FA84/2R				N/A			
10							FA84X	FA84R	FA84SV			MD6059D			
11							FA92X	FA92R				MD6007D			
12							315	315G							
13							315	315G							
14							313								
15							310								
16							FA496	FA496HH			FA496V	MD1004			
17							FA496	FA496HH			FA496V	MD1181			
18							341								
19							350								
20							310								
21							313								
22							310								
23							318								
24							318								
25							318								
26							350								
27							350								
28							350								
29							312	312G							
30							325	325G							
31							319	319G							
32							330	330G							
33							331	331G							
34							331	331G							
35							344	344G							
36							FA131X	FA131R			MXS131	MD6009D			
37							FA131X	FA131R			MXS131	MD6002D			
38							FA131X	FA131R			MXS131	MD6002D			
39		MD6001CX	OS6001EC	OSX6001E	BRK004	N/A	FA131X	FA131R			MXS131	MD6002D			MD6002CX
40		MD6037CX	OS6037C	OSX6037	BRK008	SMX6037	BRK009	FA131X	FA131R	EPFA131HH	MXS131	MD6002D			MD6002CX
41		MD6037CX	OS6037C	OSX6037	BRK008	SMX6037	BRK009	FA131X	FA131R	EPFA131HH	MXS131	MD6124D		MD6124C	MD6124CX
42		MD6037CX	OS6037C	OSX6037	BRK008	SMX6037	BRK009	FA346X	FA346R	EPFA346HH	MXS346	MD6191D		MD6191C	MD6191CX
43		MD6037CX	OS6437C	OSX6437	BRK005	SMX6437	BRK006	FA346X	FA346R	EPFA346HH	MXS346	MD6191D		MD6191C	MD6191CX
44		MD6372CX					FA629X	FA629R						MD6373C	MD6373CX
45		MD6372CX					FA629X	FA629R						MD6373C	MD6373CX
46							FA629X	FA629R						MD6373C	MD6373CX
47							FA629X	FA629R						MD6373C	MD6373CX
48		MD6037CX	OS6437C	OSX6437	BRK005	SMX6437	BRK006	FA346X	FA346R	EPFA346HH	MXS346	MD6191D		MD6191C	MD6191CX
49		MD6389CX		OSX6389	BRK042	SMX6389	BRK041	FA346X	FA346R	EPFA346HH	MXS346	MD6191D		MD6191C	MD6191CX
50		MD6389CX		OSX6389	BRK042	SMX6389	BRK041	FA346X	FA346R	EPFA346HH	MXS346	MD6191D		MD6191C	MD6191CX
51		MD6037CX	OS6437C	OSX6437	BRK005	SMX6437	BRK006	FA346X	FA346R	EPFA346HH	MXS346	MD6191D		MD6191C	MD6191CX
52															
53															
54							FA40	N/A							
55							306	306G							
56							312	312G							
56							312	312G							

REAR

MD6191C ● = PLAIN UNDRILLED DISC FOR ENDURO USE. REAR FITMENTS ONLY. ORDER MD6191CE.

*-2 Sets Required. † For Vee disc colours add RED, BLU, GRN, GLD, ORG suffix to part number. **SAFETY WARNING:** DO NOT USE HH PADS ON REAR UNLESS ALSO USED ON FRONT TO AVOID BRAKE IMBALANCE

⚠ This symbol indicates a rotor made of billet steel, and should be only used with EBC FA Kevlar® Organic or Vee pads.
SAFETY NOTICE - With vehicles primarily designed for off highway use such as quads now being used on the highway, we would recommend the use of X or MXS pads for highway use and ONLY using the R and SV higher density / harder pad series for off road riding.

BRAKE APPLICATIONS

FRONT: HONDA



HONDA



DISC PAD CHOICES - FRONT

BRAKE ROTOR CHOICES - FRONT

											Line #
NSF 250 R (Moto 3)	18-20			EPFA347HH	GPFAX347HH						1
NSS 250/250 A/AS Reflex	01-07	SFA281	SFA281HH				MD922D				2
NX 250	88-90	FA185X	FA185R	EPFA185HH	GPFAX185HH	MXS185	MD6001D			MD6001C	3
PS 250 Big Ruckus	05-06	SFA388	SFA388HH				MD922D				4
TL 250	75-76	304	304G								5
TRX 250 Fourtrax	85-87	339*	339G*								6
TRX 250 R Fourtrax	86-87	FA125X*	FA125R*				MD6046D	MD6046D			7
TRX 250 R Fourtrax	88-89	FA125X*	FA125R*				MD6006D	MD6006D			8
TRX 250 X Fourtrax	87-92	FA84X*	FA84R*	FA84SV*			MD6006D	MD6006D			9
TRX 250 EX Sportrax	01-08	FA84X*	FA84R*	FA84SV*			MD6006D	MD6006D			10
TRX 250 TE Recon ES	97-21	345*	345G*								11
TRX 250 TM Recon	97-21	345*	345G*								12
TRX 250 X	09-14	FA84X*	FA84R*	FA84SV*			MD6006D	MD6006D			13
VTR 250 Interceptor	88-89	FA80/2					N/A				14
VTR 250 Interceptor	90	FA124/2	FA124/2HH				N/A				15
XL 250 K/76	72-76	311	311G								16
XL 250 S	78-80	312	312G								17
XL 250 S	81	312	312G								18
XL 250 R Pro Link	82-87	330	330G								19
XR 250	79-80	312	312G								20
XR 250 R Pro Link	81-82	327	327G								21
XR 250 R Pro Link	84-87	FA92X	FA92R				MD6087D				22
XR 250 R Pro Link	88-89	FA125X	FA125R			MXS125	MD6087D				23
XR 250 R Pro Link	90	FA125X	FA125R			MXS125	MD6087D				24
XR 250 R Pro Link	91-95	FA125X	FA125R			MXS125	MD6001D			MD6001C	25
XR 250 R	96-04	FA185X	FA185R	EPFA185HH	GPFAX185HH	MXS185	MD6001D			MD6001C	26
XR 250 L	91-92	FA125X	FA125R			MXS125	MD6001D			MD6001C	27
XR 250 L	93-96	FA185X	FA185R	EPFA185HH	GPFAX185HH	MXS185	MD6001D			MD6001C	28
CB 300 F	15	FA226	FA226HH	EPFA226HH				MD1180X			29
CB 300 F	18-19	FA196	FA196HH				N/A				30
CB 300 F (ABS)	17-19	FA196	FA196HH				N/A				31
CB 300 R ABS	18-21	FA679	FA679HH				N/A				32
CBR 300 R (Non ABS Model)	15-19	FA226	FA226HH	EPFA226HH				MD1180X			33
CBR 300 RA (ABS Model)	15-21	FA226	FA226HH	EPFA226HH				MD1180X			34
CBR 300 R (Non ABS Model)	18-20	FA196	FA196HH					MD1180X			35
CBR 300 R (ABS Model)	18-20	FA196	FA196HH					MD1180X			36
CMX 300 Rebel (Non ABS)	18-21	FA196	FA196HH				TBC				37
CMX 300 Rebel (ABS)	18-21	FA196	FA196HH				TBC				38
CRF 300 L ABS	22	FA465X	FA465R			MXS465				MD6372C	39
CRF 300 Rally	22	FA465X	FA465R			MXS465				MD6409C	40
NSS 300 Forza (Non ABS)	14-16	SFA388	SFA388HH					MD1006			41
NSS 300 Forza (Non ABS) - Parking brake shoe	14-16	333									42
NSS 300 A Forza (ABS)	18-21	SFA196	SFA196HH					TBC			43
NSS 300 A Forza (ABS) - Parking brake shoe	18-21	333									44
TRX 300 (2WD) Fourtrax	88-00	345*	345G*								45
TRX 300 FW Fourtrax (4WD)	88-00	347*	347G*								46
TRX 300 EX Fourtrax	93-08	FA84X*	FA84R*	FA84SV*			MD6006D	MD6006D			47
TRX 300 X	09-11	FA84X*	FA84R*	FA84SV*			MD6006D	MD6006D			48
ATC 350 X	85	FA92X	FA92R				MD6059D				49
ATC 350 X	86	FA125X	FA125R				MD6059D				50
CB 350 F/G		FA13					N/A				51
CB 350 K		314									52
FL 350 R Odyssey	85-87	339*	339G*								53
SL 350 K	69-70	314									54
SL 350 K	69-73	308									55
TRX 350/TRX 350 D Fourtrax/Foreman	86-89	342*	342G*								56

*-2 Sets Required. † For Vee disc colours add RED, BLU, GRN, GLD, ORG suffix to part number. **SAFETY WARNING:- DO NOT USE HH PADS ON REAR UNLESS ALSO USED ON FRONT TO AVOID BRAKE IMBALANCE**

⚡ This symbol indicates a rotor made of billet steel, and should be only used with EBC FA Kevlar® Organic or Vee pads.

SAFETY NOTICE - With vehicles primarily designed for off highway use such as quads now being used on the highway, we would recommend the use of X or MXS pads for highway use and ONLY using the R and SV higher density / harder pad series for off road riding.

FRONT: HONDA Cont'd

REAR: HONDA

Line #

BRAKE ROTOR CHOICES - FRONT							DISC PAD CHOICES - REAR					BRAKE ROTOR CHOICES - REAR				
CC Custom Rotor	CX Extreme® /Vee-Rotor	OS Series Oversize 250/280mm Rotor Kit	OSX Series Oversize 280mm Rotor Kit	Relocating Bracket for Oversize Rotor	SMX Series Oversize 320mm Rotor Kit	Relocating Bracket for 320mm Rotor		Sintered/HH Pads/ Grooved Shoes	SV Series Severe Duty Pads	EPFA Sintered Fast Road/ Track Pads	Specialty Pads SXR/ VEE/MXS Race	Standard Rotor	Vintage Rotor / UTV Oversize Brake Kit	Contour Profile Rotor	CX Extreme® /Vee-Rotor	
1																
2							SFA358	SFA358HH				MD1004				
3		MD6001CX					323	323G								
4							351									
5							304	304G								
6							315	315G								
7							FA92X	FA92R				MD6007D				
8							FA92X	FA92R				MD6007D				
9							FA84X	FA84R	FA84SV			MD6064D				
10							340	340G								
11							340	340G								
12							340	340G								
13							309									
14							309									
15							312	312G								
16							323	323G								
17							318	318G								
18							323	323G								
19							323	323G								
20							323	323G								
21							323	323G								
22							304	304G								
23							304	304G								
24							FA131X	FA131R			MXS131	MD6013D		MD6013C		
25		MD6001CX	OS6001CE	OSX6001E	BRK004	N/A	N/A	FA131X	FA131R		MXS131	MD6013D		MD6013C	MD6013CX	
26		MD6001CX	OS6001C	OSX6001	BRK008	SMX6001	BRK009	FA131X	FA131R		MXS131	MD6013D		MD6013C	MD6013CX	
27		MD6001CX	OS6001CE	OSX6001E	BRK004	N/A	N/A	FA131X	FA131R		MXS131	MD6013D		MD6013C	MD6013CX	
28		MD6001CX	OS6001C	OSX6001	BRK008	SMX6001	BRK009	FA131X	FA131R		MXS131	MD6013D		MD6013C	MD6013CX	
29							FA496	FA496HH				TBC				
30							FA496	FA496HH				TBC				
31							FA496	FA496HH								
32							FA496	FA496HH								
33							FA496	FA496HH				TBC				
34							FA496	FA496HH				TBC				
35							FA496	FA496HH								
36							FA496	FA496HH								
37							FA496	FA496HH				TBC				
38							FA496	FA496HH				TBC				
39		MD6372CX					FA629X	FA629R						MD6373C	MD6373CX	
40							FA629X	FA629R						MD6373C	MD6373CX	
41							SFA415	SFA415HH				MD1149D				
42																
43							SFA415	SFA415HH				TBC				
44																
45							315	315G								
46							315	315G								
47							FA84X	FA84R	FA84SV			MD6064D				
48							FA84X	FA84R	FA84SV			MD6064D				
49							FA84X	FA84R				MD6061D				
50							FA84X	FA84R				MD6061D				
51							315									
52							315									
53							FA111X	FA111R				N/A				
54							315									
55							309									
56							343	343G								

REAR

BRAKE APPLICATIONS

⚠ This symbol indicates a rotor made of billet steel, and should be only used with EBC FA Kevlar® Organic or Vee pads. SAFETY NOTICE - With vehicles primarily designed for off highway use such as quads now being used on the highway, we would recommend the use of X or MXS pads for highway use and ONLY using the R and SV higher density / harder pad series for off road riding.

*-2 Sets Required. † For Vee disc colours add RED, BLU, GRN, GLD, ORG suffix to part number. **SAFETY WARNING:** DO NOT USE HH PADS ON REAR UNLESS ALSO USED ON FRONT TO AVOID BRAKE IMBALANCE

FRONT: HONDA



HONDA



DISC PAD CHOICES - FRONT

BRAKE ROTOR CHOICES - FRONT

												Line #
TRX 350 TE Fourtrax Rancher ES/FE Fourtrax Rancher 4x4 ES	00-06		347* ❖	347G*								1
TRX 350 TM Fourtrax Rancher/FM Fourtrax Rancher 4x4	00-06		347* ❖	347G*								2
XL 350 R	84-85		FA92X	FA92R				MD6087D				3
XR 350 R	83		331	331G								4
XR 350 R	84-85		FA92X	FA92R				MD6087D				5
CB 360			314									6
CB 360 G/T	74-76		FA13				FA13V	N/A				7
CJ 360 T/76/77	76-77		314									8
CB 400 F	75-77		FA13				FA13V	N/A				9
CB 400 A Hondamatic	78		FA45					N/A				10
CB 400 T MKI Hawk	78-79		314									11
CB 400 T MK II Hawk	78-79		FA45									12
CB 400 T Hawk	80-81		FA45					N/A				13
CB-1 (CB 400F)	89-90		FA142	FA142HH			FA142V		MD1036RS	VMD1036		14
CM 400 A/T	79-81		FA45					MD1036LS		VMD1036		15
CM 400 C Custom	81		FA69/2					MD1036LS		VMD1036		16
CM 400 E	80-81		314									17
FL 400 R Pilot	89-90		339*	339G*								18
TRX 400 EX Fourtrax	99-00		FA84X*	FA84R*	FA84SV*			MD6006D	MD6006D			19
TRX 400 EX Sportrax	01-08		FA84X*	FA84R*	FA84SV*			MD6006D	MD6006D			20
TRX 400 FW Fourtrax Foreman	95-01/03		347* ❖	347G*								21
TRX 400 FM Fourtrax Foreman	02		347* ❖	347G*								22
TRX 400 FA Fourtrax Rancher AT	04-07		347* ❖	347G*								23
TRX 400 FGA Fourtrax Rancher AT Gpscape	04-07		347* ❖	347G*								24
TRX 400 X	09-13		FA84X*	FA84R*	FA84SV*			MD6006D	MD6006D			25
XR 400 R	96-04		FA185X	FA185R	EPFA185HH		MXS185	MD6001D			MD6001C	26
TRX 420 TM Fourtrax Rancher	07-13		FA84X*	FA84R*	FA84SV*			MD6302D	MD6302D			27
TRX 420 TM1 Rancher	14-21		FA84X*	FA84R*	FA84SV*			TBC	TBC			28
TRX 420 TE Fourtrax Rancher ES	07-13		FA84X*	FA84R*	FA84SV*			MD6302D	MD6302D			29
TRX 420 TE1 Rancher ES	14-21		FA84X*	FA84R*	FA84SV*			TBC	TBC			30
TRX 420 FPA Power Steering Fourtrax Rancher AT	09-12		FA84X*	FA84R*	FA84SV*			MD6302D	MD6302D			31
TRX 420 FA Fourtrax Rancher AT	09-14		FA84X*	FA84R*	FA84SV*			MD6302D	MD6302D			32
TRX 420 FA1 Rancher 4 x 4/Auto/DCT	14-21		FA84X*	FA84R*	FA84SV*			MD6387D	MD6387D			33
TRX 420 FA2 Rancher 4 x 4/Auto/DCT/EP	14-21		FA84X*	FA84R*	FA84SV*			MD6387D	MD6387D			34
TRX 420 FA5 Rancher 4 x 4/Auto/DCT/IRS	14-21		FA84X*	FA84R*	FA84SV*			MD6387D	MD6387D			35
TRX 420 FA6 Fourtrax Rancher 4 x 4/Auto/DCT/IRS/EP	14-21		FA84X*	FA84R*	FA84SV*			MD6387D	MD6387D			36
TRX 420 FPE Fourtrax Rancher 4 x 4 ES/EP	09-13		FA84X*	FA84R*	FA84SV*			MD6302D	MD6302D			37
TRX 420 FE Fourtrax Rancher 4 x 4/ES	07-13		FA84X*	FA84R*	FA84SV*			MD6302D	MD6302D			38
TRX 420 FE1 Rancher 4 x 4/ES	14-21		FA84X*	FA84R*	FA84SV*			MD6387D	MD6387D			39
TRX 420 FPM Fourtrax Rancher 4 x 4 PS	09-13		FA84X*	FA84R*	FA84SV*			MD6302D	MD6302D			40
TRX 420 FM Fourtrax Rancher 4 x 4	07-13		FA84X*	FA84R*	FA84SV*			MD6302D	MD6302D			41
TRX 420 FM1 Rancher 4 x 4	14-21		FA84X*	FA84R*	FA84SV*			MD6387D	MD6387D			42
TRX 420 FM2 Rancher 4 x 4/EP	14-21		FA84X*	FA84R*	FA84SV*			MD6387D	MD6387D			43
CB 450 K	70-71		FA12				FA12V	N/A				44
CB 450 K	72-74		FA13				FA13V	N/A				45
CB 450 T Hawk	82		FA90					MD1036LS		VMD1036		46
CB 450 SC Nighthawk	82		FA90					MD1036LS		VMD1036		47
CB 450 SC Nighthawk	83-86		FA69	FA69HH				MD1040LS				48
CB 450 DX-K	89-92		FA122*					N/A	N/A			49
CM 450 E	82-83		314									50
CM 450 C Custom (to CM 001211)	82		FA69/2					MD1036LS		VMD1036		51
CM 450 C Custom (from CM 001212)	82		FA90					MD1036LS		VMD1036		52
CM 450 A Hondamatic	82		FA69/2					MD1036LS		VMD1036		53
CM 450 A Hondamatic	83		FA90					MD1040LS				54
❖ ATV Work XBD 100 disc conversion kit replacement pads			FA271X*	FA271R*								55
❖ Super ATV disc conversion kit replacement pads			FA395X*	FA395R*								56

*-2 Sets Required. † For Vee disc colours add RED, BLU, GRN, GLD, ORG suffix to part number. **SAFETY WARNING:- DO NOT USE HH PADS ON REAR UNLESS ALSO USED ON FRONT TO AVOID BRAKE IMBALANCE**

APPLIATIONS

⚡ This symbol indicates a rotor made of billet steel, and should be only used with EBC FA Kevlar® Organic or Vee pads. SAFETY NOTICE - With vehicles primarily designed for off highway use such as quads now being used on the highway, we would recommend the use of X or MXS pads for highway use and ONLY using the R and SV higher density / harder pad series for off road riding.

FRONT: HONDA Cont'd

REAR: HONDA

Line #

BRAKE ROTOR CHOICES - FRONT							DISC PAD CHOICES - REAR					BRAKE ROTOR CHOICES - REAR			
CC Custom Rotor	CX Extreme® /Vee-Rotor	OS Series Oversize 250/280mm Rotor Kit	OSX Series Oversize 280mm Rotor Kit	Relocating Bracket for Oversize Rotor	SMX Series Oversize 320mm Rotor Kit	Relocating Bracket for 320mm Rotor		Sintered/HH Pads/ Grooved Shoes	SV Series Severe Duty Pads	EPFA Sintered Fast Road/ Track Pads	Specialty Pads SXR/ VEE/MXS Race	Standard Rotor	Vintage Rotor / UTV Oversize Brake Kit	Contour Profile Rotor	CX Extreme® /Vee-Rotor
1							351	351G							
2							351	351G							
3							323	323G							
4							304	304G							
5							304	304G							
6							315								
7							315								
8							315								
9							315								
10							313								
11							313								
12							313								
13							313								
14							FA140	FA140HH			FA140V	MD1020			
15							313								
16							313								
17							313								
18							FA111X	FA111R				MD6144D			
19							FA84X	FA84R	FA84SV			MD6164D			
20							FA84X	FA84R	FA84SV			MD6164D			
21							351	351G							
22							351	351G							
23							351	351G							
24							351	351G							
25							FA84X	FA84R	FA84SV			MD6164D			
26	MD6001CX	OS6001C	OSX6001	BRK008	SMX6001	BRK009	FA131X	FA131R		EPFA131HH	MXS131	MD6013D		MD6013C	MD6013CX
27							351	351G							
28							351	351G							
29							351	351G							
30							351	351G							
31							FA373X	FA373R	FA373SV			MD6217D			
32							FA373X	FA373R	FA373SV			MD6217D			
33							351	351G							
34							351	351G							
35							351	351G							
36							FA373X	FA373R	FA373SV			MD6217D			
37							351	351G							
38							351	351G							
39							351	351G							
40							351	351G							
41							351	351G							
42							351	351G							
43							351	351G							
44							316								
45							316								
46							313								
47							313								
48							313								
49							FA122					N/A			
50							313								
51							313								
52							313								
53							313								
54							313								
55															
56															

REAR

BRAKE APPLICATIONS

⚠ This symbol indicates a rotor made of billet steel, and should be only used with EBC FA Kevlar® Organic or Vee pads. SAFETY NOTICE - With vehicles primarily designed for off highway use such as quads now being used on the highway, we would recommend the use of X or MXS pads for highway use and ONLY using the R and SV higher density / harder pad series for off road riding.

*-2 Sets Required. † For Vee disc colours add RED, BLU, GRN, GLD, ORG suffix to part number. SAFETY WARNING:- DO NOT USE HH PADS ON REAR UNLESS ALSO USED ON FRONT TO AVOID BRAKE IMBALANCE

FRONT: HONDA



HONDA



DISC PAD CHOICES - FRONT

BRAKE ROTOR CHOICES - FRONT

CMX 450 C Rebel	FA69	FA69HH				MD1041LS			
CR 450 R	327	327G							
CRF 450 R	FA185X	FA185R		EPFA185HH	MXS185	MD6037D			MD6037C
CRF 450 R (240mm F/Disc)	FA185X	FA185R		EPFA185HH	MXS185	MD6037D			MD6037C
CRF 450 R (F-disc 260mm, R-disc 240mm)	FA185X	FA185R		EPFA185HH	MXS185				MD6389C
CRF 450 R-S (F-disc 260mm, R-disc 240mm)	FA185X	FA185R			MXS185				MD6389C
CRF 450 RWE	FA185X	FA185R		EPFA185HH	MXS185				MD6389C
CRF 450 RX (18" Rear wheel)	FA185X	FA185R		EPFA185HH	MXS185				MD6389C
CRF 450 X (18" Rear wheel)	FA185X	FA185R		EPFA185HH	MXS185	MD6037D			MD6037C
CRF 450 L (18" Rear Wheel)	FA185X	FA185R		EPFA185HH	MXS185	TBC			
CRF 450 RL	FA185X	FA185R		EPFA185HH	MXS185				
TRX 450 ES Fourtrax Foreman ES	347S*	347SG*							
TRX 450 S Fourtrax Foreman S	347S*	347SG*							
TRX 450 FE Fourtrax Foreman ES	347* ♣	347G*							
TRX 450 FM Fourtrax Foreman S	347* ♣	347G*							
TRX 450 R/ER	FA185X*	FA185R*		EPFA185HH*		MD6006D	MD6006D		
CR 480 R	327	327G							
CR 480 R	328	328G							
CB 500 K	FA13				FA13V	N/A			
CB 500 T/76	FA13				FA13V	N/A			
CB 500 F (Non ABS)	FA196	FA196HH			FA196V		MD1200C		TBC
CB 500 FA (ABS)	FA196	FA196HH			FA196V		MD1200C		TBC
CB 500 X (Non ABS)	FA196	FA196HH			FA196V		MD1200C		TBC
CB 500 XA (ABS)	FA196	FA196HH			FA196V		MD1200C		TBC
CBR 500 R (Non ABS)	FA196	FA196HH			FA196V		MD1200C		TBC
CBR 500 RA (ABS)	FA196	FA196HH			FA196V		MD1200C		TBC
CMX 500 Rebel (Non ABS)	FA196	FA196HH			FA196V		MD1200C		TBC
CMX 500 Rebel (ABS)	FA196	FA196HH			FA196V		MD1200C		TBC
CR 500 R	FA92X	FA92R				MD6087D			
CR 500 R	FA92X	FA92R				MD6087D			
CR 500 R	FA125X	FA125R			MXS125	MD6087D			
CR 500 R	FA125X	FA125R			MXS125	MD6008D			
CR 500 R	FA125X	FA125R			MXS125	MD6003D			
CR 500 R	FA125X	FA125R			MXS125	MD6001D			MD6001C
CR 500 R	FA185X	FA185R		EPFA185HH	MXS185	MD6037D			MD6037C
CX 500	FA29					N/A			
CX 500 C Custom	FA29					N/A			
CX 500 D Deluxe	FA29					N/A			
CX 500 C Custom	FA69	FA69HH				N/A			
CX 500 TC Turbo	FA69*	FA69HH*				N/A	N/A		
FT 500 Ascot	FA69	FA69HH				MD1131LS			
GB 500	FA69	FA69HH				MD1001			
GL 500 Silverwing	FA69	FA69HH				N/A			
GL 500 I Silverwing Interstate	FA69/2*					N/A	N/A		
SXS 500 M2 Pioneer	FA712X	FA712R	FA712SV			MD6341D			
	FA712X	FA712R	FA712SV			MD6341D			
TRX 500 FA Fourtrax Rubicon	347* ♣	347G*							
TRX 500 FA5 Foreman Rubicon 4 x 4/Auto/DCT	FA84X*	FA84R*	FA84SV*			MD6387D	MD6387D		
TRX 500 FA6 Foreman Rubicon 4 x 4/Auto/DCT/EPS	FA84X*	FA84R*	FA84SV*			MD6387D	MD6387D		
TRX 500 FGA Fourtrax Foreman Rubicon Gpscape	347* ♣	347G*							
TRX 500 FA/FAA Fourtrax Foreman Rubicon	FA410X*	FA410R*	FA410SV*			MD6251D	MD6251D		
TRX 500 FGA Fourtrax Foreman Rubicon Gpscape	FA410X*	FA410R*	FA410SV*			MD6251D	MD6251D		
TRX 500 FE/FEA Fourtrax Foreman 4x4/ES	FA410X*	FA410R*	FA410SV*			MD6251D	MD6251D		
♣ ATV Work XBD 100 disc conversion kit replacement pads	FA271X*	FA271R*							
♣ Super ATV disc conversion kit replacement pads	FA395X*	FA395R*							

FRONT

Line #

APPLICATIONS
BRAKE
 This symbol indicates a rotor made of billet steel, and should be only used with EBC FA Kevlar® Organic or Vee pads.
 SAFETY NOTICE - With vehicles primarily designed for off highway use such as quads now being used on the highway, we would recommend the use of X or MXS pads for highway use and ONLY using the R and SV higher density / harder pad series for off road riding.

*-2 Sets Required. † For Vee disc colours add RED, BLU, GRN, GLD, ORG suffix to part number. **SAFETY WARNING:- DO NOT USE HH PADS ON REAR UNLESS ALSO USED ON FRONT TO AVOID BRAKE IMBALANCE**

FRONT: HONDA Cont'd

REAR: HONDA

BRAKE ROTOR CHOICES - FRONT

DISC PAD CHOICES - REAR

BRAKE ROTOR CHOICES - REAR

Line #

CC Custom Rotor	CX Extreme® /Vee-Rotor	OS Series Oversize 250/280mm Rotor Kit	OSX Series Oversize 280mm Rotor Kit	Relocating Bracket for Oversize Rotor	SMX Series Oversize 320mm Rotor Kit	Relocating Bracket for 320mm Rotor		Sintered/HH Pads/ Grooved Shoes	SV Series Severe Duty Pads	EPFA Sintered Fast Road/ Track Pads	Specialty Pads SXR/ VEE/MXS Race	Standard Rotor	Vintage Rotor / UTV Oversize Brake Kit	Contour Profile Rotor	CX Extreme® /Vee-Rotor		
1							313										
2							319	319G									
3	MD6037CX	OS6037C	OSX6037	BRK008	SMX6001	BRK009	FA346X	FA346R		EPFA346HH	MXS346	MD6191D		MD6191C	MD6191CX		
4	MD6037CX	OS6437C	OSX6437	BRK005	SMX6437	BRK006	FA346X	FA346R		EPFA346HH	MXS346	MD6191D		MD6191C	MD6191CX		
5	MD6389CX		OSX6389	TBC	SMX6389	TBC	FA346X	FA346R		EPFA346HH	MXS346	MD6191D		MD6191C	MD6191CX		
6	MD6389CX		OSX6389	TBC	SMX6389	TBC	FA346X	FA346R		EPFA346HH	MXS346	MD6191D		MD6191C	MD6191CX		
7	MD6389CX		OSX6389	TBC	SMX6389	TBC	FA346X	FA346R		EPFA346HH	MXS346	MD6191D		MD6191C	MD6191CX		
8	MD6389CX		OSX6389	BRK042	SMX6389	BRK041	FA346X	FA346R		EPFA346HH	MXS346	MD6191D		MD6191C	MD6191CX		
9	MD6037CX	OS6037C	OSX6037	BRK005	SMX6037	BRK006	FA346X	FA346R		EPFA346HH	MXS346	MD6191D		MD6191C	MD6191CX		
10							● MD6191C = PLAIN UNDRILLED DISC FOR ENDURO USE. REAR FITMENTS ONLY. ORDER MD6191CE.										
11							FA346X	FA346R		EPFA346HH	MXS346	MD6190D					
12							FA346X	FA346R		EPFA346HH	MXS346	MD6191D		MD6191C	MD6191CX		
13							351	351G									
14							351	351G									
15							351	351G									
16							351	351G									
17							FA373X	FA373R	FA373SV			MD6233D					
18							330	330G									
19							331	331G									
20							316										
21							316										
22							FA140	FA140HH			FA140V	MD1156		TBC			
23							FA140	FA140HH			FA140V	MD1156		TBC			
24							FA140	FA140HH			FA140V	MD1156		TBC			
25							FA140	FA140HH			FA140V	MD1156		TBC			
26							FA140	FA140HH			FA140V	MD1156		TBC			
27							FA140	FA140HH			FA140V	MD1156		TBC			
28							FA496	FA496HH									
29							FA496	FA496HH									
30							331	331G									
31							344	344G									
32							FA131X	FA131R			MXS131	MD6009D					
33							FA131X	FA131R			MXS131	MD6002D					
34							FA131X	FA131R			MXS131	MD6002D					
35	MD6001CX	OS6001EC	OSX6001E	BRK004	N/A	N/A	FA131X	FA131R			MXS131	MD6002D				MD6002CX	
36	MD6037CX	OS6037C	OSX6037	BRK008	SMX6037	BRK009	FA131X	FA131R		EPFA131HH	MXS131	MD6002D				MD6002CX	
37							321										
38							321										
39							321										
40							321										
41							FA69	FA69HH			FA69V	N/A					
42							FA69	FA69HH			FA69V	MD1048					
43							340										
44							321										
45							321										
46							FA714X	FA714R	FA714SV			MD6217D					
47																	
48							343	343G									
49							FA373X	FA373R	FA373SV			MD6217D					
50							FA373X	FA373R	FA373SV			MD6217D					
51							343	343G									
52							343	343G									
53							343	343G									
54							343	343G									
55																	
56																	

REAR

BRAKE APPLICATIONS

⚠ This symbol indicates a rotor made of billet steel, and should be only used with EBC FA Kevlar® Organic or Vee pads. SAFETY NOTICE - With vehicles primarily designed for off highway use such as quads now being used on the highway, we would recommend the use of X or MXS pads for highway use and ONLY using the R and SV higher density / harder pad series for off road riding.

*-2 Sets Required. † For Vee disc colours add RED, BLU, GRN, GLD, ORG suffix to part number. SAFETY WARNING:- DO NOT USE HH PADS ON REAR UNLESS ALSO USED ON FRONT TO AVOID BRAKE IMBALANCE

FRONT: HONDA



HONDA



DISC PAD CHOICES - FRONT

BRAKE ROTOR CHOICES - FRONT

											Line #
TRX 500 FE Fourtrax Foreman 4x4	12-13	FA84X*	FA84R*	FA84SV*			MD6365D	MD6365D			1
TRX 500 FE1 Foreman ES	14-21	FA84X*	FA84R*	FA84SV*			MD6387D	MD6387D			2
TRX 500 FE2 Foreman ES/EPS	14-21	FA84X*	FA84R*	FA84SV*			MD6387D	MD6387D			3
TRX 500 FM/FMA Fourtrax Foreman 4x4	05-11	FA410X*	FA410R*	FA410SV*			MD6251D	MD6251D			4
TRX 500 FM Fourtrax Foreman 4x4	12-13	FA84X*	FA84R*	FA84SV*			MD6365D	MD6365D			5
TRX 500 FM Foreman	14-21	FA84X*	FA84R*	FA84SV*			MD6387D	MD6387D			6
TRX 500 FM2 Foreman/EPS	14-21	FA84X*	FA84R*	FA84SV*			MD6387D	MD6387D			7
TRX 500 FM5 Foreman Rubicon 4 x 4	15-21	FA84X*	FA84R*	FA84SV*			MD6387D	MD6387D			8
TRX 500 FM6 Foreman Rubicon 4 x 4/EPS	15-21	FA84X*	FA84R*	FA84SV*			MD6387D	MD6387D			9
TRX 500 FPE Fourtrax Foreman 4x4 ES/EPS	08-11	FA410X*	FA410R*	FA410SV*			MD6251D	MD6251D			10
TRX 500 FPE Fourtrax Foreman 4x4	12-13	FA84X*	FA84R*	FA84SV*			MD6365D	MD6365D			11
TRX 500 FPM Fourtrax Foreman 4x4/EPS	08-11	FA410X*	FA410R*	FA410SV*			MD6251D	MD6251D			12
TRX 500 FPM Fourtrax Foreman 4x4	12-13	FA84X*	FA84R*	FA84SV*			MD6365D	MD6365D			13
TRX 500 TM5/TM6 Fourtrax Foreman 2x4	05-06	FA410X*	FA410R*	FA410SV*			MD6251D	MD6251D			14
VF 500 C V30 Magna	84-85	FA69	FA69HH				MD1047LS				15
VF 500 F Interceptor	84-86	FA69*	FA69HH*				MD1006	MD1006		MD1006C*	16
VT 500 C Shadow	83-86	FA69	FA69HH				MD1047LS				17
VT 500 FT Ascot	83-84	FA69	FA69HH				MD1047LS				18
XL 500 S	79-81	312	312G								19
XL 500 R Pro Link	82	332	332G								20
XR 500	79-80	324	324G								21
XR 500 R Pro Link	81-82	327	327G								22
XR 500 R Pro Link	83-84	FA92X	FA92R								23
CB 550 F	75-77	FA13				FA13V	N/A				24
CB 550 K1/76	74-78	FA13				FA13V	N/A				25
CB 550 SC Nighthawk	83	FA69	FA69HH				MD1047LS				26
599 (CB 600 F)	04/06	FA226*	FA226HH*		EPFA226HH*		MD1139	MD1139		MD1139C*	27
CBR 600 F Hurricane	87-90	FA121*	FA121HH*				MD1001	MD1001			28
CBR 600 F2 EBC Floating Rotor Conversion 310mm											29
(Note - Will Require Relocation Brackets - BRK15S)											30
CBR 600 F2 Solid rotor	91-94	FA203*	FA203HH*				MD601LS	MD601LS			31
CBR 600 F3/SJR/SE	95-98	FA226*	FA226HH*		EPFA226HH*		MD1003X	MD1003X		MD1003XC*	32
CBR 600 F4 (Carb Model)	99-00		FA296HH*		EPFA296HH*	GPFAX296HH*	MD1014X	MD1014X		MD1014XC*	33
CBR 600 F4i Sport (Injection Model)	01-06		FA296HH*		EPFA296HH*	GPFAX296HH*	MD1141X	MD1141X		MD1141XC*	34
CBR 600 RR	03-04		FA296HH*		EPFA296HH*	GPFAX296HH*	MD1152X	MD1152X		MD1152XC*	35
CBR 600 RR	05-06		FA390HH*		EPFA390HH*	GPFAX390HH*	MD1152X	MD1152X		MD1152XC*	36
CBR 600 RR	07-17		FA390HH*		EPFA390HH*	GPFAX390HH*	MD1152X	MD1152X		MD1152XC*	37
CBR 600 RRA (ABS Model)	09-17		FA390HH*		EPFA390HH*	GPFAX390HH*	MD1152X	MD1152X		MD1152XC*	38
CBR 600 RR (Non ABS Model)	18-21		FA700HH*		EPFA700HH*	GPFAX700HH*	MD1152X	MD1152X		MD1152XC*	39
CBR 600 RR (ABS Model)	18-21		FA700HH*		EPFA700HH*	GPFAX700HH*	MD1152X	MD1152X		MD1152XC*	40
FSC 600/D Silverwing Non ABS Model (256mm f/disc)	02-06	SFA281	SFA281HH				MD1006			MD1006C	41
FSC 600/D Silverwing Non ABS Model (256mm f/disc) Parking brake	02-06	SFA257/2									42
FSC 600 A Silverwing ABS Model (276mm f/disc)	03-14	SFA281	SFA281HH				MD1172LS				43
FSC 600 A Silverwing ABS Model (276mm f/disc) Parking brake	03-10	SFA257/2									44
FSC 600 D Silverwing Non ABS Model (276mm f/disc)	07-10	SFA281	SFA281HH				MD1172LS				45
FSC 600 D Silverwing Non ABS Model (276mm f/disc) Parking brake	07-10	SFA257/2									46
VLX 600 Shadow (VT 600 C/CD)	88-93	FA124/2				FA124/2V	MD1047LS				47
VT 600 C/CD/CD2 Shadow/Shadow Deluxe VLX	94-07	FA196	FA196HH			FA196V	MD1047LS				48
XL 600 V Transalp	89-90	FA69	FA69HH				MD6044D				49
XL 600 R	83-87	FA92X	FA92R				MD6087D				50
XR 600 R	85-87	FA92X	FA92R				MD6087D				51
XR 600 R	88-90	FA125X	FA125R			MXS125	MD6087D				52
XR 600 R	91-92	FA125X	FA125R			MXS125	MD6001D			MD6001C	53
XR 600 R	93-00	FA185X	FA185R		EPFA185HH	MXS185	MD6001D			MD6001C	54
CB 650	79-81	FA45				FA45V	MD1036LS		VMD1036		55
CB 650 C Custom	80	FA45				FA45V	MD1036LS		VMD1036		56

FRONT

APPLICTIONS

* This symbol indicates a rotor made of billet steel, and should be only used with EBC FA Kevlar® Organic or Vee pads.
 SAFETY NOTICE - With vehicles primarily designed for off highway use such as quads now being used on the highway, we would recommend the use of X or MXS pads for highway use and ONLY using the R and SV higher density / harder pad series for off road riding.

*-2 Sets Required. † For Vee disc colours add RED, BLU, GRN, GLD, ORG suffix to part number. **SAFETY WARNING:- DO NOT USE HH PADS ON REAR UNLESS ALSO USED ON FRONT TO AVOID BRAKE IMBALANCE**

FRONT: HONDA Cont'd

REAR: HONDA

Line #	BRAKE ROTOR CHOICES - FRONT							DISC PAD CHOICES - REAR					BRAKE ROTOR CHOICES - REAR			
	CC Custom Rotor	CX Extreme® /Vee-Rotor	OS Series Oversize 250/280mm Rotor Kit	OSX Series Oversize 280mm Rotor Kit	Relocating Bracket for Oversize Rotor	SMX Series Oversize 320mm Rotor Kit	Relocating Bracket for 320mm Rotor		Sintered/HH Pads/ Grooved Shoes	SV Series Severe Duty Pads	EPFA Sintered Fast Road/ Track Pads	Specialty Pads SXR/ VEE/MXS Race	Standard Rotor	Vintage Rotor / UTV Oversize Brake Kit	Contour Profile Rotor	CX Extreme® /Vee-Rotor
1								343	343G							
2								351	351G							
3								351	351G							
4								343	343G							
5								343	343G							
6								351	351G							
7								351	351G							
8								FA373X	FA373R	FA373SV			MD6217D			
9								FA373X	FA373R	FA373SV			MD6217D			
10								343	343G							
11								343	343G							
12								343	343G							
13								343	343G							
14								343	343G							
15									321							
16		VR1006*						FA69	FA69HH		FA69V	MD1006		MD1006C	VR1006	
17								313								
18								313								
19								318	318G							
20								318	318G							
21								318	318G							
22								318	318G							
23								304	304G							
24								316								
25								316								
26								313								
27								FA174	FA174HH		FA174V	MD1004		MD1004C		
28								FA69/3	FA69/3HH		FA69/3V	MD1002				
29																
30																
31					BRK15S			FA174	FA174HH		FA174V	MD1004		MD1004C		
32								FA174	FA174HH		FA174V	MD1004		MD1004C		
33	MD1003CC*	VR1003BLK*†						FA174	FA174HH		FA174V	MD1004		MD1004C	VR1004	
34	MD1014CC*	VR1014BLK*†						FA174	FA174HH		FA174V	MD1004		MD1004C	VR1004	
35	MD1141CC*	VR1141BLK*†						FA174	FA174HH		FA174V	MD1004		MD1004C	VR1004	
36	MD1152CC*	VR1152BLK*†						FA174	FA174HH		FA174V	MD1004		MD1004C	VR1004	
37	MD1152CC*	VR1152BLK*†						FA174	FA174HH		FA174V	MD1004		MD1004C	VR1004	
38	MD1152CC*	VR1152BLK*†						FA436	FA436HH		FA436V	MD1004		MD1004C	VR1004	
39	MD1152CC*	VR1152BLK*†						FA436	FA436HH		FA436V	MD1173		MD1173C	VR1173	
40	MD1152CC*	VR1152BLK*†						FA436	FA436HH		FA436V	MD1004X		MD1004C	VR1004	
41	MD1152CC*	VR1152BLK*†						FA436	FA436HH		FA436V	MD1004X		MD1004C	VR1004	
42		VR1006						SFA196	SFA196HH			MD1149		MD1149C		
43								SFA196	SFA196HH			MD1149				
44								SFA196	SFA196HH			MD1149				
45								SFA196	SFA196HH			MD1149				
46																
47								321								
48								321								
49								318	318G							
50								318	318G							
51								304	304G							
52								304	304G							
53		MD6001CX	OS6001EC	OSX6001E	BRK004	N/A	N/A	FA131X	FA131R		MXS131	MD6013D		MD6013C	MD6013CX	
54		MD6001CX	OS6001C	OSX6001	BRK008	SMX6001	BRK009	FA131X	FA131R		MXS131	MD6013D		MD6013C	MD6013CX	
55								320								
56								320								

BRAKE APPLICATIONS

⚠ This symbol indicates a rotor made of billet steel, and should be only used with EBC FA Kevlar® Organic or Vee pads. SAFETY NOTICE - With vehicles primarily designed for off highway use such as quads now being used on the highway, we would recommend the use of X or MXS pads for highway use and ONLY using the R and SV higher density / harder pad series for off road riding.

*-2 Sets Required. † For Vee disc colours add RED, BLU, GRN, GLD, ORG suffix to part number. **SAFETY WARNING:- DO NOT USE HH PADS ON REAR UNLESS ALSO USED ON FRONT TO AVOID BRAKE IMBALANCE**

FRONT: HONDA



HONDA



DISC PAD CHOICES - FRONT

BRAKE ROTOR CHOICES - FRONT

				Sintered/HH Pads/ Grooved Shoes	SV Series Severe Duty Pads	EPFA Sintered Fast Road/ Track Pads	GPFA Sintered RACE ONLY Pads	Specialty Pads SXR/ VEE/MXS Race	Standard Rotor Left	Standard Rotor Right	Vintage Rotor / UTV Oversize Brake Kit	Contour Profile Rotor	Line #
CB 650 C Custom	81		FA45*					FA45V*	MD1036LS	MD1036RS	VMD1036*		1
CB 650	82		FA69	FA69HH				FA69V	N/A				2
CB 650 SC Nighthawk	82		FA90*					FA90V*	MD1036LS	MD1036RS	VMD1036*		3
CB 650 SC Nighthawk	83-85		FA69*	FA69HH*				FA69V*	MD1001	MD1001			4
CB 650 F (Non ABS Model)	14-16		FA142*	FA142HH*				FA142V*	MD1201C	MD1200C			5
CB 650 FA (ABS Model)	14-18		FA142*	FA142HH*				FA142V*	MD1201C	MD1200C			6
CB 650 R	19-21			FA679HH*					MD1194X	MD1194X			7
CB 650 RA ABS	19-21			FA679HH*					MD1194X	MD1194X			8
CBR 650 F (Non ABS Model)	14-16		FA142*	FA142HH*				FA142V*	MD1201C	MD1200C			9
CBR 650 FA (ABS Model)	14-18		FA142*	FA142HH*				FA142V*	MD1201C	MD1200C			10
CBR 650 R	19-21			FA679HH*					MD1194X	MD1194X			11
CBR 650 RA ABS	19-21			FA679HH*					MD1194X	MD1194X			12
CX 650 C Custom	83		FA69	FA69HH				FA69V	MD1047LS				13
CX 650 T Turbo	83		FA69*	FA69HH*				FA69V	N/A	N/A			14
GL 650 Silverwing/GL 650 Silverwing Interstate	83		FA69*	FA69HH*				FA69V*	MD1040LS	MD1040RS			15
NT 650 Hawk GT	88-91		FA142	FA142HH				FA142V	MD1021LS				16
NX 650	88-89		FA124/2	FA124/2HH					MD6010D				17
TRX 650 FA Rincon	03-05		347* ❀	347G*									18
TRX 650 FGA Fourtrax Rincon Gpscape	04-05		347* ❀	347G*									19
XR 650 L	93-21		FA185X	FA185R		EPFA185HH		MXS185	MD6010D				20
XR 650 R	00-07		FA185X	FA185R		EPFA185HH		MXS185	MD6001D			MD6001C	21
TRX 680 FGA Fourtrax Rincon Gpscape	06-09		FA410X*	FA410R*	FA410SV*				MD6251D	MD6251D			22
TRX 680 FA Fourtrax Rincon	06-21		FA410X*	FA410R*	FA410SV*				MD6251D	MD6251D			23
CB 700 SC/S Nighthawk	84-86		FA69*	FA69HH*				FA69V*	MD1001	MD1001			24
CTX 700 (Top Fairing/Manual G/Box)	14-17		FA196	FA196HH				FA196V				MD1186C	25
CTX 700 D (Top Fairing/Auto G/Box)	14-19		FA196	FA196HH				FA196V				MD1186C	26
CTX 700 D (Top Fairing/Auto G/Box) - Parking brake	14-19		SFA257/2										27
CTX 700 N (Naked/Manual G/Box)	14-16		FA196	FA196HH				FA196V				MD1186C	28
CTX 700 ND (Naked/Auto G/Box)	14-19		FA196	FA196HH				FA196V				MD1186C	29
CTX 700 ND (Naked/Auto G/Box) - Parking brake	14-19		SFA257/2										30
MUV 700 Big Red	09-13	Left	FA476X						MD6341D				31
		Right	FA477X						MD6341D				32
NC 700 X (Manual G/box)	12-17		FA196	FA196HH								MD1186C	33
NC 700 XD (Auto G/box/ABS)	12-17		FA388	FA388HH		EPFA388HH						MD1187C	34
NC 700 XD (Auto G/box/Non ABS)	12-17		FA196	FA196HH								MD1186C	35
NC 700 XD (Auto G/box) - Parking brake	12-17		SFA257/2										36
NM4 - NC 700 JD (DCT)	15-19		FA196	FA196HH								MD1187C	37
NM4 - NC 700 JD (DCT) - Parking brake	15-19		SFA257/2										38
NSA 700 A9 DN-01	09-11		SFA388*	SFA388HH*					MD1180X	MD1180X			39
NSA 700 A9 DN-01 Parking Brake	09-11		SFA257/2						MD1180X	MD1180X			40
NT 700 V/A (ABS)	10-13			FA388HH*		EPFA388HH*			MD1008	MD1008			41
SXS 700 M2 Pioneer (2 Seat)	14-18		FA712X*	FA712R*	FA712SV*				MD6341D	MD6341D			42
SXS 700 M4 Pioneer (4 Seat)	14-18		FA712X*	FA712R*	FA712SV*				MD6341D	MD6341D			43
TRX 700 XX	08-11		FA185X*	FA185R*		EPFA185HH*		MXS185*	MD6006D	MD6006D			44
VF 700 C Magna	84		FA69*	FA69HH*				FA69V*	MD1040LS	MD1040RS			45
VF 700 C Magna	85-86		FA69*	FA69HH*				FA69V*	MD1040LS	MD1040RS			46
VF 700 C Magna	87		FA69/3	FA69/3HH				FA69/3V	MD1059LS				47
VF 700 F Interceptor	84		FA69*	FA69HH*					MD1001	MD1001			48
VF 700 F Interceptor	85		FA69*	FA69HH*					MD1001	MD1001			49
VF 700 S Sabre	84-85		FA69*	FA69HH*				FA69V*	MD1001	MD1001			50
VFR 700 F/F2 Interceptor	86-87		FA124*	FA124HH*					MD1001	MD1001			51
VT 700 C Shadow	84-85		FA90*					FA90V*	MD1040LS	MD1040RS			52
VT 700 C Shadow	86-87		FA69	FA69HH				FA69V	MD1047LS				53
CB 750 A Hondamatic	76-78		FA13					FA13V	N/A				54
❖ ATV Work XBD 100 disc conversion kit replacement pads			FA271X*	FA271R*									55
❖ Super ATV disc conversion kit replacement pads			FA395X*	FA395R*									56

*-2 Sets Required. † For Vee disc colours add RED, BLU, GRN, GLD, ORG suffix to part number. **SAFETY WARNING:- DO NOT USE HH PADS ON REAR UNLESS ALSO USED ON FRONT TO AVOID BRAKE IMBALANCE**

APPLICATIONS

BRAKE

⚡ This symbol indicates a rotor made of billet steel, and should be only used with EBC FA Kevlar® Organic or Vee pads.

SAFETY NOTICE - With vehicles primarily designed for off highway use such as quads now being used on the highway, we would recommend the use of X or MXS pads for highway use and ONLY using the R and SV higher density / harder pad series for off road riding.

FRONT: HONDA Cont'd

REAR: HONDA

Line #

BRAKE ROTOR CHOICES - FRONT							DISC PAD CHOICES - REAR					BRAKE ROTOR CHOICES - REAR			
CC Custom Rotor	CX Extreme® /Vee-Rotor	OS Series Oversize 250/280mm Rotor Kit	OSX Series Oversize 280mm Rotor Kit	Relocating Bracket for Oversize Rotor	SMX Series Oversize 320mm Rotor Kit	Relocating Bracket for 320mm Rotor		Sintered/HH Pads/ Grooved Shoes	SV Series Severe Duty Pads	EPFA Sintered Fast Road/ Track Pads	Specialty Pads SXR/ VEE/MXS Race	Standard Rotor	Vintage Rotor / UTV Oversize Brake Kit	Contour Profile Rotor	CX Extreme® /Vee-Rotor
1							320								
2							320								
3							320								
4							321								
5							FA496	FA496HH			FA496V	MD1156		MD1186C	
6							FA496	FA496HH			FA496V	MD1156		MD1186C	
7							FA496	FA496HH			FA496V	MD1156			
8							FA496	FA496HH			FA496V	MD1156			
9							FA496	FA496HH			FA496V	MD1156		MD1186C	
10							FA496	FA496HH			FA496V	MD1156		MD1186C	
11							FA496	FA496HH			FA496V	MD1156			
12							FA496	FA496HH			FA496V	MD1156			
13							321								
14							FA69	FA69HH			FA69V	N/A			
15							321								
16							FA140	FA140HH			FA140V	MD1022			
17	MD6010CX						318	318G							
18							FA373X	FA373R	FA373SV			MD6217D			
19							FA373X	FA373R	FA373SV			MD6217D			
20	MD6010CX	N/A	N/A	N/A	SMX6010	BRK009	FA131X	FA131R			MXS131	MD6045D			MD6045CX
21	MD6001CX	OS6001C	OSX6001	BRK008	SMX6001	BRK009	FA131X	FA131R			MXS131	MD6181D		MD6181C	MD6181CX
22							FA373X	FA373R	FA373SV			MD6217D			
23							FA373X	FA373R	FA373SV			MD6217D			
24							343								
25							FA140	FA140HH			FA140V			MD1185C	
26							FA140	FA140HH			FA140V			MD1185C	
27															
28							FA140	FA140HH			FA140V			MD1185C	
29							FA140	FA140HH			FA140V			MD1185C	
30															
31							FA478X					MD6341D			
32							FA479X					MD6341D			
33							FA140	FA140HH			FA140V			MD1185C	
34							FA174	FA174HH			FA174V			MD1185C	
35							FA140	FA140HH			FA140V			MD1185C	
36															
37							FA140	FA140HH			FA140V			MD1185C	
38															
39							SFA196	SFA196HH				TBC			
40															
41								FA261HH				MD1016			
42							FA714X	FA714R				MD6217D			
43							FA714X	FA714R				MD6217D			
44							FA410X	FA410R				MD6331D			
45							321								
46							343								
47							343								
48							FA69/3	FA69/3HH			FA69/3V	MD1068			
49							FA69/3	FA69/3HH			FA69/3V	MD1079			
50							321								
51							FA69/3	FA69/3HH			FA69/3V	MD1006			
52							321								
53							343								
54							320								
55															
56															

⚠ This symbol indicates a rotor made of billet steel, and should be only used with EBC FA Kevlar® Organic or Vee pads.
 SAFETY NOTICE - With vehicles primarily designed for off highway use such as quads now being used on the highway, we would recommend the use of X or MXS pads for highway use and ONLY using the R and SV higher density / harder pad series for off road riding.

BRAKE APPLICATIONS

*-2 Sets Required. † For Vee disc colours add RED, BLU, GRN, GLD, ORG suffix to part number. **SAFETY WARNING:- DO NOT USE HH PADS ON REAR UNLESS ALSO USED ON FRONT TO AVOID BRAKE IMBALANCE**

FRONT: HONDA



HONDA



DISC PAD CHOICES - FRONT

BRAKE ROTOR CHOICES - FRONT

Model	Year	Disc Pad Choice	Sintered/HH Pads/Grooved Shoes	SV Series Severe Duty Pads	EPFA Sintered Fast Road/Track Pads	GPFAX Sintered RACE ONLY Pads	Specialty Pads SXR/VEE/MXS Race	Standard Rotor		Vintage Rotor / UTV Oversize Brake Kit	Contour Profile Rotor	Line #
								Standard Rotor Left	Standard Rotor Right			
CB 750 C Custom	80	FA45					FA45V	MD1052LS		VMD1052		1
CB 750 C Custom	81	FA45*					FA45V*	MD1036LS	MD1036RS	VMD1036*		2
CB 750 C Custom	82	FA69/2*					FA69/2V*	MD1036LS	MD1036RS	VMD1036*		3
CB 750 C (from frame CM 204182)	82	FA90*					FA90V*	MD1036LS	MD1036RS	VMD1036*		4
CB 750 F Supersport	75-76	FA13					FA13V	MD1062LS		VMD1062		5
CB 750 F Supersport	77-78	FA31*					FA31V*	N/A	N/A			6
CB 750 F Supersport	79-80	FA30*					FA30V*	MD1036LS	MD1036RS	VMD1036*		7
CB 750 F Supersport	81-82	FA69/2*						MD1036LS	MD1036RS	VMD1036*		8
CB 750 K	70-75	FA12					FA12V	N/A				9
CB 750 76	70-76	FA12					FA12V	MD1062LS		VMD1062		10
CB 750 K	77-78	FA13					FA13V	MD1062LS		VMD1062		11
CB 750 K	79-82	FA45					FA45V	MD1052LS		VMD1052		12
CB 750 L Limited Edition	79	FA45					FA45V	MD1052LS		VMD1052		13
CB 750 SC Nighthawk	82-83	FA69*	FA69HH*				FA69V*	MD1036LS	MD1036RS	VMD1036*		14
CB 750 Nighthawk	91-03	FA196	FA196HH				FA196V	MD1021LS				15
RVF 750 R (RC45)	94-95	FA187*	FA187HH*		EPFA187HH*			MD1012LS	MD1012RS			16
VF 750 C V45 Magna	82-83	FA69*	FA69HH*				FA69V*	MD1040LS	MD1040RS			17
VF 750 C Magna/Magna Delux CD/C2	94-03	FA196	FA196HH				FA196V	MD1021LS				18
VF 750 C V45 Magna	88	FA69/3	FA69/3HH				FA69/3V	MD1059LS				19
VF 750 F V45 Interceptor	83-84	FA69*	FA69HH*					MD1001	MD1001			20
VFR 750 F Interceptor	86	FA124*	FA124HH*					MD1001	MD1001			21
VFR 750 F	90-93	FA142*	FA142HH*					MD1008	MD1008			22
VFR 750 F	94-97	FA142*	FA142HH*					MD1003X	MD1003X		MD1003XC*	23
VFR 750 R (RC 30)	90	FA187*	FA187HH*		EPFA187HH*			MD1010LS	MD1010RS			24
VF 750 S Sabre	82-83	FA69*	FA69HH*				FA69V*	MD1001	MD1001			25
VT 750 C Shadow	83	FA90*					FA90V*	MD1040LS	MD1040RS			26
VT 750 C/CD Shadow/Shadow Deluxe	98-02	FA196	FA196HH				FA196V	MD1159				27
VT 750 DC Shadow Spirit	01-02	FA196	FA196HH				FA196V	MD1159				28
VT 750 DC Shadow Spirit	03-07	FA196	FA196HH				FA196V	MD1159				29
VT 750 C2 Shadow Spirit	07-14	FA196	FA196HH				FA196V		MD1159			30
VT 750 CSE Shadow Spirit (ABS/Rear Disc Model)	13-14		FA388HH		EPFA388HH				TBC			31
VT 750 CD Shadow American Classic Edition 750 Deluxe	02-03	FA196	FA196HH				FA196V	MD1159				32
VT 750 Shadow Aero	04-07	FA196	FA196HH				FA196V	MD1159				33
VT 750 Shadow Aero	08-15	FA196	FA196HH				FA196V		MD1159			34
VT 750 C Shadow Aero (Non ABS)	18-21	FA388	FA388HH						MD1159			35
VT 750 C Shadow Aero (ABS)	18-21	FA388	FA388HH						MD1159			36
VT 750 C2B Shadow Phantom	10-21	FA196	FA196HH				FA196V		MD1159			37
VT 750 RS Shadow	10-14	FA196	FA196HH				FA196V	MD1159				38
VFR 800 Fi Interceptor	98-99		FA261HH*		EPFA261HH*			MD1014X	MD1014X		MD1014XC*	39
VFR 800 Interceptor	00-05		FA261HH*		EPFA261HH*			MD1014X	MD1014X		MD1014XC*	40
VFR 800 Interceptor	06-09		FA388HH*					MD1014X	MD1014X		MD1014XC*	41
VFR 800 A Interceptor ABS	02-05		FA261HH*		EPFA261HH*			MD1157X	MD1157X		MD1157XC*	42
VFR 800 A Interceptor ABS	06-11	FA388*	FA388HH*		EPFA388HH*			MD1157X	MD1157X		MD1157XC*	43
VFR 800 F Interceptor (Non ABS Model)	14-21		FA390HH*		EPFA390HH*	GPFAX390HH*		MD1188X	MD1188X			44
VFR 800 FD Interceptor DLX (ABS Model)	14-21		FA390HH*		EPFA390HH*	GPFAX390HH*		MD1188X	MD1188X			45
VFR 800 X Crossrunner ABS	17-21		FA390HH*		EPFA390HH*	GPFAX390HH*		MD1188X	MD1188X			46
VT 800 C Shadow	88	FA69	FA69HH				FA69V	MD1047LS				47
PC 800 Pacific Coast	89-90/94-98	FA142*	FA142HH*				FA142V*	MD1001	MD1001			48
CB 900 C Custom	80	FA30*					FA30V*	MD1036LS	MD1036RS	VMD1036*		49
CB 900 C Custom	81	FA29*					FA29V*	MD1036LS	MD1036RS	VMD1036*		50
CB 900 C Custom	82	FA69/2*					FA69/2V*	MD1036LS	MD1036RS	VMD1036*		51
CB 900 F Supersport	81-82	FA69/2*						MD1036LS	MD1036RS	VMD1036*		52
CBR 900 RR Fireblade	93-94	FA187*	FA187HH*		EPFA187HH*			MD1014X	MD1014X		MD1014XC*	53
CBR 900 RR Fireblade	95-97	FA187*	FA187HH*		EPFA187HH*			MD1003X	MD1003X		MD1003XC*	54
CBR 900 RR Fireblade	98-99		FA265HH*		EPFA265HH*			MD1134X	MD1134X		MD1134XC*	55
919 (CB 900 F)	02-07	FA187*	FA187HH*		EPFA187HH*			MD1141X	MD1141X		MD1141XC*	56

APPLICATIONS
BRAKE
SAFETY NOTICE - With vehicles primarily designed for off highway use such as quads now being used on the highway, we would recommend the use of X or MXS pads for highway use and ONLY using the R and SV higher density / harder pad series for off road riding.

⚡ This symbol indicates a rotor made of billet steel, and should be only used with EBC FA Kevlar® Organic or Vee pads.

*-2 Sets Required. † For Vee disc colours add RED, BLU, GRN, GLD, ORG suffix to part number. **SAFETY WARNING:- DO NOT USE HH PADS ON REAR UNLESS ALSO USED ON FRONT TO AVOID BRAKE IMBALANCE**

FRONT: HONDA Cont'd

REAR: HONDA

Line #	BRAKE ROTOR CHOICES - FRONT						DISC PAD CHOICES - REAR					BRAKE ROTOR CHOICES - REAR				
	CC Custom Rotor	CX Extreme® /Vee-Rotor	OS Series Oversize 250/280mm Rotor Kit	OSX Series Oversize 280mm Rotor Kit	Relocating Bracket for Oversize Rotor	SMX Series Oversize 320mm Rotor Kit	Relocating Bracket for 320mm Rotor		Sintered/HH Pads/ Grooved Shoes	SV Series Severe Duty Pads	EPFA Sintered Fast Road/ Track Pads	Specialty Pads SXR/ VEE/MXS Race	Standard Rotor	Vintage Rotor / UTV Oversize Brake Kit	Contour Profile Rotor	CX Extreme® /Vee-Rotor
1								320								
2								320								
3								320								
4								320								
5								FA32				FA32V	MD1064			
6								FA31				FA31V	MD1064			
7								FA30				FA30V	MD1071			
8								FA69				FA69V	MD1082			
9								320								
10								320								
11								320								
12								320								
13								320								
14								321								
15								FA143					MD1013			
16								321								
17								343								
18								343								
19								FA69/3	FA69/3HH			FA69/3V	MD1068			
20								FA69/3	FA69/3HH			FA69/3V	MD1006			
21								FA196	FA196HH			FA196V	MD1007			
22								FA196	FA196HH			FA196V	MD1007		MD1007C	
23	MD1003CC*							FA143					MD1011			
24								321								
25								321								
26								343								
27								343								
28								343								
29								343								
30								343								
31								FA254	FA254HH			FA254V	TBC			
32								343								
33								343								
34								343								
35								FA254	FA254HH			FA254V				
36								FA254	FA254HH			FA254V				
37								343								
38								343								
39	MD1014CC*	VR1014BLK*†						FA261HH	EPFA261HH				MD1165		MD1165C	N/A
40	MD1014CC*	VR1014BLK*†						FA261HH	EPFA261HH				MD1164		MD1164C	N/A
41	MD1014CC*	VR1014BLK*†						FA261HH	EPFA261HH				MD1165		MD1165C	N/A
42								FA261HH	EPFA261HH				MD1164		MD1164C	
43								FA261HH	EPFA261HH				MD1164		MD1164C	
44								FA488HH					MD1190		TBC	
45								FA488HH					MD1190		TBC	
46								FA488HH					MD1190		TBC	
47								343								
48								343								
49								FA29				FA29V	MD1071			
50								FA29				FA29V	MD1071			
51								FA69				FA69V	MD1082			
52								FA69				FA69V	MD1082			
53	MD1014CC*	VR1014BLK*†						FA174	FA174HH			FA174V	MD1004		MD1004C	VR1004
54	MD1003CC*	VR1003BLK*†						FA174	FA174HH			FA174V	MD1004		MD1004C	VR1004
55	MD1134CC*	VR1134BLK*†						FA174	FA174HH			FA174V	MD1004		MD1004C	VR1004
56	MD1141CC*	VR1141BLK*†						FA174	FA174HH			FA174V	MD1020		MD1020C	VR1020

BRAKE APPLICATIONS

⚠ This symbol indicates a rotor made of billet steel, and should be only used with EBC FA Kevlar® Organic or Vee pads. SAFETY NOTICE - With vehicles primarily designed for off highway use such as quads now being used on the highway, we would recommend the use of X or MXS pads for highway use and ONLY using the R and SV higher density / harder pad series for off road riding.

*-2 Sets Required. † For Vee disc colours add RED, BLU, GRN, GLD, ORG suffix to part number. **SAFETY WARNING: DO NOT USE HH PADS ON REAR UNLESS ALSO USED ON FRONT TO AVOID BRAKE IMBALANCE**

FRONT: HONDA



HONDA



DISC PAD CHOICES - FRONT

BRAKE ROTOR CHOICES - FRONT

											Line #
CBR 929 RR (929cc model)	00-01	FA265HH*		EPFA265HH*			MD1137X	MD1137X		MD1137XC*	1
CBR 954 RR (954cc model)	02-03	FA265HH*		EPFA265HH*			MD1137X	MD1137X		MD1137XC*	2
CBX	79-80	FA31*					MD1036LS	MD1036RS	VMD1036*		3
CBX	81-82	FA69/2*					N/A	N/A			4
CB 1000 C Custom	83	FA69*	FA69HH*			FA69V*	MD1040LS	MD1040RS			5
CB 1000	94-95	FA187*	FA187HH*	EPFA187HH*			MD1056	MD1056			6
CB 1000 R	10-16		FA390HH*	EPFA390HH*	GPFAX390HH*		MD1152X	MD1152X		MD1152XC*	7
CB 1000 R	17-21		FA296HH*	EPFA296HH*	GPFAX296HH*		MD1193X	MD1193X		TBC	8
CBF 1000 A8 (Canada)	08-11		FA388HH*	EPFA388HH*			MD1160	MD1160			9
CBR 1000 F (Hurricane)	87-88	FA124*	FA124HH*				MD1008	MD1008			10
CBR 1000 F	90-91	FA142*	FA142HH*				MD1008	MD1008			11
CBR 1000 F	93-99	FA189*	FA189HH*				MD1008	MD1008			12
CBR 1000 RR	04-05		FA390HH*	EPFA390HH*	GPFAX390HH*		MD1153X	MD1153X		MD1153XC*	13
CBR 1000 RR	06-07		FA390HH*	EPFA390HH*	GPFAX390HH*		MD1161X	MD1161X		MD1161XC*	14
CBR 1000 RR	08-15		FA390HH*	EPFA390HH*	GPFAX390HH*		MD1171X	MD1171X		MD1171XC*	15
CBR 1000 RRA ABS Model	09-16		FA390HH*	EPFA390HH*	GPFAX390HH*		MD1171X	MD1171X		MD1171XC*	16
CBR 1000 RRA ABS Model (Nissin Front Caliper)	17-20		FA700HH*				MD1199X	MD1199X		MD1199XC*	17
CBR 1000 RR	18-21		FA700HH*	EPFA700HH*	GPFAX700HH*		MD1199X	MD1199X		MD1199XC*	18
CBR 1000 RR SP (Brembo Front Calipers)	14-17		FA447HH*	EPFA447HH*	GPFAX447HH*		MD1171X	MD1171X		MD1171XC*	19
CBR 1000 RR SP	18-21		FA447HH*	EPFA447HH*	GPFAX447HH*		MD1202X	MD1202X			20
CRF 1000 Africa Twin ABS (Manual)	16-20		FA679HH*								21
CRF 1000 Africa Twin ABS (DCT)	16-20		FA679HH*								22
CRF 1000 Africa Twin ABS (DCT) - Parking Brake	16-20	SFA257/2									23
CRF 1000 Africa Twin Adventure Sport ES ABS (Manual)	18-20		FA679HH*				MD1198X	MD1198X		MD1198XC*	24
CRF 1000 Africa Twin Adventure Sport ES ABS (DCT)	18-20		FA679HH*				MD1198X	MD1198X		MD1198XC*	25
GL 1000 K76/L Goldwing (6 Bolt Fixing)	75-77	FA29*				FA29V*	MD1074LS	MD1074RS			26
GL 1000 Goldwing	78	FA29*				FA29V*	N/A	N/A			27
GL 1000 Goldwing (5 Bolt Fixing)	79	FA29*				FA29V*	MD1036LS	MD1036RS	VMD1036*		28
Pioneer 1000 SXS (2 Seater)	Left 16-21	FA701X	FA701R	FA701SV		SXR701HH	MD6410D		UTX6410		29
	Right	FA702X	FA702R	FA702SV		SXR702HH		MD6410D	UTX6410		30
Pioneer 1000 SXS (4 Seater)	Left 16-21	FA701X	FA701R	FA701SV		SXR701HH	MD6410D		UTX6410		31
	Right	FA702X	FA702R	FA702SV		SXR702HH		MD6410D	UTX6410		32
SXS Talon 1000 R	Left 19-21	FA701X	FA701R	FA701SV		SXR701HH	MD6425D			MD6425C	33
	Right	FA702X	FA702R	FA702SV		SXR702HH		MD6425D		MD6425C	34
SXS Talon 1000X (2 Seater)	Left 19-21	FA701X	FA701R	FA701SV		SXR701HH	MD6425D			MD6425C	35
	Right	FA702X	FA702R	FA702SV		SXR702HH		MD6425D		MD6425C	36
SXS Talon 1000X-4 (4 Seater)	Left 19-21	FA701X	FA701R	FA701SV		SXR701HH	MD6425D			MD6425C	37
	Right	FA702X	FA702R	FA702SV		SXR702HH		MD6425D		MD6425C	38
PVT 1000 RS Pursuer	17-18	FA700*	FA700HH*	EPFA700HH*			MD1186X	MD1186X		MD1186XC*	39
RC 213 V-S	15-17		FA447HH*	EPFA447HH*	GPFAX447HH*						40
RVT 1000 R (RC51)	00-06		FA265HH*	EPFA265HH*			MD1161X	MD1161X		MD1161XC*	41
VF 1000 F Interceptor	84	FA69*	FA69HH*				MD1001	MD1001			42
VF 1000 R	85-86	FA69*	FA69HH*				MD1146	MD1146			43
VTR 1000 F Super Hawk	98-05	FA187*	FA187HH*	EPFA87HH*			MD1003X	MD1003X		MD1003XC*	44
XL 1000 VA8 Varadero (Canada)	08		FA388HH*	EPFA388HH*			MD1014X			MD1014XC*	45
CB 1100 (Non ABS)	13-14		FA296HH*	EPFA296HH*			TBC	TBC			46
CB 1100 A (ABS)	13-14		FA388HH*	EPFA388HH*			TBC	TBC			47
CB 1100 EX (ABS)	14-21		FA296HH*	EPFA296HH*			TBC	TBC			48
CB 1100 F Supersport	83	FA69*	FA69HH*				MD1001	MD1001			49
CBR 1100 XX Blackbird	97-98		FA261HH*	EPFA261HH*			MD1120X	MD1120X		MD1120XC*	50
CBR 1100 XX Blackbird	99-03		FA261HH*	EPFA261HH*			MD1136X	MD1136X		MD1136XC*	51
CRF 1100 L Africa Twin Adventure Sport	20-21		FA679HH*				MD1198X	MD1198X		MD1198XC*	52
CRF 1100 L Africa Twin Adventure Sport Plus	20-21		FA679HH*				MD1198X	MD1198X		MD1198XC*	53
GL 1100/1100 I Goldwing (5 Bolt Fixing)	80	FA30*				FA30V*	MD1036LS	MD1036RS	VMD1036*		54
GL 1100/1100 I Goldwing/Interstate (5 Bolt Fixing)	81	FA29*				FA29V*	MD1036LS	MD1036RS	VMD1036*		55
GL 1100/1100 I Goldwing/Interstate (5 Bolt Fixing)	82	FA69/2*				FA69/2V*	MD1036LS	MD1036RS	VMD1036*		56

FRONT

*2 Sets Required. † For Vee disc colours add RED, BLU, GRN, GLD, ORG suffix to part number. **SAFETY WARNING:- DO NOT USE HH PADS ON REAR UNLESS ALSO USED ON FRONT TO AVOID BRAKE IMBALANCE**

⚡ This symbol indicates a rotor made of billet steel, and should be only used with EBC FA Kevlar® Organic or Vee pads.

SAFETY NOTICE - With vehicles primarily designed for off highway use such as quads now being used on the highway, we would recommend the use of X or MXS pads for highway use and ONLY using the R and SV higher density / harder pad series for off road riding.

FRONT: HONDA Cont'd

REAR: HONDA

Line #	BRAKE ROTOR CHOICES - FRONT							DISC PAD CHOICES - REAR					BRAKE ROTOR CHOICES - REAR			
	CC Custom Rotor	CX Extreme® /Vee-Rotor	OS Series Oversize 250/280mm Rotor Kit	OSX Series Oversize 280mm Rotor Kit	Relocating Bracket for Oversize Rotor	SMX Series Oversize 320mm Rotor Kit	Relocating Bracket for 320mm Rotor		Sintered/HH Pads/ Grooved Shoes	SV Series Severe Duty Pads	EPFA Sintered Fast Road/ Track Pads	Specialty Pads SXR/ VEE/MXS Race	Standard Rotor	Vintage Rotor / UTV Oversize Brake Kit	Contour Profile Rotor	CX Extreme® /Vee-Rotor
1	MD1137CC*	VR1137BLK*†					FA174	FA174HH			FA174V	MD1004		MD1004C	VR1004	
2	MD1137CC*	VR1137BLK*†					FA174	FA174HH			FA174V	MD1004		MD1004C	VR1004	
3							FA31				FA31V	MD1071				
4							FA69				FA69V	MD1082				
5							FA69	FA69HH			FA69V	MD1078				
6							FA174	FA174HH			FA174V	MD1016				
7	MD1152CC*	VR1152BLK*†						FA488HH				MD1177		MD1177C	N/A	
8								FA488HH				MD1177		TBC		
9								FA388HH	EPFA388HH			MD1156				
10							FA69/3	FA69/3HH			FA69/3V	MD1001				
11							FA196	FA196HH			FA196V	MD1016				
12							FA189	FA189HH				MD1006				
13	MD1153CC*	VR1153BLK*†					FA174	FA174HH			FA174V	MD1004		MD1004C	VR1004	
14	MD1161CC*	VR1161BLK*†					FA436	FA436HH			FA436V	MD1004		MD1004C	VR1004	
15		VR1171BLK*†					FA436	FA436HH			FA436V	MD1004		MD1004C	VR1004	
16		VR1171BLK*†					FA436	FA436HH			FA436V	MD1004		MD1004C	VR1004	
17							FA436	FA436HH			FA436V	TBC		TBC		
18							FA436	FA436HH			FA436V					
19		VR1171BLK*†					FA436	FA436HH			FA436V	MD1004		MD1004C	VR1004	
20							FA436	FA436HH			FA436V					
21							FA174	FA174HH			FA174V			TBC		
22							FA174	FA174HH			FA174V			TBC		
23																
24							FA174	FA174HH			FA147V					
25							FA174	FA174HH								
26							FA32				FA32V	MD1064				
27							FA32				FA32V	MD1064				
28							FA32				FA32V	MD1064				
29							FA703X	FA703R			SXR703HH	MD6410D	UTX6410			
30							FA704X	FA704R			SXR704HH	MD6410D	UTX6410			
31							FA703X	FA703R	FA703SV		SXR703HH	MD6410D	UTX6410			
32							FA704X	FA704R	FA704SV		SXR704HH	MD6410D	UTX6410			
33							FA703X	FA703R	FA703SV		SXR703HH	MD6425D	TBC	MD6425C		
34							FA704X	FA704R	FA704SV		SXR704HH	MD6425D	TBC	MD6425C		
35							FA703X	FA703R	FA703SV		SXR703HH	MD6425D	TBC	MD6425C		
36							FA704X	FA704R	FA704SV		SXR704HH	MD6425D	TBC	MD6425C		
37							FA703X	FA703R	FA703SV		SXR703HH	MD6425D	TBC	MD6425C		
38							FA704X	FA704R	FA704SV		SXR704HH	MD6425D	TBC	MD6425C		
39							FA109					MD1079				
40							FA266	FA266HH			FA266V					
41	MD1161CC*						FA174	FA174HH			FA174V	MD1004		MD1004C		
42							FA69/3	FA69/3HH			FA69/3V	MD1079				
43							FA109					N/A				
44	MD1003CC*	VR1003BLK*†					FA174	FA174HH			FA174V	MD1004		MD1004C	VR1004	
45	MD1014CC*	VR1014BLK*†	MD1014X	MD1014X				FA261HH		EPFA261HH		MD1006		MD1006C	VR1006	
46							FA174	FA174HH			FA174V	TBC				
47							FA174	FA174HH			FA174V	TBC				
48							FA174	FA174HH			FA174V	TBC				
49							FA69	FA69HH			FA69V	MD1068				
50		VR1120BLK*†						FA261HH		EPFA261HH		MD1006		MD1006C	VR1006	
51		VR1136BLK*†						FA261HH		EPFA261HH		MD1006		MD1006C	VR1006	
52							FA174	FA174HH				MD1196				
53							FA174	FA174HH				MD1196				
54							FA29				FA29V	MD1071				
55							FA29				FA29V	MD1071				
56							FA69				FA69V	MD1082				

BRAKE APPLICATIONS

⚠ This symbol indicates a rotor made of billet steel, and should be only used with EBC FA Kevlar® Organic or Vee pads.
SAFETY NOTICE - With vehicles primarily designed for off highway use such as quads now being used on the highway, we would recommend the use of X or MXS pads for highway use and ONLY using the R and SV higher density / harder pad series for off road riding.

*-2 Sets Required. † For Vee disc colours add RED, BLU, GRN, GLD, ORG suffix to part number. **SAFETY WARNING:- DO NOT USE HH PADS ON REAR UNLESS ALSO USED ON FRONT TO AVOID BRAKE IMBALANCE**

FRONT: HONDA



HONDA



DISC PAD CHOICES - FRONT

BRAKE ROTOR CHOICES - FRONT

											Line #
GL 1100/1100 I Goldwing/Interstate (5 Bolt Fixing)	83	FA69*	FA69HH*			FA69V*	MD1036LS	MD1036RS	VMD1036*		1
GL 1100 A Goldwing Aspencade (5 Bolt Fixing)	82-83	FA69/2*				FA69/2V*	MD1133	MD1133			2
ST 1100	91-02	FA142*	FA142HH*				MD1021LS	MD1021RS			3
ST 1100 A ABS Model	95	FA142*	FA142HH*				MD1021LS	MD1021RS			4
ST 1100 A ABS Model	96-02		FA261HH*	EPFA261HH*			MD1008	MD1008			5
VF 1100 C V65 Magna	83-86	FA69*	FA69HH*			FA69V*	MD1040LS	MD1040RS			6
VF 1100 S V65 Sabre	84-85	FA69*	FA69HH*			FA69V*	MD1001	MD1001			7
VT 1100 C Shadow	85-86	FA69*	FA69HH*			FA69V*	MD1040LS	MD1040RS			8
VT 1100 C Shadow	87-94	FA69/3	FA69/3HH			FA69/3V		MD1080RS			9
VT 1100 C Shadow	95-96	FA196	FA196HH			FA196V		MD1167RS			10
VT 1100 C Shadow Spirit	97-07	FA196	FA196HH			FA196V		MD1167RS			11
VT 1100 C2 Shadow American Classic Edition	95-99	FA196	FA196HH			FA196V	MD1179				12
VT 1100 C2 Shadow Sabre	00-07	FA196	FA196HH			FA196V	MD1179				13
VT 1100 C2-2 Shadow 1100 American Classic Edition	97	FA196	FA196HH			FA196V	MD1179				14
VT 1100 C3 Shadow Aero	98-02	FA196	FA196HH			FA196V	MD1179				15
VT 1100 D2 Shadow American Classic Edition	99	FA196	FA196HH			FA196V	MD1179				16
VT 1100 T Shadow American Classic Edition Tourer	98-01	FA196	FA196HH			FA196V	MD1179				17
GL 1200/1200 I/1200 A (5mm rotor) Goldwing	84-85	FA69/3*	FA69/3HH*			FA69/3V*	MD1083LS	MD1083RS			18
GL 1200 L (10mm rotor) Goldwing	85	FA69/3*	FA69/3HH*			FA69/3V*	MD1125	MD1125			19
GL 1200 I Goldwing (5mm rotor)	86-87	FA69/3*	FA69/3HH*			FA69/3V*	MD1083LS	MD1083RS			20
GL 1200 A/SEi Goldwing (10mm rotor)	86-87	FA69/3*	FA69/3HH*			FA69/3V*	MD1125	MD1125			21
VFR 1200 F (Manual Gearbox Model)	10-14		FA499/4HH*				MD1176X	MD1176X			22
VFR 1200 FD (Automatic Transmission Model)	10-14		FA499/4HH*				MD1176X	MD1176X			23
VFR 1200 FD (Automatic Transmission Model) - Parking brake	10-14	SFA257/2									24
VFR 1200 XA (Manual G/Box)	16-17		FA388HH*	EPFA388HH*			MD1197	MD1197			25
VFR 1200 XD DCT (Automatic Transmission Model)	16-17		FA388HH*	EPFA388HH*			MD1197	MD1197			26
VFR 1200 XD DCT (Automatic Transmission Model) - Parking Brake	16-17	SFA257/2									27
CTX 1300	14-19		FA388HH*	EPFA388HH*			MD1188X	MD1188X			28
CTX 1300 DLX (ABS)	14		FA388HH*	EPFA388HH*			MD1188X	MD1188X			29
ST 1300/ST 1300 A (ABS)	02-07		FA261HH*	EPFA261HH*		FA261V*	MD1154X	MD1154X		MD1154XC*	30
ST 1300/ST 1300 A (ABS)	08-13		FA388HH*	EPFA388HH*			MD1154X	MD1154X		MD1154XC*	31
VT 1300 CX Fury (Non ABS Model)	10-20	FA196	FA196HH			FA196V	TBC				32
VT 1300 CXA Fury (ABS Model)	10-21		FA388HH*	EPFA388HH*			TBC				33
VT 1300 CS Sabre (Non ABS)	10-15	FA196	FA196HH			FA196V	TBC				34
VT 1300 CSA Sabre (ABS)	11-14		FA388HH*	EPFA388HH*			TBC				35
VT 1300 CR Stataline(Non ABS)	10-15	FA196	FA196HH			FA196V	TBC				36
VT 1300 CRA Stataline (ABS)	11-15		FA388HH*	EPFA388HH*			TBC				37
VT 1300 CT Interstate (Non ABS)	10-15	FA196	FA196HH			FA196V	TBC				38
VT 1300 CTA Interstate (ABS)	11-15		FA388HH*	EPFA388HH*			TBC				39
VTX 1300 S Retro (Spoke Wheel)	03-07	FA196	FA196HH			FA196V		MD1158RS			40
VTX 1300 C (Solid Wheel)	04-09	FA196	FA196HH			FA196V		MD1182RS			41
VTX 1300 R (Solid Wheel)	05-09	FA196	FA196HH			FA196V		MD1182RS			42
VTX 1300 T (Solid Wheel)	08-11	FA196	FA196HH			FA196V		MD1182RS			43
GL 1500 Goldwing All models	88-89	FA124/2*	FA124/2HH*			FA124/2V*	MD1126	MD1126			44
GL 1500/1500 SE/A/I Goldwing	90-00	FA124/2*	FA124/2HH*			FA124/2V*	MD1126	MD1126			45
GL 1500 C/CT Valkyrie/Valkyrie Tourer	97-99	FA142*	FA142HH*			FA142V*	MD1014X	MD1014X		MD1014XC*	46
GL 1500 C/CT/CF/CD Valkyrie/Valkyrie Tourer/Valkyrie Interstate	00-03	FA142*	FA142HH*			FA142V*	MD1014X	MD1014X		MD1014XC*	47
GL 1800/1800 A (ABS) Goldwing All models	01-17		FA261HH*	EPFA261HH*		FA261V*	MD1014X	MD1014X		MD1014XC*	48
F6B Goldwing (GL 1800 B)	13-17		FA261HH*	EPFA261HH*		FA261V*	TBC	TBC			49
F6B Goldwing Deluxe (GL 1800 BD)	13-17		FA261HH*	EPFA261HH*		FA261V*	TBC	TBC			50
GL 1800 B Goldwing J (Manual)	18-21	FA717	FA717HH								51
GL 1800 B Goldwing J (Manual) Parking Brake	18-21	SFA257/2									52
GL 1800 Goldwing Tour J (Manual)	18-21	FA717	FA717HH								53
GL 1800 Goldwing Tour J (Manual) Parking Brake	18-21	SFA257/2									54
GL 1800 BD Goldwing J (DCT)	18-21	FA717	FA717HH								55
GL 1800 D Goldwing Tour J (DCT)	18-21	FA717	FA717HH								56

*-2 Sets Required. † For Vee disc colours add RED, BLU, GRN, GLD, ORG suffix to part number. **SAFETY WARNING:- DO NOT USE HH PADS ON REAR UNLESS ALSO USED ON FRONT TO AVOID BRAKE IMBALANCE**

⚠ This symbol indicates a rotor made of billet steel, and should be only used with EBC FA Kevlar® Organic or Vee pads.

SAFETY NOTICE - With vehicles primarily designed for off highway use such as quads now being used on the highway, we would recommend the use of X or MXS pads for highway use and ONLY using the R and SV higher density / harder pad series for off road riding.

FRONT: HONDA Cont'd

REAR: HONDA

BRAKE ROTOR CHOICES - FRONT

DISC PAD CHOICES - REAR

BRAKE ROTOR CHOICES - REAR

Line #

CC Custom Rotor	CX Extreme® /Vee-Rotor	OS Series Oversize 250/280mm Rotor Kit	OSX Series Oversize 280mm Rotor Kit	Relocating Bracket for Oversize Rotor	SMX Series Oversize 320mm Rotor Kit	Relocating Bracket for 320mm Rotor		Sintered/HH Pads/ Grooved Shoes	SV Series Severe Duty Pads	EPFA Sintered Fast Road/ Track Pads	Specialty Pads SXR/ VEE/MXS Race	Standard Rotor	Vintage Rotor / UTV Oversize Brake Kit	Contour Profile Rotor	CX Extreme® /Vee-Rotor	
1							FA69	FA69HH			FA69V	MD1082				
2							FA69				FA69V	MD1082				
3							FA196	FA196HH			FA196V	MD1077				
4							FA196	FA196HH			FA196V	MD1077				
5								FA261HH			FA261V	MD1135				
6							FA69/3	FA69/3HH			FA69/3V	MD1078				
7							FA69/3	FA69/3HH			FA69/3V	MD1079				
8							343									
9							343									
10							343									
11							343									
12							FA174	FA174HH			FA174V	MD1016				
13							FA174	FA174HH			FA174V	MD1016				
14							FA174	FA174HH			FA174V	MD1016				
15							FA174	FA174HH			FA174V	MD1016				
16							FA174	FA174HH			FA174V	MD1016				
17							FA174	FA174HH			FA174V	MD1016				
18							FA69/3	FA69/3HH			FA69/3V	MD1082				
19							FA69/3	FA69/3HH			FA69/3V	MD1082				
20							FA69/3	FA69/3HH			FA69/3V	MD1082				
21							FA69/3	FA69/3HH			FA69/3V	MD1082				
22								FA488HH				MD1175				
23								FA636HH			FA636V	MD1175				
24																
25								FA636HH			FA636V	MD1175				
26								FA636HH			FA636V	MD1175				
27																
28								FA261HH			FA261V	TBC				
29								FA261HH			FA261V	TBC				
30											FA261V	MD1163				
31											FA261V	MD1163				
32							FA174	FA174HH			FA174V	MD1159				
33								FA261HH	EPFA261HH		FA261V	TBC				
34							FA174	FA174HH			FA174V	TBC				
35								FA261/2HH	EPFA261/2HH			TBC				
36							FA174	FA174HH			FA174V	TBC				
37								FA261/2HH	EPFA261/2HH			TBC				
38							FA174	FA174HH			FA174V	TBC				
39								FA261/2HH	EPFA261/2HH			TBC				
40							FA174	FA174HH			FA174V	MD1159				
41							FA174	FA174HH			FA174V	MD1159				
42							FA174	FA174HH			FA174V	MD1159				
43							FA174	FA174HH			FA174V	MD1159				
44							FA69/3	FA69/3HH			FA69/3V	MD1127				
45							FA69/3	FA69/3HH			FA69/3V	MD1077				
46	MD1014CC*	VR1014BLK*†					FA196	FA196HH			FA196V	MD1077		N/A	N/A	
47	MD1014CC*	VR1014BLK*†					FA196	FA196HH			FA196V	MD1148		N/A	N/A	
48	MD1014CC*	VR1014BLK*†						FA261/2HH	EPFA261/2HH			N/A		N/A	N/A	
49								FA261/2HH	EPFA261/2HH			N/A				
50								FA261/2HH	EPFA261/2HH			N/A				
51								FA388/2HH								
52								FA388/2HH								
53								FA388/2HH								
54								FA388/2HH								
55								FA388/2HH								
56								FA388/2HH								

REAR

BRAKE APPLICATIONS

⊗ This symbol indicates a rotor made of billet steel, and should be only used with EBC FA Kevlar® Organic or Vee pads. SAFETY NOTICE - With vehicles primarily designed for off highway use such as quads now being used on the highway, we would recommend the use of X or MXS pads for highway use and ONLY using the R and SV higher density / harder pad series for off road riding.

*-2 Sets Required. † For Vee disc colours add RED, BLU, GRN, GLD, ORG suffix to part number. SAFETY WARNING: DO NOT USE HH PADS ON REAR UNLESS ALSO USED ON FRONT TO AVOID BRAKE IMBALANCE

FRONT: HONDA



HONDA



DISC PAD CHOICES - FRONT

BRAKE ROTOR CHOICES - FRONT

											Line #
GL 1800 DA Goldwing Tour Airbag J (DCT)	18-21	FA717	FA717HH								1
GL 1800 C Valkyrie	14-15		FA296HH*	EPFA296HH*			TBC	TBC			2
NRX 1800 Rune D/E	04-05		FA261HH*	EPFA261HH*		FA261V*	TBC	TBC			3
VTX 1800 C	02-08		FA261HH*	EPFA261HH*		FA261V*	MD1141X	MD1141X		MD1141XC*	4
VTX 1800 R (Cast Model)	02-08		FA261HH*	EPFA261HH*		FA261V*	MD1141X	MD1141X		MD1141XC*	5
VTX 1800 S (Spoke Model)	02-07		FA261HH*	EPFA261HH*		FA261V*	MD1141X	MD1141X		MD1141XC*	6
VTX 1800 F	05-11		FA261HH*	EPFA261HH*		FA261V*	MD1141X	MD1141X		MD1141XC*	7
VTX 1800 N	04-11		FA261HH*	EPFA261HH*		FA261V*	MD1141X	MD1141X		MD1141XC*	8
VTX 1800 T	07-11		FA261HH*	EPFA261HH*		FA261V*	MD1141X	MD1141X		MD1141XC*	9
											10
											11
											12
											13
											14
											15
											16
											17
											18
											19
											20
											21
											22
											23
											24
											25
											26
											27
											28
											29
											30
											31
											32
											33
											34
											35
											36
											37
											38
											39
											40
											41
											42
											43
											44
											45
											46
											47
											48
											49
											50
											51
											52
											53
											54
											55
											56

FRONT

APPLIATIONS
BRAKE
 * This symbol indicates a rotor made of billet steel, and should be only used with EBC FA Kevlar® Organic or Vee pads.
 SAFETY NOTICE - With vehicles primarily designed for off highway use such as quads now being used on the highway, we would recommend the use of X or MXS pads for highway use and ONLY using the R and SV higher density / harder pad series for off road riding.

*-2 Sets Required. † For Vee disc colours add RED, BLU, GRN, GLD, ORG suffix to part number. **SAFETY WARNING:- DO NOT USE HH PADS ON REAR UNLESS ALSO USED ON FRONT TO AVOID BRAKE IMBALANCE**

FRONT: HONDA Cont'd

REAR: HONDA

Line #	BRAKE ROTOR CHOICES - FRONT						DISC PAD CHOICES - REAR					BRAKE ROTOR CHOICES - REAR				
	CC Custom Rotor	CX Extreme® /Vee-Rotor	OS Series Oversize 250/280mm Rotor Kit	OSX Series Oversize 280mm Rotor Kit	Relocating Bracket for Oversize Rotor	SMX Series Oversize 320mm Rotor Kit	Relocating Bracket for 320mm Rotor		Sintered/HH Pads/ Grooved Shoes	SV Series Severe Duty Pads	EPFA Sintered Fast Road/ Track Pads	Specialty Pads SXR/ VEE/MXS Race	Standard Rotor	Vintage Rotor / UTV Oversize Brake Kit	Contour Profile Rotor	CX Extreme® /Vee-Rotor
1								FA388/2HH								
2								FA261/2HH	EPFA261/2HH			N/A				
3								FA261HH	EPFA261HH		FA261V	TBC				
4	MD1141CC*	VR1141BLK*†						FA261HH	EPFA261HH		FA261V	MD1148		N/A	N/A	
5	MD1141CC*	VR1141BLK*†						FA261HH	EPFA261HH		FA261V	MD1148		N/A	N/A	
6	MD1141CC*	VR1141BLK*†						FA261/2HH	EPFA261/2HH		FA261/2V	MD1148		N/A	N/A	
7	MD1141CC*	VR1141BLK*†						FA261/2HH	EPFA261/2HH		FA261/2V	MD1148		N/A	N/A	
8	MD1141CC*	VR1141BLK*†						FA261/2HH	EPFA261/2HH		FA261/2V	MD1148		N/A	N/A	
9	MD1141CC*	VR1141BLK*†						FA261/2HH	EPFA261/2HH		FA261/2V	MD1148		N/A	N/A	
10																
11																
12																
13																
14																
15																
16																
17																
18																
19																
20																
21																
22																
23																
24																
25																
26																
27																
28																
29																
30																
31																
32																
33																
34																
35																
36																
37																
38																
39																
40																
41																
42																
43																
44																
45																
46																
47																
48																
49																
50																
51																
52																
53																
54																
55																
56																

REAR

BRAKE APPLICATIONS

⚠ This symbol indicates a rotor made of billet steel, and should be only used with EBC FA Kevlar® Organic or Vee pads.
 SAFETY NOTICE - With vehicles primarily designed for off highway use such as quads now being used on the highway, we would recommend the use of X or MXS pads for highway use and ONLY using the R and SV higher density / harder pad series for off road riding.

*-2 Sets Required. † For Vee disc colours add RED, BLU, GRN, GLD, ORG suffix to part number. **SAFETY WARNING:- DO NOT USE HH PADS ON REAR UNLESS ALSO USED ON FRONT TO AVOID BRAKE IMBALANCE**

FRONT: KAWASAKI



KAWASAKI



DISC PAD CHOICES - FRONT

BRAKE ROTOR CHOICES - FRONT

											Line #
AR 50 A	82	SFA83	FA83HH				MD4040LS				1
KDX 50 A	03-06	613	613G								2
KSF 50 A (KFX 50)	03-05	614*	614G*								3
KFX 50 (KSF 50 B)	07-09/13-17	338*	338G*								4
KX 60 A	83-84	715	715G								5
KX 60 B	85-03	715	715G								6
KX 65	00-22	FA302X	FA302R			MXS302	MD6166D				7
AR 80 A	82	SFA83	FA83HH				MD4040LS				8
KD 80 M	80-87	603	603G								9
KD 80 N	88-90	FA83X	FA83R				TBC				10
KDX 80 A	80-81	701	701G								11
KDX 80 B	82-83	701	701G								12
KDX 80 C	84-88	714	714G								13
KSF 80 A (KFX 80)	03-06	614*	614G*								14
KX 80 C	81-82	701	701G								15
KX 80 E	83	714	714G								16
KX 80 E	84-85	FA83X	FA83R				MD6027D				17
KX 80 G	86-87	FA83X	FA83R				MD6027D				18
KX 80 J	87	FA83X	FA83R				MD6027D				19
KX 80 L/N/R	88-91	FA83X	FA83R				MD6027D				20
KX 80 R	92-96	FA83X	FA83R				MD6026D				21
KX 80 R/W	97-00	FA258X	FA258R				MD6026D				22
KX 85 AC	01-21	FA258X	FA258R				MD6186D			MD6186C	23
KFX 90 (KSF 90 A)	07-17	338*	338G*								24
KE 100 A	76-81	603	603G								25
KE 100 B	82-01	603	603G								26
KM 100 A	76-81	603	603G								27
KX 100 B	95-96	FA83X	FA83R				MD6026D				28
KX 100 B/C	97-00	FA258X	FA258R				MD6026D				29
KX 100 D/F	01-09/11-21	FA258X	FA258R				MD6186D			MD6186C	30
KX 112 19" F/wheel 16" R/wheel	21-22	FA258X	FA258R				MD6186D			MD6186C	31
KLF 110 A/B Mojave	87-88	603*	603G*								32
KLT 110 A	84-86	603	603G								33
KLX 110	02-21	715	715G								34
KLX 110 L	10-21	715	715G								35
BN 125 A Eliminator	01-09	FA197	FA197HH					MD4137RS			36
KD 125 A	75-79	704	704G								37
KE 125 A	76-83	704	704G								38
KLX 125 A	03-06	604	604G								39
KLX 125 L (B)	03-06	FA230X	FA230R				MD6212D				40
KX 125 A	74-81	704	704G								41
KX 125 B	82	FA83X	FA83R				N/A				42
KX 125 B/C/D	83-85	FA67X	FA67R				N/A				43
KX 125 E	86	FA67X	FA67R				MD6036D				44
KX 125 E/F	87-88	FA130X	FA130R				MD6036D				45
KX 125 G/H/J	89-93	FA135X	FA135R			MXS135	MD6015D			MD6015C	46
KX 125 K	94	FA185X	FA185R	EPFA185HH		MXS185	MD6015D			MD6015C	47
KX 125 K/L	95-02	FA185X	FA185R	EPFA185HH		MXS185	MD6015D			MD6015C	48
KX 125 M	03-05	FA185X	FA185R	EPFA185HH		MXS185	MD6213D			MD6213C	49
Z 125 (BR 125)	17-21	FA691	FA691HH							MD4171C	50
Z 125 Pro (BR 125 J/FB)	17-21	FA691	FA691HH							MD4171C	51
Z 125 Pro SE (BR 125 J/FS)	17-21	FA691	FA691HH							MD4171C	52
KLX 140 (17" front/14" rear wheels)	08-21	FA135X	FA135R			MXS135				MD6328C	53
KLX 140 L (19" front/16" rear wheel)	08-21	FA135X	FA135R			MXS135				MD6328C	54
KLX 140 G (21" front/18" rear wheel)	17-21	FA135X	FA135R			MXS135				MD6328C	55
KLX 150 S	09-11	FA135X	FA135R			MXS135				MD6363C	56

FRONT

APPLIATIONS
BRAKE
 * This symbol indicates a rotor made of billet steel, and should be only used with EBC FA Kevlar® Organic or Vee pads.
 † For Vee disc colours add RED, BLU, GRN, GLD, ORG suffix to part number. **SAFETY WARNING:- DO NOT USE HH PADS ON REAR UNLESS ALSO USED ON FRONT TO AVOID BRAKE IMBALANCE**
 ‡ pads for highway use and ONLY using the R and SV higher density / harder pad series for off road riding.

*2 Sets Required. † For Vee disc colours add RED, BLU, GRN, GLD, ORG suffix to part number. **SAFETY WARNING:- DO NOT USE HH PADS ON REAR UNLESS ALSO USED ON FRONT TO AVOID BRAKE IMBALANCE**

FRONT: KAWASAKI Cont'd

REAR: KAWASAKI

Line #

BRAKE ROTOR CHOICES - FRONT							DISC PAD CHOICES - REAR					BRAKE ROTOR CHOICES - REAR			
CC Custom Rotor	CX Extreme® /Vee-Rotor	OS Series Oversize 250/280mm Rotor Kit	OSX Series Oversize 280mm Rotor Kit	Relocating Bracket for Oversize Rotor	SMX Series Oversize 320mm Rotor Kit	Relocating Bracket for 320mm Rotor		Sintered/HH Pads/ Grooved Shoes	SV Series Severe Duty Pads	EPFA Sintered Fast Road/ Track Pads	Specialty Pads SXR/ VEE/MXS Race	Standard Rotor	Vintage Rotor / UTV Oversize Brake Kit	Contour Profile Rotor	CX Extreme® /Vee-Rotor
1							603								
2							613	613G							
3							604	604G							
4							FA305X	FA305R				MD6267D			
5							715	715G							
6							715	715G							
7		MD6166CX					FA54X	FA54R				MD6166D			MD6166CX
8							603								
9							603	603G							
10							603	603G							
11							701	701G							
12							701	701G							
13							715	715G							
14							618	618G							
15							701	701G							
16							715	715G							
17							715	715G							
18							715	715G							
19							715	715G							
20							FA84X	FA84R				MD6025D		MD6025C	
21							FA84X	FA84R				MD6025D		MD6025C	
22							FA84X	FA84R				MD6025D		MD6025C	
23		MD6186CX	OS6186C	OSX6186	BRK025	N/A	N/A	FA84X	FA84R			MD6187D		MD6187C	MD6187CX
24							FA305X	FA305R				MD6267D			
25							603	603G							
26							603	603G							
27							603	603G							
28							FA84X	FA84R				MD6025D		MD6025C	
29							FA84X	FA84R				MD6025D		MD6025C	
30		MD6166CX	OS6186C	OSX6186	BRK025	N/A	N/A	FA84X	FA84R			MD6187D		MD6187C	MD6187CX
31		MD6166CX	OS6186C	OSX6186	BRK025	N/A	N/A	FA84X	FA84R			MD6187D		MD6187C	MD6187CX
32							602	602G							
33							602	602G							
34							603	603G							
35							603	603G							
36							602	602G							
37							602	602G							
38							602	602G							
39							604	604G							
40							604	604G							
41							602	602G							
42							602	602G							
43							702	702G							
44							FA67X	FA67R				MD6161D			
45							FA67X	FA67R				MD6161D			
46		MD6015CX					FA152X	FA152R			MXS152	MD6024D		MD6024C	MD6024CX
47		MD6015CX	OS6015C	OSX6015	BRK023	SMX6015	BRK024	FA152X	FA152R		MXS152	MD6024D		MD6024C	MD6024CX
48		MD6015CX	OS6015C	OSX6015	BRK023	SMX6015	BRK024	FA131X	FA131R		MXS131	MD6024D		MD6024C	MD6024CX
49		MD6213CX	OS6213C	OSX6213	BRK023	SMX6213	BRK024	FA131X	FA131R		MXS131	MD6208D		MD6208C	MD6208CX
50							FA197	FA197HH						MD4172C	
51			OS4171C		BRK040		FA54X	FA54HH						MD4172C	
52			OS4171C		BRK040		FA54X	FA54HH						MD4172C	
53			OS4171	OSX6328	BRK040	SMX6328	TBC	FA84X	FA84R		MXS84			MD6327C	
54			OS4171	OSX6328	BRK040	SMX6328	TBC	FA84X	FA84R		MXS84			MD6327C	
55			OS4171	OSX6328	BRK040	SMX6328	TBC	FA84X	FA84R		MXS84			MD6327C	
56			OS4171	OSX6328	BRK040	SMX6328	TBC	FA54X	FA54R		MXS54			MD6362C	

REAR

BRAKE APPLICATIONS

⚠ This symbol indicates a rotor made of billet steel, and should be only used with EBC FA Kevlar® Organic or Vee pads.
 SAFETY NOTICE - With vehicles primarily designed for off highway use such as quads now being used on the highway, we would recommend the use of X or MXS pads for highway use and ONLY using the R and SV higher density / harder pad series for off road riding.

*-2 Sets Required. † For Vee disc colours add RED, BLU, GRN, GLD, ORG suffix to part number. **SAFETY WARNING:- DO NOT USE HH PADS ON REAR UNLESS ALSO USED ON FRONT TO AVOID BRAKE IMBALANCE**

FRONT: KAWASAKI



KAWASAKI



DISC PAD CHOICES - FRONT

BRAKE ROTOR CHOICES - FRONT

Model	Year	Front Disc Pad Part	Front Disc Pad Description	SV Series Severe Duty Pads	EPFA Sintered Fast Road/Track Pads	GPFAX Sintered RACE ONLY Pads	Specialty Pads SXR/VEE/MXS Race	Rotor Choices			Contour Profile Rotor	Line #
								Standard Rotor Left	Standard Rotor Right	Vintage Rotor / UTV Oversize Brake Kit		
KLT 160 A	85	603	603G									1
KDX 175 A	80-82	704	704G									2
KE 175 D	80-83	704	704G									3
KLF 185 A Bayou	85	NONE	NONE									4
KLF 185 A Bayou	86-88	705*	705G*									5
KLT 185 A	86-87	603	603G									6
KDX 200 A	83-85	703	703G									7
KDX 200 C	86-88	FA67X	FA67R					MD6036D				8
KDX 200 E	89-92	FA67X	FA67R					MD6036D				9
KDX 200 E	93-94	FA135X	FA135R				MXS135	MD6015D			MD6015C	10
KDX 200 H	95-06	FA185X	FA185R		EPFA185HH		MXS185	MD6083D				11
KLT 200 A	81-83	603	603G									12
KLT 200 B	83	603	603G									13
KLT 200 C	83-84	603	603G									14
KDX 220 R A	97-05	FA185X	FA185R		EPFA185HH		MXS185	MD6083D				15
KLF 220 A Bayou	88-02	705*	705G*									16
KLX 230	19-20	FA135X	FA135R				MXS135				TBC	17
KLX 230 R	19-21	FA135X	FA135R				MXS135				TBC	18
EL 250 B Eliminator	88-89	FA85	FA85HH						MD4002RS			19
EL 250 E 250 HS	91-95	FA85	FA85HH									20
EL 250 F EL 252	97-99	FA85	FA85HH							TBC		21
EX 250 E Ninja	86-87	FA85	FA85HH						MD4002LS			22
EX 250 F/D Ninja 250	88-07	FA129	FA129HH		EPFA129HH					MD4041RS		23
EX 250 J (Ninja 250 R)	08-12	FA197	FA197HH		EPFA197HH						MD4162C	24
EBC Floating Front Disc Conversion For Ninja 250 R		FA197	FA197HH		EPFA197HH						MD4162XC	25
KDX 250 A/B	80-82	705	705G									26
KDX 250 B	83-84	705	705G									27
KDX 250 D	91	FA135X	FA135R				MXS135	MD6083D				28
KDX 250 D	92-94	FA135X	FA135R				MXS135	MD6015D			MD6015C	29
KH 250 A	76	711										30
KL 250 A	78-80	705	705G									31
KL 250 A	80-82	704	704G									32
KL 250 C/C	83-84	704	704G									33
KL 250 D (KLR 250)	85-05	FA67X	FA67R					MD6057D				34
KL 250 G Super Sherpa	00-09	FA258X	FA258R					MD6239D				35
KLF 250 A Bayou	03-11	705*	705G*									36
KLT 250 A	82-83	603	603G									37
KLT 250 C Prairie	83-85	603	603G									38
KLT 250 P Police	84	603	603G									39
KLX 250 A	79-80	704	704G									40
KLX 250 R D	94-96	FA185X	FA185R		EPFA185HH		MXS185	MD6015D			MD6015C	41
KLX 250 S (KLX 250 H)	06-07	FA185X	FA185R		EPFA185HH		MXS185	MD6330D			MD6330C	42
												43
KLX 250 S	14-20	FA135X	FA135R				MXS135			MD6330D	MD6330C	44
KLX 250 S (KLX 250 T)	09-21	FA135X	FA135R				MXS135				MD6330C	45
KLX 250 SF (KLX 250 W) Supermotard	09-20	FA135X	FA135R				MXS135				MD6351C	46
KSF 250 A Mojave	87-04	FA128X*	FA128R*	FA128SV*				MD6133D	MD6133D			47
KX 250 A	80-81	705	705G									48
KX 250 B	82	FA83X	FA83R					N/A				49
KX 250 C/D	83-85	FA67X	FA67R					N/A				50
KX 250 D	86	FA67X	FA67R					N/A				51
KX 250 E/F	87-88	FA130X	FA130R					MD6036D				52
KX 250 G/H/J	89-93	FA135X	FA135R				MXS135	MD6015D			MD6015C	53
KX 250 K	94	FA185X	FA185R		EPFA185HH		MXS185	MD6015D			MD6015C	54
KX 250 K/L	95-02	FA185X	FA185R		EPFA185HH		MXS185	MD6015D			MD6015C	55
KX 250 M/R	03-05	FA185X	FA185R		EPFA185HH		MXS185	MD6213D			MD6213C	56

APPLICATIONS

⚡ This symbol indicates a rotor made of billet steel, and should be only used with EBC FA Kevlar® Organic or Vee pads.
SAFETY NOTICE - With vehicles primarily designed for off highway use such as quads now being used on the highway, we would recommend the use of X or MXS pads for highway use and ONLY using the R and SV higher density / harder pad series for off road riding.

*-2 Sets Required. † For Vee disc colours add RED, BLU, GRN, GLD, ORG suffix to part number. **SAFETY WARNING:- DO NOT USE HH PADS ON REAR UNLESS ALSO USED ON FRONT TO AVOID BRAKE IMBALANCE**

FRONT: KAWASAKI Cont'd

REAR: KAWASAKI

Line #

BRAKE ROTOR CHOICES - FRONT							DISC PAD CHOICES - REAR					BRAKE ROTOR CHOICES - REAR					
CC Custom Rotor	CX Extreme® /Vee-Rotor	OS Series Oversize 250/280mm Rotor Kit	OSX Series Oversize 280mm Rotor Kit	Relocating Bracket for Oversize Rotor	SMX Series Oversize 320mm Rotor Kit	Relocating Bracket for 320mm Rotor		Sintered/HH Pads/ Grooved Shoes	SV Series Severe Duty Pads	EPFA Sintered Fast Road/ Track Pads	Specialty Pads SXR/ VEE/MXS Race	Standard Rotor	Vintage Rotor / UTV Oversize Brake Kit	Contour Profile Rotor	CX Extreme® /Vee-Rotor		
1							602	602G									
2							602	602G									
3							703	703G									
4							706	706G									
5							706	706G									
6							602	602G									
7							702	702G									
8							702	702G									
9							FA152X	FA152R				MD6024D		MD6024C			
10		MD6015CX					FA152X	FA152R			MXS152	MD6024D		MD6024C			
11		MD6083CX					FA152X	FA152R			MXS152	MD6105D			MD6105CX		
12							705	705G									
13							705	705G									
14							705	705G									
15		MD6083CX					FA152X	FA152R			MXS152	MD6105D			MD6105CX		
16							706	706G									
17							FA54X	FA54R			MXS54						
18							FA54X	FA54R			MXS54						
19							706										
20							706										
21							706										
22							FA85	FA85HH			FA85V	MD4032					
23							FA141					MD4042					
24							FA197	FA197HH						MD4163C			
25							FA197	FA197HH						MD4163C			
26							605	605G									
27							602	602G									
28		MD6083CX					FA152X	FA152R			MXS152	MD6105D			MD6105CX		
29		MD6015CX					FA152X	FA152R			MXS152	MD6105D			MD6105CX		
30							708										
31							605	605G									
32							703	703G									
33							703	703G									
34							703	703G									
35							FA67X	FA67R				MD6107D					
36							706	706G									
37							705	705G									
38							705	705G									
39							705	705G									
40							602	602G									
41			OS6015C	OSX6015	BRK023	SMX6015	BRK024	FA152X	FA152R		MXS152	MD6085D					
42		MD6330CX	OS6330C	OSX6330	BRK021★	SMX6330	BRK022★	FA131X	FA131R		MXS131	MD6105D			MD6105CX		
43	★ When installing oversize disc kit also order Hose Bracket KHB1																
44		MD6330CX	OS6330C	OSX6330	BRK019	SMX6330	BRK020	FA131X	FA131R		MXS131			MD6326C			
45			OS6329C	OSX6329	BRK019	SMX6329	BRK020	FA131X	FA131R		MXS131			MD6326C			
46								FA131X	FA131R		MXS131			MD6352C			
47								FA84X	FA84R	FA84SV		MD6132D					
48							605	605G									
49							602	602G									
50							602	602G									
51							FA67X	FA67R				MD6161D					
52							FA67X	FA67R				MD6161D					
53		MD6015CX	OS6015C	OSX6015	BRK023	SMX6015	BRK024	FA152X	FA152R		MXS152	MD6024D		MD6024C	MD6024CX		
54		MD6015CX	OS6015C	OSX6015	BRK023	SMX6015	BRK024	FA152X	FA152R		MXS152	MD6024D		MD6024C	MD6024CX		
55		MD6015CX	OS6015C	OSX6015	BRK023	SMX6015	BRK024	FA131X	FA131R		MXS131	MD6024D		MD6024C	MD6024CX		
56		MD6213CX	OS6213C	OSX6213	BRK023	SMX6213	BRK024	FA131X	FA131R		MXS131	MD6208D		MD6208C	MD6208CX		

REAR

BRAKE APPLICATIONS

⚠ This symbol indicates a rotor made of billet steel, and should be only used with EBC FA Kevlar® Organic or Vee pads. SAFETY NOTICE - With vehicles primarily designed for off highway use such as quads now being used on the highway, we would recommend the use of X or MXS pads for highway use and ONLY using the R and SV higher density / harder pad series for off road riding.

*-2 Sets Required. † For Vee disc colours add RED, BLU, GRN, GLD, ORG suffix to part number. SAFETY WARNING: DO NOT USE HH PADS ON REAR UNLESS ALSO USED ON FRONT TO AVOID BRAKE IMBALANCE

FRONT: KAWASAKI



KAWASAKI



DISC PAD CHOICES - FRONT

BRAKE ROTOR CHOICES - FRONT

Model	Year	Front Disc Pad Choice	DISC PAD CHOICES - FRONT				BRAKE ROTOR CHOICES - FRONT				Line #		
			Sintered/HH Pads/Grooved Shoes	SV Series Severe Duty Pads	EPFA Sintered Fast Road/Track Pads	GPFA Sintered RACE ONLY Pads	Specialty Pads SXR/VEE/MXS Race	Standard Rotor Left	Standard Rotor Right	Vintage Rotor / UTV Oversize Brake Kit		Contour Profile Rotor	
KX 250 R (2T)	06-07	FA185X	FA185R		EPFA185HH			MXS185	MD6264D			MD6264C	1
KX 250 N (KX 250 F)	04-05	FA185X	FA185R		EPFA185HH			MXS185	MD6213D			MD6213C	2
KX 250 F (T) (4T)	06-08	FA185X	FA185R		EPFA185HH			MXS185	MD6264D			MD6264C	3
KX 250 F (W/X/Y/Z) (4T)	09-14	FA185X	FA185R		EPFA185HH			MXS185				MD6264C	4
KX 250 F (F-rotor 270mm, R-rotor 240mm)	15-19	FA185X	FA185R		EPFA185HH			MXS185				MD6388C	5
KX 250 F (F-rotor 270mm, R-rotor 250mm)	20	FA185X	FA185R		EPFA185HH			MXS185				MD6388C	6
KX 250 F (F-rotor 270mm, R-rotor 240mm)	21-22	FA185X	FA185R		EPFA185HH			MXS185				MD6388C	7
KX-F 250 XC F (4T) 270mm f/disc, 240mm r/disc, 18" rear wheel	21-22	FA185X	FA185R		EPFA185HH			MXS185				MD6388C	8
KXF 250 A Tecate	87-88	FA128X*	FA128R*	FA128SV*					MD6133D	MD6133D			9
KXT 250 A Tecate	84	705	705G										10
KXT 250 A Tecate	85	FA67X	FA67R	FA67SV					N/A				11
KXT 250 B Tecate	86	FA67X	FA67R	FA67SV					MD6138D				12
KXT 250 B Tecate	87	FA67X	FA67R	FA67SV					MD6138D				13
KZ 250 D (LTD)/D(CSR)	80-81	605											14
KZ 250 L (CSR)	82	605											15
KZ 250 W (LTD)	83	605											16
S1-A/B/C (250cc)	73-75	711											17
300 Ninja (EX 300 A) Non ABS	13-16	FA197	FA197HH		EPFA197HH							MD4166C	18
EBC Floating Front Disc Conversion For Ninja 300												MD4166XC	19
300 Ninja SE (EX 300 A) Non ABS	14-16	FA197	FA197HH		EPFA197HH							MD4166C	20
EBC Floating Front Disc Conversion For Ninja 300 SE												MD4166XC	21
300 Ninja (EX 300 B) ABS Model	13-16	FA197	FA197HH		EPFA197HH							MD4166C	22
EBC Floating Front Disc Conversion For Ninja 300												MD4166XC	23
300 Ninja SE (EX 300 B) ABS Model	13-16	FA197	FA197HH		EPFA197HH							MD4166C	24
EBC Floating Front Disc Conversion For Ninja 300												MD4166XC	25
KAF 300 A/B (Mule 500)	92-95	628*	628G*										26
KAF 300 C (Mule 550)	97-03	628*	628G*										27
KAF 300 D (Mule 520)		628*	628G*										28
KEF 300 A Lakota	95-00	FA128X*	FA128R*	FA128SV*					MD6133D	MD6133D			29
KEF 300 B Lakota Sport	01-03	FA128X*	FA128R*	FA128SV*					MD6133D	MD6133D			30
KLF 300 A Bayou	86-87	717*	717G*										31
KLF 300 B Bayou	88-04	FA67X*	FA67R*	FA67SV*					MD6133D	MD6133D			32
KLF 300 C Bayou (4x4)	89-05	FA165X	FA165R	FA165SV					MD6131D				33
		FA135X	FA135R	FA135SV						MD6131D			34
KLX 300 R A	97-07	FA185X	FA185R		EPFA185HH			MXS185	MD6015D			MD6015C	35
KLX 300	21	FA135X	FA135R					MXS135				MD6015C	36
KLX 300 R	19-21	FA135X	FA135R					MXS135				MD6388C	37
KVF 300 A (4 x 4) Prairie	99-02	FA54X*	FA54R*	FA54SV*					MD6131D	MD6131D			38
KVF 300 B (2 x 4) Prairie	99-02	FA54X*	FA54R*	FA54SV*					MD6131D	MD6131D			39
KVF 300 C Brute Force	12-21	FA377X*	FA377R*						MD6267D	MD6267D			40
KLE 300 Versys-X	18-21	FA142	FA142HH	FA142V								MD4166XC	41
KZ 305 A (CSR)	81-82	FA68	FA68HH						MD4043LS				42
KZ 305 B (CSR)	82	FA68	FA68HH						MD4043LS				43
KZ 305 B (LTD)	87-88	FA68	FA68HH						MD4043LS				44
EX 305 B (GPz)	83	FA85	FA85HH						MD4099				45
S2 (350cc)	72-73	711											46
S2-A (350cc)	72-73	FA33							N/A				47
KVF 360 A Prairie 360 4x4	03-12	FA54X*	FA54R*	FA54SV*					MD6188D	MD6188D	UTVX6188*		48
KVF 360 B Prairie 360	03-09	FA54X*	FA54R*	FA54SV*					MD6188D	MD6188D	UTVX6188*		49
KVF 360 C Prairie 360 4x4 Hardwoods Green HD	03-11	FA54X*	FA54R*	FA54SV*					MD6188D	MD6188D	UTVX6188*		50
KAF 400 B (Mule 600)	05	718*	N/A*										51
KAF 400 A/C (Mule 610 4x4)	05	718*	N/A*										52
KAF 400 A (Mule 610 4x4)	06-10	718*	N/A*										53
KAF 400 A (Mule 610 4x4)	11-16	718*	N/A*										54
KAF 400 B (Mule 600)	06-16	718*	N/A*										55
KAF 400 C (Mule 610 4x4 Hardwoods Green HD)	06-09	718*	N/A*										56

*-2 Sets Required. † For Vee disc colours add RED, BLU, GRN, GLD, ORG suffix to part number. **SAFETY WARNING:- DO NOT USE HH PADS ON REAR UNLESS ALSO USED ON FRONT TO AVOID BRAKE IMBALANCE**

APPLICATIONS

BRAKE

⊛ This symbol indicates a rotor made of billet steel, and should be only used with EBC FA Kevlar® Organic or Vee pads.

SAFETY NOTICE - With vehicles primarily designed for off highway use such as quads now being used on the highway, we would recommend the use of X or MXS pads for highway use and ONLY using the R and SV higher density / harder pad series for off road riding.

FRONT: KAWASAKI Cont'd

REAR: KAWASAKI

BRAKE ROTOR CHOICES - FRONT

DISC PAD CHOICES - REAR

BRAKE ROTOR CHOICES - REAR

Line #

CC Custom Rotor	CX Extreme® /Vee-Rotor	OS Series Oversize 250/280mm Rotor Kit	OSX Series Oversize 280mm Rotor Kit	Relocating Bracket for Oversize Rotor	SMX Series Oversize 320mm Rotor Kit	Relocating Bracket for 320mm Rotor		Sintered/HH Pads/ Grooved Shoes	SV Series Severe Duty Pads	EPFA Sintered Fast Road/ Track Pads	Specialty Pads SXR/ VEE/MXS Race	Standard Rotor	Vintage Rotor / UTV Oversize Brake Kit	Contour Profile Rotor	CX Extreme® /Vee-Rotor
1	MD6264CX	OS6264C	OSX6264	BRK023	SMX6264	BRK024	FA131X	FA131R			MXS131	MD6208D		MD6208C	MD6208CX
2	MD6213CX	OS6213C	OSX6213	BRK023	SMX6213	BRK024	FA367X	FA367R			MXS367	MD6208D		MD6208C	MD6208CX
3	MD6264CX	OS6264C	OSX6264	BRK023	SMX6264	BRK024	FA367X	FA367R			MXS367	MD6208D		MD6208C	MD6208CX
4	MD6264CX	OS6264C	OSX6264	BRK023	SMX6264	BRK024	FA367X	FA367R			MXS367			MD6208C	MD6208CX
5	MD6388CX						FA367X	FA367R			MXS367			MD6208C	MD6208CX
6	MD6388CX						FA367X	FA367R			MXS367	MD6421D		MD6421C	MD6421CX
7	MD6388CX						FA367X	FA367R			MXS367			MD6208C	MD6208CX
8	MD6388CX						FA367X	FA367R			MXS367			MD6208C	MD6208CX
9							FA84X	FA84R	FA84SV			MD6136D			
10							FA83X	FA83R				N/A			
11							FA67X	FA67R	FA67SV			N/A			
12							FA67X	FA67R	FA67SV			MD6138D			
13							FA84X	FA84R	FA84SV			MD6134D			
14							602								
15							602								
16							602								
17							708								
18							FA197	FA197HH						MD4163C	VR4163
19	VR4166BLK						FA197	FA197HH						MD4163C	VR4163
20															
21	VR4166BLK														
22							FA197	FA197HH						MD4179AC	
23	VR4166BLK														TBC
24							FA197	FA197HH						MD4179AC	
25	VR4166BLK														TBC
26							718*	N/A							
27							718*	N/A							
28							718*	N/A							
29							FA84X	FA84R	FA84SV			MD6132D			
30							FA84X	FA84R	FA84SV			MD6132D			
31							706*	706G*							
32							706*	706G*							
33							710	710G							
34															
35	MD6015CX						FA131X	FA131R			MXS131	MD6105D			MD6105CX
36	MD6015CX						FA131X	FA131R			MXS131			MD6326C	
37	MD6388CX						FA131X	FA131R			MXS131			MD6326C	
38							710	710G							
39							710	710G							
40							FA377X	FA377R				MD6267D			
41							FA197	FA197HH						MD4179AC	
42							706								
43							706								
44							706								
45							706								
46							708								
47							708								
48							N/A								
49							N/A								
50							N/A								
51							718*	N/A*							
52							718*	N/A*							
53							718*	N/A*							
54							719*	N/A*							
55							718*	N/A*							
56							718*	N/A*							

REAR

BRAKE APPLICATIONS

⚠ This symbol indicates a rotor made of billet steel, and should be only used with EBC FA Kevlar® Organic or Vee pads.
 SAFETY NOTICE - With vehicles primarily designed for off highway use such as quads now being used on the highway, we would recommend the use of X or MXS pads for highway use and ONLY using the R and SV higher density / harder pad series for off road riding.

*-2 Sets Required. † For Vee disc colours add RED, BLU, GRN, GLD, ORG suffix to part number. **SAFETY WARNING:** DO NOT USE HH PADS ON REAR UNLESS ALSO USED ON FRONT TO AVOID BRAKE IMBALANCE

FRONT: KAWASAKI



KAWASAKI



DISC PAD CHOICES - FRONT

BRAKE ROTOR CHOICES - FRONT

Model	Year	Side	DISC PAD CHOICES - FRONT					BRAKE ROTOR CHOICES - FRONT				Line #		
			Disc Pad Icon	Sintered/HH Pads/Grooved Shoes	SV Series Severe Duty Pads	EPFA Sintered Fast Road/Track Pads	GPFAX Sintered RACE ONLY Pads	Specialty Pads SXR/VEE/MXS Race	Standard Rotor Left	Standard Rotor Right	Vintage Rotor / UTV Oversize Brake Kit		Contour Profile Rotor	
KAF 400 D (Mule 610 4x4 XC)	10-16			718*	N/A*									1
KAF 400 F (Mule 610 4x4 XC - SE)	14-16			718*	N/A*									2
KAF 400 E (Mule 610 4x4 XC Realtree/Camo)	11-16			718*	N/A*									3
KAF 400 G (Mule 610 4x4 SE)	16			718*	N/A*									4
KAF 400 J (Mule SX)	17			718*	N/A*									5
KAF 400 H (Mule SX 4x4)	17			718*	N/A*									6
KAF 400 N (Mule SX 4x4 SE)	17			718*	N/A*									7
KAF 400 K (Mule SX 4x4 XC)	17			718*	N/A*									8
KAF 400 L (Mule SX 4x4 XC Camo)	17			718*	N/A*									9
KAF 400 M (Mule SX 4x4 XC SE)	17			718*	N/A*									10
KDX 400 A	79-80			705	705G									11
KH 400 A	76-78			FA33								VMD4123		12
KLF 400 B Bayou (4 x 4)	93-99	Left		FA165X	FA165R	FA165SV					MD6131D			13
		Right		FA135X	FA135R	FA135SV					MD6131D			14
KLX 400 SR (KLX 400 A)	03-04			FA185X	FA185R		EPFA185HH		MXS185	MD6017D			MD6017C	15
KLX 400 R (KLX 400 B)	03-04			FA185X	FA185R		EPFA185HH		MXS185	MD6017D			MD6017C	16
KSF 400 A (KFX 400)	03-05			FA84X*	FA84R*	FA84SV*				MD6210D	MD6210D			17
KVF 400 A/B Prairie	97-98			FA54X*	FA54R*	FA54SV*				MD6131D	MD6131D			18
KVF 400 C (4 x 4) Prairie	99-02			FA54X*	FA54R*	FA54SV*				MD6131D	MD6131D			19
KVF 400 D (2 x 4) Prairie	99-02			FA54X*	FA54R*	FA54SV*				MD6131D	MD6131D			20
KZ 400 S Series	75-77			711										21
S3/S3-A (400cc)	74-75			FA33						N/A				22
Ninja EX 400 ABS	17-21			FA197	FA197HH		EPFA197HH	GPFAX197HH		MD4174X			MD4174XC	23
Ninja EX 400 KRT ABS	18-21			FA197	FA197HH		EPFA197HH	GPFAX197HH		MD4174X			MD4174XC	24
Z 400 ABS	19-21			FA197	FA197HH		EPFA197HH	GPFAX197HH		MD4174X			MD4174XC	25
KDX 420 B	81			705	705G									26
KX 420 A	80-81			705	705G									27
KZ 440 A	80-82			FA73						MD4047LS				28
KZ 440 A	83			FA68	FA68HH					MD4047LS				29
KZ 440 B	80-81			711										30
KZ 440 K/D (LTD)	80-82			FA73						MD4047LS				31
KZ 440 D (LTD)	83			FA68	FA68HH					MD4010LS				32
KZ 440 G	82			FA68	FA68HH					MD4010LS				33
EN 450 A (454 LTD)	85-90			FA85	FA85HH					MD4006LS				34
KAF 450 B (Mule 1000)				719*	N/A*									35
KDX 450 A	82			705	705G									36
KFX 450 R (KSF 450 B)	08-14	Left			FA342R	FA342SV					MD6137D			37
		Right			FA349R	FA349SV					MD6137D			38
KLX 450 R A	08-12			FA185X	FA185R		EPFA185HH		MXS185				MD6264C	39
														40
KX 450 F (D)	06-08			FA185X	FA185R		EPFA185HH		MXS185		MD6264D		MD6264C	41
KX 450 F E/F (4T)	09-14			FA185X	FA185R		EPFA185HH		MXS185				MD6264C	42
KX 450 F (F/H) (4T) 270mm Front Rotor	15-17			FA185X	FA185R		EPFA185HH		MXS185				MD6388C	43
KX 450 F (4T) 270mm Front 250mm Rear Rotor	18-22			FA185X	FA185R		EPFA185HH		MXS185				MD6388C	44
KX 450 XC (4T) 270mm F/Disc / 240mm R/Disc 18" rear wheel	21-22			FA185X	FA185R		EPFA185HH		MXS185				MD6388C	45
KX 450 F (4T) Tomac	18-19			FA185X	FA185R				MXS185				MD6388C	46
EX 500 A Solid rotor	87-93			FA129	FA129HH		EPFA129HH			MD4016				47
EX 500 A EBC floating conversion	87-93			FA129	FA129HH		EPFA129HH			MD714X				48
EX 500 D Ninja 500 Solid rotor	94-09			FA129	FA129HH		EPFA129HH				MD4016			49
EX 500 D Ninja 500 EBC floating conversion	94-09			FA129	FA129HH		EPFA129HH				MD714X			50
EN 500 A/B	90-95			FA85	FA85HH					MD4006LS				51
EN 500 C Vulcan	96-09			FA85	FA85HH					MD4124LS				52
HI 500 Mach III	69-70			N/A										53
HI-A 500 S Mach III	71			N/A										54
HI-B 500 Mach III	72			N/A										55
HI-C 500 Mach III	72			N/A										56

APPLIATIONS
BRAKE
SAFETY NOTICE - With vehicles primarily designed for off highway use such as quads now being used on the highway, we would recommend the use of X or MXS pads for highway use and ONLY using the R and SV higher density / harder pad series for off road riding.

⚡ This symbol indicates a rotor made of billet steel, and should be only used with EBC FA Kevlar® Organic or Vee pads.

*-2 Sets Required. † For Vee disc colours add RED, BLU, GRN, GLD, ORG suffix to part number. **SAFETY WARNING:- DO NOT USE HH PADS ON REAR UNLESS ALSO USED ON FRONT TO AVOID BRAKE IMBALANCE**

FRONT: KAWASAKI Cont'd

REAR: KAWASAKI

Line #

BRAKE ROTOR CHOICES - FRONT							DISC PAD CHOICES - REAR					BRAKE ROTOR CHOICES - REAR			
CC Custom Rotor	CX Extreme® /Vee-Rotor	OS Series Oversize 250/280mm Rotor Kit	OSX Series Oversize 280mm Rotor Kit	Relocating Bracket for Oversize Rotor	SMX Series Oversize 320mm Rotor Kit	Relocating Bracket for 320mm Rotor		Sintered/HH Pads/ Grooved Shoes	SV Series Severe Duty Pads	EPFA Sintered Fast Road/ Track Pads	Specialty Pads SXR/ VEE/MXS Race	Standard Rotor	Vintage Rotor / UTV Oversize Brake Kit	Contour Profile Rotor	CX Extreme® /Vee-Rotor
1							719*	N/A*							
2							719*	N/A*							
3							719*	N/A*							
4							718*	N/A*							
5							718*	N/A*							
6							718*	N/A*							
7							718*	N/A*							
8							718*	N/A*							
9							718*	N/A*							
10							718*	N/A*							
11							605	605G							
12							708								
13							710	710G							
14															
15	MD6017CX	OS6017C	OSX6017	BRK023	SMX6017	BRK024	FA131X	FA131R			MXS131	MD6014D		MD6014C	MD6014CX
16	MD6017CX	OS6017C	OSX6017	BRK023	SMX6017	BRK024	FA131X	FA131R			MXS131	MD6014D		MD6014C	MD6014CX
17							FA137X	FA137R	FA137SV			MD6211D			
18							710	710G							
19							710	710G							
20							710	710G							
21							708								
22							708								
23							FA197	FA197HH		EPFA197HH				MD4179AC	
24							FA197	FA197HH		EPFA197HH				MD4179AC	
25							FA197	FA197HH		EPFA197HH					
26							605	605G							
27							605	605G							
28							706								
29							706								
30							706								
31							706								
32							706								
33							706								
34							709								
35							720*	N/A*							
36							605	605G							
37							FA84X	FA84R	FA84SV					MD6304C	
38															
39	MD6264CX	OS6264C	OSX6264	BRK023	SMX6264	BRK024	FA367X	FA367R			MXS367			MD6208C●	MD6208CX
40							MD6208C● = PLAIN UNDRILLED DISC FOR ENDURO USE. REAR FITMENTS ONLY. ORDER MD6208CE.								
41	MD6264CX	OS6264C	OSX6264	BRK023	SMX6264	BRK024	FA367X	FA367R			MXS367	MD6208D		MD6208C	MD6208CX
42	MD6264CX	OS6264C	OSX6264	BRK023	SMX6264	BRK024	FA367X	FA367R			MXS367	MD6208D		MD6208C	MD6208CX
43	MD6388CX						FA367X	FA367R			MXS367			MD6208C	MD6208CX
44	MD6388CX						FA367X	FA367R			MXS367	MD6421D		MD6421C	MD6421CX
45	MD6388CX						FA367X	FA367R			MXS367			MD6208C	MD6208CX
46	MD6388CX						FA367X	FA367R			MXS367	MD6421D		MD6421C	MD6421CX
47							706								
48							706								
49							FA67/3					MD4051			
50							FA67/3					MD4051			
51							709								
52							709								
53							N/A								
54							N/A								
55							N/A								
56							N/A								

● This symbol indicates a rotor made of billet steel, and should be only used with EBC FA Kevlar® Organic or Vee pads.
 SAFETY NOTICE - With vehicles primarily designed for off highway use such as quads now being used on the highway, we would recommend the use of X or MXS pads for highway use and ONLY using the R and SV higher density / harder pad series for off road riding.

BRAKE APPLICATIONS

*-2 Sets Required. † For Vee disc colours add RED, BLU, GRN, GLD, ORG suffix to part number. **SAFETY WARNING:- DO NOT USE HH PADS ON REAR UNLESS ALSO USED ON FRONT TO AVOID BRAKE IMBALANCE**

FRONT: KAWASAKI



KAWASAKI



DISC PAD CHOICES - FRONT

BRAKE ROTOR CHOICES - FRONT

											Line #
HI-D 500	73	FA55					MD4069LS		VMD4069		1
HI-E 500	74	FA55					MD4069LS		VMD4069		2
HI-F 500	75	FA55					MD4069LS		VMD4069		3
KH 500 A	76	FA33					MD4052LS		VMD4052		4
KX 500 A/B	83-85	FA67X	FA67R								5
KX 500 B	86	FA67X	FA67R								6
KX 500 C/D	87-88	FA130X	FA130R				MD6036D				7
KX 500 E	89-93	FA135X	FA135R			MXS135	MD6015D			MD6015C	8
KX 500 E	94-95	FA185X	FA185R	EPFA185HH		MXS185	MD6015D			MD6015C	9
KX 500 E	96-04	FA185X	FA185R	EPFA185HH		MXS185	MD6015D			MD6015C	10
KAF 540 C (Mule 2010)		719*	N/A*								11
KAF 540 D (Mule 2020)		719*	N/A*								12
KAF 540 E (Mule 2030)		719*	N/A*								13
KZ 550 A	80	FA73					MD4053LS				14
KZ 550 A	81-83	FA68	FA68HH				MD4006LS				15
KZ 550 C (LTD)	80-83	FA68	FA68HH				MD4006LS				16
KZ 550 D (GPz)	81	FA68*	FA68HH*				MD4010LS	MD4010RS			17
KZ 550 F (Spectre) (LTD)	83-84	FA68	FA68HH				MD4006LS				18
KZ 550 H (GPz)	82-83	FA68*	FA68HH*				MD4099	MD4099			19
KZ 550 M (LTD)	83	FA68	FA68HH				MD4006LS				20
ZR 550 B Zephyr	90-92	FA129*	FA129HH*	EPFA129HH*			MD4008X	MD4008X		MD4008XC*	21
ZR 550 B Zephyr	93	FA129*	FA129HH*	EPFA129HH*			MD4008X	MD4008X		MD4008XC*	22
ZX 550 A (GPz)	84-86	FA85*	FA85HH*				MD4002LS	MD4002RS			23
KL 600 A	84	FA67X	FA67R				MD6080D				24
KL 600 B (KLR)	85-86	FA67X	FA67R				MD6080D				25
ZL 600 A	86-87	FA85	FA85HH			FA85V	MD4016				26
ZL 600 B Eliminator	96-97	FA129	FA129HH	EPFA129HH		FA129V		MD4008		MD4008C	27
ZX 600 A/B Ninja	85-87	FA85*	FA85HH*				MD4028	MD4028			28
ZX 600 C Ninja 600 R	88-96	FA129*	FA129HH*	EPFA129HH*			MD4026LS	MD4026RS			29
ZX 600 E (Ninja ZX6)	93-95	FA158*	FA158HH*	EPFA158HH*			MD4008X	MD4008X		MD4008XC*	30
ZX 600 E (ZZR 600)	96-05	FA158*	FA158HH*	EPFA158HH*			MD4153X	MD4153X		MD4153XC*	31
ZX 600 D (ZX6)	90-93	FA158*	FA158HH*	EPFA158HH*			MD4141X	MD4141X		MD4141XC*	32
ZX6R (ZX 600 F)	95-97	FA158*	FA158HH*	EPFA158HH*			MD4008X	MD4008X		MD4008XC*	33
ZX6R (ZX 600 G/J)	98-02	FA188*	FA188HH*	EPFA188HH*			MD4136X	MD4136X		MD4136XC*	34
ZX6R (ZX 600 P/R)	07-12		FA417/4HH*	EPFA417/4HH*GPFA417/4HH*						MD4152XC*	35
ZX6RR (ZX 600 K/M) 599cc	03-04		FA369/4HH*	EPFA369/4HH*			MD4151X	MD4151X		MD4151XC*	36
ZX6RR (ZX 600 N) 599cc	05-06		FA369/4HH*	EPFA369/4HH*						MD4152XC*	37
ZZR 600 (ZX 600 J)	05	FA188*	FA188HH*	EPFA188HH*			MD4136X	MD4136X		MD4136XC*	38
ZZR 600 J	06-08	FA188*	FA188HH*	EPFA188HH*			MD4136X	MD4136X		MD4136XC*	39
KAF 620 A (Mule 2510)		719*	N/A*								40
KAF 620 B (Mule 2520)		719*	N/A*								41
KAF 620 C (Mule 2500)		719*	N/A*								42
KAF 620 E Mule 3010		719*	N/A*								43
KAF 620 F Mule 3020		719*	N/A*								44
KAF 620 G Mule 3000		719*	N/A*								45
KAF 620 H Mule 3010 4x4	03-05	719*	N/A*								46
KAF 620 K Mule 3010 Trans 4x4	05-07	719*	N/A*								47
KAF 620 J Mule 3010 Trans 4x4	05	719*	N/A*								48
KAF 620 M (Mule 4010 4x4)	09-17	719*	N/A*								49
KAF 620 N (Mule 4010 4x4 Hardwoods Green)	09	719*	N/A*								50
KAF 620 P (Mule 4000)	09-17	719*	N/A*								51
KAF 620 R (Mule 4010 Trans 4x4)	09-17	719*	N/A*								52
KAF 620 S (Mule 4010 Trans 4x4 Hardwoods Green HD)	09-17	719*	N/A*								53
KAF 620 T (Mule 4010 4x4 SE)	16-17	719*	N/A*								54
KAF 620 V (Mule 4010 Trans 4x4 SE)	16-17	719*	N/A*								55
ZX6R (ZX 636 A) 636cc	02	FA188*	FA188HH*	EPFA188HH*			MD4136X	MD4136X		MD4136XC*	56

FRONT

BRAKE APPLICATIONS

* This symbol indicates a rotor made of billet steel, and should be only used with EBC FA Kevlar® Organic or Vee pads. SAFETY NOTICE - With vehicles primarily designed for off highway use such as quads now being used on the highway, we would recommend the use of X or MXS pads for highway use and ONLY using the R and SV higher density / harder pad series for off road riding.

*-2 Sets Required. † For Vee disc colours add RED, BLU, GRN, GLD, ORG suffix to part number. **SAFETY WARNING:- DO NOT USE HH PADS ON REAR UNLESS ALSO USED ON FRONT TO AVOID BRAKE IMBALANCE**

FRONT: KAWASAKI Cont'd

REAR: KAWASAKI

Line #

BRAKE ROTOR CHOICES - FRONT							DISC PAD CHOICES - REAR					BRAKE ROTOR CHOICES - REAR			
CC Custom Rotor	CX Extreme® /Vee-Rotor	OS Series Oversize 250/280mm Rotor Kit	OSX Series Oversize 280mm Rotor Kit	Relocating Bracket for Oversize Rotor	SMX Series Oversize 320mm Rotor Kit	Relocating Bracket for 320mm Rotor		Sintered/HH Pads/ Grooved Shoes	SV Series Severe Duty Pads	EPFA Sintered Fast Road/ Track Pads	Specialty Pads SXR/ VEE/MXS Race	Standard Rotor	Vintage Rotor / UTV Oversize Brake Kit	Contour Profile Rotor	CX Extreme® /Vee-Rotor
1							710								
2							710								
3							710								
4							710								
5							602	602G							
6							FA67X	FA67R				MD6161D			
7							FA67X	FA67R				MD6161D			
8							FA152X	FA152R			MXS152	MD6024D		MD6024C	MD6024CX
9		MD6015CX	OS6015C	OSX6015	BRK023	SMX6015	BRK024	FA152X	FA152R		MXS152	MD6024D		MD6024C	MD6024CX
10		MD6015CX	OS6015C	OSX6015	BRK023	SMX6015	BRK024	FA131X	FA131R		MXS131	MD6024D		MD6024C	MD6024CX
11							720*	N/A*							
12							720*	N/A*							
13							720*	N/A*							
14							709								
15							709								
16							709								
17							FA68	FA68HH			FA68V	MD4169			
18							709								
19							FA68	FA68HH			FA68V	MD4024			
20							709								
21	MD4008CC*	VR4008BLK*†					FA141					MD4009		MD4009C	VR4009
22	MD4008CC*	VR4008BLK*†					FA192	FA192HH			FA192V	MD4009		MD4009C	VR4009
23							FA85	FA85HH			FA85V	MD4001			
24							602	602G							
25							602	602G							
26							709								
27	MD4008CC	VR4008BLK					709								
28							FA85	FA85HH			FA85V	MD4015			
29							FA129	FA129HH		EPFA129HH	FA129V	MD4027			
30	MD4008CC*	VR4008BLK*†					FA192	FA192HH			FA192V	MD4009		MD4009C	VR4009
31	MD4153CC*	VR4153BLK*†					FA192	FA192HH			FA192V	MD4009		MD4009C	VR4009
32	MD4141CC*						FA129	FA129HH		EPFA129HH	FA129V	MD4007		MD4007C	
33	MD4008CC*	VR4008BLK*†					FA192	FA192HH			FA192V	MD4023		MD4023C	VR4023
34	MD4136CC*	VR4136BLK*†					FA192	FA192HH			FA192V	MD4138		MD4138C	VR4138
35	MD4152CC*	VR4152BLK*†					FA192	FA192HH			FA192V			MD4138C	VR4138
36							FA192	FA192HH			FA192V	MD4138		MD4138C	VR4138
37	MD4152CC*	VR4152BLK*†					FA192	FA192HH			FA192V	MD4138		MD4138C	VR4138
38	MD4136CC*	VR4136BLK*†					FA192	FA192HH			FA192V	MD4138		MD4138C	VR4138
39	MD4136CC*	VR4136BLK*†					FA192	FA192HH			FA192V	MD4138		MD4138C	VR4138
40							720*	N/A*							
41							720*	N/A*							
42							720*	N/A*							
43							720*	N/A*							
44							720*	N/A*							
45							720*	N/A*							
46							720*	N/A*							
47							720*	N/A*							
48							720*	N/A*							
49							720*	N/A*							
50							720*	N/A*							
51							720*	N/A*							
52							720*	N/A*							
53							720*	N/A*							
54							720*	N/A*							
55							720*	N/A*							
56	MD4136CC*	VR4136BLK*†					FA192	FA192HH			FA192V	MD4138		MD4138C	VR4138

REAR

BRAKE APPLICATIONS

⚠ This symbol indicates a rotor made of billet steel, and should be only used with EBC FA Kevlar® Organic or Vee pads. SAFETY NOTICE - With vehicles primarily designed for off highway use such as quads now being used on the highway, we would recommend the use of X or MXS pads for highway use and ONLY using the R and SV higher density / harder pad series for off road riding.

*-2 Sets Required. † For Vee disc colours add RED, BLU, GRN, GLD, ORG suffix to part number. SAFETY WARNING: DO NOT USE HH PADS ON REAR UNLESS ALSO USED ON FRONT TO AVOID BRAKE IMBALANCE

FRONT: KAWASAKI



KAWASAKI



DISC PAD CHOICES - FRONT

BRAKE ROTOR CHOICES - FRONT

Model	Year	Front	Sintered/HH Pads/Grooved Shoes	SV Series Severe Duty Pads	EPFA Sintered Fast Road/Track Pads	GPFAX Sintered RACE ONLY Pads	Specialty Pads SXR/VEE/MXS Race	Standard Rotor		Vintage Rotor / UTV Oversize Brake Kit	Contour Profile Rotor	Line #
								Standard Rotor Left	Standard Rotor Right			
ZX6R (ZX 636 B) 636cc	03-04		FA369/4HH*		EPFA369/4HH*			MD4151X	MD4151X		MD4151XC*	1
ZX6R (ZX 636 C) 636cc	05-06		FA369/4HH*		EPFA369/4HH*						MD4152XC*	2
ZX6R (ZX 636 E) Non ABS	13-17		FA296HH*		EPFA296HH*	GPFAX296HH*					MD4155XC*	3
ZX6R (ZX 636 E) 636 cc/Non ABS/30th Anniversary Edition	15		FA296HH*		EPFA296HH*	GPFAX296HH*					MD4155XC*	4
ZX6R (ZX 636 E) 636 cc/Non ABS/KRT Edition	16-17		FA296HH*		EPFA296HH*	GPFAX296HH*					MD4155XC*	5
ZX6R (ZX 636 F) ABS Model	13-17		FA296HH*		EPFA296HH*	GPFAX296HH*					MD4155XC*	6
ZX6R (ZX 636 F) 636 cc/ABS/30th Anniversary Edition ABS	15		FA296HH*		EPFA296HH*	GPFAX296HH*					MD4155XC*	7
ZX6R (ZX 636 F) 636 cc/ABS/ KRT Edition	16-17		FA296HH*		EPFA296HH*	GPFAX296HH*					MD4155XC*	8
ZX 6R (ZX 636 E)JF	18-21		FA296HH*		EPFA296HH*	GPFAX296HH*					MD4155XC*	9
ZX 6R ABS (ZX 636 E)JF	18-21		FA296HH*		EPFA296HH*	GPFAX296HH*					MD4155XC*	10
ZX 6R ABS KRT Edition (ZX 636 E)JF	18-21		FA296HH*		EPFA296HH*	GPFAX296HH*					MD4155XC*	11
EN 650 Vulcan S (Non ABS) - EN 650 A	15-20		FA281HH						TBC			12
EN 650 Vulcan S (ABS) - EN 650 B	15-21		FA281HH						TBC			13
EN 650 Vulcan S Café (ABS)	18-21		FA281HH									14
EN 650 Vulcan S (ABS) SE	18-21		FA281HH									15
ER 650 C ER-6n	09-10	Left	FA229	FA229HH	EPFA229HH						MD4159XC	16
		Right	FA231	FA231HH	EPFA231HH						MD4159XC	17
EX 650 Ninja 650 R (A/C) Ninja 650R	06-10	Left	FA229	FA229HH	EPFA229HH						MD4159XC	18
		Right	FA231	FA231HH	EPFA231HH						MD4159XC	19
EX 650 Ninja 650 R (EX 650 C)	11	Left	FA229	FA229HH	EPFA229HH						MD4159XC	20
		Right	FA231	FA231HH	EPFA231HH						MD4159XC	21
EX 650 Ninja 650 (EX 650 E) Non ABS	12-16	Left	FA229	FA229HH	EPFA229HH						MD4159XC	22
		Right	FA231	FA231HH	EPFA231HH						MD4159XC	23
EX 650 Ninja 650 (EX 650 F) ABS Model	13-16	Left	FA229	FA229HH	EPFA229HH						MD4156AXC	24
		Right	FA231	FA231HH	EPFA231HH						MD4156XC	25
Ninja 650 (EX 650 KH/KHFA - ABS)	17-21	Left	FA226	FA226HH	EPFA226HH						MD4156AXC	26
		Right	FA226	FA226HH	EPFA226HH						MD4156XC	27
Ninja 650 (EX 650 JHF - Non ABS)	17	Left	FA226	FA226HH	EPFA226HH						MD4156AXC	28
		Right	FA226	FA226HH	EPFA226HH						MD4156XC	29
Ninja 650 KRT Edition ABS	18-21	Left	FA226	FA226HH	EPFA226HH						MD4156AXC	30
		Right	FA226	FA226HH	EPFA226HH						MD4156XC	31
KL 650 A (KLR)	87-07		FA130X	FA130R			FA130V	MD6042D			MD6042C	32
KL 650 B Tengai	90-91		FA129	FA129R				MD6081D				33
KL 650 E (KLR 650)	08-15			FA228HH							MD6309C	34
KLE 650 A/C Versys	07-14	Left	FA229	FA229HH	EPFA229HH						MD4159XC	35
		Right	FA231	FA231HH	EPFA231HH						MD4159XC	36
KLE 650 D Versys (ABS Model)	14	Left	FA229	FA229HH	EPFA229HH						MD4156AXC	37
		Right	FA231	FA231HH	EPFA231HH						MD4159XC	38
KLE 650 F Versys/Versys LT (ABS Model)	15		FA142*	FA142HH*			FA142V*	MD4156AXC	MD4156AXC		TBC*	39
KLE 650 F Versys/Versys LT (ABS Model)	16-20		FA142*	FA142HH*			FA142V*	MD4156AXC	MD4156AXC		TBC*	40
KLE 650 Versys	20-21		FA142*	FA142HH*			FA142V*	MD4156AXC	MD4156AXC		TBC*	41
KLE 650 Versys Tourer	20-21		FA142*	FA142HH*			FA142V*	MD4156AXC	MD4156AXC		TBC*	42
KLE 650 Versys Grand Tourer	20-21		FA142*	FA142HH*			FA142V*	MD4156AXC	MD4156AXC		TBC*	43
KLX 650 R A	93-95		FA185X	FA185R	EPFA185HH		MXS185	MD6015D			MD6015C	44
KLX 650 R D	96		FA185X	FA185R	EPFA185HH		MXS185	MD6015D			MD6015C	45
KLX 650 C	93-96		FA185X	FA185R	EPFA185HH		MXS185	MD6086D				46
KVF 650 A/B Prairie	02-03	Left	FA342R	FA342SV				MD6188D		UTVX6188		47
		Right	FA349R	FA349SV					MD6188D	UTVX6188		48
KVF 650 D Brute Force 4x4	05-11	Left	FA342R	FA342SV				MD6188D		UTVX6188		49
		Right	FA349R	FA349SV					MD6188D	UTVX6188		50
KVF 650 E1 Brute Force 4x4 Hardwoods Green HD	05-09	Left	FA342R	FA342SV				MD6188D		UTVX6188		51
		Right	FA349R	FA349SV					MD6188D	UTVX6188		52
KVF 650 F Brute Force 650 4x4i	06-11	Left	FA165X	FA165R	FA165SV			MD6188D		UTVX6188		53
		Right	FA135X	FA135R	FA135SV				MD6188D	UTVX6188		54
KVF 650 F Brute Force 4x4i	08	Left	FA165X	FA165R	FA165SV			MD6188D		UTVX6188		55
		Right	FA135X	FA135R	FA135SV				MD6188D	UTVX6188		56

*-2 Sets Required. † For Vee disc colours add RED, BLU, GRN, GLD, ORG suffix to part number. **SAFETY WARNING:** DO NOT USE HH PADS ON REAR UNLESS ALSO USED ON FRONT TO AVOID BRAKE IMBALANCE

APPLIATIONS
BRAKE
 This symbol indicates a rotor made of billet steel, and should be only used with EBC FA Kevlar® Organic or Vee pads.
 SAFETY NOTICE - With vehicles primarily designed for off highway use such as quads now being used on the highway, we would recommend the use of X or MXS pads for highway use and ONLY using the R and SV higher density / harder pad series for off road riding.

FRONT: KAWASAKI Cont'd

REAR: KAWASAKI

Line #

BRAKE ROTOR CHOICES - FRONT							DISC PAD CHOICES - REAR					BRAKE ROTOR CHOICES - REAR			
CC Custom Rotor	CX Extreme® /Vee-Rotor	OS Series Oversize 250/280mm Rotor Kit	OSX Series Oversize 280mm Rotor Kit	Relocating Bracket for Oversize Rotor	SMX Series Oversize 320mm Rotor Kit	Relocating Bracket for 320mm Rotor		Sintered/HH Pads/ Grooved Shoes	SV Series Severe Duty Pads	EPFA Sintered Fast Road/ Track Pads	Specialty Pads SXR/ VEE/MXS Race	Standard Rotor	Vintage Rotor / UTV Oversize Brake Kit	Contour Profile Rotor	CX Extreme® /Vee-Rotor
1															
2	MD4152CC*	VR4152BLK*†					FA192	FA192HH			FA192V	MD4138		MD4138C	
3		VR4155BLK*†					FA192	FA192HH			FA192V			MD4138C	VR4138
4		VR4155BLK*†					FA436	FA436HH						MD4165C	VR4165
5		VR4155BLK*†					FA436	FA436HH						MD4165C	VR4165
6		VR4155BLK*†					FA436	FA436HH						MD4165C	VR4165
7		VR4155BLK*†					FA436	FA436HH						MD4165C	VR4165
8		VR4155BLK*†					FA436	FA436HH						MD4165C	VR4165
9							FA436	FA436HH			FA436V			MD4165C	VR416
10							FA436	FA436HH			FA436V			MD4165C	VR416
11							FA436	FA436HH			FA436V			MD4165C	VR416
12							FA174	FA174HH			FA174V	MD4165			
13							FA174	FA174HH			FA174V	MD4165			
14							FA174	FA174HH			FA174V	MD4165			
15							FA174	FA174HH			FA174V	MD4165			
16		VR4159BLK					FA192	FA192HH			FA192V			MD4138C	VR4138
17		VR4159BLK													
18		VR4159BLK					FA192	FA192HH			FA192V			MD4138C	VR4138
19		VR4159BLK													
20		VR4159BLK					FA192	FA192HH			FA192V			MD4138C	VR4138
21		VR4159BLK													
22		VR4159BLK					FA192	FA192HH			FA192V			MD4138C	VR4138
23		VR4159BLK													
24							FA192	FA192HH			FA192V			MD4164AC	
25															
26							FA174	FA174HH			FA174V			TBC	
27															
28							FA174	FA174HH			FA174V			TBC	
29															
30							FA174	FA174HH			FA174V			TBC	
31															
32		MD6042CX			N/A	SMX6042	BRK017	FA67X	FA67R			MD6082D			MD6082CX
33								FA67X	FA67R			MD6082D			
34		MD6309CX	N/A	N/A	N/A	SMX6309	BRK018		FA197HH					MD6310C	MD6310CX
35		VR4159BLK						FA192	FA192HH		FA192V	MD4138D		MD4138C	
36		VR4159BLK													
37							FA192	FA192HH			FA192V			MD4164AC	
38		VR4159BLK													
39							FA140	FA140HH			FA140V			MD4178AC	
40							FA174	FA174HH			FA174V			MD4178AC	
41							FA174	FA174HH			FA174V			MD4178AC	
42							FA174	FA174HH			FA174V			MD4178AC	
43							FA174	FA174HH			FA174V			MD4178AC	
44		MD6015CX	OS6015C	OSX6015	BRK023	SMX6015	BRK024	FA152X	FA152R		MXS152	MD6085D			
45		MD6015CX	OS6015C	OSX6015	BRK023	SMX6015	BRK024	FA131X	FA131R		MXS131	MD6105D			MD6105CX
46								FA152X	FA152R		MXS152	MD6085D			
47								N/A							
48								N/A							
49								N/A							
50								N/A							
51								N/A							
52								N/A							
53								N/A							
54								N/A							
55								N/A							
56								N/A							

REAR

BRAKE APPLICATIONS

⚠ This symbol indicates a rotor made of billet steel, and should be only used with EBC FA Kevlar® Organic or Vee pads. SAFETY NOTICE - With vehicles primarily designed for off highway use such as quads now being used on the highway, we would recommend the use of X or MXS pads for highway use and ONLY using the R and SV higher density / harder pad series for off road riding.

*-2 Sets Required. † For Vee disc colours add RED, BLU, GRN, GLD, ORG suffix to part number. SAFETY WARNING:- DO NOT USE HH PADS ON REAR UNLESS ALSO USED ON FRONT TO AVOID BRAKE IMBALANCE

FRONT: KAWASAKI



KAWASAKI



DISC PAD CHOICES - FRONT

BRAKE ROTOR CHOICES - FRONT

Model	Side	Year	DISC PAD CHOICES - FRONT					BRAKE ROTOR CHOICES - FRONT				Line #		
			Icon	Sintered/HH Pads/Grooved Shoes	SV Series Severe Duty Pads	EPFA Sintered Fast Road/Track Pads	GPFA Sintered RACE ONLY Pads	Specialty Pads SXR/VEE/MXS Race	Standard Rotor Left	Standard Rotor Right	Vintage Rotor / UTV Oversize Brake Kit		Contour Profile Rotor	
KVF 650 F Brute Force 650 4x4i	Left	12		FA165X	FA165R	FA165SV				MD6188D		UTVX6188		1
	Right		FA135X	FA135R	FA135SV					MD6188D		UTVX6188		2
KVF 650 G Brute Force 650 4x4i Hardwood Green HD	Left	06-10		FA165X	FA165R	FA165SV				MD6188D		UTVX6188		3
	Right		FA135X	FA135R	FA135SV					MD6188D		UTVX6188		4
KVF 650 H Brute Force 4x4i	Left	07-08		FA165X	FA165R	FA165SV				MD6188D		UTVX6188		5
	Right		FA135X	FA135R	FA135SV					MD6188D		UTVX6188		6
KZ 650 B		77-79		FA33					MD4052LS		VMD4052		7	
KZ 650 C Custom use to F/No. 23100		77-79		FA33					MD4059LS	MD4059RS	VMD4059*		8	
KZ 650 C Custom use from F/No. 23101		79		FA73					MD4059LS	MD4059RS	VMD4059*		9	
KZ 650 D SR Series		78-79		FA33*					MD4059LS	MD4059RS	VMD4059*		10	
KZ 650 D SR Series		79		FA73*					MD4059LS	MD4059RS	VMD4059*		11	
KZ 650 E (LTD)		80		FA73					MD4064LS		VMD4064		12	
KZ 650 F		80		FA73					MD4064LS		VMD4064		13	
KZ 650 H (CSR)		81-83		FA68	FA68HH			FA68V	MD4065LS				14	
W 650 (EJ 650 A)		00-02		FA231	FA231HH		EPFA231HH			MD4008		MD4008C		15
Z 650 (EER 650 GHF / Non ABS)		17		FA142*	FA142HH*			FA142V*				MD4156XC*		16
Z 650 (EER 650 HHF / Non ABS)		17		FA142*	FA142HH*			FA142V*				MD4156XC*		17
Z 650 (ER 650 GJF/HJF) ABS		18-21		FA226*	FA226HH*		EPFA226HH*							18
KSV 700 A/B (KFX 700 V Force)	Left	04			FA342R	FA342SV				MD6137D				19
	Right				FA349R	FA349SV				MD6137D				20
KVF 700 A (Prairie 700 4x4) (KFX 700)	Left	04-09			FA342R	FA342SV				MD6188D		UTVX6188		21
	Right				FA349R	FA349SV				MD6188D		UTVX6188		22
KVF 700 B/C (KFX 700 4x4)	Left	04-09			FA342R	FA342SV				MD6188D		UTVX6188		23
	Right				FA349R	FA349SV				MD6188D		UTVX6188		24
KVF 700 D Team Green Special Edition	Left	05-06			FA342R	FA342SV				MD6188D		UTVX6188		25
	Right				FA349R	FA349SV				MD6188D		UTVX6188		26
KZ 700 A		84		FA68*	FA68HH*			FA68V*	MD4010LS	MD4010RS			27	
ST 700 Stallion		14-18		FA380*	FA380HH*				MD4155X	MD4155X		MD4155XC*		28
VN 700 A Vulcan		85		FA85*	FA85HH*			FA85V*	MD4010LS	MD4010RS			29	
ZN 700 A (LTD)		84-85		FA85*	FA85HH*			FA85V*	MD4067LS	MD4067RS			30	
H2/H2-A Mach IV (750-2T)		72-73		FA55					MD4069LS		VMD4069		31	
H2-B/H-C Mach IV (750-2T)		74-75		FA55					MD4069LS		VMD4069		32	
KRF 750 A/B Teryx 4x4	Left	08		FA165X	FA165R	FA165SV				MD6325D		UTVX6325		33
	Right		FA135X	FA135R	FA135SV					MD6325D		UTVX6325		34
KRF 750 C/D Teryx 4x4 LE	Left	08		FA165X	FA165R	FA165SV				MD6325D		UTVX6325		35
	Right		FA135X	FA135R	FA135SV					MD6325D		UTVX6325		36
KRF 750 F Teryx 4x4 NRA Outdoors	Left	08		FA165X	FA165R	FA165SV				MD6325D		UTVX6325		37
	Right		FA135X	FA135R	FA135SV					MD6325D		UTVX6325		38
KRF 750 G/N Teryx 750 Fi 4x4	Left	09-13		FA165X	FA165R	FA165SV				MD6325D		UTVX6325		39
	Right		FA135X	FA135R	FA135SV					MD6325D		UTVX6325		40
KRF 750 J/K/P/R Teryx 750 Fi 4x4 LE	Left	09-13		FA165X	FA165R	FA165SV				MD6325D		UTVX6325		41
	Right		FA135X	FA135R	FA135SV					MD6325D		UTVX6325		42
KRF 750 L Teryx 750 Fi 4x4 LE Sport	Left	09		FA165X	FA165R	FA165SV				MD6325D		UTVX6325		43
	Right		FA135X	FA135R	FA135SV					MD6325D		UTVX6325		44
KRF 750 M Teryx 750 Fi 4x4 NRA Outdoors	Left	09		FA165X	FA165R	FA165SV				MD6325D		UTVX6325		45
	Right		FA135X	FA135R	FA135SV					MD6325D		UTVX6325		46
KRF 750 S Teryx 750 Fi 4x4 Sport LE Sport	Left	10-13		FA165X	FA165R	FA165SV				MD6325D		UTVX6325		47
	Right		FA135X	FA135R	FA135SV					MD6325D		UTVX6325		48
KRF 750 T/V Teryx 750 Fi 4x4 SGE	Left	10-11		FA165X	FA165R	FA165SV				MD6325D		UTVX6325		49
	Right		FA135X	FA135R	FA135SV					MD6325D		UTVX6325		50
KRT 750 A (Teryx 4 750 4x4)	Left	12-13		FA165X	FA165R	FA165SV				MD6399D		UTVX6399		51
	Right		FA135X	FA135R	FA135SV					MD6399D		UTVX6399		52
KRT 750 A (Teryx 4 750 4x4 EPS)	Left	12-13		FA165X	FA165R	FA165SV				MD6399D		UTVX6399		53
	Right		FA135X	FA135R	FA135SV					MD6399D		UTVX6399		54
KRT 750 C (Teryx 4 750 4x4 EPS LE)	Left	12-13		FA165X	FA165R	FA165SV				MD6399D		UTVX6399		55
	Right		FA135X	FA135R	FA135SV					MD6399D		UTVX6399		56

*-2 Sets Required. † For Vee disc colours add RED, BLU, GRN, GLD, ORG suffix to part number. **SAFETY WARNING:** DO NOT USE HH PADS ON REAR UNLESS ALSO USED ON FRONT TO AVOID BRAKE IMBALANCE

⊛ This symbol indicates a rotor made of billet steel, and should be only used with EBC FA Kevlar® Organic or Vee pads.

SAFETY NOTICE - With vehicles primarily designed for off highway use such as quads now being used on the highway, we would recommend the use of X or MXS pads for highway use and ONLY using the R and SV higher density / harder pad series for off road riding.

FRONT: KAWASAKI



KAWASAKI



DISC PAD CHOICES - FRONT

BRAKE ROTOR CHOICES - FRONT

Model	Side	Year	Image	Sintered/	SV Series	EPFA	GPFX	Specialty	Standard	Standard	Vintage	Contour	Line #
				HH Pads/ Grooved Shoes	Severe Duty Pads	Sintered Fast Road/ Track Pads	Sintered RACE ONLY Pads	Pads SXR/ VEE/MXS Race	Rotor Left	Rotor Right	Rotor / UTV Oversize Brake Kit	Profile Rotor	
KRT 750 D (Teryx 4 750 4x4 EPS Realtree)	Left	12-13		FA165X	FA165R	FA165SV						UTVX6399	1
	Right		FA135X	FA135R	FA135SV						MD6399D	UTVX6399	2
KVF 750 A Brute Force 750 4x4i	Left	05-07		FA165X	FA165R	FA165SV						UTVX6188	3
	Right		FA135X	FA135R	FA135SV						MD6188D	UTVX6188	4
KVF 750 B/E Brute Force 750 4x4i Hardwoods Green HD	Left	05/08-09		FA165X	FA165R	FA165SV						UTVX6188	5
	Right		FA135X	FA135R	FA135SV						MD6188D	UTVX6188	6
KVF 750 B Brute Force 750 4x4i	Left	06-07		FA165X	FA165R	FA165SV						UTVX6188	7
	Right		FA135X	FA135R	FA135SV						MD6188D	UTVX6188	8
KVF 750 C/D Brute Force 750 4x4i	Left	05-11		FA165X	FA165R	FA165SV						UTVX6188	9
	Right		FA135X	FA135R	FA135SV						MD6188D	UTVX6188	10
KVF 750 E Brute Force 750 4x4i NRA Outdoors	Left	08-10		FA165X	FA165R	FA165SV						UTVX6188	11
	Right		FA135X	FA135R	FA135SV						MD6188D	UTVX6188	12
KVF 750 F Brute Force 750 4x4i	Left	08/10-11		FA165X	FA165R	FA165SV						UTVX6188	13
	Right		FA135X	FA135R	FA135SV						MD6188D	UTVX6188	14
KVF 750 G Brute Force 750 4x4 i/EPS	Left	12-17		FA165X	FA165R	FA165SV						UTVX6188	15
	Right		FA135X	FA135R	FA135SV						MD6188D	UTVX6188	16
KVF 750 H Brute Force 750 4x4 i / EPS / Camo	Left	12-21		FA165X	FA165R	FA165SV						UTVX6188	17
	Right		FA135X	FA135R	FA135SV						MD6188D	UTVX6188	18
KVF 750 J Brute Force 750 4x4 i / EPS	Left	12-21		FA165X	FA165R	FA165SV						UTVX6188	19
	Right		FA135X	FA135R	FA135SV						MD6188D	UTVX6188	20
KVF 750 L Brute Force 750 4x4i	Left	12-17		FA165X	FA165R	FA165SV						UTVX6188	21
	Right		FA135X	FA135R	FA135SV						MD6188D	UTVX6188	22
KZ 750 B		76-79		FA33							VMD4052	23	
KZ 750 E		80-82		FA68*	FA68HH*			FA68V*	MD4010LS	MD4010RS		24	
KZ 750 F (LTD)		83		FA68*	FA68HH*			FA68V*	MD4010LS	MD4010RS		25	
KZ 750 G (LTD)		80		FA73					N/A			26	
KZ 750 H (LTD)		80-83		FA68*	FA68HH*			FA68V*	MD4010LS	MD4010RS		27	
KZ 750 K (LTD)		83-84		FA85	FA85HH			FA85V	MD4070LS			28	
KZ 750 L		83		FA68*	FA68HH*			FA68V*	MD4010LS	MD4010RS		29	
KZ 750 M (CSR)		82		FA68	FA68HH			FA68V	MD4066LS			30	
KZ 750 N Spectre		82-83		FA68*	FA68HH*			FA68V*	MD4010LS	MD4010RS		31	
KZ 750 R (GPz)		82		FA68*	FA68HH*				MD4010LS	MD4010RS		32	
VN 750 A Vulcan		86-06		FA85*	FA85HH*			FA85V*	MD4010LS	MD4010RS		33	
Z 750 (ZR 750 J)	Left	04		FA229	FA229HH		EPFA229HH	FA229V	MD4141X			MD4141XC*	34
	Right		FA231	FA231HH		EPFA231HH	FA231V		MD4141X			MD4141XC*	35
Z 750 S (ZR 750 K)	Left	05-06		FA229	FA229HH		EPFA229HH	FA229V	MD4141X			MD4141XC*	36
	Right		FA231	FA231HH		EPFA231HH	FA231V		MD4141X			MD4141XC*	37
ZR 750 C		91-93		FA129*	FA129HH*		EPFA129HH*	FA129V*	MD4008X	MD4008X		MD4008XC*	38
ZR 750 F (ZR-7)	Left	00-01		FA229	FA229HH		EPFA229HH	FA229V	MD4141X			MD4141XC*	39
	Right		FA231	FA231HH		EPFA231HH	FA231V		MD4141X			MD4141XC*	40
ZR7-S (ZR 750) H	Left	01-05		FA229	FA229HH		EPFA229HH	FA229V	MD4141X			MD4141XC*	41
	Right		FA231	FA231HH		EPFA231HH	FA231V		MD4141X			MD4141XC*	42
ZX 750 A (GPz)		83-85		FA85*	FA85HH*				MD4028	MD4028		43	
ZX 750 E Turbo		84-85		FA85*	FA85HH*				MD4016	MD4016		44	
ZX 750 F Ninja		87-90		FA129*	FA129HH*		EPFA129HH*		MD4071LS	MD4071RS		45	
ZX 750 H (ZX-7)		89-90		FA158*	FA158HH*		EPFA158HH*		MD4012X	MD4012X		MD4012XC*	46
Ninja ZX-750 J/L (ZX-7)		91-95		FA158*	FA158HH*		EPFA158HH*		MD4022X	MD4022X		MD4022XC*	47
Ninja ZX 7R (ZX 750 K/M)		91-95		FA158*	FA158HH*		EPFA158HH*		MD4022X	MD4022X		MD4022XC*	48
Ninja ZX 7R (ZX 750 P) (Six piston pad) Tokico caliper		96-03		FA188*	FA188HH*		EPFA188HH*		MD4022X	MD4022X		MD4022XC*	49
ZX7RR (ZX 750 N) (Six piston pad) Nissin caliper		96-99		FA424*	FA424HH*				MD4022X	MD4022X		MD4022XC*	50
KRF 800 B/F (Teryx)	Left	14-21		FA165X	FA165R	FA165SV						UTVX6399	51
	Right		FA135X	FA135R	FA135SV						MD6399D	UTVX6399	52
KRF 800 C/G (Teryx LE)	Left	14-21		FA165X	FA165R	FA165SV						UTVX6399	53
	Right		FA135X	FA135R	FA135SV						MD6399D	UTVX6399	54
KRF 800 D/H (Teryx Camo)	Left	14-21		FA165X	FA165R	FA165SV						UTVX6399	55
	Right		FA135X	FA135R	FA135SV						MD6399D	UTVX6399	56

*-2 Sets Required. † For Vee disc colours add RED, BLU, GRN, GLD, ORG suffix to part number. **SAFETY WARNING:- DO NOT USE HH PADS ON REAR UNLESS ALSO USED ON FRONT TO AVOID BRAKE IMBALANCE**

APPLIATIONS

⚠ This symbol indicates a rotor made of billet steel, and should be only used with EBC FA Kevlar® Organic or Vee pads. SAFETY NOTICE - With vehicles primarily designed for off highway use such as quads now being used on the highway, we would recommend the use of X or MXS pads for highway use and ONLY using the R and SV higher density / harder pad series for off road riding.

FRONT: KAWASAKI Cont'd

REAR: KAWASAKI

Line #	BRAKE ROTOR CHOICES - FRONT							DISC PAD CHOICES - REAR					BRAKE ROTOR CHOICES - REAR			
	CC Custom Rotor	CX Extreme® /Vee-Rotor	OS Series Oversize 250/280mm Rotor Kit	OSX Series Oversize 280mm Rotor Kit	Relocating Bracket for Oversize Rotor	SMX Series Oversize 320mm Rotor Kit	Relocating Bracket for 320mm Rotor		Sintered/HH Pads/ Grooved Shoes	SV Series Severe Duty Pads	EPFA Sintered Fast Road/Track Pads	Specialty Pads SXR/VEE/MXS Race	Standard Rotor	Vintage Rotor / UTV Oversize Brake Kit	Contour Profile Rotor	CX Extreme® /Vee-Rotor
1								N/A								
2								N/A								
3								N/A								
4								N/A								
5								N/A								
6								N/A								
7								N/A								
8								N/A								
9								N/A								
10								N/A								
11								N/A								
12								N/A								
13								N/A								
14								N/A								
15								N/A								
16								N/A								
17								N/A								
18								N/A								
19								N/A								
20								N/A								
21								N/A								
22								N/A								
23								FA37				N/A				
24								FA68	FA68HH		FA68V	MD4169				
25								FA68	FA68HH		FA68V	MD4169				
26								709								
27								FA68	FA68HH		FA68V	MD4169				
28								709								
29								FA68	FA68HH		FA68V	MD4169				
30								709								
31								FA68	FA68HH		FA68V	MD4169				
32								FA68	FA68HH		FA68V	MD4169				
33								709								
34	MD4141CC*							FA192	FA192HH		FA192V	MD4138		MD4138C		
35																
36	MD4141CC*							FA192	FA192HH		FA192V	MD4138		MD4138C		
37																
38	MD4008CC*	VR4008BLK*†						FA129	FA129HH	EPFA129HH	FA129V	MD4007		MD4007C	VR4007	
39	MD4141CC*							FA231	FA231HH	EPFA231HH	FA231V	MD4142		MD4142C		
40																
41	MD4141CC							FA231	FA231HH	EPFA231HH	FA231V	MD4142		MD4142C		
42	MD4141CC															
43								FA85	FA85HH		FA85V	MD4019⊗				
44								FA85	FA85HH		FA85V	MD4017⊗				
45								FA129	FA129HH	EPFA129HH	FA129V	MD4007		MD4007C		
46	MD4012CC*	VR4012BLK*†						FA161	FA161HH		FA161V	MD4013		MD4013C	VR4013	
47	MD4022CC*	VR4022BLK*†						FA161	FA161HH		FA161V	MD4013		MD4013C	VR4013	
48	MD4022CC*	VR4022BLK*†						FA161	FA161HH		FA161V	MD4013		MD4013C	VR4013	
49	MD4022CC*	VR4022BLK*†						FA161	FA161HH		FA161V	MD4013		MD4013C	VR4013	
50	MD4022CC*	VR4022BLK*†						FA254	FA254HH		FA254V	MD4013		MD4013C	VR4013	
51								N/A								
52								N/A								
53								N/A								
54								N/A								
55								N/A								
56								N/A								

BRAKE APPLICATIONS

⊗ This symbol indicates a rotor made of billet steel, and should be only used with EBC FA Kevlar® Organic or Vee pads. SAFETY NOTICE - With vehicles primarily designed for off highway use such as quads now being used on the highway, we would recommend the use of X or MXS pads for highway use and ONLY using the R and SV higher density / harder pad series for off road riding.

*-2 Sets Required. † For Vee disc colours add RED, BLU, GRN, GLD, ORG suffix to part number. SAFETY WARNING:- DO NOT USE HH PADS ON REAR UNLESS ALSO USED ON FRONT TO AVOID BRAKE IMBALANCE

FRONT: KAWASAKI



KAWASAKI



DISC PAD CHOICES - FRONT

BRAKE ROTOR CHOICES - FRONT

												Line #
KRT 800 B/F (Teryx 4)	Left	14-21	FA165X	FA165R	FA165SV			MD6399D		UTVX6399		1
	Right		FA135X	FA135R	FA135SV				MD6399D	UTVX6399		2
KRT 800 C/G (Teryx 4 LE)	Left	14-21	FA165X	FA165R	FA165SV			MD6399D		UTVX6399		3
	Right		FA135X	FA135R	FA135SV				MD6399D	UTVX6399		4
KRT 800 D/H (Teryx 4 Camo)	Left	14-21	FA165X	FA165R	FA165SV			MD6399D		UTVX6399		5
	Right		FA135X	FA135R	FA135SV				MD6399D	UTVX6399		6
W 800 (Solid Front Disc)		11-12	FA231	FA231HH			FA231V		MD4158			7
W 800 Café (Cockpit Fairing)		11	FA231	FA231HH			FA231V		MD4008X		MD4008XC	8
W 800 Special (Black Exhaust)		12	FA231	FA231HH			FA231V		MD4008X		MD4008XC	9
W 800 ABS		13-16	FA231	FA231HH			FA231V		MD4008X		MD4008XC	10
W 800 ABS Special		13-16	FA231	FA231HH			FA231V		MD4008X		MD4008XC	11
VN 800 A Vulcan		95-05	FA85	FA85HH			FA85V	MD4124LS				12
VN 800 B Vulcan Classic		96-05	FA229	FA229HH		EPFA229HH	FA229V	MD4125LS				13
VN 800 Drifter C/E		99-06	FA229	FA229HH		EPFA229HH	FA229V	MD4125LS				14
KAF 820 A Mule PRO - FXT	Left	15-21	FA165X	FA165R	FA165SV			MD6398D		UTVX6398		15
	Right		FA135X	FA135R	FA135SV				MD6398D	UTVX6398		16
KAF 820 BF Mule PRO - FXT/EPS	Left	15-21	FA165X	FA165R	FA165SV			MD6398D		UTVX6398		17
	Right		FA135X	FA135R	FA135SV				MD6398D	UTVX6398		18
KAF 820 C Mule PRO - FXT/EPS LE	Left	15-21	FA165X	FA165R	FA165SV			MD6398D		UTVX6398		19
	Right		FA135X	FA135R	FA135SV				MD6398D	UTVX6398		20
KAF 820 D Mule PRO - FXT/EPS Camo	Left	15-21	FA165X	FA165R	FA165SV			MD6398D		UTVX6398		21
	Right		FA135X	FA135R	FA135SV				MD6398D	UTVX6398		22
KAF 820 E Mule PRO - FX	Left	16-21	FA165X	FA165R	FA165SV			MD6398D		UTVX6398		23
	Right		FA135X	FA135R	FA135SV				MD6398D	UTVX6398		24
KAF 820 F Mule PRO - FX/EPS	Left	16-21	FA165X	FA165R	FA165SV			MD6398D		UTVX6398		25
	Right		FA135X	FA135R	FA135SV				MD6398D	UTVX6398		26
KAF 820 G Mule PRO - FX/EPS LE	Left	16-21	FA165X	FA165R	FA165SV			MD6398D		UTVX6398		27
	Right		FA135X	FA135R	FA135SV				MD6398D	UTVX6398		28
KAF 820 H Mule PRO - FX/EPS Camo	Left	16-21	FA165X	FA165R	FA165SV			MD6398D		UTVX6398		29
	Right		FA135X	FA135R	FA135SV				MD6398D	UTVX6398		30
KAF 820 J Mule PRO - FXT Ranch Edition	Left	16-21	FA165X	FA165R	FA165SV			MD6398D		UTVX6398		31
	Right		FA135X	FA135R	FA135SV				MD6398D	UTVX6398		32
Z1/A/B 900		73-75	FA55					MD4069LS		VMD4069		33
KZ 900 B LTD		76	FA33*					MD4076LS	MD4076RS	VMD4076*		34
KZ 900 A		76-77	FA33					MD4052LS		VMD4052		35
VN 900 Vulcan Classic LT (Spoke wheels & Screen)		06-21	FA229	FA229HH		EPFA229HH	FA229V	MD4158				36
VN 900 B Vulcan Classic (Spoke Wheels)		06-21	FA229	FA229HH		EPFA229HH	FA229V	MD4158				37
VN 900 C Vulcan Custom (Cast Wheels)		07-21	FA229	FA229HH		EPFA229HH	FA229V	MD4158				38
ZL 900 A Eliminator		85-86	FA85*	FA85HH*			FA85V*	MD4016	MD4016			39
Z 900 (ZR 900 AHF/Non ABS)		17	FA347*	FA347HH*		EPFA347HH*	GPFAX347HH*	FA347V*			TBC*	40
Z 900 (ZR 900 BHF/ABS)		17	FA347*	FA347HH*		EPFA347HH*	GPFAX347HH*	FA347V*			TBC*	41
Z 900 ABS		18-21	FA347*	FA347HH*		EPFA347HH*	GPFAX347HH*	FA347V*				42
Z 900 RS ABS		18-21	FA347*	FA347HH*		EPFA347HH*	GPFAX347HH*	FA347V*				43
Z 900 RS Café		18-21	FA347*	FA347HH*		EPFA347HH*	GPFAX347HH*	FA347V*				44
ZX 900 A Ninja		84-86	FA85*	FA85HH*				MD4016	MD4016			45
ZX-9R B Ninja		94-95	FA158*	FA158HH*		EPFA158HH*		MD4022X	MD4022X		MD4022XC*	46
ZX-9R B Ninja		96-97	FA188*	FA188HH*		EPFA188HH*		MD4022X	MD4022X		MD4022XC*	47
ZX-9R (ZX 900 C)		98-99	FA188*	FA188HH*		EPFA188HH*		MD4167X	MD4167X		MD4167XC*	48
ZX-9R (ZX 900 E)		00-01	FA188*	FA188HH*		EPFA188HH*		MD4012X	MD4012X		MD4012XC*	49
ZX-9R (ZX 900 F)		02-03		FA347HH*		EPFA347HH*	GPFAX347HH*	MD4022X	MD4022X		MD4022XC*	50
KAF 950 A (Mule 2510 Diesel)			719*	N/A								51
KAF 950 B (Mule 3010 Diesel)		03-05	719*	N/A								52
KAF 950 D Mule 3010 Diesel 4x4		08	719*	N/A								53
KAF 950 E Mule 3010 Trans 4x4 Diesel		08	719*	N/A								54
KAF 950 F (Mule 4010 Diesel 4x4)		09-12	719*	N/A								55
KAF 950 G (Mule 4010 Trans 4x4 Diesel)		09-12	719*	N/A								56

*-2 Sets Required. † For Vee disc colours add RED, BLU, GRN, GLD, ORG suffix to part number. **SAFETY WARNING:- DO NOT USE HH PADS ON REAR UNLESS ALSO USED ON FRONT TO AVOID BRAKE IMBALANCE**

⚡ This symbol indicates a rotor made of billet steel, and should be only used with EBC FA Kevlar® Organic or Vee pads. SAFETY NOTICE - With vehicles primarily designed for off highway use such as quads now being used on the highway, we would recommend the use of X or MXS pads for highway use and ONLY using the R and SV higher density / harder pad series for off road riding.

FRONT: KAWASAKI Cont'd

REAR: KAWASAKI

Line #

BRAKE ROTOR CHOICES - FRONT							DISC PAD CHOICES - REAR					BRAKE ROTOR CHOICES - REAR			
CC Custom Rotor	CX Extreme® /Vee-Rotor	OS Series Oversize 250/280mm Rotor Kit	OSX Series Oversize 280mm Rotor Kit	Relocating Bracket for Oversize Rotor	SMX Series Oversize 320mm Rotor Kit	Relocating Bracket for 320mm Rotor		Sintered/HH Pads/ Grooved Shoes	SV Series Severe Duty Pads	EPFA Sintered Fast Road/ Track Pads	Specialty Pads SXR/ VEE/MXS Race	Standard Rotor	Vintage Rotor / UTV Oversize Brake Kit	Contour Profile Rotor	CX Extreme® /Vee-Rotor
1							N/A								
2							N/A								
3							N/A								
4															
5															
6															
7							706								
8	MD4008CC	VR4008BLK					706								
9	MD4008CC	VR4008BLK					706								
10	MD4008CC	VR4008BLK					706								
11	MD4008CC	VR4008BLK					706								
12							709								
13							709								
14							FA231	FA231HH		EPFA231HH	FA231V	MD4148			
15							FA686X	FA686R				MD6398D	UTVX6398		
16							FA686X	FA686R				MD6398D	UTVX6398		
17							FA686X	FA686R				MD6398D	UTVX6398		
18							FA686X	FA686R				MD6398D	UTVX6398		
19							FA686X	FA686R				MD6398D	UTVX6398		
20							FA686X	FA686R				MD6398D	UTVX6398		
21							FA686X	FA686R				MD6398D	UTVX6398		
22							FA686X	FA686R				MD6398D	UTVX6398		
23							FA686X	FA686R				MD6398D	UTVX6398		
24							FA686X	FA686R				MD6398D	UTVX6398		
25							FA686X	FA686R				MD6398D	UTVX6398		
26							FA686X	FA686R				MD6398D	UTVX6398		
27							FA686X	FA686R				MD6398D	UTVX6398		
28							FA686X	FA686R				MD6398D	UTVX6398		
29							FA686X	FA686R				MD6398D	UTVX6398		
30							FA686X	FA686R				MD6398D	UTVX6398		
31							FA686X	FA686R				MD6398D	UTVX6398		
32							FA686X	FA686R				MD6398D	UTVX6398		
33							713								
34							FA37					MD4073			
35							713								
36								FA231HH		EPFA231HH	FA231/2V	MD4085			
37								FA231HH		EPFA231HH	FA231/2V	MD4085			
38								FA231HH		EPFA231HH	FA231/2V	MD4085			
39							FA85	FA85HH			FA85V	MD4017			
40							FA140	FA140HH			FA140V				TBC
41							FA140	FA140HH			FA140V				TBC
42							FA140	FA140HH			FA140V				
43							FA140	FA140HH			FA140V				
44							FA140	FA140HH			FA140V				
45							FA85	FA85HH			FA85V	MD4017			
46	MD4022CC*	VR4022BLK*†					FA192	FA192HH			FA192V	MD4013		MD4013C	VR4013
47	MD4022CC*	VR4022BLK*†					FA192	FA192HH			FA192V	MD4013		MD4013C	VR4013
48							FA192	FA192HH			FA192V	MD4138		MD4138C	VR4138
49	MD4012CC*	VR4012BLK*†					FA192	FA192HH			FA192V	MD4138		MD4138C	VR4138
50	MD4022CC*	VR4022BLK*†					FA192	FA192HH			FA192V	MD4138		MD4138C	VR4138
51							720*	N/A*							
52							720*	N/A*							
53							720*	N/A*							
54							720*	N/A*							
55							720*	N/A*							
56							720*	N/A*							

⚠ This symbol indicates a rotor made of billet steel, and should be only used with EBC FA Kevlar® Organic or Vee pads.
SAFETY NOTICE - With vehicles primarily designed for off highway use such as quads now being used on the highway, we would recommend the use of X or MXS pads for highway use and ONLY using the R and SV higher density / harder pad series for off road riding.

BRAKE APPLICATIONS

*-2 Sets Required. † For Vee disc colours add RED, BLU, GRN, GLD, ORG suffix to part number. **SAFETY WARNING: DO NOT USE HH PADS ON REAR UNLESS ALSO USED ON FRONT TO AVOID BRAKE IMBALANCE**

FRONT: KAWASAKI



KAWASAKI



DISC PAD CHOICES - FRONT

BRAKE ROTOR CHOICES - FRONT

Model	Side	Year	DISC PAD CHOICES - FRONT					BRAKE ROTOR CHOICES - FRONT				Line #	
			Icon	Sintered/HH Pads/Grooved Shoes	SV Series Severe Duty Pads	EPFA Sintered Fast Road/Track Pads	GPFA Sintered RACE ONLY Pads	Specialty Pads SXR/VEE/MXS Race	Standard Rotor Left	Standard Rotor Right	Vintage Rotor / UTV Oversize Brake Kit		Contour Profile Rotor
KAF 950 H (Mule 4010 Trans 4x4 Diesel Realtree)		10	719*	N/A									1
KAF 1000 A - Mule Pro DXT/ Diesel	Left	16-17	FA165X	FA165R	FA165SV				MD6398D		UTVX6398		2
	Right		FA135X	FA135R	FA135SV					MD6398D	UTVX6398		3
KAF 1000 B - Mule Pro DXT/Diesel EPS	Left	16-17	FA165X	FA165R	FA165SV				MD6398D		UTVX6398		4
	Right		FA135X	FA135R	FA135SV					MD6398D	UTVX6398		5
KAF 1000 C - Mule Pro DXT EPS LE/Diesel	Left	16-21	FA165X	FA165R	FA165SV				MD6398D		UTVX6398		6
	Right		FA135X	FA135R	FA135SV					MD6398D	UTVX6398		7
KAF 1000 D - Mule Pro DX /Diesel	Left	16-17	FA165X	FA165R	FA165SV				MD6398D		UTVX6398		8
	Right		FA135X	FA135R	FA135SV					MD6398D	UTVX6398		9
KAF 1000 E - Mule Pro DX EPS/Diesel	Left	16-21	FA165X	FA165R	FA165SV				MD6398D		UTVX6398		10
	Right		FA135X	FA135R	FA135SV					MD6398D	UTVX6398		11
KAF 1000 F - Mule Pro DX EPS LE/Diesel	Left	16-17	FA165X	FA165R	FA165SV				MD6398D		UTVX6398		12
	Right		FA135X	FA135R	FA135SV					MD6398D	UTVX6398		13
KLZ 1000 B - Versys (ABS Model)		15-17	FA158*	FA158HH*		EPFA158HH*			TBC*				14
KLZ 1000 Versys LT ABS		18-21	FA158*	FA158HH*		EPFA158HH*							15
KLZ 1000 Versys SE LT ABS		18-21	FA158*	FA158HH*		EPFA158HH*							16
KLZ 1000 Versys SE LT+ ABS		19-21		FA379HH*		EPFA379HH*							17
KZ 1000 A		77-78	FA33						MD4052LS		VMD4052		18
KZ 1000 A		79-80	FA73*						MD4064LS	MD4064RS	VMD4064*		19
KZ 1000 B (LTD)		77-78	FA33*						MD4076LS	MD4076RS	VMD4076*		20
KZ 1000 B (LTD)		79-80	FA73*						MD4064LS	MD4064RS	VMD4064*		21
KZ 1000 C Police series		78	FA33*						MD4076LS	MD4076RS	VMD4076*		22
KZ 1000 C		79-81	FA73*						MD4064LS	MD4064RS	VMD4064*		23
KZ 1000 D (Z1-R series)		78	FA33*						MD4076LS	MD4076RS	VMD4076*		24
KZ 1000 D (Z1-R series)		80	FA73*						MD4076LS	MD4076RS	VMD4076*		25
KZ 1000 E ST & Shaft		79-80	FA62*						MD4078LS	MD4078RS	VMD4078*		26
KZ 1000 G Classic		80	FA73*						MD4064LS	MD4064RS	VMD4064*		27
KZ 1000 J		81-82	FA68*	FA68HH*					MD4006LS	MD4006RS			28
KZ 1000 J		83	FA68*	FA68HH*					MD4038	MD4038			29
KZ 1000 K (LTD)		81-82	FA68*	FA68HH*				FA68V*	MD4006LS	MD4006RS			30
KZ 1000 M (CSR)		81-82	FA68*	FA68HH*				FA68V*	MD4080LS	MD4080RS			31
KZ 1000 P (Police)		82-01	FA68*	FA68HH*					MD4091LS	MD4091RS			32
KZ 1000 P (Police)	Left	02-03/05	FA229	FA229HH		EPFA229HH			MD4091				33
	Right		FA231	FA231HH		EPFA231HH				MD4091			34
KZ 1000 R (Replica)		82-83	FA68*	FA68HH*					MD4038	MD4038			35
Teryx KRX 1000		20-21		FA738R*					MD6434D	MD6434D			36
Teryx KRX 1000 Special Edition		20-21		FA738R*					MD6434D	MD6434D			37
Teryx KRX 1000 Trail edition		20-21		FA738R*					MD6434D	MD6434D			38
Z 1000 (ZR 1000 A)		03-05		FA347HH*		EPFA347HH*			MD4154X	MD4154X		MD4154XC*	39
Z 1000 (ZR 1000 A)		06		FA347HH*		EPFA347HH*			MD4154X	MD4154X		MD4154XC*	40
Z 1000 (ZR 1000 B)		07-08		FA417/4HH*		EPFA417/4HH*	GPFA417/4HH*					MD4152XC*	41
Z 1000 (ZR 1000 C)		07		FA417/4HH*		EPFA417/4HH*	GPFA417/4HH*					MD4152XC*	42
Z 1000 (ZR 1000 D) Non ABS		10-13		FA379HH*		EPFA379HH*						TBC*	43
Z 1000 ABS (ZR 1000 G) ABS Model		14-20		FA379HH*		EPFA379HH*						MD4155XC*	44
ZG 1000 A Concours		94-05	FA129*	FA129HH*		EPFA129HH*		FA129V*	MD4008X	MD4008X		MD4008XC*	45
ZG 1000 A Concours		06	FA129*	FA129HH*		EPFA129HH*		FA129V*	MD4008X	MD4008X		MD4008XC*	46
ZL 1000 A		87	FA85*	FA85HH*				FA85V*	MD4016	MD4016			47
ZX10 R Ninja (ZX 1000 A1/A2)		86-87	FA85*	FA85HH*				FA85V*	MD4016	MD4016			48
ZX10 R Ninja (ZX 1000 B1/B2/B3)		88-90	FA129*	FA129HH*		EPFA129HH*		FA129V*	MD4021	MD4021			49
ZX10 R Ninja (ZX 1000 C1/C2/D6F/D7F)		04-07		FA369/4HH*		EPFA369/4HH*						MD4152XC*	50
ZX10 R Ninja (ZX 1000 E8F/E9F/FAF)		08-10		FA379HH*		EPFA379HH*	GPFA379HH*					MD4161XC*	51
ZX10 R Ninja (ZX 1000 GBF/GCF/GDF)		11-13		FA379HH*		EPFA379HH*	GPFA379HH*					TBC*	52
ZX10 R Ninja (ZX 1000 JBF/JCF/JDF/JEF/JFF)		11-15		FA379HH*		EPFA379HH*	GPFA379HH*					MD4161XC*	53
ZX10 R Ninja ABS (ZX 1000 KBF/KCF/KDF/KEF/KFF)		11-15		FA379HH*		EPFA379HH*	GPFA379HH*					MD4161XC*	54
ZX10 R Ninja ABS (ZX 1000 HCF/HDF)		12-13		FA379HH*		EPFA379HH*	GPFA379HH*					TBC*	55
ZX10 R Ninja ABS (ZX 1000 MEF/MFF)		14-19		FA379HH*		EPFA379HH*	GPFA379HH*					TBC*	56

*-2 Sets Required. † For Vee disc colours add RED, BLU, GRN, GLD, ORG suffix to part number. **SAFETY WARNING:- DO NOT USE HH PADS ON REAR UNLESS ALSO USED ON FRONT TO AVOID BRAKE IMBALANCE**

⚡ This symbol indicates a rotor made of billet steel, and should be only used with EBC FA Kevlar® Organic or Vee pads.

SAFETY NOTICE - With vehicles primarily designed for off highway use such as quads now being used on the highway, we would recommend the use of X or MXS pads for highway use and ONLY using the R and SV higher density / harder pad series for off road riding.

FRONT: KAWASAKI Cont'd

REAR: KAWASAKI

BRAKE ROTOR CHOICES - FRONT

DISC PAD CHOICES - REAR

BRAKE ROTOR CHOICES - REAR

Line # 1 2 3 4 5 6 7 8 9 10 11 12 13 14 15 16 17 18 19 20 21 22 23 24 25 26 27 28 29 30 31 32 33 34 35 36 37 38 39 40 41 42 43 44 45 46 47 48 49 50 51 52 53 54 55 56

CC Custom Rotor	CX Extreme® /Vee-Rotor	OS Series Oversize 250/280mm Rotor Kit	OSX Series Oversize 280mm Rotor Kit	Relocating Bracket for Oversize Rotor	SMX Series Oversize 320mm Rotor Kit	Relocating Bracket for 320mm Rotor		Sintered/HH Pads/ Grooved Shoes	SV Series Severe Duty Pads	EPFA Sintered Fast Road/Track Pads	Specialty Pads SXR/ VEE/MXS Race	Standard Rotor	Vintage Rotor / UTV Oversize Brake Kit	Contour Profile Rotor	CX Extreme® /Vee-Rotor	
							720*	N/A*								
							FA686X	FA686R				MD6398D	UTVX6398			
							FA686X	FA686R				MD6398D	UTVX6398			
							FA686X	FA686R				MD6398D	UTVX6398			
							FA686X	FA686R				MD6398D	UTVX6398			
							FA686X	FA686R				MD6398D	UTVX6398			
							FA686X	FA686R				MD6398D	UTVX6398			
							FA686X	FA686R				MD6398D	UTVX6398			
							FA686X	FA686R				MD6398D	UTVX6398			
							FA686X	FA686R				MD6398D	UTVX6398			
							FA686X	FA686R				MD6398D	UTVX6398			
							FA686X	FA686R				MD6398D	UTVX6398			
							FA686X	FA686R				MD6398D	UTVX6398			
							FA686X	FA686R				MD6398D	UTVX6398			
							FA686X	FA686R				MD6398D	UTVX6398			
							FA686X	FA686R				MD6398D	UTVX6398			
							FA174	FA174HH			FA174V			TBC		
							FA174	FA174HH			FA174V					
							FA174	FA174HH			FA174V					
							FA228	FA228HH								
							FA36				FA36V					
							FA36				FA36V	MD4077				
							FA37					N/A				
							FA36				FA36V	MD4063				
							FA36				FA36V	MD4077				
							FA36				FA36V	MD4077				
							FA36				FA36V	MD4077				
							FA36				FA36V	MD4077				
							FA36				FA36V	MD4090				
							FA36				FA36V	MD4063				
							FA68	FA68HH			FA68V	MD4054				
							FA68	FA68HH			FA68V	MD4054				
							FA68	FA68HH			FA68V	MD4054				
							FA68	FA68HH			FA68V	MD4054				
							FA68	FA68HH			FA68V	MD4054				
							FA68	FA68HH			FA68V	MD4054				
								FA231HH		EPFA231HH	FA231/3V	MD4054				
							FA68	FA68HH			FA68V	MD4054				
								FA739R*				MD6434D*				
								FA739R*				MD6434D*				
								FA739R*				MD6434D*				
MD4154CC*	VR4154BLK*†						FA192	FA192HH			FA192V	MD4138		MD4138C	VR4138	
MD4154CC*	VR4154BLK*†						FA192	FA192HH			FA192V	MD4138		MD4138C	VR4138	
MD4152CC*	VR4152BLK*†						FA174	FA174HH			FA174V			MD4157C	VR4157	
MD4152CC*	VR4152BLK*†						FA174	FA174HH			FA174V			MD4157C	VR4157	
							FA192	FA192HH			FA192V			MD4157C	VR4157	
							FA192	FA192HH			FA192V			MD4157C	VR4157	
MD4008CC*	VR4008BLK*†						FA85	FA85HH			FA85V	MD4082		N/A	N/A	
MD4008CC*	VR4008BLK*†						FA85	FA85HH			FA85V	MD4082		N/A	N/A	
							FA85	FA85HH			FA85V	MD4017				
							FA85	FA85HH			FA85V	MD4019				
							FA129	FA129HH		EPFA129HH	FA129V	MD4015				
MD4152CC*							FA192	FA192HH			FA192V			MD4138C	VR4138	
							FA192	FA192HH			FA192V			MD4138C	VR4138	
							FA192	FA192HH			FA192V			MD4157C	VR4157	
							FA436	FA436HH			FA436V			MD4165C	VR4165	
							FA436	FA436HH			FA436V			MD4165C	VR4165	
							FA192	FA192HH			FA192V			MD4157C	VR4157	
							FA192	FA192HH			FA192V			MD4157C	VR4157	

REAR

BRAKE APPLICATIONS

⚠ This symbol indicates a rotor made of billet steel, and should be only used with EBC FA Kevlar® Organic or Vee pads.
 SAFETY NOTICE - With vehicles primarily designed for off highway use such as quads now being used on the highway, we would recommend the use of X or MXS pads for highway use and ONLY using the R and SV higher density / harder pad series for off road riding.

*-2 Sets Required. † For Vee disc colours add RED, BLU, GRN, GLD, ORG suffix to part number. **SAFETY WARNING:** DO NOT USE HH PADS ON REAR UNLESS ALSO USED ON FRONT TO AVOID BRAKE IMBALANCE

FRONT: KAWASAKI



KAWASAKI



DISC PAD CHOICES - FRONT

BRAKE ROTOR CHOICES - FRONT

Model	Year	Front	DISC PAD CHOICES - FRONT					BRAKE ROTOR CHOICES - FRONT				Line #	
			Icon	Sintered/HH Pads/Grooved Shoes	SV Series Severe Duty Pads	EPFA Sintered Fast Road/Track Pads	GPFA Sintered RACE ONLY Pads	Specialty Pads SXR/VEE/MXS Race	Standard Rotor Left	Standard Rotor Right	Vintage Rotor / UTV Oversize Brake Kit		Contour Profile Rotor
ZX10 R Ninja 30th Anniversary Edition (ZX 1000 JFFA)	15			FA379HH*		EPFA379HH*	GPFA379HH*					MD4161XC*	1
ZX10 R Ninja 30th Anniversary Edition ABS (ZX 1000 KFFA)	15			FA379HH*		EPFA379HH*	GPFA379HH*					MD4161XC*	2
ZX10 RR Ninja (ZX 1000 ZHF/ZJF)	17-18			FA447HH*		EPFA447HH*	GPFA447HH*					MD4175X*	3
ZX10 R Ninja ABS (ZX 1002 EKF/FKF)	19-21			FA447HH*		EPFA447HH*	GPFA447HH*					MD4170X*	4
ZX10 R Ninja ABS KRT Edition (ZX 1002 EKFA/FKFA)	19-21			FA447HH*		EPFA447HH*	GPFA447HH*					MA4170X*	5
ZX10 RR Ninja (ZX 1002 GKF)	19-21			FA447HH*		EPFA447HH*	GPFA447HH*					MD4175X*	6
Ninja H2/Carbon (ZX 1000 NFF/NGF/XHF/XHFA)	15-18			FA447HH*		EPFA447HH*	GPFA447HH*					TBC*	7
Ninja H2/Carbon (ZX 1002 JFK/JKFA)	19-21			FA447HH*		EPFA447HH*	GPFA447HH*					TBC*	8
Ninja 1000 H2R (ZX 1000 P)	15-21			FA379HH*		EPFA379HH*	GPFA379HH*					TBC*	9
Ninja H2 SX (ZX 1002 AJF)	18-20			FA379HH*		EPFA379HH*	GPFA379HH*					TBC*	10
Ninja H2 SX SE (ZX 1002 BJF)	18-20			FA379HH*		EPFA379HH*	GPFA379HH*					TBC*	11
Ninja H2 SX SE+ (ZX 1002 DKF)	19-21			FA447HH*		EPFA447HH*	GPFA447HH*					TBC*	12
Z H2	20-21			FA447HH*		EPFA447HH*	GPFA447HH*					TBC*	13
Z H2 SE	20-21			FA447HH*		EPFA447HH*	GPFA447HH*					TBC*	14
KZ 1100 A	81-83		FA68*	FA68HH*				FA68V*	MD4006LS	MD4006RS			15
KZ 1100 B (GPz)	81		FA68*	FA68HH*					MD4006LS	MD4006RS			16
KZ 1100 B (GPz)	82		FA68*	FA68HH*					MD4038	MD4038			17
KZ 1100 D (Spectre)	82-83		FA68*	FA68HH*				FA68V*	MD4006LS	MD4006RS			18
KZ 1100 L (LTD)	83		FA68*	FA68HH*				FA68V*	MD4006LS	MD4006RS			19
ZN 1100 B (LTD)	84-85		FA85*	FA85HH*				FA85V*	MD4084	MD4084			20
ZR 1100 A Zephyr	92-95		FA158*	FA158HH*		EPFA158HH*			MD4012X	MD4012X		MD4012XC*	21
ZR 1100 B Zephyr	96	Left	FA229	FA229HH		EPFA229HH			MD4012X			MD4012XC	22
		Right	FA231	FA231HH		EPFA231HH				MD4012X		MD4012XC	23
ZX 1100 A (GPz)	83-84		FA85*	FA85HH*					MD4016	MD4016			24
ZX 1100 C (ZX-11) Ninja	90-93		FA158*	FA158HH*		EPFA158HH*			MD4012X	MD4012X		MD4012XC*	25
ZX 1100 D (ZX-11) Ninja	93-01		FA158*	FA158HH*		EPFA158HH*			MD4022X	MD4022X		MD4022XC*	26
GPz 1100 (ZX 1100 E)	95-97	Left	FA229	FA229HH		EPFA229HH			MD4008X			MD4008C	27
		Right	FA231	FA231HH		EPFA231HH				MD4008X		MD4008C	28
GPz 1100 ABS Models (ZX 1100 F)	96-97	Left	FA229	FA229HH		EPFA229HH			MD4008X			MD4008XC	29
		Right	FA231	FA231HH		EPFA231HH				MD4132X		MD4132XC	30
(ZR 1100 C) ZRX 1100	99-00		FA188*	FA188HH*		EPFA188HH*			MD4012X	MD4012X		MD4012XC*	31
ZG 1200 A/B (Voyager XII)	86-03		FA85*	FA85HH*				FA85V*	MD4087	MD4087			32
ZRX 1200 R (ZR 1200 A)	01-05		FA188*	FA188HH*		EPFA188HH*			MD4012X	MD4012X		MD4012XC*	33
ZX12R (ZX 1200 A/B)	00-03		FA188*	FA188HH*		EPFA188HH*			MD4022X	MD4022X		MD4022XC*	34
ZX12R (ZX 1200 B)	04-05		FA369/4HH*			EPFA369/4HH*			MD4154X	MD4154X		MD4154XC*	35
ZZR 1200 (ZX 1200 C)	02-05		FA158*	FA158HH*		EPFA158HH*			MD4022X	MD4022X		MD4022XC*	36
KZ 1300 A	79-82		FA62*						MD4089LS	MD4089RS		VMD4089*	37
KZ 1300 B (Touring)	80		FA62*						MD4089LS	MD4089RS		VMD4089*	38
ZN 1300 A (Voyager)	83-88		FA85*	FA85HH*					MD4091	MD4091			39
Concours 1400 (ZG 1400 A/C/E) ABS	08-21			FA417/4HH*		EPFA417/4HH*						MD4155XC*	40
Concours 1400 (ZG 1400 B/D)	08-10			FA417/4HH*		EPFA417/4HH*						MD4155XC*	41
ZX 1400 R (ZX 1400 A6F/A7F)	06-07			FA417/4HH*		EPFA417/4HH*						MD4155XC*	42
ZX 1400 R ABS (ZX 1400 B6F/B7F)	06-07			FA417/4HH*		EPFA417/4HH*						MD4155XC*	43
ZX 1400 R ABS	08-11			FA417/4HH*		EPFA417/4HH*						MD4155XC*	44
ZX 1400 R ABS	12-21			FA417/4HH*		EPFA417/4HH*						MD4155XC*	45
ZX 1400 R ABS Performance	12-19			FA447HH*		EPFA447HH*			MD4155X	MD4155X		MD4155XC*	46
ZX 1400 R ABS Performance Sport (ZX 1400 JGF)	14-21			FA447HH*		EPFA447HH*			MD4155X	MD4155X		MD4155XC*	47
VN 1500 A Vulcan 88	87-99		FA85	FA85HH				FA85V	MD4124LS				48
VN 1500 B Vulcan 88 SE	87-90		FA85	FA85HH				FA85V	MD4094LS				49
VN 1500 C	96-97		FA85	FA85HH				FA85V	MD4124LS				50
VN 1500 D/E Vulcan Classic	96-00		FA229	FA229HH		EPFA229HH		FA229V	MD4125LS				51
VN 1500 E Vulcan Classic	01-04		FA229	FA229HH		EPFA229HH		FA229V	MD4125LS				52
VN 1500 G Nomad	99-00	Left	FA229	FA229HH		EPFA229HH		FA229V	MD4150				53
		Right	FA231	FA231HH		EPFA231HH		FA231V		MD4150			54
VN 1500 G Nomad	01	Left	FA229	FA229HH		EPFA229HH		FA229V	MD4150				55
		Right	FA231	FA231HH		EPFA231HH		FA231V		MD4150			56

*-2 Sets Required. † For Vee disc colours add RED, BLU, GRN, GLD, ORG suffix to part number. **SAFETY WARNING:- DO NOT USE HH PADS ON REAR UNLESS ALSO USED ON FRONT TO AVOID BRAKE IMBALANCE**

⚡ This symbol indicates a rotor made of billet steel, and should be only used with EBC FA Kevlar® Organic or Vee pads.

SAFETY NOTICE - With vehicles primarily designed for off highway use such as quads now being used on the highway, we would recommend the use of X or MXS pads for highway use and ONLY using the R and SV higher density / harder pad series for off road riding.

FRONT: KAWASAKI Cont'd

REAR: KAWASAKI

Line #	BRAKE ROTOR CHOICES - FRONT							DISC PAD CHOICES - REAR					BRAKE ROTOR CHOICES - REAR			
	CC Custom Rotor	CX Extreme® /Vee-Rotor	OS Series Oversize 250/280mm Rotor Kit	OSX Series Oversize 280mm Rotor Kit	Relocating Bracket for Oversize Rotor	SMX Series Oversize 320mm Rotor Kit	Relocating Bracket for 320mm Rotor		Sintered/HH Pads/ Grooved Shoes	SV Series Severe Duty Pads	EPFA Sintered Fast Road/ Track Pads	Specialty Pads SXR/ VEE/MXS Race	Standard Rotor	Vintage Rotor / UTV Oversize Brake Kit	Contour Profile Rotor	CX Extreme® /Vee-Rotor
1		VR4161BLK*						FA436	FA436HH			FA436V			MD4165C	VR4165
2		VR4161BLK*						FA436	FA436HH			FA436V			MD4165C	VR4165
3								FA436	FA436HH			FA436V	MD4165		MD4165C	VR4165
4								FA436	FA436HH			FA436V	MD4166		MD4165C	VR4165
5								FA436	FA436HH			FA436V	MD4166		MD4165C	VR4165
6								FA436	FA266HH			FA436V	MD4165		MD4165C	VR4165
7								FA266	FA266HH						TBC	
8																
9								FA266	FA266HH							
10								FA228	FA228HH							
11								FA228	FA228HH							
12								FA228	FA228HH							
13								FA228	FA228HH							
14								FA228	FA228HH							
15								FA68	FA68HH			FA68V	MD4054			
16								FA68	FA68HH			FA68V	MD4054			
17								FA68	FA68HH			FA68V	MD4054			
18								FA68	FA68HH			FA68V	MD4054			
19								FA68	FA68HH			FA68V	MD4054			
20								FA85	FA85HH			FA85V	MD4085			
21	MD4012CC*	VR4012BLK*						FA129	FA129HH		EPFA129HH	FA129V	MD4027		MD4027C	VR4027
22	MD4012CC	VR4012BLK						FA129	FA129HH		EPFA129HH	FA129V	MD4027		MD4027C	VR4027
23	MD4012CC	VR4012BLK														
24								FA85				FA85V	MD4017			
25	MD4012CC*	VR4012BLK*						FA129	FA129HH		EPFA129HH	FA129V	MD4015		MD4015C	VR4015
26	MD4022CC*	VR4022BLK*						FA161	FA161HH			FA161V	MD4014		MD4014C	VR4014
27	MD4008CC							FA192	FA192HH			FA192V	MD4130		MD4130C	VR4130
28	MD4008CC															
29								FA192	FA192HH			FA192V	MD4130		MD4130C	VR4130
30																
31	MD4012CC*	VR4012BLK*						FA161	FA161HH			FA161V	MD4133		MD4133C	VR4133
32								FA85	FA85HH			FA85V	MD4088			
33	MD4012CC*	VR4012BLK*						FA161	FA161HH			FA161V	MD4133		MD4133C	VR4133
34	MD4022CC*	VR4022BLK*						FA161	FA161HH			FA161V	MD4023		MD4023C	VR4023
35	MD4154CC*	VR4154BLK*						FA161	FA161HH			FA161V	MD4023		MD4023C	VR4023
36	MD4022CC*	VR4022BLK*						FA161	FA161HH			FA161V	MD4133		MD4133C	VR4133
37								FA36				FA36V	MD4090			
38								FA36				FA36V	MD4090			
39								FA85	FA85HH			FA85V	MD4092			
40	MD4155CC*	VR4155BLK*						FA254	FA254HH			FA254V			MD4160C	VR4160
41	MD4155CC*	VR4155BLK*						FA254	FA254HH			FA254V			MD4160C	VR4160
42	MD4155CC*	VR4155BLK*						FA254	FA254HH				MD4157		MD4157C	VR4157
43	MD4155CC*	VR4155BLK*						FA254	FA254HH				MD4157		MD4157C	VR4157
44	MD4155CC*	VR4155BLK*						FA254	FA254HH				MD4157		MD4157C	VR4157
45	MD4155CC*	VR4155BLK*						FA254	FA254HH				MD4157		MD4157C	VR4157
46								FA254	FA254HH				MD4157		MD4157C	VR4157
47								FA254	FA254HH				MD4157		MD4157C	VR4157
48								FA85	FA85HH			FA85V	MD4054			
49								FA85	FA85HH			FA85V	MD4054			
50								FA85	FA85HH			FA85V	MD4128			
51								FA85	FA85HH			FA85V	MD4128			
52								FA231	FA231HH		EPFA231HH	FA231V	MD4148			
53								FA85	FA85HH			FA85V	MD4147			
54																
55												FA231/3V	MD4147			
56																

BRAKE APPLICATIONS

⚠ This symbol indicates a rotor made of billet steel, and should be only used with EBC FA Kevlar® Organic or Vee pads.
SAFETY NOTICE - With vehicles primarily designed for off highway use such as quads now being used on the highway, we would recommend the use of X or MXS pads for highway use and ONLY using the R and SV higher density / harder pad series for off road riding.

*-2 Sets Required. † For Vee disc colours add RED, BLU, GRN, GLD, ORG suffix to part number. **SAFETY WARNING:- DO NOT USE HH PADS ON REAR UNLESS ALSO USED ON FRONT TO AVOID BRAKE IMBALANCE**

FRONT: KAWASAKI



KAWASAKI



DISC PAD CHOICES - FRONT

BRAKE ROTOR CHOICES - FRONT

Model	Year	Side	Disc Pad Part	Sintered/HH Pads/Grooved Shoes	SV Series Severe Duty Pads	EPFA Sintered Fast Road/Track Pads	GPFAX Sintered RACE ONLY Pads	Specialty Pads SXR/VEE/MXS Race	Standard Rotor		Vintage Rotor / UTV Oversize Brake Kit	Contour Profile Rotor	Line #
									Standard Rotor Left	Standard Rotor Right			
VN 1500 Drifter J/R	99-05		FA229	FA229HH		EPFA229HH		FA229V	MD4125LS				1
VN 1500 N Vulcan 1500 Classic FI	00-02		FA229	FA229HH		EPFA229HH		FA229V	MD4125LS				2
VN 1500 N/T Vulcan 1500 Classic	05-06		FA229	FA229HH		EPFA229HH		FA229V	MD4125LS				3
VN 1500 N Vulcan 1500 Classic	07-08		FA229	FA229HH		EPFA229HH		FA229V	MD4125LS				4
VN 1500 L Vulcan 1500 Nomad FI	01-05	Left	FA229	FA229HH		EPFA229HH		FA229V	MD4150				5
		Right	FA231	FA231HH		EPFA231HH		FA231V		MD4150			6
VN 1500 P Vulcan Mean Streak	02-03		FA188*	FA188HH*		EPFA188HH*			MD4022X	MD4022X		MD4022XC*	7
VN 1600 A Vulcan Classic	01-06	Left	FA229	FA229HH		EPFA229HH		FA229V	MD4158				8
		Right	FA231	FA231HH		EPFA231HH		FA231V		MD4158			9
VN 1600 A Vulcan Classic	03-08	Left	FA229	FA229HH		EPFA229HH		FA229V	MD4158				10
		Right	FA231	FA231HH		EPFA231HH		FA231V		MD4158			11
VN 1600 B Mean Streak	04		FA188*	FA188HH*		EPFA188HH*			MD4022X	MD4022X		MD4022XC*	12
VN 1600 B/E/F Mean Streak	05-06			FA369/4HH*		EPFA369/4HH*			MD4022X	MD4022X		MD4022XC*	13
VN 1600 B Mean Streak	07-08			FA369/4HH*		EPFA369/4HH*			MD4022X	MD4022X		MD4022XC*	14
VN 1600 D	05-06	Left	FA229	FA229HH		EPFA229HH		FA229V	MD4158				15
		Right	FA231	FA231HH		EPFA231HH		FA231V		MD4158			16
VN 1600 D Nomad	07-08	Left	FA229	FA229HH		EPFA229HH		FA229V	MD4158				17
		Right	FA231	FA231HH		EPFA231HH		FA231V		MD4158			18
VN 1700 A Vulcan 1700 Voyager	09-13		FA158*	FA158HH*		EPFA158HH*			MD4158	MD4158			19
VN 1700 B Vulcan 1700 Voyager ABS	09-21		FA158*	FA158HH*		EPFA158HH*			MD4158	MD4158			20
VN 1700 C Vulcan 1700 Nomad	09-13	Left	FA229	FA229HH		EPFA229HH		FA229V	MD4158				21
		Right	FA231	FA231HH		EPFA231HH		FA231V		MD4158			22
VN 1700 C Vulcan 1700 Nomad 2T	09	Left	FA229	FA229HH		EPFA229HH		FA229V	MD4158				23
		Right	FA231	FA231HH		EPFA231HH		FA231V		MD4158			24
VN 1700 D Voyager Nomad	14		FA158*	FA158HH*		EPFA158HH*			TBC*				25
N 1700 E Vulcan 1700 Classic	09-11	Left	FA229	FA229HH		EPFA229HH		FA229V	MD4158				26
		Right	FA231	FA231HH		EPFA231HH		FA231V		MD4158			27
VN 1700 G Vulcan 1700 Classic LT	09-11	Left	FA229	FA229HH		EPFA229HH		FA229V	MD4158				28
		Right	FA231	FA231HH		EPFA231HH		FA231V		MD4158			29
VN 1700 J Voyager Vaquero	11-13		FA158*	FA158HH*		EPFA158HH*			TBC*				30
VN 1700 K Vulcan Vaquero ABS	14-21		FA158*	FA158HH*		EPFA158HH*			TBC*				31
VN 1700 K Vulcan Vaquero ABS SE	14		FA158*	FA158HH*		EPFA158HH*			TBC*				32
VN 2000 D Vulcan Ltd	05-06		FA158*	FA158HH*		EPFA158HH*			MD4158	MD4158			33
VN 2000 A/G Vulcan	04-09		FA158*	FA158HH*		EPFA158HH*			MD4158	MD4158			34
VN 2000 E/H Vulcan Classic	06-09		FA158*	FA158HH*		EPFA158HH*			MD4158	MD4158			35
VN 2000 F/J Vulcan Classic LT	06-10		FA158*	FA158HH*		EPFA158HH*			MD4158	MD4158			36
													37
													38
													39
													40
													41
													42
													43
													44
													45
													46
													47
													48
													49
													50
													51
													52
													53
													54
													55
													56

FRONT

APPLIATIONS
BRAKE
SAFETY NOTICE - With vehicles primarily designed for off highway use such as quads now being used on the highway, we would recommend the use of X or MXS pads for highway use and ONLY using the R and SV higher density / harder pad series for off road riding.

This symbol indicates a rotor made of billet steel, and should be only used with EBC FA Kevlar® Organic or Vee pads.

*-2 Sets Required. † For Vee disc colours add RED, BLU, GRN, GLD, ORG suffix to part number. **SAFETY WARNING:- DO NOT USE HH PADS ON REAR UNLESS ALSO USED ON FRONT TO AVOID BRAKE IMBALANCE**

FRONT: KAWASAKI Cont'd

REAR: KAWASAKI

Line # 1 2 3 4 5 6 7 8 9 10 11 12 13 14 15 16 17 18 19 20 21 22 23 24 25 26 27 28 29 30 31 32 33 34 35 36 37 38 39 40 41 42 43 44 45 46 47 48 49 50 51 52 53 54 55 56

BRAKE ROTOR CHOICES - FRONT							DISC PAD CHOICES - REAR					BRAKE ROTOR CHOICES - REAR			
CC Custom Rotor	CX Extreme® /Vee-Rotor	OS Series Oversize 250/280mm Rotor Kit	OSX Series Oversize 280mm Rotor Kit	Relocating Bracket for Oversize Rotor	SMX Series Oversize 320mm Rotor Kit	Relocating Bracket for 320mm Rotor		Sintered/HH Pads/ Grooved Shoes	SV Series Severe Duty Pads	EPFA Sintered Fast Road/ Track Pads	Specialty Pads SXR/ VEE/MXS Race	Standard Rotor	Vintage Rotor / UTV Oversize Brake Kit	Contour Profile Rotor	CX Extreme® /Vee-Rotor
							FA231	FA231HH		EPFA231HH	FA231V	MD4148			
											FA231/3V	MD4148			
											FA231/3V	MD4148			
											FA231/2V	MD4148			
											FA231/3V	MD4147			
	MD4022CC*	VR4022BLK*†									FA231/3V	MD4146		N/A	N/A
											FA231/3V	MD4146		N/A	N/A
											FA231/2V	MD4146		N/A	N/A
	MD4022CC*	VR4022BLK*†									FA231/3V	MD4146		N/A	N/A
	MD4022CC*	VR4022BLK*†									FA231/3V	MD4146		N/A	N/A
	MD4022CC*	VR4022BLK*†									FA231/2V	MD4146		N/A	N/A
											FA231/2V	MD4146			
											FA231/2V	MD4146			
											FA231/2V	TBC			
											FA231/2V	TBC			
											FA231/2V	TBC			
											FA231/2V	TBC			
											FA231/2V	TBC			
											FA231/2V	TBC			
											FA231/2V	TBC			
											FA231/2V	MD4147			
											FA231/2V	MD4147			
											FA231/2V	MD4147			
											FA231/2V	MD4147			

REAR

⚠ This symbol indicates a rotor made of billet steel, and should be only used with EBC FA Kevlar® Organic or Vee pads.
SAFETY NOTICE - With vehicles primarily designed for off highway use such as quads now being used on the highway, we would recommend the use of X or MXS pads for highway use and ONLY using the R and SV higher density / harder pad series for off road riding.

BRAKE APPLICATIONS

*-2 Sets Required. † For Vee disc colours add RED, BLU, GRN, GLD, ORG suffix to part number. **SAFETY WARNING:- DO NOT USE HH PADS ON REAR UNLESS ALSO USED ON FRONT TO AVOID BRAKE IMBALANCE**

FRONT: SUZUKI



SUZUKI



DISC PAD CHOICES - FRONT

BRAKE ROTOR CHOICES - FRONT

											Line #
AC 50 R	70-71	603									1
AS 50 Sport/Colt	68-69	603									2
DR-Z 50	18-21	301									3
FA 50 T/X/MX/Z/D/E/F/G/H/J/K/L/M	80-91	614									4
FS 50 T/X	80-81	614									5
FZ 50 N/T/X/Z/D	79-83	601									6
GSXR 50 (RB 50 H)	87	FA67	FA67HH				MD3010LS				7
JR 50 C/N/T/X/Z/RD/F/G/H/J/K/L/M/N/P/R/V/W/X/Y/K1-K6	78-06	613	613G								8
LT 50 E/F/G/H	84-87	NONE	NONE								9
LT-A 50 K Quadsport	02-05	614*	614G*								10
LTZ 50 K/ZK Quadsport	06-11/17-22	614*	614G*								11
OR 50 T	80	604									12
RM 50 C/N/T	78-80	603	603G								13
RM 50 X	81	604	604G								14
RM 60 N/T	79-80	603	603G								15
RM 60 X/Z/D	81-83	604	604G								16
RM 60 K	03	715	715G								17
RM 65 K	03-05	FA302X	FA302R			MXS302	MD6166D				18
DR-Z 70 K/L	08-09/15-18	301									19
DS 80 T/X/Z/D/F/G/H/J/K/L/M/N/P/R/S/T/V/W/X/Y	80-00	604	604G								20
JR 80 K	01-04	604	604G								21
LT 80 H/J/K/L/M/N/P/R/S/T/V/W/X/Y/K1-K6	87-06	614*	614G*								22
RM 80 T/X	80-81	604	604G								23
RM 80 Z/D/E/F	82-85	615									24
RM 80 G/H/J/K	86-89	FA83X	FA83R				MD6018D			MD6018C	25
RM 80 L/M/N/P/R/S	90-95	FA83X	FA83R				MD6018D			MD6018C	26
RM 80 T/V/W/X/Y/K1	96-01	FA230X	FA230R				MD6018D			MD6018C	27
RM 85 L/K/K	02-04	FA230X	FA230R				MD6018D			MD6018C	28
RM 85	05-12/15-22	FA258X	FA258R				MD6030D			MD6030C	29
LT-Z 90 K/Z/L Quadsport	07-11	604*	604G*								30
TC 90 Blazer	70	602	602G								31
TC 90 R/J Blazer	71-72	603	603G								32
TS 90 Honcho	70	602	602G								33
TS 90 R/J Honcho	71-72	603	603G								34
A 100 A/B Gofor	76-77	602									35
B 100 P Magnum (118cc)	65-66	602									36
DR 100 D/E/F/G/H/J/K/L	83-90	604	604G								37
DS 100 C/N/T/X	78-81	602	602G								38
RM 100 K	03	FA258X	FA258R				MD6186D			MD6186C	39
SP 100 D	83	617	617G								40
TC 100 K/L/M Blazer	73-75	603	603G								41
TC 100 A/B Blazer	76-77	602	602G								42
TS 100 K/L/M Honcho	73-75	603	603G								43
TS 100 A/B Honcho	76-77	602	602G								44
TS 100 A/B/C/N/T/X	76-81	602	602G								45
RM 100 A/B/C	76-78	603	603G								46
RM 100 N/T/X	79-81	603	603G								47
B 105 P Bearcat (118cc)	67-68	602	602G								48
DR-Z 110 K	03-05	715	715G								49
B 120 (118cc)	71-77	602									50
KT 120 Trail	68-70	602	602G								51
TC 120 Trailcat	68-71	602	602G								52
DR 125 Z/D	82-83	602	602G								53
DR 125 E	84	602	602G								54
DR 125 G/H/J/SER/SES/SET	86-96	FA54X	FA54R			MXS54	MD6073D				55
DR-Z 125 K/L	03-21	604	604G								56

FRONT

APPLIATIONS
SAFETY NOTICE - With vehicles primarily designed for off highway use such as quads now being used on the highway, we would recommend the use of X or MXS pads for highway use and ONLY using the R and SV higher density / harder pad series for off road riding.

*** This symbol indicates a rotor made of billet steel, and should be only used with EBC FA Kevlar® Organic or Vee pads.**

*-2 Sets Required. † For Vee disc colours add RED, BLU, GRN, GLD, ORG suffix to part number. **SAFETY WARNING:- DO NOT USE HH PADS ON REAR UNLESS ALSO USED ON FRONT TO AVOID BRAKE IMBALANCE**

FRONT: SUZUKI Cont'd

REAR: SUZUKI

Line #	BRAKE ROTOR CHOICES - FRONT							DISC PAD CHOICES - REAR					BRAKE ROTOR CHOICES - REAR			
	CC Custom Rotor	CX Extreme® /Vee-Rotor	OS Series Oversize 250/280mm Rotor Kit	OSX Series Oversize 280mm Rotor Kit	Relocating Bracket for Oversize Rotor	SMX Series Oversize 320mm Rotor Kit	Relocating Bracket for 320mm Rotor		Sintered/HH Pads/ Grooved Shoes	SV Series Severe Duty Pads	EPFA Sintered Fast Road/ Track Pads	Specialty Pads SXR/ VEE/MXS Race	Standard Rotor	Vintage Rotor / UTV Oversize Brake Kit	Contour Profile Rotor	CX Extreme® /Vee-Rotor
1								603								
2								603								
3								301								
4								614								
5								614								
6								601								
7								604								
8								613	613G							
9								613	613G							
10								604	604G							
11								604	604G							
12								604	604G							
13								603	603G							
14								604	604G							
15								603	603G							
16								604	604G							
17								715	715G							
18		MD6166CX						FA54X	FA54R				MD6166D			MD6166CX
19								301								
20								604	604G							
21								604	604G							
22								618	618G							
23								604	604G							
24								502	502G							
25								502	502G							
26								FA83X	FA83R				MD6025D		MD6025C	
27			OS6018C	OSX6018	BRK001	N/A	N/A	FA83X	FA83R				MD6025D		MD6025C	
28			OS6018C	OSX6018	BRK001	N/A	N/A	FA83X	FA83R				MD6025D		MD6025C	
29		MD6030CX	OSS6030C	OSXS6030	BRK029	N/A	N/A	FA401X	FA401R				MD6246D		MD6246C	MD6246CX
30								618	618G							
31								602	602G							
32								602	602G							
33								602	602G							
34								602	602G							
35								603								
36								602								
37								604	604G							
38								602	602G							
39		MD6186CX	OS6186C	OSX6186	BRK025	N/A	N/A	FA84X	FA84R				MD6187D		MD6187C	
40								604	604G							
41								602	602G							
42								602	602G							
43								602	602G							
44								602	602G							
45								602	602G							
46								603	603G							
47								617	617G							
48								602	602G							
49								603	603G							
50								602								
51								602	602G							
52								602	602G							
53								602	602G							
54								602	602G							
55								602	602G							
56								604	604G							

⚠ This symbol indicates a rotor made of billet steel, and should be only used with EBC FA Kevlar® Organic or Vee pads.
SAFETY NOTICE - With vehicles primarily designed for off highway use such as quads now being used on the highway, we would recommend the use of X or MXS pads for highway use and ONLY using the R and SV higher density / harder pad series for off road riding.

BRAKE APPLICATIONS

*-2 Sets Required. † For Vee disc colours add RED, BLU, GRN, GLD, ORG suffix to part number. **SAFETY WARNING:- DO NOT USE HH PADS ON REAR UNLESS ALSO USED ON FRONT TO AVOID BRAKE IMBALANCE**

FRONT: SUZUKI



SUZUKI



DISC PAD CHOICES - FRONT

BRAKE ROTOR CHOICES - FRONT

											Line #
DR-Z 125 L	03-20	FA230X	FA230R				MD6212D				1
DS 125 N/T/X	79-81	602	602G								2
GN 125 Z/D	82-83	602									3
GN 125 E	91-96	FA67	FA67HH				N/A				4
GSX-R 125 RLX/RL	18-21	FA715	FA715HH				MD3110			MD3110C	5
GSX-R 125 MLX/ML	18-21	FA715	FA715HH				MD3110			MD3110C	6
LT 125 D	83	NONE	NONE								7
LT 125 E	84	NONE	NONE								8
LT 125 F/G/H	85-87	NONE	NONE								9
RM 125 A/B/C	76-78	602	602G								10
RM 125 N/T	79-80	602	602G								11
RM 125 X/Z/D	81-83	618	618G								12
RM 125 E	84	622	622G								13
RM 125 F/G	85-86	FA106X	FA106R				MD6163D				14
RM 125 H	87	FA135X	FA135R			MXS135	MD6163D				15
RM 125 J	88	FA135X	FA135R			MXS135	MD6163D				16
RM 125 K	89	FA135X	FA135R			MXS135	MD6017D			MD6017C	17
RM 125 L	90	FA135X	FA135R			MXS135	MD6017D			MD6017C	18
RM 125 M/V/P	91-93	FA135X	FA135R			MXS135	MD6017D			MD6017C	19
RM 125 R/S	94-95	FA135X	FA135R			MXS135	MD6017D			MD6017C	20
RM 125 T/V/W	96-98	FA185X	FA185R			MXS185	MD6017D			MD6017C	21
RM 125 X/Y/K	99-05	FA185X	FA185R			MXS185	MD6017D			MD6017C	22
RM 125 K	06-08	FA185X	FA185R			MXS185	MD6017D			MD6017C	23
RV 125 K Tracker	73	603	603G								24
RV 125 L/M/A/B Tracker	74-77	602	602G								25
SP 125 Z/D	82-83	602	602G								26
SP 125 G/H/J	86-88	FA54X	FA54R			MXS54	MD6073D				27
T 125 / 11 / R Stinger	69-71	602									28
TC 125 J/K Prospector	72-73	603	603G								29
TC 125 L/M/A/B Prospector	74-77	602	602G								30
TM 125 K/L/M Challenger	73-75	603	603G								31
TS 125 TX	80-81	602	602G								32
S32 (150cc) Single Cam Front Brake	65	605									33
S32-2 (150cc)	66-67	N/A									34
LT 160 EK/EL/EM/EN	89-92	624*	624G*								35
LT-F 160 M/N/P/R/S/T/V/W/X/Y/K1/K3	91-01/03	624*	624G*								36
LT 160 K QuadSport	03-04	624*	624G*								37
PE 175 T/X	80-81	602	602G								38
PE 175 Z/D/E	82-84	618	618G								39
RS 175 T/X/Z	80-82	602	602G								40
DS 185 T	80	602	602G								41
GT 185 K Adventurer (Drum Brake)	73	N/A									42
GT 185 L/M/A/B Adventurer	74-76	FA55						N/A			43
LT 185 E/F/G/H	84-87	NONE	NONE								44
TS 185 T/X	80-81	602	602G								45
DR 200 G/H/J	86-90	FA54X	FA54R			MXS54	MD6073D				46
DR 200 SE	96-09/13/15-21	FA54X	FA54R			MXS54	MD6073D				47
RV 200 L Van-Van	16-19	FA231	FA231HH	EPFA231HH			MD6281D				48
SP 200 G/H/J	86-88	FA54X	FA54R			MXS54	MD6073D				49
T 200 X5 Invader	68-69	N/A									50
TC 200 X5 Stingray	67-69	N/A									51
UH 200 AL Burgman ABS	14-22	SFA388	SFA388HH					MD9117D			52
LT 230 GEF/GEG	85-86	625*	625G*								53
LT 230 EH Early axle 64710 22A00	86	FA128X*	FA128R*	FA128SV*			MD6020D	MD6020D			54
LT 230 EH Late axle 64710 22A01	86	FA128X*	FA128R*	FA128SV*			MD6020D	MD6020D			55
LT 230 EJ/EK/EL/EM/EN/EP	87-93	FA128X*	FA128R*	FA128SV*			MD6020D	MD6020D			56

FRONT

APPLICATIONS

⚡ This symbol indicates a rotor made of billet steel, and should be only used with EBC FA Kevlar® Organic or Vee pads.

SAFETY NOTICE - With vehicles primarily designed for off highway use such as quads now being used on the highway, we would recommend the use of X or MXS pads for highway use and ONLY using the R and SV higher density / harder pad series for off road riding.

*-2 Sets Required. † For Vee disc colours add RED, BLU, GRN, GLD, ORG suffix to part number. SAFETY WARNING:- DO NOT USE HH PADS ON REAR UNLESS ALSO USED ON FRONT TO AVOID BRAKE IMBALANCE

FRONT: SUZUKI Cont'd

REAR: SUZUKI

Line #	BRAKE ROTOR CHOICES - FRONT						DISC PAD CHOICES - REAR					BRAKE ROTOR CHOICES - REAR				
	CC Custom Rotor	CX Extreme® /Vee-Rotor	OS Series Oversize 250/280mm Rotor Kit	OSX Series Oversize 280mm Rotor Kit	Relocating Bracket for Oversize Rotor	SMX Series Oversize 320mm Rotor Kit	Relocating Bracket for 320mm Rotor		Sintered/HH Pads/ Grooved Shoes	SV Series Severe Duty Pads	EPFA Sintered Fast Road/ Track Pads	Specialty Pads SXR/ VEE/MXS Race	Standard Rotor	Vintage Rotor / UTV Oversize Brake Kit	Contour Profile Rotor	CX Extreme® /Vee-Rotor
1								604	604G							
2								602	602G							
3								602								
4								602								
5								FA629	FA629HH				MD3111		MD3111C	
6								FA629	FA629HH				MD3111		MD3111C	
7								621	621G							
8								605	605G							
9								621	621G							
10								602	602G							
11								617	617G							
12								616	616G							
13								616	616G							
14								616	616G							
15								616	616G							
16								N/A	FA84/3R		MXS84/3		MD6014D			
17		MD6017CX	OS6017EC	OSX6017E	BRK031	N/A		FA152X	FA152R		MXS152		MD6014D		MD6014C	MD6014CX
18		MD6017CX	OS6017EC	OSX6017E	BRK031	N/A		FA152X	FA152R		MXS152		MD6014D		MD6014C	MD6014CX
19		MD6017CX	OS6017EC	OSX6017E	BRK031	N/A		FA152/2X	FA152/2R		MXS152/2		MD6014D		MD6014C	MD6014CX
20		MD6017CX	OS6017EC	OSX6017E	BRK031	N/A		FA152/2X	FA152/2R		MXS152/2		MD6014D		MD6014C	MD6014CX
21		MD6017CX	OS6017C	OSX6017	BRK023	SMX6017	BRK024	FA131X	FA131R		MXS131		MD6014D		MD6014C	MD6014CX
22		MD6017CX	OS6017C	OSX6017	BRK023	SMX6017	BRK024	FA131X	FA131R		MXS131		MD6157D		MD6157C	MD6157CX
23		MD6017CX	OS6017C	OSX6017	BRK023	SMX6017	BRK024	FA131X	FA131R		MXS131		MD6305D		MD6305C	MD6305CX
24								602	602G							
25								602	602G							
26								602	602G							
27								602	602G							
28								602	602G							
29								602	602G							
30								602	602G							
31								602	602G							
32								602	602G							
33								605								
34								605								
35								605	605G							
36								605	605G							
37								605	605G							
38								619	619G							
39								619	619G							
40								617	617G							
41								602	602G							
42								602								
43								602								
44								605	605G							
45								602	602G							
46								602	602G							
47								602	602G							
48								603								
49								602	602G							
50								605								
51								605								
52		VR9117						SFA413	SFA413HH							VR9117
53								605	605G							
54								FA84X	FA84R	FA84SV			MD6021D			
55								FA84X	FA84R	FA84SV			MD6063D			
56								FA84X	FA84R	FA84SV			MD6063D			

BRAKE APPLICATIONS

⚠ This symbol indicates a rotor made of billet steel, and should be only used with EBC FA Kevlar® Organic or Vee pads.
 SAFETY NOTICE - With vehicles primarily designed for off highway use such as quads now being used on the highway, we would recommend the use of X or MXS pads for highway use and ONLY using the R and SV higher density / harder pad series for off road riding.

*-2 Sets Required. † For Vee disc colours add RED, BLU, GRN, GLD, ORG suffix to part number. **SAFETY WARNING:** DO NOT USE HH PADS ON REAR UNLESS ALSO USED ON FRONT TO AVOID BRAKE IMBALANCE

FRONT: SUZUKI



SUZUKI



DISC PAD CHOICES - FRONT

BRAKE ROTOR CHOICES - FRONT

											Line #
LT 230 SF/SG	85-86	FA128X*	FA128R*	FA128SV*			MD6020D	MD6020D			1
LT 230 SH up to F. no. 2108531	87	FA128X*	FA128R*	FA128SV*			MD6020D	MD6020D			2
LT 230 SH from F. no. 2108532/SJ	87-88	FA128X*	FA128R*	FA128SV*			MD6020D	MD6020D			3
LT-F 230 G/H	86-87	625*	625G*								4
DL 250 V-Strom	18-21	FA226	FA226HH							MD3112C	5
DR 250 Z/D	82-83	602	602G								6
DR 250 F	85	FA54X	FA54R			MXS54	MD6074D				7
DR 250 L/M/N/P/R/S	90-95	FA135X	FA135R			MXS135	MD6040D				8
DR 250 S/SE	90-95	FA135X	FA135R			MXS135	MD6040D				9
DR-Z 250 K	01-07	FA185X	FA185R			MXS185	MD6017D			MD6017C	10
DS 250 T	80	605	605G								11
GN 250 Z/D/F	82-85	N/A									12
GN 250 J	88	FA51					MD3014LS		VMD3014		13
GS 250 TT/TX	80-81	FA51					MD3014LS		VMD3014		14
GSX 250 R	17-21	FA226	FA226HH		EPFA226HH					MD3112C	15
GSX 250 R ABS	18-21	FA226	FA226HH		EPFA226HH						16
GT 250 K/L/M/A/B Hustler	73-77	FA55						MD3014RS			17
GW 250 L	14-15	FA142	FA142HH				MD3105LS				18
GZ 250 X/Y/K/L0 Marauder	99-10	FA106					N/A				19
LT 250 EFF/EFK	85-86	625*	625G*								20
LT-F 250 J/K/L/M/N/P/R/S/T/V/W/X/Y/K1 250 Quadrunner	88-01	628*	628G*								21
LT 250 SK/SL	89-90	FA128X*	FA128R*	FA128SV*			MD6020D	MD6020D			22
LT 250 RH/RJ/RK/RL/RM/RN	87-92	FA128X*	FA128R*	FA128SV*			MD6020D	MD6020D			23
LT-F 250 FX/FY/FK1/FK2 Quadrunner	99-02	628*	628G*								24
LT-F 250 K/L Ozark	02-14	FA54X*	FA54R*	FA54SV*			MD6207D	MD6207D			25
LT-Z 250 K QuadSport	04-11	FA84X*	FA84R*	FA84SV*			MD6210D	MD6210D			26
LT-4WD H/J/K/L/M/N/P/R/S/T/V 250 Quadrunner	87-97	628*	628G*								27
LT-F 4WD V/W Quadrunner 250	97-98	628*	628G*								28
LT-F 4WD V/W Quadrunner 4WD (250cc)	97-98	FA54X*	FA54R*	FA54SV*			MD6195D	MD6195D			29
PE 250 B/C/N/T/X	77-81	605	605G								30
RM 250 A/B/C/C2	76-78	602	602G								31
RM 250 N	79	605	605G								32
RM 250 T	80	618	618G								33
RM 250 X/Z	81-82	621	621G								34
RM 250 D	83	622	622G								35
RM 250 E	84	622	622G								36
RM 250 F/G	85-86	FA106X	FA106R				MD6163D				37
RM 250 H/J	87-88	FA135X	FA135R			MXS135	MD6163D				38
RM 250 K	89	FA135X	FA135R			MXS135	MD6017D			MD6017C	39
RM 250 L	90	FA135X	FA135R			MXS135	MD6017D			MD6017C	40
RM 250 M/N/P	91-93	FA135X	FA135R			MXS135	MD6017D			MD6017C	41
RM 250 R/S	94-95	FA135X	FA135R			MXS135	MD6017D			MD6017C	42
RM 250 T/V/W	96-98	FA185X	FA185R			MXS185	MD6017D			MD6017C	43
RM 250 X/Y/K	99-05	FA185X	FA185R			MXS185	MD6017D			MD6017C	44
RM 250 K	06-08	FA185X	FA185R			MXS185	MD6017D			MD6017C	45
RMX 250 K/M/N/P	89-93	FA135X	FA135R			MXS135	MD6017D			MD6017C	46
RMX 250 R/S	94-95	FA135X	FA135R			MXS135	MD6017D			MD6017C	47
RMX 250 T/V/W	96-98	FA185X	FA185R			MXS185	MD6017D			MD6017C	48
RMX 250 XY	99-00	FA185X	FA185R			MXS185	MD6017D			MD6017C	49
RM-Z 250 K	04-06	FA185X	FA185R			MXS185	MD6213D			MD6213C	50
RM-Z 250 K7	07	FA185X	FA185R			MXS185	MD6254D			MD6254C	51
RM-Z 250	08-21	FA185X	FA185R			MXS185	MD6254D			MD6254C	52
RM-Z 250 (270mm F/Disc 240mm R/Disc)	19-22	FA185X	FA185R			MXS185					53
RS 250 T/X	80-81	602	602G								54
SP 250 Z/D	82-83	620	620G								55

FRONT

APPLIATIONS
BRAKE
SAFETY NOTICE - With vehicles primarily designed for off highway use such as quads now being used on the highway, we would recommend the use of X or MXS pads for highway use and ONLY using the R and SV higher density / harder pad series for off road riding.

⚡ This symbol indicates a rotor made of billet steel, and should be only used with EBC FA Kevlar® Organic or Vee pads.

*-2 Sets Required. † For Vee disc colours add RED, BLU, GRN, GLD, ORG suffix to part number. **SAFETY WARNING:- DO NOT USE HH PADS ON REAR UNLESS ALSO USED ON FRONT TO AVOID BRAKE IMBALANCE**

FRONT: SUZUKI Cont'd

REAR: SUZUKI

Line # 1 2 3 4 5 6 7 8 9 10 11 12 13 14 15 16 17 18 19 20 21 22 23 24 25 26 27 28 29 30 31 32 33 34 35 36 37 38 39 40 41 42 43 44 45 46 47 48 49 50 51 52 53 54 55 56

BRAKE ROTOR CHOICES - FRONT							DISC PAD CHOICES - REAR					BRAKE ROTOR CHOICES - REAR			
CC Custom Rotor	CX Extreme® /Vee-Rotor	OS Series Oversize 250/280mm Rotor Kit	OSX Series Oversize 280mm Rotor Kit	Relocating Bracket for Oversize Rotor	SMX Series Oversize 320mm Rotor Kit	Relocating Bracket for 320mm Rotor		Sintered/HH Pads/ Grooved Shoes	SV Series Severe Duty Pads	EPFA Sintered Fast Road/ Track Pads	Specialty Pads SXR/ VEE/MXS Race	Standard Rotor	Vintage Rotor / UTV Oversize Brake Kit	Contour Profile Rotor	CX Extreme® /Vee-Rotor
							N/A	FA84/3R			MXS84/3	MD6021D			
							N/A	FA84/3R				MD6021D			
							N/A	FA84/3R				MD6063D			
							605	605G							
							FA496	FA496HH						MD3113C	
							602	602G							
							602	602G							
	MD6040CX	OS6040C	OSX6040	BRK031	N/A	N/A	FA152X	FA152R			MXS152	MD6038D			MD6038CX
	MD6040CX	OS6040C	OSX6040	BRK031	N/A	N/A	FA152X	FA152R			MXS152	MD6038D			MD6038CX
	MD6017CX	OS6017C	OSX6017	BRK023	SMX6017	BRK024	FA152/2X	FA152/2R			MXS152/2	MD6110D			MD6110CX
							605	605G							
							602								
							602								
							606								
							FA496	FA496HH						MD3113C	
							FA496	FA496HH							
							609								
							FA496	FA496HH				MD3093			
							602								
							634	634G							
							629	629G							
							FA84X	FA84R	FA84SV			MD6063D			
							N/A	FA84/3R			MXS84/3	MD6062D			
							FA137X	FA137R	FA137SV			MD6021D			
							629	629G							
							636	636G							
							636	636G							
							629	629G							
							629	629G							
							606	606G							
							605	605G							
							605	605G							
							620	620G							
							620	620G							
							616	616G							
							616	616G							
							618	618G							
							618	618G							
							N/A	FA84/3R				MD6014D			
	MD6017CX	OS6017EC	OSX6017E	BRK031	N/A	N/A	FA152X	FA152R			MXS152	MD6014D	MD6014C	MD6014CX	
	MD6017CX	OS6017EC	OSX6017E	BRK031	N/A	N/A	FA152X	FA152R			MXS152	MD6014D	MD6014C	MD6014CX	
	MD6017CX	OS6017EC	OSX6017E	BRK031	N/A	N/A	FA152/2X	FA152/2R			MXS152/2	MD6014D	MD6014C	MD6014CX	
	MD6017CX	OS6017EC	OSX6017E	BRK031	N/A	N/A	FA152/2X	FA152/2R			MXS152/2	MD6014D	MD6014C	MD6014CX	
	MD6017CX	OS6017C	OSX6017	BRK023	SMX6017	BRK024	FA131X	FA131R			MXS131	MD6014D	MD6014C	MD6014CX	
	MD6017CX	OS6017C	OSX6017	BRK023	SMX6017	BRK024	FA131X	FA131R			MXS131	MD6157D	MD6157C	MD6157CX	
	MD6017CX	OS6017C	OSX6017	BRK023	SMX6017	BRK024	FA131X	FA131R			MXS131	MD6305D	MD6305C	MD6305CX	
	MD6017CX	OS6017EC	OSX6017E	BRK031	N/A	N/A	FA152X	FA152R			MXS152	MD6014D	MD6014C	MD6014CX	
	MD6017CX	OS6017EC	OSX6017E	BRK031	N/A	N/A	FA152X	FA152R			MXS152	MD6014D	MD6014C	MD6014CX	
	MD6017CX	OS6017C	OSX6017	BRK023	SMX6017	BRK024	FA152X	FA152R			MXS152	MD6014D	MD6014C	MD6014CX	
	MD6017CX	OS6017C	OSX6017	BRK023	SMX6017	BRK024	FA131X	FA131R			MXS131	MD6157D	MD6157C	MD6157CX	
	MD6213CX	OS6213C	OSX6213	BRK023	SMX6213	BRK024	FA367X	FA367R			MXS367	MD6208D	MD6208C	MD6208CX	
	MD6254CX	OS6254C	OSX6254	BRK023	SMX6254	BRK024	FA367X	FA367R			MXS367	MD6255D	MD6255C	MD6255CX	
	MD6254CX	OS6254C	OSX6254	BRK023	SMX6254	BRK024	FA367X	FA367R			MXS367	MD6255D	MD6255C	MD6255CX	
	MD6422CX	OS6254C	OSX6254	BRK023	SMX6254	BRK024	FA367X	FA367R			MXS367	MD6255D	MD6255C	MD6255CX	
							605	605G							
							602	602G							

REAR

BRAKE APPLICATIONS

⚠ This symbol indicates a rotor made of billet steel, and should be only used with EBC FA Kevlar® Organic or Vee pads.
 SAFETY NOTICE - With vehicles primarily designed for off highway use such as quads now being used on the highway, we would recommend the use of X or MXS pads for highway use and ONLY using the R and SV higher density / harder pad series for off road riding.

*-2 Sets Required. † For Vee disc colours add RED, BLU, GRN, GLD, ORG suffix to part number. **SAFETY WARNING:- DO NOT USE HH PADS ON REAR UNLESS ALSO USED ON FRONT TO AVOID BRAKE IMBALANCE**

FRONT: SUZUKI



SUZUKI



DISC PAD CHOICES - FRONT

BRAKE ROTOR CHOICES - FRONT

											Line #
SP 250 F	85	FA54X	FA54R			MXS54	MD6074D				1
T10 - 250cc (E/No T10 16816 onwards - Twin Leading Shoe F/Brake - Cable Rear Brake)	66-67	608									2
T20 X6 - 250cc	65-69	608									3
T 250 11/R/J Hustler	69-72	608									4
TC 250 X6 Scrambler	67-69	608									5
TS 250 R/J/K/L/M/A/B/C/N/T/X	71-81	605	605G								6
TU 250 XK/XL	09-16	FA229	FA229HH				N/A				7
LT 300 EH/EJ/EK	87-89	625*	625G*								8
LT-F 4WD XM/N/P/R/S/T/V/W King Quad 300	91-98	633*	633G*								9
GS 300 L	82-83	N/A									10
GS 300 L	85	612									11
LT-F 300 FX/FY/FK1 King Quad	99-01	633*	633G*								12
LT-F 300 FK2 King Quad	02	FA165X	FA165R	FA165SV			MD6206D				13
	Left	FA135X	FA135R	FA135SV				MD6206D			14
	Right										15
T 305 Raider	68-69	608									16
DR 350 L/M/N/P/R/S/T	90-96	FA135X	FA135R			MXS135	MD6040D				17
DR 350 V/W/X	97-99	FA185X	FA185R			MXS185	MD6017D			MD6017C	18
DR 350 S/SE	90-95	FA135X	FA135R			MXS135	MD6040D				19
DR 350 SET/SEV	96-97	FA135X	FA135R			MXS135	MD6040D				20
DR 350 SEW/SEX	98-99	FA185X	FA185R			MXS185	MD6017D			MD6017C	21
T 350 Rebel	69-72	608									22
DR 370 C/N	78-79	602	602G								23
RM 370 A/B	76-77	602	602G								24
SP 370 C/N	78-79	605	605G								25
GT 380 J Sebring (Drum Brake)	72	608									26
GT 380 K/L/M/A/B Sebring	73-77	FA55						MD3014RS			27
AN 400 K/SK Burgman	03-06	SFA283/4	SFA283/4HH				MD994D				28
AN 400 K/AK/AL Burgman	07-16	SFA228	SFA228HH				MD994D				29
	Left	SFA197	SFA197HH					MD994D			30
	Right										31
AN 400 Z Burgman (ABS)	14-21	SFA228	SFA228HH				MD994D				32
	Left	SFA197	SFA197HH					MD994D			33
	Right										34
DR 400 T	80	602	602G								35
DR-Z 400 S	00-21	FA185X	FA185R	EPFA185HH		MXS185	MD6017D			MD6017C	36
DR-Z 400 SM	05-09/13-22	FA185X	FA185R	EPFA185HH		MXS185	MD6247D			MD6247C	37
DR-Z 400 Y/K/EY/EK	00-07	FA185X	FA185R	EPFA185HH		MXS185	MD6017D			MD6017C	38
GS 400 B/C (Disc Brake)	77-78	FA35						MD3014RS			39
GS 400 XB/XC (Drum Brake)	77-78	612									40
GSF 400 M/N/P Bandit	91-93	FA129	FA129HH				MD3006X			MD3006XC	41
GN 400 T/X/XX/TX/TZ	80-82	FA51					MD3014LS		VMD3014		42
LT-A 400 FK/FCK Eiger (4WD Auto)	02-07	FA54X*	FA54R*	FA54SV*			MD6195D	MD6195D			43
LT-A 400 FK King Quad Auto 4WD	08-18	FA413X	FA413R	FA413SV			MD6195D				44
	Left	FA414X	FA414R	FA414SV				MD6195D			45
	Right										46
LT-A 400 K Eiger (Auto 2WD)	06-18	FA54X*	FA54R*	FA54SV*			MD6195D	MD6195D			47
LT-A 400 FK/FL King Quad 400 AS	08-18	FA413X	FA413R	FA413SV			MD6195D				48
	Left	FA414X	FA414R	FA414SV				MD6195D			49
	Right										50
LT-A 400 FCK King Quad 400 AS Camo	09	FA413X	FA413R	FA413SV			MD6195D				51
	Left	FA414X	FA414R	FA414SV				MD6195D			52
	Right										53
LT-A 400 FQK King Quad 400	08-09	FA413X	FA413R	FA413SV			MD6195D				54
AS Anniversary Edition		FA414X	FA414R	FA414SV				MD6195D			55
LT-A 400 FL King Quad 400 Asi	11-22	FA413X	FA413R	FA413SV			MD6195D				56
	Left	FA414X	FA414R	FA414SV				MD6195D			57
	Right										58
LT-A 400 FCL King Quad 400 Asi Camo	11-16	FA413X	FA413R	FA413SV			MD6195D				59
	Left	FA414X	FA414R	FA414SV				MD6195D			60
	Right										61
LT-F 400 FK/FCK (Eiger 4WD)	02-07	FA54X*	FA54R*	FA54SV*			MD6195D	MD6195D			62
LT-F 400 K Eiger Manual 2WD	02	FA54X*	FA54R*	FA54SV*			MD6195D	MD6195D			63

APPLIATIONS

BRAKE

X This symbol indicates a rotor made of billet steel, and should be only used with EBC FA Kevlar® Organic or Vee pads.

S SAFETY NOTICE - With vehicles primarily designed for off highway use such as quads now being used on the highway, we would recommend the use of X or MXS pads for highway use and ONLY using the R and SV higher density / harder pad series for off road riding.

*-2 Sets Required. † For Vee disc colours add RED, BLU, GRN, GLD, ORG suffix to part number. **SAFETY WARNING:** DO NOT USE HH PADS ON REAR UNLESS ALSO USED ON FRONT TO AVOID BRAKE IMBALANCE

FRONT: SUZUKI Cont'd

REAR: SUZUKI

Line #	BRAKE ROTOR CHOICES - FRONT							DISC PAD CHOICES - REAR					BRAKE ROTOR CHOICES - REAR			
	CC Custom Rotor	CX Extreme® /Vee-Rotor	OS Series Oversize 250/280mm Rotor Kit	OSX Series Oversize 280mm Rotor Kit	Relocating Bracket for Oversize Rotor	SMX Series Oversize 320mm Rotor Kit	Relocating Bracket for 320mm Rotor		Sintered/HH Pads/Grooved Shoes	SV Series Severe Duty Pads	EPFA Sintered Fast Road/Track Pads	Specialty Pads SXR/VEE/MXS Race	Standard Rotor	Vintage Rotor / UTV Oversize Brake Kit	Contour Profile Rotor	CX Extreme® /Vee-Rotor
1								602	602G							
2								609								
3								609								
4								609								
5								609								
6								609								
7								605	605G							
8								602								
9								634	634G							
10								634	634G							
11								606								
12								606								
13								634	634G							
14								634	634G							
15																
16								609								
17		MD6040CX	OS6040C	OSX6040	BRK031	N/A	N/A	FA152X	FA152R			MXS152	MD6038D			MD6038CX
18		MD6017CX	OS6017C	OSX6017	BRK023	SMX6017	BRK024	FA152X	FA152R			MXS152	MD6110D			MD6110CX
19		MD6040CX	OS6040C	OSX6040	BRK031	N/A	N/A	FA152X	FA152R			MXS152	MD6038D			MD6038CX
20		MD6040CX	OS6040C	OSX6040	BRK031	N/A	N/A	FA152X	FA152R			MXS152	MD6110D			MD6110CX
21		MD6017CX	OS6017C	OSX6017	BRK023	SMX6017	BRK024	FA152X	FA152R			MXS152	MD6110D			MD6110CX
22								609								
23								605	605G							
24								605	605G							
25								605	605G							
26								609								
27								609								
28								SFA411	SFA411HH				N/A			
29								SFA412	SFA412HH				MD9109D			
30																
31								SFA412	SFA412HH				MD9109D			
32																
33								605	605G							
34		MD6017CX	OS6017C	OSX6017	BRK023	SMX6017/1	BRK038	FA131X	FA131R			MXS131	MD6014D		MD6014C	MD6014CX
35								FA131X	FA131R			MXS131	MD6157D		MD6157C	
36		MD6017CX	OS6017C	OSX6017	BRK023	SMX6017/1	BRK038	FA131X	FA131R			MXS131	MD6014D		MD6014C	MD6014CX
37								609								
38								609								
39	MD3006CC	VR3006BLK						FA63	FA63HH				MD3002		MD3002C	VR3002
40								606								
41								606	606G							
42								606	606G							
43								606	606G							
44								606	606G							
45								606	606G							
46																
47								606	606G							
48																
49								606	606G							
50																
51								606	606G							
52																
53								606	606G							
54																
55								606	606G							
56								606	606G							

REAR

BRAKE APPLICATIONS

⚠ This symbol indicates a rotor made of billet steel, and should be only used with EBC FA Kevlar® Organic or Vee pads.
SAFETY NOTICE - With vehicles primarily designed for off highway use such as quads now being used on the highway, we would recommend the use of X or MXS pads for highway use and ONLY using the R and SV higher density / harder pad series for off road riding.

*-2 Sets Required. † For Vee disc colours add RED, BLU, GRN, GLD, ORG suffix to part number. **SAFETY WARNING: DO NOT USE HH PADS ON REAR UNLESS ALSO USED ON FRONT TO AVOID BRAKE IMBALANCE**

FRONT: SUZUKI



SUZUKI



DISC PAD CHOICES - FRONT

BRAKE ROTOR CHOICES - FRONT

Model	Side	Year	DISC PAD CHOICES - FRONT					BRAKE ROTOR CHOICES - FRONT				Line #		
			Icon	Sintered/HH Pads/Grooved Shoes	SV Series Severe Duty Pads	EPFA Sintered Fast Road/Track Pads	GPFX Sintered RACE ONLY Pads	Specialty Pads SXR/VEE/MXS Race	Standard Rotor Left	Standard Rotor Right	Vintage Rotor / UTV Oversize Brake Kit		Contour Profile Rotor	
LT-F 400 K		03-08	FA54*	FA54R*	FA54SV*					MD6195D	MD6195D		1	
LT-F 400 K Manual 2WD	Left	08	FA413X	FA413R	FA413SV					MD6195D			2	
	Right		FA414X	FA414R	FA414SV						MD6195D		3	
LT-F 400 F King Quad 400 FS	Left	08-10	FA413X	FA413R	FA413SV					MD6195D			4	
	Right		FA414X	FA414R	FA414SV						MD6195D		5	
LT-F 400 FCK King Quad 400 FS Camo	Left	08-09	FA413X	FA413R	FA413SV					MD6195D			6	
	Right		FA414X	FA414R	FA414SV						MD6195D		7	
LT-F 400 FQK King Quad 400	Left	09	FA413X	FA413R	FA413SV					MD6195D			8	
FS Anniversary Edition	Right		FA414X	FA414R	FA414SV						MD6195D		9	
LT-F 400 FL King Quad 400 FSi	Left	11-16	FA413X	FA413R	FA413SV					MD6195D			10	
	Right		FA414X	FA414R	FA414SV						MD6195D		11	
LT-F 400 FCL King Quad 400 FSi Camo	Left	11-16	FA413X	FA413R	FA413SV					MD6195D			12	
	Right		FA414X	FA414R	FA414SV						MD6195D		13	
LT-Z 400 K/ZK/L/ZL QuadSport		03-14	FA84*	FA84R*					MXS84*	MD6210D	MD6210D		14	
TM 400 R/J/K/L/M Cyclone		71-75	602	602G									15	
TS 400 J/K/L/M/A/B		72-77	605	605G									16	
RM 400 C		78	602	602G									17	
RM 400 N		79	605	605G									18	
RM 400 T		80	618	618G									19	
SP 400 T		80	605	605G									20	
PE 400 TX		80-81	605	605G									21	
GS 425 N (Spoke Wheel)		79	FA35							MD3014LS		VMD3014	22	
GS 425 EN (Cast Wheel)		79	FA35							MD3014LS		VMD3014	23	
GS 425 LN		79	FA38					FA38V		MD3014LS		VMD3014	24	
GS 450 E		80-83	FA51							MD3014LS		VMD3014	25	
GS 450 GA		82-85	FA51							MD3014LS		VMD3014	26	
GS 450 L		80-88	FA51							MD3014LS		VMD3014	27	
GS 450 T		81-82	FA51							MD3014LS		VMD3014	28	
GS 450 TXZ		82	FA51							MD3014LS		VMD3014	29	
GS 450 TXD		83	612										30	
LT-A 450 XCK King Quad 450 AXi Camo	Left	07-09	FA413X	FA413R	FA413SV					MD6261D			31	
	Right		FA414X	FA414R	FA414SV						MD6261D		32	
LT-A 450 ZCK King Quad 450 AXi Limited	Left	08-09	FA413X	FA413R	FA413SV					MD6261D			33	
	Right		FA414X	FA414R	FA414SV						MD6261D		34	
LT-A 450 XK/XL King Quad 4x4 Axi	Left	07-10	FA413X	FA413R	FA413SV					MD6261D			35	
	Right		FA414X	FA414R	FA414SV						MD6261D		36	
LT-R 450 K	Left	06-11	FA165X	FA165R						MD6277D			37	
	Right		FA135X	FA135R							MD6277D		38	
LT-R 450 ZK Quadracer Limited Edition	Left	08-10	FA165X	FA165R						MD6277D			39	
	Right		FA135X	FA135R							MD6277D		40	
RMX 450 ZL		10	FA185X	FA185R				MXS185				MD6254C	41	
													42	
RM-Z 450 K/ZK		05-07	FA185X	FA185R				MXS185		MD6254D		MD6254C	43	
RM-Z 450 K/L		08-17	FA185X	FA185R				MXS185		MD6254D		MD6254C	44	
RM-Z 450 L		18-22	FA185X	FA185R				MXS185		TBC			45	
RM 465 X/Z		81-82	621	621G									46	
DR 500 X/Z/D		81-83	602	602G									47	
GS 500 E		89-95	FA129	FA129HH							MD3006X		MD3006XC	48
GS 500 E/K		96-03	FA231	FA231HH							MD3006X		MD3006XC	49
GS 500 FK		04-10	FA231	FA231HH							MD3006X		MD3006XC	50
GT 500 A/B Titan		76-77	FA55								MD3019RS	VMD3019	51	
LT 500 R		87-90	FA128*	FA128R*	FA128SV*					MD6022D	MD6022D		52	
LT-F 500 F Quadrunner	Left	98-02	FA165X	FA165R	FA165SV					MD6145D			53	
	Right		FA135X	FA135R	FA135SV						MD6145D		54	
LT-F 500 F Vinson Quadrunner		03-07	FA54*	FA54R*	FA54SV*					MD6195D	MD6195D		55	
													56	

*-2 Sets Required. † For Vee disc colours add RED, BLU, GRN, GLD, ORG suffix to part number. **SAFETY WARNING:- DO NOT USE HH PADS ON REAR UNLESS ALSO USED ON FRONT TO AVOID BRAKE IMBALANCE**

APPLIATIONS

BRAKE

⚠ This symbol indicates a rotor made of billet steel, and should be only used with EBC FA Kevlar® Organic or Vee pads.

SAFETY NOTICE - With vehicles primarily designed for off highway use such as quads now being used on the highway, we would recommend the use of X or MXS pads for highway use and ONLY using the R and SV higher density / harder pad series for off road riding.

FRONT: SUZUKI Cont'd

REAR: SUZUKI

Line #
1
2
3
4
5
6
7
8
9
10
11
12
13
14
15
16
17
18
19
20
21
22
23
24
25
26
27
28
29
30
31
32
33
34
35
36
37
38
39
40
41
42
43
44
45
46
47
48
49
50
51
52
53
54
55
56

BRAKE ROTOR CHOICES - FRONT							DISC PAD CHOICES - REAR					BRAKE ROTOR CHOICES - REAR			
CC Custom Rotor	CX Extreme® /Vee-Rotor	OS Series Oversize 250/280mm Rotor Kit	OSX Series Oversize 280mm Rotor Kit	Relocating Bracket for Oversize Rotor	SMX Series Oversize 320mm Rotor Kit	Relocating Bracket for 320mm Rotor		Sintered/HH Pads/ Grooved Shoes	SV Series Severe Duty Pads	EPFA Sintered Fast Road/ Track Pads	Specialty Pads SXR/ VEE/MXS Race	Standard Rotor	Vintage Rotor / UTV Oversize Brake Kit	Contour Profile Rotor	CX Extreme® /Vee-Rotor
							606	606G							
							606	606G							
							606	606G							
							606	606G							
							606	606G							
							606	606G							
							606	606G							
							606	606G							
							606	606G							
							606	606G							
							FA137X	FA137R	FA137SV			MD6211D			
							605	605G							
							605	605G							
							605	605G							
							620	620G							
							620	620G							
							605	605G							
							605	605G							
							609								
							606								
							606								
							606								
							606								
							606								
							609								
							606								
							N/A					N/A			
							N/A					N/A			
							N/A					N/A			
							FA137X	FA137R				MD6278D			
							FA137X	FA137R				MD6278D			
							FA367X	FA367R			MXS367	MD6255D		MD6255C	MD6255CX
							MD6255C ● = PLAIN UNDRILLED DISC FOR ENDURO USE. REAR FITMENTS ONLY. ORDER MD6255CE.								
							FA367X	FA367R			MXS367	MD6255D		MD6255C	MD6255CX
							FA367X	FA367R			MXS367	MD6255D		MD6255C	MD6255CX
							FA367X	FA367R			MXS367	MD6255D		MD6255C	MD6255CX
							602	602G							
							605	605G							
							FA63	FA63HH			FA63V	MD3002		MD3002C	VR3002
							FA63	FA63HH			FA63V	MD3002		MD3002C	VR3002
							FA63	FA63HH			FA63V	MD3002		MD3002C	VR3002
							609								
							FA137X	FA137R	FA137SV			MD6023D			
							634	634G							
							FA372X	FA372R	FA372SV			MD6196D			

REAR

BRAKE APPLICATIONS

● This symbol indicates a rotor made of billet steel, and should be only used with EBC FA Kevlar® Organic or Vee pads. SAFETY NOTICE - With vehicles primarily designed for off highway use such as quads now being used on the highway, we would recommend the use of X or MXS pads for highway use and ONLY using the R and SV higher density / harder pad series for off road riding.

*-2 Sets Required. † For Vee disc colours add RED, BLU, GRN, GLD, ORG suffix to part number. SAFETY WARNING:- DO NOT USE HH PADS ON REAR UNLESS ALSO USED ON FRONT TO AVOID BRAKE IMBALANCE

FRONT: SUZUKI



SUZUKI



DISC PAD CHOICES - FRONT

BRAKE ROTOR CHOICES - FRONT

												Line #
LT-A 500 FV/FK1 Quadmaster	Left	00-01	FA165X	FA165R	FA165SV			MD6145D				1
	Right		FA135X	FA135R	FA135SV				MD6145D			2
LT-A 500 FK2 Vinson 4WD		02-07	FA54X*	FA54R*	FA54SV*			MD6195D	MD6195D			3
LT-A 500 FCK/FK Vinson 4WD		03-07	FA54X*	FA54R*	FA54SV*			MD6195D	MD6195D			4
LT-A 500 XPZ King Quad 500 AXi	Left	09/13	FA413X	FA413R	FA413SV			MD6355D				5
Power Steering Limited	Right		FA414X	FA414R	FA414SV				MD6355D			6
LT-A 500 XL King Quad 500AXi	Left	11-22	FA413X	FA413R	FA413SV			MD6355D				7
	Right		FA414X	FA414R	FA414SV				MD6355D			8
LT-A 500 XPC	Left	09-16	FA413X	FA413R	FA413SV			MD6355D				9
King Quad 500 AXi Power Steering Camo	Right		FA414X	FA414R	FA414SV				MD6355D			10
LT-A 500 XCL King Quad 500 AXi Camo	Left	11-16	FA413X	FA413R	FA413SV			MD6355D				11
	Right		FA414X	FA414R	FA414SV				MD6355D			12
LT-A 500 XPK/XPL King Quad 500 AXi Power Steering	Left	09-16	FA413X	FA413R	FA413SV			MD6355D				13
	Right		FA414X	FA414R	FA414SV				MD6355D			14
RE 5 M/A (Rotary)			FA55*					MD3019LS	MD3019RS	VMD3019*		15
SP 500 X/Z/D		81-83	605	605G								16
RM 500 D/E		83-84	622	622G								17
T 500 1 Cobra		68	612									18
T 500 2/3/R/J/K/L/M Titan		69-75	612									19
GS 550 B		77	FA38				FA38V	MD3019LS		VMD3019		20
GS 550 C/N/EC/EN		77-79	FA38				FA38V	MD3020LS				21
GS 550 ET		80	FA65					MD3014LS		VMD3014		22
GS 550 MZ		82	FA65*					MD3014LS	MD3014RS	VMD3014*		23
GS 550 LT		80	FA65					MD3020LS				24
GS 550 LX		81	FA65					MD3022LS				25
GS 550 LZ		82	FA65					MD3022LS				26
GS 550 L		83-86	FA63	FA63HH				MD3014LS		VMD3014		27
GS 550 TX		81	FA65					MD3022LS				28
GS 550 E/ES		83-86	FA63*	FA63HH*				MD3024RS				29
GT 550 J Indy (Drum Front Brake)		72	N/A									30
GT 550 K/L/M Indy		73-75	FA55					MD3019RS		VMD3019		31
GT 550 A/B Indy (Tokico Caliper)		76-77	FA55					MD3019RS		VMD3019		32
GT 550 B Indy (Asco Caliper)		77	FA38				FA38V	MD3019RS		VMD3019		33
GSF 600 Bandit S		96-98	FA142	FA142HH				MD3003X	MD3003X		MD3003XC*	34
GSF 600 S/SK Bandit	Left	00-03	FA229	FA229HH		EPFA229HH		MD3003X			MD3003XC	35
	Right		FA231	FA231HH		EPFA231HH			MD3003X		MD3003XC	36
GSX 600 FJ Katana		88	FA146*	FA146HH*				MD3001	MD3001			37
GSX 600 F Katana		89-97	FA146*	FA146HH*				MD3003X	MD3003X		MD3003XC*	38
GSX 600 F/FK Katana	Left	98-02	FA229	FA229HH		EPFA229HH		MD3003X			MD3003XC*	39
	Right		FA231	FA231HH		EPFA231HH			MD3003X		MD3003XC*	40
GSX 600 FK - Katana	Left	03-06	FA229	FA229HH		EPFA229HH		MD3090X			MD3090XC	41
	Right		FA231	FA231HH		EPFA231HH			MD3090X		MD3090XC	42
GSX-R 600 W		92-93	FA145*	FA145HH*		EPFA145HH*		MD3007X	MD3007X		MD3007XC*	43
GSX-R 600 V/W/X/Y/K/ZK		97-03	FA158*	FA158HH*		EPFA158HH*		MD3058X	MD3058X		MD3058XC*	44
GSX-R 600 K/XK (Radial Caliper)		04-05		FA379HH*		EPFA379HH*	GPFAX379HH*	MD3104X	MD3104X		MD3104XC*	45
GSX-R 600 K (Tokico Radial Caliper)		06-07		FA379HH*		EPFA379HH*	GPFAX379HH*	MD3091X	MD3091X		MD3091XC*	46
GSX-R 600 K (Tokico Radial Caliper)		08-10		FA379HH*		EPFA379HH*	GPFAX379HH*	MD3100X	MD3100X		MD3100XC*	47
GSX-R 600 L (Brembo Radial Caliper)		11-20		FA447HH*		EPFA447HH*	GPFAX447HH*	MD3100X	MD3100X		MD3100XC*	48
GSX-R 600 100th Anniversary (Brembo Radial Caliper)		21		FA447HH*		EPFA447HH*	GPFAX447HH*	MD3100X	MD3100X		MD3100XC*	49
RF 600 R		94-97	FA142*	FA142HH*				MD3003X	MD3003X		MD3003XC*	50
SP 600 F		85-87	FA106/2X	FA106/2R				MD6075D				51
QUV 620 FK5 Side x Side		05	719*	N/A								52
AN 650 K Burgman (Non ABS)		03	SFA142*	SFA142HH*				MD987D	MD987D			53
AN 650 K/L Burgman (Non ABS)		04-12	SFA142*	SFA142HH*				MD994D	MD994D			54
AN 650 AK/AL Burgman (ABS)		04-12	SFA142*	SFA142HH*				MD994D	MD994D			55
AN 650 L Burgman (ABS)		13-16	SFA142*	SFA142HH*				MD9144D	MD9144D			56

FRONT

APPLIATIONS
BRAKE
SAFETY NOTICE - With vehicles primarily designed for off highway use such as quads now being used on the highway, we would recommend the use of X or MXS pads for highway use and ONLY using the R and SV higher density / harder pad series for off road riding.

⚡ This symbol indicates a rotor made of billet steel, and should be only used with EBC FA Kevlar® Organic or Vee pads.

*-2 Sets Required. † For Vee disc colours add RED, BLU, GRN, GLD, ORG suffix to part number. **SAFETY WARNING:- DO NOT USE HH PADS ON REAR UNLESS ALSO USED ON FRONT TO AVOID BRAKE IMBALANCE**

FRONT: SUZUKI Cont'd

REAR: SUZUKI

Line # 1 2 3 4 5 6 7 8 9 10 11 12 13 14 15 16 17 18 19 20 21 22 23 24 25 26 27 28 29 30 31 32 33 34 35 36 37 38 39 40 41 42 43 44 45 46 47 48 49 50 51 52 53 54 55 56

BRAKE ROTOR CHOICES - FRONT							DISC PAD CHOICES - REAR					BRAKE ROTOR CHOICES - REAR			
CC Custom Rotor	CX Extreme® /Vee-Rotor	OS Series Oversize 250/280mm Rotor Kit	OSX Series Oversize 280mm Rotor Kit	Relocating Bracket for Oversize Rotor	SMX Series Oversize 320mm Rotor Kit	Relocating Bracket for 320mm Rotor		Sintered/HH Pads/Grooved Shoes	SV Series Severe Duty Pads	EPFA Sintered Fast Road/Track Pads	Specialty Pads SXR/VEE/MXS Race	Standard Rotor	Vintage Rotor / UTV Oversize Brake Kit	Contour Profile Rotor	CX Extreme® /Vee-Rotor
							634	634G							
							FA317X	FA317R	FA317SV			MD6196D			
							FA372X	FA372R	FA372SV			MD6196D			
							N/A								
							N/A								
							N/A								
							N/A								
							634								
							605	605G							
							618	618G							
							609								
							609								
							611								
							FA36				FA36V	MD3014RS			
							FA36				FA36V	MD3014RS			
							FA36				FA36V	MD3014RS			
							FA36				FA36V	MD3014RS			
							FA36				FA36V	MD3014RS			
							611								
							606								
							FA36				FA36V	MD3014RS			
							FA63	FA63HH			FA63V	MD3025			
							609								
							609								
							611								
							611								
	MD3003CC*	VR3003BLK*†					FA63	FA63HH			FA63V	MD3008		MD3008C	VR3008
	MD3003CC	VR3003BLK					FA63	FA63HH			FA63V	MD3008		MD3008C	VR3008
	MD3003CC	VR3003BLK													
							FA63	FA63HH			FA63V	MD3002		MD3002C	
	MD3003CC*	VR3003BLK*†					FA63	FA63HH			FA63V	MD3002		MD3002C	VR3002
	MD3003CC*	VR3003BLK*†					FA63	FA63HH			FA63V	MD3008		MD3008C	VR3008
	MD3003CC*	VR3003BLK*†													
	MD3090CC	VR3090BLK					FA63	FA63HH			FA63V	MD3008		MD3008C	VR3008
	MD3090CC	VR3090BLK													
		VR3007BLK*†					FA63	FA63HH			FA63V	MD3008		MD3008C	VR3008
	MD3058CC*	VR3058BLK*†					FA63	FA63HH			FA63V	MD3060		MD3060C	VR3060
		VR3104BLK*†					FA254	FA254HH			FA254V	MD3060		MD3060C	VR3060
	MD3091CC*	VR3091BLK*†					FA419	FA419HH			FA419V	MD3060		MD3060C	VR3060
		VR3100BLK*†					FA419	FA419HH			FA419V	MD3060		MD3060C	VR3060
		VR3100BLK*†					FA436	FA436HH			FA436V	MD3060		MD3060C	VR3060
		VR3100BLK*†					FA436	FA436HH			FA436V	MD3060		MD3060C	VR3060
		VR3100BLK*†					FA436	FA436HH			FA436V	MD3060		MD3060C	VR3060
	MD3003CC*	VR3003BLK*†					FA63	FA63HH			FA63V	MD3008		MD3008C	VR3060
							602	602G							
							720*	N/A							
		VR987*					SFA412	SFA412HH				MD988D			VR988
		VR994*					SFA412	SFA412HH				MD988D			VR998
		VR994*					SFA412	SFA412HH				MD988D			VR998
		VR9144BLK*†					SFA412	SFA412HH				MD988D			VR998

REAR

BRAKE APPLICATIONS

⚠ This symbol indicates a rotor made of billet steel, and should be only used with EBC FA Kevlar® Organic or Vee pads.
 SAFETY NOTICE - With vehicles primarily designed for off highway use such as quads now being used on the highway, we would recommend the use of X or MXS pads for highway use and ONLY using the R and SV higher density / harder pad series for off road riding.

*-2 Sets Required. † For Vee disc colours add RED, BLU, GRN, GLD, ORG suffix to part number. **SAFETY WARNING:** DO NOT USE HH PADS ON REAR UNLESS ALSO USED ON FRONT TO AVOID BRAKE IMBALANCE

FRONT: SUZUKI



SUZUKI



DISC PAD CHOICES - FRONT

BRAKE ROTOR CHOICES - FRONT

												Line #
AN 650 ZL Burgman Executive (ABS)		13-19	SFA142*	SFA142HH*				MD9144D	MD9144D			1
DL 650 K V-Strom	Left	04-06	FA229	FA229HH		EPFA229HH		MD3088X			MD3088XC	2
	Right		FA231	FA231HH		EPFA231HH		MD3088X			MD3088XC	3
DL 650 K V-Strom	Left	07-09	FA229	FA229HH		EPFA229HH		MD3092X			MD3092XC	4
	Right		FA231	FA231HH		EPFA231HH		MD3092X			MD3092XC	5
DL 650 AK/A V-Strom (ABS Model)	Left	07-17	FA229	FA229HH		EPFA229HH		MD3092X			MD3092XC	6
	Right		FA231	FA231HH		EPFA231HH		MD3092X			MD3092XC	7
DL 650 XT V-Strom ABS (DL 650 XAL)	Left	15-21	FA229	FA229HH		EPFA229HH		MD3092X			MD3092XC	8
	Right		FA231	FA231HH		EPFA231HH		MD3092X			MD3092XC	9
XT V-Strom Touring ABS	Left	18-21	FA229	FA229HH		EPFA229HH		MD3092X	MD3092X		MD3092XC	10
	Right		FA231	FA231HH		EPFA231HH		MD3092X	MD3092X		MD3092XC	11
DL 650 XT V-Strom Adventure ABS	Left	12-21	FA229	FA229HH		EPFA229HH		MD3092X			MD3092XC	12
	Right		FA231	FA231HH		EPFA231HH		MD3092X			MD3092XC	13
DR 650 SL/SM		90-91	FA147X	FA147R				MD6076D				14
DR 650 S/SE		92-95	FA147X	FA147R				MD6078D				15
DR 650 S		96-21	FA185X	FA185R		EPFA185HH	MXS185	MD6094D				16
GR 650 D/XD Tempter		83	FA65				FA65V	MD3014LS		VMD3014		17
GS 650 E		81-82	FA65*				FA65V*	MD3014LS	MD3014RS	VMD3014*		18
GS 650 G		81-83	FA65*				FA65V*	MD3014LS	MD3014RS	VMD3014*		19
GS 650 GL		81-83	FA65				FA65V	MD3022LS				20
GS 650 MD		83	FA65*				FA65V*	MD3014LS	MD3014RS	VMD3014*		21
GSX 650 FK/FL		08-10	FA158*	FA158HH*		EPFA158HH*		MD3092X	MD3092X		MD3092XC*	22
LS 650 F/P/PK Savage		86-88/95-04	FA106				FA106V	MD3017LS				23
LS 650 K/L (Boulevard S40 650cc)		05-15	FA106				FA106V	MD3017LS				24
SFV 650 K/L	Left	09-10/13-15	FA229	FA229HH		EPFA229HH		MD3103X			MD3103XC	25
	Right		FA231	FA231HH		EPFA231HH		MD3103X			MD3103XC	26
SV 650 X/Y/K/SK	Left	99-02	FA229	FA229HH		EPFA229HH		MD3003X			MD3003XC	27
	Right		FA231	FA231HH		EPFA231HH		MD3003X			MD3003XC	28
SV 650 K/SK	Left	03-10	FA229	FA229HH		EPFA229HH		MD3090X			MD3090XC	29
	Right		FA231	FA231HH		EPFA231HH		MD3090X			MD3090XC	30
SV 650 AK ABS	Left	07-10	FA229	FA229HH		EPFA229HH		MD3103X			MD3103XC	31
	Right		FA231	FA231HH		EPFA231HH		MD3103X			MD3103XC	32
SV 650	Left	16-21	FA229	FA229HH		EPFA229HH		MD3103X			MD3103XC	33
	Right		FA231	FA231HH		EPFA231HH		MD3103X			MD3103XC	34
SV 650 A ABS	Left	16-21	FA229	FA229HH		EPFA229HH		MD3103X			MD3103XC	35
	Right		FA231	FA231HH		EPFA231HH		MD3103X			MD3103XC	36
SV 650 X ABS	Left	16-21	FA229	FA229HH		EPFA229HH		MD3103X			MD3103XC	37
	Right		FA231	FA231HH		EPFA231HH		MD3103X			MD3103XC	38
SV 650 SAK ABS	Left	07-10	FA229	FA229HH		EPFA229HH		MD3103X			MD3103XC	39
	Right		FA231	FA231HH		EPFA231HH		MD3103X			MD3103XC	40
XN 85 D (673cc)		83	FA65*				FA65V*	MD3028LS	MD3028RS			41
LT-A 700 XK/XCK King Quad	Left	05-07	FA413X	FA413R	FA413SV			MD6261D				42
	Right		FA414X	FA414R	FA414SV			MD6261D				43
LT-V 700 FK Twin Peaks 700 4x4	Left	04-05		FA342R	FA342SV			MD6188D		UTVX6188		44
	Right			FA349R	FA349SV			MD6188D		UTVX6188		45
GS 700 E		85	FA51*				FA51V*	MD3028LS	MD3028RS			46
GV 700 GLF		85	FA51*				FA51V*	MD3030LS	MD3030RS			47
VS 700 GLE		86-87	FA103	FA103HH			FA103V	MD3073LS				48
VS 700 G		86-87	FA103	FA103HH			FA103V	MD3032LS				49
VS 700 GL		86-87	FA103	FA103HH			FA103V	MD3031LS				50
GS 750 B (8 Valve)		77	FA35				FA35V	MD3019LS		VMD3019		51
GS 750 C/N (8 Valve)		78-79	FA35				FA35V	MD3020LS				52
GS 750 E (8 Valve)		78-79	FA35*				FA35V*	MD3014LS	MD3014RS	VMD3014*		53
GS 750 LN (8 Valve)		79	FA38*				FA38V*	MD3014LS	MD3014RS	VMD3014*		54
GS 750 E (16 Valve)		80-82	FA51*				FA51V*	MD3014LS	MD3014RS	VMD3014*		55

FRONT

APPLICATIONS
BRAKE
⚠ This symbol indicates a rotor made of billet steel, and should be only used with EBC FA Kevlar® Organic or Vee pads.
SAFETY NOTICE - With vehicles primarily designed for off highway use such as quads now being used on the highway, we would recommend the use of X or MXS pads for highway use and ONLY using the R and SV higher density / harder pad series for off road riding.

*-2 Sets Required. † For Vee disc colours add RED, BLU, GRN, GLD, ORG suffix to part number. **SAFETY WARNING:- DO NOT USE HH PADS ON REAR UNLESS ALSO USED ON FRONT TO AVOID BRAKE IMBALANCE**

FRONT: SUZUKI Cont'd

REAR: SUZUKI

Line #	BRAKE ROTOR CHOICES - FRONT						DISC PAD CHOICES - REAR					BRAKE ROTOR CHOICES - REAR			
	CC Custom Rotor	CX Extreme® /Vee-Rotor	OS Series Oversize 250/280mm Rotor Kit	OSX Series Oversize 280mm Rotor Kit	Relocating Bracket for Oversize Rotor	SMX Series Oversize 320mm Rotor Kit	Relocating Bracket for 320mm Rotor		Sintered/HH Pads/ Grooved Shoes	SV Series Severe Duty Pads	EPFA Sintered Fast Road/ Track Pads	Specialty Pads SXR/ VEE/MXS Race	Standard Rotor	Vintage Rotor / UTV Oversize Brake Kit	Contour Profile Rotor
1		VR9144BLK†					SFA412	SFA412HH				MD998D			VR998
2															
3		VR3088BLK					FA174	FA174HH				MD6232D			MD6232CX
4		VR3088BLK					FA174	FA174HH				MD6232D			MD6232CX
5		VR3092BLK					FA174	FA174HH				MD6232D			MD6232CX
6		VR3092BLK					FA174	FA174HH				MD6232D			MD6232CX
7		VR3092BLK					FA174	FA174HH				MD6232D			MD6232CX
8		VR3092BLK					FA174	FA174HH				MD6232D			MD6232CX
9		VR3092BLK					FA174	FA174HH				MD6232D			MD6232CX
10		VR3092BLK					FA174	FA174HH				MD6232D			MD6232CX
11		VR3092BLK					FA174	FA174HH				MD6232D			MD6232CX
12		VR3092BLK					FA174	FA174HH				MD6232D			MD6232CX
13		VR3092BLK					FA174	FA174HH				MD6232D			MD6232CX
14		VR3092BLK					FA157X	FA157R				MD6077D			
15							FA157X	FA157R				MD6077D			
16		MD6094CX	N/A	N/A	N/A	SMX6094	BRK003	FA152X	FA152R		MXS152	MD6095D			MD6095CX
17							606								
18							FA36				FA36V	MD3027			
19							FA36				FA36V	MD3027			
20							FA36				FA36V	MD3027			
21							FA36				FA36V	MD3027			
22							FA174	FA174HH			FA174V	MD3093		MD3093C	VR3093
23	MD3092CC*	VR3092BLK†					606								
24							606								
25							FA496	FA496HH			FA496V	MD3093		MD3093C	
26															
27							FA63	FA63HH			FA63V	MD3008		MD3008C	VR3008
28	MD3003CC	VR3003BLK					FA174	FA174HH			FA174V	MD3060		MD3060C	VR3060
29	MD3003CC	VR3003BLK					FA174	FA174HH			FA174V	MD3060		MD3060C	VR3060
30	MD3090CC	VR3090BLK					FA174	FA174HH			FA174V	MD3093		MD3093C	
31	MD3090CC	VR3090BLK					FA174	FA174HH			FA174V	MD3093		MD3093C	
32							FA496	FA496HH			FA496V	MD3093		MD3093C	
33							FA496	FA496HH			FA496V	MD3093		MD3093C	
34							FA496	FA496HH			FA496V	MD3093		MD3093C	
35							FA496	FA496HH			FA496V	MD3093		MD3093C	
36							FA496	FA496HH			FA496V	MD3093		MD3093C	
37							FA174	FA174HH			FA174V	MD3093		MD3093C	
38							FA36				FA36V	MD3014RS			
39							N/A								
40							N/A								
41							FA36				FA36V	MD3029			
42							626								
43							626								
44							626								
45							626								
46							FA36				FA36V	MD3019RS			
47							FA36				FA36V	MD3014RS			
48							FA36				FA36V	MD3014RS			
49							FA36				FA36V	MD3014RS			
50							FA36				FA36V	MD3014RS			
51							FA36				FA36V	MD3014RS			
52							FA36				FA36V	MD3014RS			
53							FA36				FA36V	MD3014RS			
54							FA36				FA36V	MD3014RS			
55							FA36				FA36V	MD3014RS			
56							FA36				FA36V	MD3014RS			

BRAKE APPLICATIONS

⚠ This symbol indicates a rotor made of billet steel, and should be only used with EBC FA Kevlar® Organic or Vee pads. SAFETY NOTICE - With vehicles primarily designed for off highway use such as quads now being used on the highway, we would recommend the use of X or MXS pads for highway use and ONLY using the R and SV higher density / harder pad series for off road riding.

*-2 Sets Required. † For Vee disc colours add RED, BLU, GRN, GLD, ORG suffix to part number. **SAFETY WARNING:- DO NOT USE HH PADS ON REAR UNLESS ALSO USED ON FRONT TO AVOID BRAKE IMBALANCE**

FRONT: SUZUKI



SUZUKI



DISC PAD CHOICES - FRONT

BRAKE ROTOR CHOICES - FRONT

Model	Side	Year	Front Disc Pad Choice	DISC PAD CHOICES - FRONT					BRAKE ROTOR CHOICES - FRONT				Line #
				Sintered/HH Pads/Grooved Shoes	SV Series Severe Duty Pads	EPFA Sintered Fast Road/Track Pads	GPFAX Sintered RACE ONLY Pads	Specialty Pads SXR/VEE/MXS Race	Standard Rotor Left	Standard Rotor Right	Vintage Rotor / UTV Oversize Brake Kit	Contour Profile Rotor	
GS 750 L (16 Valve)		80-81	FA51*					FA51V*	MD3014LS	MD3014RS	VMD3014*		1
GS 750 T (16 Valve)		82-83	FA51					FA51V	MD3022LS				2
GS 750 E		83	FA51*					FA51V*	MD3028LS	MD3028RS			3
GS 750 SD		83	FA65*					FA65V*	MD3014LS	MD3014RS	VMD3014*		4
GSR 750 L (Non ABS)	Left	15-16	FA229	FA229HH		EPFA229HH			MD3092X			MD3092XC	5
	Right		FA231	FA231HH		EPFA231HH				MD3092X		MD3092XC	6
GSR 750 AL (ABS)	Left	15-16	FA229	FA229HH		EPFA229HH			MD3092X			MD3092XC	7
	Right		FA231	FA231HH		EPFA231HH				MD3092X		MD3092XC	8
GSX-R 750 RG/G/H		86-87	FA103*	FA103HH*					MD3005	MD3005			9
GSX-R 750 J/K/L/M/N/WP		88-93	FA145*	FA145HH*		EPFA145HH*			MD3007X	MD3007X		MD3007XC*	10
GSX-R 750 W		94-95	FA188*	FA188HH*		EPFA188HH*			MD3007X	MD3007X		MD3007XC*	11
GSX-R 750 T/V/W/X		96-99	FA188*	FA188HH*		EPFA188HH*			MD3058X	MD3058X		MD3058XC*	12
GSX-R 750 Y/K		00-03	FA158*	FA158HH*		EPFA158HH*			MD3058X	MD3058X		MD3058XC*	13
GSX-R 750 K/XK (Tokico Radial Caliper)		04-05		FA379HH*		EPFA379HH*	GPFAX379HH*		MD3104X	MD3104X		MD3104XC*	14
GSX-R 750 K (Tokico Radial Caliper)		06-07		FA379HH*		EPFA379HH*	GPFAX379HH*		MD3091X	MD3091X		MD3091XC*	15
GSX-R 750 K (Tokico Radial Caliper)		08-10		FA379HH*		EPFA379HH*	GPFAX379HH*		MD3100X	MD3100X		MD3100XC*	16
GSX-R 750 L (Brembo Radial Caliper)		11-20		FA447HH*		EPFA447HH*	GPFAX447HH*		MD3100X	MD3100X		MD3100XC*	17
GSX-R 750 100th Anniversary (Brembo Radial Caliper)		21		FA447HH*		EPFA447HH*	GPFAX447HH*		MD3100X	MD3100X		MD3100XC*	18
GSX 750 F Katana		89-97	FA146*	FA146HH*					MD3003X	MD3003X		MD3003XC*	19
GSX 750 F/FK Katana	Left	98-02	FA229	FA229HH		EPFA229HH			MD3003X			MD3003XC	20
	Right		FA231	FA231HH		EPFA231HH				MD3003X		MD3003XC	21
GSX 750 FK Katana	Left	03-06	FA229	FA229HH		EPFA229HH			MD3090X			MD3090XC	22
	Right		FA231	FA231HH		EPFA231HH				MD3090X		MD3090XC	23
GSX-S 750 L	Left	15-18	FA229	FA229HH		EPFA229HH			MD3092X			MD3092XC	24
	Right		FA231	FA231HH		EPFA231HH				MD3092X		MD3092XC	25
GSX-S 750 LZ5	Left	15-18	FA229	FA229HH		EPFA229HH			MD3092X			MD3092XC	26
	Right		FA231	FA231HH		EPFA231HH				MD3092X		MD3092XC	27
GSX-S 750 A ABS		18-21		FA347HH*		EPFA347HH*			MD3092X	MD3092X		MD3092XC*	28
GSX-S 750 Y ABS		18-21		FA347HH*		EPFA347HH*			MD3092X	MD3092X		MD3092XC*	29
GSX-S 750 Z ABS		18-21		FA347HH*		EPFA347HH*			MD3092X	MD3092X		MD3092XC*	30
GSX-S 750 ZL ABS		18-21		FA347HH*		EPFA347HH*			MD3092X	MD3092X		MD3092XC*	31
GT 750 J LE Mans (Front Drum Brake Model)		72	N/A										32
GT 750 K/L/M/A/B		73-77	FA55*						MD3019LS	MD3019RS	VMD3019*		33
LT-A 750 XK/XL King Quad 750 AXi	Left	08-22	FA413X	FA413R	FA413SV				MD6261D				34
	Right		FA414X	FA414R	FA414SV					MD6261D			35
LT-A 750 XCK/XCL King Quad 750 AXi Camo	Left	08-16	FA413X	FA413R	FA413SV				MD6261D				36
	Right		FA414X	FA414R	FA414SV					MD6261D			37
LT-A 750 XZ King Quad 750 AXi Limited	Left	08-09/14	FA413X	FA413R	FA413SV				MD6261D				38
	Right		FA414X	FA414R	FA414SV					MD6261D			39
LT-A 750 XR King Quad 750 AXi Rockstar Edition	Left	09	FA413X	FA413R	FA413SV				MD6355D				40
	Right		FA414X	FA414R	FA414SV					MD6355D			41
LT-A 750 XP King Quad 750 AXi Power Steering	Left	09-16	FA413X	FA413R	FA413SV				MD6355D				42
	Right		FA414X	FA414R	FA414SV					MD6355D			43
LT-A 750 XPZ King Quad 750 AXi Power Steering Limited	Left	09/15-16	FA413X	FA413R	FA413SV				MD6355D				44
	Right		FA414X	FA414R	FA414SV					MD6355D			45
LT-A 750 XPC/XPL King Quad 750 AXi Power Steering Camo	Left	09-16	FA413X	FA413R	FA413SV				MD6355D				46
	Right		FA414X	FA414R	FA414SV					MD6355D			47
VS 750 G Intruder		88-91	FA103	FA103HH				FA103V		MD3032RS			48
VL 800 K Intruder Volusia		01-04	FA231	FA231HH		EPFA231HH		FA231V		MD3095RS			49
VL 800 ZK Intruder Volusia		03-04	FA231	FA231HH		EPFA231HH		FA231V		MD3095RS			50
VL 800 K/CK/L C50 Boulevard		05-21	FA231	FA231HH		EPFA231HH		FA231V		MD3095RS			51
VL 800 TK/TL C50T Boulevard Tourer		05-21	FA231	FA231HH		EPFA231HH		FA231V		MD3095RS			52
VL 800 BTL4 (Boulevard C50 B.O.S.S./Cast Wheels)		14	FA231	FA231HH		EPFA231HH		FA231V		MD3095RS			53
VL 800 CL3 (Boulevard C50 B.O.S.S./Cast Wheels)		13	FA231	FA231HH		EPFA231HH		FA231V		MD3095RS			54
VS 800 Intruder GL/GLK		92-04	FA103	FA103HH				FA103V		MD3032RS			55
VS 800 K/ZK/L (S50 Boulevard)		05-09	FA103	FA103HH				FA103V		MD3032RS			56

APPLIATIONS
BRAKE
SAFETY NOTICE - With vehicles primarily designed for off highway use such as quads now being used on the highway, we would recommend the use of X or MXS pads for highway use and ONLY using the R and SV higher density / harder pad series for off road riding.

⚡ This symbol indicates a rotor made of billet steel, and should be only used with EBC FA Kevlar® Organic or Vee pads.

*2 Sets Required. † For Vee disc colours add RED, BLU, GRN, GLD, ORG suffix to part number. **SAFETY WARNING:- DO NOT USE HH PADS ON REAR UNLESS ALSO USED ON FRONT TO AVOID BRAKE IMBALANCE**

FRONT: SUZUKI Cont'd

REAR: SUZUKI

Line #	BRAKE ROTOR CHOICES - FRONT						DISC PAD CHOICES - REAR					BRAKE ROTOR CHOICES - REAR				
	CC Custom Rotor	CX Extreme® /Vee-Rotor	OS Series Oversize 250/280mm Rotor Kit	OSX Series Oversize 280mm Rotor Kit	Relocating Bracket for Oversize Rotor	SMX Series Oversize 320mm Rotor Kit	Relocating Bracket for 320mm Rotor		Sintered/HH Pads/Grooved Shoes	SV Series Severe Duty Pads	EPFA Sintered Fast Road/Track Pads	Specialty Pads SXR/VEE/MXS Race	Standard Rotor	Vintage Rotor / UTV Oversize Brake Kit	Contour Profile Rotor	CX Extreme® /Vee-Rotor
1								FA36				FA36V	MD3014RS			
2								634								
3								FA36				FA36V	MD3029			
4								FA36				FA36V	MD3014RS			
5		VR3092BLK														
6		VR3092BLK						FA174	FA174HH			FA174V	MD3093		MD3093C	VR3093
7		VR3092BLK														
8		VR3092BLK						FA174	FA174HH			FA174V	MD3093		MD3093C	VR3093
9								FA63	FA63HH			FA63V	MD3009			
10		VR3007BLK†						FA63	FA63HH			FA63V	MD3008		MD3008C	VR3008
11		VR3007BLK†						FA63	FA63HH			FA63V	MD3008		MD3008C	VR3008
12	MD3058CC*	VR3058BLK†						FA63	FA63HH			FA63V	MD3060		MD3060C	VR3060
13	MD3058CC*	VR3058BLK†						FA63	FA63HH			FA63V	MD3060		MD3060C	VR3060
14		VR3104BLK†						FA254	FA254HH			FA254V	MD3060		MD3060C	VR3060
15	MD3091CC*	VR3091BLK†						FA419	FA419HH			FA419V	MD3060		MD3060C	VR3060
16		VR3100BLK†						FA419	FA419HH			FA419V	MD3060		MD3060C	VR3060
17		VR3100BLK†						FA436	FA436HH			FA436V	MD3060		MD3060C	VR3060
18		VR3100BLK†						FA436	FA436HH			FA436V	MD3060		MD3060C	VR3060
19	MD3003CC*	VR3003BLK†						FA63	FA63HH			FA63V	MD3002		MD3002C	VR3002
20	MD3003CC	VR3003BLK						FA63	FA63HH			FA63V	MD3008		MD3008C	VR3008
21	MD3003CC	VR3003BLK														
22	MD3090CC	VR3090BLK						FA63	FA63HH			FA63V	MD3008		MD3008C	VR3008
23	MD3090CC	VR3090BLK														
24		VR3092BLK						FA174	FA174HH			FA174V	MD3093		MD3093C	VR3093
25		VR3092BLK														
26		VR3092BLK						FA174	FA174HH			FA174V	MD3093		MD3093C	VR3093
27		VR3092BLK														
28		VR3092BLK†						FA174	FA174HH			FA174V	MD3093		MD3093C	VR3093
29		VR3092BLK†						FA174	FA174HH			FA174V	MD3093		MD3093C	VR3093
30		VR3092BLK†						FA174	FA174HH			FA174V	MD3093		MD3093C	VR3093
31		VR3092BLK†						FA174	FA174HH			FA174V	MD3093		MD3093C	VR3093
32								634								
33								634								
34								N/A								
35																
36								N/A								
37																
38								N/A								
39																
40								N/A								
41																
42								N/A								
43																
44								N/A								
45																
46								N/A								
47																
48								626								
49								626								
50								626								
51								626								
52								626								
53								626								
54								626								
55								626								
56								626								

⚠ This symbol indicates a rotor made of billet steel, and should be only used with EBC FA Kevlar® Organic or Vee pads.
SAFETY NOTICE - With vehicles primarily designed for off highway use such as quads now being used on the highway, we would recommend the use of X or MXS pads for highway use and ONLY using the R and SV higher density / harder pad series for off road riding.

BRAKE APPLICATIONS

*-2 Sets Required. † For Vee disc colours add RED, BLU, GRN, GLD, ORG suffix to part number. **SAFETY WARNING:- DO NOT USE HH PADS ON REAR UNLESS ALSO USED ON FRONT TO AVOID BRAKE IMBALANCE**

FRONT: SUZUKI



SUZUKI



DISC PAD CHOICES - FRONT

BRAKE ROTOR CHOICES - FRONT

Model	Year	Left	Right	DISC PAD CHOICES - FRONT					BRAKE ROTOR CHOICES - FRONT				Line #		
				Sintered/HH Pads/Grooved Shoes	SV Series Severe Duty Pads	EPFA Sintered Fast Road/Track Pads	GPFA Sintered RACE ONLY Pads	Specialty Pads SXR/VEE/MXS Race	Standard Rotor Left	Standard Rotor Right	Vintage Rotor / UTV Oversize Brake Kit	Contour Profile Rotor			
VX 800 L/M/N/P	90-93			FA129	FA129HH			EPFA129HH		FA129V	MD3033LS				1
VZ 800 Marauder VW/X/Y/K	97-04			FA231	FA231HH			EPFA231HH		FA231V		MD3045			2
VZ 800 K/ZK (M50 Boulevard)	05-10			FA231	FA231HH			EPFA231HH		FA231V		MD3096RS			3
GS 850 GN	79			FA35*						FA35V*	MD3014LS	MD3014RS	VMD3014*		4
GS 850 G	80-81			FA51*						FA51V*	MD3014LS	MD3014RS	VMD3014*		5
GS 850 G	80-83			FA51*						FA51V*	MD3014LS	MD3014RS	VMD3014*		6
RF 900 R	94-95			FA145*	FA145HH*			EPFA145HH*			MD3006X	MD3006X		MD3006XC*	7
RF 900 R	96-98			FA145*	FA145HH*			EPFA145HH*			MD3006X	MD3006X		MD3006XC*	8
DL 1000 K/L V-Strom	02-12	Left		FA229	FA229HH			EPFA229HH			MD3088X			MD3088XC	9
		Right		FA231	FA231HH			EPFA231HH			MD3088X			MD3088XC	10
DL 1000 AL V-Strom Adventure	12	Left		FA229	FA229HH			EPFA229HH			MD3088X			MD3088XC	11
		Right		FA231	FA231HH			EPFA231HH			MD3088X			MD3088XC	12
DL 1000 AL (V-Strom ABS)	14-20				FA379HH*			EPFA379HH*	GPFA379HH*		MD3092*			MD3092XC*	13
DL 1000 AAL (V-Strom Adventure ABS)	14-20				FA379HH*			EPFA379HH*	GPFA379HH*		MD3092*			MD3092XC*	14
DL 1000 XT V-Strom (XAL8/ABS)	18-20				FA379HH*			EPFA379HH*	GPFA379HH*		MD3092*			MD3092XC*	15
GS 1000 C/N	78-79			FA38						FA38V	MD3020LS				16
GS 1000 EC/EN/SN/LN	78-79			FA38*						FA38V*	MD3014LS	MD3014RS	VMD3014*		17
GS 1000 ET/ST/SZ	80-82			FA65*							MD3014LS	MD3014RS	VMD3014*		18
GS 1000 G	80-81			FA51*							MD3014LS	MD3014RS	VMD3014*		19
GS 1000 GL	80-81			FA51*							MD3014LS	MD3014RS	VMD3014*		20
GSX-R 1000 K	01-02			FA188*	FA188HH*			EPFA188HH*			MD3058X	MD3058X		MD3058XC*	21
GSX-R 1000 K	03				FA369/4HH*			EPFA369/4HH*			MD3089X	MD3089X		MD3089XC*	22
GSX-R 1000 K/ZK (Tokico Radial Caliper)	04				FA379HH*			EPFA379HH*	GPFA379HH*		MD3104X	MD3104X		MD3104XC*	23
GSX-R 1000 K (Tokico Radial Caliper)	05-06				FA379HH*			EPFA379HH*	GPFA379HH*		MD3091X	MD3091X		MD3091XC*	24
GSX-R 1000 K (Tokico Radial Caliper)	07-08				FA379HH*			EPFA379HH*	GPFA379HH*		MD3091X	MD3091X		MD3091XC*	25
GSX-R 1000 K/L (Tokico Radial Caliper)	09-11				FA379HH*			EPFA379HH*	GPFA379HH*		MD3102X	MD3102X		MD3102XC*	26
GSX-R 1000 L (Brembo Radial Caliper)	12-16				FA447HH*			EPFA447HH*	GPFA447HH*		MD3102X	MD3102X		MD3102XC*	27
GSX-R 1000 ZL Special Edition (Brembo Radial Caliper)	13				FA447HH*			EPFA447HH*	GPFA447HH*		MD3102X	MD3102X		MD3102XC*	28
GSX-R 1000 AL ABS (Brembo Radial Caliper/310mm Disc)	15-16				FA447HH*			EPFA447HH*	GPFA447HH*		MD3102X	MD3102X		MD3102XC*	29
GSX-R 1000 AL ABS (Brembo Radial Caliper/320mm Disc)	17-21				FA447HH*			EPFA447HH*	GPFA447HH*		MD3107X	MD3107X		MD3107XC*	30
GSX-R 1000 R RAL (Brembo Radial Caliper/320mm Disc)	17-21				FA447HH*			EPFA447HH*	GPFA447HH*		MD3107X	MD3107X		MD3107XC*	31
GSX-R 1000 100th Anniversary	21				FA447HH*			EPFA447HH*	GPFA447HH*		MD3107X	MD3107X		MD3107XC*	32
GSX-R 1000 R 100th Anniversary	21				FA447HH*			EPFA447HH*	GPFA447HH*		MD3107X	MD3107X		MD3107XC*	33
GSX-R 1000 R RZL8 (Brembo Radial Caliper/320mm Disc)	18-20				FA447HH*			EPFA447HH*	GPFA447HH*		MD3107X	MD3107X		MD3107XC*	34
GSX 1000 Katana	19-21				FA447HH*			EPFA447HH*	GPFA447HH*						35
GSX-S 1000 L (Non ABS)	16-21				FA447HH*			EPFA447HH*	GPFA447HH*		MD3109X	MD3109X		MD3109XC*	36
GSX-S 1000 AL (ABS)	16-21				FA447HH*			EPFA447HH*	GPFA447HH*		MD3109X	MD3109X		MD3109XC*	37
GSX-S 1000 F L (Non ABS)	16-21				FA447HH*			EPFA447HH*	GPFA447HH*		MD3109X	MD3109X		MD3109XC*	38
GSX-S 1000 F AL (ABS)	16-21				FA447HH*			EPFA447HH*	GPFA447HH*		MD3109X	MD3109X		MD3109XC*	39
GSX-S 1000 F ZL8	18-20				FA447HH*			EPFA447HH*	GPFA447HH*		MD3109X	MD3109X		MD3109XC*	40
SV 1000 K/SK	03-07			FA158*	FA158HH*			EPFA158HH*			MD3088X	MD3088X		MD3088XC*	41
TL 1000 S	97-01			FA158*	FA158HH*			EPFA158HH*			MD3058X	MD3058X		MD3058XC*	42
TL 1000 R/RK	98-03			FA188*	FA188HH*			EPFA188HH*			MD3058X	MD3058X		MD3058XC*	43
V-Strom 1050 S ABS	20-21				FA379HH*			EPFA379HH*	GPFA379HH*		MD3092X	MD3092X		MD3092XC*	44
V-Strom 1050 XT/XA ABS	20-21				FA379HH*			EPFA379HH*	GPFA379HH*		MD3092X	MD3092X		MD3092XC*	45
V-Strom 1050 XT Adventure ABS	20-21				FA379HH*			EPFA379HH*	GPFA379HH*		MD3092X	MD3092X		MD3092XC*	46
GS 1100 E	80-83			FA65*							MD3014LS	MD3014RS	VMD3014*		47
GS 1100 LT	80			FA65*						FA65V*	MD3014LS	MD3014RS	VMD3014*		48
GS 1100 G	82-83			FA51*							MD3014LS	MD3014RS	VMD3014*		49
GS 1100 GL	82-83			FA51*							MD3014LS	MD3014RS	VMD3014*		50
GS 1100 GK	82-83			FA51*							MD3014LS	MD3014RS	VMD3014*		51
GS 1100 SD	83			FA65*							MD3014LS	MD3014RS	VMD3014*		52
GSX 1100 G	91-93			FA129*	FA129HH*			EPFA129HH*			MD3037LS	MD3037RS			53
GSX 1100 F Katana	88-93			FA146*	FA146HH*						MD3039LS	MD3039RS			54
GSX-R 1100 G/H/J	86-88			FA103*	FA103HH*						MD3004	MD3004			55
GSX-R 1100 K/L/M/N	89-92			FA145*	FA145HH*			EPFA145HH*			MD3007X	MD3007X		MD3007XC*	56

*2 Sets Required. † For Vee disc colours add RED, BLU, GRN, GLD, ORG suffix to part number. **SAFETY WARNING:- DO NOT USE HH PADS ON REAR UNLESS ALSO USED ON FRONT TO AVOID BRAKE IMBALANCE**

APPLICTIONS

BRAKE

⚡ This symbol indicates a rotor made of billet steel, and should be only used with EBC FA Kevlar® Organic or Vee pads.

SAFETY NOTICE - With vehicles primarily designed for off highway use such as quads now being used on the highway, we would recommend the use of X or MXS pads for highway use and ONLY using the R and SV higher density / harder pad series for off road riding.

FRONT: SUZUKI Cont'd

REAR: SUZUKI

Line #	BRAKE ROTOR CHOICES - FRONT						DISC PAD CHOICES - REAR					BRAKE ROTOR CHOICES - REAR				
	CC Custom Rotor	CX Extreme® /Vee-Rotor	OS Series Oversize 250/280mm Rotor Kit	OSX Series Oversize 280mm Rotor Kit	Relocating Bracket for Oversize Rotor	SMX Series Oversize 320mm Rotor Kit	Relocating Bracket for 320mm Rotor		Sintered/HH Pads/Grooved Shoes	SV Series Severe Duty Pads	EPFA Sintered Fast Road/Track Pads	Specialty Pads SXR/VEE/MXS Race	Standard Rotor	Vintage Rotor / UTV Oversize Brake Kit	Contour Profile Rotor	CX Extreme® /Vee-Rotor
1								FA146	FA146HH			FA146V	MD3061			
2								626								
3								626								
4								FA36				FA36V	MD3014RS			
5								FA36				FA36V	MD3014RS			
6								FA36				FA36V	MD3027			
7	MD3006CC*	VR3006BLK*†						FA222					MD3008		MD3008C	VR3008
8	MD3006CC*	VR3006BLK*†						FA63				FA63V	MD3008		MD3008C	VR3008
9		VR3088BLK						FA174	FA174HH				MD6232D			MD6232CX
10		VR3088BLK														
11		VR3088BLK						FA174	FA174HH				MD6232D			MD6232CX
12		VR3088BLK														
13	MD3092C*							FA419	FA419HH				MD6232D			MD6232CX
14	MD3092C*							FA419	FA419HH				MD6232D			MD6232CX
15	MD3092C*							FA419	FA419HH				MD6232D			MD6232CX
16								FA36				FA36V	MD3014RS			
17								FA36				FA36V	MD3014RS			
18								FA36				FA36V	MD3014RS			
19								FA36				FA36V	MD3014RS			
20								FA36				FA36V	MD3014RS			
21	MD3058CC*	VR3058BLK*†						FA254	FA254HH			FA254V	MD3060		MD3060C	VR3060
22	MD3089CC*	VR3089BLK						FA254	FA254HH			FA254V	MD3060		MD3060C	VR3060
23		VR3104BLK*†						FA254	FA254HH			FA254V	MD3060		MD3060C	VR3060
24	MD3091CC*	VR3091BLK*†						FA254	FA254HH			FA254V	MD3060		MD3060C	VR3060
25	MD3091CC*	VR3091BLK*†						FA419	FA419HH			FA419V	MD3060		MD3060C	VR3060
26		VR3102BLK*†						FA436	FA436HH			FA436V	MD3060		MD3060C	VR3060
27		VR3102BLK*†						FA436	FA436HH			FA436V	MD3060		MD3060C	VR3060
28		VR3102BLK*†						FA436	FA436HH			FA436V	MD3060		MD3060C	VR3060
29		VR3102BLK*†						FA436	FA436HH			FA436V	MD3106		MD3106C	VR3106
30		VR3107BLK*†						FA436	FA436HH			FA436V	MD3106		MD3106C	VR3106
31		VR3107BLK*†						FA436	FA436HH			FA436V	MD3106		MD3106C	VR3106
32		VR3107BLK*†						FA436	FA436HH			FA436V	MD3106		MD3106C	VR3106
33		VR3107BLK*†						FA436	FA436HH			FA436V	MD3106		MD3106C	VR3106
34		VR3107BLK*†						FA436	FA436HH			FA436V	MD3106		MD3106C	VR3106
35								FA436	FA436HH			FA436V				
36		VR3109BLK*†						FA174	FA174HH			FA174V	MD3108		MD3108C	VR3108
37		VR3109BLK*†						FA174	FA174HH			FA174V	MD3108		MD3108C	VR3108
38		VR3109BLK*†						FA174	FA174HH			FA174V	MD3108		MD3108C	VR3108
39		VR3109BLK*†						FA174	FA174HH			FA174V	MD3108		MD3108C	VR3108
40		VR3109BLK*†						FA174	FA174HH			FA174V	MD3108		MD3108C	VR3108
41	MD3088CC*	VR3088BLK*†						FA174	FA174HH			FA174V	MD3060		MD3060C	VR3060
42	MD3058CC*	VR3058BLK*†						FA63	FA63HH			FA63V	MD3060		MD3060C	VR3060
43	MD3058CC*	VR3058BLK*†						FA63	FA63HH			FA63V	MD3060		MD3060C	VR3060
44								FA419	FA419HH				MD6232D			MD6232CX
45								FA419	FA419HH				MD6232D			MD6232CX
46								FA419	FA419HH				MD6232D			MD6232CX
47								FA36				FA36V	MD3014RS			
48								FA36				FA36V	MD3014RS			
49								FA36				FA36V	MD3027			
50								FA36				FA36V	MD3027			
51								FA36				FA36V	MD3027			
52								FA36				FA36V	MD3014RS			
53								FA146	FA146HH			FA146V	MD3038			
54								FA103	FA103HH			FA103V	MD3036			
55								FA63	FA63HH			FA63V	MD3009			
56		VR3007BLK*†						FA63	FA63HH			FA63V	MD3008		MD3008C	VR3008

BRAKE APPLICATIONS

⚠ This symbol indicates a rotor made of billet steel, and should be only used with EBC FA Kevlar® Organic or Vee pads. SAFETY NOTICE - With vehicles primarily designed for off highway use such as quads now being used on the highway, we would recommend the use of X or MXS pads for highway use and ONLY using the R and SV higher density / harder pad series for off road riding.

*-2 Sets Required. † For Vee disc colours add RED, BLU, GRN, GLD, ORG suffix to part number. **SAFETY WARNING: DO NOT USE HH PADS ON REAR UNLESS ALSO USED ON FRONT TO AVOID BRAKE IMBALANCE**

FRONT: SUZUKI



SUZUKI



DISC PAD CHOICES - FRONT

BRAKE ROTOR CHOICES - FRONT

Model	Year	Front Disc Pad Choice	Sintered/HH Pads/Grooved Shoes	SV Series Severe Duty Pads	EPFA Sintered Fast Road/Track Pads	GPFX Sintered RACE ONLY Pads	Specialty Pads SXR/VEE/MXS Race	Standard Rotor		Vintage Rotor / UTV Oversize Brake Kit	Contour Profile Rotor	Line #
								Standard Rotor Left	Standard Rotor Right			
GSX-R 1100 W	93-98	FA188*	FA188HH*		EPFA188HH*			MD3007X	MD3007X		MD3007XC*	1
GS 1150 ES	83-86	FA103*	FA103HH*					MD3039LS	MD3039RS			2
GSF 1200 S	96-99	FA145*	FA145HH*		EPFA145HH*			MD3006X	MD3006X		MD3006XC*	3
GSF 1200 SAV Bandit - ABS	97	FA145*	FA145HH*		EPFA145HH*			MD3075LS	MD3075RS			4
GSF 1200 SK/K Bandit	01-05	FA188*	FA188HH*		EPFA188HH*			MD3006X	MD3006X		MD3006XC*	5
GV 1200 GL Madura	85-86	FA51*						MD3030LS	MD3030RS			6
GSF 1250 AK/SAK (ABS)	07-10	FA158*	FA158HH*		EPFA158HH*			MD3092X	MD3092X		MD3092XC*	7
GSF 1250 SK Bandit	07-10	FA158*	FA158HH*		EPFA158HH*			MD3092X	MD3092X		MD3092XC*	8
GSX 1250 FAL	11-14	FA158*	FA158HH*		EPFA158HH*			MD3092X	MD3092X		MD3092XC*	9
GSX 1250 SAL Bandit	16	FA158*	FA158HH*		EPFA158HH*			MD3092X	MD3092X		MD3092XC*	10
GSX 1300 R/RK/RZK Hayabusa	99-07	FA188*	FA188HH*		EPFA188HH*			MD3058X	MD3058X		MD3058XC*	11
GSX 1300 RK/RL Hayabusa	08-12		FA379HH*		EPFA379HH*			MD3098X	MD3098X		MD3098XC*	12
GSX 1300 RAL ABS Hayabusa (Brembo Calipers)	13-20		FA447HH*		EPFA447HH*			MD3098X	MD3098X		MD3098XC*	13
GSX 1300 RZL (Hayabusa 50th Anniversary Edition)	14		FA447HH*		EPFA447HH*			MD3098X	MD3098X		MD3098XC*	14
GSX 1300 BKAK/K B-King ABS	08-10		FA347HH*		EPFA347HH*			MD3098X	MD3098X		MD3098XC*	15
GSX 1300 BKK/K B-King	08-10		FA347HH*		EPFA347HH*			MD3098X	MD3098X		MD3098XC*	16
GV 1400 G (up to frame No. 103764) (Cavalcade)	86	FA103*	FA103HH*				FA103V*	MD3042	MD3042			17
GV 1400 G (From frame No. 103765) (Cavalcade)	86	FA146*	FA146HH*				FA146V*	MD3042	MD3042			18
GV 1400 GCG/GDH/GTH/GCH/GDJ (Cavalcade)	86-88	FA146*	FA146HH*				FA146V*	MD3042	MD3042			19
VS 1400 GLP/GLF/GLPK Intruder	87-04	FA103	FA103HH				FA103V		MD3032RS			20
VS 1400 GLPK/K/L (Boulevard S83) (1400cc)	05-10	FA103	FA103HH				FA103V		MD3032RS			21
VL 1500 W/X Intruder Legendary Classic	98-99	FA103	FA103HH				FA103V		MD3078RS			22
VL 1500 Y/K Intruder Legendary Classic	00-01	FA103	FA103HH				FA103V		MD3078RS			23
VL 1500 K Intruder LC	02-04	Left	FA229	FA229HH	EPFA229HH		FA229V	MD3087LS				24
		Right	FA231	FA231HH	EPFA231HH		FA231V		MD3087RS			25
VL 1500 BK/K/TK (C90/C90T Boulevard)	05-10	Left	FA229	FA229HH	EPFA229HH		FA229V	MD3087LS				26
		Right	FA231	FA231HH	EPFA231HH		FA231V		MD3087RS			27
VL 1500 BL (Boulevard C90 B.O.S.S.)	13-15		FA196	FA196HH			FA196V	TBC				28
VL 1500 BTL (Boulevard C90T B.O.S.S. / With Windshield)	13-14		FA196	FA196HH			FA196V	TBC				29
VL 1500 L (Boulevard C90)	13		FA196	FA196HH			FA196V	TBC				30
VL 1500 TL (Boulevard C90T With Windshield)	13-15		FA196	FA196HH			FA196V	TBC				31
VZ 1500 K/L M90 Boulevard	09/13-15	Left	FA229	FA229HH	EPFA229HH		FA229V	MD3090X			MD3090XC	32
		Right	FA231	FA231HH	EPFA231HH		FA231V		MD3090X		MD3090XC	33
VZ 1600 K Marauder	04		FA188*	FA188HH*	EPFA188HH*			MD4022X	MD4022X		MD4022XC*	34
VZ 1600 K (M95 Boulevard)	05		FA369/4HH*		EPFA369/4HH*			MD4022X	MD4022X		MD4022XC*	35
VLR 1800 TK/TL (C109RT Boulevard Touring)	08-10		FA388*	FA388HH*	EPFA388HH*			MD3090X	MD3090X		MD3090XC*	36
VLR 1800 K (C109R Boulevard)	08-10		FA388*	FA388HH*	EPFA388HH*			MD3090X	MD3090X		MD3090XC*	37
VZR 1800 K/L (Boulevard M109R)	06-14			FA379HH*	EPFA379HH*			MD3091X	MD3091X		MD3091XC*	38
VZR 1800 NK (Boulevard Limited M109R2)	08-09			FA379HH*	EPFA379HH*			MD3091X	MD3091X		MD3091XC*	39
VZR 1800 ZK/ZL (Boulevard RZ Limited (M109RZ))	08-14			FA379HH*	EPFA379HH*			MD3091X	MD3091X		MD3091XC*	40
VZR 1800 (Boulevard B.O.S.S. M109R)	14-21		FA379HH*		EPFA379HH*			MD3091X	MD3091X		MD3091XC*	41
												42
												43
												44
												45
												46
												47
												48
												49
												50
												51
												52
												53
												54
												55
												56

APPLICATIONS
BRAKE
SAFETY NOTICE - With vehicles primarily designed for off highway use such as quads now being used on the highway, we would recommend the use of X or MXS pads for highway use and ONLY using the R and SV higher density / harder pad series for off road riding.

This symbol indicates a rotor made of billet steel, and should be only used with EBC FA Kevlar® Organic or Vee pads.

*-2 Sets Required. † For Vee disc colours add RED, BLU, GRN, GLD, ORG suffix to part number. **SAFETY WARNING:- DO NOT USE HH PADS ON REAR UNLESS ALSO USED ON FRONT TO AVOID BRAKE IMBALANCE**

FRONT: SUZUKI Cont'd

REAR: SUZUKI

Line #	BRAKE ROTOR CHOICES - FRONT						DISC PAD CHOICES - REAR					BRAKE ROTOR CHOICES - REAR				
	CC Custom Rotor	CX Extreme® /Vee-Rotor	OS Series Oversize 250/280mm Rotor Kit	OSX Series Oversize 280mm Rotor Kit	Relocating Bracket for Oversize Rotor	SMX Series Oversize 320mm Rotor Kit	Relocating Bracket for 320mm Rotor		Sintered/HH Pads/ Grooved Shoes	SV Series Severe Duty Pads	EPFA Sintered Fast Road/ Track Pads	Specialty Pads SXR/ VEE/MXS Race	Standard Rotor	Vintage Rotor / UTV Oversize Brake Kit	Contour Profile Rotor	CX Extreme® /Vee-Rotor
1		VR3007BLK*						FA63	FA63HH			FA63V	MD3008		MD3008C	VR3008
2								FA103	FA103HH			FA103V	MD3039			
3	MD3006CC*	VR3006BLK*						FA63	FA63HH			FA63V	MD3008		MD3008C	VR3008
4								FA63	FA63HH			FA63V	MD3076			
5	MD3006CC*	VR3006BLK*						FA63	FA63HH			FA63V	MD3008		MD3008C	VR3008
6								FA36				FA36V	MD3041			
7	MD3092CC*	VR3092BLK*						FA174	FA174HH			FA174V	MD3093		MD3093C	VR3093
8	MD3092CC*	VR3092BLK*						FA174	FA174HH			FA174V	MD3093		MD3093C	VR3093
9	MD3092CC*	VR3092BLK*						FA174	FA174HH			FA174V	MD3093		MD3093C	VR3093
10	MD3092CC*	VR3092BLK*						FA174	FA174HH			FA174V	MD3093		MD3093C	VR3093
11	MD3058CC*	VR3058BLK*						FA63	FA63HH			FA63V	MD3008		MD3008C	VR3008
12	MD3098CC*	VR3098BLK*						FA419	FA419HH			FA419V	MD3099		MD3099C	VR3099
13	MD3098CC*	VR3098BLK*						FA419	FA419HH			FA419V	MD3099		MD3099C	VR3099
14	MD3098CC*	VR3098BLK*						FA419	FA419HH			FA419V	MD3099		MD3099C	VR3099
15	MD3098CC*	VR3098BLK*						FA419	FA419HH			FA419V	MD3099		MD3099C	VR3099
16	MD3098CC*	VR3098BLK*						FA419	FA419HH			FA419V	MD3099		MD3099C	VR3099
17								FA103	FA103HH			FA103V	MD3043			
18								FA150	FA150HH			FA150V	MD3043			
19								FA150	FA150HH			FA150V	MD3043			
20								FA103	FA103HH			FA103V	MD3044			
21								FA103	FA103HH			FA103V	MD3044			
22								FA103	FA103HH			FA103V	MD3079			
23								FA103	FA103HH			FA103V	MD3086			
24								FA366	FA366HH			FA366V/VLD	MD3086			
25																
26								FA366	FA366HH			FA366V/VLD	MD3086			
27																
28								USE V PAD	FA231HH		EPFA231HH	FA231/2V	MD3086			
29								USE V PAD	FA231HH		EPFA231HH	FA231/2V	MD3086			
30								USE V PAD	FA231HH		EPFA231HH	FA231/2V	MD3086			
31								USE V PAD	FA231HH		EPFA231HH	FA231/2V	MD3086			
32	MD3090CC	VR3090BLK						USE V PAD	FA231HH		EPFA231HH	FA231/2V	MD3097			N/A
33	MD3090CC	VR3090BLK														
34	MD4022CC*	VR4022BLK*						USE V PAD	FA231HH		EPFA231HH	FA231/3V	MD4146		N/A	N/A
35	MD4022CC*	VR4022BLK*						USE V PAD	FA231HH		EPFA231HH	FA231/3V	MD4146		N/A	N/A
36	MD3090CC*	VR3090BLK						USE V PAD	FA231HH		EPFA231HH	FA231/2V	MD3097			N/A
37	MD3090CC*	VR3090BLK						USE V PAD	FA231HH		EPFA231HH	FA231/2V	MD3097			
38	MD3091CC*	VR3091BLK*						USE V PAD	FA231HH		EPFA231HH	FA231/2V	MD3097		N/A	N/A
39	MD3091CC*	VR3091BLK*						USE V PAD	FA231HH		EPFA231HH	FA231/2V	MD3097		N/A	N/A
40	MD3091CC*	VR3091BLK*						USE V PAD	FA231HH		EPFA231HH	FA231/2V	MD3097		N/A	N/A
41	MD3091CC*	VR3091BLK*						USE V PAD	FA231HH		EPFA231HH	FA231/2V	MD3097		N/A	N/A
42																
43																
44																
45																
46																
47																
48																
49																
50																
51																
52																
53																
54																
55																
56																

BRAKE APPLICATIONS

⚠ This symbol indicates a rotor made of billet steel, and should be only used with EBC FA Kevlar® Organic or Vee pads.
SAFETY NOTICE - With vehicles primarily designed for off highway use such as quads now being used on the highway, we would recommend the use of X or MXS pads for highway use and ONLY using the R and SV higher density / harder pad series for off road riding.

*-2 Sets Required. † For Vee disc colours add RED, BLU, GRN, GLD, ORG suffix to part number. **SAFETY WARNING:- DO NOT USE HH PADS ON REAR UNLESS ALSO USED ON FRONT TO AVOID BRAKE IMBALANCE**

FRONT: YAMAHA



YAMAHA



DISC PAD CHOICES - FRONT

BRAKE ROTOR CHOICES - FRONT

											Line #
3 (50cc Scooter) (XF 50 W/X/Y/Z/A)	07-11	530									1
CA 50 K/L/N/S Riva	83-86	501									2
CE 50 E	86-87	501									3
CG 50 EU/W/A/B	88-91	501									4
CY 50 D/E/F/K/L Jog	92-94/98-99	519									5
CY 50 N Jog	01	519									6
CV 50 L Riva	84	503									7
CW 50 W/TA Riva Zuma	89-90	518									8
CW 50 K Riva	98	503									9
CW 50 (Bws)	98-99	SFA193	SFA193HH				MD916D				10
CW 50 L/TL Zuma/Zuma II	99	SFA193	SFA193HH				MD904D				11
CW 50 M/N Zuma II	00-01	SFA193	SFA193HH				MD923D			MD923C	12
DT 50 U/W/A (DTL/C)	88-90	518	518G								13
EW 50 Stunt (5LH2/5YN1)	01-03	SFA268	SFA268HH				MD923D			MD923C	14
LB 50 P Chappy	80-82	504									15
LC 50 G/H Champ	80-81	519									16
MJ 50 J Towny	82	501									17
PW 50 H/J/K/N/S/T	81-87	501	N/A								18
PW 50	90-09/12-21	501	N/A								19
QT 50 G/2G/H/J/K/L/N/S/T Yamahopper	80-87	501									20
RX 50 MK/K/L	83-84	FA70					N/A				21
SH 50 T/EMT/U/MU/W/MW/A/MA/B/D/MD/E/F/K/L Razz	87-94/98-99	501									22
SH 50 ED Mint (3PR1/4CK1/3/4)	89-94	519									23
TT-R 50 E	06-09/12-21	301									24
XC 50 V/W/X/Y/Z/A/D/E/F/G/H Vino Classic	06-17	530									25
YFM 50 S/T/R Raptor	04-07	503*	503G*								26
YFZ 50 Y	17-18	346*	346G*								27
YJ 50 R Vino 50	01-04	530									28
YJ 50 RA Vino Classic	02-05	530									29
YSR 50 T/U/W/A/B/D	87-92	FA101					N/A				30
YZ 50 G	80	502	502G								31
Zuma 50 2T (YW 50 P/R/S/T/X/Y/Z/A)	02-05/08-11	SFA169	SFA169HH				N/A				32
Zuma 50 F (Twin Headlights) F 4T (YW 50 F)	12-16	SFA384									33
Zuma 50 FX (Single Headlight) 4T (YW 50 FX)	14-21	SFA384									34
YF 60 S (Moto 4)	86	NONE	NONE								35
YT 60 L/N (Tri-Zinger)	84-85	NONE	NONE								36
YZ 60 H/J/K	81-83	502	502G								37
YZ 65 J	18-21	FA119X	FA119R				MD6418D			MD6418C	38
BW 80 S/T/U/A	86-88/90	502	502G								39
CV 80 K/L/N/S/T Riva	83-87	503									40
DT 80 H/J	81-82	504	504G								41
DT 80 K	83	503	503G								42
LB 80 11 - A Chappy (3VS2/4RP1)	95-98	503									43
PW 80 K/N	83-85	502	502G								44
PW 80 B	91	502	502G								45
PW 80 D/E/F/G/H/J/K/L/M/N/P/R/S/T/V	92-08	502	502G								46
V 80 (3NX3/4)	94	503									47
V 80 (4GC5/6/3NX6)	98	503									48
V 80 D (4GC2/3/4) - 3 = Single Seat / 4 = Dual Street	94-96	503									49
YFM 80 N/S (Moto 4)	85-86	NONE	NONE								50
YFM 80 T/U	87-88	518*	518G*								51
YFM 80 D/E/F/G/H/J/K/L/M/N Badger	92-01	503*	503G*								52
YFM 80 W/R Raptor	02-08	503*	503G*								53
YFM 80 G Grizzly	05-08	503*	503G*								54
YZ 80 G/H/J/K/L/N	80-85	502	502G								55
YZ 80 S/T/U	86-88	FA119X	FA119R				MD6029D				56

FRONT

APPLICATIONS
BRAKE
⚡ This symbol indicates a rotor made of billet steel, and should be only used with EBC FA Kevlar® Organic or Vee pads.
SAFETY NOTICE - With vehicles primarily designed for off highway use such as quads now being used on the highway, we would recommend the use of X or MXS pads for highway use and ONLY using the R and SV higher density / harder pad series for off road riding.

*-2 Sets Required. † For Vee disc colours add RED, BLU, GRN, GLD, ORG suffix to part number. **SAFETY WARNING:- DO NOT USE HH PADS ON REAR UNLESS ALSO USED ON FRONT TO AVOID BRAKE IMBALANCE**

FRONT: YAMAHA Cont'd

REAR: YAMAHA

Line #

BRAKE ROTOR CHOICES - FRONT							DISC PAD CHOICES - REAR					BRAKE ROTOR CHOICES - REAR			
CC Custom Rotor	CX Extreme® /Vee-Rotor	OS Series Oversize 250/280mm Rotor Kit	OSX Series Oversize 280mm Rotor Kit	Relocating Bracket for Oversize Rotor	SMX Series Oversize 320mm Rotor Kit	Relocating Bracket for 320mm Rotor		Sintered/HH Pads/ Grooved Shoes	SV Series Severe Duty Pads	EPFA Sintered Fast Road/ Track Pads	Specialty Pads SXR/ VEE/MXS Race	Standard Rotor	Vintage Rotor / UTV Oversize Brake Kit	Contour Profile Rotor	CX Extreme® /Vee-Rotor
1							530								
2							519								
3							519								
4							519								
5							503								
6							503								
7							503								
8							518								
9							503								
10							503								
11							503								
12							503								
13							518	518G							
14							503								
15							504								
16							519								
17							501								
18							501	N/A							
19							501	N/A							
20							501								
21							504								
22							519								
23							519								
24							301								
25							530								
26							527	527G							
27							307	307G							
28							530								
29							530								
30							503								
31							502	502G							
32							531								
33		VR9159					530								
34		VR9159					530								
35							518	518G							
36							518	518G							
37							502	502G							
38							FA84/3	FA84/3R			MXS84/3	MD6419D		MD6419C	
39							519	N/A							
40							503								
41							504	504G							
42							503	503G							
43							503								
44							518	518G							
45							518	518G							
46							503	503G							
47							503								
48							503								
49							503								
50							506	506G							
51							506	506G							
52							527	527G							
53							527	527G							
54							527	527G							
55							502	502G							
56							502	502G							

REAR

BRAKE APPLICATIONS

⚠ This symbol indicates a rotor made of billet steel, and should be only used with EBC FA Kevlar® Organic or Vee pads.
 SAFETY NOTICE - With vehicles primarily designed for off highway use such as quads now being used on the highway, we would recommend the use of X or MXS pads for highway use and ONLY using the R and SV higher density / harder pad series for off road riding.

*-2 Sets Required. † For Vee disc colours add RED, BLU, GRN, GLD, ORG suffix to part number. **SAFETY WARNING:** DO NOT USE HH PADS ON REAR UNLESS ALSO USED ON FRONT TO AVOID BRAKE IMBALANCE

FRONT: YAMAHA



YAMAHA



DISC PAD CHOICES - FRONT

BRAKE ROTOR CHOICES - FRONT

											Line #
YZ 80 W/A/B/D	89-92	FA119X	FA119R				MD6029D				1
YZ 80 E/F/G/H/J/K/L/M/N	93-01	FA119X	FA119R				MD6030D			MD6030C	2
YZ 85 (17/14" wheel models)	01-22	FA119X	FA119R				MD6030D			MD6030C	3
YZ 85 LW (19/16" wheel models)	21-22	FA119X	FA119R				MD6030D			MD6030C	4
JYM 90 T Axis	01	SFA169	SFA169HH				MD904D				5
TT-R 90 M/N/P/R/ES/S/ET/EV/EW	00-07	502	502G								6
YA 90 Axis	91-95	SFA169	SFA169HH				MD904D				7
YA 90 Axis	96	SFA169	SFA169HH				MD904D				8
YFM 90 R Raptor (No Rear Parking Brake)	09	536*	536G*								9
YFM 90 R Raptor (With Rear Parking Brake)	10-13	536*	536G*								10
YFM 90 RYXG/H Raptor 90	16-17	346*	346G*								11
DT 100 G/H/J	80-82	504	504G								12
DT 100 K	83	503	503G								13
MX 100 G/H/J	80-82	504	504G								14
MX 100 K	83	503	503G								15
RT 100 A/D/E/F/G/H/J/K/L/M	91-00	503	503G								16
RX 100	01-03	503									17
RX 100	04	503									18
RX 100 C	04	503									19
RXZ 100 S	88-95	503									20
XC 100 Jog	05-06	530									21
YA 100 W Grand Axis	01-03	SFA169	SFA169HH				MD904D				22
YFM 100 T/U Champ	87-88	518*	518G*								23
YFM 100 W/A/B Champ	89-91	503*	503G*								24
YW 100 BW's	97-08	SFA169	SFA169HH				MD904D				25
YZ 100 F/G/H	80-81	504	504G								26
YZ 100 J/K	82-83	503	503G								27
T 105 E Crypton	99-02	SFA275	SFA275HH					MD963D			28
T 105 SE Crypton	10	SFA464						TBC			29
T 110	11-13	SFA464						TBC			30
T 110 C	11-13	SFA464						TBC			31
TT-R 110 E	08-21	502	502G								32
AF 115 S Fino	12	SFA464						TBC			33
AT 115 (21P1)	07	SFA275	SFA275HH					TBC			34
AT 115 C Nuvo	05-06	SFA275	SFA275HH					TBC			35
RXS 115 (3HB6/7)	94-97	FA81	FA81R					N/A			36
RXS 115 (3HB8)	99	FA275	FA275HH					N/A			37
DT 125 G/H	80-81	506	506G								38
GT 125 Hammerhead	12-18	FA181X					MD6158D			MD6158C	39
IT 125 G/H	80-81	504	504G								40
TT-R 125 M/N/P/R/S/E (17"/14" wheels for drum brakes)	00-09	503	503G								41
TT-R 125 LWM/L/LE (19"/16" wheels disc front rear drum)	00-09/11-21	FA119X	FA119R				MD6158D			MD6158C	42
WR 125 K	98	FA135X	FA135R			MXS135	MD6028D			MD6028C	43
XA 125 Cygnus (2BK1)	12	SFA464						TBC			44
XC 125 N/S/T/C/U/W/Z Riva	85-92	521									45
XC 125 E/F/K Riva	93-94/98	521									46
XT 125 J/K/KC	82-83	506	506G								47
YBA 125 Vision	01	FA142	FA142HH					TBC			48
YBA 125 Enticer	05	FA181X	FA181HH					TBC			49
YBA 125 Enticer	05	506									50
YBA 125 Enticer	07-12	FA181X	FA181HH					TBC			51
YBR 125	01	503									52
YBR 125	11-13	531									53
YBR 125 C	08-13	531									54
YBR 125 E	06-13	531									55
YBR 125 EB	02-05	FA197	FA197HH					N/A			56

FRONT

APPLICTIONS
BRAKE

⚡ This symbol indicates a rotor made of billet steel, and should be only used with EBC FA Kevlar® Organic or Vee pads.

SAFETY NOTICE - With vehicles primarily designed for off highway use such as quads now being used on the highway, we would recommend the use of X or MXS pads for highway use and ONLY using the R and SV higher density / harder pad series for off road riding.

*-2 Sets Required. † For Vee disc colours add RED, BLU, GRN, GLD, ORG suffix to part number. SAFETY WARNING:- DO NOT USE HH PADS ON REAR UNLESS ALSO USED ON FRONT TO AVOID BRAKE IMBALANCE

FRONT: YAMAHA Cont'd

REAR: YAMAHA

BRAKE ROTOR CHOICES - FRONT

DISC PAD CHOICES - REAR

BRAKE ROTOR CHOICES - REAR

Line #

CC Custom Rotor	CX Extreme® /Vee-Rotor	OS Series Oversize 250/280mm Rotor Kit	OSX Series Oversize 280mm Rotor Kit	Relocating Bracket for Oversize Rotor	SMX Series Oversize 320mm Rotor Kit	Relocating Bracket for 320mm Rotor		Sintered/HH Pads/ Grooved Shoes	SV Series Severe Duty Pads	EPFA Sintered Fast Road/ Track Pads	Specialty Pads SXR/ VEE/MXS Race	Standard Rotor	Vintage Rotor / UTV Oversize Brake Kit	Contour Profile Rotor	CX Extreme® /Vee-Rotor	
1							502	502G								
2	MD6030CX	OSY6030C	OSXY6030	BRK036	N/A	N/A	N/A	FA84/3R			MXS84/3	MD6031D		MD6031C	MD6031CX	
3	MD6030CX	OSY6030C	OSXY6030	BRK036	N/A	N/A	N/A	FA84/3R			MXS84/3	MD6031D		MD6031C	MD6031CX	
4	MD6030CX	OSY6030C	OSXY6030	BRK036	N/A	N/A	N/A	FA84/3R			MXS84/3	MD6031D		MD6031C	MD6031CX	
5							503									
6							503	503G								
7							518									
8							503									
9							FA83X	FA83R				MD6282D				
10							FA67X	FA67R				MD6282D				
11							307	307G								
12							504	504G								
13							503	503G								
14							504	504G								
15							503	503G								
16							503	503G								
17							503									
18							503									
19							503									
20							503									
21							530									
22							527									
23							506	506G								
24							506	506G								
25							527									
26							506	506G								
27							506	506G								
28							518									
29							530									
30							530									
31							530									
32							503	503G								
33							531									
34							531									
35							531									
36							518									
37							506	506G								
38							FA152X	FA152R			MXS152	MD6011D				
39							506	506G								
40							503	503G								
41							503	503G								
42							503	503G								
43		OS6028EC	OSX6028E	BRK035	N/A	N/A	FA152X	FA152R			MXS152	MD6011D				
44							530									
45							506									
46							527									
47							503	503G								
48							527									
49							506									
50							506									
51							535									
52							503									
53							527									
54							531									
55							531									
56							527									

REAR

BRAKE APPLICATIONS

⚠ This symbol indicates a rotor made of billet steel, and should be only used with EBC FA Kevlar® Organic or Vee pads.
 SAFETY NOTICE - With vehicles primarily designed for off highway use such as quads now being used on the highway, we would recommend the use of X or MXS pads for highway use and ONLY using the R and SV higher density / harder pad series for off road riding.

*-2 Sets Required. † For Vee disc colours add RED, BLU, GRN, GLD, ORG suffix to part number. **SAFETY WARNING:- DO NOT USE HH PADS ON REAR UNLESS ALSO USED ON FRONT TO AVOID BRAKE IMBALANCE**

FRONT: YAMAHA



YAMAHA



DISC PAD CHOICES - FRONT

BRAKE ROTOR CHOICES - FRONT

											Line #
YBR 125 EB	06-08	FA197	FA197HH					N/A			1
YBR 125 ED	01	527									2
YBR 125 ED (Cast Wheel)	07-09	FA101						MD2097RS			3
YBR 125 ED Cast Wheel	10-13	FA101						MD2097RS			4
YBR 125 ESD Cast Wheel	07-09	FA101						MD2097RS			5
YBR 125 ESD (Cast Wheel)	10-13	FA101						MD2097RS			6
YBR 125 ESG	11-13	FA464						MD2104RS			7
YBR 125 K	02-06	527									8
YBR 125 R	11-12	FA464						MD2104RS			9
YFA1 W/A/B Breeze	89-91	503*	503G*								10
YFA1 D/E/F/G/H/J/K/L/M/N/P/R/S Breeze	92-04	503*	503G*								11
YFM 125 S/G Grizzly	04-13	503*	503G*								12
YFM 125 R Raptor	11-13	FA54*	FA54R*	FA54SV*			MD6054D	MD6054D			13
YJ 125 S/T/V/W/X/Y Vino	04-09	SFA101	SFA101HH					N/A			14
YT 125 G/H/J (Tri Moto)	80-82	NONE	NONE								15
YT 125 J/K/L/N (Tri Moto)	82-85	NONE	NONE								16
YW 125 Y/Z/A/B/D/E/F Zuma (Rear Drum Model)	09-15	SFA492					MD986D				17
YW 125 G Zuma (Rear Disc Model)	16-21	SFA196	SFA196HH								18
YW Zuma 125 MB (245 F/Disc & 230 R/disc)	21-22	SFA196	SFA196HH								19
YW 125 X	10-13	SFA632									20
YZ 125 F/G/H/J	80-82	507	507G								21
YZ 125 K	83	507	507G								22
YZ 125 L	84	508	508G								23
YZ 125 N	85	FA105X	FA105R				MD6324D				24
YZ 125 S/T	86-87	FA105X	FA105R				MD6067D				25
YZ 125 U	88	FA105X	FA105R				MD6039D				26
YZ 125 W	89	FA135X	FA135R			MXS135	MD6016D				27
YZ 125 A	90	FA135X	FA135R			MXS135	MD6012D				28
YZ 125 B	91	FA135X	FA135R			MXS135	MD6012D				29
YZ 125 D/E	92-93	FA135X	FA135R			MXS135	MD6028D			MD6028C	30
YZ 125 F/G/H/J	94-97	FA135X	FA135R			MXS135	MD6028D			MD6028C	31
YZ 125 K/L/M	98-00	FA185X	FA185R			MXS185	MD6028D			MD6028C	32
YZ 125 N	01	FA185X	FA185R			MXS185	MD6356D			MD6356C	33
YZ 125 P	02	FA185X	FA185R			MXS185	MD6356D			MD6356C	34
YZ 125 R/S	03-04	FA185X	FA185R			MXS185	MD6356D			MD6356C	35
YZ 125 T/V/W	05-07	FA185X	FA185R			MXS185	MD6356D			MD6356C	36
YZ 125 X/Y/Z/A/B/D/E/F/G (2T)	08-16	FA450X	FA450R			MXS450	MD6356D			MD6356C	37
YZ 125 (2T)	17-21	FA450X	FA450R			MXS450				MD6392C	38
YZ 125 2T - 270 F/Rotor, 240 R/Rotor	21-22	FA450X	FA450R			MXS450				MD6392C	39
YZ 125 Monster Energy 2T - 270 F/Rotor, 240 R/Rotor	22	FA450X	FA450R			MXS450				MD6392C	40
YZ 125 X Cross Country	21	FA450X	FA450R			MXS450				MD6392C	41
RX-Z 135	87-89	FA81	FA81R					N/A			42
RX-Z 135	93-97	FA81	FA81R					N/A			43
RX-Z 135	00-05	FA81	FA81R					N/A			44
FZ 150	07-08	FA464						TBC			45
SR 150	95	510									46
YZF-R 15 (150cc)	10-13	FA464						TBC			47
XC 155 F/G S-Max	15-20	SFA196	SFA196HH								48
FZ 16 (160cc)	10-13	FA181X	FA181HH					TBC			49
FZ 16 S (160cc)	12-13	FA181X	FA181HH					TBC			50
FZ 16 ST (160cc)	11-13	FA181X	FA181HH					TBC			51
DT 175 G/H	80-81	506	506G								52
IT 175 G/H/J/K	80-83	507	507G								53
MX 175 G/H	80-81	504	504G								54
YT 175 J/K (Tri Moto)	82-83	503	503G								55
RT 180 A/B/D	90-92	FA101X	FA101R				N/A				56

FRONT

APPLICATIONS

BRAKE
 This symbol indicates a rotor made of billet steel, and should be only used with EBC FA Kevlar® Organic or Vee pads.
 SAFETY NOTICE - With vehicles primarily designed for off highway use such as quads now being used on the highway, we would recommend the use of X or MXS pads for highway use and ONLY using the R and SV higher density / harder pad series for off road riding.

*-2 Sets Required. † For Vee disc colours add RED, BLU, GRN, GLD, ORG suffix to part number. **SAFETY WARNING:- DO NOT USE HH PADS ON REAR UNLESS ALSO USED ON FRONT TO AVOID BRAKE IMBALANCE**

FRONT: YAMAHA Cont'd

REAR: YAMAHA

Line #

BRAKE ROTOR CHOICES - FRONT							DISC PAD CHOICES - REAR					BRAKE ROTOR CHOICES - REAR			
CC Custom Rotor	CX Extreme® /Vee-Rotor	OS Series Oversize 250/280mm Rotor Kit	OSX Series Oversize 280mm Rotor Kit	Relocating Bracket for Oversize Rotor	SMX Series Oversize 320mm Rotor Kit	Relocating Bracket for 320mm Rotor		Sintered/HH Pads/ Grooved Shoes	SV Series Severe Duty Pads	EPFA Sintered Fast Road/ Track Pads	Specialty Pads SXR/ VEE/MXS Race	Standard Rotor	Vintage Rotor / UTV Oversize Brake Kit	Contour Profile Rotor	CX Extreme® /Vee-Rotor
1							527								
2							527								
3							531								
4							531								
5							531								
6							531								
7							531								
8							527								
9							531								
10							506	506G							
11							527	527G							
12							527	527G							
13							FA84X	FA84R	FA84SV			MD6236D			
14							530								
15							FA20X	N/A				N/A			
16							FA21X	FA21R				N/A			
17							533								
18		VR9133					SFA213	SFA213HH				MD9150D			VR9150
19		VR9133					SFA213	SFA213HH							VR927
20		VR9133					533								
21							506	506G							
22							517	517G							
23							517	517G							
24							517	517G							
25							506	506G							
26							FA101X	FA101R				MD6011D			
27							N/A	FA84/3R				MD6011D			
28							FA152X	FA152R			MXS152	MD6011D			
29							FA152/2X	FA152/2R			MXS152/2	MD6011D			
30			OS6028EC	OSX6028E	BRK035	N/A	FA152/2X	FA152/2R			MXS152/2	MD6011D			
31			OS6028EC	OSX6028E	BRK035	N/A	FA152/2X	FA152/2R			MXS152/2	MD6011D			
32		MD6028CX	OS6028C	OSX6028	BRK008	SMX6028	BRK009	FA131X	FA131R		MXS131	MD6135D		MD6135C	MD6135CX
33		MD6356CX	OS6028C	OSX6028	BRK008	SMX6028	BRK009	FA131X	FA131R		MXS131	MD6135D		MD6135C	MD6135CX
34		MD6356CX	OS6028C	OSX6028	BRK008	SMX6028	BRK009	FA131X	FA131R		MXS131	MD6190D		MD6190C	MD6190CX
35		MD6356CX	OS6028C	OSX6028	BRK008	SMX6028	BRK009	FA367X	FA367R		MXS367	MD6190D		MD6190C	MD6190CX
36		MD6356CX	OS6028C	OSX6028	BRK008	SMX6028	BRK009	FA367X	FA367R		MXS367	MD6190D		MD6190C	MD6190CX
37		MD6356CX	OS6728C	OSX6728	BRK002	SMX6728	BRK034	FA367X	FA367R		EPFA367HH	MXS367	MD6190D		MD6190C
38		MD6392CX						FA367X	FA367R		EPFA367HH	MXS367	MD6190D		MD6190C
39		MD6392CX	OSX6392		BRK			FA367X	FA367R		EPFA367HH	MXS367			MD6135C
40		MD6392CX	OSX6392		BRK			FA367X	FA367R		EPFA367HH	MXS367			MD6135C
41		MD6392CX						FA367X	FA367R		EPFA367HH	MXS367	MD6190D		MD6190C
42							504								
43							527								
44							531								
45							528								
46							FA152					TBC			
47		VR9145					SFA213	SFA213HH							VR9133
48							535								
49							535								
50							506	506G							
51							506	506G							
52							506	506G							
53							FA21X	FA21R				N/A			
54							506	506G							
55							506	506G							
56							506	506G							

REAR

BRAKE APPLICATIONS

⚠ This symbol indicates a rotor made of billet steel, and should be only used with EBC FA Kevlar® Organic or Vee pads.
 SAFETY NOTICE - With vehicles primarily designed for off highway use such as quads now being used on the highway, we would recommend the use of X or MXS pads for highway use and ONLY using the R and SV higher density / harder pad series for off road riding.

*-2 Sets Required. † For Vee disc colours add RED, BLU, GRN, GLD, ORG suffix to part number. **SAFETY WARNING:- DO NOT USE HH PADS ON REAR UNLESS ALSO USED ON FRONT TO AVOID BRAKE IMBALANCE**

FRONT: YAMAHA



YAMAHA



DISC PAD CHOICES - FRONT

BRAKE ROTOR CHOICES - FRONT

											Line #
RT 180 E/G/H/J	93-97	FA101X	FA101R				N/A				1
XC 180 K/KC/L/LC/N/NC/ZL/ZLC/ZV/ZNC/DN/DWC Riva	83-85	521									2
SR 185 H/J	81-82	506									3
BW 200 N/S/ES/ET/EU	85-87	503	503G								4
IT 200 L/N	84-85	517	517G								5
IT 200 S	86	FA105X	FA105R				MD6039D				6
TW 200 T/TC/U/UC/W/WC/A/AC/B/BC	87-91	506	506G								7
TW 200 D/E/F/G/H/J/KE/EC/L/M	92-00	527	527G								8
TW 200	01-21	FA275X	FA275HH				MD6067D				9
WR 200 D	92	FA135X	FA135R				MD6066D				10
XC 200 T/ZCT/U/W/ZU/ZW/ZA/ZB Riva	87-91	521									11
XT 200 J/K/KC	82-83	506	506G								12
YFM 200 N/D (Moto 4)	85-89	503*	503G*								13
YFS 200 U/W/A/B/D/E/F/G/H/J/K/L/M/N/P Blaster	88-02	503*	503G*								14
YFS 200 R/S/T/V Blaster	03-06	FA54X*	FA54R*	FA54SV*			MD6054D	MD6054D			15
YTM 200 K/L/N (Tri Moto)	83-85	503	503G								16
YTM 200 E (Tri Moto)	83-84	503	503G								17
YTM 200 E (Tri Moto)	85	503	503G								18
TT 225 S/T	86-87	FA101X	FA101R				MD6067D				19
TT-R 225 L/M/N/P/R/S	99-03	FA101X	FA101R				MD6067D				20
YFM 225 S/T/U (Moto 4)	86-88	503*	503G*								21
YTM 225 D (Tri Moto)	83-85	503	503G								22
YTM 225 D (Tri Moto)	85-86	503	503G								23
XT 225 D/DC/E/EC/F/FC/G/GC/F/FH/J/JC/K/KC/L/M/MC	92-00	FA101X	FA101R				MD6067D				24
XT 225 N/NC/P/PC/R/R/S/SC/T/TC/N/VC/W/WC	01-07	FA275X					MD6067D				25
TT-R 230	05-09/11-21	FA135X	FA135R			MXS135	MD6067D				26
YFU1TW Pro Hauler	89	528*	528G*								27
YFU1W Pro Hauler	89	528*	528G*								28
CP 250 V/W/X Morphus	06-08	SFA199	SFA199HH					MD9107D			29
DT 250 A	74	510	510G								30
DT 250 B/C/D/E/F	75-79	528	528G								31
IT 250 F/G	77-80	507	507G								32
IT 250 H/J	81-82	507	507G								33
IT 250 K	83	508	508G								34
SR 250 G/H/J/TH EXCiter VII	80-82	528									35
SR 250 K	93	522									36
SR 250	93-08	522									37
SRX 250 T	87	FA104	FA104HH					MD2011		MD2011C	38
TT 250 G/H/J	80-82	507	507G								39
TT-R 250 L/M/N/P/R/S/T/V	99-06	FA135X	FA135R			MXS135	MD6066D				40
WR 250 ZB	91	FA135X	FA135R			MXS135	MD6012D				41
WR 250 Z	92-97	FA135X	FA135R			MXS135	MD6028D			MD6028C	42
WR 250 F (4T)	01	FA185X	FA185R			MXS185	MD6356D			MD6356C	43
WR 250 F (4T)	02	FA185X	FA185R			MXS185	MD6356D			MD6356C	44
WR 250 F (4T)	03-04	FA185X	FA185R			MXS185	MD6356D			MD6356C	45
WR 250 F (4T)	05-06	FA185X	FA185R			MXS185	MD6356D			MD6356C	46
WR 250 F (4T)	07-18	FA185X	FA185R			MXS185	MD6356D			MD6356C	47
WR 250 F (4T)	18-21	FA450X	FA450R			MXS450				MD6392C	48
WR 250 X (Supermotard)	08-11	FA142	FA142HH							MD6323C	49
WR 250 R	08-20	FA185X	FA185R			MXS185				MD6320C	50
XT 250 G/H/J/K/L	80-84	506	506G								51
XT 250	08-21	FA275X	FA275HH				MD6067D				52
XTZ 250 Lander	07-14	FA135X	FA135R			MXS135	MD6068D				53
XTZ 250 Lander	16-18	FA465X	FA465R			MXS465	MD6068D				54
XTZ 250 X	08-10	FA135X	FA135R			MXS135	MD6068D				55
MD6190C ● = PLAIN UNDRILLED DISC FOR ENDURO USE. REAR FITMENTS ONLY. ORDER MD6190CE											56

FRONT

APPLIATIONS
BRAKE
 This symbol indicates a rotor made of billet steel, and should be only used with EBC FA Kevlar® Organic or Vee pads.
 SAFETY NOTICE - With vehicles primarily designed for off highway use such as quads now being used on the highway, we would recommend the use of X or MXS pads for highway use and ONLY using the R and SV higher density / harder pad series for off road riding.

*-2 Sets Required. † For Vee disc colours add RED, BLU, GRN, GLD, ORG suffix to part number. **SAFETY WARNING:- DO NOT USE HH PADS ON REAR UNLESS ALSO USED ON FRONT TO AVOID BRAKE IMBALANCE**

FRONT: YAMAHA Cont'd

REAR: YAMAHA

Line #

BRAKE ROTOR CHOICES - FRONT							DISC PAD CHOICES - REAR					BRAKE ROTOR CHOICES - REAR			
CC Custom Rotor	CX Extreme® /Vee-Rotor	OS Series Oversize 250/280mm Rotor Kit	OSX Series Oversize 280mm Rotor Kit	Relocating Bracket for Oversize Rotor	SMX Series Oversize 320mm Rotor Kit	Relocating Bracket for 320mm Rotor		Sintered/HH Pads/ Grooved Shoes	SV Series Severe Duty Pads	EPFA Sintered Fast Road/ Track Pads	Specialty Pads SXR/ VEE/MXS Race	Standard Rotor	Vintage Rotor / UTV Oversize Brake Kit	Contour Profile Rotor	CX Extreme® /Vee-Rotor
1							527	527G							
2							537								
3							503								
4							503	503G							
5							517	517G							
6							517	517G							
7							503	503G							
8							503	503G							
9							503	503G							
10							FA152/2X	FA152/2R				MD6121D			
11							537								
12							503	503G							
13							FA21X	FA21R	FA21SV			N/A			
14							FA155X	FA155R				MD6050D			
15							FA84X	FA84R	FA84SV			MD6237D			
16							FA21X	FA21R				N/A			
17							FA21X	FA21R				N/A			
18							FA21X	FA21R				N/A			
19							503	503G							
20							527	527G							
21							FA21X	FA21R	FA21SV			N/A			
22							FA21X	FA21R				N/A			
23							FA21X	FA21R				N/A			
24							503	503G							
25							503	503G							
26							527	527G							
27							523*	523G*							
28							523*	523G*							
29							SFA408	SFA408HH				MD9108D			
30							510	510G							
31							510	510G							
32							528	528G							
33							510	510G							
34							510	510G							
35							506								
36							506								
37							527								
38		VR2011					510								
39							506	506G							
40							FA152X	FA152R			MXS152	MD6121D			
41							FA152X	FA152R			MXS152	MD6011D			
42			OS6028EC	OSX6028E	BRK035	N/A	FA152X	FA152R			MXS152	MD6011D			
43		MD6356CX	OS6028C	OSX6028	BRK008	SMX6028	BRK009	FA131X	FA131R		MXS131	MD6135D		MD6135C	MD6135CX
44		MD6356CX	OS6028C	OSX6028	BRK008	SMX6028	BRK009	FA131X	FA131R		MXS131	MD6190D		MD6190C	MD6190CX
45		MD6356CX	OS6028C	OSX6028	BRK008	SMX6028	BRK009	FA367X	FA367R		MXS367	MD6190D		MD6190C	MD6190CX
46		MD6356CX	OS6028C	OSX6028	BRK008	SMX6028	BRK009	FA367X	FA367R		MXS367	MD6190D		MD6190C	MD6190CX
47		MD6356CX	OS6028C	OSX6028	BRK008	SMX6028	BRK009	FA367X	FA367R		MXS367	MD6190D		MD6190C	MD6190CX
48		MD6392CX						FA367X	FA367R		MXS367			MD6190C	MD6190CX
49								FA367X	FA367R		MXS367			MD6319C	
50								FA367X	FA367R		MXS367			MD6319C	
51							506	506G							
52							FA152X	FA152R			MXS152	MD6244D			
53							FA152X	FA152R			MXS152	MD6244D			
54							FA152X	FA152R			MXS152	MD6244D			
55							FA152X	FA152R			MXS152	MD6244D			
56															

REAR

BRAKE APPLICATIONS

⚠ This symbol indicates a rotor made of billet steel, and should be only used with EBC FA Kevlar® Organic or Vee pads. SAFETY NOTICE - With vehicles primarily designed for off highway use such as quads now being used on the highway, we would recommend the use of X or MXS pads for highway use and ONLY using the R and SV higher density / harder pad series for off road riding.

*-2 Sets Required. † For Vee disc colours add RED, BLU, GRN, GLD, ORG suffix to part number. SAFETY WARNING:- DO NOT USE HH PADS ON REAR UNLESS ALSO USED ON FRONT TO AVOID BRAKE IMBALANCE

FRONT: YAMAHA



YAMAHA



DISC PAD CHOICES - FRONT

BRAKE ROTOR CHOICES - FRONT

											Line #
XV 250 U/W/A	88-90	FA81	FA81R					MD2019RS			1
XV 250 Virago G/H/J/L/M/N/P/R/T/V/W	95-07	FA199	FA199HH			FA199V	MD2067				2
XV 250 V-Star	08-12	FA199	FA199HH			FA199V	MD2067				3
XV 250 V-Star	13-21	FA199	FA199HH				MD2067				4
YBR 250	10-12	FA464						TBC			5
YFB 250 D/E/F Timberwolf	92-94	503*	503G*								6
YFB 250 G/H/UH/J/UJ/UK/K	95-98	528*	528G*								7
YFB 250 F Timberwolf	94-00	528*	528G*								8
YFM 250 W/A/B	89-91	528*	528G*								9
YFM 250 XL/M Bear Tracker	99-00	528*	528G*								10
YFM 250 X Beartracker	01-04	FA54X*	FA54R*	FA54SV*			MD6054D	MD6054D			11
YFM 250 B Bruin	05-06	FA54X*	FA54R*	FA54SV*			MD6054D	MD6054D			12
YFM 250 B Big Bear	07-09	FA54X*	FA54R*	FA54SV*			MD6054D	MD6054D			13
YFM 250 R Raptor	08-13	Left FA443X	FA443R	FA443SV			MD6054D				14
		Right FA444X	FA444R	FA444SV				MD6054D			15
YFM 250 RSPX/RSEY Special Edition	08-09	Left FA443X	FA443R	FA443SV			MD6054D				16
		Right FA444X	FA444R	FA444SV				MD6054D			17
YFM 250 RSPXC Special Edition Custom	08	Left FA443X	FA443R	FA443SV			MD6054D				18
		Right FA444X	FA444R	FA444SV				MD6054D			19
YFM 250 RSPA Special Edition	11	Left FA443X	FA443R	FA443SV			MD6054D				20
		Right FA444X	FA444R	FA444SV				MD6054D			21
YP 250 Majesty	97	SFA199	SFA199HH					MD903D		MD903C	22
YP 250 Majesty	00-03	SFA199	SFA199HH					MD903D		MD903C	23
YS 250 Fazer	06-10	FA197	FA197HH					MD2106RS			24
YZ 250 N/S (Tri Moto)	85-86	FA101X	FA101R				MD6047D				25
YZ 250 G	80	507	507G								26
YZ 250 H	81	507	507G								27
YZ 250 J/K/L	82-84	508	508G								28
YZ 250 N/S	85-	FA105X	FA105R				MD6324D				29
YZ 250 S/T	86-87	FA105X	FA105R				MD6067D				30
YZ 250 U	88	FA105X	FA105R				MD6039D				31
YZ 250 W	89	FA135X	FA135R				MD6016D				32
YZ 250 WRW	89	FA135X	FA135R			MXS135	MD6016D				33
YZ 250 WRA	90	FA135X	FA135R			MXS135	MD6028D			MD6028C	34
YZ 250 A/B	90-91	FA135X	FA135R			MXS135	MD6012D				35
YZ 250 D/E	92-93	FA135X	FA135R			MXS135	MD6028D			MD6028C	36
YZ 250 F/G/H/J	94-97	FA135X	FA135R			MXS135	MD6028D			MD6028C	37
YZ 250 K/L/M	98-00	FA185X	FA185R			MXS185	MD6028D			MD6028C	38
YZ 250 N	01	FA185X	FA185R			MXS185	MD6356D			MD6356C	39
YZ 250 P	02	FA185X	FA185R			MXS185	MD6356D			MD6356C	40
YZ 250 R/S (2T)	03-04	FA185X	FA185R			MXS185	MD6356D			MD6356C	41
YZ 250 T/V/W (2T)	05-07	FA185X	FA185R			MXS185	MD6356D			MD6356C	42
YZ 250 (2T)	08-16	FA450X	FA450R			MXS450				MD6356C	43
YZ 250 (2T)	16-20	FA450X	FA450R			MXS450				MD6356C	44
YZ 250 270 F/Rotor, 245 R/Rotor (2T)	17-22	FA450X	FA450R			MXS450				MD6392C	45
YZ 250 270 F/Rotor, 240 R/Rotor (2T)	21-22	FA450X	FA450R			MXS450				MD6392C	46
YZ 250 270 F/Rotor, 240 R/Rotor Monster Energy (2T)	22	FA450X	FA450R			MXS450				MD6392C	47
YZ 250 F (4T)	01	FA185X	FA185R			MXS185	MD6356D			MD6356C	48
YZ 250 F (4T)	02	FA185X	FA185R			MXS185	MD6356D			MD6356C	49
YZ 250 F (4T)	03-04	FA185X	FA185R			MXS185	MD6356D			MD6356C	50
YZ 250 F (4T)	05-06	FA185X	FA185R			MXS185	MD6356D			MD6356C	51
YZ 250 F (4T)	07-15	FA450X	FA450R			MXS450	MD6356D			MD6356C	52
YZ 250 F (4T/270mm F/Disc)	16-19	FA450X	FA450R			MXS450				MD6392C	53
YZ 250 F 270mm F/Disc, 245mm R/Disc	20-22	FA755X	FA755R			MXS755				MD6392C	54
YZ 250 FX 270 F/Rotor, 245 R/Rotor	21	FA450X	FA450R			MXS450				MD6392C	55
YZ 250 FX 270 F/Rotor, 240 R/Rotor	22	FA450X	FA450R			MXS450				MD6392C	56

FRONT

APPLIATIONS
SAFETY NOTICE - With vehicles primarily designed for off highway use such as quads now being used on the highway, we would recommend the use of X or MXS pads for highway use and ONLY using the R and SV higher density / harder pad series for off road riding.

* This symbol indicates a rotor made of billet steel, and should be only used with EBC FA Kevlar® Organic or Vee pads.

*-2 Sets Required. † For Vee disc colours add RED, BLU, GRN, GLD, ORG suffix to part number. **SAFETY WARNING:- DO NOT USE HH PADS ON REAR UNLESS ALSO USED ON FRONT TO AVOID BRAKE IMBALANCE**

FRONT: YAMAHA Cont'd

REAR: YAMAHA

Line # 1 2 3 4 5 6 7 8 9 10 11 12 13 14 15 16 17 18 19 20 21 22 23 24 25 26 27 28 29 30 31 32 33 34 35 36 37 38 39 40 41 42 43 44 45 46 47 48 49 50 51 52 53 54 55 56

BRAKE ROTOR CHOICES - FRONT							DISC PAD CHOICES - REAR					BRAKE ROTOR CHOICES - REAR			
CC Custom Rotor	CX Extreme® /Vee-Rotor	OS Series Oversize 250/280mm Rotor Kit	OSX Series Oversize 280mm Rotor Kit	Relocating Bracket for Oversize Rotor	SMX Series Oversize 320mm Rotor Kit	Relocating Bracket for 320mm Rotor		Sintered/HH Pads/ Grooved Shoes	SV Series Severe Duty Pads	EPFA Sintered Fast Road/ Track Pads	Specialty Pads SXR/ VEE/MXS Race	Standard Rotor	Vintage Rotor / UTV Oversize Brake Kit	Contour Profile Rotor	CX Extreme® /Vee-Rotor
							506								
							527								
							527								
							535								
							528	528G							
							528	528G							
							528	528G							
							FA21X	FA21R	FA21SV			N/A			
							528	528G							
							528	528G							
							532	532G							
							532	532G							
							FA84X	FA84R	FA84SV			MD6236D			
							FA84X	FA84R	FA84SV			MD6236D			
							FA84X	FA84R	FA84SV			MD6236D			
							FA84X	FA84R	FA84SV			MD6236D			
							516								
							SFA275	SFA275HH				MD953D		MD953C	
							535								
							FA101X	FA101R				N/A			
							506	506G							
							510	510G							
							506	506G							
							506	506G							
							506	506G							
							FA101X	FA101R				MD6011D			
							N/A	FA84/3R				MD6011D			
							N/A	FA84/3R			MXS84/3	MD6011D			
		OS6028EC	OSX6028E	BRK035	N/A	N/A	FA152X	FA152R			MXS152	MD6011D			
							FA152X	FA152R			MXS152	MD6011D			
		OS6028EC	OSX6028E	BRK035	N/A	N/A	FA152/2X	FA152/2R			MXS152/2	MD6011D			
		OS6028EC	OSX6028E	BRK035	N/A	N/A	FA152/2X	FA152/2R			MXS152/2	MD6011D			
	MD6028CX	OS6028C	OSX6028	BRK008	SMX6028	BRK009	FA131X	FA131R			MXS131	MD6135D		MD6135C	MD6135CX
	MD6356CX	OS6028C	OSX6028	BRK008	SMX6028	BRK009	FA131X	FA131R			MXS131	MD6135D		MD6135C	MD6135CX
	MD6356CX	OS6028C	OSX6028	BRK008	SMX6028	BRK009	FA131X	FA131R			MXS131	MD6190D		MD6190C	MD6190CX
	MD6356CX	OS6028C	OSX6028	BRK008	SMX6028	BRK009	FA367X	FA367R			MXS367	MD6190D		MD6190C	MD6190CX
	MD6356CX	OS6028C	OSX6028	BRK008	SMX6028	BRK009	FA367X	FA367R			MXS367	MD6190D		MD6190C	MD6190CX
	MD6356CX	OS6728C	OSX6728	BRK002	SMX6728	BRK034	FA367X	FA367R	EPFA367HH		MXS367			MD6190C	MD6190CX
	MD6356CX	OS6728C	OSX6728	BRK002	SMX6728	BRK034	FA367X	FA367R	EPFA367HH		MXS367			MD6190C	MD6190CX
	MD6392CX						FA367X	FA367R	EPFA367HH		MXS367			MD6190C	MD6190CX
	MD6392CX						FA367X	FA367R	EPFA367HH		MXS367			MD6190C	MD6190CX
	MD6392CX						FA367X	FA367R	EPFA367HH		MXS367			MD6135C	MD6135CX
	MD6392CX						FA367X	FA367R	EPFA367HH		MXS367			MD6135C	MD6135CX
	MD6356CX	OS6028C	OSX6028	BRK008	SMX6028	BRK009	FA131X	FA131R			MXS131	MD6135D		MD6135C	MD6135CX
	MD6356CX	OS6028C	OSX6028	BRK008	SMX6028	BRK009	FA131X	FA131R			MXS131	MD6190D		MD6190C	MD6190CX
	MD6356CX	OS6028C	OSX6028	BRK008	SMX6028	BRK009	FA367X	FA367R			MXS367	MD6190D		MD6190C	MD6190CX
	MD6356CX	OS6028C	OSX6028	BRK008	SMX6028	BRK009	FA367X	FA367R			MXS367	MD6190D		MD6190C	MD6190CX
	MD6356CX	OS6728C	OSX6728	BRK002	SMX6728	BRK034	FA367X	FA367R		EPFA367HH	MXS367	MD6190D		MD6190C	MD6190CX
	MD6392CX		OSX6392	BRK			FA367X	FA367R		EPFA367HH	MXS367			MD6190C	MD6190CX
	MD6392CX		OSX6392	BRK			FA367X	FA367R		EPFA367HH	MXS367			MD6190C	MD6190CX
	MD6392CX		OSX6392	BRK			FA367X	FA367R		EPFA367HH	MXS367	MD6135C			MD6135CX
	MD6392CX		OSX6392	BRK			FA367X	FA367R		EPFA367HH	MXS367	MD6135C			MD6135CX

REAR

BRAKE APPLICATIONS

⚠ This symbol indicates a rotor made of billet steel, and should be only used with EBC FA Kevlar® Organic or Vee pads.
 SAFETY NOTICE - With vehicles primarily designed for off highway use such as quads now being used on the highway, we would recommend the use of X or MXS pads for highway use and ONLY using the R and SV higher density / harder pad series for off road riding.

*-2 Sets Required. † For Vee disc colours add RED, BLU, GRN, GLD, ORG suffix to part number. **SAFETY WARNING:** DO NOT USE HH PADS ON REAR UNLESS ALSO USED ON FRONT TO AVOID BRAKE IMBALANCE

FRONT: YAMAHA



YAMAHA



DISC PAD CHOICES - FRONT

BRAKE ROTOR CHOICES - FRONT

											Line #
YZ 250 F MME Monster 270mm F/Disc, 245mm R/Disc	21	FA755X	FA755R			MXS755				MD6392C	1
YZ 250 FGY 60th Anniversary Model (4T/270mm F/Disc)	16	FA450X	FA450R			MXS450				MD6392C	2
MT-03	16-21	FA663	FA663HH					MD2119X		MD2119XC	3
XMAX 300	18-21	SFA705	SFA705HH				MD9169D				4
YFM 300 G Grizzly	12-13	FA83X*	FA83R*				MD6283D	MD6283D			5
YZF R3 (321cc)	15-21	FA663	FA663HH			GPFAX663HH	FA663V	MD2119X		MD2119XC	6
YZF R3 Monster Energy Yamaha Moto GP Edition (321cc)	19-21	FA663	FA663HH			GPFAX663HH	FA663V	MD2119X		MD2119XC	7
BW 350 T/U	87-88	517	517G								8
R5/5A/5B - 350cc	70-72	513									9
RD 350 A/B	73-75	FA11						TBC			10
RZ 350 L/N/NC11	84-85	FA81*	FA81R				MD2011	MD2011		MD2011C*	11
TT 350 S/T	86-87	FA105X	FA105R				MD6039D				12
TY 350 N/S	85-86	517	517G								13
XT 350 N/S	85-86	FA101X	FA101R				MD6068D				14
XT 350 T/U/W/A	87-90	FA101X	FA101R				MD6068D				15
XT 350 B/D/E/F/G/H/J/K/L/M	91-00	FA101X	FA101R				MD6068D				16
YFM 350 ER	87-88	503*	503G*								17
YFM 350 ER	89-92	528*	528G*								18
YFM 350 ER	93-95	528*	528G*								19
YFM 350 FX Wolverine	95-05	FA54X*	FA54R*	FA54SV*			MD6123D	MD6123D			20
YFM 350 V Wolverine (2WD)	06	FA54X*	FA54R*	FA54SV*			MD6215D	MD6215D			21
YFM 350 G Grizzly 2x4 (2WD)	07-11	FA54X*	FA54R*	FA54SV*			MD6215D	MD6215D			22
YFM 350 FGI Grizzly Auto IRS 4x4	07-11	FA54X*	FA54R*	FA54SV*			MD6215D	MD6215D			23
YFM 350 FG Grizzly Auto 4x4	07-13	FA54X*	FA54R*	FA54SV*			MD6215D	MD6215D			24
YFM 350 FW Big Bear	87-88	520*	520G*								25
YFM 350 FW Big Bear	89-95	524*	524G*								26
YFM 350 FW Big Bear	96-98	524*	524G*								27
YFM 350 XT	87	FA101X*	FA101R*				MD6051D	MD6051D			28
YFM 350 FWBL/LC Big Bear	99	FA54X*	FA54R*	FA54SV*			MD6123D	MD6123D			29
YFM 350 XU Warrior	88	FA101X*	FA101R*				MD6051D	MD6051D			30
YFM 350 XW Warrior	89	FA54X*	FA54R*	FA54SV*			MD6054D	MD6054D			31
YFM 350 X Warrior	90-04	FA54X*	FA54R*	FA54SV*			MD6054D	MD6054D			32
YFM 350 U	96-98	524*	524G*								33
YFZ 350 Banshee T/U/W	87-89	FA101X*	FA101R*				MD6051D	MD6051D			34
YFZ 350 A/B/D/E/F/G/H/J/K/L/M/N/P/R/S/T/V Banshee	90-06	FA54X*	FA54R*	FA54SV*			MD6054D	MD6054D			35
YFM 350 UL/U/LC	99	FA54X*	FA54R*	FA54SV*			MD6123D	MD6123D			36
YFM 350 FA 350 Bruin 4x4 Auto	04-06	FA54X*	FA54R*	FA54SV*			MD6215D	MD6215D			37
YFM 350 A 350 Bruin 2x4 Auto	04-06	FA54X*	FA54R*	FA54SV*			MD6215D	MD6215D			38
YFM 350 R Raptor	04-13	FA84X*	FA84R*	FA84SV*			MD6054D	MD6054D			39
YFM 350 X Wolverine (2WD)	06-09	FA54X*	FA54R*	FA54SV*			MD6215D	MD6215D			40
YFP 350 U Terrapro	88	528*	528G*								41
FZR 400 U/SUC/W/SWC	88-89	FA88*	FA88HH*		EPFA88HH*		MD2020LS	MD2020RS			42
FZR 400 A	90	FA123*	FA123HH*				MD2022LS	MD2022RS			43
FZR 400 RRSP/RR	91-92	FA252*	FA252HH*		EPFA252HH*		MD2001X	MD2001X		MD2001XC*	44
RD 400 C/D/E	76-78	FA11						N/A			45
RD 400 F Daytona	79	FA41				FA41V		MD2025	VMD2025		46
SR 400	15-20	FA179	FA179HH					MD2076			47
WR 400 FK	98	FA185X	FA185R		EPFA185HH	MXS185	MD6028D			MD6028C	48
WR 400 FL/FM	99-00	FA185X	FA185R		EPFA185HH	MXS185	MD6028D			MD6028C	49
WR 400 FN	01	FA185X	FA185R		EPFA185HH	MXS185	MD6017D			MD6017C	50
XS 400 2G/H	80-81	513									51
XS 400 SG/SH	80-81	FA41				FA41V		MD2019RS			52
XS 400 SJ	82	513									53
XS 400 J/K Maxim	82-83	FA81	FA81R					MD2019RS			54
XS 400 R/J/RK	82-83	FA81	FA81R					MD2011		MD2011C	55
XJ 400 S Seca II	93	FA179	FA179HH				MD2031LS				56

FRONT

APPLIATIONS
BRAKE

* This symbol indicates a rotor made of billet steel, and should be only used with EBC FA Kevlar® Organic or Vee pads.
SAFETY NOTICE - With vehicles primarily designed for off highway use such as quads now being used on the highway, we would recommend the use of X or MXS pads for highway use and ONLY using the R and SV higher density / harder pad series for off road riding.

*-2 Sets Required. † For Vee disc colours add RED, BLU, GRN, GLD, ORG suffix to part number. SAFETY WARNING:- DO NOT USE HH PADS ON REAR UNLESS ALSO USED ON FRONT TO AVOID BRAKE IMBALANCE

FRONT: YAMAHA Cont'd

REAR: YAMAHA

Line #

BRAKE ROTOR CHOICES - FRONT							DISC PAD CHOICES - REAR					BRAKE ROTOR CHOICES - REAR			
CC Custom Rotor	CX Extreme® /Vee-Rotor	OS Series Oversize 250/280mm Rotor Kit	OSX Series Oversize 280mm Rotor Kit	Relocating Bracket for Oversize Rotor	SMX Series Oversize 320mm Rotor Kit	Relocating Bracket for 320mm Rotor		Sintered/HH Pads/ Grooved Shoes	SV Series Severe Duty Pads	EPFA Sintered Fast Road/ Track Pads	Specialty Pads SXR/ VEE/MXS Race	Standard Rotor	Vintage Rotor / UTV Oversize Brake Kit	Contour Profile Rotor	CX Extreme® /Vee-Rotor
1	MD6392CX		OSX6392	BRK			FA367X	FA367R	EPFA367HH		MXS367				
2	MD6392CX		OSX6392	BRK			FA367X	FA367R	EPFA367HH		MXS367			MD6190C	MD6190CX
3	VR2119BLK						FA662	FA662HH			FA662V	MD2123		MD2123C	VR2123
4							SFA706	SFA706HH				MD9168D			
5							FA67R		FA67SV			MD6369D			
6	VR2119BLK						FA662	FA662HH			FA662V	MD2123		MD2123C	VR2123
7	VR2119BLK						FA662	FA662HH			FA662V	MD2123		MD2123C	VR2123
8							504	504G							
9							514								
10							514								
11	VR2011						FA88	FA88HH			FA88V	MD2011		MD2011C	VR2011
12							506	506G							
13							504	504G							
14							506	506G							
15							506	506G							
16							527	527G							
17							FA21X	FA21R	FA21SV			N/A			
18							FA21X	FA21R	FA21SV			N/A			
19							FA21X	FA21R	FA21SV			N/A			
20							FA84X	FA84R	FA84SV			MD6053D			
21							532	532G							
22							532	532G							
23							N/A					N/A			
24							532	532G							
25							FA21X	FA21R	FA21SV			N/A			
26							FA21X	FA21R	FA21SV			N/A			
27							516	516G							
28							FA84X	FA84R				N/A			
29							516	516G							
30							FA84X	FA84R				MD6053D			
31							FA84X	FA84R	FA84SV			MD6053D			
32							FA84X	FA84R	FA84SV			MD6055D			
33							516	516G							
34							FA84X	FA84R				MD6053D			
35							FA84X	FA84R	FA84SV			MD6237D			
36							516	516G							
37							532	532G							
38							532	532G							
39							FA84X	FA84R	FA84SV			MD6236D			
40							532	532G							
41							523*	523G*							
42							FA104	FA104HH			FA104V	MD2021			
43							FA104	FA104HH			FA104V	MD2021			
44	MD2001CC*	VR2001BLK*†					FA104	FA104HH			FA104V	MD2021		MD2021C	VR2021
45							FA11					N/A			
46							FA41				FA41V	MD2025			
47							510								
48	MD6028CX	OS6028C	OSX6028	BRK008	SMX6028	BRK009	FA152X	FA152R			MXS152	MD6011D			
49	MD6028CX	OS6028C	OSX6028	BRK008	SMX6028	BRK009	FA131X	FA131R			MXS131	MD6135D		MD6135C	MD6135CX
50	MD6017CX	OS6028C	OSX6028	BRK008	SMX6028	BRK009	FA131X	FA131R			MXS131	MD6135D		MD6135C	MD6135CX
51							516								
52							516								
53							516								
54							516								
55	VR2011						516								
56							FA88	FA88HH			FA88V	MD2002			

REAR

BRAKE APPLICATIONS

⚠ This symbol indicates a rotor made of billet steel, and should be only used with EBC FA Kevlar® Organic or Vee pads.
 SAFETY NOTICE - With vehicles primarily designed for off highway use such as quads now being used on the highway, we would recommend the use of X or MXS pads for highway use and ONLY using the R and SV higher density / harder pad series for off road riding.

*-2 Sets Required. † For Vee disc colours add RED, BLU, GRN, GLD, ORG suffix to part number. **SAFETY WARNING:- DO NOT USE HH PADS ON REAR UNLESS ALSO USED ON FRONT TO AVOID BRAKE IMBALANCE**

FRONT: YAMAHA



YAMAHA



DISC PAD CHOICES - FRONT

BRAKE ROTOR CHOICES - FRONT

Model	Year	Front	DISC PAD CHOICES - FRONT					BRAKE ROTOR CHOICES - FRONT				Line #		
			HH Pads/ Grooved Shoes	SV Series Severe Duty Pads	EPFA Sintered Fast Road/ Track Pads	GPFA Sintered RACE ONLY Pads	Specialty Pads SXR/ VEE/MXS Race	Standard Rotor Left	Standard Rotor Right	Vintage Rotor / UTV Oversize Brake Kit	Contour Profile Rotor			
YFM 400 FW Kodiak	93-98		524*	524G*										1
YFM 400 FW Kodiak	99		FA54X*	FA54R*	FA54SV*					MD6123D	MD6123D			2
YFM 400 N (2x4) Big Bear	03-04		FA54X*	FA54R*	FA54SV*					MD6123D	MD6123D			3
YFM 400 FA Kodiak Auto	03		FA54X*	FA54R*	FA54SV*					MD6215D	MD6215D			4
YFM 400 FA Kodiak	00-02		FA54X*	FA54R*	FA54SV*					MD6123D	MD6123D			5
YFM 400 FAH Kodiak 4x4/Hunter	00-02		FA54X*	FA54R*	FA54SV*					MD6123D	MD6123D			6
YFM 400 Kodiak 2WD A	00-01		FA54X*	FA54R*	FA54SV*					MD6123D	MD6123D			7
YFM 400 Big Bear 2WD NM/NMC/NN/NHN/P/HP	00-02		FA54X*	FA54R*	FA54SV*					MD6123D	MD6123D			8
YFM 400 S Big Bear 2WD	04		FA54X*	FA54R*	FA54SV*					MD6123D	MD6123D			9
YFM 400 FWB Big Bear	00-01		FA54X*	FA54R*	FA54SV*					MD6123D	MD6123D			10
YFM 400 FW/FH/F Big Bear 4WD/Real Tree-tra	00-04		FA54X*	FA54R*	FA54SV*					MD6123D	MD6123D			11
YFM 400 F (Big Bear 4x4)	05-06		FA54X*	FA54R*	FA54SV*					MD6123D	MD6123D			12
YFM 400 FWNHM/FHM Big Bear Buckmaster 4WD	01		FA54X*	FA54R*	FA54SV*					MD6123D	MD6123D			13
YFM 400 A Kodiak 2WD	03-04		FA54X*	FA54R*	FA54SV*					MD6215D	MD6215D			14
YFM 400 FA Kodiak 4WD	04		FA54X*	FA54R*	FA54SV*					MD6215D	MD6215D			15
YFM 400 FA Kodiak (Auto 4x4)	05-06		FA54X*	FA54R*	FA54SV*					MD6215D	MD6215D			16
YFM 400 FG Grizzly 4x4	07-08		FA54X*	FA54R*	FA54SV*					MD6215D	MD6215D			17
YFM 400 F Big Bear 4WD	04-06		FA54X*	FA54R*	FA54SV*					MD6123D	MD6123D			18
YFM 400 FBH Big Bear 400 Hunter IRS	07-10		FA54X*	FA54R*	FA54SV*					MD6215D	MD6215D			19
YFM 400 FBEW Big Bear 400 IRS Exploring Edition	07		FA54X*	FA54R*	FA54SV*					MD6215D	MD6215D			20
YFM 400 FB Big Bear 4WD IRS	08-12		FA54X*	FA54R*	FA54SV*					MD6215D	MD6215D			21
YP 400 TV/W/X/Y/Z/B/D/E Majesty	05-10/12-14		SFA179	SFA179HH						MD9102D				22
YZ 400 FK	98		FA185X	FA185R					MXS185	MD6028D			MD6028C	23
YZ 400 FL	99		FA185X	FA185R					MXS185	MD6028D			MD6028C	24
IT 425 G	80		507	507G										25
WR 426 FN	01		FA185X	FA185R		EPFA185HH		MXS185		MD6356D			MD6356C	26
WR 426 FP	02		FA185X	FA185R		EPFA185HH		MXS185		MD6356D			MD6356C	27
YZ 426 FM	00		FA185X	FA185R		EPFA185HH		MXS185		MD6028D			MD6028C	28
YZ 426 FN	01		FA185X	FA185R		EPFA185HH		MXS185		MD6356D			MD6356C	29
YZ 426 FP	02		FA185X	FA185R		EPFA185HH		MXS185		MD6356D			MD6356C	30
WR 450 F	03-04		FA185X	FA185R		EPFA185HH		MXS185		MD6356D			MD6356C	31
WR 450 F	05-06		FA185X	FA185R		EPFA185HH		MXS185		MD6356D			MD6356C	32
WR 450 F	07-15		FA185X	FA185R		EPFA185HH		MXS185		MD6356D			MD6356C	33
WR 450 F (270mm F/Disc)	16-20		FA450X	FA450R		EPFA450HH		MXS450					MD6392C	34
WR 450 FM (270mm F/Disc)	21-22		FA755X	FA755R				MXS755		MD6392C				35
YFM 450 FA Kodiak	03-04		FA54X*	FA54R*	FA54SV*					MD6215D	MD6215D			36
YFM 450 FG Grizzly 4x4	07-08		FA54X*	FA54R*	FA54SV*					MD6215D	MD6215D			37
YFM 450 FX Wolverine Auto 4x4	06-10		FA54X*	FA54R*	FA54SV*					MD6215D	MD6215D			38
YFM 450 FG Grizzly Auto 4x4 IRS	07		FA54X*	FA54R*	FA54SV*					MD6215D	MD6215D			39
YFM 450 FG Grizzly Auto 4x4	08-13		FA54X*	FA54R*	FA54SV*					MD6215D	MD6215D			40
YFM 450 FGP Grizzly 450 Auto/4x4/EPS	11-13		FA54X*	FA54R*	FA54SV*					MD6215D	MD6215D			41
YFM 450 FA Kodiak (Auto 4x4)	05-06		FA54X*	FA54R*	FA54SV*					MD6215D	MD6215D			42
YFM 450 FXSEW Wolverine Sport Special Edition	07		FA54X*	FA54R*	FA54SV*					MD6215D	MD6215D			43
YFZ 450 LES Limited Edition	04	Left	FA165X	FA165R	FA165SV					MD6054D				44
		Right	FA135X	FA135R	FA135SV						MD6054D			45
YFZ 450 SET Special Edition	05	Left	FA165X	FA165R	FA135SV					MD6054D				46
		Right	FA135X	FA135R	FA135SV						MD6054D			47
YFZ 450 BB Bill Balance Edition	06-07	Left	FA165X	FA165R	FA165SV					MD6054D				48
		Right	FA135X	FA135R	FA135SV						MD6054D			49
YFZ 450 SPV/SEW/SPX Special Edition	06-08	Left	FA165X	FA165R	FA165SV					MD6054D				50
		Right	FA135X	FA135R	FA135SV						MD6054D			51
YFZ 450 S/T	04-05	Left	FA165X	FA165R						MD6054D				52
		Right	FA135X	FA135R							MD6054D			53
YFZ 450 VNV/X/Y/B/D	06-09/12-13	Left	FA165X	FA165R						MD6054D				54
		Right	FA135X	FA135R							MD6054D			55
MD6190C ● = PLAIN UNDRILLED DISC FOR ENDURO USE. REAR FITMENTS ONLY.			ORDER MD6190C.											56

*2 Sets Required. † For Vee disc colours add RED, BLU, GRN, GLD, ORG suffix to part number. **SAFETY WARNING:- DO NOT USE HH PADS ON REAR UNLESS ALSO USED ON FRONT TO AVOID BRAKE IMBALANCE**

⊗ This symbol indicates a rotor made of billet steel, and should be only used with EBC FA Kevlar® Organic or Vee pads.

SAFETY NOTICE - With vehicles primarily designed for off highway use such as quads now being used on the highway, we would recommend the use of X or MXS

pads for highway use and ONLY using the R and SV higher density / harder pad series for off road riding.

FRONT: YAMAHA Cont'd

REAR: YAMAHA

Line # 1 2 3 4 5 6 7 8 9 10 11 12 13 14 15 16 17 18 19 20 21 22 23 24 25 26 27 28 29 30 31 32 33 34 35 36 37 38 39 40 41 42 43 44 45 46 47 48 49 50 51 52 53 54 55 56

BRAKE ROTOR CHOICES - FRONT							DISC PAD CHOICES - REAR					BRAKE ROTOR CHOICES - REAR			
CC Custom Rotor	CX Extreme® /Vee-Rotor	OS Series Oversize 250/280mm Rotor Kit	OSX Series Oversize 280mm Rotor Kit	Relocating Bracket for Oversize Rotor	SMX Series Oversize 320mm Rotor Kit	Relocating Bracket for 320mm Rotor		Sintered/HH Pads/ Grooved Shoes	SV Series Severe Duty Pads	EPFA Sintered Fast Road/ Track Pads	Specialty Pads SXR/ VEE/MXS Race	Standard Rotor	Vintage Rotor / UTV Oversize Brake Kit	Contour Profile Rotor	CX Extreme® /Vee-Rotor
							516	516G							
							528	528G							
							516	516G							
							516	516G							
							FA307X	FA307R	FA307SV			MD6174D			
							FA307X	FA307R	FA307SV			MD6174D			
							FA307X	FA307R	FA307SV			MD6174D			
							516	516G							
							516	516G							
							516	516G							
							532	532G							
							516	516G							
							532	532G							
							532	532G							
							FA307X	FA307R	FA307SV			MD6252D			
							FA307X	FA307R	FA307SV			MD6252D			
							532	532G							
							N/A					N/A			
							N/A					N/A			
							N/A					N/A			
							SFA408	SFA408HH				MD9103D			
							FA152X	FA152R			MXS152	MD6011D			
	MD6028CX	OS6028C	OSX6028	BRK008	SMX6028	BRK009	FA131X	FA131R			MXS131	MD6135D		MD6135C	MD6135CX
							528	528G							
	MD6356CX	OS6028C	OSX6028	BRK008	SMX6028	BRK009	FA131X	FA131R			MXS131	MD6135D		MD6135C	MD6135CX
	MD6356CX	OS6028C	OSX6028	BRK008	SMX6028	BRK009	FA131X	FA131R			MXS131	MD6190D		MD6190C	MD6190CX
	MD6028CX	OS6028C	OSX6028	BRK008	SMX6028	BRK009	FA131X	FA131R			MXS131	MD6135D		MD6135C	MD6135CX
	MD6356CX	OS6028C	OSX6028	BRK008	SMX6028	BRK009	FA131X	FA131R			MXS131	MD6135D		MD6135C	MD6135CX
	MD6356CX	OS6028C	OSX6028	BRK008	SMX6028	BRK009	FA131X	FA131R			MXS131	MD6190D		MD6190C	MD6190CX
	MD6356CX	OS6028C	OSX6028	BRK008	SMX6028	BRK009	FA367X	FA367R			MXS367	MD6190D		MD6190C	MD6190CX
	MD6356CX	OS6028C	OSX6028	BRK008	SMX6028	BRK009	FA367X	FA367R			MXS367	MD6190D		MD6190C	MD6190CX
	MD6356CX	OS6028C	OSX6028	BRK008	SMX6028	BRK009	FA367X	FA367R			MXS367	MD6190D		MD6190C	MD6190CX
	MD6392CX	TBC	TBC	TBC	TBC	TBC	FA367X	FA367R		EPFA367HH	MXS367			MD6190C	MD6190CX
	MD6392CX		OSX6392	BRK			FA367X	FA367R		EPFA367HH	MXS367			MD6190C	MD6190CX
							FA307X	FA307R	FA307SV			MD6174D			
							FA307X	FA307R	FA307SV			MD6252D			
							FA307X	FA307R	FA307SV			MD6174D			
							FA307X	FA307R	FA307SV			MD6252D			
							N/A					N/A			
							N/A					N/A			
							FA307X	FA307R	FA307SV			MD6252D			
							FA307X	FA307R	FA307SV			MD6174D			
							FA84X	FA84R				MD6236D			
							FA84X	FA84R				MD6236D			
							FA84X	FA84R				MD6236D			
							FA323X	FA323R				MD6263D			
							FA323X	FA323R				MD6263D			
							FA84X	FA84R				MD6236D			
							FA323X	FA323R				MD6263D			

⚠ This symbol indicates a rotor made of billet steel, and should be only used with EBC FA Kevlar® Organic or Vee pads.
SAFETY NOTICE - With vehicles primarily designed for off highway use such as quads now being used on the highway, we would recommend the use of X or MXS pads for highway use and ONLY using the R and SV higher density / harder pad series for off road riding.

BRAKE APPLICATIONS

*-2 Sets Required. † For Vee disc colours add RED, BLU, GRN, GLD, ORG suffix to part number. **SAFETY WARNING:- DO NOT USE HH PADS ON REAR UNLESS ALSO USED ON FRONT TO AVOID BRAKE IMBALANCE**

FRONT: YAMAHA



YAMAHA



DISC PAD CHOICES - FRONT

BRAKE ROTOR CHOICES - FRONT

											Line #
YFZ 450 BB/DB		FA84*	FA84R*	FA84SV*			MD6054D	MD6054D			1
YFZ 450 R	Left	FA165X	FA165R	FA165SV			MD6054D				2
	Right	FA135X	FA135R	FA135SV				MD6054D			3
YFZ 450 R R	Left	FA165X	FA165R	FA165SV			MD6054D				4
	Right	FA135X	FA135R	FA135SV				MD6054D			5
YFZ 450 E RSE	Left	FA165X	FA165R	FA165SV			MD6054D				6
	Right	FA135X	FA135R	FA135SV				MD6054D			7
YXR 450 F	Left	FA165X	FA165R	FA165SV			MD6241D		UTVX6241		8
	Right	FA135X	FA135R	FA135SV				MD6241D	UTVX6241		9
▲ - 190mm Oversize Rear Disc Kit Available Order OS6242C / Separate											
YZ 450 F		FA185X	FA185R		EPFA185HH	MXS185	MD6356D			MD6356C	10
YZ 450 F		FA185X	FA185R		EPFA185HH	MXS185	MD6356D			MD6356C	11
YZ 450 F	07	FA185X	FA185R		EPFA185HH	MXS185	MD6356D			MD6356C	12
YZ 450 F	08-15	FA450X	FA450R		EPFA450HH	MXS450	MD6356D			MD6356C	13
YZ 450 F	16-19	FA450X	FA450R			MXS450				MD6392C	14
YZ 450 F 270mm F/Disc, 245mm R/Disc	20-22	FA755X	FA755R			MXS755				MD6392C	15
YZ 450 F MME Monster 270mm F/Disc, 245mm R/Disc	21	FA755X	FA755R			MXS755				MD6392C	16
YZ 450 FXM 270mm F/Disc, 245mm R/Disc	21	FA755X	FA755R			MXS755				MD6392C	17
YZ 450 FXM 270mm F/Disc, 240mm R/Disc	22	FA755X	FA755R			MXS755				MD6392C	18
YZ 450 F 60th Anniversary Model (4T/270mm F/Disc)	2016	FA450X	FA450R			MXS450				MD6392C	19
IT 465 H/J	81-82	508	508G								20
YZ 465 G	80	508	508G								21
YZ 465 H	81	508	508G								22
IT 490 K/L	83-84	508	508G								23
YZ 490 J	82	508	508G								24
YZ 490 K	83	508	508G								25
YZ 490 L	84	508	508G								26
YZ 490 N	85	FA105X	FA105R				MD6324D				27
YZ 490 S/T	86-87	FA105X	FA105R				MD6067D				28
YZ 490 U/W	88-89	FA105X	FA105R				MD6039D				29
RZ 500	84-86	FA88*	FA88HH*		EPFA88HH*		MD2069	MD2069			30
SR 500 E/F/G/H	79-81	FA34				FA34V	MD2023LS				31
TT 500 G/H	80-81	507	507G								32
WR 500 Z	92-93	FA135X	FA135R			MXS135	MD6016D				33
XP 500 Y/Z/A (T-Max) 4B51	09-11	SFA252*	SFA252HH*				MD2107	MD2107		MD2107C*	34
XP 500 F/G (T-Max 530cc)	15-16	SFA252*	SFA252HH*				MD2098	MD2098		MD2098C*	35
XP 500 F/G (T-Max 530cc) Parking Brake	15					SFA621V					36
XS 500 B	75	FA11						N/A			37
XS 500 C/D/E	76-78	FA34					MD2024	MD2024	VMD2024*		38
XT 500 G/H	80-81	528	528G								39
XV 500 K Virago	83	FA81	FA81R				MD2023LS				40
XV 535 Virago T/TC/U/A/AC/E/EC/F/FC/SF/SFC	87-94	FA136						MD2023RS			41
XV 535 Virago G/GC/SG/SGC/H/HC/SH/SHC/J/JC/SJ/SJC	95-99	FA179	FA179HH			FA179V		MD2076			42
XJ 550 H/J/K Maxim	81-83	FA70						MD2023RS			43
XJ 550 R Seca	81-83	FA70						MD2023RS			44
XT 550 J/K	82-83	510	510G								45
XZ 550 RJ	82	FA81	FA81R				MD2076				46
XZ 550 RK	83	FA81*	FA81R				MD2011	MD2011		MD2011C*	47
YFM 550 FGY/Z/A/B/D/E 4WD Grizzly Auto FI	Left	FA443X	FA443R				MD6291D				48
	Right	FA444X	FA444R					MD6291D			49
YFM 550 FGPY/Z/A/B/D/E EPS Grizzly Auto Fi	Left	FA443R	FA443X				MD6291D				50
	Right	FA444X	FA444R					MD6291D			51
FJ 600 L/N	84-85	FA88*	FA88HH*		EPFA88HH*		MD2011	MD2011		MD2011C*	52
FZ 600 S/T/U	86-88	FA88*	FA88HH*		EPFA88HH*		MD2011	MD2011		MD2011C*	53
FZR 600 W	89	FA88*	FA88HH*		EPFA88HH*		MD2001X	MD2001X		MD2001XC*	54
FZR 600 A/R	90-99	FA160*	FA160HH*				MD2001X	MD2001X		MD2001XC*	55

*2 Sets Required. † For Vee disc colours add RED, BLU, GRN, GLD, ORG suffix to part number. **SAFETY WARNING:- DO NOT USE HH PADS ON REAR UNLESS ALSO USED ON FRONT TO AVOID BRAKE IMBALANCE**

APPLICATIONS

BRAKE

⚠ This symbol indicates a rotor made of billet steel, and should be only used with EBC FA Kevlar® Organic or Vee pads.

SAFETY NOTICE - With vehicles primarily designed for off highway use such as quads now being used on the highway, we would recommend the use of X or MXS pads for highway use and ONLY using the R and SV higher density / harder pad series for off road riding.

FRONT: YAMAHA Cont'd

REAR: YAMAHA

Line # 1 2 3 4 5 6 7 8 9 10 11 12 13 14 15 16 17 18 19 20 21 22 23 24 25 26 27 28 29 30 31 32 33 34 35 36 37 38 39 40 41 42 43 44 45 46 47 48 49 50 51 52 53 54 55 56

BRAKE ROTOR CHOICES - FRONT

DISC PAD CHOICES - REAR

BRAKE ROTOR CHOICES - REAR

CC Custom Rotor	CX Extreme® /Vee-Rotor	OS Series Oversize 250/280mm Rotor Kit	OSX Series Oversize 280mm Rotor Kit	Relocating Bracket for Oversize Rotor	SMX Series Oversize 320mm Rotor Kit	Relocating Bracket for 320mm Rotor		Sintered/HH Pads/ Grooved Shoes	SV Series Severe Duty Pads	EPFA Sintered Fast Road/ Track Pads	Specialty Pads SXR/ VEE/MXS Race	Standard Rotor	Vintage Rotor / UTV Oversize Brake Kit	Contour Profile Rotor	CX Extreme® /Vee-Rotor
							FA323X	FA323R				MD6263D			
							FA323X	FA323R				MD6263D			
							FA323X	FA323R						MD6263C	
							FA323X	FA323R						MD6263C	
							FA428X	FA428R	FA428SV			MD6242D▲	UTVX6242		
													OS6242▲		
	MD6356CX	OS6028C	OSX6028	BRK008	SMX6028	BRK009	FA367X	FA367R			MXS367	MD6190D		MD6190C	MD6190CX
	MD6356CX	OS6028C	OSX6028	BRK008	SMX6028	BRK009	FA367X	FA367R			MXS367	MD6190D		MD6190C	MD6190CX
	MD6356CX	OS6028C	OSX6028	BRK008	SMX6028	BRK009	FA367X	FA367R			MXS367	MD6190D		MD6190C	MD6190CX
	MD6356CX	OS6728C	OSX6728	BRK002	SMX6728	BRK034	FA367X	FA367R		EPFA367HH	MXS367	MD6190D		MD6190C	MD6190CX
	MD6392CX		OSX6392	BRK			FA367X	FA367R		EPFA367HH	MXS367			MD6190C	MD6190CX
	MD6392CX		OSX6392	BRK			FA367X	FA367R		EPFA367HH	MXS367			MD6190C	MD6190CX
	MD6392CX		OSX6392	BRK			FA367X	FA367R		EPFA367HH	MXS367			MD6190C	MD6190CX
	MD6392CX		OSX6392	BRK			FA367X	FA367R		EPFA367HH	MXS367			MD6190C	MD6190CX
	MD6392CX		OSX6392	BRK			FA367X	FA367R		EPFA367HH	MXS367			MD6135C	MD6135CX
	MD6392CX		OSX6392	BRK			FA367X	FA367R		EPFA367HH	MXS367			MD6190C	MD6190CX
							510	510G							
							528	528G							
							510	510G							
							510	510G							
							510	510G							
							510	510G							
							510	510G							
							510	510G							
							510	510G							
							510	510G							
							510	510G							
							FA104	FA104HH			FA104V	MD2070			
							510	510G							
							528	528G							
							FA152X	FA152R			MXS152	MD6011D			
							SFA408	SFA408HH				MD2011		MD2011C	
							SFA319	SFA319HH				MD9143D		MD9143C	
							512	510G							
							FA34	510G			FA34V	MD2025			
							510	510G							
							512	510G							
							515	510G							
							515	510G							
							512	510G							
							516	510G							
							510	510G							
							512	510G							
	VR2011*						512	510G							
							FA445X	FA445R				MD6292D			
							FA446X	FA446R				MD6292D			
							FA445X	FA445R				MD6292D			
							FA446X	FA446R				MD6292D			
	VR2011*						FA88	FA88HH		EPFA88HH	FA88V	MD2011		MD2011C	VR2011
	VR2011*						FA104	FA104HH			FA104V	MD2002		MD2002C	VR2002
MD2001CC*	VR2001BLK*†						FA88	FA88HH		EPFA88HH	FA88V	MD2002		MD2002C	VR2002
MD2001CC*	VR2001BLK*†						FA88	FA88HH		EPFA88HH	FA88V	MD2002		MD2002C	VR2002

REAR

⚠ This symbol indicates a rotor made of billet steel, and should be only used with EBC FA Kevlar® Organic or Vee pads.
 SAFETY NOTICE - With vehicles primarily designed for off highway use such as quads now being used on the highway, we would recommend the use of X or MXS pads for highway use and ONLY using the R and SV higher density / harder pad series for off road riding.

BRAKE APPLICATIONS

*-2 Sets Required. † For Vee disc colours add RED, BLU, GRN, GLD, ORG suffix to part number. **SAFETY WARNING:** DO NOT USE HH PADS ON REAR UNLESS ALSO USED ON FRONT TO AVOID BRAKE IMBALANCE

FRONT: YAMAHA



YAMAHA



DISC PAD CHOICES - FRONT

BRAKE ROTOR CHOICES - FRONT

Model	Year	Front	DISC PAD CHOICES - FRONT					BRAKE ROTOR CHOICES - FRONT				Line #	
			Sintered/HH Pads/Grooved Shoes	SV Series Severe Duty Pads	EPFA Sintered Fast Road/Track Pads	GPFA Sintered RACE ONLY Pads	Specialty Pads SXR/VEE/MXS Race	Standard Rotor Left	Standard Rotor Right	Vintage Rotor / UTV Oversize Brake Kit	Contour Profile Rotor		
FZ6 (FZ 600 S) (2 piston caliper)	04-06		FA199*	FA199HH*					MD2082X	MD2082X		MD2082XC*	1
FZ6 VXXY (4 Piston Caliper)	07-09		FA252*	FA252HH*		EPFA252HH*			MD2082X	MD2082X		MD2082XC*	2
FZ6R (2 Piston Caliper)	09-17		FA199*	FA199HH*					MD2082X	MD2082X		MD2082XC*	3
SRX 600 S	86		FA104*	FA104HH*					MD2011	MD2011		MD2011C*	4
TT 600 K/L	83-84		508	508G									5
TT 600 N/S	85-86		FA101X	FA101R					MD6039D				6
XJ 600 S Seca IISD/SDC/SE/EF/SFC/SG/SH/SJ/SK	92-98		FA179	FA179HH					MD2031LS				7
XT 600 L/LC/N/LNS/SC	84-86		FA81	FA81R					MD6070D				8
XT 600 T/TC/U/UC/W/WC	87-89		FA81	FA81R					MD6070D				9
XT 600 E	90-95		FA172X	FA172R					MD6070D				10
YFM 600 FW Grizzly	98-00		FA84X*	FA84R*	FA84SV*				MD6140D	MD6140D			11
YFM 600 FWA Grizzly/Hunter Edition	01		FA84X*	FA84R*	FA84SV*				MD6140D	MD6140D			12
YFM 600 HM Grizzly Hunting	00		FA84X*	FA84R*	FA84SV*				MD6140D	MD6140D			13
YFM 660 R Raptor	01-05		FA84X*	FA84R*	FA84SV*				MD6054D	MD6054D			14
YX 600 S/SC/T/TC/UC/U/W/WC/A/A/C Radian	86-90		FA88*	FA88HH*					MD2011	MD2011		MD2011C*	15
YZF 600 R	95-96		FA160*	FA160HH*					MD2001X	MD2001X		MD2001XC*	16
(YZF 600 R) R	97-07		FA252*	FA252HH*		EPFA252HH*			MD2074X	MD2074X		MD2074XC*	17
YZF 600 RR (R6)	99-02		FA252*	FA252HH*		EPFA252HH*			MD2074X	MD2074X		MD2074XC*	18
YZF 600 R6 RR	03-04		FA252*	FA252HH*		EPFA252HH*			MD2082X	MD2082X		MD2082XC*	19
YZF-R6 T/V/W (310mm rotor)	05-07			FA380HH*		EPFA380HH*	GPFA380HH*		MD2095X	MD2095X		MD2095XC*	20
YZF-R6 X/Y/Z/A/B/D/E/F/G (310mm Rotor)	08-16			FA380HH*		EPFA380HH*	GPFA380HH*		MD2105X	MD2105X		MD2105XC*	21
YZF-R6 H (320mm Rotor)	17-21			FA380HH*		EPFA380HH*	GPFA380HH*		MD2124X	MD2124X		MD2124XC*	22
YZF-R6 S (YZFR 6 S) (298mm rotor/5 Bolt Fixing)	06-09		FA252*	FA252HH*		EPFA252HH*	GPFA380HH*		MD2082X	MD2082X		MD2082XC*	23
TX 650 A/XS 650 B/C	74-76		FA11							N/A			24
XJ 650 G/H/J/K Maxim	80-83		FA61					FA61V	MD2023LS		VMD2023		25
XJ 650 LH Midnight	81		FA61					FA61V	MD2024		VMD2024		26
XJ 650 RJ Seca	82		FA34*						MD2019LS	MD2019RS			27
XJ 650 LK Seca	83		FA81*	FA81R					MD2011	MD2011		MD2011C*	28
XJ 650 LJ Seca Turbo	82		FA81*	FA81R					MD2011	MD2011		MD2011C*	29
XS2/TX 650	72-73		FA11							N/A			30
XS 650 D/E/F/2F	77-79		FA34					FA34V	MD2024		VMD2024		31
XS 650 S	78-80		FA34					FA34V		MD2023RS			32
XS 650 G/H/SH	80-81		FA34					FA34V		MD2023RS			33
XS 650 S Heritage Special	82-83		FA34					FA34V	MD2023LS	MD2023RS	VMD2023*		34
XVS 650 V Star Custom	97-11/13-20		FA179	FA179HH				FA179V		MD2076RS			35
XVS 650 V Star Classic	98-10		FA179	FA179HH				FA179V		MD2076RS			36
XVS 650 V-Star Silverado	03-10		FA179	FA179HH				FA179V		MD2076RS			37
YFM 660 F Grizzly/660 Hunter Edition	02-08		FA84X*	FA84R*	FA84SV*				MD6189D	MD6189D			38
YFM 660 FAHDV/W Ducks Unlimited Edition/Side x Side	06-07		FA84X*	FA84R*	FA84SV*				MD6189D	MD6189D			39
YXR 660 FA/FD/FE/FH/FS/FW	04-07	Left	FA165X	FA165R	FA165SV				MD6241D		UTVX6241		40
		Right	FA135X	FA135R	FA135SV					MD6241D	UTVX6241		41
▲ 190mm Oversize Rear Disc Kit Available Order OS6242C													
/ Separate Bracket Ref = BRK030													
FZ 700 T/A Genesis	87		FA88*	FA88HH*		EPFA88HH*		FA88V*	MD2011	MD2011		MD2011C*	44
FZX 700 S/T Fazer	86-87		FA88*	FA88HH*		EPFA88HH*		FA88V*	MD2011	MD2011		MD2011C*	45
FZ-07 (689cc/2 Cyl)	15-17		FA252*	FA252HH*		EPFA252HH*			MD2127X	MD2127X		MD2127XC*	46
FZ-07 A (689cc/2 Cyl/ABS)	17		FA252*	FA252HH*		EPFA252HH*			MD2127X	MD2127X		MD2127XC*	47
MT 07	18-21		FA252*	FA252HH*		EPFA252HH*			MD2119X	MD2119X		MD2119XC*	48
XJ 700 N/X/S	85-86		FA88*	FA88HH*		EPFA88HH*			MD2011	MD2011		MD2011C*	49
XV 700 L/N/C/S	84-87		FA88*	FA88HH*		EPFA88HH*			MD2011	MD2011		MD2011C*	50
XSR 700 (MTM 690-U)	18-21		FA252*	FA252HH*		EPFA252HH*						MD2127XC*	51
XSR 700 X Tribute	20-21		FA252*	FA252HH*		EPFA252HH*						MD2127XC*	52
XTZ 700 Tenere	19-21		FA181X*	FA181R*					MD2127X	MD2127X		MD2127XC*	53
XTZ 700 Tenere Rally	20-21		FA181X*	FA181R*					MD2127X	MD2127X		MD2127XC*	54
YFM 700 R - Raptor 50th Anniversary Edition	06	Left	FA165X	FA165R	FA165SV				MD6054D				55
		Right	FA135X	FA135R	FA135SV					MD6054D			56

*-2 Sets Required. † For Vee disc colours add RED, BLU, GRN, GLD, ORG suffix to part number. **SAFETY WARNING: DO NOT USE HH PADS ON REAR UNLESS ALSO USED ON FRONT TO AVOID BRAKE IMBALANCE**

APPLIATIONS

⚡ This symbol indicates a rotor made of billet steel, and should be only used with EBC FA Kevlar® Organic or Vee pads. SAFETY NOTICE - With vehicles primarily designed for off highway use such as quads now being used on the highway, we would recommend the use of X or MXS pads for highway use and ONLY using the R and SV higher density / harder pad series for off road riding.

FRONT: YAMAHA Cont'd

REAR: YAMAHA

Line #	BRAKE ROTOR CHOICES - FRONT							DISC PAD CHOICES - REAR					BRAKE ROTOR CHOICES - REAR			
	CC Custom Rotor	CX Extreme® /Vee-Rotor	OS Series Oversize 250/280mm Rotor Kit	OSX Series Oversize 280mm Rotor Kit	Relocating Bracket for Oversize Rotor	SMX Series Oversize 320mm Rotor Kit	Relocating Bracket for 320mm Rotor		Sintered/HH Pads/Grooved Shoes	SV Series Severe Duty Pads	EPFA Sintered Fast Road/Track Pads	Specialty Pads SXR/VEE/MXS Race	Standard Rotor	Vintage Rotor / UTV Oversize Brake Kit	Contour Profile Rotor	CX Extreme® /Vee-Rotor
1	MD2082CC*	VR2082BLK*†						FA174	FA174HH			FA174V	MD2093		MD2093C	VR2093
2	MD2082CC*	VR2082BLK*†						FA174	FA174HH			FA174V	MD2093		MD2093C	VR2093
3	MD2082CC*	VR2082BLK*†						FA140	FA140HH			FA140V	MD2117			VR2117
4		VR2011*						FA104	FA104HH			FA104V	MD2002		MD2002C	VR2002
5								506	506G							
6								506	506G							
7								FA104	FA104HH			FA104V	MD2002			
8								510	510G							
9								510	510G							
10								FA101X	FA101R				MD6072D			
11								516	516G							
12								516	516G							
13								516	516G							
14								FA84X	FA84R	FA84SV			MD6237D			
15		VR2011*						512								
16	MD2001CC*	VR2001BLK*†						FA88	FA88HH			FA88V	MD2002		MD2002C	VR2002
17	MD2074CC*	VR2074BLK*†						FA88	FA88HH		EPFA88HH	FA88V	MD2002		MD2002C	VR2002
18	MD2074CC*	VR2074BLK*†						FA275	FA275HH				MD2084		MD2084C	VR2084
19	MD2082CC*	VR2082BLK*†						FA174	FA174HH			FA174V	MD2091		MD2091C	VR2091
20	MD2095CC*	VR2095BLK*†						FA174	FA174HH			FA174V	MD2091		MD2091C	VR2091
21		VR2105BLK*†						FA174	FA174HH			FA174V	MD2091		MD2091C	VR2091
22		VR2124BLK*†						FA436	FA436HH				MD2091		MD2091C	VR2091
23	MD2082CC*	VR2082BLK*†						FA174	FA174HH			FA174V	MD2091		MD2091C	VR2091
24								514								
25								512								
26								512								
27								515								
28		VR2011*						515								
29		VR2011*						515								
30								514								
31								514								
32								FA34				FA34V	MD2025			
33								514								
34								514								
35								515								
36								515								
37								515								
38								FA344X	FA344R	FA344SV			MD6197D			
39								FA344X	FA344R				MD6197D			
40								FA428X	FA428R	FA428SV			MD6242D	UTVX6242		
41																
42																
43												OS6242				
44		VR2011*						FA88	FA88HH		EPFA88HH	FA88V	MD2011		MD2011C	VR2011
45		VR2011*						FA88	FA88HH		EPFA88HH	FA88V	MD2069			
46		VR2127BLK*†						FA174	FA174HH			FA174V	MD2120		MD2120C	VR2120
47		VR2127BLK*†						FA174	FA174HH			FA174V	MD2120		MD2120C	VR2120
48								FA174	FA174HH			FA174V	MD2120		MD2120C	VR2120
49		VR2011*						515								
50		VR2011*						515								
51		VR2127BLK*†						FA174	FA174HH			FA174V			MD2120C	
52		VR2127BLK*†						FA174	FA174HH			FA174V			MD2120C	
53		VR2127BLK*†						FA208X	FA208R						MD2120C	
54		VR2127BLK*†						FA208X	FA208R						MD2120C	
55								FA428X	FA428R	FA428SV			MD6263D			
56																

BRAKE APPLICATIONS

⚠ This symbol indicates a rotor made of billet steel, and should be only used with EBC FA Kevlar® Organic or Vee pads. SAFETY NOTICE - With vehicles primarily designed for off highway use such as quads now being used on the highway, we would recommend the use of X or MXS pads for highway use and ONLY using the R and SV higher density / harder pad series for off road riding.

*-2 Sets Required. † For Vee disc colours add RED, BLU, GRN, GLD, ORG suffix to part number. **SAFETY WARNING:- DO NOT USE HH PADS ON REAR UNLESS ALSO USED ON FRONT TO AVOID BRAKE IMBALANCE**

FRONT: YAMAHA



YAMAHA



DISC PAD CHOICES - FRONT

BRAKE ROTOR CHOICES - FRONT

Model	Side	Year	DISC PAD CHOICES - FRONT					BRAKE ROTOR CHOICES - FRONT				Line #		
			Icon	Sintered/HH Pads/Grooved Shoes	SV Series Severe Duty Pads	EPFA Sintered Fast Road/Track Pads	GPFX Sintered RACE ONLY Pads	Specialty Pads SXR/VEE/MXS Race	Standard Rotor Left	Standard Rotor Right	Vintage Rotor / UTV Oversize Brake Kit		Contour Profile Rotor	
YFM 700 R Raptor	Left	06-12		FA165X	FA165R	FA165SV				MD6054D				1
	Right			FA135X	FA135R	FA135SV					MD6054D			2
YFM 700 R Raptor	Left	13-14		FA165X	FA165R	FA165SV				MD6054D				3
	Right			FA135X	FA135R	FA135SV					MD6054D			4
YFM 700 RS Raptor Special Edition	Left	07-08		FA165X	FA165R	FA165SV				MD6054D				5
	Right			FA135X	FA135R	FA135SV					MD6054D			6
YFM 700 R Raptor Special Edition	Left	09-15		FA165X	FA165R	FA165SV				MD6054D				7
	Right			FA135X	FA135R	FA135SV					MD6054D			8
YFM 700 FGP Grizzly Auto 4x4 (Power steering) EPS	Left	07-14		FA443X	FA443R	FA443SV				MD6291D				9
	Right			FA444X	FA444R	FA444SV					MD6291D			10
YFM 700 FGPD Ducks Unlimited Edition	Left	07-09		FA443X	FA443R	FA443SV				MD6291D				11
	Right			FA443X	FA443R	FA443SV					MD6291D			12
YFM 700 FG Grizzly	Left	08-14		FA443X	FA443R	FA443SV				MD6291D				13
	Right			FA444X	FA444R	FA444SV					MD6291D			14
YFM 700 FGPS Grizzly	Left	09-14		FA443X	FA443R	FA443SV				MD6291D				15
FI Auto 4x4 EPS Special Edition	Right			FA444X	FA444R	FA444SV					MD6291D			16
YFM 700 D Grizzly 4WD	Left	15		FA443X	FA443R	FA443SV				MD6291D				17
	Right			FA444X	FA444R	FA444SV					MD6291D			18
YFM 700 P Grizzly EPS/4WD	Left	15		FA443X	FA443R	FA443SV				MD6291D				19
	Right			FA444X	FA444R	FA444SV					MD6291D			20
YFM 700 D Grizzly 4WD Hunter	Left	15		FA443X	FA443R	FA443SV				MD6291D				21
	Right			FA444X	FA444R	FA444SV					MD6291D			22
YFM 700 P Grizzly EPS Hunter	Left	15		FA443X	FA443R	FA443SV				MD6291D				23
	Right			FA444X	FA444R	FA444SV					MD6291D			24
YXR 700 F Rhino	Left	08		FA165X	FA165R	FA165SV				MD6241D		UTVX6241		25
	Right			FA135X	FA135R	FA135SV					MD6241D	UTVX6241		26
YXR 700 F Rhino Parking brake		08												27
YXP 700 A Pro Hauler 700		04-06		N/A										28
YXR 700 Rhino FI Auto 4x4 Ducks Unlimited Version	Left	09		FA165X	FA165R	FA165SV				MD6241D		UTVX6241		29
	Right			FA135X	FA135R	FA135SV					MD6241D	UTVX6241		30
YXR 700 Rhino FI Auto 4x4 Ducks Unlimited Version Parking brake		09												31
YXR 700 Rhino FI Auto 4x4 Sport Edition	Left	09/11-13		FA165X	FA165R	FA165SV				MD6241D		UTVX6241		32
	Right			FA135X	FA135R	FA135SV					MD6241D	UTVX6241		33
YXR 700 Rhino FI Auto 4x4 Sport Edition Parking brake		09/11-13												34
YXR 700 Rhino FI Auto 4x4	Left	09/11-13		FA165X	FA165R	FA165SV				MD6241D		UTVX6241		35
	Right			FA135X	FA135R	FA135SV					MD6241D	UTVX6241		36
YXR 700 Rhino FI Auto 4x4 Parking brake		09/11-13												37
YXC 700 D Viking VI	Left	15-16		FA642X	FA642R	FA642SV				MD6382D		UTVX6382		38
	Right			FA645X	FA645R	FA645SV					MD6382D	UTVX6382		39
YXC 700 D Viking VI Parking Brake		15-16												40
YXC 700 P Viking VI EPS	Left	15-16		FA642X	FA642R	FA642SV				MD6382D		UTVX6382		41
	Right			FA645X	FA645R	FA645SV					MD6382D	UTVX6382		42
YXC 700 P Viking VI EPS Parking Brake		15-16												43
YXC 700 P Viking VI EPS SE	Left	15-16		FA642X	FA642R	FA642SV				MD6382D		UTVX6382		44
	Right			FA645X	FA645R	FA645SV					MD6382D	UTVX6382		45
YXC 700 P Viking VI EPS SE Parking Brake		15-16												46
YXC 700 P Viking VI EPS Ranger Edition	Left	16		FA642X	FA642R	FA642SV				MD6382D		UTVX6382		47
	Right			FA645X	FA645R	FA645SV					MD6382D	UTVX6382		48
YXC 700 P Viking VI EPS Ranger Edition Parking Brake		16												49
YXM 700 D/VD Viking	Left	14-16		FA642X	FA642R	FA642SV				MD6382D		UTVX6382		50
	Right			FA645X	FA645R	FA645SV					MD6382D	UTVX6382		51
YXM 700 D/VD Viking Parking Brake		14-16		FA497X						MD6381D				52
YXM 700 P/VP Viking EPS	Left	14-16		FA642X	FA642R	FA642SV				MD6382D		UTVX6382		53
	Right			FA645X	FA645R	FA645SV					MD6382D	UTVX6382		54
YXM 700 P/VP Viking EPS Parking Brake		14-16		FA497X						MD6381D				55

*-2 Sets Required. † For Vee disc colours add RED, BLU, GRN, GLD, ORG suffix to part number. **SAFETY WARNING:- DO NOT USE HH PADS ON REAR UNLESS ALSO USED ON FRONT TO AVOID BRAKE IMBALANCE**

APPLICATIONS

BRAKE

⚡ This symbol indicates a rotor made of billet steel, and should be only used with EBC FA Kevlar® Organic or Vee pads.

SAFETY NOTICE - With vehicles primarily designed for off highway use such as quads now being used on the highway, we would recommend the use of X or MXS pads for highway use and ONLY using the R and SV higher density / harder pad series for off road riding.

FRONT: YAMAHA Cont'd

REAR: YAMAHA

Line # 1 2 3 4 5 6 7 8 9 10 11 12 13 14 15 16 17 18 19 20 21 22 23 24 25 26 27 28 29 30 31 32 33 34 35 36 37 38 39 40 41 42 43 44 45 46 47 48 49 50 51 52 53 54 55 56

BRAKE ROTOR CHOICES - FRONT							DISC PAD CHOICES - REAR					BRAKE ROTOR CHOICES - REAR			
CC Custom Rotor	CX Extreme® /Vee-Rotor	OS Series Oversize 250/280mm Rotor Kit	OSX Series Oversize 280mm Rotor Kit	Relocating Bracket for Oversize Rotor	SMX Series Oversize 320mm Rotor Kit	Relocating Bracket for 320mm Rotor		Sintered/HH Pads/ Grooved Shoes	SV Series Severe Duty Pads	EPFA Sintered Fast Road/ Track Pads	Specialty Pads SXR/ VEE/MXS Race	Standard Rotor	Vintage Rotor / UTV Oversize Brake Kit	Contour Profile Rotor	CX Extreme® /Vee-Rotor
							FA428X	FA428R	FA428SV			MD6263D			
							FA323X	FA323R				MD6263D		MD6263C	
							FA428X	FA428R	FA428SV			MD6263D		MD6263C	
							FA428X	FA428R	FA428SV			MD6263D		MD6263C	
							FA445X	FA445R	FA445SV			MD6292D			
							FA446X	FA446R	FA446SV			MD6292D			
							FA445X	FA445R	FA445SV			MD6292D			
							FA446X	FA446R	FA446SV			MD6292D			
							FA445X	FA445R	FA445SV			MD6292D			
							FA446X	FA446R	FA446SV			MD6292D			
							FA445X	FA445R	FA445SV			MD6292D			
							FA446X	FA446R	FA446SV			MD6292D			
							FA445X	FA445R	FA445SV			MD6292D			
							FA446X	FA446R	FA446SV			MD6292D			
							FA445X	FA445R	FA445SV			MD6292D			
							FA446X	FA446R	FA446SV			MD6292D			
							FA445X	FA445R	FA445SV			MD6292D			
							FA446X	FA446R	FA446SV			MD6292D			
							FA445X	FA445R	FA445SV			MD6292D			
							FA446X	FA446R	FA446SV			MD6292D			
							FA445X	FA445R	FA445SV			MD6292D			
							FA446X	FA446R	FA446SV			MD6292D			
							FA165X	FA165R	FA165SV			MD6332D	UTVX6332		
							FA135X	FA135R	FA135SV			MD6332D	UTVX6332		
							FA497X	FA497R				MD6333D			
							534*	534G*							
							FA165X	FA165R	FA165SV			MD6332D	UTVX6332		
							FA135X	FA135R	FA135SV			MD6332D	UTVX6332		
							FA497X	FA497R				MD6333D			
							FA165X	FA165R	FA165SV			MD6332D	UTVX6332		
							FA135X	FA135R	FA135SV			MD6332D	UTVX6332		
							FA497X	FA497R				MD6333D			
							FA165X	FA165R	FA165SV			MD6332D	UTVX6332		
							FA135X	FA135R	FA135SV			MD6332D	UTVX6332		
							FA497X	FA497R				MD6333D			
							FA165X	FA165R	FA165SV			MD6332D	UTVX6332		
							FA135X	FA135R	FA135SV			MD6332D	UTVX6332		
							FA497X	FA497R				MD6333D			
							FA674X	FA674R	FA674SV			MD6382D	UTVX6382		
							FA675X	FA675R	FA675SV			MD6382D	UTVX6382		
							FA497X	FA497R				MD6381D			
							FA674X	FA674R	FA674SV			MD6382D	UTVX6382		
							FA675X	FA675R	FA675SV			MD6382D	UTVX6382		
							FA497X	FA497R				MD6381D			
							FA674X	FA674R	FA674SV			MD6382D	UTVX6382		
							FA675X	FA675R	FA675SV			MD6382D	UTVX6382		
							FA497X	FA497R				MD6381D			
							FA674X	FA674R	FA674SV			MD6382D	UTVX6382		
							FA675X	FA675R	FA675SV			MD6382D	UTVX6382		
							FA497X	FA497R				MD6381D			
							FA674X	FA674R	FA674SV			MD6382D	UTVX6382		
							FA675X	FA675R	FA675SV			MD6382D	UTVX6382		
							FA497X	FA497R				MD6381D			
							FA674X	FA674R	FA674SV			MD6382D	UTVX6382		
							FA675X	FA675R	FA675SV			MD6382D	UTVX6382		
							FA497X	FA497R				MD6381D			
							FA674X	FA674R	FA674SV			MD6382D	UTVX6382		
							FA675X	FA675R	FA675SV			MD6382D	UTVX6382		
							FA497X	FA497R				MD6381D			

BRAKE APPLICATIONS

⚠ This symbol indicates a rotor made of billet steel, and should be only used with EBC FA Kevlar® Organic or Vee pads.
SAFETY NOTICE - With vehicles primarily designed for off highway use such as quads now being used on the highway, we would recommend the use of X or MXS pads for highway use and ONLY using the R and SV higher density / harder pad series for off road riding.

*-2 Sets Required. † For Vee disc colours add RED, BLU, GRN, GLD, ORG suffix to part number. **SAFETY WARNING:- DO NOT USE HH PADS ON REAR UNLESS ALSO USED ON FRONT TO AVOID BRAKE IMBALANCE**

FRONT: YAMAHA



YAMAHA



DISC PAD CHOICES - FRONT

BRAKE ROTOR CHOICES - FRONT

Model	Side	Year	DISC PAD CHOICES - FRONT					BRAKE ROTOR CHOICES - FRONT				Line #		
			Icon	Sintered/HH Pads/Grooved Shoes	SV Series Severe Duty Pads	EPFA Sintered Fast Road/Track Pads	GPFAX Sintered RACE ONLY Pads	Specialty Pads SXR/VEE/MXS Race	Standard Rotor Left	Standard Rotor Right	Vintage Rotor / UTV Oversize Brake Kit		Contour Profile Rotor	
YXM 700 PS/VPS Viking EPSSE	Left	14-16		FA642X	FA642R	FA642SV				MD6382D		UTVX6382		1
	Right			FA645X	FA645R	FA645SV					MD6382D	UTVX6382		2
YXM 700 PS/VPS Viking EPSSE Parking Brake		14-16												3
YZF-R7		22		FA252	FA252HH					MD2119X			MD2119XC	4
YYXE 70 Wolverine	Left	16-18		FA642X	FA642R	FA642SV				MD6382D		UTVX6382		5
	Right			FA645X	FA645R	FA645SV					MD6382D	UTVX6382		6
YXE 70 Wolverine Hunter	Left	17		FA642X	FA642R	FA642SV				MD6382D		UTVX6382		7
	Right			FA645X	FA645R	FA645SV					MD6382D	UTVX6382		8
YXE 70 Wolverine EPS	Left	17		FA642X	FA642R	FA642SV				MD6382D		UTVX6382		9
	Right			FA645X	FA645R	FA645SV					MD6382D	UTVX6382		10
YXE 70 Wolverine EPS Hunter	Left	17		FA642X	FA642R	FA642SV				MD6382D		UTVX6382		11
	Right			FA645X	FA645R	FA645SV					MD6382D	UTVX6382		12
YXE 70 Wolverine R Spec	Left	16		FA642X	FA642R	FA642SV				MD6382D		UTVX6382		13
	Right			FA645X	FA645R	FA645SV					MD6382D	UTVX6382		14
YXE 70 Wolverine R Spec EPS	Left	16-17		FA642X	FA642R	FA642SV				MD6382D		UTVX6382		15
	Right			FA645X	FA645R	FA645SV					MD6382D	UTVX6382		16
YXE 70 Wolverine R Spec EPS Hunter	Left	16		FA642X	FA642R	FA642SV				MD6382D		UTVX6382		17
	Right			FA645X	FA645R	FA645SV					MD6382D	UTVX6382		18
YXE 70 Wolverine R Spec EPS Hunter	Left	16-17		FA642X	FA642R	FA642SV				MD6382D		UTVX6382		19
	Right			FA645X	FA645R	FA645SV					MD6382D	UTVX6382		20
YXE 70 Wolverine R Spec EPS SE	Left	16-17		FA642X	FA642R	FA642SV				MD6382D		UTVX6382		21
	Right			FA645X	FA645R	FA645SV					MD6382D	UTVX6382		22
YXE 70 Wolverine R Spec EPS	Left	18		FA642X	FA642R	FA642SV				MD6382D		UTVX6382		23
	Right			FA645X	FA645R	FA645SV					MD6382D	UTVX6382		24
FZ 750 N/S/SC/U/UC		85-88		FA88*	FA88HH*		EPFA88HH*			MD2069	MD2069			25
FZR 750 Genesis RU/RT		87-88		FA123*	FA123HH*					MD2003X	MD2003X		MD2003XC*	26
FZR 750 (OW01)		89-92		FA145*	FA145HH*		EPFA145HH*			MD2009LS	MD2009RS			27
TX 750/TX 750 A		73-74		FA11							N/A			28
XJ 750 J/K/MK Maxim		82		FA81*	FA81R*					MD2019LS	MD2019RS			29
XJ 750 R Seca		81-83		FA70*				FA70V*		MD2023LS	MD2023RS	VMD2023*		30
XS 750 D/2D/E/F		77-79		FA34*				FA34V*		MD2025	MD2025	VMD2025*		31
XS 750 S	Left	78-79		FA61				FA61V		MD2025		VMD2025		32
	Right			FA41				FA41V			MD2025	VMD2025		33
XV 750 H/J/K/MK Virago		81-83		FA61				FA61V		MD2023LS		VMD2023		34
XV 750 U/UC/W/WC/A/AC/B/BC/D/DE/E/EC Virago		88-94		FA88*	FA88HH*		EPFA88HH*	FA88V*		MD2011	MD2011		MD2011C*	35
XV 750 F/FC/G/GC/H/HC/J/JC Virago		94-97		FA88*	FA88HH*		EPFA88HH*	FA88V*		MD2067	MD2067			36
YZF 750 R/SP		93-96		FA190*	FA190HH*		EPFA190HH*			MD2003X	MD2003X		MD2003XC*	37
YZF 750 R7 OW02 Race Version		99-01		FA424*	FA424HH*		EPFA424HH*			N/A	N/A			38
YZF 750 R7 OW02 Road Version		99-01		FA252*	FA252HH*		EPFA252HH*			MD2083	MD2083			39
FZ8		11-13			FA380HH*		EPFA380HH*			MD2095X	MD2095X		MD2095XC*	40
FJ-09 (847cc/3 Cyl)		15-16		FA252*	FA252HH*		EPFA252HH*			MD2119X	MD2119X		MD2119XC*	41
FZ-09 (847cc/3 Cyl)		14-17		FA252*	FA252HH*		EPFA252HH*			MD2119X	MD2119X		MD2119XC*	42
MT 09		18-21		FA252*	FA252HH*		EPFA252HH*			MD2119X	MD2119X		MD2119XC*	43
YXE 85 Wolverine X4	Left	18		FA642X	FA642R	FA642SV		SXR642HH		MD6382D		UTVX6382		44
	Right			FA645X	FA645R	FA645SV		SXR645HH			MD6382D	UTVX6382		45
YXE 85 Wolverine X4 SE	Left	18		FA642X	FA642R	FA642SV		SXR642HH		MD6382D		UTVX6382		46
	Right			FA645X	FA645R	FA645SV		SXR645HH			MD6382D	UTVX6382		47
XS 850 G/H		80-81		FA34*				FA34V*		MD2025	MD2025	VMD2025*		48
XS 850 L/S	Left	80-81		FA61				FA61V		MD2024	MD2024	VMD2024*		49
	Right			FA41				FA41V				VMD2024*		50
TDM 850 D/E		92-93		FA123*	FA123HH*			FA123V*		MD2001X	MD2001X		MD2001XC*	51
Niken		18-21			FA380HH*		EPFA380HH*							52
Niken GT		19-21			FA380HH*		EPFA380HH*							53
Tracer 900		18-21		FA252*	FA252HH*		EPFA252HH*			MD2119X	MD2119X		MD2119XC*	54
Tracer 900 GT		20-21		FA252*	FA252HH*		EPFA252HH*			MD2119X	MD2119X		MD2119XC*	55
XJ 900 RK Seca		83		FA88*	FA88HH*		EPFA88HH*	FA88V*		MD2069	MD2069			56

*-2 Sets Required. † For Vee disc colours add RED, BLU, GRN, GLD, ORG suffix to part number. **SAFETY WARNING:- DO NOT USE HH PADS ON REAR UNLESS ALSO USED ON FRONT TO AVOID BRAKE IMBALANCE**

⚠ This symbol indicates a rotor made of billet steel, and should be only used with EBC FA Kevlar® Organic or Vee pads. SAFETY NOTICE - With vehicles primarily designed for off highway use such as quads now being used on the highway, we would recommend the use of X or MXS pads for highway use and ONLY using the R and SV higher density / harder pad series for off road riding.

FRONT: YAMAHA Cont'd

REAR: YAMAHA

Line #	BRAKE ROTOR CHOICES - FRONT							DISC PAD CHOICES - REAR					BRAKE ROTOR CHOICES - REAR			
	CC Custom Rotor	CX Extreme® /Vee-Rotor	OS Series Oversize 250/280mm Rotor Kit	OSX Series Oversize 280mm Rotor Kit	Relocating Bracket for Oversize Rotor	SMX Series Oversize 320mm Rotor Kit	Relocating Bracket for 320mm Rotor		Sintered/HH Pads/ Grooved Shoes	SV Series Severe Duty Pads	EPFA Sintered Fast Road/ Track Pads	Specialty Pads SXR/ VEE/MXS Race	Standard Rotor	Vintage Rotor / UTV Oversize Brake Kit	Contour Profile Rotor	CX Extreme® /Vee-Rotor
1								FA674X	FA674R	FA674SV			MD6382D	UTVX6382		
2								FA675X	FA675R	FA675SV			MD6382D	UTVX6382		
3								FA497X	FA497R				MD6381D			
4								FA174	FA174HH				MD2120		MD2120C	VR2120
5								FA674X	FA674R	FA674SV			MD6382D	UTVX6382		
6								FA675X	FA675R	FA675SV			MD6382D	UTVX6382		
7								FA674X	FA674R	FA674SV			MD6382D	UTVX6382		
8								FA675X	FA675R	FA675SV			MD6382D	UTVX6382		
9								FA674X	FA674R	FA674SV			MD6382D	UTVX6382		
10								FA675X	FA675R	FA675SV			MD6382D	UTVX6382		
11								FA674X	FA674R	FA674SV			MD6382D	UTVX6382		
12								FA675X	FA675R	FA675SV			MD6382D	UTVX6382		
13								FA674X	FA674R	FA674SV			MD6382D	UTVX6382		
14								FA675X	FA675R	FA675SV			MD6382D	UTVX6382		
15								FA674X	FA674R	FA674SV			MD6382D	UTVX6382		
16								FA675X	FA675R	FA675SV			MD6382D	UTVX6382		
17								FA674X	FA674R	FA674SV			MD6382D	UTVX638		
18								FA675X	FA675R	FA675SV			MD6382D	UTVX6382		
19								FA674X	FA674R	FA674SV			MD6382D	UTVX6382		
20								FA675X	FA675R	FA675SV			MD6382D	UTVX6382		
21								FA674X	FA674R	FA674SV			MD6382D	UTVX6382		
22								FA675X	FA675R	FA675SV			MD6382D	UTVX6382		
23								FA674X								
24								FA675X								
25								FA88	FA88HH		EPFA88HH	FA88V	MD2069			
26	MD2003CC*	VR2003BLK*†						FA88	FA88HH			FA88V	MD2011		MD2011C	VR2011
27								FA88	FA88HH		EPFA88HH	FA88V	MD2008			
28								515								
29								515								
30								515								
31								FA34				FA34V	MD2025			
32								FA34				FA34V	MD2025			
33																
34								512								
35		VR2011*						515								
36								515								
37	MD2003CC*	VR2003BLK*†						FA88	FA88HH		EPFA88HH	FA88V	MD2002		MD2002C	VR2002
38								N/A					N/A			
39								FA267	FA267HH				MD2086			
40	MD2095CC	VR2095BLK*†						FA174	FA174HH			FA174V	MD2116		MD2116C	VR2116
41		VR2119BLK*†						FA174	FA174HH			FA174V	MD2120		MD2120C	VR2120
42		VR2119BLK*†						FA174	FA174HH			FA174V	MD2120		MD2120C	VR2120
43		VR2119BLK*†						FA174	FA174HH			FA174V	MD2120		MD2120C	VR2120
44								FA674X	FA674R							
45								FA675X	FA675R							
46								FA674X	FA674R							
47								FA675X	FA675R							
48								FA34				FA34V	MD2025			
49								FA34				FA34V	MD2025			
50																
51	MD2001CC*	VR2001BLK*†						FA88	FA88HH			FA88V	MD2002		MD2002C	VR2002
52								FA436	FA436HH			FA436V				
53								FA436	FA436HH			FA436V				
54								FA174	FA174HH			FA174V	MD2120		MD2120C	VR2120
55		VR2119BLK						FA174	FA174HH			FA174V	MD2120		MD2120C	VR2120
56								FA88	FA88HH		EPFA88HH	FA88V	MD2069			

BRAKE APPLICATIONS

⚠ This symbol indicates a rotor made of billet steel, and should be only used with EBC FA Kevlar® Organic or Vee pads. SAFETY NOTICE - With vehicles primarily designed for off highway use such as quads now being used on the highway, we would recommend the use of X or MXS pads for highway use and ONLY using the R and SV higher density / harder pad series for off road riding.

*-2 Sets Required. † For Vee disc colours add RED, BLU, GRN, GLD, ORG suffix to part number. **SAFETY WARNING:- DO NOT USE HH PADS ON REAR UNLESS ALSO USED ON FRONT TO AVOID BRAKE IMBALANCE**

FRONT: YAMAHA



YAMAHA



DISC PAD CHOICES - FRONT

BRAKE ROTOR CHOICES - FRONT

											Line #
XSR 900 ABS (MTM 850)	16-21	FA380HH*		EPFA380HH*			MD2119X	MD2119X		MD2119XC*	1
XV 920 R	81-82	FA34*				FA34V*	MD2019LS	MD2019RS			2
XV 920 J Virago	82	FA70*				FA70V*	MD2019LS	MD2019RS			3
XV 920 K	83	FA61				FA61V	MD2024		VMD2024		4
XV 920 MK Virago	83	FA61				FA61V	MD2024		VMD2024		5
SCR 950 (SCR 950 H)	17	FA179	FA179HH			FA179V	TBC				6
XVS 950 (V-Star 950)	09-14	FA179	FA179HH			FA179V	MD2089X			MD2089XC	7
XVS 950 (V-Star 950 Tourer)	09-14	FA179	FA179HH			FA179V	MD2089X			MD2089XC	8
XVS 950 Bolt (Standard Rear Shocks)	14-16	FA179	FA179HH			FA179V	MD2074X			MD2074XC	9
XVS 950 Bolt C Spec (Remote Reservoir Rear Shocks)	15-21	FA179	FA179HH			FA179V	MD2074X			MD2074XC	10
XVS 950 Bolt R Spec (Remote Reservoir Rear Shocks)	14-21	FA179	FA179HH			FA179V	MD2074X			MD2074XC	11
FZR 1000 Genesis T/U	87-88	FA123*	FA123HH*				MD2003X	MD2003X		MD2003XC*	12
FZR 1000 Genesis W	89	FA123*	FA123HH*				MD2003X	MD2003X		MD2003XC*	13
FZR 1000 EX UP A	90-91	FA160*	FA160HH*				MD2003X	MD2003X		MD2003XC*	14
FZR 1000 EX UP D/E	92-93	FA182*	FA182HH*				MD2003X	MD2003X		MD2003XC*	15
FZR 1000 EX UP F/G	94-96	FA190*	FA190HH*	EPFA190HH*			MD2003X	MD2003X		MD2003XC*	16
FZ1 (FZS 1000 N/P/R/T) (FZ1)	01-05	FA252*	FA252HH*	EPFA252HH*			MD2074X	MD2074X		MD2074XC*	17
FZ1 (FZS 1000 V/W/X/Y/Z/A/B/D/E) (FZ1)	06-14		FA380HH*	EPFA380HH*			MD2101X	MD2101X		MD2101XC*	18
FZ-10	17		FA380HH*	EPFA380HH*			MD2124X	MD2124X		MD2124XC*	19
MT 10 (MT10 KB/KCB/KCGY/KGY)	18-21		FA380HH*	EPFA380HH*			MD2124X	MD2124X		MD2124XC*	20
GTS 1000 A	93-96	FA191					N/A				21
XV 1000 L/N	84-85	FA88*	FA88HH*				MD2068	MD2068			22
YXE 1000 YXE 10WPLML Wolverine RMAX 2 LE & SE	2021-2022	FA676X*	SXR676HH*	FA676SV*			MD6395D		UTVX6395*		23
YXE 1000 YXF 10WPAMS Wolverine RMAX 4 LE & SE	2021-2022	FA676X*	SXR676HH*	FA676SV*			MD6395D*		UTVX6395*		24
YXP 1000 A Pro Hauler 1000	04-05	534*	534G*								25
YZF 1000 R	16-21	FA676X*	FA676R*	FA676SV*		SXR676HH*	MD6395D	MD6395D	UTVX6395*		26
YZF 1000 R SE	16-21	FA676X*	FA676R*	FA676SV*		SXR676HH*	MD6395D	MD6395D	UTVX6395*		27
YZF 1000 R Thunderace	97-	FA252*	FA252HH*	EPFA252HH*	GPFAX380HH*		MD2074X	MD2074X		MD2074XC*	28
YZFR1	98-01	FA252*	FA252HH*	EPFA252HH*	GPFAX380HH*		MD2074X	MD2074X		MD2074XC*	29
YZFR1	02-03	FA252*	FA252HH*	EPFA252HH*	GPFAX380HH*		MD2074X	MD2074X		MD2074XC*	30
YZFR1 (5V)	04-06		FA380HH*	EPFA380HH*	GPFAX380HH*		MD2094X	MD2094X		MD2094XC*	31
YZF-R1 LE	06		FA380HH*	EPFA380HH*	GPFAX380HH*		MD2112X	MD2112X			32
YZF-R1 (6 piston caliper)	07-08	FA442/4*	FA442/4HH*	EPFA442/4HH*	GPFAX442/4HH*		MD2102X	MD2102X		MD2102XC*	33
YZF-R1 (6 piston caliper)	09-14	FA442/4*	FA442/4HH*	EPFA442/4HH*	GPFAX442/4HH*		MD2102X	MD2102X		MD2102XC*	34
YZF-R1	15-21		FA380HH*	EPFA380HH*	GPFAX380HH*		MD2124X	MD2124X		MD2124XC*	35
YZF-R1 M	15-21		FA380HH*	EPFA380HH*	GPFAX380HH*		MD2124X	MD2124X		MD2124XC*	36
YZF-R1 S	16-19		FA380HH*	EPFA380HH*	GPFAX380HH*		MD2124X	MD2124X		MD2124XC*	37
FJ 1100 L/N	84-85	FA88*	FA88HH*	EPFA88HH*			MD2068	MD2068			38
XJ 1100 J	82	FA70*					MD2024	MD2024	VMD2024*		39
XS 1100 E/F/G/H	78-81	FA34*					MD2024	MD2024	VMD2024*		40
XS 1100 S	Left 79-81	FA61				FA61V	MD2024		VMD2024		41
	Right	FA41				FA41V		MD2024			42
XS 1100 L Midnight Special	Left 80	FA61				FA61V	MD2024		VMD2024		43
	Right	FA41				FA41V		MD2024			44
XS 1100 L Midnight Special	81	FA70*				FA70V*	MD2024	MD2024	VMD2024*		45
XV 1100 All models	86-97	FA88*	FA88HH*	EPFA88HH*		FA88V*	MD2011	MD2011		MD2011C*	46
XVS 1100 V-Star L/M/N/P/R/V/T-F-V-Star Custom	99-08	FA199*	FA199HH*			FA199V*	MD2076	MD2076			47
XVS 1100 A V-Star Classic	01-03	FA199*	FA199HH*			FA199V*	MD2076	MD2076			48
XVS 1100 V-Star Silverado	03	FA199*	FA199HH*			FA199V*	MD2076	MD2076			49
XVS 1100 AT V-Star Silverado	04-09	FA199*	FA199HH*			FA199V*	MD2074X	MD2074X		MD2074XC*	50
XVS 1100 AS V-Star Classic	04-09	FA199*	FA199HH*			FA199V*	MD2074X	MD2074X		MD2074XC*	51
XVS 1100 W-M V-Star Custom Midnight	07-08	FA199*	FA199HH*			FA199V*	MD2076	MD2076			52
FJ 1200 S/T	86-87	FA88*	FA88HH*	EPFA88HH*			MD2068	MD2068			53
FJ 1200 W	89-90	FA123*	FA123HH*				MD2001X	MD2001X		MD2001XC*	54
FJ 1200 A	90-92	FA123*	FA123HH*				MD2001X	MD2001X		MD2001XC*	55
FJ 1200 A	92-93	FA160*	FA160HH*				MD2046	MD2046			56

*-2 Sets Required. † For Vee disc colours add RED, BLU, GRN, GLD, ORG suffix to part number. **SAFETY WARNING:- DO NOT USE HH PADS ON REAR UNLESS ALSO USED ON FRONT TO AVOID BRAKE IMBALANCE**

⚡ This symbol indicates a rotor made of billet steel, and should be only used with EBC FA Kevlar® Organic or Vee pads.

SAFETY NOTICE - With vehicles primarily designed for off highway use such as quads now being used on the highway, we would recommend the use of X or MXS pads for highway use and ONLY using the R and SV higher density / harder pad series for off road riding.

FRONT: YAMAHA Cont'd

REAR: YAMAHA

Line #	BRAKE ROTOR CHOICES - FRONT						DISC PAD CHOICES - REAR					BRAKE ROTOR CHOICES - REAR			
	CC Custom Rotor	CX Extreme® /Vee-Rotor	OS Series Oversize 250/280mm Rotor Kit	OSX Series Oversize 280mm Rotor Kit	Relocating Bracket for Oversize Rotor	SMX Series Oversize 320mm Rotor Kit	Relocating Bracket for 320mm Rotor		Sintered/HH Pads/ Grooved Shoes	SV Series Severe Duty Pads	EPFA Sintered Fast Road/ Track Pads	Specialty Pads SXR/ VEE/MXS Race	Standard Rotor	Vintage Rotor / UTV Oversize Brake Kit	Contour Profile Rotor
1		VR2119BLK*					FA174	FA174HH			FA174V	MD2120		MD2120C	VR2120
2							515								
3							515								
4							515								
5							515								
6							FA319/2	FA319/2HH			FA319/2V			MD2130C	
7	MD2089CC	VR2089BLK					FA319/2	FA319/2HH			FA319/2V	MD2103			VR2103
8	MD2089CC	VR2089BLK					FA319/2	FA319/2HH			FA319/2V	MD2103			VR2103
9	MD2074CC						FA319/2	FA319/2HH			FA319/2V			MD2130C	
10	MD2074CC						FA319/2	FA319/2HH			FA319/2V			MD2130C	
11	MD2074CC						FA319/2	FA319/2HH			FA319/2V			MD2130C	
12	MD2003CC*	VR2003BLK*					FA88	FA88HH			FA88V	MD2011		MD2011C	VR2011
13	MD2003CC*	VR2003BLK*					FA88	FA88HH			FA88V	MD2011		MD2011C	VR2011
14	MD2003CC*	VR2003BLK*					FA88	FA88HH			FA88V	MD2011		MD2011C	VR2011
15	MD2003CC*	VR2003BLK*					FA88	FA88HH			FA88V	MD2011		MD2011C	VR2011
16	MD2003CC*	VR2003BLK*					FA88	FA88HH		EPFA88HH	FA88V	MD2011		MD2011C	VR2011
17	MD2074CC*	VR2074BLK*					FA348	FA348HH				MD2011		MD2011C	VR2011
18		VR2101BLK*					FA174	FA174HH			FA174V	MD2093		MD2093C	VR2093
19		VR2124BLK*					FA174	FA174HH			FA174V	MD2091		MD2091C	VR2091
20		VR2124BLK*					FA174	FA174HH			FA174V	MD2091		MD2091C	VR2091
21							FA88	FA88HH			FA88V	MD2075			
22							515								
23							FA677X	SXR677HH*	FA677SV*			MD6395D*	UTVX6395*		
24							FA677X*	SXR677HH*	FA677SV*			MD6395D*	UTVX6395*		
25							534*	534G*							
26							FA677X*	FA677R*	FA677SV*		SXR677HH*	MD6395D*	UTVX6395*		
27							FA677X*	FA677R*	FA677SV*		SXR677HH*	MD6395D*	UTVX6395*		
28	MD2074CC*	VR2074BLK*					FA88	FA88HH		EPFA88HH	FA88V	MD2002		MD2002C	VR2002
29	MD2074CC*	VR2074BLK*					FA267	FA267HH				MD2086		MD2086C	VR2086
30	MD2074CC*	VR2074BLK*					FA275	FA275HH				MD2084		MD2084C	VR2084
31	MD2094CC*	VR2094BLK*					FA174	FA174HH			FA174V	MD2091		MD2091C	VR2091
32							FA174	FA174HH			FA174V	MD2118			
33	MD2102CC*	VR2102BLK*					FA174	FA174HH			FA174V	MD2091		MD2091C	VR2091
34	MD2102CC*	VR2102BLK*					FA174	FA174HH			FA174V	MD2091		MD2091C	VR2091
35		VR2124BLK*					FA436	FA436HH			FA436V	MD2125		MD2125C	VR2125
36		VR2124BLK*					FA436	FA436HH			FA436V	MD2125		MD2125C	VR2125
37		VR2124BLK*					FA436	FA436HH			FA436V	MD2125		MD2125C	VR2125
38							FA88	FA88HH		EPFA88HH	FA88V	MD2068			
39							FA41				FA41V	MD2024			
40							FA34				FA34V	MD2024			
41							FA34				FA34V	MD2024			
42															
43							FA34				FA34V	MD2024			
44															
45							FA41				FA41V	MD2024			
46		VR2011*					515								
47							FA88	FA88HH			FA88V	MD2092			
48							FA88	FA88HH			FA88V	MD2092			
49							FA88	FA88HH			FA88V	MD2092			
50	MD2074CC*	VR2074BLK*					FA88	FA88HH			FA88V	MD2092		MD2092C	VR2092
51	MD2074CC*	VR2074BLK*					FA88	FA88HH			FA88V	MD2092		MD2092C	VR2092
52							FA88	FA88HH			FA88V	MD2092			
53							FA88	FA88HH		EPFA88HH	FA88V	MD2068			
54		VR2001BLK*					FA88	FA88HH			FA88V	MD2068			N/A
55		VR2001BLK*					FA88	FA88HH			FA88V	MD2068			N/A
56							FA88	FA88HH			FA88V	MD2068			

BRAKE APPLICATIONS

⊗ This symbol indicates a rotor made of billet steel, and should be only used with EBC FA Kevlar® Organic or Vee pads.
SAFETY NOTICE - With vehicles primarily designed for off highway use such as quads now being used on the highway, we would recommend the use of X or MXS pads for highway use and ONLY using the R and SV higher density / harder pad series for off road riding.

*-2 Sets Required. † For Vee disc colours add RED, BLU, GRN, GLD, ORG suffix to part number. **SAFETY WARNING:- DO NOT USE HH PADS ON REAR UNLESS ALSO USED ON FRONT TO AVOID BRAKE IMBALANCE**

FRONT: YAMAHA



YAMAHA



DISC PAD CHOICES - FRONT

BRAKE ROTOR CHOICES - FRONT

Model	Year	Front Disc Pad Choice	SV Series Severe Duty Pads	EPFA Sintered Fast Road/Track Pads	GPFX Sintered RACE ONLY Pads	Specialty Pads SXR/VEE/MXS Race	Standard Rotor		Vintage Rotor / UTV Oversize Brake Kit	Contour Profile Rotor	Line #
							Standard Rotor Left	Standard Rotor Right			
XT 1200 Z Super Tenere	12-19	FA380HH*		EPFA380HH*						MD2095XC*	1
XT 1200 Z Super Tenere ES	14-21	FA380HH*		EPFA380HH*						MD2095XC*	2
XVZ12 TK Venture	83	FA88*	FA88HH*	EPFA88HH*		FA88V*	MD2081†	MD2081†			3
XVZ12 L/KC2 Venture	84	FA88*	FA88HH*	EPFA88HH*		FA88V*	MD2081†	MD2081†			4
XVZ12 TDK/DL/DKC2 Venture Royale	83-84	FA88*	FA88HH*	EPFA88HH*		FA88V*	MD2081†	MD2081†			5
XVZ12 DN Venture Royale	85	FA88*	FA88HH*	EPFA88HH*		FA88V*	MD2081†	MD2081†			6
V-Max VMX 12 N/S/U/W/A/B/D	85-92	FA88*	FA88HH*	EPFA88HH*			MD2068‡	MD2068‡			7
VMX 12 (V-Max 1200 All Models)	93-07	FA160*	FA160HH*				MD2129X	MD2129X		MD2129XC*	8
FJR 1300 R	03	FA252*	FA252HH*	EPFA252HH*			MD2074X	MD2074X		MD2074XC*	9
FJR 1300 S/AS/T/AT	04-05	FA252*	FA252HH*	EPFA252HH*			MD2089X	MD2089X		MD2089XC*	10
FJR 1300 A (Manual Gear Shift Model)	06-12		FA423/4HH*				MD2089X	MD2089X		MD2089XC*	11
FJR 1300 A	13-20		FA423/4HH*				MD2089X	MD2089X		MD2089XC*	12
FJR 1300 ES	14-21		FA423/4HH*				MD2089X	MD2089X		MD2089XC*	13
FJR 1300 AE (Electric Gear Shift Model)	06-09		FA423/4HH*				MD2089X	MD2089X		MD2089XC*	14
XVS 1300 V-Star	07-14	FA199*	FA199HH*			FA199V*	MD2074X	MD2074X		MD2074XC*	15
XVS 1300 V-Star De Luxe	13-14	FA199*	FA199HH*			FA199V*	MD2074X	MD2074X		MD2074XC*	16
XVS 1300 V-Star Tourer	07-14	FA199*	FA199HH*			FA199V*	MD2074X	MD2074X		MD2074XC*	17
XVS 1300 Stryker	11-14	FA179	FA179HH			FA179V	MD2101X			MD2101XC	18
XVZ 13 D Series Venture Royale	86-93	FA123*	FA123HH*			FA123V*	MD2096‡	MD2096‡			19
XVZ 13 T/U Venture	87-88	FA123*	FA123HH*			FA123V*	MD2096‡	MD2096‡			20
XVZ 1300 LTK Venture	96-98	FA123*	FA123HH*			FA123V*	MD2076	MD2076			21
XVZ 1300 Venture MM Limited Edition	01	FA123*	FA123HH*			FA123V*	MD2076	MD2076			22
XVZ 1300 Royal Star	96-97/00	FA123*	FA123HH*			FA123V*	MD2076	MD2076			23
XVZ 1300 Royal Star Boulevard	99-01	FA123*	FA123HH*			FA123V*	MD2076	MD2076			24
XVZ 1300 Royal Star Standard	98	FA123*	FA123HH*			FA123V*	MD2076	MD2076			25
XVZ 1300 Royal Star Venture	99-07	FA123*	FA123HH*			FA123V*	MD2076	MD2076			26
XVZ 1300 Royal Star Venture S	08-13	FA179*	FA179HH*			FA179V*	MD2076	MD2076			27
XVZ 1300 Royal Star Midnight Tour Deluxe	06-07	FA179*	FA179HH*			FA179V*	MD2076	MD2076			28
XVZ 1300 Royal Star Midnight Venture	02-07	FA179*	FA179HH*			FA179V*	MD2076	MD2076			29
XVZ 1300 Royal Star Tour Classic	96-00	FA123*	FA123HH*			FA123V*	MD2076	MD2076			30
XVZ 1300 Royal Star Tour Deluxe	97-01	FA123*	FA123HH*			FA123V*	MD2076	MD2076			31
XVZ 1300 Royal Star Tour Deluxe	05-07	FA179*	FA179HH*			FA179V*	MD2076	MD2076			32
XV 1600 Road Star	99-05	FA179*	FA179HH*			FA179V*	MD2076	MD2076			33
XV 1600 Road Star Silverado	99-09	FA179*	FA179HH*			FA179V*	MD2076	MD2076			34
XV 1600 Road Star Midnight	03	FA179*	FA179HH*			FA179V*	MD2076	MD2076			35
XV 1600 Midnight Star	02-03	FA179*	FA179HH*			FA179V*	MD2076	MD2076			36
VMX 1700 V-Max (6 piston radial caliper)	09-16	FA442/4*	FA442/4HH*	EPFA442/4HH*						MD2109XC*	37
VMX 1700 V-Max (6 piston radial caliper)	17-21	FA442/4*	FA442/4HH*	EPFA442/4HH*						MD2109XC*	38
XV 1700 Road Star (9 Spoke Cast wheels - XV17 AS/AW)	04-08	FA252*	FA252HH*				MD2074X	MD2074X		MD2074XC*	39
XV 1700 Road Star (Spoke wheel / Solid Front Discs - XV17 ATW)	05-07	FA252*	FA252HH*				MD2076	MD2076			40
XV 1700 Road Star S (9 Spoke Cast wheels - XV17 AS)	08-14	FA252*	FA252HH*				MD2074X	MD2074X		MD2074XC*	41
XV 1700 Road Star Midnight (9 Spoke Cast Wheels - XV17 AM)	04-07	FA252*	FA252HH*				MD2074X	MD2074X		MD2074XC*	42
XV 1700 Road Star Midnight Warrior (3 Spoke Cast Wheels - XV17 PCT)	05	FA252*	FA252HH*				MD2074X	MD2074X		MD2074XC*	43
XV 1700 Road Star Midnight Warrior (5 Spoke Cast Wheels - XV17 PCM)	06-09	FA252*	FA252HH*				MD2082X	MD2082X		MD2082XC*	44
XV 1700 Road Star Midnight Silverado (9 Spoke Cast wheels - XV17 ATM)	04-07	FA252*	FA252HH*				MD2074X	MD2074X		MD2074XC*	45
XV 1700 Road Star (Spoke wheel / Solid Front Discs - XV17 ATW)	05-07	FA252*	FA252HH*				MD2076	MD2076			46
XV 1700 Road Star Silverado (Spoke Wheel / Solid Discs - XV17 AT)	07-10	FA252*	FA252HH*				MD2076	MD2076			47
XV 1700 Road Star Silverado S (9 Spoke Cast Wheel - XV17 ATS)	11-14	FA252*	FA252HH*				MD2074X	MD2074X		MD2074XC*	48
XV 1700 Road Star Warrior (3 Spoke Cast Wheels - XV17 PC)	04-05	FA252*	FA252HH*				MD2074X	MD2074X		MD2074XC*	49
XV 1700 Road Star Warrior (5 Spoke Cast Wheels - XV17 PC)	06-08	FA252*	FA252HH*				MD2082X	MD2082X		MD2082XC*	50
Star Venture	18-21		FA380HH*	EPFA380HH*			MD2119X	MD2119X		MD2119XC*	51
Star Venture Transcontinental	18-21		FA380HH*	EPFA380HH*			MD2119X	MD2119X		MD2119XC*	52
Star Eluder	18-21		FA380HH*	EPFA380HH*			MD2119X	MD2119X		MD2119XC*	53
Star Eluder GT	18-21		FA380HH*	EPFA380HH*			MD2119X	MD2119X		MD2119XC*	54
XV 1900 Roadliner	06-07	FA252*	FA252HH*				MD2074X	MD2074X		MD2074XC*	55
XV 1900 Roadliner Midnight	06-09	FA252*	FA252HH*				MD2074X	MD2074X		MD2074XC*	56

APPLIATIONS
BRAKE
SAFETY NOTICE - With vehicles primarily designed for off highway use such as quads now being used on the highway, we would recommend the use of X or MXS pads for highway use and ONLY using the R and SV higher density / harder pad series for off road riding.

⚡ This symbol indicates a rotor made of billet steel, and should be only used with EBC FA Kevlar® Organic or Vee pads.

*-2 Sets Required. † For Vee disc colours add RED, BLU, GRN, GLD, ORG suffix to part number. **SAFETY WARNING:- DO NOT USE HH PADS ON REAR UNLESS ALSO USED ON FRONT TO AVOID BRAKE IMBALANCE**

FRONT: YAMAHA Cont'd

REAR: YAMAHA

Line #	BRAKE ROTOR CHOICES - FRONT						DISC PAD CHOICES - REAR					BRAKE ROTOR CHOICES - REAR				
	CC Custom Rotor	CX Extreme® /Vee-Rotor	OS Series Oversize 250/280mm Rotor Kit	OSX Series Oversize 280mm Rotor Kit	Relocating Bracket for Oversize Rotor	SMX Series Oversize 320mm Rotor Kit	Relocating Bracket for 320mm Rotor		Sintered/HH Pads/Grooved Shoes	SV Series Severe Duty Pads	EPFA Sintered Fast Road/Track Pads	Specialty Pads SXR/VEE/MXS Race	Standard Rotor	Vintage Rotor / UTV Oversize Brake Kit	Contour Profile Rotor	CX Extreme® /Vee-Rotor
1								FA319/2	FA319/2HH						MD2115C	
2								FA319/2	FA319/2HH						MD2115C	
3								FA88	FA88HH		EPFA88HH	FA88V	MD2081			
4								FA88	FA88HH		EPFA88HH	FA88V	MD2081			
5								FA88	FA88HH		EPFA88HH	FA88V	MD2081			
6								FA88	FA88HH		EPFA88HH	FA88V	MD2081			
7								FA88	FA88HH		EPFA88HH	FA88V	MD2068			
8								FA88	FA88HH			FA88V	MD2068			
9	MD2074CC*	VR2074BLK*†						FA319/2	FA319/2HH			FA319/2V	MD2092	MD2092C	VR2092	
10	MD2089CC*	VR2089BLK*†						FA319/2	FA319/2HH			FA319/2V	MD2092	MD2092C	VR2092	
11	MD2089CC*	VR2089BLK*†						FA319/2	FA319/2HH			FA319/2V	MD2100	MD2100C	VR2100	
12	MD2089CC*	VR2089BLK*†						FA319/2	FA319/2HH			FA319/2V	MD2100	MD2100C	VR2100	
13	MD2089CC*	VR2089BLK*†						FA319/2	FA319/2HH			FA319/2V	MD2100	MD2100C	VR2100	
14	MD2089CC*	VR2089BLK*†						FA319/2	FA319/2HH			FA319/2V	MD2100	MD2100C	VR2100	
15	MD2074CC*	VR2074BLK*†						FA319/2	FA319/2HH			FA319/2V	MD2103	MD2103C	VR2103	
16	MD2074CC*	VR2074BLK*†						FA319/2	FA319/2HH			FA319/2V	MD2103	MD2103C	VR2103	
17	MD2074CC*	VR2074BLK*†						FA319/2	FA319/2HH			FA319/2V	MD2103	MD2103C	VR2103	
18		VR2101BLK						FA319/2	FA319/2HH			FA319/2V	MD2114	MD2114C	N/A	
19								FA123	FA123HH			FA123V	MD2049			
20								FA123	FA123HH			FA123V	MD2049			
21								FA123	FA123HH			FA123V	MD2078			
22								FA123	FA123HH			FA123V	MD2078			
23								FA123	FA123HH			FA123V	MD2078			
24								FA123	FA123HH			FA123V	MD2078			
25								FA123	FA123HH			FA123V	MD2078			
26								FA123	FA123HH			FA123V	MD2078			
27								FA123	FA123HH			FA123V	MD2078			
28								FA123	FA123HH			FA123V	MD2078			
29								FA123	FA123HH			FA123V	MD2078			
30								FA123	FA123HH			FA123V	MD2078			
31								FA123	FA123HH			FA123V	MD2078			
32								FA123	FA123HH			FA123V	MD2078			
33								FA123	FA123HH			FA123V	MD2088			
34								FA123	FA123HH			FA123V	MD2088			
35								FA123	FA123HH			FA123V	MD2088			
36								FA123	FA123HH			FA123V	MD2088			
37								FA319/2	FA319/2HH			FA319/2V		MD2108C		
38								FA319/2	FA319/2HH			FA319/2V		MD2108C		
39	MD2074CC*	VR2074BLK*†						N/A	FA123HH			FA123V	MD2088	N/A	N/A	
40								N/A	FA123HH			FA123V	MD2088			
41	MD2074CC*	VR2074BLK*†						N/A	FA123HH			FA123V	MD2088	N/A	N/A	
42	MD2074CC*	VR2074BLK*†						N/A	FA123HH			FA123V	MD2088	N/A	N/A	
43	MD2074CC*	VR2074BLK*†						N/A	FA319/2HH			FA319/2V	MD2092	MD2092C	VR2092	
44	MD2082CC*							N/A	FA319/2HH			FA319/2V	MD2092	MD2092C	VR2092	
45	MD2074CC*	VR2074BLK*†						N/A	FA123HH			FA123V	MD2088	N/A	N/A	
46								N/A	FA123HH			FA123V	MD2088			
47								N/A	FA123HH			FA123V	MD2088			
48	MD2074CC*	VR2074BLK*†						N/A	FA123HH			FA123V	MD2088	N/A	N/A	
49	MD2074CC*	VR2074BLK*†						N/A	FA319/2HH			FA319/2V	MD2092	MD2092C	VR2092	
50	MD2082CC*							N/A	FA319/2HH			FA319/2V	MD2092	MD2092C	VR2092	
51		VR2119BLK*†							FA725HH				MD2131			
52		VR2119BLK*†							FA725HH				MD2131			
53		VR2119BLK*†							FA725HH				MD2131			
54		VR2119BLK*†							FA725HH				MD2131			
55	MD2074CC*	VR2074BLK*†						FA319/2	FA319/2HH			FA319/2V	MD2099		N/A	
56	MD2074CC*	VR2074BLK*†						FA319/2	FA319/2HH			FA319/2V	MD2099		N/A	

BRAKE APPLICATIONS

⚠ This symbol indicates a rotor made of billet steel, and should be only used with EBC FA Kevlar® Organic or Vee pads. SAFETY NOTICE - With vehicles primarily designed for off highway use such as quads now being used on the highway, we would recommend the use of X or MXS pads for highway use and ONLY using the R and SV higher density / harder pad series for off road riding.

*-2 Sets Required. † For Vee disc colours add RED, BLU, GRN, GLD, ORG suffix to part number. **SAFETY WARNING: DO NOT USE HH PADS ON REAR UNLESS ALSO USED ON FRONT TO AVOID BRAKE IMBALANCE**



YAMAHA



FRONT: YAMAHA

DISC PAD CHOICES - FRONT

BRAKE ROTOR CHOICES - FRONT

											Line #
XV 1900 Roadliner S	06-10/12-14	FA252*	FA252HH*				MD2074X	MD2074X		MD2074XC*	1
XV 1900 Raider	08-14	FA252*	FA252HH*				MD2082X	MD2082X		MD2082XC*	2
XV 1900 Raider S	08-14	FA252*	FA252HH*				MD2082X	MD2082X		MD2082XC*	3
XV 1900 Raider SCL	12-14	FA252*	FA252HH*				MD2082X	MD2082X		MD2082XC*	4
XV 1900 Stratoliner	06-09	FA252*	FA252HH*				MD2074X	MD2074X		MD2074XC*	5
XV 1900 Stratoliner Midnite	06-08	FA252*	FA252HH*				MD2074X	MD2074X		MD2074XC*	6
XV 1900 Stratoliner S	06-14	FA252*	FA252HH*				MD2074X	MD2074X		MD2074XC*	7
XV 1900 Stratoliner Deluxe	11-14	FA252*	FA252HH*				MD2074X	MD2074X		MD2074XC*	8
											9
											10
											11
											12
											13
											14
											15
											16
											17
											18
											19
											20
											21
											22
											23
											24
											25
											26
											27
											28
											29
											30
											31
											32
											33
											34
											35
											36
											37
											38
											39
											40
											41
											42
											43
											44
											45
											46
											47
											48
											49
											50
											51
											52
											53
											54
											55
											56

FRONT

* This symbol indicates a rotor made of billet steel, and should be only used with EBC FA Kevlar® Organic or Vee pads.

SAFETY NOTICE - With vehicles primarily designed for off highway use such as quads now being used on the highway, we would recommend the use of X or MXS pads for highway use and ONLY using the R and SV higher density / harder pad series for off road riding.

*-2 Sets Required. † For Vee disc colours add RED, BLU, GRN, GLD, ORG suffix to part number. **SAFETY WARNING:- DO NOT USE HH PADS ON REAR UNLESS ALSO USED ON FRONT TO AVOID BRAKE IMBALANCE**

FRONT: YAMAHA Cont'd

REAR: YAMAHA

BRAKE ROTOR CHOICES - FRONT

DISC PAD CHOICES - REAR

BRAKE ROTOR CHOICES - REAR

Line #

CC Custom Rotor	CX Extreme® /Vee-Rotor	OS Series Oversize 250/280mm Rotor Kit	OSX Series Oversize 280mm Rotor Kit	Relocating Bracket for Oversize Rotor	SMX Series Oversize 320mm Rotor Kit	Relocating Bracket for 320mm Rotor		Sintered/HH Pads/ Grooved Shoes	SV Series Severe Duty Pads	EPFA Sintered Fast Road/ Track Pads	Specialty Pads SXR/ VEE/MXS Race	Standard Rotor	Vintage Rotor / UTV Oversize Brake Kit	Contour Profile Rotor	CX Extreme® /Vee-Rotor
1	MD2074CC*	VR2074BLK*†					FA319/2	FA319/2HH			FA319/2V	MD2099			N/A
2	MD2082CC*	VR2082BLK*†					FA319/2	FA319/2HH			FA319/2V	MD2114		MD2114C	N/A
3	MD2082CC*	VR2082BLK*†					FA319/2	FA319/2HH			FA319/2V	MD2114		MD2114C	N/A
4	MD2082CC*	VR2082BLK*†					FA319/2	FA319/2HH			FA319/2V	MD2114		MD2114C	N/A
5	MD2074CC*	VR2074BLK*†					FA319/2	FA319/2HH			FA319/2V	MD2099			N/A
6	MD2074CC*	VR2074BLK*†					FA319/2	FA319/2HH			FA319/2V	MD2099			N/A
7	MD2074CC*	VR2074BLK*†					FA319/2	FA319/2HH			FA319/2V	MD2099			N/A
8	MD2074CC*	VR2074BLK*†					FA319/2	FA319/2HH			FA319/2V	MD2099			N/A
9															
10															
11															
12															
13															
14															
15															
16															
17															
18															
19															
20															
21															
22															
23															
24															
25															
26															
27															
28															
29															
30															
31															
32															
33															
34															
35															
36															
37															
38															
39															
40															
41															
42															
43															
44															
45															
46															
47															
48															
49															
50															
51															
52															
53															
54															
55															
56															

REAR

BRAKE APPLICATIONS

⚠ This symbol indicates a rotor made of billet steel, and should be only used with EBC FA Kevlar® Organic or Vee pads. SAFETY NOTICE - With vehicles primarily designed for off highway use such as quads now being used on the highway, we would recommend the use of X or MXS pads for highway use and ONLY using the R and SV higher density / harder pad series for off road riding.

*-2 Sets Required. † For Vee disc colours add RED, BLU, GRN, GLD, ORG suffix to part number. **SAFETY WARNING:- DO NOT USE HH PADS ON REAR UNLESS ALSO USED ON FRONT TO AVOID BRAKE IMBALANCE**

FRONT: Non-Japanese Bikes

APPLICATIONS

BRAKE



ADLY



DISC PAD CHOICES - FRONT

BRAKE ROTOR CHOICES - FRONT

Model	Year	Disc Pad Choice	Sintered/HH Pads/Grooved Shoes	SV Series Severe Duty Pads	EPFA Sintered Fast Road/Track Pads	GPFAX Sintered RACE ONLY Pads	Specialty Pads SXR/VEE/MXS Race	Standard Rotor		Vintage Rotor / UTV Oversize Brake Kit	Contour Profile Rotor	Line #	
								Standard Rotor Left	Standard Rotor Right				
Jet 50	07-09	SFA83	SFA83HH					MD904D				1	
Fox 50	07-09	SFA169	SFA169HH					MD904D				2	
Noble 50/Thunderbike	07-09	SFA83	SFA83HH					TBC				3	
Panther 50	07-08	SFA83	SFA83HH					TBC				4	
Jaguar 90 R	07-08	TBC*										5	
Pursuit 90 R	07-08	TBC*										6	
Cross X Road 150/300	07-08	TBC*						N/A	N/A			7	
Cross X Over 150/300	07-08	TBC*						N/A	N/A			8	
Interceptor 150/300	07-08	TBC*						N/A	N/A			9	
Thunderbike 150	07-09	SFA83	SFA83HH					MD923D				10	
Cross X Road 200 R	07-08	TBC*						N/A	N/A			11	
Q 280/300	07-08	TBC*						N/A	N/A			12	
Interceptor 300	06	FA83X*	FA83R*					N/A	N/A			13	
300 Utility	06	FA83X*	FA83R*					N/A	N/A			14	
AJP													
PR3 125 Enduro	13-15	FA465X	FA465R				MXS465	MD6400D				17	
PR3 125 Enduro Pro	13-15	FA465X	FA465R				MXS465	MD6400D				18	
PR3 125 Extreme	13-15	FA465X	FA465R				MXS465	MD6400D				19	
PR3 125 Supermoto	13-15	FA465X	FA465R				MXS465	MD6400D				20	
PR3 200 Enduro	12-14	FA194	FA194HH					MD6400D				21	
PR3 200 Enduro Pro	12-14	FA194	FA194HH					MD6400D				22	
PR3 200 M/X Pro	12-14	FA194	FA194HH					MD6400D				23	
PR3 240 Enduro	14-17	FA465X	FA465R				MXS465	TBC				24	
PR4 240 Enduro	14-17	FA465X	FA465R				MXS465				TBC	25	
PR4 240 Extreme	17	FA465X	FA465R				MXS465				TBC	26	
PR5 250 Enduro	14-17	FA465X	FA465R				MXS465				TBC	27	
PR5 250 Extreme	17	FA465X	FA465R				MXS465				TBC	28	
PR7 650 Adventure	17	FA465X	FA465R				MXS465				TBC	29	
ALPHASPORTS (SEE HYOSUNG)													
ALTAMOTORS (Electric)													
Redshift - MX	16-18	FA181X	FA181R				MXS181					TBC	34
Redshift - SM	16-18		FA322/4HH									TBC	35
APRILIA													
Mojito Custom 50	04-06	SFA193	SFA193HH					MD943D				38	
Mojito Retro 50	04-05	SFA193	SFA193HH					MD943D				39	
MX 50	04	FA194	FA194HH					MD6214D				40	
Rally 50 (Air Cooled)	04-05	SFA193	SFA193HH					MD943D				41	
RS 50 Replica	99-05	FA194	FA194HH					MD672LS				42	
RX 50/RX 50 Racing	04	FA194	FA194HH					MD6214D				43	
Scarabeo 50 Street (Drum rear)	99-05	SFA193	SFA193HH					MD945D				44	
Scarabeo 50 Ditech (Rear rotor model)	02-08	SFA193	SFA193HH					MD945D				45	
Sportcity 50 (4T)	08-12	SFA353	SFA353HH					MD924D				46	
SR 50	99-03	SFA193	SFA193HH					MD943D				47	
SR 50 (Factory)	04-15	SFA193	SFA193HH					MD943D				48	
SR 50 Motard (4T)	12-15	SFA353	SFA353HH					MD924D				49	
Scarabeo 100 4T	04-14	SFA193	SFA193HH					MD945D				50	
RS 125	06-12	FA432	FA432HH						MD621X		MD621XC	51	
Atlantic 200	04-06	SFA324	SFA324HH					MD997D				52	
Scarabeo 125/250 GT	04-05	SFA256	SFA256HH					MD952D				53	
Sportcity 125 (4T)	08-14	SFA256	SFA256HH					MD952D				54	
Mojito Custom 150	05-09	SFA301	SFA301HH					MD943D				55	
Scarabeo 150	99-06	SFA256	SFA256HH					MD952D				56	

FRONT

* This symbol indicates a rotor made of billet steel, and should be only used with EBC FA Kevlar® Organic or Vee pads.
 † For Vee disc colours add RED, BLU, GRN, GLD, ORG suffix to part number. SAFETY WARNING:- DO NOT USE HH PADS ON REAR UNLESS ALSO USED ON FRONT TO AVOID BRAKE IMBALANCE
 pads for highway use and ONLY using the R and SV higher density / harder pad series for off road riding.

*-2 Sets Required. † For Vee disc colours add RED, BLU, GRN, GLD, ORG suffix to part number. SAFETY WARNING:- DO NOT USE HH PADS ON REAR UNLESS ALSO USED ON FRONT TO AVOID BRAKE IMBALANCE

FRONT: Non-Japanese Bikes Cont'd

REAR: Non-Japanese Bikes

Line #	BRAKE ROTOR CHOICES - FRONT						DISC PAD CHOICES - REAR					BRAKE ROTOR CHOICES - REAR				
	CC Custom Rotor	CX Extreme® /Vee-Rotor	OS Series Oversize 250/280mm Rotor Kit	OSX Series Oversize 280mm Rotor Kit	Relocating Bracket for Oversize Rotor	SMX Series Oversize 320mm Rotor Kit	Relocating Bracket for 320mm Rotor		Sintered/HH Pads/ Grooved Shoes	SV Series Severe Duty Pads	EPFA Sintered Fast Road/ Track Pads	Specialty Pads SXR/ VEE/MXS Race	Standard Rotor	Vintage Rotor / UTV Oversize Brake Kit	Contour Profile Rotor	CX Extreme® /Vee-Rotor
1								503								
2								503								
3								503								
4								503								
5								TBC								
6								TBC								
7								TBC					TBC			
8								TBC					N/A			
9								TBC					N/A			
10								SFA83	SFA83HH				MD982D			
11								TBC					N/A			
12								TBC					N/A			
13								FA83X	FA83R				N/A			
14								FA83X	FA83R				N/A			
15																
16																
17								FA131X	FA131R				MD6401D			
18								FA131X	FA131R				MD6401D			
19								FA131X	FA131R				MD6401D			
20								FA131X	FA131R				MD6401D			
21								FA131X	FA131R				MD6401D			
22								FA131X	FA131R				MD6401D			
23								FA131X	FA131R				MD6401D			
24								FA367X	FA367R				TBC			
25								FA367X	FA367R						TBC	
26								FA367X	FA367R						TBC	
27								FA367X	FA367R						TBC	
28								FA367X	FA367R						TBC	
29								FA367X	FA367R						TBC	
30																
31																
32																
33																
34								FA368X	FA368R			MXS368			TBC	
35								FA368X	FA368R						TBC	
36																
37																
38								817								
39								817								
40								FA60						N/A		
41								893								
42								FA60						MD664		
43								FA60						N/A		
44								893								
45								SFA193	SFA193HH					MD943D		
46								816								
47								SFA193	SFA193HH					MD943D		
48								SFA298	SFA298HH					MD996D		
49								816								
50								816								
51								FA298	SFA298HH					MD664		MD664C
52								SFA298	SFA298HH					MD996D		
53								SFA298	SFA298HH					MD942D		
54								816								
55								816								
56								SFA298	SFA298HH					MD942D		

⚠ This symbol indicates a rotor made of billet steel, and should be only used with EBC FA Kevlar® Organic or Vee pads.
 SAFETY NOTICE - With vehicles primarily designed for off highway use such as quads now being used on the highway, we would recommend the use of X or MXS pads for highway use and ONLY using the R and SV higher density / harder pad series for off road riding.

BRAKE APPLICATIONS

*-2 Sets Required. † For Vee disc colours add RED, BLU, GRN, GLD, ORG suffix to part number. **SAFETY WARNING:** DO NOT USE HH PADS ON REAR UNLESS ALSO USED ON FRONT TO AVOID BRAKE IMBALANCE

FRONT: Non-Japanese Bikes



APRILIA



DISC PAD CHOICES - FRONT

BRAKE ROTOR CHOICES - FRONT

			Sintered/HH Pads/ Grooved Shoes	SV Series Severe Duty Pads	EPFA Sintered Fast Road/ Track Pads	GPFX Sintered RACE ONLY Pads	Specialty Pads SXR/ VEE/MXS Race	Standard Rotor Left	Standard Rotor Right	Vintage Rotor / UTV Oversize Brake Kit	Contour Profile Rotor	Line #
Scarabeo 200	08-14	SFA324	FA324HH					MD952D				1
RS 250	99-03	FA244*	FA244HH*					MD660LS	MD660RS			2
Scarabeo 250	06-08	SFA324	FA324HH					MD952D				3
Sport City 250	07-14	SFA256*	SFA256HH*					MD952D	MD952D			4
Sport City Cube 250	08-09	SFA256	SFA256HH					MD952D				5
MXV 4.5	09-12	FA185X	FA185R		EPFA185HH		MXS185	TBC				6
Atlantic 500 ie	03-05	SFA256*	SFA256HH*					MD952D	MD952D			7
Scarabeo 500 ie	03-14	SFA256*	SFA256HH*					MD952D	MD952D			8
Pegaso 650 ie (All models)	99-04	FA209/2	FA209/2HH					MD6129D				9
RVX 4.5/5.5	06-12	FA185X	FA185R		EPFA185HH		MXS185	TBC				10
SXV 4.5/5.5	09-12				EPFA405HH		MXS405	TBC				11
RS 660 8V (ABS)	20-21	FA630HH*										12
RS 660 8V Tuono (ABS)	20-21	FA630HH*										13
Dorsoduro 750 (ABS)	08-15	FA432*	FA432HH*					TBC				14
Shiver SL 750	07-14	FA432*	FA432HH*					MD621X	MD621X		MD621XC*	15
Mana 850	08-12	FA432*	FA432HH*					MD621X	MD621X		MD621XC*	16
Mana 850 Parking brake	08-12	SFA257/2										17
Mana 850 GT ABS	09-16	FA432*	FA432HH*					TBC	TBC			18
Mana 850 GT ABS Parking brake	09-16	SFA257/2										19
Shiver 900	18-21	FA432*	FA432HH*					MD2003X	MD2003X		MD2003XC*	20
Dorsoduro 900	18-21	FA432*	FA432HH*					MD2003X	MD2003X		MD2003XC*	21
RSV 1000 Mille/SP	98-01	FA244*	FA244HH*		EPFA244HH*			MD666X	MD666X		MD666XC*	22
RSV Mille R/1000 Mille (inc Radial Mount Caliper)	01-03		FA322/4HH*		EPFA322/4HH*			MD621X	MD621X		MD621XC*	23
RSV 1000 R Factory/R	04-12		FA322/4HH*		EPFA322/4HH*			MD621X	MD621X		MD621XC*	24
RSV Tuono (Standard Caliper)	02-05	FA244*	FA244HH*		EPFA244HH*			MD621X	MD621X		MD621XC*	25
RSV Tuono R/Factory R (Radial Caliper)	02-12		FA322/4HH*		EPFA322/4HH*			MD621X	MD621X		MD621XC*	26
Tuono V4 R APRC ABS	12-15		FA630HH*		EPFA630HH*			TBC	TBC			27
Tuono V4 1100 RR/Factory	18-21		FA447HH*		EPFA447HH*			MD8004X	MD8004X			28
RSV4 R	09-12		FA447HH*		EPFA447HH*			MD2003X	MD2003X		MD2003XC*	29
RSV4 Factory	09-12		FA447HH*		EPFA447HH*			MD2003X	MD2003X		MD2003XC*	30
RSV4 R APRC	11-12		FA447HH*		EPFA447HH*			MD2003X	MD2003X		MD2003XC*	31
RSV4 Factory APRC SE	11-12		FA447HH*		EPFA447HH*			MD2003X	MD2003X		MD2003XC*	32
RSV4 Factory APRC ABS	13-15		FA447HH*		EPFA447HH*			MD2003X	MD2003X		MD2003XC*	33
RSV4 R APRC ABS	13-15		FA447HH*		EPFA447HH*			MD2003X	MD2003X		MD2003XC*	34
RSVR 1100 RF/RF/LE/RR	18-21		FA447HH*		EPFA447HH*			MD8004X	MD8004X			35
SL 1000 Falco	00-05	FA244*	FA244HH*		EPFA244HH*			MD666X	MD666X		MD666XC*	36
ETV 1000 Caponord (Non ABS - Bolt fixing)	01-03	FA209/2*	FA209/2HH*					MD6307D	MD6307D			37
ETV 1000 Caponord Rally (Non ABS - Bush fixing)	03	FA209/2*	FA209/2HH*					MD6406D	MD6406D			38
ETV 1000 Caponord (ABS - Bush fixing)	04-07	FA209/2*	FA209/2HH*					MD6406D	MD6406D			39
RST Futura 1000	01-05	FA244*	FA244HH*		EPFA244HH*			MD2001X	MD2001X		MD2001XC*	40
Caponord 1200	14-15		FA630HH*		EPFA630HH*			MD2003X	MD2003X			41
Caponord 1200 Rally	18-19	FA244*	FA244HH*		EPFA244HH*							42
Dorsoduro 1200	11-14	FA244*	FA244HH*		EPFA244HH*			MD2003X	MD2003X			43
												44
												45
KRG1	19-20	FA175*	FA175HH*		EPFA175HH*							46
1S	19-20	FA175*	FA175HH*		EPFA175HH*							47
Method 143	19-20	FA175*	FA175HH*		EPFA175HH*							48
												49
												50
ARCTIC CAT (ATV)												51
50 2 x 4 Youth (2T)	04-06	338*	338G*									52
50 DVX Sport (4T)	06-08	338*	338G*									53
50 4 x 4 Auto Youth	06-08	338*	338G*									54
90 2 x 4 Youth (2T) Rear Drum Model	02-04	338*	338G*									55
90 2 x 4 Youth (4T) Rear Drum Model	04-05	338*	338G*									56
90 2 x 4 Youth (4T) Rear Disc Model	06	338*	338G*									57

*-2 Sets Required. † For Vee disc colours add RED, BLU, GRN, GLD, ORG suffix to part number. **SAFETY WARNING:- DO NOT USE HH PADS ON REAR UNLESS ALSO USED ON FRONT TO AVOID BRAKE IMBALANCE**

APPLIATIONS

BRAKE

⚡ This symbol indicates a rotor made of billet steel, and should be only used with EBC FA Kevlar® Organic or Vee pads.

SAFETY NOTICE - With vehicles primarily designed for off highway use such as quads now being used on the highway, we would recommend the use of X or MXS pads for highway use and ONLY using the R and SV higher density / harder pad series for off road riding.

FRONT: Non-Japanese Bikes Cont'd

REAR: Non-Japanese Bikes

Line #	BRAKE ROTOR CHOICES - FRONT						DISC PAD CHOICES - REAR					BRAKE ROTOR CHOICES - REAR				
	CC Custom Rotor	CX Extreme® /Vee-Rotor	OS Series Oversize 250/280mm Rotor Kit	OSX Series Oversize 280mm Rotor Kit	Relocating Bracket for Oversize Rotor	SMX Series Oversize 320mm Rotor Kit	Relocating Bracket for 320mm Rotor		Sintered/HH Pads/ Grooved Shoes	SV Series Severe Duty Pads	EPFA Sintered Fast Road/ Track Pads	Specialty Pads SXR/ VEE/MXS Race	Standard Rotor	Vintage Rotor / UTV Oversize Brake Kit	Contour Profile Rotor	CX Extreme® /Vee-Rotor
1								SFA298	SFA298HH				TBC			
2								FA47	FA47HH				MD665			
3								SFA298	SFA298HH				MD942D			
4								SFA298	SFA298HH				MD942D			
5								SFA298	SFA298HH				MD942D			
6								FA367X	FA367R			MXS367	TBC			
7								SFA298	SFA298HH				MD990D			
8								SFA298	SFA298HH				MD990D			
9								FA173					MD6128D			
10								FA367X	FA367R			MXS367	TBC			
11								FA367X	FA367R			MXS367	TBC			
12								FA266	FA266HH							
13								FA266	FA266HH							
14			TBC	TBC				FA213	FA213HH			FA213V	TBC			
15								FA213	FA213HH				TBC			
16		VR621BLK†						FA256	FA256HH				MD858		MD858C	VR858
17																
18								FA256	FA256HH				MD872		MD872C	VR872
19																
20	MD2003CC*							FA213	FA213HH				MD613		MD613C	VR613
21	MD2003CC*							FA213	FA213HH				MD613		MD613C	VR613
22								FA266	FA266HH			FA266V	MD613		MD613C	VR613
23		VR621BLK†						FA266	FA266HH			FA266V	MD613		MD613C	VR613
24		VR621BLK†						FA266	FA266HH			FA266V	MD613		MD613C	VR613
25		VR621BLK†						FA266	FA266HH			FA266V	MD613		MD613C	VR613
26		VR621BLK†						FA266	FA266HH			FA266V	MD613		MD613C	VR613
27								FA266	FA266HH			FA266V	MD613		MD613C	VR613
28								FA266	FA266HH			FA266V	MD613		MD613C	VR613
29		VR2003BLK†						FA266	FA266HH			FA266V	MD613		MD613C	VR613
30		VR2003BLK†						FA266	FA266HH			FA266V	MD613		MD613C	VR613
31		VR2003BLK†						FA266	FA266HH			FA266V	MD613		MD613C	VR613
32		VR2003BLK†						FA266	FA266HH			FA266V	MD613		MD613C	VR613
33		VR2003BLK†						FA266	FA266HH			FA266V	MD613		MD613C	VR613
34		VR2003BLK†						FA266	FA266HH			FA266V	MD613		MD613C	VR613
35								FA266	FA266HH			FA266V	MD613		MD613C	VR613
36								FA266	FA266HH			FA266V	MD613		MD613C	VR613
37								FA266	FA266HH			FA266V	MD6308D			
38								FA266	FA266HH			FA266V	MD6308D			
39								FA266	FA266HH			FA266V	MD6308D			
40		VR2001BLK†						FA181X	FA181HH		EPFA181HH		MD697		MD697C	N/A
41								FA213	FA213HH			FA213V	TBC			
42								FA213	FA213HH			FA213V				
43								FA213	FA213HH			FA213V	TBC			
44																
45																
46								FA47	FA47HH			FA47V				
47								FA47	FA47HH			FA47V				
48								FA47	FA47HH			FA47V				
49																
50																
51								N/A								
52								FA305X	FA305R				MD6267D			
53								FA305X	FA305R				MD6267D			
54								307	307G							
55								307	307G							
56								FA305X	FA305R							

BRAKE APPLICATIONS

⚠ This symbol indicates a rotor made of billet steel, and should be only used with EBC FA Kevlar® Organic or Vee pads.
 SAFETY NOTICE - With vehicles primarily designed for off highway use such as quads now being used on the highway, we would recommend the use of X or MXS pads for highway use and ONLY using the R and SV higher density / harder pad series for off road riding.

*-2 Sets Required. † For Vee disc colours add RED, BLU, GRN, GLD, ORG suffix to part number. **SAFETY WARNING:** DO NOT USE HH PADS ON REAR UNLESS ALSO USED ON FRONT TO AVOID BRAKE IMBALANCE

FRONT: Non-Japanese Bikes



ARCTIC CAT (ATV)



DISC PAD CHOICES - FRONT

BRAKE ROTOR CHOICES - FRONT

Model	Year	Front Disc Pad Choice	SV Series Severe Duty Pads	EPFA Sintered Fast Road/Track Pads	GPFX Sintered RACE ONLY Pads	Specialty Pads SXR/VEE/MXS Race	Rotor Choice			Line #
							Standard Rotor Left	Standard Rotor Right	Vintage Rotor / UTV Oversize Brake Kit	
Alterra 90	18	338*	338G							1
90 DVX	06-12	338*	338G*							2
90 DVX	18	338*	338G*							3
90 DVX SE	09	338*	338G*							4
90 Reverse Gear Model (2 x 4 Utility)	10-13	338*	338G*							5
150 Utility 2 x 4	09-15	303*	303G*							6
Utility 2 x 4	15-18	303*	303G*							7
250 2 x 4 Utility	99-04	FA271X*	FA271R*				MD6173D	MD6173D	UTVX6173*	8
250 2 x 4 Utility	05-09	FA395X*	FA395R*	FA395SV*			MD6173D	MD6173D	UTVX6173*	9
250 4 x 4 Utility	01-04	FA271X*	FA271R*				MD6173D	MD6173D	UTVX6173*	10
250 4 x 4 Utility	05/08	FA395X*	FA395R*	FA395SV*			MD6173D	MD6173D	UTVX6173*	11
250 DVX Sport	06-08	FA377X*	FA377R*				MD6267D	MD6267D		12
300 (4 x 4)	98-04	FA271X*	FA271R*				MD6173D	MD6173D	UTVX6173*	13
300 4 x 4 Utility	05	FA395X*	FA395R*	FA395SV*			MD6173D	MD6173D	UTVX6173*	14
300 Alterra	17-19	FA377X*	FA377R*				MD6267D	MD6267D		15
300 ATV 2 x 4 Utility (Mid Size)	10-14	FA377X*	FA377R*				MD6267D	MD6267D		16
300 DVX	09-12	FA377X*	FA377R*				MD6267D	MD6267D		17
350 ATV	12	FA395X*	FA395R*	FA395SV*			MD6173D	MD6173D	UTVX6173*	18
366 4 x 4 Auto Utility	08-09	FA395X*	FA395R*	FA395SV*			MD6173D	MD6173D	UTVX6173*	19
366 SE	10	FA395X*	FA395R*	FA395SV*			MD6173D	MD6173D	UTVX6173*	20
400 4 x 4 ACT	04	FA271X*	FA271R*				MD6173D	MD6173D	UTVX6173*	21
400 4 x 4 Auto ACT	04	FA271X*	FA271R*				MD6173D	MD6173D	UTVX6173*	22
400 2 x 4 Utility	98-04	FA271X*	FA271R*				MD6173D	MD6173D	UTVX6173*	23
400 2 x 4 Auto Utility	04	FA271X*	FA271R*				MD6173D	MD6173D	UTVX6173*	24
400 4 x 4 Utility	00-04	FA271X*	FA271R*				MD6173D	MD6173D	UTVX6173*	25
400 4 x 4 Utility	05-07	FA395X*	FA395R*	FA395SV*			MD6173D	MD6173D	UTVX6173*	26
400 4 x 4 VP Utility	05-06	FA395X*	FA395R*	FA395SV*			MD6173D	MD6173D	UTVX6173*	27
400 4 x 4 Auto Utility	04	FA271X*	FA271R*				MD6173D	MD6173D	UTVX6173*	28
400 4 x 4 Auto Utility	05-08	FA395X*	FA395R*	FA395SV*			MD6173D	MD6173D	UTVX6173*	29
400 4 x 4 Auto LE Utility	05-07	FA395X*	FA395R*	FA395SV*			MD6173D	MD6173D	UTVX6173*	30
400 4 x 4 Auto VP Utility	05-06	FA395X*	FA395R*	FA395SV*			MD6173D	MD6173D	UTVX6173*	31
400 DVX Sport	04-08	FA84X*	FA84R*			MXS84*	MD6210D	MD6210D		32
400 DVX TS Sport	06-07	FA84X*	FA84R*			MXS84*	MD6210D	MD6210D		33
400 4 x 4 Auto TBX Utility	04	FA271X*	FA271R*				MD6173D	MD6173D	UTVX6173*	34
400 4 x 4 Auto TBX Utility	05-06	FA395X*	FA395R*	FA395SV*			MD6173D	MD6173D	UTVX6173*	35
Alterra 400	16-18	FA395X*	FA395R*	FA395SV*			MD6383D	MD6383D	UTVX6383*	36
400 TRV	09	FA395X*	FA395R*	FA395SV*			MD6173D	MD6173D	UTVX6173*	37
400 TRV H1	10	FA395X*	FA395R*	FA395SV*			MD6173D	MD6173D	UTVX6173*	38
400 TRV	13	FA395X*	FA395R*	FA395SV*			TBC	TBC		39
400 4 x 4 Auto TRV Multirider	06	FA395X*	FA395R*	FA395SV*			MD6173D	MD6173D	UTVX6173*	40
400 4 x 4 Auto TRV Plus Multirider	07	FA395X*	FA395R*	FA395SV*			MD6173D	MD6173D	UTVX6173*	41
400 ATV (Core/Mid Size)	13-14	FA395X*	FA395R*	FA395SV*			MD6375D	MD6375D		42
425i	12	FA395X*	FA395R*	FA395SV*			MD6173D	MD6173D	UTVX6173*	43
425i SE	12	FA395X*	FA395R*	FA395SV*			MD6173D	MD6173D	UTVX6173*	44
450 H1 EFI	10	FA395X*	FA395R*	FA395SV*			MD6173D	MD6173D	UTVX6173*	45
450i	11-12	FA395X*	FA395R*	FA395SV*			MD6173D	MD6173D	UTVX6173*	46
450i GT	12	FA395X*	FA395R*	FA395SV*			MD6173D	MD6173D	UTVX6173*	47
450 TRV	11-12	FA395X*	FA395R*	FA395SV*			MD6173D	MD6173D	UTVX6173*	48
450i TRV	11	FA395X*	FA395R*	FA395SV*			MD6173D	MD6173D	UTVX6173*	49
Alterra 450	16	FA395X*	FA395R*	FA395SV*			MD6173D	MD6173D	UTVX6173*	50
450 ATV (Core/Mid Size)	13-14	FA395X*	FA395R*	FA395SV*			MD6375D	MD6375D		51
XC 450i	11-12	FA395X*	FA395R*	FA395SV*			MD6173D	MD6173D	UTVX6173*	52
450i XC	13	FA395X*	FA395R*	FA395SV*			MD6375D	MD6375D		53
450i XC	15-17	FA395X*	FA395R*	FA395SV*			MD6173D	MD6173D	UTVX6173*	54
454 Bearcat 2 x 4	97-98	FA271X*	FA271R*				MD6173D	MD6173D	UTVX6173*	55
454 Bearcat 4 x 4	96-98	FA271X*	FA271R*				MD6173D	MD6173D	UTVX6173*	56

APPLIATIONS

BRAKE

⚡ This symbol indicates a rotor made of billet steel, and should be only used with EBC FA Kevlar® Organic or Vee pads.

SAFETY NOTICE - With vehicles primarily designed for off highway use such as quads now being used on the highway, we would recommend the use of X or MXS pads for highway use and ONLY using the R and SV higher density / harder pad series for off road riding.

*-2 Sets Required. † For Vee disc colours add RED, BLU, GRN, GLD, ORG suffix to part number. SAFETY WARNING:- DO NOT USE HH PADS ON REAR UNLESS ALSO USED ON FRONT TO AVOID BRAKE IMBALANCE

FRONT: Non-Japanese Bikes Cont'd

REAR: Non-Japanese Bikes

Line #	BRAKE ROTOR CHOICES - FRONT							DISC PAD CHOICES - REAR					BRAKE ROTOR CHOICES - REAR			
	CC Custom Rotor	CX Extreme® /Vee-Rotor	OS Series Oversize 250/280mm Rotor Kit	OSX Series Oversize 280mm Rotor Kit	Relocating Bracket for Oversize Rotor	SMX Series Oversize 320mm Rotor Kit	Relocating Bracket for 320mm Rotor		Sintered/HH Pads/ Grooved Shoes	SV Series Severe Duty Pads	EPFA Sintered Fast Road/ Track Pads	Specialty Pads SXR/ VEE/MXS Race	Standard Rotor	Vintage Rotor / UTV Oversize Brake Kit	Contour Profile Rotor	CX Extreme® /Vee-Rotor
1								FA305X	FA305R							
2								FA305X	FA305R				MD6267D			
3								FA377X	FA377R							
4								FA305X	FA305R				MD6267D			
5								FA305X	FA305R				MD6267D			
6								FA305X	FA305R				MD6267D			
7								FA377X	FA377R							
8								FA271X	FA271R				MD6173D	UTVX6173		
9								FA395X	FA395R	FA395SV			MD6173D	UTVX6173		
10								FA271X	FA271R				MD6173D	UTVX6173		
11								FA395X	FA395R	FA395SV			MD6173D	UTVX6173		
12								FA355/4X	FA355/4R				MD6268D			
13								FA271X	FA271R				MD6173D	UTVX6173		
14								FA395X	FA395R	FA395SV			MD6173D	UTVX6173		
15								FA377X	FA377R							
16								FA377*	FA377*				TBC			
17								FA355/4X	FA355/4R				MD6268D			
18								FA395X	FA395R	FA395SV			MD6173D	UTVX6173		
19								FA395X	FA395R	FA395SV			MD6173D	UTVX6173		
20								FA395X	FA395R	FA395SV			MD6173D	UTVX6173		
21								FA271X	FA271R				MD6173D	UTVX6173		
22								FA271X	FA271R				MD6173D	UTVX6173		
23								FA271X	FA271R				MD6173D	UTVX6173		
24								FA271X	FA271R				MD6173D	UTVX6173		
25								FA271X	FA271R				MD6173D	UTVX6173		
26								FA395X	FA395R	FA395SV			MD6173D	UTVX6173		
27								FA395X	FA395R	FA395SV			MD6173D	UTVX6173		
28								FA271X	FA271R				MD6173D	UTVX6173		
29								FA395X	FA395R	FA395SV			MD6173D	UTVX6173		
30								FA395X	FA395R	FA395SV			MD6173D	UTVX6173		
31								FA395X	FA395R	FA395SV			MD6173D	UTVX6173		
32								FA137X	FA137R	FA137SV			MD6211D			
33								FA137X	FA137R	FA137SV			MD6211D			
34								FA271X	FA271R				MD6173D	UTVX6173		
35								FA395X	FA395R	FA395SV			MD6173D	UTVX6173		
36								FA395X	FA395R	FA395SV			MD6383D	UTVX6383		
37								FA395X	FA395R	FA395SV			MD6173D	UTVX6173		
38								FA395X	FA395R	FA395SV			MD6173D	UTVX6173		
39								FA395X	FA395R	FA395SV			TBC			
40								FA395X	FA395R	FA395SV			MD6173D	UTVX6173		
41								FA395X	FA395R	FA395SV			MD6173D	UTVX6173		
42								FA395X	FA395R	FA395SV			MD6375D			
43								FA395X	FA395R	FA395SV			MD6173D	UTVX6173		
44								FA395X	FA395R	FA395SV			MD6173D	UTVX6173		
45								FA395X	FA395R	FA395SV			MD6173D	UTVX6173		
46								FA395X	FA395R	FA395SV			MD6173D	UTVX6173		
47								FA395X	FA395R	FA395SV			MD6173D	UTVX6173		
48								FA395X	FA395R	FA395SV			MD6173D	UTVX6173		
49								FA395X	FA395R	FA395SV			MD6173D	UTVX6173		
50								FA395X	FA395R	FA395SV			MD6173D	UTVX6173		
51								FA395X	FA395R	FA395SV			MD6375D			
52								FA395X	FA395R	FA395SV			MD6173D	UTVX6173		
53								FA395X	FA395R	FA395SV			MD6375D			
54								FA395X	FA395R	FA395SV			MD6173D	UTVX6173		
55								FA271X	FA271R				MD6173D	UTVX6173		
56								FA271X	FA271R				MD6173D	UTVX6173		

BRAKE APPLICATIONS

⚠ This symbol indicates a rotor made of billet steel, and should be only used with EBC FA Kevlar® Organic or Vee pads.
SAFETY NOTICE - With vehicles primarily designed for off highway use such as quads now being used on the highway, we would recommend the use of X or MXS pads for highway use and ONLY using the R and SV higher density / harder pad series for off road riding.

*-2 Sets Required. † For Vee disc colours add RED, BLU, GRN, GLD, ORG suffix to part number. **SAFETY WARNING:- DO NOT USE HH PADS ON REAR UNLESS ALSO USED ON FRONT TO AVOID BRAKE IMBALANCE**

FRONT: Non-Japanese Bikes



ARCTIC CAT (ATV)



DISC PAD CHOICES - FRONT

BRAKE ROTOR CHOICES - FRONT

Model	Year	Front Disc Pad Choice	DISC PAD CHOICES - FRONT					BRAKE ROTOR CHOICES - FRONT				Line #	
			Sintered/HH Grooved Shoes	SV Series Severe Duty Pads	EPFA Sintered Fast Road/Track Pads	GPFX Sintered RACE ONLY Pads	Specialty Pads SXR/VEE/MXS Race	Standard Rotor Left	Standard Rotor Right	Vintage Rotor / UTV Oversize Brake Kit	Contour Profile Rotor		
500 4 x 4 Auto Utility	98-04	FA271X*	FA271R*							MD6173D	MD6173D	UTVX6173*	1
500 4 x 4 Auto Utility	05-08	FA395X*	FA395R*	FA395SV*						MD6173D	MD6173D	UTVX6173*	2
500 4 x 4 Auto LE Utility	05-06	FA395X*	FA395R*	FA395SV*						MD6173D	MD6173D	UTVX6173*	3
500 4 x 4 Manual G/Box Utility	98-04	FA271X*	FA271R*							MD6173D	MD6173D	UTVX6173*	4
500 4 x 4 Manual G/Box Utility	05-09	FA395X*	FA395R*	FA395SV*						MD6173D	MD6173D	UTVX6173*	5
500 4 x 4 Auto TBX Utility	04	FA271X*	FA271R*							MD6173D	MD6173D	UTVX6173*	6
500 4 x 4 Auto TBX Utility	05-06	FA395X*	FA395R*	FA395SV*						MD6173D	MD6173D	UTVX6173*	7
500 4 x 4 Auto TRV Utility	04	FA271X*	FA271R*							MD6173D	MD6173D	UTVX6173*	8
500 4 x 4 Auto TRV Multirider	05-06/08	FA395X*	FA395R*	FA395SV*						MD6173D	MD6173D	UTVX6173*	9
500 ATV (Mid Size)	13-14	FA395X*	FA395R*	FA395SV*						MD6375D	MD6375D		10
500 ATV XT (Mid Size)	13-14	FA395X*	FA395R*	FA395SV*						MD6375D	MD6375D		11
500 TRV	13	FA395X*	FA395R*	FA395SV*						MD6375D	MD6375D		12
Alterra 500	16-19	FA395X*	FA395R*	FA395SV*						MD6383D	MD6383D	UTVX6383*	13
550 HI EFI	09-10	FA395X*	FA395R*	FA395SV*						MD6173D	MD6173D	UTVX6173*	14
550 HI EFI LE	09-10	FA395X*	FA395R*	FA395SV*						MD6173D	MD6173D	UTVX6173*	15
550 TRV	11	FA395X*	FA395R*	FA395SV*						MD6173D	MD6173D	UTVX6173*	16
550 TRV Cruiser	11	FA395X*	FA395R*	FA395SV*						MD6173D	MD6173D	UTVX6173*	17
550 TRV EFI	09-10	FA395X*	FA395R*	FA395SV*						MD6173D	MD6173D	UTVX6173*	18
550 TRV EFI LE	09-10	FA395X*	FA395R*	FA395SV*						MD6173D	MD6173D	UTVX6173*	19
550i	11-12	FA395X*	FA395R*	FA395SV*						MD6173D	MD6173D	UTVX6173*	20
550i LTD	11-12	FA395X*	FA395R*	FA395SV*						MD6173D	MD6173D	UTVX6173*	21
550i GT	11-12	FA395X*	FA395R*	FA395SV*						MD6173D	MD6173D	UTVX6173*	22
550i GT TRV	11	FA395X*	FA395R*	FA395SV*						MD6173D	MD6173D	UTVX6173*	23
550i TRV Cruiser	11	FA395X*	FA395R*	FA395SV*						MD6173D	MD6173D	UTVX6173*	24
550 GT TRV	11-12	FA395X*	FA395R*	FA395SV*						MD6173D	MD6173D	UTVX6173*	25
550 GT S TRV	10	FA395X*	FA395R*	FA395SV*						MD6173D	MD6173D	UTVX6173*	26
550 S	10	FA395X*	FA395R*	FA395SV*						MD6173D	MD6173D	UTVX6173*	27
550 S LTD	10	FA395X*	FA395R*	FA395SV*						MD6173D	MD6173D	UTVX6173*	28
550 ATV (Mid Sized)	13-14	FA395X*	FA395R*	FA395SV*						MD6375D	MD6375D		29
550 ATV LTD (Mid Sized)	13-14	FA395X*	FA395R*	FA395SV*						MD6375D	MD6375D		30
550 ATV XT (Mid Sized)	13-14	FA395X*	FA395R*	FA395SV*						MD6375D	MD6375D		31
550 TRV LTD	13	FA395X*	FA395R*	FA395SV*						MD6375D	MD6375D		32
Alterra TRV 550 XT	16-19	FA395X*	FA395R*	FA395SV*						MD6383D	MD6383D	UTVX6383*	33
Alterra 570	19	FA395X*	FA395R*	FA395SV*						MD6383D	MD6383D	UTVX6383*	34
650 H1 4 x 4 Auto Utility	04	FA271X*	FA271R*							MD6173D	MD6173D	UTVX6173*	35
650 H1 4 x 4 Auto Utility	05/08	FA271X*	FA271R*							MD6173D	MD6173D	UTVX6173*	36
650 H1 4 x 4 Auto LE Utility	07	FA271X*	FA271R*							MD6173D	MD6173D	UTVX6173*	37
650 H1 4 x 4 SE Auto Utility	06	FA271X*	FA271R*							MD6173D	MD6173D	UTVX6173*	38
650 H1	10	FA395X*	FA395R*	FA395SV*						MD6173D	MD6173D	UTVX6173*	39
650 Mudpro	10-11	FA395X*	FA395R*	FA395SV*						MD6173D	MD6173D	UTVX6173*	40
650 H1 Mudpro	10	FA395X*	FA395R*	FA395SV*						MD6173D	MD6173D	UTVX6173*	41
650 H1 TRV	09	FA395X*	FA395R*	FA395SV*						MD6173D	MD6173D	UTVX6173*	42
650 H1 TBX 4 x 4 Auto Utility	07	FA395X*	FA395R*	FA395SV*						MD6173D	MD6173D	UTVX6173*	43
650 H1 TRV 4 x 4 Auto Plus Multirider	07	FA395X*	FA395R*	FA395SV*						MD6173D	MD6173D	UTVX6173*	44
650 H1 TRV 4 x 4 Auto Plus LE Multirider	07	FA395X*	FA395R*	FA395SV*						MD6173D	MD6173D	UTVX6173*	45
650 H1 TRV 4 x 4 Auto	08	FA395X*	FA395R*	FA395SV*						MD6173D	MD6173D	UTVX6173*	46
650 TBX	09	FA395X*	FA395R*	FA395SV*						MD6173D	MD6173D	UTVX6173*	47
650 V2 4 x 4 Auto Utility	04-06	FA395X*	FA395R*	FA395SV*						MD6173D	MD6173D	UTVX6173*	48
650 V2 4 x 4 Auto LE Utility	04-05	FA395X*	FA395R*	FA395SV*						MD6173D	MD6173D	UTVX6173*	49
650 V2 4 x 4 Auto LE TS Utility	06	FA395X*	FA395R*	FA395SV*						MD6173D	MD6173D	UTVX6173*	50
700 Diesel Utility	07-08	FA395X*	FA395R*	FA395SV*						MD6173D	MD6173D	UTVX6173*	51
700i GT	11-12	FA395X*	FA395R*	FA395SV*						MD6173D	MD6173D	UTVX6173*	52
700 TRV H2 EFI Cruiser	09-10	FA395X*	FA395R*	FA395SV*						MD6173D	MD6173D	UTVX6173*	53
700 TRV	11-12	FA395X*	FA395R*	FA395SV*						MD6173D	MD6173D	UTVX6173*	54
700 TRV Cruiser	11-12	FA395X*	FA395R*	FA395SV*						MD6173D	MD6173D	UTVX6173*	55
700 TRV GT	11-12	FA395X*	FA395R*	FA395SV*						MD6173D	MD6173D	UTVX6173*	56

APPLICATIONS

BRAKE

⚡ This symbol indicates a rotor made of billet steel, and should be only used with EBC FA Kevlar® Organic or Vee pads.

SAFETY NOTICE - With vehicles primarily designed for off highway use such as quads now being used on the highway, we would recommend the use of X or MXS pads for highway use and ONLY using the R and SV higher density / harder pad series for off road riding.

*-2 Sets Required. † For Vee disc colours add RED, BLU, GRN, GLD, ORG suffix to part number. **SAFETY WARNING:- DO NOT USE HH PADS ON REAR UNLESS ALSO USED ON FRONT TO AVOID BRAKE IMBALANCE**

FRONT: Non-Japanese Bikes Cont'd

REAR: Non-Japanese Bikes

Line #	BRAKE ROTOR CHOICES - FRONT						DISC PAD CHOICES - REAR					BRAKE ROTOR CHOICES - REAR				
	CC Custom Rotor	CX Extreme® /Vee-Rotor	OS Series Oversize 250/280mm Rotor Kit	OSX Series Oversize 280mm Rotor Kit	Relocating Bracket for Oversize Rotor	SMX Series Oversize 320mm Rotor Kit	Relocating Bracket for 320mm Rotor		Sintered/HH Pads/ Grooved Shoes	SV Series Severe Duty Pads	EPFA Sintered Fast Road/ Track Pads	Specialty Pads SXR/ VEE/MXS Race	Standard Rotor	Vintage Rotor / UTV Oversize Brake Kit	Contour Profile Rotor	CX Extreme® /Vee-Rotor
1								FA271X	FA271R				MD6173D	UTVX6173		
2								FA395X	FA395R	FA395SV			MD6173D	UTVX6173		
3								FA395X	FA395R	FA395SV			MD6173D	UTVX6173		
4								FA271X	FA271R				MD6173D	UTVX6173		
5								FA395X	FA395R	FA395SV			MD6173D	UTVX6173		
6								FA271X	FA271R				MD6173D	UTVX6173		
7								FA395X	FA395R	FA395SV			MD6173D	UTVX6173		
8								FA271X	FA271R				MD6173D	UTVX6173		
9								FA395X	FA395R	FA395SV			MD6173D	UTVX6173		
10								FA395X	FA395R	FA395SV			MD6375D			
11								FA395X	FA395R	FA395SV			MD6375D			
12								FA395X	FA395R	FA395SV			MD6375D			
13								FA395X	FA395R	FA395SV			MD6383D	UTVX6383		
14								FA395X	FA395R	FA395SV			MD6173D	UTVX6173		
15								FA395X	FA395R	FA395SV			MD6173D	UTVX6173		
16								FA395X	FA395R	FA395SV			MD6173D	UTVX6173		
17								FA395X	FA395R	FA395SV			MD6173D	UTVX6173		
18								FA395X	FA395R	FA395SV			MD6173D	UTVX6173		
19								FA395X	FA395R	FA395SV			MD6173D	UTVX6173		
20								FA395X	FA395R	FA395SV			MD6173D	UTVX6173		
21								FA395X	FA395R	FA395SV			MD6173D	UTVX6173		
22								FA395X	FA395R	FA395SV			MD6173D	UTVX6173		
23								FA395X	FA395R	FA395SV			MD6173D	UTVX6173		
24								FA395X	FA395R	FA395SV			MD6173D	UTVX6173		
25								FA395X	FA395R	FA395SV			MD6173D	UTVX6173		
26								FA395X	FA395R	FA395SV			MD6173D	UTVX6173		
27								FA395X	FA395R	FA395SV			MD6173D	UTVX6173		
28								FA395X	FA395R	FA395SV			MD6173D	UTVX6173		
29								FA395X	FA395R	FA395SV			MD6375D			
30								FA395X	FA395R	FA395SV			MD6375D			
31								FA395X	FA395R	FA395SV			MD6375D			
32								FA395X	FA395R	FA395SV			MD6375D			
33								FA395X	FA395R	FA395SV			MD6383D	UTVX6383		
34								FA395X	FA395R	FA395SV			MD6383D	UTVX6383		
35								FA271X	FA271R				MD6173D	UTVX6173		
36								FA271X	FA271R				MD6173D	UTVX6173		
37								FA271X	FA271R				MD6173D	UTVX6173		
38								FA271X	FA271R				MD6173D	UTVX6173		
39								FA395X	FA395R	FA395SV			MD6173D	UTVX6173		
40								FA395X	FA395R	FA395SV			MD6173D	UTVX6173		
41								FA395X	FA395R	FA395SV			MD6173D	UTVX6173		
42								FA395X	FA395R	FA395SV			MD6173D	UTVX6173		
43								FA395X	FA395R	FA395SV			MD6173D	UTVX6173		
44								FA395X	FA395R	FA395SV			MD6173D	UTVX6173		
45								FA395X	FA395R	FA395SV			MD6173D	UTVX6173		
46								FA395X	FA395R	FA395SV			MD6173D	UTVX6173		
47								FA395X	FA395R	FA395SV			MD6173D	UTVX6173		
48								FA395X	FA395R	FA395SV			MD6173D	UTVX6173		
49								FA395X	FA395R	FA395SV			MD6173D	UTVX6173		
50								FA395X	FA395R	FA395SV			MD6173D	UTVX6173		
51								FA395X	FA395R	FA395SV			MD6173D	UTVX6173		
52								FA395X	FA395R	FA395SV			MD6173D	UTVX6173		
53								FA395X	FA395R	FA395SV			MD6173D	UTVX6173		
54								FA395X	FA395R	FA395SV			MD6173D	UTVX6173		
55								FA395X	FA395R	FA395SV			MD6173D	UTVX6173		
56								FA395X	FA395R	FA395SV			MD6173D	UTVX6173		

BRAKE APPLICATIONS

⚠ This symbol indicates a rotor made of billet steel, and should be only used with EBC FA Kevlar® Organic or Vee pads. SAFETY NOTICE - With vehicles primarily designed for off highway use such as quads now being used on the highway, we would recommend the use of X or MXS pads for highway use and ONLY using the R and SV higher density / harder pad series for off road riding.

*-2 Sets Required. † For Vee disc colours add RED, BLU, GRN, GLD, ORG suffix to part number. **SAFETY WARNING:- DO NOT USE HH PADS ON REAR UNLESS ALSO USED ON FRONT TO AVOID BRAKE IMBALANCE**

FRONT: Non-Japanese Bikes



ARCTIC CAT (ATV)



DISC PAD CHOICES - FRONT

BRAKE ROTOR CHOICES - FRONT

										Line #
700 EFI 4 x 4 Utility	FA395X*	FA395R*	FA395SV*			MD6173D	MD6173D	UTVX6173*		1
700 EFI 4 x 4 LE Utility	FA395X*	FA395R*	FA395SV*			MD6173D	MD6173D	UTVX6173*		2
700 EFI 4 x 4 SE Utility	FA395X*	FA395R*	FA395SV*			MD6173D	MD6173D	UTVX6173*		3
700 EFI Cruiser	FA395X*	FA395R*	FA395SV*			MD6173D	MD6173D	UTVX6173*		4
700 EFI 4 x 4 Auto M4	FA395X*	FA395R*	FA395SV*			MD6173D	MD6173D	UTVX6173*		5
700 EFI 4 x 4 Auto TRV LE	FA395X*	FA395R*	FA395SV*			MD6173D	MD6173D	UTVX6173*		6
700 H1 EFI	FA395X*	FA395R*	FA395SV*			MD6173D	MD6173D	UTVX6173*		7
700 H1 EFI LE	FA395X*	FA395R*	FA395SV*			MD6173D	MD6173D	UTVX6173*		8
700 H1 EFI 4 x 4 Auto SE	FA395X*	FA395R*	FA395SV*			MD6173D	MD6173D	UTVX6173*		9
700 H1 TBX EFI	FA395X*	FA395R*	FA395SV*			MD6173D	MD6173D	UTVX6173*		10
700 Super Duty Diesel	FA395X*	FA395R*	FA395SV*			MD6173D	MD6173D	UTVX6173*		11
700 Mudpro	FA395X*	FA395R*	FA395SV*			MD6173D	MD6173D	UTVX6173*		12
700 H1 EFI Mudpro	FA395X*	FA395R*	FA395SV*			MD6173D	MD6173D	UTVX6173*		13
700i	FA395X*	FA395R*	FA395SV*			MD6173D	MD6173D	UTVX6173*		14
700i LTD	FA395X*	FA395R*	FA395SV*			MD6173D	MD6173D	UTVX6173*		15
700i Mudpro	FA395X*	FA395R*	FA395SV*			MD6173D	MD6173D	UTVX6173*		16
700i Mudpro LTD	FA395X*	FA395R*	FA395SV*			MD6173D	MD6173D	UTVX6173*		17
700 S	FA395X*	FA395R*	FA395SV*			MD6173D	MD6173D	UTVX6173*		18
700 S LTD	FA395X*	FA395R*	FA395SV*			MD6173D	MD6173D	UTVX6173*		19
700 TBX LTD	FA395X*	FA395R*	FA395SV*			MD6173D	MD6173D	UTVX6173*		20
700 ATV (Core/Mid Size)	FA395X*	FA395R*	FA395SV*			TBC	TBC			21
700 ATV Diesel	FA395X*	FA395R*	FA395SV*			MD6375D	MD6375D			22
700 ATV LTD	FA395X*	FA395R*	FA395SV*			MD6375D	MD6375D			23
700 ATV XT	FA395X*	FA395R*	FA395SV*			MD6375D	MD6375D			24
700 TBX	FA395X*	FA395R*	FA395SV*			MD6375D	MD6375D			25
700 TRV XT	FA395X*	FA395R*	FA395SV*			MD6375D	MD6375D			26
Alterra 700 inc XT and Mudpro	FA395X*	FA395R*	FA395SV*			MD6383D	MD6383D	UTVX6383*		27
Alterra TBX 700	FA395X*	FA395R*	FA395SV*			MD6383D	MD6383D	UTVX6383*		28
Alterra VLX 700	FA395X*	FA395R*	FA395SV*			MD6383D	MD6383D	UTVX6383*		29
XR 700 LTD/XT	FA395X*	FA395R*	FA395SV*			MD6383D	MD6383D	UTVX6383*		30
1000 Mudpro	FA395X*	FA395R*	FA395SV*		SXR395HH*	MD6271D	MD6271D	UTVX6271*		31
Alterra 1000 TRV XT EPS	FA395X*	FA395R*	FA395SV*			MD6383D	MD6383D	UTVX6383*		32
1000 H2 Mudpro EFI	FA395X*	FA395R*	FA395SV*		SXR395HH*	MD6173D	MD6173D	UTVX6173*		33
1000 Mudpro SE EPS	FA395X*	FA395R*	FA395SV*			MD6383D	MD6383D	UTVX6383*		34
1000 TRV Cruiser	FA395X*	FA395R*	FA395SV*		SXR395HH*	MD6173D	MD6173D	UTVX6173*		35
1000 TRV H2 EFI Cruiser	FA395X*	FA395R*	FA395SV*		SXR395HH*	MD6173D	MD6173D	UTVX6173*		36
Thundercat 1000 H2	FA395X*	FA395R*	FA395SV*		SXR395HH*	MD6173D	MD6173D	UTVX6173*		37
Thundercat 1000 H2 LE	FA395X*	FA395R*	FA395SV*		SXR395HH*	MD6173D	MD6173D	UTVX6173*		38
1000 TRV H2 Efi	FA395X*	FA395R*	FA395SV*		SXR395HH*	MD6173D	MD6173D	UTVX6173*		39
1000 XT	FA395X*	FA395R*	FA395SV*			TBC	TBC			40
										41
										42
500 Prowler	FA377X*	FA377R*				MD6267D	MD6267D			43
HDX 500 Prowler	FA395X*	FA395R*	FA395SV*		SXR395HH*	MD6271D	MD6271D	UTVX6271*		44
HDX 500 LTD Prowler	FA395X*	FA395R*	FA395SV*		SXR395HH*	MD6271D	MD6271D	UTVX6271*		45
HDX 500 XT Prowler	FA395X*	FA395R*	FA395SV*		SXR395HH*	MD6271D	MD6271D	UTVX6271*		46
550 H1 EFI Prowler	FA395X*	FA395R*	FA395SV*		SXR395HH*	MD6271D	MD6271D	UTVX6271*		47
XT 550	FA395X*	FA395R*	FA395SV*		SXR395HH*	MD6271D	MD6271D	UTVX6271*		48
XT 550 Prowler	FA395X*	FA395R*	FA395SV*		SXR395HH*	MD6271D	MD6271D	UTVX6271*		49
XT 650 H1 Prowler	FA395X*	FA395R*	FA395SV*		SXR395HH*	MD6271D	MD6271D	UTVX6271*		50
650 H1 Prowler	FA395X*	FA395R*	FA395SV*		SXR395HH*	MD6271D	MD6271D	UTVX6271*		51
650 Prowler 4 x 4/M4	FA395X*	FA395R*	FA395SV*		SXR395HH*	MD6271D	MD6271D	UTVX6271*		52
HDX 700 Prowler	FA395X*	FA395R*	FA395SV*		SXR395HH*	MD6271D	MD6271D	UTVX6271*		53
DX 700 LTD Prowler	FA395X*	FA395R*	FA395SV*		SXR395HH*	MD6271D	MD6271D	UTVX6271*		54
HDX 700 Trail	FA395X*	FA395R*	FA395SV*		SXR395HH*	MD6271D	MD6271D	UTVX6271*		55
XTX 700 H1 LE Prowler	FA395X*	FA395R*	FA395SV*		SXR395HH*	MD6271D	MD6271D	UTVX6271*		56

FRONT

ARCTIC CAT (SIDE X SIDE)

500 Prowler	18-19
HDX 500 Prowler	14
HDX 500 LTD Prowler	14
HDX 500 XT Prowler	14
550 H1 EFI Prowler	09
XT 550	10-11
XT 550 Prowler	11-14
XT 650 H1 Prowler	06-09
650 H1 Prowler	07
650 Prowler 4 x 4/M4	08
HDX 700 Prowler	11-14
DX 700 LTD Prowler	14
HDX 700 Trail	14
XTX 700 H1 LE Prowler	08

*2 Sets Required. † For Vee disc colours add RED, BLU, GRN, GLD, ORG suffix to part number. **SAFETY WARNING:** DO NOT USE HH PADS ON REAR UNLESS ALSO USED ON FRONT TO AVOID BRAKE IMBALANCE

APPLICATIONS

BRAKE

⚡ This symbol indicates a rotor made of billet steel, and should be only used with EBC FA Kevlar® Organic or Vee pads.

SAFETY NOTICE - With vehicles primarily designed for off highway use such as quads now being used on the highway, we would recommend the use of X or MXS pads for highway use and ONLY using the R and SV higher density / harder pad series for off road riding.

FRONT: Non-Japanese Bikes Cont'd

REAR: Non-Japanese Bikes

Line #	BRAKE ROTOR CHOICES - FRONT							DISC PAD CHOICES - REAR					BRAKE ROTOR CHOICES - REAR			
	CC Custom Rotor	CX Extreme® /Vee-Rotor	OS Series Oversize 250/280mm Rotor Kit	OSX Series Oversize 280mm Rotor Kit	Relocating Bracket for Oversize Rotor	SMX Series Oversize 320mm Rotor Kit	Relocating Bracket for 320mm Rotor		Sintered/HH Pads/ Grooved Shoes	SV Series Severe Duty Pads	EPFA Sintered Fast Road/ Track Pads	Specialty Pads SXR/ VEE/MXS Race	Standard Rotor	Vintage Rotor / UTV Oversize Brake Kit	Contour Profile Rotor	CX Extreme® /Vee-Rotor
1								FA395X	FA395R	FA395SV			MD6173D	UTVX6173		
2								FA395X	FA395R	FA395SV			MD6173D	UTVX6173		
3								FA395X	FA395R	FA395SV			MD6173D	UTVX6173		
4								FA395X	FA395R	FA395SV			MD6173D	UTVX6173		
5								FA395X	FA395R	FA395SV			MD6173D	UTVX6173		
6								FA395X	FA395R	FA395SV			MD6173D	UTVX6173		
7								FA395X	FA395R	FA395SV			MD6173D	UTVX6173		
8								FA395X	FA395R	FA395SV			MD6173D	UTVX6173		
9								FA395X	FA395R	FA395SV			MD6173D	UTVX6173		
10								FA395X	FA395R	FA395SV			MD6173D	UTVX6173		
11								FA395X	FA395R	FA395SV			MD6173D	UTVX6173		
12								FA395X	FA395R	FA395SV			MD6173D	UTVX6173		
13								FA395X	FA395R	FA395SV			MD6173D	UTVX6173		
14								FA395X	FA395R	FA395SV			MD6173D	UTVX6173		
15								FA395X	FA395R	FA395SV			MD6173D	UTVX6173		
16								FA395X	FA395R	FA395SV			MD6173D	UTVX6173		
17								FA395X	FA395R	FA395SV			MD6173D	UTVX6173		
18								FA395X	FA395R	FA395SV			MD6173D	UTVX6173		
19								FA395X	FA395R	FA395SV			MD6173D	UTVX6173		
20								FA395X	FA395R	FA395SV			MD6173D	UTVX6173		
21								FA395X	FA395R	FA395SV			TBC			
22								FA395X	FA395R	FA395SV			MD6375D			
23								FA395X	FA395R	FA395SV			MD6375D			
24								FA395X	FA395R	FA395SV			MD6375D			
25								FA395X	FA395R	FA395SV			MD6375D			
26								FA395X	FA395R	FA395SV			MD6375D			
27								FA395X	FA395R	FA395SV			MD6383D	UTVX6383		
28								FA395X	FA395R	FA395SV			MD6383D	UTVX6383		
29								FA395X	FA395R	FA395SV			MD6383D	UTVX6383		
30								FA395X	FA395R	FA395SV			MD6383D	UTVX6383		
31								FA395X	FA395R	FA395SV		SXR395HH	MD6271D	UTVX6271		
32								FA395X	FA395R	FA395SV			MD6383D	UTVX6383		
33								FA395X	FA395R	FA395SV		SXR395HH	MD6173D	UTVX6173		
34								FA395X	FA395R	FA395SV			MD6383D	UTVX6383		
35								FA395X	FA395R	FA395SV		SXR395HH	MD6173D	UTVX6173		
36								FA395X	FA395R	FA395SV		SXR395HH	MD6173D	UTVX6173		
37								FA395X	FA395R	FA395SV		SXR395HH	MD6173D	UTVX6173		
38								FA395X	FA395R	FA395SV		SXR395HH	MD6173D	UTVX6173		
39								FA395X	FA395R	FA395SV		SXR395HH	MD6173D	UTVX6173		
40								FA395X	FA395R	FA395SV			TBC			
41																
42																
43								FA377X	FA377R				MD6267			
44								FA395X	FA395R	FA395SV		SXR395HH	N/A			
45								FA395X	FA395R	FA395SV		SXR395HH	N/A			
46								FA395X	FA395R	FA395SV		SXR395HH	N/A			
47								FA395X	FA395R	FA395SV		SXR395HH	N/A			
48								FA395X	FA395R	FA395SV		SXR395HH	N/A			
49								FA395X	FA395R	FA395SV		SXR395HH	N/A			
50								FA395X	FA395R	FA395SV		SXR395HH	N/A			
51								FA395X	FA395R	FA395SV		SXR395HH	N/A			
52								FA395X	FA395R	FA395SV		SXR395HH	N/A			
53								FA395X*	FA395R*	FA395SV*		SXR395HH*	MD6173D*	UTVX6173*		
54								FA395X*	FA395R*	FA395SV*		SXR395HH*	MD6173D*	UTVX6173*		
55								FA395X*	FA395R*	FA395SV*		SXR395HH*	MD6173D*	UTVX6173*		
56								FA395X	FA395R	FA395SV		SXR395HH	N/A			

BRAKE APPLICATIONS

⚠ This symbol indicates a rotor made of billet steel, and should be only used with EBC FA Kevlar® Organic or Vee pads.
SAFETY NOTICE - With vehicles primarily designed for off highway use such as quads now being used on the highway, we would recommend the use of X or MXS pads for highway use and ONLY using the R and SV higher density / harder pad series for off road riding.

*-2 Sets Required. † For Vee disc colours add RED, BLU, GRN, GLD, ORG suffix to part number. **SAFETY WARNING:- DO NOT USE HH PADS ON REAR UNLESS ALSO USED ON FRONT TO AVOID BRAKE IMBALANCE**

FRONT: Non-Japanese Bikes



ARCTIC CAT (SIDE X SIDE)



DISC PAD CHOICES - FRONT

BRAKE ROTOR CHOICES - FRONT

Model	Year	Disc Pad Choice	SV Series Severe Duty Pads	EPFA Sintered Fast Road/Track Pads	GPFAX Sintered RACE ONLY Pads	Specialty Pads SXR/VEE/MXS Race	Rotor Choices			Contour Profile Rotor	Line #
							Standard Rotor Left	Standard Rotor Right	Vintage Rotor / UTV Oversize Brake Kit		
XTX 700 H1 EFI Prowler	09	FA395X*	FA395R*	FA395SV*		SXR395HH*	MD6271D	MD6271D	UTVX6271*		1
XTX 700 Prowler	11-14	FA395X*	FA395R*	FA395SV*		SXR395HH*	MD6271D	MD6271D	UTVX6271*		2
Wildcat Sport 700	15	TBC									3
Wildcat Sport XT 700	15	TBC									4
Wildcat Sport LTD	16	TBC									5
Wildcat Sport 700 XT inc LTD	18-19	TBC									6
Wildcat Trail 700 XT inc LTD	15-19	FA395X*	FA395R*	FA395SV*		SXR395HH*	MD6384D	MD6384D	UTVX6384*		7
Stampede 900 XT, XTR inc LTD	17-19	TBC									8
Stampede 900 4 Inferno inc TT Kanati	18	TBC									9
Havoc X EPS	18	TBC									10
XTZ 1000 Prowler	10-14	FA395X*	FA395R*	FA395SV*		SXR395HH*	MD6271D	MD6271D	UTVX6271*		11
Wildcat 1000 GT	11-12	FA395X*	FA395R*	FA395SV*		SXR395HH*	MD6271D	MD6271D	UTVX6271*		12
Wildcat 1000 GT	13-14	FA395X*	FA395R*	FA395SV*		SXR395HH*	TBC	TBC			13
Wildcat 1000 LTD	13-14	FA395X*	FA395R*	FA395SV*		SXR395HH*	TBC	TBC			14
Wildcat X 1000	14-16	FA395X*	FA395R*	FA395SV*		SXR395HH*	TBC	TBC			15
Wildcat X-SE-EPS 1000	16	FA395X*	FA395R*	FA395SV*		SXR395HH*	TBC	TBC			16
Wildcat X-LTD 1000	14-15	FA395X*	FA395R*	FA395SV*		SXR395HH*	TBC	TBC			17
Wildcat X-LTD-EPS 1000	16	FA395X*	FA395R*	FA395SV*		SXR395HH*	TBC	TBC			18
Wildcat 4X 1000	14-16		FA610R*	FA610SV*		SXR610HH*	MD6384D	MD6384D	UTVX6384*		19
Wildcat 4X-LTD 1000	14-15		FA610R*	FA610SV*		SXR610HH*	MD6384D	MD6384D	UTVX6384*		20
Wildcat 4 1000	13-14		FA610R*	FA610SV*		SXR610HH*	MD6384D	MD6384D	UTVX6384*		21
Wildcat 4 LTD 1000	14		FA610R*	FA610SV*		SXR610HH*	MD6384D	MD6384D	UTVX6384*		22
Wildcat 1000 X, XT and LTD	19	FA740X*	FA740X*								23
1000 Prowler Pro Crew and XT	19-20	FA740X*	FA740X*								24
1000 Cushman Hauler 4x4 Diesel	19	FA740X*	FA740X*								25
1000 Cushman Hauler 4x4 Crew and EPS Diesel	19	FA740X*	FA740X*								26
Hand Brake Pads And Disc Not Available For Any Models In This Range Of Quads.											27
											28
											29
ARGO											30
AR 150-18	07-08	TBC						TBC			31
AR 150-2	07-08	TBC					N/A				32
											33
											34
BAJAJ											35
Chetak 150	04-08	TBC									36
											37
BENELLI											38
Caffenero Scooter 150		SFA228	SFA228HH				TBC				39
Zafferano Scooter 250 EFI		SFA228	SFA228HH				TBC				40
		SFA197	SFA197HH					TBC			41
BN125	18-20	FA711				FA711V					42
Leoncino 125	18-20	FA658				FA658V					43
T125	18-20	FA711				FA711V					44
TRK125	18-19	FA658	FA658HH			FA658V					45
Leoncino 250	18-19	FA658	FA658HH			FA658V					46
TNT 300	17-18	FA658*	FA658HH*			FA658V*				TBC	47
Leoncino 500	18-19		FA322/4HH								48
Leoncino 500 Trail	18-19	FA142*	FA142HH*								49
502C	18-19		FA322/4HH*								50
TRK502	18-21		FA322/4HH*								51
TRK502X	18-21	FA209/2*	FA209/2HH*								52
TNT 600											53
BENNCHE (ATV)											54
500 Gray Wolf	15-16	FA84X*	FA84R*	FA84SV*			TBC	TBC			55
700 Gray Wolf	15-16	FA84X*	FA84R*	FA84SV*			TBC	TBC			56

APPLIATIONS

BRAKE

⚡ This symbol indicates a rotor made of billet steel, and should be only used with EBC FA Kevlar® Organic or Vee pads.

SAFETY NOTICE - With vehicles primarily designed for off highway use such as quads now being used on the highway, we would recommend the use of X or MXS pads for highway use and ONLY using the R and SV higher density / harder pad series for off road riding.

*-2 Sets Required. † For Vee disc colours add RED, BLU, GRN, GLD, ORG suffix to part number. **SAFETY WARNING:- DO NOT USE HH PADS ON REAR UNLESS ALSO USED ON FRONT TO AVOID BRAKE IMBALANCE**

FRONT: Non-Japanese Bikes Cont'd

REAR: Non-Japanese Bikes

Line #	BRAKE ROTOR CHOICES - FRONT							DISC PAD CHOICES - REAR					BRAKE ROTOR CHOICES - REAR			
	CC Custom Rotor	CX Extreme® /Vee-Rotor	OS Series Oversize 250/280mm Rotor Kit	OSX Series Oversize 280mm Rotor Kit	Relocating Bracket for Oversize Rotor	SMX Series Oversize 320mm Rotor Kit	Relocating Bracket for 320mm Rotor		Sintered/HH Pads/ Grooved Shoes	SV Series Severe Duty Pads	EPFA Sintered Fast Road/ Track Pads	Specialty Pads SXR/ VEE/MXS Race	Standard Rotor	Vintage Rotor / UTV Oversize Brake Kit	Contour Profile Rotor	CX Extreme® /Vee-Rotor
1								FA395X	FA395R	FA395SV		SXR395HH	N/A			
2								FA395X	FA395R	FA395SV		SXR395HH	N/A			
3																
4																
5																
6																
7								FA395X*	FA395R*	FA395SV*		SXR395HH*	MD6384D*	UTVX6384*		
8																
9																
10																
11								FA395X*	FA395R*	FA395SV*		SXR395HH*	MD6173D*	UTVX6173*		
12								FA395X*	FA395R*	FA395SV*		SXR395HH*	MD6173D*	UTVX6173*		
13								FA395X*	FA395R*	FA395SV*		SXR395HH*	TBC			
14								FA395X*	FA395R*	FA395SV*		SXR395HH*	TBC			
15								FA395X*	FA395R*	FA395SV*		SXR395HH*	MD6383D*	UTVX6383*		
16								FA395X*	FA395R*	FA395SV*		SXR395HH*	MD6383D*	UTVX6383*		
17								FA395X*	FA395R*	FA395SV*		SXR395HH*	TBC	TBC		
18								FA395X*	FA395R*	FA395SV*		SXR395HH*	TBC	TBC		
19								FA395X*	FA395R*	FA395SV*		SXR395HH*	MD6384D*	UTVX6384*		
20								FA395X*	FA395R*	FA395SV*		SXR395HH*	MD6384D*	UTVX6384*		
21								FA395X*	FA395R*	FA395SV*		SXR395HH*	MD6384D*	UTVX6384*		
22								FA395X*	FA395R*	FA395SV*		SXR395HH*	MD6384D*	UTVX6384*		
23								FA742X*	FA742R*							
24								FA742X*	FA742R*							
25								FA742X*	FA742R*							
26								FA742X*	FA742R*							
27																
28																
29																
30								TBC					N/A			
31								TBC					N/A			
32																
33																
34								TBC								
35																
36																
37																
38								SFA228	SFA228HH					TBC		
39																
40								FA629								
41								FA698	FA698HH							
42								FA629								
43								FA698	FA698HH							
44								FA698	FA698HH							
45								FA698	FA698HH			FA698V			TBC	
46								FA698	FA698HH			FA698V				
47								FA698	FA698HH			FA698V				
48								FA698	FA698HH			FA698V				
49								FA698	FA698HH			FA698V				
50								FA698	FA698HH			FA698V				
51								FA698	FA698HH			FA698V				
52																
53																
54								FA344X	FA344R	FA344SV				TBC		
55								FA344X	FA344R	FA344SV				TBC		
56																

BRAKE APPLICATIONS

⚠ This symbol indicates a rotor made of billet steel, and should be only used with EBC FA Kevlar® Organic or Vee pads.
 SAFETY NOTICE - With vehicles primarily designed for off highway use such as quads now being used on the highway, we would recommend the use of X or MXS pads for highway use and ONLY using the R and SV higher density / harder pad series for off road riding.

*-2 Sets Required. † For Vee disc colours add RED, BLU, GRN, GLD, ORG suffix to part number. **SAFETY WARNING:- DO NOT USE HH PADS ON REAR UNLESS ALSO USED ON FRONT TO AVOID BRAKE IMBALANCE**

FRONT: Non-Japanese Bikes



BENNCHE (UTV Side X Side)



			DISC PAD CHOICES - FRONT					BRAKE ROTOR CHOICES - FRONT				
												Line #
250 Cowboy	Left	15-16	FA165X	FA165R	FA165SV				TBC			1
	Right		FA135X	FA135R	FA135SV				TBC			2
250 Spire	Left	15-16	FA165X	FA165R	FA165SV				TBC			3
	Right		FA135X	FA135R	FA135SV				TBC			4
400 Bighorn	Left	11-16	FA165X	FA165R	FA165SV				TBC			5
	Right		FA135X	FA135R	FA135SV				TBC			6
400 Bighorn Parking Brake		11-16										7
400 Cowboy	Left	15-16	FA165X	FA165R	FA165SV				TBC			8
	Right		FA135X	FA135R	FA135SV				TBC			9
400 Cowboy Parking Brake		15-16										10
500 Bighorn	Left	15-16	FA165X	FA165R	FA165SV				TBC			11
	Right		FA135X	FA135R	FA135SV				TBC			12
500 Bighorn Parking Brake		15-16										13
700 Bighorn	Left	15-16	FA165X	FA165R	FA165SV				TBC			14
	Right		FA135X	FA135R	FA135SV				TBC			15
700 Bighorn Parking Brake		15-16										16
700 X Bighorn	Left	15-16	FA165X	FA165R	FA165SV				TBC			17
	Right		FA135X	FA135R	FA135SV				TBC			18
700 X Bighorn Parking Brake		15-16										19
500 Cowboy	Left	14-16	FA165X	FA165R	FA165SV				TBC			20
	Right		FA135X	FA135R	FA135SV				TBC			21
500 Cowboy Parking Brake		14-16										22
700 Cowboy	Left	14-16	FA165X	FA165R	FA165SV				TBC			23
	Right		FA135X	FA135R	FA135SV				TBC			24
700 Cowboy Parking Brake		14-16										25
800 Spire	Left	14-16	FA165X	FA165R	FA165SV				TBC			26
	Right		FA135X	FA135R	FA135SV				TBC			27
1000 Cowboy	Left	15-16	FA165X	FA165R	FA165SV				TBC			28
	Right		FA135X	FA135R	FA135SV				TBC			29
1000 Cowboy Parking Brake		15-16										30
1000 Spire	Left	14-16	FA165X	FA165R	FA165SV				TBC			31
	Right		FA135X	FA135R	FA135SV				TBC			32
1000 Spire Parking Brake		14-16										33
1000 X Spire	Left	14-16	FA165X	FA165R	FA165SV				TBC			34
	Right		FA135X	FA135R	FA135SV				TBC			35
1000 X Spire Parking Brake		14-16										36
												37
												38
BETA												39
Electric 20XL		18-19	CFA327									39
Electric 20		18-19	CFA327									40
Electric 16		18-19	CFA327									41
Eikon 50 Team		02-03	SFA115	SFA115HH				MD901D				42
Mini Trial 50		09-12	FA351					N/A				43
Rev 50/80		02-06	FA115X	FA115R				N/A				44
RR 50 Motard		06	FA167	FA167HH				N/A				45
RR 50		18-19	FA194									46
RR 50 Sport/Racing		18-19	FA194									47
Evo 80 Junior		09-12	FA303X					N/A				48
Evo 80 Junior		18-19	FA115X	FA115R								49
Evo 80		09-19	FA303X					N/A				50
125 TR32/33		86-87	FA99X	N/A				N/A				51
125 TR34		88	FA99X	N/A				N/A				52
125 TR34/35		89-90	FA115X	FA115R			MXS115	N/A				53
Evo 125 (2T)		10-19	FA164X					N/A				54
Trial Evo 125 (2T) MY20		20	FA164X	FA164R								55
Eikon 150		04	SFA47	SFA47HH				N/A				56

FRONT

APPLICATIONS

BRAKE

* This symbol indicates a rotor made of billet steel, and should be only used with EBC FA Kevlar® Organic or Vee pads.
 SAFETY NOTICE - With vehicles primarily designed for off highway use such as quads now being used on the highway, we would recommend the use of X or MXS pads for highway use and ONLY using the R and SV higher density / harder pad series for off road riding.

*-2 Sets Required. † For Vee disc colours add RED, BLU, GRN, GLD, ORG suffix to part number. **SAFETY WARNING:- DO NOT USE HH PADS ON REAR UNLESS ALSO USED ON FRONT TO AVOID BRAKE IMBALANCE**

FRONT: Non-Japanese Bikes Cont'd

REAR: Non-Japanese Bikes

Line #	BRAKE ROTOR CHOICES - FRONT						DISC PAD CHOICES - REAR					BRAKE ROTOR CHOICES - REAR				
	CC Custom Rotor	CX Extreme® /Vee-Rotor	OS Series Oversize 250/280mm Rotor Kit	OSX Series Oversize 280mm Rotor Kit	Relocating Bracket for Oversize Rotor	SMX Series Oversize 320mm Rotor Kit	Relocating Bracket for 320mm Rotor		Sintered/HH Pads/ Grooved Shoes	SV Series Severe Duty Pads	EPFA Sintered Fast Road/ Track Pads	Specialty Pads SXR/ VEE/MXS Race	Standard Rotor	Vintage Rotor / UTV Oversize Brake Kit	Contour Profile Rotor	CX Extreme® /Vee-Rotor
1								FA428X	FA428R	FA428SV			TBC			
2																
3								FA428X	FA428R	FA428SV			TBC			
4																
5								FA165X	FA165R	FA165SV			TBC			
6								FA135X	FA135R	FA135SV			TBC			
7								FA428X	FA428R				TBC			
8								FA165X	FA165R	FA165SV			TBC			
9								FA135X	FA135R	FA135SV			TBC			
10								FA428X	FA428R				TBC			
11								FA165X	FA165R	FA165SV			TBC			
12								FA135X	FA135R	FA135SV			TBC			
13								FA428X	FA428R				TBC			
14								FA165X	FA165R	FA165SV			TBC			
15								FA135X	FA135R	FA135SV			TBC			
16								FA428X	FA428R				TBC			
17								FA165X	FA165R	FA165SV			TBC			
18								FA135X	FA135R	FA135SV			TBC			
19								FA428X	FA428R				TBC			
20								FA165X	FA165R	FA165SV			TBC			
21								FA135X	FA135R	FA135SV			TBC			
22								FA428X	FA428R				TBC			
23								FA165X	FA165R	FA165SV			TBC			
24								FA135X	FA135R	FA135SV			TBC			
25								FA428X	FA428R				TBC			
26								FA165X	FA165R	FA165SV			TBC			
27								FA135X	FA135R	FA135SV			TBC			
28								FA165X	FA165R	FA165SV			TBC			
29								FA135X	FA135R	FA135SV			TBC			
30								FA428X	FA428R				TBC			
31								FA165X	FA165R	FA165SV			TBC			
32								FA135X	FA135R	FA135SV			TBC			
33								FA428X	FA428R				TBC			
34								FA165X	FA165R	FA165SV			TBC			
35								FA135X	FA135R	FA135SV			TBC			
36								FA428X	FA428R				TBC			
37																
38																
39								CFA327R								
40								CFA327R								
41								CFA327R								
42								SFA115	SFA115HH				MD901D			
43								N/A					N/A			
44								FA115X	FA115R				N/A			
45								FA115	FA115HH				N/A			
46								FA367/2X	FA367/2R							
47								FA367/2X	FA367/2R							
48								FA115X	FA115R				N/A			
49								FA115X	FA115R				N/A			
50								FA403X					N/A			
51									841G				N/A			
52								FA116					N/A			
53								FA115X	FA115R		MXS115		N/A			
54								FA495X					N/A			
55								FA495X					N/A			
56								SFA298	SFA298HH				N/A			

BRAKE APPLICATIONS

⚠ This symbol indicates a rotor made of billet steel, and should be only used with EBC FA Kevlar® Organic or Vee pads.
SAFETY NOTICE - With vehicles primarily designed for off highway use such as quads now being used on the highway, we would recommend the use of X or MXS pads for highway use and ONLY using the R and SV higher density / harder pad series for off road riding.

*-2 Sets Required. † For Vee disc colours add RED, BLU, GRN, GLD, ORG suffix to part number. **SAFETY WARNING:- DO NOT USE HH PADS ON REAR UNLESS ALSO USED ON FRONT TO AVOID BRAKE IMBALANCE**

FRONT: Non-Japanese Bikes



BETA



DISC PAD CHOICES - FRONT

BRAKE ROTOR CHOICES - FRONT

Model	Year	X	DISC PAD CHOICES - FRONT					BRAKE ROTOR CHOICES - FRONT				Line #	
			Icon	Sintered/HH Pads/Grooved Shoes	SV Series Severe Duty Pads	EPFA Sintered Fast Road/Track Pads	GPFA Sintered RACE ONLY Pads	Specialty Pads SXR/VEE/MXS Race	Standard Rotor Left	Standard Rotor Right	Vintage Rotor / UTV Oversize Brake Kit		Contour Profile Rotor
Rev 3 125/200/250/270	00-08		FA303X						N/A				1
RR Enduro 125 LC (2T) MY20	20-21		FA185X	FA185R		EPFA185HH			MXS185				2
RR Enduro 125 LC (4T)	18-19		FA185X	FA185R		EPFA185HH			MXS185				3
RR 2T 125	18-19		FA185X	FA185R		EPFA185HH			MXS185				4
RR 2T 125 RC	18-19		FA185X	FA185R		EPFA185HH			MXS185				5
Alp 200 4T	00-06		FA115X	FA115R					MXS115	N/A			6
Evo 200 (2T)	10-15		FA303X							N/A			7
Trial Evo 200 (2T) MY20	20		FA164X	FA164R									8
RR Enduro 200 (2T) MY20	20-21		FA185X	FA185R		EPFA185HH			MXS185				9
240 TR33	86-88		FA99X	N/A						N/A			10
Evo 250 (2T)	09-19		FA164X	FA164R						N/A			11
Evo 250 (2T) Factory	18-19		FA164X	FA164R									12
Evo 250 (4T)	09-19		FA164X	FA164R						N/A			13
Evo 250 (4T)	18-19		FA164X	FA164R									14
Trial Evo 250 (2T) MY20	20		FA164X	FA164R									15
Trial Evo 250 (2T) MY20 GB	20		FA164X	FA164R									16
Rev 3 250/270	05-08		FA303X							N/A			17
RR 250 (2T)	13-19		FA185X	FA185R		EPFA185HH			MXS185			N/A	18
RR 250 (2T) RC	18-19		FA185X	FA185R		EPFA185HH			MXS185				19
Enduro RR 250 (2T) MY20	20-21		FA185X	FA185R		EPFA185HH			MXS185				20
RR 250 4T	05-08		FA185X	FA185R		EPFA185HH			MXS185	N/A			21
260 TR34	86-88		FA99X	N/A						N/A			22
260 TR34/35/Zero	89-92		FA115X	FA115R					MXS115	N/A			23
Synt/Gara	93-96		FA115X	FA115R					MXS115	N/A			24
Evo 300 (2T)	09-19		FA303X							N/A			25
Trial Evo 300 (2T) MY20	20		FA164X	FA164R									26
Trial Evo 300 (2T) MY20 GB	20		FA164X	FA164R									27
Trial Evo 300 (2T) SS MY20	20		FA164X	FA164R									28
RR 300 (2T)	13-19		FA185X	FA185R		EPFA185HH			MXS185			N/A	29
Enduro RR 300 (2T) MY20	20-21		FA185X	FA185R		EPFA185HH			MXS185				30
RR 300 (2T) RC	18-19		FA185X	FA185R		EPFA185HH			MXS185				31
Xtrainer (2T) 300	18-19		FA185X	FA185R		EPFA185HH			MXS185				32
RR/RC 350 4T	11-19		FA185X	FA185R		EPFA185HH			MXS185			MD6367C	33
RS 350 4T	11-12		FA185X	FA185R		EPFA185HH			MXS185	N/A			34
Enduro RR-S 350 (4T) MY20	20-21		FA185X	FA185R		EPFA185HH			MXS185			N/A	35
RR/RC 390 4T	15-19		FA185X	FA185R		EPFA185HH			MXS185			N/A	36
Enduro RR-S 390 (4T) MY20	20-21		FA185X	FA185R		EPFA185HH			MXS185				37
RR 400 4T	05-11		FA185X	FA185R		EPFA185HH			MXS185	N/A			38
RR 400 4T	12-14		FA185X	FA185R		EPFA185HH			MXS185			MD6367C	39
SM 400 4T	10-11		FA185X	FA185R		EPFA185HH			MXS185	N/A			40
RR/RC 430 (4T)	15-19		FA185X	FA185R		EPFA185HH			MXS185			N/A	41
RS 430 (4T)	15		FA185X	FA185R		EPFA185HH			MXS185			N/A	42
Enduro RR 430 (4T) MY20	20-21		FA185X	FA185R		EPFA185HH			MXS185				43
RR 450 4T	05-11		FA185X	FA185R		EPFA185HH			MXS185	N/A			44
RR 450 4T	12-14		FA185X	FA185R		EPFA185HH			MXS185			MD6367C	45
RS 450 4T	08-14		FA185X	FA185R		EPFA185HH			MXS185	N/A			46
SM 450 4T	10-11		FA185X	FA185R		EPFA185HH			MXS185	N/A			47
RR/RC 480 4T	15-19		FA185X	FA185R		EPFA185HH			MXS185			N/A	48
Enduro RR 480 (4T) MY20	20		FA185X	FA185R		EPFA185HH			MXS185				49
RR 498 4T	15		FA185X	FA185R		EPFA185HH			MXS185			N/A	50
RS 500 4T	15		FA185X	FA185R		EPFA185HH			MXS185			N/A	51
Enduro RR-S 500 (4T) MY20	20-21		FA185X	FA185R		EPFA185HH			MXS185				52
RR 520 4T	11-12		FA185X	FA185R		EPFA185HH			MXS185	N/A			53
RR 525 4T	05-09		FA185X	FA185R		EPFA185HH			MXS185			MD6367C	54
RR 525 4T	10-11		FA185X	FA185R		EPFA185HH			MXS185			N/A	55
SM 525 4T	10-11		FA185X	FA185R		EPFA185HH			MXS185	N/A			56

APPLIATIONS
BRAKE
SAFETY NOTICE - With vehicles primarily designed for off highway use such as quads now being used on the highway, we would recommend the use of X or MXS pads for highway use and ONLY using the R and SV higher density / harder pad series for off road riding.

This symbol indicates a rotor made of billet steel, and should be only used with EBC FA Kevlar® Organic or Vee pads.

*-2 Sets Required. † For Vee disc colours add RED, BLU, GRN, GLD, ORG suffix to part number. **SAFETY WARNING:- DO NOT USE HH PADS ON REAR UNLESS ALSO USED ON FRONT TO AVOID BRAKE IMBALANCE**

FRONT: Non-Japanese Bikes Cont'd

REAR: Non-Japanese Bikes

Line #	BRAKE ROTOR CHOICES - FRONT						REAR	DISC PAD CHOICES - REAR					BRAKE ROTOR CHOICES - REAR			
	CC Custom Rotor	CX Extreme® /Vee-Rotor	OS Series Oversize 250/280mm Rotor Kit	OSX Series Oversize 280mm Rotor Kit	Relocating Bracket for Oversize Rotor	SMX Series Oversize 320mm Rotor Kit		Relocating Bracket for 320mm Rotor	 Sintered/HH Pads/ Grooved Shoes	SV Series Severe Duty Pads	EPFA Sintered Fast Road/ Track Pads	Specialty Pads SXR/ VEE/MXS Race	Standard Rotor	Vintage Rotor / UTV Oversize Brake Kit	Contour Profile Rotor	CX Extreme® /Vee-Rotor
1								FA303X							N/A	
2								FA367/2X	FA367/2R							
3								FA367/2X	FA367/2R							
4								FA367/2X	FA367/2R							
5								FA367/2X	FA367/2R							
6								FA115X	FA115R		MXS115	N/A				
7								FA495X				N/A				
8								FA495X								
9								FA367/2X	FA367/2R							
10									841G							
11								FA495X				N/A				
12								FA495X								
13								FA495X				N/A				
14								FA495X								
15								FA495X								
16								FA495X								
17								FA403X				N/A				
18								FA367X	FA367R					N/A		
19								FA367/2X	FA367/2R		MXS367					
20								FA367/2X	FA367/2R							
21								FA367X	FA367R		MXS367	N/A				
22								FA116				N/A				
23								FA164X	FA164R			N/A				
24								FA156X	N/A			N/A				
25								FA495X				N/A				
26								FA495X								
27								FA495X								
28								FA495X								
29								FA367X	FA367R		MXS367			N/A		
30								FA367/2X	FA367/2R							
31								FA367/2X	FA367/2R		MXS367/2					
32								FA367/2X	FA367/2R		MXS367/2					
33								FA367X	FA367R		MXS367			MD6368C		
34								FA367X	FA367R		MXS367	N/A				
35								FA367/2X	FA367/2R		MXS367/2			N/A		
36								FA367X	FA367R		MXS367			N/A		
37								FA367/2X	FA367/2R		MXS367/2					
38								FA367X	FA367R		MXS367	N/A				
39								FA367X	FA367R		MXS367			MD6368C		
40								FA367X	FA367R		MXS367	N/A				
41								FA367X	FA367R		MXS367			N/A		
42								FA367X	FA367R		MXS367			N/A		
43								FA367/2X	FA367/2R		MXS367/2					
44								FA367X	FA367R		MXS367	N/A				
45								FA367X	FA367R		MXS367			MD6368C		
46								FA367X	FA367R		MXS367	N/A				
47								FA367X	FA367R		MXS367	N/A				
48								FA367X	FA367R		MXS367			N/A		
49								FA367/2X	FA367/2R		MXS367/2					
50								FA367X	FA367R		MXS367			N/A		
51								FA367X	FA367R		MXS367			N/A		
52								FA367/2X	FA367/2R		MXS367/2					
53								FA367X	FA367R		MXS367	N/A				
54								FA367X	FA367R		MXS367			MD6368C		
55								FA367X	FA367R		MXS367			N/A		
56								FA367X	FA367R		MXS367	N/A				

BRAKE APPLICATIONS

⚠ This symbol indicates a rotor made of billet steel, and should be only used with EBC FA Kevlar® Organic or Vee pads.
 SAFETY NOTICE - With vehicles primarily designed for off highway use such as quads now being used on the highway, we would recommend the use of X or MXS pads for highway use and ONLY using the R and SV higher density / harder pad series for off road riding.

*-2 Sets Required. † For Vee disc colours add RED, BLU, GRN, GLD, ORG suffix to part number. **SAFETY WARNING:- DO NOT USE HH PADS ON REAR UNLESS ALSO USED ON FRONT TO AVOID BRAKE IMBALANCE**

FRONT: Non-Japanese Bikes



BETA



RS 520 4T 08-14

♦ Remove old speedo pick up magnet and refit to new EBC disc

BMW

C Evolution Electric 18-20

C1 125 99-03

C1 200 01-03

G 310 R 17-21

G 310 GS 17-21

G 310 GS Edition 40 20-21

C 400 X 18-21

G 450 X 08-11

R 45/45 N (Single rotor with ATE caliper) 78-09/80

R 45/45 N (Twin rotor with ATE caliper) 08-09/80

R 45/45 N (Single rotor with ATE caliper) 10/80-85

R 45/45 N (Twin rotor with ATE caliper) 10/80-85

R 45/45 N (Single rotor with Brembo caliper) 78-09/80

R 45/45 N (Twin rotor with Brembo caliper) 78-09/80

R 45/45 N (Single rotor with Brembo caliper) 10/80-85

R 45/45 N (Twin rotor with Brembo calipers) 10/80-85

R 45 T 80-85

R 50/5/60/5/60/6/75/5 69-76

C 600 Sport (Scooter) (K18C) 12-15

C 600 Sport (Scooter) (K18C) Parking Brake 12-15

R 60/7 (Single rotor) 76-80

R 60/7 (Double rotor model) 76-80

R 60 TIC (Single rotor) 78-82

R 60 TIC (Double rotor model) 78-82

C 650 GT (Scooter) (K19C) 12-21

C 650 GT (Scooter) (K19C) Parking Brake 12-21

C 650 GT Special Edition (Scooter) 15

C 650 GT Special Edition (Scooter) Parking Brake 15

C 650 Sport (Scooter) 16-21

C 650 Sport (Scooter) Parking Brake 16-21

F 650 (E169/0161) 09/93-96

F 650 (E169/0162 Funduro/High Screen/19" Front Wheel) 97-00

F 650 CS Scarver (K14/0174/0184/Belt Drive/17" Cast Wheel) 00-03

F 650 CS Scarver (K14/0177/0187/Belt Drive/17" Cast Wheel) 04-07

F 650 GS (R13/0172/0182) 99-03

F 650 GS (R13/0175/0185/Single Cylinder/19" Front Wheel) 04-07

F 650 GS (K72/0218/0228/798cc Twin Cylinder/Cast Wheels) 07-13

F 650 GS (30 Years GS/798cc Twin Cylinder/Cast Wheels) 11

F 650 GS Dakar (R13/0173/0183/21" Front Wheel) 99-03

F 650 GS Dakar (R13/0176/0186/Single Cylinder/21" Front Wheel) 04-07

F 650 ST (E169/163/168/Strada/18" Front Wheel/Low Screen) 97-00

G 650 GS (R131/Single Cylinder/Chain Drive/Cast Wheels) 09-15

G 650 GS Sertao (Spoke Wheel/Single Cylinder/Chain Drive) 10-14

G 650 XChallenge 07-09

G 650 Xmoto 07-09

G 650 XCountry 07-09

R 65 (Single rotor) 07/88-08/89

R 65 (Double rotor model) 07/88-08/89

R 65 GS 87-92

R 65 GS 87-92

R 65 LS 81-85

R 65 LS (Brembo caliper) 81-85

DISC PAD CHOICES - FRONT

BRAKE ROTOR CHOICES - FRONT

										Line #
RS 520 4T 08-14	FA185X	FA185R	EPFA185HH		MXS185	N/A				1
♦ Remove old speedo pick up magnet and refit to new EBC disc										
BMW										
C Evolution Electric 18-20	SFA142*	SFA142HH*			SFAC142*					5
C1 125 99-03	SFA209/2	SFA209/2HH				MD968D				6
C1 200 01-03	SFA209/2	SFA209/2HH				MD968D				7
G 310 R 17-21	FA606	FA606HH				MD881				8
G 310 GS 17-21	FA606	FA606HH				MD881				9
G 310 GS Edition 40 20-21	FA606	FA606HH				MD881				10
C 400 X 18-21	FA606	FA606HH				MD671				11
G 450 X 08-11	FA181X	FA181R	EPFA181HH		MXS181				MD6343C	12
R 45/45 N (Single rotor with ATE caliper) 78-09/80	FA57				FA57V	MD606LS				13
R 45/45 N (Twin rotor with ATE caliper) 08-09/80	FA57*				FA57V*	MD606LS	MD606RS			14
R 45/45 N (Single rotor with ATE caliper) 10/80-85	FA57				FA57V	MD606LS				15
R 45/45 N (Twin rotor with ATE caliper) 10/80-85	FA57*				FA57V*	MD606LS	MD606RS			16
R 45/45 N (Single rotor with Brembo caliper) 78-09/80	FA18	FA18HH			FA18V	MD606LS				17
R 45/45 N (Twin rotor with Brembo caliper) 78-09/80	FA18*	FA18HH*			FA18V*	MD606LS	MD606RS			18
R 45/45 N (Single rotor with Brembo caliper) 10/80-85	FA18	FA18HH			FA18V	MD606LS				19
R 45/45 N (Twin rotor with Brembo calipers) 10/80-85	FA18*	FA18HH*			FA18V*	MD606LS	MD606RS			20
R 45 T 80-85	FA57				FA57V	MD606LS				21
R 50/5/60/5/60/6/75/5 69-76	864									22
C 600 Sport (Scooter) (K18C) 12-15	SFA142*	SFA142HH*				MD671	MD671			23
C 600 Sport (Scooter) (K18C) Parking Brake 12-15	SFA257/2									24
R 60/7 (Single rotor) 76-80	FA22				FA22V	MD602LS				25
R 60/7 (Double rotor model) 76-80	FA22*				FA22V*	MD602LS	MD602RS			26
R 60 TIC (Single rotor) 78-82	FA22				FA22V	MD602LS				27
R 60 TIC (Double rotor model) 78-82	FA22*				FA22V*	MD602LS	MD602RS			28
C 650 GT (Scooter) (K19C) 12-21	SFA142*	SFA142HH*				MD671	MD671			29
C 650 GT (Scooter) (K19C) Parking Brake 12-21	SFA257/2									30
C 650 GT Special Edition (Scooter) 15	SFA142*	SFA142HH*				MD671	MD671			31
C 650 GT Special Edition (Scooter) Parking Brake 15	SFA257/2									32
C 650 Sport (Scooter) 16-21	SFA142*	SFA142HH*				MD671	MD671			33
C 650 Sport (Scooter) Parking Brake 16-21	SFA257/2									34
F 650 (E169/0161) 09/93-96	FA209/2	FA209/2HH			FA209/2V	MD650				35
F 650 (E169/0162 Funduro/High Screen/19" Front Wheel) 97-00	FA209/2	FA209/2HH			FA209/2V	MD650				36
F 650 CS Scarver (K14/0174/0184/Belt Drive/17" Cast Wheel) 00-03	FA209/2	FA209/2HH			FA209/2V	MD834				37
F 650 CS Scarver (K14/0177/0187/Belt Drive/17" Cast Wheel) 04-07	FA209/2	FA209/2HH			FA209/2V	MD834				38
F 650 GS (R13/0172/0182) 99-03	FA209/2	FA209/2HH			FA209/2V	MD834				39
F 650 GS (R13/0175/0185/Single Cylinder/19" Front Wheel) 04-07	FA209/2	FA209/2HH			FA209/2V	MD834				40
F 650 GS (K72/0218/0228/798cc Twin Cylinder/Cast Wheels) 07-13	FA209/2	FA209/2HH			FA209/2V	MD834X				41
F 650 GS (30 Years GS/798cc Twin Cylinder/Cast Wheels) 11	FA209/2	FA209/2HH			FA209/2V	MD834X				42
F 650 GS Dakar (R13/0173/0183/21" Front Wheel) 99-03	FA209/2	FA209/2HH			FA209/2V	MD834				43
F 650 GS Dakar (R13/0176/0186/Single Cylinder/21" Front Wheel) 04-07	FA209/2	FA209/2HH			FA209/2V	MD834				44
F 650 ST (E169/163/168/Strada/18" Front Wheel/Low Screen) 97-00	FA209/2	FA209/2HH			FA209/2V	MD650				45
G 650 GS (R131/Single Cylinder/Chain Drive/Cast Wheels) 09-15	FA209/2	FA209/2HH			FA209/2V	MD834X				46
G 650 GS Sertao (Spoke Wheel/Single Cylinder/Chain Drive) 10-14	FA209/2	FA209/2HH			FA209/2V	MD834X				47
G 650 XChallenge 07-09	FA209/2	FA209/2HH			FA209/2V	MD809			MD809C	48
G 650 Xmoto 07-09	FA244	FA244HH	EPFA244HH		FA244V	MD621X			MD621XC	49
G 650 XCountry 07-09	FA209/2	FA209/2HH			FA209/2V	MD809			MD809C	50
R 65 (Single rotor) 07/88-08/89	FA77				FA77V	N/A				51
R 65 (Double rotor model) 07/88-08/89	FA18*	FA18HH*			FA18V*	MD605LS	MD605RS			52
R 65 GS 87-92	FA18	FA18HH			FA18V		MD606RS			53
R 65 GS 87-92	FA18	FA18HH			FA18V		MD606RS			54
R 65 LS 81-85	FA57*				FA57V*	MD606LS	MD606RS			55
R 65 LS (Brembo caliper) 81-85	FA18*	FA18HH*			FA18V*	MD606LS	MD606RS			56

FRONT

APPLICATIONS

BRAKE
 This symbol indicates a rotor made of billet steel, and should be only used with EBC FA Kevlar® Organic or Vee pads.
 SAFETY NOTICE - With vehicles primarily designed for off highway use such as quads now being used on the highway, we would recommend the use of X or MXS pads for highway use and ONLY using the R and SV higher density / harder pad series for off road riding.

*-2 Sets Required. † For Vee disc colours add RED, BLU, GRN, GLD, ORG suffix to part number. **SAFETY WARNING:- DO NOT USE HH PADS ON REAR UNLESS ALSO USED ON FRONT TO AVOID BRAKE IMBALANCE**

FRONT: Non-Japanese Bikes Cont'd

REAR: Non-Japanese Bikes

Line #
1
2
3
4
5
6
7
8
9
10
11
12
13
14
15
16
17
18
19
20
21
22
23
24
25
26
27
28
29
30
31
32
33
34
35
36
37
38
39
40
41
42
43
44
45
46
47
48
49
50
51
52
53
54
55
56

BRAKE ROTOR CHOICES - FRONT							DISC PAD CHOICES - REAR					BRAKE ROTOR CHOICES - REAR			
CC Custom Rotor	CX Extreme® /Vee-Rotor	OS Series Oversize 250/280mm Rotor Kit	OSX Series Oversize 280mm Rotor Kit	Relocating Bracket for Oversize Rotor	SMX Series Oversize 320mm Rotor Kit	Relocating Bracket for 320mm Rotor		Sintered/HH Pads/ Grooved Shoes	SV Series Severe Duty Pads	EPFA Sintered Fast Road/ Track Pads	Specialty Pads SXR/ VEE/MXS Race	Standard Rotor	Vintage Rotor / UTV Oversize Brake Kit	Contour Profile Rotor	CX Extreme® /Vee-Rotor
							FA367X	FA367R			MXS367	N/A			
							SFA196	SFA196HH							
							SFA213	SFA213HH				MD968D			
							SFA213	SFA213HH				MD968D			
							FA213	FA213HH			FA213V	MD882			
							FA213	FA213HH			FA213V	MD882			
							FA213	FA213HH			FA213V	MD882			
							FA213	FA213HH			FA213V	MD671			
		OSG343C	OSXG6343	BRK011	SMXG6343	BRK012	FA368X	FA368R		EPFA368HH	MXS368	MDG342D		MD6342C	
							860								
							860								
							861								
							861								
							860								
							860								
							861								
							861								
							861								
							860								
							SFA196	SFA196HH				MD671			
							860								
							860								
							860								
							SFA196	SFA196HH				MD671			
							SFA196	SFA196HH				MD671			
							SFA196	SFA196HH				MD671			
							FA213	FA213HH			FA213V	MD651			
							FA213	FA213HH			FA213V	MD651			
							FA213	FA213HH			FA213V	MD651			
							FA213	FA213HH			FA213V	MD651			
							FA213	FA213HH			FA213V	MD651			
							FA213	FA213HH			FA213V	MD651			
							FA213	FA213HH			FA213V	MD651			
							FA213	FA213HH			FA213V	MD671			
							FA213	FA213HH			FA213V	MD651			
							FA213	FA213HH			FA213V	MD651			
							FA213	FA213HH			FA213V	MD651			
							FA213	FA213HH			FA213V	MD651			
							FA213	FA213HH			FA213V	MD651			
							FA213	FA213HH			FA213V	MD651			
							FA213	FA213HH			FA213V	MD651			
							FA213	FA213HH			FA213V	MD810		MD810C	
							FA213	FA213HH			FA213V	MD845			
							FA213	FA213HH			FA213V	MD810		MD810C	
							861								
							861								
							861								
							861								
							862								
							862								

REAR

⚠ This symbol indicates a rotor made of billet steel, and should be only used with EBC FA Kevlar® Organic or Vee pads.
 SAFETY NOTICE - With vehicles primarily designed for off highway use such as quads now being used on the highway, we would recommend the use of X or MXS pads for highway use and ONLY using the R and SV higher density / harder pad series for off road riding.

BRAKE APPLICATIONS

*-2 Sets Required. † For Vee disc colours add RED, BLU, GRN, GLD, ORG suffix to part number. **SAFETY WARNING:- DO NOT USE HH PADS ON REAR UNLESS ALSO USED ON FRONT TO AVOID BRAKE IMBALANCE**

FRONT: Non-Japanese Bikes



BMW



DISC PAD CHOICES - FRONT

BRAKE ROTOR CHOICES - FRONT

											Line #	
R 65 RT	85-88	FA18*	FA18HH*			FA18V*	MD605LS	MD605RS			1	
R 65 T	80-85	FA57				FA57V	MD606LS				2	
R 65 T (Brembo caliper)	80-85	FA18	FA18HH			FA18V	MD606LS				3	
F 700 GS (Twin cylinder model/798cc/Spoke wheel)	11-18	FA209/2*	FA209/2HH*			FA209/2V*	MD834X	MD834X			4	
K 75/75-S (Non ABS)	84-08/88	FA18*	FA18HH*			FA18V*	MD604LS	MD604RS			5	
K 75/75-2 (Non ABS)	84-07/90	FA18*	FA18HH*			FA18V*	MD603LS	MD603RS			6	
K 75/75-2 (Non ABS)	09/88-96	FA171*	FA171HH*			FA171V*	MD604LS	MD604RS			7	
K 75/75-S (ABS Model)	08/90-96	FA171*	FA171HH*			FA171V*	MD603LS	MD603RS			8	
K 75 C	85-08/88	FA18*	FA18HH*			FA18V*	MD604LS	MD604RS			9	
K 75 C	02/88-90	FA171*	FA171HH*			FA171V*	MD604LS	MD604RS			10	
K 75 RT (Non ABS)	89-96	FA171*	FA171HH*			FA171V*	MD604LS	MD604RS			11	
K 75 RT (ABS Model)	89-96	FA171*	FA171HH*			FA171V*	MD603LS	MD603RS			12	
K 75 S (Non ABS)	85-09/88	FA18*	FA18HH*			FA18V*	MD604LS	MD604RS			13	
K 75 S (Non ABS Model)	09/88-95	FA171*	FA171HH*			FA171V*	MD604LS	MD604RS			14	
K 75 S (ABS Model)	85-09/88	FA18*	FA18HH*			FA18V*	MD603LS	MD603RS			15	
K 75 S (ABS Model)	09/88-95	FA171*	FA171HH*			FA171V*	MD603LS	MD603RS			16	
R 75/6 (Single rotor) 75/7	73-79	FA22				FA22V	MD602LS				17	
R 75/6 (Twin rotor) 75/7	73-79	FA22*				FA22V*	MD602LS	MD602RS			18	
F 750 GS	18-19	FA181X*					FA181HH*				19	
F 750 GS Edition 40	20-21	FA209/2*	FA209/2HH*			FA209/2V*	MD687	MD687			20	
F 800 GS (Twin cylinder model/798cc/Spoke wheel)	08-18	FA209/2*	FA209/2HH*			FA209/2V*	MD834X	MD834X			21	
F 800 GS Adventure (Twin cylinder model/798cc/Spoke wheel)	12-18	FA209/2*	FA209/2HH*			FA209/2V*	MD834X	MD834X			22	
F 850 GS	18-21	FA209/2*	FA209/2HH*			FA209/2V*	MD687	MD687			23	
F 850 GS Edition 40	20-21	FA209/2*	FA209/2HH*			FA209/2V*	MD687	MD687			24	
F 850 GS Adventure	18-21	FA209/2*	FA209/2HH*			FA209/2V*	MD687	MD687			25	
F 800 GT	13-18	FA244*	FA244HH*		EPFA244HH*	FA244V*	TBC	TBC			26	
F 800 R (Disc has fixed bobbins)	09-14	FA244*	FA244HH*		EPFA244HH*	FA244V*	N/A	N/A			27	
F 800 R (Disc has fixed bobbins)	15-18		FA630HH*		EPFA630HH*		N/A	N/A			28	
F 800 S/ST (Disc has loose bobbins)	06-08	FA244*	FA244HH*		EPFA244HH*	FA244V*	MD803	MD803			29	
F 800 ST (Disc has fixed bobbins)	09-13	FA244*	FA244HH*		EPFA244HH*	FA244V*	N/A	N/A			30	
R 80 GS	80-87	FA18	FA18HH					MD606RS			31	
R 80 GS	87-95	FA77				FA77V	MD606RS				32	
R 80 PD/CH	90-95	FA77				FA77V	MD606RS				33	
R 80 (Single rotor)	77-09/80	FA22				FA22V	MD602LS				34	
R 80 (Double rotor)	77-09/80	FA22*				FA22V*	MD602LS	MD602RS			35	
R 80 (Single rotor)	10/80-84	FA22				FA22V	MD602LS				36	
R 80 (Double rotor)	10/80-84	FA22*				FA22V*	MD602LS	MD602RS			37	
R 80/R 80 RT (Single rotor)	84-07/90	FA77				FA77V	N/A				38	
R 80 RT (Double rotor)	82-84	FA18*	FA18HH*			FA18V*	MD602LS	MD602RS			39	
R 80/R 80 RT (Double rotor)	84-08/88	FA18*	FA18HH*			FA18V*	MD605LS	MD605RS			40	
R 80/R 80 RT (Single rotor)	08/90-95	FA77				FA77V		MD605RS			41	
R 80/R 80 RT (Double rotor)	09/88-95	FA171*	FA171HH*			FA171V*	MD605LS	MD605RS			42	
R 80 ST	82-84	FA18	FA18HH			FA18V		MD606RS			43	
R 80 TIC	78-08/80	FA22*				FA22V*	MD602LS	MD602RS			44	
R 80 TIC	09/80-85	FA18*	FA18HH*			FA18V*	MD602LS	MD602RS			45	
R 80 Mystic	94-95	FA407*	FA407HH*		EPFA407HH*		MD605LS	MD605RS			46	
R 80 R	91-94	FA407*	FA407HH*		EPFA407HH*		MD605LS	MD605RS			47	
R 850 C (Cast wheel/ABS)	97-00	FA407*	FA407HH*		EPFA407HH*		MD652	MD652		MD652C*	48	
R 850 C (Spoke wheel/ABS)	97-00	FA407*	FA407HH*		EPFA407HH*		MD652	MD652		MD652C*	49	
R 850 GS	96	FA77				FA77V		MD605RS			50	
R 850 GS (Std & ABS models)	96-00	FA407*	FA407HH*		EPFA407HH*		MD652	MD652		MD652C*	51	
R 850 R (Cast wheel/ABS)	94-02	FA407*	FA407HH*		EPFA407HH*		MD607LS	MD607RS			52	
R 850 R (Spoke wheel)	94-05/96	FA407*	FA407HH*		EPFA407HH*		MD652	MD652		MD652C*	53	
R 850 RT (Cast wheel/ABS)	96-01	FA407*	FA407HH*		EPFA407HH*		MD607LS	MD607RS			54	
① - remove rotor outer ring from centre casting and refit.												55
② - remove ABS ring from old rotor and refit to new EBC rotor. Note: Ensure all mounting surfaces are clean and when refitting bolts use a thread lock cement to hold them in place.												56

*-2 Sets Required. † For Vee disc colours add RED, BLU, GRN, GLD, ORG suffix to part number. **SAFETY WARNING:- DO NOT USE HH PADS ON REAR UNLESS ALSO USED ON FRONT TO AVOID BRAKE IMBALANCE**

⚠ This symbol indicates a rotor made of billet steel, and should be only used with EBC FA Kevlar® Organic or Vee pads. SAFETY NOTICE - With vehicles primarily designed for off highway use such as quads now being used on the highway, we would recommend the use of X or MXS pads for highway use and ONLY using the R and SV higher density / harder pad series for off road riding.

FRONT: Non-Japanese Bikes Cont'd

REAR: Non-Japanese Bikes

Line #	BRAKE ROTOR CHOICES - FRONT						DISC PAD CHOICES - REAR					BRAKE ROTOR CHOICES - REAR				
	CC Custom Rotor	CX Extreme® /Vee-Rotor	OS Series Oversize 250/280mm Rotor Kit	OSX Series Oversize 280mm Rotor Kit	Relocating Bracket for Oversize Rotor	SMX Series Oversize 320mm Rotor Kit	Relocating Bracket for 320mm Rotor		Sintered/HH Pads/ Grooved Shoes	SV Series Severe Duty Pads	EPFA Sintered Fast Road/ Track Pads	Specialty Pads SXR/ VEE/MXS Race	Standard Rotor	Vintage Rotor / UTV Oversize Brake Kit	Contour Profile Rotor	CX Extreme® /Vee-Rotor
1								861								
2								861								
3								861								
4								FA213	FA213HH			FA213V	MD671			
5								863								
6								861								
7								861								
8								FA18	FA18HH			FA18V	MD611Ⓣ			
9								861								
10								861								
11								FA18	FA18HH			FA18V	MD611			
12								FA18	FA18HH			FA18V	MD661Ⓣ			
13								FA18	FA18HH			FA18V	MD611			
14								FA18	FA18HH			FA18V	MD611			
15								FA18	FA18HH			FA18V	MD661Ⓣ			
16								FA18	FA18HH			FA18V	MD661Ⓣ			
17								860								
18								860								
19								FA213	FA213HH			FA213V	MD671			
20								FA213	FA213HH			FA213V	MD671			
21								FA213	FA213HH			FA213V	MD671			
22								FA213	FA213HH			FA213V	MD671			
23								FA213	FA213HH			FA213V	MD671			
24								FA213	FA213HH			FA213V	MD671			
25								FA213	FA213HH			FA213V	MD671			
26								FA213	FA213HH			FA213V	MD671			
27								FA213	FA213HH			FA213V	MD671			
28								FA213	FA213HH			FA213V	MD671			
29								FA213	FA213HH			FA213V	MD671			
30								FA213	FA213HH			FA213V	MD671			
31								861								
32								859								
33								859								
34								860								
35								860								
36								861								
37								861								
38								861								
39								861								
40								861								
41								861								
42								861								
43								859								
44								861								
45								860								
46								861								
47								859								
48								859								
49								FA363	FA363HH			FA363V	N/A			
50								FA363	FA363HH			FA363V	N/A			
51								859								
52								FA363	FA363HH			FA363V	MD653		MD653C	
53								FA363	FA363HH			FA363V	MD653Ⓣ			
54								FA363	FA363HH			FA363V	MD653		MD653C	
55								FA363	FA363HH			FA363V	MD653Ⓣ			
56																

BRAKE APPLICATIONS

Ⓣ This symbol indicates a rotor made of billet steel, and should be only used with EBC FA Kevlar® Organic or Vee pads. SAFETY NOTICE - With vehicles primarily designed for off highway use such as quads now being used on the highway, we would recommend the use of X or MXS pads for highway use and ONLY using the R and SV higher density / harder pad series for off road riding.

*-2 Sets Required. † For Vee disc colours add RED, BLU, GRN, GLD, ORG suffix to part number. **SAFETY WARNING:- DO NOT USE HH PADS ON REAR UNLESS ALSO USED ON FRONT TO AVOID BRAKE IMBALANCE**

FRONT: Non-Japanese Bikes



BMW



DISC PAD CHOICES - FRONT

BRAKE ROTOR CHOICES - FRONT

											Line #
R 850 RT (Spoke wheel)	96-01	FA407*	FA407HH*	EPFA407HH*			MD652	MD652		MD652C*	1
R 850 RT	06		FA335HH*	EPFA335HH*			MD620	MD620			2
R 850 R	03-06		FA294HH*	EPFA294HH*			MD616	MD616			3
F 900 R	20-21		FA630HH*	EPFA630HH*			MD804	MD804			4
F 900 XR	20-21		FA630HH*	EPFA630HH*			MD804	MD804			5
R 90 S	73-76	FA22*				FA22V*	MD602LS	MD602RS			6
R 90/6 (Single rotor)	73-76	FA22				FA22V	MD602LS				7
R 90/6 (Twin rotor)	73-76	FA22*				FA22V*	MD602LS	MD602RS			8
HP4 (1000cc)	13-14		FA447HH*	EPFA447HH*	GPFAX447HH*		MD862X	MD862X			9
K1 (16 valve - Non ABS)	88-93	FA407*	FA407HH*	EPFA407HH*			MD607LS	MD607RS			10
K1 (16 valve - ABS models)	88-93	FA407*	FA407HH*	EPFA407HH*			MD607LSⓅ	MD607RSⓅ			11
K 100 (Non ABS - 8 valve model)	82-09/88	FA18*	FA18HH*			FA18V*	MD604LS	MD604RS			12
K 100/2 (Non ABS - 8 valve model)	87-08/88	FA18*	FA18HH*			FA18V*	MD604LS	MD604RS			13
K 100/2 (Non ABS - 8 valve model)	09/88-90	FA171*	FA171HH*			FA171V*	MD604LS	MD604RS			14
K 100/2 (ABS - 8 valve model)	87-08/88	FA18*	FA18HH*			FA18V*	MD603LSⓅ	MD603RSⓅ			15
K 100/2 (ABS - 8 valve model)	09/88-90	FA171*	FA171HH*			FA171V*	MD603LSⓅ	MD603RSⓅ			16
K 100 LT (Non ABS - 8 valve model)	86-08/88	FA18*	FA18HH*			FA18V*	MD604LS	MD604RS			17
K 100 LT (Non ABS - 8 valve model)	09/88-91	FA171*	FA171HH*			FA171V*	MD604LS	MD604RS			18
K 100 LT (ABS - 8 valve model)	86-8/88	FA18*	FA18HH*			FA18V*	MD603LSⓅ	MD603RSⓅ			19
K 100 LT (ABS - 8 valve model)	09/88-91	FA171*	FA171HH*			FA171V*	MD603LSⓅ	MD603RSⓅ			20
K 100 RS (Non ABS - 8 valve)	83-09/88	FA18*	FA18HH*			FA18V*	MD604LS	MD604RS			21
K 100 RS (Non ABS - 8 valve)	10/88-89	FA171*	FA171HH*			FA171V*	MD604LS	MD604RS			22
K 100 RS (ABS Model - 8 valve)	83-09/88	FA18*	FA18HH*			FA18V*	MD603LSⓅ	MD603RSⓅ			23
K 100 RS (ABS Model - 8 valve)	10/88-89	FA171*	FA171HH*			FA171V*	MD603LSⓅ	MD603RSⓅ			24
K 100 RT (Non ABS - 8 valve)	83-09/88	FA18*	FA18HH*			FA18V*	MD604LS	MD604RS			25
K 100 RT (Non ABS - 8 valve)	10/88-89	FA171*	FA171HH*			FA171V*	MD604LS	MD604RS			26
K 100 RT (ABS - 8 valve)	83-09/88	FA18*	FA18HH*			FA18V*	MD603LSⓅ	MD603RSⓅ			27
K 100 RT (ABS - 8 valve)	10/88-89	FA171*	FA171HH*			FA171V*	MD603LSⓅ	MD603RSⓅ			28
K 100 RS (16 valve - Non ABS)	89-92	FA407*	FA407HH*	EPFA407HH*			MD607LS	MD607RS			29
K 100 RS (16 valve - ABS Models)	89-92	FA407*	FA407HH*	EPFA407HH*			MD607LSⓅ	MD607RSⓅ			30
R 100 GS	86-94	FA77				FA77V		MD605RS			31
R 100 PD	89-96	FA77				FA77V		MD605RS			32
R 100 (Single rotor)	76-77	FA22				FA22V	MD602LS				33
R 100 (Twin rotor)	76-77	FA22*				FA22V*	MD602LS	MD602RS			34
R 100/7T (Single rotor)	77-09/80	FA22				FA22V	MD602LS				35
R 100/7T (Twin rotor)	77-09/80	FA22*				FA22V*	MD602LS	MD602RS			36
R 100/7T (Spoke wheel)	09/80-84	FA18*	FA18HH*			FA18V*	MD606LS	MD606RS			37
R 100/7T (Cast wheel)	09/80-84	FA18*	FA18HH*			FA18V*	MD602LS	MD602RS			38
R 100 S	76-08/80	FA22*				FA22V*	MD602LS	MD602RS			39
R 100 RS	76-09/80	FA22*				FA22V*	MD602LS	MD602RS			40
R 100 RS	10/80-84	FA18*	FA18HH*			FA18V*	MD602LS	MD602RS			41
R 100 RS	86-08/88	FA18*	FA18HH*			FA18V*	MD605LS	MD605RS			42
R 100 RS	09/88-08/89	FA171*	FA171HH*			FA171V*	MD605LS	MD605RS			43
R 100 RS	9/9-92	FA171*	FA171HH*			FA171V*	MD605LS	MD605RS			44
R 100 RT	78-09/80	FA22*				FA22V*	MD602LS	MD602RS			45
R 100 RT	10/80-84	FA18*	FA18HH*			FA18V*	MD602LS	MD602RS			46
R 100 RT	87-08/88	FA18*	FA18HH*			FA18V*	MD605LS	MD605RS			47
R 100 RT	09/88-08/89	FA171*	FA171HH*			FA171V*	MD605LS	MD605RS			48
R 100 RT	09/89-95	FA171*	FA171HH*			FA171V*	MD605LS	MD605RS			49
R 100 Mystic	93-96	FA407*	FA407HH*	EPFA407HH*			MD605LS	MD605RS			50
R 100 R	91-95	FA407*	FA407HH*	EPFA407HH*			MD605LS	MD605RS			51
M 1000 RR	21-22		FA757HH	EPFA757HH*	GPFAX757HH*		TBC	TBC			52
S 1000 R R Naked	14-20		FA604/4HH*	EPFA604/4HH*			N/A	N/A			53
S 1000 R K47	13-20		FA604/4HH*	EPFA604/4HH*			MD862X	MD862X			54
Ⓢ - remove rotor outer ring from centre casting and refit.											55
Ⓟ - remove ABS ring from old rotor and refit to new EBC rotor. Note: Ensure all mounting surfaces are clean and when refitting bolts use a thread lock cement to hold them in place.											56

*-2 Sets Required. † For Vee disc colours add RED, BLU, GRN, GLD, ORG suffix to part number. **SAFETY WARNING:- DO NOT USE HH PADS ON REAR UNLESS ALSO USED ON FRONT TO AVOID BRAKE IMBALANCE**

FRONT: Non-Japanese Bikes Cont'd

REAR: Non-Japanese Bikes

Line #	BRAKE ROTOR CHOICES - FRONT						DISC PAD CHOICES - REAR					BRAKE ROTOR CHOICES - REAR				
	CC Custom Rotor	CX Extreme® /Vee-Rotor	OS Series Oversize 250/280mm Rotor Kit	OSX Series Oversize 280mm Rotor Kit	Relocating Bracket for Oversize Rotor	SMX Series Oversize 320mm Rotor Kit	Relocating Bracket for 320mm Rotor		Sintered/HH Pads/ Grooved Shoes	SV Series Severe Duty Pads	EPFA Sintered Fast Road/ Track Pads	Specialty Pads SXR/ VEE/MXS Race	Standard Rotor	Vintage Rotor / UTV Oversize Brake Kit	Contour Profile Rotor	CX Extreme® /Vee-Rotor
1								FA363	FA363HH			FA363V	MD653		MD653C	
2								FA363	FA363HH			FA363V	MD653			
3								FA363	FA363HH			FA363V	MD653			
4								FA213	FA213HH			FA213V				
5								FA213	FA213HH			FA213V				
6								860								
7								860								
8								860								
9								FA213	FA213HH				MD832			
10								FA18	FA18HH			FA18V	MD611			
11								FA18	FA18HH			FA18V	MD661Ⓣ			
12								FA18	FA18HH			FA18V	MD611			
13								FA18	FA18HH			FA18V	MD611			
14								FA18	FA18HH			FA18V	MD611			
15								FA18	FA18HH			FA18V	MD661Ⓣ			
16								FA18	FA18HH			FA18V	MD661Ⓣ			
17								FA18	FA18HH			FA18V	MD611			
18								FA18	FA18HH			FA18V	MD611			
19								FA18	FA18HH			FA18V	MD661Ⓣ			
20								FA18	FA18HH			FA18V	MD661Ⓣ			
21								FA18	FA18HH			FA18V	MD611			
22								FA18	FA18HH			FA18V	MD611			
23								FA18	FA18HH			FA18V	MD661Ⓣ			
24								FA18	FA18HH			FA18V	MD661Ⓣ			
25								FA18	FA18HH			FA18V	MD611			
26								FA18	FA18HH			FA18V	MD661			
27								FA18	FA18HH			FA18V	MD661Ⓣ			
28								FA18	FA18HH			FA18V	MD661Ⓣ			
29								FA18	FA18HH			FA18V	MD611			
30								FA18	FA18HH			FA18V	MD661Ⓣ			
31								859								
32								859								
33								860								
34								860								
35								860								
36								860								
37								861								
38								861								
39								860								
40								860								
41								FA18	FA18HH			FA18V	MD602LS			
42								861								
43								861								
44								859								
45								860								
46								FA18	FA18HH			FA18V	MD602LS			
47								861								
48								861								
49								859								
50								859								
51								859								
52									FA254HH				MD832			
53								FA213	FA213HH			FA213V	MD832			
54								FA213	FA213HH			FA213V	MD832			
55																
56																

BRAKE APPLICATIONS

⚠ This symbol indicates a rotor made of billet steel, and should be only used with EBC FA Kevlar® Organic or Vee pads.
SAFETY NOTICE - With vehicles primarily designed for off highway use such as quads now being used on the highway, we would recommend the use of X or MXS pads for highway use and ONLY using the R and SV higher density / harder pad series for off road riding.

*-2 Sets Required. † For Vee disc colours add RED, BLU, GRN, GLD, ORG suffix to part number. **SAFETY WARNING:- DO NOT USE HH PADS ON REAR UNLESS ALSO USED ON FRONT TO AVOID BRAKE IMBALANCE**

FRONT: Non-Japanese Bikes



BMW



DISC PAD CHOICES - FRONT

BRAKE ROTOR CHOICES - FRONT

			Sintered/HH Pads/Grooved Shoes	SV Series Severe Duty Pads	EPFA Sintered Fast Road/Track Pads	GPFA Sintered RACE ONLY Pads	Specialty Pads SXR/VEE/MXS Race	Standard Rotor Left	Standard Rotor Right	Vintage Rotor / UTV Oversize Brake Kit	Contour Profile Rotor	Line #
S 1000 RR RR	08-18		FA604/4HH*		EPFA604/4HH*	GPFA604/4HH*		MD862X	MD862X			1
S 1000 R	18-21		FA724HH*		EPFA724HH*	GPFA724HH*						2
S 1000 RR/RR Sport/RR M Sport	18-21		FA724HH*		EPFA724HH*	GPFA724HH*						3
S 1000 RR HP4 Race	17-18					GPFA611HH*						4
S 1000 RR (Models fitted with Forged race wheels 7 spoke type)	15-17		FA604/4HH*		EPFA604/4HH*			MD862X	MD862X			5
S 1000 XR K49 - Disc fitting required	14-19		FA630HH*		EPFA630HH*			MD804	MD804			6
S 1000 XR K49	14-19		FA630HH*		EPFA630HH*			MD862X	MD862X			7
S 1000 XR	19-21		FA724HH*		EPFA724HH*	GPFA724HH*		MD804	MD804			8
K 1100 LT (Non ABS)	89-07/93	FA407*	FA407HH*		EPFA407HH*			MD607LS	MD607RS			9
K 1100 LT (ABS)	89-07/93	FA407*	FA407HH*		EPFA407HH*			MD607LS	MD607RS			10
K 1100 LT (Non ABS)	08/93-99	FA407*	FA407HH*		EPFA407HH*			MD607LS	MD607RS			11
K 1100 LT (ABS Model)	08/93-99	FA407*	FA407HH*		EPFA407HH*			MD607LS	MD607RS			12
K 1100 RS (Non ABS Model)	92-96	FA407*	FA407HH*		EPFA407HH*			MD607LS	MD607RS			13
K 1100 RS (ABS Model)	92-96	FA407*	FA407HH*		EPFA407HH*			MD607LS	MD607RS			14
R 1100 GS (STD & ABS)	93-99	FA407*	FA407HH*		EPFA407HH*			MD652	MD652		MD652C*	15
R 1100 GS (STD & ABS)	93-99	FA407*	FA407HH*		EPFA407HH*			MD652	MD652		MD652C*	16
R 1100 R (Spoke wheel)	93-96	FA407*	FA407HH*		EPFA407HH*			MD652	MD652		MD652C*	17
R 1100 R (Cast wheel)	93-01	FA407*	FA407HH*		EPFA407HH*			MD607LS	MD607RS			18
R 1100 RS	92-01	FA407*	FA407HH*		EPFA407HH*			MD607LS	MD607RS			19
R 1100 S	96-11/00	FA407*	FA407HH*		EPFA407HH*			MD687	MD687			20
R 1100 S (With integral ABS)	12/00-06		FA294HH*		EPFA294HH*			MD616	MD616			21
R 1100 S (Non ABS)	12/00-06		FA335HH*		EPFA335HH*			MD803	MD803			22
R 1100 S (With Integral ABS)	02/01-06		FA294HH*		EPFA294HH*			MD616	MD616			23
R 1100 RT (Cast wheel/ABS)	94-01	FA407*	FA407HH*		EPFA407HH*			MD607LS	MD607RS			24
R 1100 RT (Spoke wheel)	94-01	FA407*	FA407HH*		EPFA407HH*			MD652	MD652		MD652C*	25
R 1150 GS (R21/0415/0495)	98-10/01	FA407*	FA407HH*		EPFA407HH*			MD652	MD652		MD652C*	26
R 1150 GS (Evo R21/0415/0495)	01-03		FA294HH*		EPFA294HH*			MD652	MD652		MD652C*	27
R 1150 GS (Evo R21A/0441/0492)	01-06		FA294HH*		EPFA294HH*			MD652	MD652		MD652C*	28
R 1150 R	01-06		FA294HH*		EPFA294HH*			MD616	MD616			29
R 1150 R Rockster/Edition 80	03-05		FA294HH*		EPFA294HH*			MD616	MD616			30
R 1150 RS (Integral ABS)	01-05		FA294HH*		EPFA294HH*			MD616	MD616			31
R 1150 RT (Integral ABS)	00-05		FA335HH*		EPFA335HH*			MD620	MD620			32
HP2 (Enduro)	05-08	FA209/2*	FA209/2HH*				FA209/2V*	MD687	MD687			33
HP2 Megamoto (Disc has loose bobbins)	Nov 07		FA335HH*		EPFA335HH*			MD803	MD803			34
HP2 Megamoto (Disc has fixed bobbins)	Dec 07-09		FA335HH*		EPFA335HH*			MD804	MD804			35
HP2 Sport (Disc has fixed bobbins)	08-11		FA447HH*		EPFA447HH*			MD804	MD804			36
G 1200 Gladiator	13-17	FA407*	FA407HH*		EPFA407HH*			MD652	MD652			37
R Nine T	18-21		FA630HH*		EPFA630HH*			MD804	MD804			38
R Nine T Pure	18-21		FA244HH*					MD804	MD804			39
R Nine T Racer	18-20		FA244HH*					MD804	MD804			40
R Nine T Scrambler	18-21		FA244HH*					MD804	MD804			41
R Nine T Urban G/S	18-21		FA244HH*					MD804	MD804			42
R 1200 (Independence)	00-03	FA407*	FA407HH*		EPFA407HH*			MD652	MD652		MD652C*	43
R 1200 C (Cast Wheel/ABS)	96-03	FA407*	FA407HH*		EPFA407HH*			MD652	MD652		MD652C*	44
R 1200 C (Spoke Wheel/ABS)	96-03	FA407*	FA407HH*		EPFA407HH*			MD652	MD652		MD652C*	45
R 1200 CL	02-04		FA294HH*		EPFA294HH*			MD652	MD652		MD652C*	46
R 1200 C Montauk	04-05		FA294HH*		EPFA294HH*			MD652	MD652		MD652C*	47
R 1200 GS Air/Oil Cooled (K25/0307/Cast/Spoke Wheel) (Disc has loose bobbins)	02-07		FA335HH*		EPFA335HH*			MD687	MD687			48
R 1200 GS/M Air/Oil Cooled (K25/0303/Cast/Spoke wheel) (Disc has fixed bobbins)	06-12		FA335HH*		EPFA335HH*			N/A	N/A			51
R 1200 GS Adventure Air/Oil Cooled (K25/0382/Spoke wheel) (Disc has loose bobbins)	05-07		FA335HH*		EPFA335HH*			MD687	MD687			53
R 1200 GS Adventure/M Air/Oil Cooled (K25/0380/Spoke wheel) (Disc has fixed bobbins)	06-13		FA335HH*		EPFA335HH*			N/A	N/A			55

FRONT

⊗ - remove ABS ring from old rotor and refit to new EBC rotor. Note: Ensure all mounting surfaces are clean and when refitting bolts use a thread lock cement to hold them in place.

*-2 Sets Required. † For Vee disc colours add RED, BLU, GRN, GLD, ORG suffix to part number. **SAFETY WARNING:- DO NOT USE HH PADS ON REAR UNLESS ALSO USED ON FRONT TO AVOID BRAKE IMBALANCE**

APPLICATIONS
BRAKE
⊗ This symbol indicates a rotor made of billet steel, and should be only used with EBC FA Kevlar® Organic or Vee pads.
SAFETY NOTICE - With vehicles primarily designed for off highway use such as quads now being used on the highway, we would recommend the use of X or MXS pads for highway use and ONLY using the R and SV higher density / harder pad series for off road riding.

FRONT: Non-Japanese Bikes Cont'd

REAR: Non-Japanese Bikes

Line #	BRAKE ROTOR CHOICES - FRONT						DISC PAD CHOICES - REAR					BRAKE ROTOR CHOICES - REAR				
	CC Custom Rotor	CX Extreme® /Vee-Rotor	OS Series Oversize 250/280mm Rotor Kit	OSX Series Oversize 280mm Rotor Kit	Relocating Bracket for Oversize Rotor	SMX Series Oversize 320mm Rotor Kit	Relocating Bracket for 320mm Rotor		Sintered/HH Pads/ Grooved Shoes	SV Series Severe Duty Pads	EPFA Sintered Fast Road/ Track Pads	Specialty Pads SXR/ VEE/MXS Race	Standard Rotor	Vintage Rotor / UTV Oversize Brake Kit	Contour Profile Rotor	CX Extreme® /Vee-Rotor
1								FA213	FA213HH			FA213V	MD832			
2								FA213	FA213HH			FA213V	MD832			
3								FA213	FA213HH			FA213V	MD832			
4									FA730HH		EPFA730HH					
5								FA213	FA213HH			FA213V	MD832			
6								FA363	FA363HH			FA363V	MD671			
7								FA363	FA363HH			FA363V	MD671			
8								FA363	FA363HH				MD671			
9								FA18	FA18HH			FA18V	MD611			
10								FA18	FA18HH			FA18V	MD661			
11								FA18	FA18HH			FA18V	MD661			
12								FA18	FA18HH			FA18V	MD661			
13								FA18	FA18HH			FA18V	MD661			
14								FA18	FA18HH			FA18V	MD661			
15								FA363	FA363HH			FA363V	MD653		MD653C	
16								FA363	FA363HH			FA363V	MD653		MD653C	
17								FA363	FA363HH			FA363V	MD653		MD653C	
18								FA363	FA363HH			FA363V	MD653			
19								FA18	FA18HH			FA18V	MD661			
20								FA363	FA363HH			FA363V	MD653		MD653C	
21								FA363	FA363HH			FA363V	MD653			
22								FA363	FA363HH			FA363V	MD653			
23								FA363	FA363HH			FA363V	MD653			
24								FA363	FA363HH			FA363V	MD653			
25								FA363	FA363HH			FA363V	MD653		MD653C	
26								FA363	FA363HH			FA363V	MD653		MD653C	
27								FA363	FA363HH			FA363V	MD653		MD653C	
28								FA363	FA363HH			FA363V	MD653		MD653C	
29								FA363	FA363HH			FA363V	MD653			
30								FA363	FA363HH			FA363V	MD653			
31								FA363	FA363HH			FA363V	MD653			
32								FA363	FA363HH			FA363V	MD653			
33								FA363	FA363HH			FA363V	MD671			
34								FA363	FA363HH			FA363V	MD671			
35								FA363	FA363HH			FA363V	MD671			
36								FA363	FA363HH			FA363V	MD671			
37								FA363	FA363HH							
38								FA363	FA363HH							
39								FA363	FA363HH							
40								FA363	FA363HH							
41								FA363	FA363HH							
42								FA363	FA363HH							
43								FA363	FA363HH			FA363V	N/A			
44								FA363	FA363HH			FA363V	N/A			
45								FA363	FA363HH			FA363V	N/A			
46								FA304	FA304HH			FA304V	N/A			
47								FA363	FA363HH			FA363V	N/A			
48																
49								FA363	FA363HH			FA363V	MD671			
50								FA363	FA363HH			FA363V	MD671			
51								FA363	FA363HH			FA363V	MD671			
52								FA363	FA363HH			FA363V	MD671			
53								FA363	FA363HH			FA363V	MD671			
54								FA363	FA363HH			FA363V	MD671			
55								FA363	FA363HH			FA363V	MD671			
56								FA363	FA363HH			FA363V	MD671			

BRAKE APPLICATIONS

⚠ This symbol indicates a rotor made of billet steel, and should be only used with EBC FA Kevlar® Organic or Vee pads.
 SAFETY NOTICE - With vehicles primarily designed for off highway use such as quads now being used on the highway, we would recommend the use of X or MXS pads for highway use and ONLY using the R and SV higher density / harder pad series for off road riding.

*-2 Sets Required. † For Vee disc colours add RED, BLU, GRN, GLD, ORG suffix to part number. **SAFETY WARNING:- DO NOT USE HH PADS ON REAR UNLESS ALSO USED ON FRONT TO AVOID BRAKE IMBALANCE**

FRONT: Non-Japanese Bikes



BMW



DISC PAD CHOICES - FRONT

BRAKE ROTOR CHOICES - FRONT

	Sintered/HH Pads/Grooved Shoes	SV Series Severe Duty Pads	EPFA Sintered Fast Road/Track Pads	GPFA Sintered RACE ONLY Pads	Specialty Pads SXR/VEE/MXS Race	Standard Rotor Left	Standard Rotor Right	Vintage Rotor / UTV Oversize Brake Kit	Contour Profile Rotor
R 1200 GS (Liquid Cooled/Radial Mount Caliper)	FA630HH*		EPFA630HH*			N/A	N/A		
R 1200 GS Adventure (Liquid Cooled/Radial Mount Caliper)	FA630HH*		EPFA630HH*			N/A	N/A		
R 1200 ST (K28/0328) Disc has loose bobbins	FA335HH*		EPFA335HH*			MD803	MD803		
R 1200 ST (K28/0328) Disc has fixed bobbins	FA335HH*		EPFA335HH*			N/A	N/A		
R 1200 R (K27) Disc has loose bobbins	FA294HH*		EPFA294HH*			MD804	MD804		
R 1200 R (K27) Disc has fixed bobbins	FA294HH*		EPFA294HH*			N/A	N/A		
R 1200 S (K29/0366) Disc Has Loose Bobbins	FA335HH*		EPFA335HH*			MD803	MD803		
R 1200 S (K29/0366) Disc Has Fixed Bobbins	FA335HH*		EPFA335HH*			N/A	N/A		
R 1200 R (K53)	FA630HH*		EPFA630HH*			MD804	MD804		
R 1200 RS (K54)	FA630HH*		EPFA630HH*			MD804	MD804		
R 1200 RT (K26/0368) Disc Has Loose Bobbins	FA335HH*		EPFA335HH*			MD803	MD803		
R 1200 RT (K52) Disc Has Fixed Bobbins	FA335HH*		EPFA335HH*			MD804	MD804		
R 1200 RT (K52) (Radial Caliper) Disc Has Fixed Bobbins	FA630HH*		EPFA630HH*			MD804	MD804		
R 1250 GS	FA724HH*		EPFA724HH*	GPFA724HH*					
R 1250 GS Edition 40	FA724HH*		EPFA724HH*	GPFA724HH*		MD687	MD687		
R 1250 GS TE	FA724HH*		EPFA724HH*	GPFA724HH*		MD687	MD687		
R 1250 GS Exclusive TE	FA724HH*		EPFA724HH*	GPFA724HH*		MD687	MD687		
R 1250 GS Rallye	FA724HH*		EPFA724HH*	GPFA724HH*		MD687	MD687		
R 1250 GS Rallye TE	FA724HH*		EPFA724HH*	GPFA724HH*		MD687	MD687		
R 1250 GS Adventure	FA724HH*		EPFA724HH*	GPFA724HH*		MD687	MD687		
R 1250 GS Adventure Edition 40	FA724HH*		EPFA724HH*	GPFA724HH*		MD687	MD687		
R 1250 R	FA630HH*		EPFA630HH*			MD804	MD804		
R 1250 RS	FA630HH*		EPFA630HH*			MD804	MD804		
R 1250 RT	FA724HH*		EPFA724HH*	GPFA724HH*		MD804	MD804		
R 1250 RT SE	FA724HH*		EPFA724HH*	GPFA724HH*		MD804	MD804		
R 1250 RT LE	FA724HH*		EPFA724HH*	GPFA724HH*		MD804	MD804		
K 1200 RS (Non ABS & ABS Models)	FA407HH*		EPFA407HH*			MD652	MD652		
K 1200 RS (With & Without Integral ABS)	FA335HH*		EPFA335HH*			MD620	MD620		
K 1200 LT (Integral ABS & STD ABS Models)	FA407HH*		EPFA407HH*			MD652	MD652		
K 1200 LT (Evo - Integral ABS/Loose Bobbin Type)	FA294HH*		EPFA294HH*			MD616	MD616		
K 1200 LT (Evo - Integral ABS/Fixed Bobbin Type)	FA294HH*		EPFA294HH*			N/A	N/A		
K 1200 GT (2 pin rear pad K41) Disc has loose bobbins	FA335HH*		EPFA335HH*			MD620	MD620		
K 1200 GT (K44) Disc has fixed bobbins	FA335HH					N/A			
	FA441HH						N/A		
K 1200 GT (K44) (Single pad fixing - pad has wire indicator wire fitted. Wear leads need to be ordered separately as not supplied with pads.)	MWL001								
K 1200 R (K27/0378) Disc has loose buttons	FA294HH*		EPFA294HH*			MD804	MD804		
K 1200 R (K27/0378) Disc has fixed bobbins	FA294HH*		EPFA294HH*			N/A	N/A		
K 1200 S With loose bobbins	FA335HH*		EPFA335HH*			MD620	MD620		
K 1200 S With fixed bobbins	FA335HH*		EPFA335HH*			N/A	N/A		
K 1300 S	FA335HH*		EPFA335HH*			N/A	N/A		
K 1300 R	FA294HH*		EPFA294HH*			N/A	N/A		
K 1300 GT (Touring)	FA335HH*		EPFA335HH*			N/A	N/A		
K 1600 B Bagger K61 - Disc fitting kit required	FA613HH*					MD616	MD616		
K 1600 B Bagger K61 - Optional front disc	FA613HH*					TBC	TBC		
K 1600 GT	FA613HH*					MD616	MD616		
K 1600 GTL	FA613HH*					MD616	MD616		
K 1600 GTL Exclusive	FA613HH*					MD616	MD616		
K 1600 Grand America	FA613HH*					MD616	MD616		
K 1600 B	FA613HH*					MD616	MD616		
R 18	FA748HH*					TBC	TBC		
R 18 Dragster	FA748HH*					MD616	MD616		
R 18 Blechmann	FA748HH*								

FRONT

Line #

⊖ - remove ABS ring from old rotor and refit to new EBC rotor. Note: Ensure all mounting surfaces are clean and when refitting bolts use a thread lock cement to hold them in place.

*-2 Sets Required. † For Vee disc colours add RED, BLU, GRN, GLD, ORG suffix to part number. **SAFETY WARNING:- DO NOT USE HH PADS ON REAR UNLESS ALSO USED ON FRONT TO AVOID BRAKE IMBALANCE**

APPLICATIONS

BRAKE

⊕ This symbol indicates a rotor made of billet steel, and should be only used with EBC FA Kevlar® Organic or Vee pads.

SAFETY NOTICE - With vehicles primarily designed for off highway use such as quads now being used on the highway, we would recommend the use of X or MXS pads for highway use and ONLY using the R and SV higher density / harder pad series for off road riding.

FRONT: Non-Japanese Bikes Cont'd

REAR: Non-Japanese Bikes

Line #	BRAKE ROTOR CHOICES - FRONT							DISC PAD CHOICES - REAR					BRAKE ROTOR CHOICES - REAR			
	CC Custom Rotor	CX Extreme® /Vee-Rotor	OS Series Oversize 250/280mm Rotor Kit	OSX Series Oversize 280mm Rotor Kit	Relocating Bracket for Oversize Rotor	SMX Series Oversize 320mm Rotor Kit	Relocating Bracket for 320mm Rotor		Sintered/HH Pads/ Grooved Shoes	SV Series Severe Duty Pads	EPFA Sintered Fast Road/ Track Pads	Specialty Pads SXR/ VEE/MXS Race	Standard Rotor	Vintage Rotor / UTV Oversize Brake Kit	Contour Profile Rotor	CX Extreme® /Vee-Rotor
1								FA209/2	FA209/2HH			FA209/2V	TBC			
2								FA209/2	FA209/2HH			FA209/2V	TBC			
3								FA363	FA363HH			FA363V	MD671			
4								FA363	FA363HH			FA363V	MD671			
5								FA363	FA363HH			FA363V	MD671			
6								FA363	FA363HH			FA363V	MD671			
7								FA363	FA363HH			FA363V	MD671			
8								FA363	FA363HH			FA363V	MD671			
9									FA209/2HH			FA209/2V	MD8001			
10									FA209/2HH			FA209/2V	MD8001			
11								FA363	FA363HH			FA363V	MD671			
12								FA363	FA363HH			FA363V	MD671			
13								FA209/2	FA209/2HH			FA209/2V	MD8001			
14								FA209/2	FA209/2HH			FA209/2V	MD8001			
15								FA209/2	FA209/2HH			FA209/2V	MD8001			
16								FA209/2	FA209/2HH			FA209/2V	MD8001			
17								FA209/2	FA209/2HH			FA209/2V	MD8001			
18								FA209/2	FA209/2HH			FA209/2V	MD8001			
19								FA209/2	FA209/2HH			FA209/2V	MD8001			
20								FA209/2	FA209/2HH			FA209/2V	MD8001			
21								FA209/2	FA209/2HH			FA209/2V	MD8001			
22								FA209/2	FA209/2HH			FA209/2V	MD8001			
23								FA209/2	FA209/2HH			FA209/2V	MD8001			
24								FA209/2	FA209/2HH			FA209/2V	MD8001			
25								FA209/2	FA209/2HH			FA209/2V	MD8001			
26								FA209/2	FA209/2HH			FA209/2V	MD8001			
27								FA18	FA18HH			FA18V	MD661			
28								FA18	FA18HH			FA18V	MD661			
29								FA304	FA304HH			FA304V	MD615			
30								FA304	FA304HH			FA304V	MD615			
31								FA304	FA304HH			FA304V	MD615			
32								FA18	FA18HH			FA18V	MD661			
33									FA438HH				MD688			
34																
35																
36								MWL002								
37								FA671	FA671HH			FA671V	MD671			
38								FA671	FA671HH			FA671V	MD671			
39								FA671	FA671HH			FA671V	MD671			
40								FA671	FA671HH			FA671V	MD671			
41								FA671	FA671HH			FA671V	MD671			
42								FA671	FA671HH			FA671V	MD671			
43								FA671	FA671HH			FA671V	MD671			
44								FA363	FA363HH			FA363V	MD688			
45								USE V/HH PAD	FA209/2HH			FA209/2V	TBC			
46								USE V/HH PAD	FA209/2HH			FA209/2V	TBC			
47								USE V/HH PAD	FA209/2HH			FA209/2V	TBC			
48								USE V/HH PAD	FA209/2HH			FA209/2V	TBC			
49								USE V/HH PAD	FA209/2HH			FA209/2V	TBC			
50								USE V/HH PAD	FA209/2HH			FA209/2V	TBC			
51									FA209/2HH							
52									FA209/2HH							
53									FA209/2HH							
54																
55																
56																

BRAKE APPLICATIONS

⊗ This symbol indicates a rotor made of billet steel, and should be only used with EBC FA Kevlar® Organic or Vee pads.
 SAFETY NOTICE - With vehicles primarily designed for off highway use such as quads now being used on the highway, we would recommend the use of X or MXS pads for highway use and ONLY using the R and SV higher density / harder pad series for off road riding.

*-2 Sets Required. † For Vee disc colours add RED, BLU, GRN, GLD, ORG suffix to part number. **SAFETY WARNING:- DO NOT USE HH PADS ON REAR UNLESS ALSO USED ON FRONT TO AVOID BRAKE IMBALANCE**

FRONT: Non-Japanese Bikes



BULTACO



Brinco (Electric Trials Bike - C/R/RE/S Models) 15-17

CAGIVA

Mito 125	92-02
WMX 125 (Rimoldi hub)	-85
WMX 125	86
WMX 125/250	87-88
WMX 125/250	89-91
WMX 250	-85
WMX 500	84-86
Alazzurra 650/Elefant 650	85-86
Elefant 650	86-87
Raptor 650/V-Raptor 650	00-02
Gran Canyon 900	99-00
Raptor 1000/V-Raptor 1000	00-02

CF MOTO (ATV)

400 C-Force	14-16
400 C-Force - Parking brake	14-16
400 C-Force	17-19
500 C-Force	17-18
500 C-Force - Parking brake	14-16
500 C-Force HO EPS	14-16
600 C-Force	18-19
600 C-Force	20
600 C-Force Touring	20
800 C-Force EPS	14-16

CF MOTO (SIDE X SIDE)

500 U-Force EPS	Left	14-16
	Right	
500 Z-Force	Left	14-16
	Right	
800 U-Force	Left	13-17
	Right	
800 Z-Force	Left	15-16
	Right	
800 EX Z-Force	Left	14-16
	Right	
950 Z-Force		20
1000 U-Force		20
1000 Z-Force		17-19

COBRA (MOTO)

King 50	04-06
P3	05-06
DC 65	06
CX50 P3	20-21
CX50 SR King	10-21
CX 50 FWE	16-17
CX 50 FWE	18-21
CX 50 SRX	20-21
CX 50 P3R	16-17
CX 50 P3R	18-21
CX 50 JR	10-17
CX 50 JR	18-21

DISC PAD CHOICES - FRONT

BRAKE ROTOR CHOICES - FRONT

	Sintered/HH Pads/Grooved Shoes	SV Series Severe Duty Pads	EPFA Sintered Fast Road/Track Pads	GPFA Sintered RACE ONLY Pads	Specialty Pads SXR/VEE/MXS Race	Standard Rotor Left	Standard Rotor Right	Vintage Rotor / UTV Oversize Brake Kit	Contour Profile Rotor
CF A689									N/A
FA95	FA95HH		EPFA95HH				MD614X		
FA47X						N/A			
FA134X	FA134R					N/A			
FA134X	FA134R					N/A			
FA47X						N/A			
FA47X						N/A			
FA47	FA47HH					N/A			
N/A						MD6265D			
FA244*	FA244HH*		EPFA244HH*			MD660LS	MD660RS		
FA142*	FA142HH*					N/A	N/A		
FA244*	FA244HH*		EPFA244HH*			MD660LS	MD660RS		
FA453X*	FA453R*					N/A	N/A		
FA726R*	FA726SV*								
FA726R*	FA726SV*					N/A	N/A		
FA453X*	FA453R*					N/A	N/A		
FA726R*	FA726SV*								
FA726R*	FA726SV*								
FA453X*	FA453R*								
FA453X*	FA453R*					N/A	N/A		
FA135X	FA135R				SXR135HH	N/A			
FA165X	FA165R				SXR165HH		N/A		
FA135X	FA135R	FA135SV				N/A			
FA165X	FA165R	FA165SV					N/A		
FA135X	FA135R	FA135SV			SXR135HH	N/A			
FA165X	FA165R	FA165SV			SXR165HH		N/A		
FA135X	FA135R	FA135SV				N/A			
FA165X	FA165R	FA165SV					N/A		
FA135X	FA135R	FA135SV				N/A			
FA165X	FA165R	FA165SV					N/A		
FA726X*	FA726R*	FA726SV*			SXR726HH*				
FA726X*	FA726R*	FA726SV*			SXR726HH*				
FA726X*	FA726R*	FA726SV*			SXR726HH*				
FA325X	FA325R					N/A			
TBC						N/A			
TBC						N/A			
FA752X	FA752R								
FA325X	FA325R								
FA325X	FA325R								
FA752R									
FA752R									
FA325X	FA325R								
FA752R									
FA325X	FA325R								
FA752R									

Line # 1 2 3 4 5 6 7 8 9 10 11 12 13 14 15 16 17 18 19 20 21 22 23 24 25 26 27 28 29 30 31 32 33 34 35 36 37 38 39 40 41 42 43 44 45 46 47 48 49 50 51 52 53 54 55 56

APPLICTIONS

BRAKE

* This symbol indicates a rotor made of billet steel, and should be only used with EBC FA Kevlar® Organic or Vee pads.

SAFETY NOTICE - With vehicles primarily designed for off highway use such as quads now being used on the highway, we would recommend the use of X or MXS pads for highway use and ONLY using the R and SV higher density / harder pad series for off road riding.

*-2 Sets Required. † For Vee disc colours add RED, BLU, GRN, GLD, ORG suffix to part number. SAFETY WARNING:- DO NOT USE HH PADS ON REAR UNLESS ALSO USED ON FRONT TO AVOID BRAKE IMBALANCE

FRONT: Non-Japanese Bikes Cont'd

REAR: Non-Japanese Bikes

Line # 1 2 3 4 5 6 7 8 9 10 11 12 13 14 15 16 17 18 19 20 21 22 23 24 25 26 27 28 29 30 31 32 33 34 35 36 37 38 39 40 41 42 43 44 45 46 47 48 49 50 51 52 53 54 55 56

BRAKE ROTOR CHOICES - FRONT							DISC PAD CHOICES - REAR					BRAKE ROTOR CHOICES - REAR				
CC Custom Rotor	CX Extreme® /Vee-Rotor	OS Series Oversize 250/280mm Rotor Kit	OSX Series Oversize 280mm Rotor Kit	Relocating Bracket for Oversize Rotor	SMX Series Oversize 320mm Rotor Kit	Relocating Bracket for 320mm Rotor		Sintered/HH Pads/ Grooved Shoes	SV Series Severe Duty Pads	EPFA Sintered Fast Road/ Track Pads	Specialty Pads SXR/ VEE/MXS Race	Standard Rotor	Vintage Rotor / UTV Oversize Brake Kit	Contour Profile Rotor	CX Extreme® /Vee-Rotor	
							CFA619								N/A	
							FA47	FA47HH 841G 977G				MD638				
							FA67X	FA67R 841G 982G				N/A				
							FA47	FA47HH				N/A				
							FA163					MD6259D				
							FA266	FA266HH			FA266V	MD617				
							FA165/2X					MD6160D				
							FA266	FA266HH			FA266V	MD617				
							FA344X	FA344R				TBC				
							FA232X	FA232R								
							FA651X	FA651R	FA651SV							
							FA651X	FA651R	FA651SV			TBC				
							FA232X	FA232R								
							FA317X	FA317R				TBC				
							FA651X*	FA651R*	FA651SV*							
							FA651X*	FA651R*	FA651SV*							
							FA317X	FA317R								
							FA344X	FA344R				TBC				
							FA67X*	FA67R*				N/A				
							FA67X*	FA67R*				N/A				
							FA651X	FA651R	FA651SV			N/A				
							FA651X	FA651R	FA651SV			N/A				
							FA67X*	FA67R*				N/A				
							FA67X*	FA67R*				N/A				
							FA651X	FA651R	FA651SV			N/A				
							FA651X	FA651R	FA651SV			N/A				
							FA651X	FA651R	FA651SV			N/A				
							FA651X	FA651R	FA651SV			N/A				
							FA651X*	FA651R*	FA651SV*		SXR651HH*					
							FA651X*	FA651R*	FA651SV*		SXR651HH*					
							FA651X*	FA651R*	FA651SV*		SXR651HH*	N/A				
							FA325X	FA325R				N/A				
							TBC									
							FA325X	FA325R				N/A				
							FA752X	FA752R								
							FA325X	FA325R								
							FA325X	FA325R								
								FA752R								
								FA752R								
							FA325X	FA325R								
								FA752R								
							FA325X	FA325R								
								FA752R								
							FA325X	FA325R								
								FA752R								

REAR

BRAKE APPLICATIONS

⚠ This symbol indicates a rotor made of billet steel, and should be only used with EBC FA Kevlar® Organic or Vee pads.
 SAFETY NOTICE - With vehicles primarily designed for off highway use such as quads now being used on the highway, we would recommend the use of X or MXS pads for highway use and ONLY using the R and SV higher density / harder pad series for off road riding.

*-2 Sets Required. † For Vee disc colours add RED, BLU, GRN, GLD, ORG suffix to part number. **SAFETY WARNING:- DO NOT USE HH PADS ON REAR UNLESS ALSO USED ON FRONT TO AVOID BRAKE IMBALANCE**

FRONT: Non-Japanese Bikes



COBRA (MOTO)



CX 50 SR King	11-17
CX 50 SR King	18-20
CX 65	11-22

COLEMAN POWERSPORTS

Outfitter 400	Left	13-15
	Right	
Outfitter 500	Left	12-15
	Right	
Outfitter 700	Left	12-15
	Right	
Outfitter 700-4	Left	12-15
	Right	
Outfitter 800	Left	12
	Right	
Trail Tamer 400	Left	15
	Right	

CPI

Apache 50/90	06-08
Enduro 50	06-08
GTR 50 (2 Pin Pad Fixing Front Caliper)	05-09
GTR 50 (1 Pin Pad Fixing Front Caliper)	05-09
Oliver City 50	05-09
GTR 125 (2 Pin Pad Fixing Front Caliper)	05-09
GTR 125 (1 Pin Pad Fixing Front Caliper)	05-09
GTR 150 (2 Pin Pad Fixing Front Caliper)	05-09
GTR 150 (1 Pin Pad Fixing Front Caliper)	05-09
Enduro 250	07-08

CSC

RX3 Cyclone 250	15-16
-----------------	-------

CZ/JAWA

Scrambler Cross 125-380 (Single/twin port models)	65-76
Jawa 250/400 Cross	65-76
250/380 (Models 513/514) Full width front hub models	77-79

DAELIM

A-Four (50cc)	06-08
E-Five 50	03-09
S-Five 50	01-09
Cordi 50	01-09
Delfino 100	01-09
Daystar 125	03-09
History 125	01-08
Roadwin 125	04-09
S1-125	06-09
S2-125	06-09
S2-250	06-09

DERBI

Atlantis 50 (All models)	99-01
Predator	99-01
Senda R 50	02-05
Senda Supermoto	04-05

DISC PAD CHOICES - FRONT

BRAKE ROTOR CHOICES - FRONT

	Sintered/HH Pads/Grooved Shoes	SV Series Severe Duty Pads	EPFA Sintered Fast Road/Track Pads	GPFA Sintered RACE ONLY Pads	Specialty Pads SXR/VEE/MXS Race	Standard Rotor Left	Standard Rotor Right	Vintage Rotor / UTV Oversize Brake Kit	Contour Profile Rotor
FA325X	FA325R								
	FA752R								
	FA752R								
FA674X	FA674R								
FA675X	FA675R								
FA674X	FA674R								
FA675X	FA675R								
FA674X	FA674R								
FA675X	FA675R								
FA674X	FA674R								
FA675X	FA675R								
FA674X	FA674R								
FA675X	FA675R								
TBC*									
FA115X	FA115R					N/A			
SFA194	SFA194HH					N/A			
SFA266	SFA266HH					N/A			
SFA235						N/A			
SFA194	SFA194HH					N/A			
SFA266	SFA266HH					N/A			
SFA194	SFA194HH					N/A			
SFA266	SFA266HH					N/A			
FA115X	FA115R					N/A			
FA664									N/A
950									
950									
N/A									
SFA264	SFA264HH					N/A			
SFA257						TBC			
SFA257						TBC			
SFA54	SFA54HH					N/A			
SFA257						TBC			
FA196	FA196HH						N/A		
SFA54	SFA54HH						N/A		
FA196	FA196HH					N/A			
SFA661/4						TBC			
SFA142	SFA142HH						TBC		
SFA142	SFA142HH					TBC			
SFA115	SFA115HH					MD943D			
SFA115	SFA115HH					MD964D			
FA115X	FA115R					N/A			
FA115X	FA115R					N/A			

Line #
1
2
3
4
5
6
7
8
9
10
11
12
13
14
15
16
17
18
19
20
21
22
23
24
25
26
27
28
29
30
31
32
33
34
35
36
37
38
39
40
41
42
43
44
45
46
47
48
49
50
51
52
53
54
55
56

FRONT

APPLICATIONS

⚠ This symbol indicates a rotor made of billet steel, and should be only used with EBC FA Kevlar® Organic or Vee pads.
SAFETY NOTICE - With vehicles primarily designed for off highway use such as quads now being used on the highway, we would recommend the use of X or MXS pads for highway use and ONLY using the R and SV higher density / harder pad series for off road riding.

*-2 Sets Required. † For Vee disc colours add RED, BLU, GRN, GLD, ORG suffix to part number. SAFETY WARNING:- DO NOT USE HH PADS ON REAR UNLESS ALSO USED ON FRONT TO AVOID BRAKE IMBALANCE

FRONT: Non-Japanese Bikes Cont'd

REAR: Non-Japanese Bikes

Line #	BRAKE ROTOR CHOICES - FRONT						REAR	DISC PAD CHOICES - REAR					BRAKE ROTOR CHOICES - REAR			
	CC Custom Rotor	CX Extreme® /Vee-Rotor	OS Series Oversize 250/280mm Rotor Kit	OSX Series Oversize 280mm Rotor Kit	Relocating Bracket for Oversize Rotor	SMX Series Oversize 320mm Rotor Kit		Relocating Bracket for 320mm Rotor	 Sintered/HH Pads/Grooved Shoes	SV Series Severe Duty Pads	EPFA Sintered Fast Road/Track Pads	Specialty Pads SXR/VEE/MXS Race	Standard Rotor	Vintage Rotor / UTV Oversize Brake Kit	Contour Profile Rotor	CX Extreme® /Vee-Rotor
1								FA325X	FA325R							
2									FA752R							
3									FA752R							
4																
5																
6								FA690X	FA690R							
7								FA690X	FA690R							
8								FA690X	FA690R							
9								FA690X	FA690R							
10								FA690X	FA690R							
11								FA690X	FA690R							
12								FA690X	FA690R							
13								FA690X	FA690R							
14								FA690X	FA690R							
15								FA690X	FA690R							
16								FA690X	FA690R							
17								FA690X	FA690R							
18																
19																
20								TBC				N/A				
21								FA115X	FA115R			N/A				
22								SFA260	SFA260HH			N/A				
23								SFA298	SFA298HH			N/A				
24								503								
25								SFA260	SFA260HH			N/A				
26								SFA298	SFA298HH			N/A				
27								SFA260	SFA260HH			N/A				
28								SFA298	SFA298HH			N/A				
29								FA115X	FA115R			N/A				
30																
31																
32								FA140						N/A		
33																
34																
35								950								
36								950								
37								950								
38																
39																
40								TBC								
41								TBC								
42								TBC								
43								TBC								
44								TBC								
45								824								
46								FA54X	FA54HH			N/A				
47								FA197	FA197HH			MD814				
48								SFA54	SFA54HH			TBC				
49								SFA197	SFA197HH			TBC				
50								SFA197	SFA197HH			TBC				
51																
52																
53								624								
54								SFA115	SFA115HH			MD964D				
55								FA115X	FA115R			N/A				
56								FA115X	FA115R			N/A				

⚠ This symbol indicates a rotor made of billet steel, and should be only used with EBC FA Kevlar® Organic or Vee pads.
 SAFETY NOTICE - With vehicles primarily designed for off highway use such as quads now being used on the highway, we would recommend the use of X or MXS pads for highway use and ONLY using the R and SV higher density / harder pad series for off road riding.

BRAKE APPLICATIONS

*-2 Sets Required. † For Vee disc colours add RED, BLU, GRN, GLD, ORG suffix to part number. **SAFETY WARNING:** DO NOT USE HH PADS ON REAR UNLESS ALSO USED ON FRONT TO AVOID BRAKE IMBALANCE

FRONT: Non-Japanese Bikes



DERBI



GPR 50 Replica	03-05
GPR 50 Nude	04-05
GRP 80 Cup	05
GPR 125/Nude (Radial Caliper)	05-06
Atlantis Bullet/City	02-05
Boulevard 150	03-05
GP 150	02-06

DINLI

Diamond Back 90	06
DMX 270	05-06
DMX 450	05-06

DUCATI

250/350/450 Desmo/Single	-76
250/350/450 Desmo/Single (4 bolt fixing)	74-77
Scrambler Sixty 2 (Cast wheels/399cc)	16-19
Supersport 400 (Single disc)	93-97
Supersport 400 (Twin disc)	93-97
400 Monster	95-97
Monster 400 (Single disc)	00-02
Monster 400 (Twin disc)	03-04
400 Monster (Japan)	00-04
Monster Dark ie 400 (Japan)	05-06
Monster Dark ie 400 (Single disc)	05
Monster 400 ie (Japan)	07-08
500 GTL	75
500 GTV Pantah	77
500 Sport Desmo	77
500 Pantah	79
549cc - Supermoto (549cc)	93-95
600 Pantah	81
Monster 600 (Twin disc)	93-97
600 Monster (Single disc)	93-99
600 Monster Dark	98-99
600 Monster City/City Dark	99
600 Monster	00-01
600 Supersport (Single disc)	91-97
620 IE Monster	02-04
620 IE Monster (Series 1 - Twin Pin Pad Fixing Caliper)	05
620 IE Monster (Series 2 - Single Pin Pad Fixing Caliper)	05-06
620 Sport	03
Monster 620 Dark	03-04
620 Multistrada (Twin Disc/Single Pin Pad Fixing)	06
620 Multistrada Dark (Single Disc/Twin Pin Pad Fixing)	06
650 Pantah	-84
695 Monster	06-09
696 Monster	08-15
M 696 Monster 20th Anniversary Model	13-14
748 R (2 pad caliper)	00
748 R (4 pad caliper)	01-02
748 Biposto	95-98
748 Biposto	99-02
748 SP	95-97
748 SP	98
748 SP/Monoposto	99-02

Line #	DISC PAD CHOICES - FRONT						BRAKE ROTOR CHOICES - FRONT			
		Sintered/HH Pads/Grooved Shoes	SV Series Severe Duty Pads	EPFA Sintered Fast Road/Track Pads	GPFAX Sintered RACE ONLY Pads	Specialty Pads SXR/VEE/MXS Race	Standard Rotor Left	Standard Rotor Right	Vintage Rotor / UTV Oversize Brake Kit	Contour Profile Rotor
1		FA167	FA167HH				N/A			
2		FA266	FA266HH				N/A			
3		FA266	FA266HH				N/A			
4		FA399					N/A			
5		SFA115	SFA115HH				MD964D			
6		SFA350	SFA350HH				MD924D			
7		SFA115	SFA115HH				MD943D			
8										
9										
10		TBC*								
11		TBC*					TBC	TBC		
12		TBC*					TBC	TBC		
13										
14										
15		928								
16		FA18	FA18HH				MD634LS			
17		FA209/2	FA209/2HH			FA209/2V	TBC			
18		FA95	FA95HH		EPFA95HH		MD2003X			MD2003XC
19		FA95*	FA95HH*		EPFA95HH*		MD2003X	MD2003X		MD2003XC*
20		FA95	FA95HH		EPFA95HH		MD2003X			MD2003XC
21		FA244	FA244HH		EPFA244HH		MD614X			MD614XC
22		FA244*	FA244HH*		EPFA244HH*		MD614X	MD614X		MD614XC*
23		FA244	FA244HH		EPFA244HH		MD614X			MD614XC
24		FA244*	FA244HH*		EPFA244HH*		MD614X	MD614X		MD614XC*
25		FA244	FA244HH		EPFA244HH		MD614X			MD614XC
26		FA181*	FA181HH*				MD626X	MD626X		MD626XC*
27		FA47*	FA47HH*				N/A	N/A		
28		FA47*	FA47HH*				N/A	N/A		
29		FA47*	FA47HH*				N/A	N/A		
30		FA47*	FA47HH*				MD657LS	MD657RS		
31		FA95*	FA95HH*		EPFA95HH*		TBC	TBC		
32		FA18*	FA18HH*				MD657LS	MD657RS		
33		FA95*	FA95HH*		EPFA95HH*		MD2003X	MD2003X		MD2003XC*
34		FA95	FA95HH		EPFA95HH		MD2003X			MD2003XC
35		FA95	FA95HH		EPFA95HH		MD2003X			MD2003XC
36		FA95	FA95HH		EPFA95HH		MD614X			MD614XC
37		FA244	FA244HH		EPFA244HH		MD614X			MD614XC
38		FA95	FA95HH		EPFA95HH		MD2003X			MD2003XC
39		FA244*	FA244HH*		EPFA244HH*		MD614X	MD614X		MD614XC*
40		FA244*	FA244HH*		EPFA244HH*		MD614X	MD614X		MD614XC*
41		FA181*	FA181HH*				MD626X	MD626X		MD626XC*
42		FA244*	FA244HH*		EPFA244HH*		MD614X	MD614X		MD614XC*
43		FA244	FA244HH		EPFA244HH		MD2003X			MD2003XC
44		FA181*	FA181HH*				MD626X	MD626X		MD626XC*
45		FA244	FA244HH		EPFA244HH		MD2003X			MD2003XC
46		FA18*	FA18HH*				N/A	N/A		
47		FA181*	FA181HH*				MD626X	MD626X		MD626XC*
48		FA244*	FA244HH*		EPFA244HH*		MD614X	MD614X		MD614XC*
49		FA244*	FA244HH*		EPFA244HH*		MD614X	MD614X		MD614XC*
50		FA244*	FA244HH*		EPFA244HH*	GPFAX244HH*	MD636X	MD636X		MD636XC*
51			FA322/4HH*		EPFA322/4HH*		MD636X	MD636X		MD636XC*
52		FA95*	FA95HH*		EPFA95HH*	GPFAX95HH*	MD2003X	MD2003X		MD2003XC*
53		FA244*	FA244HH*		EPFA244HH*	GPFAX244HH*	MD614X	MD614X		MD614XC*
54		FA95*	FA95HH*		EPFA95HH*	GPFAX95HH*	MD2003X	MD2003X		MD2003XC*
55		FA95*	FA95HH*		EPFA95HH*	GPFAX95HH*	MD2003X	MD2003X		MD2003XC*
56		FA244*	FA244HH*		EPFA244HH*	GPFAX244HH*	MD614X	MD614X		MD614XC*

APPLIATIONS

BRAKE

⚡ This symbol indicates a rotor made of billet steel, and should be only used with EBC FA Kevlar® Organic or Vee pads.

SAFETY NOTICE - With vehicles primarily designed for off highway use such as quads now being used on the highway, we would recommend the use of X or MXS pads for highway use and ONLY using the R and SV higher density / harder pad series for off road riding.

*2 Sets Required. † For Vee disc colours add RED, BLU, GRN, GLD, ORG suffix to part number. **SAFETY WARNING:- DO NOT USE HH PADS ON REAR UNLESS ALSO USED ON FRONT TO AVOID BRAKE IMBALANCE**

FRONT: Non-Japanese Bikes Cont'd

REAR: Non-Japanese Bikes

Line #	BRAKE ROTOR CHOICES - FRONT						DISC PAD CHOICES - REAR					BRAKE ROTOR CHOICES - REAR			
	CC Custom Rotor	CX Extreme® /Vee-Rotor	OS Series Oversize 250/280mm Rotor Kit	OSX Series Oversize 280mm Rotor Kit	Relocating Bracket for Oversize Rotor	SMX Series Oversize 320mm Rotor Kit	Relocating Bracket for 320mm Rotor		Sintered/HH Pads/ Grooved Shoes	SV Series Severe Duty Pads	EPFA Sintered Fast Road/ Track Pads	Specialty Pads SXR/ VEE/MXS Race	Standard Rotor	Vintage Rotor / UTV Oversize Brake Kit	Contour Profile Rotor
1							FA115	FA115HH				N/A			
2							FA115	FA115HH				N/A			
3							FA115	FA115HH				N/A			
4							FA115					N/A			
5							816								
6							816								
7							624								
8															
9															
10							FA83X	FA83R				N/A			
11							TBC					TBC			
12							TBC					TBC			
13															
14															
15							929								
16							921								
17							FA213	FA213HH			FA213V	MD2002			
18		VR2003BLK					FA47	FA47HH				MD2002		MD2002C	VR2002
19		VR2003BLK†					FA47	FA47HH				MD2002		MD2002C	VR2002
20		VR2003BLK					FA47	FA47HH				MD2002		MD2002C	VR2002
21		VR614BLK					FA47	FA47HH				MD2002		MD2002C	VR2002
22		VR614BLK†					FA47	FA47HH				MD2002		MD2002C	VR2002
23		VR614BLK					FA47	FA47HH				MD2002		MD2002C	VR2002
24		VR614BLK†					FA47	FA47HH				MD2002		MD2002C	VR2002
25		VR614BLK†					FA47	FA47HH				MD2002		MD2002C	VR2002
26		VR626BLK†					FA47	FA47HH				MD2002		MD2002C	VR2002
27							N/A								
28							FA47	FA47HH				N/A			
29							FA47	FA47HH							
30							FA47	FA47HH				MD657			
31							FA115	FA115HH				TBC			
32							FA47	FA47HH				N/A			
33		VR2003BLK†					FA47	FA47HH				MD2002		MD2002C	VR2002
34		VR2003BLK					FA47	FA47HH				MD2002		MD2002C	VR2002
35		VR2003BLK					FA47	FA47HH				MD2002		MD2002C	VR2002
36		VR614BLK					FA47	FA47HH				MD2002		MD2002C	VR2002
37		VR614BLK					FA47	FA47HH				MD2002		MD2002C	VR2002
38		VR2003BLK					FA47	FA47HH				MD2002		MD2002C	VR2002
39		VR614BLK†					FA47	FA47HH				MD2002		MD2002C	VR2002
40		VR614BLK†					FA47	FA47HH				MD2002		MD2002C	VR2002
41		VR626BLK†					FA47	FA47HH				MD2002		MD2002C	VR2002
42		VR614BLK†					FA266	FA266HH			FA266V	MD2002		MD2002C	VR2002
43		VR2003BLK					FA47	FA47HH				MD2002		MD2002C	VR2002
44		VR626BLK†					FA47	FA47HH				MD2002		MD2002C	VR2002--
45		VR2003BLK					FA47	FA47HH				MD2002		MD2002C	VR2002
46							FA18	FA18HH			FA18V	N/A			
47		VR626BLK†					FA47	FA47HH				MD2002		MD2002C	VR2002
48		VR614BLK†					FA266	FA266HH			FA266V	MD2002		MD2002C	VR2002
49		VR614BLK†					FA266	FA266HH			FA266V	MD2002		MD2002C	VR2002
50							FA47	FA47HH				MD632		MD632C	
51							FA47	FA47HH				MD632		MD632C	
52		VR2003BLK†					FA47	FA47HH				MD632		MD632C	VR632
53		VR614BLK†					FA47	FA47HH				MD632		MD2002C	VR2002
54							FA47	FA47HH				MD632		MD632C	VR632
55		VR2003BLK†					FA47	FA47HH				MD632		MD632C	VR632
56		VR614BLK†					FA47	FA47HH				MD2002		MD2002C	VR2002

⚠ This symbol indicates a rotor made of billet steel, and should be only used with EBC FA Kevlar® Organic or Vee pads.
SAFETY NOTICE - With vehicles primarily designed for off highway use such as quads now being used on the highway, we would recommend the use of X or MXS pads for highway use and ONLY using the R and SV higher density / harder pad series for off road riding.

BRAKE APPLICATIONS

*-2 Sets Required. † For Vee disc colours add RED, BLU, GRN, GLD, ORG suffix to part number. **SAFETY WARNING:- DO NOT USE HH PADS ON REAR UNLESS ALSO USED ON FRONT TO AVOID BRAKE IMBALANCE**

FRONT: Non-Japanese Bikes



DUCATI



DISC PAD CHOICES - FRONT

BRAKE ROTOR CHOICES - FRONT

			Sintered/HH Pads/ Grooved Shoes	SV Series Severe Duty Pads	EPFA Sintered Fast Road/ Track Pads	GPFA Sintered RACE ONLY Pads	Specialty Pads SXR/ VEE/MXS Race			Vintage Rotor / UTV Oversize Brake Kit	Contour Profile Rotor	Line #
748 (Biposto)	00-02		FA244*	FA244HH*	EPFA244HH*	GPFA244HH*		TBC	TBC			1
748 (Monoposto)	00-02		FA244*	FA244HH*	EPFA244HH*	GPFA244HH*		TBC	TBC			2
748 SPS	98-99		FA244*	FA244HH*	EPFA244HH*	GPFA244HH*		MD633X	MD633X		MD633XC*	3
748 Testa Bassa (Mono/Biposto)	01		FA244*	FA244HH*	EPFA244HH*	GPFA244HH*		MD614X	MD614X		MD614XC*	4
749 Dark (Monoposto/Biposto)	04-06			FA322/4HH*	EPFA322/4HH*			MD622X	MD622X		MD622XC*	5
749 R (Radial caliper)	04-06			FA322/4HH*	EPFA322/4HH*			MD622X	MD622X		MD622XC*	6
749 S (Monoposto/Biposto)	03-06			FA322/4HH*	EPFA322/4HH*			MD622X	MD622X		MD622XC*	7
749 (Monoposto/Biposto)	03-06			FA322/4HH*	EPFA322/4HH*			MD622X	MD622X		MD622XC*	8
750 Sport (4 bolt fixing)	74		FA16	FA16HH	EPFA16HH			MD634LS				9
750 SS (4 bolt fixing)	75-76		FA18*	FA18HH*				MD634LS	MD634RS			10
751 F1	86		FA18*	FA18HH*				N/A	N/A			11
750 Paso	87-90		FA18*	FA18HH*				MD630LS	MD630RS			12
750 Sport	88-90		FA18*	FA18HH*				MD630LS	MD630RS			13
750 Supersport (Single disc)	91-98		FA95	FA95HH	EPFA95HH			MD2003X			MD2003XC	14
Supersport 750 (Twin disc)	91-98		FA95*	FA95HH*	EPFA95HH*			MD2003X	MD2003X		MD2003XC	15
750 Supersport	99		FA244*	FA244HH*	EPFA244HH*			MD2003X	MD2003X		MD2003XC*	16
750 Supersport IE	00-02		FA244*	FA244HH*	EPFA244HH*			MD614X	MD614X		MD614XC*	17
750 Sport	01-02		FA244*	FA244HH*	EPFA244HH*			MD614X	MD614X		MD614XC*	18
750 Monster (Single disc)	96-97		FA95	FA95HH	EPFA95HH			MD2003X			MD2003XC	19
750 Monster (Twin disc)	96-98		FA95*	FA95HH*	EPFA95HH*			MD2003X	MD2003X		MD2003XC*	20
750 Monster City/City Dark	99		FA95*	FA95HH*	EPFA95HH*			MD2003X	MD2003X		MD2003XC*	21
750 Monster/Monster Dark	99		FA95*	FA95HH*	EPFA95HH*			MD2003X	MD2003X		MD2003XC*	22
750 Monster	00-01		FA244*	FA244HH*	EPFA244HH*			MD614X	MD614X		MD614XC*	23
750 ie Monster	02		FA244*	FA244HH*	EPFA244HH*			MD614X	MD614X		MD614XC*	24
796 Hypermotard	10-12		FA244*	FA244HH*	EPFA244HH*			MD865X	MD865X		MD865XC*	25
796 Monster (Non ABS)	10-13		FA244*	FA244HH*	EPFA244HH*			MD841X	MD841X		MD841XC*	26
796 Monster (ABS)	10-15		FA244*	FA244HH*	EPFA244HH*			MD841X	MD841X		MD841XC*	27
M 796 Monster 20th Anniversary Model	13-14		FA244*	FA244HH*	EPFA244HH*			MD841X	MD841X		MD841XC*	28
Monster 797+	17-21			FA630HH*	EPFA630HH*			MD841X	MD841X		MD841XC*	29
Monster 800	03-04		FA244*	FA244HH*	EPFA244HH*			MD614X	MD614X		MD614XC*	30
Monster S2R (803cc)	05-07		FA181*	FA181HH*	EPFA181HH*			MD626X	MD626X		MD626XC*	31
Monster S2R Dark (803cc)	05-06		FA181*	FA181HH*	EPFA181HH*			MD626X	MD626X		MD626XC*	32
800 Sport	03		FA244*	FA244HH*	EPFA244HH*			MD614X	MD614X		MD614XC*	33
800 Supersport	03-05		FA244*	FA244HH*	EPFA244HH*			MD614X	MD614X		MD614XC*	34
Scrambler Classic (Spoke wheels/803cc)	15-19			FA630HH	EPFA630HH			MD868X			MD868XC	35
Scrambler Icon (Cast wheels/803cc)	15-21			FA630HH	EPFA630HH			MD868X			MD868XC	36
Scrambler Icon Dark (Cast wheels/803cc)	20-21			FA630HH	EPFA630HH			MD868X			MD868XC	37
Scrambler Urban Enduro (Spoke wheels/803cc)	15-16			FA630HH	EPFA630HH			MD868X			MD868XC	38
Desert Sled (Spoke wheels/803cc)	18-21			FA630HH	EPFA630HH			MD868X			MD868XC	39
Scrambler Full Throttle (Cast wheels/803cc)	15-21			FA630HH	EPFA630HH			MD868X			MD868XC	40
Scrambler Flat Track Pro (Cast wheels/803cc)	16			FA630HH	EPFA630HH			MD868X			MD868XC	41
Scrambler Café Racer (Cast Wheels/803cc)	17-21			FA630HH	EPFA630HH			MD868X			MD868XC	42
Café Racer (Spoke wheels/803cc)	18-21			FA630HH	EPFA630HH			MD868X			MD868XC	43
821 Hypermotard SP	13-15			FA630HH*	EPFA630HH*			MD841X	MD841X		MD841XC*	44
821 Hypermotard SP	13-15			FA630HH*	EPFA630HH*			MD841X	MD841X		MD841XC*	45
821 Hyperstrada	13-15			FA630HH*	EPFA630HH*			MD841X	MD841X		MD841XC*	46
Monster 821	15-21			FA630HH*	EPFA630HH*			MD841X	MD841X		MD841XC*	47
Monster 821 Stealth	20-21			FA630HH*	EPFA630HH*			MD841X	MD841X		MD841XC*	48
Monster Dark 821	15-20			FA630HH*	EPFA630HH*			MD841X	MD841X		MD841XC*	49
Monster Stripe 821	15-17			FA630HH*	EPFA630HH*			MD841X	MD841X		MD841XC*	50
848 (Radial 2 pad caliper)	08-10		FA244*	FA244HH*	EPFA244HH*	GPFA244HH*		MD843X	MD843X		MD843XC*	51
848 Evo (Monobloc front calipers)	10-13			FA447HH*	EPFA447HH*	GPFA447HH*		MD843X	MD843X		MD843XC*	52
848 Evo Corse Special Edition (Monobloc front calipers)	12-13			FA447HH*	EPFA447HH*	GPFA447HH*		N/A	N/A			53
848 Streetfighter	12-15		FA244*	FA244HH*	EPFA244HH*	GPFA244HH*		N/A	N/A			54
851 Superbike Biposto	89-92		FA95*	FA95HH*	EPFA95HH*	GPFA95HH*		MD2003X	MD2003X		MD2003XC*	55
860 GT/GTS	75-76		FA18*	FA18HH*				MD634LS	MD634RS			56

FRONT

APPLIATIONS
BRAKE
SAFETY NOTICE - This symbol indicates a rotor made of billet steel, and should be only used with EBC FA Kevlar® Organic or Vee pads. pads for highway use and ONLY using the R and SV higher density / harder pad series for off road riding.

*-2 Sets Required. † For Vee disc colours add RED, BLU, GRN, GLD, ORG suffix to part number. **SAFETY WARNING:- DO NOT USE HH PADS ON REAR UNLESS ALSO USED ON FRONT TO AVOID BRAKE IMBALANCE**

FRONT: Non-Japanese Bikes Cont'd

REAR: Non-Japanese Bikes

Line #	BRAKE ROTOR CHOICES - FRONT						DISC PAD CHOICES - REAR					BRAKE ROTOR CHOICES - REAR				
	CC Custom Rotor	CX Extreme® /Vee-Rotor	OS Series Oversize 250/280mm Rotor Kit	OSX Series Oversize 280mm Rotor Kit	Relocating Bracket for Oversize Rotor	SMX Series Oversize 320mm Rotor Kit	Relocating Bracket for 320mm Rotor		Sintered/HH Pads/ Grooved Shoes	SV Series Severe Duty Pads	EPFA Sintered Fast Road/ Track Pads	Specialty Pads SXR/ VEE/MXS Race	Standard Rotor	Vintage Rotor / UTV Oversize Brake Kit	Contour Profile Rotor	CX Extreme® /Vee-Rotor
1								FA47	FA47HH				MD632			
2								FA47	FA47HH				MD632			
3								FA47	FA47HH				MD632		MD632C	VR632
4		VR614BLK*†						FA47	FA47HH				MD632		MD632C	VR632
5		VR622BLK*†						FA266	FA266HH			FA266V	MD618		MD618C	VR618
6		VR622BLK*†						FA266	FA266HH			FA266V	MD618		MD618C	VR618
7		VR622BLK*†						FA266	FA266HH			FA266V	MD618		MD618C	VR618
8		VR622BLK*†						FA266	FA266HH			FA266V	MD618		MD618C	VR618
9								N/A								
10								FA18	FA18HH			FA18V	N/A			
11								FA18	FA18HH			FA18V	N/A			
12								FA47	FA47HH			FA47V	MD631			
13								FA18	FA18HH			FA18V	MD631			
14		VR2003BLK						FA47	FA47HH				MD2002		MD2002C	VR2002
15		VR2003BLK*†						FA47	FA47HH				MD2002		MD2002C	VR2002
16		VR2003BLK*†						FA266	FA266HH			FA266V	MD2002		MD2002C	VR2002
17		VR614BLK*†						FA266	FA266HH			FA266V	MD2002		MD2002C	VR2002
18		VR614BLK*†						FA266	FA266HH			FA266V	MD2002		MD2002C	VR2002
19		VR2003BLK						FA47	FA47HH				MD2002		MD2002C	VR2002
20		VR2003BLK*†						FA47	FA47HH				MD2002		MD2002C	VR2002
21		VR2003BLK*†						FA47	FA47HH				MD2002		MD2002C	VR2002
22		VR2003BLK*†						FA47	FA47HH				MD2002		MD2002C	VR2002
23		VR614BLK*†						FA47	FA47HH				MD2002		MD2002C	VR2002
24		VR614BLK*†						FA47	FA47HH				MD2002		MD2002C	VR2002
25								FA266	FA266HH			FA266V	MD627		MD627C	VR627
26		VR841BLK*†						FA266	FA266HH			FA266V	MD627		MD627C	VR627
27		VR841BLK*†						FA266	FA266HH			FA266V	MD627		MD627C	VR627
28		VR841BLK*†						FA266	FA266HH			FA266V	MD627		MD627C	VR627
29		VR841BLK*†						FA213	FA213HH			FA213V	MD878		MD878C	VR878
30		VR614BLK*†						FA47	FA47HH				MD2002		MD2002C	VR2002
31		VR626BLK*†						FA47	FA47HH				MD627		MD627C	VR627
32		VR626BLK*†						FA47	FA47HH				MD627		MD627C	VR627
33		VR614BLK*†						FA47	FA47HH				MD2002		MD2002C	VR2002
34		VR614BLK*†						FA266	FA266HH			FA266V	MD2002		MD2002C	VR2002
35								FA213	FA213HH			FA213V	MD2002		MD2002C	VR2002
36								FA213	FA213HH			FA213V	MD2002		MD2002C	VR2002
37								FA213	FA213HH			FA213V	MD899		MD2002C	VR2002
38								FA213	FA213HH			FA213V	MD2002		MD2002C	VR2002
39								FA213	FA213HH			FA213V	MD2002		MD2002C	VR2002
40								FA213	FA213HH			FA213V	MD2002		MD2002C	VR2002
41								FA213	FA213HH			FA213V	MD2002		MD2002C	VR2002
42									FA213HH			FA213V	MD2002		MD2002C	VR2002
43								FA213	FA213HH			FA213V	MD2002		MD2002C	VR2002
44		VR841BLK*†							FA266HH			FA266V	MD627		MD627C	VR627
45		VR841BLK*†							FA266HH			FA266V	MD627		MD627C	VR627
46		VR841BLK*†							FA266HH			FA266V	MD627		MD627C	VR627
47		VR841BLK*†							FA266HH			FA266V	MD2002		MD2002C	VR2002
48		VR841BLK*†							FA266HH			FA266V	MD2002		MD2002C	VR2002
49		VR841BLK*†							FA266HH			FA266V	MD2002		MD2002C	VR2002
50		VR841BLK*†							FA266HH			FA266V	MD2002		MD2002C	VR2002
51		VR843BLK*†						FA266	FA266HH			FA266V	MD627		MD627C	VR627
52		VR843BLK*†						FA266	FA266HH			FA266V	MD627		MD627C	VR627
53								FA266	FA266HH			FA266V	MD695		MD695C	VR695
54								FA266	FA266HH			FA266V	MD627			
55		VR2003BLK*†						FA47	FA47HH				MD2002		MD2002C	VR2002
56								FA18	FA18HH			FA18V	MD634LS			

BRAKE APPLICATIONS

⚠ This symbol indicates a rotor made of billet steel, and should be only used with EBC FA Kevlar® Organic or Vee pads. SAFETY NOTICE - With vehicles primarily designed for off highway use such as quads now being used on the highway, we would recommend the use of X or MXS pads for highway use and ONLY using the R and SV higher density / harder pad series for off road riding.

*-2 Sets Required. † For Vee disc colours add RED, BLU, GRN, GLD, ORG suffix to part number. **SAFETY WARNING:- DO NOT USE HH PADS ON REAR UNLESS ALSO USED ON FRONT TO AVOID BRAKE IMBALANCE**

FRONT: Non-Japanese Bikes



DUCATI



DISC PAD CHOICES - FRONT

BRAKE ROTOR CHOICES - FRONT

												Line #
888 SP4/SP5	92-93		FA95*	FA95HH*		EPFA95HH*		TBC	TBC		TBC*	1
888 Superbike Strada	94-95		FA95*	FA95HH*		EPFA95HH*		MD2003X	MD2003X		MD2003XC*	2
899 Panigale	14-15			FA630HH*		EPFA630HH*		MD843X	MD843X		MD843XC*	3
900 GTS (4 bolt fixing)	75-76		FA18*	FA18HH*				MD634LS	MD634RS			4
900 SS Darmah (4 bolt fixing)	76-77		FA18*	FA18HH*				MD634LS	MD634RS			5
900 SS Darmah (6 bolt fixing)	78		FA18*	FA18HH*				MD609LS	MD609RS			6
900 Hailwood Replica (6 bolt fixing)	79		FA18*	FA18HH*				MD609LS	MD609RS			7
900 Supersport	89-90		FA95*	FA95HH*		EPFA95HH*		MD2001X	MD2001X		MD2001XC*	8
900 Supersport/Superlight	91-97		FA95*	FA95HH*		EPFA95HH*		MD2003X	MD2003X		MD2003XC*	9
900 Supersport	98-99		FA244*	FA244HH*		EPFA244HH*		MD2003X	MD2003X		MD2003XC*	10
900 Supersport CR USA	98		FA95*	FA95HH*		EPFA95HH*		MD2003X	MD2003X		MD2003XC*	11
900 Supersport FE	98		FA95*	FA95HH*		EPFA95HH*		MD2003X	MD2003X		MD2003XC*	12
900 Supersport IE	00-01		FA244*	FA244HH*		EPFA244HH*		MD614X	MD614X		MD614XC*	13
900 Sport	02		FA244*	FA244HH*		EPFA244HH*		MD614X	MD614X		MD614XC*	14
900 Monster	93-99		FA95*	FA95HH*		EPFA95HH*		MD2003X	MD2003X		MD2003XC*	15
900 Monster Cromo/Special	98		FA95*	FA95HH*		EPFA95HH*		MD2003X	MD2003X		MD2003XC*	16
900 Monster City/City Dark	99		FA95*	FA95HH*		EPFA95HH*		MD2003X	MD2003X		MD2003XC*	17
900 IE Monster	00-01		FA244*	FA244HH*		EPFA244HH*		MD614X	MD614X		MD614XC*	18
900 MH Evoluzione	00-01		FA244*	FA244HH*		EPFA244HH*		MD614X	MD614X		MD614XC*	19
906 Paso	88-89		FA18*	FA18HH*				TBC	TBC			20
907 IE	90-91		FA95*	FA95HH*		EPFA95HH*		MD2001X	MD2001X		MD2001XC*	21
907 IE	92-93		FA95*	FA95HH*		EPFA95HH*		MD2003X	MD2003X		MD2003XC*	22
Monster S4 Foggy (916cc)	02		FA244*	FA244HH*		EPFA244HH*		MD624	MD624			23
Monster S4 (916cc)	01-02		FA244*	FA244HH*		EPFA244HH*		MD624	MD624			24
ST4 (916cc)	99		FA244*	FA244HH*		EPFA244HH*		MD2003X	MD2003X		MD2003XC*	25
ST4 (916cc)	00		FA244*	FA244HH*		EPFA244HH*		TBC	TBC			26
ST4 (916cc)	01-02		FA244*	FA244HH*		EPFA244HH*		MD614X	MD614X		MD614XC*	27
916 (Biposto)	94-96		FA95*	FA95HH*		EPFA95HH*	GPFAX95HH*	MD2003X	MD2003X		MD2003XC*	28
916 Sienna	94-98		FA95*	FA95HH*		EPFA95HH*	GPFAX95HH*	TBC	TBC			29
Supersport (936cc)	17-21			FA630HH*		EPFA630HH*		MD841X	MD841X		MD841XC*	30
Supersport S (936cc)	17-21			FA630HH*		EPFA630HH*		MD841X	MD841X		MD841XC*	31
939 Hypermotard	16-21			FA630HH*		EPFA630HH*		MD841X	MD841X		MD841XC*	32
939 Hypermotard SP	16-21			FA447HH*		EPFA447HH*	GPFAX447HH*					33
Hypermotard 950 RVE	21			FA630HH*		EPFA630HH*		MD841X	MD841X		MD841XC*	34
939 Hyperstrada	16			FA630HH*		EPFA630HH*		MD841X	MD841X		MD841XC*	35
ST2 (944cc)	97-99		FA244*	FA244HH*		EPFA244HH*		MD2003X	MD2003X		MD2003XC*	36
ST2 (944cc)	00-03		FA244*	FA244HH*		EPFA244HH*		MD614X	MD614X		MD614XC*	37
950 Multistrada (936cc)	17-21			FA630HH*		EPFA630HH*		MD841X	MD841X		MD841XC*	38
950 Multistrada S	20-21			FA630HH*		EPFA630HH*		MD841X	MD841X		MD841XC*	39
950 Multistrada S SW	20			FA630HH*		EPFA630HH*		MD841X	MD841X		MD841XC*	40
950 Multistrada S Touring	20			FA630HH*		EPFA630HH*		MD841X	MD841X		MD841XC*	41
955 Panigale V2 ABS	19-21			FA630HH*		EPFA630HH*		MD843X	MD843X		MD843XC*	42
959 Panigale ABS	16-19			FA630HH*		EPFA630HH*		MD843X	MD843X		MD843XC*	43
959 Panigale S Corse	18-19			FA630HH*		EPFA630HH*		MD843X	MD843X		MD843XC*	44
ST3S (ABS Model) (992cc)	06-07		FA244*	FA244HH*		EPFA244HH*		MD624	MD624			45
916 SPS (996cc)	97-98		FA244*	FA244HH*		EPFA244HH*	GPFAX244HH*	TBC	TBC			46
Monster S4R (996cc) (2 pad caliper)	05-06		FA244*	FA244HH*		EPFA244HH*		MD624	MD624			47
996 SPS (996cc)	99		FA244*	FA244HH*		EPFA244HH*	GPFAX244HH*	MD624	MD624			48
996 (996cc) (Monoposto/Biposto)	99-01		FA244*	FA244HH*		EPFA244HH*	GPFAX244HH*	MD624	MD624			49
996 R	01			FA322/4HH*		EPFA322/4HH*		MD636X	MD636X		MD636XC*	50
996 S	01		FA244*	FA244HH*		EPFA244HH*		MD624	MD624			51
Panigale V4 R 1103cc	21			FA447HH*		EPFA447HH*	GPFAX244HH*					52
Monster S4R (996cc)	03-06		FA244*	FA244HH*		EPFA244HH*		MD624	MD624			53
S4RS Monster (998cc) (Radial 4 pad caliper)	06			FA322/4HH*		EPFA322/4HH*		MD843X	MD843X		MD843XC*	54
S4R Testastretta Monster (998cc) (Radial 4 pad caliper)	07-08			FA322/4HH*		EPFA322/4HH*		MD843X	MD843X		MD843XC*	55
S4RS Testastretta Monster (998cc) (Radial 4 pad caliper)	07-			FA322/4HH*		EPFA322/4HH*		MD843X	MD843X		MD843XC*	56

FRONT

APPLIATIONS
BRAKE
⚡ This symbol indicates a rotor made of billet steel, and should be only used with EBC FA Kevlar® Organic or Vee pads.
SAFETY NOTICE - With vehicles primarily designed for off highway use such as quads now being used on the highway, we would recommend the use of X or MXS pads for highway use and ONLY using the R and SV higher density / harder pad series for off road riding.

*-2 Sets Required. † For Vee disc colours add RED, BLU, GRN, GLD, ORG suffix to part number. **SAFETY WARNING:- DO NOT USE HH PADS ON REAR UNLESS ALSO USED ON FRONT TO AVOID BRAKE IMBALANCE**

FRONT: Non-Japanese Bikes Cont'd

REAR: Non-Japanese Bikes

Line #	BRAKE ROTOR CHOICES - FRONT						DISC PAD CHOICES - REAR					BRAKE ROTOR CHOICES - REAR				
	CC Custom Rotor	CX Extreme® /Vee-Rotor	OS Series Oversize 250/280mm Rotor Kit	OSX Series Oversize 280mm Rotor Kit	Relocating Bracket for Oversize Rotor	SMX Series Oversize 320mm Rotor Kit	Relocating Bracket for 320mm Rotor		Sintered/HH Pads/ Grooved Shoes	SV Series Severe Duty Pads	EPFA Sintered Fast Road/ Track Pads	Specialty Pads SXR/ VEE/MXS Race	Standard Rotor	Vintage Rotor / UTV Oversize Brake Kit	Contour Profile Rotor	CX Extreme® /Vee-Rotor
1								FA47	FA47HH				MD2002		MD2002C	
2		VR2003BLK*†						FA47	FA47HH				MD2002		MD2002C	VR2002
3		VR843BLK*†						FA266	FA266HH			FA266V	MD2002		MD2002C	VR2002
4								FA18	FA18HH			FA18V	MD634LS			
5								FA18	FA18HH			FA18V	MD634LS			
6								FA18	FA18HH			FA18V	MD634LS			
7								FA18	FA18HH			FA18V	MD609LS			
8		VR2001BLK*†						FA47	FA47HH				MD2002		MD2002C	VR2002
9		VR2003BLK*†						FA47	FA47HH				MD2002		MD2002C	VR2002
10		VR2003BLK*†						FA266	FA266HH			FA266V	MD2002		MD2002C	VR2002
11		VR2003BLK*†						FA47	FA47HH				MD2002		MD2002C	VR2002
12		VR2003BLK*†						FA47	FA47HH				MD2002		MD2002C	VR2002
13		VR614BLK*†						FA266	FA266HH			FA266V	MD2002		MD2002C	VR2002
14		VR614BLK*†						FA266	FA266HH			FA266V	MD2002		MD2002C	VR2002
15		VR2003BLK*†						FA47	FA47HH				MD2002		MD2002C	VR2002
16		VR2003BLK*†						FA47	FA47HH				MD2002		MD2002C	VR2002
17		VR2003BLK*†						FA47	FA47HH				MD2002		MD2002C	VR2002
18		VR614BLK*†						FA47	FA47HH				MD2002		MD2002C	VR2002
19		VR614BLK*†						FA266	FA266HH			FA266V	MD632		MD632C	VR632
20								FA18	FA18HH				MD631			
21		VR2001BLK*†						FA47	FA47HH				MD2002		MD2002C	VR2002
22		VR2003BLK*†						FA47	FA47HH				MD2002		MD2002C	VR2002
23		VR624BLK*†						FA47	FA47HH				MD2002			VR2002
24		VR624BLK*†						FA47	FA47HH				MD2002			VR2002
25		VR2003BLK*†						FA266	FA266HH			FA266V	MD2002		MD2002C	VR2002
26							REAR	FA266	FA266HH			FA266V	MD2002		MD2002C	VR2002
27		VR614BLK*†						FA47	FA47HH				MD2002		MD2002C	VR2002
28		VR2003BLK*†						FA47	FA47HH				MD632		MD632C	VR632
29								FA47	FA47HH				MD632		MD632C	VR632
30		VR841BLK*†						FA266	FA266HH			FA266V	MD880		MD880C	VR880
31		VR841BLK*†						FA266	FA266HH			FA266V	MD880		MD880C	VR880
32		VR841BLK*†						FA266	FA266HH			FA266V	MD878		MD878C	VR878
33		VR841BLK*†						FA266	FA266HH			FA266V	MD878		MD878C	VR878
34		VR841BLK*†						FA266	FA266HH			FA266V	MD878		MD878C	VR878
35		VR841BLK*†						FA266	FA266HH			FA266V	MD627		MD627C	VR627
36		VR2003BLK*†						FA266	FA266HH			FA266V	MD2002		MD2002C	VR2002
37		VR614BLK*†						FA266	FA266HH			FA266V	MD2002		MD2002C	VR2002
38		VR841BLK*†						FA181X	FA181HH				MD879		MD879C	VR879
39		VR841BLK*†						FA181X	FA181HH				MD879		MD879C	VR879
40		VR841BLK*†						FA181X	FA181HH				MD879		MD879C	VR879
41		VR841BLK*†						FA181X	FA181HH				MD879		MD879C	VR879
42		VR841BLK*†						FA266	FA266HH			FA266V	MD880		MD880C	VR2002
43		VR843BLK*†						FA266	FA266HH			FA266V	MD880		MD880C	VR880
44		VR843BLK*†						FA266	FA266HH			FA266V	MD880		MD880C	VR880
45		VR624BLK*†						FA266	FA266HH			FA266V	MD2002			VR2002
46								FA47	FA47HH				MD632		MD632C	VR632
47		VR624BLK*†						FA47	FA47HH				MD627		MD627C	VR627
48		VR624BLK*†						FA47	FA47HH				MD632		MD632C	VR632
49		VR624BLK*†						FA47	FA47HH				MD632		MD632C	VR632
50								FA47	FA47HH				MD632		MD632C	VR632
51		VR624BLK*†						FA47	FA47HH				MD632		MD632C	VR632
52								FA266	FA266HH							
53		VR624BLK*†						FA47	FA47HH				MD627		MD627C	VR627
54		VR843BLK*†						FA47	FA47HH				MD627		MD627C	VR627
55		VR843BLK*†						FA47	FA47HH				MD627		MD627C	VR627
56		VR843BLK*†						FA47	FA47HH				MD627		MD627C	VR627

BRAKE APPLICATIONS

⚠ This symbol indicates a rotor made of billet steel, and should be only used with EBC FA Kevlar® Organic or Vee pads.
SAFETY NOTICE - With vehicles primarily designed for off highway use such as quads now being used on the highway, we would recommend the use of X or MXS pads for highway use and ONLY using the R and SV higher density / harder pad series for off road riding.

*-2 Sets Required. † For Vee disc colours add RED, BLU, GRN, GLD, ORG suffix to part number. **SAFETY WARNING:- DO NOT USE HH PADS ON REAR UNLESS ALSO USED ON FRONT TO AVOID BRAKE IMBALANCE**

FRONT: Non-Japanese Bikes



DUCATI



DISC PAD CHOICES - FRONT

BRAKE ROTOR CHOICES - FRONT

			Sintered/HH Pads/ Grooved Shoes	SV Series Severe Duty Pads	EPFA Sintered Fast Road/ Track Pads	GPFAX Sintered RACE ONLY Pads	Specialty Pads SXR/ VEE/MXS Race			Vintage Rotor / UTV Oversize Brake Kit	Contour Profile Rotor	Line #
S4RS (Tricolore/Monster Testrastreetta) (998cc) (Radial 4 pad caliper)	08		FA322/4HH*		EPFA322/4HH*			MD843X	MD843X		MD843XC*	1
ST4S (Non ABS/996cc)	01-05	FA244*	FA244HH*		EPFA244HH*			MD624	MD624			2
ST4S (ABS Model/996cc)	03-05	FA244*	FA244HH*		EPFA244HH*			MD624	MD624			3
Desmosedici RR (D16RR/989cc)	08		FA447HH*		EPFA447HH*	GPFAX447HH*		MD694X	MD694X		MD694XC*	4
998 Matrix (998cc)	04		FA322/4HH*		EPFA322/4HH*			MD633X	MD633X		MD633XC*	5
998 R (998cc)	02		FA322/4HH*		EPFA322/4HH*			TBC	TBC			6
998 S Bayliss/Bostrom	02		FA322/4HH*		EPFA322/4HH*			MD633X	MD633X		MD633XC*	7
998 S (998cc) (4 pad caliper)	02-04		FA322/4HH*		EPFA322/4HH*			MD633X	MD633X		MD633XC*	8
998 (998cc) (2 pad caliper) (Monoposto/Biposto)	02-03	FA244*	FA244HH*		EPFA244HH*	GPFAX244HH*		MD633X	MD633X		MD633XC*	9
998 Panigale V4 Superleggera	21		FA447HH*		EPFA447HH*	GPFAX447HH*						10
999 S (Std Caliper Mount) (Monoposto/Biposto)	03-04		FA322/4HH*		EPFA322/4HH*			MD622X	MD622X		MD622XC*	11
999 (Std mount caliper)	03-06		FA322/4HH*		EPFA322/4HH*			MD622X	MD622X		MD622XC*	12
999 R (Radial mount caliper)	03-06		FA322/4HH*		EPFA322/4HH*			MD622X	MD622X		MD622XC*	13
999 R Fila (Radial mount caliper)	03-		FA322/4HH*		EPFA322/4HH*			MD622X	MD622X		MD622XC*	14
999 R Xerox	06		FA322/4HH*		EPFA322/4HH*			MD622X	MD622X		MD622XC*	15
999 S (Radial mount caliper) Monoposto/Biposto	05-06		FA322/4HH*		EPFA322/4HH*			MD622X	MD622X		MD622XC*	16
1000 R1 Hailwood Replica (6 bolt fixing)	84	FA18*	FA18HH*					MD609LS	MD609RS			17
GT 1000 (992cc)	07-10	FA209/2*	FA209/2HH*					MD614X	MD614X		MD614XC*	18
GT 1000 Touring - Sport Classic	09	FA209/2*	FA209/2HH*					MD614X	MD614X		MD614XC*	19
Monster 1000 Dark	03	FA244*	FA244HH*		EPFA244HH*			MD614X	MD614X		MD614XC*	20
Monster 1000 ie (992cc)	04-05	FA244*	FA244HH*		EPFA244HH*			MD614X	MD614X		MD614XC*	21
Monster 1000 S ie (992cc)	03-05	FA244*	FA244HH*		EPFA244HH*			MD614X	MD614X		MD614XC*	22
Monster S2R 1000 (992cc)	06-08	FA244*	FA244HH*		EPFA244HH*			MD614X	MD614X		MD614XC*	23
Multistrada 1000 DS (992cc)	03-05	FA244*	FA244HH*		EPFA244HH*			MD682	MD682			24
Multistrada S 1000 DS (992cc)	05-06	FA244*	FA244HH*		EPFA244HH*			MD682	MD682			25
Paul Smart 1000 LE (992cc)	06	FA209/2*	FA209/2HH*					MD614X	MD614X		MD614XC*	26
Sport 1000 S	07-09	FA244*	FA244HH*		EPFA244HH*			MD614X	MD614X		MD614XC*	27
Sport Classic 1000 (992cc) (Monoposto - Japan/Biposto - Europe)	06-08	FA209/2*	FA209/2HH*					MD614X	MD614X		MD614XC*	28
Supersport 1000 DS (992cc)	03-06	FA244*	FA244HH*		EPFA244HH*			MD614X	MD614X		MD614XC*	29
1098	07-08		FA447HH*		EPFA447HH*	GPFAX447HH*		MD694X	MD694X		MD694XC*	30
1098 S Tricolore	07		FA447HH*		EPFA447HH*	GPFAX447HH*		MD694X	MD694X		MD694XC*	31
1098 S	07-08		FA447HH*		EPFA447HH*	GPFAX447HH*		MD694X	MD694X		MD694XC*	32
1098 R	08-09		FA447HH*		EPFA447HH*	GPFAX447HH*		N/A	N/A			33
Streetfighter (1099cc)	09-12		FA447HH*		EPFA447HH*			N/A	N/A			34
Streetfighter S (1099cc)	09-12		FA447HH*		EPFA447HH*			N/A	N/A			35
Streetfighter V4 1103	20-21		FA447HH*		EPFA447HH*			MD694X	MD694X		MD694XC*	36
Streetfighter V4 S 1103	20-21		FA447HH*		EPFA447HH*			MD694X	MD694X		MD694XC*	37
Multistrada V4 Enduro	21		FA630HH*		EPFA630HH*			MD841X	MD841X		MD841XC*	38
Multistrada V4 S Enduro	21		FA630HH*		EPFA630HH*			MD841X	MD841X		MD841XC*	39
Multistrada V4 Sport Enduro	21		FA630HH*		EPFA630HH*			MD841X	MD841X		MD841XC*	40
Hypermotard 1100	07-09	FA244*	FA244HH*		EPFA244HH*			MD865X	MD865X		MD865XC*	41
Hypermotard 1100 Evo	10-12	FA447*	FA447HH*		EPFA447HH*			MD865X	MD865X		MD865XC*	42
Hypermotard 1100 Evo SP	10-13	FA447*	FA447HH*		EPFA447HH*			MD865X	MD865X		MD865XC*	43
Hypermotard 1100 S	07-09		FA447HH*		EPFA447HH*			MD865X	MD865X		MD865XC*	44
Monster 1100 (Non ABS)	09-10	FA244*	FA244HH*		EPFA244HH*			MD843X	MD843X		MD843XC*	45
Monster 1100 (ABS)	12	FA244*	FA244HH*		EPFA244HH*			MD843X	MD843X		MD843XC*	46
Monster 1100 S (Non ABS)	09-10	FA244*	FA244HH*		EPFA244HH*			MD843X	MD843X		MD843XC*	47
Monster 1100 S (ABS)	12	FA244*	FA244HH*		EPFA244HH*			MD843X	MD843X		MD843XC*	48
Monster 1100 Evo (ABS)	12-14	FA244*	FA244HH*		EPFA244HH*			MD843X	MD843X		MD843XC*	49
1100 Monster Diesel	13-14	FA244*	FA244HH*		EPFA244HH*			MD843X	MD843X		MD843XC*	50
M 1100 Monster 1100 Evo 20th Anniversary Model	13-14	FA244*	FA244HH*		EPFA244HH*			MD843X	MD843X		MD843XC*	51
Scrambler 1100 Special	18-21		FA630HH*		EPFA630HH*			MD841X	MD841X		MD841XC*	52
Scrambler 1100 Sport	18-21		FA630HH*		EPFA630HH*			MD841X	MD841X		MD841XC*	53
Scrambler 1100 Pro	18-21		FA630HH*		EPFA630HH*			MD841X	MD841X		MD841XC*	54
Scrambler 1100 Sport Pro	18-21		FA630HH*		EPFA630HH*			MD841X	MD841X		MD841XC*	55
Multistrada 1100 (1078cc)	07-09	FA244*	FA244HH*		EPFA244HH*			MD682	MD682			56

FRONT

APPLIATIONS
BRAKE
 * This symbol indicates a rotor made of billet steel, and should be only used with EBC FA Kevlar® Organic or Vee pads.
 † For Vee disc colours add RED, BLU, GRN, GLD, ORG suffix to part number. **SAFETY WARNING:- DO NOT USE HH PADS ON REAR UNLESS ALSO USED ON FRONT TO AVOID BRAKE IMBALANCE**
 SAFETY NOTICE - With vehicles primarily designed for off highway use such as quads now being used on the highway, we would recommend the use of X or MXS pads for highway use and ONLY using the R and SV higher density / harder pad series for off road riding.

*-2 Sets Required. † For Vee disc colours add RED, BLU, GRN, GLD, ORG suffix to part number. **SAFETY WARNING:- DO NOT USE HH PADS ON REAR UNLESS ALSO USED ON FRONT TO AVOID BRAKE IMBALANCE**

FRONT: Non-Japanese Bikes Cont'd

REAR: Non-Japanese Bikes

Line #	BRAKE ROTOR CHOICES - FRONT							DISC PAD CHOICES - REAR					BRAKE ROTOR CHOICES - REAR			
	CC Custom Rotor	CX Extreme® /Vee-Rotor	OS Series Oversize 250/280mm Rotor Kit	OSX Series Oversize 280mm Rotor Kit	Relocating Bracket for Oversize Rotor	SMX Series Oversize 320mm Rotor Kit	Relocating Bracket for 320mm Rotor		Sintered/HH Pads/ Grooved Shoes	SV Series Severe Duty Pads	EPFA Sintered Fast Road/ Track Pads	Specialty Pads SXR/ VEE/MXS Race	Standard Rotor	Vintage Rotor / UTV Oversize Brake Kit	Contour Profile Rotor	CX Extreme® /Vee-Rotor
1								FA47	FA47HH				MD627		MD627C	VR627
2		VR624BLK†						FA266	FA266HH			FA266V	MD2002			VR2002
3		VR624BLK†						FA266	FA266HH			FA266V	MD2002			VR2002
4		VR694BLK†						FA266	FA266HH			FA266V	MD618		MD618C	VR618
5								FA47	FA47HH				MD632		MD632C	VR632
6								FA47	FA47HH				MD632		MD632C	VR632
7								FA47	FA47HH				MD632		MD632C	VR632
8								FA47	FA47HH				MD632		MD632C	VR632
9								FA47	FA47HH				MD632		MD632C	VR632
10								FA266	FA266HH		EPFA266HH		MD880		MD880C	VR880
11		VR622BLK†						FA266	FA266HH			FA266V	MD618		MD618C	VR618
12		VR622BLK†						FA266	FA266HH			FA266V	MD618		MD618C	VR618
13		VR622BLK†						FA266	FA266HH			FA266V	MD618		MD618C	VR618
14		VR622BLK†						FA266	FA266HH			FA266V	MD618		MD618C	VR618
15		VR622BLK†						FA266	FA266HH			FA266V	MD618		MD618C	VR618
16		VR622BLK†						FA266	FA266HH			FA266V	MD618		MD618C	VR618
17								FA18	FA18HH			FA18V	MD609LS			
18		VR614BLK†						FA213	FA213HH			FA213V	MD899			
19		VR614BLK†						FA213	FA213HH			FA213V	MD899			
20		VR614BLK†						FA47	FA47HH				MD2002		MD2002C	VR2002
21		VR614BLK†						FA47	FA47HH				MD2002		MD2002C	VR2002
22		VR614BLK†						FA47	FA47HH				MD2002		MD2002C	VR2002
23		VR614BLK†						FA47	FA47HH				MD627			
24								FA266	FA266HH			FA266V	MD627			
25								FA266	FA266HH			FA266V	MD627			
26		VR614BLK†						FA213	FA213HH			FA213V	MD2002		MD2002C	VR2002
27		VR614BLK†						FA213	FA213HH			FA213V	MD2002		MD2002C	VR2002
28		VR614BLK†						FA213	FA213HH			FA213V	MD2002		MD2002C	VR2002
29		VR614BLK†						FA266	FA266HH			FA266V	MD2002		MD2002C	VR2002
30		VR694BLK†						FA266	FA266HH			FA266V	MD695		MD695C	VR695
31		VR694BLK†						FA266	FA266HH			FA266V	MD695		MD695C	VR695
32		VR694BLK†						FA266	FA266HH			FA266V	MD695		MD695C	VR695
33								FA266	FA266HH			FA266V	MD695		MD695C	VR695
34								FA266	FA266HH			FA266V	MD695		MD695C	VR695
35								FA266	FA266HH			FA266V	MD695		MD695C	VR695
36								FA266	FA266HH			FA266V	MD695		MD695C	VR695
37								FA266	FA266HH			FA266V	MD695		MD695C	VR695
38		VR841BLK†														
39		VR841BLK†														
40		VR841BLK†														
41								FA266	FA266HH			FA266V	MD627		MD627C	VR627
42								FA266	FA266HH			FA266V	MD627		MD627C	VR627
43								FA266	FA266HH			FA266V	MD627		MD627C	VR627
44								FA266	FA266HH			FA266V	MD627		MD627C	VR627
45		VR843BLK†						FA266	FA266HH			FA266V	MD627		MD627C	VR627
46		VR843BLK†						FA266	FA266HH			FA266V	TBC		TBC	TBC
47		VR843BLK†						FA266	FA266HH			FA266V	MD627		MD627C	VR627
48		VR843BLK†						FA266	FA266HH			FA266V	TBC		TBC	TBC
49		VR843BLK†						FA266	FA266HH			FA266V	TBC		TBC	TBC
50		VR843BLK†						FA266	FA266HH			FA266V	TBC		TBC	TBC
51		VR843BLK†						FA266	FA266HH			FA266V	TBC		TBC	TBC
52								FA266	FA266HH			FA266V	MD2002		MD2002C	VR2002
53								FA266	FA266HH			FA266V	MD2002		MD2002C	VR2002
54								FA266	FA266HH			FA266V	MD2002		MD2002C	VR2002
55								FA266	FA266HH			FA266V	MD2002		MD2002C	VR2002
56								FA266	FA266HH			FA266V	MD627			

BRAKE APPLICATIONS

⚠ This symbol indicates a rotor made of billet steel, and should be only used with EBC FA Kevlar® Organic or Vee pads. SAFETY NOTICE - With vehicles primarily designed for off highway use such as quads now being used on the highway, we would recommend the use of X or MXS pads for highway use and ONLY using the R and SV higher density / harder pad series for off road riding.

*-2 Sets Required. † For Vee disc colours add RED, BLU, GRN, GLD, ORG suffix to part number. **SAFETY WARNING:** DO NOT USE HH PADS ON REAR UNLESS ALSO USED ON FRONT TO AVOID BRAKE IMBALANCE

FRONT: Non-Japanese Bikes

APPLICATIONS

BRAKE



DUCATI



DISC PAD CHOICES - FRONT

BRAKE ROTOR CHOICES - FRONT

Model	Year	Rotor Icon	DISC PAD CHOICES - FRONT					BRAKE ROTOR CHOICES - FRONT				Line #
			Sintered/HH Pads/Grooved Shoes	SV Series Severe Duty Pads	EPFA Sintered Fast Road/Track Pads	GPFAX Sintered RACE ONLY Pads	Specialty Pads SXR/VEE/MXS Race	Standard Rotor Left	Standard Rotor Right	Vintage Rotor / UTV Oversize Brake Kit	Contour Profile Rotor	
Multistrada 1100 S (1078cc)	07-09	FA244*	FA244HH*		EPFA244HH*			MD682	MD682			1
Panigale V4 1103	18-21		FA447HH*		EPFA447HH*	GPFAX447HH*		TBC	TBC			2
Panigale V4 S 1103	18-21		FA447HH*		EPFA447HH*	GPFAX447HH*		TBC	TBC			3
Panigale V4 R 1103cc	21		FA447HH*		EPFA447HH*	GPFAX447HH*		TBC	TBC			4
Panigale V4 SP 1103cc	21		FA447HH*		EPFA447HH*	GPFAX447HH*		TBC	TBC			5
1198	09-12		FA447HH*		EPFA447HH*			N/A	N/A			6
1198 S	09-10		FA447HH*		EPFA447HH*	GPFAX447HH*		N/A	N/A			7
1198 SP	11-12		FA447HH*		EPFA447HH*	GPFAX447HH*		N/A	N/A			8
1198 R Special Edition	11		FA447HH*		EPFA447HH*	GPFAX447HH*		N/A	N/A			9
1199 Panigale	12-15		FA447HH*		EPFA447HH*	GPFAX447HH*		N/A	N/A			10
1199 Panigale S	12-15		FA447HH*		EPFA447HH*	GPFAX447HH*		N/A	N/A			11
1199 Panigale S Tricolore	12-14		FA447HH*		EPFA447HH*	GPFAX447HH*		N/A	N/A			12
1199 Panigale R	13-15		FA447HH*		EPFA447HH*	GPFAX447HH*		N/A	N/A			13
1199 Panigale Superleggera	14		FA447HH*		EPFA447HH*	GPFAX447HH*		TBC	TBC			14
1200 Monster	14-21		FA630HH*		EPFA630HH*			MD841X	MD841X		MD841XC*	15
1200 Monster Stripe	15		FA447HH*		EPFA447HH*			TBC	TBC			16
1200 S Monster	14-21		FA447HH*		EPFA447HH*			MD841X	MD841X		MD841XC*	17
1200 R Monster	16-17		FA447HH*		EPFA447HH*			MD841X	MD841X		MD841XC*	18
Multistrada 1200	10-15	FA244*	FA244HH*		EPFA244HH*			MD841X	MD841X		MD841XC*	19
Multistrada 1200	16-17		FA630HH*		EPFA630HH*			MD841X	MD841X		MD841XC*	20
Multistrada 1200 Enduro	16		FA630HH*		EPFA630HH*			MD841X	MD841X		MD841XC*	21
Multistrada 1200 Enduro	17-19		FA630HH*		EPFA630HH*			MD841X	MD841X		MD841XC*	22
Multistrada 1200 Enduro Pro	18-19		FA630HH*		EPFA630HH*			MD841X	MD841X		MD841XC*	23
Multistrada 1200 S (Sport)	10	FA244*	FA244HH*		EPFA244HH*			MD8011X	MD8011X			24
Multistrada 1200 S (Pikes Peak)	11-14	FA244*	FA244HH*		EPFA244HH*			MD8011X	MD8011X			25
Multistrada 1200 (Pikes Peak)	16-17		FA447HH*		EPFA447HH*			MD8011X	MD8011X			26
Multistrada 1200 S (Touring)	10-14	FA244*	FA244HH*		EPFA244HH*			MD8011X	MD8011X			27
Multistrada 1200 S Grandtourismo	13-14	FA244*	FA244HH*		EPFA244HH*			MD8011X	MD8011X			28
Multistrada 1200 DVT (Single Pin Pad Fixing)	15-16		FA630HH*		EPFA630HH*			MD8011X	MD8011X			29
Multistrada 1200 S	16-17		FA447HH*		EPFA447HH*			MD8011X	MD8011X			30
Multistrada 1200 S DVT	15-17		FA447HH*		EPFA447HH*			MD8011X	MD8011X			31
Multistrada 1200 S D/Air	16-17		FA447HH*		EPFA447HH*			MD8011X	MD8011X			32
Multistrada 1260	18-21		FA630HH*		EPFA630HH*			MD8011X	MD8011X			33
Multistrada 1260 S	18-21		FA447HH*		EPFA447HH*			MD8011X	MD8011X			34
Multistrada 1260 Pikes Peak	18-21		FA447HH*		EPFA447HH*			MD8011X	MD8011X			35
Multistrada 1260 Touring	20		FA630HH*		EPFA630HH*			MD8011X	MD8011X			36
Multistrada 1260 S Touring	20		FA447HH*		EPFA447HH*			MD8011X	MD8011X			37
Multistrada 1260 S Grand Tour	18-21		FA447HH*		EPFA447HH*			MD8011X	MD8011X			38
Multistrada 1260 Enduro	18-21		FA447HH*		EPFA447HH*			MD8011X	MD8011X			39
Diavel 1260	20-21		FA630HH*		EPFA630HH*			MD841X	MD841X		MD841XC*	40
Diavel 1260 S	20-21		FA447HH*		EPFA447HH*			MD841X	MD841X		MD841XC*	41
Diavel AMG	12-13		FA447HH*		EPFA447HH*			MD841X	MD841X		MD841XC*	42
Diavel ABS	11-17		FA447HH*		EPFA447HH*			MD841X	MD841X		MD841XC*	43
Diavel Carbon ABS	11-15		FA447HH*		EPFA447HH*			TBC	TBC		TBC	44
Diavel Carbon ABS	16-19		FA447HH*		EPFA447HH*			MD841X	MD841X		MD841XC*	45
Diavel Cromo (ABS)	11-14		FA447HH*		EPFA447HH*			MD841X	MD841X		MD841XC*	46
Diavel Dark (ABS)	13-15		FA447HH*		EPFA447HH*			MD841X	MD841X		MD841XC*	47
Diavel Strada (ABS)	13-15		FA447HH*		EPFA447HH*			MD841X	MD841X		MD841XC*	48
1262 X Diavel	16-21		FA630HH*		EPFA630HH*			MD841X	MD841X		MD841XC*	49
1262 X Diavel S	16-21		FA447HH*		EPFA447HH*			MD841X	MD841X		MD841XC*	50
1262 X Diavel Dark	20-21		FA447HH*		EPFA447HH*			MD841X	MD841X		MD841XC*	51
1262 X Diavel Black Star	20-21		FA447HH*		EPFA447HH*			MD841X	MD841X		MD841XC*	52
1299 Panigale V4	15-21		FA447HH*		EPFA447HH*			MD694X	MD694X			53
1299 Panigale V4 S	15-21		FA447HH*		EPFA447HH*			MD694X	MD694X			54
1299 Panigale V4 S Corse	18-21		FA447HH*		EPFA447HH*	GPFAX447HH*		MD694X	MD694X			55
1299 Panigale V4 Speciale	18-21		FA447HH*		EPFA447HH*	GPFAX447HH*		MD694X	MD694X			56

FRONT

* This symbol indicates a rotor made of billet steel, and should be only used with EBC FA Kevlar® Organic or Vee pads.
 † This symbol indicates a rotor made of billet steel, and should be only used with EBC FA Kevlar® Organic or Vee pads.

SAFETY NOTICE - With vehicles primarily designed for off highway use such as quads now being used on the highway, we would recommend the use of X or MXS pads for highway use and ONLY using the R and SV higher density / harder pad series for off road riding.

*-2 Sets Required. † For Vee disc colours add RED, BLU, GRN, GLD, ORG suffix to part number. **SAFETY WARNING:- DO NOT USE HH PADS ON REAR UNLESS ALSO USED ON FRONT TO AVOID BRAKE IMBALANCE**

FRONT: Non-Japanese Bikes Cont'd

REAR: Non-Japanese Bikes

Line #	BRAKE ROTOR CHOICES - FRONT							DISC PAD CHOICES - REAR					BRAKE ROTOR CHOICES - REAR			
	CC Custom Rotor	CX Extreme® /Vee-Rotor	OS Series Oversize 250/280mm Rotor Kit	OSX Series Oversize 280mm Rotor Kit	Relocating Bracket for Oversize Rotor	SMX Series Oversize 320mm Rotor Kit	Relocating Bracket for 320mm Rotor		Sintered/HH Pads/ Grooved Shoes	SV Series Severe Duty Pads	EPFA Sintered Fast Road/ Track Pads	Specialty Pads SXR/ VEE/MXS Race	Standard Rotor	Vintage Rotor / UTV Oversize Brake Kit	Contour Profile Rotor	CX Extreme® /Vee-Rotor
1								FA266	FA266HH			FA266V	MD627			
2								FA266	FA266HH				MD880		MD880C	VR880
3								FA266	FA266HH				MD880		MD880C	VR880
4								FA266	FA266HH				MD880		MD880C	VR880
5								FA266	FA266HH				MD880		MD880C	VR880
6								FA266	FA266HH		FA266V	MD695	MD695C		VR695	
7								FA266	FA266HH		FA266V	MD695	MD695C		VR695	
8								FA266	FA266HH		FA266V	MD695	MD695C		VR695	
9								FA266	FA266HH		FA266V	MD695	MD695C		VR695	
10								FA266	FA266HH		FA266V	MD880	MD880C		VR880	
11								FA266	FA266HH		FA266V	MD880	MD880C		VR880	
12								FA266	FA266HH		FA266V	MD880	MD880C		VR880	
13								FA266	FA266HH		FA266V	MD880	MD880C		VR880	
14								FA266	FA266HH		FA266V	MD880	MD880C		VR880	
15		VR841BLK†						FA266	FA266HH		FA266V	MD880	MD880C		VR880	
16								FA266	FA266HH		FA266V	MD880	MD880C		VR880	
17		VR841BLK†						FA266	FA266HH		FA266V	MD880	MD880C		VR880	
18		VR841BLK†						FA266	FA266HH		FA266V	MD880	MD880C		VR880	
19		VR841BLK†						FA266	FA266HH		FA266V	MD880	MD880C		VR880	
20		VR841BLK†							FA209/2HH		FA209/2V	MD879				
21		VR841BLK†							FA209/2HH		FA209/2V	TBC				TBC
22		VR841BLK†						FA181X	FA181HH			TBC				TBC
23		VR841BLK†						FA181X	FA181HH			MD879				
24								FA266	FA266HH		FA266V	MD880				TBC
25								FA266	FA266HH		FA266V	MD880				TBC
26									FA209/2HH		FA209/2V	MD879				
27								FA266	FA266HH		FA266V	MD880				TBC
28								FA266	FA266HH		FA266V	MD880				TBC
29								FA181X	FA181HH			MD879				
30									FA209/2HH		FA209/2V	MD879				
31								FA181X	FA181HH			MD879				
32								FA181X	FA181HH			MD879				
33								FA181X	FA181R			MD879				
34								FA181X	FA181R			MD879				
35								FA181X	FA181R			MD879				
36								FA209/2	FA209/2HH			MD879				
37								FA209/2	FA209/2HH			MD879				
38								FA209/2	FA209/2HH			MD879				
39								FA181X	FA181R			MD879				
40		VR841BLK†						FA209/2	FA209/2HH			MD879				
41		VR841BLK†						FA209/2	FA209/2HH			MD879				
42		VR841BLK†							FA209/2HH		FA209/2V	TBC				TBC
43		VR841BLK†							FA209/2HH		FA209/2V	MD879				
44									FA209/2HH		FA209/2V	MD879				
45		VR841BLK†							FA209/2HH		FA209/2V	MD879				
46		VR841BLK†							FA209/2HH		FA209/2V	TBC				TBC
47		VR841BLK†							FA209/2HH		FA209/2V	TBC				TBC
48		VR841BLK†							FA209/2HH		FA209/2V	TBC				TBC
49		VR841BLK†							FA209/2HH		FA209/2V	MD879				
50		VR841BLK†							FA209/2HH		FA209/2V	MD879				
51		VR841BLK†							FA209/2HH		FA209/2V	MD879				
52		VR841BLK†							FA209/2HH		FA209/2V	MD879				
53								FA266	FA266HH		FA266V	MD880		MD880C		VR880
54								FA266	FA266HH		FA266V	MD880		MD880C		VR880
55								FA266	FA266HH		FA266V	MD880		MD880C		VR880
56								FA266	FA266HH		FA266V	MD880		MD880C		VR880

BRAKE APPLICATIONS

⚠ This symbol indicates a rotor made of billet steel, and should be only used with EBC FA Kevlar® Organic or Vee pads.
SAFETY NOTICE - With vehicles primarily designed for off highway use such as quads now being used on the highway, we would recommend the use of X or MXS pads for highway use and ONLY using the R and SV higher density / harder pad series for off road riding.

*-2 Sets Required. † For Vee disc colours add RED, BLU, GRN, GLD, ORG suffix to part number. **SAFETY WARNING:- DO NOT USE HH PADS ON REAR UNLESS ALSO USED ON FRONT TO AVOID BRAKE IMBALANCE**

FRONT: Non-Japanese Bikes

APPLICATIONS

BRAKE



DUCATI



1299 Panigale V4 R 15-21
1299 Panigale R FE 18-21

ENERGICA

Energica EVA 20
Energica EGO 20
Energica EVA Esse 9 20

E-TON

IXL 40 Rascal 98-01
RXL 40E Viper Junior 01-06
Viper 40E 99-08
AXL 50 Lightning 50 99-00
Beamer 50 (PN2) 04-08
Bramer 50 III 09
Beamer II (PN2B)
Beamer Matrix (PN2C)
Beamer Matrix II (PN2E)
Beamer R2 50 (PN2G)
BXL 50 Draco 05-06
Matrix 50 09
NXL 50 Lightning 50 01-02
Sport 50 09
TXL 50 Wizz 50 98-99
Viper 50 Mini RXL 50 M (4T) 03-08
Viper 50 Mini RXL 50 M (4T) Parking Brake
Viper 50 RXL 50 03-06
Viper 70 RXL 70/70M (2T/4T) 05-09
AXL 90 Thunder 99-00
DXL 90 Sierra 99-03
NXL 90 Thunder 01-02
RXL 90 Viper 90 03-06
RXL 90 R Viper 90 R Reverse (2T/4T) 03-09
BXL 100 Draco 05-06
Beamer R4 - 150 (PN2F)
CXL 150 Yukon II/Challenger 02-09
EXL 150 Yukon ST 05-06
Matrix R4 - 150 09
RXL 150 Viper R 05-09
RXL 150 Viper 05-06
YXL 150 Yukon 00-02
Yukon ELX 150 05-06
Viper EXL 150 ST Quad 05-06
Vector VXL 250 ST Quad 06-09

FRONT

DISC PAD CHOICES - FRONT

BRAKE ROTOR CHOICES - FRONT

										Line #
	FA447HH*		EPFA447HH*			MD694X	MD694X			1
	FA447HH*		EPFA447HH*	GPFAX447HH*		MD694X	MD694X			2
										3
										4
	FA447HH									5
	FA447HH*									6
	FA447HH									7
										8
										9
	N/A									10
	N/A									11
	N/A									12
	338*	338C*								13
	SFA169	SFA169HH				TBC				14
	SFA169	SFA169HH				TBC				15
	SFA169	SFA169HH				TBC				16
	SFA169	SFA169HH				TBC				17
	SFA169	SFA169HH				TBC				18
	SFA264	SFA264HH				N/A				19
	338*	338G*								20
	SFA264	SFA264HH				TBC				21
	338*	338G*								22
	SFA264	SFA264HH				TBC				23
	338*	338G*								24
	338*	338G*								25
	338*	338G*								26
	338*	338G*								27
	338*	338G*								28
	338*	338G*								29
	614*	614G*								30
	338*	338G*								31
	338*	338G*								32
	338*	338G*								33
	338*	338G*								34
	SFA264	SFA264HH				N/A				35
	303*	303G*								36
	FA83X*	FA83R*				N/A	N/A			37
	SFA264	SFA264HH				TBC				38
	303*	303G*								39
	303*	303G*								40
	303*	303G*								41
	FA83X*	FA83R*				N/A	N/A			42
	FA83X*	FA83R*				N/A	N/A			43
	FA83X*	FA83R*				N/A	N/A			44
										45
	FA291X									46
	FA291X					N/A				47
	FA115X	FA115HH			MXS115	N/A				48
	FA303X					N/A				49
	FA167	FA167HH				N/A				50
	FA194	FA194HH				N/A				51
	FA181X*	FA181R*	EPFA181HH*		MXS181*	N/A	N/A			52
	FA167	FA167HH				N/A				53
	FA194	FA194HH				N/A				54
	FA291X					N/A				55
						N/A				56

*-2 Sets Required. † For Vee disc colours add RED, BLU, GRN, GLD, ORG suffix to part number. **SAFETY WARNING:- DO NOT USE HH PADS ON REAR UNLESS ALSO USED ON FRONT TO AVOID BRAKE IMBALANCE**

This symbol indicates a rotor made of billet steel, and should be only used with EBC FA Kevlar® Organic or Vee pads.
 SAFETY NOTICE - With vehicles primarily designed for off highway use such as quads now being used on the highway, we would recommend the use of X or MXS pads for highway use and ONLY using the R and SV higher density / harder pad series for off road riding.

FRONT: Non-Japanese Bikes Cont'd

REAR: Non-Japanese Bikes

Line #	BRAKE ROTOR CHOICES - FRONT						DISC PAD CHOICES - REAR					BRAKE ROTOR CHOICES - REAR				
	CC Custom Rotor	CX Extreme® /Vee-Rotor	OS Series Oversize 250/280mm Rotor Kit	OSX Series Oversize 280mm Rotor Kit	Relocating Bracket for Oversize Rotor	SMX Series Oversize 320mm Rotor Kit	Relocating Bracket for 320mm Rotor		Sintered/HH Pads/ Grooved Shoes	SV Series Severe Duty Pads	EPFA Sintered Fast Road/ Track Pads	Specialty Pads SXR/ VEE/MXS Race	Standard Rotor	Vintage Rotor / UTV Oversize Brake Kit	Contour Profile Rotor	CX Extreme® /Vee-Rotor
1								FA266	FA266HH			FA266V	MD880		MD880C	VR880
2								FA266	FA266HH			FA266V	MD880		MD880C	VR880
3																
4																
5								FA266	FA266HH			FA266V				
6								FA266	FA266HH			FA266V				
7								FA266	FA266HH			FA266V				
8																
9																
10								330	330G							
11								330	330G							
12								330	330G							
13								TBC	TBC							
14								TBC								
15								TBC								
16								TBC								
17								TBC								
18								TBC								
19								SFA83	SFA83HH				N/A			
20								FA83X	FA83R				N/A			
21								SFA83	SFA83HH				TBC			
22								TBC	TBC							
23								TBC								
24								TBC	TBC							
25								FA83X	FA83R				N/A			
26								FA232X								
27								FA83X	FA83R				N/A			
28								FA83X	FA83R				N/A			
29								330	330G							
30								330	330G							
31								330	330G							
32								FA83X	FA83R				N/A			
33								FA83X	FA83R				N/A			
34								FA83X	FA83R				N/A			
35								SFA83	SFA83HH				N/A			
36								FA165X	FA165R				N/A			
37								330	330G							
38								SFA83	SFA83HH				TBC			
39								FA165X	FA165R				N/A			
40								FA165X	FA165R				N/A			
41								330	330G							
42								330	330G							
43								330	330G							
44								FA83X	FA83R				N/A			
45																
46																
47								FA351X								
48								FA291X					N/A			
49								FA351X					N/A			
50								FA351X					N/A			
51								FA291X					N/A			
52								FA291X					N/A			
53								FA181X	FA181R		EPFA181HH	MXS181	N/A			
54								FA291X					N/A			
55								FA291X					N/A			
56								FA291X					N/A			

BRAKE APPLICATIONS

⚠ This symbol indicates a rotor made of billet steel, and should be only used with EBC FA Kevlar® Organic or Vee pads.
SAFETY NOTICE - With vehicles primarily designed for off highway use such as quads now being used on the highway, we would recommend the use of X or MXS pads for highway use and ONLY using the R and SV higher density / harder pad series for off road riding.

*-2 Sets Required. † For Vee disc colours add RED, BLU, GRN, GLD, ORG suffix to part number. **SAFETY WARNING:- DO NOT USE HH PADS ON REAR UNLESS ALSO USED ON FRONT TO AVOID BRAKE IMBALANCE**

FRONT: Non-Japanese Bikes



GAS-GAS



DISC PAD CHOICES - FRONT

BRAKE ROTOR CHOICES - FRONT

Model	Year	Front Disc Pad Choice	Rear Disc Pad Choice	SV Series Severe Duty Pads	EPFA Sintered Fast Road/Track Pads	GPFAX Sintered RACE ONLY Pads	Specialty Pads SXR/VEE/MXS Race	Standard Rotor		Vintage Rotor / UTV Oversize Brake Kit	Contour Profile Rotor	Line #
								Standard Rotor Left	Standard Rotor Right			
TXT 50 (Boy)	04-11	FA115X	FA115R				MXS115	N/A				1
TXT 50/80 (Rookie)	02-03	FA291X						N/A				2
MC 65	05-06	FA351X						N/A				3
TXT 70 Rookie/Cadet	10-11	FA303X						N/A				4
TXT 80 Rookie/Cadet	04-08	FA303X						N/A				5
TXT 80 Cadet Pro	15	FA303X						N/A				6
Enduros 125/250	00	FA181X	FA181R		EPFA181HH		MXS181	N/A				7
EC 125/200/250/300	00-09	FA185X	FA185R		EPFA185HH		MXS185	MD6289D			MD6289C	8
EC 125/200/250/300 (All models/2T) (See note)	10-12	FA185X	FA185R		EPFA185HH		MXS185	MD6289D			MD6289C	9
EC 200/250/300	20	FA185X	FA185R		EPFA185HH		MXS185					10
EC Ranger 200/300	20	FA181X	FA181R		EPFA181HH		MXS181					11
HP 125	07-08	FA181X*	FA181R*		EPFA181HH*		MXS181*	N/A	N/A			12
JTX 125/200/270/320	95-98	FA115X	FA115R				MXS115	N/A				13
MC 125	05	FA185X	FA185R		EPFA185HH		MXS185	MD6289D			MD6289C	14
MX 125/250	01-08	FA185X	FA185R		EPFA185HH		MXS185	MD6289D			MD6289C	15
Pampera 125/250/370	96-97	FA115X	FA115R				MXS115	N/A				16
Pampera 125/250/280	04	FA194	FA194HH					N/A				17
Pampera 125/450	05-06	FA194	FA194HH					N/A				18
SM 125/250 (2T)	01-05	FA95	FA95HH		EPFA95HH			N/A				19
Trial GP 125/250/280/300	20-22	FA291X										20
TXT 125/200/249/280/321	00-03	FA291X						N/A				21
TXT 125/200/250/280/300 (TXT Pro)	04-15	FA303X						N/A				22
TXT 125/200/250/280/300 (TXT Racing)	14-15	FA644X						N/A				23
TXT 125/250/280/300 (TXT Racing)	20-22	FA291X										24
Enduro EC 200/250/300	97-99	FA181X	FA181R		EPFA181HH		MXS181	N/A				25
HP 200	08	FA181X*	FA181R*		EPFA181HH*		MXS181*	N/A	N/A			26
MX 200/250/300	99-00	FA181X	FA181R		EPFA181HH		MXS181	N/A				27
TX 200/270/320	98	FA115X	FA115R				MXS115	N/A				28
TX 200 Radonne (4T)	14-15	FA303X						N/A				29
TXT 200/270/321	99	FA291X						N/A				30
XC 200/250/300	20	FA185X	FA185R				MXS185					31
Contact JT25 (238cc)	93-94	FA115X	FA115R				MXS115	N/A				32
Contact RR 250/280	20	FA303X										33
EC Six Days 250/300	19	FA185X	FA185R				MXS185					34
HP 240 Wild	03-05	FA181X*	FA181R*		EPFA181HH*		MXS181*	N/A	N/A			35
HP 250 Wild	08	FA181X*	FA181R*		EPFA181HH*		MXS181*	N/A	N/A			36
Pampera 250/320	98-99	FA115X	FA115R				MXS115	N/A				37
Pampera 250	02-03	FA194	FA194HH					N/A				38
TXT 250/280/300 Raga	07-11	FA303X						N/A				39
HP 300 Wild	03-05	FA181X*	FA181R*		EPFA181HH*		MXS181*	N/A	N/A			40
HP 300 RV	06	FA181X*	FA181R*		EPFA181HH*		MXS181*	N/A	N/A			41
TXT 300 Raga	07	FA303X						N/A				42
SM 400 FSE (2T)	01-02	FA95	FA95HH		EPFA95HH			N/A				43
EC 450	09	FA185X	FA185R				MXS185	N/A				44
FSE 450	05-08	FA185X	FA185R				MXS185	N/A				45
HP 450	03-08	FA181X*	FA181R*		EPFA181HH*		MXS181*	N/A	N/A			46
SM 450	03-05	FA95	FA95HH		EPFA95HH			N/A				47
EC 515	09	FA185X	FA185R				MXS185					48
HP 515 Wild	09	FA181X*	FA181R*		EPFA181HH*		MXS181*	N/A	N/A			49
NOTE EC models may also be known as XC models												50
GAS-GAS (PIERER)												51
MC-E 5 Electric	21	FA325X	FA325R									52
MC 50 2T	21	FA325X	FA325R									53
MC 65 2T	21	FA357X	FA357R									54
MC 85 2T	21	FA612X	FA612R									55

APPLICATIONS

BRAKE

⚡ This symbol indicates a rotor made of billet steel, and should be only used with EBC FA Kevlar® Organic or Vee pads.

SAFETY NOTICE - With vehicles primarily designed for off highway use such as quads now being used on the highway, we would recommend the use of X or MXS pads for highway use and ONLY using the R and SV higher density / harder pad series for off road riding.

*-2 Sets Required. † For Vee disc colours add RED, BLU, GRN, GLD, ORG suffix to part number. **SAFETY WARNING:- DO NOT USE HH PADS ON REAR UNLESS ALSO USED ON FRONT TO AVOID BRAKE IMBALANCE**

FRONT: Non-Japanese Bikes Cont'd

REAR: Non-Japanese Bikes

Line #	BRAKE ROTOR CHOICES - FRONT						DISC PAD CHOICES - REAR					BRAKE ROTOR CHOICES - REAR				
	CC Custom Rotor	CX Extreme® /Vee-Rotor	OS Series Oversize 250/280mm Rotor Kit	OSX Series Oversize 280mm Rotor Kit	Relocating Bracket for Oversize Rotor	SMX Series Oversize 320mm Rotor Kit	Relocating Bracket for 320mm Rotor		Sintered/HH Pads/ Grooved Shoes	SV Series Severe Duty Pads	EPFA Sintered Fast Road/ Track Pads	Specialty Pads SXR/ VEE/MXS Race	Standard Rotor	Vintage Rotor / UTV Oversize Brake Kit	Contour Profile Rotor	CX Extreme® /Vee-Rotor
1								FA115X	FA115R				N/A			
2								FA291X					N/A			
3								FA115X					N/A			
4								FA351X					N/A			
5								FA351X					N/A			
6								FA351X					N/A			
7								FA208X	FA208R		EPFA208HH	MXS208	N/A			
8								FA131X	FA131R			MXS131	MD6253D		MD6253C	
9								FA367X	FA367R			MXS367	MD6253D		MD6253C	
10								FA367X	FA367R							
11								FA368X	FA368R							
12								FA181X	FA181R		EPFA181HH	MXS181	N/A			
13								FA115X	FA115R			MXS115	N/A			
14								FA131X	FA131R			MXS131	MD6253D		MD6253C	
15								FA131X	FA131R			MXS131	MD6253D		MD6253C	
16								FA115X	FA115R			MXS115	N/A			
17								FA291X					N/A			
18								FA131X	FA131R				MD6253D		MD6253C	
19								FA131X					MD6253D		MD6253C	
20								FA351X					N/A			
21								FA291X					N/A			
22								FA351X					N/A			
23								FA351X					N/A			
24								FA351X					N/A			
25								FA131X	FA131R		EPFA131HH	MXS131	MD6253D		MD6253C	
26								FA181X	FA181R		EPFA181HH	MXS181	N/A			
27								FA131X	FA131R		EPFA131HH	MXS131	MD6253D		MD6253C	
28								FA115X	FA115R			MXS115	N/A			
29								FA351X					N/A			
30								FA291X					N/A			
31								FA367X	FA367R							
32								FA115X	FA115R			MXS115	N/A			
33								FA351X								
34								FA367X	FA367R							
35								FA181X	FA181R		EPFA181HH	MXS181	N/A			
36								FA181X	FA181R		EPFA181HH	MXS181	N/A			
37			N/A	N/A				FA115X	FA115R			MXS115	N/A			
38								FA291X					N/A			
39								FA351X					N/A			
40								FA181X	FA181R		EPFA181HH	MXS181	N/A			
41								FA181X	FA181R		EPFA181HH	MXS181	N/A			
42								FA351X					N/A			
43								FA131X	FA131R		EPFA131HH	MXS131	MD6253D		MD6253C	
44								FA131X	FA131R			MXS131	N/A			
45								FA131X	FA131R			MXS131	N/A			
46								FA181X	FA181R		EPFA181HH	MXS181	N/A			
47								FA131X	FA131R		EPFA131HH	MXS131	MD6253D		MD6253C	
48								FA131X	FA131R			MXS131	TBC			
49								FA181X	FA181R		EPFA181HH	MXS181	N/A			
50																
51																
52																
53								FA325X	FA325R							
54								FA325X	FA325R							
55								FA357X	FA357R							
56								FA602X	FA602R							

BRAKE APPLICATIONS

⚠ This symbol indicates a rotor made of billet steel, and should be only used with EBC FA Kevlar® Organic or Vee pads.
 SAFETY NOTICE - With vehicles primarily designed for off highway use such as quads now being used on the highway, we would recommend the use of X or MXS pads for highway use and ONLY using the R and SV higher density / harder pad series for off road riding.

*-2 Sets Required. † For Vee disc colours add RED, BLU, GRN, GLD, ORG suffix to part number. **SAFETY WARNING:** DO NOT USE HH PADS ON REAR UNLESS ALSO USED ON FRONT TO AVOID BRAKE IMBALANCE

FRONT: Non-Japanese Bikes



GAS-GAS (PIERER)



MC 125 2T	21
EX 250 F 4T	21
EX 250 4T Cross Country	21-22
MC 250 F 4T	21
EC 300 2T	21
EX 300 2T	21
EX 300 2T Cross Country	21-22
EX 350 F 4T	21
EX 350 4T Cross Country	21-22
EX 450 F 4T	21
EX 450 4T Cross Country	21-22
MC 450 F 4T	21

GOGORO (Electric Scooter)

Smart Scooter	15-17
---------------	-------

HISUN (ATV)

110 Axis	14-16
110 Forge	14-16
400 Forge	Left 15-16
	Right 15-16
400 Forge - Parking brake	15-16
500 Forge	Left 15-16
	Right 15-16
500 Forge - Parking brake	15-16
700 Forge	Left 15-16
	Right 15-16
700 Forge - Parking brake	15-16
800 Tactic	Left 15-16
	Right 15-16
800 Tactic - Parking brake	15-16
1000 Tactic	Left 15-16
	Right 15-16
1000 Tactic - Parking brake	15-16

HISUN (SIDE X SIDE)

250 Sector	Left 15-16
	Right 15-16
250 Strike	Left 15-16
	Right 15-16
HS 400	Left 15-16
	Right 15-16
HS 400 - Parking brake	15-16
450 Sector	Left 15-16
	Right 15-16
450 Sector - Parking brake	15-16
HS 500	Left 15-16
	Right 15-16
HS 500 - Parking brake	15-16
550 Sector	Left 15-16
	Right 15-16
550 Sector - Parking brake	15-16
HS 700	Left 15-16
	Right 15-16
HS 700 - Parking brake	15-16

DISC PAD CHOICES - FRONT	DISC PAD CHOICES - FRONT				BRAKE ROTOR CHOICES - FRONT				Line #	
	Sintered/HH Pads/Grooved Shoes	SV Series Severe Duty Pads	EPFA Sintered Fast Road/Track Pads	GPFA Sintered RACE ONLY Pads	Specialty Pads SXR/VEE/MXS Race	Standard Rotor Left	Standard Rotor Right	Vintage Rotor / UTV Oversize Brake Kit		Contour Profile Rotor
FA181X	FA181R				MXS181					1
FA181X	FA181R				MXS181					2
FA181X	FA181R				MXS181				MD6032C	3
FA181X	FA181R				MXS181					4
FA181X	FA181R				MXS181					5
FA181X	FA181R				MXS181					6
FA181X	FA181R				MXS181				MD6032C	7
FA181X	FA181R				MXS181					8
FA181X	FA181R				MXS181				MD6032C	9
FA181X	FA181R				MXS181					10
FA181X	FA181R				MXS181				MD6032C	11
FA181X	FA181R				MXS181					12
SFA266	SFA266HH					MD9162D				13
										14
FA83X*	FA83R*					TBC	TBC			15
FA83X*	FA83R*					TBC	TBC			16
FA165X	FA165R	FA165SV				TBC				17
FA135X	FA135R	FA135SV					TBC			18
										19
FA165X	FA165R	FA165SV				TBC				20
FA135X	FA135R	FA135SV					TBC			21
										22
FA165X	FA165R	FA165SV				TBC				23
FA135X	FA135R	FA135SV					TBC			24
										25
FA165X	FA165R	FA165SV				TBC				26
FA135X	FA135R	FA135SV					TBC			27
										28
FA165X	FA165R	FA165SV				TBC				29
FA135X	FA135R	FA135SV					TBC			30
										31
FA165X	FA165R	FA165SV				TBC				32
FA135X	FA135R	FA135SV					TBC			33
										34
										35
FA165X	FA165R	FA165SV				SXR165HH	TBC			36
FA135X	FA135R	FA135SV				SXR135HH		TBC		37
FA165X	FA165R	FA165SV				SXR165HH	TBC			38
FA135X	FA135R	FA135SV				SXR135HH		TBC		39
FA165X	FA165R	FA165SV				SXR165HH	TBC			40
FA135X	FA135R	FA135SV				SXR135HH		TBC		41
										42
FA165X	FA165R	FA165SV				SXR165HH	TBC			43
FA135X	FA135R	FA135SV				SXR135HH		TBC		44
										45
FA165X	FA165R	FA165SV				SXR165HH	TBC			46
FA135X	FA135R	FA135SV				SXR135HH		TBC		47
										48
FA165X	FA165R	FA165SV				SXR165HH	TBC			49
FA135X	FA135R	FA135SV				SXR135HH		TBC		50
										51
FA165X	FA165R	FA165SV				SXR165HH	TBC			52
FA135X	FA135R	FA135SV				SXR135HH		TBC		53
										54
										55
										56

FRONT

APPLICATIONS

BRAKE
 This symbol indicates a rotor made of billet steel, and should be only used with EBC FA Kevlar® Organic or Vee pads.
 SAFETY NOTICE - With vehicles primarily designed for off highway use such as quads now being used on the highway, we would recommend the use of X or MXS pads for highway use and ONLY using the R and SV higher density / harder pad series for off road riding.

*2 Sets Required. † For Vee disc colours add RED, BLU, GRN, GLD, ORG suffix to part number. **SAFETY WARNING:- DO NOT USE HH PADS ON REAR UNLESS ALSO USED ON FRONT TO AVOID BRAKE IMBALANCE**

FRONT: Non-Japanese Bikes Cont'd

REAR: Non-Japanese Bikes

Line # 1 2 3 4 5 6 7 8 9 10 11 12 13 14 15 16 17 18 19 20 21 22 23 24 25 26 27 28 29 30 31 32 33 34 35 36 37 38 39 40 41 42 43 44 45 46 47 48 49 50 51 52 53 54 55 56

BRAKE ROTOR CHOICES - FRONT							DISC PAD CHOICES - REAR					BRAKE ROTOR CHOICES - REAR			
CC Custom Rotor	CX Extreme® /Vee-Rotor	OS Series Oversize 250/280mm Rotor Kit	OSX Series Oversize 280mm Rotor Kit	Relocating Bracket for Oversize Rotor	SMX Series Oversize 320mm Rotor Kit	Relocating Bracket for 320mm Rotor		Sintered/HH Pads/ Grooved Shoes	SV Series Severe Duty Pads	EPFA Sintered Fast Road/ Track Pads	Specialty Pads SXR/ VEE/MXS Race	Standard Rotor	Vintage Rotor / UTV Oversize Brake Kit	Contour Profile Rotor	CX Extreme® /Vee-Rotor
							FA368X	FA368R			MXS368				
							FA368X	FA368R			MXS368				
	MD6032CX						FA368X	FA368R			MXS368			MD6035C	MD6035CX
							FA368X	FA368R			MXS368				
							FA368X	FA368R			MXS368				
	MD6032CX						FA368X	FA368R			MXS368			MD6035C	MD6035CX
							FA368X	FA368R			MXS368				
	MD6032CX						FA368X	FA368R			MXS368			MD6035C	MD6035CX
							FA368X	FA368R			MXS368				
	MD6032CX						FA368X	FA368R			MXS368			MD6035C	MD6035CX
							FA368X	FA368R			MXS368				
							FA368X	FA368R			MXS368				
	VR9162						SFA67	SFA67HH				MD9163D			VR9163
							FA67X	FA67R				TBC			
							FA67X	FA67R				TBC			
							FA135X	FA135R	FA135SV			TBC			
							FA165X	FA165R	FA165SV			TBC			
							FA428X	FA428R				TBC			
							FA135X	FA135R	FA135SV			TBC			
							FA165X	FA165R	FA165SV			TBC			
							FA428X	FA428R				TBC			
							FA135X	FA135R	FA135SV			TBC			
							FA165X	FA165R	FA165SV			TBC			
							FA428X	FA428R				TBC			
							FA135X	FA135R	FA135SV			TBC			
							FA165X	FA165R	FA165SV			TBC			
							FA428X	FA428R	TBC			TBC			
							FA428X	FA428R	FA428SV			TBC			
							FA428X	FA428R	FA428SV			TBC			
							FA135X	FA135R	FA135SV		SXR135HH	TBC			
							FA165X	FA165R	FA165SV		SXR165HH	TBC			
							FA428X	FA428R	TBC						
							FA135X	FA135R	FA135SV		SXR135HH	TBC			
							FA165X	FA165R	FA165SV		SXR165HH	TBC			
							FA428X	FA428R	TBC						
							FA135X	FA135R	FA135SV		SXR135HH	TBC			
							FA165X	FA165R	FA165SV		SXR165HH	TBC			
							FA428X	FA428R	TBC						
							FA135X	FA135R	FA135SV		SXR135HH	TBC			
							FA165X	FA165R	FA165SV		SXR165HH	TBC			
							FA428X	FA428R	TBC						

REAR

BRAKE APPLICATIONS

⚠ This symbol indicates a rotor made of billet steel, and should be only used with EBC FA Kevlar® Organic or Vee pads.
 SAFETY NOTICE - With vehicles primarily designed for off highway use such as quads now being used on the highway, we would recommend the use of X or MXS pads for highway use and ONLY using the R and SV higher density / harder pad series for off road riding.

*-2 Sets Required. † For Vee disc colours add RED, BLU, GRN, GLD, ORG suffix to part number. **SAFETY WARNING:- DO NOT USE HH PADS ON REAR UNLESS ALSO USED ON FRONT TO AVOID BRAKE IMBALANCE**

FRONT: Non-Japanese Bikes



HISUN (SIDE X SIDE)



DISC PAD CHOICES - FRONT

BRAKE ROTOR CHOICES - FRONT

												Line #
750 Sector	Left	15-16	FA165X	FA165R	FA165SV		SXR165HH	TBC				1
	Right		FA135X	FA135R	FA135SV		SXR135HH		TBC			2
750 Sector - Parking brake												3
HS 750 Crew	Left	15-16	FA165X	FA165R	FA165SV		SXR165HH	TBC				4
	Right		FA135X	FA135R	FA135SV		SXR135HH		TBC			5
HS 750 Crew - Parking brake												6
HS 800 Crew	Left	15-16	FA165X	FA165R	FA165SV		SXR165HH	TBC				7
	Right		FA135X	FA135R	FA135SV		SXR135HH		TBC			8
HS 800 Crew - Parking brake												9
800 Strike	Left	15-16	FA165X	FA165R	FA165SV		SXR165HH	TBC				10
	Right		FA135X	FA135R	FA135SV		SXR135HH		TBC			11
1000 Sector	Left	15-16	FA165X	FA165R	FA165SV		SXR165HH	TBC				12
	Right		FA135X	FA135R	FA135SV		SXR135HH		TBC			13
1000 Sector - Parking brake												14
1000 Strike	Left	15-16	FA165X	FA165R	FA165SV		SXR165HH	TBC				15
	Right		FA135X	FA135R	FA135SV		SXR135HH		TBC			16
1000 Strike - Parking brake												17
1000 Strike Crew	Left	15-16	FA165X	FA165R	FA165SV		SXR165HH	TBC				18
	Right		FA135X	FA135R	FA135SV		SXR135HH		TBC			19
1000 Strike Crew - Parking brake												20
HUSABERG												21
All models (central fixing pin in pad)			FA134X	FA134R				N/A				22
All models (fixing pin at end of brake pad)			FA181X	FA181R		EPFA181HH	MXS181	MD6125D			N/A	23
All models (fixing pin at end of brake pad)			FA181X	FA181R		EPFA181HH	MXS181	MD6125D			N/A	24
All MX/Enduro models (Brembo 2 piston caliper 260mm front disc)			FA181X	FA181R		EPFA181HH	MXS181	MD6032D			MD6032C	25
All supermotard models (Beringer 4 piston caliper central pin fixing 310mm front disc)			FA158	FA158HH		EPFA158HH		MD6270D			MD6270C	26
FS Supermotard Models (Beringer/FTE 6 piston caliper 310mm front disc)						EPFA406HH	MXS406	MD6270D			MD6270C	27
FS Supermotard Models (FTE 4 piston radial caliper)						EPFA405HH	MXS405	MD6270D			MD6270C	28
TE 250 (2T)			FA181X	FA181R		EPFA181HH	MXS181				MD6032C	29
TE 300 (2T)			FA181X	FA181R		EPFA181HH	MXS181				MD6032C	30
FE 390			FA181X	FA181R		EPFA181HH	MXS181				MD6032C	31
FE 450			FA181X	FA181R		EPFA181HH	MXS181				MD6032C	32
FX 450			FA181X	FA181R		EPFA181HH	MXS181				MD6032C	33
FE 501			FA181X	FA181R		EPFA181HH	MXS181				MD6032C	34
FE 570			FA181X	FA181R		EPFA181HH	MXS181				MD6032C	35
FS 570 Supermoto			FA433/4	FA433/4HH		EPFA433/4HH		TBC				36
MD6035C ● PLAIN UNDRILLED DISC FOR ENDURO USE, REAR FITMENTS			ONLY. ORDER MD6035CE.									37
HUSQVARNA												38
Husky Boy Racing S			984									39
Husky Boy Drum Front & Rear			984									40
Husky Boy Racing J			984									41
Husky Boy J			FA115X	FA115R			MXS115	N/A				42
Husky Boy R			FA115X	FA115R			MXS115	N/A				43
Husky Boy S			FA115X	FA115R			MXS115	N/A				44
CR 50 Junior			FA351X					N/A				45
CR 50 Junior Basic			TBC									46
CR 50 Senior Pro			FA351X					N/A				47
CR 50			FA325X	FA325R				N/A				48
EE 5			FA325X	FA325R								49
SM 50			FA167	FA167HH				TBC				50
SM 50			FA325X	FA325R				N/A				51
TC 50			FA325X	FA325R								52

APPLIATIONS
BRAKE
 This symbol indicates a rotor made of billet steel, and should be only used with EBC FA Kevlar® Organic or Vee pads.
 SAFETY NOTICE - With vehicles primarily designed for off highway use such as quads now being used on the highway, we would recommend the use of X or MXS pads for highway use and ONLY using the R and SV higher density / harder pad series for off road riding.

*-2 Sets Required. † For Vee disc colours add RED, BLU, GRN, GLD, ORG suffix to part number. **SAFETY WARNING:- DO NOT USE HH PADS ON REAR UNLESS ALSO USED ON FRONT TO AVOID BRAKE IMBALANCE**

FRONT: Non-Japanese Bikes Cont'd

REAR: Non-Japanese Bikes

Line #	BRAKE ROTOR CHOICES - FRONT						REAR	DISC PAD CHOICES - REAR					BRAKE ROTOR CHOICES - REAR			
	CC Custom Rotor	CX Extreme® /Vee-Rotor	OS Series Oversize 250/280mm Rotor Kit	OSX Series Oversize 280mm Rotor Kit	Relocating Bracket for Oversize Rotor	SMX Series Oversize 320mm Rotor Kit		Relocating Bracket for 320mm Rotor	 Sintered/HH Pads/ Grooved Shoes	SV Series Severe Duty Pads	EPFA Sintered Fast Road/Track Pads	Specialty Pads SXR/ VEE/MXS Race	Standard Rotor	Vintage Rotor / UTV Oversize Brake Kit	Contour Profile Rotor	CX Extreme® /Vee-Rotor
1								FA135X	FA135R	FA135SV		SXR135HH	TBC			
2								FA165X	FA165R	FA165SV		SXR165HH	TBC			
3								FA428X	FA428R	TBC						
4								FA135X	FA135R	FA135SV		SXR135HH	TBC			
5								FA165X	FA165R	FA165SV		SXR165HH	TBC			
6								FA428X	FA428R	TBC						
7								FA135X	FA135R	FA135SV		SXR135HH	TBC			
8								FA165X	FA165R	FA165SV		SXR165HH	TBC			
9								FA428X	FA428R	TBC						
10								FA135X	FA135R	FA135SV		SXR135HH	TBC			
11								FA165X	FA165R	FA165SV		SXR165HH	TBC			
12								FA135X	FA135R	FA135SV		SXR135HH	TBC			
13								FA165X	FA165R	FA165SV		SXR165HH	TBC			
14								FA428X	FA428R	TBC						
15								FA135X	FA135R	FA135SV		SXR135HH	TBC			
16								FA165X	FA165R	FA165SV		SXR165HH	TBC			
17								FA428X	FA428R	TBC						
18								FA135X	FA135R	FA135SV		SXR135HH	TBC			
19								FA165X	FA165R	FA165SV		SXR165HH	TBC			
20								FA428X	FA428R							
21																
22																
23								FA67X	FA67R			N/A				
24			OS6125C	OSX6125	BRK010	SMX6125	BRK007	FA67X	FA67R			MD6126D				
25			OS6125C	OSX6125	BRK010	SMX6125	BRK007	FA208X	FA208R	EPFA208HH	MXS208	MD6126D				
26		MD6032CX	OS6032C	OSX6032	BRK011	SMX6032	BRK012	FA208X	FA208R	EPFA208HH	MXS208	MD6035D		MD6035C●	MD6035CX	
27																
28								FA208X	FA208R	EPFA208HH	MXS208	MD6035D		MD6035C		
29																
30																
31								FA208X	FA208R			MXS208	MD6035D	MD6035C		
32		MD6032CX	OS6932C	OSX6932	BRK013	SMX6932	BRK014	FA208X	FA208R			MXS208	MD6035D	MD6035C		
33		MD6032CX	OS6932C	OSX6932	BRK013	SMX6932	BRK014	FA368X	FA368R	EPFA368HH	MXS368	MD6035C●	MD6035CX	MD6035C●	MD6035CX	
34		MD6032CX	OS6932C	OSX6932	BRK013	SMX6932	BRK014	FA368X	FA368R	EPPFA368HH	MXS368	MD6035C●	MD6035CX	MD6035C●	MD6035CX	
35		MD6032CX	OS6932C	OSX6932	BRK013	SMX6932	BRK014	FA368X	FA368R	EPPFA368HH	MXS368	MD6035C●	MD6035CX	MD6035C●	MD6035CX	
36		MD6032CX	OS6932C	OSX6932	BRK013	SMX6932	BRK014	FA368X	FA368R	EPFA368HH	MXS368	MD6035C●	MD6035CX	MD6035C●	MD6035CX	
37		MD6032CX	OS6932C	OSX6932	BRK013	SMX6932	BRK014	FA368X	FA368R	EPFA368HH	MXS368	MD6035C●	MD6035CX	MD6035C●	MD6035CX	
38		MD6032CX	OS6932C	OSX6932	BRK013	SMX6932	BRK014	FA368X	FA368R	EPFA368HH	MXS368	MD6035C●	MD6035CX	MD6035C●	MD6035CX	
39								FA368X	FA368R	EPFA368HH	MXS368			MD6035C		
40																
41																
42																
43								984								
44								984								
45								984								
46								984								
47								984								
48								984								
49								TBC								
50								TBC								
51								FA325X				N/A				
52								FA325X	FA325R			N/A				
53								FA325X	FA325R							
54								FA115	FA115HH			TBC				
55								FA325X	FA325R			N/A				
56								FA325X	FA325R							

BRAKE APPLICATIONS

● This symbol indicates a rotor made of billet steel, and should be only used with EBC FA Kevlar® Organic or Vee pads.
SAFETY NOTICE - With vehicles primarily designed for off highway use such as quads now being used on the highway, we would recommend the use of X or MXS pads for highway use and ONLY using the R and SV higher density / harder pad series for off road riding.

*-2 Sets Required. † For Vee disc colours add RED, BLU, GRN, GLD, ORG suffix to part number. **SAFETY WARNING: DO NOT USE HH PADS ON REAR UNLESS ALSO USED ON FRONT TO AVOID BRAKE IMBALANCE**

FRONT: Non-Japanese Bikes



HUSQVARNA



DISC PAD CHOICES - FRONT

BRAKE ROTOR CHOICES - FRONT



Sintered/HH Pads/Grooved Shoes	SV Series Severe Duty Pads	EPFA Sintered Fast Road/Track Pads	GPFA Sintered RACE ONLY Pads	Specialty Pads SXR/VEE/MXS Race
--------------------------------	----------------------------	------------------------------------	------------------------------	---------------------------------

Standard Rotor Left	Standard Rotor Right	Vintage Rotor / UTV Oversize Brake Kit	Contour Profile Rotor
---------------------	----------------------	--	-----------------------

Line #

Model	Year	Disc Pad Choices - Front	Brake Rotor Choices - Front	Line #
TE 50 Boy	05	TBC		1
WR 50	02	FA167	FA167HH	2
WRS 50 Scooter	98-00	SFA115	SFA115HH	3
CR 65	12	FA357X	FA357R	4
TC 65	18-22	FA357X	FA357R	5
TC 85 (2T 17/14" Wheels)	14-20	FA612X	FA612R	6
TC 85 (2T 19/16" Wheels)	14-20	FA612X	FA612R	7
TC 85 (17/14" Wheels, 220mm F/rotor, 210mm R/rotor)	21-22	FA181X	FA181R	8
TC 85 (19/16" Wheels, 220mm F/rotor, 210mm R/rotor)	21-22	FA181X	FA181R	9
TE 100	05	FA351X		10
CR 125	73-77	N/A		11
CR 125	78		801G	12
CR 125	79-81		801G	13
CR 125	82-84		803G	14
CR 125	85-86	FA47X		15
CR 125	91	FA134X	FA134R	16
CR 125	92-94	FA135X	FA135R	17
CR 125	95-99	FA181X	FA181R	18
CR 125 (45mm dia. Marzocchi forks = 60mm caliper mount centers)	00-01	FA181X	FA181R	19
CR 125 (48mm dia. Marzocchi or Kayaba forks = 95mm caliper mount centers)	00-01	FA181X	FA181R	20
CR 125 (45mm dia. Marzocchi forks = 60mm caliper mount centers)	02-04	FA181X	FA181R	21
CR 125 (48mm dia. Marzocchi or Kayaba forks = 95mm caliper mount centers)	02-04	FA181X	FA181R	22
CR 125 (45mm dia. Marzocchi forks = 60mm caliper mount centers)	05	FA181X	FA181R	23
CR 125 (48mm dia. Marzocchi or Kayaba forks = 95mm caliper mount centers)	05	FA181X	FA181R	24
CR 125 (45mm dia. Marzocchi forks = 60mm caliper mount centers)	06-08	FA181X	FA181R	25
CR 125 (48mm dia. Marzocchi or Kayaba forks = 95mm caliper mount centers)	06-08	FA181X	FA181R	26
CR 125 (Kayaba Forks)	09-13	FA181X	FA181R	27
SC 125	73-74	N/A		28
SM 125	98-99	FA181X	FA181R	29
SM 125 (45mm dia. Marzocchi forks = 60mm caliper mount centers)	00	FA181X	FA181R	30
SM 125 (48mm dia. Marzocchi or Kayaba forks = 95mm caliper mount centers)	00	FA181X	FA181R	31
SMS 125 (2T) (45mm dia. Marzocchi forks = 60mm caliper mount centers)	02-11	FA181X	FA181R	32
SMS 125 (2T) (48mm dia. Marzocchi or Kayaba forks = 95mm caliper mount centers)	02-11	FA181X	FA181R	33
SMS-4 125 (4T) (45mm dia. Marzocchi forks = 60mm caliper mount centers)	10-11	FA181X	FA181R	34
SMS-4 125 (4T) (48mm dia. Marzocchi or Kayaba forks = 95mm caliper mount centers)	10-11	FA181X	FA181R	35
TC 125 (2T)	14-22	FA181X	FA181R	36
TE 125 (45mm dia. Marzocchi forks = 60mm caliper mount centers)	11	FA181X	FA181R	37
TE 125 (48mm dia. Marzocchi or Kayaba forks = 95mm caliper mount centers)	11	FA181X	FA181R	38
TE 125 (2T)	14-17	FA181X	FA181R	39
TX 125 (2T)	18-19	FA181X	FA181R	40

FRONT

APPLIATIONS
BRAKE
 This symbol indicates a rotor made of billet steel, and should be only used with EBC FA Kevlar® Organic or Vee pads.
 SAFETY NOTICE - With vehicles primarily designed for off highway use such as quads now being used on the highway, we would recommend the use of X or MXS pads for highway use and ONLY using the R and SV higher density / harder pad series for off road riding.

*-2 Sets Required. † For Vee disc colours add RED, BLU, GRN, GLD, ORG suffix to part number. **SAFETY WARNING:- DO NOT USE HH PADS ON REAR UNLESS ALSO USED ON FRONT TO AVOID BRAKE IMBALANCE**

FRONT: Non-Japanese Bikes Cont'd

REAR: Non-Japanese Bikes

Line #

BRAKE ROTOR CHOICES - FRONT							DISC PAD CHOICES - REAR					BRAKE ROTOR CHOICES - REAR			
CC Custom Rotor	CX Extreme® /Vee-Rotor	OS Series Oversize 250/280mm Rotor Kit	OSX Series Oversize 280mm Rotor Kit	Relocating Bracket for Oversize Rotor	SMX Series Oversize 320mm Rotor Kit	Relocating Bracket for 320mm Rotor		Sintered/HH Pads/ Grooved Shoes	SV Series Severe Duty Pads	EPFA Sintered Fast Road/ Track Pads	Specialty Pads SXR/ VEE/MXS Race	Standard Rotor	Vintage Rotor / UTV Oversize Brake Kit	Contour Profile Rotor	CX Extreme® /Vee-Rotor
1							TBC								
2							FA115	FA115HH				N/A			
3							624								
4							FA602X	FA602R						N/A	
5							FA357X	FA357R						MD6249C	
6							FA602X	FA602R						MD6360C	
7							FA602X	FA602R						MD6360C	
8							FA602X	FA602R			MXS368			MD6360C	
9							FA602X	FA602R			MXS368			MD6360C	
10							TBC								
11							N/A								
12							N/A								
13								801G							
14								801G							
15								802G							
16							FA251					MD6126D			
17							FA84X	FA84R			MXS84	MD6126D			
18		OS6125C	OSX6125	BRK010	SMX6125	BRK007	FA208X	FA208R		EPFA208HH	MXS208	MD6126D			
19															
20		OS6184HC	OSX6184H	BRK010	SMX6184H	BRK007	FA208X	FA208R		EPFA208HH	MXS208	MD6287D			
21															
22		OS6184KC	OSX6184K	BRK011	SMX6184K	BRK012	FA208X	FA208R		EPFA208HH	MXS208	MD6287D			
23															
24		OS6184HC	OSX6184H	BRK010	SMX6184H	BRK007	FA208X	FA208R		EPFA208HH	MXS208	MD6295D			
25															
26		OS6184KC	OSX6184K	BRK011	SMX6184K	BRK012	FA208X	FA208R		EPFA208HH	MXS208	MD6295D			
27															
28		OS6184HC	OSX6184H	BRK010	SMX6184H	BRK007	FA368X	FA368R		EPFA368HH	MXS368	MD6295D			
29															
30		OS6184KC	OSX6184K	BRK011	SMX6184K	BRK012	FA368X	FA368R		EPFA368HH	MXS368	MD6295D			
31															
32		OS6184HC	OSX6184H	BRK010	SMX6184H	BRK007	FA368X	FA368R		EPFA368HH	MXS368	MD6288D		MD6288C	
33															
34		OS6184KC	OSX6184K	BRK011	SMX6184K	BRK012	FA368X	FA368R		EPFA368HH	MXS368	MD6288D		MD6288C	
35		OS6184KC	OSX6184K	BRK011	SMX6184K	BRK011	FA368X	FA368R		EPFA368HH	MXS368			TBC	
36							N/A								
37		OS6125C	OSX6125	BRK010	SMX6125	BRK007	FA208X	FA208R		EPFA208HH	MXS208	MD6126D			
38															
39		OS6184HC	OSX6184H	BRK010	SMX6184H	BRK007	FA208X	FA208R		EPFA208HH	MXS208	MD6287D			
40															
41		OS6184KC	OSX6184K	BRK011	SMX6184K	BRK012	FA208X	FA208R		EPFA208HH	MXS208	MD6287D			
42															
43		OS6184HC	OSX6184H	BRK010	SMX6184H	BRK007	FA208X	FA208R		EPFA208HH	MXS208	MD6287D			
44															
45		OS6184KC	OSX6184K	BRK011	SMX6184K	BRK012	FA208X	FA208R		EPFA208HH	MXS208	MD6287D			
46															
47		OS6184HC	OSX6184H	BRK010	SMX6184H	BRK007	FA208X	FA208R		EPFA208HH	MXS208	MD6287D			
48															
49		OS6184KC	OSX6184K	BRK011	SMX6184K	BRK012	FA208X	FA208R		EPFA208HH	MXS208	MD6287D			
50	MD6032CX		OSX6032	BRK013	SMX6032	BRK014	FA368X	FA368R		EPFA368HH	MXS368	MD6035D		MD6035C	MD6035CX
51															
52		OS6184HC	OSX6184H	BRK010	SMX6184H	BRK007	FA368X	FA368R		EPFA368HH	MXS368			TBC	
53															
54		OS6184KC	OSX6184K	BRK011	SMX6184K	BRK012	FA368X	FA368R		EPFA368HH	MXS368			TBC	
55	MD6032CX		OSX6032	BRK013	SMX6032	BRK014	FA368X	FA368R		EPFA368HH	MXS368	MD6035D		MD6035C	MD6035CX
56	MD6032CX						FA368X	FA368R		EPFA368HH	MXS368	MD6035D		MD6035C	MD6035CX

REAR

BRAKE APPLICATIONS

⚠ This symbol indicates a rotor made of billet steel, and should be only used with EBC FA Kevlar® Organic or Vee pads.
 SAFETY NOTICE - With vehicles primarily designed for off highway use such as quads now being used on the highway, we would recommend the use of X or MXS pads for highway use and ONLY using the R and SV higher density / harder pad series for off road riding.

*-2 Sets Required. † For Vee disc colours add RED, BLU, GRN, GLD, ORG suffix to part number. **SAFETY WARNING:- DO NOT USE HH PADS ON REAR UNLESS ALSO USED ON FRONT TO AVOID BRAKE IMBALANCE**

FRONT: Non-Japanese Bikes



HUSQVARNA



DISC PAD CHOICES - FRONT

BRAKE ROTOR CHOICES - FRONT

Model	Year	Front Disc Pad Choice	DISC PAD CHOICES - FRONT					BRAKE ROTOR CHOICES - FRONT				Line #
			Sintered/HH Pads/Grooved Shoes	SV Series Severe Duty Pads	EPFA Sintered Fast Road/Track Pads	GPFX Sintered RACE ONLY Pads	Specialty Pads SXR/VEE/MXS Race	Standard Rotor Left	Standard Rotor Right	Vintage Rotor / UTV Oversize Brake Kit	Contour Profile Rotor	
WR 125	73-74	N/A										1
WR 125	79	801G										2
WR 125	80-81	802G										3
WR 125	82-84	803G										4
WR 125	87-88	FA134X	FA134R						N/A			5
WR 125	91	FA134X	FA134R						N/A			6
WR 125	93-94	FA135X	FA135R					MXS135	MD6125D			7
WR 125	95-99	FA181X	FA181R			EPFA181HH		MXS181	MD6125D		N/A	8
WR 125 (45mm dia. Marzocchi forks = 60mm caliper mount centers)	00-01	FA181X	FA181R			EPFA181HH		MXS181	MD6184D		MD6184C	10
WR 125 (48mm dia. Marzocchi or Kayaba forks = 95mm caliper mount centers)	00-01	FA181X	FA181R			EPFA181HH		MXS181	MD6184D		MD6184C	12
WR 125 (45mm dia. Marzocchi forks = 60mm caliper mount centers)	02-05	FA181X	FA181R			EPFA181HH		MXS181	MD6184D		MD6184C	14
WR 125 (48mm dia. Marzocchi or Kayaba forks = 95mm caliper mount centers)	02-05	FA181X	FA181R			EPFA181HH		MXS181	MD6184D		MD6184C	16
WR 125 (45mm dia. Marzocchi forks = 60mm caliper mount centers)	06-08	FA181X	FA181R			EPFA181HH		MXS181	MD6184D		MD6184C	18
WR 125 (48mm dia. Marzocchi or Kayaba forks = 95mm caliper mount centers)	06-08	FA181X	FA181R			EPFA181HH		MXS181	MD6184D		MD6184C	20
WR 125 (Kayaba Forks)	09-13	FA181X	FA181R			EPFA181HH		MXS181			MD6184C	21
WRE 125	93-99	FA181X	FA181R			EPFA181HH		MXS181	MD6125D		N/A	22
WRE 125 (45mm dia. Marzocchi forks = 60mm caliper mount centers)	00	FA181X	FA181R			EPFA181HH		MXS181	MD6184D		MD6184C	24
WRE 125 (48mm dia. Marzocchi or Kayaba forks = 95mm caliper mount centers)	00	FA181X	FA181R			EPFA181HH		MXS181	MD6184D		MD6184C	26
WRE 125 (45mm dia. Marzocchi forks = 60mm caliper mount centers)	02-11	FA181X	FA181R			EPFA181HH		MXS181	MD6184D		MD6184C	28
WRE 125 (48mm dia. Marzocchi or Kayaba forks = 95mm caliper mount centers)	02-11	FA181X	FA181R			EPFA181HH		MXS181	MD6184D		MD6184C	30
WXE 125	07	FA167	FA167HH						MD6184D		MD6184C	31
XC 125	82-84		803G									32
XC 125	85-86	FA47X							N/A			33
TE 150 i (2T)	18-22	FA181X	FA181R			EPFA181HH		MXS181	MD6032D		MD6032C	34
CR 240	80-81		802G									35
CR 240	82-84		803G									36
CR 240	85-86	FA47X							N/A			37
CR 240	87-88	FA134X	FA134R						N/A			38
WR 240	78		801G									39
WR 240	80-81		802G									40
WR 240	82-84		803G									41
WR 240	87-88	FA134X	FA134R						N/A			42
WR 240	90-91	FA134X	FA134R						N/A			43
CR 250	71-74	N/A										44
CR 250	75-79		801G									45
CR 250	80-81		802G									46
CR 250	82-84		803G									47
CR 250	85-86	FA47X							N/A			48
CR 250	87-88	FA134X	FA134R						N/A			49
CR 250	91	FA134X	FA134R						N/A			50
CR 250	92-94	FA135X	FA135R					MXS135	MD6125D			51
CR 250	95-99	FA181X	FA181R			EPFA181HH		MXS181	MD6125D		N/A	52
CR 250 (45mm dia. Marzocchi forks = 60mm caliper mount centers)	00-01	FA181X	FA181R			EPFA181HH		MXS181	MD6184D		MD6184C	54
CR 250 (48mm dia. Marzocchi or Kayaba forks = 95mm caliper mount centers)	00-01	FA181X	FA181R			EPFA181HH		MXS181	MD6184D		MD6184C	55

FRONT

APPLIATIONS
BRAKE
SAFETY NOTICE - With vehicles primarily designed for off highway use such as quads now being used on the highway, we would recommend the use of X or MXS pads for highway use and ONLY using the R and SV higher density / harder pad series for off road riding.

This symbol indicates a rotor made of billet steel, and should be only used with EBC FA Kevlar® Organic or Vee pads.

*-2 Sets Required. † For Vee disc colours add RED, BLU, GRN, GLD, ORG suffix to part number. **SAFETY WARNING:- DO NOT USE HH PADS ON REAR UNLESS ALSO USED ON FRONT TO AVOID BRAKE IMBALANCE**

FRONT: Non-Japanese Bikes Cont'd

REAR: Non-Japanese Bikes

Line # 1 2 3 4 5 6 7 8 9 10 11 12 13 14 15 16 17 18 19 20 21 22 23 24 25 26 27 28 29 30 31 32 33 34 35 36 37 38 39 40 41 42 43 44 45 46 47 48 49 50 51 52 53 54 55 56

BRAKE ROTOR CHOICES - FRONT							DISC PAD CHOICES - REAR					BRAKE ROTOR CHOICES - REAR			
CC Custom Rotor	CX Extreme® /Vee-Rotor	OS Series Oversize 250/280mm Rotor Kit	OSX Series Oversize 280mm Rotor Kit	Relocating Bracket for Oversize Rotor	SMX Series Oversize 320mm Rotor Kit	Relocating Bracket for 320mm Rotor		Sintered/HH Pads/ Grooved Shoes	SV Series Severe Duty Pads	EPFA Sintered Fast Road/ Track Pads	Specialty Pads SXR/ VEE/MXS Race	Standard Rotor	Vintage Rotor / UTV Oversize Brake Kit	Contour Profile Rotor	CX Extreme® /Vee-Rotor
							N/A								
								801G							
								802G							
								802G							
								802G							
							FA251					MD6126D			
							FA84X	FA84R			MXS84	MD6126D			
		OS6125C	OSX6125	BRK010	SMX6125	BRK007	FA208X	FA208R		EPFA208HH	MXS208	MD6126D			
		OS6184HC	OSX6184H	BRK010	SMX6184H	BRK007	FA208X	FA208R		EPFA208HH	MXS208	MD6287D			
		OS6184KC	OSX6184K	BRK011	SMX6184K	BRK012	FA208X	FA208R		EPFA208HH	MXS208	MD6287D			
		OS6184HC	OSX6184H	BRK010	SMX6184H	BRK007	FA208X	FA208R		EPFA208HH	MXS208	MD6295D			
		OS6184KC	OSX6184K	BRK011	SMX6184K	BRK012	FA208X	FA208R		EPFA208HH	MXS208	MD6295D			
		OS6184HC	OSX6184H	BRK010	SMX6184H	BRK007	FA368X	FA368R		EPFA368HH	MXS368	MD6288D		MD6288C	
		OS6184KC	OSX6184K	BRK011	SMX6184K	BRK012	FA368X	FA368R		EPFA368HH	MXS368	MD6288D		MD6288C	
		OS6184KC	OSX6184K	BRK011	SMX6184K	BRK011	FA368X	FA368R		EPFA368HH	MXS368			TBC	
		OS6125C	OSX6125	BRK010	SMX6125	BRK007	FA208X	FA208R		EPFA208HH	MXS208	MD6126D			
		OS6184HC	OSX6184H	BRK010	SMX6184H	BRK007	FA208X	FA208R		EPFA208HH	MXS208	MD6287D			
		OS6184KC	OSX6184K	BRK011	SMX6184K	BRK012	FA208X	FA208R		EPFA208HH	MXS208	MD6287D			
		OS6184HC	OSX6184H	BRK010	SMX6184H	BRK007	FA208X	FA208R		EPFA208HH	MXS208	MD6287D			
		OS6184KC	OSX6184K	BRK011	SMX6184K	BRK012	FA208X	FA208R		EPFA208HH	MXS208	MD6287D			
		OS6184HC	OSX6184H	BRK010	SMX6184H	BRK007	FA208X	FA208R		EPFA208HH	MXS208	MD6287D			
		OS6184KC	OSX6184K	BRK011	SMX6184K	BRK012	FA208X	FA208R		EPFA208HH	MXS208	MD6287D			
		OS6184HC	OSX6184H	BRK010	SMX6184H	BRK007	FA131X	FA131R			MXS131	TBC			
								802G							
								801G							
								801G							
								802G							
								802G							
								801G							
								802G							
								802G							
								802G							
								801G							
								802G							
								802G							
								802G							
							FA251					MD6126D			
								801G							
								801G							
								801G							
								801G							
								802G							
								802G							
								802G							
								802G							
							FA251					MD6126D			
								801G							
								801G							
								801G							
								801G							
								802G							
								802G							
							FA251					MD6126D			
							FA84X	FA84R			MXS84	MD6126D			
		OS6125C	OSX6125	BRK010	SMX6125	BRK007	FA208X	FA208R		EPFA208HH	MXS208	MD6126D			
		OS6184HC	OSX6184H	BRK010	SMX6184H	BRK007	FA208X	FA208R		EPFA208HH	MXS208	MD6287D			
		OS6184KC	OSX6184K	BRK011	SMX6184K	BRK012	FA208X	FA208R		EPFA208HH	MXS208	MD6287D			

REAR

BRAKE APPLICATIONS

⚠ This symbol indicates a rotor made of billet steel, and should be only used with EBC FA Kevlar® Organic or Vee pads.
 SAFETY NOTICE - With vehicles primarily designed for off highway use such as quads now being used on the highway, we would recommend the use of X or MXS pads for highway use and ONLY using the R and SV higher density / harder pad series for off road riding.

*-2 Sets Required. † For Vee disc colours add RED, BLU, GRN, GLD, ORG suffix to part number. **SAFETY WARNING: DO NOT USE HH PADS ON REAR UNLESS ALSO USED ON FRONT TO AVOID BRAKE IMBALANCE**

FRONT: Non-Japanese Bikes



HUSQVARNA



DISC PAD CHOICES - FRONT

BRAKE ROTOR CHOICES - FRONT

CR 250 (45mm dia. Marzocchi forks = 60mm caliper mount centers) 02-04	FA181X	FA181R	EPFA181HH		MXS181	MD6184D			MD6184C
CR 250 (48mm dia. Marzocchi or Kayaba forks = 95mm caliper mount centers) 02-04	FA181X	FA181R	EPFA181HH		MXS181	MD6184D			MD6184C
CR 250 (45mm dia. Marzocchi forks = 60mm caliper mount centers) 05	FA181X	FA181R	EPFA181HH		MXS181	MD6184D			MD6184C
CR 250 (48mm dia. Marzocchi or Kayaba forks = 95mm caliper mount centers) 05	FA181X	FA181R	EPFA181HH		MXS181	MD6184D			MD6184C
FC 250 (4T) 14-22	FA181X	FA181R	EPFA181HH		MXS181	MD6032D			MD6032C
FE 250 (4T) 14-22	FA181X	FA181R	EPFA181HH		MXS181	MD6032D			MD6032C
TC 250 (45mm dia. Marzocchi forks = 60mm caliper mount centers) 02-03	FA181X	FA181R	EPFA181HH		MXS181	MD6184D			MD6184C
TC 250 (48mm dia. Marzocchi or Kayaba forks = 95mm caliper mount centers) 02-03	FA181X	FA181R	EPFA181HH		MXS181	MD6184D			MD6184C
TC 250 (45mm dia. Marzocchi forks = 60mm caliper mount centers) 05-08	FA181X	FA181R	EPFA181HH		MXS181	MD6184D			MD6184C
TC 250 (48mm dia. Marzocchi or Kayaba forks = 95mm caliper mount centers) 05-08	FA181X	FA181R	EPFA181HH		MXS181	MD6184D			MD6184C
TC 250 (45mm dia. Marzocchi forks = 60mm caliper mount centers) 09-12	FA181X	FA181R	EPFA181HH		MXS181	MD6184D			MD6184C
TC 250 (48mm dia. Marzocchi or Kayaba forks = 95mm caliper mount centers) 09-12	FA181X	FA181R	EPFA181HH		MXS181	MD6184D			MD6184C
TC 250 R (4T) (Kayaba Forks) 13	FA181X	FA181R	EPFA181HH		MXS181	MD6184D			MD6184C
TC 250 (2T) 14-22	FA181X	FA181R	EPFA181HH		MXS181	MD6032D			MD6032C
TE 250 (45mm dia. Marzocchi forks = 60mm caliper mount centers) 02-05	FA181X	FA181R	EPFA181HH		MXS181	MD6184D			MD6184C
TE 250 (48mm dia. Marzocchi or Kayaba forks = 95mm caliper mount centers) 02-05	FA181X	FA181R	EPFA181HH		MXS181	MD6184D			MD6184C
TE 250 (45mm dia. Marzocchi forks = 60mm caliper mount centers) 06-08	FA181X	FA181R	EPFA181HH		MXS181	MD6184D			MD6184C
TE 250 (48mm dia. Marzocchi or Kayaba forks = 95mm caliper mount centers) 06-08	FA181X	FA181R	EPFA181HH		MXS181	MD6184D			MD6184C
TE 250 (45mm dia. Marzocchi forks = 60mm caliper mount centers) 09-12	FA181X	FA181R	EPFA181HH		MXS181	MD6184D			MD6184C
TE 250 (48mm dia. Marzocchi or Kayaba forks = 95mm caliper mount centers) 09-12	FA181X	FA181R	EPFA181HH		MXS181	MD6184D			MD6184C
TE 250 (2T) 14-19	FA181X	FA181R	EPFA181HH		MXS181	MD6032D			MD6032C
TE 250i (2T) 19-22	FA181X	FA181R	EPFA181HH		MXS181				
TXC 250 Cross Country (45mm dia. Marzocchi forks = 60mm caliper mount centers) 08	FA181X	FA181R	EPFA181HH		MXS181	MD6184D			MD6184C
TXC 250 Cross Country (48mm dia. Marzocchi or Kayaba forks = 95mm caliper mount centers) 08	FA181X	FA181R	EPFA181HH		MXS181	MD6184D			MD6184C
TXC 250 Cross Country (45mm dia. Marzocchi forks = 60mm caliper mount centers) 09-12	FA181X	FA181R	EPFA181HH		MXS181	MD6184D			MD6184C
TXC 250 Cross Country (48mm dia. Marzocchi or Kayaba forks = 95mm caliper mount centers) 09-12	FA181X	FA181R	EPFA181HH		MXS181	MD6184D			MD6184C
TXC 250 R Cross Country (Kayaba Forks) 13	FA181X	FA181R	EPFA181HH		MXS181	MD6184D			MD6184C
WR 250 71-74	N/A								
WR 250 75-78		801G							
WR 250 80-81		802G							
WR 250 82-84		803G							
WR 250 87-88	FA134X	FA134R				N/A			
WR 250 90-91	FA134X	FA134R				N/A			
WR 250 92-94	FA135X	FA135R			MXS135	MD6125D			
WR 250 95-99	FA181X	FA181R	EPFA181HH		MXS181	MD6125D			N/A

FRONT

Line #

APPLICATIONS

BRAKE

* This symbol indicates a rotor made of billet steel, and should be only used with EBC FA Kevlar® Organic or Vee pads.

SAFETY NOTICE - With vehicles primarily designed for off highway use such as quads now being used on the highway, we would recommend the use of X or MXS pads for highway use and ONLY using the R and SV higher density / harder pad series for off road riding.

*-2 Sets Required. † For Vee disc colours add RED, BLU, GRN, GLD, ORG suffix to part number. **SAFETY WARNING:- DO NOT USE HH PADS ON REAR UNLESS ALSO USED ON FRONT TO AVOID BRAKE IMBALANCE**

FRONT: Non-Japanese Bikes Cont'd

REAR: Non-Japanese Bikes

Line #

BRAKE ROTOR CHOICES - FRONT							DISC PAD CHOICES - REAR					BRAKE ROTOR CHOICES - REAR			
CC Custom Rotor	CX Extreme® /Vee-Rotor	OS Series Oversize 250/280mm Rotor Kit	OSX Series Oversize 280mm Rotor Kit	Relocating Bracket for Oversize Rotor	SMX Series Oversize 320mm Rotor Kit	Relocating Bracket for 320mm Rotor		Sintered/HH Pads/ Grooved Shoes	SV Series Severe Duty Pads	EPFA Sintered Fast Road/ Track Pads	Specialty Pads SXR/ VEE/MXS Race	Standard Rotor	Vintage Rotor / UTV Oversize Brake Kit	Contour Profile Rotor	CX Extreme® /Vee-Rotor
1															
2			OS6184HC	OSX6184H	BRK010	SMX6184H	BRK007	FA208X	FA208R		EPFA208HH	MXS208	MD6295D		
3															
4			OS6184KC	OSX6184K	BRK011	SMX6184K	BRK012	FA208X	FA208R		EPFA208HH	MXS208	MD6295D		
5															
6			OS6184HC	OSX6184H	BRK010	SMX6184H	BRK007	FA368X	FA368R		EPFA368HH	MXS368	MD6295D		
7															
8			OS6184KC	OSX6184K	BRK011	SMX6184K	BRK012	FA368X	FA368R		EPFA368HH	MXS368	MD6295D		
9		MD6032CX		OSX6032	BRK013	SMX6032	BRK014	FA368X	FA368R		EPFA368HH	MXS368	MD6035D	MD6035C	MD6035CX
10		MD6032CX		OSX6032	BRK013	SMX6032	BRK014	FA368X	FA368R		EPFA368HH	MXS368	MD6035D	MD6035C	MD6035CX
11															
12			OS6184HC	OSX6184H	BRK010	SMX6184H	BRK007	FA208X	FA208R		EPFA208HH	MXS208	MD6295D		
13															
14			OS6184KC	OSX6184K	BRK011	SMX6184K	BRK012	FA208X	FA208R		EPFA208HH	MXS208	MD6295D		
15															
16			OS6184HC	OSX6184H	BRK010	SMX6184H	BRK007	FA368X	FA368R		EPFA368HH	MXS368	MD6288D	MD6288C	
17															
18			OS6184KC	OSX6184K	BRK011	SMX6184K	BRK012	FA368X	FA368R		EPFA368HH	MXS368	MD6288D	MD6288C	
19															
20			OS6184HC	OSX6184H	BRK010	SMX6184H	BRK007	FA368X	FA368R		EPFA368HH	MXS368		TBC	
21															
22			OS6184KC	OSX6184K	BRK011	SMX6184K	BRK012	FA368X	FA368R		EPFA368HH	MXS368		TBC	
23			OS6184KC	OSX6184K	BRK011	SMX6184K	BRK011	FA368X	FA368R		EPFA368HH	MXS368		TBC	
24		MD6032CX		OSX6032	BRK013	SMX6032	BRK014	FA368X	FA368R		EPFA368HH	MXS368	MD6035D	MD6035C	MD6035CX
25															
26			OS6184HC	OSX6184H	BRK010	SMX6184H	BRK007	FA208X	FA208R		EPFA208HH	MXS208	MD6295D		
27															
28			OS6184KC	OSX6184K	BRK011	SMX6184K	BRK012	FA208X	FA208R		EPFA208HH	MXS208	MD6295D		
29															
30			OS6184HC	OSX6184H	BRK010	SMX6184H	BRK007	FA368X	FA368R		EPFA368HH	MXS368	MD6288D		
31															
32			OS6184KC	OSX6184K	BRK011	SMX6184K	BRK012	FA368X	FA368R		EPFA368HH	MXS368	MD6288D		
33															
34			OS6184HC	OSX6184H	BRK010	SMX6184H	BRK007	FA368X	FA368R		EPFA368HH	MXS368		TBC	
35															
36			OS6184KC	OSX6184K	BRK011	SMX6184K	BRK012	FA368X	FA368R		EPFA368HH	MXS368		TBC	
37		MD6032CX		OSX6032	BRK013	SMX6032	BRK014	FA368X	FA368R		EPFA368HH	MXS368	MD6035D	MD6035C	MD6035CX
38								FA368X	FA368R		EPFA368HH	MXS368			
39															
40			OS6184HC	OSX6184H	BRK010	SMX6184H	BRK007	FA368X	FA368R		EPFA368HH	MXS368	MD6288D	MD6288	
41															
42			OS6184KC	OSX6184K	BRK011	SMX6184K	BRK012	FA368X	FA368R		EPFA368HH	MXS368	MD6288D	MD6288C	
43															
44			OS6184HC	OSX6184H	BRK010	SMX6184H	BRK007	FA368X	FA368R		EPFA368HH	MXS368		TBC	
45															
46			OS6184KC	OSX6184K	BRK011	SMX6184K	BRK012	FA368X	FA368R		EPFA368HH	MXS368		TBC	
47			OS6184KC	OSX6184K	BRK011	SMX6184K	BRK011	FA368X	FA368R		EPFA368HH	MXS368		TBC	
48															
49								801G							
50								801G							
51								802G							
52								802G							
53								802G							
54								FA251					MD6126D		
55								FA84X	FA84R			MXS84	MD6126D		
56			OS6125C	OSX6125	BRK010	SMX6125	BRK007	FA208X	FA208R		EPFA208HH	MXS208	MD6126D		

REAR

BRAKE APPLICATIONS

⚠ This symbol indicates a rotor made of billet steel, and should be only used with EBC FA Kevlar® Organic or Vee pads.
 SAFETY NOTICE - With vehicles primarily designed for off highway use such as quads now being used on the highway, we would recommend the use of X or MXS pads for highway use and ONLY using the R and SV higher density / harder pad series for off road riding.

*-2 Sets Required. † For Vee disc colours add RED, BLU, GRN, GLD, ORG suffix to part number. **SAFETY WARNING:- DO NOT USE HH PADS ON REAR UNLESS ALSO USED ON FRONT TO AVOID BRAKE IMBALANCE**

FRONT: Non-Japanese Bikes



HUSQVARNA



DISC PAD CHOICES - FRONT

BRAKE ROTOR CHOICES - FRONT

WR 250 (45mm dia. Marzocchi forks = 60mm caliper mount centers)	00-01	FA181X	FA181R			MXS181	MD6184D			MD6184C
WR 250 (48mm dia. Marzocchi or Kayaba forks = 95mm caliper mount centers)	00-01	FA181X	FA181R			MXS181	MD6184D			MD6184C
WR 250 (45mm dia. Marzocchi forks = 60mm caliper mount centers)	02-05	FA181X	FA181R			MXS181	MD6184D			MD6184C
WR 250 (48mm dia. Marzocchi or Kayaba forks = 95mm caliper mount centers)	02-05	FA181X	FA181R			MXS181	MD6184D			MD6184C
WR 250 (45mm dia. Marzocchi forks = 60mm caliper mount centers)	06-09	FA181X	FA181R			MXS181	MD6184D			MD6184C
WR 250 (48mm dia. Marzocchi or Kayaba forks = 95mm caliper mount centers)	06-09	FA181X	FA181R			MXS181	MD6184D			MD6184C
WR 250 (Kayaba Forks)	09-13	FA181X	FA181R			MXS181				MD6184C
XC 250	80-81		802G							
XC 250	82-84		803G							
XC 250	85-86	FA47X					N/A			
XC 250	87-88	FA134X	FA134R				N/A			
WR 260	90-91	FA134X	FA134R				N/A			
WR 300 (Kayaba Forks)	09-13	FA181X	FA181R		EPFA181HH	MXS181	MD6184D			MD6184C
TE 300 (2T)	14-19	FA181X	FA181R		EPFA181HH	MXS181	MD6032D			MD6032C
TE 300i (2T)	19-22	FA181X	FA181R		EPFA181HH	MXS181	MD6032D			MD6032C
TX 300i Rock Star (2T)	22	FA181X	FA181R		EPFA181HH	MXS181	MD6032D			MD6032C
TX 300i (2T)	18-22	FA181X	FA181R		EPFA181HH	MXS181	MD6032D			MD6032C
TE 310 (4T) (45mm dia. Marzocchi forks = 60mm caliper mount centers)	09-10	FA181X	FA181R		EPFA181HH	MXS181	MD6184D			MD6184C
TE 310 (4T) (48mm dia. Marzocchi or Kayaba forks = 95mm caliper mount centers)	09-10	FA181X	FA181R		EPFA181HH	MXS181	MD6184D			MD6184C
TE 310 (4T) (45mm dia. Marzocchi forks = 60mm caliper mount centers)	11-12	FA181X	FA181R		EPFA181HH	MXS181	MD6184D			MD6184C
TE 310 (4T) (48mm dia. Marzocchi or Kayaba forks = 95mm caliper mount centers)	11-12	FA181X	FA181R		EPFA181HH	MXS181	MD6184D			MD6184C
TE 310 R (4T) (Kayaba Forks)	13	FA181X	FA181R		EPFA181HH	MXS181	MD6184D			MD6184C
TXC 310 Cross Country (45mm dia. Marzocchi forks = 60mm caliper mount centers)	12	FA181X	FA181R		EPFA181HH	MXS181	MD6184D			MD6184C
TXC 310 Cross Country (48mm dia. Marzocchi or Kayaba forks = 95mm caliper mount centers)	12	FA181X	FA181R		EPFA181HH	MXS181	MD6184D			MD6184C
TXC 310 R Cross Country (Kayaba Forks)	13	FA181X	FA181R		EPFA181HH	MXS181	MD6184D			MD6184C
FC 350 (4T)	14-22	FA181X	FA181R		EPFA181HH	MXS181	MD6032D			MD6032C
FE 350 (4T) inc S model	14-22	FA181X	FA181R		EPFA181HH	MXS181	MD6032D			MD6032C
FX 350 (4T)	18-22	FA181X	FA181R		EPFA181HH	MXS181	MD6032D			MD6032C
TE 350	90-91	FA134X	FA134R				N/A			
TE 350	92-94	FA135X	FA135R			MXS135	MD6125D			
TE 350	95-97	FA181X	FA181R		EPFA181HH	MXS181	MD6125D			N/A
360 Automatic	75-77	N/A								
CR 360	75-78		801G							
CR 360	92-94	FA135X	FA135R			MXS135	MD6125D			
WR 360	75-78		801G							
WR 360	92-94	FA135X	FA135R			MXS135	MD6125D			
WR 360	95-99	FA181X	FA181R		EPFA181HH	MXS181	MD6125D			N/A
WR 360 Cross Country (45mm dia. Marzocchi forks = 60mm caliper mount centers)	00-01	FA181X	FA181R		EPFA181HH	MXS181	MD6184D			MD6184C
WR 360 Cross Country (48mm dia. Marzocchi or Kayaba forks = 95mm caliper mount centers)	00-01	FA181X	FA181R		EPFA181HH	MXS181	MD6184D			MD6184C
WR 360 Cross Country (45mm dia. Marzocchi forks = 60mm caliper mount centers)	02	FA181X	FA181R		EPFA181HH	MXS181	MD6184D			MD6184C

Line #
1
2
3
4
5
6
7
8
9
10
11
12
13
14
15
16
17
18
19
20
21
22
23
24
25
26
27
28
29
30
31
32
33
34
35
36
37
38
39
40
41
42
43
44
45
46
47
48
49
50
51
52
53
54
55
56

FRONT

⚠ This symbol indicates a rotor made of billet steel, and should be only used with EBC FA Kevlar® Organic or Vee pads.

SAFETY NOTICE - With vehicles primarily designed for off highway use such as quads now being used on the highway, we would recommend the use of X or MXS pads for highway use and ONLY using the R and SV higher density / harder pad series for off road riding.

*-2 Sets Required. † For Vee disc colours add RED, BLU, GRN, GLD, ORG suffix to part number. **SAFETY WARNING:- DO NOT USE HH PADS ON REAR UNLESS ALSO USED ON FRONT TO AVOID BRAKE IMBALANCE**

FRONT: Non-Japanese Bikes Cont'd

REAR: Non-Japanese Bikes

Line #	BRAKE ROTOR CHOICES - FRONT						DISC PAD CHOICES - REAR					BRAKE ROTOR CHOICES - REAR				
	CC Custom Rotor	CX Extreme® /Vee-Rotor	OS Series Oversize 250/280mm Rotor Kit	OSX Series Oversize 280mm Rotor Kit	Relocating Bracket for Oversize Rotor	SMX Series Oversize 320mm Rotor Kit	Relocating Bracket for 320mm Rotor		Sintered/HH Pads/ Grooved Shoes	SV Series Severe Duty Pads	EPFA Sintered Fast Road/ Track Pads	Specialty Pads SXR/ VEE/MXS Race	Standard Rotor	Vintage Rotor / UTV Oversize Brake Kit	Contour Profile Rotor	CX Extreme® /Vee-Rotor
1																
2			OS6184HC	OSX6184H	BRK010	SMX6184H	BRK007	FA208X	FA208R		EPFA208HH	MXS208	MD6287D			
3																
4			OS6184KC	OSX6184K	BRK011	SMX6184K	BRK012	FA208X	FA208R		EPFA208HH	MXS208	MD6287D			
5																
6			OS6184HC	OSX6184H	BRK010	SMX6184H	BRK007	FA208X	FA208R		EPFA208HH	MXS208	MD6295D			
7																
8			OS6184KC	OSX6184K	BRK011	SMX6184K	BRK012	FA208X	FA208R		EPFA208HH	MXS208	MD6295D			
9																
10			OS6184HC	OSX6184H	BRK010	SMX6184H	BRK007	FA208X	FA208R		EPFA208HH	MXS208	MD6288D		MD6288C	
11																
12			OS6184KC	OSX6184K	BRK011	SMX6184K	BRK012	FA208X	FA208R		EPFA208HH	MXS208	MD6288D		MD6288C	
13			OS6184KC	OSX6184K	BRK011	SMX6184K	BRK011	FA208X	FA208R		EPFA208HH	MXS208			TBC	
14																
15									802G							
16									802G							
17									801G							
18									802G							
19			OS6184KC	OSX6184K	BRK011	SMX6184K	BRK011	FA251					MD6126D			
20	MD6032CX		OS6184KC	OSX6184K	BRK011	SMX6184K	BRK011	FA208X	FA208R		EPFA208HH	MXS208			TBC	
21	MD6032CX		OSX6032	OSX6032	BRK013	SMX6032	BRK014	FA368X	FA368R		EPFA368HH	MXS368	MD6035D		MD6035C	MD6035CX
22	MD6032CX							FA368X	FA368R		EPFA368HH	MXS368				
23	MD6032CX		OSX6032	OSX6032	BRK013	SMX6032	BRK014	FA368X	FA368R		EPFA368HH	MXS368	MD6035D		MD6035C	MD6035CX
24																
25			OS6184HC	OSX6184H	BRK010	SMX6184H	BRK007	FA368X	FA368R		EPFA368HH	MXS368	MD6288D		MD6288C	
26																
27			OS6184KC	OSX6184K	BRK011	SMX6184K	BRK012	FA368X	FA368R		EPFA368HH	MXS368	MD6288D		MD6288C	
28																
29			OS6184HC	OSX6184H	BRK010	SMX6184H	BRK007	FA368X	FA368R		EPFA368HH	MXS368			TBC	
30																
31			OS6184KC	OSX6184K	BRK011	SMX6184K	BRK012	FA368X	FA368R		EPFA368HH	MXS368			TBC	
32			OS6184KC	OSX6184K	BRK011	SMX6184K	BRK011	FA368X	FA368R		EPFA368HH	MXS368			TBC	
33																
34			OS6184HC	OSX6184H	BRK010	SMX6184H	BRK007	FA368X	FA368R		EPFA368HH	MXS368			TBC	
35																
36			OS6184KC	OSX6184K	BRK011	SMX6184K	BRK012	FA368X	FA368R		EPFA368HH	MXS368			TBC	
37			OS6184KC	OSX6184K	BRK011	SMX6184K	BRK011	FA368X	FA368R		EPFA368HH	MXS368			TBC	
38	MD6032CX		OSX6032	OSX6032	BRK013	SMX6032	BRK014	FA368X	FA368R		EPFA368HH	MXS368	MD6035D		MD6035C	MD6035CX
39	MD6032CX		OSX6032	OSX6032	BRK013	SMX6032	BRK014	FA368X	FA368R		EPFA368HH	MXS368	MD6035D		MD6035C	MD6035CX
40	MD6032CX		OSX6032	OSX6032	BRK013	SMX6032	BRK014	FA368X	FA368R		EPFA368HH	MXS368	MD6035D		MD6035C	MD6035CX
41																
42								FA251					MD6126D			
43			OS6125C	OSX6125	BRK010	SMX6125	BRK007	FA84X	FA84R			MXS84	MD6126D			
44								FA208X	FA208R		EPFA208HH	MXS208	MD6126D			
45									801G							
46									801G							
47								FA84X	FA84R			MXS84	MD6126D			
48									801G							
49			OS6125C	OSX6125	BRK010	SMX6125	BRK007	FA84X	FA84R			MXS84	MD6126D			
50								FA208X	FA208R		EPFA208HH	MXS208	MD6126D			
51			OS6184HC	OSX6184H	BRK010	SMX6184H	BRK007	FA208X	FA208R		EPFA208HH	MXS208	MD6287D			
52																
53			OS6184KC	OSX6184K	BRK011	SMX6184K	BRK012	FA208X	FA208R		EPFA208HH	MXS208	MD6287D			
54																
55			OS6184HC	OSX6184H	BRK010	SMX6184H	BRK007	FA208X	FA208R		EPFA208HH	MXS208	MD6295D			
56																

BRAKE APPLICATIONS

⚠ This symbol indicates a rotor made of billet steel, and should be only used with EBC FA Kevlar® Organic or Vee pads. SAFETY NOTICE - With vehicles primarily designed for off highway use such as quads now being used on the highway, we would recommend the use of X or MXS pads for highway use and ONLY using the R and SV higher density / harder pad series for off road riding.

*-2 Sets Required. † For Vee disc colours add RED, BLU, GRN, GLD, ORG suffix to part number. **SAFETY WARNING:- DO NOT USE HH PADS ON REAR UNLESS ALSO USED ON FRONT TO AVOID BRAKE IMBALANCE**

FRONT: Non-Japanese Bikes



HUSQVARNA



		DISC PAD CHOICES - FRONT					BRAKE ROTOR CHOICES - FRONT				Line #
WR 360 Cross Country (48mm dia. Marzocchi or Kayaba forks = 95mm caliper mount centers)	02	FA181X	FA181R	EPFA181HH		MXS181	MD6184D			MD6184C	1
ACC 390	80-81		801G								2
ACCE 390	80-81		801G								3
CR 390	75-79		801G								4
CR 390	80-81		801G								5
CR 390 Automatic	78		801G								6
WR 390	78		801G								7
CR 400	71-74		801G								8
SM 400 R	02	FA95	FA95HH	EPFA95HH			MD6293D				9
TE 400 (45mm dia. Marzocchi forks = 60mm caliper mount centers)	02	FA181X	FA181R	EPFA181HH		MXS181	MD6184D			MD6184C	10
TE 400 (48mm dia. Marzocchi or Kayaba forks = 95mm caliper mount centers)	02	FA181X	FA181R	EPFA181HH		MXS181	MD6184D			MD6184C	11
WR 400	75-78		801G				N/A				12
WR 400	87-88	FA134X	FA134R								13
TE 410	95-99	FA181X	FA181R	EPFA181HH		MXS181	MD6125D			N/A	14
Svartpilen 401	18-21	FA606	FA606HH	EPFA606HH							15
Vitpilen 401	18-21	FA606	FA606HH	EPFA606HH							16
TE 410 (45mm dia. Marzocchi forks = 60mm caliper mount centers)	00	FA181X	FA181R	EPFA181HH		MXS181	MD6184D			MD6184C	17
TE 410 (48mm dia. Marzocchi or Kayaba forks = 95mm caliper mount centers)	00	FA181X	FA181R	EPFA181HH		MXS181	MD6184D			MD6184C	18
TE 410 (45mm dia. Marzocchi forks = 60mm caliper mount centers)	06	FA181X	FA181R	EPFA181HH		MXS181	MD6184D			MD6184C	19
TE 410 (48mm dia. Marzocchi or Kayaba forks = 95mm caliper mount centers)	06	FA181X	FA181R	EPFA181HH		MXS181	MD6184D			MD6184C	20
TE 410 E (45mm dia. Marzocchi forks = 60mm caliper mount centers)	00	FA181X	FA181R	EPFA181HH		MXS181	MD6184D			MD6184C	21
TE 410 E (48mm dia. Marzocchi or Kayaba forks = 95mm caliper mount centers)	00	FA181X	FA181R	EPFA181HH		MXS181	MD6184D			MD6184C	22
430 Automatic	87-88	FA134X	FA134R				N/A				23
CR 430	80-81		802G								24
CR 430	87-88	FA134X	FA134R				N/A				25
WR 430	80-81		802G								26
WR 430	87-88	FA134X	FA134R				N/A				27
WR-E 430	80-81		802G								28
WR-E 430	82-84		803G								29
WRU 430	82-84		803G								30
XC 430	80-81		802G								31
XC 430	87-88	FA134X	FA134R				N/A				32
CR 450	71-74		801G								33
FS 450 Supermoto	14-21		FA447HH	EPFA447HH						TBC	34
SM 450 R	03-06	FA95	FA95HH	EPFA95HH			MD6293D				35
SMR 450 RR (Radial caliper)	06-08		FA322/4HH	EPFA322/4HH			MD6293D				36
SM 450 R (Radial caliper)	07-10		FA322/4HH	EPFA322/4HH			MD6293D				37
TC 449 (4T) (45mm dia. Marzocchi forks = 60mm caliper mount centers)	11-12	FA181X	FA181R	EPFA181HH		MXS181	MD6185D			MD6184C	38
TC 449 (4T) (48mm dia. Marzocchi or Kayaba forks = 95mm caliper mount centers)	11-12	FA181X	FA181R	EPFA181HH		MXS181	MD6185D			MD6184C	39
TE 449 (4T) (45mm dia. Marzocchi forks = 60mm caliper mount centers)	11-12	FA181X	FA181R	EPFA181HH		MXS181	MD6185D			MD6184C	40
TE 449 (4T) (48mm dia. Marzocchi or Kayaba forks = 95mm caliper mount centers)	11-12	FA181X	FA181R	EPFA181HH		MXS181	MD6185D			MD6184C	41
FC 450 (4T)	14-22	FA181X	FA181R	EPFA181HH		MXS181	MD6032D			MD6032C	42
FC 450 Rockstar Edition (4T)	19-20	FA181X	FA181R	EPFA181HH		MXS181	MD6032D			MD6032C	43

FRONT

APPLICATIONS

BRAKE

* This symbol indicates a rotor made of billet steel, and should be only used with EBC FA Kevlar® Organic or Vee pads.

SAFETY NOTICE - With vehicles primarily designed for off highway use such as quads now being used on the highway, we would recommend the use of X or MXS pads for highway use and ONLY using the R and SV higher density / harder pad series for off road riding.

*-2 Sets Required. † For Vee disc colours add RED, BLU, GRN, GLD, ORG suffix to part number. **SAFETY WARNING:- DO NOT USE HH PADS ON REAR UNLESS ALSO USED ON FRONT TO AVOID BRAKE IMBALANCE**

FRONT: Non-Japanese Bikes Cont'd

REAR: Non-Japanese Bikes

Line #

BRAKE ROTOR CHOICES - FRONT							DISC PAD CHOICES - REAR					BRAKE ROTOR CHOICES - REAR				
CC Custom Rotor	CX Extreme® /Vee-Rotor	OS Series Oversize 250/280mm Rotor Kit	OSX Series Oversize 280mm Rotor Kit	Relocating Bracket for Oversize Rotor	SMX Series Oversize 320mm Rotor Kit	Relocating Bracket for 320mm Rotor		Sintered/HH Pads/ Grooved Shoes	SV Series Severe Duty Pads	EPFA Sintered Fast Road/ Track Pads	Specialty Pads SXR/ VEE/MXS Race	Standard Rotor	Vintage Rotor / UTV Oversize Brake Kit	Contour Profile Rotor	CX Extreme® /Vee-Rotor	
1																
2			OS6184KC	OSX6184K	BRK011	SMX6184K	BRK012	FA208X	FA208R		EPFA208HH	MXS208	MD6295D			
3									801G							
4									801G							
5									801G							
6									801G							
7									801G							
8									801G							
9									801G							
10								FA208X	FA208R		EPFA208HH	MXS208	MD6295D			
11																
12			OS6184HC	OSX6184H	BRK010	SMX6184H	BRK007	FA208X	FA208R		EPFA208HH	MXS208	MD6295D			
13																
14			OS6184KC	OSX6184K	BRK011	SMX6184K	BRK012	FA208X	FA208R		EPFA208HH	MXS208	MD6295D			
15									801G							
16									802G							
17			OS6125C	OSX6125	BRK010	SMX6125	BRK007	FA208X	FA208R		EPFA208HH	MXS208	MD6126D			
18								FA208X	FA208R		EPFA208HH	MXS208				
19								FA208X	FA208R		EPFA208HH	MXS208				
20																
21			OS6184HC	OSX6184H	BRK010	SMX6184H	BRK007	FA208X	FA208R		EPFA208HH	MXS208	MD6287D			
22																
23			OS6184KC	OSX6184K	BRK011	SMX6184K	BRK012	FA208X	FA208R		EPFA208HH	MXS208	MD6287D			
24																
25			OS6184HC	OSX6184H	BRK010	SMX6184H	BRK007	FA368X	FA368R		EPFA368HH	MXS368	MD6288D		MD6288C	
26																
27			OS6184KC	OSX6184K	BRK011	SMX6184K	BRK012	FA368X	FA368R		EPFA368HH	MXS368	MD6288D		MD6288C	
28																
29			OS6184HC	OSX6184H	BRK010	SMX6184H	BRK007	FA208X	FA208R		EPFA208HH	MXS208	MD6126D			
30																
31			OS6184KC	OSX6184K	BRK011	SMX6184K	BRK012	FA208X	FA208R		EPFA208HH	MXS208	MD6126D			
32									802G							
33									801G							
34									802G							
35									802G							
36									802G							
37									802G							
38									802G							
39									802G							
40									802G							
41									802G							
42									801G							
43								FA368X	FA368R		EPFA368HH	MXS368	MD6035D		MD6035C	MD6035CX
44								FA208X	FA208R		EPFA208HH	MXS208	MD6295D			
45								FA368X	FA368R		EPFA368HH	MXS368	MD6288D		MD6288C	
46								FA368X	FA368R		EPFA368HH	MXS368	MD6288D		MD6288C	
47																
48			OS6184HC	OSX6184H	BRK010	SMX6184H	BRK007	FA368X	FA368R		EPFA368HH	MXS368			TBC	
49																
50			OS6184KC	OSX6184K	BRK011	SMX6184K	BRK012	FA368X	FA368R		EPFA368HH	MXS368			TBC	
51																
52			OS6184HC	OSX6184H	BRK010	SMX6184H	BRK007	FA368X	FA368R		EPFA368HH	MXS368			TBC	
53																
54			OS6184KC	OSX6184K	BRK011	SMX6184K	BRK012	FA368X	FA368R		EPFA368HH	MXS368			TBC	
55		MD6032CX		OSX6032	BRK013	SMX6032	BRK014	FA368X	FA368R		EPFA368HH	MXS368	MD6035D		MD6035C	MD6035CX
56		MD6032CX		OSX6032	BRK013	SMX6032	BRK014	FA368X	FA368R		EPFA368HH	MXS368	MD6035D		MD6035C	MD6035CX

REAR

BRAKE APPLICATIONS

⚠ This symbol indicates a rotor made of billet steel, and should be only used with EBC FA Kevlar® Organic or Vee pads.
 SAFETY NOTICE - With vehicles primarily designed for off highway use such as quads now being used on the highway, we would recommend the use of X or MXS pads for highway use and ONLY using the R and SV higher density / harder pad series for off road riding.

*-2 Sets Required. † For Vee disc colours add RED, BLU, GRN, GLD, ORG suffix to part number. **SAFETY WARNING:- DO NOT USE HH PADS ON REAR UNLESS ALSO USED ON FRONT TO AVOID BRAKE IMBALANCE**

FRONT: Non-Japanese Bikes



HUSQVARNA



DISC PAD CHOICES - FRONT

BRAKE ROTOR CHOICES - FRONT

											Line #
FE 450 (4T)	14-19	FA181X	FA181R	EPFA181HH		MXS181	MD6032D			MD6032C	1
FR 450 (4T) Rally	20	FA209/2	FA209/2HH	EPFA209/2HH							2
FX 450 (4T)	18-22	FA181X	FA181R	EPFA181HH		MXS181	MD6032D			MD6032C	3
TC 450 (45mm dia. Marzocchi forks = 60mm caliper mount centers)	03	FA181X	FA181R	EPFA181HH		MXS181	MD6184D			MD6184C	4
TC 450 (48mm dia. Marzocchi or Kayaba forks = 95mm caliper mount centers)	03	FA181X	FA181R	EPFA181HH		MXS181	MD6184D			MD6184C	5
TC 450 (45mm dia. Marzocchi forks = 60mm caliper mount centers)	05-08	FA181X	FA181R	EPFA181HH		MXS181	MD6184D			MD6184C	6
TC 450 (48mm dia. Marzocchi or Kayaba forks = 95mm caliper mount centers)	05-08	FA181X	FA181R	EPFA181HH		MXS181	MD6184D			MD6184C	7
TC 450 (45mm dia. Marzocchi forks = 60mm caliper mount centers)	09-10	FA181X	FA181R	EPFA181HH		MXS181	MD6184D			MD6184C	8
TC 450 (48mm dia. Marzocchi or Kayaba forks = 95mm caliper mount centers)	09-10	FA181X	FA181R	EPFA181HH		MXS181	MD6184D			MD6184C	9
TE 450 (4T) (45mm dia. Marzocchi forks = 60mm caliper mount centers)	03-05	FA181X	FA181R	EPFA181HH		MXS181	MD6184D			MD6184C	10
TE 450 (4T) (48mm dia. Marzocchi or Kayaba forks = 95mm caliper mount centers)	03-05	FA181X	FA181R	EPFA181HH		MXS181	MD6184D			MD6184C	11
TE 450 (45mm dia. Marzocchi forks = 60mm caliper mount centers)	06-08	FA181X	FA181R	EPFA181HH		MXS181	MD6184D			MD6184C	12
TE 450 (48mm dia. Marzocchi or Kayaba forks = 95mm caliper mount centers)	06-08	FA181X	FA181R	EPFA181HH		MXS181	MD6184D			MD6184C	13
TE 450 (45mm dia. Marzocchi forks = 60mm caliper mount centers)	10	FA181X	FA181R	EPFA181HH		MXS181	MD6184D			MD6184C	14
TE 450 (48mm dia. Marzocchi or Kayaba forks = 95mm caliper mount centers)	10	FA181X	FA181R	EPFA181HH		MXS181	MD6184D			MD6184C	15
TXC 450 Cross Country (45mm dia. Marzocchi forks = 60mm caliper mount centers)	08	FA181X	FA181R	EPFA181HH		MXS181	MD6184D			MD6184C	16
TXC 450 Cross Country (48mm dia. Marzocchi or Kayaba forks = 95mm caliper mount centers)	08	FA181X	FA181R	EPFA181HH		MXS181	MD6184D			MD6184C	17
TXC 450 Cross Country (45mm dia. Marzocchi forks = 60mm caliper mount centers)	09-11	FA181X	FA181R	EPFA181HH		MXS181	MD6184D			MD6184C	18
TXC 450 Cross Country (48mm dia. Marzocchi or Kayaba forks = 95mm caliper mount centers)	09-11	FA181X	FA181R	EPFA181HH		MXS181	MD6184D			MD6184C	19
WR 450	71-72		801G								20
AE 500	82-84		803G								21
CR 500	82-84		803G								22
CR 500	85-86	FA47X					N/A				23
CR 500	87-88	FA134X	FA134R				N/A				24
XC 500	82-84		803G								25
XC 500	85-86	FA47X					N/A				26
XC 500	87-88	FA134X	FA134R				N/A				27
FC 501 (4T)	14	FA181X	FA181R			MXS181	MD6032D			MD6032C	28
FE 501 (4T)	14-15	FA181X	FA181R			MXS181	MD6032D			MD6032C	29
FE 501 (4T) Inc S Model	19-22	FA181X	FA181R			MXS181					30
SM 510 R	05	FA95	FA95HH	EPFA95HH			MD6293D				31
SM 510 R (Radial caliper)	06-10		FA322/4HH	EPFA322/4HH			MD6293D				32
TC 510	87-88	FA47X					N/A				33
TC 510	89-	FA134X	FA134R				N/A				34
TC 510	90	FA134X	FA134R				N/A				35
TC 510 (45mm dia. Marzocchi forks = 60mm caliper mount centers)	04	FA181X	FA181R	EPFA181HH		MXS181	MD6184D			MD6184C	36
TC 510 (48mm dia. Marzocchi or Kayaba forks = 95mm caliper mount centers)	04	FA181X	FA181R	EPFA181HH		MXS181	MD6184D			MD6184C	37

APPLICATIONS

BRAKE

⚠ This symbol indicates a rotor made of billet steel, and should be only used with EBC FA Kevlar® Organic or Vee pads.

SAFETY NOTICE - With vehicles primarily designed for off highway use such as quads now being used on the highway, we would recommend the use of X or MXS pads for highway use and ONLY using the R and SV higher density / harder pad series for off road riding.

*-2 Sets Required. † For Vee disc colours add RED, BLU, GRN, GLD, ORG suffix to part number. **SAFETY WARNING:- DO NOT USE HH PADS ON REAR UNLESS ALSO USED ON FRONT TO AVOID BRAKE IMBALANCE**

FRONT: Non-Japanese Bikes Cont'd

REAR: Non-Japanese Bikes

Line #

BRAKE ROTOR CHOICES - FRONT							DISC PAD CHOICES - REAR					BRAKE ROTOR CHOICES - REAR			
CC Custom Rotor	CX Extreme® /Vee-Rotor	OS Series Oversize 250/280mm Rotor Kit	OSX Series Oversize 280mm Rotor Kit	Relocating Bracket for Oversize Rotor	SMX Series Oversize 320mm Rotor Kit	Relocating Bracket for 320mm Rotor		Sintered/HH Pads/ Grooved Shoes	SV Series Severe Duty Pads	EPFA Sintered Fast Road/ Track Pads	Specialty Pads SXR/ VEE/MXS Race	Standard Rotor	Vintage Rotor / UTV Oversize Brake Kit	Contour Profile Rotor	CX Extreme® /Vee-Rotor
1	MD6032CX		OSX6032	BRK013	SMX6032	BRK014	FA368X	FA368R		EPFA368HH	MXS368	MD6035D		MD6035C	MD6035CX
2							FA368X	FA368R		EPFA368HH					
3	MD6032CX		OSX6032	BRK013	SMX6032	BRK014	FA368X	FA368R		EPFA368HH	MXS368	MD6035D		MD6035C	MD6035CX
4															
5		OS6184HC	OSX6184H	BRK010	SMX6184H	BRK007	FA208X	FA208R		EPFA208HH	MXS208	MD6295D			
6															
7		OS6184KC	OSX6184K	BRK011	SMX6184K	BRK012	FA208X	FA208R		EPFA208HH	MXS208	MD6295D			
8															
9		OS6184HC	OSX6184H	BRK010	SMX6184H	BRK007	FA368X	FA368R		EPFA368HH	MXS368	MD6288D			
10															
11		OS6184KC	OSX6184K	BRK011	SMX6184K	BRK012	FA368X	FA368R		EPFA368HH	MXS368	MD6288D		MD6288C	
12															
13		OS6184HC	OSX6184H	BRK010	SMX6184H	BRK007	FA368X	FA368R		EPFA368HH	MXS368			TBC	
14															
15		OS6184KC	OSX6184K	BRK011	SMX6184K	BRK012	FA368X	FA368R		EPFA368HH	MXS368			TBC	
16															
17		OS6184HC	OSX6184H	BRK010	SMX6184H	BRK007	FA208X	FA208R		EPFA208HH	MXS208	MD6295D			
18															
19		OS6184KC	OSX6184K	BRK011	SMX6184K	BRK012	FA208X	FA208R		EPFA208HH	MXS208	MD6295D			
20															
21		OS6184HC	OSX6184H	BRK010	SMX6184H	BRK007	FA368X	FA368R		EPFA368HH	MXS368	MD6288D		MD6288C	
22															
23		OS6184KC	OSX6184K	BRK011	SMX6184K	BRK012	FA368X	FA368R		EPFA368HH	MXS368	MD6288D		MD6288C	
24															
25		OS6184HC	OSX6184H	BRK010	SMX6184H	BRK007	FA368X	FA368R		EPFA368HH	MXS368			TBC	
26															
27		OS6184KC	OSX6184K	BRK011	SMX6184K	BRK012	FA368X	FA368R		EPFA368HH	MXS368			TBC	
28															
29		OS6184HC	OSX6184H	BRK010	SMX6184H	BRK007	FA368X	FA368R		EPFA368HH	MXS368	MD6288D		MD6288C	
30															
31		OS6184KC	OSX6184K	BRK011	SMX6184K	BRK012	FA368X	FA368R		EPFA368HH	MXS368	MD6288D		MD6288C	
32															
33		OS6184HC	OSX6184H	BRK010	SMX6184H	BRK007	FA368X	FA368R		EPFA368HH	MXS368			TBC	
34															
35		OS6184KC	OSX6184K	BRK011	SMX6184K	BRK012	FA368X	FA368R		EPFA368HH	MXS368			TBC	
36															
37															
38															
39															
40															
41															
42															
43															
44	MD6032CX		OSX6032	BRK013	SMX6032	BRK014	FA368X	FA368R		EPFA368HH	MXS368	MD6035D		MD6035C	MD6035CX
45	MD6032CX		OSX6032	BRK013	SMX6032	BRK014	FA368X	FA368R		EPFA368HH	MXS368	MD6035D		MD6035C	MD6035CX
46							FA368X	FA368R		EPFA368HH	MXS368				
47							FA208X	FA208R		EPFA208HH	MXS208	MD6295D			
48							FA368X	FA368R		EPFA368HH	MXS368	MD6288D			
49															
50															
51															
52							FA251					MD6126D			
53		OS6184HC	OSX6184H	BRK010	SMX6184H	BRK007	FA208X	FA208R		EPFA208HH	MXS208	MD6295D			
54															
55		OS6184KC	OSX6184K	BRK011	SMX6184K	BRK012	FA208X	FA208R		EPFA208HH	MXS208	MD6295D			
56															

REAR

BRAKE APPLICATIONS

⚠ This symbol indicates a rotor made of billet steel, and should be only used with EBC FA Kevlar® Organic or Vee pads.
 SAFETY NOTICE - With vehicles primarily designed for off highway use such as quads now being used on the highway, we would recommend the use of X or MXS pads for highway use and ONLY using the R and SV higher density / harder pad series for off road riding.

*-2 Sets Required. † For Vee disc colours add RED, BLU, GRN, GLD, ORG suffix to part number. **SAFETY WARNING:- DO NOT USE HH PADS ON REAR UNLESS ALSO USED ON FRONT TO AVOID BRAKE IMBALANCE**

FRONT: Non-Japanese Bikes



HUSQVARNA



DISC PAD CHOICES - FRONT

BRAKE ROTOR CHOICES - FRONT

TC 510 (45mm dia. Marzocchi forks = 60mm caliper mount centers)	FA181X	FA181R	EPFA181HH		MXS181	MD6184D			MD6184C
TC 510 (48mm dia. Marzocchi or Kayaba forks = 95mm caliper mount centers)	FA181X	FA181R	EPFA181HH		MXS181	MD6184D			MD6184C
TE 510	FA47X					N/A			
TE 510	FA134X	FA134R				N/A			
TE 510	FA134X	FA134R				N/A			
TE 510 (45mm dia. Marzocchi forks = 60mm caliper mount centers)	FA181X	FA181R	EPFA181HH		MXS181	MD6184D			MD6184C
TE 510 (48mm dia. Marzocchi or Kayaba forks = 95mm caliper mount centers)	FA181X	FA181R	EPFA181HH		MXS181	MD6184D			MD6184C
TE 510 (45mm dia. Marzocchi forks = 60mm caliper mount centers)	FA181X	FA181R	EPFA181HH		MXS181	MD6184D			MD6184C
TE 510 (48mm dia. Marzocchi or Kayaba forks = 95mm caliper mount centers)	FA181X	FA181R	EPFA181HH		MXS181	MD6184D			MD6184C
TE 510 (45mm dia. Marzocchi forks = 60mm caliper mount centers)	FA181X	FA181R	EPFA181HH		MXS181	MD6184D			MD6184C
TE 510 (48mm dia. Marzocchi or Kayaba forks = 95mm caliper mount centers)	FA181X	FA181R	EPFA181HH		MXS181	MD6184D			MD6184C
TE 511 (45mm dia. Marzocchi forks = 60mm caliper mount centers)	FA181X	FA181R	EPFA181HH		MXS181	MD6184D			MD6184C
TE 511 (48mm dia. Marzocchi or Kayaba forks = 95mm caliper mount centers)	FA181X	FA181R	EPFA181HH		MXS181	MD6184D			MD6184C
TX 510	FA47X					N/A			
TXC 510 Cross Country (45mm dia. Marzocchi forks = 60mm caliper mount centers)	FA181X	FA181R	EPFA181HH		MXS181	MD6184D			MD6184C
TXC 510 Cross Country (48mm dia. Marzocchi or Kayaba forks = 95mm caliper mount centers)	FA181X	FA181R	EPFA181HH		MXS181	MD6184D			MD6184C
TXC 510 Cross Country (45mm dia. Marzocchi forks = 60mm caliper mount centers)	FA181X	FA181R	EPFA181HH		MXS181	MD6184D			MD6184C
TXC 510 Cross Country (48mm dia. Marzocchi or Kayaba forks = 95mm caliper mount centers)	FA181X	FA181R	EPFA181HH		MXS181	MD6184D			MD6184C
TXC 511 Cross Country (45mm dia. Marzocchi forks = 60mm caliper mount centers)	FA181X	FA181R	EPFA181HH		MXS181	MD6184D			MD6184C
TXC 511 Cross Country (48mm dia. Marzocchi or Kayaba forks = 95mm caliper mount centers)	FA181X	FA181R	EPFA181HH		MXS181	MD6184D			MD6184C
WMX 510	FA134X	FA134R				N/A			
WXE 510	FA134X	FA134R				N/A			
SM 570 R (4 bolt front disc)	FA95	FA95HH	EPFA95HH			MD6293D			
SM 570 R	FA95	FA95HH	EPFA95HH			MD6293D			
TC 570 (45mm dia. Marzocchi forks = 60mm caliper mount centers)	FA181X	FA181R	EPFA181HH		MXS181	MD6184D			MD6184C
TC 570 (48mm dia. Marzocchi or Kayaba forks = 95mm caliper mount centers)	FA181X	FA181R	EPFA181HH		MXS181	MD6184D			MD6184C
TE 570 (45mm dia. Marzocchi forks = 60mm caliper mount centers)	FA181X	FA181R	EPFA181HH		MXS181	MD6184D			MD6184C
TE 570 (48mm dia. Marzocchi or Kayaba forks = 95mm caliper mount centers)	FA181X	FA181R	EPFA181HH		MXS181	MD6184D			MD6184C
TE 570 (45mm dia. Marzocchi forks = 60mm caliper mount centers)	FA181X	FA181R	EPFA181HH		MXS181	MD6184D			MD6184C
TE 570 (48mm dia. Marzocchi or Kayaba forks = 95mm caliper mount centers)	FA181X	FA181R	EPFA181HH		MXS181	MD6184D			MD6184C
LT 610 (6 bolt front disc)	FA244	FA244HH	EPFA244HH			MD6294D			
SM 610 (6 bolt front disc)	FA244	FA244HH	EPFA244HH			MD6294D			
SM 610 R (45mm dia. Marzocchi forks = 60mm caliper mount centers)	FA244	FA244HH	EPFA244HH			MD6184D			MD6184C

FRONT

Line #

APPLICATIONS

BRAKE

* This symbol indicates a rotor made of billet steel, and should be only used with EBC FA Kevlar® Organic or Vee pads.

SAFETY NOTICE - With vehicles primarily designed for off highway use such as quads now being used on the highway, we would recommend the use of X or MXS pads for highway use and ONLY using the R and SV higher density / harder pad series for off road riding.

*-2 Sets Required. † For Vee disc colours add RED, BLU, GRN, GLD, ORG suffix to part number. **SAFETY WARNING:- DO NOT USE HH PADS ON REAR UNLESS ALSO USED ON FRONT TO AVOID BRAKE IMBALANCE**

FRONT: Non-Japanese Bikes Cont'd

REAR: Non-Japanese Bikes

Line #

BRAKE ROTOR CHOICES - FRONT							DISC PAD CHOICES - REAR					BRAKE ROTOR CHOICES - REAR			
CC Custom Rotor	CX Extreme® /Vee-Rotor	OS Series Oversize 250/280mm Rotor Kit	OSX Series Oversize 280mm Rotor Kit	Relocating Bracket for Oversize Rotor	SMX Series Oversize 320mm Rotor Kit	Relocating Bracket for 320mm Rotor		Sintered/HH Pads/ Grooved Shoes	SV Series Severe Duty Pads	EPFA Sintered Fast Road/ Track Pads	Specialty Pads SXR/ VEE/MXS Race	Standard Rotor	Vintage Rotor / UTV Oversize Brake Kit	Contour Profile Rotor	CX Extreme® /Vee-Rotor
1															
2		OS6184HC	OSX6184H	BRK010	SMX6184H	BRK007	FA368X	FA368R		EPFA368HH	MXS368	MD6288D		MD6288C	
3															
4		OS6184KC	OSX6184K	BRK011	SMX6184K	BRK012	FA368X	FA368R		EPFA368HH	MXS368	MD6288D		MD6288C	
5								801G							
6								801G							
7							FA251					MD6126D			
8															
9		OS6184HC	OSX6184H	BRK010	SMX6184H	BRK007	FA208X	FA208R		EPFA208HH	MXS208	MD6295D			
10															
11		OS6184KC	OSX6184K	BRK011	SMX6184K	BRK012	FA208X	FA208R		EPFA208HH	MXS208	MD6295D			
12															
13		OS6184HC	OSX6184H	BRK010	SMX6184H	BRK007	FA368X	FA368R		EPFA368HH	MXS368	MD6288D		MD6288C	
14															
15		OS6184KC	OSX6184K	BRK011	SMX6184K	BRK012	FA368X	FA368R		EPFA368HH	MXS368	MD6288D		MD6288C	
16															
17		OS6184HC	OSX6184H	BRK010	SMX6184H	BRK007	FA368X	FA368R		EPFA368HH	MXS368			TBC	
18															
19		OS6184KC	OSX6184K	BRK011	SMX6184K	BRK012	FA368X	FA368R		EPFA368HH	MXS368			TBC	
20															
21		OS6184HC	OSX6184H	BRK010	SMX6184H	BRK007	FA368X	FA368R		EPFA368HH	MXS368			TBC	
22															
23		OS6184KC	OSX6184K	BRK011	SMX6184K	BRK012	FA368X	FA368R		EPFA368HH	MXS368			TBC	
24								801G							
25															
26		OS6184HC	OSX6184H	BRK010	SMX6184H	BRK007	FA368X	FA368R		EPFA368HH	MXS368	MD6288D		MD6288C	
27															
28		OS6184KC	OSX6184K	BRK011	SMX6184K	BRK012	FA368X	FA368R		EPFA368HH	MXS368	MD6288D		MD6288C	
29															
30		OS6184HC	OSX6184H	BRK010	SMX6184H	BRK007	FA368X	FA368R		EPFA368HH	MXS368			TBC	
31															
32		OS6184KC	OSX6184K	BRK011	SMX6184K	BRK012	FA368X	FA368R		EPFA368HH	MXS368			TBC	
33															
34		OS6184HC	OSX6184H	BRK010	SMX6184H	BRK007	FA368X	FA368R		EPFA368HH	MXS368			TBC	
35															
36		OS6184KC	OSX6184K	BRK011	SMX6184K	BRK012	FA368X	FA368R		EPFA368HH	MXS368			TBC	
37								801G							
38								801G							
39							FA208X	FA208R		EPFA208HH	MXS208	MD6287D			
40							FA208X	FA208R		EPFA208HH	MXS208	MD6295D			
41															
42		OS6184HC	OSX6184H	BRK010	SMX6184H	BRK007	FA208X	FA208R		EPFA208HH	MXS208	MD6295D			
43															
44		OS6184KC	OSX6184K	BRK011	SMX6184K	BRK012	FA208X	FA208R		EPFA208HH	MXS208	MD6295D			
45															
46		OS6184HC	OSX6184H	BRK010	SMX6184H	BRK007	FA208X	FA208R		EPFA208HH	MXS208	MD6287D			
47															
48		OS6184KC	OSX6184K	BRK011	SMX6184K	BRK012	FA208X	FA208R		EPFA208HH	MXS208	MD6287D			
49															
50		OS6184HC	OSX6184H	BRK010	SMX6184H	BRK007	FA208X	FA208R		EPFA208HH	MXS208	MD6287D			
51															
52		OS6184KC	OSX6184K	BRK011	SMX6184K	BRK012	FA208X	FA208R		EPFA208HH	MXS208	MD6287D			
53							FA208X	FA208R		EPFA208HH	MXS208	MD6295D			
54							FA208X	FA208R		EPFA208HH	MXS208	MD6126D			
55															
56		OS6184HC	OSX6184H	BRK010	SMX6184H	BRK007	FA208X	FA208R		EPFA208HH	MXS208	MD6287D			

REAR

BRAKE APPLICATIONS

⚠ This symbol indicates a rotor made of billet steel, and should be only used with EBC FA Kevlar® Organic or Vee pads.
 SAFETY NOTICE - With vehicles primarily designed for off highway use such as quads now being used on the highway, we would recommend the use of X or MXS pads for highway use and ONLY using the R and SV higher density / harder pad series for off road riding.

*-2 Sets Required. † For Vee disc colours add RED, BLU, GRN, GLD, ORG suffix to part number. **SAFETY WARNING:- DO NOT USE HH PADS ON REAR UNLESS ALSO USED ON FRONT TO AVOID BRAKE IMBALANCE**

FRONT: Non-Japanese Bikes



HUSQVARNA



DISC PAD CHOICES - FRONT

BRAKE ROTOR CHOICES - FRONT

										Line #
SM 610 R (48mm dia. Marzocchi or Kayaba forks = 95mm caliper mount centers) 00	FA244	FA244HH	EPFA244HH			MD6184D			MD6184C	1
SM 610 S (4 bolt front disc) 02-06	FA244	FA244HH	EPFA244HH			MD6293D				2
SM 610 S (Radial caliper) 06		FA322/4HH	EPFA322/4HH			MD6293D				3
SM 610 IE 07-09		FA322/4HH	EPFA322/4HH			MD6293D				4
TC 610 91	FA134X	FA134R				N/A				5
TC 610 92-94	FA135X	FA135R			MXS135	MD6125D				6
TC 610/E 95-99	FA181X	FA181R	EPFA181HH		MXS181	MD6125D			N/A	7
TC 610 (45mm dia. Marzocchi forks = 60mm caliper mount centers) 00	FA181X	FA181R	EPFA181HH		MXS181	MD6184D			MD6184C	8
TC 610 (48mm dia. Marzocchi or Kayaba forks = 95mm caliper mount centers) 00	FA181X	FA181R	EPFA181HH		MXS181	MD6184D			MD6184C	9
TE 610 91	FA134X	FA134R				N/A				10
TE 610 92-94	FA135X	FA135R			MXS135	MD6125D				11
TE 610 (45mm dia. Marzocchi forks = 60mm caliper mount centers) 00	FA181X	FA181R	EPFA181HH		MXS181	MD6184D			MD6184C	12
TE 610 (48mm dia. Marzocchi or Kayaba forks = 95mm caliper mount centers) 00	FA181X	FA181R	EPFA181HH		MXS181	MD6184D			MD6184C	13
TE 610 E 95-99	FA181X	FA181R	EPFA181HH		MXS181	MD6125D			N/A	14
TE 610 E (45mm dia. Marzocchi forks = 60mm caliper mount centers) 00	FA181X	FA181R	EPFA181HH		MXS181	MD6184D			MD6184C	15
TE 610 E (48mm dia. Marzocchi or Kayaba forks = 95mm caliper mount centers) 00	FA181X	FA181R	EPFA181HH		MXS181	MD6184D			MD6184C	16
TE 610 E (45mm dia. Marzocchi forks = 60mm caliper mount centers) 00	FA181X	FA181R	EPFA181HH		MXS181	MD6184D			MD6184C	17
TE 610 E (48mm dia. Marzocchi or Kayaba forks = 95mm caliper mount centers) 00	FA181X	FA181R	EPFA181HH		MXS181	MD6184D			MD6184C	18
TE 610 E (45mm dia. Marzocchi forks = 60mm caliper mount centers) 02-03	FA181X	FA181R	EPFA181HH		MXS181	MD6184D			MD6184C	19
TE 610 E (48mm dia. Marzocchi or Kayaba forks = 95mm caliper mount centers) 02-03	FA181X	FA181R	EPFA181HH		MXS181	MD6184D			MD6184C	20
TE 610 IE (45mm dia. Marzocchi forks = 60mm caliper mount centers) 06-09	FA181X	FA181R	EPFA181HH		MXS181	MD6184D			MD6184C	21
TE 610 IE (48mm dia. Marzocchi or Kayaba forks = 95mm caliper mount centers) 06-09	FA181X	FA181R	EPFA181HH		MXS181	MD6184D			MD6184C	22
SM 630 09-10		FA322/4HH	EPFA322/4HH			MD6293D				23
SMR 630 06	FA95	FA95HH	EPFA95HH			MD6293D				24
SMS 630 10-11		FA322/4HH	EPFA322/4HH			MD6293D				25
TE 630 (45mm dia. Marzocchi forks = 60mm caliper mount centers) 10	FA181X	FA181R	EPFA181HH		MXS181	MD6184D			MD6184C	26
TE 630 (48mm dia. Marzocchi or Kayaba forks = 95mm caliper mount centers) 10	FA181X	FA181R	EPFA181HH		MXS181	MD6184D			MD6184C	27
STR 650 CRC 07		FA322/4HH	EPFA322/4HH			MD6293D				28
TR 650 Terra (Spoke Wheels) 13	FA209/2	FA209/2HH			FA209/2V	MD834				29
TR 650 Strada (Cast Wheels) 13	FA209/2	FA209/2HH			FA209/2V	MD834				30
701 Enduro 16-21	FA209/2	FA209/2HH			FA209/2V				MD844XC	31
701 Supersmoto 18-21		FA322/4HH	EPFA322/4HH			MD6114D				32
701 Vitpilen 18-21	FA244	FA244HH	EPFA244HH							33
701 Svartpilen 18-21	FA244	FA244HH	EPFA244HH							34
900 Nuda 12-13	FA244*	FA244HH*	EPFA244HH*			N/A	N/A			35
900 R Nuda 12-13		FA447HH*	EPFA447HH*			N/A	N/A			36
										37
										38
										39
										40
										41
										42
										43
										44
										45
										46
										47
										48
										49
SB 50 M 06-08	SFA83	SFA83HH				TBC				50
SD 50 Sense 06-12	SFA83	SFA83HH				TBC				51
SF 50 Rally 06-12	SFA83	SFA83HH				TBC				52
SF 50 B Prima 06-12	SFA83	SFA83HH				TBC				53
TE 50 05-08	938*									54
TE 90 05-08	938*									55
TE 100 05-08	938*									56

FRONT

HYOSUNG

SB 50 M 06-08	SFA83	SFA83HH				TBC				50
SD 50 Sense 06-12	SFA83	SFA83HH				TBC				51
SF 50 Rally 06-12	SFA83	SFA83HH				TBC				52
SF 50 B Prima 06-12	SFA83	SFA83HH				TBC				53
TE 50 05-08	938*									54
TE 90 05-08	938*									55
TE 100 05-08	938*									56

*-2 Sets Required. † For Vee disc colours add RED, BLU, GRN, GLD, ORG suffix to part number. **SAFETY WARNING:- DO NOT USE HH PADS ON REAR UNLESS ALSO USED ON FRONT TO AVOID BRAKE IMBALANCE**

FRONT: Non-Japanese Bikes Cont'd

REAR: Non-Japanese Bikes

Line # 1 2 3 4 5 6 7 8 9 10 11 12 13 14 15 16 17 18 19 20 21 22 23 24 25 26 27 28 29 30 31 32 33 34 35 36 37 38 39 40 41 42 43 44 45 46 47 48 49 50 51 52 53 54 55 56

BRAKE ROTOR CHOICES - FRONT							DISC PAD CHOICES - REAR					BRAKE ROTOR CHOICES - REAR			
CC Custom Rotor	CX Extreme® /Vee-Rotor	OS Series Oversize 250/280mm Rotor Kit	OSX Series Oversize 280mm Rotor Kit	Relocating Bracket for Oversize Rotor	SMX Series Oversize 320mm Rotor Kit	Relocating Bracket for 320mm Rotor		Sintered/HH Pads/ Grooved Shoes	SV Series Severe Duty Pads	EPFA Sintered Fast Road/ Track Pads	Specialty Pads SXR/ VEE/MXS Race	Standard Rotor	Vintage Rotor / UTV Oversize Brake Kit	Contour Profile Rotor	CX Extreme® /Vee-Rotor
		OS6184K	OSX6184K	BRK011	SMX6184K	BRK012	FA208X	FA208R		EPFA208HH	MXS208	MD6287D			
							FA208X	FA208R		EPFA208HH	MXS208	MD6287D			
							FA208X	FA208R		EPFA208HH	MXS208	MD6288D			
							FA208X	FA208R		EPFA208HH	MXS208	MD6295D			
							FA251					MD6126D			
							FA84X	FA84R			MXS84	MD6126D			
		OS6125C	OSX6125	BRK010	SMX6125	BRK007	FA208X	FA208R		EPFA208HH	MXS208	MD6126D			
		OS6184HC	OSX6184H	BRK010	SMX6184H	BRK007	FA208X	FA208R		EPFA208HH	MXS208	MD6287D			
		OS6184KC	OSX6184K	BRK011	SMX6184K	BRK012	FA208X	FA208R		EPFA208HH	MXS208	MD6287D			
							FA251					MD6126D			
							FA84X	FA84R			MXS84	MD6126D			
		OS6184HC	OSX6184H	BRK010	SMX6184H	BRK007	FA208X	FA208R		EPFA208HH	MXS208	MD6287D			
		OS6184KC	OSX6184K	BRK011	SMX6184K	BRK012	FA208X	FA208R		EPFA208HH	MXS208	MD6287D			
		OS6125C	OSX6125	BRK010	SMX6125	BRK007	FA208X	FA208R		EPFA208HH	MXS208	MD6126D			
		OS6184HC	OSX6184H	BRK010	SMX6184H	BRK007	FA208X	FA208R		EPFA208HH	MXS208	MD6126D			
		OS6184KC	OSX6184K	BRK011	SMX6184K	BRK012	FA208X	FA208R		EPFA208HH	MXS208	MD6126D			
		OS6184HC	OSX6184H	BRK010	SMX6184H	BRK007	FA208X	FA208R		EPFA208HH	MXS208	MD6287D			
		OS6184KC	OSX6184K	BRK011	SMX6184K	BRK012	FA208X	FA208R		EPFA208HH	MXS208	MD6287D			
		OS6184HC	OSX6184H	BRK010	SMX6184H	BRK007	FA208X	FA208R		EPFA208HH	MXS208	MD6287D			
		OS6184KC	OSX6184K	BRK011	SMX6184K	BRK012	FA208X	FA208R		EPFA208HH	MXS208	MD6287D			
		OS6184HC	OSX6184H	BRK010	SMX6184H	BRK007	FA208X	FA208R		EPFA208HH	MXS208	MD6287D			
		OS6184KC	OSX6184K	BRK011	SMX6184K	BRK012	FA208X	FA208R		EPFA208HH	MXS208	MD6287D			
		OS6184HC	OSX6184H	BRK010	SMX6184H	BRK007	FA208X	FA208R		EPFA208HH	MXS208	MD6287D			
		OS6184KC	OSX6184K	BRK011	SMX6184K	BRK012	FA208X	FA208R		EPFA208HH	MXS208	MD6287D			
		OS6184HC	OSX6184H	BRK010	SMX6184H	BRK007	FA208X	FA208R		EPFA208HH	MXS208	MD6287D			
		OS6184KC	OSX6184K	BRK011	SMX6184K	BRK012	FA208X	FA208R		EPFA208HH	MXS208	MD6287D			
		OS6184HC	OSX6184H	BRK010	SMX6184H	BRK007	FA208X	FA208R		EPFA208HH	MXS208	MD6287D			
		OS6184KC	OSX6184K	BRK011	SMX6184K	BRK012	FA208X	FA208R		EPFA208HH	MXS208	MD6287D			
		OS6184HC	OSX6184H	BRK010	SMX6184H	BRK007	FA208X	FA208R		EPFA208HH	MXS208	MD6287D			
		OS6184KC	OSX6184K	BRK011	SMX6184K	BRK012	FA208X	FA208R		EPFA208HH	MXS208	MD6287D			
		OS6184HC	OSX6184H	BRK010	SMX6184H	BRK007	FA208X	FA208R		EPFA208HH	MXS208	MD6295D			
		OS6184KC	OSX6184K	BRK011	SMX6184K	BRK012	FA208X	FA208R		EPFA208HH	MXS208	MD6295D			
		OS6184HC	OSX6184H	BRK010	SMX6184H	BRK007	FA208X	FA208R		EPFA208HH	MXS208	MD6295D			
		OS6184KC	OSX6184K	BRK011	SMX6184K	BRK012	FA208X	FA208R		EPFA208HH	MXS208	MD6295D			
		OS6184HC	OSX6184H	BRK010	SMX6184H	BRK007	FA208X	FA208R		EPFA208HH	MXS208	MD6295D			
		OS6184KC	OSX6184K	BRK011	SMX6184K	BRK012	FA208X	FA208R		EPFA208HH	MXS208	MD6295D			
		OS6184HC	OSX6184H	BRK010	SMX6184H	BRK007	FA208X	FA208R		EPFA208HH	MXS208	MD6295D			
		OS6184KC	OSX6184K	BRK011	SMX6184K	BRK012	FA208X	FA208R		EPFA208HH	MXS208	MD6295D			
		OS6184HC	OSX6184H	BRK010	SMX6184H	BRK007	FA213	FA213HH			FA213V	MD671			
		OS6184KC	OSX6184K	BRK011	SMX6184K	BRK012	FA213	FA213HH			FA213V	MD671			
							FA208X	FA208R		EPFA208HH	MXS208			MD6417C	
							FA208X	FA208R		EPFA208HH	MXS208	MD6415D			
							FA208X	FA208R		EPFA208HH	MXS208				
							FA208X	FA208R		EPFA208HH	MXS208				
							FA213	FA213HH			FA213V	MD671			
							FA213	FA213HH			FA213V	MD671			
							TBC								
							TBC								
							TBC								
							TBC								
												MD6301D			
												MD6301D			
												MD6301D			

REAR

⚠ This symbol indicates a rotor made of billet steel, and should be only used with EBC FA Kevlar® Organic or Vee pads.
SAFETY NOTICE - With vehicles primarily designed for off highway use such as quads now being used on the highway, we would recommend the use of X or MXS pads for highway use and ONLY using the R and SV higher density / harder pad series for off road riding.

BRAKE APPLICATIONS

*-2 Sets Required. † For Vee disc colours add RED, BLU, GRN, GLD, ORG suffix to part number. **SAFETY WARNING:- DO NOT USE HH PADS ON REAR UNLESS ALSO USED ON FRONT TO AVOID BRAKE IMBALANCE**

FRONT: Non-Japanese Bikes



HYOSUNG



DISC PAD CHOICES - FRONT

BRAKE ROTOR CHOICES - FRONT

Model	Year	Disc Pad Choice	DISC PAD CHOICES - FRONT					BRAKE ROTOR CHOICES - FRONT				Line #	
			Sintered/HH Pads/Grooved Shoes	SV Series Severe Duty Pads	EPFA Sintered Fast Road/Track Pads	GPFA Sintered RACE ONLY Pads	Specialty Pads SXR/VEE/MXS Race	Standard Rotor Left	Standard Rotor Right	Vintage Rotor / UTV Oversize Brake Kit	Contour Profile Rotor		
MS3 125	06-07	SFA86*	SFA86HH*						TBC	TBC			1
RX 125	06-08	FA86	FA86HH						N/A				2
GT 250	06-12	FA86	FA86HH						MD690			MD690C	3
GT 250 R	06-12	FA86*	FA86HH*						MD690	MD690		MD690C*	4
GV 250	06-12	FA86	FA86HH						N/A				5
MS3 250	06-12	SFA86*	SFA86HH*						TBC	TBC			6
TE 450 S	07-12	FA54X*	FA54R*					MXS54*	TBC	TBC			7
GT 650	06-12	FA86*	FA86HH*						MD690	MD690		MD690C*	8
GT 650 R	06-12	FA86*	FA86HH*						MD690	MD690		MD690C*	9
GT 650 S	06-12	FA86*	FA86HH*						MD690	MD690		MD690C*	10
GV 650	06-12	FA86*	FA86HH*						MD691	MD691			11
ST7 Custom	10-11		FA296HH						TBC				12
ITALJET													
Dragster 50 LC	98-03	SFA115	SFA115HH						MD941D				15
Formula 50 (Air Cooled)	99-03	SFA115	SFA115HH						MD941D				16
Formula 50 (Liquid Cooled)	96-03	SFA115	SFA115HH						MD941D				17
Jet Set 50	03	SFA350	SFA350HH						TBC				18
Torpedo 50 2T	98-04	SFA115	SFA115HH						MD951D				19
Velocifero 50	98-03	350											20
Formula 125 LC	96-03	SFA115	SFA115HH						MD941D				21
Jet Set 125/150	03	SFA350	SFA350HH						TBC				22
Torpedo 125 4T	99-04	SFA115	SFA115HH						MD951D				23
Torpedo 150	03	SFA115	SFA115HH						MD951D				24
JOHN DEERE (ATV & Side X Side)													
Trail Buck 500/650 EX/EXT	Left 04-05	FA307X	FA307R	FA307SV				SXR307HH	MD6245D				27
	Right	FA317X	FA317R	FA317SV				SXR317HH		MD6245D			28
Buck 500/650 EX/EXT	Left 04-08	FA307X	FA307R	FA307SV				SXR307HH	MD6245D				29
	Right	FA317X	FA317R	FA317SV				SXR317HH		MD6245D			30
TX Gator Utility 9461	04-05		FA398R*	FA398SV*					N/A	N/A			31
TX Turf Gator 9462	04-05		FA398R*	FA398SV*					N/A	N/A			32
4PX Gator 4x2/4 x 4 Trail 9345	04-05		FA398R*	FA398SV*					N/A	N/A			33
HPX Gator 4x2/4 x 4 9446	04-08		FA398R*	FA398SV*					N/A	N/A			34
HPX 4x2 (Petrol) Gator	10-11		FA398R*	FA398SV*					N/A	N/A			35
HPX 4x2 (Petrol) Gator Parking Brake	10-11		FA398R*	FA398SV*					N/A	N/A			36
HPX 4 x 4/4 x 4 Trail (Petrol) Gator	10-11		FA398R*	FA398SV*					N/A	N/A			37
HPX 4 x 4 (Diesel) - Gator (SNO40000)	10		FA398R*	FA398SV*					N/A	N/A			38
HPX 4 x 4 (Diesel) - Gator (SNO40001 - 090000/090001-)	10-11		FA609R*						N/A	N/A			39
XUV 620i (Petrol) - Gator	10		FA609R*						N/A	N/A			40
XUV 625i (Petrol) - Gator	11		FA610R*						N/A	N/A			41
XUV 825i (Petrol) - Gator	11		FA610R*						N/A	N/A			42
XUV 850 D (Diesel) - Gator	10		FA609R*						N/A	N/A			43
XUV 855 D (Diesel) - Gator	11		FA610R*						N/A	N/A			44
KIOTI/MECHRON													
2200 UTV (Side x Side)	09-14	FA622X*	FA622R*	FA622SV*					N/A	N/A			47
KTM													
Freeride E-XC Electric	19-20	FA357X	FA357R									MD6426C	50
SX-E 5 Electric	20-22	FA325X	FA325R										51
50 SX/SXR Pro Junior/Senior/Adventure	96-03	N/A											52
50 SX Mini Adventure	04-07	N/A											53
50 SX Pro Senior LC	02-03	FA325X	FA325R						N/A				54
50 SX Pro Senior LC/Mini Senior Adventure	02-07	FA325X	FA325R						N/A				55
50 Supermoto	06	FA325X	FA325R						N/A				56

APPLICATIONS

BRAKE

⚡ This symbol indicates a rotor made of billet steel, and should be only used with EBC FA Kevlar® Organic or Vee pads.

SAFETY NOTICE - With vehicles primarily designed for off highway use such as quads now being used on the highway, we would recommend the use of X or MXS pads for highway use and ONLY using the R and SV higher density / harder pad series for off road riding.

*-2 Sets Required. † For Vee disc colours add RED, BLU, GRN, GLD, ORG suffix to part number. **SAFETY WARNING:- DO NOT USE HH PADS ON REAR UNLESS ALSO USED ON FRONT TO AVOID BRAKE IMBALANCE**

FRONT: Non-Japanese Bikes Cont'd

REAR: Non-Japanese Bikes

Line #	BRAKE ROTOR CHOICES - FRONT						DISC PAD CHOICES - REAR					BRAKE ROTOR CHOICES - REAR				
	CC Custom Rotor	CX Extreme® /Vee-Rotor	OS Series Oversize 250/280mm Rotor Kit	OSX Series Oversize 280mm Rotor Kit	Relocating Bracket for Oversize Rotor	SMX Series Oversize 320mm Rotor Kit	Relocating Bracket for 320mm Rotor		Sintered/HH Pads/ Grooved Shoes	SV Series Severe Duty Pads	EPFA Sintered Fast Road/ Track Pads	Specialty Pads SXR/ VEE/MXS Race	Standard Rotor	Vintage Rotor / UTV Oversize Brake Kit	Contour Profile Rotor	CX Extreme® /Vee-Rotor
1								SFA86	SFA86HH				TBC			
2								602								
3								FA86	FA86HH				MD689		MD689C	
4								FA86	FA86HH				MD689		MD689C	
5								606								
6								SFA86	SFA86HH				TBC			
7								FA54X	FA54R			MXS54	TBC			
8								FA86	FA86HH				MD689		MD689C	
9								FA86	FA86HH				MD689		MD689C	
10								FA86	FA86HH				MD689		MD689C	
11								FA86	FA86HH				TBC			
12								FA86	FA86HH				TBC			
13																
14																
15								SFA115	SFA115HH				MD948D			
16								624								
17								SFA115	SFA115HH				MD950D			
18								TBC								
19								624								
20								624								
21								SFA115	SFA115HH				MD950D			
22								816								
23								816								
24								816								
25																
26																
27								FA317X	FA317R	FA317SV		SXR317HH	MD6225D			
28																
29								FA317X	FA317R	FA317SV		SXR317HH	MD6225D			
30																
31									FA398R*	FA398SV*			N/A*			
32									FA398R*	FA398SV*			N/A*			
33									FA398R*	FA398SV*			N/A*			
34									FA398R*	FA398SV*			N/A*			
35									FA398R*	FA398SV*			N/A*			
36									FA398R*	FA398SV*			N/A*			
37									FA398R*	FA398SV*			N/A*			
38									FA398R*	FA398SV*			N/A*			
39									FA609R*				N/A*			
40									FA609R*				N/A*			
41									FA609R*				N/A*			
42									FA609R*				N/A*			
43									FA609R*				N/A*			
44									FA609R*				N/A*			
45																
46																
47								FA622X*	FA622R*	FA622SV*			N/A*			
48																
49																
50																
51								FA602X	FA602R							
52								FA325X	FA325R							
53								N/A								
54								N/A								
55								N/A								
56								FA325X	FA325R				N/A			

BRAKE APPLICATIONS

⚠ This symbol indicates a rotor made of billet steel, and should be only used with EBC FA Kevlar® Organic or Vee pads. SAFETY NOTICE - With vehicles primarily designed for off highway use such as quads now being used on the highway, we would recommend the use of X or MXS pads for highway use and ONLY using the R and SV higher density / harder pad series for off road riding.

*-2 Sets Required. † For Vee disc colours add RED, BLU, GRN, GLD, ORG suffix to part number. **SAFETY WARNING: DO NOT USE HH PADS ON REAR UNLESS ALSO USED ON FRONT TO AVOID BRAKE IMBALANCE**

FRONT: Non-Japanese Bikes



KTM



DISC PAD CHOICES - FRONT

BRAKE ROTOR CHOICES - FRONT

											Line #
SX 50 Junior LC	07-09	FA325X	FA325R				N/A				1
SX 50 Mini (F & R 10" wheels)	09-22	FA325X	FA325R							N/A	2
SX 50 Pro Senior LC (F 12"/R 10" wheels)	04-22	FA325X	FA325R							N/A	3
SX 60	98-99	FA115X	FA115R			MXS115	MD6192D			MD6192C	4
SX 60	00	FA115X	FA115R			MXS115	MD6192D			MD6192C	5
SX 65	98-99	FA115X	FA115R			MXS115	MD6192D			MD6192C	6
SX 65	00-01	FA115X	FA115R			MXS115	MD6192D			MD6192C	7
SX 65	02-03	FA357X	FA357R				MD6192D			MD6192C	8
SX 65	04-08	FA357X	FA357R							MD6243C	9
SX 65	09-22	FA357X	FA357R							MD6243C	10
XC 65	08	FA357X	FA357R							MD6243C	11
XC 65	09-10	FA357X	FA357R							MD6243C	12
80 MX	86-92	FA472X					N/A				13
SX 85 (17"/14" Wheels)	03-10	FA357X	FA357R							MD6258C	14
SX 85 (19"/16" Wheels)	03-10	FA357X	FA357R							MD6258C	15
SX 85 (17"/14" Wheels)	11	FA357X	FA357R							MD6258C	16
SX 85 (19"/16" Wheels)	11	FA357X	FA357R							MD6258C	17
SX 85 (17"/14" Wheels/220mm F/Disc)	12-20	FA612X	FA612R							MD6407C	18
SX 85 (19"/16" Wheels/220mm F/Disc)	12-20	FA612X	FA612R							MD6407C	19
SX 85 (17"/14" Wheels/240mm F/Disc)	21-22	FA612X	FA612R							MD6379C	20
SX 85 (19"/16" Wheels/240mm F/Disc)	21-22	FA612X	FA612R							MD6379C	21
XC 85	08-09	FA357X	FA357R							MD6258C	22
SX 105	07-11	FA357X	FA357R							MD6258C	23
XC 105	08-09	FA357X	FA357R							MD6258C	24
D-XC/E-XC/E-GS 125	90-91	FA67X	FA67R				MD6034D				25
D-XC/E-XC/E-GS 125 Grimeca Calipers	90-91	FA132X	FA132R				MD6034D				26
D-XC/E-XC/E-GS 125 Brembo Calipers	92-93	FA181X	FA181R	EPFA181HH		MXS181	MD6034D				27
D-XC/E-XC/E-GS 125 Grimeca Calipers	92-93	FA132X	FA132R				MD6034D				28
EXC 125	87	FA126X	FA126R				N/A				29
EXC 125	88	FA132X	FA132R				N/A				30
EXC 125 Brembo Calipers	89	FA67X	FA67R				MD6034D				31
EXC 125 Grimeca Calipers	89	FA132X	FA132R				MD6034D				32
EXC/EGS 125 (Standard forks)	94	FA181X	FA181R	EPFA181HH		MXS181	MD6032D			MD6032C	33
EXC 125 (Standard forks)	95-99	FA181X	FA181R	EPFA181HH		MXS181	MD6032D			MD6032C	34
EXC 125 (Upside down forks)	00-03	FA181X	FA181R	EPFA181HH		MXS181	MD6032D			MD6032C	35
EXC 125 (Upside down forks)	04-08	FA181X	FA181R	EPFA181HH		MXS181	MD6032D			MD6032C	36
EXE 125	00	FA181X	FA181R	EPFA181HH		MXS181	MD6032D			MD6032C	37
GSXC/GS 125	85	FA47X					N/A				38
LC2 125	96-98	FA181X	FA181R	EPFA181HH		MXS181	N/A				39
Sting 125	97-99	FA95	FA95HH	EPFA95HH			N/A				40
MX 125	83		811G								41
MX 125	84		814G								42
MX/MXC 125	85	FA47X					N/A				43
MX/MXC/GS 125	86	FA47X					N/A				44
MX 125	87	FA126X	FA126R				N/A				45
MX 125	88	FA132X	FA132R				N/A				46
MX 125 Brembo Calipers	89	FA67X	FA67R				N/A				47
MX 125 Grimeca Calipers	89	FA132X	FA132R				N/A				48
MX 125 Brembo Calipers	90-91	FA67X	FA67R				N/A				49
MX 125 Grimeca Calipers	90-91	FA132X	FA132R				N/A				50
MX 125 Brembo Calipers	92-93	FA181X	FA181R	EPFA181HH		MXS181	MD6032D			MD6032C	51
MX 125 Grimeca Calipers	92-93	FA132X	FA132R				MD6032D			MD6032C	52
SM 125 Supermoto	00	FA181X	FA181R	EPFA181HH		MXS181	TBC				53
SX 125 (Standard forks)	94-99	FA181X	FA181R	EPFA181HH		MXS181	MD6032D			MD6032C	54
SX 125 (Upside down forks)	00-03	FA181X	FA181R	EPFA181HH		MXS181	MD6032D			MD6032C	55

MD6035C ● = PLAIN UNDRILLED DISC FOR ENDURO USE. REAR FITMENTS ONLY. ORDER MD6035CE.

*-2 Sets Required. † For Vee disc colours add RED, BLU, GRN, GLD, ORG suffix to part number. **SAFETY WARNING:- DO NOT USE HH PADS ON REAR UNLESS ALSO USED ON FRONT TO AVOID BRAKE IMBALANCE**

⊛ This symbol indicates a rotor made of billet steel, and should be only used with EBC FA Kevlar® Organic or Vee pads.

SAFETY NOTICE - With vehicles primarily designed for off highway use such as quads now being used on the highway, we would recommend the use of X or MXS pads for highway use and ONLY using the R and SV higher density / harder pad series for off road riding.

FRONT: Non-Japanese Bikes Cont'd

REAR: Non-Japanese Bikes

Line #	BRAKE ROTOR CHOICES - FRONT							DISC PAD CHOICES - REAR					BRAKE ROTOR CHOICES - REAR			
	CC Custom Rotor	CX Extreme® /Vee-Rotor	OS Series Oversize 250/280mm Rotor Kit	OSX Series Oversize 280mm Rotor Kit	Relocating Bracket for Oversize Rotor	SMX Series Oversize 320mm Rotor Kit	Relocating Bracket for 320mm Rotor		Sintered/HH Pads/ Grooved Shoes	SV Series Severe Duty Pads	EPFA Sintered Fast Road/ Track Pads	Specialty Pads SXR/ VEE/MXS Race	Standard Rotor	Vintage Rotor / UTV Oversize Brake Kit	Contour Profile Rotor	CX Extreme® /Vee-Rotor
1								N/A								
2								FA325X	FA325R							
3								FA325X	FA325R							N/A
4								873								N/A
5								FA337X	FA337R				MD6216D			
6								873								
7								FA337X	FA337R				MD6216D			
8								FA337X	FA337R				MD6216D			
9		MD6243CX						FA325X	FA325R						MD6249C	MD6249CX
10		MD6243CX						FA357X	FA357R						MD6249C	MD6249CX
11		MD6243CX						FA325X	FA325R						MD6249C	MD6249CX
12		MD6243CX						FA357X	FA357R						MD6249C	MD6249CX
13								814G								
14			OS6258C	OSX6258	BRK028	N/A	N/A	FA357X	FA357R						MD6257C	
15			OS6258C	OSX6258	BRK028	N/A	N/A	FA357X	FA357R						MD6257C	
16			OS6258C	OSX6258	BRK028	N/A	N/A	FA602X	FA602R						MD6360C	
17			OS6258C	OSX6258	BRK028	N/A	N/A	FA602X	FA602R						MD6360C	
18			N/A	OSX6407	BRK027	N/A	N/A	FA602X	FA602R							
19			N/A	OSX6407	BRK027	N/A	N/A	FA602X	FA602R							
20			N/A	N/A	N/A	N/A	N/A	FA602X	FA602R						MD6360C	
21			N/A	N/A	N/A	N/A	N/A	FA602X	FA602R						MD6360C	
22			OS6258C	OSX6258	BRK028	N/A	N/A	FA357X	FA357R						MD6257C	
23			OS6258C	OSX6258	BRK028	N/A	N/A	FA357X	FA357R						MD6257C	
24			OS6258C	OSX6258	BRK028	N/A	N/A	FA357X	FA357R						MD6257C	
25								FA67X	FA67R				N/A			
26								FA132X	FA132R				N/A			
27								FA67X	FA67R				N/A			
28								FA67X	FA67R				N/A			
29								FA126X	FA126R				N/A			
30								FA132X	FA132R				MD6227D			
31								FA67X	FA67R				MD6227D			
32								FA132X	FA132R				MD6227D			
33		MD6032CX	OS6032EC	OSX6032E	BRK015	SMX6032E	BRK016	FA208X	FA208R		EPFA208HH	MXS208	MD6035D		MD6035C●	MD6035CX
34		MD6032CX	OS6032EC	OSX6032E	BRK015	SMX6032E	BRK016	FA208X	FA208R		EPFA208HH	MXS208	MD6035D		MD6035C●	MD6035CX
35		MD6032CX	OS6032C	OSX6032	BRK011	SMX6032	BRK012	FA208X	FA208R		EPFA208HH	MXS208	MD6035D		MD6035C●	MD6035CX
36		MD6032CX	OS6032C	OSX6032	BRK011	SMX6032	BRK012	FA368X	FA368R		EPFA368HH	MXS368	MD6035D		MD6035C●	MD6035CX
37		MD6032CX	OS6032C	OSX6032	BRK011	SMX6032	BRK012	FA208X	FA208R		EPFA208HH	MXS208	MD6035D		MD6035C●	MD6035CX
38									814G							
39								FA208X	FA208R		EPFA208HH	MXS208	N/A			
40								FA208X	FA208R		EPFA208HH		N/A			
41									812G							
42									814G							
43									814G							
44								FA47X					MD6227D			
45								FA126X	FA126R				N/A			
46								FA132X	FA132R				MD6227D			
47								FA67X	FA67R				MD6227D			
48								FA132X	FA132R				MD6227D			
49								FA67X	FA67R				N/A			
50								FA132X	FA132R				N/A			
51		MD6032CX	OS6032EC	OSX6032E	BRK015	SMX6032E	BRK016	FA67X	FA67R				N/A			
52								FA67X	FA67R				N/A			
53								FA208X	FA208R		EPFA208HH	MXS208	MD6035D		MD6035C	
54		MD6032CX	OS6032EC	OSX6032E	BRK015	SMX6032E	BRK016	FA208X	FA208R		EPFA208HH	MXS208	MD6035D		MD6035C	MD6035CX
55		MD6032CX	OS6032C	OSX6032	BRK011	SMX6032	BRK012	FA208X	FA208R		EPFA208HH	MXS208	MD6035D		MD6035C	MD6035CX
56																

BRAKE APPLICATIONS

⚠ This symbol indicates a rotor made of billet steel, and should be only used with EBC FA Kevlar® Organic or Vee pads.
 SAFETY NOTICE - With vehicles primarily designed for off highway use such as quads now being used on the highway, we would recommend the use of X or MXS pads for highway use and ONLY using the R and SV higher density / harder pad series for off road riding.

*-2 Sets Required. † For Vee disc colours add RED, BLU, GRN, GLD, ORG suffix to part number. **SAFETY WARNING:- DO NOT USE HH PADS ON REAR UNLESS ALSO USED ON FRONT TO AVOID BRAKE IMBALANCE**

FRONT: Non-Japanese Bikes



KTM



DISC PAD CHOICES - FRONT

BRAKE ROTOR CHOICES - FRONT

											Line #
SX 125 (Upside down forks)	04-08	FA181X	FA181R		EPFA181HH		MXS181	MD6032D		MD6032C	1
SX 125 (Upside down forks)	09-22	FA181X	FA181R		EPFA181HH		MXS181	MD6032D		MD6032C	2
XC 125	20-22	FA181X	FA181R		EPFA181HH		MXS181	MD6032D		MD6032C	3
SX 150	08	FA181X	FA181R		EPFA181HH		MXS181	MD6032D		MD6032C	4
SX 150	09-22	FA181X	FA181R		EPFA181HH		MXS181	MD6032D		MD6032C	5
XC 150/W	10-19	FA181X	FA181R		EPFA181HH		MXS181	MD6032D		MD6032C	6
XC-W 150 Tpi	20-22	FA181X	FA181R		EPFA181HH		MXS181				7
EXC/EGS 200 (Standard forks)	10	FA181X	FA181R		EPFA181HH		MXS181	MD6032D		MD6032C	8
EXC/EGS 200 (Upside down forks)	00-03	FA181X	FA181R		EPFA181HH		MXS181	MD6032D		MD6032C	9
XC/EXC 200 (Upside down forks)	04-08	FA181X	FA181R		EPFA181HH		MXS181	MD6032D		MD6032C	10
XC-W 200	07-09	FA181X	FA181R		EPFA181HH		MXS181	MD6032D		MD6032C	11
XC-W 200	10-16	FA181X	FA181R		EPFA181HH		MXS181	MD6032D		MD6032C	12
XC 200	06-09	FA181X	FA181R		EPFA181HH		MXS181	MD6032D		MD6032C	13
DXC/EXC 250 Grimeca Calipers	90	FA132X	FA132R					MD6034D			14
D-XC/E-XC/E-GS 250 Brembo Calipers	91	FA67X	FA67R					MD6034D			15
D-XC/E-XC/E-GS 250	91	FA132X	FA132R					MD6034D			16
D-XC/E-XC/T-XC/E-GS 250 (Grimeca calipers)	92-93	FA132X	FA132R					MD6032D		MD6032C	17
EXC/EGS 250	88	FA132X	FA132R					N/A			18
EXC/EGS 250 Brembo Calipers	89	FA67X	FA67R					MD6034D			19
EXC/EGS 250 Grimeca Calipers	89	FA132X	FA132R					MD6034D			20
EXC/EGS 250 (Standard forks)	94	FA181X	FA181R		EPFA181HH		MXS181	MD6032D		MD6032C	21
EXC 250 (Standard forks)	95-99	FA181X	FA181R		EPFA181HH		MXS181	MD6032D		MD6032C	22
EXC 250 (Upside down forks)	00-03	FA181X	FA181R		EPFA181HH		MXS181	MD6032D		MD6032C	23
XC/EXC 250 (Upside down forks)	04-07	FA181X	FA181R		EPFA181HH		MXS181	MD6032D		MD6032C	24
EXC-F 250	06-07	FA181X	FA181R		EPFA181HH		MXS181	MD6032D		MD6032C	25
EXC-F 250	18-19	FA181X	FA181R		EPFA181HH		MXS181			MD6032C	26
250 R Freeride 4T	15-21	FA612X	FA612R							TBC	27
GS 250	86	FA47X						N/A			28
GSXC/GS 250	85	FA47X						N/A			29
MX 250	88	FA132X	FA132R					N/A			30
MX 250 Grimeca Calipers	89	FA132X	FA132R					N/A			31
MX 250 Brembo Calipers	89	FA67X	FA67R					N/A			32
MX 250 Brembo Calipers	90	FA67X	FA67R					N/A			33
MX 250 Brembo Calipers	91	FA67X	FA67R					N/A			34
MX 250 Grimeca Calipers	91	FA132X	FA132R					N/A			35
MX 250 Brembo Calipers	92-93	FA181X	FA181R		EPFA181HH		MXS181	MD6032D		MD6032C	36
MX/EXC 250	87	FA126X	FA126R					N/A			37
MX/MXC/GS 250	84		814G								38
MX/MXC 250	85	FA47X						N/A			39
MX/MXC 250	86	FA47X						N/A			40
SX 250 (Standard Forks)	94-99	FA181X	FA181R		EPFA181HH		MXS181	MD6032D		MD6032C	41
SX 250 (Upside down forks)	00-02	FA181X	FA181R		EPFA181HH		MXS181	MD6032D		MD6032C	42
SX 250 (Upside down forks)	03-08	FA181X	FA181R		EPFA181HH		MXS181	MD6032D		MD6032C	43
SX 250 (2T) (Upside down forks)	09-22	FA181X	FA181R		EPFA181HH		MXS181	MD6032D		MD6032C	44
SX-F 250	05-08	FA181X	FA181R		EPFA181HH		MXS181	MD6032D		MD6032C	45
SX-F 250 Factory Edition (4T)	15	FA181X	FA181R		EPFA181HH		MXS181	MD6032D		MD6032C	46
SX-F 250 (4T)	09-22	FA181X	FA181R		EPFA181HH		MXS181	MD6032D		MD6032C	47
SX-F 250 Troy Lee Designs (Front floating rotor)	09-22	FA181X	FA181R		EPFA181HH		MXS181				48
XC 250	06-09	FA181X	FA181R		EPFA181HH		MXS181	MD6032D		MD6032C	49
XC 250 (2T)	10-19	FA181X	FA181R		EPFA181HH		MXS181				50
XC-W 250	06-08	FA181X	FA181R		EPFA181HH		MXS181	MD6032D		MD6032C	51
XC-W 250 Tpi	10-22	FA181X	FA181R		EPFA181HH		MXS181	MD6032D		MD6032C	52
XC 250 Tpi	19-22	FA181X	FA181R		EPFA181HH		MXS181	MD6032D		MD6032C	53
XC-F 250	06-09	FA181X	FA181R		EPFA181HH		MXS181	MD6032D		MD6032C	54
XC-F 250	10-22	FA181X	FA181R		EPFA181HH		MXS181	MD6032D		MD6032C	55

FRONT

MD6035C ● = PLAIN UNDRILLED DISC FOR ENDURO USE. REAR FITMENTS ONLY. ORDER MD6035CE.

*-2 Sets Required. † For Vee disc colours add RED, BLU, GRN, GLD, ORG suffix to part number. **SAFETY WARNING:- DO NOT USE HH PADS ON REAR UNLESS ALSO USED ON FRONT TO AVOID BRAKE IMBALANCE**

FRONT: Non-Japanese Bikes Cont'd

REAR: Non-Japanese Bikes

BRAKE ROTOR CHOICES - FRONT

DISC PAD CHOICES - REAR

BRAKE ROTOR CHOICES - REAR

Line #

CC Custom Rotor	CX Extreme® /Vee-Rotor	OS Series Oversize 250/280mm Rotor Kit	OSX Series Oversize 280mm Rotor Kit	Relocating Bracket for Oversize Rotor	SMX Series Oversize 320mm Rotor Kit	Relocating Bracket for 320mm Rotor		Sintered/HH Pads/ Grooved Shoes	SV Series Severe Duty Pads	EPFA Sintered Fast Road/ Track Pads	Specialty Pads SXR/ VEE/MXS Race	Standard Rotor	Vintage Rotor / UTV Oversize Brake Kit	Contour Profile Rotor	CX Extreme® /Vee-Rotor
1	MD6032CX	OS6032C	OSX6032	BRK011	SMX6032	BRK012	FA368X	FA368R		EPFA368HH	MXS368	MD6035D		MD6035C	MD6035CX
2	MD6032CX	OS6932C	OSX6932	BRK013	SMX6932	BRK014	FA368X	FA368R		EPFA368HH	MXS368	MD6035D		MD6035C	MD6035CX
3	MD6032CX		OSX6932	BRK013	SMX6932	BRK014	FA368X	FA368R			MXS368	MD6035D		MD6035C	MD6035CX
4	MD6032CX	OS6032C	OSX6032	BRK011	SMX6032	BRK012	FA368X	FA368R		EPFA368HH	MXS368	MD6035D		MD6035C	MD6035CX
5	MD6032CX	OS6932C	OSX6932	BRK013	SMX6932	BRK014	FA368X	FA368R		EPFA368HH	MXS368	MD6035D		MD6035C	MD6035CX
6	MD6032CX	OS6932C	OSX6932	BRK013	SMX6932	BRK014	FA368X	FA368R		EPPFA368HH	MXS368	MD6035D		MD6035C	MD6035CX
7							FA368X	FA368R		EPFA368HH	MXS368	MD6035D		MD6035C	MD6035CX
8	MD6032CX	OS6032EC	OSX6032E	BRK015	SMX6032E	BRK016	FA208X	FA208R		EPFA208HH	MXS208	MD6035D		MD6035C	MD6035CX
9	MD6032CX	OS6032C	OSX6032	BRK011	SMX6032	BRK012	FA208X	FA208R		EPFA208HH	MXS208	MD6035D		MD6035C	MD6035CX
10	MD6032CX	OS6032C	OSX6032	BRK011	SMX6032	BRK012	FA368X	FA368R		EPFA368HH	MXS368	MD6035D		MD6035C	MD6035CX
11	MD6032CX	OS6032C	OSX6032	BRK011	SMX6032	BRK012	FA368X	FA368R		EPFA368HH	MXS368	MD6035D		MD6035C	MD6035CX
12	MD6032CX	OS6932C	OSX6932	BRK013	SMX6932	BRK014	FA368X	FA368R		EPFA368HH	MXS368	MD6035D		MD6035C	MD6035CX
13	MD6032CX	OS6032C	OSX6032	BRK011	SMX6032	BRK012	FA368X	FA368R		EPFA368HH	MXS368	MD6035D		MD6035C	MD6035CX
14							FA132X	FA132R				N/A			
15							FA67X	FA67R				N/A			
16							FA132X	FA132R				N/A			
17							FA67X	FA67R				N/A			
18							FA132X	FA132R				MD6227D			
19							FA67X	FA67R				MD6227D			
20							FA132X	FA132R				MD6227D			
21	MD6032CX	OS6032EC	OSX6032E	BRK015	SMX6032E	BRK016	FA208X	FA208R		EPFA208HH	MXS208	MD6035D		MD6035C	MD6035CX
22	MD6032CX	OS6032EC	OSX6032E	BRK015	SMX6032E	BRK016	FA208X	FA208R		EPFA208HH	MXS208	MD6035D		MD6035C	MD6035CX
23	MD6032CX	OS6032C	OSX6032	BRK011	SMX6032	BRK012	FA208X	FA208R		EPFA208HH	MXS208	MD6035D		MD6035C	MD6035CX
24	MD6032CX	OS6032C	OSX6032	BRK011	SMX6032	BRK012	FA368X	FA368R		EPFA368HH	MXS368	MD6035D		MD6035C	MD6035CX
25	MD6032CX	OS6032C	OSX6032	BRK011	SMX6032	BRK012	FA368X	FA368R		EPFA368HH	MXS368	MD6035D		MD6035C	MD6035CX
26	MD6032CX						FA368X	FA368R		EPFA368HH	MXS368	MD6035D		MD6035C	MD6035CX
27							FA602X	FA602R						MD6360C	
28							FA47X					MD6227D			
29								814G							
30							FA132X	FA132R				MD6227D			
31							FA132X	FA132R				MD6227D			
32							FA67X	FA67R				MD6227D			
33							FA67X	FA67R				N/A			
34							FA67X	FA67R				N/A			
35							FA132X	FA132R				N/A			
36	MD6032CX	OS6032EC	OSX6032E	BRK015	SMX6032E	BRK016	FA67	FA67R				N/A			
37							FA126	FA126R				N/A			
38								814G							
39								814G							
40							FA47X					MD6227D			
41	MD6032CX	OS6032EC	OSX6032E	BRK015	SMX6032E	BRK016	FA208X	FA208R		EPFA208HH	MXS208	MD6035D		MD6035C	MD6035CX
42	MD6032CX	OS6032C	OSX6032	BRK011	SMX6032	BRK012	FA208X	FA208R		EPFA208HH	MXS208	MD6035D		MD6035C	MD6035CX
43	MD6032CX	OS6032C	OSX6032	BRK011	SMX6032	BRK012	FA368X	FA368R		EPFA368HH	MXS368	MD6035D		MD6035C	MD6035CX
44	MD6032CX	OS6932C	OSX6932	BRK013	SMX6932	BRK014	FA368X	FA368R		EPFA368HH	MXS368	MD6035D		MD6035C	MD6035CX
45	MD6032CX	OS6032C	OSX6032	BRK011	SMX6032	BRK012	FA368X	FA368R		EPFA368HH	MXS368	MD6035D		MD6035C	MD6035CX
46	MD6032CX	OS6932C	OSX6932	BRK013	SMX6932	BRK014	FA368X	FA368R		EPFA368HH	MXS368	MD6035D		MD6035C	MD6035CX
47	MD6032CX	OS6932C	OSX6932	BRK013	SMX6932	BRK014	FA368X	FA368R		EPFA368HH	MXS368	MD6035D		MD6035C	MD6035CX
48	MD6433CX		OSX6932	BRK013	SMX6932	BRK014	FA368X	FA368R		EPFA368HH	MXS368	MD6035C		MD6035C	MD6035CX
49	MD6032CX	OS6032C	OSX6032	BRK011	SMX6032	BRK012	FA368X	FA368R		EPFA368HH	MXS368	MD6035D		MD6035C	MD6035CX
50							FA368X	FA368R		EPFA368HH	MXS368	MD6035D		MD6035C	MD6035CX
51	MD6032CX	OS6032C	OSX6032	BRK011	SMX6032	BRK012	FA368X	FA368R		EPFA368HH	MXS368	MD6035D		MD6035C	MD6035CX
52							FA368X	FA368R		EPFA368HH	MXS368	MD6035D		MD6035C	MD6035CX
53							FA368X	FA368R		EPFA368HH	MXS368	MD6035D		MD6035C	MD6035CX
54	MD6032CX	OS6032C	OSX6032	BRK011	SMX6032	BRK012	FA368X	FA368R		EPFA368HH	MXS368	MD6035D		MD6035C	MD6035CX
55	MD6032CX	OS6932C	OSX6932	BRK013	SMX6932	BRK014	FA368X	FA368R		EPFA368HH	MXS368	MD6035D		MD6035C	MD6035CX
56															

REAR

BRAKE APPLICATIONS

This symbol indicates a rotor made of billet steel, and should be only used with EBC FA Kevlar® Organic or Vee pads. SAFETY NOTICE - With vehicles primarily designed for off highway use such as quads now being used on the highway, we would recommend the use of X or MXS pads for highway use and ONLY using the R and SV higher density / harder pad series for off road riding.

*-2 Sets Required. † For Vee disc colours add RED, BLU, GRN, GLD, ORG suffix to part number. SAFETY WARNING:- DO NOT USE HH PADS ON REAR UNLESS ALSO USED ON FRONT TO AVOID BRAKE IMBALANCE

FRONT: Non-Japanese Bikes



KTM



DISC PAD CHOICES - FRONT

BRAKE ROTOR CHOICES - FRONT

											Line #			
XC-F-W 250	06-10	FA181X	FA181R			EPFA181HH				MXS181	MD6032D		MD6032C	1
XC-F-W 250	12-19	FA181X	FA181R			EPFA181HH				MXS181	MD6032D		MD6032C	2
XC-F-W 250 Six Days	11	FA181X	FA181R			EPFA181HH				MXS181	MD6032D		MD6032C	3
EGS 300 (Standard forks)	94-98	FA181X	FA181R			EPFA181HH				MXS181	MD6032D		MD6032C	4
EXC 300 (Standard forks)	94-98	FA181X	FA181R			EPFA181HH				MXS181	MD6032D		MD6032C	5
EXC 300 (Upside down forks)	99-03	FA181X	FA181R			EPFA181HH				MXS181	MD6032D		MD6032C	6
EXC 300 (Upside down forks)	04-05	FA181X	FA181R			EPFA181HH				MXS181	MD6032D		MD6032C	7
EXC 300 Tpi Erzbergroede	20	FA181X	FA181R			EPFA181HH				MXS181	MD6032D		MD6032C	8
GSXC/GS 300	85	FA47X								N/A				9
MX/MXC 300	85	FA47X								N/A				10
MXC 300 (Standard forks)	94-98	FA181X	FA181R			EPFA181HH				MXS181	MD6032D		MD6032C	11
MXC 300 (Upside down forks)	99-03	FA181X	FA181R			EPFA181HH				MXS181	MD6032D		MD6032C	12
MXC 300 (Upside down forks)	04-06	FA181X	FA181R			EPFA181HH				MXS181	MD6032D		MD6032C	13
MX/MXC/GS 300	86	FA47X								N/A				14
SX 300	94-96	FA181X	FA181R			EPFA181HH				MXS181	MD6032D		MD6032C	15
XC 300	06-09	FA181X	FA181R			EPFA181HH				MXS181	MD6032D		MD6032C	16
XC 300 (2T)	10-19	FA181X	FA181R			EPFA181HH				MXS181	MD6032D		MD6032C	17
XC 300 Tpi (2T)	19-22	FA181X	FA181R			EPFA181HH								18
XC-W 300	06-09	FA181X	FA181R			EPFA181HH				MXS181	MD6032D		MD6032C	19
XC-W 300	10-19	FA181X	FA181R			EPFA181HH				MXS181	MD6032D		MD6032C	20
XC-W 300 Six Days (2T)	14-19	FA181X	FA181R			EPFA181HH				MXS181	MD6032D		MD6032C	21
XC-W 300 Six Days Tpi (2T)	19	FA181X	FA181R											22
XC-W 300 Tpi Erzbergroede	20-21	FA181X	FA181R										MD6032C	23
XC-W 300 Tpi (2T)	20-22	FA181X	FA181R											24
DXC/EXC/EGS 350 Brembo Calipers	90-91	FA67X	FA67R								MD6034D			25
DXC/EXC/EGS 350 Grimeca Calipers	90-91	FA132X	FA132R								MD6034D			26
EXC 350 Brembo Calipers	89	FA67X	FA67R								MD6034D			27
EXC 350 Grimeca Calipers	89	FA132X	FA132R								MD6034D			28
EXC 350 LC4 (Standard forks)	94-95	FA181X	FA181R			EPFA181HH				MXS181	MD6032D		MD6032C	29
MX/MXC/GS 350	86	FA47X								N/A				30
MX/EXC 350	87	FA126X	FA126R								N/A			31
MX/EXC/EGS 350	88	FA132X	FA132R								N/A			32
MX 350 Brembo Calipers	90-91	FA67X	FA67R								N/A			33
MX 350 Grimeca Calipers	90-91	FA132X	FA132R								N/A			34
MX 350 Brembo Calipers	89	FA67X	FA67R								N/A			35
MX 350 Grimeca Calipers	89	FA132X	FA132R								N/A			36
EXC 350 (Standard forks)	96-97	FA181X	FA181R			EPFA181HH				MXS181	MD6032D		MD6032C	37
EXC-F 350	12-22	FA181X	FA181R			EPFA181HH				MXS181	MD6032D		MD6032C	38
SX-F 350	11-22	FA181X	FA181R			EPFA181HH				MXS181	MD6032D		MD6032C	39
XC-F 350	11-22	FA181X	FA181R			EPFA181HH				MXS181	MD6032D		MD6032C	40
KTM XC-F 350 KailubRussell	21	FA181X	FA181R			EPFA181HH				MXS181				41
XC-F-W 350	12-22	FA181X	FA181R			EPFA181HH				MXS181	MD6032D		MD6032C	42
XC-F-W 350 Six Days (4T)	14-19	FA181X	FA181R			EPFA181HH				MXS181	MD6032D		MD6032C	43
SX 360 (Standard forks)	96-97	FA181X	FA181R			EPFA181HH				MXS181	MD6032D		MD6032C	44
EXC 380 (Standard forks)	98-99	FA181X	FA181R			EPFA181HH				MXS181	MD6032D		MD6032C	45
EXC 380 (Upside down forks)	00-03	FA181X	FA181R			EPFA181HH				MXS181	MD6032D		MD6032C	46
SX 380 (Standard forks)	98-99	FA181X	FA181R			EPFA181HH				MXS181	MD6032D		MD6032C	47
SX 380 (Upside down forks)	00-03	FA181X	FA181R			EPFA181HH				MXS181	MD6032D		MD6032C	48
390 Adventure (Solid disc option)	21	FA606	FA606HH									MD864		49
390 Adventure (Floating front disc option)	21	FA606	FA606HH										MD864XC	50
390 Duke (300mm Solid front disc)	15-21	FA606	FA606HH									MD864		51
390 Duke (300mm Floating front disc option)	15-21	FA606	FA606HH										MD864XC	52
RC 390 (300mm Solid front disc)	15-21	FA606	FA606HH									MD864		53
RC 390 (300mm Floating front disc option)	15-21	FA606	FA606HH										MD864XC	54
Duke 400 LC4	94-98	FA95	FA95HH			EPFA95HH					MD6199D		MD6199C	55

FRONT

MD6035C ● = PLAIN UNDRILLED DISC FOR ENDURO USE. REAR FITMENTS ONLY. ORDER MD6035CE.

*-2 Sets Required. † For Vee disc colours add RED, BLU, GRN, GLD, ORG suffix to part number. **SAFETY WARNING:- DO NOT USE HH PADS ON REAR UNLESS ALSO USED ON FRONT TO AVOID BRAKE IMBALANCE**

APPLICATIONS

BRAKE

⊛ This symbol indicates a rotor made of billet steel, and should be only used with EBC FA Kevlar® Organic or Vee pads.

SAFETY NOTICE - With vehicles primarily designed for off highway use such as quads now being used on the highway, we would recommend the use of X or MXS pads for highway use and ONLY using the R and SV higher density / harder pad series for off road riding.

FRONT: Non-Japanese Bikes Cont'd

REAR: Non-Japanese Bikes

Line #	BRAKE ROTOR CHOICES - FRONT						DISC PAD CHOICES - REAR					BRAKE ROTOR CHOICES - REAR				
	CC Custom Rotor	CX Extreme® /Vee-Rotor	OS Series Oversize 250/280mm Rotor Kit	OSX Series Oversize 280mm Rotor Kit	Relocating Bracket for Oversize Rotor	SMX Series Oversize 320mm Rotor Kit	Relocating Bracket for 320mm Rotor		Sintered/HH Pads/ Grooved Shoes	SV Series Severe Duty Pads	EPFA Sintered Fast Road/ Track Pads	Specialty Pads SXR/ VEE/MXS Race	Standard Rotor	Vintage Rotor / UTV Oversize Brake Kit	Contour Profile Rotor	CX Extreme® /Vee-Rotor
1		MD6032CX	OS6032C	OSX6032	BRK011	SMX6032	BRK012	FA368X	FA368R		EPFA368HH	MXS368	MD6035D		MD6035C●	MD6035CX
2		MD6032CX	OS6932C	OSX6932	BRK013	SMX6932	BRK014	FA368X	FA368R		EPFA368HH	MXS368	MD6035D		MD6035C●	MD6035CX
3		MD6032CX	OS6032C	OSX6032	BRK011	SMX6032	BRK012	FA368X	FA368R		EPFA368HH	MXS368	MD6035D		MD6035C●	MD6035CX
4		MD6032CX	OS6032EC	OSX6032E	BRK015	SMX6032E	BRK016	FA208X	FA208R		EPFA208HH	MXS208	MD6035D		MD6035C●	MD6035CX
5		MD6032CX	OS6032EC	OSX6032E	BRK015	SMX6032E	BRK016	FA208X	FA208R		EPFA208HH	MXS208	MD6035D		MD6035C●	MD6035CX
6		MD6032CX	OS6032C	OSX6032	BRK011	SMX6032	BRK012	FA208X	FA208R		EPFA208HH	MXS208	MD6035D		MD6035C●	MD6035CX
7		MD6032CX	OS6032C	OSX6032	BRK011	SMX6032	BRK012	FA368X	FA368R		EPFA368HH	MXS368	MD6035D		MD6035C●	MD6035CX
8								FA368X	FA368R		EPFA368HH	MXS368	MD6035D		MD6035C●	MD6035CX
9								814G								
10								814G								
11		MD6032CX	OS6032EC	OSX6032E	BRK015	SMX6032E	BRK016	FA208X	FA208R		EPFA208HH	MXS208	MD6035D		MD6035C●	MD6035CX
12		MD6032CX	OS6032C	OSX6032	BRK011	SMX6032	BRK012	FA208X	FA208R		EPFA208HH	MXS208	MD6035D		MD6035C●	MD6035CX
13		MD6032CX	OS6032C	OSX6032	BRK011	SMX6032	BRK012	FA368X	FA368R		EPFA368HH	MXS368	MD6035D		MD6035C●	MD6035CX
14								FA47X					MD6227D			
15		MD6032CX	OS6032C	OSX6032	BRK011	SMX6032	BRK012	FA208X	FA208R		EPFA208HH	MXS208	MD6035D		MD6035C●	MD6035CX
16		MD6032CX	OS6032C	OSX6032	BRK011	SMX6032	BRK012	FA368X	FA368R		EPFA368HH	MXS368	MD6035D		MD6035C●	MD6035CX
17		MD6032CX	OS6932C	OSX6932	BRK013	SMX6932	BRK014	FA368X	FA368R		EPFA368HH	MXS368	MD6035D		MD6035C●	MD6035CX
18								FA368X	FA368R		EPFA368HH	MXS368	MD6035D		MD6035C●	MD6035CX
19		MD6032CX	OS6032C	OSX6032	BRK011	SMX6032	BRK012	FA368X	FA368R		EPFA368HH	MXS368	MD6035D		MD6035C●	MD6035CX
20		MD6032CX	OS6932C	OSX6932	BRK013	SMX6932	BRK014	FA368X	FA368R		EPFA368HH	MXS368	MD6035D		MD6035C●	MD6035CX
21		MD6032CX	OS6932C	OSX6932	BRK013	SMX6932	BRK014	FA368X	FA368R		EPFA368HH	MXS368	MD6035D		MD6035C●	MD6035CX
22								FA368X	FA368R		EPFA368HH					
23		MD6032CX						FA368X	FA368R			MXS368	MD6035C		MD6035C●	MD6035CX
24								FA368X	FA368R			MXS368	MD6035C		MD6035C●	MD6035CX
25								FA67	FA67R				N/A			
26								FA132X	FA132R				N/A			
27								FA67X	FA67R				MD6227D			
28								FA132X	FA132R				MD6227D			
29		MD6032CX	OS6032C	OSX6032	BRK011	SMX6032	BRK012	FA208X	FA208R		EPFA208HH	MXS208	MD6371D		MD6371C	
30								FA47X					MD6227D			
31								FA126X	FA126R				N/A			
32								FA132X	FA132R				MD6227D			
33								FA67X	FA67R				N/A			
34								FA132X	FA132R				N/A			
35								FA67X	FA67R				MD6227D			
36								FA132X	FA132R				MD6227D			
37		MD6032CX	OS6032C	OSX6032	BRK011	SMX6032	BRK012	FA208X	FA208R		EPFA208HH	MXS208	MD6035D		MD6035C●	MD6035CX
38		MD6032CX	OS6932C	OSX6932	BRK013	SMX6932	BRK014	FA368X	FA368R		EPFA368HH	MXS368	MD6035D		MD6035C●	MD6035CX
39		MD6032CX	OS6932C	OSX6932	BRK013	SMX6932	BRK014	FA368X	FA368R		EPFA368HH	MXS368	MD6035D		MD6035C●	MD6035CX
40		MD6032CX	OS6932C	OSX6932	BRK013	SMX6932	BRK014	FA368X	FA368R		EPFA368HH	MXS368	MD6035D		MD6035C●	MD6035CX
41		MD6433CX		OSX6932	BRK013			FA368X	FA368R		EPFA368HH	MXS368			MD6035C●	
42		MD6032CX	OS6932C	OSX6932	BRK013	SMX6932	BRK014	FA368X	FA368R		EPFA368HH	MXS368	MD6035D		MD6035C●	MD6035CX
43		MD6032CX	OS6932C	OSX6932	BRK013	SMX6932	BRK014	FA368X	FA368R		EPFA368HH	MXS368	MD6035D		MD6035C●	MD6035CX
44		MD6032CX	OS6032EC	OSX6032E	BRK015	SMX6032E	BRK016	FA208X	FA208R		EPFA208HH	MXS208	MD6035D		MD6035C●	MD6035CX
45		MD6032CX	OS6032EC	OSX6032E	BRK015	SMX6032E	BRK016	FA208X	FA208R		EPFA208HH	MXS208	MD6035D		MD6035C●	MD6035CX
46		MD6032CX	OS6032C	OSX6032	BRK011	SMX6032	BRK012	FA208X	FA208R		EPFA208HH	MXS208	MD6035D		MD6035C●	MD6035CX
47		MD6032CX	OS6032EC	OSX6032E	BRK015	SMX6032E	BRK016	FA208X	FA208R		EPFA208HH	MXS208	MD6035D		MD6035C●	MD6035CX
48		MD6032CX	OS6032C	OSX6032	BRK011	SMX6032	BRK012	FA208X	FA208R		EPFA208HH	MXS208	MD6035D		MD6035C●	MD6035CX
49								FA213	FA213HH			FA213V	MD850			
50								FA213	FA213HH			FA213V	MD850			
51								FA213	FA213HH			FA213V	MD850			
52								FA213	FA213HH			FA213V	MD850			
53								FA213	FA213HH			FA213V	MD850			
54								FA213	FA213HH			FA213V	MD850			
55								FA208X	FA208R		EPFA208HH	MXS208	MD6371D		MD6371C	
56																

⚠ This symbol indicates a rotor made of billet steel, and should be only used with EBC FA Kevlar® Organic or Vee pads.
SAFETY NOTICE - With vehicles primarily designed for off highway use such as quads now being used on the highway, we would recommend the use of X or MXS pads for highway use and ONLY using the R and SV higher density / harder pad series for off road riding.

BRAKE APPLICATIONS

*-2 Sets Required. † For Vee disc colours add RED, BLU, GRN, GLD, ORG suffix to part number. **SAFETY WARNING:- DO NOT USE HH PADS ON REAR UNLESS ALSO USED ON FRONT TO AVOID BRAKE IMBALANCE**

FRONT: Non-Japanese Bikes



KTM



DISC PAD CHOICES - FRONT

BRAKE ROTOR CHOICES - FRONT

											Line #
EGS 400/EGS-E/SE (LC4 Enduro)	96-99	FA181X	FA181R		EPFA181HH		MXS181	MD6130D			1
EXC 400 Racing (USD)	00-03	FA181X	FA181R		EPFA181HH		MXS181	MD6032D		MD6032C	2
XC/EXC 400	04-07	FA181X	FA181R		EPFA181HH		MXS181	MD6032D		MD6032C	3
EXC/EGS 400 (USD)	00-02	FA181X	FA181R		EPFA181HH		MXS181	MD6032D		MD6032C	4
LC4-E 400 Enduro	00-01	FA181X	FA181R		EPFA181HH		MXS181	MD6130D			5
SC 400 (Supercompetition LC4)	96-99	FA181X	FA181R		EPFA181HH		MXS181	MD6032D		MD6032C	6
SX 400 (Upside down forks)	00-02	FA181X	FA181R		EPFA181HH		MXS181	MD6032D		MD6032C	7
XC-W 400	08-09	FA181X	FA181R		EPFA181HH		MXS181	MD6032D		MD6032C	8
XC-W 400	10-11	FA181X	FA181R		EPFA181HH		MXS181	MD6032D		MD6032C	9
EXC 440	94-95	FA181X	FA181R		EPFA181HH		MXS181	MD6032D		MD6032C	10
SX 440	94-95	FA181X	FA181R		EPFA181HH		MXS181	MD6032D		MD6032C	11
EXC 450	03	FA181X	FA181R		EPFA181HH		MXS181	MD6032D		MD6032C	12
EXC 450 (4T)	09	FA181X	FA181R		EPFA181HH		MXS181	MD6032D		MD6032C	13
EXC 450	10-11	FA181X	FA181R		EPFA181HH		MXS181	MD6032D		MD6032C	14
EXC-F 450/Six Days	18-19	FA181X	FA181R		EPFA181HH		MXS181	MD6032D		MD6032C	15
EXC-R 450	08	FA181X	FA181R		EPFA181HH		MXS181	MD6032D		MD6032C	16
SMR 450	04				EPFA406HH		MXS406	MD6270D		MD6270C	17
SMR 450	05-06				EPFA405HH		MXS405	MD6270D		MD6270C	18
450 SMR	07-12	FA433/4	FA433/4HH		EPFA433/4HH					MD6313C	19
SX 450	09-12		FA462R*							MD6336C*	20
SX-F 450 (USD)	03-08	FA181X	FA181R		EPFA181HH		MXS181	MD6032D		MD6032C	21
SX-F 450 (USD)	09-22	FA181X	FA181R		EPFA181HH		MXS181	MD6032D		MD6032C	22
SX-F 450 Factory Edition (Front floating rotor)	18-22	FA181X	FA181R		EPFA181HH		MXS181				23
XC 450	08-12		FA462R*							MD6336C*	24
XC/EXC 450	04-07	FA181X	FA181R		EPFA181HH		MXS181	MD6032D		MD6032C	25
XC-F 450	08-09	FA181X	FA181R		EPFA181HH		MXS181	MD6032D		MD6032C	26
XC-F 450	13-22	FA181X	FA181R		EPFA181HH		MXS181	MD6032D		MD6032C	27
XCR-W 450 (4T)	08	FA181X	FA181R		EPFA181HH		MXS181	MD6032D		MD6032C	28
XCR-W 450	13	FA181X	FA181R		EPFA181HH		MXS181	MD6032D		MD6032C	29
450 XC-W (4T) Six Days/Champion Edition	10	FA181X	FA181R		EPFA181HH		MXS181	MD6032D		MD6032C	30
XC-W 450	08-09	FA181X	FA181R		EPFA181HH		MXS181	MD6032D		MD6032C	31
XC-W 450	12-16	FA181X	FA181R		EPFA181HH		MXS181	MD6032D		MD6032C	32
XC-W 450 Champions Edition	10	FA181X	FA181R		EPFA181HH		MXS181	MD6032D		MD6032C	33
XC-W 450 Six Days	10-11	FA181X	FA181R		EPFA181HH		MXS181	MD6032D		MD6032C	34
EXC-F 500	12-22	FA181X	FA181R		EPFA181HH		MXS181	MD6032D		MD6032C	35
EXC 500 Six Days	16-21	FA181X	FA181R		EPFA181HH		MXS181	MD6032D		MD6032C	36
XCF-W 500	12-22	FA181X	FA181R		EPFA181HH		MXS181	MD6032D		MD6032C	37
LC-4 MX/EXC 500	89	FA132X	FA132R					MD6034D			38
LC-4 MX 500 Brembo Calipers	90-91	FA67X	FA67R					N/A			39
LC-4 EXC 500 Brembo Calipers	90-91	FA67X	FA67R					MD6034D			40
LC-4 MX 500 Grimeca Calipers	90-91	FA132X	FA132R					N/A			41
LC-4 EXC 500 Grimeca Calipers	90-91	FA132X	FA132R					MD6034D			42
MX/MXC/XC-GS 500	85	FA47X						N/A			43
MX 500	92-94	FA181X	FA181R		EPFA181HH		MXS181	N/A			44
MX 500	95	FA181X	FA181R		EPFA181HH		MXS181	N/A			45
SX 505	09-12		FA462R*							MD6336C*	46
SX-F 505	07-08	FA181X	FA181R		EPFA181HH		MXS181	MD6032D		MD6032C	47
XC-F 505	08-09	FA181X	FA181R		EPFA181HH		MXS181	MD6032D		MD6032C	48
EXC 520	01-03	FA181X	FA181R		EPFA181HH		MXS181	MD6032D		MD6032C	49
SX 520	01-03	FA181X	FA181R		EPFA181HH		MXS181	MD6032D		MD6032C	50
EXC 525	03	FA181X	FA181R		EPFA181HH		MXS181	MD6032D		MD6032C	51
EXC 525	04-07	FA181X	FA181R		EPFA181HH		MXS181	MD6032D		MD6032C	52
MXC 525 (Desert Racing)	03	FA181X	FA181R		EPFA181HH		MXS181	MD6032D		MD6032C	53
MXC 525 (Desert Racing)	04	FA181X	FA181R		EPFA181HH		MXS181	MD6032D		MD6032C	54
SMR 525	04				EPFA406HH		MXS406	TBC			55

MD6035C● = PLAIN UNDRILLED DISC FOR ENDURO USE. REAR FITMENTS ONLY. ORDER MD6035CE.

*-2 Sets Required. † For Vee disc colours add RED, BLU, GRN, GLD, ORG suffix to part number. **SAFETY WARNING:- DO NOT USE HH PADS ON REAR UNLESS ALSO USED ON FRONT TO AVOID BRAKE IMBALANCE**

⚡ This symbol indicates a rotor made of billet steel, and should be only used with EBC FA Kevlar® Organic or Vee pads.

SAFETY NOTICE - With vehicles primarily designed for off highway use such as quads now being used on the highway, we would recommend the use of X or MXS pads for highway use and ONLY using the R and SV higher density / harder pad series for off road riding.

FRONT: Non-Japanese Bikes Cont'd

REAR: Non-Japanese Bikes

BRAKE ROTOR CHOICES - FRONT

DISC PAD CHOICES - REAR

BRAKE ROTOR CHOICES - REAR

Line #

CC Custom Rotor	CX Extreme® /Vee-Rotor	OS Series Oversize 250/280mm Rotor Kit	OSX Series Oversize 280mm Rotor Kit	Relocating Bracket for Oversize Rotor	SMX Series Oversize 320mm Rotor Kit	Relocating Bracket for 320mm Rotor		Sintered/HH Pads/ Grooved Shoes	SV Series Severe Duty Pads	EPFA Sintered Fast Road/ Track Pads	Specialty Pads SXR/ VEE/MXS Race	Standard Rotor	Vintage Rotor / UTV Oversize Brake Kit	Contour Profile Rotor	CX Extreme® /Vee-Rotor
1							FA208X	FA208R		EPFA208HH	MXS208	MD6371D		MD6371C	
2	MD6032CX	OS6032C	OSX6032	BRK011	SMX6032	BRK012	FA208X	FA208R		EPFA208HH	MXS208	MD6035D		MD6035C	MD6035CX
3	MD6032CX	OS6032C	OSX6032	BRK011	SMX6032	BRK012	FA368X	FA368R		EPFA368HH	MXS368	MD6035D		MD6035C	MD6035CX
4	MD6032CX	OS6032C	OSX6032	BRK011	SMX6032	BRK012	FA208X	FA208R		EPFA208HH	MXS208	MD6035D		MD6035C	MD6035CX
5							FA208X	FA208R		EPFA208HH	MXS208	MD6371D			
6		OS6032EC	OSX6032E	BRK015	SMX6032E	BRK016	FA208X	FA208R		EPFA208HH	MXS208	MD6371D		MD6371C	
7	MD6032CX	OS6032C	OSX6032	BRK011	SMX6032	BRK012	FA208X	FA208R		EPFA208HH	MXS208	MD6035D		MD6035C	MD6035CX
8	MD6032CX	OS6032C	OSX6032	BRK011	SMX6032	BRK012	FA368X	FA368R		EPFA368HH	MXS368	MD6035D		MD6035C	MD6035CX
9	MD6032CX	OS6932C	OSX6932	BRK013	SMX6932	BRK014	FA368X	FA368R		EPFA368HH	MXS368	MD6035D		MD6035C	MD6035CX
10	MD6032CX	OS6032EC	OSX6032E	BRK015	SMX6032E	BRK016	FA208X	FA208R		EPFA208HH	MXS208	MD6371D		MD6371C	
11	MD6032CX	OS6032EC	OSX6032E	BRK015	SMX6032E	BRK016	FA208X	FA208R		EPFA208HH	MXS208	MD6371D		MD6371C	
12	MD6032CX	OS6032C	OSX6032	BRK011	SMX6032	BRK012	FA208X	FA208R		EPFA208HH	MXS208	MD6035D		MD6035C	MD6035CX
13	MD6032CX	OS6032C	OSX6032	BRK011	SMX6032	BRK012	FA368X	FA368R		EPFA368HH	MXS368	MD6035D		MD6035C	MD6035CX
14	MD6032CX	OS6932C	OSX6932	BRK013	SMX6932	BRK014	FA368X	FA368R		EPFA368HH	MXS368	MD6035D		MD6035C	MD6035CX
15	MD6032CX	OS6932C	OSX6932	BRK013	SMX6932	BRK014	FA368X	FA368R		EPFA368HH	MXS368	MD6035D		MD6035C	MD6035CX
16	MD6032CX	OS6032C	OSX6032	BRK011	SMX6032	BRK012	FA368X	FA368R		EPFA368HH	MXS368	MD6035D		MD6035C	MD6035CX
17							FA368X	FA368R		EPFA368HH	MXS368	MD6035D		MD6035C	MD6035CX
18							FA368X	FA368R		EPFA368HH	MXS368	MD6035D		MD6035C	MD6035CX
19							FA368X	FA368R		EPFA368HH	MXS368	MD6035D		MD6035C	MD6035CX
20							FA368X	FA368R		EPFA368HH	MXS368	MD6035D		MD6035C	MD6035CX
21	MD6032CX	OS6032C	OSX6032	BRK011	SMX6032	BRK012	FA368X	FA368R		EPFA368HH	MXS368	MD6035D		MD6035C	MD6035CX
22	MD6032CX	OS6932C	OSX6932	BRK013	SMX6932	BRK014	FA368X	FA368R		EPFA368HH	MXS368	MD6035D		MD6035C	MD6035CX
23	MD6433CX		OSX6932	BRK013			FA368X	FA368R		EPFA368HH	MXS368	MD6035D		MD6035C	MD6035CX
24								FA463R				MD6337D			
25	MD6032CX	OS6032C	OSX6032	BRK011	SMX6032	BRK012	FA368X	FA368R		EPFA368HH	MXS368	MD6035D		MD6035C	MD6035CX
26	MD6032CX	OS6032C	OSX6032	BRK011	SMX6032	BRK012	FA368X	FA368R		EPFA368HH	MXS368	MD6035D		MD6035C	MD6035CX
27	MD6032CX	OS6932C	OSX6932	BRK013	SMX6932	BRK014	FA368X	FA368R		EPFA368HH	MXS368	MD6035D		MD6035C	MD6035CX
28	MD6032CX	OS6032C	OSX6032	BRK011	SMX6032	BRK012	FA368X	FA368R		EPFA368HH	MXS368	MD6035D		MD6035C	MD6035CX
29	MD6032CX	OS6032C	OSX6032	BRK011	SMX6032	BRK012	FA368X	FA368R		EPFA368HH	MXS368	MD6035D		MD6035C	MD6035CX
30	MD6032CX	OS6032C	OSX6032	BRK011	SMX6032	BRK012	FA368X	FA368R		EPFA368HH	MXS368	MD6035D		MD6035C	MD6035CX
31	MD6032CX	OS6032C	OSX6032	BRK011	SMX6032	BRK012	FA368X	FA368R		EPFA368HH	MXS368	MD6035D		MD6035C	MD6035CX
32	MD6032CX	OS6932C	OSX6932	BRK013	SMX6932	BRK014	FA368X	FA368R		EPFA368HH	MXS368	MD6035D		MD6035C	MD6035CX
33	MD6032CX	OS6032C	OSX6032	BRK011	SMX6032	BRK012	FA368X	FA368R		EPFA368HH	MXS368	MD6035D		MD6035C	MD6035CX
34	MD6032CX	OS6932C	OSX6932	BRK013	SMX6932	BRK014	FA368X	FA368R		EPFA368HH	MXS368	MD6035D		MD6035C	MD6035CX
35	MD6032CX	OS6932C	OSX6932	BRK013	SMX6932	BRK014	FA368X	FA368R		EPFA368HH	MXS368	MD6035D		MD6035C	MD6035CX
36	MD6032CX	OS6932C	OSX6932	BRK013	SMX6932	BRK014	FA368X	FA368R		EPFA368HH	MXS368	MD6035D		MD6035C	MD6035CX
37	MD6032CX	OS6932C	OSX6932	BRK013	SMX6932	BRK014	FA368X	FA368R		EPFA368HH	MXS368	MD6035D		MD6035C	MD6035CX
38							FA132X	FA132R				N/A			
39							FA67X	FA67R				MD6035D		MD6035C	MD6035CX
40							FA67X	FA67R				MD6035D		MD6035C	MD6035CX
41							FA132X	FA132R				MD6035D		MD6035C	MD6035CX
42							FA132X	FA132R				MD6035D		MD6035C	MD6035CX
43								814G							
44							FA67X	FA67R				N/A			
45							FA208X	FA208R		EPFA208HH	MXS208	N/A			
46								FA463R				MD6337D			
47	MD6032CX	OS6032C	OSX6032	BRK011	SMX6032	BRK012	FA368X	FA368R		EPFA368HH	MXS368	MD6035D		MD6035C	MD6035CX
48	MD6032CX	OS6032C	OSX6032	BRK011	SMX6032	BRK012	FA368X	FA368R		EPFA368HH	MXS368	MD6035D		MD6035C	MD6035CX
49	MD6032CX	OS6032C	OSX6032	BRK011	SMX6032	BRK012	FA208X	FA208R		EPFA208HH	MXS208	MD6035D		MD6035C	MD6035CX
50	MD6032CX	OS6032C	OSX6032	BRK011	SMX6032	BRK012	FA208X	FA208R		EPFA208HH	MXS208	MD6035D		MD6035C	MD6035CX
51	MD6032CX	OS6032C	OSX6032	BRK011	SMX6032	BRK012	FA208X	FA208R		EPFA208HH	MXS208	MD6035D		MD6035C	MD6035CX
52	MD6032CX	OS6032C	OSX6032	BRK011	SMX6032	BRK012	FA368X	FA368R		EPFA368HH	MXS368	MD6035D		MD6035C	MD6035CX
53	MD6032CX	OS6032C	OSX6032	BRK011	SMX6032	BRK012	FA208X	FA208R		EPFA208HH	MXS208	MD6035D		MD6035C	MD6035CX
54	MD6032CX	OS6032C	OSX6032	BRK011	SMX6032	BRK012	FA208X	FA208R		EPFA208HH	MXS208	MD6035D		MD6035C	MD6035CX
55							FA368X	FA368R		EPFA368HH	MXS368	TBC			
56															

REAR

BRAKE APPLICATIONS

This symbol indicates a rotor made of billet steel, and should be only used with EBC FA Kevlar® Organic or Vee pads.

SAFETY NOTICE - With vehicles primarily designed for off highway use such as quads now being used on the highway, we would recommend the use of X or MXS pads for highway use and ONLY using the R and SV higher density / harder pad series for off road riding.

*-2 Sets Required. † For Vee disc colours add RED, BLU, GRN, GLD, ORG suffix to part number. SAFETY WARNING:- DO NOT USE HH PADS ON REAR UNLESS ALSO USED ON FRONT TO AVOID BRAKE IMBALANCE

FRONT: Non-Japanese Bikes



KTM



DISC PAD CHOICES - FRONT

BRAKE ROTOR CHOICES - FRONT

												Line #
SMR 525	05				EPFA405HH		MXS405	N/A				1
SX 525	03-06	FA181X	FA181R		EPFA181HH		MXS181	MD6032D			MD6032C	2
XC 525	08-12		FA462R*								MD6336C*	3
XC 525 Desert Racing	07	FA181X	FA181R		EPFA181HH		MXS181	MD6032D			MD6032C	4
EXC-R 530	08	FA181X	FA181R		EPFA181HH		MXS181	MD6032D			MD6032C	5
XC 530 (4T)	09-10	FA181X	FA181R		EPFA181HH		MXS181	MD6032D			MD6032C	6
EXC 530 (4T)	11	FA181X	FA181R		EPFA181HH		MXS181	MD6032D			MD6032C	7
XCR-W 530	08	FA181X	FA181R		EPFA181HH		MXS181	MD6032D			MD6032C	8
XC-W 530	08-09	FA181X	FA181R		EPFA181HH		MXS181	MD6032D			MD6032C	9
XC-W 530 (4T) Six Days	10	FA181X	FA181R		EPFA181HH		MXS181	MD6032D			MD6032C	10
MXC 550	96	FA181X	FA181R		EPFA181HH		MXS181	MD6032D			MD6032C	11
SMR 560	06				EPFA405HH		MXS405	MD6270D			MD6270C	12
560 SMR	07	FA433/4	FA433/4HH		EPFA433/4HH						MD6313C	13
LC4 MX/EXC 600	89	FA132X	FA132R					MD6034D				14
LC4 MX 600 Brembo Calipers	90-91	FA67X	FA67R					N/A				15
LC4 EXC 600 Brembo Calipers	90-91	FA67X	FA67R					MD6034D				16
LC4 MX 600 Grimeca Calipers	90-91	FA132X	FA132R					N/A				17
LC4 EXC 600 Grimeca Calipers	90-91	FA132X	FA132R					MD6034D				18
LC4 EXC 600	92-93	FA132X	FA132R					MD6034D				19
Duke 620 LC4	94-98	FA95	FA95HH					MD6199D			MD6199C	20
EGS 620 Enduro/EGS-E/LSE	96-99	FA181X	FA181R		EPFA181HH		MXS181	MD6130D			MD6130CF	21
EGS-E 620 Adventure/Rallye	99	FA181X	FA181R		EPFA181HH		MXS181	MD6032D			MD6032C	22
LC4 620 SC Supermoto	00	FA181X	FA181R		EPFA181HH		MXS181	MD6199D			MD6199C	23
SC 620 Supercompetition	96-00	FA181X	FA181R		EPFA181HH		MXS181	MD6032D			MD6032C	24
SX 620/EXC/EGS	94	FA181X	FA181R		EPFA181HH		MXS181	MD6032D			MD6032C	25
SX EXC/EGS 620	95	FA181X	FA181R		EPFA181HH		MXS181	MD6032D			MD6032C	26
SX 620	96-99	FA181X	FA181R		EPFA181HH		MXS181	MD6032D			MD6032C	27
LC4 625 SC Supermoto	02	FA181X	FA181R		EPFA181HH		MXS181	MD6199D			MD6199C	28
LC4 625 SC Supercompetition	02	FA181X	FA181R		EPFA181HH		MXS181	MD6032D			MD6032C	29
SMC 625	05-06	FA244	FA244HH		EPFA244HH						MD6199C	30
SXC 625	03-04	FA181X	FA181R		EPFA181HH		MXS181	MD6032D			MD6032C	31
SXC 625	05-06	FA181X	FA181R		EPFA181HH		MXS181	MD6032D			MD6032C	32
640 Duke (Jet Black/Yellow/Adrenalin Orange)	03-06	FA244	FA244HH		EPFA244HH			MD6199D			MD6199C	33
Duke II 640 Orpheus/Titan/Lime	01-	FA244	FA244HH		EPFA244HH			MD6199D			MD6199C	34
Duke II 640 Black/Orange	02	FA244	FA244HH		EPFA244HH			MD6199D			MD6199C	35
LC4-E 640 Enduro	00-04	FA181X	FA181R		EPFA181HH		MXS181	MD6130D			MD6130CF	36
LC4-E 640 Supermoto	00-04	FA181X	FA181R		EPFA181HH		MXS181	MD6199D			MD6199C	37
LC-4 640 Adventure R	99-02	FA181X	FA181R		EPFA181HH		MXS181	MD6130D			MD6130CF	38
LC-4 Adventure	03	FA181X	FA181R		EPFA181HH		MXS181	MD6130D			MD6130CF	39
LC-4 640 Adventure R	04	FA209/2*	FA209/2HH*		EPFA209/2HH*			MD6266D	MD6266D			40
LC-4 640 Adventure	05-07	FA209/2*	FA209/2HH*		EPFA209/2HH*			MD6266D	MD6266D			41
640 Duke (Jet Black/Yellow/Adrenalin Orange)	03-06	FA244	FA244HH		EPFA244HH			MD6199D			MD6199C	42
SMC 660 Supermoto	03-04	FA95	FA95HH		EPFA95HH			TBC				43
SMC 640 LC4	05-06	FA244	FA244HH		EPFA244HH			TBC				44
SMC 660	05-06	FA244	FA244HH		EPFA244HH			TBC				45
690 Duke (4 Separate Pad Caliper Type)	08-11		FA322/4HH		EPFA322/4HH			MD614X			MD614XC	46
690 Duke (2 Pad Type Caliper)	12-19	FA244	FA244HH		EPFA244HH			MD856X			MD856XC	47
690 Duke R	10-11		FA322/4HH		EPFA322/4HH			MD614X			MD614XC	48
690 Rally Factory Rep	07-08	FA209/2	FA209/2HH					TBC				49
690 Enduro	08	FA181X	FA181R		EPFA181HH		MXS181	MD6130D			MD6130CF	50
690 Enduro R	10-16	FA209/2	FA209/2HH								MD6299C	51
690 Enduro R ABS	09-21		FA209/2HH		EPFA209/2HH			MD844X			MD844XC	52
690 SMC	08-11		FA322/4HH		EPFA322/4HH			MD6199D			MD6199C	53
690 SMC R ABS	14-21		FA322/4HH		EPFA322/4HH			MD6414D			MD6414C	54
690 SMR	07-09		FA322/4HH		EPFA322/4HH			MD614X			MD614XC	55

MD6035C ● = PLAIN UNDRILLED DISC FOR ENDURO USE. REAR FITMENTS ONLY. ORDER MD6035CE.

*-2 Sets Required. † For Vee disc colours add RED, BLU, GRN, GLD, ORG suffix to part number. **SAFETY WARNING:- DO NOT USE HH PADS ON REAR UNLESS ALSO USED ON FRONT TO AVOID BRAKE IMBALANCE**

⚠ This symbol indicates a rotor made of billet steel, and should be only used with EBC FA Kevlar® Organic or Vee pads.

SAFETY NOTICE - With vehicles primarily designed for off highway use such as quads now being used on the highway, we would recommend the use of X or MXS pads for highway use and ONLY using the R and SV higher density / harder pad series for off road riding.

FRONT: Non-Japanese Bikes Cont'd

REAR: Non-Japanese Bikes

Line #	BRAKE ROTOR CHOICES - FRONT						DISC PAD CHOICES - REAR					BRAKE ROTOR CHOICES - REAR				
	CC Custom Rotor	CX Extreme® /Vee-Rotor	OS Series Oversize 250/280mm Rotor Kit	OSX Series Oversize 280mm Rotor Kit	Relocating Bracket for Oversize Rotor	SMX Series Oversize 320mm Rotor Kit	Relocating Bracket for 320mm Rotor		Sintered/HH Pads/ Grooved Shoes	SV Series Severe Duty Pads	EPFA Sintered Fast Road/ Track Pads	Specialty Pads SXR/ VEE/MXS Race	Standard Rotor	Vintage Rotor / UTV Oversize Brake Kit	Contour Profile Rotor	CX Extreme® /Vee-Rotor
1																
2		MD6032CX	OS6032C	OSX6032	BRK011	SMX6032	BRK012	FA368X	FA368R		EPFA368HH	MXS368	MD6035D		MD6035C	MD6035CX
3									FA463R				MD6337D			
4		MD6032CX	OS6032C	OSX6032	BRK011	SMX6032	BRK012	FA368X	FA368R		EPFA368HH	MXS368	MD6035D		MD6035C	MD6035CX
5		MD6032CX	OS6032C	OSX6032	BRK011	SMX6032	BRK012	FA368X	FA368R		EPFA368HH	MXS368	MD6035D		MD6035C	MD6035CX
6		MD6032CX	OS6032C	OSX6032	BRK011	SMX6032	BRK012	FA368X	FA368R		EPFA368HH	MXS368	MD6035D		MD6035C	MD6035CX
7		MD6032CX	OS6932C	OSX6932	BRK013	SMX6932	BRK014	FA368X	FA368R		EPFA368HH	MXS368	MD6035D		MD6035C	MD6035CX
8		MD6032CX	OS6032C	OSX6032	BRK011	SMX6032	BRK012	FA368X	FA368R		EPFA368HH	MXS368	MD6035D		MD6035C	MD6035CX
9		MD6032CX	OS6932C	OSX6932	BRK013	SMX6932	BRK014	FA368X	FA368R		EPFA368HH	MXS368	MD6035D		MD6035C	MD6035CX
10		MD6032CX	OS6032C	OSX6032	BRK011	SMX6032	BRK012	FA368X	FA368R		EPFA368HH	MXS368	MD6035D		MD6035C	MD6035CX
11		MD6032CX	OS6032C	OSX6032E	BRK015	SMX6032E	BRK016	FA208X	FA208R		EPFA208HH	MXS208	MD6035D		MD6035C	MD6035CX
12								FA368X	FA368R		EPFA368HH	MXS368	MD6035D		MD6035C	
13								FA368X	FA368R		EPFA368HH	MXS368	MD6035D		MD6035C	
14								FA132X	FA132R				N/A			
15								FA67X	FA67R				MD6371D			
16								FA67X	FA67R				MD6371D			
17								FA132X	FA132R				MD6371D			
18								FA132X	FA132R				MD6371D			
19								FA67X	FA67R				MD6371D			
20								FA208X	FA208R		EPFA208HH	MXS208	MD6371D		MD6371C	
21								FA208X	FA208R		EPFA208HH	MXS208	MD6371D		MD6371C	
22			OS6032EC	OSX6032E	BRK015	SMX6032E	BRK016	FA208X	FA208R		EPFA208HH	MXS208	MD6371D		MD6371C	
23								FA208X	FA208R		EPFA208HH	MXS208	MD6371D		MD6371C	
24			OS6032EC	OSX6032E	BRK015	SMX6032E	BRK016	FA208X	FA208R		EPFA208HH	MXS208	MD6371D		MD6371C	
25			OS6032EC	OSX6032E	BRK015	SMX6032E	BRK016	FA208X	FA208R		EPFA208HH	MXS208	MD6371D		MD6371C	
26			OS6032EC	OSX6032E	BRK015	SMX6032E	BRK016	FA208X	FA208R		EPFA208HH	MXS208	MD6371D		MD6371C	
27			OS6032EC	OSX6032E	BRK015	SMX6032E	BRK016	FA208X	FA208R		EPFA208HH	MXS208	MD6371D		MD6371C	
28								FA208X	FA208R		EPFA208HH	MXS208	MD6371D		MD6371C	
29			OS6032C	OSX6032	BRK011	SMX6032	BRK012	FA208X	FA208R		EPFA208HH	MXS208	MD6371D		MD6371C	
30								FA208X	FA208R		EPFA208HH	MXS208	MD6035D		MD6035C	
31		MD6032CX	OS6032C	OSX6032	BRK011	SMX6032	BRK012	FA208X	FA208R		EPFA208HH	MXS208	MD6035D		MD6035C	MD6035CX
32		MD6032CX	OS6032C	OSX6032	BRK011	SMX6032	BRK012	FA368X	FA368R		EPFA368HH	MXS368	MD6035D		MD6035C	MD6035CX
33								FA213	FA213HH			FA213V	MD6035D		MD6035C	
34								FA208X	FA208R		EPFA208HH	MXS208	MD6371D		MD6371C	
35								FA208X	FA208R		EPFA208HH	MXS208	MD6371D		MD6371C	
36								FA208X	FA208R		EPFA208HH	MXS208	MD6371D		MD6371C	
37								FA208X	FA208R		EPFA208HH	MXS208	MD6371D		MD6371C	
38								FA208X	FA208R		EPFA208HH	MXS208	MD6371D		MD6371C	
39								FA208X	FA208R		EPFA208HH	MXS208	MD6371D		MD6371C	
40								FA208X	FA208R		EPFA208HH	MXS208	MD6371D		MD6371C	
41								FA208X	FA208R		EPFA208HH	MXS208	MD6371D		MD6371C	
42								FA208X	FA208R		EPFA208HH	MXS208	MD6371D		MD6371C	
43								FA208X	FA208R		EPFA208HH	MXS208	MD6371D		MD6371C	
44								FA208X	FA208R		EPFA208HH	MXS208	MD6371D		MD6371C	
45								FA208X	FA208R		EPFA208HH	MXS208	MD6371D		MD6371C	
46		VR614BLK						FA213	FA213HH			FA213V	MD681	MD681C	VR681	
47								FA213	FA213HH			FA213V	MD857	MD857C		
48		VR614BLK						FA213	FA213HH			FA213V	MD681	MD681C	VR681	
49								FA208X	FA208R		EPFA208HH	MXS208	MD6269D			
50								FA208X	FA208R		EPFA208HH	MXS208	MD6035D		MD6035C	
51								FA208X	FA208R		EPFA208HH	MXS208			MD6269C	
52								FA208X	FA208R		EPFA208HH	MXS208			MD6415D	
53								FA208X	FA208R		EPFA208HH	MXS208			MD6415C	
54								FA208X	FA208R		EPFA208HH	MXS208			MD6298D	
55								FA208X	FA208R		EPFA208HH	MXS208			MD6415D	
56								FA208X	FA208R		EPFA208HH	MXS208			MD681C	VR681

BRAKE APPLICATIONS

⚠ This symbol indicates a rotor made of billet steel, and should be only used with EBC FA Kevlar® Organic or Vee pads.
SAFETY NOTICE - With vehicles primarily designed for off highway use such as quads now being used on the highway, we would recommend the use of X or MXS pads for highway use and ONLY using the R and SV higher density / harder pad series for off road riding.

*-2 Sets Required. † For Vee disc colours add RED, BLU, GRN, GLD, ORG suffix to part number. **SAFETY WARNING:- DO NOT USE HH PADS ON REAR UNLESS ALSO USED ON FRONT TO AVOID BRAKE IMBALANCE**

FRONT: Non-Japanese Bikes



KTM



DISC PAD CHOICES - FRONT

BRAKE ROTOR CHOICES - FRONT

												Line #	
690 Supermoto	02-08		FA244	FA244HH		EPFA244HH			TBC			1	
790 Duke	18-21		FA244	FA244HH		EPFA244HH						2	
790 Adventure/R	18-21		FA244	FA244HH		EPFA244HH						3	
790 Adventure R Rally	21		FA244	FA244HH		EPFA244HH						4	
890 Duke R	21		FA244	FA244HH		EPFA244HH						5	
890 Adventure	21		FA244	FA244HH		EPFA244HH						6	
890 Adventure R	21		FA244	FA244HH		EPFA244HH						7	
890 Adventure R Rally	21		FA244	FA244HH		EPFA244HH						8	
950 Adventure/S	04-06		FA209/2*	FA209/2HH*				MD6266D	MD6266D			9	
950 R Super Enduro	07-08		FA209/2	FA209/2HH				MD6299D				10	
950 Supermoto	05-07			FA322/4HH*		EPFA322/4HH*		MD680	MD680		MD680C*	11	
950 Supermoto R	07-08			FA322/4HH*		EPFA322/4HH*		MD680	MD680		MD680C*	12	
990 Adventure (ABS Model)	07-12	Left	FA209/2	FA209/2HH				MD844X			MD844XC	13	
		Right	FA209/2	FA209/2HH					MD848X		MD848XC	14	
990 Adventure Baja Edition (ABS)	13-14	Left	FA209/2	FA209/2HH				MD844X			MD844XC	15	
		Right	FA209/2	FA209/2HH					MD848X		MD848XC	16	
990 Adventure R (Non ABS)	09-12		FA209/2*	FA209/2HH*				MD6299D	MD6299D		MD6299C*	17	
990 Adventure S (Non ABS)	06-08		FA209/2*	FA209/2HH*				MD844X	MD848X		MD844/848XC	18	
990 SM-T	10-14			FA322/4HH*				MD680	MD680		MD680C*	19	
990 SM-R	09-11			FA447HH*		EPFA447HH*		MD680	MD680		MD680C*	20	
990 Superduke	05-11			FA322/4HH*		EPFA322/4HH*		MD633X	MD633X		MD633XC*	21	
990 Superduke R	09-11			FA322/4HH*		EPFA322/4HH*		MD633X	MD633X		MD633XC*	22	
1090 Adventure L and R	18-19		FA244*	FA244HH*		EPFA244HH*		MD6424X	MD6424X		MD6424X*	23	
1190 Adventure	13-16		FA244*	FA244HH*		EPFA244HH*		MD6424X	MD6424X		MD6424X*	24	
1190 Adventure R	13-16		FA244*	FA244HH*		EPFA244HH*		MD6424X	MD6424X		MD6424X*	25	
1190 RC8	08-12			FA447HH*		EPFA447HH*		MD633X	MD633X		MD633XC*	26	
1190 RC8 R	09-14			FA447HH*		EPFA447HH*		MD633X	MD633X		MD633XC*	27	
1290 Super Adventure S and R	15-21		FA244*	FA244HH*		EPFA244HH*		MD6424D	MD6424D		MD6242C	28	
1290 Superduke R	14-21			FA447HH*		EPFA447HH*		MD2112XBLK†	MD2112XBLK†			29	
1290 Super Duke RR	21-22			FA447HH*		EPFA447HH*	GPFAX447HH	TBC	TBC			30	
1290 Superduke GT	19-21			FA447HH*		EPFA447HH*						31	
												32	
												33	
KYMCO (STREET)													
Agility 50 (4T)	05-15		SFA228	SFA228HH				MD971D				34	
Agility 50 (4T)	20-21		SFA228	SFA228HH				MD971D				35	
Campagno 50i (4T/SE50BG)	14		SFA228	SFA228HH				TBC				36	
Cobra Racer 50 (SF10AG)	00-04		SFA233					MD971D				37	
Cobra Cross/Racer 50 (SF10AF)	05-06		SFA233					MD971D				38	
Filly 50	02-05		SFA228	SFA228HH				TBC				39	
Like 50 (2T)	09-14		SFA305	SFA305HH				TBC				40	
Like 50 LX (2T)	12-14		SFA305	SFA305HH				TBC				41	
Like 50i (4T)	20		SFA305	SFA305HH								42	
Like M 50 (4T)	20		303									43	
People 50 (2T)	02-12		SFA305	SFA305HH				MD989D				44	
People S50 (4T)	05-09		SFA305	SFA305HH				MD989D				45	
Sento 50	09-12		SFA228	SFA228HH				TBC				46	
Sting 50 (2T)	07-11		SFA228	SFA228HH				MD971D				47	
Super 8 (50cc) (2T)	07-14		SFA305	SFA305HH				TBC				48	
Super 8 50X (50cc) 4T	20		SFA305	SFA305HH								49	
Super 9 (2T/AC)	02-09		SFA197	SFA197HH					MD981D			50	
Vitality 50 (4T)	05-08		SFA228	SFA228HH				MD971D				51	
Yup 50	02-06		SFA228	SFA228HH				MD971D				52	
ZX 50 Super Fever	02-05		SFA233					MD971D				53	
Campagno 110i (4T/SE22BD)	13-15		SFA228	SFA228HH				TBC				54	
Agility 125	06-15		SFA228	SFA228HH				MD971D				55	
Agility 125 (4T/12inch wheels)	19-21		SFA228	SFA228HH				MD971D				56	

APPLICATIONS

BRAKE

⚡ This symbol indicates a rotor made of billet steel, and should be only used with EBC FA Kevlar® Organic or Vee pads.

SAFETY NOTICE - With vehicles primarily designed for off highway use such as quads now being used on the highway, we would recommend the use of X or MXS pads for highway use and ONLY using the R and SV higher density / harder pad series for off road riding.

*-2 Sets Required. † For Vee disc colours add RED, BLU, GRN, GLD, ORG suffix to part number. SAFETY WARNING:- DO NOT USE HH PADS ON REAR UNLESS ALSO USED ON FRONT TO AVOID BRAKE IMBALANCE

FRONT: Non-Japanese Bikes Cont'd

REAR: Non-Japanese Bikes

Line #	BRAKE ROTOR CHOICES - FRONT						DISC PAD CHOICES - REAR					BRAKE ROTOR CHOICES - REAR				
	CC Custom Rotor	CX Extreme® /Vee-Rotor	OS Series Oversize 250/280mm Rotor Kit	OSX Series Oversize 280mm Rotor Kit	Relocating Bracket for Oversize Rotor	SMX Series Oversize 320mm Rotor Kit	Relocating Bracket for 320mm Rotor		Sintered/HH Pads/ Grooved Shoes	SV Series Severe Duty Pads	EPFA Sintered Fast Road/ Track Pads	Specialty Pads SXR/ VEE/MXS Race	Standard Rotor	Vintage Rotor / UTV Oversize Brake Kit	Contour Profile Rotor	CX Extreme® /Vee-Rotor
1								FA208X	FA208R		EPFA208HH	MXS208	MD681			
2								FA208X	FA208R		EPFA208HH	MXS208				
3								FA208X	FA208R		EPFA208HH	MXS208				
4								FA181X	FA181R		EPFA181HH	MXS181				
5								FA181X	FA181R		EPFA181HH	MXS181				
6								FA181X	FA181R		EPFA181HH	MXS181				
7								FA181X	FA181R		EPFA181HH	MXS181				
8								FA181X	FA181R		EPFA181HH	MXS181				
9								FA181X	FA181HH		EPFA181HH		MD6269D			
10								FA181X	FA181HH		EPFA181HH		MD6298D			
11								FA181X	FA181HH		EPFA181HH		MD681		MD681C	
12								FA181X	FA181HH		EPFA181HH		MD681		MD681C	
13								FA181X	FA181HH				MD6298D			
14								FA181X	FA181HH				MD6298D			
15																
16								FA181X	FA181R				MD6298D			
17								FA181X	FA181HH				MD681		MD681C	
18								FA181X	FA181HH		EPFA181HH		MD681		MD681C	
19								FA181X	FA181HH			FA213V	MD681		MD681C	
20								FA213	FA213HH			FA213V	MD681		MD681C	
21								FA213	FA213HH			FA213V	MD681		MD681C	
22								FA181X	FA181HH		EPFA181HH		MD6424D		MD6424C	
23								FA181X	FA181HH		EPFA181HH		MD6424D		MD6424C	
24								FA181X	FA181HH		EPFA181HH		MD6424D		MD6424C	
25								FA266	FA266HH			FA266V	MD812			
26								FA266	FA266HH			FA266V	MD812			
27								FA181X	FA181HH		EPFA181HH		MD6423D		MD6423C	
28								FA266	FA266HH			FA266V	MD6423D		MD6423C	
29								FA266	FA266HH		EPFA266HH		MD6423D		MD6423C	
30								FA266	FA266HH			FA266V	MD6423D		MD6423C	
31																
32																
33																
34								303								
35								303								
36								302								
37								303								
38								303								
39								303								
40								303								
41								303								
42								303								
43								303								
44								818								
45								818								
46								303								
47								303								
48								820								
49								820								
50								SFA305	SFA305HH				MD971D			
51								303								
52								303								
53								303								
54								302								
55								303								
56								303								

BRAKE APPLICATIONS
 This symbol indicates a rotor made of billet steel, and should be only used with EBC FA Kevlar® Organic or Vee pads. SAFETY NOTICE - With vehicles primarily designed for off highway use such as quads now being used on the highway, we would recommend the use of X or MXS pads for highway use and ONLY using the R and SV higher density / harder pad series for off road riding.

*-2 Sets Required. † For Vee disc colours add RED, BLU, GRN, GLD, ORG suffix to part number. **SAFETY WARNING:- DO NOT USE HH PADS ON REAR UNLESS ALSO USED ON FRONT TO AVOID BRAKE IMBALANCE**

FRONT: Non-Japanese Bikes



KYMCO (STREET)



DISC PAD CHOICES - FRONT

BRAKE ROTOR CHOICES - FRONT

Model	Year	Front	DISC PAD CHOICES - FRONT					BRAKE ROTOR CHOICES - FRONT				Line #	
			Sintered/HH Pads/Grooved Shoes	SV Series Severe Duty Pads	EPFA Sintered Fast Road/Track Pads	GPFX Sintered RACE ONLY Pads	Specialty Pads SXR/VEE/MXS Race	Standard Rotor Left	Standard Rotor Right	Vintage Rotor / UTV Oversize Brake Kit	Contour Profile Rotor		
Like s 125i	18-19		SFA603	SFA603HH									1
K-Pipe 125	20-21		FA197	FA197HH									2
People S 125	05-09		SFA305	SFA305HH					MD989D				3
Bet & Win 150/250	02-08		SFA197	SFA197HH						MD973D			4
Like 150 i ABS	20		SFA305	SFA305HH									5
Like 150 i ABS Noodoe	20		SFA305	SFA305HH									6
People 150	07-12		SFA305	SFA305HH					MD989D				7
Quannon 150 (RK30E)	09-12		FA197	FA197HH						N/A			8
Super 8 (150cc)	07-14		SFA305	SFA305HH					TBC				9
Spade 150i	20-21		FA197	FA197HH									10
Super 8 150 X	19-21		SFA305	SFA305HH									11
Downtown 200i	11-12		SFA142	SFA142HH				VR9128					12
Like 200i	10-20		SFA305	SFA305HH					TBC				13
People GT 200i	11-12		SFA324	SFA324HH						TBC			14
People S 200	05-10		SFA305	SFA305HH						MD989D			15
Yager GT 200i	09-12		SFA197	SFA197HH						TBC			16
Grandvista 250	05-10		SFA197	SFA197HH						MD973D			17
People 250	03-07		SFA197	SFA197HH						MD9100D			18
People S 250	07-11	Left	SFA228	SFA228HH					TBC				19
		Right	SFA197	SFA197HH						TBC			20
Venox 250	03-08		FA196	FA196HH					MD1101				21
XCiting 250 (All models)	05-11		SFA142*	SFA142HH*					N/A	N/A			22
Downtown 300i	10-15		SFA142	SFA142HH				VR9128				MD9128C	23
Downtown 350i	18-19		SFA324	SFA324HH									24
X Town 300i ABS	18-20		SFA324	SFA324HH									25
People GT 300i	11-15		SFA324	SFA324HH						TBC			26
XCiting 500 (All models)	04-14		SFA142*	SFA142HH*					TBC	TBC			27
AK550	17-20		FA630	FA630HH*					MD9174D	MD9174D			28
My Road 700 i	11-15		SFA432*	SFA432HH*					TBC	TBC			29
													30
													31
													32
													33
													34
													35
													36
													37
													38
													39
													40
													41
													42
													43
													44
													45
													46
													47
													48
													49
													50
													51
													52
													53
													54
													55
													56

APPLIATIONS

BRAKE

⚡ This symbol indicates a rotor made of billet steel, and should be only used with EBC FA Kevlar® Organic or Vee pads.

SAFETY NOTICE - With vehicles primarily designed for off highway use such as quads now being used on the highway, we would recommend the use of X or MXS pads for highway use and ONLY using the R and SV higher density / harder pad series for off road riding.

KYMCO (ATV)

MXer 50 Mongoose (2T)	04-08		346*	346G*									32
Mongoose 50 (4T) (Rear disc model)	08-09		346*	346G*									33
Mongoose 70 (4T)	07-16		346*	346G*									34
Mongoose 70 S (4T)	20-21		346*	346G*									35
Mongoose 90	02-16		346*	346G*									36
Mongoose 90 R (Reverse Gear)	02-14		346*	346G*									37
Mongoose 90 S	20-21		346*	346*									38
MXer 150	03-05		303*	303G*									39
MXU 150	05-14		303*	303G*									40
MXU 150 X	20-21		303*	303G*									41
KXR 250 Mongoose	04-09		FA377X*	FA377R*					MD6267D	MD6267D			42
MXU 250	04-10		FA377X*	FA377R*					MD6267D	MD6267D			43
Mongoose 270 Inc Euro	20-21		FA377X*	FA377R*									44
MXU 270	16-20		FA377X*	FA377R*									45
MXU 270 i Euro	20-21		FA377X*	FA377R*									46
MXU 270	16		FA377X*	FA377R*					TBC	TBC			47
Mongoose 300	06-16		FA377X*	FA377R*					MD6267D	MD6267D			48
MXU 300	05-21		FA377X*	FA377R*					MD6267D	MD6267D			49
Maxxer 375 4 x 4 IRS	10-12		FA395X*	FA395R*	FA395SV*				MD6173D	MD6173D	UTVX6173*		50
MXU 375 4 x 4 IRS	08-12		FA395X*	FA395R*	FA395SV*				MD6173D	MD6173D	UTVX6173*		51
Maxxer 450 4 x 4 IRS	11-16		FA395X*	FA395R*	FA395SV*				MD6173D	MD6173D	UTVX6173*		52
MXU 450 4 x 4 IRS/ MXU 450 4 x 4 IRS LE	11-14		FA395X*	FA395R*	FA395SV*				MD6173D	MD6173D	UTVX6173*		53
MXU 450 i	20-21		FA395X*	FA395R*					MD6173D	MD6173D	UTVX6173*		54
MXU 450 i LE	20-21		FA395X*	FA395R*					MD6173D	MD6173D	UTVX6173*		55
MXU 450 i LE Prime	20-21		FA395X	FA395R*					MD6173D	MD6173D	UTVX6173*		56

*-2 Sets Required. † For Vee disc colours add RED, BLU, GRN, GLD, ORG suffix to part number. SAFETY WARNING:- DO NOT USE HH PADS ON REAR UNLESS ALSO USED ON FRONT TO AVOID BRAKE IMBALANCE

FRONT: Non-Japanese Bikes Cont'd

REAR: Non-Japanese Bikes

Line #	BRAKE ROTOR CHOICES - FRONT						DISC PAD CHOICES - REAR					BRAKE ROTOR CHOICES - REAR				
	CC Custom Rotor	CX Extreme® /Vee-Rotor	OS Series Oversize 250/280mm Rotor Kit	OSX Series Oversize 280mm Rotor Kit	Relocating Bracket for Oversize Rotor	SMX Series Oversize 320mm Rotor Kit	Relocating Bracket for 320mm Rotor		Sintered/HH Pads/ Grooved Shoes	SV Series Severe Duty Pads	EPFA Sintered Fast Road/ Track Pads	Specialty Pads SXR/ VEE/MXS Race	Standard Rotor	Vintage Rotor / UTV Oversize Brake Kit	Contour Profile Rotor	CX Extreme® /Vee-Rotor
1								SFA498	SFA498HH							
2								340								
3								818								
4								SFA197	SFA197HH				MD974D			
5								SFA197	SFA197HH							
6								SFA197	SFA197HH							
7								818								
8								FA197	FA197HH				N/A			
9								818								
10								340								
11								818								
12								SFA498	SFA498HH				MD9129D			
13								SFA197	SFA197HH				TBC			
14								SFA607	SFA607HH				TBC			
15								818								
16								SFA197	SFA197HH				MD974D			
17								SFA356	SFA356HH				MD974D			
18								SFA197	SFA197HH				MD9100D			
19								SFA607	SFA607HH				TBC			
20																
21								321								
22								SFA607	SFA607HH				TBC			
23								SFA498	SFA498HH				MD9129D			
24								SFA498	SFA498HH							
25								SFA498	SFA498HH							
26								SFA607	SFA607HH				TBC			
27								SFA608	SFA608HH				TBC			
28								SFA719	SFA719HH		SFAC719		MD9173D			
29								SFA607	SFA607HH				TBC			
30																
31																
32								307	307G							
33								FA305X	FA305R				MD6267D			
34								FA305X	FA305R				MD6267D			
35								FA305X	FA305R				MD6267D			
36								FA305X	FA305R				MD6267D			
37								FA305X	FA305R				MD6267D			
38								FA305X	FA305R				MD6267D			
39								FA305X	FA305R				MD6267D			
40								FA305X	FA305R				MD6267D			
41								FA305X	FA305R				MD6267D			
42								FA355/4X	FA355/4R				MD6268D			
43								FA355/4X	FA355/4R				MD6268D			
44								FA377X	FA377R							
45								FA377X	FA377R							
46								FA377X	FA377R							
47								FA377X	FA377R				TBC			
48								FA355/4X	FA355/4R				MD6268D			
49								FA377X	FA377R				MD6267D			
50								FA395X	FA395R	FA395SV			MD6173D	UTVX6173		
51								FA395X	FA395R	FA395SV			MD6173D	UTVX6173		
52								FA395X	FA395R	FA395SV			MD6173D	UTVX6173		
53								FA395X	FA395R	FA395SV			MD6173D	UTVX6173		
54								FA395X	FA395R				MD6173D	UTVX6173		
55								FA395X	FA395R				MD6173D	UTVX6173		
56								FA395X	FA395R				MD6173D	UTVX6173		

BRAKE APPLICATIONS

⊗ This symbol indicates a rotor made of billet steel, and should be only used with EBC FA Kevlar® Organic or Vee pads.
 SAFETY NOTICE - With vehicles primarily designed for off highway use such as quads now being used on the highway, we would recommend the use of X or MXS pads for highway use and ONLY using the R and SV higher density / harder pad series for off road riding.

*-2 Sets Required. † For Vee disc colours add RED, BLU, GRN, GLD, ORG suffix to part number. **SAFETY WARNING:** DO NOT USE HH PADS ON REAR UNLESS ALSO USED ON FRONT TO AVOID BRAKE IMBALANCE

FRONT: Non-Japanese Bikes



KYMCO (ATV)



MXU 500 4 x 4 (Carb models)	07-09
MXU 500 4 x 4 IRS (Carb Models)	10-11
MXU 500i IRS (All EFI Models)	10-11
MXU 700i (All Models)	14-20

KYMCO (SIDE X SIDE)

UXV 450i (All EFI models)	15-21
UXV 500 4 x 4 (All Carb models)	08-21
UXV 500 I (All EFI models)	13-21
UXV 700i 4 x 4 (All models)	14-21

LAVERDA

Alpino 500/Montjuic	76
650 Sport Formula	94-95
668 Diamante/Ghost/Strike	96-98
750 Strike Bifaro/Mono Legend	98-00
750 S Formula/Sport	98-00
750 S Carenata	98-00
Jota 1000	76
RGS 1000	83
SFC 1000	85-86
Mirage 1200	76

LEM

RX 2/3	03-08
--------	-------

LIFAN

LF 200 GY-S	05-08
-------------	-------

MAICO/M-STAR

All Models	84-85
Front rotor models 1985	85
Most 1986 Models	86
MX 250/360/500	89
MX 500	95
All Models	
Rotor Models	86
Rotor Models	87-88
Rotor Models	89-96
Rotor Models	97-99

MALAGUTI

Ciak 50	02-04
F10 Jet Line	02-04
F12 Phantom (LC)	98-04
F12 Phantom (A/C)	98-04
Yesterday 50	98-04
Ciak 150	02-03
F15 Firefox	02-03
F15 Firefox (L/C)	04
Phantom F12 Foggy Replica	00-02
F18 (150cc)	02-04

DISC PAD CHOICES - FRONT

BRAKE ROTOR CHOICES - FRONT

	Sintered/HH Pads/Grooved Shoes	SV Series Severe Duty Pads	EPFA Sintered Fast Road/Track Pads	GPFA Sintered RACE ONLY Pads	Specialty Pads SXR/VEE/MXS Race	Standard Rotor Left	Standard Rotor Right	Vintage Rotor / UTV Oversize Brake Kit	Contour Profile Rotor
FA377X*	FA377R*					MD6173D	MD6173D	UTVX6173*	
FA600X*	FA600R*					MD6173D	MD6173D	UTVX6173*	
FA600X*	FA600R*					MD6173D	MD6173D	UTVX6173*	
FA600X*	FA600R*					MD6173D	MD6173D	UTVX6173*	
FA377X*	FA377R*					TBC	TBC	TBC*	
FA377X*	FA377R*					TBC	TBC	TBC*	
FA377X*	FA377R*					TBC	TBC	TBC*	
FA377X*	FA377R*					TBC	TBC	TBC*	
FA47*	FA47HH*					N/A	N/A		
FA95*	FA95HH*		EPFA95HH*			MD2003X	MD2003X		MD2003XC*
FA95*	FA95HH*		EPFA95HH*			MD2003X	MD2003X		MD2003XC*
FA95*	FA95HH*		EPFA95HH*			MD2003X	MD2003X		MD2003XC*
FA95*	FA95HH*		EPFA95HH*			MD2003X	MD2003X		MD2003XC*
FA95*	FA95HH*		EPFA95HH*			MD2003X	MD2003X		MD2003XC*
FA18*	FA18HH*					MD609LS	MD609RS		
FA18*	FA18HH*					MD609ALS	MD609ARS		
FA18*	FA18HH*					MD668LS	MD668RS		
FA18*	FA18HH*					MD609LS	MD609RS		
	FA325R					N/A			
FA56						N/A			
	821G					N/A			
FA47X						N/A			
FA106/2X	FA106/2R					N/A			
FA132X	FA132R					N/A			
FA132X	FA132R					N/A			
	841G								
FA99X	N/A					N/A			
FA99X	N/A					N/A			
FA115X	FA115R				MXS115	N/A			
FA181X	FA181R		EPFA181HH		MXS181	N/A			
SFA193	SFA193HH					MD955D			
SFA193	SFA193HH					MD915D			
SFA193	SFA193HH					MD946D			
SFA116						MD946D			
SFA116						MD915D			
SFA47	SFA47HH					MD955D			
SFA116						MD901D			
SFA116						MD946D			
SFA193	SFA193HH					MD946D			
SFA47	SFA47HH					TBC			

FRONT

Line #

APPLICATIONS

BRAKE

* This symbol indicates a rotor made of billet steel, and should be only used with EBC FA Kevlar® Organic or Vee pads.

SAFETY NOTICE - With vehicles primarily designed for off highway use such as quads now being used on the highway, we would recommend the use of X or MXS pads for highway use and ONLY using the R and SV higher density / harder pad series for off road riding.

*-2 Sets Required. † For Vee disc colours add RED, BLU, GRN, GLD, ORG suffix to part number. **SAFETY WARNING:- DO NOT USE HH PADS ON REAR UNLESS ALSO USED ON FRONT TO AVOID BRAKE IMBALANCE**

FRONT: Non-Japanese Bikes Cont'd

REAR: Non-Japanese Bikes

Line # 1 2 3 4 5 6 7 8 9 10 11 12 13 14 15 16 17 18 19 20 21 22 23 24 25 26 27 28 29 30 31 32 33 34 35 36 37 38 39 40 41 42 43 44 45 46 47 48 49 50 51 52 53 54 55 56

BRAKE ROTOR CHOICES - FRONT							DISC PAD CHOICES - REAR					BRAKE ROTOR CHOICES - REAR			
CC Custom Rotor	CX Extreme® /Vee-Rotor	OS Series Oversize 250/280mm Rotor Kit	OSX Series Oversize 280mm Rotor Kit	Relocating Bracket for Oversize Rotor	SMX Series Oversize 320mm Rotor Kit	Relocating Bracket for 320mm Rotor		Sintered/HH Pads/ Grooved Shoes	SV Series Severe Duty Pads	EPFA Sintered Fast Road/ Track Pads	Specialty Pads SXR/ VEE/MXS Race	Standard Rotor	Vintage Rotor / UTV Oversize Brake Kit	Contour Profile Rotor	CX Extreme® /Vee-Rotor
							FA377*	FA377R*				TBC*			
							FA600/2X*	FA600/2R*				MD6376D*	UTVX6376*		
							FA600/2X*	FA600/2R*				MD6376D*	UTVX6376*		
							FA600/2X*	FA600/2R*				MD6376D*	UTVX6376*		
							FA377X	FA377R				TBC	TBC		
							FA377X	FA377R				MD6376D	UTVX6376		
							FA377X	FA377R				MD6376D	UTVX6376		
							FA377X	FA377R				MD6376D	UTVX6376		
							FA47	FA47HH				N/A			
	VR2003BLK*†						FA47	FA47HH				MD2002		MD2002C	VR2002
	VR2003BLK*†						FA47	FA47HH				MD2002		MD2002C	VR2002
	VR2003BLK*†						FA47	FA47HH				MD2002		MD2002C	VR2002
	VR2003BLK*†						FA47	FA47HH				MD2002		MD2002C	VR2002
	VR2003BLK*†						FA47	FA47HH				MD2002		MD2002C	VR2002
							FA18	FA18HH			FA18V	N/A			
							FA18	FA18HH			FA18V	N/A			
							FA18	FA18HH			FA18V	MD609LS			
							FA18	FA18HH			FA18V	N/A			
								FA325R				N/A			
							FA165/2X					N/A			
								822G							
								822G							
							FA106/2X	FA106/2R				N/A			
							FA132X	FA132R				N/A			
							FA67X	FA67R				N/A			
								841G							
								841G							
							FA99X	N/A				N/A			
							FA115X	FA115R			MXS115	N/A			
							FA208X	FA208R		EPFA208HH	MXS208	N/A			
							893								
							893								
							SFA193	SFA193HH				MD901D			
							SFA193					MD901D			
							893								
							818								
							893								
							SFA193					MD901D			
							SFA193	SFA193HH				MD901D			
							SFA298	SFA298HH				TBC			

REAR

BRAKE APPLICATIONS

⚠ This symbol indicates a rotor made of billet steel, and should be only used with EBC FA Kevlar® Organic or Vee pads. SAFETY NOTICE - With vehicles primarily designed for off highway use such as quads now being used on the highway, we would recommend the use of X or MXS pads for highway use and ONLY using the R and SV higher density / harder pad series for off road riding.

*-2 Sets Required. † For Vee disc colours add RED, BLU, GRN, GLD, ORG suffix to part number. **SAFETY WARNING:- DO NOT USE HH PADS ON REAR UNLESS ALSO USED ON FRONT TO AVOID BRAKE IMBALANCE**

FRONT: Non-Japanese Bikes



MASSIMO (ATV)



Model	Side	Year
MSA 500	Left	13-16
	Right	
MSA 800	Left	14-16
	Right	

MASSIMO (SIDE X SIDE)

Model	Side	Year
250 Gunner	Left	15-16
	Right	
250 Gunner S	Left	15-16
	Right	
MSU 400	Left	15-16
	Right	
500 Alligator	Left	15-16
	Right	
500 Knight	Left	15-16
	Right	
MSU 500	Left	15-16
	Right	
550 EPS Alligator	Left	15-16
	Right	
700 Knight	Left	15-16
	Right	
700 Alligator	Left	15-16
	Right	
700 Alligator - Parking brake	Left	15-16
	Right	
700-4 Alligator EPS	Left	15-16
	Right	
MSU 700	Left	15-16
	Right	
MSU 700 - Parking brake	Left	15-16
	Right	
MSU 700-5	Left	15-16
	Right	
MSU 800	Left	15-16
	Right	
MSU 800 - Parking brake	Left	15-16
	Right	
1000 Militia	Left	15-16
	Right	
1000 S Militia	Left	15-16
	Right	
1000 XS Militia	Left	15-16
	Right	

MONTESA (DIRTBIKE)

Model	Year
4RT Cota (250cc)	05-08
4RT Cota Standard Edition (260cc)	09-19
4RT Cota Repsol Edition (260cc)	14-19
4RT Cota 300RR	16-19
314 R	94-96
315 R	97-00
315 R	01-04

DISC PAD CHOICES - FRONT

BRAKE ROTOR CHOICES - FRONT

Line #	Disc Pad Choice	DISC PAD CHOICES - FRONT					BRAKE ROTOR CHOICES - FRONT			
		Sintered/HH Pads/Grooved Shoes	SV Series Severe Duty Pads	EPFA Sintered Fast Road/Track Pads	GPFA Sintered RACE ONLY Pads	Specialty Pads SXR/VEE/MXS Race	Standard Rotor Left	Standard Rotor Right	Vintage Rotor / UTV Oversize Brake Kit	Contour Profile Rotor
1	FA135X	FA135R				SXR135HH	TBC			
2	FA165X	FA165R				SXR165HH		TBC		
3	FA135X	FA135R				SXR135HH	TBC			
4	FA165X	FA165R				SXR165HH		TBC		
5										
6										
7	FA165X	FA165R				SXR165HH	TBC			
8	FA135X	FA135R				SXR135HH		TBC		
9	FA165X	FA165R				SXR165HH	TBC			
10	FA135X	FA135R				SXR135HH		TBC		
11	TBC									
12	TBC									
13	FA165X	FA165R				SXR165HH	TBC			
14	FA135X	FA135R				SXR135HH		TBC		
15	FA165X	FA165R				SXR165HH	TBC			
16	FA135X	FA135R				SXR135HH		TBC		
17	FA135X	FA135R				SXR135HH	TBC			
18	FA165X	FA165R				SXR165HH		TBC		
19	FA165X	FA165R				SXR165HH	TBC			
20	FA135X	FA135R				SXR135HH		TBC		
21	FA165X	FA165R				SXR165HH	TBC			
22	FA135X	FA135R				SXR135HH		TBC		
23	FA165X	FA165R				SXR165HH	TBC			
24	FA135X	FA135R				SXR135HH		TBC		
25										
26	FA165X	FA165R				SXR165HH	TBC			
27	FA135X	FA135R				SXR135HH		TBC		
28	FA165X	FA165R				SXR165HH	TBC			
29	FA135X	FA135R				SXR135HH		TBC		
30										
31	FA165X	FA165R				SXR165HH	TBC			
32	FA135X	FA135R				SXR135HH		TBC		
33	FA165X	FA165R				SXR165HH	TBC			
34	FA135X	FA135R				SXR135HH		TBC		
35										
36	TBC						TBC			
37	TBC							TBC		
38	TBC						TBC			
39	TBC							TBC		
40	TBC						TBC			
41	TBC							TBC		
42										
43										
44	FA303X						N/A			
45	FA303X						N/A			
46	FA644X						N/A			
47	FA644X						N/A			
48	FA115X	FA115R				MXS115	N/A			
49	FA115X	FA115R				MXS115	N/A			
50	FA303X						N/A			
51										
52										
53										
54										
55										
56										

APPLICTIONS
BRAKE
 This symbol indicates a rotor made of billet steel, and should be only used with EBC FA Kevlar® Organic or Vee pads.
 SAFETY NOTICE - With vehicles primarily designed for off highway use such as quads now being used on the highway, we would recommend the use of X or MXS pads for highway use and ONLY using the R and SV higher density / harder pad series for off road riding.

*2 Sets Required. † For Vee disc colours add RED, BLU, GRN, GLD, ORG suffix to part number. **SAFETY WARNING:- DO NOT USE HH PADS ON REAR UNLESS ALSO USED ON FRONT TO AVOID BRAKE IMBALANCE**

FRONT: Non-Japanese Bikes Cont'd

REAR: Non-Japanese Bikes

Line #	BRAKE ROTOR CHOICES - FRONT						DISC PAD CHOICES - REAR					BRAKE ROTOR CHOICES - REAR			
	CC Custom Rotor	CX Extreme® /Vee-Rotor	OS Series Oversize 250/280mm Rotor Kit	OSX Series Oversize 280mm Rotor Kit	Relocating Bracket for Oversize Rotor	SMX Series Oversize 320mm Rotor Kit	Relocating Bracket for 320mm Rotor		Sintered/HH Pads/ Grooved Shoes	SV Series Severe Duty Pads	EPFA Sintered Fast Road/ Track Pads	Specialty Pads SXR/ VEE/MXS Race	Standard Rotor	Vintage Rotor / UTV Oversize Brake Kit	Contour Profile Rotor
1							FA135X	FA135R			SXR135HH	TBC			
2							FA165X	FA165R			SXR165HH	TBC			
3							FA135X	FA135R			SXR135HH	TBC			
4							FA165X	FA165R			SXR165HH	TBC			
5															
6															
7							FA428X	FA428R				TBC			
8															
9							FA428X	FA428R				TBC			
10															
11							FA165X	FA165R			SXR165HH	TBC			
12							FA135X	FA135R			SXR135HH	TBC			
13							FA428X	FA428R				TBC			
14															
15							FA165X	FA165R			SXR165HH	TBC			
16							FA135X	FA135R			SXR135HH	TBC			
17							FA165X	FA165R			SXR165HH	TBC			
18							FA135X	FA135R			SXR135HH	TBC			
19							FA428X	FA428R				TBC			
20															
21							FA165X	FA165R			SXR165HH	TBC			
22							FA135X	FA135R			SXR135HH	TBC			
23							FA165X	FA165R			SXR165HH	TBC			
24							FA135X	FA135R			SXR135HH	TBC			
25							FA428X	FA428R				TBC			
26							FA165X	FA165R			SXR165HH	TBC			
27							FA135X	FA135R			SXR135HH	TBC			
28							FA165X	FA165R			SXR165HH	TBC			
29							FA135X	FA135R			SXR135HH	TBC			
30							FA428X	FA428R				TBC			
31							FA165X	FA165R			SXR165HH	TBC			
32							FA135X	FA135R			SXR135HH	TBC			
33							FA165X	FA165R			SXR165HH	TBC			
34							FA135X	FA135R			SXR135HH	TBC			
35							FA428X	FA428R				TBC			
36							FA165X	FA165R			SXR165HH	TBC			
37							FA135X	FA135R			SXR135HH	TBC			
38							FA165X	FA165R			SXR165HH	TBC			
39							FA135X	FA135R			SXR135HH	TBC			
40							FA165X	FA165R			SXR165HH	TBC			
41							FA135X	FA135R			SXR135HH	TBC			
42															
43															
44							FA351X					N/A			
45							FA351X					N/A			
46							FA351X					N/A			
47							FA351X					N/A			
48							FA47X					N/A			
49							FA47X					N/A			
50							FA351X					N/A			
51															
52															
53															
54															
55															
56															

BRAKE APPLICATIONS

⚠ This symbol indicates a rotor made of billet steel, and should be only used with EBC FA Kevlar® Organic or Vee pads.
 SAFETY NOTICE - With vehicles primarily designed for off highway use such as quads now being used on the highway, we would recommend the use of X or MXS pads for highway use and ONLY using the R and SV higher density / harder pad series for off road riding.

*-2 Sets Required. † For Vee disc colours add RED, BLU, GRN, GLD, ORG suffix to part number. **SAFETY WARNING:- DO NOT USE HH PADS ON REAR UNLESS ALSO USED ON FRONT TO AVOID BRAKE IMBALANCE**

FRONT: Non-Japanese Bikes



MOTO-GUZZI



DISC PAD CHOICES - FRONT

BRAKE ROTOR CHOICES - FRONT



Line #

			Sintered/HH Pads/Grooved Shoes	SV Series Severe Duty Pads	EPFA Sintered Fast Road/Track Pads	GPFAX Sintered RACE ONLY Pads	Specialty Pads SXR/VEE/MXS Race	Standard Rotor Left	Standard Rotor Right	Vintage Rotor / UTV Oversize Brake Kit	Contour Profile Rotor	Line #
V35/35 II/35 III - 350	77-87		FA47*	FA47HH*				N/A	N/A			1
V35 C - 350	82-86		FA47*	FA47HH*				N/A	N/A			2
V35 Florida - 350	86-90		FA47*	FA47HH*				N/A	N/A			3
NTX 350	87-90		FA47	FA47HH				N/A	N/A			4
350 Nevada	92-97		FA47*	FA47HH*				N/A	N/A			5
350 Nevada Club	98-99		FA47*	FA47HH*				N/A	N/A			6
V50/50 III - 500	77-84		FA47*	FA47HH*				N/A	N/A			7
V50 C - 500	82-86		FA47*	FA47HH*				N/A	N/A			8
NTX 650	87-90		FA47*	FA47HH*				N/A	N/A			9
V65 C - 650	82-85		FA47*	FA47HH*				N/A	N/A			10
V65 Florida - 650	86-92		FA47*	FA47HH*				N/A	N/A			11
V75 - 750	92-96		FA47*	FA47HH*				N/A	N/A			12
750 SP	90-92		FA47*	FA47HH*				N/A	N/A			13
750 Targa	90-92		FA47*	FA47HH*				N/A	N/A			14
California Vintage 750	06-10		FA244*	FA244HH*				MD614X	MD614X		MD614XC*	15
Nevada 750	91-97		FA47*	FA47HH*				N/A	N/A			16
750 Nevada Club (Up To LK112433)	98-01		FA47*	FA47HH*				N/A	N/A			17
750 Nevada Club (From LK112434)	98-01		FA47*	FA47HH*				N/A	N/A			18
750 Nevada Base/Club	02-03		FA244	FA244HH		EPFA244HH		MD614X			MD614XC	19
Nevada Classic 750ie	04-09		FA244	FA244HH		EPFA244HH		MD614X			MD614XC	20
V750 ie Brevia	03-08		FA244	FA244HH		EPFA244HH		MD614X			MD614XC	21
V7 Classic	08-12		FA244	FA244HH		EPFA244HH		MD614X			MD614XC	22
V7 Cafe Classic	11-12		FA244	FA244HH		EPFA244HH		MD614X			MD614XC	23
V7 Racer	10-11		FA244	FA244HH		EPFA244HH		MD614X			MD614XC	24
V7 Racer	12-15		FA244	FA244HH		EPFA244HH		MD614X			MD614XC	25
V7 Special	12-15		FA244	FA244HH		EPFA244HH		MD614X			MD614XC	26
V7 Stone	12-15		FA244	FA244HH		EPFA244HH		MD614X			MD614XC	27
V7 III Racer	18-21		FA244	FA244HH								28
V7 III Limited	18-21		FA244	FA244HH								29
V7 III Special	18-21		FA244	FA244HH								30
V7 III Stone	18-21		FA244	FA244HH								31
V7 III Rough	18-21		FA244	FA244HH								32
V7 III Carbon	18-21		FA244	FA244HH								33
V 85 TT/TT Travel	19-21		FA244*	FA244HH*				MD614X	MD614X			34
850 II/III Le Mans	78-84		FA18*	FA18HH*				N/A	N/A			35
850 T3/T4/T5	79-88		FA18*	FA18HH*				N/A	N/A			36
V9 Bobber/Sport	18-21		FA244	FA244HH				MD859X				37
V9 Roamer	18-21		FA244	FA244HH				MD859X				38
Daytona 1000	92-95		FA95*	FA95HH*		EPFA95HH*		MD667	MD667			39
Daytona 1000 RS	97-98		FA95*	FA95HH*		EPFA95HH*		N/A	N/A			40
California 1000 II/III	83-93		FA18*	FA18HH*				MD835	MD835			41
1000 SP II/III	83-94		FA18*	FA18HH*				N/A	N/A			42
1000 GT	87-91		FA18*	FA18HH*				N/A	N/A			43
1000 (S)	89-94		FA18*	FA18HH*				N/A	N/A			44
1000 Le Mans	84-93		FA18*	FA18HH*				MD639LS	MD639RS			45
Strada 1000	93-94		FA18*	FA18HH*				N/A	N/A			46
Quota 1000	92-97		FA126*	FA126HH*				N/A	N/A			47
MGS-01 1000 cc	04-05			FA322/4HH*		EPFA322/4HH*		MD621X	MD621X		MD621XC*	48
V10 Centauro	97-99		FA95*	FA95HH*				MD614X	MD614X		MD614XC*	49
VII Sport/Scuro/Naked	99-00		FA244*	FA244HH*				MD614X	MD614X		MD614XC*	50
VII Le Mans Series	01-06		FA244*	FA244HH*				MD614X	MD614X		MD614XC*	51
California Stone Series	02-06		FA244	FA244HH			FA244V	MD614X			MD614XC	52
California EV/Special Series	02-06		FA244*	FA244HH*			FA244V*	MD614X	MD614X		MD614XC*	53
Brevia 1100 (Non ABS Model)	02-07		FA244*	FA244HH*				MD2003X	MD2003X		MD2003XC*	54
1100 Brevia	05-12		FA244*	FA244HH*				MD624	MD624			55
California 1100	94-97		FA18*	FA18HH*				MD835	MD835			56

FRONT

APPLIATIONS
BRAKE
 This symbol indicates a rotor made of billet steel, and should be only used with EBC FA Kevlar® Organic or Vee pads.
 SAFETY NOTICE - With vehicles primarily designed for off highway use such as quads now being used on the highway, we would recommend the use of X or MXS pads for highway use and ONLY using the R and SV higher density / harder pad series for off road riding.

*-2 Sets Required. † For Vee disc colours add RED, BLU, GRN, GLD, ORG suffix to part number. **SAFETY WARNING:- DO NOT USE HH PADS ON REAR UNLESS ALSO USED ON FRONT TO AVOID BRAKE IMBALANCE**

FRONT: Non-Japanese Bikes Cont'd

REAR: Non-Japanese Bikes

Line #	BRAKE ROTOR CHOICES - FRONT						DISC PAD CHOICES - REAR					BRAKE ROTOR CHOICES - REAR				
	CC Custom Rotor	CX Extreme® /Vee-Rotor	OS Series Oversize 250/280mm Rotor Kit	OSX Series Oversize 280mm Rotor Kit	Relocating Bracket for Oversize Rotor	SMX Series Oversize 320mm Rotor Kit	Relocating Bracket for 320mm Rotor		Sintered/HH Pads/ Grooved Shoes	SV Series Severe Duty Pads	EPFA Sintered Fast Road/ Track Pads	Specialty Pads SXR/ VEE/MXS Race	Standard Rotor	Vintage Rotor / UTV Oversize Brake Kit	Contour Profile Rotor	CX Extreme® /Vee-Rotor
1								FA47	FA47HH				N/A			
2								FA47	FA47HH				N/A			
3								FA47	FA47HH				N/A			
4								FA47	FA47HH				N/A			
5								FA47	FA47HH				N/A			
6								FA47	FA47HH				N/A			
7								FA47	FA47HH				N/A			
8								FA47	FA47HH				N/A			
9								FA47	FA47HH				N/A			
10								FA47	FA47HH				N/A			
11								FA47	FA47HH				N/A			
12								FA47	FA47HH				N/A			
13								FA47	FA47HH				N/A			
14								FA47	FA47HH				N/A			
15		VR614BLK						FA209/2	FA209/2HH			FA209/2V	MD692		MD692C	N/A
16								FA47	FA47HH				N/A			
17								FA47	FA47HH				N/A			
18								FA266	FA266HH			FA266V	MD871			
19		VR614BLK						FA266	FA266HH			FA266V	MD871			N/A
20		VR614BLK						FA266	FA266HH			FA266V	MD871			N/A
21		VR614BLK						FA266	FA266HH			FA266V	MD871			N/A
22		VR614BLK						FA266	FA266HH			FA266V	MD871			N/A
23		VR614BLK						FA266	FA266HH			FA266V	MD871			N/A
24		VR614BLK						FA266	FA266HH			FA266V	MD871			N/A
25		VR614BLK						FA256	FA256HH				N/A			N/A
26		VR614BLK						FA256	FA256HH				N/A			N/A
27		VR614BLK						FA256	FA256HH				N/A			N/A
28								FA256	FA256HH							
29								FA256	FA256HH							
30								FA256	FA256HH							
31								FA256	FA256HH							
32								FA256	FA256HH							
33								FA256	FA256HH							
34								FA256	FA256HH							
35								FA18	FA18HH				N/A			
36								FA18	FA18HH				N/A			
37								FA256	FA256HH				MD871			
38								FA256	FA256HH				MD871			
39								FA47	FA47HH				N/A			
40								FA47	FA47HH				N/A			
41								FA18	FA18HH				N/A			
42								FA18	FA18HH				N/A			
43								FA18	FA18HH				N/A			
44								FA18	FA18HH				N/A			
45								FA18	FA18HH				N/A			
46								FA18	FA18HH				N/A			
47								FA163					N/A			
48		VR621BLK†						FA266	FA266HH			FA266V	N/A			N/A
49		VR614BLK†						FA47	FA47HH				N/A			N/A
50		VR614BLK†						FA47	FA47HH				MD692		MD692C	N/A
51		VR614BLK†						FA47	FA47HH				MD692		MD692C	N/A
52		VR614BLK						FA209/2	FA209/2HH			FA209/2V	MD692		MD692C	N/A
53		VR614BLK†						FA209/2	FA209/2HH			FA209/2V	MD692		MD692C	N/A
54		VR2003BLK†						FA181X	FA181HH				N/A			N/A
55		VR624BLK†						FA181X	FA181HH				MD840			N/A
56								FA18	FA18HH				N/A			

BRAKE APPLICATIONS

⚠ This symbol indicates a rotor made of billet steel, and should be only used with EBC FA Kevlar® Organic or Vee pads.
SAFETY NOTICE - With vehicles primarily designed for off highway use such as quads now being used on the highway, we would recommend the use of X or MXS pads for highway use and ONLY using the R and SV higher density / harder pad series for off road riding.

*-2 Sets Required. † For Vee disc colours add RED, BLU, GRN, GLD, ORG suffix to part number. **SAFETY WARNING:- DO NOT USE HH PADS ON REAR UNLESS ALSO USED ON FRONT TO AVOID BRAKE IMBALANCE**

FRONT: Non-Japanese Bikes



MOTO-GUZZI



DISC PAD CHOICES - FRONT

BRAKE ROTOR CHOICES - FRONT

			Sintered/HH Pads/Grooved Shoes	SV Series Severe Duty Pads	EPFA Sintered Fast Road/Track Pads	GPFA Sintered RACE ONLY Pads	Specialty Pads SXR/VEE/MXS Race	Standard Rotor Left	Standard Rotor Right	Vintage Rotor / UTV Oversize Brake Kit	Contour Profile Rotor	Line #
California EVII	97-01	FA95*	FA95HH*				FA95V*	MD614X	MD614X		MD614XC*	1
1100 Griso (1064cc/Standard Mount Calipers)	05-12	FA244*	FA244HH*					MD621X	MD621X		MD621XC*	2
Sport 1100	94-99	FA95*	FA95HH*					MD614X	MD614X		MD614XC*	3
Sport Corsa 1100	98-99	FA95*	FA95HH*					N/A	N/A			4
California Jacket 1100	99-01	FA244*	FA244HH*				FA244V*	MD614X	MD614X		MD614XC*	5
California Special 1100	99-01	FA244*	FA244HH*				FA244V*	MD614X	MD614X		MD614XC*	6
Quota 1100 ES	99-01	FA209/2*	FA209/2HH*					N/A	N/A			7
Griso 1200 8V (1151cc/Radial Mount Calipers)	09-12	FA244*	FA244HH*								MD621XC*	8
Griso SE 1200 8V (1151cc/Radial Mount Calipers)	09-19	FA244*	FA244HH*								MD621XC*	9
Norge 1200 GT 4V	06-12	FA244*	FA244HH*					MD624	MD624			10
Stelvio 1200 NTX (ABS)	09-19	FA244*	FA244HH*				FA244V*	MD624	MD624			11
MGX-21	18-21	FA244*	FA244HH*				FA244V*					12
California 1400 Custom/Touring	13-19	FA244*	FA244HH*				FA244V*	TBC	TBC			13
												14
												15
MV (AGUSTA)												
F3 675 (Brembo Calipers)	12-18		FA244HH*		EPFA244HH*			MD884X	MD884X		MD884XC*	16
F3 675 Serie Oro (Brembo Calipers)	12-13		FA447HH*		EPFA447HH*			MD884X	MD884X		MD884XC*	17
Brutale 675 (Brembo Calipers)	12-17		FA244HH*		EPFA244HH*			MD884X	MD884X		MD884XC*	18
F4 750 (All model) (Nissin Calipers)	99-03		FA424HH*		EPFA424HH*			MD675	MD675			19
Brutale 750 (All models) (Nissin Calipers)	03-05		FA424HH*		EPFA424HH*			MD675	MD675			20
Brutale 800 (Brembo Calipers)	12-21		FA244HH*		EPFA244HH*			MD884X	MD884X		MD884XC*	21
Dragster 800 All Models	19-21		FA244HH*		EPFA244HH*			MD884X	MD884X		MD884XC*	22
F3 800 Serie Oro (Brembo Calipers)	13-19		FA447HH*		EPFA447HH*			MD884X	MD884X		MD884XC*	23
Rivale 800	13-18		FA630HH*		EPFA630HH*			MD884X	MD884X		MD884XC*	24
Superveloce 800	20-21		FA630HH*									25
Superveloce 800 Series Ono	21		FA630HH*									26
Turismo Veloce 800	14-21		FA630HH*		EPFA630HH*			MD884X	MD884X		MD884XC*	27
Turismo Veloce Louso 800	14-21		FA630HH*		EPFA630HH*			MD884X	MD884X		MD884XC*	28
Brutale 910 S (Nissin Calipers)	05-08		FA424HH*		EPFA424HH*			MD675	MD675			29
Brutale 910 R (Brembo Calipers)	05-08		FA322/4HH*		EPFA322/4HH*			TBC	TBC			30
Brutale 989 R	08-09		FA244HH*		EPFA244HH*			MD675	MD675			31
Brutale 990 R	10-11		FA244HH*		EPFA244HH*			MD675	MD675			32
Brutale 1000	19-21		FA447HH*		EPFA447HH*							33
F4 (998cc)	10-14		FA447HH*		EPFA447HH*			TBC	TBC			34
F4R (998cc)	12-14		FA447HH*		EPFA447HH*			TBC	TBC			35
F4RR (998cc)	12-14		FA447HH*		EPFA447HH*			TBC	TBC			36
F4 1000 (All models) (Nissin Calipers)	04-06		FA424HH*		EPFA424HH*			MD675	MD675			37
F4R 1000 (Brembo Calipers)	06-07		FA322/4HH*		EPFA322/4HH*			TBC	TBC			38
F4R 312R 1000 (Brembo calipers)	07		FA322/4HH*		EPFA322/4HH*			TBC	TBC			39
Brutale 1078cc RR	08-09		FA447HH*		EPFA447HH*			TBC	TBC			40
F4CC (1078cc)	07-08		FA435/4HH*		EPFA435/4HH*			TBC	TBC			41
F4RR 1078	08-09		FA447HH*		EPFA447HH*			TBC	TBC			42
Brutale 1090	13-14		FA244HH*		EPFA244HH*			TBC	TBC			43
Brutale 1090 R	12-14		FA244HH*		EPFA244HH*			TBC	TBC			44
Brutale 1090 RR	10-14		FA447HH*		EPFA447HH*			TBC	TBC			45
												46
												47
MZ/MUZ												
Moskito/SX 50/RX 50	97-05	SFA83	SFA83HH					N/A				48
Moskito 125 R	00-05	SFA83	SFA83HH					N/A				49
RT 125	02-05	FA197	FA197HH					N/A				50
SX/SM 125	02-05	FA131X	FA131R					N/A				51
500 Country	93-98	FA18	FA18HH						MD623RS			52
Mastiff 660	00-03	FA177						N/A				53
Baghira 660 (All models)	00-05	FA177						N/A				54
Skorpion Tour/Traveller	99-02	FA126	FA126HH						MD619RS			55
1000 S	03-05	FA145*	FA145HH*		EPFA145HH*			MD855X	MD855X		MD855XC*	56

FRONT

APPLIATIONS
BRAKE
⚠ This symbol indicates a rotor made of billet steel, and should be only used with EBC FA Kevlar® Organic or Vee pads.
SAFETY NOTICE - With vehicles primarily designed for off highway use such as quads now being used on the highway, we would recommend the use of X or MXS pads for highway use and ONLY using the R and SV higher density / harder pad series for off road riding.

*-2 Sets Required. † For Vee disc colours add RED, BLU, GRN, GLD, ORG suffix to part number. **SAFETY WARNING:- DO NOT USE HH PADS ON REAR UNLESS ALSO USED ON FRONT TO AVOID BRAKE IMBALANCE**

FRONT: Non-Japanese Bikes Cont'd

REAR: Non-Japanese Bikes

Line #	BRAKE ROTOR CHOICES - FRONT						DISC PAD CHOICES - REAR					BRAKE ROTOR CHOICES - REAR				
	CC Custom Rotor	CX Extreme® /Vee-Rotor	OS Series Oversize 250/280mm Rotor Kit	OSX Series Oversize 280mm Rotor Kit	Relocating Bracket for Oversize Rotor	SMX Series Oversize 320mm Rotor Kit	Relocating Bracket for 320mm Rotor		Sintered/HH Pads/ Grooved Shoes	SV Series Severe Duty Pads	EPFA Sintered Fast Road/ Track Pads	Specialty Pads SXR/ VEE/MXS Race	Standard Rotor	Vintage Rotor / UTV Oversize Brake Kit	Contour Profile Rotor	CX Extreme® /Vee-Rotor
1		VR614BLK†					FA209/2	FA209/2HH				FA209/2V	N/A			N/A
2		VR621BLK†					FA181X	FA181HH					MD840		MD840C	N/A
3		VR614BLK†					FA47	FA47HH					N/A			N/A
4							FA47	FA47HH					N/A			
5		VR614BLK†					FA209/2	FA209/2HH				FA209/2V	N/A			N/A
6		VR614BLK†					FA209/2	FA209/2HH				FA209/2V	N/A			N/A
7							FA181X	FA181HH					N/A			
8		VR621BLK†					FA181X	FA181HH					MD840		MD840C	N/A
9		VR621BLK†					FA181X	FA181HH					MD840		MD840C	N/A
10		VR624BLK†					FA181X	FA181HH					MD840			N/A
11							FA181X	FA181HH					MD840			
12							FA209/2	FA209/2HH				FA209/2V	MD840			
13							FA209/2	FA209/2HH				FA209/2V	TBC			
14																
15																
16							FA266	FA266HH				FA266V	MD885		MD885C	
17							FA266	FA266HH				FA266V	MD885		MD885C	
18							FA266	FA266HH				FA266V	MD885		MD885C	
19								FA320HH					MD696			
20								FA320HH					MD696			
21							FA266	FA266HH				FA266V	MD885		MD885C	
22							FA266	FA266HH					MD885		MD885C	
23							FA266	FA266HH				FA266V	MD885		MD885C	
24							FA266	FA266HH				FA266V	MD885		MD885C	
25							FA266	FA266HH								
26							FA266	FA266HH								
27							FA266	FA266HH				FA266V	MD885		MD885C	
28							FA266	FA266HH				FA266V	MD885		MD885C	
29								FA320HH					MD696			
30								FA320HH					MD696			
31								FA320HH					MD696			
32								FA320HH					MD696			
33								FA320HH					MD696			
34								FA320HH					MD696			
35								FA320HH					MD696			
36								FA320HH					MD696			
37								FA320HH					MD696			
38								FA320HH					MD696			
39								FA320HH					MD696			
40								FA320HH					MD696			
41								FA320HH					MD696			
42								FA320HH					MD696			
43								FA320HH					MD696			
44								FA320HH					MD696			
45								FA320HH					MD696			
46																
47																
48							503									
49							TBC									
50							FA165/2X						N/A			
51							FA165/2X						N/A			
52							978									
53							FA173						N/A			
54							FA173						N/A			
55							FA47	FA47HH					MD637			
56							FA254	FA254HH				FA254V	TBC			

BRAKE APPLICATIONS

⚠ This symbol indicates a rotor made of billet steel, and should be only used with EBC FA Kevlar® Organic or Vee pads. SAFETY NOTICE - With vehicles primarily designed for off highway use such as quads now being used on the highway, we would recommend the use of X or MXS pads for highway use and ONLY using the R and SV higher density / harder pad series for off road riding.

*-2 Sets Required. † For Vee disc colours add RED, BLU, GRN, GLD, ORG suffix to part number. **SAFETY WARNING:- DO NOT USE HH PADS ON REAR UNLESS ALSO USED ON FRONT TO AVOID BRAKE IMBALANCE**

FRONT: Non-Japanese Bikes



NORTON



750 MK V Commando Roadster/Interstate	73
850 MK 1 Commando Hi Rider/Interstate	73
850 MK 1A Commando Roadster/Interstate	73
850 MK 11/11A Commando Roadster/Hi Rider/Interstate	74
850 MK 111 Commando Roadster/Hi Rider/Interstate	75

OHVALE

GP-0 110cc,160cc	19-20
------------------	-------

PEUGEOT

Scoot Elec	04-05
Speedfight 2 X-Team (A/C)	02-05
Vivacity X-Race 50/Pulsa 50	02-05
Metal-X All models	02-05
Jet Force 50	03-05
Trekker 50	02-05
Looxor 50	02-05
Elyseo 50	02
Elyseo 50	03-05
Elystar 50 P	03-05
Ludix 50 Trend/One/Snake/Bullet (10" wheels)	04-05
Ludix 50 Elegance/Ambition (14" wheels)	04-05
X Race 50 LNDP LC/100 NP AC Speedfight	03-05
Elyseo 100	03-05
Looxor 100	02-05
Elyseo 125/150	03-05
Elystar 125/150 P	03-05
Jet Force 125 EFI/Compressor	03-05
Ludix 125	04-05

PIAGGIO

WI-Bike Active Electric	19-20
WI-Bike Comfort Electric	19-20
Fly 50 (2T)	05-06
Fly 50 (4T/2V)	07-10
Fly 50 (4T/4V)	11-15
Liberty 50 (4T)	17-20
Liberty 50 S (4T)	17-20
LT 50	97-05
Typhoon 50/SE	06
Typhoon 50 (2T/10" Wheels)	07-09
Typhoon 50 (4T/4V/12" Wheels)	10-20
Typhoon 50 (4T/4V/14" Wheels)	12-15
Typhoon 125 (4T/12" Wheels)	10-20
Fly 150 (4T/2V)	06-12
Fly 150 (4T/3V)	13-20
Liberty 150 (4T)	17-20
Liberty S 150 (4T)	17-20
LT 150	98-05
BV 200 (Grimeca Caliper)	02-06
BV 250 (Heng Tong Caliper)	06-11
MP3 (250cc) 3 Wheeler (12" Rear Wheel)	07-09
MP3 (250cc) 3 Wheeler Parking brake	07-09
MP3 (250cc) 3 Wheeler (14" Rear Wheel)	10-15
MP3 (250cc) 3 Wheeler Parking brake	10-15
BV 300 Tourer	10-12

DISC PAD CHOICES - FRONT

BRAKE ROTOR CHOICES - FRONT

										Line #
FA27						N/A				1
FA27						N/A				2
FA27						N/A				3
FA27						N/A				4
FA27						N/A				5
										6
										7
FA612R						MD9183D				8
										9
										10
303										11
SFA115	SFA115HH					MD925D				12
SFA115	SFA115HH					MD901D				13
SFA115	SFA115HH					MD901D				14
SFA115	SFA115HH					TBC				15
SFA115	SFA115HH					MD901D				16
SFA115	SFA115HH					MD954D				17
SFA115	SFA115HH					MD901D				18
SFA115	SFA115HH					MD901D				19
SFA115	SFA115HH					MD947D				20
SFA115	SFA115HH					MD904D				21
SFA115	SFA115HH					MD901D				22
SFA115	SFA115HH					MD925D				23
SFA115	SFA115HH					MD947D				24
SFA115	SFA115HH					MD954D				25
SFA194	SFA194HH					MD977D				26
SFA194	SFA194HH					MD980D				27
SFA194	SFA194HH					TBC				28
SFA115	SFA115HH					MD901D				29
										30
										31
CFA327	CFA327HH									32
CFA327	CFA327HH									33
SFA353	SFA353HH					MD910D				34
SFA353	SFA353HH					MD910D				35
SFA353	SFA353HH					MD910D				36
SFA353	SFA353HH					MD959D				37
SFA353	SFA353HH					MD959D				38
SFA260	SFA260HH					MD956D				39
SFA83/2	SFA83/2HH					MD9126D				40
SFA83/2	SFA83/2HH					MD9126D				41
SFA83/2	SFA83/2HH					MD9126D				42
SFA353	SFA353HH					TBC				43
SFA353	SFA353HH					TBC				44
SFA353	SFA353HH					MD910D				45
SFA353	SFA353HH					MD9126D				46
SFA353	SFA353HH					MD959D				47
SFA353	SFA353HH					MD959D				48
SFA260	SFA260HH					MD956D				49
SFA194	SFA194HH					MD961D				50
SFA353	SFA353HH					MD961D				51
SFA260*	SFA260HH*					MD9112D	MD9112D			52
SFA257/2										53
SFA260*	SFA260HH*					MD9112D	MD9112D			54
SFA257/2										55
SFA353	SFA353HH					MD9172D				56

FRONT

APPLICATIONS

BRAKE

⚡ This symbol indicates a rotor made of billet steel, and should be only used with EBC FA Kevlar® Organic or Vee pads.

SAFETY NOTICE - With vehicles primarily designed for off highway use such as quads now being used on the highway, we would recommend the use of X or MXS pads for highway use and ONLY using the R and SV higher density / harder pad series for off road riding.

*-2 Sets Required. † For Vee disc colours add RED, BLU, GRN, GLD, ORG suffix to part number. SAFETY WARNING:- DO NOT USE HH PADS ON REAR UNLESS ALSO USED ON FRONT TO AVOID BRAKE IMBALANCE

FRONT: Non-Japanese Bikes Cont'd

REAR: Non-Japanese Bikes

Line #
1
2
3
4
5
6
7
8
9
10
11
12
13
14
15
16
17
18
19
20
21
22
23
24
25
26
27
28
29
30
31
32
33
34
35
36
37
38
39
40
41
42
43
44
45
46
47
48
49
50
51
52
53
54
55
56

BRAKE ROTOR CHOICES - FRONT							DISC PAD CHOICES - REAR					BRAKE ROTOR CHOICES - REAR				
CC Custom Rotor	CX Extreme® /Vee-Rotor	OS Series Oversize 250/280mm Rotor Kit	OSX Series Oversize 280mm Rotor Kit	Relocating Bracket for Oversize Rotor	SMX Series Oversize 320mm Rotor Kit	Relocating Bracket for 320mm Rotor		Sintered/HH Pads/ Grooved Shoes	SV Series Severe Duty Pads	EPFA Sintered Fast Road/ Track Pads	Specialty Pads SXR/ VEE/MXS Race	Standard Rotor	Vintage Rotor / UTV Oversize Brake Kit	Contour Profile Rotor	CX Extreme® /Vee-Rotor	
								FA602R							MD904D	
							303									
							303									
							303									
							303									
							SFA115	SFA115HH							MD901D	
							303									
							303									
							303									
							SFA115	SFA115HH							MD925D	
							SFA350	SFA350HH							MD978D	
							303									
							303									
							SFA115	SFA115HH							MD925D	
							SFA115	SFA115HH							MD925D	
							SFA115	SFA115HH							MD901D	
							SFA350	SFA350HH							MD978D	
							SFA350	SFA350HH							MD978D	
							SFA350	SFA350HH							MD978D	
							303									
							CFA327	CFA327HH								
							CFA327	CFA327HH								
							816									
							816									
							816									
							816									
							816									
							816									
							899									
							893									
							893									
							816									
							816									
							816									
							SFA321	SFA321HH							MD956D	
							816									
							816									
							816									
							SFA194	SFA194HH							MD961D	
							SFA353	SFA353HH							MD961D	
							SFA425	SFA425HH							MD960D	
							SFA418	SFA418HH							MD960D	
							SFA353	SFA353HH							MD9155D	VR9155

REAR

BRAKE APPLICATIONS

⊗ This symbol indicates a rotor made of billet steel, and should be only used with EBC FA Kevlar® Organic or Vee pads. SAFETY NOTICE - With vehicles primarily designed for off highway use such as quads now being used on the highway, we would recommend the use of X or MXS pads for highway use and ONLY using the R and SV higher density / harder pad series for off road riding.

*-2 Sets Required. † For Vee disc colours add RED, BLU, GRN, GLD, ORG suffix to part number. **SAFETY WARNING:- DO NOT USE HH PADS ON REAR UNLESS ALSO USED ON FRONT TO AVOID BRAKE IMBALANCE**

FRONT: Non-Japanese Bikes



PIAGGIO



DISC PAD CHOICES - FRONT

BRAKE ROTOR CHOICES - FRONT

											Line #
BV 350 (4T/4V/330cc)	12-20	SFA353	SFA353HH				MD9172D				1
MP 3 400 ie (Three wheeler)	07-15	SFA260*	SFA260HH*				MD9112D	MD9112D			2
MP 3 400 ie (Three wheeler) Parking brake	07-15	SFA257/2									3
BV 500	06-12	SFA266*	SFA266HH*				MD961D	MD961D			4
MP 3 500 (Three wheeler - 12" Front/14" Rear Wheel)	07-14	SFA260*	SFA260HH*				MD9112D	MD9112D			5
MP 3 500 (Three wheeler) Parking brake	07-14	SFA257/2									6
MP 3 500 (Three wheeler - 12" Front/14" Rear Wheel)	15-16	SFA681*	SFA681HH*				MD9158D	MD9158D			7
MP 3 500 Sport ABS (Three wheeler)	15-20	SFA257/2									8
X9 500 Evolution	05-09	SFA181*	SFA181HH*				MD983D	MD983D			9
											10
											11
POLINI (MINI MOTOS)											12
Polini Calipers (Round shape threaded pad)		FA293	FA293S				N/A				13
											14
											15
QLINK											16
FrontRunner 500	10-13										17
FrontRunner 700	10-13										18
FrontRunner 800	12										19
Rodeo 400	07-09										20
Rodeo 500	08-13										21
Rodeo 700	08-13										22
											23
ROYAL ENFIELD											24
Continental GT (Non ABS)	13-16	FA209/2	FA209/2HH			FA209/2V	MD626X				25
Continental GT 535cc (ABS)	17-19	FA209/2	FA209/2HH			FA209/2V	MD626X				26
Bullet 500 EFI (Pricol caliper/Drum rear)	10-15	FA228	FA228HH				MD847				27
Bullet 500 EFI (Brembo caliper Front & Rear)	16-19	FA181X	FA181HH				MD847				28
Classic 500 (Pricol caliper/Drum rear)	10-15	FA228	FA228HH				MD847				29
Classic 500 (Brembo caliper Front & Rear)	16-17	FA181X	FA181HH				MD847				30
Classic 500 Battle Green (Pricol caliper/Drum rear)	10-15	FA228	FA228HH				MD847				31
Classic 500 Chrome (Pricol caliper/Drum rear)	10-15	FA228	FA228HH				MD847				32
Classic 500 Chrome (Brembo caliper Front & Rear)	16-20	FA181X	FA181HH				MD847				33
Classic 500 Desert Storm (Pricol caliper/Drum rear)	10-15	FA228	FA228HH				MD847				34
Himalayan	18-21	FA181X	FA181HH				MD893				35
Continental GT 650cc (ABS)	17-20	FA209/2	FA209/2HH			FA209/2V	MD898X			MD898XC	36
Interceptor	18-19	FA209/2	FA209/2HH			FA209/2V	MD898X			MD898XC	37
											38
											39
SACHS											40
Mad Ass 50	09	SFA86	SFA86HH				N/A				41
Mad Ass 125	10-11	SFA86	SFA86HH				N/A				42
											43
											44
SCORPA											45
SR 125 (2T)	11	FA303X					N/A				46
SY 125 F	05-09	FA115X	FA115R			MXS115	N/A				47
T-Ride 125	11	FA465X	FA465R			MXS465	N/A				48
TY-S 125 F	04-09	FA115X	FA115R			MXS115	N/A				49
SY 175 F	05-08	FA115X	FA115R			MXS115	N/A				50
TY-S 175 F	06-08	FA115X	FA115R			MXS115	N/A				51
SY 200 F (4T)	08-09	FA303X					N/A				52
SY 250 (2T)	03-10	FA303X					N/A				53
SY 250 Long Ride	05-09	FA303X					N/A				54
SY 250 F	06-10	FA303X					N/A				55
SY 250 FR	11	FA303X					N/A				56
T-Ride 250 F	06-08	FA194	FA194HH				N/A				57
T-Ride 250 F	09-10	FA465X	FA465R			MXS465	N/A				58
SR 280 (2T)	11	FA303X					N/A				59
4 Trick	06-08	N/A	N/A				N/A				60

APPLIATIONS

BRAKE

⚡ This symbol indicates a rotor made of billet steel, and should be only used with EBC FA Kevlar® Organic or Vee pads.

SAFETY NOTICE - With vehicles primarily designed for off highway use such as quads now being used on the highway, we would recommend the use of X or MXS pads for highway use and ONLY using the R and SV higher density / harder pad series for off road riding.

*-2 Sets Required. † For Vee disc colours add RED, BLU, GRN, GLD, ORG suffix to part number. **SAFETY WARNING:- DO NOT USE HH PADS ON REAR UNLESS ALSO USED ON FRONT TO AVOID BRAKE IMBALANCE**

FRONT: Non-Japanese Bikes Cont'd

REAR: Non-Japanese Bikes

Line #	BRAKE ROTOR CHOICES - FRONT						DISC PAD CHOICES - REAR					BRAKE ROTOR CHOICES - REAR			
	CC Custom Rotor	CX Extreme® /Vee-Rotor	OS Series Oversize 250/280mm Rotor Kit	OSX Series Oversize 280mm Rotor Kit	Relocating Bracket for Oversize Rotor	SMX Series Oversize 320mm Rotor Kit	Relocating Bracket for 320mm Rotor		Sintered/HH Pads/ Grooved Shoes	SV Series Severe Duty Pads	EPFA Sintered Fast Road/ Track Pads	Specialty Pads SXR/ VEE/MXS Race	Standard Rotor	Vintage Rotor / UTV Oversize Brake Kit	Contour Profile Rotor
1		VR9172					SFA418	SFA418HH				MD9164D			VR9164
2							SFA353	SFA353HH				MD960D			
3															
4							SFA266	SFA266HH				MD960D			
5							SFA353	SFA353HH				MD960D			
6															
7							SFA353	SFA353HH				MD960D			
8															
9							SFA266	SFA266HH				MD960D			
10															
11															
12							FA293	FA293S							
13															
14															
15							FA690X*	FA690R*							
16							FA690X*	FA690R*							
17							FA690X*	FA690R*							
18							FA690X*	FA690R*							
19							FA690X*	FA690R*							
20							FA690X*	FA690R*							
21															
22															
23							FA213	FA213HH			FA213V	MD651			
24							FA213	FA213HH			FA213V	MD651			
25							N/A								
26							FA213	FA213HH			FA213V	MD651			
27							N/A								
28							FA213	FA213HH			FA213V	MD651			
29							N/A								
30							N/A								
31							FA213	FA213HH			FA213V	MD651			
32							N/A								
33							FA208					MD894			
34							FA213	FA213HH			FA213V	MD894			
35							FA213	FA213HH			FA213V	MD894			
36															
37															
38							SFA54	SFA54HH				N/A			
39							SFA54	SFA54HH				N/A			
40															
41															
42							FA351X					N/A			
43							FA351X					N/A			
44							FA350X					N/A			
45							FA351X					N/A			
46							FA351X					N/A			
47							FA351X					N/A			
48							FA351X					N/A			
49							FA351X					N/A			
50							FA351X					N/A			
51							FA351X					N/A			
52							FA351X					N/A			
53							FA115X	FA115HH				N/A			
54							FA350X					N/A			
55							FA351X					N/A			
56							N/A	N/A				N/A			

BRAKE APPLICATIONS

⚠ This symbol indicates a rotor made of billet steel, and should be only used with EBC FA Kevlar® Organic or Vee pads. SAFETY NOTICE - With vehicles primarily designed for off highway use such as quads now being used on the highway, we would recommend the use of X or MXS pads for highway use and ONLY using the R and SV higher density / harder pad series for off road riding.

*-2 Sets Required. † For Vee disc colours add RED, BLU, GRN, GLD, ORG suffix to part number. **SAFETY WARNING:** DO NOT USE HH PADS ON REAR UNLESS ALSO USED ON FRONT TO AVOID BRAKE IMBALANCE

FRONT: Non-Japanese Bikes



SDG



DISC PAD CHOICES - FRONT

BRAKE ROTOR CHOICES - FRONT

50 HL Mini	04-07	TBC					TBC									1
107 Speed Mini		TBC					TBC									2
125 Pro Mini		TBC					TBC									3
																4
																5
																6
																7
																8
																9
																10
																11
																12
																13
																14
																15
																16
																17
																18
																19
																20
																21
																22
																23
																24
																25
																26
																27
																28
																29
																30
																31
																32
																33
																34
																35
																36
																37
																38
																39
																40
																41
																42
																43
																44
																45
																46
																47
																48
																49
																50
																51
																52
																53
																54
																55
																56

Line #

APPLICTIONS
BRAKE
SDG
SHERCO
FRONT
SAFETY NOTICE - With vehicles primarily designed for off highway use such as quads now being used on the highway, we would recommend the use of X or MXS pads for highway use and ONLY using the R and SV higher density / harder pad series for off road riding.

SHERCO	
50cc Americas SM-RS	19-21
50cc Americas SM-R	19-21
50cc Factory SE-RS	19-21
50cc Factory SE-R	19-21
50cc Factory SM-RS	19-21
50cc Factory SM-R	19-21
0.5/0.8/1.25/2.0 (2T)	03-10
125 FST	18-19
ST 1.25 (2T)	12-14
125 ST-R	18-19
125 TY Classic	18-19
125 SC-Factory	19-21
125 SE-R	19-21
125 X-Ride	19-21
2.5/2.9 (Trials) (2T)	03-09
2.5i Enduro	05-10
250 SC-Factory	19-21
250 SCF-Factory	19-21
250 SE-R	19-21
250 SE-Factory	19-21
250 SEF-R	19-21
250 SEF-Factory	19-21
250 ST Factory	18-19
250 ST-R	18-19
ST 2.5 (2T)	12-14
290 X-Ride	12-14
ST 2.9 (2T)	12-14
300 FST	18-19
300 ST-R	18-19
300 SC-Factory	19-21
300 SCF-Factory	19-21
300 SE-R	19-21
300 SE-Factory	19-21
300 SEF-R	19-21
300 SEF-Factory	19-21
3.2 (4T) (Trials)	05-10
4.5i Enduro	05-10
4.5 Supermoto	04-07
4.5i F Supermoto	08-10
4.5i SM	12-14
450 SCF-Factory	19-21
450 SE-R	19-21
450 SEF-Factory	19-21
500 SCF-Factory	19-21
500 SEF-R	19-21
500 SEF-Factory	19-21
5.1i Enduro	05-10

*-2 Sets Required. † For Vee disc colours add RED, BLU, GRN, GLD, ORG suffix to part number. **SAFETY WARNING:- DO NOT USE HH PADS ON REAR UNLESS ALSO USED ON FRONT TO AVOID BRAKE IMBALANCE**

FRONT: Non-Japanese Bikes Cont'd

REAR: Non-Japanese Bikes

Line #	BRAKE ROTOR CHOICES - FRONT							DISC PAD CHOICES - REAR					BRAKE ROTOR CHOICES - REAR			
	CC Custom Rotor	CX Extreme® /Vee-Rotor	OS Series Oversize 250/280mm Rotor Kit	OSX Series Oversize 280mm Rotor Kit	Relocating Bracket for Oversize Rotor	SMX Series Oversize 320mm Rotor Kit	Relocating Bracket for 320mm Rotor		Sintered/HH Pads/ Grooved Shoes	SV Series Severe Duty Pads	EPFA Sintered Fast Road/ Track Pads	Specialty Pads SXR/ VEE/MXS Race	Standard Rotor	Vintage Rotor / UTV Oversize Brake Kit	Contour Profile Rotor	CX Extreme® /Vee-Rotor
1								TBC					TBC			
2								TBC					TBC			
3								TBC					TBC			
4																
5																
6								FA83X	FA83R							
7								FA83X	FA83R							
8								FA83X	FA83R							
9								FA83X	FA83R							
10								FA83X	FA83R							
11								FA83X	FA83R							
12								FA115X	FA115R			MXS115	N/A			
13								FA351X								
14								FA351X								
15								FA351X								
16								FA351X								
17								FA368X	FA368R			MXS368			MD6430C	
18								FA368X	FA368R			MXS368			MD6430C	
19								FA83X	FA83R							
20								FA351X				N/A				
21								FA367X	FA367R		EPFA367HH	MXS367	N/A			
22								FA368X	FA368R			MXS368			MD6430C	
23								FA368X	FA368R			MXS368			MD6430C	
24								FA368X	FA368R			MXS368			MD6430C	
25								FA368X	FA368R			MXS368			MD6430C	
26								FA368X	FA368R			MXS368			MD6430C	
27								FA368X	FA368R			MXS368			MD6430C	
28								FA351X								
29								FA351X								
30								FA351X								
31								FA83X	FA83R				N/A			
32								FA351X								
33								FA351X								
34								FA351X								
35								FA368X	FA368R			MXS368			MD6430C	
36								FA368X	FA368R			MXS368			MD6430C	
37								FA368X	FA368R			MXS368			MD6430C	
38								FA368X	FA368R			MXS368			MD6430C	
39								FA368X	FA368R			MXS368			MD6430C	
40								FA368X	FA368R			MXS368			MD6430C	
41								FA351X					N/A			
42								FA367X	FA367R		EPFA367HH	MXS367	N/A			
43								FA367X	FA367R		EPFA367HH	MXS367	N/A			
44								FA367X	FA367R		EPFA367HH	MXS367	N/A			
45								FA367X	FA367R		EPFA367HH	MXS367	N/A			
46								FA368X	FA368R			MXS368			MD6430C	
47								FA368X	FA368R			MXS368			MD6430C	
48								FA368X	FA368R			MXS368			MD6430C	
49								FA368X	FA368R			MXS368			MD6430C	
50								FA368X	FA368R			MXS368			MD6430C	
51								FA368X	FA368R			MXS368			MD6430C	
52								FA367X	FA367R		EPFA367HH	MXS367	N/A			
53																
54																
55																
56																

BRAKE APPLICATIONS

⚠ This symbol indicates a rotor made of billet steel, and should be only used with EBC FA Kevlar® Organic or Vee pads.
 SAFETY NOTICE - With vehicles primarily designed for off highway use such as quads now being used on the highway, we would recommend the use of X or MXS pads for highway use and ONLY using the R and SV higher density / harder pad series for off road riding.

*-2 Sets Required. † For Vee disc colours add RED, BLU, GRN, GLD, ORG suffix to part number. **SAFETY WARNING:- DO NOT USE HH PADS ON REAR UNLESS ALSO USED ON FRONT TO AVOID BRAKE IMBALANCE**

FRONT: Non-Japanese Bikes



SYM



DISC PAD CHOICES - FRONT

BRAKE ROTOR CHOICES - FRONT

											Line #
DD 50	02-12	SFA151					MD933D				1
Fiddle 50 Drum front model	99-12	303									2
Fiddle 50 Front disc model	08-11	SFA264	SFA264HH				TBC				3
Jet Euro 50	99-12	SFA264	SFA264HH				MD9116D				4
Jet 50 EVO	14	SFA264	SFA264HH				MD9116D				5
Mio 50	05-14	SFA151					MD933D				6
RS 50	04-12	SFA306					N/A				7
Simply 50	07-12	SFA264	SFA264HH				TBC				8
Symba 100	09-14	820									9
Fiddle II 125 (AW 125 W)	08-14	SFA264	SFA264HH				TBC				10
HD 125 (LH 125 W)	08-12	SFA305	SFA305HH				TBC				11
HS 125/200	04-08	SFA305	SFA305HH				N/A				12
Sym Wolf 150 Classic	11-14	FA86	FA86					N/A			13
HD 200	08-12	SFA305	SFA305HH				TBC				14
HD 200 EVO	12-14	SFA264	SFA264HH				N/A				15
RD 200 EVO	12-14	SFA306					N/A				16
RV 250 (LM 250 W)	07-12	SFA355/4	SFA355/4HH				TBC				17
Citycom 300i (LH 300W)	08-14	SFA264	SFA264HH				TBC				18
Quadlander 300	07-10	FA377X*	FA377R*				TBC	TBC			19
Quadlander 600	08-10	FA54X*	FA54R*				TBC	TBC			20
											21
											22
											23
TGB/PEIRSPEED											
Laser R5/i (49cc)	08-11	SFA83	SFA83HH				TBC				23
R 50 X	06-11	SFA93					MD9115D				24
Sunset 50	06-08	SFA83	SFA83HH				MD923D				25
101S - 50 Key West	05-11	SFA83	SFA83HH				MD923D				26
Delivery 50 (Up to Eng/No 609099)	04-05	SFA264	SFA264HH				MD923D				27
Delivery 50 (From Eng/No 609100)	06-11	SFA83	SFA83HH				MD923D				28
Delivery 151	04-11	SFA93					MD9115D				29
Laser R9/i (151cc)	08-11	SFA93					MD9115D				30
Sunset 151	06-08	SFA83	SFA83HH				MD923D				31
Outback 425 C 4 x 4	07-09	FA377X*	FA377R*				N/A	N/A			32
Outback 425 SE 4 x 4 Auto	07-09	FA377X*	FA377R*				N/A	N/A			33
Outback 425 Real Tree Camo Edition 4 x 4 Auto	07-09	FA377X*	FA377R*				N/A	N/A			34
											35
											36
THUMPSTAR											
Thumpstar Junior 90cc	04-07	SFA169	SFA169HH				N/A				37
Thumpstar Supa 110cc	04-07	SFA169	SFA169HH				N/A				38
Thumpstar Expert 125	06-07	SFA169	SFA169HH				N/A				39
Thumpstar Pro 125	05-07	SFA169	SFA169HH				N/A				40
											41
											42
TM											
MX Models 85/100	02-03	FA181X	FA181R		EPFA181HH	MXS181	N/A				43
MX 85 JR (2T)	04	FA181X	FA181R		EPFA181HH	MXS181	N/A				44
MX 85 JR (2T)	05-08	FA181X	FA181R		EPFA181HH	MXS181	N/A				45
MX 85 JNR Small Wheel 14" -17" (2T)	10-21	FA367X	FA367R			MXS367					46
MX 85 JNR Big Wheel 16" -19" (2T)	10-21	FA367X	FA367R			MXS367					47
MX 100 JNR Small Wheel 14" -17" (2T)	19-21	FA367X	FA367R			MXS367					48
MX 100 JNR Big Wheel 16" -19" (2T)	19-21	FA367X	FA367R			MXS367					49
EN 125 (2T)	01-04	FA181X	FA181R		EPFA181HH	MXS181	N/A				50
EN 125 (2T)	05-08	FA181X	FA181R		EPFA181HH	MXS181	N/A				51
EN 125 2S Inc Tsi Enduro (2T)	10-21	FA181X	FA181R			MXS181					52
MX 125 2S (2T)	10-21	FA181X	FA181R			MXS181					53
MX Models 125/250/300	02-03	FA181X	FA181R		EPFA181HH	MXS181	N/A				54
SMM 125 Black Dream (2T)	04-08	N/A					N/A				55
SMR 125 (2T)	05-08	FA95	FA95HH		EPFA95HH		N/A				56

FRONT

APPLICTIONS

* This symbol indicates a rotor made of billet steel, and should be only used with EBC FA Kevlar® Organic or Vee pads.
 † For Vee disc colours add RED, BLU, GRN, GLD, ORG suffix to part number. SAFETY WARNING:- DO NOT USE HH PADS ON REAR UNLESS ALSO USED ON FRONT TO AVOID BRAKE IMBALANCE
 SAFETY NOTICE - With vehicles primarily designed for off highway use such as quads now being used on the highway, we would recommend the use of X or MXS pads for highway use and ONLY using the R and SV higher density / harder pad series for off road riding.

*-2 Sets Required. † For Vee disc colours add RED, BLU, GRN, GLD, ORG suffix to part number. SAFETY WARNING:- DO NOT USE HH PADS ON REAR UNLESS ALSO USED ON FRONT TO AVOID BRAKE IMBALANCE

FRONT: Non-Japanese Bikes Cont'd

REAR: Non-Japanese Bikes

Line #
1
2
3
4
5
6
7
8
9
10
11
12
13
14
15
16
17
18
19
20
21
22
23
24
25
26
27
28
29
30
31
32
33
34
35
36
37
38
39
40
41
42
43
44
45
46
47
48
49
50
51
52
53
54
55
56

BRAKE ROTOR CHOICES - FRONT							DISC PAD CHOICES - REAR					BRAKE ROTOR CHOICES - REAR				
CC Custom Rotor	CX Extreme® /Vee-Rotor	OS Series Oversize 250/280mm Rotor Kit	OSX Series Oversize 280mm Rotor Kit	Relocating Bracket for Oversize Rotor	SMX Series Oversize 320mm Rotor Kit	Relocating Bracket for 320mm Rotor		Sintered/HH Pads/ Grooved Shoes	SV Series Severe Duty Pads	EPFA Sintered Fast Road/ Track Pads	Specialty Pads SXR/ VEE/MXS Race	Standard Rotor	Vintage Rotor / UTV Oversize Brake Kit	Contour Profile Rotor	CX Extreme® /Vee-Rotor	
							333									
							302									
							303									
							303									
							303									
							302									
							TBC									
							303									
							303									
							820									
							820									
							820									
							820									
							820									
							SFA427	SFA427HH				N/A				
							SFA427					N/A				
							SFA427	SFA427HH				TBC				
							SFA264	SFA264HH				TBC				
							FA377X	FA377R				TBC				
							FA377X	FA377R				TBC				
							897									
							SFA83					MD9115D				
							897									
							897									
							897									
							897									
							820									
							820									
							820									
							FA377X	FA377R				N/A				
							FA377X	FA377R				N/A				
							FA377X	FA377R				N/A				
							SFA169	SFA169HH				N/A				
							SFA169	SFA169HH				N/A				
							SFA169	SFA169HH				N/A				
							SFA169	SFA169HH				N/A				
							FA208X	FA208R	EPFA208HH		MXS208	N/A				
							FA131X	FA131R	EPFA131HH		MXS131	N/A				
							FA367X	FA367R	EPFA367HH		MXS367	N/A				
							FA367X	FA367R			MXS367					
							FA367X	FA367R			MXS367					
							FA367X	FA367R			MXS367					
							FA367X	FA367R			MXS367					
							FA131X	FA131R	EPFA131HH		MXS131	N/A				
							FA367X	FA367R	EPFA367HH		MXS367	N/A				
							FA367X	FA367R			MXS367					
							FA367X	FA367R			MXS367					
							FA131X	FA131R	EPFA131HH		MXS131	N/A				
							FA47	FA47HH				N/A				
							FA367X	FA367R	EPFA367HH		MXS367	N/A				

REAR

BRAKE APPLICATIONS

⚠ This symbol indicates a rotor made of billet steel, and should be only used with EBC FA Kevlar® Organic or Vee pads.
 SAFETY NOTICE - With vehicles primarily designed for off highway use such as quads now being used on the highway, we would recommend the use of X or MXS pads for highway use and ONLY using the R and SV higher density / harder pad series for off road riding.

*-2 Sets Required. † For Vee disc colours add RED, BLU, GRN, GLD, ORG suffix to part number. **SAFETY WARNING:- DO NOT USE HH PADS ON REAR UNLESS ALSO USED ON FRONT TO AVOID BRAKE IMBALANCE**

FRONT: Non-Japanese Bikes



TM



		DISC PAD CHOICES - FRONT					BRAKE ROTOR CHOICES - FRONT				Line #
		Sintered/HH Pads/Grooved Shoes	SV Series Severe Duty Pads	EPFA Sintered Fast Road/Track Pads	GPFAX Sintered RACE ONLY Pads	Specialty Pads SXR/VEE/MXS Race	Standard Rotor Left	Standard Rotor Right	Vintage Rotor / UTV Oversize Brake Kit	Contour Profile Rotor	
SMR 125 Tsi (2T)	10-21	FA447HH		EPFA447HH							1
EN 144 2S Inc Tsi Enduro (2T)	10-21	FA181X	FA181R			MXS181					2
MX 144 (2T)	07-08	FA181X	FA181R	EPFA181HH		MXS181	N/A				3
MX 144 2S (2T)	10-21	FA181X	FA181R			MXS181					4
EN 250 (2T)	01-04	FA181X	FA181R	EPFA181HH		MXS181	N/A				5
EN 250 Tsi ES Enduro (2T)	10-21	FA181X	FA181R			MXS181					6
EN 250 (2T)	05-08	FA181X	FA181R	EPFA181HH		MXS181	N/A				7
EN 250 F-ES (4T)	01-04	FA181X	FA181R	EPFA181HH		MXS181	N/A				8
EN 250 FI-ES Twin Enduro (4T)	10-21	FA181X	FA181R			MXS181					9
EN 250 F-ES (4T)	05-08	FA181X	FA181R	EPFA181HH		MXS181	N/A				10
MX 250/300 (2T)	04	FA181X	FA181R	EPFA181HH		MXS181	N/A				11
MX 250/300 (2T)	05-08	FA181X	FA181R	EPFA181HH		MXS181	N/A				12
MX 250 2S (2T)	10-21	FA181X	FA181R			MXS181					13
MX 250 F (4T)	02-04	FA181X	FA181R	EPFA181HH		MXS181	N/A				14
MX 250 F (4T)	05-07	FA181X	FA181R	EPFA181HH		MXS181	N/A				15
MX 250 FI ES (4T)	10-21	FA181X	FA181R			MXS181					16
EN 300 (2T)	01-04	FA181X	FA181R	EPFA181HH		MXS181	N/A				17
EN 300 (2T)	05-08	FA181X	FA181R	EPFA181HH		MXS181	N/A				18
EN 300 2S ES Inc Tsi Enduro (2T)	10-21	FA181X	FA181R			MXS181					19
EN 300 FI ES Twin Enduro (4T)	10-21	FA181X	FA181R			MXS181					20
FT 300 2S ES (2T)	19-21	FA181X	FA181R			MXS181					21
MX 300 2S ES (2T)	10-21	FA181X	FA181R			MXS181					22
MX 300 FI ES (4T)	10-21	FA181X	FA181R			MXS181					23
SMR 300 Tsi ES (2T)	19-21	FA447HH		EPFA447HH							24
SMX 300 2S ES (2T)	19-21	FA447HH		EPFA447HH							25
EN 450 F-ES (4T)	04	FA181X	FA181R	EPFA181HH		MXS181	N/A				26
EN 450 F-ES (4T)	05-08	FA181X	FA181R	EPFA181HH		MXS181	N/A				27
EN 450 FI ES (4T)	10-21	FA181X	FA181R			MXS181					28
FT 450 FI ES (4T)	19-21	FA181X	FA181R			MXS181					29
MX 450 F	04	FA181X	FA181R	EPFA181HH		MXS181	N/A				30
MX 450 F	05-08	FA181X	FA181R	EPFA181HH		MXS181	N/A				31
MX 450 FI ES (4T)	10-21	FA181X	FA181R			MXS181					32
SMM 450 Black Dream ES (4T)	05-08	N/A					N/A				33
SMR 450 F ES (4T)	05-08	FA95	FA95HH	EPFA95HH			N/A				34
SMR 450 FI ES (2T)	19-21	FA447HH		EPFA447HH							35
SMX 450 F Competition (4T)	05-08	FA322/4HH		EPFA322/4HH			N/A				36
EN 530 F-ES (4T)	04-08	FA181X	FA181R	EPFA181HH		MXS181	N/A				37
EN 530 F-ES (4T)	05-08	FA181X	FA181R	EPFA181HH		MXS181	N/A				38
EN 530 FI ES (4T)	10-21	FA181X	FA181R			MXS181					39
MX 530 F (4T)	04	FA181X	FA181R	EPFA181HH		MXS181	N/A				40
MX 530 F (4T)	05-08	FA181X	FA181R	EPFA181HH		MXS181	N/A				41
MX 530 FI ES (4T)	10-21	FA181X	FA181R			MXS181					42
SMM 530 Black Dream ES (4T)	05-08	N/A					N/A				43
SMR 530 F ES (4T)	05-08	FA95	FA95HH	EPFA95HH			N/A				44
SMR 530 FI ES (2T)	19-21	FA447HH		EPFA447HH							45
SMX 530 F Competition	05-08	FA322/4HH		EPFA322/4HH			N/A				46
SMX 660 F	04	FA95	FA95HH	EPFA95HH			N/A				47
											48
											49
											50
											51
											52
											53
											54
											55
											56

FRONT

APPLICTIONS
BRAKE
SAFETY NOTICE - With vehicles primarily designed for off highway use such as quads now being used on the highway, we would recommend the use of X or MXS pads for highway use and ONLY using the R and SV higher density / harder pad series for off road riding.

This symbol indicates a rotor made of billet steel, and should be only used with EBC FA Kevlar® Organic or Vee pads.

*-2 Sets Required. † For Vee disc colours add RED, BLU, GRN, GLD, ORG suffix to part number. **SAFETY WARNING:- DO NOT USE HH PADS ON REAR UNLESS ALSO USED ON FRONT TO AVOID BRAKE IMBALANCE**

FRONT: Non-Japanese Bikes Cont'd

REAR: Non-Japanese Bikes

Line #	BRAKE ROTOR CHOICES - FRONT						DISC PAD CHOICES - REAR					BRAKE ROTOR CHOICES - REAR				
	CC Custom Rotor	CX Extreme® /Vee-Rotor	OS Series Oversize 250/280mm Rotor Kit	OSX Series Oversize 280mm Rotor Kit	Relocating Bracket for Oversize Rotor	SMX Series Oversize 320mm Rotor Kit	Relocating Bracket for 320mm Rotor		Sintered/HH Pads/ Grooved Shoes	SV Series Severe Duty Pads	EPFA Sintered Fast Road/ Track Pads	Specialty Pads SXR/ VEE/MXS Race	Standard Rotor	Vintage Rotor / UTV Oversize Brake Kit	Contour Profile Rotor	CX Extreme® /Vee-Rotor
1								FA367X	FA367R			MXS367				
2								FA367X	FA367R			MXS367				
3								FA367X	FA367R	EPFA367HH		MXS367	N/A			
4								FA367X	FA367R			MXS367				
5								FA131X	FA131R	EPFA131HH		MXS131	N/A			
6								FA367X	FA367R			MXS367				
7								FA367X	FA367R	EPFA367HH		MXS367	N/A			
8								FA131X	FA131R	EPFA131HH		MXS131	N/A			
9								FA367X	FA367R			MXS367				
10								FA367X	FA367R	EPFA367HH		MXS367	N/A			
11								FA131X	FA131R	EPFA131HH		MXS131	N/A			
12								FA367X	FA367R	EPFA367HH		MXS367	N/A			
13								FA367X	FA367R			MXS367				
14								FA131X	FA131R	EPFA131HH		MXS131	N/A			
15								FA367X	FA367R	EPFA367HH		MXS367	N/A			
16								FA367X	FA367R			MXS367				
17								FA131X	FA131R	EPFA131HH		MXS131	N/A			
18								FA367X	FA367R	EPFA367HH		MXS367	N/A			
19								FA367X	FA367R			MXS367				
20								FA367X	FA367R			MXS367				
21								FA367X	FA367R			MXS367				
22								FA367X	FA367R			MXS367				
23								FA367X	FA367R			MXS367				
24								FA367X	FA367R			MXS367				
25								FA367X	FA367R			MXS367				
26								FA131X	FA131R	EPFA131HH		MXS131	N/A			
27								FA367X	FA367R	EPFA367HH		MXS367	N/A			
28								FA367X	FA367R			MXS367				
29								FA367X	FA367R			MXS367				
30								FA131X	FA131R	EPFA131HH		MXS131	N/A			
31								FA131X	FA131R	EPFA131HH		MXS131	N/A			
32								FA367X	FA367R			MXS367				
33								FA47	FA47HH				N/A			
34								FA131X	FA131R	EPFA131HH		MXS131	N/A			
35								FA367X	FA367R			MXS367				
36								FA131X	FA131R	EPFA131HH		MXS131	N/A			
37								FA131X	FA131R	EPFA131HH		MXS131	N/A			
38								FA367X	FA367R	EPFA367HH		MXS367	N/A			
39								FA367X	FA367R			MXS367				
40								FA131X	FA131R	EPFA131HH		MXS131	N/A			
41								FA367X	FA367R	EPFA367HH		MXS367	N/A			
42								FA367X	FA367R			MXS367				
43								FA47	FA47HH				N/A			
44								FA367X	FA367R	EPFA367HH		MXS367	N/A			
45								FA367X	FA367R			MXS367				
46								FA367X	FA367R	EPFA367HH		MXS367	N/A			
47								FA131X	FA131R	EPFA131HH		MXS131	N/A			
48																
49																
50																
51																
52																
53																
54																
55																
56																

BRAKE APPLICATIONS

⚠ This symbol indicates a rotor made of billet steel, and should be only used with EBC FA Kevlar® Organic or Vee pads.
SAFETY NOTICE - With vehicles primarily designed for off highway use such as quads now being used on the highway, we would recommend the use of X or MXS pads for highway use and ONLY using the R and SV higher density / harder pad series for off road riding.

*-2 Sets Required. † For Vee disc colours add RED, BLU, GRN, GLD, ORG suffix to part number. **SAFETY WARNING:- DO NOT USE HH PADS ON REAR UNLESS ALSO USED ON FRONT TO AVOID BRAKE IMBALANCE**

FRONT: Non-Japanese Bikes



TOMOS



DISC PAD CHOICES - FRONT

BRAKE ROTOR CHOICES - FRONT

											Line #
MC 36	05-07	TBC									1
Revival/TS/Streetmate	03-08	SFA116					N/A				2
MC 50 Senior Pro	03-08	FA116					N/A				3
MC 50 Senior	03-04/05-07	TBC									4
MC 50 Senior Pro	05-07	TBC					N/A				5
MC 50 Junior	03-04	TBC									6
MC 50 Junior	05-07	TBC									7
MC 80 (Drum Model)	05-07	TBC									8
											9
											10
											11
											12
											13
											14
											15
											16
											17
											18
											19
											20
											21
											22
											23
											24
											25
											26
											27
											28
											29
											30
											31
											32
											33
											34
											35
											36
											37
											38
											39
											40
											41
											42
											43
											44
											45
											46
											47
											48
											49
											50
											51
											52
											53
											54
											55
											56

TRIUMPH (MERIDEN PRODUCED MACHINES)

Cub 500		858									
T120 (650cc/Twin Leading Shoe)	66-70	853									
T140 V Bonneville (Drum Rear Brake/5 Speed G/Box)	73-74	FA16*	FA16HH*		EPFA16HH*		MD656⊕	MD656⊕	VMD656*⊕		
T140 V Bonneville (Discs All Round/5 Speed G/Box)	75-78	FA16*	FA16HH*		EPFA16HH*		MD656⊕	MD656⊕	VMD656*⊕		
T140 Silver Jubilee Bonneville	77	FA16*	FA16HH*		EPFA16HH*		MD656⊕	MD656⊕	VMD656*⊕		
T140 E Bonneville	78-83	FA16*	FA16HH*		EPFA16HH*		MD656⊕	MD656⊕	VMD656*⊕		
T140 D Bonneville (Lester Alloy Wheels/6 Bolt disc)	79-81	FA16*	FA16HH*		EPFA16HH*		MD838⊕	MD838⊕			
T140 ES (Electric Start)	80-81	FA16*	FA16HH*		EPFA16HH*		MD656⊕	MD656⊕	VMD656*⊕		
T140 E/ES (Executive/Morris Alloy Wheels/5 Bolt disc)	81-83	FA16*	FA16HH*		EPFA16HH*		N/A	N/A	N/A*		
TSS 750 (8 Valve)	83	FA16*	FA16HH*		EPFA16HH*		MD656⊕	MD656⊕	VMD656*⊕		
TSX 750 (8 Valve)	83	FA16*	FA16HH*		EPFA16HH*		MD656⊕	MD656⊕	VMD656*⊕		
T140 Bonneville (L.F. Harris Production Bike/Brembo Calipers)	85-88	FA18*	FA18HH*			FA18V*	N/A	N/A			

⊕ MD656 = 4 bolt fixing, ⊕ MD838 = 6 bolt fixing. Listing should be correct but please check quantity of bolts on the original disc and order accordingly.

TRIUMPH (HINCKLEY PRODUCED MACHINES)

Daytona 600	03-04	FA236*	FA236HH*				MD662X	MD662X		MD662XC*	
Speedfour 600	02-05	FA236*	FA236HH*				MD662X	MD662X		MD662XC*	
TT 600	00-03	FA236*	FA236HH*				MD662X	MD662X		MD662XC*	
Daytona 650	05	FA236*	FA236HH*				MD662X	MD662X		MD662XC*	
Daytona 675	06-08		FA347HH*		EPFA347HH*		MD800X	MD800X		MD800XC*	
Daytona 675 (Black Nissin Monobloc Radial Caliper & Nissin Rear)	09-12		FA491HH*		EPFA491HH*	GPFAX491HH*	MD800X	MD800X		MD800XC*	
Daytona 675 SE (Black Nissin Monobloc Radial Front Caliper & Nissin Rear)	12		FA491HH*		EPFA491HH*	GPFAX491HH*	MD800X	MD800X		MD800XC*	
Daytona 675 (Black Nissin Monobloc Radial Front Caliper & Brembo Rear/Inc ABS Models)	13-17		FA491HH*		EPFA491HH*	GPFAX491HH*	MD800X	MD800X		MD800XC*	
Daytona 675 R (Brembo calipers Front & Nissin Rear)	11-12		FA447HH*		EPFA447HH*		MD800X	MD800X		MD800XC*	
Daytona 675 R (Brembo calipers Front & Rear/Inc ABS Models)	13-19		FA447HH*		EPFA447HH*		MD852X	MD852X			
Street Triple 675 (Nissin Rear Caliper) Up to Vin # 560476	07-12	FA226*	FA226HH*		EPFA226HH*		MD800X	MD800X		MD800XC*	
Street Triple R 675 (Nissin Front Radial/Nissin Rear Caliper) Up to Vin # 540476	09-12		FA347HH*		EPFA347HH*		MD800X	MD800X		MD800XC*	
Street Triple 675 (Brembo Rear Caliper) From Vin #560477	13-19	FA226*	FA226HH*		EPFA226HH*		MD852X	MD852X			
Street Triple R 675 (Nissin Front Radial/Brembo Rear Caliper) From Vin # 560477	13-17		FA347HH*		EPFA347HH*		MD800X	MD800X		MD800XC*	
Street Triple RX SE 675 (Nissin Front Radial/Brembo Rear Caliper/ABS)	15		FA491HH*		EPFA491HH*		MD800X	MD800X		MD800XC*	
Daytona 750 (3 cyl)	92	FA236*	FA236HH*								
Speed Triple 750/900 (Carb Models)	94-96	FA236*	FA236HH*				MD640	MD640			
Street Triple S 765 (Nissan2-Piston sliding calipers, Brembo single piston rear caliper, ABS)	18-21	FA226*	FA226HH*		EPFA226HH*						
Street Triple R R/LRH 765 (Brembo M4.32 4 piston radial caliper, Brembo single piston rear caliper ABS)	18-19		FA630HH*		EPFA630HH*	GPFAX630HH*	MD852X	MD852X		MD852XC	
Street Triple R R/LRH 765 (Brembo M4.32 4 piston radial caliper, Brembo single piston rear caliper ABS)	20-22		FA447HH*		EPFA447HH*	GPFAX447HH*	MD852X	MD852X		MD852XC	
RS Street Triple RS 765 (Brembo M50 4-piston radial monobloc caliper, Brembo single piston sliding caliper, ABS)	18-21		FA630HH*		EPFA630HH*	GPFAX630HH*	MD852X	MD852X		MD852XC	
Bonneville America (790cc)	02-06	FA196	FA196HH			FA196V	MD649				
Bonneville America (790cc) Floating disc conversion							MD601LS				
Bonneville T100 (790cc & 865cc)	02-09	FA196	FA196HH			FA196V	MD649				

FRONT

*-2 Sets Required. † For Vee disc colours add RED, BLU, GRN, GLD, ORG suffix to part number. **SAFETY WARNING:- DO NOT USE HH PADS ON REAR UNLESS ALSO USED ON FRONT TO AVOID BRAKE IMBALANCE**

FRONT: Non-Japanese Bikes Cont'd

REAR: Non-Japanese Bikes

Line #	BRAKE ROTOR CHOICES - FRONT						DISC PAD CHOICES - REAR					BRAKE ROTOR CHOICES - REAR				BRAKE APPLICATIONS
	CC Custom Rotor	CX Extreme® /Vee-Rotor	OS Series Oversize 250/280mm Rotor Kit	OSX Series Oversize 280mm Rotor Kit	Relocating Bracket for Oversize Rotor	SMX Series Oversize 320mm Rotor Kit	Relocating Bracket for 320mm Rotor		Sintered/ HH Pads/ Grooved Shoes	SV Series Severe Duty Pads	EPFA Sintered Fast Road/ Track Pads	Specialty Pads SXR/ VEE/MXS Race	Standard Rotor	Vintage Rotor / UTV Oversize Brake Kit	Contour Profile Rotor	
1								TBC								
2								TBC								
3								FA116					N/A			
4								TBC								
5								TBC					N/A			
6								TBC								
7								TBC								
8								TBC								
9																
10																
11								858								
12								854								
13								N/A								
14								FA16	FA16HH		EPFA16HH		MD656⊙			
15								FA16	FA16HH		EPFA16HH		MD656⊙			
16								FA16	FA16HH		EPFA16HH		MD656⊙			
17								FA16	FA16HH		EPFA16HH		MD838⊙			
18								FA16	FA16HH		EPFA16HH		MD656⊙			
19								FA16	FA16HH		EPFA16HH		N/A			
20								FA16	FA16HH		EPFA16HH		MD656⊙			
21								FA16	FA16HH		EPFA16HH		MD656⊙			
22								FA18	FA18HH			FA18V	N/A			
23																
24																
25							REAR									
26		VR662BLK†						FA140	FA140HH			FA140V	MD648		MD648C	VR648
27		VR662BLK†						FA140	FA140HH			FA140V	MD648		MD648C	VR648
28		VR662BLK†						FA140	FA140HH			FA140V	MD648		MD648C	VR648
29		VR662BLK†						FA140	FA140HH			FA140V	MD648		MD648C	VR648
30		VR800BLK†						FA140	FA140HH			FA140V	MD648		MD648C	VR648
31		VR800BLK†						FA140	FA140HH			FA140V	MD648		MD648C	VR648
32		VR800BLK†						FA140	FA140HH			FA140V	MD648		MD648C	VR648
33																
34		VR800BLK†						FA213	FA213HH			FA213V	MD851		MD851C	
35		VR800BLK†						FA140	FA140HH			FA140V	MD648		MD648C	VR648
36		VR800BLK†						FA213	FA213HH			FA213V	MD851		MD851C	
37		VR800BLK†						FA140	FA140HH			FA140V	MD648		MD648C	VR648
38																
39		VR800BLK†						FA140	FA140HH			FA140V	MD648		MD648C	VR648
40		VR800BLK†						FA213	FA213HH			FA213V	MD851		MD851C	
41																
42		VR800BLK†						FA213	FA213HH			FA213V	MD851		MD851C	
43		VR800BLK†						FA213	FA213HH			FA213V	MD851		MD851C	
44		VR640BLK†						FA215/2	FA215/2HH			FA215/2V	MD641			VR641
45								FA215/2	FA215/2HH			FA215/2V	MD641			VR641
46																
47								FA213	FA213HH			FA213V	MD851		MD851C	
48																
49								FA213	FA213HH			FA213V	MD851		MD851C	
50																
51								FA213	FA213HH			FA213V	MD851		MD851C	
52																
53								FA213	FA213HH			FA213V	MD851		MD851C	
54		MD649CX						FA214/2	FA214/2HH			FA214/2V	MD643			VR643
55																
56		MD649CX						FA214/2	FA214/2HH			FA214/2V	MD663			VR663

*-2 Sets Required. † For Vee disc colours add RED, BLU, GRN, GLD, ORG suffix to part number. **SAFETY WARNING:** DO NOT USE HH PADS ON REAR UNLESS ALSO USED ON FRONT TO AVOID BRAKE IMBALANCE

⊙ This symbol indicates a rotor made of billet steel, and should be only used with EBC FA Kevlar® Organic or Vee pads.

SAFETY NOTICE - With vehicles primarily designed for off highway use such as quads now being used on the highway, we would recommend the use of X or MXS pads for highway use and ONLY using the R and SV higher density / harder pad series for off road riding.

FRONT: Non-Japanese Bikes



TRIUMPH (HINCKLEY PRODUCED MACHINES)



DISC PAD CHOICES - FRONT

BRAKE ROTOR CHOICES - FRONT

										Line #
Bonneville T100 (790cc & 865cc) Floating disc conversion							MD601LS			1
Bonneville 800 (790cc)	FA196	FA196HH			FA196V	MD649				2
Bonneville 800 (790cc) Floating disc conversion						MD601LS				3
Speedmaster (790cc/Carbs)	FA142*	FA142HH*			FA142V*	MD649	MD649			4
Speedmaster (790cc/Carbs) Floating disc conversion						MD601LS	MD601RS			5
Tiger 800 (Non ABS/Cast Wheels)	FA226*	FA226HH*	EPFA226HH*			MD842X	MD842X		MD842XC*	6
Tiger 800 (With ABS/Cast Wheels)	FA226*	FA226HH*	EPFA226HH*			MD842X	MD842X		MD842XC*	7
Tiger 800 XR (With ABS/Cast Wheels)	FA226*	FA226HH*	EPFA226HH*			MD842X	MD842X		MD842XC*	8
Tiger 800 XR Touring (With ABS/Cast Wheels)	FA226*	FA226HH*	EPFA226HH*			MD842X	MD842X		MD842XC*	9
Tiger 800 XRt (With ABS/Cast Wheels)	FA226*	FA226HH*	EPFA226HH*			MD842X	MD842X		MD842XC*	10
Tiger 800 XRx (With ABS/Cast Wheels/STD & Low)	FA226*	FA226HH*	EPFA226HH*			MD842X	MD842X		MD842XC*	11
Tiger 800 XC (Non ABS/Spoke Wheels)	FA226*	FA226HH*	EPFA226HH*			MD842X	MD842X		MD842XC*	12
Tiger 800 XC (With ABS/Spoke Wheels)	FA226*	FA226HH*	EPFA226HH*			MD842X	MD842X		MD842XC*	13
Tiger 800 XC Adventure (With ABS/Spoke Wheels)	FA226*	FA226HH*	EPFA226HH*			MD842X	MD842X		MD842XC*	14
Tiger 800 XCx (With ABS/Spoke Wheels)	FA226*	FA226HH*	EPFA226HH*			MD842X	MD842X		MD842XC*	15
Tiger 800 XCx (With ABS/Spoke Wheels/STD & Low)	FA226*	FA226HH*	EPFA226HH*			MD842X	MD842X		MD842XC*	16
Tiger 800 XC-SE (With ABS/Spoke Wheels)	FA226*	FA226HH*	EPFA226HH*			MD842X	MD842X		MD842XC*	17
America (865cc) (Cast wheel)	FA196	FA196HH			FA196V	MD649				18
America (865cc) (Cast wheel) Floating disc conversion						MD601LS				19
America (865cc) (Cast wheel)	FA196	FA196HH			FA196V	MD822				20
America (865cc) (Cast wheel) America LT (865cc) (Cast wheel/Wind Shield)	FA196	FA196HH			FA196V	MD822				21
Bonneville/Bonneville Black (865cc)	FA196	FA196HH			FA196V	MD649				22
Bonneville/Bonneville Black (865cc) Floating disc conversion						MD601LS				23
Bonneville (865cc) (Cast wheel)	FA196	FA196HH			FA196V	MD821				24
Bonneville (865cc) (Cast wheel) Floating disc conversion						MD821X			MD821XC	25
Bonneville SE (865cc) (Cast wheel)	FA196	FA196HH			FA196V	MD821				26
Bonneville SE (865cc) (Cast wheel) Floating disc conversion						MD821X			MD821XC	27
Bonneville T100 (865cc) (Spoke wheel)	FA196	FA196HH			FA196V	MD822				28
Bonneville T100 (900cc)	FA142	FA142HH			FA142V	MD886X				29
Bonneville T100 Black (865cc) (Spoke wheel)	FA196	FA196HH			FA196V	MD822				30
Bonneville T100 Black (900cc)	FA142	FA142HH			FA142V	MD886X				31
Bonneville T100 - Steve McQueen SE (865cc) (Spoke wheel)	FA196	FA196HH			FA196V	MD822				32
Bonneville T100 Spirit SE (865cc/Spoke wheel)	FA196	FA196HH			FA196V	MD822				33
Bonneville T214 (865cc/Black Rim/Spoke wheel)	FA196	FA196HH			FA196V	MD822				34
Bonneville T100 Newchurch (865cc/Cast wheel)	FA196	FA196HH			FA196V	MD821				35
Bonneville T100 Newchurch (865cc/Cast wheel) Floating disc conversion						MD821X			MD821XC	36
Bonneville Bobber (1200cc)	FA142	FA142HH			FA142V					37
Bobber Black (1200cc)	FA181X	FA181HH*	EPFA181HH*		FA181V*					38
Speedmaster (865cc/Carbs)	FA142*	FA142HH*			FA142V*	MD649	MD649			39
Speedmaster (865cc/Carbs) Floating disc conversion						MD601LS	MD601RS			40
Speedmaster (865cc/EFI)	FA142*	FA142HH*			FA142V*	MD649	MD649			41
Speedmaster (865cc/EFI) Floating disc conversion available						MD601LS	MD601RS			42
Speedmaster (865cc/EFI) Cast Wheels -										43
Eng # 392060 to 46049/6 Bolt F/Disc	FA196	FA196HH			FA196V	MD822				44
Speedmaster (865cc/EFI) 5 Spoke Cast Wheel -										45
From Eng # 4609050/5 Bolt F/Disc	FA196	FA196HH			FA196V	MD821				46
Speedmaster (865cc/EFI) 5 Spoke Cast Wheel -										47
From Eng # 4609050/5 Bolt F/Disc Floating disc conversion						MD821X			MD821XC	48
Adventurer	FA196	FA196HH			FA196V	MD642LS				49
Adventurer Floating disc conversion						MD629X			MD629XC	50
Tiger 885cc Left	FA214	FA214HH			FA214V	MD644				51
Right	FA215	FA215HH			FA215V		MD644			52
Tiger 885cc	FA196*	FA196HH*			FA196V*	MD649	MD649			53
Tiger 885cc Floating disc conversion						MD601LS	MD601RS			54
Scrambler (865cc/Carbs)	FA196	FA196HH			FA196V	MD649				55

FRONT

APPLICTIONS
SAFETY NOTICE - With vehicles primarily designed for off highway use such as quads now being used on the highway, we would recommend the use of X or MXS pads for highway use and ONLY using the R and SV higher density / harder pad series for off road riding.

* This symbol indicates a rotor made of billet steel, and should be only used with EBC FA Kevlar® Organic or Vee pads.

*-2 Sets Required. † For Vee disc colours add RED, BLU, GRN, GLD, ORG suffix to part number. **SAFETY WARNING:- DO NOT USE HH PADS ON REAR UNLESS ALSO USED ON FRONT TO AVOID BRAKE IMBALANCE**

FRONT: Non-Japanese Bikes Cont'd

REAR: Non-Japanese Bikes

Line #	BRAKE ROTOR CHOICES - FRONT						DISC PAD CHOICES - REAR					BRAKE ROTOR CHOICES - REAR				
	CC Custom Rotor	CX Extreme® /Vee-Rotor	OS Series Oversize 250/280mm Rotor Kit	OSX Series Oversize 280mm Rotor Kit	Relocating Bracket for Oversize Rotor	SMX Series Oversize 320mm Rotor Kit	Relocating Bracket for 320mm Rotor		Sintered/HH Pads/ Grooved Shoes	SV Series Severe Duty Pads	EPFA Sintered Fast Road/ Track Pads	Specialty Pads SXR/ VEE/MXS Race	Standard Rotor	Vintage Rotor / UTV Oversize Brake Kit	Contour Profile Rotor	CX Extreme® /Vee-Rotor
1																
2		MD649CX						FA214/2	FA214/2HH			FA214/2V	MD663			VR663
3																
4		MD649CX*						FA214/2	FA214/2HH			FA214/2V	MD643			VR643
5																
6		VR842BLK††						FA140	FA140HH			FA140V	MD663		MD663C	VR663
7		VR842BLK††						FA140	FA140HH			FA140V	MD820		MD820C	VR820
8		VR842BLK††						FA140	FA140HH			FA140V	MD820		MD820C	VR820
9		VR842BLK††						FA140	FA140HH			FA140V	MD820		MD820C	VR820
10		VR842BLK††						FA140	FA140HH			FA140V	MD820		MD820C	VR820
11		VR842BLK††						FA140	FA140HH			FA140V	MD820		MD820C	VR820
12		VR842BLK††						FA140	FA140HH			FA140V	MD820		MD820C	VR820
13		VR842BLK††						FA140	FA140HH			FA140V	MD820		MD820C	VR820
14		VR842BLK††						FA140	FA140HH			FA140V	MD820		MD820C	VR820
15		VR842BLK††						FA140	FA140HH			FA140V	MD820		MD820C	VR820
16		VR842BLK††						FA140	FA140HH			FA140V	MD820		MD820C	VR820
17		VR842BLK††						FA140	FA140HH			FA140V	MD820		MD820C	VR820
18		MD649CX						FA214/2	FA214/2HH			FA214/2V	MD643			VR643
19																
20								FA214/2	FA214/2HH			FA214/2V	MD643			
21																
22								FA214/2	FA214/2HH			FA214/2V	MD643			
23		MD649CX						FA214/2	FA214/2HH			FA214/2V	MD663		MD663C	VR663
24																
25								FA214/2	FA214/2HH			FA214/2V	MD663		MD663C	VR663
26																
27								FA214/2	FA214/2HH			FA214/2V	MD663		MD663C	VR663
28																
29								FA214/2	FA214/2HH			FA214/2V	MD663		MD663C	VR663
30								FA214/2	FA214/2HH			FA214/2V	MD874			
31								FA214/2	FA214/2HH			FA214/2V	MD663		MD663C	VR663
32								FA214/2	FA214/2HH			FA214/2V	MD874			
33								FA214/2	FA214/2HH			FA214/2V	MD663		MD663C	VR663
34								FA214/2	FA214/2HH			FA214/2V	MD663		MD663C	VR663
35								FA214/2	FA214/2HH			FA214/2V	MD663		MD663C	VR663
36								FA214/2	FA214/2HH			FA214/2V	MD663		MD663C	VR663
37																
38								FA140	FA140HH			FA140V	MD874			
39								FA140	FA140HH			FA140V				
40								FA214/2	FA214/2HH			FA214/2V	MD643			VR643
41																
42								FA214/2	FA214/2HH			FA214/2V	MD643			VR643
43																
44																
45								FA214/2	FA214/2HH			FA214/2V	MD643			VR643
46																
47								FA214/2	FA214/2HH			FA214/2V	MD643			VR643
48																
49																
50																
51		VR629BLK						FA196	FA196HH			FA196V	MD643			VR643
52								FA215/2	FA215/2HH			FA214V	MD645			
53																
54		MD649CX*										MD643				VR643
55																
56		MD649CX						FA214/2	FA214/2HH			FA214/2V	MD663			VR663

BRAKE APPLICATIONS

⚠ This symbol indicates a rotor made of billet steel, and should be only used with EBC FA Kevlar® Organic or Vee pads. SAFETY NOTICE - With vehicles primarily designed for off highway use such as quads now being used on the highway, we would recommend the use of X or MXS pads for highway use and ONLY using the R and SV higher density / harder pad series for off road riding.

*-2 Sets Required. † For Vee disc colours add RED, BLU, GRN, GLD, ORG suffix to part number. **SAFETY WARNING: DO NOT USE HH PADS ON REAR UNLESS ALSO USED ON FRONT TO AVOID BRAKE IMBALANCE**

FRONT: Non-Japanese Bikes



TRIUMPH (HINCKLEY PRODUCED MACHINES)



DISC PAD CHOICES - FRONT

BRAKE ROTOR CHOICES - FRONT

Scrambler (865cc/Carbs) Floating disc conversion						MD601LS			
Scrambler (865cc/EFI)	FA196	FA196HH			FA196V	MD822			
Scrambler (865cc/EFI) F/Disc Floating disc conversion						MD822X			MD821XC
Scrambler (900cc/EFI)	FA196	FA196HH			FA196V	MD822			
Scrambler (900cc/EFI) F/Disc Floating disc conversion						MD822X			MD821XC
Daytona Super III (3 cyl)	FA190*	FA190HH*				MD640	MD640		
Legend TT	FA196	FA196HH			FA196V	MD642LS			
Legend TT Floating disc conversion						MD629X			
Speed Triple T509 (EFI 885cc - 6 Bolt Front Disc)	FA236*	FA236HH*				MD647X	MD647X		MD647XC*
Thunderbird Sport	FA196*	FA196HH*			FA196V*	MD649	MD649		
Thunderbird Sport Floating disc conversion						MD601LS	MD601RS		
Daytona 900 (3 cyl)	FA236*	FA236HH*				MD640	MD640		
Street Cup (900cc)	FA142	FA142HH			FA142V	MD886X			
Street Twin (900cc)	FA142	FA142HH			FA142V	MD873			
Street Twin (900cc) Floating disc conversion						MD873X			
New Street (900cc)		FA604/4HH				MD873			
New Street (900cc) Floating disc conversion						MD873X			
Street Scrambler Brembo M50 4-piston radial caliper, Brembo single 2-piston floating caliper, ABS		FA447HH*	EPFA447HH*	GPFAX447HH*					
Street Scrambler Single Brembo 4-piston fixed caliper, Nissin 2-piston floating caliper, ABS	FA142	FA142HH			FA142V				
Thunderbird	FA196	FA196HH			FA196V	MD642LS			
Thunderbird Floating disc conversion						MD629X			
Thruxtun 900	FA142	FA142HH			FA142V	MD629X			MD629XC
Thruxtun 900 SE	FA142	FA142HH			FA142V	MD629X			MD629XC
Thruxtun 900 Ace Café SE	FA142	FA142HH			FA142V	MD629X			MD629XC
Tiger 900		FA447HH*	EPFA447HH*	GPFAX447HH*					
Tiger 900 GT		FA447HH*	EPFA447HH*	GPFAX447HH*					
Tiger 900 GT Low		FA447HH*	EPFA447HH*	GPFAX447HH*					
Tiger 900 GT Pro		FA447HH*	EPFA447HH*	GPFAX447HH*					
Tiger 900 Rally		FA447HH*	EPFA447HH*	GPFAX447HH*					
Tiger 900 Pro		FA447HH*	EPFA447HH*	GPFAX447HH*					
Trident 900	Left	FA214	FA214HH		FA214V	MD646LS			
	Right	FA215	FA215HH		FA215V		MD646RS		
Trophy 900 (3 cyl) (up to VIN 9082)	Left	FA214	FA214HH		FA214V	MD646LS			
	Right	FA215	FA215HH		FA215V		MD646RS		
Trophy 900 (3 cyl) (from VIN 9083)		FA236*	FA236HH*			MD640	MD640		
Daytona 955i (6 bolt) (single sided swinging arm) front disc		FA236*	FA236HH*			MD647X	MD647X		MD647XC*
Daytona 955i (from VIN132513) (5 bolt) (Single sided s/arm)		FA236*	FA236HH*			MD669X	MD669X		MD669XC*
Daytona 955i (from VIN132513) (5 bolt front disc) (Double sided s/arm)		FA236*	FA236HH*			MD669X	MD669X		MD669XC*
Speed Triple (EFI 955cc - 6 Bolt Front Disc)		FA236*	FA236HH*			MD647X	MD647X		MD647XC*
T595 Daytona (6 bolt) front disc		FA236*	FA236HH*			MD647X	MD647X		MD647XC*
Tiger 955icc (Spoke wheel) (up to VIN 198874)		FA196*	FA196HH*		FA196V*	MD649	MD649		
Tiger 955icc (Spoke wheel) (up to VIN 198874) Floating disc conversion						MD601LS	MD601RS		
Tiger 955icc (cast wheel model) (from VIN 198875)		FA196*	FA196HH*		FA196V*	MD676	MD676		
Daytona 1000 (4 cyl)		FA236*	FA236HH*			MD640	MD640		
Speed Triple (1050cc - Nissin Radial F/Caliper/220mm R/Disc)			FA347HH*	EPFA347HH*		MD679X	MD679X		MD679XC*
Speed Triple (1050cc - 4 Pad Brembo F/Caliper /220mm R/Disc/Non ABS Model)	07-09		FA322/4HH*	EPFA322/4HH*		MD817X	MD817X		MD817XC*
Speed Triple (1050cc - 4 Pad Brembo F/Caliper /220mm R/Disc/ABS Model)	07-09		FA322/4HH*	EPFA322/4HH*		MD817X	MD817X		MD817XC*
Speed Triple (1050cc - 4 Pad Brembo F/Caliper /220mm R/Disc/Non ABS Model)	10-12		FA604/4HH*	EPFA604/4HH*		MD817X	MD817X		MD817XC*
Speed Triple (1050cc - 4 Pad Brembo F/Caliper /220mm R/Disc/ABS Model)	10-12		FA604/4HH*	EPFA604/4HH*		MD817X	MD817X		MD817XC*

FRONT

Line #

APPLICATIONS

BRAKE

* This symbol indicates a rotor made of billet steel, and should be only used with EBC FA Kevlar® Organic or Vee pads.

SAFETY NOTICE - With vehicles primarily designed for off highway use such as quads now being used on the highway, we would recommend the use of X or MXS pads for highway use and ONLY using the R and SV higher density / harder pad series for off road riding.

*-2 Sets Required. † For Vee disc colours add RED, BLU, GRN, GLD, ORG suffix to part number. **SAFETY WARNING:- DO NOT USE HH PADS ON REAR UNLESS ALSO USED ON FRONT TO AVOID BRAKE IMBALANCE**

FRONT: Non-Japanese Bikes Cont'd

REAR: Non-Japanese Bikes

Line #	BRAKE ROTOR CHOICES - FRONT						REAR	DISC PAD CHOICES - REAR					BRAKE ROTOR CHOICES - REAR			
	CC Custom Rotor	CX Extreme® /Vee-Rotor	OS Series Oversize 250/280mm Rotor Kit	OSX Series Oversize 280mm Rotor Kit	Relocating Bracket for Oversize Rotor	SMX Series Oversize 320mm Rotor Kit		Relocating Bracket for 320mm Rotor		Sintered/HH Pads/ Grooved Shoes	SV Series Severe Duty Pads	EPFA Sintered Fast Road/ Track Pads	Specialty Pads SXR/ VEE/MXS Race	Standard Rotor	Vintage Rotor / UTV Oversize Brake Kit	Contour Profile Rotor
1																
2								FA214/2	FA214/2HH			FA214/2V	MD663			
3																
4								FA214/2	FA214/2HH			FA214/2V	MD663			
5																
6		VR640BLK†						FA215/2	FA215/2HH			FA215/2V	MD641			VR641
7								FA196	FA196HH			FA196V	MD643			VR643
8																
9								FA214/2	FA214/2HH			FA214/2V	MD648		MD648C	VR648
10		MD649CX*						FA196	FA196HH			FA196V	MD643			VR643
11																
12		VR640BLK†						FA215/2	FA215/2HH			FA215/2V	MD641			VR641
13								FA214/2	FA214/2HH			FA214/2V	MD874			
14								FA214/2	FA214/2HH			FA214/2V	MD874			
15																
16								FA214/2	FA214/2HH			FA214/2V	MD874			
17																
18																
19								FA228	FA228HH							
20																
21								FA214/2	FA214/2HH			FA214/2V				
22								FA196	FA196HH			FA196V	MD643			VR643
23		VR629BLK														
24		VR629BLK						FA214/2	FA214/2HH			FA214/2V	MD663		MD663C	VR663
25		VR629BLK						FA214/2	FA214/2HH			FA214/2V	MD663		MD663C	VR663
26		VR629BLK						FA214/2	FA214/2HH			FA214/2V	MD663		MD663C	VR663
27								FA140	FA140HH			FA140V				
28								FA140	FA140HH			FA140V				
29								FA140	FA140HH			FA140V				
30								FA140	FA140HH			FA140V				
31								FA140	FA140HH			FA140V				
32								FA140	FA140HH			FA140V				
33		VR646BLK						FA215/2	FA215/2HH			FA215/2V	MD641			VR641
34		VR646BLK														
35		VR646BLK						FA215/2	FA215/2HH			FA215/2V	MD641			VR641
36		VR646BLK														
37		VR640BLK†						FA215/2	FA215/2HH			FA215/2V	MD641			VR641
38		VR647BLK†						FA214/2	FA214/2HH			FA214/2V	MD648		MD648C	VR648
39		VR669BLK†						FA140	FA140HH			FA140V	MD648		MD648C	VR648
40		VR669BLK†						FA140	FA140HH			FA140V	MD648		MD648C	VR648
41								FA214/2	FA214/2HH			FA214/2V	MD648		MD648C	VR648
42		VR647BLK†						FA214/2	FA214/2HH			FA214/2V	MD648		MD648C	VR648
43		MD649CX*						FA196	FA196HH			FA196V	MD643			VR643
44																
45								FA215/2	FA215/2HH			FA215/2V	MD677			
46		VR640BLK†						FA215/2	FA215/2HH			FA215/2V	MD641			VR641
47								FA214/2	FA214/2HH			FA214/2V	MD648		MD648C	VR648
48																
49								FA214/2	FA214/2HH			FA214/2V	MD648		MD663C	VR663
50																
51								FA214/2	FA214/2HH			FA214/2V	MD648			
52																
53								FA214/2	FA214/2HH			FA214/2V	MD663		MD663C	VR663
54																
55								FA214/2	FA214/2HH			FA214/2V	MD820			
56																

BRAKE APPLICATIONS

⚠ This symbol indicates a rotor made of billet steel, and should be only used with EBC FA Kevlar® Organic or Vee pads.
 SAFETY NOTICE - With vehicles primarily designed for off highway use such as quads now being used on the highway, we would recommend the use of X or MXS pads for highway use and ONLY using the R and SV higher density / harder pad series for off road riding.

*-2 Sets Required. † For Vee disc colours add RED, BLU, GRN, GLD, ORG suffix to part number. **SAFETY WARNING:- DO NOT USE HH PADS ON REAR UNLESS ALSO USED ON FRONT TO AVOID BRAKE IMBALANCE**

FRONT: Non-Japanese Bikes



TRIUMPH (HINCKLEY PRODUCED MACHINES)



DISC PAD CHOICES - FRONT

BRAKE ROTOR CHOICES - FRONT



Line #

			Sintered/HH Pads/Grooved Shoes	SV Series Severe Duty Pads	EPFA Sintered Fast Road/Track Pads	GPFAX Sintered RACE ONLY Pads	Specialty Pads SXR/VEE/MXS Race	Standard Rotor Left	Standard Rotor Right	Vintage Rotor / UTV Oversize Brake Kit	Contour Profile Rotor	Line #
Speed Triple R (1050cc - 2 Pad Brembo F/Caliper/255mm R/Disc/Non ABS Model)	13-15		FA447HH*		EPFA447HH*			MD679X	MD679X		MD679XC*	1
Speed Triple R (1050cc - 2 Pad Brembo F/Caliper/255mm R/Disc/ABS Model)	13-17		FA447HH*		EPFA447HH*			MD679X	MD679X		MD679XC*	2
Speed Triple S (1050cc - 2 Pad Brembo F/Caliper/255mm R/Disc/ABS Model)	16-21		FA447HH*		EPFA447HH*						MD8008XC*	3
Speed Triple RS (1050cc - 2 Pad Brembo F/Caliper/255mm R/Disc/ABS Model)	16-21		FA447HH*		EPFA447HH*						MD8008XC*	4
Sprint (All carb models) Up to VIN 9082	93	Left	FA214	FA214HH			FA214V	MD646X				5
		Right	FA215	FA215HH			FA215V		MD646RS			6
Sprint (All carb models) from VIN 9083	94-98		FA236*	FA236HH*				MD640X	MD640X			7
Sprint RS (up to VIN 139276) (6 bolt front disc) (double sided swinging arm)	99-01		FA236*	FA236HH*				MD647X	MD647X		MD647XC*	8
Sprint RS (from VIN 139277) (6 bolt front disc) FA215/2V												9
Note: up to VIN 161317 double sided swinging arm	02		FA236*	FA236HH*				MD647X	MD647X		MD647XC*	10
Sprint RS (from VIN 139277) (Single sided swing arm up to VIN 161317) (6 bolt front disc) Note: from VIN 161318 double sided swinging arm	03-04		FA236*	FA236HH*				MD647X	MD647X		MD647XC*	11
Sprint GT (1050cc/ABS)	10-11		FA236*	FA236HH*				MD817X	MD817X		MD817XC*	12
Sprint GT SE (1050cc/ABS)	13-20		FA236*	FA236HH*				MD817X	MD817X		MD817XC*	13
Sprint ST 955i (Front Disc With Offset/6 Bolt Fixing)	99-04		FA236*	FA236HH*				MD647X	MD647X		MD647XC*	14
Sprint ST 1050 (5 Spoke Wheel/Non ABS/ F Disc With Offset/5 Bolt Fixing) Vin 208167>	05-10		FA236*	FA236HH*				MD669X	MD669X		MD669XC*	15
Sprint ST 1050 (5 Spoke Wheel/ABS/ F Disc With Offset/5 Bolt Fixing) Vin 208167>	05-10		FA236*	FA236HH*				MD669X	MD669X		MD669XC*	16
Sprint ST 1050i (Non ABS Model - No Offset On Front Disc)	11-12		FA236*	FA236HH*				MD817X	MD817X		MD817XC*	17
Sprint ST 1050i (ABS Model - No Offset On Front Disc)	11-12		FA236*	FA236HH*				MD817X	MD817X		MD817XC*	18
Tiger 1050 (Radial Caliper)	07-15		FA347HH*		EPFA347HH*			MD679X	MD679X		MD679XC*	19
Tiger 1050 SE (Radial Caliper/ABS)	11-13		FA347HH*		EPFA347HH*			MD679X	MD679X		MD679XC*	20
Tiger 1050 Sport (Radial Caliper/ABS)	13-21		FA347HH*					MD679X	MD679X		MD679XC*	21
Bonneville T120 (1200cc)	16-21		FA142*	FA142HH*			FA142V*	MD873	MD873			22
Bonneville T120 (1200cc) Floating disc conversion	16-21							MD873X	MD873X			23
Bonneville T120 Black (1200cc)	16-21		FA142*	FA142HH*			FA142V*	MD873	MD873			24
Bonneville T120 Black (1200cc) Floating disc conversion	16-21							MD873X	MD873X			25
Daytona 1200 (4 cyl)	93-98		FA236*	FA236HH*				MD640	MD640			26
Bonneville Speedmaster 1200	18-21		FA142*	FA142HH*			FA142V*	MD873	MD873			27
Bonneville Speed Twin 1200	19-21		FA604/4HH*									28
Bonneville Speedmaster 1200 Floating disc conversion	19-21		FA181X*	FA181HH*			FA181V*	MD873X	MD873X			29
Scrambler 1200 XC	19-21		FA447HH*								MD8008XC*	30
Scrambler 1200 XE	19-21		FA447HH*								MD8008XC*	31
Thruxton (1200cc)	16-19		FA142*	FA142HH*			FA142V*	MD873	MD873			32
Thruxton (1200cc) Floating disc conversion	16-19							MD873X	MD873X			33
Thruxton R (1200cc)	16-21		FA447HH*		EPFA447HH*			MD883X	MD883X			34
Thruxton TFC (1200cc)	19-21		FA447HH*		EPFA447HH*			MD883X	MD883X			35
Trophy 1200 (4 cyl) (up to VIN 4901)	92-93	Left	FA214	FA214HH			FA214V	MD646LS				36
		Right	FA215	FA215HH			FA215V		MD646RS			37
Trophy 1200 (4 cyl) (from VIN 4902)	94-01		FA236*	FA236HH*				MD640X	MD640X			38
Tiger Explorer 1200 (1215cc/Cast Wheels)	16-20		FA236*	FA236HH*				MD842X	MD842X		MD842XC*	39
Tiger Explorer XC 1200												40
(Up to Vin # 740276/1215cc/Cast & Spoke Wheels)	16-20		FA236*	FA236HH*				MD842X	MD842X		MD842XC*	41
Tiger XC 1200												42
(Vin # 740277 onwards/1215cc/Spoke Wheels)	16-21		FA630HH*		EPFA630HH*		FA630V*	MD842X	MD842X		MD842XC*	43
Tiger XCa 1200 (1215cc/Spoke Wheels)	16-21		FA630HH*		EPFA630HH*		FA630V*	MD842X	MD842X		MD842XC*	44
Tiger XCx 1200 (1215cc/Spoke Wheels/STD & Low)	16-21		FA630HH*		EPFA630HH*		FA630V*	MD842X	MD842X		MD842XC*	45
Tiger XR 1200 (1215cc/Cast Wheels)	16-21		FA630HH*		EPFA630HH*		FA630V*	MD842X	MD842X		MD842XC*	46
Tiger XRx 1200 (1215cc/Cast Wheels/STD & Low)	16-21		FA630HH*		EPFA630HH*		FA630V*	MD842X	MD842X		MD842XC*	47
Tiger XRt 1200 (1215cc/Cast Wheels)	16-21		FA630HH*		EPFA630HH*		FA630V*	MD842X	MD842X		MD842XC*	48

FRONT

APPLIATIONS
BRAKE
 * This symbol indicates a rotor made of billet steel, and should be only used with EBC FA Kevlar® Organic or Vee pads.
 † For Vee disc colours add RED, BLU, GRN, GLD, ORG suffix to part number. **SAFETY WARNING:- DO NOT USE HH PADS ON REAR UNLESS ALSO USED ON FRONT TO AVOID BRAKE IMBALANCE**
 SAFETY NOTICE - With vehicles primarily designed for off highway use such as quads now being used on the highway, we would recommend the use of X or MXS pads for highway use and ONLY using the R and SV higher density / harder pad series for off road riding.

FRONT: Non-Japanese Bikes Cont'd

REAR: Non-Japanese Bikes

Line #	BRAKE ROTOR CHOICES - FRONT						REAR	DISC PAD CHOICES - REAR					BRAKE ROTOR CHOICES - REAR			
	CC Custom Rotor	CX Extreme® /Vee-Rotor	OS Series Oversize 250/280mm Rotor Kit	OSX Series Oversize 280mm Rotor Kit	Relocating Bracket for Oversize Rotor	SMX Series Oversize 320mm Rotor Kit		Relocating Bracket for 320mm Rotor		Sintered/HH Pads/ Grooved Shoes	SV Series Severe Duty Pads	EPFA Sintered Fast Road/ Track Pads	Specialty Pads SXR/ VEE/MXS Race	Standard Rotor	Vintage Rotor / UTV Oversize Brake Kit	Contour Profile Rotor
1																
2								FA214/2	FA214/2HH			FA214/2V	MD663		MD663C	VR648
3																
4								FA214/2	FA214/2HH			FA214/2V	TBC			
5																
6								FA214/2	FA214/2HH			FA214/2V	TBC			
7																
8								FA214/2	FA214/2HH			FA214/2V	TBC			
9		VR646BLK						FA215/2	FA215/2HH			FA215/2V	MD641			VR641
10		VR646BLK														
11		VR640BLK†						FA215/2	FA215/2HH			FA215/2V	MD641			VR641
12																
13		VR647BLK†						FA215/2	FA215/2HH			FA215/2V	MD663		MD663C	VR663
14																
15		VR647BLK†						FA215/2	FA215/2HH			FA215/2V	MD663		MD663C	VR663
16																
17		VR647BLK†						FA214/2	FA214/2HH			FA214/2V	MD663		MD663C	VR663
18		VR817BLK†						FA214/2	FA214/2HH			FA214/2V	MD820		MD820C	VR820
19		VR817BLK†						FA214/2	FA214/2HH			FA214/2V	MD820		MD820C	VR820
20								FA214/2	FA214/2HH			FA214/2V	MD663		MD663C	VR663
21																
22		VR669BLK†						FA214/2	FA214/2HH			FA214/2V	MD663		MD663C	VR663
23																
24		VR669BLK†						FA214/2	FA214/2HH			FA214/2V	MD820		MD820C	VR820
25		VR817BLK†						FA214/2	FA214/2HH			FA214/2V	MD820		MD820C	VR820
26		VR817BLK†						FA214/2	FA214/2HH			FA214/2V	MD820		MD820C	VR820
27		VR679BLK†						FA214/2	FA214/2HH			FA214/2V	MD663		MD663C	VR663
28		VR679BLK†						FA214/2	FA214/2HH			FA214/2V	MD663		MD663C	VR663
29		VR679BLK†						FA214/2	FA214/2HH			FA214/2V	MD663		MD663C	VR663
30								FA214/2	FA214/2HH			FA214/2V	TBC			
31																
32								FA214/2	FA214/2HH			FA214/2V	TBC			
33																
34		VR640BLK†						FA215/2	FA215/2HH			FA215/2V	MD641			VR641
35								FA140	FA140HH			FA140V	MD874			
36								FA215	FA215HH							
37																
38								FA209/2	FA209/2HH				MD874			
39								FA209/2	FA209/2HH				MD874			
40								FA214/2	FA214/2HH			FA214/2V	MD851			
41																
42								FA214/2	FA214/2HH			FA214/2V	MD851			
43								FA214/2	FA214/2HH			FA214/2V	MD851			
44		VR646BLK						FA215/2	FA215/2HH			FA215/2V	MD641			VR641
45		VR646BLK														
46		VR640BLK†						FA215/2	FA215/2HH			FA215/2V	MD641			VR641
47		VR842BLK†						FA214/2	FA214/2HH			FA214/2V	MD863			TBC
48																
49		VR842BLK†						FA214/2	FA214/2HH			FA214/2V	MD863			TBC
50																
51		VR842BLK†						FA214/2	FA214/2HH			FA214/2V	MD863			TBC
52		VR842BLK†						FA214/2	FA214/2HH			FA214/2V	MD863			TBC
53		VR842BLK†						FA214/2	FA214/2HH			FA214/2V	MD863			TBC
54		VR842BLK†						FA214/2	FA214/2HH			FA214/2V	MD863			TBC
55		VR842BLK†						FA214/2	FA214/2HH			FA214/2V	MD863			TBC
56		VR842BLK†						FA214/2	FA214/2HH			FA214/2V	MD863			TBC

BRAKE APPLICATIONS

⚠ This symbol indicates a rotor made of billet steel, and should be only used with EBC FA Kevlar® Organic or Vee pads. SAFETY NOTICE - With vehicles primarily designed for off highway use such as quads now being used on the highway, we would recommend the use of X or MXS pads for highway use and ONLY using the R and SV higher density / harder pad series for off road riding.

*-2 Sets Required. † For Vee disc colours add RED, BLU, GRN, GLD, ORG suffix to part number. **SAFETY WARNING:** DO NOT USE HH PADS ON REAR UNLESS ALSO USED ON FRONT TO AVOID BRAKE IMBALANCE

FRONT: Non-Japanese Bikes



TRIUMPH (HINCKLEY PRODUCED MACHINES)



Tiger 1200 Alpine Edition (1215cc/Cast Wheels/STD & Low)	20-21
Tiger 1200 Desert Edition (1215cc/Spoke Wheels)	20-21
Trophy SE (1215cc)	13-20
Rocket III (2300cc)	04-09
Rocket III Classic (2300cc)	07-09
Rocket III Roadster (2300cc)	11-19
Rocket III Touring (2300cc) ABS & Non ABS	09-17
Rocket 3 R	19-21
Rocket 3 GT	19-21
Thunderbird (1600cc/Cast wheel)	09-19
Thunderbird (1600cc/Windscreen)	12
Thunderbird Commander (1700cc/Cast wheel)	14-20
Thunderbird LT (1700cc/Cast wheel)	14-20
Thunderbird Storm (1700cc/Cast wheel)	09-19
Thunderbird NightStorm (1700cc/Cast wheel)	09-19

U.M. (UNITED MOTORS)

Dirt Tracker 50 (DT 50)	00-05
DTF 50	06-08
Moontrax 50 R	03-06
Squirt 50	04-05
Xpeed 50 Special Edition	00-05
Xpeed 50 R	07-08
Zyclone 50	04-05
Dirt Thrasher 90	04-05
DTF 90	06-08
Earthlander 90 R	05-06
Moontrax 90 R	03-06
Reptile 90	00-05
DTF 110	06-08
Dirt Tracker 125/200 (DT 125/200)	00-05
Matrix 150 XX (Single piston caliper)	05-06
Matrix II - 150	07-08
Matrix II - 150 Handbrake Shoes	07-08
Powermax 150 XX (Single piston caliper)	05-06
Powermax 150 XX (Single piston caliper) Handbrake Shoes	05-06
Powermax 150 XX (Two piston caliper)	05-06
Powermax 150 XX (Two piston caliper) Handbrake Shoes	05-06
DSF 200	06-08
Duel Sport Moto 2000 (DS 200)	00-05
DTF 200	06-08
Earthlander 200	05-06
Renegade 200	03-06
SMF 200	08
V2C 250 T	06-08
V2S 250 R	06-08
Xpeed 250 i	08
Bull 320 Side x Side	08
MTX 450	08
V2C 650 S	06-08
V2S 650 R	06-08

Line #	DISC PAD CHOICES - FRONT						BRAKE ROTOR CHOICES - FRONT			
		SV Series Severe Duty Pads	EPFA Sintered Fast Road/Track Pads	GPFA Sintered RACE ONLY Pads	Specialty Pads SXR/VEE/MXS Race	Standard Rotor Left	Standard Rotor Right	Vintage Rotor / UTV Oversize Brake Kit	Contour Profile Rotor	
1		FA630HH*	EPFA630HH*		FA630V*	MD842X	MD842X		MD842XC*	
2		FA630HH*	EPFA630HH*		FA630V*	MD842X	MD842X		MD842XC*	
3		FA423/4HH*				MD817X	MD817X		MD817XC*	
4		FA236HH*				MD669X	MD669X		MD669XC*	
5		FA236HH*				MD669X	MD669X		MD669XC*	
6		FA236HH*				TBC	TBC			
7		FA236HH*				TBC	TBC			
8		FA447HH*	EPFA447HH*			MD8008XC	MD8008XC			
9		FA447HH*	EPFA447HH*			MD8008XC	MD8008XC			
10	FA236*	FA236HH*				MD825	MD825			
11	FA236*	FA236HH*				MD825	MD825			
12	FA236*	FA236HH*				MD825	MD825			
13	FA236*	FA236HH*				MD825	MD825			
14	FA236*	FA236HH*				MD825	MD825			
15	FA236*	FA236HH*				MD825	MD825			
16										
17										
18										
19	SFA169	SFA169HH				N/A				
20	TBC*									
21	TBC*									
22	SFA83	SFA83HH				MD923D				
23	SFA83	SFA83HH				N/A				
24	SFA235					MD923D				
25	TBC*									
26	SFA264	SFA264HH				N/A				
27	TBC*									
28	TBC*									
29	TBC*									
30	SFA264	SFA264HH				N/A				
31	FA56									
32	SFA54	SFA54HH					N/A			
33	SFA323	SFA323HH					N/A			
34	TBC									
35	SFA54	SFA54HH					N/A			
36	TBC									
37	SFA323	SFA323HH					N/A			
38	TBC									
39	FA135X	FA135R				MXS135	N/A			
40	FA56									
41	FA135X	FA135R				MXS135	N/A			
42	TBC*									
43	FA196	FA196HH				TBC				
44	FA135X	FA135R				MXS135	N/A			
45	FA86	FA86HH				N/A				
46	FA86*	FA86HH*				MD691	MD691			
47	SFA228	SFA228HH				N/A				
48	SFA197	SFA197HH					N/A			
49	TBC*					N/A	N/A			
50	FA54X*	FA54R*				MXS54*	N/A	N/A		
51	FA86*	FA86HH*				N/A	N/A			
52	FA86*	FA86HH*				MD690	MD690		MD690C*	
53										
54										
55										
56										

APPLICATIONS

⚡ This symbol indicates a rotor made of billet steel, and should be only used with EBC FA Kevlar® Organic or Vee pads. SAFETY NOTICE - With vehicles primarily designed for off highway use such as quads now being used on the highway, we would recommend the use of X or MXS pads for highway use and ONLY using the R and SV higher density / harder pad series for off road riding.

*-2 Sets Required. † For Vee disc colours add RED, BLU, GRN, GLD, ORG suffix to part number. SAFETY WARNING:- DO NOT USE HH PADS ON REAR UNLESS ALSO USED ON FRONT TO AVOID BRAKE IMBALANCE

FRONT: Non-Japanese Bikes Cont'd

REAR: Non-Japanese Bikes

Line #	BRAKE ROTOR CHOICES - FRONT						DISC PAD CHOICES - REAR					BRAKE ROTOR CHOICES - REAR				
	CC Custom Rotor	CX Extreme® /Vee-Rotor	OS Series Oversize 250/280mm Rotor Kit	OSX Series Oversize 280mm Rotor Kit	Relocating Bracket for Oversize Rotor	SMX Series Oversize 320mm Rotor Kit	Relocating Bracket for 320mm Rotor		Sintered/HH Pads/ Grooved Shoes	SV Series Severe Duty Pads	EPFA Sintered Fast Road/ Track Pads	Specialty Pads SXR/ VEE/MXS Race	Standard Rotor	Vintage Rotor / UTV Oversize Brake Kit	Contour Profile Rotor	CX Extreme® /Vee-Rotor
1		VR842BLK†						FA214/2	FA214/2HH			FA214/2V	MD863			TBC
2		VR842BLK†						FA214/2	FA214/2HH			FA214/2V	MD863			TBC
3								FA214/2	FA214/2HH			FA214/2V	TBC			
4		VR669BLK†							FA209/2HH			FA209/2V	MD699		N/A	N/A
5		VR669BLK†							FA209/2HH			FA209/2V	MD699		N/A	N/A
6									FA209/2HH			FA209/2V	MD699			
7									FA209/2HH			FA209/2V	MD699			
8									FA630HH							
9									FA630HH							
10									FA209/2HH			FA209/2V	MD831			
11									FA209/2HH			FA209/2V	MD831			
12									FA209/2HH			FA209/2V	MD831			
13									FA209/2HH			FA209/2V	MD831			
14									FA209/2HH			FA209/2V	MD831			
15									FA209/2HH			FA209/2V	MD831			
16																
17																
18																
19								TBC								
20								FA83X	FA83R				N/A			
21								TBC								
22								503								
23								TBC								
24								504								
25								TBC								
26								TBC								
27								FA83X	FA83R				N/A			
28								FA83X	FA83R				N/A			
29								TBC								
30								TBC								
31																
32								TBC					TBC			
33								SFA264	SFA264HH				N/A			
34																
35								TBC					TBC			
36																
37								TBC					TBC			
38																
39								FA115X	FA115R				N/A			
40																
41								FA115X	FA115R				N/A			
42								FA83X	FA83R				N/A			
43								TBC								
44								FA115X	FA115R				N/A			
45								602								
46								FA86	FA86HH				N/A			
47								SFA197	SFA197HH				N/A			
48																
49													N/A			
50								FA54X	FA54R			MXS54	N/A			
51								FA86	FA86HH				N/A			
52								FA86	FA86HH				MD689		MD689C	
53																
54																
55																
56																

BRAKE APPLICATIONS

⚠ This symbol indicates a rotor made of billet steel, and should be only used with EBC FA Kevlar® Organic or Vee pads.
 SAFETY NOTICE - With vehicles primarily designed for off highway use such as quads now being used on the highway, we would recommend the use of X or MXS pads for highway use and ONLY using the R and SV higher density / harder pad series for off road riding.

*-2 Sets Required. † For Vee disc colours add RED, BLU, GRN, GLD, ORG suffix to part number. **SAFETY WARNING:- DO NOT USE HH PADS ON REAR UNLESS ALSO USED ON FRONT TO AVOID BRAKE IMBALANCE**

FRONT: Non-Japanese Bikes



UNISON



		DISC PAD CHOICES - FRONT					BRAKE ROTOR CHOICES - FRONT				Line #
		Sintered/HH Pads/Grooved Shoes	SV Series Severe Duty Pads	EPFA Sintered Fast Road/Track Pads	GPFAX Sintered RACE ONLY Pads	Specialty Pads SXR/VEE/MXS Race	Standard Rotor Left	Standard Rotor Right	Vintage Rotor / UTV Oversize Brake Kit	Contour Profile Rotor	
Desert Cat Mini 50 (2T)	04-	346*	346G*								1
Desert Cat 70/90/100 (4T)	04-	346*	346G*								2
Desert Cat 90 (2T)	04-	346*	346G*								3
Desert Cat 150	04-	FA83X*	FA83R*				N/A	N/A			4
Black Widow 150	04-	FA83X*	FA83R*				N/A	N/A			5
Mobility 250	04-	FA83X*	FA83R*				N/A	N/A			6
Rage 250	04-	TBC*	TBC*				N/A	N/A			7
Mobility 500 (Side x Side)	12-	FA453X*	FA453R*				N/A	N/A			8
Mobility 500 (Side x Side) Parking Brake		FA232X	FA232R								9
Mobility 650 (Side x Side)	12-	TBC*	TBC*				N/A	N/A			10
VERTEMATI											
C 450/500/570 (MX)	03-04	FA181X	FA181R		EPFA181HH	MXS181	N/A				13
E 450/501/570 (Enduro)	03-04	FA181X	FA181R		EPFA181HH	MXS181	N/A				14
S 450/501/570/E (Super Motard)	03-04	FA158	FA158HH		EPFA158HH		N/A				15
SR 450/SR 600 Motard Racing	03-04	FA158	FA158HH		EPFA158HH		N/A				16
495	99-02	FA181X	FA181R		EPFA181HH	MXS181	N/A				17
VESPA											
Electrica	19-20	SFA260	SFA260HH								20
LX 50	05-15	SFA260	SFA260HH				MD910D				21
Primavera 50 (4T/4V)	13-15	SFA353	SFA353HH				MD910D				22
Primavera 50 (4T/3V)	16-21	SFA260	SFA260HH				MD910D				23
S50 (4T/4V)	08-15	SFA260	SFA260HH				MD910D				24
Sprint 50 (4T/4V)	14-15	SFA353	SFA353HH				MD910D				25
Sprint 50cc (4T/3V)	16-20	SFA260	SFA260HH				MD910D				26
GTS 125 4V ABS/Super Sport/Touring	18-21	SFA353	SFA353HH								27
946 Red 125cc (4T/3V)	19-20	SFA353	SFA353HH								28
Primavera 125 4T	13-21	SFA353	SFA353HH								29
Primavera 125 4T Sean Wotherspoon	21	SFA353	SFA353HH								30
Primavera 125 4T Touring	20-21	SFA353	SFA353HH								31
Sprint S 125	21	SFA353	SFA353HH								32
ET4 150cc	99-04	SFA260	SFA260HH				MD910D				33
GTS 150 4V ABS	18-19	SFA353	SFA353HH								34
LX 150 ie	05-15	SFA260	SFA260HH				MD910D				35
LXV 150 ie	10-15	SFA260	SFA260HH				MD910D				36
PX 150 (All models)	05-06	SFA186						MD910D			37
Primavera 150 (4T/3V/ie)	13-20	SFA353	SFA353HH				MD910D				38
S150 ie	08-15	SFA260	SFA260HH				MD910D				39
Sprint 150 (4T/3V/ie)	14-15	SFA353	SFA353HH				MD910D				40
Sprint 150 (4T/3V) S	16-20	SFA260	SFA260HH				MD910D				41
946 (155cc/ABS/4T/3V/ie)	13-15	SFA353	SFA353HH				TBC				42
GT 200 L (Grimeca caliper)	05-09	SFA194	SFA194HH				MD956D				43
GT 200 L Gran Turismo (Heng Tong caliper)	05-09	SFA353	SFA353HH				MD956D				44
ET 250cc	97-04	SFA260	SFA260HH				MD910D				45
GT 60 (250cc Ltd Edition)	06-08	SFA353	SFA353HH				MD956D				46
GTS 250	05-09	SFA353	SFA353HH				MD956D				47
GTV 250	07-09	SFA353	SFA353HH				MD956D				48
LXV 250	07-09	SFA353	SFA353HH				MD956D				49
GTS 300 4V ABS/Super Sport/Touring Inc HPE	18-21	SFA353	SFA353HH				MD956D				50
GTS 300 ie	08-15	SFA353	SFA353HH				MD956D				51
GTS Super 300 HPE-Tech (4T/4V)	18-21	SFA353	SFA353HH				MD956D				52
GTS 300 Super	10-15	SFA353	SFA353HH				MD956D				53
GTV 300 ie	10-15	SFA353	SFA353HH				MD956D				54
GTV SEI Giorni 300cc IE ABS	19-20	SFA353	SFA353HH				MD956D				55

APPLICATIONS

BRAKE

⚡ This symbol indicates a rotor made of billet steel, and should be only used with EBC FA Kevlar® Organic or Vee pads.

SAFETY NOTICE - With vehicles primarily designed for off highway use such as quads now being used on the highway, we would recommend the use of X or MXS pads for highway use and ONLY using the R and SV higher density / harder pad series for off road riding.

FRONT

*-2 Sets Required. † For Vee disc colours add RED, BLU, GRN, GLD, ORG suffix to part number. SAFETY WARNING:- DO NOT USE HH PADS ON REAR UNLESS ALSO USED ON FRONT TO AVOID BRAKE IMBALANCE

FRONT: Non-Japanese Bikes Cont'd

REAR: Non-Japanese Bikes

Line #	BRAKE ROTOR CHOICES - FRONT						DISC PAD CHOICES - REAR					BRAKE ROTOR CHOICES - REAR				
	CC Custom Rotor	CX Extreme® /Vee-Rotor	OS Series Oversize 250/280mm Rotor Kit	OSX Series Oversize 280mm Rotor Kit	Relocating Bracket for Oversize Rotor	SMX Series Oversize 320mm Rotor Kit	Relocating Bracket for 320mm Rotor		Sintered/HH Pads/ Grooved Shoes	SV Series Severe Duty Pads	EPFA Sintered Fast Road/ Track Pads	Specialty Pads SXR/ VEE/MXS Race	Standard Rotor	Vintage Rotor / UTV Oversize Brake Kit	Contour Profile Rotor	CX Extreme® /Vee-Rotor
1								N/A					N/A			
2								307	307G							
3								307	307G							
4								TBC					N/A			
5								TBC					N/A			
6								TBC	TBC				N/A			
7								TBC	TBC				N/A			
8								TBC	TBC				N/A			
9																
10								TBC	TBC				N/A			
11																
12																
13								FA208X	FA208R		EPFA208HH	MXS208	N/A			
14								FA208X	FA208R		EPFA208HH	MXS208	N/A			
15								FA208X	FA208R		EPFA208HH	MXS208	N/A			
16								FA208X	FA208R		EPFA208HH	MXS208	N/A			
17								FA208X	FA208R		EPFA208HH	MXS208	N/A			
18																
19																
20								816								
21								899								
22								816								
23								816								
24								899								
25								816								
26								816								
27								SFA321	SFA321HH							
28								SFA321	SFA321HH							
29								816								
30								816								
31								816								
32								816								
33								899								
34								SFA321	SFA321HH							
35								899								
36								899								
37								903								
38								816								
39								899								
40								816								
41								816								
42								SFA321	SFA321HH				TBC			
43								SFA321	SFA321HH				MD956D			
44								SFA321	SFA321HH				MD956D			
45								899								
46								SFA321	SFA321HH				MD956D			
47								SFA321	SFA321HH				MD956D			
48								SFA321	SFA321HH				MD956D			
49								SFA321	SFA321HH				MD956D			
50								SFA321	SFA321HH				MD956D			
51								SFA321	SFA321HH				MD956D			
52								SFA321	SFA321HH				MD956D			
53								SFA321	SFA321HH				MD956D			
54								SFA321	SFA321HH				MD956D			
55								SFA321	SFA321HH				MD956D			
56								SFA321	SFA321HH				MD956D			

BRAKE APPLICATIONS

⚠ This symbol indicates a rotor made of billet steel, and should be only used with EBC FA Kevlar® Organic or Vee pads.
 SAFETY NOTICE - With vehicles primarily designed for off highway use such as quads now being used on the highway, we would recommend the use of X or MXS pads for highway use and ONLY using the R and SV higher density / harder pad series for off road riding.

*-2 Sets Required. † For Vee disc colours add RED, BLU, GRN, GLD, ORG suffix to part number. **SAFETY WARNING:- DO NOT USE HH PADS ON REAR UNLESS ALSO USED ON FRONT TO AVOID BRAKE IMBALANCE**

FRONT: Non-Japanese Bikes

APPLICATIONS
BRAKE



VOR



DISC PAD CHOICES - FRONT

BRAKE ROTOR CHOICES - FRONT

											Line #
EN/EN-E 450/530	04	FA181X	FA181R	EPFA181HH		MXS181	N/A				1
MX 450/530	04	FA181X	FA181R	EPFA181HH		MXS181	N/A				2
SM-E 450/530	04	FA95	FA95HH	EPFA95HH			N/A				3
											4
											5
											6
											7
											8
											9
											10
											11
											12
											13
											14
											15
											16
											17
											18
											19
											20
											21
											22
											23
											24
											25
											26
											27
											28
											29
											30
											31
											32
											33
											34
											35
											36
											37
											38
											39
											40
											41
											42
											43
											44
											45
											46
											47
											48
											49
											50
											51
											52
											53
											54
											55
											56

FRONT





⚠ This symbol indicates a rotor made of billet steel, and should be only used with EBC FA Kevlar® Organic or Vee pads.
SAFETY NOTICE - With vehicles primarily designed for off highway use such as quads now being used on the highway, we would recommend the use of X or MXS pads for highway use and ONLY using the R and SV higher density / harder pad series for off road riding.

*-2 Sets Required. † For Vee disc colours add RED, BLU, GRN, GLD, ORG suffix to part number. SAFETY WARNING:- DO NOT USE HH PADS ON REAR UNLESS ALSO USED ON FRONT TO AVOID BRAKE IMBALANCE

FRONT: Non-Japanese Bikes Cont'd

REAR: Non-Japanese Bikes

Line # 1 2 3 4 5 6 7 8 9 10 11 12 13 14 15 16 17 18 19 20 21 22 23 24 25 26 27 28 29 30 31 32 33 34 35 36 37 38 39 40 41 42 43 44 45 46 47 48 49 50 51 52 53 54 55 56

BRAKE ROTOR CHOICES - FRONT							DISC PAD CHOICES - REAR					BRAKE ROTOR CHOICES - REAR			
CC Custom Rotor	CX Extreme® /Vee-Rotor	OS Series Oversize 250/280mm Rotor Kit	OSX Series Oversize 280mm Rotor Kit	Relocating Bracket for Oversize Rotor	SMX Series Oversize 320mm Rotor Kit	Relocating Bracket for 320mm Rotor		Sintered/HH Pads/ Grooved Shoes	SV Series Severe Duty Pads	EPFA Sintered Fast Road/ Track Pads	Specialty Pads SXR/ VEE/MXS Race	Standard Rotor	Vintage Rotor / UTV Oversize Brake Kit	Contour Profile Rotor	CX Extreme® /Vee-Rotor
								FA208X	FA208R		EPFA208HH	MXS208	N/A		
								FA208X	FA208R		EPFA208HH	MXS208	N/A		
								FA208X	FA208R		EPFA208HH	MXS208	N/A		

REAR

BRAKE APPLICATIONS

⚠ This symbol indicates a rotor made of billet steel, and should be only used with EBC FA Kevlar® Organic or Vee pads.
 SAFETY NOTICE - With vehicles primarily designed for off highway use such as quads now being used on the highway, we would recommend the use of X or MXS pads for highway use and ONLY using the R and SV higher density / harder pad series for off road riding.

*-2 Sets Required. † For Vee disc colours add RED, BLU, GRN, GLD, ORG suffix to part number. **SAFETY WARNING:- DO NOT USE HH PADS ON REAR UNLESS ALSO USED ON FRONT TO AVOID BRAKE IMBALANCE**

RECOMMENDED DEALER INVENTORY - BRAKE PADS/SHOES

BRAKE APPLICATIONS

Harley Davidson (S Suffix means Streetbike)	
FA400HH	(S) 6
FA94HH	(S) 4
FA409HH	(S) 4
FA200HH	(S) 3
FA400V	(S) 3
FA409V	(S) 3
FA71	(S) 2
FA72	(S) 2
FA200	(S) 2
FA381	(S) 2
FA400	(S) 2
FA409	(S) 2
FA434	(S) 2
FA381HH	(S) 2
FA94V	(S) 2
FA434HH	(S) 2
FA457HH	(S) 2
FA458HH	(S) 2
FA605/4HH	(S) 2
FA24/2	(S) 2
FA24/2V	(S) 2
FA71V	(S) 2
FA94V	(S) 2
FA216/3	(S) 2
FA216/3HH	(S) 2
FA216/3V	(S) 2
FA296HH	(S) 2
FA381	(S) 2
FA381V	(S) 2
FA381HH	(S) 2
FA387	(S) 2
FA387HH	(S) 2
FA387V	(S) 2
FA409	(S) 2
FA457V	(S) 2
FA434HH	(S) 2
FA457HH	(S) 2
FA458V	(S) 2
FA605/4V	(S) 2
FA640	(S) 2
FA640V	(S) 2
FA640HH	(S) 2
FA78	(S) 1
FA79	(S) 1
FA201	(S) 1
FA387	(S) 1
FA201HH	(S) 1
FA387HH	(S) 1
FA72V	(S) 1
FA78V	(S) 1
FA79V	(S) 1
FA200V	(S) 1
FA201V	(S) 1
FA254	(S) 1
FA254V	(S) 1
FA254HH	(S) 1
FA434V	(S) 1
FA638	(S) 2
FA638V	(S) 2
FA638HH	(S) 2

BMW (S Suffix means Streetbike)

FA171	(S) 2
FA171V	(S) 2
FA209/2	(S) 2
FA209/2V	(S) 2
FA213HH	(S) 2
FA22	(S) 2
FA22V	(S) 2
FA294HH	(S) 2
FA363	(S) 2
FA363HH	(S) 2
FA407	(S) 2
FA407HH	(S) 2
FA57	(S) 2
FA57V	(S) 2
FA604/4HH	(S) 2
FA613HH	(S) 2
FA630HH	(S) 2
FA77	(S) 2
FA671	(S) 2
FA671HH	(S) 2
FA77V	(S) 2
FA213	(S) 1
FA213V	(S) 1
FA304HH	(S) 1
FA304V	(S) 1
FA335HH	(S) 1
FA363V	(S) 1
FA438HH	(S) 1
FA441HH	(S) 1
FA724HH	(S) 1
FA730HH	(S) 4
FA748HH	(S) 8
FA749HH	(S) 8

Ducati (S Suffix means Streetbike)	
FA18V	(S) 2
FA209/2	(S) 2
FA209/2HH	(S) 2
FA209/2V	(S) 2
FA244	(S) 2
FA244HH	(S) 2
FA244V	(S) 2
FA266HH	(S) 2
FA322/2HH	(S) 2
FA447HH	(S) 2
FA47	(S) 2
FA630HH	(S) 2
FA95	(S) 2
FA95HH	(S) 2
FA95V	(S) 2
FA266	(S) 1
FA266V	(S) 1
FA47HH	(S) 1

Triumph (S Suffix means Streetbike)	
FA196	(S) 2
FA196HH	(S) 2
FA196V	(S) 2
FA209/2	(S) 2
FA209/2HH	(S) 2
FA209/2V	(S) 2
FA214	(S) 1
FA214HH	(S) 2
FA215	(S) 1
FA215/2	(S) 1
FA215/2HH	(S) 2
FA226	(S) 2
FA226HH	(S) 2
FA236	(S) 2
FA236HH	(S) 2
FA236V	(S) 2
FA322/2HH	(S) 2
FA347HH	(S) 2
FA447HH	(S) 2
FA491HH	(S) 2
FA604/4HH	(S) 2
FA630HH	(D) 2

Polaris (A Suffix means ATV)	
FA159R	(A) 4
FA354R	(A) 3
FA354SV	(A) 3
FA159SV	(A) 2
FA159X	(A) 2
FA232R	(A) 2
FA270R	(A) 2
FA452R	(A) 2
FA452X	(A) 2
FA456R	(A) 2
FA456X	(A) 2
FA475R	(A) 2
FA475X	(A) 2
FA489R	(A) 2
FA490R	(A) 2
FA656R	(A) 2
FA656X	(A) 2
FA657X	(A) 2
FA657R	(A) 2
FA680R	(A) 2
FA83R	(A) 2
FA270X	(A) 1
FA273R	(A) 1
FA314R	(A) 1
FA728	(A) 4

KTM (D Suffix means Dirtbike, S means Streetbike)	
FA181R	(D) 2
FA181X	(D) 2
FA208R	(D) 4
FA208X	(D) 2
FA325R	(D) 1
FA325X	(D) 1
FA357R	(D) 1
FA357X	(D) 1
FA368R	(D) 3
FA368X	(D) 3
FA433/3HH	(D) 2
FA447HH	(S) 2
FA462R	(D) 1
FA463R	(D) 2
FA612R	(D) 1
FA612X	(D) 1

Honda — Shoes			
Item Code	Qty for Dealer to Stock	Franchise	Market Segment
347	6	H	A
351	4	H	A
333	4	H	D/S
315	4	H	S/A
343	3	H	S/A
304	3	H	D
306	3	H	A
340	3	H	D/A
303	3	H	A
345	2	H	A
338	2	KTM/P	D
330	2	H	D
321	2	H	S
301	2	H	S
347G	2	H	A
347S	2	H	A
351G	2	H	A
313	2	H	S
333G	1	H	D
304G	1	H	D
338G	1	H/K	D/A
322	1	KTM	D
315G	1	H	D/A
310	1	H	S/D
320	1	H	S
306G	1	H	A
340G	1	H	A
318	1	H	S/D
343G	1	H	A
307G	1	P	A
339	1	H	A
346	1	H	A

Kawasaki — Shoes			
Item Code	Rank in Overall Shoe Sales (not just this franchise)	Franchise	Market Segment
706	4	K	D/A
709	3	K	S
715	2	K/S	D
705	2	K	D/A
720	2	K/S	A
710	2	K	A/S
718	1	K	A
719	1	K	A
715G	1	K/S	D
705G	1	K	D/A
706G	1	K	A

Suzuki — Shoes			
Item Code	Rank in Overall Shoe Sales (not just this franchise)	Franchise	Market Segment
606	4	S/K	D/A
626	3	S	S/A
602	3	S/K	S/D
636	3	S	A
604	2	S	D
603	2	S/K	D/A
628	2	S/K	A
633	2	S	A
634	2	S	A/S
614	2	S/K	D/A
636G	2	S	A
605	2	S	D/A
629	1	S	A
618	1	S/K	D/A
603G	1	K	D/A
634G	1	S	A
633G	1	S	A
604G	1	S	D/A
613	1	S/K	D/A
602G	1	S	D
606G	1	S	A
628G	1	K/S	A

Yamaha — Shoes			
Item Code	Rank in Overall Shoe Sales (not just this franchise)	Franchise	Market Segment
503	5	Y	A/D
516	4	Y	S/A
528	4	Y	S/D/A
515	4	Y	S
527	3	Y	S/D/A
524	3	Y	A
532	3	Y	S
506	3	Y	D/A/S
503G	3	Y	D/A
501	3	Y	S/D/A
516G	3	Y	A
531	2	Y	S
524G	2	Y	A
532G	2	Y	D
502	2	S/Y	D
512	2	Y	S
528G	2	Y	D/A
530	1	Y	S
510	1	Y	D/S
506G	1	Y	D/A
518	1	Y	D/A
504	1	Y	D
527G	1	Y	D/A
514	1	Y	S
507	1	Y	D
520	1	Y	A

Accessory Store — Shoes			
Item Code	Rank in Overall Shoe Sales (not just this franchise)	Franchise	Market Segment
347	1	H	A
351	2	H	A
333	3	H	D/S
503	4	Y	A/D
315	5	H	S/A
343	6	H	S/A
304	7	H	D
516	8	Y	S/A
306	9	H	A
340	10	H	D/A
303	11	H	A
345	12	H	A
528	13	Y	S/D/A
338	14	KTM/P	D
330	15	H	D
321	16	H	S
515	17	Y	S
301	18	H	S
527	19	Y	S/D/A
347G	20	H	A
524	21	Y	A
532	22	Y	S
606	23	S/K	D/A
626	24	S	S/A
602	25	S/K	S/D
347S	26	H	A
706	27	K	D/A
506	28	Y	D/A/S
709	29	K	S
636	30	S	A

ROAD RACING APPLICATIONS

Make & Model	Year	FRONT					REAR		
		Organic Pads or Shoes	Sintered/ HH Pads Grooved shoes	Sintered Pads EPFA	Sintered Pads GPFA	Brake Rotor Left	Brake Rotor Right	Organic Pads or Shoes	Brake Rotor
HONDA									
RS125	88-89	FA124					N/A	FA151	MD713
RS125	90-94	FA226	FA226HH	EPFA226HH			MD1003X	FA151	MD713
RS125	95-03	FA239	FA239HH	EPFA239HH			MD1003X	FA151	MD713
RS125 (Radial caliper)	04-07		FA347HH	EPFA347HH	GPFA347HH		MD1003X	FA151	MD713
NSF250 R (Moto 3)	12-13		FA347HH	EPFA347HH	GPFA347HH		N/A	FA151	N/A
RS250	88-89	FA124*				MD1003X	MD1003X	FA151	MD724
RS250	90-94	FA226*	FA226HH*	EPFA226HH*		MD1003X	MD1003X	FA151	MD724
RS250	95-02	FA239*	FA239HH*	EPFA239HH*		MD1003X	MD1003X	FA151	MD724
MORIWAKI									
MD250H	08-13		FA347HH	EPFA347HH	GPFA347HH		MD1003X	FA151	N/A
YAMAHA									
TZ125	94-97	FA145	FA145HH	EPFA145HH			MD711RD	FA162	MD732
TZ250	89-90	FA145*	FA145HH*	EPFA145HH*		MD711LD	MD711RD	FA162	MD732
TZ250	91	FA145*	FA145HH*	EPFA145HH*		MD711LD	MD711RD	FA162	MD2021
TZ250	92-96	FA145*	FA145HH*	EPFA145HH*		MD711LD	MD711RD	FA162	MD732
TZ250	97-01	FA145*	FA145HH*	EPFA145HH*		MD730LD	MD730RD	FA162	MD732
TZ250 (Radial Caliper)	02-10		FA347HH*	EPFA347HH*	GPFA347HH*	MD730LD	MD730RD	FA162	

PADS FOR AFTERMARKET CALIPERS

	STANDARD ORGANIC PAD	OPTIONAL ORGANIC PAD	SEMI-SINTERED VEE PAD	CHROME BACKED SEMI-SINTERED VEE PAD	FULLY SINTERED PAD	EPFA FULLY SINTERED TRACK DAY PAD	GPFA FULLY SINTERED RACE PAD
AMERICAN SUSPENSION CALIPERS							
B17 Phantom 2 piston brake caliper	FA18	N/A	FA18V	N/A	N/A	N/A	N/A
B17 Mach 8 Radial mount 4 Piston caliper	N/A	N/A	N/A	N/A	N/A	N/A	N/A
B17 Mach 8 Standard mount 2 Piston caliper	FA18	N/A	FA18V	N/A	N/A	N/A	N/A
P26 2 Piston Caliper	FA18	N/A	FA18V	N/A	N/A	N/A	N/A
AP LOCKHEED							
2 Piston / 2 Pin (CP2195/CP2696 -38E0)	FA16	FA16S	N/A		FA16HH	EPFA16HH	GPFA16HH
2 Piston Sidecar caliper (CP2576/2577/3176/3177/3178)	N/A	N/A	N/A		N/A	N/A	N/A
2 Piston / 1 Pin (CP4226 - 2S0)	FA272	N/A	N/A		N/A	N/A	N/A
2 Piston / 1 Pin (CP4227 - 2S0)	FA272	N/A	N/A		N/A	N/A	N/A
6 Piston / No Pins (CP3366/67)	N/A	N/A	N/A		N/A	N/A	N/A
6 Piston / 2 Pins (CP4466)	N/A	N/A	N/A		N/A	EPFA263HH	N/A
4 Piston (CP3086/CP3369/CP4484 D27)	N/A	N/A	N/A		N/A	N/A	N/A
4 Piston (CP4485/CP4679)	N/A	N/A	N/A		N/A	N/A	N/A
4 Piston Radial 2 Piece (CP4488)	N/A	N/A	N/A		N/A	N/A	N/A
4 Piston (CP4680) 1 Piece Pad	N/A	N/A	N/A		N/A	N/A	N/A
4 Piston Radial Mount / 4 Separate Pads (CP6688 - 8E0M/9E0M)	N/A	N/A	N/A		FA435/4HH	EPFA435/4HH	N/A
2 Piston / 1 Pin (CP7003-2S0) Radial mount	N/A	N/A	N/A		N/A	N/A	N/A
4 Piston Sidecar Caliper (CP7030-3S0 / 5S0)	N/A	N/A	N/A		N/A	N/A	N/A
4 Piston Radial Monobloc 1 Piece Pad (CP7853 D27 2E0/3E0)	N/A	N/A	N/A		N/A	N/A	N/A
BERINGER							
2 Piston Quad Caliper	N/A	N/A	N/A		N/A	N/A	N/A
4 Piston (Old Design)	FA158	N/A	N/A		FA158HH	EPFA158HH	N/A
4 Piston (Radial)	N/A	N/A	N/A		MXS405	N/A	N/A
6 Piston (Old Design)	FA249	N/A	N/A		FA249HH	EPFA249HH	N/A
6 Piston (Old design/2 piston)	FA47	FA47S	N/A		FA47HH	N/A	N/A
6 Piston (Old Design /Endurance)	N/A	N/A	N/A		N/A	N/A	N/A
6 Piston (New Design)	N/A	N/A	N/A		MXS406	N/A	N/A

PADS FOR AFTERMARKET CALIPERS

BREMBO

	STANDARD ORGANIC PAD	OPTIONAL ORGANIC PAD	SEMI-SINTERED VEE PAD	CHROME BACKED SEMI-SINTERED VEE PAD	FULLY SINTERED PAD	EPFA FULLY SINTERED TRACK DAY PAD	GPFAX FULLY SINTERED RACE PAD
120A44110 P2/34 Supersport Rear Caliper	FA266	N/A	FA266V	N/A	FA266HH	N/A	N/A
122A99021 P2/24 Off Road Caliper	FA181TT	N/A	N/A	N/A	FA181R	EPFA181HH	N/A
20 4756 52/62 - 4 Piston P4 30/34 @40mm Spacing (Single pin pad fixing)	FA95	N/A	FA95V		FA95HH	EPFA95HH	GPFAX95HH
20 5161 43 or 81 - 2 Piston P 2/32 Rear caliper (Single Pad Fixing Pin / With Anti Rattle Shim)	FA47	FA47S	N/A		FA47HH	N/A	N/A
20 5165 55/68 - Goldline 4 piston P4 30/34 @ 40mm Spacing (Single Pin pad Fixing)	FA95	N/A	FA95V		FA95HH	EPFA95HH	GPFAX95HH
20 6800 10/20 - Goldline 4 piston P4 30/34 @ 65mm Spacing (Two Pin Pad Fixing)	FA244	N/A	FA244V		FA244HH	EPFA244HH	GPFAX244HH
20 6950 51 - 2 Piston P2/32 Rear Caliper (Single Pad Fixing Pin / With Wire Clip)	FA266	N/A	FA266V		FA266HH	N/A	N/A
20 6951 12/50/63 - P2/34 Rear Caliper (Single Pad Fixing Pin / With Wire Clip)	FA266	N/A	FA266V		FA266HH	N/A	N/A
20 7850 11/21 - 4 Piston P4 /34 @ 65mm Spacing (Wire clip pad retention only)	N/A	N/A	N/A		FA322/4HH	EPFA322/4HH	N/A
20 8343 11/21 or 35/45 - 4 Piston P4 /34 @ 100mm Spacing (Wire clip pad retention only)	N/A	N/A	N/A		FA322/4HH	EPFA322/4HH	N/A
20.9883 Radial Mount 100mm Monobloc Caliper	N/A	N/A	N/A	N/A	FA447HH	EPFA447HH	GPFAX447HH
206121 P4/24 Rear Caliper	N/A	N/A	N/A	N/A	N/A	N/A	N/A
220988530 P4/34 Radial Mount 100mm Monobloc Caliper	N/A	N/A	N/A	N/A	FA447HH	EPFA447HH	GPFAX447HH
220A0610 P4 30/34 Radial Mount Caliper 108mm 2 Pin Pad Fixing	FA244	N/A	FA244V	N/A	FA244HH	EPFA244HH	GPFAX244HH
220A16810 P4 30/34 Radial Mount Caliper 100mm 2 Pin Pad Fixing	FA244	N/A	FA244V	N/A	FA244HH	EPFA244HH	GPFAX244HH
220A16820 P30/34 Yamaha R1 07-10 Radial Mount	FA244	N/A	FA244V	N/A	FA244HH	EPFA244HH	GPFAX244HH
220A39710 P4/34 Radial Mount 108mm Monobloc Caliper	N/A	N/A	N/A	N/A	FA447HH	EPFA447HH	GPFAX447HH
220A80210 P4 30/34 Radial Mount Caliper 108mm 2 Pin Pad Fixing	FA244	N/A	FA244V	N/A	FA244HH	EPFA244HH	GPFAX244HH
220A80310 P4 30/34 Radial Mount 100mm 2 Pin Pad Fixing	FA244	N/A	FA244V	N/A	FA244HH	EPFA244HH	GPFAX244HH
220B01010 - GP4-RX 4 Piston Radial Mount @ 108mm Spacing					FA447HH	EPFA447HH	GPFAX447HH
X1017.40/41 4 Piston / 40mm Axial Monobloc Caliper	N/A	N/A	N/A			EPFA218/2HH	GPFAX218/2HH
X20-60-01 -2 Piston P2/24 Rear Caliper Rear caliper @ 64mm Spacing	N/A	N/A	N/A		N/A	N/A	N/A
X20-61-01 -4 Piston P4/24 Rear Caliper Rear caliper @ 64mm Spacing	N/A	N/A	N/A		N/A	N/A	N/A
X97.37.60/61- 4 Piston Monobloc 32/36 Radial mount@ 108mm (Single Pin Fixing)	N/A	N/A	N/A		FA218HH	EPFA218HH	N/A
X9737 80/81 Radial Mount 108mm Endurance Caliper	N/A	N/A	N/A	N/A	N/A	EPFA295HH	GPFAX295HH
X97C4 60/61 P4/34 Radial Monobloc 108mm 4 Pad Type Caliper	N/A	N/A	N/A	N/A	FA435/4HH	EPFA435/4HH	N/A
X98-88-70 -2 Piston P2/34 Rear Caliper Rear caliper @ 64mm Spacing	N/A	N/A	N/A		N/A	N/A	N/A
X99.C04 60/61 - 4 Piston P 34/34 Radial Mount Caliper @ 108mm Spacing (4 Pad Set)	N/A	N/A	N/A		N/A	EPFA435/4HH	N/A
XA07680 - 2 Piston P2 34 Radial Mount) (Note Only Sold As Set Of 4 pads)	N/A	N/A	N/A		FA435/4HH	EPFA435/4HH	N/A
XA1J040 P2/30 Rear Caliper	N/A	N/A	N/A	N/A	N/A	N/A	N/A
XA1K480 Motocross Radial Caliper	N/A	N/A	N/A	N/A	N/A	N/A	N/A
XA3.B8.30/31 - 4 Piston P32/36 Radial Mount Caliper @ 108mm Spacing (Titanium Pistons)	N/A	N/A	N/A		N/A	EPFA218/2HH	GPFAX218/2HH
XA3.B8.60/61 - 4 Piston P32/36 Radial Mount Caliper @ 108mm Spacing (Aluminum Pistons)	N/A	N/A	N/A		N/A	EPFA218/2HH	GPFAX218/2HH
XA3.J7.50/51 - 4 Piston P 34/38 Radial Mount @ 108mm Spacing (Pinless Fixing)	N/A	N/A	N/A		N/A		GPFAX611HH
XA3.J7.60/61 - 4 Piston P 34/38 Radial Mount @ 108mm Spacing (Pinless Fixing / Lithium Body)	N/A	N/A	N/A		N/A		GPFAX611HH
XA32950 P4/34 Axial Radial Mount 65mm - 4 Pad Set	N/A	N/A	N/A	N/A	FA322/4HH	EPFA322/4HH	N/A
XA69510 P4 30/34 Motard Radial Mount 108mm 2 Pin Pad Fixing	FA244	N/A	FA244V	N/A	FA244HH	EPFA244HH	GPFAX244HH
XA78910 P4 30/34 Motard Radial Caliper 100mm Mount 2 Pin Pad Fixing	FA244	N/A	FA244V	N/A	FA244HH	EPFA244HH	GPFAX244HH
XA7G2 10/11 P4 32/36 Radial Mount Caliper 100mm	N/A	N/A	N/A	N/A	N/A	EPFA218/2HH	GPFAX218/2HH
XA7G2.40/41 4 Piston / 100mm CNC Monobloc Caliper	N/A	N/A	N/A			EPFA218/2HH	GPFAX218/2HH
XA8.Y3.310/11 - 4 Piston P 34/38 Radial Mount @ 130mm Spacing (Pinless Fixing)	N/A	N/A	N/A		N/A		GPFAX611HH
XA9.33.10/11- 4 Piston P32/36 Radial Mount Monobloc @108mm Spacing (Single Pin fixing)	N/A	N/A	N/A		FA218HH	EPFA218HH	N/A
XB0 B1 30/31 P4 30/34							GPFAX673HH
XB2P710/XB2P711 Endurance Caliper							GPFAX646HH
XQ21361 P2/28 Off Road Caliper	FA181	N/A	N/A	N/A	FA181R	EPFA181HH	N/A
XQ21390 PF 26 Off Road Rear Caliper	FA368	N/A	N/A	N/A	FA368R	EPFA368HH	N/A
M4-32 Monoblock Radial Front Caliper	N/A	N/A	N/A	N/A	FA630HH	EPFA630HH	GPFAX630HH
EBC							
4 Piston	FA216/2	N/A	N/A		FA216/2HH	N/A	N/A
FTE							
4 Piston Radial Supermoto	N/A	N/A	N/A		MXS405	N/A	N/A
6 Piston Radial Supermoto	N/A	N/A	N/A		MXS406	N/A	N/A

PADS FOR AFTERMARKET CALIPERS

	STANDARD ORGANIC PAD	OPTIONAL ORGANIC PAD	SEMI-SINTERED VEE PAD	CHROME BACKED SEMI-SINTERED VEE PAD	FULLY SINTERED PAD	EPFA FULLY SINTERED TRACK DAY PAD	GPFA FULLY SINTERED RACE PAD
GMA							
2 Piston rear (large) caliper model A (CCI #09-997)	FA36	N/A	FA36V		N/A	N/A	N/A
2 Piston (small) caliper model B (CCI # 09-996)	FA76	N/A	FA76V		FA76HH	N/A	N/A
4 Piston model F	FA115	N/A	FA115V		FA115HH	N/A	N/A
HARRISON BILLET							
Big 4 Piston (1296033)	FA47	FA47S	N/A		FA47HH	N/A	N/A
Big 6 Piston (1296033)	FA47	FA47S	N/A		FA47HH	N/A	N/A
2 Piston (1296040)	FA175		N/A		FA175HH	EPFA175HH	N/A
Slim Design	FA175		N/A		FA175HH	EPFA175HH	N/A
Mini 6	FA175		N/A		FA175HH	EPFA175HH	N/A
HHI - HAWG HALTERS							
4 Piston - All Types	FA216/3	N/A	FA216/3V	FA216/3VLD	FA216/3HH	N/A	N/A
4 Piston -Sprocket brake	FA623	N/A	N/A		FA623HH	N/A	N/A
6 Piston - All Types	FA424	N/A	N/A		FA424HH	EPFA424HH	N/A
IRON PEGASUS							
Small caliper (Single Pin Fixing)	FA47	FA47S	N/A		FA47HH	N/A	N/A
Small caliper (2 Pin Fixing)	FA115	N/A	FA115V		FA115HH	N/A	N/A
ISR							
22-023-0A (2 Piston)	FA11	N/A	N/A		N/A	N/A	N/A
22-025-XX (4 Piston)	FA47	FA47S	N/A		FA47HH	N/A	N/A
22-026-0A (Sprocket Caliper)	FA11	N/A	N/A		N/A	N/A	N/A
22-027 (2 Piston Rear)	FA47	FA47S	N/A		FA47HH	N/A	N/A
22-028 (2 Piston)	FA47	FA47S	N/A		FA47HH	N/A	N/A
22-029 (Rear 2 Piston)	FA47	FA47S	N/A		FA47HH	N/A	N/A
22-030 (2 Piston Rear)	FA16	FA16S	N/A		FA16HH	EPFA16HH	GPFA16HH
22-032 (6 Piston Large)	FA175	N/A	N/A		FA175HH	N/A	N/A
22-033 (2 Piston HD)	FA16	FA16S	N/A		FA16HH	EPFA16HH	GPFA16HH
22-034 (6 Piston Small)	FA184	N/A	N/A		N/A	N/A	N/A
22-036 (2 Piston)	FA184	N/A	N/A		N/A	N/A	N/A
22-042 (6 Piston Racing)	FA175	N/A	N/A		FA175HH	N/A	N/A
22-043 (4 Piston)	FA184	N/A	N/A		N/A	N/A	N/A
Radial 6 Piston Monoblock	FA184	N/A	N/A		N/A	N/A	N/A
JAYBRAKE							
Dual / Quad (300-04) (2 & 4 Piston)	FA115	N/A	FA115V		FA115HH	N/A	N/A
J-Four (300-44) (4 Piston)	FA188	N/A	N/A		FA188HH	EPFA188HH	N/A
J-Six (300-64) (6 Piston)	FA243	N/A	N/A		FA243HH	N/A	N/A
6 PF-L (6 Piston for 13" disc - Full Height Friction)	N/A	N/A	N/A		FA455HH	N/A	N/A
6 PF-L (6 Piston for 11.5" disc - Lower Height Friction)	N/A	N/A	N/A		FA649HH	N/A	N/A
Early Design 2 Piston	FA76	N/A	FA76V		FA76HH	N/A	N/A
LYNDALL BRAKES							
IMPORTANT NOTE - DO NOT USE FULLY SINTERED PADS ON LYNDALL COMPOSITE ROTORS.							
PAD REF 7058	FA200	N/A	FA200V		N/A	N/A	N/A
PAD REF 7059	FA94	N/A	FA94V		N/A	N/A	N/A
PAD REF 7138	FA95	N/A	FA95V		N/A	N/A	N/A
PAD REF 7153	FA115	N/A	FA115V		N/A	N/A	N/A
PAD REF 7157	FA201	N/A	FA201V		N/A	N/A	N/A
PAD REF 7174	FA244	N/A	FA244		N/A	N/A	N/A
PAD REF 7175	N/A	N/A	N/A		N/A	N/A	N/A
PAD REF 7176	FA196	N/A	FA196V		N/A	N/A	N/A
PAD REF 7177	N/A	N/A	N/A		N/A	N/A	N/A
PAD REF 7182	FA216/3	N/A	FA216/3V		N/A	N/A	N/A

PADS FOR AFTERMARKET CALIPERS

	STANDARD ORGANIC PAD	OPTIONAL ORGANIC PAD	SEMI-SINTERED VEE PAD	CHROME BACKED SEMI-SINTERED VEE PAD	FULLY SINTERED PAD	EPFA FULLY SINTERED TRACK DAY PAD	GPFA FULLY SINTERED RACE PAD
LYNDALL BRAKES Contd.							
PAD REF 7183	FA216/3	N/A	FA216/3V		N/A	N/A	N/A
PAD REF 7195	FA400	N/A	FA400V		N/A	N/A	N/A
PAD REF 7196	FA434	N/A	FA434V		N/A	N/A	N/A
PAD REF 7202	FA424	N/A	N/A		N/A	N/A	N/A
PAD REF 7230	FA209/2	N/A	FA209/2V		N/A	N/A	N/A
PAD REF 7231	N/A	N/A	N/A		N/A	N/A	N/A
PAD REF 7233	FA381	N/A	FA381V		N/A	N/A	N/A
PAD REF 7234	FA387	N/A	FA387V		N/A	N/A	N/A
PAD REF 7254	FA409	N/A	FA409V		N/A	N/A	N/A
PAD REF 7255	N/A	N/A	FA605/4V		N/A	N/A	N/A
PAD REF 7256	N/A	N/A	FA457V		N/A	N/A	N/A
PAD REF 7257	N/A	N/A	FA458V		N/A	N/A	N/A
MAGURA							
4 Piston Radial Supermoto Caliper	FA433/4	N/A	N/A		FA433/4HH	EPFA433/4HH	N/A
MOTOMASTER							
4 Piston	FA158	N/A	N/A		FA158HH	EPFA158HH	N/A
NOVA/LEGENDS							
4 Piston	FA216/3	N/A	FA216/3V	FA216/3VLD	FA216/3HH	N/A	N/A
OMP							
4 Piston (Front and Rear fitment)	FA95	N/A	FA95V		FA95HH	EPFA95HH	GPFA95HH
6 Piston	FA116	N/A	N/A		N/A	N/A	N/A
Sprocket caliper	FA116	N/A	N/A		N/A	N/A	N/A
PERFORMANCE MACHINE							
112 X 6B	FA249	N/A	N/A		FA249HH	EPFA249HH	N/A
112 X 6QC	FA249	N/A	N/A		FA249HH	EPFA249HH	N/A
112 X 6RSB	FA190	N/A	FA190V		FA190HH	EPFA190HH	N/A
112 X 6SSB	FA190	N/A	FA190V		FA190HH	EPFA190HH	N/A
124 X 4HR	FA216/2	N/A	N/A		FA216/2HH	N/A	N/A
125 X 2	FA115	N/A	FA115V		FA115HH	N/A	N/A
125 X 4R	FA216/3	N/A	FA216/3V	FA216/3VLD	FA216/3HH	N/A	N/A
125 X 4RSPH	FA216/3	N/A	FA216/3V	FA216/3VLD	FA216/3HH	N/A	N/A
125 X 4S	FA115	N/A	FA115V		FA115HH	N/A	N/A
125 X 4SL	FA115	N/A	FA115V		FA115HH	N/A	N/A
125 X 6	FA210	N/A	FA210V		N/A	N/A	N/A
125 X 6QC	FA190	N/A	FA190V		FA190HH	N/A	N/A
137 X 4	FA216/2	N/A	N/A		FA216/2HH	N/A	N/A
137 X 4 (2006)	N/A	N/A	N/A		FA420HH	N/A	N/A
137 X 4B	FA216/3	N/A	FA216/3V	FA216/3VLD	FA216/3HH	N/A	N/A
137 X 6	FA210	N/A	FA210V		N/A	N/A	N/A
162 X 2	FA32	N/A	FA32V		N/A	N/A	N/A
PFM							
6 Piston Superbike caliper	N/A	N/A	N/A		N/A	EPFA263HH	N/A
PRE TECH							
4 Piston (Uni P401)	FA180	N/A	N/A		FA180HH	N/A	N/A
4 Piston (P402) Lockheed Replacement Caliper	FA158	N/A	N/A		FA158HH	EPFA158HH	N/A
6 Piston	FA190	N/A	FA190V		FA190HH	EPFA190HH	N/A
6 Piston (Radial Mount)	FA249	N/A	N/A		FA249HH	EPFA249HH	N/A

PADS FOR AFTERMARKET CALIPERS

	STANDARD ORGANIC PAD	OPTIONAL ORGANIC PAD	SEMI-SINTERED VEE PAD	CHROME BACKED SEMI-SINTERED VEE PAD	FULLY SINTERED PAD	EPFA FULLY SINTERED TRACK DAY PAD	GPFAX FULLY SINTERED RACE PAD
PRO-ONE							
2 Piston	FA47	FA47S	N/A		FA47HH	N/A	N/A
4 Piston	FA158	N/A	N/A		FA158HH	EPFA158HH	N/A
P.V.M							
2 Piston Rear Caliper (Note Only 2 Pads Required)	N/A	N/A	N/A		FA435/4HH	EPFA435/4HH	N/A
4 Piston Radial Mount Caliper	N/A	N/A	N/A		FA435/4HH	EPFA435/4HH	N/A
4 Piston race caliper (Old Design)		N/A	N/A		N/A	N/A	N/A
6 Piston (Old large design)	N/A	N/A	N/A		N/A		GFA183HH
6 Piston (New small design)	N/A	N/A	N/A		N/A		
REVTECH							
CCI Polished Caliper (Front/Rear)	FA95	N/A	FA95V		FA95HH	EPFA95HH	GPFAX95HH
New Black 4 Piston Caliper	FA216/3	N/A	FA216/3V	FA216/3VLD	FA216/3HH	N/A	N/A
6 Piston VR1000 Race Caliper	N/A	N/A	N/A		N/A	N/A	N/A
SPONDON							
4 Piston Caliper	N/A	N/A	N/A		N/A	N/A	N/A
4 Piston Caliper	N/A	N/A	N/A		N/A	N/A	N/A
SPIEGLER							
4 Piston Caliper S4B	N/A	N/A	N/A		N/A	N/A	N/A
8 Piston Caliper S8B	N/A	N/A	N/A		N/A	N/A	N/A
THUNDERHEART							
4 Piston Caliper	FA216/3	N/A	FA216/3V	FA216/3VLD	FA216/3HH	N/A	N/A
6 Piston Caliper	FA249	N/A	N/A		FA249HH	N/A	N/A
WILWOOD							
PS1 Caliper (Part # 150-4091K)	FA271X	N/A	N/A		FA271R	N/A	N/A
GP300/310 (Part # 150-8733-2)	FA95	N/A	FA95V		FA95HH	EPFA95HH	GPFAX95HH
GP320 (Part # 154-8596K)	FA95/2	N/A	N/A		N/A	N/A	N/A

BRAKE LINES

EBC Brakes braided brake lines are manufactured in Great Britain from the highest quality materials, with braided stainless steel PTFE hose and grade 303 stainless steel precision machined fittings. At EBC Brakes we do not use mild steel or aluminum components in our brake lines, instead we choose stainless steel for every fitting, as this material offers maximum quality in terms of strength and corrosion resistance. EBC brake line kits are supplied 100% complete and include brand new stainless steel bolts for maximum visuals.

EBC Brakes braided hoses fit many bikes in front, rear and race designs. Braided hoses improve brake pressure transfer to the caliper and disc pads, they help improve lever feel and reduce "bulging" which may happen with standard rubber hoses. Braided hoses are also more resistant to abrasion or cuts common with off road riding and thereby improve safety.

EBC brake lines are designed and built to last, that's why every line is offered with a lifetime warranty. Every individual line is pressure tested after assembly and as an absolute guarantee of quality, EBC brake lines are manufactured to Federal Motor Vehicle Safety Standards (FMVSS-106) and have the following approvals: DOT, TÜV, ISO9001, DEKRA, ARAI, CQC AND ADR.



ISO9001



DEKRA ARAI



ADR

BLM is our standard braided hose series whereas BLMR series race hoses have fewer lines and are the choice for track and performance use giving an even firmer lever feel and improving service time. Racing kits take the shortest route from the master cylinder to the caliper. The lines usually bypass any Y-splitters in the existing system, this reduces the number of places where the brakes can leak. The two lines from the master cylinder are a lot easier to bleed than a system with a Y piece as each line bleeds independent of the other whereas with a Y piece they don't until fluid is below the Y piece.

Hose numbers are suffixed with a number and letter designating the number of hoses in the kits and front or rear, for example;

BLM6038-1F is a kit with a single hose for front fitment

BLM8111-3F is a kit with three hoses for front fitment

BLM8113-1R is a kit with a single hose for rear fitment

BLMR8114-2F is a race kit with two hoses for front fitment.

We do not sell BLMR race hoses for rear fitments, only front.

Some kits are sold as complete bike sets only and examples of numbering are:
BLM8169-4FR which is a four hose kit for a complete bike (front and rear).

All motorcycle brake lines (except Harley) are supplied with black stainless fittings, clear hose and red/blue EBC Brakes heat shrink.

HARLEY-DAVIDSON® BRAKE LINES

EBC Harley-Davidson® lines are supplied in a unique finish, with chromed stainless fittings, black hose and black/space-grey EBC Brakes heat shrink.

Additionally, where many competitors use 'off the shelf' components, EBC Harley-Davidson® lines are manufactured using our own bespoke design of chrome plated hardware and brackets, ensuring perfect fitment for complex Harley-Davidson® brake line assemblies.

MOTOCROSS AND OFF-ROAD BRAKE LINES

EBC Brakes motocross and off-road brake lines are supplied with a hardened plastic sheath around the lower portion of the hose, to provide additional protection against damage which could otherwise result from the harsh and unforgiving conditions of off-road terrain. These brake lines are built to withstand a lifetime of off-road abuse, ensuring high performance and safe riding for the lifetime of the vehicle.

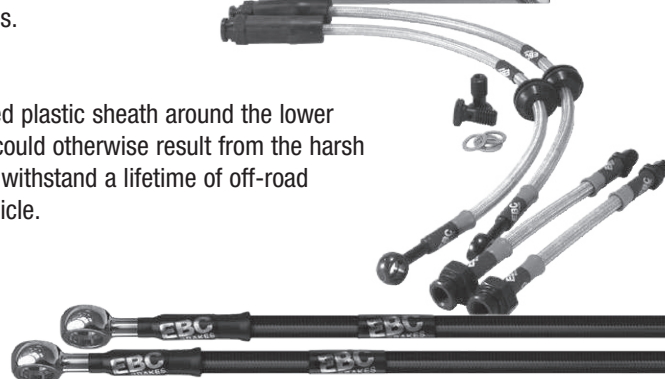

BRAKE LINES



APRILIA



OE Replacement
Brake Lines (Front)

Race Standard
Brake Lines (Front)

OE Replacement
Brake Lines (Rear)

Line #

		FRONT	FRONT	REAR	
RS 250	94-97	BLM8008-3F	BLMR8008-2F	BLM8008-1R	1
RS 250	98-99	BLM8009-3F	BLMR8009-2F	BLM8009-1R	2
RS 250	00-02	BLM8010-3F	BLMR8010-2F	BLM8010-1R	3
Pegaso 650	93-96	BLM8002-1F		BLM8002-1R	4
Pegaso 650	97-03	BLM8003-1F		BLM8002-1R	5
Pegaso Strada 650	97-09	BLM8004-1F		BLM8004-1R	6
RST 1000 Futura	01-04	BLM8013-3F	BLMR8013-2F	BLM8013-1R	7
RSV 1000 Mille	98-03	BLM8015-3F	BLMR8015-2F	BLM8015-1R	8
RSV 1000 Mille R	03-04	BLM8017-3F	BLMR8017-2F	BLM8017-1R	9
RSV 1000 Mille Tuono	03-09	BLM8018-3F	BLMR8018-2F	BLM8018-1R	10
RSV 1000 R + RSV4 Non ABS	08-13	BLM8019-3F	BLMR8019-2F	BLM8019-1R	11
RSV 1000 R Factory My	04-09	BLM8020-3F	BLMR8019-2F	BLM8020-1R	12
SL 1000 Falco	99-03	BLM8022-3F	BLMR8022-2F	BLM8022-1R	13
Tuono V4 R + V4 R APRC	11	BLM8023-2F	BLMR8023-2F	BLM8023-1R	14
					15
					16
BIMOTA					
SB6	ALL	BLM8024-3F	BLMR8024-2F	BLM8024-1R	17
					18
					19
BMW					
F650	94-00	BLM8025-1F		BLM8025-1R	20
F650 GS/Dakar Non ABS	00-07	BLM8026-1F		BLM8026-1R	21
R65 Flexible Front	81-85	BLM8077-3F			22
R65 Flexible Front	85-88	BLM8078-1F			23
R65 Full Front	81-85	BLM8079-3F			24
R80 GS Flexible Front	86-94	BLM8086-1F			25
R80 GS Full Front	80-85	BLM8087-1F			26
R80 R Flexible Front	94	BLM8088-1F			27
R80 RT	84-90	BLM8089-2F		BLM8089-1R	28
R80 RT Flexible Front	82-84	BLM8090-3F			29
R80 ST Flexible Front	82-85	BLM8091-1F			30
R100/R100 CS Full Front	80-84	BLM8043-3F			31
R100 GS	91-96	BLM8044-1F			32
R100 GS Flexible Front	91-96	BLM8044-1F			33
R100 RS	87-93	BLM8046-4F			34
R1100 GS ABS	94-00	BLM8054-4F		BLM8054-1R	35
R1100 GS Non ABS	94-00	BLM8055-3F			36
R1100 R	95-96	BLM8056-4FR		Supplied as front & rear kit complete	37
R1100 R	97-01	BLM8057-4FR		Supplied as front & rear kit complete	38
R1100 RS ABS	93-00	BLM8058-5FR		Supplied as front & rear kit complete	39
R1100 RT ABS	95-00	BLM8059-5FR		Supplied as front & rear kit complete	40
R1100 S ABS	98-04	BLM8060-5FR		Supplied as front & rear kit complete	41
R1100 S Non ABS	01/98-01/01	BLM8062-4FR		Supplied as front & rear kit complete	42
R1100 S Non ABS	02/01-11/03	BLM8063-4FR		Supplied as front & rear kit complete	43
R1150 GS ABS (Retaining Hardline)	11/99-02	BLM8064-5FR		Supplied as front & rear kit complete	44
R1150 GS ABS 2 (Retaining Hardline)	11/99-02	BLM8065-5FR		Supplied as front & rear kit complete	45
R1150 GS Non ABS (Replacing Hardline)	11/99-02	BLM8066-3F		BLM8066-1R	46
R1150 GS Non ABS (Retaining Hardline)	11/99-02	BLM8067-3F		BLM8066-1R	47
R1150 GS Non ABS Evo Brakes	03-04	BLM8068-4F		BLM8066-1R	48
R1150 GS Non ABS Evo Brakes	11/99-02	BLM8069-4F		BLM8066-1R	49
R1150 R	00-02	BLM8070-5FR		Supplied as front & rear kit complete	50
R1150 RT ABS	01	BLM8071-4F			51
R1200 C ABS	96-05	BLM8072-4F		BLM8072-1R	52
R1200 R ABS	11-13	BLM8073-4F		BLM8073-1R	53
R850 C ABS	00-01	BLM8072-4F		BLM8072-1R	54
R850 GS ABS	00-01	BLM8054-4F		BLM8054-1R	55
R850 R ABS	97-01	BLM8094-5FR		Supplied as front & rear kit complete	56

BRAKE LINES

Line #	Motorcycle Model	Year	FRONT		REAR
			OE Replacement Brake Lines (Front)	Race Standard Brake Lines (Front)	
BMW					
1	R850 R	95-96	BLM8056-4FR		Supplied as front & rear kit complete
2	R850 R	97-01	BLM8057-4FR		Supplied as front & rear kit complete
3	S1000 RR Non ABS	10-14	BLM8100-3F	BLMR8100-2F	BLM8100-1R
CAGIVA					
6	Raptor 650 (Naked)	03-06	BLM8107-3F		
7	Elefant 900	93-00	BLM8104-3F		BLM8104-1R
8	Elefant 900 IE	91-92	BLM8103-1F		BLM8103-1R
9	V-Raptor 1000 (Faired)	2003-	BLM8108-3F		BLM8108-1R
DUCATI					
12	M 400 Monster	94-02	BLM8141-1F		BLM8141-1R
13	Pantah 600TL	84-85	BLM8148-3F		BLM8148-1R
14	600 SS	94-98	BLM8116-1F		BLM8116-1R
15	M 600 Monster	94-02	BLM8141-1F		BLM8141-1R
16	M 620 Monster	02-04	BLM8143-3F	BLMR8143-2F	BLM8143-1R
17	M 696 Monster	06-08	BLM8144-2F		BLM8144-1R
18	748 Biposta/Strada	95-98	BLM8117-3F	BLMR8117-2F	BLM8117-1R
19	748 Biposta/Strada/SPS	99-03	BLM8111-3F	BLMR8118-2F	BLM8111-1R
20	748R	99-02	BLM8119-3F	BLMR8119-2F	BLM8119-1R
21	749	03-05	BLM8109-2F		BLM8109-1R
22	749S	04-05		BLMR8120-2F	BLM8120-1R
23	750/906 Paso	86-94	BLM8121-3F		BLM8121-1R
24	750 SS	91-93	BLM8116-1F		BLM8116-1R
25	750 SS	94-97		BLMR8124-2F	BLM8116-1R
26	750 SS	98-02		BLMR8125-2F	BLM8125-1R
27	M 750 Monster	96-02	BLM8141-1F		BLM8141-1R
28	851 SP/888 Strada	92-93		BLMR8126-2F	BLM8126-1R
29	851 SP3	1991	BLM8127-3F		BLM8127-1R
30	851 Strada	88-92	BLM8128-3F		BLM8128-1R
31	848	2007-		BLMR8110-2F	
32	900 Superlight	94-97		BLMR8129-2F	BLM8129-1R
33	900 SS	94-97		BLMR8129-2F	BLM8130-1R
34	900 SS	98-02		BLMR8125-2F	BLM8125-1R
35	900 SS Supersport	1977		BLMR8132-3F	BLM8132-1R
36	900 SS/Superlight	91-93		BLMR8129-2F	BLM8133-1R
37	M 900 Monster	93-99	BLM8146-3F	BLMR8146-2F	BLM8146-1R
38	907 IE	91-94	BLM8134-3F		BLM8134-1R
39	916 Biposta/SP	98-01	BLM8111-3F	BLMR8118-2F	BLM8111-1R
40	916 Biposta/Strada	94-97	BLM8117-3F	BLMR8117-2F	BLM8117-1R
41	ST2	97-03	BLM8151-3F		BLM8151-1R
42	ST4	98-03	BLM8152-3F		BLM8152-1R
43	996	98-01	BLM8111-3F	BLMR8111-2F	BLM8111-1R
44	996 R	00-01	BLM8119-3F	BLMR8119-2F	BLM8119-1R
45	S4/S4R Monster	00-08		BLMR8149-2F	BLM8146-1R
46	999 R	03-05	BLM8138-2F	BLMR8138-2F	BLM8138-1R
47	998	01-03	BLM8111-3F	BLMR8111-2F	BLM8111-1R
48	999	02-05		BLMR8113-2F	BLM8113-1R
49	Sport Classic 2006	2006	BLM8150-3F		BLM8150-1R
50	1098/1098R/1098S/1198/1198S	2007	BLM8114-3F	BLMR8114-2F	BLM8114-1R
HONDA					
53	CBR 125 R	05-13	BLM1057-1F		BLM1057-1R
54	MSX 125	16-17	BLM1167-1F		BLM1167-1R
55	NSR 125 RK-R3	90-03	BLM1110-1F		BLM1110-1R
56	XLR 125	00-03	BLM1159-1F		

BRAKE LINES



HONDA



OE Replacement
Brake Lines (Front)

Race Standard
Brake Lines (Front)

OE Replacement
Brake Lines (Rear)

Line #

		OE Replacement Brake Lines (Front)	Race Standard Brake Lines (Front)	OE Replacement Brake Lines (Rear)	Line #
CB 250 Hornet Import	1996	BLM1010-1F		BLM1010-1R	1
CBR 250 R	11-13	BLM1058-1F		BLM1058-1R	2
CBR 250 RRM-RRX (MC22)	90-99		BLMR1060-2F	BLM1060-1R	3
CBR 300 R	15-17	BLM1170-1F		BLM1170-1R	4
CBR 300 R ABS	15-17	BLM1168-4F		BLM1168-3R	5
CB1 (Super 400)	92-96	BLM1000-2F	BLMR1000-2F	BLM1000-1R	6
NT Bros 400/600/650	88-95	BLM1114-1F		BLM1114-1R	7
RVF 400 RRR-RRT (NC35)	94-96	BLM1120-3F	BLMR1120-2F	BLM1120-1R	8
VFR 400 RRL-RRM (NC30)	90-92		BLMR1135-2F	BLM1135-1R	9
CB 450 DXK	89-92	BLM1019-3F		BLM1019-1R	10
CB 500 V-3	97-03	BLM1024-1F		BLM1024-1R	11
CBF 500	04-08	BLM1048-1F		BLM1048-1R	12
CB 500 F ABS	13-15	BLM1163-2F		BLM1163-2R	13
CB 500 F ABS	16-17	BLM1162-2F		BLM1162-2R	14
CBR 500 R ABS	13-15	BLM1163-2F		BLM1163-2R	15
CBR 500 R ABS	16-17	BLM1162-2F		BLM1162-2R	16
CB 600 F5-F8 Hornet	05-08		BLMR1028-2F	BLM1028-1R	17
CB 600 FW-F4 Hornet	98-05	BLM1029-3F	BLMR1029-2F	BLM1029-1R	18
CBF 600 S	04-06	BLM1049-3F	BLMR1049-2F	BLM1049-1R	19
CBR 600 F	11-13		BLMR1063-2F	BLM1063-1R	20
CBR 600 FH-FL	87-90	BLM1064-3F	BLMR1064-2F	BLM1064-1R	21
CBR 600 FM-FR	91-94	BLM1065-3F	BLMR1065-2F	BLM1065-1R	22
CBR 600 FS-FW	95-98	BLM1066-3F	BLMR1066-2F	BLM1066-1R	23
CBR 600 FX-F4/Sport	99-04	BLM1067-3F	BLMR1067-2F	BLM1067-1R	24
CBR 600 RR3-RR4	03-04	BLM1069-3F	BLMR1069-2F	BLM1069-1R	25
CBR 600 RR5	2005		BLMR1070-2F	BLM1070-1R	26
CBR 600 RR6	2006		BLMR1071-2F	BLM1071-1R	27
CBR 600 RR7	2007		BLMR1072-2F	BLM1072-1R	28
CBR 600 RR Non ABS	08-13		BLMR1068-2F	BLM1068-1R	29
CBR 600 RR ABS	09-17	BLM1164-4F		BLM1164-2R	30
VT 600 CN-CW Shadow	92-98	BLM1146-1F			31
XL 600 LMF Paris Dakar	1985	BLM1154-1F			32
XL 600 VH-VT Transalp	87-96	BLM1156-1F		BLM1156-1R	33
XL 600 VV-VX Transalp	97-99		BLMR1157-2F	BLM1156-1R	34
NT 650 V Deauville (Nissin Calipers)	98-03	BLM1115-3F		BLM1115-1R	35
NX 650 J-T Dominator	88-96	BLM1117-1F		BLM1117-1R	36
NX 650 V-X Dominator	97-99	BLM1118-1F		BLM1117-1R	37
SLR 650 V-W	97-98	BLM1123-1F			38
XL 650 Y-3 Transalp	00-05		BLMR1157-2F	BLM1156-1R	39
CB 750 F Supersport		BLM1032-3F		BLM1032-1R	40
CB 750 F2N-Y	92-02	BLM1037-3F		BLM1037-1R	41
RVF 750 RR-RS (RC45)	94-95	BLM1121-3F	BLMR1121-2F	BLM1121-1R	42
VFR 750 FL-FP	90-93	BLM1138-3F	BLMR1138-2F	BLM1138-1R	43
VFR 750 FR-FV	94-97	BLM1139-3F	BLMR1139-2F	BLM1139-1R	44
VFR 750 RJ-RL (RC30)	88-90		BLMR1140-2F	BLM1140-1R	45
VT 750 V-W Shadow	97-98	BLM1148-1F			46
XRV 750 L-3 Africa Twin	90-03	BLM1161-3F	BLMR1161-2F	BLM1161-1R	47
Pacific Coast PC800	89-98	BLM1119-3F			48
VFR 800 FW-FY Non ABS	98-00	BLM1141-10FR		Supplied as front & rear kit complete	49
VFR 800 V-TEC ABS	02-10	BLM1142-13FR		Supplied as front & rear kit complete	50
VFR 800 V-TEC Non ABS	02-10	BLM1143-10FR		Supplied as front & rear kit complete	51
CB 900 F2-F3 Hornet	02-06	BLM1042-3F	BLMR1042-2F	BLM1042-1R	52
CBR 900 RR2-RR3	02-03		BLMR1073-2F	BLM1073-1R	53
CBR 900 RRN-RRS Retaining Bundy	92-95	BLM1074-3F			54
CBR 900 RRN-S Fireblade	92-95	BLM1075-3F	BLMR1075-2F	BLM1075-1R	55
CBR 900 RRT-RRX Retaining Bundy	96-99	BLM1076-3F	BLMR1076-2F	BLM1076-1R	56

FRONT

REAR

BRAKE LINES



Line #

HONDA

			OE Replacement Brake Lines (Front)	Race Standard Brake Lines (Front)		OE Replacement Brake Lines (Rear)
1	CBR 900 RRT-X Fireblade	96-99	BLM1077-3F	BLMR1076-2F		BLM1076-1R
2	CBR 900 RRY-RR1	00-01		BLMR1073-2F		BLM1078-1R
3	CB 1000 P-T Big One	93-96	BLM1001-3F	BLMR1001-2F		BLM1001-1R
4	CB 1000 R	08-14		BLMR1002-2F		BLM1002-1R
5	CBF 1000	2006	BLM1046-3F			BLM1046-1R
6	CBR 1000 FH-FJ	87-88	BLM1050-3F			BLM1050-1R
7	CBR 1000 FK-FN	89-92	BLM1051-3F			BLM1051-1R
8	CBR 1000 FP-FR	93-99	BLM1052-10FR			Supplied as front & rear kit complete
9	CBR 1000 RR	04-05	BLM1054-2F	BLMR1053-2F		BLM1054-1R
10	CBR 1000 RR	06-08		BLMR1054-2F		BLM1053-1R
11	CBR 1000 RR (Non ABS)	09-14		BLMR1055-2F		BLM1055-1R
12	CBR 1000 RR ABS	09-17	BLM1165-4F			BLM1165-2R
13	CBR 1000 RR ABS (INC SP1/SP2)	2017	BLM1166-4F			BLM1166-2R
14	VTR 1000 SP1-SP2	99-08		BLMR1149-2F		BLM1149-1R
15	VTR 1000 FV-F4	97-05	BLM1150-3F	BLMR1150-2F		BLM1150-1R
16	XL 1000 VW-V3 Varedero	98-06	BLM1152-10FR			Supplied as front & rear kit complete
17	CB 1100 RC-RD	82-83	BLM1003-3F			BLM1003-1R
18	CB 1100 SF-X11	99-02	BLM1004-10FR			Supplied as front & rear kit complete
19	CBR 1100 XX Blackbird	96-08	BLM1056-10FR			Supplied as front & rear kit complete
20	GL 1100 A-B Goldwing	80-81	BLM1097-3F			BLM1097-1R
21	GL 1100 AD Aspencade	1983	BLM1098-2F			BLM1098-1R
22	GL 1100 DC Deluxe	1982	BLM1099-3F			BLM1099-1R
23	ST 1100 ABS/TCS/CBS	02-03	BLM1124-16FR			Supplied as front & rear kit complete
24	ST 1100 AN-AS Pan European ABS	92-95	BLM1125-7FR			Supplied as front & rear kit complete
25	ST 1100 L-2 Pan European Non ABS	90-02	BLM1126-3F			BLM1126-2R
26	GL 1200 AE-AH Aspencade	84-87	BLM1100-3F			BLM1100-1R
27	CB 1300 (SL38)	97-03	BLM1007-3F			BLM1007-1R
28	CB 1300 UK Model	02-03	BLM1008-3F	BLMR1008-2F		BLM1008-1R
29	CB 1300 SA ABS	05-06	BLM1009-4F			BLM1009-3R
30	F6C (GL 1500 CV-CW) Valkyrie	96-03	BLM1094-3F			BLM1094-1R
31	V65 Magna		BLM1127-3F			
32	GL 1500 J-SEY Goldwing	88-00	BLM1101-4FR			Supplied as front & rear kit complete

FRONT

REAR

HONDA OFF-ROAD

35	CR 85 R	03-08	BLM6002-1F			BLM6002-1R
36	CR 85 R Expert	03-08	BLM6002-1F			BLM6003-1R
37	CR 125 R/250 R	97-07	BLM6000-1F			BLM6000-1R
38	CRF 230 L	2008-	BLM6004-1F			BLM6004-1R
39	CRF 250 F/450 F	03-04	BLM6005-1F			BLM6005-1R
40	CRF 250 L	13-17	BLM6012-1F			BLM6012-1R
41	CRF 250 R/CRF 450 R	04-08	BLM6006-1F			BLM6006-1R
42	CRF 250 R/CRF 450 R	09-17	BLM6007-1F			BLM6007-1R
43	CRF 250 X/CRF 450 X	05-17	BLM6008-1F			BLM6008-1R
44	CRF 450 R/RX	2016-	BLM6007-1F			BLM6013-1R
45	XR 400 R	96-04	BLM6009-1F			BLM6009-1R
46	CR 500	97-04	BLM6000-1F			BLM6000-1R
47	XR 650 L	2004-	BLM6010-1F			BLM6010-1R
48	XR 650 R	00-03	BLM6011-1F			BLM6011-1R
49	XR 650 R	2004-	BLM6010-1F			BLM6010-1R

KAWASAKI

52	KDX 125 A1-B2	90-94	BLM4032-1F			BLM4032-1R
53	KDX 200/220	95-99	BLM4033-1F			BLM4033-1R
54	KDX 200 E1	90-94	BLM4032-1F			BLM4032-1R
55	ZZR 250 H1-H2	90-92	BLM4178-1F			BLM4178-1R
56	KR1-KR1S	89-92	BLM4051-3F	BLMR4051-2F		BLM4051-1R

BRAKE LINES

APPLICTIONS
BRAKE



KAWASAKI



		OE Replacement Brake Lines (Front)	Race Standard Brake Lines (Front)	OE Replacement Brake Lines (Rear)	Line #
EX 300 Ninja	13-15	BLM4182-1F		BLM4182-1R	1
EX 300 Ninja ABS	16-17	BLM4183-2F			2
KLX 300 R	97-99	BLM4048-1F		BLM4048-1R	3
ZXR 400 L1-L9	91-03	BLM4169-3F	BLMR4169-2F	BLM4169-1R	4
GPZ 500 S A1-A6	87-93	BLM4018-1F			5
GPZ 500 S D1-E8	94-01	BLM4019-1F		BLM4019-1R	6
GPZ 500 S E9-E10	02-04	BLM4020-2F	BLMR4020-2F	BLM4019-1R	7
KLE 500 A1-A7	91-99	BLM4043-1F		BLM4043-1R	8
KLE 500 B	05-06	BLM4044-1F		BLM4044-1R	9
Vulcan 500	96-97	BLM4066-1F			10
ZR 550 B2-B6 Zephyr	91-98	BLM4136-3F		BLM4136-1R	11
ZX 550 A1-A4 (GPZ550)	83-91	BLM4150-5F		BLM4150-1R	12
ER6 F/N	13-14	BLM4008-2F		BLM4008-1R	13
ER6 F/N	06-09	BLM4009-2F	BLMR4009-2F	BLM4009-1R	14
ER6 F/N	10-12	BLM4010-2F	BLMR4010-2F	BLM4010-1R	15
GPX 600 R C1-C7	88-96	BLM4012-3F	BLMR4012-2F	BLM4012-1R	16
GPZ 600 R A1-A5	85-90	BLM4021-5F		BLM4021-1R	17
KLR 600 A1/B1-B4	84-90	BLM4046-1F			18
ZL 600 B1 Eliminator	95-97	BLM4129-1F			19
ZZR 600 D1-D3	90-93	BLM4179-3F	BLMR4179-2F	BLM4179-1R	20
ZZR 600 D4-E12H	94-06	BLM4180-3F	BLMR4179-2F	BLM4180-1R	21
ZX6R	07-08	BLM4151-2F	BLMR4151-2F	BLM4151-1R	22
ZX6R	09-12	BLM4152-3F	BLMR4152-2F	BLM4152-1R	23
ZX6R	13-16	BLM4153-2F	BLMR4153-2F	BLM4153-1R	24
ZX6R ABS	13-17	BLM4184-3F		BLM4184-1R	25
ZX6R B1/ZX6RR K1	2003	BLM4154-2F	BLMR4154-2F	BLM4154-1R	26
ZX6R F1-F3	95-97	BLM4155-3F	BLMR4155-2F	BLM4155-1R	27
ZX6R G1-G2	98-99	BLM4156-3F	BLMR4156-2F	BLM4156-1R	28
ZX6R J1-J2/A1P (636)	00-02	BLM4157-3F	BLMR4157-2F	BLM4157-1R	29
ZX6RR 04	2004	BLM4158-2F	BLMR4158-2F	BLM4158-1R	30
ZX6RR ZX636	05-06	BLM4159-2F	BLMR4159-2F	BLM4159-1R	31
KLR 650 A1-A3/C1-C8	87-02	BLM4047-1F		BLM4047-1R	32
KLX 650 C1-C2	93-96	BLM4049-1F		BLM4049-1R	33
Versys 650 ABS	06-10	BLM4052-5FR		Supplied as front & rear kit complete	34
Versys 650 ABS	11-13	BLM4053-7FR		Supplied as front & rear kit complete	35
Versys 650 Non ABS	06-10	BLM4054-2F		BLM4054-1R	36
Versys 650 Non ABS	2011	BLM4055-2F		BLM4055-1R	37
W 650	03-04	BLM4067-1F			38
ZX7R P1-P7/ZX7RR N1	96-03	BLM4160-3F	BLMR4160-2F	BLM4160-1R	39
GPX 750 R F1-F3	87-91	BLM4013-3F	BLMR4013-2F	BLM4013-1R	40
VN 750 A Front	86-94	BLM4064-3F			41
Z 750	03-05	BLM4112-2F	BLMR4112-2F	BLM4112-1R	42
Z 750	06-07	BLM4113-2F	BLMR4113-2F	BLM4113-1R	43
Z 750	08-11	BLM4070-2F	BLMR4070-2F	BLM4070-1R	44
Z 750 R	2011	BLM4119-2F		BLM4119-1R	45
Z 750 Y1 Twin Ltd	1982	BLM4121-3F			46
ZR-7	2006	BLM4130-2F		BLM4130-1R	47
ZR-7 F1-F5/ZR-7S H3	99-03	BLM4131-3F	BLMR4131-2F	BLM4131-1R	48
ZR 750 C1-C4/D1 Zephyr	91-99	BLM4137-3F	BLMR4137-2F	BLM4137-1R	49
ZXR 750 H1-H2	89-90	BLM4170-3F	BLMR4170-2F	BLM4170-1R	50
ZXR 750 J1-J2	91-92	BLM4171-3F	BLMR4171-2F	BLM4171-1R	51
ZXR 750 K1-L1	91-96	BLM4172-3F	BLMR4172-2F	BLM4172-1R	52
ZXR 750 M1-M2	92-94	BLM4173-3F	BLMR4173-2F	BLM4173-1R	53
VN 800 A1-A3/B2-B8 Classic/E1-E2 Drifter	95-03	BLM4065-1F			54
W 800 Inc Special Edition	11-13	BLM4068-1F			55
Z 800 Non ABS	2013	BLM4122-2F	BLMR4122-2F	BLM4122-1R	56

BRAKE LINES



KAWASAKI



Line #

			OE Replacement Brake Lines (Front)	Race Standard Brake Lines (Front)		OE Replacement Brake Lines (Rear)
1	Z 800 E 2013 2 Pot	2013	BLM4123-2F			
2	GPZ 900 R A1-A6	84-89	BLM4024-5F			BLM4024-1R
3	GPZ 900 R A7-A8	90-96	BLM4025-3F	BLMR4025-2F		BLM4025-1R
4	VN 900/VN 900 Custom	06-13	BLM4031-1F			BLM4031-1R
5	Z 900 ABS	2017	BLM4187-3F			BLM4187-2R
6	ZX9R B1-B2	94-95	BLM4161-3F	BLMR4161-2F		BLM4161-1R
7	ZX9R B3-B4	96-97	BLM4162-3F	BLMR4161-2F		BLM4161-1R
8	ZX9R C1-C2	98-99	BLM4163-3F	BLMR4163-2F		BLM4163-1R
9	ZX9R E1-E2	00-01	BLM4164-3F	BLMR4164-2F		BLM4164-1R
10	ZX9R F1P-F2P	02-04	BLM4165-3F	BLMR4165-2F		BLM4165-1R
11	GTR 1000 A5-A14	90-99	BLM4030-3F			BLM4030-1R
12	Z 1000	07-09	BLM4070-2F	BLMR4070-2F		BLM4070-1R
13	Z 1000	10-13		BLMR4071-2F		BLM4071-1R
14	Z 1000	2015-	BLM4072-2F			BLM4072-1R
15	Z 1000 ABS	15-17	BLM4188-4F			BLM4188-1R
16	Z 1000 SX	11-13		BLMR4085-2F		BLM4085-1R
17	Z 1000 SX	14-17	BLM4189-4F			BLM4189-1R
18	ZL 1000	87-90	BLM4128-3F			BLM4128-1R
19	ZR 1000 A1-A2	03-06	BLM4132-2F	BLMR4132-2F		BLM4132-1R
20	ZX10R	04-05	BLM4142-2F	BLMR4142-2F		BLM4142-1R
21	ZX10R	2006	BLM4143-2F	BLMR4143-2F		BLM4143-1R
22	ZX10R	2007	BLM4144-2F	BLMR4144-2F		BLM4144-1R
23	ZX10R	08-10		BLMR4145-2F		BLM4145-1R
24	ZX10R (Non ABS)	11-14	BLM4146-3F	BLMR4146-2F		BLM4146-1R
25	ZX10R ABS	11-17	BLM4185-4F			BLM4185-2R
26	GPZ 1100 S E1-E2	95-99	BLM4016-3F			BLM4016-1R
27	ZR 1100 A1-A4/B1 Zephyr	92-97	BLM4133-3F	BLMR4133-2F		BLM4133-1R
28	ZRX 1100 C1-C2	97-01	BLM4138-3F	BLMR4138-2F		BLM4138-1R
29	ZZR 1100 C1-C3	90-92	BLM4174-3F	BLMR4174-2F		BLM4174-1R
30	ZZR 1100 D1-D9	92-01	BLM4175-3F	BLMR4175-2F		BLM4175-1R
31	ZRX 1200 A1-A3P/ZRX 1200S B1-B3P	01-04	BLM4139-3F	BLMR4139-2F		BLM4139-1R
32	ZRX 1200 R	2006	BLM4140-3F			BLM4140-1R
33	ZX12R A1-B2	99-03	BLM4147-3F	BLMR4147-2F		BLM4147-1R
34	ZX12R B3-B4	04-05		BLMR4148-2F		BLM4147-1R
35	ZX12R B6	05-07	BLM4149-3F	BLMR4149-2F		BLM4147-1R
36	ZZR 1200	02-04	BLM4176-3F			BLM4176-1R
37	Z 1300 A1-A5	79-84	BLM4090-3F			BLM4090-1R
38	ZG 1300 A1-A3	87-90	BLM4127-3F			BLM4127-1R
39	ZZR 1400 (Non ABS)	06-10	BLM4177-3F	BLMR4177-2F		BLM4177-1R
40	ZZR 1400 ABS	07-17	BLM4186-6F			BLM4186-3R
41	VN 1500 B2-B6 Vulcan/G1-C2 Classic	88-96	BLM4056-1F			BLM4056-1R
42	VN 1500 D1-D2/E1 Classic/J1-J2 Drifter	96-99	BLM4057-1F			BLM4057-1R
43	VN 1500 E2 Classic Tourer/Nomad	01-04	BLM4058-3F			BLM4058-1R
44	VN 1500 E2 Classic/G1-G2 Nomad	98-99	BLM4059-2F			BLM4059-1R
45	VN 1600 A3H Classic	03-06		BLMR4060-2F		BLM4060-1R
46	VN 1600 B2H Meanstreak	03-06	BLM4061-3F			BLM4061-1R
47	VN 1700 Classic	2009		BLMR4062-2F		
48	VN 2000	03-09	BLM4063-3F	BLMR4063-2F		BLM4063-1R
49						
50	KAWASAKI OFF ROAD					
51	KX 85	00-11	BLM6017-1F			BLM6017-1R
52	KX 100	97-11	BLM6017-1F			BLM6017-1R
53	KX 125/250	03-05	BLM6018-1F			BLM6017-1R
54	KDX 200 R/220 R	05-06	BLM6014-1F			BLM6014-1R
55	KX 250	06-07	BLM6019-1F			BLM6019-1R
56	KX 250 F	04-05	BLM6018-1F			BLM6017-1R

FRONT

REAR

BRAKE LINES

APPLI
CATIONS



KAWASAKI OFF-ROAD



OE Replacement
Brake Lines (Front)

Race Standard
Brake Lines (Front)

OE Replacement
Brake Lines (Rear)

Line #

		FRONT	FRONT	REAR	
KX 250 F	2006	BLM6021-1F		BLM6021-1R	1
KX 250 F	07-08	BLM6022-1F		BLM6022-1R	2
KX 250 F	2009	BLM6023-1F		BLM6023-1R	3
KX 250 F	2011	BLM6024-1F		BLM6024-1R	4
RM 250	06-08	BLM6029-1F		BLM6029-1R	5
KLX 300 R	05-08	BLM6015-1F		BLM6015-1R	6
DR-Z 400 E	00-07	BLM6013-1F		BLM6013-1R	7
KLX 450 R	08-09	BLM6016-1F		BLM6016-1R	8
KX 450 F	06-08	BLM6021-1F		BLM6021-1R	9
KX 450 F	09-17	BLM6023-1F		BLM6023-1R	10
KX 500	95-04	BLM6018-1F		BLM6017-1R	11
KLR 650	08-17	BLM6105-1F		BLM6105-1R	12
					13
					14
KTM OFF ROAD					
125/200/250 EXC	00-03	BLM6032-1F		BLM6032-1R	15
125/200/250 SX	04-05	BLM6033-1F			16
125/200 EXC	98-99			BLM6032-1R	17
125/200 SX/MXC	00-03	BLM6035-1F		BLM6032-1R	18
125/200 SX/MXC	95-99	BLM6036-1F		BLM6032-1R	19
125 EXC/SX/SXS	04-17	BLM6038-1F		BLM6038-1R	20
150 SX	04-17	BLM6038-1F		BLM6038-1R	21
200 EXC/XC/XCW MXC	00-09	BLM6038-1F			22
250 MXC/SXC	00-01	BLM6038-1F			23
250 EXC/SX	03-09			BLM6038-1R	24
250 SX-F/SX-F Factory	11-17	BLM6038-1F		BLM6038-1R	25
250 EXC/XC/XCF	02-09	BLM6038-1F			26
250 SX/MXC	00-02	BLM6035-1F		BLM6032-1R	27
250 SX/MXC	94-99	BLM6036-1F		BLM6032-1R	28
360/380 EXC	00-03	BLM6032-1F		BLM6032-1R	29
300/360/380 SX/MXC	00-02	BLM6035-1F		BLM6032-1R	30
360/380 SX/MXC	94-99	BLM6036-1F		BLM6032-1R	31
300 EXC/MXC	04-09			BLM6038-1R	32
300 EXC/XC/MXC	06-09	BLM6038-1F			33
350 SX-F	16-17	BLM6038-1F		BLM6038-1R	34
380 EXC/MXC/SX	00-02	BLM6038-1F			35
400/520 SX/MXC	00-02	BLM6035-1F			36
400/540/620 SC/EXC	98-99	BLM6036-1F			37
400/540/620 SX	96-99	BLM6032-1F			38
400 EXC/MXC	00-09	BLM6038-1F			39
450/525 SX	04-05	BLM6033-1F			40
450 EXC/MXC/SXS/XC	03-09	BLM6038-1F			41
450 SX-F Factory	16-17	BLM6038-1F		BLM6038-1R	42
505 XC	08-09	BLM6038-1F			43
520 SC/EXC	00-02	BLM6032-1F			44
520 EXC/SX/MXC	00-02	BLM6038-1F			45
525 EXC/MXC/SX/XC	03-07	BLM6038-1F			46
525 MXC	2003	BLM6036-1F		BLM6032-1R	47
525 SX/450SX	2003	BLM6036-1F		BLM6032-1R	48
530 EXC/XCR/XCW	08-09	BLM6038-1F			49
625 SC/SXC	02-07	BLM6038-1F			50
660 Rallye	00-03	BLM6038-1F			51
					52
					53
LAVERDA					
750 Formula/750 SS	97-02	BLM8160-2F		BLM8160-1R	54
Mirage 1200	78-79	BLM8162-3F		BLM8162-1R	55
					56

BRAKE LINES



Line #

MOTO GUZZI

			OE Replacement Brake Lines (Front)	Race Standard Brake Lines (Front)	OE Replacement Brake Lines (Rear)
1	750 Targa	90-94	BLM8176-3FR		Supplied as front & rear kit complete
2	1000 Le Mans MK5	88-94	BLM8167-4FR		Supplied as front & rear kit complete
3	1000 Mille Gt	88-91	BLM8168-4FR		Supplied as front & rear kit complete
4	1000 Spada MK1-MK2	80-88	BLM8169-4FR		Supplied as front & rear kit complete
5	1000 Spada MK3	89-95	BLM8170-4FR		Supplied as front & rear kit complete
6	1000 T3 California		BLM8171-5FR		Supplied as front & rear kit complete
7	1100 California EV	97-02	BLM8172-2F		
8	1100 California Jackal	99-01	BLM8173-3FR		Supplied as front & rear kit complete
9	1100 California MK3	94-97	BLM8174-3FR		Supplied as front & rear kit complete
10	1100 Sport Carb	96-99	BLM8175-3F		BLM8175-1R

MV AGUSTA

13	F3 675 Agusta	2013	BLM8192-2F		BLM8192-1R
14	Brutale S 750	2004	BLM8191-3F		BLM8191-1R
15	F4 750	00-04	BLM8194-3F	BLMR8194-2F	
16	F4 1000 S	2004	BLM8193-3F		BLM8193-1R

SUZUKI

19	DR 350 SES-SEX	95-99	BLM3005-1F		BLM3005-1R
20	DR 350 SL-SR	90-94	BLM3006-1F		BLM3006-1R
21	GSF 400 M-R Bandit	91-95	BLM3041-2F		BLM3041-1R
22	GS 500 EK-ER	89-94	BLM3024-1F		BLM3024-1R
23	GS 500 ES-K4	95-05	BLM3025-1F		BLM3025-1R
24	GS 500 F	03-09	BLM3026-1F		BLM3026-1R
25	RG 500 G-CH	85-89	BLM3137-3F	BLMR3137-2F	BLM3137-1R
26	GSF 600 S Bandit	1995	BLM3042-3F	BLMR3042-2F	BLM3042-1R
27	GSF 600 T-X Bandit	96-99	BLM3043-3F	BLMR3043-2F	BLM3042-1R
28	GSF 600 Y-K4 Bandit	00-05	BLM3044-3F	BLMR3044-2F	BLM3044-1R
29	GSR 600	06-10	BLM3049-2F	BLMR3049-2F	BLM3049-1R
30	GSR 600 ABS	06-11	BLM3050-5FR		Supplied as front & rear kit complete
31	GSX 600 FJ-FV	88-97	BLM3071-3F	BLMR3071-2F	BLM3071-1R
32	GSX 600 FW-K3	98-03	BLM3072-3F	BLMR3072-2F	BLM3072-1R
33	GSXR 600	04-05	BLM3097-2F	BLMR3097-2F	BLM3097-1R
34	GSXR 600	06-10	BLM3098-2F	BLMR3098-2F	BLM3098-1R
35	GSXR 600	11-17	BLM3099-2F	BLMR3099-2F	BLM3099-1R
36	GSXR 600 K1-K3	01-03	BLM3100-2F	BLMR3100-2F	BLM3100-1R
37	GSXR 600 V-W	97-98	BLM3101-2F	BLMR3101-2F	BLM3101-1R
38	GSXR 600 X-Y	99-00	BLM3102-2F	BLMR3101-2F	BLM3102-1R
39	RF 600 RP-RV	93-97	BLM3130-3F	BLMR3130-2F	BLM3130-1R
40	VS 600 GLS-GLT Intruder	95-97	BLM3155-1F		
41	DL 650 ABS	2013	BLM3003-5FR		Supplied as front & rear kit complete
42	DR 650 RSEM-SET	91-97	BLM3008-1F		BLM3008-1R
43	GX 650 GTX-GTD	81-85	BLM3031-3F		BLM3031-1R
44	GSF 650 Bandit Non ABS	2008	BLM3045-2F		
45	GSF 650 Bandit Non ABS	05-07	BLM3046-2F	BLMR3046-2F	BLM3046-1R
46	GSF 650 A Bandit ABS	05-13	BLM3047-7FR		Supplied as front & rear kit complete
47	GSF 650 S Bandit K5 - K8 Non ABS	05-13	BLM3048-2F	BLMR3048-2F	BLM3048-1R
48	GSX 650 F Non ABS	07-13	BLM3073-2F	BLMR3073-2F	BLM3073-1R
49	LS 650 FG/PJ-PT Savage	87-98	BLM3129-1F		
50	SV 650 Unfaired	03-13	BLM3143-3F	BLMR3143-2F	BLM3143-1R
51	SV 650 S Faired	03-13	BLM3144-3F	BLMR3144-2F	BLM3143-1R
52	SV 650 SX-SK2	99-02	BLM3145-3F	BLMR3145-2F	BLM3145-1R
53	SV 650 X-K1	99-02	BLM3146-3F	BLMR3146-2F	BLM3145-1R
54	SVF 650 Gladius Non ABS	09-13	BLM3147-2F	BLMR3147-2F	BLM3147-1R
55	V-Strom 650	04-12	BLM3153-3F	BLMR3153-2F	BLM3153-1R
56	GSR 750	11-13	BLM3051-2F		

FRONT

REAR

BRAKE LINES



SUZUKI



OE Replacement
Brake Lines (Front)

Race Standard
Brake Lines (Front)

OE Replacement
Brake Lines (Rear)

Line #

		OE Replacement Brake Lines (Front)	Race Standard Brake Lines (Front)	OE Replacement Brake Lines (Rear)	Line #
GSX 750 EE/EF/ES	84-89	BLM3074-5F		BLM3074-1R	1
GSX 750 FK-FV	89-97	BLM3077-3F	BLMR3077-2F	BLM3077-1R	2
GSX 750 FW-K3	98-03	BLM3078-3F	BLMR3078-2F	BLM3078-1R	3
GSX 750 W-K1	97-02	BLM3081-3F	BLMR3081-2F	BLM3081-1R	4
GSXR 750	11-16	BLM3099-2F	BLMR3099-2F	BLM3099-1R	5
GSXR 750	06-10	BLM3098-2F	BLMR3098-2F	BLM3098-1R	6
GSXR 750 K4/K5	04-05	BLM3097-2F	BLMR3097-2F	BLM3097-1R	7
GSXR 750 L	1990	BLM3109-3F	BLMR3109-2F	BLM3109-1R	8
GSXR 750 M	1991	BLM3110-3F	BLMR3110-2F	BLM3110-1R	9
GSXR 750 T-W	96-98	BLM3101-2F	BLMR3101-2F	BLM3101-1R	10
GSXR 750 WN-WP	92-93	BLM3112-3F	BLMR3112-2F	BLM3112-1R	11
GSXR 750 WR-WS	94-95	BLM3113-2F	BLMR3113-2F	BLM3113-1R	12
GSXR 750 X	1999	BLM3102-2F	BLMR3101-2F	BLM3102-1R	13
GSXR 750 Y-K3	00-03	BLM3115-2F	BLMR3115-2F	BLM3115-1R	14
GSX-S 750	2017	BLM3166-3F		BLM3166-2R	15
GSX-S 750 Z	2017	BLM3166-3F		BLM3166-2R	16
VS 750 GLPG-GLPM Intruder	85-91	BLM3155-1F			17
DR 800 SL-SM	90-91	BLM3010-1F		BLM3010-1R	18
VS 800 GLM-GLV Intruder	91-97	BLM3155-1F			19
VX 800 L-R	90-95	BLM3158-1F		BLM3158-1R	20
VZ 800 V-W Marauder	97-98	BLM3159-1F			21
GS 850 GN-GT	79-80	BLM3035-3F		BLM3035-1R	22
GS 850 GX-GG	81-88	BLM3036-3F		BLM3036-1R	23
GSXR 1000	12-14	BLM3082-2F	BLMR3082-2F	BLM3082-1R	24
GSXR 1000 ABS	15-16	BLM3083-3F		BLM3082-1R	25
GSXR 1000 ABS	2017	BLM3167-3F		BLM3167-2R	26
GSXR 1000 K5/K6	05-06	BLM3084-2F	BLMR3084-2F	BLM3084-1R	27
GSXR 1000 K7 - K8	07-08	BLM3085-2F	BLMR3085-2F	BLM3085-1R	28
GSXR 1000 K9 - K11	09-11	BLM3086-2F	BLMR3086-2F	BLM3086-1R	29
GSXR 1000 K1-K2	01-02	BLM3087-2F	BLMR3087-2F	BLM3087-1R	30
GSXR 1000 K3-K4	03-04	BLM3088-2F	BLMR3088-2F	BLM3088-1R	31
GSXS 1000 F ABS	15-17	BLM3168-3F		BLM3168-2R	32
SV 1000 N	03-06	BLM3141-2F	BLMR3141-2F	BLM3141-1R	33
SV 1000 SK3-K7	03-07	BLM3142-2F	BLMR3142-2F	BLM3142-1R	34
TL 1000 RW-RK1	98-02	BLM3148-2F	BLMR3148-2F	BLM3148-1R	35
TL 1000 SV-SX	97-01	BLM3149-2F	BLMR3149-2F	BLM3149-1R	36
GSX 1100 FJ-FR	88-94	BLM3057-3F		BLM3057-1R	37
GSX 1100 GM-GN	91-94	BLM3058-3F		BLM3058-1R	38
GSXR 1100 WP-WT	93-96	BLM3095-2F	BLMR3095-2F	BLM3095-1R	39
GSF 1200 K1-K5 Bandit	01-06	BLM3037-3F	BLMR3037-2F	BLM3037-1R	40
GSF 1200 T-Y Bandit	96-00	BLM3038-3F	BLMR3038-2F	BLM3038-1R	41
GSF 1250 Bandit	06-13	BLM3039-2F	BLMR3039-2F	BLM3039-1R	42
GSF 1250 A Bandit ABS	07-13	BLM3040-8F			43
B-King	07-10	BLM3000-2F		BLM3000-1R	44
GSX 1300 R Hayabusa	99-06	BLM3060-2F	BLMR3060-2F	BLM3060-1R	45
GSX 1300 R Hayabusa Non ABS	07-14	BLM3061-2F	BLMR3061-2F	BLM3061-1R	46
GSX1300 R Hayabusa ABS	13-17	BLM3169-3F*		BLM3169-2R*	47
*Premium kit including stainless steel replacement front master cylinder to ABS hardline					48
GSX1300 R Hayabusa ABS	13-17	BLM3169A-3F**		BLM3169A-2R**	49
**Kit supplied with full length flexible hoses to replace all original hardlines					50
GSX1300 R Hayabusa ABS	13-17	BLM3170-3F***		BLM3170-2R***	51
***Kit supplied with full length front master cylinder to ABS and rear master cylinder to ABS hose to replace original hardline					52
GSX 1400	01-09	BLM3062-3F	BLMR3062-2F	BLM3062-1R	53
VZR 1800	2006-	BLM3160-3F	BLMR3160-2F	BLM3160-1R	54
					55
					56

BRAKE LINES



SUZUKI OFF ROAD



Line #

			OE Replacement Brake Lines (Front)	Race Standard Brake Lines (Front)		OE Replacement Brake Lines (Rear)
1	DRZ 125/DRZ 125L	2003-	BLM6077-1F			
2	DRZ 250	04-07	BLM6078-1F			BLM6078-1R
3	RM-Z 250	04-09	BLM6080-1F			BLM6080-1R
4	RM-Z 250	2011	BLM6081-1F			BLM6081-1R
5	DRZ 400	05-07	BLM6079-1F			
6	RM-Z 450	05-07	BLM6080-1F			BLM6080-1R
7	RM-Z 450	08-09	BLM6083-1F			BLM6083-1R
8	RM-Z 450	2011	BLM6084-1F			BLM6084-1R
9						
10	TRIUMPH					
11	Bonneville/T100 (<Ch 437492)	01-12	BLM8195-1F			
12	Bonneville America	03-06	BLM8196-1F			BLM8196-1R
13	Bonneville Thruxton 900	03-13	BLM8197-1F			BLM8197-1R
14	Daytona 600	03-04	BLM8198-2F	BLMR8198-2F		BLM8198-1R
15	Daytona 675	06-13	BLM8199-2F	BLMR8199-2F		BLM8199-1R
16	Daytona 750/1000	91-93	BLM8200-3F	BLMR8200-2F		BLM8200-1R
17	Daytona 900/1200	92-97	BLM8201-3F	BLMR8201-2F		BLM8201-1R
18	Daytona 955i	01-03	BLM8202-2F	BLMR8202-2F		BLM8202-1R
19	Daytona 955i	99-00	BLM8202-2F	BLMR8202-2F		BLM8203-1R
20	Daytona T595	97-00	BLM8202-2F	BLMR8202-2F		BLM8204-1R
21	Legend	98-01	BLM8205-1F			BLM8205-1R
22	Rocket III (Standard Bars)	04-15	BLM8206-3F			BLM8206-1R
23	Rocket III Classic (Higher Bars)	04-15	BLM8207-3F			BLM8206-1R
24	Scrambler 865	06-13	BLM8208-1F			
25	Speed Four	03-06	BLM8209-2F			BLM8209-1R
26	Speed III	94-96	BLM8210-3F	BLMR8210-2F		BLM8210-1R
27	Speed III T509	97-03	BLM8211-2F	BLMR8211-2F		BLM8211-1R
28	Speed Triple 1050	04-10	BLM8212-3F	BLMR8212-2F		BLM8212-1R
29	Speedmaster	03-11	BLM8213-2F	BLMR8213-2F		BLM8213-1R
30	Sprint	93-97	BLM8214-3F	BLMR8214-2F		BLM8214-1R
31	Sprint RS	99-05	BLM8215-2F			BLM8215-1R
32	Sprint ST 1050 (Non ABS) To Vin 291665	05-12	BLM8216-2F			BLM8216-1R
33	Sprint ST/Executive	98-03	BLM8217-2F	BLMR8217-2F		BLM8217-1R
34	Sprint ST/Executive Late 03 On	2003-	BLM8218-2F			BLM8218-1R
35	Street Triple 675	06-15	BLM8219-2F	BLMR8219-2F		BLM8219-1R
36	Street Triple 675R	09-15	BLM8220-2F	BLMR8220-2F		BLM8220-1R
37	Thunderbird (Low Bar)	95-02	BLM8221-1F			BLM8205-1R
38	Thunderbird 900 Sport	98-03	BLM8222-3F			BLM8222-1R
39	Thunderbird/Adventurer	95-03	BLM8223-1F			BLM8205-1R
40	Tiger	93-99	BLM8224-3F	BLMR8224-2F		BLM8224-1R
41	Tiger 1050 (Non ABS)	2013	BLM8225-3F			BLM8225-1R
42	Tiger 800 XC	11-14		BLMR8226-2F		BLM8226-1R
43	Tiger 955	00-03	BLM8227-2F			BLM8227-1R
44	Trident 750/900	-1991	BLM8228-3F	BLMR8228-2F		BLM8228-1R
45	Trident 750/900	91-98	BLM8229-3F	BLMR8229-2F		BLM8228-1R
46	Trophy 900/1200 (From Vin 71699)	2003-	BLM8230-2F			BLM8230-1R
47	Trophy 900/1200 (Up To Vin 71698)	-2003	BLM8231-3F	BLMR8231-2F		BLM8231-1R
48	TT 600	00-03	BLM8232-2F	BLMR8232-2F		BLM8232-1R
49						
50	YAMAHA					
51	DT 125 X	2006	BLM2002-1F			BLM2002-1R
52	YZFR 125	08-13	BLM2146-1F			BLM2146-1R
53	FZ1 Fazer	06-13	BLM2010-3F	BLMR2010-2F		BLM2010-1R
54	TZ 250	1991-		BLMR2078-2F		BLM2078-1R
55	YZF 300 R Non ABS	2017	BLM2156-1F			BLM2156-1R
56	YZF 300 R ABS	2017	BLM2155-3F			BLM2155-1R

FRONT

REAR

BRAKE LINES

APPLI
CA
TIONS



YAMAHA



OE Replacement
Brake Lines (Front)

Race Standard
Brake Lines (Front)

OE Replacement
Brake Lines (Rear)

Line #

		OE Replacement Brake Lines (Front)	Race Standard Brake Lines (Front)	OE Replacement Brake Lines (Rear)	Line #
XT 350	85-96	BLM2116-1F		BLM2116-1R	1
FZR 400 RR	92-96	BLM2024-3F	BLMR2024-2F	BLM2024-1R	2
FZR 400 RRSP	91-92	BLM2025-3F	BLMR2025-2F	BLM2025-1R	3
FZ6	04-06	BLM2011-3F	BLMR2011-2F	BLM2011-1R	4
FZ6 S2	07-08	BLM2012-2F	BLMR2012-2F	BLM2011-1R	5
FZ 600	87-88	BLM2013-3F	BLMR2013-2F	BLM2013-1R	6
FZR 600	89-90	BLM2026-3F	BLMR2026-2F	BLM2026-1R	7
FZR 600 Genesis	91-93	BLM2027-3F	BLMR2027-2F	BLM2027-1R	8
FZR 600 R	94-96	BLM2028-2F		BLM2028-1R	9
FZS 600 Fazer	98-03	BLM2032-3F	BLMR2032-2F	BLM2032-1R	10
R6	08-15		BLMR2049-2F	BLM2049-1R	11
R6	06-07		BLMR2048-2F	BLM2048-1R	12
R6	2005	BLM2047-3F	BLMR2047-2F	BLM2047-1R	13
R6	03-04	BLM2046-2F		BLM2046-1R	14
R6	98-02	BLM2045-2F		BLM2045-1R	15
XJ 600	84-92	BLM2084-3F		BLM2084-1R	16
XJ 600 N	94-97	BLM2085-1F		BLM2085-1R	17
XJ 600 N/S Diversion	98-03	BLM2086-2F		BLM2086-1R	18
XJ 600 S Diversion	92-97	BLM2087-1F		BLM2085-1R	19
XJ6/XJ6 Diversion/XJ6 SP	09-13	BLM2083-2F	BLMR2083-2F	BLM2083-1R	20
XT 600 Tenere	86-90	BLM2118-1F		BLM2118-1R	21
XT 600 E	93-03	BLM2119-1F		BLM2119-1R	22
YF 600 R Thundercat	96-03	BLM2144-2F		BLM2144-1R	23
XVS 650 Drag Star	97-03	BLM2137-1F			24
XVS 650 A Drag Star Classic	98-03	BLM2138-1F			25
SZR 660	96-97	BLM2067-1F		BLM2067-1R	26
XT 660 R	04-13	BLM2120-1F		BLM2120-1R	27
XT 660 X	04-13	BLM2121-1F		BLM2121-1R	28
XT 660 Z	09-13	BLM2122-3F		BLM2122-1R	29
XTZ 660	91-99	BLM2119-1F		BLM2119-1R	30
FZ-07	16-17	BLM2157-3F			31
MT-07	14-17	BLM2153-3F		BLM2153-4R	32
XSR 700	16-17	BLM2154-3F		BLM2154-4R	33
XTZ 750 Super Tenere	89-96	BLM2124-3F	BLMR2124-2F	BLM2124-1R	34
XV 750	92-97	BLM2133-3F			35
XV 750 SE	81-83	BLM2134-1F			36
YZF 750	93-97	BLM2145-2F		BLM2145-1R	37
FZ8-Non ABS	10-13		BLMR2016-2F	BLM2016-1R	38
TDM 850	91-96	BLM2069-3F	BLMR2069-2F	BLM2069-1R	39
TDM 850	97-02	BLM2070-3F	BLMR2070-2F	BLM2069-1R	40
TRX 850	96-00	BLM2074-2F		BLM2074-1R	41
XS 850	80-85	BLM2114-3F		BLM2114-1R	42
TDM 900 Non ABS	02-13	BLM2071-3F	BLMR2071-2F	BLM2071-1R	43
XJ 900	83-85	BLM2091-3F		BLM2091-1R	44
XJ 900 F	85-94	BLM2092-3F		BLM2092-1R	45
XJ 900 S Diversion	94-96	BLM2093-2F		BLM2093-1R	46
XJ 900 S Diversion	97-03	BLM2094-3F	BLMR2094-2F	BLM2094-1R	47
XSR 900	16-17	BLM2148-5F		BLM2148-2R	48
MT-09	13-16	BLM2037-2F		BLM2037-1R	49
MT-09 ABS	13-17	BLM2151-5F		BLM2151-2R	50
MT-09 Tracer ABS	15-17	BLM2152-5F		BLM2151-2R	51
MT10 ABS	16-17	BLM2150-5F		BLM2150-2R	52
FZR 1000 Ex-Up	95-96	BLM2017-2F		BLM2017-1R	53
FZR 1000 Ex-Up	89-90	BLM2018-2F		BLM2018-1R	54
FZR 1000 Ex-Up	1991	BLM2019-3F	BLMR2019-2F	BLM2019-1R	55
FZR 1000 Genesis	87-88	BLM2020-3F	BLMR2020-2F	BLM2020-1R	56

FRONT

REAR

BRAKE LINES



YAMAHA



Line #

			OE Replacement Brake Lines (Front)	Race Standard Brake Lines (Front)		OE Replacement Brake Lines (Rear)
1	FZR 1000 RU	92-94	BLM2021-3F	BLMR2021-2F		BLM2021-1R
2	FZS 1000 Fazer	01-05	BLM2031-3F	BLMR2031-2F		BLM2031-1R
3	GTS 1000 A	93-96	BLM2034-7FR			Supplied as front & rear kit complete
4	XV 1000 TR1	81-85	BLM2125-3F			
5	XV 1000 Virago	86-89	BLM2126-3F			
6	XV 1000 Virago	89-99	BLM2127-3F	BLMR2127-2F		
7	YZF 1000 R Thunderace	96-02	BLM2143-2F			BLM2143-1R
8	R1	98-01	BLM2039-2F			BLM2039-1R
9	R1	02-03		BLMR2040-2F		BLM2040-1R
10	R1	04-05		BLMR2041-2F		BLM2041-1R
11	R1	2006		BLMR2041-2F		BLM2042-1R
12	R1	07-08		BLMR2043-2F		BLM2043-1R
13	R1	09-14		BLMR2044-2F		BLM2044-1R
14	R1/R1M/R1S	15-17	BLM2149-5F			BLM2149-2R
15	BT 1100 Bulldog	01-03	BLM2000-3F			BLM2000-1R
16	FJ 1100	85-86	BLM2003-5F			BLM2003-1R
17	XVS 1100/A Dragstar	98-06	BLM2135-3F			BLM2135-1R
18	XVS 1100/A Dragstar Classic	98-06	BLM2136-3F			BLM2135-1R
19	FJ 1200 (Antidive)	86-87	BLM2004-5F			BLM2004-1R
20	FJ 1200 (Non Antidive)	88-96	BLM2005-3F	BLMR2005-2F		BLM2005-1R
21	FJ 1200 ABS	91-96	BLM2006-6F			BLM2006-2R
22	XJR 1200	95-98	BLM2095-2F			BLM2095-1R
23	V-MAX	91-04	BLM2081-3F	BLMR2081-2F		BLM2081-1R
24	FJR 1300	00-02	BLM2007-3F			BLM2007-1R
25	FJR 1300	03-04	BLM2008-3F			BLM2007-1R
26	XJR 1300	99-01	BLM2096-3F	BLMR2096-2F		BLM2096-1R
27	XJR 1300	02-03		BLMR2097-2F		BLM2097-1R
28	XJR 1300	04-13		BLMR2098-2F		BLM2098-1R
29	XVZ 1300 A/AT Royal Star/Tour Classic	96-99	BLM2139-3F	BLMR2139-2F		BLM2139-1R
30	XVZ 1300 TF Venture Star	00-02	BLM2129-3F			BLM2129-1R
31	XV 1600 Wild Star	98-03	BLM2129-3F			BLM2129-1R
32	XV 1900 Midnight Star	05-09	BLM2130-3F	BLMR2130-2F		BLM2130-1R
33						
34	YAMAHA OFF ROAD					
35	YZ 85	01-17	BLM6102-1F			BLM6093-1R
36	YZ 125/250	06-07	BLM6091-1F			BLM6091-1R
37	YZ 125/250	08-17	BLM6092-1F			BLM6092-1R
38	YZ 125/250/250 F	03-05	BLM6094-1F			BLM6094-1R
39	WR 250 F	07-11	BLM6086-1F			BLM6086-1R
40	WR 250 R	08-09	BLM6087-1F			BLM6087-1R
41	WR 250 X	08-09	BLM6088-1F			BLM6088-1R
42	YZ 250 F	01-02	BLM6093-1F			BLM6093-1R
43	YZ 250 F	06-08	BLM6091-1F			BLM6091-1R
44	YZ 250 F/YZ 450 F	10-11	BLM6097-1F			BLM6087-1R
45	WR 450 F	04-06	BLM6089-1F			BLM6089-1R
46	WR 450 F	07-11	BLM6090-1F			BLM6090-1R
47	YZ 450 F	03-05	BLM6099-1F			BLM6099-1R
48	YZ 450 F	2007	BLM6098-1F			BLM6098-1R
49	YZ 450 F	08-17	BLM6100-1F			BLM6100-1R
50						
51						
52						
53						
54						
55						
56						

FRONT

REAR

EBC BRAKE PAD BUYERS GUIDE

NOTE:- Size identification is shown as follows

Dimension 1=Width or Diameter, Dimension 2=Height or Diameter, Dimension 3=Thickness (Material and backplate)

BUYERS GUIDE
BRAKE PADS

NOTE:- Size identification is shown as follows
Dimension 1=Width or Diameter, Dimension 2=Height or Diameter, Dimension 3=Thickness (Material and backplate)

FA11 48 x 9mm



MATERIAL AVAILABILITY												
FA	X	V	R	HH	SV	MXS	SXR	EPFA	GPFA	GPFAFX	SFA	SFAHH
✓												

ISR AFTERMARKET CALIPER	RD 400 C/D/E	76-78	F & R
22-023-0A (2 Piston)	XS 500 B	75	F
22-026-0A (Sprocket Caliper)	XS 2/TX 650	72-73	F
YAMAHA	TX 650 A / XS 650 B/C	74-76	F
RD 250 B	75 F TX 750 / TX 750 A	73-74	F
RD 350 A/B	73-75 F		

FA12 50 x 13/20mm

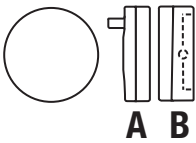

MATERIAL AVAILABILITY												
FA	X	V	R	HH	SV	MXS	SXR	EPFA	GPFA	GPFAFX	SFA	SFAHH
✓		✓										

HONDA	CB 450 K3/K4	70-71	F CB 750 K1/K2/K3/K4/K5/76	70-76	F
--------------	--------------	-------	----------------------------	-------	---

FA13 52 x 13/20mm

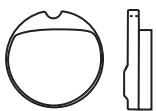

MATERIAL AVAILABILITY												
FA	X	V	R	HH	SV	MXS	SXR	EPFA	GPFA	GPFAFX	SFA	SFAHH
✓		✓										

HONDA	CB 500 T/76	75-76	F
CB 350 F/F1/G	F CB 550 F	75-77	F
CB 360 G/T/T 76	74-76 F CB 550 K/K1/76	74-78	F
CB 400 F	75-77 F CB 750 A 'Hondamatic'	76-78	F
CB 450 K5-K7	72-74 F CB 750 F Supersport	75-76	F
CB 500 K/K1/K2	F CB 750 K	77-78	F

FA16 60 x 51.5 x 10mm



MATERIAL AVAILABILITY												
FA	X	V	R	HH	SV	MXS	SXR	EPFA	GPFA	GPFAFX	SFA	SFAHH
✓				✓				✓		✓		

AP/LOCKHEED AFTERMARKET CALIPER	T 140 Silver Jubilee Bonneville	77	F & R
2 piston/2 pin (CP2195/CP2696-38E0)	T 140 E Bonneville	78-83	F & R
DUCATI	T140 D Bonneville		
750 Sport	74 F (Lester Alloy Wheels/6 Bolt disc)	79-81	F & R
ISR AFTERMARKET CALIPER	T 140 ES (750cc)	80-81	F & R
22-030 (2 Piston Rear)	T140 E/ES (Executive/Morris Alloy Wheels/5 Bolt disc)	81-83	F & R
22-033 (2 Piston HD)	T 150 V (Trident 3 cyl)	73-74	F & R
TRIUMPH (Meriden Produced Models)	T 160 V (Trident 3 cyl)	75	F & R
T 140 V Bonneville	73-74 F TSS 750 (8 valve)	83	F & R
T 140 V Bonneville	75-78 F & R TSX 750	83	F & R

FA18 56 x 55 x 9mm

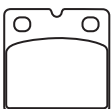

MATERIAL AVAILABILITY												
FA	X	V	R	HH	SV	MXS	SXR	EPFA	GPFA	GPFAFX	SFA	SFAHH
✓		✓		✓								

AMERICAN SUSPENSION CALIPER

B17 Phantom 2 piston brake caliper
B17 Mach 8 Standard mount 2 Piston caliper
P26 2 Piston caliper

BMW

R 45/45 N (with Brembo calipers)	78-85	F	R 100 RT	10/80-84	F & R	K 100 LT	09/88-91	R
R 65 (double disc model)	07/88-08/89	F	R 1100 RS	92-01	R	K1 (16 valve models)	88-93	R
R 65 GS	87-92	F	K 75/75-2	84-07/90	F	K 1100 LT	89-99	R
R 65 RT	85-88	F	K 75/75-2 (ABS Model)	08/90-96	R	K 1100 RS	92-96	R
R 65 LS (Brembo caliper)	81-85	F	K 75 C	85-08/88	F	K 1200 RS	96-05	R
R 65 T (Brembo caliper)	80-85	F	K 75 RT	89-96	R	K 1200 GT	03-06	R
R 80 RT (Double disc)	82-84	F	K 75 S (Non ABS)	85-09/88	F & R	DUCATI		
R 80/R 80 RT (Double Disc)	84-08/88	F	K 75 S (Non ABS Model)	09/88-95	R	250/350/450 Desmo	74-77	F
R 80 GS	80-87	F	K 75 S (ABS Model)	85-09/88	F & R	600 Pantah	81	F

FA18 56 x 55 x 9mm Contd.

650 Pantah	-84 F & R	1000 R1 Hailwood Replica	84 F & R	1000 SP II/III	83-94 F & R
750 SS	75-76 F & R	LAVERDA		1000 GT	87-91 F & R
751 F1	86 F & R	Jota 1000	76 F & R	1000 S	89-94 F & R
750 Paso	87-90 F	RGS 1000	83 F & R	1000 Le-Mans	84-93 F & R
750 Sport	88-90 F & R	1000 SFC	85-86 F & R	Strada 1000	93-94 F & R
860 GT/GTS	75-76 F & R	Mirage 1200	76 F & R	California 1100	94-97 F & R
900 GTS	75-76 F & R	MOTO GUZZI			
900 SS - Darmah	76-78 F & R	850 II/III Le Mans	78-84 F & R	500 Country	93-98 F
900 Hailwood Replica	79 F & R	850 T3/T4/T5	79-88 F & R	TRIUMPH (Meriden Produced Models)	
906 Paso	88-89 F & R	California 1000 II/III	83-93 F & R	T 140 Bonneville	85-88 F & R

FA019 55.5 x 55 x 7.5mm

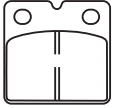

MATERIAL AVAILABILITY												
FA	X	V	R	HH	SV	MXS	SXR	EPFA	GPFA	GPFAF	SFA	SFAHH
✓												

DUCATI
 750 SS (4 bolt disc fixing) Note thinner pad version for shaved down caliper 75-76 F&R
 900 SS Note thinner pad version for shaved down caliper 75-76 F&R

FA20 45 x 80mm



MATERIAL AVAILABILITY												
FA	X	V	R	HH	SV	MXS	SXR	EPFA	GPFA	GPFAF	SFA	SFAHH
	✓											

YAMAHA
 YT 125 G/H/J 'Tri Moto' 80-82 R

FA21 47 x 16.2mm



MATERIAL AVAILABILITY												
FA	X	V	R	HH	SV	MXS	SXR	EPFA	GPFA	GPFAF	SFA	SFAHH
	✓		✓		✓							

YAMAHA
 YT 125 J/K/L/N 'Tri Moto' 81-85 R YTM 225 DRN/DRS 'Tri Moto' 85-86 R
 YT 175 J/K 'Tri Moto' 82-83 R YFM 225 S/T/U (Moto 4) 86-88 R
 YTM 200 K/L/N 'Tri Moto' 83-85 R YFM 250 W/A/B 89-91 R
 YTM 200 EK/EL 'Tri Moto' 83-84 R YFM 350 ERT/ERU 87-88 R
 YTM 200 ERN 'Tri Moto' 85 R YFM 350 FWT/FWU/FWW/FWA/FWB/ 87-95 R
 YFM 200 N/DXS/DXT/DXU/D/DXW 85-89 R FWD/FWE/FWF/FWG Big Bear 87-95 R
 YTM 225 DXK/DXL/DXN 'Tri Moto' 83-85 R YFM 350 ERW/ERA/ERD/ERE/ERF/ERG 89-95 R

FA22 72 x 35mm

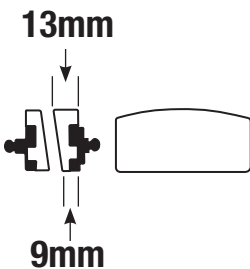

MATERIAL AVAILABILITY												
FA	X	V	R	HH	SV	MXS	SXR	EPFA	GPFA	GPFAF	SFA	SFAHH
✓		✓										

BMW
 R 60/7 76-80 F R 90/6 73-76 F
 R 60 TIC 78-82 F R 100 76-77 F
 R 75/6, 75/7 73-79 F R 100/7T 77-09/80 F
 R 80 77-84 F R 100 S 76-08/80 F
 R 80 TIC 78-08/80 F R 100 RS 76-09/80 F
 R 90 S 73-76 F R 100 RT 78-09/80 F

FA24/2 114 x 67 x 7mm



MATERIAL AVAILABILITY												
FA	X	V	R	HH	SV	MXS	SXR	EPFA	GPFA	GPFAF	SFA	SFAHH
✓		✓										

HARLEY DAVIDSON
 FX/FXE/FXEF/FXWG/FXS 73-83 R FL/FLH 72-80 R
 FL/FLH 72-84 F (BANANA CALIPER)

FA26 78 x 52.5 x 6mm



MATERIAL AVAILABILITY												
FA	X	V	R	HH	SV	MXS	SXR	EPFA	GPFA	GPFAF	SFA	SFAHH
✓												

HARLEY DAVIDSON
 XLH/XLCH 73-77 F
 FX/FXE 73-77 F

BUYERS GUIDE
BRAKE PADS

NOTE:- Size identification is shown as follows
 Dimension 1 = Width or Diameter, Dimension 2 = Height or Diameter, Dimension 3 = Thickness (Material and backplate)

NOTE:- Size identification is shown as follows
Dimension 1=Width or Diameter, Dimension 2=Height or Diameter, Dimension 3=Thickness (Material and backplate)

FA27 44.5 x 55.5 x 9.5mm



MATERIAL AVAILABILITY												
FA	X	V	R	HH	SV	MXS	SXR	EPFA	GPFA	GPFAFX	SFA	SFAHH
✓												

NORTON 850 MK 11/11A Commando Roadster / 74 F&R
 750 MK V Commando Roadster / Interstate 73 F&R Hi Rider / Interstate
 850 MK 1 Commando Hi Rider / Interstate 73 F&R 850 MK 111 Commando Roadster /
 850 MK 1A Commando Roadster / Interstate 73 F&R Hi Rider / Interstate 75 F&R

FA29 67 x 49 x 11mm

FA30 67 x 49 x 10mm

FA31 67 x 49 x 9mm

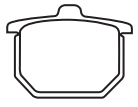

MATERIAL AVAILABILITY												
FA	X	V	R	HH	SV	MXS	SXR	EPFA	GPFA	GPFAFX	SFA	SFAHH
✓		✓										

FA29 - HONDA GL 1100/1100 I Goldwing 80 R
 CX 500 78-79 F GL 1100/1100 I Goldwing Interstate 81 F & R
 CX 500 C Custom 79-81 F
FA30 - HONDA
 CX 500 D Deluxe 79-81 F CB 750 F Supersport 79-80 F & R
 CB 900 C Custom 80 R CB 900 C Custom 80 F
 CB 900 C Custom 81 F & R
FA31 - HONDA
 GL 1000 K/76/L Goldwing 75-77 F CB 750 F Supersport 77-78 F & R
 GL 1000 Goldwing 78-79 F CBX 79-80 F & R

FA32 58 x 65.5 x 11mm

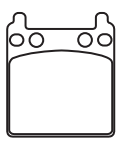

MATERIAL AVAILABILITY												
FA	X	V	R	HH	SV	MXS	SXR	EPFA	GPFA	GPFAFX	SFA	SFAHH
✓		✓										

HONDA **PERFORMANCE MACHINE AFTERMARKET CALIPER**
 CB 750 F Supersport 75-76 R 162 X 2
 GL 1000 'All models' 75-79 R

**FA33 A. 51.5 x 12.5mm
B. 50 x 12.5mm**

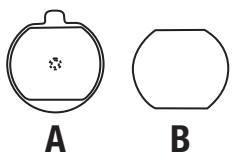

MATERIAL AVAILABILITY												
FA	X	V	R	HH	SV	MXS	SXR	EPFA	GPFA	GPFAFX	SFA	SFAHH
✓												

KAWASAKI
 S2-A (350cc) 72-73 F KZ 750 B1/B2/B3/B4 76-79 F
 S3/S3-A (400cc) 74-75 F KZ 900 A4/A5 76-77 F
 KH 400 A3/A4/A5 76-78 F KZ 900 B1 'Ltd' 76 F
 KH 500 A8 76 F KZ 1000 A1/A2/A2A 77-78 F
 KZ 650 B1/B2/B2A/B3 77-79 F KZ 1000 B1/B2 'Ltd' 77-78 F
 KZ 650 C1/C2/C3 (up to T F/no 023100) 77-79 F KZ 1000 C1/C1A 'Police Series' 78 F
 KZ 650 D1/D1A 'SR Series' 78-79 F KZ 1000 D1 (ZI-R Series) 78 F

FA34 66 x 49.5 x 11mm

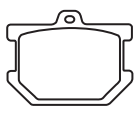

MATERIAL AVAILABILITY												
FA	X	V	R	HH	SV	MXS	SXR	EPFA	GPFA	GPFAFX	SFA	SFAHH
✓		✓										

YAMAHA XS 750 D/2D/E/F 77-79 F & R
 SR 500 E/F/G/H 78-81 F XS 750 SE/SF 78-79 R
 XS 500 C/D/E 76-78 F & R XS 850 G/H 80-81 F & R
 XJ 650 RJ 'Seca' 82 F XS 850 LG/LH/SG/SH 80-81 F
 XS 650 D/E/F/2F 77-79 F XV 920 RH/RJ 81-82 F
 XS 650 SE/SF/SG 78-80 F & R XS 1100 E/F/G/H 78-81 F & R
 XS 650 G/H/SH 80-81 F XS 1100 SF/SG/SH 79-81 R
 XS 650 SJ/SK Heritage Special 82-83 F XS 1100 LG 'Midnight Special' 80 R

**FA35 A. 50 x 11mm
B. 50.5 x 12.5mm**

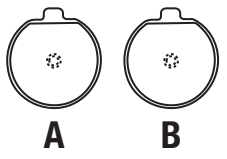

MATERIAL AVAILABILITY												
FA	X	V	R	HH	SV	MXS	SXR	EPFA	GPFA	GPFAFX	SFA	SFAHH
✓												

SUZUKI
 GS 400 B/C (Disc Brake) 77-78 F GS 750 B/C/N (8 Valve) 77-79 F
 GS 425 N (Spoke Wheel) 79 F GS 750 EC/EN (8 Valve) 78-79 F
 GS 425 EN (Cast Wheel) 79 F GS 850 GN 79 F

FA36 57.5 x 53 x 9mm

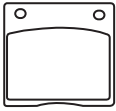

GMA AFTERMARKET CALIPER

2 Piston Rear (large) caliper model A (CCI #09-997)

KAWASAKI

KZ 650 C3 (from F/no 023101)	-79	R
KZ 650 D1/D1A/D2 'SR Series'	78-79	R
KZ 1000 A1/A2/A2A	77-78	R
KZ 1000 A3/A3A/A4	79-80	R
KZ 1000 B3/B4 'Ltd'	79-80	R
KZ 1000 C1/C1A 'Police Series'	78	R
KZ 1000 C2/C3/C4	79-81	R
KZ 1000 D1/D3 (Z1-R Series)	78-80	R
KZ 1000 E1/E2 ST & Shaft	79-80	R
KZ 1000 G1 'Classic'	80	R
KZ 1300 A1/A2/A3/A4	79-82	R
KZ 1300 B2 'Touring'	80	R

MATERIAL AVAILABILITY												
FA	X	V	R	HH	SV	MXS	SXR	EPFA	GPFA	GPFAFX	SFA	SFAHH
✓		✓										

SUZUKI

XN 85 D (673cc)	83	R	GS 1000 ET/ST/SZ	80-82	R
GS 550 C/N/EC/EN/ET	77-80	R	GS 1000 GT/GX	80-81	R
GS 550 MZ	82	R	GS 1000 GLT/GLX	80-81	R
GS 550 LT/LX	80-81	R	GS 1000 ET/EX/EZ/ED/ESD	80-83	R
GS 550 TX	81	R	GS 1100 LT	80	R
GS 650 EX/EZ	81-82	R	GS 1100 GZ/GD	82-83	R
GS 650 GX/GZ/GD	81-83	R	GS 1100 GLZ/GLD	82-83	R
GS 650 GLX/GLZ/GLD	81-83	R	GS 1100 GKZ/GK2/GKD	82-83	R
GS 650 MD	83	R	GS 1100 SD	83	R
GS 700 EF/ESF	85	R	GV 1200 GLF/GLF2/GLG "Madura"	85-86	R
GS 750 B/C/N/EC/EN/LN (8 valve)	77-79	R			
GS 750 ET/EX/EZ (16 Valve)	80-82	R			
GS 750 LT/LX (16 Valve)	80-81	R			
GS 750 ED/ESD	83	R			
GS 750 SD	83	R			
GS 850 GN/GT/GX/GLT/GLX/GLZ/GZ/GLD/GD	79-83	R			
GS 1000 C/N/EC/CN/SN/LN	78-79	R			

FA37 51.5 x 13/12mm

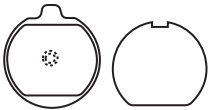

MATERIAL AVAILABILITY												
FA	X	V	R	HH	SV	MXS	SXR	EPFA	GPFA	GPFAFX	SFA	SFAHH
✓												

KAWASAKI

KZ 650 C1/C2/C3 (up to F/no 023100)	77-79	R	KZ 900 B1 'Ltd'	76	R
KZ 750 B1/B2/B3/B4	76-79	R	KZ 1000 B1/B2 'Ltd'	77-78	R

FA38 50 x 12mm

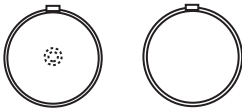

MATERIAL AVAILABILITY												
FA	X	V	R	HH	SV	MXS	SXR	EPFA	GPFA	GPFAFX	SFA	SFAHH
✓		✓										

SUZUKI

GS 425 LN	79	F	GS 750 LN (8 Valve)	79	F
GS 550 B/C/N/EC/EN	77-79	F	GS 1000 C/N	78-79	F
GT 550 B Indy	77	F	GS 1000 EC/EN/SN/LN	78-79	F

FA40 A 41 x 21mm B 41 x 11mm



MATERIAL AVAILABILITY												
FA	X	V	R	HH	SV	MXS	SXR	EPFA	GPFA	GPFAFX	SFA	SFAHH
✓												

HONDA

FL 250 Odyssey	77-84	R	Cyclone 250 X	87	R
			Trail Boss (2x4)	85-87	R

POLARIS

Scrambler (3 wheeler) 85-86 R

FA41 94.5 x 56mm x 20mm

20mm

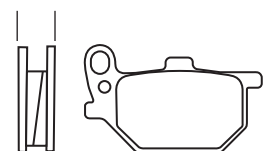

MATERIAL AVAILABILITY												
FA	X	V	R	HH	SV	MXS	SXR	EPFA	GPFA	GPFAFX	SFA	SFAHH
✓		✓										

YAMAHA

RD 400 F Daytona	79	F & R	XS 1100 SF/SG/SH Right	79-81	F
XS 400 SG/SH	80-81	F	XS 1100 LG 'Midnight Special' Right	80	F
XS 750 SE/SF (Right)	78-79	F	XS 1100 LH 'Midnight Special'	81	R
XS 850 LG/LH/SG/SH Right	80-81	F	XJ 1100 J	82	R

FA45 54 x 53 x 11mm

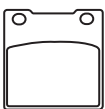

MATERIAL AVAILABILITY												
FA	X	V	R	HH	SV	MXS	SXR	EPFA	GPFA	GPFAFX	SFA	SFAHH
✓		✓										

HONDA

CB 250 N/T		F	CB 650 C Custom	80	F
CM 250 T		F	CB 650 C Custom	81	F
CB 400 A 'Hondamatic'	78	F	CB 750 C Custom	80	F
CB 400 MK11 'Hawk'	78-79	F	CB 750 C Custom	81	F
CM 400 A/T	79-81	F	CB 750 K	79-82	F
CB 650	79-81	F	CB 750 L 'Limited Edition'	79	F

FA47 40 x 58 x 7mm

FA47/2 40 x 58 x 55mm



MATERIAL AVAILABILITY - FA47												
FA	X	V	R	HH	SV	MXS	SXR	EPFA	GPFA	GPFAFX	SFA	SFAHH
✓	✓	✓		✓							✓	✓

MATERIAL AVAILABILITY - FA47/2												
FA	X	V	R	HH	SV	MXS	SXR	EPFA	GPFA	GPFAFX	SFA	SFAHH
✓												

BRAND	Model	Year	Configuration	Part No.	Year	Configuration	Part No.	Year	Configuration	Part No.	Year	Configuration
APRILIA	RS 250	99-03	R	851 Superbike Biposto	89-92	R	MX/MXC/GS 300/350			86	F & R	
				888 SP4/SP5	92-93	R	MX/MXC/XC-GS 500			85	F	
ATK	560	84-88	F	888 Superbike Strada	94-95	R	LAVERDA					
	All models	92	R	900 Supersport/Superlight	89-90	R	Alpine 500/Montjuic			76	F & R	
BERINGER AFTERMARKET CALIPER	6 Piston (Old Design/2 Piston)			900 Supersport CR USA	98	R	650 Sport			94-95	R	
				900 Supersport FE	98	R	668 Diamante/Ghost/Strike			96-98	R	
BREMBO AFTERMARKET CALIPER	20 5161 43 or 81 - 2 Piston P 2/32 Rear Caliper			900 Monster	93-99	R	750 Strike Bifaro/Monofaro			98-00	R	
				900 Monster Cromo/Special	98	R	750 S Formula/Sport/Carenta			98-00	R	
CAGIVA	Mito 125	92-92	R	900 Monster City/City Dark	99	R	MAICO/M-STAR					
	WMX 125	86	F	900 IE Monster	00-01	R	Front Disc Models					F
DUCATI	400 Monster	93-97	R	907 IE	90-93	R	MONTESA					
	600 Monster Dark ie 400 (Japan)	95-04	R	916 Biposto-Sienna	94-98	R	314 R			94-96	R	
HARRISON AFTERMARKET CALIPER	620 Multistrada (Twin disc/single pin pad fixing)	06	R	916 SPS (996cc)	97-98	R	315 R			97-00	R	
	620 Multistrada Dark (Single disc/twin pin pad fixing)	06	R	916 SPS (996cc) (Monoposto/Biposto)	99-01	R	MOTO GUZZI					
HUSQVARNA	695 Monster	06-09	R	996 R/S	01-02	R	V35/35III/35III (350)			77-87	F & R	
	748 SP	95-98	R	996 R/S	01	R	V 35 C (350)			82-86	F & R	
ISR AFTERMARKET CALIPER	748 SP/Monoposto	99-02	R	998 Matrix (998cc)	04	R	V 35 Florida (350)			86-90	F & R	
	748 Biposto	95-02	R	998 R (998cc)	02	R	V 50/50 III (500)			87-90	F & R	
KTM	748 SPS	98-99	R	998 S Bayliss/Bostrom	02	R	V 65 C (650)			82-85	F & R	
	748 R	00-02	R	998 S (998cc) (4 pad caliper)	02-04	R	V 65 Florida (650)			86-92	F & R	
MALAGUTI	748 Testa Bassa (Mono/Biposto)	01	R	998 S (998cc) (2 pad caliper) (Monoposto/Biposto)	02-03	R	V 75 (750)			92-96	F & R	
	750 Paso	87-90	R	998 S (998cc) (2 pad caliper) (Monoposto/Biposto)	02-03	R	750 SP/Targa			90-92	F & R	
SUZUKI	750 Supersport	91-98	R	998 S (998cc) (4 pad caliper)	02-04	R	Nevada 750			91-97	F & R	
	750 Monster/Monster City/City Dark	96-99	R	998 S (998cc) (2 pad caliper) (Monoposto/Biposto)	02-03	R	750 Nevada Club (Up To LK112433)			98-01	F & R	
TM (DIRT)	750 Monster/Monster Dark	99-01	R	998 S (998cc) (2 pad caliper) (Monoposto/Biposto)	02-03	R	750 Nevada Club (From LK112434)			98-01	F	
	800 Sport	03	F	998 S (998cc) (2 pad caliper) (Monoposto/Biposto)	02-03	R	750 Nevada Club (From LK112434)			92-95	R	
FA47 ONLY - BETA	Monster 800	03-04	R	998 S (998cc) (2 pad caliper) (Monoposto/Biposto)	02-03	R	750 Nevada Club (From LK112434)			97-98	R	
	Monster S2R (803cc)	05-07	R	998 S (998cc) (2 pad caliper) (Monoposto/Biposto)	02-03	R	750 Nevada Club (From LK112434)			97-99	R	
FA47/2 - KTM	Monster S2R Dark (803cc)	05-06	R	998 S (998cc) (2 pad caliper) (Monoposto/Biposto)	02-03	R	750 Nevada Club (From LK112434)			94-99	R	
				998 S (998cc) (2 pad caliper) (Monoposto/Biposto)	02-03	R	750 Nevada Club (From LK112434)			98-99	R	

FA51 78 x 50 x 11.5mm



MATERIAL AVAILABILITY												
FA	X	V	R	HH	SV	MXS	SXR	EPFA	GPFA	GPFAFX	SFA	SFAHH
✓		✓										

BRAND	Model	Year	Configuration	Part No.	Year	Configuration	Part No.	Year	Configuration	Part No.	Year	Configuration
SUZUKI	GN 250 J			GV 700 GLF/GLF2						85	F	
	GS 250 TT/TX			GS 750 ET/EX/EZ (16 Valve)	80-82	F				80-82	F	
	GN 400 T/XT/XX/TX/TZ			GS 750 LT/LX (16 Valve)	80-81	F				80-81	F	
	GS 450 ET/ST/EX/SX/EZ/ED			GS 750 TZ/TD (16 Valve)	80-82	F				82-83	F	
	GS 450 GAZ/GAD/GAF			GS 750 ED/ESD	80-83	F				83	F	
	GS 450 LT/LX/LZ/LD/LF/LG/LH/LJ			GS 850 GT/GX/GLX/GLZ/GLD/GZ/GLD/GD	82-85	F				80-83	F	
	GS 450 TX/TZ			GS 1000 GT/GX/GLT/GLX	80-88	F				80-81	F	
	GS 450 TXZ			GS 1100 GZ/GD/GLZ/GLD/GKZ/GK2/GKD	81-82	F				82-83	F	
	GS 700 EF/ESF			GV 1200 GLF/GLF2/GLG 'Madura'	82	F				85-86	F	
					85	F						

BUYERS GUIDE
BRAKE PADS

NOTE:- Size identification is shown as follows
Dimension 1=Width or Diameter, Dimension 2=Height or Diameter, Dimension 3=Thickness (Material and backplate)

FA54 41.5 x 45 x 7.5mm



MATERIAL AVAILABILITY												
FA	X	V	R	HH	SV	MXS	SXR	EPFA	GPFA	GPFA	SFA	SFAHH
	✓		✓	✓	✓	✓					✓	✓

HONDA		SP 200 G/H/J	86-88	F	YFM 350 FGW/FGX/FGY/FGZ/FGA/FGB/FGD							
MB 5	82	F	DR 250 F	85	F	Grizzly Auto 4x4					07-13	F
CG 125 ES12/ES2/3/4 (VC30)	01-04	F	LT-F 250 K2-K9/L2-L4 Ozark	02-14	F	YFM 400 FWBM/FWBN "Big Bear"					00-01	F
ATC* 250 R	81-82	F	LT-F 400 FK2-FK7/FCK5-FCK7 (Eiger 4WD Auto)	02-07	F	YFM 400 FAM/FAN/FAP Kodiak					00-02	F
* ATC is a Registered Trademark of Honda Motor Corp			SP 250 F	85	F	YFM 400 AM/AN					00-01	F
HYOSUNG			LT-A 400 K2-K4/K6/FCK5-FCK7 Eiger	06-18	F	YFM 400 NM/NMC/NN/NHN/P/HP					00-02	F
TE 450 S	07-12	F	LT-A 400 FK2/FK3/FK4/FK5/FK6/FK7	02-07	F	YFM 400 FAHM/MC/N/NC/P 4x4						
KAWASAKI			LT-F 400 K3/4/5/6/7	03-08	F	Kodiak Hunter					00-02	F
KX 65	00-22	R	LT-F 400 K3/4/5/6/7	03-08	F	YFM 400 FWNM/FMC/FWNN/FWNN/FHP						
Ninja 125 ABS	19-21	R	LT-A 500 FK2-FK7/FCK5-FCK7 Vinson 4WD	02-07	F	/FP/FR/FS/FT/FV Big Bear 4WD					00-06	F
Z 125 (BR125 JF)	17-21	R	LT-F 500 FK3-FK5 Vinson Quadrunner	03-06	F	YFM 400 NR/NS (2x4) Big Bear					03-04	F
Z 125 Pro (BR125 JJFB)	17-21	R	YAMAHA			YFM 400 FAR/FAS/AR/AS Kodiak Auto					03-04	F
Z 125 Pro SE (BR 125 JJFS)	17-21	R	YFM 125 RA/RB/RD Raptor	11-13	F	YFM 400 FAS/FAT/FAHT/FAV Kodiak 4WD					04-05	F
KLX 150 S	09	R	YFS 200 R/S/T/V Blaster	03-06	F	YFM 400 S Big Bear 2WD					04	F
KLX 230	19-20	R	YFM 250 XN/XHN/XP/XHP/XR/XHR/XS	01-04	F	YFM 400 FS/FT Big Bear 4WD					04-05	F
KLX 230 R	19-21	R	YFM 250 BT/BV Bruin	05-06	F	YFM 400 FWBL Kodiak					99	F
KLX 300 R	19-20	R	YFM 250 BW/BX/BY Big Bear	07-09	F	YFM 400 FGW/FGX Grizzly 4x4					07-08	F
KVF 300 A1-A4/B1-B4 'Prairie'	99-02	F	YFM 350 XW/XA/XB/XD/XE/XF/XG/XH/XJ			YFM 400 FBHW/FBHX/Y/Z Big Bear 400						
KVF 360 A1-A3-A9F/AAF/ABF/ACF Prairie 360 4x4	03-12	F	/XK/XL/XM/XN/XP/XR/XS Warrior	89-04	F	Hunter IRS					07-10	F
KVF 360 B1-B3/B6F-B9F Prairie 360	03-09	F	YFZ 350 A/B/D/E/F/G/H/J/K/L/M/N/P/R/S/T/V	90-06	F	YFM 400 FBEW Big Bear 400 IRS						
KVF 360 C1-C3/C6F-C9F/CAF/CBF Prairie 360			YFM 350 FXG/FXH/FXJ/FXK/FXL/FXM/			Exploring Edition					07	F
4x4 Hardwoods Green HD	03-11	F	FXN/FXP/FXR/FXS/FXT	95-05	F	YFM 400 FBW/FBX/FBY/FBA/FBB Big Bear						
KVF 400 C1-C4/D1-D4	99-02	F	YFM 350 AS/AT/FAS/FAT Bruin 2x4	04-05	F	4WD IRS					08-12	F
SUZUKI			YFM 350 FWBL/LC Big Bear	99	F	YFM 450 FAT/FAHT/FAV Kodiak 4WD					05-06	F
RM 65 K3/K4/K5	03-05	R	YFM 350 UL/ULC	99	F	YFM 450 FGW/FGX Grizzly 4x4					07-08	F
DR 125 G/H/J/SER/SES/SET	86-96	F	YFM 350 GW/GX/GY/GZ/GA Grizzly 2x4 (2WD)	07-11	F	YFM 450 FXV/FXW/FXX/FXY/FXZ						
SP 125 G/H/J	86-88	F	YFM 350 XV/XW/XX/XY Wolverine (2WD)	06-09	F	Wolverine Auto 4x4					06-10	F
DR 200 G/H/J/SET/SEV/SEW/SE/SEY			YFM 350 FGIW/FGIX/FGIY/FGIZ/FGIA									
/SEK1-SEK9/SEL3-SEL6	86-88/96-09/13/15-20	F	Grizzly Auto IRS 4x4	07-11	F							

FA55 50 x 12/9mm

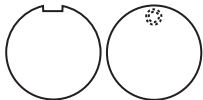

MATERIAL AVAILABILITY												
FA	X	V	R	HH	SV	MXS	SXR	EPFA	GPFA	GPFA	SFA	SFAHH
✓												

KAWASAKI		Z1 A/B 900	73-75	F	GT 250 K/L Hustler						73-74	F
		HI-D/Hi-E/Hi-F 500	73-75	F	GT 250 M/A/B Hustler						75-77	F
		H2/H2-A Mach IV	72-73	F	GT 380 K/L/M/A/B Sebring						73-77	F
		H2-B/H2-C Mach IV	74-75	F	GT 550 K/L/M Indy						73-75	F
SUZUKI					GT 550 A/B Indy (Tokico Caliper)						76-77	F
		RE 5 M/A (Rotary)	75-76	F	GT 750 K/L/M/A/B "Le Mans"						73-77	F
		GT 185 L/M/A/B Adventurer	74-76	F								

FA56 44 x 8mm

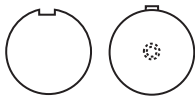

MATERIAL AVAILABILITY												
FA	X	V	R	HH	SV	MXS	SXR	EPFA	GPFA	GPFA	SFA	SFAHH
✓												

LIFAN		LF 200 GY-S	05-08	F	Dirt Tracker						00-05	F
					Duel Sport Moto 2000 (DS 200)						00-05	F

FA57 55.5 x 53 x 9mm



MATERIAL AVAILABILITY												
FA	X	V	R	HH	SV	MXS	SXR	EPFA	GPFA	GPFA	SFA	SFAHH
✓		✓										

BMW		R45/45 N (with ATE calipers)	78-85	F	R 65 LS						81-85	F
		R 45 T	80-85	F <td>R 65 T</td> <td></td> <td></td> <td></td> <td></td> <td></td> <td>80-85</td> <td>F</td>	R 65 T						80-85	F

BUYERS GUIDE
BRAKE PADS
NOTE:- Size identification is shown as follows
Dimension 1 = Width or Diameter, Dimension 2 = Height or Diameter, Dimension 3 = Thickness (Material and backplate)

NOTE:- Size identification is shown as follows
Dimension 1=Width or Diameter, Dimension 2=Height or Diameter, Dimension 3=Thickness (Material and backplate)

FA60 35.5 x 51.5 x 6mm

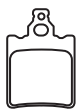

MATERIAL AVAILABILITY

FA	X	V	R	HH	SV	MXS	SXR	EPFA	GPFA	GPFAF	SFA	SFAHH
✓												

APRILIA RX 50/RX 50 Replica 04 R
RS 50 (Replica) 99-05 R MX 50 04 R

FA61 94.5 x 56 x 20mm

20mm

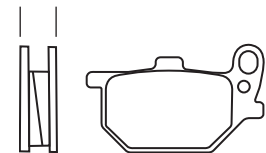

MATERIAL AVAILABILITY

FA	X	V	R	HH	SV	MXS	SXR	EPFA	GPFA	GPFAF	SFA	SFAHH
✓		✓										

YAMAHA
XJ 650 G/H/J/K 'Maxim' 80-83 F XS 850 LG/LH/SG/SH 80-81 F Left
XJ 650 LH 'Midnight' 81 F XV 920 K/MK 'Virago' 83 F
XS 750 SE/SF 78-79 F Left XS 1100 SF/SG/SH 79-81 F Left
XV 750 H/J/K/MK Virago 81-83 F XS 1100 LG 'Midnight Special' 80 F Left

FA62 51 x 11mm



MATERIAL AVAILABILITY

FA	X	V	R	HH	SV	MXS	SXR	EPFA	GPFA	GPFAF	SFA	SFAHH
✓												

KAWASAKI KZ 1300 A1/A2/A3/A4 79-82 F
KZ 1000 E1/E2 ST & Shaft 79-80 F KZ 1300 B2 'Touring' 80 F

FA63 52.5 x 53 x 9mm

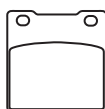

MATERIAL AVAILABILITY

FA	X	V	R	HH	SV	MXS	SXR	EPFA	GPFA	GPFAF	SFA	SFAHH
✓		✓		✓								

SUZUKI
GSF 400 M/N/P Bandit 91-93 R GSX 750 FK/FL/FM/FN/FP/FR/FS/FT/FV 'Katana' 89-97 R
GS 500 EK/EL/EM/EN/EP/ER/ES/ET/EV/ GSXR 750 RG/GH/GJ/K/L/M/N/WP 86-93 R
EW/EX/EY/K1-K3/FK4-FK9/FLO 89-10 R GSX-R 750 WR/WS/T/V/W/X 94-99 R
GS 550 LD/LF/LG 83-86 F GSXR 750 Y/K1/K2/K3 00-03 R
GS 550 ED/ESD/ES3/ES/EF/ESF/ESG 83-86 F & R RF 900 RT/RV 96-98 R
RF 600 RR/RS/RT/RV 94-97 R TL 1000 SV/SW/SX/SY/SK1 97-01 R
GSX 600 FJ/FK/FL/FM/FN/FP/FR/FT/FW TL 1000 RW/RX/RY/RK1/RK2/RK3 98-03 R
'Katana' 88-06 R GSXR 1100 G/H/J/K/L/M/N 86-92 R
GSX-R 600 WN/WP 92-93 R GSXR 1100 WP/WR/WS/WT/WV/WW/WWW 86-98 R
GSF 600 Bandit ST/SV/SW 96-98 R GSF 1200 Bandit SV/SAV/SW/SAW/SX
GSF 600 SY/SK1/SK2/SK3 00-03 R /SAX/SY/SK1-SK5/K1-K3 97-05 R
GSXR 600 V/W/X/Y/K1/K2/K3/ZK3 97-03 R GSX 1300 RX/RY/RK1-RK6
SV 650 X/Y/K1/SK1/K2/SK2 99-02 R /RZK3-RZK6 Hayabusa 99-06 R

FA65 71.5 x 45 x 11.5mm



MATERIAL AVAILABILITY

FA	X	V	R	HH	SV	MXS	SXR	EPFA	GPFA	GPFAF	SFA	SFAHH
✓		✓										

SUZUKI GS 650 MD 83 F
GS 550 ET 80 F XN 85 D (673cc) 83 F
GS 550 MZ 82 F GS 750 SD 83 F
GS 550 LT/LX 80-81 F GS 1000 ET/ST/SZ 80-82 F
GS 550 LZ/TX 81-82 F GS 1100 ET/EX/EZ/ED/ESD 80-83 F
GR 650 D/XD Tempter 83 F GS 1100 LT 80 F
GS 650 EX/EZ 81-82 F GS 1100 SD 83 F
GS 650 GX/GZ/GD/GLX/GLZ/GLD 81-83 F

FA67 A 55.5 x 37 x 10mm B 85 x 43 x 8mm

MATERIAL AVAILABILITY - FA67

FA	X	V	R	HH	SV	MXS	SXR	EPFA	GPFA	GPFAF	SFA	SFAHH
✓	✓		✓	✓	✓						✓	✓

FA67/3 A 55.5 x 37 x 10mm B 85 x 43 x 7mm

MATERIAL AVAILABILITY - FA67/3

FA	X	V	R	HH	SV	MXS	SXR	EPFA	GPFA	GPFAF	SFA	SFAHH
✓												



FA67 - CAGIVA WMX 125/250 89-91 R **KAWASAKI** KX 125 B2/C1/D1 83-85 F
CF MOTO KX 125 E1 86 F & R
500 U-Force EPS 14-16 R KX 125 E2/F1 87-88 R
800 U-Force 13-17 R KDX 200 C1-C3/E1-E4 86-92 F
GOGORO KL 250 D2-D22 (KL R 250) 85-05 F
SmartScooter 15-17 R KL 250 G4-G8 "Super Sherpa" 00-09 R

**FA67 A 55.5 x 37 x 10mm
B 85 x 43 x 8mm**

KX 250 C1/C2/D1	83-85	F
KX 250 D2	86	F & R
KX 250 E1/F1	87-88	R
KXT 250 A2/B1 'Tecate'	85-86	F & R
KXT 250 B2 'Tecate'	87	F
KLF 300 B1-B17 Bayou	88-09	F
KX 500 A1/A2/B1	83-85	F
KX 500 B2	86	F & R
KX 500 C1/D1	87-88	R
KL 600 A1/B1/B2 (KLR)	84-86	F
KL 650 A1 -A19/A6F/A7F (KLR)	87-07	R
KL 650 B2/B3 (TENGA)	90-91	R
KTM		
D-XC/E-XC/E-GS 125	90-91	F & R
D-XC/E-XC/E-GS 125	92-93	R
EXC 125 Brembo calipers	89	F & R
MX 125 Brembo calipers	89-91	F & R

**FA67/3 A 55.5 x 37 x 10mm
B 85 x 43 x 7mm**

MX 125	92-93	R
D-XC/E-XC/E-GS 250 Brembo calipers	91	F & R
D-XC/E-XC/T-XC/E-GS 250 Grimeca	92-93	R
EXC/EGS 250 Brembo Calipers	89	F & R
MX 250 Brembo calipers	89-91	F & R
MX 250 Brembo calipers	93	R
DXC/EXC/EGS 350 Brembo calipers	90-91	F & R
EXC 350 Brembo calipers	89	F & R
MX 350 Brembo calipers	90-91	F & R
LC-4 MX/EXC 500 Brembo calipers	92-94	R
MX 500	90-91	F & R
LC4 MX/EXC 600 Brembo calipers	90-91	F & R
LC4 EXC 600	92-93	R
SX 620/EXC/EGS	94	R
MAICO/M-STAR		
MX 500	95	R

POLARIS		
200 Phoenix Quadricycle Model		
(EA/EB/Rear disc model)	05	R
200 Phoenix Quadricycle Model (Rear disc model)	10	R
200 Phoenix Quadricycle Model		
(EC/ED Models/Rear disc model)	05-09	R
200 Sawtooth Quadricycle (Rear Disc Model)	06/08	R
SUZUKI		
GSXR 50 (RB 50 H)	87	F
GN 125 EM/EN/EP/ER/ES/ET	91-96	F
YAMAHA		
YFM 90 RZ/RA/RB/RD Raptor	10-13	R
YFM 300 GB/GD Grizzly	12-13	R
FA67/3 - KAWASAKI		
EX 500 D1-D12/D6F/D7F/D8F/D9F	94-09	R

FA68 68 x 41 x 9.5mm



KAWASAKI

KZ 305 A1/A2/B1 (CSR)/ B2/B3 (LTD)	81-82/87-88	F
KZ 440 G1/A4/D5 (LTD)	82-83	F
KZ 550 A2/A3/A4/C1/C2/C3/C4 (LTD)	81-83	F
KZ 550 D1 (GPz)	81	F & R
KZ 550 F1 (Spectre) F2 (LTD)	83-84	F
KZ 550 H1/H2 (GPz)	82-83	F & R
KZ 550 M1 (LTD)	83	F

MATERIAL AVAILABILITY												
FA	X	V	R	HH	SV	MXS	SXR	EPFA	GPFA	GPFAF	SFA	SFAHH
✓		✓		✓								

KZ 650 H1/H2/H3 (CSR)	81-83	F	KZ 1000 K1/K2 (LTD)	81-82	F & R
KZ 700 A1	84	F & R	KZ 1000 M1/M2 (CSR)	81-82	F & R
KZ 750 E1/E2/E3/F1/H1/H2/H3/H4 (LTD)	80-83	F & R	KZ 1000 P1-P20 'Police'	82-01	F & R
KZ 750 L3	83	F & R	KZ 1000 P21-P22 'Police'	02-03	R
KZ 750 M1 (CSR)	82	F	KZ 1000 R1/R2 'Replica'	82-83	F & R
KZ 750 N1/N2 'Spectre'	82-83	F & R	KZ 1100 A1/A2/A3	81-83	F & R
KZ 750 R1 (GPz)	82	F & R	KZ 1100 B1/B2 (GPz)/D1/D2 'Spectre'	81-83	F & R
KZ 1000 J1/J2/J3	81-83	F & R	KZ 1100 L1 (LTD)	83	F & R

FA69 90 x 49 x 10mm

FA69/2 90 x 49 x 9mm

FA69/3 90 x 49 x 11.5mm



HONDA

CN 250 Helix	86-87	F
CB 450 SC 'Nighthawk'	83-86	F
CMX 450 C Rebel	86-87	F
CX 500 C Custom	82	F
CX 500 TC Turbo	82	F & R
FT 500 'Ascot'	82-83	F & R
GB 500	89-90	F
GL 500 Silverwing	81-82	F
VT 500 C 'Shadow'	83-86	F
VT 500 FT 'Ascot'	83-84	F
VF 500 C 'V30 Magna'	84-85	F
VF 500 F 'Interceptor'	84-86	F & R
CB 550 SC 'Nighthawk'	83	F
XL 600 V Transalp	89-90	F
CB 650	82	F
CB 650 SC 'Nighthawk'	83-85	F
CX 650 C 'Custom'	83	F
CX 650 T 'Turbo'	83	F & R
GL 650 Silverwing/GL 650 Silverwing Interstate	83	F
CB 700 SC/S 'Nighthawk'	84-86	F
VF 700 C 'Magna'	84	F
VF 700 C 'Magna'	85-86	F
VF 700 F 'Interceptor'	84-85	F
VF 700 S 'Sabre'/C Shadow	84-87	F

MATERIAL AVAILABILITY - FA69												
FA	X	V	R	HH	SV	MXS	SXR	EPFA	GPFA	GPFAF	SFA	SFAHH
✓		✓		✓								

MATERIAL AVAILABILITY - FA69/2												
FA	X	V	R	HH	SV	MXS	SXR	EPFA	GPFA	GPFAF	SFA	SFAHH
✓		✓										

MATERIAL AVAILABILITY - FA69/3												
FA	X	V	R	HH	SV	MXS	SXR	EPFA	GPFA	GPFAF	SFA	SFAHH
✓		✓		✓								

CB 750 F Supersport	81-82	R	CB 750/900 C Custom	82	F
CB 750 SC 'Nighthawk'	82-83	F	CB 750/900 F Supersport	81-82	F
VF 750 C 'V45 Magna'	82-83	F	CBX	81-82	F
VF 750 F 'V45 Interceptor'	83-84	F	GL 1100/1100 I Goldwing/Interstate	82	F
VF 750 S 'Sabre'	82-83	F	FA69/3 HONDA		
VT 800 C Shadow	88	F	CBR 600 F 'Hurricane'	87-90	R
CB 900 C Custom	82	R	VF 700 F 'Interceptor'	84-85	R
CB 900 F Supersport	81-82	R	VF 700 C Magna	87	F
CBX	81-82	R	VFR 700 F/F2 'Interceptor'	86-87	R
CB 1000 C Custom	83	F & R	VF 750 F V45 'Interceptor'	83-84	R
VF 1000 F 'Interceptor'	84	F	VFR 750 F 'Interceptor'	86	R
VF 1000 R	85-86	F	VF 750 C V45 Magna	88	F
CB 1100 F Supersport	83	F & R	CBR 1000 F (Hurricane)	87-88	R
GL 1100/1100 I Goldwing/Interstate	82	R	VF 1000 F 'Interceptor'	84	R
GL 1100/1100 I Goldwing/Interstate	83	F & R	GL 1100 A Goldwing Aspencade	82-83	F
GL 1100 A Goldwing Aspencade	82-83	R	VF 1100 C 'V65 Magna'	83-86	R
VF 1100 C V65 Magna	83-86	F	VF 1100 S 'V65 Sabre'	84-85	R
VF 1100 S V65 Sabre	84-85	F	VT 1100 C Shadow	87-93	F
VT 1100 C Shadow	85-86	F	GL 1200/1200 I/1200 A Goldwing	84-85	F & R
FA69/2 HONDA			GL 1200 L Goldwing	85	F & R
CN 250 Helix	92-93	F	GL 1200 I/1200 A/GL12SE-i Goldwing	86-87	F & R
CM 400 C Custom	81	F	GL 1500 Goldwing All models	88-89	R
CM 450 C Custom (to CM 001211)	82	F	GL 1500/1500 SE/A/I Goldwing	90-00	R
CM 450 A Hondamatic	82	F			
GL 500 I Silverwing Interstate	81-82	F			

NOTE:- Size identification is shown as follows
Dimension 1=Width or Diameter, Dimension 2=Height or Diameter, Dimension 3=Thickness (Material and backplate)

FA70 66.5 x 59 x 10mm

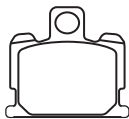

MATERIAL AVAILABILITY												
FA	X	V	R	HH	SV	MXS	SXR	EPFA	GPFA	GPFAF	SFA	SFAHH
✓		✓										

YAMAHA						XJ 750 RH/RJ/RK 'Seca'	81-83	F
RX 50 MK/K/L	83-84	F	XV 920 J 'Virago'	82	F			
XJ 550 H/J/K 'Maxim'	81-83	F	XJ 1100 J	82	F			
XJ 550 RH/RJ/RK 'Seca'	81-83	F	XS 1100 LH 'Midnight Special'	81	F			

FA71 69.5 x 54 x 6.5mm

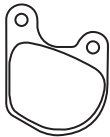

MATERIAL AVAILABILITY												
FA	X	V	R	HH	SV	MXS	SXR	EPFA	GPFA	GPFAF	SFA	SFAHH
✓		✓										

HARLEY DAVIDSON						Late 78-83	F	FXD/FXDL/FXDWG/FXR/FXRS/FXRT				
FX, FXE, FXEF, FXWG, FXS	79-83	F	/FXRD/FXLR	82-83	F							
XL, XLH, XLCH, XLS, XLX												

FA72 89 x 71 x 6.5mm



MATERIAL AVAILABILITY												
FA	X	V	R	HH	SV	MXS	SXR	EPFA	GPFA	GPFAF	SFA	SFAHH
✓		✓										

HARLEY DAVIDSON						79-81	R
XL, XLH, XLCH, XLS, XLX	80-83	F					
FLT, FLHT, FLHTC							

FA73 A 51.5 x 9.4mm B 50 x 8mm

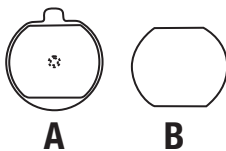

MATERIAL AVAILABILITY												
FA	X	V	R	HH	SV	MXS	SXR	EPFA	GPFA	GPFAF	SFA	SFAHH
✓												

KAWASAKI						KZ 650 F1	80	F
KZ 440 A1/A2/A3	80-82	F	KZ 750 G1 (Ltd)	80	F			
KZ 440 K1/D1/D2/D3/D4 (Ltd)	80-82	F	KZ 1000 C2/C3/C4	79-81	F			
KZ 550 A1	80	F	Z 1000 A3/A3A/A4	79-80	F			
KZ 650 C1/C2/C3 (from F/no 023101)	77-79	F	Z 1000 B3.B4 (Ltd)	79-80	F			
KZ 650 D2 "SR Series"	79	F	Z 1000 D3 (Z1-R)	80	F			
KZ 650 E1 (Ltd)	80	F	Z 1000 G1 Classic	80	F			

FA76 49 x 59 x 7mm

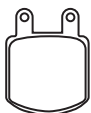

MATERIAL AVAILABILITY												
FA	X	V	R	HH	SV	MXS	SXR	EPFA	GPFA	GPFAF	SFA	SFAHH
✓		✓		✓								

GMA AFTERMARKET CALIPER						JAYBRAKE AFTERMARKET CALIPER					
2 Piston (small) caliper model B (CCI # 09-996)						Early Design 2 Piston					

FA77 60 x 58 x 9mm

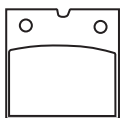

MATERIAL AVAILABILITY												
FA	X	V	R	HH	SV	MXS	SXR	EPFA	GPFA	GPFAF	SFA	SFAHH
✓		✓										

BMW						R 80 PD/CH	90-95	F
R 65	07/88-08/9	F	R 100 GS	86-90	F			
R 80/R 80 RT	84-95	F	R 100 PD	89-96	F			
R 80 GS	87-95	F	R 850 GS	96	F			

FA78 74 x 49 x 12mm



MATERIAL AVAILABILITY												
FA	X	V	R	HH	SV	MXS	SXR	EPFA	GPFA	GPFAF	SFA	SFAHH
✓		✓		✓								

HARLEY DAVIDSON						FXWG, FXSB	83	R
FXST, FXSTB, FXSTC, FXSTS, FLST, FLSTC, FLSTF,	84-Early 87	R	XL, XLH, XLCH, XLS, XLX	82-Early 87	R			
FLSTS, FLSTN			FXD, FXDL, FXDWG, FXR, FXRS, FXRT, FXRD, FXLR					
FX, FXE, FXEF, FXWG, FXS	84-86	R	82-Early 87				R	

FA79 174 x 73 x 9.5mm

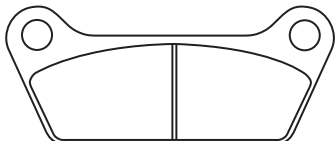

MATERIAL AVAILABILITY												
FA	X	V	R	HH	SV	MXS	SXR	EPFA	GPFA	GPFAF	SFA	SFAHH
✓		✓										

HARLEY DAVIDSON						81-84	R	FLT, FLHT, FLHTC	80-85	R
FL, FLH										

FA80/2 92 x 53 x 9.5mm

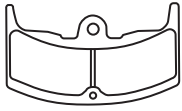

MATERIAL AVAILABILITY												
FA	X	V	R	HH	SV	MXS	SXR	EPFA	GPFA	GPFA	SFA	SFAHH
✓												

HONDA

VTR 250 Interceptor 88-89 F

FA81 68 x 60 x 10.5mm

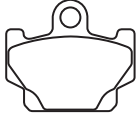

MATERIAL AVAILABILITY												
FA	X	V	R	HH	SV	MXS	SXR	EPFA	GPFA	GPFA	SFA	SFAHH
✓			✓									

YAMAHA

RXS 115 (3HB6/7)	94-97	F	XV 500 K 'Virago'	83	F
RX-Z 135 (3XL3/5PV1/5PV2)	00-05	F	XZ 550 RJ	82	F
RX-Z 135 (2UX/3UK1)	87-89	F	XZ 550 RK	83	F
RX-Z 135 (3UK3/3RSA/3RSB)	93-97	F	XT 600 L/LC/N/LN/S/SC	84-86	F
XV 250 U/UC/W/WC/A/AC	88-90	F	XT 600 T/TC/U/UC/W/WC	87-89	F
RZ 350 L/N/NC11	84-85	F	XJ 650 LK 'Seca'	83	F
XS 400 J/K 'Maxim'	82-83	F	XJ 650 LJ 'Seca Turbo'	82	F
XS 400 RJ/RK	82-83	F	XJ 750 J/K/MK 'Maxim'	82	F

FA83 A 47.5 x 37 x 9mm B 85 x 42.5 x 7mm

MATERIAL AVAILABILITY - FA83												
FA	X	V	R	HH	SV	MXS	SXR	EPFA	GPFA	GPFA	SFA	SFAHH
✓	✓		✓	✓							✓	✓

FA83/2 A 47.5 x 37 x 10mm B 85 x 42.5 x 8mm

MATERIAL AVAILABILITY - FA83/2												
FA	X	V	R	HH	SV	MXS	SXR	EPFA	GPFA	GPFA	SFA	SFAHH
	✓										✓	✓



FA83

ADLY

Noble 50/Thunderbike 07-09 F
Interceptor 300 06 F & R
300 Utility 06 F & R

BOMBARDIER/BRP

Rally 200 03-06 F

CAN-AM

DS 90 X (2X4/4T) 08-15 F & R

Rally 200 (4A7A/B/C/D/E/F) 07 F

DINLI

Diamond Back 90 06 R

E-TON

BXL-50 Draco 05-06 R

RXL-50 M Viper (4T) 05-06 R

Viper 50 RXL 50 03-06 R

Viper 70 RXL 70/70 M 05-09 R

RXL 90 Viper 90 03-06 R

RXL 90 R Viper 90 R Reverse 03-09 R

BXL 100 Draco 05-06 R

Yukon EXL 150 05-06 F

Viper EXL 150 ST Quad 05-06 F

Vector 250 ST Quad VXL 06-09 F&R

EXL 150 Yukon ST 05-06 F

HISUN

110 Axis 14-16 F

110 Forge 14-16 F

KAWASAKI

KX 80 E2/E3 84-85 F

KX 80 G1/G2 86-87 F

KX 80 J2/L1-L3/N1-N3/R1-R6 87-96 F

KD 80 N1/N2/N3 88-90 F

KX 100 B5/B6 95-96 F

KX 125 B1 82 F

KX 250 B1 82 F

KXT 250 A1 'Tecate' 84 R

POLARIS

200 Phoenix (AC/AD Model and 06-09 F

Following/Rear Drum Model) 06-09 F

200 Sawtooth (Rear Drum Model) 06-07 F

200 Phoenix Quadricycle Model

(EC/ED Models/Rear disc model) 05-09 F

200 Sawtooth Quadricycle (Rear Disc Model) 06 F

200 Sawtooth Quadricycle (Rear Disc Model) 08 F

SUZUKI

RM 80 G/H/J/K 86-89 F

RM 80 L/M/N/P/R/S 90-95 F & R

RM 80 T/V/W/X/Y 96-00 R

RM 85 K2/K3/LK3/K4/LK4 02-04 R

SHERCO

290 X-Ride 12-14 F & R

125-X-Ride 19-21 F & R

50cc Americas SM-RS 19-21 F & R

50cc Americas SM-R 19-21 F & R

50cc Factory SE-RS 19-21 F & R

50cc Factory SE-R 19-21 F & R

50cc Factory SM-RS 19-21 F & R

50cc Factory SM-R 19-21 F & R

UM (UNITED MOTORS)

X-Peed 50/Special Edition 00-05 F

X-Peed 50 R 07-08 F

Earthlander 90 R 05-06 R

Earthlander 200 05-06 R

Moontrax 50 R 03-06 R

Moontrax 90 R 03-06 R

UNISON

Desert Cat 150 04- F

Black Widow 150 04- F

Mobility 250 04- F

Rage 250 04- F

YAMAHA

YFM 90 RY Raptor 09- R

YFM 300 GB/GD Grizzly 12-13 F

ZERO ELECTRIC BIKE

DS ZF6.0/DF9.0 (2 Pin Fixing Pad) 10-12 F

MX (2 Pin Fixing Pad) 10-12 F

S ZF6.0 (2 Pin Fixing Pad) 10-12 F

X (2 Pin Fixing Pad) 10-12 F

XU (2 Pin Fixing Pad) 11-12 F

SFA83

ADLY

Fox 50 07-09 F

Jet 50 07-09 F

Panther 50 07-08 F

Thunderbike 150 07-09 F & R

E-TON

Matrix 50 09 R

Matrix R4-150 09 R

HYOSUNG

SD 50 Sense 06-12 F

SF 50 Rally 06-12 F

SB 50 M 06-08 F

SF 50 B Prima 06-12 F

KAWASAKI

AR 50 A1 82 F

AR 80 A1 82 F

MZ

Moskito/SX 50/RX 50 97-05 F

Moskito 125 R 00-05 F

TGB SCOOTER

Laser R5/i (49cc) 08-11 F

Delivery 50 (From F/No 609100) 06-11 F

101 S (50)/ Key West 05-11 F

R 50 X 06-11 R

Sunset 50 06-08 F

Sunset 151 06-08 F

FA83/2

PIAGGIO

Typhoon 50/SE 06 F

Typhoon 50 (2T) 07-09 F

NOTE:- Size identification is shown as follows
Dimension 1=Width or Diameter, Dimension 2=Height or Diameter, Dimension 3=Thickness (Material and backplate)

FA84 46 x 45 x 8mm

FA84/2 46 x 45 x 6.5/8mm

FA84/3 46 x 45 x 6.5mm



MATERIAL AVAILABILITY - FA84												
FA	X	V	R	HH	SV	MXS	SXR	EPFA	GPFA	GPFA	SFA	SFAHH
	✓		✓		✓	✓						

MATERIAL AVAILABILITY - FA84/2												
FA	X	V	R	HH	SV	MXS	SXR	EPFA	GPFA	GPFA	SFA	SFAHH
			✓									

MATERIAL AVAILABILITY - FA84/2												
FA	X	V	R	HH	SV	MXS	SXR	EPFA	GPFA	GPFA	SFA	SFAHH
	✓		✓			✓						

Model	Year	Material	Part No.	Year	Material	Part No.	Year	Material	Part No.	Year	Material	Part No.
FA84		TRX 500 FM1/FM2 Foreman/EP	14-15	F	YFM 250 RSPX/RSEY Special Edition	08	R					
ARCTIC CAT		TRX 500 FPE/FE Fourtrax Foreman	12-13	F	YFM 250 RSPXC Special Edition Custom	08-09	R					
DXV 400	04-08	F	TRX 500 FE1 Foreman ES	14-15	F	YFM 250 RSPA Special Edition	11	R				
400 DVX (2 x 4) Sport	04-08	F	TRX 500 FE2 Foreman ES/EP	14-15	F	YFM 350 XT/XU/XW/XA/XB/XD/XE/XF/XG/						
400 DVX TS Sport	06-07	F	TRX 500 FM5 Rubicon 4 x 4	15	F	XH/XJ/XK/XL/XM/XN/XP/XR/XS Warrior	87-04	R				
BENNCHE		TRX 500 FM6 Rubicon 4 x 4 / EPS	15	F	YFM 350 FXG/FXH/FXJ/FXKFXL/FXM/							
500/700 Gray Wolf	15-16	F	*ATC is a Registered Trademark of Honda Motor Corp			FXN/FXP/FXR/FXS/FXT	95-05	R				
HONDA		HUSQVARNA			YFM 350 RS/RT/RV/RW/RX/RY/RZ/RA							
CR 80 R/RB Expert	86-02	F	CR 125	92-94	R	/RB/RD Raptor	04-13	F&R				
CR 85 R/85 R Expert	03-07	F	WR 125	93-94	R	YFZ 350 T/U/W/A/B/D/E/F/G/H/J/K/L/M						
CRF 150 R/RB	07-21	F	CR 250	92-94	R	/N/P/R/S/T/V Banshee	87-06	R				
ATC 200 X	83-85	F	WR 250	92-94	R	YFZ 450 S/T	04-05	R				
ATC 200 X	86-87	F&R	TE 350	92-94	R	YFZ 450 LES Limited Edition	04	R				
ATC 250 R	83-84	F&R	CR 360	92-94	R	YFZ 450 SET Special Edition	05	R				
TRX 250 X	87-92	F&R	WR 360	92-94	R	YFZ 450 BB/DB	12-13	F				
TRX 250 EX/X	01-14	F	TC 610/TE 610	92-94	R	YFM 600 FWAK/FWK/FWALLC/FWAM/MC	98-00	F				
TRX 300 X	09-11	F&R	KAWASAKI			YFM 600 HM/HMC	00	F				
ATC 350 X	85-86	R	KX 80 L1-L3/N1-N3/R1-R7/W1-W3	88-00	R	YFM 600 FWAN/FWAHN	01	F				
TRX 300 EX Fourtrax/Sportrax	93-08	F&R	KX 85	01-22	R	YFM 660 RN/RP/RPB/RR/RS/RT Raptor	01-05	F&R				
TRX 400 EX Fourtrax/Sportrax	99-08	F&R	KX 100	95-21	R	YFM 660 FAP/FHAP/FSAP/FAR/FHS/FHT/						
TRX 400 X	09-14	F&R	KX 112	21-22	R	FS/FT/FV/FAW/FGHW/FGX/FGHX Grizzly						
TRX 420 TE/TE1 Fourtrax Rancher ES	07-21	F	KLX 140	08-21	R	/660 Hunter Edition	02-08	F				
TRX 420 TM/TM1 Fourtrax Rancher	07-21	F	KLX 140 L	08-21	R	YFM 660 FAHDV/W Ducks Unlimited						
TRX 420 FPA Power Steering Fourtrax			KLX 140 G	17-21	R	Edition/Side x Side	06-08	F				
Rancher AT/IRS	09-14	F	KSF 250 A1-A18 'Mojave'	87-04	R	FA84/2						
TRX 420 FA Fourtrax Rancher AT/IRS	09-14	F	KXT 250 B2 'Tecate'	87	R	HONDA						
TRX 420 FA1 Fourtrax Rancher 4x4 Auto/DCT	14-21	F	KXF 250 A1/A2 Tecate	87-88	R	ATC 200 X	83-85	R				
TRX 420 FA2 Fourtrax Rancher 4x4 Auto			KEF 300 A1/A2/A3/A4/A5/A6 Lakota	95-00	R	ATC 250 R	82	R				
- DCT/Power Steering	14	F	KEF 300 B1/B2/B3 Lakota Sport	01-03	R	FA84/3						
TRX 420 FA6 Fourtrax Rancher 4x4 Auto			KSF 400 A1/A2/A3/A6F (KFX 400)	03-06	F	SUZUKI						
- DCT/IRS/EP	14-21	F	KFX 450 R (KSF 450 B8F/B9F/BAF/BBF/BCS)	08-12	R	RM 125 J	88	R				
TRX 420 FPE Fourtrax Rancher 4x4 ES/EP	09-13	F	SUZUKI			LT 230 SF/SG/SH/SJ	85-88	R				
TRX 420 FE/FE1 Fourtrax Rancher 4x4/ES	07-21	F	RM 100 K3	03	R	LT 250 RF/RG	85-86	R				
TRX 420 FPM Fourtrax Rancher 4x4 PS	09-13	F	LT 230 EH/EJ/EK/EL/EM/EN/EP	86-93	R	YAMAHA						
TRX 420 FM/FM1 Fourtrax Rancher 4x4	07-21	F	LT 250 SK/SL	89-90	R	YZ 65	18-21	R				
TRX 420 FM2 Fourtrax Rancher 4x4			LT-Z 250 K4-K9 QuadSport	04-11	F	YZ 80 E/F/G/H/J/K/L/M/N	93-01	R				
With Power Steering	14	F	LT-Z 400 K3-K9/ZK9/LZ/ZL2/L3 QuadSport	03-13	F	YZ 85	02-21	R				
TRX 500 FA5 Foreman Rubicon 4 x 4 /Auto/DCT	15-21	F	YAMAHA			YZ 85 LW	21-22	R				
TRX 500 FA6 Foreman Rubicon 4 x 4			YFM 125 RA/RB/RD Raptor	11-13	R	YZ 125 W	89	R				
/Auto/DCT/EP	15-21	F	YFS 200 R/S/T/V Blaster	03-06	R	YZ 250 W/WRW	89	R				
TRX 500 FPM/FM Fourtrax Foreman	12-13	F	YFM 250 RX/RY/RZ/RA/RB/RD Raptor	08-13	R							

FA85 A 111 x 50 x 9.5mm B 69 x 43.5 x 9mm



MATERIAL AVAILABILITY												
FA	X	V	R	HH	SV	MXS	SXR	EPFA	GPFA	GPFA	SFA	SFAHH
✓		✓		✓								

Model	Year	Material	Part No.	Year	Material	Part No.	Year	Material	Part No.	Year	Material	Part No.
KAWASAKI		VN 800 A1-A11 Vulcan	95-05	F								
EX 250 E1/E2 'Ninja'	86-87	F & R	ZL 900 A1/A2 'Eliminator'	85-86	F & R							
EL 250 B2/B3 Eliminator	88-89	F	ZX 900 A1/A2/A3 Ninja	84-86	F & R							
EL 250 E1/E2/E3/E4 250 HS	91-95	F	ZG 1000 A1/A2/A3/A4/A5/A7/A8 'Concours'	86-93	F & R							
EL 250 F2 'EL252'	97-99	F	ZG 1000 A9-A20 'Concours'	94-05	R							
EX 305 B1 (GPz)	83	F	ZG 1000 A6F 'Concours'	06	R							
EN 450 A1/A2/A3/A4/A5/A6 (454 Ltd)	85-90	F	ZL 1000 A1	87	F & R							
EN 500 A1/A2/A3/A4/A5/A6	90-95	F	ZX 1000 A1/A2 'Ninja'	86-87	F & R							
EN 500 C1-C10/C6F/C7F/C8F/C9F Vulcan	96-09	F	ZN 1100 B1/B2 (LTD)	84-85	F & R							
ZX 550 A1/A2/A3 (GPz)	84-86	F & R	ZX 1100 A1/A2 (GPz)	83-84	F & R							
ZL 600 A1/A2	86-87	F	ZG 1200 A1/A2/B1-B4/B6-B17 'Voyager XII'	86-03	F & R							
ZX 600 A1/A2/A3/B1 'Ninja'	85-87	F & R	ZN 1300 A1/A2/A3/A4/A5/A6 'Voyager'	83-88	F & R							
VN 700 A1 'Vulcan'	85	F	VN 1500 A1-A13 'Vulcan'	87-99	F & R							
ZN 700 A1/A2 (LTD)	84-85	F & R	VN 1500 B1/B2/B3/B4/Vulcan 88									
KZ 750 K1/K2 (LTD)	83-84	F	SE/C3/C4 'Vulcan'	87-97	F & R							
VN 750 A2-A21/A6F 'Vulcan'	86-06	F	VN 1500 D1/D2/E1/E2 Vulcan Classic	96-97	R							
ZX 750 A1/A2/A2L/ A3 (GPz)	83-85	F & R	VN 1500 G1/G1A/G2A Nomad	99-00	R							
ZX 750 E1/E2 'Turbo'	84-85	F & R										

FA86 77 x 42 x 7mm



MATERIAL AVAILABILITY															
FA	X	V	R	HH	SV	MXS	SXR	EPFA	GPFA	GPFAF	SFA	SFAHH			
✓				✓							✓	✓			
ATK						GT 650						06-12	F&R		
GT 250 R V-Twin Sport						11	F&R	GV 650						06-12	F&R
GV 250 V-Twin Cruiser						11	F	ST7 Custom						10-11	R
GT 650 R V-Twin Sport						11	F&R	UM							
GV 650 V-Twin Cruiser						11	F&R	V2C 250 T						06-08	F
CSC						V2S 250 R						06-08	F&R		
RX3 Cyclone 250						15-16	R	V2C 650 S						06-08	F&R
HONDA						V2S 650/650 R						06-08	F&R		
CMX 250 C/CD Rebel						85-87	F								
HYOSUNG						SFA86									
RX 125							F	HYOSUNG							
GT 250						06-12	F&R	MS3 125						06-07	F&R
GT 250 R						06-12	F&R	MS3 250						06-12	F&R
GV 250						06-12	F	SACHS							
GT 650 R						06-12	F&R	Mad Ass 50						09	F
GT 650 S						06-12	F&R	Mad Ass 125						10-11	F

FA88 64 x 55 x 9mm

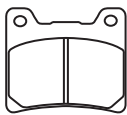

MATERIAL AVAILABILITY															
FA	X	V	R	HH	SV	MXS	SXR	EPFA	GPFA	GPFAF	SFA	SFAHH			
✓		✓		✓				✓							
YAMAHA						TDM 850 D/DC/E/EC						92-93	R		
RZ 350 L/N/NC11						84-85	R	XJ 900 RK 'Seca'						83	F & R
FZR 400 U/SUC/W/SWC						88-89	F	XV 1000 L/LC/N/NC						84-85	F
XJ 400 S Seca II						93	R	FZR 1000 'Genesis' T/TC/U/UC						87-88	R
RZ 500						84-86	F	FZR 1000 W/WC/A/AC/B/BC EX-UP						89-91	R
FJ 600 L/LC/N/NC						84-85	F & R	FZR 1000 D/DC/E/EC/F/FC/G/GC EX-UP						92-96	R
FZ 600 S/SC/T/TC/U/UC						86-88	F	GTS 1000 AE/AEC/AF/AFC						93-96	R
YX 600 S/SC/T/U/W/A/TC/UC/WC/AC 'Radian'						86-90	F	YZF 1000 R (RJ)						97	R
FZR 600 W/WC						89	F & R	FJ 1100 L/LC/N/NC						84-85	F & R
FZR 600 AC/RAC/RA/RBC/RD/RDC/RE/								XV 1100 'All Models'						86-97	F
REC/RF/RFC/RG/RGC/RH/RHC/RJ/RJC/								XVS 1100 ATS V-Star Silverado/Custom						04-08	R
RK/RKC/RL/RLC						90-00	R	XVS 1100 AS V-Star Classic						04-08	R
YZF 600 RG/RGC/RH/RHC						95-96	R	XVS 1100 V Star Custom/V Star Classic						99-09	R
YZF 600 RJ/RK/RL/RM/RN/RP/RR/RS/RT/RV/RW						97-07	R	XVS 1100 V-Star Silverado						03-09	R
FZ 700 T/TC Genesis						87	F & R	XVS 1100 W-M V-Star Custom Midnight						07-09	R
FZX 700 S/SC/T/TC 'Fazer'						86-87	F & R	FJ 1200 S/SC/T/TC						86-87	F & R
XJ 700 N/NC/XN/XNC/XS/XSC/S/SC						85-86	F	FJ 1200 W/WC/A/ACB/BC/D/DC/AD							
XV 700 L/LC/N/NC/CS/CT/CTC/CSC/SS								/ADC/AE/AEC						89-93	R
/SSC/ST/STC						84-87	F	VMX 12 - (V-Max 1200 All Models)						93-07	R
FZ 750 N/S/SC/U/UC						85-88	F & R	XVZ 12 TK 'Venture'						83	F & R
XV 750 U/UC/W/WC/A/AC/B/BC/D/DE/E/								XVZ 12 L/KC2 Venture						84	F & R
EC/F/FC/G/GC/H/HC/J/JC Virago						88-97	F	XVZ 12 TDK/DL/DKC2 Venture Royale						83-84	F & R
FZR 750 'Genesis' RU/RT						87-88	R	XVZ 12 DN 'Venture Royale'						85	F & R
FZR 750 (OW01)						89-92	R	V-Max VMX 12 N/NC/S/SC/U/UC/W/WC/							
YZF 750 R/SP						93-96	R	A/AC/B/BC/D/DC						85-92	F & R

FA90 91 x 51 x 10mm



MATERIAL AVAILABILITY															
FA	X	V	R	HH	SV	MXS	SXR	EPFA	GPFA	GPFAF	SFA	SFAHH			
✓		✓													
HONDA						CB 650 SC 'Nighthawk'						82	F		
CB 450 T 'Hawk'						82	F	VT 700 C 'Shadow'						84-85	F
CB 450 SC 'Nighthawk'						82	F	CB 750 C (from CM 204182)						82	F
CM 450 C Custom (from CM 001212)						82	F	VT 750 C 'Shadow'						83	F
CM 450 A Hondamatic						83	F								

FA92 81 x 42 x 7.5mm



MATERIAL AVAILABILITY															
FA	X	V	R	HH	SV	MXS	SXR	EPFA	GPFA	GPFAF	SFA	SFAHH			
	✓		✓												
HONDA						XL 350 R						84-85	F		
CR 125 R						84-86	F & R	CR 500 R						84-86	F
ATC* 250 R						84-86	F	XR 500 R Pro Link						83-84	F
CR 250 R						86-89	R	XL 600 R						83-87	F
TRX 250 R						84-87	F	XR 600 R						85-87	F
XR 250 R Pro Link						85	F	* - ATC is a Registered Trademark of							
ATC* 350 X						84-85	F	Honda Motor Corporation							
XR 350 R															

SFA93 A 88 x 48 x 8mm
B 56 x 36.5 x 10mm



MATERIAL AVAILABILITY												
FA	X	V	R	HH	SV	MXS	SXR	EPFA	GPFA	GPFAX	SFA	SFAHH
											✓	

TGB SCOOTER
Delivery 151 05-11 F R 50 X 06-11 F

FA94 60 x 63 x 13mm



MATERIAL AVAILABILITY												
FA	X	V	R	HH	SV	MXS	SXR	EPFA	GPFA	GPFAX	SFA	SFAHH
✓		✓		✓				✓				

HARLEY DAVIDSON FLT, FLHT, FLHTCI 84-99 F
FXD, FXDL, FXDWG, FXR, FXRS, FXRT, FLHR, FLHRCI 94-99 F
FXRD, FXLR 84-99 F FXSTS/FLSTSi 00-05 F
FXST, FXSTB, FXSTC, FXSTS, FLST, FLSTC, FLSTSC/FLSTSCI Springer Classic 05-07 F
FLSTF, FLSTS, FLSTN 84-99 F FLSTSB Softail Cross Bones 08-11 F
FX, FXE, FXEF, FXWG, FXS 84-86 F **LYNDALL BRAKES**
XL, XLH, XLCH, XLS, XLX 84-99 F PAD REF 7059

FA95 69 x 51 x 8mm

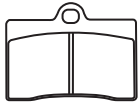

MATERIAL AVAILABILITY												
FA	X	V	R	HH	SV	MXS	SXR	EPFA	GPFA	GPFAX	SFA	SFAHH
✓		✓		✓				✓				

ATK Motard 450 07 F **GAS-GAS** SM 125/250 (2T) 01-05 F
600 DTM Dirt Track Motard 03 F SM 400 FSE (2T) 01-02 F
BREMO AFTERMARKET CALIPER SM 450 03-05 F
20 5165 55/68 - Goldline 4 Piston P4 30/34 @40mm spacing (single pin pad fixing) **HUSQVARNA** SM 400 R 02 F
20 4756 52/62 - 4 Piston P4 30/34 @40mm spacing (single pin pad fixing) SM 450 R 03-06 F
SM 510 R 05 F
SM 570 R 01-04 F
CAGIVA Mito 125 92-02 F SMR 630 06 F
UCATI Supersport 400 93-97 F Chief Blackhawk (Brembo calipers) 11 F
400 Monster 95-97 F Chief Blackhawk Dark (Brembo calipers) 11 F
(549cc) Supermoto 93-95 F Chief Classic (Brembo calipers) 11-13 F
600 Monster 93-99 F Chief Standard (Brembo calipers) 09-11 F
600 Monster Dark 98-99 F Chief Deluxe (Brembo calipers) 09 F
600 Monster City/City Dark 99 F Chief Roadmaster (Brembo calipers) 09-11 F
600 Supersport 91-97 F Chief Vintage (Brembo calipers) 09-13 F
748 SP/Biposto 95-98 F Bomber (Brembo calipers) 10-11 F
750 Supersport 91-98 F Dark Horse (Brembo calipers) 10-13 F
750 Monster 96-98 F **KTM** Duke 125 11 F
750 Monster City/City Dark 99 F Duke 400 LC4 94-98 F
750 Monster/Monster Dark 99 F Duke 620 LC4 94-98 F
851 Superbike Biposto 89-92 F SMC 660 Supermoto 03-04 F
888 SP4/SP5 92-93 F **LAVERDA** 650 Sport 94-95 F
888 Superbike Strada 94-95 F 668 Diamante/Ghost/Strike 96-98 F
900 Supersport 89-90 F 750 S Formula/Sport 98-00 F
900 Supersport/Superlight 91-97 F 750 Strike Bifaro/Monofaro 98-00 F
900 Supersport - CR USA 98 F 750 S Carenta 98-00 F
900 Supersport FE 98 F **LYNDALL BRAKES**
900 Monster 93-99 F PAD REF 7138
900 Monster Cromo/Special 98 F
900 Monster City/City Dark 99 F
907 IE 90-93 F
916 Biposto-Senna 94-98 F

FA99 60 x 63 x 13mm



MATERIAL AVAILABILITY												
FA	X	V	R	HH	SV	MXS	SXR	EPFA	GPFA	GPFAX	SFA	SFAHH
	✓		✓									

BETA 260 TR 34 86-88 F
125 TR 32/33 86-87 F **MAICO/M-STAR**
125 TR 34 88 F Rotor models 86 F
240 TR 33 86-88 F Rotor models 87-88 F & R

BUYERS GUIDE
BRAKE PADS

NOTE:- Size identification is shown as follows
Dimension 1=Width or Diameter, Dimension 2=Height or Diameter, Dimension 3=Thickness (Material and backplate)

FA101 71 x 36 x 9mm



MATERIAL AVAILABILITY													
FA	X	V	R	HH	SV	MXS	SXR	EPFA	GPFA	GPFAFX	SFA	SFAHH	
✓	✓		✓								✓	✓	

BETA	YZ 250 U	88	R
YSR 50 T/U/W/A/B/D	87-92	F	XT 350 N/NC/S/SC/T/TC/U/UC/W/WC/A/B/BC
YBR 125 ESD (4P26/4P2A/4P2G) Cast Wheel	07-13	F	/D/E/EG/F/FC/G/GC/H/HC/J/JC/K/KC/L/M
YBR 125 ED (4P28/4P2C/4P2J) Cast Wheel	07-13	F	YFM 350 XT/XU Warrior
YZ 125 U	88	R	YFZ 350 Banshee T/U/W
RT 180 A/B/D/E/G/H/J	90-97	F	XT 600 EA/EB/ED/EDC/EE/EEC/EF/EFC/EG/EGC
XT 225 D/DC/E/EC/F/FC/G/GC/F/FH/J			TT 600 N/S
/JC/K/KC/L	92-98	F	
TT 225 S/T	86-87	F	SFA101
TT-R 225 L/M/N/P/R/S	99-04	F	YAMAHA
YZ 250 N/S 'Tri Moto'	85-86	F & R	YJ 125 S/T/V/W/X Vlna
			04-09

FA103 58 x 53.5 x 9mm

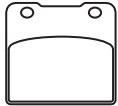

MATERIAL AVAILABILITY													
FA	X	V	R	HH	SV	MXS	SXR	EPFA	GPFA	GPFAFX	SFA	SFAHH	
✓		✓		✓							✓	✓	

SUZUKI	VS 700 All models	86-87	F	GV 1400 GDG/GTG (up to frame no. 103764)	86	F & R
	VS 750 GLPJ/GLPK/GLPL/GLPM 'Intruder'	88-91	F	VS 1400 GLPH/GLFH/GLPJ/GLPL/GLPM/		
	GSX-R 750 RG/G/H	86-87	F	GLPN/GLPP/GLPR/GLPS/GLPT/GLPV/GLPW/		
	VS 800 GLN/GLP/GLR/GLS/GLT/GLV/			GLPX/GLPY/GLPK1/GLPK2/GLPK3	Intruder	87-03 F & R
	GLW/GLX/GLY/GLK1/GLK2/GLK3/GLK4	92-04	F	VS 1400 GLPK5/GLPK6/K7/K8/K9/ZK9/L0		
	VS 800 K5/K6/K7/K8/ZK8/K9 S50 Boulevard	05-09	F	Boulevard S83 (1400cc)		05-10 F & R
	GSX 1100 FJ/FK/FL/FM/FN/FP 'Katana'	88-93	R	VL 1500 W/X/Y/K1		
	GSX-R 1100 G/H/J	86-88	F	'Intruder Legendary Classic'		98-01 F & R

FA104 58 x 56 x 9mm



MATERIAL AVAILABILITY													
FA	X	V	R	HH	SV	MXS	SXR	EPFA	GPFA	GPFAFX	SFA	SFAHH	
✓		✓		✓							✓	✓	

YAMAHA	SRX 250 T/TC	87	F	FZ 600 S/SC/T/TC/U/UC	86-88	R
	FZR 400 U/SUC/W/SWC	88-89	R	SRX 600 S/SC		86 F & R
	FZR 400 A/RRSP/RR	90-92	R	XJ 600 S Seca II SD/SDC/SE/SEC/EF/SFC		
	RZ 500	84-86	R	/SG/SGC/SH/SHC/SJ/SJC/SK/SKC	92-98	R

FA105 91 x 30.5 x 8mm



MATERIAL AVAILABILITY													
FA	X	V	R	HH	SV	MXS	SXR	EPFA	GPFA	GPFAFX	SFA	SFAHH	
	✓		✓										

YAMAHA	YZ 125 N/S/T/U	85-88	F	TT 350 S/T	86-87	F
	IT 200 S	86	F	YZ 490 N/S/T	85-87	F
	YZ 250 N/S/T/U	85-88	F	YZ 490 U/W	88-89	F

FA106 77 x 54 x 8mm

FA106/2 77 x 54 x 9.5mm



MATERIAL AVAILABILITY - FA106													
FA	X	V	R	HH	SV	MXS	SXR	EPFA	GPFA	GPFAFX	SFA	SFAHH	
	✓	✓	✓										

MATERIAL AVAILABILITY - FA106/2													
FA	X	V	R	HH	SV	MXS	SXR	EPFA	GPFA	GPFAFX	SFA	SFAHH	
	✓		✓										

FA106	SUZUKI	RM 125 F/G	85-86	F	Most '86 models	F&R
		GZ 250 X/Y/K1-K8 Marauder	99-09	F	SUZUKI	
		RM 250 F/G	85-86	F	SP 600 F	85-87 F
		TU 250 X/K9/L1	09-11	F		
		LS 650 FG/PG/PH/FH/PJ/PS/PT				
		/PV/PW/PX/PY/PK1-PK4 Savage	86-88/95-04	F		
		LS 650 K5-/K9/L1-/L5 Boulevard S40 (650cc)	05-15	F		
	FA106/2	MAICO/M-STAR				

FA109 50 x 55 x 11mm

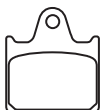

MATERIAL AVAILABILITY													
FA	X	V	R	HH	SV	MXS	SXR	EPFA	GPFA	GPFAFX	SFA	SFAHH	
✓													

HONDA	VF 1000 R	85-86	R	
--------------	-----------	-------	---	--

BUYERS GUIDE
BRAKE PADS
 NOTE:- Size identification is shown as follows
 Dimension 1=Width or Diameter, Dimension 2=Height or Diameter, Dimension 3=Thickness (Material and backplate)

FA111 64 x 57 x 11mm

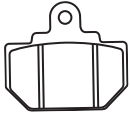

MATERIAL AVAILABILITY

FA	X	V	R	HH	SV	MXS	SXR	EPFA	GPFA	GPFAF	SFA	SFAHH
	✓		✓									

HONDA

FL 350 R 'Odyssey'	85-87	R
FL 400 R Pilot	89-90	R

FA115 36 x 45 x 6mm



MATERIAL AVAILABILITY

FA	X	V	R	HH	SV	MXS	SXR	EPFA	GPFA	GPFAF	SFA	SFAHH
✓	✓	✓	✓	✓		✓					✓	✓

ATK

560	87-88	R									04-09	F
-----	-------	---	--	--	--	--	--	--	--	--	-------	---

BETA

RR 50 Motard	06	R									05-09	F
Evo 80 Junior	09-12	R									05-08	F
Evo 80 Junior	18-19	F									06-08	F

Synt/Gara

125 TR 34/35	93-96	F									06-08	R
--------------	-------	---	--	--	--	--	--	--	--	--	-------	---

260 TR 34/35/Zero

Rev 50/80	89-90	F & R									03-10	F & R
-----------	-------	-------	--	--	--	--	--	--	--	--	-------	-------

Alp 200 4T

	89-92	F										
--	-------	---	--	--	--	--	--	--	--	--	--	--

CPI

Enduro 50	02-06	F & R									06-08	R
-----------	-------	-------	--	--	--	--	--	--	--	--	-------	---

Enduro 250

	00-06	F & R									06-08	R
--	-------	-------	--	--	--	--	--	--	--	--	-------	---

DERBI

Senda R 50	07-08	F & R									08	R
------------	-------	-------	--	--	--	--	--	--	--	--	----	---

GRP 50 Nude

	02-05	F & R									02-03	F & R
--	-------	-------	--	--	--	--	--	--	--	--	-------	-------

GRP 50 Replica

	04-05	R										
--	-------	---	--	--	--	--	--	--	--	--	--	--

GRP 80 Cup

	03-05	R									02-05	F
--	-------	---	--	--	--	--	--	--	--	--	-------	---

Senda Supermoto

	05	R									02-06	F
--	----	---	--	--	--	--	--	--	--	--	-------	---

GPR 125/Nude (Radial Caliper)

	04-05	F & R									99-01	F & R
--	-------	-------	--	--	--	--	--	--	--	--	-------	-------

DUCATI

(549cc) Supermoto	05-06	R									02-05	F
-------------------	-------	---	--	--	--	--	--	--	--	--	-------	---

GAS-GAS

EC 50 Boy (Air Cooled)	93-95	R									99-00	F
------------------------	-------	---	--	--	--	--	--	--	--	--	-------	---

TXT 50 (Boy)

	03-05	F & R									98-03	F & R
--	-------	-------	--	--	--	--	--	--	--	--	-------	-------

MC 65

	04-11	F & R									99-03	F
--	-------	-------	--	--	--	--	--	--	--	--	-------	---

JTX 125/200/270/320

	05-06	R									96-03	F & R
--	-------	---	--	--	--	--	--	--	--	--	-------	-------

Pampera 125/250/370

	95-98	F & R									98-03	F
--	-------	-------	--	--	--	--	--	--	--	--	-------	---

TX 200/270/320

	96-97	F & R									96-03	F & R
--	-------	-------	--	--	--	--	--	--	--	--	-------	-------

Contact JT25 (238cc)

	98	F & R									99-03	F
--	----	-------	--	--	--	--	--	--	--	--	-------	---

Pampera 250/320

	93-94	F & R									03	F
--	-------	-------	--	--	--	--	--	--	--	--	----	---

HONDA

XR 6 50cc	98-99	F & R										
-----------	-------	-------	--	--	--	--	--	--	--	--	--	--

HUSQVARNA

Husky Boy 50 J/S/R	03-05	F									02-05	F
--------------------	-------	---	--	--	--	--	--	--	--	--	-------	---

SM 50

	01-02	F									02-05	F
--	-------	---	--	--	--	--	--	--	--	--	-------	---

WR 50

	02	R									02-05	F & R
--	----	---	--	--	--	--	--	--	--	--	-------	-------

KTM

60 SX	02	R									02-05	F
-------	----	---	--	--	--	--	--	--	--	--	-------	---

65 SX

	02	R									02-05	F
--	----	---	--	--	--	--	--	--	--	--	-------	---

LYNDALL BRAKES

PAD REF 7153	98-00	F									03-05	F & R
--------------	-------	---	--	--	--	--	--	--	--	--	-------	-------

MAICO/M-STAR

Disc models	98-01	F									03-05	F & R
-------------	-------	---	--	--	--	--	--	--	--	--	-------	-------

MONTESA

314 R	89-96	F & R									04-05	F
-------	-------	-------	--	--	--	--	--	--	--	--	-------	---

PEUGEOT

Metal-X	97-00	F									04-05	F
---------	-------	---	--	--	--	--	--	--	--	--	-------	---

Ludix 125

	94-96	F										
--	-------	---	--	--	--	--	--	--	--	--	--	--

BUYERS GUIDE
BRAKE PADS

NOTE:- Size identification is shown as follows
Dimension 1=Width or Diameter, Dimension 2=Height or Diameter, Dimension 3=Thickness (Material and backplate)

FA116 31.5 x 57 x 5.5mm

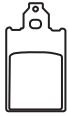

MATERIAL AVAILABILITY												
FA	X	V	R	HH	SV	MXS	SXR	EPFA	GPFA	GPFA	SFA	SFAHH
✓											✓	

ATK 560 & other models	89-91	R	MALAGUTI Yesterday	98-04	F
BETA 125 TR34	88	R	F15 Firefox	02-04	F
260 TR34	86-88	R	F12 Phantom (A/C)	98-04	F
OMP AFTERMARKET CALIPERS 6 Piston			TOMOS Revival/TS/Roadmate	03-08	F
Sprocket Brake			MC 50 Senior Pro	03-08	F&R

FA119 82.5 x 22 x 7mm



MATERIAL AVAILABILITY												
FA	X	V	R	HH	SV	MXS	SXR	EPFA	GPFA	GPFA	SFA	SFAHH
	✓		✓									

YAMAHA YZ 65	18-21	F	YZ 85	02-22	F
YZ 80 S/T/U/W/A/B/D/E/F/G/H/J/K/L/M/N	86-01	F	YZ 85 LW	21-22	F
			TT-R 125	00-21	F

FA121 81 x 42 x 9mm



MATERIAL AVAILABILITY												
FA	X	V	R	HH	SV	MXS	SXR	EPFA	GPFA	GPFA	SFA	SFAHH
✓				✓								

HONDA CBR 600 F 'Hurricane'	87-90	F
---------------------------------------	-------	---

FA122 55 x 52.5 x 9.5mm



MATERIAL AVAILABILITY												
FA	X	V	R	HH	SV	MXS	SXR	EPFA	GPFA	GPFA	SFA	SFAHH
✓												

HONDA CB 450 DX-K	89-92	F & R
-----------------------------	-------	-------

FA123 75 x 54 x 10mm

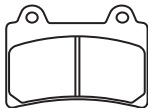

MATERIAL AVAILABILITY												
FA	X	V	R	HH	SV	MXS	SXR	EPFA	GPFA	GPFA	SFA	SFAHH
✓		✓		✓								

YAMAHA FZR 400 A	90	F	XV 1600 Road Star Silverado	07-09	R
FZR 750 Genesis RU/RT	87-88	F	XV 1600 Road Star Midnight	03	R
TDM 850 D/DC/E/EC	92-93	F	XV 1600 Midnight Star	02-03	R
FZR 1000 Genesis T/TC/U/UC	87-88	F	XV 1700 Road Star S (9 Spoke Cast)		
FZR 1000 W/WC Genesis	89	F	XV17ASX/ASY/ASZ/ASA/ASB	08-14	R
FJ 1200 W/WC	89-90	F	XV 1700 Road Star Silverado Spoke		
FJ 1200 A/AC/B/BC/D/DC	90-92	F	Wheel XV17 ATW	07	R
XVZ 13 D Series 'Venture Royale	86-93	F & R	XV 1700 Road Star Silverado S		
XVZ 1300 T/TC/U/UC Venture	87-88	F & R	(9 Spoke Cast Wheel) XV17 ATSA/ATSB	11-14	R
XVZ 13 'Royal Star' All models	96-01	F & R	XV 1700 Road Star Silverado Spoke		
XVZ 1300 TF Royal Star Midnight Venture	02-07	R	Wheel XV17 ATX/ATY/ATZ	08-10	R
XVZ 1300 Royal Star Tour Deluxe	06-08	R	XV 1700 Road Star AT/ATC/AV/AVC/ATW	08	R
XVZ 1300 Royal Star Midnight Tour Deluxe	06-10	R	XV 1700 Road Star (Solid front discs		
XVZ 1300 Royal Star Boulevard	99-00	F & R	/spoke wheels) XV17 AT/ATC/AV/AVC/ATW	05-07	R
XVZ 1300 Royal Star Tour Deluxe	97-01	F & R	XV 1700 Road Star Midnight		
XVZ 1300 Royal Star Tour Deluxe	05-07	R	(Floating front discs/9 spoke cast wheels)		
XVZ 1300 LTK Venture	96-98	F & R	(XV17 AMT/ATMC/AMV/AMVC)	05-06	R
XVZ 1300 Venture MM Limited Edition	01	R	XV 1700 Road Star Front floating discs/		
XVZ 1300 Royal Star	96-97/00	F & R	9 spoke cast wheels XV17 AWT/AWTC		
XVZ 1300 Royal Star Boulevard	99-01	F & R	/AWV/AWVC	05-06	R
XVZ 1300 Royal Star Midnight Venture	02-07	R	XV 1700 Road Star Cast Wheels 9 spoke		
XVZ 1300 Royal Star Standard	98	F & R	XV17 AS/ASC/AWY/AW/AWVC	04-09	R
XVZ 1300 Royal Star Tour Classic	96-00	F & R	XV 1700 Road Star Midnight Floating		
XVZ 1300 Royal Star Venture	99-07	R	front discs/cast wheels spoke XV17		
XVZ 1300 Royal Star Venture S	08-13	R	AMS/AMSC/AMW/AMWC	04/07	R
XV 1300 Royal Star Midnight Tour Deluxe	06-07	R	XV 1700 Road Star Midnight Silverado		
XV 1600 Road Star/Midnight Star	99-02	R	Floating front discs/cast spoke wheels		
XV 1600 Road Star	01-05	R	XV17 ATMS/ATMSC /ATMTC/ATMW/	04-07	R

BUYERS GUIDE
BRAKE PADS

NOTE:- Size identification is shown as follows
Dimension 1=Width or Diameter, Dimension 2=Height or Diameter, Dimension 3=Thickness (Material and backplate)

NOTE:- Size identification is shown as follows
Dimension 1=Width or Diameter, Dimension 2=Height or Diameter, Dimension 3=Thickness (Material and backplate)

FA124 88 x 41 x 8.5mm

FA124/2 88 x 41 x 10mm

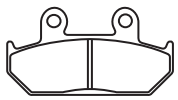

MATERIAL AVAILABILITY - FA124												
FA	X	V	R	HH	SV	MXS	SXR	EPFA	GPFA	GPFAF	SFA	SFAHH
✓				✓								

MATERIAL AVAILABILITY - FA124/2												
FA	X	V	R	HH	SV	MXS	SXR	EPFA	GPFA	GPFAF	SFA	SFAHH
✓		✓		✓								

FA124						FA124/2						
HONDA						HONDA						
RS 125				88-89	F	CB 125 TT					90	F
RS 250				88-89	F	VTR 250 Interceptor					90	F
VFR 700 F/F2 'Interceptor'				86-87	F	VLX 600 Shadow (VT 600 C/CD)					88-93	F
VFR 750 F 'Interceptor'				86	F	NX 650					88-89	F
CBR 1000 F (Hurricane)				87-88	F	GL 1500 Goldwing All models					88-00	F

FA125 94 x 32 x 7.5mm



MATERIAL AVAILABILITY												
FA	X	V	R	HH	SV	MXS	SXR	EPFA	GPFA	GPFAF	SFA	SFAHH
	✓		✓			✓						

HONDA												
CR 125 R				87-94	F	ATC* 350 X					86	F
CR 250 R				87-94	F	CR 500 R					87-94	F
TRX 250 R				86-89	F	XR 600 R					88-92	F
XR 250 L				91-92	F	* - ATC is a Registered Trademark of						
XR 250 R Pro Link				88-95	F	Honda Motor Corporation						

FA126 67.5 x 51 x 7mm

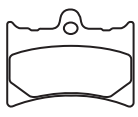

MATERIAL AVAILABILITY												
FA	X	V	R	HH	SV	MXS	SXR	EPFA	GPFA	GPFAF	SFA	SFAHH
	✓		✓	✓								

ATK						MOTO GUZZI						
560 & other models				89-91	F	Quota 1000					92-97	F
All Models				92	F	MZ						
KTM						Skorpion Tour/Traveller						
MX/EXC 250				87	F & R						95-02	F
MX/EXC 350				87	F & R							

FA128 A 37 x 85 x 8mm B 37 x 55 x 10mm



MATERIAL AVAILABILITY												
FA	X	V	R	HH	SV	MXS	SXR	EPFA	GPFA	GPFAF	SFA	SFAHH
	✓		✓		✓							

KAWASAKI						SUZUKI						
KSF 250 A1-A18 'Mojave'				87-03	F	LT 230 SF/SG/SH/SJ					85-88	FLT
KXF 250 A1/A2 Tecate				87-88	F	230 EH/EJ/EK/EL/EM/EN/EP					86-93	F
KEF 300 A1/A2/A3/A4/A5/A6 Lakota				95-00	F	LT 250 SK/SL					89-90	F
KEF 300 B1/B2/B3 Lakota Sport				01-03	F	LT 250 RF/RG					85-86	F
						LT 250 RH/RJ/RK/RL/RM/RN					87-92	F
						LT 500 RH/RJ/RK/RL					87-90	F

FA129 A 141 x 41.5 x 10mm B 95 x 34.5 x 10mm

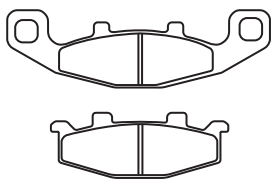

MATERIAL AVAILABILITY												
FA	X	V	R	HH	SV	MXS	SXR	EPFA	GPFA	GPFAF	SFA	SFAHH
✓		✓	✓	✓				✓				

KAWASAKI												
EX 250 F2-F19/D6F/D7F Ninja 250				88-07	F	ZG 1000 A6F Concours					06	F
EX 500 A1-A7/D1-D12/D6F/D7F/D8F/D9F				87-09	F	ZX 1000 B1/B2/B3 Ninja (ZX10)					88-90	F & R
ZR 550 B1/B2/B3/B4 Zephyr				90-93	F	ZX 1100 C1-C4 ZX11 Ninja					90-93	R
ZL 600 B2/B3 Eliminator				96-97	F	ZR 1100 A1/A2/A3/A4 Zephyr					92-95	R
ZX 600 C1-C9 Ninja 600R				88-96	F & R	ZR 1100 B1 Zephyr					96	R
ZX 600 D1/D2/D3/D4 (ZX6)				90-93	R	SUZUKI						
KL 650 B2/B3 Tengai				90-91	F	GSF 400 M/N/P Bandit					91-93	F
ZR 750 C1/C2/C3 Zephyr				91-93	F & R	GS 500 EK/EL/EM/EN/EP/ER/ES					89-95	F
ZX 750 F1/F2/F3/F4 Ninja				87-90	F & R	VX 800 L/M/N/P					90-93	F
ZG 1000 A9-A20 Concours				94-05	F	GSX 1100 GM/GN/GP					91-93	F

FA130 A 73.5 x 49.5 x 7mm
B 61 x 63 x 9mm

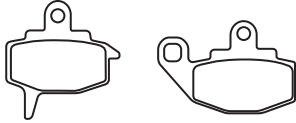

MATERIAL AVAILABILITY												
FA	X	V	R	HH	SV	MXS	SXR	EPFA	GPFA	GPFAFX	SFA	SFAHH
	✓	✓	✓									

KAWASAKI

EX 250 F2-F19/D6F/D7F Ninja 250	88-07	F	KX 500 C1/D1	87-88	F
KX 125 E2/F1	87-88	F	KL 650 A1-A19/A6F/A7F (KLR)	87-07	F
KX 250 E1/F1	87-88	F			

FA131 75 x 36 x 10.5mm
FA131R 75 x 36 x 9mm



MATERIAL AVAILABILITY												
FA	X	V	R	HH	SV	MXS	SXR	EPFA	GPFA	GPFAFX	SFA	SFAHH
	✓		✓			✓		✓				

AJP							KLX 250 S (KLX 250 H6F/H7F)				06-07	R
PR3 125 Enduro	13-15	R	KLX 250 S (KLX 250 T9F/TAF/TBF/TCF/TDF/TEF)	09-21	R							
PR3 125 Enduro Pro	13-15	R	KLX 250 SF (KLX 250 W9F/TAF) Supermotard	09-21	R							
PR3 125 Extreme	13-15	R	KX 250 K2-K5/L1-L4/M1/M2/R1	95-05	R							
PR3 125 Supermoto	13-15	R	KX 250 R6F/R7F	06	R							
PR3 200 Enduro	12-14	R	KLX 300 R A2-A10/A6F/A7F	97-06	R							
PR3 200 Enduro Pro	12-14	R	KLX 300	21	R							
PR3 200 M/X Pro	12-14	R	KLX 300 R	19-21	R							
GAS-GAS							KLX 400 SR (KLX 400 A1/A2)				03-04	R
Enduro EC 200/250/300	99-00	R	KLX 400 R (KLX 400 B1/B2)	03-04	R							
EC 125/200/250/300	01-09	R	KX 500 E8-E16	96-04	R							
MC 125	05	R	KLX 650 R D1	96	R							
MC 125/250	01-04	R	SUZUKI									
Pampera 125/450	05-06	R	RM 125 T/V/W/X/K1-K8	96-08	R							
SM 125/250 (2T)	01-05	R	RM 250 T/V/W/X/K1-K8	96-08	R							
MX 200/250/300	99-00	R	RMX 250 X/Y	99-00	R							
SM 400 FSE (2T)	01-02	R	DR-Z 400 SY/SK1-SK9/SL1-SL6	00-16	R							
EC 450	09	R	DR-Z 400 EY/Y/EK1-EK7/K2-K4	00-07	R							
FSE 450	05-08	R	DR-Z 400 SMK5-SMK9/SML3-SML6	05-09/13-6	R							
SM 450	03-05	R	T.M.									
EC 515	09	R	MX 85 JR (2T)	04-	R							
HONDA							EN 125 (2T)				01-04	R
Dream 50 R (CB 50) (AR02)	04	R	MX Models 125/250/300	02-04	R							
NSR 50 R (RS 50)	04	R	SMR 125 (2T)	05-08	R							
CR 80 R/RB Expert	92-02	R	EN 250 (2T)	01-03	R							
CR 85 R/85 R Expert	03-07	R	EN 250 F-ES (4T)	04-	R							
NSF 100 R	06	R	EN 300 (2T)	01-04	R							
CR 125 R	87-01	R	EN 450 F-ES (4T)	04-	R							
CRF 230 L	08-11	R	MX 450 F	04-	R							
CRF 230 M	09-11	R	SMR 450 F ES (4T)	05-08	R							
CR 250 R	87-01	R	SMX 450 F Competition (4T)	05-08	R							
XR 250 R	90-04	R	EN 530 F-ES (4T)	04-	R							
XR 250 L	91-96	R	MX 530 F (4T)	04-	R							
XR 400 R	96-04	R	SMX 660 F	04	R							
CR 500 R	87-01	R	YAMAHA									
XR 600 R	91-00	R	YZ 125 K/L/M/N/P	98-02	R							
XR 650 L	93-21	R	WR 250 FN/FP	01-02	R							
XR 650 R	00-07	R	YZ 250 K/L/M/N/P/FN/FP	98-02	R							
HUSQVARNA							WR 400 FL/FM				99-00	R
WXE 125	07	R	YZ 400 FL	99	R							
KAWASAKI							YZ 426 FM/FN/FP				00-02	R
KX 125 K2-K5/L1-L4/M1-M3	95-05	R	WR 426 FN/FP	01-02	R							

FA132 79.5 x 46.5 x 9mm



MATERIAL AVAILABILITY												
FA	X	V	R	HH	SV	MXS	SXR	EPFA	GPFA	GPFAFX	SFA	SFAHH
	✓		✓									

KTM							EXC/EGS 250 Grimeca caliper				89	F & R
D-XC/E-XC/E-GS 125 Grimeca caliper	90-91	F & R	MX 250	88-91	F & R							
D-XC/E-XC/E-GS 125 Grimeca caliper	92-93	F	DXC/EXC/EGS 350 Grimeca caliper	90-91	F & R							
EXC/MX 125	88	F & R	EXC 350 Grimeca caliper	89	F & R							
EXC 125 Brembo caliper	89	F & R	MC/EXC/EGS 350	88	F & R							
MX 125 Grimeca caliper	89-91	F & R	MX 350 Grimeca caliper	89-91	F & R							
MX 125 Grimeca caliper	92-93	F	LC-4 MX/EXC 500	89	F & R							
DXC/EXC 250 Grimeca caliper	90	F & R	LC-4 MX/EXC 500 Grimeca Caliper	90-91	F & R							
D-XC/E-XC/E-GS 250	91	F & R	LC-4 MX/EXC 600	89	F & R							
D-XC/E-XC/T-XC/E-GS 250 Grimeca caliper	92-93	F	LC-4 MX/EXC 600 Grimeca caliper	90-91	F & R							
EXC/EGS 250	88	F & R	LC4 EXC 600	92-93	F							

FA134 79.5 x 46.5 x 9mm

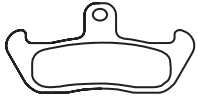

MATERIAL AVAILABILITY

FA	X	V	R	HH	SV	MXS	SXR	EPFA	GPFA	GPFAF	SFA	SFAHH
	✓		✓									

FA	X	V	R	HH	SV	MXS	SXR	EPFA	GPFA	GPFAF	SFA	SFAHH
GAS-GAS												
WCX 125/250												
HUSQVARNA												
CR 125												
WR 125												
WR 125												
CR 240												
WR 240												
WR 240												
CR 250												
CR 250												
WR 250												
WR 250												
XC 250												
WR 260												
TE 350												
WR 400												
430 Automatic												
CR 430												
WR 430												
XC 430												
CR 500												

FA135 A 97 x 43 x 7.5mm B 77 x 42 x 9mm



MATERIAL AVAILABILITY

FA	X	V	R	HH	SV	MXS	SXR	EPFA	GPFA	GPFAF	SFA	SFAHH
	✓		✓		✓	✓	✓					

FA	X	V	R	HH	SV	MXS	SXR	EPFA	GPFA	GPFAF	SFA	SFAHH
BENNCHE												
250 Cowboy												
250 Spire												
400 Bighorn												
400 Cowboy												
500 Bighorn												
500 Cowboy												
700 Bighorn												
700 Cowboy												
700 X Bighorn												
800 Spire												
1000 Cowboy												
1000 Spire												
1000 X Spire												
CAN-AM SIDE X SIDE												
Commander 800 (XT/DPS)												
Commander 800 R (STD)												
Commander XT 800 R												
Commander 1000 STD												
Commander 1000 XT												
Commander 1000 XT-P												
Commander 1000 X												
Commander 1000 LTD												
Ryker 600 Ace												
Ryker 900 Ace												
CF MOTO												
500 U-Force EPS												
500 Z-Force												
800 U-Force												
800 Z-Force												
800 EX Z-Force												
HISUN												
250 Sector												
250 Strike												
400 Forge												
HS 400												
450 Sector												
500 Forge												
HS 500												
550 Sector												

BUYERS GUIDE
BRAKE PADS

NOTE:- Size identification is shown as follows
Dimension 1=Width or Diameter, Dimension 2=Height or Diameter, Dimension 3=Thickness (Material and backplate)

FA135 A 97 x 43 x 7.5mm B 77 x 42 x 9mm

Contd.

KAWASAKI Contd.

KRF 750 J9FA/K9F/PAF/PBF/RAF/RBF/RCS/RDF /PCF/PDF (Teryx 750 F1 4x4 LE)	09-13	F (Right)
KRT 750 ACF/ADF (Teryx 4 750 4X4)	12-13	F (Right)
KRT 750 ACFA/ADFA (Teryx 4 750 4X4 EPS)	12-13	F (Right)
KRT 750 CCF/CDF (Teryx 4 750 4X4 EPS LE)	12-13	F (Right)
KRT 750 DCF/DDF (Teryx 4 750 4X4 EPS Realtree)	12-13	F (Right)
KVF 750 B1/E8F/E9F Brute Force		
750 4x4i Hardwoods Green HD	05/08-09	F (Right)
KVF 750 E8FA/E9FA/EAF Brute Force		
750 4x4i NRA Outdoors	08-09	F (Right)
KRF 800 (Teryx)	14-21	F (Right)
KRF 800 (Teryx LE)	14-21	F (Right)
KRF 800 (Teryx Camo)	14-21	F (Right)
KRT 800 (Teryx 4)	14-21	F (Right)
KRT 800 (Teryx 4 LE)	14-21	F (Right)
KRT 800 (Teryx 4 Camo)	14-21	F (Right)
KRT 800 (Teryx 4 Camo LE)	20-21	F (Right)
KAF 820 AFF/AGF/AHF Mule Pro - FXT	15-21	F (Right)
KAF 820 BFF/BGF/BHF Mule Pro - FXT /EPS	15-21	F (Right)
KAF 820 CFF/CGF/CHF Mule Pro - FXT /EPS LE	15-21	F (Right)
KAF 820 DFF/DGF/DHF Mule Pro - FXT /EPS Camo	15-21	F (Right)
KAF 820 EGF/EHF Mule Pro - FX	16-21	F (Right)
KAF 820 FGF/FHF Mule Pro - FX/EPS	16-21	F (Right)
KAF 820 GGF/GHF Mule Pro - FX/EPS LE	16-21	F (Right)
KAF 820 HGF/HHF Mule Pro - FX/EPS Camo	16-21	F (Right)
KAF 820 JGF/JHF Mule Pro - FXT Ranch Edition	16-21	F (Right)
KAF 1000 AGF/AHF - Mule Pro DXT/Diesel	16-17	F (Right)

KAF 1000 BGF/BHF - Mule Pro DXT/Diesel EPS	16-17	F (Right)
KAF 1000 CGF/CHF - Mule Pro DXT EPS LE/Diesel	16-17	F (Right)
KAF 1000 DGF/DHF - Mule Pro DX/Diesel	16-17	F (Right)
KAF 1000 EGF/EHF - Mule Pro DX EPS/Diesel	16-17	F (Right)
KAF 1000 FGF/FHF - Mule Pro DX EPS LE/Diesel	16-17	F (Right)
MASSIMO		
250 Gunner/Gunner S	15-16	F (Right)
MSU 400	15-16	R (Right)
500 Alligator	15-16	F (Right)
500 Knight	15-16	F (Right) & R (Right)
MSA 500	13-16	F (Left) & R (Left)
MSU 500	15-16	R (Right)
550 EPS Alligator	15-16	F (Right)
700 Alligator	15-16	F (Right) & R (Right)
700 Knight	15-16	F (Right) & R (Right)
700-4 Alligator EPS	15-16	F (Right) & R (Right)
MSU 700	15-16	F (Right) & R (Right)
MSU 700-5	15-16	F (Right) & R (Right)
MSA 800	14-16	F (Left) & R (Left)
MSU 800	15-16	F (Right) & R (Right)
1000 Militia/S/XS	15-16	R (Right)
MZ		
SX/SM 125	02-05	F
SUZUKI		
RM 125 H/J/K/L/M/N/P	87-93	F
DR 250 L/M/N/P/R/S	90-95	F
RM 250 H/J/K/L/M/N/P	87-93	F
RMX 250 K/M/N/P/R/S	89-95	F
DR 250 SL/SM/SN/SEP/SER/SES	90-95	F
LT-F 300 FK2	02	F (Right)
DR 350 SL/SM/SN/SP/SEP /SES/SET/SEW	90-97	F
DR 350 L/M/N/P/R/S/TV	90-97	F
LT-R 450 K6/K7/K8/K9	06-11	F (Right)
LT-R 450 ZK8/ZK9 Quad Racer Ltd Edition	08-09	F (Right)
LT-F 500 FW/FX/FY/FK1/FK2/Z0 Quadrunner	98-02	F (Right)
LT-A 500 FY/FK1 Quadmaster	00-01	F (Right)

UM (UNITED MOTORS)

DSF 200	06-08	F
DTF 200	06-08	F
SMF 200	08	F
YAMAHA		
YZ 125 W/A/B/D/E	89-93	F
WR 125 K	98	F
WR 200 D	92	F
TT-R 230 T/V/W/X/Y/A/B/D/E/F	05-15	F
TT-R 250 L/M/N/P/R/S/TV	99-06	F
XTZ 250 Lander (F 21" / R 18" Wheels)	07-14	F
XTZ 250 X (F & R 17" Wheels)	08-10	F
YZ 250 WRW/WRA	89-90	F
YZ 250 W/A/B/D/E	89-93	F
WR 250 ZB/ZD/ZE/ZF/ZG/ZH/ZJ	91-97	F
YXR 450 Rhino (All models)	06-09	F (Right)
YFZ 450 RY/RZ/RA/RB/RD /RE/RSE/RF	09-15	F (Right)
YFZ 450 S/T/W/X/Y/B/D	04-09/12-13	F (Right)
YFZ 450 LES Special Edition	04	F (Right)
YFZ 450 SET Special Edition	05	F (Right)
YFZ 450 SEW Special Edition	07	F (Right)
YFZ 450 BBV/BBW Bill Balance Edition	06-07	F (Right)
YFZ 450 SPV/SEW/SEX Special Edition	06-08	F (Right)
WR 500 ZD/ZE	92-93	F
YXR 660 Rhino	04-07	F (Right)
YFM 700 RV/RW/RX/RY/RA /RB/RD/RE Raptor	06-14	F (Right)
YFM 700 RSEW/RSPX/RSEA/RSEY /RSEZ/RSEB/RSED/RSE/RSF Special Edition	07-15	F (Right)
YXM 700 Viking Fi 4 x 4	14	R
YXM 700 Viking Fi 4 x 4 EPS	14	R
YXR 700 Rhino (All models)	08-13	F (Right) & R (Right)

FA136 80 x 40 x 10mm



MATERIAL AVAILABILITY												
FA	X	V	R	HH	SV	MXS	SXR	EPFA	GPFA	GPFAFX	SFA	SFAHH
✓												

YAMAHA

XV 535 T/TC/U/A/AC/E/EC/F/FC/SF/SFC 87-94 F

FA137 47 x 45 x 7.5mm



MATERIAL AVAILABILITY												
FA	X	V	R	HH	SV	MXS	SXR	EPFA	GPFA	GPFAFX	SFA	SFAHH
	✓		✓		✓							

ARCTIC CAT

400 DVX (2 x 4) Sport 04-08 R
400 DVX TS Sport 06-07 R

HYOSUNG

TE 450 06 R

KAWASAKI

KSF 400 A1/A2/A3/A6F (KFX 400) 03-06 R

SUZUKI

LT 250 RJ/RK/RL/RM/RN 88-92 R
LT-Z 400 K3-K9/ZK9/L0/LZ/ZL2/L3 Quadport 03-13 R
LT-R 450 K6/K7/K8/K9 06-11 R
LT-R 450 ZK8/ZK9 Quad Racer Ltd Edition 08-09 R
LT 500 RH/RJ/RK/RL 87-90 R

FA140 86 x 40 x 10.5mm



MATERIAL AVAILABILITY

FA	X	V	R	HH	SV	MXS	SXR	EPFA	GPFA	GPFA	SFA	SFAHH
✓		✓		✓								

BUELL

M2 Cyclone, S1 Lightning, S1 White Lightning,												
S3 Thunderbolt, S3T Thunderbolt, X1 Lightning	98-05				R							
XB9R	02-07				R							
XB9S	03-04				R							
XB9SX Lightning City X	05-09				R							
XB9SX Lightning	08-10				R							
XB12R	04-08				R							
XB12S	04-08				R							
XB12X Ulysses	06-10				R							
XB12XT Ulysses	08-10				R							
XB12 SCG Lightning	06-10				R							
XB12 SS Lightning Long	06-09				R							
XB12 STT Lightning	08				R							
Blast	00-07				R							
XB 12 R Firebolt	09-10				R							
XB 12 SS Lightning	09-10				R							

HONDA

CB-1 (CB 400 F)	89-90				R							
CB 500 F (Non ABS)	13-21				F							
CB 500 FA (ABS)	13-21				F							
CB 500 X (Non ABS)	13-21				F							
CB 500 XA (ABS)	13-21				F							
CBR 500 R (Non ABS)	13-21				F							
CBR 500 RA (ABS)	13-21				F							
NT 650 Hawk GT	88-91				R							
CTX 700 (Top Fairing/Manual G/Box)	14				R							
CTX 700 D (Top Fairing/Auto G/Box)	14-19				R							
CTX 700 N (Naked/Manual G/Box)	14				R							
CTX 700 ND (Naked/Auto G/Box)	14-19				R							
NC 700 (Top Fairing/Manual G/box)	14				R							
NC 700 D (Naked/Manual G/box)	14				R							
NM4 - NC 700 JD (DCT)	15-19				R							
NC 700 X (2 Piston F/Caliper & Manual G/box)	12-14				R							

KAWASAKI

KLE 650 FFF/FFFAS Versys/Versys LT	15				R							
Z 800 BGF (ABS)	16-19				R							
Z 900 (ZR 900 AHF/NON ABS)	17-19				R							
Z 900 (ZR 900 BHF/ABS)	17-19				R							
Z 900 ABS	18-21				R							
Z900 RS ABS	18-21				R							
Z900 RS Café	18-21				R							

TRIUMPH

Bonneville Bobber (1200cc)	17-21				R							
Bonneville Bobber Black 1200	18-21				R							
Bonneville Speedmaster 1200	18-21				R							
Bonneville Speed Master	19-21				R							
Daytona 600	03-04				R							
Daytona 650	05				R							
Daytona 675 SE	12				R							
Daytona 955i (From VIN132513)	01-06				R							
Speedfour 600	02-05				R							
Daytona 675	06-08				R							
Daytona 675 R	11-12				R							
675 Daytona Black Monobloc radial caliper	09-13				R							
Street Triple 675	07-12				R							
Street Triple R 675 (Radial caliper)	09-12				R							
Trident 660cc	21				R							
Tiger 800 (Cast Wheels)	11-14				R							
Tiger 800 (With ABS/Cast Wheels)	11-14				R							
Tiger 800 XR (With ABS/Cast Wheels)	15-20				R							
Tiger 800 XR Touring (With ABS/Cast Wheels)	15				R							
Tiger 800 XRt (With ABS/Cast Wheels)	16-20				R							
Tiger 800 XRx (With ABS/Cast Wheels)					R							
/STD & Low)	15-20				R							
Tiger 800 XC (Spoke Wheels)	11-20				R							
Tiger 800 XC (With ABS/Spoke Wheels)	11-20				R							
Tiger 800 XCa (With ABS/Spoke Wheels)	15-20				R							
Tiger 800 XCx (With ABS/Spoke Wheels)					R							
/STD & Low)	15-20				R							
YAMAHA					R							
FZ6R (Y/Z/A)	09-11				R							
FZ6R	09-17				R							

BUYERS GUIDE
BRAKE PADS

NOTE:- Size identification is shown as follows
Dimension 1=Width or Diameter, Dimension 2=Height or Diameter, Dimension 3=Thickness (Material and backplate)

FA141 A 106 x 38 x 9mm B 76.5 x 27 x 10.5mm



MATERIAL AVAILABILITY

FA	X	V	R	HH	SV	MXS	SXR	EPFA	GPFA	GPFA	SFA	SFAHH
✓												

KAWASAKI

EX 250 F2-F19/D6F/D7F Ninja 250	88-07				R							
ZR 550 B1/B2/B3 Zephyr	90-92				R							

FA142 101 x 35 x 9mm

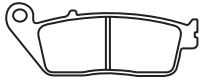

MATERIAL AVAILABILITY

FA	X	V	R	HH	SV	MXS	SXR	EPFA	GPFA	GPFAX	SFA	SFAHH
✓		✓		✓							✓	✓

BENELLI												
Leoncino 500 Trail				18-19	F						01	F
CAGIVA												
Gran Canyon 900				99-00	F							
HONDA												
CB-1 (CB 400 F)				89-90	F						12-15	F
CB 650 F (Non ABS)				18-21	F						16-21	F
CB 650 F (ABS)				18-21	F						12-21	F
CBR 650 F (Non ABS Model)				14-21	F						15	F
CBR 650 FA (ABS Model)				14-21	F							
CBR 650 R				18-21	F						06-09	F
NT 650 Hawk GT				88-91	F						06-09	F
VFR 750 F				90-97	F							
PC 800 Pacific Coast				89-90/94-98	F						94-01/05-07	F
CBR 1000 F				90-91	F							
ST 1100				91-02	F						11-12	F
ST 1100 A				95	F						05-11	F
GL 1500 C/CT/CF/FD Valkyrie/Valkyrie Tourer				97-03	F						10-15	F
KAWASAKI												
KLE 300 Versys-X				18-21	F							
KLE 650 Versys/Versys LT				15-20	F							
NEW Versys 650				15	F						03-11	F
NEW Vulcan S 650 ABS				15	F							
Z 650 (ER 650 GHF/Non ABS)				17	F						06-16	F
Z 650 (ER 650 HHF/ABS)				17-21	F						13-21	F
SUZUKI												
GW 250 L4/L5 (Naked)				14-15	F						03-17	F
GW 250 FL5 (Fairing)				15	F							
RF 600 RR/RS/RT/RV				94-97	F							
GSF 600 Bandit ST/SV/SW				96-98	F							
TRIUMPH												
Bonneville T100 (900cc)				16-21	F							
Bonneville T100 Black (900cc)				16-21	F							
Bonneville Speedmaster 1200				18-21	F							
Bonneville Speed Twin 1200				19-21	F							
Bonneville Bobber (1200cc)				17-21	F							
Bonneville T120				16-17	F							
Bonneville T120 Black				16-17	F							
Speedmaster (790cc/Carbs)				03-04	F							
Speedmaster (865cc/Carbs)				05-07	F							
Speedmaster (865cc/EFI)				08-10	F							
Street Cup (900cc)				16-21	F							
Street Twin (900cc)				16-21	F							
Thruxton 900				04-15	F							
Thruxton 900 Ace Café SE				14-15	F							
Thruxton SE (865cc)				12	F							
Thruxton 1200 (1200cc)				16-21	F							

FA143 94 x 31 x 10mm



MATERIAL AVAILABILITY

FA	X	V	R	HH	SV	MXS	SXR	EPFA	GPFA	GPFAX	SFA	SFAHH
✓												

HONDA												
VFR 750 R (RC 30)					90		R					
RVF 750 R (RC 45)					94-95		R					

FA145 70 x 55.5 x 8mm

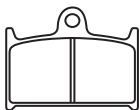

MATERIAL AVAILABILITY

FA	X	V	R	HH	SV	MXS	SXR	EPFA	GPFA	GPFAX	SFA	SFAHH
✓				✓				✓				

MZ												
1000 S				03-05	F						94-	F
SUZUKI												
GSX-R 600 WN/WP				92-93	F						89-01	F
RF 900 RR/RS/RS2/RT/RV/RW				94-98	F						89-92	F
GSX-R 1100 K/L/M/N				89-92	F							
GSF 1200 SV/SAV/SW/SAW/SX/SAX/SY				97-00	F							
YAMAHA												
TZ 125					F							
TZ 250					F							
FZR 750 (0W01)					F							

BUYERS GUIDE
BRAKE PADS

NOTE:- Size identification is shown as follows
Dimension 1=Width or Diameter, Dimension 2=Height or Diameter, Dimension 3=Thickness (Material and backplate)

NOTE:- Size identification is shown as follows
Dimension 1=Width or Diameter, Dimension 2=Height or Diameter, Dimension 3=Thickness (Material and backplate)

FA146 59 x 57 x 9mm

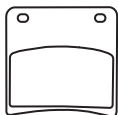

MATERIAL AVAILABILITY												
FA	X	V	R	HH	SV	MXS	SXR	EPFA	GPFA	GPFAX	SFA	SFAHH
✓		✓		✓								

SUZUKI

GSX 600 FJ/FK/FL/FM/FN/FP/FR /FS/FT 'Katana'	88-97	F	GSX 1100 FJ/FK/FL/FM/FN/FP 'Katana'	88-93	F
GSX 750 FK/FL/FM/FN/FP/FR /FS/FT/FV 'Katana'	89-97	F	GSX 1100 GM/GN/GP	91-93	R
VX 800 L/M/N/P	90-93	R	GV 1400 GDG (from F No:103765)	86	F
			GV 1400 GCG/GDH/GTH/GCH/GDJ	86-88	F

FA147 A 118 x 48 x 8.5mm B 97.5 x 57 x 11mm

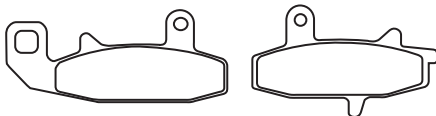

MATERIAL AVAILABILITY												
FA	X	V	R	HH	SV	MXS	SXR	EPFA	GPFA	GPFAX	SFA	SFAHH
	✓		✓									

SUZUKI

DR 650 SL/SM/SN/SP/SER/SES	90-95	F
----------------------------	-------	---

FA150 57.5 x 59 x 9mm

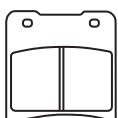

MATERIAL AVAILABILITY												
FA	X	V	R	HH	SV	MXS	SXR	EPFA	GPFA	GPFAX	SFA	SFAHH
✓		✓		✓								

SUZUKI

GV 1400 GDG (from F No:103765)	86	R
GV 1400 Cavalcade GCG/GDH/GTH/GCH/GDJ	86-88	R

FA151 51 x 36.5 x 8.5mm



MATERIAL AVAILABILITY												
FA	X	V	R	HH	SV	MXS	SXR	EPFA	GPFA	GPFAX	SFA	SFAHH
✓											✓	

HONDA

RS 125	88-07	R	SYM MIO 50	05-14	F
NSF 250 R Moto 3	13-20	R	DD 50	02-12	F
RS 250	88-02	R			

MORIWAKI/HONDA

MD 250 H	08-13	R
MD 250 S	08-11	R

FA152 62 x 41 x 9mm

FA152/2 62 x 41 x 11mm



MATERIAL AVAILABILITY - FA152												
FA	X	V	R	HH	SV	MXS	SXR	EPFA	GPFA	GPFAX	SFA	SFAHH
	✓		✓			✓						

MATERIAL AVAILABILITY - FA152/2												
FA	X	V	R	HH	SV	MXS	SXR	EPFA	GPFA	GPFAX	SFA	SFAHH
	✓		✓			✓						

FA152

KAWASAKI

KX 125 G1/H1/H2/J1/J2/K1	89-94	R	YZ 125 A	90	R
KDX 200 E1-E6/H1-H10/H6F	89-06	R	WR 125 K	98	R
KDX 220 R A4-A12/A6F	97-06	R	TT-R 250 L/M/N/P/R/S/T/V	99-06	R
KLX 250 R D2/D3/D4	94-96	R	XT 250 X/Y/Z/A/B/D/E/F/G/H	08-17	R
KX 250 G1/H1/H2/J1/J2/K1	89-94	R	XTZ 250 Lander		
KDX 250 D1/D2/D3/D4	91-94	R	(F 21" / R 18" Wheels)	07-14/ 16-18	R
KX 500 E1-E7	89-95	R	XTZ 250 X (F & R 17" Wheels)	08-10	R
KLX 650 A1-A3 (KLX 650 R)			YZ 250 A	90	R
/KLX 650 C1-C4 (KLX 650)	93-96	R	YZ 250 WRA	90	R
			WR 250 ZB/ZD/ZE/ZF/ZG/ZH/ZJ	91-97	R

SUZUKI

RM 125 K/L	89-90	R	YZ 400 FK	98	R
RMX 250 K/L/M/N/P/R/S/T/V/W	89-98	R	WR 400 FK	98	R
DR 250 L/M/N/P/R/S/SL/SM/SN/SEP /SER/SES	90-95	R	WR 500 ZD/ZE	92-93	R
RM 250 K/L	89-90	R	YXR 700 Rhino Parking brake	08-09	F
DR 350 L/M/N/P/R/S/T/SL/SM/SN /SP/SEP/SES/SET/SEW/SEX	90-99	R			
DR 650 S	96-21	R			

YAMAHA

**FA155 A 37 x 7.8mm
B 39 x 23mm**



MATERIAL AVAILABILITY												
FA	X	V	R	HH	SV	MXS	SXR	EPFA	GPFA	GPFAF	SFA	SFAHH
	✓		✓									

YAMAHA
YFS 200 U/W/A/B/D/E/F/G/H/J/K
/L/M/N/P 'Blaster' 88-02 R

FA156 56 x 45.5 x 6mm



MATERIAL AVAILABILITY												
FA	X	V	R	HH	SV	MXS	SXR	EPFA	GPFA	GPFAF	SFA	SFAHH
	✓											

BETA
SYNT/GARA 93-96 R

**FA157 A 99.5 x 44 x 7.5mm
B 47.5 x 83.5 x 9.5mm**

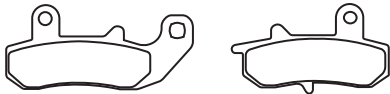

MATERIAL AVAILABILITY												
FA	X	V	R	HH	SV	MXS	SXR	EPFA	GPFA	GPFAF	SFA	SFAHH
	✓		✓									

SUZUKI
DR 650 SL/SM/SN/SP/SER/SES 90-95 R

FA158 46.5 x 70 x 8mm



MATERIAL AVAILABILITY												
FA	X	V	R	HH	SV	MXS	SXR	EPFA	GPFA	GPFAF	SFA	SFAHH
✓				✓				✓				

KAWASAKI												
ZX 600 D1-D4 (ZX6)				90-93	F						97-03	F
ZX 600 E1-E13 (Ninja ZX6)				93-05	F						08-10	F
ZX6R (ZX 600 F1/F2/F3)				94-97	F						00-03	F
ZXR 750 H1/H2/J1/J2/L1-L3 'Ninja' ZX-7				89-95	F						03-07	F
ZX 750 K1/K2/M1/M2 Ninja ZX- 7R				91-95	F						97-01	F
ZX9R B1/B2 Ninja				94-95	F						07-11	F
KLZ 1000 BFF/BFFAS/BGF/BGFAS											07-11	F
/BHF - Versys				15-17	F						11-12	F
KLZ 1000 BJF - Versys LT				18-21	F						16	F
KLZ 1000 BJF - Versys SE LT				18-21	F							
ZX 1100 C1-C4/D1-D9 (ZX11)				90-01	F						00-03	F
ZR 1100 A1/A2/A3/A4 Zephyr				92-95	F							
ZZR 1200 (ZX 1200 C1/C2/C3)				02-04	F						03-04	F
VN 1700 Vulcan Voyager				09	F						03-04	F
VN 1700 A9FA/AAF/ABF/ACF/ADF												
Vulcan 1700 Voyager				09-13	F							
VN 1700 B9FA/BAF/BBF/BCF/BDF/BEF												
/BFF/BGF/BHF Vulcan 1700 Voyager ABS				09-21	F							
VN 1700 Voyager Vaquero JBF/JBFA												
/JCF/JCFA/JDF				11-13	F							
VN 1700 KEF/KFF/KGF/Voyager												
Vaquero ABS				14-21	F							
VN 1700 KEFA Voyager Vaquero ABS SE				14	F							
VN 2000 A1/A2/A6F/A7F/G8F/G9F Vulcan				04-09	F							
VN 2000 D1/D6F Vulcan Ltd				05-06	F							
VN 2000 E6F/E7F/H8F/H9F Vulcan Classic				06-09	F							
VN 2000 F6F/F7F/J8F/J9F/JAF												
Vulcan Classic LT				06-10	F							

FA159 97 x 40 x 8mm



MATERIAL AVAILABILITY												
FA	X	V	R	HH	SV	MXS	SXR	EPFA	GPFA	GPFAF	SFA	SFAHH
	✓		✓		✓		✓					

POLARIS
All disc front brake models - check application pages
for main fitments.

BUYERS GUIDE
BRAKE PADS

NOTE:- Size identification is shown as follows
Dimension 1=Width or Diameter, Dimension 2=Height or Diameter, Dimension 3=Thickness (Material and backplate)

NOTE:- Size identification is shown as follows
Dimension 1=Width or Diameter, Dimension 2=Height or Diameter, Dimension 3=Thickness (Material and backplate)

FA160 75 x 54 x 10mm

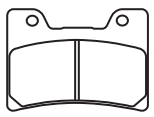

MATERIAL AVAILABILITY												
FA	X	V	R	HH	SV	MXS	SXR	EPFA	GPFA	GPFAFX	SFA	SFAHH
✓				✓								

YAMAHA

FZR 600 AC/RA/RAC/RBC/RD/RDC/RE/REC/ RF/RFC/RG/RGC/RH/RHC/RJ/RJC/RK/RKC /RL/RLC	90-99	F	FZR 1000 EX-UP /A/AC/B/BC	90-91	F
YZF 600 RG/RGC/RH/RHC	95-96	F	FJ 1200 AD/ADC/AE/AEC	92-93	F
			VMX 12 - (V-Max 1200 All Models)	93-07	F

FA161 52.5 x 52.5 x 8mm



MATERIAL AVAILABILITY												
FA	X	V	R	HH	SV	MXS	SXR	EPFA	GPFA	GPFAFX	SFA	SFAHH
✓		✓		✓								

KAWASAKI

ZXR 750 H1/H2/J1/J2/L1/L2/L3 Ninja ZX-7	89-95	R	ZX 1100 D1-D9 (ZX11)	93-01	R
ZX 750 K1/K2/M1/M2 Ninja ZX-7R	91-95	R	ZX 12 R (ZX 1200 A1/A2/B1/B2/B3/B4)	00-05	R
Ninja ZX-7R (ZX 750 P1-P8)	96-03	R	ZRX 1200 R (ZR 1200 A1/A2/A3/A4/A5)	01-05	R
(ZR 1100 C3/C4) ZRX 1100	99-00	R	ZZR 1200 (ZX 1200 C1/C2/C3/C4)	02-05	R
			ZX 12R (ZX 1200 A1/A2/B1-B4)	00-05	R

FA162 48 x 48.5 x 7mm



MATERIAL AVAILABILITY												
FA	X	V	R	HH	SV	MXS	SXR	EPFA	GPFA	GPFAFX	SFA	SFAHH
✓												

YAMAHA

TZ 125			TZ 250	89-01	R
			TZ 250 (Radial Calipers)	02-10	R

FA163 99.5 x 52 x 8mm

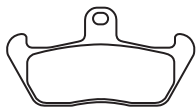

MATERIAL AVAILABILITY												
FA	X	V	R	HH	SV	MXS	SXR	EPFA	GPFA	GPFAFX	SFA	SFAHH
✓												

CAGIVA Elephant 650

MOTO GUZZI Quota 1000

86-87	R	92-97	R
-------	---	-------	---

FA164 74 x 40.5 x 6.5mm



MATERIAL AVAILABILITY												
FA	X	V	R	HH	SV	MXS	SXR	EPFA	GPFA	GPFAFX	SFA	SFAHH
	✓		✓									

BETA

Evo 125 (2T)	10-19	R	Trial Evo 250 (2T) MY20	20-21	R
260 TR34/35/Zero	89-92	R	Trial Evo 250 (2T) MY20 GB	20-21	R
Trial Evo 125 (2T) MY20	20-21	R	Trial Evo 300 (2T) MY20	20-21	R
Trial Evo 200 (2T) MY20	20-21	R	Trial Evo 300 (2T) MY20 GB	20-21	R
			Trial Evo 300 (2T) SS MY20	20-21	R

FA165 A 96.5 x 42 x 7.5mm B 77.5 x 42 x 7.5mm

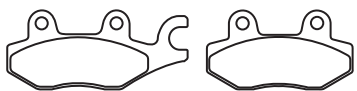

MATERIAL AVAILABILITY - FA165												
FA	X	V	R	HH	SV	MXS	SXR	EPFA	GPFA	GPFAFX	SFA	SFAHH
	✓		✓		✓	✓						

FA165/2 A 96.5 x 42 x 9.5mm B 77.5 x 42 x 8mm

MATERIAL AVAILABILITY - FA165/2												
FA	X	V	R	HH	SV	MXS	SXR	EPFA	GPFA	GPFAFX	SFA	SFAHH
	✓		✓				✓					

BENNCHE

250 Cowboy/Spire	15-16		F (Left)	Commander 1000 XT-P	14-15		F Left
400 Bighorn	11-16		F&R (Left)	Commander 1000 X	11-13		F Left
400 Cowboy	15-16		F&R (Left)	Commander 1000 LTD	12-15		F Left
500 Bighorn	15-16		F&R (Left)	Commander 1000 DPS	13-15		F Left
500 Cowboy	14-16		F&R (Left)	Maverick 1000 - STD/XRS	13		F Left
700 Bighorn	15-16		F&R (Left)	CF MOTO			
700 Cowboy	14-16		F&R (Left)	500 U-Force EPS	14-16		F (Right)
700 X Bighorn	15-16		F&R (Left)	500 Z-Force	14-16		F (Right)
800 Spire	14-16		F&R (Left)	800 U-Force	13-17		F (Right)
1000 Cowboy	15-16		F&R (Left)	800 Z-Force	15-16		F (Right)
1000 Spire/X Spire	14-16		F&R (Left)	800 EX Z-Force	14-16		F (Right)

CAN-AM

Commander 800 STD/R XT/DPS	11-15		F Left	E-TON QUADS			
Commander 800 R XT	11-14		F Left	CXL 150 Yukon II/Challenger	02-09		R
Commander 1000 STD/XT	11-15		F Left	RXL 150 Viper R	05-09		R
				RXL 150 Viper	05-06		R

FA165 A 96.5 x 42 x 7.5mm
B 77.5 x 42 x 7.5mm

FA165/2 A 96.5 x 42 x 9.5mm
B 77.5 x 42 x 8mm

Contd.

HISUN

250 Sector	15-16	F (Left)
250 Strike	15-16	F (Left)
400 Forge	15-16	F (Left) & R (Right)
HS 400	15-16	F (Left) & R (Right)
450/550/750/1000 Sector	15-16	F (Left) & R (Right)
500 Forge	15-16	F (Left) & R (Right)
HS 500	15-16	F (Left) & R (Right)
700 Forge	15-16	F (Left) & R (Right)
HS 700	15-16	F (Left) & R (Right)
HS 750 Crew	15-16	F (Left) & R (Right)
800 Tactic	15-16	F (Left) & R (Right)
HS 800 Crew	15-16	F (Left) & R (Right)
800 Strike	15-16	F (Left) & R (Right)
1000 Strike	15-16	F (Left) & R (Right)
1000 Strike Crew	15-16	F (Left) & R (Right)
1000 Tactic	15-16	F (Left) & R (Right)

KAWASAKI

KLF 300 C1-C17 Bayou	89-05	F Left
KLF 400 B1-B7 Bayou	93-99	F Left
KVF 650 H7F/H8F Brute Force 4x4i	07-08	F Left
KVF 650 F6F-F9F/FAF/FBF Brute Force 650 4x4i	06-11	F Left
KVF 650 G6F-G9F/FGAF Brute Force 650 4x4i Hardwoods Green HD	06-10	F Left
KVF 650 FCS (Brute Force 650 4x4i)	12	F Left
KVF 750 A1/B6F/B7FA/A6F/C7F/D8F/F8F/D9F/DAF/DBF Brute Force 750 4x4	05-11	F Left
KVF 750 A1/A6F/A7F Brute Force 750 4x4i	05-07	F Left
KVF 750 B6F/B7F/B7FA Brute Force 750 4x4i	06-07	F Left
KVF 750 F8F/FAF/FBF Brute Force 750 4x4i	08/10-11	F Left
KVF 750 B1/E8F/E9F Brute Force 750 4x4i Hardwoods Green HD	05/08-09	F Left
KVF 750 E8FA/E9FA/EAF Brute Force 750 4x4i NRA Outdoors	08-09	F Left
KVF 750 GCF/GDF/GEF/GFF/GGF/GHF (Brute Force 750 4x4i/EPS)	12-17	F Left
KVF 750 HCF/HDF/HEF/HFF/GGF/GHF (Brute Force 750 4x4i/EPS)	12-17	F Left
KVF 750 JCF/JDF/JEF/JFF/JGF/JHF (Brute Force 750 4x4i/EPS)	12-17	F Left
KVF 750 LCF/LDF/LEF/LFF/LGF/LHF (Brute Force 750 4x4i)	12-17	F Left
KRF 750 A8F/B8F (Teryx 750 4x4)	08	F Left
KRF 750 C8F/D8F (Teryx 750 4x4 LE)	08	F Left
KRF 750 F8F (Teryx 750 4x4 NRA Outdoors)	08	F Left
KRF 750 G9F/NAF/NBF/NDF/NCS (Teryx 750 Fi 4x4)	09-13	F Left
KRF 750 J9FA/K9F/PAF/PBF/RAF/RBF/RCS/RDF/PCF/PDF (Teryx 750 Fi 4x4 LE)	09-13	F Left
KRF 750 L9F (Teryx 750 Fi 4x4 Le Sport)	09	F Left
KRF 750 M9F (Teryx 750 Fi 4x4 NRA Outdoors)	09	F Left
KRF 750 SAF/SAFA/SBF/SBFA/SCS/SCSA (Teryx 750 Fi 4x4 Sport)	10-12	F Left
KRF 750 SAF (RUV) Teryx 4x4 Le Sport	10	F Left
KRF 750 TAF/VBF/VCS (Teryx 750 Fi 4x4 SGE)	10-12	F Left
KRT 750 ACF/ADF (Teryx 4 750 4X4)	12-13	F Left
KRT 750 ACFA/ADFA (Teryx 4 750 4X4 EPS)	12-13	F Left
KRT 750 CCF/CDF (Teryx 4 750 4X4 EPS LE)	12-13	F Left
KRT 750 DCF/DDF (Teryx 4 750 4X4 EPS Realtree)	12-13	F Left
KRF 800 (Teryx)	14-21	F Left
KRF 800 (Teryx LE)	14-21	F Left
KRF 800 (Teryx Camo)	14-21	F Left
KRT 800 (Teryx 4)	14-21	F Left
KRT 800 (Teryx 4 LE)	14-21	F Left
KRT 800 (Teryx 4 Camo)	14-21	F Left
KRT 800 (Teryx 4 LE Camo)	20-21	F Left
KAF 820 AFF/AGF/AHF Mule PRO - FXT	15-21	F Left
KAF 820 BFF/BGF/BHF Mule PRO - FXT /EPS	15-21	F Left
KAF 820 CFF/CGF/CHF Mule PRO - FXT /EPS LE	15-21	F Left
KAF 820 DFF/DGF/DHF Mule PRO - FXT /EPS Camo	15-21	F Left
KAF 820 EGF/EHF Mule PRO - FX	16-21	F Left
KAF 820 FGF/FHF Mule PRO - FX/EPS	16-21	F Left

KAF 820 GGF/GHF Mule PRO - FX/EPS LE	16-21	F Left
KAF 820 HGF/HHF Mule PRO - FX/EPS Camo	16-21	F Left
KAF 820 JGF/JHF Mule PRO - FXT Ranch Edition	16-21	F Left
KAF 1000 AGF/AHF - Mule Pro DXT/ Diesel	16-17	F Left
KAF 1000 BGF/BHF - Mule Pro DXT/Diesel EPS	16-17	F Left
KAF 1000 CGF/CHF - Mule Pro DXT EPS LE/Diesel	16-17	F Left
KAF 1000 DGF/DHF - Mule Pro DX /Diesel	16-17	F Left
KAF 1000 EGF/EHF - Mule Pro DX EPS/Diesel	16-17	F Left
KAF 1000 FGF/FHF - Mule Pro DX EPS LE/Diesel	16-17	F Left
MASSIMO		
250 Gunner/Gunner S	15-16	F Left
MSU 400	15-16	R Left
500 Alligator	15-16	F Left
500 Knight	15-16	F Left & R Right
MSA 500	13-16	F Right & R Right
MSU 500	15-16	F Right & F Left
550 EPS Alligator	15-16	F Left
700 Alligator	15-16	F Left & R Left
700 Knight	15-16	F Left & R Left
700-4 Alligator EPS	15-16	F Left & R Left
MSU 700	15-16	F Left & R Left
MSU 700-5	15-16	F Left & R Left
MSA 800	14-16	F Right & R Right
MSU 800	15-16	F Left & R Left
1000 Militia/S Militia/XS Militia	15-16	R Left
SUZUKI		
LT-F 300 FK2 King Quad	02	F Left
LT-R 450 K6/K7/K8/K9	06-11	F Left
LT-R 450 ZK8/ZK9 Quad Racer Ltd Edition	08-09	F Left
LT-F 500 FW/FX/FY/FK1/FK2 Quadrunner (Right)	98-02	F Left
LT-A 500 FY/FK1 Quadmaster (Right)	00-01	F Left
YAMAHA		
YFZ 450 S/T/N/W/X/Y/B/D	04-09/12-13	F Left
YFZ 450 RY/RZ/RA/RB/RD/RE/RSE/RF	09-15	F Left
YXR 450 Rhino (All models)	06-09	F Left
YFZ 450 SEW/SEX Special Edition	07-08	F Left
YFZ 450 BBV/BBW Bill Balance Edition	06-07	F Left
YFZ 450 SPV/SEW/SPX Special Edition	06-08	F Left
YFZ 450 LES Limited Edition	04	F Left
YFZ 450 SET Special Edition	05	F Left
YXR 660 Rhino	04-07	F Left
YFM 700 RV/RW/RX/RY/RA/RB/RD/RE Raptor	06-14	F Left
YFM 700 R RSEW/RSPX/RSEY/RSEZ/RSEA/RSEB/RSED /RSE/RSF Special Edition	07-15	F Left
YXR 700 Rhino (All models)	08-13	F Left & R Left
FA165/2		
CAGIVA		
Gran Canyon 900	99-00	R
MZ		
RT 125	02-05	R
SX/SM 125	02-05	R
LIFAN		
LF 200 GY-S	05-08	R
SXR165HH		
CAN-AM		
Commander 800 (XT/DPS)	11-15	Front Left
Commander 800 R (STD)	11-15	Front Left
Commander 800 R XT	11-14	Front Left
Commander 1000 STD	11-15	Front Left
Commander 1000 (DPS)	13-15	Front Left
Commander 1000 LTD	12-15	Front Left
Commander 1000 X	11-13	Front Left
Commander 1000 XT	11-15	Front Left
Commander 1000 XT-P	14-15	Front Left
Maverick 1000 STD	13	Front Left
Maverick XRS	13	Front Left

BUYERS GUIDE
BRAKE PADS

NOTE:- Size identification is shown as follows
Dimension 1 = Width or Diameter, Dimension 2 = Height or Diameter, Dimension 3 = Thickness (Material and backplate)

NOTE:- Size identification is shown as follows
Dimension 1=Width or Diameter, Dimension 2=Height or Diameter, Dimension 3=Thickness (Material and backplate)

FA167 77 x 42 x 7.5mm



MATERIAL AVAILABILITY												
FA	X	V	R	HH	SV	MXS	SXR	EPFA	GPFA	GPFA	SFA	SFAHH
✓				✓								

BETA RR 50 Motard	06	F	SM 50	02	F
DERBI GPR 50 Replica	03-05	F	WR 50 WXE 125	02 07	F F
GAS-GAS EC 50 (Rookie) SM 50 (Rookie)	01-04 01-04	F	XR 6 50cc	03-05	F

SFA169 61 x 27 x 7.5mm



MATERIAL AVAILABILITY												
FA	X	V	R	HH	SV	MXS	SXR	EPFA	GPFA	GPFA	SFA	SFAHH
											✓	✓

ADLY Fox 50	07-09	F	DTF 50	06-08	F
E-TON Beamer 50 (PN2) Beamer II (PN2B) Beamer 50 III Beamer Matrix (PN2C) Beamer Matrix II (PN2E)	04-08 09	F	YW 50 P/R/S/T/X/Y/Z Zuma JYM90T Axis 4RT6 YA 90 Axis (4CY1/5 - 4EN5/6 4CY7-4EN7) YA 100 W Grand Axis (5TC/4/5) YW 100 BW's (4VPS/PC/PV/PX/5XR1-R4)	02-05/08-10 01 91-96 01-03 97-08	F F F F F
THUMPSTAR Thumpstar Junior 90cc Thumpstar Supa 110cc Thumpstar Expert 125 Thumpstar Pro 125	04-07 04-07 06-07 05-07	F&R F&R F&R F&R			

FA171 57.5 x 53.5 x 9mm

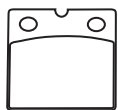

MATERIAL AVAILABILITY												
FA	X	V	R	HH	SV	MXS	SXR	EPFA	GPFA	GPFA	SFA	SFAHH
✓		✓		✓								

BMW R 80/R 80 RT (Double disc) R 100 RS R 100 RT K 75/75-2 (Non ABS) K 75/75-2 (ABS Model) K 75 C K 75 RT	09/88-95 09/88-92 09/88-95 09/88-96 08/90-96 09/88-90 89-96	F F F F F F F	K 75 S K 100/2 K 100 LT K 100 RS (Non ABS - 8 valve) K 100 RS (ABS Model - 8 valve) K 100 RT (Non ABS - 8 valve) K 100 RT (ABS - 8 valve)	09/88-95 09/88-90 09/88-91 10/88-89 10/88-89 10/88-89 10/88-89	F F F F F F F
---	---	---------------------------------	---	--	---------------------------------

FA172 A 104 x 46 x 10mm B 88 x 46 x 10mm



MATERIAL AVAILABILITY												
FA	X	V	R	HH	SV	MXS	SXR	EPFA	GPFA	GPFA	SFA	SFAHH
	✓		✓									

YAMAHA XT 600 EA/EB/ED/EDC/EE/EEC/EF/EFC /EG/EGC	90-95	F			
---	-------	---	--	--	--

FA173 A 82 x 42.5 x 7.5mm B 56 x 35 x 9.5mm



MATERIAL AVAILABILITY												
FA	X	V	R	HH	SV	MXS	SXR	EPFA	GPFA	GPFA	SFA	SFAHH
✓												

APRILIA Pegaso 650 ie (All models)	99-04	R	Mastiff 660 Baghira 660 (All models)	00-03 00-05	R R
--	-------	---	---	----------------	--------

FA174 86.5 x 41.5 x 10mm



MATERIAL AVAILABILITY												
FA	X	V	R	HH	SV	MXS	SXR	EPFA	GPFA	GPFAX	SFA	SFAHH
✓		✓		✓								

HONDA

599 (CB 600 F)	04/06	R
CBR 600 F2/F3/SJR/SE	91-98	R
CBR 600 F4 (Carb Model)	99-00	R
CBR 600 F4i Sport Injection Model)	01-06	R
CBR 600 RR	03-06	R
NC 700 XD (Auto G/Box)	12-14	R
919 (CB 900 F)	02-07	R
CBR 900 RR Fireblade	93-99	R
CBR 929 RR (929cc model)	00-01	R
CBR 954 RR (954cc model)	02-03	R
CBR 1000	94-95	R
CBR 1000 RR	04-05	R
CRF 1000 LAG/LAH Africa Twin	16-21	R
CRF 1000 LADG/LADH Africa Twin	16-21	R
CRF 1100 L Africa Twin	20-21	R
CRF 1100 L Africa Twin Plus	20-21	R
CRF 1100 L Adventure Sports	20-21	R
CRF 1100 L Adventure Sports Plus	20-21	R
RVT 1000 R (RC51)	00-05	R
VTR 1000 F 'Superhawk'	98-05	R
CB 1100 (Non ABS)	13-14	R
CB 1100 A (ABS)	13-14	R
CB 1100 EX (ABS)	14-17	R
VT 1100 C2 American Classic Edition		
/C2-2/C3/C2 Sabre	95-07	R
VT 1100 T Shadow American Classic Edition Tourer	98-01	R
VT 1300 CX Fury	10-21	R
VT 1300 CS Sabre (Non ABS)	10-14	R
VT 1300 CR Stateline (Non ABS)	10-15	R
VT 1300 CT Interstate (Non ABS)	10-15	R
VTX 1300 S	03-07	R
VTX 1300 C	04-11	R
VTX 1300 R	05-11	R
VTX 1300 T	08-11	R

KAWASAKI

EN 650 Vulcan S (Non ABS) EN 650 AFF	15-21	R
/AGF/CHF		
EN 650 Vulcan S (ABS) EN 650 BFF	15-21	R
/BGF/DHF		
EN 650 Vulcan S Café ABS	18-21	R
EN 650 Vulcan S SE ABS	18-21	R
KLE 650 FGF/FGFAS Versys/Versys LT	16-21	R
Ninja 650 (EX 650 KH/KHFA - ABS)	17-21	R
Ninja 650 (EX 650 JHF -NON ABS)	17-21	R
Ninja KRT Edition ABS	17-21	R
Z 650 (ER650GHF/ NON ABS)	17	
Z 650 (ER650HHF/ ABS)	17-21	R
KLZ 1000 BFF/BFFAS/BGF/BGFAS/BHF		
Versys 1000	15-21	R
Z 1000 (ZR 1000 B7F)	07	
Z 1000 (ABS) ZR 1000 C7F	07	
ZR 1000 B7F/B8F	07-08	R

SUZUKI

DL 650 V-Strom K4/K5/K6/K7/K8/K9	04-09	R
DL 650 V-Strom ABS	07-21	R
DL 650 V-Strom XT ABS	15-21	R
DL 650 V-Strom Adventure ABS	12-21	R
GSX 650 FK8/FK9/FL0	08-09	R
SV 650 K3-K9/SK3-SK8	03-10	R
SV 650 AK7/AK8/K7/K8/K9/AK9 ABS	07-10	R
SV 650 SAK7/SAK8/SAK9 ABS	07-10	R
GSX-S 750 L5/L6	15-17	R
GSX-S 750 ZL5	15-17	R
GSX-S 750 A	18-21	R
GSX-S 750 Y	18-21	R
GSX-S 750 Z	18-21	R
GSX-S 750 ZL	18-21	R
DL 1000 K2-K9/L2 V-Strom	02-12	R
DL 1000 AL2 V-Strom Adventure	12	R
GSX-S 1000 (Non ABS)	16-21	R
GSX-S 1000 (ABS)	16-21	R

GSX-S 1000 F (Non ABS)	16-21	R
GSX-S 1000 F (ABS)	16-21	R
SV 1000 K3-K6/SK3-SK7	03-07	R
GSF 1250 SAK7/SAK8/SAK9 (ABS)	07-10	R
GSF 1250 SK7/SK8/SK9 Bandit	07-10	R
GSX 1250 FAL1/FAL2	11-14	R
GSX 1250 SAL6 Bandit	16	R

YAMAHA

YZF 600 RRR/RRS (R6)	03-04	R
FZ6	04-06	R
FZ6 (4 piston caliper)	07-09	R
FZ6R	12-14	R
FZ-07 (689cc/2 Cyl)	15-17	R
FZ-07 A (689cc/2 Cyl/ABS)	17	R
MT-07	18-21	R
YZF-R7	22	R
XSR 700 (MTM 690-U)	18-21	R
FJ-09 (847cc/3 Cyl)	15-16	R
FZ-09 (847cc/3 Cyl)	14-17	R
MT-09	18-21	R
Tracer 900	18-21	R
Niken	18-21	R
XSR 900 (MTM 850)	16-21	R
YZF-R1 (5VY)	04-06	R
YZF R1 LE	06	R
(FZ1) FZS 1000 V/W/X/Y/Z/A/B/D/E	06-14	R
FZ-10	17	R
MT-10 (KB/KCB/KCGY/KGY)	18-21	R
YZF-R6 T/V/W (310mm rotor)	05-07	R
YZF-R6S (YZF-R6 SV/SW/SX/SY)		
(298mm rotor)	06-09	R
YZF-R6 X/Y/Z/A/B/D/E/F/G	08-16	R
YZF-R1 (6 piston radial caliper)	07-14	R
FZ8	11-13	R

FA175 33.5 x 50.5 x 7mm



MATERIAL AVAILABILITY												
FA	X	V	R	HH	SV	MXS	SXR	EPFA	GPFA	GPFAX	SFA	SFAHH
✓				✓				✓				

ARCH MOTORCYCLE

KRGT-1	19-20	F
1S	19-20	F
Method 143	19-20	F

ISR AFTERMARKET CALIPER

22-032 (6 Piston Large)
22-042 (6 Piston Racing)

HARRISON BILLET AFTERMARKET CALIPER

2 Piston (1296040)
Slim Design
Mini 6

FA177 87 x 53 x 7.5mm

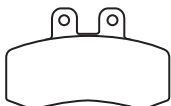

MATERIAL AVAILABILITY												
FA	X	V	R	HH	SV	MXS	SXR	EPFA	GPFA	GPFAX	SFA	SFAHH
✓												

MZ

Mastiff 660	00-03	F
Baghira 660 (All models)	00-05	F

BUYERS GUIDE
BRAKE PADS

NOTE:- Size identification is shown as follows
Dimension 1=Width or Diameter, Dimension 2=Height or Diameter, Dimension 3=Thickness (Material and backplate)

FA179 102 x 41 x 10mm

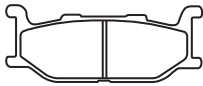

MATERIAL AVAILABILITY												
FA	X	V	R	HH	SV	MXS	SXR	EPFA	GPFA	GPFAFX	SFA	SFAHH
✓		✓		✓							✓	✓

YAMAHA		SR 400 F	15-16	F	SCR 950 (SCR 950 H)	17	F	XVZ 1300 Venture MM Limited Edition	01	F
SR 400 F	15-16	F	SCR 950 (SCR 950 H)	17	F	XVZ 1300 Royal Star Midnight Venture	02-07	F		
XJ 400 S "Seca II"	93	F	XVS 950 (V-Star 950)	09-14	F	XVS 1300 Stryker	11-14	F		
XP 400 T/V/W/X/Y/Z/B Majesty	05-10/12/13	F	XVS 950 (V-Star 950 Tourer)	09-14	F	XVZ 1300 Royal Star Venture S	08-13	F		
XP 500 T-Max (5GJ5)	01	F	XVS 950 Bolt (Standard Rear Shocks)	14-16	F	XVZ 1300 Royal Star Venture	99-07	F		
XV 535 G/GC/SG/SGC/H/HC/SH/SHCJ		F	XVS 950 Bolt C Spec (Remote Reservoir Rear Shocks)	15-21	F	XV 1300 Royal Star Midnight Tour Deluxe	06-07	F		
/JC/SJ/SJC/K	95-99	F	XVS 950 Bolt R Spec		F	XV 1600 Road Star	01-05	F		
XJ 600 S "Seca II" SD/SDC/SE/SEC/SF/SFC/SG/SGC/SH/SHC//SJ/SJC/SK/SKC	92-98	F	(Remote Reservoir Rear Shocks)	14-21	F	XV 1600 Road Star Silverado	07-09	F		
XVS 650 V Star Custom	97-11/13-14	F	XVZ 1300 Royal Midnight Venture Star	02-07	F	XV 1600 Road Star Midnight	03	F		
XVS 650 V-Star Classic	98-10	F	XVZ 1300 Royal Star Tour Deluxe	06-08	F	XV 1600 Midnight Star	02-03	F		
XVS 650 V-Star Silverado	03-10	F	XVZ 1300 Royal Star Tour Deluxe	05-07	F					

FA180 59 x 40 x 8mm

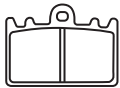

MATERIAL AVAILABILITY												
FA	X	V	R	HH	SV	MXS	SXR	EPFA	GPFA	GPFAFX	SFA	SFAHH
✓				✓								

PRE TECH AFTERMARKET CALIPER
4 Piston (Uni P401)

FA181 94 x 37.5 x 7.5mm



MATERIAL AVAILABILITY												
FA	X	V	R	HH	SV	MXS	SXR	EPFA	GPFA	GPFAFX	SFA	SFAHH
	✓	✓	✓	✓		✓		✓			✓	✓

ALTA MOTORS (Electric)		GAS-GAS		CR 250		95-05		F	
Redshift - MX	16-18	F	Wild HP 300/450	03-06	F&R	FC 250 (4T)	14-21	F	
Redshift - SM	16-18	F	Enduros 125/250	00	F	FE 250 (4T)	14	F	
APRILIA		Enduro EC 200/250/300		99-00	F	TC 250	02-11	F	
RST 1000 Futura	01-05	R	EC Ranger 200/300	20	F	TC 250 R (4T) (Kayaba Forks)	13	F	
ATK		MX 200/250/300		99-00	F	TC 250 (2T)	14-21	F	
All Models	97-	F	Wild HP 300/450	03-06	F&R	TE 250	02-12	F	
125 (2 stroke enduro)	03	F	GAS-GAS PIERER			TE 250 (2T)	14-20	F	
250/260 (2 stroke enduro)	03	F	MC 125 2T	21-22	F	TE 250 Tpi (2T)	19-20	F	
450 MX	07	F	EC 250 2T	21-22	F	TXC 250 Cross Country	08-12	F	
450 XC	07	F	EC 250 F 4T	21-22	F	TXC 250 R (4T) (Kayaba Forks)	13	F	
Enduro 450	07	F	EX 250 F 4T	21-22	F	TC 250 (2T)	14-15	F	
500/605 Enduro	03	F	MC 250 F 4T	21-22	F	WR 250	95-12	F	
620/700 (2T) Intimidator	04	F	EC 300 2T	21-22	F	TE 300 Tpi (2T)	19-20	F	
250/370/500 (2T)	04	F	EX 300 2T	21-22	F	TX 300 Tpi (2T)	19-21	F	
BMW		EC 350 F 4T		21-22	F	TE 300 (2T)	14-19	F	
G 450 X	08-11	F	EX 350 F 4T	21-22	F	WR 300	09-12	F	
F 750 GS	18-19	F	EX 450 F 4T	21-22	F	TE 310 (4T)	09-12	F	
F 850 GS	18-19	F	MC 450 F 4T	21-22	F	TE 310 R (4T) (Kayaba Forks)	13	F	
F 850 GS Adventure	18-19	F	HARLEY DAVIDSON			TXC 310 Cross Country	12	F	
DUCATI		XG 500 Street (300mm Discs)		16-21	R	TXC 310 R (4T) (Kayaba Forks)	13	F	
Monster 400 ie (Japan)	07-08	F	XG 750 Street (300mm Discs)	16-21	R	FC 350 (4T)	14-21	F	
Monster S2R (803cc)	05-07	F	XG 750 A Street Rod (300mm Discs)	17-21	R	FE 350 (4T)	14-20	F	
Monster S2R Dark (803cc)	05-06	F	HUSABERG			FX 350 (4T)	18-21	F	
620 Multistrada (Twin Disc/ Single pin pad fixing)	06	F	All Models (fixing pin at end of brake pad)	93-99	F	TE 350	95-97	F	
Multistrada Dark 620	03-05	F	All MX/Enduro Models	00-08	F	WR 360	95-02	F	
Monster 620	05-06	F	TE250/300 (2T)	11-14	F	TE 400	02	F	
Monster 620ie (Series 2 - Single Pin Pad Fixing Caliper)	05	F	FE390 (4T)	10-12	F	TE 410	95-00/06	F	
Monster 695	06-09	F	FE450 (4T)	09-14	F	TE 410 E	00	F	
950 Multistrada (936cc)	17-21	R	FX450 (4T)	10-11	F	TC 449	11-12	F	
950 Multistrada S	20-21	R	FE501 (4T)	11-14	F	TE 449 (4T)	11-12	F	
950 Multistrada S SW	20	R	FE570 (4T)	09-12	F	FC 450 (4T)	14-21	F	
950 Multistrada S Touring	20	R	HUSQVARNA			FE 450 (4T)	14-20	F	
Multistrada 1200	15-19	R	TC 85 Small Wheel 17/14 wheel size	21-22	F	FX 450 (4T)	18-21	F	
Multistrada 1200 Enduro	17-19	R	TC 85 Big Wheel 19/16 wheel size	21-22	F	TE 450	03-11	F	
Multistrada 1200 S	15-17	R	CR 125	95-12	F	TXC 450 Cross Country	08-10	F	
Multistrada 1200 S D/air	16-17	R	SM 125	98-00	F	FE 501 (4T)	14-20	F	
Multistrada 1260/1260 S	18-21	R	SMS 125 (2T)	02-11	F	TC 510	04-09	F	
Multistrada 1260 Pikes Peak	18-19	R	SMS-4-125 (4T)	10-11	F	TE 510	04-10	F	
Multistrada 1260 Enduro	18-19	R	TC 125 (2T)	14-22	F	TXC 510 Cross Country	08-12	F	
		R	TE 125	11	F	TE 511 (4T)	11-12	F	
		R	TE 125 (2T)	14	F	TXC 511 Cross Country	11-12	F	
		R	WR 125	95-10	F	TC 570	02-03	F	
		R	WRE 125	93-11	F	TE 570	01-04	F	

BUYERS GUIDE
BRAKE PADS

Dimension 1=Width or Diameter, Dimension 2=Height or Diameter, Dimension 3=Thickness (Material and backplate)

NOTE:- Size identification is shown as follows

FA181 Contd. 94 x 37.5 x 7.5mm

HUSQVARNA Contd.

TC 610/E	95-99	F	450 XC-W (4T) Six Days/Champion Edition	13-22	F	250 SC Factory	19-21	F
TC 610	00	F	XC-W 450 Six Days	10-11	F	250 SCF-Factory	19-21	F
TE 610	00	F	XC-W 450	08-09	F	250 SE-R	19-21	F
TE 610/E	95-03	F	XC-W 450 Champions Edition	10	F	250 SE-Factory	19-21	F
TE 610/E	06-09	F	XC-W 450	12-16	F	250 SEF-R	19-21	F
TE 630	10-11	F	XC-W 450	12-22	F	250 SEF-Factory	19-21	F
KTM								
SX 85 Small Wheel 17"/14" wheel size	21-22	F	EXC 500 Six Days	16-20	F	300 SC-Factory	19-21	F
SX 85 Big Wheel 19"/16" wheel size	21-22	F	MX 500	92-95	F	300 SCF-Factory	19-21	F
SX 125	09-22	F	XC-F 500	08	F	300 SE-R	19-21	F
SX 125	09-22	F	XC-F 505	08	F	300 SE-Factory	19-21	F
XC 125	20-22	F	EXC 520/SX 520	01-03	F	300 SEF-R	19-21	F
SX 150	08-22	F	EXC 525	03-07	F	300 SEF-Factory	19-21	F
XC 150	10-15	F	MXC 525	03-04	F	4.5i Enduro	05-12	F
XC-W 150 Tpi	20-22	F	SX 525	03-05	F	4.5 Supermoto	04-07	F
XC-W 200	06-16	F	XC 525 Desert Racing	07	F	450 SCF-Factory	19-21	F
XC 200	06-08	F	EXC 530 (4T)	09-11	F	450 SE-R	19-21	F
EXC-F 250	18-19	F	EXC 530	10-11	F	450 SEF-Factory	19-21	F
SX 250 (2T)	94-16	F	XCR-W 530	08	F	500 SCF-Factory	19-21	F
SX 250 (2T)	09-22	F	XC-W 530 Six Day	10-11	F	500 SEF-R	19-21	F
SX-F 250 (4T)	06-22	F	XC-W 530 (4T) Six Days	10	F	500 SEF-Factory	19-21	F
SX-F 250 Factory Edition & Troy Lee Designs	09-22	F	MXC 550	96	F	5.1i Enduro	05-12	F
XC/EXC 250	94-07	F	EGS 620 Enduro/EGS0E/LSE	96-99	F	TM		
XC/EXCF 250	06-07	F	EGS-E 620 Adventure/Rallye	99	F	MX Models 85/100	02-08	F
XC-F 250	06-09	F	LC4 620 SC Supermoto	00	F	MX Models 125/250/300	02-08	F
XC-F 250	10-22	F	SC 620 Supercompetition	96-00	F	EN 125 2S Inc Tsi (2T)	10-21	F
XC-F-W 250	06-16	F	SX 620 EXC/EGS	94	F	MX 125 2S (2T)	10-21	F
XC-F-W 250 Six Days	11	F	SX EXC/EGS 620	95	F	EN 144 2S Inc Tsi Enduro (2T)	10-21	F
XC 250 (2T)	06-16	F	SX 620	96-99	F	MX 144 2S (2T)	10-21	F
XC 250 Tpi (2T)	19-22	F	LC4 625 SC Supermoto/Supercompetition	02	F	MX 144 (2T)	07-08	F
XC-W 250	06-16	F	SXC 625	03-06	F	MX 450 F	04-08	F
XC-W 250 Tpi (2T)	19-22	F	LC4-E 640 Enduro/Supermoto	00-04	F	MX 530 F (4T)	04-08	F
EGS 300/EXC 300 (Standard forks)	94-98	F	LC-4 640 Adventure R	01-03	F	EN 125 (2T)	01-08	F
EXC 300	04-07	F	LC-4 Adventure	03	F	EN 250 (2T)	01-08	F
EXC 300 (Upside down forks)	99-05	F	690 Enduro	08	F	EN 250 F-ES (4T)	01-08	F
EXC 300 Tpi Erzbergroede	20	F	790 Adventure	18-21	R	EN 250 2S Inc Tsi (2T)	10-21	F
MXC 300 (Standard forks)	94-98	F	790 Adventure R	19-21	R	EN 250 Fi ES (4T)	10-21	F
MXC 300 (Upside down forks)	99-06	F	790 Adventure R Rally	19-21	R	MX 250 2S ES (2T)	10-21	F
SX 300	94-96	F	890 Adventure	21	R	MX 250 Fi ES (4T)	10-21	F
XC 300 (2T)	06-16	F	890 Adventure R	21	R	EN 300 (2T)	01-08	F
XC 300 Tpi (2T)	19-22	F	890 Adventure R Rally	21	R	EN 300 2S Inc Tsi (2T)	10-21	F
XC-W 300	06-16	F	950 Supermoto	05-08	R	EN 300 Fi ES Twin Enduro (4T)	10-21	F
XC-W 300 Tpi (2T)	20-22	F	950 Adventure/S	04-06	R	FT 300 2S ES (2T)	10-21	F
XC-W 300 Six Days	14-16	F	950 R Super Enduro	07-08	R	MX 300 2S ES (2T)	10-21	F
XC-W 300 Six Days Tpi (2T)	20	F	SX-F 505	07	F	MX 300 Fi ES (4T)	10-21	F
EXC 350 LC4	94-95	F	990 Adventure S (Non ABS)	06-08	R	EN 450 F-ES (4T)	04-08	F
EXC-F 350	12-22	F	990 Adventure (ABS Model)	07-12	R	EN 450 Fi ES (4T)	10-21	F
EXC-R 530	08	F	990 Adventure Baja Edition (ABS)	13-14	R	MX 450 Fi ES (4T)	10-21	F
EXC 350/SX 350	96-97	F	990 Adventure R	09-12	R	EN 530 F-ES (4T)	04-08	F
SX-F 350	10-22	F	990 SM-T	10-14	R	EN 530 Fi ES (4T)	10-21	F
XC-F 350	10-22	F	990 SM-R	09-11	R	MX 530 Fi ES (4T)	10-21	F
XCF-W 350	12-22	F	1190 Adventure/Adventure R	13-16	R	TRIUMPH		
XCF-W 350 Side Days	14-16	F	1290 Super Adventure	13-16	R	Bobber Black 1200cc	18-21	F
EXC 380/SX 380	98-03	F	MAICO/M-STAR			Bonneville Speedmaster 1200 Twin	18-21	F
EGS 400/EGS-E/LSE	96-99	F	Disc models	97-99	F	Tiger XCa (With ABS/Spoke Wheels)	15-21	F
EXC/EGS 400	00-02	F	MOTO GUZZI			Tiger XCx (With Abs/Spoke Wheels)	15-21	F
EXC 400 Racing	00	F	1100 Brevia	05-12	R	VERTEMATI		
LC4-E 400 Enduro	00-01	F	Griso 1100	05-08	R	495	99-02	F
SC 400 (Supercompetition LC4)	96-99	F	Quota 1100 ES	99-01	R	C 450/500/570 (MX)	03-04	F
SX 400	00-02	F	1100 Griso (1064cc) Standard Mount Caliper	05-12	R	E 450/501/570 (Enduro)	03-04	F
XC/EXC 400	04-07	F	1200 Griso SE (8v) (Radial caliper) 1151cc	09-19	R	VOR		
XC-W 400	08-11	F	Griso 1200 8V (1151cc)	09-12	R	MX 450/530	04	F
EXC 440	94-95	F	Norge 1200 GT/2V	06-12	R	EN/EN-E 450/530	04	F
SX 440	94-95	F	Norge 1200 GT 8V	10-19	R	YAMAHA		
EXC 450/SX 450	03-07	F	Stelvio 1200 NTX 8V (ABS)	09-19	R	YBA 125 Enticer (3P41)	05	F
EXC 450 (4T)	09-10	F	ROYAL ENFIELD			YBA 125 Enticer (16C1/3P42/3)	07-12	F
EXC 450	10-16	F	Bullet 500 EFI (Brembo caliper Front & Rear)	16-17	F	FZ16 (160cc) (IES1/2/3)	10-13	F
EXC-F 450	18-19	F	Classic 500 (Brembo caliper Front & Rear)	16-17	F	FZ16S (160cc) (IES4)	12-13	F
SX-F 450	03-08	F	Classic 500 Chrome (Brembo caliper Front & Rear)	16-20	F	FZ16ST-Fazer (IKS2/3)	11-13	F
SX-F 450 Inc Factory Edition	09-22	F	Front & Rear)	16-20	F	XTZ 700 Tenere	19-21	F
EXC-R 450	08	F	SHERCO DIRT			ZERO ELECTRIC BIKES		
XCR-W 450	08	F	2.5i Enduro	05-12	F	FX ZF2.8/ZF5.7	15	F
XC-F 450	08-09	F	125 SC-Factory	19-21	F	SFA181 - PIAGGIO		
		F	125 SE-R	19-21	F	X9 500	05-09	F

BUYERS GUIDE
BRAKE PADS

NOTE:- Size identification is shown as follows
Dimension 1=Width or Diameter, Dimension 2=Height or Diameter, Dimension 3=Thickness (Material and backplate)

NOTE:- Size identification is shown as follows
Dimension 1=Width or Diameter, Dimension 2=Height or Diameter, Dimension 3=Thickness (Material and backplate)

FA182 75 x 54 x 10mm

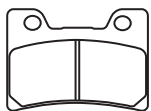

MATERIAL AVAILABILITY												
FA	X	V	R	HH	SV	MXS	SXR	EPFA	GPFA	GPFAFX	SFA	SFAHH
✓				✓								

YAMAHA
FZR 1000 EX-UP D/DC/E/EC 92-93 F

GFA183HH 102.5 x 55 x 8mm

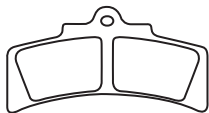

MATERIAL AVAILABILITY												
FA	X	V	R	HH	SV	MXS	SXR	EPFA	GFA	GPFAFX	SFA	SFAHH
									✓			

PVM AFTERMARKET CALIPER
6 Piston (old large design)

FA184 28.5 x 46 x 7mm



MATERIAL AVAILABILITY												
FA	X	V	R	HH	SV	MXS	SXR	EPFA	GPFA	GPFAFX	SFA	SFAHH
✓												

ISR AFTERMARKET CALIPER 22-043 (4 Piston)
22-034 (6 Piston Small) Radial 6 Piston Monoblock
22-036 (2 Piston)

FA185 94 x 34 x 7mm



MATERIAL AVAILABILITY												
FA	X	V	R	HH	SV	MXS	SXR	EPFA	GPFA	GPFAFX	SFA	SFAHH
	✓		✓			✓		✓				

BRAND	Model	Year	Material	Width	Height	Thickness	Part No.	Material	Width	Height	Thickness	Part No.	
APRILIA	RR 2T 125 RC	18-19	F	18-19	15	15	EC 450		01-04	F	KLX 400 SR (KLX 400 A1/A2)	03-04	F
	Enduro RR 125 (2T) MY20	20-21	F	20-21	15	15	EC 450		09	F	KLX 400 R (KLX 400 B1/B2)	03-04	F
	Enduro RR 200 (2T) MY20	20-21	F	20-21	15	15	FSE 450		05-08	F	KLX 450 R (A8F/A9F/AAF/ABF/ACF)	08-12	F
	RR 250 (2T)	15	F	15	15	15	EC 515		09	F	KX 450 F (D6F/D7F/D8F)	06-08	F
	RR 250 2T RC	18-19	F	18-19	15	15	HONDA				KX 450 F (E9F/EAF/EBF/FCF/FDF		
	RR 250 4T	05-08	F	05-08	15	15	CR 125 R		95-07	F	/FEF/FFF/HGF/HHF) (4T)	09-17	F
	Enduro RR 250 (2T) MY20	20-21	F	20-21	15	15	CRF 125 F (17/14" Small Wheels)		14-21	F	KX 450 F 4T	18-22	F
	RR 300 (2T)	15	F	15	15	15	CRF 125 F (19/16" Large Wheels)		14-21	F	KX-F 450 XC	21-22	F
	RR 300 2T RC	18-19	F	18-19	15	15	CRF 150 F		03-21	F	KX 500 E6-E16	94-04	F
	Enduro RR 300 (2T) MY20	20-21	F	20-21	15	15	NRX 150 (KD02/KD03)		03-08	F	KLX 650 R A1-A3/C1-C4/D1	93-96	F
	RR 350 4T Enduro	11-15	F	11-15	15	15	CRF 230 F		03-21	F	SUZUKI		
	RS 350 Dual Sport	11-12	F	11-12	15	15	CRF 230 L		08-11	F	RM 125 T/V/W/X/Y/K1-K8	96-08	F
	Enduro RR 350 (4T) MY20	20-21	F	20-21	15	15	CRF 230 M		09-11	F	DR-Z 250 K1-K7	01-07	F
	RR 390 (4T)	15	F	15	15	15	CR 250 R		95-07	F	RM 250 T/V/W/X/Y/K1-K8	96-08	F
	Enduro RR 390 (4T) MY20	20-21	F	20-21	15	15	CRF 250 R		04-22	F	RMX 250 T/V/W/X/Y	96-00	F
	RR 400 4T	10-11	F	10-11	15	15	CRF 250 RX		19-21	F	RM-Z 250	04-21	F
	RR 400 T Enduro	12-14	F	12-14	15	15	CRF 250 X		04-16	F	DR 350 SEW/SEX	98-99	F
	RS 400 Dual Sport	08-11	F	08-11	15	15	NX 250		88-90	F	DR-Z 400 SY/SK1-SK9/SL1-SL5	00-16	F
	SM 400 Supermoto	10-11	F	10-11	15	15	XR 250 L		93-96	F	DR-Z 400 EY/EK1-EK7/K2-K6	00-07	R
	RR 430 (4T)	15	F	15	15	15	XR 250 R		96-04	F	DR-Z 400 SMK5-SMK9/SML3-SML6	05-09/13-16	F
	RS 430 (4T)	15	F	15	15	15	XR 400 R		96-04	F	RM-Z 450	05-21	F
	Enduro RR 430 (4T) MY20	20-21	F	20-21	15	15	CRF 450 R		02-22	F	DR 650 S	96-21	F
	RR 450 4T	05-11	F	05-11	15	15	CRF 450 RL		21-22	F	YAMAHA		
	RR 450 4T Enduro	12-14	F	12-14	15	15	CRF 450 R-S		2022	F	YZ 125 K/L/M/N/P/R/S/T/V/W	98-07	F
	RS 450 Dual Sport	08-14	F	08-14	15	15	CRF 450 RWE		19-22	F	WR 250 FN/FP/FR/FS/FT/FV/FW/FX/FY		
	SM 450 Supermoto	10-11	F	10-11	15	15	CRF 450 X		05-21	F	/FZ/FA/FB/FD/FE/FF/FG/FH/FJ	01-18	F
	RR 480 (4T)	15	F	15	15	15	CRF 450 RX (18" Rear wheel)		17-21	F	WR 250 R	08-21	F
	Enduro RR 480 (4T) MY20	20	F	20	15	15	TRX 450 R/ER		04-11	F	YZ 250 K/L/M/N/P/FP/R/FR/S/FS/FT		
	RR 498 (4T)	15	F	15	15	15	CR 500 R		95-01	F	/T/FV/N/W	98-07	F
	RS 500 (4T)	15	F	15	15	15	XR 600 R		93-16	F	WR 400 FK/FL/FM	98-00	F
	Enduro 500 RR-S (4T) MY20	20-21	F	20-21	15	15	XR 650 R		00-02	F	YZ 400 FK/FL	98-99	F
	RS 520 Dual Sport	08-14	F	08-14	15	15	XR 650 L		93-21	F	YZ 426 FM/FN/FP	00-02	F
	SM 520 Supermoto	10-11	F	10-11	15	15	TRX 700 XX		00-07	F	WR 426 FN/FP	01-02	F
	RR 525 4T	10-11	F	10-11	15	15	KAWASAKI		08-11	F	YZ 450 FR/FS/FT/FV/FW	03-07	F
	RR 525 4T Enduro	05-09	F	05-09	15	15	KX 125 K1-K5/L1-L4/M1-M2/R1/R6F/R7F				WR 450 FW/FX/FY/FZ/FA/FB/FD/FE/FF	07-15	F
	Xtrainer 2T 200	18-19	F	18-19	15	15	KX 250 N1/N2/T6F/T7F/T8F (KX 250 F)				ZERO ELECTRIC BIKE		
	GAS-GAS						KX 250 F (4T)		94-05	F	DS ZF8.5/ZF11.4 (Nissin calipers)	13	F
	EC 125/200/250/300	01-12	F	01-12	15	15	KX-F 250 XC		95-06	F	DS ZF8.5/ZF11.4 (Nissin Fr calipers)	14	F
	EC 125/250/300	20	F	20	15	15	KLX 250 R D2/D3/D4		97-06	F	FX ZF2.8/ZF5.7 (Nissin calipers)	13	F
	EC Six Days 250/300	19	F	19	15	15	KLX 250 S (KLX 250 H6F/H7F)		94-07	F	FX ZF2.8/ZF5.7 (Nissin Fr calipers)	14	F
	XC 200/250/300	20	F	20	15	15	KLX 300 R A2-A10/A6F/A7F		04-08	F	MX ZF2.8/ZF5.7 (Nissin calipers)	13	F
	MC 125	05	F	05	15	15			09-22	F	S ZF8.5/ZF11.4 (Nissin calipers)	13	F
									94-96	F	S ZF8.5/ZF11.4 (Nissin Fr calipers)	14	F
									06-07	F	SR ZF11.4 (Nissin Fr calipers)	14	F
									97-07	F			

SFA186 31.5 x 51 x 5.5mm



MATERIAL AVAILABILITY												
FA	X	V	R	HH	SV	MXS	SXR	EPFA	GPFA	GPFAFX	SFA	SFAHH
											✓	

VESPA
PX 150 (All models) 05-06 F

FA187 68 x 54 x 8mm

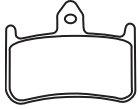

MATERIAL AVAILABILITY												
FA	X	V	R	HH	SV	MXS	SXR	EPFA	GPFA	GPFAFX	SFA	SFAHH
✓				✓				✓				

HONDA
VFR 750 R (RC30) 90 F CBR 900 RR Fireblade 93-97 F
RVF 750 R (RC45) 94-95 F VTR 1000 F 'Superhawk' 98-05 F
919 (CB 900 F) 02-07 F CB 1000 94-95 F

FA188 89 x 53 x 8.5mm

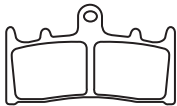

MATERIAL AVAILABILITY												
FA	X	V	R	HH	SV	MXS	SXR	EPFA	GPFA	GPFAFX	SFA	SFAHH
✓				✓				✓				

KAWASAKI
ZX-6R (ZX 600 G1/G2) 98-99 F VN 1500 P1/P2 'Vulcan 1500 Mean Streak' 02-03 F
ZX6R (ZX 600 J1/J2/J3) 00-02 F VN 1600 B1 Mean Streak 04 F
ZX6R (ZX 636 A1) 02 F **SUZUKI**
ZZR 600 (ZX 600 J4/J6F/J7F/J8F) 05-08 F GSX-R 750 WR/WS/T/V/W/X 94-99 F
Ninja ZX 7R (6 Piston Pad) GSXR 1000 K1/K2 01-02 F
(ZX 750 P1-P8) Tokico Caliper 96-03 F GSX-R 1100 WP/WR/WS/WT/WV/MW 93-98 F
ZX-9R B3/B4/C1/C2 "Ninja" 96-99 F TL 1000 RW/RX/RY/RK1/RK2/RK3 98-03 F
ZX9R (ZX 900 E1/E2) 00-01 F GSX 1200 SK1/SK3-SK5/K1-K3 01-05 F
(ZR 1100 C3/C4) ZRX 1100 99-00 F GSX 1300 RX/RY/RK1/RK2-RK6
ZRX 1200 R (ZR 1200 A1/A2/A3/A4/A5) 01-05 F /RZK3-RZK6 Hayabusa 99-06 F
ZX12R (ZX 1200 A1/A2/B1/B2) 00-03 F VZ 1600 K4 Marauder 04 F Left

FA189 125.5 x 45 x 9mm

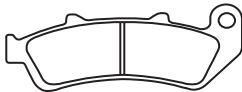

MATERIAL AVAILABILITY												
FA	X	V	R	HH	SV	MXS	SXR	EPFA	GPFA	GPFAFX	SFA	SFAHH
✓				✓								

HONDA
CBR 1000 F 93-99 F & R

FA190 99 x 49.5 x 9.5mm

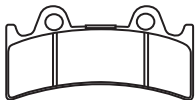

MATERIAL AVAILABILITY												
FA	X	V	R	HH	SV	MXS	SXR	EPFA	GPFA	GPFAFX	SFA	SFAHH
✓		✓		✓				✓				

PRE TECH AFTERMARKET CALIPER **YAMAHA**
6 Piston YZF 750 R/SP 93-96 F
TRIUMPH FZR 1000 EX-UP F/FC/G/GC 94-96 F
Daytona Super III (3 cyl) 94-97 F

FA191 132 x 80 x 9.5mm

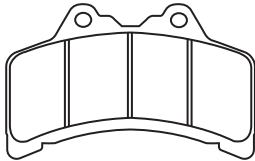

MATERIAL AVAILABILITY												
FA	X	V	R	HH	SV	MXS	SXR	EPFA	GPFA	GPFAFX	SFA	SFAHH
✓												

YAMAHA
GTS 1000 AE/AEC/AF/AFC 93-96 F

FA192 A 90 x 51 x 8.5mm
B 68 x 52 x 9.5mm



MATERIAL AVAILABILITY												
FA	X	V	R	HH	SV	MXS	SXR	EPFA	GPFA	GPFAFX	SFA	SFAHH
✓		✓		✓								

KAWASAKI
ZR 550 B4 Zephyr 93 R EX 650 Ninja (EX 650 ECF/EDS/EEF/EGF) (Non ABS) 12-16 R Z 1000 (ZR 1000 A1-A3/A6F) 03-06 R
ZX 6R (ZX 600 F1-F3/G1/G2/J1-J3) 94-02 R EX 650 Ninja (EX 650 FDS/FEF/FFF/FGF) (ABS) 13-16 R Z 1000 (ZR 1000 C1/C2/E1/E2/F1/F2) 98-03 R
ZX 6RR (ZX 600 K1/M1/N1) 599cc 03-05 R KLE 650 A7F-A9F/CAF/CBF/CCF/CDF/CEF Versys 07-14 R Z 1000 HCF/HDF Ninja 1000 ABS 12-13 R
ZX 6R (ZX 636 A1) 02 R KLE 650 DEF Versys (ABS Model) 14 R 1000 Ninja (ZX 1000 GBF/GCF/GDF) 11-13 R
ZX 6R (ZX 636 B1/B2/C1/C6F/D6F) 636cc 03-06 R Z 750 S (ZR 750 K1/K6F) 05-06 R 1000 Ninja ABS (ZX 1000 MEF/MFF) 14-20 R
ZX 6R (ZX 600 P7F/P8F/R9F/RAF/RBF/RCF) 07-12 R ZX-9R B1/B2/B3/B4 Ninja 94-97 R GPZ 1100 (ZX 1100 E1-E3/F1) 95-97 R

SFA193 40 x 51 x 7mm



MATERIAL AVAILABILITY												
FA	X	V	R	HH	SV	MXS	SXR	EPFA	GPFA	GPFAFX	SFA	SFAHH
											✓	✓

APRILIA				MALAGUTI								
Scarabeo Road 50 (drum rear)	99-05	F	Phantom F12	98-04	F & R							
Scarabeo 50 Ditech (rear disc model)	02-08	F & R	Ciak 50	02-04	F							
SR 50	99-03	F & R	F10 Jetline	02-04	F							
SR 50 (Factory)	04-15	F	F15 Firefox (LC)	04	R							
Rally 50 (Air cooled)	04-05	F	PIAGGIO									
Mojito Retro 50	04-05	F	Typhoon 50 (2T/10" Wheels)	07-09	F							
Mojito Custom 50	04-06	F	YAMAHA									
Scarabeo 100 4T	04-14	F	CW 50 (BW's)	98-99	F							
			CW 50 M/N Zuma II	00-01	F							
			CW 50 L/TL Zuma/Zuma II	99	F							

FA194 A 90 x 51 x 8.5mm B 68 x 52 x 9.5mm



MATERIAL AVAILABILITY												
FA	X	V	R	HH	SV	MXS	SXR	EPFA	GPFA	GPFAFX	SFA	SFAHH
✓				✓							✓	✓

AJP				Pampera 125/450				05-06 F				
PR3 200 Enduro/Enduro Pro	12-14	F	Pampera 250	02-03	R							
PR3 200 M/X Pro	12-14	F	SCORPA									
APRILIA				4T-Ride 250 F				06-08 F				
RS 50 "Replica"	99-05	F	VESPA									
RX 50/RX 50 Racing	04	F	GT 200 L Granturismo (Grimeca caliper)	05-09	F							
MX 50	04	F	SFA194									
BETA				CPI								
RR 50	18-19	F	GTR 50	05-09	F							
RR 50 Sport/Racing	18-19	F	GTR 150/180	05-09	F							
RR Enduro LC	18-19	F	PEUGEOT									
RR 2T 125	18-19	F	Elyseo 125/150	03-05	F							
GAS-GAS				Elystar 125/150 P				03-05 F				
EC 50	05	F	Jet Force 125 EFI/Compressor	03-05	F							
SM 50	05	F	PIAGGIO									
Pampera 125/250/280	04	F	BV 200 (Grimeca Caliper)	02-06	F & R							

FA196 101 x 39 x 9mm

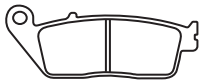

MATERIAL AVAILABILITY												
FA	X	V	R	HH	SV	MXS	SXR	EPFA	GPFA	GPFAFX	SFA	SFAHH
✓		✓		✓							✓	✓

BMW				NM4 - NC 700 JD (DCT)				15-20 F VTX 1300 T				
C600 Sport	12-15	R	NC 700 X (Manual G/Box)	12-14	F	GL 1500 C/CT/CF/CD Valkyrie /Valkyrie Tourer	97-03	R				
C650 Sport	16-21	R	VF 750 C Magna/Magna Deluxe CD/C2	94-03	F	INDIAN						
C650 GT	12-21	R	VFR 750 F	90-97	R	Chief	22	R				
BUELL				CB 750 Nighthawk				91-03 F Dark Horse				
Blast	00-07	F	VT 750 C/CD/CD2	98-02	F	Bobber	22	R				
DAELIM				VT 750 CD/DC/DCA/DCB Shadow Spirit				01-08 F Bobber Dark Horse				
Roadwin 125	04-09	F	VT 750 CDA/CDB/CDC/CDD Shadow			Super Chief	22	R				
Daystar 125	03-09	F	Ace 750 Deluxe	02-03	F	Super Chief Limited	22	R				
HONDA				VT 750 C2/C2F Shadow Spirit				07-13 F Chief Dark Horse (Nissin calipers)				
CBR 300 R	18-20	F	VT 750 T Shadow Tourer	09	F	Chief Vintage (Nissin calipers)	14-21	R				
CMX 300 Rebel	18-21	F	VT 750 C/CA Shadow Aero	04-07	F	Chieftain (Nissin Calipers/Cast Wheels)	14-21	R				
CMX 300 Rebel ABS	18-21	F	VT 750 C2 Shadow Spirit	07-14	F	Chieftain Dark Horse (Nissin Calipers /Cast Wheels)	14-21	R				
NSS 300 A Forza	18-21	F	VT 750 DC/DCA/DCB Shadow Spirit	01-07	F	Chieftain Limited (Nissin Calipers /cast wheels)	14-21	R				
CB 500 F (Non ABS)	13-21	F	VT 750 RS Shadow	10-14	F	Chieftain Elite (Nissin Calipers/Cast Wheels)	14-21	R				
CB 500 FA (ABS)	13-21	F	VT 750 C2B Shadow Phantom	10-21	F	Challenger (Brembo calipers/cast wheels)	20-21	R				
CB 500 X (Non ABS)	13-21	F	VT 750 Shadow Aero	08-15	F	Challenger Dark Horse (Brembo calipers /cast wheels)	20-21	R				
CB 500 XA (ABS)	13-21	F	CBR 1000 F	90-91	R	Challenger Limited (Brembo calipers /cast wheels)	20-21	R				
CBR 500 R (Non ABS)	13-21	F	ST 1100	91-02	R	Roadmaster (Nissin Calipers/Cast Wheels)	15-21	R				
CBR 500 RA (ABS)	13-21	F	ST 1100 A 'ABS Model'	95	R	Roadmaster Dark Horse (Nissin Calipers /Cast Wheels)	15-21	R				
CMX 500 Rebel	13-21	F	VT 1100 C Shadow/Shadow Spirit	94-07	F	Roadmaster Limited (Nissin Calipers /Cast Wheels)	15-21	R				
CMX 500 Rebel ABS	13-21	F	VT 1100 C2 American Classic Edition			Roadmaster Dark Horse (Nissin Calipers /Cast Wheels)	15-21	R				
VT 600 C/CD/CD2 Shadow VLX/Deluxe	94-07	F	/C2-2/C3/C2 Sabre	95-07	F	Roadmaster Elite (Nissin Calipers /Cast Wheels)	15-21	R				
CTX 700 (Top Faring/Manual G/Box)	14-17	F	VT 1100 T Shadow American Classic			Roadmaster Elite (Nissin Calipers /Cast Wheels)	15-21	R				
CTX 700 D (Top Faring/Auto G/Box)	14-20	F	Edition Tourer	98-01	F	Roadmaster Limited (Nissin Calipers /Cast Wheels)	15-21	R				
CTX 700 N (Naked/Manual G/Box)	14-16	F	VT 1300 CX Fury (Non ABS Model)	10-21	F	Roadmaster Dark Horse Jack Daniel's Edition (Nissin Calipers/Cast Wheels)	21	R				
CTX 700 ND (Naked/Auto G/Box)	14-19	F	VT 1300 CS Sabre (Non ABS)	10-14	F	Roadmaster Elite (Nissin Calipers /Cast Wheels)	15-21	R				
FSC600/D Silverwing	02-10	F	VT 1300 CR Stataline/CT Interstate (Non ABS)	10-15	F	Roadmaster Elite (Nissin Calipers /Cast Wheels)	15-21	R				
FSC600 A Silverwing ABS Model (276mm front disc)	03-14	F	VTX 1300 C	04-11	F	Roadmaster Elite (Nissin Calipers /Cast Wheels)	15-21	R				
NSA 700 A9 "DN-01"	09-11	R	VTX 1300 S	03-07	F	Roadmaster Elite (Nissin Calipers /Cast Wheels)	15-21	R				
			VTX 1300 R	05-11	F	Roadmaster Elite (Nissin Calipers /Cast Wheels)	15-21	R				

BUYERS GUIDE
BRAKE PADS

NOTE:- Size identification is shown as follows
Dimension 1=Width or Diameter, Dimension 2=Height or Diameter, Dimension 3=Thickness (Material and backplate)

FA196 101 x 39 x 9mm Contd.

Springfield	16-21	R	Bonneville T214 (Black/Spoke Wheel)	15	F	Vision Tour (All models)	08-17	R
Springfield Dark Horse	19-21	R	Legend TT	98-01	F & R	Cory Ness Jackpot	08-10	R
KYMCO STREET			Speedmaster 800	03-04	F	Cory Ness Victory Cross Country	11-12	R
Venox 250	03-07	F	Scrambler (865cc/Carbs)	06-09	F	Cross Country	10-17	R
LYNDALL BRAKES			Scrambler (865cc/EFI)	10-16	F	Cross Country Touring	13-17	R
PAD REF 7176			Scrambler (900cc/EFI)	17	F	Cross Country 8-Ball	15-16	R
SUZUKI			Speedmaster(865cc/EFI) Cast Wheel Eng # 392060 to 46049/ 6 Bolt F/Disc	09-10	F	Cross Roads Classic (Spoke Wheel) Cross Roads 8 Ball (Cast Wheel)	10-13 13-14	R R
VL 1500 BL3/BL4/BL5 (Boulevard C90 B.O.S.S./Cast Wheels)	13-15	F	Speedmaster(865cc/EFI) 5 Spoke Cast Wheel Eng # 46050 Onwards/ 5 Bolt F/Disc	11-17	F	Gunner	15-17	R
VL 1500 BLT3 (Boulevard C90 B.O.S.S. /With Windshield)	13	F	Thunderbird	95-03	F & R	Vision 8 Ball	10-11	R
VL1500 L3 (Boulevard C90)	13	F	Thunderbird Sport	98-03	F & R	Jackpot	10-16	R
VL1500 TL3/TL4/TL5 (Boulevard C90T /With Windshield)	13-15	F	Tiger (885cc)	97-99	F & R	Magnum/Magnum X-1	15-17	R
TRIUMPH			Tiger 885i	98-99	F & R	Arlen Ness Victory Vision	09-12	R
Adventurer	96-01	F & R	Tiger 955cc	99-04	F & R	Zach Ness Vegas	11-12	R
America 865cc (Cast wheel)	06-17	F	Tiger 955 (Cast wheel model)	04-06	F	Judge	12-17	R
America LT 865cc (Cast wheel/Wind Shield)	14-17	F	VICTORY			Hard Ball (Spoke Wheel)	12-13	R
Bonneville America	02-06	F	Broadwalk (Spoke Wheels)	13-14	F	SFA196		
Bonneville 800	01-06	F	Vegas	08-17	R	BMW		
Bonneville (865cc/cast wheel)	09-15	F	Vegas Low	08-09	R	C600 Sport	12-14	R
Bonneville/Bonneville Black	06-08	F	Vegas Jackpot	08-12	R	C650 GT	12-15	R
Bonneville SE (865cc/cast wheel)	09-12	F	Hammer	08-11	R	C650 GT Special Edition	15	R
Bonneville T100 (Spoke wheels/865cc)	10-15	F	Hammer S	08-17	R	HONDA		
Bonneville T100 (865cc) Steve McQueen	12	F	Hammer 8 Ball	10-16	R	FSC600/D Silverwing	02-10	F
Bonneville T100	02-09	F	Highball (Cast & Spoke Wheel)	12-17	R	FSC600 A Silverwing ABS Model		
Bonneville T100 (865cc)	10-14	F	King Pin	08-12	R	(276mm front disc)	03-14	F
Bonneville T100 (865cc) Steve McQueen	12	F	Kingpin Tour	08-09	R	NSA 700 A9 "DN-01"	09-11	R
Bonneville T100 Black	14-15	F	Kingpin 8-Ball	08-11	R	YAMAHA		
Bonneville T100 Spirit SE (Spoke Wheels)	15	F	Kingpin-Low	09	R	XC 155 S-Max	15-19	F
Bonneville T100 Newchurch SE (Cast Wheels)	15	F	Vegas 8-Ball	08-17	R	G Zuma	16-21	
		F	Vision Street	08-09	R	YW 125 MB	21-22	

FA197 A 96.5 x 42 x 9mm B 77.5 x 42 x 9mm



DAELIM													
Roadwin 125	04-09	R											
HONDA													
Dream 50 R (CB 50) (AR02)	04	F											
NSR 50 R (RS 50)	04	F											
NSF 100 R	06	F											
KAWASAKI													
BN 125 A4-A8/A6F/A7F/A9F Eliminator	01-09	F											
Ninja 125	17-21	F & R											
Z 125	17-21	F & R											
EX 250 (Ninja 250 R) J8F/J9F/JAF/JBF/JCF	08-12	F & R											
EX 300 ADF/ADFA/AEF/AEFA/AES/AFF/AGF													
Ninja 300 (Non ABS)	13-16	F & R											
EX 300 AEF/AEFA/AES/AFF/AGFA													
Ninja SE 300 (Non ABS)	14-16	F & R											

MATERIAL AVAILABILITY												
FA	X	V	R	HH	SV	MXS	SXR	EPFA	GPFA	GPFAFX	SFA	SFAHH
✓				✓				✓		✓	✓	✓

EX 300 BDF/BDFA/BEF/BES/BFF/BGF	13-16	F & R											
Ninja 300 (ABS Model)													
EX 300 BEFA/BESA/BFFA/BGFA Ninja	14-16	F & R											
/Ninja SE 300 (ABS Model)													
KLE 300 Versys-X	18-21	R											
Ninja 400	17-21	F & R											
Ninja 400 KRT	18-21	F & R											
Z 400 ABS	19-21	F & R											
EL 650 E8F/E9F/EAF/EBF/ECF/EDF	08-15	R											
/EEF/EFF (KLR 650)													
MZ													
RT 125	02-05	F											
YAMAHA													
YBR 125 EB (5RR2/3/4/5/6/8/9)	02-08	F											
YS 250 Fazer (5D41/2/3/56C1)	06-10	F											
Ninja 400	17-18	F & R											
SFA197 - DAELIM													
S2-125/S2-250	06-09	R											
KYMCO													
Super 9 AC	02-09	F											
K-Pipe 125	20-21	F											
Spade 150i	20-21	F											
Bet & Win 150/250	02-08	F & R											
Grand Vista 250 (SH 50 DF)	05-11	F											
People 250	03-07	R											
People S 250	07-11	F Right											
Yager GT 200 i	09-12	F & R											
Like 200i (All Models)	10-15	R											
Quannon 150 (RK30E)	09-12	F & R											
SUZUKI Street													
UH 200 Burgman ABS	14-22	F											
AN 400 K7-K9/AK9/AL0-AL6 Burgman	07-16	F Right											
AN 400 ZA	14-21	F Right											
UM (UNITED MOTORS)													
X-Peed 250 i	08	R Right											

FA199 94 x 40.5 x 10mm



MATERIAL AVAILABILITY												
FA	X	V	R	HH	SV	MXS	SXR	EPFA	GPFA	GPFAFX	SFA	SFAHH
✓		✓		✓							✓	✓

YAMAHA													
XV 250 Virago All models	95-07	F											
XV 250 V-Star	08-13	F											
FZ6	04-06	F											
FZ6R	09-17	F											
XVS 1100 V Star Custom/V Star Classic	99-09	F											
XVS 1100 V-Star Silverado	03-09	F											
XVS 1100 W-M V-Star Custom Midnight	07	F											
XVS 1300 V-Star 1300 Tourer	07-14	F											
XVS 1300 V-Star	07-14	F											
XVS 1300 V-Star Deluxe	13-14	F											
SFA199 - YAMAHA ROAD													
CP 250 V/W/X Morphus	06-08	F											
YP 250 Majesty (5CV1)	97	F											
YP 250 Majesty (5GM2/9-5SJ2/5/9)	00-03	F											
XP 500 T-Max (5VUA/15B1)	05-08	F											

BUYERS GUIDE
BRAKE PADS

NOTE:- Size identification is shown as follows
Dimension 1=Width or Diameter, Dimension 2=Height or Diameter, Dimension 3=Thickness (Material and backplate)

NOTE:- Size identification is shown as follows
Dimension 1=Width or Diameter, Dimension 2=Height or Diameter, Dimension 3=Thickness (Material and backplate)

FA200 104 x 62.5 x 11mm

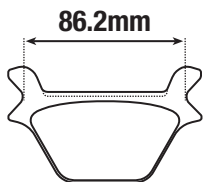

**INCLUDES STEEL
SLIDER SHIMS**

MATERIAL AVAILABILITY												
FA	X	V	R	HH	SV	MXS	SXR	EPFA	GPFA	GPFAX	SFA	SFAHH
✓		✓		✓				✓				

HARLEY DAVIDSON
FXD/FXDL/FXDWG/FXR/FXRS/FXRT
/FXRD/FXLR
FXST, FXSTB, FXSTC, FXSTS, FLST, FLSTC, FLSTF, Late 87-99 R

FLSTS, FLSTN
XL/XLH/XLCH/XLS/XLX
Late 87-99 R

LYNDALL BRAKES
PAD REF 7058

Late 87-99 R
Late 87-99 R

FA201 104 x 62.5 x 11.5mm

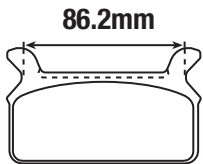

MATERIAL AVAILABILITY												
FA	X	V	R	HH	SV	MXS	SXR	EPFA	GPFA	GPFAX	SFA	SFAHH
✓		✓		✓								

LYNDALL BRAKES
PAD REF 7157

FA203 81 x 42 x 9.5mm



MATERIAL AVAILABILITY												
FA	X	V	R	HH	SV	MXS	SXR	EPFA	GPFA	GPFAX	SFA	SFAHH
✓				✓								

HONDA
CBR 600 F2 91-94 F

FA208 78 x 41 x 9mm



MATERIAL AVAILABILITY												
FA	X	V	R	HH	SV	MXS	SXR	EPFA	GPFA	GPFAX	SFA	SFAHH
	✓		✓			✓		✓				

ATK

All Models 97-03 R
125 (2 stroke enduro) 03 R
250/260 (2 stroke engine) 03 R
450 MX 07 R
450 XC 07 R
Enduro 450 07 R
500 Enduro 03 R
605 Enduro 03 R
700 (2T) Intimidator 04 R
620 (2T) Intimidator 04 R
500 (2T) 04 R
370 (2T) 04 R
250 (2T) 04 R

GAS-GAS

Enduros 125/250 00 R

HUSABERG

All Models 95-12 R

HUSQVARNA

CR 125 95-04 R
SM 125 98-00 R
SMS 125 (2T) 02-11 R
SMS-4-125 (4T) 10-11 R
WR 125 95-05 R
WRE 125 93-11 R
CR 250 95-04 R
TC 250 02-03 R
TE 250 02-05 R
WR 250 95-05 R
WR 250 06-12 R
XC-W 250 10 R
XCF-W 250 10 R
TE 300 (2T) 11 R
WR 300 09-12 R
TE 350 95-97 R
WR 360 95-02 R
SM 400 R 02 R
TE 400 02 R
Vitpilen 401 18-21 R
Svartpilen 401 19-21 R
TE 410 95-00 R
TE 410 E 00 R

SM 450 R 03-06 R EXC 450 03 R
TC 450 03 R MX 500 95 R
TE 450 03-05 R EXC 520/SX 520 01-03 R
SM 510 R 05- R EXC 525 03 R
TC 510 04 R MXC 525 03-04 R
TE 510 04-05 R MXC 550 96 R
SM 570 R (4 bolt front disc) 01-04 R Duke 620 LC4 94-98 R
TC 570 02-03 R EGS 620 Enduro/EGS-E/LSE 96-99 R
TE 570 01-04 R EGS-E 620 Adventure/rally 99 R
LT 610 (6 bolt front disc) 00 R LC4 620 SC Supermoto 00 R
SM 610 (6 bolt front disc) 98-99 R SC 620 Supercompetition 96-00 R
SM 610 R 00 R SX EXC/EGS 620 95 R
SM 610/S (4 bolt front disc) 02-06 R SX 620 96-99 R
SM 610 S (Radial caliper) 06 R LC4 625 SC Supermoto/Supercompetition 02 R
SM 610 IE 07-09 R SMC 625 05 R
TC 610/E 95-99 R SXC 625 03-04 R
TC 610 00 R Duke II 640 Orpheus/Titan/Lime 01- R
TE 610 00 R Duke II 640 Black/Orange 02 R
TE 610/E 95-03 R LC4-E 640 Enduro/Supermoto 00-04 R
TE 610/IE 06-09 R LC-4 640 Adventure-R 99-02/04 R
SM 630 09-10 R LC-4 640 Adventure 03/05-07 R
SMR 630 06 R 640 Duke Jet Black/Yellow/Adrenalin Orange 03-05 R
SMS 630 10-11 R SMC 640 LC4 05 R
STR 650 CRC 07 R SMC 660 Supermoto 03-04 R
KTM
SMC 660 05 R
EXC/EGS 200 98-03 R 690 Rally Factory Rep 07-08 R
SX 250 94-02 R 690 Enduro 08 R
EGS 300 (Standard forks) 94-98 R 690 Enduro R Inc ABS 10-19 R
EXC 300 (Standard forks) 94-98 R 690 SMC 08-11 R
EXC 300 (Upside down forks) 99-03 R 690 SMC R ABS 10-19 R
MXC 300 (Standard forks) 94-98 R 690 Supermoto 02-08 R
MXC 300 (Upside down forks) 99-03 R 790 Duke 18-19 R
SX 300 94-96 R 790 Adventure/R 18-19 R
EXC 350 LC4 94-95 R
EXC 350/SX 360 96-97 R
EXC 380/SX 380 98-03 R
Duke 400 LC4 94-98 R
EGS 400/EGS-E/LSE (LC4 Enduro) 96-99 R
EXC/EGS 400 00-02 R
EXC 400 Racing 00 R
LC4-E 400 Enduro 00-01 R
SC 400 Supercompetition LC4 96-99 R
SX 400 00-02 R
EXC 440 94-95 R

FA210 112 x 56.5 x 11mm



MATERIAL AVAILABILITY												
FA	X	V	R	HH	SV	MXS	SXR	EPFA	GPFA	GPFAFX	SFA	SFAHH
✓		✓										

BUELL
M2 Cyclone® (Disc has Countersunk bolt holes) 94-97 F **S3 Thunderbolt®** (Disc has Countersunk bolt holes) 94-97 F
S1 Lightning® (Disc has Countersunk bolt holes) 94-97 F **PERFORMANCE MACHINE AFTERMARKET CALIPER** 125 X 6
S2 Thunderbolt® (Disc has Countersunk bolt holes) 94-97 F 137 X 6

FA213 78 x 41 x 9mm



MATERIAL AVAILABILITY												
FA	X	V	R	HH	SV	MXS	SXR	EPFA	GPFA	GPFAFX	SFA	SFAHH
✓		✓		✓							✓	✓

APRILIA		S 1000 RR/RR Sport/RR M Sport		18-21	R	SFA213						
Dorsoduro 750	08-15	R	HP4 (1000cc)	13-14	R	BMW						
Shiver 750 SL	07-15	R	DUCATI			C1 125					99-03	R
Dorsoduro 900	18-21	R	Scrambler Sixty 2 (Cast Wheels/399cc)	16-17	R	C1 200					01-03	R
Shiver 900	18-21	R	797 Monster	17	R	YAMAHA						
Caponord 1200	14-15	R	Scrambler Classic (Spoke Wheels/803cc)	15-17	R	YW125 G Zuma (Rear Disc Model)					16	R
Dorsoduro 1200	11-14	R	Scrambler Icon (Cast Wheels/803cc)	15-21	R	XC155 F/G - S-Max					15-16	R
BMW			Scrambler Urban Enduro			ZERO ELECTRIC						
F 650 (E169/0161)	09/93-96	R	(Spoke Wheels/803cc)	15-21	R	DS ZF805/ZF11.4					15	R
F 650 (E169/0162) Funduro/			Scrambler Full Throttle			DS ZF9.8/ZF13.0					16-17	R
High Screen/19" front wheel	97-00	R	(Cast Wheels/803cc)	15-21	R	DS ZF7.2/14.4					19-20	R
F 650 CS Scarver (K14/0174/0184)			Scrambler Flat Tracker Pro			DSR ZF13.0					17-20	R
Belt drive/17" cast wheel	00-03	R	(Cast Wheels/803cc)	16-17	R	DS ZF7.2/14.4					19-20	R
F 650 CS Scarver K14/0177/0187			Scrambler Café Racer			FX ZF2.8/ZF5.7					15	R
Belt drive 17" cast wheel	04-07	R	(Cast wheels/803cc)	17-21	R	FX ZF3.3/ZF6.5					16-17	R
F 650 GS (R13/0172/0182)	99-03	R	GT 1000 (992cc)	07-10	R	FXS ZF3.3/ZF6.5					17	R
F 650 GS Dakar (R13/0173/0183)			GT 1000 Touring Sport Classic	09	R	S ZF9.4/ZF12.5					15	R
21" front wheel	99-03	R	Paul Smart 1000 LE (992cc)	06	R	S ZF9.8/ZF13.0					16-17	R
F 650 GS (R13/0175/0185)			Sport 1000 S	07-09	R	S ZF7.2/14.4					19-20	R
Single cylinder 19" front wheel	04-07	R	Sport Classic 1000 (992cc)	06-08	R	SR ZF12.5					15	R
F 650 GS Dakar (R13/0176/0186)			HARLEY DAVIDSON			SR ZF13.0					16-17	R
21" front wheel	04-07	R	Pan America Adventure 1250	20-21	R	SR ZF7.2/14.4					19-20	R
F 650 GS (K72/0218/0228)			HUSQVARNA			SR/F ZF75-10/14.4					19-20	R
(798cc twin cylinder/cast wheel)	06-17	R	TR 650 Terra (Spoke wheel)	13	R							
F 650 GS (30 Years GS)			TR 650 Strada (Cast wheel)	13	R							
(Twin cylinder 798cc/cast wheel)	11	R	900 Nuda	12-13	R							
F 650 GS Sertao (Spoke wheel			900 Nuda R	12-13	R							
/single cylinder/chain drive)	10-14	R	INDIAN									
F 650 ST (E169/163/168) Strada			Scout all options	17-21	R							
(18" front wheel/low screen)	97-00	R	Scout Bobber	19-21	R							
G 310 R/GS	17-18	R	Scout Sixty	17-21	R							
G 310 GS Edition 40	20-21	R	KTM									
G 650 GS (R131) (Single cylinder/			Duke 390	15-21	R							
chain drive/Cast Wheels)	09-15	R	RC 390	15-21	R							
G 650 Xchallenge	07-09	R	690 Duke (4 Pad Type Caliper)	08-11	R							
G 650 Xmoto	07-09	R	690 Duke (2 Pad Type Caliper)	12-15	R							
G 650 Xcountry	07-09	R	690 Duke R (4 Pad Type Caliper)	10-11	R							
F 700 GS (Twin Cylinder/798cc/			790 Duke	20-21	R							
Cast Wheel)	11-18	R	990 Superduke	05-11	R							
F 750 GS	18-19	R	990 Superduke R	07-11	R							
F 750 GS Edition 40	20-21	R	ROYAL ENFIELD									
F 800 GS (Twin Cylinder/798cc			Bullet 500 EFI (Brembo caliper Front & Rear)	16-17	R							
/spoke wheel)	08-18	R	Continental GT (Non ABS)	13-17	R							
F 800 GS Adventure (Twin Cylinder			Continental GT (ABS)	13-20	R							
/798cc/spoke wheel)	12-18	R	Classic 500 (Brembo caliper Front & Rear)	16-17	R							
F 800 GT	13-18	R	Classic 500 Chrome (Brembo caliper									
F 800 R	09-18	R	Front & Rear)	16-20	R							
F 800 S/ST	06-13	R	TRIUMPH									
F 850 GS	18-21	R	Daytona 675	13-17	R							
F 850 GS Edition 40	20-21	R	Daytona 675 R	13-17	R							
F 850 GS Adventure	18-21	R	Street Triple 675	13-17	R							
F 850 GS Adventure Edition 40	20-21	R	Street Triple R 675	13-17	R							
S 1000 R Naked	14-21	R	Street Triple 675 RXSE (ABS)	15	R							
S 1000 RR	10-17	R	Street Triple S 765	18-21	R							
S 1000 RR (Models fitted with Forged			Street Triple R/LRH 765	18-21	R							
race wheels 7 spoke type)	15-17	R	Street Triple RS 765	18-21	R							

BUYERS GUIDE
BRAKE PADS

NOTE:- Size identification is shown as follows
 Dimension 1=Width or Diameter, Dimension 2=Height or Diameter, Dimension 3=Thickness (Material and backplate)

FA214 A 96.5 x 42 x 7.5mm
B 77.5 x 42 x 8mm

FA214/2 A 96.5 x 42 x 9.5mm
B 77.5 x 42 x 8mm

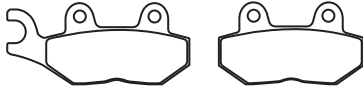

MATERIAL AVAILABILITY - FA214												
FA	X	V	R	HH	SV	MXS	SXR	EPFA	GPFA	GPFAF	SFA	SFAHH
✓		✓		✓								

MATERIAL AVAILABILITY - FA214/2												
FA	X	V	R	HH	SV	MXS	SXR	EPFA	GPFA	GPFAF	SFA	SFAHH
✓		✓		✓								

FA214	TRIUMPH	Year	Side	Model	Year	Side	Model	Year	Side	Model	Year	Side	Model	
				Speed Triple (EFI)				97-01					R	
				Speed Triple 955cc				02-04					R	
				Speed Triple (Radial caliper 1050cc)				05-13					R	
				Tiger 885cc	92-98	F	Left	Speed Triple (1050cc)					08-15	R
				Trident 900	92-98	F	Left	Speed Triple R (1050cc)					13-21	R
				Trophy 900 (3 cyl)	92-93	F	Left	Speed Triple RS (1050cc - 2Pad Brembo F/Caliper/255mm R/Disc/ABS Model)					16-21	R
				Trophy 1200 (4 cyl)	92-93	F	Left	Speed Triple S (1050cc - 2Pad Brembo F/Caliper/255mm R/Disc/ABS Model)					13-21	R
				FA214/2				Speed Twin 1200cc					19-21	R
				TRIUMPH				America (Cast wheel/865cc)	06-20	R			10-12	R
				America LT (Cast wheel/865cc/Wind Shield)	14-20	R		Sprint GT (1050cc/ABS)					10-12	R
				Bonneville/Bonneville Black	06-08	R		Sprint GT SE (1050cc/ABS)					13-16	R
				Bonneville America	02-06	R		Sprint RS (from VIN 139277)					03-04	R
				Bonneville 800	01-06	R		Sprint ST (Up to VIN 139276)					99-01	R
				Bonneville (865cc/Cast Wheel)	09-15	R		Sprint 1050 ST (from VIN 208167)					05-10	R
				Bonneville SE (865cc/Cast wheel)	09-12	R		Sprint 1050 ST Zero Offset Disc					11-12	R
				Bonneville T100	02-09	R		Thrupton SE (865cc)					12	R
				Bonneville T100 (865cc)	10-12	R		Thrupton 900					04-15	R
				Bonneville T100 (Spoke wheels/865cc)	10-14	R		Thrupton 900 Ace Café SE					14-15	R
				Bonneville T100 Black (Spoke wheels/865cc)	14-20	R		Thrupton (1200cc)					16	R
				Bonneville T100 (865cc) Steve McQueen	12	R		Thrupton TFC 1200cc					19-21	R
				Bonneville T100 Spirit SE (Spoke Wheels)	15	R		Thrupton R (1200cc)					16-21	R
				Bonneville T100 Newchurch SE (Cast Wheels)	15	R		Tiger 1200 Explorer (1215cc/Cast Wheels)					12-15	R
				Bonneville T214 (Black/Spoke Wheel)	15	R		Tiger 1050 (Radial Caliper)					07-15	R
				Bonneville T100/T100 Black (900cc)	17-21	R		Tiger 1050 SE (Radial Caliper/ABS)					11-13	R
				Bonneville T120/T120 Black (1200cc)	16-21	R		Tiger 1050 Sport (Radial Caliper/ABS)					13-21	R
				T595 Daytona	97	R		Tiger Explorer XC 1200 (1215cc /Spoke Wheels)					13-15	R
				Speedmaster 800	03-04	R		Tiger 1200 XC (Vin # 740277 onwards /1215cc/Spoke Wheels)					16-21	R
				Speedmaster (790cc/Carbs)	03-04	R		Tiger 1200 XCx (1215cc/Spoke Wheels /STD & Low)					16-21	R
				Speedmaster (865cc/Carbs)	05-07	R		Tiger 1200 XR (1215cc/Cast Wheels)					16-21	R
				Speedmaster (865cc/EFI) Cast Wheel				Tiger 1200 XRx (1215cc/Cast Wheels /STD & Low)					16-21	R
				Eng # 392060 to 46049/ 6 Bolt F/Disc	09-10	R		Tiger 1200 XRT 1200 (1215cc/Cast Wheels)					16-21	R
				Speedmaster (865cc/EFI) 5 Spoke Cast Wheel				Tiger 1200 Alpine Edition (1215cc /Cast Wheels/STD & Low)					20-21	R
				Eng # 46050 Onwards/ 5 Bolt F/Disc	11-20	R		Tiger 1200 Desert Edition (1215cc/Spoke Wheels)					20-21	R
				Speedmaster(865cc/EFI)	08-10	R		Trophy SE (1215cc)					13-15	R
				Scrambler (865cc/Carbs)	06-09	R								
				Scrambler (865cc/EFI)	10-16	R								
				Scrambler (900cc/EFI)	17	R								
				Street Cup (900cc)	17-21	R								
				Street Twin (900cc)	16-21	R								
				Daytona 955i	98-00	R								
				Daytona 955i (from VIN No 132513)	01-04	R								

FA215 A 96.5 x 42 x 7.5mm
B 77.5 x 42 x 8mm

FA215/2 A 96.5 x 42 x 9.5mm
B 77.5 x 42 x 8mm



MATERIAL AVAILABILITY - FA215												
FA	X	V	R	HH	SV	MXS	SXR	EPFA	GPFA	GPFAF	SFA	SFAHH
✓		✓		✓								

MATERIAL AVAILABILITY - FA215/2												
FA	X	V	R	HH	SV	MXS	SXR	EPFA	GPFA	GPFAF	SFA	SFAHH
✓		✓		✓								

FA214	TRIUMPH	Year	Side	Model	Year	Side	Model	Year	Side	Model	Year	Side	Model	
				Daytona 1200 (4 cyl)				93-98					R	
				Speed Triple (Carb models)				94-97					R	
				Sprint (All carb models)	93	F	Right	Sprint						
				Speed Twin	19-21	R		(All carb models up to VIN 9082)					93	R
				Tiger (885cc)	92-96	F	Right	Sprint						
				Trident 900	92-98	F	Right	(All carb models from VIN 9083)					94-98	R
				Trophy 900 (3 cyl)	92-93	F	Right	Sprint RS (Up to VIN 139276)					99-01	R
				Trophy 1200 (4 cyl)	92-93	F	Right	Sprint RS (From VIN 139277)					02	R
				FA215/2				Tiger					92-96	R
				TRIUMPH				Tiger 885cc					92-98	R
				Daytona 750 (3 cyl)	92	R		Tiger 955 (cast wheel model)					04-06	R
				Daytona 1000 (4 cyl)	92	R		Trident 900					92-98	R
				Daytona 900 (3 cyl)	93-96	R		Trophy 900 (3 cyl)					92-01	R
				Daytona Super III (3 cyl)	94-97	R		Trophy 1200 (4 cyl)					92-01	R
								Tiger 1050 (Twin sided s/arm)					07-12	R

BUYERS GUIDE
BRAKE PADS
 NOTE:- Size identification is shown as follows
 Dimension 1=Width or Diameter, Dimension 2=Height or Diameter, Dimension 3=Thickness (Material and backplate)

NOTE:- Size identification is shown as follows
Dimension 1=Width or Diameter, Dimension 2=Height or Diameter, Dimension 3=Thickness (Material and backplate)

FA216/2 69.5 x 49 x 10.5mm

FA216/3 69.5 x 49 x 8mm

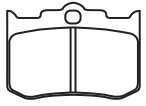

MATERIAL AVAILABILITY - FA216/2												
FA	X	V	R	HH	SV	MXS	SXR	EPFA	GPFA	GPFA	SFA	SFAHH
✓				✓								

MATERIAL AVAILABILITY - FA216/3												
FA	X	V	R	HH	SV	MXS	SXR	EPFA	GPFA	GPFA	SFA	SFAHH
✓		✓		✓								

FA216/2
EBC AFTERMARKET CALIPER
 4 Piston
PERFORMANCE MACHINE AFTERMARKET CALIPER
 124 x 4HR
 137 x 4

FA216/3
HHL - Hawg Halters AFTERMARKET CALIPERS
 4 Piston - All types
INDIAN
 All models 02-08 F&R
LYNDALL BRAKES
 PAD REF 7182 & 7183

NOVA/LEGENDS AFTERMARKET CALIPER
 4 Piston
PERFORMANCE MACHINE AFTERMARKET CALIPER
 125 x 4R
 125 x 4RSPH
 137 x 4B
REVTECH AFTERMARKET CALIPER
 New Black 4 Piston Caliper
THUNDERHEART AFTERMARKET CALIPER
 4 Piston Caliper

FA218 77.5 x 40.5 x 9.5mm

EFA218/2HH 77.5 x 40.5 x 8mm

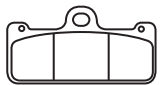

MATERIAL AVAILABILITY - FA218												
FA	X	V	R	HH	SV	MXS	SXR	EPFA	GPFA	GPFA	SFA	SFAHH
				✓				✓				

MATERIAL AVAILABILITY - FA218/2												
FA	X	V	R	HH	SV	MXS	SXR	EPFA	GPFA	GPFA	SFA	SFAHH
								✓				

BREMBO AFTERMARKET CALIPER
 XA9.33.10/11 - 4 Piston P32/36 Radial Mount @ 108mm (Single pin fixing)
 X97.37.60/61 - 4 Piston Monobloc 32/36 Radial mount @ 108mm (single pin fixing)

FA218/2
BREMBO AFTERMARKET CALIPER
 XA3.B8.30/31 - 4 Piston P32/36 Radial Mount Caliper @ 108mm Spacing (Titanium Pistons)
 XA3.B8.60/61 - 4 Piston P32/36 Radial Mount Caliper @ 108mm Spacing (Aluminum Pistons)
 X1017.40/41 - 4 Piston/40mm Axial Monobloc
 XA762.40/41 100mm CNC Monobloc

FA222 52.5 x 56.5 x 9mm

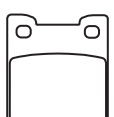

MATERIAL AVAILABILITY												
FA	X	V	R	HH	SV	MXS	SXR	EPFA	GPFA	GPFA	SFA	SFAHH
✓												

SUZUKI
 RF 900 RR/RS/RS2 94-95 R

FA226 102 x 39 x 9mm

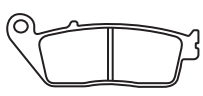

MATERIAL AVAILABILITY												
FA	X	V	R	HH	SV	MXS	SXR	EPFA	GPFA	GPFA	SFA	SFAHH
✓				✓				✓				

HONDA
 RS 125 90-94 F
 CBR 250 R (Non ABS) 11-14 F
 RS 250 90-94 F
 CB 300 F 15-21 F
 CBR 300 R (Non ABS Model) 15-21 F
 CBR 300 RA (ABS Model) 15-21 F
 CBR 600 F3/SJR/SE 95-98 F
 599 04/06 F

KAWASAKI
 Ninja 650 (EX 650 KHf/KHFA - ABS) 17-21 F
 Ninja 650 (EX 650 JHF - Non ABS) 17-21 F
 Ninja 650 KRT Edition (EX 650) 18-21 F
 Z 650 ABS (ER 650 GJF/HJF) 18-21 F

SUZUKI
 DL250 V-Strom 18 F
 GSX 250 R 17-20 F
 GSX 250 R ABS 18-20 F

TRIUMPH
 Trident 660cc 21 F
 Street Triple 675 07-17 F
 Street Triple S 765 18-19 F
 Tiger 800 (Cast Wheels) 11-14 F
 Tiger 800 (With ABS/Cast Wheels) 11-14 F
 Tiger 800 XR (With ABS/Cast Wheels) 15-20 F
 Tiger 800 XR Touring (With ABS/Cast Wheels) 15 F
 Tiger 800 XRt (With ABS/Cast Wheels) 16-20 F
 Tiger 800 XRx (With ABS/Cast Wheels) 15-20 F
 Tiger 800 XC (Spoke Wheels) 11-14 F
 Tiger 800 XC (With ABS/Spoke Wheels) 11-20 F
 Tiger 800 XC Adventure (With ABS /Spoke Wheels) 15 F
 Tiger 800 XCa (With ABS/Spoke Wheels) 15-17 F
 Tiger 800 XCx (With ABS/Spoke Wheels /STD & Low) 15-17 F

FA228 A 96.5 x 42 x 9mm
B 77.5 x 42 x 9mm



MATERIAL AVAILABILITY												
FA	X	V	R	HH	SV	MXS	SXR	EPFA	GPFA	GPFAFX	SFA	SFAHH
✓				✓							✓	✓

HONDA				SFA228			
CMX 250 C 'Rebel'		96/97/99-14	F	BENELLI			
CMX 250 C2		99-00	F	Caffenero Scooter 150			F
CMX 250 X		15	F	Zafferano Scooter 250 EFI			R
KAWASAKI				KYMCO STREET			
KL 650 E8F/E9F/EAF/EBF/ECF/EDF				Agility 50 (4T)			05-15 F
/EEF/EFF (KLR 650)		08-15	F	Agility 50 (4T)			20-21 F
ROYAL ENFIELD				Campagno 50i (4T/SE50BG)			14 F
Bullet 500 EFI (Pricol caliper/Drum rear)	10-15	F Left		Filly 50			02-05 F
Classic 500 (Pricol caliper/Drum rear)	10-15	F Left		Sento 50			09-12 F
Classic 500 Battle Green (Pricol caliper/Drum rear)	10-15	F Left		Sting 50 (2T)			07-11 F
Classic 500 Chrome (Pricol caliper/Drum rear)	10-15	F Left		Vitality 50 (4T)			05-08 F
Classic 500 Desert Storm (Pricol caliper/Drum rear)	10-15	F Left		Yup 50			02-06 F
SUZUKI				Campagno 110i (4T/SE22BD)			13-15 F
AN 400 K7-K9/AK9/AL1-AL6 Burgman	07-16	F Left		Agility 125			06-15 F
AN 400 ZAL4/ZAL5/ZAL6	14-19	F Left		Agility 125 (4T/12 Inch Wheels)			19-21 F
				People S 250			07-11 F Left
				U.M. (UNITED MOTORS)			
				Xpeed 250 i			08 F Left

FA229 A 133.5 x 37 x 8.5mm
B 110 x 51.5 x .5mm

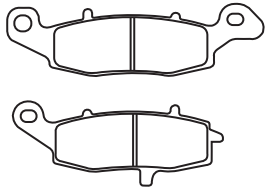

MATERIAL AVAILABILITY												
FA	X	V	R	HH	SV	MXS	SXR	EPFA	GPFA	GPFAFX	SFA	SFAHH
✓		✓		✓				✓				

KAWASAKI				VN 1600 D1 Nomad D6F/D7F/D7FA			
ER 650 C9F/CAF ER-6N		09-10	F Left	/D8F/D8FA			05-08 F Left
EX 650 Ninja 650 R A6F-A8F/C9F/CAF		06-10	F Left	VN 1700 C9F/CAF/CBF/CCF/CDF			
EX 650 Ninja (EX 650 ECF/EDS/EEF/EEF/EGF) (Non ABS)		12-15	F Left	Vulcan 1700 Nomad			09-13 F Left
EX 650 Ninja (EX 650 FDS/FEF/FFF/FGF) (ABS Model)		13-15	F Left	VN 1700 C9FA Vulcan 1700 Nomad 2T			09 F Left
EX650 R (EX 650 CBF)		11	F Left	VN 1700 E9F/EAF/EBF Vulcan			09-12 F Left
KLE 650 A7F/A8F/A9F/CAF/CBF/CCF/CDF/CEF Versys		07-14	F Left	1800 Classic			09-11 F Left
KLE 650 DEF Versys (ABS Model)		14	F Left	VN 1700 G9F/GAF Vulcan 1700 Classic LT			09-11 F Left
ZR 750 F2 (ZR-7)		00	F Left	SUZUKI			
ZR7-S (ZR 750 H1/H2/H3/H4/H5)		01-05	F Left	TU 250 XK9/XL1/XL2/XL3/XL4/XL5/XL6			09-16 F
Z 750 S (ZR 750 K1/K6F)		05-06	F Left	GSF 600 SY/SK1/SK2/SK3/AL1			00-03 F Left
VN 800 B1-B10		96-05	F	GSX 600 FW/FX/FY/FK1-FK6 Katana			98-06 F Left
VN 800 Drifter C1/C2/E1-E5/E6F		99-06	F	DL 650 K4/K5/K6/K7/K8/K9 V-Strom			04-09 F Left
VN 900 Vulcan Classic LT		06-21	F	DL 650 V-Strom ABS			07-21 F Left
VN 900 Vulcan Classic		06-21	F	DL 650 XT ABS			15-21 F Left
VN 900 C (Cast Wheels)		07-21	F	DL 650 V-Strom Adventure ABS			12-21 F Left
KZ 1000 P21-P22/P24		02-03/05	F Left	DL 650 V-Strom XT Touring			18-21 F Left
Ninja H2 SX (ZX 1002 AJF)		18-21	R	SFV 650 K9/L3/L4			09-10/13-14 F Left
Ninja H2 SX SE (ZX 1002 BJF)		18-21	R	SV 650 X/Y/K1/SK1-SK9/K2-K8/			
Ninja H2 SX SE+ (ZX 1002 DKF)		19-21	R	SF8/SF9/SFL0			99-10 F Left
Z H2		20-21	R	SV 650 AK7/AK8/K7-K9/L0 ABS			07-10 F Left
Z H2 SE		20-21	R	SV 650 SAK7-SAK9/SFA8/SFA9/SFL0 ABS			07-10 F Left
GPZ 1100 (ZX 1100 E1/E2/E3)		95-97	F Left	GSR 750 L5/L6 (Non ABS)			15-16 F Left
ZR 1100 B1 Zephyr		96	F Left	GSR 750 AL5/AL6 (ABS)			15-16 F Left
VN 1500 G1/G1A/G2A/G3 Nomad		99-02	F Left	GSR 750 L5/L6/L7/L8			98-06 F Left
VN 1500 Drifter J1/J2/R1/R2/R3/R4/R5		99-05	F	GSR-S 750 ZL5/ZL6/ZL7/ZL8			15-18 F Left
VN 1500 D1/D2/E1-E7 Vulcan Classic		96-04	F	DL 1000 K2-K9/L2 V-Strom			02-12 F Left
VN 1500 N1-N3 Vulcan Classic Fi				DL 1000 AL2 V-Strom Adventure			12 F Left
/L2-L5 Nomad Fi		00-05	F Left	VL 1500 K2/K3/K4			02-03 F Left
VN 1500 N4/N6F/N7F/N8F/N8FA				VL 1500 BK5/BK6/K5-K9/TK5-TK9			
Vulcan 1500 Classic		05-08	F	Boulevard C90/C90T			05-10 F Left
VN 1600 A1/A2/A3/A6F/A7F/A7FA				VZ 1500 K9/L3-L5 M90 Boulevard			09/13-15 F Left
/A8F/A8FA Vulcan Classic		03-08	F Left				

FA230 A 99 x 40 x 7.5mm
B 75.5 x 38 x 8mm



MATERIAL AVAILABILITY												
FA	X	V	R	HH	SV	MXS	SXR	EPFA	GPFA	GPFAFX	SFA	SFAHH
	✓		✓									

SUZUKI				KAWASAKI			
RM 80 T/V/W/X/Y/K1		96-01	F	KLX 125 L (B1/B2/B3/B6F)			03-06 F
RM 85 K2/K3/LK3/K4/LK4		02-04	F				
DR-Z 125		03-20	F				

BUYERS GUIDE
BRAKE PADS

NOTE:- Size identification is shown as follows
 Dimension 1=Width or Diameter, Dimension 2=Height or Diameter, Dimension 3=Thickness (Material and backplate)

FA231 A 133.5 x 37 x 8.5mm
B 109.5 x 52 x 8.5mm

MATERIAL AVAILABILITY - FA231												
FA	X	V	R	HH	SV	MXS	SXR	EPFA	GPFA	GPFAFX	SFA	SFAHH
✓		✓		✓				✓				

FA231/2 A 133.5 x 37 x 10.5mm
B 109.5 x 52 x 10.5mm

MATERIAL AVAILABILITY - FA231/2												
FA	X	V	R	HH	SV	MXS	SXR	EPFA	GPFA	GPFAFX	SFA	SFAHH
		✓										

FA231/3 A 133.5 x 37 x 10.5mm
B 109.5 x 52 x 11.5mm

MATERIAL AVAILABILITY - FA231/3												
FA	X	V	R	HH	SV	MXS	SXR	EPFA	GPFA	GPFAFX	SFA	SFAHH
		✓										



★ = REAR FA231/2V @ 10.7mm (HH USE FA231HH)
▲ = REAR FA231/3V @ 11.4mm (HH USE FA231HH)

KAWASAKI

ER 650 C9F/CAF ER-6N 09-10 F Right
 EX 650 Ninja 650 R A6F-A8F/C9F/CAF 06-10 F Right
 EX 650 Ninja (EX 650 ECF/EDS/EEF/EFF/EGF) (Non ABS) 12-16 F Right
 EX 650 Ninja (EX 650 FDS/FEF/FFF/FGF) (ABS Model) 13-16 F Right
 EX 650 R (EX 650 CBF) 11 F Right
 KLE 650 A7F-A9F/CAF/CBF/CCF/BCF/EDF Versys 07-13 F Right
 KLE 650 DEF Versys (ABS Model) 14 F Right
 W 650 (EJ 650 A2/A3/A4) 00-02 F
 ZR 750 F2 (ZR-7/ZR7'S) 00-01 F Right & R
 ZR7-S (ZR 750 H1/H2/H3/H4/H5) 01-05 F Right & R
 Z 750 S (ZR 750 K1/K6F) 05-06 F Right
 VN 800 Drifter C1/C2/E1/E2/E3/E4/E5/E6F 99-06 R ▲
 W 800 (Solid Front Disc) 11-12 F
 W 800 Café (Cockpit Fairing) 11 F
 W 800 Special (Black Exhaust) 12 F
 W 800 ABS/ABS Special 13-16 F
 VN 900 Classic LT 06-21 R ▲
 VN 900 Vulcan Classic 06-21 R ▲
 VN 900 (Cast Wheels) 07-21 R ▲
 KZ 1000 P21-P22/P23 02-03/05 F Right
 GPZ 1100 (ZX 1100 E1/E2/E3/F1) 95-97 F Right
 ZR 1100 B1 ZEPHYR 96 F Right
 VN 1500 G1/G1A/G2A/G3/L2/L3/L4/L5/L6 Nomad Fi 99-05 F Right & R
 VN 1500 Drifter J1/J2/R1/R2/R3/R4/R5 99-05 R
 VN 1500 N1/N2/N3 Vulcan Classic Fi 00-02 R ★
 VN 1500 E4/E5/E6/E7 Vulcan Classic 01-04 R
 VN 1500 P1/P2 Mean Streak 02-03 R ★
 VN 1500 N4/N6F/N7F/N8F/N8FA Vulcan 1500 Classic 05-08 R ▲
 VN 1600 A1-A3/A6F/A7F/A7FA/A8F/A8FA Vulcan Classic 03-08 F Right ▲
 VN 1600 B1 Mean Streak 04 R ★
 VN 1600 D1/D6F/D7F/D7FA/D8F/D8FA Nomad 05-08 F Right & R ▲
 VN 1600 B2/B6F/B7F/B7FA/B8F/B8FA Mean Streak 05-08 R
 VN 1700 A9FA/AAF/ABF/ACF/ADF Vulcan 1700 Voyager 09-13 R
 VN 1700 B9FA/BAF/BBF/BCF/BDF/BEF/BFF/BGF/BHF Vulcan 1700 Voyager ABS 09-17 R
 VN 1700 C9F/CAF/CBF/CCF/DCF Vulcan 1700 Nomad 09-13 F Right & R ▲
 VN 1700 DEF/DEFA Vulcan 1700 Nomad ABS 14 R ▲
 VN 1700 C9FA Vulcan 1700 Nomad 2T 09 F Right & R ▲
 VN 1700 E9F/EAF/EBF/ECF Vulcan 1700 Classic 09-12 F Right & R ▲
 VN 1700 G9F/GAF Vulcan 1700 Classic LT 09-11 F Right & R ▲
 VN 1700 JBF/JBFA/JCF/JCFA/JDF Vulcan Vaquero 11-13 F Right & R ▲
 VN 1700 KEF/KFF/KFG Vulcan Vaquero ABS 14-21 R ▲
 VN 1700 KEFA Vulcan Vaquero ABS SE 14 R ▲
 VN 2000 D1/D6F Vulcan Ltd 05-06 R ▲
 VN 2000 E6F/E7F/H8F/H9F Vulcan Classic 06-09 R ▲
 VN 2000 F6F/F7F/J8F/J9F/JAF Vulcan Classic LT 06-10 R ▲

SUZUKI

RV 200 L6/L7 Van-Van 16-19 F
 GS 500 ET/EV/EW/EX/EY/K1-K3/FK4-FK9/FLO 96-10 F
 GSF 600 SY/SK1/SK2/SK3 00-03 F Right
 GSX 600 FW/FX/FY/FK1-FK6 Katana 98-06 F Right
 DL 650 K4/K5/K6/K7/K8/K9 V-Strom 04-09 F Right
 DL 650 V-Strom 07-21 F Right
 DL 650 V-Strom XT ABS 15-21 F Right
 DL 650 V-Strom Adventure ABS 12-21 F Right
 DL 650 V-Strom XT Touring 18-21 F Left
 SFV 650 K9/L3/L4 09-10/13-14 F Right
 SV 650 X/Y/K1-K8/SK1-SK9 99-10 F Right
 SV 650 AK7/AK8/K7/K8/K9 ABS 07-10 F Right
 SV 650 ABS 16-21 F Right
 SV 650 SAK7-SAK9 ABS 07-10 F Right
 GSR 750 L5/L6 (Non ABS) 15-16 F Right
 GSR 750 AL5/AL6 (ABS) 15-16 F Right
 GSX 750 FW/FX/FY/FK1-FK6 Katana 98-06 F Right
 GSX 750 W/X/Y Inazuma 98-00 F Right
 GSX-S 750 L5/L6/L7/L8/ZL5/ZL6/ZL7/ZL8 15-18 F Right
 VL 800 K1/K2/K3/K4 Intruder Volusia 01-04 F
 VL 800 Boulevard Touring 05-20 F
 VL 800 ZK3/ZK4 Volusia Ltd (Seat trimmed with chrome studs) 03-04 F
 VL 800 C50 Boulevard 05-20 F
 VL 800 BTL4 (Boulevard C50 B.O.S.S./Cast Wheels) 14 F
 VL 800 CL3 (Boulevard C50 Special Edition/Cast Wheels) 13 F
 VZ 800 Marauder V/W/X/Y/K1-K4 97-04 F
 VZ 800 K5-K9/BK6/ZK7-ZK9 M50 Boulevard 05-09 F
 VZ 800 L0/L1-L5 M50 Boulevard 10-15 F
 DL 1000 K2-K4 V-Strom 02-04 F Right
 DL 1000 K2-K9 02-09 F Right
 DL 1000 AL2 V-Strom Adventure 12 F Right
 VL 1500 K2-K4 02-04 F Right
 VL 1500 BK5/K5-K9/TK5-TK9 Boulevard C90/C90T 05-09 F Right
 VL 1500 BL3/BL4/BL5 (Boulevard C90 B.O.S.S./Cast Wheels) 13-15 R ▲
 VL 1500 BLT3 (Boulevard C90 B.O.S.S./With Windshield) 13 R ▲
 VL 1500 L3 (C90 Boulevard) 13 R ▲
 VL 1500 TL3/TL4/TL5 (C90T Boulevard/With Windshield) 13-15 R ▲
 VZ 1500 K9/L3/L4/L5 M90 Boulevard 09/13-15 F Right & R ▲
 VZ 1600 K4 Marauder 04 R ★
 VZ 1600 K5 M95 Boulevard/Marauder 05 R ★
 VLR 1800 TK8/TK9 C109 RT Touring 08-10 R ▲
 VLR 1800 K8/K9/L0 C109 R 08-10 R ▲
 VZR 1800 K6/K7/K8/K9/L1/L2/L3/L4 (Boulevard M109R) 06-14 R ▲
 VZR 1800 NK8/NK9 (Boulevard Limited M109R2) 08-09 R ▲
 VZR 1800 ZK8/ZK9/ZL1/ZL2/ZL3/ZL4 08-14 R ▲
 (Boulevard RZ Limited M109RZ)
 VZR 1800 BL4/BL5/BL6/BL7 (Boulevard B.O.S.S. M109R) 14-21 R ▲

FA232 72.5 x 43.5 x 7mm

MATERIAL AVAILABILITY												
FA	X	V	R	HH	SV	MXS	SXR	EPFA	GPFA	GPFAFX	SFA	SFAHH
	✓		✓		✓							



CF MOTO

400 C-Force 14-16 Parking brake
 500 C-Force 14-16 Parking brake

E-TON QUADS

RXL-50M Viper (4T)

POLARIS

All disc rear brake models - check application pages for main fitments.
 This pad has increased friction area. Can be fitted in place of FA178 to improve wear life on Polaris ATV's

SFA233 75 x 37 x 9.5mm



MATERIAL AVAILABILITY												
FA	X	V	R	HH	SV	MXS	SXR	EPFA	GPFA	GPFA	SFA	SFAHH
											✓	

KYMCO STREET
Cobra Racer 50 (SF10AG) 00-04 F ZX 50 Super Fever

Cobra Cross/Racer 50 (SF10AF) 05-06 F
02-05 F

SFA235 59.5 x 44.5 x 9mm



MATERIAL AVAILABILITY												
FA	X	V	R	HH	SV	MXS	SXR	EPFA	GPFA	GPFA	SFA	SFAHH
											✓	

CPI
Oliver City 50 05-09 F

UM (UNITED MOTORS)
Zyclone 50 04-05 R

FA236 70 x 55.5 x 8.5mm

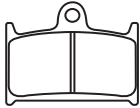

MATERIAL AVAILABILITY												
FA	X	V	R	HH	SV	MXS	SXR	EPFA	GPFA	GPFA	SFA	SFAHH
✓				✓								

TRIUMPH

Daytona 600	03-04	F	Sprint GT (1050cc/ABS)	10-12	F
T595 Daytona	97	F	Sprint GT SE (1050cc/ABS)	13-16	F
Daytona 955i	98-00	F	Sprint RS	99-04	F
Daytona 955i (From VIN 132513)	01-04	F	Sprint ST	99-04	F
Daytona 650	05	F	Sprint 1050 ST	05-12	F
Daytona 675 SE	12	F	Trophy 900 (3cyl)	94-01	F
Daytona 750 (3 cyl)	92	F	Tiger Explorer XC 1200		
Daytona 100 (4 cyl)	92	F	(Up to Vin # 740276/1215cc /Cast & Spoke Wheels)	13-15	F
Daytona 900 (3 cyl)	93-96	F	Trophy 1200 (4 cyl)	94-01	F
Daytona 1200 (4 cyl)	93-98	F	Thunderbird 1600 (Cast wheel)	09-17	F
Speed Triple (Carb models)	94-97	F	Thunderbird (1600cc/Windscreen)	12	F
Speed Triple (EFI)	97-01	F	Thunderbird Commander		
Speed Triple 955cc (from VIN 141872)	02-04	F	(1700cc/Cast wheel)	14-17	F
Speedfour 600	02-05	F	Thunderbird LT (1700cc/Cast wheel)	14-17	F
Rocket III 2300cc	04-09	F	Thunderbird NightStorm		
Rocket III Classic	07-09	F	(1700cc/Cast wheel)	09-17	F
Rocket III Roadster	11-17	F	Thunderbird Storm (1700cc/Cast wheel)	09-17	F
Rocket III Touring (ABS & Non ABS)	09-17	F	TT 600	00-03	F
Sprint (carb models from VIN 9083)	94-98	F			

FA239 69.5 x 52 x 8mm

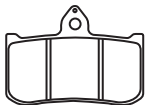

MATERIAL AVAILABILITY												
FA	X	V	R	HH	SV	MXS	SXR	EPFA	GFA	GPFA	SFA	SFAHH
✓								✓				

HONDA RACE BIKES
RS 125/250 95-03

FA243 99 x 49.5 x 8.5mm

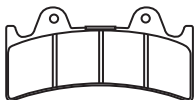

MATERIAL AVAILABILITY												
FA	X	V	R	HH	SV	MXS	SXR	EPFA	GFA	GPFA	SFA	SFAHH
✓				✓								

JAYBRAKE CALIPERS
J-Six (300-64) (6 Piston)

FA244 75 x 55 x 8.5mm

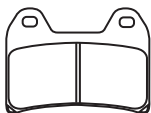

MATERIAL AVAILABILITY												
FA	X	V	R	HH	SV	MXS	SXR	EPFA	GPFA	GPFA	SFA	SFAHH
✓		✓		✓				✓		✓		

ALTA MOTORS (Electric)

Redshift - SM	16-18	F										
APRILIA												
RS 250	99-03	F										
RSV 1000/Mille/SP	98-01	F										
RSV Tuono (Standard Mount Caliper)	02-09	F										
Tuono V4 R STD	11-13	F										
Tuono V4 R APRC	11-13	F										
SL 1000 "Falco"	00-05	F										
Caponord 1200 Rally	18-19	F										
Dorsoduro 1200	11-14	F										

BREMBO AFTERMARKET CALIPER

20 6800 10/20 Goldline 4 Piston											00-04	F
P4 30/34 @ 65mm Spacing											05-06	F
(Two pin pad fixing)											00-01	F
BMW											02-04	F
G 650 X-Moto	07-09	F									03-04	F
F 800 GT	13-18	F									06	F
F 800 S/ST	06-13	F									03	F
F 800 R	09-14	F										
R Nine T Pure	18-21	F									05	F
R Nine T Racer	18-20	F									08-15	F
R Nine T Scrambler	18-21	F										
R Nine T Urban G/S	18-21	F										
DUCATI											13-14	F
400 Monster	00-02	F									98-99	F
											00	F

BUYERS GUIDE
BRAKE PADS

NOTE:- Size identification is shown as follows
Dimension 1=Width or Diameter, Dimension 2=Height or Diameter, Dimension 3=Thickness (Material and backplate)

FA244 75 x 55 x 8.5mm

Contd.

DUCATI Contd.

748 SP/Monoposto	99-02	F	Hypermotard 1100	07-09	F	V7 Stone	12-15	F
748 (Biposto/Monoposto)	00-02	F	Monster 1100/1100 S	09-10	F	V7 III Racer	18-21	F
748 Testa Bassa	01	F	1100 Monster Evo	11-13	F	V7 III Limited	18-21	F
750 Supersport	99	F	M 1100 Evo Monster			V7 III Special	18-21	F
750 Supersport IE	00-02	F	- 20th Anniversary Model	13	F	V7 III Stone	18-21	F
750 Sport	01-02	F	Monster 1100 (ABS)	09-10	F	V7 III Rough	18-21	F
750 Monster	00-01	F	1100 Monster S (ABS)	09-10	F	V7 III Carbon	18-21	F
Monster ie 750	02	F	1100 Monster - Diesel	13	F	V 85 TT	19-21	F
Hypermotard 796	10-13	F	Multiestrada 1100/1100 S (1078cc)	07-09	F	V9 Bobber/Sport	18-21	F
796 Monster (Non ABS)	10-14	F	Multiestrada 1200	10-15	F	V9 Roamer	18-21	F
796 Monster (ABS)	10-15	F	Multiestrada 1200 S (Sport)	10	F	California Jackel 1100/Special 1100	99-01	F
M 796 Monster -20th Anniversary Model	13-14	F	Multiestrada 1200 S Pikes Peak	11-14	F	Griso 1100	05-08	F
Monster 800	03-04	F	Multiestrada 1200 S Grandtourismo	13-14	F	V11 Sport/Scuro/Naked	99-00	F
800 Sport	03	F	Multiestrada 1200 S Touring	10-14	F	V11 Le Mans Series	01-06	F
800 Supersport	03-05	F	HUSQVARNA			California Stone Series/EV Series	02-06	F
848 (Radial 2 pad caliper)	08-09	F	LT 610	00	F	California Vintage 750	06-10	F
848 Streetfighter	12-15	F	SM 610 R/610 S/610	99-06	F	1100 Brevia	05-12	F
900 Supersport	98-99	F	701 Svartpilen/Vitpilen	18-21	F	1100 Griso (1064cc) Standard mount caliper	05-12	F
900 Supersport IE	00-01	F	KTM			Griso 1200 8V (1151cc)	09-12	F
900 Sport	02	F	SMC 625	05	F	1200 Griso SE (8v) (Radial caliper) 1151cc	09-14	F
ST2 (944cc)	00-03	F	Duke II 640 Orpheus/Titan/Lime	01-	F	MGX-21 1400 4V	18-21	F
Monster 1000 ie (992cc)	04-05	F	Duke II 640 Black/Orange	02	F	Norge 1200 GT 2V	06-12	F
900 IE Monster	00-01	F	640 Duke			Norge 1200 GT 8V	10-14	F
900 MH Evoluzione	00-01	F	(Jet Black/Yellow/Adrenalin Orange)	03-05	F	Stelvio 1200 NTX 8V (ABS)	09-15	F
916 SPS (996cc)	97-98	F	SMC 640 LC4	05	F	California 1400 Custom/Touring	13-15	F
Monster S4 Foggy (916cc)	01-02	F	SMC 660	05	F	MOTUS		
ST4 (916cc)	99-02	F	690 Duke (2 Pad Type Caliper)	12-15	F	MST/MSTR	14-18	R
ST2 (944cc)	97-99	F	690 Supermoto	02-08	F	MV (AGUSTA)		
996 SPS (996cc)	99	F	790 Adventure/R	18-21	F	Brutale 675	12-14	F
996 (996cc) (Monoposto/Biposto)	99-01	F	790 Adventure R Rally	21	F	F3 675	12-14	F
996 S	01	F	790 Duke	18-20	F	Brutale 800	12-21	F
Sport 1000 S	07-09	F	890 Duke R	21	F	Brutale 989 R	08-09	F
Supersport 1000 DS (992cc)	03-06	F	890 Adventure/Adventure R/Adventure R Rally	21	F	Brutale 990 R	10-11	F
ST3 S (ABS) (992cc)	06-07	F	1090 Adventure	18-19	F	Brutale 1090	13-14	F
Monster S4R (996cc) (2 pad caliper)	05-06	F	1190 Adventure/Adventure R	13-16	F	Brutale 1090 R	12-14	F
Monster S4R (996cc)	03-06	F	1290 Super Adventure	13-16	F	Dragster 800 All Models	19-21	F
ST4S (Non ABS/996cc)	01-05	F	1290 Super Adventure R	15-21	F	VICTORY		
ST4S (ABS Model/996cc)	03-05	F	LYNDALL BRAKES			V92C/SC	98-03	F
996 Monster (ABS)	10-12	F	PAD REF 7174			Empulse TT	16	F
998 (998cc) (2 pad caliper)			MOTO GUZZI			Hammer	05-07	F
(Monoposto/Biposto)	02-03	F	750 Nevada Base/Club	02-03	F	Hammer S	07	F
Monster 1000 Dark	03	F	Nevada Classic 750 ie	04-09	F	Vegas 8 Ball/Jackpot	05-07	F
Monster 1000 ie (992cc)	04-05	F	V7 Cafe Classic	11-12	F	Ness Signature Series	05-07	F
Monster 1000 S ie (992cc)	03-05	F	V 750 ie Brevia	03-08	F	King Pin Tour	04-07	F
Monster S2R 1000 (992cc)	06-08	F	V7 Classic	08-12	F	Vegas	03-07	F
Multiestrada 1000 DS (992cc)	03-05	F	V7 Racer	10-15	F	ZERO ELECTRIC		
Multiestrada S 1000 DS (992cc)	05-06	F	V7 Special	12-15	F	SR/F & SR/S ZF75-10/14.4	19-21	F

FA249 91.5 x 51.5 x 10mm

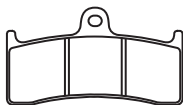

MATERIAL AVAILABILITY												
FA	X	V	R	HH	SV	MXS	SXR	EPFA	GPFA	GPFAFX	SFA	SFAHH
✓				✓								

PRE TECH AFTERMARKET CALIPER
6 Piston (Radial Mount)

THUNDERHEART AFTERMARKET CALIPER
6 Piston Caliper

FA251 A 55.5 x 37 x 10mm B 85 x 43 x 8mm



MATERIAL AVAILABILITY												
FA	X	V	R	HH	SV	MXS	SXR	EPFA	GPFA	GPFAFX	SFA	SFAHH
✓												

BUELL												
S2/S3 Thunderbolt	94-97	R	WR 240	90-91	R							
M2 Cyclone	94-97	R	CR 250	91	R							
S1 Lightning	94-97	R	WR 250	90-91	R							
HISUN			WR 260	90-91	R							
110 Axis	14-16	R	TE 350	90-91	R							
110 Forge	14-16	R	TC 510	90	R							
HUSQVARNA			TE 510	90	R							
CR 125	91	R	TC 610	91	R							
WR 125	91	R	TE 610	91	R							

BUYERS GUIDE
BRAKE PADS

NOTE:- Size identification is shown as follows
Dimension 1=Width or Diameter, Dimension 2=Height or Diameter, Dimension 3=Thickness (Material and backplate)

FA252 50.5 x 69 x 8.5mm

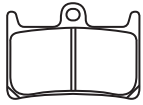

MATERIAL AVAILABILITY

FA	X	V	R	HH	SV	MXS	SXR	EPFA	GPFA	GPFAFX	SFA	SFAHH
✓				✓				✓			✓	✓

YAMAHA					XV 1700 Road Star (Solid front discs /Spoke wheels) XV17 AT/ATC/AV/AVC/ATW 05-07								F
FZR 400 RRSP/RR/RW				91-92	F								
YZF 600 RJ/RK/RL/RM/RN/RR/RS/RT/RV				97-07	F								
YZF 600 RRL/RRM/RRN/RRP/RRR/RRS "R6"				99-04	F								
YZF R6S (YZFR SV/SW/SX/SY) (298mm rotor)				06-09	F							05-06	F
FZ6 W/X/Y (4 piston caliper)				07-09	F								
FZ-07 (689cc/2Cyl)				15-17	F								
FZ-07 A (689cc/2Cyl/ABS)				17	F							05	F
MT 07				18-21	F								
YZF-R7				22	F								
XSR 700 (MTM 690-U)				18-21	F							05-06	F
YZF 750 R7 OW02 Road version				99-01	F								
FJ-09 (847cc/3 Cyl)				15-16	F							04-07/09	F
FZ-09 (847cc/3 Cyl)				14-17	F								
MT 09				18-21	F								
Tracer 900				18-21	F								
Niken				18-21	F								
XSR 900 ABS (MTM 850)				16-21	F								
FZS 1000 N/NC/P/PC/R/RC/S/RS/T 'FZ1'				01-05	F								
YZF 1000 RJ				97	F							04-07	F
YZF R1				98-03	F								
FJR 1300 R/RC				03-05	F								
XV 1700 Road Star S 9 Spoke Cast												04-05	F
XV17 ASX/ASY/ASZ/ASA/ASB				08-14	F							06-07	F
XV 1700 Road Star Silverado Spoke Wheel XV17 ATW				07	F							06-09	F
XV 1700 Road Star Silverado S												06-10/12-13	F
9 Spoke Cast Wheel XV17 ATSA/ATSB				11-14	F							06-09	F
XV 1700 Road Star Midnight Warrior												06-08	F
5 Spoke Cast Wheel XV17 PCMV/PCMVC /PCMW/PCMX/PCMY				06-09	F							06-14	F
XV 1700 Road Star Warrior 5 Spoke Cast Wheel XV17 PCV/PCW/PCX				06-08	F							11-14	F
XV 1700 Road Star Silverado Spoke Wheel XV17 ATX/ATY/ATZ				08-10	F							08-14	F
XV 1700 Road Star 9 Spoke Cast XV17 AWX				08	F							08-14	F

FA254 59.5 x 57 x 8mm

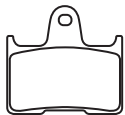

MATERIAL AVAILABILITY

FA	X	V	R	HH	SV	MXS	SXR	EPFA	GPFA	GPFAFX	SFA	SFAHH
✓		✓		✓				✓				

HARLEY DAVIDSON					KAWASAKI									
XL883 L Super Low (Cast Wheel)				14-18	R								96-99	R
XL883 N Iron (Cast Wheel)				14-21	R								08-10	R
XL883 R Roadster (Cast Wheel)				14-15	R									
XL1200 C Custom (Spoke Wheel)				14-21	R								08-16	R
XL1200 CX Roadster				16-21	R									
XL1200 T Superlow				14-21	R								06-14	R
XL1200 V Seventy Two				14-16	R									
XL1200 X Forty Eight				14-21	R								13-17	R
XL1200 Forty Eight Anniversary				18	R									
HONDA													16-21	R
VT 750 C2E Shadow Aero (ABS/Rear Disc Model)				13-19	R								03-05	R
VT 750 C2S Shadow Spirit (ABS/Rear Disc Model)				13-19	R								04-05	R
													04-05	R
													01-06	R

BUYERS GUIDE
BRAKE PADS

NOTE:- Size identification is shown as follows
Dimension 1=Width or Diameter, Dimension 2=Height or Diameter, Dimension 3=Thickness (Material and backplate)

NOTE:- Size identification is shown as follows
Dimension 1=Width or Diameter, Dimension 2=Height or Diameter, Dimension 3=Thickness (Material and backplate)

FA256 78.5 x 47 x 7.5mm



MATERIAL AVAILABILITY															
FA	X	V	R	HH	SV	MXS	SXR	EPFA	GPFA	GPFA	SFA	SFAHH			
✓				✓							✓	✓			
APRILIA						V7 III Carbon						18-21	R		
Mana 850						08-12	R	V9 Bobber/Sport						18-21	R
Mana 850 GT ABS						09-15	R	V9 Roamer						18-21	R
MOTO GUZZI						SFA256									
V7 Racer						12-15	R	APRILIA							
V7 Special						12-15	R	Scarabeo 150						99-03	F
V7 Stone						12-15	R	Atlantic 500						03-05	F
V7 III Racer						18-21	R	Scarabeo 125/250 GT						04-05	F
V7 III Limited						18-21	R	Sport City 125 (4T)						08-14	F
V7 III Special						18-21	R	Sporty City 250						07-14	F
V7 III Stone						18-21	R	Sport City Cube 250						08-09	F
V7 III Rough						18-21	R	Scarabeo 500/ie						03-14	F

SFA257 41 x 43 x 7.5mm



MATERIAL AVAILABILITY															
FA	X	V	R	HH	SV	MXS	SXR	EPFA	GPFA	GPFA	SFA	SFAHH			
											✓				
DAELIM															
E-Five 50						03-09	F	Delfino 100						01-09	F
S-Five 50						01-09	F								

SFA257/2 41 x 43 x 5.5mm



MATERIAL AVAILABILITY															
FA	X	V	R	HH	SV	MXS	SXR	EPFA	GPFA	GPFA	SFA	SFAHH			
											✓				
APRILIA															
Mana 850 Parking brake						08-12		VFR 1200 FD (Auto G/Box) Parking Brake						10-14	
Mana 850 GT ABS (Parking brake)						09-15		VFR 1200 XD DCT (Automatic Transmission Model) - Parking Brake						16-17	
BMW															
C600 Sport (Parking Brake)						12-15		GL 1800 B Goldwing J (Manual) Parking Brake						18	
C650 Sport (Parking Brake)						16-21									
C650 GT (Parking Brake)						12-21		GL 1800 Goldwing J (Manual) Parking Brake						18	
C650 GT Special Edition (Parking Brake)						15									
HONDA															
FSC 600/D Parking brake						02-06		MXU 400 Parking Brake							
FSC 600 A Parking brake						03-11		PIAGGIO							
FSC 600 D Parking brake						07-10		MP3 (250cc) (3 wheeler) Parking Brake						07-15	
CTX 700 D (Auto G/Box) Parking Brake						14-17		MP3 400ie (3 wheeler) Parking Brake						07-15	
CTX 700 ND (Naked/Auto G/Box) Parking Brake						12-16		MP3 500 (3 wheeler - 12" Front / 14" Rear Wheel)						07-14	
NM4 - NC 700 JD (DCT)						15-16	F	MP3 500 Sport ABS (Three wheeler - 13" Front / 14" Rear Wheel)						15-16	
NSA 700 A9 (DN01) (Parking Brake)						09-11									
CRF 1000 LADG/LADH Africa Twin (DCT/ABS) - Parking Brake						16-21									

FA258 A 119.5 x 26 x 7mm B 94.5 x 35.5 x 8mm



MATERIAL AVAILABILITY															
FA	X	V	R	HH	SV	MXS	SXR	EPFA	GPFA	GPFA	SFA	SFAHH			
	✓		✓												
KAWASAKI															
KX 80 R7/W1/W2/W3						97-00	F	KL 250 G4-G8 "Super Sherpa"						00-09	F
KX 85						01-22	F	SUZUKI							
KX 100						97-09/11-21	F	RM 85						05-12/15-21	F
KX 112						21-22	F	RM 100 K3						03	F

SFA260 35 x 49 x 7mm



MATERIAL AVAILABILITY															
FA	X	V	R	HH	SV	MXS	SXR	EPFA	GPFA	GPFA	SFA	SFAHH			
											✓	✓			
GPI															
GTR 50						05-09	R	ET2 50cc						97-05	F
GTR 150						05-09	R	LX 50						05-15	F
PIAGGIO															
MP3 250 (12" Rear Wheel)						07-09	F	Primavera 50cc (3V/4T)						16-21	F
MP3 250 LE (14" Rear Wheel)						10-14	F	S 50 4T/4V						08-15	F
MP3 400ie (Three wheeler)						07-14	F	Sprint 50cc (4T/3V)						16-21	F
MP3 500 (Three wheeler - 12" Front / 14" Rear Wheel)						07-14	F	ET4 150cc						99-05	F
VESPA															
Electrica						19-21	F	LX 150 ie						05-15	F
								LXV 150 ie						10-15	F
								S 150 ie						08-15	F
								Sprint 150 (4T/3V/ie)						16-21	F

FA261 A 115.5 x 41 x 8.5mm
B 115.5 x 41 x 8.5mm

MATERIAL AVAILABILITY - FA261												
FA	X	V	R	HH	SV	MXS	SXR	EPFA	GPFA	GPFAF	SFA	SFAHH
✓		✓						✓				

FA261/2 A 115.5 x 41 x 11.5mm
B 115.5 x 41 x 11.5mm

MATERIAL AVAILABILITY - FA261/2												
FA	X	V	R	HH	SV	MXS	SXR	EPFA	GPFA	GPFAF	SFA	SFAHH
		✓		✓				✓				

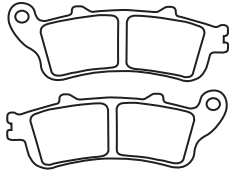

FA261													VTX 1800 F1/F2/F3	05-11	F
HONDA													VTX 1800 N1/N2/N3	04-11	F
NT 700 V/VA					10-13	R							VTX 1800 T1/T2	07-11	F
VFR 800 Fi Interceptor					98-05	F & R							VICTORY		
VFR 800 A Interceptor ABS					02-05	F & R							Vision Street	08-09	F
VFR 800 Interceptor					06-09	R							Vision Tour (All models)	08-17	F
XL 1000 VA Varadero (Canada)					08	R							Vision 8 Ball	10-11	F
CBR 1100 XX 'Blackbird'					97-03	F & R							Arlen Ness Victory Vision	09-12	F
CTX 1300/CTX 1300 DLX (ABS)					14	R							FA261/2 - HONDA		
ST 1100 A ABS model					96-02	F & R							VT 1300 CSA Sabre ABS	10-14	R
ST 1300 ABS/ST 1300					02-13	R							VT 1300 CRA Staline/CTA Interstate ABS	10-15	R
VT 1300 CXA (Fury ABS)					10-15	R							GL 1800/1800 A (ABS) Goldwing All models	01-17	R
GL 1800/1800 A (ABS) Goldwing All models					01-17	F							Goldwing F6B (GL1800B)	13-17	R
F6B Goldwing (GL1800B)					13-17	F							Goldwing F6B Deluxe (GL1800BD)	13-17	R
F6B Goldwing Deluxe (GL1800BD)					13-17	F							GL 1800 C Valkyrie	14-15	R
NRX 1800 Rune (DA/DB/EA/EB)					04-05	F & R							VTX 1800 S (Spoke Wheels)	02-07	R
VTX 1800 R (Cast Wheels)					02-08	F & R							VTX 1800 F1/F2/F3	05-11	R
VTX 1800 C/C1/C2/C3					02-08	F & R							VTX 1800 N1/N2/N3	04-11	R
VTX 1800 S (Spoke Wheels)					02-07	F							VTX 1800 T1/T2	07-11	R

FA263 106 x 31.5 x 8.5mm

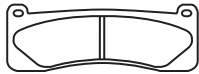

MATERIAL AVAILABILITY												
FA	X	V	R	HH	SV	MXS	SXR	EPFA	GPFA	GPFAF	SFA	SFAHH
								✓				

AP/LOCKHEED AFTERMARKET CALIPER
 6 Piston/2 Pins (CP4466)

PFM AFTERMARKET CALIPER
 6 Piston Superbike Caliper

FA264 A 85 x 43 x 8mm
B 70 x 41 x 8mm



DAELIM															
A-Four (50cc)					06-09	F									
E-TON															
Beamer R4-150 (PN2F)						F									
Beamer R2 50 (PN2G)						F									
Matrix 50					09	F									
Matrix R4-150					09	F									
Sport 50					09	F									

MATERIAL AVAILABILITY												
FA	X	V	R	HH	SV	MXS	SXR	EPFA	GPFA	GPFAF	SFA	SFAHH
✓				✓							✓	✓

SYM															
Fiddle 50					08-11	F							DTF 90	06-08	F
Jet Euro 50					99-12	F							DTF 110	06-08	F
Jet 50 EVO					14	F							Matrix 150 XX	05-06	F
Simply 50					07-12	F							Matrix II-150	07-08	R
Fiddle II 125 (AW 125 W)					08-14	F							ZERO ELECTRIC BIKE		
HD200 EVO					13-14	F & R							DS ZF6.0/ZF9.00	10-12	F
Citycom 300i (LH 300W)					08-14	F & R							MX (2 Pin fixing F/Pad)	10-12	F
TGB SCOOTER													S ZF6.0 (2 Pin fixing F/Pad)	10-12	F
Delivery 50 (Up to E/No 609099)					05-06	F							X (2 Pin fixing F/Pad)	10-12	F

FA265 75 x 55.5 x 8.5mm

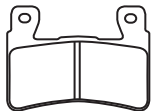

MATERIAL AVAILABILITY												
FA	X	V	R	HH	SV	MXS	SXR	EPFA	GPFA	GPFAF	SFA	SFAHH
				✓				✓				

HONDA													CBR 954 RR (954cc model)	02-03	F
CBR 900 RR 'Fireblade'					98-99	F							RVT 1000 R (RC51)	00-06	F
CBR 929 RR (929cc model)					00-01	F									

FA266 54 x 51 x 8mm



APRILIA															
ETV 1000 Caponord (Non ABS - Bolt fixing)					01-03	R									
ETV 1000 Caponord Rally (Non ABS - Bush fixing)					03	R									
ETV 1000 Caponord (ABS - Bush fixing)					04-07	R									
RSV 1000 All models (All models)					98-03	R									

MATERIAL AVAILABILITY												
FA	X	V	R	HH	SV	MXS	SXR	EPFA	GPFA	GPFAF	SFA	SFAHH
✓		✓	✓	✓				✓			✓	✓

RSV 1000 R Factory/R					04-12	R							RSV4 R APRC	11-12	R
SL 1000 "Falco" (All models)					00-05	R							RSV4 Factory APRC ABS	13-15	R
RSV Tuono					02-09	R							RSV4 R APRC ABS	13-15	R
RSV Tuono R/Factory R					02-10	R							RSV4 RF/RF LE/RR	18-19	R
Tuono V4 R APRC					11-13	R							Tuono V4 1100 RR/Factory	18-21	R
Tuono V4 R APRC ABS					14-15	R							RSVR 1100 RF/RF/LE/RR	18-21	R
RSV4 R					09-12	R							BENELLI		
RSV4 Factory					09-12	R							TNT 600i Tornado	16-17	R
RSV4 Factory APRC SE					11-12	R									

FA266 54 x 51 x 8mm

Contd.

BOMBARDIER

Traxter (4x4)	99-00	F & R
Traxter XL (4x4)	01	F & R
Traxter XT (4x4)	00	F & R
Traxter Autoshift	01	F & R
Traxter Footshift	01	F & R

BREMO AFTERMARKET CALIPER

20 6950 51 - 2 Piston P2/32 Rear Caliper
20 6951 12//50/63 - P2/34 Rear Caliper

CAGIVA

Raptor/V-Raptor 650/1000	01-02	R
--------------------------	-------	---

DERBI

GPR 50 Nude	04-05	F
GPR 80 Cup	05	F

DUCATI

620 Multistrada (Twin disc /single pin pad fixing)	06	R
620 Multistrada Dark (Single disc /twin pin pad fixing)	06	R
620 Sport	03	R
Monster 696	08-14	R
M 696 Monster - 20th Anniversary Model	13-14	R
749 Dark	04-06	R
749 R (Radial caliper)	04-06	R
749 S (Monoposto/Biposto)	03-06	R
749 (Monoposto/Biposto)	03-06	R
750 Supersport	99	R
750 Supersport IE	00-02	R
750 Sport	01-02	R
Hypermotard 796	10-13	R
796 Monster (Non ABS)	10-14	R
796 Monster (ABS)	10-15	R
M 796 Monster - 20th Anniversary Model	13-14	R
800 Supersport	03-05	R
Hypermotard (821cc)	13-15	R
Hypermotard SP (821cc)	13-15	R
Hyperstrada (821cc)	13-15	R
Monster 821	15-21	R
Monster Dark 821	15	R
Monster Stripe 821	15-17	R
848	08-09	R
848 Evo (Monobloc Front Calipers)	10-13	R
848 Evo Corse Special Edition	12-13	R
848 Streetfighter	12-15	R
899 Panigale	14-15	R
900 Supersport	98-99	R
900 Supersport IE	00-01	R
900 Sport	02	R
900 MH Evoluzione	00-01	R
ST4 (916cc)	99-00	R
Supersport (936cc)	17-19	R
Supersport S (936cc)	17-19	R
939 Hypermotard	16-17	R
939 Hypermotard SP	16-17	R
939 Hyperstrada	16	R
ST2 (944cc)	97-03	R
959 Panigale ABS	16-19	R

ST3 S (ABS Model) (992cc)	06-07	R
ST4S (996cc)	01-05	R
996 Monster (ABS)	10-12	R
998 Panigale V4 Superleggera	21	R
999 S (Std Caliper Mount) (Monoposto/Biposto)	03-04	R
999 S (Radial mount caliper) Monoposto/Biposto	05-06	R
999 (Std Mount Caliper)	03-06	R
999 R (Radial mount caliper)	03-06	R
Desmosedici (989cc) DD16RR	08	R
Multistrada 1000 DS/S 1000 DS (992cc)	03-05	R
Supersport 1000 DS (992cc)	03-06	R
Streetfighter (1099cc)	09-12	R
Streetfighter S (1099cc)	09-12	R
Hypermotard 1100/1100 S	07-09	R
Hypermotard 1100 Evo	10-12	R
Hypermotard 1100 Evo SP	10-13	R
Monster 1100/1100 S	09-10	R
Monster 1100 EV (ABS)	11-12	R
Multistrada 1100 (1078cc)	07-09	R
Multistrada 1100 S (1078cc)	07-09	R
1098	07-08	R
1098 S	07-08	R
1098 S Tricolore (1099cc)	07	R
1098 R	08-09	R
Monster 1100	09-10	R
Monster 1100 S	09-10	R
1100 Monster Evo	11-14	R
1100 Monster (ABS)	09-10	R
1100 Monster S (ABS)	09-10	R
1100 Monster Diesel	13-14	R
M 1100 Evo Monster - 20th Anniversary Model	13-14	R
Scrambler 1100 Special/Sport	18-21	R
Scrambler 1100 Sport	18-21	R
Scrambler 1100 Special	18-21	R
Scrambler 1100 Pro	18-21	R
Scrambler 1100 Sport Pro	18-21	R
1198	09-12	R
1198 S	09-11	R
1198 SP	11-12	R
1198 R Corse Special Edition	11	R
1199 Panigale	12-15	R
1199 Panigale S	12-15	R
1199 Panigale S Tricolore	12-14	R
1199 Panigale R	13-15	R
1199 Panigale Superleggera	14-15	R
1200 Monster	14-21	R
1200 S Monster	14-21	R
1200 S Monster Stripe	15	R
1200 R Monster	16-17	R
Multistrada 1200	10-15	R
Multistrada 1200 S (Sport)	10	R
Multistrada 1200 S Pikes Peak	11-14	R
Multistrada 1200 S Grandtourismo	13-14	R
Multistrada 1200 S Touring	10-14	R

1299 Panigale	15-21	R
1299 Panigale S	15-21	R
1299 Panigale R	15-21	R
1299 Panigale R FE	18-21	R
ENERGICA ELECTRIC		
Electric EVA	20	R
Electric EGO	20	R
Electric EVA Esse Esse 9	20	R
GOGORO		
SmartScooter	15-17	F
HARLEY DAVIDSON		
LiveWire	18-21	R
HONDA		
MSX125 GROM (Brembo Aftermarket Single Pin Caliper)	14-17	F&R
RC 213 V-S	15-17	R
INDIAN		
FTR 1200	19-21	R
FTR 1200 S	19-21	R
FTR 1200 S Race Replica	19-21	R
FTR 1200 Rally	19-21	R
KAWASAKI		
Ninja H2/Carbon (ZX1000NNF/NGF/XHF)	15-21	R
Ninja H2R(ZX1000PFF/PGF/YHF)	15-21	R
KTM		
1190 RC8	08-12	R
1190 RC8 R	09-14	R
1290 Super Duke R	14-21	R
1290 Super Duke GT	19-21	R
MOTO GUZZI		
750 Nevada Club (From LK112434)	98-01	R
750 Nevada Base/Club	02-03	R
Nevada Classic 750 ie	04-09	R
V7 Cafe Classic	11-12	R
V 750 ie Brevia	03-08	R
V7 Classic	08-12	R
V7 Racer	10-11	R
MGS-01 1000cc	04-05	R
MOTUS		
MST-01	12-13	R
MST	14-18	R
MSTR-01	12-13	R
MSTR	14-18	R
MV		
Brutale 675	12-14	R
F3 675 Serie Oro	12	R
F3 675	12-14	R
Brutale 800	12-21	R
Dragster 800 All Models	19-21	R
F3 800 Serie Oro (Brembo Calipers)	13-21	R
Rivale 800	13-14	R
Superveloce 800	20-21	R
Turismo Veloce 800	14-21	R
Turismo Veloce Lusso 800	14-21	R
PIAGGIO		
X9 500	05-09	R
BV 500	06-10	F&R

BUYERS GUIDE
BRAKE PADS

NOTE:- Size identification is shown as follows
Dimension 1=Width or Diameter, Dimension 2=Height or Diameter, Dimension 3=Thickness (Material and backplate)

FA267 52 x 60 x 9mm



MATERIAL AVAILABILITY												
FA	X	V	R	HH	SV	MXS	SXR	EPFA	GPFA	GPFAFX	SFA	SFAHH
✓				✓								

YAMAHA

YZF 750 R7 OW02 Road version	99-00	R
YZF 1000 R1	98-01	R

SFA268 46 x 53 x 6.5mm



MATERIAL AVAILABILITY												
FA	X	V	R	HH	SV	MXS	SXR	EPFA	GPFA	GPFAX	SFA	SFAHH
											✓	✓

YAMAHA
EW 50 Stunt (5LH2/5YN1) 01-03 F

FA270 74 x 53 x 7mm



MATERIAL AVAILABILITY												
FA	X	V	R	HH	SV	MXS	SXR	EPFA	GPFA	GPFAX	SFA	SFAHH
	✓		✓		✓							

POLARIS
All disc rear brake models - check application pages for main fitments.

FA271 67.5 x 44 x 8mm



MATERIAL AVAILABILITY												
FA	X	V	R	HH	SV	MXS	SXR	EPFA	GPFA	GPFAX	SFA	SFAHH
	✓		✓									

ARCTIC CAT

250 (2 x 4)													96-98 F & R
250 (2 x 4 / 4 x 4)					99-00 F & R								97-98 F & R
300 (2 x 4 / 4 x 4)					01-04 F & R		454 Bearcat (2 x 4)						97-98 F & R
375 (Auto)					98-04 F & R		454 Bearcat (4 x 4)						96-98 F & R
400 (Auto 2 x 4 / 4 x 4)					01 F & R		500 (4 x 4)						98-02 F & R
400 (2 x 4 / 4 x 4)					03-04 F & R		500 (Auto)						00-04 F & R
400 (2 x 4)					98/00-04 F & R		500 (4 x 4) Manual)						03-04 F & R
400 2 x 4 Utility					98 F & R		500 4 x 4 Auto TRV Utility						04 F & R
400 4 x 4 Auto Act Utility					98-04 F & R		500 4 x 4 Auto TBX Utility						04 F & R
400 4 x 4 Auto Utility					04 F & R		500 4 x 4 Auto Utility						98-04 F & R
400 4 x 4 ACT					04 F & R		500 4 x 4 Utility / Manual Gearbox						98-04 F & R
400 4 x 4 Utility					00-04 F & R								
400 2 x 4 Auto Utility					04 F & R								

FA272 39.5 x 44.5 x 7mm



MATERIAL AVAILABILITY												
FA	X	V	R	HH	SV	MXS	SXR	EPFA	GPFA	GPFAX	SFA	SFAHH
✓												

AP LOCKHEED CALIPERS
2 Piston / 1 Pin (CP4226 - 2S0)
2 Piston / 1 Pin (CP4227 - 2S0)

FA273 60.5 x 50.5 x 12.5mm



MATERIAL AVAILABILITY												
FA	X	V	R	HH	SV	MXS	SXR	EPFA	GPFA	GPFAX	SFA	SFAHH
			✓									

POLARIS
400 Big Boss L 6 x 6 96 Middle Axle Brake
425 Magnum 6 x 6 96 Middle Axle Brake
Ranger 99 R

FA275 99.5 x 30 x 9mm



MATERIAL AVAILABILITY												
FA	X	V	R	HH	SV	MXS	SXR	EPFA	GPFA	GPFAX	SFA	SFAHH
✓	✓			✓								

YAMAHA		SFA275	
TW 200 N/NC/P/PC/R/RC/S/SCT/TC/V/VC		YAMAHA	
/W/WC/X/Y/Z/A/B/D/E/F	01-15	F AT 115-C Nuovo (5MX6/2D51)	05-06 F
XT 225 N/NC/P/PC/R/RC/S/SC/T/TC		AT 115 (21P1)	07 F
/V/VC/W/WC	01-07	F RXS 115 (3HB8)	99 F
XT 250 X/Y/Z/A/B/D/E/F/G/H	08-17	F YP 250 Majesty (5GM2/9-5SJ2/5/9)	00-03 R
YZF 600 RRL/RRM/RRN/RRP 'R6'	99-02	R T10SE Crypton (5AM4)	99-02 F
YZF 1000 R1	02-03	R T105SE Crypton (1D81/1D82)	03-09 F

NOTE:- Size identification is shown as follows
Dimension 1=Width or Diameter, Dimension 2=Height or Diameter, Dimension 3=Thickness (Material and backplate)

FA281 115.5 x 41 x 9.5mm



MATERIAL AVAILABILITY												
FA	X	V	R	HH	SV	MXS	SXR	EPFA	GPFA	GPFA	SFA	SFAHH
				✓								✓

KAWASAKI

EN 650 Vulcan S (Non ABS) EN 650 AFF /AGF/CHF 15-21
 EN 650 Vulcan S (ABS) 15-21
 EN 650 BFF/BGF/DHF 15-21
 EN 650 Vulcan S Café (ABS) 18-21
 EN 650 Vulcan S (ABS) SE 18-21

SFA281

HONDA

NSS 250/250 A/AS Reflex 01-07 F
 FSC 600 Silverwing 02-10 F
 FSC 600/D Silverwing Non ABS
 Model (256mm f/disc) 02-06 F

SFA283/4 53.5 x 44.5 x 8.5mm



MATERIAL AVAILABILITY												
FA	X	V	R	HH	SV	MXS	SXR	EPFA	GPFA	GPFA	SFA	SFAHH
											✓	✓

SUZUKI

AN 400 K3/K4/K5/K6/SK6 Burgman 03-06 F

FA291 43.5 x 57 x 6.5mm



MATERIAL AVAILABILITY												
FA	X	V	R	HH	SV	MXS	SXR	EPFA	GPFA	GPFA	SFA	SFAHH
	✓											

GAS-GAS

EC 50 (Boy) 01-04 F&R TXE Electric 20 F
 EC 50 (Rookie) 01-04 R Pampera 125/250/280 04 R
 EC 50 05 R TXT 125/200/249/280/321 00-03 F&R
 SM 50 (Rookie) 01-04 R TXT 200/270/321 99 F&R
 SM 50 05 R TXT Racing 125/250/280/300 20-22 F
 TXT 50 (Boy) 01 F&R Trial GP 125/250/280/300 20-22 F
 TXT 50/80 (Rookie) 02-03 F&R Pampera 250 02-03 R

FA293 22 x 6mm



MATERIAL AVAILABILITY												
FA	X	V	R	HH	SV	MXS	SXR	EPFA	GPFA	GPFA	SFA	SFAHH
✓												

POLINI CALIPERS

Polini Calipers (Round shape threaded pad)

FA294 81 x 46 x 7.5mm



MATERIAL AVAILABILITY												
FA	X	V	R	HH	SV	MXS	SXR	EPFA	GPFA	GPFA	SFA	SFAHH
				✓				✓				

BMW

R 850 R 03-06 F R 1200 CL 02-04 F
 R 1100 S 12/00-06 F K 1200 LT (Evo Integral ABS) 11/00-09 F
 R 1150 GS (Evo-R21/0415/0495) 11/01-03 F K 1200 R 05-09 F
 R 1150 GS Adventure 07/01-06 F R 1200 C Montauk 04-05 F
 R 1150 R 01-06 F R 1200 R (K27) 06-11/07 F
 R 1150 R Rockster 03-06 F R 1200 R (Disc has fixed bobbins) 08-14 F
 R 1150 RS 01-05 F K 1300 R 09-15 F

EPFA295HH 74 x 53 x 7mm



MATERIAL AVAILABILITY												
FA	X	V	R	HH	SV	MXS	SXR	EPFA	GPFA	GPFA	SFA	SFAHH
								✓		✓		

BREMBO

X9737 80/81 Radial Mount Endurance Caliper
 108mm Spacing

FA296 75 x 55.5 x 7.5mm

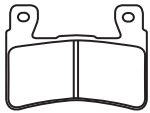

MATERIAL AVAILABILITY													
FA	X	V	R	HH	SV	MXS	SXR	EPFA	GPFA	GPFAX	SFA	SFAHH	
				✓				✓		✓			
HARLEY DAVIDSON						HONDA							
XR 1200					08-10	F	CBR 600 F4/F4i Sport				99-06	F	
XR 1200 X					10-12	F	CBR 600 RR				03-04	F	
FLS Softail Slim					15-17	F	CB 1000 R				17-21	F	
FLSS Softail Slim S					16-17	F	CB 1100 (Non ABS)				13-14	F	
FLSTC Heritage Softail Classic					15-17	F	CB 1100 EX (ABS)				14-17	F	
FLSTF Fat Boy					15-17	F	GL 1800 C Valkyrie				14-15	F	
FLSTFB Fat Boy Lo					15-17	F	HYOSUNG						
FLSTFBS Fat Boy S					16-17	F	ST7 Custom				10-11	F	
FLSTN Softail Deluxe					15-17	F	KAWASAKI						
FXSB Breakout					15-17	F	ZX6R (ZX 636 EDF/EEF/EFF/EGF/EHF)						
FXST Softail Standard					15	F	636cc/Non ABS				13-17	F	
FLFB Fat Boy					18-21	F	ZX6R (ZX 636 EEFA) 636cc						
FLFBS Fat boy 114					18-21	F	/30th Anniversary Edition						
FLFBS Fat Boy Anniv					18	F	/Non ABS				15	F	
FLHC Heritage Classic					18-21	F	ZX6R (ZX 636 EGFA/EHFA) 636cc						
FLHCS Heritage Classic 114					18-21	F	/Non ABS/KRT Edition				16-17	F	
FLHCS Heritage Classic 114 Anniv.					18	F	ZX6R (ZX 636 FDF/FEF/FFF/FGF/FHF)						
FLSB Sport Glide 1745					18-21	F	636cc/ABS				13-17	F	
FLSL Softail Slim					18-21	F	ZX6R (ZX 636 FFFA) 636cc						
FXBR Breakout					18	F	/30th Anniversary Edition						
FXBRS Breakout 114					18-21	F	/Non ABS				15	F	
FXBRS Breakout 114 Anniv					18	F	ZX6R (ZX 636 FGFA/FHFA) 636cc/						
FLDE Deluxe					18	F	ABS/KRT Edition				16-17	F	
FXBB Street Bob					18-21	F	ZX 6R (ZX636EJF)				18-21	F	
FXFB Fat Bob					18	F	ZX 6R ABS (ZX636EJF)				18-21	F	
FXBS Fat Bob 114					18-21	F	ZX 6R ABS KRT Edition (ZX636EJF)				18-21	F	
FXLR Low Rider					18-21	F							
FXLRS Low Rider S					18-21	F							

FA298 51 x 53.5 x 9.5mm



MATERIAL AVAILABILITY													
FA	X	V	R	HH	SV	MXS	SXR	EPFA	GPFA	GPFAX	SFA	SFAHH	
✓											✓	✓	
APRILIA													
RS 125					06-12	R	Scarabeo 200				08-14	R	
SFA298							Scarabeo 250				06-08	R	
APRILIA							Sport City 250				07-14	R	
SR50 (Factory)					04-15	R	Scarabeo 500 ie				03-14	R	
Scarabeo 150					99-03	R	BETA						
Sport City Cube 250					08-09	R	Eikon 150				04	R	
Atlantic 500					03-05	R	MALAGUTI						
Atlantic 200					04-06	R	F18 Warrior				03-04	R	
Scarabeo 125/250 GT					04-05	R							

SFA301 54 x 51 x 8mm

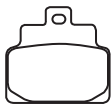

MATERIAL AVAILABILITY													
FA	X	V	R	HH	SV	MXS	SXR	EPFA	GPFA	GPFAX	SFA	SFAHH	
											✓	✓	
APRILIA													
Mojito Custom 150					05-09	F							

FA302 A 67.5 x 36.5 x 7.5mm B 52 x 40 x 7.5mm



MATERIAL AVAILABILITY													
FA	X	V	R	HH	SV	MXS	SXR	EPFA	GPFA	GPFAX	SFA	SFAHH	
	✓		✓			✓							
KAWASAKI						SUZUKI							
KX 65					00-22	F	RM 65 K3/K4/K5				03-05	F	

NOTE:- Size identification is shown as follows
Dimension 1=Width or Diameter, Dimension 2=Height or Diameter, Dimension 3=Thickness (Material and backplate)

FA303 50 x 44 x 6mm



MATERIAL AVAILABILITY

FA	X	V	R	HH	SV	MXS	SXR	EPFA	GPFA	GPFAFX	SFA	SFAHH
	✓											

BETA												
Evo 80				09-19	F							TXT 80 Cadet Pro 15 F
Evo 80 JR				09-12	F							Contact RR 250/280 20 F
Rev 3 (125/200/250/270)				00-04	F&R							TXT 125/200/250/280/300 (TXT Pro) 04-15 F
Rev 3 125/200				05	F&R							TXT 250/280/300 Raga 07-11 F
Rev 3 125/200				06-08	F							MONTESA
Evo 125 (2T)				10-15	F							315 R 01-04 F
Evo 200 (2T)				10-15	F							4RT Cota (250cc) 05-08 F
Rev 3 250/270				05-08	F							4RT Cota Standard Edition (260cc) 09-17 F
Evo 250 (2T)				09-15	F							SCORPA
Evo 250 (4T)				09-15	F							SR 125 (2T) 11 F
Evo 250 Factory 2T				18-19	F							SY 250 03-10 F
Evo 250 Factory 4T				18-19	F							SY 250 Long Ride 05-09 F
Evo 300 (2T)				09-15	F							SY 250 F 06-09 F
Evo 300 (4T)				09-15	F							SY 250 FR 11 F
												SR 280 (2T) 11 F
GAS-GAS												SHERCO
EC 50 Boy (LC)				05	F							2.5/2.9 (2T) 03-10 F
TX 200 Randonne (4T)				14-15	F							3.2 (4T) 05-10 F
TXT 70 Cadet/Rookie				10-11	F							
TXT 80 Rookie/Cadet				04-08	F							

FA304 75 x 55 x 9mm



MATERIAL AVAILABILITY

FA	X	V	R	HH	SV	MXS	SXR	EPFA	GPFA	GPFAFX	SFA	SFAHH
✓		✓		✓								

BMW												
R 1200 CL				02-04	R							
K 1200 LT				97-09	R							

FA305 A 85 x 43.5 x 8.5mm B 69/95 x 36 x 11mm



MATERIAL AVAILABILITY

FA	X	V	R	HH	SV	MXS	SXR	EPFA	GPFA	GPFAFX	SFA	SFAHH
	✓		✓								✓	✓

ARCTIC CAT												
50 4x4 Auto Youth				08	R							Mongoose 70 (4T) 07-16 R
DVX 50 (Y6)				06	R							Mongoose 90 02-16 R
50 Utility				06-08	R							Mongoose 90 R (Reverse gear) 10-14 R
50 DVX (4T)				06-08	R							Like 150 I ABS 20-21 F
50 DVX (4T) Sport				06/08	R							Like 150 I ABS Noodoe 20-21 F
DVX 90 (Y12 4 Stroke)				06-09	R							MXer 150 03-05 R
90 2x4 (4T) Youth Rear Disc Model				06	R							MXU 150 05-16 R
90 Utility (2x4)				06-11	R							Super 8 (50c) (2T) 07-14 F
90 DVX				06-14	R							Super 8 (150cc) 07-12 F
90 DVX SE				09	R							Super 8 150 X 19-21 F
90 SE				09	R							Super 9 LC/AC 02-08 R
90 (Reverse Gear Model)				10-14	R							Like 50 (2T) 09-14 F
150 Utility				09-14	R							People 50 (2T) 02-12 F
KAWASAKI												People S 50 05-08 F
KFX 50 (KSF 50 B7F/B8F/B9S/BDF/BEF /BFF/BGF/BHF)				07-09/13-17	R							People S 125 05-08 F
KFX 90 (KSF 90 A7F/A8F/A9F/AAF/ABF /ACF/ADF/AEF/AFF/AGF/AHF)				07-17	R							People 150 07-12 F
												People S 200 05-10 F
KYMCO												Like 200i (All Models) 10-21 F
Like 50i (4T)				20-21	F							SYM
Super 8 50 X (50cc 4T)				20-21	F							HS 125/200 04-08 F
												HD 125 (LH 125 W) 08-12 F
												HD 200 08-12 F

SFA306 70 x 42 x 8mm



MATERIAL AVAILABILITY

FA	X	V	R	HH	SV	MXS	SXR	EPFA	GPFA	GPFAFX	SFA	SFAHH
											✓	

SYM												
RS 50				04-10	F							
RV 200 EVO				12-14	F							

FA307 A 82 x 41 x 9.5mm B 62 x 41 x 9.5mm



BOMBARDIER/BRP

Rally 200	05-06		R
Outlander 330 HO	04-05	F Left & R	
Outlander 400	03-05	F Left & R	
Outlander 400 Max HO	03-06	F Left & R	
Traxter Autoshift	01-05	F Left & R	
Traxter Footshift	01	F Left	
Quest 500 (2x4)	02	F Left	
Quest 500 (4x4)	02-04	F Left	
Quest 650 (2x4)	02	F Left	
Quest 650 (4x4)	02-04	F Left	
Quest 650 XT (4x4)	02	F Left	
Quest Max 650	03-05	F Left	
DS 650	00-05	F Left & R	
DS 650 Baja/X	01-06	F Left & R	
Traxter Max	03-04	F Left	
Traxter Max 650	04-05	F Left	
Outlander 650 HO EFI 4x4			
/HO EFI XT 4x4	06	F Left & R	
Outlander Max 650 HO EFI 4x4			
/HO EFI XT 4x4	06	F Left & R	
Traxter XL (7920/7921)	04	F Left	
Quest Max/Std/XT	04-05	F Left	
Outlander 800 (All models)	06	F Left & R	

CAN-AM

Rally 200 (4A7A/B/C/D/E/F)	07		R
Outlander 400 (4x4 STD)			
(2D7A/B/C/D/E/F/G/H 4x4 STD)	07-14	F Left & R	
Outlander 400 (XT 4x4)			
(2E7A/B/C/D/E/F)	07-14	F Left & R	
Outlander Max 400 (STD 4x4)			
(2F7B/C/D/E/F/G/H/J)	07-14	F Left & R	

MATERIAL AVAILABILITY

FA	X	V	R	HH	SV	MXS	SXR	EPFA	GPFA	GPFAFX	SFA	SFAHH
	✓		✓		✓		✓					

Outlander Max 400 (XT 4x4) (2G7A/B/C/D/E)	07-08	F Left & R											Outlander Max 800 R EFI 09-11 F Left & R
Outlander 500 (STD 4x4) (2T7A/B/C/D)	07-12	F Left & R											Outlander Max 800 R XT 09-10 F Left & R
Outlander 500 (XT 4x4) (2U7A/B/C/D)	07-12	F Left & R											Renegade 800 X (4x4/EFI) 08 F Left & R
Outlander Max 500 (Std 4x4) (2W7A/B/C)	07-12	F Left & R											Renegade 800 (4x4/EFI) 07-08 F Left & R
Outlander Max 500 (XT 4x4) (2X7A/B/C)	07-12	F Left & R											Renegade 800 R EFI 09-11 F Left & R
Renegade 500 (4x4/EFI)	08-11	F Left & R											Renegade 800 R X 09-11 F Left & R
DS 650 X (3B7A/B)	07	F Left & R											Renegade 800 R (XXC) 11 F Left & R
Outlander 650 (4x4 STD) (2N7A/B/C/D/E/F/G/H)	07-11	F Left & R											Commander Max 1000 DPS/XT 14 R Left
Outlander 650 (XT 4x4) (2P7A/B/C/D/E/F)	07-11	F Left & R											Commander Max 1000 LTD 15 R Left
Outlander Max 650 (STD 4x4) (2R7A/B/C/D/E/F/G/H/J/K)	07-11	F Left & R											Maverick 1000 - STD 13 R Left
Outlander Max 650 (XT 4x4) (2S7A/B/C/D/E/F)	07-10	F Left & R											Maverick 1000 - XRS 13 R Left
Outlander Max XT-P 650	12	F Left & R											Maverick 1000 - XRS -DPS 14-15 R Left
Outlander 800 (STD 4x4) (2H7A/B/C/D/E/F/G/H)	07-08	F Left & R											Maverick 1000 - XMR 14-15 R Left
Outlander 800 (XT 4x4) (2J7A/B/C/D/E/F)	07-08	F Left & R											Maverick 1000 - XXC 14-15 R Left
Outlander 800 R EFI	09	F Left & R											Maverick Max 1000 - STD 14-15 R Left
Outlander 800 R XT	09-10	F Left & R											Maverick Max 1000 - XRS-DPS 14-15 R Left
Outlander 800 R (XMR)	11	F Left & R											JOHN DEERE ATV
Outlander 800 R (XXC)	11	F Left & R											Trail Buck 500/650 EX/EXT 04-08 F Left
Outlander Max XT-P 800 R	12	F Left & R											Buck 500/650 EX/EXT 04-08 F Left
Outlander Max 800 Ltd 4x4 (2M7A/B/C)	07-08	F Left & R											YAMAHA
Outlander Max 800 (Std 4x4) (2J7A/B/C/D/E/F/G/H/J)	07-11	F Left & R											YFM 400 FAM/FAN/FAP 00-02 R
Outlander Max 800 (XT 4X4) (2L7A/B/C/D/E/F)	07-11	F Left & R											YFM 400 AM/AN 00-01 R

FA313 123.5 x 55 x 9mm



MATERIAL AVAILABILITY

FA	X	V	R	HH	SV	MXS	SXR	EPFA	GPFA	GPFAFX	SFA	SFAHH
			✓		✓							

POLARIS

500 Sportsman 6 x 6	00-08		R
PPS LUH 6 x 6	02		R
PPS/PTV 6 x 6/Series 10			R

FA314 90.5 x 41 x 8mm



MATERIAL AVAILABILITY

FA	X	V	R	HH	SV	MXS	SXR	EPFA	GPFA	GPFAFX	SFA	SFAHH
			✓		✓							

POLARIS

500 Sportsman HO/EFI Demand Drive	03-04		R
250 Trail Blazer	05-06	R	500 Sportsman EFI/HO 07-08 R
325 Magnum (2 x 4) HDS	02	R	500 Sportsman Forest 12 R
325 Magnum 4 x 4 (A02CD32AA/AB/AC)	02	R	500 Sportsman EFI/HO 04-06 R
325 Xpedition	02	R	500 Sportsman HO (Built up to 15/12/2008) 08 R
325 Magnum 4 x 4 HDS (A02CD32FB)	02	R	500 Sportsman X2 06-08 R
330 Magnum (4 x 4/HDS)	03-04	R	500 Sportsman EFI Quad H.O. 08-11 R
330 Magnum (2 x 4/HDS)	03-06	R	600 Sportsman 4 x 4 03-05 R
330 Trail Boss	05-13	R	700 Sportsman (4 x 4)/EFI 02-06 R
330 Trail Blazer	08-13	R	700 Sportsman EFI 07 R
400 Sportsman	03-04	R	700 Sportsman MV 05-06 R
450 Sportsman	06-07	R	800 Sportsman EFI 05-06 R
500 Magnum (2 x 39906 x 4 HDS)	02	R	800 Sportsman EFI 08-09 R
500 ATV Pro 4 x 4 PPS	02	R	800 Sportsman EFI Intl/HO 07-11 R
500 Magnum 4 x 4 HDS	02-03	R	800 Sportsman Big Boss/EFI 6 x 6/EFI 09-14 R
500 Scrambler 4 x 4	05-12	R	PPS/PTV 4 x 4/Series 10 07-08 R
500 Scrambler 2 x 4	07-08	R	

BUYERS GUIDE
BRAKE PADS

NOTE:- Size identification is shown as follows
Dimension 1=Width or Diameter, Dimension 2=Height or Diameter, Dimension 3=Thickness (Material and backplate)

FA317 A 82 x 41 x 9.5mm B 62 x 41 x 9.5mm



BOMBARDIER/BRP

Outlander 330 HO	04-05	F Right
Outlander 400	03-05	F Right
Outlander 400 Max HO	03-06	F Right
Traxter (4x4)	01	F Right
Traxter XL (4x4)	01-04	F Right & R
Traxter XT (4x4)	01	F Right & R
Traxter Autoshift	01-05	F Right & R
Traxter Footshift	01	F Right & R
Quest 500 (2x4)	02	F Right
Quest 500 (4x4)	02-04	F Right & R
Quest 650 (2x4)	02	F Right & R
Quest 650 (4x4)	02-04	F Right & R
Quest 650 XT (4x4)	02	F Right & R
DS 650	00-05	F Right
DS 650 Baja/X	01-06	F Right
Outlander 650 HO EFI 4x4/HO EFI XT 4x4	06	F Right
Outlander Max 650 HO EFI 4x4 /HO EFI XT 4x4	06	F Right
Quest Max 650	03-05	F Right & R
Traxter Max	03-05	F Right
Traxter Max 650	04-05	F Right & R
Traxter XL (7920/7921)	04	F Right & R
Quest Max/STD/XT	04-05	F Right & R
Outlander 800 (All models)	06	F Right
CAN AM		
DS 650 X (3B7A/B)	07	F Right
Outlander 400 (4x4 STD) (2D7A/B/C/D/E/F/G/H)	07-14	F Right

MATERIAL AVAILABILITY												
FA	X	V	R	HH	SV	MXS	SXR	EPFA	GPFA	GPFA	SFA	SFAHH
	✓		✓		✓		✓					

Outlander 400 (XT 4x4) (2E7A/B/C/D/E/F)	07-14	F Right	Outlander Max 800 Ltd 4x4 (2M7A/B/C)	07-08	F Right
Outlander Max 400 (STD 4x4) (2F7B/C/D/E/F/G/H/J)	07-14	F Right	Outlander Max 800 (STD 4x4) (2K7A/B/C/D/E/F/G/H/J)	07-08	F Right
Outlander Max 400 (XT 4x4) (2G7A/B/C/D/E)	07-08	F Right	Outlander Max 800 (XT 4x4) (2L7A/B/C/D/E/F)	07-08	F Right
Outlander 500 (STD 4x4) (2T7A/B/C/D)	07-12	F Right	Outlander Max 800 R EFI/XT	09-11	F Right
Outlander 500 (XT 4x4) (2U7A/B/C/D)	07-12	F Right	Outlander Max XT-P 800 R	12	F Right
Outlander Max 500 (STD 4x4) (2WA/B/C)	07-12	F Right	Renegade 800 X (4x4/EFI)	08	F Right
Outlander Max 500 (XT 4x4) (2X7A/B/C)	07-12	F Right	Renegade 800 X (4x4/EFI)	07-08	F Right
Renegade 500 (4x4/EFI)	08-11	F Right	Renegade 800 R EFI/X	09-11	F Right
Outlander 650 (4x4 STD) (2N7A/B/C/D/E/F/G/H)	07-11	F Right	Renegade 800 R (XXC)	11	F Right
Outlander 650 (XT 4x4) (2P7A/B/C/D/E/F)	07-11	F Right	Commander Max 1000 DPS/XT	14	R Right
Outlander Max 650 (STD 4x4) (2R7A/B/C/D/E/F/G/H/J/K)	07-11	F Right	Commander Max 1000 LTD	15	R Right
Outlander Max 650 (XT 4x4) (2S7A/B/C/D/E/F)	07-11	F Right	Maverick 1000 - STD/XRS	13	R Right
Outlander Max XT-P 650	12	F Right	Maverick 1000 - XRS -DPS	14-15	R Right
Outlander 800 R EFI	09	F Right	Maverick 1000 - XMR/XXC	14-15	R Right
Outlander 800 R XT	09-11	F Right	Maverick Max 1000 - STD/XRS-DPS	14-15	R Right
Outlander 800 R (XMR)	11	F Right	CF MOTO		
Outlander 800 R (XXC)	11	F Right	500 C-Force HO EPS	14-16	R
Outlander 800 (STD 4x4) (2H7A/B/C/D/E/F/G/H)	07-08	F Right	600 C-Force/C-Force Touring	20	R
Outlander 800 (XT 4x4) (2J7A/B/C/D/E/F)	07-08	F Right	JOHN DEERE		
			Trail Buck 500/650 EX/EXT	04-08	F Right & R
			Buck 500/650 EX/EXT	04-08	F Right & R
			SUZUKI		
			LT-A 500 FK2 Vinson 4WD	02	R

SFA319 100 x 36 x 12mm FA319/2 100 x 36 x 9.5mm



SFA319

YAMAHA

XP 500 T-Max (5GJ5)	01	R
---------------------	----	---

FA319/2

YAMAHA

SCR 950 (SCR 950 H)	17	R
XVS 950 (V-Star 950)	09-14	R
XVS 950 (V-Star 950 Tourer)	09-14	R
XVS 950 Bolt C Spec (Remote Reservoir Rear Shocks)	15-21	R
XVS 950 Bolt R Spec (Remote Reservoir Rear Shocks)	14-21	R
XT 1200 Z Super Tenere	12-21	R
XT 1200 Z Super Tenere ES	14-21	R

MATERIAL AVAILABILITY - FA319												
FA	X	V	R	HH	SV	MXS	SXR	EPFA	GPFA	GPFA	SFA	SFAHH
											✓	✓

MATERIAL AVAILABILITY - FA319/2												
FA	X	V	R	HH	SV	MXS	SXR	EPFA	GPFA	GPFA	SFA	SFAHH
✓		✓									✓	

FJR 1300 R/RC/S/AS/T/AT	03-05	R	XV17 PCV/PCW/PCX	06-08	R
FJR 1300 AV/AW/AX/AZ/AA/AB	06-12	R	XV 1700 Road Star Midnight Warrior		
FJR 1300 AEW/AEX/AEY Electric Shift	06-09	R	(Front floating discs/3 spoke cast wheels)		
FJR 1300 A	13-18	R	XV17 PCTC/PCTB/PCTCB	05	R
FJR 1300 ES	14-18	R	XV 1700 Road Star Warrior (Floating discs /3 spoke cast wheels) (XV17 PCS/PCT)	04-05	R
XVS 1300 V-Star 1300 Tourer	07-14	R	XV 1900 Roadliner	06-07	R
XVS 1300 V-Star	07-14	R	XV 1900 Roadliner Midnight	06-09	R
XVS 1300 V-Star Deluxe	13-14	R	XV 1900 Roadliner S	06-10/12-14	R
XVS 1300 Stryker	11-14	R	XV 1900 Stratoliner	06-09	R
VMX 1700 V-Max (6 piston radial caliper)	09-16	R	XV 1900 Stratoliner S	06-14	R
XV 1700 Road Star Midnight Warrior			XV 1900 Stratoliner Deluxe	11-14	R
5 spoke cast wheel XV17 PCMV/PCMVC/PCMW/PCMX/PCMY	06-09	R	XV 1900 Raider/Raider S	08-14	R
XV 1700 Road Star Warrior 5 spoke wheel			XV 1900 Raider SCL	12-14	R

FA320 70 x 42.5 x 7.5mm



MV

F4 750 (All models) (Nissin Calipers)	99-03	R
Brutale 750 (All models) (Nissin Calipers)	03-06	R
Brutale 910 S (Nissin Calipers)	05-07	R
Brutale 910 R (Brembo Calipers)	05-07	R
Brutale 989 R	08-09	R
Brutale 990 R	10	R

MATERIAL AVAILABILITY												
FA	X	V	R	HH	SV	MXS	SXR	EPFA	GPFA	GPFA	SFA	SFAHH
				✓								

Brutale 1000	19-20	R	F4RR 312 1078cc	08-09	R
F4 (998cc)	10-14	R	F4 100 CC (1078cc)	07	R
F4R (998cc)	12-14	R	Brutale 1078 RR	08-09	R
F4 RR(998cc)	12-14	R	F4 RR 1078	08-09	R
F4 1000 (All models) (Nissin Calipers)	04-06	R	Brutale 1090	13-14	R
F4R 1000 (Brembo Calipers)	06-07	R	Brutale 1090 R	12-14	R
F4RR 312R 1000 (Brembo Calipers)	07	R	Brutale 1090 RR	10-14	R

BUYERS GUIDE
BRAKE PADS

NOTE:- Size identification is shown as follows
Dimension 1=Width or Diameter, Dimension 2=Height or Diameter, Dimension 3=Thickness (Material and backplate)

SFA321 55.5 x 49 x 7.5mm

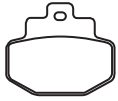

MATERIAL AVAILABILITY															
FA	X	V	R	HH	SV	MXS	SXR	EPFA	GPFA	GPFAX	SFA	SFAHH			
											✓	✓			
PIAGGIO												LXV 250	07-09	R	
Fly 150 (4T/3V)						13-20						R	GTS 300 ie	08-15	R
VESPA												GTS 300 Super	10-15	R	
GTS 125 4V ABS/Super Sport/Touring						18-21						R	GTV 300 ie	10-15	R
946 Red 125cc (4T/3V)						19-20						R	GTS 300 4V ABS/Super Sport/Touring	18-21	R
946 (155cc/ABS/4T/3V/ie)						13-15						R	GTS Super 300 HPE-Tech (4T/4V)	18-21	R
GTS 150 4V ABS						18-19						R	GT 60 (250cc Ltd Edition)	06-08	R
GT 200 L Granturismo						05-09						R	GTV SEI GIORNI 300cc IE ABS	19-21	R
GTS 250						05-09						R			
GTV 250						07-09						R			

FA322/4 35 x 40.5 x 7.5mm



MATERIAL AVAILABILITY															
FA	X	V	R	HH	SV	MXS	SXR	EPFA	GPFA	GPFAX	SFA	SFAHH			
				✓				✓							
APRILIA												KTM			
RSV Mille R/1000/Mille (All models)						01-03						F	690 Duke (4 Separate Pad Type Caliper)	08-11	F
RSV Tuono R/Factory R													690 Duke R (4 Separate Pad Type Caliper)	10-11	F
(Radial mount Caliper)						02-10						F	690 SMC	08-11	F
RSV 1000 R Factory/R						04-12						F	950 Supermoto	05-08	F
BENELLI													950 Supermoto R	07-08	F
TNT 600i Tornado						16-17						F	990 Superduke	05-11	F
BREMBO AFTERMARKET CALIPER													990 Superduke T	07-11	F
20 7860 11/21 4 Piston P4/34													990 SM-T	10-14	F
20 8343 11/21 or 35/45 4 Piston P4/34													MOTO GUZZI		
DUCATI													MGS-01 1000 cc	04-05	F
748 R						01-02						F	MOTUS		
749 Dark (Monoposto/Biposto)						04-06						F	MST-01	12-13	F
749 R (Radial caliper)						04-06						F	MSTR-01	12-13	F
749 S (Monoposto/Biposto)						03-06						F	MV		
749 (Monoposto/Biposto)						03-06						F	Brutale 910 R (Brembo Calipers)	05-07	F
996 R						01						F	F4R 1000 (Brembo Calipers)	06-07	F
S4RS Monster (998cc)													F4RR 312R 1000 (Brembo Calipers)	07	F
(Radial 4 pad caliper)						06						F	SHERCO		
S4R/S4RS Testastretta Monster (998cc)						07-08						F	4.5iF Supermoto	08-12	F
(Radial 4 pad caliper)													SM4.5i	12-14	F
998 Matrix (998cc)						04						F	TM		
998 R (998cc)						02						F	SMX 450 F Competition (4T)	05-08	F
998 S Bayliss/Bostrom						02						F	SMX 530 F Competition	05-08	F
998 S (998cc) (4 pad caliper)						02-06						F	TRIUMPH		
999 S (Std caliper mount)													Speed Triple (1050cc - 4 Pad Brembo F/		
(Monoposto/Biposto)						03-04						F	Caliper/220mm R/Disc/Non ABS Model)	07-09	F
999 (Std mount caliper)						03-06						F	Speed Triple (1050cc - 4 Pad Brembo F/		
999 R (Radial mount caliper)						03-06						F	Caliper/220mm R/Disc/ABS Model)	07-09	F
HUSQVARNA															
SMR 450 RR						06-08						F			
SM 450 R						07-10						F			
SM 510 R						06-11						F			
SM 610 S						06						F			
SM 610 IE						07-09						F			
SM 630						09-10						F			
SMS 630						10-11						F			
STR 650 CRC						07						F			

FA323 81 x 42 x 9mm



MATERIAL AVAILABILITY															
FA	X	V	R	HH	SV	MXS	SXR	EPFA	GPFA	GPFAX	SFA	SFAHH			
	✓		✓								✓	✓			
YAMAHA												SFA323			
YFZ 450 V/W/X/Y/B/D						06-09/12-13						R	HONDA		
YFZ 450 RY/RZ/RA/RB/RD/RE/RSE/RF						09-15						R	NHX 110 Elite	10-11	F
YFZ 450 BBV/BBW Bill Balance Edition						06-07						R	SH 150 i	10-11	F
YFZ 450 SPV/SEW/SPX Special Edition						06-08						R	U.M.		
YFZ 450 BB/DB						12-13						R	Powermax 150 XX	05-06	F
YFM 700 RD/RE Raptor						13-14						R	Matrix II-150	07-08	F

NOTE:- Size identification is shown as follows
Dimension 1=Width or Diameter, Dimension 2=Height or Diameter, Dimension 3=Thickness (Material and backplate)

SFA324 117.5 x 41.5 x 8.5mm

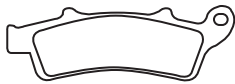

MATERIAL AVAILABILITY												
FA	X	V	R	HH	SV	MXS	SXR	EPFA	GPFA	GPFAFX	SFA	SFAHH
											✓	✓

APRILIA												
Atlantic 200					04-06	F	People GT 200 i				11-12	F
Scarabeo 200					08-14	F	People GT 300i				11-15	F
Scarabeo 250					06-08	F	X Town 300i ABS				18-21	F

FA325 43 x 25 x 5mm



MATERIAL AVAILABILITY												
FA	X	V	R	HH	SV	MXS	SXR	EPFA	GPFA	GPFAFX	SFA	SFAHH
	✓		✓									

COBRA												
King 50					04-06	F&R	TC 50 Mini				18-20	F&R
DC 65					06	R	SM 50				11	F&R
50 FWE					16-17	F&R	KTM					
50 P3R					16-17	F&R	50 SX Pro Senior LC				02-03	F
50 JR					10-17	F&R	50 SX Pro Senior LC/Mini Senior Adventure				02-07	F
CX 50 SR King					11-17	F&R	50 Supermoto				06	F&R
GAS-GAS (PIERER)							SX 50 Junior LC				07-09	F
MC-E 5							SX-E 5 Electric				20-22	F&R
MC 50 2T					21	F&R	SX 50 Mini (F&R 10" wheels)				09-22	F&R
HUSQVARNA							SX 50 Pro Senior (F12"/R10)				09-22	F&R
CR 50 Senior Pro					05	R	65 SX				04-09	R
CR 50					11	F&R	XC 65				08-09	R
EE 5 Electric					21-22	F&R	LEM					
TC 50					18-22	F&R	RX 2/3				03-08	F

CFA327 35 x 30.7 x 4mm



MATERIAL AVAILABILITY												
CFA	X	V	R	HH	SV	MXS	SXR	EPFA	GPFA	GPFAFX	SFA	SFAHH
✓			✓	✓								

BETA												
Electric 20XL					18-19	F	WI-Bike Active Electric				19-20	F&R
Electric 20					18-19	F	WI-Bike Comfort Electric				19-20	F&R
Electric 16					18-19	F						

FA335 77 x 51.5 x 8.5mm

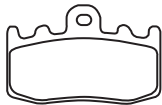

MATERIAL AVAILABILITY												
FA	X	V	R	HH	SV	MXS	SXR	EPFA	GPFA	GPFAFX	SFA	SFAHH
				✓				✓				

BMW												
R 850 RT					06	F	R 1200 GS Adventure/M				06-12	F
R 1100 S (Without integral ABS)					12/00-06	F	R 1200 GS/M				06-12	F
R 1150 RT (Integral ABS)					00-06	F	R 1200 GS Water Cooled Model				13	F
K 1200 RS					01-05	F	R 1200 RT				05-13	F
K 1200 GT					03-06	F	R 1200 S				06-08	F
K 1200 GT (K44)					06	F Left	R 1200 ST (K28)				03-08	F
K 1200 S					05-08	F	HP2 Megamoto				Nov 07-09	F
R 1200 GS					02-07	F	K 1200 S				03-08	F
R 1200 GS Adventure					05-07	F	K 1300 S				09-15	F
							K 1300 GT Touring				09-11	F

FA337 35 x 51.5 x 6mm



MATERIAL AVAILABILITY												
FA	X	V	R	HH	SV	MXS	SXR	EPFA	GPFA	GPFAFX	SFA	SFAHH
	✓		✓									

KTM												
60 SX					00	R	65 SX				00-03	R

FA342 A 26 x 120.5 x 7mm B 35.5 x 94.5 x 8mm

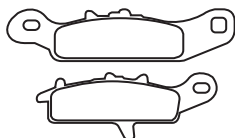

MATERIAL AVAILABILITY												
FA	X	V	R	HH	SV	MXS	SXR	EPFA	GPFA	GPFAFX	SFA	SFAHH
			✓		✓							

KAWASAKI												
KFX 450 R (KSF 450 B8F/B9F/BAF /BBF/BCS)					08-12	F Left	KSV 700 A1/A2/A6F-A9F (KFX 700 V-Force)				04-09	F Left
KVF 650 A1/A2/B2					02-03	F Left	KSV 700 A1/B1 (KFX 700 V-Force)				04	F Left
KVF 650 D1/D6F/D7F/D8F/DAF							KVF 700 A1/A2/A6F (Prairie 700 4x4)/B1/B2/B6F				04-06	F Left
Brute Force 4x4					05-10	F Left	(Prairie 700 4x4 Hardwoods Green HD)				04-06	F Left
KVF 650 E1/E6F/E7F/E8F							KVF 700 D1/D6F Team Green Special Edition				05-06	F Left
Brute Force 4x4 Hardwoods Green HD					05-08	F Left	KSV 700 B1/B2/B6F/B7F/B8F					
KVF 650 E1/E6F/E7F/E8F/E9F Brute Force							(KFX 700 V Force)				04-08	F Left
650 4x4 Hardwoods Green HD					05-09	F Left	SUZUKI					
							LT-V 700 FK4/FK5 Twin Peaks 700 4x4				04-05	F Left

FA343 A 107 x 41 x 10mm
B 91.5 x 40.5 x 10mm



MATERIAL AVAILABILITY												
FA	X	V	R	HH	SV	MXS	SXR	EPFA	GPFA	GPFAF	SFA	SFAHH
✓				✓								

HONDA CBR 125 R4/R5/RS5/RW5-/RW9/RWA (6 Bolt Front Disc / Canada)	04-10	R	Monkey 125 YAMAHA YZF-R15 (150cc) (54C2/3/6-2PB1)	18-21	R
--	-------	---	---	-------	---

FA344 65.5 x 45 x 11.5mm

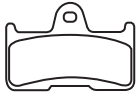

MATERIAL AVAILABILITY												
FA	X	V	R	HH	SV	MXS	SXR	EPFA	GPFA	GPFAF	SFA	SFAHH
	✓		✓		✓							

BENNCHE 500 Gray Wolf 700 Gray Wolf	15-16 15-16	R	YAMAHA YFM 660 FAP/FHAP/FSAP/FAR/FS/FHS /FHT/FT/FV/FGHW/FGX/FGHX		
CF MOTO 400/500 C-Force 800 C-Force EPS	14-16 14-16	R	Grizzly/660 Hunter Edition YFM 660 FAHDV/W Ducks Unlimited Edition/Side x Side	02-08	R
UNISON Mobility 500	04	R		06-07	R

FA345 92 x 49.5 x 8mm



MATERIAL AVAILABILITY												
FA	X	V	R	HH	SV	MXS	SXR	EPFA	GPFA	GPFAF	SFA	SFAHH
				✓				✓				

BUELL XB9R XB9S XB9SX Lightning City X XB9SX Lightning XB12R	02-07 03-04 05-09 08-10 04-08	F	XB12S XB12X Ulysses XB12 SCG Lightning XB12 SS Lightning Long XB12 STT Lightning XB 12 XT Ulysses	04-08 06-10 06-08 06-08 08 08-10	F
--	---	---	--	---	---

FA346 A 60 x 45 x 11mm
B 60 x 45 x 11mm



MATERIAL AVAILABILITY												
FA	X	V	R	HH	SV	MXS	SXR	EPFA	GPFA	GPFAF	SFA	SFAHH
	✓		✓			✓		✓				

HONDA CR 125 R CRF 150 R/RB CR 250 R CRF 250 R AC CRF 250 RX CRF 250 X	02-07 07-21 02-07 04-22 19-22 04-16	R	CRF 450 R CRF 450 RL CRF 450 R-S CRF 450 RWE CRF 450 X 260mm F/disc 18" Rear wheel CRF 450 X 18inc R/Wheel CRF 450 L	02-22 21-22 22 19-22 17-21 05-21 18-21	R
---	--	---	--	--	---

FA347 69.5 x 49.5 x 7mm



MATERIAL AVAILABILITY												
FA	X	V	R	HH	SV	MXS	SXR	EPFA	GPFA	GPFAF	SFA	SFAHH
				✓				✓		✓		

HONDA RS 125 (Radial caliper)	04-07	F										
INDIAN Chief Dark Horse Bobber Bobber Dark Horse Super Chief Super Chief Limited Chief Dark Horse (Nissin calipers) Chief Vintage (Nissin calipers) Chieftain (Nissin Calipers/Cast Wheels) Chieftain Dark Horse (Nissin Calipers/Cast Wheels) Chieftain Ltd (Nissin Calipers/Cast Wheels) Chieftain Elite (Nissin Calipers/Cast Wheels) Roadmaster (Nissin Calipers/Cast Wheels) Roadmaster Dark Horse (Nissin Calipers/Cast Wheels) Roadmaster Ltd (Nissin Calipers/Cast Wheels) Roadmaster Dark Horse Jack Daniel's Edition (Nissin Calipers/Cast Wheels) Roadmaster Elite (Nissin Calipers/Cast Wheels) Springfield Springfield Dark Horse	22 22 22 22 22 22 16-21 14-21 14-21 14-21 14-21 14-21 15-21 15-21 15-21 21 15-21 16-21 19-21	F F										

KAWASAKI Z 800 BGF (ABS) ZX9R (ZX 900 F1/F2) Z 900 (ZR 900 AHF/Non ABS) Z 900 (ZR 900 BHF/ABS) Z 900 ABS/RS ABS/RS Café Z 1000 (ZR 1000 A1/A2/A3/A6F)	16 02-03 17 17 18-21 03-06	F F F F F F	Vegas Jackpot Gunner Hammer Hammer S Hammer 8 Ball Highball (Cast & Spoke Wheels) Kingpin Kingpin Tour Kingpin 8-Ball Kingpin-Low Cory Ness Jackpot Cory Ness Victory Cross Country Cross Country Cross Country Touring Cross Country 8-Ball Cross Roads Cross Roads Classic (Spoke Wheel) Cross Country Touring Cross Country 8-Ball Cross Roads Cross Roads Classic (Spoke Wheel) Cross Country Touring Jackpot Judge Magnum/Magnum X-1 Zach Ness Vegas	08-12 15-17 08-11 08-17 10-16 14-17 08-12 08-09 08-11 09 08-11 11-12 10-17 13-17 15-16 10-13 13-14 13-17 10-16 13-17 15-17 11-12	F F
SUZUKI GSX-S 750 A/N/Z/ZL GSX 1300 BKAK8/K9 B-King ABS GSX 1300 BKK8/K9 B-King	18-21 08-09 08-09	F F F			
TRIUMPH Speed Triple R (Radial caliper 1050cc) Street Triple R 675 (Nissin Radial caliper) Street Triple 675 RXSE (ABS) Daytona 675 Tiger (1050cc) Tiger 1050 SE/ABS Tiger 1050 Sport (Radial Caliper/ABS)	05-11 09-17 15 06-08 07-15 11-13 13-17	F F F F F F F			
VICTORY Broadwalk (Spoke Wheels) Vegas/Vegas 8-Ball Vegas Low	13-14 08-17 08-09	F F F			
YAMAHA RACING TZ 250 (Radial Calipers)	02-10	F			

BUYERS GUIDE
BRAKE PADS

NOTE:- Size identification is shown as follows
Dimension 1=Width or Diameter, Dimension 2=Height or Diameter, Dimension 3=Thickness (Material and backplate)

FA348 63.5 x 60.5 x 9mm



MATERIAL AVAILABILITY												
FA	X	V	R	HH	SV	MXS	SXR	EPFA	GPFA	GPFAX	SFA	SFAHH
✓				✓								

YAMAHA

FZS 1000 N/NC/P/PC/R/RC/S/RS/T 'FZ1' 01-05 R

FA349 A 119.5 x 26 x 7mm B 94.5 x 35.5 x 8mm



MATERIAL AVAILABILITY												
FA	X	V	R	HH	SV	MXS	SXR	EPFA	GPFA	GPFAX	SFA	SFAHH
			✓		✓							

KAWASAKI

KFX 450 R (KSF 450 B8F/B9F /BAF/BBF/BCS)	08-12	F Right	KSV 700 A1/B1 (KFX 700 V-Force)	04	F Right
KVF 650 A1/A2/B2	02-03	F Right	KVF 700 A1/B2/A2/A6F (Prairie 700 4x4) /B1/B6F (Prairie 700 4x4 Hardwoods Green HD)	04-06	F Right
KVF 650 D1/D6F/D7F/D8F/DAF Brute Force 4x4	05-10	F Right	KVF 700 D1/D6F Team Green Special Edition	05-06	F Right
KVF 650 E1/E6F/E7F/E8F Brute Force 4x4 Hardwoods Green HD	05-08	F Right	KSV 700 B1/B2/B6F/B7F/B8F (KXF 700 V Force)	04-08	F Right
KVF 650 E1/E6F/E7F/E8F/E9F Brute Force 650 4x4 Hardwoods Green HD	05-09	F Right	SUZUKI		
KSV 700 A1/A2/A6F/A7F/A8F/A9F (KXF 700 V-Force)	04-09	F Right	LT-V 700 FK4/FK5 Twin Peaks 700 4x4	04-05	F Right

FA350 50 x 47.5 x 7mm



MATERIAL AVAILABILITY												
FA	X	V	R	HH	SV	MXS	SXR	EPFA	GPFA	GPFAX	SFA	SFAHH
	✓										✓	✓

SCORPA

T-Ride 125 (4T)
T-Ride 250 F

SFA350

DERBI

Boulevard 150

ITALJET

Jet Set 50
Jet Set 125/150

PEUGEOT

Elyseo 125/150
Elystar 50 P/125/150 P
Jet Force 125 EFI/Compressor

FA351 36 x 39 x 6mm



MATERIAL AVAILABILITY												
FA	X	V	R	HH	SV	MXS	SXR	EPFA	GPFA	GPFAX	SFA	SFAHH
	✓											

BETA DIRT BIKES

Mini Trail 50

GAS-GAS

EC 50 Boy (Air Cooled)
EC Boy (LC)
MC 65
TXE Electric
TX 200 Randonne (4T)
TXT 70 Cadet/Rookie
TXT 80 Rookie/Cadet
TXT 80 Cadet Pro
TXT 80 Racing
TXT 125/250/280/300
TXT 125/200/250/280/300 (TXT Pro)
TXT 125/200/250/280/300 (TXT Racing)
Contact RR 250/280
TXT 250/280/300 (Raga)
Trial GP 125/250/280/300

HUSQVARNA

CR 50 Junior/Senior Pro
TE 100

MONTESA

315 R
4RT Cota (250cc)
4RT Cota Standard Edition (260cc)
4RT Cota Repsol Edition (260cc)
4RT Cota 300RR

SCORPA

TY-S 125 F
SR 125 (2T)
SY 125 F
SY 175 F
SY 250
SY 250 F
SY 250 Long Ride
SY 250 FR
SR 280 (2T)
SHERCO
ST 1.25 (2T)
2.5/2.9 (2T)
ST 2.5 (2T)
ST 2.9 (2T)
3.2 (4T)
125 FST
125 ST-R
125 TY Classic
250 ST Factory
250 ST-R
300 FST
300 ST-R

SFA353 A 97 x 39.5 x 9.5mm
B 77 x 42 x 9.5mm

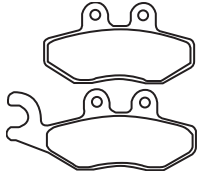

MATERIAL AVAILABILITY

FA	X	V	R	HH	SV	MXS	SXR	EPFA	GPFA	GPFAFX	SFA	SFAHH
											✓	✓

APRILIA						VESPA						
Sportcity 50 (4T)				08-14	F	Primavera 50 (4T/4V)					13-15	F
SR 50 Motard (4T)				12-15		Sprint 50 (4T/4V)					14-15	F
PIAGGIO						GTS 125 4V ABS/Super Sport/Touring						
Fly 50 (2T)				05-06	F	946 Red 125cc (4T/3V)					18-21	F
Fly 50 (4T/2V)				07-10	F	Primavera 150 (4T/3V/ie)					13-21	F
Fly 50 (4T/4V)				11-15	F	Sprint 150 (4T/3V/ie)					14-15	F
Liberty 50 (4T)				17-20	F	946 (155cc/ABS/4T/3V/ie)					13-15	F
Liberty 50 S (4T)				17-20	F	GT 200 L Granturismo						
Typhoon 50 (4T/4V/12" wheels)				10-11	F	(Heng Tong Caliper)					05-09	F
Typhoon 50 (4T/4V/14" wheels)				12-15	F	GTS 250					05-09	F
Typhoon 125 (4T) (12" wheels)				10-20	F	GTV 250					07-09	F
Fly 150 (4T/2V)				06-12	F	LXV 250					07-09	F
Fly 150 (4T/3V)				13-20	F	GTS 300 4V ABS/Super Sport						
Liberty 150 (4T)				17-20	F	/Touring Inc HPE					18-21	F
Liberty 150 S (4T)				17-20	F	GTS 300 ie					08-15	F
BV 250 (Heng Tong Caliper)				06-11	F&R	GTS Super 300 HPE-Tech (4T/4V)					18-21	F
BV 300 Tourer				10-12	F&R	GTS 300 Super					10-14	F
BV 350 (4V/4T/330cc)				12-20	F	GTV 300 ie					10-15	F
MP3 400ie (Three wheeler)				07-15	R	GT 60 (250cc Ltd Edition)					06-08	F
MP3 500 (Three wheeler - 12" Front / 14" Rear)				07-14	R	GTV SEI GIORNI 300 IE ABS					19-21	F
MP3 500 Sport ABS (Three wheeler - 12" Front / 14" Rear)				15-16	R							

FA354 97 x 51.5 x 7mm

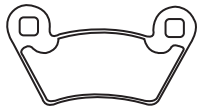

MATERIAL AVAILABILITY

FA	X	V	R	HH	SV	MXS	SXR	EPFA	GPFA	GPFAFX	SFA	SFAHH
			✓		✓		✓					

POLARIS						MATERIAL AVAILABILITY						
Ace 570 EFI Euro (R08) All models				17-20	R							
325 Ranger ETX				15-16	F & R	Ace 570					17-20	R
325 Sportsman Ace				14	R	570 Ranger EFI EU, Inc Crew, EPS						
325 Sportsman Ace EFI				15	R	HDPE, MD and HDPS					14-20	R
325 Sportsman Ace Euro				14-15	R	570 Sportsman Ace					15-20	R
325 Sportsman Ace HD				15	R	570 Sportsman Ace Euro					15-20	R
400 Ranger (All Models)				10-14	F & R	570 Ranger Crew EFI					14-15	R
Ranger 499 ETX, HDPE				17	F & R	700 Ranger 6 x 4 EFI					08	R
500 Ranger (EFI) 4 x 4 H.O.				09-11	R	700 Ranger XP 4 x 4					08	R
500 Ranger Series 10 6 x 6					F & R	700 Ranger 6 x 6 EFI					06-09	F & R
500 Ranger (4 x 4 EFI)				08-10	R	700 Ranger XP 4 x 4					06	F & R
500 Ranger (Carb) 2 x 4				08-09	R	700 Ranger 4 x 4 EFI/LE					07	F & R
500 Ranger Crew				11-13	R	700 Ranger 4 x 4 EFI					09	R
500 Ranger (2 x 4/4 x 4)				06-07	F & R	800 Ranger Mid Size					13-14	F & R
500 Ranger (4 x 4 EFI)				06-07/11-13	F & R	800 Ranger Crew					10-14	R
500 Sportsman Touring H.O.				11-13	R	800 Ranger					10-12	R
Ranger 500 2WD, HDPE, ETX				17-20	F & R	800 Ranger EFI					13-14	R
Ranger Series 10					F & R	RZR-4 800 EPS					12	R
Ranger 2 x 4/4 x 4				04-05	F & R	900 D Ranger Diesel					11-14	R
Ranger Series 11					F & R	900 (Ranger XP 900)					15-19	R
Ranger 6 x 6				04-05	F & R	900 (Ranger XP 900)					13-14	R
Ranger TM				04-05	F & R	RZR XP 900 (Inc EPS Models)					11-14	R
Ranger XP				05	F & R	1000 Ranger Diesel Crew					15	R
PPS/UTV 2 x 4/4 x 6 Series 10					F & R	1000 Ranger Diesel EU (R12)					15-20	R
PPS/Series 11 2 x 4/4 x 4					F & R	1500 PPS/UTV 2 x 4 Series 11						F & R
PPS/Series 11 6 x 6					F & R	Ranger EV (Electric)					10-15	R
Ranger TM				06	F & R	Brutus HD HDPTO (R03)					13-17	R

FA355/4 45 x 51 x 7mm



MATERIAL AVAILABILITY

FA	X	V	R	HH	SV	MXS	SXR	EPFA	GPFA	GPFAFX	SFA	SFAHH
	✓		✓								✓	✓

ARCTIC CAT						SYM						
250 DVX Sport				06-08	R	RV 250 (LM 250 W)					07-12	F
300 DVX				09-12	R							
KYMGCO ATV												
KXR 250 Mongoose				04-10	R							
MXU 250				04-10	R							
Mongoose 300				06-16	R							

BUYERS GUIDE
BRAKE PADS

NOTE:- Size identification is shown as follows
Dimension 1=Width or Diameter, Dimension 2=Height or Diameter, Dimension 3=Thickness (Material and backplate)

NOTE:- Size identification is shown as follows
Dimension 1=Width or Diameter, Dimension 2=Height or Diameter, Dimension 3=Thickness (Material and backplate)

SFA356 55.5 x 46 x 7mm



MATERIAL AVAILABILITY												
FA	X	V	R	HH	SV	MXS	SXR	EPFA	GPFA	GPFAX	SFA	SFAHH
											✓	✓

KYMCO STREET
Grand Vista 240 (SH 50 DF) 05-11 R

FA357 A 62 x 31.5 x 6.5mm B 62 x 31.5 x 6.5mm



MATERIAL AVAILABILITY												
FA	X	V	R	HH	SV	MXS	SXR	EPFA	GPFA	GPFAX	SFA	SFAHH
	✓		✓									

GAS-GAS (PIERER) XC 65 08-10 F
MC 65 2T 21 F & R 85 SX 03-10 F&R
HUSQVARNA Freeride E-XC Electric 19-21 F
CR 65 12 F SX 85 (19"/16" wheels) 03-10 F&R
TC 65 18-22 F & R SX 85 (17"/14" wheels) 11 F
KTM XC 85 08-10 F&R
65 SX 02-08 F SX 105 07-11 F&R
SX 65 09-22 F&R XC 105 08-10 F&R

SFA358 A 86 x 40 x 9mm B 86 x 40 x 9mm

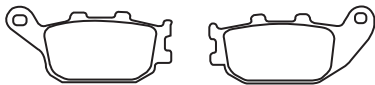

MATERIAL AVAILABILITY												
FA	X	V	R	HH	SV	MXS	SXR	EPFA	GPFA	GPFAX	SFA	SFAHH
											✓	✓

HONDA
NSS 250/250 A/A5 Reflex 01-07 R

FA363 A 94 x 37.5 x 8.5mm B 89.5 x 37.5 x 10mm



MATERIAL AVAILABILITY												
FA	X	V	R	HH	SV	MXS	SXR	EPFA	GPFA	GPFAX	SFA	SFAHH
✓		✓		✓								

BMW R 1200 GS Adventure 05-07 R
R 850 GS (K25/0382/Spoke wheel) 96-00 R
R 850 C 97-00 R R 1200 GS Adventure/M
R 850 R 94-06 R (K25/0380/spoke wheel) 06-12 R
R 850 RT 96-01/06 R R 1200 GS/M (K25/0303
S 1000 XR 14-17 R /Cast/Spoke Wheel) 06-12 R
R 1100 GS R 1200 R (K27) 06-11/07 R
R 1100 R 93-99 R R 1200 R (Disc has fixed bobbins) 08-14 R
R 1100 S 93-06/96 R R 1200 RT 05-13 R
R 1100 S 96-11/00 R R 1200 S 06-08 R
R 1100 S 12/00-06 R R 1200 ST (K28) 03-08 R
R 1100 RT 94-01 R R Nine T (1200cc) 14-18 R
R 1150 GS (Evo-R21/0415/0495) 11/01-03 R
R 1150 GS (R21/0415/0495) 98-10/01 R **R Nine T** 18-21 R
R 1150 GS Adventure 07/01-06 R **R Nine T Pure** 18-21 R
R 1150 R 01-06 R **R Nine T Racer** 18-20 R
R 1150 R Rockster 03-05 R **R Nine T Scrambler** 18-21 R
R 1150 RS 01-05 R **R Nine T Urban G/S** 18-21 R
R 1150 RT 00-06 R HP-2 Enduro 05-09 R
R 1200 00-02 R HP2 Megamoto Nov 07-09 R
R 1200 C 96-03 R HP2 Sport 08-11 R
R 1200 C 96-03 R K 1300 GT (Touring) 09-11 R
R 1200 C Montauk 04-05 R **S 1000 XR** 14-21 R
R 1200 GS (K25/0307/Cast/Spoke wheel) 02-07 R

FA366 90 x 46.5 x 13mm



MATERIAL AVAILABILITY												
FA	X	V	R	HH	SV	MXS	SXR	EPFA	GPFA	GPFAX	SFA	SFAHH
✓		✓		✓								

SUZUKI VL 1500 K5/TK5/K6/TK6/K7/TK7/
VL 1500 K2/K3/K4 Intruder LC 02-04 R K8/TK8/K9/TK9/L0 (C90/C90T) 05-10 R

FA367 67 x 36 x 11mm

FA367/2 67 x 36 x 8.5mm



MATERIAL AVAILABILITY - FA367												
FA	X	V	R	HH	SV	MXS	SXR	EPFA	GPFA	GPFAF	SFA	SFAHH
	✓		✓			✓		✓				

MATERIAL AVAILABILITY - FA367/2												
FA	X	V	R	HH	SV	MXS	SXR	EPFA	GPFA	GPFAF	SFA	SFAHH
	✓		✓									

AJP

PR3 240 Enduro	14-17
PR4 240 Enduro	14-17
PR4 240 Extreme	17
PR5 250 Enduro	14-17
PR5 250 Extreme	17
PR7 650 Adventure	17

APRILIA

RVX 450/550	06-12
MXV 4.5	09-12
SVX 4.5/5.5 (450/550)	
(Radial mount caliper)	06-12

BETA

RR 250 (2T)	13-15
RR 250 4T	05-08
RR 300 (2T)	13-15
RR 350 (4T)	11-15
RS 350 Dual Sport	11-12
RR 390 (4T)	15
RR 400 4T	05-14
RS 400 Dual Sport (4T)	08-11
SM 400 Supermoto (4T)	10-11
RR 430 (4T)	15
RS 430 (4T)	15
RR 450 4T	05-14
RS 450 Dual Sport (4T)	08-14
SM 450 Supermoto (4T)	10-11
RR 480 (4T)	15
RR 498 (4T)	12-14
RS 500 (4T)	15
RS 520 Dual Sport (4T)	08-14
SM 520 Supermoto (4T)	10-11
RR 525 4T	05-09

GAS-GAS

EC 125 (All models/2T)	10-12
EC 200/250/300 (All models/2T)	10-12
EC 200/250/300 (All models/2T)	20
EC Six Days 250/300	19
XC 200/250/300	20

KAWASAKI

KX 250 N1/N2 (KX 250 F)	04-05
KX 250 F (T6F/T7F/T8F)	06-08
KX 250 F (4T)	09-22
KX-F 250 XC	21-22
KX 450 F (D6F/D7F/D8F)	06-08
KX 450 F	09-22
KX-F 450 XC	21-22

SHERCO

2.5i Enduro	05-12
4.5i Enduro	05-12
4.5 Supermoto	04-07
4.5i Supermoto	08-12
SM4.5i	12-14
5.1i Enduro	05-12

SUZUKI

RM-Z 250 K4-K9/L0/L1-L7	04-21
RM-Z 450 K5-K9/L0/L1-L7	05-21
TM	
MX 85 KR (2T)	05-08
MX 85 (2T) JNR Small wheel	10-21
MX 85 (2T) JNR Big wheel	10-21
MX 100 (2T) JNR Small wheel	10-21
MX 100 (2T) JNR Big wheel	10-21
EN 125 (2T)	05-08
EN 125 2S Inc Tsi Enduro (2T)	10-21
MX 125 2S (2T)	10-21
SMR 125 (2T)	10-21
EN 144 2S Inc Tsi Enduro (2T)	10-21
MX 144 2S (2T)	10-21
MX 144 (2T)	07-08
EN 250 (2T)	05-08
EN 250 F-ES (4T)	05-08
EN 250 2S Inc Tsi Enduro (2T)	10-21
EN 250 Fi ES Twin Enduro (4T)	10-21
MX 250/300 (2T)	05-08
MX 250 F (4T)	05-07
MX 250 2S (2T)	10-21
MX 250 Fi ES (4T)	10-21
EN 300 (2T)	05-08
EN 300 ES Inc Tsi Enduro (2T)	10-21
EN 300 Fi ES Twin Enduro (4T)	10-21
FT 300 2S ES (2T)	19-21
MX 300 2S ES (2T)	10-21
MX 300 Fi ES (4T)	10-21
FT 300 2S ES (2T)	19-21
SMR 300 Tsi ES (2T)	19-21
SMX 300 2S ES (2T)	19-21
EN 450 F-ES (4T)	05-08
EN 450 Fi ES Twin Enduro (4T)	10-21
FT 450 Fi ES (4T)	19-21
MX 450 F	05-08
MX 450 Fi ES (4T)	10-21
FT 450 Fi ES (4T)	19-21
SMR 450 Fi ES (4T)	05-21
SMX 450 F Competition (4T)	05-08
EN 530 F-ES (4T)	05-08
EN 530 Fi ES Twin Enduro (4T)	10-21
MX 530 F (4T)	05-08
MX 530 Fi ES (4T)	10-21
SMX 530 F Competition	05-08
SMR 530 F ES (4T)	05-21

YAMAHA

YZ 125 (2T)	03-22	R
YZ 125 Monster Energy	22	R
YZ 125 (2T)	03-21	R
YZ 125 X Cross Country	21	R
YZ 250 2T	03-21	R
YZ 250 Monster Energy 2T	21-22	R
YZ 250 X (2T)	16-22	R
YZ 250 F 4T	03-21	R
YZ 250 FX 270mm F/Rotor 4T	21	R
YZ 250 F Monster Energy Yamaha		
Racing Edition 270mm F/Rotor 4T	21	R
WR 250 F (4T)	03-21	R
WR 250 XX/XY/XZ (Supermotard)	08-11	R
WR 250 R	08-21	R
YZ 450 F	03-21	R
YZ 450 F Monster Energy Edition		
270mm F/Rotor	21	R
YZ 450 FX 270mm F/Rotor	21	R
WR 450 F	03-21	R
FA367/2		
BETA		
RR 125 Enduro LC (4T)	18-19	R
RR 350 3T Enduro	11	R
RR 400 T Enduro	12	R
RR 450 4T Enduro	12	R
RR 525 4T Enduro	05-09	R
Enduro RR 125 (2T)	20-21	R right
Enduro RR 200 (2T)	20-21	R right
Enduro RR 250 (2T)	20-21	R right
Enduro RR 300 (2T)	20-21	R right
Enduro RR 350 (4T)	20-21	R right
Enduro RR 390 (4T)	20-21	R right
Enduro RR 430 (4T)	20-21	R right
Enduro RR 480 (4T)	20	R right
Enduro 500 RR-S (4T)	21	R right

BUYERS GUIDE
BRAKE PADS

NOTE:- Size identification is shown as follows
Dimension 1=Width or Diameter, Dimension 2=Height or Diameter, Dimension 3=Thickness (Material and backplate)

FA368 A 64 x 41.5 x 9mm B 64 x 41.5 x 9mm



MATERIAL AVAILABILITY												
FA	X	V	R	HH	SV	MXS	SXR	EPFA	GPFA	GPFAF	SFA	SFAHH
	✓		✓			✓		✓				

ALTA MOTORS (Electric)

Redshift - MX/SM	16-18	R	TC 450	05-11	R	XC-W 500					12-20	R
BMW			TE 450	06-11	R	XC-F 505					08	R
G 450 X	08-11	R	TXC 450 Cross Country	08-11	R	EXC 525					04-07	R
GAS-GAS (PIERER)			FE 501 (4T)	14-20	R	SMR 525					04-05	R
MC 125 2T	21-22	R	SM 510 R (Radial caliper)	06-11	R	SX 525					03-05	R
EC 250 2T	21-22	R	TC 510	05-09	R	EXC 530 (4T)					09-11	R
EC 250 F 4T	21-22	R	TE 510	06-11	R	EXC 530					10-11	R
EX 250 F 4T	21-22	R	TXC 510 Cross Country	08-10	R	XCR-W 530					08	R
MC 250 F 4T	21-22	R	TE 511 (4T)	11-13	R	EXC-R 530					08	R
EC 300 2T	21-22	R	TXC 511 Cross Country	11-12	R	XC-W 530 (4T) Six Days					10	R
EX 300 2T	21-22	R	KTM			SMR 560					06	R
EC 350 F 4T	21-22	R	SX 85 Small Wheel 17"/14"	21-22	R	SXC 625					05-06	R
EX 350 F 4T	21-22	R	SX 85 Big Wheel 19"/16"	21-22	R	SX-F 505					07	R
EX 450 F 4T	21-22	R	SX 125	09-22	R	XC 525 Desert Racing					07	R
MC 450 F 4T	21-22	R	XC 125	20-22	R	450 SMR					07	R
HUSABERG			SX 150	09-22	R	560 SMR					07	R
TE 250 (2T)	11-14	R	XC-W 150	10-19	R	SHERCO						
TE 300 (2T)	11-14	R	XC-W 150 Tpi	20-21	R	125 SC-Factory					19-21	R
FE 390	10-12	R	XC/EXC 200	04-08	R	125 SE-R					19-21	R
FE 450 Enduro	09-14	R	XC-W 200	07-16	R	250 SC-Factory					19-21	R
FX 450	10-11	R	XC 200	06-08	R	250 SCF-Factory					19-21	R
FE 501 (4T)	13-14	R	SX 250 (2T)	09-22	R	250 SE-R					19-21	R
FE 570 Enduro	09-12	R	XC/EXC 250	04-07	R	250 SE-Factory					19-21	R
FS 570 Supermoto	10-11	R	XC/XC 250 F	06-07	R	250 SEF-R					19-21	R
HUSQVARNA			SX-F 250 (4T)	06-22	R	250 SEF-Factory					19-21	R
TC 85 Small Wheel 17"/14"	21-22	R	SX-F 250 Factory Edition	15-22	R	300 SC-Factory					19-21	R
TC 85 Big Wheel 19"/16"	21-22	R	SX 250 (2T)	03-19	R	300 SCF-Factory					19-21	R
CR 125	05-13	R	XC-F 250	06-22	R	300 SE-R					19-21	R
TC 125 (2T)	14-22	R	XCF-W 250	06-19	R	300 SE-Factory					19-21	R
TE 125	11	R	XCF-W 250 Six Days	11-12	R	300 SEF-R					19-21	R
TE125 (2T)	14	R	XC 250 (2T)	06-19	R	300 SEF-Factory					19-21	R
TX 125 (2T)	18-19	R	XC 250 Tpi (2T)	20-22	R	450 SCF-Factory					19-21	R
WR 125	06-13	R	XC-W 250	06-19	R	450 SE-R					19-21	R
TE 150 (2T)	18-19	R	XC-W 250 Tpi (2T)	19-21	R	450 SEF-Factory					19-21	R
CR 250	05	R	EXC 300 (Upside down forks)	04-08	R	500 SCF-Factory					19-21	R
FC 250 (4T)	14-22	R	EXC 300	04-07	R	500 SEF-R					19-21	R
FE 250 (4T)	14	R	MXC 300 (Upside down forks)	04-06	R	500 SEF-Factory					19-21	R
TC 250	05-12	R	XC 300 (2T)	06-19	R							
TC 250 R (4T) (Kayaba Forks)	13	R	XC 300 Tpi (2T)	19-21	R							
TC 250 (2T)	14-22	R	XC-W 300	06-19	R							
TE 250	06-12	R	XC-W 300 Tpi	19-21	R							
TE 250 (2T)	11	R	XC-W 300 Six Days	14-19	R							
TE 250 (2T)	14-19	R	XC-W 300 Six Days Tpi	19-21	R							
TXC 250 Cross Country	08-12	R	EXC-F 350	12-21	R							
TXC 250 R (4T) (Kayaba Forks)	13	R	SX-F 350	11-22	R							
TE 300 (2T)	14-19	R	XC-F 350	11-22	R							
TE 300 Tpi (2T)	19-20	R	XCF-W 350	12-21	R							
TX 300 Tpi (2T)	18-22	R	XCF-W 350 Six Days	14-19	R							
TE 310 (4T)	09-13	R	XC/EXC 400	04-07	R							
TE 310 R (4T) (Kayaba Forks)	13	R	XC-W 400	08-11	R							
TE 310 (4T) (Kayaba Forks)	11-12	R	EXC 450	04-07	R							
TXC 310 Cross Country	12	R	EXC 450 (4T)	09-10	R							
TXC 310 R (4T) (Kayaba Forks)	13	R	EXC 450	10-11	R							
FC 350 (4T)	14-22	R	SMR 450	04-12	R							
FE 350 (4T)	14-20	R	SX-F 450	09-22	R							
FX 350 (4T)	18-22	R	XCR-W 450	08	R							
XC-W 400	10	R	EXC-R 450	08	R							
TE 410	06	R	XC-F 450	08-09	R							
TC 449	11-13	R	XC-F 450	13-22	R							
TE 449 (4T)	11-12	R	450 XC-W (4T) Six Days/Champion Edition	10	R							
FC 450 (4T)	14-22	R	XCR-W 450	09	R							
FE 450 (4T)	14-20	R	XC-W 450 Six Days	10-11	R							
FR 450 Rally	20	R	XC-W 450 Champions Edition	10	R							
FX 450 (4T)	18-22	R	XC-W 450	12-16	R							
FS 450 Supermoto	15-21	R	EXC 500	12-21	R							
SMR 450 RR (Radial caliper)	06-08	R	EXC 500 Six Days	16-20	R							

BUYERS GUIDE
BRAKE PADS

NOTE:- Size identification is shown as follows
Dimension 1=Width or Diameter, Dimension 2=Height or Diameter, Dimension 3=Thickness (Material and backplate)

FA369/4 64 x 51.5 x 8mm



MATERIAL AVAILABILITY												
FA	X	V	R	HH	SV	MXS	SXR	EPFA	GPFA	GPFAFX	SFA	SFAHH
				✓				✓				

KAWASAKI		VN 1600 B2/B6F/B7F/B7FA/B8F/B8FA										
ZX6RR (ZX 600 K1/M1/N1/N6F)	03-06	F	Mean Streak								05-08	F
ZX6R (ZX 636 B1/B2/C1/C6F)	03-06	F	SUZUKI									
ZX-10 R (ZX 1000 C1/C2/D6F/D7F)	04-06	F	GSR 1000 K3								03	F
ZX-12 R (ZX 1200 B3/B4)	04-05	F	VZ 1600 K5 M95 Boulevard/Marauder								05	F

FA372 A 55.5 x 37 x 11mm B 85 x 43 x 8.5mm



MATERIAL AVAILABILITY												
FA	X	V	R	HH	SV	MXS	SXR	EPFA	GPFA	GPFAFX	SFA	SFAHH
	✓		✓		✓							

SUZUKI												
LT-A 500 FK3-FK7/FCK5-FCK7	03-07	R										
LT-F 500 FK3/FK4/FK5/FK6	03-06	R										

FA373 75.5 x 39.5 x 12mm



MATERIAL AVAILABILITY												
FA	X	V	R	HH	SV	MXS	SXR	EPFA	GPFA	GPFAFX	SFA	SFAHH
	✓		✓		✓							

HONDA												
TRX 420 FPA Power Steering Fourtrax Rancher AT/IRS	09-14	R	4x4/Auto/DCT/EPS								15	R
TRX 420 FA Fourtrax Rancher AT/IRS	09-14	R	TRX 500 FM5 Foreman Rubicon 4x4								15	R
TRX 420 FA5 Fourtrax Rancher Auto/DCT/IRS	14-15	R	TRX 500 FM6 Foreman Rubicon 4x4/EP								15	R
TRX 420 FA6 Fourtrax Rancher Auto/DCT/IRS/EP	14-15	R	TRX 650 FA Rincon								03-05	R
TRX 450 R/ER	04-11	R	TRX 650 FGA Fourtrax Rincon Gpscape								04-05	R
TRX 500 FA5 Foreman Rubicon 4 x 4 Auto/DCT	15	R	TRX 680 FGA6/FGA7/FGA8									
			Fourtrax Rincon (675cc) Gpscape								06-09	R
			TRX 680 FA Fourtrax Rincon								06-15	R

FA375 A 110.5 x 34.5 x 7.5mm B 99 x 33.5 x 7.5mm



MATERIAL AVAILABILITY												
FA	X	V	R	HH	SV	MXS	SXR	EPFA	GPFA	GPFAFX	SFA	SFAHH
✓				✓								

HONDA												
CBR 125 R4/R5/RS5/RW5/RWW6/RW7/RW8/RW9/												
RWA (6 Bolt Front Disc / Canada)	04-10	F	MSX 125 D/E/F/G/H/ Grom (Non ABS)								14-21	F
CBR 125 RWB/RC/RD			MSX 125 AH Grom (ABS)								19-21	F
(5 Bolt Front Disc / Canada)	11-13	F	Monkey 125								18-21	F

FA377 A 94 x 46 x 8.5mm B 73 x 46 x 11mm



MATERIAL AVAILABILITY												
FA	X	V	R	HH	SV	MXS	SXR	EPFA	GPFA	GPFAFX	SFA	SFAHH
✓	✓	✓	✓	✓								

ARCTIC CAT												
250 Utility	06-09	F & R	Mongoose 270 inc Euro								20	F&R
250 DVX	06-08	F	MXU 270								16-20	F&R
250 DVX Sport	06-08	F	MXU 270 I Euro								20	F&R
300 ATV 2x4 Utility	10-13	F & R	MXU 300								05-21	F & R
300 DVX	09-12	F	Mongoose 300								06-16	F
500 Prowler	18-19	F	UXV 450i All EFI Models								15-21	F&R
BOMBARDIER			UXV 700i 4X4 All Models								14-20	F&R
DS 250	06	F & R	MXU 500 (Carb Model)								07-09	F & R
DS 250 (3J7A/B)	07-14	F & R	UXV 500 4x4 (All Carb models)								08-21	F & R
INDIAN			UXV 500i (All EFI models)								13-21	F & R
Scout (Toso Calipers/Cast Wheels)	15-16	R	UXV 700i LE 4x4 (All models)								14-21	F & R
Scout Sixty (Toso Calipers/Cast Wheels)	16	R	SYM									
KAWASAKI			Quadlander 300								07-10	F & R
KVF 300 CCF/CDF/CEF/CFF/CGF/CHF			Quadlander 600								08-10	R
Brute Force	12-17	F & R	TGB									
KAF 820 BFF Mule PRO-FXT EPS		R (L&R)	Outback 425 X 4x4								07-09	F & R
KAF 820 BFF Mule PRO-FXT EPS / LE		R (L&R)	Outback 425 S.E. 4x4 Auto								07-09	F & R
KAF 820 BFF Mule PRO-FXT EPS / Camo		R (L&R)	Outback 425 Real Tree Camo Edition 4x4 Auto								07-09	F & R
KYMGCO												
KXR 250 Mongoose	04-10	F										
MXU 250	04-11	F										

BUYERS GUIDE
BRAKE PADS

NOTE:- Size identification is shown as follows
Dimension 1=Width or Diameter, Dimension 2=Height or Diameter, Dimension 3=Thickness (Material and backplate)

FA379 71.5 x 50 x 8mm

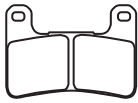

MATERIAL AVAILABILITY												
FA	X	V	R	HH	SV	MXS	SXR	EPFA	GPFA	GPFAFX	SFA	SFAHH
				✓				✓		✓		

KAWASAKI

ZX10R (ZX 1000 E8F/E9F/FAF)	08-10	F										
ZX10R (ZX 1000 JBF/JCF/JDF/JEF/JFF - Non ABS Model)	11-15	F										
ZX10R (ZX 1000 JFFA - 30th Anniversary Edition - Non ABS Version)	15	F										
ZX10R ABS (ZX 1000 KBF/KCF/KDF/KEF/KFF)	11-15	F										
ZX10R ABS (ZX 1000 KFFA - 30th Anniversary Edition - ABS Version)	15	F										
Z 1000 (ZR 1000 DAF/DBF/DCF/DDF/DDFA) Non ABS	10-13	F										
Z 1000 ABS (ZR 1000 GEG/GEFA/GFF/GGF) ABS	14-16	F										
ZX 1000 HCF/HDF Ninja 1000 ABS	12-13	F										
1000 Ninja (ZX 1000 GBF/GCF/GDF)	11-13	F										
1000 Ninja ABS (ZX 1000 MEF/MFF)	14-15	F										
Ninja H2 SX (ZX 1002 AJF)	18-21	F										
Ninja H2 SX SE (ZX 1002 BJF)	18-21	F										
KLZ 1000 Versys SE LT+ ABS	19-21	F										

SUZUKI

GSXR 600 K4/K5/XK5/K6/K7/K8/K9	04-10	F										
GSXR 750 K4/K5/XK5/K6/K7/K8/K9	04-10	F										
DL 1000 AL4-AL8 V-Strom ABS	14-21	F										
DL 1000 AAL4/AAL5/AAL6												
V-Strom Adventure ABS	14-21	F										
DL 1000 XT XAL8 V-Strom (ABS)	18-21	F										
GSXR 1000 K4/ZK4/K5/K6/K7/K8/K9	04-11	F										
V-Strom 1050 A ABS	20-21	F										
V-Strom 1050 XT/XA ABS	20-21	F										
V-Strom 1050 XT Adventure ABS	20-21	F										
GSX 1300 RK8/RK9/RL/RL2	08-12	F										
VZR 1800 K6-K9/L1-L4 (Boulevard M109R)	06-14	F										
VZR 1800 NK8/NK9 (Boulevard Limited M109R2)	08-09	F										
VZR 1800 ZK8/ZK9/ZL1-ZL4 (Boulevard RZ Limited -M109RZ)	08-14	F										
VZR 1800 BL4-BL7												
VZR 1800 B.O.S.S. M109R)	14-21	F										

FA380 50.5 x 69 x 8.5mm



MATERIAL AVAILABILITY												
FA	X	V	R	HH	SV	MXS	SXR	EPFA	GPFA	GPFAFX	SFA	SFAHH
				✓				✓		✓		

YAMAHA

YZF-R6 T/V/W (310mm rotor)	05-07	F										
YZF-R6 X/Y/Z/A/B/D/E/F/G	08-16	F										
XSR 900 ABS (MTM 850)	16-17	F										
YZF R1	04-05	F										
YZF R1 LE	06	F										
YZF R1	15-21	F										
YZF R1M	15-21	F										
YZF R1S	16-17	F										
YZF-R6 X/Y/Z/A/B/D/E/F/G	08-16	F										

YZF-R6 H (320mm Rotor)	17	F										
(FZ1) FZS 1000 V/W/X/Y/Z/A/B/D/E	06-14	F										
FZ8	11-13	F										
FZ-10	17	F										
XT 1200 Z Super Tenere	12-18	F										
XT 1200 Z Super Tenere ES	14-18	F										
Star Venture	18-21	F										
Star Venture Transcontinental	18-21	F										
Star Eluder	18-21	F										
Star Eluder GT	18-21	F										

FA381 103 x 48 x 11mm

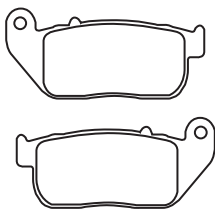

MATERIAL AVAILABILITY												
FA	X	V	R	HH	SV	MXS	SXR	EPFA	GPFA	GPFAFX	SFA	SFAHH
✓		✓		✓				✓				

HARLEY DAVIDSON

XL 50 50th Anniversary	07	F										
XL 883 Sportster Standard	04-08	F										
XL 883 C Sportster Custom	04-10	F										
XL 883 L Low	04-10	F										
XL 883 L Superlow	11-13	F										
XL 883 N Iron	09-13	F										
XL 883 R Sportster R	05-13	F										
XL 883 R Roadster	10-13	F										
XL 1200 R Sportster Roadster	04-08	F										
XL 1200 C Sportster Custom	04-13	F										
XL 1200 L Sportster Low	07-11	F										

XL 1200 L Sportster Low	07-11	F										
XL 1200 N Nightstart	08-12	F										
XL 1200 V Seventy Two	12-13	F										
XL 1200 X Forty Eight	10-13	F										
LYNDALL BRAKES												
PAD REF 7233												

SFA384 A 99 x 42.5 x 9mm B 77 x 41 x 9mm

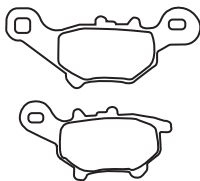

MATERIAL AVAILABILITY												
FA	X	V	R	HH	SV	MXS	SXR	EPFA	GPFA	GPFAFX	SFA	SFAHH
											✓	

YAMAHA (TWIN HEADLIGHTS)

Zuma 50 F (YW 50 FB/FD/FE/FF/FG)	12-16	F										
----------------------------------	-------	---	--	--	--	--	--	--	--	--	--	--

YAMAHA (SINGLE HEADLIGHTS)

Zuma 50 FX (YW 50 FXE/AFX/FXG)	14-21	F										
--------------------------------	-------	---	--	--	--	--	--	--	--	--	--	--

FA387 87 x 50 x 10.5mm

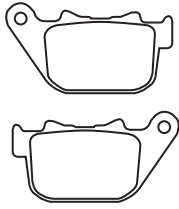

MATERIAL AVAILABILITY												
FA	X	V	R	HH	SV	MXS	SXR	EPFA	GPFA	GPFAFX	SFA	SFAHH
✓		✓		✓				✓				

HARLEY DAVIDSON

FXDR 114	18-21	R	XL 1200 L Sportster Low	07-11	R
XL 883 Sportster Standard	04-08	R	XL 1200 N Nightster (Spoke wheel)	08-12	R
XL 883 C Sportster Custom	04-10	R	XL 1200 R Sportster Roadster	04-08	R
XL 883 L "883 Low"	04-10	R	XL 1200 X Sportster Forty Eight	10-12	R
XL 883 R Sportster R	05-09	R	XL 1200 V Sportster Seventy Two	12-13	R
XL 883 R Roadster	10-13	R	XR 1200	08-10	R
XL 883 N Iron	09-12	R	XR 1200 X	10-12	R
XL 883 L Superlow	11-12	R	LYNDALL BRAKES		
XL 1200 C Sportster Custom	04-12	R	PAD REF 7234		

FA388 118 x 47 x 8.5mm

FA388/2 118 x 47 x 10.5mm

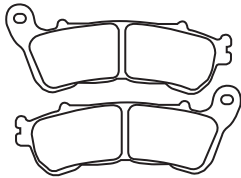

MATERIAL AVAILABILITY - FA388												
FA	X	V	R	HH	SV	MXS	SXR	EPFA	GPFA	GPFAFX	SFA	SFAHH
✓				✓				✓			✓	✓

MATERIAL AVAILABILITY - FA388/2												
FA	X	V	R	HH	SV	MXS	SXR	EPFA	GPFA	GPFAFX	SFA	SFAHH
				✓								

HONDA

CBR 250 RA (ABS Model)	11-14	F	GL 1800 Goldwing Tour J (Manual)	18-21	F
NSS 300 Forza (Non ABS)	14-16	F	GL 1800 BD Goldwing J (DCT)	18-21	F
NSS 300 A Forza (ABS)	14-21	F	GL 1800 D Goldwing Tour J (DCT)	18-21	F
NC 700 XD (Auto G/Box)	12-14	F	GL 1800 DA Goldwing Tour Airbag J (DCT)	18-21	F
NT 700 V/VA (ABS)	10-13	F	SUZUKI		
VT 750 C2E Shadow Aero (ABS/Rear Disc Model)	13-14	F	C 109 RT Boulevard (1783cc)		
VT 750 C2S Shadow Spirit (ABS/Rear Disc Model)	13-14	F	VLR 1800 RTK8/RTK9/RLO	08-10	F
VT 750 C Shadow Aero	18-19	F	C 109 R Boulevard (VLR 1800 K8/K9 1783cc)	08-10	F
VT 750 C Shadow Aero ABS	18-19	F	VLR 1800 TK8/TK9/TKLO C109 RT Touring	08-10	F
VFR 800 Interceptor	06-09	F	VLR 1800 K8/K9/LO C109 R	08-10	F
CBF 1000 A8 (Canada)	08	F&R	SFA388		
XL 1000 VA8 Varadero (Canada)	08	F	HONDA		
CB 1100 A (ABS)	13-14	F	PS 250 Big Ruckus	05-06	F
VFR 1200 XA (Manual G/Box)	16-17	F	NSA 700 A9 "DN-01"	09-11	F
VFR 1200 XD DCT (Automatic Transmission Model)	16-17	F	CBR 600 RR	05-15	F
CTX 1300	14	F	NSS300 (Non ABS)	14-16	F
CTX 1300 DLX (ABS)	14	F	NSS300A (ABS)	14-21	F
ST 1300/ST 1300 A ABS	08-13	F	UH 200 Burgman ABS	14-21	F
VT 1300 CXA Fury (ABS Model)	10-15	F	FA388/2HH		
VT 1300 CSA Sabre ABS	10-14	F	HONDA		
VT 1300 CRA Stateline ABS	10-15	F	GL 1800 B Goldwing J (Manual)	18-21	R
VT 1300 CTA Interstate ABS	10-15	F	GL 1800 Goldwing Tour J (Manual)	18-21	R
F6B Goldwing (GL1800B)	13-15	F	GL 1800 BD Goldwing J (DCT)	18-21	R
F6B Goldwing Deluxe (GL1800BD)	13-15	F	GL 1800 D Goldwing Tour J (DCT)	18-21	R
GL 1800 B Goldwing J (Manual)	18-21	F	GL 1800 DA Goldwing Tour Airbag J (DCT)	18-21	R

FA390 75 x 48 x 8mm



MATERIAL AVAILABILITY												
FA	X	V	R	HH	SV	MXS	SXR	EPFA	GPFA	GPFAFX	SFA	SFAHH
				✓				✓		✓		

HONDA

CBR 600 RR (Non ABS)	05-17	F	VFR 800 X Crossrunner ABS	17-21	F
CBR 600 RRA (ABS Model)	09-17	F	CB 1000 R	10-16	F
VFR 800 F Interceptor (Non ABS)	14-21	F	CBR 1000 RR	04-15	F
VFR 800 FA Interceptor (ABS Model)	14-21	F	CBR 1000 RRA (ABS)	09-16	F

FA395 95 x 48 x 7mm



MATERIAL AVAILABILITY

FA	X	V	R	HH	SV	MXS	SXR	EPFA	GPFA	GPFAFX	SFA	SFAHH
	✓		✓		✓		✓					
ARCTIC CAT												
250 2 X 4 Utility				05-09	F & R		650 V2 4 X 4 Auto LE Utility				04-05	F & R
250 4 X 4 Utility				05/08	F & R		650 V2 4 X 4 Auto LE TS Utility				06	F & R
300 4 X 4 Utility				05	F & R		XT 650 H1 Prowler				06-09	F & R
300 ATV				10-12	F & R		700 ATV/Core				13-14	F & R
350 ATV				12	F & R		700 ATV Diesel				12-14	F & R
366 4 X 4 Auto Utility				08-09	F & R		700 ATV LTD				12-14	F & R
366 SE				10	F & R		700 ATV Mud Pro LTD				12-14	F & R
400 4 X 4 Utility				05-07	F & R		700 Diesel Utility				07-08	F & R
400 4 X 4 VP Utility				05-06	F & R		700i GT				11-12	F & R
400 4 X 4 Auto Utility				05-08	F & R		700 TBX				13	F & R
400 4 X 4 Auto LE Utility				05-07	F & R		700 TRV H2 EFI Cruiser				09-10	F & R
400 4 X 4 Auto VP/TBX Utility				05-06	F & R		700 TRV/TRV Cruiser/GT				11-12	F & R
400 ATV/TRV (Core/2-UP)				13-14	F & R		700 TRV LTD (2-UP)				13-14	F & R
400 TRV H1				10	F & R		700 TRV XT/ATV XT				13-14	F & R
400 4X Auto TRV/TRV Plus Multirider				06-07	F & R		700 EFI 4 X 4 Utility				07-08	F & R
425i/425i SE				12	F & R		700 EFI 4 X 4 LE/SE Utility				06	F & R
450 ATV (Core/2-UP)				13-14	F & R		700 EFI Cruiser				11	F & R
450 H1 EFI				10	F & R		700 EFI 4 x 4 Auto M4/TRV LE				08	F & R
450i				11-12	F & R		700 H1 EFI/EFI LE				09-10	F & R
450i GT				12	F & R		700 HI EFI 4x4 Auto SE				08-09	F & R
450 TRV				11-12	F & R		700 H1 TBX EFI				10	F & R
450i TRV				11	F & R		700 Super Duty Diesel				10-11	F & R
450i XC				13-14	F & R		700 Mudpro				10-11	F & R
XC450i				11-12	F & R		700 H1 EFI Mudpro				09-11	F & R
500 4 x 4 Auto Utility				05-08	F & R		700i				11-12	F & R
500 4 x 4 Auto LE Utility				05-06	F & R		700i LTD				11-12	F & R
500 4 x 4 Manual G/Box Utility				05-09	F & R		700i Mudpro				11-12	F & R
500 4 x 4 Auto TBX Utility				05-06	F & R		700i Mudpro LTD				11	F & R
500 ATV (Mid Size)				13-14	F & R		700 S/S LTD				10	F & R
500 ATV XT (Mid Size)				13-14	F & R		700 TBX LTD				11	F & R
TRV 500 (Core/2-UP)				13-14	F & R		HDX 700 Prowler				11-13	F & R
550 HI EFI				09-10	F & R		HDX 700 LTD Prowler				14	F & R
500 4 x 4 Auto TRV Multirider				05-06/08	F & R		XTX 700 Hi LE Prowler				08	F & R
550 ATV (Mid Size)				13-14	F & R		XTX 700 Hi EFI Prowler				09	F & R
550 ATV LTD (Mid Size)				12-13	F & R		XTX 700 Prowler				11-14	F & R
550 ATV XT (Mid Size)				13	F & R		Prowler 700 HDX Trail				14-17	F & R
550 HI EFI LE				09-10	F & R		1000 GT				11-12	F & R
550 TRV				11	F & R		1000 Mudpro				10-11	F & R
550 TRV Cruiser				11	F & R		1000 ATV 4x4 Auto Mudpro				10	F & R
550 TRV EFI				09-10	F & R		1000 H2 Mudpro EFI				11-12	F & R
550 TRV EFI LE				09-10	F & R		1000 ATV H2 Efi				11	F & R
TRV 550 LTD (2-UP)				13-14	F & R		1000i Mudpro LTD				12-14	F & R
TRV 550 XT (2-UP)				13-14	F & R		1000 TRV Cruiser				11	F & R
550i				11-12	F & R		1000 TRV H2 EFI Cruiser				09-10	F & R
550i LTD				11-12	F & R		Thundercat 1000 H2				08-10	F & R
550i GT				11-12	F & R		Thundercat 1000 H2 LE				10	F & R
550i GT TRV				11	F & R		1000 TRV H2 Efi				10	F & R
550i TRV Cruiser				11	F & R		TRV 1000 LTD (2-UP)				13-14	F & R
550 GT TRV				11-12	F & R		1000 XT				13-14	F & R
550 GT S TRV				10	F & R		XTZ 1000 Prowler				09-14	F & R
550 Hi Efi Prowler				09	F & R		Wildcat 1000i GT				12	F & R
HDX 500 Prowler				14	F & R		Wildcat 1000 GT/LTD				13-14	F & R
HDX 500 LTD Prowler				14	F & R		Wildcat X1000				14	R
HDX 500 XT Prowler				14	F & R		Wildcat 4 X1000				14	R
550 S				10	F & R		Wildcat 4 1000				14	R
550 S LTD				10	F & R		Wildcat 4 LTD 1000				14	R
XT 550				10-11	F & R		Wildcat 1000/1000 4				15-18	R
XT 550 Prowler				11-14	F & R		Wildcat X EPS 1000				15-18	R
650 H1 Prowler				07	F & R		KYMCO ATV					
650 H1				10	F & R		Maxxer 375 4 x 4 IRS				10-12	F & R
650 Mudpro/H1 Mudpro				10-11	F & R		MXU 375 4 x 4 IRS				08-12	F & R
650 H1 TRV				09	F & R		Maxxer 450 4 x 4 IRS				11-16	F & R
650 H1 TBX 4x4 Auto Utility				07	F & R		MXU 450 4 x 4 IRS/IRS LE				11-14	F & R
650 H1 TRV 4X4 Auto Plus Multirider				07	F & R		MXU 450 i				20	F & R
650 H1 TRV 4X4 Auto Plus LE Multirider				07	F & R		MXU 450 I LE/LE Prime				20	F & R
650 H1 TRV 4X4 Auto				08	F & R		POLARIS					
650 Prowler 4 X 4 / M4				08	F & R		Hawkeye 300 2x4/4x4				06	F & R
650 TBX				09	F & R							
650 V2 4 X 4 Auto Utility				04-06	F & R							

BUYERS GUIDE
BRAKE PADS

NOTE:- Size identification is shown as follows
Dimension 1=Width or Diameter, Dimension 2=Height or Diameter, Dimension 3=Thickness (Material and backplate)

FA398 95.5 x 39.5 x 7mm



MATERIAL AVAILABILITY												
FA	X	V	R	HH	SV	MXS	SXR	EPFA	GPFA	GPFAFAX	SFA	SFAHH
			✓		✓							

CAN-AM

DS 450 (2x4/EFI)
 DS 450 X (2x4/EFI)
 DS 450 Xxc/Xmx

08-15
 08-11
 10-15

JOHN DEERE

Gator HPX All models
 HPX 4x2 Gator (Petrol)
 & Parking brake
 HPX 4x4/4x4 Trail Gator (Petrol)
 HPX 4x4 (Diesel) (SN040000)

04-08 F & R
 10-11 F & R
 10-11 F & R
 10 F & R

FA399 69.5 x 51.5 x 7mm

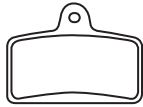

MATERIAL AVAILABILITY												
FA	X	V	R	HH	SV	MXS	SXR	EPFA	GPFA	GPFAFAX	SFA	SFAHH
✓												

DERBI

GPR 125/Nude (Radial Caliper) 05-06 F

FA400 A 97.5 x 64 x 8mm B 97.5 x 64 x 8mm

HH = 7.5mm thickness

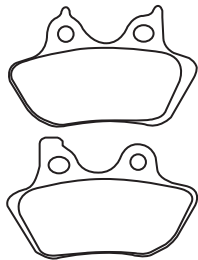

MATERIAL AVAILABILITY												
FA	X	V	R	HH	SV	MXS	SXR	EPFA	GPFA	GPFAFAX	SFA	SFAHH
✓		✓		✓				✓				

HARLEY DAVIDSON

XLH883 Sportster	00-03	F&R	FXST/FXSTi Softail Standard	00-05	F&R
XLH883r Sportster Flat Track	00-03	F&R	FXSTB/FXSTBi Night Train	00-05	F&R
XL883 Sportster Hugger	00-03	F&R	FXSTDI/FXSTD Softail Deuce/i	00-07	F&R
XL53c Sportster Custom (883cc)	00-03	F&R	FLSTF/FLSTFi Fat Boy	00-06	F&R
XL883 R 100th Anniversary Edition	03	F&R	FLSTF/FLSTFi Fat Boy	07	F&R
XL1200c Sportster Custom	00-03	F&R	FLSTCi/FLSTC Heritage Classic/i	00-07	F&R
XL1200s Sportster Sport	00-03	F&R	FLSTN/FLSTNi Softail Deluxe	05-07	F&R
FXD Super Glide	00-03	F&R	FLST/FLSTi Heritage Softail	06	F&R
FXDX Super Glide Sport	00-03	F&R	FXST/FXSTi Softail Standard	06-07	F&R
FXDL Low Rider	00-03	F&R	FXSTB/FXSTBi Night Train Softail	06-07	F&R
FXDWG Wide Glide	00-03	F&R	FXSTC Softail Custom	07	F&R
FXDS-CON Dyna Convertible	00-02	F&R	FLSTC Heritage Softail Classic	07	F&R
FXDXT Superglide T-Sport	01-03	F&R	FLHRI/FLHR Road King	00-07	F&R
FXDi Super Glide 1450	04-05	F&R	FLHRCi Road King Classic	00-07	F&R
FXDi 35 35th Anniversary Super Glide (Spoke wheels)	06	F&R	FLHT/FLHTi Electra Glide Standard	00-07	F&R
FXDXi Super Glide Sport	04-05	F&R	FLTR/FLTR-i Road Glide	00-07	F&R
FXDLi Low Rider 1450	04-05	F&R	FLHTCU-i Electra Glide Ultra Classic	00-07	F&R
FXDLi Dyna Low Rider (Spoke wheels)	04-05	F&R	FLHRS/FLHRSi Road King Custom	04-07	F&R
FXDWGi Wide Glide 1450	04-05	F&R	FLHTC/FLHTCi Electra Glide Classic	04-07	F&R
FXDWGi Dyna Wide Glide (Spoke wheels)	06-07	F&R	FLHX/FLHXi Street Glide	06-07	F&R
FXDC/FXDCi Super Glide Custom	05	F&R	V-Rod (Hayes Caliper)	02-05	F&R
FXDCi Dyna Superglide Custom (Spoke wheels)	06-07	F&R	XLH883 Sportster	00-03	F&R
FXDBi Street Bob (Spoke wheels)	06-07	F&R	XLH883r Sportster Flat Track	00-03	F&R
FXDi Super Glide (Cast wheel)	06-07	F&R	XL883 Sportster Hugger	00-03	F&R
FXDLi Low Rider (Cast wheel)	06-07	F&R	XL53c Sportster Custom (883cc)	00-03	F&R
FXDLi Low Rider (Spoke wheel)	06-07	F&R	XL883 R 100th Anniversary Edition	03	F&R
FXDCi Superglide Custom (Cast wheel)	06	F&R	XL1200c Sportster Custom	00-03	F&R
			XL1200s Sportster Sport	00-03	F&R

FA401 A 99 x 40 x 7.5mm B 75.5 x 38 x 8mm



MATERIAL AVAILABILITY												
FA	X	V	R	HH	SV	MXS	SXR	EPFA	GPFA	GPFAFAX	SFA	SFAHH
	✓		✓									

SUZUKI

RM 85 05-12/15-21 R

FA403 41 x 45 x 6.5mm



MATERIAL AVAILABILITY												
FA	X	V	R	HH	SV	MXS	SXR	EPFA	GPFA	GPFAFAX	SFA	SFAHH
	✓											

BETA

Evo 80 09-19 R Rev 3 125/200 06-08 R
 Rev 3 250/270 05-08 R

NOTE:- Size identification is shown as follows
 Dimension 1 = Width or Diameter, Dimension 2 = Height or Diameter, Dimension 3 = Thickness (Material and backplate)

NOTE:- Size identification is shown as follows
Dimension 1=Width or Diameter, Dimension 2=Height or Diameter, Dimension 3=Thickness (Material and backplate)

FA405 41 x 45 x 6.5mm



MATERIAL AVAILABILITY												
FA	X	V	R	HH	SV	MXS	SXR	EPFA	GPFA	GPFAFX	SFA	SFAHH
						✓		✓				

APRILIA SVX 4.5/5.5 (450/550) (Radial mount caliper)06-12 FTE AFTERMARKET CALIPER 4 Piston Radial Supermoto	HUSABERG F FS Supermotard Models KTM SMR 450/525 SMR 560	05-08 05 06	F F F
--	--	-------------------	-------------

FA406 102 x 48 x 8mm



MATERIAL AVAILABILITY												
FA	X	V	R	HH	SV	MXS	SXR	EPFA	GPFA	GPFAFX	SFA	SFAHH
						✓		✓				

HUSABERG FS Models	04	FTE AFTERMARKET CALIPER 6 Piston Radial Supermoto	
------------------------------	----	---	--

FA407 100 x 57 x 8.5mm

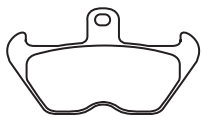

MATERIAL AVAILABILITY												
FA	X	V	R	HH	SV	MXS	SXR	EPFA	GPFA	GPFAFX	SFA	SFAHH
✓				✓				✓				

BMW R 80 Mystic R 80 R R 100 Mystic R 100 R R 850 GS (STD & ABS models) R 850 C (Cast wheel/ABS) R 850 C (Spoke wheel/ABS) R 850 R (Cast wheel/ABS) R 850 R (Spoke wheel) R 850 R (Spoke wheel) R 850 RT (Cast wheel/ABS) R 850 RT (Spoke wheel) R 1100 GS (STD & ABS)	94-95 91-94 93-96 91-95 96-00 97-00 97-00 94-02 94-05/96 06/96-02 96-01 96-01 93-99	F F F F F F F F F F F F F	R 1150 GS (R21/0415/0495) R 1100 R R 1100 RS R 1100 S R 1100 RT R 1200 (Independence) R 1200 C K 100 RS (16 valve) K 1 (16 valve) K 1200 RS K 1200 LT K 1100 LT K 1100 RS	98-10/01 93-01 92-01 96-11/00 94-01 00-02 96-02 89-92 88-93 96-00 97-10/00 89-99 92-96	F F F F F F F F F F F F F
--	---	---	---	--	---

SFA408 100 x 38.5 x 12mm



MATERIAL AVAILABILITY												
FA	X	V	R	HH	SV	MXS	SXR	EPFA	GPFA	GPFAFX	SFA	SFAHH
											✓	✓

YAMAHA CP 250 V/W/X Morphus YP 400 RS/T/N/W/X/Y/Z/B Majesty	06-08 05-10-12-13	R R	XP 500 Y/Z/A (T-Max) XP 500 T-Max (5VUA/15B1)	09-11 05-08	R R
--	----------------------	--------	--	----------------	--------

FA409 92 x 56 x 7mm



MATERIAL AVAILABILITY												
FA	X	V	R	HH	SV	MXS	SXR	EPFA	GPFA	GPFAFX	SFA	SFAHH
✓		✓		✓				✓				

HARLEY DAVIDSON VRSCR Street Rod VRSCA V-Rod VRSCD Night Rod VRSCDX Night Rod Special VRSCAW V-Rod VRSCF V-Rod Muscle VRSC Night Rod Special VRSC 10th Anniversary V-Rod FLHR Road King (Spoke Wheel Type) FLHR Road King (Cast Wheel Type) FLHRC Road King Classic FLHRXS Road King Special FLTRXSE CVO Road Glide FLHX Street Glide FLHX Street Glide Anniv. FLHXS Street Glide Special FLHXS Street Glide Special Anniv. FLHXSE CVO Street Glide FLTR Road Glide FLTRX Road Glide Custom	06-07 06 06-08 07-20 08-11 09-20 12 12 08-16 15-21 08-20 18 21 08-21 18 15-21 18 21 08-09 10-12	F & R F & R F & R F & R F & R F & R F & R F & R F & R F & R F & R F & R F & R F & R F & R F & R F & R F & R F & R F & R	FLTRX Road Glide FLTRXS Road Glide Special FLTRXS Road Glide Special FLHT Electra Glide Standard FLHTC Electra Glide Classic FLHTCU Ultra Glide Classic Electra Glide FLHTCUL Electra Glide Ultra Classic Low FLHTK Electra Glide Ultra Ltd FLHTK Ultra Ltd FLHTK Electra Glide Ultra LTD Anniv. FLHTK Electra Glide Ultra LTD Shrine Edition FLHTK Ultra Ltd Low FLHTKSE CVO Limited FLHTCUTG Tri Glide Ultra Classic (Trike) FLHTCUTGSE CVO Tri Glide FLTRU Road Glide Ultra Pan American Adventure LYNDALL BRAKES PAD REF 7254	15-20 15-20 18-21 08-10 08-12 08-20 15-16 10-13 15-21 18 18 15-20 21 09-13 21 11-12/16-17 20-21	F & R F & R F & R F & R F & R F & R F & R F & R F & R F & R F & R F & R F F F & R R
--	--	--	---	---	--

FA410 82 x 38.5 x 11mm



MATERIAL AVAILABILITY												
FA	X	V	R	HH	SV	MXS	SXR	EPFA	GPFA	GPFAX	SFA	SFAHH
	✓		✓		✓							

HONDA

TRX 500 FA/FAA Fourtrax Foreman Rubicon				05-14	F						08-11	F
TRX 500 FE5/FE6/FE7/FE8 Fourtrax Foreman 4x4/ES				05-08	F						08-11	F
TRX 500 FE8/FE9 Fourtrax Foreman 4x4 EPS				08-09	F						05-06	F
TRX 500 FE/FEA Fourtrax Foreman Rubicon Gpscape				05-11	F						06-15	F
TRX 500 FM/FMA Fourtrax Foreman 4x4				05-10	F						06-09	F
											08-11	R

SFA411 81 x 42 x 8mm



MATERIAL AVAILABILITY												
FA	X	V	R	HH	SV	MXS	SXR	EPFA	GPFA	GPFAX	SFA	SFAHH
											✓	✓

SUZUKI

AN 400 K3/K4/K5/K6/SK6 Burgman				03-06	R							
--------------------------------	--	--	--	-------	---	--	--	--	--	--	--	--

SFA412 88 x 41 x 8.5mm



MATERIAL AVAILABILITY												
FA	X	V	R	HH	SV	MXS	SXR	EPFA	GPFA	GPFAX	SFA	SFAHH
											✓	✓

SUZUKI

AN 400 K7-K9/AK9/AL1-AL6 Burgman				07-16	R						06-16	R
AN 400 Z Burgman (ABS)				14-21	R							
AN 650 K3-K9/L1 Burgman (Non ABS)				03-11	R						13-21	R

FA413 A 82 x 41 x 8mm B 62 x 41 x 8.5mm



MATERIAL AVAILABILITY												
FA	X	V	R	HH	SV	MXS	SXR	EPFA	GPFA	GPFAX	SFA	SFAHH
	✓		✓		✓						✓	✓

SUZUKI

LT-A 400 FK8/FK9/FLO King Quad 400 AS				08-18	F Left						11-22	F Left
LT-A 400 FCK8/9 King Quad 400 AS Camo				08-18	F Left							
LT-A 400 FQK9 King Quad 400 AS Anniversary Edition				09	F Left						11-16	F Left
LT-F 400 FK8/FK9/FLO King Quad 400 FS				08-10	F Left						05-09	F Left
LT-F 400 FCK8/FCK9 King Quad 400 FS Camo				08-09	F Left						08-22	F Left
LT-F 400 FQK9 King Quad 400 FS Anniversary Edition				09	F Left						08-16	F Left
LT-A 400 FK8 King Quad Auto 4WD				08-09	F Left							
LT-F 400 K8 Manual 2WD				08	F Left						08-09/14	F Left
LT-A 400 FL1-FL6 King Quad 400 ASi				11-16	F Left							
LT-A 400 FCL1-FCL6 King Quad 400 FSi Camo				11-16	F Left						09	F Left
LT-F 400 FL1-FL6 King Quad 400 FSi				11-22	F Left							
LT-F 400 FCL1-FCL6 King Quad 400 FSi Camo				11-16	F Left						09/15-16	F Left
LT-A 450 XK7-XK9/XL0 King Quad 4x4				07-10	F Left							
LT-A 450 XCK7/8/9 King Quad 450 AXi Camo				07-09	F Left						09-16	F Left
LT-A 450 XZK8/XZK9 King Quad 450 AXi Special Edition				08-09	F Left							
LT-A 500 XPK9/XPL1-XPL6 King Quad 500 AXi Power Steering				09-16	F Left						14-22	R
LT-A 500 XPZK9/XPZL1 King Quad 500 AXi Power Steering Limited				09/11	F Left							

NOTE:- Size identification is shown as follows
Dimension 1=Width or Diameter, Dimension 2=Height or Diameter, Dimension 3=Thickness (Material and backplate)

FA414 A 82 x 41 x 8mm
B 62 x 41 x 8.5mm

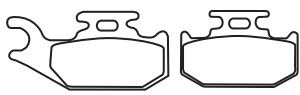

MATERIAL AVAILABILITY

FA	X	V	R	HH	SV	MXS	SXR	EPFA	GPFA	GPFA	SFA	SFAHH
	✓		✓		✓							

SUZUKI

LT-A 400 FK8/FK9/FLO King Quad 400 AS Anniversary Edition	08-18	F Right	500 AXi Power Steering	09-16	F Right
LT-A 400 FCK8/9 King Quad 400 AS Camo	08-18	F Right	LT-A 500 XPZK9/XPZL3 King Quad 500 AXi Power Steering Limited	09/13	F Right
LT-F 400 FQK9 King Quad 400 FS	08-10	F Right	LT-A 500 XCL1-XCL6 King Quad 500 AXi Camo	11-16	F Right
LT-F 400 FCK8/FCK9 King Quad 400 FS Camo	08-09	F Right	LT-A 700 XK5/XCK6/XK6/XK7/XCK7 /XCK8/XCK9 "King Quad"	05-09	F Right
LT-F 400 FQK9 King Quad 400 FS Anniversary Edition	09	F Right	LT-A 750 XK8/XK9/XL1-XL6 King Quad 750 AXi	08-22	F Right
LT-A 400 FK8 King Quad Auto 4WD	08-09	F Right	LT-A 750 XCK8/XCK9/XCL1-XCL6 King Quad 750 AXi Camo	08-16	F Right
LT-A 400 FL1-FL6 King Quad 400 ASi	11-22	F Right	LT-A 750 XZK8/XZK9/XZL4 King Quad 750 AXi Limited	08-09/14	F Right
LT-A 400 FCL1-FCL6 King Quad 400 ASi Camo	11-16	F Right	LT-A 750 XRK9 King Quad 750 AXi Rockstar Edition	09	F Right
LT-F 400 K8 Manual 2WD	08	F Right	LT-A 750 XPK9/XPL1-XPL6 King Quad 750 AXi Power Steering	09-16	F Right
LT-F 400 FL1-FL6 King Quad 400 FSi	11-16	F Right	LT-A 750 XPZK9/XPZL5/XPZL6 King Quad 750 AXi Power Steering Limited	09/15-16	F Right
LT-F 400 FCL1-FCL6 King Quad 400 FSi Camo	11-16	F Right	LT-A 750 XPCK9/XPCL1-XPCL6 King Quad 750 AXi Power Steering Camo	09-16	F Right
LT-A 450 XK7/XK8/XK9/XL0 King Quad 4x4	07-10	F Right			
LT-A 450 XCK7/8/9 King Quad 450 AXi Camo	07-09	F Right			
LT-A 450 XZK8/XZK9 King Quad 450 AXi Special Edition	08-09	F Right			

SFA415 82 x 37 x 9mm



MATERIAL AVAILABILITY

FA	X	V	R	HH	SV	MXS	SXR	EPFA	GPFA	GPFA	SFA	SFAHH
											✓	✓

HONDA

150 ADV Scooter	21	R	NSS 300 A (ABS)	14-16	R
NSS 300 Forza (Non ABS)	14-16	R			

FA417/4 50 x 38 x 8mm

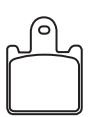

MATERIAL AVAILABILITY

FA	X	V	R	HH	SV	MXS	SXR	EPFA	GPFA	GPFA	SFA	SFAHH
				✓				✓		✓		

KAWASAKI

ZX6R (ZX 600 P7F/P8F/R9F/RAF/RBF/RCF)	07-12	F	ZX14R Ninja (ZX 1400 A6F/A7F/C8F/C9F /CAF/CBF/ECF/ECFA/EDF/EDFA/EEF)	06-14	F
Z 1000 (ZR 1000 B7F/B8F)	07-08	F	ZX14R Ninja ABS (ZX 1400 FDF/FEFA /FFFA/FFFB/HGF/HHF) ABS Model	13-17	F
Z 1000 (ABS) ZR 1000 C7F	07	F	ZX 14 R ABS	08-21	F
Concours 14 (ZG 1400 B8F/B9F/DAF)	08-10	F			
Concours 14 ABS (ZG 1400 A8F/A9F /CAF/CBF/CCF/CDF/CEF/EFF/EGF)	08-16	F			

SFA418 A 97 x 39.5 x 9.5mm
B 77 x 42 x 9.5mm

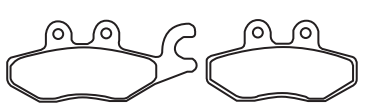

MATERIAL AVAILABILITY

FA	X	V	R	HH	SV	MXS	SXR	EPFA	GPFA	GPFA	SFA	SFAHH
											✓	✓

PIAGGIO

BV 350 (4T/4V/330cc)	12-20	R			
MP3 250 LE (14" Rear Wheel)	10-15	R			

FA419 A 89 x 40.5 x 9.5mm
B 89 x 40.5 x 9.5mm



MATERIAL AVAILABILITY

FA	X	V	R	HH	SV	MXS	SXR	EPFA	GPFA	GPFA	SFA	SFAHH
✓		✓		✓								

SUZUKI

GSXR 600 K6/K7/K8/K9	06-10	R	V-Strom 1050 XT/XA ABS	20-21	R
GSXR 750 K6/K7/K8/K9	06-10	R	V-Strom 1050 XT Adventure ABS	20-21	R
DL 1000 AL4-AL8 V-Strom ABS	14-21	R	GSX 1300 RK8/RK9/RL1/RL2	08-12	R
DL 1000 AAL4-AAL6 V-Strom Adventure ABS	14-21	R	GSX 1300 RAL3-RAL7	13-20	R
DL 1000 XT XAL8 V-Strom (ABS)	18-21	R	GSX 1300 RZL4 (Hayabusa 50th Anniversary Edition)	14	R
GSXR 1000 K7/K8	07-08	R	GSX 1300 BKAK8/K9 B-King ABS	08-09	R
V-Strom 1050 A ABS	20-21	R	GSX 1300 BKK8/K9 B-King	08-09	R

FA420 69.5 x 54.5 x 8mm

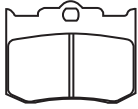

MATERIAL AVAILABILITY												
FA	X	V	R	HH	SV	MXS	SXR	EPFA	GPFA	GPFAX	SFA	SFAHH
				✓								

PERFORMANCE MACHINE CALIPERS
137 X 4 (2006)

FA423/4 45 x 53.5 x 8.5mm



MATERIAL AVAILABILITY												
FA	X	V	R	HH	SV	MXS	SXR	EPFA	GPFA	GPFAX	SFA	SFAHH
				✓								

TRIUMPH
Trophy SE (1215cc) 13-15 F FJR 1300 AEW/AEW/AEX/AEY Electric Shift 06-09 F

YAMAHA
FJR 1300 A 13-18 F
FJR 1300 AV/AW/AX/AZ/AA/AB 06-12 F FJR 1300 ES 14-18 F

FA424 91.5 x 51.5 x 8.5mm

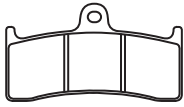

MATERIAL AVAILABILITY												
FA	X	V	R	HH	SV	MXS	SXR	EPFA	GPFA	GPFAX	SFA	SFAHH
✓				✓								

BUELL
M2 Cyclone 98-05 F
S1 Lightning 98-00 F
S1 White Lightning 98-00 F
S3/S3T Thunderbolt 98-00 F
X1 Lightning 98-05 F

HHI - HAWG HALTERS AFTERMARKET CALIPER
6 Piston - All types
JAYBRAKE AFTERMARKET CALIPER
J-Four (300-44) (4 Piston)

KAWASAKI
ZX-7RR (6 piston pad) Nissin Caliper (ZX 750 N1/N2) 96-99 F

LYNDALL BRAKES
PAD REF 7202
MV
F4 750 (All models) (Nissin Calipers) 99-03 F
F4 (All models) 99-05 F
Brutale 750 (All models) (Nissin Calipers) 03-05 F
Brutale 910 S (Nissin Calipers) 05-07 F
F4 1000 (All models) (Nissin Calipers) 04-06 F

YAMAHA
YZF 750 R7 0W02 Race version 99-01 F

SFA425 55.5 x 54.5 x 8mm



MATERIAL AVAILABILITY												
FA	X	V	R	HH	SV	MXS	SXR	EPFA	GPFA	GPFAX	SFA	SFAHH
											✓	✓

PIAGGIO
MP3 (250cc) 07-12 R

SFA427 94 x 36 x 10.5mm

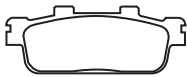

MATERIAL AVAILABILITY												
FA	X	V	R	HH	SV	MXS	SXR	EPFA	GPFA	GPFAX	SFA	SFAHH
											✓	✓

SYM
RV 200 12-14 R
RV 250 (LM 250 W) 07-12 R

SFA428 A 82 x 41 x 9.5mm B 62 x 41 x 9.5mm

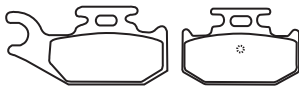

MATERIAL AVAILABILITY												
FA	X	V	R	HH	SV	MXS	SXR	EPFA	GPFA	GPFAX	SFA	SFAHH
	✓		✓		✓							

BENNCHE
250 Cowboy 15-16 R
250 Spire 15-16 R
400 Bighorn Parking Brake 11-16
400 Cowboy Parking Brake 15-16
500 Bighorn Parking Brake 15-16
700 Bighorn Parking Brake 15-16
700 X Bighorn Parking Brake 15-16
500/700 Cowboy Parking Brake 14-16
1000 Cowboy Parking Brake 15-16
1000 Spire/X Spire Parking Brake 14-16

HISUN
250 Sector Parking brake 15-16
250 Strike Parking Brake 15-16
400 Forge Parking Brake 15-16
HS 400 Parking Brake 15-16
450 Sector Parking Brake 15-16
500/700 Forge Parking Brake 15-16
HS 500 Parking Brake 15-16
550 Sector Parking Brake 15-16
HS 700 Parking Brake 15-16
750 Sector Parking Brake 15-16
HS 750 Crew Parking Brake 15-16
800 Tactic Parking Brake 15-16
HS 800 Crew Parking Brake 15-16
1000 Sector Parking Brake 15-16
1000 Strike/Strike Crew Parking Brake 15-16
1000 Tactic Parking Brake 15-16

MASSIMO
250 Gunner/250 Gunner S 15-16 R (Left)
500 Alligator 15-16 R (Left)
550 EPS Alligator 15-16 R (Left)
700 Alligator Parking Brake 15-16
MSU 700/800 Parking Brake 15-16

YAMAHA
YXR 450 Rhino (All models) 06-09 R
YXR 660 Rhino 04-07 R
YFM 700 RSPV 50th Anniversary Edition 06 R
YFM 700 RSEW/RSPX/RSPY/RSEA /RSEB/RSED/RSE/RSF 07-15 R
YFM 700 RV/RW/RX/RV/RA/RB Raptor 06-12 R

BUYERS GUIDE
BRAKE PADS
NOTE:- Size identification is shown as follows
Dimension 1=Width or Diameter, Dimension 2=Height or Diameter, Dimension 3=Thickness (Material and backplate)

NOTE:- Size identification is shown as follows
Dimension 1=Width or Diameter, Dimension 2=Height or Diameter, Dimension 3=Thickness (Material and backplate)

FA432 68 x 55 x 9mm



MATERIAL AVAILABILITY												
FA	X	V	R	HH	SV	MXS	SXR	EPFA	GPFA	GPFA	SFA	SFAHH
✓				✓							✓	✓

APRILIA

RS 125 06-12 F
Dorsoduro 750 (ABS) 08-15 F
Shiver 750 SL 07-15 F
Mana 850 08-12 F
Mana 850 GT ABS 09-15 F
Dorsoduro 900 18-21 F
Shiver 900 18-21 F

SFA432

KYMCO STREET
My Road 700i 11-15 F

FA433/4 46 x 35 x 7.5mm



MATERIAL AVAILABILITY												
FA	X	V	R	HH	SV	MXS	SXR	EPFA	GPFA	GPFA	SFA	SFAHH
✓				✓				✓				

HUSABERG

FS 570 Supermoto 10-11 F
450 SMR 07-12 F
560 SMR 07 F

MAGURA AFTERMARKET CALIPER

4 Piston Radial Supermoto Caliper

FA434 A 97.5 x 64 x 8mm B 97.5 x 64 x 8mm

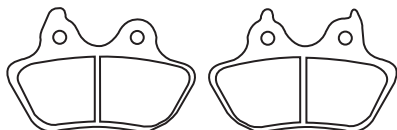

MATERIAL AVAILABILITY												
FA	X	V	R	HH	SV	MXS	SXR	EPFA	GPFA	GPFA	SFA	SFAHH
✓		✓		✓				✓				

HARLEY DAVIDSON

FXST/FXSTI Softail Standard 06-07 R
FXSTB/FXSTBi Night Train Softail 06-07 R
FLSTC Heritage Softail Classic 07 R
FLSTF/FLSTFi Fat Boy 07 R
FXSTC Softail Custom 07 R

LYNDALL BRAKES

PAD REF 7196

FA435/4 49 x 43.5 x 9.5mm



MATERIAL AVAILABILITY												
FA	X	V	R	HH	SV	MXS	SXR	EPFA	GPFA	GPFA	SFA	SFAHH
				✓				✓				

AP/LOCKHEED AFTERMARKET CALIPER

4 Piston Radial Mount / 4 Separate Pads (CP6688 - 8EOM/9EOM)
BREMBO AFTERMARKET CALIPER
X99/C04 60/61 4 Piston P 34/34 Radial Mount Caliper @ 108mm Spacing (4 pad set)
XA07680 2 Piston P2 34 Radial Mount

MV

F4 100 CC (1078cc) 07-08 F
PVM AFTERMARKET CALIPER
2 Piston Rear Caliper
4 Piston Radial Mount Caliper

FA436 77.5 x 42.5 x 9mm



MATERIAL AVAILABILITY												
FA	X	V	R	HH	SV	MXS	SXR	EPFA	GPFA	GPFA	SFA	SFAHH
✓		✓		✓								

HONDA

CBR 600 RR (Non ABS) 07-21 R
CBR 600 RRA (ABS Model) 09-21 R
CBR 1000 RR 06-15 R
CBR 1000 RRA (ABS Model) 09-21 R
CBR 1000 RR SP 14-21 R
KAWASAKI
ZX-6R (ZX 636 EDF/EEF/EFF/EGF/EHF) 636cc/Non ABS 13-21 R
ZX-6R (ZX 636 EFFA) 636cc/Non ABS 30th Anniversary Edition 15 R
ZX-6R (ZX 636 EGFA/EHFA) 636cc /Non ABS/KRT Edition 16-21 R
ZX-6R (ZX 636 FDF/FEF/FFF/FGF/FHF) 636cc/ABS 13-21 R
ZX-6R (ZX 636 FFFA) 636cc/ ABS 30th Anniversary Edition 15 R
ZX-6R (ZX 636 FGFA/FHFA) 636cc/ ABS/KRT Edition 16-21 R
ZX10R (ZX 1000 JBF/JCF/JDF/JEF/JFF - Non ABS Model) 11-15 R
ZX10R (ZX 1000 JFFA 30th Anniversary Edition - Non ABS Version) 15 R

ZX10R ABS (ZX 1000 KBF/KCF/KDF/KEF/KFF) 11-15 R
ZX10R ABS (ZX 1000 KFFA 30th Anniversary Edition - ABS Version) 15 R
ZX10R ABS (ZX 1000 SGF/SHF/SJF) 16-21 R
ZX10R ABS KRT Replica (ZX 1000 SGFA/SHFA/SJFA) 16-21 R
Ninja ZX-10 RR (ZX1000 ZHF) 17-21 R
SUZUKI
GSXR 600 ABS 11-21 R
GSXR-R 600 100th Anniversary (Brembo Radial Caliper) 21 R
GSXR 750 ABS 11-21 R
GSXR-R 750 100th Anniversary (Brembo Radial Caliper) 21 R
GSXR 1000 K9/L1/L2/L3/L4/L5/L6 09-16 R
GSXR 1000 ABS 15-21 R
GSXR 1000R (Brembo Radial) 17-21 R
GSX 1000 Katana 19-21 R
YAMAHA
YZF R1 15-21 R
YZF R1M 15-21 R
YZF R1S 16-20 R
YZF-R6 H (320mm Front Rotor) 17 R

NOTE:- Size identification is shown as follows
Dimension 1=Width or Diameter, Dimension 2=Height or Diameter, Dimension 3=Thickness (Material and backplate)

FA438 103 x 37.5 x 8.5mm



MATERIAL AVAILABILITY												
FA	X	V	R	HH	SV	MXS	SXR	EPFA	GPFA	GPFA	SFA	SFAHH
				✓								

BMW
K 1200 GT (K44) 06-08 R

FA441 77.5 x 51.5 x 8.5mm

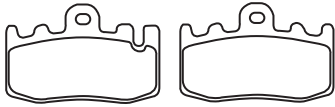

MATERIAL AVAILABILITY												
FA	X	V	R	HH	SV	MXS	SXR	EPFA	GPFA	GPFA	SFA	SFAHH
				✓								

BMW
K 1200 GT (K44) 06-08 F Right

**FA442/4 A 61.5 x 44 x 8mm
B 48 x 31 x 8mm**



MATERIAL AVAILABILITY												
FA	X	V	R	HH	SV	MXS	SXR	EPFA	GPFA	GPFA	SFA	SFAHH
✓				✓				✓		✓		

YAMAHA VMX 1700 V-Max
YZF-R1 (6 piston caliper) 07-14 F (6 piston radial caliper) 09-16 F

**FA443 A 107 x 34 x 8mm
B 91.5 x 38 x 8mm**

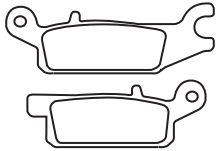

MATERIAL AVAILABILITY												
FA	X	V	R	HH	SV	MXS	SXR	EPFA	GPFA	GPFA	SFA	SFAHH
	✓		✓		✓							

YAMAHA YFM 250 RX/RV/RZ/RA/RB/RD Raptor 08-13 F Left Ducks Unlimited Edition 07-09 F
YFM 250 RSPX/RSEY Special Edition 08-09 F Left YFM 700 FGX/FGY/FGZ/FGA 08-13 F Left
YFM 250 RSPXC Special Edition Custom 08 F Left /FGB/FGD Grizzly
YFM 250 R (RSPA) 11 F Left YFM 700 FGPSEY/Z/A/B/D Grizzly
YFM 250 RSPA Special Edition 11 F Left Fi Auto 4x4 EPS Special Edition 09-13 F Left
YFM 550 FGY/Z/A/B/D/E 4WD 15 F Left
YFM 550 FGPY/Z/A/B/D/E EPS 09-14 F Left YFM 700 DFG/DFL Grizzly 4WD Hunter 15 F Left
Grizzly Auto Fi 15 F Left
YFM 550 FGPY/Z/A/B/D/E EPS 15 F Left
Grizzly Auto Fi 09-14F Left & R YFM 700 PHFH Grizzly EPS Hunter 15 F Left
YFM 700 FGPW/FGPX/FGPY/FGPZ/FGPA/FGPB/FGPD
Grizzly Fi Auto 4x4 07-13 F Left

**FA444 A 107 x 34 x 8mm
B 91.5 x 38 x 8mm**

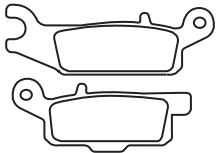

MATERIAL AVAILABILITY												
FA	X	V	R	HH	SV	MXS	SXR	EPFA	GPFA	GPFA	SFA	SFAHH
	✓		✓		✓							

YAMAHA YFM 250 RX/RV/RZ/RA/RB/RD Raptor 08-13 F Right YFM 700 FGX/FGY/FGZ/FGA/FGB/FGD/E
YFM 250 RSPX/RSEY Special Edition 08-09 F Right Grizzly 08-14 F Right
YFM 250 RSPXC Special Edition Custom 08 F Right YFM 700 FGPDUW/FGPDUX/FGPDUY
YFM 250 R (RSPA) 11 F Right Ducks Unlimited Edition 07-09 F Right
YFM 250 RSPA Special Edition 11 F Right YFM 700 FGPSEY/Z/A/B/D/E Grizzly Fi Auto 4x4
YFM 550 FGY/Z/A/B/D/E 4WD EPS Special Edition 09-14 F Right
Grizzly Auto Fi 09-14 F Right YFM 700 DHFH Grizzly 4WD Hunter 15 F Right
YFM 550 FGPY/Z/A/B/D/E EPS 15 F Right
Grizzly Auto Fi 09-14 F Right YFM 700 DFG/DFL Grizzly 4WD 15 F Right
YFM 700 FGPW/FGPX/FGPY/FGPZ/FGPA/FGPB/FGPD/E Grizzly Fi Auto 4x4 15 F Right
07-14 F Right YFM 700 PHFH Grizzly EPS Hunter 15 F Right

**FA445 A 107 x 34 x 8mm
B 91.5 x 38 x 8mm**

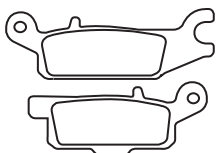

MATERIAL AVAILABILITY												
FA	X	V	R	HH	SV	MXS	SXR	EPFA	GPFA	GPFA	SFA	SFAHH
	✓		✓		✓							

YAMAHA YFM 550 FGPY/Z/A/B/D/E EPS 08-14 R Left
Grizzly Auto Fi 09-14 R Left YFM 700 FGPSEY/Z/A/B/D/E Grizzly Fi
YFM 550 FGY/Z/A/B/D/E Grizzly Auto Fi 09-14 R Left Auto 4x4 EPS Special Edition 09-14 R Left
YFM 700 FGPW/FGPX/FGPY/FGPZ/FGPA/FGPB/FGPD/E Grizzly Fi Auto 4x4 15 R Left
YFM 700 DHFH Grizzly 4WD Hunter 15 R Left
YFM 700 FGPDUW/FGPDUX/FGPDUY 15 R Left
Ducks Unlimited Edition 07-09 R Left YFM 700 PFG Grizzly EPS/4WD 15 R Left
YFM 700 PHFH Grizzly EPS Hunter 15 R Left

**FA446 A 107 x 34 x 9mm
B 91.5 x 38 x 9mm**

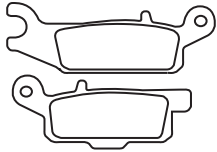

MATERIAL AVAILABILITY

FA	X	V	R	HH	SV	MXS	SXR	EPFA	GPFA	GPFAFX	SFA	SFAHH
	✓		✓		✓							

YAMAHA			MATERIAL AVAILABILITY		
YFM 550 FGPY/Z/A/B/D/E EPS					08-14 R Right
Grizzly Auto Fi	09-14 R Right				YFM 700 FGPSEY/Z/A/B/D/E Grizzly Fi
YFM 550 FGY/Z/A/B/D/E Grizzly Auto Fi	09-14 R Right				Auto 4x4 EPS Special Edition
YFM 700 FGPW/FGPX/FGPY/FGPZ/FGPA/FGPB					YFM 700 DHFH Grizzly 4WD Hunter
/FGPD/E Grizzly Fi Auto 4x4	07-14 R Right				YFM 700 DFG/DFL Grizzly 4WD
YFM 700 FGPDUW/FGPDUX/FGPDUY					YFM 700 PFG Grizzly EPS/4WD
Ducks Unlimited Edition	07-09 R Right				YFM 700 PHFH Grizzly EPS Hunter

FA447 102 x 42 x 7.5mm



MATERIAL AVAILABILITY

FA	X	V	R	HH	SV	MXS	SXR	EPFA	GPFA	GPFAFX	SFA	SFAHH
				✓				✓		✓		

APRILIA			MATERIAL AVAILABILITY									
RSV4 R/RSV4 Factory	09-12	F	1299 Panigale R FE	18-21	F	TM RACING						
RSV4 Factory APRC SE	11-12	F	ENERGICA ELECTRIC			SMR 125 Tsi (2T)	10-21	F				
RSV4 R APRC	11-12	F	Electric EVA/EGO	20	F	SMR 300 Tsi ES (2T)	19-21	F				
RSV4 Factory APRC ABS	13-15	F	Electric EVA Esse 9	20	F	SMX 300 Tsi ES (2T)	19-21	F				
RSV4 R APRC ABS	13-15	F	HONDA			SMR 450 Fi ES (4T)	19-21	F				
RSV4 RF/RF LE/RR	18-21	F	CBR 1000 RR SP	14-19	F	SMR 530 Fi ES (4T)	19-21	F				
Tuono V4 1100 RR/Factory	18-21	F	RC 213 V-S	15-17	F	TRIUMPH						
BMW			HUSQVARNA			Daytona 675 R (Brembo calipers)	11-19	F				
HP2 Sport	08-11	F	FS450 Supermoto	15-21	F	Street Scrambler	18-21	F				
HP4 (1000cc)	13-14	F	900 Nuda R	12-13	F	Street Triple R 765	20-22	F				
BREMBO AFTERMARKET CALIPER			KAWASAKI			Street Triple RS 765	18-21	F				
220B01010 GP4-RX 4 Piston Radial Mount 108mm spacing			ZX10 R Ninja ABS (ZX 1000 RGF/SGF /RHF/SHF/RJF/SJF)	16-18	F	Tiger 900	19-21	F				
DUCATI			ZX10 R Ninja ABS KRT Edition (ZX 1000 RGFA/SGFA/RHFA/SHFA/RJFA/SJFA)	16-18	F	Tiger 900 GT	19-21	F				
848 Evo (Monobloc front calipers)	10-13	F	ZX10 RR Ninja (ZX 1000 ZHF/ZJF)	17-18	F	Tiger 900 GT Low	19-21	F				
848 Evo Corse Special Edition	12-13	F	ZX10 R Ninja ABS (ZX 1002 EKJ/KFA)	19-21	F	Tiger 900 GT Pro	19-21	F				
998 Panigale V4 Superleggera	21	F	ZX10 RR Ninja (ZX 1002)	19-21	F	Tiger 900 Rally	19-21	F				
Hypermotard 1100 S	07-09	F	ZX10 R Ninja ABS KRT Edition (ZX 1002 EKFA/PKFA)	19-21	F	Tiger 900 Pro	19-21	F				
Hypermotard 1100 Evo	10-12	F	Ninja H2/Carbon (ZX 1000)	15-18	F	Speed Triple R (1050cc)	13-17	F				
Hypermotard 1100 Evo SP	10-13	F	Ninja H2/Carbon (ZX 1002 JFK/JKFA)	19-21	F	Speed Triple S (1050cc - 2 Pad Brembo F/Caliper/255mm R/Disc/ABS Model)	16-17	F				
Desmosedici RR (989cc) (D16RR)	08	F	Ninja 1000 H2R (ZX 1000 P)	15-21	F	Speed Triple RS (1050cc - 2 Pad Brembo F/Caliper/255mm R/Disc/ABS Model)	16-21	F				
1098/1098 S	07-08	F	Z H2/Z H2 SE	20-21	F	Scrambler 1200 XC/XE	19-21	F				
1098 S Tricolore	07	F	ZX 14 R ABS Performance	12-21	F	Thruxton R (1200cc)	16-19	F				
1098 R	08-09	F	ZX 14 R ABS Performance Sport	14-21	F	Thruxton TFC 1200cc	19-21	F				
1103 Panigale V4	18-21	F	(ZX 1400 JGF)	14-21	F	Rocket 3 R	19-21	F				
1103 Panigale V4 S	18-21	F	KTM			Rocket 3 GT	19-21	F				
1103 Panigale V4 R	21	F	890 Duke R	21	F							
1103 Panigale V4 SP	21	F	990 SM-R	09-11	F							
Streetfighter/ Streetfighter S (1099cc)	09-12	F	1190 RC8	08-12	F							
1198	09-12	F	1190 RC8 R	09-14	F							
1198 S	09-10	F	1290 Super Duke R	14-21	F							
1198 SP	11-12	F	1290 Super Duke GT	19-21	F							
1198 R Corse Special Edition	11	F	MV (AGUSTA)									
1199 Panigale/Panigale S Tricolore	12-14	F	Brutale 1078 RR	08-09	F							
1199 Panigale S	12-15	F	Brutale 1090 RR	10-14	F							
1199 Panigale R	13-15	F	F3 675 Serie Oro	12	F							
1199 Panigale Superleggera	14-15	F	F3 800 Serie Oro (Brembo calipers)	13-21	F							
Monster 1200 S	14-21	F	F4 RR 312 1078	08-09	F							
Diavel ABS	11-15	F	F4 R/RR (998cc)	12-14	F							
Multistrada 1200 S DVT	15-17	F	F4 (998cc)	10-14	F							
Multistrada 1200 S/S D/Air/Pikes Peak	16-17	F	SUZUKI									
Monster 1200 S Stripe	15	F	GSX-R 600/750 ABS	11-21	F							
Multistrada 1260 S/Pikes Peak	18-21	F	GSX-R 600/750 100th Anniversary	21	F							
Multistrada 1260 S Touring	20-21	F	GSXR 1000 L2-L6/ZL3 (Brembo caliper)	12-16	F							
Multistrada 1260 Enduro	18-21	F	GSXR 1000 ABS (Brembo caliper)	15-21	F							
Diavel Carbon ABS	11-19	F	GSX-R 1000R RAL (Brembo Radial)	17	F							
Diavel AMG	12	F	GSX-S 1000 L5 ABS (Brembo caliper)	15	F							
Diavel Cromo	12-14	F	GSX-S 1000/GSX-S 1000 F	16-21	F							
Diavel Dark (ABS)	13	F	GSX 1000 Katana	19-21	F							
Diavel Strada	13-15	F	GSX 1300 R ABS Hayabusa (Brembo caliper)	13-20	F							
1262 X Diavel S	16-21	F	GSX 1300 RZL4 (Hayabusa 50th Anniversary Edition)	14	F							
1299 Panigale V4	15-19	F										
1299 Panigale R/S	15-19	F										
1299 Panigale V4 S Corse	18-21	F										
1299 Panigale V4 Speciale	18-21	F										

BUYERS GUIDE
BRAKE PADS

NOTE:- Size identification is shown as follows
Dimension 1=Width or Diameter, Dimension 2=Height or Diameter, Dimension 3=Thickness (Material and backplate)

FA450 A 94 x 32 x 7mm
B 94 x 32 x 7mm



MATERIAL AVAILABILITY												
FA	X	V	R	HH	SV	MXS	SXR	EPFA	GPFA	GPFAFX	SFA	SFAHH
	✓		✓			✓		✓				

YAMAHA			YZ 250 Monster Energy 2T					21-22		F
WR 250 F	18-20	F	YZ 250 X (2T)	16-22	F					
YZ 125 (2T)	08-18	F	YZ 250 F (4T)	07-18	F					
YZ 125 (2T)	17-22	F	YZ 450 F (4T)	08-18	F					
YZ 125 Monster Energy 2T	21-22	F	YZ 450 F (4T)	16-20	F					
YZ 250 2T	08-22	F	WR 450 F (4T)	16-20	F					

FA452 120.5 x 57.5 x 8mm



MATERIAL AVAILABILITY												
FA	X	V	R	HH	SV	MXS	SXR	EPFA	GPFA	GPFAFX	SFA	SFAHH
	✓		✓		✓		✓					

POLARIS			RZR-4 800							10-14		F
Brutus HD HDPTO (R03)	13-17	F	RZR-4 800 EPS	12	F							
Ranger EV (Electric)	10-15	F	Ranger 4x4 900 D (Diesel)	11-12	F							
Ranger 500 4x4 EFI	08-10	F	Ranger RZR XP 900	11/13	F							
500 Ranger (Carb) 2x4	08-09	F	Ranger RZR XP 900 White Lightning LE	11	F							
500 Ranger (EFI) 4x4 H.O.	09-11	F	900 Ranger RZR XP EFI	12	F							
Ranger 500 Crew	11-13	F	900 Ranger RZR XP	12	F							
RGR 570 Full Size (R06)	16	F	900 (RZR XP 900 Ranger All Models)	11-13	F							
700 Ranger 6x4 Efi	08	F	RZR-4 XP900	12-14	F & R							
Ranger XP 700 4x4	08	F	900 (RZR XP4 900)	13	F & R							
700 Ranger 4x4 EFI	09	F	900 D Ranger Diesel	11-14	F & R							
700 Ranger Crew (EFI) 4x4	09	F & R	900 D Crew Ranger Diesel	13-14	F & R							
800 Ranger Crew	10-14	F & R	RZR XP1000 (R11 EU/MD, R12,R14)	16-17	F & R							
800 Ranger RZR 4 EPS	12	F	1000 Ranger Diesel	15	F							
800 Ranger 6x6	10-17	F & R	1000 Ranger Diesel Crew	15	F							
800 Ranger XP	10-12	F	1000 General EPS (2 Seat)	16-20	F							
800 Ranger	10-12	F	1000 General 4 EPS (4 Seat)	17-20	F							
800 Ranger RZR-4	11	F										

FA453 97 x 37 x 7mm



MATERIAL AVAILABILITY												
FA	X	V	R	HH	SV	MXS	SXR	EPFA	GPFA	GPFAFX	SFA	SFAHH
	✓		✓									

CF MOTO			600 C-Force Touring							20		F
400 C-Force	14-16	F	800 C-Force EPS	14-16	F							
500 C-Force	14-16	F	UNISON									
500 C-Force HO EPS	14-16	F	Mobility 500	04-	F							
600 C-Force	20	F										

FA454/4 61.5 x 47 x 7.5mm



MATERIAL AVAILABILITY												
FA	X	V	R	HH	SV	MXS	SXR	EPFA	GPFA	GPFAFX	SFA	SFAHH
				✓				✓				

BUELL			1125 CR							09-10		F
XB12 Ss Lightning	09-10	F	EBR									
XB12 SCG Lightning	09-10	F	1190 RS (Sport)	14-15	F							
XB12 R Firebolt	09-10	F	1190 RX (Sport)	14-15	F							
1125 R	08-10	F	1190 SX (Naked)	14-15	F							

FA455 99 x 55 x 9mm



MATERIAL AVAILABILITY												
FA	X	V	R	HH	SV	MXS	SXR	EPFA	GPFA	GPFAFX	SFA	SFAHH
				✓								

JAYBRAKE CALIPERS
6 PF-L (6 Piston for 13" disc - Full Height Friction)

BUYERS GUIDE
BRAKE PADS

NOTE:- Size identification is shown as follows
Dimension 1=Width or Diameter, Dimension 2=Height or Diameter, Dimension 3=Thickness (Material and backplate)

NOTE:- Size identification is shown as follows
Dimension 1=Width or Diameter, Dimension 2=Height or Diameter, Dimension 3=Thickness (Material and backplate)

FA456 97 x 47 x 8mm



MATERIAL AVAILABILITY												
FA	X	V	R	HH	SV	MXS	SXR	EPFA	GPFA	GPFAX	SFA	SFAHH
	✓		✓		✓		✓					
POLARIS						Ranger 1000XP PS NSTR, Crew Mud						
1000 General EPS (2 Seat)				16	R		(R15, R17, R18)				18-20	R
1000 General 4 EPS PS XP DLX (R01, R14, 18, 4 Seat)				17-20	R		Ranger 902D EU Tractor R07				19-20	R
1000 General EPS PS MD (R09, R13, 2 Seat)				17-20	F&R		Scrambler 1000 XP				15-20	R
RZR 570 S/EU/MD (R05)				14-19	R		Sportsman 1000 XP S 55				20-21	R
1000 XP Scrambler				20	R		RZR XP 1000 S4 R02				18-20	R
Ranger Crew 1000 (R04, R06, R08, R11)				18-20	R		RZR 4 900 (R05, R12)				16-18	R
Ranger 1000XP PS Crew Inc EU, EPS, HD, MD (R03, R09, R13, R20)				18-20	R		RZR 900 (50" Inch All Options)				15-20	R
							RZR-S 900 (60" Inch All Options)				15-20	R
							RZR 1000 60 Inch PS EU/Tractor/Zug (R01, R06, R07, R09)				17-20	R

FA457 A 90.5 x 62 x 8mm B 90.5 x 62 x 8mm

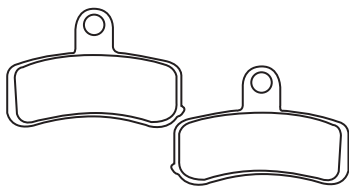

MATERIAL AVAILABILITY												
FA	X	V	R	HH	SV	MXS	SXR	EPFA	GPFA	GPFAX	SFA	SFAHH
		✓		✓				✓				
HARLEY DAVIDSON						FLSTC Heritage Softail Classic						
FXD Super Glide				08-10	F		FXCW Rocker				08-09	F
FXDC Super Glide Custom				08-14	F		FXCWC Rocker C				08-13	F
FXDB Street Bob				08-21	F		FXDWG Dyna Wide Glide (Spoke wheels)				08-20	F
FXDBC Street Bob LTD				16	F		FXS Blackline				11-13	F
FDXL Low Rider (Cast Wheel)				08-20	F		FXSB Breakout				13-14	F
FDXL Low Rider (Spoke Wheel)				14-20	F		FXST Softail Standard				08-14	F
FDXLS Low Rider S				17	F		FLSTFB Fat Boy Special				10-13	F
FXDF Fat Bob				08-20	F		FLD Switchback				12-16	F
FXSTB Night Train				08-09	F		FLSTFB Fat Boy LO Softail				10-14	F
FXSTC Softail Custom				08-10	F		FLS Softail Slim				12-14	F
FLSTF Fat Boy				08-14	F		LYNDALL BRAKES					
FLSTN Softail Deluxe				08-14	F		PAD REF 7256					

FA458 A 130 x 56.5 x 8mm B 130 x 56.5 x 8mm HH thickness = 7.5mm

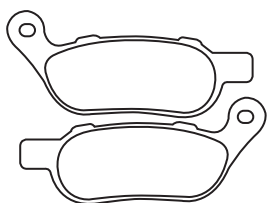

MATERIAL AVAILABILITY												
FA	X	V	R	HH	SV	MXS	SXR	EPFA	GPFA	GPFAX	SFA	SFAHH
		✓		✓				✓				
HARLEY DAVIDSON						FLSTN Softail Deluxe						
FLD Switchback				12-16	R		FLSTC Heritage Softail Classic				08-20	R
FXD Super Glide				08-10	R		FXCW Rocker				08-09	R
FXDC Super Glide Custom				08-14	R		FXCWC Rocker C				08-11	R
FXDB Street Bob				08-21	R		FXDWG Dyna Wide Glide (Spoke wheels)				08-20	R
FXDBC Street Bob LTD				08-16	R		FXSB Breakout				13-20	R
FDXL Low Rider (Cast Wheel)				08-20	R		FXST Softail Standard				08-15	R
FDXL Low Rider (Spoke Wheel)				08-20	R		FLSTSB Softail Cross Bones				08-11	R
FDXLS Low Rider S				17	R		FLS Softail Slim				12-20	R
FXDF Fat Bob				08-20	R		FLSS Softail Slim S				16-20	R
FXSTB Night Train				08-09	R		LYNDALL BRAKES					
FXSTC Softail Custom				08-10	R		PAD REF 7257					
FXS Blackline				11-13	R							
FLSTF Fat Boy				08-20	R							
FLSTFB Fat Boy Lo				10-16	R							
FLSTFBS Fat Boy S				16-20	R							

FA460 49 x 46.5 x 7mm



MATERIAL AVAILABILITY												
FA	X	V	R	HH	SV	MXS	SXR	EPFA	GPFA	GPFAX	SFA	SFAHH
				✓								
BUELL						EBR						
1125 R				08-10	R		1190RS (Sport)				14-15	R
1125 CR				09-10	R		1190RX (Sport)				14-15	R
							1190SX (Naked)				14-15	R

FA462 75 x 37 x 7.5mm



MATERIAL AVAILABILITY												
FA	X	V	R	HH	SV	MXS	SXR	EPFA	GPFA	GPFAX	SFA	SFAHH
			✓									
KTM												
SX 450				09-12	F		SX 505				09-12	F
XC 450				08-12	F		XC 525				08-12	F

FA463 58.5 x 35.5 x 8.5mm



MATERIAL AVAILABILITY												
FA	X	V	R	HH	SV	MXS	SXR	EPFA	GPFA	GPFA	SFA	SFAHH
			✓									

KTM												
SX 450				09-12	R	SX 505					09-12	R
XC 450				08-12	R	XC 525					08-12	R

FA464 A 109.5 x 50.5 x 8.5mm B 95.5 x 37 x 8.5mm

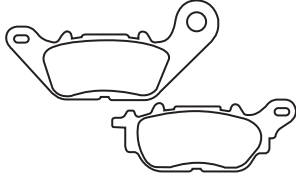

MATERIAL AVAILABILITY												
FA	X	V	R	HH	SV	MXS	SXR	EPFA	GPFA	GPFA	SFA	SFAHH
✓											✓	

YAMAHA												
YBR 125 R (1PX1/X2)				11-12	F	SFA464						
YBR 125 ESG (43B1/3/5/6/8)				08-13	F	YAMAHA					11-13	F
FZ 150 (3C12/3C11)				07-08	F	T 110 C (40B4/7)						
YZF-R15 (150cc) (54C2/3/6-2PB1)				10-13	F	T 110 (40B3)					10	F
YBR 250 (41S2/3)				10-12	F	AF 115 S Fino (2BN1/2)					12	F
					F	XA 125 Cygnus (2BK1)					12	F

FA465 A 110.5 x 34.5 x 7.5mm B 98.5 x 33.5 x 7.5mm

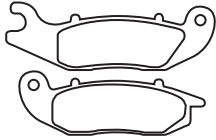

MATERIAL AVAILABILITY												
FA	X	V	R	HH	SV	MXS	SXR	EPFA	GPFA	GPFA	SFA	SFAHH
	✓		✓			✓						

AJP												
PR3 125 Enduro				13-15	F	CRF 250 L (Non ABS)					13-21	F
PR3 125 Enduro Pro				13-15	F	CRF 250 LA (ABS)					17-21	F
PR3 125 Extreme				13-15	F	CRF 250 RL Rally (Non ABS)					17-21	F
PR3 125 Supermoto				13-15	F	CRF 250 RLA Rally (ABS)					17-21	F
PR3 240 Enduro				14-17	F	CRF 300 L ABS					22	F
PR4 240 Enduro				14-17	F	CRF 300 Rally ABS					22	F
PR4 240 Extreme				14-17	F	SCORPA						
PR5 250 Enduro				14-17	F	T-Ride 125 (4T)					11	F
PR5 250 Extreme				17	F	T-Ride 250 F					09-11	F
PR7 650 Adventure				17	F	YAMAHA						
						XTZ 250 Lander					16-18	F

FA468 67 x 52 x 7.5mm



MATERIAL AVAILABILITY												
FA	X	V	R	HH	SV	MXS	SXR	EPFA	GPFA	GPFA	SFA	SFAHH
			✓									

CAN AM												
DS 450 (2x4/EFI)				08-15	F							
DS 450 X (2x4/EFI)				08-11	F							
DS 450 Xxc/Xxm				10-15	F							

FA473 110.5 x 54.5 x 8mm



MATERIAL AVAILABILITY												
FA	X	V	R	HH	SV	MXS	SXR	EPFA	GPFA	GPFA	SFA	SFAHH
✓		✓										

CAN AM												
Spyder RS SES 990cc				08-09	R	Spyder RS-S					10-12	R
Spyder RS SMS 990cc				08-09	R	Spyder RT-S					10-12	R
Spyder RS Phantom Black				09	R	Spyder RT					10-12	R
Spyder RS				10-12	R	Spyder RT Ltd					11-12	R

FA474 A 75.5 x 32 x 8mm B 75.5 x 32 x 8mm



MATERIAL AVAILABILITY												
FA	X	V	R	HH	SV	MXS	SXR	EPFA	GPFA	GPFA	SFA	SFAHH
✓		✓										

CAN AM												
Spyder RS SES 990cc				08-09	F	Spyder RS-S					10-12	F
Spyder RS SMS 990cc				08-09	F	Spyder RT-S					10-12	F
Spyder RS Phantom Black				09	F	Spyder RT					10-12	F
Spyder RS				10-12	F	Spyder RT Ltd					11-12	F

BUYERS GUIDE
BRAKE PADS

NOTE:- Size identification is shown as follows
Dimension 1=Width or Diameter, Dimension 2=Height or Diameter, Dimension 3=Thickness (Material and backplate)

NOTE:- Size identification is shown as follows
Dimension 1=Width or Diameter, Dimension 2=Height or Diameter, Dimension 3=Thickness (Material and backplate)

FA475 97 x 42.5 x 7mm



MATERIAL AVAILABILITY

FA	X	V	R	HH	SV	MXS	SXR	EPFA	GPFA	GPFAFX	SFA	SFAHH
	✓		✓		✓							

POLARIS		Sportsman 570 6X6 Tractor		17-21	R800	
325 Hawkeye 2 x 4		15	R	Sportsman	12-14	F & R
400 Hawkeye H.O. 2 x 4		13-14	R	800 Sportsman Forest	12	F & R
400 Sportsman HO 4 x 4		11-14	R	850 Forest	15	F & R
500 XP Sportsman		09	F & R	850 Scrambler	15	F & R
500 Sportsman HO (Built from 16/12/2008)		09-12	R	850 Sportsman Touring EPS	10-13	F & R
550 Sportsman		11-13	F & R	850 Sportsman Touring H.O. EPS	13-15	F & R
550 Sportsman EPS		10-14	F & R	850 Sportsman Forest	12	F & R
550 Sportsman Forest		10-12	F & R	850 XP H.O. Scrambler	13-15	F & R
550 XP Sportsman EPS		09-11	F & R	850 XP Sportsman	09-13	F & R
550 Sportsman X2		10-14	F & R	850 XP EPS Sportsman	09-13	F & R
550 Sportsman Touring EPS		10-14	F & R	850 XP H.O. EPS Sportsman	13-15	F & R
Sportsman 570 Efi		11-21	R	1000 Forest	15	F & R
Sportsman 570 Efi X2		15-21	R	1000 Scrambler	15	F & R
Sportsman 570 Forest Tracker Efi/EPS		15	R	1000 XP Scrambler	15	F & R
Sportsman 570 Touring Efi		14-21	R	1000 XP Scrambler	20	F
Sportsman 570 Touring Tractor Efi EPS		16-21	R	1000 Sportsman MD/XP	15	F & R
Sportsman 570 6X6		17-21	R			

FA476 A 104 x 43.5 x 13mm B 104 x 43.5 x 13mm

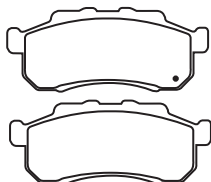

MATERIAL AVAILABILITY

FA	X	V	R	HH	SV	MXS	SXR	EPFA	GPFA	GPFAFX	SFA	SFAHH
	✓											

HONDA			
MUV 700 Big Red		09-13	F Left
SXS 700 M2 Pioneer (2 Seat)		14	F Left
SXS 700 M4 Pioneer (4 Seat)		14	F Left

FA477 A 104 x 43.5 x 13mm B 104 x 43.5 x 13mm

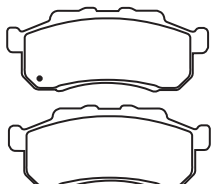

MATERIAL AVAILABILITY

FA	X	V	R	HH	SV	MXS	SXR	EPFA	GPFA	GPFAFX	SFA	SFAHH
	✓											

HONDA			
MUV 700 Big Red		09-13	F Right
SXS700M2 Pioneer (2 Seat)		14	F Right
SXS700M4 Pioneer (4 Seat)		14	F Right

FA478 A 89 x 36.5 x 14mm B 89 x 36.5 x 14mm

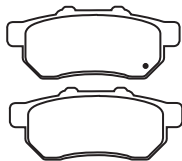

MATERIAL AVAILABILITY

FA	X	V	R	HH	SV	MXS	SXR	EPFA	GPFA	GPFAFX	SFA	SFAHH
	✓											

HONDA			
MUV 700 Big Red		09-13	R Left

FA479 A 89 x 36.5 x 14mm B 89 x 36.5 x 14mm



MATERIAL AVAILABILITY

FA	X	V	R	HH	SV	MXS	SXR	EPFA	GPFA	GPFAFX	SFA	SFAHH
	✓											

HONDA			
MUV 700 Big Red		09-13	R Right

FA480 A. 74 x 36.5 x 7mm B. 38 x 27 x 9mm



MATERIAL AVAILABILITY

FA	X	V	R	HH	SV	MXS	SXR	EPFA	GPFA	GPFAFX	SFA	SFAHH
	✓											

COBRA			
CX 65		11-22	R

FA488 A 99.5 x 38.5 x 9mm
B 99.5 x 38.5 x 9mm

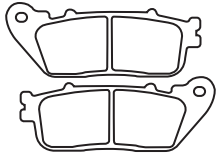

MATERIAL AVAILABILITY												
FA	X	V	R	HH	SV	MXS	SXR	EPFA	GPFA	GPFA	SFA	SFAHH
				✓								

HONDA

VFR 800 F Interceptor Non ABS	14-15	R	CB 1000 R	10-20	R
VFR 800 FD Interceptor DLX ABS	14-15	R	VFR 1200 F	10-14	R

VFR 800 X Crossrunner ABS 17-21 R

FA489 88.5 x 46.5 x 8mm



MATERIAL AVAILABILITY												
FA	X	V	R	HH	SV	MXS	SXR	EPFA	GPFA	GPFA	SFA	SFAHH
			✓									

POLARIS

RZR 170	09-15	R			
---------	-------	---	--	--	--

FA490 87 x 42.5 x 8mm



MATERIAL AVAILABILITY												
FA	X	V	R	HH	SV	MXS	SXR	EPFA	GPFA	GPFA	SFA	SFAHH
			✓									

POLARIS

RZR 170	09-15	F	200 Phoenix Quadricycle Model		
200 Phoenix (Rear Drum Model)	10-14	F	(Rear disc model)	10	F

FA491 78 x 46 x 7.5mm



MATERIAL AVAILABILITY												
FA	X	V	R	HH	SV	MXS	SXR	EPFA	GPFA	GPFA	SFA	SFAHH
				✓				✓		✓		

TRIUMPH (Hinckley Produced Models)

675 Daytona Black Monobloc			Daytona 675 SE	12	F
Radial caliper/Nissin Rear Caliper	09-12	F	Street Triple 675 RXSE (ABS)	15	F
675 Daytona Black Monobloc					
Radial caliper/Brembo Rear Caliper	13-17	F			

SFA492 A 109.5 x 51 x 9.5mm
B 114 x 41.5 x 9mm

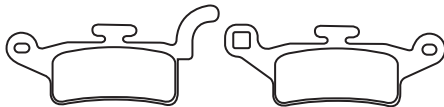

MATERIAL AVAILABILITY												
FA	X	V	R	HH	SV	MXS	SXR	EPFA	GPFA	GPFA	SFA	SFAHH
											✓	

YAMAHA

YYW125 Y/Z/A/B/D/E/F Zuma (Rear Drum Model)	09-15	F			
---	-------	---	--	--	--

FA495 35.5 x 42 x 5.5mm



MATERIAL AVAILABILITY												
FA	X	V	R	HH	SV	MXS	SXR	EPFA	GPFA	GPFA	SFA	SFAHH
	✓											

BETA

Evo 125/200 (2T)	10-15	R	Trial Evo 125/200/250 (2T) MY20	20-21	R
Evo 250 (2T/4T)	09-15	R	Trial Evo 250 (2T) MY20 GB	20-21	R
Evo 300 (2T/4T)	09-15	R	Trial Evo 300 (2T) MY20	20-21	R
Evo 250 (2T) Factory	18-19	R	Trial Evo 300 (2T) MY20 GB	20-21	R
Evo 250 (4T)	18-19	R	Trial Evo 300 (2T) SS MY20	20-21	R

FA496 86 x 40 x 9mm



MATERIAL AVAILABILITY												
FA	X	V	R	HH	SV	MXS	SXR	EPFA	GPFA	GPFA	SFA	SFAHH
✓		✓		✓								

HONDA			KAWASAKI		
CRB 250 R (Non ABS)	11-14	R	Vulcan 650 S ABS	15	R
CBR 250 RA (ABS Model)	11-14	R	Versys 650	15	R
CB 300 F	15	R	SUZUKI		
CBR 300 R (Non ABS Model)	15	R	GW 250 L4/L5 (Naked)	14-15	R
CBR 300 R (ABS Model)	15	R	GW 250 FL5 (Fairing)	15	R
CB 650 F (Non ABS)	18-20	R	SFV 650 K9/L3/L4/L5	09-10/13-15	R
CB 650 F (ABS)	18-20	R	SV 650 AL (ABS)	17-18	R
CBR 650 F (Non ABS Model)	14-20	R	GSX 250 R	17-20	R
CBR 650 F (ABS Model)	14-20	R			

NOTE:- Size identification is shown as follows
Dimension 1=Width or Diameter, Dimension 2=Height or Diameter, Dimension 3=Thickness (Material and backplate)

FA497 62 x 41 x 7mm



MATERIAL AVAILABILITY												
FA	X	V	R	HH	SV	MXS	SXR	EPFA	GPFA	GPFAF	SFA	SFAHH
	✓											

YAMAHA
 Rhino (All Models) 08-13 Parking Brake
 YXC 700 DFG/DXG Viking VI 15-16 Parking Brake
 YXC 700 PFG/PXG Viking VI EPS 15-16 Parking Brake
 YXC 700 PSFS/PXGS Viking 15-16 Parking Brake

VI EPS SE 15-16 Parking Brake
 YXM 700 DEG/DFG/VDXG Viking 14-16 Parking Brake
 YXM 700 PEG/PFG/VPXG Viking EPS 14-16 Parking Brake
 YXM 700 PSE/PSF/VPSG Viking 14-16 Parking Brake
 EPS SE 14-16 Parking Brake

SFA498 90 x 33.5 x 10mm



MATERIAL AVAILABILITY												
FA	X	V	R	HH	SV	MXS	SXR	EPFA	GPFA	GPFAF	SFA	SFAHH
											✓	✓

KYMC
 Like S 458i 18-19 R
 Movie 150i (SE30BC) 13-14 F & R
 Downtown 200i 11-12 R

People GT 200i 11-12 R
 Downtown 300i 10-15 R
 X Town 300i 18-20 R
 Downtown 350i 18-19 R

FA499/4 A 69 x 51.5 x 9mm B 33 x 51.5 x 9mm

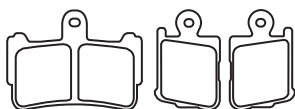

MATERIAL AVAILABILITY												
FA	X	V	R	HH	SV	MXS	SXR	EPFA	GPFA	GPFAF	SFA	SFAHH
				✓								

HONDA
 VFR 1200 F 10-14 F
 VFR 1200 FD (Automatic Transmission Model) 10-14 F

FA600 102.5 x 42.5 x 8mm



MATERIAL AVAILABILITY												
FA	X	V	R	HH	SV	MXS	SXR	EPFA	GPFA	GPFAF	SFA	SFAHH
	✓		✓									

KYMC **ATV**
 MXU 500 4x4 IRS (Carb Model) 10-11 F
 MXU 500i IRS (All Efi Models) 10-11 F
 MXU 700i (All Models) 14-21 F

FA600/2 102.5 x 42.5 x 7mm



MATERIAL AVAILABILITY												
FA	X	V	R	HH	SV	MXS	SXR	EPFA	GPFA	GPFAF	SFA	SFAHH
	✓		✓									

KYMC **ATV**
 MXU 500 4x4 IRS (Carb Model) 10-11 R
 MXU 500i IRS (All Efi Models) 10-11 R
 MXU 700i (All Models) 14-21 R

FA602 41 x 42.5 x 7.5mm



MATERIAL AVAILABILITY												
FA	X	V	R	HH	SV	MXS	SXR	EPFA	GPFA	GPFAF	SFA	SFAHH
	✓		✓									

GAS-GAS (PIERER)
 MC 85 2T 21 R
HUSQVARNA
 CR 65 12 R
 TC85 (17/14" wheels) 14-20 R
 TC85 (19/16" wheels) 14-20 R

KTM
 SX 85 (17/14" wheels) 11-20 R
 SX 85 (19/16" wheels) 11-20 R
 250R Freeride 15-21 R
 350 Freeride 12/14 R
 Freeride E-XC Electric 19-20 R
 Freeride E 12 R

SFA603 A 111.5 x 43 x 8mm B 109.5 x 43 x 8mm

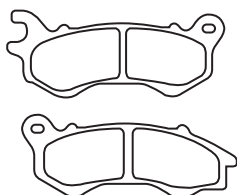

MATERIAL AVAILABILITY												
FA	X	V	R	HH	SV	MXS	SXR	EPFA	GPFA	GPFAF	SFA	SFAHH
											✓	✓

HONDA
 PCX 125 11 F
 PCX 150 (WW150) 13-21 F
 PCX 150 ABS 18-21 F

KYMC
 Like S 125i 18-19 F

FA604/4 35 x 40.5 x 8mm



MATERIAL AVAILABILITY												
FA	X	V	R	HH	SV	MXS	SXR	EPFA	GPFA	GPFA	SFA	SFAHH
				✓				✓		✓		

BMW

S 1000 R Naked 14
 S 1000 RR 10-17
 S 1000 RR (Models fitted with Forged
 race wheels 7 spoke type) 15-17

TRIUMPH

Speed Triple (1050cc - 4 Pad Brembo)
 F/Caliper/220mm R/Disc/Non ABS Model) 10-12 F
 Speed Triple (1050cc - 4 Pad Brembo
 F/Caliper/220mm R/Disc/ABS Model) 10-12 F
 Street Twin 900cc 18-21 F
 Speed Twin 1200cc 19-21 F

FA605/4 98 x 47 x 8mm



MATERIAL AVAILABILITY												
FA	X	V	R	HH	SV	MXS	SXR	EPFA	GPFA	GPFA	SFA	SFAHH
		✓		✓								

HARLEY DAVIDSON®

Harley Trikes 09-13

LYNDALL BRAKES

PAD REF 7255

FA606 69.5 x 45 x 8.5mm

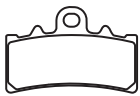

MATERIAL AVAILABILITY												
FA	X	V	R	HH	SV	MXS	SXR	EPFA	GPFA	GPFA	SFA	SFAHH
✓				✓				✓				

BMW

G 310 R 17-21
 G 310 GS 17-21
 G 310 GS 20-21

HUSQVARNA

Vitpilen 401 18-21 F
 Svartpilen 401 19-21 F
KTM
 390 Duke 15-21 F
 RC390 15-21 F

SFA607 94 x 36 x 10.5mm



MATERIAL AVAILABILITY												
FA	X	V	R	HH	SV	MXS	SXR	EPFA	GPFA	GPFA	SFA	SFAHH
											✓	✓

KYMCO STREET

People GT 300i 11-15 R

SFA608 102 x 38 x 10.5mm

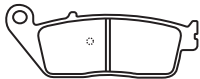

MATERIAL AVAILABILITY												
FA	X	V	R	HH	SV	MXS	SXR	EPFA	GPFA	GPFA	SFA	SFAHH
											✓	✓

KYMCO STREET

People S 250 07-11 R Xciting 500 04-14 R
 Xciting 250 05-11 R My Road 700i 11-15 R

FA609 98 x 42.5 x 7.5mm



MATERIAL AVAILABILITY												
FA	X	V	R	HH	SV	MXS	SXR	EPFA	GPFA	GPFA	SFA	SFAHH
			✓									

JOHN DEERE

XUV 620i Gator (Petrol) 10 F & R XUV 850 D Gator (Diesel) 10 F & R
 XUV 625i Gator (Petrol) 11 R XUV 855 Gator D (Diesel) 11 R
 XUV 825i (Petrol) 11 R HPX 4x4 (Diesel) 10-11 F & R

FA610 135.5 x 55 x 8mm



MATERIAL AVAILABILITY												
FA	X	V	R	HH	SV	MXS	SXR	EPFA	GPFA	GPFA	SFA	SFAHH
			✓		✓		✓					

ARCTIC CAT (SIDE X SIDE)

Wildcat 1000 15-18
 Wildcat 1000 4 15-18
 Wildcat X EPS 1000 15-18

JOHN DEERE

XUV 625i Gator (Petrol) 11 F
 XUV 825i (Petrol) 11 F
 XUV 855 Gator D (Diesel) 11 F
 HPX 4x4 (Diesel) 10-11 F & R

BUYERS GUIDE
BRAKE PADS

NOTE:- Size identification is shown as follows
Dimension 1=Width or Diameter, Dimension 2=Height or Diameter, Dimension 3=Thickness (Material and backplate)

NOTE:- Size identification is shown as follows
Dimension 1=Width or Diameter, Dimension 2=Height or Diameter, Dimension 3=Thickness (Material and backplate)

GPFX611HH 82 x 29 x 9.5mm



MATERIAL AVAILABILITY												
FA	X	V	R	HH	SV	MXS	SXR	EPFA	GPFA	GPFX	SFA	SFAHH
										✓		

BMW
S 1000 RR HP4 Race 17-18 F
BREMBO AFTERMARKET CALIPER
XA3.J7.50/51 - 4 Piston P 34/38 Radial Mount @108mm Spacing
XA3.J7.60/61 - 4 Piston P 34/38 Radial Mount @108mm Spacing
XA8.Y3.310/11 - 4 Piston P 34/38 Radial Mount @130mm Spacing

FA612 40 x 59 x 7.5mm



MATERIAL AVAILABILITY												
FA	X	V	R	HH	SV	MXS	SXR	EPFA	GPFA	GPFX	SFA	SFAHH
	✓		✓									

GAS-GAS (PIERER)
MC 85 2T 21 F
HUSQVARNA
TC85 (17/14" wheels) 14-21 F
TC85 (19/16" wheels) 14-21 F
KTM
SX 85 (17/14" wheels) 12-20 F
SX 85 (19/16" wheels) 12-20 F
250R Freeride 15-21 F
OHVALE
GP-0 110cc,160cc 19-20 F
SHERCO
ST1.25 (2T) 12-14 F
ST2.5 (2T) 12-14 F
ST2.9 (2T) 12-14 F

FA613 81 x 46 x 9.5mm



MATERIAL AVAILABILITY												
FA	X	V	R	HH	SV	MXS	SXR	EPFA	GPFA	GPFX	SFA	SFAHH
				✓								

BMW
K 1600 B Bagger 17-21 F K 1600 GTL 11-21 F
K 1600 GT 11-21 F K 1600 GTL Exclusive 15 F

FA617 A 109 x 39 x 9mm B 33 x 51.5 x 9mm

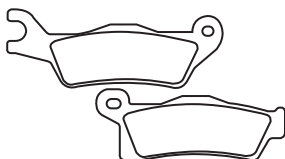

MATERIAL AVAILABILITY												
FA	X	V	R	HH	SV	MXS	SXR	EPFA	GPFA	GPFX	SFA	SFAHH
	✓		✓		✓							

CAN-AM												
Outlander L 450 EFI	15		F (Right)	Renegade 800 R STD/EFI	12-15						F (Right) & R (Right)	
Outlander L Max 450 EFI	15		F (Right)	Renegade 800 R XXC	12-14						F (Right) & R (Right)	
Outlander 500 4x4 (STD/DPS/XT)	13-15		F (Right)	Outlander 800R 4x4 (X-mr)	15						F (Right)	
Outlander L 500 EFI	15		F (Right)	Outlander 1000 STD	12-14						F (Right) & R (Right)	
Outlander L Max 500 EFI	15		F (Right)	Outlander 1000 XT/XT-P	12-14						F (Right) & R (Right)	
Outlander Max 500 4x4 (STD/DPS/XT)	13-14		F (Right)	Outlander 1000 4x4 (DPS)	13						F (Right)	
Renegade 500 (STD/EFI)	12-15		F (Right) & R (Right)	Outlander 1000 (4x4 X mr)	13-14						F (Right)	
Outlander Max 650 4x4 (STD/DPS/XT)	13-14		F (Right)	Outlander Max 1000 (4x4 LTD)	13						F (Right)	
Outlander 650 4x4 (DPS/XT/STD)	13-15		F (Right)	Outlander Max 1000 (4x4 XMR)	13						F (Right)	
Outlander 650 4x4 (X-mr)	15		F (Right)	Outlander Max 1000 (4x4 DPS/XT/XT-P/LTD/STD)	13-14						F (Right)	
Outlander 800 R STD	12-15		F (Right)	Outlander 6 x 6 XT	15						F (Right) & R (Right)	
Outlander 800 R XT	12-14		F (Right)	Renegade 1000 STD/EFI	12-15						F (Right) & R (Right)	
Outlander 800 R XT-P	13-14		F (Right)	Renegade 1000 XXC	12-14						F (Right) & R (Right)	
Outlander 800 R 4x4 DPS	13		F (Right)									
Outlander Max 800 R 4x4 (STD/XT/XT-P)	13-14		F (Right)									

FA618 A 109 x 39 x 7.5mm
B 96.5 x 36.5 x 7.5mm

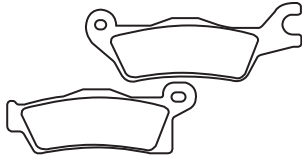

MATERIAL AVAILABILITY												
FA	X	V	R	HH	SV	MXS	SXR	EPFA	GPFA	GPFAX	SFA	SFAHH
	✓		✓		✓							

CAN-AM

Outlander L 450 EFI	15		F (Left)	Renegade 800 R STD/EFI	12-15						F (Left) & R (Left)	
Outlander L Max 450 EFI	15		F (Left)	Renegade 800 R XXC	12-14						F (Left) & R (Left)	
Outlander 500 4x4 (STD/DPS/XT)	13-15		F (Left)	Outlander 800R 4x4 (X-mr)				15			F (Left)	
Outlander L 500 EFI	15		F (Left)	Outlander 1000 STD	12-14						F (Left) & R (Left)	
Outlander L Max 500 EFI	15		F (Left)	Outlander 1000 XT/XT-P	12-14						F (Left) & R (Left)	
Outlander Max 500 4x4 (STD/DPS/XT)	13-14		F (Left)	Outlander 1000 4x4 (DPS)				13			F (Left)	
Renegade 500 (STD/EFI)	12-15		F (Left) & R (Left)	Outlander 1000 (4x4 X mr)	13-14						F (Left)	
Outlander Max 650 4x4 (STD/DPS/XT)	13-14		F (Left)	Outlander Max 1000 (4x4 LTD)				13			F (Left)	
Outlander 650 4x4 (DPS/XT/STD)	13-15		F (Left)	Outlander Max 1000 (4x4 XMR)				13			F (Left)	
Outlander 650 4x4 (X-mr)	15		F (Left)	Outlander Max 1000 (4x4 DPS/XT/XT-P/LTD/STD)	13-14						F (Left)	
Outlander 800 R STD	12-15		F (Left)	Outlander 6 x 6 XT				15			F (Left) & R (Left)	
Outlander 800 R XT	12-14		F (Left)	Renegade 1000 STD/EFI	12-15						F (Left) & R (Left)	
Outlander 800 R XT-P	13-14		F (Left)	Renegade 1000 XXC	12-14						F (Left) & R (Left)	
Outlander 800 R 4x4 DPS	13		F (Left)									
Outlander Max 800 R 4x4 (STD/XT/XT-P)	13-14		F (Left)									

CFA619 33.5 x 30 x 4mm



MATERIAL AVAILABILITY												
CFA	X	V	R	HH	SV	MXS	SXR	EPFA	GPFA	GPFAX	SFA	SFAHH
✓												

BULTACO

Brinco (Electric Trials Bike C/R/RE/S Models 15-17 R

SFA621 27.8mm Ø



MATERIAL AVAILABILITY												
FA	X	V	R	HH	SV	MXS	SXR	EPFA	GPFA	GPFAX	SFA	SFAHH
		✓										

YAMAHA

XP 500 F/G (T-Max 530cc) Parking Brake 15-16 R

FA622 77.5 x 42 x 7mm



MATERIAL AVAILABILITY												
FA	X	V	R	HH	SV	MXS	SXR	EPFA	GPFA	GPFAX	SFA	SFAHH
	✓		✓		✓							

KOTI/MECHRON

2200 UTV (Side x Side) 09-14 F&R

FA623 84.5 x 59.5 x 10mm

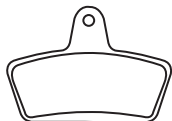

MATERIAL AVAILABILITY												
FA	X	V	R	HH	SV	MXS	SXR	EPFA	GPFA	GPFAX	SFA	SFAHH
✓				✓								

HHI HAWG HALTERS AFTERMARKET CALIPERS

4 Piston Sprocket Brake

FA629 A 91.5 x 41 x 7.5mm
B 96.5 x 36.5 x 7.5mm

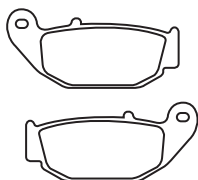

MATERIAL AVAILABILITY												
FA	X	V	R	HH	SV	MXS	SXR	EPFA	GPFA	GPFAX	SFA	SFAHH
✓	✓		✓	✓								

BENELLI

BN 125 18-20 R CRF 250 L (Non ABS) 13-21 R
 TNT 125 18-20 R CRF 250 LA (ABS) 17-21 R
 CRF 250 RL Rally (Non ABS) 17-21 R

HONDA

CB 125 F 15-21 R CRF 250 RLA Rally (ABS) 17-21 R
 CB 125 R 19-21 R CRF 300 L ABS 22 R
 CRF 300 Rally ABS 22 R

SUZUKI

CBR 125 RWB/RC/RD (5 Bolt Front Disc / Canada) 11-13 R GSX-R 125 18-21 R
 MSX 125 D/E/F/G/H Grom (Non ABS) 14-21 R GSX-S 125 18-21 R
 MSX 125 AH Grom (ABS) 18-21 R

FA630 85 x 50.5 x 8mm

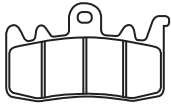

MATERIAL AVAILABILITY												
FA	X	V	R	HH	SV	MXS	SXR	EPFA	GPFA	GPFA	SFA	SFAHH
		✓		✓				✓		✓		

APRILIA

Tuono V4 R APRC ABS 14-15 F
Caponord 1200 14-15 F

BMW

F 800 R 15-18 F
F 900 R/RX 20-21 F
R 1200 GS (Liquid Cooled/Radial Mount Caliper) 13-18 F
R 1200 GS Adventure (Liquid Cooled /Radial Mount Caliper) 14-18 F
R Nine T (K21/1170cc) 14-21 F
R 1200 R/RS 15-18 F
R 1200 RT 14-18 F
R 1250 R/RS 19-21 F
S 1000 XR 14-18 F

BREMBO

M4-32 Monobloc Radial

CAN-AM

Spyder RS/RS-S (Brembo Caliper) 13-16 F
Spyder RT (3 Cyl Eng/ 6 Speed) 13-21 F
Spyder RT LTD (3 Cyl Eng/ 6 Speed) 13-21 F
Spyder RT-S (3 Cyl Eng/ 6 Speed) 13-15 F
Spyder RT-S (Special Series) 16-17 F
Spyder ST/ST-S (Brembo Calipers) 13-16 F
Spyder ST LTD (Brembo Calipers) 13-15 F
Spyder F3 (SE6/SM6) 15-21 F
Spyder F3 LTD 16-21 F
Spyder F3-S (SE6/SM6) 15-21 F
Spyder F3-S (Special Series) 16-21 F
Spyder F3-S Daytona 500 17 F
Spyder F3-T 16-21 F

DUCATI

797 Monster 17 F
Scrambler Classic (Spoke Wheels/803cc) 15-17 F
Scrambler Icon (Cast Wheels/803cc) 15-21 F
Scrambler Urban Enduro (Spoke Wheels/803cc) 15-17 F

Scrambler Full Throttle

(Cast Wheels/803cc) 15-21 F
Scrambler Flat Track Pro (Cast Wheels/803cc) 16-17 F
Scrambler Café Racer (Cast wheels/803cc) 17-21 F
Hypermotard(821cc) 13-15 F
Hypermotard SP (821cc) 13-15 F
Hyperstrada(821cc) 13-15 F
Monster 821 15-21 F
Monster Dark 821 15 F
Monster Stripe 821 15-17 F
899 Panigale 14-15 F
Supersport (936cc) 17-21 F
Supersport S (936cc) 17-21 F
939 Hypermotard 16-17 F
939 Hypermotard SP 16-17 F
939 Hyperstrada 16 F

950 Multistrada (936cc) 17-21 F
950 Multistrada S (936cc) 20-21 F
950 Multistrada S SW (936cc) 20-21 F
950 Multistrada S Touring (936cc) 20-21 F
959 Panigale (ABS) 16-19 F
Scrambler 1100 Sport 18-21 F
Scrambler 1100 Special 18-21 F
Scrambler 1100 Pro 18-21 F
Scrambler 1100 Sport Pro 18-21 F
1200 Monster 14-21 F
Multistrada 1200 16-17 F
1200 Multistrada Enduro 16-17 F
1200 Multistrada DVT 15 F
Multistrada 1260 20-21 F
Multistrada 1260 Touring 20-21 F
Diavel 1260 20-21 F
1262 Xdiavel 16-21 F

HARLEY DAVIDSON ELECTRIC

LiveWire 18-21 F
Pan American Adventure 20-21 F
Sportster S 21-22 F

INDIAN

Challenger All options 20-21 F
FTR 1200/FTR 1200 Rally 19-21 F
FTR 1200 S 19-21 F
FTR 1200 S Race Replica 19-20 F

MV

Rivale 800 13-14 F
Superverloce 800 20-21 F
Turismo Veloce 800 14-21 F
Turismo Veloce Lusso 800 14-21 F

TRIUMPH

Street Triple R 765
(Brembo M4.32 4 piston radial caliper, Brembo single piston rear caliper ABS) 18-19 F
Street Triple R/LRH 765 (Brembo M4.32 4 piston radial caliper, Brembo single piston rear caliper ABS) 18-21 F
Street Triple RS 765 (Brembo M50 4 piston radial monobloc caliper, Brembo single piston sliding caliper, ABS) 18-21 F
Tiger 1200 XC (Vin # 740277 onwards /1215cc/Spoke Wheels) 16-21 F
Tiger 1200 XCa (1215cc/Spoke Wheels) 16-21 F
Tiger 1200 XCx (1215cc/Spoke Wheels /STD & Low) 16-21 F
Tiger 1200 XR (1215cc/Cast Wheels) 16-21 F
Tiger 1200 XRx (1215cc/Cast Wheels /STD & Low) 16-21 F
Tiger 1200 XRt 1200 (1215cc/Cast Wheels) 16-21 F
Tiger 1200 Alpine Edition (1215cc /Cast Wheels/STD & Low) 20-21 F
Tiger 1200 Desert Edition (1215cc /Spoke Wheels) 20-21 F
Rocket 3 R/GT 19-21 R

FA631 96.5 x 43.5 x 8mm

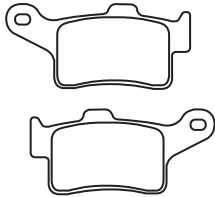

MATERIAL AVAILABILITY												
FA	X	V	R	HH	SV	MXS	SXR	EPFA	GPFA	GPFA	SFA	SFAHH
		✓		✓								

CAN-AM

Spyder ST-S (Brembo Calipers) 13-16 R
Spyder RS (Brembo Caliper) 13-16 R
Spyder RS-S (Brembo Caliper) 13-16 R
Spyder RT (3 Cyl Eng/ 6 Speed) 13-21 R
Spyder RT LTD (3 Cyl Eng/ 6 Speed) 13-21 R
Spyder RT-S (3 Cyl Eng/ 6 Speed) 13-15 R
Spyder RT-S (Special Series) 16-17 R
Spyder ST (Brembo Calipers) 13-16 R
Spyder ST LTD (Brembo Calipers) 13-15 R

HARLEY DAVIDSON

FLHTCUTGSE CVO Tri Glide 21 R

SFA632 90 x 39.5 x 10.5mm

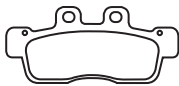

MATERIAL AVAILABILITY												
FA	X	V	R	HH	SV	MXS	SXR	EPFA	GPFA	GPFA	SFA	SFAHH
											✓	

YAMAHA

YW125 X (1DN1/2) 10-13 F

BUYERS GUIDE
BRAKE PADS

NOTE:- Size identification is shown as follows
Dimension 1=Width or Diameter, Dimension 2=Height or Diameter, Dimension 3=Thickness (Material and backplate)

FA636 102 x 40 x 9.5mm

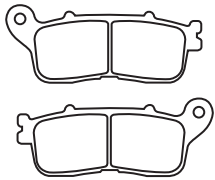

MATERIAL AVAILABILITY												
FA	X	V	R	HH	SV	MXS	SXR	EPFA	GPFA	GPFAF	SFA	SFAHH
		✓		✓								

HONDA
 VFR 1200 FD 10-14 R VFR 1200 XD DCT (Automatic
 VFR 1200 XA (Manual G/Box) 16-17 R Transmission Model) 16-17 R

FA638 174 x 50 x 8.5mm

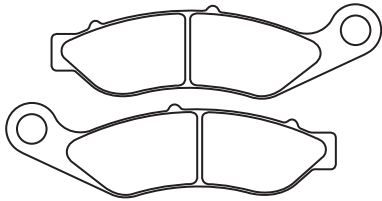

MATERIAL AVAILABILITY												
FA	X	V	R	HH	SV	MXS	SXR	EPFA	GPFA	GPFAF	SFA	SFAHH
		✓		✓				✓				

HARLEY DAVIDSON
 FLRT Freewheeler Trike 15-21 F FLHTCUTG Tri Glide Ultra Trike
 FLHTCUTG Trike 14-21 F Anniversary 18-20 F

FA640 118 x 47.5 x 9mm

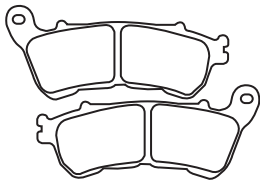

MATERIAL AVAILABILITY												
FA	X	V	R	HH	SV	MXS	SXR	EPFA	GPFA	GPFAF	SFA	SFAHH
✓		✓		✓				✓				

HARLEY DAVIDSON XL1200 CX Roadster 16-21 F
 XL883 L Super Low (Cast Wheel) 14-20 F XL1200 T Superlow 14-21 F
 XL883 N Iron (Cast Wheel) 14-21 F XL1200 V Seventy Two 14-20 F
 XL883 R Roadster (Cast Wheel) 14-15 F XL1200 X Forty Eight 14-21 F
 XL1200 C Custom (Spoke Wheel) 14-21 F XL1200 Forty Eight Anniv. 18-20 F

FA641/4 88 x 43 x 8.7mm



MATERIAL AVAILABILITY												
FA	X	V	R	HH	SV	MXS	SXR	EPFA	GPFA	GPFAF	SFA	SFAHH
		✓		✓								

HARLEY DAVIDSON FLHTCUTG Trike 14-21 R
 FLRT Freewheeler Trike 15-21 R FLHTCUTG Tri Glide Ultra Trike Anniversary 18-20 R

**FA642 A 104 x 46 x 8.5mm
B 88 x 46 x 8.5mm**

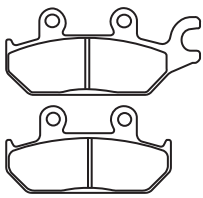

MATERIAL AVAILABILITY												
FA	X	V	R	HH	SV	MXS	SXR	EPFA	GPFA	GPFAF	SFA	SFAHH
	✓		✓		✓		✓					

CAN-AM		YAMAHA	
Commander Max 1000 DPS/XT	14 F Left	YXC 700 DFG/DXG Viking VI	15-16 F Left
Commander Max 1000 LTD	14 F Left	YXC 700 PFG/PXG Viking VI EPS	15-16 F Left
Maverick 1000 - XRS -DPS	14 F Left	YXC 700 PSFS/PXGS Viking VI EPS SE	15-16 F Left
Maverick 1000 - XMR	14-15 F Left	YXC 70 PRGC Viking VI EPS Edition	16 F Left
Maverick 1000 - XXC	14-15 F Left	YXE 70 WDBGG Wolverine	16 F Left
Maverick 1000 - XDS -DPS	15 F Left	YXE 70 WDXGG Wolverine R Spec	16 F Left
Maverick Max 1000 - STD	14-15 F Left	YXE 70 WPXGG Wolverine R Spec EPS	16 F Left
Maverick Max 1000 - XRS-DPS	14-15 F Left	YXM 700 DEG/DFG/VDXG Viking	14-16 F Left
Maverick Max STD/XRS/DPS	15 F Left	YXM 700 PEG/PFG/VPXG Viking EPS	14-16 F Left
Maverick Max 1000 - XDS -DPS	15 F Left	YXM 700 PSE/PSF/VPSG Viking EPS SE	14-16 F Left

**FA643 A 94 x 37.5 x 9mm
B 94 x 37.5 x 9mm**



MATERIAL AVAILABILITY												
FA	X	V	R	HH	SV	MXS	SXR	EPFA	GPFA	GPFAF	SFA	SFAHH
✓		✓		✓								

HARLEY DAVIDSON
 XG 500 Street 14-15 F & R
 XG 750 Street 14-15 F & R

FA644 56 x 32 x 5mm



MATERIAL AVAILABILITY												
FA	X	V	R	HH	SV	MXS	SXR	EPFA	GPFA	GPFAF	SFA	SFAHH
	✓											

GAS-GAS		MONTESA	
TXT 125/200/250/280/300 (TXT Racing)	14-15 F	4RT Cota Repsol Edition (260cc)	14-17 F
		4RT Cota 300RR	16 F

NOTE:- Size identification is shown as follows
Dimension 1=Width or Diameter, Dimension 2=Height or Diameter, Dimension 3=Thickness (Material and backplate)

FA645 A 104 x 46 x 8.5mm
B 88 x 46 x 8.5mm

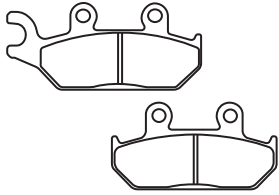

MATERIAL AVAILABILITY												
FA	X	V	R	HH	SV	MXS	SXR	EPFA	GPFA	GPFAFX	SFA	SFAHH
	✓		✓		✓		✓					

CAN-AM			YAMAHA		
Commander Max 1000 DPS/XT	14	F Right	YXC 700 DFG/DXG Viking VI	15-16	F Right
Commander Max 1000 LTD	15	F Right	YXC 700 PFG/PXG Viking VI EPS	15-16	F Right
Maverick 1000 - XRS -DPS	14-15	F Right	YXC 700 PSFS/PXGS Viking VI EPS SE	15-16	F Right
Maverick 1000 - XMR	14-15	F Right	YXC 70 PRGC Viking VI EPS Edition	16	F Right
Maverick 1000 - XXC	14-15	F Right	YXE 70 WDBGG Wolverine	16	F Right
Maverick 1000 - XDS -DPS	15	F Right	YXE 70 WDXGG Wolverine R Spec	16	F Right
Maverick Max 1000 - STD	14-15	F Right	YXE 70 WPXGG Wolverine R Spec EPS	16	F Right
Maverick Max 1000 - XRS-DPS	14-15	F Right	YXM 700 DEG/DFG/VDXG Viking	14-16	F Right
Maverick Max STD/XRS/DPS	15	F Right	YXM 700 PEG/PFG/VPXG Viking EPS	14-16	F Right
Maverick Max 1000 - XDS -DPS	15	F Right	YXM 700 PSE/PSF/VPSG Viking EPS SE	14-16	F Right

GFA646HH 94 x 34 x 11.5mm

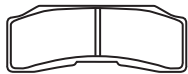

MATERIAL AVAILABILITY												
FA	X	V	R	HH	SV	MXS	SXR	EPFA	GPFA	GPFAFX	SFA	SFAHH
										✓		

BREMBO AFTERMARKET CALIPER
XB2P710/XB2P711 Endurance Caliper

FA649 99 x 55 x 8.5mm



MATERIAL AVAILABILITY												
FA	X	V	R	HH	SV	MXS	SXR	EPFA	GPFA	GPFAFX	SFA	SFAHH
				✓								

JAYBRAKE CALIPER
6 PF-L (6 Piston for 11.5" disc - Lower Height Friction)

FA651 72.5 x 30.5 x 10mm



MATERIAL AVAILABILITY												
FA	X	V	R	HH	SV	MXS	SXR	EPFA	GPFA	GPFAFX	SFA	SFAHH
	✓		✓				✓					

GF MOTO			800 EX Z-Force			14-16 R (left) & R (Right)		
500 Z-Force	14-16	R (left) & R (Right)	950 Z-Force	20	Rear			
800 U-Force	15-16	R (left) & R (Right)	1000 U-Force	20	Rear			
800 Z-Force	15-16	R (left) & R (Right)	1000 Z-Force	18-19	Rear			

FA656 121 x 57 x 8mm

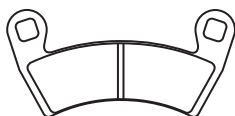

MATERIAL AVAILABILITY												
FA	X	V	R	HH	SV	MXS	SXR	EPFA	GPFA	GPFAFX	SFA	SFAHH
	✓	✓	✓				✓					

POLARIS

325 Sportsman Ace	14	F
325 Sportsman Ace Efi	15-16	F
325 Sportsman Ace Euro	14-15	F
325 Sportsman Ace HD	15	F
Ace 570 Efi, HD, MD	15-16	F
570 Sportsman Ace Euro	15	F
570 Ranger Crew	14-15	F
RZR XP Turbo	16	R
RZR XP 4 Turbo	16	R
Ace 570	18	F
Ace 570	17	F
Ace 900 Efi, EPS	16	F
MIL RZR2 XP MV1000 TD (R01)	17	F&R
MIL RZR2 XP MV1000 TD Nelo (R01)	18	F&R
MIL RZR4 XP MV 1000 TD (R04)	17	F&R
RGR 1000D (R13)	18	F
RGR 1000D (R17)	17	F
Ranger 1000 Diesel Inc Crew	15-16	F&R
RGR 1000D CRW (R09)	18	F
RGR 1000D CRW (R16)	17	F
RGR 1000D EU (R14)	17	F
RGR 1000D Poland (R07)	18	F
RGR 570, Full Size (R03)	19-20	F
RGR 570, Full Size (R06)	18-20	F
RGR 570, Full Size (R12)	17-20	F

RGR CRW 1000 PS (R10)	18	F	RZR XP 4 1000 (R02) All Options	16-20	F&R
RGR CRW 1000 XP 6P,PS,NB,MD (R08)	17	F	RZR XP 4 1000 MD (R04)	17	F&R
RGR CRW 1000 XP PS All Options (R09)	18	F	RZR XP 4 1000 MD (R05)	18	F&R
RGR CRW 1000 XP PS All Options (R32)	17	F	RZR XP TURBO (R07)	17-20	R
RGR CRW 1000 XP PS MD (R08)	18	F	RZR XP Pro Turbo	20-22	R
RGR CRW 570 FS (R03)	19-20	F&R	RZR XP Turbo Latin (R03)	18	R
RGR CRW 570 FS (R05)	18-20	F&R	RZR XP Turbo MD (R02)	17	R
RGR CRW 570FS (R08)	17-20	F&R	RZR XP Turbo MD (R05)	18	R
RGR CRW 900 6P SP (R14)	17	F	RZR XP Turbo S (R02)	18-20	R
RGR CRW 900 EPS (R03)	19	F	RZR XP Turbo Tractor (R03)	17	R
RGR CRW 900 XP 6P SP (R10)	18	F	RZR XP Turbo Tractor (R05)	18	R
RGR EV (R02)	18-19	F&R	RZR XP4 Turbo (R06)	17-20	R
RGR EV (R03)	16-18	F&R	RZR XP4 Turbo INTL (R03)	17	R
RGR EV (R12)	16-17	F&R	RZR XP4 Turbo MD (R04)	18-20	R
RGR EV LIION (R03)	16-18	F&R	RZR XP4 Turbo S (R02)	19-20	R
RGR EV LIION (R08)	16-18	F&R	RZR XP Turbo S Velocity	19-20	R
RGR EV MD (R02)	18	F&R			
RGR 570 Full Size Inc Crew (R02)	16-20	F&R			
RGR 570 CRW (R03)	18-20	F			
RGR 570 Efi CRW (R10)	17-20	F			
RGR 570 EPS CRW MD(R04)	18-20	F			
RGR 800 6X6 MD Poland (R02)	16-17	F			
Ranger 900 Crew all Options	16	F			
RZR 1000S4 (R03)	19	F			
RZR 4 900 (R05)	17	F			
RZR 4 900 (R05)	15-18	F			
RZR RS1 (R03)	19	R			
RZR RS1 (R06)	18	R			
RZR Turbo 4 (R06)	19	R			

FA657 98 x 53 x 8mm

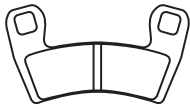

MATERIAL AVAILABILITY												
FA	X	V	R	HH	SV	MXS	SXR	EPFA	GPFA	GPFA	SFA	SFAHH
	✓		✓		✓		✓					

POLARIS
RZR 900 (50 Inch All Options) 15-20 F RZR 1000 60 Inch PS EU/Tractor
RZR-S 900 (60 Inch All Options) 15-20 F /Zug (R01, R06, R07, R09) 17-20 F

FA658 67.5 x 48.5 x 7mm



MATERIAL AVAILABILITY												
FA	X	V	R	HH	SV	MXS	SXR	EPFA	GPFA	GPFA	SFA	SFAHH
✓		✓		✓								

BENELLI
Leoncino 125 18-20 F Leoncino 250 18-19 F
TRK 125 18-19 F

**FA659 A 134.5 x 44.5 x 7.5mm
4 x 12mm holes
B 134.5 x 44.5 x 7.5mm
2 x 10mm holes**

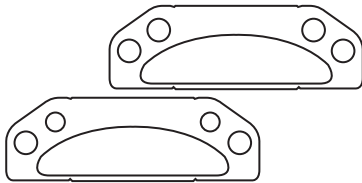

MATERIAL AVAILABILITY												
FA	X	V	R	HH	SV	MXS	SXR	EPFA	GPFA	GPFA	SFA	SFAHH
	✓											

POLARIS
Ranger Handbrake Pads -
Various Models 05-16 05-16 Parking Brake

**SFA661/4 53.5 x 45 x 7.5mm
(4 pad set)**



MATERIAL AVAILABILITY												
FA	X	V	R	HH	SV	MXS	SXR	EPFA	GPFA	GPFA	SFA	SFAHH
											✓	

DAELIM
S1-125 06-09 F

**FA662 A 109.5 x 50.5 x 11mm
B 95.5 x 37 x 11mm**

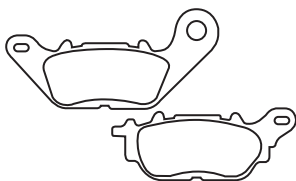

MATERIAL AVAILABILITY												
FA	X	V	R	HH	SV	MXS	SXR	EPFA	GPFA	GPFA	SFA	SFAHH
✓		✓		✓						✓		

YAMAHA
YZF R3 (321cc) 15-21 R

**FA663 A 113.5 x 54.5 x 8.5mm
B 99 x 45.5 x 8.5mm**



MATERIAL AVAILABILITY												
FA	X	V	R	HH	SV	MXS	SXR	EPFA	GPFA	GPFA	SFA	SFAHH
✓				✓						✓		

YAMAHA
YZF R3 (321cc) 15-21 F

**FA664 A 94 x 32 x 8mm
B 94 x 32 x 8mm**



MATERIAL AVAILABILITY												
FA	X	V	R	HH	SV	MXS	SXR	EPFA	GPFA	GPFA	SFA	SFAHH
✓												

CSC
RX3 Cyclone 250 15-16 F

Dimension 1=Width or Diameter, Dimension 2=Height or Diameter, Dimension 3=Thickness (Material and backplate)

NOTE:- Size identification is shown as follows

FA669/4 137.5 x 49.5 x 15mm
(4 pad set)

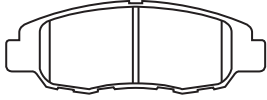

MATERIAL AVAILABILITY												
FA	X	V	R	HH	SV	MXS	SXR	EPFA	GPFA	GPFA	SFA	SFAHH
✓												

Also available in Yellow Coded Sport Upgrade Pad Blend - Order FA4669/4

POLARIS													
Slingshot Base					15-17	F	Slingshot SL				15-18	F	
Slingshot S					18	F	Slingshot SLR				17-18	F	

FA670 137.5 x 50 x 6mm
(2 pad set)

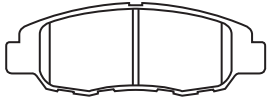

MATERIAL AVAILABILITY												
FA	X	V	R	HH	SV	MXS	SXR	EPFA	GPFA	GPFA	SFA	SFAHH
✓												

Also available in Yellow Coded Sport Upgrade Pad Blend - Order FA4670

POLARIS													
Slingshot Base					15-17	R	Slingshot SL				15-18	R	
Slingshot S					18	R	Slingshot SLR				17-18	R	

FA671 A 94 x 37.5 x 10mm
B 94 x 37.5 x 8.5mm



MATERIAL AVAILABILITY												
FA	X	V	R	HH	SV	MXS	SXR	EPFA	GPFA	GPFA	SFA	SFAHH
✓		✓		✓								

BMW													
K 1200 S					03-08	R	K 1300 S				09-15	R	
K 1200 R					05-10	R	K 1300 R				09-15	R	

FA672 114.5 x 39 x 9.5mm



MATERIAL AVAILABILITY												
FA	X	V	R	HH	SV	MXS	SXR	EPFA	GPFA	GPFA	SFA	SFAHH
✓		✓		✓				✓				

INDIAN (Toso Caliper / Cast Wheels)													
Scout (Toso Calipers/Cast Wheels)					15-16	F	Scout Sixty (Toso Calipers/Cast Wheels)				16	F	

GFAX673HH 114.5 x 39 x 9.5mm



MATERIAL AVAILABILITY												
FA	X	V	R	HH	SV	MXS	SXR	EPFA	GPFA	GPFA	SFA	SFAHH
										✓		

BREMBO CALIPER
XB0 B1 30/31 P4 30/34

FA674 A 96.5 x 42 x 7.5mm
B 77 x 42 x 8mm

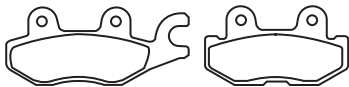

MATERIAL AVAILABILITY												
FA	X	V	R	HH	SV	MXS	SXR	EPFA	GPFA	GPFA	SFA	SFAHH
	✓		✓		✓							

YAMAHA													
YXC 700 DFG/DXG Viking VI					15-16	R Left	YXE 70 Wolverine R Spec EPS				18	R Left	
YXC 700 PFG/PXG Viking VI EPS					15-16	R Left	YXE 70 WXGG Wolverine R Spec EPS				16	R Left	
YXC 700 PSFS/PXGS Viking VI EPS SE					15-16	R Left	YXM 700 DEG/DFG/VDXG Viking				14-16	R Left	
YXC 700 PRGC Viking VI EPS Ranger Edition					16	R Left	YXM 700 PEG/PFG/VPXG Viking EPS				14-16	R Left	
YXE 70 WDBGG Wolverine					16	R Left	YXM 700 PSE/PSF/SPSG Viking EPS SE				14-16	R Left	
YXE 70 WDGG Wolverine R Spec					16	R Left	YXE 85 Wolverine X4 Inc X4 SE				18	R Left	

FA675 A 96.5 x 42 x 7.5mm
B 77 x 42 x 8mm



MATERIAL AVAILABILITY												
FA	X	V	R	HH	SV	MXS	SXR	EPFA	GPFA	GPFA	SFA	SFAHH
	✓		✓		✓							

YAMAHA													
YXC 700 DFG/DXG Viking VI					15-16	R Right	YXE 70 WXGG Wolverine R Spec EPS				16	R Right	
YXC 700 PFG/PXG Viking VI EPS					15-16	R Right	YXE 70 Wolverine R Spec EPS				18	R Left	
YXC 700 PSFS/PXGS Viking VI EPS SE					15-16	R Right	YXM 700 DEG/DFG/VDXG Viking				14-16	R Right	
YXC 700 PRGC Viking VI EPS Ranger Edition					16	R Right	YXM 700 PEG/PFG/VPXG Viking EPS				14-16	R Right	
YXE 70 WDBGG Wolverine					16	R Right	YXM 700 PSE/PSF/SPSG Viking EPS SE				14-16	R Right	
YXE 70 WDGG Wolverine R Spec					16	R Right	YXE 85 Wolverine X4 Inc X4 SE				18	R Left	

FA676 114 x 36.6 x 9mm



MATERIAL AVAILABILITY												
FA	X	V	R	HH	SV	MXS	SXR	EPFA	GPFA	GPFA	SFA	SFAHH
	✓		✓		✓		✓					

YAMAHA													
YXZ 1000 R					16-21	F	YXZ 1000 EPS Special Edition				16-21	F	

FA677 104 x 35 x 9mm



MATERIAL AVAILABILITY												
FA	X	V	R	HH	SV	MXS	SXR	EPFA	GPFA	GPFAFAX	SFA	SFAHH
	✓		✓		✓		✓					

YAMAHA
 YXZ 1000 R 16-21 R
 YXZ 1000 EPS Special Edition 16-21 R

FA679 83 x 40 x 8mm



MATERIAL AVAILABILITY												
FA	X	V	R	HH	SV	MXS	SXR	EPFA	GPFA	GPFAFAX	SFA	SFAHH
				✓								

HONDA
 CB 125 F 15-21 F CRF 1000 LDAG/LDAH Africa Twin 16-21 F
 CB 125 R 19-21 F CRF 1000 Africa Twin Adventure 18-21 F
 CB 300 F 18-19 F Sport ES ABS (Manual)
 CB 300 F ABS 18-20 F CRF 1000 Africa Twin Adventure 18-21 F
 CB 300 R 18-21 F Sport ES ABS (DCT)
 CB 650 RA/RA AC 19-21 F CRF 1100 L Africa Twin 20-21 F
 CBR 650 R 2AC/RA 2AC 19-21 F CRF 1100 L Africa Twin Plus 20-21 F
 CRF 1000 LAG/LAH Africa Twin 16-21 F CRF 1100 L Adventure Sports 20-21 F
 CRF 1000 LAG/LAH Africa Twin 16-21 F CRF 1100 L Adventure Sports Plus 20-21 F

FA680 158 x 54.5 x 7mm

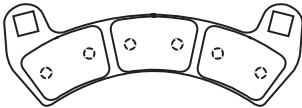

MATERIAL AVAILABILITY												
FA	X	V	R	HH	SV	MXS	SXR	EPFA	GPFA	GPFAFAX	SFA	SFAHH
			✓				✓					

POLARIS
 RZR XP Turbo RZR XP Turbo MD 17-18 F
 RZR XP Turbo 16 F RZR XP Turbo S 18-20 F
 RZR XP 4 Turbo 16 F RZR XP Turbo Tractor 17-18 F
 RZR XP Turbo 17-20 F RZR XP4 Turbo 17-20 F
 RZR XP Pro Turbo 20-22 F RZR XP4 Turbo Intl 17 F
 RZR XP Turbo Latin 18 F RZR XP4 Turbo MD 18-20 F

SFA681 55.5 x 49.5 x 7.5mm

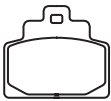

MATERIAL AVAILABILITY												
FA	X	V	R	HH	SV	MXS	SXR	EPFA	GPFA	GPFAFAX	SFA	SFAHH
											✓	✓

PIAGGIO
 MP3 500 Sport ABS
 (Three wheeler - 13" Front / 14" Rear) 15-16 R

**FA682 A 117.5 x 50.5 x 8mm
B 95 x 50.5 x 8mm**

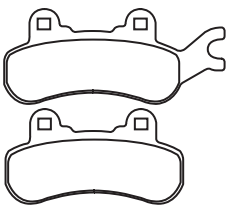

MATERIAL AVAILABILITY												
FA	X	V	R	HH	SV	MXS	SXR	EPFA	GPFA	GPFAFAX	SFA	SFAHH
	✓		✓		✓		✓					

CAN-AM (Side x Side)
 Defender 799cc 16 F Left Maverick X3 17 F Left/R Left
 Defender DPS 799cc 16 F Left Maverick X3 Max 17 F Left/R Left
 Defender XT 799cc 16 F Left Maverick X3 Turbo 18 F Left/R Left
 Defender XT Cab 799cc 16 F Left Maverick X3 Max Turbo 18 F Left/R Left
 Defender 976cc 16 F Left Maverick X3 Turbo R 18 F Left/R Left
 Defender DPS 976cc 16 F Left Maverick X3 Max Turbo R 18 F Left/R Left
 Defender XT 976cc 16 F Left
 Defender XT Cab 976cc 16 F Left

**FA683 A 117.5 x 50.5 x 8mm
B 95 x 50.5 x 8mm**

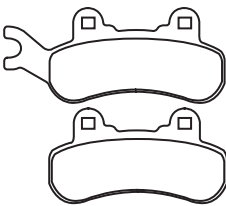

MATERIAL AVAILABILITY												
FA	X	V	R	HH	SV	MXS	SXR	EPFA	GPFA	GPFAFAX	SFA	SFAHH
	✓		✓		✓		✓					

CAN-AM (Side x Side)
 Defender 799cc 16 F Right Maverick X3 17 F Right/R Right
 Defender DPS 799cc 16 F Right Maverick X3 Max 17 F Right/R Right
 Defender XT 799cc 16 F Right Maverick X3 Turbo 18 F Right/R Right
 Defender XT Cab 799cc 16 F Right Maverick X3 Max Turbo 18 F Right/R Right
 Defender 976cc 16 F Right Maverick X3 Turbo R 18 F Right/R Right
 Defender DPS 976cc 16 F Right Maverick X3 Max Turbo R 18 F Right/R Right
 Defender XT 976cc 16 F Right
 Defender XT Cab 976cc 16 F Right

NOTE:- Size identification is shown as follows
Dimension 1=Width or Diameter, Dimension 2=Height or Diameter, Dimension 3=Thickness (Material and backplate)

FA684 A 101.5 x 44 x 8mm
B 83 x 43 x 8mm



MATERIAL AVAILABILITY												
FA	X	V	R	HH	SV	MXS	SXR	EPFA	GPFA	GPFA	SFA	SFAHH
	✓		✓		✓		✓					

CAN-AM (Side x Side)
 Defender 799cc/976cc 16 R Left Defender XT 799cc/976cc 16 R Left
 Defender DPS 799cc/976cc 16 R Left Defender XT Cab 799cc/976cc 16 R Left

FA685 A 101.5 x 44 x 8mm
B 83 x 43 x 8mm



MATERIAL AVAILABILITY												
FA	X	V	R	HH	SV	MXS	SXR	EPFA	GPFA	GPFA	SFA	SFAHH
	✓		✓		✓		✓					

CAN-AM (Side x Side)
 Defender 799cc/976cc 16 R Right Defender XT 799cc/976cc 16 R Right
 Defender DPS 799cc/976cc 16 R Right Defender XT Cab 799cc/976cc 16 R Right

FA686 A 94 x 44.5 x 8.5mm
B 73 x 46 x 10mm

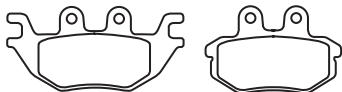

MATERIAL AVAILABILITY												
FA	X	V	R	HH	SV	MXS	SXR	EPFA	GPFA	GPFA	SFA	SFAHH
	✓		✓									

KAWASAKI
KAF 820 AFF/AGF/AHF Mule PRO - FXT 15-21 R Left & Right
KAF 820 BFF/BGF/BHF Mule PRO - FXT /EPS 15-21 R Left & Right
KAF 820 CFF/CGF/CHF Mule PRO - FXT /EPS LE 15-21 R Left & Right
KAF 820 DFF/DGF/DHF Mule PRO - FXT /EPS Camo 15-21 R Left & Right
KAF 820 EGF/EHF Mule PRO - FX 16-21 R Left & Right
KAF 820 FGF/FHF Mule PRO - FX/EPS 16-21 R Left & Right
KAF 820 GGF/GHF Mule PRO - FX/EPS LE 16-21 R Left & Right
KAF 820 HGF/HHF Mule PRO - FX/EPS Camo 16-21 R Left & Right
KAF 820 JGF/JHF Mule PRO - FXT Ranch Edition 16-21 R Left & Right
 KAF 1000 AGF/AHF - Mule Pro 16-17 R Left & Right
 DXT Diesel 16-17 R Left & Right
 KAF 1000 BGF/BHF - Mule Pro 16-17 R Left & Right
 DXT Diesel EPS 16-17 R Left & Right
 KAF 1000 CGF/CHF - Mule Pro 16-17 R Left & Right
 DXT EPS LE/Diesel 16-17 R Left & Right
 KAF 1000 DGF/DHF - Mule Pro 16-17 R Left & Right
 DX Diesel 16-17 R Left & Right
 KAF 1000 EGF/EHF - Mule Pro 16-17 R Left & Right
 DX EPS/Diesel 16-17 R Left & Right
 KAF 1000 FGF/FHF - Mule Pro 16-17 R Left & Right
 DX EPS LE/Diesel 16-17 R Left & Right

CFA689 43.5 x 29 x 3.5mm



MATERIAL AVAILABILITY												
FA	X	V	R	HH	SV	MXS	SXR	EPFA	GPFA	GPFA	SFA	SFAHH
✓												

BULTACO
 Brinco (Electric Trials Bike - C/R/RE/S Models) 15-17 F

FA690 43.5 x 29 x 3.5mm



MATERIAL AVAILABILITY												
FA	X	V	R	HH	SV	MXS	SXR	EPFA	GPFA	GPFA	SFA	SFAHH
	✓		✓									

BENNCHE		DIAMO	
Bighorn 400 11-16 R	Discovery All Models 09-10 R		
Bighorn 500/700 10-16 R	HISUN		
Bighorn 500 HD/700 HD 13-14 R	Forge 400 16-17 R		
Bighorn 700X Crew/Crew HD 14 R	Forge 500/700 16 R		
Bighorn 700X 10-13 R	HS400/500/700 14-17 R		
Bighorn 700X HD 13 R	HS700-4 14-15 R		
Cowboy 400/500/700 15-16 R	Tactic 800 16 R		
Gray Wolf 500/700 10-16 R	Vector 400/700 16 R		
Spire 800 10-12 R	Vector 500 16-17 R		
CF MOTO	MASSIMO		
CF500 14-15 R	Alligator 500/700 15-16 R		
COLEMAN POWERSPORTS	Alligator 700 4 15 R		
Outfitter 400 13-15 R	Knight 500/700 16 R		
Outfitter 500/700 12-15 R	MSA 500 15-16 R		
Outfitter 700-4 12-15 R	MSU 400/500 15-16 R		
Outfitter 800 12 R	MSU 700/700 4 15 R		
Trail Tamer 400 15 R	QLINK		
CUB CADET	FrontRunner 500/700 10-13 R		
Challenger 400/400 LX 16 R	FrontRunner 800 12 R		
Challenger 500/700 15-16 R	Rodeo 400 07-09 R		
	Rodeo 500/700 08-13 R		

NOTE:- Size identification is shown as follows
Dimension 1=Width or Diameter, Dimension 2=Height or Diameter, Dimension 3=Thickness (Material and backplate)

FA691 A 84.5 x 44 x 7mm
B 74 x 41.5 x 7mm

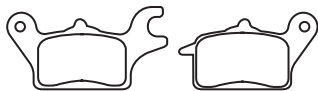

MATERIAL AVAILABILITY												
FA	X	V	R	HH	SV	MXS	SXR	EPFA	GPFA	GPFA	SFA	SFAHH
✓				✓								

KAWASAKI
Z 125 Pro (BR125 JJFB) 17-21 F
Z 125 Pro SE (BR 125 JJFS) 17-21 F

SFA693 A 110.5 x 34.5 x 7.5mm
B 98.5 x 33.5 x 7.5mm

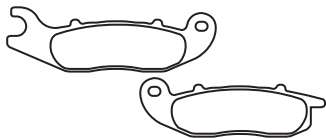

MATERIAL AVAILABILITY												
FA	X	V	R	HH	SV	MXS	SXR	EPFA	GPFA	GPFA	SFA	SFAHH
											✓	✓

HONDA
PCX 125 18-21 F
PCX 150 18-21 F

FA696 55 x 53.6 x 9mm

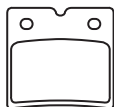

MATERIAL AVAILABILITY												
FA	X	V	R	HH	SV	MXS	SXR	EPFA	GPFA	GPFA	SFA	SFAHH
✓		✓		✓								

INDIAN
Chief Deluxe (Brembo calipers) 09 R
Chief Blackhawk (Brembo calipers) 11 R Chief Roadmaster (Brembo calipers) 09-11 R
Chief Blackhawk Dark (Brembo calipers) 11 R Chief Vintage (Brembo calipers) 09-13 R
Chief Classic (Brembo calipers) 11-13 R Bomber (Brembo calipers) 10-11 R
Chief Standard (Brembo calipers) 09-11 R Dark Horse (Brembo calipers) 10-13 R

FA698 81.5 x 37.5 x 9mm



MATERIAL AVAILABILITY												
FA	X	V	R	HH	SV	MXS	SXR	EPFA	GPFA	GPFA	SFA	SFAHH
✓		✓		✓								

BENELLI
Leoncino 125 18-20 R TRK125 18-19 R
Leoncino 250 18-19 R

FA700 78 x 43 x 8mm



MATERIAL AVAILABILITY												
FA	X	V	R	HH	SV	MXS	SXR	EPFA	GPFA	GPFA	SFA	SFAHH
				✓				✓		✓		

HONDA
CBR 600 RR (Non ABS) 18-21 F CBR 1000 RRA (ABS Model Nissin Caliper) 17-20 F
CBR 600 RR (ABS) 18-21 F CBR 1000 RR 18-21 F

FA701 115 x 40.5 x 11mm



MATERIAL AVAILABILITY												
FA	X	V	R	HH	SV	MXS	SXR	EPFA	GPFA	GPFA	SFA	SFAHH
	✓		✓		✓		✓					

HONDA
Pioneer 1000 SXS (2 Seater) 16-21 F Left Talon 1000 R 19-21 F
Pioneer 1000 SXS (4 Seater) 16-21 F Left Talon 1000 X 19-21 F
Talon 1000 X-4 19-21 F

FA702 115 x 40.5 x 11mm



MATERIAL AVAILABILITY												
FA	X	V	R	HH	SV	MXS	SXR	EPFA	GPFA	GPFA	SFA	SFAHH
	✓		✓		✓		✓					

HONDA
Pioneer 1000 SXS (2 Seater) 16-21 F Right Talon 1000 R 19-21 F
Pioneer 1000 SXS (4 Seater) 16-21 F Right Talon 1000 X 19-21 F
Talon 1000 X-4 19-21 F

FA703 82 x 38.5 x 10.5mm

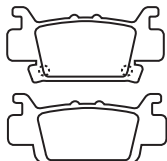

MATERIAL AVAILABILITY												
FA	X	V	R	HH	SV	MXS	SXR	EPFA	GPFA	GPFA	SFA	SFAHH
	✓		✓		✓		✓					

HONDA
Pioneer 1000 SXS (2 Seater) 16-21 R Left Talon 1000 R 19-21 R
Pioneer 1000 SXS (4 Seater) 16-21 R Left Talon 1000 X 19-21 R
Talon 1000 X-4 19-21 R

NOTE:- Size identification is shown as follows
Dimension 1=Width or Diameter, Dimension 2=Height or Diameter, Dimension 3=Thickness (Material and backplate)

FA704 82 x 38.5 x 10.5mm



MATERIAL AVAILABILITY												
FA	X	V	R	HH	SV	MXS	SXR	EPFA	GPFA	GPFA	SFA	SFAHH
	✓		✓		✓		✓					

HONDA
 Pioneer 1000 SXS (2 Seater) 16-21 R Right Talon 1000 X 19-21 R
 Pioneer 1000 SXS (4 Seater) 16-21 R Right Talon 1000 X-4 19-21 R

FA705 A. 113.5 x 55 x 8.5mm B. 98.5 x 44.5 x 8.5mm



MATERIAL AVAILABILITY												
FA	X	V	R	HH	SV	MXS	SXR	EPFA	GPFA	GPFA	SFA	SFAHH
											✓	✓

YAMAHA
 XMax 300 ABS 18-21 F

FA706 A. 113.5 x 52 x 9.5mm B. 97.5 x 39.5 x 9.5mm



MATERIAL AVAILABILITY												
FA	X	V	R	HH	SV	MXS	SXR	EPFA	GPFA	GPFA	SFA	SFAHH
											✓	✓

YAMAHA
 XMax 300 ABS 18-21 R

FA710 82 x 42 x 10mm



MATERIAL AVAILABILITY												
FA	X	V	R	HH	SV	MXS	SXR	EPFA	GPFA	GPFA	SFA	SFAHH
		✓		✓				✓				

HARLEY DAVIDSON
 FLFB Fat Boy 18-21 R FXBRS Breakout 114 18-21 R
 FLFBS Fat boy 114 18-21 R FXBRS Breakout 114 Anniv 18-20 R
 FLFBS Fat Boy Anniv 18-20 R FLDE Deluxe 18-20 R
 FLHC Heritage Classic 18-21 R FXBB Street Bob 18-21 R
 FLHCS Heritage Classic 114 18-21 R FXFB Fat Bob 18-20 R
 FLHCS Heritage Classic 114 Anniv. 18-20 R FXBS Fat Bob 18-21 R
 FLSL Softail Slim 18-21 R FXLR Low Rider 18-21 R
 FXBR Breakout 18-20 R FXLRS Low Rider S 18-21 R

FA711 A 124 x 43 x 9mm B 115.5 x 43 x 9mm

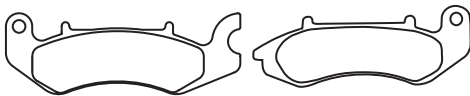

MATERIAL AVAILABILITY												
FA	X	V	R	HH	SV	MXS	SXR	EPFA	GPFA	GPFA	SFA	SFAHH
✓		✓										

BENELLI
 BN 125 18-20 F
 TNT 125 18-20 F

FA712 A 104 x 43.5 x 15mm B 104 x 43.5 x 15mm



MATERIAL AVAILABILITY												
FA	X	V	R	HH	SV	MXS	SXR	EPFA	GPFA	GPFA	SFA	SFAHH
	✓		✓		✓							

HONDA
 SXS 500 M2 Pioneer (2 Seat) 15-17 F SXS 700 M4 Pioneer (4 Seat) 16-18 F
 SXS 700 M2 Pioneer (2 Seat) 16-18 F

FA714 75.5 x 39.5 x 12mm



MATERIAL AVAILABILITY												
FA	X	V	R	HH	SV	MXS	SXR	EPFA	GPFA	GPFA	SFA	SFAHH
	✓		✓		✓							

HONDA
 SXS 500 M2 Pioneer (2 Seat) 15-17 R SXS 700 M4 Pioneer (4 Seat) 16-18 R

FA715 75.5 x 39.5 x 12mm

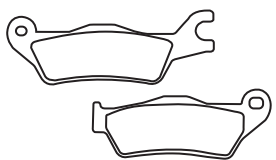

MATERIAL AVAILABILITY												
FA	X	V	R	HH	SV	MXS	SXR	EPFA	GPFA	GPFA	SFA	SFAHH
✓		✓		✓								

SUZUKI
 GSX-R 125 RLXL8/RL8 18-21 F
 GSX-S 125 MLXL8/ML8 18-21 F

NOTE:- Size identification is shown as follows
Dimension 1=Width or Diameter, Dimension 2=Height or Diameter, Dimension 3=Thickness (Material and backplate)

FA717 129.5 x 40 x 9mm



MATERIAL AVAILABILITY												
FA	X	V	R	HH	SV	MXS	SXR	EPFA	GPFA	GPFA	SFA	SFAHH
				✓								

HONDA

GL 1800 B Goldwing J (Manual)	18-21	F	GL 1800 D Goldwing Tour J (DCT)	18-21	F
GL 1800 Goldwing Tour J (Manual)	18-21	F	GL 1800 DA Goldwing Tour		
GL 1800 BD Goldwing J (DCT)	18-21	F	Airbag J (DCT)	18-21	F

SFA719 81.5 x 37.5 x 9mm

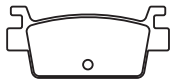

MATERIAL AVAILABILITY												
FA	X	V	R	HH	SV	MXS	SXR	EPFA	GPFA	GPFA	SFA	SFAHH
				✓							✓	

KYMCO

AK 550	17-21	R
--------	-------	---

FA724 73 x 54.5 x 8.5mm



MATERIAL AVAILABILITY												
FA	X	V	R	HH	SV	MXS	SXR	EPFA	GPFA	GPFA	SFA	SFAHH
				✓				✓		✓		

BMW

R 1250 GS	18-21	F	R 1250 GS Rallye TE	18-21	F
R 1250 GS Edition 40	20-21	F	R 1250 RT	18-21	F
R 1250 GS Adventure	18-21	F	R 1250 RT SE	18-21	F
R 1250 GS Adventure Edition 40	20-21	F	R 1250 RT LE	18-21	F
R 1250 GS TE	18-21	F	S 1000 R	18-21	F
R 1250 GS Exclusive TE	18-21	F	S 1000 RR/RR Sport/RR M Sport	18-21	F
R 1250 GS Rallye	18-21	F	S 1000 XR	19-21	F

**FA725 A 115.5 x 41 x 11mm
B 115.5 x 41 x 11mm**



MATERIAL AVAILABILITY												
FA	X	V	R	HH	SV	MXS	SXR	EPFA	GPFA	GPFA	SFA	SFAHH
				✓								

YAMAHA

Star Venture	18-21	F	Star Eluder	18-21	F
Star Venture Transcontinental	18-21	F	Star Eluder GT	18-21	F

FA726 101.5 x 36.5 x 11mm



MATERIAL AVAILABILITY												
FA	X	V	R	HH	SV	MXS	SXR	EPFA	GPFA	GPFA	SFA	SFAHH
	✓		✓				✓					

C F MOTO

Z Force 1000	18-19	F	400 C-Force	18-19	F
950 Z-Force	20	F	1000 U-Force	20	F

FA728 163.5 x 50 x 9.5mm



MATERIAL AVAILABILITY												
FA	X	V	R	HH	SV	MXS	SXR	EPFA	GPFA	GPFA	SFA	SFAHH
			✓		✓		✓					

POLARIS RZR (SIDE X SIDE MODELS)

RZR XP4 Turbo S	19-20	F	RZR Turbo S XP4	19	F
RZR XP Turbo S Velocity	19-20	F			

FA730 49.5 x 36 x 8mm



MATERIAL AVAILABILITY												
FA	X	V	R	HH	SV	MXS	SXR	EPFA	GPFA	GPFA	SFA	SFAHH
				✓				✓				

BMW

S 1000 RR HP4 Race	17-18	R	XA1J040 P2/30 Rear Race Caliper	18-21
--------------------	-------	---	---------------------------------	-------

BREMBO

FA737 49.5 x 36 x 8mm



MATERIAL AVAILABILITY												
FA	X	V	R	HH	SV	MXS	SXR	EPFA	GPFA	GPFA	SFA	SFAHH
	✓		✓									

ARCTIC CAT

Cushman Hauler 800	12-18	F
--------------------	-------	---

FA738 114 x 40 x 9mm

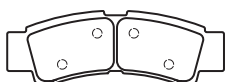

MATERIAL AVAILABILITY												
FA	X	V	R	HH	SV	MXS	SXR	EPFA	GPFA	GPFA	SFA	SFAHH
			✓				✓					

KAWASASKI

KRX 1000 Teryx	20-21	F
----------------	-------	---

NOTE:- Size identification is shown as follows
Dimension 1=Width or Diameter, Dimension 2=Height or Diameter, Dimension 3=Thickness (Material and backplate)

FA739 82 x 34.5 x 9mm

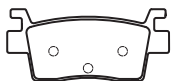

MATERIAL AVAILABILITY												
FA	X	V	R	HH	SV	MXS	SXR	EPFA	GPFA	GPFAX	SFA	SFAHH
			✓				✓					

KAWASAKI
KRX 1000 Teryx 20-21 R

FA740 122 x 55 x 8mm



MATERIAL AVAILABILITY												
FA	X	V	R	HH	SV	MXS	SXR	EPFA	GPFA	GPFAX	SFA	SFAHH
	✓		✓				✓					

ARCTIC CAT
Wildcat 1000 X XT and LTD 19 F 1000 Cushman Hauler Diesel 4X4
1000 Prowler Pro Crew and XT 19-20 F Crew and EPS Diesel 19 F
1000 Cushman Hauler Diesel 4X4 19 F Cushman Hauler 1200 12-15 F

FA741 120 x 51 x 7.5mm



MATERIAL AVAILABILITY												
FA	X	V	R	HH	SV	MXS	SXR	EPFA	GPFA	GPFAX	SFA	SFAHH
	✓		✓				✓					

ARCTIC CAT
Wildcat Sport 700 15 F Wildcat Trail 700 XT inc LTD 15-19 F
Wildcat Sport XT 700 15 F Cushman Hauler 800 12-18 F
Wildcat Sport LTD 16 F Stampede 900 XT, XTR inc LTD 17-19 F
Wildcat Sport 700 XT inc LTD 18-19 F Stampede 900 4 Inferno inc TT Kanati 18 F

FA742 122 x 48.5 x 8mm



MATERIAL AVAILABILITY												
FA	X	V	R	HH	SV	MXS	SXR	EPFA	GPFA	GPFAX	SFA	SFAHH
	✓		✓				✓					

ARCTIC CAT
Wildcat 1000 X XT and LTD 19 F 1000 Cushman Hauler Diesel
1000 Prowler Pro Crew and XT 19-20 F 4X4 Crew and EPS Diesel 19 F
1000 Cushman Hauler Diesel 4X4 19 F Cushman Hauler 1200 12-15 F

FA743 122 x 55 x 8mm



MATERIAL AVAILABILITY												
FA	X	V	R	HH	SV	MXS	SXR	EPFA	GPFA	GPFAX	SFA	SFAHH
										✓		

YAMAHA
TZ 250 F
TZ 350 F

FA747 89 x 37 x 11mm



MATERIAL AVAILABILITY												
FA	X	V	R	HH	SV	MXS	SXR	EPFA	GPFA	GPFAX	SFA	SFAHH
	✓		✓				✓					

CF MOTO
Z Force 1000 19-20 F

FA748 93 x 57 x 8mm

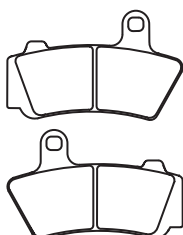

MATERIAL AVAILABILITY												
FA	X	V	R	HH	SV	MXS	SXR	EPFA	GPFA	GPFAX	SFA	SFAHH
				✓								

BMW
R 18 20-21 F R 18 Blechmann 20-21 F
R 18 Dragster 20-21 F

FA749 93 x 57 x 8mm

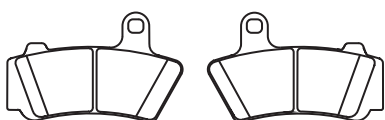

MATERIAL AVAILABILITY												
FA	X	V	R	HH	SV	MXS	SXR	EPFA	GPFA	GPFAX	SFA	SFAHH
				✓								

BMW
R 18 20-21 R R 18 Blechmann 20-21 R
R 18 Dragster 20-21 R

FA752 58 x 24.5 x 5mm



MATERIAL AVAILABILITY												
FA	X	V	R	HH	SV	MXS	SXR	EPFA	GPFA	GPFA	SFA	SFAHH
			✓									

COBRA

50 FEW		18-21	F&R	50 JR		18-21	F&R
50 SRX		20-21	F&R	CX 50 SR King		18-20	F&R
50 P3R		18-21	F&R	CX 65		11-22	F

FA755 94 x 33.8 x 7.5mm

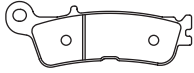

MATERIAL AVAILABILITY												
FA	X	V	R	HH	SV	MXS	SXR	EPFA	GPFA	GPFA	SFA	SFAHH
	✓		✓			✓		✓				

YAMAHA

YZ 250 F		20-22	F	YZ 450 F		20-22	F
YZ 250 F MME Monster		21	F	YZ 450 F MME Monster		21	F
WR 450 FM		21-22	F	YZ 450 FXM		21	F

FA757 80 x 42 x 8mm

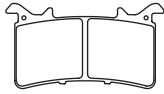

MATERIAL AVAILABILITY												
FA	X	V	R	HH	SV	MXS	SXR	EPFA	GPFA	GPFA	SFA	SFAHH
				✓				✓		✓		

BMW

M 1000 RR

HONDA

F CBR 1000 RR-R SP Fireblade

20-22 F

BRAKE SHOE BUYERS GUIDE

Part No.	Make/Model	Year	Fr/Rear	Part No.	Make/Model	Year	Fr/Rear	
301	HONDA CRF 50 F	04-21	F & R	303/303G Contd.	HONDA Contd. CH 125 'Elite'	84	F & R	
	MR 50 KO/K1 Elsinore	74-75	F & R		CB 125 S	84-85	R	
	NA 50 Express II	79-81	F		CL 125 S (Single)	67-74	F & R	
	NB 50/NB 50 M Aero 50	83-87	F		CL 125 S1 (Single) Up to frame no. 1120001	67-74	F & R	
	NC 50 Express	77-80	F & R		NH 125 Aero	84	F & R	
	NC 50 Express	81-83	F		SL 125 K1/K2	71-73	F	
	NN 50 MD 'Gyro'	84	F & R		TRX 125 Fourtrax	85-88	F	
	NQ 50 D/NQ 50 Spree/Spree Special	84-87	F & R		XL 125	77-78	F & R	
	NX 50 M Express SR	81-82	F		CH 150/150 D Elite/Elite Deluxe	85-87	F & R	
	P 50		F		ATC* 185	80	F	
	PA 50	78-81	F		ATC* 185 S	81-83	F	
	PA 50	82-83	F & R		ATC* 200	81-83	F	
	SA 50 Elite LX/SR	88-93	F		ATC* 200 E Big Red	82-83	F	
	SB 50/SB 50 P Elite/Elite ES	88-90	F & R		ATC* 200 ES Big Red	84	F	
	SE 50/SE 50 P Elite/Elite 50 S	87-88	F		ATC* 200 M	84-85	F	
	TG 50/TG 50 M Gyro S	85-86	F & R		ATC* 200 S	84-86	F	
	XR 50 R	00-03	F & R		* - ATC is a Registered Trademark of Honda Motor Corporation			
	Z 50 R	80-99	F & R		KYMGCO			
	Z 50 RD	86	F & R		Agility 50 (4T)	05-12	R	
	SUZUKI				Agility 50 (4T)	20	R	
DR-Z 50	18-20	F & R	Cobra Racer 50 (SF 10 AG)	00-04	R			
DR-Z 70 K8/K9	08-09/15-18	F & R	Cobra Cross/Racer 50 (SF 10 AF)	05-06	R			
YAMAHA			Like 50 (2T)	09-12	R			
TT-R 50 EV/EW/EX/EY/EB/ED/EE	06-09/14	F & R	Like 50 LX (2T)	12-14	R			
302	HONDA			Like 50 i (4T)	20	R		
	NA 50 Express II	79-81	R	Like M 50 (4T)	20	R		
	NC 50 Express	81-83	R	Sento 50cc (4T)	09-12	R		
	NB 50/NB 50 M Aero 50	83-87	R	Sting 50 (2T)	05-11	R		
	NU 50/NU 50 M Urban Express	82-83	R	Vitality 50 (4T)	05-08	R		
	NX 50 M Express SR	81-82	R	Agility 125	06-11	R		
	SA 50 Elite LX/SR	88-93	R	Agility 125 (4T/12 Inch Wheels)	19-20	R		
	SE 50/SE 50 P Elite/Elite 50 S	88-87	R	Yup 50	02-06	R		
	NH 80 MD 'Aero'	83-84	R	ZX 50	02-05	R		
	KYMGCO STREET			Filly 50	02-05	R		
	Compagno 50i 4T (SE 50 BG)	14	R	MXer 150	03-05	F		
	Compagno 110i (4T - SE22BD)	13-14	R	MXU 150	05-11	F		
	SYM			MXU 150 X	20	F		
Fiddle 50	99-12	R	PEUGEOT					
303/303G	ARCTIC CAT			Speedfight 2 X/Team (A/C)	02-05	R		
	150 Utility 2x4	09-14	F	Vivacity X-Race 50/Pulsa 50	02-05	R		
	E-TON QUADS			Metal-X	02-05	R		
	CXL 150 Yukon II/Challenger	02-09	F	Trekker 50	02-05	R		
	YXL 150 Yukon	00-02	F	Looxor 50	02-05	R		
	RXL 150 Viper R	05-09	F	Elyseo 50	02-05	R		
	RXL 150 Viper	05-06	F	Scoot Elec	04-05	F & R		
	HONDA			Ludix 50 Trend/One/Snake/Bullet	04-05	R		
	NS 50 F	90	F	Ludix 50 Elegance/Ambition	04-05	R		
	QA 50 K1-K3		F & R	Ludix 125	04-05	R		
	ZB 50	88	F & R	SYM				
	C 70 Passport	80-83	F & R	Jet Euro 50	99-12	R		
	CT 70 Trail	77-82	F & R	Jet 50 Evo	14	R		
	CT 70 Trail	91-94	F & R	Fiddle 50 Front drum model	99-12	F		
	SL 70 K1	70-73	F & R	Fiddle 50 Front disc model	08-11	R		
	XL 70 (Up to F # 103001)	74	F & R	Mi0 50	05-12	R		
	XL 75	78	F & R	Simply 50	07-12	R		
	XR 75 K1/K2/76	71-76	F & R	Symba 110	09-12	R		
	NH 80 MD 'Aero'	83-84	F	304/304G	HONDA			
	NH 80 'Aero'	85	F		MB 5	82	R	
	CH 80 Elite	85-07	F		NCH 50 Metropolitan	13-21	R	
	EZ 90 'CUB'	91-96	F & R		NS 50 F	90	R	
	TRX 90 Fourtrax	93-06	F		XL 70 (From F. # 1030002)	74	F & R	
	TRX 90 EX	07-08	F		XL 70 K1/76	75-76	F & R	
	TRX 90 X	09-15	F		XL 75	77/79	F & R	
	SL 100 K1/K2/K3	70-74	F & R		XR 75	77-78	F & R	
	XL 100 (Up to F # 1020001)	74	F & R		CR 80 R	80-81	F & R	
	XL 100	77-78	F & R		CR 80 R	82	F	
	CT 110	80-86	F & R		XL 80 S	80-85	F & R	
	ATC* 125 M	84-87	F		XR 80	79-84	F & R	

BRAKE SHOE BUYERS GUIDE

Part No.	Make/Model	Year	Fr/Rear	Part No.	Make/Model	Year	Fr/Rear	
304/304G Contd.	HONDA Contd.			307/307G	ARCTIC CAT			
	XL 100 (From F. # 1020002)	74	F & R		90-Y12 Youth (2T)	02-04	R	
	XL 100 K1	75	F & R		90-Y12 Youth (4T)	04-05	R	
	XL 100	76	F & R		90 2x4 (4T) Youth Rear Drum Model	04-05	R	
	XL 100 S	79-85	F & R		90 2x4 (2T) Youth	02-04	R	
	XR 100	81-84	F & R		CAN AM			
	CB 125 S	79-82	F & R		DS 70 244/4T	08-15	R	
	CL 125 S1 (Single)				DS 90 (2x4/4T)	07-15	R	
	From frame no. 1120002	67-74	F & R		DAELIM			
	CR 125 M/M1 Elsinore	73-78	F & R		Daystar 125	03-08	R	
	CT 125	77	F & R		HONDA			
	MT 125/K1 Elsinore	74-76	F & R		CL 125 A (Scrambler Twin)	65	F	
	NX 125	88-90	R		SS 125 A (Supersport 125)	65	R	
	NXR 125 (JC30)	03-08	R		KYMCO ATV			
	SL 125 K1/K2	71-73	R		MXer 50 Mongoose (2T)	04-14	R	
	TL 125 K1/K2	71-75	F & R		POLARIS ATV			
	TL 125 S	76	F & R		50 Outlaw	08-18	R	
	XL 125 K1/76	74-76	F & R		50 Predator (2 stroke)	04-07	R	
	XL 125 S	79-84	F & R		50 Scrambler	01-03	R	
	XL 125 S	85	R		90 Outlaw	07-16	R	
	CRF 150 F	07-19	R		90 Predator	03-06	R	
	NXR 150 (KD02)	03-05	R		90 Scrambler X	01-03	R	
	NXR 150 (KD03)	06-08	R		90 Sportsman	01-16	R	
	MR 175 Elsinore	75-77	F & R		110 Outlaw	16-18	R	
	XL 185 S	79-83	F & R		YAMAHA			
	XR 185	79	F & R		YFM09 RYXG/H Raptor 90	16-17	R	
	TLR 200 Reflex	86-87	F		YFZ 50 Y	17-18	R	
	TR 200 'Fatcat'	86-87	F & R					
	XR 200 R	80-84	F & R		308	HONDA		
	XR 200 R	81-02	F & R		SL 350 K1/K2	70-73	F	
	XL 200 R	83-84	F & R					
	CRF 230 F	03-20	R		309	HONDA		
	TL 250	75-76	F & R		SL 175/K1	72-73	F & R	
XR 250 R Pro Link	84-89	R	VTR 250 Interceptor	88-90	R			
XR 350 R	83-85	R	SL 350 K1/K2	70-73	F			
XR 500 R Pro Link	83-84	R						
XR 600 R	85-90	R	310/310G	HONDA				
			ATC* 70	78-85	R			
			CB 125 TT	90	R			
			XL 175 K1/K2	73-75	R			
			XL 175	76-78	R			
			CM 200 T 'Twinstar'	80-82	R			
			CM 250 C 'Custom'	82-83	R			
			CMX 250 C/CD Rebel	85-87	R			
			CB 250 Nighthawk	91-08	R			
			XL 350 K1	74-75	R			
			XL 350	76-78	R			
			* - ATC is a Registered Trademark of Honda Motor Corporation					
			311	HONDA				
			XL 250 K1/K2/76	72-76	R			
			312/312G	HONDA				
			XL 175 K1/K2	73-75	F			
			XL 175	76-78	F			
			CM 200 T 'Twinstar'	80-82	F			
			CM 250 C 'Custom'	82-83	F			
			CB 250 Nighthawk	91-08	F			
			CR 250 M1/M/M76 Elsinore	73-77	F & R			
			MR 250 Elsinore	76	F & R			
			MT 250 K1/76	74-76	F & R			
			XL 250 K1/K2/76	72-76	F			
			XL 250 S	78-81	F			
			XR 250	79-80	F			
			XL 350 K1/XL 350	74-78	R			
			XL 500 S	79-81	F			
			313	HONDA				
			CB 250 N/T		R			
			CM 250 T		R			
306/306G	HONDA							
	TRX 90 Fourtrax	93-06	R					
	TRX 90 EX	07-08	R					
	TRX 90 X	09-15	R					
	ATC* 110	79-85	R					
	ATC* 125 M	84-87	R					
	CL 125 A (Scrambler Twin)	65	F					
	SS 125 A (Supersport 125)	65	F					
	TRX 125 Fourtrax	85-88	R					
	ATC* 185	80	R					
	ATC* 185 S	81-83	R					
	ATC* 200	81-83	R					
	ATC* 200 E Big Red	82-83	R					
	ATC* 200 ES Big Red	84	R					
	ATC* 200 M	84-85	R					
	ATC* 200 S	84-86	R					
	TRX 200 Fourtrax	84/90-91	R					
	TRX 200 SX Fourtrax	86-88	R					
	TRX 200 D "Type II" Fourtrax	91-97	R					
	200 Phoenix	06-10	R					
	ATC* 250 R	81	R					
	ATC* 250 ES Big Red	85-87	F					
	ATC* 250 SX	85-87	F					
	FL 250 Odyssey	77-84	R					
	* - ATC is a Registered Trademark of Honda Motor Corporation							
	POLARIS							
	200 Phoenix (AA/AB Model/Rear Drum Model)	05	R					
	200 Phoenix (AC/AD Model/Rear Drum Model)	06-09	R					
	200 Sawtooth (Rear Drum Model)	06-07	R					

BRAKE SHOE BUYERS GUIDE

Part No.	Make/Model	Year	Fr/Rear	Part No.	Make/Model	Year	Fr/Rear	
313 Contd.	HONDA Contd.			320 Contd.	HONDA Contd.			
	CB 400 A 'Hondamatic'	78	R		CB 650 SC 'Nighthawk'	82	R	
	CB 400 Mk I/2 'Hawk'	78-79	R		CB 750 A Hondamatic	76-78	R	
	CB 400 T Hawk	80-81	R		CB 750 C Custom	80-82	R	
	CM 400 A/T	79-81	R		CB 750 C (from frame CM 204182)	82	R	
	CM 400 C Custom	81	R		CB 750 K1-76	70-76	R	
	CM 400 E	80-81	R		CB 750 K	77-78	R	
	CB 450 T 'Hawk'	82	R		CB 750 K	79-82	R	
	CB 450 SC 'Nighthawk'	82-86	R		CB 750 L Limited Edition	79	R	
	CM 450 E	82-83	R		CB 750 SC Nighthawk	82-83	R	
	CM 450 C Custom (to CM 001211)	82	R		321 HONDA	CX 500	78-79	R
	CM 450 C Custom (from CM 001212)	82	R			CX 500 C Custom	79-82	R
	CM 450 A Hondamatic	82	R			CX 500 D Deluxe	79-81	R
	CM 450 A Hondamatic	83	R			GL 500 Silverwing	81-82	R
	CMX 450 C Rebel	86-87	R			GL 500 I Silverwing Interstate	81-82	R
	VT 500 C 'Shadow'	83-86	R			VF 500 C 'V30 Magna'	84-85	R
VT 500 FT 'Ascot'	83-84	R	V LX 600 Shadow (VT 600 C/CD)	88-93		R		
CB 550 SC 'Nighthawk'	83	R	VT 600 C/CD/CD2 Shadow VLX/Deluxe	94-07		R		
314/314G	HONDA			CB 650 SC 'Nighthawk'		83-85	R	
	CB 350 K2/K3/K4		F	CX 650 C 'Custom'		83	R	
	SL 350 K	69-70	F	GL 650 Silverwing/GL 650 Silverwing Interstate		83	R	
	CB 360		F	VF 700 C 'Magna'		84	R	
	CJ 360 T/76/77	76-77	F	VF 700 'S' Sabre		84-85	R	
	CB 400 T/MK 1 Hawk	78-79	F	VF 750 S 'Sabre'		82-83	R	
	CM 400 E	80-81	F	VT 700 C 'Shadow'		84-85	R	
	CM 450 E	82-83	F	VF 750 C 'V45 Magna'		82-83	R	
315/315G	HONDA			VT 750 C 'Shadow'	83	R		
	ATC* 250 ES Big Red	85-87	R	CB 750 Nighthawk	91-03	R		
	ATC* 250 SX	85-87	R	KYMCO STREET				
	TRX 250 'fourtrax'	85-87	R	Venox 250	03-07	R		
	TRX 300 (2WD & 4WD FW 'Fourtrax')	88-00	R	322 HONDA	PA 50	78-81	R	
	CB 350 F/F1/G		R		KTM			
	CB 350 K2/K3/K4		R		50 SX/SXR Pro Junior/Senior/Adventure	96-07	F & R	
	SL 350 K	69-70	R		50 SX Mini Adventure	04-05	F & R	
	CB 360 G/T/T76	74-76	R		50 SX Pro Senior LC	02-03	R	
	CB 360		R		50 SX Pro Senior LC/Mini Senior Adventure	02-07	R	
	CJ 360 T/76/77	76-77	R		SX 50 Junior LC	07-09	R	
	CB 400 F	75-77	R		323/323G	HONDA		
* - ATC is a Registered Trademark of Honda Motor Corporation			XL 250 S	78-80		R		
316	HONDA			XL 250 R Pro Link		82-87	R	
	CB 450 K3-K7	70-74	R	XR 250		79-80	R	
	CB 500 K1/K2		R	XR 250 R Pro Link		81-82	R	
	CB 500 T/76	75-76	R	NX 250	88-90	R		
	CB 550 F	75-77	R	XL 350 R	84-85	R		
CB 550 K1/76	74-78	R	324/324G	HONDA				
318/318G	HONDA				CR 125 R	79-81	F	
	CMX 250 C 'Rebel'	96/97/99-14		R	CR 250 R	78-80	F	
	CMX 250 C2	99-00		R	XR 500	79-80	F	
	CMX 250 X Rebel	15		R	325/325G	HONDA		
	XL 250 S	81	R	CR 250 R		78-80	R	
	XL 500 S	79-81	R	327/327G		HONDA		
	XL 500 R Pro Link	82	R		CR 250 R	81-	F	
	XR 500	79-80	R		XR 250 R Pro Link	81-82	F	
	XR 500 R Pro Link	81-82	R		CR 450 R	81	F	
	XL 600 R	83-87	R		CR 480 R	82	F	
XL 600 V Transalp	89-90	R	XR 500 R Pro Link	81-82	F			
NX 650	88-89	R	328/328G	HONDA				
319/319G	HONDA				CR 250 R	82-83	F	
	CR 250 R	81		R	CR 480 R	83	F	
	CR 450 R	81	R	320	HONDA			
320	HONDA				CB 650	79-81	R	
	CB 650	82	R		CB 650	82	R	
	CB 650 C Custom	80-81	R		CB 650 C Custom	80-81	R	

BUYERS GUIDE
BRAKE SHOES

BRAKE SHOE BUYERS GUIDE

Part No.	Make/Model	Year	Fr/Rear	Part No.	Make/Model	Year	Fr/Rear
330/330G	BOMBARDIER			338/338G	ARCTIC CAT		
	DS 50 (2 stroke)	02-06	R		50 2x4 Youth (2T)	04-06	F
	Quest 50	03-04	R		50 DVX Sport (4T)	06-08	F
	DS 90 (2/4 stroke)	02-06	R		50 4x4 Auto Youth	06-08	F
	Quest 90 (2/4 stroke)	03-04	R		90 2x4 Youth (2T) Rear Drum Model	02-04	F
	E-TON QUADS				90 2x4 Youth (4T) Rear Drum Model	04-05	F
	IXL 40 Rascal	98-01	R		90 2x4 Youth (4T) Rear Disc Model	06	F
	RXL-40 E Viper Junior	01-06	R		Alterra 90	18	F
	Viper 40 E	99-08	R		90 DVX and DVX SE	09	F
	AXL 90 Thunder	99-00	R		90 Reverse Gear Model	10-13	F
	DXL-90 Sierra	99-03	R		HONDA		
	NXL 90 Thunder	01-02	R		CR 80 R	85-91	R
	YXL 150 Yukon	00-02	R		E-TON QUADS		
	Yukon EXL 150	05-06	R		AXL 50 Lightning 50	99-00	F
	Viper EXL 150 ST Quad	05-06	R		BXL 50 Draco	05-06	F
	EXL 150 Yukon ST	05-06	R		NXL 50 Lightning 50	01-02	F
	HONDA				RXL-50M Viper (4T)		F
	TRX 70 Fourtrax	86-87	R		TXL 50 Wizz 50	98-99	F
	CB 125 S	84-85	F		Viper 70 RXL 70/70M	05-09	F
	CR 125 R	82	F & R		AXL 90 Thunder	99-00	F
	CR 125 R	79-81	R		NXL 90 Thunder	01-02	F
	XL 125 S	85	F		RXL 90 Viper 90	03-06	F
	CH 250 Elite	85-90	F		RXL 90 R Viper 90 R Reverse	03-09	F
	CR 250 R	82	R		BXL 100 Draco	05-06	F
	XL 250 R Pro Link	82-87	F		KAWASAKI		
	CR 480 R	82	R		KFX 50 (KSF 50 B7F/B8F/B9F/BDF	07-09	
	* - ATC is a Registered Trademark of				/BEF/BFF/BGF/BHF)	/13-17	F
Honda Motor Corporation			KFX 90 (KSF 90 A7F/A8F/A9F/AAF/ABF				
			/ACF/ADF/AEF/AF/AGF/AHF)	07-17	F		
			POLARIS ATV				
			50 Outlaw	08-18	F		
			50 Predator (2 stroke)	04-07	F		
			50 Scrambler	01-03	F		
			90 Outlaw	07-16	F		
			90 Predator	03-06	F		
			90 Scrambler X	01-03	F		
			90 Sportsman	01-16	F		
			110 Outlaw	16-18	F		
331/331G	HONDA			339/339G	HONDA		
CR 125 R	83	F & R		TRX 200 'Fourtrax'	84	F	
CR 125 R	84-85	R		TRX 250 'fourtrax'	85-87	F	
CR 250 R	83-85	R		FL 350 R Odyssey	85-87	F	
XR 350 R	83	F		FL 400 R Pilot	89-90	F	
CR 480 R	83	R					
CR 500 R	84-85	R		340/340G	HONDA		
				TRX 250 EX Sportrax 250 EX	01-08	R	
				TRX 250 X	09-14	R	
				TRX 250 TE Recon ES	97-14	R	
				TRX 250 TM Recon	97-14	R	
				GB 500	89-90	R	
				KYMCO			
				K-Pipe 125	20	R	
				Spade 150i	20	R	
				341	HONDA		
				CH 250 'Elite'	85-86	R	
				342/342G	HONDA		
				TRX 350/TRX 350 D Fourtrax Foreman	86-89	F	
				343/343G	HONDA		
				TRX 350/TRX 350/D Fourtrax Foreman	86-89	R	
				TRX 500 FA Fourtrax Foreman Rubicon	01-14	R	
				TRX 500 FGA Fourtrax Foreman			
				Rubicon Gpscape	04-08	R	
				TRX 500 FE/FA Fourtrax Foreman 4x4/ES	05-08	R	
				TRX 500 FM/FMA Fourtrax Foreman 4x4	05-11	R	
				TRX 500 FE Fourtrax Foreman	12-13	R	
				TRX 500 FM Fourtrax Foreman	12-13	R	
				TRX 500 FPE Fourtrax Foreman	12-13	R	
332/332G	HONDA						
XL 500 R Pro Link	82	F					
333/333G	HONDA						
CHF 50/50 P/S Metropolitan							
/Metropolitan II/Jazz	02-11	F & R					
NCH 50 Metropolitan	13-21	F					
NPS 50/50 S Ruckus	03-21	F & R					
NU 50/NU 50 M Urban Express	82-83	F					
SA 50 Elite SR/SA 50 P Elite S	94-01	F & R					
CR 60 R	83-84	F & R					
CRF 70 F	04-14	F & R					
XR 70 R	97-03	F & R					
CH 80 Elite	85-07	R					
CRF 80 F	04-14	F & R					
CR 80 R	82	R					
CR 80 R	83-84	F & R					
CR 80 R	85	F					
NH 80 Aero	85	R					
XR 80 R	85-03	F & R					
CRF 100 F	04-16	F & R					
XR 100 R	85-03	F & R					
CRF 110 R	13-21	F & R					
CRF 125 F (17/14" Small Wheels)	14-21	R					
CRF 125 FB (19/16" Big Wheels)	14-20	R					
TLR 200 Reflex	86-87	R					
NSS 300 Forza (Non ABS)							
- Parking brake shoe	14-16						
NSS 300 Forza (ABS)							
- Parking brake shoe	14-16						
SYM							
DD 50	02-12	R					

BUYERS GUIDE
BRAKE SHOES

BRAKE SHOE BUYERS GUIDE

Part No.	Make/Model	Year	Fr/Rear	Part No.	Make/Model	Year	Fr/Rear	
343/343G Contd.	HONDA Contd.			346/346G Contd.	KYMCO Contd.			
	TRX 500 FPM Fourtrax Foreman	12-13	R		Mongoose 90 R (Reverse Gear)	10-14	F	
	TRX 500 FPA Fourtrax Rubicon				Mongoose 90	02-10	F	
	with EPS/Power Steering	09-14	R		Mongoose 90 S	20	F	
	TRX 500 TM5/TM6 Fourtrax Foreman 2x4	05-06	R		YAMAHA			
	TRX 500 FPE Fourtrax Foreman 4x4 ES/EP	08-11	R		YFM09 RYXG/H Raptor 90	16-17	F	
	CB 700 SC/S 'Nighthawk'	84-86	R		YZF 50 Y	17-18	F	
	VF 700 C 'Magna'	85-87	R					
	VT 700 C 'Shadow'	86-87	R		347/347G	HONDA		
	VF 750 C Magna/Magna Deluxe CD/C2	94-03	R		TRX 300 FW Fourtrax (4WD)	TRX 300 FW Fourtrax (4WD)	88-00	F
	VF 750 C V45 Magna	88	R	TRX 350 TE/FE	TRX 350 TE/FE	00-06	F	
	VT 750 DC/DCA/DCB Shadow Spirit	01-08	R	TRX 350 TM/FM	TRX 350 TM/FM	00-06	F	
	VT 750 C/CD/CD2	98-02	R	TRX 400 FW Fourtrax Foreman	TRX 400 FW Fourtrax Foreman	95-00/03	F	
	VT 750 CDA/CDB/CDC/CDD	02-03	R	TRX 400 FM Fourtrax Foreman	TRX 400 FM Fourtrax Foreman	02	F	
	VT 750 C2/C2F Shadow Spirit	07-10	R	TRX 400 FGA/FA	TRX 400 FGA/FA	04-07	F	
	VT 750 RS Shadow	10-14	R	TRX 450 FE	TRX 450 FE	02-04	F	
	VT 750 Shadow Aero	08-14	R	TRX 450 FM	TRX 450 FM	02-04	F	
	VT 750 C2B Shadow Phantom	10-19	R	TRX 500 FA Foreman Rubicon	TRX 500 FA Foreman Rubicon	01-04	F	
	VT 750 T Shadow Tourer	09	R	TRX 500 FGA	TRX 500 FGA	04-	F	
	VT 750 C/CA Shadow Aero	04-07	R	TRX 650 FA Rincon	TRX 650 FA Rincon	03-05	F	
VT 750 DC Shadow Spirit	01-02	R	TRX 650 FGA	TRX 650 FGA	04-05	F		
VT 750 DCA/DCB Shadow Spirit	03-07	R						
VT 750 C Shadow Spirit	08-14	R	347S/347SG	HONDA				
PC 800 Pacific Coast	89-90/94-99	R	TRX 450 ES	TRX 450 ES	98-01	F		
VT 800 C Shadow	88	R	TRX 450 S	TRX 450 S	98-01	F		
VT 1100 C Shadow/Shadow Spirit	85-07	R						
344/344G	HONDA			350	HONDA			
	CR 125 R	86	R		NX 125	88-90	F	
	CR 250 R	86	R		CH 250 Elite	87-90	R	
	CR 500 R	86	R		CN 250 Helix	86-01/05-07	R	
345/345G	HONDA			351/351G	HONDA			
	TRX 200 SX 'fourtrax'	86-88	F		PS 250 Big Ruckus	05-06	R	
	TRX 200 'Fourtrax'	90-91	F		TRX 350 TE/FE	00-06	R	
	TRX 200 D Type II 'Fourtrax'	91-97	F		TRX 350 TM/FM	00-06	R	
	TRX 250 TE Recon ES	97-21	F		TRX 400 FW Fourtrax Foreman	95-01/03	R	
TRX 250 TM Recon	97-21	F	TRX 400 FM Fourtrax Foreman	02	R			
TRX 300 (2WD)	88-00	F	TRX 400 FGA/FA	04-07	R			
346/346G	ARCTIC CAT			TRX 420 FA1 Rancher 4x4 Auto DCT	14-15	R		
	50-Y6 Youth (2T)	04-05	F	TRX 420 FA2 Rancher 4x4 Auto/DCT/EP	14-15	R		
	50 DVX (4T)	06-08	F	TRX 420 FA5 Rancher 4x4 Auto/DCT/EP	14-15	R		
	50 DVX (4T) Sport	06/08	F	TRX 420 FE1 Rancher 4x4/ES	14-15	R		
	50 Utility	06-08	F	TRX 420 FM1 Rancher 4x4	14-15	R		
	50 2x4 (2T) Youth	02-04	F	TRX 420 FM2 Rancher 4x4/EP	14-15	R		
	50 4x4 Auto Youth	08	F	TRX 420 Fourtrax Rancher	07-13	R		
	90-Y12 Youth (2T)	02-04	F	TRX 420 TE Fourtrax Rancher ES	07-13	R		
	90-Y12 Youth (4T)	04-05	F	TRX 420 FM Fourtrax Rancher 4x4	07-13	R		
	90 DVX	06-14	F	TRX 420 FPE Fourtrax Rancher 4x4 ES/EP	09-13	R		
	90 DVX SE	09	F	TRX 420 FE Fourtrax Rancher 4x4/ES	07-13	R		
	90 SE	09	F	TRX 420 FE1 Rancher 4x4 ES	14-15	R		
	90 Utility (2x4)	06-11	F	TRX 420 FPM Fourtrax Rancher 4x4 PS	09-13	R		
	90 2x4 (2T) Youth	02-04	F	TRX 420 TM1 Rancher	14-15	R		
	90 2x4 (4T) Youth Rear Drum Model	04-05	F	TRX 420 TE1 Rancher ES	14-15	R		
	90 2x4 (4T) Youth Rear Disc Model	06	F	TRX 500 FE Fourtrax Foreman 4x4 EP	07-10	R		
	90 (Reverse Gear Model)	10-14	F	TRX 500 FE1 Foreman ES	14-15	R		
	BOMBARDIER			TRX 500 FE2 Foreman ES	14-15	R		
	DS 50 (2 strokes)	02-06	F	TRX 500 FE2 Foreman ES/EP	14-15	R		
	Quest 50	03-04	F	TRX 500 FM1 Foreman	14-15	R		
	DS 90 (2/4 stroke)	02-06	F	TRX 500 FPM Fourtrax Foreman 4x4/EP	09-10	R		
	Quest 90 (2/4 stroke)	03-04	F	TRX 500 FPE Fourtrax Foreman 4x4 ES/EP	08-10	R		
	CAN AM			TRX 450 ES	98-01	R		
	DS 70 (2x4/4T)	08-15	F	TRX 450 S	98-01	R		
	DS 90 (4T/2x4)	07-15	F	TRX 450 FE	02-04	R		
	HONDA			TRX 450 FM	02-04	R		
	TRX 70 Fourtrax	86-87	F					
	KYMCO							
	MXer 50 Mongoose (2T)	02-07	F					
	Mongoose 70 (4T)	07-14	F					
	Mongoose 70 S (4T)	20	F					

BUYERS GUIDE
BRAKE SHOES

BRAKE SHOE BUYERS GUIDE

Part No.	Make/Model	Year	Fr/Rear	Part No.	Make/Model	Year	Fr/Rear
352	HONDA			503/503G Contd.	YAMAHA Contd.		
	NHX 110 Elite	10-11	R		JYM 90 T Axis 4RT6	01	R
	CG 125 CA12/KS12/CA2/3/4/KS2/3/4				TT-R 90 M/N/P/R/ES/S/ET/EV/EW	00-07	R
	/5/6/KSE2/3/4 (JC30)	01-06	F & R		YA 90 Axis (4CY7-4EN7)	96	R
	CCT 125 ES12/ES2/3/4 (JC30)	01-04	R		DT 100 K	83	F & R
	NXR 125 (JC30)	03-08	F		MX 100 K	83	F & R
	PCX 125	11	R		RT 100 A/D/E/F/G/H/J/K/L/M	91-00	F & R
	NXR 150 (KD03)	06-08	F		RX 100 (5RD3/4)	04	F & R
	PCX 150 (WW 150)	13-20	R		RX 100 (36L/36LO/5RD1/2)	01-03	F & R
	SH 150 i	10-11	R		RX 100 C (5RC1/2/3)	04	F & R
	Super Cub C 125	18-20	R		RXZ 100 S (3HS1/2)	88-95	F & R
501	YAMAHA			YFM 100 W/A/B Champ	89-91	F	
	CA 50 K/L/N/S Riva	83-86	F	YFAI D/E/F/G/H/J/K/L/M/N/P/R/S "Breeze"	92-04	F	
	CE 50 ES/ET	86-87	F	YZ 100 J/K	82-83	F	
	CG 50 EU/W/A/B	88-91	F	T 105 SE Crypton (1D81/1D82)	03-09	R	
	MJ 50 J 'Towny'	82	F & R	TT-R 110	08-20	F	
	PW 50 H/J/K/N/S/T/A/B/D/E/F/G/H/J/K	81-09		TTR 125 M/N/P/R/ER/S/ES/ET/EV/EW/EX/EY	00-09	F & R	
	/L/M/N/P/R/S/T/V/W/X/Y/B/D/E/F	/12-15	F & R	TTR 125	00-09		
	QT 50 G/2G/H/J/K/L/N/S/T Yamahopper	80-87	F & R		/11-20	R	
	SH 50 T/EMT/U/MU/W/MW/A/MA/B/D	87-94		XT 125 J/K/KC	82-83	R	
	/MD/E/F/K/L Razz	/98-99	F	YBR 125 (5PY1/2)	01	F & R	
	YFM 90 RY Raptor	09	F	YFM 125 S/GT/GHT/GV/GW/GX/GY/GZ			
502/502G	SUZUKI			/GA/GB/GD Grizzly	04-13	F	
	RM 80 Z/D/E/F	82-85	R	YT 175 J/K 'Tri-Moto'	82-83	F	
	RM 80 G/H/J/K	86-89	R	SR 185 H/J	81-82	R	
	YAMAHA			BW 200 N/S/ES/ET/EU	85-87	F & R	
	YZ 50 G	80	F & R	TW 200 T/TC/U/UC/W/WC/A/AC/B/BC/D			
	YZ 60 H/J/K	81-83	F & R	/DC/E/EC/F/FC/G/GC/H/HC/J/JC/EK/ECK			
	BW 80 S/T/U/A	86-88/90	F	/L/LC/M/MC/N/NC/P/PC/R/RC/S/SC/T			
	PW 80 K/N/B/D/E/F/G/H/J/K/L/M	83-85		/TC/V/VC/W/WC/X/Y/Z/A/B/D/E/F	87-15	R	
	/N/P/R/S/T/V	/91-08	F	XT 200 J/K/KC	82-83	R	
	YZ 80 G/H/J/K/L/N	80-85	F & R	YFM 200 N 'Moto 4'	85	F	
	YZ 80 S/T/U/W/A/B/D	86-92	R	YFM 200 DXS/DXT/DXU/D/DXW 'Moto 4'	86-89	F	
TT-R 90 M/N/P/R/ES/S/ET/EV/EW	00-07	F	YFS 200 U/W/A/B/D/E/F/G/H/J				
TT-R 110 EX/EY/EA/EB/ED/EE/EF/EG	08-20	F	/K/L/M/N/P 'Blaster'	88-02	F		
503/503G	ADLY			YTM 200 K/L/N 'Tri-Moto'	83-85	F	
	Noble 50/Thunderbike	07-09	R	YTM 200 EK/EL 'Tri-Moto'	83-84	F	
	Panther 50	07-08	R	YTM 200 ERN 'Tri-Moto'	85	F	
	Jet 50	07-09	R	TT 225 S/T	86-87	R	
	Fox 50	07-09	R	XT 225 D/DC/E/EC/F/FC/G/GC/F/FH/J/JC			
	CPI			/K/KC/L/M/MC/N/NC/P/PC/R/RC/S/SC			
	Oliver City 50	05-09	R	/T/TC/V/VC/W/WC	93-07	R	
	MZ/MUZ			YTM 225 DXK/DXL/DXN 'Tri-Moto'	83-85	F	
	Moskito/SX 50/RX 50	97-05	R	YTM 225 DRN/DRS 'Tri-Moto'	85-86	F	
	POLARIS			YFM 225 S/T/U 'Moto 4'	86-88	F	
	Trail Boss (2x4)	85-87	F	YFB 250 D/E/F Timberwolf	92-94	F	
Scrambler (3 wheeler)	85-86	F	YFM 350 ERT/ERU 'Moto 4'	87-88	F		
Cyclone 250 X	87	F					
UM (UNITED MOTORS)			504/504G	UM (UNITED MOTORS)			
X-Peed 50/Special Edition	00-05	R		Zyclone 50	04-05	R	
YAMAHA				YAMAHA			
CW 50 K Riva	98	F & R		LB 50 PG/PH/PJ Chappy	80-82	F & R	
CW 50 L/TL Zuma/Zuma II	99	R		RX 50 MK/K/L	83-84	R	
CV 50 L 'Riva'	84	F & R		DT 80 H/J	81-82	F & R	
CY 50 D/E/F/K Jog	92-94/98	R		DT 100 G/H/J	80-82	F & R	
EW 50 Stunt (5LH2/5YN1)	01-03	R		MX 100 G/H/J	80-82	F & R	
YFM 50 S/T/RV/RW/RX Raptor	04-08	F		YZ 100 F/G/H	80-81	F	
YSR 50 T/U/W/A/B/D	87-92	R		IT 125 G/H	80-81	F	
CV 80 K/L/N/S/T 'Riva'	83-87	F & R		RXZ 135 (2UX/3UK1)	87-89	R	
DT 80 K	83	F & R		MX 175 G/H	80-81	F	
LB 80 II-A Chappy 3VS2/4RP1	95-98	F & R		TY 350 N/S	85-86	R	
PW 80 D/E/F/G/H/J/K/L/M/N/P/R/S/T/V	92-08	R		BW 350 T/U	87-88	R	
V 80 (3NX3/4)	94	F & R		506/506G			
V 80 D (4GC2/3/4)	93-96	F & R		YAMAHA			
V 80 (4GC5/6/3NX6)	98	F & R		YFM 80 N/S/T/U	85-88	R	
YFM 80 D/E/F/G/H/J/K/L/M/N	92-01	F		YFAI W/A/B Breeze	89-91	R	
YFM 80 WP/WR/WS/RT/RV/RW/RX Raptor	02-08	F		YFM 100 T/U/W/A/B Champ	87-91	R	
YFM 80 GT/GV/GW/GX Grizzly	05-08	F		YZ 100 F/G/H/J/K	80-83	R	
				DT 125 G/H	80-81	F & R	
				IT 125 G/H	80-81	R	
				XC 125 N/NC/SC/T/TC/U/W/ZS/ZSC			

BRAKE SHOE BUYERS GUIDE

Part No.	Make/Model	Year	Fr/Rear	Part No.	Make/Model	Year	Fr/Rear	
506/506G Contd.	YAMAHA Contd.			512 Contd.	YAMAHA Contd.			
	/ZT/ZTC/ZU/ZW/ZA/B/D Riva	85-92	R		YX 600 S/SC/T/TC/UC/N/W/WC/A	86-90	R	
	XT 125 J/K/KC	82-83	F		/ACC 'Radian'	80-83	R	
	YBA 125 Enticer (5US1/3P41)	05	F & R		XJ 650 G/H/J/K 'Maxim'	81	R	
	YZ 125 F/G/H/J	80-82	R		XJ 650 LH 'Midnight'	81-83	R	
	YZ 125 T	87	R		XV 750 H/J/K/MK Virago			
	DT 175 G/H	80-81	F & R					
	IT 175 G/H/J/K	80-83	R		513	YAMAHA		
	MX 175 G/H	80-81	R		XS 400 2G/H	80-81	F	
	RT 180 A/B/D	90-92	R		XS 400 SJ	82	F	
	SR 185 H/J	81-82	F					
	TW 200 T/TC/U/UC/W/WC/A/AC/B/BC	87-89	F		514	YAMAHA		
	XT 200 J/K/KC	82-83	F		TX 650 A/XS 650 B/C	74-76	R	
	SR 250 G/H/J/TH Exciter I/II	80-82	R		XS 2/TX 650	72-73	R	
	SR 250 K (3Y9)	93	R		XS 650 D/E/F/2F/G/H/SH	77-81	R	
	TT 250 G/H/J	80-82	R		XS 650 SJ/SK Heritage Special	82-83	R	
	XT 250 G/H/J/K/KC/L/LC	80-84	F & R					
	XV 250 U/UC/W/WC/A/AC	88-90	R		515	YAMAHA		
	YZ 250 G	80	R		XV 535 Virago All Models	87-99	R	
	YZ 250 J/K/L/N/S/T	82-87	R		XJ 650 RJ 'Seca'	82	R	
TT 350 S/T	86-87	R	XJ 650 LK 'Seca'	83	R			
XT 350 N/NC/S/SC	85-86	R	XJ 650 LJ 'Seca Turbo'	82	R			
XT 350 T/TC/U/UC/W/WC/A	87-90	R	XVS 650 V Star Classic	98-10	R			
YZ 490 K	83	R	XVS 650 V Star Custom	97-11/13-14	R			
TT 600 K/L	83-84	R	XVS 650 V-Star Silverado	03-10	R			
TT 600 N/S	85-86	R	XJ 700 N/NC/XN/XNC/XS/XSC/S/SC	85-86	R			
			XV 700 L/LC/N/NC/CS/CT/CTCCSC/SS					
			/SSC/ST/STC	84-87	R			
507/507G	YAMAHA			TX 750/TX 750 A	73-74	R		
YZ 125 F/G/H/J/K	80-83	F		XJ 750 J/K/MK 'Maxim'	82	R		
IT 175 G/H/J/K	80-83	F		XJ 750 RH/RJ/RK 'Seca'	81-83	R		
IT 250 F/G/H/J	77-82	F		XV 750 U/UC/W/WC/A/AC/B/BC/D/DC				
TT 250 G/H/J	80-82	F		/E/EC/F/FC/G/GC/H/HC/J/JC Virago	88-97	R		
YZ 250 G/H	80-81	F		XV 920 RH/RJ	81-82	R		
IT 425 G	80	F		XV 920 J 'Virago'	82	R		
TT 500 G/H	80-81	F		XV 920 K/MK 'Virago'	83	R		
				XV 1000 L/LC/N/NC	84-85	R		
				XV 1100 'All models'	86-97	R		
508/508G	YAMAHA			516/516G	YAMAHA			
YZ 125 L	84	F		YP 250 Majesty (5CV1)	97	R		
IT 250 K	83	F		YFM 350 UH/UJ/UK/UL/ULC	96-99	R		
YZ 250 J/K/L	82-84	F		YFM 350 FWH/FWJ/FWBK	96-98	R		
IT 465 H/J	81-82	F		XS 400 2G/H	80-81	R		
YZ 465 G/H	80-81	F		XS 400 SG/SH	80-81	R		
IT 490 K/L	83/84	F		XS 400 SJ	82	R		
YZ 490 J/K/L	82-84	F		XS 400 J/K 'Maxim'	82-83	R		
TT 600 K/L	83-84	F		XS 400 RJ/RK	82-83	R		
				YFM 400 FWE/FWF/FWG/FWH/FWJ				
510/510G	YAMAHA			/FWK Kodiak	93-98	R		
DT 250 A	74	F & R		YFM 400 FWHM/FWHN/FHP/FP 'Big Bear'	00-02	R		
DT 250 B/C/D/E/F	75-79	R		YFM 400 FWNM/MC/FWNN/FWHN/FHP				
IT 250 H/J	81-82	R		/FP/FR/FS Big Bear 4WD	00-04	R		
IT 250 K	83	R		YFM 400 NR/NS (2x4) Big Bear	03-04	R		
YZ 250 H	81	R		YFM 400 FAR Kodiak Auto	03-04	R		
SR 400 F	15	R		YFM 400 S Big Bear 4WD	04	R		
IT 465 H/J	81-82	R		YFM 400 NM/NMC/NN/NHN/P/HP	00-02	R		
YZ 465 H	81	R		XJ 550 RH/RJ/RK 'Seca'	81-83	R		
IT 490 K/L	83-84	R		YFM 600 FWAK/FWAL/LC/FWAM				
YZ 490 J	82	R		/MC Grizzly	98-00	R		
YZ 490 L	84	R		YFM 600 HM/HMC 'Grizzly Hunting'	00	R		
YZ 490 N/S/T/U/W	85-89	R		YFM 600 FWAN/FWAHN	01	R		
SR 500 E/F/G/H	78-81	R						
XT 500 G/H	80-81	R						
XT 550 J/K	82-83	F & R						
XT 600 L/LC/N/LN/S/SC	84-86	R						
XT 600 T/TC/U/UC/W/WC	87-89	R						
512	YAMAHA			517/517G	YAMAHA			
XV 500 K 'Virago'	83	R		YZ 125 K/L/N/S	83-86	R		
XS 500 B	75	R		IT 200 L/N	84-85	F & R		
XJ 550 H/J/K 'Maxim'	81-83	R		IT 200 S	86	R		
XZ 550 RJ	82	R		TY 350 N/S	85-86	F		
XZ 550 RK	83	R		BW 350 T/U	87-88	F		

BUYERS GUIDE
BRAKE SHOES

BRAKE SHOE BUYERS GUIDE

Part No.	Make/Model	Year	Fr/Rear	Part No.	Make/Model	Year	Fr/Rear
518/518G	YAMAHA			527/527G Contd.	YAMAHA Contd.		
	CW 50 W/TA Riva Zuma	89-90	F & R		/JC/EK/ECK/L/LC/M/MC	92-00	F
	DT 50 U/W/A (DTL/C)	88-90	F & R		TT-R 225 L/M/N/P/R/S	99-04	R
	YT 60 L/N 'Tri-Zinger'	84-85	R		TT-R 230 T/V/W/X/Y/A/B/D/E/F	05-09/11-15	R
	YF 60 S 'Moto 4'	86	R		SR 250 (4GR1/2/3/4/9)	93-08	R
	PW 80 K/N/B	83-85/91	R		XV 250 Virago All models	95-07	R
	YFM 80 T/U	87-88	F		XV 250 V-Star	08-12	R
	YA 90 Axis (4CY1/5 - 4EN5/6)	91-95	R		XT 350 B/BC/D/E/EC/F/FC/G/GC/H/HC		
	YFM 100 T/U Champ	87-88	F		/J/JC/K/KC/L/M	91-00	R
	T 105 SE 'Crypton' (5AM4)	99-02	R		YFA1D/E/F/G/H/J/K/L/M/N/P/R/S Breeze	92-04	R
	RXS 115 (3HB6/7)	94-97	R		YFM 125 S/GT/GHT/GV/GW/GX/GY/GZ		
	RXS 115 (3HB8)	99	R		/GA/GB/GD Grizzly	04-13	R
519	YAMAHA			528/528G	YAMAHA		
	LC 50 G/H Champ	80-81	F & R		DT 250 B/C/D/E/F	75-79	F
	CA 50 K/L/N/S 'Riva'	83-86	R		IT 250 F/G	77-80	R
	CE 50 ES/ET	86-87	R		SR 250 G/H/J/TH Exciter I/II	80-82	F
	CG 50 EU/W/A/B	88-91	R		YFB 250 D/E/F Timberwolf	92-94	R
	SH 50 T/EMT/U/MU/W/MW/A/MA/D	87-94			YFB 250 G/H/UH/J/UJ/K/UK	95-98	F&R
	/MD/E/F/K/L Razz	/98-99	R		YFB 250 FWF/FWG/FWH/FWJ/FWK/FWL		
	SH 50 Ed-Mint (3PR1/4CK1/3/4)	89-94	F & R		/FWM Timberwolf	94-00	F & R
	CY 50 D/E/F/K/L Jog	92-94/98-99	F		YFM 250 M/MC Beartracker	00	F & R
	YJ 50 RAP/YJ 50 RRP Vino/Vino Classic	-02	F		YFM 250 XN/XHN/XP/XHP/XR/XHR/XS		
BW 80 S/T/U/A	86/88-90	R	Beartracker	00-04	R		
520/520G	YAMAHA			YFM 250 W/A/B	89-91	F	
	YMF 350 FWT/FWU 'Big Bear'	87-88	F	YFM 350 ERE/ERF/ERG	93-95	F	
521	YAMAHA			YFM 350 FWBL/LC	99	R	
	XC 125 N/NC/SC/T/TC/U/W/ZS/ZSC/ZT			YFM 350 ERW/ERA/ERD	89-92	F	
	/ZTC/ZU/ZW/ZA/B/D Riva	85-92	F	YFP 350 U Terrapro	88	F	
	XC 125 E/F/K Riva	93-94/98	F	YFUITW Pro Hauler	89	F	
	XC 180 K/KC/L/LC/N/NC/ZL/ZLC/ZN/			YFUIW Pro Hauler	89	F	
ZNC/DN/DWC Riva	83-85	F	YFM 400 FWBL Kodiak	99	R		
XC 200 T/ZCT/U/W/ZU/ZW/ZA/ZB Riva	87-91	F	IT 425 G	80	R		
522	YAMAHA			YZ 465 G	80	R	
	SR 250 K (3Y9)	93	F	TT 500 G/H	80-81	R	
SR 250 (4GR1/2/3/4/9)	93-08	F	XT 500 G/H	80-81	F		
523/523G	YAMAHA			530	YAMAHA		
	YFP 350 U Terrapro	88	R		C3 (50cc Scooter) (XF 50 W/X/Y/Z/A)	07-11	F & R
	YFUITW Pro Hauler	89	R		XC 50 V/W/X/Y/Z/A/D/E/F/G/H Vino Classic	06-17	F & R
YFUIW Pro Hauler	89	R	YJ 50 RN/RP/RR/RS Vino		01-04	F & R	
524/524G	YAMAHA				YJ 50 RAP/RAR/RAS/RAT Vino Classic 50	02-05	F & R
	YFM 350 FWW/FWA/FWB/FWD/FWE				Zuma 50 F Twin Headlights		
	/FWF/FWG/FWH/FWJ/FWBK Big Bear	89-98	F		(YW 50 FB/FD/FE/FF/FG)	12-16	R
YFM 350 UH/UJ/UK	96-98	F	Zuma 50 FX Single headlight				
YFM 400 FWE/FWF/FWG/FWH/FWJ			(YW 50 FXE/XXF/XXG)		14-20	R	
/FWK Kodiak	93-98	F	XC 100 Jog (3D31/EP51)		05-06	F & R	
527/527G	YAMAHA			T 110 (40B3)	10	R	
	YFM 50 S/T/RV/RW/RX Raptor	04-08	R	T 110 C (40B4/7)	11-13	R	
	YFM 80 D/E/F/G/H/J/K/L/M/N	92-01	R	XA 125 Cygnus (2BK1)	12	R	
	YFM 80 WP/WR/WS/RT/RV/RW/RX Raptor	02-08	R	YJ 125 S/T/V/W/X/Y Vino	04-09	R	
	YFM 80 GT/GV/GW/GX Grizzly	05-08	R	531	YAMAHA		
	YA 100 W Grand Axis (5TC2/4/5)	01-03	R		Zuma 50 (YW 50 P/R/S/T/X/Y/Z/A)	02-05/08-11	R
	YW 100 BW's (4VPS/PC/PV/PX/5R1				AF 115 S Fino (2BN1/2)	12	R
	/R2/R3/R4)	97-08	R		AT 115C Nuovo (5MX6/2D51)	05-06	R
	XC 125 E/F/K Riva	93-94/98	R		AT 115 (21P1)	07	R
	YB 125 Vision (5AP1)	01	R		YBR 125 R (1PX1/X2)	11-12	R
	YBR 125 EB (5RR2/3/4/5/6/8/9)	02-08	R		YBR 125 (2DOD/2CS1)	11-13	F & R
	YBR 125 ESD (4P26) Cast Wheel	07-09	R		YBR 125 ESG (43B1/3/5/6/8)	08-13	R
	YBR 125 ED (4P28) Cast Wheel	07-09	R		YBR 125 ESD (4P2A/4P2G) Cast Wheel	10-13	R
	YBR 125 ED (5RR1)	01	F & R		YBR 125 ED (4P2C/4P2J) Cast Wheel	10-13	R
	YBR 125 K (STU1/2/4/6/8)	02-06	F & R		YBR 125 C (36S1/2/3/4)	08-13	F & R
RX-Z 135 (3XL3/5PV1/5PV2)	00-05	R	YBR 125 E (4P24/4P27/4P2B/4P2H)				
RX-Z 135 (3UK3/3RSA/3RSB)	93-97	R	Spoke wheel		06-13	F & R	
RT 180 E/G/H/J	93-97	R	FZ 150 (3C12/3C11)		07-08	R	
TW 200 D/DC/E/EC/F/FC/G/GC/H/HC/J			532/532G		YAMAHA		
532/532G	YAMAHA				YFM 250 BT/BV Bruin	05-06	R
	YFM 250 BW/BX/BY Big Bear				YFM 250 BW/BX/BY Big Bear	07-09	R
	YFM 350 FAS/FAT/FAV Bruin 4x4			YFM 350 FAS/FAT/FAV Bruin 4x4	04-06	R	

BUYERS GUIDE
BRAKE SHOES

BRAKE SHOE BUYERS GUIDE

Part No.	Make/Model	Year	Fr/Rear	Part No.	Make/Model	Year	Fr/Rear	
532/532G Contd.	YAMAHA Contd.			602/602G Contd.	SUZUKI Contd.			
	YFM 350 AS/AT/AV Bruin 2x4	04-06	R		TS 90 Honcho	70	F & R	
	YFM 350 GW/GX/GY/GZ/GA (2WD)				TS 90 R/J Honcho	71-72	R	
	Grizzly 2x4	07-11	R		A100 A/B Go-Fer	76-77	F	
	YFM 350 FGW/FGX/FGY/FGZ/FGA/FGB				B100 P Magnum (118cc)	65-66	F & R	
	/FGD Grizzly Auto 4x4	07-13	R		DS 100 C/N/T/X	78-81	F & R	
	YFM 350 XV/XW/XX/XY Wolverine (2WD)	06-09	R		RM 100 A/B/C	76-78	R	
	YFM 400 AR/AS Kodiak 2WD	03-04	R		TC 100 K/L/M Blazer	73-75	R	
	YFM 400 FAS Kodiak 4WD	04	R		TC 100 A/B Blazer	76-77	F & R	
	YFM 400 FS/FT/FAV Big Bear 4WD	04-06	R		TS 100 A/B/C/N/T/X	76-81	F & R	
	YFM 400 FT/FV Big Bear	05-06	R		TS 100 A/B Honcho	76-77	F & R	
YAMAHA (ATV)			TS 100 K/L/M Honcho	73-75	R			
YFM 350 DE Grizzly Auto 4x4	14	R	B 105 P Bear Cat (118cc)	67-68	F & R			
533	YAMAHA YW125 Y/Z/A/B/D/E/F Zuma (Rear Drum Model) YW 125 X (1DN1/2)	09-15	R	B 120 (118cc)	71-77	F & R		
		10-13	R	KT 120 Trail	68-70	F & R		
534/534G	YAMAHA YXP 700 AS/AT/AV Pro Hauler 700 Side x Side YXP 1000 AS/AT Pro Hauler 1000 Side x Side	04-06	R	TC 120 Trailcat	68-71	F & R		
		04-05	F & R	DR 125 Z/D	82-83	F & R		
535	YAMAHA YBA 125 Enticer (16C1/3P42/3) FZ 16 (160cc) (IES1/2/3) FZ 16 S (160cc) (IES40) FZ 16 ST-Fazer (1KS2/3) XV 250 V-Star YBR 250 (41S2/3) YS 250 Fazer (5D41/2/3/56C1)			DR 125 E	84	F & R		
		07-12	R	DR 125 G/H/J/SER/SES/SET	86-96	R		
		10-13	R	DS 125 N/T/X	79-81	F & R		
		12-13	R	GN 125 Z/D	82-83	F & R		
		11-13	R	GN 125 EM/EN/EP/ER/ES/ET	91-96	R		
		12-14	R	RM 125 A/B/C	76-78	F & R		
		10-12	R	RM 125 N/T	79-80	F		
536/536G	YAMAHA YFM 90 RY/RZ/RA/RB/RD Raptor	09-13	F	RV 125 K Tracker	73	R		
		537	YAMAHA XC 180 K/KC/L/LC/N/NC/ZL/ZLC/ZN /ZNC/DN/DWC/ Riva XC 200 T/ZCT/U/W/ZU/ZW/ZA/ZB Riva SRX 250 T/TC			RV 125 L/M/A/B Tracker	74-77	F & R
				83-85	R	SP 125 Z/D	82-83	F & R
				87-91	R	SP 125 G/H/J	86-88	R
				87	R	T125/11/R Stinger	69-71	F & R
						TC 125 J/K Prospector	72-73	R
						TC 125 L/M/A/B Prospector	74-77	F & R
						TM 125 K/L/M Challenger	73-75	R
		601	SUZUKI FZ 50 N/T/X/Z/D	79-83	F & R	TS 125 T/X	80-81	F & R
						PE 175 C/N	78-79	F & R
		602/602G	HYOSUNG RX 125 KAWASAKI KLF 110 A1/A2/B1/B2 'Mojave' KLT 110 A1/A2/A3 BN 125 A4-A8/A6F/A7F/A9F KD 125 A2/A3/A4/A5 KE 125 A3-A10 KX 125 A/A3/A4/A5/A6/A7 KX 125 B1 KLT 160 A1 KDX 175 A1/A2/A3 KLT 185 A1/A2 KDX 250 B3/B4 KLX 250 A1/A2 KX 250 B1 KX 250 C1/C2/D1 KZ 250 D1 (LTD)/D2(CSR) KZ 250 L1 (CSR) KZ 250 W1 (LTD) KX 500 A1/A2/B1 KL 600 A1/B1/B2 (KLR) SUZUKI TC 90 Blazer TC 90 R/J Blazer			PE 175 T/X	80-81	F
				RS 175 T/X/Z	80-82	F		
				DS 185 T	80	F & R		
				GT 185 K Adventurer (Drum Front)	73	R		
				GT 185 L/M/A/B Adventurer	74-76	R		
				TS 185 T/X	80-81	F & R		
				DR 200 G/H/J/SET/SEV/SEW/SEX/SEY /SEK1/SEK2/SEK3/SEK4/SEK5/SEK6 /SEK7/SEK8/SEK9/SEL3/SEL5/SEL6	86-90 /96-09 /13-20	R R R		
				SP 200 G/H/J	86-88	R		
				DR 250 Z/D	82-83	F & R		
				DR 250 F	85	R		
				GN 250 Z/D/F/J	82-88	R		
				GZ 250 X/Y/K1-K9/L0 Marauder	99-10	R		
				RM 250 A/B/C/C2	76-78	F		
				RS 250 T/X	80-81	F		
				SP 250 Z/D	82-83	R		
				SP 250 F	85	R		
				TU 250 XK9/XL1/XL2/XL3/XL4/XL5/XL6	09-16	R		
				DR 370 C/N	78-79	F		
				RM 370 A/B	76-77	F		
				DR 400 T	80	F		
				RM 400 C	78	F		
				TM 400 R/J/K/L/M Cyclone	71-75	F		
				RM 465 X/Z	81-82	R		
		DR 500 X/Z/D	81-83	F				
		SP 600 F	85-87	R				
		U.M. V2C-250T	06	R				
603/603G	KAWASAKI AR 50 A1 AR 80 A1 KD 80 M1-M8 KD 80 N1/N2/N3 KE 100 A5/A6/A7/A8/A9/A10 KE 100 B1-B3/B6-B20							
		82	R					
		82	R					
		80-87	F & R					
		88-90	R					
		76-81	F & R					

BUYERS GUIDE
BRAKE SHOES

BRAKE SHOE BUYERS GUIDE

Part No.	Make/Model	Year	Fr/Rear	Part No.	Make/Model	Year	Fr/Rear		
603/603G Contd.	KAWASAKI Contd.			605/605G Contd.	SUZUKI Contd.				
	KM 100 A1/A2/A3/A3A/A4/A6/A7	76-81	F & R		S32-11 (150cc)	66-67	F		
	KLT 110 A1/A2/A3	84-86	F		LT 160 EK/EL/EM/EN	89-92	R		
	KLF 110 A1/A2/B1/B2 'Mojave'	87-88	F		LT-F 160 M/N/P/R/S/T/V/W/X/Y/K1/K3	91-01/03	R		
	KLX 110	02-20	R		LT 160 K3/K4	03-04	R		
	KLX 110L	10-20	R		ALT 185 F	85	R		
	KLT 160 A1	85	F		LT 185 E/F/G/H	84-86	R		
	KLT 185 A1/A2	86-87	F		T 200 X5 Invader	67-69	R		
	KLT 200 A1/A2/A3/A4/A4A	81-83	F		TC 200 X5 Stingray	67-69	R		
	KLT 200 B1	83	F		LT 230 GEF/GEG	85-86	R		
	KLT 200 C1/C2	83-84	F		LT-F 230 G/H	86-87	R		
	KLT 250 A1/A2	82-83	F		DS 250 T	80	F & R		
	KLT 250 C1/C2/C3 'Prairie'	83-85	F		PE 250 B/C/N/T/X	77-81	F & R		
	KLT 250 P1 'Police'	84	F		RS 250 T/X	80-81	R		
	SUZUKI				TS 250 R/J/K/L/M/A/B/C/N/T/X	71-81	F & R		
	AC 50/R	70-71	F & R		RM 250 A/B/C/C2	76-78	R		
	AS 50 Sport/Colt	68-69	F & R		RM 250 N	79	F		
	TC 90 R/J Blazer	71-72	F		DR 370 C/N	78-79	F & R		
	TS 90 R/J Honcho	71-72	F		RM 370 A/B	76-77	R		
	A100 A/B Go-Fer	76-77	R		SP 370 C/N	78-79	F & R		
	RM 100 A/B/C	76-78	F		DR 400 T	80	R		
	TC 100 K/L/M Blazer	73-75	F		SP 400 T	80	F & R		
	TS 100 K/L/M Honcho	73-75	F		PE 400 T/X	80-81	F & R		
	DR-Z 110 K3/K4/K5	03-05	R		RM 400 C	78	R		
	RV 125 K Tracker	73	F		RM 400 N	79	F		
	TC 125 J/K Prospector	72-73	F		TM 400 R/J/K/L/M Cyclone	71-75	R		
	TM 125 K/L/M Challenger	73-75	F		TS 400 J/K/L/M/A/B	72-77	F & R		
	RV 200 L6/L7 Van-Van	16-19	R		DR 500 X/Z/D	81-83	R		
					SP 500 X/Z/D	81-83	F & R		
	604/604G	KAWASAKI				606/606G	ATK		
		KSF 50 A1/A2/A3 (KFX 50)	03-05		R		GV 250 V-Twin Cruiser	11	R
		KLX 125 A1/A2/A3/A6F	03-06		F & R		HYOSUNG		
		KLX 125 L (B1/B2/B3/B6F)	03-06		R		GV 250 V	16-12	R
SUZUKI				SUZUKI					
GSXR 50 (RB 50 H)		87	R	GS 250 TT/TX	80-81		R		
LT-A 50 K2/K3/K4/K5		02-05	R	GS 300 LZ/LD	82-83		R		
LT-Z 50 K6/K7/K8/K9/ZK9		06-22	R	GS 300 LF	85		R		
LT-Z 50 L7/L8		17-18	R	GN 400 T/XT/XX/TX/TZ	80-82		R		
OR 50 T		80	F & R	LT-A 400 FK2/FK3/FK4/FK5/FK6/FCK5					
RM 50 C/N/T		78-80	F & R	/FCK6/FK7/FK8/FLO	02-10		R		
RM 50 X		81	F & R	LT-A 400 FL1/FL2/FL3/FL4/FL5					
RM 60 N/T		79-80	F & R	King Quad 400 Asi	11-22		R		
RM 60 X/Z/D		81-83	F & R	LT-A 400 FCL1/FCL2/FCL3/FCL4/FCL5					
DS 80 T/X/Z/D/F/G/H/J/K/L/M/N/P/R/S				King Quad 400 Asi Camo	11-22		R		
/T/V/W/X/Y		80-00	F & R	LT-A 400 K2/K3/K4/K6	02-04/06		R		
JR 80 K1/K2/K3/K4		01-04	F & R	LT-A 400 FK8 King Quad Auto 4WD	08		R		
RM 80 T/X		80-81	F & R	LT-A 400 K8 King Quad Auto 2WD	08		R		
LT-Z 90 K7/K8/K9/ZK9/L4/L5/L6		07-11		LT-A 400 FCK8/9 King Quad	09		R		
Quadsport		/14-18	F	LT-A 400 FQK9 King Quad	08-09		R		
DR 100 D/E/F/G/H/J/K/L		83-90	F & R	LT-F 400 FK2/FK3/FK4/FK5/FK6/FCK5					
RM 100 N/T/X		79-81	F	/FCK6/FCK7/K8	02-08		R		
SP 100 D		83	R	LT-F 4WD V/W Quadrunner 4WD (250cc)	97-98		R		
DR-Z 125 K3/K4/K5/K6/K7/K8/K9/L2				LT-F 400 K2 Eiger Manual 2WD	02		R		
/L3/L4/L5/L6		03-16	F & R	LT-F 400 K3/4/5/6/7	03-08		R		
DR-Z 125		03-20	R	LT-F 400 FL1-FL5 King Quad 400 FSi	11-15		R		
				LT-F 400 FCL1/FCL2/FCL3/FCL4/FCL5					
			King Quad 400 FSi Camo	11-15	R				
			LT-F 400 FK8/FK9/FLO	08-10	R				
			GS 425 EN (Cast Wheel)	79	R				
			GS 425 LN	79	R				
			GS 450 ET/ST/EX/SX/EZ/ED	80-83	R				
			GS 450 GAZ/GAD/GAF	82-85	R				
			GS 450 LT/LX/LZ/LD/LF/LG/LH/LJ	80-88	R				
			GS 450 TX/TZ	81-82	R				
			GS 450 TXD	83	R				
			GS 550 LD/LF/LG	83-86	R				
			LS 650 FG/PG/PH/FH/PJ/PS/PT/PV/PW	86-88	R				
			/PX/PY/PK1/PK2/PK3/PK4 Savage	/95-04	R				
			LS 650 K5-K9/L1-L5 S40 Boulevard	05-15	R				
			GR 650 D/XD Tempter	83	R				
605/605G	KAWASAKI								
	KDX 250 A1/B1/B2	80-82	R						
	KL 250 A1/A1A/A2	78-80	R						
	KX 250 A6/A7	80-81	R						
	KZ 250 D1 (LTD) D2 (CSR)	80-81	F						
	KZ 250 L1 (CSR)	82	F						
	KZ 250 W1 (LTD)	83	F						
	KDX 400 A1/A2	79-80	R						
	KDX 420 B1	81	R						
	KX 420 A1/A2	80-81	R						
	KDX 450 A1	82	R						
	SUZUKI								
ALT 125 E/F/G	84-86	R							
LT 125 E	84	R							
S32 (150cc) (Single cam f/brake)	65	F & R							

BUYERS GUIDE
BRAKE SHOES

BRAKE SHOE BUYERS GUIDE

Part No.	Make/Model	Year	Fr/Rear	Part No.	Make/Model	Year	Fr/Rear	
608	SUZUKI			615	SUZUKI			
	T 250 II/R/J Hustler	69-72	F		RM 80 Z/D/E/F	82-85	F	
	TC 250 X6 Scrambler	67-69	F		616/616G	SUZUKI		
	GS 300 LZ/LD	82-83	F			RM 125 X/Z/D/E/F/G/H	81-87	R
	T 305 Raider	68-69	F		RM 250 X/Z/D	81-83	R	
	TC 305 Laredo	68	F		617/617G	SUZUKI		
	T 350 1/2/R/J Rebel	69-72	F			SP 100 D	83	F
	GT 380 J Sebring	72	F			RM 100 N/T/X	79-81	R
	T10 (Twin leading shoe f/brake cable rear brake) E/No T10 16816 - T20 X6	66-67 65-69	F F			RM 125 N/T	79-80	R
						RS 175 T/X/Z	80-82	R
609	SUZUKI			618/618G	KAWASAKI			
	GT 250 K/L/M/A/B Hustler	73-77	R		KSF 80 A1/A2/A3/A6F (KFX 80)	03-06	R	
	T 250 II/R/J Hustler	69-72	R		SUZUKI			
	TC 250 X6 Scrambler	67-69	R		LT 80 H/J/K/L/M/N/P/R/S/T/V/W/X/Y			
	T 305 Raider	68-69	R		/K1/K2/K3/K4/K5/K6	87-06	R	
	TC 305 Laredo	68	R		LT-Z 90 K7/K8/K9/ZK9/L4/L5/L6	07-11/14-18	R	
	T 350 1/2/R/J Rebel	69-72	R		PE 175 Z/D/E	82-84	F	
	GT 380 J/K/L/M/A/B Sebring	72-77	R		RM 125 X/Z/D	81-83	F	
	GS 400 XB/XC (Drum Brake)	77-78	R		RM 250 T	80	F	
	GS 400 B/C (Disc Brake)	77-78	R		RM 250 E/F/G	84-86	R	
	GS 425 N (Spoke wheel)	79	R	RM 400 T	80-	F		
	GS 450 TXZ	82	R	RM 500 D/E	83-84	R		
	T 500 I Cobra	68	R	619/619G	SUZUKI			
	T 500 2/3 Titan	69-70	R		PE 175 T/X/Z/D/E	80-84	R	
	T 500 R/J/K/L/M Titan	71-75	R	620/620G	SUZUKI			
	GT 550 K Indy (Front drum brake)	72	R		SP 250 Z/D	82-83	F	
	GT 550 K/L/M Indy	73-75	R		RM 250 N/T	79-80	R	
	T10 (Twin leading shoe f/brake cable rear brake) E/No T10 16816 - T20 X6	66-67 65-69	R R	RM 400 N/T	79-	R		
611	SUZUKI			621/621G	SUZUKI			
	GS 550 LZ	82	R		RM 250 X/Z	81-82	F	
	GS 550 B	77	R		RM 465 X/Z	81-82	F	
	GT 550 A/B Indy (Tokico Caliper)	76-77	R		LT 125 D	83	R	
GT 550 B Indy (Asco Caliper)	77	R	LT 125 F/G/H	85-87	R			
				ALT 125 D	83	R		
612	SUZUKI			622/622G	SUZUKI			
	GS 300 LF	85	F		RM 125 E	84	F	
	GS 400 XB/XC (Drum Brake)	77-78	F		RM 250 D/E	83-84	F	
	GS 450 TXD	83	F	RM 500 D/E	83-84	F		
	T 500 I Cobra	68	F	624/624G	DERBI			
	T 500 2/3 Titan	69-70	F		Atlantis 50 (All models)	99-01	R	
T 500 R/J/K/L/M Titan	71-75	F	GP1 50		02-06	R		
613/613G	KAWASAKI			HUSQVARNA				
	KDX 50 A1/A2/A3/A6F	03-06	F & R	WRS 50 Scooter	98-00	R		
	SUZUKI			ITALJET				
	JR 50 C/N/T/X/Z/RD/F/G/H/J/K/L			Formula 50 (Air Cooled)	99-03	R		
	/M/N/P/R/V/W/X/Y/K1-K6	78-06	F & R	Torpedo 50	98-04	R		
LT 50 E/F/G/H	84-87	R	Velocifero 50	98-03	R			
ALT 50 D/E	83-84	R	625/625G	SUZUKI				
614/614G	E-TON QUADS				LT 160 EK/EL/EM/EN	89-92	F	
	DXL-90 Sierra	99-03		F	LT 160 K3/K4	03-04	F	
	KAWASAKI				LT-F 160 M/N/P/R/S/T/V/W/X/Y/K1/K3	91-01/03	F	
	KSF 50 A1/A2/A3 (KFX 50)	03-05		F	625/625G	SUZUKI		
	KSF 80 A1/A2/A3/A6F (KFX 80)	03-06	F	LT 230 GEF/GEG		85-86	F	
SUZUKI			LT-F 230 G/H	86-87		F		
FA 50 T/X/MX/Z/D/E/F/G/H/J/K/L/M	80-91	F & R	LT 250 EFF/EFK	85-86		F		
FS 50 T/X	80-81	F & R	LT 300 EH/EJ/EK	87-89		F		
SUZUKI ATV								
LT-A 50 K2-K5 QuadSport	02-05	F						
LT-Z 50 K6/K7/K8/K9/ZK9	06-22	F						
LT-Z 50 L7/L8	17-18	F						
LT 80 H/J/K/L/M/N/P/R/S/T/V/W/X/Y								
/K1/K2/K3/K4/K5/K6	87-06	F						

BRAKE SHOE BUYERS GUIDE

Part No.	Make/Model	Year	Fr/Rear	Part No.	Make/Model	Year	Fr/Rear			
626	SUZUKI			702/702G	KAWASAKI					
	LT-F 4 WDXM/N/P/R/S/T/V/W	91-98	R		KX 125 B2/C1/D1	83-85	R			
	LT-F 400 FK2/K2/FK3/K3 Eiger	02-03	R		KDX 200 A1/A2/A3	83-85	R			
	LT-A 400 FK2/FK3 Eiger 4WD	02-03	R		KDX 200 C1/C2/C3	86-88	R			
	LS 650 K5 Boulevard S40 (650cc)	05	R		703/703G	KAWASAKI				
	GV 700 GLF/GLF2	85	R			KE 175 D2/D3/D4/D5	80-83	R		
	VS 700 All models	86-87	R			KDX 200 A1/A2/A3	83-85	F		
	VS 750 GLP/J/GLPK/GLPL/GLPM Intruder	88-91	R			KL 250 A3/A4/A5	80-82	R		
	VL 800 K1-K4 'Intruder Volusia'	01-05	R			KL 250 C1/C2	83-84	R		
	VL 800 Boulevard C50/Touring	05-20	R			KL 250 D2/D3 (KLR 250)	85-86	R		
	VL 800 ZL2 C 50 T Boulevard Classic	12	R			KL 250 D4-D22 (KLR 250)	87-05	R		
	VL 800 ZK3/ZK4 Volusia Ltd	03-04	R			704/704G	KAWASAKI			
	VL 800 CL3 (Boulevard C50 Special Edition/Cast Wheels)	13	R				KD 125 A2/A3/A4/A5	75-79	R	
	VL 800 BT L4 (Boulevard C50 B.O.S.S. Cast Wheels)	14	R				KE 125 A3-A10	76-83	F	
	VS 800 GLN/GLP/GLR/GLS/GLT/GLV/GLW/GLX/GLY/GLK1/GLK2/GLK3/GLK4 Intruder	92-04	R		KX 125 A/A3/A4/A5/A6/A7		74-81	F		
	VS 800 K5/CK5/K6/CK6/K7/ZK8/ZK9/L1/L2/L3/L4/L5 C50 Boulevard	05-15	R		KDX 175 A1/A2/A3		80-82	F		
	VZ 800 V/W/X/Y/K1-K4 'Marauder'	97-04	R		KE 175 D2/D3/D4/D5		80-83	F		
VZ 800 K5/K6/BK6/K7/ZK7/K8/ZK8/K9/ZK9/L0/L1/L2/L3/L4/L5 M50 Boulevard	05-15	R	KL 250 A3/A4/A5	80-82	F					
			KL 250 C1/C2	83-84	F					
			KLX 250 A1/A2	79-80	F					
			705/705G	KAWASAKI						
628/628G	KAWASAKI KAF 300 A1/B1/B2 (Mule 500) KAF 300 C1/C2/C3/C4/C6/C7 (Mule 550) KAF 300 D1/D2 (Mule 520)				KLF 185 A2/A3/A4 'Bayou'	86-88	F			
					KLT 200 A1/A2/A3/A4/A4A	81-83	R			
					KLT 200 B1	83	R			
629/629G	SUZUKI LT-4WD H/J/K/L/M/N/P/R/S/T/V LT-F 4 WDT/V LT-F 4 WD/V/W LT-F 250 J/K/L/M/N/P/R/S/T/V/W LT-F 250 FX/FY/FK1/FK2 "Quadrunner"				KLT 200 C1/C2	83-84	R			
					KLF 220 A1-A15 Bayou	88-02	F			
					KDX 250 A1/B1/B2	80-82	F			
					KDX 250 B3/B4	83-84	F			
					KL 250 A1/A1A/A2	78-80	F			
					KLF 250 A1/A2/A3/A6F/A7F/A8F/A9F/AAF/ABF Bayou	03-11	F			
633/633G	SUZUKI LT-F 4WDXM/N/P/R/S/T/V/W LT-F 300 FX/FY/FK1 "King Quad"			KLT 250 A1/A2	82-83	R				
				KLT 250 C1/C2/C3 'Prairie'	83-85	R				
				KLT 250 P1 'Police'	84	R				
				KX 250 A6/A7	80-81	F				
				KXT 250 A1 'Tecate'	84	F				
				KDX 400 A1/A2	79-80	F				
634/634G	SUZUKI LT 250 EFF/EFB LT 300 EH/EJ/EK LT-F 300 FX/FY/FK1 "King Quad" LT-F 300 FK2 LT-F 300 FX/FY LT-F 4WD XM/N/P/R/S/T/V/W LT-A 500 FY/FK1 LT-F 500 FW/FX/FY/FK1/FK2 RE 5 M/A (Rotary) GS 750 TZ/TD (16 valve) GT 750 J (Drum Brake) Le-Mans GT 750 K/L/M/A/B			KDX 420 B1	81	F				
				KX 420 A1/A2	80-81	F				
				KDX 450 A1	82	F				
				706/706G	KAWASAKI KLF 185 A1/A1A 'Bayou' KLF 185 A2/A3/A4 'Bayou' KLF 220 A1-A15 Bayou EL 250 B2/B3 Eliminator EL 250 E1/E2/E3/E4 250 HS EL 250 F2 'EL252' KLF 250 A1-A3/A6F-A9F/AAF/ABF Bayou KLF 300 A1/A2 Bayou KLF 300 B1-B17 'Bayou' KZ 305 A1/A2 (CSR) KZ 305 B1 (CSR) KZ 305 B2/B3 (LTD) EX 305 B1 (GPz) KZ 440 A1/A2/A3/A4 KZ 440 B1/B2 KZ 440 D1/D2/D3/D4 (LTD) KZ 440 D5 (LTD) KZ 440 G1 EX 500 A1-A7 W 650 (EJ 650 A1/A2/A3/A4) W 800 (Solid Front Disc) W 800 Café (Cockpit Fairing) W 800 Special (Black Exhaust) W 800 ABS W 800 ABS Special			KX 420 A1/A2	80-81	F
								KX 420 A1/A2	80-81	F
								KX 420 A1/A2	82	F
								KLF 185 A1/A1A 'Bayou'	85	R
								KLF 185 A2/A3/A4 'Bayou'	86-88	R
								KLF 220 A1-A15 Bayou	88-02	R
								EL 250 B2/B3 Eliminator	88-89	R
EL 250 E1/E2/E3/E4 250 HS	91-95	R								
EL 250 F2 'EL252'	97-99	R								
KLF 250 A1-A3/A6F-A9F/AAF/ABF Bayou	03-11	R								
KLF 300 A1/A2 Bayou	86-87	R								
KLF 300 B1-B17 'Bayou'	88-04	R								
KZ 305 A1/A2 (CSR)	81-82	R								
KZ 305 B1 (CSR)	82	R								
KZ 305 B2/B3 (LTD)	87-88	R								
EX 305 B1 (GPz)	83	R								
KZ 440 A1/A2/A3/A4	80-83	R								
KZ 440 B1/B2	80-81	R								
KZ 440 D1/D2/D3/D4 (LTD)	80-82	R								
KZ 440 D5 (LTD)	83	R								
KZ 440 G1	82	R								
EX 500 A1-A7	87-93	R								
W 650 (EJ 650 A1/A2/A3/A4)	00-02	R								
W 800 (Solid Front Disc)	11-12	R								
W 800 Café (Cockpit Fairing)	11	R								
W 800 Special (Black Exhaust)	12	R								
W 800 ABS	13-16	R								
W 800 ABS Special	13-16	R								
636/636G	SUZUKI LT-Z 250 K4/K5/K6/K7/K8/K9 QuadSport LT-F 250 K2-K9/L2/L3/L4 Ozark									
701/701G	KAWASAKI KDX 80 A1/A2 KDX 80 B2/B3 KX 80 C1/C2									

BUYERS GUIDE
BRAKE SHOES

BRAKE SHOE BUYERS GUIDE

Part No.	Make/Model	Year	Fr/Rear	Part No.	Make/Model	Year	Fr/Rear
708	KAWASAKI			718	KAWASAKI		
	KH 250 A5	76	R		KAF 300 A1/B1/B2 (Mule 500)	92-95	R
	S1-A/B/C (250cc)	73-75	R		KAF 300 C1/C2/C3/C4/C6/C7 (Mule 550)		R
	S2 (350cc)	72-73	R		KAF 300 D1/D2 (Mule 520)		R
	S2-A (350cc)	72-73	R		KAF 400 ABF/ACF/ADF/AEF/AFF		
	S3/S3-A (400cc)	74-75	R		(Mule 610 4x4)	11-15	F
	KH 400 A3/A4/A5	76-78	R		KAF 400 B1 Mule 600	05	F & R
KZ 400 S/S2/S3	75-77	R	KAF 400 A1/C1 Mule 610 4x4	05	F & R		
709	KAWASAKI			719	KAWASAKI		
	EN 450 A1-A6 (454 Ltd)	85-90	R		KAF 400 A6F/A7F/A8F/A9F/AAF	06-10	F & R
	EN 500 A1-A6/B2/C1 Vulcan	90-96	R		(Mule 610 4x4)		
	EN 500 C1-C10/C6F/C7F/C8F/C9F Vulcan	96-09	R		KAF 400 B6F/B7F/B8F/B9F/BAF/BBF	06-15	F & R
	KZ 550 A1/A2/A3/A4	80-83	R		/BCF/BDF/BEF/BFF (Mule 600)		
	KZ 550 C1/C2/C3/C4 (LTD)	80-83	R		KAF 400 C6F/C7F/C8F/C9F	06-09	F & R
	KZ 550 F1 (Spectre) F2 (LTD)	83-84	R		(Mule 610 4x4 Hardwoods Green HD)		
	KZ 550 M1 (LTD)	83	R		KAF 400 DAF/DBD/DCF/DDF/DEF/DFE	10-15	F
	ZL 600 A1/A2	86-87	R		(Mule 610 4x4 XC)		
	ZL 600 B2/B3 Eliminator	96-97	R		KAF 400 DBF/DCF/DDF/EBF/ECF/EDF/EEF	11-15	F
	KZ 650 B1/B2/B2A/B3	77-79	R		/EFF (Mule 610 4x4 Realtree/Camo)	14-15	F
	KZ 650 E1 (LTD)	80	R		KAF 400 FEF/FFF (Mule 610 4x4 XC SE)	17	F&R
	KZ 650 F1	80	R		KAF 400 JHF (Mule SX)	17	F&R
	KZ 650 H1/H2/H3 (CSR)	81-83	R		KAF 400 HHF (Mule SX 4X4)	17	F&R
	VN 700 A1 'Vulcan'	85	R		KAF 400 NHF (Mule SX 4X4 SE)	17	F&R
	KZ 750 G1 (LTD)	80	R		KAF 400 KHf (Mule SX 4X4 XC)	17	F&R
	KZ 750 K1/K2 (LTD)	83-84	R		KAF 400 LHF (Mule SX 4X4 XC Camo)	17	F&R
	KZ 750 M1 (CSR)	82	R		KAF 400 MHF (Mule SX 4X4 XC SE)	17	F&R
	VN 750 A2-A21/A6F 'Vulcan'	86-06	R				
	VN 800 A1-A11/B1-B9 Vulcan/Vulcan Classic	95-05	R				
710/710G	KAWASAKI			719	KAWASAKI		
	KLF 300 C1-C17	89-05	R		KAF 400 ABF/ACF/ADF/AEF/AFF	11-15	R
	KVF 300 A1-A4/B1-B4 Prairie	99-02	R		(Mule 610 4x4)		
	KLF 400 B1-B7	93-99	R		KAF 400 DAF/DBD/DCF/DDF/DEF/DFE	10-15	R
	KVF 400 A1/A2/B1/C1-C4/D1-D4 'Prairie'	97-02	R		(Mule 610 4x4 XC)		
	KH 500 A8	76	R		KAF 400 EBF/ECF/EDF/EEF/EFF	11-15	R
HI-D/Hi-E/Hi-F 500	73-75	R	(Mule 610 4x4 Realtree Camo XC)	14	R		
711	KAWASAKI			719	KAWASAKI		
	KH 250 A5	76	F		KAF 400 FEF (Mule 610 4x4 XC SE)		F
	S1-A/B/C (250cc)	73-75	F		KAF 450 B1 (Mule 1000)		F
	S2 (350cc)	72-73	F		KAF 540 C1 (Mule 2010)		F
	KZ 400 S/S2/S37	75-77	F		KAF 540 D1 (Mule 2020)		F
	KZ 440 B1/B2	80-81	F		KAF 540 E1 (Mule 2030)		F
713	KAWASAKI			719	KAWASAKI		
	H2/H2-A "Mach IV"	72-73	R		KAF 620 A1-A6 (Mule 2510)		F
	H2-B/H2-C "Mach IV"	74-75	R		KAF 620 B1-B6 (Mule 2520)		F
	Z1/A/B 900	73-75	R		KAF 620 C1-C6 (Mule 2500)		F
	KZ 900 A4/A5	76-77	R		KAF 620 E1-E5 Mule 3010		F
714/714G	KAWASAKI			719	KAWASAKI		
	KDX 80 C1/C2/C3/C4/C5	84-88	F		KAF 620 F1/F2/F3 Mule 3020		F
	KX 80 E1	83	F		KAF 620 G1-G5 Mule 3000		F
715/715G NOW with SPRING to avoid fouling	KAWASAKI			719	KAWASAKI		
	KX 60 A1/A2	83-84	F & R		KAF 620 H1-H3 Mule 3010 4x4	03-05	F
	KX 60 B1-B19	85-03	F & R		KAF 620 K1/K6F/K7F Mule 3010 Trans 4x4	05-07	F
	KDX 80 C1/C2/C3/C4/C5	84-88	R		KAF 620 J1 Mule 3010 Trans 4x4	05	F
	KX 80 E1-E3	83-85	R		KAF 620 M9F/MAF/MBF/MCF/MDF/MEF		
	KX 80 G1/G2	86-87	R		/MFF/MGF/MHF (Mule 4010 4x4)	09-17	F
	KX 80 J2	87	R		KAF 620 N9F (Mule 4010 4x4 Hardwoods Green)	09	F
	KLX 110	02-20	F		KAF 620 P9F/PAF /PBF/PCF/PDF/PEF		
	KLX 110	10-20	R		/PFF/PGF/PHF (Mule 4000)	09-17	F
	SUZUKI				KAF 620 R9F/RAF/RBF/RCF/RDF/REF/RF		
RM 60 K3	03	F & R	/RFFA/RGF/RHF (Mule 4010 Trans 4x4)	09-17	F		
DR-Z 110 K3/K4/K5	03-05	F	KAF 620 S9F/SAF/SBF/SCF/SDF/SEF/SFF				
717/717G	KAWASAKI			719	KAWASAKI		
	KLF 300 A1/A2 'Bayou'	86-87	F		/SFG/SHF (Mule 4010 Trans 4x4		
					Hardwoods Green HD)	09-17	F
					KAF 620 TGF/TGF (Mule 4010 4x4 SE)	16-17	F
					KAF 620 VGF/VHF (Mule 4010 Trans 4x4 SE)	16-17	F
			KAF 950 A1/A2/A3 (Mule 2510 Diesel)		F		
			KAF 950 B1-B3/B6F/B7F (Mule 3010 Diesel)	03-07	F		
			KAF 950 C8F/D8F Mule 3010 Diesel 4x4	07-08	F		
			KAF 950 E8F Mule 3010 Trans 4x4 Diesel	08	F		
			KAF 950 F9F/FAF/FBF/FCF/FDF				
			(Mule 4010 Diesel 4x4)	09-13	F		
			KAF 950 G9F/GAF/GBF/GCF/GDF				
			(Mule 4010 Trans 4x4 Diesel)	09-13	F		
			KAF 950 HAF (Mule 4010 Trans				
			4x4 Diesel Realtree)	10	F		
			SUZUKI				
			QUV 620 FK5 Side x Side	05	F		

BRAKE SHOE BUYERS GUIDE

Part No.	Make/Model	Year	Fr/Rear	Part No.	Make/Model	Year	Fr/Rear				
814G Contd.	KTM Contd.			822G	MAICO/M-STAR						
	GSXC/GS 300	85	R		All Models	84-85	R				
	MX/MXC 300	85	R		Front disc models	85	R				
816	APRILIA Sport City 50 (4T) SR 50 Motard (4T) Mojito Custom 150 Scarabeo 100 4T Sport City 125 (4T) DERBI Boulevard 150 Atlantis Bullet/City ITALJET Torpedo 125 4T Torpedo 150 Jet Set 125/150 PIAGGIO Fly 50 Fly 50 (4T/2V) Fly 50 (4T/4V) Liberty 50 (4T) Liberty 50 S (4T) LT 50 Typhoon 50 (4T/4V/14" wheels) Typhoon 50 (4T/4V/12" wheels) Typhoon 125 (4T) (12" wheels) Liberty 150 (4T) Liberty 150 S (4T) LT 150 Fly 150 VESPA Electrica Primavera 50 (4T/4V) Primavera 50 (4T/3V) Sprint 50 (4T/4V) Sprint 50cc (4T/3V) Primavera 150 (4T/3V/ie) Sprint 150 ABS (4T/3V/ie) Sprint 150 (4T/3V) S	08-12	R	841G	BETA 125 TR 32/33 240 TR 33 CAGIVA WMX 125/250 MAICO/M-STAR All models Disc Models	86-87	R				
		12-15	R			86-88	R				
		05-09	R			-85	R				
		04-12	R	853	TRIUMPH T 120 (650cc/Twin Leading Shoe) T 150 (Trident 3 cycl)	86	F & R R				
		08-12	R								
		03-05	R	854	TRIUMPH T 120 (650cc/Twin Leading Shoe) T 150 (Trident 3 cycl)	66-70 69-72	F F				
		02-05	R								
		99-04	R	858	TRIUMPH Cub 500	66-70 69-72	R R				
		03	R								
		03	R	859	BMW R 80/R 80 RT R 80 GS R 80 PD/CH R 100 GS R 100 PD R 100 RS R 100 RT R 80 Mystic R 80 R R 100 Mystic R 100 R R 850 GS	09/8-95 87-95 90-95 86-94 89-96 9/89-92 09/89-95 94-95 91-94 93-96 91-95 96	R R R R R R R R R R R R				
		03	R								
		05-11	R								
		07-10	R								
		11-15	R								
		17-20	R								
		17-20	R								
		97-05	R								
		12-15	R								
		10-11	R								
		10-20	R								
		17-20	R								
		17-20	R								
		17-20	R								
		98-04	R								
		06-11	R								
		19-20	R								
		13-15	R								
		16-20	R								
		14-15	R								
		16-20	R								
		13-20	R								
		14-15	R								
		16-20	R								
		817	APRILIA Mojito Retro 50 Mojito Custom 50 Scarabeo 100 4T	04-05 04-06 04-05	R R R	860	BMW R 45/45 N R 50/5 / 60/5 / 60/6 / 75/5 R 60/7 R 60 TIC R 75/6, 75/5 R 80 R 80 TIC R 90 S R 90/6 R 100 R 100/7 T R 100 S R 100 RS R 100 RT	78-09/80 69-76 76-80 78-82 73-79 77-09/80 78-08/80 73-76 73-76 76-77 77-09/80 76-08/80 76-09/80 78-09/80	R R R R R R R R R R R R R		
		818	KYMCO STREET People 50 (2T) People S 50/125 People 150 Super 8 (150cc) Super 8 X (150cc) People S200 MALAGUTI Ciak 150	02-10 05-09 07-12 07-12 20 05-10	R R R R R R						
		820	KYMCO STREET Super 8 (50cc) (2T) SYM Symba 110 HS 125/200 Fiddle II 125 (AW 125 W) Sym Wolf 150 Classic TGB/PEIRSPEED Laser R9/i (151cc)	07-12	R						
				09-12	F						
				04-10	R						
				08-12	R						
				11-14	R						
				08-11	R						
		821G	MAICO/M-STAR All Models	84-85	F			861	BMW R 45/45 N R 45 T R 65 R 65 GS R 65 RT R 65 T R 80 R 80/R 80 RT R 80 RT R 80 GS R 80 ST R 80 TIC R 100/7T R 100 RS R 100 RT K 75/75-2 (Non ABS)	10/80-85 80-85 07/88-08/89 87-92 85-88 80-85 10/80-84 84-95 82-84 80-87 82-84 09/80-85 09/80-84 86/08/89 87-08/89 84-96	R R R R R R R R R R R R R R

BUYERS GUIDE
BRAKE SHOES

BRAKE SHOE BUYERS GUIDE

Part No.	Make/Model	Year	Fr/Rear	Part No.	Make/Model	Year	Fr/Rear
861 Contd.	BMW Contd. K 75/75-2 (ABS model) K 75 C	84-07/90 85-12/88	R R	977G	CAGIVA WMX 125/250	86-88	R
862	BMW R 65 LS	81-85	R	978	MUZ 500 Country	93-98	R
863	BMW K 75/75-S (Non ABS)	84-08/88	R	982G	CAGIVA WMX 500	84-86	R
864	BMW R 50/5 / 60/5 / 60/6 / 75/5	69-76	F	984	HUSQVARNA Husky Boy Racing S Husky Boy Drum front & rear Husky Boy Racing J Husky Boy J/S Husky Boy R	00 00-02 00 01-02 01	F & R F & R F & R R R
873	KTM 60 SX 65 SX	98-99 98-99	R R				
893	APRILIA Scarabeo 50 Rally 50 (Air cooled) MALAGUTI Yesterday Ciak 50 F10 Jet Line F15 Firefox PIAGGIO Typhoon 50 Typhoon 50 (4T/4V/12" Wheels)	99-05 04-05 98-04 02-04 02-04 02-03 07-09 10-20	R R R R R R R R				
897	TGB/PEIRSPEED 101 S/Key West (50) Delivery 50 (Up to E.No. 609099) Delivery 50 (From F.No. 609100) Sunset 50	05-08 05-06 06-08 06-08	R R R R				
899	PIAGGIO Typhoon 50/SE Typhoon 50 (2T) 10" wheels VESPA ET2 50cc LX 50 S 50 4T/4V ET4 150cc LX 150 ie LXV 150 ie S 150	06 07-09 97-05 05-15 08-15 99-05 05-15 10-15 08-15	R R R R R R R R				
903	VESPA PX 150 (All models)	05-06	R				
921	DUCATI 250/350/450 'Desmo'	74-77	R				
928	DUCATI 250/350/450 'Desmo'	-76	F				
929	DUCATI 250/350/450 'Desmo'	-76	R				
938	HYOSUNG TE 50 TE 90 TE 100	05-08 05-08 05-08	F F F				
944G	CAGIVA WMX 125	-85	F				
950	CZ/JAWA Scrambler Cross 125-380 Jawa 250/400 Cross 250/380 (Models 513/514)	65-76 65-76 77-79	F & R F & R R				

BRAKE SHOE ILLUSTRATIONS

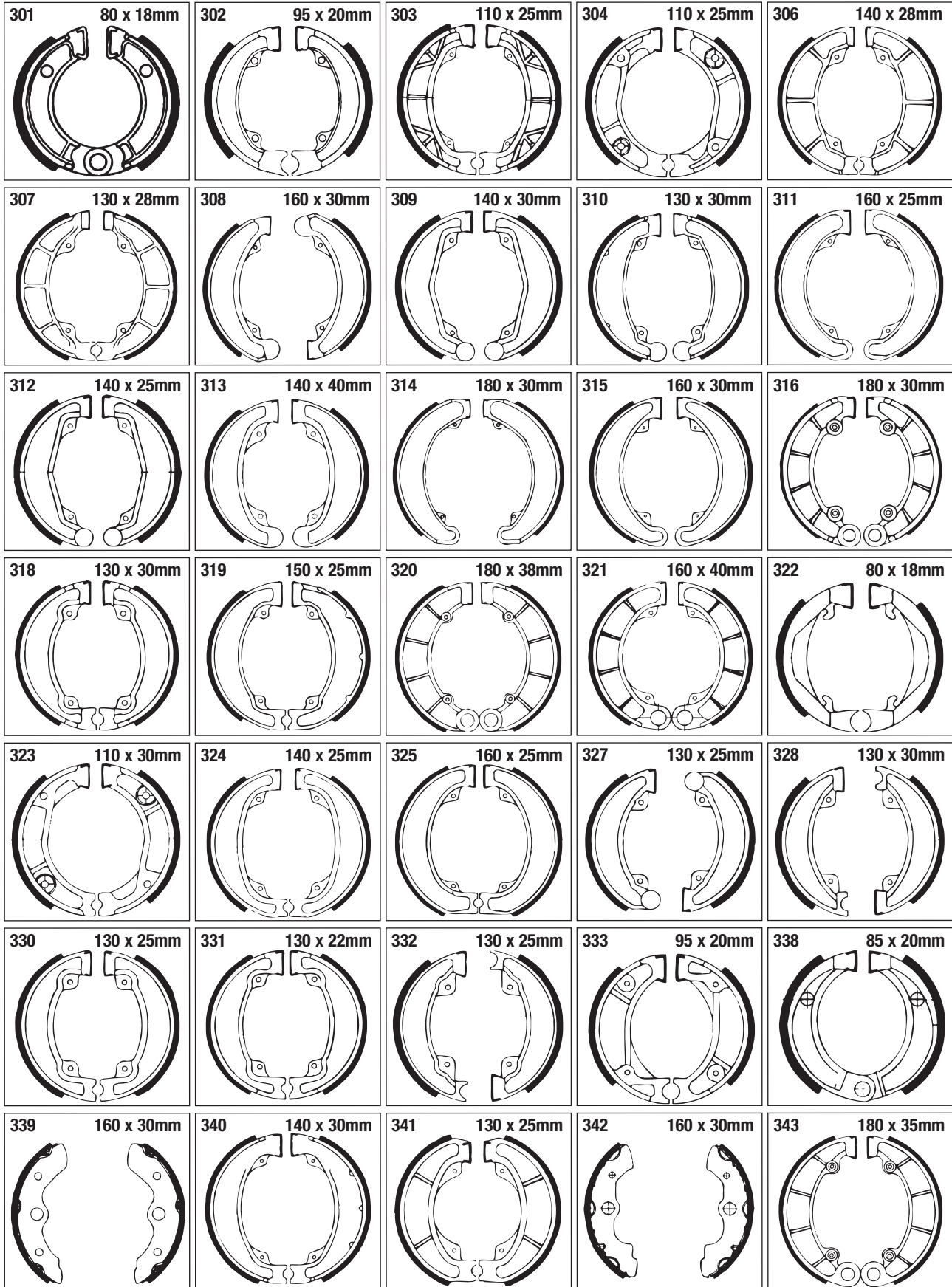

BRAKE SHOE ILLUSTRATIONS

BUYERS GUIDE
BRAKE SHOES

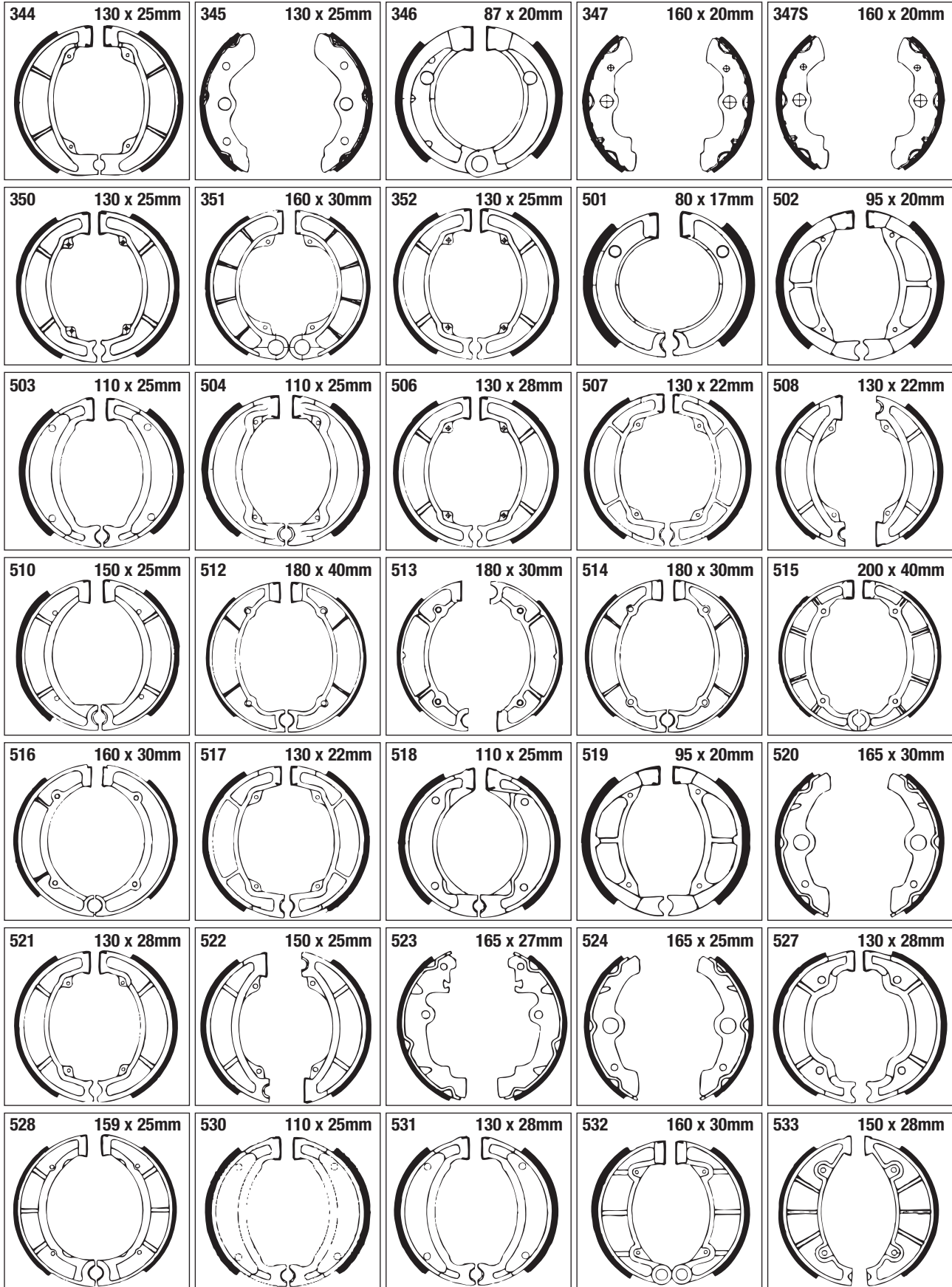

BRAKE SHOE ILLUSTRATIONS

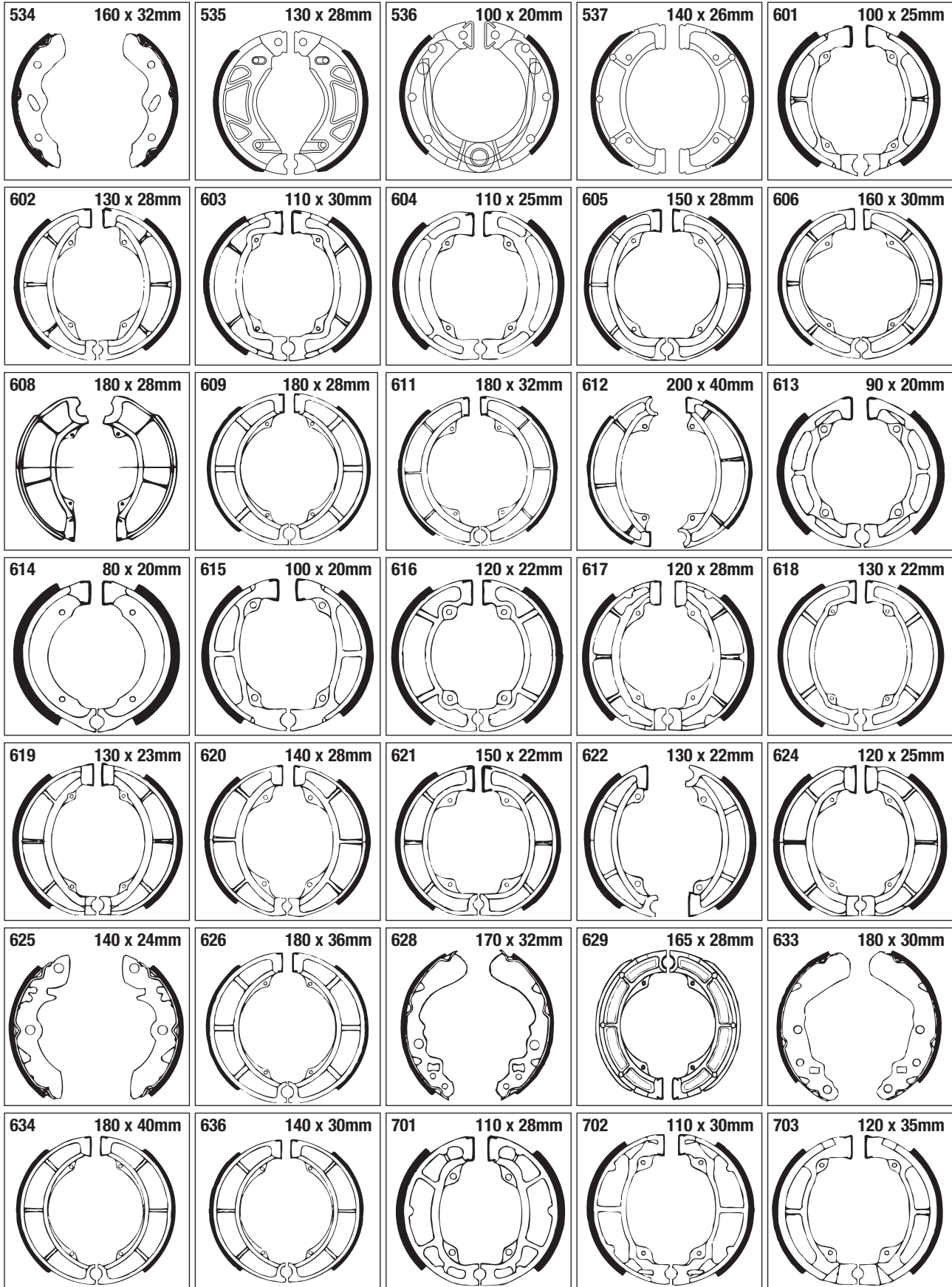

BRAKE SHOE ILLUSTRATIONS

BUYERS GUIDE
BRAKE SHOES

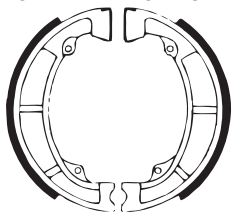
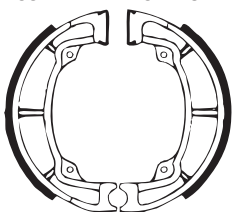
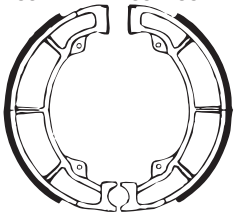
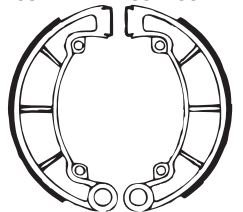
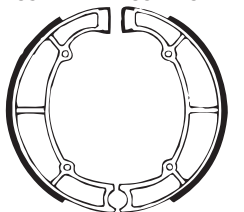
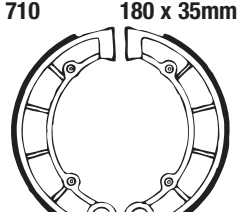
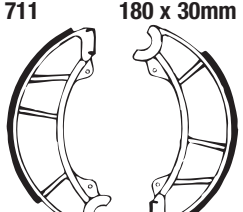
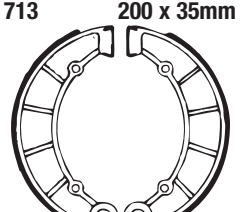
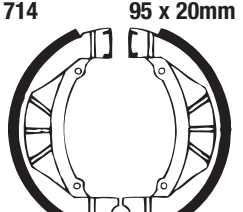
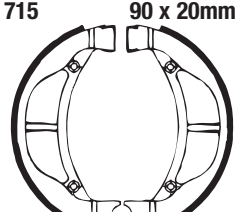
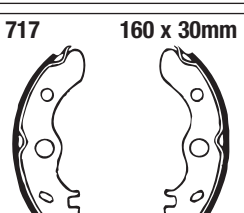
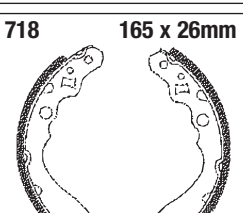
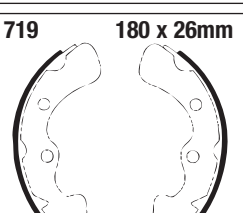
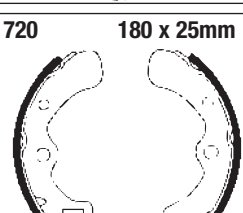
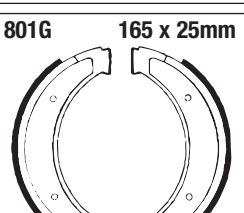
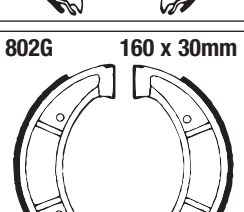
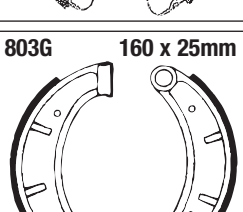
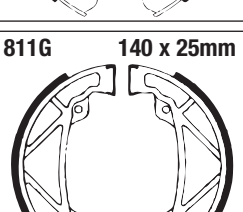
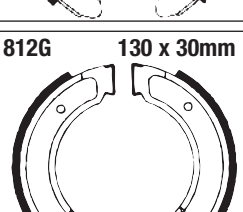
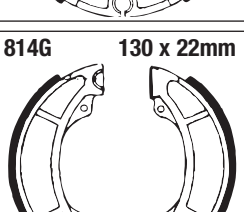
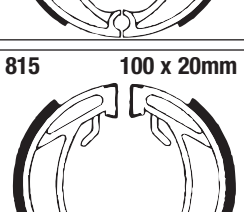
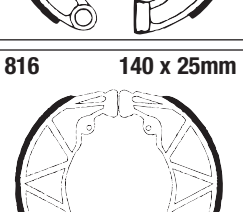
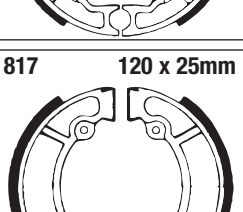
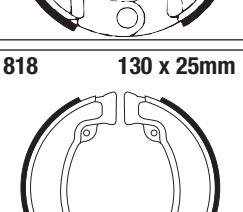
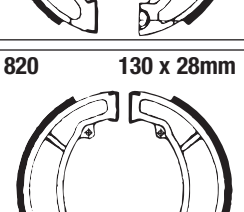
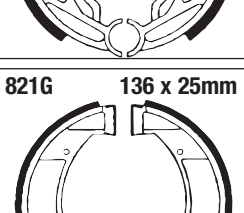
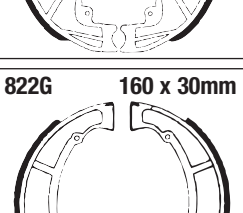
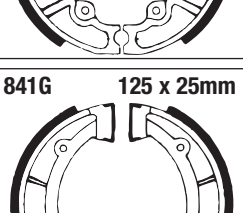
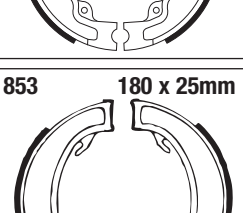
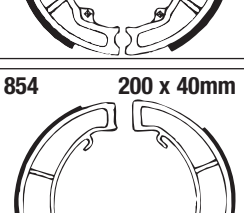
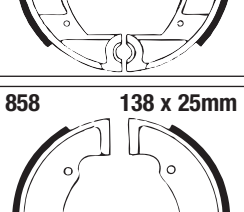
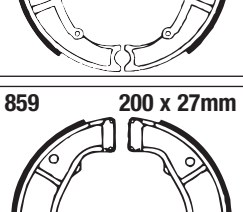
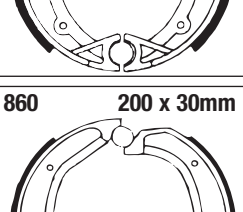
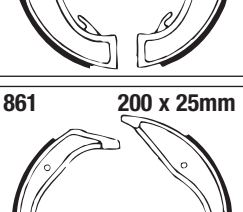
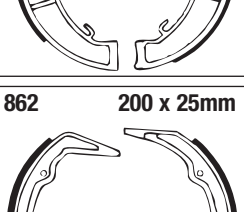
704  120 x 28mm	705  140 x 28mm	706  160 x 30mm	708  180 x 30mm	709  180 x 40mm
710  180 x 35mm	711  180 x 30mm	713  200 x 35mm	714  95 x 20mm	715  90 x 20mm
717  160 x 30mm	718  165 x 26mm	719  180 x 26mm	720  180 x 25mm	801G  165 x 25mm
802G  160 x 30mm	803G  160 x 25mm	811G  140 x 25mm	812G  130 x 30mm	814G  130 x 22mm
815  100 x 20mm	816  140 x 25mm	817  120 x 25mm	818  130 x 25mm	820  130 x 28mm
821G  136 x 25mm	822G  160 x 30mm	841G  125 x 25mm	853  180 x 25mm	854  200 x 40mm
858  138 x 25mm	859  200 x 27mm	860  200 x 30mm	861  200 x 25mm	862  200 x 25mm

BRAKE SHOE ILLUSTRATIONS

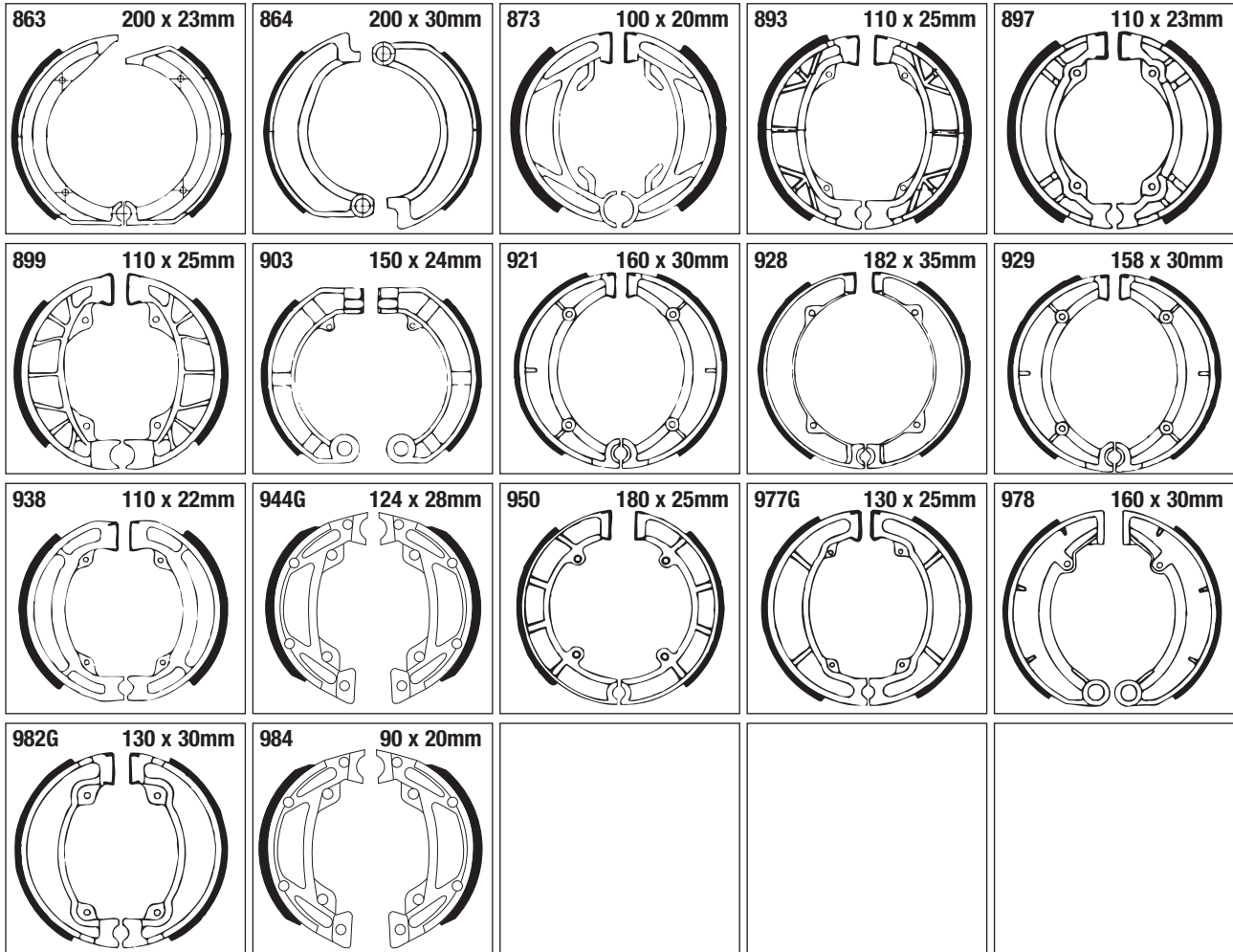

BUYERS GUIDE
BRAKE SHOES

BRAKE SHOE DIAMETER CHART
(in mm)

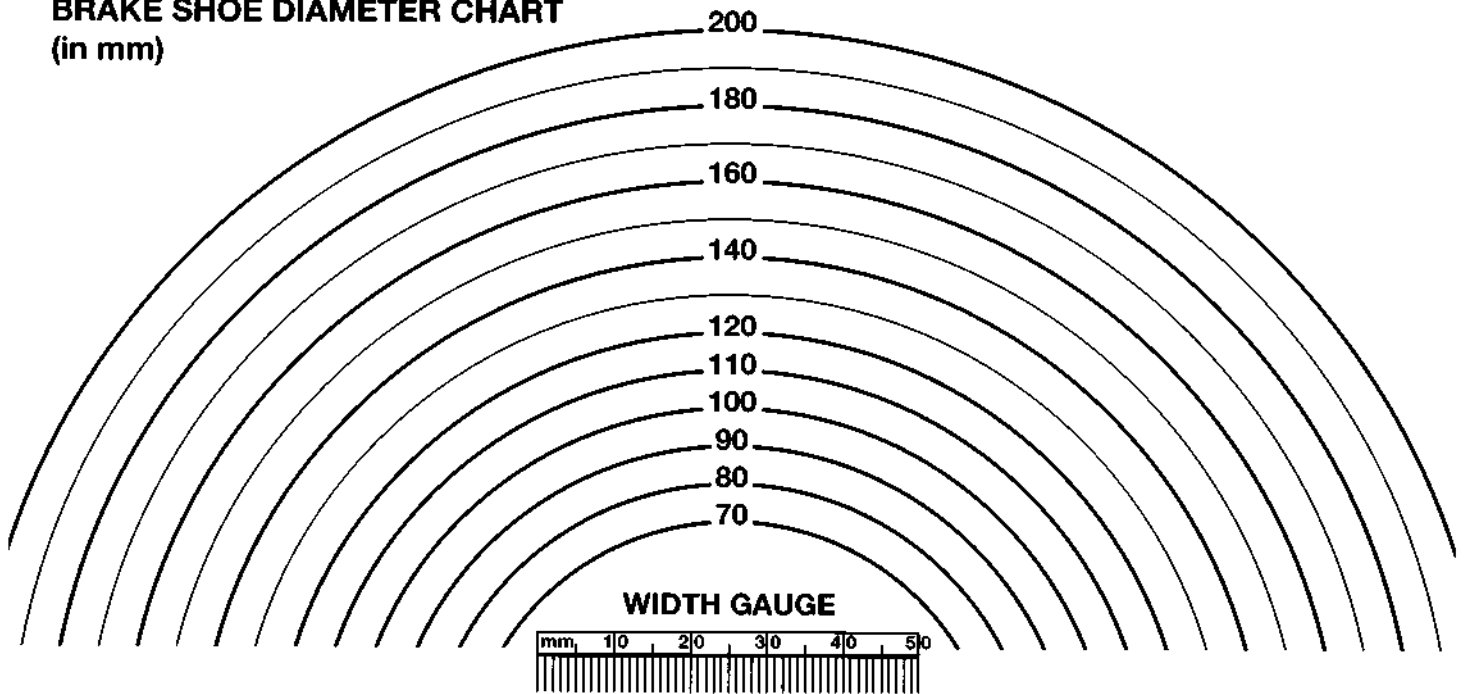

BRAKE ROTOR BUYERS GUIDE - STREET

Rotor No.	F/R	Type	Dia. (mm)	Hub Color	Profile	Bobbins	Left Bracket	Right Bracket	Model	Year
Disc Group 001 FSD008 FSD010 FSD010BLK FSD012C FSD012CBLK FSD023 FSD023BLK FSD027C FSD027CBLK VR009 VR010BLK VR023BLK OSMD004-14BLK OSMD004-15BLK OSMD004-15/6BLK OSVR004-14BLK OSVR004-15BLK OSVR004-15/6BLK	F F F F F F F F F F F F F F F F F F F	Solid Floating Floating Floating Floating Floating Floating Floating Floating Solid Floating Floating Floating Floating Floating Floating Floating Floating Floating	290 290 290 290 290 290 290 290 290 290 290 290 355 381 381 355 381 381	N/A Polished Black Polished Black Polished Black Polished Black N/A Black Black Black Black Black Black Black Black Black	Plain Plain Plain Contour Contour Plain Plain Contour Contour Vee Vee Vee Plain Plain Plain Vee Vee Vee	N/A 5 5 5 5 10 10 10 10 N/A 5 10 5 5 5 5 5 5 5			HARLEY DAVIDSON® All models, 00 onwards (Check main catalogue for model fitments)	
Disc Group 002 FSD007 FSD009 FSD009BLK FSD011C FSD011CBLK FSD022 FSD022BLK FSD026C FSD026CBLK VR007 VR011BLK	F F F F F F F F F F F	Solid Floating Floating Floating Floating Floating Floating Floating Floating Solid Floating	290 290 290 290 290 290 290 290 290 290 290	N/A Chrome Black Chrome Black Chrome Black Chrome Black N/A Black	Plain Plain Plain Contour Contour Plain Plain Contour Contour Vee Vee	N/A 5 5 5 5 10 10 10 10 N/A 5			HARLEY DAVIDSON® 11 1/2" F Floating Disc Conversion. (Sportsters & Big Twins with speedo notch) See main catalogue listing for full fitment info.	
Disc Group 003 RSD008 RSD020 RSD018C RSD020BLK RSD018CBLK VR008 VR020BLK	R R R R R R R	Solid Floating Floating Floating Floating Solid Floating	290 290 290 290 290 290 290	N/A Chrome Chrome Black Black N/A Black	Plain Plain Contour Plain Contour Vee Vee	N/A 10 10 10 10 N/A 10			HARLEY DAVIDSON® All models, 00 onwards (Check main catalogue for model fitments)	
Disc Group 004 RSD007 RSD019 RSD019C RSD019BLK RSD017CBLK VR019BLK RSD007A	R R R R R R R	Solid Floating Floating Floating Floating Floating Solid	290 290 290 290 290 290 290	N/A Chrome Chrome Black Black Black N/A	Plain Plain Contour Plain Contour Vee Plain	N/A 10 10 10 10 10 N/A			HARLEY DAVIDSON® 11 1/2" F Floating Disc Conversion. (Sportsters & Big Twins with speedo notch) See main catalogue listing for full fitment info. INDIAN Chief/Deluxe/Springfield/Road Master/Vintage/Scout/Spirit	02-08
MD509SR Billet	R	Solid	290	N/A	Plain	N/A			HARLEY DAVIDSON® FLT, FLHT, FLHTCI FLHR, FLHRCI	86-99 94-99
Disc Group 005 MD511	R	Solid	240	N/A	Plain	N/A			BUELL All Model	94-02
Disc Group 006 MD514LS/RS VR514	F F	Solid Solid	292 292	N/A N/A	Plain Vee	N/A N/A			HARLEY DAVIDSON® VRSCA V-Rod	43953
MD515	R	Solid	292	N/A	Plain	N/A			HARLEY DAVIDSON® VRSCA V-Rod	02-05

**ROTOR
BUYERS GUIDE**

BRAKE ROTOR BUYERS GUIDE - STREET

Rotor No.	F/R	Type	Dia. (mm)	Hub Color	Profile	Bobbins	Left Bracket	Right Bracket	Model	Year	
Disc Group 007 MD516 MD516X VR516 VR516BLK OSMD516-14 OSMD516-14BLK OSVR516-14 OSMD516-15 OSMD516-15BLK OSMD516-15/6 OSMD516-15/6BLK OSVR516-15	F F F F F F F F F F F F	Solid Floating Solid Floating Floating Floating Floating Floating Floating Floating Floating Floating	300 300 300 300 355 355 355 381 381 381 381 381	N/A Chrome N/A Black Polished Black Black Polished Black Polished Black Black	Plain Plain Vee Vee Plain Plain Vee Plain Plain Plain Plain Vee	N/A 5 N/A 5 5 5 5 5 5 5 5 5		BRK703 BRK703 BRK703 BRK711 BRK711 BRK711 BRK711	BRK704 BRK704 BRK704 BRK712 BRK712 BRK712 BRK712	HARLEY DAVIDSON® V-Rod Models	06-17
Disc Group 008 MD517 VR517 VR517BLK	R R R	Solid Solid Floating	300 300 300	N/A N/A Black	Plain Vee Vee	N/A N/A 9			HARLEY DAVIDSON® V-Rod Models	06-17	
Disc Group 009 MD518 MD518BLK MD518CBLK MD518/5 MD518/5BLK VR518 VR518BLK OSMD518-14 OSMD518-14BLK	F F F F F F F F F	Floating Floating Floating Floating Floating Solid Floating Floating Floating	300 300 300 300 300 300 300 355 355	Polished Black Black Polished Black Polished Black Polished Black	Plain Plain Contour Plain Plain Vee Vee Plain Plain	10 10 10 5 5 N/A 10 5 5		BRK701 BRK701	BRK702 BRK702	HARLEY DAVIDSON® Various models 06 onwards with spoke wheels. See main catalogue listings for full fitment info.	
Disc Group 010 MD520 VR520 VR520BLK	F F F	Floating Solid Floating	300 300 300	Polished N/A Black	Plain Vee Vee	5 N/A 5			HARLEY DAVIDSON® Touring Series Models FLHTCUTG Tri Glide Ultra Classic Trike FLHXXX Street Glide Trike	08-13 09-13 10-11	
Disc Group 011 MD521 MD521C MD521BLK VR521 VR521BLK	R R R R R	Floating Floating Floating Solid Floating	300 300 300 300 300	Polished Polished Black N/A Black	Plain Contour Plain Vee Vee	10 10 10 N/A 10			HARLEY DAVIDSON® Touring Series Models FLHRC Road King Classic FLHTCU Ultra Classic Electra Glide FLHTCHL Ultra Classic Electra Glide LOW FLHTK Ultra LTD FLHTKL Ultra LTD LOW FLHTKSE CVO Limited FLHX Street Glide FLHXS Street Glide Special FLHXSE CVO Street Glide FLTRX Road Glide FLTRXS Road Glide Special FLTRXSE CVO Road Glide FLHR Road King (Cast Wheel Type) FLTRU Road Glide Ultra	08-14 14-20 14-20 15 15-20 15-20 21 14-21 14-21 21 15-20 15-21 21 15-21 16-20	
MD522	R	Solid	240	N/A	Plain	N/A			BUELL XB12R Firebolt XB12 SS Lightning Firebolt XB9R XB9S Lightning XB12S Lightning XB9SX Lightning City/X XB12X Ulysses XB12XT Ulysses XB12SCG Lightning XB12SS Lightning Long XB12STT Lightning XB12SCG Lightning XB9 SX Lightning	04-10 09-10 02-07 03-04 04-08 05-09 06-10 08-10 06-08 06-08 06-08 09-10 08-10	

ROTOR BUYERS GUIDE

BRAKE ROTOR BUYERS GUIDE - STREET

Rotor No.	F/R	Type	Dia. (mm)	Hub Color	Profile	Bobbins	Left Bracket	Right Bracket	Model	Year
Disc Group 012 MD523 FSD523 MD523X VR523BLK	F F F F	Solid Floating Floating Floating	290 290 290 290	N/A Polished Gold Black	Plain Plain Plain Plain	N/A 5 5 5			HARLEY DAVIDSON® XR 1200 X XR 1200	10-12 08-10
Disc Group 013 MD524 RSD524 MD524X VR524BLK	R R R R	Solid Floating Floating Floating	260 260 260 260	N/A Polished Gold Black	Plain Plain Plain Vee	N/A 10 10 10			HARLEY DAVIDSON® XL 883 L Superlow XL 883 L Superlow (Cast wheel) XL 883 R Roadster (Cast wheel) XL 883 N Iron (Cast wheel) XL 883 N XL 1200 C Custom XL 1200 L Sportster Low XL 1200 T Superlow XL 1200 V Seven Two XL 1200 X Forty Eight XR 1200 XR 1200 X	11-13 14-20 11-15 11-15 16-21 11-21 07-11 14-21 14-15 14-21 08-10 10-12
Disc Group 014 MD525 VR525BLK	R R	Floating Floating	300 300	Polished Black	Plain Vee	9 9			HARLEY DAVIDSON® VRSCF V-Rod Muscle	14-17
Disc Group 015 MD526 MD526X MD526XBLK VR526 VR526BLK	F F F F F	Solid Floating Floating Solid Floating	300 300 300 300 300	N/A Polished Black N/A Black	Plain Plain Plain Vee Vee	N/A 5 5 N/A 5			HARLEY DAVIDSON® XL 883 L (Superlow/Cast wheel) XL 883 R Roadster (Cast wheel) XL 883 N Iron (Cast wheel) XL 1200 C Custom (Spoke wheel) XL 1200 T Superlow XL 1200 V Seven Two XL 1200 X Forty Eight FXST Softail Standard FLS Softail Slim FLSL Softail Slim FLSTC Heritage Softail Classic FLHC Heritage Classic FLHCS Heritage Classic 114 FLHCS Heritage Classic 114 Anniversary FLSTN Softail Deluxe FLDE Deluxe FXBB Street Bob FXLR Low Rider FXLRS Low Rider S	14-20 14-15 14-17 14-21 14-21 14-15 14-21 15 15-17 18-21 15-17 18-21 18-21 18 15 18-20 18-21 18-21 18-21
MD527									USE MD530	
Disc Group 016 MD528 MD528C VR528 VR528BLK	R R R R	Floating Floating Solid Floating	290 290 290 290	Polished Polished N/A Black	Plain Contour Vee Vee	10 10 N/A 10			HARLEY DAVIDSON® FXSB Breakout FLFB Fat Boy FLFBS Fat Boy 114 FLFBS Fat Boy 114 Anniversary FXBR Breakout FXBRS Breakout 114 FXBRS Breakout 114 Anniversary FXFB Fat Bob FXBS Fat Bob 114 FLDE Deluxe FXBB Street Bob FXLR Low Rider FXLRS Low Rider S	13-17 18-21 18-21 18 18-20 18-21 18-20 18-20 18-21 18-20 18-21 18-21 18-21 18-21
Disc Group 017 MD529 VR529 OSMD529-14 OSVR529-14	F F F F F F	Solid Solid Solid Solid Solid Solid	300 300 355 355 300 300	N/A N/A N/A N/A N/A N/A	Plain Vee Plain Vee Plain Vee	N/A N/A N/A N/A N/A N/A	BRK705 BRK705	BRK706 BRK706	HARLEY DAVIDSON® FLHRC Road King Classic FLHTCU Ultra Classic Electra Glide FLHTCUL Ultra Classic Electra Glide LOW FLHTK Ultra LTD FLHTKL Ultra LTD LOW FLHTKSE CVO Limited FLHX Street Glide	14-17 14-20 15 15-20 15-20 21 14-21

ROTOR BUYERS GUIDE

BRAKE ROTOR BUYERS GUIDE - STREET

Rotor No.	F/R	Type	Dia. (mm)	Hub Color	Profile	Bobbins	Left Bracket	Right Bracket	Model	Year
Disc Group 017 MD529 VR529 OSMD529-14 OSVR529-14 Contd.	F F	Solid Solid	355 355	N/A N/A	Plain Vee	N/A N/A	BRK705 BRK705	BRK706 BRK706	HARLEY DAVIDSON® FLHXS Street Glide Special FLHXSE CVO Street Glide FLTRX Road Glide FLTRXS Road Glide Special FLTRXSE CVO Road Glide FLHR Road King (Cast Wheel Type) FLTRX Road Glide Custom FLTRU Road Glide Ultra LiveWire	15-21 21 15-20 15-21 21 15-21 15-17 16-20 18-21
Disc Group 018 MD530 MD530BLK VR530 VR530BLK	F F F F	Floating Floating Solid Floating	300 300 300 300	Polished Black N/A Black	Plain Plain Vee Vee	5 5 N/A 5			HARLEY DAVIDSON® FLHTCUTG Trike Tri Glide Ultra FLHTCUTGSE CVO Tri Glide FLRT Freewheel Trike FLSTF Fatboy FLSTFB Fatboy LO FLFB Fat Boy FLFBS Fat Boy 114 FLFBS Fat Boy 114 Anniversary FXSB Breakout FXBRS Breakout 114 FXBRS Breakout 114 Anniversary FXFB Fat Bob FXBS Fat Bob 114	14-21 21 15-21 15-17 15-17 18-21 18-21 18 15-20 18-21 18-20 18-20 18-21
MD531	F	Solid	292	N/A	Plain	N/A			HARLEY DAVIDSON® XG 500 Street XG 750 Street	14-15 14-15
MD532	R	Solid	260	N/A	Plain	N/A			HARLEY DAVIDSON® XG 500 Street XG 750 Street	14-15 14-15
Disc Group 019 MD533 MD533BSDF MD533BSDR	F/R F R	Solid Solid Solid	299 299 299	Black Black Black	Plain Plain Plain	N/A N/A N/A			POLARIS Slingshot Slingshot S Slingshot SL Slingshot SL SE POLARIS Slingshot Slingshot S Slingshot SL Slingshot SL SE POLARIS Slingshot Slingshot S Slingshot SL Slingshot SL SE	15-17 18 15-18 15-18 15-17 18 15-18 15-18 15-17 18 15-18 15-18
Disc Group 020 MD534 MD534X VR534BLK	F/R F/R F/R	Solid Floating Floating	298 298 298	N/A Gold Black	Plain Plain Vee	N/A 5 10			INDIAN Scout (Cast Wheel/Toso Calipers) Scout Sixty (Cast Wheel/Toso Calipers) Scout Scout Bobber Scout Sixty VICTORY Octane 1200cc	15-16 16 17-21 18-21 17-21 17
Disc Group 021 MD535 MD535BLK VR535BLK	F/R F/R F/R	Floating Floating Floating	292 292 292	Polished Black Black	Plain Plain Vee	5 5 5			INDIAN Chief Blackhawk (Brembo calipers) Chief Blackhawk Dark (Brembo calipers) Chief Classic (Brembo calipers) Chief Standard (Brembo calipers) Chief Deluxe (Brembo calipers) Chief Roadmaster (Brembo calipers) Chief Vintage (Brembo calipers) Bomber (Brembo Calipers) Dark Horse (Brembo calipers)	11 11 11-13 09-11 09 09-11 09-13 10-11 10-13

ROTOR
 BUYERS GUIDE

BRAKE ROTOR BUYERS GUIDE - STREET

Rotor No.	F/R	Type	Dia. (mm)	Hub Color	Profile	Bobbins	Left Bracket	Right Bracket	Model	Year
Disc Group 022 MD536 MD536X MD536XBLK VR536	F F F F	Solid Floating Floating Solid	300 300 300 300	N/A Polished Black N/A	Plain Plain Plain Vee	N/A 5 5 N/A			HARLEY DAVIDSON® XG 500 Street (300mm Discs) XG 750 Street (300mm Discs) XG 750 Street Rod	16-21 16-21 17-21
Disc Group 023 MD537 MD537X MD537XBLK VR537	R R R R	Solid Floating Floating Solid	300 300 300 300	N/A Polished Black N/A	Plain Plain Plain Vee	N/A 5 5 N/A			HARLEY DAVIDSON® XG 500 Street (300mm Discs) XG 750 Street (300mm Discs) XG 750 Street Rod	16-21 16-21 17-21
MD538BSD	R	Solid	270.5	N/A	N/A	N/A			HARLEY DAVIDSON® FLRT Freewheeler Trike FLHTCUTG Tri Glide Ultra Trike FLHTCUTGSE CVO Tri Glide	15-20 14-20 21
MD540BSD	R	Solid	233	N/A	N/A	N/A			HARLEY DAVIDSON® FLHTCUTG Tri Glide Ultra Classic Trike FLHXXX Street Glide Trike	09-13 10-11
MD541	F	Solid	300	N/A	Plain	N/A			HARLEY DAVIDSON® FLHR Road King (Spoke Wheel Type) FLHRC Road King Classic FLTR Road Glide FLTRX Road Glide Custom FLTRU Road Glide Ultra FLHTC Electra Glide Classic FLHTCU Ultra Classic Electra Glide FLHT Electra Glide Standard FLHTK Electra Glide Ultra LTD FLHX Street Glide FLHTCUTG Tri Glide Ultra Classic Trike FLHXXX Street Glide Trike	08-16 08-20 08-09 10-12 11-12 08-12 08-13 08-10 10-13 08-13 09-13 10-11
MD601LS MD601RS	F F	Floating Floating	310 310	Silver Silver	Plain Plain	9 9			HONDA CBR 600 F2 TRIUMPH Floating conversion for Triumph models using MD649 solid disc. Will require bracket kit on HONDA models only - order BRK15S.	91-94
MD602LS MD602RS	F F	Floating Floating	260 260	Silver Silver	Plain Plain	9 9			BMW R 60/7 R 60 TIC R 65 LS R 75/6 R 80 R 80 RT BMW R 80 TIC R 90 S R 90/6 R 100 R 100/7T R 100 S R 100 RS R 100 RT R 100 S R 100 RS R 100 RT	76-80 78-82 81-85 73-79 77-84 82-84 78-85 73-76 73-76 76-77 77-84 76-80 76-84 78-84 09/80-80 10/80-84 10/80-84
MD602LS MD602RS	F & R F & R	Floating Floating	260 260	Silver Silver	Plain Plain	9 9			BMW R 80 TIC R 90 S R 90/6 R 100 R 100/7T R 100 S R 100 RS R 100 RT R 100 S R 100 RS R 100 RT	78-85 73-76 73-76 76-77 77-84 76-80 76-84 78-84 09/80-80 10/80-84 10/80-84
MD603LS MD603RS (ABS)	F F	Floating Floating	285 285	Silver Silver	Plain Plain	9 9			BMW K 75/75-2 K 75 RT K 75 S K 100/2 K 100 LT K 100 RS K 100 RT	84-96 89-96 85-95 87-90 86-91 83-89 83-89

ROTOR BUYERS GUIDE

BRAKE ROTOR BUYERS GUIDE - STREET

Rotor No.	F/R	Type	Dia. (mm)	Hub Color	Profile	Bobbins	Left Bracket	Right Bracket	Model	Year
MD604LS MD604RS (Non ABS)	F F	Floating Floating	285 285	Silver Silver	Plain Plain	9 9			BMW K 75/75-2 K 75 C K 75 RT K 75 S K 100 K 100/2 K 100 LT K 100 RS K 100 RT	84-96 85-12/88 89-96 85-95 82-09/88 87-90 86-91 83-89 83-89
MD605LS MD605RS	F F	Floating Floating	285 285	Silver Silver	Plain Plain	9 9			BMW R 65 R 65 RT R 80/R 80 RT R 100 RS R 100 RT R 80 Mystic R 80 R R 100 GS R 100 PD R 100 Mystic R 100 R R 850 GS	07/88-08/89 85-88 84-95 86-92 87-95 94-95 91-94 86-94 89-96 93-96 91-95 96
MD606LS MD606RS	F F	Floating Floating	260 260	Silver Silver	Plain Plain	9 9			BMW R 45/45 N R 45 T R 65 GS R 65 T R 65 LS R 80 GS R 80 PD/CH R 80 ST R 100/7T	78-85 80-85 87-92 80-85 81-85 80-95 90-95 82-84 09/80-84
MD607LS MD607RS	F F	Floating Floating	305 305	Silver Silver	Plain Plain	12 12			BMW K 100 RS K1 K 1100 LT K 1100 RS R 850 R R 850 RT R 1100 R R 1100 RS R 1100 RT	89-92 88-93 89-99 92-96 94-02 96-01 93-01 92-01 94-01
MD609LS MD609RS	F F	Floating Floating	280 280	Gold Gold	Plain Plain	9 9			DUCATI 900 SS Darmah 900 Hailwood Replica 1000 R1 Hailwood Replica	78 79 84
MD609LS	R	Floating	280	Gold	Plain	9			LAVERDA Jota 1000 Mirage 1200 900 Hailwood Replica 1000 R1 Hailwood Replica 1000 SFC	76 76 79 84 85-86
MD609ALS MD609ARS	F F	Floating Floating	280 280	Gold Gold	Plain Plain	9 9			LAVERDA RGS 1000	83
MD611 Non ABS Models	R	Floating	285	Silver	Plain	9			BMW K 75/75-2 K 75 RT K 75 S K 100 K 100/2 K 100 LT K 100 RS K 100 RT	08/90-96 89-96 85-95 82-09/88 87-90 86-91 83-89 83-09/88

ROTOR
BUYERS GUIDE

BRAKE ROTOR BUYERS GUIDE - STREET

Rotor No.	F/R	Type	Dia. (mm)	Hub Color	Profile	Bobbins	Left Bracket	Right Bracket	Model	Year
MD611 Non ABS Models Contd.	R	Floating	285	Silver	Plain	9			BMW K 100 RS (Non ABS) K1 (16 valve - Non ABS)	89-92 88-93
MD613 MD613C VR613	R R R	Solid Solid Solid	220 220 220	N/A N/A N/A	Plain Contour Vee	N/A N/A N/A			APRILIA Shiver 900 Dorsoduro 900 RSV4 R/RSV4 Factory RSV4 Factory APRC SBK RSV4 R APRC RSV4 Factory APRC ABS RSV Mille All models RSV 1000 Tuono/Tuono R/Factory R SL 1000 Falco RSV 1000 R Factory/R Tuono V4 R STD Tuono V4R APRC Tuono V4R APRC/ABS	18-21 18-21 09-12 11-14 11-14 13-15 98-03 02-10 00-05 04-12 11-12 11-12 13-15
MD614X MD614XC VR614BLK VR614BLU VR614RED VR614GLD VR614ORG	F F F F F F F	Floating Floating Floating Floating Floating Floating Floating	320 320 320 320 320 320 320	Gold Gold Black Blue Red Gold Orange	Plain Contour Vee Vee Vee Vee Vee	6 6 6 6 6 6 6			CAGIVA Mito 125 DUCATI Monster 400 (Single disc) Monster 400 (Twin disc) 400 Monster (Japan) Monster Dark ie 400 (Japan) Monster Dark ie 400 (Single disc) 600 Monster City/City Dark 600 Monster 620 IE Monster 620 ie Monster (Series 1 - Twin Pin Pad Fixing Caliper) 620 Sport 696 Monster M 696 Monster 20th Anniversary Model 748 Biposto 748 SP/Monoposto 748 Testa Bassa (Mono/Biposto) 750 Supersport IE 750 Sport 750 Monster Monster ie 750 Monster 800 800 Sport 800 Supersport 900 Supersport IE 900 Sport 900 IE Monster 900 MH Evoluzione ST4 (916cc) ST2 (944cc) GT 1000 (992cc) GT 1000 Touring - Sport Classic Monster 1000 Dark Monster 1000 ie (992cc) Monster 1000 S ie (992cc) Monster S2R 1000 (992cc) Paul Smart 1000 LE (992cc) Sport 1000 S Sport Classic 1000 (992cc) (Monoposto - Japan/Biposto - Europe) Supersport 1000 DS (992cc) KTM 690 Duke MOTO GUZZI 750 Nevada Base/Club Nevada Classic 750 ie V 750 ie Brevia V 7 Classic V 7 Cafe Classic V 7 Racer V 7 Special	92-02 00-02 03-04 00-04 05-06 05 99 00-01 02-04 05 03 08-14 13-14 99-02 99-02 01 00-02 01-02 00-01 02 03-04 03 03-05 00-01 02 00-01 00-01 01-02 00-03 07-10 09 03 04-05 03-05 06-08 06 07-09 06-08 03-06 08-11 02-03 04-09 03-08 08-12 11-12 10-14 12-14

ROTOR BUYERS GUIDE

BRAKE ROTOR BUYERS GUIDE - STREET

Rotor No.	F/R	Type	Dia. (mm)	Hub Color	Profile	Bobbins	Left Bracket	Right Bracket	Model	Year
MD614X MD614XC VR614BLK VR614BLU VR614RED VR614GLD VR614ORG Contd.									V 7 Stone V10 Centauro California EVII Sport 1100 California Jackel 1100 California Special 1100 V11 Sport/Scuro/Naked V11 Le-Mans Series California Stone Series California EV Series California Vintage 750	02-14 97-99 97-01 94-99 99-01 99-01 99-00 01-06 02-06 02-06 06-10
MD615	R	Floating	285	Natural	Plain	9			BMW K 1200 LT R 1200 CL	97-09 02-04
MD616 Loose bobbin type	F	Solid	320	N/A	Plain	N/A			BMW R 850 R R 1100 S R 1150 R R 1150 Rockster R 1150 RS R 1150 GS K 1200 R-Urban (K43) K 1200 LT R 1200 R K 1300 R	03-06 12/00-06 01-06 03-06 01-05 03-06 05-08 11/00-07 07-08 09
MD617	R	Solid	220	N/A	Plain	N/A			CAGIVA Raptor 650/V-Raptor 650 Raptor 1000/V-Raptor 1000	00-02 00-02
MD618 MD618C VR618	R R R	Solid Solid Solid	240 240 240	N/A N/A N/A	Plain Contour Vee	N/A N/A N/A			DUCATI 749/749 S/749 R 999/999 S/999 R Desmosedici 1000	03-06 03-06 08
MD619RS	F	Floating	315	Natural	Plain	9			MZ/MUZ Skorpion Tour/Traveller	95-02
MD620 Loose bobbin type	F	Solid	320	N/A	Plain	N/A			BMW R 850 RT K 1200 RS R 1100 S R 1150 RT K 1200 GT (K41) K 1200 R K 1200 S R 1200 S	06 01-05 12/00-05 00-06 03-06 05-08 03-08 06-08
MD621X MD621XC VR621BLK VR621BLU VR621RED VR621GLD	F F F F F F	Floating Floating Floating Floating Floating Floating	320 320 320 320 320 320	Gold Gold Black Blue Red Gold	Plain Contour Vee Vee Vee Vee	6 6 6 6 6 6			APRILIA RS 125 Shiver 750 Mana 850 RSV Mille/Mille R (All models) RSV Tuono/Tuono R/Factory R BMW G 650 Xmoto MOTO GUZZI MGS-01 1100 Griso (1064cc) Standard mount calipers Griso 1200 8V 1200 Griso SE (8V) (Radial caliper) 1151cc	06-12 07-14 08-12 01-03 02-10 07-09 04-05 05-12 09-12 09-12
MD622X MD622XC VR622BLK VR622BLU VR622RED VR622GLD	F F F F F F	Floating Floating Floating Floating Floating Floating	320 320 320 320 320 320	Gold Gold Black Blue Red Gold	Plain Contour Vee Vee Vee Vee	6 6 6 6 6 6			DUCATI 749 Dark (Monoposto/Biposto) 749 R (Radial caliper) 749 S (Monoposto/Biposto) 749 (Monoposto/Biposto) 999 S (Std Caliper Mount) (Monoposto/Biposto)	04-06 04-06 03-06 03-06 03-04

BRAKE ROTOR BUYERS GUIDE - STREET

Rotor No.	F/R	Type	Dia. (mm)	Hub Color	Profile	Bobbins	Left Bracket	Right Bracket	Model	Year
MD622X MD622XC VR622BLK VR622BLU VR622RED VR622GLD Contd.									999 (Std mount caliper) 999 R (Radial mount caliper) 999 R Fila (Radial mount caliper) 999 R Xerox 999 S (Radial mount caliper) Monoposto/Biposto	03-06 03-06 03-06 06 05-06
MD623RS	F	Solid	280	N/A	Plain	N/A			MUZ 500 Country	93-98
MD624 VR624BLK VR624BLU VR624RED VR624GLD	F F F F F	Floating Floating Floating Floating Floating	320 320 320 320 320	Gold Black Blue Red Gold	Plain Vee Vee Vee Vee	6 6 6 6 6			DUCATI Monster S4 Foggy (916cc) Monster S4 (916cc) ST3 S (ABS Model) (992cc) Monster S4R (996cc) (2 pad caliper) 996 SPS (996cc) 996 (996cc) (Monoposto/Biposto) 996 S Monster S4R (996) ST4S (Non ABS/996cc) ST4S (ABS Model/996cc) Monster S4 Foggy(916cc) Monster S4 (916cc) ST3 S (ABS Model) (992cc) Monster S4R (996cc) (2 pad caliper) 996 SPS (996cc) 996 (996cc) (Monoposto/Biposto) 996 S MOTO-GUZZI 1100 Brevia Norge 1200 GT/2V (ABS Model) Norge 1200 GT 8V Stelvio 1200 NTX 8V (ABS)	02 01-02 06-07 05-06 99 99-01 01 03-06 01-05 03-05 02 01-02 06-07 05-06 99 99-01 01 05-12 06-12 10-19 09-19
MD626X MD626XC VR626BLK VR626BLU VR626RED VR626GLD	F F F F F F	Floating Floating Floating Floating Floating Floating	300 300 300 300 300 300	Gold Gold Black Blue Red Gold	Plain Contour Vee Vee Vee Vee	6 6 6 6 6 6			DUCATI Monster 400 ie (Japan) 620 Multistrada (Twin Disc/Single Pin Pad Fixing) 695 Monster Monster S2R (803cc) Monster S2R Dark (803cc) 620 ie Monster (Series 2 - Single Pin Pad Fixing Caliper) ROYAL ENFIELD Continental GT (Non ABS) Continental GT (ABS)	07-08 06 06-09 05-07 05-06 05-06 13-16 17-18
MD627 MD627C VR627	R R R	Solid Solid Solid	245 245 245	N/A N/A N/A	Plain Contour Vee	N/A N/A N/A			DUCATI Hypermotard 796 796 Monster (Non ABS) Monster S2R (803cc) Monster S2R Dark (803cc) Hypermotard (821cc)/Hypermotard SP (821cc) Hyperstrada (821cc) 848 (Radial 2 pad caliper) 848 Evo (Monobloc F Calipers) 848 Streetfighter Monster S4R (996cc) (2 pad caliper) Monster S4R (996cc) S4RS Monster (998cc) (Radial 4 pad caliper) S4R Testastretta Monster (998cc) (Radial 4 pad caliper) S4RS Testastretta Monster (998cc) (Radial 4 pad caliper) S4RS (Tricolore/Monster Testastretta) (998cc)# (Radial 4 pad caliper) Monster S2R 1000 (992cc) Multistrada 1000 DS (992cc) Multistrada S 1000 DS (992cc) 1100 Monster Evo Hypermotard 1100/Hypermotard 1100 S Hypermotard 1100 Evo/Hypermotard 1100 Evo SP Monster 1100 (Non-ABS)/Monster 1100 S (Non-ABS) Multistrada 1100 (1078cc) Multistrada 1100 S (1078cc)	10-12 10-13 05-07 05-06 13-14 13-14 08-09 10-12 10-12 12-14 05-06 03-06 06 07-08 07-08 07-08 08 06-08 03-05 05-06 11-12 07-09 10-12 09-10 07-09 07-09

ROTOR BUYERS GUIDE

BRAKE ROTOR BUYERS GUIDE - STREET

Rotor No.	F/R	Type	Dia. (mm)	Hub Color	Profile	Bobbins	Left Bracket	Right Bracket	Model	Year
MD627 MD627C VR627 Contd.	R R R	Solid Solid Solid	245 245 245	N/A N/A N/A	Plain Contour Vee	N/A N/A N/A			1199 Panigale R 1200 Monster/1200 S Monster 1200 R Monster	13-14 14-21 16-17
MD629X MD629XC VR629BLK VR629BLU VR629RED VR629GLD MD630LS MD630RS	F F F F F F F F	Floating Floating Floating Floating Floating Floating Solid Solid	320 320 320 320 320 320 280 280	Silver Silver Black Blue Red Gold N/A N/A	Plain Contour Vee Vee Vee Vee Plain Plain	6 6 6 6 6 6 N/A N/A			TRIUMPH Thrupton SE (865cc) Thrupton 900 Thrupton 900 Ace Cafe SE DUCATI 750 Paso 750 Sport	 12 04-15 14-20 88-90 88-90
MD631	R	Solid	270	N/A	Plain	N/A			DUCATI 906 Paso 750 Paso/Sport	88-89 87-90
MD632 MD632C VR632	R R R	Solid Solid Solid	220 220 220	N.A N.A N.A	Plain Contour Vee	N/A N/A N/A			DUCATI 748 R (2 pad caliper) 748 R (4 pad caliper) 748 Biposto 748 SP 748 (Biposto/Monoposto) 748 SPS 748 Testa Bassa (Mono/Biposto) 900 MH Evoluzione 916 (Biposto) 916 Sienna 916 SPS (996cc) 996 SPS (996cc) 996 (996cc) (Monoposto/Biposto) 996 R/S 998 Matrix (998cc) 998 R (998cc) 998 S Bayliss/Bostrom 998 S (998cc) (4 pad caliper) 998 (998cc) (2 pad caliper) (Monoposto/Biposto)	 00 01-02 95-02 95-98 00-02 98-99 01 00-01 94-96 94-98 97-98 99 99-01 01 04 02 02 02-04 02-03
MD633X MD633XC VR633ORG NOTE: Disc type with Counterbored holes. Check correct type before fitting.	F F F	Floating Floating Floating	320 320 320	Gold Gold Orange	Plain Contour Vee	6 6 6			DUCATI 998 Matrix (998cc) 998 S Bayliss/Bostrom 998 S (998cc) (4 pad caliper) 998 (998cc) (2 pad caliper) (Monoposto/Biposto) ST4 (916cc) KTM 990 Superduke 990 Superduke R 1190 RC8 1190 RC8 R	04 02 02-04 02-03 99 05-11 07-11 08-12 09-14
MD634LS MD634RS	F F	Floating Floating	280 280	Silver Silver	Plain Plain	9 9			DUCATI 250/350/450 Desmo 750 Sport 750 SS 860 GT/GTS 900 GTS 900 SS Darmah	74-77 74 75-76 75-76 75-76 76-77
MD634LS	R	Floating	280	Silver	Plain	9			DUCATI 860 GT/GTS 900 GTS 900 SS Darmah	75-76 75-76 76-78
MD636X MD636XC	F F	Floating Floating	320 320	Gold Gold	Plain Contour	6 6			DUCATI 748 R 996 R	00-02 01

ROTOR BUYERS GUIDE

BRAKE ROTOR BUYERS GUIDE - STREET

Rotor No.	F/R	Type	Dia. (mm)	Hub Color	Profile	Bobbins	Left Bracket	Right Bracket	Model	Year
MD640 VR640BLK VR640BLU VR640RED VR640GLD (Will not fit early models with dished-solid rotor)	F F F F F	Floating Floating Floating Floating Floating	310 310 310 310 310	Silver Black Blue Red Gold	Plain Vee Vee Vee Vee	6 6 6 6 6			TRIUMPH Daytona 750 (3cyl) Daytona 1000 (4cyl) Daytona 900 (3cyl) Daytona Super III (3cyl) Daytona 1200 (4cyl) Speed Triple (Carb Models) Sprint (All carb models) Trophy 900 (3cyl) Trophy 1200 (4cyl)	92 92 93-96 94-97 93-98 94-96 94-98 94-01 94-01
MD641 VR641	R R	Solid Solid	255 255	N/A N/A	Plain Vee	N/A N/A			TRIUMPH Daytona 750 (3cyl)/Daytona 1000 (4cyl) Daytona 900 (3cyl) Daytona Super III (3cyl) Daytona 1200 (4cyl) Speed Triple (Carb Models) Sprint (All carb models) Tiger 885cc Trident 900 Trophy 900 (3cyl) Trophy 1200 (4cyl)	92 93-96 94-97 93-98 94-97 93-98 92-96 92-98 92 93-01
MD642LS Note: Floating conversion kit available see MD629	F	Solid	320	N/A	Plain	N/A			TRIUMPH Adventurer Legend TT Thunderbird	96-01 98-01 95-03
MD643 VR643	R R	Solid Solid	285 285	N/A N/A	Plain Vee	N/A N/A			TRIUMPH Legend TT Adventurer Bonneville America America (Cast Wheel) 865cc America (865cc/cast wheel) America LT (865cc) Speedmaster 800 Scrambler (865cc/EFI) Speedmaster (865cc/Carbs) Speedmaster (865cc EFI) Cast Wheel Eng # 392060 to 460949/6 bolt fr disc Speedmaster (865cc EFI) 5 Spoke Wheel Eng # 4609050 onwards/5 bolt fr disc Thunderbird Thunderbird Sport Tiger 885i Tiger 885i/955cc (Spoke wheel)	98-01 96-01 02-06 06-09 10-20 14-20 03-04 10-15 05-09 09-10 11-20 95-03 98-03 98-99 99-04
MD644 (6 Bolt)	F	Solid	276	N/A	Plain	N/A			HONDA CBR 125 R4/R5/RS5/RW5/RW6/RW7/RW8/RW9/RWA (Canada) TRIUMPH Tiger	04-10 92-98
MD645	R	Solid	255	N/A	Plain	N/A			TRIUMPH Tiger	92-98
MD646LS MD646RS VR646BLK VR646BLU VR646RED VR646GLD	F F F F F F	Floating Floating Floating Floating Floating Floating	296 296 296 296 296 296	Gold Gold Black Blue Red Gold	Plain Plain Vee Vee Vee Vee	6 6 6 6 6 6			TRIUMPH Trident 750 Trophy 900/1200 Sprint (All carb models) Trident 900 Trophy 900 (3cyl)/Trophy 1200 (4cyl)	92 92 93 92-98 92-93
MD647X MD647XC VR647BLK VR647BLU VR647RED VR647GLD	F F F F F F	Floating Floating Floating Floating Floating Floating	320 320 320 320 320 320	Gold Gold Black Blue Red Gold	Plain Contour Vee Vee Vee Vee	6 6 6 6 6 6			TRIUMPH T595 Daytona Daytona 955i Speed Triple (EFI) T509 Sprint RS Sprint ST	97 98-00 97-01 99-04 99-04
MD648 MD648C VR648	R R R	Solid Solid Solid	220 220 220	N/A N/A N/A	Plain Contour Vee	N/A N/A N/A			TRIUMPH T595 Daytona Daytona 600	97 03-04

ROTOR BUYERS GUIDE

BRAKE ROTOR BUYERS GUIDE - STREET

Rotor No.	F/R	Type	Dia. (mm)	Hub Color	Profile	Bobbins	Left Bracket	Right Bracket	Model	Year
MD648 MD648C VR648 Contd.	R R R	Solid Solid Solid	220 220 220	N/A N/A N/A	Plain Contour Vee	N/A N/A N/A			TRIUMPH Daytona 650 Daytona 675 Daytona 675 SE 675 Daytona Black Monobloc Radial Caliper Daytona 955i Speed Triple (EFI) Speed Triple 955cc Speed Triple (Radial caliper 1050cc) Speed Four 600 TT 600 Street Triple 675 Speed Triple R 675 675 R (Brembo calipers) Tiger 1050 (Radial caliper)	05 06-08 12 09-12 98-06 97-01 02-04 05-11 02-05 00-03 07-12 09-12 11 07-09
MD649 MD649CX Note: Floating conversion kit available MD601LS/RS	F F	Solid Solid	310 310	N/A N/A	Plain Contour	N/A N/A			TRIUMPH Speedmaster (765cc/Carbs) Bonneville America Bonneville 800 Bonneville T-100 Thunderbird Sport Scrambler (865cc) Speedmaster (865cc/Carbs) Tiger 885cc Tiger 885i Tiger 955cc America (Cast Wheel) 865cc Bonneville/Bonneville Black (865cc)	03-04 02-06 01-05 02-09 98-03 06-11 05-08 97-99 98-99 99-04 06-09 06-08
MD650	F	Solid	300	N/A	Plain	N/A			BMW F 650 (E169/0161) F 650 (E169/0162) Funduro/High Screen/19" F wheel F 650 ST (E169/163/168) Strada (18" F wheel/low screen)	09/93-96 97-00 97-00
MD651	R	Solid	240	N/A	Plain	N/A			BMW F 650 (E169/0161) F 650 (E169/0162) Funduro/High Screen/19" fr whl F 650 ST (E169/163/168) Strada (18" F wheel/low screen) F 650 GS (R13/0172/0182) F 650 GS Dakar (R13/0173/0183) 21" F wheel F 650 GS (R13/0175/0185) Single Cylinder 19" F wheel F 650 GS Dakar (R13/0176/0186) 21" F wheel F 650 CS Scarver (K14/0174/0184) (Belt drive/17" cast wheel) F 650 CS Scarver K14/0177/087 Belt Drive 17" cast wheel F 650 GS "Sertao" (Spoke wheel/single cylinder/Chain drive) G 650 GS (R131) (Single cylinder/chain drive/Cast Wheel) TR 650 Terra (Spoke Wheel) TR 650 Strada (Cast Wheel) ROYAL ENFIELD Continental GT 535 (ABS) Bullet 500 EFI (Brembo caliper F & R) Classic 500 (Brembo caliper F & R) Classic 500 Chrome (Brembo caliper F & R)	09/93-96 97-00 97-00 99-03 99-03 04-07 04-07 00-03 04-07 10-14 09-15 13 13 13-19 16-17 16-19 16-20
MD652 MD652C (Rotor ring only)	F F	Solid Solid	305 305	N/A N/A	Plain Contour	N/A N/A			BMW K 1200 RS K 1200 LT R 850 GS R 850 C R 850 R R 850 RT R 1100 GS R 1100 R R 1100 RT R 1150 GS (Evo-R21/0415/0495) R 1150 GS (R21/0415/0495) R 1150 GS Adventure R 1200 R 1200 C	96-00 97-10/00 96-00 97-00 94-02 96-01 93-99 93-06/96 94-01 11/01-03 98-10/01 07/01-06 00-02 96-03

ROTOR BUYERS GUIDE

BRAKE ROTOR BUYERS GUIDE - STREET

Rotor No.	F/R	Type	Dia. (mm)	Hub Color	Profile	Bobbins	Left Bracket	Right Bracket	Model	Year
MD652 MD652C (Rotor ring only)	F F	Solid Solid	305 305	N/A N/A	Plain Contour	N/A N/A			BMW R 1200 CL R 1200 C Montauk	02-04 04-05
MD653 MD653C	R R	Solid Solid	276 276	N/A N/A	Plain Contour	N/A N/A			BMW R 850 GS R 850 R R 850 RT R 1100 GS R 1100 R R 1100 S R 1100 RT R 1150 GS (Evo-R21/0415/0495) R 1150 GS (R21/0415/0495) R 1150 GS Adventure R 1150 R R 1150 Rockster R 1150 RS R 1150 RT	96-00 94-06 96-01/06 93-99 93-01 96-06 94-01 11/01-03 98-10/01 07/01-06 01-06 03-06 01-05 00-06
MD656 VMD656 4 bolt fixing	F & R F & R	Floating Floating	250 250	Gold Black	Plain Plain	9 9			TRIUMPH T 140 V Bonneville T 140 Silver Jubilee Bonneville T 140 E Bonneville T 140 D Bonneville T 140 ES (750cc) T 140 E/ES (750cc) TSS 750 (8 valve) TSX 750	73-78 77 78-83 79-81 80-81 81-83 83 83
MD657LS MD657RS	F F	Floating Floating	260 260	Gold Gold	Plain Plain	9 9			DUCATI 500/600 Pantah	79-81 79-81
MD657LS	R	Floating	260	Gold	Plain	9			DUCATI Ducati 500 Pantah	79
MD660LS MD660RS	F F	Floating Floating	298 298	Silver Silver	Plain Plain	9 9			APRILIA Aprilia RS 250	99-03
MD661 ABS Models	R	Floating	285	Silver	Plain	9			BMW K 75 'S' K 75 TY (ABS) K 100/2 K 100 LT K 100 RS K 100 RT K1 K 1200 RS K 1200 GT K 1100 RS KL 1100 LT R 1100 RS	85-95 89-96 87-90 86-91 83-92 83-89 88-93 96-05 03-06 92-96 89-99 92-01
MD662X MD662XC VR662BLK VR662BLU VR662RED VR662GLD	F F F F F F	Floating Floating Floating Floating Floating Floating	310 310 310 310 310 310	Gold Gold Black Blue Red Gold	Plain Contour Vee Vee Vee Vee	6 6 6 6 6 6			TRIUMPH Speedfour 600 TT 600 Daytona 650	02-05 00-03 05
MD663 VR663	R R	Solid Solid	255 255	N/A N/A	Plain Vee	N/A N/A			TRIUMPH Bonneville 800 Bonneville T-100 Scrambler (865cc/Carbs) Scrambler (865cc/EFI) Sprint RS Tiger 800 (Non ABS) Tiger 800 XC (Non ABS) Thrupton SE (865cc) Thrupton 900	01-05 02-12 06-09 10-16 99-04 11-14 11-14 12 04-15

BRAKE ROTOR BUYERS GUIDE - STREET

Rotor No.	F/R	Type	Dia. (mm)	Hub Color	Profile	Bobbins	Left Bracket	Right Bracket	Model	Year
MD663 VR663 Contd.	R R	Solid Solid	255 255	N/A N/A	Plain Vee	N/A N/A			TRIUMPH Thrupton 900 Ace Cafe SE Bonneville/Bonneville Black (865cc) Bonneville (865cc/cast wheel) Bonneville SE (865cc/cast wheel) Bonneville T100 (865cc) Bonneville T100 (865cc) Steve McQueen Bonneville T100 Black (865cc/Spoke Wheels) Bonneville T100 Spirit SE (Spoke wheels) Bonneville T100 Newchurch SE (Cast wheels) Bonneville T214 (Black/Spoke Wheels) Speed Triple (1050cc) Brembo radial calipers Speed Triple R (1050cc) 5 Spoke Cast Wheel Brembo Monobloc Radial Calipers Speed Triple (1050cc) Non ABS/Brembo calipers From VIN 461332 Sprint 1050 ST VIN 208167- (5 Spoke Wheel/Non ABS) Sprint 1050 ST Non ABS/Zero offset disc Tiger 1050 Twin Side S/Arm	14-20 06-08 09-20 09-12 10-20 12 14-15 15 15 15 08-11 12 11-12 05-10 11-12 07-20
MD664 MD664C	R R	Solid Solid	220 220	N/A N/A	Plain Contour	N/A N/A			APRILIA RS 50 Replica RS 125	99-05 06-10
MD666X MD666XC	F F	Floating Floating	320 320	Gold Gold	Plain Contour	6 6			APRILIA RSV 1000 'Mille'/SP SL 1000 "Falco"	98-01 00-05
MD667	F	Floating	300	Silver	Plain	9			MOTO GUZZI Daytona 1000	92-95
MD668LS MD668RS	F F	Floating Floating	299 299	Gold Gold	Plain Plain	9 9			LAVERDA 1000 SFC	85-86
MD669X MD669XC VR669BLK VR669BLU VR669RED VR669GLD	F F F F F F	Floating Floating Floating Floating Floating Floating	320 320 320 320 320 320	Gold Gold Black Blue Red Gold	Plain Contour Vee Vee Vee Vee	6 6 6 6 6 6			TRIUMPH Daytona 955i Speedtriple 955cc Sprint 1050 ST VIN 208167- (5 Spoke Wheel) Rocket III 2300cc Rocket III Classic Rocket III Roadstar ZERO SR/F ZF 14.4 kWh SR/S ZF 14.4 kWh	01-06 02-04 05-10 04-08 07-08 11-19 19-21 19-21
MD671	F/R	Solid	265	N/A	Plain	N/A			BMW C 400 X F 650 GS (K72/0218/0228) (798cc twin cylinder/cast wheel) F 650 GS (30 Years GS) (Twin cylinder 798cc/cast wheel) F 700 GS (Twin cylinder model/798cc/Spoke wheel) F 750 GS F 750 GS Edition 40 F 800 GS (Twin cylinder model/798cc/Spoke wheel) F 800 GS Adventure (Twin cylinder model/798cc/Spoke wheel) F 800 R F 800 S/ST F 800 GT F 850 GS Edition 40 F 850 GS Adventure F 850 GS Adventure Edition 40 K 1200 S/R-Urban (K43) K 1200 R K 1200 R-Sport (K43) HP2 Enduro HP2 Megamoto HP2 Sport RnineT (K21/1170cc) R NineT R NineT Pure R NineT Racer R NineT Scrambler R NineT Urban G/S	18-21 07-13 11 11-18 18-21 20-21 08-18 12-18 09-15 06-12 13-15 20-21 18-21 20-21 05-08 05-09 07-08 05-09 Nov 07-09 08-11 14-18 18-21 18-21 18-21 18-21 18-21

ROTOR BUYERS GUIDE

BRAKE ROTOR BUYERS GUIDE - STREET

Rotor No.	F/R	Type	Dia. (mm)	Hub Color	Profile	Bobbins	Left Bracket	Right Bracket	Model	Year
MD671 Contd.	F/R	Solid	265	N/A	Plain	N/A			BMW Contd. R 1200 RT R 1200 ST R 1200 GS R 1200 S R 1200 R (K27) R 1200 R (Disc has fixed bobbins) K 1300 R/S S 1000 XR HUSQVARNA 900 Nuda / Nuda R	05-15 03-08 02-12 06-10 06-11/07 08-13 09-15 14-21 12-13
MD675	F	Floating	310	Silver	Plain	9			MV (AUGUSTA) F4 750 (All models) (Nissin Calipers) Brutale 750 (All models) (Nissin calipers) Brutale 910 S (Nissin calipers) Brutale 989 R Brutale 990 R F4 1000 (All models) (Nissin Calipers)	99-03 03-05 05-07 08-09 10 04-06
MD676	F	Floating	310	Gold	Plain	6			TRIUMPH Tiger 955 (Cast wheel) (From VIN 198875)	04-06
MD677	R	Solid	285	N/A	Plain	N/A			TRIUMPH Tiger 955 (Cast wheel) (From VIN 198875)	04-06
MD678 MD678BLK VR678BLK	F F F	Floating Floating Floating	300 300 300	Natural Black Black	Plain Plain Vee	9 9 9			VICTORY Cory Ness Victory Cross Country Cross Roads Arlen Ness Victory Vision Cory Ness Jackpot Victory Vegas Victory King Pin King Pin King Pin Tour King Pin - 8 Ball King Pin Low Vegas Vegas - 8 Ball Ness Signature Series Vegas Jackpot Hammer Hammer 8 Ball Hammer S Jackpot Zach Ness Vegas Vegas Low Vision 8 Ball Vision Street Vision Tour Hard Ball (Spoke Wheel) Judge	11-12 10-13 10-12 08-10 03-07 04-07 04-12 04-09 08-11 09 03-12 05-12 05-07 06-09 05-11 10-16 07-16 10-16 11-12 08-09 10-11 08-09 08-14 12-13 12-16
MD678	R	Floating	300	Natural	Plain	9			VICTORY Cross Country Cross Country 8 Ball Cory Ness Victory Cross Country Arlen Ness Victory Vision Cory Ness Jackpot Victory Vegas Victory King Pin King Pin King Pin Tour King Pin - 8 Ball King Pin Low Vegas Vegas - 8 Ball Ness Signature Series Vegas Jackpot Hammer	10-17 10-16 11-12 10-12 08-10 03-07 04-07 04-12 04-09 08-11 09 03-17 05-17 05-07 06-09 05-11

ROTOR BUYERS GUIDE

BRAKE ROTOR BUYERS GUIDE - STREET

Rotor No.	F/R	Type	Dia. (mm)	Hub Color	Profile	Bobbins	Left Bracket	Right Bracket	Model	Year
MD678 Contd.	R	Floating	300	Natural	Plain	9			VICTORY Hammer 8 Ball Hammer S Jackpot Zach Ness Vegas Vegas Low Vision 8 Ball Vision Street Hard Ball (Spoke Wheel) Judge	10-16 07-17 10-16 11-12 08-09 10-11 08-09 12-13 12-17
MD679X MD679XC VR679BLK VR679BLU VR679RED VR679GLD MD680 MD680C	F F F F F F F F	Floating Floating Floating Floating Floating Floating Floating Floating	320 320 320 320 320 320 305 305	Gold Gold Black Blue Red Gold Gold Gold	Plain Contour Vee Vee Vee Vee Plain Contour	6 6 6 6 6 6 9 9			TRIUMPH Tiger 1050 (Radial Caliper) Tiger 1050 SE Tiger 1050 Sport (Radial Caliper/ABS) Speed Triple R (1050cc - 2Pad Brembo F/Caliper/255mm R/Disc/ABS Model) Speed Triple S (1050cc - 2Pad Brembo F/Caliper/255mm R/Disc/ABS Model) KTM 950 Superenduro 950 Supermoto R 990 SM-R 990 SM-T	07-15 11-12 13-21 13-20 13-20 05-08 07-08 09-11 10-14
MD681 MD681C VR681	R R R	Solid Solid Solid	240 240 240	N/A N/A N/A	Plain Contour Vee	N/A N/A N/A			KTM 690 Duke 690 Supermoto 790 Duke 950 SM 950 SMR Superduke 990 990 Superduke R 990 SM-R 990 SM-T	08-11 02-08 20-21 05-07 07-08 05-11 07-11 09-11 10-14
MD682	F	Solid	320	N/A	Plain	N/A			DUCATI Multistrada 1000 DS/S 1000 DS (992cc) Multistrada 1100 (1078cc) Multistrada 1100 S (1078cc)	03-06 07-09 07-09
MD687	F	Solid	305	N/A	Plain	N/A			BMW F 750 GS F 750 GS Edition 40 F 850 GS F 850 GS Edition 40 F 850 GS Adventure BMW F 850 GS Adventure Edition 40 HP2 Enduro R 1200 GS R 1200 GS/M R 1200 GS Adventure R 1200 GS Adventure/M R 1200 GS R 1200 GS Adventure R 1250 GS R 1250 GS Edition 40 R 1250 GS Adventure R 1250 GS Adventure Edition 40 R 1250 GS TE R 1250 GS Exclusive TE R 1250 GS Rallye R 1250 GS Rallye TE	18-21 20-21 18-21 20-21 18-21 20-21 05-08 02-07 06-12 05-07 06-13 13-18 14-18 18-21 20-21 18-21 20-21 18-21 18-21 18-21 18-21 18-21
MD688	R	Solid	294	N/A	Plain	N/A			BMW K 1200 GT (K44) K 1300 GT (Touring)	06-08 09-11

BRAKE ROTOR BUYERS GUIDE - STREET

Rotor No.	F/R	Type	Dia. (mm)	Hub Color	Profile	Bobbins	Left Bracket	Right Bracket	Model	Year
MD689 MD689C	R R	Solid Solid	220 220	N/A N/A	Plain Contour	N/A N/A			ATK GT 250 R V-Twin Sport GT 650 R V-Twin Sport HYOSUNG GT 250 R GT 250 GT 650 R GT 650 S GT 650 UM V2S-650	11 11 06-12 06-12 06-12 06-12 06-12 06-07
MD690 MD690C	F F	Floating Floating	300 300	Gold Gold	Plain Contour	9 9			ATK GT 250 R V-Twin Sport GT 650 R V-Twin Sport HYOSUNG GT 250 R GT 250 GT 650 R GT 650 S GT 650 UM V2S-650	11 11 06-12 06-12 06-12 06-12 06-12 06-07
MD691	F	Floating	300	Gold	Plain	6			HYOSUNG GV 650 UM V2C-650	06-12 06-08
MD692 MD692C	R R	Solid Solid	282 282	N/A N/A	Plain Contour	N/A N/A			MOTO GUZZI V11 Sport/Scuro/Naked V11 Le Mans Series California Stone Series California EV/Special Series California Vintage 750 Norge 1200/GT/GV	99-00 01-06 02-06 02-06 06-10 06-12
MD693LS MD693RS	F F	Floating Floating	272 272	Gold Gold	Plain Plain	6 6			MOTO GUZZI 1000 Lemans	84-93
MD694X MD694XC VR694BLK VR694BLU VR694RED VR694GLD	F F F F F F	Floating Floating Floating Floating Floating Floating	330 330 330 330 330 330	Gold Gold Black Blue Red Gold	Plain Contour Vee Vee Vee Vee	6 6 6 6 6 6			DUCATI 1098 1098 S 1098 S Tricolore (1099cc)	07-08 07-09 07 07
MD695 MD695C VR695	R R R	Solid Solid Solid	245 245 245	N/A N/A N/A	Plain Contour Vee	N/A N/A N/A			DUCATI 848 Evo Corse Special Edition 1098 1098 S 1098 S Tricolore (1099cc) 1098 R Streetfighter (1099cc) Streetfighter S (1099cc) Streetfighter V4 1103 Streetfighter V4 S 1103 1198 1198 S 1198 SP 1198 R Corse Special Edition	12 07-08 07-08 07 08-09 09-11 09-11 20-21 20-21 09-12 09-10 11-12 11
MD696	R	Solid	210	N/A	Plain	N/A			MV (AUGUSTA) F3 675 F4 750 (All models) (Nissin Calipers) Brutale 750 (All models) (Nissin calipers) Brutale 910 S (Nissin calipers) Brutale 910 R (Brembo calipers) Brutale 989 R Brutale 990 R	12 99-03 03-05 05-07 05-07 08-09 10

ROTOR BUYERS GUIDE

BRAKE ROTOR BUYERS GUIDE - STREET

Rotor No.	F/R	Type	Dia. (mm)	Hub Color	Profile	Bobbins	Left Bracket	Right Bracket	Model	Year
MD696 Contd.	R	Solid	210	N/A	Plain	N/A			MV (AUGUSTA) F4 (998cc) F4 RR (998cc) F4 R (998cc) F4 1000 (All models) (Nissin Calipers) F4R 1000 (Brembo calipers) F4RR 312R 1000 Brembo calipers F4 1000cc (1078cc) Brutale 1078 RR F4 RR 312 1078cc Brutale 1090 R Brutale 1090 RR Brutale 1090	10 12 12 04-06 06-07 07 07 08-09 08-09 12 10 13-14
MD699	R	Solid	316	N/A	Plain	N/A			TRIUMPH Rocket III Rocket III Classic (2300cc) Rocket III Roadster Rocket III Touring (2300cc)	04-09 07-09 11-17 09-17
MD711LD MD711RD	F F	Floating Floating	282 282	Gold Gold	Plain Plain	10 10			YAMAHA TZ 250	89-96
MD713	R	Solid	185	N/A	Plain	N/A			MORIWAKI/HONDA MD 250 H MD 250 S	08-11
MD714X MD714XC	F F	Floating Floating	280 280	Gold Gold	Plain Contour	6 6			KAWASAKI EX 500 A1-A7 EX 500 D1/D2/D3/D4/D5/D6	87-93 94-99
MD719RS Countersunk screw fixing models	F 98-00	Floating	340	Natural	Plain	9			BUELL	All twin
MD727 VR727BLK	F F	Floating Floating	300 300	Gold Black	Plain Vee	9 9			VICTORY V92/SC	98-03
MD727	R	Floating	300	Gold	Plain	9			VICTORY V92/SC	98-03
MD730	F	Floating	298	Gold	Plain	10			YAMAHA TZ 250 TZ 250 (Radial Calipers)	97-01 02-10
MD732	R	Solid	185	N/A	Plain	N/A			YAMAHA TZ 250 TZ 250 (Radial Calipers)	89-90/92-01 02-10
MD734RS	F	Floating	340	Silver	Plain	9			BUELL (All models counterbored fixing)	00-05
MD735RS	F	Solid	375	N/A	Plain	N/A			BUELL (All models with 375mm rotor) EBR 1190 RX (Sport) 1190 SX (Naked) 1190 RS (Sport)	02-10 14-15 14-15 14-15
MD737	F	Solid	320	N/A	Plain	N/A			BUELL Blast	00-07
MD738	F	Solid	220	N/A	Plain	N/A			BUELL Blast	00-07
MD800X MD800XC VR800BLK VR800BLU VR800GLD	F F F F F	Floating Floating Floating Floating Floating	308 308 308 308 308	Gold Gold Black Blue Gold	Plain Contour Vee Vee Vee	6 6 6 6 6			TRIUMPH Daytona 675 Daytona 675 SE Daytona 675 Daytona 675 R	06-12 12 13-17 13-17

ROTOR BUYERS GUIDE

BRAKE ROTOR BUYERS GUIDE - STREET

Rotor No.	F/R	Type	Dia. (mm)	Hub Color	Profile	Bobbins	Left Bracket	Right Bracket	Model	Year
MD800X MD800XC VR800BLK VR800BLU VR800GLD Contd.	F F F F F	Floating Floating Floating Floating Floating	308 308 308 308 308	Gold Gold Black Blue Gold	Plain Contour Vee Vee Vee	6 6 6 6 6			TRIUMPH Contd. Street Triple 675 Street Triple 675 (Brembo R Caliper) Street Triple R 675 (Radial Caliper) Street Triple R 675 (Nissin F Radial/Brembo R Caliper) From Vin # 560477 Street Triple 675 RXSE (ABS)	07-12 13-18 09-12 13-17 15
MD801 VR801	F F	Solid Solid	260 260	N/A N/A	Plain Vee	N/A N/A			CAN-AM Spyder RS SES/SMS 990cc Spyder RS Phantom Black Spyder RT-S/RT Spyder RS-S/RS Spyder RT Ltd	08-09 09 10-12 10-12 11-12
MD802 VR802	R R	Solid Solid	260 260	N/A N/A	Plain Vee	N/A N/A			CAN-AM Spyder RS SES/SMS 990cc Spyder RS Phantom Black Spyder RT-S/RT Spyder RS-S/RS Spyder RT Ltd	08-09 09 10-12 10-12 11-12
MD803 Loose bobbin type	F	Solid	320	N/A	Plain	N/A			BMW F 800 S/ST R 1100 S (Non ABS) R 1200 RT R 1200 ST R 1200 S HP2 Megamoto Loose bobbins INDIAN FTR 1200 FTR 1200 S FTR 1200 S Race Replica FTR 1200 Rally	06-08 12/00-06 05-10 03-08 06-11/07 Nov 07 18-21 19-21 19-20 20-21
MD804 Loose bobbin type	F	Solid	320	N/A	Plain	N/A			BMW K 1200 R-Sport (K43) K 1200 R R 1200 R (K27) F 800 GT F 800 R F 800 ST F 900 R/XR S 1000 R Naked S 1000 R S 1000 XR R Nine T/R Nine T Pure R Nine T Racer R Nine T Scrambler R Nine T Urban GS K 1200 LT K 1200 GT K 1200 R K 1200 S K 1300 R/S K 1300 GT K 1600 B Bagger K 1600 GT K 1600 GTL K 1600 GTL Exclusive K 1600 Grand America/K 1600 B	07-08 11/05-11/07 06-11/07 13-19 09-18 09-13 20-21 14-20 18-20 14-21 18-21 18-20 18-21 18-21 18-21 07-09 06-08 07-10 07-08 09-15 09-11 17-21 11-21 10-21 15-16 18-21
MD809 MD809C	F F	Solid Solid	300 300	N/A N/A	Plain Contour	N/A N/A			BMW G 650 X-challenge/G 650 X-country	07-09
MD810 MD810C	R R	Solid Solid	240 240	N/A N/A	Plain Contour	N/A N/A			BMW G 650 X-challenge G 650 X-country	07-09 07-09

ROTOR BUYERS GUIDE

BRAKE ROTOR BUYERS GUIDE - STREET

Rotor No.	F/R	Type	Dia. (mm)	Hub Color	Profile	Bobbins	Left Bracket	Right Bracket	Model	Year
MD812	R	Solid	220	N/A	Plain	N/A			KTM 1190 RC8 1190 RC8 R	08-12 09-14
MD814	R	Solid	220	N/A	Plain	N/A			DAELIM Roadwin 125	04-09
MD817X MD817XC VR817BLK VR817BLU VR817RED VR817GLD	F F F F F F	Floating Floating Floating Floating Floating Floating	320 320 320 320 320 320	Gold Gold Black Blue Red Gold	Plain Contour Vee Vee Vee Vee	6 6 6 6 6 6			TRIUMPH Sprint GT (1050cc/ABS) Sprint GT SE(1050cc/ABS) Speed Triple (1050cc) From VIN 333179 Speed Triple (1050cc) Non ABS/Brembo calipers From VIN 461332 Speed Triple (1050cc) ABS from VIN 461332 (Brembo Calipers) Speed Triple R (1050cc) 5 Spoke Cast Wheel Brembo Monobloc Radial Calipers Sprint 1050 ST Zero offset disc Trophy SE (1215cc)	10-12 13-20 07-11 07-11 11-16 12 11-12 13-17
MD820 MD820C VR820	R R R	Solid Solid Solid	255 255 255	N/A N/A N/A	Plain Contour Vee	N/A N/A N/A			TRIUMPH Tiger 800 (with ABS) Tiger 800 XC (With ABS) Tiger 800 XC SE (Spoke wheel) Tiger 800 XCX (ABS/Spoke Wheels) Tiger 800 XCa (ABS/Spoke Wheels) Tiger 800 XCx (With ABS/Spoke Wheels/STD & Low) Tiger 800 XR (ABS/Cast Wheel) Tiger 800 XR Touring (ABS/Cast Wheel) Tiger 800 XRt (With ABS/Cast Wheels) Tiger 800 XRx (With ABS/Cast Wheels/STD & Low) Tiger 1050 (Single Sided S/Arm) Speed Triple (1050cc) ABS from VIN 461332 (Brembo Calipers) Sprint GT (1050cc/ABS) Sprint GT SE(1050cc/ABS) Sprint 1050 ST VIN 208167- (5 Spoke Wheel/ABS Model) Sprint 1050 ST ABS/Zero Offset Disc	11-14 11-17 14 15-20 15-20 15-20 15-20 15-20 15-20 15-20 15-20 13-15 11-15 10-12 13-20 05-10 11-12
MD821 MD821X MD821XC Floating Conversion	F F F	Solid Floating Floating	310 310 310	N/A Gold Gold	Plain Plain Contour	N/A 6 6			TRIUMPH Bonneville (865cc/cast wheel) Bonneville SE (865cc/cast wheel) Bonneville T100 Newchurch SE (Cast Wheels) Speedmaster (865cc/EFI) Speedmaster (865cc EFI) 5 Spoke Wheel Eng # 4609050 onwards /5 bolt fr disc	09-15 09-12 15 11-12 11-20
MD822 MD822X MD822XC Floating Conversion	F F F	Solid Floating Floating	310 310 310	N/A Gold Gold	Plain Plain Contour	N/A 6 6			TRIUMPH Bonneville T100 (865cc) Bonneville T100 (865cc) Steve McQueen Bonneville T100 Black (865cc/Spoke Wheels) Bonneville T100 Spirit SE (Spoke Wheels) Bonneville T214 (Black/Spoke Wheels) America (865cc/cast wheel) America (865cc) (Cast wheel) America LT (865cc) (Cast wheel/Wind Shield) Speedmaster (865cc EFI) Cast Wheel Eng # 392060 to 46049/6 bolt fr disc Scrambler (865cc/EFI) Scrambler (900cc/EFI)	10-15 12 14-15 15 15 10-20 14-20 09-10 10-16 17
MD825	F	Floating	310	Gold	Plain	6			TRIUMPH Thunderbird (1600cc/Cast Wheel) Thunderbird (1600cc/Windscreen) Thunderbird Commander (1700cc/Cast wheel) Thunderbird LT (Windscreen) (1700cc/Cast wheel) Thunderbird Storm (1700cc/Cast wheel) Thunderbird NightStorm (1700cc/Cast wheel)	09-20 12 14-20 14-20 09-20 09-20
MD831	R	Solid	310	N/A	Plain	N/A			TRIUMPH Thunderbird (1600cc/Cast Wheel) Thunderbird (1600cc/Windscreen) Thunderbird Commander (1700cc/Cast wheel) Thunderbird LT (Windscreen) (1700cc/Cast wheel) Thunderbird Storm (1700cc/Cast wheel) Thunderbird Night Storm (1700cc/Cast wheel)	09-20 12 14-20 14-20 09-20 09-20

ROTOR BUYERS GUIDE

BRAKE ROTOR BUYERS GUIDE - STREET

Rotor No.	F/R	Type	Dia. (mm)	Hub Color	Profile	Bobbins	Left Bracket	Right Bracket	Model	Year
MD832	R	Solid	220	N/A	Plain	N/A			BMW S 1000 RR S 1000 RR (Models fitted with Forged race wheels 7 spoke type) S 1000 R Naked S 1000 R S 1000 RR/RR Sport/RR M Sport HP4 (1000cc)	10-17 15-17 14-15 18-21 18-21 13-14
MD834	F	Solid	300	N/A	Plain	N/A			BMW F 650 GS (R13/0172/0182) F 650 GS Dakar (R13/0173/0183) 21" F wheel F 650 GS (R13/0175/0185) Single Cylinder 19" F wheel F 650 GS Dakar (R13/0176/0186) 21" F wheel F 650 CS Scarver (K14/0174/0184) (Belt drive/17" cast wheel) F 650 CS Scarver K14/0177/087 Belt Drive 17" cast wheel F 650 GS (30 Years GS) (Twin cylinder 198cc /cast wheel)	99-03 99-03 04-07 04-07 00-03 04-07 11
MD834X	F	Floating	300	Gold	Plain	6			HUSQVARNA TR 650 Terra (Spoke wheel) TR 650 Strada (Cast Wheel) BMW F 650 GS (K72/0218/0228) (798cc twin cylinder/cast wheel) F 650 GS "Sertao" (Spoke wheel/single cylinder/Chain drive) G 650 GS (R131) (Single cylinder/chain drive/cast wheel) F 700 GS (Twin cylinder model/798cc/Spoke wheel) F 800 GS (Twin cylinder model/798cc/Spoke wheel) F 800 GS Adventure (Twin cylinder model/798cc/Spoke wheel)	13 13 06-17 10-14 09-15 11-18 08-18 12-18
MD835	F	Floating	300	Gold	Plain	6			MOTO GUZZI California II/III California 1100	83-93 94-97
MD838 6 bolt fixing	F & R	Floating	250	Gold	Plain	6			TRIUMPH T140 D Bonneville (Lester Alloy Wheels) T140 D Bonneville (Lester Alloy Wheels)	79-81 79-81
MD840 MD840C	R R	Solid Solid	282 282	N/A N/A	Plain Contour	N/A N/A			MOTO GUZZI 1100 Griso (1064cc) Standard mount calipers 1100 Brevia Norge 1200/GT/GV Norge 1200 GT 8V Griso 1200 8V 1200 Griso SE (8V) (Radial caliper) 1151cc Stelvio 1200 8V (NTX/ABS) MGX-21 California 1400 Custom/Touring	05-12 05-12 06-12 10-19 09-12 09-19 09-19 18-21 13-19
MD841X MD841XC VR841BLK VR841BLU VR841RED VR841GLD	F F F F F F	Floating Floating Floating Floating Floating Floating	320 320 320 320 320 320	Gold Gold Black Blue Red Gold	Plain Contour Vee Vee Vee Vee	6 6 6 6 6 6			DUCATI 796 Monster (ABS/Non ABS) M796 Monster 20th Anniversary Model 797 Monster Monster 821 Monster Dark 821 Monster Stripe 821 848 Streetfighter Supersport (936cc) Supersport S (936cc) Scrambler 1100 Pro 4 Sport Pro 939 Hypermotard 939 Hypermotard SP 950 Multistrada (936cc) Scrambler 1100 Sport Scrambler 1100 Special Scrambler 1100 Pro Scrambler 1100 Sport Pro Multistrada 1200 Multistrada 1200 Enduro Multistrada 1200 Enduro Pro Multistrada 1200 S (Sport) Multistrada 1200 S Multistrada 1200 S Pikes Peak	10-14 13-14 17-19 15-19 15-20 15-17 12-14 17-21 17-21 18-21 16-21 16-21 17-21 18-21 18-21 18-21 18-21 10-17 16-19 18-19 10- 16-17 11-14

ROTOR BUYERS GUIDE

BRAKE ROTOR BUYERS GUIDE - STREET

Rotor No.	F/R	Type	Dia. (mm)	Hub Color	Profile	Bobbins	Left Bracket	Right Bracket	Model	Year
MD841X MD841XC VR841BLK VR841BLU VR841RED VR841GLD Contd.	F F F F F F	Floating Floating Floating Floating Floating Floating	320 320 320 320 320 320	Gold Gold Black Blue Red Gold	Plain Contour Vee Vee Vee Vee	6 6 6 6 6 6			DUCATI Contd. Multistrada 1200 Pikes Peak 1200 S Multistrada Grandtourismo 1200 S Touring 1200 Monster 1200 S Monster Diavel 1260/Diavel 1260 S 1200 R Monster Diavel ABS Diavel Carbon (ABS) Diavel AMG Diavel Cromo Diavel Dark (ABS) Diavel Dark Diavel Strada 11262 X Diavel 1262 X Diavel S	16-17 13-14 10-14 14-19 14-19 20 16-17 11-17 16-19 12 12-14 13-14 13-14 13-14 16-21 16-21
MD842X MD842XC VR842BLK VR842BLU VR842RED VR842GLD	F F F F F F	Floating Floating Floating Floating Floating Floating	305 305 305 305 305 305	Gold Gold Black Blue Red Gold	Plain Contour Vee Vee Vee Vee	6 6 6 6 6 6			TRIUMPH Tiger 800 (Inc ABS) Tiger 800 XC (Inc ABS) Tiger 800 XC SE (Spoke wheel) Tiger 800 XCX (ABS/Spoke Wheels) Tiger 800 XCa (With ABS/Spoke Wheels) Tiger 800 XcX (With ABS/Spoke Wheels/STD & Low) Tiger 800 XR (ABS/Cast Wheel) Tiger 800 XR Touring (ABS/Cast Wheel) Tiger 800 XRt (With ABS/Cast Wheels) Tiger 800 XRx (With ABS/Cast Wheels/STD & Low) Tiger 1200 Explorer (1215cc) Tiger 1200 Alpine Edition / Tiger 1200 Desert Edition Tiger Explorer XC 1200 (Up to Vin # 740276/1215cc/Cast & Spoke Wheels) Tiger Explorer XC 1200 (Vin # 740277 onwards/1215cc/Spoke Wheels) Tiger Explorer XCa 1200 (1215cc/Spoke Wheels) Tiger Explorer XcX 1200 (1215cc/Spoke Wheels/STD & Low) Tiger Explorer XR 1200 (1215cc/Cast Wheels) Tiger Explorer XRx 1200 (1215cc/Cast Wheels/STD & Low) Tiger Explorer XRt 1200 (1215cc/Cast Wheels) Tiger 1200 Alpine Edition (1215cc/Cast Wheels/STD & Low) Tiger 1200 Desert Edition (1215cc/Spoke Wheels)	11-14 11-20 14 15 15 15-20 15-20 15 16-20 15-20 12-15 20-21 13-15 16-17 16-21 16-21 16-21 16-21 16-21 20-21 20-21
MD843X MD843XC VR843BLK VR843BLU VR843RED VR843GLD	F F F F F	Floating Floating Floating Floating Floating	320 320 320 320 320	Gold Gold Black Blue Red Gold	Plain Contour Vee Vee Vee Vee	6 6 6 6 6 6			DUCATI 848 (Radial 2 pad caliper) 848 Evo (Monobloc F Calipers) 899 Panigale 959 Panigale (ABS) 959 Panigale S Corse Monster 1100 (Non ABS) Monster 1100 (ABS) Monster 1100 S (Non ABS) Monster 1100 S (ABS) Monster 1100 EV (ABS) 1100 Monster Diesel M 1100 Evo Monster 20th Anniversary Model S4RS Monster (998cc) (Radial 4 pad caliper) S4R Testastretta Monster (998cc) (Radial 4 pad caliper) S4RS Testastretta Monster (998cc) (Radial 4 pad caliper) S4RS (Tricolore/Monster Testastretta) (998cc)# (Radial 4 pad caliper)	08-09 10-12 14-15 16-19 18-19 09-10 09-10 09-10 11-12 13-14 13-14 06 07-08 07- 08
MD844X MD844XC	F F	Floating Floating	300 300	Gold Gold	Plain Contour	6 6			KTM 690 Enduro R ABS 990 Adventure (ABS Model) (For left side)	09-17 07-12
MD845	R	Solid	240	N/A	Plain	N/A			BMW G 650 X Moto	07-09
MD847	F	Solid	280	N/A	Plain	N/A			ROYAL ENFIELD Bullet 500 EFI (Pricol caliper/Drum R) Bullet 500 EFI (Brembo caliper F & R) Classic 500 (Pricol caliper/Drum R)	10-15 16-17 10-15

ROTOR BUYERS GUIDE

BRAKE ROTOR BUYERS GUIDE - STREET

Rotor No.	F/R	Type	Dia. (mm)	Hub Color	Profile	Bobbins	Left Bracket	Right Bracket	Model	Year
MD847 Contd.	F	Solid	280	N/A	Plain	N/A			ROYAL ENFIELD Contd. Classic 500 (Brembo caliper F & R) Classic 500 Battle Green (Pricol caliper/Drum R) Classic 500 Chrome (Pricol caliper/Drum R) Classic 500 Chrome (Brembo caliper F & R) Classic 500 Desert Storm (Pricol caliper/Drum R)	16-17 10-15 10-15 16-17 10-15
MD848X MD848XC	F F	Floating Floating	300 300	Gold Gold	Plain Contour	6 6			KTM 990 Adventure (ABS Model) (For right side) 990 Adventure Baja Edition	07-12 13-14
MD850	R	Solid	230	N/A	Plain	6			KTM Duke 390 RC 390 390 Adventure	15-21 15-21 21
MD851 MD851C	R R	Solid Solid	220 220	N/A N/A	Plain Contour	N/A N/A			TRIUMPH Daytona 675 Daytona 675 R Street Triple 675 Street Triple R 675 Street Triple 675 RXSE (ABS) Street Triple S 675 (Nissan2-Piston sliding calipers, Brembo single piston R caliper, ABS) Street Triple R/LRH 765 (Brembo M4.32 4 piston radial caliper, Brembo single piston R caliper ABS) Street Triple RS 765 (Brembo M50 4-piston radial monobloc caliper, Brembo single piston sliding caliper, ABS) Thruxton R (1200cc) Thruxton TFC (1200cc)	13-17 13-19 13-19 13-19 15 18-21 18-21 18-21 18-21 16-21 19-21
MD852X MD852XC	F F	Floating Floating	310 310	Gold Gold	Plain Contour	6 6			TRIUMPH Street Triple 675 Street Triple R 675 Street Triple R 765 Street Triple RS 765 Thruxton (1200cc) Floating disc conversion Thruxton R (1200cc) Thruxton TFC (1200cc)	13-19 13-19 18-22 18-21 16-21 16-21 19-21
MD853 VR853	F F	Solid Solid	270 270	N/A N/A	Plain Vee	N/A N/A			CAN AM Spyder F3 Spyder F3 LTD Spyder F3-S (SE6/SM6) Spyder F3-S (Special Series) Spyder F3-S Daytona 500 Spyder F3-T Spyder RT (3 Cyl Eng/6 Speed) Spyder RT-S (3 Cyl Eng/6 Speed) Spyder RT-S (Special Series) Spyder RT Ltd (3 Cyl Eng/6 Speed) Spyder ST Brembo Calipers Spyder ST-S Brembo Calipers Spyder ST LTD Brembo Calipers Spyder RS Brembo Calipers Spyder RS-S Brembo Calipers	15-21 16-21 15-21 16-21 17 16-21 13-21 13-15 16-17 13-21 13-16 13-16 13-15 13-16 13-16
MD854 VR854	R R	Solid Solid	270 270	N/A N/A	Plain Vee	N/A N/A			CAN AM Spyder F3 Spyder F3 LTD Spyder F3-S (SE6/SM6) Spyder F3-S (Special Series) Spyder F3-S Daytona 500 Spyder F3-T Spyder RT (3 Cyl Eng/ 6 Speed) Spyder RT-S (3 Cyl Eng/ 6 Speed) Spyder RT Ltd (3 Cyl Eng/ 6 Speed) Spyder ST Brembo Calipers Spyder ST-S Brembo Calipers Spyder ST LTD Brembo Calipers	15-21 16-21 15-21 16-21 17 16-21 13-21 13-15 16-17 13-21 13-16 13-21 13-16

BRAKE ROTOR BUYERS GUIDE - STREET

Rotor No.	F/R	Type	Dia. (mm)	Hub Color	Profile	Bobbins	Left Bracket	Right Bracket	Model	Year
MD854 VR854 Contd.	R R	Solid Solid	270 270	N/A N/A	Plain Vee	N/A N/A			CAN AM Contd. Spyder RS Brembo Calipers Spyder RS-S Brembo Calipers	13-15 13-16
MD856X MD856XC	F F	Floating Floating	320 320	Gold Gold	Plain Contour	6 6			KTM 690 Duke (2 pad caliper) 890 Duke R	12-19 21
MD857 MD857C MD858 MD858C VR858	R R R R R	Solid Solid Solid Solid Solid	240 240 260 260 260	N/A N/A N/A N/A N/A	Plain Contour Plain Contour Vee	N/A N/A N/A N/A N/A			KTM 690 Duke (2 pad caliper) APRILIA Mana 850	12-19 08-12
MD859	F	Floating	320	Gold	Plain	5			MOTO GUZZI V9 Bobber/Sport V9 Roamer	18-21 18-21
MD862X	F	Floating	320	Gold	Plain	6			BMW HP4 K42 S 1000 RR (Models fitted with Forged race wheels 7 spoke type) S 1000 R K47 S 1000 XR K69	13-14 15-17 13-20 18-19
MD863	R	Solid	282	N/A	Plain	N/A			TRIUMPH Tiger Explorer 1200 Tiger 1200 XC (Vin # 740277 onwards/1215cc/Spoke Wheels) Tiger 1200 XCa (1215cc/Spoke Wheels) Tiger 1200 XCx/XRx (1215cc/Spoke Wheels/STD & Low) Tiger 1200 XR (1215cc/Cast Wheels) Tiger 1200 XRt 1200 (1215cc/Cast Wheels) Tiger 1200 Alpine Edition (1215cc/Cast Wheels/STD & Low) Tiger 1200 Desert Edition (1215cc/Spoke Wheels)	12-15 16-21 16-21 16-21 16-21 16-21 20-21 20-21
MD864 MD864X MD864XC	F F F	Solid Floating Floating	300 300 300	N/A Gold Gold	Plain Plain Contour	N/A 6 6			KTM Duke 390 RC 390	15-21 15-21
MD865X MD865XC	F F	Floating Floating	305 305	Gold Gold	Plain Contour	6 6			DUCATI 796 Hypermotard 1100 Hypermotard 1100 Hypermotard GVO 1100 Hypermotard GVOSP 1100 Hypermotard 1100S	10-12 07-09 10-12 10-13 07-09
MD868X MD868XC	F F	Floating Floating	330 330	Gold Gold	Plain Contour	6 6			DUCATI Scrambler Café Racer (Cast wheels/803cc) Scrambler Icon (Cast wheels/803cc) Scrambler Icon Dark (Cast wheels/803cc) Desert Sled (Spoke wheels/803cc) Scrambler Full Throttle (Cast wheels/803cc)	17-21 15-21 20-21 18-21 15-21
MD871	R	Solid	260	N/A	Plain	N/A			MOTO GUZZI 750 Nevada Club (From LK112434) 750 Nevada Base/Club Nevada Classic 750ie V 750 ie Breva V7 Classic V7 Cafe Classic V7 Racer V 750 ie Breva V9 Bobber/Sport V9 Roamer	98-01 02-03 04-09 03-08 08-12 11-12 10-11 03-08 18-21 18-21
MD872 MD872C VR872	R R R	Solid Solid Solid	256 256 256	N/A N/A N/A	Plain Contour Vee	N/A N/A N/A			APRILIA Mana 850 GT ABS	09-16

ROTOR BUYERS GUIDE

BRAKE ROTOR BUYERS GUIDE - STREET

Rotor No.	F/R	Type	Dia. (mm)	Hub Color	Profile	Bobbins	Left Bracket	Right Bracket	Model	Year
MD873 MD873X	F F	Solid Floating	310 310	N/A Gold	Plain Plain	N/A 6			TRIUMPH Bonneville T100 (900cc) Bonneville T100 Black (900cc) Bonneville T120 (1200cc) Bonneville T120 Black (1200cc) Street Twin (900cc) Bonneville Speedmaster 1200	17 17 16-21 16-21 16-21 18-21
MD874	R	Solid	255	N/A	Plain	N/A			TRIUMPH Bonneville Bobber (1200cc) Bonneville Bobber Black (1200cc) Bonneville T100 (900cc) Bonneville T100 Black (900cc) Street Cup (900cc) Street Twin (900cc) New Street (900cc) Bonneville Speedmaster 1200 Scrambler 1200 XC Scrambler 1200 XE Speed Twin 1200	17-21 18-21 17-21 17-21 17-20 16-21 18-20 18-21 19-21 19-21 19-21
MD877	R	Solid	240	N/A	Plain	N/A			ROYAL ENFIELD Continental GT (ABS)	17-18
MD878 MD878C VR878	R R R	Solid Solid Solid	245 245 245	N/A N/A N/A	Plain Contour Vee	N/A N/A N/A			DUCATI 796 Monster (ABS) 950 Hypermotard 950 Hypermotard SP 950 Hypermotard RVE	10-15 16-21 16-21 21
MD879	R	Solid	265	N/A	Plain	N/A			DUCATI 950 Multistrada (936) 950 Multistrada S Multistrada 1200 Multistrada 1200 Pikes Peak Multistrada 1200 S Multistrada 1200 Enduro Pro Diavel ABS Diavel Carbon ABS Diavel 1260 Diavel 1260 S 1262 X Diavel 1262 X Diavel S 1260 Multistrada/Multistrada Enduro 1260 Multistrada Pikes Peak 1260 Multistrada S 1260 Multistrada S Grand Tour	17-21 20-21 16-17 16-17 16-17 18-19 11-17 11-19 20-21 20-21 16-21 16-21 18-21 18-21 18-21 18-21
MD880 MD880C VR880	R R R	Solid Solid Solid	245 245 245	N/A N/A N/A	Plain Contour Vee	N/A N/A N/A			DUCATI Supersport (936cc) Supersport S (936cc) 955 Panigale V2 955 Panigale V2 S Corse 959 Panigale S Corse 998 Panigale V4 Superleggera 1103 Panigale V4 1103 Panigale V4 S 1103 Panigale V4 R 1103 Panigale V4 SP 1199 Panigale 1199 Panigale S 1199 Panigale S Tricolore 1199 Panigale R 1199 Panigale Superleggera 1200 Monster 1200 Monster S 1200 Monster R 1200 Monster Stripe 1200 Multistrada 1200 Multistrada S (Sport)	17-21 17-21 19-21 19-21 18-19 21 18-21 18-21 21 21 12-15 12-15 12-14 13-15 14 14-21 14-21 16-17 15 10-15 10

ROTOR BUYERS GUIDE

BRAKE ROTOR BUYERS GUIDE - STREET

Rotor No.	F/R	Type	Dia. (mm)	Hub Color	Profile	Bobbins	Left Bracket	Right Bracket	Model	Year
MD880 MD880C VR880 Contd.	R R R	Solid Solid Solid	245 245 245	N/A N/A N/A	Plain Contour Vee	N/A N/A N/A			DUCATI Contd. 1200 Multistrada S (Pikes Peak) 1299 Panigale V4 1299 Panigale V4 S 1299 Panigale V4 S Corse 1299 Panigale V4 Speciale 1299 Panigale V4 R 1299 Panigale R FE	11-14 15-21 15-21 18-21 18-21 15-21 18-21
MD881	F	Solid	300	N/A	Plain	N/A			BMW G 310 R G 310 GS G 310 GS Edition 40	17-21 17-21 20-21
MD882	R	Solid	240	N/A	Plain	N/A			BMW G 310 R G 310 GS G 310 GS Edition 40	17-21 17-21 20-21
MD883X MD883XC	F F	Floating Floating	310 310	Gold Gold	Plain Contour	6 6			TRIUMPH Thrupton R 1200 (Liquid Cooled)	16-21
MD884X MD884XC	F F	Floating Floating	320 320	Gold Gold	Plain Contour	6 6			MV 675 Brutale 675 F3 675 F3 Serie Oro 675 F3 RC 800 Brutale 800 Brutale Dragster 800 Dragster RC 800 Dragster RR 800 F3 800 F3 Ago 800 F3 RC 800 Stradale 800 Turismo Veloce 800 Turismo Veloce Lusso 800 Turismo Veloce RC Rivale 800	12-17 12-18 12-13 15-18 12-21 14-15 17-21 15-21 13-18 14-15 15-18 15 14-21 15-21 17-18 14-18
MD885 MD885C	R R	Solid Solid	220 220	N/A N/A	Plain Contour	N/A N/A			MV 675 Brutale 675 F3 675 F3 Serie Oro 675 F3 RC 800 Brutale 800 Brutale Dragster 800 Dragster RC 800 Dragster RR 800 F3 800 F3 Ago 800 F3 RC 800 Stradale 800 Turismo Veloce 800 Turismo Veloce Lusso 800 Turismo Veloce RC Rivale 800	12-17 12-18 12-13 15-18 12-21 14-15 17-21 15-21 13-18 14-15 15-18 15 14-21 15-21 17-18 14-18
MD886X	F	Floating	310	Gold	Plain	6			TRIUMPH Bonneville T100 (900cc/Liquid Cooled/Spoke Wheel) Bonneville T100 Black (900cc/Liquid Cooled/Spoke Wheel) Street Cup (900cc Liquid Cooled)	16-21 16-21 16-21
MD887BLK VR887BLK	R R	Floating Floating	299 299	Black Black	Plain Vee	9 9			INDIAN Chief Dark Horse (Nissin calipers) Chief Vintage (Nissin calipers) Chieftain (Nissin Calipers/Cast Wheels) Chieftain Dark Horse (Nissin Calipers/Cast Wheels) Chieftain Limited (Nissin Calipers/Cast Wheels) Chieftain Elite (Nissin Calipers/Cast Wheels)	16-21 14-21 14-21 14-21 14-21 14-21

ROTOR BUYERS GUIDE

BRAKE ROTOR BUYERS GUIDE - STREET

Rotor No.	F/R	Type	Dia. (mm)	Hub Color	Profile	Bobbins	Left Bracket	Right Bracket	Model	Year
MD887BLK VR887BLK Contd.	R R	Floating Floating	299 299	Black Black	Plain Vee	9 9			INDIAN Contd. Roadmaster (Nissin Calipers/Cast Wheels) Roadmaster Dark Horse (Nissin Calipers/Cast Wheels) Roadmaster Limited (Nissin Calipers/Cast Wheels) Roadmaster Dark Horse Jack Daniel's Edition (Nissin Calipers/Cast Wheels) Roadmaster Elite (Nissin Calipers/Cast Wheels) Springfield Springfield Dark Horse	15-21 15-21 15-21 21 15-21 16-21 19-21
MD890BLK VR890BLK	F F	Floating Floating	299 299	Black Black	Plain Vee	9 9			INDIAN Chief Dark Horse (Nissin calipers) Chief Vintage (Nissin calipers) Chieftain (Nissin Calipers/Cast Wheels) Chieftain Dark Horse (Nissin Calipers/Cast Wheels) Chieftain Limited (Nissin Calipers/Cast Wheels) Chieftain Elite (Nissin Calipers/Cast Wheels) Roadmaster (Nissin Calipers/Cast Wheels) Roadmaster Dark Horse (Nissin Calipers/Cast Wheels) Roadmaster Limited (Nissin Calipers/Cast Wheels) Roadmaster Dark Horse Jack Daniel's Edition (Nissin Calipers/Cast Wheels) Roadmaster Elite (Nissin Calipers/Cast Wheels) Springfield Springfield Dark Horse	16-21 14-21 14-21 14-21 14-21 14-21 15-21 15-21 15-21 21 15-21 16-21 19-21
MD891	F	Floating	300	Silver	Plain	9			MOTO GUZZI G5 V1000	78-83
MD893	F	Solid	300	N/A	Plain	N/A			ROYAL ENFIELD Himalayan	16-21
MD894 MD894C	R R	Solid Solid	240 240	N/A N/A	Plain Contour	N/A N/A			ROYAL ENFIELD Himalayan Continental GT 650cc (ABS) Interceptor 650	16-21 17-20 18-19
MD896X	F	Floating	320	Black	Plain	6			KTM 1090 Adventure R 1190 Adventure Inc R model 1290 Super Adventure R, S and T models	17-19 14-16 15-21
MD898X MD898XC	F F	Floating Floating	320 320	Gold Gold	Plain Contour	6 6			ROYAL ENFIELD Continental GT 650cc (ABS) Interceptor 650	17-20 18-19
MD899	R	Solid	245	N/A	Plain	N/A			DUCATI Scrambler Icon (Cast Wheels/803cc) Scrambler Full Throttle (Cast Wheels/803cc) Scrambler Desert Sled (Spoke Wheels/803cc) Scrambler Café Racer (Spoke Wheels/803cc) Monster Dark 821 GT 1000 (992cc) GT 1000 Touring - Sport Classic	15-21 15-21 18-21 18-21 15-20 07-10 09
MD8001	R	Solid	275	N/A	Plain	N/A			BMW R 1200 GS (Liquid Cooled/Radial Mount Caliper) R 1200 GS Adventure (Liquid Cooled/Radial Mount Caliper) R 1200 R R 1200 RS R 1200 RT (Radial Caliper) Disc Has Fixed Bobbins R 1250 GS R 1250 GS TE R 1250 GS Exclusive TE R 1250 GS Rallye R 1250 GS Rallye TE R 1250 R R 1250 RS R 1250 RT R 1250 RT SE R 1250 RT LE	13-18 14-18 15-18 15-18 14-18 18-21 18-21 18-21 18-21 18-21 18-21 19-21 19-21 18-21 18-21 18-21 18-21

ROTOR BUYERS GUIDE

BRAKE ROTOR BUYERS GUIDE - STREET

Rotor No.	F/R	Type	Dia. (mm)	Hub Color	Profile	Bobbins	Left Bracket	Right Bracket	Model	Year
MD8002	F	Solid	300	N/A	Plain	N/A			APRILIA RX 50 Racing	03-06
MD8003X ABS sensor disc	F	Floating	305	Gold	Plain	6			KTM 990 Supermoto T (SM-T) 990 Supermoto R (SM-R) 990 Supermoto R (SM-R)	09-13 08-09 10-13
MD8004X	F	Floating	330	Gold	Plain	6			APRILIA RSV4 RF 1000 RSV4 RR 1000 Tuono 1000 V4 Factory Tuono 1000 V4R Tuono 1100 V4 RR	17-20 17-20 17-20 17-20 17-20
MD8005	F	Solid	230	N/A	Plain	N/A			BOOM TRIKE Various Models	10-18
MD8006 MD8006C	R R	Solid Solid	265 265	N/A N/A	Plain Contour	N/A N/A			DUCATI 1200 Multistrada Enduro 1200 Multistrada Enduro 1200 Multistrada Enduro Pro	16 17-18 18-19
MD8007	R	Solid	260	N/A	Plain	N/A			INDIAN FTR 1200 FTR 1200 S FTR 1200 S Race Rep FTR 1200 Rally	19-21 19-21 19-21 19-21
MD8008XC	Front	Floating	320	Gold	Contour	6			TRIUMPH Scrambler 1200 XC Scrambler 1200 XE Speed Triple S Speed Triple RS Rocket 3 GT Rocket 3 R Tiger 900 Tiger 900 GT Tiger 900 Rally Tiger 900 GT Pro	19-21 19-21 17-21 18-21 19-21 19-21 20-21 20-21 20-21 20-21 20-21
MD8009	Front	Solid	300	N/A	Plain	N/A			KTM 125 Duke 200 Duke	17-21 17-21
MD8010	Front	Solid	300	N/A	Plain	N/A			KTM RC 390	17-21
MD8011	Front	Floating	330	Gold	Plain	6			DUCATI Multistrada 1200 S (Sport) Multistrada 1200 S Multistrada 1200 S Pikes Peak Multistrada 1200 Pikes Peak 1200 S Multistrada Grandtourismo 1200 S Touring 1260 Multistrada 1260 Multistrada Touring 1260 S Multistrada 1260 S Multistrada D Air 1260 S Multistrada Pikes Peak 1260 Multistrada Enduro 1260 Multistrada S Grand Tour Multistrada V4 Multistrada V4 S Multistrada V4 Sport	10- 16-17 11-14 16-17 13-14 10-14 18-20 18 18-20 18-20 18-20 18-20 19-20 21 21 21
MD901D	F & R	Solid	190	N/A	Plain	N/A			BETA Eikon 50 Team MALAGUTI F15 Firefox	02-03 02-03

BRAKE ROTOR BUYERS GUIDE - STREET

Rotor No.	F/R	Type	Dia. (mm)	Hub Color	Profile	Bobbins	Left Bracket	Right Bracket	Model	Year
MD901D Contd.	F & R	Solid	190	N/A	Plain	N/A			MALAGUTI Contd. F12 Phantom (A/C) Phantom F12 F15 Firefox (L/C) PEUGEOT Vivacity X-Race 50/Pulsa 50 Metal-X Trekker 50 Elyseo 50 Jet Force 50 Ludix 50 (14" wheels) Elegance/Ambition Ludix 125	98-03 98-03 04 02-05 02-05 02-05 03-05 03-05 04-05 04-05
MD903D	F	Solid	245	N/A	Plain	N/A			YAMAHA YP 250 Majesty (5CV1) YP 250 Majesty (5GM2/9-5SJ2/5/9)	97 00-03
MD904D	F	Solid	155	N/A	Plain	N/A			PEUGEOT Ludix 50 (10" wheels) Trend/One/Snake/Bullet Fox 50 CW 50 L/TL Zuma/Zuma II JYM 90 T Axis 4RT6 YA 90 Axis (4CY1/5/7 - 4EN5/6/7) YA 100 W Grand Axis (5TC2/4/5) YW 100 BW's (4VPS/PC/PV/PX/5XR1/R2/R3/R4)	04 07-08 99 01 91-96 01-03 97-08
MD908D	F	Solid	186	N/A	Plain	N/A			HONDA CN 250 Helix CN 250 Helix	86-87 92-01/05-07
MD910D	F	Solid	200	N/A	Plain	N/A			PIAGGIO Fly 50 Fly 50 (4T/2V) Typhoon 50 (4T/4V/12" Wheels) Fly 150 (Fly 150) VESPA ET2 50cc LX 50 Primavera 50 (4T/4V) S 50 4T/4V Sprint 50 (4T/4V) ET4 150cc Primavera 150 (4T/3V/ie) PX 150 (All models) LX 150 ie LXV 150 ie S 150 ie	05-12 07-14 10-11 05-12 97-05 05-15 13-15 08-15 14-15 99-05 13-15 05-06 05-15 10-15 08-15
MD915D	F	Solid	155	N/A	Plain	N/A			MALAGUTI Yesterday 50 F10 Fast Time	98-03 02-03
MD922D	F	Solid	240	N/A	Plain	N/A			HONDA NSS 250/250 A/A5 Reflex PS 250 Big Ruckus	01-07 05-06
MD923D	F	Solid	190	N/A	Plain	N/A			YAMAHA CW 50 M/N Zuma II Delivery 50 (From F. No 609100) EW 50 Stunt (5LH2/5YN1) X-peed 50/Special Edition Zyclone 50 Thunderbike 150	00-01 06-08 01-03 00-05 04-05 07-08
MD924D	F	Solid	220	N/A	Plain	N/A			DERBI Boulevard 150 Sport City 50 (4T) SR 50 Motard (4T)	03-05 08-14 12-15

ROTOR BUYERS GUIDE

BRAKE ROTOR BUYERS GUIDE - STREET

Rotor No.	F/R	Type	Dia. (mm)	Hub Color	Profile	Bobbins	Left Bracket	Right Bracket	Model	Year
MD925D	F	Solid	180	N/A	Plain	N/A			PEUGEOT Speedfight 2 X-Team (A/C) Elyseo 50 Elyseo 100 Speedfight X-Race 50 LNDP/100 NP	02-05 03-05 03-05 03-05
MD925D	R	Solid	180	N/A	Plain	N/A			PEUGEOT Speedfight X-Race 50 LNDP/100 NP	03-05
VR927	Rear	Solid	230	N/A	Vee	N/A			YAMAHA Zuma 125 YW 125 MB	21-22
MD931D	F	Solid	190	N/A	Plain	N/A			HONDA NHX 110 Elite	10-11
MD933D	F	Solid	160	N/A	Plain	N/A			SYM Mio 50 DD 50	05-12 02-12
MD941D	F	Solid	175	N/A	Plain	N/A			ITALJET Dragster 50 Formula 50 (Air Cooled) Formula 50 (Liquid Cooled) Formula 125 LC	98-03 99-03 96-03 96-03
MD942D	R	Solid	220	N/A	Plain	N/A			APRILIA Scarabeo 150 Scarabeo 125/200 GT Scarabeo 250 Sport City 250 Sport City Cube 250	99-06 04 06-08 07-14 08-09
MD943D	F & R	Solid	190	N/A	Plain	N/A			DERBI Atlantis 50 GP1 50 APRILIA Rally 50 (Air Cooled) Mojito Retro 50 Scarabeo 50 Ditech (R disc model) SR 50 (Factory) Mojito Custom 50 Mojito Custom 150	02-06 02-06 04-05 04-05 02-08 99-15 04-06 05-08
MD945D	F	Solid	220	N/A	Plain	N/A			APRILIA Scarabeo 50 Ditech (R disc model) Scarabeo Street 50 Scarabeo 100 4T	02-08 99-05 04-14
MD946D	F	Solid	200	N/A	Plain	N/A			MALAGUTI Phantom F12 F12 Phantom (A/C) F15 Firefox (L/C)	98-03 98-03 04
MD947D	F	Solid	226	N/A	Plain	N/A			PEUGEOT Elyseo 100 Elystar 50 P	03-05 03-05
MD948D	R	Solid	190	N/A	Plain	N/A			ITALJET Dragster 50 LC	96-03
MD950D	F	Solid	175	N/A	Plain	N/A			ITALJET Formula 50 (Liquid Cooled) Formula 125 LC	96-03 96-03
MD951D	F	Solid	220	N/A	Plain	N/A			ITALJET Torpedo 50 Torpedo 125 4T Torpedo 150	98-03 99-03 03

BRAKE ROTOR BUYERS GUIDE - STREET

Rotor No.	F/R	Type	Dia. (mm)	Hub Color	Profile	Bobbins	Left Bracket	Right Bracket	Model	Year
MD952D	F	Solid	260	N/A	Plain	N/A			APRILIA Scarabeo 150 Scarabeo 125/250 GT Sport City 125 (4T) Scarabeo 200 Sport City 250 Sport City Cube 250 Scarabeo 250 Atlantic 500 Scarabeo 500/ie	99-06 04-05 08-14 08-14 07-14 08-09 06-08 03-05 03-14
MD953D MD953C MD954D	R R F	Solid Solid Solid	230 230 226	N/A N/A N/A	Plain Contour Plain	N/A N/A N/A			YAMAHA YP 250 Majesty (5GM2/9-5SJ2/5/9) PEUGEOT Looxor 50	00-03 02-05
MD955D	F	Solid	230	N/A	Plain	N/A			MALAGUTI Ciak 50/150	02-03
MD956D	F & R	Solid	220	N/A	Plain	N/A			PIAGGIO LT 50 Fly 150 (4T/3V) LT 150 GT 200 L Granturismo VESPA GT 60 (250cc Ltd Edition) GTS 250 GTV 250/LXV 250 GTS 300 ie GTS 300 Super/GTV 300 ie GTS 300 4V ABS/Super Sport/Touring Inc HPE GTS Super 300 HPE-Tech (4T/4V)	97-05 13-15 98-05 05-08 06-08 05-08 07-08 08-15 10-15 18-21 18-21
MD959D VR959									PIAGGIO Liberty 50 (4T) Liberty 50 S (4T) Liberty 150 (4T) Liberty S 150 (4T)	17-20 17-20 17-20 17-20
MD960D	R	Solid	240	N/A	Plain	N/A			PIAGGIO BV 300 Tourer MP3 (250cc)/MP3 400ie MP3 500 (Three wheeler - 12" F/14" R Wheel) MP3 500 (Three wheeler - 13" F/14" R Wheel) X9 500 Evolution BV 500	10-12 07-15 07-14 15-16 05-09 06-12
MD961D	F & R	Solid	260	N/A	Plain	N/A			PIAGGIO BV 200 BV 250 BV 500	02-06 06-11 06-12
MD963D	F	Solid	220	N/A	Plain	N/A			YAMAHA T 105 SE Crypton (5AM4/1D81/1D82)	99-09
MD964D	F & R	Solid	190	N/A	Plain	N/A			DERBI Predator Atlantis Bullet/City HUSQVARNA WRS 50 Scooter	99-01 02-05 98-00
MD968D	F & R	Solid	220	N/A	Plain	N/A			BMW C1 125 C1 200	99-03 01-03
MD970D	F	Solid	220	N/A	Plain	N/A			HONDA SH 150i	10-11

BRAKE ROTOR BUYERS GUIDE - STREET

Rotor No.	F/R	Type	Dia. (mm)	Hub Color	Profile	Bobbins	Left Bracket	Right Bracket	Model	Year
MD971D	F & R	Solid	180	N/A	Plain	N/A			KYMCO Agility 50 (4T) Cobra Racer 50 (SF10AG) Cobra Cross/Racer 50 (SF10AF) Sting 50 (2T) Vitality 50 (4T) Yup 50 Super 9 LC/AC ZX 50 Super Fever Agility 125	05-15 00-04 05-06 07-11 05-08 02-06 02-09 02-04 06-15
MD973D	F	Solid	220	N/A	Plain	N/A			KYMCO 150/250 Bet & Win Grand Vista 250	02-08 04-10
MD974D	R	Solid	200	N/A	Plain	N/A			KYMCO 150/250 Bet & Win Yager GT 200 i Grand Vista 250	02-08 09-10 04-10
MD977D	F	Solid	226	N/A	Plain	N/A			PEUGEOT Elyseo 125/150	03-05
MD978D	R	Solid	210	N/A	Plain	N/A			PEUGEOT Elystar 50 P Elyseo 125/150 Elystar 125/150 P Jet Force 125 EFI/Compressor	03-05 03-05 03-05 03-05
MD980D	F	Solid	226	N/A	Plain	N/A			PEUGEOT Elysar 125/150 P	03-05
MD981D	F	Solid	180	N/A	Plain	N/A			KYMCO Super 9 AC	02-09
MD982D	R	Solid	165	N/A	Plain	N/A			ADLY Thunderbike 150	07-08
MD983D	F	Solid	260	N/A	Plain	N/A			PIAGGIO BV 300 Tourer X9 500 Evolution	10-12 05-09
MD986D	F	Solid	220	N/A	Plain	N/A			YAMAHA YW125 Y/Z/A/B/D/E/F Zuma (R Drum Model)	09-15
MD987D VR987	F F	Solid Solid	260 260	N/A N/A	Plain Vee	N/A N/A			SUZUKI AN 650 K3 Burgman	03
MD988D VR988 4 Bolt type	R R	Solid Solid	250 250	N/A N/A	Plain Vee	N/A N/A			SUZUKI AN 650 K3 Burgman	03
MD989D	F	Solid	225	N/A	Plain	N/A			KYMCO People 50 (2T) People S 50/125 People 150 People S 200	02-12 05-09 07-12 05-10
MD990D	R	Solid	220	N/A	Plain	N/A			APRILIA Atlantic 500 Scarabeo 500/ie	03-05 03-14
MD994D VR994	F F	Solid Solid	260 260	N/A N/A	Plain Vee	N/A N/A			SUZUKI AN 400 K3-K9/SK6/AK9/ALO-AL5/AS6 Burgman AN 400 Z Burgman ABS AN 650 K4-K9/AK4-AK9/AL1/AL2	03-16 14-21 04-12
MD996D	R	Solid	190	N/A	Plain	N/A			APRILIA SR 50 (Factory) Atlantic 200	04-15 04-06

BRAKE ROTOR BUYERS GUIDE - STREET

Rotor No.	F/R	Type	Dia. (mm)	Hub Color	Profile	Bobbins	Left Bracket	Right Bracket	Model	Year
MD998D VR998 5 Bolt type	R R	Solid Solid	250 250	N/A N/A	Plain Vee	N/A N/A			SUZUKI AN 650 K4/K5/K6/K7/K8/K9/AK9/L1 Burgman Non ABS AN 650 AK4/AK5/AK6/AK7/AK8/AK9/AL1/AL2 Burgman AN 650 L3/L4/L5/L6 Burgman ABS AN 650 Burgman Executive ABS	04-12 04-12 13-16 13-21
MD9100D	F	Solid	260	N/A	Plain	N/A			KYMCO People 250 SH 50 DF	03-08
MD9102D	F	Solid	267	N/A	Plain	N/A			YAMAHA YP 400 T/V/W/X/Y/Z/B/D/E	05-10/12-14
MD9103D	R	Solid	267	N/A	Plain	N/A			YAMAHA YP 400 T/V/W/X/Y/Z/B/D/E	05-10/12-14
MD9104D	Rear	Solid	240	N/A	Plain	N/A			YAMAHA XMAX 300	18-21
MD9107D	F	Solid	245	N/A	Plain	N/A			YAMAHA CP 250 V/W/X Morphus	06-08
MD9108D	R	Solid	245	N/A	Plain	N/A			YAMAHA CP 250 V/W/X Morphus	06-08
MD9109D	R	Solid	210	N/A	Plain	N/A			SUZUKI AN 400 K7/K8/K9/AK9/AL1/AL2/AL3/AL4/AL5/AL6 Burgman AN 400 Z Burgman ABS	07-16 14-21
MD9112D	F	Solid	240	N/A	Plain	N/A			PIAGGIO MP3 (250cc) MP3 400ie (Three wheeler) MP3500 (Three wheeler - 12" F/14" R Wheel)	07-15 07-15 07-14
MD9115D	F	Solid	220	N/A	Plain	N/A			TGB/PEIRSPEED R 50 X Delivery 151 Laser R9/i (151cc)	06-11 04-11 08-11
MD9115D	R	Solid	220	N/A	Plain	N/A			TGB/PEIRSPEED R 50 X	06-11
MD9116D	F	Solid	190	N/A	Plain	N/A			SYM Jet Euro X 50 Jet 50 Evo	99-11 14
MD9117D VR9117	F & R F & R	Solid Solid	240 240	N/A N/A	Plain Vee	N/A N/A			SUZUKI UH 200 AL4/AL5/AL6 Burgman ABS	14-16
MD9119D	F	Solid	256	N/A	Plain	N/A			HONDA NSS 300 Forza non ABS NSS 300 Forza ABS	14-16 18-21
MD9126D	F	Solid	190	N/A	Plain	N/A			PIAGGIO Typhoon 50/SE Typhoon 50 Typhoon 50 (2T) 10" wheels	06 07-08 07-09
VR9128	F	Floating	260	Black	Vee	5			KYMCO Downtown 200i Downtown 300i	11-12 10-15
MD9129D	R	Solid	240	N/A	Plain	N/A			KYMCO Downtown 200i Downtown 300i	11-12 10-15
VR9133	F	Solid	245	N/A	Vee	N/A			YAMAHA YW125 G Zuma (Rear Disc Model) Zuma 125 XC155 F/G S-Max	16-21 21-22 15-16

BRAKE ROTOR BUYERS GUIDE - STREET

Rotor No.	F/R	Type	Dia. (mm)	Hub Color	Profile	Bobbins	Left Bracket	Right Bracket	Model	Year
MD9134D	F	Solid	190	N/A	Plain	N/A			HONDA PCX 125 PCX 150 (WW 150)	11 13-21
MD9139D	R	Solid		N/A	Plain	N/A			HONDA NSS 300 Forza Non ABS NSS 300 Forza ABS	14-16 14-16
MD9143D MD9143C	R R	Solid Solid	282 282	N/A N/A	Plain Contour	N/A N/A			YAMAHA XP500 F/G (T-Max 530cc)	15-16
MD9144D VR9144BLK	F F	Floating Floating	260 260	Black Black	Plain Vee	5 5			SUZUKI AN 650 L3/L4/L5/L6 Burgman ABS AN 650 Burgman Executive ABS	13-16 13-21
VR9145	F	Solid	267	N/A	Plain	N/A			YAMAHA XC155 F/G S-Max	15-16
MD9150D VR9150	R R	Solid Solid	200 200	N/A N/A	Plain Vee	N/A N/A			YAMAHA YW125 G Zuma (R Disc Model)	16-21
MD9155D VR9155 MD9158D	R R F	Solid Solid Solid	240 240 258	N/A N/A N/A	Plain Vee Plain	N/A N/A N/A			PIAGGIO BV 300 Tourer PIAGGIO MP3 500 (Three wheeler - 13" F/14" R Wheel)	10-12 15-16
VR9159	F	Solid	180	N/A	Vee	N/A			YAMAHA Zuma50 F (Twin Headlights) F 4T (YW 50 FB/FD/FE/FF/FG) Zuma50 FX (Single Headlight) 4T (YW 50 FXE/XXF/XXG)	12-16 14-21
MD9162D VR9162	F F	Solid Solid	205 205	N/A N/A	Plain Vee	N/A N/A			GOGORO SmartScooter	15-17
MD9163D VR9163	R R	Solid Solid	162 162	N/A N/A	Plain Vee	N/A N/A			GOGORO SmartScooter	15-17
MD9164D VR9164	R R	Solid Solid	240 240	N/A N/A	Plain Vee	N/A N/A			PIAGGIO BV 350 (4T/4V/330cc)	12-14
MD9168D	Rear	Solid	245	N/A	Plain	N/A			YAMAHA XMAX 300 CZD300	18-21
MD9169D	Front	Solid	267	N/A	Plain	N/A			YAMAHA	
MD9174D									KYMCO AK 550	17-21
MD9172D VR9172	F F	Solid Solid	300 300	N/A N/A	Plain Vee	N/A N/A			PIAGGIO BV 300 Tourer BV 350 (4T/4V/330cc)	10-12 12-14
MD9176D	F & R	Solid	240	N/A	Plain	N/A			SUZUKI UH 200 AL4/AL5/AL6 Burgman ABS	14-22
MD9177D	F	Solid	220	N/A	Plain	N/A			HONDA PCX 125 (ABS Model) PCX 150 (ABS Model)	18-21 18-21
MD9182D	F & R	Solid	270	N/A	Plain	N/A			BMW C 600 Sport Scooter K18C C 650 GT Scooter K19C C 650 GT Special Edition Scooter C 650 Sport Scooter	12-15 12-21 15 16-21
MD9183D	Front	Solid	180	N/A	Plain	N/A			OHVALE GP-O 110 160	19-20

ROTOR BUYERS GUIDE

BRAKE ROTOR BUYERS GUIDE - STREET

Rotor No.	F/R	Type	Dia. (mm)	Hub Color	Profile	Bobbins	Left Bracket	Right Bracket	Model	Year
MD1001	F & R	Solid	276	N/A	Plain	N/A			HONDA CBR 1000 F Hurricane GB 500 CBR 600 F Hurricane CBR 600 F2 CB 650 SC Nighthawk CB 700 SC/S Nighthawk VF 700 F Interceptor VFR 700 F/F2 Interceptor VF 700 S Sabre VF 750 V45 Interceptor VFR 750 F Interceptor VF 750 S Sabre PC 800 Pacific Coast VF 1000 F Interceptor VF 1100 S V65 Sabre CB 1100 F Supersport	87-88 89-90 87-90 91-94 83-85 84-86 84-85 86-87 84-85 83-84 86 82-83 89-90/94-98 84 84-85 83
MD1002	R	Solid	220	N/A	Plain	N/A			HONDA CBR 600 F Hurricane	87-90
MD1003X MD1003XC MD1003CC VR1003BLK VR1003BLU VR1003RED (Check bolt PCD with 1014LS/RS)	F F F F F	Floating Floating Floating Floating Floating	296 296 296 296 296	Gold Gold Chrome Black Blue Red	Plain Contour Contour Vee Vee Vee	6 6 6 6 6 6			HONDA CBR 600 F3/SJR/SE VFR 750 F VFR 800 Fi-W CBR 900 RR Fireblade (Hub bolt PCD 74mm) VTR 1000 F Superhawk MORIWAKI/HONDA MD 250 H MD 250 S	95-98 94-97 98-99 95-97 98-05 08-13 08-11
MD1004 MD1004C VR1004	R R R	Solid Solid Solid	220 220 220	N/A N/A N/A	Plain Contour Vee	N/A N/A N/A			HONDA CBR 250 R (Non ABS Models) NSS 250/250 A/A5 Reflex 599 (CB 600 F) CBR 600 F2 CBR 600 F3/SJR/SE CBR 600 F4 CBR 600 F4i Sport CBR 600 RR CBR 900 RR Fireblade CBR 929 RR (929cc model) CBR 954 RR CBR 1000 RR CBR 1000 RR SP (Brembo F calipers) CBR 1000 RA/RAA VTR 1000 F Super Hawk RVT 1000 R (RC5I)	11-14 01-07 04/06 91-94 95-98 99-03 01-06 03-21 93-00 00-01 02-03 04-14 14-20 09-20 98-05 00-06
MD1006 MD1006C VR1006	R R R	Solid Solid Solid	256 256 256	N/A N/A N/A	Plain Contour Vee	N/A N/A N/A			HONDA VF 500 F Interceptor FSC 600/D Silverwing VFR 700 F/F2 Interceptor VFR 750 F Interceptor CBR 1000 F XL 1000 VA8 Varadero (Canada) CBR 1100 XX Blackbird	84-86 02-06 86-87 86 93-99 08 97-03
MD1007 MD1007C	R R	Solid Solid	256 256	N/A N/A	Plain Contour	N/A N/A			HONDA VFR 750 F	90-98
MD1008	F	Solid	296	N/A	Plain	N/A			HONDA NT 700 V/VA (ABS) VFR 750 F CBR 1000 F (Hurricane) CBR 1000 F ST 1100 A	10-13 90-93 87-88 90-91/93-99 96-02

ROTOR BUYERS GUIDE

BRAKE ROTOR BUYERS GUIDE - STREET

Rotor No.	F/R	Type	Dia. (mm)	Hub Color	Profile	Bobbins	Left Bracket	Right Bracket	Model	Year
MD1010LS MD1010RS	F F	Floating Floating	310 310	Silver Silver	Plain Plain	6 6			HONDA VFR 750 R (RC 30)	90
MD1011	R	Solid	220	N/A	Plain	N/A			HONDA VFR 750 R (RC 30)	90
MD1012LS MD1012RS MD1013	F F R	Floating Floating Solid	310 310 220	Silver Silver N/A	Plain Plain Plain	6 6 N/A			HONDA RVF 750 R (RC45) HONDA RVF 750 R (RC45)	94-95 94-95
MD1014X MD1014XC MD1014CC VR1014BLK VR1014BLU VR1014RED (Check bolt PCD with MD1003LS/RS)	F F F F F F	Floating Floating Floating Floating Floating Floating	296 296 296 296 296 296	Gold Gold Chrome Black Blue Red	Plain Contour Contour Vee Vee Vee	6 6 6 6 6 6			HONDA CBR 600 F4 CBR 900 RR Fireblade (Hub bolt PCD 78mm) VFR 800 Fi/Interceptor XL 1000 VA8 Varadero (Canada) GL 1500 Valkyrie All models GL1800/1800 A (ABS) Goldwing All models	99-00 93-94 98-05 08 97-03 01-17
MD1016	R	Solid	276	N/A	Plain	N/A			HONDA NT 700 V/VA (ABS) CB 1000 CBR 1000 F VT 1100 C2 American Classic Edition/C2-2/C3 VT 1100 C2 Shadow American Classic Tourer VT 1100 C2 Shadow Sabre	10-13 94-95 90-91 95-02 98-02 00-07
MD1020 MD1020C VR1020	R R R	Solid Solid Solid	240 240 240	N/A N/A N/A	Plain Contour Vee	N/A N/A N/A			HONDA CB-1 (CB 400 F) CB 900 F (919)	89-90 02-07
MD1021LS MD1021RS (Original Disc is solid)	F F	Floating Floating	316 316	Silver Silver	Plain Plain	6 6			HONDA NT 650 Hawk GT CB 750 Nighthawk VF 750 C Magna/Magna Delux CD/C2 ST 1100 ST 1100 A	88-91 91-03 94-03 91-02 95
MD1022	R	Solid	240	N/A	Plain	N/A			HONDA NT 650 Hawk GT	88-91
MD1030	F	Solid	240	N/A	Plain	N/A			HONDA CMX 250 C Rebel CMX 250 C/CD Rebel CMX 250 C2 CMX 250 X Rebel	96/97/99-14 85-87 99-00 15
MD1036LS MD1036RS VMD1036	F F F	Floater Floater Floater	276 276 276	Silver Silver Black	Plain Plain Plain	6 6 6			HONDA CB 250 N/T CM 250 T CB 400 T Hawk CM 400 A/T CM 400 C Custom CB 450 T Hawk CB 450 SC Nighthawk CM 450 C Custom CM 450 A Hondamatic CB 650 CB 650 C Custom CB 650 SC Nighthawk CB 750 C Custom CB 750 F Supersport CB 750 SC Nighthawk CB 900 C Custom CB 900 F Supersport CBX GL 1000 Goldwing GL 1100/1100 I Goldwing GL 1100/1100 I Goldwing/Interstate	80-81 79-81 81 82 82 82 82 79-81 80-81 82 81-82 79-82 82-83 80-82 81-82 79-80 79 80 81-83

ROTOR BUYERS GUIDE

BRAKE ROTOR BUYERS GUIDE - STREET

Rotor No.	F/R	Type	Dia. (mm)	Hub Color	Profile	Bobbins	Left Bracket	Right Bracket	Model	Year
MD1038RS	F	Floating	310	Gold	Plain	6			HONDA CB-1 (CB 400F)	89-90
MD1040LS MD1040RS	F F	Solid Solid	276 276	N/A N/A	Plain Plain	N/A N/A			HONDA CB 450 SC Nighthawk CM 450 A Hondamatic GL 650 Silverwing/GL 650 Silverwing Interstate VF 700 C Magna VT 700 C Shadow VF 750 C V45 Magna VT 750 C Shadow CB 1000 C Custom VF 1100 C V65 Magna VT 1100 C Shadow	83-86 83 83 84-86 84-85 82-83 83 83 83-86 85-86
MD1041LS	F	Solid	276	N/A	Plain	N/A			HONDA CMX 450 C Rebel	86-87
MD1047LS	F	Solid	296	N/A	Plain	N/A			HONDA VT 500 FT Ascot VT 500 C Shadow VF 500 C V30 Magna CB 550 SC 'Nighthawk' VLX 600 Shadow (VT 600 C/CD) VT 600 C/CD/C2D Shadow VLX/Deluxe CX 650 C Custom VT 700 C Shadow VT 800 C Shadow	83-84 83-86 84-85 83 88-93 94-07 83 86-87 88
MD1048	R	Floating	276	Silver	Plain	9			HONDA FT 500 Ascot	82-83
MD1052LS MD1052RS VMD1052	F F F	Floating Floating Floating	296 296 296	Gold Gold Black	Plain Plain Plain	9 9 9			HONDA CB 750 C Custom CB 750 L "Ltd Edition" CB 750 K	80 79 79-82
MD1056	F	Floating	310	Silver	Plain	9			HONDA CB 1000	94-95
MD1059LS	F	Solid	316	N/A	Plain	N/A			HONDA VF 700 C Magna VF 750 C V45 Magna	87 88
MD1062LS VMD1062	F F	Floating Floating	296 296	Silver Black	Plain Plain	9 9			HONDA CB 750 F 'Supersport' CB 750 76/K7	75-76 76-78
MD1064	R	Floating	296	Silver	Plain	9			HONDA CB 750 F 'Supersport' GL 1000 Goldwing All models	75-78 75-79
MD1068	R	Solid	296	N/A	Plain	N/A			HONDA VF 700 F Interceptor VF 750 V 45 Interceptor CB 1100 F Supersport	84 83-84 83
MD1071	R	Floating	296	Natural	Plain	9			HONDA CB 750 F Supersport CB 900 C Custom CBX GL 1100/1100 I Goldwing GL 1100/1100 I Goldwing/Interstate	79-80 80-81 79-80 80 81
MD1074LS MD1074RS	F F	Floating Floating	276 276	Gold Gold	Plain Plain	9 9			HONDA GL 1000 K/76/L Goldwing	75-77

BRAKE ROTOR BUYERS GUIDE - STREET

Rotor No.	F/R	Type	Dia. (mm)	Hub Color	Profile	Bobbins	Left Bracket	Right Bracket	Model	Year
MD1077	R	Solid	316	N/A	Plain	N/A			HONDA ST 1100 ST 1100 A GL 1500 'Valkyrie'/CT Tourer GL 1500/1500SE/A/I Goldwing	91-02 95 97-99 90-00
MD1078	R	Solid	296	N/A	Plain	N/A			HONDA CB 1000 C Custom VF 1100 C V65 Magna	83 83-86
MD1079	R	Solid	276	N/A	Plain	N/A			HONDA VF 700 F Interceptor VF 1000 Interceptor VF 1100 S V65 Sabre	85 84 84-85
MD1080RS	F	Floating	336	Silver	Plain	9			HONDA VT 1100 C Shadow/Shadow Spirit	87-94
MD1082	R	Floating	296	Silver	Plain	9			HONDA CB 750 F Supersport CB 900 C Custom CB 900 F Supersport CBX GL 1100/1100 I Goldwing/Interstate GL 1100 A Goldwing Aspencade GL 1200 All models	81-82 82 81-82 81-82 82-83 82-83 84-87
MD1083LS MD1083RS	F F	Floating Floating	276 276	Silver Silver	Plain Plain	9 9			HONDA GL 1200/1200I/1200 A Goldwing (5mm rotor)	84-85
MD1101	F	Solid	316	N/A	Plain	N/A			HONDA Venox 250	00-07
MD1120X MD1120XC VR1120BLK VR1120BLU VR1120RED	F F F F F	Floating Floating Floating Floating Floating	310 310 310 310 310	Gold Gold Black Blue Red	Plain Contour Vee Vee Vee	6 6 6 6 6			HONDA CBR 1100 XX Blackbird	97-98
MD1125 Billet	F	Floating	276	Silver	Plain	9			HONDA GL 1200 L/1200 I/1200 A/GL 12SE-i Goldwing (10mm rotor)	85-87
MD1126 Billet	F	Solid	296	N/A	Plain	N/A			HONDA GL 1500 Goldwing All models GL 1500 SE/A/I/Goldwing	88-89 90-00
MD1127 Billet	R	Solid	296	N/A	Plain	N/A			HONDA GL 1500 Goldwing All models	88-89
MD1131LS MD1133 Billet	F F	Floating Floating	296 296	Silver Gold	Plain Plain	9 9			HONDA FT 500 Ascot HONDA GL 1100 A Goldwing Aspencade	82-83 82-83
MD1134X MD1134XC MD1134CC VR1134BLK VR1134BLU VR1134RED	F F F F F F	Floating Floating Floating Floating Floating Floating	310 310 310 310 310 310	Gold Gold Chrome Black Blue Red	Plain Contour Contour Vee Vee Vee	6 6 6 6 6 6			HONDA CBR 900 RR Fireblade	98-99
MD1135	R	Solid	296	N/A	Plain	N/A			HONDA ST 1100 A	96-02
MD1136X MD1136XC VR1136BLK VR1136BLU VR1136RED	F F F F F	Floating Floating Floating Floating Floating	310 310 310 310 310	Gold Gold Black Blue Red	Plain Contour Vee Vee Vee	6 6 6 6 6			HONDA CBR 1100 XX Blackbird	99-03

ROTOR BUYERS GUIDE

BRAKE ROTOR BUYERS GUIDE - STREET

Rotor No.	F/R	Type	Dia. (mm)	Hub Color	Profile	Bobbins	Left Bracket	Right Bracket	Model	Year
MD1137X MD1137XC VR1137BLK VR1137BLU VR1137RED	F F F F F	Floating Floating Floating Floating Floating	330 330 330 330 330	Gold Gold Black Blue Red	Plain Contour Vee Vee Vee	6 6 6 6 6			HONDA CBR 929 RR (929cc model) CBR 954 RR (954cc)	00-01 02-03
MD1138X MD1138XC MD1138CC									Use MD1161X Use MD1161XC Use MD1161CC	
MD1139 MD1139C	F F	Floating Floating	296 296	Gold Gold	Plain Contour	9 9			HONDA 599 (CB 600 F)	04/06
MD1141X MD1141XC MD1141CC VR1141BLK VR1141BLU VR1141RED	F F F F F F	Floating Floating Floating Floating Floating Floating	296 296 296 296 296 296	Gold Gold Chrome Black Blue Red	Plain Contour Contour Vee Vee Vee	6 6 6 6 6 6			HONDA CBR 600 Sport F4i 919 (CB 900 F) VTX 1800 R VTX 1800 S VTX 1800 C/C1/C2/C3 VTX 1800 F1/F2/F3 VTX 1800 N1/N2/N3 VTX 1800 T1/T2	01-06 02-07 02-08 02-07 02-08 05-11 04-11 07-11
MD1146	F	Solid	276	N/A	Plain	N/A			HONDA VF 1000 R	85-86
MD1148	R	Solid	316	N/A	Plain	N/A			HONDA GL 1500 CF/CD Valkyrie All models VTX 1800 C/C1/C2/C3 VTX 1800 R VTX 1800 S VTX 1800 F1/F2/F3 VTX 1800 N1/N2/N3 VTX 1800 T1/T2	00-02 02-08 02-08 02-07 05-11 04-11 07-11
MD1149 MD1149C	R R	Solid Solid	240 240	N/A N/A	Plain Contour	N/A N/A			HONDA NSS 300 Forza FSC 600 Silverwing All models	18-21 02-14
MD1151	R	Solid	220	N/A	Plain	N/A			HONDA CBR 125 RW4/RW5/RW6/RW7/RW8/RW9/RWA/RWB/RWC/RWD	04-16
MD1152X MD1152XC MD1152CC VR1152BLK VR1152BLU VR1152RED VR1152CHRD	F F F F F F F	Floating Floating Floating Floating Floating Floating Floating	310 310 310 310 310 310 310	Gold Gold Chrome Black Blue Red Red	Plain Contour Contour Vee Vee Vee Vee	6 6 6 6 6 6 6			HONDA CBR 600 RR CBR 600 RRA CB 1000 R	03-21 09-21 10-16
MD1153X MD1153XC VR1153BLK VR1153BLU VR1153RED	F F F F F	Floating Floating Floating Floating Floating	310 310 310 310 310	Gold Gold Black Blue Red	Plain Contour Vee Vee Vee	6 6 6 6 6			HONDA CBR 1000 RR	04-05
MD1154X MD1154XC	F F	Floating Floating	310 310	Gold Gold	Plain Contour	6 6			HONDA ST 1300/1300 A	02-13
MD1156	Rear	Solid	240	N/A	Plain	N/A			HONDA CB 500 F CB 500 FA CB 500 X CB 500 XA CBR 500 R CBR 500 RA CB 650 F CB 650 FA CB 650 R CB 650 R ABS	13-20 13-21 13-20 13-21 13-20 13-21 14-16 14-18 19-21 19-21

ROTOR BUYERS GUIDE

BRAKE ROTOR BUYERS GUIDE - STREET

Rotor No.	F/R	Type	Dia. (mm)	Hub Color	Profile	Bobbins	Left Bracket	Right Bracket	Model	Year
MD1156 Contd.	Rear	Solid	240	N/A	Plain	N/A			HONDA Contd. CBR 650 F CBR 650 FA CBR 650 R CBR 650 RA CBF 1000 A8	14-16 14-18 19-21 19-21 08-11
MD1157X MD1157XC	F F	Floating Floating	296 296	Gold Gold	Plain Contour	6 6			HONDA VFR 800 A/Interceptor ABS GL 1800/1800 ABS (All models)	02-11 01-17
MD1158RS	F	Floating	336	Gold	Plain	9			HONDA VTX 1300 S	03-07
MD1159 MD1159	F Rear	Solid Solid	296 296	N/A N/A	Plain Plain	N/A N/A			HONDA VT 750 C2/C2F Shadow Spirit VT 750 RS Shadow VT 750 Shadow Phantom VT 750 Shadow Aero HONDA VT 750 C/CD/CD2 Shadow/Shadow Deluxe VT 750 CDA/CDB/CDC/CDD Shadow American Classic Edition 750 Deluxe VT 1300 CXA Fury (Non ABS Model) VT 1300 CXAA Fury (ABS Model) VT 1300 Sabre/Sabre ABS VT 1300 Stateline/Stateline ABS VT 1300 Interstate VTX 1300 S VTX 1300 C VTX 1300 R VTX 1300 T	07-12 10-13 10-12 08-12 98-02 02-05 10-21 10-11 10-13 10-13 10-13 03-07 04-11 05-11 08-11
MD1160	F	Floating	296	Silver	Plain	9			HONDA CBF 1000 A8 (Canada)	08
MD1161X MD1161XC MD1161CC VR1161BLK VR1161BLU VR1161RED	F F F F F F	Floating Floating Floating Floating Floating Floating	320 320 320 320 320 320	Gold Gold Chrome Black Blue Red	Plain Contour Contour Vee Vee Vee	6 6 6 6 6 6			HONDA CBR 1000 RR RVT 1000 R (RC51)	06-08 00-06
MD1163 (MILD STEEL ROTOR USE ORGANIC PADS ONLY)	R	Solid	316	N/A	Plain	N/A			HONDA ST 1300/1300 A	02-13
MD1164 MD1164C	R R	Solid Solid	256 256	N/A N/A	Plain Contour	N/A N/A			HONDA VFR 800 Interceptor VFR 800 A Interceptor (ABS)	00-10 02-10
MD1165 MD1165C	R R	Solid Solid	256 256	N/A N/A	Plain Contour	N/A N/A			HONDA VFR 800 Fi Interceptor	98-99
MD1166RS	F	Solid	276	N/A	Plain	N/A			HONDA CBR 125 RWB/RC/RD (5 Bolt F Disc / Canada)	11-13
MD1167RS	F	Solid	330	N/A	Plain	N/A			HONDA VT 1100 C	95-07
MD1169C MD1169CF	F F	Solid Floating	220 220	N/A Gold	Contour Contour	N/A 6			HONDA NSF 100 R	06
MD1170C	R	Solid	160	N/A	Contour	N/A			HONDA NSF 100 R	06
MD1171X MD1171XC VR1171BLK VR1171BLU VR1171RED	F F F F F	Floating Floating Floating Floating Floating	320 320 320 320 320	Gold Gold Black Blue Red	Plain Contour Vee Vee Vee	5 5 5 5 5			HONDA CBR 1000 RR CBR 1000 RR SP (Brembo F calipers) CBR 1000 RA	08-14 14-20 09-20

BRAKE ROTOR BUYERS GUIDE - STREET

Rotor No.	F/R	Type	Dia. (mm)	Hub Color	Profile	Bobbins	Left Bracket	Right Bracket	Model	Year
MD1172LS	F	Solid	276	N/A	Plain	N/A			HONDA FSC 600 Silverwing (All models)	03-14
MD1173 MD1173C VR1173	R R R	Solid Solid Solid	220 220 220	N/A N/A N/A	Plain Contour Vee	N/A N/A N/A			HONDA CBR 600 RA (ABS)	09-16
MD1175	R	Solid	276	N/A	Plain	N/A			HONDA VFR 1200 FD (Automatic Transmission Model) VFR 1200 F (Manual Gearbox Model)	10-14 10-14
MD1176X	F	Floating	320	Gold	Plain	6			HONDA CBR 1000 RR Fireblade SP2 VFR 1200 FD (Automatic Transmission Model) VFR 1200 F (Manual Gearbox Model)	17-18 10-14 10-14
MD1177 MD1177C	R R	Solid Solid	256 256	N/A N/A	Plain Contour	N/A N/A			HONDA CB 1000 R	10-21
MD1179	F	Solid	316	N/A	Plain	N/A			HONDA VT 1100 C2/C3/D2/T	95-07
MD1180X MD1180XC	F F	Floating Floating	296 296	Gold Gold	Plain Contour	6 6			HONDA CBR 250 R (Non ABS) CBR 250 RA (ABS Model) CB 300 F CB 300 R ABS CBR 300 R (Non ABS) CBR 300 RA (ABS Model) NSA DN-01	11-14 11-14 15 18-21 15 15-21 09-11
MD1181 MD1181C	R R	Solid Solid	220 220	N/A N/A	Plain Contour	N/A N/A			HONDA CBR 250 RA (ABS Model) CBR 300 RA (ABS Model)	11-14 15
MD1182RS	F	Solid	330	N/A	Plain	N/A			HONDA VTX 1300 C VTX 1300 R VTX 1300 T	04-11 05-11 08-11
MD1183 MD1183C VR1183 OSX1183	F F F F	Solid Solid Solid Floating	220 220 220 280	N/A N/A N/A Black	Plain Contour Vee Contour	N/A N/A N/A 6		BRK037	HONDA MSX 125 D/E/F/G/H Grom (Non ABS)	14-20
MD1184 VR1184	R R	Solid Solid	190 190	N/A N/A	Plain Vee	N/A N/A			HONDA MSX 125 D/E/F/G/H Grom (Non ABS) MSX 125 AH Grom (ABS)	14-20 18-21
MD1185C	R	Solid	240	N/A	Contour	N/A			HONDA NC 700 NM4	15-20
MD1186C	F	Solid	320	N/A	Contour	N/A			HONDA CTX 700 CTX 700 D CTX 700 N CTX 700 ND NC 700 X NC 700 XD PVT 1000 PVT 1000 RS Pursuer	14-17 14-19 14-16 14-19 12-17 12-17 17-18
MD1187C	F	Solid	320	N/A	Contour	N/A			HONDA CB 650 F (ABS) CBR 650 F (ABS) NC 700 NM4 ZERO DS ZF13.0 DS ZF6.0/ZF9.0 DS II ZF14.4 DS II ZF7.2	18-20 14-20 15-20 16-19 10-12 19-21 19-21

BRAKE ROTOR BUYERS GUIDE - STREET

Rotor No.	F/R	Type	Dia. (mm)	Hub Color	Profile	Bobbins	Left Bracket	Right Bracket	Model	Year
MD1187C Contd.	F	Solid	320	N/A	Contour	N/A			ZERO Contd. DSR ZF13.0 DSR ZF14.4.0 DSR Black Forest Edition - ZF14.4.0 FXS ZF3.3/ZF6.5 S ZF14.4 S ZF6.0 S ZF7.2 S ZF8.5/ZF11.4 S ZF9.4/ZF12.5 S ZF9.8/ZF13.0 SR ZF11.4 SR ZF12.5 SR ZF13.0 SR/F ZF13.0 SR/S ZF13.0 SR/S Deus X ZF13.0	17-19 19-21 19-21 17-21 19-21 10-12 19-21 13 15 16-19 14 15 16-21 19-21 19-21 21
MD1188X	F	Floating	310	Gold	Plain	6			HONDA VFR 800 F Interceptor (Non ABS Model) VFR 800 FD Interceptor DLX (ABS Model) VFR 800 X Crossrunner ABS	14-21 14-21 17-21
MD1190	R	Solid	256	N/A	Plain	N/A			HONDA VFR 800 F Interceptor (Non ABS Model) VFR 800 FD Interceptor DLX (ABS Model) VFR 800 X Crossrunner ABS	14-21 14-21 17-21
MD1191 MD1191C VR1191 OSX1191	F F F F	Solid Solid Solid Floating	220 220 220 220	N/A N/A N/A Floating	Plain Contour Vee Contour	N/A N/A N/A 5		BRK048	HONDA MSX 125 AH Grom (ABS)	18-21
MD1193X	F	Floating	310	Gold	Plain	6			HONDA CB 1000 R ABS	17-20
MD1194X	F	Floating	310	Gold	Plain	6			HONDA CB 650 R (Non ABS) CB 650 RA (ABS) CBR 650 R (Non ABS) CBR 650 RA (ABS)	19-21 19-21 19-21 19-21
MD1195	R	Solid	190	N/A	Plain	N/A			HONDA TRX 420 All Models TRX 500 All Models	14-19 14-19
MD1196	R	Solid	256	N/A	Plain	N/A			HONDA CRF 1000 Africa Twin CRF 1100 L Africa Twin Adventure Sport CRF 1100 L Africa Twin Adventure Sport Plus YAMAHA Star Venture Star Venture Transcontinental Star Eluder/Star Eluder GT	16-19 20-21 20-21 18-20 18-20 18-20
MD1197 Fitting Kit Required	F	Solid	310	N/A	Plain	N/A			HONDA VFR 1200 X AC Crosstourer (Manual G/Box) VFR 1200 XD AC DCT Crosstourer VFR 1200 Crosstourer Highlander T/DCT	16-17 16-17 16-17
MD1198X	F	Floating	310	Gold	Plain	6			HONDA CRF 1000 Africa Twin ABS CRF 1000 Africa Twin ABS DCT CRF 1100 Africa Twin Adventure Sport ES ABS (Manual) CRF 1100 Africa Twin Adventure Sport ES ABS (DCT) CRF 1100 Africa Twin Adventure Sport Plus ES ABS (Manual) CRF 1100 Africa Twin Adventure Sport Plus ES ABS (DCT)	16-17 16-19 19-21 19-21 19-21 19-21

BRAKE ROTOR BUYERS GUIDE - STREET

Rotor No.	F/R	Type	Dia. (mm)	Hub Color	Profile	Bobbins	Left Bracket	Right Bracket	Model	Year
MD1199X	F	Floating	320	Gold	Plain	6			HONDA CBR 1000 RRA ABS Model (Nissin Front Caliper) CBR 1000 RR	17-20 18-21
MD1200C	F	Solid	320	N/A	Contour	N/A			HONDA CB 650 F (Non ABS) CB 650 FA (ABS) CBR 650 F (Non ABS) CBR 650 FA (ABS) CB 500 F (Non ABS) CB 500 FA (ABS) CB 500 X (Non ABS) CB 500 XA (ABS) CBR 500 R (Non ABS) CBR 500 RA (ABS)	14-16 14-18 14-16 14-18 13-16 13-21 13-16 13-21 13-16 13-21
MD1201C	F	Solid	320	N/A	Contour	N/A			HONDA CB 650 F (Non ABS) CB 650 FA (ABS) CBR 650 F (Non ABS) CBR 650 FA (ABS)	14-16 14-18 14-16 14-18
MD1202X	F	Floating	320	Gold	Plain	6			HONDA CBR 1000 RR SP	18-21
MD2001X MD2001XC MD2001CC VR2001BLK VR2001BLU VR2001RED	F F F F F F	Floating Floating Floating Floating Floating Floating	299 299 299 299 299 299	Gold Gold Chrome Black Blue Red	Plain Contour Contour Vee Vee Vee	6 6 6 6 6 6			APRILIA RST 1000 Futura DUCATI 900 Supersport 907 IE YAMAHA FZR 400 RRSP/RR FZR 600 W/WC FZR 600 AC/RA/RAC/RBC/RD/RE/REC/RF/RFC/RG/RGC/RH/RHC/RJ/RJC /RK/RKC/RL/RLC YZF 600 RG/RGC/RH/RHC TDM 850 D/DC/E/EC FJ 1200 W/WC/A/B/AD/ADC/AE/AEC/D/DC	01-05 89-90 90-91 91-92 89 90-00 95-96 92-93 89-92
MD2002 MD2002C VR2002	R R R	Solid Solid Solid	245 245 245	Gold Gold Gold	Plain Contour Vee	N/A N/A N/A			DUCATI Scrambler Sixty 2 (Cast wheels/399cc) Supersport 400 (Single disc) Supersport 400 (Twin disc) 400 Monster Monster 400 (Single disc) Monster 400 (Twin disc) 400 Monster (Japan) Monster Dark ie 400 (Japan) Monster Dark ie 400 (Single disc) Monster 400 ie (Japan) Monster 600 (Twin disc) 600 Monster (Single disc) 600 Monster Dark 600 Monster City/City Dark 600 Monster 600 Supersport (Single disc) 620 IE Monster 620 ie Monster (Series 1 - Twin Pin Pad Fixing Caliper) 620 ie Monster (Series 2 - Single Pin Pad Fixing Caliper) 620 Sport Monster 620 Dark Monster 620 620 Multistrada (Twin Disc/Single Pin Pad Fixing) 620 Multistrada Dark (Single Disc/Twin Pin Pad Fixing) 695 Monster 696 Monster M 696 Monster 20th Anniversary Model 748 SP/Monoposto 750 Supersport (Single disc) Supersport 750 (Twin disc)	16-19 93-97 93-97 95-97 00-02 03-04 00-04 05-06 05 07-08 93-97 93-99 98-99 99 00-01 91-97 02-04 05 05-06 03 03-04 05-06 06 06 06-09 08-14 13-14 99-02 91-98 91-98

ROTOR BUYERS GUIDE

BRAKE ROTOR BUYERS GUIDE - STREET

Rotor No.	F/R	Type	Dia. (mm)	Hub Color	Profile	Bobbins	Left Bracket	Right Bracket	Model	Year
MD2002	R	Solid	245	Gold	Plain	N/A			DUCATI	
MD2002C	R	Solid	245	Gold	Contour	N/A			750 Supersport	99
VR2002	R	Solid	245	Gold	Vee	N/A			750 Supersport IE	00-02
Contd.									750 Sport	01-02
									750 Monster (Single disc)	96-97
									750 Monster (Twin disc)	96-98
									750 Monster City/City Dark	99
									750 Monster/Monster Dark	99
									750 Monster	00-01
									Monster ie 750	02
									Monster 797 /+	17-21
									Monster 800	03-04
									800 Sport	03
									800 Supersport	03-05
									Scrambler Classic (Spoke Wheels/803cc)	15-19
									Scrambler Icon (Cast Wheels/803cc)	15-19
									Scrambler Urban Enduro (Spoke Wheels/803cc)	15-19
									Scrambler Full Throttle (Cast Wheels/803cc)	15-19
									Scrambler Flat Track Pro (Cast wheels/803cc)	16-17
									Scrambler Café Racer (Cast wheels/803cc)	17
									Monster 821	15-21
									Monster 821 Dark	15
									Monster 821 Stealth	20-21
									Monster 821 Stripe	15-19
									851 Superbike Biposto	89-92
									888 SP4/SP5	92-93
									888 Superbike Strada	94-95
									899 Panigale	14
									900 Supersport	89-90
									900 Supersport/Superlight	91-97
									900 Supersport	98-99
									900 Supersport CR USA	98
									900 Supersport FE	98
									900 Supersport IE	00-01
									900 Sport	02
									900 Monster	93-99
									900 Monster Cromo/Special	98
									900 Monster City/City Dark	99
									900 IE Monster	00-01
									907 IE	90-93
									Monster S4 Foggy(916cc)	02
									Monster S4 (916cc)	01-02
									ST4 (916cc)	99-02
									ST2 (944cc)	97-03
									ST3 S (ABS Model) (992cc)	06-07
									ST4S (Non ABS/996cc)	01-05
									ST4S (ABS Model/996cc)	03-05
									959 Panigale (ABS)	16-19
									Monster 1000 Dark	03
									Monster 1000 ie (992cc)	04-05
									Monster 1000 S ie (992cc)	03-05
									Paul Smart 1000 LE (992cc)	06
									Sport 1000 S	07-09
									Sport Classic 1000 (992cc) (Monoposto - Japan/Biposto - Europe)	06-08
									Supersport 1000 DS (992cc)	03-06
									Scrambler 1100	18-21
									Scrambler 1100 Sport	18-21
									Scrambler 1100 Special	18-21
									Scrambler 1100 Pro/Sport Pro	18-21
									LAVERDA	
									All models	94-00
									YAMAHA	
									XJ 400 S Seca II	93
									FZ 600 S/SC/T/TC/U/UC	86-88
									FZR 600 W/WC	89
									FZR 600 AC/RA/RAC/RBC/RD/RE/REC/RF/RFC/RG/RGC/RH/RHC/RJ	
									/RJC/RK/RKC/RL/RLC	90-00
									YZF 600 RG/RGC/RH/RHC	95-96
									YZF 600 R RJ/RK/RL/RM/RN/RP/RR/RS/RT/RV/RW	97-07
									SRX 600 S/SC	86

BRAKE ROTOR BUYERS GUIDE - STREET

Rotor No.	F/R	Type	Dia. (mm)	Hub Color	Profile	Bobbins	Left Bracket	Right Bracket	Model	Year
MD2002 MD2002C VR2002 Contd.	R R R	Solid Solid Solid	245 245 245	Gold Gold Gold	Plain Contour Vee	N/A N/A N/A			YAMAHA XJ 600 Seca IISD/SDC/SE/SEC/SF/SFC/SG/SGC/SH/SHC/SJ/SJC/SK/SKC YZF 750 R/SP YZF 750 R7 OW02 Road version TDM 850 D/DC/E/EC YZF 1000 R RJ YZF 1000 R1	92-98 93-96 99 92-93 97 98-00
MD2003X MD2003XC MD2003CC VR2003BLK VR2003BLU VR2003RED	F F F F F F	Floating Floating Floating Floating Floating Floating	320 320 320 320 320 320	Gold Gold Chrome Black Blue Red	Plain Contour Contour Vee Vee Vee	6 6 6 6 6 6			APRILIA RSV4 R RSV4 Factory RSV4 Factory APRC ABS DUCATI Supersport 400 (Single disc) Supersport 400 (Twin disc) 400 Monster Monster 600 (Twin disc) 600 Monster Dark 600 Monster (Single disc) 600 Supersport (Single disc) Monster 620 Dark 620 Multistrada Dark (Single Disc/Twin Pin Pad Fixing) RS 660 8V RS 660 8V Tuono 748 Biposto 748 SP 750 Supersport (Single disc) Supersport 750 (Twin disc) 750 Supersport 750 Monster (Single disc) 750 Monster (Twin disc) 750 Monster City/City Dark 750 Monster/Monster Dark 851 Superbike Biposto 888 Superbike Strada 900 Supersport/Superlight 900 Supersport 900 Supersport CR USA 900 Supersport FE 900 Monster 900 Monster Cromo/Special 900 Monster City/City Dark 907 IE 916 (Biposto) ST2 (944cc) LAVERDA All models YAMAHA FZR 750 Genesis RU/RT YZF 750 R/SP FZR 1000 Genesis T/TC/U/UC/W/WC FZR 1000 EX UP A/AC/B/BC/D/DC/E/EC/F/FC/G/GC	09-12 09-12 13-15 93-97 93-97 95-97 93-97 98-99 93-99 91-97 03-04 06 20-21 20-21 95-98 98 91-98 91-98 99 96-97 96-98 99 99 89-92 94-95 91-97 98-99 98 98 93-99 98 99 92-93 94-96 97-99 94-00 87-88 93-96 87-89 90-96
MD2008	R	Solid	210	N/A	Plain	N/A			YAMAHA FZR 750 (OW01)	89-92
MD2009LS MD2009RS	F F	Floating Floating	320 320	Silver Silver	Plain Plain	9 9			YAMAHA FZR 750 (OW01)	89-92
MD2011 MD2011C VR2011	F F F	Solid Solid Solid	267 267 267	N/A N/A N/A	Plain Contour Vee	N/A N/A N/A			YAMAHA SRX 250 T/TC RX 350 L/N/NC11 XS 400 RJ/RK XZ 550 RK FJ 600 L/LC/N/NC FZ 600 S/SC/T/TC/U/UC YX 600 S/SC/T/TC/UC/U/W/WC/A/AC Radian SRX 600 S/SC XJ 650 LK Seca/LJ Seca Turbo FZ 700 T/TC Genesis	87 84-85 82-83 -83 84-85 86-88 86-90 86 82-83 87

ROTOR BUYERS GUIDE

BRAKE ROTOR BUYERS GUIDE - STREET

Rotor No.	F/R	Type	Dia. (mm)	Hub Color	Profile	Bobbins	Left Bracket	Right Bracket	Model	Year
MD2011 MD2011C VR2011 Contd.	F F F	Solid Solid Solid	267 267 267	N/A N/A N/A	Plain Contour Vee	N/A N/A N/A			YAMAHA Contd. FZX 700 S/SC/T/TC Fazer XJ 700 N/NC/XN/XNC/XS/XSC/S/SC XV 700 L/LC/N/NC/CS/CT/CTC/CSC/SS/SSC/ST/STC XV 750 U/UC/W/WC/A/AC/B/BC/D/DC/E/EC Virago XV 1100 All models RX 350 L/N/NC11 XP 500 Y/Z/A (T-Max) FJ 600 L/LC/N/NC FZ 700 T/TC Genesis FZR 750 Genesis RU/RT FZR 1000 Genesis T/TC/U/UC/W/WC FZR 1000 EX UP A/AC/B/BC/D/DC/E/EC/F/FC/G/GC FZS 1000 N/NC/P/PC/R/RC/S/SC/RS/T 'FZ1'	86-87 85-86 84-87 88-94 86-97 84-85 09-11 84-85 87 87-88 87-89 90-96 01-05
MD2019LS MD2019RS	F F	Floating Floating	266 266	Silver Silver	Plain Plain	9 9			YAMAHA XV 250 U/UC/W/WC/A/AC XS 400 SG/SH XS 400 J/K Maxim XJ 650 RJ Seca XJ 750 J/K/MK Maxim XV 920 RH/RJ XV 920 J Virago	88-90 80-81 82-83 82 82 81-82 82
MD2020LS MD2020RS	F F	Floating Floating	282 282	Gold Gold	Plain Plain	9 9			YAMAHA FZR 400 U/SUC/W/SWC	88-89
MD2021 MD2021C VR2021	R R R	Solid Solid Solid	210 210 210	N/A N/A N/A	Plain Contour Vee	N/A N/A N/A			YAMAHA TZ 250 FZR 400 U/SUC/W/SWC FZR 400 A FZR 400 RRSP/RR	91 88-89 90 91-92
MD2022LS MD2022RS	F F	Floating Floating	282 282	Gold Gold	Plain Plain	9 9			YAMAHA FZR 400 A	90
MD2023LS MD2023RS VMD2023	F F F	Floating Floating Floating	299 299 299	Silver Silver Black	Plain Plain Plain	9 9 9			YAMAHA XV 500 K Virago SR 500 E/F/G/H XV 535 Virago T/TC/U/A/AC/E/EC/F/FC/SF/SFC XJ 550 H/J/K Maxim XJ 550 RH/RJ/RK Seca XJ 650 G/H/J/K Maxim XS 650 SE/SF/SG XS 650 G/H/SH XS 650 SJ/SK Heritage Special XJ 750 RH/RJ/RK Seca XV 750 H/J/K/MK Virago	83 78-81 87-94 81-83 81-83 80-83 78-80 80-81 82-83 81-83 81-83
MD2024 VMD2024	F F	Floating Floating	299 299	Silver Black	Plain Plain	9 9			YAMAHA XS 500 C/D/E XS 650 D/E/F/2F XJ 650 LH Midnight XV 920 MK 'Virago' XV 920 K XJ 1100 J	76-78 77-79 81 83 83 82
MD2024 VMD2024	R R	Floating Floating	298 298	Gold Black	Plain Plain	9 9			YAMAHA XS 1100 E/F/G/H XS 1100 SF/SG/SH XS 1100 LG/LH Midnight Special XJ 1100 J XS 1100 E/F/G/H XS 1100 SF/SG/SH XS 1100 LG Midnight Special XS 1100 LH Midnight Special	78-81 79-81 80-81 82 78-81 79-81 80 81
MD2025LS MD2025RS VMD2025	F F F	Floating Floating Floating	266 266 266	Silver Silver Black	Plain Plain Plain	9 9 9			YAMAHA XS 750 D/2D/E/F/SE/SF XS 850 G/H XS 850 LG/LH/SG/SH	77-79 80-81 80-81

ROTOR BUYERS GUIDE

BRAKE ROTOR BUYERS GUIDE - STREET

Rotor No.	F/R	Type	Dia. (mm)	Hub Color	Profile	Bobbins	Left Bracket	Right Bracket	Model	Year
MD2025 VMD2025	R R	Floating Floating	266 266	Silver Black	Plain Plain	9 9			YAMAHA RD 400 F Daytona XS 650 SE/SF XS 750 SE/SF XS 750 D/E2/2D/E/F XS 850 G/H XS 1100 LH Midnight Special XS 500 C/D/E XS 850 LG/LH/SG/SH XS 1100 E/F/G/H XS 1100 SF/SG/SH XS 1100 LG Midnight Special XJ 1100 J	79 78-79 78-79 77-79 80-81 81 76-78 80-81 78-81 79-81 80 82
MD2031LS	F	Solid	320	N/A	Plain	N/A			XJ 400 'S' Seca II XJ 600 Seca IISD/SDC/SE/SEC/SF/SFC/SG/SGC/SH/SHC/SJ/SJC/SK/SKC	93 92-98
MD2046	F	Floating	299	Silver	Plain	9			YAMAHA FJ 1200 AD/ADC/AE/AEC	92-93
MD2049	R	Floating	320	Gold	Plain	9			YAMAHA XVZ 13 D Series Venture Royale XVZ 13 T/T/C/U/UC Venture	86-93 87-88
MD2067	F	Solid	282	N/A	Plain	N/A			YAMAHA XV 250 Virago All models XV 250 V-Star XV 750 F/FC/G/GC/H/HC/J/JC Virago	95-07 08-14 94-97
MD2068	F	Solid	280	N/A	Plain	N/A			YAMAHA V-Max All models FJ 1100 L/LC/N/NC FJ 1200 S/SC/T/TC VMX 12 R/RC V-Max	85-92 84-85 86-87 03
MD2068	R	Solid	280	N/A	Plain	N/A			YAMAHA XV 1100 L/LC/N/NC FJ 1100 L/LC/N/NC FJ 1200 S/SC/T/TC/W/WC/A/B/AC/BC/D/DC V-Max 'All models'	84-85 84-85 86-93 85-07
MD2069	R	Solid	267	N/A	Plain	N/A			YAMAHA FZ 750 N/S/SC/U/UC FZX 700 S/SC/T/TC Fazer XJ 900 RK Seca	85-88 86-87 83
MD2069	F	Solid	267	N/A	Plain	N/A			YAMAHA RZ 500 FZ 750 N/S/SC/U/UC XJ 900 RK Seca	84-86 85-88 83
MD2070	R	Solid	245	N/A	Plain	N/A			YAMAHA RZ 500	84-86
MD2074X MD2074XC MD2074CC VR2074BLK VR2074BLU VR2074RED VR2074CHBL	F F F F F F F	Floating Floating Floating Floating Floating Floating Floating	299 299 299 299 299 299 299	Gold Gold Chrome Black Blue Red Blue	Plain Contour Contour Vee Vee Vee Vee	6 6 6 6 6 6 6			YAMAHA YZF 600 R RJ/RK/RL/RM/RN/RP/RR/RS/RT/RV/RW YZF 600 RRL/RRM/RRN/RRP 'R6' XVS 950 Bolt C Spec (Remote Reservoir R Shocks) XVS 950 Bolt R Spec (Remote Reservoir R Shocks) FZS 1000 N/NC/P/PC/R/RC/S/RS/T 'FZ1' YZF R1 YZF 1000 R (RJ) FZS 1000 R/RC FZ1 XVS 1100 ATS V-Star Silverado XVS 1100 AS V-Star Classic FJR 1300 R/RC XVS 1300 V-Star 1300 Tourer XVS 1300 V-Star XVS 1300 V-Star Deluxe XV 1700 Road Star S 9 Spoke Cast XV17 ASX/ASY/ASZ/ASA/ASB XV 1700 Road Star Silverado 9 Spoke Cast XV17 ATSA/ATSB XV 1700 Road Star Midnight (Floating F discs/9 spoke cast wheel)	97-07 99-02 15-21 14-21 01-05 98-03 97 03 04-09 04-09 03 07-14 07-14 13-14 08-14 11-14

ROTOR BUYERS GUIDE

BRAKE ROTOR BUYERS GUIDE - STREET

Rotor No.	F/R	Type	Dia. (mm)	Hub Color	Profile	Bobbins	Left Bracket	Right Bracket	Model	Year
MD2074X MD2074XC MD2074CC VR2074BLK VR2074BLU VR2074RED VR2074CHBL	F	Floating	299	Gold	Plain	6			YAMAHA Contd. XV17 AMT/AMTC/AMV/AMVC XV 1700 Road Star Midnight Warrior (F Floating Discs /3 spoke cast wheels) XV17 PCTC/PCT/PCTB/PCTCB XV 1700 Road Star (F floating discs/9 spoke cast wheels) XV17 AWT/AWTC/AWV/AWVC XV 1700 Road Star 9 Spoke Cast Wheels XV17 AS/ASC/AWY/AW/AWWC XV 1700 Road Star Midnight Floating F discs/9 spoke cast wheel XV17 AMS/AMSC/AMW/AMWC XV 1700 Road Star Midnight Silverado Floating F discs /9 spoke cast wheel XV17 ATMS/ATMSC/ATMT/ATMTC/ATMW/ATMVC XV 1700 Road Star Warrior (Floating discs/3 spoke cast wheel) XV17 PCS/PCT XV 1900 Roadliner XV 1900 Roadliner Midnight XV 1900 Roadliner S XV 1900 Stratoliner XV 1900 Stratoliner Midnight XV 1900 Stratoliner S XV 1900 Stratoliner Deluxe	05-06 05 05-06 04-07/09 04-07 04-07 04-05 06-07 06-09 06-10/12-14 06-09 06-08 06-14 11-14
MD2075	R	Solid	280	N/A	Plain	N/A			YAMAHA GTS 1000 AE/AEC/AF/AFC	93-96
MD2076	F	Solid	298	N/A	Plain	N/A			YAMAHA SR 400 XZ 500 RJ XV 535 Virago G/GC/SG/SGC/H/HC/SH/SHC/J/JC/SJ/SJC XVS 650 V Star Custom XVS 650 V Star Classic XVS 650 V-Star Silverado XVS 1100 V Star Custom XVS 1100 V-Star Silverado XVS 1100 W-M V-Star Custom Midnight XVZ 1300 Royal Star XVZ 1300 Royal Star Tour Classic XVZ 1300 Royal Star Standard XVZ 1300 Royal Star Boulevard XVZ 1300 Royal Star Midnight Venture XVZ 1300 Royal Star Midnight Tour Deluxe XVZ 1300 Royal Star Venture XVZ 1300 Royal Star Venture S XVZ 1300 Royal Star Tour Deluxe XVZ 1300 LTK Venture XVZ 1300 Venture MM Limited Edition XV 1600 Road Star XV 1600 Road Star Silverado XV 1600 Road Star Midnight XV 1600 Midnight Star XV 1700 Road Star (Spoke wheels) XV 1700 Road Star Silverado 9 Spoke Cast XV17 ATV XV 1700 Road Star Silverado Spoke Wheel (XV17 ATX/ATY/ATZ) XV 1700 Road Star 9 Spoke Cast XV17 AWX XV 1700 Road Star (Solid F discs/spoke wheels) (XV17 AT/ATC/AV/AVC/ATW)	15-20 82 95-99 97-11/13-14 98-10 03-10 99-07 03- 07-09 96-97/00 96-00 98 99-01 02-07 06-07 99-07 08-12 97-01/05-07 96-98 01 99-05 99-09 03 02-03 06 07 08-10 08 05-07
MD2078	R	Solid	320	N/A	Plain	N/A			YAMAHA XVZ 1300 Royal Star XVZ 1300 Royal Star Tour Classic XVZ 1300 Royal Star Standard XVZ 1300 Royal Star Boulevard XVZ 1300 Royal Star Midnight Venture XVZ 1300 Royal Star Midnight Tour Deluxe XVZ 1300 Royal Star Venture XVZ 1300 Royal Star Venture S XVZ 1300 Royal Star Tour Deluxe XVZ 1300 LTK Venture XVZ 1300 Venture MM Limited Edition	96-97/00 96-00 98 99-01 02-07 06-07 99-07 08-12 97-01/05-07 96-98 01

ROTOR BUYERS GUIDE

BRAKE ROTOR BUYERS GUIDE - STREET

Rotor No.	F/R	Type	Dia. (mm)	Hub Color	Profile	Bobbins	Left Bracket	Right Bracket	Model	Year
MD2081	F	Solid	298	N/A	Plain	N/A			YAMAHA XVZ 12 TK/L/KC2 Venture	83-84
MD2081	R	Solid	298	N/A	Plain	N/A			XVZ 12 TDK/DL/DKC2/DN Venture Royale XVZ 12 TK/L/KC2 Venture XVZ 12 TDK/DL/DKC2/DN Venture Royale	83-84 83-84 83-84
MD2082X	F	Floating	299	Gold	Plain	6			YAMAHA YZF 600 RRR/RRS R6	03-04
MD2082XC	F	Floating	299	Gold	Contour	6			FZ6	04-06
MD2082CC	F	Floating	299	Chrome	Contour	6			FZ6 (4 piston caliper)	07-09
VR2082BLK	F	Floating	299	Black	Vee	6			FZ6R	09-17
VR2082BLU	F	Floating	299	Blue	Vee	6			FZ6R (Y/Z/A) YZF R6S (YZFR 6 SV/SW/SX/SY) (298mm rotor) XV 1700 Road Star Midnight Warrior 5 Spoke Cast Wheel XV17 PCMV/PCMVC/PCMW/PCMX/PCMY XV 1700 Road Star Warrior 5 Spoke Cast Wheel XV17 PCV/PCW/PCX XV 1900 Raider XV 1900 Raider S XV 1900 Raider SCL	09-11 06-09 06-09 06-08 08-14 08-14 12-14
MD2083	F	Floating	320	Gold	Plain	9			YAMAHA YZF 750 R7 0W02 Road version	99-00
MD2084	R	Solid	220	N/A	Plain	N/A			YAMAHA YZF 600 RRL/RRM/RRN/RRP 'R6'	99-02
MD2084C	R	Solid	220	N/A	Contour	N/A			YZF R1	02-03
VR2084	R	Solid	220	N/A	Vee	N/A				
MD2086	R	Solid	245	N/A	Plain	N/A			YAMAHA YZF 750 R7	99
MD2086C	R	Solid	245	N/A	Contour	N/A			YZF R1	98-01
VR2086	R	Solid	245	N/A	Vee	N/A				
MD2088	R	Solid	320	N/A	Plain	N/A			YAMAHA XV 1600 Road Star XV 1600 Road Star Silverado XV 1600 Road Star Midnight XV 1600 Midnight Star XV 1700 Road Star Silverado 9 Spoke Cast XV17 ATV XV 1700 Road Star S 9 Spoke Cast XV17 ASX/ASY/ASZ/ASA/ASB XV 1700 Road Star Silverado 9 Spoke Cast XV17 ATSA/ATSB XV 1700 Road Star Silverado Spoke Wheel XV17 ATX/ATY/ATZ XV 1700 Road Star 9 Spoke Cast XV17 AWX XV 1700 Road Star (Solid F discs/spoke wheels) (XV17 AT/ATC/AV/AVC/ATW) XV 1700 Road Star Midnight (Floating F discs/9 spoke cast wheel) XV17 AMT/AMTC/AMV/AMVC XV 1700 Road Star (F floating discs/9 spoke cast wheels) XV17 AWT/AWTC/AWV/AWVC XV 1700 Road Star 9 Spoke Cast Wheels XV17 AS/ASC/AWY/AW/AWWC XV 1700 Road Star Midnight Floating F discs/9 spoke cast wheel XV17 AMS/AMSC/AMW/AMWC XV 1700 Road Star Midnight Silverado Floating F discs/9 spoke cast wheel XV17 ATMS/ATMSC/ATMT/ATMTC/ATMW/ATMVC	99-05 99-09 03 02-03 07 08-14 11-14 08-10 08 05-07 05-06 05-06 04-07/09 04-07 04-07
MD2089X	F	Floating	320	Gold	Plain	6			YAMAHA XVS 950 (V-Star 950)	09-14
MD2089XC	F	Floating	320	Gold	Contour	6			XVS 950 (V-Star 950 Tourer)	09-14
MD2089CC	F	Floating	320	Chrome	Contour	6			FJR 1300 S/RS/T/AS/T/AT	04-05
VR2089BLK	F	Floating	320	Black	Vee	6			FJR 1300 AV/AW/AX/AY/AZ/AA/AB	06-12
VR2089BLU	F	Floating	320	Blue	Vee	6			FJR 1300 A	13-18
VR2089RED	F	Floating	320	Red	Vee	6			FJR 1300 AEW/AEW/AEX/AEY Electric Shift FJR 1300 ES	06-09 14-21
MD2091	R	Solid	220	N/A	Plain	N/A			YAMAHA YZF 600 RRR/RRS R6	03-04
MD2091C	R	Solid	220	N/A	Contour	N/A			YZF-R1 (5VY) YZF-R1 (6 piston caliper)	04-06 07-14
VR2091	R	Solid	220	N/A	Vee	N/A			YZF-R6 T/W (310mm rotor) YZF R6S (YZFR 6 SV/SW) (298mm rotor) YZF-R6 X/Y/Z/A/B/D/E/G YZF-R6 H (320mm F Rotor) MT 10	05-07 06-08 08-16 17-21 18-21

ROTOR BUYERS GUIDE

BRAKE ROTOR BUYERS GUIDE - STREET

Rotor No.	F/R	Type	Dia. (mm)	Hub Color	Profile	Bobbins	Left Bracket	Right Bracket	Model	Year
MD2092 MD2092C VR2092	R R R	Solid Solid Solid	282 282 282	N/A N/A N/A	Plain Contour Vee	N/A N/A N/A			YAMAHA XVS 1100 V-Star Custom/Classic XVS 1100 V-Star Silverado XVS 1100 W-M V-Star Custom Midnight FJR 1300 R/RC/S/AS/T/AT XV 1700 Road Star Midnight Warrior 5 Spoke Cast Wheel XV17 PCMV/PCMVC/PCMW/PCMX/PCMY XV 1700 Road Star Warrior 5 Spoke Cast Wheel XV17 PCV/PCW/PCX XV 1700 Road Star Midnight Warrior (F Floating Discs/3 spoke cast wheels) XV17 PCTC/PCT/PCTB/PCTCB XV 1700 Road Star Warrior (Floating discs/3 spoke cast wheel) XV17 PCS/PCT	99-09 03-09 07-09 03-05 06-09 06-08 05 04-05
MD2093 MD2093C VR2093	R R R	Solid Solid Solid	245 245 245	N/A N/A N/A	Plain Contour Vee	N/A N/A N/A			YAMAHA FZ6 FZS 1000 V/W/X/Y/Z/A/B/D/E (FZ1) FZ6 (4 piston caliper) W/X/Y	04-06 06-14 07-09
MD2094X MD2094XC MD2094CC VR2094BLK VR2094BLU VR2094RED	F F F F F F	Floating Floating Floating Floating Floating Floating	320 320 320 320 320 320	Gold Gold Chrome Black Blue Red	Plain Contour Contour Vee Vee Vee	6 6 6 6 6 6			YAMAHA YZF R1	04-06
MD2095X MD2095XC MD2095CC VR2095BLK VR2095BLU VR2095RED	F F F F F F	Floating Floating Floating Floating Floating Floating	310 310 310 310 310 310	Gold Gold Chrome Black Blue Red	Plain Contour Contour Vee Vee Vee	6 6 6 6 6 6			YAMAHA YZF-R6 TC/SV/SVC YZF-R6 T/V/W (310mm rotor) FZ8 XT 1200 Z Super Tenere XT 1200 Z Super Tenere ES	05-06 05-07 11-13 12-18 14-21
MD2096	F	Solid	282	N/A	Plain	N/A			YAMAHA XVZ 13 D Series Venture Royale XVZ 13 T/TC/U/UC Venture	86-93 87-88
MD2097RS	F	Solid	245	N/A	Plain	N/A			YAMAHA YBR 125 ESD (4P26/4P2A/4P2G) Cast Wheel YBR 125 ED (4P28/4P2C/4P2J) Cast Wheel	07-13 07-13
MD2098	F	Floating	267	Gold	Plain	5			YAMAHA XP500 F/G (T-Max 530cc)	15-16
MD2099	R	Solid	320	N/A	Plain	N/A			YAMAHA XV 1700 Road Star Warrior XV 1900 Roadliner XV 1900 Roadliner Midnight XV 1900 Roadliner S XV 1900 Stratoliner XV 1900 Stratoliner Midnight XV 1900 Stratoliner S XV 1900 Stratoliner Deluxe	02-05 06-07 06-09 06-10/12-14 06-09 06-08 06-14 11-14
MD2100 MD2100C VR2100	R R R	Solid Solid Solid	282 282 282	N/A N/A N/A	Plain Contour Vee	N/A N/A N/A			YAMAHA FJR 1300 AV/AW/AX/AY/AZ/AA/AB FJR 1300 A FJR 1300 AEV/AEW/AEX/AEY Electric Shift FJR 1300 ES XT 1200 Z Super Tenere ES	06-12 13-18 06-09 14-21 14-21
MD2101X MD2101XC VR2101BLK VR2101BLU VR2101RED	F F F F F	Floating Floating Floating Floating Floating	320 320 320 320 320	Gold Gold Black Blue Red	Plain Contour Vee Vee Vee	6 6 6 6 6			YAMAHA FZS 1000 V/W/X/Y/Z/A/B/D/E (FZ1) XVS 1300 Stryker	06-14 11-14

BRAKE ROTOR BUYERS GUIDE - STREET

Rotor No.	F/R	Type	Dia. (mm)	Hub Color	Profile	Bobbins	Left Bracket	Right Bracket	Model	Year
MD2102X MD2102XC MD2102CC VR2102BLK VR2102BLU VR2102RED	F F F F F F	Floating Floating Floating Floating Floating Floating	310 310 310 310 310 310	Gold Gold Chome Black Blue Red	Plain Contour Contour Vee Vee Vee	6 6 6 6 6 6			YAMAHA YZF-1 (6 piston caliper)	07-14
MD2103 MD2103C VR2103	R R R	Solid Solid Solid	298 298 298	N/A N/A N/A	Plain Contour Vee	N/A N/A N/A			YAMAHA XVS 950 (V-Star 950/V-Star 950 Tourer) XVS 1300 V-Star/XVS 1300 V-Star 1300 Tourer XVS 1300 V-Star Deluxe	10-14 07-14 13-14
MD2104RS	F	Solid	245	N/A	Plain	N/A			YAMAHA YBR 125 R (1PX1/X2) YBR 125 ESG (43B1/3/5/6/8)	11-12 08-13
MD2105X MD2105XC VR2105BLK VR2105BLU VR2105RED	F F F F F	Floating Floating Floating Floating Floating	310 310 310 310 310	Gold Gold Gold Gold Gold	Plain Plain Plain Plain Plain	6 6 6 6 6			YAMAHA YZF-R6 X/Y/Z/A/B/D/E/F/G	08-16
MD2106RS	F	Solid	280	N/A	Plain	N/A			YAMAHA YS 250 Fazer (5D41/2/3/56C1)	06-10
MD2107 MD2107C	F F	Floating Floating	267 267	Black Black	Plain Contour	6 6			YAMAHA XP 500 Y/Z/A (T-Max)	09-11
MD2108C	R	Floating	298	Gold	Contour	6			YAMAHA VMX 1700 V-Max (6 piston radial caliper)	09-21
MD2109XC	F	Floating	320	Gold	Contour	6			YAMAHA VMX 1700 V-Max (6 piston radial caliper)	09-21
MD2112XBLK	F	Floating	320	Black	Plain	6			KTM Super Duke R Super Duke R SE Super Duke GT	14-19 16-17 16-18
MD2114 MD2114C	R R	Solid Solid	310 310	N/A N/A	Plain Contour	N/A N/A			YAMAHA XVS 1300 Stryker XV 1900 Raider/XV 1900 Raider S XV 1900 Raider SCL	11-14 08-14 12-14
MD2115C	R	Solid	280	N/A	Contour	N/A			YAMAHA XT 1200 Z Super Tenere XT 1200 Z Super Tenere ES	12-18 14-21
MD2116 MD2116C VR2116	R R R	Solid Solid Solid	267 267 267	N/A N/A N/A	Plain Contour Vee	N/A N/A N/A			YAMAHA FZ8	11-13
MD2117 VR2117	R R	Solid Solid	245 245	N/A N/A	Plain Vee	N/A N/A			YAMAHA FZ6R FZ6R (Y/Z/A)	09-17 09-11
MD2118	R	Solid	220	N/A	Plain	N/A			YZF-R1 LE	06
MD2119X MD2119XC VR2119BLK VR2119BLU VR2119RED	F F F F F	Floating Floating Floating Floating Floating	298 298 298 298 298	Gold Gold Black Blue Red	Plain Contour Vee Vee Vee	6 6 6 6 6			YAMAHA MT-03 YZF R3 (321cc) YZF R3 Monster Energy Yamaha Moto GP Edition (321cc) MT-07/MT-09 YZF-R7 FZ-09 (847cc/3 cyl) Tracer 900 Tracer 900 GT XSR 900 ABS (MTM 850) Star Venture/Star Venture Transcontinental Star Eluder/Star Eluder GT	16-21 15-21 19-21 18-21 14-17 18-21 20-21 16-21 18-21 18-21

BRAKE ROTOR BUYERS GUIDE - STREET

Rotor No.	F/R	Type	Dia. (mm)	Hub Color	Profile	Bobbins	Left Bracket	Right Bracket	Model	Year
MD2120 MD2120C VR2120	R R R	Solid Solid Solid	245 245 245	N/A N/A N/A	Plain Contour Vee	N/A N/A N/A			YAMAHA FZ-07 (689cc/2 cyl) FZ-07 A (689cc/2 Cyl/ABS) MT 07 XSR 700 (MTM 690-U) XSR 700 X Tribute XTZ 700 Tenere inc Rally YZF-R7 FZ-09 (847cc/3 cyl) MT 09 Tracer 900 Tracer 900 GT XSR 900 ABS (MTM 850)	15-17 17 18-21 18-21 20-21 18-21 22 14-17 18-21 18-21 20-21 16-21
MD2123 MD2123C VR2123	R R R	Solid Solid Solid	220 220 220	N/A N/A N/A	Plain Contour Vee	N/A N/A N/A			YAMAHA MT-03 YZF R3 (321cc) YZF R3 Monster Energy Yamaha Moto GP Edition (321cc)	16-21 15-21 19-21
MD2124X MD2124XC VR2124BLK VR2124BLU VR2124RED	F F F F F	Floating Floating Floating Floating Floating	320 320 320 320 320	Gold Gold Black Blue Red	Plain Contour Vee Vee Vee	6 6 6 6 6			YAMAHA YZF-R6 H (320mm Rotor) MT-10 (MT 10 KB/KCB/KCGY/KGY) YZF-R1 YZF-R1 M YZF-R1 S	17-21 18-21 15-21 15-21 16-20
MD2125 MD2125C VR2125	R R R	Solid Solid Solid	220 220 220	N/A N/A N/A	Plain Contour Vee	N/A N/A N/A			YAMAHA YZF-R1 / YZF-R1 M YZF-R1 S	15-21 16-20
MD2127X MD2127XC VR2127BLK VR2127BLU VR2127RED	F F F F F	Floating Floating Floating Floating Floating	282 282 282 282 282	Gold Gold Black Blue Red	Plain Contour Vee Vee Vee	6 6 6 6 6			YAMAHA FZ-07 (689cc/2 cyl) FZ-07 A (689cc/2 Cyl/ABS) XSR 700 (MTM 690-U) XSR 700 X Tribute XTZ 700 Tenere XTZ 700 Tenere Rally	15-17 17 18-21 20-21 19-21 20-21
MD2129X MD2129XC	F F	Floating Floating	298 298	Gold Gold	Plain Contour	6 6			YAMAHA VMX12 (V-Max 1200 All models)	93-07
MD2130C	R	Solid	298	N/A	Contour	N/A			YAMAHA SCR 950 (SCR 950 H) XVS 950 Bolt (Standard R Shocks) XVS 950 Bolt C Spec (Remote Reservoir R Shocks) XVS 950 Bolt R Spec (Remote Reservoir R Shocks)	17 14-16 15-21 14-21
MD2131	R	Solid							YAMAHA Star Venture Star Venture Transcontinental Star Eluder Star Eluder GT	18-21 18-21 18-21 18-21
MD3001	F	Solid	290	N/A	Plain	N/A			SUZUKI GSX 600 FJ	88
MD3002 MD3002C VR3002	R R R	Solid Solid Solid	250 250 250	N/A N/A N/A	Plain Contour Vee	N/A N/A N/A			SUZUKI GSF 400 M/N/P Bandit GS 500 EK/EL/EM/EN/EP/ER/ES/ET/EV/EW/EX/EY/K1/K2/K3 GS 500 FK4/FK5/FK6/FK7/FK8/FK9 GSX 600 FJ/FK/FL/FM/FN/FP/FR/FT Katana GSX 750 FK/FL/FM/FN/FP/FR/FS/FT Katana	91-93 89-03 04-10 88-97 89-97
MD3003X MD3003XC MD3003CC VR3003BLK VR3003BLU VR3003RED VR3003CHBR	F F F F F F F	Floating Floating Floating Floating Floating Floating Floating	290 290 290 290 290 290 290	Gold Gold Chrome Black Blue Red Blue	Plain Contour Contour Vee Vee Vee Vee	6 6 6 6 6 6 6			SUZUKI GSF 600 Bandit ST/SV/V GSX 600 FK/FL/FM/FN/FP/FR/FS/FT/FV/FW/FX/FY/FK1/FK2 Katana GSF 600 SY/SK1/SK2/SK3 RF 600 RR/RS/RT/RV SV 650 X/Y/K1/SK1/K2/SK2 GSX 750 FK/FL/FM/FN/FP/FR/FS/FT/FV/FW/FX/FY/K1/FK2 Katana	96-97 89-02 89-02 00-03 00-03 94-97 99-02

ROTOR BUYERS GUIDE

BRAKE ROTOR BUYERS GUIDE - STREET

Rotor No.	F/R	Type	Dia. (mm)	Hub Color	Profile	Bobbins	Left Bracket	Right Bracket	Model	Year
MD3004	F	Floating	310	Silver	Plain	6			SUZUKI GSX-R 1100 G/H/J	86-88
MD3005	F	Floating	300	Silver	Plain	6			SUZUKI GSX-R 750 RG/G/H	86-87
MD3006X MD3006XC MD3006CC VR3006BLK VR3006BLU VR3006RED VR3006CHBR	F F F F F F F	Floating Floating Floating Floating Floating Floating Floating	310 310 310 310 310 310 310	Gold Gold Chrome Black Blue Red Blue	Plain Contour Contour Vee Vee Vee Vee	6 6 6 6 6 6 6			SUZUKI GSF 400 M/N/P Bandit GS 500 EK/EL/EM/EN/EP/ER/ES/ET/EV/EW/EX/EY/K1/K2/K3 GS 500 FK4/FK5/FK6/FK7/FK8/FK9 RF 900 RR/RS/RS2/RT/RV/RW GSF 1200 SV/SW/SX/SY/SK1/SK2/SK3/SK4/SK5/K1/K2/K3	91-93 89-03 04-10 94-98 96-05
MD3007X MD3007XC VR3007BLK VR3007BLU VR3007RED	F F F F F	Floating Floating Floating Floating Floating	310 310 310 310 310	Gold Gold Black Blue Red	Plain Contour Vee Vee Vee	6 6 6 6 6			SUZUKI GSX-R 600 WN/WP GSX-R 750 J/K/L/M/N/WP GSX-R 750 WR/WS GSX-R 1100 K/L/M/N GSX-R 1100 WP/WR/WS/WT/WV/WW	92-93 89-93 94-95 89-92 93-98
MD3008 MD3008C VR3008	R R R	Solid Solid Solid	240 240 240	N/A N/A N/A	Plain Contour Vee	N/A N/A N/A			SUZUKI GSF 600 Bandit ST/S/SV/V GSF 600 SY/SK1/SK2/SK3 GSX-R 600 WN/WP GSX 600 FW/FX/FY/FK1-FK6 Katana RF 600 RR/RS/RT/RV SV 650 X/Y/K1/SK1/K2/SK2 GSX 750 W/X/Y Inazuma GSX 750 FW/FX/FY/FK1/FK2/FK3 Katana GSK 750 FK4/FK5/FK6 GSX-R 750 J/K/L/M/N/WP/WR/WS RF 900 RR/RS/RS2/RT/RV/RW GSX-R 1100 K/L/M/N GSX-R 1100 WP/WR/WS/WT/WV/WW GSF 1200 SV-SK5/K1-K3 GSX 1300 RX/RV/RK1/RK2/RZK3/RK4/RZK4/RK5/RZK6/RK6/RK7	96-97 00-03 92-93 98-06 94-97 99-02 98-00 98-03 04-06 89-95 94-98 89-92 93-98 96-05 99-07
MD3009	R	Solid	220	N/A	Plain	N/A			SUZUKI GSX-R 750 RG/G/H GSX-R 1100 G/H/J	86-87 86-88
MD3010LS	F	Solid	162	N/A	Plain	N/A			SUZUKI GSXR 50 (RB 50 H)	87
MD3014LS MD3014RS VMD3014	F F F	Floating Floating Floating	276 276 276	Silver Silver Black	Plain Plain Plain	6 6 9			SUZUKI GS 250 TT/TX GN 250 J GT 250 K/L/M/A/B Hustler GT 380 K/L/M/A/B Sebring GN 400 T/XT/XX/TX/TZ GS 400 B/C (Disc Brake) GS 425 N (Spoke Wheel) GS 425 EN (Cast Wheel) GS 425 LN GS 450 ET/ST/EX/SX/EZ/ED GS 450 GAZ/GAD/GAF GS 450 LT/LX/LZ/LD/LF/LG/LH/LJ GS 450 TX/TZ GS 450 TXZ GS 550 ET GS 550 MZ GS 550 LD/LF/LG GR 650 D/XD 'Tempter' GS 650 EX/EZ GS 650 GX/GZ/GD GS 650 MD GS 750 EC/EN/LN (8 valve) GS 750 ET/EX/EZ (16 valve) GS 750 LT/LX (16 valve)	80-81 88 73-77 73-77 80-82 77-78 79 79 79 80-83 82-85 80-88 81-82 82 80 82 83-86 83 81-82 81-83 83 78-79 80-82 80-81

**ROTOR
BUYERS GUIDE**

BRAKE ROTOR BUYERS GUIDE - STREET

Rotor No.	F/R	Type	Dia. (mm)	Hub Color	Profile	Bobbins	Left Bracket	Right Bracket	Model	Year
MD3014LS MD3014RS VMD3014 Contd.	F F F	Floating Floating Floating	276 276 276	Silver Silver Black	Plain Plain Plain	6 6 9			SUZUKI Contd. GS 750 SD GS 850 GN/GT/GX/GLT/GLX/GLZ/GZ/GLD/GD GS 1000 ET/ST/SZ GS 1000 EC/EN/SN/LN GS 1000 GT/GX GS 1000 GLT/GLX GS 1100 ET/EX/EZ/ED/ESD GS 1100 LT GS 1100 GZ/GD GS 1100 GLZ/GLD GS 1100 GKZ/GK2/GKD GS 1100 SD	83 79-83 80-82 78-79 80-81 80-81 80-83 80 82-83 82-83 82-83 83
MD3014RS VMD3014	R R	Floating Floating	276 276	Silver Black	Plain Plain	6 9			SUZUKI XN 85 D (673cc) GS 550 C/N/E/EN GS 550 ET/TX GS 550 MZ GS 550 LT/LX GS 750 ET/EX/EZ (16 valve) GS 750 LT/LX (16 valve) GS 750 SD GS 750 C/N/EC/EN/LN (8 valve) GS 850 GN/GT/GX/GLT GS 1000 C/N GS 1000 EC/EN/SN/LN GS 1000 ET/ST/SZ GS 1000 GT/GX GS 1000 GLT/GLX GS 1100 ET/EX/EZ/ED/ESD GS 1100 LT GS 1100 SD	83 77-79 80-81 82 80-81 80-82 80-81 83 78-79 79-81 78-79 78-79 80-82 80-81 80-81 80-83 80 83
MD3017LS	F	Solid	260	N/A	Plain	N/A			LS 650 FG/PG/PH/FH/PJ/PS/PT/PV/PW/PX/PY/PK1-PK4 Savage LS 650 K5/K6/K7/K8/K9/L1/L2/L3/L4/L5 Boulevard S40	86-88/95-04 05-15
MD3019LS MD3019RS VMD3019	F F F	Floating Floating Floating	276 276 276	Silver Silver Black	Plain Plain Plain	6 6 9			SUZUKI GS 550 B GT 550 K/L/M Indy GT 550 A/B Indy (Tokico Caliper) GT 550 B Indy (Asco Caliper) GS 750 B (8 valve) GT 750 K/L/M/A/B RE 5 M/A (Rotary)	77 73-75 76-77 77 77 73-77 75-76
MD3019RS VMD3019	R R	Floating Floating	276 276	Gold Black	Plain Plain	6 9			SUZUKI GS 750 (8 valve)	77
MD3020LS	F	Floating	296	Gold	Plain	6			SUZUKI GS 550 C/N/EC/EN GS 550 LT GS 750 C/N (8 Valve) GS 1000 C/N	77-79 80 78-79 78-79
MD3022LS	F	Floating	295	Gold	Plain	6			SUZUKI GS 550 LX GS 550 LZ GS 550 TX GS 650 GLX/GLZ/GLD GS 750 TZ/TD (16 valve)	81 82 81 81-83 82-83
MD3024LS MD3024RS	F F	Floating Floating	260 260	Silver Silver	Plain Plain	6 6			SUZUKI GS 550 ED/ESD/ES3/ES/EF/ESF/ESG	83-86
MD3025	R	Solid	250	N/A	Plain	N/A			SUZUKI GS 550 ED/ESD/ES3/ES/EF/ESF/ESG	83-86

BRAKE ROTOR BUYERS GUIDE - STREET

Rotor No.	F/R	Type	Dia. (mm)	Hub Color	Profile	Bobbins	Left Bracket	Right Bracket	Model	Year
MD3027	R	Solid	276	N/A	Plain	N/A			SUZUKI GS 650 EX/EZ GS 650 GX/GZ/GD GS 650 GLX/GLZ/GLD GS 650 MD GS 850 GLX/GLZ/GZ/GLD/GD GS 1100 GZ/GLZ/GD/GLD GS 1100 GKZ/GK2/GKD	81-82 81-83 81-83 83 80-83 82-83 82-83
MD3028LS MD3028RS	F F	Floating Floating	260 260	Silver Silver	Plain Plain	6 6			SUZUKI XN 85 D (673cc) GS 700 EF/ESF GS 750 ED/ESD	83 85 83
MD3029	R	Floating	260	Silver	Plain	6			SUZUKI GS 700 EF/ESF GS 750 ED/ESD	85 83
MD3030LS MD3030RS	F F	Solid Solid	276 276	N/A N/A	Plain Plain	N/A N/A			SUZUKI GV 700 GLF/GLF2 GV 1200 GLF/GLF2/GLG 'Madura'	85 85-86
MD3031LS	F	Solid	296	N/A	Plain	N/A			SUZUKI VS 700 GLFG/GLPG	86-87
MD3032LS MD3032RS	F F	Floating Floating	296 296	Gold Gold	Plain Plain	6 6			SUZUKI VS 700 GLFH/GLPH VS 750 GLP/J/GLPK/GLPL/GLPM Intruder VS 800 Intruder GLN/GLP/GLR/GLS/GLT/GLV/GLW/GLX/GLY/GLK1-GLK4 VS 800 K5/K6/K7/K8/K9/ZK9/LO S50 Boulevard VS 1400 GLPH/GLFH/GLP/J/GLPL/GLPM/GLPN/GLPP/GLPR/GLPS/GLPT /GLPV/GLPW/GLPX/GLPY/GLPK1-GLPK4 Intruder VS 1400 GLPK5/GLPK6/GLPK7/GLPK8/K9/LO Boulevard S83 (1400cc)	86-87 88-91 92-04 05-10 87-04 05-10
MD3033LS	F	Solid	310	N/A	Plain	N/A			SUZUKI VX 800 L/M/N/P	90-93
MD3036	R	Solid	275	N/A	Plain	N/A			SUZUKI GSX 1100 FK/FL/FM/FN/FP Katana	88-93
MD3037LS MD3037RS	F F	Solid Solid	310 310	N/A N/A	Plain Plain	N/A N/A			SUZUKI GSX 1100 GM/GN/GP	91-93
MD3038	R	Solid	295	N/A	Plain	N/A			SUZUKI GSX 1100 GM/GN/GP	91-93
MD3039 MD3039LS MD3039RS	R F F	Floating Floating Floating	276 276 276	Gold Gold Gold	Plain Plain Plain	6 6 6			SUZUKI GSX 1150 ES3/ESE/EF/ESF/EF2/EG/ESG SUZUKI GSX 1100 FK/FL/FM/FN/FP Katana GSX 1150 ES3/ESE/EF/ESF/EF2/EG/ESG	83-86 88-93 83-86
MD3041	R	Floating	275	Gold	Plain	6			SUZUKI GV 1200 GLF/GLF2/GLG 'Madura'	85-86
MD3042	F	Solid	275	N/A	Plain	N/A			SUZUKI GV 1400 GDG/GTG/GCG/GDH/GTH/GCH/GDJ	86-88
MD3043	R	Solid	296	N/A	Plain	N/A			SUZUKI GV 1400 GDG/GTG/GCG/GDH/GTH/GCH/GDJ	86-88
MD3044	R	Solid	275	N/A	Plain	N/A			SUZUKI VS 1400 GLPH/GLFH/GLP/J/GLPL/GLPM/GLPN/GLPP/GLPR/GLPS/GLPT /GLPV/GLPW/GLPX/GLPY/GLPK1-GLPK4 Intruder VS 1400 GLPK5/GLPK6/GLPK7/GLPK8/K9/LO Boulevard S83 (1400cc)	87-04 05-10
MD3045	F	Floating	300	Gold	Plain	6			SUZUKI VZ 800 V/W/X/Y/K1-K4 'Marauder'	97-04

BRAKE ROTOR BUYERS GUIDE - STREET

Rotor No.	F/R	Type	Dia. (mm)	Hub Color	Profile	Bobbins	Left Bracket	Right Bracket	Model	Year
MD3058X MD3058XC MD3058CC VR3058BLK VR3058BLU VR3058RED VR3058CHBR	F F F F F F F	Floating Floating Floating Floating Floating Floating Floating	320 320 320 320 320 320 320	Gold Gold Chrome Black Blue Red Blue	Plain Contour Contour Vee Vee Vee Vee	6 6 6 6 6 6 6			SUZUKI GSXR 600 V/W/X/W/Y/K1/K2/K3/ZK3 GSXR 750 T/V/W/X/Y/K1/K2/K3 GSXR 1000 K1/K2 TL 1000 SV/SW/SX/SY/RW/RX/RY/SK1/RK1-RK3 GSX 1300 RX/RY/RK1-RK7/RZK3-RZK6 Hayabusa	97-03 96-03 01-02 97-03 99-07
MD3060 MD3060C VR3060	R R R	Solid Solid Solid	220 220 220	N/A N/A N/A	Plain Contour Vee	N/A N/A N/A			SUZUKI GSXR 600 V/W/X/Y/K1/K2/K3/ZK3 GSXR 600 K4/K5/XK5/K6/K7/K8/K9 GSXR 600 ABS GSXR 600 100th Anniversary (Brembo Radial Caliper) SV 650 SK3-SK9/K3-K9/SF9/L0/SFL0 GSXR 750 ABS	97-03 04-10 11-20 21 03-10 96-20
MD3060 MD3060C VR3060	R R R	Solid Solid Solid	220 220 220	N/A N/A N/A	Plain Contour Vee	N/A N/A N/A			SUZUKI GSXR 750 100th Anniversary (Brembo Radial Caliper) TL 1000 SV/SW/SX/SYSK1//RW/RX/RY/RK1-RK3 GSXR 1000 K1-K9/L1/L2/L3/ZL3/L4/L5/L6 SV 1000 SK3/K3/SK4/K4/SK5/K5/SK6/SK7	21 97-03 01-16 03-07
MD3061	R	Solid	250	N/A	Plain	N/A			SUZUKI VX 800 L/M/N/P	90-93
MD3073LS	F	Floating	296	Gold	Plain	6			SUZUKI VS 700 GLEFG/GLEPG/GLEFH/GLEPH	86-87
MD3075LS MD3075RS	F F	Floating Floating	310 310	Gold Gold	Plain Plain	6 6			SUZUKI GSF 1200 SAV 'ABS model Bandit'	97
MD3076	R	Solid	276	N/A	Plain	N/A			SUZUKI GSF 1200 SAV 'ABS model Bandit'	97
MD3078LS MD3078RS	F F	Solid Solid	300 300	N/A N/A	Plain Plain	N/A N/A			SUZUKI VL 1500 W/X/Y/K1 Intruder Legendary Classic	98-01
MD3079	R	Floating	276	Gold	Plain	6			SUZUKI VL 1500 W/X Intruder Legendary Classic	98-99
MD3086	R	Floating	276	Gold	Plain	6			SUZUKI VL 1500 Y/K1/K2/K3/K4 VL 1500 BK5/BK6/K5-K9/TK5-TK9/L0 Boulevard C90/C90T VL 1500 L3 (C90 Boulevard) VL 1500 TL3/TL4/TL5 (C90T Boulevard with windshield) V 1500 BL3/BL4/BL5 (Boulevard C90 B.O.S.S.) V 1500 BTL3/4 (Boulevard C90 B.O.S.S. with windshield)	00-04 05-10 13 13-15 13-15 13-14
MD3087LS MD3087RS	F F	Solid Solid	290 290	N/A N/A	Plain Plain	N/A N/A			SUZUKI VL 1500 K2-K9/BK5/BK6/TK5-TK9/L0	02-10
MD3088X MD3088XC MD3088CC VR3088BLK VR3088BLU VR3088RED	F F F F F F	Floating Floating Floating Floating Floating Floating	310 310 310 310 310 310	Gold Gold Chrome Black Blue Red	Plain Contour Contour Vee Vee Vee	6 6 6 6 6 6			SUZUKI DL 650 K4/K5/K6 V-Strom DL 1000 V-Strom ABS DI 1000 V-Strom Adventure SV 1000 K3/SK3/K4/SK4/K5/SK5/SK6/SK7	04-06 02-20 12-20 03-07
MD3089X MD3089XC MD3089CC VR3089BLK VR3089BLU VR3089RED	F F F F F F	Floating Floating Floating Floating Floating Floating	300 300 300 300 300 300	Gold Gold Gold Gold Gold Gold	Plain Plain Plain Plain Plain Plain	6 6 6 6 6 6			SUZUKI GSXR 1000 K3	03

ROTOR BUYERS GUIDE

BRAKE ROTOR BUYERS GUIDE - STREET

Rotor No.	F/R	Type	Dia. (mm)	Hub Color	Profile	Bobbins	Left Bracket	Right Bracket	Model	Year
MD3090X	F	Floating	290	Gold	Plain	6			SUZUKI	
MD3090XC	F	Floating	290	Gold	Contour	6			SV 650 K3/SK3/K4/SK4/K5/SK5/SK6/K6/K7//K8/SK8/SK9/K9	03-10
MD3090CC	F	Floating	290	Chrome	Contour	6			GSX 600 FK3/FK4/FK5/FK6	03-06
VR3090BLK	F	Floating	290	Black	Vee	6			GSX 750 FK3/FK4/FK5/FK6	03-06
VR3090BLU	F	Floating	290	Blue	Vee	6			VZ 1500 K9/L3/L4/L5 M90 Boulevard	09/13-15
VR3090RED	F	Floating	290	Red	Vee	6			C 109 RT Boulevard (1783cc) VLR 1800 RTK8/RTK9	08-09
									C 109 R VLR 1800 RK8/RK9	08-09
									VLR 1800 TK8/TK9/TL0 C109 RT Touring	08-10
MD3091X	F	Floating	310	Gold	Plain	6			SUZUKI	
MD3091XC	F	Floating	310	Gold	Contour	6			GSXR 600 K6/K7	06-07
MD3091CC	F	Floating	310	Chrome	Contour	6			GSXR 750 K6/K7	06-07
VR3091BLK	F	Floating	310	Black	Vee	6			GSXR 1000 K5/K6/K7/K8/K9	05-08
VR3091BLU	F	Floating	310	Blue	Vee	6			VZR 1800 BL4/BL5/BL6/BL7 (Boulevard M109R B.O.S.S.)	14-21
VR3091RED	F	Floating	310	Red	Vee	6			VZR 1800 K6/K7/K8/K9/L1/L2/L3/L4 (M109R Boulevard)	06-14
VR3091CHBR	F	Floating	310	Blue	Vee	6			VZR 1800 NK8/NK9 M109 R2 Limited	08-09
									VZR 1800 ZK8/ZK9/ZL1/ZL2/ZL3/ZL4 M109 RZ Limited	08-14
MD3092X	F	Floating	310	Gold	Plain	6			SUZUKI	
MD3092XC	F	Floating	310	Gold	Contour	6			DL 650 AK7-AK9/K7-K9/AL1-AL7 V-Strom	07-17
MD3092CC	F	Floating	310	Chrome	Contour	6			DL 650 V-Strom Adventure ABS	12-21
VR3092BLK	F	Floating	310	Black	Vee	6			DL 650 V-Strom XT ABS	15-21
VR3092BLU	F	Floating	310	Blue	Vee	6			DL 650 V-Strom XT Touring	18-21
VR3092RED	F	Floating	310	Red	Vee	6			GSX 650 FK8/FK9/FL0	08-10
									GSR 750 L5/L6 (Non ABS)	15-16
									GSR 750 AL5/AL6 (ABS)	15-16
									GSX-S 750 A AL8 ABS	18-21
									GSX-S 750 Y AZL8 ABS	18-21
									GSX-S 750 Z L8	18-21
									GSX-S 750 ZL	18-21
									DL 1000 V-Strom Adventure ABS	14-20
									DL 1000 XT V-Strom (ABS)	18-20
									V-Strom 1050 A/XT/XA/XT Adventure ABS	20-21
									GSF 1250 K7/AK7/SAK7/SAK8/SAK9	07-10
									GSF 1250 SK7/SK8/SK9 Bandit	07-10
									GSX 1250 FAL1/FAL2	11-14
MD3093	R	Solid	240	N/A	Plain	N/A			SUZUKI	
MD3093C	R	Solid	240	N/A	Contour	N/A			GW 250 L3	13
VR3093	R	Solid	240	N/A	Vee	N/A			GW 250 FL5 (Fairing)	15
									GSX 650 FK8/FK9	08-10
									SV 650 SAK7/SAK8/SAK9/AK9 ABS	07-10
									SFV 650 K9/L3/L4 Gladius	09-10/13-14
									SV 650	16-21
									SV 650 A ABS	16-21
									SV 650 X ABS	16-21
									GSR 750 L5/L6 (Non ABS)	15-16
									GSR 750 AL5/AL6 (ABS)	15-16
									GSX-S 750 A ABS	18-21
									GSX-S 750 Y ABS	18-21
									GSX-S 750 Z ABS	18-21
									GSX-S 750 ZL ABS	18-21
									GSF 1250 AK7/SAK7/SAK8/SAK9 ABS	07-10
									GSF 1250 SK7/SK8/SK9 Bandit	07-10
									GSX 1250 FAL1/FAL2	11-12
MD3095RS	F	Solid	300	N/A	Plain	N/A			SUZUKI	
									VL 800 K1-K8/CK5-CK8/K6-K9/TK5-TK9/ZK9/ZK8/L1-L5/TL1-TL5	05-17
									VL 800 ZK3/ZK4 Volusia Ltd	03-04
									VL 800 BTL4 (Boulevard C50 B.O.S.S. Cast Wheels)	14
									VL 800 CL3 (Boulevard C50 Special Edition/Cast Wheels)	13
MD3096RS	F	Solid	300	N/A	Plain	N/A			SUZUKI	
									VZ 800 K5/K6/BK6/K7/ZK7/K8/ZK8/K9/ZK9/L0 M50 Boulevard	05-10
									VZ 800 L0/L1/L2/L3/L4/L5 (M50 Boulevard)	10-15

ROTOR BUYERS GUIDE

BRAKE ROTOR BUYERS GUIDE - STREET

Rotor No.	F/R	Type	Dia. (mm)	Hub Color	Profile	Bobbins	Left Bracket	Right Bracket	Model	Year
MD3097	R	Floating	275	Silver	Plain	6			SUZUKI VZ 1500 K9/L3/L4/L5 M90 Boulevard VLR 1800 TK8/TK9/TLO C109 RT Touring VLR 1800 K8/K9/LO C109 R VZR 1800 BL4/BL5/BL6/BL7 (Boulevard M109R B.O.S.S.) VZR 1800 K6/K7/K8/K9/L1/L2/L3/L4 (M109R Boulevard) VZR 1800 NK8/NK9 M109 R2 Limited VZR 1800 ZK8/ZK9/ZL1/ZL2/ZL3/ZL4 M109 RZ Limited	09/13-15 08-10 08-10 14-21 06-14 08-09 08-14
MD3098X MD3098XC MD3098CC VR3098BLK VR3098BLU VR3098RED	F F F F F F	Floating Floating Floating Floating Floating Floating	310 310 310 310 310 310	Gold Gold Chrome Black Blue Red	Plain Contour Contour Vee Vee Vee	6 6 6 6 6 6			SUZUKI GSX 1300 RK8/RK9/RL1/RL2 GSX 1300 BKAK8/BKAK9 B-King ABS GSX 1300 BKK8/BKK9 B-King GSX 1300 RZL4 Hayabusa 50th Anniversary Edition GSX 1300 RAL3-RAL7 ABS Hayabusa (Brembo Caliper)	08-12 08-10 08-10 14 13-20
MD3099 MD3099C VR3099	R R R	Solid Solid Solid	260 260 260	N/A N/A N/A	Plain Contour Vee	N/A N/A N/A			SUZUKI GSX 1300 RK8/RK9/RL1/RL2 GSX 1300 BKAK8/BKAK9 B-King ABS GSX 1300 BKK8/BKK9 B-King GSX 1300 RZL4 Hayabusa 50th Anniversary Edition GSX 1300 RAL3/RAL4/RAL5/RAL6/RAL7 ABS Hayabusa (Brembo Caliper)	08-12 08-10 08-10 14 13-20
MD3100X MD3100XC VR3100BLK VR3100BLU VR3100RED	F F F F F	Floating Floating Floating Floating Floating	310 310 310 310 310	Gold Gold Black Blue Red	Plain Contour Vee Vee Vee	6 6 6 6 6			SUZUKI GSXR 600 ABS GSX-R 600 100th Anniversary (Brembo Radial Caliper) GSXR 750 ABS GSX-R 750 100th Anniversary (Brembo Radial Caliper)	08-20 21 08-20 21
MD3102X MD3102XC VR3102BLK VR3102BLU VR3102RED	F F F F F	Floating Floating Floating Floating Floating	310 310 310 310 310	Gold Gold Black Blue Red	Plain Contour Vee Vee Vee	6 6 6 6 6			SUZUKI GSXR 1000 K9/L1/L2/L3/ZL3/L4/L5/L6 GSXR 1000 AL5/AL6 ABS	09-16 15-16
MD3103X MD3103XC	F F	Floating Floating	290 290	Gold Gold	Plain Contour	6 6			SUZUKI SFV 650 K9/L3/L4 SV 650 SAK7/SAK8/SAK9/AK9/ALO/SFA8/SFA9/SFLO ABS SV 650 SV 650 A ABS SV 650 X ABS	09-10/13-14 07-10 16-21 16-21 16-21
MD3104X MD3104XC VR3104BLK VR3104BLU VR3104RED	F F F F F	Floating Floating Floating Floating Floating	300 300 300 300 300	Gold Gold Black Blue Red	Plain Contour Vee Vee Vee	6 6 6 6 6			SUZUKI GSXR 600 K4/K5/XK5 GSXR 750 K4/K5/XK5 GSXR 1000 K4/ZK4	04-05 04-05 04
MD3105LS	F	Solid	290	N/A	Plain	N/A			SUZUKI GW 250 L4/L5 GW 250 FL5 (Fairing)	14-15 15
MD3106 MD3106C VR3106	R R R	Solid Solid Solid	220 220 220	N/A N/A N/A	Plain Contour Vee	N/A N/A N/A			SUZUKI GSX-R 1000 ABS GSX-R 1000R ABS GSX-R 1000 100th Anniversary GSX-R 1000 R 100th Anniversary	15-21 17-21 21 21
MD3107X MD3107XC VR3107BLK VR3107BLU VR3107RED	F F F F F	Floating Floating Floating Floating Floating	320 320 320 320 320	Gold Gold Black Blue Red	Plain Contour Vee Vee Vee	6 6 6 6 6			SUZUKI GSX-R 1000 ABS GSX-R 1000 R ABS GSX-R 1000 100th Anniversary GSX-R 1000 R 100th Anniversary	17-21 17-21 21 21
MD3108 MD3108C VR3108	R R R	Solid Solid Solid	250 250 250	N/A N/A N/A	Plain Contour Vee	N/A N/A N/A			SUZUKI GSX-S 1000 (Non ABS) GSX-S 1000 (ABS) GSX-S 1000 F (Non ABS) GSX-S 1000 F (ABS)	16-21 16-21 16-21 16-21

BRAKE ROTOR BUYERS GUIDE - STREET

Rotor No.	F/R	Type	Dia. (mm)	Hub Color	Profile	Bobbins	Left Bracket	Right Bracket	Model	Year
MD3109X MD3109XC VR3109BLK VR3109BLU VR3109RED	F F F F F	Floating Floating Floating Floating Floating	310 310 310 310 310	Gold Gold Black Blue Red	Plain Contour Vee Vee Vee	6 6 6 6 6			SUZUKI GSX-S 1000 (Non ABS) GSX-S 1000 (ABS) GSX-S 1000 F (Non ABS) GSX-S 1000 F (ABS)	16-21 16-21 16-21 16-21
MD3110C	F	Solid	290	N/A	Contour	N/A			SUZUKI GSX-R 125 RLXL8/RLL8 GSX-S 125 MLXL8/MLL8	18-21 18-21
MD3111 MD3111C	R R	Solid Solid	190 190	N/A N/A	Plain Contour	N/A N/A			SUZUKI GSX-R 125 RLXL8/RLL8 GSX-S 125 MLXL8/MLL8	18-21 18-21
MD3112C	F	Solid	290	N/A	Contour	N/A			SUZUKI DL 250 V-Strom AL8 (ABS) GSX 250 RL7/RL8	18-20 17-20
MD3113C	R	Solid	240	N/A	Contour	N/A			SUZUKI DL 250 V-Strom AL8 (ABS) GSX 250 RL7/RL8	18-20 17-20
MD3114X MD3114XC									USE MD3092X USE MD3092XC	
MD4001	R	Solid	260	N/A	Plain	N/A			KAWASAKI ZX 550 A1-A3 (GPZ)	84-86
MD4002LS MD4002RS	F F	Solid Solid	260 260	N/A N/A	Plain Plain	N/A N/A			KAWASAKI EL 250 B2/B3 Eliminator EX 250 E1-E2 Ninja ZX 550 A1-A3 (GPZ)	88-89 86-87 84-86
MD4006LS MD4006RS (5mm thickness)	F F	Solid Solid	270 270	N/A N/A	Plain Plain	N/A N/A			KAWASAKI EN 450 A1-A6 (454 LTD) EN 500 A1-A6/B2 Vulcan KZ 550 F1 (Spectre) F2 (Ltd) KZ 550 M1 (LTD) KZ 550 A2/A3/A4/C1-C4 (Ltd) KZ 1000 J1-J2 KZ 1000 K1/K2 (LTD) KZ 1100 A1-A3 KZ 1100 B1 (GPZ) KZ 1100 D1/D2 (Spectre) KZ 1100 L1 (LTD)	85-90 90-95 83-84 83 80-83 81-82 81-82 81-83 81 82-83 83
MD4007 MD4007C VR4007	R R R	Solid Solid Solid	230 230 230	N/A N/A N/A	Plain Contour Vee	N/A N/A N/A			KAWASAKI ZX 600 D1-D4 (ZX6) ZX 750 F1-F4 Ninja ZR 750 C1-C3	90-93 87-90 91-93
MD4008X MD4008XC MD4008CC VR4008BLK VR4008GRN	F F F F F	Floating Floating Floating Floating Floating	300 300 300 300 300	Gold Gold Chrome Black Green	Plain Contour Contour Vee Vee	6 6 6 6 6			KAWASAKI ZR 550 B1-B4 Zephyr ZL 600 B2/B3 Eliminator ZX 600 F1/F2/F3 (ZX6R) EJ 650 A2/A3/A4 (W650) W 800 Café (Cockpit Fairing) W 800 Special (Black Exhaust) W 800 ABS W 800 ABS Special ZR 750 C1-C3 ZG 1000 A9-A20/A6F Con Cours GPZ 1100 (ZX 1100 E1/E2/E3)	90-93 96-97 95-97 00-02 11 12 13-16 13-16 91-93 94-06 95-97
MD4009 MD4009C VR4009	R R R	Solid Solid Solid	240 240 240	N/A N/A N/A	Plain Contour Vee	N/A N/A N/A			KAWASAKI ZR 550 B1-B4 Zephyr ZX 600 E1-E13 (Ninja ZX6)	90-93 93-05

BRAKE ROTOR BUYERS GUIDE - STREET

Rotor No.	F/R	Type	Dia. (mm)	Hub Color	Profile	Bobbins	Left Bracket	Right Bracket	Model	Year
MD4010LS MD4010RS 5mm thickness	F F	Solid Solid	260 260	N/A N/A	Plain Plain	N/A N/A			KAWASAKI KZ 440 D5 (LTD) KZ 440 G1 KZ 550 D1 (GPZ) KZ 700 A1 VN 700 A1 Vulcan KZ 750 E1-E3 KZ 750 F1 (LTD) KZ 750 H1-H4 (LTD) KZ 750 L3 KZ 750 N1/N2 Spectre KZ 750 R1 (GPZ) VN 750 A2-A21/A6F Vulcan	83 82 81 84 85 80-82 83 80-83 83 82-83 82 86-06
MD4012X MD4012XC MD4012CC VR4012BLK VR4012GRN	F F F F F	Floating Floating Floating Floating Floating	310 310 310 310 310	Gold Gold Chrome Black Green	Plain Contour Contour Vee Vee	6 6 6 6 6			KAWASAKI ZX 750 H1/H2 (ZX7) ZX 9R (ZX 900 E1/E2) ZR 1100 A1-A4 Zephyr ZR 1100 B1 Zephyr ZX 1100 C1-C4 (ZX11) Ninja (ZR 1100 C3/C4) ZRX 1100 ZRX 1200 R (ZR 1200 A1/A2/A3/A4/A5)	89-90 00-01 92-95 96 90-93 99-00 01-05
MD4013 MD4013C VR4013	R R R	Solid Solid Solid	230 230 230	N/A N/A N/A	Plain Contour Vee	N/A N/A N/A			KAWASAKI ZX 750 H1/H2/J1/J2/L1-L3 (ZX-7) ZX 750 K1/K2/M1/M2/P1/P2/P3/P4/P5/P6/P7/P8 (ZX7R) ZX7RR (ZX 750 N1/N2) ZX 900 B1-B4 (ZX9R)	89-95 91-03 96-99 94-97
MD4014 MD4014C VR4014	R R R	Solid Solid Solid	250 250 250	N/A N/A N/A	Plain Contour Vee	N/A N/A N/A			KAWASAKI ZX 1100 D1-D9 Ninja (ZX11)	93-01
MD4015 MD4015C VR4015	R R R	Solid Solid Solid	250 250 250	N/A N/A N/A	Plain Contour Vee	N/A N/A N/A			KAWASAKI ZX 600 A1-A3/B1 Ninja ZX 1000 B1-B3 Ninja ZX10 ZX 1100 C1-C4 (ZX11) Ninja	85-87 88-90 90-93
MD4016 *Floating Disc kit available for these bikes See MD714LS/RS	F	Solid	280	N/A	Plain	N/A			KAWASAKI EX 500 A1-A7* EX 500 D1-D12/D6F/D7F/D8F/D9F* ZL 600 A1/A2 ZX 750 E1/E2 Turbo ZL 900 A1/A2 Eliminator ZX 900 A1-A3 Ninja ZL 1000 A1 ZX 1000 A1/A2 (Ninja) ZX 1100 A1/A2 (GPZ)	87-93 94-09 86-87 84-85 85-86 84-86 87 86-87 83-84
MD4017	R	Solid	270	N/A	Plain	N/A			KAWASAKI ZX 750 E1/E2 Turbo ZL 900 A1/A2 Eliminator ZX 900 A1/A2/A3 ZL 1000 A1 ZX 1100 A1/A2 (GPZ)	84-85 85-86 84-86 87 83-84
MD4019	R	Solid	260	N/A	Plain	N/A			KAWASAKI ZX 750 A1/A2/A2L/A3 (GPZ) ZX 1000 A1/A2 (Ninja)	83-85 86-87
MD4021	F	Solid	300	N/A	Plain	N/A			KAWASAKI ZX 1000 B1-B3 Ninja ZX10	88-90
MD4022X MD4022XC MD4022CC VR4022BLK VR4022GRN	F F F F F	Floating Floating Floating Floating Floating	320 320 320 320 320	Gold Gold Chrome Black Green	Plain Contour Contour Vee Vee	6 6 6 6 6			KAWASAKI Ninja ZX-750 J1/J2/L1-L3 (ZX-7) Ninja ZX 7R (ZX750 K1/K2/M1/M2) Ninja ZX 7R (ZX 750 P1-P8) Ninja ZX-7RR (ZX750 N1/N2) ZX-9R B1-B4 Ninja ZX-9R F1/F2 Ninja	91-95 91-95 96-03 96-99 94-97 02-03

BRAKE ROTOR BUYERS GUIDE - STREET

Rotor No.	F/R	Type	Dia. (mm)	Hub Color	Profile	Bobbins	Left Bracket	Right Bracket	Model	Year
MD4022X MD4022XC MD4022CC VR4022BLK VR4022GRN Contd.	F F F F F	Floating Floating Floating Floating Floating	320 320 320 320 320	Gold Gold Chrome Black Green	Plain Contour Contour Vee Vee	6 6 6 6 6			KAWASAKI Contd. ZX 1100 D1-D9 Ninja ZR 1200 R (ZR 1200 A1-A4) ZX 12 R A1/A2/B1/B2 ZX 1200 C1/C2/C3/C4 (ZZR 1200) VN 1500 P1/P2 Vulcan Mean Streak VZ 1600 K4/K5 VN 1600 B1/B2/B6F/B7F/B7FA/B8F/B8FA	93-01 01-04 00-03 02-05 02-03 04-05 04-08
MD4023 MD4023C VR4023	R R R	Solid Solid Solid	230 230 230	N/A N/A N/A	Plain Contour Vee	N/A N/A N/A			KAWASAKI ZX 6R (ZX 600 F1-F3) ZX 12R (ZX 1200 A1/A2/B1/B2/B3/B4)	95-97 00-05
MD4024	R	Solid	260	N/A	Plain	N/A			KAWASAKI KZ 550 H1/H2 (GPZ)	82-83
MD4026LS MD4026RS	F F	Solid Solid	260 260	N/A N/A	Plain Plain	N/A N/A			KAWASAKI ZX 600 C1-C9 Ninja 600 R	88-96
MD4027 MD4027C VR4027	R R R	Solid Solid Solid	240 240 240	N/A N/A N/A	Plain Contour Vee	N/A N/A N/A			KAWASAKI ZX 600 C1-C9 Ninja 600 R ZR 1100 A1-A4/B1 Zephyr	88-96 92-96
MD4028	R	Solid	270	N/A	Plain	N/A			KAWASAKI ZX 600 A1-A3/B1 Ninja ZX 750 A1-A3 (GPZ) ZG 1000 A1-A8 Con Cours	85-87 83-85 86-93
MD4032	R	Solid	240	N/A	Plain	N/A			KAWASAKI EX 250 E1-E2 Ninja	86-87
MD4038	F	Solid	280	N/A	Plain	N/A			KAWASAKI KZ 1000 R1/R2 (Replica) KZ 1000 J3 KZ 1100 B2 (GPZ)	82-83 83 82
MD4040LS	F	Solid	210	N/A	Plain	N/A			KAWASAKI AR 50 A1 AR 80 A1	82 82
MD4041RS	F	Solid	260	N/A	Plain	N/A			KAWASAKI EX 250 F2-F19/D6F/D7F Ninja 250	88-07
MD4042	R	Solid	230	N/A	Plain	N/A			KAWASAKI EX 250 F2-F19/D6F/D7F Ninja 250	88-07
MD4043LS	F	Floating	260	Gold	Plain	6			KAWASAKI KZ 305 A1/A2/B1 (CSR) KZ 305 B2/B3 (LTD)	81-82 87-88
MD4047LS	F	Floating	278	Gold	Plain	6			KAWASAKI KZ 440 A1-A4 KZ 440 K1/D1-D4 (LTD)	80-83 80-82
MD4051 MD4051C	R R	Solid Solid	230 230	N/A N/A	Plain Contour	N/A N/A			KAWASAKI EX 500 D1-D12/D6F/D7F/D8F/D9F	94-09
MD4052LS MD4052RS VMD4052	F F F	Floating Floating Floating	295 295 295	Gold Gold Black	Plain Plain Plain	6 6 9			KAWASAKI KH 500 A8 KZ 650 B1-B3 KZ 750 B1-B4 KZ 900 A4/A5 KZ 1000 A1/A2/A2A	76 77-79 76-79 76-77 77-78
MD4053LS	F	Solid	260	N/A	Plain	N/A			KAWASAKI KZ 550 A1	80

BRAKE ROTOR BUYERS GUIDE - STREET

Rotor No.	F/R	Type	Dia. (mm)	Hub Color	Profile	Bobbins	Left Bracket	Right Bracket	Model	Year
MD4054 (7mm thickness)	R	Solid	270	N/A	Plain	N/A			KAWASAKI KZ 1000 J1-J3 KZ 1000 K1/K2 (LTD) KZ 1000 M1/M2 (CSR) KZ 1000 P1-P22/P24 (Police) KZ 1000 R1/R2 (Replica) KZ 1100 A1-A3 KZ 1100 B1/B2 (GPZ) KZ 1100 D1/D2 (Spectre) KZ 1100 L1 (LTD) VN 1500 A1-A13 Vulcan VN 1500 B1-B4 Vulcan 88 SE	81-83 81-82 81-82 82-03/05 82-83 81-83 81-82 82-83 83 87-99 87-90
MD4059LS MD4059RS VMD4059	F F F	Floating Floating Floating	278 278 278	Silver Silver Black	Plain Plain Plain	6 6 9			KAWASAKI KZ 650 C1-C3 Custom KZ 650 D1/D1A/D2 'SR' series	77-79 78-79
MD4062	R	Floating	276	Silver	Plain	6			KAWASAKI KZ 650 C3 Custom From F/No 023101	-79
MD4063 VMD4063	R R	Floating Floating	295 295	Silver Black	Plain Plain	6 9			KAWASAKI KZ 650 D2 'SR' series KZ 1000 B3/B4 (LTD) KZ 1000 G1 Classic	79 79-80 80
MD4064LS MD4064RS VMD4064	F F F	Floating Floating Floating	295 295 295	Silver Silver Black	Plain Plain Plain	6 6 9			KAWASAKI KZ 650 E1 (LTD) KZ 650 F1 KZ 1000 A3/A3A/A4 KZ 1000 B3/B4 (LTD) KZ 1000 C2/C3/C4 KZ 1000 G1 Classic	80 80 79-80 79-80 79-81 80
MD4065LS	F	Floating	280	Gold	Plain	6			KAWASAKI KZ 650 H1-H3 (CSR)	81-83
MD4066LS	F	Floating	280	Gold	Plain	6			KAWASAKI KZ 750 M1 (CSR)	82
MD4067LS MD4067RS	F F	Solid Solid	270 270	N/A N/A	Plain Plain	N/A N/A			KAWASAKI ZN 700 A1/A2 (LTD)	84-85
MD4068	R	Solid	260	N/A	Plain	N/A			KAWASAKI ZN 700 A1/A2 (Ltd)	84-85
MD4069LS MD4069RS VMD4069	F F F	Floating Floating Floating	296 296 296	Silver Silver Black	Plain Plain Plain	6 6 9			KAWASAKI HI-D/HI-E/HI-F 500 H2/H2-A "Mach IV" H2-B/H2-C "Mach IV" Z1/A/B 900	73-75 72-73 74-75 73-75
MD4070LS	F	Floating	270	Gold	Plain	6			KAWASAKI KZ 750 K1/K2 (LTD)	83-84
MD4071LS MD4071RS	F F	Solid Solid	270 270	N/A N/A	Plain Plain	N/A N/A			KAWASAKI ZX 750 F1-F4 Ninja	87-90
MD4076LS MD4076RS VMD4076	F F F	Floating Floating Floating	296 296 296	Silver Silver Black	Plain Plain Plain	6 6 9			KAWASAKI KZ 900 B1 'LTD' KZ 1000 B1/B2 'LTD' KZ 1000 D1/D3 (Z1-R series) KZ 1000 C1/C1A Police Series	76 77-78 78-80 78
MD4077 VMD4077	R R	Floating Floating	290 290	Silver Black	Plain Plain	6 9			KAWASAKI KZ 1000 A1/A2/A2A/A3/A3A/A4 KZ 1000 C1/C1A Police Series KZ 1000 C2/C3/C4 KZ 1000 D1/D3 (Z1-R series)	77-80 78 79-81 78-80

ROTOR BUYERS GUIDE

BRAKE ROTOR BUYERS GUIDE - STREET

Rotor No.	F/R	Type	Dia. (mm)	Hub Color	Profile	Bobbins	Left Bracket	Right Bracket	Model	Year
MD4078LS MD4078RS VMD4078	F F F	Floating Floating Floating	286 286 286	Gold Gold Black	Plain Plain Plain	6 6 9			KAWASAKI KZ 1000 E1/E2 ST & Shaft	79-80
MD4080LS MD4080RS	F F	Floating Floating	270 270	Gold Gold	Plain Plain	6 6			KAWASAKI KZ 1000 M1/M2 (CSR)	81-82
MD4082	R	Solid	280	N/A	Plain	N/A			KAWASAKI ZG 1000 A1-A8 Con Cours ZG 1000 A9-A20/A6F Con Cours	86-93 94-06
MD4084	F	Solid	280	N/A	Plain	N/A			KAWASAKI ZN 1100 B1/B2 (LTD)	84-85
MD4085	R	Solid	270	N/A	Plain	N/A			KAWASAKI Vulcan Classic LT (Spoke wheels & Screen) VN 900 BBFA/CCFA Vulcan Custom Special Edition Vulcan Custom (Cast Wheels) Vulcan Classic (Spoke Wheels) ZN 1100 B1/B2 (LTD)	06-21 11-12 07-21 06-21 84-85
MD4087	F	Solid	280	N/A	Plain	N/A			KAWASAKI ZG 1200 A1/A2/B1-B17 (Voyager XII)	86-03
MD4088	R	Solid	290	N/A	Plain	N/A			KAWASAKI ZG 1200 A1/A2/B1-B17 (Voyager XII)	86-03
MD4089LS MD4089RS VMD4089	F F F	Floating Floating Floating	299 299 299	Silver Silver Black	Plain Plain Plain	6 6 9			KAWASAKI KZ 1300 A1-A4 KZ 1300 B2 (Touring)	79-82 80
MD4090	R	Solid	290	N/A	Plain	N/A			KAWASAKI KZ 1000 E1/E2 ST & Shaft KZ 1300 A1-A4 KZ 1300 B2 (Touring)	79-80 79-82 80
MD4091	F	Solid	300	N/A	Plain	N/A			KAWASAKI KZ 1000 P1-P22/P24 (Police) ZN 1300 A1-A6 (Voyager)	82-03/05 83-88
MD4092	R	Solid	330	N/A	Plain	N/A			KAWASAKI ZN 1300 A1-A6 (Voyager)	83-88
MD4094LS	F	Floating	300	Silver	Plain	6			KAWASAKI VN 1500 B1-B4 Vulcan 88 SE	87-90
MD4099	F	Solid	260	N/A	Plain	N/A			KAWASAKI EX 305 B1 (GPZ) KZ 550 H1/H2 (GPZ)	83 82-83
VMD4123	F	Floating	278	Black	Plain	9			KAWASAKI KH 400 A3/A4/A5	76-78
MD4124LS	F	Floating	300	Silver	Plain	6			KAWASAKI EN 500 C1-C10/C6F/C7F/C8F/C9F Vulcan 500 Ltd VN 800 A1-A11 Vulcan Classic VN 1500 C3/C4 VN 1500 A1-A13 Vulcan	96-09 96-05 96-97 87-99
MD4125LS	F	Solid	300	N/A	Plain	N/A			KAWASAKI VN 800 B1-B10 Vulcan Classic VN 800 C1/C 2/E1/E2/E3/E4/E5/E6F VN 1500 D1/D2/E1-E7 Vulcan Classic VN 1500 J1/J2/R1/R2/R3/R4/R5 VN 1500 N1/N2/N3 Classic Fi VN 1500 N4/N6F/N7F/N8F/N8FA Vulcan 1500 Classic	96-05 99-06 96-04 99-05 00-02 05-08
MD4128	R	Solid	270	N/A	Plain	N/A			KAWASAKI VN 1500 C3/C4 VN 1500 D1/D2/E1-E3 Vulcan Classic	96-97 96-00

BRAKE ROTOR BUYERS GUIDE - STREET

Rotor No.	F/R	Type	Dia. (mm)	Hub Color	Profile	Bobbins	Left Bracket	Right Bracket	Model	Year
MD4130 MD4130C VR4130	R R R	Solid Solid Solid	250 250 250	N/A N/A N/A	Plain Contour Vee	N/A N/A N/A			KAWASAKI GPZ 1100 (ZX1100 E1/E2/E3) GPZ 1100 (ZX1100 F1)	95-97 96-97
MD4132X MD4132XC VR4132BLK VR4132GRN	F F F F	Floating Floating Floating Floating	300 300 300 300	Gold Gold Black Green	Plain Contour Vee Vee	6 6 6 6			KAWASAKI GPZ 1100 F1 ABS Model	96-97
MD4133 MD4133C VR4133	R R R	Solid Solid Solid	250 250 250	N/A N/A N/A	Plain Contour Vee	N/A N/A N/A			KAWASAKI (ZR 1100 C3/C4) ZRX 1100 ZRX 1200 R (ZR 1200 A1/A2/A3/A4/A5) ZX 1200 C1/C2/C3/C4 (ZZR 1200)	99-00 01-05 02-05
MD4136X MD4136XC MD4136CC VR4136BLK VR4136GRN	F F F F F	Floating Floating Floating Floating Floating	300 300 300 300 300	Gold Gold Chrome Black Green	Plain Contour Contour Vee Vee	6 6 6 6 6			KAWASAKI ZX 6R (ZX 600 G1/G2/J1/J2/J3) ZX 6R (ZX636A1) ZZR 600 (ZX 600 J4/J6F/J7F/J8F) ZX 9R (ZX 900 C1/C2)	98-02 02 05-08 98-99
MD4137RS	F	Solid	260	N/A	Plain	N/A			KAWASAKI BN 125 A4-A8/A6F/A7F/A9F	01-09
MD4138 MD4138C VR4138	R R R	Solid Solid Solid	250 250 250	N/A N/A N/A	Plain Contour Vee	N/A N/A N/A			KAWASAKI ZX 6R (ZX 600 G1/G2/J1/J2/J3) ZX 6R (ZX636A1) ZX 6R (ZX 636 C1/C6F/D6F 636cc) ZX 6RR (ZX 600 K1/M1/N1) 599cc ZX 6R (ZX 636 B1/B2) 636cc ZX6R (ZX 600 P7F/P8F/R9F/RAF/RBF/RCF) ZZR 600 (ZX 600 J4/J6F/J7F/J8F) ER 650 C9F/CAF ER-6N EX 650 Ninja (EX 650 ECF/EDS/EEF/EFF) (Non ABS) EX 650 R (EX 650 CBF) KLE 650 A7F/A8F/A9F/CAF/CBF/CCF/CDF/CEF Versys Ninja 650 R (EX 650 A6F/A7F/A8F/C9F/CAF) Z 650 (ER 650 GHF Non ABS) Z 650 (ER 650 HHF ABS) Z 750 S (ZR 750 K1/K6F) ZX 9R (ZX 900 C1/C2/E1/E2/F1/F2) Z 1000 (ZR 1000 A1/A2/A3/A6F) ZX 10R (ZX 1000 C1/C2/DF6/D7F/E8F/E9F/FAF)	98-02 02 05-06 03-05 03-04 07-12 05-08 09-10 12-15 11 07-14 06-10 17 17 05-06 98-03 03-06 04-10
MD4141X MD4141XC MD4141CC	F F F	Floating Floating Floating	300 300 300	Silver Silver Chrome	Plain Contour Contour	6 6 6			KAWASAKI ZX 600 D1-D4 (ZX6) ZR 750 F2 (ZR-7) ZR 750 H1/H2/H3/H4/H5 (ZR7S) ZR 750 S (ZR 750 K1/K6F)	90-93 00-01 01-05 05-06
MD4142 MD4142C	R R	Solid Solid	240 240	N/A N/A	Plain Contour	N/A N/A			KAWASAKI ZR 750 F2 (ZR-7) ZR 750 H1/H2/H3/H4/H5 (ZR7S)	00-01 01-05
MD4146 MD4146C	R R	Solid Solid	300 300	N/A N/A	Plain Contour	N/A N/A			KAWASAKI VN 1500 P1/P2 VN 1600 A1/A2/A3/A6F/A7F/B6F/B7F/A7FA/A8F/A8FA Classic VN 1600 B1/B2/B6F/B7F/B7FA/B8F/B8FA Mean Streak VN 1600 D1/D6F/D7F/D7FA/D8F/D8FA Nomad SUZUKI VZ 1600 K4 Marauder VZ 1600 K5 M95 Boulevard/Marauder	02-03 03-08 04-08 05-08 04 05
MD4147	R	Solid	320	N/A	Plain	N/A			KAWASAKI VN 1500 G1/G2/G3/L2/L3/L4/L5 VN 00 D1/D6F Vulcan Ltd VN 00 A1/A2/A6F/A7F/G8F/G9F Vulcan VN 00 E6F/E7F/H8F/H9F Vulcan Classic	99-05 05-06 04-09 06-09

ROTOR BUYERS GUIDE

BRAKE ROTOR BUYERS GUIDE - STREET

Rotor No.	F/R	Type	Dia. (mm)	Hub Color	Profile	Bobbins	Left Bracket	Right Bracket	Model	Year
MD4148	R	Solid	270	N/A	Plain	N/A			KAWASAKI VN 00 F6F/F7F/J8F/J9F Vulcan Classic LT VN 800 C1/C2/E1/E2/E3/E4/E5/E6F VN 1500 J1/J1L/J2/J2L/R1/R2/R3/R4/R5/N1/N2/E4/E5/E6/E7 VN 1500 N4/N6F/N7F/N7FA/N8F/N8FA Vulcan 1500 Classic	06-09 99-06 00-05 05-08
MD4150	F	Solid	280	N/A	Plain	N/A			KAWASAKI VN 1500 G1/G1A/G2A/G3/L2/L3/L4/L5	99-05
MD4151X MD4151XC	F F	Floating Floating	280 280	Gold Gold	Plain Contour	6 6			KAWASAKI ZX 6RR (ZX 600 K1/M1) 599cc ZX 6R (ZX 636 B1/B2) 636cc	03-04 03-04
MD4152XC MD4152CC VR4152BLK VR4152GRN	F F F F	Floating Floating Floating Floating	300 300 300 300	Gold Gold Black Green	Contour Contour Vee Vee	6 6 6 6			KAWASAKI ZX6RR (ZX 600 N1/N6F 599cc) ZX6R (ZX 636 C1/C6F/D6F 636cc) ZX6R (ZX 600 P7F/P8F/R9F/RAF/RBF/RCF) ZX 1000 C1/C2/D6F/D7F (ZX10R) Z 1000 (ZR 1000 B7F/B8F)	05-06 05-06 07-12 04-07 07-08
MD4153X MD4153XC MD4153CC VR4153BLK VR4153GRN	F F F F F	Floating Floating Floating Floating Floating	300 300 300 300 300	Gold Gold Chrome Black Green	Plain Contour Contour Vee Vee	6 6 6 6 6			KAWASAKI ZX 600 E4-E13 (ZZR 600)	96-05
MD4154X MD4154XC MD4154CC VR4154BLK VR4154GRN	F F F F F	Floating Floating Floating Floating Floating	300 300 300 300 300	Gold Gold Chrome Black Green	Plain Contour Contour Vee Vee	6 6 6 6 6			KAWASAKI Z 1000 (ZR 1000 A1-A3/A6F) ZX 12 R (EX 1200 B3-B4)	03-06 04-05
MD4155XC MD4155CC VR4155BLK VR4155GRN VR4155CHGR	F F F F F	Floating Floating Floating Floating Floating	310 310 310 310 310	Gold Chrome Black Green Green	Contour Contour Vee Vee Vee	6 6 6 6 6			KAWASAKI ZX6R (ZX 636 EDF/EEF/EFF/EGF/EHF) 636 cc/ Non ABS ZX6R (ZX 636 EFFA) 636 cc/ 30th Anniversary Edition Non ABS ZX6R (ZX 636 EGFA/EHFA) 636 cc/ Non ABS/ KRT Edition ZX6R (ZX 636 FDF/FDF/FFF/FGF/FHF) 636 cc/ ABS ZX6R (ZX 636 FFFA) 636 cc/ 30th Anniversary Edition ABS ZX6R (ZX 636 FGFA/FHFA) 636 cc/ ABS/ KRT Edition ZX6R (ZX636EJF)/ZX6R ABS (ZX636EJF) ZX6R ABS KRT Edition (ZX636EJF) Z 1000 ABS (ZR 1000 G) ABS Model Concours 14 (ZG 1400 B8F/B9F/DAF) Concours 14 ABS (ZG 1400 A8F/A9F/CAF/CBF/CCF/CDF/CEF) ZX 14 R ZX 14 R ABS ZX 14 R ABS Performance ZX 14 R ABS Performance Sport	13-17 15 16-17 13-17 15 16-17 18-21 18-21 14-20 08-11 08-14 06-07 06-21 12-19 14-21
MD4156XC (Right side no ABS ring)	F	Floating	300	Gold	Contour	6			KAWASAKI EX 650 Ninja (KHF/KHFA - ABS) EX 650 Ninja (JHF -Non ABS) Ninja KRT Edition ABS Z 650 (ER 650 GHF Non ABS/HHF ABS) Z 650 ABS	17-21 17 18-21 17 18-21
MD4156AXC (Left side with ABS ring fitted)	F	Floating	300	Gold	Contour	6			KAWASAKI EX 650 Ninja (KHF/KHFA - ABS) EX 650 Ninja (JHF -Non ABS) Ninja KRT Edition ABS Z 650 (ER 650 GHF Non ABS) Z 650 (ER 650 HHF ABS) Z 650 ABS	17-21 17 18-21 17 17 18-21
MD4157C VR4157	R R	Solid Solid	250 250	N/A N/A	Contour Vee	N/A N/A			KAWASAKI Versys LT ABS Versys SE LT ABS Versys SE LT+ ABS Z 1000 (ZR 1000 B) Z 1000 (ZR 1000 C) Z 1000 (ZR 1000 D) Non ABS	18-21 18-21 19-21 07-08 07 10-13

ROTOR BUYERS GUIDE

BRAKE ROTOR BUYERS GUIDE - STREET

Rotor No.	F/R	Type	Dia. (mm)	Hub Color	Profile	Bobbins	Left Bracket	Right Bracket	Model	Year
MD4157C VR4157 Contd.	R R	Solid Solid	250 250	N/A N/A	Contour Vee	N/A N/A			KAWASAKI Contd. Z 1000 ABS (ZR 1000 G) ABS Model ZX10 R Ninja (ZX 1000 GBF/GCF/GDF) ZX10 R Ninja ABS (ZX 1000 HCF/HDF) ZX10 R Ninja ABS (ZX 1000 MEF/MFF) ZX 14 R ZX 14 R ABS ZX 14 R ABS ZX 14 R ABS ZX 14 R ABS Performance ZX 14 R ABS Performance Sport	14-20 11-13 12-13 14-19 06-07 06-07 08-11 12-21 12-19 14-21
MD4158	F	Solid	300	N/A	Plain	N/A			KAWASAKI W 800 (Solid F Disc) VN 900 Classic VN 900 BBFA/CCFA Vulcan Custom Special Edition VN 900 C (Cast wheels) VN 900 Classic LT VN 1600 D1/D6F/D7F/D7FA/D8F/D8FA Nomad VN 1700 A9FA/AAF/ABF/ACF Vulcan 1700 Voyager VN1700 B9FA/BAF/BBF/BCF/BDF/BEF/BFF/BGF/BHF Vulcan 1700 Voyager ABS VN 1700 C9F/CAF/CBF/CCF Vulcan 1700 Nomad VN 1700 C9FA Vulcan 1700 Nomad 2T VN 1700 DEF/DEFA (Vulcan Nomad ABS) VN 1700 E9F/EAF/EBF/ECF Vulcan 1700 Classic VN 1700 G9F/GAF Vulcan 1700 Classic LT VN 1700 KEF/KEFA Vaquero ABS Voyager VN 1600 A1/A2/A3/A6F/A7F/A7FA/A8F/A8FA VN 00 D1/D6F Vulcan Ltd VN 00 A1/A2/A6F/A7F/G8F/G9F Vulcan VN 00 E6F/E7F/H8F/H9F Vulcan Classic VN 00 F6F/F7F/J8F/J9F/JAF Vulcan Classic LT	11-12 06-21 11-12 07-21 06-21 05-08 09-12 09-21 09-12 09 14 09-12 09-12 14-21 03-08 05-06 04-09 06-09 06-10
MD4159XC VR4159BLK VR4159GRN	F F F	Floating Floating Floating	300 300 300	Gold Black Green	Contour Vee Vee	6 6 6			KAWASAKI ER 650 C9F ER-6N EX 650 A6F/A7F/A8F/C9F/CAF (Ninja 650 R) EX 650 Ninja (EX 650 ECF/EDS/EEF/EFF) (Non ABS) EX 650 R (EX 650 CBF) KLE 650 A7F/A8F/A9F/CAF/CBF/CCF/CDF/CEF Versys	09 06-10 12-15 11 07-14
MD4160C VR4160	R R	Solid Solid	270 270	N/A N/A	Contour Vee	N/A N/A			KAWASAKI Concours 14 (ZG 1400 B8F/B9F/DAF) Concours 14 ABS (ZG 1400 A8F/A9F/CAF/CBF/CCF/CDF/CEF)	08-11 08-14
MD4161X MD4161XC VR4161BLK VR4161GRN	F F F F	Floating Floating Floating Floating	310 310 310 310	Gold Gold Black Green	Plain Contour Vee Vee	6 6 6 6			KAWASAKI ZX 10 R E8F/E9F/FAF ZX 10 R (ZX 1000 JBF/JCF/JDF/JEF/JFF) Non ABS ZX 10 R (ZX 1000 KBF/KCF/KDF/KEF/KFF) ABS ZX 10 R (ZX 1000 VFFA) 30th Anniversary Edition (Non ABS Version) ZX 10 R (ZX 1000 KFFA) 30th Anniversary Edition (ABS Version)	08-10 11-15 12-15 15 15
MD4162C MD4162XC VR4162BLK VR4162GRN	F F F F	Solid Floating Floating Floating	290 290 290 290	N/A Gold Black Green	Contour Contour Vee Vee	N/A 6 6 6			KAWASAKI EX 250 J8F/J9F/JAF/JBF/JCF (Ninja 250 R)	08-12
MD4163C VR4163	R R	Solid Solid	220 220	N/A N/A	Contour Vee	N/A N/A			KAWASAKI EX 250 J8F/J9F/JAF/JBF/JCF (Ninja 250 R) EX 300 ADF/ADFA/AEF/AES/AESA/AFF Ninja 300 (Non ABS) Ninja 300 SE - Non ABS (ZX 300 AEF/AEFA/AFFA/AESA)	08-12 13-15 14-15
MD4164AC	R	Solid	220	N/A	Contour	N/A			KAWASAKI EX 650 Ninja (EX 650 FDS/FEF/FFF) (ABS Model) KLE 650 DEF Versys (ABS) Z 650 ABS	13-15 13 18-21

BRAKE ROTOR BUYERS GUIDE - STREET

Rotor No.	F/R	Type	Dia. (mm)	Hub Color	Profile	Bobbins	Left Bracket	Right Bracket	Model	Year
MD4165 MD4165C VR4165	R R R	Solid Solid Solid	220 220 220	N/A N/A N/A	Plain Contour Vee	N/A N/A N/A			KAWASAKI Z 125 (BR125) ZX6R (ZX 636 EDF/EEF/EFF/EGF/EHF) 636 cc/Non ABS ZX6R (ZX 636 EFFA) 636 cc/ 30th Anniversary Edition Non ABS ZX6R (ZX 636 EGFA/EHFA) 636 cc/ Non ABS/KRT Edition ZX6R (ZX 636 FDF/FDF/FFF/FGF/FHF) 636 cc/ABS ZX6R (ZX 636 FFFA) 636 cc/30th Anniversary Edition ABS ZX6R (ZX 636 FGFA/FHFA) 636 cc/ABS/KRT Edition EN 650 Vulcan S (Non ABS) - EN 650 A EN 650 Vulcan S (ABS) - EN 650 B EN 650 Vulcan S Café (ABS) EN 650 Vulcan S (ABS) SE ZX 10 R (ZX 1000 JBF/JCF/JDF/JEF/JFF) (Non ABS) ZX 10 R (ZX 1000 KBF/KCF/KDF/KEF/KFF) ABS ZX 10 R (ZX 1000 KFFA) 30th Anniversary Edition ZX 10 R Ninja (ZX 1000 SGF/SHF/SJF) ZX 10 R Ninja KRT Replica (ZX 1000 SGFA/SHFA/SJFA) Ninja ZX-10 RR (ZX1000 ZHF) ZX10 R Ninja ABS (ZX 1002 EKf/FKf) ZX10 R Ninja ABS KRT Edition (ZX 1002 EKFA/FKFA) ZX10 RR Ninja (ZX 1002 GKF)	17-21 13-17 15 16-17 13-17 15 16-17 15-20 15-21 18-21 18-21 11-15 12-15 15 16-19 16-19 17-19 19-21 19-21 19-21
MD4166C MD4166X MD4166XC VR4166BLK VR4166GRN 5 bolt fixing	F F F F F	Solid Floating Floating Floating Floating	290 290 290 290 290	N/A Gold Gold Black Green	Contour Plain Contour Vee Vee	N/A 6 6 6 6			KAWASAKI Ninja 125 Z 125 EX 300 Ninja (EX 300 ADF/ADFA/AEF) EX 300 Ninja (EX 300 BADF/BDF/BEF) Ninja 300 SE - Non ABS (ZX 300 AEF/AEFA/AFFA/AESA) Ninja 300 SE - ABS (ZX 300 BEFA/BESA/BFFA)	17-21 17-21 13-14 13-14 14-15 14-15
MD4167X MD4167XC	F F	Floating Floating	296 296	Gold Gold	Plain Contour	6 6			KAWASAKI ZX9R C1/C2	98-99
MD4169 7mm thickness	R	Solid	260	N/A	Plain	N/A			KAWASAKI KZ 550 D1 (GPZ) KZ 700 A1 KZ 750 E1-E3 KZ 750 F1 (LTD) KZ 750 H1-H4 (LTD) KZ 750 L3 KZ 750 N1/N2 Spectre KZ 750 R1 (GPZ)	81 84 80-82 83 80-83 83 82-83 82
MD4170X	F	Floating	330	Gold	Plain	6			KAWASAKI ZX10 R Ninja ABS (ZX 1002 EKf/FKf) ZX10 R Ninja ABS KRT Edition (ZX 1002 EKFA/FKFA)	19-21 19-21
MD4171C OS4171C	F F	Solid Floating	200 250	N/A Black	Contour Contour	N/A 6			KAWASAKI Ninja 125 ABS Z 125 (BR125 JJF) Z 125 Pro (BR125 JJFB) Z 125 Pro SE (BR 125 JJFS)	19-21 17-21 17-21 17-21
MD4172C	R	Solid	184	N/A	Contour	N/A			KAWASAKI Ninja 125 ABS Z 125 (BR125 JJF) Z 125 Pro (BR125 JJFB)/Z 125 Pro SE (BR 125 JJFS)	19-21 17-21 17-21
MD4174X MD4174XC VR4174BLK VR4174GRN	F F F F	Floating Floating Floating Floating	310 310 310 310	Gold Gold Black Green	Plain Contour Vee Vee	6 6 6 6			KAWASAKI Ninja 400 (all models) Z 400 ABS	17-21 19-21
MD4175X	F	Floating	330	Gold	Plain	6			KAWASAKI ZX10 RR Ninja (ZX 1002 GKF)	18-21

ROTOR BUYERS GUIDE

BRAKE ROTOR BUYERS GUIDE - STREET

Rotor No.	F/R	Type	Dia. (mm)	Hub Color	Profile	Bobbins	Left Bracket	Right Bracket	Model	Year
MD4178AC	Rear	Solid	250	N/A	Plain	N/A			KAWASAKI KLE 650 F Versys/Versys LT (ABS Model) KLE 650 Versys 650 KLE 650 Versys 650 Tourer KLE 650 Versys 650 Grand Tourer	16-20 20-21 20-21 20-21
MD4179AC	Rear	Solid	220	N/A	Contour	N/A			KAWASAKI 300 Ninja (EX 300 B) ABS Model 300 Ninja SE (EX 300 B) ABS Model KLE 300 Versys-X Ninja EX 400 ABS Ninja EX 400 KRT ABS	13-16 13-16 18-21 17-21 18-21

BRAKE ROTOR BUYERS GUIDE - DIRTBIKE/ATV/UTV

Rotor No.	F/R	Type	Dia. (mm)	Hub Color	Profile	Bobbins	Left Bracket	Right Bracket	Model	Year
MD6001D MD6001C MD6001CX OSX6001 OSX6001E SMX6001	F F F F F F	Solid Solid Solid Floating Floating Floating	240 240 240 280 280 320	N/A N/A N/A Silver Silver Black	Plain Contour Vee Contour Contour Contour	N/A N/A N/A 6 6 6			HONDA CR 125 R CRF 230 F CRF 230 L CRF 230 M CR 250 R NX 250 XR 250 R Pro Link XR 250 R XR 250 L XR 400 R CR 500 R XR 600 R XR 650 R	92-94 03-20 08-11 09-11 92-94 88-90 91-95 96-04 91-96 96-04 92-94 91-00 00-07
MD6002D MD6002CX	R R	Solid Solid	220 220	N/A N/A	Plain Vee	N/A N/A			HONDA CR 125 R CR 250 R CR 500 R	89-97 89-96 89-00
MD6003D	F	Solid	240	N/A	Plain	N/A			HONDA CR 125 R CR 250 R CR 500 R	90-91 90-91 90-91
MD6004D	F	Solid	215	N/A	Plain	N/A			HONDA CR 80 R	86-95
MD6005D MD6005C MD6005CX	R R R	Solid Solid Solid	190 190 190	N/A N/A N/A	Plain Contour Vee	N/A N/A N/A			HONDA CR 80 R CR 80 R/RB Expert CR 85R/85R Expert	92-95 96-02 03-07
MD6006D	F	Solid	174	N/A	Plain	N/A			HONDA TRX 250 R 'Fourtrax' TRX 250 EX Sportrax 250 EX TRX 250 X TRX 300 EX Fourtrax TRX 300 X TRX 400 EX Fourtrax TRX 400 X TRX 450 R/ER Sportrax TRX 700 XX	88-92 01-07 09-14 93-08 09-11 99-08 09-14 04-14 08-11
MD6007D	R	Solid	186	N/A	Plain	N/A			HONDA ATC 250 R TRX 250 R 'Fourtrax'	85-86 86-89
MD6008D	F	Solid	240	N/A	Plain	N/A			HONDA CR 125 R CR 250 R CR 500 R	89 89 89
MD6009D MD6010D SM6010C MD6010CX	R F F F	Solid Solid Solid Solid	220 256 320 256	N/A N/A N/A N/A	Plain Plain Contour Vee	N/A N/A N/A N/A			HONDA CR 125 R CR 250 R CR 500 R HONDA NX 650 XR 650 L	87-88 87-88 87-88 88-89 93-21
MD6011D	R	Solid	220	N/A	Plain	N/A			YAMAHA YZ 125 U/W/A/B/D/E/F/G/H/J WR 125 K YZ 250 U/A/B/D/E/F/G/H/J YZ 250 WRW/WRA WR 250 ZB/ZD/ZE/ZF/ZG/ZH/ZJ WR 400 FK WR 500 ZD/ZE	88-97 98 88-97 89-90 91-97 98 92-93

ROTOR BUYERS GUIDE

BRAKE ROTOR BUYERS GUIDE - DIRTBIKE/ATV/UTV

Rotor No.	F/R	Type	Dia. (mm)	Hub Color	Profile	Bobbins	Left Bracket	Right Bracket	Model	Year
MD6012D	F	Solid	245	N/A	Plain	N/A			YAMAHA YZ 125 A/B YZ 250 A/B WR 250 ZB	90-91 90-91 91
MD6013D MD6013C MD6013CX	R R R	Solid Solid Solid	220 220 220	N/A N/A N/A	Plain Contour Contour	N/A N/A N/A			HONDA CRF 230 L CRF 230 M XR 250 R Pro Link XR 250 R XR 250 L XR 400 R XR 600 R	08-11 09-11 90-95 96-04 91-96 96-04 91-00
MD6014D MD6014C MD6014CX	R R R	Solid Solid Solid	220 220 220	N/A N/A N/A	Plain Contour Vee	N/A N/A N/A			KAWASAKI KLX 400 R (KLX 400 B1/B2) KLX 400 SR (KLX 400 A1/A2) SUZUKI RM 125 J RM 125 K/L/M/N/P/R/S/T/V/W RM 250 H/J RM 250 K/L/M/N/P/R/S/T/V/W RMX 250 K/M/N/P/R/S/T/V/W DR-Z 400 S DR-Z 400 EY/Y/EK1/K1/EK2/K2/K3/EK3/K4/EK4/EK5/EK6/EK7	03-04 03-04 88 89-98 87-88 89-98 89-98 00-21 00-07
MD6015D MD6015C MD6015CX OSX6015 SMX6015	F F F F F	Solid Solid Solid Floating Floating	250 250 250 280 320	N/A N/A N/A Silver Black	Plain Plain Vee Contour Contour	N/A N/A N/A 6 6	BRK023 BRK024		KAWASAKI KX 125 G1/H1/H2/J1/J2/K1-K5/L1-L4 KDX 200 E5/E6 KDX 250 D2/D3/D4 KLX 250 R D2/D3/D4 KX 250 G1/H1/H2/J1/J2/K1-K5/L1-L4 KLX 300 R A2-A10/A6F/A7F KLX 300 KX 500 E1-E16 KLX 650 R A1/A2/A3 KLX 650 R D1	89-02 93-94 92-94 94-96 89-02 97-07 21 89-04 93-94 96
MD6016D	F	Solid	230	N/A	Plain	N/A			YAMAHA YZ 125 W YZ 250 W YZ 250 WRW WR 500 ZD/ZE	89 89 89 92-93
MD6017D MD6017C MD6017CX OSX6017 OSX6017E SMX6017	F F F F F F	Solid Solid Solid Floating Floating Floating	250 250 250 280 280 320	N/A N/A N/A Silver Silver Black	Plain Plain Vee Contour Contour Contour	N/A N/A N/A 6 6 6	BRK031 BRK038		KAWASAKI KLX 400 R (KLX 400 B1/B2) KLX 400 SR (KLX 400 A1/A2) SUZUKI RM 125 K/L/M/N/P/R/S/T/V/W/X/Y/K1-K8 DR-Z 250 K1/K2/K3/K4/K5/K6 RM 250 K/L/M/N/P/R/S/T/V/W/X/Y/K1-K8 RMX 250 K/M/N/P/R/S/T/V/W/X/Y DR 350 SEW/SEX DR-Z 400 S DR-Z 400 EY/Y/EK1/K1/EK2/K2/K3/EK3/K4/EK4/EK5/EK6/EK7 YAMAHA WR 426 FN/FP YZ 426 FN/FP	03-04 03-04 89-08 01-06 89-08 89-00 98-99 00-21 00-07 01-02 01-02
MD6018D MD6018C OSX6018	F F F	Solid Solid Floating	200 200 250	N/A N/A Silver	Plain Plain Contour	N/A N/A 6	BRK001		SUZUKI RM 80 G/H/J/K/L/M/N/P/R/S/T/V/W/X/Y/K1 RM 85 K2/K3/LK3/K4/LK4	86-01 02-04

BRAKE ROTOR BUYERS GUIDE - DIRTBIKE/ATV/UTV

Rotor No.	F/R	Type	Dia. (mm)	Hub Color	Profile	Bobbins	Left Bracket	Right Bracket	Model	Year
MD6020D	F	Solid	160	N/A	Plain	N/A			SUZUKI LT 230 EH/EJ/EK/EL/EM/EN/EP LT 230 SF/SG/SH/ LT 250 RF/RG/RH/RJ/RK/RL/RM/RN	86-93 85-90 85-92
MD6021D	R	Solid	220	N/A	Plain	N/A			CAN AM DS 450 XXC/XMX off road without handbrake SUZUKI LT 250 RH/RJ/RK/RL/RM/RN LT 230 EH Early axle 64710 22A00 LT 230 SF/SG LT 230 SH up to F no 2108531 LT 250 RF/RG	08-15 87-92 86 85-86 87 85-86
MD6022D	F	Solid	170	N/A	Plain	N/A			SUZUKI LT 500 RH/RJ/RK/RL	87-90
MD6023D	R	Solid	240	N/A	Plain	N/A			SUZUKI LT 500 RH/RJ/RK/RL	87-90
MD6024D MD6024C MD6024CX	R R R	Solid Solid Solid	220 220 220	N/A N/A N/A	Plain Contour Vee	N/A N/A N/A			KAWASAKI KX 125 G1/H1/H2/J1/J2/K1-K5/L1-L4 KDX 200 E1/E2/E3/E4/ E5/E6 KX 250 G1/H1/H2/J1/J2/K1-K5/L1-L4 KX 500 E1-E16	89-02 89-94 89-02 89-04
MD6025D MD6025C	R R	Solid Solid	185 185	N/A N/A	Plain Contour	N/A N/A			KAWASAKI KX 80 L1-L3/N1-N3/R1-R7/W1-W3 RM 80 L/M/N/P/R/S/T/V/W/X/Y/K1 RM 85 K2/K3/LK3/K4/LK4 KX 100 B5/B6/B7/C1/C2/C3	88-00 90-01 02-04 95-00
MD6026D	F	Solid	220	N/A	Plain	N/A			KAWASAKI KX 80 R2/R3/R4/R5/R6/R7/W1/W2/W3 KX 100 B5/B6/B7/C1/C2/C3	92-00 95-00
MD6027D	F	Solid	200	N/A	Plain	N/A			KAWASAKI KX 80 L1/L2/L3/N1/N2/N3/R1 KX 80 E2/E3/G1/G2/J2	88-91 84-87
MD6028D MD6028C MD6028CX OSX6028 OSX6028E SMX6028	F F F F F F	Solid Solid Solid Floating Floating Floating	245 245 245 280 280 320	N/A N/A N/A Silver Silver Black	Plain Plain Vee Contour Contour Contour	N/A N/A N/A 6 6 6		BRK035	YAMAHA YZ 125 D/E/F/G/H/J/K/L/M WR 125 K YZ 250 D/E/F/G/H/J/ K/L/M YZ 250 WRA WR 250 ZD/ZE/ZF/ZG/ZH/ZJ WR 400 FK/FL/FM YZ 400 FK/ FL WR 426 FN/FP YZ 426 FN/FP	98-00 98 92-00 90 92-97 98-00 98-99 01-02 00-02
MD6029D	F	Solid	190	N/A	Plain	N/A			YAMAHA YZ 80 S/T/U/W/A/B/D	86-92
MD6030D MD6030C MD6030CX OSY6030C OSS6030C	F F F F F	Solid Solid Solid Floating Floating	220 220 220 250 250	N/A N/A N/A Silver Silver	Plain Contour Vee Contour Contour	N/A N/A N/A 6 6		BRK036 BRK029	SUZUKI RM 85 YAMAHA YZ 80 E/F/G/H/J/K/L/M/N YZ 85	05-12/15-21 93-01 02-21
MD6031D MD6031C MD6031CX	R R R	Solid Solid Solid	190 190 190	N/A N/A N/A	Plain Contour Vee	N/A N/A N/A			YZ 80 E/F/G/H/J/K/L/M/N YZ 85	93-01 02-21

BRAKE ROTOR BUYERS GUIDE - DIRTBIKE/ATV/UTV

Rotor No.	F/R	Type	Dia. (mm)	Hub Color	Profile	Bobbins	Left Bracket	Right Bracket	Model	Year
MD6032D	Front	Solid	260	N/A	Plain				ATK	
MD6032C	Front	Solid	260	N/A	Contour				250	04
MD6032CX	Front	Solid	260	N/A	Vee				370	04
OSX6032	Front	Floating	280	Silver	Contour	6	BRK011		500	04
OSX6032E	Front	Floating	280	Silver	Contour	6	BRK015		ATK 620 Intimidator	04
OSX6032ORG	Front	Floating	280	Orange	Contour	6	BRK011ORG		ATK 700 Intimidator	04
OSX6032EORG	Front	Floating	280	Orange	Contour	6	BRK015ORG		BETA	
SMX6032	Front	Floating	320	Black	Contour	6	BRK012		Enduro RR 125	20-21
SMX6032E	Front	Floating	320	Black	Contour	6	BRK016		Enduro RR 200	20-21
SMX6032ORG	Front	Floating	320	Orange	Contour	6	BRK012ORG		Enduro RR 250	20-21
SMX6032EORG	Front	Floating	320	Orange	Contour	6	BRK016ORG		Enduro RR 300	20-21
SMX6932	Front	Floating	320	Black	Contour	6			Enduro RR 350 RR-S	20-21
SMX6932ORG	Front	Floating	320	Orange	Contour				Enduro RR 390 RR-S	20-21
									Enduro RR 430 RR-S	20-21
									Enduro RR 480	20-21
									Enduro RR 500	21
									GAS-GAS (PIERER)	
									MC 125	21-22
									EC 250 2T	21-22
									EC 250 F	21-22
									EX 250 F	21-22
									MC 250 F	21-22
									EC 300 2T	21-22
									EX 300 2T	21-22
									EC 350 F	21-22
									EX 350 F	21-22
									EX 450 F	21-22
									MC 450 F	21-22
									HUSABERG	
									All MX/Enduro models	00-08
									TE 250	11-14
									TE 300	11-14
									FE 390	10-12
									FE 450	09-14
									FX 450	10-11
									FE 501	13-14
									FE 570	09-12
									HUSQVARNA	
									TC 125	14-22
									TE 125	14-17
									TX125	18-19
									TE 150 i	18-21
									FC 250	14-22
									FE 250	14-21
									TC 250	14-22
									TE 250	14-19
									TE 300	14-19
									TX 300 Tpi	18-22
									FC 350	14-22
									FE 350	14-21
									FX 350	18-22
									FC 450	14-22
									FE 450	14-21
									FX 450	18-22
									FC 501	14
									FE 501	14-15
									KTM	
									EXC/EGS 125	94
									EXC 125	95-99
									EXC 125	00-03
									EXC 125	04-08
									EXE 125	
									MX 125	92-93
									MX 125	92-93
									SX 125	94-99
									SX 125	00-03
									SX 125	04-08
									SX 125	09-22
									XC 125	20-22
									SX 150	08

BRAKE ROTOR BUYERS GUIDE - DIRTBIKE/ATV/UTV

Rotor No.	F/R	Type	Dia. (mm)	Hub Color	Profile	Bobbins	Left Bracket	Right Bracket	Model	Year
MD6032D	Front	Solid	260	N/A	Plain				KTM Contd.	
MD6032C	Front	Solid	260	N/A	Contour				SX 150	09-22
MD6032CX	Front	Solid	260	N/A	Vee				XC 150	10-19
OSX6032	Front	Floating	280	Silver	Contour	6	BRK011		XC-W 150	19-22
OSX6032E	Front	Floating	280	Silver	Contour	6	BRK015		EXC/EGS 200	98-99
OSX6032ORG	Front	Floating	280	Orange	Contour	6	BRK011ORG		EXC/EGS 200	00-03
OSX6032EORG	Front	Floating	280	Orange	Contour	6	BRK015ORG		XC/EXC 200	04-08
SMX6032	Front	Floating	320	Black	Contour	6	BRK012		XC-W 200	07-09
SMX6032E	Front	Floating	320	Black	Contour	6	BRK016		XC-W 200	10-16
SMX6032ORG	Front	Floating	320	Orange	Contour	6	BRK012ORG		XC 200	06-09
SMX6032EORG	Front	Floating	320	Orange	Contour	6	BRK016ORG		D-XC/E-XC/T-XC/E-GS 250	92-93
SMX6932	Front	Floating	320	Black	Contour	6			EXC/EGS 250	94
SMX6932ORG	Front	Floating	320	Orange	Contour				EXC 250	95-99
Contd.									EXC 250	00-03
									XC/EXC 250	04-07
									EXC-F 250	06-07
									MX 250	92-93
									SX 250	94-99
									SX 250	00-02
									SX 250	03-08
									SX 250	09-22
									SX-F 250	05-08
									SX-F 250 Factory Edition	15
									SX-F 250	09-22
									XC 250	06-09
									XC 250	10-22
									XC-W 250	06-08
									XC-W 250 Tpi	10-22
									XC 250 Tpi	19-22
									XC-F 250	06-09
									XC-F 250	10-22
									XCF-W 250	06-10
									XCF-W 250	12-19
									XCF-W 250 Six Days	11
									EGS 300	94-98
									EXC 300	94-98
									EXC 300	99-03
									EXC 300	04-05
									EXC 300	20
									MXC 300	94-98
									MXC 300	99-03
									MXC 300	04-06
									SX 300	94-96
									XC 300	06-09
									XC 300	10-19
									XC 300 Tpi	19-22
									XC-W 300	06-09
									XC-W 300	10-18
									XC-W 300 Tpi Inc Erzberg Rodeo	19-22
									XC-W 300 Six Days	14-18
									EXC 350	94-95
									EXC 350	96-97
									EXC-F 350	12-22
									SX-F 350	10-22
									XC-F 350 Inc Kailub Russell	10-22
									XC-F 350	12-22
									SX 360	96-97
									EXC 380	98-99
									EXC 380	00-03
									SX 380	98-99
									SX 380	00-03
									EXC/EGS 400	00-02
									EXC 400 Racing	00-03
									XC/EXC 400	04-07
									SC 400 (Supercompetition LC4)	96-99
									SX 400	00-02
									XC-W 400	08-09
									XC-W 400	10-11
									EXC 440	94-95
									SX 440	94-95

ROTOR BUYERS GUIDE

BRAKE ROTOR BUYERS GUIDE - DIRTBIKE/ATV/UTV

Rotor No.	F/R	Type	Dia. (mm)	Hub Color	Profile	Bobbins	Left Bracket	Right Bracket	Model	Year
MD6032D	Front	Solid	260	N/A	Plain				KTM Contd.	
MD6032C	Front	Solid	260	N/A	Contour				EXC 450	03
MD6032CX	Front	Solid	260	N/A	Vee				EXC 450	09
OSX6032	Front	Floating	280	Silver	Contour	6	BRK011		EXC 450	10-11
OSX6032E	Front	Floating	280	Silver	Contour	6	BRK015		EXC-F 450/Six Days	18-19
OSX6032ORG	Front	Floating	280	Orange	Contour	6	BRK0110RG		EXC-R 450	08
OSX6032EORG	Front	Floating	280	Orange	Contour	6	BRK0150RG		SX-F 450	03-08
SMX6032	Front	Floating	320	Black	Contour	6	BRK012		SX-F 450 Inc Factory Edition	09-22
SMX6032ORG	Front	Floating	320	Orange	Contour	6	BRK0120RG		XC/EXC 450	04-07
SMX6032EORG	Front	Floating	320	Orange	Contour	6	BRK0160RG		XC-F 450	08-09
SMX6932	Front	Floating	320	Black	Contour	6			XC-F 450	13-22
SMX6932ORG	Front	Floating	320	Orange	Contour				XCR-W 450	08
Contd.									XCR-W 450	13
									XC-W 450 Six Days/Champion Edition	10
									XC-W 450	08-09
									XC-W 450	12-16
									XC-W 450 Champions Edition	10
									XC-W 450 Six Days	10-11
									XC-F 500	12-22
									EXC 500 Six Days	16-20
									XCF-W 500	12-21
									SX-F 505	07-08
									XC-F 505	08-09
									EXC 520	01-03
									SX 520	01-03
									EXC 525	03
									EXC 525	04-07
									MXC 525	03
									MXC 525	04
									SX 525	03-06
									XC 525 Desert Racing	07
									EXC-R 530 EXC-R 530	08
									EXC 530	09-10
									EXC 530	11
									XCR-W 530	08
									XC-W 530	08-09
									XC-W 530 Six Days	10
									MXC 550	96
									EGS-E 620 Adventure/Rallye	99
									SC 620 Supercompetition	96-00
									SX 620/EXC/EGS	94
									SX EXC/EGS 620	95
									SX 620	96-99
									LC4 625 SC Supercompetition	02
									SXC 625	03-04
									SXC 625	05-06
MD6034D	F	Solid	220	N/A	Plain	N/A			KTM	
									D-XC/E-XC/E-GS 125	90-93
									EXC 125 B	89
									DXC/EXC 250	90
									DXC/E-XC/E-GS 250	91
									EXC/EGS 250	89
									DXC/EXC/EGS 350	90-91
									EXC 350	89
									LC-4 MX/EXC 500	89
									LC-4 EXC 500	90-91
									LC4 MX/EXC 600	89
									LC4 EXC 600	90-91
									LC4 EXC 600	90-93
MD6035D	Rear	Solid	220	N/A	Plain	N/A			ATK	
MD6035C	Rear	Solid	220	N/A	Contour	N/A			250 2T	04
MD6035CE	Rear	Solid	220	N/A	Contour	N/A			370 2T	04
MD6035CX	Rear	Solid	220	N/A	Vee	N/A			500 2T	04
									620 Intimidator 2T	04
									700 Intimidator 2T	04
									GAS-GAS (PIERER)	
									MC 125	21-22
									EC 250	21-22

BRAKE ROTOR BUYERS GUIDE - DIRTBIKE/ATV/UTV

Rotor No.	F/R	Type	Dia. (mm)	Hub Color	Profile	Bobbins	Left Bracket	Right Bracket	Model	Year
MD6035D	Rear	Solid	220	N/A	Plain	N/A			GAS-GAS (PIERER) Contd.	
MD6035C	Rear	Solid	220	N/A	Contour	N/A			EC 250 F	21-22
MD6035CE	Rear	Solid	220	N/A	Contour	N/A			EX 250 F	21-22
MD6035CX	Rear	Solid	220	N/A	Vee	N/A			MC 250 F	21-22
Contd.									EC 300	21-22
									EX 300 2T	21-22
									EC 350 F	21-22
									EX 350 F	21-22
									EX 450 F	21-22
									MC 450 F	21-22
									HUSABERG	
									All MX/Enduro models	00-08
									All Supermotard models	00-03
									FS Supermotard models	04
									FS Supermotard models	05-08
									TE 250	11-14
									TE 300	11-14
									FE 390	10-12
									FE 450	09-14
									FX 450	10-11
									FE 501	13-14
									FE 570	09-12
									FS 570 Supermoto	10-11
									HUSQVARNA	
									TC 125	14-22
									TE 125	14-17
									TX125	18-19
									TE 150 i	18-21
									FC 250	14-22
									FE 250	14-21
									TC 250	14-22
									TE 250	14-19
									TE 300	14-19
									TX 300 Tpi	18-22
									FC 350	14-22
									FE 350 350	14-21
									FX 350	18-22
									FS 450 Supermoto	14-21
									FC 450	14-22
									FX 450	18-22
									FC 501	14
									FE 501	14-15
									KTM	
									EXC 125	95-99
									SM 125	
									SX 125	94-99
									EXC 125	00-03
									EXC 125	04-08
									EXE 125	
									SX 125	00-03
									SX 125	04-08
									SX 125	09-22
									XC 125	20-22
									SX 150	09-22
									XC 150	10-19
									XC-W 150	20-22
									EXC/EGS 200	98-99
									EXC/EGS 200	00-03
									XC/EXC 200	04-08
									XC-W 200	07-09
									XC-W 200	10-16
									XC 200	06-09
									EXC/EGS 250	94
									EXC 250	95-99
									EXC 250	00-03
									XC/EXC 250	04-07
									EXC-F 250	06-07
									EXC-F 250 250	18-19
									SX 250	94-99
									SX 250	00-02

ROTOR BUYERS GUIDE

BRAKE ROTOR BUYERS GUIDE - DIRTBIKE/ATV/UTV

Rotor No.	F/R	Type	Dia. (mm)	Hub Color	Profile	Bobbins	Left Bracket	Right Bracket	Model	Year
MD6035D	Rear	Solid	220	N/A	Plain	N/A			KTM Contd.	
MD6035C	Rear	Solid	220	N/A	Contour	N/A			SX 250	03-08
MD6035CE	Rear	Solid	220	N/A	Contour	N/A			SX 250	09-22
MD6035CX	Rear	Solid	220	N/A	Vee	N/A			SX-F 250	05-08
Contd.									SX-F 250 Factory Edition	15
									SX-F 250	09-22
									SX-F 250 Troy Lee Designs	09-22
									XC 250	06-09
									XC 250	10-19
									XC-W 250	06-08
									XC-W 250 Tpi	10-22
									XC 250 Tpi	19-22
									XC-F 250	06-09
									XC-F 250	10-22
									XC-F-W 250	06-10
									XC-F-W 250	12-19
									XC-F-W 250 Six Days	11
									EGS 300	94-98
									EXC 300	94-98
									EXC 300	99-03
									EXC 300	04-05
									EXC 300	20
									MXC 300	94-98
									MXC 300	99-03
									MXC 300	04-06
									SX 300	94-96
									XC 300	06-09
									XC 300	10-19
									XC 300	19-22
									XC-W 300	06-09
									XC-W 300 Inc Erzberg Rodeo	10-22
									XC-W 300 Six Days	14-18
									EXC 350	96-97
									EXC-F 350	12-22
									XC-F 350 Inc Kailub Russell	10-22
									XCF-W 350	12-22
									SX 360	96-97
									EXC 380	98-99
									EXC 380	00-03
									SX 380	98-99
									SX 380	00-03
									EXC/EGS 400	00-02
									EXC 400 Racing	00-03
									XC/EXC 400	04-07
									SX 400	00-02
									XC-W 400	08-09
									XC-W 400	10-11
									EXC 450	03
									EXC 450	09
									EXC 450	10-11
									EXC-R 450	08
									SMR 450	04
									SMR 450	05-06
									450 SMR	07-12
									SX-F 450	03-08
									SX-F 450	09-22
									SX-F 450 Factory Edition	18-22
									XC/EXC 450	04-07
									XC-F 450	08-09
									XC-F 450	13-22
									XCR-W 450	08
									XCR-W 450	13
									XC-W 450 Six Days/Champion Edition	10
									XC-W 450	08-09
									XC-W 450	12-16
									XC-W 450 Champions Edition	10
									XC-W 450 Six Days	10-11
									EXC-F 500	12-22
									EXC 500 Six Days	16-20
									XCF-W 500	12-22

ROTOR BUYERS GUIDE

BRAKE ROTOR BUYERS GUIDE - DIRTBIKE/ATV/UTV

Rotor No.	F/R	Type	Dia. (mm)	Hub Color	Profile	Bobbins	Left Bracket	Right Bracket	Model	Year
MD6035D MD6035C MD6035CE MD6035CX Contd.	Rear Rear Rear Rear	Solid Solid Solid Solid	220 220 220 220	N/A N/A N/A N/A	Plain Contour Contour Vee	N/A N/A N/A N/A			KTM Contd. LC-4 MX 500 LC-4 EXC 500 LC-4 MX 500 LC-4 EXC 500 SX-F 505 XC-F 505 EXC 520 SX 520 EXC 525 EXC 525 MXC 525 MXC 525 SMR 525 SX 525 XC 525 Desert Racing EXC-R 530 EXC-R 530 EXC 530 EXC 530 XCR-W 530 XC-W 530 XC-W 530 Six Days MXC 550 SMR 560 SMR 560 SMC 625 SXC 625 SXC 625 690 Enduro	90-91 90-91 90-91 90-91 07-08 08-09 01-03 01-03 03 04-07 03 04 05 03-06 07 08 09-10 11 08 08-09 10 96 06 07 05-06 03-04 05-06 08
MD6036D	F	Solid	250	N/A	Plain	N/A			KAWASAKI KX 125 E1/E2/F1 KDX 200 C1/C2/C3 KDX 200 E1/E2/E3/E4 KX 250 E1/F1 KX 500 C1/D1	86-88 86-88 89-92 87-88 87-88
MD6037D MD6037C MD6037CX OSX6037 SMX6037	F F F F	Solid Solid Solid Floating Floating	240 240 240 280 320	N/A N/A N/A Silver Black	Plain Contour Vee Contour Contour	N/A N/A N/A 6 6			HONDA CR 125 R CR 250 R CRF 250 R CRF 250 X CRF 450 R CRF 450 X CR 500 R	95-07 95-08 04-14 04-21 02-14 05-22 95-01
MD6038D MD6038CX	R R	Solid Solid	220 220	N/A N/A	Plain Vee	N/A N/A			SUZUKI DR 250 L/M/N/P/R/S DR 250 SL/SM/SN/SEP/SER/SES DR 350 L/M/N/P/R/S/T DR 350 SL/SM/SN/SP/SEP/SES	90-95 90-95 90-96 90-95
MD6039D	F	Solid	230	N/A	Plain	N/A			YAMAHA YZ 125 U IT 200 S YZ 250 U/W TT 350 S/T YZ 490 U/W TT 600 N/S	88 86 88-89 86-87 88-89 85-86
MD6040D MD6040CX OSX6040	F F F	Solid Solid Floating	250 250 280	N/A N/A Silver	Plain Vee Contour	N/A N/A 6			SUZUKI DR 250 L/M/N/P/R/S DR 250 SL/SM/SN/SEP/SER/SES DR 350 L/M/N/P/R/S/T DR 350 SL/SM/SN/SP/SEP/SES/SET/SEV	90-95 90-95 90-96 90-97
MD6042D MD6042CX SMX6042	F F F	Solid Solid Floating	260 260 320	N/A N/A Black	Plain Vee Contour	N/A N/A 6		BRK017	KAWASAKI KL 650 A1-A19/A6F/A7F (KLR)	87-07

BRAKE ROTOR BUYERS GUIDE - DIRTBIKE/ATV/UTV

Rotor No.	F/R	Type	Dia. (mm)	Hub Color	Profile	Bobbins	Left Bracket	Right Bracket	Model	Year
MD6044D	F	Solid	276	N/A	Plain	N/A			HONDA XL 600 V Transalp	89-90
MD6045D MD6045CX MD6046D	R R F	Solid Solid Solid	220 220 166	N/A N/A N/A	Plain Vee Plain	N/A N/A N/A			HONDA XR 650 L HONDA TRX 250 R 'Fourtrax'	93-21 86-87
MD6047D	F	Solid	203	N/A	Plain	N/A			YAMAHA YTZ 250 N/S (Tri Moto)	85-86
MD6050D	R	Solid	220	N/A	Plain	N/A			YAMAHA YFS 200 U/W/A/B/D/E/F/G/H/J/K/L/M/N/P Blaster	88-02
MD6051D	F	Solid	161	N/A	Plain	N/A			YAMAHA YFM 350 XT YFM 350 XU Warrior YFZ 350 Banshee T/U/W	87 88 87-89
MD6053D	R	Solid	220	N/A	Plain	N/A			YAMAHA YFM 350 FXG/FXH/FXJ/FXK/FXL/FXM/FXN/FXP/FXR/FXS/FXT 'Wolverine' YFM 350 XU/XW Warrior YFZ 350 Banshee T/U/W	95-05 88-89 87-89
MD6054D	F	Solid	161	N/A	Plain	N/A			YAMAHA YFM 125 RA/RB/RD Raptor YFS 200 R/S/T/V Blaster YFM 250 XN/XHN/XP/XHP/XR/XHR/XS Beartracker YFM 250 BT/B Bruin YFM 250 BW/BX/BY Big Bear YFM 250 RX/RV/RZ/RA/RB/RD Raptor YFM 250 RSPA Special Edition YFM 250 RSPX/RSEY Special Edition YFM 250 RSXPC Special Edition Custom YFM 250 R (RSPA) YFM 350 XW/XA/XB/XD/XE/XF/XG/XH/XJ/XK/XL/XM/XN/XP/XR/XS Warrior YFM 350 RS/RT/RV/RW/RX/RV/RZ/RA/RB/RD Raptor YFZ 350 A/B/D/E/F/G/H/J/K/L/M/N/P/R/S/T/V Banshee YFZ 450 RY/RZ/RA/RB/RD YFZ 450 LES Limited Edition YFZ 450 R Special Edition (3 spring clutch) YFZ 450 RSE YFZ 450 S/T YFZ 450 SET Special Edition YFZ 450 SPV Special Edition YFZ 450 V/W/X/Y/Z/A YZF 450 BBV/BBW Bill Balance Edition YZF 450 SPV/SEW/SPX Special Edition YFZ 450 BB/DB YFM 660 RN/RP/RPB/RR/RS/RT YFM 700 RV/RW/RX/RV/RA/RB/RD/RE Raptor YFM 700 RSEW/RSPX/RSEY/RSEA/RSEB/RSED/RSE Special Edition YFM 700 R RD/RE Raptor YFM 700 R (RSEY/RSEZ/RSEA/RSEB/RSED/RSE/RSF) Raptor Special Edition YFM 700 50th Anniversary Edition - YFM 700 RSPV YFM 700 RD/RE/RF Raptor	11-13 03-06 01-04 05-06 07-09 08-13 11 08-09 08 11 90-04 04-13 90-06 09-13 04 14 04-05 05 06 06-11 06-07 06-08 12-13 01-05 06-14 07-14 13-14 09-15 06 13-15
MD6055D	R	Solid	245	N/A	Plain	N/A			YAMAHA YFM 350 XA/XB/XD/XE/XF/XG/XH/XJ/XK/XL/XM/XN/XP/XR/X Warrior	90-04
MD6057D	F	Solid	240	N/A	Plain	N/A			KAWASAKI KL 250 D2-D22 (KLR 250)	85-05
MD6058D MD6058C MD6058CX OSX6058	F F F F	Solid Solid Solid Floating	220 220 220 280	N/A N/A N/A Silver	Plain Contour Vee Contour	N/A N/A N/A 6		BRK026	HONDA CR 80 R/RB Expert CR 85R/85R Expert	96-02 03-07

BRAKE ROTOR BUYERS GUIDE - DIRTBIKE/ATV/UTV

Rotor No.	F/R	Type	Dia. (mm)	Hub Color	Profile	Bobbins	Left Bracket	Right Bracket	Model	Year
MD6059D	F & R	Solid	206	N/A	Plain	N/A			HONDA ATC 200 X ATC 250 R ATC 350 X	83-87 83-86 85-86
MD6060D	F	Solid	156	N/A	Plain	N/A			HONDA ATC 250 R	81-82
MD6061D	R	Solid	206	N/A	Plain	N/A			HONDA ATC 350 X	85-86
MD6063D	R	Solid	220	N/A	Plain	N/A			SUZUKI LT 230 EH Late axle 64710 22A01 LT 230 EJ/EK/EL/EM/EN/EP LT 230 SH from F no 2108532/AJ LT 250	86 87-93 87-88 85-90
MD6064D	R	Solid	220	N/A	Plain	N/A			HONDA TRX 250 X 'Fourtrax' TRX 300 EX Fourtrax TRX 300 X	87-92 93-08 09-11
MD6066D	F	Solid	245	N/A	Plain	N/A			YAMAHA WR 200 D TT-R 250 L/M/N/P/R/S/TV	92 99-06
MD6067D	F	Solid	220	N/A	Plain	N/A			YAMAHA IT 225 S/T YZ 125 T TW 200 N/NC/P/PC/R/RC/S/SC/T/TC/N/VC/W/WC/X/Y/Z/A/B/D/E/F TT-R 225 L/M/N/P/R/S XT 225 D/DC/E/EC/F/FC/G/GC/F/FH/J/JC/K/KC/L/M/MC/N/NC/P/PC /R/RC/S/SC/T/TC/N/VC/W/WC TT-R 230 XT 250 X/Y/Z/A/B/D/E/F/G/H YZ 250 T YZ 490 N/S/T	86-87 87 01-15 99-04 92-07 05-09/11-21 08-17 87 85-87
MD6068D	F	Solid	245	N/A	Plain	N/A			YAMAHA XTZ 250 Lander (F 21" / R 18" Wheels) XTZ 250 Lander (F 21" / R 18" Wheels) XTZ 250 X (F & R 17" Wheels) XT 350 N/NC/S/SC XT 350 T/TC/U/UC/W/WC/A XT 350 B/BC/D/E/EC/F/FC/G/GC/H/HC/J/JC/K/KC/L/M	07-14 16-18 08-10 85-86 87-90 91-00
MD6070D	F	Solid	267	N/A	Plain	N/A			YAMAHA XT 600 L/LC/N/LN/S/SC XT 600 T/TC/U/UC/W/WC XT 600 EA/EB/ED/EDC/EE/EEC/EF/EFC/EG/EGC	84-86 87-89 90-95
MD6072D	R	Solid	220	N/A	Plain	N/A			YAMAHA XT 600 EA/EB/ED/EDC/EE/EEC/EF/EFC/EG/EGC	90-95
MD6073D	F	Solid	230	N/A	Plain	N/A			SUZUKI DR 125 G/H/J/SER/SES/SET SP 125 G/H/J DR 200 G/H/J DR 200 SP 200 G/H/J	86-96 86-88 86-90 96-09/13/15-21 86-88
MD6074D	F	Solid	260	N/A	Plain	N/A			SUZUKI DR 250 F SP 250 F	85 85
MD6075D	F	Solid	240	N/A	Plain	N/A			SUZUKI SP 600 F	85-87
MD6076D	F	Solid	280	N/A	Plain	N/A			SUZUKI DR 650 SL/SM	90-91

BRAKE ROTOR BUYERS GUIDE - DIRTBIKE/ATV/UTV

Rotor No.	F/R	Type	Dia. (mm)	Hub Color	Profile	Bobbins	Left Bracket	Right Bracket	Model	Year
MD6077D	R	Solid	250	N/A	Plain	N/A			SUZUKI DR 650 SL/SM/SN/SP/SER/SES	90-95
MD6078D	F	Solid	300	N/A	Plain	N/A			SUZUKI DR 650 SN/SP/SER/SES	92-95
MD6080D	F	Solid	250	N/A	Plain	N/A			KAWASAKI KL 600 A1/B1/B2 (KLR)	84-86
MD6081D	F	Solid	280	N/A	Plain	N/A			KAWASAKI KL 650 B2/B3 Tengai	90-91
MD6082D MD6082CX	R R	Solid Solid	230 230	N/A N/A	Plain Contour	N/A N/A			KAWASAKI KL 650 A1-A19/A6F/A7F (KLR) KL 650 B2/B3 Tengai	87-07 90-91
MD6083D MD6083CX	F F	Solid Solid	250 250	N/A N/A	Plain Vee	N/A N/A			KAWASAKI KDX 200 H1-H11/H6F KDX 220 R A4-A12/A6F KDX 250 D1	95-06 97-06 91
MD6085D	R	Solid	230	N/A	Plain	N/A			KAWASAKI KLX 250 R D2/D3/D4 KLX 650 R A1/A2/A3 KLX 650 C1/C2/C3/C4	94-96 93-94 93-96
MD6086D	F	Floating	290	Gold	Plain	9			KAWASAKI KLX 650 C1/C2/C3/C4	93-96
MD6087D	F	Floating	240		Plain	9			HONDA CR 125/250 R XR 250 R Pro Link XL 350 R XR 350 R CR 500 R XR 500 R Pro Link XL 600 R XR 600 R	84-88 84-90 84-85 84-85 84-88 83-84 83-87 85-90
MD6094D MD6094CX SMX6094	F F F	Solid Solid Floating	290 290 320	N/A N/A Black	Plain Vee Contour	N/A N/A 6		BRK003	SUZUKI DR 650 S	96-21
MD6095D MD6095CX MD6105D MD6105CX	R R R R	Solid Solid Solid Solid	240 240 220 220	N/A N/A N/A N/A	Plain Vee Plain Vee	N/A N/A N/A N/A			SUZUKI DR 650 S KAWASAKI KDX 200 H1-H11/H6F KDX 220 R A4-A12/A6F KDX 250 D1/D2/D3/D4 KLX 250 S (KLX 250 H6F/H7F) KLX 300 R A2-A10/A6F/A7F KLX 650 R D1	96-21 95-06 97-06 91-94 06-07 97-07 96
MD6107D	R	Solid	210	N/A	Plain	N/A			KAWASAKI KL 250 G4-G8 Sherpa	00-09
MD6110D MD6110CX	R R	Solid Solid	220 220	N/A N/A	Plain Vee	N/A N/A			SUZUKI DR-Z 250 K1/K2/K3/K4/K5/K6/K7 DR 350 SET/SEV/SEW/SEX	01-07 96-98
MD6121D	R	Solid	220	N/A	Plain	N/A			YAMAHA WR 200 D TT-R 250 L/M/N/P/R/S/T/V	92 99-06
MD6123D	F	Solid	180	N/A	Plain	N/A			YAMAHA YFM 350 FXG/FXH/FXJ/FXK/FXL/FXM/FXN/FXP/FXR/FXS/FXT Wolverine YFM 350 FWB/LC Big Bear YFM 350 UL/ULC YFM 350 UL/ULC YFM 400 FAM/FAN/FAP Kodiak	95-05 99 99 99 00-02

BRAKE ROTOR BUYERS GUIDE - DIRTBIKE/ATV/UTV

Rotor No.	F/R	Type	Dia. (mm)	Hub Color	Profile	Bobbins	Left Bracket	Right Bracket	Model	Year
MD6123D Contd.	F	Solid	180	N/A	Plain	N/A			YAMAHA Contd. YFM 400 FWNM/MC/FWNN/FWHN/FHP/FP/FR/FS/FT/FV "Big Bear" YFM 400 AM/AN YFM 400 NN/NHN/P/HP YFM 400 FWNHM/FHM Big Bear Buckmaster 4WD YFM 400 FAHM/MC/N/NC/P Kodiak 4x4 Kodiak/Hunter YFM 400 NR/NS (2x4) Big Bear YFM 400 S Big Bear 2WD YFM 400 FS/FT/FAV Big Bear 4WD YFM 400 FWBL Kodiak	00-06 00-01 00-02 01 00-02 03-04 04 04-06 99
MD6124D MD6124C MD6124CX	R R R	Solid Solid Solid	240 240 240	N/A N/A N/A	Plain Contour Vee	N/A N/A N/A			HONDA CR 125 R CR 250 R	98-01 97-01
MD6125D OSX6125 SMX6125	F F F	Solid Floating Floating	260 280 320	N/A Silver Black	Plain Contour Contour	N/A 6 6		BRK007	HUSQVARNA CR 125 SM 125 WR 125 WRE 125 CR 250 WR 250 TE 350 CR 360 WR 360 TE 410 TC 610 TC 610/E TE 610 TE 610/E	92-99 98-99 93-99 93-99 92-99 92-99 92-97 92-94 92-99 95-99 92-94 95-99 92-94 95-99
MD6126D	R	Solid	220	N/A	Plain	N/A			HUSQVARNA CR 125 SM 125 WR 125 WRE 125 WR 240 CR 250 WR 250 WR 260 TE 350 CR 360 WR 360 TE 410 TE 410 E TC 510 TE 510 SM 610 (6 bolt F disc) TC 610 TC 610/E TE 610 TE 610/E	91-99 98-99 91-99 93-99 90-91 91-99 90-99 90-91 90-97 92-94 92-99 95-99 00 90 90 98-99 91-94 95-99 91-94 95-00
MD6128D	R	Solid	220	N/A	Plain	N/A			APRILIA Pegaso 650 ie (All models)	99-04
MD6129D	F	Solid	300	N/A	Plain	N/A			APRILIA Pegaso 650 ie (All models)	99-04
MD6130D MD6130CF MD6130DF	F F F	Solid Floating Floating	300 300 300	N/A Silver Silver	Plain Contour Plain	N/A 9 9			KTM EGS 400/EGS-E/LSE (LC4 Enduro) LC4-E 400 Enduro EGS 620 Enduro/EGS-E/LSE LC4-E 640 Enduro LC-4 640 Adventure LC-R 640 Adventure R 690 Enduro	96-99 00-01 96-99 00-04 99-02 00 08

ROTOR BUYERS GUIDE

BRAKE ROTOR BUYERS GUIDE - DIRTBIKE/ATV/UTV

Rotor No.	F/R	Type	Dia. (mm)	Hub Color	Profile	Bobbins	Left Bracket	Right Bracket	Model	Year
MD6131D	F	Solid	200	N/A	Plain	N/A			KAWASAKI KLF 300 C1-C17 Bayou KVF 300 A1/A2/A3/A4 (4 x 4) 'Prairie' KVF 300 B1/B2/B3/B4 (2 x 4) 'Prairie' KLF 400 B1-B7 Bayou (4 x 4) KVF 400 A1/A2/B1 Prairie KVF 400 C1/C2/C3/C4 (4 x 4) Prairie KVF 400 D1/D2/D3/D4 (2 x 4) Prairie LTA 700 XK5 Kingquad	89-05 99-02 99-02 93-99 97-98 99-02 99-02 05
MD6132D	R	Solid	220	N/A	Plain	N/A			KAWASAKI KSF 250 A1-A18 Mojave KEF 300 A1/A2/A3/A4/A5/A6 Lakota KEF 300 B1/B2/B3 Lakota Sport	87-04 95-00 01-03
MD6133D	F	Solid	170	N/A	Plain	N/A			KAWASAKI KSF 250 A1-A18 Mojave KXF 250 A1/A2 Tecate KEF 300 A1/A2/A3/A4/A5/A6 Lakota KEF 300 B1/B2/B3 Lakota Sport KLF 300 B1-B17 Bayou	87-04 87-88 95-00 01-03 88-04
MD6134D	R	Solid	220	N/A	Plain	N/A			KAWASAKI KXT 250 B2	87
MD6135D MD6135C MD6135CX	R R R	Solid Solid Solid	240 240 240	N/A N/A N/A	Plain Contour Vee	N/A N/A N/A			YAMAHA YZ 125 K/L/M/N WR 250 FN YZ 250 K/L/M/N WR 400 FL/FM WR 426 FN YZ 400 FL YZ 426 FM/FN	98-01 01 98-01 99-00 01 99 00-01
MD6136D	R	Solid	230	N/A	Plain	N/A			KAWASAKI KXF 250 A1/A2 Tecate	87-88
MD6137D	F	Solid	163	N/A	Plain	N/A			KAWASAKI KFX 450 R (KSF 450 B8F/B9F/BAF/BBF/BCS/BDF/BEF) KSV 700 A1/A2/A6F/A7F/A8F (KFX 700 V-Force) KSV 700 B1/B2/B6F/B7F/B8F (KFX 700 V Force)	08-14 04-08 04-08
MD6138D	F/R	Solid	206	N/A	Plain	N/A			KAWASAKI KXT 250 B1/B2	86-87
MD6140D	F	Solid	220	N/A	Plain	N/A			YAMAHA YFM 600 FWAK/FWK/FWAL/LL/FWAM/AK Grizzly YFM 600 HM/HMC Grizzly Hunting	98-00 00
MD6144D	R	Solid	256	N/A	Plain	N/A			HONDA FL 400 R Pilot	89-90
MD6145D	F	Solid	206	N/A	Plain	N/A			SUZUKI LT-F 500 FW/FX/FY/FK1/FK2 Quadrunner LT-A 500 FY/FK1	98-02 00-01
MD6147D	F	Solid	165	N/A	Plain	N/A			POLARIS Trail Boss '4 x 4' Big Boss 250 '4 x 6' Trail Boss Trail Boss '2 x 4 / 4 x 4' Trail Blazer	87 89-90 88-90 88-89 90
MD6149D	F	Solid	228	N/A	Plain	N/A			POLARIS Big Boss 250 '4 x 6' Middle Axle Brake Big Boss 250 '6 x 6' Middle Axle Brake Big Boss 350 L Big Boss 300 '6 x 6' Middle Axle Brake Big Boss 400 L '6 x 6' Big Boss 500 '6 x 6'	89-92 91-93 93 94 94-97 98-99

ROTOR BUYERS GUIDE

BRAKE ROTOR BUYERS GUIDE - DIRTBIKE/ATV/UTV

Rotor No.	F/R	Type	Dia. (mm)	Hub Color	Profile	Bobbins	Left Bracket	Right Bracket	Model	Year
MD6149D	F	Solid	228	N/A	Plain	N/A			POLARIS Contd. Magnum 325 (2x4/4x4) Magnum 330 (2x4/HDS) 350 L '4 x 4' 250 '2 x 4 / 4 x 4' 400 L '4 x 4' Magnum 425 '4 x 4' Magnum 425 '6 x 6' Magnum 500 (4x4) Sportsman 350 '4 x 4' Sportsman 400 L '4 x 4' Sportsman 400 Sportsman 500 '4 x 4' Sportsman 500 HO/EFI Sportsman/Worker 500 Sportsman 335 '4 x 4' Sportsman 6x6 (500)/Big Boss Sportsman 6x6 Trail Boss 350 L '4 x 4' Xplorer 400 L '4 x 4' Xplorer 500 '4 x 4' Xplorer 4x4/400 Xpedition 425 Diesel 455/4x4 EBS PTV (Personal Task Vehicle) 6x6 PPS/PTV 6x6/Series 10 Ranger PPS LUB 6x6	00 03-05 90 90 94 95-98 96-97 99-02 93 94-97 01-05 96-00 03-04 01-02 99-00 00-07 07-08 91 95-00 97 01-02 00 99-01 03 99 02
MD6150D	F	Solid	175	N/A	Plain	N/A			POLARIS Big Boss 250 '4 x 6' Big Boss 250 '6 x 6' Big Boss 300 '6 x 6' 350 L '2 x 4' 250 '2 x 4 / 4 x 4' 350 L '4 x 4' 300 '2 x 4 / 4 x 4' 400 L '2 x 4' Magnum 425 '2 x 4' Scrambler 400 L '4 x 4' Scrambler 500 '4 x 4' Sport 400 L/400 Trail Boss 250 Trail Boss 250 '2 x 4 / 4 x 4' Trail Boss 350 L '2 x 4' Trail Blazer Trail Blazer '250' Xpress 300 / 400 L Xpress 300 '2 x 4' Xplorer 300 '4 x 4'	91-92 92-93 94 90 93 93 94-95 94-95 95-98 95-97 97 94-00 91-99 91-92 91-93 91-93 94-98 96-97 98-00 96-00
MD6153D	F	Solid	254	N/A	Plain	N/A			POLARIS Big Boss 400 L '6 x 6' Magnum 425 '6 x 6' Middle Axle Brake	96 96
MD6154D	R	Solid	150	N/A	Plain	N/A			POLARIS Sportsman 500	97
MD6155D	F	Solid	182	N/A	Plain	N/A			POLARIS Xplorer 250 Trailblazer/Freedom 250 Magnum 325 2x4/4x4 Muse Magnum 325 4x4/2x4 Trail Boss 325 Xpedition 325 Trail Boss 330 Scrambler 400 '4 x 4' Trailblazer 400 Scrambler 500 '4 x 4' Scrambler 4 x 4/2 x 4	00 99-06 01 02 00-01 00 03-04 98-02 03 98-10 00

ROTOR BUYERS GUIDE

BRAKE ROTOR BUYERS GUIDE - DIRTBIKE/ATV/UTV

Rotor No.	F/R	Type	Dia. (mm)	Hub Color	Profile	Bobbins	Left Bracket	Right Bracket	Model	Year
MD6155D Contd.	F	Solid	182	N/A	Plain	N/A			POLARIS Contd. Scrambler 500 2x4	01-02
MD6156D	R	Solid	178	N/A	Plain	N/A			POLARIS Magnum 325 2x4/4x4 Muse Trail Boss 325 Sport 400 (4x4) Trailblazer 400 Magnum 500 (4x4) Scrambler 400 (2x4/4x4) Scrambler 500 (2x4/4x4) Trail Blazer 250/Freedom Xpedition 325 Xpedition 425 (4x4) Xplorer 4x4/400 Trail Boss 325	00-01 01 99-00 03 00-01 98-02 98-04 99-06 00 00 01-02 00
MD6157D MD6157C MD6157CX	R R R	Solid Solid Solid	240 240 240	N/A N/A N/A	Plain Contour Vee	N/A N/A N/A			SUZUKI RM 125 X/Y/K1/K2/K3/K4/K5 RM 250 X/Y/K1/K2/K3/K4/K5 RMX 250 X/Y DR-Z 400 SM	99-05 99-05 99-00 05-09/13-21
MD6158D MD6158C	F F	Solid Solid	220 220	N/A N/A	Plain Contour	N/A N/A			YAMAHA TT-R 125	00-09/11-21
MD6160D	R	Solid	220	N/A	Plain	N/A			CAGIVA Gran Canyon 900	99-00
MD6161D	R	Solid	220	N/A	Plain	N/A			KAWASAKI KX 125 E1/E2/F1 KX 250 D2/E1/F1 KX 500 B2/C1/D1	86-88 86-88 86-88
MD6163D	F	Solid	240	N/A	Plain	N/A			SUZUKI RM 125 F/G/H/J RM 250 F/G/H/J	85-88 85-88
MD6164D	R	Solid	220	N/A	Plain	N/A			HONDA TRX 400 EX TRX 400 X	99-08 09-14
MD6166D MD6166CX	F F	Solid Solid	180 180	N/A N/A	Plain Vee	N/A N/A			KAWASAKI KX 65 SUZUKI RM 65 K3/K4/K5	00-22 03-05
MD6166D MD6166CX	R R	Solid Solid	180 180	N/A N/A	Plain Vee	N/A N/A			KAWASAKI KX 65 SUZUKI RM 65 K3/K4/K5	00-22 03-05
MD6169D	R	Solid	203	N/A	Plain	N/A			POLARIS Xplorer 400 L 4x4	99-00
MD6170D	R	Solid	228	N/A	Plain	N/A			POLARIS Sportsman 6x6 PPS LUB 6x6	00-08 02
MD6171D	F	Solid	166	N/A	Plain	N/A			BOMBARDIER/BRP DS 650 DS 650 Baja/X CAN-AM DS 650 X	00-05 01-06 07
MD6172D	R	Solid	196	N/A	Plain	N/A			BOMBARDIER/BRP DS 650 DS 650 Baja/X CAN-AM DS 650 X	00-05 01-06 07

BRAKE ROTOR BUYERS GUIDE - DIRTBIKE/ATV/UTV

Rotor No.	F/R	Type	Dia. (mm)	Hub Color	Profile	Bobbins	Left Bracket	Right Bracket	Model	Year
MD6173D UTVX6173	F	Solid	202	N/A	Plain	N/A			ARCTIC CAT	
	F	Solid	202	N/A	Vee	N/A			250 2 x 4 Utility	99-09
									250 4 x 4 Utility	01-04/05/08
									300 (4 x 4)	98-04
									300 4 x 4 Utility	05
									350 ATV	12
									366 4 x 4 Auto Utility	08-09
									366 SE	10
									400 4 x 4 ACT	04
									400 4 x 4 Auto ACT	04
									400 2 x 4 Utility	98-04
									400 2 x 4 Auto Utility	04
									400 4 x 4 Utility	00-07
									400 4 x 4 VP Utility	05-06
									400 4 x 4 Auto Utility	04-08
									400 4 x 4 Auto LE Utility	05-07
									400 4 x 4 Auto VP Utility	05-06
									400 4 x 4 Auto TBX Utility	04-06
									400 TRV	09
									400 TRV H1	10
									400 4 x 4 Auto TRV Multirider	06
									400 4 x 4 Auto TRV Plus Multirider	07
									425i	12
									425i SE	12
									450 H1 EFI	10
									450i	11-12
									450i GT	12
									450 TRV	11-12
									450i TRV	11
									XC 450i	11-12
									454 Bearcat 2 x 4	97-98
									454 Bearcat 4 x 4	96-98
									500 4 x 4 Auto Utility	98-08
									500 4 x 4 Auto LE Utility	05-06
									500 4 x 4 Manual G/Box Utility	98-09
									500 4 x 4 Auto TBX Utility	04-06
									500 4 x 4 Auto TRV Utility	04
									500 4 x 4 Auto TRV Multirider	05-06/08
									550 HI EFI	09-10
									550 HI EFI LE	09-10
									550 TRV	11
									550 TRV Cruiser	11
									550 TRV EFI	09-10
									550 TRV EFI LE	09-10
									550i	11-12
									550i LTD	11-12
									550i GT	11-12
									550i GT TRV	11
									550i TRV Cruiser	11
									550 GT TRV	11-12
									550 GT S TRV	10
									550 S	10
									550 S LTD	10
									650 H1 4 x 4 Auto Utility	04/05/08
									650 H1 4 x 4 Auto LE Utility	07
								650 H1 4 x 4 SE Auto Utility	06	
								650 H1	10	
								650 Mudpro	10-11	
								650 H1 Mudpro	10	
								650 H1 TRV	09	
								650 H1 TBX 4 x 4 Auto Utility	07	
								650 H1 TRV 4 x 4 Auto Plus Multirider	07	
								650 H1 TRV 4 x 4 Auto Plus LE Multirider	07	
								650 H1 TRV 4 x 4 Auto	08	
								650 TBX	09	
								650 V2 4 x 4 Auto Utility	04-06	
								650 V2 4 x 4 Auto LE Utility	04-05	
								650 V2 4 x 4 Auto LE TS Utility	06	
								700 Diesel Utility	07-08	
								700i GT	11-12	

ROTOR BUYERS GUIDE

BRAKE ROTOR BUYERS GUIDE - DIRTBIKE/ATV/UTV

Rotor No.	F/R	Type	Dia. (mm)	Hub Color	Profile	Bobbins	Left Bracket	Right Bracket	Model	Year
MD6173D UTVX6173 Contd.	F	Solid	202	N/A	Plain	N/A			ARCTIC CAT Contd. 700 TRV H2 EFI Cruiser 700 TRV 700 TRV Cruiser 700 TRV GT 700 EFI 4 x 4 Utility 700 EFI 4 x 4 LE/SE Utility 700 EFI Cruiser 700 EFI 4 x 4 Auto M4 700 EFI 4 x 4 Auto TRV LE 700 H1 EFI 700 H1 EFI LE 700 H1 EFI 4 x 4 Auto SE 700 H1 TBX EFI 700 Super Duty Diesel 700 Mudpro 700 H1 EFI Mudpro 700i 700i LTD 700i Mudpro 700i Mudpro LTD 700 S 700 S LTD 700 TBX LTD 1000 H2 Mudpro EFI 1000 TRV Cruiser 1000 TRV H2 EFI Cruiser Thundercat 1000 H2 Thundercat 1000 H2 LE 1000 TRV H2 EFI KYMCO Maxxer 375 4 x 4 IRS MXU 375 4 x 4 IRS Maxxer 450 4 x 4 IRS MXU 450 4 x 4 IRS MXU 450 4 x 4 IRS LE MXU 500 4 x 4 (Carb models) MXU 500 4 x 4 IRS (Carb Models) MXU 500i IRS (All EFI Models) MXU 700i (All Models)	09-10 11-12 11-12 11-12 07-08 06 11 08 08 09-10 09-10 08-09 10 10-11 10-11 09-10 11-12 11-12 11-13 11 10 10 11 10 11 09-10 08-10 10 10
	R	Solid	202	N/A	Plain	N/A			ARCTIC CAT HDX 700 Prowler HDX 700 LTD Prowler XTZ 1000 Prowler Wildcat 1000 GT KYMCO Maxxer 375 4x4 IRS MXU 375 4x4 IRS Maxxer 450i IRS MXU 450 i (IRS/IRS-LE)	96-12 11-14 14 10-14 11-12 10-12 08-12 11-12 11-12
MD6173D UTVX6173	R	Solid	202	N/A	Plain	N/A			ARCTIC CAT HDX 700 Prowler HDX 700 LTD Prowler XTZ 1000 Prowler Wildcat 1000 GT KYMCO Maxxer 375 4x4 IRS MXU 375 4x4 IRS Maxxer 450i IRS MXU 450 i (IRS/IRS-LE)	96-12 11-14 14 10-14 11-12 10-12 08-12 11-12 11-12
MD6174D	R	Solid	220	N/A	Plain	N/A			YAMAHA YFM 400 FAM/FAN/FAP Kodiak YFM 400 AM/AN YFM 400 FAHM/MC/N/NC/P Kodiak 4x4 Kodiak/Hunter YFM 450 FAR/FAS Kodiak YFM 450 FXV/FXW/FXX/FXY/FXZ Wolverine Auto 4x4 YFM 450 FXSEW Wolverine Sport Special Edition	00-02 00-01 00-02 03-04 07-10 07-08
MD6181D MD6181C MD6181CX	R R R	Solid Solid Solid	240 240 240	N/A N/A N/A	Plain Contour Vee	N/A N/A N/A			HONDA XR 650 R	00-11
MD6184D MD6184C OSX6184 OSX6184K OSX6184K9 SMX6184K / K9 SMX6184H	F F F F F F F	Solid Solid Floating Floating Floating Floating Floating	260 260 280 280 280 320 320	N/A N/A Silver Silver Silver Black Black	Plain Contour Contour Contour Contour Contour Contour	N/A N/A 6 6 6 6 6			HUSQVARNA CR 125 SM 125 SMS 125 (2T) SMS-4-125 (4T) WR 125 WRE 125	00-10 00 02-11 10-11 00-10 00-11

ROTOR BUYERS GUIDE

BRAKE ROTOR BUYERS GUIDE - DIRTBIKE/ATV/UTV

Rotor No.	F/R	Type	Dia. (mm)	Hub Color	Profile	Bobbins	Left Bracket	Right Bracket	Model	Year
MD6184D	F	Solid	260	N/A	Plain	N/A			HUSQVARNA Contd.	
MD6184C	F	Solid	260	N/A	Contour	N/A			WXE 125	07
OSX6184	F	Floating	280	Silver	Contour	6			CR 250	00-05
OSX6184K	F	Floating	280	Silver	Contour	6			TC 250	02-12
OSX6184K	F	Floating	280	Silver	Contour	6			TE 250	02-12
OSX6184K9	F	Floating	280	Silver	Contour	6			TR 250 R (4T)	13
SMX6184K	F	Floating	320	Black	Contour	6			TXC 250 R (4T)	13
SMX6184H	F	Floating	320	Black	Contour	6			TXC 250 Cross Country	09-12
SMX6184K9	F	Floating	320	Black	Contour	6			WR 250	00-12
Contd.									TE 310 (4T)	09-12
									TE 310 R (4T)	13
									TXC 310 Cross Country	12
									TXC 310 R (4T)	13
									WR 360	00-02
									TE 400	02
									TE 410	00/06
									TE 410 E	00
									TC 449	11-12
									TE 449	11-12
									TC 450	03/05-08
									TE 450	03-08
									TXC 450 Cross Country	08
									TC 510	04-09
									TE 510	04-10
									TXC 510 Cross Country	09-10
									TE 511	11-12
									TXC 511 Cross Country	11-12
									TC 570	02-03
									TE 570	01-04
									SM 610 R	00
									TC 610/TE 610	00
									TE 610 E	00-03
									TE 610/E	06-09
									TE 630	10
MD6186D	F	Solid	220	N/A	Plain	N/A			KAWASAKI	
MD6186C	F	Solid	220	N/A	Contour	N/A			KX 85	01-22
MD6186CX	F	Solid	220	N/A	Vee	N/A			KX 100	01-09/11-21
OSX6186	F	Floating	280	Silver	Contour	6	BRK025		KX112	21-22
									SUZUKI	
									RM 100 K3	03
MD6187D	R	Solid	185	N/A	Plain	N/A			KAWASAKI	
MD6187C	R	Solid	185	N/A	Contour	N/A			KX 85	01-22
MD6187CX	R	Solid	185	N/A	Vee	N/A			KX 100	01-09/11-21
									KX112	21-22
									SUZUKI	
									RM 100 K3	03
MD6188D	F	Solid	200	N/A	Plain	N/A			KAWASAKI	
UTVX6188	F	Solid	200	N/A	Vee	N/A			KVF 360 A1/A2/A3/A6F/A7F/A8F/A9F/AAF/ABF/ACF Prairie 360 4x4	03-12
									KVF 360 B1/B2/B3/B6F/B7F/B8F/BF Prairie 360	03-09
									KVF 360 C1-C3/C6F-C9F/CAF/CBF Prairie 360 4x4 Hardwoods Green HD	03-11
									KVF 650 A1/A2/B2 Prairie	02-03
									KVF 650 D1/D6F/D7F/D8F/D9F/DAF/DBF Brute Force 4x4	05-11
									KVF 650 E1/E6F-E9F Brute Force 650 4x4 Hardwoods Green HD	05-09
									KVF 650 F6F/F7F/F8F/F9F/FAF/FBF Brute Force 650 4x4i	06-11
									KV 650 FCS (Brute Force 650 4x4i)	12
									KVF 650 G6F-G9F/GAF Brute Force 650 4x4i Hardwoods Green HD	06-10
									KVF 650 H7F/H8F Brute Force 4x4i	07-08
									KSV 700 A1/B1 (KFX 700 V-Force)	04
									KVF 700 D1/D6F Team Green Special Edition	05-06
									KVF 700 A1/A2/A6F-A9F (Prairie 700 4x4)/B1/B2/B6F (Prairie 700 4x4 Hardwoods Green HD)	04-09
									KVF 750 A1/A6F/A7F Brute Force 750 4x4i	05-07
									KVF 750 B6F/B7F/B7FA Brute Force 750 4x4i	06-07
									KVF 750 B1/E8F/E9F Brute Force 750 4x4i Hardwoods Green HD	05/08-09
									KVF 750 E8FA/E9FA/EAF Brute Force 750 4x4i NRA Outdoors	08-09
									KVF 750 F8F/FAF/FBF Brute Force 750 4x4i	08/10-11
									KVF 750 GCF/GDF/GEF/GFF/GGF/GHF (Brute Force 750 4x4i/EPS)	12-17

ROTOR BUYERS GUIDE

BRAKE ROTOR BUYERS GUIDE - DIRTBIKE/ATV/UTV

Rotor No.	F/R	Type	Dia. (mm)	Hub Color	Profile	Bobbins	Left Bracket	Right Bracket	Model	Year
MD6188D UTVX6188 Contd.	F F	Solid Solid	200 200	N/A N/A	Plain Vee	N/A N/A			KAWASAKI Contd. KVF 750 HCF/HDF/HEF/HFF/HGF/HHF Brute Force 750 4x4i/EPS KVF 750 JCF/JDF/JEF/JFF/JGF/JHF Brute Force 750 4x4i/EPS KVF 750 LCF/LDF/LEF/LFF/LGF/LHF (Brute Force 750 4x4i) SUZUKI LT-V 700 FK4/FK5 Twin Peaks 700 4x4	12-17 12-17 12-17 04-05
MD6189D	F	Solid	220	N/A	Plain	N/A			YAMAHA YFM 660 FAP/FHAP/FSAP/FAR/FR/FS/FHS/FHT/FT/FV/FGHW/FGX /FGHX Grizzly YFM 660 FAHDV/W Ducks Unlimited Edition/Side x Side	02-08 06-07
MD6190D MD6190C MD6190CE MD6190CX	R R R R	Solid Solid Solid Solid	245 245 245 245	N/A N/A N/A N/A	Plain Contour Contour Vee	N/A N/A N/A N/A			YAMAHA YZ 125 P/R/S/T/N/W/X/Y/Z/A/B/D/E/F/G/H/J (2T) YZ 250 P/R/S/T/N/W/X/Y/Z/A/B/D/E/F/G/H/J (2T) YZ 250 FP/FR/FS/FT/FV/FW/FX/FY/FZ/FA/FB/FD/FE/FF/FG/FH/FJ WR 250 FR/FS/FT/FV/FW/FX/FY/FZ/FA/FB/FD/FE/FF/FG/FH/FJ (4T) YZ 426 FP WR 426 FP CRF 450 L YZ 450 FR/FS/FT/FV/FW/FX/FY/FZ/FA/FB/FD/FE/FF/FG/FH/FJ WR 450 FR/FS/FT/FV/FW/FX/FY/FZ/FA/FB/FD/FE/FF/FG/FH/FJ	02-18 02-18 02-18 03-18 02 02 18-21 03-18 03-18
MD6191D MD6191C MD6191CE MD6191CX	Rear Rear Rear Rear	Solid Solid Solid Solid	240 240 240 240	N/A N/A N/A N/A	Plain Contour Contour Vee	N/A N/A N/A N/A			HONDA CR 125 R CR 125 R CR 250 R CR 250 R CRF 250 R CRF 250 R AC CRF 250 RX CRF 250 X CRF 450 R CRF 450 R CRF 450 R CRF 450 R CRF 450 R-S F-disc 260mm, R-disc 240mm CRF 450 RWE CRF 450 RX CRF 450 X CRF 450 L CRF 450 RL	02-03 04-07 02-03 04-07 04-14 15-22 19-22 04-16 02-03 04-14 15-21 17-22 22 19-22 17-21 05-21 18-20 21-22
MD6192D MD6192C	F F	Solid Solid	198 198	N/A N/A	Plain Contour	N/A N/A			KTM 60 SX 65 SX	98-99 00-03
MD6195D	F	Solid	190	N/A	Plain	N/A			SUZUKI LT-A 400 FK8/FK9/FL0 King Quad 400 AS LT-A 400 FCK8/9 King Quad 400 AS Camo LT-A 400 FQK9 King Quad 400 AS Anniversary Edition LT-A 400 FL1/FL2/FL3/FL4/FL5 King Quad 400 ASi LT-A 400 FCL1/FCL2/FCL3/FCL4/FCL5 King Quad 400 ASi Camo LT-F 400 FK8/FK9/FL0 King Quad 400 FS LT-F 400 FCK8/FCK9 King Quad 400 FS Camo LT-F 400 FQK9 King Quad 400 FS Anniversary Edition LT-F 4WD V/W Quadrunner 4WD (250cc) LT-A 400 FK2/FK3/FK4/FK5/FK6/FCK5/FCK6/FCK7/FK7 Eiger LT-A 400 FK8 Kingquad Auto 4WD LT-A 400 K8 Kingquad Auto 2WD LT-A 400 K2/K3/K4/K6 Eiger LT-F 400 FK2/FK3/FK4/FK5/FK6/FCK5/FCK6/FCK7/FK7 (Eiger 4WD) LT-F 400 FL1/FL2/FL3/FL4/FL5 King Quad 400 FSi LT-F 400 FCL1/FCL2/FCL3/FCL4/FCL5 King Quad 400 FSi Camo LT-F 400 K2 Eiger Manual 2WD LT-F 400 K3/4/5/6/7 LT-F 400 K8 Manual LT-A 500 FK2/FK3/FK4/FK5/FK6/FK7 Vinson 4WD LT-F 500 FK3/FK4/FK5 Vinson Quadrunner	08-18 08-09 -09 11-22 11-15 08-18 08-09 09 97-98 02-07 08-09 08 06-18 02-07 11-15 11-15 02 03-08 08 02-07 03-05

ROTOR BUYERS GUIDE

BRAKE ROTOR BUYERS GUIDE - DIRTBIKE/ATV/UTV

Rotor No.	F/R	Type	Dia. (mm)	Hub Color	Profile	Bobbins	Left Bracket	Right Bracket	Model	Year
MD6196D	R	Solid	216	N/A	Plain	N/A			SUZUKI LT-A 500 FK2/FK3/FK4/FK5/FK6/FK7 Vinson 4WD LT-F 500 FK3/FK4/FK5 Vinson Quadrunner	02-07 03-05
MD6197D	R	Solid	150	N/A	Plain	N/A			YAMAHA YFM 660 FAP/FHAP/FSAP/FAR/FS/FHS/FHT/FT/FV/FGHW/FGX/FGHX Grizzly YFM 660 FAHDV/W Ducks Unlimited Edition/Side x Side	02-08 06-07
MD6199D MD6199C	F F	Floating Floating	320 320	Gold Gold	Plain Contour	9 9			KTM Duke 400 LC4 Duke 620 LC4 LC4 620 SC Supermoto LC4 625 SC Supermoto SMC 625 LC4 640 Adventure -R LC4 640 Adventure 640 Duke (Jet Black/Yellow/Adrenalin Orange) Duke II 640 Orpheus/Titan/Lime Duke II 640 Black/Orange LC4-E 640 Supermoto	94-98 94-98 00 02 05 99-02 03 03-06 01- 02 00-04
MD6200D	R	Solid	206	N/A	Plain	N/A			POLARIS Magnum 330 (2x4/4x4/HDS) ATP 330 (4x4) ATV Pro 500 4x4 PPS Magnum 500 4x4 HDS PPS/PTV 4x4/Series 10 PPS/PTV 6x6/Series 10	03-06 04-05 02 02-04
MD6201D	R	Solid	218	N/A	Plain	N/A			POLARIS 400 Sportsman Sportsman 500 HO/EFI Sportsman 600 (4x4) Sportsman 700 (4x4)/EFI Sportsman MV 700 Sportsman 800 EFI PPS/Series 10 UTV 2x4 PPS/Series 10 UTV 4X6 PPS/Series 11 UTV 1500 2x4 Ranger Series 10 Ranger Series 10 500 6x6 Ranger Series 11 PPS/Series 11 2x4/4x4 PPS/Series 11 6x6 Ranger 6x6 Ranger TM Ranger XP Ranger 2x4/4x4 Sportsman 800 EFI	03-04 03-06 03-05 02-06 05-06 05-06 04-05 04-05 05 04-05 07
MD6202D UTVX620Z	F F	Solid Solid	228 228	N/A N/A	Plain Vee	N/A N/A			POLARIS 325 Hawkeye 2x4 325 Ranger ETX 325 Sportsman Ace Magnum 330 (4x4/HDS) ATP 330 (4x4) 330 Trail Boss/Trail Blazer 400 Hawkeye H.O. (2x4) 400 Ranger 4x4 400 Ranger (All models) 400 Sportsman HO 4x4 400 Sportsman ATP 500 H.O (4x4) ATV Pro 500 4x4 PPS Magnum 500 4x4 HDS Sportsman 450 500 Ranger 4x4 EFI 500 Scrambler 4x4 Sportsman 500 HO/EFI Sportsman 500 X2/EFI	15 15 14 03-06 04-05 10-12 13-14 12 10-13 11-12 04 04-05 02 02-04 07 11-12 10-12 04-08 06-08

BRAKE ROTOR BUYERS GUIDE - DIRTBIKE/ATV/UTV

Rotor No.	F/R	Type	Dia. (mm)	Hub Color	Profile	Bobbins	Left Bracket	Right Bracket	Model	Year
MD6202D UTVX6202 Contd.	F	Solid	228	N/A	Plain	N/A			POLARIS Contd.	
									500 Sportsman Touring HO	11-12
									570 Forest Tractor EFI/EPS	15
									570 Sportsman Ace/Ace Euro	15
									Sportsman 600 4x4	03-05
									Sportsman 700 4x4/EFI	03-06
									Sportsman MV 700	05-06
									Sportsman 800 EFI	05-07
									PPS/PTV 4x4/Series 10	
									PPS/Series 10 UTV 2x4/4x6	
									PPS/Series 11 UTV 1500 2x4	
									Ranger Series 10	
									Ranger Series 10 500 6x6	
									Ranger Series 11	
									PPS/Series 11 2x4/4x4	
									PPS/Series 11 6x6	
									Sportsman 500 EFI/HO	07-08
									500 Ranger (Carb) 2x4	08-09
									Ranger 6x6	04-05
									Ranger TM	04-05
									Ranger XP	05
									Ranger 2x4/4x4	04-05
									Ranger 400 HO	10-11
									Ranger 500 (2x4/4x4)	06-07
									Ranger 500 (4x4 EFI)	06-08
									Ranger 500 2x4	08
									Ranger Crew 500	11-12
									570 Ranger EFI	14
									700 Ranger Crew (EFI) 4x4	09
									Ranger 6x6 EFI 700	06-09
									Ranger XP 700 4x4	06
									Ranger TM	06
									Ranger 700 6x4 EFI	08
									Ranger 700 4x4 EFI/LE	07
									Ranger XP 700 4x4	08
									Ranger EV (Electric)	10-15
									Sportsman 700 EFI	07
									700 Sportsman X2	08
									Sportsman 800 EFI	07
									Sportsman X2 500 EFI	07-09
									500 Sportsman Forest	12
									500 Sportsman Touring H.O.	08-12
									500 Sportsman EFI Quad H.O.	08-10
									500 Sportsman HO	08-12
									570 Ranger Crew EFI	14-15
									570 Sportsman EFI (inc EPS)	14-15
									570 Sportsman Touring EFI	14-15
800 Ranger Mid Size	13									
Sportsman X2 800 EFI	07-09									
Sportsman 800 EFI Intl/HO	07-09									
800 Sportsman Forest/Forest Trader	12									
800 Sportsman Big Boss 6x6/EFI	09-12									
800 Sportsman Touring/EFI	08-10									
800 Sportsman HO/EFI	08-09									
800 Sportsman EFI	10-12									
MD6206D	F	Solid	168	N/A	Plain	N/A			SUZUKI LT-F 300 FK2	02
MD6207D	F	Solid	160	N/A	Plain	N/A			SUZUKI LT-F 250 K2/K3/K4/K5/K6/K7/K8/K9/L2/L3/L4 Ozark	02-14
MD6208D	R	Solid	240	N/A	Plain	N/A			KAWASAKI KX 125 M1/M2/M3 KX 250 M1/M2/R1/R6F KX 250 F N1/N2 KX 250 F (T6F/T7F/T8F) (4T) KX 250 F (W9F/XAFB/YBF/YCF/ZDF/ZEF) KX 250 F KX 250 F	03-05
MD6208C	R	Solid	240	N/A	Contour	N/A				03-06
MD6208CE	R	Solid	240	N/A	Contour	N/A				04-05
MD6208CX	R	Solid	240	N/A	Vee	N/A				06-08
										09-14
										15-19
										21-22

BRAKE ROTOR BUYERS GUIDE - DIRTBIKE/ATV/UTV

Rotor No.	F/R	Type	Dia. (mm)	Hub Color	Profile	Bobbins	Left Bracket	Right Bracket	Model	Year
MD6208D MD6208C MD6208CE MD6208CX	R R R R	Solid Solid Solid Solid	240 240 240 240	N/A N/A N/A N/A	Plain Contour Contour Vee	N/A N/A N/A N/A			KAWASAKI KX-F 250 XC KX-F 250 XC F XC KLX 450 R A8F/A9F/AAF/ABF/ACF KX 450 F (D6F/D7F/D8F) KX 450 F E9F/EAF/EBF/FCF/FDF/FEF KX 450 F (FFF/HGF/HHF) KX 450 XC F XC SUZUKI RM-Z 250 K4/K5/K6/K7	21-22 21 08-12 06-08 09-14 15-17 21 04-07
MD6210D	F	Solid	170	N/A	Plain	N/A			KAWASAKI KSF 400 A1/A2/A3/A6F (KFX 400) SUZUKI LT-Z 250 K4/K5/K6/K7/K8/K9 LT-Z 400 K3/K4/K5/K6/K7/K8/K9/L0/ZK9/L2/ZL2 ARCTIC CAT 400 DVX (2x4) Sport	03-06 04-11 03-12 04-08
MD6211D	R	Solid	220	N/A	Plain	N/A			ARCTIC CAT 400 DVX (2x4) Sport 400 DVX TS Sport KAWASAKI KSF 400 A1/A2/A3/A6F (KFX 400) SUZUKI LT-Z 400 K3/K4/K5/K6/K7/K8/K9/L0/ZK9/L2/ZL2	04-08 06-07 03-06 03-12
MD6212D	F	Solid	220	N/A	Plain	N/A			KAWASAKI KLX 125 L (B1/B2/B3/B6F) SUZUKI DR-Z 125	03-06 03-21
MD6213D MD6213C MD6213CX OSX6213 SMX6213	F F F F F	Solid Solid Solid Floating Floating	250 250 250 280 320	N/A N/A N/A Silver Black	Plain Contour Vee Contour Contout	N/A N/A N/A 6 6			KAWASAKI KX 125 M1/M2/M3 KX 250 M1/M2/R1/R6F KX 250 N1/N2 (KX 250 F) KX 250 F (T6F) KX 250 R6F/R7F KX 450 F (D6F) SUZUKI RM-Z 250 K4/K5/K6/K7	03-05 03-06 04-05 06 06-07 06 04-07
MD6214D	F	Solid	230	N/A	Plain	N/A			APRILIA MX 50 RX 50/RX 50 Racing	04 04
MD6215D	F	Solid	200	N/A	Plain	N/A			YAMAHA YFM 350 FAS/FAT 350 Bruin 4x4 Auto YFM 350 AS/AT/AV 350 Bruin 2x4 Auto YFM 350 GW/GX/GY/GZ/GA Grizzly 2x4 (2WD) YFM 350 XV/XW/XX/XY Wolverine (2WD) YFM 350 FGW/FGIX/FGIY/FGIZ/FGIA/FGB/FGD Grizzly Auto IRS 4x4 YFM 350 DE Grizzly Auto 4x4 YFM 400 FGW/FGX/FGY/FGZ/FGA Grizzly 4x4 YFM 400 FAR/FAS Kodiak Auto YFM 400 AR/AS Kodiak 2WD YFM 400 FAS/FAT/FAHT/FAV Kodiak 4WD YFM 400 FBHW/FBHZ/Y/Z Big Bear 400 Hunter-IRS YFM 400 FBEW Big Bear 400 IRS Exploring Edition YFM 400 FBW/FBX/FBY/FBA/FBB Big Bear 4WD IRS YFM 450 DE Grizzly 450 Auto 4x4 YFM 450 FAR/FAS/FAT/FAHT/FAV Kodiak YFM 450 FGPA/B/D (Grizzly 450 Auto/4x4/EPS) YFM 450 FGW Grizzly Auto 4x4 IRS YFM 450 FGX/FGY/FGZ/FGA/FGB/FGD Grizzly 450 Auto 4x4 YFM 450 FXV/FXW/FXX/FXY/FXZ Wolverine Auto 4x4 YFM 450 FXSEW Wolverine Sport Special Edition YFM 450 PE Grizzly 450 Auto 4x4 EPS	04-06 04-06 07-11 06-09 07-13 14 07-11 03-04 03-04 04-05 07-10 07 08-12 14 03-05 11-13 07 08-13 06-10 07 14

ROTOR BUYERS GUIDE

BRAKE ROTOR BUYERS GUIDE - DIRTBIKE/ATV/UTV

Rotor No.	F/R	Type	Dia. (mm)	Hub Color	Profile	Bobbins	Left Bracket	Right Bracket	Model	Year
MD6216D	R	Solid	160	N/A	Plain	N/A			KTM 60 SX 65 SX	00 00-03
MD6217D	R	Floating	170	Silver	Plain	N/A			HONDA TRX 420 FPA Power Steering Fourtrax Rancher AT/IRS TRX 420 FA Fourtrax Rancher AT/IRS TRX 420 FA5 Rancher 4x4 Auto DCT/IRS TRX 420 FA6 Rancher 4x4 Auto/DCT/IRS/EPS SXS 500 M2 Pioneer TRX 500 FA5 Foreman Rubicon 4x4 Auto/DCT TRX 500 FA6 Foreman Rubicon 4x4 Auto/DCT/EPS TRX 500 FM5 Foreman Rubicon 4x4 TRX 500 FM6 Foreman Rubicon 4x4/EPS TRX 650 FA TRX 650 FGA TRX 680 FGA6/FGA7/FGA8 Fourtrax Rincon Gpscape (675cc) TRX 680 FA Fourtrax Rincon SXS 700 M2 Pioneer (2 Seat) SXS 700 M4 Pioneer (4 Seat)	09-14 09-14 14-15 14-15 15-17 15 15 15 15 03-05 04-05 06-08 06-14 16-18 16-18
MD6218D	R	Solid	196	N/A	Plain	N/A			POLARIS Outlaw 450 S Predator 500 500 E Predator	08 03-07 06
MD6219D	F	Solid	178	N/A	Plain	N/A			POLARIS Phoenix 200/200 Phoenix Quadricycle 200 Phoenix (AA/AB Model/R drum model) 200 Phoenix (EA/EB) Quadricycle Model (R disc model) Outlaw 450 S Outlaw 450 MXR Outlaw 500 Predator 500 500 E Predator 525 S Outlaw 525 Outlaw IRS	05 05 05 08 09-10 06-07 03-07 06 08-10 08-10
MD6220D	F	Solid	155	N/A	Plain	N/A			BOMBARDIER Rally 200 CAN-AM Rally 200	03-06 06
MD6221D	R	Solid	155	N/A	Plain	N/A			BOMBARDIER Rally 200	03-05
MD6222D UTVX6222	F F	Solid Solid	205 205	N/A N/A	Plain Vee	N/A N/A			BOMBARDIER Outlander 330 H.O. Outlander 400 Outlander 400 Max H.O. Outlander 650 HO EFI 4x4/HO EFI XT 4x4 Outlander Max 650 HO EFI 4x4/HO EFI XT 4x4 Outlander 800 (All models) CAN-AM Outlander 400 (4x4 STD) 2D7A/B/C/D/E/F/G/H) Outlander 400 (XT 4X4) Outlander Max 400 (4x4/XT 4x4) Outlander 500 (STD 4x4) Outlander 500 (XT 4x4) Outlander Max 500 (Std 4x4/XT 4x4) Renegade 500 (4x4/EFI) Outlander 650 (4x4 STD) Outlander 650 (XT 4x4) Outlander Max 650 (Std 4x4/XT 4x4) Outlander Max XTP 650 Outlander 800 (STD 4x4) Outlander 800 (XT 4x4) Outlander 800 R EFI Outlander 800 R XT Outlander Max 800 R XT	04-05 03-05 03-06 06 06 06 07-14 07-14 07-14 07-12 07-12 07-12 08-12 07-12 07-12 07-12 12 07-08 07-08 09 09-12 09-10

ROTOR BUYERS GUIDE

BRAKE ROTOR BUYERS GUIDE - DIRTBIKE/ATV/UTV

Rotor No.	F/R	Type	Dia. (mm)	Hub Color	Profile	Bobbins	Left Bracket	Right Bracket	Model	Year
MD6222D UTVX6222	F F	Solid Solid	205 205	N/A N/A	Plain Vee	N/A N/A			CAN-AM Contd. Outlander Max 800 R EFI Outlander Max 800 (Ltd 4x4/Std 4x4/XT 4x4) Outlander Max XT-P 800 R	09-12 07-08 12
MD6223D UTVX6223	R R	Solid Solid	180 180	N/A N/A	Plain Vee	N/A N/A			BOMBARDIER Outlander 330 H.O. Outlander 400 Outlander 400 Max H.O. Outlander 650 HO EFI 4x4/HO EFI XT 4x4 Outlander Max 650 HO EFI 4x4/HO EFI XT 4x4 Outlander 800 (All models) CAN-AM Outlander 400 (4x4 STD) 2D7A/B/C/D/E/F/G/H) Outlander 400 (XT 4X4) Outlander Max 400 (Std 4x4/XT 4x4) Outlander 500 (STD 4x4) Outlander 500 (XT 4x4) Outlander Max 500 (Std 4x4/XT 4x4) Renegade 500 (4x4/EFI) Outlander 650 (4x4 STD) Outlander 650 (XT 4x4) Outlander Max 650 (Std 4x4/XT 4x4) Outlander Max XTP 650 Outlander 800 (STD 4x4) Outlander 800 (XT 4x4) Outlander 800 R EFI Outlander Max 800 R EFI Outlander Max 800 R XT Outlander 800 R XT Outlander Max 800 (Ltd 4x4/Std 4x4/XT 4x4) Outlander Max XT-P 800 R	04-05 03-05 03-06 06 06 06 07-14 07-14 07-14 07-14 07-12 07-12 08-12 07-12 07-12 07-12 07-12 12 07-08 07-08 09 09-11 09-11 09-12 07-08 12
MD6224D	F	Solid	203	N/A	Plain	N/A			BOMBARDIER Quest 500 (4x4) Quest 500 (2x4) Quest 650 (2x4) Quest 650 (4x4) Quest 650 XT (4x4) Quest Max 650	02-04 02 02 02-04 02 03-04
MD6224D	R	Solid	203	N/A	Plain	N/A			BOMBARDIER Traxter Autoshift	01-04
MD6225D	R	Solid	218	N/A	Plain	N/A			BOMBARDIER Quest 500 (4x4) Quest 500 (2x4) Quest 650 (2x4) Quest 650 (4x4) Quest 650 XT (4x4) Traxter Max Traxter Max 650 Traxter XL (7920/7921) Quest Max/STD/XT JOHN DEERE Trail Buck 500/650 EX/EXT Buck 500/650 EX/EXT	02-04 02 02 02-04 02 03-05 04-05 04 03-05 04-08 04-08
MD6227D	R	Solid	220	N/A	Plain	N/A			KTM EXC 125 MX/MXC/GS 125 MX 125 EXC/EGS 250 GS 250 MX 250 MX/MXC 250 MX/MXC/GS 300 EXC 350 MX/MXC/GS 350 MX 350	88-89 86 88-89 88-89 86 88-89 86 86 89 86/88 89

ROTOR BUYERS GUIDE

BRAKE ROTOR BUYERS GUIDE - DIRTBIKE/ATV/UTV

Rotor No.	F/R	Type	Dia. (mm)	Hub Color	Profile	Bobbins	Left Bracket	Right Bracket	Model	Year
MD6229D	F	Solid	205	N/A	Plain	N/A			BOMBARDIER Traxter (4x4) Traxter XL (4x4) Traxter XT (4x4) Traxter Autoshift Traxter Footshift Traxter (4x4) Traxter XL (4x4)	99-00 01 00-01 01 01 01 01-04
MD6230D	R	Solid	220	N/A	Plain	N/A			BOMBARDIER Traxter (4x4) Traxter (4x4) Traxter XL (4x4) Traxter XT (4x4) Traxter Autoshift Traxter Footshift	99-00 01 01-04 00-01 01 01
MD6232D MD6232CX	R R	Solid Solid	260 260	N/A N/A	Plain Vee	N/A N/A			SUZUKI DL 650 K4-K9/AK7-AK9/K9/AL1-AL7 V-Strom DL 650 V-Strom Adventure ABS DL 650 V-Strom XT ABS DL 650 V-Strom XT Touring DL 1000 K2/K3/K4/K5/K6/K7/K8/K9/L2 DL 1000 V-Strom Adventure DL 1000 V-Strom ABS	04-17 12-21 15-21 18-21 02-12 12/14-21 14-21
MD6233D	R	Solid	190	N/A	Plain	N/A			HONDA TRX 450 R/ER	04-14
MD6236D	R	Solid	200	N/A	Plain	N/A			YAMAHA YFM 125 RA/RB/RD Raptor YFM 250 R (RSPA) YFM 250 RX/RV/RZ/RA/RB/RD Raptor YFM 250 RSPA Special Edition YFM 250 RSPX/RSEY Special Edition YFM 250 RSXPC Special Edition Custom YFM 350 RS/RT/RV/RW/RX/RV/RZ/RA/RB/RD Raptor YFZ 450 LES Limited Edition YFZ 450 S/T YFZ 450 SET Special Edition YFZ 450 BB/DB YFM 700 Raptor	11-13 11 08-13 11 08-09 08 04-13 04 04-05 05 12-13 13
MD6237D	R	Solid	220	N/A	Plain	N/A			YAMAHA YFS 200 R/S/T/V Blaster YFZ 350 A/B/D/E/F/G/H/J/K/L/M/N/P/R/S/T/V Banshee YFM 660 RN/RP/RPB/RR/RS	03-06 90-06 01-04
MD6239D	F	Solid	240	N/A	Plain	N/A			KAWASAKI KL 250 G4-G8	00-09
MD6241D UTVX6241	F F	Solid Solid	200 200	N/A N/A	Plain Vee	N/A N/A			YAMAHA YXR 450 Rhino (All models) YXR 660 Rhino YXR 700 Rhino FI Unlimited Version	06-09 04-07 08-09/11-13
MD6242D UTVX6242 OSX6242	R R R	Solid Solid Floating	165 165 190	N/A N/A Silver	Plain Vee Contour	N/A N/A N/A		BRK030	YAMAHA YXR 450 Rhino (All models) YXR 660 Rhino	06-09 04-07
MD6243D MD6243C MD6243CX	F F F	Solid Solid Solid	198 198 198	N/A N/A N/A	Plain Contour Vee	N/A N/A N/A			GAS GAS (Pierer Mob) MC 65 HUSQVARNA TC 65 KTM SX 65 SX 65 XC 65	21 21 04-09 09-22 08-10

BRAKE ROTOR BUYERS GUIDE - DIRTBIKE/ATV/UTV

Rotor No.	F/R	Type	Dia. (mm)	Hub Color	Profile	Bobbins	Left Bracket	Right Bracket	Model	Year
MD6244D	R	Solid	203	N/A	Plain	N/A			YAMAHA XT 250 X/Y/Z/A/B/D/E/F/G/H XTZ 250 Lander (F 21" / R 18" Wheels) XTZ 250 Lander (F 21" / R 18" Wheels) XTZ 250 X (F & R 17" Wheels)	08-17 07-14 16-18 08-10
MD6245D	F	Solid	203	N/A	Plain	N/A			BOMBARDIER Traxter Max Traxter Max 650/Quest Max/STD/XT Traxter XL (7920/7921) JOHN DEERE Trail Buck 500/650 EX/EXT Buck 500/650 EX/EXT	03-05 04-05 04 04-08 04-08
MD6246C MD6246CX	R R	Solid Solid	200 200	N/A N/A	Plain Vee	N/A N/A			SUZUKI RM 85	05-12/15-21
MD6247D MD6247C	F F	Floating Floating	310 310	Silver Silver	Plain Contour	6 6			SUZUKI DR-Z 400 SM	05-09/13-21
MD6249C MD6249CX	R R	Solid Solid	160 160	N/A N/A	Contour Vee	N/A N/A			GAS GAS (Pierer Mob) MC 65 HUSQVARNA TC 65 KTM SX 65 XC 65	21-22 18-22 04-22 08-10
MD6251D	F	Solid	180	N/A	Profile	N/A			HONDA TRX 500 FA/FG TRX 500 FE/FA Fourtrax Foreman 4x4/ES TRX 500 FMA Fourtrax Foreman 4x4 TRX 500 TM5/TM6 Fourtrax Foreman 2x4 TRX 500 FPA Fourtrax Rubicon with EPS/Power Steering TRX 500 FPE Fourtrax Foreman 4x4 ES/EP TRX 500 FPM8 Fourtrax Foreman 4x4/EP TRX 680 FA Fourtrax Rincon	05-14 05-12 05-12 05-06 09-14 08-12 08-11 06-21
MD6252D	R	Solid	220	N/A	Profile	N/A			YAMAHA YFM 400 FAT/FAHT/FAV YFM 400 FGW/FGX Grizzly 4x4 YFM 450 FGW/FGX/FGY/FGZ Grizzly Auto 4x4 IRS YFM 450 FAT/FAHT/FAV	05-06 07-08 07-10 05-06
MD6253D MD6253C	R R	Solid Solid	220 220	N/A N/A	Profile Contour	N/A N/A			GAS-GAS Enduro EC 200/250/300 EC 125/200/250/300 EC 200/250/300 (All models/2T) MC 125 MX 125/250 Pampera 125/450 SM 125/250 (4T) MX 200/250/300 SM 400 FSE (2T) SM 450	99-00 01-09 10-12 05 01-04 05 01-05 99-00 01-02 03-05
MD6254D MD6254C MD6254CX OSX6254 SMX6254	F F F F F	Solid Solid Solid Solid Solid	250 250 250 280 320	N/A N/A N/A Silver Black	Plain Contour Vee Contour Contour	N/A N/A N/A 6 6			SUZUKI RM-Z 250 RM-Z 450	07-21 05-21
MD6255D MD6255C MD6255CE MD6255CX	R R R R	Solid Solid Solid Solid	240 240 240 240	N/A N/A N/A N/A	Plain Contour Contour Vee	N/A N/A N/A N/A			SUZUKI RM-Z 250 RM-Z 450	07-21 05-21

ROTOR BUYERS GUIDE

BRAKE ROTOR BUYERS GUIDE - DIRTBIKE/ATV/UTV

Rotor No.	F/R	Type	Dia. (mm)	Hub Color	Profile	Bobbins	Left Bracket	Right Bracket	Model	Year
MD6256D UTVX6256	R R	Solid Solid	203 203	N/A N/A	Plain Contour	N/A N/A			POLARIS Scrambler 500 (2X4/4X4) 500 Scrambler 4x4 Trail Blazer 250 Trail Boss 330 330 Trail Blazer 330 Trail Boss	05-10 10-12 05-06 05-10 08-12 10-12
MD6257C	R	Solid	200	N/A	Contour	N/A			KTM SX 85 (17"/14" wheels / 19"/16" wheels) XC 85 SX 105 XC 105	03-11 08-09 07-11 08-10
MD6258C OSX6258 OSX6258ORG	F F F	Solid Floating Floating	220 220 220	N/A Silver Silver	Contour Contour Contour	N/A 6 6		BRK028 BRK028ORG	KTM SX 85 (17"/14" wheels) SX 85 (19"/16" wheels) XC 85 SX 105 XC 105	03-11 03-11 08-09 07-11 08-10
MD6259D	R	Solid	240	N/A	Plain	N/A			CAGIVA Elefant 650	86-87
MD6261D	F	Solid	200	N/A	Plain	N/A			SUZUKI LT-A 450 XK7/XK8/XK9 LT-A 450 XCK7/8/9 King Quad 450 AXi Camo LT-A 450 XZK8/XZK9 King Quad 450 AXi Special Edition LT-A 700 XK5/XCK6/XK6/XK7/XCK7 LT-A 750 XK8/XK9/XL1/XL2/XL3/XL4 King Quad 750 AXi LT-A 750 XCK8/XCK9 King Quad 750 AXi Camo LT-A 750 XZK8/XZK9/XCL1/XCL2/XCL3/XCL4 King Quad 750 AXi Limited LT-A 750 XRK9 King Quad 750 AXi Rockstar Edition	07-09 07-09 08-09 05-07 08-22 08-14 08-09/13 09
MD6262D	F	Solid	182	N/A	Plain	N/A			POLARIS Trail Blazer 250 Trail Boss 330 330 Trail Blazer Scrambler 500 2x4	05-06 05-10 08-10 07-08
MD6263D MD6263C	R R	Solid Solid	200 200	N/A N/A	Plain Plain	N/A N/A			YAMAHA YZF 450 V/W/X/Y/B/D YZF 450 RY/RZ/RA/RB/RD/RE YZF 450 R Special Edition (3 spring clutch) YZF 450 RSE YZF 450 BBV/BBW Bill Balance Edition YZF 450 SPV/SEW/SPX Special Edition YFM 700 RV/RW/RX/RY/RA/RB/RD/RE Raptor YFM 700 RSEW/RSPX/RSEA/RSEY/RSEZ/RSEA/RSEB/RSED/RSE/RSEF Raptor Special Edition YFM 700 R (RSEY/RSEZ/RSEA/RSEB/RSED/RSE/RSEF) Raptor Special Edition YFM 700 50th Anniversary Edition - YFM 700 RSPV YFM 700 RD/RE/RF Raptor	06-09/11-13 09-14 14 06-07 06-08 06-14 07-14 09-15 06 13-15
MD6264D MD6264C MD6264CX OSX6264 SMX6264	F F F F F	Floating Floating Floating Floating Floating	250 250 250 250 250	Silver Silver Silver Silver Black	Plain Contour Vee Contour Contour	6 6 6 6 6			KAWASAKI KX 250 R6F/T6F/R7F/T7F/T8F KX 250 F (4T) KX 450 D6F/D7F/D8F KX 450 F (E9F/EAF/EBF/FCF/FDF/FEF) (4T) KX 450 F KLX 450 R (A8F/A9F/AAF/ABF/ACF)	06-08 09-14 06-08 09-14 18-21 08-12
MD6265D	F	Floating	260	Silver	Plain	6			CAGIVA Elefant 650	86-87 86-87
MD6266D	F	Solid	300	N/A	Plain	N/A			ARCTIC CAT 250 DVX Sport KTM LC-4 640 Adventure-R LC-4 640 Adventure 950 Adventure/S	06-08 04 05-07 04-06

BRAKE ROTOR BUYERS GUIDE - DIRTBIKE/ATV/UTV

Rotor No.	F/R	Type	Dia. (mm)	Hub Color	Profile	Bobbins	Left Bracket	Right Bracket	Model	Year
MD6267D	F & R	Solid	180	N/A	Plain	N/A			ARCTIC CAT 50 4x4 Auto Youth 50 DVX (4T) 50 DVX (4T) Sport 50 Utility 90 (Reverse Gear) 90 DVX 90 DVX SE 90 SE 90 Utility (2 x 4) 90 2x4 (4T) Youth 150 Utility 2x4 250 Utility 250 DVX 250 DVX Sport 300 ATV 2x4 Utility 300 DVX KAWASAKI KFX 50 (KSF 50 B7F/B8F/B9F/BDF/BEF/BFF/BGF/BHF) KFX 90 (KSF 90 A7F/A8F/A9F/AAF/ABF/ACF/ADF/AEF/AFF/AGF/AHF) KVF 300 CCF/CDF/CEF/CFE/CGF/CHF Brute Force KYMCO Mongoose 70 (4T) Mongoose 90 Mongoose 90 R (Reverse gear) KXR 250 MXU 150 Mongoose 300 MXU 300	09 06-08 06/08 06-08 10-14 06-14 09 09 06-10 06 09-14 06-09 06-08 06-08 10-14 09-14 07-09/13-17 07-17 12-17 0714 02-10 10-14 04-10 03-14 06-14 05-14
MD6268D	R	Solid	220	N/A	Plain	N/A			ARCTIC CAT 250 DVX 300 DVX KYMCO KXR 250 MXU 250 Mongoose 300	06-08 09-14 04-10 04-10 06-14
MD6269D MD6269C	R R	Solid Solid	240 240	N/A N/A	Plain Contour	N/A N/A			KTM 690 Rally Factory Rep 690 Enduro R 950 Adventure/S	07-08 10-15 04-06
MD6270D MD6270C	F F	Floating Floating	310 310	Gold Gold	Plain Contour	9 9			HUSABERG All Supermotard models (Beringer 4 piston caliper central pin fixing 310mm F disc) FS Supermotard Models (Beringer/FTE 6 piston caliper 310mm F disc) FS Supermotard Models (FTE 4 piston radial caliper) KTM SMR 450/560	00-03 04 05-08 05-06
MD6271D UTVX6271	F F	Solid Solid	252 252	N/A N/A	Plain Vee	N/A N/A			ARCTIC CAT 1000 Mudpro 550 H1 EFI Prowler HDX 500 Prowler HDX 500 LTD Prowler HDX 500 XT Prowler XT 550 XT 550 Prowler XT 650 H1 Prowler 650 H1 Prowler 650 Prowler 4 x 4/M4 HDX 700 Prowler HDX 700 LTD Prowler XTX 700 H1 LE Prowler XTX 700 H1 EFI Prowler XTX 700 Prowler XTZ 1000 Prowler Wildcat 1000 GT	10-13 09 14 14 14 10-11 11-14 06-09 07 08 11-14 14 08 09 11-14 10-14 11-12

ROTOR BUYERS GUIDE

BRAKE ROTOR BUYERS GUIDE - DIRTBIKE/ATV/UTV

Rotor No.	F/R	Type	Dia. (mm)	Hub Color	Profile	Bobbins	Left Bracket	Right Bracket	Model	Year
MD6271D UTVX6271	R R	Solid Solid	252 252	N/A N/A	Plain Vee	N/A N/A			ARCTIC CAT 1000 Mudpro	10-13
MD6272D	F	Solid	198	N/A	Plain	N/A			POLARIS Hawkeye 300 2x2/4x2 Hawkeye 2x4/4x4 Sportsman 300 (4x4) 400 Sportsman HO 4x4	06 07 08-10 08-10
MD6273D	R	Solid	202	N/A	Plain	N/A			POLARIS Hawkeye 300 2x2/4x2 Hawkeye 2x4/4x4 Sportsman 300 (4x4) 400 Sportsman HO 4x4	06 07 08-10 08-10
MD6274D	F	Solid	173	N/A	Plain	N/A			POLARIS 200 Phoenix (AC/AD Model and following R drum model) 200 Phoenix (R drum model) 200 Phoenix (EC/ED Onwards - Quadricycle R Disc Model) 200 Phoenix Quadricycle (R disc model) 200 Sawtooth (R drum model) 200 Sawtooth Quadricycle (R disc model)	05-09 10-14 05-09 05-10 06-07 06/08
MD6275D UTVX6275	R R	Solid Solid	218 218	N/A N/A	Plain Vee	N/A N/A			POLARIS 325 Hawkeye 2x4 325 Sportsman Ace 325 Sportsman Ace EFI 325 Sportsman Ace Euro 325 Sportsman Ace HD 325 Ranger ETX Sportsman 500 EFI/HO 500 Sportsman EFI Quad H.O. Sportsman 450 Sportsman 500 X2/EFI 500 Sportsman Touring H.O. 400 Hawkeye H.O. (2x4) 400 Ranger 400 Ranger 4x4 400 Ranger (All models) Ranger 400 HO 400 Sportsman HO 4x4 Ranger EV (Electric) 500 Ranger (Carb) 2x4 500 Ranger (EFI) 2x4 500 Ranger 4x4 EFI Ranger 500 (2x4/4x4) Ranger 500 (4x4 EFI) 500 Sportsman Touring HO Ranger Crew 500 Sportsman X2 500 EFI 570 Forest Tractor EFI/EPS 570 Ranger EFI 570 Ranger Crew EFI RZR 570 570 Sportsman EFI (inc EPS) 570 Sportsman Touring EFI 570 Sportsman Ace/Ace Euro 700 Ranger 4x4 EFI 700 Ranger Crew (EFI) 4x4 Ranger 6x6 EFI 700 Ranger XP 700 4x4 Ranger TM Ranger 700 6x4 EFI Ranger 700 4x4 EFI/LE Ranger XP 700 4x4 Sportsman 700 EFI 700 Sportsman X2 Ranger Crew 800 800 Ranger 6x6 800 Ranger XP	15 14 15 14-15 15 15 07-08 08-10 07 06-08 08-10 13-14 10 12 10-13 10-11 11-12 10 08-09 09-10 11-12 06-07 06-08 11-12 11-12 07-09 15 14 14-15 14-15 15 09 09 06 06 06 08 07 08 07 08 10-12 10-12 10-12

BRAKE ROTOR BUYERS GUIDE - DIRTBIKE/ATV/UTV

Rotor No.	F/R	Type	Dia. (mm)	Hub Color	Profile	Bobbins	Left Bracket	Right Bracket	Model	Year
MD6275D UTVX6275 Contd.	R	Solid	218	N/A	Plain	N/A			POLARIS 800 Ranger HD 800 Ranger RZR-4 800 Ranger RZR 4 EPS RZR 800 EFI (inc EPS Models) RZR 4 800 EFI RZR 4 800 EPS RZR S 800 EFI 800 Ranger Mid Size 800 Ranger 6x6 800 800 Ranger EFI Ranger EV (Electric) Sportsman X2 800 EFI Sportsman 800 EFI Intl/HO Sportsman 500 EFI intl 500 Sportsman Forest 500 Sportsman Touring 500 Sportsman EFI Quad 500 Sportsman HO 800 Sportsman Forest/Forest Trader 800 Sportsman Touring/EFI 800 Sportsman Big Boss 6x6/EFI 800 Sportsman HO/EFI 800 Sportsman EFI Ranger 900 D (Diesel) 900 Ranger XP 900 900 Ranger Crew Diesel 900 Ranger Crew 900 (Ranger XP 900) 1000 Ranger Diesel/Diesel Crew Brutus	10-12
	R	Solid	218	N/A	Vee	N/A				11 12 08-14 10-14 12 09-14 13 10-15 13-14 10-15 07-09 07-10 07 12 08-12 08-09 08-12 12 08-09 09-12 08-09 10-12 11-12 13 13 10-15 15 15 13-14
MD6277D	F	Solid	160	N/A	Plain	N/A			SUZUKI LT-R 450 K6/K7/K8/K9/L1 LT-R 450 ZK8/ZK9 Quad Racer Ltd Edition	06-11 08-09
MD6278D	R	Solid	190	N/A	Plain	N/A			SUZUKI LT-R 450 K6/K7/K8/K9/L1 LT-R 450 ZK8/ZK9 Quad Racer Ltd Edition	06-11 08-09
MD6281D	F	Solid	220	N/A	Plain	N/A			SUZUKI RV 200 L6/L7 Van-Van	16-19
MD6282D	R	Solid	190	N/A	Plain	N/A			BOMBARDIER DS 250	06
									CAN-AM DS 250	07-15
									YAMAHA YM 90 RY/RZ/RA/RB/RD Raptor	09-13
MD6283D	F	Solid	175	N/A	Plain	N/A			BOMBARDIER DS 250	06
									CAN-AM DS 250	07-15
									YAMAHA YFM 300 GB/GD Grizzly	12-13
									YFM 350 FB Grizzly	12
MD6285D	R	Solid	200	N/A	Plain	N/A			BOMBARDIER Rally 200	05-06
									CAN-AM Rally 200	07
MD6287D	R	Solid	220	N/A	Plain	N/A			HUSQVARNA CR 125	00-01
									SM 125	00
									SMS 125 (2T)	02-11
									SMS-4-125 (4T)	10-11
									WR 125	00-01
									WRE 125	00-11

BRAKE ROTOR BUYERS GUIDE - DIRTBIKE/ATV/UTV

Rotor No.	F/R	Type	Dia. (mm)	Hub Color	Profile	Bobbins	Left Bracket	Right Bracket	Model	Year
MD6287D Contd.	R	Solid	220	N/A	Plain	N/A			HUSQVARNA Contd. CR 250 WR 250 WR 360 TE 410 SM 570 R (4 bolt F disc) TE 570 SM 610 R SM 610/S (4 bolt F disc) TC 610 TE 610 TE 610 E TE 610/E	00-01 00-01 00-01 00 01- 01-04 00 02-06 00 00 02-03 06-09
MD6288D MD6288C	R R	Solid Solid	240 240	N/A N/A	Plain Contour	N/A N/A			HUSQVARNA CR 125 WR 125 TC 250 TE 250 TXC 250 Cross Country WR 250 TE 310 (4T) TE 410 SMR 450 RR (Radial caliper) SM 450 R (Radial caliper) TC 450 TE 450 TXC 450 Cross Country SM 510 R (Radial caliper) TC 510 TE 510 TXC 510 Cross Country SM 610 S (Radial caliper)	06-08 06-08 05-08 06-08 08 06-09 09 06 06-08 07-10 05-10 06-10 08 06-10 05-09 06-10 08 06
MD6289D MD6289C	F F	Solid Solid	260 260	N/A N/A	Plain Contour	N/A N/A			GAS-GAS EC 125/200/250/300 (2T) MC 125 MX 125/250	00-12 05 01-08
MD6290D	R	Solid	228	N/A	Plain	N/A			POLARIS 450 Outlaw MXR Outlaw 500 525 S Outlaw 525 Outlaw IRS	09-10 06-07 08-10 08-10
MD6291D	F	Solid	220	N/A	Plain	N/A			YAMAHA YFM 550 FGY/Z/A/B/D/E 4WD Grizzly Auto Fi YFM 550 FGPY/Z/A/B/D/E EPS Grizzly Auto Fi YFM 700 FGPW/FGPX/FGPY/FGPZ/FGPA/FGPB/FGPD/E Grizzly YFM 700 FGPSEY/Z/A/B/D/E Grizzly FI Auto 4x4 EPS Special Edition YFM 700 FGX/FGY/FGZ/FGA/FGB/FGD/E Grizzly YFM 700 FGPDUW/FGPDUX/FGPDUY Ducks Unlimited Edition	09-14 09-14 07-14 09-14 08-14 07-09
MD6292D	R	Solid	205	N/A	Plain	N/A			YAMAHA YFM 550 FGY/Z/A/B/D/E 4WD Grizzly Auto Fi YFM 550 FGPY/Z/A/B/D/E EPS Grizzly Auto Fi YFM 700 FGPW/FGPX/FGPY/FGPZ/FGPA/FGPB/FGPD/E Grizzly YFM 700 FGPSEY/Z/A/B/D/E Grizzly FI Auto 4x4 EPS Special Edition YFM 700 FGX/FGY/FGZ/FGA/FGB/FGD/E Grizzly YFM 700 FGPDUW/FGPDUX Ducks Unlimited Edition	09-14 09-14 07-14 09-14 08-14 07-08
MD6293D	F	Floating	240	Gold	Plain	9			HUSQVARNA SM 400 R SM 450 R SMR 450 RR (Radial caliper) SM 450 R (Radial caliper) SM 510 R SM 510 R (Radial caliper) SM 570 R (4 bolt F disc) SM 570 R	02 03-06 06-08 07-10 05 06-10 01- 02-04

BRAKE ROTOR BUYERS GUIDE - DIRTBIKE/ATV/UTV

Rotor No.	F/R	Type	Dia. (mm)	Hub Color	Profile	Bobbins	Left Bracket	Right Bracket	Model	Year
MD6293D Contd.	F	Floating	240	Gold	Plain	9			HUSQVARNA Contd. SM 610/S (4 bolt F disc) SM 610 S (Radial caliper) SM 610 IE SM 630 SMR 630 SMS 630 STR 650 CRC	02-06 06 07-09 09-10 06 10-11 07
MD6294D	F	Floating	320	Gold	Plain	9			HUSQVARNA LT 610 (6 bolt F disc) SM 610 (6 bolt F disc)	00 98-99
MD6295D	R	Solid	220	N/A	Plain	N/A			HUSQVARNA CR 125 WR 125 CR 250 TC 250 TE 250 WR 250 WR 360 SM 400 R TE 400 SM 450 R TC 450 TE 450 SM 510 R TC 510 TE 510 SM 570 R TC 570 LT 610 (6 bolt F disc) SM 610 IE SM 630 SMR 630 SMS 630 TE 630 STR 650 CRC	02-05 02-05 02-05 02-03 02-05 02-05 02 02 02 03-06 03 03-05 05 04 04-05 02-04 02-03 00 07-09 09-10 06 10-11 10 07
MD6298D	R	Floating	240	Gold	Plain	9			KTM 690 SMC 950 R Super Enduro 990 Adventure R 990 Adventure S 990 Adventure (ABS Model) 990 Adventure Baja Edition	08-10 07-08 09-12 06-08 07-12 13-14
MD6299D MD6299C	F F	Floating Floating	300 300	Gold Gold	Plain Contour	9 9			KTM 690 Enduro R 950 R Super Enduro 990 Adventure R (Non ABS) 990 Adventure S (Non ABS)	10-13 07-08 09-12 06-08
MD6301D	R	Solid	160	N/A	Plain	N/A			HYOSUNG TE 50 TE 90 TE 100	05-08 05-08 05-08
MD6302D	F	Solid	185	N/A	Plain	N/A			HONDA TRX 420 FA Fourtrax Rancher AT/IRS TRX 420 FM Fourtrax Rancher 4x4 TRX 420 FPE Fourtrax Rancher 4x4 ES/EPS TRX 420 FPM Fourtrax Rancher 44 PS TRX 420 TM Fourtrax Rancher TRX 420 TE Fourtrax Rancher ES TRX 420 FPA Power Steering Fourtrax Rancher AT/IRS	09-14 07-13 09-13 09-13 07-13 07-13 09-14
MD6304C	R	Solid	200	N/A	Contour	N/A			KAWASAKI KSF 450 B8F/B9F/BAF/BBF/BCF/BDF/BEF (KFX 450 R)	07-14

BRAKE ROTOR BUYERS GUIDE - DIRTBIKE/ATV/UTV

Rotor No.	F/R	Type	Dia. (mm)	Hub Color	Profile	Bobbins	Left Bracket	Right Bracket	Model	Year
MD6305D MD6305C MD6305CX	R R R	Solid Solid Solid	240 240 240	N/A N/A N/A	Plain Contour Vee	N/A N/A N/A			SUZUKI RM 125 K6/K7/K8 RM 250 K6/K7/K8	06-08 06-08
MD6307D	F	Solid	300	N/A	Plain	N/A			APRILIA ETV 1000 Caponord (ABS - Bolt fixing)	01-03
MD6308D	R	Solid	270	N/A	Plain	N/A			APRILIA ETV 1000 Caponord (Non ABS - Bolt fixing) ETV 1000 Caponord Rally (Non ABS - Bush fixing) ETV 1000 Caponord (ABS - Bush fixing)	01-03 03 04-07
MD6309C MD6309CX SMX6309	F F F	Solid Solid Floating	280 280 280	N/A N/A Black	Contour Vee Contour	N/A N/A 6			KAWASAKI KL 650 E8F/E9F/EAF/EBF/ECF/EDF/EEF/EFF (KLR 650)	08-15
MD6310C MD6310CX	R R	Solid Solid	240 240	N/A N/A	Contour Vee	N/A N/A			KAWASAKI KL 650 E8F/E9F/EAF/EBF/ECF/EDF/EEF/EFF (KLR 650)	08-15
MD6311D	R	Solid	220	N/A	Plain	N/A			POLARIS 200 Phoenix (EA/EB) Quadricycle Model (R disc model) 200 Phoenix (EC/ED Onwards - Quadricycle R Disc Model) 200 Sawtooth Quadricycle (R disc model) 200 Phoenix Quadricycle (R disc model)	05 05-09 06/08 05-09
MD6312D UTVX6312	F F	Solid Solid	235 235	N/A N/A	Plain Vee	N/A N/A			POLARIS RZR 570 RZR 800 EFI (inc EPS Models) RZR S 800 EFI	12-13 08-14 09-14
MD6313C	F	Solid	310	N/A	Contour	N/A			KTM 450 SMR 560 SMR	07-12 07
MD6314D MD6314C MD6314CX OSX6314 SMX6314	F F F F F	Solid Solid Solid Floating Floating	220 220 220 280 320	N/A N/A N/A Silver Black	Plain Contour Vee Contour Contour	N/A N/A N/A 6 6			HONDA CRF 150 R/RB	07-21
MD6316D MD6316C MD6316CX	R R R	Solid Solid Solid	190 190 190	N/A N/A N/A	Plain Contour Vee	N/A N/A N/A			HONDA CRF 150 R/RB	07-21
MD6317D MD6317C OSX6317 SMX6317	F F F F	Solid Solid Floating Floating	240 240 280 320	N/A N/A Silver Black	Plain Contour Contour Contour	N/A N/A 6 6			HONDA CRF 150 F	03-20
MD6319C	R	Solid	230	N/A	Contour	N/A			YAMAHA WR 250 RX/RV/RZ/RA/RB/RD/RE/RF WR 250 XX/XY/XZ/XA (Supermotard)	08-15 08-11
MD6320C MD6320CX	F	Floating	250	Gold	Contour	6			YAMAHA WR 250 RX/RV/RZ/RA/RB/RD/RE/RF	08-15
MD6321C	R	Solid	198	N/A	Contour	N/A			CAN AM DS 450 (2x4/EFI) DS 450 X (2x4/EFI) DS 450 Xxc/Xxm	08-15 08-09 10-15
MD6322C	F	Solid	225.5	N/A	Contour	N/A			CAN AM DS 450 (2x4/EFI) DS 450 X (2x4/EFI) DS 450 Xxc/Xxm	08-15 08-09 10-15
MD6323C	F	Floating	298	Gold	Contour	6			HUSQVARNA WR 250 XX/XY/XZ/XA (Supermotard)	08-11

ROTOR BUYERS GUIDE

BRAKE ROTOR BUYERS GUIDE - DIRTBIKE/ATV/UTV

Rotor No.	F/R	Type	Dia. (mm)	Hub Color	Profile	Bobbins	Left Bracket	Right Bracket	Model	Year
MD6325D UTVX6325	F F	Solid Solid	220 220	N/A N/A	Plain Vee	N/A N/A			KAWASAKI KRF 750 A8F/B8F (Teryx 750 4x4) KRF 750 C8F/D8F (Teryx 750 4x4 LE) KRF 750 F8F (Teryx 750 4x4 NRA Outdoors) KRF 750 G9F/NAF/NBF/NCS/NDF (Teryx 750 Fi 4x4) KRF 750 J9FA/K9F/PAF/PBF/RAF/RBF/RCS/PCF/RDF/PDF (Teryx 750 Fi 4x4 LE) KRF 750 L9F (Teryx 750 Fi 4x4 Le Sport) KRF 750 M9F (Teryx 750 Fi 4x4 NRA Outdoors) KRF 750 SAF/SAFA/SBF/SBFA/SCS/SCSA/SDF (Teryx 750 Fi 4x4 Sport) KRF 750 TAF/VBF/VCS (Teryx 750 Fi 4x4 SGE)	08 08 08 09-13 09-13 09 09 10-13 10-12
MD6326C	R	Solid	240	N/A	Contour	N/A			KAWASAKI KLX 250 S KLX 300 KLX 300 R	09-21 21 19-21
MD6327C	R	Solid	186	N/A	Contour	N/A			KAWASAKI KLX 140 KLX 140 L	08-21 08-21
MD6328C	F	Solid	220	N/A	Contour	N/A			KAWASAKI KLX 140/KLX 140 L	08-21
MD6329C OSX6329 SMX6329									USE MD6330C USE OS6330 USE SMX6330	
MD6330D MD6330C MD6330CX OSX6330 SMX6330	F F F F F	Floating Floating Floating Floating Floating	250 250 250 280 320	Silver Silver Silver Silver Black	Plain Contour Vee Contour Contour	6 6 6 6 6		BRK021 BRK022	KAWASAKI KLX 250 S KLX 250	06-07 14-20
MD6331D	R	Solid	200	N/A	Plain	N/A			HONDA TRX 700 XX	08-11
MD6332D UTVX6332	R R	Solid Solid	185 185	N/A N/A	Plain Vee	N/A N/A			YAMAHA YXR 700 Rhino F1 (All models)	08-09/11-13
MD6333D	R	Solid	165	N/A	Plain	N/A			YAMAHA YXR 700 Rhino F1 (All models)	08-09/11-13
MD6334D	R	Solid	180	N/A	Plain	N/A			BOMBARDIER DS 90 X (2x4/4T)	08-15
MD6335D	F	Solid	165	N/A	Plain	N/A			BOMBARDIER DS 90 X (2x4/4T)	08-15
MD6336C	F	Floating	180	Gold	Contour	6			KTM SX 450 XC 450 SX 505 XC 525	09-12 08-12 09-12 08-12
MD6337D	R	Solid	200	N/A	Plain	N/A			KTM SX 450 XC 450 SX 505 XC 525	09-12 08-12 09-12 08-12
MD6338D UTVX6338	F F	Solid Solid	227 227	N/A N/A	Plain Vee	N/A N/A			POLARIS 500 Ranger (EFI) 4x4 H.O. RZR 570 700 Ranger 4x4 EFI RZR 4 800 EFI RZR 4 800 EPS Ranger Crew 800 800 Ranger 6x6 800 Ranger XP/HD 800 Ranger 6x6 800	09-10 14-19 09 10-14 12 10-12 10-15 10-12 10-13

BRAKE ROTOR BUYERS GUIDE - DIRTBIKE/ATV/UTV

Rotor No.	F/R	Type	Dia. (mm)	Hub Color	Profile	Bobbins	Left Bracket	Right Bracket	Model	Year
MD6338D UTVX6338 Contd.	F	Solid	227	N/A	Plain	N/A			POLARIS Contd. 800 Ranger EFI Ranger 4x4 900 D (Diesel) 900 Ranger RZR XP 900 Ranger XP 900 900 Ranger Crew Diesel 900 Ranger Crew RZR XP 900 (inc EPS Models) RZR-4 XP 900 RZR 900 50 inch all options RZR S 900 60 inch all options 900 (Ranger XP 900) 1000 Ranger Diesel/Diesel Crew 1000 General 4 EPS (2 Seat) 1000 General 4 EPS (4 Seat) Brutus Sportsman 1000 MD/XP Sportsman XP S 55"	13-14 11-12 12 13 11-14 10-15 11-14 12-15 15-19 15-19 15 15 16 17-19 13-14 15-19 20-21
MD6339D	F & R	Solid	246	N/A	Plain	N/A			POLARIS 550 XP Sportsman EPS 550 Sportsman 550 Sportsman X2 550 Sportsman Touring EPS 550 Sportsman EPS 550 Sportsman Forest 800 Sportsman XP 850 HO EPS 850 Forest 850 Scrambler XP HO 850 Scrambler 850 XP Sportsman 850 Sportsman XP EPS 850 Sportsman Touring EPS 850 Sportsman Touring H.O. EPS 850 Sportsman Forest 1000 Forest 1000 Scrambler 1000 XP Scrambler 1000 Sportsman MD/XP	09-10 11-12 10-12 10-12 10-12 12 13-15 15 13-15 15 09-10 09-10 10-12 13-15 12 15 15 14 15
MD6341D	F & R	Solid	200	N/A	Plain	N/A			HONDA SXS 500 M2 Pioneer MUV 700 Big Red SXS 700 M2 Pioneer (2 Seat) SXS 700 M4 Pioneer (4 Seat)	15-17 09-13 16-18 16-18
MD6342D MD6342C	R R	Solid Solid	220 220	N/A N/A	Plain Contour	N/A N/A			BMW G 450 X	08-11
MD6343C OSX6343 SMX6343	F F F	Solid Floating Floating	260 280 320	N/A Silver Black	Contour Contour Contour	N/A 6 6			BMW G 450 X	08-11
MD6344D UTVX6344	R R	Solid Solid	220 220	N/A N/A	Plain Vee	N/A N/A			POLARIS RZR 170	09-15
MD6351C	F	Floating	300	Gold	Contour	6			KAWASAKI KLX 250 SF Supermotard (KLX 250 W9F/WAF)	09-10
MD6352C	R	Solid	240	N/A	Contour	N/A			KAWASAKI KLX 250 SF Supermotard (KLX 250 W9F/WAF)	09-10
MD6353D UTVX6353	F F	Solid Solid	125 125	N/A N/A	Plain Vee	N/A N/A			POLARIS RZR 170	09-15
MD6355D	F	Solid	190	N/A	Plain	N/A			SUZUKI LT-A 500 XPZK9/XPZL3 King Quad 500 AXi Power Steering Limited LT-A 500 XPCK9 King Quad 500 AXi Power Steering Camo LT-A 500 XPK9/XPL1/XPL2/XPL3/XPL4/XPL5 King Quad 500 AXi Power Steering LT-A 500 XL1/XL2/XL3/XL4/XL5 King Quad 500 AXi	09/13 09 09-15 11-22

BRAKE ROTOR BUYERS GUIDE - DIRTBIKE/ATV/UTV

Rotor No.	F/R	Type	Dia. (mm)	Hub Color	Profile	Bobbins	Left Bracket	Right Bracket	Model	Year
MD6355D Contd.	F	Solid	190	N/A	Plain	N/A			SUZUKI Contd. LT-A 500 XCLi/XCL2/XCL3/XCL4/XCL5 King Quad 500 AXi Camo LT-A 750 CRK9 King Quad 740 AXi Rockstar Edition LT-A 750 XPX9/XPL1/XPL2/XPL3/XPL4/XPL5 King Quad 750 AXi Power Steering LT-A 750 XPZX9/XPZL5 King Quad 750 AXi Power Steering Limited LT-A 750 XPCK9/XPCL1/XPL2-XPL5 King Quad 750 AXi Power Steering Camo	11-15 09 09-22 09/15 09-15
MD6356D MD6356C MD6356CX	F F F	Floating Floating Floating	250 250 250	Gold Gold Gold	Plain Contour Vee	6 6 6			YAMAHA YZ 125 N/P/R/S/T/N/W/X/Y/Z/A/B/D/E/F/G WR 250 FN/FP/FR/FS/FT/FV/FW/FX/FY/FZ/FA/FB/FD/FE/FF/FG/FH/FJ (4T) YZ 250 N/P/R/S/T/N/W/X/Y/Z/A/B/D/E/F/G (2T) YZ 250 FN/FP/FR/FS/FT/FV/FW/FX/FY/FZ/FA/FB/FD/FE/FF/FG/FH/FJ YZ 450 FR/FS/FT/FV/FW/FX/FY/FZ/FA/FB/FD/FE/FF WR 450 FR/FS/FT/FV/FW/FX/FY/FZ/FA/FB/FD/FE	01-16 01-18 01-16 01-18 03-15 03-14
MD6360C	R	Solid	210	N/A	Contour	N/A			GAS GAS (Pierer Mob) MC 85 HUSQVARNA TC 85 Small Wheel 17"/14" TC 85 Big Wheel 19"/16" KTM SX 85 (17"/14" wheels) SX 85 (19"/16" wheels) Freeride 250 R 350 Freewind (4T) 350 Freewind Electric	21-22 14-22 14-22 12-20 12-20 15-21 12 12
MD6362C	R	Solid	190	N/A	Contour	N/A			KAWASAKI KLX 150 S	09
MD6363C	F	Solid	240	N/A	Contour	N/A			KAWASAKI KLX 150 S	09
MD6365D	F	Solid	196	N/A	Plain	N/A			HONDA TRX 500 FPM Fourtrax Foreman TRX 500 FM Fourtrax Foreman TRX 500 FPE Fourtrax Foreman TRX 500 FE Fourtrax Foreman	12-13 12-13 12-13 12-13
MD6366D UTVX6366	F & R F & R	Solid Solid	215 215	N/A N/A	Contour Vee	N/A N/A			CAN AM Commander 800 R (STD) Commander 800 (XT/DPS) Commander 1000 (DPS) Commander 1000 (LTD) Commander 1000 (STD) Commander 1000 X Commander 1000 XT Commander 1000 XT-P	11-15 11-15 13-15 12-15 11-15 11-13 11-15 14-15
MD6367C	F	Floating	260	Gold	Contour	6			BETA RR 350 4T Enduro RR 525 4T Enduro	11 05-09
MD6368C	R	Solid	240	N/A	Contour	N/A			BETA RR 350 4T Enduro RR 525 4T Enduro	11 05-09
MD6369D	R	Solid	220	N/A	Plain	N/A			YAMAHA YFM 300 FB Grizzly YFM 300 GB/GD Grizzly	12 12-13
MD6370D UTVX6370	F & R F & R	Solid Solid	215 215	N/A N/A	Contour Vee	N/A N/A			CAN AM Outlander L 450 EFI Outlander L Max 450 EFI Outlander L 500 EFI Outlander 500 4x4 (DPS) Outlander 6x6 XT Renegade 500 (STD/EFI) Outlander 650 (4x4 DPS/XT/STD) Outlander 500 (STD)	15 15 15 13-14 14-15 12-15 13-14 13-14

ROTOR BUYERS GUIDE

BRAKE ROTOR BUYERS GUIDE - DIRTBIKE/ATV/UTV

Rotor No.	F/R	Type	Dia. (mm)	Hub Color	Profile	Bobbins	Left Bracket	Right Bracket	Model	Year
MD6370D UTVX6370 Contd.	F & R	Solid	215	N/A	Contour	N/A			CAN AM Contd. Outlander 500 XT Outlander Max 500 XT Outlander Max 500 4x4 (DPS) Outlander Max 500 (STD) Outlander L Max 500 EFI Outlander Max 650 4x4 (STD/DPS/XT) Outlander 650 XMR Outlander 800 R STD/R XT Outlander 800 R XT-P Outlander 800 R (DPS) Outlander 800 R XMR Outlander Max 800 R 4x4 (DPS/XT/XT-P) Renegade 800 R STD Renegade 800 R Xxc Commander Max 1000 DPS/XT Commander Max 1000 LTD Maverick 1000 STD Maverick 1000 STD/XRS/XRS-DPS Maverick 1000 XDS-DPS Maverick 1000 XMR Maverick 1000 XRS/Maverick 1000 XRS - DPS Maverick 1000 XXC Maverick Max 1000 STD Maverick Max 1000 XRS-DPS Maverick Max 1000 XDS-DPS Outlander 1000 STD Outlander 1000 XT/XTP Outlander 1000 4x4 (DPS) Outlander Max 1000 (4x4/DPS/XT/XT-P/LTD/STD) Renegade 1000 STD/EFI Renegade 1000 Xxc	
	F & R	Solid	215	N/A	Vee	N/A				
MD6371D MD6371C	R	Solid	220	N/A	Plain	N/A			KTM EXC 350 LC4 (Standard forks) Duke 400 LC4 EGS 400/EGS-E/LSE (LC4 Enduro) LC4-E 400 Enduro SC 400 (Supercompetition LC4) EXC 440 SX 440 LC4 MX 600 Brembo Calipers LC4 EXC 600 Brembo Calipers LC4 MX 600 Grimeca Calipers LC4 EXC 600 Grimeca Calipers LC4 EXC 600 Duke 620 LC4 EGS 620 Enduro/EGS-E/LSE EGS-E 620 Adventure/Rallye LC4 620 SC Supermoto SC 620 Supercompetition SX 620/EXC/EGS SX EXC/EGS 620 SX 620 LC4 625 SC Supermoto LC4 625 SC Supercompetition Duke II 640 Orpheus/Titan/Lime Duke II 640 Black/Orange LC4-E 640 Enduro LC4-E 640 Supermoto LC-4 640 Adventure R LC-4 Adventure LC 640 Adventure R LC 640 Adventure 640 Duke (Jet Black/Yellow/Adrenalin Orange) SMC 660 Supermoto SMC 640 LC4 SMC 660	
	R	Solid	220	N/A	Contour	N/A				

BRAKE ROTOR BUYERS GUIDE - DIRTBIKE/ATV/UTV

Rotor No.	F/R	Type	Dia. (mm)	Hub Color	Profile	Bobbins	Left Bracket	Right Bracket	Model	Year
MD6372C MD6372CX	F F	Solid Solid	256 256	N/A N/A	Contour Vee	N/A N/A			HONDA CRF 250 L (Non ABS) CRF 250 LA (ABS)	13-17 17
MD6373C MD6373CX	R R	Solid Solid	220 220	N/A N/A	Contour Vee	N/A N/A			HONDA CRF 250 L (Non ABS) CRF 250 LA (ABS) CRF 250 RL Rally (Non ABS) CRF 250 RLA Rally (ABS)	13-21 17-21 17-21 17-21
MD6374D UTVX6374	R R	Solid Solid	218 218	N/A N/A	Contour Vee	N/A N/A			POLARIS See application listings for more details	
MD6375D	F & R	Solid	200	N/A	Plain	N/A			ARCTIC CAT See application listings for more details	
MD6376D UTVX6376	R R	Solid Solid	200 200	N/A N/A	Plain Vee	N/A N/A			KYMCO MXU 500 (4x4/IRS) MXU 500 (Side x Side) MXU 500i/IRS (All EFI Models) UXV 500i (All EFI Models) MXU 700i (All models)	10-11 09-14 12-14 13-14 13-14
MD6379C	F	Solid	240	N/A	Contour	N/A			GAS GAS (Pierer Mob) MC 85 KTM SX 85 (Wheel 17/14" 240mm F/disc) SX 85 (Wheel 19/16" 240mm F/disc)	21-22 21-22 21-22
MD6380D UTVX6380	F & R F & R	Solid Solid	245 245	N/A N/A	Plain Vee	N/A N/A			POLARIS RZR XP 1000 RZR RS1 (R03)/(R06) RZR XP 4 1000 (R02) RZR XP 4 1000 (R07) RZR XP 4 1000 (R11) RZR XP 4 1000 MD (R04)/(R05) RZR XP4 Turbo S RZR XP Turbo S Velocity	14-15 18-19 19 18 17 17-18 19-20 19-20
MD6381D	R	Solid	200	N/A	Plain	N/A			YAMAHA YXM 700 Viking Fi 4x4 EPS (Parking brake) YXM 700 Viking Fi (Parking brake) YXC 700 DFG Viking V1 (Parking brake) YXC 700 PFG Viking V1 EPS (Parking brake) YXC 700 PSF Viking EPS (Parking brake) YXM 700 PSE/PSF Viking EPS (Parking brake)	14-15 14-15 14-15 15-16 15 15 14-15
MD6382D UTVX6382	F & R F & R	Solid Solid	205 205	N/A N/A	Plain Vee	N/A N/A			YAMAHA YXM 700 Viking Fi 4x4 EPS YXM 700 Viking Fi YXC 700 DFG/dxg Viking V1 YXC 700 PFG Viking V1 EPS YXC 700 PSF Viking EPS YXM 700 PSE/PSF Viking EPS	14-15 14-15 14-15 15-16 15 15 14-15
MD6383D UTVX6383	F & R F & R	Solid Solid	203 203	N/A N/A	Plain Vee	N/A N/A			ARCTIC CAT (ATV) Alterra 400 Alterra 500 Alterra TRV 550 XT Alterra 570 Alterra 700 inc XT & Mudpro Alterra TBX 700 Alterra VLX 700 XR 700 LTD/XT Alterra 1000 TRV XT EPS 1000 Mudpro SE EPS ARCTIC CAT (SIDE X SIDE) Wildcat X 1000 Wildcat x SE EPS 1000	16-18 16-19 16-19 19 16-19 17-18 17-18 15 17 16 14-16 16

BRAKE ROTOR BUYERS GUIDE - DIRTBIKE/ATV/UTV

Rotor No.	F/R	Type	Dia. (mm)	Hub Color	Profile	Bobbins	Left Bracket	Right Bracket	Model	Year
MD6384D UTVX6384	F & R F & R	Solid Solid	252 252	N/A N/A	Plain Vee	N/A N/A			ARCTIC CAT (SIDE X SIDE) Wildcat Trail 700 XT inc LTD Wildcat 4X 1000 Wildcat 4X LTD 1000 Wildcat 4 1000 Wildcat 4 LTD 1000	15-19 14-16 14-15 13-14 14
MD6387D	F	Solid	190	N/A	Plain	N/A			HONDA TRX 420 TM1 Rancher TRX 420 TE1 Rancher ES TRX 420 FA1 Rancher 4x4 Auto DCT TRX 420 FA2 Rancher 4x4 Auto/DCT/EPS TRX 420 FA6 Rancher 4x4 Auto/DCT/IRS/EPS TRX 420 FE1 Rancher 4x4/ES TRX 420 FM1 Rancher 4x4 TRX 420 FM2 Rancher 4x4/EPS TRX 500 FA5 Foreman Rubicon 4x4 Auto/DCT TRX 500 FA6 Foreman Rubicon 4x4 Auto/DCT/EPS TRX 500 FE1 Foreman ES TRX 500 FM1 Foreman TRX 500 FM2 Foreman EPS TRX 500 FM5 Foreman Rubicon 4x4 TRX 500 FM6 Foreman Rubicon 4x4/EPS TRX 500 FZ2 Foreman ES/EPS	14-21 14-21 14-21 14-21 14-21 14-21 14-21 14-21 15-21 15-21 14-21 14-21 14-21 14-21 15-21 15-21 14-21 14-21 15-21 15-21 14-21
MD6388C MD6388CX	F F	Floating Floating	270 270	Gold Gold	Contour Vee	6 6			KAWASAKI KX 250 F 270mm f/rotor, 240mm r/rotor KX 250 F 270mm f/rotor, 250mm r/rotor KX 250 F 270mm f/rotor, 240mm r/rotor KX-F 250 XC F XC KLX 300 R KX 450 F (FFF/HGF/HHF) KX-F 450 KXF 450 Tomac KX-F 450 XC	15-19 20 21-22 21 16-21 15-17 18-22 18-19 21-22
MD6389C MD6389CX OSX6389 SMX6389	F F F F	Floating Floating Floating Floating	260 260 280 320	Gold Gold Silver Black	Contour Vee Contour Contour	6 6 6 6			HONDA CRF 250 R AC CRF 250 RX CRF 450 R CRF 450 R CRF 450 R-S F-disc 260mm, R-disc 240mm CRF 450 RWE CRF 450 X	15-22 19-22 15-21 17-22 22 19-22 17-21
MD6390D MD6390C	F F	Solid Solid	220 220	N/A N/A	Plain Contour	N/A N/A			HONDA CRF 125F CRF 125FB	14-21 14-21
MD6392C MD6392CX	F F	Floating Floating	270 270	Gold Gold	Contour Vee	6 6			YAMAHA YZ 125 YZ 125 Monster energy YZ 250 2T YZ 250 Monster Energy 2T YZ 250 F YZ 250 FGY 60th Anniversary Model YZ 450 F YZ 450 FGY 60th Anniversary Model WR 450 F	17-22 22 21-22 22 16-21 16 16-21 16 16-21
MD6395D UTVX6395	F & R F & R	Solid Solid	245 245	N/A N/A	Plain Vee	N/A N/A			YAMAHA YXZ 1000 R EPS Special Edition	16-21

BRAKE ROTOR BUYERS GUIDE - DIRTBIKE/ATV/UTV

Rotor No.	F/R	Type	Dia. (mm)	Hub Color	Profile	Bobbins	Left Bracket	Right Bracket	Model	Year
MD6396D UTVX6396	F & R F & R F & R F & R	Solid Solid Solid Solid	220 220 220 220	N/A N/A N/A N/A	Plain Vee Plain Vee	N/A N/A N/A N/A			CAN AM Defender 799cc Defender DPS 799cc Defender XT 799cc Defender XT Cab 799cc Defender 976cc Defender DPS 976cc Defender XT 976cc/XT Cab 976cc	16 16 16 16 16 16 16
MD6397D UTVX6397 OSUTVX6397	F & R F & R	Solid Solid	248 248	N/A N/A	Plain Vee	N/A N/A			POLARIS RZR XP Turbo/Latin RZR XP Turbo MD RZR XP Turbo S RZR XP Pro Turbo RZR XP Turbo Tractor RZR XP4 Turbo RZR XP4 Turbo Intl RZR XP4 Turbo MD RZR XP4 Turbo S RZR XP Turbo S Velocity RZR XP/XP4 Turbo RZR Turbo 4	17-20 17-18 18-20 20-22 17-18 17-20 17 18-20 19-20 19-20 16 19-20
MD6398D UTVX6398	F & R F & R	Solid Solid	212 212	N/A N/A	Plain Vee	N/A N/A			KAWASAKI KAF820 AFF/AGF/AHF Mule PRO - FXT KAF820 BFF/BGF/BHF Mule PRO - FXT /EPS KAF820 CFF/CGF/CHF Mule PRO - FXT /EPS LE KAF820 DFF/DGF/DHF Mule PRO - FXT /EPS Camo KAF820 EGF/EHF Mule PRO - FX KAF820 FGF/FHF Mule PRO - FX/EPS KAF820 GGF/GHF Mule PRO - FX/EPS LE KAF820 HGF/HHF Mule PRO - FX/EPS Camo KAF820 JGF/JHF Mule PRO - FXT Ranch Edition KAF1000 AGF/AHF - Mule Pro DXT/ Diesel KAF1000 BGF/BHF - Mule Pro DXT/Diesel EPS KAF1000 CGF/CHF - Mule Pro DXT EPS LE/Diesel KAF1000 DGF/DHF - Mule Pro DX /Diesel KAF1000 EGF/EHF - Mule Pro DX EPS/Diesel KAF1000 FGF/FHF - Mule Pro DX EPS LE/Diesel	15-21 15-21 15-21 15-21 16-21 16-21 16-21 16-21 16-21 16-21 16-17 16-17 16-17 16-17 16-17 16-17
MD6399D UTVX6399	F & R F & R	Solid Solid	200 200	N/A N/A	Plain Vee	N/A N/A			KAWASAKI KRT750 ACF/ADF (Tyrex 4 750 4X4) KRT750 ACFA/ADFA (Tyrex 4 750 4X4 EPS) KRT750 CCF/CDF (Tyrex 4 750 4X4 EPS LE) KRT750 DCF/DDF (Tyrex 4 750 4X4 EPS Realtree) KRF800 BEF/BFF/FGF/FHF (Tyrex) KRF800 CEF/CFE/GGF/GHF (Tyrex LE) KRF800 DEF/DFE/HGF/HFF (Tyrex Camo) KRT800 BEF/BFF/FGF/FHF (Tyrex 4) KRT800 CEF/CFE/GGF/GHF (Tyrex 4 LE) KRT800 DEF/DFE/HGF/HFF (Tyrex 4 Camo)	12-13 12-13 12-13 12-13 14-17 14-17 14-17 14-17 14-17 14-17
MD6401D	R	Solid		N/A	Plain	N/A			AJP PR3 125 Enduro PR3 125 Enduro Pro PR3 125 Extreme PR3 125 Supermoto PR3 200 Enduro/Enduro Pro PR3 200 M/X Pro	13-15 13-15 13-15 13-15 12-14 12-14
MD6406D	F	Solid	300	N/A	Plain	N/A			APRILIA ETV 1000 Caponord Rally (Non ABS - Bush fixing) ETV 1000 Caponord (ABS - Bush fixing)	03 04-07
MD6407C OSX6407	F F	Solid Floating	220 280	N/A Silver	Contour Contour	N/A 6	BRK027		HUSQVARNA TC 85 Small Wheel 17"/14" TC 85 Big Wheel 19"/16" KTM SX 85 (Wheel 17/14" 240mm F/rotor - 220mm R/rotor) SX 85 (Wheel 19/16" 240mm F/rotor, 220mm R/rotor)	21-22 21-22 21-22 21-22

ROTOR BUYERS GUIDE

BRAKE ROTOR BUYERS GUIDE - DIRTBIKE/ATV/UTV

Rotor No.	F/R	Type	Dia. (mm)	Hub Color	Profile	Bobbins	Left Bracket	Right Bracket	Model	Year
MD6408D UTVX6408	F & R F & R	Solid Solid	227 227	N/A N/A	Plain Vee	N/A N/A			POLARIS 1000 General EPS (2 Seat) 1000 General 4 EPS (4 Seat)	17-19 17-19
MD6409C	F	Floating	296	Gold	Contour	6			HONDA CRF 250 RL Rally (Non ABS) CRF 250 RLA Rally (ABS)	17 17
MD6410D UTVX6410	F & R F & R	Solid Solid	210 210	N/A N/A	Plain Vee	N/A N/A			HONDA Pioneer 1000 SXS (2 Seater) Pioneer 1000 SXS (4 Seater)	16-21 16-21
MD6411D UTVX6411	F F	Solid Solid	260 260	N/A N/A	Plain Vee	N/A N/A			Maverick X3 Maverick X3 Max Maverick X3 Turbo Maverick X3 Max Turbo Maverick X3 Turbo R Maverick X3 Max Turbo R	17 17 18 18 18 18
MD6412D UTVX6412 OSKIT6411 (Oversize Rotor & Bracket Kit) OSUTVX6411 (Replacement Oversize Rotors) (Same OS Rotors used F and R)	R R	Solid Solid	247.5 247.5	N/A N/A	Plain Vee	N/A N/A			Maverick X3 Maverick X3 Max Maverick X3 Turbo Maverick X3 Max Turbo Maverick X3 Turbo R Maverick X3 Max Turbo R	17 17 18 18 18 18
MD6414D MD6414C	F F	Floating Floating	320 320	Gold Gold	Plain Contour	6 6			KTM 690 SMC R (ABS) HUSQVARNA 701 Supermoto	14-21 18-21
MD6415D MD6415C	R R	Solid Solid	240 240	N/A N/A	Plain Contour	N/A N/A			KTM 690 Enduro R (ABS) 690 SMC R (ABS) HUSQVARNA 701 Supermoto	09-21 14-21 18-21
MD6417C	R	Floating	240	Gold	Contour	6			HUSQVARNA 701 Enduro	16-21
MD6418D MD6418C	F	Solid Solid	197 197	N/A N/A	Plain Contour	N/A N/A			YAMAHA YZ 65	18-21
MD6419D MD6419C	R	Solid Solid	190 190	N/A N/A	Plain Contour	N/A N/A			YAMAHA YZ 65	18-21
MD6420D MD6420C	F F	Floating Floating	270 270	Gold Gold	Plain Contour	6 6			USE MD6388C	
MD6421D MD6421C MD6421CX	R R R	Solid Solid Solid	250 250 250	N/A N/A N/A	Plain Contour Vee	N/A N/A N/A			KAWASAKI KX-F 250 KX 450 F	20 18-22
MD6422CX	Rear	Solid	270	N/A	Contour	N/A			SUZUKI RMX 250 RMZ 450	19-21 18-21
MD6423D MD6423C	R R	Solid Solid	240 240	N/A N/A	Plain Contour	N/A N/A			KTM Super Duke 1290 R Super Duke 1290 GT 1290 Super Adventure S 1290 Super Adventure R	14-21 16-21 15-21 15-21
MD6424D	F	Floating	267	Gold	Plain	6			KTM Adventure 1090 Adventure 1190 Super Adventure 1290 S/R	15-18 13-16 15-21

BRAKE ROTOR BUYERS GUIDE - DIRTBIKE/ATV/UTV

Rotor No.	F/R	Type	Dia. (mm)	Hub Color	Profile	Bobbins	Left Bracket	Right Bracket	Model	Year
MD6425D	F & R	Solid	250	N/A	Plain	N/A			HONDA SXS 1000 R Talon Talón 1000 X Talón 1000 X-4	19-21 19-21 19-21
MD6426C	F & R	Solid		N/A	Contour	N/A			KTM 250 R Freeride 4T	15-21
MD6429D MD6429C	F F	Solid Solid	260 260	N/A N/A	Plain Contour	N/A N/A			SHERCO 250/300 SC-Factory 250/300/450/500 SCF-Factory 250/300/450 SE-R 250/300 SE-Factory 250/300/500 SEF-R 250/300/450/500 SEF-Factory	19-21 19-21 19-21 19-21 19-21 19-21
MD6430C	F	Solid	220	N/A	Contour	N/A			SHERCO 250/300 SC-Factory 250/300/450/500 SCF-Factory 250/300/450 SE-R 250/300 SE-Factory 250/300/500 SEF-R 250/300/450/500 SEF-Factory	19-21 19-21 19-21 19-21 19-21 19-21
MD6431C									USE MD6373C	
MD6432CX									USE MD6372C	
MD6433CX	F	Floating	260	Silver	Contour				HUSQVARNA FC 450 Rockstar Edition KTM 125 EXC 250 EXC-F Six Days 250 EXC Six Days Inc Tpi (2T) 250 SXF Prado & Troy Lee Designs 300 EXC Six Days Inc Tpi 300 XC-W 350 EXC-F Six Days 350 XCF-W 450 EXC-F Six Days 450 SXF Factory Edition Inc Herlings and Cairoli Replicas 500 EXC-F Six Days	19-21 15-16 15-20 15-20 20-22 15-20 15-18 15-20 15-16 15-20 18-20 15-21
MD6434D	F & R	Solid	260	N/A	Plain	N/A			KAWASAKI KRX 1000 Teryx	19-21
MD6435C	F	Solid	240	N/A	Plain	N/A			ZERO DS ZF8.5/ZF11.4 DS ZF8.5/ZF11.4 DS ZF9.4/ZF12.5 FX ZF2.8/ZF5.7 FX ZF2.8/ZF5.7 FX ZF2.8/ZF5.7 FX ZF3.3/ZF6.5	13 14 15 15 13 14 16-21
MD6435C	R	Solid	240	N/A	Plain	N/A			ZERO DS ZF13.0 DS ZF6.0/ZF9.0 DS ZF8.5/ZF11.4 DS ZF8.5/ZF11.4 DS ZF9.4/ZF12.5 DS II ZF14.4 DS II ZF7.2 DSR ZF13.0 DSR ZF14.4.0 DSR Black Forest Edition - ZF14.4.0 FX ZF2.8/ZF5.7 FX ZF2.8/ZF5.7 FX ZF2.8/ZF5.7 FX ZF3.3/ZF6.5	16-19 10-12 13 14 15 19-21 19-21 17-19 19-21 19-21 15 13 14 16-21

ROTOR BUYERS GUIDE

BRAKE ROTOR BUYERS GUIDE - DIRTBIKE/ATV/UTV

Rotor No.	F/R	Type	Dia. (mm)	Hub Color	Profile	Bobbins	Left Bracket	Right Bracket	Model	Year
MD6435C Contd.	R	Solid	240	N/A	Plain	N/A			ZERO Contd. FXS ZF3.3/ZF6.5 S ZF14.4 S ZF6.0 S ZF7.2 S ZF8.5/ZF11.4 S ZF8.5/ZF11.4 S ZF9.4/ZF12.5 S ZF9.8/ZF13.0 SR ZF11.4 SR ZF12.5 SR ZF13.0 SR/ F ZF13.0 SR/S ZF13.0 SR/S Deus X ZF13.0	17-21 19-21 10-12 19-21 13 14 15 16-19 14 15 16-21 19-21 19-21 21
MD6436CX	R	Solid	240	N/A	Contour	N/A			TM RACING MX 125 2S EN 125 2S Inc Tsi 2T EN 144 2S Inc Tsi MX 144 2S EN 250 Fi ES Twin Enduro 4T EN 250 Tsi ES Enduro MX 250 ES 2S 2T MX 250 Fi ES 4T EN 300 2S Inc Tsi 2T EN 300 Fi Es Twin Enduro MX 300 2S ES 2T MX 300 Fi ES 4T EN 450 Fi ES MX 450 Fi ES EN 530 Fi ES MX 530 Fi ES	10-21 10-21 10-21 10-21 10-21 10-21 10-21 10-21 10-21 10-21 10-21 10-21 10-21 10-21 10-21 10-21 10-21 10-21
MD6437CX	F	Solid	270	N/A	Contour	N/A			TM RACING MX 125 2S EN 125 2S Inc Tsi 2T EN 144 2S Inc Tsi MX 144 2S EN 250 Fi ES Twin Enduro 4T EN 250 Tsi ES Enduro MX 250 ES 2S 2T MX 250 Fi ES 4T EN 300 2S Inc Tsi 2T EN 300 Fi Es Twin Enduro MX 300 2S ES 2T MX 300 Fi ES 4T EN 450 Fi ES MX 450 Fi ES EN 530 Fi ES	10-21 10-21 10-21 10-21 10-21 10-21 10-21 10-21 10-21 10-21 10-21 10-21 10-21 10-21 10-21 10-21 10-21 10-21
MD6438CX	Rear	Solid	220	N/A	contour	N/A			CAN AM DS 450 Xxc/Xxm	10-15

ROTOR BUYERS GUIDE

EBC BRAKES CLUTCH KITS



HONDA



		CK cork OEM style Kit #	CKF carbon fiber style upgrade Kit #	CSK Spring Kit #	DRC Series Kit #	DRCF Series Kit #	SRC Series Kit #	SRK Series Kit #	CT Tool #
MB 5	82	CK1150		CSK3					CT012SP
CRF 50 F	04-21	CK1148		N/A			SRC90		
Dream 50 R (CB 50 R) (AR02)	04	CK1150		CSK48					CT012SP
NSR 50 R (RS 50)	04	CK1150		CSK3					CT012SP
XR 50 R	00-03	CK1148		N/A					
CR 60 R	83-84	CK1151	CKF1151	CSK3					CT012SP
ATC 70	78-85	CK1148		CSK18					
C 70	80-81	CK1148		CSK18					
C 70	82-83	CK1148		CSK18					
CRF 70 F	04-14	CK1148		CSK18					
CT 70 Trail	77-82	CK1148		CSK18					
CT 70 Trail	91-94	CK1148		CSK18					
SL 70 /K1	70-73	CK1105		N/A					
TRX 70 Fourtrax	86-87	CK1148		CSK18					
XR 70 R	97-03	CK1148		CSK18					
XL 75	77-79	CK1150		CSK48					CT012SP
CR 80 R	80-82	CK1151	CKF1151	CSK3					CT012SP
CR 80 R	83	CK1151	CKF1151	CSK23					CT012SP
CR 80 R	84	CK1119		CSK23					CT012SP
CR 80 R	85-86	CK1119		CSK173	DRC1				CT012SP
CR 80 R/RB Expert	87-02	CK1119		CSK173	DRC1				CT012SP
CRF 80 F	04-16	CK1150		CSK48					CT012SP
XL 80 S	80-85	CK1150		CSK22					CT012SP
XR 80/XR 80 R	79-94	CK1150		CSK22					CT012SP
XR 80 R	95-03	CK1150		CSK48					CT012SP
CR 85 R/RB	03-07	CK1119		CSK173	DRC1				CT012SP
TRX 90 Fourtrax/Sportrax	93-06	CK1151	CKF1151	N/A					CT012SP
TRX 90 EX	07-08	CK1151	CKF1151	N/A					CT012SP
TRX 90 X	09-15	CK1151	CKF1151	N/A					CT012SP
CRF 100 F	04-15	CK1151	CKF1151	CSK23	DRC49	DRCF49			CT012SP
NSF 100 R	06	CK1151	CKF1151	CSK23					CT012SP
SL 100 K	70-74	CK1119		CSK4					CT012SP
XL 100	74	CK1119		CSK4					CT012SP
XL 100 K	75	CK1119		CSK4					CT012SP
XL 100	76-78	CK1119		CSK167					CT012SP
XL 100 S	79-80	CK1151	CKF1151	CSK8					CT012SP
XL 100 S	81-85	CK1151	CKF1151	CSK8					CT012SP
XR 100 R	81-86	CK1151	CKF1151	CSK22					CT012SP
XR 100 R	87-03	CK1151	CKF1151	CSK23	DRC49	DRCF49			CT012SP
ATC 110	79-85	CK1156		CSK18					
CRF 110 R	13-19	TBA		N/A					
CT 110 Trail	80-86	CK1156		CSK18					
ATC 125 M	84-85	CK1156		CSK21					
ATC 125 M	86-87	CK1151	CKF1151	CSK48					CT012SP
CB 125 S	80-82	CK1119		CSK167					CT012SP
CB 125 S	84-85	CK1119		CSK167					CT012SP
CB 125 TT	90	CK1252		CSK167					CT012SP
CBR 125 R/RW (With Judder Spring / Canada)	04-06	CK1252		CSK193					CT012SP
CBR 125 R/RW (No Judder Spring / Canada)	07-13	CK1119	CKF1119	CSK193			SRC119	SRK119	CT012SP
CG 125 (CA/KS/KSE) Drum Front Brake	01-06	CK1119		CSK167					CT012SP
CG 125 (ES) Disc Front Brake	01-04	CK1119		CSK167					CT012SP
CL 125 A (Scrambler Twin)	65	N/A		N/A					
CL 125 S (Single)	67-74	CK1119		CSK4					CT012SP
CR 125 M Elsinore	74-78	CK1144		CSK36					CT002
CR 125 R Elsinore	79-80	CK1199		CSK31					
CR 125 R Elsinore	81	CK1191	CKF1191	CSK31					CT002
CR 125 R	82	CK1186		CSK31					CT002

CLUTCH
APPLICATIONS

EBC BRAKES CLUTCH KITS



HONDA



		CK cork OEM style Kit #	CKF carbon fiber style upgrade Kit #	CSK Spring Kit #	DRC Series Kit #	DRCF Series Kit #	SRC Series Kit #	SRK Series Kit #	CT Tool #
CR 125 R	83-84	CK1190	CKF1190	CSK24	DRC67				CT013
CR 125 R	85	CK1200		CSK24	DRC68				CT001
CR 125 R	86-99	CK1222		CSK24	DRC2				CT001
CR 125 R	00-03	CK1293	CKF1293	CSK77	DRC262	DRCF262			CT001
CR 125 R	00-07	CK1293	CKF1293	CSK77	DRC101	DRCF101			CT001
CRF 125 F	14-16	CK1325		TBA					
CRF 125 FB	14-16	CK1325		TBA					
CT 125	77	CK1119		CSK167					CT012SP
Monkey 125	19-21	CK1315		CSK197			SRC122	SRK122	CT084SP
MSX 125 GROM	13-21	CK1315		CSK197			SRC122	SRK122	CT084SP
MSX 125 GROM (ABS)	18-21	CK1315		CSK197			SRC122	SRK122	CT084SP
MT 125/K1 Elsinore	74-76	CK1144		N/A					CT002
NX 125	88-90	CK1252		CSK167	DRC50				CT012SP
NXR 125 (JC30)	03-08	CK1119		CSK167					CT012SP
SL 125 K	71-73	CK1119		CSK4					CT012SP
SS 125 A (Supersport 125)	65	N/A		N/A					
TL 125 K	71-75	CK1151		CSK167					CT012SP
TL 125 S	76	CK1119		CSK167					CT012SP
TRX 125 Fourtrax	85-86	CK1156		CSK21					
TRX 125 Fourtrax	87-88	CK1151	CKF1151	CSK48					CT012SP
XL 125 K	74-75	CK1119		CSK4					CT012SP
XL 125	76-78	CK1119		CSK4					CT012SP
XL 125 S	79-84	CK1119		CSK31					CT012SP
XL 125 S	85	CK1119		CSK167					CT012SP
CRF 150 F	03-05	CK1304		CSK77	DRC180				CT012SP
CRF 150 R (Small Wheel F 17 Inch/ R 14 Inch)	07-21	CK1191	CKF1191	CSK134	DRC182	DRCF182			CT002
CRF 150 RB (Big Wheel F 19 Inch/ R 16 Inch)	07-21	CK1191	CKF1191	CSK134	DRC182	DRCF182			CT002
NXR 150 (KD02)	03-08	CK1252		TBA					CT012SP
NXR 150 (KD03) Front Disc Model	03-08	CK1119		TBA					CT012SP
NXR 150 (KD03) Front Drum Model	03-08	CK1119		TBA					CT012SP
CD 175	67-68	CK1123		CSK8					
CD 175 K	69-71	CK1134		CSK8					
CL 175 (6 Friction Plate Clutch)	68-69	CK1123		CSK8					
CL 175 K (5 Friction Plate Clutch)	70-71	CK1134		CSK8					
MR 175 Elsinore	75-77	CK1144		CSK36					CT002
SL 175 K	72-73	CK1134		CSK8					
XL 175 K/76/77/78	72-78	CK1134		CSK8					
ATC 185/185 S	80-83	CK1151	CKF1151	CSK22					CT012SP
ATC 185/185 S Centrifugal (one way) clutch	80-83	CK5544							
XL 185 S	79-80	CK1119		CSK167					CT012SP
XL 185 S	81-83	CK1119		CSK9					CT012SP
XR 185	79	CK1119		CSK167					CT012SP
ATC 200	81-83	CK1151	CKF1151	CSK22					CT012SP
ATC 200 Centrifugal (one way) clutch	81-83	CK5544							
ATC 200 E Big Red	82-83	CK1151	CKF1151	CSK22					CT012SP
ATC 200 E Big Red Centrifugal (one way) clutch	82-83	CK5544							
ATC 200 ES Big Red	84	CK1151	CKF1151	CSK22					CT012SP
ATC 200 ES Big Red Centrifugal (one way) clutch	84	CK5544							
ATC 200 M	84-85	CK1151	CKF1151	CSK22					CT012SP
ATC 200 M Centrifugal (one way) clutch	84-85	CK5544							
ATC 200 S	84-86	CK1151	CKF1151	CSK22					CT012SP
ATC 200 S Centrifugal (one way) clutch	84-86	CK5544							
ATC 200 X	83-85	CK1119		CSK24					CT012SP
ATC 200 X	86-87	CK1119		CSK30					CT012SP
CM 200 T	80-82	CK1119		CSK9					CT012SP
TLR 200	86-87	CK1119		CSK167					CT012SP
TR 200 Fatcat	86-87	CK1119		CSK172					CT012SP

CLUTCH APPLICATIONS

EBC BRAKES CLUTCH KITS



HONDA



		CK cork OEM style Kit #	CKF carbon fiber style upgrade Kit #	CSK Spring Kit #	DRC Series Kit #	DRCF Series Kit #	SRC Series Kit #	SRK Series Kit #	CT Tool #
TRX 200 Fourtrax	84	CK1151	CKF1151	CSK22					CT012SP
TRX 200 Fourtrax Centrifugal (one way) clutch	84	CK5544							
TRX 200 SX Fourtrax	86-88	CK1119		CSK172	DRC4				CT012SP
TRX 200 Fourtrax	90-91	CK1119		CSK172	DRC4				CT012SP
TRX 200 D Type II Fourtrax	91-97	CK1119		CSK172	DRC4				CT012SP
XL 200 R	83-84	CK1119		CSK105					CT012SP
XR 200	80-84	CK1119		CSK105	DRC91				CT012SP
XR 200 R	81-83	CK1119		CSK105	DRC91				CT012SP
XR 200 R	84-85	CK1180		CSK4	DRC60				CT013SP
XR 200 R	86-02	CK1119		CSK105	DRC91				CT012SP
CRF 230 F	03-16	CK1304		CSK24	DRC136				CT012SP
CRF 230 L	08-11	CK1252		CSK9	DRC249				CT012SP
CRF 230 M	09-11	CK1252		CSK9	DRC249				CT012SP
ATC 250 R	81-84	CK1163		CSK31					
ATC 250 R	85	CK1193	CKF1193	CSK28	DRC93				CT013SP
ATC 250 R	86	CK1193	CKF1193	CSK32	DRC5				CT013SP
ATC 250 ES Big Red	85-87	CK1194		CSK4					CT013SP
ATC 250 SX	85-87	CK1194		CSK4					CT013SP
CB 250 Nighthawk	91-08	CK1191	CKF1191	CSK24					CT012SP
CBR 250 R (Non ABS)	11-14	CK1313	CKF1313	CSK188					
CBR 250 RA (ABS Model)	11-14	CK1313	CKF1313	CSK188					
CM 250 C Rebel	82-83	CK1191	CKF1191	CSK105					CT012SP
CMX 250 C/CD Rebel	85-87	CK1191	CKF1191	CSK105					CT012SP
CMX 250 C/C2 Rebel	96/97/99-14	CK1191	CKF1191	CSK105					CT012SP
CMX 250 X	15	CK1191	CKF1191	CSK105					CT012SP
CRF 250 F A/AC	19-21	CK1217		TBA	DRC335				
CR 250 M 76 Elsinore	73-77	CK1131		N/A					CT009
CR 250 R Elsinore	78-80	CK1163		CSK31					
CR 250 R Elsinore	81	CK1131		CSK41					CT009
CR 250 R	82	CK1170	CKF1170	CSK41					CT009
CR 250 R	83-89	CK1170	CKF1170	CSK28	DRC3				CT009
CR 250 R	90-93	CK1247	CKF1247	CSK28	DRC75				CT009
CR 250 R	94-07	CK1247	CKF1247	CSK178	DRC79	DRCF79			CT009
CRF 250 L (Non ABS)	13-21	CK1314	CKF1314	CSK188	DRC277	DRCF277			CT081SP
CRF 250 LA (ABS)	17-21	CK1314	CKF1314	CSK188	DRC277	DRCF277			CT081SP
CRF 250 Rally (Non ABS)	17-21	CK1314	CKF1314	CSK188	DRC277	DRCF277			CT081SP
CRF 250 Rally (ABS)	17-21	CK1314	CKF1314	CSK188	DRC277	DRCF277			CT081SP
CRF 250 R	04-07	CK1293	CKF1293	CSK176	DRC129	DRCF129			CT001
CRF 250 R	08-09	CK1305	CKF1305	CSK176	DRC208	DRCF208			CT001
CRF 250 R	10	CK1293	CKF1293	CSK164	DRC256	DRCF256			CT001
CRF 250 R	11-21	CK1305	CKF1305	CSK215	DRC261	DRCF261			CT001
CRF 250 X	04-17	CK1305	CKF1305	CSK176	DRC208	DRCF208			CT001
CRF 250 RX	18-21	CK1305	CKF1305	CSK215	DRC261	DRCF261			CT001
MR 250 Elsinore	76	CK1131		N/A					CT009
MT 250 K1/76	74-76	CK1131		N/A					CT009
NX 250	88-90	CK1190	CKF1190	CSK30	DRC51				CT013SP
TL 250	75-76	CK1131		CSK4					
TRX 250 Fourtrax	85-87	CK1194		CSK4					CT013SP
TRX 250 R Fourtrax	86-87	CK1193	CKF1193	CSK32	DRC5				CT013
TRX 250 R Fourtrax	88-89	CK1193	CKF1193	CSK45	DRC81				CT013
TRX 250 X Fourtrax	87-88/91-92	CK1190	CKF1190	CSK4	DRC44	DRCF44			CT013SP
TRX 250 EX (Sportrax 250 EX)	01-08	CK1119		CSK172	DRC4				CT012SP
TRX 250 TE Recon ES	97-14	CK1119		CSK172	DRC4				CT012SP
TRX 250 TM Recon	97-14	CK1119		CSK172	DRC4				CT012SP
TRX 250 X	09-14	CK1119		TBA					CT012SP
VTR 250 Interceptor	88-90	CK1235		CSK9					CT012SP
XL 250 K/76	72-76	CK1119		CSK4					

CLUTCH
APPLICATIONS

EBC BRAKES CLUTCH KITS



HONDA



		CK cork OEM style Kit #	CKF carbon fiber style upgrade Kit #	CSK Spring Kit #	DRC Series Kit #	DRCF Series Kit #	SRC Series Kit #	SRK Series Kit #	CT Tool #
XL 250 S	78-80	CK1152		CSK9					CT013SP
XL 250 S	81	CK1153		CSK9					CT013SP
XL 250 R	82-83	CK1153		CSK9					CT013SP
XL 250 R	84-87	CK1180		CSK4	DRC60				CT013SP
XR 250	79-80	CK1152		CSK9					CT013SP
XR 250 R	81-82	CK1153		CSK9					CT013SP
XR 250 R	84-85	CK1180		CSK4	DRC60				CT013SP
XR 250 R	86-95	CK1190	CKF1190	CSK4	DRC44	DRCF44			CT013SP
XR 250 R	96-04	CK1190	CKF1190	CSK77	DRC84				CT013SP
XR 250 L	91-96	CK1190	CKF1190	CSK4	DRC44	DRCF44			CT013SP
CB 300 F	15	TBA		TBA					
CBF 300 NA	18-21	CK1314		CSK188	DRC277				CT081SP
CBR 300 R (Non ABS Model)	15	TBA		TBA					
CBR 300 R (ABS Model)	15	TBA		TBA					
TRX 300 All models (2wd & 4wd) Fourtrax	88-00	CK1196		CSK23	DRC6				CT013SP
TRX 300 EX Fourtrax/Sportrax	93-08	CK1190	CKF1190	CSK4	DRC44	DRCF44			CT013SP
TRX 300 X	09-11	CK1190	CKF1190	CSK4	DRC44	DRCF44			CT013SP
ATC 350 X	85-86	CK1190	CKF1190	CSK173					CT013SP
CB 350 F/F1		CK1140		CSK82					CT013SP
CB 350 G/K		CK1132		CSK82					CT009
SL 350 K0/K1/K2	69-73	CK1134		CSK3					
TRX 350 All models	86-89	CK1196		CSK23	DRC6				CT013SP
TRX 350 TE/FE (Electric Shift)	00-05	CK1160		CSK48	DRC127				CT013SP
TRX 350 TM/FM (Manual Shift)	00-05	CK1196		CSK48	DRC126				CT013SP
XL 350 R	84-85	CK1217		CSK4					CT013SP
XR 350 R	83-85	CK1190	CKF1190	CSK4	DRC44	DRCF44			CT013SP
CB 360/360 G/T	75-76	CK1132		CSK82					CT009
CJ 360 T	76-77	CK1132		CSK82					CT009
CB 400 F	75-77	CK1140		CSK82					CT013SP
CB 400 T Hawk All models	78-81	CK1140		CSK15					CT013SP
CB-1 (CB 400 F)	89-90	CK1228		CSK6					CT009SP
CM 400 T	79-81	CK1140		CSK47					CT013SP
CM 400 C Custom	81	CK1140		CSK47					CT013SP
CM 400 E	80-81	CK1140		CSK47					CT013SP
FL 400 R Pilot	89-90	CK1234		TBA					
TRX 400 FW Fourtrax Foreman	95-01/03	CK1196		CSK23	DRC6				CT013SP
TRX 400 EX Fourtrax/Sportrax	99-08	CK1193	CKF1193	CSK73	DRC100	DRCF100			
TRX 400 FM Fourtrax Foreman	02	CK1196		CSK23	DRC6				CT013SP
TRX 400 X	09-14	CK1193	CKF1193	CSK73	DRC100	DRCF100			CT013
XR 400 R	96	CK1193	CKF1193	CSK28	DRC93				CT013
XR 400 R	97-04	CK1193	CKF1193	CSK33	DRC106				CT013
TRX 420 TM Fourtrax Rancher	07-13	CK1196		CSK154	DRC239				CT013SP
TRX 420 TM1 Rancher	14-15	CK1196		CSK154	DRC239				CT013SP
TRX 420 TE Fourtrax Rancher ES	07-13	CK1196		CSK155	DRC238				CT013SP
TRX 420 TE1 Rancher ES	13-15	CK1196		CSK155	DRC238				CT013SP
TRX 420 FP/FPA Fourtrax Rancher 4x4 ES/EPS	09-13	CK1196		CSK155	DRC238				CT013SP
TRX 420 FE/FEA Fourtrax Rancher 4x4/ES	07-13	CK1196		CSK155	DRC238				CT013SP
TRX 420 FE1 Rancher 4x4/ES	14-15	CK1196		CSK155	DRC238				CT013SP
TRX 420 FM/FMA Fourtrax Rancher 4x4	07-13	CK1154		CSK154	DRC239				CT013SP
TRX 420 FM1 Rancher 4x4	14-15	CK1196		CSK154	DRC239				CT013SP
TRX 420 FM2 Rancher 4x4 With Power Steering	14-15	CK1196		CSK154	DRC239				CT013SP
TRX 420 FPM/FPMA Fourtrax 4WD	09-13	CK1154		CSK154	DRC239				CT013SP
CB 450 K		CK1130		N/A					CT031
CB 450 T Hawk	82	CK1140		CSK47					CT013SP
CB 450 SC Nighthawk	82-86	CK1140		TBA					CT013SP
CB 450 DX-K	89-92	CK1140		CSK47					CT013SP
CM 450 E	82/83	CK1140		CSK15					CT013SP

CLUTCH APPLICATIONS

EBC BRAKES CLUTCH KITS



HONDA



		CK cork OEM style Kit #	CKF carbon fiber style upgrade Kit #	CSK Spring Kit #	DRC Series Kit #	DRCF Series Kit #	SRC Series Kit #	SRK Series Kit #	CT Tool #
CM 450 C Custom	82	CK1140		CSK15					CT013SP
CMX 450 C Rebel	86-87	CK1140		TBA					CT013SP
CR 450 R	81	CK1131		CSK41					CT009
CRF 450 R (6 Spring type)	02-03	CK1247	CKF1247	CSK178	DRC112				CT009
CRF 450 R (6 Spring type)	04-05	CK1247	CKF1247	CSK120	DRC148	DRCF148			CT009
CRF 450 R (6 Spring type)	06-08	CK1247	CKF1247	CSK178	DRC112				CT009
CRF 450 R (4 Spring type)	09-10	CK1247	CKF1247	CSK157	DRC244	DRCF244			CT009
CRF 450 R (4 Spring type)	11-12	CK3433	CKF3433	CSK174	DRC259	DRCF259			CT009
CRF 450 R (6 Spring type)	13	CK3433	CKF3433	CSK201	DRC276	DRCF276			CT009
CRF 450 R (6 Spring type)	14-17	CK3433	CKF3433	CSK227	DRC301	DRCF301			CT009
CRF 450 R (6 Spring type)	17-21	CK1317	CKF1317	CSK227	DRC299	DRCF299			CT092
CRF 450 R 8 Plate kit	2022	TBA	TBA	TBA	TBA	TBA			TBA
CRF 450 R-S 7 Plate kit	2022	TBA	TBA	TBA	TBA	TBA			TBA
CRF 450 RX (18" Rear wheel)	17-21	CK1317	CKF1317	CSK227	DRC299	DRCF299			CT092
CRF 450 X	05-17	CK1247	CKF1247	CSK120	DRC148	DRCF148			CT009
CRF 450 X	18-21	CK1317	CKF1317	CSK227	DRC299	DRCF299			CT092
CRF 450 L	18-21	CK1317	CKF1317	CSK227	DRC299	DRCF299			CT092
TRX 450 ES	98-01	CK1196		CSK23	DRC6				CT013SP
TRX 450 R/ER	04-14	CK1302	CKF1302	CSK178	DRC131	DRCF131			CT009
TRX 450 S	98-01	CK1196		CSK23	DRC6				CT013SP
TRX 450 FE	02-04	CK1196		CSK23	DRC6				CT013SP
TRX 450 FM	02-04	CK1196		CSK23	DRC6				CT013SP
CR 480 R	82	CK1170	CKF1170	CSK24					CT009
CR 480 R	83	CK1170	CKF1170	CSK28	DRC3				CT009
CB 500 K	71-73	CK1135		CSK82					CT009
CB 500 F (Non ABS)	13-21	CK1323		CSK33					
CB 500 FA (ABS)	13-21	CK1323		CSK33					
CB 500 X (Non ABS)	13-21	CK1323		CSK33					
CB 500 XA (ABS)	13-21	CK1323		CSK33					
CBR 500 R (Non ABS)	13-21	CK1323		CSK33					
CBR 500 RA (ABS)	13-21	CK1323		CSK33					
CR 500 R	84-89	CK1170	CKF1170	CSK28	DRC3				CT009
CR 500 R	90-94	CK1247	CKF1247	CSK28	DRC75				CT009
CR 500 R	95-01	CK1247	CKF1247	CSK28	DRC75				CT009
CX 500 C/D Custom/Deluxe	79-82	CK1146		CSK41					
CX 500 TC Turbo	82	CK1159		CSK167					
SXS 500 M2 Pioneer	15	CK1140		TBA					
FT 500 Ascot	82-83	CK1140		CSK248					CT013SP
GB 500	89-90	CK1219		CSK16					CT009
GL 500/500 I Silverwing/Silverwing Interstate	81-82	CK1146		CSK41					
TRX 500 FE/FEA Fourtrax Foreman 4x4/ES	05-11	CK1154		CSK117	DRC236				CT013SP
TRX 500 FE Fourtrax Foreman 4x4	12-13	CK1154		CSK29	DRC270				CT013SP
TRX 500 FM/FMA Fourtrax Foreman 4x4	05-11	CK1154		CSK153	DRC237				CT013SP
TRX 500 FM Fourtrax Foreman 4x4	12-13	CK1154		CSK79	DRC271				CT013SP
TRX 500 FPE Fourtrax Foreman 4x4 ES/EPS	08-11	CK1154		CSK117	DRC236				CT013SP
TRX 500 FPE Fourtrax Foreman 4x4	12-13	CK1154		CSK29	DRC270				CT013SP
TRX 500 FPM Fourtrax Foreman 4x4 EPS	08-11	CK1154		CSK153	DRC237				CT013SP
TRX 500 FPM Fourtrax Foreman 4x4	12-13	CK1154		CSK79	DRC271				CT013SP
TRX 500 TM Fourtrax Foreman 2x4	05-06	CK1154		CSK153	DRC237				CT013SP
VT 500 C Shadow	83-86	CK1160		N/A					CT013SP
VT 500 FT Ascot	83-84	CK1160		N/A					CT013SP
VF 500 C V 30 Magna	84-85	CK1177		CSK9					CT002
VF 500 F Interceptor	84-86	CK1177		CSK9					CT002
XL 500 S	79-81	CK1140		CSK248					CT013SP
XL 500 R	82	CK1140		CSK248					CT013SP
XR 500	79-80	CK1154		CSK248					CT013SP
XR 500 R	81-82	CK1154		CSK248					CT013SP

CLUTCH
APPLICATIONS

EBC BRAKES CLUTCH KITS



HONDA



		CK cork OEM style Kit #	CKF carbon fiber style upgrade Kit #	CSK Spring Kit #	DRC Series Kit #	DRCF Series Kit #	SRC Series Kit #	SRK Series Kit #	CT Tool #
XR 500 R	83-84	CK1170	CKF1170	CSK248					CT009
CB 550 F/K	75-78	CK1146		CSK9					
CB 550 K/K1	74-75	CK1147		CSK9					
CB 550 SC Nighthawk	83	CK1171		CSK167					CT009
599 (CB 600 F)	04/06	CK1206		CSK45			SRC19	SRK19	CT014SP
CBR 600 F Hurricane	87	CK1228		CSK12			SRC16	SRK16	CT009SP
CBR 600 F1	88-89	CK1228		CSK12			SRC16	SRK16	CT009SP
CBR 600 F1	90	CK1228		CSK47			SRC42	SRK42	CT009SP
CBR 600 F2	91-94	CK1206		CSK45			SRC19	SRK19	CT014SP
CBR 600 F3/SJR/SE	95-98	CK1206		CSK45			SRC19	SRK19	CT014SP
CBR 600 F4 (Carb Model)	99-00	CK1193	CKF1193	CSK29			SRC66	SRK66	CT014
CBR 600 F4i Sport Injection Model)	01-06	CK1218	CKF1218	CSK178			SRC143	SRK143	CT014
CBR 600 RR	03-20	CK1218	CKF1218	CSK101			SRC75	SRK75	CT014
CBR 600 RRA ABS Model	09-20	CK1218	CKF1218	CSK101			SRC75	SRK75	CT014
VT 600 C Shadow VLX	88	CK1181		CSK33					CT013SP
VT 600 C Shadow VLX	89-90	CK1230		CSK28					CT013SP
VT 600 C/CD Shadow VLX/Shadow Deluxe CD2	91-07	CK1181		CSK33					CT013SP
XL 600 V	89-90	CK1181		CSK33	DRC53				CT013SP
XL 600 R	83-84	CK1170	CKF1170	CSK15	DRC92				CT009
XL 600 R to 520822	85	CK1170	CKF1170	CSK15	DRC92				CT009
XL 600 R from 5208023	85	CK1170	CKF1170	CSK15	DRC92				CT009
XL 600 R	86-87	CK1170	CKF1170	CSK15	DRC92				CT009
XR 600 R	85-00	CK1170	CKF1170	CSK16	DRC54	DRCF54			CT009
CB 650	79-82	CK1147		CSK167					
CB 650 C Custom	80-81	CK1147		CSK167					
CB 650 SC Nighthawk	82	CK1147		CSK167					
CB 650 SC Nighthawk	83-85	CK1171		CSK167					CT009
CBR 650 F (Non ABS Model)	14-21	CK1181		CSK246			SRC149	SRK149	CT014
CBR 650 FA (ABS Model)	14-21	CK1181		CSK246			SRC149	SRK149	CT014
CX 650 C Custom	83	CK1147		CSK12					
CX 650 T Turbo	83	CK1159		CSK167					
GL 650/650 I Silverwing/Silverwing Interstate	83	CK1147		CSK12					
NT 650 Hawk GT	88-90	CK1230		CSK28			SRC64	SRK64	CT013SP
NX 650	88-89	CK1170	CKF1170	CSK16	DRC54	DRCF54			CT009
XR 650 L	93-15	CK1170	CKF1170	CSK16	DRC54	DRCF54			CT009
XR 650 R	00-07	CK1295		CSK45	DRC179				
CB 700 SC/S Nighthawk	84-86	CK1166		CSK167					CT031
CTX 700 (Top Fairing/Manual Clutch Model)	14	CK1230		CSK33			SRC62	SRK62	CT013SP
CTX 700 N (Naked/ Manual Clutch Model)	14	CK1230		CSK33			SRC62	SRK62	CT013SP
NC 700 X (Manual Clutch Model)	12-17	CK1230		CSK33			SRC62	SRK62	CT013SP
NT 700 V/VA	10-13	CK1230		CSK33			SRC62	SRK62	CT013SP
TRX 700 XX	08-11	CK1302	CKF1302	CSK178	DRC240	DRCF240			CT009
VF 700 C Magna	84-87	CK1166		CSK167					CT031
VF 700 F Interceptor	84-85	CK1167		CSK900			SRC2	SRK2	CT031
VFR 700 F Interceptor	86-87	CK1206		CSK28			SRC3	SRK3	CT014
VF 700 S Sabre	84-85	CK1166		CSK167					CT031
VT 700 C Shadow	84-87	CK1166		N/A					CT031
CB 750 C Custom	80-82	CK1149		CSK41					CT078SP
CB 750 F Supersport	76	CK1145		CSK82					CT076SP
CB 750 F Supersport	79-82	CK1149		CSK41					CT078SP
CB 750 K	71-75	CK1133		CSK82					CT076SP
CB 750 K	77-78	CK1145		CSK82					CT076SP
CB 750 K	79-82	CK1149		CSK41					CT078SP
CB 750 L Limited Edition	79	CK1149		CSK9					CT078SP
CB 750 SC Nighthawk	82-83	CK1149		CSK41					CT078SP
CB 750 Nighthawk	91-03	CK1265		CSK12					CT009SP
NC 750 S	14-15	CK1230		CSK33			SRC62	SRK62	CT013SP

CLUTCH APPLICATIONS

EBC BRAKES CLUTCH KITS



HONDA



		CK cork OEM style Kit #	CKF carbon fiber style upgrade Kit #	CSK Spring Kit #	DRC Series Kit #	DRCF Series Kit #	SRC Series Kit #	SRK Series Kit #	CT Tool #
NC 750 S (ABS)	14-18	CK1230		CSK33			SRC62	SRK62	CT013SP
NC 750 X	14-15	CK1230		CSK33			SRC62	SRK62	CT013SP
NC 750 X (ABS)	14-18	CK1230		CSK33			SRC62	SRK62	CT013SP
VF 750 C V45 Magna	82-88	CK1166		CSK167					CT031
VF 750 F V45 Interceptor	83-84	CK1167		CSK900			SRC2	SRK2	CT031
VF 750 C Magna/CD Magna Deluxe	94-03	CK1206		CSK28			SRC3	SRK3	CT014
RVF 750 R (RC 45)	94	CK1257		N/A					CT031
VFR 750 F Interceptor 750	86	CK1206		CSK28			SRC3	SRK3	CT014
VFR 750 F	90-97	CK1206		CSK28			SRC3	SRK3	CT014
VFR 750 R (RC 30)	90	CK1229		CSK901			SRC5	SRK5	CT014
VF 750 S V45 Sabre	82	CK1166		CSK167					CT031
VF 750 S V45 Sabre	83	CK1166		N/A					CT031
VT 750 C Shadow	83	CK1166		N/A					CT031
VT 750 C/CD Shadow/Shadow Deluxe	98-02	CK1230		CSK28					CT013SP
VT 750 Shadow Aero	04-07	CK1230		CSK28					CT013SP
VT 750 Shadow Aero	08-14	CK1230		CSK28					CT013SP
VT 750 CSE Shadow Aero	13-14	CK1230		CSK28					CT013SP
VT 750 C2 Shadow Spirit	08-14	CK1230		CSK28					CT013SP
VT 750 DC Shadow Spirit	01-02	CK1230		CSK28					CT013SP
VT 750 C2S Shadow Spirit	13-14	CK1230		CSK28					CT013SP
VT 750 DC Shadow Spirit	03-07	CK1230		CSK28					CT013SP
VT 750 CD Shadow American Classic Edition	02-03	CK1230		CSK28					CT013SP
VT 750 C2B Shadow Phantom	10-15	CK1230		CSK28					CT013SP
VT 750 RS Shadow	10-14	CK1230		CSK28					CT013SP
VT 800 Shadow	88	CK1166		CSK24					CT031
VFR 800 Fi	98-99	CK1206		CSK135					CT014
VFR 800 Fi	00-01	CK1253		CSK101					CT014
VFR 800 Interceptor/ABS	02-11	CK1218	CKF1218	CSK101			SRC75	SRK75	CT014
VFR 800 F Interceptor	14-15	CK1218	CKF1218	CSK101			SRC75	SRK75	CT014
VFR 800 FD Interceptor DLX	14-15	CK1218	CKF1218	CSK101			SRC75	SRK75	CT014
PC 800 Pacific Coast	89-90/94-98	CK1167		CSK30					CT009
CB 900 C Custom	80-82	CK1149		CSK167					CT078SP
CB 900 F Supersport	81-82	CK1149		CSK167					CT078SP
CBR 900 RR	96-97	CK1206		CSK247			SRC94	SRK94	CT014
CBR 900 RR	96-97	CK1284		CSK45			SRC55	SRK55	CT014
CBR 900 RR	98-99	CK1218	CKF1218	CSK45			SRC57	SRK57	CT014
919 (CB 900 F)	02-07	CK1218	CKF1218	CSK45			SRC57	SRK57	CT014
CBR 929 RR (929cc model)	00-01	CK1206		CSK45			SRC19	SRK100	CT014
CBR 954 RR	02-03	CK1206		CSK45			SRC19	SRK100	CT014
CBX	79	CK1183		CSK167					CT066SP
CBX	80-82	CK1183		CSK10					CT066SP
RVT 1000 R (RC51)	00-01	CK1291		CSK43					CT021
RVT 1000 (RC51)	02-06	CK1300		CSK43					CT021
VTR 1000 F Superhawk	98-05	CK1290		CSK206			SRC60	SRK60	CT009
CB 1000 C Custom	83	CK1149		CSK207					CT078SP
CB 1000	94-95	CK1248		CSK29			SRC4	SRK4	CT009
CB 1000 R	11-14	CK1303		CSK90					CT009SP
CBF 1000 A8 (Canada)	08	CK1303		CSK90					
CBR 1000 F Hurricane	87-88	CK1248		CSK29			SRC4	SRK4	CT009
CBR 1000 F	90-96	CK1248		CSK29			SRC4	SRK4	CT009
CBR 1000 RR (Coil Spring Type Clutch)	04-07	CK1303		CSK112			SRC80	SRK80	CT009SP
CBR 1000 RR (Diaphragm Type Clutch)	08-16	CK1312		CSK905			SRC95	SRK95	CT043SP
CBR 1000 RAA ABS Model (Diaphragm Type Clutch)	09-16	CK1312		CSK905			SRC95	SRK95	CT043SP
CBR 1000 RR SP	14-15	CK1312		CSK905			SRC95	SRK95	CT043SP
CBR 1000 RR Fireblade	17-19								
CRF 1000 L Africa Twin (Manual clutch/Non ABS)	16	CK1319	CKF1319	CSK254	DRC306	DRCF306			CT009
CRF 1000 LAG Africa Twin (Manual clutch/ABS)	16-20	CK1319	CKF1319	CSK254	DRC306	DRCF306			CT009

CLUTCH
APPLICATIONS

EBC BRAKES CLUTCH KITS



HONDA



		CK cork OEM style Kit #	CKF carbon fiber style upgrade Kit #	CSK Spring Kit #	DRC Series Kit #	DRCF Series Kit #	SRC Series Kit #	SRK Series Kit #	CT Tool #
GL 1000 K Goldwing (Up to Eng No 1020727)	75	CK1143		CSK167					CT076SP
GL 1000 K Goldwing (From Eng No 1020728)	75	CK1221		CSK167					CT053SP
GL 1000 Goldwing All models	76-79	CK1143		CSK167					CT076SP
VF 1000 F Interceptor	84	CK1176		N/A					CT031
VF 1000 R	85-86	CK1176		N/A					CT031
XL 1000 VAB Varadero (Canada)	08	CK1257		CSK138					CT009
CB 1100 F Supersport	83	CK1149		CSK207					CT078SP
CB 1100 (Non ABS)	13-14	CK1257		CSK43					CT009
CB 1100 (ABS)	13-14	CK1257		CSK43					CT009
CB 1100 EX	16-19	CK1332		CSK70			SRC161	SRK161	
CBR 1100 XX Blackbird	97-98	CK1286		CSK70					CT021
CBR 1100 XX Blackbird	99-03	CK1291		CSK43					CT021
GL 1100/1100 I Goldwing/Goldwing Interstate	80-83	CK1159		CSK167					CT053SP
GL 1100 A Goldwing Aspencade	82-83	CK1159		CSK167					CT053SP
ST 1100/1100A	91-01	CK1264		CSK33			SRC70	SRK70	CT056SP
VF 1100 C V65 Magna	83-86	CK4409		N/A					
VF 1100 S V65 Sabre	84-85	CK4409		N/A					
VT 1100 C Shadow 1100	85-86	CK1209		N/A					CT009
VT 1100 C Shadow 1100	87-94	CK1239		N/A					CT009
VT 1100 C Shadow 1100	95-96	CK1239		N/A					CT009
VT 1100 C Shadow 1100 Spirit	97-06	CK1176		CSK68					CT009
VT 1100 CS Shadow American Classic Edition	95-97	CK1176		CSK68					CT009
VT 1100 C2-2 Shadow American Classic Edition	97	CK1176		CSK68					CT009
VT 1100 D2 Shadow American Classic Edition	99	CK1176		CSK68					CT009
VT 1100 C2 Shadow Sabre	00-06	CK1176		CSK68					CT009
VT 1100 C3 Shadow Aero	98-02	CK1176		CSK68					CT009
VT 1100 T Shadow American Classic Edition Tourer	98-01	CK1176		CSK68					CT009
GL 1200/1200 I-A/1200 L Goldwing All models	84-85	CK1210		N/A					CT053SP
GL 1200 I-A/GL 12SE-I	86	CK1224		N/A					
GL 1200 1/A Goldwing All models	87	CK1224		N/A					
VFR 1200 F (Manual Gearbox Model)	10-14	CK1312		CSK907			SRC103	SRK103	CT043SP
CTX 1300	14	TBA		TBA					
CTX 1300 DLX (ABS)	14	TBA		TBA					
ST 1300/1300 A	02-13	CK1297		CSK175					CT021
VT 1300 CX Fury (Non ABS Model)	10-15	CK1298		CSK90					TBA
VT 1300 CXA Fury (ABS Model)	10-15	CK1298		CSK90					TBA
VT 1300 CS Sabre (Non ABS)	10-14	CK1298		CSK90					TBA
VT 1300 CSA Sabre (ABS)	11-14	CK1298		CSK90					TBA
VT 1300 CT Interstate (Non ABS)	10-15	CK1298		CSK90					TBA
VT 1300 CTA Interstate (ABS)	11-15	CK1298		CSK90					TBA
VT 1300 CR Stateline (Non ABS)	10-15	CK1298		CSK90					TBA
VT 1300 CRA Stateline (ABS)	11-15	CK1298		CSK90					TBA
VTX 1300 C	04-11	CK1298		CSK90					TBA
VTX 1300 S	03-07	CK1298		CSK90					TBA
VTX 1300 R	05-11	CK1298		CSK90					TBA
VTX 1300 T	08-11	CK1298		CSK90					TBA
GL 1500 Goldwing	88-96	CK1285		N/A					CT068SP
GL 1500 A/SE/I Goldwing	99-00	CK1285		N/A					CT068SP
GL 1500 C/CT Valkyrie/Valkyrie Tourer	97-03	CK1285		N/A					CT068SP
GL 1800 A (ABS)/1800 Goldwing (All models)	01-16	CK1297		N/A					CT073
F6B Goldwing (GL 1800 B)	13-16	CK1297		N/A					CT073
F6B Goldwing Deluxe (GL 1800 BD)	13-16	CK1297		N/A					CT073
GL 1800 C Valkyrie	13-14	CK1297		N/A					CT073
NRX 1800 Rune DA/DB/EA	04-05	CK1297		N/A					CT073
VTX 1800 C	02-08	CK1298		CSK90					TBA
VTX 1800 R (Cast Models)	02-08	CK1298		CSK90					TBA
VTX 1800 S (Spoke Model)	02-07	CK1298		CSK90					TBA

CLUTCH APPLICATIONS

EBC BRAKES CLUTCH KITS



HONDA



		CK cork OEM style Kit #	CKF carbon fiber style upgrade Kit #	CSK Spring Kit #	DRC Series Kit #	DRCF Series Kit #	SRC Series Kit #	SRK Series Kit #	CT Tool #
VTX 1800 T	07-11	CK1298		CSK90					TBA
VTX 1800 F	05-11	CK1298		CSK90					TBA
VTX 1800 N	04-11	CK1298		CSK90					TBA
KAWASAKI									
AR 50 A	82	CK4442		CSK18					
KDX 50 A	03-06	CK3366		N/A					
KX 60 A	83-84	CK4438	CKF4438	CSK18					CT070SP
KX 60 B	85-03	CK4438	CKF4438	CSK18	DRC7				CT070SP
KX 65	00-21	CK4438	CKF4438	CSK40	DRC98	DRCF98			CT070SP
AR 80 A	82	CK4440		CSK18					
KD 80 M	80-81	CK4440		CSK19					
KD 80 M	82-87	CK4440		CSK19					
KD 80 N	88-90	CK4440		CSK19					
KX 80 A	80	CK4440		CSK18					
KDX 80 A	81	CK4440		CSK40					
KDX 80 B	82-83	CK4438	CKF4438	CSK40					CT070SP
KDX 80 C	84-88	CK4438	CKF4438	CSK40					CT070SP
KX 80 C	81/82	CK4438	CKF4438	CSK40					CT070SP
KX 80 E	83/84	CK4438	CKF4438	CSK40					CT070SP
KX 80 E/G/J	85-87	CK4468		CSK34	DRC8				CT070SP
KX 80 L	88	CK4477		CSK35	DRC9				
KX 80 L/N	89-90	CK4478		CSK35	DRC10				
KX 80 R	91-97	CK4478		CSK35	DRC10				
KX 80 W	98-00	CK4453	CKF4453	CSK41	DRC45	DRCF45			CT002
KX 85 (F 17"/R 14")	01-21	CK4453	CKF4453	CSK41	DRC45	DRCF45			CT002
KX 85 (F 19"/R 16")	01-21	CK4453	CKF4453	CSK41	DRC45	DRCF45			CT002
KE 100 A	76-81	CK4440		CSK19					
KE 100 B	85-01	CK4440		CSK19					
KM 100 A	76-81	CK4440		CSK19					
KX 100 B	95-97	CK4478		CSK35	DRC10				
KX 100 C/D/F	98-09/11-16	CK4453	CKF4453	CSK41	DRC45	DRCF45			CT002
KLF 110 A/B Mojave	87-88	CK4463		N/A					
KLT 110 A	84-86	CK4463		N/A					
KLX 110	02-21	CK4438	CKF4438	CSK40	DRC98	DRCF98			CT070SP
KLX 110 L (KLX 110 D)	10-21	CK4438	CKF4438	CSK40	DRC98	DRCF98			CT070SP
BN 125 A Eliminator	01-09	CK4511		CSK41					
KD 125 A	75-79	CK4411		CSK143					CT058
KE 125 A	80-83	CK4411		CSK143					CT058
KLX 125 A	03-06	CK3318	CKF3318	CSK34					CT011
KLX 125 L (B)	03-06	CK3318	CKF3318	CSK34					CT011
KX 125 A	78-81	CK4436		CSK143					CT058
KX 125 B	82	CK4436		CSK143					CT058
KX 125 B	83	CK4457		CSK152					CT058
KX 125 C	84	CK4457		CSK143					CT058
KX 125 D/E	85-87	CK4469		CSK143	DRC11				CT042
KX 125 F/G	88-89	CK4482		CSK6	DRC13				CT042
KX 125 H	90-91	CK4485		CSK116	DRC36				CT042
KX 125 J	92	CK4485		CSK116	DRC83				CT042
KX 125 J	93	CK4498		CSK116	DRC69				CT042
KX 125 K	94-96	CK4425		CSK7	DRC73				CT004
KX 125 K/L	97-02	CK4425		CSK65	DRC73				CT004
KX 125 M	03-05	CK4425		CSK97	DRC122				CT004
Z 125 (BR 125 GGF/GHF Auto G/Box)	16-17	CK4438		TBA					
Z 125 Pro (BR 125 HGF/JHF Manual G/Box)	16-21	CK4438		TBA					
KLX 140 (F 17"/R 14")	08-21	CK4522		CSK142	DRC211				
KLX 140 L (F 19"/R 16")	08-21	CK4522		CSK142	DRC211				

CLUTCH
APPLICATIONS

EBC BRAKES CLUTCH KITS



KAWASAKI



		CK cork OEM style Kit #	CKF carbon fiber style upgrade Kit #	CSK Spring Kit #	DRC Series Kit #	DRCF Series Kit #	SRC Series Kit #	SRK Series Kit #	CT Tool #
KLX 140 G (F 21"/R 18")	17-21	CK4522		CSK142	DRC211				
KLX 150 S	09-11	CK4522		CSK142	DRC211				
KLT 160 A	85	CK1119		CSK3					CT012SP
KDX 175 A	80-82	CK4436		CSK143					CT058
KE 175 D	80-83	CK4411		CSK39					CT058
KLF 185 A Bayou	85-88	CK1119		CSK3					CT012SP
KLT 185 A	86-87	CK1119		CSK3					CT012SP
KDX 200 A	83-84	CK4457		CSK152					CT058
KDX 200 A	85	CK4457		CSK143					CT058
KDX 200 C	86-88	CK4469		CSK143	DRC74				CT042
KDX 200 E	89-94	CK4482		CSK10	DRC61				CT042
KDX 200 H	95-06	CK4505		CSK30	DRC62				
KLT 200 A	81-83	CK4425		CSK148					CT004
KLT 200 B	83	CK4425		CSK148					CT004
KLT 200 C	83-84	CK4425		CSK148					CT004
KDX 220 R A	97-06	CK4505		CSK30	DRC62				
KLF 220 A Bayou	88-02	CK1180		CSK116	DRC224				CT013SP
KLX 230	20	CK4514	CKF4514	CSK97	DRC123	DRCF123			CT004
EL 250 B Eliminator	88-89	CK4473		CSK4					CT016
EL 250 E 250 HS	91-95	CK4473		CSK4					CT016
EX 250 E Ninja	86-87	CK4473		CSK4					CT016
EX 250 F/D Ninja	88-07	CK4484		CSK4					CT016
EX 250 J Ninja 250 R	08-12	CK4521		CSK142					CT009
KDX 250 A/B	80-81	CK4439		CSK10					CT006
KDX 250 B	82-84	CK4433		CSK10					CT006
KDX 250 D	91-94	CK4475		CSK30	DRC41				CT006
KE 250 B	77-79	CK4439		CSK116					CT006
KH 250 A	76	CK4436		CSK1					CT058
KL 250 A	78-79	CK4425		CSK148					CT004
KL 250 A	80-82	CK4425		CSK148					CT004
KL 250 C	83-84	CK4425		CSK148					CT004
KL 250 G Super Sherpa	00-04	CK4469		CSK74					
KLF 250 A Bayou	03-11	CK1180		CSK116	DRC224				CT013SP
KLR 250 (KL 250) D	85-05	CK4446		CSK148	DRC63				CT004
KLT 250 A	82-83	CK4425		CSK148					CT004
KLT 250 C	83-85	CK4425		CSK148					CT004
KLT 250 P Police	84	CK4425		CSK148					CT004
KLX 250 A	79-80	CK4425		CSK148					CT004
KLX 250 D	93-95	CK4469		CSK1					CT042
KLX 250 S (KLX 250 H)	06-07	CK4469		CSK144	DRC212				CT042
KLX 250 S (KLX 250 T)	09-14	CK4469		CSK144	DRC212				CT042
KLX 250 SF (KLX 250 W) Supermotard	09-10	CK4469		CSK144	DRC212				CT042
KSF 250 A Mojave	87-04	CK4425		CSK148	DRC225				CT004
KX 250 A	80-81	CK4439		CSK10					CT006
KX 250 B/C	82-83	CK4433		CSK10					CT006
KX 250 C	84	CK4465		CSK10					CT006
KX 250 D	85-86	CK4459		CSK10					CT006
KX 250 E/F	87-88	CK4475		CSK10					CT006
KX 250 G	89	CK4475		CSK7	DRC15				CT006
KX 250 H	90	CK4475		CSK6	DRC17				CT006
KX 250 H	91	CK4475		CSK30	DRC41				CT006
KX 250 J/K/L/M/R	92-07	CK4435	CKF4435	CSK7	DRC46	DRCF46			CT016
KX 250 N (KX 250 F)	04-05	CK4514	CKF4514	CSK97	DRC123	DRCF123			CT004
KX 250 F (T)	06-08	CK4514	CKF4514	CSK97	DRC123	DRCF123			CT004
KX-F 250 (4T)	09-19	CK4514	CKF4514	CSK97	DRC123	DRCF123			CT004
KX-F 250 (4T)	19-21	CK4514	CKF4514	TBA	DRC336	TBA			TBA
KXF 250 A Teccate 4	87-88	CK4475		CSK10					CT006

CLUTCH APPLICATIONS

EBC BRAKES CLUTCH KITS



KAWASAKI



		CK cork OEM style Kit #	CKF carbon fiber style upgrade Kit #	CSK Spring Kit #	DRC Series Kit #	DRCF Series Kit #	SRC Series Kit #	SRK Series Kit #	CT Tool #
KXT 250 A Tecate	84	CK4433		CSK148					CT006
KXT 250 A Tecate	85	CK4465		CSK148					CT006
KXT 250 B Tecate	86-87	CK4459		CSK10	DRC38				CT006
KZ 250 D (LTD)	80	CK4425		CSK148					CT004
KZ 250 D (CSR)	81	CK4425		CSK148					CT004
KZ 250 L (CSR)	82	CK4425		CSK148					CT004
KZ 250 W (LTD)	83	CK4425		CSK148					CT004
S1-A/B/C (250cc)	73-75	CK4436		CSK1					CT058
EX 300 A (Non ABS) Ninja 300	13-19	CK4524		CSK203			SRC118	SRK118	CT009
EX 300 A (Non ABS) Ninja SE 300	14-19	CK4524		CSK203			SRC118	SRK118	CT009
EX 300 B (With ABS) Ninja 300	13-19	CK4524		CSK203			SRC118	SRK118	CT009
EX 300 B (With ABS) Ninja SE 300	14-19	CK4524		CSK203			SRC118	SRK118	CT009
KEF 300 A Lakota	95-00	CK4419		CSK151	DRC233				CT006
KEF 300 B Lakota Sport	01-03	CK4419		CSK151	DRC233				CT006
KLF 300 A/B/C Bayou	86-05	CK4419		CSK151	DRC233				CT006
KLX 300 R A	97	CK4469		CSK1					CT042
KLX 300 R A	98-07	CK4469		CSK144	DRC212				CT042
KLX 300 R	19-21	CK4469		CSK144	DRC212				CT042
Versys-X 300 ABS	17-21	CK4524		CSK203			SRC118	SRK118	CT009
EX 305 B (GPz)	83	CK4433		CSK6					CT006
KZ 305 A (CSR)	81-82	CK4433		CSK6					CT006
KZ 305 B (CSR)	82	CK4433		CSK6					CT006
KZ 305 B (LTD)	87-88	CK4433		CSK6					CT006
S2/S2-A (350cc)	72-73	CK4436		CSK192					CT058
KDX 400 A	79-80	CK4439		CSK10					CT006
KH 400 A	76-78	CK4457		CSK192					CT058
KLF 400 B Bayou (4 x 4)	93-98	CK4439		CSK151	DRC234				CT006
KLX 400 R (KLX 400 B)	03-04	CK3433	CKF3433	CSK79	DRC105	DRCF105			CT006
KLX 400 SR (KLX 400 A)	03-04	CK3433	CKF3433	CSK79	DRC105	DRCF105			CT006
KSF 400 A (KFX 400)	03-04	CK3433	CKF3433	CSK79	DRC105	DRCF105			CT006
KSF 400 A (KFX 400)	05-06	CK3447	CKF3447	CSK79	DRC137	DRCF137			CT006
S3/S3-A (400cc)	74-75	CK4457		CSK192					CT058
KZ 400 S Series	75-77	CK4421		CSK7					
KDX 420 B	81	CK4439		CSK10					CT006
Ninja 400	17-21	CK4530		CSK264			SRC167	SRK167	
Z 400	17-21	CK4530		CSK264			SRC167	SRK167	
KX 420 A	80-81	CK4439		CSK10					CT006
KZ 440 A	80-83	CK4421		CSK4					
KZ 440 B	80-81	CK4421		CSK4					
KZ 440 D	80-83	CK4421		CSK4					
KZ 440 G	82	CK4421		CSK4					
EN 450 A (454 LTD)	85-90	CK4424		CSK10			SRC11	SRK11	CT016
KDX 450 A	82	CK4439		CSK10					CT006
KFX 450 R (KSF 450 B8)	08-14	CK4519		CSK177	DRC185				CT006
KLX 450 R A	08-12	CK1247	CKF1247	CSK180	DRC158	DRCF158			CT006
KX 450 F D/E	06-11	CK1247	CKF1247	CSK180	DRC158	DRCF158			CT006
KX-F 450 (4T)	12-19	CK1247	CKF1247	CSK29	DRC269	DRCF269			CT006
KX-F 450 (4T)	19-21	CK4531	TBA	TBA	TBA	TBA			TBA
EN 500 A/C	90-09	CK4424		CSK10			SRC11	SRK11	CT016
EX 500 A/D	87-09	CK4424		CSK10			SRC11	SRK11	CT016
HI 500 Mach III	69-70	CK4425		CSK194					CT004
HI-A 500 S Mach III	71	CK4425		CSK194					CT004
HI-B 500 Mach III	72	CK4425		CSK194					CT004
HI-C 500 Mach III	72	CK4425		CSK194					CT004
HI-D 500	73	CK4425		CSK194					CT004
HI-E 500	74	CK4425		CSK194					CT004
HI-F 500	75	CK4425		CSK194					CT004

CLUTCH
APPLICATIONS

EBC BRAKES CLUTCH KITS



KAWASAKI



		CK cork OEM style Kit #	CKF carbon fiber style upgrade Kit #	CSK Spring Kit #	DRC Series Kit #	DRCF Series Kit #	SRC Series Kit #	SRK Series Kit #	CT Tool #
KH 500 A8		CK4425		CSK194					CT004
KX 500 A	83/84	CK4433		CSK10					CT006
KX 500 B	85-86	CK4459		CSK10					CT006
KX 500 C/D	87-88	CK4475		CSK10	DRC16				CT006
KX 500 E	89-04	CK4475		CSK10	DRC16				CT006
KZ 550 A	80-83	CK4424		CSK10			SRC11	SRK11	CT016
KZ 550 C (LTD)	80-83	CK4424		CSK10			SRC11	SRK11	CT016
KZ 550 D (GPz)	81	CK4424		CSK10			SRC11	SRK11	CT016
KZ 550 F Spectre	83	CK4424		CSK10			SRC11	SRK11	CT016
KZ 550 F (LTD)	84	CK4424		CSK10			SRC11	SRK11	CT016
KZ 550 H (GPz)	82-83	CK4424		CSK10			SRC11	SRK11	CT016
KZ 550 M (LTD)	83	CK4424		CSK10			SRC11	SRK11	CT016
ZX 550 A (GPz)	84-86	CK4424		CSK10			SRC11	SRK11	CT016
ZR 550 B Zephyr	90-93	CK4424		CSK10			SRC11	SRK11	CT016
KLR 600 (KL 600 A/B)	84-86	CK4424		CSK23	DRC64				CT016
ZL 600 A	86-87	CK4424		CSK10			SRC11		CT016
ZL 600 Eliminator B	96-97	CK4424		CSK10					CT016
ZX 600 A/B Ninja	85-87	CK4424		CSK23					CT016
ZX 600 C Ninja R	88-89	CK4424		CSK10			SRC11	SRK11	CT016
ZX 600 C Ninja R	90-97	CK4424		CSK10			SRC11	SRK44	CT016
ZX 600 D (ZX6)	90-93	CK4424		CSK10			SRC22	SRK22	CT016
ZX 600 E (ZX6)	93-05	CK4424		CSK43			SRC43	SRK43	CT016
ZX6R (ZX 600 F/G)	95-99	CK4503		CSK56			SRC38	SRK108	CT004
ZX6R (ZX 600 J)	00-02	CK4503		CSK56			SRC38	SRK38	CT004
ZX6R (ZX 636 A)	02	CK4503		CSK56			SRC38	SRK38	CT004
ZX6R (ZX 636 B) 636cc	03-04	CK4503		CSK56			SRC38	SRK38	CT004
ZX6R (ZX 636 C) 636cc	05-06	CK4514	CKF4514	CSK117			SRC84	SRK84	CT004
ZX6R (ZX 600 P/R)	07-12	CK4514	CKF4514	CSK165			SRC101	SRK101	CT004
ZX6R (ZX 636 E) 636cc/Non ABS	13-19	CK4514		CSK202					CT004
ZX6R (ZX 636 E) 636cc/Non ABS/30th Anniversary Edition	15	CK4514		CSK202					CT004
ZX6R (ZX 636 E) 636cc/Non ABS/KRT Edition	16-19	CK4514		CSK202					CT004
ZX6R (ZX 636 F) 636cc/ABS	13-19	CK4514		CSK202					CT004
ZX6R (ZX 636 F) 636cc/ABS/30th Anniversary Edition ABS	15	CK4514		CSK202					CT004
ZX6R (ZX 636 F) 636cc/ABS/KRT Edition	16-19	CK4514		CSK202					CT004
ZX6RR (ZX 600 K) 599cc	03	CK4503		CSK99			SRC76	SRK76	CT004
ZX6RR (ZX 600 M)	04	CK4514	CKF4514	CSK99			SRC83	SRK83	CT004
ZX6RR (ZX 600 N) 599cc	05-06	CK4514	CKF4514	CSK117				SRK107	CT004
ZZR 600 (ZX 600 J)	05	CK4503		CSK56			SRC38	SRK38	CT004
ZZR 600 J	06-08	CK4503		CSK56			SRC38	SRK38	CT004
EN 650 Vulcan S (Non ABS) EN 650 A	15	CK4424		CSK10			SRC22	SRK22	CT016
EN 650 Vulcan S (ABS) EN 650 B	15	CK4424		CSK10			SRC22	SRK22	CT016
ER6-n (ER 650 C)	09-10	CK4424		CSK10			SRC22	SRK22	CT016
ER-6F (EX 650)	06-11	CK4424	CKF4424	CSK10			SRC22	SRK102	CT016
ER-6F ABS (EX 650 ABS)	06-11	CK4424	CKF4424	CSK10			SRC22	SRK102	CT016
Ninja 650 (EX 650)	12-18	CK4527					SRC155	SRK155	
Ninja 650 ABS (EX 650 ABS)	12-18	CK4527					SRC155	SRK155	
ER-6N (ER 650)	06-11	CK4424	CKF4424	CSK10			SRC22	SRK102	CT016
ER-6N ABS (ER 650 ABS)	06-11	CK4424	CKF4424	CSK10			SRC22	SRK102	CT016
Z 650 (ER 650)	12-18	CK4527					SRC155	SRK155	
Z 650 ABS (ER 650 ABS)	12-18	CK4527					SRC155	SRK155	
KL 650 B Tengai	90-91	CK4424		CSK7	DRC65				CT016
KL 650 E Up To KL650AEA72319 = 8 Friction Plates (KLR 650)	08-11	CK4435	CKF4435	CSK224	DRC168				CT016
KL 650 E From KL650AEA72320 = 7 Friction Plates (KLR 650)	11-15	CK4424		CSK10					CT016
KLE 650 A/C/D Versys	07-14	CK4424		CSK10			SRC22		CT016
KLE 650 F Versys/Versys LT	15-16	CK4424		CSK10					CT016
KLR 650 (KL 650 A)	87-95	CK4424		CSK7	DRC65				CT016
KLR 650 (KL 650 A)	96-07	CK4435	CKF4435	CSK224	DRC168				CT016

CLUTCH APPLICATIONS

EBC BRAKES CLUTCH KITS



KAWASAKI



		CK cork OEM style Kit #	CKF carbon fiber style upgrade Kit #	CSK Spring Kit #	DRC Series Kit #	DRCF Series Kit #	SRC Series Kit #	SRK Series Kit #	CT Tool #
KLX 650 A/D (KLX 650 R)	93-96	CK4424		CSK10	DRC64				CT016
KLX 650 C	93-96	CK4424		CSK7	DRC65				CT016
KZ 650 B	77-79	CK4413		CSK10					CT019
KZ 650 C Custom	77-79	CK4413		CSK10					CT019
KZ 650 D SR	78-79	CK4413		CSK10					CT019
KZ 650 E (LTD)	80	CK4413		CSK10					CT019
KZ 650 F	80	CK4413		CSK10					CT019
KZ 650 H (CSR)	81-83	CK4413		CSK10					CT019
W 650 (EJ 650 A)	00-02	CK4435	CKF4435	CSK10			SRC46	SRK46	CT016
KZ 700 A	84	CK4413		CSK10					CT019
VN 700 A Vulcan	85	CK4435	CKF4435	CSK10			SRC46	SRK46	CT016
ZN 700 A (LTD)	84-85	CK4413		CSK10					CT019
H1/H2-A Mach IV (750-2T)	72-73	CK4415		CSK23					CT004
H2-B/H2-C Mach IV (750-2T)	74-75	CK4523		CSK23					CT004
KZ 750 E	80-82	CK4413		CSK10					CT016
KZ 750 F (LTD)	83	CK4413		CSK10					CT019
KZ 750 G (LTD)	80	CK4435		CSK10			SRC46	SRK46	CT016
KZ 750 H (LTD)	80-83	CK4413		CSK10					CT019
KZ 750 K (LTD)	83-84	CK4435	CKF4435	CSK10					CT016
KZ 750 L	83	CK4413		CSK10					CT019
KZ 750 M (CSR)	82	CK4435	CKF4435	CSK10			SRC46	SRK46	CT016
KZ 750 N Spectre	82-83	CK4413		CSK10					CT019
KZ 750 R (GPz)	82	CK4413		CSK10					CT019
VN 750 A Vulcan	86-06	CK4435	CKF4435	CSK10			SRC46	SRK46	CT016
ZX 750 A (GPz)	83-85	CK4413		CSK10					CT019
ZX 750 E (GPz Turbo)	84-85	CK4443		CSK10					CT019
ZX 750 F Ninja	87-90	CK4435	CKF4435	CSK7			SRC53	SRK53	CT016
ZX 750 H Ninja ZX-7	89-90	CK4424		CSK23					CT016
ZX 750 K	91-92	CK4435	CKF4435	CSK88			SRC24	SRK24	CT016
ZX 750 J	91-92	CK4435	CKF4435	CSK88			SRC24	SRK24	CT016
ZX 750 L (ZX-7)	93-95	CK4435	CKF4435	CSK88			SRC24	SRK24	CT016
ZX 750 M (ZX-7R)	93-94	CK4435	CKF4435	CSK88			SRC24	SRK24	CT016
ZX 750 P (ZX 7 R)	96-03	CK4435	CKF4435	CSK88			SRC24	SRK24	CT016
ZX 750 N (ZX 7 RR)	96-99	CK4435	CKF4435	CSK38			SRC41	SRK41	CT016
ZR 750 C Zephyr	91-93	CK4493		CSK10					CT019
ZR 750 F (ZR-7)	00-01	CK4493		CSK117					CT019
Z 750 S (ZR 750 K)	05-06	CK4503		CSK56			SRC38	SRK38	CT004
ZR7-S (ZR 750 H)	01-05	CK4493		CSK117					CT019
VN 800 A/B	95-05	CK4435	CKF4435	CSK10			SRC46	SRK46	CT016
VN 800 Drifter C/E	99-06	CK4435	CKF4435	CSK7			SRC53	SRK53	CT016
VN 900 Vulcan Classic LT (Spoke Wheels & Screen) (D)	06-19	CK4435	CKF4435	CSK7			SRC53	SRK53	CT016
VN 900 Vulcan Classic (Spoke Wheels) (B)	06-19	CK4435	CKF4435	CSK7			SRC53	SRK53	CT016
VN 900 Vulcan Custom (Cast Wheels) (C)	07-19	CK4435	CKF4435	CSK7			SRC53	SRK53	CT016
Z1/A/B 900	73-75	CK4409		CSK10					CT019
KZ 900 A	76-77	CK4409		CSK10					CT019
KZ 900 B LTD	76	CK4409		CSK10					CT019
Z 900 (ZR 900 A)	17-21	CK4510		CSK169					CT004
Z 900 ABS (ZR 900 B)	17-21	CK4510		CSK169					CT004
Z 900 RS (ZR 900 C)	18-21	CK4510		CSK169					CT004
Z 900 RS Café (ZR 900 E)	18-21	CK4510		CSK169					CT004
ZL 900 A Eliminator	85-86	CK4434		CSK23			SRC20	SRK20	CT016
ZX 900 A Ninja	84-86	CK4435	CKF4435	CSK7			SRC53	SRK53	CT016
ZX9R B Ninja	94-97	CK4435	CKF4435	CSK38			SRC41	SRK41	CT016
ZX9R (ZX 900 C)	98-99	CK4510		CSK67			SRC59	SRK59	CT004
ZX9R (ZX 900 E/F)	00-03	CK4510		CSK128			SRC89	SRK89	CT004
KLZ 1000 B Versys	15-19	CK4503		TBA					CT004
KZ 1000 A	77-80	CK4409		CSK10					CT019

CLUTCH
APPLICATIONS

EBC BRAKES CLUTCH KITS



KAWASAKI



		CK cork OEM style Kit #	CKF carbon fiber style upgrade Kit #	CSK Spring Kit #	DRC Series Kit #	DRCF Series Kit #	SRC Series Kit #	SRK Series Kit #	CT Tool #
KZ 1000 B (LTD)	79-80	CK4409		CSK10					CT019
KZ 1000 C Police	78-81	CK4409		CSK10					CT019
KZ 1000 D (Z1-R)	78-80	CK4409		CSK10					CT019
KZ 1000 E Shaft	79-80	CK4434		CSK23			SRC20	SRK20	CT016
KZ 1000 G Classic	80	CK4409		CSK10					CT019
KZ 1000 J	81-83	CK4434		CSK10			SRC54	SRK54	CT016
KZ 1000 K (LTD)	81-82	CK4434		CSK10			SRC54	SRK54	CT016
KZ 1000 M (CSR)	81-82	CK4434		CSK10			SRC54	SRK54	CT016
KZ 1000 P Police	82-03/05	CK4434		CSK10			SRC54	SRK54	CT016
KZ 1000 R Replica	82-83	CK4434		CSK10			SRC54	SRK54	CT016
Z 1000 (ZR 1000 A)	03-05	CK4510		CSK128			SRC89	SRK89	CT004
Z 1000 (ZR 1000 A)	06	CK4510		CSK128			SRC89	SRK89	CT004
Z 1000 (ZR 1000 B)	07-08	CK4510		CSK110					CT004
Z 1000 (ZR 1000 C)	07	CK4510		CSK110					CT004
Z 1000 (ZR 1000 D) Non ABS	10-13	CK4510		CSK169					CT004
Z 1000 ABS (ZR 1000 D) ABS	14-15	CK4510		CSK169					CT004
Z 1000 ABS (ZR 1000 G) ABS/3 Spring Clutch	16	CK4503		TBA					CT004
Z 1000 Performance	16-19	CK4510		CSK169					CT004
Z 1000 SX Tourer	16-19	CK4510		CSK169					CT004
ZG 1000 A Concours	86-05	CK4434		CSK23			SRC20	SRK20	CT016
ZG 1000 A Concours	06	CK4434		CSK23			SRC20	SRK20	CT016
ZL 1000 A	87	CK4434		CSK23			SRC20	SRK20	CT016
ZX 1000 A Ninja	86-87	CK4434		CSK23			SRC20	SRK20	CT016
ZX 1000 B Ninja ZX10	88-90	CK4434		CSK23			SRC20		CT016
1000 Ninja ABS (ZX 1000 H)	12-13	CK4510		CSK169					CT004
1000 Ninja (ZX 1000 G)	11-13	CK4510		CSK169					CT004
1000 Ninja ABS (ZX 1000 M)	14-15	CK4510		CSK169					CT004
Ninja H2	15-21	CK4528		CSK269			SRC163	SRK163	
Ninja H2R	15-21	CK4529		CSK270			SRC164	SRK164	
ZX10 R (ZX 1000 C)	04-05	CK4510		CSK111			SRC79	SRK79	CT004
ZX10 R (ZX 1000 D/E/F)	06-10	CK4510		CSK111			SRC79		CT004
ZX10 R (ZX 1000 J - Non ABS)	11-15	CK4510		CSK111			SRC79		CT004
ZX10 R (ZX 1000 J 30th Anniversary Edition - Non ABS)	15	CK4510		CSK111			SRC79		CT004
ZX10 R (ZX 1000 K - ABS)	11-15	CK4510		CSK111			SRC79		CT004
ZX10 R (ZX 1000 F 30th Anniversary Edition - ABS)	15	CK4510		CSK111			SRC79		CT004
ZX10 R (ZX 1000 SGF)	16	CK4510		CSK111			SRC79		CT004
ZX10 R KRT Replica (ZX 1000 SGFA)	16	CK4510		CSK111			SRC79		CT004
ZX10 R (ZX 1000 SGF)	16-19	CK4510		CSK111			SRC79		CT004
ZX10 R KRT Replica (ZX 1000 SGFA)	16-19	CK4510		CSK111			SRC79		CT004
ZX10 RR	17-21	CK4510	CKF4510	CSK111			SRC79	SRK79	CT004
ZX10 RR Performance	17-21	CK4510	CKF4510	CSK111			SRC79	SRK79	CT004
KZ 1100 A	81-83	CK4434		CSK23			SRC20	SRK20	CT016
KZ 1100 B (GPz)	81-82	CK4434		CSK23			SRC20	SRK20	CT016
KZ 1100 D Spectre	82-83	CK4434		CSK23			SRC20	SRK20	CT016
KZ 1100 L (LTD)	83	CK4434		CSK23			SRC20	SRK20	CT016
ZN 1100 B (LTD)	84-85	CK4434		CSK23			SRC20	SRK20	CT016
ZX 1100 A (GPz)	83-84	CK4434		CSK23			SRC20	SRK20	CT016
ZR 1100 A Zephyr	92-95	CK4434		CSK23			SRC20	SRK20	CT016
(ZR 1100 C) ZRX 1100	99-00	CK4434		CSK23			SRC20	SRK20	CT016
ZX 1100 C/D (ZX11)	90-01	CK4488		CSK29			SRC25	SRK25	CT021
ZX 1100 E/F GPZ 1100	95-97	CK4488		CSK29			SRC25	SRK25	CT021
ZG 1200 A/B	86-90	CK4434		CSK23			SRC20		CT016
ZG 1200 B Voyager X11	91-03	CK4434		CSK23			SRC20		CT016
ZX12 R (ZX 1200 A)	00	CK4513		CSK109					CT009
ZX12 R (ZX 1200 A/B)	01-05	CK4515		CSK67					CT009
ZRX 1200 R (ZR 1200 A)	01-05	CK4434		CSK38					CT016
ZZR 1200 (ZX 1200 C)	02-05	CK4488		CSK29			SRC25	SRK25	CT021

CLUTCH APPLICATIONS

EBC BRAKES CLUTCH KITS



KAWASAKI



		CK cork OEM style Kit #	CKF carbon fiber style upgrade Kit #	CSK Spring Kit #	DRC Series Kit #	DRCF Series Kit #	SRC Series Kit #	SRK Series Kit #	CT Tool #
KZ 1300 A	79-81	CK4452		CSK10					
KZ 1300 A	82	CK4458		CSK10					
KZ 1300 B Touring	80	CK4452		CSK10					
ZN 1300 A Voyager	83-88	CK4455		CSK10					CT032
Concours 14 (ZG 1400 A/C/E) ABS	08-16	CK4520		CSK23					CT021
Concours 14 (ZG 1400 B/D)	08-10	CK4520		CSK23					CT021
ZX 14 R (ZX 1400 A6F/A7F)	06-07	CK4518		CSK124					CT021
ZX 14 R ABS (ZX 1400 B6F/B7F)	06-07	CK4518		CSK124					CT021
ZX 14 R ABS	08-11	CK4518		CSK124					CT021
ZX 14 R ABS	12-16	CK4518		CSK23					CT021
ZX 14 R ABS Performance	12-21	CK4518		CSK23					CT021
ZX 14 R ABS Performance Sport (ZX 1400 JGF)	14-21	CK4518		CSK23					CT021
VN 1500 A Vulcan 88	87-99	CK4455		N/A					CT032
VN 1500 B/C Vulcan 88 SE/Classic	87-99	CK4455		N/A					CT032
VN 1500 D/E Vulcan 88 SE/Classic	96-04	CK4455		N/A					CT032
VN 1500 G Nomad	99-01	CK4455		N/A					CT032
VN 1500 Drifter J/R	99-05	CK4455		N/A					CT032
VN 1500 L Vulcan 1500 Nomad F1	01-05	CK4455		N/A					CT032
VN 1500 N Vulcan 1500 Classic Fi	00-02	CK4455		N/A					CT032
VN 1500 Vulcan Mean Streak P	02-03	CK4455		N/A					CT032
VN 1500 N Vulcan 1500 Classic	05-08	CK4455		N/A					CT032
VN 1600 A Classic	03-08	CK4455		N/A					CT032
VN 1600 B Mean Streak	04	CK4455		N/A					CT032
VN 1600 B Mean Streak	05-08	CK4455		N/A					CT032
VN 1600 D Nomad	05-08	CK4455		N/A					CT032
VN 1700 G Vulcan 1700 Classic LT	09-10	CK4516		CSK170					CT032
VN 1700 A Vulcan 1700 Voyager	09-13	CK4516		CSK170					CT032
VN 1700 B Vulcan 1700 Voyager ABS	09-16	CK4516		CSK170					CT032
VN 1700 C Vulcan 1700 Nomad	09-13	CK4516		CSK170					CT032
VN 1700 D Vulcan 1700 Nomad	14	CK4516		CSK170					CT032
VN 1700 C Vulcan 1700 Nomad 2T	09	CK4516		CSK170					CT032
VN 1700 E Vulcan 1700 Classic	09-11	CK4516		CSK170					CT032
VN 1700 G Vulcan 1700 Classic LT	09-10	CK4516		CSK170					CT032
VN 1700 J Vulcan Vaquero	11-13	CK4516		CSK170					CT032
VN 1700 K Vulcan Vaquero ABS	14-21	CK4516		CSK170					CT032
VN 1700 K Vulcan Vaquero ABS SE	14-21	CK4516		CSK170					CT032
VN 2000 A/G Vulcan	04-09	CK4516		CSK110					CT032
VN 2000 D/G Vulcan Ltd	05-06	CK4516		CSK110					CT032
VN 2000 E/H Vulcan Classic	06-09	CK4516		CSK110					CT032
VN 2000 F/J Vulcan Classic LT	06-10	CK4516		CSK110					CT032
SUZUKI									
AC 50 R	70-71	CK3311		CSK25					CT051
AS 50 Sport/Colt	68-69	CK3311		CSK25					CT051
DR-Z 50	19-21	CK3458							
JR 50 C/N/T/X/Z/F/G/H/J/K/L/N/P/R/S/T/V/W/X/Y/K	78-06	CK3366		N/A					
RB 50 H (GSXR 50)	87	CK3380		CSK13					CT051
RM 50 C/N/T	78-80	CK3328		CSK1					CT011
RM 60 N/T/X/Z/D	79-83	CK3318	CKF3318	CSK1					CT011
RM 60 K	03	CK4438	CKF4438	CSK18	DRC7				CT070SP
RM 65 K	03-05	CK4438	CKF4438	CSK40	DRC98	DRCF98			CT070SP
DR-Z 70	15-21	CK3458		N/A					
DS 80 T/X/Z	80-82	CK3340		CSK1					CT011
DS 80 D/F/G/H/J/K/L/M/N/P/R/S/T/V/W/X/Y	83-00	CK3340		CSK1					CT011
JR 80 K	01-04	CK3340		CSK1					CT011
RM 80 T/X	80-81	CK3318	CKF3318	CSK1					CT011
RM 80 Z/D	82-83	CK3340		CSK36					CT011

CLUTCH
APPLICATIONS

EBC BRAKES CLUTCH KITS



SUZUKI



		CK cork OEM style Kit #	CKF carbon fiber style upgrade Kit #	CSK Spring Kit #	DRC Series Kit #	DRCF Series Kit #	SRC Series Kit #	SRK Series Kit #	CT Tool #
RM 80 E/F	84-85	CK3318	CKF3318	CSK34					CT011
RM 80 G	86	CK3367		CSK34					
RM 80 H/J	87-88	CK3367		CSK55	DRC19				
RM 80 K/L	89-90	CK3318		CSK36	DRC20				CT011
RM 80 M/N/P/R/S/T/N/W/X/Y/K	91-01	CK3318	CKF3318	CSK14	DRC25	DRCF25			CT011
RM 85 (Small Wheel F 17 Inch/R 14 Inch Wheel)	02-21	CK3318	CKF3318	CSK14	DRC25	DRCF25			CT011
RM 85 (Big Wheel F 19 Inch/ R 16 Inch)	02-21	CK3318	CKF3318	CSK14	DRC25	DRCF25			CT011
TC 90/R/J Blazer	70-72	CK3312		CSK25					CT051
TS 90/R/J Honcho	70-72	CK3312		CSK25					CT051
A 100 A/B Gofer	76-77	CK3312		CSK25					CT051
B 100 P Magnum (118cc)	65-66	N/A		N/A					
DR 100 D/E	83-84	CK3318	CKF3318	CSK34					CT011
DR 100 F/G/H/J/K/L	85-90	CK3318	CKF3318	CSK34					CT011
DS 100 C/N/T/X	78-81	CK3318	CKF3318	CSK25					CT011
RM 100 A	76	CK3319	CKF3319	CSK25					CT011
RM 100 A/B	77-78	CK3329		CSK25					CT011
RM 100 N/T/X	79-81	CK3319		CSK25					CT011
RM 100 K	03-04	CK4438	CKF4438	CSK40	DRC98	DRCF98			CT070SP
SP 100 D	83	CK3318	CKF3318	CSK1					CT011
TC 100 K/L/M/A/B Blazer	73-77	CK3326		CSK25					CT051
TS 100 K/L/M/A/B Honcho	73-77	CK3326		CSK25					CT051
TS 100 T/X	80-81	CK3337		CSK25					CT011
DR-Z 110 K	03-05	CK4438	CKF4438	CSK40	DRC98	DRCF98			CT070SP
B 120 (118cc - 106mm outer diameter friction plate)	71-77	CK3306		CSK1					CT052
KT 120 Trail	68-70	N/A		N/A					CT052
TC 120 Trailcat	68-71	CK3306		CSK1					CT052
ALT 125 D/E/F/G	83-86	CK3328		N/A					CT011
DR 125 Z/D/E	82-84	CK3318		CSK34					CT011
DR 125 G/H/J	86-88	CK3318		CSK34					CT011
DR 125 SER/SES/SET	94-96	CK3318		CSK34					CT011
DR-Z 125 K/L	03-20	CK3318		CSK34					CT011
DR-Z 125 LK/LL	03-20	CK3318		CSK34					CT011
DS 125 N/T/X	79-81	CK3318		CSK25					CT011
GN 125 Z/D	82-83	CK3318	CKF3318	CSK34					CT011
GN 125 E	91-97	CK3318	CKF3318	CSK34					CT011
GSX-R 125	18-21	CK3318	CKF3318	CSK245			SRC148	SRK148	CT011
GSX-S 125	18-21	CK3318	CKF3318	CSK245			SRC148	SRK148	CT011
LT 125 D/E/F/G/H	83-87	CK3328		N/A					CT
RM 125 A/B/C	76-78	CK3329		CSK25					CT011
RM 125 X/Z	81-82	CK3329		CSK36					CT011
RM 125 D	83	CK3329		CSK34					CT011
RM 125 E	84	CK3356		CSK34					CT011
RM 125 F	85	CK3329		CSK34					CT011
RM 125 G/H	86-87	CK3319		CSK1	DRC21				CT011
RM 125 J/K/L/M	88-91	CK3356		CSK53	DRC22				CT011
RM 125 N	92	CK3401		CSK32	DRC114				CT003
RM 125 P/R/S/T/V/W	93-98	CK3401		CSK27	DRC76S				CT003
RM 125 X/Y/K	99-01	CK3401		CSK91	DRC115				CT003
RM 125 K	02-08	CK4514	CKF4514	CSK91	DRC130	DRCF130			CT003
RV 125 K/L/M/A/B Tracker	73-77	CK3318	CKF3318	CSK25					CT011
SP 125 Z/D	82-83	CK3318	CKF3318	CSK34					CT011
SP 125 G/H/J	86-88	CK3318	CKF3318	CSK34					CT011
T 125/11/R Stinger	69-71	CK3306		CSK25					CT052
TC 125 J/K/L/M/A/B Prospector	72-77	CK3318	CKF3318	CSK25					CT011
TM 125 K/L/M Challenger	73-75	CK3319	CKF3319	CSK25					CT011
TS 125 T/X	80-81	CK3337		CSK25					CT011
GSX-R 150	18-21	CK3318	CKF3318	CSK245			SRC148	SRK148	CT011

CLUTCH
APPLICATIONS

EBC BRAKES CLUTCH KITS



SUZUKI



		CK cork OEM style Kit #	CKF carbon fiber style upgrade Kit #	CSK Spring Kit #	DRC Series Kit #	DRCF Series Kit #	SRC Series Kit #	SRK Series Kit #	CT Tool #
GSX-S 150	18-21	CK3318	CKF3318	CSK245			SRC148	SRK148	CT011
S32 (150cc)	65	N/A		N/A					
S32-11 (150cc)	66-67	N/A		N/A					
LT 160 EK/EL/EM/EN	89-92	CK3364		CSK48	DRC218				CT011
LT 160 K	03-04	CK3364		CSK48	DRC218				CT011
LT-F 160 M/N/P/R/S/T/V/W/X/Y/K1/K3	91-03	CK3364		CSK48	DRC218				CT011
PE 175 T/X/Z/D/E	80-84	CK3329		CSK25					CT011
RS 175 T/X/Z	80-82	CK3329		CSK25					CT011
ALT 185 F	85	CK3328		N/A					CT011
DS 185 T	80	CK3319		CSK25					CT011
GT 185 K/L/M/A/B Adventurer	73-77	CK3319		CSK25					CT011
LT 185 E/F/G/H	84-87	CK3328		N/A					CT011
TS 185 T/X	80-81	CK3319		CSK25					CT011
DR 200 G/H/J	86-88	CK3319	CKF3319	CSK34	DRC94				CT011
DR 200 SE	96-19	CK3319	CKF3319	CSK34	DRC274				CT011
SP 200 G/H/J	86-88	CK3319	CKF3319	CSK34	DRC94				CT011
T 200 X5 - Invader	68-69	CK3319		CSK25					
TC 200 X5 Stingray	67-69	CK3319	CKF3319	CSK25					
LT 230 GEF/GEG	85-86	CK3364		CSK48	DRC218				CT011
LT 230 S up to E/No. 104360	85-88	CK3364		CSK34					CT011
LT 230 S from E/No. 104361	85-88	CK3319		CSK34	DRC94				CT011
LT-F 230 G/H	86-87	CK3364		CSK48	DRC218				CT011
LT 230 E	87-93	CK3364		CSK48	DRC218				CT011
DR 250 Z/D/F	82-85	CK3358		CSK26					CT029
DR 250 L/M/N/P	90-93	CK3399	CKF3399	CSK34	DRC58	DRCF58			CT022
DR 250 S/SE	90-95	CK3399	CKF3399	CSK34	DRC58	DRCF58			CT022
DR-Z 250 K	01-07	CK1181	CKF1181	CSK46	DRC280	DRCF280			CT013
DS 250 T	80	CK3315		CSK158					CT022
GS 250 TT/TX	80-81	CK3329		CSK36					CT011
GN 250 Z/D/F/J	82-88	CK3358		CSK158					CT029
GT 250 K/L Hustler	73-74	CK3313		CSK6					CT022
GT 250 M/A/B Hustler	75-77	CK3315		CSK6					CT022
GW 250 L (Naked)	14-15	CK3358		CSK204					CT029
GW 250 FL (Fairing)	14-15	CK3358		CSK204					CT029
GZ 250 X/Y/K/L Marauder	99-10	CK3358		CSK68					CT029
LT 250 EFF/EG	85-86	CK3390		CSK48	DRC89				CT011
LT 250 SK/SL	89-90	CK3329		CSK34	DRC96				CT011
LT 250 R	85	CK3319		CSK34					CT011
LT 250 R	86	CK3319		CSK146					CT011
LT 250 R	87-92	CK3372		CSK34	DRC23				CT022
LT 4WD Quadrunner 4WD H/J/K/L/M/N/P/R/S/T/V	87-97	CK3390		CSK48	DRC89				CT011
LT-F 4WD V/W Quadrunner 4WD (250cc)	97-98	CK3390		CSK48	DRC89				CT011
LT-F 250 J/K/L/M/N/P/R/S/V/W/X/Y/K1	88-01	CK3390		CSK48	DRC89				CT011
LT-F 250 FX/FY/FK1/FK2 Quadrunner	99-02	CK3390		CSK48	DRC89				CT011
LT-F 250 K Ozark Up to frame JSAAJ51A22100696	02	CK3364		CSK48	DRC220				CT011
LT-F 250 K Ozark From frame JSAAJ51A22100697-	02	CK3364		CSK147	DRC297				CT011
LT-F 250 K Ozark	03	CK3390		CSK147	DRC221				CT011
LT-F 250 K Ozark	04	CK3448		CSK48	DRC222				CT011
LT-F 250 K/L Ozark	05-14	CK3390		CSK147	DRC221				CT011
LT-Z 250 K Quadsport	04-11	CK3448		CSK48	DRC222				CT011
PE 250 T/X	80-81	CK3331		CSK158					CT022
RM 250 T/X/Z/D/E/F	80-85	CK3331		CSK158					CT022
RM 250 G	86	CK3372		CSK34					CT022
RM 250 H	87	CK3372		CSK55	DRC52				CT022
RM 250 J/K/L	88-90	CK3374		CSK27	DRC24				CT022
RM 250 M	91	CK3400		CSK45	DRC40				CT022
RM 250 N/P	92-93	CK3400		CSK32	DRC48				CT022

CLUTCH APPLICATIONS

EBC BRAKES CLUTCH KITS



SUZUKI



		CK cork OEM style Kit #	CKF carbon fiber style upgrade Kit #	CSK Spring Kit #	DRC Series Kit #	DRCF Series Kit #	SRC Series Kit #	SRK Series Kit #	CT Tool #
RM 250 R/S	94-95	CK3374		CSK32	DRC72				CT022
RM 250 T	96	CK4435	CKF4435	CSK32	DRC80				CT016
RM 250 V/W/X/Y/K	97-02	CK4435	CKF4435	CSK91	DRC95				CT016
RM 250 K	03-05	CK3454		CSK91	DRC161				CT016
RM 250 K	06-08	CK3453		CSK119	DRC160				CT016
RMX 250 K/L	89-90	CK3374		CSK27					CT022
RMX 250 M	91	CK3374		CSK45					CT022
RMX 250 N/P	92-93	CK3400		CSK32					CT022
RMX 250 R/S/T/V/W/X/Y	94-00	CK3374		CSK32	DRC72				CT022
RM-Z 250 K	04-06	CK4514	CKF4514	CSK97	DRC123	DRCF123			CT004
RM-Z 250 K	07-09	CK4514	CKF4514	CSK141	DRC189	DRCF189			CT004
RM-Z 250 L	10-21	CK4514	CKF4514	CSK164	DRC255	DRCF255			CT004
RS 250 TX	80-81	CK3331		CSK158					CT022
SP 250 Z/D/F	82-85	CK3358		CSK26					CT029
T 10 (250cc)	66-67	N/A		N/A					
T 20 X6 (250cc)	65-69	CK3310		CSK76					CT038SP
T 250 11/R/J Hustler	69-72	CK3313		CSK6					CT046
TC 250 X6 Scrambler	67-69	CK3310		CSK76					CT038SP
TS 250 N/T/X	80-81	CK3315		CSK158					CT022
TU 250 XK/XL	09-16	CK3358		CSK158					CT029
GS 300 LZ/LD/LF	82-85	CK3356		CSK34					CT011
LT 300 EH/EJ/EK Quadrunner	87-88	CK3390		CSK48	DRC89				CT011
LT-F 300 F/FK King Quad	99-02	CK3356		CSK48	DRC103				CT011
LT-F 4WD XM/N/P/R/S/T/V/W 300 King Quad	91-97	CK3356		CSK48	DRC103				CT011
T 305 Raider	68-69	CK3313		CSK6					CT046
TC 305 Laredo	68	CK3313		CSK6					CT046
DR 350 L/M/N/P/R/S/T/V/W	90-98	CK3399	CKF3399	CSK34	DRC58	DRCF58			CT022
DR 350 S/SE	90-99	CK3399	CKF3399	CSK34	DRC58	DRCF58			CT022
T 350 Rebel	69-72	CK3313		CSK6					CT046
DR 370 C/N (4T)	78-79	CK3334		CSK158					CT022
RM 370 A/B (2T)	76-77	CK3315		CSK158					CT022
GT 380 J/K/L/M/A/B Sebring	72-77	CK3315		CSK6					CT022
DR 400 T	80	CK3332		CSK158					CT022
DR-Z 400 S	00-16	CK3433	CKF3433	CSK79	DRC105	DRCF105			CT006
DR-Z 400 EY/Y/EK/K	00-07	CK3433	CKF3433	CSK79	DRC105	DRCF105			CT006
DR-Z 400 SMK/SML	05-19	CK3433	CKF3433	CSK79	DRC105	DRCF105			CT006
GSF 400 M/N/P	91-93	CK3397		CSK34					CT011
GN 400 T/XT/TX/TZ	80-82	CK3332		CSK158					CT022
GS 400 B/C	77-78	CK3343		CSK6					CT018SP
GS 400 XB/XC	77-78	CK3343		CSK6					CT018SP
LT-F 400 FK King Quad 400 FS	08-09	CK4439		CSK98	DRC120				CT006
LT-F 400 FCK King Quad 400 FS Camo	08-09	CK4439		CSK98	DRC120				CT006
LT-F 400 FK (Eiger 4WD)	02-07	CK4439		CSK98	DRC120				CT006
LT-F 400 K Eiger Manual 2WD	02	CK4439		CSK98	DRC223				CT006
LT-F 400 K	03-08	CK4439		CSK98	DRC120				CT006
LT-F 400 FQK King Quad 400 FS Anniversary Edition	09	CK4439		CSK98	DRC120				CT006
LT-F 400 FL King Quad 400 FSi	11-16	CK4439		CSK98	DRC120				CT006
LT-F 400 FCL King Quad Camo 400 FSi	11-16	CK4439		CSK98	DRC120				CT006
LT-Z 400 K Quadsport	03-04	CK3433	CKF3443	CSK79	DRC105	DRCF105			CT006
LT-Z 400 K/ZK/L2	05-14	CK3447	CKF3447	CSK79	DRC137	DRCF137			CT006
PE 400 TX	80-81	CK3332		CSK158					CT022
RM 400 C	78	CK3315		CSK158					CT022
RM 400 N/T	79-80	CK3332		CSK158					CT022
SP 400 T	80	CK3332		CSK158					CT022
TM 400 R/J/K/L/M Cyclone	71-75	CK3316		CSK158					CT022
GS 425 N (Spoke Wheel)	79	CK3343		CSK6					CT018SP
GS 425 EN (Cast Wheel)	79	CK3343		CSK6					CT018SP

CLUTCH APPLICATIONS

EBC BRAKES CLUTCH KITS



SUZUKI



		CK cork OEM style Kit #	CKF carbon fiber style upgrade Kit #	CSK Spring Kit #	DRC Series Kit #	DRCF Series Kit #	SRC Series Kit #	SRK Series Kit #	CT Tool #
GS 425 LN	79	CK3343		CSK6					CT018SP
GS 450 E	80-83	CK3333		CSK158					CT022
GS 450 L	80-88	CK3333		CSK158					CT022
GS 450 T	81-83	CK3333		CSK158					CT022
LT-R 450 K	06-11	CK3450	CKF3450	CSK125	DRC164	DRCF164			CT045
LT-R 450 ZK Quadracer SE	08-10	CK3450	CKF3450	CSK125	DRC164	DRCF164			CT045
RMX 450 ZL	10-11	CK3450	CKF3450	CSK186	DRC155	DRCF155			CT045
RM-Z 450 K	05-07	CK3450	CKF3450	CSK164	DRC254	DRCF254			CT045
RM-Z 450	08-21	CK3450	CKF3450	CSK186	DRC155	DRCF155			CT045
RM 465 X/Z	81-82	CK3348		CSK158					CT029
DR 500 X/Z/D	81-83	CK3359		CSK115					CT029SP
GS 500 E/K	89-03	CK3333		CSK61					CT022
GS 500 FK	04-10	CK3333		CSK61					CT022
LT 500 RH/RJ/RK/RL	87-90	CK3374		CSK34	DRC26				CT022
LT-F 500 F/FK Quadracer	98-02	CK4439		CSK88	DRC217				CT006
LT-F 500 FK Vinson 4WD	03-07	CK3452		CSK7	DRC216				CT006
RM 500 D/E	83-84	CK3348		CSK158					CT029
SP 500 X/Z/D	81-83	CK3359		CSK115					CT029SP
T 500 1 Cobra (18 Ear Clutch Plate)	68	CK3314		CSK6					CT046
T 500 39873 Titan (18 Ear Clutch Plate)	69-70	CK3314		CSK6					CT046
T 500 R/J/K/L/M Titan (12 Ear Clutch Plate)	71-75	CK3316		CSK6					CT022
RE 5 M/A (Rotary)	75-76	CK3373		CSK6					CT035SP
GS 550 B/C/EC/N/EN/ET	77-80	CK3344		CSK159					CT018SP
GS 550 MZ	82	CK3344		CSK159					CT018SP
GS 550 LT/LX/LZ	80-82	CK3344		CSK159					CT018SP
GS 550 LD/LF/LG/TX	81-85	CK3344		CSK159					CT018SP
GS 550 E/ES	83	CK3344		CSK159					CT018SP
GS 550 ES/E	84-85	CK3344		CSK159					CT018SP
GT 550 J/K/L/M/A/B Indy	72-77	CK3321		CSK158					CT035SP
GSF 600 S Bandit	96-98	CK3348		CSK198					CT047SP
GSF 600 S/SK	00-02	CK3348		CSK198					CT047SP
GSX 600 F Katana	88-91	CK3348		CSK26			SRC13	SRK13	CT047SP
GSX 600 F Katana	92-97	CK3387		CSK198			SRC17	SRK17	CT036SP
GSX 600 F/FK - Katana	98-06	CK3357		CSK198					CT047SP
GSX-R 600 WN/WP	92-93	CK3387		CSK198			SRC17	SRK104	CT036SP
GSX-R 600 V/W	97-98	CK1206		CSK902			SRC58	SRK106	CT055SP
GSX-R 600 X/Y	99-00	CK1206		CSK902			SRC58	SRK58	CT055SP
GSX-R 600 K/ZK	01-03	CK3466		CSK261			SRC112	SRK112	CT014
GSX-R 600 K	04-05	CK1206		CSK156			SRC78	SRK78	CT014
GSX-R 600 K	06-07	CK3455		CSK205			SRC86	SRK86	CT015
GSX-R 600 K	08-10	CK3456		CSK205			SRC88	SRK109	CT015
GSX-R 600 L	11-21	CK3456		CSK183			SRC110	SRK110	CT015
RF 600 R	94-96	CK3408		CSK198			SRC45	SRK45	CT036SP
SP 600 F	85	CK3359		CSK115					CT029SP
DL 650 K V-Strom	04-09	CK1219		CSK133					CT033SP
DL 650 AK/AL V-Strom (ABS Model)	07-21	CK1219		CSK133			SRC82	SRK82	CT033SP
DL 650 XT V-Strom ABS (DL 650 XAL5/XAL6)	15-21	CK1219		CSK133			SRC82	SRK82	CT033SP
DL 650 AAL V-Strom (ABS Adventure)	12-21	CK1219		CSK133			SRC82	SRK82	CT033SP
DR 650 S	90-93	CK3402		CSK115	DRC59				CT029SP
DR 650 S	94-95	CK3402		CSK115	DRC142				CT029SP
DR 650 SE/SEK/SEL	96-16	CK3386		CSK26	DRC87				CT024
GR 650 D/XD	83	CK3357		CSK26					CT029
GS 650 E/G	81-83	CK3330		CSK159					CT018SP
GS 650 GL	81-83	CK3330		CSK159					CT018SP
GS 650 MD	83	CK3330		CSK159					CT018SP
GSX 650 FK	08-10	CK1218	CKF1218	CSK122					CT014
LS 650 F/P/PPK	86-88/95-04	CK3359		CSK26					CT029SP

CLUTCH
APPLICATIONS

EBC BRAKES CLUTCH KITS



SUZUKI



		CK cork OEM style Kit #	CKF carbon fiber style upgrade Kit #	CSK Spring Kit #	DRC Series Kit #	DRCF Series Kit #	SRC Series Kit #	SRK Series Kit #	CT Tool #
LS 650 K/L Boulevard S40 (650cc)	05-15	CK3359		CSK26					CT029SP
SFV 650 K/L	09-10/13-15	CK1219		CSK133			SRC82	SRK82	CT033SP
SV 650 X/Y/K/SK	99-02	CK3377		CSK69			SRC81	SRK81	CT022
SV 650 K/SK	03-10	CK1219		CSK133			SRC82	SRK82	CT033SP
SV 650 AK/SAK ABS	07-10	CK1219		CSK133			SRC82	SRK82	CT033SP
SV 650 AL (ABS)	16-21	CK1219		CSK133			SRC82	SRK82	CT033SP
XN 85 D	83	CK3347		CSK158					CT018SP
GS 700 E	85	CK3330		CSK115					CT018SP
GV 700 GL	85	CK3374		CSK115					CT022
VS 700 GL	86-87	CK3377		CSK115					CT029
GS 750 B/C/E/N/E	77-79	CK3324		CSK158					CT018SP
GS 750 E	80-82	CK3330		CSK158					CT018SP
GS 750 T	82-83	CK3330		CSK158					CT018SP
GS 750 L	80-81	CK3330		CSK158					CT018SP
GS 750 E/ES	83	CK3330		CSK115					CT018SP
GS 750 SD	83	CK3330		TBA					CT018SP
GSX 750 F	89-96	CK3391		CSK12					
GSX 750 F Katana	98-06	CK3357		CSK198					CT047SP
GSX-R 750 RG (Dry Clutch - Sintered Friction)	86	CK3376		CSK198			N/A	SRK138	CT072SP
GSX-R 750 G/H	86-87	CK3348		CSK115			SRC13	SRK13	CT047SP
GSX-R 750 J/K	88-89	CK3387		CSK12			SRC14	SRK14	CT036SP
GSX-R 750 L/M/N	90-92	CK3387		CSK198			SRC17	SRK17	CT036SP
GSX-R 750 WP/WR/WS	93-95	CK3387		CSK198			SRC17	SRK104	CT036SP
GSX-R 750 TN/W/X	96-99	CK3417		CSK902			SRC40	SRK40	CT055SP
GSX-R 750 Y	00	CK1229		CSK156			SRC71	SRK71	CT014
GSX-R 750 K	01-03	CK3465		CSK156			SRC111	SRK111	CT014
GSX-R 750 K	04-05	CK3417		CSK75			SRC121	SRK121	CT014
GSX-R 750 K	06-07	CK3456		CSK205			SRC88	SRK88	CT015
GSX-R 750 K/L	08-10	CK3456		CSK205			SRC88	SRK109	CT015
GSX-R 750	11-21	CK3456		CSK183			SRC110	SRK110	CT015
GSX-S 750	15-16	CK3417		CSK109			SRC169	SRK169	CT014
GSX-S 750 ABS	17-21	CK3417		CSK109			SRC169	SRK169	CT014
GT 750 J/K/L/M/A/B	73-77	CK3324		CSK158					CT018SP
VS 750 GLP	88-91	CK3377		CSK115					CT029
VL 800 K Intruder Volusia	01-04	CK3377		CSK66					CT029
VL 800 ZK Volusia LTD (Seat Trimmed With Chrome Studs)	03-04	CK3377		CSK66					CT029
VL 800 CK/K/ZK/L (C 50 Boulevard)	05-15	CK3377		CSK66					CT029
VL 800 TK/TL (C 50 T Boulevard Tourer)	05-15	CK3377		CSK66					CT029
VL 800 BTL4 (Boulevard C50 B.O.S.S./Cast Wheels)	14	CK3377		CSK66					CT029
VL 800 CL3 (Boulevard C50/Cast Wheels)	13	CK3377		CSK66					CT029
VX 800 L/M/N/P (8 spring CSK kit)	90-93	CK3377		CSK162					CT029
VS 800 Intruder GL/GLK	92-04	CK3377		CSK115					CT029
VS 800 K/L S50 Boulevard	05-10	CK3377		CSK115					CT029
VZ 800 V/W/X/Y/K Marauder (8 spring CSK kit)	97-04	CK3377		CSK162					CT029
VZ 800 K/BK/ZK (M50 Boulevard)	05-10	CK3377		CSK66					CT029
VZ 800 L (M50 Boulevard)	10-15	CK3377		CSK66					CT029
GS 850 G	79-80	CK3330		CSK158					CT018SP
GS 850 G	81-83	CK3330		CSK158					CT018SP
GS 850 G	80-81	CK3330		CSK158					CT018SP
GS 850 G	82-83	CK3330		CSK158					CT018SP
RF 900 R	94	CK3418		CSK902			SRC39	SRK39	CT055SP
RF 900 R	95-97	CK3417		CSK29					CT014
DL 1000 K/L V-Strom	02-12	CK3443		CSK43					CT021
DL 1000 AL V-Strom ABS	14-20	CK3443		CSK43					CT021
DL 1000 AL/AAL V-Strom Adventure	14-20	CK3443		CSK43					CT021
GS 1000 C/N/EC/EN/SN/ET/ST	78-80	CK3345		CSK158			SRC115	SRK115	CT035SP
GS 1000 SZ	82	CK3335		CSK6					CT024SP

CLUTCH APPLICATIONS

EBC BRAKES CLUTCH KITS



SUZUKI



		CK cork OEM style Kit #	CKF carbon fiber style upgrade Kit #	CSK Spring Kit #	DRC Series Kit #	DRCF Series Kit #	SRC Series Kit #	SRK Series Kit #	CT Tool #
GS 1000 GT/GX	80-81	CK3335		CSK158			SRC50	SRK50	CT024SP
GS 1000 GLT/GLX/SZ	80-82	CK3335		CSK158			SRC50	SRK50	CT024SP
GSX-R 1000 K/ZK	01-04	CK4510		CSK128			SRC89	SRK89	CT004
GSX-R 1000 K	05-08	CK3451		CSK145			SRC85	SRK85	CT015
GSX-R 1000 K/L	09-11	CK3462		CSK160			SRC97	SRK97	CT009
GSX-R 1000 L	12-16	CK3462		CSK196			SRC120	TBA	CT009
GSX-R 1000 AL ABS	15-16	CK3462		CSK196			SRC120	TBA	CT009
GSX-R 1000 AL ABS/3 Spring clutch	17	CK3468		CSK242			SRC142	SRK142	CT009
GSX-S 1000	16-17	CK4510		CSK223					CT004
GSX-S 1000 ABS	16-17	CK4510		CSK223					CT004
GSX-S 1000	18-21	CK3451		CSK145			SRC85	SRK85	CT015
GSX-S 1000 ABS	18-21	CK3451		CSK145			SRC85	SRK85	CT015
GSX-S 1000 F	16-17	CK4510		CSK223					CT004
GSX-S 1000 F ABS	16-17	CK4510		CSK223					CT004
GSX-S 1000 F	18-21	CK3451		CSK145			SRC85	SRK85	CT015
GSX-S 1000 F ABS	18-21	CK3451		CSK145			SRC85	SRK85	CT015
Katana	19-21	CK3451		CSK145			SRC85	SRK85	CT015
SV 1000 K/SK	03-07	CK3443		CSK114					CT021
TL 1000 S	97-98	CK3417		CSK78					CT014
TL 1000 S	99-00	CK3428		CSK71			SRC68	SRK68	CT009
TL 1000 R	98-00	CK3428		CSK71			SRC68	SRK68	CT009
TL 1000 RK	01-03	CK3435		CSK71					CT009
TL1 000 SK	01-02	CK3435		CSK71					CT009
GS 1100 E	80-82	CK3335		CSK158			SRC50	SRK50	CT024SP
GS 1100 E	83	CK3346		CSK6					CT024SP
GS 1100 G	82-83	CK3335		CSK158			SRC50	SRK50	CT024SP
GS 1100 GL	82-83	CK3335		CSK158			SRC50	SRK50	CT024SP
GS 1100 GK	82-84	CK3335		CSK158			SRC50	SRK50	CT024SP
GS 1100 LT	80	CK3335		CSK158			SRC50	SRK50	CT024SP
GS 1100 SD	83	CK3346		CSK6					CT024SP
GSX 1100 F	88-93	CK3381		CSK12					CT048SP
GSX 1100 G	91-93	CK3392		CSK902			SRC10	SRK10	CT055SP
GSX-R 1100 G/H/J	86-88	CK3381		CSK115			SRC15	SRK15	CT048SP
GSX-R 1100 K/L/M/N	89-92	CK3392		CSK902			SRC10	SRK10	CT055SP
GSX-R 1100 W	93-98	CK3418		CSK902			SRC39	SRK39	CT055SP
GS 1150 ES	83-86	CK3335		CSK6					CT024SP
GSF 1200 S/SK	97-05	CK3417		CSK902			SRC40	SRK40	CT055SP
GV 1200 GL	85-86	CK3375		CSK115					CT029
GSF 1250 SAK (ABS)	07-10	CK3459		CSK124					CT021
GSF 1250 SK Bandit	07-10	CK3459		CSK124					CT021
GSX 1250 FAL	11-12	CK3459		CSK124					CT021
GSX 1250 SAL Bandit	16	CK3459		CSK124					CT021
GSX 1300 RX Hayabusa	99	CK3430		CSK72			SRC67	SRK67	CT021
GSX 1300 RY/RK1 Hayabusa	00-01	CK3430		CSK171					CT021
GSX 1300 RK/RZK	02-07	CK3443		CSK171					CT021
GSX 1300 RK/RL	08-12	CK3443		CSK139					CT021
GSX 1300 RAL ABS Hayabusa	13-16	CK3443		CSK139					CT021
GSX 1300 RZL (Hayabusa 50th Anniversary Edition)	14	CK3443		CSK139					CT021
GSX 1300 BKA/K B-King ABS	08-10	CK3443		CSK139					CT021
GSX 1300 BKK/K B-King	08-10	CK3443		CSK139					CT021
GV 1400 G	86-88	CK3388		CSK115					CT029
VS 1400 GLP/GLF	87-04	CK3382		N/A					CT029
VS 1400 GLPK/K/L Boulevard S83 (1400cc)	05-10	CK3382		N/A					CT029
VL 1500 W/X/Y/K Intruder Legendary Classic	98-04	CK3335		CSK31					CT024SP
VL 1500 BK/K/TK/L Boulevard C90/C90T	05-10/13	CK3335		CSK31					CT024SP
VL 1500 BL (Boulevard C90 B.O.S.S.)	13-15	CK3459		TBA					CT021
VL 1500 BTL (Boulevard C90T B.O.S.S./With Windshield)	13-14	CK3459		TBA					CT021

CLUTCH
APPLICATIONS

EBC BRAKES CLUTCH KITS



SUZUKI



		CK cork OEM style Kit #	CKF carbon fiber style upgrade Kit #	CSK Spring Kit #	DRC Series Kit #	DRCF Series Kit #	SRC Series Kit #	SRK Series Kit #	CT Tool #
VL 1500 L (Boulevard C90)	13	CK3459		TBA					CT021
VL 1500 TL (Boulevard C90T/With Windshield)	13-14	CK3459		TBA					CT021
VZ 1500 K/L M90 Boulevard	09/13-15	CK3459		TBA					CT021
VZ 1600 K Marauder	04	CK4455		N/A					CT032
VZ 1600 K M95 Boulevard/Marauder	05	CK4455		N/A					CT032
VLR 1800 RTK (C109RT Boulevard Touring)	08-10	CK3463		CSK75					
VLR 1800 K (C109R Boulevard)	08-10	CK3463		CSK75					
VZR 1800 K/L Boulevard M109R	06-14	CK3457		CSK122					
VZR 1800 NK Boulevard Limited M109R2	08-09	CK3457		CSK122					
VZR 1800 ZK/ZL Boulevard RZ Limited (M109RZ)	08-14	CK3457		CSK122					
VZR 1800 BL (Boulevard B.O.S.S. M109R)	14-15	CK3457		CSK122					
YAMAHA									
DT 50 U/W/A (DTL/C)	88-89	CK2206		CSK42					CT044
RX 50 MK Midnight Special	83	CK2205		CSK42					CT044
RX 50 K/L 50 Special	83/84	CK2205		CSK42					CT044
TT-R 50 E	06-09/12-14	TBA		N/A					
YFM 50 S/T/R Raptor	04-08	CK2303		N/A					
YSR 50 T/U/W	87-89	CK2205		CSK42					CT044
YSR 50 A/B/D	90-92	CK2205		CSK42					CT044
YZ 50 G	80	CK2206		CSK42					CT044
YZ 60 H/J/K	81-83	CK2265		CSK42					CT010
YZ 65	19-21	CK2304		CSK42					CT010
BW 80 S/T/U/A	86-90	CK2303		N/A					
DT 80 H/J/K	81-83	CK2206		CSK42					CT044
MX 80 G/H/J	80-82	CK2206		CSK42					CT044
PW 80 K/N/B/D/E/F/G/H/J/K/L/M/N/P/R/S/T/V	83-06	CK2303		N/A					
V 80 (3NX3/4)	94	CK2303		N/A					
V 80 (4GC5/6/3NX6)	98	CK2303		N/A					
V 80 D (4GC2/3/4) - 3 = Single Seat / 4 = Dual Street	94-96	CK2303		N/A					
YFM 80 N/S/T/U (Moto 4)	85-88	CK2303		N/A					
YFM 80 D/E/F/G/H/J/K/L/M/N Badger	91-01	CK2303		N/A					
YFM 80 WP/MR/WS/RT/RV/RW/RX Raptor	02-08	CK2303		N/A					
YFM 80 GT/GV/GW/GX Grizzly	05-08	CK2303		N/A					
YZ 80 G	80	CK2238		CSK42					CT044
YZ 80 H/J/K/L/N	81-85	CK2287		CSK42					CT010
YZ 80 S/T/U/W/A/B/D	86-92	CK2304		CSK42	DRC27				CT010
YZ 80 E/F	93-94	CK2304		CSK39	DRC66				CT010
YZ 80 G/H/J/K/L/M/N	95-01	CK2335	CKF2335	CSK42	DRC78				CT010
YZ 85 (2T/Small Wheel F 17 Inch/R 14 Inch)	02-21	CK2335	CKF2335	CSK42	DRC111	DRCF111			CT010
YZ 85 (2T/Big Wheel F 19 Inch/R 16 Inch)	02-21	CK2335	CKF2335	CSK42	DRC111	DRCF111			CT010
TT-R 90 M/N/P/R/ES/S/ET/EV/EW	00-07	CK2354		N/A					
DT 100 G/H/J/K	80-83	CK2254	CKF2254	CSK42					CT044
MX 100 G/H/J/K	80-83	CK2254	CKF2254	CSK42					CT044
RT 100 A/D/E/F/G/H/J/K/L/M	92-00	CK2254	CKF2254	CSK42					CT044
RX 100 (36L/36LO/5RD1/2)	01-03	CK2254		CSK42					CT044
RX 100 (5RD3/4)	04	CK2254		CSK42					CT044
RX 100 C (5RC1/2/3)	04	CK2254		CSK42					CT044
RXZ 100 S (3HS1/2)	88-95	CK2208		CSK42					CT039
YFM 100 T/U/W/A/B Champ	87-91	N/A		N/A					
YZ 100 G/H/J/K	80-83	CK2234		CSK39					CT039
T 105 E Crypton (5AM4)	99-02	CK2354		N/A					
T 105 SE Crypton (1D81/1D82)	03-09	CK2354		N/A					
TTR 110 E	08-21	CK2375		CSK150					
RXS 115 (3HB6/7)	94-97	CK2254		CSK42					CT044
RXS 115 (3HB8)	99	CK2254		CSK42					CT044
DT 125 G/H	80-81	CK2236		CSK42					CT039

CLUTCH APPLICATIONS

EBC BRAKES CLUTCH KITS



YAMAHA



		CK cork OEM style Kit #	CKF carbon fiber style upgrade Kit #	CSK Spring Kit #	DRC Series Kit #	DRCF Series Kit #	SRC Series Kit #	SRK Series Kit #	CT Tool #
IT 125 G/H	80-81	CK2234		CSK42					CT039
TT-R 125 M/N/P/R/S/E	00-09	CK2254	CKF2254	CSK42	DRC230	DRCF230			CT044
TT-R 125 LWM/L/LE	00-19	CK2254	CKF2254	CSK42	DRC230	DRCF230			CT044
XT 125 J/K/KC	82-83	CK2256		CSK52					CT039
YBA 125 Vision (5AP1)	01	CK2254		CSK42					CT044
YBA 125 Enticer (3P41)	05	TBA		TBA					
YBA 125 Enticer (5US1)	05	TBA		TBA					
YBA 125 Enticer (16C1/3P42/3)	07-12	TBA		TBA					
YBR 125 (5PY1/2)	01	CK2283		CSK42					CT044
YBR 125 (2D0D/2CS1)	11-13	CK1151		N/A					CT012
YBR 125 C (36S1/2/3/4)	08-13	CK1151		N/A					CT012
YBR 125 E (4P24/4P27/4P2B/4P2H)	06-13	CK1151		N/A					CT012
YBR 125 EB (5RR2/3/4/5/6)	02-05	CK2254		CSK42					CT044
YBR 125 EB (5RR8/9)	06-08	CK2254		CSK42					CT044
YBR 125 ED (5RR1)	01	CK2254		CSK42					CT044
YBR 125 ED (4P28) Cast Wheel	07-09	CK1151		N/A					CT012
YBR 125 ED (4P2C/4P2J) Cast Wheel	10-13	CK1151		N/A					CT012
YBR 125 ESD (4P26) Cast Wheel	07-09	CK1151		N/A					CT012
YBR 125 ESD (4P2A/4P2G) Cast Wheel	10-13	CK1151		N/A					CT012
YBR 125 ESG (43B1/3/5/6/8)	08-13	CK1151		N/A					CT012
YBR 125 K (5TU1/2/4/6/8)	02-06	CK2254		CSK42					CT044
YBR 125 R (1PX1/X2)	11-12	CK1151		N/A					CT012
YFM 125 R Raptor	11-13	CK1151	CKF1151	CSK42					CT012
YT 125 G/H	80-81	CK2252		N/A					
YT 125 J/K/L/N	82-85	CK2251		N/A					
YZ 125 G	80	CK2234		CSK42					CT039
YZ 125 H	81	CK2235		CSK39					CT039
YZ 125 J	82	CK2276		CSK39					
YZ 125 K/L/N	83-85	CK2278		CSK39					CT054SP
YZ 125 S/T	86-87	CK2278		CSK2	DRC28				CT054SP
YZ 125 U	88	CK2312		CSK2	DRC29				CT054SP
YZ 125 W/A	89-90	CK2311		CSK2	DRC30				CT054SP
YZ 125 B/D	91-92	CK2319		CSK81	DRC39				CT005
YZ 125 E/F/G	93-95	CK2325	CKF2325	CSK81	DRC70	DRCF70			CT005
YZ 125 H	96	CK2325	CKF2325	CSK14	DRC85				CT005
YZ 125 J/K/L/M/N	97-01	CK2325	CKF2325	CSK81	DRC70	DRCF70			CT005
YZ 125 P/R/S	02-04	CK2325	CKF2325	CSK14	DRC85				CT005
YZ 125 (2T)	05-21	CK2325	CKF2325	CSK81	DRC70	DRCF70			CT005
RX-Z 135 (2UX/3UK1)	87-89	CK2349		CSK42					
RX-Z 135 (3UK3/3RSA/3RSB/3UK1)	93-97	CK2349		CSK42					
RX-Z 135 (3XL3/5PV1/5PV2)	00-05	CK2304		CSK42					CT010
FZ 150 (3C12/3C11)	07-08	TBA		TBA					
SR 150 (3UR8)	95	CK2304		CSK42					CT010
YZF-R 15 (150cc) (54C2/3/6)	10-13	TBA		TBA					
FZ 16 (160cc) (1ES1/2/3)	10-13	TBA		TBA					
FZ 16 (160cc) (1ES4)	12-13	TBA		TBA					
FZ 16 ST (160cc) (1ES4)	11-13	TBA		TBA					
DT 175 G/H	80-81	CK2245		CSK42					CT039
IT 175 G/H/J/K	80-83	CK2235		CSK39					CT039
MX 175 G/H	80-81	CK2245		CSK42					CT039
YT 175 J/K	82-83	CK2251		N/A					
RT 180 A/B/D/E/G/H/J	90-97	CK2245		CSK42					CT039
XC 180 K/KC/L/LC/N/NC/DN/DWC/ZL/ZLC/ZN/ZNC	83-85	CK2298		N/A					
SR 185 H/J	81/82	CK2234		CSK42					CT039
BW 200 N/S/ES/ET/EU	85-88	CK2292		CSK149	DRC55				CT039
IT 200 L/VS	84-86	CK2235		CSK1					CT039

CLUTCH
APPLICATIONS

EBC BRAKES CLUTCH KITS



YAMAHA



		CK cork OEM style Kit #	CKF carbon fiber style upgrade Kit #	CSK Spring Kit #	DRC Series Kit #	DRCF Series Kit #	SRC Series Kit #	SRK Series Kit #	CT Tool #
TW 200 T/TC/U/UC/W/WCA/AC/D/DC/E/EC/F/FC/H/HC/J/JC/EK/EKC/L/LC/M /MC/N/NC/P/PC/R/RC/S/SC/T/TC/V/VC/W/WC/X/Y/Z/A/B/D/E/F Trailway	87-15	CK2234		CSK149	DRC231				CT039
WR 200 D	92	CK2313	CKF2313	CSK42	DRC42	DRCF42			CT010
XT 200 J/K/KC	82-83	CK2236		N/A					CT039
YFM 200 N	85	CK2287		CSK149	DRC232				CT010SP
YFM 200 D (Moto 4)	86-89	CK2287		CSK149	DRC232				CT010SP
YFS 200 U/W/A/B/D/E/F/G/H/J/K/L/M/N/P/R/S/TV Blaster	88-06	CK2313	CKF2313	CSK42	DRC42	DRCF42			CT010
YTM 200 K/L/N	83-85	CK2287		CSK149	DRC232				CT010SP
YTM 200 E	83-85	CK2287		CSK149	DRC232				CT010SP
TT 225 S/T	86-87	CK2324		CSK149	DRC229				CT039
TT-R 225 L/M/N/P/R/S	99-04	CK2324		CSK149	DRC229				CT039
XT 225 D/DC/E/EC/F/FC/G/GC/H/HC	92-96	CK2234		CSK149	DRC231				CT039
XT 225 J/JC/K/KC/L/M/MC/N/NC/P/PC/R/RC/S/SC/T/TC/V/VC/W/WC	92-07	CK2324		CSK149	DRC229				CT039
YFM 225 S/T/U/W (Moto 4)	86-89	CK2287		CSK52	DRC104				CT010SP
YTM 225 DX	83-85	CK2287		CSK52	DRC104				CT010SP
YTM 225 DR	85-86	CK2287		CSK149	DRC232				CT010SP
TT-R 230 T/V/W/X/Y/A/B/D/E/F	05-09/11-15	CK2324		CSK149	DRC229				CT039
DT 250 A/B/C	74-76	CK2240		CSK2					CT008
DT 250 D/E/F	77-79	CK2223		CSK2					CT008
IT 250 F/G	80	CK2250		CSK2					CT008
IT 250 H/J	81-82	CK2279	CKF2279	CSK2					CT008
IT 250 K	83	CK2280		CSK2	DRC32				CT060
SR 250 G/H/TH	80-81	CK2267		CSK2					CT008
SR 250 J	82	CK2267		CSK2					CT008
SR 250 K (3Y9)	93	CK2261		CSK2					CT008
SR 250 (4GR1/2/3/4/9)	93-08	CK2261		CSK2					CT008
SRX 250 T/TC	87	CK2261		CSK49					CT008
TT 250 G/H/J	80-82	CK2267		CSK1					CT008
TT-R 250 L/M/N/P/R/S/TV	99-06	CK2319		CSK14	DRC226				CT005
WR 250 Z	91-93	CK2309		CSK81					CT020
WR 250 Z	94-97	CK2274	CKF2274	CSK81	DRC71				CT020
WR 250 F	01	CK2355	CKF2355	CSK81	DRC109	DRCF109			
WR 250 F	02-13	CK2355	CKF2355	CSK2	DRC119	DRCF119			
WR 250 F Reverse Cylinder 4T	15-21	CK2355	CKF2355	CSK214					CT005
WR 250 R	08-15	CK2319		CSK81	DRC39				CT005
WR 250 X Supermotard	08-11	CK2319		CSK81	DRC39				CT005
XT 250 G/H/J/K/KC/L/LC	80-84	CK2267		CSK2					CT008
XT 250 X/Y/Z/A/B/D/E/F/G/H	08-17	CK2370	CKF2370	CSK81	DRC295				CT005
XTZ 250 Lander	07-14	CK1217		CSK132					CT014
XTZ 250 Lander	16-18	CK1217		CSK132					CT014
XTZ 250 X	08-10	CK1217		CSK132					CT014
XV 250 Route 66/Virago	88-90/95-07	CK2316		CSK2					CT008
XV 250 V-Star	08-13	CK2316		CSK2					CT008
YBR 250 (41S2/3)	10-12	CK1217		CSK132					CT014
YFB 250 D/E Timberwolf	92-93	CK2287		CSK52	DRC104				CT010SP
YFB 250 F/G/H/UH/J/UJ/UK Timberwolf	94-98	CK2287		CSK52	DRC104				CT010SP
YFB 250 FWF Timberwolf	94-00	CK2287		CSK52	DRC104				CT010SP
YFM 250 W/A/B	89-91	CK2287		CSK52	DRC104				CT010SP
YFM 250 Bear Tracker L/M/X	99-03	CK2287		CSK52	DRC104				CT010SP
YFM 250 B Bruin	05-06	CK2287		CSK52	DRC104				CT010SP
YFM 250 B Big Bear	07-09	CK2287		CSK52	DRC104				CT010SP
YFM 250 R Raptor	08-13	CK2370	CKF2370	CSK58	DRC200	DRCF200			CT005
YFM 250 RS Special Edition	08-09	CK2370	CKF2370	CSK58	DRC200	DRCF200			CT005
YFM 250 RSPXC Special Edition Custom	08	CK2370	CKF2370	CSK58	DRC200	DRCF200			CT005
YFM 250 RSPA Special Edition	11	CK2370	CKF2370	TBA					CT005
YFUJW/YFUJTW Pro Hauler (230cc)	89	CK2287		CSK52	DRC104				CT010SP
YP 250 Fazer (5D41/2/3/56C1)	06-10	CK1217		CSK132					CT014

CLUTCH APPLICATIONS

EBC BRAKES CLUTCH KITS



YAMAHA



		CK cork OEM style Kit #	CKF carbon fiber style upgrade Kit #	CSK Spring Kit #	DRC Series Kit #	DRCF Series Kit #	SRC Series Kit #	SRK Series Kit #	CT Tool #
YZ 250 N/S	85-86	CK2280		CSK2	DRC32				CT060
YZ 250 H	81	CK2279	CKF2279	CSK2					CT008
YZ 250 J/K/L	82-84	CK2280		CSK2					CT060
YZ 250 N/S/T	85-87	CK2280		CSK103	DRC35				CT060
YZ 250 U/W/A/B/D	88-92	CK2309		CSK2	DRC31				CT020
YZ 250 WR	89-90	CK2309		CSK2					CT020
YZ 250 E/F/G/H/J/K/L	93-99	CK2274	CKF2274	CSK81	DRC71				CT020
YZ 250 M/N	00-01	CK2274	CKF2274	CSK49	DRC97				CT020
YZ 250 P/R/S/T/N/W/X/Y/Z/A/B/D/E/F/G (2T)	02-16	CK2274	CKF2274	CSK92	DRC113	DRCF113			CT020
YZ 250 XG (2T)	16	CK2274	CKF2274	CSK92	DRC113	DRCF113			CT020
YZ 250 F (4T)	01-07	CK2355	CKF2355	CSK191	DRC109	DRCF109			CT005
YZ 250 F (4T)	08-13	CK2355	CKF2355	CSK137	DRC227	DRCF227			CT005
YZ 250 F (4T)	14-21	CK2355	CKF2355	CSK214	DRC288	DRCF288			CT005
YZ 250 F FK (4T)	19-21	CK2387	CKF2387		DRC315	DRCF315			
MT-03	12-21	CK1193		CSK219			SRC128	SRK128	CT080
YZ-F R3 (321cc)	15-21	CK1193		CSK219			SRC128	SRK128	CT080
BW 350 T/U	87-88	CK2240		CSK103					CT008
R5/5A/5B - 350cc	70-72	CK2240		CSK39					CT008
RD 350 73-75	72-75	CK2240		CSK39					CT008
RZ 350 L/N/NCII	84-85	CK2240		CSK2					CT008
TT 350 S/T	86-87	CK2240		CSK14	DRC56				CT008
TY 350 N/S	85-86	CK2295		CSK34					CT060
XT 350 N/NC/S/SC/C/AC/B/BCT/TC/U/UC/W/WC/D/DC/E/EC/F/FC/G/GC/H/H/C									
/J/JC/K/KC/L/M/MC	85-00	CK2240		CSK14	DRC56				CT008
YFM 350 ER	87-94	CK2290	CKF2290	CSK58	DRC33	DRCF33			CT090SP
YFM 350 ER	95	CK2290	CKF2290	CSK49	DRC82				CT008
YFM 350 FW (Big Bear)	87-93	CK2290	CKF2290	CSK58	DRC33	DRCF33			CT008
YFM 350 FW (Big Bear)	94-97	CK2290	CKF2290	CSK49	DRC82				CT090SP
YFM 350 FWB (Big Bear)	99	CK2240		CSK81	DRC228				CT008
YFM 350 FX Wolverine	95-05	CK2240		CSK81	DRC228				CT008
YFM 350 U	96-99	CK2290	CKF2290	CSK49	DRC82				CT090SP
YFM 350 X (Warrior)	87-04	CK2290	CKF2290	CSK58	DRC33	DRCF33			CT090SP
YFM 350 R Raptor	04-13	CK2290	CKF2290	CSK58	DRC33	DRCF33			CT090SP
YZF 350 T/U/W/A/B/D/E/F/G/H/J/K/L/M/N/P/R/S/T/V (Banshee)	87-06	CK2279	CKF2279	CSK2	DRC43	DRCF43			CT008
YFP 350 U (Terrapro)	88	CK2279	CKF2279	CSK58					CT008
FZR 400 U/W/SUC/SWC/A/SAC	88-90	CK2317		CSK185			SRC6	SRK6	CT010
RD 400 C/D/E	76-78	CK2240		CSK2					CT008
RD 400 F Daytona	79	CK2240		CSK2					CT008
SR 400 F	14	CK2296		CSK2					CT008
XS 400 G/SG/H/SH/SJ	80-82	CK2279	CKF2279	CSK2					CT008
XS 400 J/K/RJ/RK	82-83	CK2262		CSK2					CT017
YFM 400 FW Kodiak	93-99	CK2290	CKF2290	CSK49	DRC82				CT090SP
YFM 400 FWN Big Bear 4WD/Real Tree Xtra	00-01	CK2240		CSK81	DRC228				CT008
YFM 400 NM/NMC/NN/NHN/P/HP Big Bear 2WD	00-03	CK2240		CSK81	DRC228				CT008
YFM 400 FWR (4x4) Big Bear	03	CK2290	CKF2290	CSK49	DRC82				CT008
YFM 400 S Big Bear 2WD	04	CK2240		CSK81	DRC228				CT008
YFM 400 F Big Bear 4WD	04-05	CK2240		CSK81	DRC228				CT008
YFM 400 FB Big Bear 4WD IRS	08-12	CK2240		CSK81	DRC228				CT008
YFM 400 FBHW Big Bear 400 Hunter-IRS	07	CK2240		CSK81	DRC228				CT008
YFM 400 FBEW Big Bear 400 IRS Exploring Edition	07	CK2240		CSK81	DRC228				CT008
WR 400 F	98-00	CK2310		CSK49	DRC99				CT008
YZ 400 F	98-99	CK2310		CSK181	DRC265				CT008
IT 425 G	80	CK2279	CKF2279	CSK2					CT008
WR 426 F	01-02	CK2356		CSK62	DRC110				CT020
YZ 426 F	00	CK2352		CSK181	DRC102				CT020
YZ 426 F	01-02	CK2356		CSK92	DRC116				CT020
WR 450 F	03	CK2356		CSK62	DRC110				CT020

CLUTCH
APPLICATIONS

EBC BRAKES CLUTCH KITS



YAMAHA



		CK cork OEM style Kit #	CKF carbon fiber style upgrade Kit #	CSK Spring Kit #	DRC Series Kit #	DRCF Series Kit #	SRC Series Kit #	SRK Series Kit #	CT Tool #
WR 450 F	04	CK2352		CSK62	DRC263				CT020
WR 450 F	05-15	CK2274	CKF2274	CSK92	DRC194				CT020
WR 450 F	16-21	CK2274	CKF2274	CSK37	DRC298	DRCF298			CT020
YFZ 450 S/T/V	04-06	CK2364	CKF2364	CSK187	DRC159	DRCF159			CT020
YFZ 450 W/X/Y	07-09	CK2364	CKF2364	CSK58	DRC201	DRCF201			CT020
YFZ 450 B/D	12-13	CK2364	CKF2364	CSK92					CT020
YFZ 450 LES Limited Edition	04	CK2364	CKF2364	CSK187	DRC159	DRCF159			CT020
YFZ 450 BB Bill Balance Edition	06	CK2364	CKF2364	CSK187	DRC159	DRCF159			CT020
YFZ 450 BB Bill Balance Edition	07	CK2274		CSK58					CT020
YFZ 450 SET/SPV Special Edition	05-06	CK2364	CKF2364	CSK187	DRC159	DRCF159			CT020
YFZ 450 SEW/SPX Special Edition	07-08	CK2364	CKF2364	CSK58	DRC201	DRCF201			CT020
YFZ 450 R R	09-13	CK2274	CKF2274	CSK58					CT020
YFZ 450 R (3 Spring Clutch - YFZ 450 RE)	14	CK2364		TBA					
YFZ 450 R Special Edition (3 Spring Clutch - YFZ 450 RSE)	14	CK2364		TBA					
YFZ 450 R	14-21	CK2389		TBA	DRC322				TBA
YZ 450 F	03-04	CK2352		CSK92	DRC121				CT020
YZ 450 F	05-06	CK2352		CSK58	DRC162				CT020
YZ 450 F (4T)	07-13	CK2274	CKF2274	CSK37	DRC195	DRCF195			CT020
YZ 450 F (4T)	14-21	CK2274	CKF2274	CSK213	DRC287	DRCF287			CT020
IT 465 H/J	81-82	CK2279	CKF2279	CSK2					CT008
YZ 465 G/H	80-81	CK2279	CKF2279	CSK2					CT008
IT 490 K/L	83-84	CK2280		CSK2	DRC32				CT060
YZ 490 J/K/L/N/S/T/U/W	82-89	CK2280		CSK2	DRC32				CT060
SR 500 E/F/G/H	78-81	CK2296		CSK14					CT008
TT 500 G/H	80-81	CK2255		CSK14					CT008
WR 500 Z	92-93	CK2280		CSK2	DRC32				CT060
XP 500 T-Max (5GJ5)	01	CK2378		CSK189					
XP 500 T-Max (5VUA/15B1)	05-08	CK2378		CSK189					
XP 500 T-Max (4B51)	09-11	CK2378		CSK189					
XT 500 G/H	80-81	CK2296		CSK14					CT008
XV 500 K Virago	83	CK2299		CSK91					CT020
T Max 530 ABS	12-19	CK2382		CSK267	DRC284				
T Max 530 DX ABS	17-19	CK2382		CSK267	DRC284				
T Max 530 SX ABS	17-19	CK2382		CSK267	DRC284				
T Max 530 Black Max ABS	13	CK2382		CSK267	DRC284				
T Max 530 Bronze Max ABS	14	CK2382		CSK267	DRC284				
T Max 530 Iron Max ABS	15	CK2382		CSK267	DRC284				
XV 535 T/TC/U/A/AC/E/EC/F/FC/SF/SFC/G/GC/SG/SGG/H/HC/SH/SHC /J/JC/SJ/SJC Virago	87-99	CK2299		CSK91					CT020
XJ 550 H/J/K Maxim	81-83	CK2306		CSK14					CT008SP
XJ 550 R Seca	81-83	CK2306		CSK14					CT008SP
XT 550 J	82	CK2306		CSK14					CT008
XT 550 K	83	CK2297	CKF2297	CSK14					CT008
XZ 550 R/RK Vision	82-83	CK2296		CSK14					CT008
FJ 600 L/N	84-85	CK2255		CSK14					CT008SP
FZ 600 S/SC/T/TC/UC/U	86-88	CK2255		CSK14					CT008SP
FZR 600 W/R/A/H	89-99	CK2315		CSK185			SRC7	SRK7	CT010
FZ6	04-09	CK2255		CSK17			SRC51	SRK51	CT008SP
FZ6R (FZS 6 YZ/A/B/D/E)	09-14	CK2306		CSK17					CT008SP
YZF 600 R	95-07	CK2332		CSK102			SRC33	SRK33	CT054SP
YZF 600 R/RR/PC R6	99-02	CK2255		CSK17			SRC51	SRK51	CT008SP
YZF-R6 RR/T	03-05	CK2255		CSK92			SRC74	SRK74	CT008SP
YZF-R6 V/W/X/Y/Z/A/B/D/E/F/G	06-17	CK2318		CSK126			SRC87	SRK87	CT008SP
YZF-R6	18-21	CK2358		CSK126			SRC160	SRK160	CT008SP
YZF-R6 S	06-09	CK2255		CSK92			SRC74	SRK74	CT008SP
SRX 600 S	86	CK2297	CKF2297	CSK14			SRC72	SRK72	CT008
TT 600 K/L/N/S	83-86	CK2297	CKF2297	CSK2	DRC57				CT008

CLUTCH APPLICATIONS

EBC BRAKES CLUTCH KITS



YAMAHA



		CK cork OEM style Kit #	CKF carbon fiber style upgrade Kit #	CSK Spring Kit #	DRC Series Kit #	DRCF Series Kit #	SRC Series Kit #	SRK Series Kit #	CT Tool #
XJ 600 SD/SE/SF/SG/SH/SJ/SK Seca 11	92-98	CK2255		CSK14					CT008SP
XT 600 L/LC/N/NC/S/SC/T/TC/U/UC/W/WC	84-89	CK2297	CKF2297	CSK2	DRC57				CT008
XT 600 E	90-95	CK2297	CKF2297	CSK14	DRC88	DRCF88			CT008
YX 600 S/SC/T/TC/U/UC/W/WC/A/AC	86-90	CK2255		CSK14					CT008SP
XJ 650 G/H/J/K Maxim	80-83	CK2255		CSK81					CT008SP
XJ 650 LH Midnight	81	CK2255		CSK81					CT008SP
XJ 650 LJ/LK Seca Turbo	82-83	CK2255		CSK14					CT008SP
XJ 650 RJ Seca	82	CK2255		CSK81					CT008SP
TX 650 A/XS 650 B/C	74-76	CK2226		CSK2					CT074
XS 650 D/E/F/2F	77-79	CK2226		CSK2					CT074
XS 650 SG/G/H/SH/SJ/SK	80-83	CK2242		CSK14					CT074
XVS 650 V-Star Custom	97-11/13-14	CK2309		CSK91					CT020
XVS 650 V-Star Classic	98-10	CK2309		CSK91					CT020
XVS 650 V-Star Silverado	03-10	CK2309		CSK91					CT020
YFM 660 R Raptor	01-05	CK2297	CKF2297	CSK14	DRC88	DRCF88			CT008
FZ 700 T/TC	87	CK2306		CSK17					CT008SP
FZX 700 S/SC/T/TC	86-87	CK2255		CSK17			SRC51	SRK51	CT008SP
FZ-07 (689cc/2Cyl)	15-16	CK2309		CSK37					CT0
MT-07	14-21	CK2309		CSK37			SRC125	SRK125	CT020
MT-07 ABS	14-21	CK2309		CSK37			SRC125	SRK125	CT020
XJ 700 N/NC/S/SC Maxim	85-86	CK2255		CSK37					CT008SP
XJ 700 XV/XS Maxim	85-86	CK2255		N/A					CT008SP
XV 700 L/N Virago	84-85	CK2274	CKF2274	CSK81					CT020
XV 700 CS/CSC/SS/ST/STC/CT/CTC/SSC Virago	86-87	CK2274	CKF2274	CSK81					CT020
YFM 700 R Raptor	06-14	CK2364	CKF2364	CSK37	DRC128	DRCF128			CT020
YFM 700 RSPV Raptor 50th Anniversary Edition	06	CK2364	CKF2364	CSK37	DRC128	DRCF128			CT020
YFM 700 RS Raptor Special Edition	07-14	CK2364	CKF2364	CSK37	DRC128	DRCF128			CT020
FZ 750 N	85	CK2255		CSK17			SRC51	SRK51	CT008SP
FZ 750 S/SC	86	CK2255		CSK17			SRC51	SRK51	CT008SP
FZ 750 U/UC	88	CK2306		CSK17					CT008SP
FZR 750 R	87-88	CK2308		CSK17			SRC8	SRK8	CT008SP
FZR 750 OW01	89-91	CK2318		CSK17			SRC9	SRK9	CT008SP
XJ 750 J/K/MK Maxim	82-83	CK2255		CSK14					CT008SP
XJ 750 R Seca	81-83	CK2255		CSK14					CT008SP
XS 750 D/2D/E/F/SE/SF	77-79	CK2279	CKF2279	CSK14					CT008SP
XV 750 H/J/K/MK Virago	81-83	CK2274	CKF2274	CSK81					CT020
XV 750 U/UC/W/WCM Virago	88-89	CK2274	CKF2274	CSK81					CT020
XV 750 A/AC/B/BC Virago	90	CK2274	CKF2274	CSK81					CT020
XV 750 D/DC/E/EC/F/FC/G/GC/H/HV/J/JC Virago	92-97	CK2274	CKF2274	CSK81					CT020
YZF 750 SP/RF/RFC/RG/RGC/RH/RHC	94-96	CK2318		CSK17			SRC9	SRK9	CT008SP
YZF 750 R7 OW02	99-01	CK2353		N/A					CT020
FZ8	11-13	CK2364	CKF2364	CSK119					CT020
XS 850 G/H/LG/LH/SG/SH	80-81	CK2273		CSK14					CT008SP
TDM 850 D/DC/E/EC	92-93	CK2255		CSK17			SRC51	SRK51	CT008SP
FJ-09	15-16	CK2352		CSK119					CT020
FZ-09 (6 Spring clutch)	14-16	CK2352		CSK119					CT020
FZ-09 (3 Spring clutch)	17	TBA		TBA					
MT-09 Tracer ABS (847cc/3 Cyl Engine)	15-21	CK2352	CKF2352	CSK119			SRC124	SRK124	CT020
MT-09A (2DR/ABS/847cc/3 Cyl Engine)	14-21	CK2352	CKF2352	CSK119			SRC124	SRK124	CT020
MT-09A Sport Tracker ABS (847cc/3 Cyl Engine)	14-21	CK2352	CKF2352	CSK119			SRC124	SRK124	CT020
MT-09A Street Rally ABS (847cc/3 Cyl Engine)	14-21	CK2352	CKF2352	CSK119			SRC124	SRK124	CT020
XJ 900 RK Seca	83	CK2255		CSK49					CT008SP
XSR 900 ABS (MTM850)	16-21	CK2388					SRC162	SRK162	
XV 920 R	81-82	CK2274	CKF2274	CSK14					CT020
XV 920 J/K/MK Virago	82-83	CK2274	CKF2274	CSK14					CT020
XVS 950 (V-Star 950)	09-14	CK2379		CSK911					CT017
XVS 950 (V-Star 950 Tourer)	09-14	CK2379		CSK911					CT017

CLUTCH APPLICATIONS

EBC BRAKES CLUTCH KITS



YAMAHA



		CK cork OEM style Kit #	CKF carbon fiber style upgrade Kit #	CSK Spring Kit #	DRC Series Kit #	DRCF Series Kit #	SRC Series Kit #	SRK Series Kit #	CT Tool #
XVS 950 Bolt (Standard Rear Shocks)	14-16	CK2379		CSK911					CT017
XVS 950 Bolt C-Spec (Remote Rear Shocks)	15-16	CK2379		CSK911					CT017
XVS 950 Bolt R-Spec (Remote Rear Shocks)	14-16	CK2379		CSK911					CT017
FZR 1000 TU Genesis	87-88	CK2308		CSK17			SRC8	SRK8	CT008SP
FZR 1000 W/WC/A/AC/B/BC/D/DC	89-92	CK2321		CSK37			SRC31	SRK31	CT008SP
FZR 1000 E/EC/F/FC/G/GC	93-95	CK2327		CSK37			SRC29	SRK29	CT008SP
FZ1-FZS 1000 N/P/R/S/T	01-05	CK2358		CSK37					CT008SP
FZ1-FZS 1000 V/W/X/Y/Z/A/B/D/E	06-14	CK2356		CSK119			SRC77	SRK77	CT020
FZ-10	17	CK4510		CSK218			SRC129	SRK129	CT079SP
GTS 1000 A	93-94	CK2327		CSK17					CT008SP
XV 1000 L/N Virago	84-85	CK2274	CKF2274	CSK14					CT020
YZF 1000 R (RJ)	97	CK2327		CSK37			SRC29	SRK29	CT008SP
YZF 1000 R1	98	CK2226		CSK903			SRC56	SRK56	CT017
YZF 1000 R1	99-03	CK2350		CSK903			SRC65	SRK65	CT017
YZF R1 (5VY)	04-06	CK2356		CSK119			SRC77	SRK77	CT020
YZF R1 LE	06	CK2356		CSK211			SRC93	SRK93	CT020
YZF R1 (6 piston caliper)	07-08	CK2356		CSK211			SRC93	SRK93	CT020
YZF R1 (6 piston caliper)	09-14	CK2352		CSK211			SRC96	SRK96	CT020
YZF R1	15-21	CK4510		CSK218			SRC129	SRK129	CT079SP
YZF R1 M	15-21	CK4510		CSK218			SRC129	SRK129	CT079SP
YZF R1 S	16	CK4510		CSK218			SRC129	SRK129	CT079SP
FJ 1100 L/LC/W/NC	84-85	CK2285		CSK903					CT017
XJ 1100 J Maxim	82	CK2230		CSK14					CT017
XS 1100	82	CK2230		CSK14					CT077SP
XS 1100 H Venturer	82	CK2230		CSK14					CT077SP
XS 1100 SF/SG/SH	82	CK2230		CSK14					CT077SP
XS 1100 LG/LH Midnight Special	82	CK2230		CSK14					CT077SP
XV 1100 S/T/U/W/A/B/D/E/F/G/H/SH/J/SJ Virago	86-97	CK2274	CKF2274	N/A					CT020
XVS 1100 V-Star Custom L/LC/M/MC/N/NC/P/PC/R/RC/S/T	99-08	CK2274	CKF2274	N/A					CT020
XVS 1100 V-Star Classic	01-09	CK2274	CKF2274	N/A					CT020
XVS 1100 ATS V-Star Silverado	03-09	CK2274	CKF2274	N/A					CT020
XVS 1100 W-M V-Star Custom Midnight	07	CK2274	CKF2274	N/A					CT020
FJ 1200 S/T/U/W/A/B/AD/D/AE	86-94	CK2285		CSK903					CT017
V-Max VMX 12 N/NC	85	CK2300		CSK906					CT050SP
V-Max VMX 12 S/SC	86	CK2300		CSK906					CT050SP
VMX 12 (V-Max 1200 All Models)	88-07	CK2300		CSK906					CT050SP
XT 1200 Z Super Tenere	12-13	CK2362		CSK903			SRC131	SRK131	CT017
XVZ 12 TK Venture	83	CK2300		CSK46					CT050SP
XVZ 12 TDK Venture Royale	83	CK2300		CSK46					CT050SP
XVZ 12 L/KC2 Venture	84	CK2300		CSK46					CT050SP
XVZ 12 DL/DKC2 Venture Royale	84	CK2300		CSK46					CT050SP
XVZ 12 DN Venture Royale	85	CK2300		CSK46					CT050SP
FJR 1300 R/RC/S/AS/T/AT	03-05	CK2362		CSK903			SRC131	SRK131	CT017
FJR 1300 A	06-15	CK2362		CSK903			SRC131	SRK131	CT017
FJR 1300 AE (Electric Gear shift Model)	06-09	CK2362		N/A			N/A	N/A	CT017
FJR 1300 ES	14-15	TBA		TBA					
XVS 1300 V-Star	07-14	CK2362		CSK903			SRC131	SRK131	CT017
XVS 1300 V-Star De Luxe	13-14	CK2362		CSK903			SRC131	SRK131	CT017
XVS 1300 V-Star Tourer	07-14	CK2362		CSK903			SRC131	SRK131	CT017
XVS 1300 Stryker	11-14	CK2362		CSK903			SRC131	SRK131	CT017
XVZ 13 DS/DSC Venture	86	CK2300		CSK906					CT050SP
XVZ 13 T/TC Venture	87-88	CK2300		CSK906					CT050SP
XVZ 13 D Venture Royale	86-89	CK2300		CSK906					CT050SP
XVZ 13 D Venture Royale	92-93	CK2300		CSK906					CT050SP
XVZ 1300 Royal Star	96-97/00	CK2300		CSK906					CT050SP
XVZ 1300 Royal Star Boulevard	99-01	CK2300		CSK906					CT050SP
XVZ 1300 Royal Star Midnight Venture	02-07	CK2300		CSK906					CT050SP

CLUTCH
APPLICATIONS

EBC BRAKES CLUTCH KITS



YAMAHA



		CK cork OEM style Kit #	CKF carbon fiber style upgrade Kit #	CSK Spring Kit #	DRC Series Kit #	DRCF Series Kit #	SRC Series Kit #	SRK Series Kit #	CT Tool #
XVZ 1300 Royal Star Standard	98	CK2300		CSK906					CT050SP
XVZ 1300 Royal Star Tour Classic	96-00	CK2300		CSK906					CT050SP
XVZ 1300 Royal Star Tour Deluxe	97-01/05-07	CK2300		CSK906					CT050SP
XVZ 1300 Royal Star Venture	99-07	CK2300		CSK906					CT050SP
XVZ 1300 Royal Star Venture S	08-13	CK2300		CSK906					CT050SP
XVZ 1300 CTM Royal Star Midnight Tour Deluxe	06-07	CK2300		CSK906					CT050SP
XVZ 1300 LTK Venture	96-98	CK2300		CSK906					CT050SP
XVZ 1300 Venture MM Limited Edition	01	CK2300		CSK906					CT050SP
XV 1600 Road Star	99-05	CK2351		CSK906					CT050SP
XV 1600 Road Star Silverado	99-09	CK2351		CSK906					CT050SP
XV 1600 Road Star Midnight	03	CK2351		CSK906					CT050SP
XV 1600 Midnight Star	02-03	CK2351		CSK906					CT050SP
VMX 1700 V-Max (6 piston radial caliper)	09-16	CK2380		CSK903					CT017
XV 1700 Road Star (9 Spoke Cast wheels - XV17 AS/AW)	04-07/09	CK2351		CSK906					CT050SP
XV 1700 Road Star (9 Spoke Cast wheels - XV17 AWX)	08	CK2363		CSK906					CT050SP
XV 1700 Road Star (Spoke wheel / Solid Front Discs - XV17 ATW)	05-07	CK2351		CSK906					CT050SP
XV 1700 Road Star S (9 Spoke Cast wheels - XV17 AS)	08-13	CK2363		CSK906					CT050SP
XV 1700 Road Star Midnight (9 Spoke Cast Wheels - XV17 AM)	04-07	CK2351		CSK906					CT050SP
XV 1700 Road Star Midnight Warrior (3 Spoke Cast Wheels - XV17 PCT)	05	CK2351		CSK906					CT050SP
XV 1700 Road Star Midnight Warrior (5 Spoke Cast Wheels - XV17 PCM)	06-09	CK2363		CSK906					CT050SP
XV 1700 Road Star Midnight Silverado (9 Spoke Cast wheels - XV17 ATM)	04-07	CK2351		CSK906					CT050SP
XV 1700 Road Star (Spoke wheel / Solid Front Discs - XV17 ATW)	05-07	CK2351		CSK906					CT050SP
XV 1700 Road Star Silverado (Spoke Wheel - XV17 AT)	07	CK2363		CSK906					CT050SP
XV 1700 Road Star Silverado (Spoke Wheel - XV17 AT)	08-10	CK2363		CSK906					CT050SP
XV 1700 Road Star Silverado S (9 Spoke Cast Wheel - XV17 ATS)	11-13	CK2363		CSK906					CT050SP
XV 1700 Road Star Warrior (3 Spoke Cast Wheels - XV17 PC)	04-05	CK2363		CSK906					CT050SP
XV 1700 Road Star Warrior (5 Spoke Cast Wheels - XV17 PC)	06-08	CK2363		CSK906					CT050SP
XV 1900 Roadliner	06-07	CK2367		CSK903					CT017
XV 1900 M Roadliner Midnight	06-09	CK2367		CSK903					CT017
XV 1900 Roadliner S (Diaphragm Spring Clutch)	06-10/12	CK2367		CSK903					CT017
XV 1900 Roadliner S (3 Spring Clutch)	13-14	TBA		TBA					
XV 1900 Raider (Diaphragm Spring Clutch)	08-12	CK2367		TBA					CT017
XV 1900 Raider S (Diaphragm Spring Clutch)	08-12	CK2367		TBA					CT017
XV 1900 Raider SCL (Diaphragm Spring Clutch)	12	CK2367		TBA					CT017
XV 1900 Raider (3 Spring Clutch)	13-14	TBA		TBA					
XV 1900 Raider S (3 Spring Clutch)	13-14	TBA		TBA					
XV 1900 Raider SCL (3 Spring Clutch)	13-14	TBA		TBA					
XV 1900 Stratoliner	06-09	CK2367		CSK903					CT017
XV 1900 Stratoliner Midnight	06-08	CK2367		CSK903					CT017
XV 1900 Stratoliner S (Diaphragm Spring Clutch)	06-13	CK2367		CSK903					CT017
XV 1900 Stratoliner Deluxe (Diaphragm Spring Clutch)	11-12	CK2367		CSK903					CT017
XV 1900 Stratoliner S (3 Spring Clutch)	13-14	TBA		TBA					
XV 1900 Stratoliner Deluxe (3 Spring Clutch)	13-14	TBA		TBA					
ARCTIC CAT (NOTE MANUAL GEARBOX MODELS ONLY)									
250 (2 x 4 / 4 x 4)	01-04	CK3390		CSK48	DRC89				CT011
250 (2 x 4 / 4 x 4)	05	CK3390		CSK48	DRC89				CT011
300 (2 x 4 / 4 x 4)	98-04	CK3356		CSK48	DRC103				CT011
300 (4 x 4)	05	CK3356		CSK48	DRC103				CT011
400 (2 x 4 / 4 x 4)	98-	CK4439		CSK88	DRC215				CT006
400 (2 x 4)	98	CK4439		CSK88	DRC214				CT006
400 (2 x 4 / 4 x 4)	00-02	CK4419		CSK88	DRC215				CT006
400 (2 x 4 / 4 x 4)	03-04	CK4439		CSK98	DRC120				CT006
400 (4 x 4 Manual)	05-08	CK4439		CSK98	DRC120				CT006
400 DVX	04-06	CK3433	CKF3433	CSK79	DRC105	DRCF105			CT006
400 DVX	07-08	CK3447	CKF3447	CSK79	DRC137	DRCF137			CT006
Bearcat 454 (4 x 4)	96-98	CK4439		CSK88	DRC216				CT006

CLUTCH APPLICATIONS

EBC BRAKES CLUTCH KITS



AJP



		CK cork OEM style Kit #	CKF carbon fiber style upgrade Kit #	CSK Spring Kit #	DRC Series Kit #	DRCF Series Kit #	SRC Series Kit #	SRK Series Kit #	CT Tool #
Bearcat 454 (2 x 4)	97-98	CK4439		CSK88	DRC216				CT006
500 (4 x 4)	98-02	CK4439		CSK88	DRC214				CT006
500 (4 x 4 Manual)	03-04	CK3452		CSK7	DRC216				CT006
500 (Manual 4x4)	05-09	CK3452		CSK7	DRC216				CT006
PR5 TR	13-17	CK1318		CSK226	DRC300				CT091
PR5 SM	13-17	CK1318		CSK226	DRC300				CT091
PR5 EN	13-17	CK1318		CSK226	DRC300				CT091
PR5 EX	13-17	CK1318		CSK226	DRC300				CT091

APRILIA

RSV 1000 R Factory/R	04-08	CK6680		CSK200					
RSV4 R	10-12	CK6681		CSK184			SRC113	SRK113	CT041
RSV4 Factory	09-12	CK6681		CSK184			SRC113	SRK113	CT041
RSV4 Factory APRC	11-12	CK6681		CSK184			SRC113	TBA	CT041
RSV4 APRC	11-12	CK6681		CSK184			SRC113	TBA	CT041

BENELLI

TNT 600 i Tornado	16-17	CK1230		CSK241			SRC141	SRK141	CT014SP
-------------------	-------	--------	--	--------	--	--	--------	--------	---------

BETA

Enduro RR 250 2T	18-20	CK5672							
Enduro RR 300 2T	18-20	CK5672							
Enduro RR 350 4T	18-20	CK5672							
Enduro RR 390 4T	18-20	CK5672							
Enduro RR 400 4T	10-15	CK2364			DRC333				
Enduro RR 430 4T	18-20	CK5672							
Enduro RR 450 4T	10-15	CK2364			DRC333				
Enduro RR 480 4T	18-20	CK5672							

BMW

G 310 GS	17-21	CK1253		CSK249			SRC151	SRK151	CT013
G 310 R	17-21	CK1253		CSK249			SRC151	SRK151	CT013
F 650 (E169/0161)	09/93-96	CK5605		CSK104					
F 650 (E169/0162/Funduro/High Screen/19" Front Wheel)	97-00	CK5605		CSK104					
F 650 CS Scarver (K14/0174/0184/Belt Drive/17" Front Wheel)	00-03	CK5636		CSK104					
F 650 CS Scarver (K14/0177/0187/Belt Drive/17" Front Wheel)	04-07	CK5636		CSK104					
F 650 GS Dakar (R13/0173/0183/21" Front Wheel)	99-03	CK5636		CSK104					
F 650 GS Dakar (R13/0176/0186/21" Front Wheel)	04-07	CK5635		CSK104					
F650 GS (Late type plates 2 x 13mm/7 x 14mm ears)	07-19	CK5660		CSK240			SRC130	SRK130	CT085
F 650 ST (E169/163/168/Strada/18" Front Wheel)	97-00	CK5605		CSK104					
G 650 GS (R13)	08-16	CK5635		CSK133			SRC145	SRK145	CT083
G 650 GS Sertao (R13)	10-14	CK5635		CSK133			SRC145	SRK145	CT083
G 650 XCountry (K15)	08-10	CK5635		CSK133			SRC145	SRK145	CT083
F700 GS (Late type plates 2 x 13mm/7 x 14mm ears)	11-19	CK5660		CSK240			SRC130	SRK130	CT085
F 750 GS (OB08, OB018, OB28 & OB38)	16-22	CK5685		CSK271			SRC170	SRK170	TBA
F800 S (Early type plates 14mm ears)	08-11	CK5667		CSK240			SRC144	SRK144	CT085
F800 GS (Late type plates 2 x 13mm/7 x 14mm ears)	12-19	CK5660		CSK240			SRC130	SRK130	CT085
F800 GS Adventure (Late type plates 2 x 13mm/7 x 14mm ears)	12-19	CK5660		CSK240			SRC130	SRK130	CT085
F800 GT (Early type plates 14mm ears)	04-06	CK5667		CSK240			SRC144	SRK144	CT085
F800 GT (Late type plates 2 x 13mm/7 x 14mm ears)	07-19	CK5660		CSK240			SRC130	SRK130	CT085
F800 S (Early type plates 14mm ears)	04-06	CK5667		CSK240			SRC144	SRK144	CT085
F800 S (Late type plates 2 x 13mm/7 x 14mm ears)	07-19	CK5660		CSK240			SRC130	SRK130	CT085
F800 ST (Early type plates 14mm ears)	04-06	CK5667		CSK240			SRC144	SRK144	CT085
F800 ST (Late type plates 2 x 13mm/7 x 14mm ears)	07-19	CK5660		CSK240			SRC130	SRK130	CT085
F800 R (Late type plates 2 x 13mm/7 x 14mm ears)	05-17	CK5660		CSK240			SRC130	SRK130	CT085
F 850 GS (OB09, OB019, OB29 & OB39) Inc Adventure models	16-22	CK5685		CSK271			SRC170	SRK170	TBA

CLUTCH APPLICATIONS

EBC BRAKES CLUTCH KITS



BMW



CK cork OEM style Kit #	CKF carbon fiber style upgrade Kit #	CSK Spring Kit #	DRC Series Kit #	DRCF Series Kit #	SRC Series Kit #	SRK Series Kit #	CT Tool #
----------------------------------	--	------------------------	------------------------	-------------------------	------------------------	------------------------	-----------------

R 1200 GS	19-21	CK5676		TBA		SRC165	SRK165	
R 1200 GS Adventure	19-21	CK5676		TBA		SRC165	SRK165	
R 1200 R	19-21	CK5676		TBA		SRC165	SRK165	
R 1200 RS	19-21	CK5676		TBA		SRC165	SRK165	
R 1250 GS	19-21	CK5676		TBA		SRC165	SRK165	
R 1250 GS TE	19-21	CK5676		TBA		SRC165	SRK165	
R 1250 GS Rallye	19-21	CK5676		TBA		SRC165	SRK165	
R 1250 GS Rallye TE	19-21	CK5676		TBA		SRC165	SRK165	
R 1250 GS Adventure	19-21	CK5676		TBA		SRC165	SRK165	
R 1250 GS Adventure TE	19-21	CK5676		TBA		SRC165	SRK165	
R 1250 GS Adventure Rallye	19-21	CK5676		TBA		SRC165	SRK165	
R 1250 GS Adventure Rallye TE	19-21	CK5676		TBA		SRC165	SRK165	
K 1300 GT	08-11	CK5682						
K 1300 R	08-12	CK5682						
K 1300 S	08-16	CK5682						

DUCATI

Monster 620 ie	01-06	CK5675						
899 Panigale	13-15	CK5661						
959 Panigale	17-20	CK5670						

HARLEY-DAVIDSON DYNA

FLD 103 Switchback	12-16	CK7008		CSK916		SRC7012	SRK7012	CT703SP
FLD Dyna Switchback	12-21	CK7008		CSK916		SRC7013	SRK7013	CT703SP
FLDE Deluxe	18	TBA		CSK236		TBA	TBA	
FXB Super Glide B80	81-82	CK7012		CSK255		SRC7018	SRK7018	CT704SP
FXD Super Glide	98-03	CK7008		CSK917		SRC7011	SRK7011	CT703SP
FXD Super Glide	95-97	CK7009		TBA		SRC7019	SRK7019	CT701SP
FXD Super Glide	04-05	CK7008		CSK916		SRC7012	SRK7012	CT703SP
FXD Super Glide	07-10	CK7008		CSK915		SRC7013	SRK7013	CT703SP
FXD 35th Anniversary Super Glide	06	CK7008		CSK915		SRC7013	SRK7013	CT703SP
FXDB 103 Street Bob	14-17	CK7008		CSK916		SRC7012	SRK7012	CT703SP
FXDB Daytona	92	CK7009		TBA		SRC7019	SRK7019	CT701SP
FXDB Dyna Street Bob	07-21	CK7008		CSK915		SRC7013	SRK7013	CT703SP
FXDB Sturgis	91	CK7009		TBA		SRC7019	SRK7019	CT701SP
FXDBA 103 Street Bob (H-D1)	13-15	CK7008		CSK916		SRC7012	SRK7012	CT703SP
FXDBA Street Bob (H-D1)	13-15	CK7008		CSK915		SRC7013	SRK7013	CT703SP
FXDBC 103 Street Bob Limited	16	CK7008		CSK916		SRC7012	SRK7012	CT703SP
FXDBC Street Bob Limited	16	CK7008		CSK915		SRC7013	SRK7013	CT703SP
FXDBI Street Bob	06	CK7008		CSK915		SRC7013	SRK7013	CT703SP
FXDBP 103 Dyna Street Bob	16	CK7008		CSK916		SRC7012	SRK7012	CT703SP
FXDC 103 Super Glide Custom	14	CK7008		CSK916		SRC7012	SRK7012	CT703SP
FXDC Super Glide Custom	05	CK7008		CSK916		SRC7012	SRK7012	CT703SP
FXDC Super Glide Custom	07-14	CK7008		CSK915		SRC7013	SRK7013	CT703SP
FXDC Super Glide Custom	92	CK7009		TBA		SRC7019	SRK7019	CT701SP
FXDC ANV Super Glide Custom Anniversary	13	CK7008		CSK915		SRC7013	SRK7013	CT703SP
FXDCI Super Glide Custom	05-06	CK7008		CSK915		SRC7013	SRK7013	CT703SP
FXDF 103 Fat Bob	12-17	CK7008		CSK916		SRC7012	SRK7012	CT703SP
FXDF Fat Bob	08-17	CK7008		CSK915		SRC7013	SRK7013	CT703SP
FXDG Super Glide Custom	83	CK7012		CSK255		SRC7018	SRK7018	CT704SP
FXDI Super Glide	04-06	CK7008		CSK915		SRC7013	SRK7013	CT703SP
FXDL 103 Low Rider	14-16	CK7008		CSK916		SRC7012	SRK7012	CT703SP
FXDL 103 Low Rider	17	CK7008		CSK916		SRC7012	SRK7012	CT703SP
FXDL Low Rider	93-97	CK7009		TBA		SRC7019	SRK7019	CT701SP
FXDL Low Rider	98-03	CK7008		CSK917		SRC7011	SRK7011	CT703SP
FXDL Low Rider	04-05	CK7008		CSK916		SRC7012	SRK7012	CT703SP
FXDL Dyna Low Rider	06-21	CK7008		CSK915		SRC7013	SRK7013	CT703SP

CLUTCH
APPLICATIONS

EBC BRAKES CLUTCH KITS



HARLEY-DAVIDSON DYNA



		CK cork OEM style Kit #	CKF carbon fiber style upgrade Kit #	CSK Spring Kit #	DRC Series Kit #	DRCF Series Kit #	SRC Series Kit #	SRK Series Kit #	CT Tool #
FXDLI Low Rider	04-05	CK7008		CSK916			SRC7012	SRK7012	CT703SP
FXDLS Low Rider S	16-21	CK7008		CSK914			SRC7009	SRK7009	CT703SP
FXDS Glide Convertible	93	CK7009		TBA			SRC7019	SRK7019	CT701SP
FXDS Glide Convertible	99-00	CK7008		CSK917			SRC7011	SRK7011	CT703SP
FXDWG 103 Wide Glide	12-17	CK7008		CSK916			SRC7012	SRK7012	CT703SP
FXDWG Wide Glide	93-97	CK7009		TBA			SRC7019	SRK7019	CT701SP
FXDWG Wide Glide	98-05	CK7008		CSK917			SRC7011	SRK7011	CT703SP
FXDWG Wide Glide	07-16	CK7008		CSK915			SRC7013	SRK7013	CT703SP
FXDWG Wide Glide 105th Anniversary	08	CK7008		CSK915			SRC7013	SRK7013	CT703SP
FXDWGI Wide Glide	04-05	CK7008		CSK916			SRC7012	SRK7012	CT703SP
FXDWGI Wide Glide	06	CK7008		CSK915			SRC7013	SRK7013	CT703SP
FXDX Super Glide Sport	99-03	CK7008		CSK917			SRC7011	SRK7011	CT703SP
FXDX Super Glide Sport	04-05	CK7008		CSK916			SRC7012	SRK7012	CT703SP
FXDXT Super Glide T-Sport	01-03	CK7008		CSK917			SRC7011	SRK7011	CT703SP
FXE Super Glide	81-84	CK7012		CSK255			SRC7018	SRK7018	CT704SP
FXE Super Glide	84	CK7010		TBA			SRC7016	SRK7016	CT705SP
FXEF Super Glide Fat Bob	81	CK7012		CSK255			SRC7018	SRK7018	CT704SP
FXEF Super Glide Fat Bob	85	CK7010		TBA			SRC7016	SRK7016	CT705SP
FXWG Wide Glide	81-84	CK7012		CSK255			SRC7018	SRK7018	CT704SP
FXWG Wide Glide	84-86	CK7010		TBA			SRC7016	SRK7016	CT705SP

HARLEY-DAVIDSON SOFTAIL

FXBB Street Bob	18	TBA		CSK236			TBA	TBA	
FXBR Breakout	18-21	TBA		CSK236			TBA	TBA	
FXBRS Breakout 114	18-21	CK7007		CSK236			SRC7008	SRK7008	CT708SP
FXBRS Breakout 114 Anniversary	18	CK7007		CSK236			SRC7008	SRK7008	CT708SP
FXCW Rocker	08-09	CK7008		CSK915			SRC7013	SRK7013	CT703SP
FXCWC Rocker C	08-11	CK7008		CSK915			SRC7013	SRK7013	CT703SP
FXFB Fat Bob	18-21	TBA		CSK236			TBA	TBA	
FXFBS Fat Bob 114	18-21	CK7007		CSK236			SRC7008	SRK7008	CT708SP
FXLR Low Rider	18	TBA		CSK236			TBA	TBA	
FXS Super Glide	81-82	CK7012		CSK255			SRC7018	SRK7018	CT704SP
FXS 103 Blackline	12-13	CK7008		CSK916			SRC7012	SRK7012	CT703SP
FXS Blackline	11	CK7008		CSK915			SRC7013	SRK7013	CT703SP
FXS Blackline	12	CK7008		CSK916			SRC7012	SRK7012	CT703SP
FXS Blackline	13	CK7008		CSK915			SRC7013	SRK7013	CT703SP
FXSB 103 Breakout	13-15	CK7008		CSK916			SRC7012	SRK7012	CT703SP
FXSB Low Rider	83-84	CK7012		CSK255			SRC7018	SRK7018	CT704SP
FXSB Low Rider	84-85	CK7010		TBA			SRC7016	SRK7016	CT705SP
FXSB Breakout	13-17	CK7008		CSK915			SRC7013	SRK7013	CT703SP
FXST Softail Standard	90	CK7009		TBA			SRC7019	SRK7019	CT701SP
FXST Softail Standard	84-89	CK7010		TBA			SRC7016	SRK7016	CT705SP
FXST Softail Standard	99-03	CK7008		CSK917			SRC7011	SRK7011	CT703SP
FXST Softail Standard	04-06	CK7008		CSK916			SRC7012	SRK7012	CT703SP
FXST Softail Standard	07-11	CK7008		CSK915			SRC7013	SRK7013	CT703SP
FXST Softail Standard	12-15	CK7008		CSK916			SRC7012	SRK7012	CT703SP
FXST Softail Standard	Early 1984	CK7012		CSK255			SRC7018	SRK7018	CT704SP
FXSTB Night Train	99-03	CK7008		CSK917			SRC7011	SRK7011	CT703SP
FXSTB Night Train	04-05	CK7008		CSK916			SRC7012	SRK7012	CT703SP
FXSTB Night Train	06-09	CK7008		CSK915			SRC7013	SRK7013	CT703SP
FXSTBI Night Train	01-03	CK7008		CSK917			SRC7011	SRK7011	CT703SP
FXSTBI Night Train	04-05	CK7008		CSK916			SRC7012	SRK7012	CT703SP
FXSTBI Night Train	06	CK7008		CSK915			SRC7013	SRK7013	CT703SP
FXSTC Softail Custom	90-97	CK7009		TBA			SRC7019	SRK7019	CT701SP
FXSTC Softail Custom	86-89	CK7010		TBA			SRC7016	SRK7016	CT705SP
FXSTC Softail Custom	98-99	CK7008		CSK917			SRC7011	SRK7011	CT703SP
FXSTC Softail Custom	07-10	CK7008		CSK915			SRC7013	SRK7013	CT703SP

CLUTCH APPLICATIONS

EBC BRAKES CLUTCH KITS



HARLEY-DAVIDSON SOFTAIL



		CK cork OEM style Kit #	CKF carbon fiber style upgrade Kit #	CSK Spring Kit #	DRC Series Kit #	DRCF Series Kit #	SRC Series Kit #	SRK Series Kit #	CT Tool #
FXSTD Softail Deuce	00-03	CK7008		CSK917			SRC7011	SRK7011	CT703SP
FXSTD Softail Deuce	04-05	CK7008		CSK916			SRC7012	SRK7012	CT703SP
FXSTD Softail Deuce	06-07	CK7008		CSK915			SRC7013	SRK7013	CT703SP
FXSTDI Softail Deuce	01-03	CK7008		CSK917			SRC7011	SRK7011	CT703SP
FXSTDI Softail Deuce	04-05	CK7008		CSK916			SRC7012	SRK7012	CT703SP
FXSTDI Softail Deuce	06	CK7008		CSK915			SRC7013	SRK7013	CT703SP
FXSTI Softail Standard	01-03	CK7008		CSK917			SRC7011	SRK7011	CT703SP
FXSTI Softail Standard	04-05	CK7008		CSK916			SRC7012	SRK7012	CT703SP
FXSTI Softail Standard	06	CK7008		CSK915			SRC7013	SRK7013	CT703SP
FXSTS Softail Springer	90-97	CK7009		TBA			SRC7019	SRK7019	CT701SP
FXSTS Softail Springer	88-89	CK7010		TBA			SRC7016	SRK7016	CT705SP
FXSTS Softail Springer	98-03	CK7008		CSK917			SRC7011	SRK7011	CT703SP
FXSTS Softail Springer	04-05	CK7008		CSK916			SRC7012	SRK7012	CT703SP
FXSTS Softail Springer	06	CK7008		CSK915			SRC7013	SRK7013	CT703SP
FXSTSI Softail Springer	01-03	CK7008		CSK917			SRC7011	SRK7011	CT703SP
FXSTSI Softail Springer	04-05	CK7008		CSK916			SRC7012	SRK7012	CT703SP
FXSTSI Softail Springer	06	CK7008		CSK915			SRC7013	SRK7013	CT703SP
FLFB Fat Boy	18-21	CK7007		CSK236			SRC7013	SRK7013	CT703SP
FLFBS Fat Boy 114	18-21	CK7007		CSK236			SRC7008	SRK7008	CT708SP
FLFBS Fat Boy 114 Anniversary	18-21	CK7007		CSK236			SRC7008	SRK7008	CT708SP
FLS 103 Slim	13-15	CK7008		CSK916			SRC7012	SRK7012	CT703SP
FLS 103 Slim	12	CK7008		CSK916			SRC7012	SRK7012	CT703SP
FLS Slim	12-15	CK7008		CSK915			SRC7013	SRK7013	CT703SP
FLS Softail Slim	16-21	CK7008		CSK916			SRC7012	SRK7012	CT703SP
FLSL Slim	18	TBA		CSK236			TBA	TBA	
FLSS Slim S	17-21	CK7002		CSK235			SRC7003	SRK7003	CT702SP
FLST Heritage	08-09	CK7008		CSK915			SRC7013	SRK7013	CT703SP
FLST Heritage	06	CK7008		CSK915			SRC7013	SRK7013	CT703SP
FLST Heritage	89-89	CK7010		TBA			SRC7016	SRK7016	CT705SP
FLST Heritage	90	CK7009		TBA			SRC7019	SRK7019	CT701SP
FLSTC 103 Heritage Classic	12-15	CK7008		CSK916			SRC7012	SRK7012	CT703SP
FLSTC Heritage Classic	98-03	CK7008		CSK917			SRC7011	SRK7011	CT703SP
FLSTC Heritage Classic	04-05	CK7008		CSK916			SRC7012	SRK7012	CT703SP
FLSTC Heritage Classic	06-15	CK7008		CSK915			SRC7013	SRK7013	CT703SP
FLSTC Heritage Classic	16-17	CK7008		CSK916			SRC7012	SRK7012	CT703SP
FLSTC Heritage Classic	87-89	CK7010		TBA			SRC7016	SRK7016	CT705SP
FLSTC Heritage Classic	90-97	CK7009		TBA			SRC7019	SRK7019	CT701SP
FLSTC Heritage Classic Anniversary	13	CK7008		CSK916			SRC7012	SRK7012	CT703SP
FLSTC Heritage Classic Anniversary	13	CK7008		CSK915			SRC7013	SRK7013	CT703SP
FLSTCI Heritage Classic	01-03	CK7008		CSK917			SRC7011	SRK7011	CT703SP
FLSTCI Heritage Classic	04-05	CK7008		CSK916			SRC7012	SRK7012	CT703SP
FLSTCI Heritage Classic	06	CK7008		CSK915			SRC7013	SRK7013	CT703SP
FLSTCI Heritage Classic Shrine	05	CK7008		CSK916			SRC7012	SRK7012	CT703SP
FLSTF 103 Fat Boy	12-14	CK7008		CSK916			SRC7012	SRK7012	CT703SP
FLSTF 103 Fat Boy	15	CK7008		CSK916			SRC7012	SRK7012	CT703SP
FLSTF Fat Boy	91-97	CK7009		TBA			SRC7019	SRK7019	CT701SP
FLSTF Fat Boy	12	CK7008		CSK915			SRC7013	SRK7013	CT703SP
FLSTF Fat Boy	98-99	CK7008		CSK917			SRC7011	SRK7011	CT703SP
FLSTF Fat Boy	00-03	CK7008		CSK917			SRC7011	SRK7011	CT703SP
FLSTF Fat Boy	04-05	CK7008		CSK916			SRC7012	SRK7012	CT703SP
FLSTF Fat Boy	06-15	CK7008		CSK915			SRC7013	SRK7013	CT703SP
FLSTF Fat Boy	16-17	CK7008		CSK916			SRC7012	SRK7012	CT703SP
FLSTF Fat Boy	90	CK7009		TBA			SRC7019	SRK7019	CT701SP
FLSTFB 103 Fat Boy LO	12-15	CK7008		CSK916			SRC7012	SRK7012	CT703SP
FLSTFB Fat Boy LO	10-11	CK7008		CSK915			SRC7013	SRK7013	CT703SP
FLSTFB Fat Boy LO	12	CK7008		CSK916			SRC7012	SRK7012	CT703SP
FLSTFB Fat Boy LO	13-15	CK7008		CSK915			SRC7013	SRK7013	CT703SP

CLUTCH
APPLICATIONS

EBC BRAKES CLUTCH KITS



HARLEY-DAVIDSON SOFTAIL



		CK cork OEM style Kit #	CKF carbon fiber style upgrade Kit #	CSK Spring Kit #	DRC Series Kit #	DRCF Series Kit #	SRC Series Kit #	SRK Series Kit #	CT Tool #
FLSTFB Fat Boy LO	16-17	CK7008		CSK916			SRC7012	SRK7012	CT703SP
FLSTFB Fat Boy 103 LO Anniversary	13	CK7008		CSK916			SRC7012	SRK7012	CT703SP
FLSTFB Fat Boy LO Anniversary	13	CK7008		CSK915			SRC7013	SRK7013	CT703SP
FLSTFB Fat Boy S	16-17	CK7002		CSK235			SRC7003	SRK7003	CT702SP
FLSTFI Fat Boy	01-03	CK7008		CSK917			SRC7011	SRK7011	CT703SP
FLSTFI Fat Boy	04-05	CK7008		CSK916			SRC7012	SRK7012	CT703SP
FLSTFI Fat Boy	06	CK7008	CSK915	SRC7013	SRK7013	CT703SP			
FLSTFI Fat Boy Shrine	05	CK7008	CSK916	SRC7012	SRK7012	CT703SP			
FLSTI Heritage	06	CK7008	CSK915	SRC7013	SRK7013	CT703SP			
FLSTN 103 Deluxe	12-15	CK7008	CSK916	SRC7012	SRK7012	CT703SP			
FLSTN Deluxe	17	CK7008	CSK916	SRC7012	SRK7012	CT703SP			
FLSTN Heritage Nostalgia	93-96	CK7009	TBA	SRC7019	SRK7019	CT701SP			
FLSTN Deluxe	05	CK7008	CSK916	SRC7012	SRK7012	CT703SP			
FLSTN Deluxe	06	CK7008	CSK915	SRC7013	SRK7013	CT703SP			
FLSTN Deluxe	07-15	CK7008	CSK915	SRC7013	SRK7013	CT703SP			
FLSTN Deluxe	16	CK7008	CSK916	SRC7012	SRK7012	CT703SP			
FLSTNI Deluxe	06	CK7008	CSK915	SRC7013	SRK7013	CT703SP			
FLSTNI Deluxe	05	CK7008	CSK916	SRC7012	SRK7012	CT703SP			
FLSTS Heritage Springer	97	CK7009	TBA	SRC7019	SRK7019	CT701SP			
FLSTS Heritage Springer	98-03	CK7008	CSK917	SRC7011	SRK7011	CT703SP			
FLSTSB Cross Bones	08-11	CK7008	CSK915	SRC7013	SRK7013	CT703SP			
FLSTSC Springer Classic	06-07	CK7008	CSK915	SRC7013	SRK7013	CT703SP			
FLSTSC Springer Classic	05	CK7008	CSK916	SRC7012	SRK7012	CT703SP			
FLSTSI Heritage Springer	01-03	CK7008	CSK917	SRC7011	SRK7011	CT703SP			
FLHC Heritage Classic	18	TBA	CSK236	TBA	TBA				
FLHC Electra Glide Classic	81-82	CK7012	CSK255	SRC7018	SRK7018	CT704SP			
FLHCS Heritage Classic 114	18-21	CK7007	CSK236	SRC7008	SRK7008	CT708SP			
FLHCS Heritage Classic 114 Anniversary	18-21	CK7007	CSK236	SRC7008	SRK7008	CT708SP			
HARLEY-DAVIDSON SPORTSTER									
XL 883	86-90		CK7014	CSK921	SRC7024	SRK7024	CT709SP		
XL 883	04-09		CK7009	CSK918	SRC7021	SRK7021	CT701SP		
XL 883	91-03		CK7009	CSK920	SRC7023	SRK7023	CT701SP		
XL 883 C Custom	98-03		CK7009	CSK920	SRC7023	SRK7023	CT701SP		
XL 883 C Custom	04-10		CK7009	CSK918	SRC7021	SRK7021	CT701SP		
XL 883 DLX Deluxe	86-90		CK7014	CSK921	SRC7024	SRK7024	CT709SP		
XL 883 DLX Deluxe	91-95		CK7009	CSK920	SRC7023	SRK7023	CT701SP		
XL 883 HUG Hugger	87-90		CK7014	CSK921	SRC7024	SRK7024	CT709SP		
XL 883 HUG Hugger	91-03		CK7009	CSK920	SRC7023	SRK7023	CT701SP		
XL 883 L Low	05-11		CK7009	CSK918	SRC7021	SRK7021	CT701SP		
XL 883 L SuperLow	12-21		CK7009	CSK918	SRC7021	SRK7021	CT701SP		
XL 883 N Iron	09-21		CK7009	CSK918	SRC7021	SRK7021	CT701SP		
XL 883 R Roadster	11-15		CK7009	CSK918	SRC7021	SRK7021	CT701SP		
XL 883 R	02-06		CK7009	CSK920	SRC7023	SRK7023	CT701SP		
XL 883 R	07-10		CK7009	CSK918	SRC7021	SRK7021	CT701SP		
XLH 1000 Standard	70		CK7016	TBA	TBA	TBA			
XLCH 1000	70		CK7016	TBA	TBA	TBA			
XLH 1000 Standard	71-78		CK7015	CSK256	SRC7025	SRK7025	CT709SP		
XLCH 1000	71-80		CK7015	CSK257	SRC7025	SRK7025	CT709SP		
XLH 1000	81-84		CK7015	CSK257	SRC7025	SRK7025	CT709SP		
XLS 1000 Roadster	81-84		CK7015	CSK257	SRC7025	SRK7025	CT709SP		
XLS 1000 Roadster	84		CK7014	CSK921	SRC7024	SRK7024	CT709SP		
XLS 1000 Roadster	84		CK7014	CSK921	SRC7024	SRK7024	CT709SP		
XR 1000	84		CK7014	CSK921	SRC7024	SRK7024	CT709SP		
XLH 1000	84		CK7014	CSK921	SRC7024	SRK7024	CT709SP		
XR 1000	83-84		CK7015	CSK257	SRC7025	SRK7025	CT709SP		
XLH 1100	86-87		CK7014	CSK921	SRC7024	SRK7024	CT709SP		

CLUTCH APPLICATIONS

EBC BRAKES CLUTCH KITS



HARLEY-DAVIDSON SPORTSTER



		CK cork OEM style Kit #	CKF carbon fiber style upgrade Kit #	CSK Spring Kit #	DRC Series Kit #	DRCF Series Kit #	SRC Series Kit #	SRK Series Kit #	CT Tool #
XLH 1200	88-90		CK7014	CSK921	SRC7024	SRK7024	CT709SP		
XL 1200 Forty Eight Anniversary	18		CK7009	CSK919	SRC7020	SRK7020	CT701SP		
XL 1200	91-03		CK7009	CSK920	SRC7023	SRK7023	CT701SP		
XL 1200 C Custom	96-03		CK7009	CSK920	SRC7023	SRK7023	CT701SP		
XL 1200 C Custom	17-21		CK7009	CSK919	SRC7020	SRK7020	CT701SP		
XL 1200 CA Custom Limited A	13-16		CK7009	CSK919	SRC7020	SRK7020	CT701SP		
XL 1200 CANV Custom Anniversary	13		CK7009	CSK919	SRC7020	SRK7020	CT701SP		
XL 1200 CB Custom Limited B	13-17		CK7009	CSK919	SRC7020	SRK7020	CT701SP		
XL 1200 CP 1200 Custom (H-D1)	11-21		CK7009	CSK919	SRC7020	SRK7020	CT701SP		
XL 1200 CX Roadster	18-21		CK7009	CSK919	SRC7020	SRK7020	CT701SP		
XL 1200 L Low	06-11		CK7009	CSK919	SRC7020	SRK7020	CT701SP		
XL 1200 N Nightster	07-12		CK7009	CSK919	SRC7020	SRK7020	CT701SP		
XL 1200 R Roadster	04-09		CK7009	CSK919	SRC7020	SRK7020	CT701SP		
XL 1200 S Sport	96-03		CK7009	CSK920	SRC7023	SRK7023	CT701SP		
XL 1200 T SuperLow	18-21		CK7009	CSK919	SRC7020	SRK7020	CT701SP		
XL 1200 V Seventy-Two	12-16		CK7009	CSK919	SRC7020	SRK7020	CT701SP		
XL 1200 X Forty Eight	10-21		CK7009	CSK919	SRC7020	SRK7020	CT701SP		
XL 50 50th Anniversary	07		CK7009	CSK919	SRC7020	SRK7020	CT701SP		
XR 1200 Sportster	08-10		CK7013	CSK913	SRC7022	SRK7022	CT701SP		
XR 1200 X	10-13		CK7013	CSK913	SRC7022	SRK7022	CT701SP		

HARLEY-DAVIDSON STREET

XG 500	15-21			CK7004	CSK230	SRC7005	SRK7005		
XG 750	15-21			CK7004	CSK229	TBA	TBA		

HARLEY-DAVIDSON TOURING

FLH Electra Glide	81-83		CK7012	CSK255	SRC7018	SRK7018	CT704SP		
FLH Electra Glide	84	Early 1984	CK7011	CSK255	SRC7017	SRK7017	CT704SP		
FLH Electra Glide Shrine Shovelhead	83		CK7012	CSK255	SRC7018	SRK7018	CT704SP		
FLH Electra Glide Shrine Shovelhead	84	Early 1984	CK7011	CSK255	SRC7017	SRK7017	CT704SP		
FLHP Road King Police	11-16		CK7008	CSK914	SRC7009	SRK7009	CT703SP		
FLHP Road King Police	17		CK7007	CSK236	SRC7008	SRK7008	CT708SP		
FLHPE Road King Police	11		CK7008	CSK914	SRC7009	SRK7009	CT703SP		
FLHR 103 Road King	11		CK7008	CSK916	SRC7012	SRK7012	CT703SP		
FLHR 96 Road King	11		CK7008	CSK915	SRC7013	SRK7013	CT703SP		
FLHR Road King	17		CK7002	CSK236	SRC7010	SRK7010	CT702SP		
FLHR Road King	93-97		CK7009	TBA	SRC7014	SRK7014	CT701SP		
FLHR Road King	06-11		CK7008	CSK915	SRC7013	SRK7013	CT703SP		
FLHR Road King	12-13		CK7008	CSK916	SRC7012	SRK7012	CT703SP		
FLHR Road King	15-21		CK7008	CSK917	SRC7011	SRK7011	CT703SP		
FLHR Road King	98-03		CK7008	CSK917	SRC7011	SRK7011	CT703SP		
FLHR Road King	04-05		CK7008	CSK916	SRC7012	SRK7012	CT703SP		
FLHR Road King Anniversary	13		CK7008	CSK916	SRC7012	SRK7012	CT703SP		
FLHRC 103 Road King Classic	11		CK7008	CSK916	SRC7012	SRK7012	CT703SP		
FLHRC Road King Classic	18-21		CK7002	CSK236	SRC7010	SRK7010	CT702SP		
FLHRC Road King Classic	07-11		CK7008	CSK915	SRC7013	SRK7013	CT703SP		
FLHRC Road King Classic	12-13		CK7008	CSK916	SRC7012	SRK7012	CT703SP		
FLHRC Road King Classic	14-16		CK7008	CSK917	SRC7011	SRK7011	CT703SP		
FLHRCI Road King Classic	98-03		CK7008	CSK917	SRC7011	SRK7011	CT703SP		
FLHRCI Road King Classic	05		CK7008	CSK916	SRC7012	SRK7012	CT703SP		
FLHRCI Road King Classic	06		CK7008	CSK915	SRC7013	SRK7013	CT703SP		
FLHRCI Road King Classic	04		CK7008	CSK916	SRC7012	SRK7012	CT703SP		
FLHRI Road King	00-03		CK7008	CSK917	SRC7011	SRK7011	CT703SP		
FLHRI Road King	04-05		CK7008	CSK916	SRC7012	SRK7012	CT703SP		
FLHRI Road King	06		CK7008	CSK915	SRC7013	SRK7013	CT703SP		
FLHRS Road King Custom	04-05		CK7008	CSK916	SRC7012	SRK7012	CT703SP		
FLHRS Road King Custom	06-07		CK7008	CSK915	SRC7013	SRK7013	CT703SP		

CLUTCH
APPLICATIONS

EBC BRAKES CLUTCH KITS



HARLEY-DAVIDSON TOURING



		CK cork OEM style Kit #	CKF carbon fiber style upgrade Kit #	CSK Spring Kit #	DRC Series Kit #	DRCF Series Kit #	SRC Series Kit #	SRK Series Kit #	CT Tool #
FLHRSI 1FYW Road King Custom	04-05		CK7008	CSK916	SRC7012	SRK7012	CT703SP		
FLHRSI 1FYW Road King Custom	06		CK7008	CSK915	SRC7013	SRK7013	CT703SP		
FLHRXS Road King Special	18-21		CK7002	CSK236	SRC7010	SRK7010	CT702SP		
FLHS Electra Glide Heritage	81		CK7012	CSK255	SRC7018	SRK7018	CT704SP		
FLHS Electra Glide Sport	81-83		CK7012	CSK255	SRC7018	SRK7018	CT704SP		
FLHS Electra Glide Sport - Early 1984	84		CK7011	CSK255	SRC7017	SRK7017	CT704SP		
FLHS Electra Glide Sport	84-89	CK7010		TBA			SRC7016	SRK7016	CT705SP
FLHS Electra Glide Sport	91-94	CK7009		TBA			SRC7014	SRK7014	CT701SP
FLHS Electra Glide Sport	90	CK7009		TBA			SRC7015	SRK7015	CT701SP
FLHT Electra Glide - Early 1984	84	CK7011		CSK255			SRC7017	SRK7017	CT704SP
FLHT Electra Glide - Later 1984	84	CK7010		TBA			SRC7016	SRK7016	CT705SP
FLHT Electra Glide Classic	83	CK7012		CSK255			SRC7018	SRK7018	CT704SP
FLHT Electra Glide Classic - Early 1984	84	CK7011		CSK255			SRC7017	SRK7017	CT704SP
FLHT Electra Glide Classic - Later 1984	84	CK7010		TBA			SRC7016	SRK7016	CT705SP
FLHT Electra Glide Shrine Shovelhead - Later 1984	84	CK7010		TBA			SRC7016	SRK7016	CT705SP
FLHT Electra Glide Standard	83	CK7012		CSK255			SRC7018	SRK7018	CT704SP
FLHT Electra Glide Standard	88	CK7010		TBA			SRC7016	SRK7016	CT705SP
FLHT Electra Glide Standard	94-97	CK7009		TBA			SRC7014	SRK7014	CT701SP
FLHT Electra Glide Standard	98-03	CK7008		CSK917			SRC7011	SRK7011	CT703SP
FLHT Electra Glide Standard	04-05	CK7008		CSK916			SRC7012	SRK7012	CT703SP
FLHT Electra Glide Standard	06-10	CK7008		CSK915			SRC7013	SRK7013	CT703SP
FLHT Electra Glide	83	CK7012		CSK255			SRC7018	SRK7018	CT704SP
FLHTC 103 Electra Glide Classic	11	CK7008		CSK916			SRC7012	SRK7012	CT703SP
FLHTC Electra Glide Classic	83-84	CK7012		CSK255			SRC7018	SRK7018	CT704SP
FLHTC Electra Glide Classic	84-89	CK7010		TBA			SRC7016	SRK7016	CT705SP
FLHTC Electra Glide Classic	91-97	CK7009		TBA			SRC7014	SRK7014	CT701SP
FLHTC Electra Glide Classic	98-03	CK7008		CSK917			SRC7011	SRK7011	CT703SP
FLHTC Electra Glide Classic	04-05	CK7008		CSK916			SRC7012	SRK7012	CT703SP
FLHTC Electra Glide Classic	07-11	CK7008		CSK915			SRC7013	SRK7013	CT703SP
FLHTC Electra Glide Classic	12-13	CK7008		CSK916			SRC7012	SRK7012	CT703SP
FLHTC Electra Glide Classic	90	CK7009		TBA			SRC7015	SRK7015	CT701SP
FLHTCI Electra Glide Classic	96-97	CK7009		TBA			SRC7014	SRK7014	CT701SP
FLHTCI Electra Glide Classic	98-03	CK7008		CSK917			SRC7011	SRK7011	CT703SP
FLHTCI Electra Glide Classic	04-05	CK7008		CSK916			SRC7012	SRK7012	CT703SP
FLHTCI Electra Glide Classic	06	CK7008		CSK915			SRC7013	SRK7013	CT703SP
FLHTCI Ultra Classic	05	CK7008		CSK916			SRC7012	SRK7012	CT703SP
FLHTCU 103 Ultra Classic	11	CK7008		CSK916			SRC7012	SRK7012	CT703SP
FLHTCU Electra Glide Classic Ultra	89	CK7010		TBA			SRC7016	SRK7016	CT705SP
FLHTCU Electra Glide Classic Ultra	18-21	CK7002		CSK236			SRC7010	SRK7010	CT702SP
FLHTCU TC Ultra Classic Twin-Cooled	14-16	CK7008		CSK917			SRC7011	SRK7011	CT703SP
FLHTCU Electra Glide Classic Ultra	90	CK7009		TBA			SRC7015	SRK7015	CT701SP
FLHTCU Ultra Classic	91-97	CK7009		TBA			SRC7014	SRK7014	CT701SP
FLHTCU Ultra Classic	07-11	CK7008		CSK915			SRC7013	SRK7013	CT703SP
FLHTCU Ultra Classic	12-13	CK7008		CSK916			SRC7012	SRK7012	CT703SP
FLHTCU Ultra Classic	14-21	CK7008		CSK917			SRC7011	SRK7011	CT703SP
FLHTCU Ultra Classic	04	CK7008		CSK916			SRC7012	SRK7012	CT703SP
FLHTCU Ultra Classic	98-03	CK7008		CSK917			SRC7011	SRK7011	CT703SP
FLHTCU Ultra Classic	06	CK7008		CSK915			SRC7013	SRK7013	CT703SP
FLHTCUL TC Ultra Classic Low Twin-Cooled	15-21	CK7002		CSK235			SRC7003	SRK7003	CT702SP
FLHTCUL Ultra Classic Low	15-21	CK7002		CSK235			SRC7003	SRK7003	CT702SP
FLHTI Electra Glide Standard	03	CK7008		CSK917			SRC7011	SRK7011	CT703SP
FLHTI Electra Glide Standard	04-05	CK7008		CSK916			SRC7012	SRK7012	CT703SP
FLHTI Electra Glide Standard	06	CK7008		CSK915			SRC7013	SRK7013	CT703SP
FLHTK 103 CVO Limited	14	CK7002		CSK235			SRC7003	SRK7003	CT702SP
FLHTK Electra Glide Ultra Limited	10-13	CK7008		CSK916			SRC7012	SRK7012	CT703SP
FLHTK Ultra Limited	14-16	CK7008		CSK917			SRC7011	SRK7011	CT703SP
FLHTK Ultra Limited	17-21	CK7002		CSK236			SRC7010	SRK7010	CT702SP

CLUTCH APPLICATIONS

EBC BRAKES CLUTCH KITS



HARLEY-DAVIDSON TOURING



		CK cork OEM style Kit #	CKF carbon fiber style upgrade Kit #	CSK Spring Kit #	DRC Series Kit #	DRCF Series Kit #	SRC Series Kit #	SRK Series Kit #	CT Tool #
FLHTK Ultra Limited Anniversary	18-21	CK7002		CSK236			SRC7010	SRK7010	CT702SP
FLHTK Ultra Limited Shrine Edition	18	CK7002		CSK236			SRC7010	SRK7010	CT702SP
FLHTK ANV Electra Glide Ultra Limited Anniversary	13	CK7008		CSK916			SRC7012	SRK7012	CT703SP
FLHTK Ultra Limited Low	15-21	CK7002		CSK235			SRC7003	SRK7003	CT702SP
FLHTP Electra Glide Standard Police	11-16	CK7008		CSK914			SRC7009	SRK7009	CT703SP
FLHTP Electra Glide Standard Police	17	CK7007		CSK236			SRC7008	SRK7008	CT708SP
FLHX 103 Street Glide	11	CK7008		CSK916			SRC7012	SRK7012	CT703SP
FLHX Street Glide	12-13	CK7008		CSK916			SRC7012	SRK7012	CT703SP
FLHX Street Glide	14-16	CK7008		CSK917			SRC7011	SRK7011	CT703SP
FLHX Street Glide	17-18	CK7002		CSK236			SRC7010	SRK7010	CT702SP
FLHX Street Glide Anniversary	18-21	CK7002		CSK236			SRC7010	SRK7010	CT702SP
FLHX Street Glide	06-11	CK7008		CSK915			SRC7013	SRK7013	CT703SP
FLHXS Street Glide Special	14-16	CK7008		CSK917			SRC7011	SRK7011	CT703SP
FLHXS Street Glide Special	17-21	CK7002		CSK236			SRC7010	SRK7010	CT702SP
FLHXS Street Glide Anniversary	18	CK7002		CSK236			SRC7010	SRK7010	CT702SP
FLT Classic Tour Glide Classic - Early 1984	84	CK7011		CSK255			SRC7017	SRK7017	CT704SP
FLT Tour Glide	81-83	CK7012		CSK255			SRC7018	SRK7018	CT704SP
FLT Tour Glide - Early 1984	84	CK7011		CSK255			SRC7017	SRK7017	CT704SP
FLT Tour Glide - Later 1984	84	CK7010		TBA			SRC7016	SRK7016	CT705SP
FLTC Tour Glide Classic	80-84	CK7012		CSK255			SRC7018	SRK7018	CT704SP
FLTC Tour Glide Classic	84-89	CK7010		TBA			SRC7016	SRK7016	CT705SP
FLTC Tour Glide Classic	90-92	CK7009		TBA			SRC7014	SRK7014	CT701SP
FLTCU Tour Glide Classic Ultra	89	CK7010		TBA			SRC7016	SRK7016	CT705SP
FLTCU Tour Glide Classic Ultra	90-95	CK7009		TBA			SRC7014	SRK7014	CT701SP
FLTCUI Tour Glide Classic Ultra	96	CK7009		TBA			SRC7014	SRK7014	CT701SP
FLTR Road Glide	98-03	CK7008		CSK917			SRC7011	SRK7011	CT703SP
FLTR Road Glide	06-09	CK7008		CSK915			SRC7013	SRK7013	CT703SP
FLTRI Road Glide	04-05	CK7008		CSK916			SRC7012	SRK7012	CT703SP
FLTRU Road Glide Ultra	16	CK7008		CSK917			SRC7011	SRK7011	CT703SP
FLTRU Road Glide Ultra	11-13	CK7008		CSK916			SRC7012	SRK7012	CT703SP
FLTRU Road Glide Ultra	18-21	CK7002		CSK236			SRC7010	SRK7010	CT702SP
FLTRX 103 Road Glide Custom	11	CK7008		CSK916			SRC7012	SRK7012	CT703SP
FLTRX Road Glide	15-16	CK7008		CSK917			SRC7011	SRK7011	CT703SP
FLTRX Road Glide	18-21	CK7002		CSK236			SRC7010	SRK7010	CT702SP
FLTRX 103 Road Glide Custom	10-11	CK7008		CSK915			SRC7013	SRK7013	CT703SP
FLTRX 103 Road Glide Custom	12-13	CK7008		CSK916			SRC7012	SRK7012	CT703SP
FLTRXS Road Glide Special	15-16	CK7008		CSK917			SRC7011	SRK7011	CT703SP
FLTRXS Road Glide Special	18-21	CK7002		CSK236			SRC7010	SRK7010	CT702SP
HARLEY-DAVIDSON TRIKE									
FLHTCUTG Tri Glide Ultra	17-18	CK7007		CSK236			SRC7008	SRK7008	CT708SP
FLHTCUTG Tri Glide Ultra Anniversary	18-21	CK7007		CSK236			SRC7008	SRK7008	CT708SP
FLHTCUTG Tri Glide Ultra Classic	09-13	CK7008		CSK914			SRC7009	SRK7009	CT703SP
FLHTCUTG Tri Glide Ultra Classic	14-16	CK7002		CSK235			SRC7003	SRK7003	CT702SP
FLHTCUTG ANV Tri Glide Ultra Classic Anniversary	13	CK7008		CSK914			SRC7009	SRK7009	CT703SP
FLHXXX Street Glide Trike	10-11	CK7008		CSK914			SRC7009	SRK7009	CT703SP
FLRT Freewheeler	15-16	CK7002		CSK235			SRC7003	SRK7003	CT702SP
FLRT Freewheeler	17-18	CK7007		CSK236			SRC7008	SRK7008	CT708SP
HARLEY-DAVIDSON V-ROD									
VRSCA	02-06	CK7006		CSK232			SRC7007	SRK7007	CT707SP
VRSCAW	09-10	CK7005		CSK233			SRC7006	SRK7006	CT706SP
VRSCAW Wide Tire	07	CK7006		CSK232			SRC7007	SRK7007	CT707SP
VRSCAW Wide Tire	08	CK7005		CSK233			SRC7006	SRK7006	CT706SP
VRSCAWA Wide Tire With ABS	08	CK7005		CSK233			SRC7006	SRK7006	CT706SP
VRSCD Night Rod	08	CK7005		CSK233			SRC7006	SRK7006	CT706SP
VRSCDA Night Rod With ABS	08	CK7005		CSK233			SRC7006	SRK7006	CT706SP

CLUTCH
APPLICATIONS

EBC BRAKES CLUTCH KITS



HARLEY-DAVIDSON V-ROD



		CK cork OEM style Kit #	CKF carbon fiber style upgrade Kit #	CSK Spring Kit #	DRC Series Kit #	DRCF Series Kit #	SRC Series Kit #	SRK Series Kit #	CT Tool #
VRSCDX Night Rod Special	12	CK7005		CSK233			SRC7006	SRK7006	CT706SP
VRSCDX Night Rod Special	08-21	CK7005		CSK233			SRC7006	SRK7006	CT706SP
VRSCDXA Night Rod Special With ABS	08	CK7005		CSK233			SRC7006	SRK7006	CT706SP
VRSCF Muscle 1HPH V-Rod	09-21	CK7005		CSK233			SRC7006	SRK7006	CT706SP
VRSCR Street Rod	06-07	CK7006		CSK232			SRC7007	SRK7007	CT707SP
VRSCSE CVO V-Rod	05-06	CK7006		CSK232			SRC7007	SRK7007	CT707SP
VRSCX Screamin' Eagle	07	CK7006		CSK232			SRC7007	SRK7007	CT707SP
VRXSE CVO VR Destroyer	06	CK7006		CSK232			SRC7007	SRK7007	CT707SP

HUSQVARNA

TC 50	17-19	CK5674							
TC 85 (F17"/R14")	14-17	CK5610		CSK042	DRC139				CT028
TC 85 (F19"/R16")	14-17	CK5610		CSK042	DRC139				CT028
TC 85 (F17"/R14")	18-21	CK5668	CKF5668	CSK908	DRC304	DRCF304			CT087SP
TC 85 (F19"/R16")	18-21	CK5668	CKF5668	CSK908	DRC304	DRCF304			CT087SP
CR 125	00-11	CK1222		CSK182	DRC264				CT001
TC 125	14-18	CK5611	CKF5611	CSK210	DRC303	DRCF303			CT001
TC 125	19-21	TBA	TBA	TBA	TBA	TBA			CT001
TE 125	14-16	CK5611	CKF5611	CSK210	DRC303	DRCF303			CT001
TX 125	17-18	CK5611	CKF5611	CSK210	DRC303	DRCF303			CT001
WR 125	00-11	CK1222		CSK182	DRC264				CT001
WRE 125	00-11	CK1222		CSK182	DRC264				CT001
SMS 125	00-11	CK1222		CSK182	DRC264				CT001
TE 150	17-18	CK5611	CKF5611	CSK210	DRC303	DRCF303			CT001
TE 150i	19-22	TBA	TBA	TBA	TBA	TBA			TBA
FC 250	14-17	CK5651	CKF5651	CSK221	DRC293				CT023
FC 250	18-22	TBA	TBA	TBA	TBA	TBA			CT023
TC 250	03-08	CK5657							
TC 250	14-22	CK5651	CKF5651	CSK910	TBA				CT023
TE 250 2T	03-09	CK5657							
TE 250 2T	14-17	CK5651	CKF5651	CSK910	TBA				CT023
TE 250 2T	18-22	CK5651	CKF5651	CSK910	TBA				CT023
TE 300 2T	14-17	CK5651	CKF5651	CSK910	TBA				CT023
TE 300i 2T	18-22	CK5651	CKF5651	CSK910	TBA				CT023
TX 300i	18-22	CK5651	CKF5651	CSK910	TBA				CT023
TE 310	08-10	CK5657							
FC 350	14-17	CK5651	CKF5651	CSK221	DRC293				CT023
FC 350	18-22	TBA	TBA	TBA	TBA				CT023
FE 350	14-17	CK5651	CKF5651	CSK910	DRC275				CT023
FE 350 Inc S models	18-22	TBA	TBA	TBA	TBA				CT023
FX 350	17-18	CK5651	CKF5651	CSK221	DRC293				CT023
FX 350	18-22	TBA	TBA	TBA	TBA				CT023
FC 450	14-17	CK5651	CKF5651	CSK910	DRC296				CT023
FC 450 Inc Rockstar Edition models	18-22	TBA	TBA	TBA	TBA				CT023
FE 450	14-17	CK5651	CKF5651	CSK910	DRC275				CT023
FE 450	18-21	TBA	TBA	TBA	TBA				CT023
FR 450 Rally	17-21	CK5651	CKF5651	CSK909	DRC281				CT023
FS 450	15-18	CK5651	CKF5651	CSK909	DRC281				CT023
FX 450	17	CK5651	CKF5651	CSK909	DRC281				CT023
FX 450	18-22	TBA	TBA	TBA	TBA				CT023
TC 450	02-06	CK5656							
TE 450	02-06	CK5656							
FE 501	14-16	CK5651	CKF5651	CSK910	DRC275				CT023
FE 501	17-22	CK5651	CKF5651	CSK910	DRC275				CT023
FE 501S	16-22	CK5651	CKF5651	CSK910	DRC275				CT023
SMR 570	03-04	CK5656							
TC 570	03-04	CK5656							

CLUTCH APPLICATIONS

EBC BRAKES CLUTCH KITS



HUSQVARNA



		CK cork OEM style Kit #	CKF carbon fiber style upgrade Kit #	CSK Spring Kit #	DRC Series Kit #	DRCF Series Kit #	SRC Series Kit #	SRK Series Kit #	CT Tool #
TE 570	03-04	CK5656							
TE 610	05-12	CK5656							
701 Enduro R	16-21	CK5642		CSK131	DRC205				CT069
701 Supermoto	16-18	CK5642		CSK131	DRC205				CT069
Svartpilen 401	18-21	CK5642		CSK131	DRC205				CT069
Svartpilen 701	18-21	CK5642		CSK131	DRC205				CT069
Vitpilen 401	18-21	CK5642		CSK131	DRC205				CT069
Vitpilen 701	18-21	CK5642		CSK131	DRC205				CT069
INDIAN									
Chief Classic	14-21	CK7003		CSK232			SRC7004	SRK7004	
Chief Dark Horse	16-21	CK7003		CSK232			SRC7004	SRK7004	
Chief Vintage	14-21	CK7003		CSK232			SRC7004	SRK7004	
Chieftain	14-18	CK7003		CSK232			SRC7004	SRK7004	
Chieftain Dark Horse	16-21	CK7003		CSK232			SRC7004	SRK7004	
Chieftain Elite	17-21	CK7003		CSK232			SRC7004	SRK7004	
Chieftain Limited	17-18	CK7003		CSK232			SRC7004	SRK7004	
FTR 1200 FTR 1200	19-21	CK7018							
Octane	17	CK7001		CSK231			SRC7001	SRK7001	
Roadmaster	15-21	CK7003		CSK232			SRC7004	SRK7004	
Roadmaster Classic	17-21	CK7003		CSK232			SRC7004	SRK7004	
Roadmaster Elite	18-21	CK7003		CSK232			SRC7004	SRK7004	
Scout	15-16	CK7001		CSK231			SRC7001	SRK7001	
Scout	17-21	CK7001		CSK235			SRC7002	SRK7002	
Scout 1200	17-21	CK7001		CSK235			SRC7002	SRK7002	
Scout Bobber	18	CK7001		CSK235			SRC7002	SRK7002	
Scout Sixty	16-17	CK7001		CSK231			SRC7001	SRK7001	
Scout Sixty	17-21	CK7001		CSK235			SRC7002	SRK7002	
Springfield	16-20	CK7003		CSK232			SRC7004	SRK7004	
Springfield Dark Horse	18	CK7003		CSK232			SRC7004	SRK7004	
KTM									
SX 50	13-19	CK5674							
SX 60	98-00	CK5594	CKF5594	CSK64	DRC107	DRCF107			CT027
SX 65	98-08	CK5594	CKF5594	CSK64	DRC107	DRCF107			CT027
SX 65	09-18	CK5594	CKF5594	CSK21	DRC241	DRCF241			CT057SP
XC 65	08	CK5594	CKF5594	CSK64	DRC107	DRCF107			CT027
XC 65	09-10	CK5594	CKF5594	CSK21	DRC241	DRCF241			CT057SP
SX 85 (17"/14")	03-17	CK5610		CSK42	DRC139				CT028
SX 85 (19"/16")	03-17	CK5610		CSK42	DRC139				CT028
SX 85 (F 17"/R 14")	18-21	CK5668	CKF5668	CSK908	DRC304	DRCF304			CT087SP
SX 85 (19"/16")	18-21	CK5668	CKF5668	CSK908	DRC304	DRCF304			CT087SP
XC 85	08-09	CK5610		CSK42	DRC139				CT028
SX 105	04-10	CK5610		CSK42	DRC139				CT028
XC 105	08-10	CK5610		CSK42	DRC139				CT028
125 EGS	98-99	CK5611		CSK24	DRC145				CT001
125 EXC	98-05	CK5611		CSK24	DRC145				CT001
125 EXE	00-01	CK5611		CSK24	DRC145				CT001
125 LC 2 Sting	96-98	N/A		N/A	N/A				
125 Supermoto	00-01	CK5611		CSK24	DRC145				CT001
SX 125	98-07	CK5611		CSK24	DRC145				CT001
SX 125	08	CK5611		CSK132	DRC174				CT001
SX 125	15-18	CK5611		CSK24	DRC145				CT001
SX 125	19-22	TBA		TBA	TBA				CT001
125 SXS	01-02	CK5611		CSK24	DRC145				CT001
SX 150	08-18	CK5611		CSK91	DRC144				CT001
SX 150	19-22	TBA		TBA	TBA				CT001

CLUTCH APPLICATIONS

EBC BRAKES CLUTCH KITS



KTM



		CK cork OEM style Kit #	CKF carbon fiber style upgrade Kit #	CSK Spring Kit #	DRC Series Kit #	DRCF Series Kit #	SRC Series Kit #	SRK Series Kit #	CT Tool #
XC 150	10-14	CK5611		CSK91	DRC144				CT001
XC-W 150 Tpi	17-22	CK5611		CSK91	DRC144				CT001
200 EGS	98-99	CK5611		CSK91	DRC144				CT001
200 EXC	97-05	CK5611		CSK91	DRC144				CT001
200 MXC	98-03	CK5611		CSK91	DRC144				CT001
SX 200	03	CK5611		CSK91	DRC144				CT001
XC-W 200	07-16	CK5611		CSK91	DRC144				CT001
XC 200	06-09	CK5611		CSK91	DRC144				CT001
250 EGS	94-99	CK5595	CKF5595	CSK80	DRC108	DRCF108			CT007
250 EXC	94-05	CK5595	CKF5595	CSK80	DRC108	DRCF108			CT007
250 EXC Racing	02-03	CK5612		CSK210	DRC171				CT023
250 EXC Racing	04	CK5602		CSK210	DRC117				CT059
250 EXC Racing	05	CK5612		CSK210	DRC154				CT023
250 EXG-G Racing	03	CK5612		CSK210	DRC171				CT023
250 EXC-G Racing	04	CK5602		CSK210	DRC117				CT059
250 MXC	98-99	CK5595	CKF5595	CSK80	DRC108	DRCF108			CT007
SX 250 (2T)	94-12	CK5595	CKF5595	CSK80	DRC108	DRCF108			CT007
SSX 250 (2T) (Diaphragm Spring)	13-22	CK5651		CSK910	DRC275				CT023
SX-F 250	05-12	CK1293	CKF1293	CSK179	DRC163	DRCF163			CT001
SX-F 250	13-15	CK5651		CSK91	DRC260				CT023
SX-F 250	16-18	CK5612		CSK210	DRC171				CT023
SX-F 250	19-22	TBA		TBA	TBA				CT023
SX-F 250 Factory Edition	16-18	CK5612		CSK210	DRC171				CT023
250 R Freeride	15-16	CK5612		TBA					
XC 250 (2T)	06-12	CK5595	CKF5595	CSK80	DRC108	DRCF108			CT007
XC 250 (2T) (Diaphragm Spring)	13-16	CK5651		CSK910	DRC275				CT023
XC-F 250	06-12	CK1293	CKF1293	CSK179	DRC163	DRCF163			CT001
XC-F 250	13-15	CK5651		CSK91	DRC260				CT023
XC-F 250	16	CK5612		CSK221	DRC292				CT023
XC-F-W 250	06-13	CK1293	CKF1293	CSK179	DRC163	DRCF163			CT001
XC-F-W 250 (Diaphragm spring)	14-16	CK5651		CSK910	DRC273				CT023
XC-W 250	06-12	CK5595	CKF5595	CSK80	DRC108	DRCF108			CT007
XC-W 250 (Diaphragm Spring)	13-16	CK5651		CSK910	DRC275				CT023
XC-W 250	06-12	CK5595	CKF5595	CSK80	DRC108	DRCF108			CT007
Rekluse Aftermarket Clutch for SX/XC 250/300 (2T Models/24 Tooth Steel Plate)	03-11	CK5595	CKF5595	N/A	N/A	N/A			CT049
250 SXS	01-03	CK5595	CKF5595	CSK80	DRC108	DRCF108			CT007
300 EGS	94-99	CK5595	CKF5595	CSK80	DRC108	DRCF108			CT007
300 EXC	94-05	CK5595	CKF5595	CSK80	DRC108	DRCF108			CT007
300 MXC	94-03	CK5595	CKF5595	CSK80	DRC108	DRCF108			CT007
300 MXC	04-05	CK5595	CKF5595	CSK80	DRC108	DRCF108			CT007
SX 300	94	CK5595	CKF5595	CSK80	DRC108	DRCF108			CT007
300 Six Days	96	CK5595	CKF5595	CSK80	DRC108	DRCF108			CT007
XC 300	06-12	CK5595	CKF5595	CSK80	DRC108	DRCF108			CT007
XC 300	13-21	CK5651		CSK910	DRC275				CT023
XC-W 300 (Diaphragm Spring)	13-21	CK5651		CSK910	DRC275				CT023
XC-W 300 (2T)	14-16	CK5651		CSK910	DRC275				CT023
350 EXC	94	CK5631		CSK80	DRC169				CT030
350 Super Comp	94-95	CK5631		CSK80	DRC169				CT030
EXC-F 350 (Diaphragm spring)	12-17	CK5651		CSK910	DRC273				CT023
EXC-F 350 (Diaphragm spring)	18-22	TBC		TBC	TBC				CT023
SX-F 350	11-15	CK5651		CSK91	DRC260				CT023
SX-F 350	16-18	CK5612		CSK221	DRC292				CT023
SX-F 350	19-22	TBC		TBC	TBC				CT023
XC-F 350	12-15	CK5651		CSK91	DRC260				CT023
XC-F 350	16-21	CK5612		CSK221	DRC292				CT023
XC-F-W 350 (Diaphragm spring)	12-15	CK5651		CSK910	DRC273				CT023

CLUTCH
APPLICATIONS

EBC BRAKES CLUTCH KITS



KTM



		CK cork OEM style Kit #	CKF carbon fiber style upgrade Kit #	CSK Spring Kit #	DRC Series Kit #	DRCF Series Kit #	SRC Series Kit #	SRK Series Kit #	CT Tool #
XC-F-W 350	2014 - 2021	CK5651		CSK910	DRC273				CT023360 EGS
96-97	CK5595	CKF5595	CSK80	DRC108	DRCF108			CT007	
360 EXC	96-97	CK5595	CKF5595	CSK80	DRC108	DRCF108			CT007
360 MXC	96-97	CK5595	CKF5595	CSK80	DRC108	DRCF108			CT007
360 SX	96-97	CK5595	CKF5595	CSK80	DRC108	DRCF108			CT007
360 Six Days	96	CK5595	CKF5595	CSK80	DRC108	DRCF108			CT007
380 EGS	98-99	CK5631		CSK129	DRC170				CT030
380 EXC	98-02	CK5595	CKF5595	CSK80	DRC108	DRCF108			CT007
380 MXC	98-01	CK5595	CKF5595	CSK80	DRC108	DRCF108			CT007
SX 380	98-02	CK5595	CKF5595	CSK80	DRC108	DRCF108			CT007
390 Duke	13-14	CK5665		CSK237			SRC139	SRK139	
RC 390	14-15	CK5665		CSK237			SRC139	SRK139	
390 Duke	15-17	CK5666		CSK239			SRC140	SRK140	
RC 390	16-17	CK5666		CSK239			SRC140	SRK140	
400 Duke	94-95	CK5631		CSK80	DRC169				CT030
400 EGS	94	CK5631		CSK80	DRC169				CT030
400 EGS	96-97	CK5631		CSK129	DRC170				CT030
400 EGS-E	97	CK5631		CSK129	DRC170				CT030
EXC 400 (LC4 Engine)	93-95	CK5632		CSK11	DRC178				CT075
400 EXC	94	CK5631		CSK80	DRC169				CT030
400 EXC	96	CK5631		CSK129	DRC170				CT030
400 EXC	00-01	CK5602		CSK210	DRC117				CT059
400 EXC	07	CK5612		CSK210	DRC171				CT023
400 EXC Racing	02	CK5612		CSK210	DRC171				CT023
400 EXC Racing	05	CK5612		CSK210	DRC154				CT023
400 EXC-G Racing	02	CK5612		CSK210	DRC171				CT023
400 EXC-G Racing	05	CK5612		CSK210	DRC154				CT023
400 EXC-G Racing	06	CK5612		CSK210	DRC171				CT023
400 LC-4	98	CK5631		CSK129	DRC170				CT030
LC4-R 400	99	CK5631		CSK129	DRC170				CT030
400 LC4-E	00-01	CK5631		CSK129	DRC170				CT030
400 LSE	97	CK5631		CSK129	DRC170				CT030
400 LSE	04	CK5631		CSK129	DRC170				CT030
400 MXC	01	CK5602		CSK210	DRC117				CT059
400 MXC	02	CK5612		CSK210	DRC171				CT023
400 Super Comp	95	CK5631		CSK80	DRC169				CT030
RXC-E 400	95	CK5595	CKF5595	CSK11	DRC108	DRCF108			CT007
400 Super Comp/EXC	96-99	CK5631		CSK129	DRC170				CT030
400 RXC-E	95	CK5632		CSK11	DRC178				CT075
400 RXC-E	96-97	CK5631		CSK129	DRC170				CT030
SC 400 (LC4 Engine)	93-95	CK5632		CSK11	DRC178				CT075
SXC 400	97	CK5631		CSK129	DRC170				CT030
400 SXC	98	CK5631		CSK129	DRC170				CT030
400 SX	99	CK5631		CSK129	DRC170				CT030
SX 400	00-01	CK5602		CSK210	DRC117				CT059
400 SX Racing	02	CK5612		CSK210	DRC171				CT023
400 SXC	00	CK5631		CSK129	DRC170				CT030
400 TXC	98	CK5631		CSK129	DRC170				CT030
XC-W 400	10-11	CK5648		CSK140	DRC252				CT041
EXC 440	94-95	N/A		N/A	N/A				
SX 440	94	N/A		N/A	N/A				
MXC 440	94	N/A		N/A	N/A				
450 EXC	06-07	CK5612		CSK210	DRC171				CT023
EXC 450	10-11	CK5648		CSK140	DRC252				CT041
450 EXC Racing	03	CK5612		CSK210	DRC171				CT023
450 EXC-G Racing	03	CK5612		CSK210	DRC171				CT023
450 EXC Racing	04	CK5602		CSK210	DRC117				CT059

CLUTCH APPLICATIONS

EBC BRAKES CLUTCH KITS



KTM



		CK cork OEM style Kit #	CKF carbon fiber style upgrade Kit #	CSK Spring Kit #	DRC Series Kit #	DRCF Series Kit #	SRC Series Kit #	SRK Series Kit #	CT Tool #
450 EXC Racing	05	CK5612		CSK210	DRC154				CT023
450 EXC-G Racing	04	CK5602		CSK210	DRC117				CT059
450 LXC-G Racing	05	CK5612		CSK210	DRC154				CT023
450 EXC	04-05	CK5612		CSK210	DRC154				CT023
EXC-R 450	08	CK5648		CSK140	DRC252				CT041
MXC 450	06	CK5612		CSK210	DRC171				CT023
450 MXC-G Racing	03	CK5612		CSK210	DRC171				CT023
450 MXC-G Racing	04	CK5602		CSK210	DRC117				CT059
450 MXC-G Racing	05	CK5612		CSK210	DRC154				CT023
450 SMR	04-05	CK5612		CSK210	DRC154				CT023
SMR 450	06	CK5612		CSK210	DRC171				CT023
SMR 450	07-12	TBA		TBA					
450 SMS	04	CK5612		CSK210	DRC172				CT023
SX 450	06	CK5612		CSK210	DRC171				CT023
SX 450	09-12	CK5638		CSK136	DRC184				CT009
450 SX Racing	03	CK5612		CSK210	DRC171				CT023
450 SX Racing	04	CK5602		CSK210	DRC117				CT059
450 SX Racing	05	CK5612		CSK210	DRC154				CT023
SX-F 450 (Coil Spring)	07-11	CK5638		CSK136	DRC184				CT009
SX-F 450 (Diaphragm spring)	12	CK5651		CSK910	DRC273				CT023
SX-F 450 (Diaphragm spring)	13	CK5651		CSK910	DRC275				CT023
SX-F 450 (Diaphragm spring)	14-17	CK5651		CSK910	DRC281				CT023
SX-F 450 (Diaphragm spring)	18	CK5651		CSK909	DRC281				CT023
SX-F 450 (Diaphragm spring)	19-22	CK5651		CSK909	DRC281				CT023
XC 450	08-12	CK5612		CSK210	DRC171				CT023
XC-F 450	08-09	CK5638		CSK136	DRC184				CT009
XC-F 450 (Diaphragm spring)	13	CK5651		CSK910	DRC275				CT023
XC-F 450 (Diaphragm spring)	14-21	CK5651		CSK909	DRC281				CT023
XCR-W 450	08	CK5648		CSK140	DRC252				CT041
XC-W 450	08-09	CK5638		CSK136	DRC184				CT009
XC-W 450 Champions Edition	10	CK5648		CSK140	DRC252				CT041
XC-W 450 (Diaphragm spring)	12-13	CK5651		CSK910	DRC273				CT023
XC-W 450 (Diaphragm spring)	14-21	CK5651		CSK909	DRC281				CT023
XC-W 450 Six Days	10-11	CK5648		CSK140	DRC252				CT041
EXC 500 (Diaphragm spring)	12	CK5651		CSK910	DRC273				CT023
EXC 500 (Diaphragm spring)	13-15	CK5651		CSK910	DRC275				CT023
EXC-F 500 (Diaphragm spring)	17	CK5651		CSK909	DRC281				CT023
EXC-F 500 (Diaphragm spring)	18-21	CK5651		CSK909	DRC281				CT023
EXC 500 Six Days	13-16	CK5651		CSK910	DRC275				CT023
EXC-F 500 Six Days (Diaphragm spring)	18-21	CK5651		CSK909	DRC281				CT023
XC-W 500 (Diaphragm spring)	12	CK5651		CSK910	DRC273				CT023
XC-W 500 (Diaphragm spring)	13-15	CK5651		CSK910	DRC275				CT023
SX 505	09-12	CK5638		CSK136	DRC184				CT009
SX-F 505	07-08	CK5638		CSK136	DRC184				CT009
XC-F 505	08-09	CK5638		CSK136	DRC184				CT009
520 EXC	00-01	CK5602		CSK210	DRC117				CT059
SX 520	00-01	CK5602		CSK210	DRC117				CT059
520 SX Racing	02	CK5612		CSK210	DRC171				CT023
525 EXC-G Racing	03	CK5612		CSK210	DRC171				CT023
525 EXC	03	CK5612		CSK210	DRC171				CT023
525 EXC Racing	04	CK5602		CSK210	DRC117				CT059
525 EXC Racing	05	CK5612		CSK210	DRC154				CT023
525 EXC-G Racing	04	CK5602		CSK210	DRC117				CT059
525 EXC-G Racing	05	CK5612		CSK210	DRC154				CT023
EXC 525 Racing	07	CK5612		CSK210	DRC171				CT023
MXC 525	06	CK5612		CSK210	DRC171				CT023
525 MXC Desert Racing	03	CK5612		CSK210	DRC171				CT023

CLUTCH APPLICATIONS

EBC BRAKES CLUTCH KITS



KTM



		CK cork OEM style Kit #	CKF carbon fiber style upgrade Kit #	CSK Spring Kit #	DRC Series Kit #	DRCF Series Kit #	SRC Series Kit #	SRK Series Kit #	CT Tool #
525 MXC Desert Racing	04	CK5602		CSK210	DRC117				CT059
525 MXC Desert Racing	05	CK5612		CSK210	DRC154				CT023
525 MXC-G Racing	04	CK5602		CSK210	DRC117				CT059
525 SMR	04-05	CK5612		CSK210	DRC154				CT023
SX 525	06	CK5612		CSK210	DRC171				CT023
525 SX Racing	03	CK5612		CSK210	DRC171				CT023
525 SX Racing	04	CK5602		CSK210	DRC117				CT059
525 SX Racing	05	CK5602		CSK210	DRC154				CT023
XC 525	08-12	CK5612		CSK210	DRC171				CT023
EXC 530 (9 Friction plates)	10-11	CK5648		CSK140	DRC252				CT041
EXC 530 Champion Edition (9 Friction plates)	10	CK5648		CSK140	DRC252				CT041
EXC-R 530 (9 Friction plate kit)	08	CK5648		CSK140	DRC252				CT041
WCR-W 530 (9 Friction plate kit)	08	CK5648		CSK140	DRC252				CT041
XC-W 530 Six Days (9 Friction plates)	10-11	CK5648		CSK140	DRC252				CT041
540 SXC	98-99	CK5639		CSK129	DRC196				CT030
540 SXS Racing	02	CK5612		CSK210	DRC171				CT023
MXC 550	94-96	N/A		N/A	N/A				
SMR 560	06	CK5612		CSK210	DRC171				CT023
620 Duke	94	CK5631		CSK80	DRC169				CT030
620 Duke	97	CK5631		CSK129	DRC170				CT030
620 EGS	94-95	CK5631		CSK80	DRC169				CT030
620 EGS-E	97	CK5631		CSK129	DRC170				CT030
620 EGS/Adventure	96-97	CK5631		CSK129	DRC170				CT030
620 Enduro Ltd	97	CK5631		CSK129	DRC170				CT030
620 EXC	94-95	CK5631		CSK80	DRC169				CT030
620 LC4	98	CK5631		CSK129	DRC170				CT030
620 LC4 Competition	99	CK5639		CSK129	DRC196				CT030
620 LC4 Super Moto	99	CK5639		CSK129	DRC196				CT030
620 LSE	97	CK5631		CSK129	DRC170				CT030
620 Six Days	96	CK5631		CSK129	DRC170				CT030
620 Super Comp	94-95	CK5631		CSK80	DRC169				CT030
620 Super Comp	96-99	CK5639		CSK129	DRC196				CT030
SX 620	97-99	CK5639		CSK129	DRC196				CT030
SX 620	99	CK5639		CSK129	DRC196				CT030
RXC-E 620	95	CK5595	CKF5595	CSK11	DRC108	DRCF108			CT007
620 RXC-E	95	CK5632		CSK11	DRC178				CT075
620 RXC-E	96-97	CK5631		CSK129	DRC170				CT030
620 SC	00-01	CK5639		CSK129	DRC196				CT030
SXC 620	97	CK5631		CSK129	DRC170				CT030
620 Supermoto	98	CK5639		CSK129	DRC196				CT030
620 TXC	98	CK5639		CSK129	DRC196				CT030
625 SMC	04/06	CK5639		CSK129	DRC196				CT030
625 SC	02	CK5639		CSK129	DRC196				CT030
625 SXC	03-04	CK5639		CSK129	DRC196				CT030
640 Adventure-R	98-02	CK5639		CSK129	DRC196				CT030
640 Duke-E	98	CK5639		CSK129	DRC196				CT030
640 Duke-II	99-04	CK5639		CSK129	DRC196				CT030
640 LC Rallye Dakar	97	CK5631		CSK129	DRC170				CT030
640 LC4	99-00	CK5639		CSK129	DRC196				CT030
640 LC4-E	00-02	CK5639		CSK129	DRC196				CT030
640 LC4 Adventure	03-06	CK5639		CSK129	DRC196				CT030
640 LC4 Supermoto	03-04	CK5639		CSK129	DRC196				CT030
640 LC4 Six Days	99	CK5639		CSK129	DRC196				CT030
660 LC4	97	CK5631		CSK129	DRC170				CT030
660 LC4 Rallye	99-00	CK5639		CSK129	DRC196				CT030
660 Rallye	01-03	CK5633		CSK129	DRC176				CT030
660 Rallye Factory	04	CK5633		CSK129	DRC176				CT030

CLUTCH APPLICATIONS

EBC BRAKES CLUTCH KITS



KTM



		CK cork OEM style Kit #	CKF carbon fiber style upgrade Kit #	CSK Spring Kit #	DRC Series Kit #	DRCF Series Kit #	SRC Series Kit #	SRK Series Kit #	CT Tool #
660 SM Factory Replica	02-03	CK5639		CSK131	DRC175				CT030
660 SMC	03-04	CK5639		CSK131	DRC175				CT030
660 SMS	04	CK5639		CSK131	DRC175				CT030
690 Duke	08-14	CK5642		CSK131	DRC205				CT069
690 Enduro	08	CK5642		CSK131	DRC205				CT069
690 Enduro R	10-16	CK5642		CSK131	DRC205				CT069
690 Rally Factory Rep	07-08	CK5641		CSK131	DRC199				CT030
690 SMC	08-11	CK5642		CSK131	DRC205				CT069
690 SMR (Cast Wheel)	07-09	CK5642		CSK131	DRC205				CT069
690 Supermoto	07-08	CK5642		CSK131	DRC205				CT069
790 Duke	17-20	CK5669		TBA	DRC320				TBA
790 Adventure	17-20	CK5669		TBA	DRC320				TBA
890 Duke	21	CK5669		TBA	DRC320				TBA
890 Adventure	21	CK5669		TBA	DRC320				TBA
950 Adventure S	03-04	CK5634		CSK130	DRC177				CT015
950 Adventure	06	CK5634		CSK130	DRC177				CT015
950 Superenduro R	07-08	CK5634		CSK130	DRC177				CT015
950 Supermoto	05-07	CK5634		CSK130	DRC177				CT015
990 Adventure	07-11	CK5634		CSK130	DRC177				CT015
990 Adventure Baja Edition	13-14	CK5634		CSK130	DRC177				CT015
990 Adventure S	07-09	CK5634		CSK130	DRC177				CT015
990 SM-T	10-14	CK5634		CSK130	DRC177				CT015
990 SM-R	09-11	CK5634		CSK130	DRC177				CT015
990 Superduke	05-11	CK5634		CSK130	DRC177				CT015
990 Superduke R	07-11	CK5634		CSK130	DRC177				CT015
1050 Adventure	15-16	CK5683		TBA			SRC168	SRK168	
1090 Adventure Inc R model	17-19	CK5683		TBA			SRC168	SRK168	
1090 Adventure L and S models	2019	CK5683		TBA			SRC168	SRK168	
1190 Adventure/Adventure R	13-16	CK5683		TBA			SRC168	SRK168	
1190 RC8 R (3 Spring Type Clutch)	13-14	CK5683		TBA			SRC168	SRK168	
1290 Super Adventure	15-16	CK5683		TBA			SRC168	SRK168	
1290 Super Adventure R&S models	17-21	CK5683		TBA			SRC168	SRK168	
1290 Super Adventure T	2017	CK5683		TBA			SRC168	SRK168	
1290 Superduke GT	17-19	CK5683		TBA			SRC168	SRK168	
1290 Superduke R	16-19	CK5683		TBA			SRC168	SRK168	
LIFAN									
LF 200 GY-S	05-08	CK1119		CSK77	DRC209				CT012SP
OHVALE									
GP-O 110cc, 160cc	19-20	CK1119							
MORIWAKI/HONDA									
MD 250 H	08-11	CK1305	CKF1305	CSK176					CT001
MD 250 S	08-11	CK1305	CKF1305	CSK176					CT001
TRIUMPH									
Adventurer	96-01	CK5588	CKF5588	CSK68					CT021
America (Cast Wheel)	07-09	CK5608		CSK15					
Bonneville 800 (790cc) Up to Engine no. 211132	01-04	CK5597		CSK15					CT009SP
Bonneville 800 From Engine no. 211133	01-04	CK5608		CSK15					
Bonneville America	02-06	CK5608		CSK15					
Bonneville/Bonneville Black (865cc)	07-08	CK5608		CSK15					
Bonneville (865cc)	09	CK5608		TBA					
Bonneville SE (865cc)	09	CK5608		TBA					
Bonneville T-100 (790cc) Up to Engine no. 211132	02-04	CK5597		CSK15					CT009SP
Bonneville T-100 From Engine No. 211133	02-04	CK5608		CSK15					

CLUTCH APPLICATIONS

EBC BRAKES CLUTCH KITS



TRIUMPH



		CK cork OEM style Kit #	CKF carbon fiber style upgrade Kit #	CSK Spring Kit #	DRC Series Kit #	DRCF Series Kit #	SRC Series Kit #	SRK Series Kit #	CT Tool #
Bonneville T-100 (865cc)	05-09	CK5608		CSK15					
Bonneville - Steve McQueen SE	12	CK5608		CSK15					
Bonneville T100 (900cc/Liquid Cooled)	16-21	CK5669		CSK244			SRC147	SRK147	CT086SP
Bonneville T100 Black (900cc/Liquid Cooled)	16-21	CK5669		CSK244			SRC147	SRK147	CT086SP
Bonneville T120 (1200cc Liquid Cooled)	16-21	CK5669		CSK243			SRC146	SRK146	CT086SP
Bonneville T120 Black (1200cc Liquid Cooled)	16-21	CK5669		CSK243			SRC146	SRK146	CT086SP
Bonneville Bobber (1200cc Liquid Cooled)	17-21	CK5669		CSK243			SRC146	SRK146	CT086SP
Bonneville Bobber Black (1200cc Liquid Cooled)	18-21	CK5669		CSK243			SRC146	SRK146	CT086SP
T595 Daytona (9 Friction Plates)	97-98	CK5589	CKF5589	CSK29					CT009
Daytona 600	02-05	CK1206	CKF1206	CSK83					CT013SP
Daytona 650	05	CK1181		CSK15					CT014
Daytona 675	06-12	CK1206	CKF1206	CSK135					CT014
Daytona 675	13-	CK5664							
Daytona 675 R	11-12	CK1206	CKF1206	CSK135					CT014
Daytona 675 R	13-	CK5664							
Daytona 750 (3cyl)	92	CK5588	CKF5588	CSK68					CT021
Daytona 900 (3cyl)	93-96	CK5588	CKF5588	CSK68					CT021
Daytona 955i (10 Friction Plates)	99-06	CK5599	CKF5599	CSK29					CT009
Daytona 1000 (4cyl)	92	CK5588	CKF5588	CSK15					CT021
Daytona Super III (3cyl)	94-97	CK5588	CKF5588	CSK68					CT021
Daytona 1200 (4cyl)	93-98	CK5588	CKF5588	CSK45					CT021
Legend TT	98-01	CK5588	CKF5588	CSK68					CT021
Rocket III 2300cc	04-09	CK5624		CSK118					CT021
Rocket III Classic	07-09	CK5624		CSK118					CT021
Rocket III Roadster ABS	10-12	CK5624		CSK118					CT021
Rocket III Touring	08-12	CK5624		CSK118					CT021
Scrambler (865cc)	06-09	CK5608		CSK15					
Speedmaster 800 (790cc) Up to VIN 210261	03-04	CK5608		CSK15					
Speedmaster From VIN 210262	03-04	CK5608		CSK15					
Speedmaster (865cc)	05-09	CK5608		CSK15					
Speed Triple (Carb models)	94-97	CK5588	CKF5588	CSK68					CT021
Speed Triple (EFI)	97-01	CK5589	CKF5589	CSK29					CT009
Speed Triple 955cc (From VIN 141872 to 210444)	02-04	CK5599		CSK29					CT009
Speed Triple (1050cc)	05-08	CK5599		CSK29					CT009
Speed Triple R (1050cc)	12	CK5599		CSK29					
Sprint GT 1050	10-12	CK5599		CSK29					
Sprint ST (1050cc) (From VIN 208167)	05-09	CK5599		CSK29					CT009
Rocket III 2300cc (All models)	04-09	CK5624		CSK118					CT021
Sprint (All carb models up to VIN 9082)	93	CK5588	CKF5588	CSK68					CT021
Sprint (All carb models from VIN 9083)	94-98	CK5588	CKF5588	CSK68					CT021
Sprint RS (Up to VIN 139276)	99-01	CK5589	CKF5589	CSK29					CT009
Sprint RS (From VIN 139277)	02-04	CK5599		CSK29					CT009
Sprint ST (Up to VIN 139276)	99-01	CK5589	CKF5589	CSK29					CT009
Sprint ST (From VIN 139277 to 208166)	02-04	CK5599		CSK29					CT009
Street Cup (900cc Liquid Cooled)	16-20	CK5669		CSK244			SRC147	SRK147	CT086SP
Street Scrambler (900cc Liquid Cooled)	16-20	CK5669		CSK244			SRC147	SRK147	CT086SP
Street Triple 675	07-16	CK1206	CKF1206	CSK135					CT014
Street Triple R 675	09-16	CK1206	CKF1206	CSK135					CT014
Street Triple S 765	17-21	CK1206	CKF1206	CSK135					CT014
Street Triple R 765	17-21	CK1206	CKF1206	CSK135					CT014
Street Triple RS 765	17-21	CK1206	CKF1206	CSK135					CT014
Street Twin (900cc Liquid Cooled)	16-21	CK5669		CSK244			SRC147	SRK147	CT086SP
TT 600	00-03	CK1206	CKF1206	CSK83					CT013SP
Thunderbird	95-03	CK5588	CKF5588	CSK68					CT021
Thunderbird Sport	98-04	CK5588	CKF5588	CSK68					CT021
Thunderbird (1597cc)	09-12	TBA		TBA					
Thunderbird Storm (1699cc)	11-12	TBA		TBA					

CLUTCH
APPLICATIONS

EBC BRAKES CLUTCH KITS



TRIUMPH



		CK cork OEM style Kit #	CKF carbon fiber style upgrade Kit #	CSK Spring Kit #	DRC Series Kit #	DRCF Series Kit #	SRC Series Kit #	SRK Series Kit #	CT Tool #
Thruxton 900	04-12	CK5608		CSK15					
Tiger 800	11-12	CK1206	CKF1206	CSK135			SRC166	SRK166	CT014
Tiger 800 XC	11-12	CK1206	CKF1206	CSK135			SRC166	SRK166	CT014
Tiger 800 XR (from VIN 674842)	>2018	CK5681		TBA			SRC166	SRK166	CT014
Tiger 900cc (Up to VIN 71698) Carb Models	93-96	CK5588	CKF5588	CSK68					CT021
Tiger 900cc (From VIN 71699) Injection Models	97-98	CK5589	CKF5589	CSK29					CT009
Tiger 955cc (Up to VIN 198874)	99-04	CK5589	CKF5589	CSK29					CT009
Tiger 955 (From VIN 198875)	04-06	CK5589	CKF5589	CSK29					CT009
Tiger 1050	07-12	CK5599		CSK29					CT009
Tiger 1050 SE	10-12	CK5599		CSK29					CT009
Tiger Explorer 1200	12	TBA		TBA					
Trident 750	92-98	CK5588	CKF5588	CSK68					CT021
Trident 900	92-98	CK5588	CKF5588	CSK68					CT021
Trophy 900 (3cyl)	92-01	CK5588	CKF5588	CSK68					CT021
Trophy 1200 (4cyl)	92-01	CK5588	CKF5588	CSK15					CT021
Thruxton 1200 (Liquid Cooled)	16-21	CK5669		CSK243			SRC146	SRK146	CT086SP
Thruxton R 1200 (Liquid Cooled)	16-21	CK5669		CSK243			SRC146	SRK146	CT086SP

CLUTCH
APPLICATIONS

CK CLUTCH KIT BUYERS GUIDE

Part No.	Make/Model	Year	Part No.	Make/Model	Year
CK1105	HONDA SL70 K1	70-73	CK1133	HONDA CB 750 K1/K2/K3/K4/K5	71-75
CK1119 CKF1119 CT012SP ■	HONDA CR 80 R CR 85 R/85 R Expert SL 100 K1/K2/K3 XL 100 XL 100 K1 CB 125 S/S1/S2 CG 125 (CA12/KS12/CA2/3/4/KS2/3/4/5/6 /KSE2/3/4) Drum Front Brake CGT 125 (ES12/ES2/3/4) Disc Front Brake CL 125 S CT 125 NXR 125 (JC30) SL 125 K1/K2 TL 125 S XL 125 S XL 125 K1 XL 125 CRF 150 F NXR 150 (KD03) XL 185 S XR 185 ATC 200 X CM 200 T TRX 200 SX Fourtrax TLR 200 TR 200 'Fatcat' XL 200 R XR 200 TRX 200 D Type II Fourtrax XR 200 R XR 200 R TRX 250 EX TRX 250 X TRX 250 TE Recon ES TRX 250 TM Recon KAWASAKI KLT 160 A1 KLF 185 A1/A1A/A2/A3/A4 Bayou KLT 185 A1/A2 LIFAN LF 200 GY-S OHVALE GP-O 110cc,160cc	84-02 ■ 03-07 ■ 70-74 ■ 74/76-78 ■ 75 ■ 80-82 ■ 01-06 ■ 01-04 ■ 84-85 ■ 77 ■ 03-08 ■ 71-73 ■ 76 ■ 79-85 ■ 74-75 ■ 76-78 ■ 06-19 ■ 03-08 ■ 79-83 ■ 79 ■ 83-87 ■ 80-82 ■ 86-91 ■ 86-87 ■ 86-87 ■ 83-84 ■ 80-84 ■ 91-97 ■ 81-83 ■ 86-02 ■ 01-08 ■ 09-14 ■ 97-14 ■ 97-14 ■ 85 ■ 85-88 ■ 86-87 ■ 05-08 ■ 19-20 ■	CK1134	HONDA SL 175 K1 XL 175 K1/K2 XL 175 SL 350 K/K1/K2	73-73 73-75 72-78 69-73
CK1123	HONDA CD 175 CL 175 (6 Friction Plate Clutch)	67-68 68-69	CK1135	HONDA CB 500 / K1 / K3	71-73
CK1130 CT031 ▲	HONDA CB 450 K2-K7	▲	CK1140 CT013SP ■	HONDA CB 350 F/F1 CB 400 F CB 400 T 'Hawk' All models CM 400 T/C/E CB 450 DX-K CB 450 T 'Hawk' CB 450 SC 'Nighthawk' CM 450 C Custom CM 450 E CMX 450 C 'Rebel' FT 500 'Ascot' XL 500 S XL 500 R	75-77 ■ 78-81 ■ 79-81 ■ 89-92 ■ 82 ■ 82-86 ■ 82 ■ 82-83 ■ 86-87 ■ 82-83 ■ 79-81 ■ 82 ■
CK1131 CT009 ▲	HONDA CR 250 R CR 250 M1/M/M76 Elsinore MR 250 Elsinore MT 250 K1/76 TL 250 XL 250 K1/K2/76 XL 350 K1 XL 350 CR 450 R	81 ▲ 73-77 ▲ 76 ▲ 74-76 ▲ 75-76 ▲ 72-76 ▲ 74-75 ▲ 76-78 ▲ 81 ▲	CK1143	HONDA GL 1000 K Goldwing (Up to Eng No 1020727) GL 1000 Goldwing All models	75 76-79
CK1132 CT009 ▲	HONDA CB 350 G/K2/K3/K4 CB 360/360 G/T	▲ 75-77 ▲	CK1144 CT002 ▲	HONDA CT 125 M/M1 Elsinore MT 125 K1 Elsinore MR 175 Elsinore	73-78 ▲ 74-76 ▲ 75-77 ▲
			CK1145	HONDA CB 750 F 'Supersport' CB 750 K	76 77-78
			CK1146	HONDA CX 500 C/D Custom/Deluxe GL 500/500 I Silverwing/Silverwing Interstate CB 550 F/K	79-82 81-82 75-78
			CK1147	HONDA CB 550 K/K1 CB 650 CB 650 C Custom CB 650 SC 'Nighthawk' CX 650 C Custom GL 650/650 I Silverwing/Silverwing Interstate	74-75 79-82 80-81 82 83 83
			CK1148	HONDA CRF 50 F XR 50 R C 70 CRF 70 F CT 70 Trail SL 70 K1 XR 70 R ATC 70 TRX 70	04-21 00-03 80-83 04-14 77-82/91-94 70-73 97-03 78-85 86-87
			CK1149 CT021 ▲	HONDA CB 750 C Custom CB 750 F 'Supersport' CB 750 K CB 750 Limited Edition CB 750 SC 'Nighthawk' CB 900 C Custom	80-82 ▲ 79-82 ▲ 79-82 ▲ 79 ▲ 82-83 ▲ 80-82 ▲

CK CLUTCH KIT BUYERS GUIDE

Part No.	Make/Model	Year	Part No.	Make/Model	Year
CK1149 CT021 ▲ Contd.	HONDA CB 900 F Supersport CB 1000 C Custom CB 1100 F Supersport	81-82 ▲ 83 ▲ 83 ▲	CK1156	HONDA ATC 110 ATC 125 M TRX 125 Fourtrax CT 110 Trail	79-85 84-85 85-86 80-86
CK1150 CT012SP ■	HONDA Dream 50 R (CB50) NSR 50 MB5 XL 75 XR 75/K1/K2/76 XR 75 CRF 80 F XL 80 S 80/ XR 80 R	04 ■ 04 ■ 82 ■ 77-79 ■ 71-76 77-78 ■ 04-16 ■ 80-85 ■ 79-03 ■	CK1159 CT053SP ▲	HONDA CX 500 TC Turbo CX 650 T Turbo GL 1100/1100 1 Goldwing/Goldwing Interstate GL 1100 A Goldwing Aspencade	82 ▲ 83 ▲ 80-83 ▲ 82-83 ▲
CK1151 CKF1151 CT012SP ■	HONDA CRF 100 F ATC 125 M ATC 185/185 S ATC 200/E/ES/M/S TRX 125 Fourtrax TRX 200 Fourtrax CR 60 R CR 80 R TRX 90 TRX 90 EX TRX 90 X XL 100 S XR 100 R TL 125 K1/K2 YAMAHA YBR 125 (2D0D/2CS1) YBR 125 C (36S1/2/3/4) YBR 125 E (4P24/4P27/4P2B/4P2H) YBR 125 ED (4P28) Cast Wheel YBR 125 ED (4P2C/4P2J) Cast Wheel YBR 125 ESD (4P26) Cast Wheel YBR 125 ESD (4P2A/4P2G) Cast Wheel YBR 125 ESG (43B1/3/5/6/8) YBR 125 R (1PX1/X2) YFM 125 RA/RB/RD Raptor	04-14 ■ 86-87 ■ 80-83 ■ 81-86 ■ 87-88 ■ 84 ■ 83-84 ■ 80-83 ■ 93-06 ■ 07-08 ■ 09-14 ■ 79-85 ■ 81-03 ■ 71-75 ■ 11-13 ■ 08-13 ■ 06-13 ■ 07-09 ■ 10-13 ■ 07-09 ■ 10-13 ■ 08-13 ■ 11-12 ■ 11-13 ■	CK1160 CT013SP ■	HONDA TRX 350 TE/FE VT 500 C 'Shadow' VT 500 FT 'Ascot'	00-05 ■ 83-86 ■ 83-84 ■
CK1152 CT013SP ■	HONDA XL 250 S XR 250	78-80 ■ 79-80 ■	CK1163	HONDA ATC 250 R CR 250 R	81-84 78-80
CK1153 CT013SP ■	HONDA XL 250 S XL 250 R XR 250 R	81 ■ 82-83 ■ 81-82 ■	CK1166 CT031 ▲	HONDA CB 700 SC/S 'Nighthawk' VF 700 C 'Magna' VF 700 S 'Sabre' VT 700 C 'Shadow' VF 750 C V45 'Magna' VF 750 S V45 'Sabre' VT 750 C 'Shadow' VT 800 Shadow	84-86 ▲ 84-87 ▲ 84-85 ▲ 84-87 ▲ 82-88 ▲ 82-83 ▲ 83 ▲ 88 ▲
CK1154 CT013SP ■	HONDA TRX 420 TM Fourtrax Rancher TRX 420 FM7/FM8/FM9 Fourtrax Rancher 4x4 TRX 420 FPM/FPMA Fourtrax 4WD TRX 500 FE Fourtrax Foreman 4x4/ES TRX 500 FM Fourtrax Foreman 4x4 TRX 500 FM Fourtrax Foreman TRX 500 TM Fourtrax Foreman 2x4 TRX FE Fourtrax Foreman TRX 500 FPE Fourtrax Foreman 4x4 ES/EPS TRX FPE Fourtrax Foreman TRX 500 FPM Fourtrax Foreman 4x4/EPS TRX 500 FPM Fourtrax Foreman XR 500 XR 500 R	07-13 ■ 07-13 ■ 09-13 ■ 05-11 ■ 05-11 ■ 12-13 ■ 05-06 ■ 12-13 ■ 08-11 ■ 12-13 ■ 08-11 ■ 12-13 ■ 08-11 ■ 12-13 ■ 79-80 ■ 81-82 ■	CK1167 CT031 ▲ CT009 ■	HONDA VF 700 F 'Interceptor' VF 750 F V45 'Interceptor' PC 800 Pacific Coast	84-85 ▲ 83-84 ▲ 89-90/94-98 ■
			CK1170 CKF1170 CT009 ▲	HONDA CR 250 R CR 480 R CR 500 R XR 500 R XL 600 R XR 600 R NX 650 XR 650 L	82-89 ▲ 82-83 ▲ 84-89 ▲ 83-84 ▲ 83-87 ▲ 85-00 ▲ 88-89 ▲ 93-16 ▲
			CK1171 CT009 ▲	HONDA CB 550 SC 'Nighthawk' CB 650 SC 'Nighthawk'	83 ▲ 83-85 ▲
			CK1176 CT031 ■ CT009 ▲	HONDA VF 1000 F 'Interceptor' VF 1000 R VT 1100 C Shadow 1100 Spirit VT 1100 C2 Shadow 1100 American Classic Edition VT 1100 C2-2 Shadow 1100 American Classic Edition VT 1100 D2 Shadow 1100 American Classic Edition VT 1100 CD2 Shadow Sabre VT 1100 C3 Shadow Aero VT 1100 T Shadow 1100 American Classic Edition Tourer	84 ■ 85-86 ■ 97-06 ▲ 95-97 ▲ 97 ▲ 99 ▲ 00-06 ▲ 98-02 ▲ 98-01 ▲
			CK1177 CT002 ▲	HONDA VF 500 C 'V30 Magna' VF 500 F 'Interceptor'	84-85 ▲ 84-86 ▲
			CK1180 CT013SP ■	HONDA XR 200 R XL 250 R XR 250 R	84-85 ■ 84-87 ■ 84-85 ■

CLUTCH BUYERS GUIDE

CK CLUTCH KIT BUYERS GUIDE

Part No.	Make/Model	Year	Part No.	Make/Model	Year
CK1180 CT013SP ■ Contd.	KAWASAKI KLF 220 A1-A15 Bayou KLF 250 A1/A2/A3/A6F/A7F/A8F/A9F/AAF/ABF Bayou	88-02 ■ 03-11 ■	CK1196 CT013SP ■ Contd.	TRX 450 FE Fourtrax Foreman ES/ FM Fourtrax Foreman S	02-04 ■
CK1181 CKF1181 CT013 ▲ CT013SP ■ CT014 ★	HONDA CB 500 R/T/V/W XL 600 V VT 600 C/CD Shadow VLX CD2 Shadow Deluxe CBR 650 F (Non ABS) CBR 650 FA (ABS) SUZUKI DR-Z 250 K1/K2/K3/K4/K5/K6/K7 TRIUMPH Daytona 650	94-98 ■ 89-90 ■ 88/91-07 ■ 14-21 ■ 14-21 ■ 01-07 ▲ 05 ★	CK1199 HONDA CR 125 R Elsinore		79-80
CK1183 CT066SP ▲	HONDA CBX	79-82 ▲	CK1200 CT001 ▲	HONDA CR 125 R	85 ▲
CK1186 CT002	HONDA CR 125 R	82	CK1206 CKF1206 CT014 ▲ CT014SP ● CT055SP ■	HONDA CBR 600 F2 CBR 600 F3/SJR/SE 599 (CB 600 F) VFR 700 F/F2 'Interceptor' VFR 750 F 'Interceptor' 750 VFR 750 F VF 750 C Magna/CD Magna Deluxe VFR 800 Fi CBR 900 RR CBR 929 RR CBR 954 RR SUZUKI GSX R 600 V/W/X/Y GSX R 600 K4/K5/XK5 TRIUMPH Daytona 600 Speedfour 600 TT 600 Daytona 675 Street Triple 675 Street Triple R 675 Street Triple S/R/RS 675 Tiger 800 Tiger 800 XC Tiger XR	91-94 ● 95-98 ● 04/06 ● 86 ▲ 86 ▲ 90-97 ▲ 94-03 ▲ 98-99 ▲ 93-95 ▲ 00-01 ▲ 02-03 ▲ 97-00 ■ 04-05 ■ 03-04 02-05 00-03 06-09 ▲ 07-12 ▲ 09-16 ▲ 17-21 ▲ 11-12 ▲ 11-12 ▲ 2018-
CK1190 CKF1190 CT013 ▲ CT013SP ■	HONDA CR 125 R NX 250 TRX 250 X Fourtrax XR 250 L XR 250 R TRX 300 EX Fourtrax/Sportrax TRX 300 X XR 350 R ATC 350 X	83-84 ▲ 88-90 ■ 87-88/91-92 ■ 91-96 ■ 86-04 ■ 93-08 ■ 09-11 ■ 83-85 ■ 85-86 ■	CK1209 CT008 ▲	HONDA VT 1100 C Shadow 1100	85-86 ▲
CK1191 CKF1191 CT002 ▲ CT012SP ■	HONDA CR 125 R Elsinore CRF 150 R/RB CB 250 Nighthawk CM 250 C Rebel CMX 250 C/C2 Rebel CMX 250 C/CD Rebel	81 ▲ 07-21 ▲ 91-08 ■ 82-83 ■ 96/97/99-14 ■ 85-87 ■	CK1210 CT053SP ▲	HONDA GL 1200/1200 1-A/1200 L Goldwing	84-85 ▲
CK1193 CKF1193 CT013 ▲ CT013SP ■ CT014 ★ CT080 ●	HONDA ATC 250 R TRX 250 R Fourtrax TRX 400 EX TRX 400 X XR 400 R TRX 450 S/ES CBR 600 F4 (Carb Model) YAMAHA YZ-F R3 (321cc) MT-03	85-86 ■ 86-89 ▲ 99-08 ▲ 09-14 ▲ 96-04 ▲ 99-00 ■ 99-00 ★ 15-21 ● 12-21 ●	CK1217 CT013SP ▲ CT014 ■	HONDA CRF 250 F A/AC XL 350 R YAMAHA XTZ 250 Lander XTZ 250 Lander XTZ 250 X YBR 250 (41S2/3) YP 250 Fazer (5D41/2/3/56C1)	19-21 84-85 ▲ 07-14 ■ 16-18 ■ 08-10 ■ 10-12 ■ 06-10 ■
CK1194 CT013SP ■	HONDA ATC 250 ES Big Red ATC 250 SX TRX 250 'Fourtrax'	85-87 ■ 85-87 ■ 85-87 ■	CK1218 CKF1218 CT014 ▲	HONDA CBR 600 RR/RA CBR 600 F4i Sport (Injection Model) VFR 800/A Interceptor ABS CBR 900 RR 919 (CB 900 F) SUZUKI GSX 650 FK8/FK9	03-20 ▲ 01-06 ▲ 02-11 ▲ 98-99 ▲ 02-07 ▲ 08-10 ▲
CK1196 CT013SP ■	HONDA TRX 300 (All Models 2WD/4WD) TRX 350 (All Models 2WD/4WD) TRX 350 TM/FM TRX 400 FW 'Fourtrax Foreman' TRX 400 FM TRX 420 TE Fourtrax Rancher ES TRX 420 FPA Fourtrax Rancher 4x4 ES/EP TRX 420 FE/FEA Fourtrax Rancher 4x4/ES TRX 420 FE1 Rancher 4x4 ES TRX 420 FM1 Rancher 4x4/4x4 EPS TRX 420 TE1 Rancher ES TRX 420 TM1 Rancher TRX 450 ES/S	88-00 ■ 86-89 ■ 00-05 ■ 95-01/03 ■ 02 ■ 07-13 ■ 09-13 ■ 07-13 ■ 14-15 ■ 14-15 ■ 14-15 ■ 14-15 ■ 14-15 ■ 98-03 ■	CK1219 CT009 ▲ CT022 ■ CT033SP ●	HONDA GB 500 SUZUKI DL 650 K4/K5/K6/K7/AK7/K8/K9/AK8/AK9/AL0 /AL1/AL2/AL3/AL4/AL5/AL6 V-Strom DL 650 AAL2/AAL3/AAL4/AAL5 DL 650 XT V-Strom ABS (DL650 XAL5/XAL6) SFV 650 K9/L3/L4/L5 SV 650 AK7/AK8 ABS	89-90 ▲ 04-21 ● 12-21 ● 15-21 ● 09-10/13-15 ● 07-08 ■

CK CLUTCH KIT BUYERS GUIDE

Part No.	Make/Model	Year	Part No.	Make/Model	Year
CT033SP ● Contd.	SV 650 AL (ABS) SV 650 SAK7/SAK8/SAK9 ABS	16-21 ● 07-10 ●	CK1248 CT009 ▲	HONDA CB 1000 CBF 1000 F CBR 1000 F Hurricane	94-95 ▲ 90-96 ▲ 87-88 ▲
CK1221 CT053SP ▲	HONDA GL 1000 K Goldwing (From Eng No.1020728)	75 ▲	CK1252 CT012SP ■	HONDA NX 125 CB 125 TT NXR 150 (KD02) CRF 230 L CRF 230 M	88-90 ■ 90 ■ 03-08 ■ 08-11 ■ 09-11 ■
CK1222 CT001 ▲	HONDA CR 125 R	86-99 ▲	CK1253 CT013 ■ CT014 ▲	BMW G 310 GS G 310 R HONDA VFR 800 Fi	17-21 ■ 17-21 ■ 00-01 ▲
CK1224	HONDA GL 1200 1-A/GL 12 SE/I GL 1200 1/A Goldwing	86 87	CK1257 CT031 ▲ CT009 ■	HONDA RVF 750 R (RC45) XL 1000 VA8 Varadero (Canada) CB 1100 (Non ABS) CB 1100 A (ABS)	94 ▲ 08 ■ 13-14 ■ 13-14 ■
CK1228 CT009SP ■	HONDA CB-1 400 (CB 400F) CBR 600 F Hurricane CB 600 F1	89-90 ■ 87 ■ 88-90 ■	CK1264 CT056SP ■	HONDA ST 1100/1100 A	91-01 ■
CK1229 CT014 ▲	HONDA VFR 750 R (RC30) GSXR 750 Y	90 ▲ 00 ▲	CK1265 CT009SP ■	HONDA CB 750 Nighthawk	91-03 ■
CK1230 CT013SP ■ CT014SP ▲	HONDA PCX 150 VT 600 C Shadow VLX NT 650 Hawk GT CTX 700 N (Naked/Manual G/box) CTX 700 (Top Fairing/Manual G/box) NC 700 X (2 Piston Caliper) NT 700 V/VA NC 750 S NC 750 S (ABS) NC 750X VT 750 C/CD/CD2/DC/DCA/DCB VT 750 CDA/CDB/CDC/CDD Shadow American Classic Edition 750 Deluxe VT 750 C Shadow Spirit VT 750 DC Shadow Spirit VT 750 DCA/DCB Shadow Spirit VT 750 Shadow Aero VT 750 Shadow Aero VT 750 C2 Shadow Spirit VT 750 CSE Shadow Aero (ABS/Rear disc) VT 750 C2S Shadow Spirit (ABS/Rear disc) VT 750 RS Shadow VT 750 T Shadow Tourer VT 750 C2B Shadow Phantom BENELLI TNT 600 i Tornado	13-14 ■ 89-90 ■ 88-90 ■ 14 ■ 14 ■ 12-17 ■ 10-13 ■ 14-15 ■ 14-18 ■ 14-15 ■ 98-08 ■ 02-03 ■ 07-14 ■ 01-02 ■ 03-07 ■ 08-15 ■ 04-14 ■ 07-14 ■ 13-14 ■ 13-14 ■ 10-14 ■ 09 ■ 10-15 ■ 16-17 ▲	CK1284 CT068SP ▲	HONDA CBR 900 RR	96-97 ▲
CK1234	HONDA FL 400 R Pilot	89-90	CK1285 CT021 ▲	HONDA GL 1500 Goldwing GL 1500 A/SE/I Goldwing GL 1500 C/CT/CF/CD Valkyrie/Valkyrie Tourer	88-96 ▲ 99-00 ▲ 97-03 ▲
CK1235 CT012SP ■	HONDA VTR 250 Interceptor	88-90 ■	CK1286 CT021 ▲	HONDA CBR 1100 XX Blackbird	97-98 ▲
CK1239 CT009 ▲	HONDA VT 1100 C Shadow 1100	87-96 ▲	CK1290 CT009 ▲	HONDA VTR 1000 F Superhawk	98-05 ▲
CK1247 CKF1247 CT009 ▲ CT006 ■	HONDA CR 250 R CFR 450 R CRF 450 X CR 500 R KAWASAKI KLX 450 R A8F/A9F/AAF/ABF/ACF KX 450 F	90-07 ▲ 02-12 ▲ 05-17 ▲ 90-01 ▲ 08-12 ■ 06-21 ■	CK1293 CKF1293 CT001 ▲	GAS-GAS EC 125 (All models/2T) HONDA CR 125 R CRF 250 R CRF 250 R SX-F 250 (4T) XC-F 250 XC-F-W 250 XC-F-W 250 Six Days	10-11 ▲ 00-07 ▲ 04-07 ▲ 10 ▲ 05-12 ▲ 06-12 ▲ 06-13 ▲ 11 ▲
			CK1295 CT009 ▲	HONDA XR 650 R	00-07 ▲
			CK1297 CT021 ▲ CT073 ■	HONDA ST 1300/1300 A GL 1800/ABS (All models) Goldwing F6B Deluxe (GL 1800 B2) Goldwing G6B (GL 1800 B) NRX 1800 DA/DB/EA/EB	02-13 ▲ 01-13 ■ 13 ■ 13 ■ 04-05 ■

CLUTCH BUYERS GUIDE

CK CLUTCH KIT BUYERS GUIDE

Part No.	Make/Model	Year	Part No.	Make/Model	Year
CK1298	HONDA		CK1318 CT091 ■	AJP	
	VT 1300 CXA Fury (ABS Model)	10-15		250 - PR5 Trail	13-17 ■
	VT 1300 CX Fury (Non ABS Model)	10-15		250 - PR5 Supermoto	13-17 ■
	VT 1300 CSA Sabre	10-14		250 - PR5 Enduro	13-17 ■
	VT 1300 CSA Sabre (ABS)	11-14		250 - PR5 EX Extreme	13-17 ■
	VT 1300 CR Stataline	10-15			
	VT 1300 CRA Stataline (ABS)	10-15			
	VT 1300 CT Interstate	10-15			
	VT 1300 CTA Interstate (ABS)	11-14			
	VTX 1300 C	04-11			
	VTX 1300 R	05-10			
	VTX 1300 S/T	03-10			
	VTX 1800 C/C1/C2/C3	02-08			
	VTX 1800 R	02-08			
	VTX 1800 S	02-07			
VTX 1800 C1/C2/C3	05-08				
VTX 1800 F1/F2/F3	05-11				
VTX 1800 N1/N2/N3	04-11				
VTX 1800 T1/T2	07-11				
CK1300 CT021 ▲	HONDA RVT 1000 (RC51)	02-06 ▲	CK1319 CKF1319 CT009 ■	HONDA CRF 1000 L Africa Twin (Manual clutch/Non ABS) CRF 1000 LAG Africa Twin (Manual clutch/ABS)	16 ■ 16-20 ■
CK1302 CKF1302 CT009 ▲	HONDA TRX 450 R/ER TRX 700 XX	04-14 ▲ 08-11 ▲	CK1323	HONDA CB 500 F (Non ABS) CB 500 FA (ABS) CB 500 X (Non ABS) CB 500 XA (ABS) CBR 500 R (Non ABS) CBR 500 RA (ABS)	13-21 13-21 13-21 13-21 13-21 13-21
CK1303 CT009 ▲	HONDA CB 1000 R CBF 1000 A8 (Canada) CBR 1000 RR	11-14 ▲ 08 ▲ 04-07 ▲	CK1325	HONDA CRF 125 F/FB	14-21
CK1304 CT012SP ■	HONDA CRF 150 F CRF 230 F	03-05 ■ 03-16 ■	CK1332	HONDA CB 1100 EX	16-19
CK1305 CKF1305 CT001 ▲	HONDA CRF 250 RX CRF 250 X CRF 250 R	18-21 ▲ 04-17 ▲ 08-09/11-21 ▲	CK2205 CT044 ▲	YAMAHA RX 50 MK 'Midnight Special' RX 50 K/L 50 Special YSR 50 T/U/W/A/B/D	83 ▲ 83-84 ▲ 87-92 ▲
CK1312 CT043SP ▲	HONDA CBR 1000 RR CBR 1000 RAA ABS Model VFR 1200 FA	08-16 ▲ 09-16 ▲ 10-14 ▲	CK2206 CT044 ▲	YAMAHA YZ 50 G DT 50 U/W/A (DTL/C) DT 80 H/J/K MX 80 G/H/J	80 ▲ 88-89 ▲ 81-83 ▲ 80-82 ▲
CK1313 CKF1313	HONDA CBR 250 R/RA (ABS/Non ABS Model)	11-14	CK2208	YAMAHA RXZ 100 S (3HS1/2)	88-95
CK1314 CKF1314 CT081SP ■	HONDA CRF 250 L (Non ABS) CRF 250 LA (ABS) CRF 250 Rally (Non ABS) CRF 250 Rally (ABS) CBF 300 NA	13-21 ■ 17-21 ■ 17-21 ■ 17-21 ■ 18-21 ■	CK2223 CT008 ▲	YAMAHA DT 250 D/E/F	77-79 ▲
CK1315 CT084SP ■	HONDA MSX 125 D/E/F/G/H Grom (Non ABS) MSX 125 AH Grom (ABS) Monkey 125	14-21 ■ 18-21 ■ 19-21 ■	CK2226 CT017 ▲ CT074 ■	YAMAHA TX 650 A/XS 650 B/C YZF 1000 R1 XS 650 D/E/F/2F	74-76 ▲ 98 ▲ 77-79 ■
CK1317 CKF1317 CT092 ■	HONDA CRF 450 R (6 Spring type) CRF 450 RX (18" Rear wheel) CRF 450 X CRF 450 L	17-21 ■ 17-21 ■ 18-21 ■ 18-21 ■	CK2230 CT017 ▲	YAMAHA XJ 1100 J 'Maxim' XS 1100 XS 1100 H 'Venturer' XS 1100 SF/SG/SH XS 1100 LG/LH 'Midnight Special'	82 ▲ 80 ▲ 81 ▲ 79-81 ▲ 80-81 ▲
			CK2234 CT039 ▲	YAMAHA YZ 100 G/H/J/K IT 125 G/H YZ 125 G SR 185 H/J TW 200 T/TC/U/UC/W/WC/A/AC/D/DC/E/EC/F /FC/H/HC/J/JC/EK/EKC/L/LC/M/MC/N/NC/P /PC/R/RCS/SC/T/TC/V/VG/W/WC/X/Y/Z/A /B/D/E/F Trailway XT 225 D/DC/E/EC/F/FC/G/GC/H/HC	80-83 ▲ 80-81 ▲ 80 ▲ 81/82 ▲
			CK2235 CT039 ▲	YAMAHA YZ 125 H IT 175 G/H/J/K IT 200 L/N/S	87-15 ▲ 92-96 ▲
					81 ▲ 80-83 ▲ 84-86 ▲

CK CLUTCH KIT BUYERS GUIDE

Part No.	Make/Model	Year	Part No.	Make/Model	Year
CK2236 CT039 ▲	YAMAHA DT 125 G/H XT 200 J/K/KC	80-81 ▲ 82-83 ▲	CK2255 CT008 ▲ CT008SP ■ Contd.	YAMAHA YZF-R6 RRR/RRS/T/TC YZF R6S (SV/SW/SX/SY) FZ6 (All models) YX 600 S/SC/T/TC/U/UC/W/WC/A/AC YZR 600 RL/RR/LRM/RMC/RN/RNC/P/PC "R6" XJ 650 G/H/J/K 'Maxim' XJ 650 LH 'Midnight' XJ 650 LJ/LK 'Seca Turbo' XJ 650 RJ 'Seca' FZX 700 S/SC/T/TC XJ 700 N/NC/S/SC/XN/XNC/XS/XSC 'Maxim' FZ 750 N FZ 750 S/SC XJ 750 J/K/MK 'Maxim' XJ 750 RH/RJ/RK Seca TDM 850 D/DC/E/EC XJ 900 RK 'Seca'	03-05 ■ 06-09 ■ 04-09 ■ 86-90 ■ 99-02 ■ 80-83 ■ 81 ■ 82-83 ■ 82 ■ 86-87 ■ 85-86 ■ 85 ■ 86 ■ 82-83 ■ 81-83 ■ 92-93 ▲ 83 ■
CK2238 CT044 ▲	YAMAHA YZ 80 G	80 ▲	CK2256 CT039 ▲	YAMAHA XT 125 J/K/KC	82-83 ▲
CK2240 CT008 ▲	YAMAHA DT 250 A/B/C BW 350 T/U R5/5A/5B - 350cc RD 350 73-75 RZ 350 L/N/NCII TT 350 S/T YFM 350 FWBL/LC Big Bear XT 350 N/NC/S/SC/C/AC/B/BC/T/TC/U/UC /W/WC/D/DC/E/EC/F/FC/G/GC/H/HC/J /JC/K/KC/L/M/MC YFM 350 FXG/FXH/FXJ/FXK/FXL/FXM/FXN /FXP/FXR/FXS/FXT RD 400 C/D/E RD 400 F Daytona YFM 400 NM/NMC/NN/NHN/P/HP/NR YFM 400 S Big Bear 2WD YFM 400 FS/FT Big Bear 4WD YFM 400 FBHW Big Bear 400 Hunter IRS YFM 400 FBEW Big Bear 400 IRS Exploring Edition YFM 400 FBW/FBX/FBY/FBA/FBB Big Bear 4WD IRS	74-76 ▲ 87-88 ▲ 70-72 ▲ 72-75 ▲ 84-85 ▲ 86-87 ▲ 99 ▲ 85-00 ▲ 95-05 ▲ 76-78 ▲ 79 ▲ 00-03 ▲ 04 ▲ 04-05 ▲ 07- ▲ 07 ▲ 07-12 ▲	CK2261 CT008 ▲	YAMAHA SRX 250 T/TC SR 250 K (3Y9) SR 250 (4GR1/2/3/4/9)	87 ▲ 93 ▲ 93-08 ▲
CK2242	YAMAHA XS 650 SG/G/H/SH/SJ/SK	80-83	CK2262 CT017 ▲	YAMAHA XS 400 J/K/RJ/RK	82-83 ▲
CK2245 CT039 ▲	YAMAHA DT 175 G/H MX 175 G/H RT 180 A/B/D/E/G/H/J	80-81 ▲ 80-81 ▲ 90-97 ▲	CK2265 CT010 ▲	YAMAHA YZ 60 H/J/K	81-83 ▲
CK2250 CT008 ▲	YAMAHA IT 250 F/G	80 ▲	CK2267 CT008 ▲	YAMAHA IT 250 G/H/J XT 250 G/H/J/K/KC/L/LC SR 250 G/H/TH/J	80-82 ▲ 80-84 ▲ 80-82 ▲
CK2251	YAMAHA YT 125 J/K/L/N YT 175 J/K	82-85 82-83	CK2273 CT008SP ■	YAMAHA XS 850 G/H/LG/LH/SG/SH	80-81 ■
CK2252	YAMAHA YT 125 G/H	80-81	CK2274 CKF2274 CT020 ▲	YAMAHA WR 250 ZF/ZG/ZH/ZJ YZ 250 E/F/G/H/J/K/L/M/N/P/R/S/T/V/W/X/Y /Z/A/B/D/E/F/G (2T) YZ 450 FE/FF//FG/FGY (4T) WR 450 FT/FV/FW/FX/FY/FZ/FA/FB/FD/FE/FF/FG/HH YFZ 450 RY/RZ/RA/RB/RD YZ 450 FW/FX/FY/FZ/FA/FB/FD/FE/FF/FG/GY (4T) YFZ 450 BBW Bill Balance Edition XV 700 L/LC/N/NC 'Virago' XV 700 CS/CSC/SS/ST/STC/CT/CTC/SSC Virago XV 750 H/J/K/MK 'Virago' XV 750 U/UC/W/WCM/A/AC/B/BC Virago XV 750 D/DC/E/EC/F/FC/G/GC/HI/HC/J/JC Virago XV 920 RH/RJ XV 920 J/K/MK 'Virago' XV 1000 L/LC/N/NC 'Virago' XV 1100 S/SC/T/TC/U/UC/W/WC/A/AC/B/BC/D /DC/E/EC/F/FC/G/GC/H/HC/SH/SHC/J/JC /S/J/SJC Virago XVS 1100 V Star/V Star Custom XVS 1100 ATS V-Star Silverado XVS 1100 AS V-Star Classic XVS 1100 W-M V-Star Custom Midnight	94-97 ▲ 93-16 ▲ 14-21 ▲ 05-21 ▲ 09-13 ▲ 07-16 ▲ 07 ▲ 84-85 ▲ 86-87 ▲ 81-83 ▲ 88-90 ▲ 92-97 ▲ 81-82 ▲ 82-83 ▲ 84-85 ▲
CK2254 CKF2254 CT044 ▲	YAMAHA DT 100 G/H/J/K MX 100 G/H/J/K RT 100 A/D/E/F/G/H/J/K/L/M RX 100 (36L/36L0/5RD1/2) RX 100 (5RD3/4) RX 100 C (5RC1/2/3) RXS 115 (3HB6/7) RXS 115 (3HB8) TT-R 125 M/N/P/R/ER/S/ES/ET/EV/EW/EX/EY TT-R 125 LWM/LN/LP/LER/LR/LES/LS/LET /LT/LV/LEV/LW/LEW/LX/LEX/LEY/LEA/LEB/LED /LEE/LEF YBA 125 Vision (5AP1) YBR 125 EB (5RR2/3/4/5/6/8/9) YBR 125 ED (5RR1) YBR 125 K (5TU1/2/4/6/8)	80-83 ▲ 80-83 ▲ 92-00 ▲ 01-03 ▲ 04 ▲ 04 ▲ 94-97 ▲ 99 ▲ 00-09 ▲ 00-09/11-19 ▲ 01 ▲ 02-08 ▲ 01 ▲ 02-06 ▲	CK2276	YAMAHA YZ 125 J	82
CK2255 CT008 ▲ CT008SP ■	YAMAHA TT 500 G/H FJ 600 L/LC/N/NC FZ 600 S/SC/T/TC/UC/U XJ 600 SD/SDC/SE/SEC/SF/SFC/SG/SGC/SH /SHC/SJ/SJC/SK/SKC "Seca II"	80-81 ▲ 84-85 ■ 86-88 ■ 92-98 ■	CK2278 CT054SP ▲	YAMAHA YZ 125 K/L/N/S/T	83-87 ▲

CLUTCH BUYERS GUIDE

CK CLUTCH KIT BUYERS GUIDE

Part No.	Make/Model	Year	Part No.	Make/Model	Year
CK2279 CKF2279 CT008 ▲	YAMAHA YFP 350 U Terrapro YFZ 350 T/U/W/A/B/D/E/F/G/H/J/K/L/M/N /P/R/S/T/V Banshee XS 400 G/SG/H/SH/SJ IT 250 H/J YZ 250 H IT 425 G IT 465 H/J YZ 465 G/H XS 750 D/2D/E/F/SE/SF	88 ▲ 87-06 ▲ 80-82 ▲ 81-82 ▲ 81 ▲ 80 ▲ 81-82 ▲ 80-81 ▲ 77-79 ■	CK2297 CKF2297 CT008 ▲	YAMAHA XT 550 K TT 600 K/L/N/S XT 600 L/LC/N/NC/S/SC/T/TC/U/UC/W/WC XT 600 EA/EAC/EB/EBC/ED/EDC/EE/EEC/EF /EFC/EG/EGC SRX 600 S/SC YFM 660 RN/RP/RPB/RR/RS/RT Raptor	83 ▲ 83-86 ▲ 84-89 ▲ 90-95 ▲ 86 ▲ 01-05 ▲
CK2280 CT060 ▲	YAMAHA YZ 250 J/K/L/N/S/T IT 490 K/L YZ 490 J/K/L/N/S/T/U/W YTZ 250 N/S IT 250 K WR 500 ZD/ZE	82-87 ▲ 83-84 ▲ 82-89 ▲ 85-86 ▲ 83 ▲ 92-93 ▲	CK2298	YAMAHA XC 180 All Models	83-85
CK2283	YAMAHA YBR 125 (5PY1/2)	01	CK2299 CT020 ▲	YAMAHA XV 500 K 'Virago' XV 535 T/TC/U/A/AC/E/EC/F/FC/SF/SFC/G/GC /SG/SGC/H/HC/SH/SHC/J/JC/SJ/SJC Virago	83 ▲ 87-99 ▲
CK2285 CT017 ▲	YAMAHA FJ 1100 L/LC/N/NC FJ 1200 S/SC/T/TC/U/UC/W/WC/A/AB/AD /ADC/D/DC/AE/AEC	84-85 ▲ 86-94 ▲	CK2300 CT050SP ▲	YAMAHA XVZ 12 'All models' V-Max VMX 12 All models XVZ 1300 Royal Star Tour Deluxe XVZ 1300 LTK Venture XVZ 1300 Venture MM Limited Edition XVZ 1300 Royal Star XVZ 1300 Royal Star Standard XVZ 1300 Royal Star Boulevard XVZ 1300 Royal Star Midnight Venture XVZ 1300 Royal Star Midnight Tour Deluxe XVZ 1300 Royal Star Tour Classic XVZ 1300 Royal Star Venture XVZ 1300 Royal Star Venture S	83-85 ▲ 85-07 ▲ 97-01/05-07 ▲ 96-98 ▲ 01 ▲ 96-97/00 ▲ 98 ▲ 99-01 ▲ 02-07 ▲ 06-07 ▲ 96-00 ▲ 99-07 ▲ 08-13 ▲
CK2287 CT010 ▲ CT010SP ■	YAMAHA YZ 80 H/J/K/L/N YFM 200 N YFM 200 DXS/DXT/DXU/DXW YFB 250 D/E/F/G/H/UH/J/UJ/UK/FWF/FWG/FWH /FWJ/FWK/FWL/FWM YFM 250 W/A/B YFM 250 XL/XLC/M/MC/XN/XHN/XP /XHP/XR/XHR/XS Beartracker YTM 200 K/L/N/EK/EL/ERN YTM 225 DXK/DXL/DXN YTM 225 DRN/DRS YFM 225 S/T/U/W YFUJW/YFUITW Pro Hauler (230cc) YFM 250 BT/BV/BW/BX/BY	81-85 ▲ 85 ■ 86-89 ■ 92-00 ■ 89-91 ■ 00-04 ■ 83-85 ■ 83-85 ■ 85-86 ■ 86-89 ■ 89 ■ 05-09 ■	CK2303	YAMAHA YFM 50 S/T/RV/RW/RX Raptor V 80 (3NX3/4) V 80 D (4GC2/3/4) - 3= Single Seat / 4= Dual Street YFM 80 N/S/T/U/D/E/F/G/H/J/K/L/M/N BW 80 S/T/U/A PW 80 K/N/B/D/E/F/G/H/J/K/L/M/N/P/R/S/T/V YFM 80 WP/WR/WS/RT/RV/RW/RX Raptor YFM 80 GT/GV/GW/GX	04-08 94 94-96 85-02 86-90 83-06 02-08 05-08
CK2290 CKF2290 CT090SP ▲ CT008 ■	YAMAHA YFM 350 ERT/ERU/ERW/ERA/ERD/ERE/ERF/ERG YFM 350 FWT/FWU/FWW/FWA/FWB/FWD/FWE /FWF/FWG/FWH/FWJ Big Bear YFM 350 XT/XU/XW/XA/XB/XD/XE/XF/XG/XH/XJ /XK/XL/XM/XN/XP/XR/XS Warrior YFM 350 UH/UJ/UK/UL/ULC YFM 350 RS/RT/RV/RW/RX/RZ/RA/RB/RD Raptor YFM 400 FWE/FWF/FWG/FWH/FWJ/FWK/FWL Kodiak YFM 400 FWR	87-95 ▲ 87-97 ▲ 87-04 ▲ 96-99 ▲ 04-13 ▲ 93-99 ▲ 03 ■	CK2304 CT010 ▲	YAMAHA YZ 80 S/T/U/W/A/B/D/E/F YZ 65 RX-Z 135 (3XL3/5PV1/5PV2) SR 150 (3UR8)	86-94 ▲ 19-21 ▲ 00-05 ▲ 95 ▲
CK2292 CT039 ▲	YAMAHA BW 200 N/S/ES/ET/EU	85-88 ▲	CK2306 CT008SP ■	YAMAHA XJ 550 H/J/K 'Maxim' XJ 550 RH/RJ/RK 'Seca' XT 550 J FZ6R FZ 700 T/TC FZ 750 U/UC	81-83 ■ 81-83 ■ 82 ■ 09-14 ■ 87 ■ 88 ■
CK2295 CT060 ▲	YAMAHA TY 350 N/S	85-86 ▲	CK2308 CT008 ■	YAMAHA FZR 750 RT/RU FZR 1000 T/TC/U/UC/Genesis	87-88 ■ 87-88 ■
CK2296 CT008 ▲	YAMAHA SR 500 E/F/G/H XT 500 G/H XZ 550 RJ/RK Vision	78-81 ▲ 80-81 ▲ 82-83 ▲	CK2309 CT020 ▲	YAMAHA FZ 09 YZ 250 U/W/A/B/D YZ 250 WRW/WRA WR 250 ZB/ZD/ZE XVS 650 V Star Custom XVS 650 A V-Star Classic XVS 650 V Star Silverado MT-07 (689cc/2Cyl) MT-07 ABS (689cc/2Cyl)	15-16 88-92 ▲ 89-90 ▲ 91-93 ▲ 97-11/13-14 ▲ 98-10 ▲ 03-10 ▲ 14-21 ▲ 14-21 ▲

CK CLUTCH KIT BUYERS GUIDE

Part No.	Make/Model	Year	Part No.	Make/Model	Year
CK2310 CT008 ▲	YAMAHA WR 400 FK/FL/FM YZ 400 FK/FL	98-00 ▲ 98-99 ▲	CK2350 CT017 ▲	YAMAHA YZF R1 (1000)	99-03 ▲
CK2311 CT054SP ▲	YAMAHA YZ 125 W/A	89-90 ▲	CK2351 CT050SP ▲	YAMAHA XV 1600 Road Star XV 1600 Road Star Silverado XV 1600 Midnight Star XV 1700 Road Star Silverado XV 1700 Road Star XV 1700 Road Star Midnight XV 1700 Road Star Midnight Silverado	99-05 ▲ 99-09 ▲ 02-03 ▲ 07 ▲ 05-09 ▲ 04-07 ▲ 04-07 ▲
CK2312 CT054SP ▲	YAMAHA YZ 125 U	88 ▲	CK2352 CKF2352 CT020 ▲	YAMAHA YZ 426 FM WR 450 FS YZ 450 FR/FS/FT/FV YZF-R1 FZ-09 (847cc/3 cyl/6 Spring clutch) MT-09 Tracer ABS (847cc/3 Cyl Engine) MT-09A (2DR/ABS/847cc/3 Cyl Engine) MT-09A Sport Tracker ABS (847cc/3 Cyl Engine) MT-09A Street Rally ABS (847cc/3 Cyl Engine)	00 ▲ 04 ▲ 03-06 ▲ 09-14 ▲ 14-16 ▲ 15-21 ▲ 14-21 ▲ 14-21 ▲ 14-21 ▲
CK2313 CKF2313 CT010 ▲	YAMAHA YFS 200 U/W/A/B/D/E/F/G/H/J/K/L/M/N/P/R /S/T/V Blaster WR 200 D	88-06 ▲ 92 ▲	CK2353 CT020 ▲ CK2354	YAMAHA YZF 750 R7 OW02 YAMAHA TT-R 90 M/N/P/R/ES/S/ET/EV/EW T 105 E Crypton (5AM4) T 105 SE Crypton (1D81/1D82)	99-01 ▲ 04-07 99-02 03-09
CK2315 CT010 ▲	YAMAHA FZR 600 W/WC/RA/AC/RAC/RB/RBC/RD/RDC/RE /REC/RF/RFC/RG/RGC/H/RHC/RJ/RJC/RK /RKC/RL/RLC	89-99 ▲	CK2355 CKF2355 CT005 ▲	YAMAHA WR 250 FN WR 250 FP/FR/FS/FT/FV/FW/FX/FY/FZ/FA/FB/FD WR 250 F Reverse Cylinder 4T YZ 250 FN/FP/FR/FS/FT/FV/FW (4T) YZ 250 FX/FY/FZ/FA/FB/FD (4T) YZ 250 F (4T)	01 02-13 15-21 01-07 08-13 14-21
CK2316 CT008 ▲	YAMAHA XV 250 Route 66/Nirago XV 250 X V-Star	88-90/95-07 ▲ 08-12 ▲	CK2356 CT020 ▲	YAMAHA WR 426 FN/FP/YZ 426 FN/FP WR 450 FR YZF R1 (5VY) YZF R1 YZR R1 IE FZ1 V/W/X/Z/A/B/D/E	01-02 ▲ 03- ▲ 04-06 ▲ 07-08 ▲ 06 ▲ 06-14 ▲
CK2317 CT010 ▲	YAMAHA FZR 400 U/W/SUC/SWC/A/SAC	88-90 ▲	CK2358 CT008SP ■	YAMAHA FZS 1000 N/NC/P/PC/R/RC/S/RS/T FZ1 YZF-R6	01-05 ■ 18-21 ■
CK2318 CT008SP ■	YAMAHA FZR 750 OW01 YZF 750 SP/RF/RFC/RG/RGC/RH/RHC YZF-R6 V/W/X/Y/Z/A/B/D/E/F/G/H/J	89-91 ■ 94-96 ■ 06-17 ■	CK2361	YAMAHA YZ 250 F 4T	16-21
CK2319 CT005 ▲	YAMAHA YZ 125 B/D TT-R 250 L/M/N/P/R/S/T/V WR 250 RX/RV/RZ/RA/RB/RD/RE/RF WR 250 XX/XY/XZ/ZA Supermotard	91-92 ▲ 99-06 ▲ 08-15 ▲ 08-11 ▲	CK2362 CT017 ▲	YAMAHA XT 1200 Z Super Tenere FJR 1300 R/RC/S/AS/T/AT/AV/AW/AX/AY/AZ/AA/AB FJR 1300 AEV/AEW/AEX/AEY FJR 1300 A FJR 1300 ES XVS 1300 V-Star 1300 Tourer XVS 1300 V-Star XVS 1300 Stryker XVS 1300 V-Star De Luxe	12-13 ▲ 03-12 ▲ 06-09 ▲ 06-15 ▲ 14-15 ▲ 07-14 ▲ 07-14 ▲ 11-14 ▲ 13-14 ▲
CK2321 CT008SP ■	YAMAHA FZR 1000 W/WC/A/AC/B/BC/D/DC	89-92 ■	CK2363 CT050SP ▲	YAMAHA XV 1700 Road Star S (9 Spoke Cast Wheel) XV 1700 Road Star Silverado S XV 1700 Road Star Silverado XV 1700 Road Star XV 1700 Road Star Midnight Warrior XV 1700 Road Star Warrior	08-14 ▲ 11-14 ▲ 08-10 ▲ 08 ▲ 05-09 ▲ 04-08 ▲
CK2324 CT039 ▲	YAMAHA XT 225 D/DC/E/EC/F/FC/G/GC/H/HC/J/JC/K/KC/L /M/MC/N/NC/P/PC/R/RC/S/SC/T/TC/V/VC/W/WC TT 225 S/T TT-R 225 L/M/N/P/R/S/T TT-R 230 T/V/W/X/Y/A/B/D/E/F	92-07 ▲ 86-87 ▲ 99-05 ▲ 05-09/11-15 ▲			
CK2325 CKF2325 CT005 ▲	YAMAHA YZ 125 E/F/G/H/J/K/L/M/N/P/R/S/T/V/W/X/Y /Z/A/B/D/E/F/G (2T)	93-21 ▲			
CK2327 CT008SP ■	YAMAHA GTS 1000 AE/AEC/AF/AFC FZR 1000 E/EC/F/FC/G/GC YZF 1000 Thunderace	93-94 ■ 93-95 ■ 97-00 ■			
CK2332 CT054SP ▲	YAMAHA YZF 600 RG/RGC/RH/RHC YZF 600 R RJ/RK/RL/RM/RN/RR/RS/RT/RV/RW	95-96 ▲ 97-07 ▲			
CK2335 CKF2335 CT010 ▲	YAMAHA YZ 80 G/H/J/K/L/M/N YZ 85 (2T/Small Wheel F 17"/R 14") YZ 85 (2T/Big Wheel F 19"/R 16")	95-01 ▲ 02-21 ▲ 02-21 ▲			
CK2349	YAMAHA RX-Z 135 (2UX/3UK1) RX-Z 135 (3UK3/3RSA/3RSB/3UK1)	87-89 93-97			

CLUTCH BUYERS GUIDE

CK CLUTCH KIT BUYERS GUIDE

Part No.	Make/Model	Year	Part No.	Make/Model	Year
CK2364 CKF2364 CT020 ▲ CT045 ■	YAMAHA YFZ 450 LES Limited Edition YFZ 450 S/T/W/X/Y/B/D YFZ 450 BBW Bill Balance Edition YFZ 450 SET Special Edition YFZ 450 SPV/SEW/SPX Special Edition YFZ 450 SPV Special Edition YFZ 450 BB/DB YFZ 450 R (3 Spring Clutch - YFZ 450 RE) YFZ 450 R Special Edition (3 Spring Clutch - YFZ 450 RSE) YFM 700 RV/RW/RX/RY/RA/RB/RD/RE Raptor YFM 700 RSEW/RSPX/RSPY/RSEA/RSEB/RSED /RSE Special Edition YFM 700 RSEY/RSEZ/RSEA/RSEB/RSED/RSE/RSF Raptor Special Edition YFM 700 RV/RW/RX/RY/RA/RB/RD/RE Raptor YFM 700 50th Anniversary Edition - YFM 700 RSPV FZ8	04 ▲ 04-09/12-13 ▲ 07 ▲ 05 ■ 06-08 ▲ 06 ▲ 12-13 ▲ 14 14 06-14 ▲ 07-14 ▲ 09-15 ▲ 06-14 ▲ 06-13 ▲ 11-13 ▲	CK3306 CT052 ▲	SUZUKI B120 (118cc) (106mm outer dia. friction plate) TC 120 Trailcat T 125/11/R Stinger	71-77 ▲ 68-71 ▲ 69-71 ▲
			CK3310 CT038SP ▲	SUZUKI T 20 X6 TC 250 X6 Scrambler	65-69 ▲ 67-69 ▲
			CK3311 CT051 ▲	SUZUKI AC 50/R AS 50 Sport/Colt	70-71 ▲ 68-69 ▲
			CK3312 CT051 ▲	SUZUKI TC 90 R/J Blazer TS 90 R/J Honcho A 100 A/B Go-Fer	70-72 ▲ 70-72 ▲ 76-77 ▲
			CK3313 CT046 ▲	SUZUKI GT 250 K/L Hustler T 250 II/R/J Hustler T 305 Raider TC 305 Laredo T 350 1/2/R/J Rebel	73-74 ▲ 69-72 ▲ 68-69 ▲ 68 ▲ 69-72 ▲
CK2367 CT017 ▲	YAMAHA XV 1900 Roadliner XV 1900 Roadliner Midnight XV 1900 Roadliner S XV 1900 Raider XV 1900 Raider S XV 1900 Raider SCL XV 1900 Stratoliner S	06-07 ▲ 06-09 ▲ 06-12 ▲ 08-12 ▲ 08-12 ▲ 12 ▲ 06-12 ▲	CK3314 CT046 ▲	SUZUKI T 500 1 Cobra (18 Ear Clutch Plate) T 500 2/3 Titan (18 Ear Clutch Plate)	68 ▲ 69-70 ▲
CK2370 CKF2370 CT005 ▲	YAMAHA XT 250 X/Y/Z/A/B/D/E/F/G/H YFM 250 RX/RY/RZ/RA/RB/RD Raptor YFM 250 RSPA Special Edition YFM 250 RSPX/RSEY Special Edition YFM 250 RSPXC Special Edition Custom	08-17 ▲ 08-13 ▲ 11 ▲ 08-09 ▲ 08 ▲	CK3315 CT022 ▲	SUZUKI DS 250 T GT 250 M/A/B Hustler TS 250 N/T/X RM 370 A/B (2T) GT 380 J/K/L/M/A/B Sebring RM 400 C	80 ▲ 75-77 ▲ 80-81 ▲ 76-77 ▲ 72-77 ▲ 78 ▲
CK2375	YAMAHA TTR 110 EX/EY/EA/EB/ED/EE/EF/EG	08-21	CK3316 CT022 ▲	SUZUKI TM 400 R/J/K/L/M Cyclone T 500 R/J/K/L/M Titan (12 Ear Clutch Plate)	71-75 ▲ 71-75 ▲
CK2378	YAMAHA XP 500 T-Max (5GJ5) XP 500 T-Max (5VUA/15B1/4B51)	01 05-11	CK3318 CKF3318 CT011 ▲	KAWASAKI KLX 125 A1/A2/A3/A6F KLX 125 L (B1/B2/B3/B6F) SUZUKI RM 60 N/T/X/Z/D RM 80 T/X RM 80 E/F RM 80 K/L/M/N/P/R/S/T/V/W/X/Y/K1 RM 85 (Small Wheel F 17"/R 14" Wheel) RM 85 (Big Wheel F 19"/R 16" Wheel) DR 100 D/E/F/G/H/J/K/L DS 100 C/N/T/X SP 100 D GN 125 Z/D GN 125 EM/EN/EP/ER/ES/ET/EV DR 125 Z/D/E/G/H/J DR 125 SER/SES/SET DR-Z 125 K3/K4/L5/K6/K7/K8/K9/L2/L3/L4/L5/L6 DR-Z 125 LK3/LK4/LK5/LK6/LK7/LK8/LK9/LL2 /LL3/LL4/LL5/LL6 DS 125 N/T/X GSX-R 125 GSX-S 125 RV 125 K/L/M/A/B Tracker SP 125 Z/D SP 125 G/H/J TC 125 J/K/L/M/A/B Prospector GSX-R 150 GSX-S 150	03-06 ▲ 03-06 ▲ 79-83 ▲ 80-81 ▲ 84-85 ▲ 89-01 ▲ 02-21 ▲ 02-21 ▲ 83-90 ▲ 78-81 ▲ 83 ▲ 82-83 ▲ 91-97 ▲ 82-88 ▲ 94-96 ▲ 03-20 ▲ 03-20 ▲ 79-81 ▲ 18-21 ▲ 18-21 ▲ 73-77 ▲ 82-83 ▲ 86-88 ▲ 72-77 ▲ 18-21 ▲ 18-21 ▲
CK2379 CT017 ▲	YAMAHA XVS 950 (V-Star 950) XVS 950 (V-Star 950 Tourer) XVS 950 Bolt (Standard rear shocks) XVS 950 R (Remote reservoir rear shocks)	09-14 ▲ 09-14 ▲ 14-16 ▲ 14-16 ▲			
CK2380 CT017 ▲	YAMAHA VMX 1700 V-Max (6 piston radial caliper)	09-14 ▲			
CK2382	YAMAHA T Max 530 ABS T Max 530 DX ABS T Max 530 SX ABS T Max 530 Black Max ABS T Max 530 Bronze Max ABS T Max 530 Iron Max ABS	12-19 17-19 17-19 13 14 15			
CK2387 CKF2387	YAMAHA YZ 250 F FK	19-21			
CK2388	YAMAHA XSR 900 ABS (MTM850)	16-21			
CK2389	YAMAHA YFZ 450 R Quad	14-21			

CK CLUTCH KIT BUYERS GUIDE

Part No.	Make/Model	Year	Part No.	Make/Model	Year
CK3319 CKF3319 CT011 ▲	SUZUKI RM 100 A RM 100 N/T/X RM 125 G/H TM 125 K/L/M Challenger	76 ▲ 79-81 ▲ 86-87 ▲ 73-75 ▲	CK3333 CT022 ▲	SUZUKI GS 450 ET/ST/EX/SX/EZ/ED GS 450 LT/LX/LZ/LD/LF/LG/LH/LJ GS 450 TX/TZ/TXZ/TXD GS 500 EK/EL/EM/EN/EP/ER/ES/ET/EV/EW /EX/EY/K1/K2/K3 GS 500 FK4/FK5/FK6/FK7/FK8/FK9	80-83 ▲ 80-88 ▲ 81-83 ▲ 89-03 ▲ 04-09 ▲
CK3319 CKF3319 CT011 ▲	SUZUKI DS 185 T GT 185 K/L/M/A/B Adventurer TS 185 T/X DR 200 G/H/J DR 200 SET/SEV/SEW/SEX/SEY/SEK1-SEK9/SEL3 /SEL5/SEL6 SP 200 G/H/J T 200 X5-Invader TC 200 X5 Stingray DR 200 G/H/J DR 200 SET/SEV/SEW/SEX/SEY/SEK1-SEK9 /SEL3/SEL5 SP 200 G/H/J LT 230 SF/SG/SH/SJ (from E/No.104361) LT 250 RF/RG	80 ▲ 73-76 ▲ 80-81 ▲ 86-88 ▲ 96-19 ▲ 86-88 ▲ 67-69 ▲ 67-69 ▲ 86-88 ▲ 96-09/13/15 ▲ 86-88 ▲ 85-88 ▲ 85-86 ▲	CK3334 CT022 ▲	SUZUKI DR 370 C/N (4T)	78-79 ▲
CK3321 CT035SP ▲	SUZUKI GT 550 J/K/L/M Indy GT 550 A/B Indy	72-75 ▲ 76-77 ▲	CK3335 CT024SP ▲	SUZUKI GS 1000 SZ GS 1000 GT/GX/GLT/GLX/SZ GS 1100 ET/EX/EZ GS 1100 GZ/GD/GLZ/GLD GS 1100 LT GS 1150 ES3/ESE/EF/ESF/EF2/EG/ESG VL 1500 W/X/Y/K1-K4 Intruder Legendary Classic VL 1500 BK5/K5/TK5/BK6/K6/TK6/K7//TK7 /TK8/K8/K9/TK9 Boulevard C90/C90T VL 1500 BK5/K5/TK5/BK6/K6/TK6/K7/TK7/TK8 /K8/K9/TK9/L3/TL3 Boulevard C90/C90T	82 ▲ 80-82 ▲ 80-82 ▲ 82-83 ▲ 80 ▲ 83-86 ▲ 98-04 ▲ 05-10 ▲ 13 ▲
CK3324 CT018SP ▲	SUZUKI GS 750 B/C/EC/N/EN/LN GT 750 J/K/L/M/A/B	77-79 ▲ 73-77 ▲	CK3337 CT011 ▲	SUZUKI TS 100 T/X TS 125 T/X	80-81 ▲ 80-81 ▲
CK3326 CT051 ▲	SUZUKI TC 100 K/L/M/A/B Blazer TS 100 K/L/M/A/B Honcho	74-77 ▲ 74-77 ▲	CK3340 CT011 ▲	SUZUKI DS 80 T/X/Z/D/F/G/H/J/K/L/M/N/P/R/S/T/V/W/X/Y JR 80 K1/K2/K3/K4 RM 80 Z/D	80-00 ▲ 01-04 ▲ 82-83 ▲
CK3328 CT011 ▲	SUZUKI LT 125 D/E/F/G/H LT 185 E/F/G/H ALT 125 D/E/F/G ALT 185 F RM 50 C/N/T	83-87 ▲ 84-87 ▲ 83-86 ▲ 85 ▲ 78-80 ▲	CK3343 CT018SP ▲	SUZUKI GS 400 XB/XC GS 400 B/C GS 425 N (Spoke Wheel) GS 425 EN (Cast Wheel) GS 425 LN	77-78 ▲ 77-78 ▲ 79 ▲ 79 ▲ 79 ▲
CK3329 CT011 ▲	SUZUKI RM 100 B/C RM 125 A/B/C RM 125 X/Z/D RM 125 F PE 175 T/X/Z/D/E RS 175 T/X/Z GS 250 TT/TX LT 250 SK/SL	77-78 ▲ 76-78 ▲ 81-83 ▲ 85 ▲ 80-84 ▲ 80-82 ▲ 80-81 ▲ 89-90 ▲	CK3344 CT018SP ▲	SUZUKI GS 550 B/C/EC/N/EN/ET GS 550 MZ GS 550 LT/LX/LZ GS 550 LD/LF/LG/TX GS 550 ED/ESD/ES3/ESE/EF/ESF/ESG	77-80 ▲ 82 ▲ 80-82 ▲ 81-85 ▲ 83-85 ▲
CK3330 CT018SP ▲	SUZUKI GS 650 EX/EZ/GX/GZ/GD/GLX/GLZ/GLD/MD GS 700 EF/ESF GS 750 ET/EX/EZ/TZ/TD GS 750 LT/LX GS 750 ED/ESD/SD GS 850 GN/GT/GX/GZ/GD/GLT/GLX/GLZ/GLD	81-83 ▲ 85 ▲ 80-83 ▲ 80-81 ▲ 83 ▲ 79-83 ▲	CK3345 CT035SP ▲	SUZUKI GS 1000 C/N/EC/EN/SN/ET/ST	78-80 ▲
CK3331 CT022 ▲	SUZUKI PE 250 T/X RS 250 T/X RM 250 T/X/Z/D/E/F	80-81 ▲ 80-81 ▲ 80-85 ▲	CK3346 CT024SP ▲	SUZUKI GS 1100 SD GS 1100 ED/ESD	83 ▲ 83 ▲
CK3332 CT022 ▲	SUZUKI GN 400 T/XT/TX/TZ DR 400 T SP 400 T PE 400 T/X RM 400 N/T	80-82 ▲ 80 ▲ 80 ▲ 80-81 ▲ 79-80 ▲	CK3347 CT018SP ▲	SUZUKI XN 85 D	83 ▲
			CK3348 CT029 ▲ CT047SP ■	SUZUKI RM 465 X/Z RM 500 D/E GSX 600 FJ/FK/FL/FM 'Katana' GSF 600 ST/SV/SW Bandit GSF 600 SY/SK1/SK2/SK3 GSX R 750 G/H	81-82 ■ 83-84 ■ 88-91 ▲ 96-98 ▲ 00-03 ▲ 86-87 ▲
			CK3356 CT011 ▲	SUZUKI GS 300 LZ/LD/LF RM 125 E RM 125 J/K/L/M LT-F 4WD XM/N/P/R/S/T/V/W 250 (2 x 4)	82-85 ▲ 84 ▲ 88-91 ▲ 91-97 ▲ 99-00 ▲

CK CLUTCH KIT BUYERS GUIDE

Part No.	Make/Model	Year	Part No.	Make/Model	Year
CK3356 CT011 ▲	SUZUKI LT-F 300 FX/FY/FK1/FK2 "King Quad" 300 (2 x 4 / 4 x 4) 30 (4 x 4)	99-02 ▲ 98-04 ▲ 05 ▲	CK3377 CT022 ▲ CT029 ■	YAMAHA VL 800 K5/CK5/K6/CK6/K7/ZK7/K8/ZK8/K9 /ZK9/L1/L2/L3/L4/L5 (C50 Boulevard) VL 800 TK5/TK6/TK7/TK8/TK9/TL1/TL2/TL3 /TL4/TL5 (C50T Boulevard Tourer) VL 800 K1/K2/K3/K4 Intruder Volusia VL 800 K5/K6/CK5/TK5/CK6/TK6/K7/TK7/ZK7 /K8/TK8/ZK8/K9/TK9/ZK9/L1/L2 Boulevard C50/C50 T VL 800 ZL2 C 50 T Boulevard Classic VL 800 BTL4 (Boulevard C50 B.O.S.S. Cast Wheels) VL 800 CL3 (Boulevard C50 Special Edition /Cast Wheels) VX 800 L/M/N/P VS 800 Intruder GLN/GLP/GLR/GLS/GLT/GLV/GLW /GLX/GLY/GLK1/GLK2/GLK3/GLK4 VZ 800 V/W/X/Y/K1-K4 Marauder VZ 800 K5/K6/BK6/K7/ZK7/K8/ZK8/K9/ZK9 M50 Boulevard VS 800 K5/K6/K7/K8/K9/L0 S50 Boulevard	05-15 ■ 05-15 ■ 01-04 ■ 05-12 ■ 12 ■ 14 ■ 13 ■ 90-93 ■ 92-04 ■ 97-04 ■ 05-10 ■ 05-10 ■
CK3357 CT029 ■ CT047SP ▲	SUZUKI GSX 600 FW/FX/FY/FK1-FK6/FK8 Katana GR 650 D/XD GSX 750 FW/FX/FY/FK1-FK6 Katana	98-06/08 ▲ 83 ■ 98-06 ▲	CK3380 CT051 ▲	SUZUKI RB 50 H (GSXR50)	87 ▲
CK3358 CT029 ■	SUZUKI GN 250 Z/D/F/J DR 250 Z/D/F GW 250 L4/L5 GZ 250 X/Y/K1-K9/L0 Marauder SP 250 Z/D/F TU 250 XL1/XL2/XL3/XL4/XL5/XL6	82-88 ■ 82-85 ■ 14-15 ■ 99-10 ■ 82-85 ■ 09-16 ■	CK3381 CT048SP ▲	SUZUKI GSX 1100 FJ/FK/FL/FM/FN/FP GSXR 1100 G/H/J	88-93 ▲ 86-88 ▲
CK3359 CT029SP ■	SUZUKI DR 500 X/Z/D SP 500 X/Z/D SP 600 F LS 650 FG/PG/FH/PH/PJ/PS/PT/PV/PW/PX/PY /PK1/PK2/PK3/PK4 LS 650 K5-K9/L1/L2/L3/L4/L5 Boulevard S40 (650cc)	81-83 ■ 81-83 ■ 85 ■ 86-88/95-04 ■ 05-15 ■	CK3382 CT029 ■	SUZUKI VS 1400 GLPH/GLFH/GLPJ/GLPL/GLPM/GLPN /GLPP/GLPR/GLPS/GLPT/GLPV/GLPW/GLPX /GLPY/GLPK1/GLPK2//GLPK3/GLPK4 VS 1400 GLPK5/K6/K7/K8/K9/L0 Boulevard S83 (1400cc)	87-04 ■ 05-10 ■
CK3364 CT011 ▲	SUZUKI LT 160 EK/EL/EM/EN LT-F 160 M/N/P/R/S/T/V/W/X/Y/K1/K3 LT 160 K3/K4 Quadrunner LT-F 230 G/H LT 230 GEF/GEG LT 230 EH/EJ/EK/EL/EM/EN/EP LT 230 SF/SG/SH/SJ up to E. no 104360 LT-F 250 K2	89-92 ▲ 91-01/03 ▲ 03-04 ▲ 86-87 ▲ 85-86 ▲ 87-93 ▲ 85-88 ▲ 02 ▲	CK3386 CT024 ▲	SUZUKI DR 650 SET/SEV/SEW/SEX/SEY/SEK1/SEK2 /SEK3/SEK4/SEK5/SEK6/SEK7/SEK8/SEK9 /SEL1/SEL2/SEL3/SEL4/SEL5/SEL6	96-16 ▲
CK3366	KAWASAKI KDX 50 A1/A2/A3/A6F SUZUKI JR 50 C/N/T/X/Z/F/G/H/J/K/L/N/P/R/S/T/V/W /X/Y/K1/K2/K3/K4/K5/K6	03-06 78-06	CK3387 CT036SP ▲	SUZUKI GSXR 600 WN/WP GSX 600 FN/FP/FR/FS/FT/FV Katana GSX R 750 J/K/L/M/N GSX-R 750 WP/WR/WS	92-93 ▲ 92-97 ▲ 88-92 ▲ 92-95 ▲
CK3367	SUZUKI RM 80 G/H/J	86-88	CK3388 CT029 ▲	SUZUKI GV 1400 GDG/GTG/GCG/GDH/GTH/GCH/GDJ	86-88 ▲
CK3372 CT022 ▲	SUZUKI LT 250 RH/RJ/RK/RL/RM/RN RM 250 G/H	87-92 ▲ 86-87 ▲	CK3390 CT011 ▲	SUZUKI LT 250 EFF/EFG LT-4WD (250cc) Quadrunner 4WD LT-F 4WD V/W Quadrunner 4WD (250cc) LT-F 250 J/K/L/M/N/P/R/S/V/W/X/Y/K1 LT-F 250 FX/FY/FK1/FK2 "Quadrunner" LT-F 250 K3/K5/K6/K7/K8/K9/L2/L3/L4 Ozark 250 (2 x 4 / 4 x 4) LT 300 EH/EJ/EK	85-86 ▲ 87-97 ▲ 97-98 ▲ 88-01 ▲ 99-02 ▲ 03/05-14 ▲ 01-05 ▲ 87-88 ▲
CK3373 CT035SP ▲	SUZUKI RE 5 M/A (Rotary)	75-76 ▲	CK3391	SUZUKI GSX 750 FK/FL/FM/FN/FP/FR/FS/FT	89-96
CK3374 CT022 ▲	SUZUKI RM 250 J/K/L/R/S RMX 250 K/L/M RMX 250 R/S/T/V/W/X/Y LT 500 RH/RJ/RK/RL GV 700 GLFG/GLF2	88-90/94-95 ▲ 89-91 ▲ 94-00 ▲ 87-90 ▲ 85 ▲	CK3392 CT055SP ▲	SUZUKI GSX R 1100 K/L/M/N GSX 1100 GM/GN/GP	89-92 ▲ 91-93 ▲
CK3375	SUZUKI GV 1200 GLF/GLF2/GLG	85-86	CK3397 CT011 ▲	SUZUKI GSF 400 M/N/P	91-93 ▲
CK3376 CT072SP ▲	SUZUKI GSX-R 750 RG (Dry Clutch - Sintered Friction)	86 ▲			
CK3377 CT022 ▲ CT029 ■	YAMAHA SV 650 X/Y/K1/SK1/K2/SK2 VS 700 GLF/GLP/GLEF/GLEP/GLEG/GLEH VS 750 GLPJ/GLPK/GLPL/GLPM VL 800 ZK3/ZK4 Volusia LTD (Seat Trimmed With Chrome Studs)	99-02 ▲ 86-87 ■ 88-91 ■ 03-04 ■			

CK CLUTCH KIT BUYERS GUIDE

Part No.	Make/Model	Year	Part No.	Make/Model	Year
CK3399 CKF3399 CT022 ▲	SUZUKI DR 250 L/M/N/P DR 250 SL/SM/SN/SEP/SER/SES DR 350 L/M/N/P/R/S/T DR 350 SL/SM/SN/SP/SER/SES/SET/SEV/SEW/SEX	90-93 ▲ 90-95 ▲ 90-96 ▲ 90-99 ▲	CK3443 Contd.	SUZUKI Contd. GSX 1300 RK2/RZK3/RK4/RZK4/RK5/RZK6/RK6 /RK7/RK8/RK9/RL1/RL2 GSX 1300 RZL4 Hayabusa 50th Anniversary Edition GSX 1300 BKAK8/K9 B-King ABS GSX 1300 BKK8/K9 B-King	02-12 ▲ 14 ▲ 08-09 ▲ 08-09 ▲
CK3400 CT022 ▲	SUZUKI RM 250 M/N/P RMX 250 N/P	91-93 ▲ 92-93 ▲	CK3447 CKF3447 CT006 ▲	ARCTIC CAT 400 DVX KAWASAKI KSF 400 A3/A6F (KFX 400) SUZUKI LT-Z 400 K5/K6/K7/K8/K9/ZK9/L2/L3/L4	07-08 ▲ 05-06 ▲ 05-14 ▲
CK3401 CT003 ●	SUZUKI RM 125 N/P/R/S/T/V/W/X/Y/K1	92-01 ●	CK3448 CT011 ▲	SUZUKI LT-Z 250 K4/K5/K6/K7/K8/K9/L0 Quad Sport LT-F 250 K4 Ozark	04-10 ▲ 04 ▲
CK3402 CT029SP ■	SUZUKI DR 650 SL/SM/SN/SP/SER/SES	90-95 ■	CK3450 CKF3450 CT045 ▲	SUZUKI RM-Z 450 LT-R 450 K6/K7/K8/K9 LTR 450 ZK8/ZK9 Quadracer Limited	05-21 ▲ 06-11 ▲ 08-10 ▲
CK3408 CT036SP ▲	SUZUKI RF 600 RR/RS/RT	94-96 ▲	CK3451 CT015 ▲	SUZUKI GSXR 1000 K5/K6/K7/K8 GSX-S 1000 L8 (Naked - Non ABS) GSX-S 1000 AL8 (Naked - ABS) GSX-S 1000 F L8 (Faired -Non ABS) GSX-S 1000 F AL8 (Faired -ABS) Katana	05-08 ▲ 18-21 ▲ 18-21 ▲ 18-21 ▲ 18-21 ▲ 19-21 ▲
CK3417 CT014 ▲ CT055SP ■	SUZUKI GSX-R 750 T/V/W/X GSXR 750 K4/K5 GSX-S 750 GSX-S 750 ABS RF 900 RS/RS2/RT/RV TL 1000 SV/SW GSF 1200 SV/SAV/SW/SX/SY/SK1/SK2K1/K2 /SK3/K3/SK4/SK5	96-99 ■ 04-05 ▲ 15-16 ▲ 15-21 ▲ 95-97 ▲ 97-98 ▲ 97-05 ■	CK3452 CT006 ▲	SUZUKI LT-F 500 FK3/FK4/FK5/FK6/FK7 500 (Manual 4x4)	03-07 ▲ 03-09 ▲
CK3418 CT055SP ▲	SUZUKI RF 900 RR GSXR 1100 WR/WP/WS/WT/WV/WW	94 ▲ 93-98 ▲	CK3453 CT016 ▲	SUZUKI RM 250 K6/K7/K8	06-08 ▲
CK3428 CT009 ▲	SUZUKI TL 1000 RW/RX/RY TL 1000 SX/SY	98-00 ▲ 99-00 ▲	CK3454 CT016 ▲	SUZUKI RM 250 K3/K4/K5	03-05 ▲
CK3430 CT021 ▲	SUZUKI GSX 1300 RX Hayabusa GSX 1300 RY/RK1 Hayabusa	99 ▲ 00-01 ▲	CK3455 CT015 ▲	SUZUKI GSXR 600 K6/K7	06-07 ▲
CK3433 CKF3433 CT006 ▲ CT009 ■	ARCTIC CAT 400 DVX HONDA CRF 450 R (4 Spring type) CRF 450 R (6 Spring type) CRF 450 R (6 Spring type) KAWASAKI KLX 400 R (KLX 400 B1) KLX 400 SR (KLX 400 A1) SUZUKI KSF 400 A1/A2 (KFX 400) DR-Z 400 SY/SK1/SK2/SK3/SK4/SK5/SK6/SK7 /SK8/SK9/SL1/SL2/SL3/SL4/SL5/SL6 DR-Z 400 /EY/Y/EK1/K1/EK2/K2/K3/EK3/K4 /EK4/EK5/EK6/EK7 DR-Z 400 SMK5/SMK6/SMK7/SMK8/SMK9 /SML3/SML4/SML5/SML6 LT-Z 400 K3/K4	04-06 ▲ 11-12 ■ 13 ■ 14-16 ■ 03-04 ▲ 03-04 ▲ 03-04 ▲ 00-16 ▲ 00-08 ▲ 05-08/13-19 ▲ 03-04 ▲	CK3456 CT015 ▲	SUZUKI GSXR 600 GSXR 600 L GSXR 750	08-21 ▲ 11-21 ▲ 06-21 ▲
CK3435 CT009 ▲	SUZUKI TL 1000 RK1/RK2/RK3 TL 1000 SK1	01-03 ▲ 01 ▲	CK3457	SUZUKI VZR 1800 BL4/BL5 (Boulevard M109R B.O.S.S.) VZR 1800 K6/K7/K8/K9/L1/L2/3/L4 (M109R Boulevard) VZR 1800 NK8/NK9 M109R2 Limited VZR 1800 ZK8/ZK9/ZL1/ZL2/ZL3/ZL4 M109RZ Limited	14-15 06-14 08-11 08-14
CK3443 CKF3443 CT021 ▲	SUZUKI DL 1000 AL4/AL5/AL6 DL 1000 AL2/AAL4/AAL5/AAL6 V-Strom Adventure DL 1000 K2-K9/L2 V-Strom SV 1000 K3/SK3/K4/SK4/K5/SK5/SK6/SK7 GSX 1300 ral3/ral4/ral5/ral6	12/14-20 ▲ 12/14-20 ▲ 02-12 ▲ 03-07 ▲ 13-16	CK3458	SUZUKI DR-Z 50 DR-Z 70	19-21 08-09/15-21
			CK3459 CT021 ▲	SUZUKI GSF 1250 SKA7/SKA8/SKA9 GSF 1250 SK7/SK8/SK9 Bandit GSX 1250 FAL1/FAL2 GSX 1250 SAL6 Bandit V 1500 BL3/BL4/BL5 (Boulevard C90 B.O.S.S.) V 1500 BTL3/4 (Boulevard C90T B.O.S.S. with windshield) VZ 1500 L3 C90 Boulevard VZ 1500 TL3/TL4/TL5 C90T Boulevard with windshield VZ 1500 K9/L3/L4/L5 M90 Boulevard	07-10 ▲ 07-10 ▲ 11-12 ▲ 16 ▲ 13-15 ▲ 13-14 ▲ 13 ▲ 13-15 ▲ 09/13-15 ▲

CLUTCH BUYERS GUIDE

CK CLUTCH KIT BUYERS GUIDE

Part No.	Make/Model	Year	Part No.	Make/Model	Year
CK3462 CT009 ▲	SUZUKI GSXR 1000 K9/L1/L2/L3/ZL3/L4/L5/L6	09-16 ▲	CK4424 CKF4424 CT016 ▲ Contd.	KAWASAKI KZ 550 M1 (Ltd) KZ 550 A1/A2/A3/A4 KZ 550 C1/C2/C3/C4 (Ltd) ZX 550 A1/A2/A3 (GPZ) ZR 550 B1-B4 "Zephyr" ZL 600 A1/A2 ZL 600 Eliminator B2/B3 ZX 600 C1-C10 Ninja R ZX 600 D1-D4/E1-E13 (ZX6) ZX 600 A1/A2/A3/B1 'Ninja' ER-6N (ER 650 C9F/CAF) EN 650 Vulcan S EN650 Aff/BFF ER-6F (EX 650) ER-6F ABS (EX 650 ABS) Ninja 650 (EX 650) Ninja 650 ABS (EX 650 ABS) ER-6N (ER 650) ER-6N ABS (ER 650 ABS) Z 650 (ER 650) Z 650 ABS (ER 650 ABS) KLE 650 A7F/A8F/AAF/CAF/CBF/CCF/CDF/CEF Vervsys KLE 650 FFF/FFFAS/FGF/FGFAS Vervsys/Vervsys LT KLR 650 (KL 650 A1-A9) KLX 650 C1/C2/C3/C4 KL 650 B2/B3 "Tengai" KL 650 EBF/ECF/EDF/EEF (from KL 650 AEA 72320-) KLX 650 A1/A2/A3/D1 (KLX650R) ZX 750 H1/H2 Ninja ZX-7	83 ▲ 80-83 ▲ 80-83 ▲ 84-86 ▲ 90-93 ▲ 86-87 ▲ 96-97 ▲ 88-97 ▲ 90-05 ▲ 85-87 ▲ 09-10 ▲ 15 ▲ 06-11 ▲ 06-11 ▲ 12-18 12-18 06-11 ▲ 06-11 ▲ 12-18 12-18 07-11 ▲ 15-16 ▲ 87-95 ▲ 93-96 ▲ 90-91 ▲ 11-15 ▲ 93-96 ▲ 89-90 ▲
CK3463	SUZUKI VLR 1800 TK8/TK9 C109 RT Touring VLR 1800 K8/K9 C109 R	08-10 08-10	CK4425 CT004 ▲	KAWASAKI KX 125 K1/K2/K3/K4/K5/L1-L4/M1-M3 KLT 200 A1/A2/A3/A4/A4A KLT 200 B1/C1/C2 KL 250 A1/A1A/A2/A3/A4/A5 KL 250 C1/C2 KLT 250 A1/A2/C1/C2/C3/P1 KZ 250 D1 (Ltd) KZ 250 D2/L1 (CSR) KZ 250 W1 (Ltd) KLX 250 A1/A2 KSF 250 A1-A18 Mojave HI 500 Mach III KH 500 A8	94-05 ▲ 81-83 ▲ 83-84 ▲ 78-82 ▲ 83-84 ▲ 82-85 ▲ 80 ▲ 81-82 ▲ 83 ▲ 79-80 ▲ 87-04 ▲ 69-75 ▲ ▲
CK3465 CT014 ▲	SUZUKI GSXR 750 K1/K2/K3	01-03 ▲	CK4433 CT006 ▲	KAWASAKI KXT 250 A1 'Tecate' KZ 305 A1/A2/B1 (CSR) EX 305 B1 (GPZ) KZ 305 B2/B3 (Ltd) KDX 250 B2/B3/B4 KX 250 B1/C1 KX 500 A1/A2	84 ▲ 81-82 ▲ 83 ▲ 87-88 ▲ 82-84 ▲ 82-83 ▲ 83-84 ▲
CK3466 CT014 ▲	SUZUKI GSXR6 600 K1/K2/K3/ZK3	01-03 ▲	CK4434 CT016 ▲	KAWASAKI ZL 900 A1/A2 'Eliminator' ZG 1000 A1-A20 'Concours' ZL 1000 A1 KZ 1000 E1/E2 'Shaft' KZ 1000 K1/K2 (Ltd) KZ 1000 M1/M2 (CSR) KZ 1000 P1-P22/P24 Police KZ 1000 R1/R2 'Replica' KZ 1000 J1/J2/J3 ZG 1000 A6F Concours ZX 1000 A1/A2 Ninja ZX 1000 B1/B2/B3 Ninja ZX10 KZ 1100 A1/A2/A3 KZ 1100 B1/B2 (GPZ) KZ 1100 D1/D2 'Spectre' KZ 1100 L1 (Ltd)	85-86 ▲ 86-05 ▲ 87 ▲ 79-80 ▲ 81-82 ▲ 81-82 ▲ 82-03/05 ▲ 82-83 ▲ 81-83 ▲ 06 ▲ 86-87 ▲ 88-90 ▲ 81-83 ▲ 81-82 ▲ 82-83 ▲ 83 ▲
CK3468 CT009 ▲	SUZUKI GSX-R 1000 AL7	17 ▲			
CK4409 CT019 ▲	KAWASAKI Z1/A/B 900 KZ 900 A4/A5 Z 900 B1 Ltd KZ 1000 A1-A4 KZ 1000 B1-B4 (Ltd) KZ 1000 C1/C1A/C2/C3/C4 Police KZ 1000 D1/D3 (Z1-R) KZ 1000 G1 Classic	73-75 ▲ 76-77 ▲ 76 ▲ 77-80 ▲ 77-80 ▲ 78-81 ▲ 78-80 ▲ 80 ▲			
CK4411 CT058 ▲	KAWASAKI KD 125 A2/A3/A4/A5 KE 125 A7/A8/A9/A10 KE 175 D2/D3/D4/D5	75-79 ▲ 80-83 ▲ 80-83 ▲			
CK4413 CT019 ▲	KAWASAKI KZ 650 B1/B2/B2A/B3 KZ 650 C1/C2/C3 Custom KZ 650 D1/D1A/D2 SR KZ 650 E1 (Ltd)/F1/H1/H2/H3 (CSR) KZ 700 A1 ZN 700 A1/A2 (Ltd) KZ 750 E1/E2/E3 KZ 750 F1 (Ltd) KZ 750 H1/H2/H3/H4 (Ltd) KZ 750 L3 KZ 750 N1/N2 'Spectre' KZ 750 R1 (GPZ) ZX 750 A1/A2/A3 (GPZ)	77-79 ▲ 77-79 ▲ 78-79 ▲ 80-83 ▲ 84 ▲ 84-85 ▲ 80-82 ▲ 83 ▲ 80-83 ▲ 83 ▲ 82-83 ▲ 82 ▲ 83-85 ▲			
CK4415 CT004 ▲	KAWASAKI H2/H2-A "Mach IV"	72-73 ▲			
CK4419 CT006 ▲	ARCTIC CAT 400 (2 x 4 / 4 x 4) KAWASAKI KLF 300 A1/A2/B1-B17/C1-C17 'Bayou' KEF 300 A1/A2/A3/A4/A5/A6 'Lakota' KEF 300 B1/B2/B3 "Lakota Sport"	00-02 ▲ 86-05 ▲ 95-00 ▲ 01-03 ▲			
CK4421	KAWASAKI KZ 400 S/S2/S3 KZ 440 A1/A2/A3/A4 KZ 440 B1/B2/D1/D2/D3/D4/D5 KZ 440 G1	75-77 80-83 80-83 82			
CK4424 CKF4424 CT016 ▲	KAWASAKI KLR 600 (KL 600 A1/B1/B2) EN 450 A1-A6 (454 Ltd) EN 500 A1-A7/C1-C10/C6F/C7F/C8F/C9F EX 500 A1-A7/D1-D12/D6F/D7F/D8F/D9F KZ 550 D1 (GPZ) KZ 550 F1 'Spectre' KZ 550 F2 (Ltd) KZ 550 H1/H2 (GPZ)	84-86 ▲ 85-90 ▲ 90-09 ▲ 87-09 ▲ 81 ▲ 83 ▲ 84 ▲ 82-83 ▲			

CK CLUTCH KIT BUYERS GUIDE

Part No.	Make/Model	Year	Part No.	Make/Model	Year	
CK4434 CT016 ▲	ZN 1100 B1/B2 (Ltd)	84-85 ▲	CK4439 Contd.	ARCTIC CAT Contd.		
	ZX 1100 A1/A2 Ninja	86-87 ▲		500 (4 x 4)	98-02	
CK4435 CKF4435 CT016 ▲	ZR 1100 A1/A2/A3/A4 Zephyr	92-95 ▲	KAWASAKI	KDX 250 A1/B1	80-81	
	(ZR 1100 C3/C4) ZRX 1100	99-00 ▲		KE 250 B1/B2/B3	77-79	
	ZG 1200 A1/B1-B17 Voyager X11	86-03 ▲		KX 250 A6/A7	80-81	
	ZRX 1200 R (ZR 1200 A1/A2/A3/A4/A5)	01-05 ▲		KDX 400 A1/A2	79-80	
	KAWASAKI			KLF 400 B1-B7 Bayou (4 x 4)	93-98	
	KX 250 J1/J2/K1-K5/L1-L4/M1/M2/R1/R6F/R7F	92-07 ▲		KDX 420 B1	81	
	KL 650 E8F/E9F/EA/EBF (KLR 650)	08-11 ▲		KX 420 A1/A2	80-81	
	KLR 650 (KL 650 A10-A19/A6F/A7F)	96-07 ▲		KDX 450 A1	82	
	W 650 (EJ 650 A2/A3/A4)	00-02 ▲		SUZUKI		
	VN 700 A1 'Vulcan'	85 ▲		LT-F 400 K2 Eiger Manual 2WD	03	
	VN 750 A2-A21/A6F 'Vulcan'	86-06 ▲		LT-F 400 K3/4/5/6/7	03-08	
	ZX 750 F1/F2/F3/F4 Ninja	87-90 ▲		LT-F 400 FK2/FK3/FK4/FK5/FK6/FK7 (Eiger 4WD)	02-07	
	ZX 750 L1/L2/L3 (ZX7)	93-95 ▲		LT-F 400 FK8/FK9/FLO King Quad 400 FS	08-10	
	ZX 750 J1/J2	91-92 ▲		LT-F 400 FCK8/FCK9 King Quad 400 FS Camo	08-09	
	ZX 750 P1-P8 (ZX7R)	96-03 ▲		LT-F 400 FL1-FL6 King Quad 400 FSi	11-16	
	ZX 750 N1/N2 (ZX7RR)	96-99 ▲		LT-F 400 FCL1/FCL2/FCL3/FCL4/FCL5/FCL6		
	ZX 750 K1/K2	91-92 ▲		King Quad Camo 400 FSi	11-16	
	ZX 750 M1/M2 (ZX7R)	93-94 ▲		LT-F 500 FW/FX/FY/FK1-FK2	98-02	
	KZ 750 G1 (Ltd)	80 ▲				
	KZ 750 M1 (CSR)	82 ▲				
	VN 800 A1-A11/B1-B10	95-05 ▲		CK4440	KAWASAKI	
	VN 800 C1/C2/E1-E5/E6F Drifter	99-06 ▲		AR 80 A1	82	
	VN 900 B6F/B7F/B8F/B9F/BAF/BBF/BCF			KD 80 M1-M8/N1/N2/N3	80-90	
	/BDF/BEF/BEFA/BFF	06-15 ▲		KDX 80 A1/A2	80-81	
	VN 900 D6F/D7F/D8F/D9F/DAF/DBF/DCF/DDF			KE 100 A5/A6/A7/A8/A9/A10	76-81	
	/DEF/DFE	06-15 ▲		KE 100 B1-B20	82-01	
	VN 900 Custom C7F/C8F/C9F/CAF/CBF/CCF			KM 100 A1/A2/A3/A3A/A4/A6/A7	76-81	
/CDF/CEFA/CFE	07-16 ▲					
VN 900 Vulcan Classic LT		CK4442	KAWASAKI			
(Spoke Wheels & Screen) (D)	06-19 ▲	AR 50 A1	82			
VN 900 Vulcan Classic (Spoke Wheels) (B)	06-19 ▲					
VN 900 Vulcan Custom (Cast Wheels) (C)	07-19 ▲	CK4443 CT019 ▲	KAWASAKI			
ZX 900 A1/A2/A3 'Ninja'	84-86 ▲	ZX 750 E1/E2 (GPZ Turbo)	84-85 ▲			
ZX-9R B1/B2/B3/B4 Ninja	94-97 ▲					
SUZUKI		CK4446 CT004 ▲	KAWASAKI			
RM 250 T/V/W/X/Y/K1/K2	96-02 ▲	KLR 250 (KL 250 D2-D22)	85-05 ▲			
		CK4452	KAWASAKI			
CK4436 CT058 ▲	KAWASAKI	KZ 1300 B2 'Touring'	80			
KX 125 A4/A5/A6/A7/B1	78-82 ▲	KZ 1300 A1/A2/A3	79-81			
KDX 175 A1/A2/A3	80-82 ▲					
S1-A/B/C (250cc)	73-75 ▲	CK4453 CKF4453 CT002 ▲	KAWASAKI			
KH 250 A5	76 ▲	KX 80 W1/W2/W3	98-00 ▲			
S2/S2A (350cc)	72-73 ▲	KX 85 (F 17"/R 14") (F 19"/R 16")	01-21 ▲			
		KX 100 C1-C3/D1-D5/D6F-D9F/DBF/DCF/DDF/FEF/FFF/FGF	98-09/11-17 ▲			
CK4438 CKF4438 CT070SP	KAWASAKI	CK4455 CT032 ▲	KAWASAKI			
KX 60 A1/A2/B1-B19	83-03	ZN 1300 A1-A6 'Voyager'	83-88 ▲			
KX 65	00-21	VN 1500 A1-A13 Vulcan 88	87-99 ▲			
KX 80 C1/C2	81-82	VN 1500 B1-B4/C3/C4/D1/D2/E1-E7 All Vulcan 88 SE	87-04 ▲			
KX 80 E1/E2	83-84	VN 1500 G1/G1A/G2A/G3 Nomad	99-01 ▲			
KDX 80 B2/B3	82-83	VN 1500 Classic Fi (VN 1500 N1/N2/N3)	00-02 ▲			
KDX 80 C1/C2/C3/C4/C5	84-88	VN 1500 J1/J2/R1-R5 Drifter	99-05 ▲			
KLX 110	02-21	VN 1500 P1/P2 'Vulcan Mean Streak'	02-03 ▲			
KLX 110 L	10-21	VN 1500 L2/L3/L4/L5 Nomad Fi	01-05 ▲			
Z 125 (BR 125 GGF/GHF Auto G/Box)	16-17	VN 1500 N4/N6F/N7F/N7FA/N8F/N8FA	05-08 ▲			
Z 125 Pro (BR 125 HGF/JHF Manual G/Box)	16-21	VN 1600 A1/A2/A3/A6F/A7F/A7FA/A8F/A8FA Classic	03-08 ▲			
SUZUKI		VN 1600 B1 Mean Streak	04 ▲			
RM 60 K3	03	VN 1600 B2/B6F/B7F/B7FA/B8F/B8FA Mean Streak	05-08 ▲			
RM 65 K3/K4/K5	03-05	VN 1600 D1/D6F/D7F/D7FA/D8F/D8FA Nomad	05-08 ▲			
RM 100 K3/K4	03-04	SUZUKI				
DR-Z 110 K3/K4/K5	03-05	VZ 1600 K4 Marauder	04 ▲			
		VZ 1600 K5 M95 Boulevard/Marauder	05 ▲			
CK4439	ARCTIC CAT	CK4457 CT058 ▲	KAWASAKI			
400 (2 x 4 / 4 x 4)	98-	KDX 200 A1/A2/A3	83-85 ▲			
400 (2 x 4)	98	KX 125 B2/C1	83-84 ▲			
400 (2 x 4 / 4 x 4)	03-04	KH 400 A3/A4/A5	76-78 ▲			
400 (4 x 4 Manual)	05-08	S3/S3-A (400cc)	74-75 ▲			
Bearcat 454 (4 x 4)	96-98					
Bearcat 454 (2 x 4)	97-98					

CLUTCH BUYERS GUIDE

CK CLUTCH KIT BUYERS GUIDE

Part No.	Make/Model	Year	Part No.	Make/Model	Year
CK4458	KAWASAKI KZ 1300 A4	82	CK4503 CT004 ▲	KAWASAKI ZX6-R (ZX 600 F1-F3/G1/G2/J1/J2/J3) ZX6RR (ZX 600 K1) ZX6R (ZX 636 B1/B2) ZZR 600 J6F/J7F/J8F Z 750 S (ZR 750 K1/K6F) KLZ 1000 B Versys	95-02 ▲ 03 03-04 ▲ 06-08 ▲ 05-06 ▲ 15-19 ▲
CK4459	KAWASAKI KXT 250 B1/B2 'Tecate' KX 250 D1/D2 KX 500 B1/B2	86-87 85-86 85-86			
CK4463	KAWASAKI KLT 110 A1/A2/A3 KLF 110 A1/A2/B1/B2 'Mojave'	84-86 87-88	CK4505	KAWASAKI KDX 200 H1-H11/H6F KDX 220 R A4-A12/A6F	95-06 97-06
CK4465 CT002 ▲	KAWASAKI KXT 250 A2 Tecate KX 250 C2	85 ▲ 84 ▲	CK4510 CKF4510 CT004 ▲ CT079SP ●	KAWASAKI Z 900 (ZR 900 A) Z 900 ABS (ZR 900 B) Z 900 RS (ZR 900 C)/RS Café (ZR 900 E) ZX9R (ZX 900 C1/C2/E1/E2/F1/F2) Z 1000 (ZR 1000 A1/A2/A3) Z 1000 ABS (ZR 1000 A6F/C7F) Z 1000 (ZR 1000 DAF/DBF/DCF/DDF) ZR 1000 B7F/B8F (Z1000) Z 1000 Performance Z 1000 SX Tourer ZX 10C1/C2/D6F/D7F/E8F/E9F/FAF/JBF/KBF/ JCF/KCF/JDF/JEF/JFF (ZX10R) ZX 1000 Ninja GBF/GCF/GDF 1000 Ninja ABS (ZX1000 HCF/HDF) 1000 Ninja ABS (ZX1000 MEF/MFF) ZX-10R (ZX 1000 KBF/KCF/KDF/KEF/KFF) ZX10 R (ZX 1000 C1/C2) ZX10 R (ZX 1000 D6F/D7F/E8F/E9F/FAF) ZX10 R (ZX 1000 JBF/JCF/JDF/JEF /JJF Non ABS) ZX10 R (ZX 1000 FFFA 30th Anniversary Edition - ABS) ZX10 R (ZX 1000 SGF) KRT Replica (ZX1000SGFA) ZX10 RR ZX10 RR Performance SUZUKI GSXR 1000 K1/K2/K3/K4/ZK4 GSX-S 1000 (Naked)/ABS (Naked) GSX-S 1000 F (Faired)/F ABS (Faired) YAMAHA FZ-10 YZF-R1/R1M YZF-R1S	17-21 ▲ 17-21 ▲ 18-21 ▲ 98-03 ▲ 03-05 ▲ 06-07 ▲ 10-13 ▲ 07-08 ▲ 16-19 ▲ 16-19 ▲ 11-13 ▲ 12-13 ▲ 14-15 ▲ 11-15 ▲ 04-05 ▲ 06-10 ▲ 11-15 ▲ 15 ▲ 16 ▲ 16-19 ▲ 17-21 ▲ 17-21 ▲
CK4468	KAWASAKI KX 80 E3/G1/G2/J2	85-87			
CK4469 CT042 ▲	KAWASAKI KX 125 D1/E1/E2 KDX 200 C1/C2/C3 KL 250 G4/G5/G6/G7/G8 "Super Sherpa" KLX 250 D2/D3/D4 KLX 250 S (KLX 250 H6F/H7F) KLX 250 S (KLX 250 T9F/TAF/TBF/TCF/TDF/TEF) KLX 250 SF (KLX 250 W9F/TAF) Supermotard KLX 300 R A2-A10/A6F/A7F KLX 300 R CLF	85-87 ▲ 86-88 ▲ 00-04 ▲ 93-95 ▲ 06-07 ▲ 09-14 ▲ 09-10 ▲ 97-07 ▲ 19-21 ▲			
CK4473 CT016 ▲	KAWASAKI EL 250 B2/B3 Eliminator EL 250 E1/E2/E3/E4 (250 HS) EX 250 E1/E2 Ninja EX 250 F2-F19/D6F/D7F Ninja	88-89 ▲ 91-95 ▲ 86-87 ▲ 88-07 ▲			
CK4475 CT006 ▲	KAWASAKI KX 250 E1/F1/G1/H1/H2 KX 500 C1/D1/E1-E16 KXF 250 A1/A2 Tecate 4 KDX 250 D1/D2/D3/D4	87-91 ▲ 87-04 ▲ 87-88 ▲ 91-94 ▲			
CK4477	KAWASAKI KX 80 L1	88			
CK4478	KAWASAKI KX 80 L2/N2/L3/N3/R1/R2/R3/R4/R5/R6/R7 KX 100 B5/B6/B7	89-97 95-97			
CK4482 CT042 ▲	KAWASAKI KX 125 KDX 200 E1-E6	88-89 ▲ 89-94 ▲			
CK4485 CT042 ▲	KAWASAKI KX 125 H1/H2/J1	90-92 ▲			
CK4488 CT021 ▲	KAWASAKI ZX 1100 C1-C4/D1-D9 (ZX11) ZX 1100 E1/E2/E3/F1 'GPZ 1100' ZX 1200 C1/C2/C3/C4 (ZZR 1200)	90-01 ▲ 95-97 ▲ 02-04 ▲			
CK4493 CT019 ▲	KAWASAKI ZR 750 C1/C2/C3/C4 Zephyr ZR 750 F2 (ZR-7) ZR 750 H1/H2/H3/H4/H5 (ZR-7S)	91-93 ▲ 00 ▲ 01-05 ▲			
CK4498 CT042 ▲	KAWASAKI KX 125 J2	93 ▲			
CK4511	KAWASAKI BN 125 A4-A8/A6F/A7F/A9F	01-09			
CK4513 CT009 ▲	KAWASAKI ZX12R (ZX 1200 A1)	00 ▲			
CK4514 CKF4514 CT003 ● CT004 ▲	KAWASAKI KLX 230 KX 250 F ZX6RR (ZX 600 M1/N1/N6F) ZX6R (ZX 600 P7F/P8F/R9F/RAF/RBF/RCF) ZX 636 C1/C6F ZX6R (ZX 636 EDF/EEF/EFF/EGF/EHF) 636cc/Non ABS ZX6R (ZX 636 EFFA) 636cc/ 30th Anniversary Edition Non ABS ZX6R (ZX 636 EGFA/EHFA) 636cc/Non ABS/KRT Edition ZX6R (ZX 636 FDF/FDF/FFF/FGF/FHF) 636cc/ABS ZX6R (ZX 636 FFFA) 636cc/ 30th Anniversary Edition ABS ZX6R (ZX 636 FGFA/FHFA) 636cc/ABS/KRT Edition SUZUKI RM 125 K2/K3/K4/K5/K6/K7/K8 RM-Z 250	20 ▲ 04-21 ▲ 04-06 ▲ 07-12 ▲ 05-06 ▲ 13-19 ▲ 15 ▲ 16-19 ▲ 13-19 ▲ 15 ▲ 16-19 ▲ 02-08 ● 04-21 ▲			

CK CLUTCH KIT BUYERS GUIDE

Part No.	Make/Model	Year	Part No.	Make/Model	Year
CK4515 CT009 ▲	KAWASAKI ZX12R (ZX 1200 A2/B1/B2/B3/B4)	01-05 ▲	CK5544 Contd.	HONDA ATC 200 ES Big Red Centrifugal (one way) clutch ATC 200 M Centrifugal (one way) clutch ATC 200 S Centrifugal (one way) clutch TRX 200 Fourtrax Centrifugal (one way) clutch	84 84-85 84-86 84
CK4516 CT032 ▲	KAWASAKI VN 1700 G9F/GAF Vulcan 1700 Classic LT VN 1700 A9FA/AAF/ABF/ACF/ADF Vulcan 1700 Voyager VN 1700 B9FA/BAF/BBF/BCF/BDF/BEF Vulcan 1700 Voyager ABS VN 1700 C9F/CAF/CBF/CCF/CDF Vulcan 1700 Nomad VN 1700 C9FA Vulcan 1700 Nomad 2T VN 1700 E9F/EAF/EBF/ECF Vulcan 1700 Classic VN 1700 JBF/JBFA/JCF Vaquero VN 1700 DEF/DEFA (Vulcan Nomad ABS) VN 1700 KEF (Vaquero ABS Vulcan) VN 2000 A1/A2/A6F/A7F/G8F/G9F Vulcan VN 2000 D1/D6F/G8F Vulcan Ltd VN 2000 E6F/E7F/H8F/H9F Vulcan Classic VN 2000 F6F/F7F/J8F/J9F/JAF Vulcan Classic LT	09-10 ▲ 09-13 ▲ 09-14 ▲ 09-13 ▲ 09 ▲ 09-12 ▲ 11-13 ▲ 14-21 ▲ 14-21 ▲ 04-09 ▲ 05-06 ▲ 06-09 ▲ 06-10 ▲	CK5588 CKF5588 CT021 ▲	TRIUMPH Adventurer Daytona 750 (3cyl) Daytona 1000 (4cyl) Daytona 900 (3cyl) Daytona Super III (3cyl) Daytona 1200 (4cyl) Legend TT Speed Triple (carb model) Sprint (All carb models) Thunderbird Thunderbird Sport Tiger 900cc Trident 900 Trophy 900 (3cyl) Trophy 1200 (4cyl)	96-01 ▲ 92 ▲ 92 ▲ 93-96 ▲ 94-97 ▲ 93-98 ▲ 98-01 ▲ 94-97 ▲ 93-98 ▲ 95-03 ▲ 98-04 ▲ 93-96 ▲ 92-98 ▲ 92-01 ▲ 92-01 ▲
CK4518 CT021 ▲	KAWASAKI ZX 14 R (ZX 1400 A6F/A7F) ZX 14 R ABS (ZX 1400 B6F/B7F) ZX 14 R ABS ZX 14 R ABS Performance ZX 14 R ABS Performance Sport (ZX 1400 JGF)	06-07 ▲ 06-07 ▲ 08-16 ▲ 12-21 ▲ 14-21 ▲	CK5589 CKF5589 CT009 ▲	TRIUMPH T595 Daytona Daytona 955i Speed Triple (EFI) Sprint RS Sprint ST Tiger 900cc Tiger 955cc	97-98 ▲ 98-00 ▲ 97-01 ▲ 99-01 ▲ 99-01 ▲ 97-98 ▲ 99-06 ▲
CK4519 CT006 ▲	KAWASAKI KFX 450 R (KSF 450 B8F/B9F/BAF/BBF/BCS)	08-12 ▲	CK5594 CKF5594 CT027 ▲ CT057SP ■	KTM SX 60 SX 65 SX 65 XC 65 XC 65	98-00 ▲ 98-08 ▲ 09-18 ■ 08 ▲ 09-13 ■
CK4520 CT021 ▲	KAWASAKI Concours 14 (ZG 1400 B8F/B9F/DAF) Concours 14 ABS (ZG 1400 A8F/A9F/CAF/CBF /CCF/CDF/CEF)	08-10 ▲ 08-14 ▲	CK5595 CKF5595 CT007 ▲ CT049 ■	KTM 250 EGS 250 EXC SX 250 (2T) 250 MXC 250 SXS XC 250 (2T) XC-W 250 (2T) 300 E-GS 300 EXC 300 MXC SX 300 300 Six Days XC 300 XC-W 300 360 EXC 360 EGS 360 MXC 360 SX 360 Six Days SX 380 380 MXC 380 EXC RXE-E 400 RXE-E 620 Reklus Aftermarket Clutch for SX/XC (2T Models/24 tooth steel plate)	94-99 ▲ 94-05 ▲ 94-12 ▲ 98-99 ▲ 01-03 ▲ 06-12 ▲ 06-12 ▲ 94-99 ▲ 94-05 ▲ 94-05 ▲ 94 ▲ 96 ▲ 06-12 ▲ 06-11 ▲ 96-97 ▲ 96-97 ▲ 96-97 ▲ 96-97 ▲ 96 ▲ 98-02 ▲ 98-01 ▲ 98-02 ▲ 95 ▲ 95 ▲ 03-11 ■
CK4521 CT009 ▲	KAWASAKI EX 250 J8F/J9F/JAF/JBF/JCF Ninja 250 R	08-12 ▲	CK5597 CT009SP ■	TRIUMPH Bonneville 800 Bonneville T-100	01-06 ■ 02-04 ■
CK4522	KAWASAKI KLX 140 (F 17"/R 14") KLX 140 L (F 19"/R 16") KLX 140 G (F 21"/R 18") KLX 150 S	08-21 08-21 17-21 09			
CK4523 CT004 ▲	KAWASAKI H2-B Mach IV (2T) H2-C Mach IV (2T)	74- ▲ 75 ▲			
CK4524 CT009 ▲	KAWASAKI EX 300 ADF/ADFA/AEF/AEFA/AES/AESA Ninja EX 300 BDFA/BDF/BEF/BEFA Ninja Versys-X 300 ABS	13-19 ▲ 13-19 ▲ 17-21 ▲			
CK4528	KAWASAKI Ninja H2	15-21			
CK4529	KAWASAKI Ninja H2R	15-21			
CK4530	KAWASAKI Ninja 400 Z 400	17-21 17-21			
CK4531	KAWASAKI KX-F 450	19-21			
CK5544	HONDA ATC 185/185 S Centrifugal (one way) clutch ATC 200 Centrifugal (one way) clutch ATC 200 E Big Red Centrifugal (one way) clutch	80-83 81-83 82-83			

CLUTCH BUYERS GUIDE

CK CLUTCH KIT BUYERS GUIDE

Part No.	Make/Model	Year	Part No.	Make/Model	Year
CK5599 CKF5599 CT009 ▲	TRIUMPH Daytona 955i Speedtriple 955cc Sprint RS Sprint ST Speedtriple (1050cc) Tiger (1050cc)	01-06 ▲ 02-04 ▲ 02-04 ▲ 02-09 ▲ 05-09 ▲ 07-09 ▲	CK5612 CT023 ▲	KTM 250 EXC Racing 250 EXC-G Racing 400 SX Racing 400 EXC 400 EXC Racing 400 EXC-G Racing 400 MXC 450 EXC-G Racing 450 EXC Racing 450 EXC 450 LXC-G Racing 450 MXC-G Racing 450 SX Racing MXC 450 SMR 450 450 SMS SX 450 XC 450 (Quad) 520 SX Racing 525 EXC 525 EXC Racing 525 EXC Racing EXC 525 Racing (4T) 525 EXC G Racing 525 MXC Desert Racing MXC 525 SX 525 525 SX Racing 525 SMR XC 525 (Quad) 540 SXS Racing SMR 560	02-03/05 ▲ 03 ▲ 02 ▲ 07 ▲ 02/05 ▲ 02/05-06 ▲ 02 ▲ 03 ▲ 03/05 ▲ 04-07 ▲ 05 ▲ 03/05 ▲ 03/05 ▲ 06 ▲ 04-06 ▲ 04 ▲ 06 ▲ 08-12 ▲ 02 ▲ 03 ▲ 05 ▲ 07 ▲ 03/05 ▲ 03/05 ▲ 06 ▲ 06 ▲ 03 ▲ 04-05 ▲ 08-12 ▲ 02 ▲ 06 ▲
CK5602	KTM 250 EXC-G Racing 250 EXC Racing 400 EXC 400 MXC SX 400 450 EXC-G Racing 450 EXC racing 450 MXC-G Racing 450 SX Racing 520 EXC SX 520 525 EXC Racing 525 EXC-G Racing 525 MXC-G Racing 525 MXC Desert Racing 525 SX Racing	04 04 00-01 01 00-01 04 04 04 04 04 00-01 00-01 04 04 04 04 04-05			
CK5605	BMW F 650 (E169/0161) F 650 (E169/0162) F 650 ST (E169/163/168) Strada	09/93-96 97-00 97-00			
CK5608	TRIUMPH America (865cc) Bonneville (865cc) (Cast wheel) Bonneville SE (865cc) (Cast wheel) Bonneville America Speedmaster 800 Scrambler (865cc) Thruxton SE (865cc) Thruxton 900 Bonneville T100 Bonneville T100 (865cc) Steve McQueen	08-12 09-12 42713 02-08 03-09 06-09 12 04-09 05-09 12			
CK5610 CT027 ▲ CT028 ■	KTM 85 SX (17/14" & 19/16" Wheel Models) SX 85 (17"/14") SX 85 (19"/16") 85 XC 105 SX XC 105	03-17 ▲ 03-17 ■ 03-17 ■ 08-09 ▲ 04-11 ▲ 08 ▲			
CK5611 CKF5611 CT001 ▲	HUSQVARNA TC 125 KTM SX 125 125 EXC 125 EXE 125 EGS 125 Supermoto 125 SXS SX 150 XC 150 SX 200 200 EGS 200 EXC 200 MXC XC-W 200 XC 200	14-20 ▲ 98-21 ▲ 98-05 ▲ 00-01 ▲ 98-99 ▲ 00-01 ▲ 01-02 ▲ 08-21 ▲ 10-15 ▲ 03 ▲ 98-99 ▲ 97-05 ▲ 98-03 ▲ 07-15 ▲ 06-09 ▲			
			CK5619	KTM 660 SM Factory Replica 660 SMC 660 SMS	02-03 03-04 04
			CK5624 CT021 ▲	TRIUMPH Rocket III (All models)	04-12 ▲
			CK5631 CT031 ▲	KTM 350 EXC 350 Super Comp 380 EGS 400 Duke 400 EGS 400 EGS-E 400 EXC 400 Super Comp 400 Super Comp/EXC 400 LSE 400 LC-4 400 LS-E 400 RXC-E 400 SX-C 400 SX SXC 400 400 SXC 400 LC4-E LC4 R 400 400 TXC 620 Duke 620 Super Comp 620 EXC 620 EGS 620 EGS/Adventure 620 EGS-E 620 LSE 620 Enduro Ltd 620 LC-4	94 ▲ 94-95 ▲ 98-99 ▲ 94-95 ▲ 94/96-97 ▲ 97 ▲ 94/96 ▲ 95 ▲ 96-99 ▲ 97 ▲ 98 ▲ 04 ▲ 96-97 ▲ 98 ▲ 99 ▲ 97 ▲ 00 ▲ 00-01 ▲ 99 ▲ 98 ▲ 94/97 ▲ 94-95 ▲ 94-95 ▲ 94-95 ▲ 96-97 ▲ 97 ▲ 97 ▲ 97 ▲ 97 ▲ 97 ▲ 98 ▲

CLUTCH BUYERS GUIDE

CK CLUTCH KIT BUYERS GUIDE

Part No.	Make/Model	Year	Part No.	Make/Model	Year
CK5631 CT031 ▲ Contd.	KTM 620 RXC-E SXC 620 620 Six Days 640 LC Rallye Dakar 660 LC4	96-97 ▲ 97 ▲ 96 ▲ 97 ▲ 97 ▲	CK5641 CT031 ▲	KTM 690 Rally Factory Rep	07-08 ▲
	CK5632 CT075 ▲	KTM 400 RXC-E EXC 400 (LC4 Engine) SC 400 620 RXC-E		95 ▲ 93-95 ▲ 95 ▲ 95 ▲	CK5642
CK5633 CT031 ▲	KTM 660 Rallye 660 Rallye Factory	01-03 ▲ 04 ▲	CK5644 CT021 ▲	KTM 1190 RC8-R (6 spring type clutch) 1190 RC8 (6 spring type clutch)	
CK5634 CT015 ▲	KTM 950 Adventure 950 R Superenduro 950 Supermoto 990 Superduke 990 Adventure 990 Adventure S 990 Adventure Baja Edition 990 Superduke R 990 SM-R/SM-T	03-04/06 ▲ 07-08 ▲ 13-14 ▲ 06-09 ▲ 07-11 ▲ 07-09 ▲ 13-14 ▲ 07-11 ▲ 09-11 ▲		CK5648 CT041 ▲	KTM XC-W 400 XCR-W 450 XC-W 450 Champions Edition EXC-R 450 EXC 450 XC-W 450 Six Days XCR-W 530 EXC 530 EXC 530 Champion Edition EXC-R 530 XC-W 530 Six Days
CK5635 CT083 ▲	BMW F 650 GS Dakar (R13/0176/0186) F 650 CS Scarver (K14/0177/0187) G 650 GS (R13) G 650 GS Sertao (R13) G 650 X Country (K15)	04-07 04-07 08-16 ▲ 10-14 ▲ 08-10 ▲	CK5651 CKF5651 CT023 ▲	HUSQVARNA FC 250 TC 250 TE 250 TE 300 TX 300i FC 350 FE 350 FX 350 FC 450 FC 450 Rockstar Edition FE 450 FR 450 Rally FS 450 FX 450 FE 501 FE 501S	14-21 ▲ 14-21 ▲ 14-21 ▲ 14-21 ▲ 18-21 ▲ 14-21 ▲ 14-21 ▲ 17-21 ▲ 14-21 ▲ 20-21 ▲ 14-21 ▲ 17-21 ▲ 15-21 ▲ 17-21 ▲ 14-21 ▲ 16 ▲
CK5636	BMW F 650 GS Dakar (R13/0173/0183) F 650 CS Scarver (K14/0174/0184)	99-03 00-03		KTM SX-F 250 (4T) SX 250 (2T) XC 250 (2T) XC-W 250 (2T) (Diaphragm Spring) XC-F 250 XC-W 300 (Diaphragm Spring) XC 300 (Diaphragm Spring) XC 300 EXC-F 350 SX-F 350 XC-F 350 XCF-W 350 SX-F 450 SX-F 450 Diaphragm Spring XC-F 450 Diaphragm Spring XC-W 450 XC-W 450 Diaphragm Spring	13-21 ▲ 13-21 ▲ 13-15 ▲ 13-15 ▲ 13-15 ▲ 13-15 ▲ 13-21 ▲ 13-21 ▲ 13 12-15 ▲ 11-21 ▲ 11-21 ▲ 12-21 ▲ 12-15 ▲ 13-21 ▲ 13-15 ▲ 12 ▲ 12-15 ▲
CK5638 CT009 ▲	KTM XC-W 450 SX-F 450 SX 450 (Quad) XC-F 450 SX-F 505 SX 505 (Quad) XC-F 505	08-09 ▲ 07-11 ▲ 09-12 ▲ 08-09 ▲ 07-08 ▲ 09-12 ▲ 08-09 ▲	CK5639 CT031 ▲	KTM 540 SXC 620 LC4 Competition/Supermoto 620 Super Comp SX 620 620 SC 620 Supermoto/TXC 625 SMC 625 SC 625 SXC 640 Adventure-R 640 Duke-E 640 Duke II 640 LC4 640 LC4-E 640 LC4 Adventure 640 LC4 Supermoto 640 LC4 Six Days 660 LC4 Rallye 660 SMC 660 SMS 660 SM Factory Replica	98-99 99 ▲ 96-99 ▲ 97-99 ▲ 00-01 ▲ 98 ▲ 04/06 ▲ 02 ▲ 03-04 ▲ 98-02 ▲ 98 ▲ 99-04 ▲ 99-00 ▲ 00-02 ▲ 05-06 ▲ 03-04 ▲ 99 ▲ 99-00 ▲ 03-04 ▲ 04 ▲ 02-03 ▲

CLUTCH BUYERS GUIDE

CK CLUTCH KIT BUYERS GUIDE

Part No.	Make/Model	Year	Part No.	Make/Model	Year
CK5651 CKF5651 CT023 ▲	HUSQVARNA EXC 500 EXC 500 Diaphragm Spring XC-W 500 XC-W 500 Diaphragm Spring	12 ▲ 13-15 ▲ 12 ▲ 13-15 ▲	CK5669 CT086SP ▲ Contd.	TRIUMPH Bonneville Bobber Black (1200cc Liquid Cooled) Street Cup (900cc Liquid Cooled) Street Scrambler (900cc Liquid Cooled) Street Twin (900cc Liquid Cooled) Thrupton 1200 (Liquid Cooled) Thrupton R 1200 (Liquid Cooled)	18-21 ▲ 16-21 ▲ 16-21 ▲ 16-21 ▲ 16-21 ▲ 16-21 ▲
CK5656	HUSQVARNA TC 450 TE 450 SMR 570 TC 570 TE 570 TE 610	02-06 02-06 03-04 03-04 03-04 05-12	CK5670	DUCATI 959 Panigale	17-20
CK5657	HUSQVARNA TC 250 TE 250 2T TE 310	03-08 03-09 08-10	CK5672	BETA Enduro RR 250 2T Enduro RR 300 2T Enduro RR 350 4T Enduro RR 390 4T Enduro RR 430 4T Enduro RR 480 4T	18-20 18-20 18-20 18-20 18-20 18-20
CK5660 CT085 ▲	BMW F650 GS (Late type plates 2 x 13mm /7 x 14mm ears) F700 GS (Late type plates 2 x 13mm /7 x 14mm ears) F800 GS (Late type plates 2 x 13mm /7 x 14mm ears) F800 GS Adventure (Late type plates 2 x 13mm /7 x 14mm ears) F800 GT (Late type plates 2 x 13mm /7 x 14mm ears) F800 S (Late type plates 2 x 13mm /7 x 14mm ears) F800 ST (Late type plates 2 x 13mm /7 x 14mm ears) F800 R (Late type plates 2 x 13mm /7 x 14mm ears)	07-19 ▲ 11-19 ▲ 12-19 ▲ 12-19 ▲ 07-19 ▲ 07-19 ▲ 07-19 ▲ 07-19 ▲ 05-19 ▲	CK5672	KTM TBC	
CK5661	DUCATI 899 Panigale	13-15	CK5674	HUSQVARNA TC 50 KTM SX 50	17-19 13-19
CK5664	DUCATI Daytona 675 Daytona 675 R	13- 13-	CK5675	DUCATI Monster 620 ie	01-06
CK5665	KTM 390 Duke RC 390	13-14 14-15	CK5676	BMW R 1200 GS R 1200 GS Adventure R 1200 R R 1200 RS R 1250 GS/GS TE R 1250 GS Rallye/GS Rallye TE R 1250 GS Adventure R 1250 GS Adventure TE R 1250 GS Adventure Rallye R 1250 GS Adventure Rallye TE	13-18 13-18 13-18 14-18 19-21 19-21 19-21 19-21 19-21 19-21 19-21
CK5666	KTM 390 Duke RC 390	15-17 16-17	CK5681	TRIUMPH Tiger 800 XR (from VIN 674842)	>2018
CK5667 CT085 ▲	BMW F800 GS (Early type plates 14mm ears) F800 GT (Early type plates 14mm ears) F800 S (Early type plates 14mm ears) F800 ST (Early type plates 14mm ears)	08-11 ▲ 04-06 ▲ 04-06 ▲ 04-06 ▲	CK5682	BMW K 1300 GT K 1300 R K 1300 S	08-11 08-12 08-16
CK5668 CKF5668 CT087SP ▲	HUSQVARNA TC 85 (F 17"/R 14") TC 85 (F 19"/R 16") KTM SX 85 (F 17"/R 14") SX 85 (F 17"/R 14")	18-21 ▲ 18-21 ▲ 18-21 ▲ 18-21 ▲	CK5683	KTM 1050 Adventure 1090 Adventure Inc R model 1090 Adventure L and S models 1190 Adventure 1190 Adventure R 1190 RC8 R (3 Spring Type Clutch) 1290 Super Adventure 1290 Super Adventure R&S models 1290 Super Adventure T 1290 Superduke GT 1290 Superduke R	15-16 17-19 2019 13-16 13-16 13-15 15-16 17-21 17 17-19 16-19
CK5669 CT086SP ▲	TRIUMPH Bonneville T100 (900cc/Liquid Cooled) Bonneville T100 Black (900cc/Liquid Cooled) Bonneville T120 (1200cc Liquid Cooled) Bonneville T120 Black (1200cc Liquid Cooled) Bonneville Bobber (1200cc Liquid Cooled)	16-21 ▲ 16-21 ▲ 16-21 ▲ 16-21 ▲ 17-21 ▲	CK6680	APRILIA RSV 1000 R Factory/R	04-08
			CK6681 CT014 ▲	APRILIA RSV4R RSV4 Factory RSV4 Factory APRC	10-12 ▲ 09-12 ▲ 11-12 ▲

CK CLUTCH KIT BUYERS GUIDE

Part No.	Make/Model	Year	Part No.	Make/Model	Year
CK7001	INDIAN Octane Scout Scout/Scout 1200 Scout Bobber Scout Sixty	17 15-16 17-21 18 16-21	CK7007 CT708SP ▲	HARLEY DAVIDSON FLHTCUTG Tri Glide Ultra FLRT Freewheeler FLHTCUTG Tri Glide Ultra Anniversary FLHP Road King Police FLHTP Electra Glide Standard Police FLFBS Fat Boy 114 Anniversary FLHCS Heritage Classic 114 FLHCS Heritage Classic 114 Anniversary FXFBS Fat Bob 114 FLFBS Fat Boy 114 FXBRS Breakout 114 FXBRS Breakout 114 Anniversary	17-21 ▲ 17-21 ▲ 18-21 ▲ 17 ▲ 17 ▲ 18-21 ▲ 18-21 ▲ 18-21 ▲ 18-21 ▲ 18 ▲ 18-21 ▲ 18 ▲
	CK7002 CT702SP ▲	HARLEY DAVIDSON FLHTCUTG 1MAL Tri Glide Ultra Classic FLRT 1MCM Freewheeler FLHTK 103 1TEL CVO Limited FLHTCUL 1KDM Ultra Classic Low FLHTCUL TC 1KFL Ultra Classic Low Twin-Cooled FLHTKL 1KKL Ultra Limited Low FLHR 1FBC Road King FLHRC 1FRC Road King Classic FLHTCU 1FCC Electra Glide Ultra Classic FLHTK 1KED Ultra Limited FLHTKL 1KKD Ultra Limited Low FLHX 1KBC Street Glide FLHXS 1KRC Street Glide Special FLTRU 1KGD Road Glide Ultra FLTRX 1KHC Road Glide FLTRXS 1KTC Road Glide Special FLHRXS 1KVC Road King Special FLHTK 1KND Ultra Limited Shrine Edition FLHTK 1KWD Ultra Limited Anniversary FLHX 1KXC Street Glide Anniversary FLHXS 1KYC Street Glide Special Anniversary FLSS 1JS9 Softail Slim S FLSTFBS 1JT9 Fat Boy S FLSS 1JS9 Slim S FLSTFBS 1JT9 Fat Boy S		14-16 ▲ 15-16 ▲ 14 ▲ 15-21 ▲ 15-21 ▲ 15-16 ▲ 17 ▲ 17 ▲ 17-21 ▲ 17-21 ▲ 17-21 ▲ 17-18 ▲ 17-21 ▲ 17-21 ▲ 17-21 ▲ 17-21 ▲ 18 ▲ 18 ▲ 18 ▲ 18 ▲ 18 ▲ 18 ▲ 18 ▲ 16 ▲ 16-17 ▲ 17-21 ▲ 17 ▲	CK7008 CT703SP ▲
CK7003	INDIAN Chief Classic Chief Dark Horse Chief Vintage Chieftain Chieftain Dark Horse Chieftain Elite Chieftain Limited Roadmaster Roadmaster Classic Roadmaster Elite Springfield Springfield Dark Horse	14-21 16-21 14-18 14-21 16-21 17-21 17-18 15-18 17-21 18-21 16-21 18			
CK7004	HARLEY DAVIDSON STREET XG500 XG750	15-20 15-20			
CK7005 CT706SP ▲	HARLEY DAVIDSON VRSCAW 1HFH V-Rod Wide Tire VRSCAWA 1HKH W/ABS VRSCD 1HDH Night Rod VRSCDA 1HLH Night Rod W/ABS VRSCDXA 1HMH Night Rod Special W/ABS VRSCDX 1HHH Night Rod Special VRSCAW 1HFH V-Rod VRSCF 1HPH V-Rod Muscle VRSCDX ANV 1HHH_ANV Night Rod Special Anv	08 ▲ 08 ▲ 08 ▲ 08 ▲ 08 ▲ 08-21 ▲ 09-10 ▲ 09-21 ▲ 12 ▲			
CK7006 CT707SP ▲	HARLEY DAVIDSON VRSCA V-Rod VRSCSE CVO V-Rod VRXSE CVO VR Destroyer VRSCR Street Rod VRSCX Screamin' Eagle V-Rod	02-07 ▲ 05-06 ▲ 06 ▲ 06-07 ▲ 07 ▲			

CLUTCH BUYERS GUIDE

CK CLUTCH KIT BUYERS GUIDE

Part No.	Make/Model	Year	Part No.	Make/Model	Year
CK7008	HARLEY DAVIDSON		CK7008	HARLEY DAVIDSON	
CT703SP ▲	FLHPE 1FTM Road King Police	11 ▲	CT703SP ▲	FXDBA 1VB4 Dyna Street Bob (H-D1)	13 ▲
Contd.	FLHR 103 1FBM Road King	11 ▲		FXDC ANV 1GV4_ANV Dyna Super Glide Custom ANV	13 ▲
	FLHR 96 FB4 Road King	11 ▲		FXS 1JP5 Blackline	13 ▲
	FLHRC 103 1FRM Road King Classic	11 ▲		FXDBP 103 1VAM Dyna Street Bob (H-D1)	13-14 ▲
	FLHTC 103 1FFM Electra Glide Classic	11 ▲		FXSB 103 1BFV Softail Breakout	13-15 ▲
	FLHTCU 103 1FCM Ultra Classic	11 ▲		FXSB 1BF5 Softail Breakout	13-15 ▲
	FLHX 103 1KBM Street Glide	11 ▲		FXDC 103 1GVM Dyna Super Glide Custom	14 ▲
	FLTRX 103 1KHM Road Glide Custom	11 ▲		FXDBB 103 1VCM Dyna Street Bob (H-D1)	14-15 ▲
	FLHP 1FHM Road King Police	11-16 ▲		FXDB 103 1GXM Dyna Street Bob	14-16 ▲
	FLHTP 1FMM Electra Glide Standard Police	11-16 ▲		FXDL 103 1GNM Dyna Low Rider	14-16 ▲
	FLTRU 1KGM Road Glide Ultra	11-13 ▲		FXDBB 1VC4 Dyna Street Bob (H-D1)	15 ▲
	FLHTC 1FFM Electra Glide Classic	12 ▲		FXDBP 103 1VAM Dyna Street Bob (H-D1)	15 ▲
	FLHR 1FBM Road King	12-13 ▲		FXDBC 103 1VDM Dyna Street Bob Limited	16 ▲
	FLHRC 1FRM Road King Classic	12-13 ▲		FXDBC 1VD4 Dyna Street Bob Limited	16 ▲
	FLHTCU 1FCM Ultra Classic	12-13 ▲		FXDBP 103 1VAM Dyna Street Bob	16 ▲
	FLHX 1KBM Street Glide	12-13 ▲		FXDWG 103 1GPM Dyna Wide Glide	16 ▲
	FLTRX 1KHM Road Glide Custom	12-13 ▲		FXSB 1BFV Softail Breakout	16 ▲
	FLHR ANV 1FBM_ANV Road King ANV	13 ▲		FXDLS 1GS8 Dyna Low Rider S	16-21 ▲
	FLHTC 1FFM Electra Glide Classic	13 ▲		FXDB 103 1GXM Dyna Street Bob 103	17 ▲
	FLHTK ANV 1KEM_ANV Electra Glide Ultra Limited ANV	13 ▲		FXDL 103 1GNM Low Rider 103	17 ▲
	FLHRC 1FRM Road King Classic	14-21 ▲		FXDWG 103 1GPM Dyna Wide Glide 103	17 ▲
	FLHTCU 1FCM Ultra Classic	14-21 ▲		FXSB 1BFV Breakout	17 ▲
	FLHTCU TC 1KSL Ultra Classic Twin-Cooled	14-16 ▲		FLSTC 1BJL Heritage Softail Classic	98-99 ▲
	FLHTK 1KEL Ultra Limited	14-16 ▲		FLSTF 1BML Fat Boy	98-99 ▲
	FLHX 1KBM Street Glide	14-16 ▲		FXSTC 1BKL Softail Custom	98-99 ▲
	FLHXS 1KRM Street Glide Special	14-16 ▲		FXSTS 1BLL Springer Softail	98-99 ▲
	FLTRXS 1KTM Road Glide Special	15 ▲		FLSTS 1BRL Heritage Springer	98-03 ▲
	FLHR 1FBM Road King	15-21 ▲		FXST 1BHL Softail Standard	99 ▲
	FLTRX 1KHM Road Glide	15-16 ▲		FXSTB 1BTL Night Train	99 ▲
	FLTRU 1KGL Road Glide Ultra	16 ▲		FLSTC 1BJY Heritage Softail Classic	00-03 ▲
	FLTRXS 1KTM Road Glide Special	16 ▲		FLSTF 1BMY Fat Boy	00-03 ▲
	FXD 1GHL Dyna Super Glide	98 ▲		FXST 1BHY Softail Standard	00-03 ▲
	FXDWG 1GEL Dyna Wide Glide	98 ▲		FXSTB 1BTY Night Train	00-03 ▲
	FXDL 1GDL Dyna Low Rider	98-03 ▲		FXSTD 1BSY Softail Deuce	00-03 ▲
	FXDS-CONV GGVX Dyna Glide Convertible	99 ▲		FXSTS 1BLY Springer Softail	00-03 ▲
	FXDX 1GJV Dyna Super Glide Sport	99-03 ▲		FLSTCI 1BWB Heritage Softail Classic	01-03 ▲
	FXDWG 1GEV Dyna Wide Glide	99-05 ▲		FLSTFI 1BXB Fat Boy	01-03 ▲
	FXDS-CONV GGVY Dyna Glide Convertible	00 ▲		FLSTSI 1BYB Heritage Springer	01-03 ▲
	FXD 1GHV Dyna Super Glide	00-03 ▲		FXSTBI 1JAB Night Train	01-03 ▲
	FXDXT 1GLV Dyna Super Glide T-Sport	01-03 ▲		FXSTDI 1JBB Softail Deuce	01-03 ▲
	FXDWGI 1GPW Dyna Wide Glide	04 ▲		FXSTI 1BVB Softail Standard	01-03 ▲
	FXD 1GHV Dyna Super Glide	04-05 ▲		FXSTSI 1BZB Springer Softail	01-03 ▲
	FXDI 1GMW Dyna Super Glide	04-05 ▲		FLSTC 1BJY Heritage Softail Classic	04-05 ▲
	FXDL 1GDV Dyna Low Rider	04-05 ▲		FLSTCI 1BWB Heritage Softail Classic	04-05 ▲
	FXDLI 1GNW Dyna Low Rider	04-05 ▲		FLSTF 1BMY Fat Boy	04-05 ▲
	FXDX 1GJV Dyna Super Glide Sport	04-05 ▲		FLSTFI 1BXB Fat Boy	04-05 ▲
	FXDXI 1GRW Dyna Super Glide Sport	04-05 ▲		FXSTB 1BTY Night Train	04-05 ▲
	FXDC 1GTV Dyna Super Glide Custom	05 ▲		FXSTBI 1JAB Night Train	04-05 ▲
	FXDCI 1GVW Dyna Super Glide Custom	05 ▲		FXSTD 1BSY Softail Deuce	04-05 ▲
	FXDWGI 1GPW Dyna Wide Glide	05 ▲		FXSTDI 1JBB Softail Deuce	04-05 ▲
	FXD35 1GW1 Dyna 35th Anniversary Super Glide	06 ▲		FXSTI 1BVB Softail Standard	04-05 ▲
	FXDBI 1GX1 Dyna Street Bob	06 ▲		FXSTS 1BLY Springer Softail	04-05 ▲
	FXDCI 1GV1 Dyna Super Glide Custom	06 ▲		FXSTSI 1BZB Springer Softail	04-06 ▲
	FXDI 1GM1 Dyna Super Glide	06 ▲		FXST 1BHY Softail Standard	04-06 ▲
	FXDWGI 1GP1 Dyna Wide Glide	06 ▲		FLSTCI Shrine 1JHB Heritage Softail Classic Shrine	05 ▲
	FXDL 1GN4 Dyna Low Rider	07-21 ▲		FLSTFI Shrine 1JGB Fat Boy Shrine	05 ▲
	FXD 1GM4 Dyna Super Glide	07-10 ▲		FLSTN 1BNY Softail Deluxe	05 ▲
	FXDC 1GV4 Dyna Super Glide Custom	07-14 ▲		FLSTNI 1JDB Softail Deluxe	05 ▲
	FXDWG 1GP4 Dyna Wide Glide	07-16 ▲		FLSTSC 1BRY Springer Classic	05 ▲
	FXDB 1GX4 Dyna Street Bob	07-21 ▲		FLSTSCI 1BYB Springer Classic	05-06 ▲
	FXDWG ANV 1GP4 Dyna Wide Glide 105th Anniversary	08 ▲		FLST 1JEY Heritage Softail	06 ▲
	FXDF 1GY4 Dyna Fat Bob	08-17 ▲		FLSTC 1BJY Heritage Softail Classic	06 ▲
	FXS 1JP5 Blackline	11 ▲		FLSTCI 1BWB Heritage Softail Classic	06 ▲
	FXS 1JP5 Blackline	12 ▲		FLSTFI 1BXB Fat Boy	06 ▲
	FXS 103 1JPV Blackline	12-13 ▲		FLSTI 1JFB Heritage Softail	06 ▲
	FXDWG 103 1GPM Dyna Wide Glide	12-15 ▲		FLSTN 1BNY Softail Deluxe	06 ▲
	FLD 103 1GZM Dyna Switchback	12-16 ▲		FLSTNI 1JDB Softail Deluxe	06 ▲
	FLD 1GZ4 Dyna Switchback	12-21 ▲		FLSTSC 1BRY Springer Classic	06 ▲
	FXDF 103 1GYM Dyna Fat Bob	12-17 ▲		FXSTB 1BTY Night Train	06 ▲
	FXDBA 103 1VBM Dyna Street Bob (H-D1)	13 ▲		FXSTBI 1JAB Night Train	06 ▲

CK CLUTCH KIT BUYERS GUIDE

Part No.	Make/Model	Year	Part No.	Make/Model	Year
CK7008 CT703SP ▲ Contd.	HARLEY DAVIDSON		CK7009 CT701SP ▲ Contd.	HARLEY DAVIDSON	
	FXSTD 1BSY Softail Deuce	06 ▲		FXDWG 1GEL Dyna Wide Glide	93-97 ▲
	FXSTDI 1JBB Softail Deuce	06 ▲		FXD 1GHL Dyna Super Glide	95-97 ▲
	FXSTI 1BVB Softail Standard	06 ▲		XL883DLX 4CFM Sportster 883 Deluxe	91-95 ▲
	FXSTS 1BLY Springer Softail	06 ▲		XL1200 1CAP Sportster 1200	91-03 ▲
	FXSTSI 1BZB Springer Softail	06 ▲		XL883 4CAM Sportster 883	91-03 ▲
	FLSTF 1BMY Fat Boy	06-15 ▲		XL883HUG 4CEM Sportster 883 Hugger	91-03 ▲
	FLSTSC 1BY5 Springer Classic	07 ▲		XL1200C 1CGP Sportster 1200 Custom	96-03 ▲
	FXSTD 1JB5 Softail Deuce	07 ▲		XL1200S 1CHP Sportster 1200 Sport	96-03 ▲
	FXSTB 1JA5 Night Train	07-09 ▲		XL883C 4CJM Sportster 883 Custom	98-03 ▲
	FXSTC 1JL5 Softail Custom	07-10 ▲		XL883R 4CKM Sportster 883R	02-06 ▲
	FXST 1BV5 Softail Standard	07-11 ▲		XL1200C 1CGP Sportster 1200 Custom	04-06 ▲
	FLSTC 1BW5 Heritage Softail Classic	07-15 ▲		XL1200R 1CLP Sportster 1200 Roadster	04-06 ▲
	FLSTN 1JD5 Softail Deluxe	07-15 ▲		XL883 4CAM Sportster 883	04-06 ▲
	FLST 1JE5 Heritage Softail	08-09 ▲		XL883C 4CJM Sportster 883 Custom	04-06 ▲
	FXCW 1JJ5 Rocker	08-09 ▲		XL883L 4CMM Sportster XL883 Low	05 ▲
	FLSTSB 1JM5 Cross Bones	08-11 ▲		XL1200L 1CWP Sportster 1200 Low	06 ▲
	FXCWC 1JK5 Rocker C	08-11 ▲		XL883L 4CMM Sportster XL883 Low	06 ▲
	FLSTFB 1JN5 Fat Boy LO	10-11 ▲		XL50 1CY3 50th ANV Sportster	07 ▲
	FLS 103 1JRV Softail Slim	12 ▲		XL1200R 1CV3 Sportster 1200 Roadster	07-09 ▲
	FLSTC 103 1BWV Heritage Softail Classic	12 ▲		XL883 4CN2 Sportster 883	07-09 ▲
	FLSTF 1BX5 Fat Boy	12 ▲		XL883L 4CR2 Sportster XL883 Low	07-09 ▲
	FLSTFB 1JN5 Fat Boy LO	12 ▲		XL883C 4CP2 Sportster 883 Custom	07-10 ▲
	FLSTF 103 1BXV Fat Boy	12-14 ▲		XL883R 4CS2 Sportster 883R	07-10 ▲
	FLS 1JR5 Softail Slim	12-15 ▲		XL1200L 1CX3 Sportster 1200 Low	07-11 ▲
	FLSTFB 103 1JNV Fat Boy LO	12-15 ▲		XL1200N 1CZ3 Nightster	07-12 ▲
	FLSTN 103 1JDV Softail Deluxe	12-15 ▲		XL1200C 1CT3 Sportster 1200 Custom	17-21 ▲
	FXST 1BVV Softail Standard	12-15 ▲		XL883N 4LE2 Iron 883	09-21 ▲
	FLSTC 103 ANV 1BWV_ANV Heritage Softail Classic ANV	13 ▲		XL883L 4CR2 Sportster 883 Low	10 ▲
	FLSTC ANV 1BW5_ANV Heritage Softail Classic ANV	13 ▲		XL1200X 1LC3 Forty Eight	10-21 ▲
	FLSTFB 103 ANV 1JNV_ANV Fat Boy LO ANV	13 ▲		XL883L 4CR2 Sportster 883 Low	11 ▲
	FLSTFB ANV 1JN5_ANV Fat Boy LO ANV	13 ▲		XL883R 4CS2 883 Roadster	11-15 ▲
	FLS 103 1JRV Softail Slim	13-15 ▲		XL1200CP 1LH3 Sportster 1200 Custom (H-D1)	11-21 ▲
	FLSTC 103 1BWV Heritage Softail Classic	13-15 ▲		XL1200V 1LF3 Seventy-Two	12-16 ▲
	FLSTFB 1JN5 Fat Boy LO	13-15 ▲		XL883L 4CR2 SuperLow	12-18 ▲
	FLSTF 103 1BXV Fat Boy	15 ▲		XL1200C ANV 1CT3_ANV Sportster 1200 Custom ANV	13 ▲
	FLS 1JRV Softail Slim	17-20 ▲		XL1200CB 1LK3 Sportster 1200 Custom Limited B	13-15 ▲
	FLSTN 1JDV Softail Deluxe	16 ▲		XL1200CA 1LJ3 Sportster 1200 Custom Limited A	13-21 ▲
	FLSTC 1BWV Heritage Softail Classic	16-17 ▲		XL883R 4CS2 883 Roadster	14 ▲
	FLSTF 1BXV Fat Boy	16-17 ▲		XL883L 4CR2 SuperLow	14-16 ▲
	FLSTFB 1JNV Fat Boy LO	16-17 ▲		XL1200T 1LL3 SuperLow 1200T	14-21 ▲
FLS 1JRV Slim	17 ▲	XL1200CB 1LK3 Sportster 1200 Custom Limited A	16 ▲		
FLSTN 1JDV Deluxe	17 ▲	XL1200CX 1LM3 1200 Roadster	16-18 ▲		
		XL1200CB 1LK3 1200 Custom Limited B	17 ▲		
		XL1200 1LN3 Forty Eight Anniversary	18 ▲		
		FLST BJLL Softail Heritage	90 ▲		
		FLSTC BJ04 Softail Heritage Classic	90 ▲		
		FLSTF BMLL Softail Fat Boy	90 ▲		
		FXST BHLL Softail Standard	90 ▲		
		FXSTC BKLL Softail Custom	90 ▲		
		FXSTS BLLL Softail Springer	90 ▲		
		FLSTC 1BJL Heritage Softail Classic	91-97 ▲		
		FLSTF 1BML Fat Boy	91-97 ▲		
		FXSTC 1BKL Softail Custom	91-97 ▲		
		FXSTS 1BLL Springer Softail	91-97 ▲		
		FLSTN 1BNL Heritage Softail Nostalgia	93-96 ▲		
		FLSTF 1BML Fat Boy	95 ▲		
		FXSTSB 1BPL Springer Softail	95-97 ▲		
		FLSTS 1BRL Heritage Springer	97 ▲		
CK7009 CT701SP ▲	HARLEY DAVIDSON		CK7010 CT705SP ▲	HARLEY DAVIDSON	
	FLHS FALL Touring Electra Glide Sport	90 ▲		FLH Electra Glide	84-88 ▲
	FLHTC DJLL Touring Electra Glide Classic	90 ▲		FLH Electra Glide Shrine Shovelhead	84 ▲
	FLHTCU DPLL Touring Electra Glide Classic Ultra	90 ▲		FLHS Electra Glide Sport	84-89 ▲
	FLTC DBLL Touring Tour Glide Classic	90 ▲		FLHT Electra Glide Classic	84-89 ▲
	FLTCU DMLL Touring Tour Glide Classic Ultra	90 ▲		FLHTCU Electra Glide Classic Ultra	89 ▲
	FLTC 1DBL Tour Glide Classic	91-92 ▲		FLST Softail Heritage	86-89 ▲
	FLHS 1FAL Electra Glide Sport	91-94 ▲		FLSTC Softail Heritage Classic	87-89 ▲
	FLTCU 1DML Tour Glide Ultra Classic	91-94 ▲		FLT Tour Glide Classic	84-89 ▲
	FLHTC 1DJL Electra Glide Classic	91-97 ▲		FLT Tour Glide	84 ▲
	FLHTCU 1DPL Ultra Classic	91-97 ▲		FLTCU Tour Glide Classic Ultra	89 ▲
	FLHR FD93 Road King	93 ▲			
	FLHS 1FAL Electra Glide Sport	93 ▲			
	FLHTC 1DJL Electra Glide Classic	93 ▲			
	FLHR 1FDL Road King	94-97 ▲			
	FLHT 1DDL Electra Glide Standard	94-97 ▲			
	FLTCU 1DML Tour Glide Ultra Classic	95 ▲			
	FLHTCUI 1FCR Ultra Classic	95-96 ▲			
	FLTCUI 1FER Tour Glide Ultra Classic	96 ▲			
	FLHRI 1FBR Road King	96-97 ▲			
FLHTCI 1FFR Electra Glide Classic	96-97 ▲				
FLHTCUI 1FCR Ultra Classic	97 ▲				
FXDB 1GBL Dyna Sturgis	91 ▲				
FXDB 1GAL Dyna Daytona	92 ▲				
FXDC 1GCL Super Glide Custom	92 ▲				
FXDS-CONV GGLP Dyna Glide Convertible	93 ▲				
FXDL 1GDL Dyna Low Rider	93-97 ▲				

CLUTCH BUYERS GUIDE

CK CLUTCH KIT BUYERS GUIDE

Part No.	Make/Model	Year	Part No.	Make/Model	Year
CK7010 CT705SP ▲	HARLEY DAVIDSON FXE Super Glide FXEF Super Glide Fat Bob FXSB Low Rider FXST Softail Standard FXSTC Softail Custom FXSTS Softail Springer FXWG Wide Glide	84 ▲ 85 ▲ 84-85 ▲ 84-89 ▲ 86-89 ▲ 88-89 ▲ 84-86 ▲			
CK7011 CT704SP ▲	HARLEY DAVIDSON FLH Electra Glide FLH Electra Glide Shrine Shovelhead FLHS Electra Glide Sport FLHT Electra Glide FLHT Electra Glide Classic FLT Tour Glide Classic FLT Tour Glide	Early 84 ▲ Early 84 ▲ Early 84 ▲ Early 84 ▲ Early 84 ▲ Early 84 ▲ Early 84 ▲			
CK7012 CT704SP ▲	HARLEY DAVIDSON FFLH Electra Glide Shrine Shovelhead FLH Electra Glide FLHC Electra Glide Classic FLHC Electra Glide Classic FLHS Electra Glide Sport FLHS Heritage Electra Glide FLHT Electra Glide Standard FLHT Electra Glide Classic FLHT Electra Glide FLHTC Electra Glide Classic FLT Tour Glide FLT Tour Glide Classic FXB Super Glide B80 FXDG Dyna Glide Glide Custom FXE Super Glide FXEF Super Glide Fat Bob FXSB Low Rider FXST Softail Standard FXWG Wide Glide	83 ▲ 81-83 ▲ 81-82 ▲ 81 ▲ 81-83 ▲ 81 ▲ 83 ▲ 83 ▲ 83 ▲ 83 ▲ 83 ▲ 81-83 ▲ 80-83 ▲ 81-82 ▲ 83 ▲ 81-83 ▲ 81 ▲ 83-84 ▲ EARLY 84 ▲ 81-84 ▲			
CK7013 CT701SP ▲	HARLEY DAVIDSON XR1200 Sportster 1200 XR1200X Sportster 1200X	08-10 ▲ 10-13 ▲			
CK7014 CT709SP ▲	HARLEY DAVIDSON XL1200 Sportster 1200 XL883 Sportster 883 XL883 Sportster 883 Deluxe XL883HUG Sportster 883 Hugger XLH 1100 Sportster 1100 XLH Sportster 1000 XLH883DLX Sportster 883 Hugger Deluxe XLS Sportster Roadster 1000 XR1000 Sportster	90 ▲ 86-90 ▲ 86-90 ▲ 87-90 ▲ 86-87 ▲ 84-85 ▲ 88-89 ▲ 84-85 ▲ 84 ▲			
CK7015 CT709SP ▲	HARLEY DAVIDSON XLCH Sportster 1000 XLH Sportster 1000 XLH Sportster Standard 1000 XLS Sportster Roadster 1000 XR1000 Sportster	71-80 ▲ 79-84 ▲ 71-80 ▲ 81-84 ▲ 83-84 ▲			
CK7016	HARLEY DAVIDSON XLCH Sportster 1000 XLH Sportster 1000 Standard	70 70			
CK7018	INDIAN FTR 1200	19-21			

DRC CLUTCH KIT BUYERS GUIDE

Part No.	Make/Model	Year	Part No.	Make/Model	Year
DRC1 CT012SP ■	HONDA CR 80 R/RB Expert CR 85 R/RB	85-02 ■ 03-07 ■	DRC21 CT011 ▲	SUZUKI RM 125 G/H	86-87 ▲
DRC2 CT001 ▲	HONDA CR 125 R	86-99 ▲	DRC22 CT011 ▲	SUZUKI RM 125 J/K/L/M	88-91 ▲
DRC3 CT009 ▲	HONDA CR 250 R CR 480 R CR 500 R	83-89 ▲ 83 ▲ 84-89 ▲	DRC23	KAWASAKI LT 250 RH/RJ/RK/RL/RM/RN	87-92
DRC4 CT012SP ▲	HONDA TRX 200 SX Fourtrax TRX 200 Fourtrax TRX 200 D Type II Fourtrax TRX 250 EX (Sportrax 250 EX) TRX 250 TE Recon ES TRX 250 TM Recon	86-88 ▲ 90-91 ▲ 91-97 ▲ 01-08 ▲ 97-14 ▲ 97-14 ▲	DRC24 CT022 ▲	SUZUKI RM 250 J/K/L	88-90 ▲
DRC5 CT013 ▲	HONDA ATC 250 R TRX 250 R Fourtrax	86 ▲ 86-87 ▲	DRC25 DRCF25 CT011 ▲	SUZUKI RM 80 M/N/P/R/S/T/V/W/X/Y/K1 RM 85 (Small Wheel F 17 Inch/R 14 Inch Wheel) RM 85 (Big Wheel F 19 Inch/ R 16 Inch)	91-01 ▲ 02-21 ▲ 02-21 ▲
DRC6 CT013SP ▲	HONDA TRX 300 All models (2wd & 4wd) Fourtrax TRX 350 All models TRX 400 FW Fourtrax Foreman TRX 400 FM Fourtrax Foreman TRX 450 ES TRX 450 S TRX 450 FE TRX 450 FM	88-00 ▲ 86-89 ▲ 95-01/03 ▲ 02 ▲ 98-01 ▲ 98-01 ▲ 02-04 ▲ 02-04 ▲	DRC26 CT022 ▲	KAWASAKI LT 500 RH/RJ/RK/RL	87-90 ▲
DRC7	KAWASAKI KX 60 B1-B19 SUZUKI RM 60 K3	85-03 03	DRC27 CT010 ▲	YAMAHA YZ 80 S/T/U/W/A/B/D	86-92 ▲
DRC8	KAWASAKI KX 80 E3/G1/G2/J2	85-87	DRC28 CT054SP ▲	YAMAHA YZ 125 S/T	86-87 ▲
DRC9	KAWASAKI KX 80 L1	88	DRC29 CT054SP ▲	YAMAHA YZ 125 U	88 ▲
DRC10	KAWASAKI KX 80 L2/L3/N2/N3 KX 80 R1-R7 KX 100 B5/B6/B7	89-90 91-97 95-97	DRC30 CT054SP ▲	YAMAHA YZ 125 W/A	89-90 ▲
DRC11 CT042 ▲	KAWASAKI KX 125 D1/E1/E2	85-87 ▲	DRC31	YAMAHA YZ 250 U/W/A/B/D	88-92
DRC13 CT042 ▲	KAWASAKI KX 125 F1/G1	88-89 ▲	DRC32 CT060 ▲	YAMAHA YTZ 250 N/S IT 250 K IT 490 K/L YZ 490 J/K/L/N/S/T/U/W WR 500 ZD/ZE	85-86 ▲ 83 ▲ 83-84 ▲ 82-89 ▲ 92-93 ▲
DRC15 CT006 ▲	KAWASAKI KX 250 G1	89 ▲	DRC33 DRCF33 CT090SP ▲	YAMAHA YFM 350 ERT/ERU/ERW/ERA/ERD/ERE/ERF YFM 350 FWT/FWU/FWW/FWA/FWB/FWD /FWE (Big Bear) YFM 350 XT/XU/XW/XA/XB/XD/XE/XF/XG/XH/XJ /XK/XL/XM/XN/XP/XR/XS (Warrior) YFM 350 RS/RT/RV/RW/RX/RZ/RA/RB/RD Raptor	87-94 ▲ 87-93 ▲ 87-04 ▲ 04-13 ▲
DRC16 CT006 ▲	KAWASAKI KX 500 C1/D1 KX 500 E1-E16	87-88 ▲ 89-04 ▲	DRC35 CT060 ▲	YAMAHA YZ 250 N/S/T	85-87 ▲
DRC17 CT006 ▲	KAWASAKI KX 250 H1	90 ▲	DRC36 CT042 ▲	YAMAHA KX 125 H1/H2	90-91 ▲
DRC19	SUZUKI RM 80 H/J	87-88	DRC38 CT006 ▲	YAMAHA KXT 250 B1/B2 Tecate	86-87 ▲
DRC20 CT011 ▲	SUZUKI RM 80 K/L	89-90 ▲	DRC39 CT005 ▲	YAMAHA YZ 125 B/D WR 250 RX/RZ/RA/RB/RD/RE/RF WR 250 XX/XY/XZ/XA Supermotard	91-92 ▲ 08-15 ▲ 08-11 ▲
			DRC40 CT022 ▲	SUZUKI RM 250 M	91 ▲
			DRC41 CT006 ▲	KAWASAKI KDX 250 D1/D2/D3/D4 KX 250 H2	91-94 ▲ 91 ▲

DRC CLUTCH KIT BUYERS GUIDE

Part No.	Make/Model	Year	Part No.	Make/Model	Year
DRC42 DRCF42 CT010 ▲	YAMAHA YFS 200 U/W/A/B/D/E/F/G/H/J/K/L/M/N/P/R/S /T/V Blaster WR 200 D	88-06 ▲ 92 ▲	DRC59 CT009SP ■	SUZUKI DR 650 SL/SM/SN/SP	90-95 ■
DRC43 DRCF43 CT008 ▲	YAMAHA YFZ 350 T/U/W/A/B/D/E/F/G/H/J/K/L/M/N /P/R/S/T/V (Banshee)	87-06 ▲	DRC60 CT013SP ■	HONDA XR 200 R XL 250 R XR 250 R	84-85 ■ 84-87 ■ 84-85 ■
DRC44 DRCF44 CT013SP ▲	HONDA ATC 250 SX TRX 250 X Fourtrax XR 250 R XR 250 L TRX 300 EX Fourtrax/Sportrax TRX 300 X XR 350 R	85-87 ▲ 87-88/91-92 ▲ 86-95 ▲ 91-96 ▲ 93-08 ▲ 09-11 ▲ 83-85 ▲	DRC61 CT042 ▲	KAWASAKI KDX 200 E1-E6	89-94 ▲
DRC45 DRCF45 CT002 ■	KAWASAKI KX 80 W1/W2/W3 KX 85 (F 17"/R 14") KX 85 (F 19"/R 16") KX 100 C1/C2/C3/D1-D5/D6F/D7F/D8F/D9F /DBF/DCF/DDF/FEF/FFF/FGF/FHF	98-00 ■ 01-21 ■ 01-21 ■ 98-09/11-17 ■	DRC62	KAWASAKI KDX 200 H1-H11/H6F KDX 220 R A4-A12/A6F	95-06 97-06
DRC46 DRCF46 CT016 ▲	KAWASAKI KX 250 J1/J2/K1-K5/L1-L4/M1/M2/R1/R6F/R7F	92-07 ▲	DRC63 CT004 ▲	KAWASAKI KLR 250 (KL 250) D2 to D22	85-05 ▲
DRC48 CT022 ▲	SUZUKI RM 250 M/N/P	91-93 ▲	DRC64 CT016 ▲	KAWASAKI KLR 600 (KL 600 A1/B1/B2) KLX 650 A1/A2/A3/D1(KLX650R)	84-86 ▲ 93-96 ▲
DRC49 DRCF49 CT012SP ■	HONDA CRF 100 F XR 100 R	04-16 ■ 87-03 ■	DRC65 CT016 ▲	KAWASAKI KLR 650 (KL 650 A1-A9) KL 650 B2/B3 TENGAI KLX 650 C1/C2/C3/C4	87-95 ▲ 90-91 ▲ 93-96 ▲
DRC50 CT012SP ■	HONDA NX 125	88-90 ■	DRC66 CT010 ▲	YAMAHA YZ 80 E/F	93-94 ▲
DRC51 CT013SP ■	HONDA NX 250	88-90 ■	DRC67 CT013 ▲	HONDA CR 125 R	83-84 ▲
DRC52 CT022 ▲	SUZUKI RM 250 H	87 ▲	DRC68 CT001 ▲	HONDA CR 125 R	85 ▲
DRC53 CT013SP ■	HONDA XL 600 V	89-90 ■	DRC69 CT042 ▲	KAWASAKI KX 125 J2	93 ▲
DRC54 DRCF54 CT009 ▲	HONDA XR 600 R NX 650 XR 650 L	85-00 ▲ 88-89 ▲ 93-16 ▲	DRC70 DRCF70 CT005 ▲	YAMAHA YZ 125 E/F/G YZ 125 J/K/L/M/N YZ 125 E/F/G/H/J/K/L/M/N/P/R/S/T/V/W/X/Y/Z /A/B/D/E/F/G (2T)	93-95 ▲ 97-01 ▲ 93-21 ▲
DRC55 CT039 ▲	YAMAHA BW 200 N/S/ES/ET/EU	85-88 ▲	DRC71 CT020 ▲	YAMAHA YZ 250 E/F/G/H/J/K/L WR 250 ZF/ZG/ZH/ZJ	93-99 ▲ 94-97 ▲
DRC56 CT008 ▲	YAMAHA XT 350 N/NC/S/SC/C/AC/B/BCT/TC/U/UC/W /WC/D/DC/E/EC/F/FC/G/GC/H/HC/J/JC/K/KC /L/M/MC TT 350 S/T	85-00 ▲ 86-87 ▲	DRC72 CT022 ▲	SUZUKI RM 250 R/S RMX 250 R/S/T/V/W/X/Y	94-95 ▲ 94-00 ▲
DRC57 CT008 ▲	YAMAHA TT 600 K/L/N/S XT 600 L/LC/N/NC/S/SC/T/TC/U/UC/W/WC	83-86 ▲ 84-89 ▲	DRC73 CT004 ▲	KAWASAKI KX 125 K4/K5/L1-L4	97-02 ▲
DRC58 DRCF58 CT022 ▲	SUZUKI DR 250 L/M/N/P DR 250 SL/SM/SN/SEP/SER/SES DR 350 L/M/N/P/R/S/T DR 350 SL/SM/SN/SP/SER/SES/SET/SEV/SEW/SEX	90-93 ▲ 90-95 ▲ 90-96 ▲ 90-99 ▲	DRC74 CT042 ▲	KAWASAKI KDX 200 C1/C2/C3	86-88 ▲
			DRC75 CT009 ▲	HONDA CR 250 R CR 500 R CR 500 R	90-93 ▲ 90-94 ▲ 95-01 ▲
			DRC76S CT003 ▲	SUZUKI RM 125 P/R/S/T/V/W	93-98 ▲
			DRC78 CT010 ▲	YAMAHA YZ 80 G/H/J/K/L/M/N	95-01 ▲

DRC CLUTCH KIT BUYERS GUIDE

Part No.	Make/Model	Year	Part No.	Make/Model	Year
DRC79 DRCF79 CT009 ▲	HONDA CR 250 R	94-07 ▲	DRC97 CT020 ▲	YAMAHA YZ 250 M/N	00-01 ▲
DRC80 CT016 ▲	SUZUKI RM 250 T	96 ▲	DRC98 DRCF98	KAWASAKI KX 65 KLX 110 KLX 110 L SUZUKI RM 65 K3/K4/K5 RM 100 K3/K4 DR-Z 110 K3/K4/K5	00-21 02-21 10-21 03-05 03-04 03-05
DRC81 CT013 ▲	HONDA TRX 250 R Fourtrax	88-89 ▲	DRC99 CT008 ▲	YAMAHA WR 400 FK/FL/FM	98-00 ▲
DRC82 CT008 ▲ CT090SP ■	YAMAHA YFM 350 ERG YFM 350 FWF/FWG/FWH/FWJ/FWBK#(Big Bear) YFM 350 UH/UJ/UK/UL/ULC YFM 400 FWE/FWF/FWG/FWH/FWJ/FWK/FWL Kodiak YFM 400 FWR (4x4) Big Bear	95 ■ 94-98 ■ 96-99 ■ 93-99 ▲ 03 ▲	DRC100 DRCF100 CT013 ▲	HONDA TRX 400 EX Fourtrax/Sportrax TRX 400 X	99-08 ▲ 09-14 ▲
DRC83 CT042 ▲	KAWASAKI KX 125 J1	92 ▲	DRC101 DRCF101 CT001 ▲	HONDA CR 125 R	00-07 ▲
DRC84 CT013SP ■	HONDA XR 250 R	96-04 ■	DRC102 CT020 ▲	YAMAHA YZ 426 FM	00 ▲
DRC85 CT005 ▲	YAMAHA YZ 125 H YZ 125 P/R/S	96 ▲ 02-04 ▲	DRC103 CT011 ▲	SUZUKI LT-F 300 FX/FY/FK1/FK2 King Quad LT-F 4WDXM/N/P/R/S/T/V/W 300 King Quad 250 (2 x 4) 300 (2 x 4 / 4 x 4) 300 (4 x 4)	99-02 ▲ 91-97 ▲ 99-00 ▲ 98-04 ▲ 05 ▲
DRC87 CT024 ▲	SUZUKI DR 650 SET/SEV/SEW/SEX/SEY/SEK1/SEK2/ SEK3/SEK4/SEK5/SEK6/SEK7/SEK8/SEK9 /SEL1/SEL2/SEL3/SEL4/SEL5/SEL6	96-16 ▲	DRC104 CT010SP ■	YAMAHA YTM 225 DXK/DXL/ DXN YFM 225 S/T/U/W (Moto 4) YBF 250 D/E Timberwolf YFB 250 F/G/H/UH/J/UJ/UK Timberwolf YFB 250 FWF/FWG/FWH/FWJ/FWK/FWL/FWM Timberwolf YFM 250 W/A/B YFM 250 Bear Tracker L/LC/M/MC/XN/XHN/XP /XHP/XR/XHR/XS YFM 250 BT/BV Bruin YFM 250 BW/BX/BY Big Bear YFUW/YFUITW Pro Hauler (230cc)	83-85 ■ 86-89 ■ 92-93 ■ 94-98 ■ 94-00 ■ 89-91 ■ 99-03 ■ 05-06 ■ 07-09 ■ 89 ■
DRC88 DRCF88 CT008 ▲	YAMAHA YFM 660 RN/RP/RPB/RR/RS/RT Raptor XT 600 EA/EAC/EB/EBC/ED/EDC/EE/EEC/EF /EFC/EG/EGC	01-05 ▲ 90-95 ▲	DRC105 DRCF105 CT006 ▲	ARCTIC CAT 400 DVX KAWASAKI KLX 400 R (KLX 400 B1/B2) KLX 400 SR (KLX 400 A1/A2) KSF 400 A1/A2 (KFX 400) SUZUKI DR-Z 400 SY/SK1/SK2/SK3/SK4/SK5/SK6/SK7 /SK8/SK9/SL1/SL2/SL3/SL4/SL5/SL6 DR-Z 400 EY/EK1/K1/EK2/K2/K3/EK3/K4 /EK4/EK5/EK6/EK7 DR-Z 400 SMK5/SMK6/SMK7/SMK8/SML3 /SMK9/SML4/SML5/SML6 LT-Z 400 K3/K4 QuadSport	04-06 ▲ 03-04 ▲ 03-04 ▲ 03-04 ▲ 00-16 ▲ 00-07 ▲ 05-09/13-19 ▲ 03-04 ▲
DRC89 CT011 ▲	SUZUKI LT 250 EFF/EFG LT-4WD Quadrunner 4WD H/J/K/L/M/N/P/R/S/T/V LT-F 4WD V/W Quadrunner 4WD (250cc) LT-F 250 J/K/L/M/N/P/R/S/N/W/X/Y/K1 LT-F 250 FX/FY/FK1/FK2 Quadrunner LT 300 EH/EJ/EK Quadrunner 250 (2 x 4 / 4 x 4)	85-86 ▲ 87-97 ▲ 97-98 ▲ 88-01 ▲ 99-02 ▲ 87-88 ▲ 01-05 ▲	DRC106 CT013 ▲	HONDA XR 400 R	97-04 ▲
DRC91 CT012SP ■	HONDA XR 200 XR 200 R XR 200 R	80-84 ■ 81-83 ■ 86-02 ■	DRC107 DRCF107 CT027 ▲	KTM SX 60 SX 65 XC 65	98-00 ▲ 98-08 ▲ 08 ▲
DRC92 CT009 ▲	HONDA XL 600 R XL 600 R to 520822 XL 600 R from 5208023 XL 600 R	83-84 ▲ 85 ▲ 85 ▲ 86-87 ▲			
DRC93 CT013 ▲ CT013SP ■	HONDA ATC 250 R XR 400 R	85 ■ 96 ▲			
DRC94 CT011 ▲	SUZUKI DR 200 G/H/J SP 200 G/H/J LT 230 SF/SG/SH/SJ from E/No. 104361	86-88 ▲ 86-88 ▲ 85-88 ▲			
DRC95 CT016 ▲	SUZUKI RM 250 V/W/X/Y/K1/K2	97-02 ▲			
DRC96 CT011 ▲	KAWASAKI LT 250 SK/SL	89-90 ▲			

DRC CLUTCH KIT BUYERS GUIDE

Part No.	Make/Model	Year	Part No.	Make/Model	Year
DRC108 DRCF108 CT007 ▲	KTM SX 250 (2T) 250 EGS 250 EXC 250 MXC XC-W 250 (2T) XC 250 (2T) 250 SXS 300 E-GS 300 EXC 300 MXC 300 MXC SX 300 300 Six Days XC 300 XC-W 300 360 EGS 360 EXC 360 MXC 360 SX 360 Six Days 380 EXC 380 MXC SX 380 RXC-E 400 RXC-E 620	94-12 ▲ 94-99 ▲ 94-05 ▲ 98-99 ▲ 06-12 ▲ 06-12 ▲ 01-03 ▲ 94-99 ▲ 94-05 ▲ 94-03 ▲ 04-05 ▲ 94 ▲ 96 ▲ 06-12 ▲ 06-11 ▲ 96-97 ▲ 96-97 ▲ 96-97 ▲ 96-97 ▲ 96 ▲ 98-02 ▲ 98-01 ▲ 98-02 ▲ 95 ▲ 95 ▲	DRC119 DRCF119 CT005 ▲	YAMAHA WR 250 FP/FR/FS/FT/FV/FW/FX/FY/FZ/FA/FB/FD	02-13 ▲
DRC109 DRCF109 CT005 ▲	YAMAHA YZ 250 FN/FP/FR/FS/FT/FV/FW WR 250 FN	01-07 ▲ 01 ▲	DRC120 CT006 ▲	SUZUKI LT-F 400 FK2/FK3/FK4/FK5/FK6/FK7#(Eiger 4WD) LT-F 400 K3/4/5/6/7 LT-F 400 FK8/FK9 King Quad 400 FS LT-F 400 FCK8/FCK9 King Quad 400 FS Camo 400 (2 x 4 / 4 x 4) 400 (4 x 4 Manual)	02-07 ▲ 03-08 ▲ 08-10 ▲ 08-09 ▲ 03-04 ▲ 05-08 ▲
DRC110 CT020 ▲	YAMAHA WR 426 FN/FP WR 450 FR	01-02 ▲ 03 ▲	DRC121 CT020 ▲	YAMAHA YZ 450 FR/FS	03-04 ▲
DRC111 DRCF111 CT010 ▲	YAMAHA YZ 85 (2T/Small Wheel F 17 Inch/R 14 Inch) YZ 85 (2T/Big Wheel F 19 Inch/R 16 Inch)	02-21 ▲ 02-21 ▲	DRC122 CT004 ▲	KAWASAKI KX 125 M1/M2/M3	03-05 ▲
DRC112 CT009 ▲	HONDA CRF 450 R	02-03 ▲	DRC123 DRCF123 CT004 ▲	KAWASAKI KLX 230 KX 250 N1/N2 (KX 250 F) KX 250 F SUZUKI RM-Z 250 K4/K5/K6	20 ▲ 04-05 ▲ 06-21 ▲ 04-06 ▲
DRC113 DRCF113 CT020 ▲	YAMAHA YZ 250 P/R/S/T/V/W/X/Y/Z/A/B/D/E/F/G/H/J (2T)	02-18 ▲	DRC126 CT013SP ▲	HONDA TRX 350 TM/FM	00-05 ▲
DRC114 CT003 ▲	SUZUKI RM 125 N	92 ▲	DRC127 CT013SP ▲	HONDA TRX 350 TE/FE	00-05 ▲
DRC115 CT003 ▲	SUZUKI RM 125 X/Y/K1	99-01 ▲	DRC128 DRCF128 CT020 ▲	YAMAHA YFZ 450 BB/DB YFM 700 RV/RW/RX/RY/RA/RB/RD/RE Raptor YFM 700 RSEW/RSPX/RSPY/RSEZ/RSEA/ RSEB/RSED/RSE/RSF Special Edition YFM 700 50th Anniversary Edition - YFM 700 RSPV YFM 700 RV/RW/RX/RY/RA/RB Raptor	12-13 ▲ 06-14 ▲ 07-15 ▲ 06-13 ▲ 06-12 ▲
DRC116 CT020 ▲	YAMAHA YZ 426 FN/FP	01-02 ▲	DRC129 DRCF129 CT001 ▲	HONDA CRF 250 R	04-07 ▲
DRC117	KTM 250 EXC Racing 250 EXC-G Racing 400 EXC 400 MXC SX 400 450 EXC Racing 450 EXC-G Racing 450 MXC-G Racing 450 SX Racing 520 EXC SX 520 525 EXC/EXC-G Racing 525 MXC Desert Racing 525 MXC-G Racing 525 SX Racing	04 04 00-01 01 00-01 04 04 04 04 04 00-01 00-01 04 04 04 04 00-01 00-01 04 04 04 04	DRC130 DRCF130 CT003 ▲	SUZUKI RM 125 K2/K3/K4/K5/K6/K7/K8	02-08 ▲
			DRC131 DRCF131 CT009 ▲	HONDA TRX 450 R/ER	04-14 ▲
			DRC136 CT002 ▲	HONDA CRF 230 F	03-16 ▲
			DRC137 DRCF137 CT006 ▲	ARCTIC CAT 400 DVX KAWASAKI KSF 400 A3/A6F (KFX 400) SUZUKI LT-Z 400 K5/K6/K7/K8/K9/K9/L2/ZL2/L3/L4	07-08 ▲ 05-06 ▲ 05-14 ▲
			DRC139 CT028 ▲	KTM SX 85 (17/14" & 19/16" Wheel Models) SX 85 (17"/14") SX 85 (19"/16") XC 85 SX 105 XC 105	03-17 ▲ 03-17 ▲ 03-17 ▲ 08-09 ▲ 04-11 ▲ 08-09 ▲
			DRC142 CT029SP ■	SUZUKI DR 650 SER/SES	94-95 ■

CLUTCH BUYERS GUIDE

DRC CLUTCH KIT BUYERS GUIDE

Part No.	Make/Model	Year	Part No.	Make/Model	Year
DRC144 CT001 ▲	KTM SX 150 XC 150 200 EGS 200 EXC 200 MXC SX 200 XC-W 200 XC 200 XC 250	08-21 ▲ 10-15 ▲ 98-99 ▲ 97-05 ▲ 98-03 ▲ 03 ▲ 07-15 ▲ 06-09 ▲ 10 ▲	DRC168 CT016 ▲	KAWASAKI KLR 650 (KL 650 A10-A19/A6F/A7F) KL 650 E8F/E9F/EAF/EBF (KLR 650)	96-07 ▲ 08-11 ▲
	DRC145 CT001 ▲	KTM 125 EXC 125 EXE 125 Supermoto SX 125 125 SXS		98-05 ▲ 125 EXE 00-01 ▲ 00-01 ▲ 98-07/09-21 ▲ 01-02 ▲	DRC169 CT030 ▲
DRC148 DRCF148 CT009 ▲	HONDA CRF 450 R CRF 450 X	04-08 ▲ 05-17 ▲	DRC170 CT030 ▲	KTM 380 EGS 400 EGS 400 EGS-E 400 EXC 400 LC-4 LC4 R 400 400 LC4-E 400 LSE 400 LS-E 400 Super Comp/EXC 400 RXC-E SXC 400 400 SX-C 400 SX 400 SXC 400 TXC 620 Duke 620 EGS-E 620 EGS/Adventure 620 Enduro Ltd 620 LC-4 620 LSE 620 Six Days 620 RXC-E SXC 620 640 LC Rallye Dakar 660 LC4	
DRC154 CT023 ▲	KTM 250 EXC Racing 400 EXC Racing 400 EXC-G Racing 450 EXC Racing 450 EXC 450 LXC-G Racing 450 MXC-G Racing 450 SMR 450 SX Racing 525 EXC Racing 525 EXC-G Racing 525 MXC Desert Racing 525 SMR 525 SX Racing	05 ▲ 05 ▲ 05 ▲ 05 ▲ 04-05 ▲ 05 ▲ 05 ▲ 05 ▲ 04-05 ▲ 05 ▲ 05 ▲ 05 ▲ 05 ▲ 04-05 ▲ 05 ▲		DRC171 CT023 ▲	KTM XC 450/525 (Quad) 250 EXC Racing 250 EXG-G Racing 400 EXC 400 EXC Racing 400 EXC-G Racing 400 MXC 400 SX Racing 450 EXC 450 EXC Racing 450 EXC-G Racing MXC 450 450 MXC-G Racing SMR 450 SX 450 450 SX Racing 520 SX Racing 525 EXC-G/EXC Racing EXC 525 Racing (4T) MXC 525 525 MXC Desert Racing SX 525 525 SX Racing 540 SXS Racing SMR 560
	DRC155 DRCF155 CT045 ▲	SUZUKI RMX 450 ZLO RM-Z 450	10-11 ▲ 05-21 ▲		DRC161 CT016 ▲
DRC158 DRCF158 CT006 ▲	KAWASAKI KLX 450 R (A8F/A9F/AAF/ABF/ACF) KX 450 F (D6F/D7F/D8F/D9F/EAF/EBF)	08-12 ▲ 06-11 ▲	DRC162 CT020 ▲	YAMAHA YZ 450 FT/FV	05-06 ▲
DRC159 DRCF159 CT020 ▲ CT045 ■	YAMAHA YZF 450 LES Limited Edition YZF 450 S/T/V YZF 450 SET Special Edition YZF 450 SPV Special Edition	04 ▲ 04-06 ▲ 05 ■ 06 ▲	DRC163 DRCF163 CT001 ▲	KTM SX-F 250 (4T) XC-F 250 XC-F-W 250 XC-F-W 250 Six Days	05-12 ▲ 06-12 ▲ 06-13 ▲ 11 ▲
DRC160 CT016 ▲	SUZUKI RM 250 K6/K7/K8	06-08 ▲	DRC164 DRCF164 CT045 ▲	SUZUKI LT-R 450 K6/K7/K8/K9 LT-R 450 ZK8/ZK9 Quadracer SE	06-11 ▲ 08-10 ▲

CLUTCH BUYERS GUIDE

DRC CLUTCH KIT BUYERS GUIDE

Part No.	Make/Model	Year	Part No.	Make/Model	Year
DRC172 CT023 ▲	KTM 450 SMS	04 ▲	DRC196 CT030 ▲	KTM 540 SXC 620 LC4 Competition 620 LC4 Super Moto 620 Super Comp SX 620 SX 620 620 SC 620 Supermoto 620 TXC 625 SMC 625 SC 625 SXC 640 Adventure-R 640 Duke-E 640 Duke-II 640 LC4 640 LC4-E 640 LC4 Adventure 640 LC4 Supermoto 640 LC4 Six Days 660 LC4 Rallye	98-99 ▲ 99 ▲ 99 ▲ 96-99 ▲ 97-99 ▲ 99 ▲ 00-01 ▲ 98 ▲ 98 ▲ 04/06 ▲ 02 ▲ 03-04 ▲ 98-02 ▲ 98 ▲ 99-04 ▲ 99-00 ▲ 00-02 ▲ 03-06 ▲ 03-04 ▲ 99 ▲ 99-00 ▲
DRC174 CT001 ▲	KTM SX 125	08 ▲			
DRC175 CT030 ▲	KTM 660 SM Factory Replica 660 SMC 660 SMS	02-03 ▲ 03-04 ▲ 04 ▲			
DRC176 CT030 ▲	KTM 660 Rallye 660 Rallye Factory	01-03 ▲ 04 ▲			
DRC177 CT015 ▲	KTM 950 Adventure S 950 Adventure 950 Superduke 950 R Super Enduro 990 Adventure 990 Adventure S 990 Superduke R 990 SM-R 990 SM-T	03-04 ▲ 06 ▲ 05-11 ▲ 07-08 ▲ 07-11 ▲ 07-09 ▲ 07-11 ▲ 09-11 ▲ 09-14 ▲			
DRC178 CT075 ▲	KTM 400 RXC-E EXC 400 SC 400 620 RXC-E	95 ▲ 93-95 ▲ 95 ▲ 95 ▲	DRC199 CT030 ▲	KTM 690 Rally Factory Rep	07-08 ▲
DRC179 CT009 ▲	HONDA XR 650 R	00-07 ▲	DRC200 DRCF200 CT005 ▲	YAMAHA YFM 250 RX/RV/RZ/RA/RB/RD Raptor YFM 250 RSPX/RSEY Special Edition YFM 250 RSPXC Special Edition Custom	08-13 ▲ 09-11 ▲ 08 ▲
DRC180 CT012SP ■	HONDA CRF 150 F	03-05 ■	DRC201 DRCF201 CT020 ▲	YAMAHA YZF 450 BBW Bill Balance Edition YZF 450 SEW/SPX Special Edition YZF 450 W/X/Y/A/B/D	07 ▲ 07-08 ▲ 07-09/12-13 ▲
DRC181 CT012SP ■	HONDA CRF 150 F	06-19 ■	DRC205 CT069 ▲	KTM 690 Duke 690 Enduro 690 Enduro R 690 Supermoto 690 SMR (Cast Wheel) 690 SMC HUSQVARNA Svartpilen 401 Vitpilen 401 701 Enduro R 701 Supermoto Svartpilen 701 Vitpilen 701	08-14 ▲ 08 ▲ 10-15 ▲ 07-08 ▲ 07-09 ▲ 08-11 ▲ 18-21 ▲ 18-21 ▲ 16-21 ▲ 16-19 ▲ 18-21 ▲ 18-21 ▲
DRC182 DRCF182 CT002 ▲	HONDA CRF 150 R/RB	07-21 ▲	DRC208 DRCF208 CT001 ▲	HONDA CRF 250 R CRF 250 X	08-09 ▲ 04-17 ▲
DRC184 CT009 ▲	KTM SX 450 (Quad) SX 505 (Quad) SX-F 450 XC-F 450 SX-F 505 XC-F 505	09-12 ▲ 09-12 ▲ 07-11 ▲ 08-09 ▲ 07-08 ▲ 08-09 ▲	DRC209 CT012SP ▲	LIFAN LF 200 GY-S	05-08 ▲
DRC185 CT006 ▲	KAWASAKI KFX 450 R (KSF 450 B8F/B9F/BAF /BBF/BCF/BDF/BEF)	08-14 ▲	DRC211	KAWASAKI KLX 140 (F 17"/R 14") KLX 140 L (F 19"/R 16") KLX 140 G (F 21"/R 18") KLX 150 S	08-21 08-21 17-21 09
DRC189 DRCF189 CT004 ▲	SUZUKI RM-Z 250 K7/K8/K9	07-09 ▲	DRC212 CT042 ▲	KAWASAKI KLX 250 S (KLX 250H6F/H7F) KLX 250 S (KLX 250 T9F/TAF/TBF/TCF/TDF/TEF) KLX 250 SF (KLX 250 W9F/TAF) Supermotard KLX 300 R A3-A10/A6F/A7F KLX 300 R CLF	06-07 ▲ 09-14 ▲ 09-10 ▲ 98-07 ▲ 19-21 ▲
DRC194 CT020 ▲	YAMAHA WR 450 FT/FV/FW/FX/FY/FZ/FA/FB/FD/FE/FF	05-15 ▲			
DRC195 DRCF195 CT020 ▲	YAMAHA YZ 450 FW/FX/FY/FZ/FA/FB/FD	07-13 ▲			

DRC CLUTCH KIT BUYERS GUIDE

Part No.	Make/Model	Year	Part No.	Make/Model	Year
DRC214 CT006 ▲	ARCTIC CAT 400 (2 x 4) 500 (4 x 4)	98 ▲ 98-02 ▲	DRC229 CT039 ▲	YAMAHA TT 225 S/T TT-R 225 L/M/N/P/R/S XT 225 J/JC/K/KC/L/M/MC/N/NC/P/PC/R /RC/S/SC/T/TC/N/VC/W/WC TT-R 230 T/V/W/X/Y/A/B/D/E/F	86-87 ▲ 99-04 ▲ 92-07 ▲ 05-09/11-15 ▲
DRC215 CT006 ▲	ARCTIC CAT 400 (2 x 4 / 4 x 4) 400 (2 x 4 / 4 x 4)	98- ▲ 00-02 ▲	DRC230 DRCF230 CT044 ▲	YAMAHA TT-R 125 M/N/P/R/ER/S/ES/ET/EV/EW/EX/EY TT-R 125 LWM/LN/LP/LER/LR/LES/LS/LET /LT/LEV/LV/LEW/LW/LEX/LX/LEY/LEA/LEB /LED/LEE/LEF	00-09 ▲ 00-09/11-19 ▲
DRC216 CT006 ▲	ARCTIC CAT Bearcat 454 (4 x 4) Bearcat 454 (2 x 4) 500 (4 x 4 Manual) 500 (Manual 4x4) SUZUKI LT-F 500 FK3/FK4/FK5/FK6/FK7 #Vinson 4WD	96-98 ▲ 97-98 ▲ 03-04 ▲ 05-09 ▲ 03-07 ▲	DRC231 CT039 ▲	YAMAHA TW 200 T/TC/U/UC/W/WCA/AC/D/DC/E/EC /F/FC/H/HC/J/JC/EK/EKC/L/LC/M/MC/N/NC /P/PC/R/RC/S/SC/T/TC/N/VC/W/WC/X/Y/Z /A/B/D/E/F Trailway XT 225 D/DC/E/EC/F/FC/G/GC/H/HC	87-15 ▲ 92-96 ▲
DRC217 CT006 ▲	SUZUKI LT-F 500 FW/FX/FY/FK1/FK2 Quadrunner	98-02 ▲	DRC232 CT010SP ■	YAMAHA YTM 200 K/L/N YTM 200 EK/EL/ERN YTM 225 DRN/DRS YFM 200 N YFM 200 DXS/DXT/DXU/DXW (Moto 4)	83-85 ■ 83-85 ■ 85-86 ■ 85 ■ 86-89 ■
DRC218 CT011 ▲	SUZUKI LT 160 EK/EL/EM/EN LT 160 K3/K4 LT-F 160 M/N/P/R/S/T/V/W/X/Y/K1/K3 LT 230 GEF/GEG LT-F 230 G/H LT 230 EH/EJ/EK/EL/EM/EN/EP	89-92 ▲ 03-04 ▲ 91-03 ▲ 85-86 ▲ 86-87 ▲ 87-93 ▲	DRC233 CT006 ▲	KAWASAKI KEF 300 A1-A6 Lakota KEF 300 B1/B2/B3 Lakota Sport KLF 300 A1/A2/B1-B17/C1-C17 Bayou	95-00 ▲ 01-03 ▲ 86-05 ▲
DRC220 CT011 ▲	SUZUKI LT-F 250 K2 Ozark Up to frame JSAAJ51A22100696	02 ▲	DRC234 CT006 ▲	KAWASAKI KLF 400 B1-B7 Bayou (4 x 4)	93-98 ▲
DRC221 CT011 ▲	SUZUKI LT-F 250 K3 Ozark LT-F 250 K5/K6/K7/K8/K9/L2/L3/L4 Ozark	03 ▲ 05-14 ▲	DRC236 CT013SP ▲	HONDA TRX 500 FPE Fourtrax Foreman 4x4 ES/EPS TRX 500 FE/FEA Fourtrax Foreman 4x4 EPS	08-11 ▲ 08-11 ▲
DRC222 CT011 ▲	SUZUKI LT-F 250 K4 LT-Z 250 K4-K9 QuadSport	04 ▲ 04-11 ▲	DRC237 CT013SP ▲	HONDA TRX 500 FE5/FE6/FE7/FE8 Fourtrax Foreman 4x4/ES TRX 500 FM Fourtrax Foreman 4x4 TRX 500 FPM Fourtrax Foreman 4x4/ES TRX 500 TM Fourtrax Foreman 2x4	05-08 ▲ 05-11 ▲ 08-11 ▲ 05-06 ▲
DRC223 CT006 ▲	SUZUKI LT-F 400 K2 Eiger Manual 2WD	02 ▲	DRC238 CT013SP ▲	HONDA TRX 420 TE Fourtrax Rancher ES TRX 420 FP/FPA Fourtrax Rancher 4x4 ES/EPS TRX 420 FE/FEA Fourtrax Rancher 4x4/ES TRX 420 FE1 Rancher 4x4 ES TRX 420 TE1 Rancher ES TRX 420 FM1 Rancher 4x4 TRX 420 FM1 Rancher 4x4 EPS TRX 420 TM Fourtrax Rancher	07-13 ▲ 09-13 ▲ 07-13 ▲ 14-15 ■ 14-15 ■ 14-15 ■ 14-15 ■ 07-13 ▲
DRC224 CT013SP ■	KAWASAKI KLF 220 A1-A15 Bayou KLF 250 A1/A2/A3/A6F/A7F/A8F/A9F /AAF/ABF Bayou	88-02 ■ 03-11 ■	DRC239 CT013SP ▲	HONDA TRX 420 FM Fourtrax Rancher 4x4 TRX 420 FPM/FPMA Fourtrax 4WD TRX 420 TM1 Rancher	07-11 ▲ 09-11 ▲ 14-15 ■
DRC225 CT004 ▲	KAWASAKI KSF 250 A1-A18 Mojave	87-04 ▲	DRC240 DRCF240 CT009 ▲	HONDA TRX 700 XX	08-11 ▲
DRC226 CT005 ▲	YAMAHA TT-R 250 L/M/N/P/R/S/T/V	99-06 ▲	DRC241 DRCF241 CT057SP ▲	KTM SX 65 XC 65	09-19 ▲ 09-10 ▲
DRC227 DRCF227 CT005 ▲	YAMAHA YZ 250 FX/FY/FZ/FA/FB/FD (4T)	08-13 ▲			
DRC228 CT008 ▲	YAMAHA YFM 350 FWBL/LC Big Bear YFM 350 FXG/FXH/FXJ/FXK/FXL/FXM/FXN /FXP/FXR/FXS/FXT Wolverine YFM 400 FWNMC/FWNN/FWNHM Big Bear 4WD/Real Tree Xtra YFM 400 NM/NMC/NN/NHN/P/HP Big Bear 2WD YFM 400 S Big Bear 2WD YFM 400 FS/FT Big Bear 4WD YFM 400 FBW/FBX/FBY/FBA/FBB Big Bear 4WD IRS YFM 400 FBHW Big Bear 400 #Hunter-IRS YFM 400 FBEW Big Bear 400 IRS #Exploring Edition	99 ▲ 95-05 ▲ 00-01 ▲ 00-03 ▲ 04 ▲ 04-05 ▲ 07-12 ▲ 07- ▲ 07 ▲			

DRC CLUTCH KIT BUYERS GUIDE

Part No.	Make/Model	Year	Part No.	Make/Model	Year
DRC244 DRCF244 CT009 ▲	HONDA CRF 450 R/RA (4 spring)	09-10 ▲	DRC271 CT013SP ▲	HONDA TRX 500 FM Fourtrax Foreman TRX 500 FPM Fourtrax Foreman	12-13 ▲ 12-13 ▲
DRC249 CT012SP ■	HONDA CRF 230 L CRF 230 M	08-11 ■ 09-11 ■	DRC273 CT023 ▲	KTM EXC-F 350 Inc 6 Days (Diaphragm Spring) 350 Freeride EXC 450 Inc 6 Days SX-F 450 XC-W 450 EXC 500 XC-W 500 EXC-F 350 XC-F-W 350 Diaphragm spring 350 Freeride HUSQVARNA TC 250 (2T) TE 250 Inc Tpi TE 300 Inc Tpi TX 300	12-20 ▲ 12-15 ▲ 12 ▲ 12 ▲ 12 ▲ 12-14 ▲ 12 ▲ 12-15 ▲ 11-21 ▲ 12 ▲ 14-21 ▲ 14-21 ▲ 14-21 ▲ 18-21 ▲
DRC252 CT041 ▲	KTM XC-W 400 XC-W 450 Six Days EXC 450 EXC-R 450 XCR-W 450 XCR-W 530 XC-W 450 Champions Edition EXC 530 EXC 530 Champion Edition EXC-R 530 XC-W Six Days	10-11 ▲ 10-11 ▲ 10-11 ▲ 08 ▲ 08 ▲ 08 ▲ 10 ▲ 10 ▲ 10-11 ▲ 10 ▲ 08 ▲ 10-11 ▲	DRC274 CT011 ▲	SUZUKI DR 200 SET/SEV/SEW/SEX/SEY /SEK1-SEK9/SEL3/SEL5/SEL6	96-09 /13/15-19 ▲
DRC254 DRCF254 CT045 ▲	SUZUKI RM-Z 450 K5/K6/K7	05-07 ▲	DRC275 CT023 ▲	KTM EXC 250 (2T) Inc 6 Days EXC-F 250 Inc 6 Days EXC 300 (2T) Inc 6 Days Diaphragm Spring XC-W 300 Diaphragm Spring EXC-F 450 Inc 6 Days Diaphragm Spring SX-F 450 Diaphragm Spring SX-F FACTORY 450 XC-F 450 Diaphragm Spring XC-W 450 EXC-F 450 6 DAYS EXC 500, inc 6 Days Diaphragm Spring XC-W 500 Diaphragm Spring HUSQVARNA FE 350 FE 450 FE 501 FE 501 S	13-18 ▲ 14-18 ▲ 13-21 ▲ 13-21 ▲ 13-18 ▲ 2016-17 ▲ 2016 ▲ 2016-17 ▲ 2016 ▲ 2017 ▲ 2016 ▲ 2016 ▲ 14-21 ▲ 14-21 ▲ 14-21 ▲ 16 ▲
DRC255 DRCF255 CT004 ▲	SUZUKI RM-Z 250 L0/L1/L2/L3/L4/L5/L6	10-21 ▲	DRC276 DRCF276 CT009 ▲	HONDA CRF 450 R (6 spring type)	13 ▲
DRC256 DRCF256 CT001 ▲	HONDA CRF 250 R	10 ▲	DRC277 DRCF277 CT081SP ▲	HONDA CRF 250 L (Non ABS) CRF 250 LA (ABS) CRF 250 Rally (ABS/Non ABS) CRF 300 NA	13-21 ▲ 17-21 ▲ 17-21 ▲ 18-21 ▲
DRC259 DRCF259 CT009 ▲	HONDA CRF 450 R (4 Spring type)	11-12 ▲	DRC280 DRCF280 CT013 ▲	SUZUKI DR-Z 250 K1-K7	01-07 ▲
DRC260 CT023 ▲	KTM SX-F 250 (4T) XC-F 250 SX-F 350 XC-F 350	13-21 ▲ 13-20 ▲ 11-21 ▲ 11-21 ▲	DRC281 CT023 ▲	KTM SX-F 450 (4T) XC-F 450 XC-W 500 HUSQVARNA FR 450 Rally FS 450 FX 450	14-21 ▲ 14-15 ▲ 16 ▲ 17-21 ▲ 15-21 ▲ 17-21 ▲
DRC261 DRCF261 CT001 ▲	HONDA CRF 250 R CRF 250 RX	11-21 ▲ 18-21 ▲			
DRC262 DRCF262 CT001 ▲	HONDA CR 125 R	00-03 ▲			
DRC263 CT020 ▲	YAMAHA WR 450 FS	04 ▲			
DRC264 CT001 ▲	HUSQVARNA CR 125 WR 125 WRE 125 SMS 125	00-11 ▲ 00-11 ▲ 00-11 ▲ 00-11 ▲			
DRC265 CT008 ▲	YAMAHA YZ 400 FK/FL	98-99 ▲			
DRC269 DRCF269 CT013SP ▲	KAWASAKI KX 450 F-FCF/FDF/FEF/FFF/HGF/HHF (4T)	12-21 ▲			
DRC270 CT013SP ▲	HONDA TRX 500 FE Fourtrax Foreman TRX 500 FPE Fourtrax Foreman	12-13 ▲ 12-13 ▲			

DRC CLUTCH KIT BUYERS GUIDE

Part No.	Make/Model	Year	Part No.	Make/Model	Year
DRC284	YAMAHA		DRC306 DRCF306 CT009 ▲	HONDA	
	T Max 530 ABS	12-19		CRF 1000 LAG (Manual Clutch/ABS) CRF 1000 L (Manual clutch/ABS)	16 ▲
	T Max 530 DX ABS	17-19			16-20 ▲
	T Max 530 SX ABS	17-19			
	T Max 530 Black Max ABS	13			
T Max 530 Bronze Max ABS	14				
T Max 530 Iron Max ABS	15				
DRC287 DRCF287 CT005 ▲	YAMAHA		DRC313 DRCF313 CT005 ▲	YAMAHA	
	YZ 450 FE/FF//FG/FGY (4T)	14-21 ▲		YZ 250 F 4T	16-21
DRC288 DRCF288 CT020 ▲	YAMAHA		DRC315 DRCF315 CT004 ▲	YAMAHA	
	YZ 250 FE/FF/FG/FGY (4T)	14-21 ▲		YZ 250 F	19-21 ▲
DRC292 CT023 ▲	KTM		DRC320	KTM	
	SX-F 250	16 ▲		790 Duke 790 Adventure 890 Duke 890 Adventure	17-20
	SX-F 250 Factory Edition	15 ▲			17-20
	XC-F 250	16 ▲			2021
	SX-F 350	16 ▲			2021
XC-F 350	16 ▲				
DRC293 CT023 ▲	KTM		DRC322	YAMAHA	
	SX 250 (2T) Diaphragm spring	13-21 ▲		YZF 450 R	14-21
	HUSQVARNA				
FC 250	14-21 ▲				
FC/FX 350	14-21 ▲				
DRC295 CT005 ▲	YAMAHA		DRC333	BETA	
	XT 250 X/Y/Z/A/B/D/E/F/G/H	08-17 ▲		Enduro 400 RR Enduro 450 RR	10-15
DRC296 CT023 ▲	HUSQVARNA		DRC335		HONDA
	FC 450	14-21 ▲		CRF 250 F	19-21
FC 450 Rockstar Edition	20-21 ▲				
DRC297 CT011 ▲	HONDA		DRC336	KAWASAKI	
	LT-F 250 K Ozark From frame JSAAJ51A221006	02 ▲		KX-F 250	19-21
DRC298 DRCF298 CT020 ▲	YAMAHA		DRC337		KAWASAKI
	WR 450 FG/FH	16-21 ▲		KX-F 450	19-21
DRC299 DRCF299 CT092 ▲	HONDA				
	CRF 450 R	17-21 ▲			
	CRF 450 RX (18" Rear wheel)	17-21 ▲			
	CRF 450 X (18" Rear wheel)	18-21 ▲			
	CRF 450 L	18-21 ▲			
DRC300 CT091 ■	AJP				
	250 - PR5 Trail	13-17 ■			
	250 - PR5 Supermoto	13-17 ■			
	250 - PR5 Enduro	13-17 ■			
250 - PR5 EX Extreme	13-17 ■				
DRC301 DRCF301 CT009 ▲	HONDA				
	CRF 450 R	14-16 ▲			
DRC303 DRCF303 CT001 ▲	HUSQVARNA				
	TC 125	14-18 ▲			
	TE 125	14-16 ▲			
TX 125	17-18 ▲				
DRC304 DRCF304 CT087SP ■	HUSQVARNA				
	TC 85 (F 17"/R 14")	18-21 ■			
	TC 85 (F 19"/R 16")	18-21 ■			
	KTM				
	SX 85 (F 17"/R 14")	18-21 ■			
SX 85 (F 19"/R 16")	18-21 ■				

SRC/SRK CLUTCH KIT BUYERS GUIDE

Part No.	Make/Model	Year	Part No.	Make/Model	Year
SRC2 SRK2 CT031 ▲	HONDA VF 700 F Interceptor VF 750 F V45 Interceptor	84-85 ▲ 83-84 ▲	SRC16 SRK16 CT009SP ■	HONDA CBR 600 F Hurricane CBR 600 F1	87 ■ 88-89 ■
SRC3 SRK3 CT014 ▲	HONDA VFR 700 F/F2 Interceptor VF 750 C Magna/CD Magna Deluxe VFR 750 F Interceptor 750 VFR 750 F	86-87 ▲ 94-03 ▲ 86 ▲ 90-97 ▲	SRC17 SRK17 CT036SP ▲	SUZUKI GSX 600 FN/FP/FR/FS/FT/FV Katana GSX R 600 WN/WP GSX-R 750 L/M/N GSX-R 750 WP/WR/WS	92-97 ▲ 92-93 ▲ 90-92 ▲ 92-95 ▲
SRC4 SRK4 CT009 ▲	HONDA CB 1000 CBF 1000 F CBR 1000 F Hurricane	94-95 ▲ 90-96 ▲ 87-88 ▲	SRC19 SRK19 CT014 ▲ CT014SP ●	HONDA 599 (CB 600 F) CBR 600 F2/F3/SJR/SE CBR 929 RR (929cc model) CBR 954 RR	04/06 ● 91-98 ● 00-01 ▲ 02-03 ▲
SRC5 SRK5 CT014 ▲	HONDA VFR 750 R (RC 30)	90 ▲	SRC20 SRK20 CT016 ▲	KAWASAKI ZL 900 A1/A2 Eliminator KZ 1000 E1/E2 Shaft ZG 1000 A1-A20 Concours ZG 1000 A6F Concours ZL 1000 A1 ZX 1000 A1/A2 Ninja ZX 1000 B1/B2/B3 Ninja ZX10 KZ 1100 B1/B2 (GPz) KZ 1100 A1/A2/A3 KZ 1100 D1/D2 Spectre KZ 1100 L1 (LTD) ZX 1100 A1/A2 (GPz) ZR 1100 A1/A2/A3/A4 Zephyr (ZR 1100 C3/C4) ZRX 1100 ZN 1100 B1/B2 (LTD) ZG 1200 A1/B1-B4 Voyager X11 ZG 1200 B5-B17 Voyager X11	85-86 ▲ 79-80 ▲ 86-05 ▲ 06 ▲ 87 ▲ 86-87 ▲ 88-90 ▲ 81-82 ▲ 81-83 ▲ 82-83 ▲ 83 ▲ 83-84 ▲ 92-95 ▲ 99-00 ▲ 84-85 ▲ 86-90 ▲ 91-03 ▲
SRC6 SRK6 CT010 ▲	YAMAHA FZR 400 U/W/SUC/SWC/A/SAC	88-90 ▲	SRC22 SRK22 CT016 ▲	KAWASAKI ER-6N (ER 650 C9F/CAF) ZX 600 D1/D2/D3/D4 (ZX6) ER-6F (EX 650) ER-6F ABS (EX 650 ABS) ER-6N (ER 650) ER-6N ABS (ER 650 ABS) KLE 650 A7F/A8F/A9F/CAF/CBF /CCF/CDF/DEF Versys	09-10 ▲ 90-93 ▲ 06-11 ▲ 06-11 ▲ 06-11 ▲ 06-11 ▲ 06-11 ▲ 07-14 ▲
SRC7 SRK7 CT010 ▲	YAMAHA FZR 600 W/WC/RA/AC/RAC/RB/RBC/RD /RDC/RE/REC/RF/RFC/RG/RGC/H/RHC/RJ /RJC/RK/RKC/RL/RLC	89-99 ▲	SRC24 SRK24 CT016 ▲	KAWASAKI KZ 750 K1/K2 (LTD) ZX 750 J1/J2/K1/K2 ZX 750 L1/L2/L3 (ZX-7) ZX 750 M1/M2 (ZX-7R) ZX 750 P1-P8 (ZX 7 R)	83-84 ▲ 91-92 ▲ 93-95 ▲ 93-94 ▲ 96-03 ▲
SRC8 SRK8 CT008SP ■	YAMAHA FZR 750 RT/RU FZR 1000 T/TC/U/UC Genesis	87-88 ■ 87-88 ■	SRC25 SRK25 CT021 ▲	KAWASAKI ZX 1100 C1-C4/D1-D9 (ZX11) ZX 1100 E1/E2/E3/F1 GPZ 1100 ZZR 1200 (ZX 1200 C1-C4)	90-01 ▲ 95-97 ▲ 02-05 ▲
SRC9 SRK9 CT008SP ■	YAMAHA FZR 750 OW01 YZF 750 SP/RF/RFC/RG/RGC/RH/RHC	89-91 ■ 94-96 ■	SRC29 SRK29 CT008SP ■	YAMAHA FZR 1000 E/EC/F/FC/G/GC YZF 1000 R (RJ)	93-95 ■ 97 ■
SRC10 SRK10 CT055SP ▲	SUZUKI GSX 1100 GM/GN/GP GSXR 1100 K/L/M/N	91-93 ▲ 89-92 ▲	SRC31 SRK31 CT008SP ■	YAMAHA FZR 1000 W/WC/A/AC/B/BC/D/DC	89-92 ■
SRC11 SRK11 CT016 ▲	KAWASAKI EN 450 A1-A6 (454 LTD) EN 500 A1-A7/C1-C10/C6F/C7F/C8F/C9F EX 500 A1-A7/D1-D12/D6F/D7F/D8F/D9F KZ 550 A1/A2/A3/A4 KZ 550 C1/C2/C3/C4 (LTD) KZ 550 D1 (GPz) KZ 550 F1 Spectre KZ 550 F2 (LTD) KZ 550 H1/H2 (GPz) KZ 550 M1 (LTD) ZX 550 A1/A2/A3 (GPz) ZR 550 B1/B2/B3/B4 Zephyr ZX 600 A1/A2/A3/B1 Ninja ZX 600 C1-C10 Ninja R ZL 600 A1/A2 ZL 600 B1/B2	85-90 ▲ 90-09 ▲ 87-09 ▲ 80-83 ▲ 80-83 ▲ 81 ▲ 83 ▲ 84 ▲ 82-83 ▲ 83 ▲ 84-86 ▲ 90-93 ▲ 85-87 ▲ 88-97 ▲ 86-87 ▲ 96-97 ▲	SRC33 SRK33 CT054SP ▲	YAMAHA YZF 600 RJ/RK/RL/RM/RN/RP/RR/RS/RT/RV/RW	95-07 ▲
SRC13 SRK13 CT029 ▲	SUZUKI GSX 600 FJ/FK/FL/FM Katana GSX-R 750 G/H	88-91 ▲ 86-87 ▲			
SRC14 SRK14 CT036SP ▲	SUZUKI GSX-R 750 J/K	88-89 ▲			
SRC15 SRK15 CT048SP ▲	SUZUKI GSXR 1100 G/H/J	86-88 ▲			

SRC/SRK CLUTCH KIT BUYERS GUIDE

Part No.	Make/Model	Year	Part No.	Make/Model	Year
SRC38 SRK38 CT004 ▲	KAWASAKI ZX 6R (ZX 600 F1/F2/F3/G1/G2) ZX 6R (ZX 600 J1/J2/J3) ZZR 600 (ZX 600 J4) ZZR 600 J6F/J7F/J8F ZX 6R (ZX 636 A1) ZX6R (ZX 636 B1/B2) 636cc Z 750 S (ZR 750 K1/K6F)	95-99 ▲ 00-02 ▲ 05 ▲ 06-08 ▲ 02 ▲ 03-04 ▲ 05-06 ▲	SRC54 SRK54 CT016 ▲	KAWASAKI KZ 1000 J1/J2/J3 KZ 1000 K1/K2 (LTD) KZ 1000 M1/M2 (CSR) KZ 1000 P1-P22/P24 Police KZ 1000 R1/R2 Replica	81-83 ▲ 81-82 ▲ 81-82 ▲ 82-03/05 ▲ 82-83 ▲
SRC39 SRK39 CT055SP ▲	SUZUKI RF 900 RR GSXR 1100 WR/WP/WS/WT/WV/WW	94 ▲ 93-98 ▲	SRC55 SRK55 CT014 ▲	HONDA CBR 900 RR	96-97 ▲
SRC40 SRK40 CT055SP ▲	SUZUKI GSX-R 750 T/V/W/X GSF 1200 SV/SAV/SW/SX/SY/SK1-SK5	96-99 ▲ 97-05 ▲	SRC56 SRK56 CT017 ▲	YAMAHA YZF 1000 R1	98 ▲
SRC41 SRK41 CT016 ▲	KAWASAKI ZX 750 N1/N2 (ZX 7 RR) ZX-9R B1/B2/B3/B4 Ninja	96-99 ▲ 94-97 ▲	SRC57 SRK57 CT014 ▲	HONDA CBR 900 RR 919 (CB 900 F)	98-99 ▲ 02-07 ▲
SRC42 SRK42 CT009SP ■	HONDA CBR 600 F1	90 ■	SRC58 SRK58 CT055SP ▲	SUZUKI GSX R 600 V/W/X/Y	97-00 ▲
SRC43 SRK43 CT016 ▲	KAWASAKI ZX 600 E1-E13 (ZX6)	93-05 ▲	SRC59 SRK59 CT004 ▲	KAWASAKI ZX 9R (ZX 900 C1/C2)	98-99 ▲
SRC45 SRK45 CT036SP ▲	SUZUKI RF 600 RR/RS/RT	94-96 ▲	SRC60 SRK60 CT009 ▲	HONDA VTR 1000 F Superhawk	98-05 ▲
SRC46 SRK46 CT016 ▲	KAWASAKI W 650 (EJ650A1/A2/A3/A4) VN 800 A1-A11/B1-B10 VN 700 A1 Vulcan KZ 750 G1 (LTD) KZ 750 M1 (CSR) VN 750 A2-A21/A6F Vulcan	00-02 ▲ 95-05 ▲ 85 ▲ 80 ▲ 82 ▲ 86-06 ▲	SRC62 SRK62 CT013SP ■	HONDA CTX 700 N (Naked/Manual G/box) CTX 700 (Top Fairing/Manual G/box) NC 700 X (2 Piston Caliper) NT 700 V/VA NC 750 S/X NC 750 S/X (ABS)	14 ▲ 14 ■ 12-14 ■ 10-13 ■ 14-15 ■ 14-18 ■
SRC50 SRK50 CT024SP ▲	SUZUKI GS 1000 SZ GS 1000 GT/GX GS 1000 GLT/GLX/SZ GS 1100 ET/EX/EZ GS 1100 GZ/GD GS 1100 GLZ/GLD GS 1100 GKZ/GK2/GKD/GKE GS 1100 LT GS 1150 ES3/ESE/EFESF/EF2/EG/ESG	82 ▲ 80-81 ▲ 80-82 ▲ 80-82 ▲ 82-83 ▲ 82-83 ▲ 82-84 ▲ 80 ▲ 83-86 ▲	SRC64 SRK64 CT013SP ■	HONDA NT 650 Hawk GT XRV 650 J/K Africa Twin	88-90 ▲ 88-89 ■
SRC51 SRK51 CT008SP ■	YAMAHA FZ6 (All models) YZF 600 RL/RRL/RM/RMC/RN/RNC/P/PC R6 FZX 700 S/SC/T/TC FZ 750 N FZ 750 S/SC TDM 850 D/DC/E/EC	04-09 ■ 99-02 ■ 86-87 ■ 85 ■ 86 ■ 92-93 ■	SRC65 SRK65 CT017 ▲	YAMAHA YZF 1000 R1	99-03 ▲
SRC53 SRK53 CT016 ▲	KAWASAKI ZX 750 F1/F2/F3/F4 Ninja VN 800 Drifter C1/C2/E1-E5/E6F VN 900 Vulcan Classic LT (D6F/D7F/D8F/D9F /DAF/DBF/DCF/DDF/DEF/DFE) VN 900 B6F/B7F/B8F/B9F/BAF/BBF/BCF/BDFA /BEF/BEFA/BFF Vulcan Classic VN 900 C7F/C8F/C9F/CAF/CBF/CCF/CDF /CEFA/CFE ZX 900 A1/A2/A3 Ninja	87-90 ▲ 99-06 ▲ 06-19 ▲ 06-19 ▲ 07-19 ▲ 84-86 ▲	SRC66 SRK66 CT014 ★	HONDA CBR 600 F4 (Carb Model)	99-00 ★
			SRC67 SRK67 CT021 ▲	SUZUKI GSX 1300 RX Hayabusa	99 ▲
			SRC68 SRK68 CT009 ▲	SUZUKI TL 1000 RW/RX/RY TL 1000 SX/SY	98-00 ▲ 99-00 ▲
			SRC70 SRK70 CT056SP ■	HONDA ST 1100/1100 A	91-01 ■
			SRC71 SRK71 CT014 ▲	SUZUKI GSXR 750 Y	00- ▲
			SRC72 SRK72 CT008 ▲	YAMAHA SRX 600 S/SC	86 ▲

SRC/SRK CLUTCH KIT BUYERS GUIDE

Part No.	Make/Model	Year	Part No.	Make/Model	Year
SRC74 SRK74 CT008SP ■	YAMAHA YZF-R6 RRR/RRS/T/TC YZF-R6S (SV/SW/SX/SY)	03-05 ■ 06-09 ■	SRC88 SRK88 CT015 ▲	SUZUKI GSXR 600 K8/K9/L0 GSXR 750 K6/K7	08-10 ▲ 06-07 ▲
SRC75 SRK75 CT014 ▲	HONDA CBR 600 RR CBR 600 RA	03-20 ▲ 09-20 ▲	SRC89 SRK89 CT004 ▲	SUZUKI GSXR 1000 K1/K2/K3/K4/ZK4 KAWASAKI ZX9R (ZX 900 E1/E2/F1/F2) Z 1000 (ZR 1000 A1/A2/A3) Z 1000 (ZR 1000 A6F)	01-04 ▲ 01-03 ▲ 03-05 ▲ 06 ▲
SRC76 SRK76 CT004 ▲	KAWASAKI ZX6RR (ZX 600 K1) 599cc	03 ▲	SRC90	HONDA CRF 50 F	04-21 ▲
SRC77 SRK77 CT020 ▲	YAMAHA (FZ1) FZS 1000 V/W/X/Y/Z/A/B/D/E YZF R1 (5VY)	06-14 ▲ 04-06 ▲	SRC93 SRK93 CT020 ▲	YAMAHA YZF R1 LE YZF-R1 (6 piston caliper)	06 ▲ 07-08 ▲
SRC78 SRK78 CT014 ▲	SUZUKI GSXR 600 K4/K5	04-05 ▲	SRC94 SRK94 CT014 ▲	HONDA CBR 900 RR	93-95 ▲
SRC79 SRK79 CT004 ▲	KAWASAKI ZX-10R (ZX 1000 C1/C2/D6F/D7F) ZX10R (ZX 1000 E8F/E9F/FAF/JBF/KBF/JCF /KCF/KDF/JDF/JEF/KEF/JJF/KFF) ZX10 RR ZX10 RR Performance	04-07 ▲ 08-15 ▲ 17-21 ▲ 17-21 ▲	SRC95 SRK95 CT043SP ▲	HONDA CBR 1000 RR/RRA CBR 1000 RA/RAA	08-16 ▲ 09-16 ▲
SRC80 SRK80 CT009SP ■	HONDA CBR 1000 RR	04-07 ■	SRC96 SRK96 CT020 ▲	YAMAHA YZF-R1 (6 piston caliper)	09-14 ▲
SRC81 SRK81 CT022 ▲	SUZUKI SV 650 X/Y/K1/SK1/SK2/K2	99-02 ▲	SRC97 SRK97 CT009 ▲	SUZUKI GSXR 1000 K9/L1	09-11 ▲
SRC82 SRK82 CT033SP ▲	SUZUKI SFV 650 K9/L3/L4/L5 SV 650 K3/SK3/K4/SK4/K5/SK5/K6/SK6/K7 /SK7/SK8/K8/SK9/SLO SV 650 AK7/AK8 SV 650 AL (ABS) SV 650 SAK7/SAK8/SK9/SALO ABS DL 650 AK/AL V-Strom (ABS Model) DL 650 XT V-Strom ABS (DL 650 XAL5/XAL6) DL 650 AAL V-Strom (ABS Adventure)	09-10/13-15 ▲ 03-10 ▲ 07-08 ▲ 16-21 ▲ 07-10 ▲ 04-21 ▲ 12-21 ▲ 15-21 ▲	SRC98 SRK98 CT021 ▲	KTM 1190 RC8 (6 spring type clutch) 1190 RC8 R (6 spring type clutch)	09-12 ▲ 08-12 ▲
SRC83 SRK83 CT004 ▲	KAWASAKI ZX6RR (ZX 600 M1)	04 ▲	SRC101 SRK101 CT004 ▲	KAWASAKI ZX 6R (ZX 600 P7F/P8F/P9F/R9F/RAF/RBF/RCF)	07-12 ▲
SRC84 SRK84 CT004 ▲	KAWASAKI ZX6R (ZX 636 C1/C6F 636cc)	05-06 ▲	SRC103 SRK103 CT009 ▲	HONDA VFR 1200	10-14 ▲
SRC85 SRK85 CT015 ▲	SUZUKI GSXR 1000 K5/K6/K7/K8 GSX-S 1000 (Naked) GSX-S 1000 ABS (Naked) GSX-S 1000 F (Faired) GSX-S 1000 F ABS (Faired) Katana	05-08 ▲ 18-21 ▲ 18-21 ▲ 18-21 ▲ 18-21 ▲ 19-21 ▲	SRC110 SRK110 CT015 ▲	SUZUKI GSXR 600 GSXR 750	08-21 ▲ 11-21 ▲
SRC86 SRK86 CT015 ▲	SUZUKI GSXR 600 K6/K7	06-07 ▲	SRC111 SRK111 CT014 ▲	SUZUKI GSXR 750 K1/K2/K3	01-03 ▲
SRC87 SRK87 CT008SP ■	YAMAHA YZF-R6	06-17 ■	SRC112 SRK112 CT014 ▲	SUZUKI GSXR6 600 K1/K2/K3/ZK3	01-03 ▲
			SRC113 SRK113 CT014 ▲	APRILIA RSV4R RSV4 Factory RSV4 Factory APRC RSV4 R APRC	10-12 ▲ 09-14 ▲ 11-14 ▲ 11-14 ▲
			SRC115 SRK115 CT035SP ▲	SUZUKI GS 1000 C/N/EC/EN/SN/ET/ST	78-80 ▲

SRC/SRK CLUTCH KIT BUYERS GUIDE

Part No.	Make/Model	Year	Part No.	Make/Model	Year
SRC118 SRK118 CT009 ▲	KAWASAKI EX 300 ADF/BDF/ADFA/AEF/AEFA/AES /AESB/BDF/BEF/BEFA (Ninja) EX 300 BDF/ADF/BEF/BEFA Ninja Verisy-X 300 ABS	13-19 ▲ 13-19 ▲ 17-21 ▲	SRC139 SRK139	KTM 390 Duke RC 390	13-14 14-15
SRC119 SRK119 CT012SP ▲	HONDA CBR 125 RW7/RW8/RW9/RWA/RWB/RC/RD (No judder spring)	07-13 ▲	SRC140 SRK140	KTM 390 Duke RC 390	15-17 16-17
SRC120 SRK120 CT009 ▲	SUZUKI GSX-R 1000 L2/L3/ZL3/L4/L5/L6	12-16 ▲	SRC141 SRK141 CT014SP ▲	BENELLI TNT 600 i Tornado	16-17 ▲
SRC121 SRK121 CT014 ▲	SUZUKI GSX-R 750 K4/K5	04-05 ▲	SRC142 SRK142 CT009 ▲	SUZUKI GSX-R 1000 AL7 ABS (3 Spring clutch)	17 ▲
SRC122 SRK122 CT084SP ▲	HONDA MSX 125 D/E/F/G/H Grom (Non ABS) MSX 125 AH Grom (ABS) Monkey 125	14-21 ▲ 18-21 ▲ 19-21 ▲	SRC143 SRK143 CT014 ▲	SUZUKI CBR 600 F4i Sport Injection Model)	01-06 ▲
SRC124 SRK124 CT020 ▲	YAMAHA MT-09 Tracer ABS (847cc/3 Cyl Engine) MT-09A (2DR/ABS/847cc/3 Cyl Engine) MT-09A Sport Tracker ABS (847cc/3 Cyl Engine) MT-09A Street Rally ABS (847cc/3 Cyl Engine)	15-21 ▲ 14-21 ▲ 14-21 ▲ 14-21 ▲	SRC144 SRK144 CT085 ▲	BMW F800 GS (Early type plates 14mm ears) F800 GT (Early type plates 14mm ears) F800 S/ST (Early type plates 14mm ears)	08-11 ▲ 04-06 ▲ 04-06 ▲
SRC125 SRK125	YAMAHA MT-07 Non ABS (689cc/2 Cyl) MT-07A ABS (689cc/2 Cyl)	14-21 14-21	SRC145 SRK145 CT083 ▲	BMW G 650 GS (R13) G 650 GS Sertao (R13) G 650 X Country (K15)	08-16 ▲ 10-14 ▲ 08-10 ▲
SRC128 SRK128 CT080 ▲	YAMAHA YZ-F R3 (321cc) MT-03	15-21 ▲ 12-21 ▲	SRC146 SRK146 CT086SP ▲	TRIUMPH Bonneville T120 (1200cc Liquid Cooled) Bonneville T120 Black (1200cc Liquid Cooled) Bonneville Bobber (1200cc Liquid Cooled) Bonneville Bobber Black (1200cc Liquid Cooled) Thrupton 1200 (Liquid Cooled) Thrupton R 1200 (Liquid Cooled)	16-21 ▲ 16-21 ▲ 17-21 ▲ 18-21 ▲ 16-21 ▲ 16-21 ▲
SRC129 SRK129 CT079SP ●	YAMAHA FZ-10 YZF-R1 YZF-R1M YZF-R1S	17 ● 15-21 ● 15-21 ● 16 ●	SRC147 SRK147 CT086SP ▲	TRIUMPH Bonneville T100 (900cc/Liquid Cooled/Spoke Wheel) Bonneville T100 Black (900cc/Liquid Cooled/Spoke Wheel) Street Cup (900cc Liquid Cooled) Street Scrambler (900cc Liquid Cooled) Street Twin (900cc Liquid Cooled)	16-21 ▲ 16-21 ▲ 16-20 ▲ 16-20 ▲ 16-21 ▲
SRC130 SRK130 CT085 ▲	BMW F650 GS (Late type plates 2 x 13mm /7 x 14mm ears) F700 GS (Late type plates 2 x 13mm /7 x 14mm ears) F800 GS (Late type plates 2 x 13mm /7 x 14mm ears) F800 GS Adventure (Late type plates 2 x 13mm /7 x 14mm ears) F800 GT (Late type plates 2 x 13mm /7 x 14mm ears) F800 S (Late type plates 2 x 13mm /7 x 14mm ears) F800 ST (Late type plates 2 x 13mm /7 x 14mm ears) F800 R (Late type plates 2 x 13mm /7 x 14mm ears)	07-17 ▲ 11-17 ▲ 12-17 ▲ 12-17 ▲ 07-17 ▲ 07-17 ▲ 07-17 ▲ 07-17 ▲ 05-17 ▲	SRC148 SRK148 CT011 ▲	SUZUKI GSX-R 125 GSX-S 125 GSX 150 L6/DZAL6 Gixxer GSX-R 150 RF-Q/RFX-Q GSX-R 150 RFL8/RFXL8 GSX-S 150 MFL8/MFXL8	18-21 ▲ 18-21 ▲ 16 ▲ 17-18 ▲ 18-21 ▲ 18-21 ▲
SRC131 SRK131 CT017 ▲	YAMAHA XT 1200 Z Super Tenere FJR 1300 R/RC/S/AS/T/AT FJR 1300 A XVS 1300 V-Star/V-Star Tourer XVS 1300 V-Star De Luxe XVS 1300 Stryker	12-13 ▲ 03-05 ▲ 06-15 ▲ 07-14 ▲ 13-14 ▲ 11-14 ▲	SRC149 SRK149 CT014 ▲	HONDA CB 650 FE/FG (Non ABS) CB 650 FAE/FAF/FAG/FAH/FAJ (ABS) CBR 650 F (Non ABS) CBR 650 FA (ABS)	14-16 ▲ 14-18 ▲ 14-21 ▲ 14-21 ▲
			SRC151 SRK151 CT083 ▲	BMW G 310 GS G 310 R	17-21 ▲ 17-21 ▲
			SRC155 SRK155 CT009 ▲	KAWASAKI Ninja 650 (EX 650) Ninja 650 ABS (EX 650 ABS) Z 650 (ER 650) Z 650 ABS (ER 650 ABS)	12-18 ▲ 12-18 ▲ 12-18 ▲ 12-18 ▲

SRC/SRK CLUTCH KIT BUYERS GUIDE

Part No.	Make/Model	Year	Part No.	Make/Model	Year
SRC160 SRK160 CT008SP ▲	YAMAHA YZF-R6	18-21 ▲	SRC7003 SRK7003 CT702SP ▲	HARLEY DAVIDSON FLHTKL 1KKL Ultra Limited Low FLRT 1MCM Freewheeler FLSS 1JS9 Slim S FLSS 1JS9 Softail Slim S FLSTFBS 1JT9 Fat Boy S FLSTFBS 1JT9 Fat Boy S	15-16 ▲ 15-16 ▲ 17-21 ▲ 16 ▲ 16-17 17
SRC161 SRK161	HONDA CB 1100 EX	16-19	SRC7004 SRK7004	INDIAN Chief Classic Chief Dark Horse Chief Vintage Chieftain Chieftain Dark Horse Chieftain Elite Chieftain Limited Roadmaster Roadmaster Classic Roadmaster Elite Springfield Springfield Dark Horse	14-21 16-21 14-21 14-18 16-21 17-21 17-18 15-18 17-21 18-21 16-21 18
SRC162 SRK162	YAMAHA XSR 900 ABS (MTM850)	16-21	SRC7005 SRK7005	HARLEY DAVIDSON XG500 XG750	15-20 15-20
SRC163 SRK163	KAWASAKI Ninja H2	15-21	SRC7006 SRK7006 CT702SP ▲	HARLEY DAVIDSON VRSCAW V-Rod Wide Tire VRSCAWA W/ABS VRSCD Night Rod VRSCDA Night Rod W/ABS VRSCDXA Night Rod Special W/ABS VRSCDX Night Rod Special VRSCAW V-Rod VRSCF V-Rod Muscle VRSCDX ANV Night Rod Special Anv	08 ▲ 08 ▲ 08 ▲ 08 ▲ 08 ▲ 08-21 ▲ 09-10 ▲ 09-21 ▲ 12 ▲
SRC164 SRK164	KAWASAKI Ninja H2R	15-21	SRC7007 SRK7007 CT707SP ▲	HARLEY DAVIDSON VRSCA V-Rod VRSCAW V-Rod VRSCB V-Rod VRSCR Street Rod VRSCSE CVO V-Rod VRSCSE2 CVO V-Rod VRSCX Screamin' Eagle V-Rod VRXSE CVO VR Destroyer	02-06 ▲ 07 ▲ 04-05 ▲ 06-07 ▲ 05 ▲ 06 ▲ 07 ▲ 06 ▲
SRC165 SRK165	BMW R 1200 GS R 1200 GS Adventure R 1200 R R 1200 RS R 1250 GS R 1250 GS TE R 1250 GS Rallye R 1250 GS Rallye TE R 1250 GS Adventure R 1250 GS Adventure TE R 1250 GS Adventure Rallye R 1250 GS Adventure Rallye TE	13-18 13-18 13-18 14-18 19-21 19-21 19-21 19-21 19-21 19-21 19-21 19-21 19-21	SRC7008 SRK7008 CT708SP ▲	HARLEY DAVIDSON FLFBS 1YK Fat Boy 114 FLFBS 1YRK Fat Boy 114 Anniversary FLFBS 1YSK Fat Boy 114 Anniversary FLHCS 1YBK Heritage Classic 114 FLHCS 1YPK Heritage Classic 114 Anniversary FLHP 1FHC Road King Police FLHTCUTG 1MAD Tri Glide Ultra FLHTCUTG 1MDD Tri Glide Ultra Anniversary FLHTP 1FMC Electra Glide Standard Police FLRT 1MCC Freewheeler FXBRS 1YHK Breakout 114 FXBRS 1YTK Breakout 114 Anniversary FXFBS 1YLK Fat Bob 114	18-21 ▲ 18-21 ▲ 18-21 ▲ 18-21 ▲ 18-21 ▲ 17 ▲ 17-21 ▲ 18-21 ▲ 17 ▲ 17-21 ▲ 18 ▲ 18 ▲ 18 ▲
SRC166 SRK166	TRIUMPH Tiger 800 Tiger 800 XC Tiger 800 XR	11-12 11-12 2018-	SRC7009 SRK7009 CT703SP ▲	HARLEY DAVIDSON FLHP 1FHM Road King Police FLHPE 1FTM Road King Police FLHTCUTG 1MAM Tri Glide Ultra Classic FLHTCUTG ANV 1MAM_ANV Tri Glide Ultra Classic Anv FLHTP 1FMM Electra Glide Standard Police FLHXXX 1MBM Street Glide Trike FXDLS 1GS8 Dyna Low Rider S	11-16 ▲ 11 ▲ 09-13 ▲ 13 ▲ 11-16 ▲ 10-11 ▲ 16-21 ▲
SRC167 SRK167	KAWASAKI Ninja 400 Z 400	17-21 17-21	SRC7003 SRK7003 CT702SP ▲	HARLEY DAVIDSON FLHTCUL 1KDM Ultra Classic Low FLHTCUL TC 1KFL Ultra Classic Low Twin-Cooled FLHTCUTG 1MAL Tri Glide Ultra Classic FLHTK 103 1TEL CVO Limited	15-21 ▲ 15-21 ▲ 14-16 ▲ 14 ▲
SRC168 SRK168	KTM 1050 Adventure 1090 Adventure Inc R model 1090 Adventure L and S models 1190 Adventure 1190 Adventure R 1190 RC8 R (3 Spring Type Clutch) 1290 Super Adventure 1290 Super Adventure R&S models 1290 Super Adventure T 1290 Superduke GT 1290 Superduke R	15-16 17-19 2019 13-16 13-16 13-15 15-16 17-21 2017 17-19 16-19			
SRC169 SRK169	SUZUKI GSX-S 750	15-21			
SRC7001 SRK7001	INDIAN Octane Scout Scout Sixty	17 15-16 16-17			
SRC7002 SRK7002	INDIAN Scout Scout 1200 Scout Bobber Scout Sixty	17-21 17-21 18 17-21			

SRC/SRK CLUTCH KIT BUYERS GUIDE

Part No.	Make/Model	Year	Part No.	Make/Model	Year
SRC7010 SRK7010 CT702SP ▲	HARLEY DAVIDSON		SRC7011 SRK7011 CT703SP ▲	HARLEY DAVIDSON	
	FLHR 1FBC Road King	17		FXSTS 1BLL Springer Softail	98-99 ▲
	FLHRC 1FRC Road King Classic	17		FXSTS 1BLY Springer Softail	00-03 ▲
	FLHRXS 1KVC Road King Special	18		FXSTSI 1BZB Springer Softail	01-03 ▲
	FLHTCU 1FCC Electra Glide Ultra Classic	17-21			
	FLHTK 1KED Ultra Limited	17-21			
	FLHTK 1KND Ultra Limited Shrine Edition	18			
	FLHTK 1KWD Ultra Limited Anniversary	18			
	FLHTKL 1KKD Ultra Limited Low	17-18			
	FLHX 1KBC Street Glide	17-21			
	FLHX 1KXC Street Glide Anniversary	18			
	FLHXS 1KRC Street Glide Special	17-18			
	FLHXS 1KYC Street Glide Special Anniversary	18			
	FLTRU 1KGD Road Glide Ultra	17-21			
	FLTRX 1KHC Road Glide	17-21			
	FLTRXS 1KTC Road Glide Special	17-21			
SRC7011 SRK7011 CT703SP ▲	HARLEY DAVIDSON			HARLEY DAVIDSON	
	FLHR 1FBM Road King	15-21 ▲		FLD 103 1GZM Dyna Switchback	12-16 ▲
	FLHR 1FDL Road King	98-03 ▲		FLHR 103 1FBM Road King	11 ▲
	FLHRC 1FRM Road King Classic	14-21 ▲		FLHR 1FBM Road King	12-13 ▲
	FLHRCI 1FRR Road King Classic	98 ▲		FLHR 1FDV Road King	04-05 ▲
	FLHRCI 1FRW Road King Classic	99-03 ▲		FLHR ANV 1FBM_ANV Road King ANV	13 ▲
	FLHRI 1FBW Road King	00-03 ▲		FLHRC 103 1FRM Road King Classic	11 ▲
	FLHT 1DDV Electra Glide Standard	03 ▲		FLHRC 1FRM Road King Classic	12-13 ▲
	FLHT 1DDL Electra Glide Standard	98-02 ▲		FLHRCI 1FRW Road King Classic	04 ▲
	FLHTC 1DJL Electra Glide Classic	98 ▲		FLHRCI 1FRW Road King Classic	05 ▲
	FLHTC 1DJV Electra Glide Classic	99-03 ▲		FLHRI 1FBW Road King	04-05 ▲
	FLHTCI 1FFR Electra Glide Classic	98-03 ▲		FLHRS 1FXV Road King Custom	04-05 ▲
	FLHTCI 1FFW Electra Glide Classic	01 ▲		FLHRSI 1FYW Road King Custom	04 ▲
	FLHTCU 1FCM Ultra Classic	14-21 ▲		FLHRSI 1FYW Road King Custom	05 ▲
	FLHTCU TC 1KSL Ultra Classic Twin-Cooled	14-16 ▲		FLHT 1DDV Electra Glide Standard	04-05 ▲
	FLHTCUI 1FCR Ultra Classic	98-03 ▲		FLHTC 103 1FFM Electra Glide Classic	11 ▲
	FLHTI 1FWW Electra Glide Standard	03 ▲		FLHTC 1DJV Electra Glide Classic	04-05 ▲
	FLHTK 1KEL Ultra Limited	14-16 ▲		FLHTC 1FFM Electra Glide Classic	12 ▲
	FLHX 1KBM Street Glide	14-16 ▲		FLHTC 1FFM Electra Glide Classic	13 ▲
	FLHXS 1KRM Street Glide Special	14-16 ▲		FLHTCI 1FCW Ultra Classic	05 ▲
	FLSTC 1BJL Heritage Softail Classic	98-99 ▲		FLHTCI 1FFW Electra Glide Classic	04-05 ▲
	FLSTC 1BJY Heritage Softail Classic	00-03 ▲		FLHTCU 103 1FCM Ultra Classic	11 ▲
	FLSTCI 1BWB Heritage Softail Classic	01-03 ▲		FLHTCU 1FCM Ultra Classic	12-13 ▲
	FLSTF 1BML Fat Boy	98-99 ▲		FLHTCUI 1FCW Ultra Classic	04 ▲
	FLSTF 1BMY Fat Boy	00-03 ▲		FLHTI 1FWW Electra Glide Standard	04-05 ▲
	FLSTFI 1BxB Fat Boy	01-03 ▲		FLHTK 1KEM Electra Glide Ultra Limited	10-13 ▲
	FLSTS 1BRL Heritage Springer	98-03 ▲		FLHTK ANV 1KEM_ANV Electra Glide Ultra Limited ANV	13 ▲
	FLSTSI 1BYB Heritage Springer	01-03 ▲		FLHX 103 1KBM Street Glide	11 ▲
	FLTR 1FPL Road Glide	98 ▲		FLHX 1KBM Street Glide	12-13 ▲
	FLTR 1FPV Road Glide	99-03 ▲		FLS 103 1JRV Softail Slim	13-15 ▲
	FLTRI 1FSR Road Glide	98 ▲		FLS 103 1JRV Softail Slim	12 ▲
	FLTRI 1FSW Road Glide	99-03 ▲		FLS 1JRV Slim	17-21 ▲
	FLTRU 1KGL Road Glide Ultra	16 ▲		FLS 1JRV Softail Slim	16 ▲
	FLTRX 1KHM Road Glide	15-16 ▲		FLSTC 103 1BWV Heritage Softail Classic	13-15 ▲
	FLTRXS 1KTM Road Glide Special	15 ▲		FLSTC 103 ANV 1BWV_ANV Heritage Softail Classic ANV	13 ▲
	FLTRXS 1KTM Road Glide Special	16 ▲		FLSTC 1BJY Heritage Softail Classic	04-05 ▲
	FXD 1GHL Dyna Super Glide	98 ▲		FLSTC 1BWV Heritage Softail Classic	16-17 ▲
	FXD 1GHV Dyna Super Glide	00-03 ▲		FLSTCI 1BWB Heritage Softail Classic	04-05 ▲
	FXDL 1GDL Dyna Low Rider	98-03 ▲		FLSTCI Shrine 1JHB Heritage Softail Classic Shrine	05 ▲
	FXDS-CONV GGXX Dyna Glide Convertible	99 ▲		FLSTF 103 1BXV Fat Boy	12-14 ▲
	FXDS-CONV GGYY Dyna Glide Convertible	00 ▲		FLSTF 103 1BXV Fat Boy	15 ▲
	FXDWG 1GEL Dyna Wide Glide	98 ▲		FLSTF 1BMY Fat Boy	04-05 ▲
	FXDWG 1GEV Dyna Wide Glide	99-05 ▲		FLSTF 1BXV Fat Boy	16-17 ▲
	FXDX 1GJV Dyna Super Glide Sport	99-03 ▲		FLSTFB 103 1JNV Fat Boy LO	12-15 ▲
	FXDXT 1GLV Dyna Super Glide T-Sport	01-03 ▲		FLSTFB 103 ANV 1JNV_ANV Fat Boy LO ANV	13 ▲
	FXST 1BHL Softail Standard	99 ▲		FLSTFB 1JN5 Fat Boy LO	12 ▲
	FXST 1BHY Softail Standard	00-03 ▲		FLSTFB 1JNV Fat Boy LO	16-17 ▲
	FXSTB 1BTL Night Train	99 ▲		FLSTFI 1BxB Fat Boy	04-05 ▲
	FXSTB 1BTY Night Train	00-03 ▲		FLSTFI Shrine 1JGB Fat Boy Shrine	05 ▲
	FXSTBI 1JAB Night Train	01-03 ▲		FLSTN 103 1JDV Softail Deluxe	12-15 ▲
	FXSTC 1BKL Softail Custom	98-99 ▲		FLSTN 1BNY Softail Deluxe	05 ▲
	FXSTD 1BSY Softail Deuce	00-03 ▲		FLSTN 1JDV Deluxe	17 ▲
	FXSTDI 1JBB Softail Deuce	01-03 ▲		FLSTN 1JDV Softail Deluxe	16 ▲
	FXSTI 1BVB Softail Standard	01-03 ▲		FLSTNI 1JDB Softail Deluxe	05 ▲
			FLSTSC 1BRY Springer Classic	05 ▲	
			FLSTSCI 1BYB Springer Classic	05-06 ▲	
			FLTRI 1FSW Road Glide	04-05 ▲	
			FLTRU 1KGM Road Glide Ultra	11-13 ▲	
			FLTRX 103 1KHM Road Glide Custom	11 ▲	
			FLTRX 1KHM Road Glide Custom	12-13 ▲	
			FXD 1GHV Dyna Super Glide	04-05 ▲	
			FXDB 103 1GXM Dyna Street Bob	14-16 ▲	
			FXDB 103 1GXM Dyna Street Bob 103	17 ▲	
			FXDBA 103 1VBM Dyna Street Bob (H-D1)	13 ▲	
			FXDBB 103 1VCM Dyna Street Bob (H-D1)	14-15 ▲	
			FXDBC 103 1VDM Dyna Street Bob Limited	16 ▲	

SRC/SRK CLUTCH KIT BUYERS GUIDE

Part No.	Make/Model	Year	Part No.	Make/Model	Year		
SRC7012 SRK7012 CT703SP ▲ Contd.	HARLEY DAVIDSON		SRC7013 SRK7013 CT703SP ▲ Contd.	HARLEY DAVIDSON			
	FXDBP 103 1VAM Dyna Street Bob	16 ▲		FLSTI 1JFB Heritage Softail	06 ▲		
	FXDBP 103 1VAM Dyna Street Bob (H-D1)	15 ▲		FLSTN 1BNY Softail Deluxe	06 ▲		
	FXDBP 103 1VAM Dyna Street Bob (H-D1)	13-14 ▲		FLSTN 1JD5 Softail Deluxe	07-15 ▲		
	FXDC 103 1GVM Dyna Super Glide Custom	14 ▲		FLSTNI 1JDB Softail Deluxe	06 ▲		
	FXDC 1GTV Dyna Super Glide Custom	05 ▲		FLSTSB 1JM5 Cross Bones	08-11 ▲		
	FXDCI 1GVW Dyna Super Glide Custom	05 ▲		FLSTSC 1BRY Springer Classic	06 ▲		
	FXDF 103 1GYM Dyna Fat Bob	12-17 ▲		FLSTSC 1BY5 Springer Classic	07 ▲		
	FXDI 1GMW Dyna Super Glide	04-05 ▲		FLTR 1FS4 Road Glide	07-09 ▲		
	FXDL 103 1GNM Dyna Low Rider	14-16 ▲		FLTRI 1FSW Road Glide	06 ▲		
	FXDL 103 1GNM Low Rider 103	17 ▲		FLTRX 1KH4 Road Glide Custom	10-11 ▲		
	FXDL 1GDV Dyna Low Rider	04-05 ▲		FXCW 1JJ5 Rocker	08-09 ▲		
	FXDLI 1GNW Dyna Low Rider	04-05 ▲		FXCWC 1JK5 Rocker C	08-11 ▲		
	FXDWG 103 1GPM Dyna Wide Glide	12-15 ▲		FXD 1GM4 Dyna Super Glide	07-10 ▲		
	FXDWG 103 1GPM Dyna Wide Glide 103	17 ▲		FXD35 1GW1 Dyna 35th Anniversary Super Glide	06 ▲		
	FXDWG 103 1GPM Dyna Wide Glide	16 ▲		FXDB 1GX4 Dyna Street Bob	07-21 ▲		
	FXDWGI 1GPW Dyna Wide Glide	04 ▲		FXDBA 1VB4 Dyna Street Bob (H-D1)	13 ▲		
	FXDWGI 1GPW Dyna Wide Glide	05 ▲		FXDBB 1VC4 Dyna Street Bob (H-D1)	15 ▲		
	FXDX 1GJV Dyna Super Glide Sport	04-05 ▲		FXDBC 1VD4 Dyna Street Bob Limited	16 ▲		
	FXDXI 1GRW Dyna Super Glide Sport	04-05 ▲		FXDBI 1GX1 Dyna Street Bob	06 ▲		
	FXS 103 1JPV Blackline	12-13 ▲		FXDC 1GV4 Dyna Super Glide Custom	07-14 ▲		
	FXS 1JP5 Blackline	12 ▲		FXDC ANV 1GV4_ANV Dyna Super Glide Custom ANV	13 ▲		
	FXSB 103 1BFV Softail Breakout	13-15 ▲		FXDCI 1GV1 Dyna Super Glide Custom	06 ▲		
	FXSB 1BFV Breakout	17 ▲		FXDF 1GY4 Dyna Fat Bob	08-17 ▲		
	FXSB 1BFV Softail Breakout	16 ▲		FXDI 1GM1 Dyna Super Glide	06 ▲		
	FXST 1BHY Softail Standard	04-06 ▲		FXDL 1GN4 Dyna Low Rider	07-21 ▲		
	FXST 1BVV Softail Standard	12-15 ▲		FXDWG 1GP4 Dyna Wide Glide	07-16 ▲		
	FXSTB 1BTY Night Train	04-05 ▲		FXDWG ANV 1GP4 Dyna Wide Glide 105th Anniversary	08 ▲		
	FXSTBI 1JAB Night Train	04-05 ▲		FXDWGI 1GP1 Dyna Wide Glide	06 ▲		
	FXSTD 1BSY Softail Deuce	04-05 ▲		FXS 1JP5 Blackline	11 ▲		
	FXSTDI 1JBB Softail Deuce	04-05 ▲		FXS 1JP5 Blackline	13 ▲		
FXSTI 1BVB Softail Standard	04-05 ▲	FXSB 1BF5 Softail Breakout	13-15 ▲				
FXSTS 1BLY Springer Softail	04-05 ▲	FXST 1BV5 Softail Standard	07-11 ▲				
FXSTSI 1BZB Springer Softail	04-05 ▲	FXSTB 1BTY Night Train	06 ▲				
		FXSTB 1JA5 Night Train	07-09 ▲				
		FXSTBI 1JAB Night Train	06 ▲				
		FXSTC 1JL5 Softail Custom	07-10 ▲				
		FXSTD 1BSY Softail Deuce	06 ▲				
		FXSTD 1JB5 Softail Deuce	07 ▲				
		FXSTDI 1JBB Softail Deuce	06 ▲				
		FXSTI 1BVB Softail Standard	06 ▲				
		FXSTS 1BLY Springer Softail	06 ▲				
		FXSTSI 1BZB Springer Softail	06 ▲				
SRC7013 SRK7013 CT703SP ▲	HARLEY DAVIDSON		SRC7014 SRK7014 CT701SP ▲	HARLEY DAVIDSON			
	FLD 1GZ4 Dyna Switchback	14-21 ▲		FLHR Road King	93-97 ▲		
	FLHR 1FB4 Road King	07-11 ▲		FLHS Electra Glide Sport	91-94 ▲		
	FLHR 1FDV Road King	06 ▲		FLHT Electra Glide Standard	94-97 ▲		
	FLHR 96 FB4 Road King	11 ▲		FLHTC Electra Glide Classic	91-97 ▲		
	FLHRC 1FR4 Road King Classic	07-11 ▲		FLHTCU Ultra Classic	91-97 ▲		
	FLHRCI 1FRW Road King Classic	06 ▲		FLTC Tour Glide Classic	91-96 ▲		
	FLHRI 1FBW Road King	06 ▲					
	FLHRS 1FXV Road King Custom	06 ▲		SRC7015 SRK7015 CT701SP ▲	HARLEY DAVIDSON		
	FLHRSI 1FYW Road King Custom	06 ▲			FLHS Touring Electra Glide Sport	90 ▲	
	FLHT 1DDV Electra Glide Standard	06-10 ▲			FLHTC Touring Electra Glide Classic	90 ▲	
	FLHT 1FV4 Electra Glide Standard	08 ▲			FLHTCU Touring Electra Glide Classic Ultra	90 ▲	
	FLHTC 1FF4 Electra Glide Classic	07-11 ▲			FLTC Touring Tour Glide Classic	90 ▲	
	FLHTCI 1FFW Electra Glide Classic	06 ▲			FLTCU Touring Tour Glide Classic Ultra	90 ▲	
	FLHTCU 1FC4 Ultra Classic	07-11 ▲					
	FLHTCUI 1FCW Ultra Classic	06 ▲			SRC7016 SRK7016 CT705SP ▲	HARLEY DAVIDSON	
	FLHTI 1FWW Electra Glide Standard	06 ▲				FLH Touring Electra Glide	84 ▲
	FLHX 1KAV Street Glide	06 ▲				FLH Touring Electra Glide Shrine Shovelhead	84 ▲
	FLHX 1KB4 Street Glide	07-11 ▲		FLHS Touring Electra Glide Sport		84-89 ▲	
	FLHX 1KB4 Street Glide	09 ▲		FLHT Touring Electra Glide Standard		88 ▲	
	FLHXI 1KBW Street Glide	06 ▲		FLHT Electra Glide Classic		84 ▲	
	FLS 1JR5 Softail Slim	12-15 ▲		FLHT Electra Glide		84 ▲	
	FLST 1JE5 Heritage Softail	08-09 ▲		FLHTC Touring Electra Glide Classic		84-89 ▲	
	FLST 1JEY Heritage Softail	06 ▲		FLHTCU Touring Electra Glide Classic Ultra		89 ▲	
	FLSTC 103 1BWV Heritage Softail Classic	12 ▲		FLST Softail Heritage		86-89 ▲	
	FLSTC 1BJY Heritage Softail Classic	06 ▲		FLSTC Softail Heritage Classic	87-89 ▲		
	FLSTC 1BW5 Heritage Softail Classic	07-15 ▲		FLT Classic Tour Glide Classic	84 ▲		
	FLSTC ANV 1BW5_ANV Heritage Softail Classic ANV	13 ▲					
	FLSTCI 1BWB Heritage Softail Classic	06 ▲					
	FLSTF 1BX5 Fat Boy	12 ▲					
	FLSTF 1BMV Fat Boy	06-15 ▲					
FLSTFB 1JN5 Fat Boy LO	10-11 ▲						
FLSTFB 1JN5 Fat Boy LO	13-15 ▲						
FLSTFB ANV 1JN5_ANV Fat Boy LO ANV	13 ▲						
FLSTFI 1BVB Fat Boy	06 ▲						

SRC/SRK CLUTCH KIT BUYERS GUIDE

Part No.	Make/Model	Year	Part No.	Make/Model	Year
SRC7016 SRK7016 CT705SP ▲ Contd.	HARLEY DAVIDSON		SRC7020 SRK7020 CT701SP ▲	HARLEY DAVIDSON	
	FLT Tour Glide	84 ▲		XL1200 1LN3 Forty Eight Anniversary	18 ▲
	FLTC Touring Tour Glide Classic	84-89 ▲		XL1200C 1CGP Sportster 1200 Custom	04-06 ▲
	FLTCU Touring Tour Glide Classic Ultra	89 ▲		XL1200C 1CT3 Sportster 1200 Custom	17-21 ▲
	FXE FX Super Glide	84 ▲		XL1200C ANV 1CT3_ANV Sportster 1200 Custom ANV	13 ▲
	FXEF FX Super Glide Fat Bob	85 ▲		XL1200CA 1LJ3 Sportster 1200 Custom Limited A	13-21 ▲
	FXSB FX Low Rider	84-85 ▲		XL1200CB 1LK3 1200 Custom Limited B	17 ▲
	FXST Softail Standard	84-89 ▲		XL1200CB 1LK3 Sportster 1200 Custom Limited A	16 ▲
	FXSTC Softail Custom	86-89 ▲		XL1200CB 1LK3 Sportster 1200 Custom Limited B	13-15 ▲
	FXSTS Softail Springer	88-89 ▲		XL1200CP 1LH3 Sportster 1200 Custom (H-D1)	11-21 ▲
FXWG FX Wide Glide	84-86 ▲	XL1200CX 1LM3 1200 Roadster	16-18 ▲		
SRC7017 SRK7017 CT704SP ▲	HARLEY DAVIDSON		XL1200L 1CWP Sportster 1200 Low	06 ▲	
	FLH Touring Electra Glide	EARLY 84 ▲	XL1200L 1CX3 Sportster 1200 Low	07-11 ▲	
	FLH Touring Electra Glide Shrine Shovelhead	EARLY 84 ▲	XL1200N 1CZ3 Nightster	07-12 ▲	
	FLHS Touring Electra Glide Sport	EARLY 84 ▲	XL1200R 1CLP Sportster 1200 Roadster	04-06 ▲	
	FLHT Electra Glide	EARLY 84 ▲	XL1200R 1CV3 Sportster 1200 Roadster	07-09 ▲	
	FLHT Electra Glide Classic	EARLY 84 ▲	XL1200T 1LL3 SuperLow 1200T	14-21 ▲	
	FLT Classic Tour Glide Classic	EARLY 84 ▲	XL1200V 1LF3 Seventy-Two	12-16 ▲	
	FLT Tour Glide	EARLY 84 ▲	XL1200X 1LC3 Forty Eight	10-21 ▲	
XL50 1CY3 50th ANV Sportster	07 ▲				
SRC7018 SRK7018 CT704SP ▲	HARLEY DAVIDSON		SRC7021 SRK7021 CT701SP ▲	HARLEY DAVIDSON	
	FLH Touring Electra Glide Shrine Shovelhead	83 ▲		XL883 4CAM Sportster 883	04-06 ▲
	FLH Electra Glide	81-83 ▲		XL883 4CN2 Sportster 883	07-09 ▲
	FLHC Touring Electra Glide Classic	81-82 ▲		XL883C 4CJM Sportster 883 Custom	04-06 ▲
	FLHC Electra Glide Classic	81 ▲		XL883C 4CP2 Sportster 883 Custom	07-10 ▲
	FLHS Touring Electra Glide Sport	81-83 ▲		XL883L 4CMM Sportster XL883 Low	05 ▲
	FLHS Heritage, Electra Glide	81 ▲		XL883L 4CR2 Sportster 883 Low	11 ▲
	FLHT Touring Electra Glide Standard	83 ▲		XL883L 4CR2 SuperLow	14-16 ▲
	FLHT Electra Glide Classic	83 ▲		XL883L 4CMM Sportster XL883 Low	06 ▲
	FLHT Electra Glide	83 ▲		XL883L 4CR2 Sportster 883 Low	10 ▲
	FLHTC Touring Electra Glide Classic	83-84 ▲	XL883L 4CR2 Sportster XL883 Low	07-09 ▲	
	FLT Touring Tour Glide	81-83 ▲	XL883L 4CR2 SuperLow	12-18 ▲	
	FLT Classic Tour Glide Classic	81-83 ▲	XL883N 4LE2 Iron 883	09-21 ▲	
	FLT Tour Glide	81-83 ▲	XL883R 4CS2 883 Roadster	14 ▲	
	FLTC Touring Tour Glide Classic	80-84 ▲	XL883R 4CS2 883 Roadster	11-15 ▲	
	FXB Super Glide B80	81-82 ▲	XL883R 4CS2 Sportster 883R	07-10 ▲	
	FXDG Dyna Glide Glide Custom	83 ▲			
	FXE FX Super Glide	81-84 ▲			
	FXEF FX Super Glide Fat Bob	81 ▲			
	FXS FX Super Glide	81-82 ▲			
FXSB FX Low Rider	83-84 ▲				
FXST Softail Standard	84 ▲				
FXWG FX Wide Glide	81-84 ▲				
SRC7022 SRK7022 CT701SP ▲	HARLEY DAVIDSON		HARLEY DAVIDSON		
	XR 1200 Sportster		XR 1200 Sportster	08-10 ▲	
	XR 1200 X		XR 1200 X	10-13 ▲	
	SRC7023 SRK7023 CT701SP ▲	HARLEY DAVIDSON		HARLEY DAVIDSON	
		XL1200 Sportster 1200		XL1200 Sportster 1200	91-03 ▲
		XL1200C Sportster 1200 Custom		XL1200C Sportster 1200 Custom	96-03 ▲
		XL1200S Sportster 1200 Sport		XL1200S Sportster 1200 Sport	96-03 ▲
		XL883 Sportster 883		XL883 Sportster 883	91-03 ▲
		XL883C Sportster 883 Custom		XL883C Sportster 883 Custom	98-03 ▲
		XL883DLX Sportster 883 Deluxe		XL883DLX Sportster 883 Deluxe	91-95 ▲
XL883HUG Sportster 883 Hugger		XL883HUG Sportster 883 Hugger	91-03 ▲		
XL883R Sportster 883R		XL883R Sportster 883R	02-06 ▲		
SRC7024 SRK7024 CT701SP ▲	HARLEY DAVIDSON		HARLEY DAVIDSON		
	XL1200 Sportster 1200		XL1200 Sportster 1200	88-90 ▲	
	XL883 Sportster 883		XL883 Sportster 883	86-90 ▲	
	XL883 Sportster 883 Deluxe		XL883 Sportster 883 Deluxe	86-90 ▲	
	XL883HUG Sportster 883 Hugger		XL883HUG Sportster 883 Hugger	87-90 ▲	
	XLH 1100 Sportster 1100		XLH 1100 Sportster 1100	86-87 ▲	
	XLH Sportster 1000		XLH Sportster 1000	84-85 ▲	
	XLS Sportster Roadster 1000		XLS Sportster Roadster 1000	84 ▲	
XR-1000 Sportster		XR-1000 Sportster	84 ▲		
SRC7025 SRK7025 CT701SP ▲	HARLEY DAVIDSON		HARLEY DAVIDSON		
	XLCH-1000 Sportster 1000		XLCH-1000 Sportster 1000	71-84 ▲	
	XLH-1000 Sportster 1000		XLH-1000 Sportster 1000	79-80 ▲	
	XLH-1000 Sportster Standard		XLH-1000 Sportster Standard	71-78 ▲	
	XLS 1000 Sportster Roadster		XLS 1000 Sportster Roadster	81-84 ▲	
XR 1000 Sportster		XR 1000 Sportster	83-84 ▲		
SRC7019 SRK7019 CT701SP ▲	HARLEY DAVIDSON				
	FLST Softail Heritage	90 ▲			
	FLSTC Heritage Softail Classic	90-97 ▲			
	FLSTF Fat Boy	91-97 ▲			
	FLSTF Softail Fat Boy	90 ▲			
	FLSTN Heritage Softail Nostalgia	93-96 ▲			
	FLSTS Heritage Springer	97 ▲			
	FXD Dyna Super Glide	95-97 ▲			
	FXDB Dyna Daytona	92 ▲			
	FXDB Dyna Sturgis	91 ▲			
	FXDC Super Glide Custom	92 ▲			
	FXDL Dyna Low Rider	93-97 ▲			
	FXDS-CONV Dyna Glide Convertible	93 ▲			
	FXDWG Dyna Wide Glide	93-97 ▲			
FXST Softail Standard	90 ▲				
FXSTC Softail Custom	90-97 ▲				
FXSTS Springer Softail	90-97 ▲				

CLUTCH BUYERS GUIDE

How To Make Precision Pilot Jets

Everyone knows how sensitive an engine is to pilot jets in the acceleration stages from 1000 to 3500 rpm and getting fuel mixture right in this area is critical. For this reason jets have be perfectly accurate in their marked size and incremental size steps. EBC Brakes' sister company A-BAX Precision Engineering Ltd in the UK has purchased the most accurate machine on the planet for this work shown below. A-BAX Precision Engineering Ltd pilot jets are precise, clearly marked and reliably gauged using pin gauges, accurate to one tenth of a thousandth of an inch, you can rely on their accuracy.

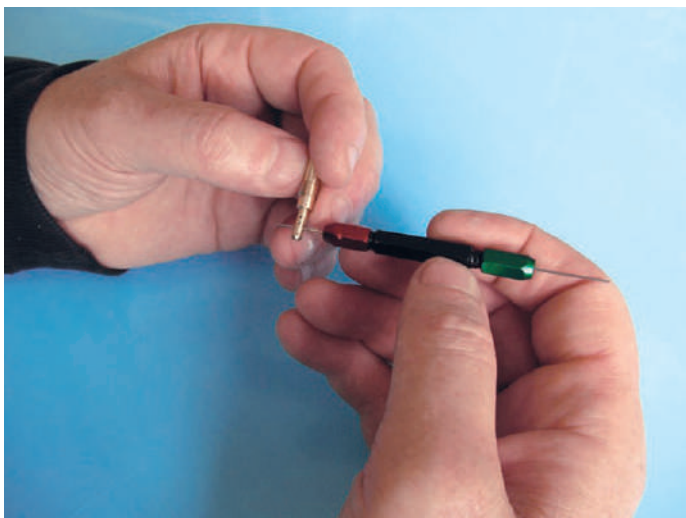
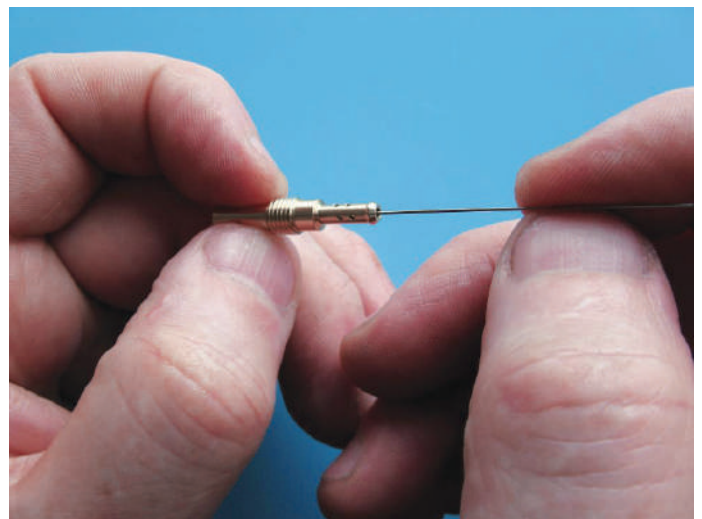
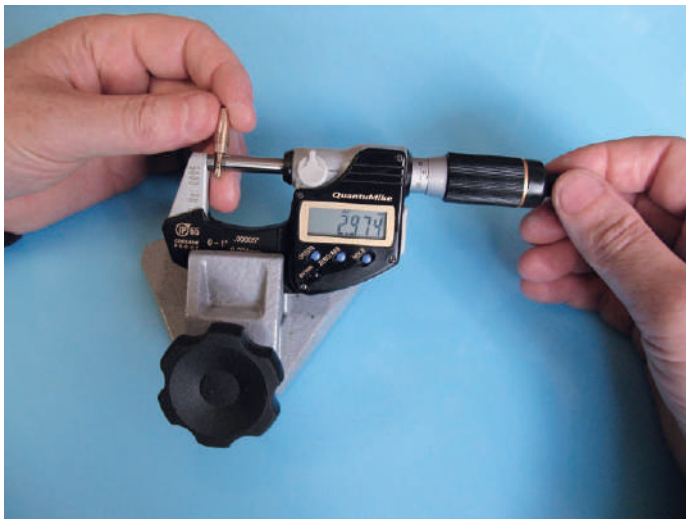
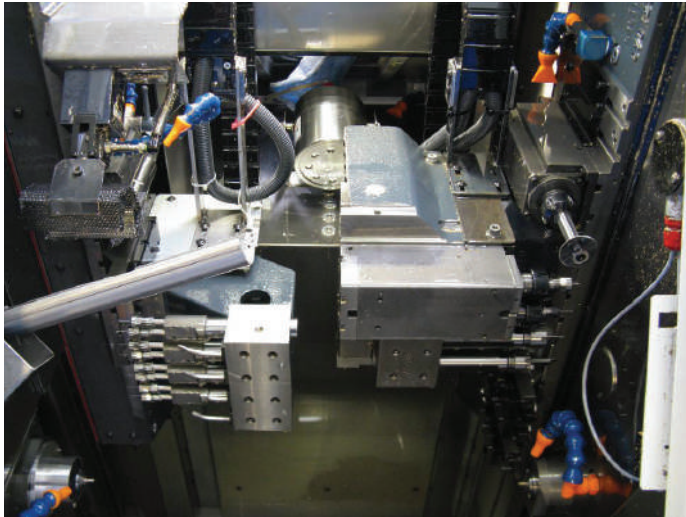

PILOT JETS

A-BAX Precision Engineering Ltd Pilot Jets for Mikuni Carbs (Sold in packs of 4)

Jet Style - VM22/210
8 bleed hole type
VM18 / VM22 / VM26-34 Flange Type
VM26-44 Spigot Type
TM24-38 (No accelerator pump)
Early TMX/TMXCarb Types

Size	Part #
10	EBC22/210-10
12.5	EBC22/210-12.5
15	EBC22/210-15
17.5	EBC22/210-17.5
20	EBC22/210-20
22.5	EBC22/210-22.5
25	EBC22/210-25
27.5	EBC22/210-27.5
30	EBC22/210-30
32.5	EBC22/210-32.5
35	EBC22/210-35
37.5	EBC22/210-37.5
40	EBC22/210-40
42.5	EBC22/210-42.5
45	EBC22/210-45
47.5	EBC22/210-47.5
50	EBC22/210-50
52.5	EBC22/210-52.5
55	EBC22/210-55
57.5	EBC22/210-57.5
60	EBC22/210-60
65	EBC22/210-65
70	EBC22/210-70
75	EBC22/210-75
80	EBC22/210-80
85	EBC22/210-85
90	EBC22/210-90
95	EBC22/210-95
100	EBC22/210-100
105	EBC22/210-105
110	EBC22/210-110
120	EBC22/210-120
130	EBC22/210-130
140	EBC22/210-140



Jet Style - N224.103
2.5mm bleed end
Early TMS/TMX
OEM MX36/38 BSR CVtype
Honda / Kawasaki / Suzuki / Yamaha

Size	Part #
10	EBC224-10
12.5	EBC224-12.5
15	EBC224-15
17.5	EBC224-17.5
20	EBC224-20
22.5	EBC224-22.5
25	EBC224-25
27.5	EBC224-27.5
30	EBC224-30
32.5	EBC224-32.5
35	EBC224-35
37.5	EBC224-37.5
40	EBC224-40
42.5	EBC224-42.5
45	EBC224-45
47.5	EBC224-47.5
50	EBC224-50
52.5	EBC224-52.5
55	EBC224-55
57.5	EBC224-57.5
60	EBC224-60
62.5	EBC224-62.5
65	EBC224-65
67.5	EBC224-67.5
70	EBC224-70



Jet Style - N151.067
No bleed holes
Later OEM BSR range CVcarbs
Kawasaki / Suzuki / Yamaha

Size	Part #
30	EBC151-30
32.5	EBC151-32.5
35	EBC151-35
37.5	EBC151-37.5
40	EBC151-40
42.5	EBC151-42.5
45	EBC151-45
47.5	EBC151-47.5
50	EBC151-50
52.5	EBC151-52.5
55	EBC151-55
57.5	EBC151-57.5
60	EBC151-60



Jet Style - VM28/486
2mm bleed hole type
HS40 / HSR42 / 45 / 48 / RS34-40
TM33 / 36 / 40 with accelerator pump
Kawasaki / Suzuki / Yamaha

Size	Part #
10	EBC28/486-10
12.5	EBC28/486-12.5
15	EBC28/486-15
17.5	EBC28/486-17.5
20	EBC28/486-20
22.5	EBC28/486-22.5
25	EBC28/486-25
27.5	EBC28/486-27.5
30	EBC28/486-30
32.5	EBC28/486-32.5
35	EBC28/486-35
37.5	EBC28/486-37.5
40	EBC28/486-40
42.5	EBC28/486-42.5
45	EBC28/486-45
47.5	EBC28/486-47.5
50	EBC28/486-50
52.5	EBC28/486-52.5
55	EBC28/486-55
57.5	EBC28/486-57.5
60	EBC28/486-60
62.5	EBC28/486-62.5
65	EBC28/486-65
67.5	EBC28/486-67.5
70	EBC28/486-70



Jet Style - BS30/96
6 bleed hole type
Various OEM BSR range CV carbs
Kawasaki / Suzuki / Yamaha

Size	Part #
30	EBC30/96-30
32.5	EBC30/96-32.5
35	EBC30/96-35
37.5	EBC30/96-37.5
40	EBC30/96-40
42.5	EBC30/96-42.5
45	EBC30/96-45
47.5	EBC30/96-47.5
50	EBC30/96-50
52.5	EBC30/96-52.5
55	EBC30/96-55
57.5	EBC30/96-57.5
60	EBC30/96-60



Jet Style - M28/1001
Yamaha P/No. 260-14142-Size
Blaster/Banshee/LC

Size	Part #
15	EBC1001-15
17.5	EBC1001-17.5
20	EBC1001-20
22.5	EBC1001-22.5
25	EBC1001-25
27.5	EBC1001-27.5
30	EBC1001-30
32.5	EBC1001-32.5
35	EBC1001-35
37.5	EBC1001-37.5
40	EBC1001-40
42.5	EBC1001-42.5
45	EBC1001-45
47.5	EBC1001-47.5
50	EBC1001-50
52.5	EBC1001-52.5
55	EBC1001-55
57.5	EBC1001-57.5
60	EBC1001-60
62.5	EBC1001-62.5
65	EBC1001-65
67.5	EBC1001-67.5
70	EBC1001-70



A-BAX Precision Engineering Ltd Pilot Jets for Keihin Carbs (Sold in packs of 4)

Jet Style - N424-21
Pilot / Slow Running Jet
PB16 / 18 / 20
Yamaha R6 99-07
Various Kawasaki / Suzuki Quads

Size	Part #
35	EBC424-21-35
38	EBC424-21-38
40	EBC424-21-40
42	EBC424-21-42
45	EBC424-21-45
48	EBC424-21-48
50	EBC424-21-50
52	EBC424-21-52
55	EBC424-21-55
58	EBC424-21-58
60	EBC424-21-60
62	EBC424-21-62
65	EBC424-21-65
68	EBC424-21-68
70	EBC424-21-70
72	EBC424-21-72
75	EBC424-21-75
78	EBC424-21-78
80	EBC424-21-80



Jet Style - N424-25
Pilot / Slow Running Jet
FCR 28 / 32 / 33 / 35 / 37 / 39 / 41mm
Harley D Keihin BH (Non CVType)
Various Kawasaki / Yamaha Models with CVK / FCR / BD style carbs

Size	Part #
35	EBC424-25-35
38	EBC424-25-38
40	EBC424-25-40
42	EBC424-25-42
45	EBC424-25-45
48	EBC424-25-48
50	EBC424-25-50
52	EBC424-25-52
55	EBC424-25-55
58	EBC424-25-58
60	EBC424-25-60
62	EBC424-25-62
65	EBC424-25-65



PILOT JETS

Dealer Pilot Jet Selection Kits

(Kits include one pilot jet per size)



KIT NUMBER	CARB MODEL	JET STYLE	QTY JETS IN KIT	SIZES
KPJK-01	Keihin	N424-21	19	35-80
KPJK-02	Keihin	N424-25B	13	35-65
MPJK-01	Mikuni	VM22/210	34	10-140
MPJK-02	Mikuni	N224.103	25	10-70
MPJK-03	Mikuni	N151.067	13	30-60
MPJK-04	Mikuni	BS30/96	13	30-60
MPJK-05	Mikuni	M28/486	25	10-70

Precision machined in the UK A-BAX Precision Engineering Ltd Dealer selection kits include all the popular sizes for the better selling pilot jets and refills can be purchased from your distributor in packets of four.



MAIN JETS







A-BAX Precision Engineering Ltd MAINJETS

Made in the UK, these high precision BRASS carburettor jets are available in dealer selection kits or in top-up packs of 5 jets or 4 jets. All jets are flow calibrated and extremely accurate in terms of fuel flow rate as stamped.

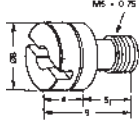
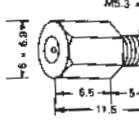
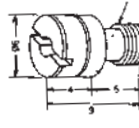
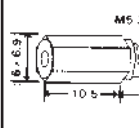
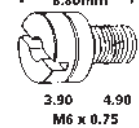

DEALER SELECTION KITS

KIT TYPE	PART#	CONTENTS	
Mikuni Slot	SJK 36	4pcs each jet sizes 72.5 thru 160	144 Jets
Mikuni Hex	HJK 27A	2pcs each jet sizes 70 thru 230	54 Jets
Mikuni Hex	HJK 27B	2pcs each jet sizes 240 thru 500	54 Jets
Keihin Slot	KJK 30	4pcs each jet sizes 80 thru 190	132 Jets
Keihin Hex	CRK 32A	2pcs each jet sizes 80 thru 158	64 Jets
Keihin Hex	CRK 32B	2pcs each jet sizes 160 thru 235	64 Jets

 A-BAX Slot Jets for Mikuni	 A-BAX Hex Jets for Mikuni	 A-BAX Slot Jets for Keihin	 A-BAX Hex Jets for Keihin	 A-BAX Slot Jets for Dell 'Orto'
 <p>(N 100/604) SJ Prefix</p>	 <p>(4/042) HJ Prefix</p>	 <p>(N102 221) KJ Prefix</p>	 <p>(357) CR Prefix</p>	 <p>(6413) DO Prefix</p>

SJ SIZES AVAILABLE	HJ SIZES AVAILABLE		KJ SIZES AVAILABLE	CR SIZES AVAILABLE		DO SIZES AVAILABLE
SJ72.5	HJ70	HJ340	KJ72.5	CR80	CR172	D070
SJ75	HJ80	HJ350	KJ75	CR82	CR175	D075
SJ77.5	HJ90	HJ360	KJ77.5	CR85	CR178	D080
SJ80	HJ100	HJ370	KJ80	CR88	CR180	D085
SJ82.5	HJ105	HJ380	KJ82.5	CR90	CR182	D090
SJ85	HJ110	HJ390	KJ85	CR92	CR185	D095
SJ87.5	HJ115	HJ400	KJ87.5	CR95	CR188	D0100
SJ90	HJ120	HJ410	KJ90	CR98	CR190	D0105
SJ92.5	HJ125	HJ420	KJ92.5	CR100	CR192	D0110
SJ95	HJ130	HJ430	KJ95	CR102	CR195	D0115
SJ97.5	HJ135	HJ440	KJ97.5	CR105	CR198	D0120
SJ100	HJ140	HJ450	KJ100	CR108	CR200	D0125
SJ102.5	HJ145	HJ460	KJ102.5	CR110	CR202	D0130
SJ105	HJ150	HJ470	KJ105	CR112	CR205	D0135
SJ107.5	HJ155	HJ480	KJ107.5	CR115	CR208	D0140
SJ110	HJ160	HJ490	KJ110	CR118	CR210	D0145
SJ112.5	HJ165	HJ500	KJ112.5	CR120	CR212	D0150
SJ115	HJ170	HJ510	KJ115	CR122	CR215	D0155
SJ117.5	HJ175	HJ520	KJ117.5	CR125	CR218	D0160
SJ120	HJ180	HJ530	KJ120	CR128	CR220	D0165
SJ122.5	HJ185	HJ540	KJ122.5	CR130	CR222	D0170
SJ125	HJ190	HJ550	KJ125	CR132	CR225	D0175
SJ127.5	HJ195	HJ560	KJ127.5	CR135	CR228	D0180
SJ130	HJ200	HJ570	KJ130	CR138	CR230	D0185
SJ132.5	HJ210	HJ580	KJ132.5	CR140	CR232	D0190
SJ135	HJ220	HJ590	KJ135	CR142	CR235	D0195
SJ137.5	HJ230	HJ600	KJ137.5	CR145	CR238	D0200
SJ140	HJ240	HJ610	KJ140	CR148		
SJ142.5	HJ250	HJ620	KJ142.5	CR150		
SJ145	HJ260	HJ630	KJ145	CR152		
SJ147.5	HJ270	HJ640	KJ147.5	CR155		
SJ150	HJ280	HJ650	KJ150	CR158		
SJ152.5	HJ290	HJ660	KJ152.5	CR160		
SJ155	HJ300	HJ670	KJ160	CR162		
SJ157.5	HJ310	HJ680	KJ170	CR165		
SJ160	HJ320	HJ690	KJ190	CR168		
SJ170	HJ330			CR170		

NOTE: The names Mikuni & Keihin are for description purposes only. These are NOT original Mikuni or Keihin jets, simply a high quality replacement.

MAIN JETS



**DEALER SELECTION KIT
PART NO - HDJK-12**

A-BAX Precision Engineering Ltd brass main jets for Keihin CVH carburettors, used on most big twins. Sold in packets of 2 pieces and in dealer assortment kits of 12 sizes (2 pieces each size).

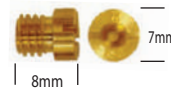

A-BAX Slot Jets for Harley Davidson

**(424-27)
HDJK Prefix**

SIZES AVAILABLE	
EBC424-27-165	
EBC424-27-170	
EBC424-27-175	
EBC424-27-180	
EBC424-27-185	
EBC424-27-190	
EBC424-27-195	
EBC424-27-200	
EBC424-27-205	
EBC424-27-210	
EBC424-27-220	

ACCESSORIES

BRAKE FLUID



EBC Brake Fluid is available in DOT 4 or DOT 5 (Silicone) Grades or BF 307 Race Grade.

Now tested to meet Florida EPA requirements. Bottle label shows all specifications of the fluid.

- DOT 4** - A refined specification polyglycol fluid as fitted to most faster street bikes now produced.
- DOT 5** - Silicone fluid as used in Harley Davidson Motorcycles and many special High Performance Brake systems.
- BF307** - Highly refined DOT 4 Brake fluid, ideal for Racing or High Performance Road bikes. Can be used in all systems specifying DOT 3 or DOT 4 but **NOT** with (DOT 5) silicone fluids.

TO ORDER USE THESE NUMBERS

SIX PACK	SINGLE BOTTLES
DOT 4 (Six Pack)..... DOT-4	DOT 4 (Single) DOT-4/1
DOT 5 (Six Pack) (Silicone) DOT-5	DOT 5 (Single) (Silicone) DOT-5/1
BF 307 (Six Pack) BF-307	BF 307 (Single)..... BF-307/1

CAUTION: Please check carefully the type of brake fluid used in your system. Adding incorrect fluids could cause major brake failure. DO NOT ever mix glycol fluids (DOT 3, DOT 4 or BF-307) with DOT 5 silicone.

BRAKE CALIPER LUBE

These sachets of dedicated, high viscosity greases are perfect for all of your customers' brake service needs. Always use sparingly on caliper slider pins and rails, but to NOT get near the pad surface and do NOT use as anti-squeal as it will not help at all. Each sachet contains 5 grammes of grease.

TO ORDER USE THESE NUMBERS

Ten Sachets	LUBE010
Fifty Sachets.....	LUBE050



NOTES



WARNING: Cancer and
Reproductive Harm —
www.P65Warnings.ca.gov

Cover Photograph:
© 2020 Catherine Simpson Photography



**Distribution Center for The Americas, Canada, Mexico, West Indies,
Puerto Rico, Virgin Islands and Central American States.**

Head Office: EBC Brakes USA Inc. 6180 South Pearl Street, Las Vegas, Nevada 89120 Tel: +1 (702) 826-2400

The letters EBC form a registered trademark in the United States and most countries worldwide.

www.ebcbrakes.com sales@ebcbrakesusa.com