



**Superior Boating Products at a Great Value**

# Donovan Marine's Exclusive Private Label



## CALL CENTERS



<b>New Orleans</b> HEADQUARTERS 800.347.4464	<b>Des Moines</b> 515.964.4205	<b>Ft. Lauderdale</b> 877.936.4722	<b>Little Rock</b> 888.562.5008	<b>Rochester</b> 1-800-836-5300
--	-----------------------------------	---------------------------------------	------------------------------------	------------------------------------

## OUR DISTRIBUTION NETWORK TO BETTER SERVE YOU



Birmingham Charleston Charlotte Chesapeake	Chicago Clearwater Cocoa Dallas Des Moines	Ft. Lauderdale/ International Harvey Houston Jacksonville	Little Rock Miami Nashville New Orleans Norwich	Paducah Pensacola Port Clinton Rochester
---	--	---	---	---

# INDEX

Alphabetical Index	Page No.	Alphabetical Index	Page No.	Alphabetical Index	Page No.
<b>A</b>					
Accent Light	101	Bolster Bracket	98	Hose	47
Access Hatch	68	Bolts		Spring	68
Accessory Plug	11	Barrel	69	Cleaners	
Acetone	83	Lug	58	Bilge	79
Adapter, Trailer	91	Boot, Toggle Switch	23	Black Streak Remover	79
Adjuster		Bottom Paint	84-85	Boat Wash	79
Fender	39, 104	Bow Chock	42	Deck	79
Aerator Strainer	50	Bow Eye	42	Hull	79
All Purpose Rope	40-41	Bow Light	25-26	Plastic	79
All-Round Light	28-30	Bow Safety Chain	58	Clearance Light	89-90
Alligator Clips	10	Box, Battery	23	Cleat	41
Anchor	34-37	Bracket		Clevis Pin	60
Anchor Buoy	104	Filter	57	Clips	
Anchor Chain	38	License Plate	91	Alligator	10
Anchor Chain Retainer	34	Life Ring Buoy	65	Battery	10
Anchor Connector	34	Trailer	98	Fender (Pontoon Boat)	39
Anchor Display Rack	36	Breaker, Circuit	14-15	Storage, Pole Light	30
Anchor Kit	35	Brush		Coast Guard Kits	1-2
Anchor Line	37	Deck	65	Coax Connector Kit	3
Anchor Locking Control	34	Paint	86	Cold Zinc Galvanizing	87
Anchor Quick Link	38	Bulb		Coloring Agent	82
Anchor Rodes	37	Light	32-33, 104	Combination Mat	83
Anchor Roller	34	Primer	51	Connector	
Anchor Rope	37	Bulkhead Fitting	54	Anchor	34
Anchor Shackle	38	Bunk Bracket	98	Antenna	3
Angle Bracket	70	Bunk Padding	58	Bullet	8
Antenna, VHF	3	Buoy, Anchor	104	Butt	8
Antenna Extension Cable	3	Bus Bar	18	Closed End	8
Antenna Mount	3	<b>C</b>		Electrical Kit	8
Antifouling Paint	84-85	Cabin Fan	77	Fuel	52-53, 108
Anti-Siphon Valve	54	Cable		Heat Shrink	8
<b>B</b>		Antenna	3	Quick Disconnect	8
Bags, Storage (for Life Vests)	64	Battery	8	Ring	8
Baitwell Strainer	50	Starter	7	Spade	8
Baitwell Light	31	Ties	9	Thru-Hull	47-48
Baitwell Plug	46	Winch	93	Trolling Motor	24
Baitwell Pump	50	Cable Boot	45	Control, Engine	45
Ball, Trailer Hitch	58	Cable Outlet	11	Control Knob, Steering Wheel	44
Ball Catch	69	Caddy, Boat	66-67	Controller, Light	104
Ball Mount	94	Camera Pouch	108	Cooler, Mounting Kit	68
Ball Valve	47, 5	Camouflage Paint	86	Cord, Shock	41
Barb, Hose	54	Canvas Fastener Kit	76	Copper Lug	7
Barrel Bolt	69	Carrier, Tire	96	Cord Set	24
Base, Seat	106	Catch, Ball	69	Cotter Pin	75
Battery Box	23	Cell Phone Chargers	12	Coupler Lock	58, 94
Battery Cable	8	Cell Phone Pouch	108	Cover	
Battery Clips	10	Center Console Cover	106	Center Console	106
Battery Hold Down Strap	23	Chain		Flip Flop Seat	106
Battery Selector Switch	17	Anchor	38	Leaning Post	107
Battery Switch	17	Safety	58, 94	Outboard Motor	107
Battery Terminal Guard	8	Chair Cover	106	Personal Watercraft	107
Battery Tray	23	Chair Cushion	106	Power Pole	106
Bearing Seal	58	Changer, Oil	62, 108	Roller	86
Bearing Kits	58	Charger		Cup Holder	66
Bearing Protector	59	Mobile Devices	12	Cushions	
Bell	43	Phone	12	Seat	106
Bilge Cleaner	79	USB	12	Cutoff Switch	17
Bilge Pump	48, 105	Chart Light	11	Cutter, Rope/Line	41
Hand	48	Chock		<b>D</b>	
Bilge Pump Plumbing Kit	48	Bow	42	Deck Brush with Handle	65
Bilge Pump Switch	48, 105	Straight	42	Deck Cleaner	79
Bimini Top, Accessories	59-60, 107	Cigar Foam Roller Cover	86	Deck Fill	55
Black Streak Remover	79	Cigarette Lighter	11	Deck Hatch	68
Boat Caddy	66-67	Circuit Breaker	14-15	Deck Light	32
Boat Cover Accessories	107	Circuit Breaker Bracket	15, 100	Deck Plate	68, 108
Boat Hook	66	Circuit Breaker Kit	15	Deck Plate Key	55
Boat Hook Holder	68	Clam Shell Vent	11	Denatured Alcohol	83
Boat Wash	79	Clamp		Depth Sounders	4
		Hold Down	72	Destroyer Wheel	44-45

Alphabetical Index	Page No.	Alphabetical Index	Page No.	Alphabetical Index	Page No.
Display (Retail)		Flag Pole	67	Hitch	
Anchor	36	Flashlight	31	Pin	94
Cotter Pin	77	Flex Light	31	Trailer	94
Electrical	10	Float, Key	77	Hitch Ball	58
Fastener	76	Float Switch	105	Hitch Lock	95
Fuse	16	Floatation Foam	84	Hold Down Clamp	72
Heat Shrink Crimp Terminal	9	Flotation Vest	64	Holder	
Hose Clamp	47	Floating Key Chain	77	Boat Hook	68
Light	102	Floodlight	31	Cup/Drink	66, 108
Light Bulb	33	Fluid Extractor	62	Fender	39, 104
Wire	7	Flusher, Motor/Engine	62	Fuse	15-16
Diver Ladders	65	Footman Loops	23	Knife and Pliers	67
Dock Cleat	41	Frame Clips	91	Holding Tank Treatment	50
Dock Light	32, 104	Fuel Connectors and Fittings	52-53, 108	Hook	
Dock Line	40	Fuel Elbow	53	Boat	66
Dome Light	31	Fuel Fill	55	Snap	78
Door Latch	69	Fuel Filter	55-57	Winch	108
Drain Plug	46	Fuel Filter Brackets	57	Horn, Signal	43
Oil	62	Fuel Gauge	4-5	Horn Switch	20
Drain Tube	46	Fuel Hose	52	Hose	
Drawer Knob	70	Fuel Hose Barb	54	Fuel	52
Drink Holder	66, 108	Fuel Line Assembly	51	Washdown	49
<b>E</b>		Fuel Primer Bulb	51	Hose Clamp	47
Elbow, Fuel	53	Fuel Sender	51	Hose Clamp Display	47
Electrical Connector	8-9	Fuel Sender Gasket	51	Hose Nozzle	49
Electrical Display	10	Fuel Tank, Pick-Up	51	Hose Splicer	53
Electrical Panel	12-14, 23, 100	Fuel Valve	54	Hourmeter	4-5
Electrical Terminal Kit	9	Fuel Vent	55	Hub Kits	96
Electrical Wire	6-7	Fuel/Water Separator	55-57	Hull Cleaner	79
Electronic Ball Mount	3	Funnel	61	Hydrofoil	61
Engine Control	45	Fuse	15-16	<b>I</b>	
Engine Flusher	62	Fuse Display	16	Ice Chest, Mounting Kit	68
Engine Spray Paint	87	Fuse Block	17-18	Ignition Switch	19
Epoxy, Hardener	80	Fuse Holder	15-16	Inflatable Fender	39, 104
Epoxy Glue	84	<b>G</b>		Inlet	24
Epoxy Mixing Tub	87	Garboard Drain Plug	46	Water	48
Epoxy Resin	80	Gas Fill	55	Instruments	4-5
Extractor		Gas Tank Vent	55	Interior Light	30-31
Fluid	62	Gauge	4-5	Inverter, Power	24
Eye		Gear Lube Pump	61	Isolator	108
Bow	42	Gel Coat	81	<b>J</b>	
Lifting	42	Globe, Light	29	Jack, Trailer	93-94
Stern	42	Grommet		<b>K</b>	
Eye Strap	60	Hole	11	Keel Plate	42
<b>F</b>		Utility	45	Key	
Fan, Cabin	77	Gun, Paint Spray	65	Deck Plate	55
Fastener Display	76	Gunwale Ladder	65	Key Float	77
Fasteners	74-76	Gunwale Tie Down	95	Kill Switch	61
Fender		<b>H</b>		Kill Switch Lanyard	61
Adjuster	39, 104	Hand Bilge Pump	48	Kits, USCG Safety	1-2
Holder	39, 104	Hand Pump	62	Knife Holder	67
Inflatable	39, 104	Hand Rail Base	73	Knob, Steering Wheel	44
Fender Clip (Pontoon Boat)	39	Hand Rail Fitting	73	<b>L</b>	
Fender Holder	39, 104	Handle		Label Kit, Switch Panel	14
Fender Line	40-41	Lifting	69	Lacquer Thinner	83
Fiberglass		Transom	71	Ladder	65
Cloth	82	Winch (Trailer)	92	Ladder Bracket	65
Matting	82	Hardener, Epoxy	80	Lanyard, Kill Switch	61
Resin	81	Harness, Trailer Wiring	91-92	Latch	
Woven Roving	82	Hasp	70	Door	69
Fill, Deck	55	Hatch		Lift & Turn	69
Filler, Epoxy	80	Access	68	Push to Close	69-70
Filter, Fuel	55-57	Support Spring	71	T-Handle	72
Fish Blood Remover	79	Hatch Lift	72	Leaning Post Cover	107
Fishing Light	103	Hatch Pull	69-70	Letter and Number Kit	77
Fittings		Heat Shrink Connector	9	License Plate Bracket	91
Fuel	52-53	Heat Shrink Display	9	Life Ring Brackets	65
Rail	73	Heat Shrink Tubing	9	Life Vest	64
Flag, Water Ski	64	Hinge	70-71	Life Vest Storage Bag	64

# INDEX

Alphabetical Index	Page No.	Alphabetical Index	Page No.	Alphabetical Index	Page No.
Lift & Turn Latch	69	Motor Flusher	62	Pole Light	28-30
Lift Cord, Trolling Motor	33	Motor Lock	98	Pole Light Storage Clips	30
Lift Ring	69	Motor Support Bracket	99	Pole, Flag	67
Lifting Eye	42	Motor Well Boot	45	Polyester Resin	81
Lifting Handle	69	Mount		Pontoon Light Kit	102
Light		Antenna	3	Portable Light	25, 101
Accent	101	Electronic	3	Power Inverter	24
All-Round	28-30	Ball (Hitch)	94	Power Outlet	11
Baitwell	31	Ice Chest	68	Power Panel	12
Bow	25-26	Mounting Isolators	108	Power Pole Cover	106
Chart	11	<b>N</b>		Power Socket	11
Deck	32	Navigation Light Kit	27	Primary Wire	6
Dock	32, 104	Nozzle, Hose	49	Primer	85
Dome	31	Number and Letter Kit	77	Primer Bulb	51
Fishing	103	Nut		Propeller Wrench	60
Flashlight	31	Hex	75	Protector	
Flex	31	Lock	75	Steering Cable	45
Flood	31	Lug	58	Wheel Bearing	59
Interior	30	Lug	58	Pump	
Livewell	103	Well	75	Baitwell	50
Navigation	27	Wing	75	Bilge	48, 105
Pontoon	102	<b>O</b>		Gear Lube	61
Portable	25, 101	Oar	43	Hand	48, 62
Rail	101	Oarlock Bushing	43	Livewell	50, 105
Side	26-27	Oarlock Horn	43	Macerator	49
Side Marker Trailer	89-90	Oil Changer	62, 108	Washdown	49
Spreader	103	Oil Drain Plug	62	Water Pressure System	49
Stern	28	Oil Pressure Gauge	4-5	Push Button Switch	20
Strip	101	Outlet		Push/Pull Switch	21
Tail	88-89	Cable	11	Push to Close Latch	69-70
Trailer	88-90	Water	48	<b>Q</b>	
Transom	28	<b>P</b>		Quick Link	38
Underwater	102-103	Padding, Trailer Bunk	58	<b>R</b>	
Utility	31	Paddle	43	Rail Light	101
Light Bar	90	Padlock	77	Ratchet Strap	95
Light Base, Plug-In	30	Paint		Ratchet Tie Down	95
Light Bulb	32-33, 104	Antifouling	84-85	Receptacle, Trolling Motor	24
Light Bulb Display	33	Camouflage	86	Reflective Tape	90
Light Controller	104	Primer	85	Reflector, Trailer	90
Light Display	102	Spray	87	Resin	1020
Light Globe	29	Thinner	86	Epoxy	80
Light Tester, Trailer	92	Topside	86	Polyester	81
Line		Undercoater	86	Vinylester	80
Anchor	37	Paint Brush	86	Resin Roller	82
Dock	40	Paint Mixing Tub	87	Ring Buoy Bracket	65
Fender	40	Paint Spray Gun	65	Rocker Switch	21-22
Fuel	52	Panel		Rod Hold-Down	68
Livewell Light	103	Power	12	Rod Holder	67-68
Livewell Pump	50, 105	Switch	12-14, 23, 100	Roller	
Lock		Panel Bracket	98	Anchor	34
Coupler	58, 94	Parts Washer Solution	83	Resin	82
Hitch	95	Pedestal, Seat	106	Trailer	96-97, 108
Receiver	95	Peg Board Hook	77	Roller Cover	86
Louvered Vent	57	Personal Watercraft Cover	107	Cigar Foam	86
Lube Cap	59	Phone Charger	12	Roller Shaft	97
Lube Grommet	59	Pin		Rope	
Lube Pump	61	Coupler Lock	58, 94	All-Purpose	40-41
Lug		Hitch	94	Anchor	37
Battery	7	Pitot Tube	5	Cutting Gun - Electric	41
Nuts & Bolts	58	Plastic Cleaner and Restorer	79	Dock	40
<b>M</b>		Plate		Fender	40
Macerator Pump	49	Deck	68, 108	Rope Deck Pipe	42
M.E.K.P.	81	Keel	42	<b>S</b>	
Micro Balloons	81	Plug		Safety Chain	58, 94
Milled Fibers	81	Accessory	11	Safety Kits, USCG	1-2
Mineral Spirits	83	Baitwell	46	Salt Terminator	79
Mixing Tub	87	Trolling Motor	24	Scotch Lock	8
Mooring Anchor	36	Drain	46	Screws	74
Motor Cover	107	Plug-In Light Base	30	Scupper Valve	47
		Plumbing Kit	48		

MARPAC

MARPRO

TOUGH GUY

BOATER SPORTS

Alphabetical Index	Page No.	Alphabetical Index	Page No.	Alphabetical Index	Page No.
Seal, Bearing	58	Tail Light	88-89	<b>U</b>	
Sealant, Silicone	84	Tank Vent	54	U-Bolt	98
Seat Base	106	Tape		Underwater Light	102-103
Seat Cover	106	Reflective	90	USB Charger	12
Seat Cushion	106	Thread Sealant	54	USCG Safety Kits	1-2
Seat Pedestal	106	Telescopic Ladder	65	Utility Light	31
Selector Switch	17	Temperature Gauge	4-5	<b>V</b>	
Sender, Fuel	51	Terminal		Valve	
Separator, Fuel/Water	55	Battery Guard	8	Anti-Siphon	54
Sewage Treatment	50	Bullet	8	Ball	47, 54
Shackles	38	Butt	8	Fuel	54
Shock Cord	41	Closed End	8	Scupper	47
Shut-Off Valve	54	Electrical Kit	9	Shut-Off	54
Side Light	26-27	Heat Shrink	9	Vent	
Signal Horn	43	Quick Disconnect	8	Clam Shell	11
Silicone Sealant	84	Ring	8	Fuel	55
Ski Vest	63	Spade	8	Louvered	57
Ski Flag	64	Terminal Block	18	Vest	
Snap Cap	76	Thread Sealant Tape	54	Life	64
Snap	78	Thru-Hull Connector	47-48	Ski	63
Snap Hook	78	Thinner	86	VHF Antenna	3
Sockets		Tie Down	95	Voltmeter	4-5
Portable	11	Tie Wrap	9	<b>W</b>	
Power	11	Tire Carrier	96	Wash, Boat	79
USB Charger	12	Toggle Switch	22, 100	Washdown Hose	49
Solvents	83	Toggle Switch Boot	23, 100	Washdown Pump	49
Spare Tire Carrier	96	Toilet	50	Washer	
Speaker	3	Toilet Tissue Paper	50	Finishing	75
Speedometer	4-5	Toilet Treatment	50	Flat	75
Pitot	5	Topside Paint	86	Lock	75
Splicers, Hose	53	Towing Kit	58	Water Inlet and Outlet	48
Sport/Diver Ladder	65	Trailer		Water Pressure Gauge	4-5
Spray Paint	87	Balls	58	Water Pressure System Pump	49
Spreader Light	103	Bunk Padding	58	Water Separators	55-57
Spring Clamp	68	Chain	58	Water Temperature	4-5
Starter Cable	7	Coupler Lock	58	Water/Fuel Separator	56-57
Steering Cable Protector	45	Trailer Adapter	91	Well Nut	74
Steering Fluid	45	Trailer Bracket	98	Wheel	
Steering Wheel	44-45	Trailer Clearance Light	89-90	Destroyer	44-45
Stern Eye	42	Trailer Hitch	94	Steering	44-45
Stern Light	28	Trailer Hub Kit	96	Trailer Jack	93
Storage Clips, Pole Light	30	Trailer Jack	93-94	Wheel Bearing Kits	58
Storage Bag	64	Trailer Jack Wheel	93	Wheel Hub Kits	96
Strainer, Wire Mesh	50	Trailer Light Bar	90	Wheel Stop	58
Strap		Trailer Light Kit	88	Whistle	43
Battery Hold Down	23	Trailer Light Tester	92	Winch, Trailer	92
Trailer Hold Down	95	Trailer Roller	96-97, 108	Winch Cable	93
Winch	93	Trailer Safety Chain	94	Winch Handle	92
Strip Light	101	Trailer Winch	92	Winch Hook	108
Styrene	82	Trailer Winch Cable	93	Winch Strap	93
Support, Hatch	71	Trailer Winch Strap		Windshield Fastener	71
Switch		Trailer Wire Harness	91-92	Wing Nut	74
Battery	17	Transducer Mount Kit	3	Wire	6
Bilge Pump	48, 105	Transom Handle	71	Wire Display	7
Float	105	Transom Light	28	Wire Frame Clips	91
Horn	20	Transom Saver	98-99	Wiring Harness	91-92
Ignition	19	Transom Strap	95	Wrap, Tie	9
Kill	61	Transom Tie Down	95	Wrench, Propeller	60
Push Button	20	Tray, Battery	23	<b>X</b>	
Push/Pull	21	Treatment, Water	50	Xylene	83
Rocker	21, 22	Trim Gauge	4-5	<b>Z</b>	
Toggle	22, 100	Trim Switch	61	Zinc Chromate Primer	87
Trim	61	Trolling Motor Accessories	138		
Switch Panel	12-14, 23, 100	Electrical - Plugs/Connectors	24		
Trim	61	Foot Pedal Switch	33		
Switch Panel Label Kit	14	Tie Down Strap	33		
<b>T</b>		Tub, Mixing	87		
T-Handle Latch	72	Tube, Drain	46		
Tachometer	4-5	Tubing, Heat Shrink	9		

**PRE-PACKAGED USCG COMPLIANCE AND SAFETY KITS**

*Note: All USCG Compliance and Safety Kits Contents are Subject to Change Without Notice.*

**The “Runabout” Safety Kit**

- (1) 4-Flare Kit
- (1) White Boat Cushion
- (1) Coast Guard Booklet
- (1) 1/4" Galvanized Anchor Shackle
- (1) 5BC White Fire Extinguisher without Gauge
- (2) 3/8" x 15' White, Twisted Nylon Mooring/Docklines
- (1) 3/8" x 100' Twisted Nylon Anchor Line
- (4) Adult (Over 90 lb.) Life Vests
- (1) Signal Horn
- (1) #10 Slip Ring Anchor



Product No. Description

**7-0742** "Runabout" Safety Kit



**The “Small Boater” Safety Kit**

- (1) 4-Flare Kit
- (1) White Boat Cushion
- (1) Signal Horn
- (1) #10 Slip Ring Anchor
- (1) 5BC White Fire Extinguisher without Gauge
- (2) 3/8" x 20' White, Twisted Nylon Mooring/Docklines
- (1) 3/8" x 100' Twisted Nylon Anchor Line
- (4) Adult (Over 90 lb.) Life Vests
- (1) Gear Bag
- (1) Coast Guard Booklet
- (2) 1/4" Galvanized Anchor Shackles



Product No. Description

**7-0744** "Small Boater" Safety Kit



**The “Mid-Range Deluxe Boater” Safety Kit**

- (4) 12 Gauge Red Aerial Flares
- (4) Adult (Over 90 lb.) Life Vests
- (1) Gear Bag
- (1) Coast Guard Booklet
- (2) 5/16" Galvanized Anchor Shackles
- (1) 10BC White Fire Extinguisher with Gauge
- (2) 3/8" x 20' White, Twisted Nylon Mooring/Docklines
- (1) 3/8" x 150' Twisted Nylon Anchor Line
- (1) 1/4" x 4' White Vinyl Coated Anchor Chain
- (1) 12 Gauge Flare Gun
- (1) White Boat Cushion
- (1) Signal Horn
- (1) Rapid Set #8 Anchor



Product No. Description

**7-0745** "Mid-Range Deluxe Boater" Safety Kit



**The “Deluxe Yachters” Safety Kit**

- (1) Weekender First Aid Kit
- (6) Adult (Over 90 lb.) Life Vests
- (1) Gear Bag
- (1) Orange Police Style Whistle
- (1) Rapid Set #13 Anchor
- (2) 10BC White Fire Extinguisher with Gauge
- (2) 1/2" x 25' White, Twisted Nylon Mooring/Docklines
- (1) 1/2" x 150' Twisted Nylon Anchor Line
- (1) 5/16" x 5' White Vinyl Coated Anchor Chain
- (1) Coastal Alert/Locate Flare Kit
- (1) White Boat Cushion
- (1) Signal Horn
- (1) Coast Guard Booklet
- (2) 3/8" Galvanized Anchor Shackles



Product No. Description

**7-0747** "Deluxe Yachters" Safety Kit



**PRE-PACKAGED USCG COMPLIANCE AND SAFETY KITS - UPS Able**

*Note: All USCG Compliance and Safety Kits Contents are Subject to Change Without Notice.*

**The "Budget Boater" Non-Haz-Mat Kit**

- |   |                                    |
|---|------------------------------------|
| (4) Adult (Over 90 lb.) Life Vests                    | (1) White Boat Cushion             |
| (1) Signal Horn                                       | (1) Coast Guard Booklet            |
| (1) #10 Slip Ring Anchor                              | (1) 1/4" Galvanized Anchor Shackle |
| (2) 3/8" x 15' White, Twisted Nylon Mooring/Docklines |                                    |
| (1) 3/8" x 100' Twisted Nylon Anchor Line             |                                    |

Product No. Description

**7-0738** "Budget Boater" Non-Haz-Mat Kit

**The "Small Boater" Non-Haz-Mat Kit**

- |   |   |
|---|---|
| (4) Adult (Over 90 lb.) Life Vests                    | (1) White Boat Cushion                    |
| (1) Signal Horn                                       | (1) Coast Guard Booklet                   |
| (1) #10 Slip Ring Anchor                              | (2) 1/4" Galvanized Anchor Shackle        |
| (1) Gear Bag  | (1) 3/8" x 100' Twisted Nylon Anchor Line |
| (2) 3/8" x 20' White, Twisted Nylon Mooring/Docklines |   |

Product No. Description

**7-0739** "Small Boater" Non-Haz-Mat Kit

**The "Mid-Range Deluxe Boater" Non-Haz-Mat Kit**

- |   |   |
|---|---|
| (4) Adult (Over 90 lb.) Life Vests                    | (1) White Boat Cushion                    |
| (1) Gear Bag  | (1) Signal Horn                           |
| (1) Coast Guard Booklet                               | (1) Rapid Set #8 Anchor                   |
| (2) 5/16" Galvanized Anchor Shackles                  | (1) 3/8" x 150' Twisted Nylon Anchor Line |
| (2) 3/8" x 20' White, Twisted Nylon Mooring/Docklines |   |
| (1) 1/4" x 4' White Vinyl Coated Anchor Chain         |   |

Product No. Description

**7-0740** "Mid-Range Deluxe Boater" Non-Haz-Mat Kit

**The "Deluxe Yachters" Non-Haz-Mat Kit**

- |   |   |
|---|---|
| (1) Weekender First Aid Kit                           | (6) Adult (Over 90 lb.) Life Vests        |
| (1) White Boat Cushion                                | (1) Gear Bag                              |
| (1) Signal Horn                                       | (1) Orange Police Style Whistle           |
| (1) Coast Guard Booklet                               | (1) Rapid Set #13 Anchor                  |
| (2) 3/8" Galvanized Anchor Shackles                   | (1) 1/2" x 150' Twisted Nylon Anchor Line |
| (2) 1/2" x 25' White, Twisted Nylon Mooring/Docklines |   |
| (1) 5/16" x 5' White Vinyl Coated Anchor Chain        |   |

Product No. Description

**7-0741** "Deluxe Yachters" Non-Haz-Mat Kit

**Fresh Water #1 Safety Kit**

- (4) Adult (Over 90 lb.) Life Vests
- (1) White Boat Cushion
- (1) Gear Bag
- (1) Telescoping Paddle
- (1) 5BC White Fire Extinguisher with Gauge
- (1) Signal Horn



Product No. Description

**7-0734** Fresh Water #1 Safety Kit

**Fresh Water #2 Safety Kit**

- (4) Adult (Over 90 lb.) Life Vests
- (1) White Boat Cushion
- (1) Gear Bag
- (1) Telescoping Paddle
- (1) 5BC White Fire Extinguisher with Gauge
- (1) Orange Police Style Whistle



Product No. Description

**7-0735** Fresh Water #2 Safety Kit



## Remote External Speaker

- VHF external speaker.
- 6 watt.
- Weatherproof, cyclac case.
- Works with all VHF radio.
- White



Product No.	Description
<b>7-0371</b>	Remote External Speaker

## VHF Antenna

- Sturdy fiberglass construction with a smooth white finish.
- One section.
- Length 8'.
- 6dB Gain.
- Chrome brass ferrule.
- Fits standard 1"-14 thread bases.
- PL259 connector included.



Product No.	Description
<b>7-0127</b>	VHF Antenna

## Antenna Ratchet Mount

- Deck or bulkhead mounting.
- 4-Way ratchet with handle.
- Positive locking handle.
- Marine grade nylon construction.
- Stainless steel hardware.
- Feed-through hole for coax cable.
- Standard 1"-14 male thread.



Product No.	Description
<b>7-0435</b>	Antenna Ratchet Mount

## Antenna Ratchet Mount

- Heavy duty cast stainless steel.
- Fits 7/8" and 1" rails.
- Standard 1"-14 male thread.
- Hole for antenna cable.



Product No.	Description
<b>7-1330</b>	Antenna Ratchet Rail

## Antenna Ratchet Mount

- Marine grade nylon construction.
- Stainless steel hardware.
- Can be mounted on any standard 7/8" or 1" rail.
- Feed-through hole for coax cable.
- Standard 1"-14 male thread.



Product No.	Description
<b>7-1329</b>	Antenna Ratchet Mount

## Marine Grade Antenna Extension Cable

- Molded PL-259 connectors on both ends.



Product No.	Description
<b>7-0141</b>	Length 20'
<b>7-0142</b>	Length 100'

## PL258 Coax Connector Kit

- Double female barrel.
- Used to join (2) PL259 Coax Connectors.



Product No.	Description
<b>7-0137</b>	PL258 Coax Connector Kit

## PL259 Coax Connector Kit

- Includes (1 each): PL259, UG175 and UG176 Connectors.



Product No.	Description
<b>7-0130</b>	PL259 Coax Connector Kit

## Transducer Mount Kit

- Easily mounts all Lowrance HS-WS, HS-WST, HS-WSBK, HS-WSPC, LHSWS and LHS-WST Skimmer (high speed) and Broadview transducers to any trolling motor.
- 1/2" ID on mounting ears.
- Clam shell pack for display.



Product No.	Description
<b>7-52648</b>	Transducer Mount Kit

## Electronics Ball Mount

- Highly adjustable with a small foot print for endless mounting possibilities.
- 1-1/2" rubber ball clamps down securely.
- Coated marine grade aluminum for maximum corrosion resistance.
- Pre-drilled top plate fits many common electronics up to 7".
- 2-7/16" round base.
- Mounting plate measures: 6-17/64" L x 2" W.
- Overall height 7-1/2".



Product No.	Description
<b>7-2430</b>	Electronics Ball Mount



MARPAC

## Digital Depth Sounders - White Face with Black Bezel



- Reads depths from 2 - 199 feet (1-92 meters).
- Displays depth in feet, fathoms or meters.
- Fits standard 2-1/8" gauge hole.
- Shallow and deep alarms are both audio and visual.
- Adjustable keel offset.



Product No. Description

<b>7-2491</b>	Transom Mount Transducer
<b>7-2492</b>	In Hull Mount Transducer
<b>7-2493</b>	Thru-Hull Mount Transducer

## Digital Depth Sounders - White Face with Stainless Bezel



- Reads depths from 2 - 199 feet (1-92 meters).
- Displays depth in feet, fathoms or meters.
- Fits standard 2-1/8" gauge hole.
- Shallow and deep alarms are both audio and visual.
- Adjustable keel offset.



Product No. Description

<b>7-2494</b>	Transom Mount Transducer
<b>7-2495</b>	In Hull Mount Transducer
<b>7-2496</b>	Thru-Hull Mount Transducer

MARPRO

## Digital Depth Sounders - Black Face with Black Bezel



- Reads depths from 2 - 199 feet (1-92 meters).
- Displays depth in feet, fathoms or meters.
- Fits standard 2-1/8" gauge hole.
- Shallow and deep alarms are both audio and visual.
- Adjustable keel offset.



Product No. Description

<b>7-2497</b>	Transom Mount Transducer
<b>7-2499</b>	Thru-Hull Mount Transducer

## Red Series Water Temperature - I/O



- Made in USA.
- CE Certified.
- All gauges perimeter lighted.
- Stylish graphics.
- Contoured pointers.
- Domed glass lens.
- Fully sealed construction with Fog-resistant lens, built to military specifications.
- Easy installation.
- Fit standard 2-1/16" gauge mounting hole.
- OEM replacements are also available.



Product No. Description

<b>7-2092</b>	Red Series Water Temperature - I/O
---------------	------------------------------------

TOUGH GUY

## Elite Domed Gauges with Stainless Bezel



- Made in USA.
- CE Certified.
- All gauges perimeter lighted.
- Stylish graphics.
- Contoured pointers.
- Domed glass lens.
- Fully sealed construction with Fog-resistant lens, built to military specifications.
- Easy installation.
- Fit standard 2-1/16" and 3-3/8" gauge mounting holes.
- OEM replacements are also available.



Product No. Description

<b>7-1986</b>	Fuel Gauge
<b>7-1988</b>	Hourmeter - 100k Hours
<b>7-1990</b>	Oil Pressure Gauge - 80 PSI
<b>7-1982</b>	Speedometer - 10-65 MPH
<b>7-1980</b>	Tachometer - 0-7,000 RPM
<b>7-1998</b>	Trim Gauge - Johnson/Evinrude
<b>7-1996</b>	Trim Gauge - Mercury/Yamaha (2001 to Date)
<b>7-1984</b>	Voltmeter - 10-16 Volts
<b>7-1994</b>	O/B Water Pressure - 30 PSI
<b>7-1992</b>	Water Temperature - I/O

BOATER SPORTS

## Elite Domed Gauges



- Made in USA.
- CE Certified.
- All gauges perimeter lighted.
- Stylish graphics.
- Contoured pointers.
- Domed glass lens.
- Fully sealed construction with Fog-resistant lens, built to military specifications.
- Easy installation.
- Fit standard 2-1/16" and 3-3/8" gauge mounting holes.
- OEM replacements are also available.



Product No.	Description
<b>7-2025</b>	Fuel Gauge
<b>7-2035</b>	Hourmeter - 100k Hours
<b>7-2066</b>	Oil Pressure Gauge - 80 PSI
<b>7-2015</b>	Speedometer - 10-65 MPH
<b>7-2010</b>	Tachometer - 0-7,000 RPM
<b>7-2044</b>	Trim Gauge - Johnson/Evinrude
<b>7-2042</b>	Mercury/Yamaha (2001 to Date)
<b>7-2020</b>	Voltmeter - 10-16 Volts
<b>7-2040</b>	O/B Water Pressure - 30 PSI
<b>7-2067</b>	Water Temperature - I/O

## Performance Domed Gauges



- Made in USA.
- CE Certified.
- All gauges perimeter lighted.
- Stylish graphics.
- Contoured pointers.
- Domed glass lens.
- Fully sealed construction with Fog-resistant lens, built to military specifications.
- Easy installation.
- Fit standard 2-1/16" and 3-3/8" gauge mounting holes.
- OEM replacements are also available.



Product No.	Description
<b>7-2065</b>	Fuel Gauge
<b>7-2075</b>	Hourmeter - 100k Hours
<b>7-2036</b>	Oil Pressure Gauge - 80 PSI
<b>7-2055</b>	Speedometer - 10-65 MPH
<b>7-2050</b>	Tachometer - 0-7,000 RPM
<b>7-2084</b>	Trim Gauge - Johnson/Evinrude
<b>7-2082</b>	Mercury/Yamaha (2001 to Date)
<b>7-2060</b>	Voltmeter - 10-16 Volts
<b>7-2080</b>	O/B Water Pressure - 30 PSI
<b>7-2037</b>	Water Temperature - I/O

## Universal Pitot Tube

- Calibrated for standard marine speedometers like Sierra, Faria, Marpac and others.
- Consistent pressure for accurate readings.
- Stable, yet flexible design prevents impact damage.
- Resists barnacle growth.
- Works from 5 - 80 mph.



Product No.	Description
<b>7-0893</b>	Universal Pitot Tube

**Wiring Color Code - Direct Current Systems - Under 50 Volts**
**MARPAC**

COLOR	ITEM	USE
Dark Green	Bonding System	Bonding Wires (if insulated)
Black	Ground	Return Wires (if insulated)
Red	Main Power Feeds	Positive Mains, Particularly Unfused
Yellow with a Red Stripe	Starting Circuit	Starting Switch to Solenoid
Yellow	Generator or Alternator Field	Generator to Alternator Field to Regulate Field Terminal
	Bilge Blowers	Fuse or Switch to Bilge Blowers
Dark Gray	Navigation Lights	Fuse or Switch to Lights
	Tachometer	Tachometer to Gauge
Brown	Generator Armature	Generator Armature to Regulator
	Alternator Charge Light	Generator Terminal/Alternator Auxiliary Terminal to Light to Regulator
	Pumps	Fuse or Switch to Pumps
Orange	Accessory Feed	Ammeter to Alternator or Generator Output & Accessory Fuses or Generator Switches Distribution Panel to Accessory Switch
Purple	Ignition	Ignition Switch to Coil and Electrical Instruments
	Instrument Feed	
Dark Blue	Oil Pressure	Oil Pressure Sender to Gauge
Tan	Water Temperature	Water Temperature Sender to Gauge
Pink	Fuel Gauge	Fuel Gauge Sender to Gauge

**MARPRO**
**Primary Marine Wire - Single Conductor**

- Electro-tinned, copper strands increase corrosion protection.
- Rating 221° F (105° C) dry and 167° F (75° C) wet.
- Flame retardant PVC insulation.
- Rated 600 volts.
- RoHS complaint.
- Meets USCG, DOT, ABYC, NMMA and UL 1426 Specifications.



	8 GAUGE	10 GAUGE	12 GAUGE	14 GAUGE	16 GAUGE
<b>Green</b>	7-4358 (100')	7-4350 (100')	7-4340 (100')	7-4316 (100')	7-4306 (100')
<b>White</b>	7-4357 (100')	7-4348 (100')	7-4338 (100')	7-4314 (100')	7-4304 (100')
<b>Red</b>	7-4356 (100')	7-4346 (100')	7-4336 (100')	7-4312 (100')	7-4302 (100')
		7-4352 (250')	7-4332 (250')	7-4330 (500')	
<b>Black</b>	7-4354 (100')	7-4344 (100')	7-4334 (100')	7-4310 (100')	7-4300 (100')
		7-4353 (250')	7-4333 (250')	7-4331 (500')	
<b>Blue</b>					7-4290 (100')
<b>Dark Blue</b>		7-4349 (100')	7-4342 (100')	7-4326 (100')	7-4293 (100')
<b>Light Blue</b>				7-4324 (100')	
<b>Yellow</b>		7-4351 (100')	7-4341 (100')	7-4318 (100')	
<b>Brown</b>		7-4347 (100')	7-4343 (100')	7-4320 (100')	7-4288 (100')
<b>Orange</b>			7-4345 (100')	7-4322 (100')	7-4294 (100')
<b>Pink</b>				7-4328 (100')	7-4296 (100')
<b>Gray</b>				7-4308 (100')	7-4292 (100')
<b>Purple</b>					7-4298 (100')

**TOUGH GUY**
**Bonded Parallel Plastic Primary Wire - 2-Conductor**

- Electro-tinned, copper strands increase corrosion protection.
- Rating -22° F (-30° C) to 176° F (80° C).
- Rated 60 volts.
- RoHS compliant.
- Meet SAE J1128 specifications.
- 10 Gauge.



Product No.	Description
7-4369	Red/Black, 100' Length

**Bonded Parallel Wire**

- All copper strand core.
- Heavy duty PVC jacket with color-coded conductors.
- Rating 176° F (80° C), nominal cold temperature rating of -22° F (-30° C).
- Rated 60 volts or less.
- RoHS compliant.
- Meet SAE J1128 specifications.

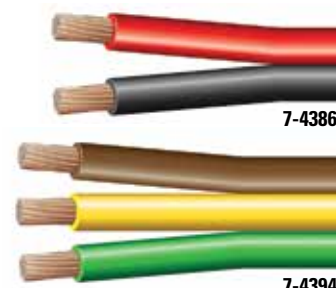

	14 GAUGE	16 GAUGE	18 GAUGE
<b>2-Conductor</b> Red/Black	7-4386 (100')	7-4382 (100') 7-4384 (500')	7-4380 (100')
<b>3-Conductor</b> Brown/Yellow/Green	7-4394 (100')	7-4392 (100')	
<b>4-Conductor</b> White/Brown/Yellow/Green	7-4400 (100')	7-4398 (100')	7-4396 (100')

**BOATER SPORTS**

## Multi-Conductor Marine Wire - Triplex

- Electro-tinned, copper strands increase corrosion protection.
- Rating 221° F (105° C) dry and 167° F (75° C) wet.
- Flame retardant PVC insulation.
- Rated 600 volts.
- RoHS compliant.
- Meets USCG, DOT, ABYC, NMMA and UL 1426 Specifications.



10 GAUGE	12 GAUGE	14 GAUGE	16 GAUGE
7-4376 (100')	7-4374 (100')	7-4372 (100')	7-4378 (500')

## Multi-Conductor Marine Wire - Duplex

- Electro-tinned, copper strands increase corrosion protection.
- Rating 221° F (105° C) dry & 167° F (75° C) wet.
- Flame retardant PVC insulation.
- Rated 600 volts.
- RoHS compliant.
- Meets USCG, DOT, ABYC, NMMA and UL 1426 Specifications.



	10/2 GAUGE	12/2 GAUGE	14/2 GAUGE	16/2 GAUGE	10 GAUGE	12 GAUGE	14 GAUGE	16 GAUGE
<b>Red/Black</b>	7-4470 (100') 7-4472 (250')	7-4474 (100') 7-4476 (250')	7-4478 (100') 7-4480 (250')	7-4482 (100') 7-4484 (250')	-	-	-	-
<b>Black/White</b>	-	-	-	-	7-4370 (100')	7-4368 (100')	7-4366 (100')	7-4364 (100')
<b>Yellow/Red</b>	-	-	-	-	7-4371 (100')	-	7-4367 (100')	7-4366 (100')

## Starter Cable

- Electro-tinned, copper strands increase corrosion protection.
- Rating 221° F (105° C) dry and 167° F (75° C) wet.
- Flame retardant PVC insulation.
- Rated 600 volts.
- RoHS compliant.
- Meets USCG, DOT, ABYC, NMMA and UL 1426 Specifications.



	4/0 GAUGE	3/0 GAUGE	2/0 GAUGE	1/0 GAUGE	1 GAUGE	2 GAUGE	4 GAUGE	6 GAUGE
<b>Yellow</b>	7-4467 (50')	7-4459 (50')	-	7-4442 (50')	7-4431 (50')	7-4425 (50')	7-4415 (50')	-
	-	-	-	-	-	-	7-4417 (100')	7-4404 (100')
<b>Black</b>	-	-	7-4432 (25')	-	7-4428 (25')	7-4420 (25')	7-4412 (25')	-
	7-4465 (50')	7-4457 (50')	-	7-4440 (50')	7-4429 (50')	7-4423 (50')	7-4413 (50')	-
	-	-	7-4436 (100')	-	-	7-4424 (100')	7-4416 (100')	7-4408 (100')
<b>Red</b>	-	-	7-4430 (25')	-	7-4426 (25')	7-4418 (25')	7-4410 (25')	-
	7-4463 (50')	7-4455 (50')	-	7-4438 (50')	7-4427 (50')	7-4421 (50')	7-4411 (50')	-
	-	-	7-4434 (100')	-	-	7-4422 (100')	7-4414 (100')	7-4406 (100')
<b>Green</b>	-	-	-	-	-	-	-	7-4402 (100')

## Tinned Copper Lugs

- Sold 2 per display package. Sold by box of 5 display packages only!



	8 AWG	6 AWG	4 AWG	2 AWG	1 AWG	1/0 AWG	2/0 AWG	4/0 AWG
#1/8	-	7-3465	-	-	-	-	-	-
#1/4	7-3450	7-3470	-	-	-	-	7-3550	-
#5/16	7-3455	7-3475	7-3490	7-3510	7-3525	7-3535	7-3555	-
#3/8	7-3460	7-3480	7-3500	7-3520	7-3530	7-3540	7-3560	7-3570
#1/2	-	-	-	-	-	7-3545	7-3565	7-3575



MARPAC

## Tinned Copper Battery Cable

- Pre-assembled battery cable.
- Made of 100% copper conductor for maximum current flow.
- Full gauge stranded copper core is flexible for easy installation and allows maximum current for quick starting.
- Copper core extends to the end of the plated lug to give a one piece solid connection.
- Recommended for engine to ground connections.
- Fits up to 3/8" stud.
- Wire meets SAE standards.



	2 GAUGE	4 GAUGE
<b>Black</b>	<b>7-4085</b> (48")	<b>7-4055</b> (24")
	<b>7-4095</b> (60")	<b>7-4065</b> (36")
	<b>7-4105</b> (72")	
<b>Red</b>	<b>7-4090</b> (48")	<b>7-4060</b> (24")
	<b>7-4100</b> (60")	<b>7-4070</b> (36")
	<b>7-4110</b> (72")	

MARPRO

## Vinyl Spade Fork Connectors

- Sold by box of 5 packages only!



Product No.	Description	Color	Per Package
<b>7-3190</b>	22-18 AWG	Red	7
<b>7-3195</b>	16-14 AWG	Blue	7
<b>7-3200</b>	12-10 AWG	Yellow	6

TOUGH GUY

## Vinyl Bullet Connectors

- Sold by box of 5 packages only!



Product No.	Description	Per Package
<b>7-3245</b>	16-14 AWG - Plug	7
<b>7-3250</b>	16-14 AWG - Receptacle	4

BOATER SPORTS

## Vinyl Quick Disconnects - Fully Insulated

- Sold by box of 5 packages only!



Product No.	Description	Color	Per Package
<b>7-3205</b>	22-18 AWG - Male	Red	4
<b>7-3210</b>	22-18 AWG - Female	Red	4
<b>7-3215</b>	16-14 AWG - Male	Blue	4
<b>7-3220</b>	16-14 AWG - Female	Blue	4
<b>7-3225</b>	12-10 AWG - Male	Yellow	4
<b>7-3230</b>	12-10 AWG - Female	Yellow	4

## Battery Terminal Guards

- Sold per pair per display package. Sold by box of 5 packages only!



Product No.	Description
<b>7-4195</b>	For 2 AWG Cable
<b>7-4200</b>	For 4 AWG Cable

## Vinyl Butt Connectors

- Sold by box of 5 packages only!



Product No.	Description	Color	Per Package
<b>7-3110</b>	22-18 AWG	Red	6
<b>7-3115</b>	16-14 AWG	Blue	6
<b>7-3120</b>	12-10 AWG	Yellow	6

## Vinyl Ring Tongue Terminals

- Sold by box of 5 packages only!



Product No.	Description	Color	Per Package
<b>7-3130</b>	22-18 AWG - #8	Red	7
<b>7-3135</b>	22-18 AWG - #10	Red	7
<b>7-3140</b>	16-14 AWG - #6	Blue	7
<b>7-3145</b>	16-14 AWG - #8	Blue	7
<b>7-3150</b>	16-14 AWG - #10	Blue	7
<b>7-3155</b>	16-14 AWG - #1/4	Blue	6
<b>7-3165</b>	16-14 AWG - #3/8	Blue	5
<b>7-3170</b>	12-10 AWG - #10	Yellow	6
<b>7-3175</b>	12-10 AWG - #1/4	Yellow	5
<b>7-3180</b>	12-10 AWG - #5/16	Yellow	5
<b>7-3185</b>	12-10 AWG - #3/8	Yellow	5

## Vinyl Closed End Connectors

- Sold by box of 5 packages only!



Product No.	Description	Per Package
<b>7-3255</b>	22-14 AWG	9
<b>7-3260</b>	18-10 AWG	8

## Vinyl Scotch Locks

- Sold by box of 5 packages only!



Product No.	Description	Color	Per Package
<b>7-3235</b>	14-18 AWG	Blue	3
<b>7-3240</b>	12-10 AWG	Yellow	3

## 81 Piece Vinyl Electrical Terminal Kit

- This kit includes 81 pieces in a closable plastic case:
- (15) Butt Connectors 22-18 AWG
- (15) Butt Connectors 16-14 AWG
- (6) Butt Connectors 12-10 AWG
- (6) Ring Tongue Terminals 22-18 AWG - #10
- (8) Ring Tongue Terminals 16-14 AWG - #10
- (5) Ring Tongue Terminals 16-14 AWG - 5/16"
- (5) Ring Tongue Terminals 12-10 AWG - #10
- (6) Ring Tongue Terminals 12-10 AWG - 3/8"
- (2) Ring Tongue Terminals 8 AWG - 3/8"
- (3) Quick Disconnects 16-14 AWG - Male
- (3) Quick Disconnects 16-14 AWG - Female
- (2) Bullet Connector 16-14 AWG - Plugs
- (2) Bullet Connector 16-14 AWG - Receptacles
- (3) Scotch Locks 14-16 AWG



Product No.	Description
<b>7-4205</b>	81 Piece Vinyl Electrical Terminal Kit

## Heat Shrink Quick Disconnects - Insulated

- Sold by box of 5 packages only!



Product No.	Description	Color	Per Package
<b>7-3395</b>	22-18 AWG - Male	Red	2
<b>7-3400</b>	22-18 AWG - Female	Red	2
<b>7-3405</b>	16-14 AWG - Male	Blue	2
<b>7-3410</b>	16-14 AWG - Female	Blue	2
<b>7-3415</b>	12-10 AWG - Male	Yellow	2
<b>7-3420</b>	12-10 AWG - Female	Yellow	2

## Heat Shrink Butt Connectors

- Sold by box of 5 packages only!



Product No.	Description	Color	Per Package
<b>7-3290</b>	22-18 AWG	Red	2
<b>7-3300</b>	16-14 AWG	Blue	2
<b>7-3310</b>	12-10 AWG	Yellow	2

## Heat Shrink Tubing

- Diameter 1/2"
- Length 3"
- Double wall 8 AWG to 4 AWG.
- Includes: 2 pieces red and 1 piece black per card.
- Sold 5 bags per box.



Product No.	Description
<b>7-4040</b>	Heat Shrink Tubing

## Heat Shrink Ring Tongues

- Sold by box of 5 packages only!



Product No.	Description	Color	Per Package
<b>7-3320</b>	22-18 AWG - #10	Red	2
<b>7-3325</b>	22-18 AWG - #1/4	Red	4
<b>7-3335</b>	16-14 AWG - #8	Blue	2
<b>7-3345</b>	16-14 AWG - #10	Blue	2
<b>7-3350</b>	16-14 AWG - #1/4	Blue	2
<b>7-3355</b>	16-14 AWG - #5/16	Blue	2
<b>7-3365</b>	16-14 AWG - #3/8	Blue	2
<b>7-3370</b>	12-10 AWG - #10	Yellow	2
<b>7-3375</b>	12-10 AWG - #1/4	Yellow	2
<b>7-3385</b>	12-10 AWG - #3/8	Yellow	2
<b>7-3390</b>	12-10 AWG - #1/2	Yellow	2
<b>7-3425</b>	12-10 AWG - #5/16	Yellow	2

## Heat Shrink Crimp Terminal Display

- This display includes 5 display packs of the following:

- 7-3290 - Butt Connectors 22-18 AWG
- 7-3325 - Ring Tongue 22-18 AWG - #1/4
- 7-3300 - Butt Connectors 16-14 AWG
- 7-3335 - Ring Tongue 16-14 AWG - #8
- 7-3310 - Butt Connectors 12-10 AWG
- 7-3345 - Ring Tongue 16-14 AWG - #10
- 7-3395 - Quick Disconnect 22-18 AWG - Male
- 7-3350 - Ring Tongue 16-14 AWG - #1/4
- 7-3400 - Quick Disconnect 22-18 AWG - Female
- 7-3355 - Ring Tongue 16-14 AWG - #5/16
- 7-3405 - Quick Disconnect 16-14 AWG - Male
- 7-3365 - Ring Tongue 16-14 AWG - #3/8
- 7-3410 - Quick Disconnect 16-14 AWG - Female
- 7-3370 - Ring Tongue 12-10 AWG - #10
- 7-3415 - Quick Disconnect 12-10 AWG - Male
- 7-3375 - Ring Tongue 12-10 AWG - #1/4
- 7-3420 - Quick Disconnect 12-10 AWG - Female
- 7-3385 - Ring Tongue 12-10 AWG - #3/8
- 7-3320 - Ring Tongue 22-18 AWG - #10



Product No.	Description
<b>7-3004</b>	Heat Shrink Crimp Terminal Display

## Black Tie Wraps - UV Resistant

- Heavy duty nylon wire ties.
- Super strong and durable.
- Useful in almost any situation.
- Sold 100 per pack.



Product No.	Description
<b>7-51048</b>	Length 4"
<b>7-51049</b>	Length 8"
<b>1-51050</b>	Length 11"
<b>1-51052</b>	Length 7", with Mount Hole



## 80 Item Electrical Display

• This display includes the following:

- (5) 7-3110 - Butt Connectors - 22-18 AWG
- (5) 7-3115 - Butt Connectors - 16-14 AWG
- (5) 7-3120 - Butt Connectors - 12-10 AWG
- (5) 7-3125 - Ring Tongue - 22-18 AWG #6
- (5) 7-3130 - Ring Tongue - 22-18 AWG #8
- (5) 7-3135 - Ring Tongue - 22-18 AWG #10
- (5) 7-3140 - Ring Tongue - 16-14 AWG #6
- (5) 7-3145 - Ring Tongue - 16-14 AWG #8
- (5) 7-3150 - Ring Tongue - 16-14 AWG #10
- (5) 7-3155 - Ring Tongue - 16-14 AWG #1/4
- (5) 7-3165 - Ring Tongue - 16-14 AWG #3/8
- (5) 7-3170 - Ring Tongue - 12-10 AWG #10
- (5) 7-3175 - Ring Tongue - 12-10 AWG #1/4
- (5) 7-3180 - Ring Tongue - 12-10 AWG #5/16
- (5) 7-3185 - Ring Tongue - 12-10 AWG #3/8
- (5) 7-3190 - Spade Fork - 22-18 AWG #10
- (5) 7-3195 - Spade Fork - 16-14 AWG #10
- (5) 7-3200 - Spade Fork - 12-10 AWG #10
- (5) 7-3205 - Quick Disconnect - 22-18 AWG Male
- (5) 7-3210 - Quick Disconnect - 22-18 AWG Female
- (5) 7-3215 - Quick Disconnect - 16-14 AWG Male
- (5) 7-3220 - Quick Disconnect - 16-14 AWG Female
- (5) 7-3225 - Quick Disconnect - 12-10 AWG Male
- (5) 7-3230 - Quick Disconnect - 12-10 AWG Female
- (5) 7-3235 - Scotch Lock - 14-18 AWG
- (5) 7-3240 - Scotch Lock - 12-10 AWG
- (5) 7-3245 - Bullet Conn. - 16-14 AWG - Plug
- (5) 7-3250 - Bullet Conn. - 16-14 AWG - Receptacle
- (5) 7-3255 - Closed End Conn. - 22-14 AWG
- (5) 7-3260 - Closed End Conn. - 18 -10 AWG
- (5) 7-3290 - Heat Shrink Butt Conn. - 22-18 AWG
- (5) 7-3300 - Heat Shrink Butt Conn. - 16-14 AWG
- (5) 7-3310 - Heat Shrink Butt Conn. - 12-10 AWG
- (5) 7-3320 - Heat Shrink Ring - 22-18 AWG #10
- (5) 7-3335 - Heat Shrink Ring - 16-14 AWG #8
- (5) 7-3345 - Heat Shrink Ring - 16-14 AWG #10
- (5) 7-3365 - Heat Shrink Ring - 16-14 AWG #3/8
- (5) 7-3385 - Heat Shrink Ring - 12-10 AWG #3/8
- (5) 7-3450 - Tinned Copper Lugs - 8 AWG #1/4
- (5) 7-3455 - Tinned Copper Lugs - 8 AWG #5/16
- (5) 7-3460 - Tinned Copper Lugs - 8 AWG #3/8
- (5) 7-3465 - Tinned Copper Lugs - 6 AWG #10
- (5) 7-3470 - Tinned Copper Lugs - 6 AWG #1/4
- (5) 7-3475 - Tinned Copper Lugs - 6 AWG #5/16
- (5) 7-3480 - Tinned Copper Lugs - 6 AWG #3/8
- (5) 7-3490 - Tinned Copper Lugs - 4 AWG #5/16
- (5) 7-3500 - Tinned Copper Lugs - 4 AWG #3/8
- (5) 7-3510 - Tinned Copper Lugs - 2 AWG #5/16
- (5) 7-3520 - Tinned Copper Lugs - 2 AWG #3/8
- (5) 7-3525 - Tinned Copper Lugs - 1 AWG #5/16
- (5) 7-3530 - Tinned Copper Lugs - 1 AWG #3/8
- (5) 7-3535 - Tinned Copper Lugs - 1/0 AWG #5/16
- (5) 7-3540 - Tinned Copper Lugs - 1/0 AWG #3/8
- (5) 7-3545 - Tinned Copper Lugs - 1/0 AWG #1/2
- (5) 7-3550 - Tinned Copper Lugs - 2/0 AWG #1/4
- (5) 7-3555 - Tinned Copper Lugs - 2/0 AWG #5/16
- (5) 7-3560 - Tinned Copper Lugs - 2/0 AWG #3/8
- (5) 7-3565 - Tinned Copper Lugs - 2/0 AWG #1/2
- (5) 7-3570 - Tinned Copper Lugs - 4/0 AWG #3/8
- (5) 7-3575 - Tinned Copper Lugs - 4/0 AWG #1/2
- (5) 7-3665 - Vinyl Hole Grommets - 1/4
- (5) 7-3670 - Vinyl Hole Grommets - 1/2
- (10) 7-3785 - Waterproof Fuse Holder
- (5) 7-3800 - ATO Fuse - 3 amp
- (5) 7-3805 - ATO Fuse - 4 amp
- (5) 7-3810 - ATO Fuse - 5 amp
- (5) 7-3815 - ATO Fuse - 7.5 amp
- (5) 7-3820 - ATO Fuse - 10 amp
- (5) 7-3825 - ATO Fuse - 15 amp
- (5) 7-3830 - ATO Fuse - 20 amp
- (5) 7-3835 - ATO Fuse - 25 amp
- (5) 7-3936 (90) Double Contact Bayonet Base
- (5) 7-3946 (94) Double Contact Bayonet Base
- (5) 7-3951 (194) Wedge
- (5) 7-3966 (1004) Double Contact Bayonet Base
- (5) 7-3980 (1142) Double Contact Bayonet Base
- (5) 7-3986 (1156) Single Contact Bayonet Base
- (5) 7-3991 (1157) Double Contact Bayonet Base
- (5) 7-4010 (70 DP1 CLR) Festoon
- (5) 7-4020 (71 DP CLR) Festoon



Product No. Description

**7-3007** 80 Item Electrical Display

### Alligator Clips - Insulated

- Length 2".
- Sold per pair.



Product No. Description

**7-0135** Alligator Clips - Insulated

### Heavy Duty Battery Clips

- Spring loaded copper plated 3" battery clips.
- Color coded coated handles.
- Fits up to 6 gauge wire.
- Sold per pair.



Product No. Description

**7-51011** 20 amp

### Gator Battery Clips

- Spring loaded copper plated battery clips commonly used for aerators and portable lights.
- Sold per pair.



Product No. Description

**7-51010** 30 amp

### Battery Clips

- Spring loaded copper plated 3" battery clips.
- Color coded coated handles.
- Sold per pair.



Product No. Description

**7-51008** 15 amp

MARPAC

MARPRO

TOUGH GUY

BOATER SPORTS



## Corrosion Resistant Deluxe Socket with Alligator Clips

- Made from corrosion resistant marine grade materials.
- This portable socket extends over 6' with its heavy duty coiled wire.



Product No. Description

**7-0869** Deluxe Socket with Alligator Clips

## Vinyl Hole Grommets

- Sold by box of 5 display packages only!
- Mini-Blister - 5 per box.



Product No. Description Per Package

**7-3665** 1/4" 6

**7-3670** 1/2" 4

## Polarized Power Outlet

- Polarized double contact connector.
- Watertight snap-on cover.
- Chrome plated brass base.
- Diameter 1-1/2".
- Uses #8 fasteners.
- 12 volt.



Product No. Description

**7-0448** Polarized Power Outlet

## Deluxe Power Socket

- Moisture resistant marine grade materials.
- Mounts in a 1-1/8" hole from the front using the plate or from the rear using the locking ring.
- Not for use with cigarette lighters.
- Includes: Mounting screws, electrical connectors and a boot for the wires.
- 12 volt.



Product No. Description

**7-0863** Deluxe Power Socket

## Stainless Steel Chart Light and Combo Cigarette Lighter

- Stainless steel mounting plate.
- Easily switch between chart light and cigarette lighter with the flick of a switch.
- Uses #8 fasteners.
- 12 volt.



Product No. Description

**7-0112** Chart Light and Combo Cigarette Lighter

## Watertight Cable Outlets

- Chrome plated brass.
- Gasketed to assure water tightness.
- Diameter 1-1/2".
- Uses #6 fasteners.



Product No. Description

**7-0451** 5/16"

**7-0452** 3/8"

## Clam Shell Vents

- Made of 18-8 stainless steel and polished, this streamlined midget ventilator has many uses, including shielding gas tank vents.



Product No. Description

**7-0089** 1-3/4" x 1-5/8"

**7-0090** 2" x 2"

## Deluxe Accessory Plug

- Made from corrosion resistant marine grade materials.
- With moisture resistant sealing ring.
- 12 volt.
- Sold 2 per display pack.



Product No. Description

**7-0862** Deluxe Accessory Plug

## Marine Quality Plug and Power Socket

- Universal mate socket/plug.
- Nickel plated phosphor bronze metal parts help reduce corrosion.
- O-ring and molded cap help reduce corrosion.
- Not for use with cigarette lighters.
- Includes: Stainless steel installation screws.
- 12 volt.



Product No. Description

**7-0867** Plug and Power Socket

**7-0868** Power Socket Only

## Stainless Steel Power Socket

- Stainless steel mounting plate.
- Corrosion-free molded cap.
- Ideal for additional power outlets.
- Uses #8 fasteners.
- Not for use with cigarette lighters.
- 12 volt.



Product No. Description

**7-0866** Power Socket

MARPAC

## Power Delivery (PD) USB 1A + 1C Charger

- Type A port - 5V 2.4A compatible with most smartphones in market.
- Type C port - PD 45W compatible with latest PD devices in market.
- Fast charges your iPhone / Android phones from 0% to 50% within 30 minutes.
- Also charges ultrabooks, MacBooks and MacBook Air (after 2018) in 20V mode.
- Blue: Standby/Charging at 5V.
- Amber: Charging at 9V or higher (PD Model).



Product No.	Description
<b>7-0823</b>	Power Delivery (PD) USB 1A + 1C Charger

MARPRO

## Switch Mount USB Charger Socket

- Dual port USB charger.
- Compatible with iPad, iPhone and Android devices.
- LED power indicator.
- Short circuit/overheat protected.
- Unique water-proof cap splash resistant to IP66 standards (when sealed).
- Enhanced uni-body water resistant design.
- 1.45" x 0.83" cut-out replaces contura style switches in existing panels.
- Easy to install, just snaps in.



Product No.	Description
<b>7-0822</b>	Switch Mount USB Charger Socket

TOUGH GUY

## Marine Grade Power Panels

- Marine grade aluminum panel.
- Modern style illuminated rocker switches glow white when ON - easy to see day or night.
- Includes weatherproof breaker boots.
- For extra flexibility, add Marpac 7-1144 - On-Off-On Rocker Switches.



7-0513



7-1134



7-0514

Product No.	Description
<b>7-0514</b>	3 Gang 5-1/4" W x 3-3/4" H
<b>7-0513</b>	6 Gang 5-1/4" W x 7-1/2" H

### ACCESSORIES

Product No.	Description
<b>7-1134</b>	Spare Weatherproof Breaker Boots - 3 Per Package

BOATER SPORTS

## Dual Port USB Charger

- Corrosion resistant.
- Weatherproof cover.
- Charge two items at the same time.
- Compatible with iPad, iPhone and Android devices.
- Rated at 4.8 amps.
- 12 volt input.



Product No.	Description
<b>7-0821</b>	Dual Port USB Charger

## Water Resistant Aluminum Switch Panels

- Panel made from corrosion proof ABS plastic with reinforced corners.
- Corrosion resistant 0.1" (2.54mm) thick coated aluminum alloy faceplate.
- Compact, modern design can be mounted vertically or horizontally.
- Splash resistant to IP66 standards.
- Push-to-reset circuit breakers with rubber boots.
- Illuminated contura style rockers glow blue when activated.
- Replaceable on-off rocker switches rated at 20 amps.
- Easy to read labels with included backlight module.
- Watertight mounting gasket included.



7-1245



7-1246



7-0822



7-1144



7-1258

Product No.	Description
<b>7-1245</b>	6 Switches 4-31/64" W x 7-33/64" H

### SWITCH PANELS WITH USB CHARGER

Product No.	Description
<b>7-1246</b>	5 Switches 4-31/64" W x 7-33/64" H
<b>7-1247</b>	7 Switches 4-31/64" W x 9-3/8" H



### ACCESSORIES

Product No.	Description
<b>7-1145</b>	Contura Style Illuminated Rocker Switch - On-Off
<b>7-1146</b>	Contura Style Illuminated Rocker Switch - On-Off-On
<b>7-0822</b>	Switch Mount USB Charger Socket
<b>7-1258</b>	Label Kit for Lighted Panels

# SWITCH PANELS



MARPAC

MARPRO

TOUGH GUY

BOATER SPORTS

## Water Resistant Curved Aluminum Switch Panels

- Panel made from corrosion proof ABS plastic with reinforced corners.
- Corrosion resistant 0.1" (2.54mm) thick coated aluminum alloy faceplate.
- Compact, modern design can be mounted vertically or horizontally.
- Splash resistant to IP66 standards.
- Push-to-reset circuit breakers with rubber boots.
- Illuminated contura style rockers glow blue when activated.
- Replaceable on-off rocker switches rated at 20 amps.
- Easy to read labels with included backlight module.
- Watertight mounting gasket included.



Product No.	Description
7-1250	4 Switches 5-15/64" W x 4-31/64" H
7-1251	6 Switches 7-33/64" W x 4-31/64" H

## SWITCH PANELS WITH USB CHARGER

Product No.	Description
7-1252	5 Switches 4-31/64" H x 7-33/64" W



## ACCESSORIES

Product No.	Description
7-1145	Contura Style Illuminated Rocker Switch - On-Off
7-1146	Contura Style Illuminated Rocker Switch - On-Off-On
7-0822	Switch Mount USB Charger Socket
7-1258	Label Kit for Lighted Panels

## Switch Panel with Toggle Boot Seals

- Corrosion proof black bakelite panel.
- Chrome plated toggle switches with boots and screw cap fuse holders.
- Corrosion resistant tinned wires.
- Rated: 15 amps at 12V DC.
- Includes #6 fasteners and easy to read (8) labels.
- Dimensions: 4-1/2" W x 6-1/4" H.

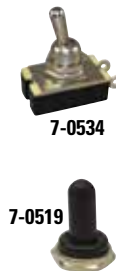

Product No.	Description
7-0517	6 Gang with Toggle Boot Seals

## ACCESSORIES

Product No.	Description
7-0534	Spare Toggle Switch
7-0519	Spare Toggle Boot Seal

## Switch Panels

- Corrosion proof black bakelite panel.
- Chrome plated toggle switches and screw cap fuse holders.
- Rated: 15 amps at 12V DC.
- Includes #6 fasteners and easy to read (8) labels.



Product No.	Description
7-0516	3 Gang 4-1/2" W x 3-5/8" H
7-0518	6 Gang 4-1/2" W x 6-1/4" H

## ACCESSORIES

Product No.	Description
7-0534	Spare Toggle Switch
7-0519	Spare Toggle Boot Seal

## Toggle Switch Panel with Dual Port USB Charger

- Compact, modern design.
- Panel made from corrosion proof ABS plastic with reinforced corners.
- Splash resistant to IP66 standards.
- Watertight design includes toggle switch boots and panel mounting gasket.
- Includes inline, spray-proof ATP/ATC fuse holders.
- Dual port USB charger rated at 4.8 amps and is compatible with iPad, iPhone and Android devices.
- Illuminated toggle switches glow when activated.
- Replaceable on-off toggle switches rated at 16 amps.
- Includes 28 pieces assorted label stickers.
- Panel dimensions: 4-7/32" x 3-3/4".
- Panel cutout: 3-7/16" x 3-1/16".



Product No.	Description
7-1240	5 Switches

## ACCESSORIES

Product No.	Description
7-1241	Spare Toggle Switch
7-1242	Spare Rubber Switch Boot
7-0821	Spare Dual Port USB Charger



## L.E.D. Advantage Switch Panel

- Panel made from corrosion proof ABS plastic with reinforced corners.
- LED backlit switch names glow when activated, know what's on at a glance.
- LED's amp draw is too small to record.
- Watertight design includes breaker and toggle switch boots as well as panel mounting gasket.
- 15 amp push button resettable breakers are easy to replace.
- Replaceable on-off toggle switches rated at 20 amps.



Product No. Description

**7-0497** 6 Gang

## Switch Panel Label Kit

- Fits all Marpac switch panels.
- Includes: Accessory, Aerator, Anchor Light, Bait Pump, Baitwell, Bilge Pump, Bilge Pump Aft, Bilge Pump Fwd, Cabin Lights, Deck Lights, Fish Finder, Flood Lights, GPS, Nav Lights, Running Lights, Spreader Lights, VHF, Wash Down, Water Pressure, Wipers.



Product No. Description

**7-0509** Switch Panel Label Kit

## Lighted Panel Label Kit

- Replacement labels for Marpac backlight panels **7-1245, 7-1246, 7-1247, 7-1250, 7-1251** and **7-1252**.
- Labels can be used for horizontal or vertical applications.
- 30 waterproof stickers.



Product No. Description

**7-1258** Lighted Panel Label Kit

## High Amp Circuit Breakers

- Type III manual reset.
- Waterproof to IP67 standards.
- Maximum voltage 42V DC.
- Stainless steel 1/4-28 threaded stud terminal, nuts and washers.



### SURFACE MOUNT

Product No. Description

**7-1713** 50 amp

**7-1716** 60 amp

## Circuit Breakers with Switch Function - Bussmann 187 Series

- Type III manual reset circuit breaker with On/Off switch capability.
- Switch is capable of 3,000 On/Off cycles @ 48V DC.
- Easily mounted to any flat surface.
- External ignition protected to ABYC E-11 standards.
- 5/16-18 threaded copper studs are plated for corrosion resistance.



7-1742



7-1745



7-1744

## High Amp Circuit Breakers

- Type III switchable with yellow manual reset lever.
- Waterproof.
- Stainless steel M6 threaded stud terminal, nuts and washers.
- Meets the stringent requirements for the SAE J1117 standard for ignition protection.



7-1720



7-1736

### PANEL MOUNT

Product No. Description

**7-1720** 50 amp

**7-1725** 80 amp

### SURFACE MOUNT

Product No. Description

**7-1731** 30 amp

**7-1732** 40 amp

**7-1733** 50 amp

**7-1736** 60 amp

**7-1734** 70 amp

**7-1735** 100 amp

### SURFACE MOUNT

Product No. Description

**7-1741** 30 amp

**7-1742** 40 amp

**7-1743** 50 amp

**7-1744** 70 amp

**7-1745** 100 amp

## Mini Circuit Breakers

- Manual push to reset operation.
- Voltage rated: 50V DC, 125V/250V AC.



Product No. Description

<b>7-1260</b>	6 amp
<b>7-1261</b>	10 amp
<b>7-1262</b>	15 amp
<b>7-1263</b>	20 amp
<b>7-1264</b>	Waterproof Boot

## Circuit Breaker Kit

- Includes: 50 amp resettable circuit breaker, bracket and boot.
- Manual reset button.
- For use with higher amperage accessories.
- For use with 12V or 24V systems.

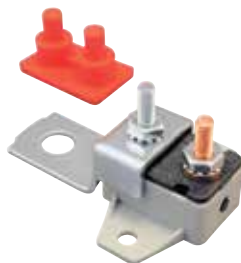

Product No. Description

<b>7-1169</b>	Circuit Breaker Kit
---------------	---------------------

## Circuit Breaker Bracket and Boot

- Simplify the mounting of a trolling motor circuit breaker.
- Can be used with most either manual or automatic two prong circuit breakers.
- Included cover protects breaker terminals from the elements, reducing corrosion.



Product No. Description

<b>7-1170</b>	Circuit Breaker Bracket and Boot
---------------	----------------------------------

## ATC Plug-in Fuses

- Sold 3 per package.
- Sold by box of 5 display packages only!

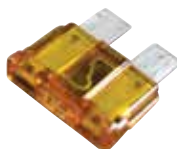

Product No.	Description	Product No.	Description
<b>7-3800</b>	3 amp Violet	<b>7-3805</b>	4 amp Pink
<b>7-3810</b>	5 amp Tan	<b>7-3815</b>	7.5 amp Brown
<b>7-3820</b>	10 amp Red	<b>7-3825</b>	15 amp Blue
<b>7-3830</b>	20 amp Yellow	<b>7-3835</b>	25 amp Clear
<b>7-3840</b>	30 amp Green	<b>7-3845</b>	40 amp Orange

## Water Resistant Plug-in Fuse Holder

- For ATO/ATC fuses up to 30 amps.
- 12 gauge wire loop.
- Fuse not included.



Product No. Description

<b>7-3780</b>	Plug-in Fuse Holder
---------------	---------------------

## Resettable Circuit Breakers with Cycling Automatic Reset

- Single pole thermal type breaker.
- Cycling automatic reset.
- For inline use, no mounting bracket required.
- For use with higher amperage accessories.
- For use with 12 volt systems.
- SAE J553 & SAE J1171 compliant.



Product No. Description

<b>7-1184</b>	40 amp
<b>7-1185</b>	50 amp

## Resettable Circuit Breakers

- Inline circuit breaker.
- Manual reset button.
- For use with higher amperage accessories.
- For use with 12V or 24V systems.



Product No. Description

<b>7-1172</b>	20 amp
<b>7-1173</b>	30 amp
<b>7-1174</b>	40 amp
<b>7-1175</b>	50 amp

## Push Button Circuit Breakers

- Fits 15/32" mounting stem.
- Optional waterproof boot to protect against dirt and moisture available (**7-1134**).

7-1134



Product No. Description

<b>7-1124</b>	6 amp	Sold 2 Per Package
<b>7-1126</b>	10 amp	Sold 2 Per Package
<b>7-1128</b>	15 amp	Sold 2 Per Package
<b>7-1129</b>	20 amp	Sold 2 Per Package
<b>7-1130</b>	30 amp	Sold 2 Per Package
<b>7-1131</b>	40 amp	Sold 1 Per Package
<b>7-1132</b>	50 amp	Sold 1 Per Package
<b>7-1134</b>	Waterproof Boot	Sold 3 Per Package

## Mini Plug-in Fuses

- Sold 3 per package.
- Sold by box of 5 display packages only!



Product No.	Description	Product No.	Description
<b>7-3855</b>	2 amp Gray	<b>7-3860</b>	3 amp Violet
<b>7-3865</b>	4 amp Pink	<b>7-3870</b>	5 amp Tan
<b>7-3875</b>	7.5 amp Brown	<b>7-3880</b>	10 amp Red
<b>7-3885</b>	15 amp Blue	<b>7-3890</b>	20 amp Yellow
<b>7-3895</b>	25 amp Clear	<b>7-3900</b>	30 amp Green



## AGA and AGC Fuses

- Sold 5 per package.
- Sold by box of 5 display packages only!



Product No.	Description	Product No.	Description
<b>7-3675</b>	AGA 20 amp	<b>7-3680</b>	AGA 30 amp
<b>7-3685</b>	AGC 1 amp	<b>7-3690</b>	AGC 1.5 amp
<b>7-3695</b>	AGC 2 amp	<b>7-3700</b>	AGC 2.5 amp
<b>7-3705</b>	AGC 3 amp	<b>7-3710</b>	AGC 4 amp
<b>7-3715</b>	AGC 5 amp	<b>7-3720</b>	AGC 7.5 amp
<b>7-3725</b>	AGC 10 amp	<b>7-3730</b>	AGC 15 amp
<b>7-3735</b>	AGC 20 amp	<b>7-3740</b>	AGC 25 amp
<b>7-3745</b>	AGC 30 amp	<b>7-3795</b>	AGC 40 amp
<b>7-3750</b>	AGC 50 amp		

## Plastic Inline Fuse Holders

- Accepts AGC glass type fuses 1/4" x 1-1/4".



Product No.	Description
<b>7-0157</b>	Includes: 10 amp Fuse and 16 Gauge Wire with 8" Loop
<b>7-1122</b>	Includes: 20 amp Fuse and 14 Gauge Wire with 8" Loop
<b>7-1120</b>	Includes: 8" Wire Loop. Fuse Not Included

## Panel Mount Fuse Holder

- For use with glass type fuses 1/4" x 1-1/4" up to 15 amp.
- Sold each per card.



Product No.	Description
<b>7-0159</b>	Panel Mount Fuse Holder

## Glass Fuse Display

- This display includes the following:

- (5) 7-3675 - AGA Fuse - 20 amp
- (5) 7-3680 - AGA Fuse - 30 amp
- (5) 7-3685 - AGC Fuse - 1 amp
- (5) 7-3690 - AGC Fuse - 1.5 amp
- (5) 7-3695 - AGC Fuse - 2 amp
- (5) 7-3700 - AGC Fuse - 2.5 amp
- (5) 7-3705 - AGC Fuse - 3 amp
- (5) 7-3710 - AGC Fuse - 4 amp
- (5) 7-3720 - AGC Fuse - 7.5 amp
- (5) 7-3725 - AGC Fuse - 10 amp
- (5) 7-3730 - AGC Fuse - 15 amp
- (5) 7-3735 - AGC Fuse - 20 amp
- (5) 7-3740 - AGC Fuse - 25 amp
- (5) 7-3745 - AGC Fuse - 30 amp
- (5) 7-3755 - SFE Fuse - 9 amp
- (5) 7-3760 - SFE Fuse - 14 amp
- (5) 7-3765 - SFE Fuse - 20 amp
- (5) 20 amp In-Line Fuse Holder
- (5) 30 amp In-Line Fuse Holder
- (5) 7-3790 - Fuse Puller



Product No.	Description
<b>7-3003</b>	Glass Fuse Display

## SFE Fuses

- Sold 5 per package.
- Sold by box of 5 display packages only!



Product No.	Description	Product No.	Description
<b>7-3755</b>	9 amp	<b>7-3760</b>	14 amp
<b>7-3765</b>	20 amp		

## Waterproof Fuse Holder

- Waterproof enclosure for reliable electrical connection.
- For up to 30 amp and 12 gauge wire.
- Includes: 20 amp fuse.

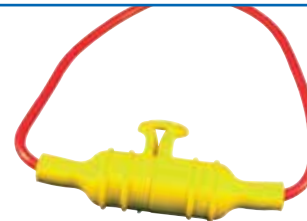

Product No.	Description
<b>7-3785</b>	Fuse Holder

## Plastic Inline Fuse Holder

- Accepts glass type fuses 1/4" x 1-1/4".
- Positive screw cap.
- Includes: 30 amp fuse and 12 gauge wire.



Product No.	Description
<b>7-0158</b>	Inline Fuse Holder

## ATC/Mini Fuse Display

- This display includes the following:

- (5) 7-3800 - ATC Plug-In Fuse - 3 amp
- (5) 7-3805 - ATC Plug-In Fuse - 4 amp
- (5) 7-3810 - ATC Plug-In Fuse - 5 amp
- (5) 7-3815 - ATC Plug-In Fuse - 7.5 amp
- (5) 7-3820 - ATC Plug-In Fuse - 10 amp
- (5) 7-3825 - ATC Plug-In Fuse - 15 amp
- (5) 7-3830 - ATC Plug-In Fuse - 20 amp
- (5) 7-3835 - ATC Plug-In Fuse - 25 amp
- (5) 7-3845 - ATC Plug-In Fuse - 40 amp
- (5) 7-3855 - Mini Plug-In Fuse - 2 amp
- (5) 7-3860 - Mini Plug-In Fuse - 3 amp
- (5) 7-3865 - Mini Plug-In Fuse - 4 amp
- (5) 7-3870 - Mini Plug-In Fuse - 5 amp
- (5) 7-3875 - Mini Plug-In Fuse - 7.5 amp
- (5) 7-3880 - Mini Plug-In Fuse - 10 amp
- (5) 7-3885 - Mini Plug-In Fuse - 15 amp
- (5) 7-3890 - Mini Plug-In Fuse - 20 amp
- (5) 7-3895 - Mini Plug-In Fuse - 25 amp
- (5) 7-3900 - Mini Plug-In Fuse - 30 amp
- (10) 7-3780 - Plug-In Fuse Holder



Product No.	Description
<b>7-3010</b>	ATC/Mini Fuse Display

MARPAC

MARPRO

TOUGH GUY

BOATER SPORTS

## Battery Main Switch - On/Off

- Unique ergonomic and aesthetic knob design.
- Knobs removable for isolation/safety.
- Robust glass fiber reinforced nylon enclosure.
- Removable windows for unobstructed wiring.
- 3 mounting options: Surface mount, front panel mount and rear panel mount.
- Terminal studs: M10 (3/8").
- Cranking rating (30 seconds): 900 amps, intermittent rating (5 minutes): 500 amp, continuous rating: 300 amp.
- Voltage rating: 48V DC.



Product No. Description

**7-0381** Sold Each

**7-0381B** Sold Pack of 10

## Battery Selector Switch - 1-2-Both-Off

- Unique ergonomic and aesthetic knob design.
- Knobs removable for isolation/safety.
- Robust glass fiber reinforced nylon enclosure.
- Removable windows for unobstructed wiring.
- 3 mounting options: Surface mount, front panel mount and rear panel mount.
- Terminal studs: M10 (3/8").
- Cranking rating (30 seconds): 900 amps, intermittent rating (5 minutes): 500 amp, continuous rating: 300 amp.
- Voltage rating: 32V DC.



Product No. Description

**7-0382** Sold Each

**7-0382B** Sold Pack of 10

## Battery Switch

- Select from battery bank 1, battery bank 2 or both for charging or emergency starting.
- Can be mounted on or behind a panel.
- Rated at 300 amps.
- Copper studs for maximum conductivity.
- Nickel plated studs for maximum corrosion resistance.
- Longer studs for attaching more cable terminals.
- Uses up to 4/0 AWG battery cables.



Product No. Description

**7-0380** Battery Switch

## Battery Selector Switch

- Allows separate and combined battery selection.
- Use as an emergency main disconnect switch in the event of an electrical problem.
- Make before break design.
- Ignition protected.
- Manufactured by PERKO, Inc.
- 250 amps continuous, 360 amps intermittent.
- For use with 6, 12, 24 or 32 volt alternator/generator systems.



Product No. Description

**7-0378** Battery Selector Switch

## Battery Cutoff Switch with Key

- Don't drain the battery, cut it off completely!
- Removable key acts as theft deterrent.
- Weather resistant rubber cap.
- 100 amp @ 12V continuous.
- 1/4" diameter mounting bolts.



Product No. Description

**7-51030** Battery Cutoff Switch with Key

## Standard Fuse Blocks

- Heavy duty black molded base.
- Use with SFE or AGC fuses up to 20 amps.
- 8-32 terminal screws.
- Tin plated brass fuse clips.



7-0478

Product No. Description

**7-0478** 4 Gang

**7-1111** 6 Gang

## Hot Feed Fuse Blocks

- Heavy duty black molded base.
- Use with SFE or AGC fuses up to 20 amps.
- Common bus bar connects hot side of fuses for power feed.
- 8-32 terminal screws and stud terminals for power connections.
- Tin plated brass fuse clips.



7-1115

Product No. Description

**7-1115** 4 Gang

**7-1116** 6 Gang

**7-1117** 8 Gang

## Combination Fuse Blocks

- Heavy duty black molded base.
- Use with SFE or AGC fuses up to 20 amps.
- Common bus bar connects hot side of fuses for power feed.
- Separate bus bar for ground or unfused common hot feed.
- 8-32 terminal screws and stud terminals for power/ground connections.
- Tin plated brass fuse clips.



7-0523



7-0532

Product No. Description

**7-0522** 4 Gang

**7-0523** 6 Gang

**7-0532** 8 Gang

MARPAC

## ATO/ATC Fuse Blocks with Ground Bus Bar

- For ATO/ATC fuses.
- Flame resistant reinforced polyester base.
- Interlocking modules snap together.
- 1/4" tin plated copper tab terminals.
- Rated 30 amps per circuit.
- With ground bus bar.

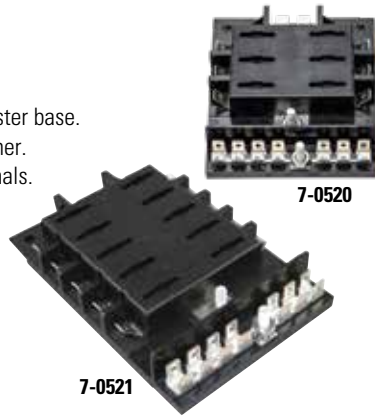

Product No. Description

<b>7-0520</b>	6 Gang
<b>7-0521</b>	10 Gang

## ATP/ATO/ATC Fuse Blocks

- Accepts automotive blade fuses (ATP/ATO/ATC).
- Includes blown fuse indication LEDs.
- Clear cover with recessed areas for label stickers.
- Maximum amperage: 100A per block, 30A per circuit.
- Maximum voltage: 32V DC.
- Includes: 60 pieces assorted label stickers set.



Product No. Description

<b>7-1268</b>	6 Gang	Storage for 2 Spare Fuses
<b>7-1269</b>	12 Gang	Storage for 4 Spare Fuses

MARPRO

## Premier Common Bus Bars

- Stainless steel studs increase electrical contact.
- Tin plated copper bus bar gives maximum conductivity.
- Corrosion resistant materials provide excellent protection and performance.
- Tin plated brass nuts.
- Maximum rating: 48 volts DC/300 volts AC.



Product No. Continuous Rating

<b>7-1176</b>	100 Amperes AC/DC	10 x 32 Stud Terminals
<b>7-1177</b>	130 Amperes AC, 150 Amperes DC	1/4" Stud Terminals

## Premier Terminal Block

- Stainless steel studs increase electrical contact.
- Tin plated copper bus bar gives maximum conductivity.
- Corrosion resistant materials provide excellent protection and performance.
- Tin plated brass nuts.
- With 5 screw terminals.
- 8 x 32 screw terminals.
- Maximum rating: 48 volts DC/300 volts AC.



Product No. Continuous Rating

<b>7-1171</b>	100 Amperes AC/DC
---------------	-------------------

TOUGH GUY

## Terminal Blocks

- Heavy duty black molded base.
- Combines negative and positive buses in one block.
- Brass terminal bar.
- 8-32 screw terminals.



Product No. Description

<b>7-1101</b>	4 Gang
<b>7-1102</b>	6 Gang
<b>7-1103</b>	8 Gang

## Terminal Junction Block with Solid Brass Bus Bar

- 10 gang.
- Common hot feed connection.
- Moisture resistant molded plastic insulator base.
- Solid brass bus bar safely carries up to 36 volts.
- 8-32 round head screws for circuit connectors.
- Two brass 1/4" stud power terminals with hex nuts included.
- Two mounting holes for #10 countersink flat head screws.



Product No. Description

<b>7-0168</b>	Terminal Junction Block with Solid Brass Bus Bar
---------------	--

BOATER SPORTS

## Double Row Terminal Blocks

- Protective insulator barrier strips.
- Moisture resistant molded plastic insulator base.
- Nickel plated brass terminal links and binding screws.
- Rated: 30 amp, 300 volts.
- RoHS Compliant, CE Certified and UL Listed.



Product No. Description

<b>7-0473</b>	4 Gang
<b>7-0474</b>	6 Gang
<b>7-0167</b>	8 Gang
<b>7-0165</b>	10 Gang



# IGNITION SWITCHES

## Ignition Switch - Brass Style

- Brass corrosion resistant construction.
- Brass back up nut.
- Hex chrome face nut.
- 3 positions: Off-Ignition-Start.
- 3 screw terminals.
- Rated: 15 amp at 12V DC.
- Maximum panel thickness: 1-1/8".
- Hole size: 7/8".



Product No. Description

**7-0482** Ignition Switch - Brass Style

## Ignition Switch - Brass Style

- Brass corrosion resistant construction.
- Brass back up nut.
- Knurled black chrome with rubber cap.
- 4 positions: Accessory-Off-Ignition-Start.
- 4 screw terminals.
- Rated: Ignition - 15 amps at 12V DC.
- Maximum panel thickness: 1".
- Hole size: 7/8".



Product No. Description

**7-0885** Ignition Switch - Brass Style

## Magneto Ignition Switch - Brass Style

- Brass corrosion resistant construction.
- Brass back up nut.
- Hex chrome face nut.
- 3 positions: Off-Ignition-Start.
- 5 screw terminals.
- Rated: 10 amp at 12V DC.
- Maximum panel thickness: 1-1/8".
- Hole size: 7/8".



Product No. Description

**7-0480** Magneto Ignition Switch - Brass Style

## Ignition Switch - Polyester Style

- Marine grade glass filled polyester housing.
- Brass back up nut.
- Knurled black chrome with rubber cap.
- 3 positions: Off-Ignition-Start.
- 3 screw terminals.
- Rated: 15 amps at 12V DC.
- Maximum panel thickness: 1-1/8".
- Hole size: 7/8".



Product No. Description

**7-0481** Ignition Switch - Polyester Style

## Ignition Switch - Polyester Style

- Marine grade glass filled polyester housing.
- Brass back up nut.
- Hex black plastic face nut.
- 4 positions: Accessory-Off-Ignition-Start.
- 4 blade terminals.
- Rated: 15 amps at 12V DC.
- Maximum panel thickness: 1-1/8".
- Hole size: 7/8".



Product No. Description

**7-0479** Ignition Switch - Polyester Style

## Magneto Ignition Switch - Polyester Style

- Marine grade glass filled polyester housing.
- Brass back up nut.
- Hex black plastic face nut.
- 3 positions: Off-Ignition-Start.
- 5 screw terminals.
- Rated: 15 amps at 12V DC.
- Maximum panel thickness: 1-1/8".
- Hole size: 7/8".



Product No. Description

**7-0391** Magneto Ignition Switch - Polyester Style

## Magneto Push-To-Choke Ignition Switches

- Delrin body with brass back-up nut and hex black plastic.
- 3 positions: Off-Ignition-Start.
- "Push-To-Choke" feature.
- Fits most Mercury Applications.
- Replaces: Mercury 87-88107 and 87-88107A5.
- Weatherproof cover included.
- Accommodates 5/8" panel.



Product No. Description

**7-1155** 6 Wires Potted Base

**7-1150** 6 Screw Terminals

## Push-To-Choke Ignition Switch

- Delrin stainless steel ignition starter switch.
- Replaces: Evinrude/Johnson 388173, 390129, 390133 and 393301.
- "Push-To-Choke" feature.
- Special weather-proofing seal and drain hole.
- Eliminates need for separate electric choke switch.
- 5 screw terminals.
- Rated: 20 amps at 12V DC.
- Accommodates 1/4" panel.
- Mounting bushing: 1/2" long, 13/16" diameter.



Product No. Description

**7-0390** Push-To-Choke Ignition Switch

## L.E.D. Stainless Steel Push Button Switches

- Corrosion resistant stainless steel housing and button.
- LED light ring can be set for either push-on (indicating power) or always on (backlit).
- Water resistant to IP67 standards.
- Mounting hole: 19mm.
- Rated: 20 amps at 12V DC.
- Use 7-1226 label kit.



Product No. Description

<b>7-1210</b>	Momentary	Blue LED Ring
<b>7-1212</b>	Self-Locking	Blue LED Ring
<b>7-1220</b>	Momentary	Red LED Ring
<b>7-1222</b>	Self-Locking	Red LED Ring

### ROUND SWITCH LABEL KIT

Product No. Description

<b>7-1226</b>	40 Waterproof Labels
---------------	----------------------

## L.E.D. Backlit Stainless Steel Push Button Switches

- Corrosion resistant stainless steel housing and button.
- LED light ring can be set for either push-on (indicating power) or always on (backlit).
- Water resistant to IP67 standards.
- Mounting hole: 19mm.
- Rated: 20 amps at 12V DC.
- Use 7-1227 label kit.



Product No. Description

<b>7-1211</b>	Momentary	Blue LED Ring
<b>7-1213</b>	Self-Locking	Blue LED Ring
<b>7-1221</b>	Momentary	Red LED Ring
<b>7-1223</b>	Self-Locking	Red LED Ring

### ROUND SWITCH LABEL KIT

Product No. Description

<b>7-1227</b>	40 Waterproof Labels
---------------	----------------------

## Heavy Duty Momentary Push Button Switch

- Glass reinforced seamless polyester housing.
- Internally rubber gasketed.
- Moisture and dust proof rubber cap.
- Accommodates 1" panel.
- 2 screw terminals.
- Rated: 30 amps at 12V DC.



Product No. Description

<b>7-0483</b>	Momentary Push Button Switch
---------------	------------------------------

## Momentary Push Button Switch

- For any application requiring momentary contact, such as horn or starting.
- Requires 5/8" diameter hole in panel for installation.
- Accommodates 1" panel.
- 2 brass blade terminals.
- Rated: 15 amps at 12V DC.



Product No. Description

<b>7-0487</b>	Momentary Push Button Switch
---------------	------------------------------

## Compact Push Button Switch

- Contoured black plastic button.
- Chrome plated brass mounting stem.
- 2 brass blade terminals.
- Uses 1/2" mounting hole in dash or panel.
- Rated: 15 amps at 12V DC.



Product No. Description

<b>7-1160</b>	Compact Push Button Switch
---------------	----------------------------

## Push Button Horn Switch

- Momentary push mini switch with boot is perfect for horn button.



Product No. Description

<b>7-51361</b>	Push Button Horn Button
----------------	-------------------------

## Push Button Horn Switch

- Chrome plated brass housing with black plastic button.
- Not ignition protected.
- Momentary on-off push button switch.
- Diameter 1-1/2", overall width 2-5/8", height 1".
- Rated: 15 amps at 12V DC.



Product No. Description

<b>7-0485</b>	Push Button Horn Switch
---------------	-------------------------

## Push/Pull Switches

- Solid brass construction.
- Chrome plated brass knob and face nut.
- 2 positions: Off-On. Normally Off.
- Mounting stem 3/8" diameter.
- Accommodates 1" panel.
- Rated: 15 amps at 12V DC.

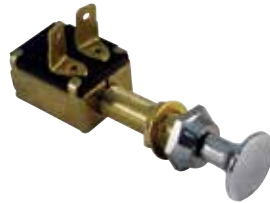

Product No. Description

**7-0489** (2) Screw Terminals

**7-0886** (2) 1/4" Blade Terminals

## Bucket of Savings - Push/Pull Switches

- Solid brass construction.
- Chrome plated brass knob and face nut.
- 2 positions: Off-On. Normally Off.
- Mounting stem 3/8" diameter.
- Accommodates 1" panel.
- Rated: 15 amps at 12V DC.
- Sold 24 push/pull switches per bucket.



Product No. Description

**7-0489S** Bucket of Savings - Push/Pull Switches

## Push/Pull Switch

- Solid brass construction.
- Chrome plated brass knob and face nut.
- 3 positions: Off-On-On. Normally Off.
- 3 screw terminals.
- Mounting stem 3/8" diameter.
- Accommodates 1" panel.
- Rated: 15 amps at 12V DC.



Product No. Description

**7-0491** Push/Pull Switch

## Push/Pull Switch

- Solid brass construction.
- Chrome plated brass knob and face nut.
- 3 positions: Off-On-On. Normally Off.
- 4 screw terminals.
- Mounting stem 3/8" diameter.
- Accommodates 1" panel.
- Rated: 15 amps at 12V DC.



Product No. Description

**7-0493** Push/Pull Switch

## Illuminated Rocker Switch

- Illuminated black plastic rocker switch.
- Glows "Red" when on.
- Rated: 10 amps at 12V DC.



Product No. Description

**7-0533** Off-On 3 Terminals

## Illuminated Rocker Switches

- Glows "Red" when switch is in "On" position.
- Single pole.
- Requires 27/32" x 1-15/32" cut out.
- 1/4" spade terminals.
- Rated: 15 amps at 12V DC.



Product No. Description

**7-0531** Off-On 3 Terminals

**7-0530** On-Off-On 4 Terminals

## Euro-Style Rocker Switches

- Black, plastic rocker switches.
- Rated: 16 amps at 12V DC.
- Fits Contura cut-out.



### NON-ILLUMINATED

Product No. Description

**7-1135** 2 Position On-Off SPST

**7-1136** 2 Position Off-Momentary On SPST

**7-1137** 3 Position On-Off-On SPDT

**7-1138** 3 Position Mon. On-Off-Momentary On SPST

**7-1139** 3 Position On-Off-On DPDT

### ILLUMINATED - GLOWS "WHITE" WHEN "ON"

Product No. Description

**7-1140** 2 Position On-Off SPST

**7-1144** 3 Position On-Off-On SPDT

## Rocker Switches

- Non-illuminated black plastic rocker switch.
- Single pole.
- Requires 27/32" x 1-15/32" cut out.
- 1/4" spade terminals.
- Rated: 15 amps at 12V DC.



Product No. Description

**7-1200** Off-On 2 Terminals

**7-1205** On-Off-On 3 Terminals

**7-1235** Mom. On-Off-Mom. On 3 Terminals

**7-1230** Off-Mom. On 3 Terminals

## Contura Style Illuminated Rocker Switches

- Water resistant switches specially designed for marine or outdoor applications.
- LED illuminated.
- Splash resistant to IP66 standards.
- Glows "Blue" when activated.
- 1.45" x 0.83" cut-out replaces contura style switches in existing panels.



Product No. Description

**7-1145** On-Off SPST

**7-1146** On-Off-On SPDT



# ROCKER SWITCHES and TOGGLE SWITCHES

## Contura Style Rocker Switches

- Non-corrosive plastic construction.
- Rated: 20 amps at 12V DC.



### NON-ILLUMINATED

Product No.	Description
<b>7-0535</b>	2 Position On-Off
<b>7-0536</b>	2 Position Off-Momentary On
<b>7-0537</b>	3 Position On-Off-On
<b>7-0538</b>	3 Position Mon. On-Off-Momentary On
<b>7-0539</b>	3 Position On-Off-On (6 Terminal)

### ILLUMINATED - BRASS BLADE TERMINALS, SILVER CONTACTS

Product No.	Description
<b>7-0540</b>	2 Position On-Off SPST
<b>7-0541</b>	2 Position Off-Momentary On SPST
<b>7-0542</b>	3 Position On-Off-On SPDT
<b>7-0543</b>	3 Position Mon. On-Off-Momentary On DPST
<b>7-0544</b>	3 Position On-Off-On DPDT

## Illuminated Toggle Switches

- Translucent plastic paddle.
- Switch illuminates "White" when dash lights are turned "On".
- Changes to "Red" when switch is in "On" position.
- 1/4" spade terminals.
- Fits panels up to 3/8".
- Rated: 15 amps at 12V DC.



Product No.	Description
<b>7-0528</b>	Off-On
<b>7-1290</b>	On-Off-On
<b>7-1242</b>	Rubber Switch Boot

## Toggle Switch

- Nickel plated off-on indicator plate; assembled.
- Bat handle. Mounting stem: 15/32" length.
- Two 6" long wire leads.
- Rated: 6 amps at 125V AC.



Product No.	Description
<b>7-0529</b>	Off-On

## Toggle Switch

- All brass with nickel plated brass face nut and brass back up nut.
- Mounting stem: 7/16"-28 thread, 3/8" length and 7/16" diameter.
- Rated: 20 amps at 12V DC.



Product No.	Description
<b>7-1270</b>	Off-On

## Illuminated Toggle Switch

- Self-illuminating handle bar.
- Fits Marpac 7-1240 Switch Panel.
- Rated: 16 amps at 12V DC.



Product No.	Description
<b>7-1241</b>	On-Off SPST
<b>7-1242</b>	Rubber Switch Boot

## Toggle Switches

- Black plastic paddle and locking ring with lever seal and knurled cap nut.
- 1/4" spade terminals.
- Mount in 15/32" diameter panel hole.
- Fits panels up to 1/4".
- Rated: 15 amps at 12V DC.



Product No.	Description
<b>7-0462</b>	Off-On 2 Terminals
<b>7-0464</b>	Off-Momentary On 2 Terminals
<b>7-0463</b>	On-Off-On 6 Terminals
<b>7-0465</b>	Mom. On-Off-Mom. On 6 Terminals

## Heavy Duty Toggle Switches

- Plastic housing with plated steel cap.
- Universal applications.
- Nickel plated brass handle - 11/16" length.
- Nickel plated brass mounting stem - 15/32"- 32 thread and 15/32" length.
- Rated: 25 amps at 12V DC.



Product No.	Description
<b>7-0880</b>	Off-On 2 Terminals SPST
<b>7-0881</b>	On-Off-On 3 Terminals SPDT
<b>7-0883</b>	Mom. On-Off-Mom. On 3 Terminals SPDT
<b>7-0884</b>	Off-Mom. On 2 Terminals SPST
<b>7-0882</b>	On-Off-On 6 Terminals DPDT

## Toggle Switch

- Chrome plated.
- 1/4" spade terminal.
- Replacement toggle switch for Marpac Switch Panels: **7-0516**, **7-0517** and **7-0518**.
- For use in panels with hole diameter 13/32" and a panel thickness up to 1/8".
- Rated: 15 amps at 12V DC.



Product No.	Description
<b>7-0534</b>	Off-On
<b>7-0519</b>	Spare Toggle Boot Seal

## Rubber Switch Boot

- Protects against dirt and moisture.
- Screw nuts: M12.
- Fits Marpac Toggle Switches: **7-0528**, **7-1241** and **7-1290**.



Product No.	Description
<b>7-1242</b>	Rubber Switch Boot

## Universal Toggle Boot Seals

- Protects against dirt and moisture.
- Brass threads.
- Fits switches with 15/32" mounting stem and handle to 11/16".
- Fits Marpac Toggle Switches: **7-0462**, **7-0463**, **7-0464**, **7-0465**, **7-0529**, **7-0880**, **7-0881**, **7-0882**, **7-0883** and **7-0884**.



Product No.	Description
<b>7-0468</b>	Black
<b>7-0887</b>	Gray

## Battery Boxes

- Non-corrosive marine grade material.
- Holds one battery.
- Fits new battery style size.
- Meets industry requirements.
- Injection molded high strength composite construction.
- Easy installation with included strap and mounting hardware.



Product No.	Description
<b>7-0034</b>	For 24 Series Batteries
<b>7-0036</b>	For 27/31 Series Batteries

## On/Off Switch Panel

- Corrosion resistant brass switch, accommodates up to 1" thick panel.
- Dimensions: 1.8" W x 2.4" H.
- Rated: 15 amps at 12V DC.



Product No.	Description
<b>7-51381</b>	On/Off Switch Panel

## Economy Battery Trays

- Made from non-corrosive composites.
- Durable construction for long life.



Product No.	Description
<b>7-2195</b>	For 24 and 24M Series Batteries
<b>7-2196</b>	For 27, 30 and 31 Series Batteries

## Deluxe Battery Trays

- Made from non-corrosive composites.
- Durable construction for long life.
- Easy to install.
- Includes: Stainless steel installation screws.



Product No.	Description
<b>7-2195</b>	For 24 and 24M Series Batteries
<b>7-2196</b>	For 27, 30 and 31 Series Batteries

## Battery Trays

- Keep batteries secure to prevent damage to passengers, boat and equipment.
- Includes: Stainless hardware and adjustable buckle strap.



Product No.	Description
<b>7-51014</b>	For 24 Series Batteries
<b>7-51016</b>	For 27 Series Batteries
<b>7-51017</b>	For 31 Series Batteries

## Battery Hold Down Strap

- Made from acid and gas resistant materials.
- Includes: Corrosion resistant hold down clamp with stainless steel screws.
- Length 39".



Product No.	Description
<b>7-0032</b>	Battery Hold Down Strap

## Footman Loops

- Perfect for use as battery and fuel tank hold-downs, etc.
- Pair of nickel-plated brass footman loops.
- Fits up to 1-1/4" straps.



Product No.	Description
<b>7-54120</b>	Footman Loops

## Battery Tray Strap

- Replacement strap for use with Marpac Battery Trays: **7-51014**, **7-51016** and **7-51017**.
- Includes: Floor mount loops.
- Length 54", width 1-1/2".



Product No.	Description
<b>7-51026</b>	Battery Tray Strap

MARPAC

## Power Inverter

- Converts 12 volt DC to 110 volt AC for power when needed.
- Charge most USB compatible devices.
- Plugs into cigarette lighter.
- Fits in most cup holders.
- Great for charging mobile phones, laptops, MP3 players.
- Automatic shut off if voltage drops below 10V or exceeds 15V DC.
- CE and E-Certified.



Product No. Description

**7-1279** Power Inverter

MARPRO

## Cord Sets

- 30 amp, 125 volt, 3 Pole, 3 Wire, twist lock.
- #10 AWG factory prewired with molded-on devices.
- Connector end has non-metallic threaded sealing ring which makes inlet/connector interface watertight.



Product No. Description

**7-1406** Yellow Length 25'

**7-1411** Yellow Length 50'

TOUGH GUY

## Trolling Motor Male Sockets - Boat Side Connector

- 8 gauge wire with attached butt connectors.
- Mounting screws included.



Product No. Description

**7-1304** 12 volt, 2 Wires Connects to: 7-1306

**7-1308** 24 volt, 3 Wires Connects to: 7-1310

## Trolling Motor Male Plugs - Motor Side Connector

- 10 gauge wire with attached butt connectors.



Product No. Description

**7-1298** 12 volt, 2 Wires Connects to: 7-1296

**7-1302** 24 volt, 3 Wires Connects to: 7-1300

BOATER SPORTS

## Trolling Motor Plug or Receptacle - 3 Prong

- 3 prong locking plug or receptacle for trolling motors.
- 50 amp, 12/24 volt.
- Replaces: Marinc 305CRRB and 305BP.



Product No. Description

**7-51557** Female Boat Side

**7-51558** Male Motor Side

## Boat Inlet

- White polycarbonate with flip cover.
- 30 amp, 125 volt, 3 pole, 3 wire, twist lock.



Product No. Description

**7-1470** Boat Inlet

## Cord Set

- 50 amp, 125/250 volt, 12,500 watts, twist lock.
- Heavy duty, super flexible cable.
- NEMA SS2-50P and NEMA SS2-50R ends.
- Connector end has non-metallic threaded sealing ring which makes inlet/connector interface watertight.



Product No. Description

**7-1420** Yellow Length 50'

## Trolling Motor Female Plugs - Motor Side Connector

- 8 gauge wire with attached butt connectors.

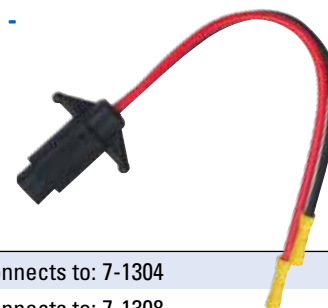

Product No. Description

**7-1306** 12 volt, 2 Wires Connects to: 7-1304

**7-1310** 24 volt, 3 Wires Connects to: 7-1308

## Trolling Motor Female Sockets - Boat Side Connector

- 10 gauge wire with attached butt connectors.
- Mounting screws included.



Product No. Description

**7-1296** 12 volt, 2 Wires Connects to: 7-1298

**7-1300** 24 volt, 3 Wires Connects to: 7-1302

## Trolling Motor Plug or Receptacle - 4 Prong

- 4 prong locking plug or receptacle for trolling motors.
- 50 amp, 12/24 volt.
- Replaces: Marinc 2018BR and 2018BP-24.



Product No. Description

**7-51555** Female Boat Side

**7-51556** Male Motor Side



**L.E.D. Advantage  
Portable Bow Lights**

- Easy to store.
- Compact size takes up less space on deck.
- Great for boats less than 23' (7 meters) with a maximum speed of 7 knots (8 MPH).
- Requires (3) "AAA" Batteries (Not included).



Product No.	Description
<b>7-1312</b>	Clamp-On Mount - Clamps Vertically or Horizontally
<b>7-1313</b>	Suction Cup Mount

**L.E.D. Advantage  
Portable All-Round Lights**

- Easy to store.
- Compact size takes up less space on deck.
- Great for boats less than 23' (7 meters) with a maximum speed of 7 knots (8 MPH).
- Requires (3) "AAA" Batteries (Not included).



Product No.	Description
<b>7-1315</b>	Clamp-On Mount
<b>7-1316</b>	Suction Cup Mount

**L.E.D. Advantage  
Bi-Color Combination Bow Light**

- Chrome plated zamack housing.
- For use on vessels up to 39.4' (12 meters).
- 1 mile visibility.
- Length 2-3/4", width 2-1/2", height 1-3/8".
- 12 volt.



Product No.	Description
<b>7-0840</b>	LED Bi-Color Combination Bow Light

**L.E.D. Advantage Compact  
Bi-Color Combination Bow Light**

- Polished stainless steel housing.
- Includes: (2) optional adapter plates to cover existing light footprint.
- Includes: Stainless steel mounting hardware.
- 12 volt.



Product No.	Description
<b>7-51164</b>	LED Compact Bi-Color Combination Bow Light

**L.E.D. Advantage  
Bi-Color Combination Bow Light**

- Low profile mounts securely on almost any flat surface.
- 2 mile visibility.
- For use on vessels up to 39.4' (12 meters).
- Dimensions: 3-1/4" L x 2-5/8" W.
- Epoxy coated electronics encased in corrosion proof composite case protected by a tough Nichromium shell.
- The #8 pan head mounting screws hidden from view (Not included).
- Meets the stringent requirements for USCG, ABYC A-16 and IMO COLREG.
- 12 volt.



Product No.	Description
<b>7-6598</b>	LED Bi-Color Combination Bow Light

**Bi-Color Combination Bow Light**

- Polished stainless steel housing.
- For use on vessels up to 65.6' (20 meters).
- 1 mile visibility.
- Visual indicator status light to verify light is on from control station.
- Dimensions: 2-3/8" L x 1-3/4" W.
- Uses (2) #6 fasteners (Included).
- Meets USCG A-16 Requirements.
- 12 volt, 5 watt.



Product No.	Description
<b>7-0060</b>	Bi-Color Combination Bow Light

**Bi-Color Combination Bow Light**

- Chrome plated finish.
- For use on vessels up to 39.4' (12 meters).
- 1 mile visibility.
- Dimensions: 4" L x 3-1/8" W x 1-7/8" H.
- Uses #8 fasteners (Not included).
- #71 12 volt bulb (Included).
- 5 year warranty.
- Made in the USA.



Product No.	Description
<b>7-0375</b>	Bi-Color Combination Bow Light
<b>7-3930</b>	Spare Bulbs, 2 Per Pack

**Bi-Color Combination Bow Light**

- Polished stainless steel housing.
- For use on vessels up to 39.4' (12 meters).
- 1 mile, 225° visibility.
- Diameter 2-3/8".
- Uses (3) #4 fasteners (Included).
- #90 12 volt bulb (Included).



Product No.	Description
<b>7-0080</b>	Bi-Color Combination Bow Light
<b>7-7200</b>	Spare Bulbs - 360° LED, 1 Per Pack
<b>7-3936</b>	Spare Bulbs, 2 Per Pack



MARPAC

## Bi-Color Combination Bow Light

- Chrome plated finish.
- For use on vessels up to 39.4' (12 meters).
- 1 mile visibility.
- Dimensions: 3" L x 2-1/2" W x 1-3/8" H.
- Uses (2) #8 fasteners (Not included).
- Meets USCG A-16 Requirements.
- #90 12 volt bulb (Included).



Product No. Description

**7-0841** Bi-Color Combination Bow Light

**7-7200** Spare Bulbs - 360° LED, 1 Per Pack

**7-3936** Spare Bulbs, 2 Per Pack

MARPRO

## Bi-Color Plug-in Bow Light

- For use on vessels up to 39.4' (12 meters).
- Heavy duty plug-in base with positive locking cover.
- 8" wire leads and bulb included.
- Uses (4) #6 fasteners (Not included).
- Meets USCG A-16 Requirements.
- 12 volt, 10 watt.



Product No. Description

**7-0055** Pole Length 12"

**7-0052** Replacement Base with Composite Cover

TOUGH GUY

## Tear Drop Bi-Color Bow Light

- Plastic housing with aluminum pole.
- Quality die-cast zamak finish.
- Red and green lens.
- 1 mile, 225° visibility.
- Pole length: 10".
- Anodized aluminum pole.
- Fits most 2-prong plug-in bases.
- 12 volt.



Product No. Description

**7-51220** Angled Pole

**7-51221** Straight Pole

BOATER SPORTS

## L.E.D. Advantage Side Lights - Horizontal Mount

- Certified USCG 2nm, for use on boats under 39.4' (12 meters).
- Dimensions: 3-1/4" L x 2-3/4" W.
- Epoxy coated electronics encased in corrosion proof composite case protected by a tough Nichromium shell.
- Uses #8 pan head mounting screws (Not included).
- 1.3 watts - red and .8 watts - green
- Meets the stringent requirements for USCG, ABYC A-16 and IMO COLREG.
- 12 volt.
- Sold per pair - red/green.



Product No. Description

**7-6555** LED Side Lights - Horizontal Mount

## L.E.D. Advantage Bi-Color Combination Bow Lights

- Polished stainless steel housing.
- Low profile housing design.
- Certified USCG 2nm for night time navigation.
- 360° visibility.
- Pole length: 12".
- Anodized aluminum pole.
- Fits most 2-prong plug-in bases.
- Meets USCG A-16 Requirements.
- 12 volt.



Product No. Description

**7-51169** Straight Pole

**7-51185** Angled Pole

## Bi-Color Plug-in Bow Light

- Classic style zamak angled bow light.
- Red and green lens.
- Stores easily and replaces most common bow lights.
- 1 mile, 225° visibility.
- Anodized aluminum angled pole.
- Fits most 2-prong plug-in bases.
- 12 volt.



Product No. Description

**7-51217** Pole Length 10"

## Bi-Color Stowaway Bow Light

- High impact construction.
- Red and green lens.
- Low profile nylon base with cap included.
- Removable, stores easily.
- 1 mile, 225° visibility.
- Stainless steel pole.
- 12 volt.



Product No. Description

**7-51216** Pole Length 12"

## Side Lights - Horizontal Mount

- Polished stainless steel housing.
- Visual indicator status light to verify light is on from control station.
- For use on vessels up to 39.4' (12 meters).
- Base dimensions: 2-1/4", height 1-5/8".
- Uses (2) #6 fasteners (Not included).
- 8" wire leads and bulb included.
- Meets USCG A-16 Requirements.
- 12 volt, 5 watt.
- Sold per pair - red/green.



Product No. Description

**7-0059** Side Lights - Horizontal Mount



# SIDE LIGHTS

## L.E.D. Advantage Side Lights - Vertical Mount



- Attractive white composite housing.
- Certified USCG 2nm, for use on vessels under 39.4' (12 meters).
- Dimensions: 3-5/8" L x 2-1/4" W.
- Uses (2) #8 flat/oval head screws (Not included).
- .9 watts.
- Meets the stringent requirements for USCG, ABYC A-16 and IMO COLREG.
- Sold per pair - red/green.
- 12 volt.



Product No. Description

**7-6559** LED Side Lights - Vertical Mount

## Side Lights - Vertical Mount

- Polished stainless steel housing.
- Red and green lens.
- 112.5° visibility.
- Diameter 2-5/16".
- Uses #4 fasteners (Included).
- #90 12 volt bulb (Included).
- Sold per pair.



Product No. Description

**7-0079** Side Light - Vertical Mount

**7-7200** Spare Bulbs - 360° LED, 1 Per Pack

**7-3936** Spare Bulbs, 2 Per Pack

## L.E.D. Advantage Side Lights - Flush Mount



- Stainless steel housing.
- Certified USCG 2nm, for use on vessels under 39.4' (12 meters).
- 112.5° visibility.
- Dimensions: 7-3/4" L x 2-11/32" H.
- Meets the stringent requirements for USCG, ABYC A-16 and IMO COLREG.
- Sold per pair - red/green.
- 12 volt.



Product No. Description

**7-6595** LED Side Lights - Flush Mount

## Side Lights - Flush Mount

- Stainless steel.
- Red and green lens.
- 112.5° visibility.
- Dimensions: 7-3/4" L x 2-1/4" H.
- #90 12 volt bulb (Included).
- Sold per pair - red/green.



Product No. Description

**7-0095** Side Lights - Flush Mount

**7-9035** Socket Assembly

**7-9034** Replacement Socket Assembly

**7-7200** Spare Bulbs - 360° LED, 1 Per Pack

**7-3936** Spare Bulbs, 2 Per Pack

## L.E.D. Advantage Side Lights - Vertical Mount



- Dimensions: 3-1/2" L x 2-1/2" W.
- Sold per pair - red/green.
- 12 volt.



Product No. Description

**7-51213** Black

**7-51215** White

## Side Lights - Vertical Mount

- Polished stainless steel housing.
- Red and green lens.
- 112.5° visibility.
- Dimensions: 4" L x 2-1/4" W.
- Uses #4 fasteners (Included).
- #90 12 volt bulb (Included).
- Sold per pair.



Product No. Description

**7-0111** Side Light - Vertical Mount

**7-7200** Spare Bulbs - 360° LED, 1 Per Pack

**7-3936** Spare Bulbs, 2 Per Pack

## L.E.D. Advantage Side Lights - Flush Mount



- Stainless steel housing with Matte Black finish.
- Certified USCG 2nm, for use on vessels under 39.4' (12 meters).
- 112.5° visibility.
- Dimensions: 7-3/4" L x 2-11/32" H.
- Meets the stringent requirements for USCG, ABYC A-16 and IMO COLREG.
- Sold per pair - red/green.
- 12 volt.



Product No. Description

**7-6596** LED Side Lights - Flush Mount

## L.E.D. Flexible Navigation Light Kit



- Perfect for the no nonsense boater that does not have time to play around with obsolete navigational lights.
- Fully sealed LED navigation lights feature an ultra low profile and flexible design which allows for installation in almost any situation.
- (1) 6" red LED strip and (1) 6" green LED strip.
- Includes: Black PCB 2-black track with adhesive on back, (4) black end caps and (4) stainless steel screws.



Product No. Description

**7-52000** LED Flexible Navigation Light Kit



MARPAC

## L.E.D. Advantage Transom Light



- Marine grade stainless steel housing.
- Certified USCG 2nm, for use on vessels under 65.5' (20 meters).
- Diameter 3".
- Uses two #8 flat/oval head screws (Not included).
- 1.2 watts.
- Meets the stringent requirements for USCG, ABYC A-16 and IMO COLREG.
- 12 volt.



Product No. Description

**7-6577** LED Transom Light

## L.E.D. Advantage Transom Light - Rectangular



- Marine grade stainless steel housing.
- Certified USCG 2nm, for use on vessels under 65.5' (20 meters).
- Diameter 4-5/8" x 2-5/8".
- Uses two #8 flat/oval head screws (Included).
- 1.2 watts.
- Meets the stringent requirements for USCG, ABYC A-16 and IMO COLREG.
- 12 volt.



Product No. Description

**7-6561** LED Transom Light - Rectangular

MARPRO

## Stern Light - Horizontal Mount

- Polished stainless steel housing.
- 135° visibility.
- Diameter 2-3/8".
- Uses (3) #4 fasteners (Included).
- #90 12 volt bulb (Included).



Product No. Description

**7-0081** Stern Light - Horizontal Mount

**7-7200** Spare Bulbs - 360° LED, 1 Per Pack

**7-3936** Spare Bulbs, 2 Per Pack

## Transom Light - Round

- Polished stainless steel housing.
- Clear lens. 2 mile visibility.
- Diameter 3-1/8", depth 1-3/4".
- Supplied with rubber mounting gasket.
- Uses (2) #8 flat/oval head screws (Included).
- 12 volt, 15 watt, .97 amp, 6 candlepower bulb included.



Product No. Description

**7-0577** Transom Light - Round

**7-4010** Spare Bulbs

TOUGH GUY

## Transom Light - Rectangular

- Polished stainless steel housing.
- Clear lens.
- Dimensions: 5-1/16" x 3-1/16".
- Supplied with rubber mounting gasket.
- Uses (2) #8 flat/oval head screws (Not included).
- 12 volt, 15 watt, .97 amp, 6 candlepower bulb included.



Product No. Description

**7-0861** Transom Light - Rectangular

**7-4010** Spare Bulbs

## Masthead All-Round Light

- Polished stainless steel housing.
- 360° visibility.
- Diameter 2-3/8".
- Uses (3) #4 fasteners (Included).
- #90 12 volt bulb (Included).



Product No. Description

**7-0101** Masthead All-Round Light

**7-7200** Spare Bulbs - 360° LED, 1 Per Pack

**7-3936** Spare Bulbs, 2 Per Pack

BOATER SPORTS

## L.E.D. Advantage Fixed All-Round Lights



- Tough marine grade aluminum for base and pole.
- Excellent for use on pontoon boats, hard tops and radar arches.
- 360° visibility.
- Certified USCG 2nm, for use on vessels under 39.4' (12 meters).
- Uses two #8 flat/oval head screws (Not included).
- 1 watt.
- Meets the stringent requirements for USCG, ABYC A-16 and IMO COLREG.
- 12 volt.



Product No. Description

**7-6550** Length 4"

**7-6552** Length 7"

## L.E.D. Advantage Fixed All-Round Light



- Amazing all-round navigation light in a super compact package.
- Featuring fully sealed LED construction and S.S. mast light is guaranteed to perform season after season.
- Small compact size lends itself to installation in hard to reach compact areas where other navigation lights falter.
- For use on vessels up to 39.4' (12 meters).
- 2 mile visibility.



Product No. Description

**7-51599** Length 5"

## All-Round Stern Light

- Anodized aluminum pole and sturdy plastic base for corrosion resistance.
- Anti-glare lens.
- Provides 2 mile, 360° visibility.
- For use on vessels up to 39.4' (12 meters).
- #1004 12 volt bulb (Included).



7-51258

Product No. Description

**7-51261** Length 8"

**7-51258** Replacement Globe

**7-3966** Spare Bulbs, 2 Per Pack

## Stern Light Globe

- Anti-glare lens.
- Fits standard All-Round Stern Lights.



Product No. Description

**7-51258** Stern Light Globe

## L.E.D. Advantage Folding All-Round Light



- Tough marine grade aluminum for base and pole.
- Excellent for use on pontoon boats, hard tops and radar arches.
- Certified USCG 2nm, for use on boats under 39.4' (12 meters).
- 360° visibility.
- Uses three #8 flat/oval head screws (Not included).
- 1 watt.
- Meets the stringent requirements for USCG, ABYC A-16 and IMO COLREG.
- 12 volt.



Product No. Description

**7-6551** Length 7"

## L.E.D. Advantage Folding All-Round Light



- All-round folding anchor/stern light adjusts to any angle with thumb screw.
- Provides 2 mile, 360° visibility.
- Anodized aluminum pole.
- Meets USCG A-16 Requirements.
- 12 volt.



Product No. Description

**7-51598** Length 10-1/2"

## Folding All-Round Light

- Includes: Fold down windshield base.
- Anti-glare lens.
- Provides 2 mile, 360° visibility.
- Anodized aluminum pole.
- #1004 12 volt bulb (Included).



Product No. Description

**7-51264** Length 11"

**7-3966** Spare Bulbs, 2 Per Pack

## Folding Anchor/Stern All-Round Light

- High impact construction.
- Dual mount 180° fold down.
- Compact fold down design.
- Low profile base.
- Provides 2 mile, 360° visibility.
- Stainless steel pole.
- 12 volt.



Product No. Description

**7-51260** Length 10-1/2"

## L.E.D. Advantage Plug-In All-Round Light



- Universal.
- Certified USCG 2nm, for use on boats under 39.4' (12 meters).
- 360° visibility.
- For use with most 2-pin plug-in bases (Not included).
- Meets the stringent requirements for USCG, ABYC A-16 and IMO COLREG.
- 12 - 24 volt.



Product No. Description

**7-6554** Length 42"

## L.E.D. Advantage All-Round Lights



- All-round navigation light.
- Anodized tube is non-corrosive and watertight.
- Fixed length.
- Provides 2 mile, 360° visibility.
- 2-pin standard plug.
- USCG approved.



Product No. Description

**7-51596** Length 36"

### BLACK POLE

Product No. Description

**1-39605** Length 48"

**1-39607** Length 54"



MARPAC

## Plug-In All-Round Light

- For use on vessels up to 65.6' (20 meters).
- Heavy duty plug-in base with positive locking cover.
- Uses (4) #6 fasteners (Not included).
- 8" wire leads and bulb included.
- Meets USCG A-16 requirements.
- 12 volt, 10 watt.



Product No. Description

<b>7-0050</b>	Length 24"
<b>7-0052</b>	Replacement Plug-in Base

MARPRO

## All-Round Light - Stow-a-way

- Chrome plated finish. Clear fresnel globe.
- Locking collar on pole. 16° rake.
- Limited cockpit illumination.
- Base has water proof snap-on cover.
- 2 mile visibility.
- For use on power boats under 65.6'.
- 12 volt, 6 C.P. bulb included.
- 5 year warranty.
- Made in the USA.



Product No. Description

<b>7-0377</b>	Length 24"
<b>7-7200</b>	Spare Bulbs - 360° LED, 1 Per Pack
<b>7-3936</b>	Spare Bulbs, 2 Per Pack

TOUGH GUY

## Pole Light Storage Clips

- Resilient plastic clip holds standard 3/4" diameter poles.
- Ideal for storing and protecting plug-in pole lights.
- Dimensions: 2" L x 1" H.



Product No. Description

<b>7-54096</b>	Pole Light Storage Clip
----------------	-------------------------

BOATER SPORTS

## Plug-In Light Base

- Chrome plated zamack.
- 2 pin socket fits most plug-in style poles.
- Built-in cover plate protects the socket and locks in the light pole.
- Keyed to help prevent wrongful insertion.
- Direct replacement for Attwood and other competitive brands.



Product No. Description

<b>7-0370</b>	Plug-In Light Base
---------------	--------------------

## All-Round Stern Lights

- Anti-glare lens.
- Provides 2 mile, 360° visibility.
- Anodized aluminum pole.
- Standardized pole fits Attwood and other competitive 2-pin bases.
- #1004 12 volt bulb (Included).

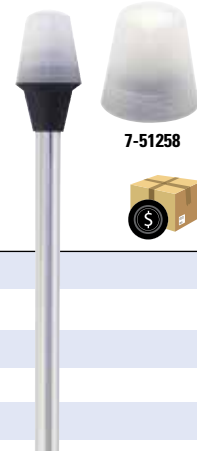

Product No. Description

<b>7-51251</b>	Length 24"
<b>7-51253</b>	Length 36"
<b>7-51255</b>	Length 48"
<b>7-51258</b>	Replacement Globe
<b>7-3966</b>	Spare Bulbs, 2 Per Pack

## L.E.D. Advantage Telescoping All-Round Light



- Tough marine grade aluminum pole with stainless steel base.
- Adjustable head allows for correct alignment independent from the base.
- 1.7 watts on 12 volt systems or 3.4 watts for 24 volt systems.
- Certified USCG 2nm, for use on boats under 39.4' (12 meters).
- 360° visibility.
- Uses two #8 flat/oval head screws (Not included).
- Meets the stringent requirements for USCG, ABYC A-16 and IMO COLREG.
- 12 - 24 volt.



Product No. Description

<b>7-6553</b>	Length 26" - 48"
---------------	------------------

## Universal Plug-In Light Base

- Fits most plug-in style poles.
- Positive locking cover.
- Composite cover.
- 8" wire leads for easier rigging.
- Requires (4) #6 fasteners (Not included).



Product No. Description

<b>7-0052</b>	Universal Plug-in Light Base
---------------	------------------------------

## Plug-In Light Base - Black

- Corrosion free high-impact black nylon.
- 2-pin contact.
- Keeps clean and dry when not in use with tethered cover.
- Fits standard stowable lights.
- Direct replacement to Attwood and other competitive bases.



Product No. Description

<b>7-51274</b>	Plug-In Light Base - Black
----------------	----------------------------

## L.E.D. Advantage Recessed Mount Interior Light

- White LED.
- Round, recessed mount interior light.
- Includes: 3 Bezels (black, white and chrome plated).



Product No. Description

<b>7-51654</b>	Diameter 3"
----------------	-------------

## L.E.D. Advantage Dome Lights

- Polished stainless steel housing and trim ring with glass lens.
- Uses #4 fasteners.
- Prewired with on/off switch.
- 12 volt, 18 LED's.



Product No.	Description
<b>7-6678</b>	Lens Diameter: 4" Outside Diameter: 5-1/2"
<b>7-6679</b>	Lens Diameter: 5" Outside Diameter: 6"

## Dome Lights

- Polished stainless steel housing and trim ring with solid glass lens.
- Prewired with on/off switch.
- 12 volt, 15 watt bulbs included.



Product No.	Description
<b>7-0578</b>	Lens Diameter: 4" Outside Diameter: 5-1/2"
<b>7-0601</b>	Lens Diameter: 5" Outside Diameter: 6"

## L.E.D. Advantage Contour Flex Lights

- Completely waterproof, self-adhesive and contours to any kind of tubing or curved surface for your Bimini top, T-top or handrails.
- Great for use at the helm, in hatches, and fits neatly under steps and countertops.
- The 12 volt LED strip can be operated in a white task mode or a blue accent mode.
- Totally silicone encapsulated, the LED strip has permanent 3M VHB adhesive and insures a long life.
- Just clean the surface and stick it, it's that easy to install.
- Length 14", width 1".

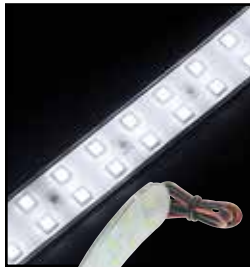

Product No.	Description
<b>7-6612</b>	Blue/White
<b>7-6613</b>	Red/White

## L.E.D. Advantage Rechargeable Utility Light

- 60 super bright LEDs for adding light anywhere it's needed.
- Lasts up to nine hours on a full charge.
- Hang where needed with the swivel hook.
- Waterproof to IP:67 standards-total immersion in water up to one meter for 30 minutes.
- Floats if dropped overboard.
- Crush and dust proof.
- Magnetic holder included.
- Cordless convenience-no power wires in the work area.
- AC and 12V DC chargers included.
- Recharges in approximately six hours.



Product No.	Description
<b>7-0040</b>	LED Rechargeable Utility Light

## L.E.D. Advantage Baitwell Lights

- Single LED diode accent lights provide as much light output as a conventional 12 volt incandescent bulb.
- Draws at least 10 times less power than incandescents.
- Completely sealed for use in livewells.
- Requires 7/8" diameter hole for mounting.



Product No.	Description
<b>7-0077</b>	White
<b>7-0078</b>	Blue

## Water Resistant L.E.D. Flashlight

- 3 LEDs.
- Water resistant.
- Operates on (2) "AA" batteries (Not included).



Product No.	Description
<b>7-57602</b>	LED Flashlight

## L.E.D. Advantage Floodlights

- 5 high power LED's produce 1050 Lumens of super bright coverage.
- Expected life of more than 22,000 hours.
- Completely sealed and water resistant to IP 67 specifications.
- Rugged die cast, powder coated aluminum housing with stainless steel mounting hardware.
- Measures approx. 1-7/8" H x 5-3/4" - about half the size of halogens.
- 12 volt.



Product No.	Description
<b>7-0037</b>	White
<b>7-0038</b>	Black

## Halogen Floodlight

- Stainless steel bracket with hardware and nylon housing.
- Dimensions: 4-1/2" x 7".
- Mounts with 1/4" screw.
- H3, 12 volt, 55 watt halogen bulb (7-9001).



Product No.	Description
<b>7-0043</b>	Halogen Floodlight
<b>7-9001</b>	Spare Bulb

## L.E.D. Advantage Deck Light

- Compact, bright LED consumes only 17 watts.
- Tough, waterproof aluminum housing.
- Built-in heat sink.
- Mounts with 5/16" screw.
- Suitable for 9-36 volts.



Product No.	Description
<b>7-0041</b>	LED Deck Light

## 360° L.E.D. Replacement Bulb

- Double contact.
- Long Life LED replaces the most popular sternlight bulbs on the market.
- Direct replacement for #90 incandescent bulb.
- Low power consumption, yet ultra bright.
- 12 volt.
- Sold each.



Product No.	Description
<b>7-7200</b>	360° LED Replacement Bulb

## Bayonet Base Bulbs

- Sold 2 per card, box of 5 cards only.



Product No.	Description	Size	Volts	Watts	Amps
<b>7-3905</b>	Size 53	14.4 volts	1.7 watts	.12 amps	
<b>7-3910</b>	Size 57	14 volts	3.4 watts	.24 amps	
<b>7-4000</b>	Size 1895	14 volts	3.8 watts	.27 amps	

## Single Contact Bayonet Base Bulbs

- Sold 2 per card, box of 5 cards only.



Product No.	Description	Size	Volts	Watts	Amps
<b>7-3915</b>	Size 67	13.5 volts	8 watts	.59 amps	
<b>7-3930</b>	Size 71	22 volts	3.96 watts	.18 amps	
<b>7-3940</b>	Size 93	12.8 volts	1.04 watts	.13 amps	
<b>7-3975</b>	Size 1141	12.8 volts	18.4 watts	1.44 amps	
<b>7-3986</b>	Size 1156	12.8 volts	26.88 watts	2.1 amps	

## Solar Dock/Deck Light

- Solar Dock/Deck Light with three position switch (flashing- on - off).
- Heavy duty cast aluminum frame.
- Waterproof construction.
- 8 hours of sunlight to fully charge.



Product No.	Description
<b>7-34162</b>	Solar Dock/Deck Light

## L.E.D. Replacement Bulbs



Product No.	Description	Size
<b>7-51580</b>	Size 906	
<b>7-51582</b>	Size 194	

## Double Contact Bayonet Base Bulbs

- Sold 2 per card, box of 5 cards only.

Product No.	Description	Size	Volts	Watts	Amps
<b>7-3920</b>	Size 68	13.5 volts	8 watts	.59 amps	
<b>7-3936</b>	Size 90	13 volts	7.5 watts	.58 amps	
<b>7-3946</b>	Size 94	12.8 volts	13.3 watts	1.04 amps	
<b>7-3966</b>	Size 1004	12.8 volts	12 watts	.94 amps	
<b>7-3970</b>	Size 1034	12.8 volts	23 watts	1.8 amps	
<b>7-3980</b>	Size 1142	12.8 volts	18.4 watts	1.44 amps	
<b>7-3991</b>	Size 1157	12.8 volts	14 watts	.71 amps	

## L.E.D. Festoon Bulb

- 3 sided - 9 cool white LED's.
- Length 1-1/8", diameter 3/8".
- Low amp draw: 30mA. 25 lumens.
- Replaces Perko 0071 Bulbs.



Product No.	Description
<b>7-38877</b>	LED Festoon Bulb

## Festoon Bulbs

- Sold 2 per card, box of 5 cards only.



Product No.	Description	Size	Volts	Watts	Amps
<b>7-3955</b>	Size 211	12.8 volts	12 watts	.97 amps	
<b>7-3960</b>	Size 212	13.5 volts	10 watts	.75 amps	
<b>7-4010</b>	-	12 volts	15 watts	.97 amps	
<b>7-4020</b>	Size 71	12 volts	10 watts	.80 amps	



## LIGHT BULBS

### Wedge Base Bulb

- Sold 2 per card, box of 5 cards only.



Product No. Description

**7-3951** Wedge Base Bulb

### Wedge Base Bulb

- Sold 2 per card, box of 5 cards only.

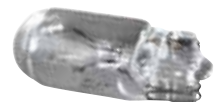

Product No. Description

**7-3925** Size 70 14 volts 2.1 watts .15 amps

### Marine Light Bulb Display

- All bulbs packed 2 per display package.
- This display includes 5 bags of the following:
  - 7-3905 (53) Bayonet Base Bulb
  - 7-3910 (57) Bayonet Base Bulb
  - 7-3915 (67) Single Contact Bayonet Base Bulb
  - 7-3920 (68) Double Contact Bayonet Base Bulb
  - 7-3925 (70) Wedge Base Bulb
  - 7-3930 (71) Single Contact Bayonet Base Bulb
  - 7-3936 (90) Double Contact Bayonet Base Bulb
  - 7-3940 (93) Single Contact Bayonet Base Bulb
  - 7-3946 (94) Double Contact Bayonet Base Bulb
  - 7-3955 (211) Festoon Bulb
  - 7-3960 (212) Festoon Bulb
  - 7-3966 (1004) Double Contact Bayonet Base Bulb
  - 7-3970 (1034) Double Contact Bayonet Base Bulb
  - 7-3975 (1141) Single Contact Bayonet Base Bulb
  - 7-3986 (1156) Single Contact Bayonet Base Bulb
  - 7-3991 (1157) Double Contact Bayonet Base Bulb
  - 7-4000 (1895) Mini Bayonet Base Bulb
  - 7-4020 (71 DP CLR) Festoon Bulb

Product No. Description

**7-3006** Marine Light Bulb Display



## TROLLING MOTOR ACCESSORIES

### Trolling Motor Lift Cord

- Great for backup.
- High impact nylon 3/16" double braid cord.
- UV inhibitor.
- Length 36".



Product No. Description

**7-52245** Trolling Motor Lift Cord

### Trolling Motor Tie Down Strap

- Keep the trolling motor secured from bouncing when traveling in rough waters or trailering to and from locations.
- Hook and loop design.
- Heavy duty webbing.
- Adjustable.



Product No. Description

**7-52640** Trolling Motor Tie Down Strap

MARPAC

MARPRO

TOUGH GUY

BOATER SPORTS

MARPAC

## Small Anchor Roller

- Electro polished marine grade stainless steel.
- Mounting dimensions: 15-1/4" (16" with bail) L x 2-1/16" W.
- Nylon roller: 1-3/4" x 2-1/2".
- For line up to 1" diameter, chain up to 3/8".
- Similar to Windline URM-2.



Product No. Description

**7-1537** Small Anchor Roller

**7-9040** Replacement Roller

## Medium Anchor Roller

- Electro polished marine grade stainless steel.
- For boats up to 35'.
- Mounting dimensions: 18" L x 3-1/2" W.
- Nylon roller: 3" x 3".
- Similar to Windline URM-4.



Product No. Description

**7-1538** Medium Anchor Roller

**7-9041** Replacement Roller

MARPRO

## Narrow Anchor Roller

- Electro polished marine grade stainless steel.
- For boats up to 35'.
- Mounting dimensions: 18" L x 3-1/2" W.
- Nylon roller: 2-1/2" x 2-3/4".
- Similar to Windline CR-1.



Product No. Description

**7-1539** Narrow Anchor Roller

**7-9042** Replacement Roller

## Anchor Roller

- Electro polished marine grade stainless steel.
- Mounting dimensions: 11" L x 2" W.
- Nylon roller 2" x 2".
- Similar to Windline AR-3.



Product No. Description

**7-1535** Anchor Roller

**7-9040** Replacement Roller

TOUGH GUY

## Anchor Locking Control

- Retrieve your mushroom or river anchor without getting up.
- Zinc plated for superior corrosion resistance.
- For use with up to 20 lb. anchors.
- Nylon wheel.
- Diameter: 1/4" - 7/16". Length 5-1/2".



Product No. Description

**7-50704** Anchor Locking Control

## Stainless Steel Anchor Chain Retainer

- Electro polished marine grade stainless steel.
- Firmly holds chain up to 3/8".
- Quick release pin locks the handle securely.
- Working load: 700 lbs.



Product No. Description

**7-1541** Anchor Chain Retainer

BOATER SPORTS

## Stainless Steel Anchor Connectors with Swivel

- Breaking load 5,500 lbs.
- When attached to anchor, it is impossible for the chain to get twisted.
- The oval shaped joint allows perfect sliding of the anchor through the roller with no risk of damaging any components.

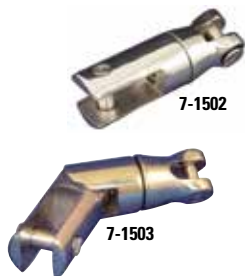

Product No. Description

**7-1501** For use with Chain Size: 1/4" - 5/16"

**7-1502** For use with Chain Size: 3/8" - 1/2"

### DELUXE SWIVEL WITH DOUBLE KNUCKLE DESIGN

Product No. Description

**7-1503** For use with Chain Size: 1/4" - 5/16"

## Poseidon Claw Anchor

- For use in a variety of bottoms: Grass, mud, rocks or sand.
- Classic style doesn't require use of chain, the wind sets the anchor.
- Galvanized steel shank and stock.
- Galvanized gray iron head.
- Height 18", width 14".



Product No. Description

**7-2355** Size #12

## Poseidon Grapnel™ Anchors

- Hot dipped galvanized finish.
- Heavy duty prongs.
- Welded ring for trip line, making recovery easier.



Product No. Description

**7-2350** Size #5

**7-2351** Size #8

**7-2352** Size #12

**7-2353** Size #18





# ANCHORS

## Poseidon Slip-Ring Anchors

- Hot dipped galvanized finish.
- Excellent for light duty conditions.
- Slip-Ring design allows easy retrieval in snagging conditions.



Product No.	Description
<b>7-2305</b>	Size #5 For Boats: 10' to 15'
<b>7-2306</b>	Size #7 For Boats: 16' to 19'
<b>7-2307</b>	Size #10 For Boats: 20' to 24'
<b>7-2308</b>	Size #13 For Boats: 25' to 28'
<b>7-2309</b>	Size #15 For Boats: 29' to 30'

## Poseidon Slip-Ring Anchor Kits

- Everything needed is included.
- Anchor, Lead Chain and Shackles are all hot dipped galvanized.
- Anchor lead chain resists chafing on rough bottom.
- Twisted nylon anchor rope.



Product No.	Description
<b>7-2302</b>	For Boats: 16' to 19'

- Included in package: **7-2306** - #7 Slip-Ring Anchor, 3/8" x 50' Twisted Nylon Anchor Rope, 1/4" x 4' Anchor Lead Chain with oversized end links for easy attachment and Two 5/16" Screw Pin Anchor Shackles.

Product No.	Description
<b>7-2303</b>	For Boats: 20' to 24'

- Included in package: **7-2307** - #10 Slip-Ring Anchor, 3/8" x 100' Twisted Nylon Anchor Rope, 1/4" x 4' Anchor Lead Chain with oversized end links for easy attachment and Two 5/16" Screw Pin Anchor Shackles.

Product No.	Description
<b>7-2301</b>	For Boats: 25' to 28'

- Included in package: **7-2308** - #13 Slip-Ring Anchor, 3/8" x 100' Twisted Nylon Anchor Rope, 1/4" x 4' Anchor Lead Chain with oversized end links for easy attachment and Two 5/16" Screw Pin Anchor Shackles.

## Poseidon Grabber™ Anchors

- Similar in design to the anchors used by oil rigs in the North Sea.
- Very effective under a wide variety of sea bed, tide and wind combinations.
- Works well with most bow rollers for easy storage.
- Sets and re-sets fast and easily.



Product No.	Description
<b>7-2338</b>	Size #11 For Boats: Up to 23'
<b>7-2339</b>	Size #16.5 For Boats: Up to 30'
<b>7-2340</b>	Size #22 For Boats: Up to 34'
<b>7-2341</b>	Size #33 For Boats: Up to 40'
<b>7-2342</b>	Size #44 For Boats: Up to 46'
<b>7-2343</b>	Size #66 For Boats: Up to 56'

## Poseidon Aluminum Rapid Set™ Anchors

- Anodized aluminum anchor that holds the bottom like a steel anchor, but only half the weight.
- Wide flukes grab fast and hold tight.
- Adjustable fluke angle, allows for better holding power in mud bottoms if needed.
- Can be stored in most fluke type anchor storage devices or disassembled if space is tight.
- Rustproof construction.
- Assembly required.



Product No.	Description
<b>7-2450</b>	Size #7 For Boats: 16' to 27'
<b>7-2452</b>	Size #11 For Boats: 28' to 32'

## Poseidon Rapid Set™ Anchors

- Wide flukes grab fast and hold tight.
- Can be stored in most fluke type anchor storage devices.
- Sits flat, easy to store and secure.



## HOT DIPPED GALVANIZED

Product No.	Description
<b>7-2315</b>	Size #2.5 For Boats: Up to 12'
<b>7-2316</b>	Size #4 For Boats: 13' to 16'
<b>7-2317</b>	Size #8 For Boats: 17' to 24'
<b>7-2318</b>	Size #13 For Boats: 25' to 30'
<b>7-2319</b>	Size #18 For Boats: 31' to 34'
<b>7-2320</b>	Size #22 For Boats: 35' to 38'
<b>7-2322</b>	Size #40 For Boats: 39' to 43'
<b>7-2323</b>	Size #65 For Boats: 44' to 53'
<b>7-2324</b>	Size #85 For Boats: 54' to 60'

## STAINLESS STEEL

Product No.	Description
<b>7-2432</b>	Size #8 For Boats: 17' to 24'
<b>7-2433</b>	Size #13 For Boats: 25' to 30'

## Poseidon Rapid Set™ Anchor Kit

- Kit includes: **7-2317** - #8 Rapid Set Anchor, 3/8" x 100' Twisted Nylon Anchor Rope, 1/4" x 4' Anchor Lead Chain with oversized end links for easy attachment and Two 5/16" Screw Pin Anchor Shackles.
- Anchor, Lead Chain and Shackles are all hot dipped galvanized.
- Anchor sits flat, easy to store and secure.
- Anchor lead chain resists chafing on rough bottom.
- Twisted nylon anchor rope.



Product No.	Description
<b>7-2304</b>	For Boats: 17' to 24'

**MARPAC**
**Poseidon Navy™ Anchors**

- Ideal for rivers and lakes having gravel and stone bottoms.
- Really digs in and holds the minute it strikes bottom!



Product No.	Description
<b>7-0552</b>	10 lbs. Black Vinyl Coated
<b>7-0553</b>	15 lbs. Black Vinyl Coated
<b>7-0554</b>	20 lbs. Black Vinyl Coated

**MARPRO**
**Poseidon Mushroom™ Anchors**

- Ideal for rivers and lakes having gravel and stone bottoms.



Product No.	Description
<b>7-0556</b>	8 lbs. Black Vinyl Coated
<b>7-0557</b>	10 lbs. Black Vinyl Coated
<b>7-0558</b>	15 lbs. Black Vinyl Coated
<b>7-0559</b>	20 lbs. Black Vinyl Coated

**TOUGH GUY**
**Poseidon River™ Anchors**

- Great for pontoon and bass boats.
- Specially designed anchor that is ideal for anchoring on sand, weed, gravel or stone bottoms.
- Recommended for strong current areas.



Product No.	Description
<b>7-0560</b>	12 lbs. Black Vinyl Coated
<b>7-0561</b>	16 lbs. Black Vinyl Coated
<b>7-0562</b>	18 lbs. Black Vinyl Coated
<b>7-0551</b>	30 lbs. Black Vinyl Coated

**BOATER SPORTS**
**Poseidon Pyramid Style Mooring Anchors**

- Rapid set design for permanent use in fresh or saltwater.
  - Extra thick short shaft and eye for maximum durability.
  - Short shaft allows usage in shallow water and reduces chain wrap.
  - Primer coated heavy cast iron.
  - Uses include mooring boats, anchoring docks or marker buoys and more.
- Anchors Shipped F.O.B. from Norwich, CT ONLY! Check with your local harbormaster for updated mooring regulations.

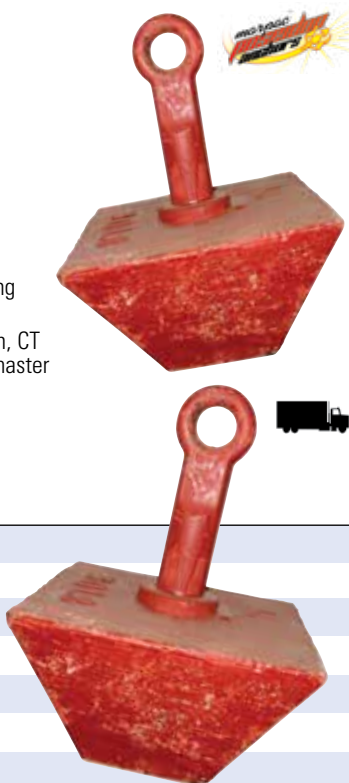

Product No.	Description
<b>7-2400</b>	50#
<b>7-2402</b>	100#
<b>7-2404</b>	200#
<b>7-2406</b>	300#
<b>7-2408</b>	400#
<b>7-2410</b>	500#
<b>7-2412</b>	800#
<b>7-2413</b>	1,000#

**Poseidon EZ Launch™ Anchors**

- Self-launching design.
- Can be used with a trip line for easy retrieval when snagged.
- Designed for greater stability and holding power.
- Use with any universal chain and rope-end fittings.

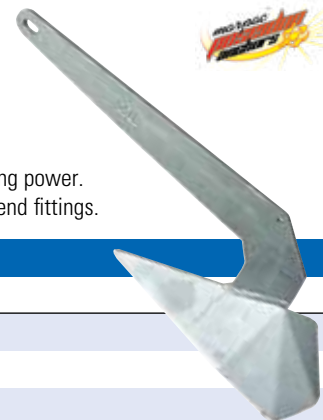
**HOT DIPPED GALVANIZED**

Product No.	Description
<b>7-2330</b>	Size #14
<b>7-2331</b>	Size #22
<b>7-2332</b>	Size #35
<b>7-2333</b>	Size #44
<b>7-2334</b>	Size #55

**STAINLESS STEEL**

Product No.	Description
<b>7-2440</b>	Size #14

**Poseidon Mushroom Mooring Anchors**

- Designed for permanent mooring.
  - Extra thick shaft and eye for maximum durability.
  - Heavy cast iron coated with red primer coating.
  - Shaft design includes large eyes for shackle hook-up.
- Anchors Shipped F.O.B. from Norwich, CT ONLY! Check with your local harbormaster for updated mooring regulations.

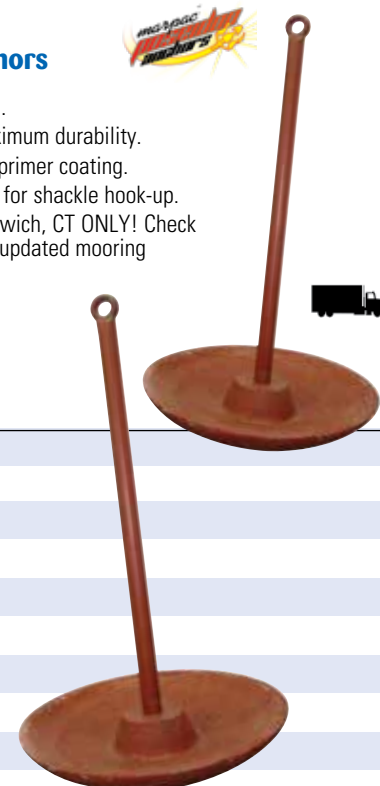

Product No.	Description
<b>7-2370</b>	25#
<b>7-2372</b>	50#
<b>7-2374</b>	75#
<b>7-2376</b>	100#
<b>7-2378</b>	150#
<b>7-2380</b>	200#
<b>7-2382</b>	250#
<b>7-2384</b>	300#
<b>7-2386</b>	400#
<b>7-2388</b>	500#
<b>7-2392</b>	800#
<b>7-2394</b>	1,000#
<b>7-2396</b>	1,500#

## Poseidon Grab N' Go™ Folding Anchor Kit

- Folding anchor system for small boats, personal watercraft, canoes, kayaks and inflatables.
- Entire kit fits in an area less than 11" x 5" x 3", including most PWC storage areas.
- 3 lb. coated four fluke grapnel anchor grips mud, sand, gravel and rock bottoms solidly.
- 25' of braided floating anchor line with stainless steel snap hook for fast deployment.
- Protective padded storage bag dampens noise vibrations.

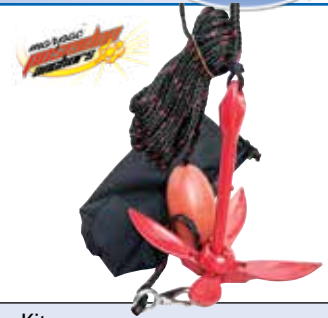

Product No.	Description
<b>7-2357</b>	Grab N' Go Folding Anchor Kit

## Solid Braid Nylon Anchor Lines with Zinc Plated Hook

- Use as a replacement for Anchormate reels.
- Hook snaps on the anchor, so there is no knot to tie.
- Resistant to oil, rot and mildew.
- Flexible and strong.

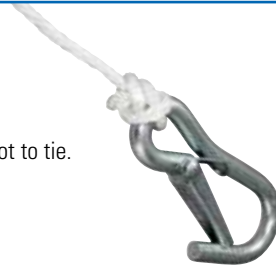

Product No.	Description
<b>7-6447</b>	3/16" x 50' White Safe Working Load: 154 lbs.
<b>7-52978</b>	3/16" x 100' White Safe Working Load: 154 lbs.
<b>7-52998</b>	3/8" x 50' White Safe Working Load: 440 lbs.

## Braided Polypropylene Rope with Zinc Plated Hook

- Hook snaps on the anchor, so there is no knot to tie.
- Resistant to oil, rot and mildew.
- Anchor line floats.



Product No.	Description
<b>7-6445</b>	1/4" x 50' White Safe Working Load: 133 lbs.
<b>7-6446</b>	3/8" x 100' White Safe Working Load: 264 lbs.

## Braid Nylon Anchor Lines

- Braided core within a braided sheath for a strong double braided line.
- Spliced in thimble makes attaching anchor/chain easier.
- Superior strength and flexibility.
- Unlikely to kink, hockle or rotate under load.
- Resistant to oil, rot and mildew.
- Excellent UV protection.



### GOLD

Product No.	Description
<b>7-6450</b>	3/8" x 100' Safe Working Load: 800 lbs.
<b>7-6443</b>	1/2" x 150' Safe Working Load: 1,040 lbs.

### BLACK

Product No.	Description
<b>7-6452</b>	3/8" x 100' Safe Working Load: 800 lbs.
<b>7-6453</b>	1/2" x 150' Safe Working Load: 1,040 lbs.
<b>7-6454</b>	5/8" x 200' Safe Working Load: 1,760 lbs.

## Twisted Nylon Anchor Lines

- Highly resistant to rot, abrasion, oil, grease, gasoline and marine growth.
- Spliced in thimble makes attaching anchor/chain easier.
- Can be stowed wet without damage to the fibers.
- Superior strength and flexibility.
- 4 stage construction for better abrasion resistance.
- Excellent UV protection.



Product No.	Description
<b>7-6433</b>	3/8" x 50' White Safe Working Load: 660 lbs.
<b>7-6434</b>	3/8" x 100' White Safe Working Load: 660 lbs.
<b>7-6435</b>	3/8" x 150' White Safe Working Load: 660 lbs.
<b>7-6436</b>	1/2" x 100' White Safe Working Load: 860 lbs.
<b>7-6437</b>	1/2" x 150' White Safe Working Load: 860 lbs.
<b>7-6438</b>	1/2" x 200' White Safe Working Load: 860 lbs.
<b>7-6439</b>	1/2" x 250' White Safe Working Load: 860 lbs.
<b>7-6441</b>	5/8" x 250' White Safe Working Load: 1,270 lbs.
<b>7-6442</b>	5/8" x 300' White Safe Working Load: 1,270 lbs.

## 3-Strand Nylon Anchor Rodes

- Windlass grade rope for shock absorption.
- Smooth transition from rope to chain with a tapered back factory splice.
- 3-strand nylon rope: Windlass grade, specially treated to remain flexible even with constant exposure to sun and saltwater.
- High test, hot dipped, galvanized G4 chain minimizes corrosion.
- Included swivel to reduce chain twisting.



Product No.	Description
<b>7-7455</b>	1/4" x 10' Chain 1/2" x 150' Rope
<b>7-7456</b>	1/4" x 15' Chain 1/2" x 200' Rope
<b>7-7457</b>	1/4" x 15' Chain 1/2" x 300' Rope
<b>7-7461</b>	5/16" x 15' Chain 9/16" x 200' Rope



## Premier 8 Plait Nylon Rope Anchor Rodes

- Extra-strong factory spliced chain to rope.
- 8 Plait nylon rope: Eliminates ALL hockling and kinking, reduces risk of jamming the windlass gypsy, resists stiffening with age, 50% more line fits in locker than standard 3-strand rope.
- High test, hot dipped, galvanized G4 chain minimizes corrosion.
- Excellent for use with most windlasses.
- Included swivel reduces chain twisting.



Product No.	Description	
<b>7-7450</b>	1/4" x 10' Chain	1/2" x 150' Rope
<b>7-7451</b>	1/4" x 15' Chain	1/2" x 200' Rope
<b>7-7453</b>	1/4" x 15' Chain	1/2" x 300' Rope
<b>7-7452</b>	5/16" x 15' Chain	5/8" x 200' Rope

## Stainless Steel Anchor Lead Chain

- Oversized end links for easy attachment.
- Resists chafing on rough bottoms.
- (2) Marine grade stainless steel anchor shackles included.

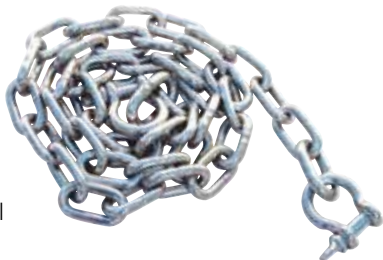

## Hot Dip Galvanized Anchor Lead Chain

- Oversized end links for easy attachment.
- Resists chafing on rough bottoms.
- Use Marpac stainless steel or galvanized shackles to connect anchor-chain-line (Not included).

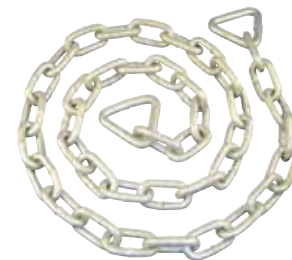

Product No.	Description
<b>7-0729</b>	3/16" x 4' Length
<b>7-0731</b>	5/16" x 5' Length
<b>7-0732</b>	1/4" x 4' Length
<b>7-0733</b>	3/8" x 6' Length

## Poseidon Vinyl Coated Anchor Chain

- Thick PVC coating protects boat finishes.
- Hot dipped galvanized.
- Oversized end links for easy attachment.
- Essential for safe anchoring (Keeps anchor in correct setting position for stronger holds).



## Poseidon Screw Pin Anchor Shackles

- Hot dipped galvanized steel.



Product No.	Description
<b>7-0395</b>	1/4" Sold 2 Per Card
<b>7-0396</b>	5/16" Sold 2 Per Card
<b>7-0397</b>	3/8" Sold 2 Per Card
<b>7-0398</b>	1/2" Sold 1 Per Card

## Screw Pin Anchor Shackles

- Cast 316 stainless steel.
- Sold 1 per card.



## Quick Links - Stainless Steel

- Stainless steel.
- Precision cast.
- Use for anchor chains.



Product No.	Description
<b>7-54506</b>	5/16" 690 lbs.

## Quick Links - Plated Steel

- Plated steel.
- Precision cast.
- Use for anchor chains.



Product No.	Description
<b>7-54534</b>	5/16" 690 lbs.
<b>7-54536</b>	3/8" 840 lbs.

MARPAC

MARPRO

TOUGH GUY

BOATER SPORTS

# FENDERS

## Inflatable Vinyl Fenders

- Made of high quality vinyl. "Super-soft" fenders.
- Non-abrasive and can be tied to cleats or rails to put protection exactly where you need it.
- Ribbed on all sides for strength and durability.
- Reinforced rope holes for added strength.



Product No. Description

7-0580	4-1/2" x 16"	White
7-0585	4-1/2" x 16"	Blue
7-0590	4-1/2" x 16"	Black
7-0581	5-1/2" x 20"	White
7-0586	5-1/2" x 20"	Blue
7-0591	5-1/2" x 20"	Black
7-0582	6-1/2" x 23"	White
7-0587	6-1/2" x 23"	Blue
7-0592	6-1/2" x 23"	Black
7-0583	8-1/2" x 27"	White
7-0588	8-1/2" x 27"	Blue
7-0593	8-1/2" x 27"	Black

## Adjustable Fender Holder

- Adjustable 4" to 22" strap.
- Easily attach or detach with quick release buckle.
- Black.



Note: Picture Displays a White Fender Holder.

Product No. Description

7-52102	Adjustable Fender Holder
---------	--------------------------

## Pontoon Fender Adjuster

- Fits standard pontoon railing.
- Easily stows with fender.
- Heavy duty construction.
- Works with 1/4" to 3/8" fender lines.
- Gray.
- Sold 2 per pack.



Product No. Description

7-52127	Pontoon Fender Adjustable
---------	---------------------------

## Fender Quick Packs

- Two fenders in one package provide coverage for one side of the boat.
- Super soft and non-abrasive.
- Ribbed on all sides for strength and durability.
- Rope holes are reinforced.
- Includes: 3/8" x 60" fender lines.
- Braided MFP fender lines can be stored wet, floats and resistant to abrasion, mildew, oil & rot.
- Includes inflation valve to vary air pressure.



Product No. Description

7-6520	5-1/2" x 20"	White
7-6524	5-1/2" x 20"	Black
7-6528	5-1/2" x 20"	Blue
7-6521	6-1/2" x 23"	White
7-6525	6-1/2" x 23"	Black
7-6529	6-1/2" x 23"	Blue
7-52146	6-1/2" x 23"	Tan
7-6522	8-1/2" x 27"	White
7-6526	8-1/2" x 27"	Black

## Hole-Thru-Middle Fenders

- Made of high quality vinyl.
- These "super-soft" fenders are non abrasive and can be tied to cleats or rails to put protection exactly where needed.
- Ribbed on all sides for strength and durability.
- Reinforced rope holes for added strength.
- Fits up to 5/8" line.
- Single fenders.



Product No. Description

7-6532	8-1/2" x 20"	White
7-6535	8-1/2" x 20"	Black
7-6533	10" x 26"	White
7-6536	10" x 26"	Black



**Premier Double Braided Nylon Dock Lines**

- Superior strength and flexibility.
- Resistant to oil, rot and mildew.
- Excellent UV protection.
- Pre-spliced 12" eye.
- Won't stain decks.

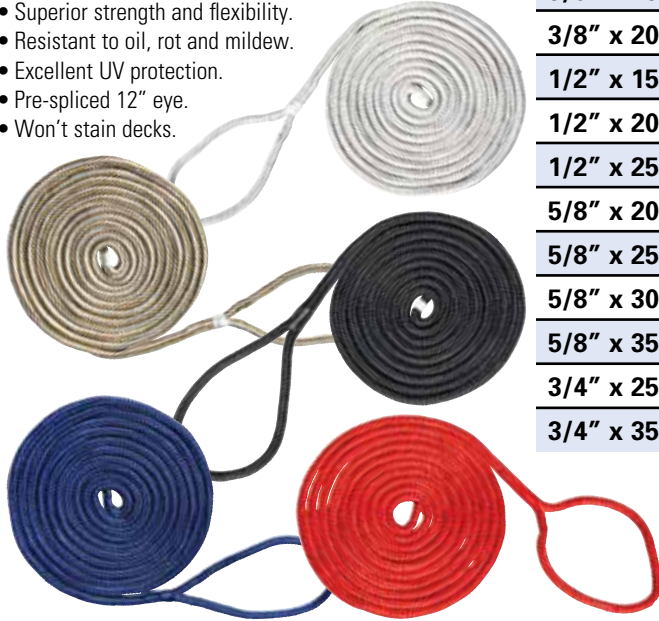

	WHITE	GOLD	BLACK	BLUE	RED
3/8" x 15'	7-6300	7-6250	7-6220	7-6230	7-6280
3/8" x 20'	7-6301	7-6251	7-6221	7-6231	
1/2" x 15'	7-6303	7-6253	7-6223	7-6233	7-6284
1/2" x 20'	7-6304	7-6254	7-6224	7-6234	
1/2" x 25'	7-6305	7-6255	7-6225	7-6235	
5/8" x 20'		7-6260	7-6227	7-6237	
5/8" x 25'		7-6257	7-6228	7-6238	
5/8" x 30'		7-6258	7-6232	7-6240	
5/8" x 35'		7-6259	7-6229	7-6239	
3/4" x 25'			7-6315		
3/4" x 35'			7-6317		

Safe Working Load (SWL)	3/8"	1/2"	5/8"	3/4"
	800 lbs.	1,040 lbs.	1,760 lbs.	2,024 lbs.

**Braided MFP Fender Lines with 2" Loop**

- Floats.
- Good strength and flexibility.
- Multifilament polypropylene double braid construction.
- Can be stored wet, resists shrink.
- Resistant to abrasion, mildew, oil and rot.
- UV protection.
- Sold 2 fender lines per pack.



Product No.	Description		
7-6480	3/8" x 72"	White	Safe Working Load: 396 lbs.
7-6482	3/8" x 72"	Black	Safe Working Load: 396 lbs.
7-6484	3/8" x 72"	Blue	Safe Working Load: 396 lbs.

**Solid Braid Nylon All Purpose Rope**

- For general tying and all purpose use.
- Can be easily knotted.
- Resistant to oil, rot and mildew.
- Flexible and strong.



Product No.	Description		
7-6218	1/4" x 50'	White	Safe Working Load: 203 lbs.

**Braided MFP Dock Lines**

- Floats.
- Good strength and flexibility.
- Multifilament polypropylene double braid construction.
- Can be stored wet, resists shrink.
- Pre-spliced, ready-to-use 12" eye.
- Resistant to abrasion, mildew, oil and rot.
- UV protection.

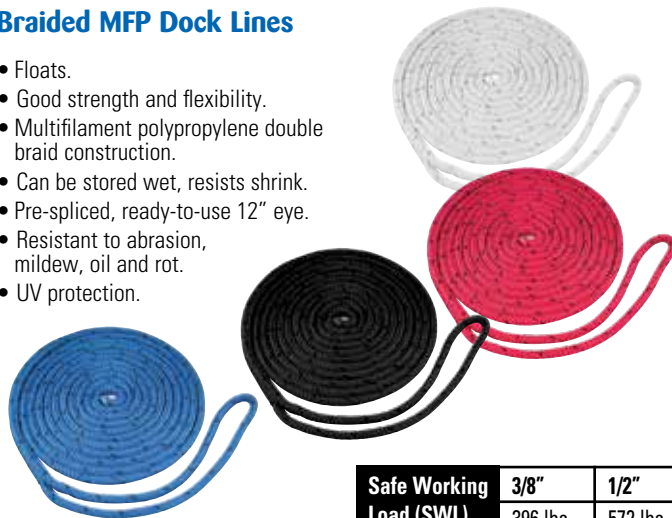

Safe Working Load (SWL)	3/8"	1/2"
	396 lbs.	572 lbs.

	WHITE	BLACK	BLUE	RED
3/8" x 15'	7-6404	7-6403	7-6400	7-6401
1/2" x 20'	7-6407	7-6417	7-6412	7-6414

**Twisted Nylon Dock Lines**

- Pre-spliced, ready-to-use 12" eye.
- Highly resistant to rot, abrasion, oil, grease, gasoline and marine growth.
- Can be stowed wet without damage to the fibers.
- Excellent UV protection.
- Superior strength and flexibility.
- 4 stage construction for better abrasion resistance.



Safe Working Load (SWL)	3/8"	1/2"	5/8"
	660 lbs.	860 lbs.	1,270 lbs.

Product No.	Description	
7-6350	3/8" x 10'	White
7-6351	3/8" x 15'	White
7-6352	3/8" x 20'	White
7-6354	1/2" x 15'	White
7-6355	1/2" x 20'	White
7-6356	1/2" x 25'	White

MARPA

MARPRO

TOUGH GUY

BOATER SPORTS

## Braided Nylon All Purpose Rope

- Excellent elasticity absorbs shock loads.
- Resistant to oil, rot and mildew.
- Flexible and strong, easy to handle and knot.



Product No.	Description	Color	Safe Working Load:
7-6491	1/8" x 500'	White	80 lbs.
7-6492	5/32" x 500'	White	102 lbs.
7-6493	3/16" x 500'	White	154 lbs.
7-6494	1/4" x 500'	White	203 lbs.
7-6495	5/16" x 500'	White	276 lbs.
7-6496	3/8" x 500'	White	440 lbs.
7-6497	1/2" x 500'	White	572 lbs.

## Electric Cutting Gun

- Cuts and seals the ends of synthetic ropes in one fast movement.
- Runs on 120 volts.
- Comes with a 5' cord.



Product No.	Description
7-2753	Electric Cutting Gun
7-2766	Cutting Gun Blade Only

## Galvanized Standard Dock Cleats

- Hot dipped galvanized gray iron.
- Measured from tip to tip.



Product No.	Description
7-2290B	Length 4"
7-2292B	Length 6"
7-2294B	Length 8"
7-2296B	Length 10"
7-2298B	Length 12"

## Deluxe Pull Up Cleats

- Use only a drill or hole saw for installation.
- Closed position only 1/2" above deck.
- Water resistant O-ring included.
- Uses standard 3/8" studs.
- Wider finger grip for ease of use.
- Eliminates standing water on base.



Product No.	Description	Design
7-1017	Length 4"	Slim Line Design
7-1018	Length 6"	Wide Base Design

## Nylon Shock Cord

- Heavy duty cover with multi-strand elastic core.
- High elastic recovery.
- Resistant to UV and mildew.
- Can be used for tie downs or snubbing.



Product No.	Description
7-6506	3/16" x 100'
7-6507	1/4" x 100'
7-6508	5/16" x 100'
7-6509	3/8" x 100'

## Stainless Steel Hollow Base Cleats

- Polished stainless steel.
- Fastens with 1/4" screws.



Product No.	Description
7-0169	Length 4-1/2"
7-0170	Length 6"
7-0171	Length 8"
7-0172	Length 10"

## Zamak Open Base Cleats

- Traditional style chrome plated zamak cleat.
- Open base.
- Uses #8 fasteners (Not included).



Product No.	Description
7-54032	Length 4-1/2"
7-54034	Length 6"

## High Impact Nylon Cleats

- Durable high impact black nylon yacht cleats.



Product No.	Description	Head Screws	Quantity
7-0340	Length 4-1/2"	#10 Oval Machine	2 Per Card
7-0340S	Length 4-1/2"	#10 Oval Machine	Bucket of 24 Cleats
7-0341	Length 6"	1/4" Oval Machine	2 Per Card
7-0341S	Length 6"	1/4" Oval Machine	Bucket of 24 Cleats
7-0338	Length 8"	1/4" Oval Machine	2 Per Card
7-0338B	Length 8"	1/4" Oval Machine	Bulk, Sold Each
7-0339	Length 10"	5/16" Oval Machine	2 Per Card

## Lifting Eye with Cleat

- Polished 316 cast stainless steel.
- Threaded for 5/8" - 11 rod.
- Sold each.



Product No.	Description
<b>7-0176</b>	Lifting Eye with Cleat

## Adjustable Keel Plate

- Cast stainless steel.
- Shank dimensions: 3/8" x 3".
- Uses 5/8" threaded rod.



Product No.	Description
<b>7-0125</b>	Adjustable Keel Plate

## Bow Chock

- Polished cast stainless steel.
- Length 4-1/2".
- Sold per pair.



Product No.	Description
<b>7-0173</b>	Bow Chock

## Stainless Steel Stern Eyes

- All stainless steel.
- Large backing plate helps distribute loads.
- Mounting nuts included.



Product No.	Description
<b>7-0124</b>	Diameter 3/8" Shaft Length: 3"
<b>7-0123</b>	Diameter 1/2" Shaft Length: 3-7/16"

## Bow/Stern Eye

- Zamak chrome plated eye.
- Cadmium plated shanks, nut and washer.
- Eye hole: 1-1/2" ID.
- Diameter: 3/8".
- Shank length: 3" and 5" included.



Product No.	Description
<b>7-54134</b>	Bow/Stern Eye

## Lifting Eye

- Polished 316 stainless steel.
- Tapped for 5/8" connecting rods.
- Large 1-1/2" inside diameter eye.
- Lifting eye with O-ring.



Product No.	Description
<b>7-0177</b>	Lifting Eye

## Straight Chock

- Stainless steel.
- Length 5".
- Sold per pair.



Product No.	Description
<b>7-0940</b>	Straight Chock

## Rope Deck Pipe

- Cast stainless steel.
- Base dimensions: 5-5/8" x 4-1/16".



Product No.	Description
<b>7-0941</b>	Rope Deck Pipe

## Stainless Steel Bow Eyes

- All stainless steel.
- Rounded plates won't gouge fiberglass.
- Mounting nuts included.



Product No.	Description
<b>7-0122</b>	Diameter 3/8" Shaft Length: 3"
<b>7-0120</b>	Diameter 1/2" Shaft Length: 3-7/16"

## Twin Shank Bow Eye

- Zamak chrome plated.
- For use on the bow or stern.
- Diameter: 3/8".
- Shaft length: 4-7/8".
- Washers and nuts included.



Product No.	Description
<b>7-54135</b>	Twin Shank Bow Eye



## Push Button Signal Horn

- Provides up to 105 blasts.
- Marine safety essential.
- Produces a piercing 120dB blast at 10'.
- Can be heard up to 1 mile away.
- Meets every signaling need.
- For boats up to 65'.
- Refill available.
- 8 oz.



Product No. Description

**7-0655** Complete Kit

**7-0656** Refill Canister

## Police Style Whistle

- International Orange plastic.
- Length 2-3/8".
- Includes: Ring for lanyard.



Product No. Description

**7-0240** Police Style Whistle

## Ship's Bells

- Uses #6 fasteners.
- Complete with bracket.



215067

215118

### HEAVY DUTY CHROME PLATED

Product No. Description

**215118** Diameter 8" Bracket: 1-1/2" x 1-3/4"

### HEAVY CAST POLISHED BRASS

Product No. Description

**215067** Diameter 6" Bracket: 1-7/16" x 1-13/16"

**215106** Diameter 8" Bracket: 1-1/2" x 1-3/4"

## Aluminum Paddles

- Corrosion resistant aluminum shaft boat paddles.
- High impact handle and molded blade.

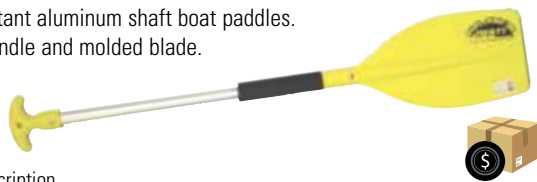

Product No. Description

**7-56014** Length 4'

**7-56022** Length 5'

## Collapsible Paddle

- This lightweight paddle adjusts easily to variable lengths with a simple twist.
- A section of the aluminum shaft disappears inside the blade to allow for compact storage under boat seats or in PWC storage compartments.
- The corrosion resistant aluminum shaft, high-impact molded blade and boat hook handle, and hassle-free locking device ensure years of service.
- The bright orange blade is great for signaling in emergencies.
- For low profile boats and PWCs.
- Adjustable length 20" - 45".



Product No. Description

**7-0603** Collapsible Paddle

## Aluminum Oar

- Corrosion resistant aluminum shaft and high impact, cupped, molded blade.
- Lightweight and durable.
- Will not warp.
- Shaft dimensions: 1-1/4".



Product No. Description

**7-56030** Length 5'

## Oarlock Horns - Clamp-On

- Clamp-on oarlocks.
- Shank OD 1/2".
- 1-5/16" to 2-1/8" diameter oar shafts.



Product No. Description

**7-56110** Oarlock Horns - Clamp-On

## Oarlock Horns - Chrome Zamak

- Chrome plated oarlock horns with pins.
- Shank OD 1/2".
- For Wooden Oars ONLY!



Product No. Description

**7-56106** Oarlock Horns

## Oarlock Bushings

- One pair of nylon injection molded oarlock bushings.
- 5/8" outside diameter, 1/2" inside diameter.



Product No. Description

**7-56107** Oarlock Bushings

## Stainless Steel Steering Wheels with Control Knob

- Steering wheel with control knob.
- Solid investment cast hub.
- No set screw required.
- Fits a standard 3/4" tapered shaft helm.



Wheel Nut

### STEERING WHEEL ONLY (WITHOUT CAP NUT)

Product No.	Description
<b>7-0689</b>	Diameter 13-1/2"
<b>7-0690</b>	Diameter 13-1/2" Black Powder Coated
<b>7-0703</b>	Diameter 15-1/2"

### STEERING WHEEL KIT FOR DOMETIC MECHANICAL STEERING

- For use with Dometic Mechanical Steering.
- 1/2"-20 thread.

Product No.	Description
<b>7-0709</b>	Diameter 13-1/2"
<b>7-0708</b>	Diameter 15-1/2"
<b>7-0706</b>	Spare 1/2" Wheel Nut

### STEERING WHEEL KIT FOR DOMETIC HYDRAULIC STEERING

- For use with Dometic Hydraulic Steering.
- 5/8"-18 thread.

Product No.	Description
<b>7-0705</b>	Diameter 13-1/2"
<b>7-0695</b>	Diameter 13-1/2" Black Powder Coated
<b>7-0704</b>	Diameter 15-1/2"
<b>7-0707</b>	Spare 5/8" Wheel Nut
<b>7-0698</b>	Spare 5/8" Wheel Nut Black Powder Coated

### STEERING WHEEL KIT FOR UFLX STEERING

- For use with Uflex Steering.
- M12 x 1.75 thread.

Product No.	Description
<b>7-0696</b>	Diameter 13-1/2"
<b>7-0697</b>	Diameter 15-1/2"
<b>7-0699</b>	Spare M12 Wheel Nut

## Stainless Steel Control Knob

- Heavy duty cast marine grade stainless steel.
- Fits most oval shaped Destroyer Type Steering Wheels.



Product No.	Description
<b>7-0255</b>	Control Knob
<b>7-9064</b>	Black Knob Cover

## Stainless Steel Steering Wheels - 5 Spoke Destroyer Type

- 5 spoke destroyer type.
- Stainless steel.
- Black composite center cap.
- Fits a standard 3/4" tapered shaft helm.

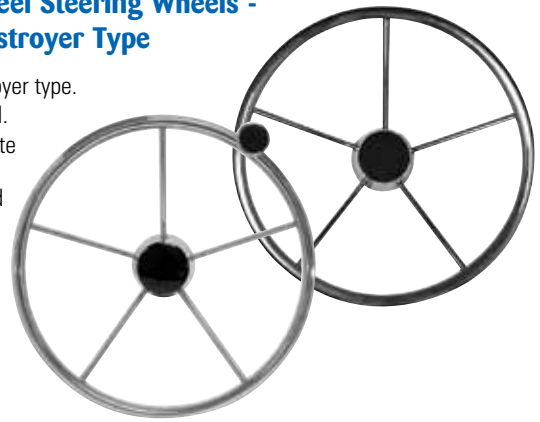

### STEERING WHEELS WITHOUT CONTROL KNOB

- 25° dish.
- Diameter spokes: 3/8".

Product No.	Description
<b>7-0248</b>	Diameter 13-1/2"
<b>7-0250</b>	Diameter 15"
<b>7-9063</b>	Replacement Center Cap

### STEERING WHEELS WITH CONTROL KNOB & FINGER GRIPS

- 22° dish.
- Diameter spokes: 1/2".

Product No.	Description
<b>7-0687</b>	Diameter 13-1/2"
<b>7-0688</b>	Diameter 15-1/2"

## Stainless Steel Steering Wheels - 5 Spoke Destroyer Type

- 5 spoke destroyer type.
- Stainless steel.
- Black composite center cap.
- Fits a standard 3/4" tapered shaft helm.
- 10° dish.
- Diameter spokes: 3/8".



Product No.	Description
<b>7-0682</b>	Diameter 15-1/2"
<b>7-0683</b>	Diameter 18"
<b>7-0684</b>	Diameter 20"

## Stainless Steel Deluxe Control Knob

- Heavy duty cast marine grade stainless steel.
- Fits most oval shaped Destroyer Type Steering Wheels.
- Finger impression for a firmer grip.
- Inner bearing spinning knob for easier control.
- Included rubber pad offers a better fit.
- Includes clamp assembly (lock nut with strap) and wrench.
- Knob diameter: 1-7/8", knob height: 1-15/16".



Product No.	Description
<b>7-0256</b>	Deluxe Control Knob
<b>7-9064</b>	Black Knob Cover

MARPAC

MARPRO

TOUGH GUY

BOATER SPORTS

# STEERING WHEELS and CONTROLS



MARPAC

MARPRO

TOUGH GUY

BOATER SPORTS

## Stainless Steel Destroyer Steering Wheels with Foam Grip

- Fits a standard 3/4" tapered shaft helm.
- 25° dish.
- Diameter spokes: 3/8".



## BLACK COMPOSITE CENTER CAP WITH BLACK FOAM GRIP

Product No. Description

- 7-0691** Diameter 13-1/2"
- 7-0692** Diameter 15-1/2"

## BLACK COMPOSITE CENTER CAP WITH GRAY FOAM GRIP

Product No. Description

- 7-0693** Diameter 13-1/2"

## Plastic Steering Wheel

- Black rugged construction.
- Fits all standard 3/4" tapered shafts.



Product No. Description

- 7-0252** Diameter 13"

## Plastic Steering Wheel

- Equidistant three spoke design.
- Heavy duty, non-magnetic, UV resistant, high impact plastic.
- 4" dish.
- Fits all standard 3/4" tapered shafts.
- Meets ABYC P-22 and ISO 8848 standards.



Product No. Description

- 7-0253** Diameter 13-1/4"

## Dual Function, Single Lever Controls

- Classic design with a modern look.
- Single lever, dual function control for easy one hand operation.
- Works with almost any outboard, I/O or inboard engine.
- Accepts any OEM control cable.
- Easy to use power trim and tilt button on the handle.
- Neutral safety switch prevents starting in gear.



Product No. Description

- 7-0118** Top Mount
- 7-0119** Side Mount

## International Controls

- Cast stainless steel.
- Single and dual lever/single action.
- Includes: Hardware for 33C and 43C cables.



Product No. Description

- 7-0114** Single
- 7-0115** Dual

## Premium Marine Steering Fluid

- Ideal for use in all marine hydraulic steering systems.
- Provides outstanding antioxidant performance in ASTM D2272 testing, as well as superior anti-wear and corrosion protection capabilities.
- Meets or exceeds OEM specifications; will not void warranty.



Product No. Description

- 7-1087** Quart (12 Per Case)
- 7-1086** Gallon (4 Per Case)

## Motor Well Boots

- Protects fuel lines, wires and cables.
- Gas and oil resistant.
- Keeps water out.
- Adjustable fit.
- Black.



Product No. Description

- 7-0677** For 3" Hole
- 7-0674** For 3-1/2" Hole
- 7-0675** For 4-1/2" Hole

## Steering Cable Protector

- Heavy duty rubber boot.
- Output end: 3/8" diameter.
- Cable end: 1" diameter.
- Overall diameter: 1-1/2".
- Maximum length: 10".
- Minimum length: 3-1/2".



Product No. Description

- 7-0678** Steering Cable Protector

## Utility Grommets

- Flexible marine vinyl.
- Black.
- Sold per pair.



Product No. Description

- 7-0615** 2-3/4" OD Maximum Hole Size: 1-3/4"
- 7-0614** 3-3/8" OD Maximum Hole Size: 2-3/8"

MARPAC

## Stainless Steel Drain Plugs

- Corrosion resistant stainless steel handle.
- Neoprene body for a leakproof, nonslip seal.



Product No.	Description	
<b>7-0563</b>	Snap Drain Plug	Fits Drain Tube: 1"
<b>7-0563S</b>	Snap Drain Plug (Bucket of 50)	Fits Drain Tube: 1"
<b>7-0565</b>	Snap Drain Plug	Fits Drain Tube: 1-1/4"
<b>7-0564</b>	Twist Drain Plug	Fits Drain Tube: 1"
<b>7-0564S</b>	Twist Drain Plug (Bucket of 50)	Fits Drain Tube: 1"
<b>7-0567</b>	Twist Drain Plug	Fits Drain Tube: 1-1/4"

MARPRO

## Baitwell Plugs with Brass Handle

- Neoprene plug.
- Brass handle.
- Snaps for a leakproof, nonslip seal.
- Sold 2 per card.



Product No.	Description
<b>7-0570</b>	1/2" ID
<b>7-0571</b>	5/8" ID
<b>7-54858</b>	11/16" ID
<b>7-0572</b>	3/4" ID
<b>7-54860</b>	7/8" ID

TOUGH GUY

## Screw-In Drain Plug

- Screw-in design with catch-T stays with boat.
- Tough nylon material with O-ring seal.
- 1-1/2" x 2" flange.
- Fits 1" hole.
- Black.



Product No.	Description
<b>7-0368</b>	Screw-In Drain Plug

## Garboard Drain Plugs

- Fits 1/2" NPT pipe.
- Flange OD 2".
- Depth 5/8".



Product No.	Description	
<b>7-0352</b>	Stainless Steel	
<b>7-0353</b>	Spare Stainless Steel Plug	1 Per Card
<b>7-0322</b>	Cast Bronze	
<b>7-0824</b>	Spare Cast Bronze Plug	2 Per Card

BOATER SPORTS

## Brass Drain Plugs

- Corrosion resistant brass handle.
- Neoprene body for a leakproof, nonslip seal.



Product No.	Description	
<b>7-0093</b>	Snap Drain Plug	Fits Drain Tube: 1"
<b>7-0093S</b>	Snap Drain Plug (Bucket of 50)	Fits Drain Tube: 1"
<b>7-0094</b>	Twist Drain Plug	Fits Drain Tube: 1"
<b>7-0094S</b>	Twist Drain Plug (Bucket of 50)	Fits Drain Tube: 1"

## The "Never Lose It Again Plug" Drain Plug Assembly

- This screw-type drain plug is constructed of black nylon and features an O-ring for positive sealing.
- Fine threads maintain sealing under heavy vibrations.
- Mounts in a 1" diameter hole.
- Ideal for transoms, livewells, water tanks or even ice chests.
- Display packaged.



Product No.	Description
<b>7-54865</b>	Drain Plug Assembly

## Garboard Drain Plug

- 3/4".
- Heavy duty nylon construction, won't rust.
- No-leak polymer seal.
- Helps to prevent losing another drain plug.
- Fits 1" hole.



Product No.	Description
<b>1-54867</b>	Garboard Drain Plug

## Flanged Drain Tube

- Brass.
- Dimensions: 1" x 3".

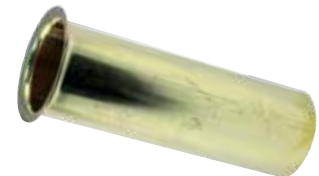

Product No.	Description
<b>7-0569</b>	Flanged Drain Tube

## Garboard Plug

- Brass.
- Fits 1" hole.
- 1/2" NPT.



Product No.	Description
<b>7-54835</b>	Garboard Plug

## Self Bailing Scupper

- Replace worn out flapper scuppers.
- Large 1-1/8" drain allows 70% more water drainage than nearest competitor.
- Clearing debris is a snap with easy twist-off design.
- Multiple mounting holes make retrofits quick and easy - no filling holes or re-drilling.
- Neutral buoyancy ball insures ball won't float up and break seal.
- Stainless steel security pin provided for added safety.
- Diameter 3", height 2-1/2".



Product No. Description

**7-0232** Self Bailing Scupper

## Stainless Steel Ball Valve

- 316 investment cast stainless steel.
- Bonding screw hole included.
- Tested to 1,000 psi WOG.
- NPT threading.
- 3/4".



Product No. Description

**7-2240** Ball Valve

## Universal Hose Clamps

- Easily attach and seal a hose onto a fitting or barb.
- Stainless steel construction for a long lifetime.
- Sold 2 per package.



Product No. Description

**7-57202** 1/4" - 5/8"

**7-57204** 3/8" - 7/8"

**7-57206** 7/16" - 1"

Product No. Description

**7-57208** 1/2" - 1-1/16"

**7-57210** 5/8" - 1-1/4"

**7-57212** 3/4" - 1-1/2"

## Nylon Thru-Hull Connectors with Stainless Steel Cover

- All nylon thru-hull with stainless steel outside cover.
- Note: These thru-hulls for hose are not recommended for use below the waterline.



Product No. Description

**7-0848** Hose ID 3/4"

**7-0850** Hose ID 1-1/8"

**7-0852** Hose ID 1-1/2"

## Stainless Steel Thru-Hull Connectors

- Stainless steel.
- Includes: Stainless steel nut.



Product No. Description

**7-0855** Hose ID 3/4" Flange OD 1-3/4" Overall Length 3-3/4"

**7-0856** Hose ID 1-1/8" Flange OD 2-1/4" Overall Length 4"

**7-0857** Hose ID 1-1/2" Flange OD 3" Overall Length 4-1/4"

## Cockpit Scupper Valve

- Molded white plastic with soft black flapper valve.
- Uses #6 fasteners (Not included).
- 2-7/8" OD.



Product No. Description

**7-0351** Cockpit Scupper Valve

## Hose Clamp Display

- This display includes the following:
  - (10) 276015 - Clamp Diameter 1/4" - 5/8"
  - (10) 276027 - Clamp Diameter 5/16" - 7/8"
  - (10) 276053 - Clamp Diameter 1/2" - 1-1/16"
  - (10) 276079 - Clamp Diameter 3/4" - 1-1/2"
  - (10) 276089 - Clamp Diameter 3/4" - 1-3/4"
  - (10) 276091 - Clamp Diameter 1" - 2"
  - (10) 276128 - Clamp Diameter 7/8" - 2-3/4"
  - (10) 276142 - Clamp Diameter 1-5/8" - 3-1/2"



Product No. Description

**7-3005** Hose Clamp Display

## Thru-Hull Connectors

- High quality UV and chemical resistant engineered resin.
- Finished head for better appearance.
- Includes pass-around nut for easier installation.
- Note: These thru-hulls for hose are not recommended for use below the waterline.



### WHITE

Product No. Description

**7-0357** Hose ID 1/2" Flange OD 1-1/2" Overall Length 1-1/4"

**7-0358** Hose ID 5/8" Flange OD 1-1/2" Overall Length 1-1/4"

**7-0359** Hose ID 3/4" Flange OD 1-7/8" Overall Length 1-7/16"

**7-0360** Hose ID 1" Flange OD 2-1/4" Overall Length 1-1/2"

**7-0363** Hose ID 1-1/8" Flange OD 2-1/4" Overall Length 1-1/2"

**7-0365** Hose ID 1-1/2" Flange OD 3" Overall Length 1-7/8"

### BLACK

Product No. Description

**7-0354** Hose ID 3/4" Flange OD 1-1/2" Overall Length 3-1/16"

**7-0356** Hose ID 1-1/8" Flange OD 1-7/8" Overall Length 3-1/2"



MARPAC

## 90° Thru-Hull Connectors

- High quality UV and chemical resistant engineered resin.
- Finished head for better appearance.
- Includes pass-around nut for easier installation.
- Note: These thru-hulls for hose are not recommended for use below the waterline.



### FITS 3/4" HOSE. THREAD LENGTH: 1"

- Flange size: 1-1/2", overall length: 2-1/2", shaft diameter 1".

Product No. Description

**7-0362** White

**7-0366** Black

### FITS 1-1/8" HOSE. THREAD LENGTH: 1-1/8"

- Flange size: 1-7/8", overall length: 3-1/2", shaft diameter 1-3/8".

Product No. Description

**7-0364** White

**7-0367** Black

MARPRO

## Cartridge Submersible Bilge Pump

- Easy installation.
- Extended life water cooled motor.
- Thermoplastic housing resists heat and stress.
- High grade 316 stainless steel shaft.
- Lightweight glass resin composite impeller resists breakage.
- Straight and omni-directional 90° hose barbs and backflow check valve included.
- Heavy duty 16 gauge corrosion resistant tinned wire.
- Quick change motor cartridge replacement (Order No. 7-2218).
- Easy to clean.
- Discharge 3/4".
- Meets and exceeds ABYC, U.S. Coast Guard, NMMA and IMCI (ISO 8849) specifications.
- 12 volt.



7-2218

Product No. Description

**7-0442** 750 GPH

**7-2218** Replacement Motor Cartridge

TOUGH GUY

## Premier Electronic Bilge Switch

- Solid state automatic bilge water detection.
- No moving parts, completely enclosed design.
- Sensors only activate when exposed to water.
- Works with both fresh and salt water.
- Multiple mounting options.
- Ignition protected - ISO 8846:1990.



Product No. Description

**7-2228** Electronic Bilge Switch

BOATER SPORTS

## Bilge Pump Plumbing Kit

- Complete the installation of your bilge pump with ease using this plumbing kit.
- Kit includes: Plastic bilge hose, thru-hull fitting and (2) stainless steel clamps.
- 3/4" x 5'.



Product No. Description

**7-57304** Bilge Pump Plumbing Kit

## Hand Bilge Pump

- 24" hand bilge pump with 36" hose.
- Perfect for use on small boats, dinghies and lockers or any other place water collects.



Product No. Description

**7-57004** Hand Bilge Pump

## Premier Automatic Bilge Pumps

- Rugged ABS fuel resistant housing.
- Patented "Field Effect" sensing technology that uses micro electrical fields to turn the pump on/off when water is detected.
- Advanced digital design that is Mercury free with no float switch to be jammed on or off.
- Simple 3 wire design is easy to install and can be run in auto or manual override mode.
- 7-2206 and 7-2208 includes a straight and omni-directional 90° hose barbs, as well as a backflow check valve.
- Made in USA, this pump is NMMA, ABYC, USCG and CE Certified.
- Includes a 3 year warranty.



7-2206

Product No. Description

**7-2206** 600 GPH Discharge 3/4"

**7-2208** 800 GPH Discharge 3/4"

**7-2212** 1,250 GPH Discharge 1-1/8" and 1-1/4"

## Stainless Steel Water Inlet and Outlet

- 316 cast stainless steel.
- 2-3/4" OD.
- For use with 1/2" hose.



7-0418

7-0419

Product No. Description

**7-0418** Water Inlet

**7-0419** Water Outlet

## Washdown Pump - 3.5 GPM

- Delivers 3.5 GPM with a maximum pressure of 40 psi.
- Self-priming to 7' 10" (2.4m).
- For fresh or salt water use.
- Automatic high performance pump for deck and anchor washdown.
- Ideal for cleaning pleasure boats, fish boxes, scaling stations, anchor chains and dinghies.
- May also be used for full flow bait tank circulation.
- Automatic pump shut-off feature when hose nozzle is in off position.
- Includes plug-in ports for easy installation: (2) 3/4" hose barb ports and (2) garden hose ports.
- 12 volt.



Product No. Description

**7-0900** Washdown Pump

## Washdown and Baitwell System

- Includes:
- (1) **7-0900** - Washdown Pump
- (1) **581858** - Rule 800 Pump
- (1) **7-0423** - Coiled Washdown Hose with Nozzle



Product No. Description

**7-0434** Washdown and Baitwell System

## Corrosion Resistant Hose Nozzle

- Corrosion resistant hose nozzle with adjustable spray pattern.
- Includes removable quick connect fitting with shut off.
- Removable front bumper.
- Molded pistol grip for comfort and control.
- Fits standard garden hose thread.



Product No. Description

**7-0425** Hose Nozzle

## Macerator Pump

- Superior performance up to 10 GPM.
- Self-priming up to 6' (1.8m).
- Direct replacement for Jabsco, Johnson and Shurflo.
- Rotary cutter shreds waste before it is pumped into or out from the holding tank.
- Inlet connection: 1-1/2" hose or 1-1/2" NPT.
- Outlet connection: 1" hose.
- 12 volt.
- 1 year warranty.



## Washdown Pump - 5.2 GPM

- Hi capacity, delivers 5.2 GPM at 70 psi for superior performance.
- Self-priming.
- Quiet, efficient, pulsation free and compact.
- Five chamber diaphragm pump that provides superior pressure.
- Strainer uses port connection for simple installation on inlet. (This makes it possible to remove entire unit for a thorough cleaning whenever it is most convenient). Strainer features a transparent cover for simple inspection.
- Easy push-in connections include 3/4" hose barbs and garden hose adapter.
- 12 volt. 3 year warranty. CE certified.
- Made in USA.



Product No. Description

**7-0440** Washdown Pump

## Coiled Washdown Hose with Nozzle

- Corrosion resistant construction with stainless steel spring and solid brass fittings.
- No-kink design. Drinking water safe.
- Quick connect fitting with shut off.
- Removable quick connect adaptor.
- 35% more flow at 40 PSI.



Product No. Description

**7-0422** 1/2" x 15' Coiled Washdown Hose with Nozzle

**7-0423** 1/2" x 25' Coiled Washdown Hose with Nozzle

**7-0425** Hose Nozzle with Quick Fitting

## Hi-Capacity Water Pressure System Pump - 5.2 GPM

- Delivers 5.2 GPM with a maximum pressure of 41 psi.
- Self-priming.
- Quiet, efficient, pulsation free and compact.
- Easy push-in connections include 1/2" hose barbs.
- 12 volt. 3 year warranty. CE certified.
- Made in USA.



Product No. Description

**7-0441** Water Pressure System Pump

Product No. Description

**7-0901** Macerator Pump



MARPAC

## Self-Contained Portable Toilets

- High-density polyethylene construction is corrosion proof.
- No external connections required.
- High efficiency piston pump uses as little as 50ml to flush.
- Double seal valve eliminates leakage and odors.
- Quick emptying with easy-pour spout.
- Matte finish conceals scratches and is easy to clean.
- T-type flush nozzle improves flow circle while saving water.



### DIMENSIONS: 16-1/4" D X 13-15/16" W X 12-1/4" H

Product No. Description

**7-0009** 2.6 Gallon - Includes: Tie Down Bracket

**7-0007** Hold Down Bracket for 7-0009

### DIMENSIONS: 16-1/4" D X 13-15/16" W X 16-1/4" H

- Waste tank level indicator shows when holding tank is full.
- Exhaust valve for a smooth, even flow when emptying wastewater.

Product No. Description

**7-0010** 5.2 Gallon

### REPLACEMENT PARTS

Product No. Description

**7-9909** Replacement Slide Valve

**7-9910** Replacement Fresh Water Tank Cap

**7-9911** Replacement Waste Tank Cap

**7-9912** Replacement Tank Gasket

## Baitwell Pump

- Hi capacity pump delivers 5.2 GPM for superior performance.
- Rated continuous for up to 20 minutes.
- Five chamber diaphragm pump that provides superior pressure.
- Strainer uses port connection for simple installation on inlet. (This makes it possible to remove entire unit for a thorough cleaning whenever it is most convenient.)
- Strainer features a transparent cover for simple inspection.
- Easy push-in connections include 3/4" ID threaded, straight and 90° hose barbs to make rigging simple.
- 12 volt. 3 year warranty.
- CE certified.



Product No. Description

**7-0439** Baitwell Pump

MARPRO

TOUGH GUY

BOATER SPORTS

## Mega Rolls Toilet Tissue

- Biodegradable.
- 100% recycled fibers.
- Resealable pouch.
- Dissolves quickly.
- Quality tissue.
- 2 rolls, 500 2-ply bath tissue.
- Dimensions: 4-3/8" x 3-3/4".



Product No. Description

**7-2731** Mega Rolls Toilet Tissue

## Instant Fresh Toilet and Holding Tank Treatment

- Heavy duty formula quickly eliminates odors.
- Fresh lemon scent.
- Breaks down waste and tissue paper.
- Formaldehyde free, safe formula.
- Lubricants prevent drain valves from sticking.



Product No. Description

**7-2727** 8 fl. oz. (Sold 4 Pack Only)

**7-2728** 32 fl. oz.

**7-2729** 64 fl. oz.

## Livewell Pumps - Cartridge Type

- Anti-airlock feature keeps water flowing.
- Removable powerhead design.
- Extended life water cooled motor.
- Lightweight glass resin composite impeller resists breakage.
- Thermoplastic housing resists heat and stress.
- High grade 316 stainless steel shaft.
- Just lift a tab and remove the motor to clean.
- Straight and omni-directional 90° hose barbs.
- Easy installation and easy to clean.
- Quick change motor cartridge replacement (Order No. **7-2218**).
- 3/4" OD discharge port.
- 3/4" Straight thread NPS.



Product No. Description

**7-2216** 750 GPH, In-line with Standard 3/4" Outlet

**7-2214** 750 GPH, 90° Inlets with Standard 3/4" Outlet

**7-2218** Replacement Motor Cartridge

## Stainless Steel Wire Mesh Strainer

- This screw-on strainers are made from formed stainless steel wire mesh cloth and then molded into a PVC base with internal threads.
- Black base with 3/4" female threads.
- Packaged for display.



Product No. Description

**7-57075** Wire Mesh Strainer





## Universal Electric Fuel Sender

- Calibrated for 33 to 240 ohms - an industry standard.
- 100% pre-inspected to ensure full range of calibrated reading from empty to full.
- For use with gasoline or diesel (with separate return line) applications.
- Not for use in water.
- Complete kit includes gasket and screws.
- Made in USA.



Product No.	Description
<b>7-6961</b>	Fits Tank Depth: 6" to 24"

## Fuel Tank Pick-Ups

- Rigid polyethylene fuel tube is formulated for today's fuels.
- E10 and E85 compatible.
- 1/4" NPT aluminum fitting.
- 3/8" ID pick up tube.



Product No.	Description
<b>7-0947</b>	Length 12"
<b>7-0948</b>	Length 24"

## Premier Maximum Flow Fuel Line Assemblies

- Rapid prime with dual big bore check valves.
- Bullet valves for greater longevity give a better prime every time.
- Stainless steel clamps.
- Reinforced hose for kink resistant performance.
- Designed for use with ethanol enriched fuels.
- Meets EPA low permeation mandates and the stringent requirements of SAE J1527 B1-15.
- CARB compliant per EO-G-11-098.



Product No.	Description		
<b>7-6902</b>	J/E	3/8" ID	OEM No. 398549
<b>7-6906</b>	Mercury	3/8" ID	OEM No. 32-827927A
<b>7-6908</b>	Yamaha	3/8" ID	OEM No. 6Y2-24306-05-00
<b>7-6909</b>	Universal	3/8" ID	Connectors Not Included

## Premier Primer Bulbs

- Rapid prime with dual big bore check valves.
- Better prime with bullet valves.
- Stainless steel clamps.
- Specifically designed for use with ethanol enriched fuel.
- Meets EPA low permeation mandates and the stringent requirements of SAE J1527 B1-15 and ISO 8469.
- For use with gasoline or diesel fuels.



Product No.	Description
<b>7-6730</b>	1/4" Fuel Line
<b>7-6732</b>	5/16" Fuel Line
<b>7-6728</b>	3/8" Fuel Line

## Universal Electric Fuel Senders

- Calibrated for 33 to 240 ohms - an industry standard.
- 100% pre-inspected to ensure full range of calibrated reading from empty to full.
- For use with gasoline or diesel (with separate return line) applications.
- Not for use in water.
- Complete kit includes gasket and screws.
- Made in USA.

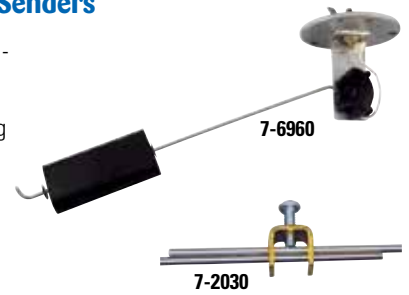

Product No.	Description
<b>7-2030</b>	Fits Tank Depth: 4" to 27"
<b>7-6960</b>	Fits Tank Depth: 6" to 12"

## Universal Electric Fuel Sender Gasket

- 5-hole design fits most electric and mechanical sending units.
- Self-sealing screws included.



Product No.	Description
<b>7-6959</b>	Universal Electric Fuel Sender Gasket

## Fuel Line Assemblies

- Durable, ethanol resistant double walled hose.
- Stainless steel clamps.
- EPA Certified low permeation and CARB compliant.
- Note: To keep from tearing the inner liner of the hose, it's recommended to coat the fuel fitting barb with a soap/water solution to make installation easier and to keep from tearing the liner.



Product No.	Description	
<b>7-6809</b>	Universal	3/8" ID x 7'
<b>7-6810</b>	Universal	5/16" ID x 7'

## Primer Bulbs

- EPA Certified low permeation and CARB compliant.
- Ethanol resistant, E10 compatible.
- Increased fuel flow rate maximizes engine performance.
- Built in check valve prevents back flow.
- Long life and dependable.



Product No.	Description
<b>7-6718</b>	3/8" Fuel Line
<b>7-6722</b>	5/16" Fuel Line



## FUEL HOSE - TYPE B1

Note: To keep from tearing the inner liner of the hose, it's recommended to coat the fuel fitting barb with a soap/water solution to make installation easier and to keep from tearing the liner. Reinforced hose for kink resistant performance.

### Premier Blue Fuel Hose - Type B1



- Meets EPA low permeation mandates & the stringent requirements of SAE J1527 B1-15. CARB compliant per EO-G-11-098.
- Specifically designed for use with ethanol enriched fuels.
- Ethanol E10 and E85 compatible.



Product No. Description

7-6991	1/4"	Length 50'
7-6995	5/16"	Length 50'
7-6799	3/8"	Length 10'
7-6901	3/8"	Length 50'
7-6997	3/8"	Length 250'

### Grey Fuel Hose - Type B1

- EPA and CARB compliant fuel hose is E10 and E85 compatible.
- Ethanol resistant, double walled fuel hose.



Product No. Description

7-6994	5/16"	Length 50'
7-6900	3/8"	Length 50'
7-6996	3/8"	Length 250'

## PREMIER FUEL SYSTEM CONNECTORS AND FITTINGS



- Increased corrosion protection with nickel plated finish.
- Vitron seals and stainless steel components.

- Specifically engineered for maximum flow
- Specifically designed for use with Ethanol E10 & E85 Fuel Blends.

### Honda Fuel System



Product No.	Description	Connects to:
7-6888	1/4" NPT Male Tank Fitting	7-6886
7-6886	3/8" Barb Female Tank Connector	7-6888
7-6890	3/8" Barb Female Tank Connector	Engine

### Johnson/Evinrude (BRP) Fuel System



Product No.	Description	Connects to:
7-6910	1/4" NPT Male Tank Fitting	7-6911/7-6912
7-6911	5/16" Barb Female Tank Connector	7-6910
7-6912	3/8" Barb Female Tank Connector	7-6910

### Mercury Fuel System



Product No.	Description	Connects to:
7-6913	1/4" NPT Male Tank Fitting	7-6914
7-6914	3/8" Barb Female Tank Connector	7-6913

### Yamaha Fuel System

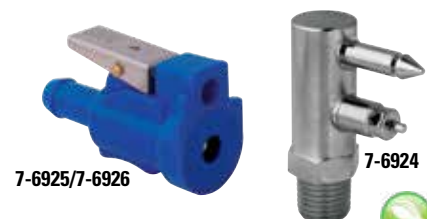

Product No.	Description	Connects to:
7-6924	1/4" NPT Male Tank Fitting	7-6925/7-6926
7-6925	5/16" Barb Female Tank Connector	7-6924
7-6926	3/8" Barb Female Tank Connector	7-6924

### Nissan/Tohatsu Fuel System

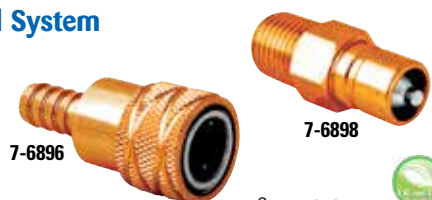

Product No.	Description	Connects to:
7-6898	1/4" NPT Male Tank Fitting	7-6896
7-6896	3/8" Barb Female Tank Connector	7-6898

### Suzuki (75 HP and Up) Fuel System



Product No.	Description	Connects to:
7-6936	1/4" NPT Male Tank Fitting	7-6934
7-6934	3/8" Barb Female Tank Connector	7-6936

## FUEL SYSTEM CONNECTORS AND FITTINGS

### J/E (BRP) Fuel System

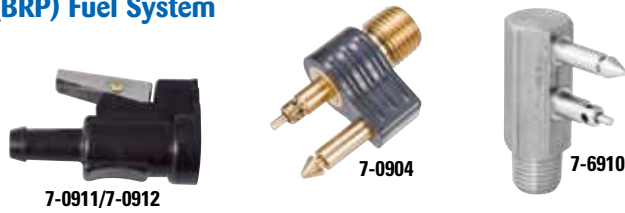

Product No.	Description	Connects to:
<b>7-0904</b>	1/4" NPT Brass Male Tank Fitting	7-0911/7-0912
<b>7-0910</b>	1/4" NPT Brass Male Tank Fitting	7-0911/7-0912
<b>7-0911</b>	5/16" Barb Female Fuel Line Conn.	7-0904/7-0910
<b>7-0912</b>	3/8" Barb Female Fuel Line Connector	7-0904/7-0910

### Yamaha/Mercury Fuel System



Product No.	Description	Connects to:
<b>7-0905</b>	1/4" NPT Brass Male Tank Fitting	7-0925/7-0926
<b>7-0924</b>	1/4" NPT Brass Male Tank Fitting	7-0925/7-0926
<b>7-0925</b>	5/16" Barb Female Fuel Line Conn.	7-0905/7-0924
<b>7-0926</b>	3/8" Barb Female Fuel Line Connector	7-0905/7-0924

### Mercury Fuel System

- Fits: 1998 and newer engines.



Product No.	Description	Connects to:
<b>7-0906</b>	1/4" NPT Brass Male Tank Fitting	7-0914
<b>7-0913</b>	1/4" NPT Brass Male Tank Fitting	7-0914
<b>7-0914</b>	3/8" Barb Female Fuel Line Connector	7-0906/7-0913

### Chrysler/Force Fuel System



Product No.	Description	Connects to:
<b>7-0920</b>	1/4" NPT Brass Male Tank Fitting	7-0921/7-0922
<b>7-0921</b>	5/16" Barb Female Fuel Line Conn.	7-0920
<b>7-0922</b>	3/8" Barb Female Fuel Line Connector	7-0920

### Mercury (Bayonet Style) Fuel System

- Die cast aluminum.



Product No.	Description	Connects to:
<b>7-0915</b>	1/4" NPT Female Tank Fitting	7-0918
<b>7-0918</b>	3/8" Barb Male Fuel Line Connector	7-0915
<b>7-0919</b>	3/8" Barb Female Fuel Line Connector	7-0915

### Suzuki Fuel System



Product No.	Description	Connects to:
<b>7-0933</b>	1/4" NPT Brass Male Tank Fitting	7-0935
<b>7-0935</b>	5/16" Barb Female Fuel Line Conn.	7-0933

### Fuel Elbows

- Solid machined brass.
- Excellent for use in tight spaces.
- Sold each per display pack.



Product No.	Description
<b>7-1646</b>	1/4" NPT x 5/16" Barb
<b>7-1647</b>	1/4" NPT x 3/8" Barb
<b>7-1648</b>	3/8" NPT x 5/16" Barb
<b>7-1649</b>	3/8" NPT x 3/8" Barb

### Brass Tank Vent Elbow

- Brass.
- 3/8" NPT Male x 3/8" FNPT Female.
- Replaces 3/8" FNPT plug on fuel tanks.
- Sold each.



Product No.	Description
<b>7-0321</b>	Tank Vent Elbow

### Brass Elbow

- Brass.
- 1/4" NPT Male x 1/4" FNPT Female.
- Sold each.



Product No.	Description
<b>7-0320</b>	Elbow

### Hose Splicers

- Machined brass.
- Length 2".
- Sold each.



Product No.	Description
<b>7-0318</b>	5/16"
<b>7-0319</b>	3/8"



## Fuel Hose Barbs

- Sold each per display pack.

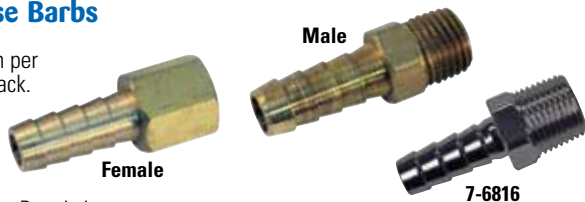

Product No.	Description	
<b>7-7307</b>	1/8" NPT x 5/16"	Male - Machined Brass
<b>7-7308</b>	1/8" NPT x 3/8"	Male - Machined Brass
<b>7-7313</b>	1/4" NPT x 1/4"	Male - Machined Brass
<b>7-7314</b>	1/4" NPT x 5/16"	Male - Machined Brass
<b>7-7315</b>	1/4" NPT x 3/8"	Male - Machined Brass
<b>7-7323</b>	3/8" NPT x 5/16"	Male - Machined Brass
<b>7-7316</b>	3/8" NPT x 3/8"	Male - Machined Brass
<b>7-7337</b>	1/4" FNPT x 1/4"	Female - Machined Brass
<b>7-7338</b>	1/4" FNPT x 5/16"	Female - Machined Brass
<b>7-7339</b>	1/4" FNPT x 3/8"	Female - Machined Brass
<b>7-6816</b>	3/8" NPT x 3/8"	Male - Aluminum

## Brass Tank Vent

- Brass.
- For use in attaching 5/8" ID vent hose to the fuel tank for thru hull ventilation.
- 3/8" NPT x 5/8" hose barb, male thread.
- Sold each.



Product No.	Description
<b>7-0310</b>	Tank Vent

## Thread Sealant Tape

- 100% pure PTFE.
- Naturally lubricated, clean to use and does not harden.
- For use in all threaded connections and fittings.
- Seals tight for professional results.
- Dimensions: 1/2" x 520".



Product No.	Description
<b>7-0305</b>	Thread Sealant Tape

## Shut-Off Valves

- Brass.
- NMMA Fire Test Approved.
- Connects motor to one permanent tank.

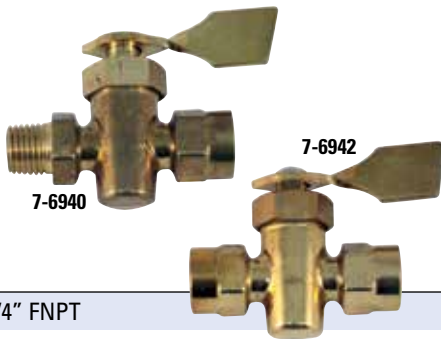

Product No.	Description
<b>7-6940</b>	1/4" NPT x 1/4" FNPT
<b>7-6942</b>	1/4" FNPT

## Brass 2-Way Ball Valve

- Made of brass with stainless steel screw stem.
- 1/4" MNPT x 3/8" barb.



## Aluminum Anti-Siphon Valve

- 1/4" NPT x 3/8" barb.
- Anti-siphon protection with hose barb simplicity.
- Meets USCG/Industry standards for anti-siphoning on gas powered boats.
- Sold each per display pack.



Product No.	Description
<b>7-6952</b>	Anti-Siphon Valve

## Aluminum Plugs

- Aluminum.
- 3/8" NPT, male thread.
- Sold 2 per display pack.



Product No.	Description
<b>7-6820</b>	Aluminum Plugs

## Brass Bulkhead Fitting

- Brass.
- Ideal for routing fuel lines safely through motor wells or bulk heads.
- 3/8" to 3/8" hose ID.
- Straight.



Product No.	Description
<b>7-0306</b>	Bulkhead Fitting

## Brass 3-Way and 4-Way Valves

- NMMA Fire Test Approved.
- Withdrawals from one tank at a time.

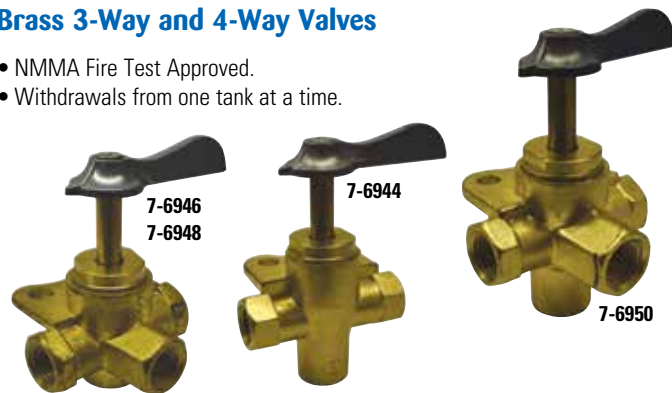

### 3-WAY VALVE (Connects Motor to Two Permanent Tanks)

Product No.	Description
<b>7-6944</b>	1/4" FNPT
<b>7-6946</b>	1/4" FNPT, with Easy Clicks
<b>7-6948</b>	3/8" FNPT

### 4-WAY VALVE (Connects Motor to Three Permanent Tanks)

Product No.	Description
<b>7-6950</b>	1/4" FNPT

Product No.	Description
<b>7-6938</b>	Brass 2-Way Ball Valve

MARPAC

MARPRO

TOUGH GUY

BOATER SPORTS

## Fuel Vents

- Stainless steel protective cover helps reduce water splash.
- 5/8" Hose ID.
- Includes: Stainless steel nut.

Product No. Description

<b>7-1020</b>	Straight	With Protective Cover
<b>7-1021</b>	90°	With Protective Cover
<b>7-1022</b>	90°	Flush Mount Design



## Gas Tank Vent

- Black nylon construction.
- 5/8" line gas tank vent.



Product No. Description

<b>7-53258</b>	Gas Tank Vent
----------------	---------------

## Nylon Deck Fill

- Black nylon deck fill.
- Two style caps included: Slotted and finger tighten cap.
- Cap labels also included.
- Designed for use with 1-1/2" hose.



Product No. Description

<b>7-53264</b>	Nylon Deck Fill
----------------	-----------------

## Gas Deck Fill with Key

- Heavy duty cast type 316 marine grade stainless steel with CNC machined threads.
- O-ring seal for leak prevention.
- Manufactured with sealant groove on back side for positive deck seal.
- Uses #10 fasteners.
- Includes chain and key.
- Flange OD 3-1/8".
- Designed for use with 1-1/2" hose.



Product No. Description

<b>7-0894</b>	Gas Deck Fill with Key
<b>7-0896</b>	Replacement Cap

## Deck Plate Key

- Stainless steel.
- Not only fits deck plates, but also doubles as a screw drive and bottle opener.



Product No. Description

<b>7-0889</b>	Deck Plate Key
---------------	----------------

## Deck Fills with Color Coded Caps

- Heavy duty cast type 316 marine grade stainless steel.
- Color coded cap and symbol for easier identification and less confusion.
- The keyless cap design makes filling easier since no tools are needed.
- Designed for use with 1-1/2" hose.



Product No. Description

<b>7-1640</b>	Diesel with Green Nylon Cap
<b>7-1641</b>	Gas with Red Nylon Cap
<b>7-1642</b>	Water with Blue Nylon Cap
<b>7-9036</b>	Replacement Green Nylon Cap
<b>7-9037</b>	Replacement Red Nylon Cap
<b>7-9038</b>	Replacement Blue Nylon Cap

## Flanged Gas Deck Fill with Spill Guard

- For gas.
- Polished stainless steel.
- Designed for use with 1-1/2" hose.
- Uses #10 fasteners.



Product No. Description

<b>7-0892</b>	Flanged Gas Deck Fill with Spill Guard
---------------	--

## Premier Fuel/Water Separating Marine Filter Kit with Racor Filter



- Can be used with all 2 and 4 stroke engines.
- Stainless steel filter head design with 3/8" NPT ports.
- Proprietary high capacity Aquabloc II filter media.
- Stops contaminants down to 10 micron in size.
- Effective on ethanol blended fuels.
- Fits universal style filter heads with 11/16" threads.
- Clear contaminate collection bowl with drain valve.
- Kit includes: Universal Stainless Steel Filter Head, (2) Aluminum Hose Barbs, (2) Aluminum Plugs, Thread Sealant - .20 fl. oz., Water Collecting Bowl and (S3213) Separating Fuel Filter.



Product No. Description

<b>7-0879</b>	Fuel/Water Separating Marine Filter Kit
---------------	---



7-0843



7-0846



7-0842



7-0844

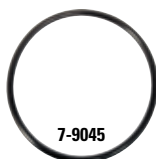

7-9045



7-0845

## Fuel/Water Separating Marine Filter Kits - Racor Inside

- Kits include: Universal Filter Head, (2) Aluminum Hose Barbs, (2) Aluminum Plugs, Thread Sealant - .20 fl. oz., Water Collecting Bowl and 10 Micron Water Separating Fuel Filter.
- Why Racor Filter Inside? Traditional filter media (paper) absorbs water. Marpac with Racor Filter Inside actually sheds water away from the filter.
- Can be used with all 2 and 4 stroke engines.
- Will not separate 2-cycle oil from gasoline.
- E-10 and E-85 ethanol compatible.
- High flow filter head design with 3/8" NPT ports.
- For vacuum (suction side) applications.
- High efficiency 10 micron media filters out 99% of water and 98% of contaminants.
- Fits universal style filter heads with 11/16" threads.
- Clear water collecting bowl extends the life of the filter by allowing water to be drained from the fuel system.
- Water collecting bowl is reusable.

Product No. Description

<b>7-0842</b>	With Stainless Steel Filter Head
<b>7-0846</b>	With Composite Filter Head
<b>7-0843</b>	Fuel Filter with Water Collecting Bowl
<b>7-0844</b>	Replacement Water Separating Fuel Filter
<b>7-0845</b>	Replacement Water Collecting Bowl
<b>7-9045</b>	Replacement Viton O-ring for 7-0845 Bowl



## Quick View Water Separating Filter System

- Quick View is a new concept in fuel filtration, just replace the part that needs replacing.
- Quick Drain casing includes an easy-turn thumb screw for quick, convenient water drainage and a red float that indicates water that needs to be drained.
- Clear bowl on all Quick View allow for quick checks on fuel quality, remove water or change filter before there is a problem.
- 10 Micron filter cartridge is replaceable and disposable (Order 7-6858).
- Ethanol fuel compatible with Viton Seals that won't shrink.
- E-10 and E-85 ethanol compatible.
- Universal replacement filter fits Mercury, Yamaha, Honda and Suzuki style filters.
- Designed for use with Portable Marine Fuel Systems.



7-6858



7-6854



7-6862

Product No.	Description
<b>7-6862</b>	Nichromium Head & Filter Assembly Kit with Drain
<b>7-6854</b>	Filter Assembly with Drain, No Head
<b>7-6858</b>	Replacement Filter Cartridge



## Fuel/Water Separating Marine Filter Kits

- Kit includes: Universal Filter Head, (2) Aluminum Hose Barbs, (2) Aluminum Plugs, Thread Sealant - .20 fl. oz. and (1 or 2) 10 Micron Water Separating Fuel Filter.
- Can be used with all 2 and 4 stroke engines.
- Will not separate 2-cycle oil from gasoline.
- Corrosion resistant filter head choices.
- E-10 ethanol compatible.
- High flow filter head design with 3/8" NPT ports.
- 10 Micron filtration ensures fuel arrives at your outboard engine(s) clean of contaminants and water.
- Fits universal style filter heads with 11/16" threads.



7-0878



7-6874



7-0871



7-0847

Product No. Description

<b>7-0878</b>	With Stainless Steel Head	1 Filter
<b>7-0874</b>	With Stainless Steel Head	2 Filter Value Pack
<b>7-0871</b>	With MarPlate Head	1 Filter
<b>7-0873</b>	With MarPlate Head	2 Filter Value Pack
<b>7-0847</b>	With Composite Head	1 Filter
<b>7-0858</b>	With Composite Head	2 Filter Value Pack
<b>7-6874</b>	With Nichromium Head	2 Filter Value Pack





MARPAC

## Fuel/Water Separating Marine Filter Kit - Yamaha

- High capacity for maximum performance.
- Can be used with all 2 and 4 stroke engines.
- Will not separate 2-cycle oil from gasoline.
- E-10 and E-85 ethanol compatible.
- 10 Micron filtration ensures fuel arrives at your outboard engine(s) clean of contaminants and water.
- Fits universal style filter heads with 11/16" threads.
- Kit includes: Water Collecting Bowl and 10 Micron Water Separating Fuel Filter.
- Replaces: Yamaha MAR-FUELF-IL-TR.



Product No. Description

<b>7-0836</b>	Filter Kit
<b>7-0838</b>	Replacement Water Separating Fuel Filter

## Disposable Fuel Filters

- Filters dirt and other particles.
- More filtration per square inch.
- Easy viewing through clear vial.
- For portable fuel systems only.



Product No. Description

<b>7-6965</b>	3/8"
<b>7-6966</b>	1/4" and 5/16"

## Replacement Filter for Mercury Engines

- Fits Mercury outboard engines.
- Direct OEM replacement.
- 2 Micron.
- Sold each.



Product No. Description

<b>4-7981</b>	Replacement Filter
---------------	--------------------

## Stainless Steel 5 Louvered Vent

- Polished 304 stainless steel.
- Uses #6 fasteners.
- Cut out dimensions: 12" x 3-3/8".
- Overall dimensions: 12-5/8" x 4-5/16".



Product No. Description

<b>7-0092</b>	5 Louvered Vent
---------------	-----------------

## Water Separating Marine Fuel Filter

- Can be used with all 2 and 4 stroke engines.
- Will not separate 2-cycle oil from gasoline.
- 10 Micron filtration ensures fuel arrives at your outboard engine(s) clean of contaminants and water.
- Fits universal style filter heads with 11/16" threads.
- Replaces: GLM 24940; Marine Power 0432-049; Mercury 35-60494-1, 35-802893Q, 35-8071272; Seachoice 20911, 20951; Sierra 18-7845, 18-7945; Yamaha ABA-FUELF-F-IL-TR, ABB-FUELF-IL-TR.



Product No. Description

<b>7-0860</b>	Sold Each Per Display Package
<b>7-0860S</b>	Case of 48 Fuel Filters

## Replacement Universal Filter Brackets

- High flow filter head design with 3/8" NPT ports.
- Fits universal style filter heads with 11/16" threads.

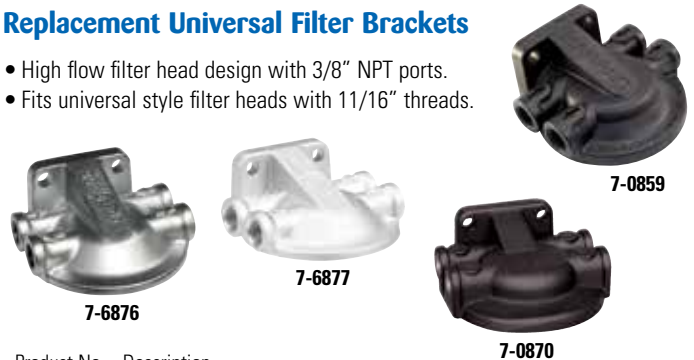

Product No. Description

<b>7-0859</b>	Composite Filter Bracket
<b>7-0870</b>	MarPlate Aluminum Filter Bracket
<b>7-6876</b>	Stainless Steel Filter Bracket
<b>7-6877</b>	Nichromium Filter Bracket

## E.Z. View Universal In-Line Fuel Filter

- Superior filtering.
- Transparent housing.
- Easy do-it-yourself installation.
- Fits all boats, cars and trucks using carbureted fuel systems.
- For above deck use only.
- Replaces any 1/4", 5/16" and 3/8" inline filter.



Product No. Description

<b>7-0875</b>	E.Z. View Universal In-Line Fuel Filter
<b>7-0876</b>	Replacement (3) Filter Elements

## Stainless Steel Louvered Vent

- Polished 304 stainless steel.
- Uses #6 fasteners.
- Dimensions: 5" x 2-5/8".



Product No. Description

<b>7-1400</b>	Louvered Vent
---------------	---------------

MARPRO

TOUGH GUY

BOATER SPORTS



# TRAILER HITCH BALLS and WHEEL BEARING KITS

MARPAC

## Bow Safety Chain

- Includes: S-hook on one end.
- 3/16" x 12 links.



Product No. Description

**7-1852** Bow Safety Chain

MARPRO

## Wheel Stop

- Lower your jack wheel into the wheel stop to prevent the tongue from moving.
- Always block your tires.



Product No. Description

**7-59202** Wheel Stop

## Trailer Hitch Balls

- Chrome plated steel.
- V5 compliant. Independently tested to SAE J684 specs.
- Includes lock washer and nut.



Product No. Ball Diameter Shaft

**7-0145** 1-7/8" 3/4" x 2-3/8"

**7-0147** 1-7/8" 1" x 2-1/8"

**7-0146** 2" 3/4" x 2-3/8"

**7-0148** 2" 1" x 1-1/8"

**7-0152** 2-5/16" 1" x 2"

**7-0153** 2-5/16" 1-1/4" x 2-1/2"

TOUGH GUY

## Lug Nuts and Lug Bolts

- Sold 5 per display package.



Product No. Description

**7-1855** Lug Bolts 1/2"

**7-1853** Lug Nuts 1/2"

## Wheel Bearing Kits

- Precision tapered roller bearings.
- Each kit includes: (2) Cones, (2) cups, seal and cotter pin.
- Dust cap shown sold separately.



Product No. Spindle Outer Hub Race OD

**7-0952** 3/4" 1.781"

**7-0953** 1" 1.980"

**7-0954** 1-1/16" 1.980"

**7-0956** 1-1/4" 2.328"

**7-0959** 1-1/16" x 3/4" 1.781"

**7-0957** 1-1/4" x 3/4" 1.781"

**7-0958** 1-3/8" x 1-1/16" 1.980" 2.361"

**7-0955** 1-3/8" x 1-1/16" 1.781" 2.328" (with Special Cup)

BOATER SPORTS

## Trailer Bunk Padding

- Protect your boat from damage and scratches.
- Easy to cut and custom fit.
- Static free and is made for minimal water retention.



Product No. Description

**7-59110** 8" W x 12' L

**7-59111** 12" W x 12' L

## Hitchlock Trailer Coupler Lock

- Solid cast, heat treated for toughness.
- Helps prevent trailer theft.
- Will not corrode, rust or clog.
- Fits all Fas-Lok and other standard couplers.



Product No. Description

**7-0899** Hitchlock Trailer Coupler Lock

## Complete Towing Kit

- 2" powder coated drop ball mount.
- Handles trailers up to 6,000 lbs.
- Includes: 2" trailer ball rated at 6,000 lbs. (1" shaft diameter).
- Max tongue weight up to 600 lbs.
- Use with 2" x 2" receiver.
- Includes 5/8" hitch pin.
- Help keep the tow vehicle cleaner with the convenient storage case.



Product No. Description

**7-1869** Complete Towing Kit

## Replacement Bearing Seals

- Sold per pair.



Product No. Lip Seal

**7-1861** 1" for 3/4"

**7-1860** 1-1/4" for 1" and 1-1/16"

**7-1862** 1-1/2" for 1-1/4"

**7-1863** 1-3/4" for 1-3/8"



## BEARING PROTECTORS

### Spring-Loaded Bearing Protector

- Steel spring keeps hub grease under pressure, guarding against water seepage and failure.
- Grease fitting in cap.
- Sold per pair.



Product No. Description

**7-59038** 1.980"

### Lube Cap

- Protection against damage from water and dirt entering the wheel bearings.
- Automatically maintains the correct internal pressure.
- Sold per pair.



Product No. Description

**7-59061** 1.980"

### Lube Grommet

- Rubber grommet for use with bearing protectors.
- Sold per pair.



Product No. Description

**7-59062** 1.980"

### Bearing Protector Caps

- Helps to protect your bearings against damage from water and dirt entering the wheel bearings.
- Sold per pair.



Product No. Description

**7-59030** 1.980"

## BIMINI TOP FITTINGS

### Hinge Rail Mount Jaw Slide

- Simplifies bimini top installation.
- Allows bimini top installation on existing hand rails.
- For use with 7/8" or 1" tubing.

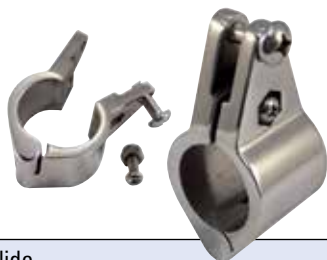

Product No. Description

**7-0196** Hinge Rail Mount Jaw Slide

### Top Caps with Set Screw

Product No. Description

**7-0194** Tube 7/8" Stainless Steel

**7-0195** Tube 1" Stainless Steel

**7-0331** Tube 3/4" Black Nylon

**7-0329** Tube 7/8" Black Nylon



### Top Slides with Set Screw

- Stainless steel bolt and set screw.



Product No. Description

**7-0197** Tube 7/8" Stainless Steel

**7-0997** Tube 1" Stainless Steel

**7-0335** Tube 3/4" Black Nylon

**7-0333** Tube 7/8" Black Nylon

### Inside Eye End Tubes

Product No. Description

**7-0325** Tube 3/4" Black Nylon

**7-0327** Tube 7/8" Black Nylon



### Deck Hinges

Product No. Description

**7-0198** Angled Base Stainless Steel

**7-0199** 90° Base Stainless Steel

**7-0999** Removable Pin Stainless Steel

**7-0294** Large Angled Black Nylon

**7-0302** Slide Lock Black Nylon

**7-0303** Large Pattern Black Nylon

**7-0347** Small Pattern Black Nylon

Product No. Description

**7-0198** Angled Base Stainless Steel

**7-0199** 90° Base Stainless Steel

**7-0999** Removable Pin Stainless Steel

**7-0294** Large Angled Black Nylon

**7-0302** Slide Lock Black Nylon

**7-0303** Large Pattern Black Nylon

**7-0347** Small Pattern Black Nylon

### Swivel Deck Hinge

- Swivel allows deck hinge to be mounted on almost any angle.
- Use with any bimini top cap fitting.
- Stainless steel.



Product No. Description

**7-0203** Swivel Deck Hinge

MARPAC

## Side Mount Deck Hinges



Product No.	Description
<b>7-0200</b>	2 Hole Stainless Steel
<b>7-0344</b>	2 Hole Black Nylon

## Bimini Top Straps

- 1" x 96" nylon web, adjustable.
- Fits most bimini tops.
- Sold per pair.



Product No.	Description
<b>7-0029</b>	Black
<b>7-0030</b>	White

## Eye Straps

- 1-3/4" long with 3/8" eye.
- Fasten with #10 oval head screws.
- Sold 4 per display card.



Product No.	Description
<b>7-0342</b>	Eye Straps

## Clevis Pin with Spring

- Stainless steel.
- 1-1/4" clevis pin.



Product No.	Description
<b>7-55124</b>	No Lanyard
<b>7-55190</b>	With Lanyard

## Pull Pin

- Stainless steel.
- 1-1/4" clevis pin with lanyard.



Product No.	Description
<b>7-55126</b>	Pull Pin

## Square Internal Eye Ends

- High impact nylon construction for exceptional durability.
- Sold per pair.



Product No.	Description
<b>7-55178</b>	3/4" Black Nylon

## Bimini Top Snaps

- Stainless steel. 1" snap.
- Sold per pair.



Product No.	Description
<b>7-0277</b>	Bimini Top Snaps

## Eye Straps

- Type 304 forged stainless steel.
- Fasten with #10 oval head screws.
- 1-3/4" long with 3/8" eye.
- Sold 4 per display card.



Product No.	Description
<b>7-0502</b>	Eye Straps

## Head Screws

- 1/4" x 20 thread.
- Molded black nylon head.
- Stainless steel threads.
- Sold 2 per display card.



Product No.	Description
<b>7-0298</b>	Head Screws

## End Stops

- Black nylon.
- Sold 2 per display card.



Product No.	Description
<b>7-0349</b>	End Stops

MARPRO

TOUGH GUY

BOATER SPORTS

## Propeller Wrench

- 6 point socket style made of high strength indestructible nylon.



Product No.	Description
<b>7-1899</b>	Propeller Wrench

# PROPELLER WRENCH

## Transom Trim Switch

- Puts tilt and trim control anywhere.
- Can also operate power jack plates.
- Weatherproof.
- 50 amp.



Product No.	Description
<b>7-1165</b>	Transom Trim Switch

## Up/Down Trim Switch Panel

- This switch is constructed of a rugged black panel and a momentary toggle switch with a protective boot.
- It allows you to control your trim from the stern area of the boat.
- Can be mounted on any flat surface.



Product No.	Description
<b>7-51380</b>	Up/Down Trim Switch Panel

## Universal Kill Switch

- Works on most outboard or inboard engines.
- Swivel snap hook eliminates tangles.
- Corrosion resistant construction, stainless steel crimps.



Product No.	Description
<b>7-0494</b>	Universal Kill Switch

## Kill Switch Lanyard

- Designed with six different heads, it will fit Honda, Yamaha, OMC and Mercury/Mariner kill switches.
- The swivel snap hook eliminates tangles, and the stainless steel crimps won't rust.



Product No.	Description
<b>7-0495</b>	Kill Switch Lanyard

## Kill Switch Lanyard

- Replacement kill switch lanyard.
- Coiled cord.
- Plastic safety vest clip and float.



Product No.	Description
<b>7-51299</b>	Kill Switch Lanyard

## Kill Switch Lanyard - Merc Style

- Replacement kill switch lanyard for Merc style switch.
- Coiled cord with brass crimps.
- Stainless steel clip and plastic safety release.

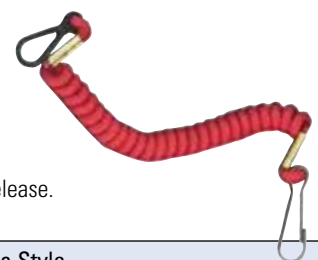

Product No.	Description
<b>7-51301</b>	Kill Switch Lanyard - Merc Style

## 2-Piece Hydrofoil

- Improve overall performance on boats with outboard or stern drives.
- Molded in two pieces, one bolting to either side of the cavitation plate.
- Improves stability and trim to keep bow down, while improving fuel economy.



Product No.	Description
<b>7-52620</b>	2-Piece Hydrofoil

# MIXING BOTTLE and GEAR LUBE PUMP

## MixMate™ Oil-Fuel Mixing Bottle

- Oil to gas measuring device for 2 cycle engines.
- Includes oil - gas mixture ratios: 100-1, 50-1, 24-1 and 10-1.
- All measurements shown are in gallons and liters.



Product No.	Description
<b>7-6022</b>	MixMate Oil-Fuel Mixing Bottle

## Funnel and Detach Flex Hose

- Flex funnel and detachable flex hose for extra length.
- Made from tough, high density polypropylene.
- Screen included to filter out sediment and large particulate.



Product No.	Description
<b>7-53281</b>	Funnel and Detach Flex Hose

## Universal Gear Lube Pump

- Quart size pump for outboard lower units, power trim and tilt units.
- Fits outboards and stern drives with 3/8-16 threaded screw.
- Fits outboards: Johnson/Evinrude, Mercury/Mariner, Suzuki 25 HP & larger and Yamaha 8 HP & larger.
- Fits stern drives: OMC, OMC Cobra, OMC SX Cobra, Mercruiser, Speedmaster and Volvo Penta SX™.
- 8 mm threaded adapter included for: Yamaha, Honda, Mercury 4 stroke (over 115 HP), Nissan and Tohatsu.



Product No.	Description
<b>7-6020</b>	Universal Gear Lube Pump



MARPAC

## Universal Hand Pump

- Self-priming design, great for pumping oil, water and other fluids.
- Siphons tank contents for quick and easy removal of large liquid quantities.
- Small size stores practically anywhere, such as tackle boxes.
- Not for use with gasoline or diesel.



Product No.	Description
<b>7-2232</b>	Universal Hand Pump

MARPRO

## 12 Volt Oil Changer

- Compact 12 volt light weight pump for portability.
- Extracts heated engine oil through the engines dipstick tube without mess.
- Includes: 10' heavy duty coiled wire with batter clips, 4' inlet hose for engine dipstick and 5' outlet hose.



Product No.	Description
<b>7-52616</b>	12 Volt Oil Changer

TOUGH GUY

## Universal Motor Flusher - Round Cup

- Fits most engines with side water inlets.
- Installs easily - No tools needed.
- Flush away sand, silt, salt and alkali to prevent clogging and corrosion to extend engine life.



Product No.	Description
<b>7-0576</b>	Motor Flusher - Round Cup
<b>7-0576S</b>	Display Box of 24 Motor Flushers

BOATER SPORTS

## Dual Water Feed Motor Flusher

- Flush sand, silt and saltwater.
- Ideal for larger horsepower engines.
- Rectangular inlet cups create a better seal.
- For use with all lower units that have side water inlets.



Product No.	Description
<b>7-0573</b>	Dual Water Feed Motor Flusher

## Fluid Xtractors

- Portable fluid extractor empties in 16 pumps or less.
- No power source needed.
- Warm or cold fluid extraction.
- Includes: Extraction tube kit.



Product No.	Description
<b>7-0951</b>	Holds 4.0 Liters or 4.2 Quarts or 1.1 Gallons
<b>7-0950</b>	Holds 6.5 Liters or 6.9 Quarts or 1.7 Gallons

## Oil Drain Plugs

- Keep the oil in and the water out.
- Includes with plugs, gasket and O-ring.
- Sold 5 packages per display box.



Product No.	Description	
<b>7-5899</b>	Drain Plug Gasket	Mercury Lower Unit
<b>7-6000</b>	Magnetic Drain Plug	Mercury Lower Unit
<b>7-6005</b>	Magnetic Drain Plug	Yamaha Lower Unit
<b>7-6006</b>	Drain Plug Gasket	Yamaha Lower Unit

## Universal Motor Flusher - Rectangular Cup

- Fits most engines with side water inlets.
- Installs easily - No tools needed.
- Flush away sand, silt, salt and alkali to prevent clogging and corrosion to extend engine life.



Product No.	Description
<b>7-0574</b>	Motor Flusher - Rectangular Cup
<b>7-0574S</b>	Display Box of 24 Motor Flushers

## Inboard Engine Flusher - Adjustable Length

- Installs easily without tools.
- Helps extend engine life.
- Flushes away sand, silt, salt and alkali.
- Adjusts from 18" to 30" with just a twist.
- Check, tune and flush your inboard engine anywhere on dry land.
- For use on gas or diesel inboard engines with thru-hull water intakes.



Product No.	Description
<b>7-0579</b>	Inboard Engine Flusher

## Xtreme Ski Nylon Vests

- For the water sports enthusiast looking for style & durability.
- EPE Foam for soft feel and comfort.
- 200 denier polyester construction.
- Deep arm holes for superior range of motion.
- 2" adjustable belts, chest strap and D ring.
- Perfect for skiing, wakeboarding, boating, fishing or just cruising across the water.
- USCG Approved Type III.



### RED

Product No.	Size	Chest Size	Weight
8-1512	X Small	28" - 32"	90 lbs. and Over
8-1514	Small	32" - 36"	90 lbs. and Over
8-1516	Medium	36" - 40"	90 lbs. and Over
8-1518	Large	40" - 44"	90 lbs. and Over
8-1520	X Large	44" - 48"	90 lbs. and Over
8-1522	XX Large	48" - 52"	90 lbs. and Over
8-1524	XXX Large	52" - 56"	90 lbs. and Over

## Tighten Up Deluxe Ski Vests

- Perfect for skiing, wakeboarding, boating, fishing or just cruising across the water.
- Increased durability and soft foam allows for maximum mobility.
- 200 denier polyester construction.
- All sizes feature closed sides.
- 2" adjustable belts, chest strap and D ring.
- Adult: USCG Approved Type III. Infant/Child: USCG Approved Type II.



### BLUE

Product No.	Size	Chest Size	Weight
8-1202	Infant/Child	-	Less than 50 lbs.
8-1204	Child	20" - 25"	30-50 lbs.
8-1206	Youth	24" - 29"	50-90 lbs.
8-1210	X Small	28" - 32"	90 lbs. and Over
8-1212	Small/Medium	32" - 40"	90 lbs. and Over
8-1214	Large/X Large	40" - 52"	90 lbs. and Over
8-1216	XX Lg/XXX Lg	50" - 60"	90 lbs. and Over

### RED

Product No.	Size	Chest Size	Weight
8-1232	Infant/Child	-	Less than 50 lbs.
8-1234	Child	20" - 25"	30-50 lbs.
8-1236	Youth	24" - 29"	50-90 lbs.
8-1240	X Small	28" - 32"	90 lbs. and Over
8-1242	Small/Medium	32" - 40"	90 lbs. and Over
8-1244	Large/X Large	40" - 52"	90 lbs. and Over
8-1246	XX Lg/XXX Lg	50" - 60"	90 lbs. and Over

## Xtreme Select-Fit Neoprene Sport Vests

- High performance neoprene jacket for all types of watersports.
- 1.5 mm thick premium neoprene (Inner and Outer layer).
- Full body neoprene for maximum comfort and protection.
- Child and Youth sizes are made of PVC foam.
- All Adult sizes are made of EPE foam.
- 2 body belts with 2" adjustable belts and YKK buckle and zipper.
- Deep arm hole for superior range of motion.
- Super strong stitching for maximum durability.
- Adult: USCG Approved Type III. Child: USCG Approved Type II.



### GREEN/BLACK

Product No.	Size	Chest Size	Weight
8-2124	Child	20" - 25"	30-50 lbs.
8-2126	Youth	24" - 29"	50-90 lbs.
8-2128	Small	32" - 36"	90 lbs. and Over
8-2130	Medium	36" - 40"	90 lbs. and Over
8-2132	Large	40" - 44"	90 lbs. and Over
8-2134	X Large	44" - 48"	90 lbs. and Over
8-2136	XX Large	48" - 52"	90 lbs. and Over

### BLUE/GRAY/BLACK

Product No.	Size	Chest Size	Weight
8-2012	Child	20" - 25"	30-50 lbs.
8-2014	Youth	24" - 29"	50-90 lbs.
8-2016	X Small	28" - 32"	90 lbs. and Over
8-2018	Small	32" - 36"	90 lbs. and Over
8-2020	Medium	36" - 40"	90 lbs. and Over
8-2022	Large	40" - 44"	90 lbs. and Over
8-2024	X Large	44" - 48"	90 lbs. and Over
8-2026	XX Large	48" - 52"	90 lbs. and Over
8-2028	XXX Large	52" - 56"	90 lbs. and Over

### RED/GRAY/BLACK

Product No.	Size	Chest Size	Weight
8-2032	Child	20" - 25"	30-50 lbs.
8-2034	Youth	24" - 29"	50-90 lbs.
8-2036	X Small	28" - 32"	90 lbs. and Over
8-2038	Small	32" - 36"	90 lbs. and Over
8-2040	Medium	36" - 40"	90 lbs. and Over
8-2042	Large	40" - 44"	90 lbs. and Over
8-2044	X Large	44" - 48"	90 lbs. and Over
8-2046	XX Large	48" - 52"	90 lbs. and Over
8-2048	XXX Large	52" - 56"	90 lbs. and Over

MARPAC

## Tighten Up General Purpose Vests



- Provides comfort and safety for all types of water activities.
- 1" adjustable belts for a snug fit.
- 200 denier polyester construction and adjustable belts for a secure fit.
- Open-sided styling for adjustability.
- Large armholes for greater mobility.
- Lightweight and durable foam fits snug, won't limit your mobility.
- Adult: USCG Approved Type III. Infant/Child: USCG Approved Type II.

### BLUE

Product No.	Size	Chest Size	Weight
<b>8-1012</b>	Infant/Child	-	Less than 50 lbs.
<b>8-1014</b>	Child	20" - 25"	30-50 lbs.
<b>8-1016</b>	Youth	24" - 29"	50-90 lbs.
<b>8-1018</b>	Universal	30" - 52"	90 lbs. and Over
<b>8-1020</b>	Oversize	52" - 62"	90 lbs. and Over

### RED

Product No.	Size	Chest Size	Weight
<b>8-1032</b>	Infant/Child	-	Less than 50 lbs.
<b>8-1034</b>	Child	20" - 25"	30-50 lbs.
<b>8-1036</b>	Youth	24" - 29"	50-90 lbs.
<b>8-1038</b>	Universal	30" - 52"	90 lbs. and Over
<b>8-1040</b>	Oversize	52" - 62"	90 lbs. and Over

MARPRO

## OSB - Overhead Storage Bag



- 600 denier polyester and nylon construction.
- Attaches fore or aft to most Bimini or T-Tops.
- Mesh top allows wet jackets to breath.
- 3 mesh & 2 solid pockets adds convenient extra storage.
- UV, mold and water resistant.
- Shock cord webbing holds towels, charts and more.
- Easy to attach with four strong 2" wide straps with nylon buckles.
- Includes installation hardware for bimini tops with canvas sleeves covering the frame.
- Holds up to (6) jackets.
- Dimensions: 37" W x 20" D x 7" H.

Product No.	Description
<b>7-7002</b>	OSB - Overhead Storage Bag

TOUGH GUY

## Water Ski Flag



- Made of 420 Denier nylon.
- High visibility orange flag.
- Dimensions: 12" x 12".
- Durable 24" pole.
- Suction cup included.

Product No.	Description
<b>7-52440</b>	Water Ski Flag

BOATER SPORTS

## Xtreme 33 Gram Adult Inflatable Life Vests



- US Coast Guard Approved Type III performance, Type V when worn.
- Lightweight and less restrictive than other PFD's.
- Neoprene collar and mesh back for cool comfort.
- One size fits all.
- Bright yellow inflation cell with SOLAS reflective tape for extra visibility.
- Safety whistle included.
- An excellent choice for a full day on the water.

### MANUAL

Product No.	Color
<b>8-0314</b>	Blue/Black
<b>8-0316</b>	Red/Black

### AUTOMATIC

Product No.	Color
<b>8-0304</b>	Blue/Black
<b>8-0306</b>	Red/Black

## Xtreme Waistbelt Personal Flotation Device



- One size fits all.
- Comfort fit.
- Halkey Roberts/UML mechanism.
- Oral backup inflatable.
- 24 gram cylinder.
- Manual activation.

Product No.	Description
<b>8-0332</b>	Black/Red

## Life Jacket Storage Bag



- Holds up to (5) Type II Life Jackets.
- Mesh top for better airflow, improved drying.
- Easy to clean with just soap and water.
- Convenient carry handles on each side.
- Made with rugged vinyl material and non-corrosive zippers.
- Dimensions: 21" L x 13" W x 16" H.

Product No.	Description
<b>7-0046</b>	Life Jacket Storage Bag

## Safety Gear Bag



- Rugged vinyl material.
- Noncorrosive zipper.
- Top and side carry handles.
- Extra sturdy seams.
- Dimensions: 26" L x 12" W x 17" H.

Product No.	Description
<b>7-0045</b>	Safety Gear Bag



**Life Ring Brackets**

- Heavy duty, commercial grade.
- Fits ring buoys 30" in diameter.
- Designed for commercial use with heavy duty welds.



Product No. Description

<b>5-0010</b>	Aluminum
<b>5-0015</b>	Stainless Steel

**Ring Buoy Bracket**

- Stainless steel.
- Predrilled.
- Width 3/4".



Product No. Description

<b>7-0097</b>	Ring Buoy Bracket
---------------	-------------------

**DECK BRUSH**

**Deck Brush with 4' Aluminum Handle**

- Deck brush with basic 4' aluminum handle with added rubber bumper, mar resistant head - medium soft bristles.
- Deluxe has telescopic aluminum handle, non-slip cam lock for positive no leak on-off use.



Product No. Description

<b>7-52702</b>	Deck Brush with Handle
----------------	------------------------

**PAINT SPRAY GUN**

**Paint Spray Gun**

- HVLP gun with durable metal body.
- Designed for use with a wide variety of paints.
- Includes polypropylene bottle.
- Low - air and paint applied in uniform layers.
- Excellent internal.



Product No. Description

<b>7-1069</b>	Paint Spray Gun
---------------	-----------------

**LADDERS**

**Stainless Steel Telescoping Drop Ladders**

- Telescopes for compact storage and easy deployment.
- Non-skid plastic treads angled for safety and comfort.
- Heavy gauge polished stainless steel finish.
- Includes easy-store bungee cord.
- Use with 1/4" bolts (not included).
- Maximum 440 lbs. weight limit.

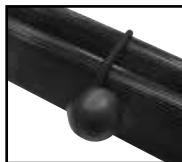

Product No.	Steps	Dimensions	Gudgeon
<b>7-1635</b>	2 Steps	11-3/4" W x 23-1/2" L (Stowed 13-1/2" L)	5-7/8" L
<b>7-1636</b>	3 Steps	12" W x 35" L (Stowed 15-5/16" L)	7" L
<b>7-1637</b>	4 Steps	12-1/2" W x 45-1/2" L (Stowed 16-1/8" L)	6-1/2" L

**Stainless Steel Sport/Diver Ladders**

- Stainless steel.
- Diameter 1-3/4" center post.
- Comfortable non-skid step surface.
- Includes: (2) Storage clips and a quick release mounting bracket.
- Maximum 440 lbs. weight limit.
- Width 14".



Product No. Description

<b>7-1630</b>	3 Steps	Length 36"
<b>7-1631</b>	4 Steps	Length 48"
<b>7-1632</b>	Quick Release Mounting Bracket	

**Gunwale Ladder - 4 Steps**

- 15" non-slip composite steps for easy boarding.
- Corrosion resistant 1" diameter polished aluminum tubing.
- 10-1/2" hooks fit over most gunwales.
- Folds flat for easy storage.
- Adjustable standoffs with non-marking tips protect the hull.
- Maximum 250 lbs. weight limit.



Product No. Description

<b>7-1634</b>	4 Steps
---------------	---------

**Quick Release Mounting Bracket**

- Constructed of stainless steel with nylon spacer (1" to 5/8" thick).
- This mounting bracket allows quick and simple removal of our **7-1630** and **7-1631** Sport/Diver Ladders.
- Stainless steel pull pin securely locks ladder in place.
- Mounts with (4) fasteners (not included).
- Dimensions: 2-1/2" W x 3-3/4" H.



Product No. Description

<b>7-1632</b>	Quick Release Mounting Bracket
---------------	--------------------------------

MARPAC

## Telescoping Boat Hook

- Perfect for docking, launching, mooring or retrieving.
- Easy to set up, it requires only a simple twist of the telescoping tubes to lock in position.
- Hook will not mar boat's finish.
- Guaranteed unbreakable hook made of noncorrosive Lexan.
- Adjustable from 49" to 76".



Product No. Description

**7-0602** Telescoping Boat Hook

## Telescopic Boat Hook

- Anodized aluminum for corrosion resistance.
- Telescoping handle has a positive CamLock for more secure use and easy stowing.
- Removable hook so pole can be used for other purposes - brush, mop, etc.
- Adjustable from 45" to 96".
- 3 Sections.



Product No. Description

**7-56114** Telescopic Boat Hook

MARPRO

## L.E.D. Advantage Cup Holder

- Dress up your dash!
- Marine grade stainless steel.
- Nylon hose barb for 3/8" hose.
- Included self-adhesive gasket.
- Cut-out size 3-1/2".
- Overall flange OD 4-1/4".
- Fits most cup holes.
- Glows "Blue" when lit



Product No. Description

**7-0974** LED Advantage Cup Holder

## Stainless Steel Drink Holder

- Marine grade stainless steel.
- Nylon hose barb for 3/8" hose.
- Included self-adhesive gasket.
- Cut-out size: 3-1/2".
- Overall flange OD: 4-1/4".
- Fits most cup holes.



Product No. Description

**7-0961** Drink Holder

TOUGH GUY

## Universal Mount Drink Holder

- Mounts with suction cups to any smooth surface.
- Mounts to any vertical or horizontal rails with supplied adapters.
- White polyethylene is easy to clean.
- Stainless steel fasteners.



Product No. Description

**7-0962** Universal Mount Drink Holder

## Adjustable Drink Holders

- Pop-up adjustable arms hold a variety of containers.
- Folding design saves space when not in use.
- Mounts on any flat surface.
- Made of reinforced nylon with stainless steel springs and nickel plated brass rivets.
- Stainless steel mounting screws included.



Product No. Description

**7-0575** Black

**7-0960** White

BOATER SPORTS

## Boat Caddy

- Large storage compartment with drink holder.
- Two large suction cups for easy installation and removal.
- Optional permanent mounting with screws (not included).
- No tools required.



Product No. Description

**7-2420** White

## Electronics Caddy

- Storage compartments keep personal items organized and accessible.
- Includes slots to hang hooks and lures.
- Easy installation and removal for security and portability.
- No tools required.



Product No. Description

**7-2422** White



## Single Drink Holder Caddy

- Includes slots to hold knives, pliers, hooks and lures.
- Two large suction cups for easy installation and removal.
- Optional permanent mounting with crews (not included).
- No tools required.



Product No. Description

**7-2424** White

## Flag Pole - Extendable

- Extendable flag pole fits in existing stern light socket.
- Compatible with most major light pole sockets.
- 26" - 48" extension to fit most flags.

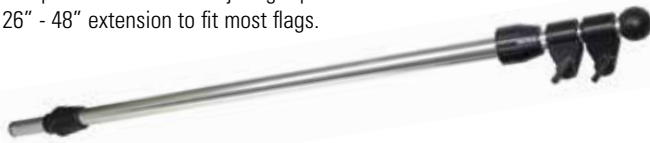

Product No. Description

**7-58007** Flag Pole - Extendable

## Stainless Steel Clamp-On Rod Holder

- Cast 316 stainless steel.
- Adjustable for 7/8" and 1" rail installation.
- Can be mounted on horizontal or vertical rails.
- Composite liner.
- Overall length 9".
- 1-1/2" ID.



Product No. Description

**7-0897** Clamp-on Rod Holder

## Flush Mount Rod Holder

- Heavy duty cast stainless steel with UV resistant liner.
- 30° angle.
- Overall length 9-1/2".
- 1-7/8" ID.



Product No. Description

**7-0890** Flush Mount Rod Holder

## One Piece Rod and Tool Holders

- Compact design.
- Solid molded construction.
- Mounts to any flat, vertical surface.
- Holds knife, screw drivers or fish hooks.

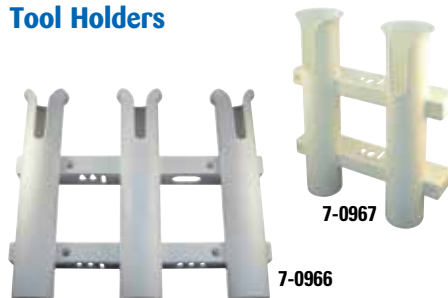

Product No. Description

**7-0967** Holds Up To 2 Poles 8-3/4" W x 10-3/4" H

**7-0966** Holds Up To 3 Poles 12-1/2" W x 10-3/4" H

## Knife & Pliers Holder

- Holds 1 set of pliers and carabiner, 2 knives, 13 hook and lure holders.
- UV protected, weather and corrosion proof.
- Screw or suction cups for customizable installation.



Product No. Description

**7-2426** White

## Tournament Clamp-On Rod Holder

- Polished stainless steel.
- Clamp-on, Tulip style.
- 32 rod angles make this one of the most versatile rod holders available.
- White vinyl liner.
- For use with 1-1/4" tube or 3/4" pipe.



Product No. Description

**7-0898** Tournament Clamp-on Rod Holder

## Flush Mount Rod Holder

- Type 304 stainless steel with UV resistant liner and cap.
- 30° angle.
- Overall length 9-1/2".
- 1-7/8" ID.
- Includes: (3) M5 x 35 oval head stainless steel screws.



Product No. Description

**7-0891** Flush Mount Rod Holder

## Flush Mount Rod Holders

- Molded nylon plastic.
- 30° angle.
- Use with rods under 1-1/2" diameter.
- Uses #10 screws (not included).
- 2-1/2" hole required for installation.



Product No. Description

**7-0437** Black Sold Each

**7-0437S** Black Sold 24 Pack

**7-0438** White Sold Each

**7-0438S** White Sold 24 Pack

## Adjustable Rod Holder

- Nylon rod holder mounts in one of 4 ways - top mount, side mount, rail mount, or square rail mount.
- Swivels and pivots to different angles.
- Black.



Product No. Description

**7-52227** Adjustable Rod Holder

## Rod Hold-Downs

- Deck mount rod hold-down.
- Includes: One rubber hold-down strap, one eye strap and three stainless steel screws.



Product No. Description

**7-52234** Length 18"

**7-52235** Length 12"

## Horizontal Mount Rod Holder

- Durable polyurethane construction securely holds up to three rods.
- Foam cushions tightly grip rods without damage.
- Easy to install - mounts to any flat surface.



Product No. Description

**7-0963** Horizontal Mount Rod Holder

## Adjustable Spring Clamps

- Stainless steel.
- Excellent for boat hooks, flashlights, oars, fishing rods, charts, etc.
- Uses #6 fasteners.
- Sold 2 per card.



Product No. Minimum Maximum Projection Clamp Width

**7-0099** 5/8" ID 1-1/4" ID 1-1/2" 1/2"

**7-0100** 1" ID 1-3/4" ID 2-1/4" 5/8"

## Access Hatches - White

- Watertight - lid overlapping frame.
- Two separate seals on frame and lid.
- Corrosion free integrated hinges allow 180° opening.
- No visible fasteners.

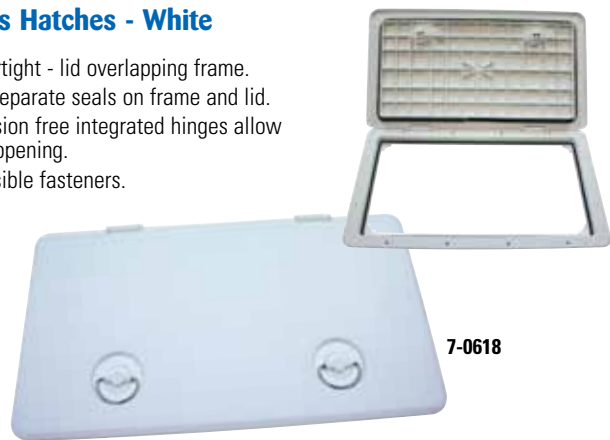

7-0618

Product No. Description

**7-0617** 11" x 15"

**7-0618** 13" x 24" (Two Handles)

## Wire Type Rod Holder

- UV resistant black plastic coating protects rod from scratches and prevents corrosion.
- 3/8" coated steel rod holder.

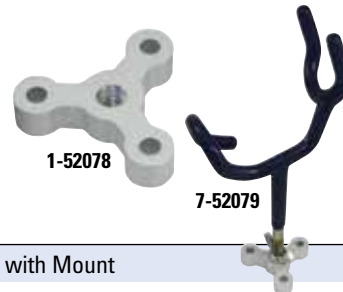

Product No. Description

**7-52079** Wire Type Rod Holder with Mount

**1-52078** Mount Only

## Boat Hook Holders

- Polished stainless steel.
- Holds boat hooks up to 1-1/4" OD.
- Uses #6 fasteners.
- Sold per pair.



Product No. Description

**7-0098** Boat Hook Holders

## Cooler Mounts

- Kit includes: (4) Corner supports and two bungee cords with stainless steel cooler clip.
- Fits almost any cooler.
- Secure coolers or tackle boxes.
- Corrosion proof design.
- Secures loose coolers from sliding, preventing damage to people and boat.
- Easy cooler removal with quick disconnecting bungees.



Product No. Description

**7-7048** Cooler Mounts

## Deck Plates

- Watertight.
- O-ring seal concealed in the lid.
- Size shown is the plate hole I.D., add approximately 2" for flange O.D.



Screw Out

Pry Out

Product No. Description

**7-0633** Diameter 6" White Textured Lids Pry Out

**7-0628** Diameter 8" White Textured Lids Pry Out

**7-0620** Diameter 4" Black Textured Lids Screw Out

**7-0621** Diameter 4" White Textured Lids Screw Out

**7-0622** Diameter 4" White Smooth Lids Screw Out

**7-0623** Diameter 6" Black Textured Lids Screw Out

**7-0624** Diameter 6" White Textured Lids Screw Out

**7-0625** Diameter 6" White Smooth Lids Screw Out

**7-0635** Diameter 8" Black Textured Lids Screw Out

**7-0636** Diameter 8" White Textured Lids Screw Out

## Stainless Steel Push to Close Latches

- Stainless steel face and pull.
- Corrosion resistant materials.
- Flush mount.
- Pull to open.
- Single, round-hole installation.
- Inside actuation when locked or unlocked.



Locking Latch

Non-Locking Latch

## NON-LOCKING LATCHES

Product No.	Description
7-2267	1-3/4" OD Cutout Size: 1-3/8"
7-2270	2-3/8" OD Cutout Size: 2"

## LOCKING LATCH

Product No.	Description
7-2271	2-3/8" OD Cutout Size: 2"

## Push to Close Latches

- Corrosion resistant materials.
- Pull to open.
- Single, 2" diameter round-hole installation.
- Fits panels .475" to .675" thick.



Product No.	Description
7-2260	Black
7-2261	White

## Stainless Steel Barrel Bolts

- Precision cast stainless steel.



Product No.	Description
7-0409	Dimensions: 3-1/2" x 1-1/2"
7-0410	Dimensions: 4-1/2" x 1-1/2"

## Stainless Steel Lift Ring

- Polished 304 stainless steel.
- Surface mount installation.
- Dimensions: 2-1/8" x 1-15/16".



Product No.	Description
7-0084	Lift Ring

## Stainless Steel Flush Lifting Handle

- Polished stainless steel.
- Dimensions: 2-1/4" x 3".
- Uses #8 fasteners.



Product No.	Description
7-0085	Flush Lifting Handle

## Stainless Steel Lift & Turn Latches

- Cast stainless steel.
- 180° turn and close capability.



Product No.	Description
7-1370	3" OD Cutout Size: 2-1/2"
7-1371	2-1/2" OD Cutout Size: 2"

## Push to Close Latch

- Corrosion resistant materials.
- Pull to open.
- Single, 2" diameter round-hole installation.
- Fits panels .475" to .675" thick.
- Black.



Product No.	Description
7-2265	Push to Close Latch

## Plastic Door Latches

- Set includes one male and one female.
- Uses #6 fasteners.
- Sold 3 sets per card.



Product No.	Description
7-0220	Plastic Door Latches

## Stainless Steel Ball Catch

- Heavy duty cast type 316 marine grade stainless steel.
- Dimensions: 2" W x 3/8" H.



Product No.	Description
7-0221	Ball Catch

## Locking Lift Ring

- Keep valuables protected with this easy to install lock.
- Includes regular and offset cams.
- Dimensions: 2-1/8" x 1-15/16".
- Includes 2 keys.



Product No.	Description
7-54205	Locking Lift Ring

## Flush Hatch Pull

- Injection molded and large enough to get your fingers in.
- Strong material will flex but not break when stepped on.
- Dimensions: 2-1/4" x 2-1/4".



Product No.	Description
7-54207	Flush Hatch Pull

MARPAC

## Stainless Steel Hatch Cover Pull

- Type 304 stainless steel with electro-polished finish.
- Stainless steel washer and keep ring.
- Lays flat - easy to use.
- Lifting disc: 1-1/4".
- Stem diameter: 3/16".



Product No. Description

**7-0651** Hatch Cover Pull

## Stainless Steel Drawer Knob

- Cast 316 stainless steel with 1" screw.
- Diameter 1"



Product No. Description

**7-0408** Drawer Knob

## Swivel Lock Hasps

- Type 304 stamped stainless steel.
- A strong versatile utility hasp with a swivel head.
- Uses #6 fasteners.



Product No. Description

**7-0216** Dimensions: 1-3/4" x 1"

**7-0218** Dimensions: 3-1/4" x 1"

## Butt Hinges

- Polished, stamped type 304 stainless steel.
- .060 gauge.
- Uses #8 fasteners, except 7-1009 uses #10 fasteners.
- Sold per pair.



Product No. Description

**7-1007** Open Width 2" Pin Length 2"

**7-1008** Open Width 2" Pin Length 3"

**7-1009** Open Width 3" Pin Length 3"

## Utility Hinge

- Stamped stainless steel.
- Open width 3". Pin length 1-1/2".
- Uses #8 fasteners.
- Sold per pair.



Product No. Description

**7-0457** Utility Hinge

## Utility Hinge

- Stainless steel.
- Flush mount.
- Dimensions: 2.664" x 1.5".
- Sold per pair.



Product No. Description

**7-1010** Utility Hinge

## Push-to-Close Latch

- Chrome.
- Corrosion and UV resistant.
- Quick, round-hole installation.
- Knob stores flush; pops out at a touch.
- Pull the knob to open, simply push the door to close.



Product No. Description

**7-2285** Push-to-Close Latch

## Locking Push-to-Close Latch

- Glass reinforced black nylon.
- Corrosion resistant.
- Locking.
- Pull tab in line with latching pawl.



Product No. Description

**7-2280** Locking Push-to-Close Latch

## Stainless Steel 90° Angle Bracket

- Polished stainless steel.
- Leg length 2-3/8", leg width 9/16".
- Sold per pair.



Product No. Description

**7-0411** 90° Angle Bracket

## Stay-Put Hinges

- 316 stainless steel and phosphor bronze construction for maximum corrosion resistance.
- No more limp hinges.
- Holds open hatches, live well lids, electronic box doors-stays where it's put.
- Eliminates the need for gas shocks or hatch springs in some applications.
- Patented friction technology from GEM.
- Replaces existing hinges with matching mounting holes.
- Used on over 100 boat manufacturers including: Chaparral Boats, Robalo Boats, Yellowfin Yachts, Sea Ray, Sea Hunt Boats, Tidewater Boats, Sundance Skiffs, Maverick, Cobia and Key West Boats.
- Uses #8 fasteners.
- Note: DO NOT attempt to adjust the tension of the friction hinge in any way.



Product No. Description

**7-1475** Butt Hinge 4 Hole 1-1/2" L x 1-1/2" W

**7-1479** Utility Hinge 6 Hole 3" L x 1-1/2" W

**7-1481** Butt Hinge 4 Hole 2" L x 2" W

**7-1483** Butt Hinge 6 Hole 3" L x 2" W

MARPRO

TOUGH GUY

BOATER SPORTS

## Utility Hinge

- Stamped stainless steel.
- Open width 2".
- Pin length 1-1/2".
- Uses #8 fasteners.
- Sold per pair.



Product No.	Description
<b>7-0458</b>	Utility Hinge

## Heavy Duty Butt Hinge

- Cast stainless steel.
- Dimensions: 1-1/2" x 1-1/2".
- Uses #10 fasteners.
- Sold per pair.



Product No.	Description
<b>7-0970</b>	Heavy Duty Butt Hinge

## Strap Hinges

- Polished, stamped type 304 stainless steel.
- Uses #8 fasteners.
- Sold per pair.



Product No.	Description
<b>7-0455</b>	Dimensions: 4" x 1-3/16"
<b>7-0456</b>	Dimensions: 6" x 1-3/16"

## Flush Mount Concealed Hinge

- Stamped type 304 stainless steel with satin finish.
- Dimensions: 2-3/4" x 1-7/8".
- Sold per pair.



Product No.	Description
<b>7-0105</b>	Flush Mount Concealed Hinge

## Chrome Plated Brass Motor Box Hinge

- Heavy duty chrome plated brass.
- Removable.
- Length 4", width at pin: 2-1/8".
- Uses #14 fasteners (not included).



Product No.	Description
<b>7-0211</b>	Motor Box Hinge

## Hatch Support Spring

- Stainless steel hatch spring holds open hatches, doors, table leaves, etc.
- Holds up to 10 lbs.
- Length 8".



Product No.	Description
<b>7-54208</b>	Hatch Support Spring

## Offset Shortside Hinge

- Polished, stamped type 304 stainless steel.
- Thickness .060" gauge.
- Open width 2", pin length 1-1/2", offset 3/8".
- Uses #8 fasteners.
- Sold per pair.



Product No.	Description
<b>7-1005</b>	Offset Shortside Hinge

## Butt Hinge

- Stainless steel.
- Dimensions: 1-5/16" W (Open) x 1-1/2" L.
- Uses #8 fasteners.
- Sold per pair.



Product No.	Description
<b>7-0686</b>	Butt Hinge

## Strap Hinges

- Polished, cast 316 stainless steel.
- Uses #10 fasteners.
- Sold per pair.



Product No.	Description
<b>7-0500</b>	Dimensions: 4" x 1" 4 Screw Holes
<b>7-0501</b>	Dimensions: 6" x 1" 6 Screw Holes

## Hatch Hinge

- Polished stainless steel.
- Length 2-7/8", width 2-5/8", height 1-5/32".
- Uses #10 fasteners.



Product No.	Description
<b>7-0213</b>	Hatch Hinge

## Windshield Fastener

- Black nylon.
- Windshield quick release fasteners make removing and installing windshield easy.



Product No.	Description
<b>7-54211</b>	Windshield Fastener

## Utility Transom Handle

- Heavy duty cast marine grade stainless steel.
- Use #10 fasteners.
- Dimensions: 5-7/8" L x 1-15/16" W x 1-13/16" H.



Product No.	Description
<b>7-0648</b>	Utility Transom Handle

MARPAC

## Gas Spring Hatch Lifts

- Stainless steel.
- Socket End Style.
- The ideal solution for lifting, lowering and counterbalancing weight.
- The gas spring is a self-contained, nitrogen-driven counterbalance product which provides uniform handle forces, non-catastrophic failure and many years of service.
- Because energy is provided through gas pressure, our gas springs give you repeatable, unvarying performance which is superior to mechanical, spring or damper type products.



Product No.	Retracted Length	Approx. Stroke	Extended Length	Output Force	Shaft Diameter
<b>7-1386</b>	5.5"	2"	7.5"	20 lbs.	6mm
<b>7-1375</b>	7"	3"	10"	40 lbs.	8mm
<b>7-1387</b>	7"	3"	10"	40 lbs.	6mm
<b>7-1388</b>	7"	3"	10"	60 lbs.	6mm
<b>7-1389</b>	8"	4"	12"	30 lbs.	6mm
<b>7-1377</b>	9.5"	5.5"	15"	20 lbs.	8mm
<b>7-1390</b>	9.5"	5.5"	15"	40 lbs.	6mm
<b>7-1379</b>	9.5"	5.5"	15"	60 lbs.	8mm
<b>7-1392</b>	10.2"	7"	17.2"	20 lbs.	6mm
<b>7-1381</b>	10.2"	7"	17.2"	40 lbs.	8mm
<b>7-1394</b>	12"	8"	20"	60 lbs.	6mm
<b>7-1383</b>	12"	8"	20"	90 lbs.	8mm
<b>7-1385</b>	12"	8"	20"	120 lbs.	8mm

MARPRO

## Brackets for Gas Spring Hatch Lifts

- Corrosion resistant stainless steel.
- Uses #10 fasteners.
- Sold per pair.



Product No.	Dimensions
<b>7-1396</b>	Flat Mount with 10mm Ball Stud
<b>7-1397</b>	90° Mount with 10mm Ball Stud
<b>7-1395</b>	90° Mount with 10mm Ball Stud

TOUGH GUY

## Soft Draw Latch

- Made with corrosion resistant materials.
- Over-center latching.
- Cushions impact, absorbs vibration, tolerates misalignment.
- Concealed mounted stainless steel keeper.
- Patented design.
- Dimensions: 4" x 1-1/2".



Product No.	Description
<b>7-2250</b>	Soft Draw Latch

BOATER SPORTS

## Stainless Steel Hold Down Clamp

- Stainless steel.
- Dimensions: 3" L x 1-1/2" W.



Product No. Description

**7-0223** Hold Down Clamp

## Stainless Steel Hold Down Clamp

- Stainless steel.
- 90° angle mounting
- Dimensions: 2-1/2" L x 1-1/2" W.



Product No. Description

**7-0224** Hold Down Clamp

## Stainless Steel Hold Down Clamp

- Stainless steel.
- Heavy duty.
- Uses #10 fasteners (not included).
- Dimensions: 4" L x 1-7/8" W x 1" H.



Product No. Description

**7-0225** Hold Down Clamp

## Chrome Plated Brass Hold Down Clamp

- Chrome plated brass.
- Heavy duty.
- Uses #10 fasteners (not included).
- Dimensions: 4" L x 1-3/4" W.



Product No. Description

**7-0214** Hold Down Clamp

## Rubber Hatch/Cooler Latch

- Rubber grip.
- Stainless steel catch.
- Easy to use.



Product No. Description

**7-54151** Rubber Hatch/Cooler Latch

## T-Handle Latch

- Flexible.
- Non-corrosive, non-conductive, UV resistant materials.
- Compensates for misalignment in 3 planes.
- Built-in drag keeps latch stationary when unlatched.
- Length 4.81".



Product No. Description

**7-2255** T-Handle Latch

Product No. Dimensions

<b>7-0187</b>	Forward 120°	For 7/8" OD Tubing
<b>7-0188</b>	Center 60°	For 7/8" OD Tubing
<b>7-0189</b>	Aft 60°	For 7/8" OD Tubing
<b>7-0987</b>	Forward 120°	For 1" OD Tubing
<b>7-0988</b>	Center 60°	For 1" OD Tubing
<b>7-0989</b>	Aft 60°	For 1" OD Tubing

## Hand Rail Bases

- 316 stainless steel hand rail bases.
- Fittings for 7/8" OD tubing have 1-1/2" base.
- Fittings for 1" OD tubing have 1-3/4" base.
- Have no set screw.

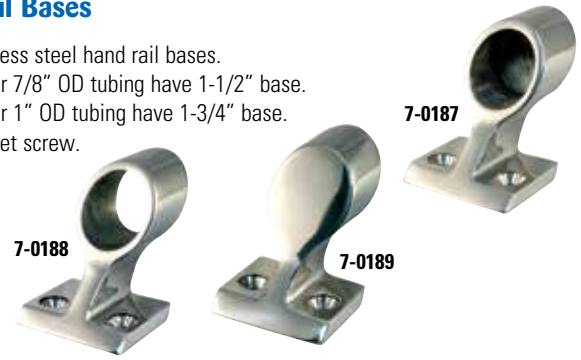

## CAST STAINLESS STEEL RAIL FITTINGS

Heavy duty cast type 316 marine grade stainless steel • Skin packed

### 30° Round Base

- Includes set screw.
- Skin packed.



Product No. Dimensions

<b>7-0178</b>	7/8" OD Tubing	2-5/8"	Uses #10 Fasteners
<b>7-0978</b>	1" OD Tubing	2-7/8"	Uses 1/4 Fasteners

### 60° Round Base

- Includes set screw.
- Skin packed.



Product No. Dimensions

<b>7-0179</b>	7/8" OD Tubing	2-5/8"	Uses #10 Fasteners
<b>7-0979</b>	1" OD Tubing	2-3/16"	Uses 1/4 Fasteners

### 90° Round Base

- Includes set screw.
- Skin packed.



Product No. Dimensions

<b>7-0180</b>	7/8" OD Tubing	2-5/8"	Uses #10 Fasteners
<b>7-0980</b>	1" OD Tubing	2-3/4"	Uses 1/4 Fasteners

### 30° Rectangular Base

- Includes set screw.
- Skin packed.



Product No. Description

<b>7-0181</b>	7/8" OD Tubing	2-5/8"	Uses #10 Fasteners
---------------	----------------	--------	--------------------

### 60° Rectangular Base

- Includes set screw.
- Skin packed.



Product No. Dimensions

<b>7-0182</b>	7/8" OD Tubing	Uses #10 Fasteners
<b>7-0982</b>	1" OD Tubing	Uses 1/4 Fasteners

### 90° Rectangular Base

- Includes set screw.
- Skin packed.



Product No. Dimensions

<b>7-0183</b>	7/8" OD Tubing	Uses #10 Fasteners
<b>7-0983</b>	1" OD Tubing	Uses 1/4 Fasteners

### 60° Tee



Product No. Dimensions

<b>7-0202</b>	7/8" OD Tubing
<b>7-1002</b>	1" OD Tubing

### 90° Tee



Product No. Dimensions

<b>7-0186</b>	7/8" OD Tubing
<b>7-0986</b>	1" OD Tubing

### 90° Elbow



Product No. Dimensions

<b>7-0192</b>	7/8" OD Tubing
<b>7-0992</b>	1" OD Tubing

### 110° Bow Form



Product No. Description

<b>7-0190</b>	7/8" OD Tubing
---------------	----------------

**Phillips Pan Sheet Metal Screws**

- Stainless steel.



Product No. Dimensions

<b>7-5200</b>	4 x 1/2	6 pieces per card
<b>7-5205</b>	6 x 1/2	8 pieces per card
<b>7-5210</b>	6 x 3/4	8 pieces per card
<b>7-5215</b>	8 x 1/2	7 pieces per card
<b>7-5220</b>	8 x 3/4	7 pieces per card
<b>7-5225</b>	8 x 1	6 pieces per card
<b>7-5230</b>	8 x 1-1/2	5 pieces per card
<b>7-5235</b>	10 x 1/2	6 pieces per card
<b>7-5240</b>	10 x 3/4	6 pieces per card
<b>7-5245</b>	10 x 1	5 pieces per card
<b>7-5250</b>	10 x 1-1/2	4 pieces per card
<b>7-5255</b>	12 x 1	4 pieces per card
<b>7-5260</b>	12 x 1-1/2	3 pieces per card
<b>7-5265</b>	14 x 1	3 pieces per card

**Phillips Pan Machine Screws with Nut**

- Stainless steel.



Product No. Dimensions

<b>7-5410</b>	8-32 x 1	6 pieces per card
<b>7-5415</b>	8-32 x 1-1/2	5 pieces per card
<b>7-5420</b>	10-24 x 1	5 pieces per card
<b>7-5425</b>	10-24 x 1-1/2	4 pieces per card
<b>7-5430</b>	10-24 x 2	4 pieces per card
<b>7-5435</b>	1/4-20 x 1-1/2	3 pieces per card
<b>7-5440</b>	1/4-20 x 2	3 pieces per card
<b>7-5445</b>	1/4-20 x 3	2 pieces per card
<b>7-5447</b>	1/4-20 x 4	2 pieces per card

**Hex Head Cap Screws**

- Stainless steel.



Product No. Dimensions

<b>7-5770</b>	1/4-20 x 1	3 pieces per card
<b>7-5575</b>	1/4-20 x 1-1/2	2 pieces per card
<b>7-5580</b>	1/4-20 x 2	2 pieces per card
<b>7-5585</b>	1/4-20 x 2-1/2	2 pieces per card
<b>7-5590</b>	1/4-20 x 3	2 pieces per card

**Wing Nuts**

- Stainless steel.

**Phillips Oval Sheet Metal Screws**

- Stainless steel.



Product No. Dimensions

<b>7-5270</b>	6 x 1/2	8 pieces per card
<b>7-5275</b>	6 x 3/4	8 pieces per card
<b>7-5280</b>	6 x 1	7 pieces per card
<b>7-5285</b>	8 x 3/4	7 pieces per card
<b>7-5290</b>	8 x 1	6 pieces per card
<b>7-5295</b>	8 x 1-1/4	6 pieces per card
<b>7-5300</b>	8 x 1-1/2	5 pieces per card
<b>7-5305</b>	10 x 3/4	6 pieces per card
<b>7-5310</b>	10 x 1	5 pieces per card
<b>7-5315</b>	10 x 1-1/4	5 pieces per card
<b>7-5320</b>	10 x 1-1/2	4 pieces per card
<b>7-5325</b>	10 x 2	4 pieces per card
<b>7-5330</b>	12 x 1	4 pieces per card
<b>7-5335</b>	12 x 1-1/2	3 pieces per card
<b>7-5340</b>	12 x 2	3 pieces per card
<b>7-5345</b>	14 x 1-1/2	3 pieces per card
<b>7-5350</b>	14 x 2	2 pieces per card
<b>7-5355</b>	14 x 2-1/2	2 pieces per card

**Phillips Oval Machine Screws with Nut**

- Stainless steel.



Product No. Dimensions

<b>7-5360</b>	6-32 x 1	6 pieces per card
<b>7-5365</b>	8-32 x 1	5 pieces per card
<b>7-5370</b>	8-32 x 1-1/2	4 pieces per card
<b>7-5375</b>	10-24 x 1	4 pieces per card
<b>7-5380</b>	10-24 x 1-1/2	4 pieces per card
<b>7-5385</b>	10-24 x 2	3 pieces per card
<b>7-5387</b>	10-24 x 3	2 pieces per card
<b>7-5390</b>	1/4-20 x 1	3 pieces per card
<b>7-5395</b>	1/4-20 x 1-1/2	2 pieces per card
<b>7-5400</b>	1/4-20 x 2	2 pieces per card
<b>7-5405</b>	1/4-20 x 3	2 pieces per card
<b>7-5407</b>	1/4-20 x 4	2 pieces per card

**Well Nuts**

- Stainless steel.



Product No. Dimensions

<b>7-5560</b>	1/4-20 x 5/8"	3 pieces per card
<b>7-5565</b>	1/4-20 x 1"	2 pieces per card
<b>7-5566</b>	10-24 x 3/4"	3 pieces per card

Product No. Dimensions

<b>7-5555</b>	1/4-20	3 pieces per card
---------------	--------	-------------------



## Finished Hex Nuts

- Stainless steel.



Product No.	Dimensions	
<b>7-5520</b>	10-24	12 pieces per card
<b>7-5525</b>	1/4-20	10 pieces per card

## Nylon Lock Nuts

- Stainless steel.



Product No.	Dimensions	
<b>7-5530</b>	3-32	4 pieces per card
<b>7-5535</b>	10-24	4 pieces per card
<b>7-5540</b>	1/4-20	3 pieces per card

## Flat Washers

- Stainless steel.

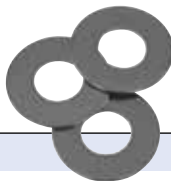

Product No.	Dimensions	
<b>7-5450</b>	#6	50 pieces per card
<b>7-5455</b>	#8	50 pieces per card
<b>7-5460</b>	#10	25 pieces per card
<b>7-5465</b>	1/4"	15 pieces per card

## Finishing Washers

- Stainless steel.



Product No.	Dimensions	
<b>7-5490</b>	#6	20 pieces per card
<b>7-5495</b>	#8	18 pieces per card
<b>7-5500</b>	#10	15 pieces per card
<b>7-5505</b>	1/4"	7 pieces per card

## Twist Stud Two Hole

- Sold 2 per bag.



Product No.	Description
<b>7-6199</b>	Twist Stud Two Hole

## Cap and Socket

- Sold 6 sets per bag.



Product No.	Dimensions
<b>7-6178</b>	11/64"
<b>7-6175</b>	1/4"

## Snap Screw Studs

- Sold 6 per bag.



Product No.	Dimensions
<b>7-6190</b>	#7 x 3/8"

## Lock Washers

- Stainless steel.



Product No.	Dimensions	
<b>7-5480</b>	#10	25 pieces per card
<b>7-5485</b>	1/4"	15 pieces per card

## Cotter Pins

- Stainless steel.
- Sold in boxes of 5 bags only.



Product No.	Dimensions	
<b>7-5005</b>	1/16 x 1/2	24 pieces
<b>7-5010</b>	1/16 x 3/4	18 pieces
<b>7-5015</b>	1/16 x 1	18 pieces
<b>7-5020</b>	1/16 x 1-1/2	10 pieces
<b>7-5040</b>	3/32 x 1	8 pieces
<b>7-5045</b>	3/32 x 1-1/2	6 pieces
<b>7-5055</b>	1/8 x 3/4	7 pieces
<b>7-5060</b>	1/8 x 1	6 pieces
<b>7-5065</b>	1/8 x 1-1/4	4 pieces
<b>7-5070</b>	1/8 x 1-1/2	4 pieces
<b>7-5075</b>	1/8 x 1-3/4	4 pieces
<b>7-5080</b>	1/8 x 2	3 pieces
<b>7-5085</b>	1/8 x 2-1/2	3 pieces
<b>7-5090</b>	5/32 x 1-1/2	3 pieces
<b>7-5095</b>	5/32 x 2	3 pieces
<b>7-5100</b>	5/32 x 2-1/2	2 pieces

## ASSORTED SIZES

Product No.	Description
<b>7-5000</b>	8 Per Pack

## Eyelet Stud and Washer

- Sold 4 sets per bag.



Product No.	Description
<b>7-6205</b>	Eyelet Stud and Washer

## Twist Stud Screw

- Sold 2 per bag.



Product No.	Dimensions
<b>7-6208</b>	#10-32 x 3/8"

## Stud and Eyelet

- Sold 6 sets per bag.



Product No.	Description
<b>7-6181</b>	Stud and Eyelet

**Phillips Machine Screw Stud**

- Stainless steel.
- Sold 5 per bag.



Product No.	Dimensions
<b>7-6196</b>	10-32 x 3/8"

**Snap Caps**

- Cap your screws with molded plastic caps.
- Sold 10 per bag.



Product No.	Description
<b>7-6050</b>	Fits Screw Sizes: #6 and #8 White
<b>7-6055</b>	Fits Screw Sizes: #6 and #8 Black
<b>7-6060</b>	Fits Screw Sizes: #10 and #12 White
<b>7-6065</b>	Fits Screw Sizes: #10 and #12 Black

**"Dot" Type Fastener Installation Tool**

- Easy to use.
- Complete instructions included.



Product No.	Description
<b>7-6211</b>	Installation Tool

**Canvas Fastener Kit**

- For repairing canvas covers, tarps, boat covers, sail covers or any heavy fabric.
- 47 pieces with handy carrying case.
- Contains: (1) Stainless steel snap tool & die set, (6) stud wood screws, (10) brass caps (10) brass eye sockets and (10) eyelets.



Product No.	Description
<b>7-54430</b>	Canvas Fastener Kit

**Marine Fastener Display**

- Display includes:

- (5) 7-5200 - Phillips Pan Sheet Metal Screws 4 x 1/2"
- (5) 7-5205 - Phillips Pan Sheet Metal Screws 6 x 1/2"
- (5) 7-5210 - Phillips Pan Sheet Metal Screws 6 x 3/4"
- (5) 7-5215 - Phillips Pan Sheet Metal Screws 8 x 1/2"
- (5) 7-5220 - Phillips Pan Sheet Metal Screws 8 x 3/4"
- (5) 7-5225 - Phillips Pan Sheet Metal Screws 8 x 1"
- (5) 7-5230 - Phillips Pan Sheet Metal Screws 8 x 1-1/2"
- (5) 7-5235 - Phillips Pan Sheet Metal Screws 10 x 1/2"
- (5) 7-5240 - Phillips Pan Sheet Metal Screws 10 x 3/4"
- (5) 7-5245 - Phillips Pan Sheet Metal Screws 10 x 1"
- (5) 7-5250 - Phillips Pan Sheet Metal Screws 10 x 1-1/2"
- (5) 7-5255 - Phillips Pan Sheet Metal Screws 12 x 1"
- (5) 7-5260 - Phillips Pan Sheet Metal Screws 12 x 1-1/2"
- (5) 7-5265 - Phillips Pan Sheet Metal Screws 14 x 1"
- (5) 7-5270 - Phillips Oval Sheet Metal Screws 6 x 1/2"
- (5) 7-5275 - Phillips Oval Sheet Metal Screws 6 x 3/4"
- (5) 7-5280 - Phillips Oval Sheet Metal Screws 6 x 1"
- (5) 7-5285 - Phillips Oval Sheet Metal Screws 8 x 3/4"
- (5) 7-5290 - Phillips Oval Sheet Metal Screws 8 x 1"
- (5) 7-5295 - Phillips Oval Sheet Metal Screws 8 x 1-1/4"
- (5) 7-5300 - Phillips Oval Sheet Metal Screws 8 x 1-1/2"
- (5) 7-5305 - Phillips Oval Sheet Metal Screws 10 x 3/4"
- (5) 7-5310 - Phillips Oval Sheet Metal Screws 10 x 1"
- (5) 7-5315 - Phillips Oval Sheet Metal Screws 10 x 1-1/4"
- (5) 7-5320 - Phillips Oval Sheet Metal Screws 10 x 1-1/2"
- (5) 7-5325 - Phillips Oval Sheet Metal Screws 10 x 2"
- (5) 7-5330 - Phillips Oval Sheet Metal Screws 12 x 1"
- (5) 7-5335 - Phillips Oval Sheet Metal Screws 12 x 1-1/2"
- (5) 7-5340 - Phillips Oval Sheet Metal Screws 12 x 2"
- (5) 7-5345 - Phillips Oval Sheet Metal Screws 14 x 1-1/2"
- (5) 7-5350 - Phillips Oval Sheet Metal Screws 14 x 2"
- (5) 7-5355 - Phillips Oval Sheet Metal Screws 14 x 2-1/2"
- (5) 7-5410 - Phillips Pan Machine Screws 8-32 x 1"
- (5) 7-5415 - Phillips Pan Machine Screws 8-32 x 1-1/2"
- (5) 7-5420 - Phillips Pan Machine Screws 10-24 x 1"
- (5) 7-5425 - Phillips Pan Machine Screws 10-24 x 1-1/2"
- (5) 7-5430 - Phillips Pan Machine Screws 10-24 x 2"

- (5) 7-5435 - Phillips Pan Machine Screws 1/4-20 x 1-1/2"
- (5) 7-5440 - Phillips Pan Machine Screws 1/4-20 x 2"
- (5) 7-5445 - Phillips Pan Machine Screws 1/4-20 x 3"
- (5) 7-5360 - Phillips Oval Machine Screw 6-32 x 1"
- (5) 7-5365 - Phillips Oval Machine Screw 8-32 x 1"
- (5) 7-5370 - Phillips Oval Machine Screw 8-32 x 1-1/2"
- (5) 7-5375 - Phillips Oval Machine Screw 10-24 x 1"
- (5) 7-5380 - Phillips Oval Machine Screw 10-24 x 1-1/2"
- (5) 7-5385 - Phillips Oval Machine Screw 10-24 x 2"
- (5) 7-5390 - Phillips Oval Machine Screw 1/4-20 x 1"
- (5) 7-5395 - Phillips Oval Machine Screw 1/4-20 x 1-1/2"
- (5) 7-5400 - Phillips Oval Machine Screw 1/4-20 x 2"
- (5) 7-5405 - Phillips Oval Machine Screw 1/4-20 x 3"
- (5) 7-5450 - Flat Washers #6
- (5) 7-5455 - Flat Washers #8
- (5) 7-5460 - Flat Washers #10
- (5) 7-5465 - Flat Washers 1/4"
- (5) 7-5480 - Lock Washers #10
- (5) 7-5485 - Lock Washers 1/4"
- (5) 7-5490 - Finishing Washers #6
- (5) 7-5495 - Finishing Washers #8
- (5) 7-5500 - Finishing Washers #10
- (5) 7-5505 - Finishing Washers 1/4"
- (5) 7-5520 - Finished Hex Nuts 10-24
- (5) 7-5525 - Finished Hex Nuts 1/4-20
- (5) 7-5530 - Nylon Lock Nuts 8-32
- (5) 7-5535 - Nylon Lock Nuts 10-24
- (5) 7-5540 - Nylon Lock Nuts 1/4-20
- (5) 7-5555 - Wing Nuts 1/4-20
- (5) 7-5560 - Well Nuts 1/4-20 x 5/8"
- (5) 7-5565 - Well Nuts 1/4-20 x 1"
- (5) 7-5770 - Hex Head Cap Screws 1/4-20 x 1"
- (5) 7-5575 - Hex Head Cap Screws 1/4-20 x 1-1/2"
- (5) 7-5580 - Hex Head Cap Screws 1/4-20 x 2"
- (5) 7-5585 - Hex Head Cap Screws 1/4-20 x 2-1/2"
- (5) 7-5590 - Hex Head Cap Screws 1/4-20 x 3"
- (5) 7-5595 - License Plate Bolts

Product No.	Description
<b>7-3009</b>	Marine Fastener Display



## Stainless Steel Cotter Pin Display

- Display includes:
  - (5) 7-5005 - 1/16" x 1/2"
  - (5) 7-5010 - 1/16" x 3/4"
  - (5) 7-5015 - 1/16" x 1"
  - (5) 7-5020 - 1/16" x 1-1/2"
  - (5) 7-5025 - 1/16" x 2"
  - (5) 7-5030 - 3/32" x 5/8"
  - (5) 7-5035 - 3/32" x 3/4"
  - (5) 7-5040 - 3/32" x 1"
  - (5) 7-5045 - 3/32" x 1-1/2"
  - (5) 7-5050 - 3/32" x 2"
  - (5) 7-5055 - 1/8" x 3/4"
  - (5) 7-5060 - 1/8" x 1"
  - (5) 7-5065 - 1/8" x 1-1/4"
  - (5) 7-5070 - 1/8" x 1-1/2"
  - (5) 7-5075 - 1/8" x 1-3/4"
  - (5) 7-5080 - 1/8" x 2"
  - (5) 7-5085 - 1/8" x 2-1/2"
  - (5) 7-5090 - 5/32" x 1-1/2"
  - (5) 7-5095 - 5/32" x 2"
  - (5) 7-5100 - 5/32" x 2-1/2"



Product No.	Description
<b>7-3002</b>	Cotter Pin Display

## Number and Letter Kits

- Contains: 4 of each number and letter - plus 16 dashes!
- 3" tall block style.
- Ideal for boat registration and identification numbers.
- Great for adding vessel names to life ring buoys.
- Black self-aligning. Pressure sensitive mylar.
- Meets Coast Guard requirements.



Product No. Description

<b>7-0780</b>	White
<b>7-0782</b>	Black

## 3" Number and Letter Kit

- Custom Letter Kits include 4 sets of the letters A-Z and the numbers 0-9 (146 total) plus 16 dashes.
- Fuel, fading and scratch resistant.
- UV coated.
- Meets US Coast Guard guidelines when properly applied on contrasting background.



Product No. Description

<b>7-52290</b>	Shaded - White/Black
----------------	----------------------

# KEY FLOATS, PADLOCKS and CABIN FAN

## Key Float

- 2-piece key float.



Product No.	Description
<b>7-52286</b>	Key Float

## Floating Key Chain

- High visibility.
- Durable soft foam.
- Holds up to 4 keys.



Product No.	Description
<b>7-52284</b>	Floating Key Chain

## Peg Board Hooks

- .148 diameter.
- Sold 25 hooks per pack.



Product No.	Description
<b>7-0549</b>	Length 2"
<b>7-0548</b>	Length 4"
<b>7-0546</b>	Length 6"
<b>7-0547</b>	Length 8"

## Key Float/Registration Holder

- Floats with 3 standard keys.
- Keep boat registration handy and dry.
- UV resistant PVC construction.
- Red.



Product No.	Description
<b>7-52261</b>	Key Float/Registration Holder

## Padlocks

- Includes: 2 nickel plated brass keys.
- Solid brass body and shackle.



Product No.	Description
<b>7-0020</b>	1-1/4"
<b>7-0022</b>	1-1/2"
<b>7-0024</b>	2"

## Marine Cabin Fan

- Weatherproof vinyl coated fan guard.
- Easy installation.
- Fixed or 90° "sweep" motion.
- 8 preset fan positions with adjustable tilt.
- 12 volt.



Product No.	Description
<b>7-0117</b>	Marine Cabin Fan

**Stainless Steel Safety Snaps**

- Stainless steel.



Product No. Description

<b>7-0284</b>	Length Overall 2-1/2"	Gauge OD 1/4"
<b>7-0285</b>	Length Overall 3-1/8"	Gauge OD 5/16"
<b>7-0286</b>	Length Overall 4"	Gauge OD 3/8"
<b>7-0290</b>	Length Overall 4-3/4"	Gauge OD 7/16"

**Safety Spring Hook**

- Interlocking tongue to insure safety.
- Spring loaded.
- Capacity shown in safe working load.
- Safe work load: 900 lbs.
- 4-1/4".
- Slide blister pack.



Product No. Description

<b>7-54333</b>	Safety Spring Hook
----------------	--------------------

**Solid Brass Swivel Eye Snap Hooks**

- Solid brass.



Product No. Description

<b>7-0280</b>	3-1/4" L with 5/8" Eye ID	Sold 2 Per Card
<b>7-0281</b>	3-5/8" L with 3/4" Eye ID	Sold 1 Per Card
<b>7-0282</b>	4-1/2" L with 7/8" Eye ID	Sold 1 Per Card

**Solid Bronze Fixed Eye Snap Hooks**

- Solid bronze.



Product No. Description

<b>7-0278</b>	Length Overall 2-1/8"	3/8" Eye ID
<b>7-0279</b>	Length Overall 2-7/8"	5/8" Eye ID
<b>7-0685</b>	Length Overall 3-1/4"	11/16" Eye ID
<b>7-1350</b>	Length Overall 3-7/8"	3/4" Eye ID

**Snap Hook**

- Malleable iron.
- 2,300 lbs. breaking strength.
- Length overall 3-1/2".
- Eye 2".



Product No. Description

<b>7-0288</b>	Snap Hook
---------------	-----------

**Utility Snap Hook**

- Forged zinc plated steel.
- 1,000 lbs. breaking strength.
- Length overall 4-1/2".
- Diameter 3/4".
- Opening 1".
- Eye ID 2-1/2".



Product No. Description

<b>7-0289</b>	Utility Snap Hook
---------------	-------------------

**Solid Brass Swivel Eye Bolt Snap Hooks**

- Solid brass.



Product No. Description

<b>7-1360</b>	Length Overall 3-1/4"	3/4" Eye ID
<b>7-1362</b>	Length Overall 3-1/2"	1" Eye ID

**Boat Wash**

- Powerful - 6 cap fulls clean a 24' boat.
- Special cleaning agents remove tar, gas stains, exhaust smudge, scum line, fish blood.
- Concentrated formula is economical to use.
- Cleans the entire boat from trailer to T-Top.



Product No.	Description
<b>7-1092</b>	32 fl. oz.
<b>7-1093</b>	Gallon (4 Per Case)

**Plastic Cleaner and Restorer**

- Safe for use on Isinglass, Strataglass, Plexiglass, plastic and vinyl.
- Removes hazing, restores clarity.
- Removes salt spray, grime, fingerprints and more from all types of clear plastic surfaces.
- Sold packs of 4 only.



Product No.	Description
<b>7-2720</b>	22 fl. oz.

**Black Streak/Fish Blood Remover**

- Removes black streak.
- Removes fish blood deposits.
- Safe for use on fiberglass, metal and painted surfaces.



Product No.	Description
<b>7-1084</b>	Gallon (4 Per Case)

**Hull Cleaner**

- Quickly removes scum line and other tough stains.
- Specifically formulated for fiberglass and painted surfaces.
- Great way to prepare a hull for polishing.
- Buffered formula is very effective, but safe to use.



Product No.	Description
<b>7-1096</b>	32 fl. oz.
<b>7-1097</b>	Gallon (4 Per Case)

**Salt Terminator**

- Dissolves salt and leaves protective sheen.
- Protects against future corrosion.
- Mixer automatically dilutes concentrate and syphons it through standard garden hose.
- Good on all surfaces exposed to saltwater or air.



**Deck Cleaner**

- Quickly and easily removes dirt, grime, fish blood and more from non-skid surfaces.
- Safe for use on all fiberglass, vinyl, metal and painted surfaces.



Product No.	Description
<b>7-1094</b>	32 fl. oz.
<b>7-1095</b>	Gallon (4 Per Case)

**Formula 9**

- All purpose heavy duty cleaner and degreaser.
- Does not leave dulling film.
- Simple spray on, wipe off application.
- Whisks away oil grease, grime, dirt and stains.



Product No.	Description
<b>7-1090</b>	Gallon (4 Per Case)

**Bilge Cleaner**

- Removes sludge, grime and odors to clean and freshen bilge.
- Heavy duty cleaning power.
- Easy to use; pour into bilge and run boat - motion "scrubs" bilge.
- Biodegradable formula won't harm hoses or bilge pumps.



Product No.	Description
<b>7-1098</b>	32 fl. oz.
<b>7-1099</b>	Gallon (4 Per Case)

**EZ On EZ Off Hull and Bottom Cleaner**

- Removes the toughest deposits and stains.
- The most effective hull & bottom cleaner available.
- Special high-tech, buffered hydrochloric acid makes it safer to use than traditional bottom cleaners.
- Ideal for cleaning RIB bottoms, too.
- Can be shipped UPS Air.



Product No.	Description
<b>7-1089</b>	32 fl. oz.
<b>7-1088</b>	Gallon (4 Per Case)

Product No.	Description
<b>7-1031</b>	32 fl. oz.
<b>7-1033</b>	32 fl. oz. Kit with Nozzle
<b>7-1032</b>	Gallon

MARPAC

## Epoxy Resin

- Zero V.O.C.'s.
- Formulated to be mixed at 5 parts resin to 1 part Fast or Slow Hardener.
- May be used as a laminating epoxy or thickened with Marpro fillers to a desired consistency for putty and adhesive.



Product No. Description

<b>7-2510</b>	Quart
<b>7-2512</b>	.98 Gallon
<b>7-2514</b>	4.35 Gallon

MARPRO

## Slow Epoxy Hardener

- The pot life for the slow hardener is approximately 20-25 minutes at 77° F; 15-20 minutes at 90° F and 30-35 minutes at 65° F.



Product No. Description

<b>7-2528</b>	.44 Pint	Use with 7-2510
<b>7-2530</b>	.84 Quart	Use with 7-2512
<b>7-2532</b>	.94 Gallon	Use with 7-2514

TOUGH GUY

## Table Top Epoxy Resin

- Self leveling, clear formula.
- Formulated for a one to one mix ratio.
- Designed for interior wood depth coat finishing.
- Apply up to 1/8" deep per coat.
- For use in temps above 75° F.
- 45 minute pot life.



Product No. Description

<b>6-7530</b>	Quart Kit
<b>6-7531</b>	Gallon Kit

BOATER SPORTS

## Hull Load Filler

- Used to build high physical strength.
- Contains Talc.



Product No. Description

<b>7-2558</b>	43 oz.
---------------	--------

## Fast Epoxy Hardener

- The pot life of the fast hardener is approximately 10-15 minutes at 77° F; 8-12 minutes at 90° F and approximately 20 minutes at 65° F.
- Providing low temperature cure down to 50° F.



Product No. Description

<b>7-2520</b>	.44 Pint	Use with 7-2510
<b>7-2522</b>	.86 Quart	Use with 7-2512
<b>7-2524</b>	.94 Gallon	Use with 7-2514

## 2:1 Epoxy Resin

- 2:1 mix ratio is easy to measure and mix.
- Non blush formula.
- Totally clear formula with excellent wet-out properties.
- Especially good for exotic fabrics.
- Designed to cure in cooler temperatures and on damp surfaces.
- Better UV resistance.



Product No. Description

<b>7-2582</b>	Resin	Gallon
<b>7-2586</b>	Medium Hardener (65° to 95° F)	1/2 Gallon

## Fumed Silica Thickening Agent

- Lightweight bulking and thickening agent.
- Minimal sanding required.



Product No. Description

<b>6-7578</b>	10#
<b>6-7579</b>	Quart
<b>7-2562</b>	Gallon

## High Quality Vinylester Resin

- For use in boat construction where the highest strength water intrusion resistance is required.
- May be used in some vacuum infusion applications.
- Contains no wax.
- Has shelf life restrictions.



Product No. Description

<b>6-7506</b>	Gallon
<b>6-7507</b>	5 Gallon

## Premium Resin with Wax

- No shrinkage.
- Tack free finish.
- Cannot be coated with gel coat or paint.
- Hardener included.



Product No. Description

**6-7514** Gallon

## Premium Resin - No Wax

- A polyester resin specially formulated to create a hard film in a minimum of time.
- Can be re-laminated up to six months from initial layup with no sanding.
- Contains no wax.
- Has an extended shelf life.
- Hardener included.



Product No. Description

**6-7410** Quart

**6-7411** Gallon

**6-7412** 5 Gallon

## M.E.K.P. (Methyl-ethyl Ketone Peroxide)

- A Methyl-ethyl ketone peroxide liquid hardener catalyst for all polyester resins, vinylester resins and gel coats.



Product No. Description

**6-7500** 1/4 oz. For Quart

**6-7501** 1 oz. For Gallon

**6-7502** Pint For 5 Gallon

**6-7503** Gallon For 55 Gallon

**7-2580** M.E.K.P. Dispenser

## Gel Coat

- Exterior gel coat is pigmented with Titanium Dioxide.
- It is resilient (will withstand good impact) and it is light stabilized.
- Designed for mold operation, a wax solution must be added when using for repairs to provide sandability.



## GEL COAT - NO WAX

Product No. Description

**6-7623** Neutral for Tint Base Quart

**6-7625** White Quart

**6-7626** White Gallon

## GEL COAT WITH WAX

Product No. Description

**6-7621** Quart

**6-7622** Gallon

## WEBBING SOLUTION

- Used to create a splatter or spider web effect with gel coat of one color and sprayed on another.

Product No. Description

**6-7634** Pint

## Milled Fibers

- Use for thickening epoxy and polyester resins.



Product No. Description

**6-7570** Quart

## Micro Balloons

- Use for thickening epoxy and polyester resins.
- Larger particle size, used for fairing compounds and putty.



Product No. Description

**6-7575** Quart

**6-7576** Gallon

MARPAC

## Styrene

- Resin and gel coat thinner.
- Use up to 10% with polyester resin.
- Use up to 5% with gel coat.



Product No. Description

<b>6-7475</b>	4 oz.
<b>6-7620</b>	Pint

## Coloring Agents

- Popular color matching agents that blend with polyester resins, gel paste and epoxy resins, Formula 27 and various putties.
- Use 1 oz. color per quart of resin.
- Colorants may be mixed to obtain desired color match.
- Use very small amounts to tint fiberglass repair putty or scratch patch.



Product No. Description

<b>6-7544</b>	Green	1 oz.
<b>6-7545</b>	Red	1 oz.
<b>6-7546</b>	Gold	1 oz.
<b>6-7547</b>	Brown	1 oz.
<b>6-7548</b>	Blue	1 oz.
<b>6-7549</b>	Black	1 oz.
<b>6-7550</b>	White	1 oz.
<b>6-7551</b>	White	4 oz.

MARPRO

## Wax Sol

- Add to gel coat that does not contain wax to produce a tack free finish.



Product No. Description

<b>6-7630</b>	4 oz.	For Gallon
---------------	-------	------------

## Resin Rollers

- Spiral threaded grooves to spread resin and glass better, removes air bubbles and laminates evenly.
- Features: Angled tapered grooved sizes, contoured angles and aluminum.

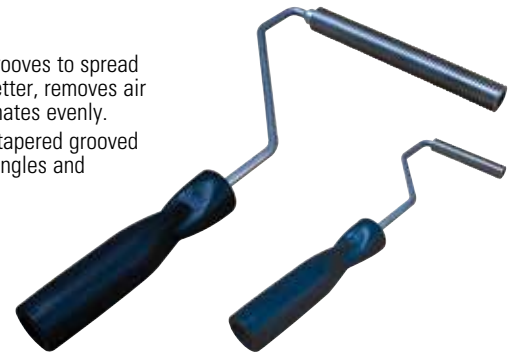

Product No. Description

<b>6-7640</b>	Dimensions: 1/2" x 3"
<b>6-7641</b>	Dimensions: 3/4" x 6"

TOUGH GUY

## Fiberglass Cloth Tape

- The finest quality fiberglass cloth woven in narrow widths with non-raveling edges.



Product No. Description

<b>6-7610</b>	2" x 50 yds.
<b>6-7611</b>	4" x 50 yds.
<b>6-7612</b>	6" x 50 yds.
<b>6-7613</b>	12" x 50 yds.

## Fiberglass Cloth

- The finest quality 7-1/2 oz. fiberglass cloth.
- Available for use with polyester & epoxy resins and gel coats.



Product No. Description

<b>6-7590</b>	38" x 1 yd.
<b>6-7591</b>	38" x 3 yds.
<b>6-7592</b>	50" x 1 yd.
<b>6-7593</b>	50" x 3 yds.
<b>6-7585</b>	38" x 60 yds.
<b>6-7586</b>	50" x 60 lineal yds.

BOATER SPORTS

## Fiberglass Matting

- 100% fiberglass in a non-woven state.
- Use as reinforcement for polyester or epoxy resin.
- Finishing mat.



Product No. Description

<b>6-7600</b>	1.5 oz.	38" x 1 yd.
<b>6-7601</b>	1.5 oz.	38" x 3 yds.
<b>6-7603</b>	1.5 oz.	50" x 1 yd.
<b>6-7604</b>	1.5 oz.	50" x 3 yds.
<b>6-7605</b>	1.5 oz.	50" x 73 lineal yds.

## Fiberglass Woven Roving

- Heavy weight fiberglass fabric.
- Very bulky for stronger repair applications where large build-up is needed.

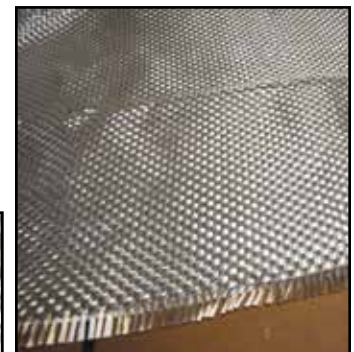

Product No. Description

<b>6-7595</b>	24 oz.	38" x 1 yd.
---------------	--------	-------------



## Combination Mats

- 25 oz. woven stitched to 1/2 oz. chopped strand mat.
- Mat and woven roving combination.



Product No. Description

<b>6-7608</b>	50" x 1 yd.
<b>6-7606</b>	50" Roll



## Biaxial Combination Mats

- 17 oz. woven stitched to 1/2 oz. chopped strand mat.
- Mat and woven roving combination.



Product No. Description

<b>6-7594</b>	50" x 1 yd.
<b>6-7588</b>	6" x 50 yds.
<b>6-7589</b>	12" x 50 yds.
<b>6-7587</b>	50" Roll

## Acetone

- Premium grade quality, 100% virgin acetone.
- A colorless, clear, fast drying solvent used extensively for cleaning brushes, rollers, as a degreaser, cleaner in fiberglass fabrication and formulations for removing paint, lacquer and varnish.



Product No. Description

<b>6-7450</b>	Quart
<b>6-7454</b>	Gallon (Single)
<b>6-7451</b>	Gallon (Case of 4)
<b>6-7452</b>	5 Gallon
<b>6-7453</b>	55 Gallon

## Lacquer Thinner

- Thins and cleans more effectively than mineral spirits.
- Used to help control brushing and spraying consistency.
- Not for use on nylon or synthetic tools.
- May be used as a cleaner for spray equipment, brushes and rollers.



Product No. Description

<b>6-7465</b>	Quart
<b>6-7468</b>	Gallon (Single)
<b>6-7466</b>	Gallon (Case of 4)
<b>6-7467</b>	5 Gallon

## Denatured Alcohol

- An excellent fuel for alcohol burning stoves and lamps.
- Burns with a clear colorless flame.



Product No. Description

<b>6-7460</b>	Quart
<b>6-7463</b>	Gallon (Single)
<b>6-7461</b>	Gallon (Case of 4)
<b>6-7462</b>	5 Gallon

## M.E.K. Solvent

- An active ketone solvent for cleaning and dissolving epoxy and polyester resins and caulks.
- Slower evaporating than acetone.



Product No. Description

<b>6-7456</b>	Quart
<b>6-7458</b>	Gallon (Single)
<b>6-7457</b>	Gallon (Case of 4)

## Mineral Spirits

- Good brush cleaning solvent.
- Low odor, quick drying.
- May be added to oil base paints, enamels and varnishes for exterior and interior use to thin and control flow rate.
- Do not use with synthetic or rubber base enamels or water thinned paints.



Product No. Description

<b>6-7470</b>	Quart
<b>6-7471</b>	Gallon

## Xylene

- Use for paint thinning and brush cleaning.



Product No. Description

<b>6-7473</b>	Gallon
---------------	--------

## Parts Washer Solution

- Low odor, quick drying, crystal clear formula.
- Effectively removes dirt, grease and grime.
- Excellent for areas where low flash point solutions can't be used.
- Good for cleaning parts, brushes and rollers.



Product No. Description

<b>6-7405</b>	Gallon
<b>6-7407</b>	5 Gallon

**Epoxy Glue**

- High viscosity.
- 1 to 1 mix ratio.
- 45 minute pot life; sandable in 4 hrs.
- Excellent bonding to properly prepared surfaces.



Product No. Description

<b>6-7520</b>	Pint Set
<b>6-7521</b>	Quart Set
<b>6-7522</b>	Gallon Set

**Marine Grade Silicone Sealant**

- This high performance silicone which exhibits excellent adhesion to glass, metal, porcelain, ceramic, fiberglass and other non-porous surfaces.
- Cures to a tough, rubbery and permanently flexible sealant.
- Sold in packs of 4 only.



Product No. Description

<b>7-2505</b>	10.1 oz. Cartridge	Clear
<b>7-2507</b>	10.1 oz. Cartridge	White

**Floataction Foam**

- A 1 to 1 mix liquid urethane foam with 2 pounds per cubic foot density which is not affected by solvents or gasoline.
- Produces 4 cubic feet per gallon.
- It bonds to wood, metal or fiberglass and foams wherever it is poured.
- Provides extra flotation in boats and sound proofs and insulates hulls, walls, floors, seats, decks or any cavity.
- Do not use below 70° F.



Product No. Description

<b>6-7560</b>	2 Quart	2 lbs. Density
<b>6-7562</b>	2 Gallon	2 lbs. Density
<b>6-7565</b>	2 Quart	4 lbs. Density
<b>6-7566</b>	2 Gallon	4 lbs. Density

**PAINT**
**Super-B Ocean™ Ablative Paint**

- Premium grade quality, 100% virgin acetone.
- A colorless, clear, fast drying solvent used extensively for cleaning brushes, rollers, as a degreaser, cleaner in fiberglass fabrication and formulations for removing paint, lacquer and varnish.
- Biocide: 45% Copper.



Product No. Description

<b>7-2641</b>	Green	Gallon
<b>7-2642</b>	Green	Quart
<b>7-2635</b>	Blue	Gallon
<b>7-2636</b>	Blue	Quart
<b>7-2637</b>	Red	Gallon
<b>7-2638</b>	Red	Quart
<b>7-2639</b>	Black	Gallon
<b>7-2640</b>	Black	Quart

**Superkote Ocean™ Hard Paint**

- Medium load copper hard modified epoxy.
- Multi seasonal protection.
- No paint build up.
- Eliminates heavy sanding.
- Good protection for moderate fouling conditions.
- Biocide: 45% Copper.



Product No. Description

<b>7-2617</b>	Green	Gallon
<b>7-2618</b>	Green	Quart
<b>7-2619</b>	Blue	Gallon
<b>7-2620</b>	Blue	Quart
<b>7-2621</b>	Red	Gallon
<b>7-2622</b>	Red	Quart
<b>7-2623</b>	Black	Gallon
<b>7-2624</b>	Black	Quart

**Super-B Atlantic™ Ablative Paint**

- Thins and cleans more effectively than mineral spirits.
- Used to help control brushing and spraying consistency.
- Not for use on nylon or synthetic tools.
- May be used as a cleaner for spray equipment, brushes and rollers.
- Biocide: 35% Copper.



Product No. Description

<b>7-2821</b>	Blue	Gallon
<b>7-2818</b>	Black	Gallon

**Super-B New England™ Ablative Paint**

- Single season copper ablative.
- Controlled polishing ablative.
- Full season protection.
- No paint buildup. Eliminates heavy sanding.
- Excellent protection for low to moderate fouling conditions.
- Biocide: 25% Copper.



Product No. Description

<b>7-2878</b>	Green	Gallon
<b>7-2872</b>	Blue	Gallon
<b>7-2876</b>	Red	Gallon
<b>7-2874</b>	Black	Gallon

**Aqua-B™ Water-Based Paint**

- High performance water based copper ablative.
- Self polishing water based ablative.
- Multi seasonal protection.
- No paint build up.
- Eliminates heavy sanding.
- Good protection for moderate fouling conditions.
- Biocide: 45% Copper.



Product No. Description

<b>7-2712</b>	Green	Gallon
<b>7-2713</b>	Green	Quart
<b>7-2708</b>	Blue	Gallon
<b>7-2709</b>	Blue	Quart
<b>7-2714</b>	Red	Gallon
<b>7-2715</b>	Red	Quart
<b>7-2710</b>	Black	Gallon
<b>7-2711</b>	Black	Quart

**Aluma Pro™ Aluminum Paint**

- Multi season self polishing ablative.
- Self polishing ablative with bright colors.
- Perfect for aluminum, fiberglass, wood and steel boats - including trailer boats.
- No paint buildup.
- Eliminates heavy sanding.
- Good protection for tough fouling conditions.
- Biocide: 45% Cuprous Thiocyanate.



Product No. Description

<b>7-2603</b>	Blue	Gallon
<b>7-2604</b>	Blue	Quart
<b>7-2605</b>	Black	Gallon
<b>7-2606</b>	Black	Quart

**Super-B ECO™ Aluminum Paint**

- Copper free antifouling.
- No copper with all hull types including aluminum.
- Contains combination of patented SCX biocides.
- Multi seasonal antifouling.
- Eliminates heavy sanding, compatible with other existing bottom systems.
- Good protection for moderate to high fouling conditions.
- Biocide: Zinc Omadine.



Product No. Description

<b>7-2811</b>	Blue	Gallon
<b>7-2798</b>	Black	Pint
<b>7-2800</b>	Black	Quart
<b>7-2802</b>	Black	Gallon

**Mar-Protect Epoxy Primer™**

- Barrier coat primer.
- Prevents water absorption and blistering.
- Eliminates direct path for water migration.
- Heavy duty 3:1 epoxy coating.
- Excellent anti-corrosive substrate for metals.



Product No. Description

<b>7-2670</b>	Gallon
---------------	--------

**Mar-Protect 70 High Solids Epoxy Primer™**

- A surface tolerant, two part 70% solids tar free epoxy anticorrosive primer.
- Epoxy anticorrosive coating for use on the entire vessel: Underwater, topside, deck, house, water ballast tank, cofferdam, voids, cargo holds and internal spaces.



Product No. Description

<b>7-2680</b>	White	Gallon
<b>7-2682</b>	Medium Gray	Gallon

MARPAC

## Fishboat Coatings™ - Alkyd Topside Enamel

- Alkyd topside enamel.
- Brushed or rolled gives a smooth finish with excellent handle and flow.
- High gloss with great UV protection.
- Good color retention.
- Good durability to cleaning solutions, abrasion and stains.
- Fiberglass, wood, aluminum and steel.
- High performance coating for marine, industrial and offshore structures.



Product No. Description

7-2649	Gloss White	Gallon
7-2650	Gloss White	Quart
7-2652	Medium Gray	Gallon
7-2653	Medium Gray	Quart
7-2654	Gloss Black	Gallon
7-2655	Gloss Black	Quart
7-2656	Green	Gallon
7-2657	Green	Quart
7-2658	Blue	Gallon
7-2659	Blue	Quart
7-2662	Semi-Gloss White	Gallon
7-2663	Semi-Gloss White	Quart
7-2664	Red	Gallon
7-2665	Red	Quart

MARPRO

## Camouflage Paint

- Dull-finish marine paint is perfect for hunting or fishing vehicles.
- High quality, temporary finish for use on duck boats, skiffs and canoes.
- Easily removed with the included neutralizer.
- Brush, roll or spray on finish.



Product No. Description

7-2661	Brown	Quart
--------	-------	-------

## White Undercoater

- One coat is good for coverage of 75 square feet/quart.
- Great coverage, quick dry, great adhesion for topcoat.



Product No. Description

7-2697	Quart
--------	-------

## Thinner for Marine Coatings

- Improves application and flow of coating.
- Improves flow for brushing and rolling.
- Compatible with antifoulings, primers and enamels.
- Cleanup of paint supplies.



Product No. Description

7-2674	Gallon
7-2675	Quart

TOUGH GUY

## Bucket of Savings Chip Brushes

- Sold 48 brushes per bucket.
- Size: 2".



Product No. Description

7-0508S	Bucket of Savings Chip Brushes
---------	--------------------------------

## Roller Covers

- 100% Polyester fabric.
- Solvent resistant core.
- For smooth to semi-smooth surface.
- Fiberglass and epoxy applications.



Product No. Description

7-1050	Size: 3"	3/8" Nap	Sold Each
7-1051	Size: 4"	3/8" Nap	Sold Each
7-1052	Size: 7"	3/8" Nap	Sold Each
7-1053	Size: 9"	3/8" Nap	Sold Each
7-1049	Size: 9"	3/16" Nap	Twin Pack

BOATER SPORTS

## Cigar Foam Roller Covers

- Foam.
- For smooth to semi-smooth surface.
- Fiberglass and epoxy applications.



Product No. Description

7-1038	Size: 4"	3/8" Nap	Sold 2 Per Pack
7-1039	Size: 6-1/2"	3/8" Nap	Sold 2 Per Pack
7-1042	Roller Frame: 4" x 16"		
7-1043	Roller Frame: 6-1/2" x 24"		

## Plastic Paint and Epoxy Mixing Tubs



Product No. Description

<b>639302</b>	8 oz.
<b>639306</b>	16 oz.
<b>639317</b>	32 oz.
<b>639320</b>	85 oz.
<b>639332</b>	5 Quarts
<b>7-9166</b>	Plastic Lid for 639332 (5 Quarts)

## Zinc Chromate Primers

- Superior bonding to aluminum lower units.
- Formulated to work with engine paints.
- For use below water line.
- Protects against corrosion.
- Quick-dry formula.
- 12 oz. can.



Product No. Description

<b>6-5605</b>	Green
<b>6-5606</b>	Yellow

Product No. Description

<b>6-0214</b>	New Caterpillar Yellow
---------------	------------------------

## Color Matched Engine Spray Paint

- Easy to use aerosols deliver professional results every time.
- Ideal for entire outboard and sterndrive reconditioning or touch up!
- Acrylic lacquer formula for a long lasting glossy base coat marine finish.
- It also protects with UV inhibitors!
- Excellent solvent, gasoline and wear resistance.
- Meet VOC requirements.
- 12 oz. canister.



Product No. Description

<b>6-7021</b>	Honda Silver Metallic
<b>6-1258</b>	Mercury Phantom Black (OEM #92-78373-12, 1960-Present)
<b>6-7040</b>	Suzuki Shadow Black

## Cold Zinc Galvanizing

- 95% pure zinc formula.
- Recommended for steel and iron surfaces (including welded joints).
- Perfect for hardware corrosion protection.
- Resists abrasions and solvents.
- Quick-dry formula.
- 13 oz. can.



Product No. Description

<b>6-0800</b>	Cold Zinc Galvanizing
---------------	-----------------------

## Inboard/Generator Engine Color

- Factory matched colors.
- Resistant to oil and gasoline.
- Fuses to the engine surface.
- Can be recoated anytime.
- Quick dry formula formulated for the marine environment.
- 12 oz. can.



MARPAC

MARPRO

TOUGH GUY

BOATER SPORTS



MARPAC

## L.E.D. Waterproof Trailer Light Kit - Trailers Over 80" Wide



- Limited LED lifetime warranty - if LED fails, we'll replace it.
- Brighter than standard conventional bulbs. Uses 90% less energy.
- LED's rated at 100,000 hours (that's 48 years at 40 hours per week).
- 100% sealed, never replace a bulb.
- Kit includes: 2 LED low profile universal-mount tail lights with red side markers/reflectors, license plate bracket, 25' wiring harness and stainless steel hardware.



Product No.	Description
<b>7-0012</b>	LED Waterproof Trailer Light Kit
<b>7-59342</b>	Right Side Tail Light Only
<b>7-59344</b>	Left Side Tail Light Only with Illuminator

## L.E.D. Waterproof Trailer Light Kit - Trailers Over 80" Wide

- Limited LED lifetime warranty - if LED fails, we'll replace it.
- Brighter than standard conventional bulbs. Uses 90% less energy.
- LED's rated at 100,000 hours (that's 48 years at 40 hours per week).
- 100% sealed, never replace a bulb.
- For trailers over 80" wide.
- Includes: Wire harness, license plate bracket, frame clips, stainless steel hardware.



Product No.	Description
<b>7-59387</b>	LED Waterproof Trailer Light Kit
<b>7-59389</b>	Right Side Tail Light Only
<b>7-59388</b>	Left Side Tail Light Only with Illuminator

MARPRO

## Low Profile Trailer Light Kit - Trailers Over 80" Wide

- Submersible multi-function light kit includes right and left tail lights, 25' wishbone wiring harness, 48" trunk connector, license plate bracket and mounting hardware.
- Clam pack for display.



Product No.	Description
<b>7-59306</b>	Low Profile Trailer Light Kit
<b>7-59304</b>	Right Side Tail Light Only
<b>7-59305</b>	Left Side Tail Light Only

## L.E.D. Waterproof Trailer Light Kit - Trailers Under 80" Wide



- Limited LED lifetime warranty - if LED fails, we'll replace it.
- Brighter than standard conventional bulbs. Uses 90% less energy.
- LED's rated at 100,000 hours (that's 48 years at 40 hours per week).
- 100% sealed, never replace a bulb.
- Kit includes: 2 LED stud-mount tail lights with red side markers/reflectors, license plate bracket, 25' wiring harness and plated hardware.



Product No.	Description
<b>7-0011</b>	LED Waterproof Trailer Light Kit
<b>7-59332</b>	Right Side Tail Light Only
<b>7-59334</b>	Left Side Tail Light Only

TOUGH GUY

## Submersible Trailer Light Kit - Trailers Under 80" Wide

- Meets all SAE/DOT specifications for under 80" wide trailers when properly installed.
- Includes: Tail lights, wiring harness, license plate bracket, mounting hardware and complete instructions.



Product No.	Description
<b>7-0013</b>	Submersible Trailer Light Kit
<b>7-59301</b>	Right Side Tail Light Only
<b>7-59302</b>	Left Side Tail Light Only

## Trailer Light Kit - Trailers Under 80" Wide

- For under 80" wide trailers.
- Includes: License plate bracket and stainless steel mounting hardware.
- Harness not included.



Product No.	Description
<b>7-59294</b>	Trailer Light Kit

BOATER SPORTS

## Tail Lights - Trailers Over 80" Wide

- For trailers over 80" wide.
- Incandescent bulb.
- Includes: Stainless steel mounting hardware.
- Clam pack for display.



Product No.	Description
<b>7-59298</b>	Right Side Tail Light Only
<b>7-59299</b>	Left Side Tail Light Only

## L.E.D. Oval Tail Light

- Sealed LED Oval Tail Light with grommet and plug.
- Easy to install.
- Clam pack for display.



Product No.	Description
<b>7-59362</b>	LED Oval Tail Light
<b>1-59309</b>	Grommet Only

# TRAILER LIGHTS

MARPAC

## L.E.D. 6" Clear Oval Tail Light

- Clear lens, white LED back-up light.
- 10 White LED's.
- Includes: Grommet and wire plug.



Product No.	Description
<b>7-59419</b>	LED 6" Clear Oval Tail Light
<b>1-59309</b>	Grommet Only

## 6" Sealed Oval Tail Light

- Easy to install.
- Includes: Grommet and wire plug.
- Clam pack for display.



Product No.	Description
<b>7-59307</b>	Oval Tail Light with Grommet and Plug
<b>7-59308</b>	Oval Tail Light Module Only
<b>1-59309</b>	Grommet Only

## L.E.D. Sleek Accent Lights

- Sleek design for an updated look.
- Vibrant illumination.
- Low amp draw.
- Features a chrome bezel.



Product No.	Description
<b>7-59365</b>	Amber
<b>7-59366</b>	Red

## L.E.D. Submersible Clearance Lights - Stud Mount

- 1 wire stud mount.
- Stud acts as ground.
- Clam pack for display.



Product No.	Description
<b>7-59312</b>	Amber
<b>7-59313</b>	Red

## L.E.D. Mini Trailer Clearance Lights

- Includes: 3/4" black grommet and chrome bezel.
- 2 wire.



Product No.	Description
<b>7-59278</b>	Amber
<b>7-59279</b>	Red

## 6" Clear Oval Reverse Light

- 6" clear lens.
- Incandescent white light bulb.
- Includes: Grommet and wire plug.
- 12 volt.



Product No.	Description
<b>7-59314</b>	6" Clear Oval Reverse Light

## L.E.D. Trailer Clearance Markers

- 1 wire stud mount.
- Stud acts as ground.



Product No.	Description
<b>7-59274</b>	Amber
<b>7-59275</b>	Red

## L.E.D. Marker Clearance Lights

- LED Advantage trailer lights are 100% maintenance free.
- Limited LED Lifetime Warranty: if the LED fails, we'll replace it.
- Meets the requirements of SAE/DOT/FMVSS/CMVSS standards when properly installed.
- Simple install-run the black wire to power, the base is self grounding.



Product No.	Description
<b>7-0070</b>	Amber
<b>7-0071</b>	Red

## L.E.D. Submersible Clearance Lights - Ear Mount

- 100% Waterproof!
- Stainless steel hardware.
- Clam pack for display.



Product No.	Description
<b>7-59310</b>	Amber
<b>7-59311</b>	Red

## L.E.D. Round Recessed Trailer Light

- 4" round recessed trailer light.
- Bright and easy to mount.



Product No.	Description
<b>7-59361</b>	Red

## Trailer Clearance Marker Lights

- Incandescent bulb.
- Stud mount.



Product No.	Description
<b>7-59217</b>	Amber
<b>7-59218</b>	Red

MARPRO

TOUGH GUY

BOATER SPORTS



MARPAC

## Snap-In Bezel Trailer Clearance Marker Lights

- Choose chrome or black snap-in bezel.
- Incandescent bulb.



Product No.	Description	
7-59270	Marker Light	Amber
7-59371	Marker Light	Red
7-59372	Light Module Only	Amber
7-59373	Light Module Only	Red

## Mini Trailer Side Marker Lights

- Incandescent bulb.
- Stud mount.
- Stainless steel base.



Product No.	Description
7-59247	Amber
7-59248	Red

MARPRO

## L.E.D. Light Bar

- Submersible 3 LED identification light bar for over 80" trailers.
- Durable, corrosion proof base.
- Dimensions: 17" x 1.75" x 1.5".
- 12 volt.
- Red.



Product No.	Description
7-59352	LED Light Bar

## L.E.D. Trailer Identification Bar

- 3 LED's.
- Stainless steel base.
- Red.

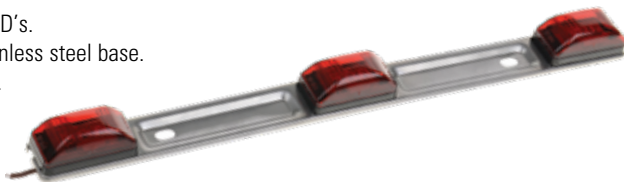

Product No.	Description
7-59260	LED Trailer Identification Bar

## Trailer Identification Bar

- Stainless steel base.
- 3-light, incandescent bulbs.
- Red.



Product No.	Description
7-59261	Trailer Identification Bar

TOUGH GUY

## Trailer Identification Bar

- Corrosion free polymer base.
- 3-light, incandescent bulbs.
- Red.



Product No.	Description
7-59249	Trailer Identification Bar

## Reflectors

- DOT approved stick-on reflectors.

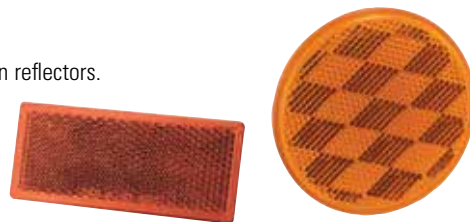

Product No.	Description		
7-59320	Amber	Rectangle	Dimensions: 1-1/2" x 3"
7-59323	Red	Rectangle	Dimensions: 1-1/2" x 3"
1-59321	Amber	Round	Dimensions: 3"

BOATER SPORTS

## Reflective Safety Tape

- (2) 2" x 12" strips.
- Dot-C2 Approved.



Product No.	Description
7-59325	Reflective Safety Tape





## License Plate Mounting Bracket

- Universal slotted mount.
- Quick and easy installation.
- Rust and corrosion proof.



Product No.	Description
<b>7-59098</b>	License Plate Mounting Bracket

## Galvanized License Plate Bracket

- Standard license plate bracket.
- 2" hole centers.



Product No.	Description
<b>7-59101</b>	License Plate Bracket

## 7-Round to 5-Flat Trailer Adapters

- These one piece adapters go from a 7-round blade socket (vehicle) to a 5-flat plug (trailer).



Product No.	Description
<b>7-0507</b>	7-Round to 5-Flat Trailer Adapter
<b>7-0527</b>	Length 16"

## 7-Round to 4-Flat Trailer Adapter

- Adapts a 7-round blade socket (vehicle) to a 4-flat plug (trailer).



Product No.	Description
<b>7-0506</b>	7-Round to 4-Flat Trailer Adapter

## 5-Way Flat Trailer/Car Wiring Harnesses

- Color-coded wire indexed connector molded to the wire, eliminating possibility of corrosion and shorting due to moisture.
- 12 and 24 volt capacity.

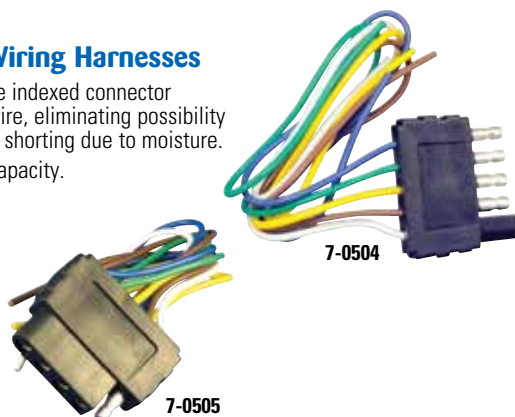

Product No.	Description
<b>7-0504</b>	Male Plug with 1' Wire Trailer Side
<b>7-0505</b>	Female Plug with 4' Wire Vehicle Side

## Polyethylene License Plate Bracket

- Standard license plate bracket.
- 2" hole centers.



Product No.	Description
<b>7-59102</b>	License Plate Bracket

## Trailer Wire Frame Clips

- Zinc plated.
- Corrosion resistant.
- Secures and organizes trailer wire along the trailer frame.



Product No.	Description
<b>7-59289</b>	Trailer Wire Frame Clips

## 7-Round to 5-Flat Coiled Trailer Adapter

- Retractable coiled design for 7-Way RV Blade (from vehicle) to 5-Way Flat (to vehicle).
- Weatherproof cable design.
- Corrosion resistant.



Product No.	Description
<b>7-59263</b>	7-Round to 5-Flat Coiled Trailer Adapter

## Trailer Wire Adapter with Short Lead

- 7-round to 5-flat trailer wire adapter provides a secure connection between your trailer and tow vehicle.
- Black plastic construction.



Product No.	Description
<b>7-59396</b>	Trailer Wire Adapter with Short Lead

## 4-Way Flat Trailer/Car Wiring Harnesses

- Color-coded wire indexed connector molded to the wire, eliminating possibility of corrosion and shorting due to moisture.

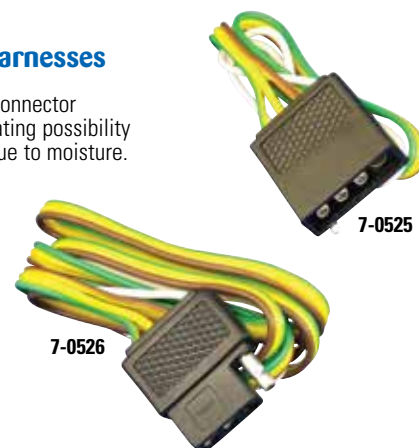

Product No.	Description
<b>7-0525</b>	Male Plug with 1' Wire Trailer Side
<b>7-0526</b>	Female Plug with 4' Wire Vehicle Side



MARPAC

## Trailer Extension Harnesses

- Color-coded 4-way and 5-way extension harness.
- Includes: Male and female ends.
- Use as an extension or cut to length for wired connectors.



Product No. Description

<b>7-59379</b>	4-Way	1' Long
<b>7-59380</b>	4-Way	2' Long
<b>7-59385</b>	5-Way	1' Long
<b>7-59386</b>	5-Way	2' Long

MARPRO

## 4-Way Trailer Wiring Kit

- Designed for the do-it-yourselfer, these trailer wiring kits are easy to install.
- 25' wishbone trailer harness.
- Includes: Vehicle & trailer connectors, (8) trailer clips and (2) wire connectors.
- Color-coded 4-way wires.



Product No. Description

<b>7-59372</b>	4-Way Trailer Wiring Kit
----------------	--------------------------

TOUGH GUY

## Trailer Winches

- Corrosion resistant zinc coating.
- Two-way ratchet with neutral.
- Ergonomic comfort grip.
- Winch strap with hook included.



Product No. Description

<b>7-1597</b>	600 lbs.	Gear Ratio: 3 to 1	Strap Length: 12'
<b>7-1589</b>	1,000 lbs	Gear Ratio: 4 to 1	Strap Length: 12'
<b>7-1591</b>	1,400 lbs	Gear Ratio: 4 to 1	Strap Length: 12'
<b>7-1592</b>	1,800 lbs	Gear Ratio: 5 to 1	Strap Length: 2" x 15'

BOATER SPORTS

## Comfort Grip Winch Handle

- Zinc plating offers maximum corrosion resistance.
- Ergonomic comfort grip included.
- Universal design fits most winches.



## 5-Way Trailer Wiring Kit

- Designed for the do-it-yourselfer, these trailer wiring kits are easy to install.
- 40' wishbone trailer harness.
- Includes: Vehicle & trailer connectors, (8) trailer clips and (2) wire connectors.
- Color-coded 4-way wires.



Product No. Description

<b>7-59437</b>	5-Way Trailer Wiring Kit
----------------	--------------------------

## Trailer Light Tester

- LED indicator.
- Test tail lights, turn signals and brake lights.
- Removable cover.
- Fits all 4 pole flat connectors.



Product No. Description

<b>7-0503</b>	Trailer Light Tester
---------------	----------------------

## Dual Gear Trailer Winch

- 2,000 lbs. maximum capacity.
- 4 to 1 gear ratio.
- Dual drive gears for uniform torque with better stability and more power.
- Corrosion resistant zinc coating.
- Two-way ratchet with neutral.
- Ergonomic comfort grip.
- 2" x 20' winch strap with hook included.



Product No. Description

<b>7-1594</b>	Dual Gear Trailer Winch
---------------	-------------------------

## 2-Speed Trailer Winch with Brake

- 2,500 lbs. maximum capacity.
- Dual speeds with 5 to 1 and 12 to 1 gear ratio.
- Heavy duty construction.
- Corrosion resistant zinc coating.
- Two-way ratchet with neutral.
- Hand brake included for safety.
- Ergonomic comfort grip.
- 2-1/2" x 20' winch strap with hook included

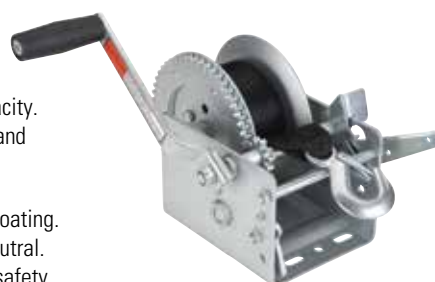

Product No. Description

<b>7-1596</b>	2-Speed Trailer Winch with Brake
---------------	----------------------------------

Product No. Description

<b>7-1600</b>	Winch Handle
---------------	--------------

# WINCH STRAPS and TRAILER JACKS



MARPAC

MARPRO

TOUGH GUY

BOATER SPORTS

## Trailer Winch Cables

- Galvanized steel 7 x 19 aircraft cable is made to handle the heavy loads.
- Each cable is fitted with a heavy duty galvanized latch hook, pull proof loop and a fastener end for replacement use on electric winches.
- Also great for hand crank winches.



Product No.	Description
<b>7-1845</b>	3/16" x 25' Cable
<b>7-1846</b>	7/32" x 25' Cable

## Winch Straps with Loop End

- Heavy duty webbing.
- Breaking strength: 6,000 lbs.
- Loads up to 2,000 lbs.
- Forged steel hook.
- Includes hardware for installation.



Product No.	Description
<b>7-2110</b>	2" x 20' Strap
<b>7-2111</b>	2" x 30' Strap

## Winch Strap with Loop End

- Heavy duty webbing.
- Breaking strength: 10,000 lbs.
- Forged steel hook.
- 2" x 25' strap.
- Includes hardware for installation.



Product No.	Description
<b>7-2113</b>	Winch Strap with Loop End

## Winch Strap with Safety Strap

- Includes a 24" Safety Strap securing your boat to the trailer in the event the winch strap fails.
- Each strap is equipped with two heavy duty utility hooks.
- 2" x 20' strap.
- Replaces: OEM 9642019.



Product No.	Description
<b>7-59822</b>	Winch Strap with Safety Strap

## Winch Strap with Hook

- High impact polyester strap.
- Fits standard trailer winches.
- Heavy duty utility hook.
- 2" x 15' strap.



Product No.	Description
<b>7-59816</b>	Winch Strap with Hook

## PWC Winch Strap

- PWC winch strap made of high impact polyester webbing.
- Breaking strength 4,500 lbs.
- Heavy duty hook.
- 2" x 12' strap with 1" x 18" loop.



Product No.	Description
<b>7-59815</b>	PWC Winch Strap

## Swing-Up Trailer Jack

- Fits 3" x 5" trailer tongues.
- 1,500 lbs. maximum tongue weight.
- Provides up to 21" of lift.
- Easy swing-up operation.
- Fell secure with locking pin for added strength and support.
- Smooth turning grip.
- Hardware kit included.



Product No.	Description
<b>7-1598</b>	Swing-Up Trailer Jack

## Swing-Up Trailer Jack

- Fits 3" x 5" trailer tongues.
- 1,000 lbs. maximum tongue weight.
- Provides up to 21" of lift.
- Easy swing-up operation.
- Feel secure with locking pin for added strength and support.
- Non-slip handle for a more comfortable and secure grip.
- Hardware kit included.



Product No.	Description
<b>7-1585</b>	Swing-Up Trailer Jack

## Replacement Trailer Jack Wheels



Product No.	Description
<b>7-1620</b>	2" Wide x 6" Diameter
<b>7-1621</b>	2" Wide x 8" Diameter

## Wide Wheel Swing-Up Trailer Jack

- Fits 3" x 5" trailer tongues.
- 2,000 lbs. maximum tongue weight.
- Provides up to 25" of lift.
- Easy swing-up operation.
- 2X wide wheel rolls smoother, is more stable with less sinking.
- Double pin for added strength and durability.
- Continued smooth operation when lubricated using convenient grease fitting.
- Hardware kit included.



Product No.	Description
<b>7-1599</b>	Wide Wheel Swing-Up Trailer Jack



# TRAILER JACKS, BALL MOUNTS and SAFETY PINS

MARPAC

## Drop-Leg Trailer Jack

- Fits 3" x 5" trailer tongues.
- 2,500 lbs. maximum tongue weight.
- Provides up to 31" of lift.
- Zinc plated for corrosion resistance.
- Easy adjustments with quick release thumb pin.
- Continued smooth operation when lubricated using convenient grease fitting.
- Zinc plated hardware kit included.



Product No.	Description
<b>7-1588</b>	Drop-Leg Trailer Jack

MARPRO

## Ball Mounts

### CLASS II

- Fits 1-1/4" square receivers.
- 7" shank.
- 3,500 lb. gross trailer weight.
- 300 lb. tongue weight.
- Use with any trailer ball with 3/4" shank diameter.
- **Note:** Trailer ball and hitch pin sold separately.



Product No.	Description
<b>7-1660</b>	2-1/2" Powder Coated Ball Drop

### CLASS IV

- Fits 2" square receivers.
- 8" shank.
- 6,000 lb. gross trailer weight.
- 600 lb. tongue weight.
- Use with any trailer ball with 1" shank diameter.
- **Note:** Trailer ball and hitch pin sold separately.



Product No.	Description
<b>7-1662</b>	2" Powder Coated Ball Drop
<b>7-1664</b>	4" Powder Coated Ball Drop

TOUGH GUY

## Tri-Ball Hitch

- Versatile mount includes 1-7/8", 2" and 2-5/16" chrome trailer balls.
- Rated for: 2,000 lb. (1-7/8"), 6,000 lb. (2") and 10,000 lb. (2-5/16") GTW.
- Solid, powder coated shank for heavy duty towing.
- Fits 2" square receivers.
- 5/8" hitch pin hole (hitch pin sold separately).



Product No.	Description
<b>7-1666</b>	Tri-Ball Hitch

BOATER SPORTS

## Hitch Pin

- Zinc plated for corrosion resistance.
- 5/8" hitch pin fits Class III and Class IV hitches.
- Hairpin cotter won't vibrate free.



## A-Frame Jack

- Heavy duty 2,000 lb. capacity round A-frame side wind jack.
- 13" of vertical travel.
- Retracted length of 8-1/2", extended length of 21-1/2".
- Corrosion resistant black powder coated finish.
- Strong 2" diameter tube.
- Either weld-on or bolt-on (bolts not included).
- Slotted universal fit mounting bracket.
- **Note:** Ground support must be purchased separately. See below.



Product No.	Description
<b>7-1615</b>	A-Frame Jack

## Foot Plate

- For use with **7-1615** A-Frame Jack or similar jacks with 2" round tube.
- Supports up to 3,000 lb.
- Measures: 6.7" x 5".



Product No.	Description
<b>7-1616</b>	Foot Plate

## Jack Castor

- For use with **7-1615** A-Frame Jack or similar jacks with 2" round tube.
- Supports up to 1,200 lb.
- 6" diameter x 2" wide wheel.



Product No.	Description
<b>7-1617</b>	Jack Castor

## Trailer Safety Chains

- Zinc plated.
- Contains: S-hooks on both ends.
- Length 31".

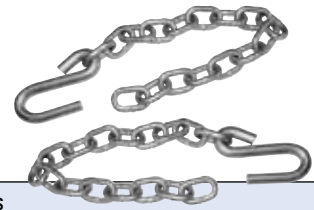

Product No.	Description
<b>7-1850</b>	Class II 3/16" x 28 Links
<b>7-1851</b>	Class III 1/4" x 26 Links

## Coupler Locking Pin

- Steel, electro-galvanized.
- Length 3", 1/4".



Product No.	Description
<b>7-0895</b>	Coupler Locking Pin

## Trailer Coupler Safety Pin

- Zinc plated. Rounded.



Product No.	Description
<b>7-59401</b>	Trailer Coupler Safety Pin

Product No.	Description
<b>7-1868</b>	Hitch Pin

## TIE DOWNS

### Locking Receiver Pin

- Chrome plated for corrosion resistance.
- Safety and security, helps prevent thefts.
- Fits Class III and Class IV hitches (2" x 2").
- Key slot cover protects lock mechanism.
- Pin diameter: 5/8".
- Fits 1/4" trigger style couplers.



Product No. Description

**7-1867** Locking Receiver Pin

### Hitch Lock

- Safety and security, helps prevent thefts.
- Fits Class III and Class IV hitches (2" x 2").
- Chrome plated for corrosion resistance.
- Key slot cover protects lock mechanism.
- Pin diameter: 5/8".



Product No. Description

**7-1866** Hitch Lock

### Deluxe Gunwale Tie Downs with S-hook and Snap Hook

- Heavy duty 2" wide webbing.
- Protective pads.
- Buckle locks securely, is easy to adjust.
- Corrosion resistant S-hook and snap hook.
- Made in USA.

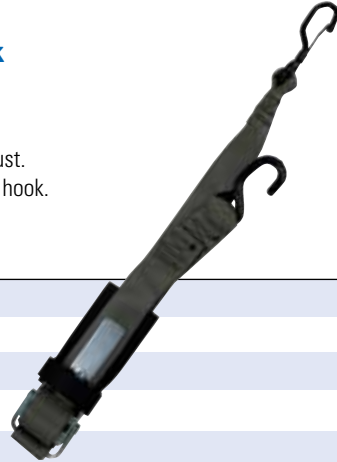

Product No. Description

**7-2120** Length 8'

**7-2121** Length 10'

**7-2122** Length 12'

**7-2123** Length 14'

**7-2124** Length 16'

### Gunwale Tie Downs with J-hook Ends

- Heavy duty 2" wide webbing.
- Buckle locks securely, is easy to adjust.
- Corrosion resistant J-hooks.
- Made in USA.



Product No. Description

**7-2100** Length 10'

**7-2101** Length 12'

**7-2102** Length 14'

**7-2103** Length 16'

### Transom Straps

- High impact polypropylene webbing.
- Fully adjustable.
- Quick release buckle.
- 4 coated J-hooks.
- Sold in pairs.



Product No. Description

**7-59784** Length 2' Width 2"

**7-59810** Length 4' Width 2"

### Heavy Duty Retractable Transom Tie Down

- The safe and easy way to secure a boat to the trailer.
- Unique ratcheting action has two-step release to prevent accidental release.
- Mounting hardware included.
- Made in USA.



Product No. Description

**7-2140** Length 40"

### Ratchet Strap

- High impact polyester webbing.
- Fully adjustable.
- Quick release buckle.
- 2 coated S-hooks.
- Sold each.



Product No. Description

**7-59802** Length 14' Width 2"

### Transom Tie Downs

- Can be quickly adjusted.
- Protective pad.
- Sold in pairs.
- Made in USA.



Product No. Description

**7-2130** Length 2' Width 2"

**7-2133** Length 3-1/2' Width 1" Adjustable

### Ratchet Tie Down

- Heavy duty 1" wide webbing.
- Easy-adjust ratchet.
- Coated S-hooks.
- Made in USA.

Product No. Description

**7-2136** Length 14'





MARPAC

## Hub Kits

- Includes: Hub, (2 each) bearings, 1/2" lug nuts, (1 each) grease seal, (1 each) cotter key and (1 each) dust cap.



### 4 STUD HUB

Product No. Description

**7-0710** 1250#, 1" Bearings, 4 Lug Nuts

### 5 STUD HUB

Product No. Description

**7-0711** 1250#, 1" Bearings, 5 Lug Nuts

**7-0712** 1350#, 1-1/16" Bearings, 5 Lug Nuts

**7-0713** 1750#, 1-1/16" and 1-3/8" Bearings, 5 Lug Nuts

MARPRO

## Poly Keel Rollers

- Made from a non-marring poly blend with UV inhibitors.
- Won't mark up the hull with ugly black streaks.
- Shaft diameter 5/8".



Product No. Description

**7-1580** Length 8"

**7-1581** Length 10"

**7-1582** Length 12"

TOUGH GUY

## Poly Spool Rollers

- Made from a non-marring poly blend with UV inhibitors.
- Won't mark up the hull with ugly black streaks.
- Shaft diameter 5/8".



Product No. Description

**7-1570** Length 4"

**7-1571** Length 5"

BOATER SPORTS

## Poly Bow Stop Rollers

- Made from a non-marring poly blend with UV inhibitors.
- Won't mark up the hull with ugly black streaks.
- Shaft diameter 1/2".



Product No. Description

**7-1566** Length 3"

**7-1567** Length 4"

## Poly V-Bow Stop

- Made from a non-marring poly blend with UV inhibitors.
- Won't mark up the hull with ugly black streaks.
- Shaft diameter 1/2".

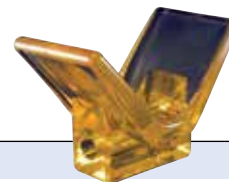

## Spare Tire Carrier

- Heavy duty steel construction, hot dipped galvanized for long lasting protection.
- Fits most 4 and 5 lug tires.
- Attaches to any trailer frame 3" wide x 4" high.
- Zinc plated mounting hardware included.

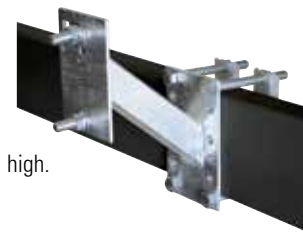

Product No. Description

**7-1755** Spare Tire Carrier

## Spare Tire Carriers

- Suitable for 4 or 5 hole rims.
- Will fit 8" through 14" and most 15" wheels.
- Heavy 7/16" U-bolt secures tire on tongue or frame up to 3" wide.
- Adjustable threaded brackets holds padlock for extra security.

Product No. Description

**7-59100** With Lock

**7-59103** With Lock Brackets

**7-59104** With Nut, No Lock

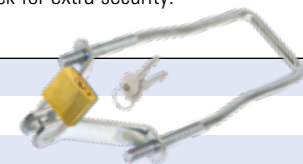

## Self-Centering Poly Keel Roller

- Made from a non-marring poly blend with UV inhibitors.
- Molded grooves center boat as it moves forward for easier loading.
- Replaces any 12" roller with shaft diameter 5/8".



Product No. Description

**7-1583** Length 12"

## Poly Bell Stop Assemblies

- Made from a non-marring poly blend with UV inhibitors.
- Won't mark up the hull with ugly black streaks.
- Stainless steel hardware.



Product No. Description

**7-1560** Length 3"

**7-1561** Length 4"

## Poly Wobble Roller

- Made from a non-marring poly blend with UV inhibitors.
- Won't mark up the hull with ugly black streaks.
- Shaft diameter 3/4".

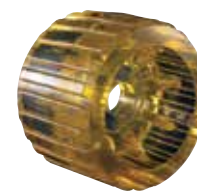

Product No. Description

**7-1575** 4" x 3"

Product No. Description

**7-1565** Length 3"



## Keel Rollers

- Black rubber with nylon bushings.
- Handles the added weight of heavier boats by properly fitting the curvature of the keel.
- Allows for easier launching and loading of the boat.
- Shaft diameter 5/8".
- Maximum roller OD 3-1/2".



Product No. Description

<b>7-1870</b>	Length 8"
<b>7-1871</b>	Length 10"
<b>7-1872</b>	Length 12"

## Bow Roller

- Black rubber.
- Normally used on the trailer winch stand, this roller acts as a bow stop for the boat.
- Shaft diameter 1/2".
- Maximum roller OD 3".



Product No. Description

<b>7-1877</b>	Length 3"
<b>7-59507</b>	Length 4"

## Spool Rollers

- Black rubber.
- Designed especially to support the keel of lighter boats.
- Maximum roller OD 3".



Product No. Description

<b>7-59508</b>	Length 4"	Shaft Diameter 1/2"
<b>7-1874</b>	Length 4"	Shaft Diameter 5/8"
<b>7-1873</b>	Length 5"	Shaft Diameter 1/2"
<b>7-1875</b>	Length 5"	Shaft Diameter 5/8"

## Shaft Spool/Bow Roller End Cap

- Durable black rubber end cap.
- For standard duty use.



Product No. Description

<b>7-59522</b>	Length 3-1/2"	Shaft Diameter 5/8"
<b>7-59523</b>	Length 2"	Shaft Diameter 1/2"
<b>7-59524</b>	Length 2-1/2"	Shaft Diameter 5/8"
<b>7-59528</b>	Length 3"	Shaft Diameter 1/2"

## Wobble Rollers

- Designed to wobble back and forth automatically adjusting to the contours of the boat hull.



### SMOOTH WITH WASHER - 4-1/4" WIDTH

Product No.	Description
<b>7-1881</b>	4-1/4" OD 7/8" ID

### THREAD WITH SLEEVE - 3" WIDTH

Product No.	Description
<b>7-1882</b>	Shaft Diameter 1/2"

## Side Guide Roller

- Black rubber.
- Helps center boat in non-drive-on applications.
- Prevents boat from damaging trailer fenders and light brackets.



Product No. Description

<b>7-59514</b>	Length 9"	Diameter 2"	Shaft Diameter 1/2"
<b>7-1883</b>	Length 12"	Diameter 2-1/2"	Shaft Diameter 5/8"

## Bow Guards - V-Block

- Black rubber.
- Attaching to the trailer's winch stand, these bow guards act as a stop to protect the boat's bow.
- Shaft diameter 1/2".



Product No. Description

<b>7-1878</b>	2" x 2"
<b>7-1880</b>	3" x 3"
<b>7-1879</b>	3-3/4" x 4"

## Galvanized Roller Shafts

- Galvanized for corrosion resistance.
- No pal nuts required.
- Includes: (2) zinc plated washers and stainless steel cotter pin.



Product No. Description

<b>7-1835</b>	1/2" OD	Length 5-1/4"	Fits 4" Roller
<b>7-1836</b>	1/2" OD	Length 6-1/4"	Fits 5" Roller
<b>7-1837</b>	5/8" OD	Length 5-1/4"	Fits 4" Roller
<b>7-1838</b>	5/8" OD	Length 6-1/4"	Fits 5" Roller
<b>7-1839</b>	5/8" OD	Length 9-1/4"	Fits 8" Roller
<b>7-1840</b>	5/8" OD	Length 11-1/8"	Fits 10" Roller
<b>7-1841</b>	5/8" OD	Length 13-1/2"	Fits 12" Roller



MARPAC

## Panel Brackets - Bulk

- Heavy 11 gauge hot dipped galvanized steel.
- One piece and designed to support keel rollers.
- Slots accept 7/16" or 1/2" diameter bolts and provide vertical roller adjustment.



Product No. Description

**7-1829** For 4" Roller

**7-1830** For 5" Roller

**7-1831** For 8" Roller

**7-1832** For 10" Roller

**7-1833** For 12" Roller

MARPRO

## Bolster Brackets - Packaged

- Heavy 11 gauge hot dipped galvanized steel.
- Slotted for vertical adjustment and feature nonslip dimples to avoid movement and increase load capacity.
- Sold 2 per package with swivel brackets.

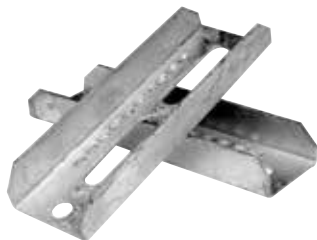

7-1825



Product No. Description

**7-1820** Length 8" Slot Length 2-3/4"

**7-1821** Length 10" Slot Length 3-3/4"

**7-1822** Length 12" Slot Length 4-3/4"

**7-1825** Angle Bracket - Pair

TOUGH GUY

## Outboard Motor Lock

- Secures O/B motor to transom.
- Coated steel tube locks over the screws blocking access.
- Includes pad lock that fits inside tube.
- Keyed.



Product No. Description

**7-52612** Outboard Motor Lock

BOATER SPORTS

## Engine/Trim Ram Mounted Transom Saver

- Quickly installs over the outboard trim ram.
- Minimizes the strain on the trim/tilt system.
- Relieves stress on the boats transom.
- Compatible with: Yamaha, Mercury, Evinrude/Johnson, Suzuki and Honda outboards.
- Prevents the outboard from slipping back into a vertical position.
- Sold each.



Product No. Description

**7-59127** Engine/Trim Ram Mounted Transom Saver

## Bunk Brackets

- Heavy 11 gauge hot dipped galvanized steel mount 2" bunks on edge.
- Slotted for vertical adjustment to standard or deep-V hulls.
- Sold per pair.



Product No. Description

**7-1815** Length 9-1/2"

**7-1816** Length 12-5/8"

## Galvanized U-Bolts

- Fully galvanized to protect against the elements.
- Includes: Galvanized nuts and washers.
- Sold per pair.

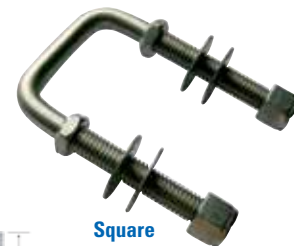

Square U-Bolt

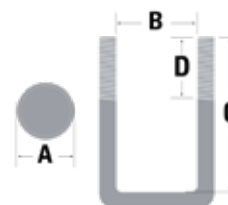

## SQUARE U-BOLTS

	Thread Size (A)	Inside Width (B)	Length (C)	Thread Length (D)
<b>7-1794</b>	3/8"	1-9/16"	2-5/8"	2"
<b>7-1776</b>	3/8"	3-1/16"	2-3/8"	2"
<b>7-1772</b>	3/8"	3-1/16"	4-1/2"	2"
<b>7-1764</b>	1/2"	2-1/16"	4-3/16"	2"
<b>7-1792</b>	1/2"	2-1/16"	4-13/16"	
<b>7-1768</b>	1/2"	2-1/16"	5-3/16"	2"
<b>7-1788</b>	1/2"	2-1/16"	5-1/2"	3"
<b>7-1802</b>	1/2"	2-1/8"	4"	2"
<b>7-1759</b>	1/2"	3-1/16"	4-3/16"	
<b>7-1774</b>	1/2"	3-1/16"	5-3/16"	2"
<b>7-1789</b>	1/2"	3-1/16"	6-3/16"	2"
<b>7-1804</b>	1/2"	3-1/8"	3"	2"
<b>7-1806</b>	1/2"	3-1/8"	4"	2"
<b>7-1808</b>	1/2"	4-1/8"	3"	2"

## ROUND U-BOLTS

	Thread Size (A)	Inside Width (B)	Length (C)	Thread Length (D)
<b>7-1762</b>	7/16"	2-1/2"	5-1/4"	2"





## Shock Absorbing Transom Saver

- Shock absorbing spring reduces transom and engine stress.
- Adjusts easily from 20.5" to 31".
- Includes 100% EPDM strap.
- Heavy duty roller mount.
- Reinforced lower unit cradle.



Product No. Description

**7-59123** Shock Absorbing Transom Saver

## Transom Saver - Dual Mount

- Comes with over the roller and bolt-on brackets for mounting to trailer.
- Made of coated steel.
- Basic adjustable: 32" - 40".
- 10" Rubber strap included.



Product No. Description

**7-59118** Transom Saver - Dual Mount

## Premier Motor Support Bracket

- Bolt-on or over-the-roller universal mount.
- Adjustable from 21" - 31".
- Indestructible polypropylene pads.
- Powder coated cast aluminum head and mounts are lightweight, durable and corrosion resistant.
- Easy-to-handle lightweight aluminum tubing will not rust.
- All stainless steel hardware and fasteners eliminate corrosion.
- EPDM rubber strap and stainless hooks included.

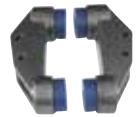

7-0387

Product No. Description

**7-0386** Motor Support Bracket

**7-0387** Spare Bracket Kit

MARPAC

## L.E.D. Switch Panels

- Water resistant switch panel.
- Customizable labels, integrated circuit breaker protection.
- Includes stainless steel mounting hardware.
- Features blue LEDs to indicate position.



1-51318



1-51319

Product No. Description

<b>1-51318</b>	4 Gang	Dimensions: 5.2" W x 4.8" H
<b>1-51319</b>	6 Gang	Dimensions: 5.2" W x 6.8" H

MARPRO

## Non-Illuminated Toggle Switch

- Black plastic lever and locking ring with paddle seal and knurled cap nut.
- Great for lights, aerators and blowers.
- Rated: 15 amps @ 12V DC.
- On-Off-Mom. On.
- 3 terminals.



Product No. Description

<b>1-51310</b>	Non-Illuminated Toggle Switch
----------------	-------------------------------

TOUGH GUY

## Rubber Toggle Switch Boot

- Fits standard toggle switches.
- Protects against moisture and dirt.
- Brass threads. Corrosion resistant.
- 1/2 boot.



Product No. Description

<b>2000068</b>	Rubber Toggle Switch Boot
----------------	---------------------------

BOATER SPORTS

## L.E.D. RGBW Slim Line Lights

- RGBW LEDs combine red, green, blue and white LEDs to form a wide variety of colors to choose from.
- Submersible. Use below or above water.
- Pig tail wire connection.
- Low amp draw.



Product No. Description

<b>1-33615</b>	Length 4"
<b>1-33616</b>	Length 6"
<b>1-33617</b>	Length 8"

## Breaker Cover

- Covers breaker terminals protecting them from elements and prevents corrosion.



Product No. Description

<b>2000326</b>	Breaker Cover
----------------	---------------

## Breaker Mounting Bracket

- For convenient mounting of trolling motor breaker.
- Use with manual or automatic trolling motor breakers.



Product No. Description

<b>2000327</b>	Breaker Mounting Bracket
----------------	--------------------------

## Brass Toggle Switch

- Chrome plated brass.
- Accommodates 10 amp @ 250V AC, 15 amp @ 120V AC and 15 amp @ 12V DC.
- Mom. On-Off.
- 2 terminals.



Product No. Description

<b>1-51331</b>	Toggle Switch
----------------	---------------

## Breaker Boot

- Waterproof, clear rubber boot for use with push button breakers.



Product No. Description

<b>1-51384</b>	Breaker Boot
----------------	--------------

## L.E.D. Slim Line Lights

- LED strip light with clear lens.
- Waterproof design to be used above or below water line.
- Low amp draw, shock resistant, 12 volt, pig tail wire connection is fully sealed.

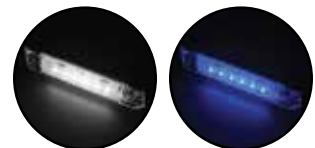

Product No. Description

<b>1-33600</b>	White	Length 4"
<b>1-33601</b>	Blue	Length 4"
<b>1-33602</b>	Green	Length 4"
<b>1-33603</b>	Red	Length 4"
<b>1-33605</b>	White	Length 6"
<b>1-33606</b>	Blue	Length 6"
<b>1-33607</b>	Green	Length 6"
<b>1-33608</b>	Red	Length 6"
<b>1-33610</b>	White	Length 8"
<b>1-33611</b>	Blue	Length 8"
<b>1-33612</b>	Green	Length 8"
<b>1-33613</b>	Red	Length 8"

# ACCENT LIGHTS and STRIP LIGHTS

## L.E.D. Accent Lights

- From early morning fishing trips to evening cruises a little accent light goes a long way.
- Low profile and extremely energy efficient design make for a very versatile light.
- Fully sealed and rugged design means this light is perfectly at home in heavy traffic areas around the deck of your boat.
- Pre-wired pig tail wire harness for ease of installation.



Product No. Description

<b>1-51945</b>	Blue
<b>1-51989</b>	White

## L.E.D. RGBW Aqua Bright Light

- RGBW LEDs combine red, green, blue and white LEDs to form a wide variety of colors to choose from.
- Submersible.
- Use below or above water.
- Pig tail wire connection.
- Low amp draw.



Product No. Description

<b>1-51081</b>	Aqua Bright Light
----------------	-------------------

## L.E.D. Portable Light Kits with Mounting Track

- Great for tool boxes and truck beds, coolers and storage, cars, motorcycles, all-terrain vehicles, kayaks and boats.
- Easy installation.
- No wiring required.
- Water resistant construction.
- Flex track with finished ends.
- Includes (3) AA Batteries.
- Length 18"



Product No. Description

<b>1-34088</b>	White
<b>1-34089</b>	Green

## L.E.D. RGBW Flex Strip Light

- RGBW LEDs combine red, green, blue and white LEDs to form a wide variety of colors to choose from.
- LED strip for additional lighting anywhere.
- Water resistant construction.
- Self-adhesive flexible LED strip.
- Pig tail wire connection.
- Low amp draw.

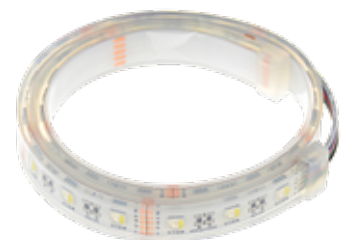

## L.E.D. Rail Light

- 12" LED rail light. On/Off switch.
- Swivel mount allows for mounting in many locations.



Product No. Description

<b>1-51117</b>	LED Rail Light
----------------	----------------

## L.E.D. Flex Strip Lights

- 4 watt LED rope light is perfect for creating sharp angles and definition lines in your boat or camper; super bright, outdoor or indoor use.
- Cool to touch when in use.
- LED lights last up to 20x longer than regular bulbs.
- Available in varying lengths and able to be trimmed to fit any size or shape.



Product No. Description

<b>1-51920</b>	White	Length 12"
<b>1-51921</b>	Blue	Length 12"
<b>1-51922</b>	Red	Length 12"
<b>1-51923</b>	Green	Length 12"
<b>1-51678</b>	White	Length 24"
<b>1-51677</b>	Blue	Length 24"
<b>1-51924</b>	Red	Length 24"
<b>1-51925</b>	Green	Length 24"
<b>1-51932</b>	Blue/White	Length 24"
<b>1-51926</b>	White	Length 48"
<b>1-51927</b>	Blue	Length 48"
<b>1-51928</b>	Red	Length 48"
<b>1-51929</b>	Green	Length 48"
<b>1-51934</b>	Blue/White	Length 48"
<b>1-51672</b>	White	Length 72"
<b>1-51671</b>	Blue	Length 72"
<b>1-51931</b>	Green	Length 72"
<b>1-51936</b>	Blue/White	Length 72"
<b>1-51942</b>	White	Length 144"
<b>1-51943</b>	Blue	Length 144"
<b>1-51939</b>	Light Track	3 pcs. x 4' with End Caps
<b>1-51889</b>	Light Track	6 pcs. x 4' with End Caps

MARPA

MARPRO

TOUGH GUY

BOATER SPORTS

## L.E.D. RGBW Light Display with Controller

- Controller operated function to display RGBW LED Lights.
- Allows for a complete demonstration of the most popular RGBW LED Lights.
- Show the full color ranges, fade and strobe features and the variable intensities available with controller operated RGBW LED lights.



Product No.	Description
<b>1-38869</b>	LED RGBW Light Display with Controller

## L.E.D. Light Display

- Push button function to show the operation of LED Lights.
- Displays the most popular single color and multi color LED lights that do not require a controller.
- Demonstrate the intensity and the impact of adding LED Lighting from one simple display.



Product No.	Description
<b>1-39868</b>	LED Light Display

## L.E.D. RGBW Pontoon Light Kit

- 48 LED modules.
- 6 lumens per module.
- (2) 24' strands of LEDs.
- Quick connect plug-in Y-harness.
- Hue slider for easy color selection.
- Water resistant.
- Includes controller.
- Stainless steel hardware and 3M adhesive tape Included.
- Low amp draw/60mA per module.

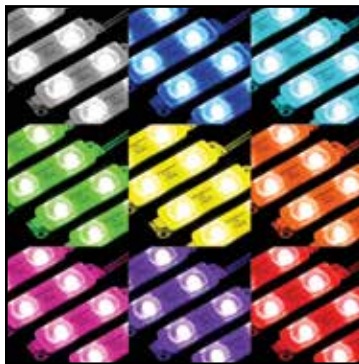

Product No.	Description
<b>1-32683</b>	LED RGBW Pontoon Light Kit

## Pontoon Light Kits

- 3M adhesive backing.
- High impact construction.
- 12" pigtail wire.
- Fully incased water resistant construction.
- Kit includes: (2) 28 module 28' strands + 12 foot pigtail 56 SS mini screws and 4 butt connectors.



Product No.	Description
<b>1-33630</b>	White
<b>1-33631</b>	Blue

## L.E.D. RGBW High Intensity Underwater Light

- RGBW LEDs combine red, green, blue and white LEDs to form a wide variety of colors to choose from.
- Stainless steel housing.
- Sealed and watertight.
- High lumens. Low amp draw.
- No burning filament.
- Pig tail wire connection.
- For underwater use only.
- Diameter 3.5", thick 0.8".



Product No.	Description
<b>1-51087</b>	LED RGBW High Intensity Underwater Light

## L.E.D. RGBW Underwater Light

- Anodized aluminum housing.
- Glass lens.
- 58" tinned 5 wire lead.
- High lumens: R: 65, G: 120, B: 25, W: 180.
- Low amp draw: R: 350mA, G: 310mA, B: 340mA, W: 500mA.
- Diameter 3.85", thick 0.85".



Product No.	Description
<b>1-39468</b>	LED RGBW Underwater Light

## L.E.D. High Intensity Underwater Lights

- Stainless steel housing.
- High lumens.
- Low amp draw.
- No burning filament.
- Pigtail wire connection.
- For underwater use only.
- Includes (3) stainless steel screws.
- Diameter 3-1/2".
- 8 watt, 6 LEDs.
- 12 volt.



Product No. Description

<b>1-51094</b>	White
<b>1-51095</b>	Blue
<b>1-51097</b>	Green

## L.E.D. RGBW High Intensity Underwater Light

- 4 colors: Red, Green, Blue and White.
- Anodized aluminum housing with glass lens.
- No controller required - works with standard two position switch.
- Diameter 3.85", thick 0.85".



Product No. Description

<b>1-39472</b>	LED RGBW High Intensity Underwater Light
----------------	--

## L.E.D. High Intensity Underwater Lights

- Totally waterproof and designed to be used above or below waterline.
- The convex glass used allows for more of a flood effect offers a wider aperture and greater light output than comparable LED models.
- Includes surface option mounting pad.
- Dimensions: 3.5" L x 1.5" W.



Product No. Description

<b>1-51088</b>	White
<b>1-51089</b>	Blue
<b>1-51090</b>	Green

## L.E.D. High Intensity Underwater Light - Oval

- Precision fit stainless steel bezel.
- Clear lens for maximum light output.
- Rustproof, impact-resistant housing.
- 6 super bright LEDs.
- 480 lumens.
- Includes: Stainless steel mounting hardware.
- For underwater use only.



Product No. Description

<b>1-51751</b>	Blue
----------------	------

## L.E.D. Stick-On Livewell Lights

- 1" round, 3 LED's per light.
- Sealed epoxy back, wires connected to back.
- Waterproof.



Product No. Description

<b>1-39421</b>	White
<b>1-39422</b>	Blue

## L.E.D. Round Front Position Light



Product No. Description

<b>139484</b>	White
---------------	-------

## L.E.D. Square Spreader Lights

- Heavy duty aluminum housing.
- Fully sealed waterproof construction.
- Great for boats, trucks, ATVs and all other vehicles.
- Dimensions: 3.22".
- 1350 Lumens. (6) 3 watt LEDs.
- Black.



Product No. Description

<b>1-39447</b>	Spot Beam
<b>1-39449</b>	Flood Beam

## L.E.D. Portable Fishing Light

- Suction mount UV fishing light.
- 2 light modes: Green and UV.
- LED strip adjusts 180 degrees.
- Easily mount and remove.
- Attract bait and fish.
- 12 volt power plug.
- No wiring required.



Product No. Description

<b>1-34128</b>	LED Portable Fishing Light
----------------	----------------------------

MARPAC

## L.E.D. Docking/Running Light Kit

- Docking LED lamps deliver more power than standard sealed beams and last longer.
- Clear lens for maximum light output.
- Rustproof, impact resistant housing.
- Works on 10-30 volts.
- Sold per pair.



Product No.	Description
<b>1-51181</b>	White

## RGBW Controller

- Controls RGBW light color and intensity.
- Hue slider for easy color selection.
- 4 preset pattern modes: Strobe, fast strobe, fade, fast fade.
- Quick buttons for red, green, blue and white.
- Illuminated power button.
- Smooth surface with a sleek design.



Product No.	Description
<b>1-33655</b>	RGBW Controller
<b>1-32656</b>	Insulated 5 Conductor Wire - 100'

MARPRO

## L.E.D. Replacement Bulbs



Product No.	Description
<b>1-51283</b>	Size 1004
<b>1-51588</b>	Size 1157

TOUGH GUY

# FENDERS and ANCHOR BUOYS

## Standard Fenders

- Made of high quality vinyl.
- These newly designed "super-soft" fenders.
- Non-abrasive and can be tied to cleats or rails to put protection exactly where you need it.
- Ribbed on all sides for strength and durability.
- Reinforced rope holes for added strength.



Product No.	Description
<b>1-52559</b>	5-1/2" x 20" Navy
<b>1-52561</b>	5-1/2" x 20" Tan
<b>1-52564</b>	6-1/2" x 23" Green

## Anchor Buoys

- Inflatable PVC buoy.
- Heavy duty construction.
- UV protection.
- Works with anchor retrieval ring.
- Orange.



Product No.	Description
<b>1-50711</b>	8-1/2" x 28"
<b>1-50712</b>	12" x 38"
<b>1-50713</b>	15" x 47"
<b>1-50714</b>	18" x 57"
<b>1-50715</b>	21" x 70"

## Adjustable Fender Holders

- Adjustable 4" to 22" strap.
- Easily attach or detach with quick release buckle.



Product No.	Description
<b>1-52100</b>	White
<b>1-52101</b>	Blue

BOATER SPORTS

## Non-Automatic Submersible Bilge Pumps

- Submersible.
- Ignition protected. Tinned wire.
- Salt or fresh water.
- Stainless steel hardware included.
- Easy removal for cleaning.
- Bilge pumps have universal mounting base allowing pumps to snap into competitors bases without modification to mounting holes or position.
- Meets USCG requirements.
- 12 volt.



Product No.	Description
<b>1-57412</b>	600 GPH Discharge 3/4"
<b>1-57420</b>	800 GPH Discharge 3/4"
<b>1-57426</b>	1,100 GPH Discharge 1-1/8"

## Cartridge Submersible Bilge Pump

- Submersible.
- High impact, fully sealed construction.
- Quick and easy installation.
- Dual mount design.
- Cartridge design means simplified maintenance and unmatched safety when out on the water.
- Cartridge easily exchanges in case of pump failure.
- Discharge 3/4".
- 12 volt.



Product No.	Description
<b>1-57446</b>	800 GPH
<b>1-57433</b>	Replacement Cartridge

## High Output Submersible Bilge Pumps

- Submersible.
- Compact and efficiency long life motor.
- High pumping capacity.
- Ignition protected. Tinned wire.
- Turbo designed impeller.
- Quiet operation.
- Easy clean snap-lock strainer.
- Includes stainless steel mounting hardware.
- Discharge 1-1/8".
- 12 volt.



Product No.	Description
<b>1-57430</b>	1,500 GPH
<b>1-57435</b>	2,000 GPH

## Automatic Submersible Bilge Pump

- Submersible.
- Ignition protected.
- Tinned wire.
- Salt or fresh water.
- Stainless steel hardware included.
- Easy removal for cleaning.
- Meets USCG requirements.
- Discharge 3/4".
- 12 volt.



Product No.	Description
<b>1-57422</b>	800 GPH

## Bilge Pump with Float Switch

- Includes: 600 GPH bilge pump packaged with **1-57438** float switch.
- Submersible.
- Ignition protected.
- Discharge 3/4".
- Meets USCG requirements.
- 12 volt.



Product No.	Description
<b>1-57418</b>	600 GPH

## Automatic Float Switch

- Activates pump automatically.
- Submersible.
- For use with all DC bilge pumps.
- Stainless steel hardware included.
- 12 volt.



Product No.	Description
<b>1-57438</b>	Automatic Float Switch

## 3-Way Bilge Pump Switch

- Marine grade tinned wire.
- Corrosion free aluminum panel.
- 3 position toggle switch - "On-Off-Auto".
- LED indicator light.
- 10 amp breaker.
- Dimensions: 3-1/4" x 2".



Product No.	Description
<b>1-57444</b>	3-Way Bilge Pump Switch

## Dual Mount Livewell Pump

- 800 GPH thru-hull, submersible livewell pump with 3/4" hose outlet.
- Straight or angled mount.
- 30" marine-grade tinned lead wires.
- Salt or freshwater.
- 12 volt.



Product No.	Description
<b>1-57473</b>	Dual Mount Livewell Pump

## Deluxe Cushion Sets

- Seat shell sold separately!



White/Blue

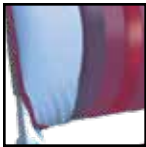

White/Red



Tan/Brown



White

Product No.	Description
<b>2000487</b>	Charcoal/Blue
<b>2000488</b>	Charcoal
<b>2000489</b>	Charcoal/Red
<b>2000500</b>	Gray/Black
<b>2000501</b>	Gray/Blue
<b>2000504</b>	Gray
<b>2000505</b>	Gray/Red
<b>2000526</b>	Tan/Brown
<b>2000531</b>	White/Blue
<b>2000532</b>	White/Red
<b>2000534</b>	White

## Seat Cushions

Product No. Description

- 1-58730** White
- 1-58731** Gray



## Seat Pedestal

- Black powder coated economy seat pedestal.
- Use with flat swivel.
- Adjustable height 11-1/2" - 17-1/2".



Product No. Description

- 1-54942** Seat Pedestal

## Stainless Steel Seat Base

- High strength stainless steel construction with a satin finish.
- Accepts all 3/4" pin-type extensions.
- Nylon bushing.



Product No. Description

- 1-54937** Seat Base

## Center Console Covers

- Designed to protect center console from the elements.
- 13 oz. acrylic-coated polyester.
- Includes draw string to ensure a snug fit.



### BLACK

Product No.	Description
<b>1-BSCCBLK</b>	Small 40" D x 33" W x 36" H
<b>1-BSCCLBLK</b>	Large 35" D x 36" W x 46" H
<b>1-BSCCXLBLK</b>	Extra Large 50" D x 40" W x 60" H

### GRAY

Product No.	Description
<b>1-BSCCGR</b>	Small 40" D x 33" W x 36" H
<b>1-BSCCLGR</b>	Large 35" D x 36" W x 46" H
<b>1-BSCCXLGR</b>	Extra Large 50" D x 40" W x 60" H

# COVERS

## Flip Flop Seat Covers

- Designed to protect flip flop seat.
- 13 oz. acrylic-coated polyester.
- Includes draw string to ensure a snug fit.
- Dimensions: 40" H x 35" W x 19" D.



Product No. Description

- 1-BSFFBLK** Black
- 1-BSFFGR** Gray

## Power Pole Cover

- Designed to protect Power Poles and Talons of all sizes.
- 13 oz. acrylic-coated polyester.
- Draw string around base to ensure a snug fit.
- Dimensions: 50" H x 10" W.



Product No. Description

- 1-BSPCBLK** Black
- 1-BSPCGR** Gray



# COVERS

## Leaning Post Cover

- Designed to protect leaning post.
- 13 oz. acrylic-coated polyester.
- Includes draw string to ensure a snug fit.
- Dimensions: 47" H x 41" W x 24" D.



Product No. Description

- 1-BSLPBLK** Black
- 1-BSLPGR** Gray

## Economy Personal Watercraft Covers - Non-Trailerable

- Water repellent and breathable.
- Colored fabric, 3 oz. 100% Marine Grade Polyester.
- Treated to resist mildew and UV rays.
- Dimensions: 128" x 135".
- Includes tie-down kit and storage bag.



Product No. Description

- 1-B19143BR** Gray
- 1-B19143BLU** Blue

## Outboard Motor Covers

- Boater Sports motor hoods have a shock cord sewn into the hem for a tight fit.
- Made from Acrylic-Coated Polyester material.



	Fits 25-50 HP 23" L x 16" W x 17" H	Fits 50-115 HP 24" L x 18" W x 23" H	Fits 115-225 HP 28" L x 19" W x 27" H	Fits 225-300 HP 31" L x 24" W x 28" H
<b>Black</b>	<b>1-B10542BLK</b>	<b>1-B10543BLK</b>	<b>1-B10544BLK</b>	<b>1-B10545BLK</b>
<b>Blue</b>	<b>1-B10542BLU</b>	<b>1-B10543BLU</b>	<b>1-B10544BLU</b>	<b>1-B10545BLU</b>
<b>Burgundy</b>	<b>1-B10542BUR</b>	<b>1-B10543BUR</b>	<b>1-B10544BUR</b>	<b>1-B10545BUR</b>
<b>Navy</b>	<b>1-B10542NA</b>			
<b>Green</b>	<b>1-B10542GRN</b>	<b>1-B10543GRN</b>	<b>1-B10544GRN</b>	<b>1-B10545GRN</b>
<b>Mt. Rock</b>	<b>1-B10542MR</b>	<b>1-B10543MR</b>	<b>1-B10544MR</b>	<b>1-B10545MR</b>
<b>Gray</b>	<b>1-B10542GR</b>	<b>1-B10543GR</b>	<b>1-B10544GR</b>	<b>1-B10545GR</b>
<b>Red</b>		<b>1-B10543RED</b>	<b>1-B10544RED</b>	<b>1-B10545RED</b>
<b>Yellow</b>				<b>1-B10545YEL</b>

# BOAT COVER and BIMINI TOP ACCESSORIES

## Telescopic Boat Cover Support Poles

- Use the telescopic adjustable pole and help eliminate standing water.
- Twist to lock and unlock.
- Rubber tips at both ends.
- Deluxe model includes canvas snap and mushroom head.
- 1" diameter.



Product No. Description

- 1-56202** Standard Pole 28" - 48"
- 1-56201** Deluxe Pole 36" - 64"

## External Eye End

- High impact nylon construction for exceptional durability.
- 3/4".
- Black nylon.
- Sold each.



Product No. Description

- 1-55162** External Eye End

## Bimini Top Replacement Strap

- High impact 1" nylon webbing with adjustable buckle and stainless steel spring snap hook.
- Black.
- Sold per foot.



Product No. Description

- 1-576561** Bimini Top Replacement Straps

## Boat Cover Tie Down Kit

- 12 Pack of black nylon boat cover tie downs to secure a boat cover.
- Dimensions: 1" wide x 8' length.



Product No. Description

- 1-55133** Boat Cover Tie Down Kit

## Internal Eye End

- High impact nylon construction for exceptional durability.
- 3/4".
- White nylon.
- Sold each.



Product No. Description

- 1-55148** Internal Eye End

## Bimini Top Support Tube Kit - Round

- Rear brace assembly to easily fold back out of the way and securely brace when not in use.
- Includes two 7/8" x 40" tubes that can be cut to length, two deck mounts and hardware.



Product No. Description

- 1-56204** Bimini Top Support Tube Kit - Round

**Suzuki Fuel Connector**

- Chrome plated brass.
- 5/16" barb female.



Product No. Description

**1-53202** Suzuki Fuel Connector**Trolling Motor Mounting Isolators**

- For mounting bow mount motors.
- Set consists of bolts and isolators.
- Set of 4 "T-Type" Isolators.



Product No. Description

**2000595** Trolling Motor Mounting Isolators**Deck Plates**

- UV stabilized, high impact ABS material.
- Hidden screws.
- O-ring seal.
- White.



Product No. Description

**1-54724** Diameter 6"**1-54727** Diameter 8"**Waterproof Pouch**

- Clear vinyl waterproof pouch for camera, phone or other valuables.
- Ziploc style closure ensures waterproof seal.
- Dimensions: 4.4" x 6.5".



Product No. Description

**1-52040** Waterproof Pouch**Utility Winch Hook**

- 4" spring loaded closure, heavy duty zinc plated steel hook.
- Safe working load: 1,500 lbs.
- Slide blister pack.



Product No. Description

**1-54336** Utility Winch Hook**Oil Change/Fluid Evacuator Kit**

- 4 liter total capacity.
- Oil changing made easy.
- Works with all styles of 4 stroke engines.



Product No. Description

**1-52614** Oil Change/Fluid Evacuator Kit**Fold-Down Drink Holder**

- Folding drink holder with pop-up adjustable arms.
- Non-corrosive material, mounting hardware included.
- Gray.

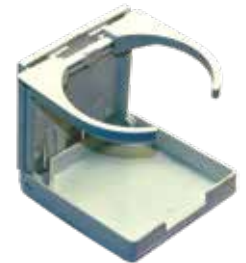

Product No. Description

**1-52014** Fold-Down Drink Holder**Spool Roller**

- Durable black rubber bow guard for standard duty use.
- Length 5".
- 1/2" shaft.



Product No. Description

**1-59510** Spool Roller



## Our Locations

### Birmingham

2401 Five Star Pkwy.  
Bessemer, AL 35022  
Phone: 1-800-288-4450  
1-888-562-5008  
Fax: 1-800-754-9181  
1-888-562-5014

### Charleston

2094 Wambaw Creek Rd., Ste. A  
Charleston, SC 29492  
Phone: 1-800-226-4562  
1-727-572-0192  
Fax: 1-800-780-5627  
1-727-573-1930

### Charlotte

10409 John Price Road  
Charlotte, NC 28273  
Phone: 1-888-562-5008  
1-800-288-4450  
Fax: 1-888-562-5014  
1-800-754-9181

### Chesapeake

65 Engerman Ave., Ste. 3  
Denton, MD 21629  
Phone: 1-800-347-4464  
Fax: 1-800-747-5783

### Chicago

5010 W. 123rd St.  
Alsip, IL 60803  
Phone: 1-800-288-4450  
1-888-562-5008  
Fax: 1-800-754-9181  
1-888-562-5014

### Clearwater

5181 110th Ave. North, Unit B  
Clearwater, FL 33760  
Phone: 1-800-226-4562  
1-727-572-0192  
Fax: 1-800-780-5627  
1-727-573-1930

### Cocoa

636 Clearlake Rd.  
Cocoa, FL 32922  
Phone: 1-877-936-4722  
Fax: 1-877-936-4723

### Dallas

1406 I-35 W  
Denton, TX 76207  
Phone: 1-888-562-5008  
1-800-288-4450  
Fax: 1-888-562-5014  
1-800-754-9181

### Des Moines

4488 112th Street  
Urbandale, IA 50322  
Phone: 1-515-964-4205  
Fax: 1-800-227-1154

### Ft. Lauderdale

2030 West McNab Road  
Ft. Lauderdale, FL 33309  
Phone: 1-877-936-4722  
1-954-581-2453  
Fax: 1-877-936-4723  
1-954-581-7368

### Harvey

3200 Westbank Expwy., Suite B  
Harvey, LA 70058  
Phone: 1-504-361-5731  
Fax: 1-504-361-1596

### Houston

3130 Pawnee  
Houston, TX 77054  
Phone: 1-800-669-8392  
1-713-734-4171  
Fax: 1-800-747-5836  
1-713-734-1674

### Jacksonville

5061 Shawland Rd., Unit A  
Jacksonville, FL 32254  
Phone: 1-800-226-4562  
Fax: 1-800-780-5627

### Little Rock

6600 Murray St., Suite 1  
Little Rock, AR 72209  
Phone: 1-888-562-5008  
1-800-288-4450  
Fax: 1-888-562-5014  
1-800-754-9181

### Miami

3590 Northwest 35th St.  
Miami, FL 33142  
Phone: 1-877-936-4722  
Fax: 1-877-936-4723

### Nashville

1890 Elm Tree Drive  
Nashville, TN 37210  
Phone: 1-800-288-4450  
1-888-562-5008  
Fax: 1-800-754-9181  
1-888-562-5014

### New Orleans

6316 Humphreys St.  
New Orleans, LA 70123  
Phone: 1-800-347-4464  
1-504-488-5731  
Fax: 1-800-747-5783

### Norwich

3 Hilltop Rd.  
Norwich, CT 06360  
Phone: 1-800-226-4562  
Fax: 1-800-780-5627

### Paducah

2401 Powell St.  
Paducah, KY 42003  
Phone: 1-270-442-6919  
Fax: 1-270-442-6923

### Pensacola

3725 North Palafox Street  
Pensacola, FL 32505  
Phone: 1-800-347-4464  
Fax: 1-800-747-5783

### Port Clinton

304 Buckeye Blvd.  
Port Clinton, OH 43452  
Phone: 1-419-732-3181

### Rochester

6013 Denny Drive  
Farmington, NY 14425  
Phone: 1-800-836-5300  
Fax: 1-888-353-8099

### International Division

2030 West McNab Road  
Ft. Lauderdale, FL 33309  
Phone: 1-877-936-4722  
1-954-581-2453  
Fax: 1-877-936-4723  
1-954-581-7368

### Commercial and Shipyard Sales

6316 Humphreys St.  
New Orleans, LA 70123  
Phone: 1-877-366-2366  
commercialsales@donovanmarine.com

**For Accounts Payable & Accounts Receivable, Please Call 877.366.2366**  
**For Returns & Service, Please Call Your Call Center**



• MOORING & ANCHORING



**Superior Boating Products at a Great Value**