



# NC1 IO IP<sup>TM</sup>

## Studio Input/Output IP Module

Operating Instructions

NDI<sup>TM</sup>

Revised – January 4, 2019

Trademarks: NewTek, NewTek VMC1, NewTek VMC1 IN, NewTek VMC1 OUT, NewTek NC1, NewTek NC1 IN, NewTek NC1 I/O, NewTek NC1 I/O IP, TriCaster, TriCaster TC1, TriCaster Advanced Edition, TriCaster XD, TriCaster 8000, TriCaster TCXD8000, TCXD8000, TriCaster 860, TriCaster TCXD860, TCXD860, TriCaster 460, TriCaster TCXD460, TCXD460, TriCaster 410, TriCaster TCXD410, TCXD410, TriCaster Mini SDI, TriCaster Mini, TriCaster 40, TriCaster TCXD40, TCXD40, TriCaster 855, TriCaster TCXD855, TCXD855, TriCaster 455, TriCaster TCXD455, TCXD455, TriCaster EXTREME, TriCaster 850 EXTREME, TriCaster TCXD850 EXTREME, TCXD850 EXTREME, TriCaster 450 EXTREME, TriCaster TCXD450 EXTREME, TCXD450 EXTREME, TriCaster 850, TriCaster TCXD850, TCXD850, TriCaster 450, TriCaster TCXD450, TCXD450, TriCaster 300, TriCaster TCXD300, TCXD300, TriCaster PRO, TriCaster STUDIO, TriCaster BROADCAST, TriCaster DUO, MediaDS, MDS1, 3PLAY, 3Play, 3Play 3P1, 3Play 4800, 3PXD4800, 3Play 440, 3PXD440, 3Play Mini, 3Play 820, 3PXD820, 3Play 425, 3PXD425 3Play 330, 3PXD330, TalkShow, TalkShow VS 4000, TalkShow VS100, Network Device Interface, NDI, NewTek Connect, NewTek Connect Spark, NewTek IsoCorder, ProTek, ProTek Care, ProTek Elite, iVGA, SpeedEDIT, IsoCorder, LiveText, LiveGraphics Creator, LiveGraphics, DataLink, LiveSet, LiveGraphics, TriCaster Virtual Set Editor, Virtual Set Editor Advanced Edition, TriCaster VSE, TriCaster VSE Advanced Edition, LiveMatte, TimeWarp, VT, VT[3], VT[4], V[T5], Video Toaster, Toaster, Inspire 3D, 3D Arsenal, Aura, LightWave, LightWave 3D and LightWave CORE are trademarks, service marks, and registered trademarks of NewTek. All other brand names, product names, or trademarks belong to their respective holders.

---

# TABLE OF CONTENTS

---

CHAPTER 1 INTRODUCTION AND SETUP .....	3
Section 1.1 Welcome .....	3
Section 1.2 Overview .....	3
Section 1.3 Setting Up.....	4
1.3.1 Command and Control .....	4
Section 1.4 Input/Output Connections .....	4
Section 1.5 Networking.....	5
1.5.1 Ethernet.....	5
1.5.2 SFP A and B (SMPTE 2110) .....	5
Section 1.6 Configuration (Administration) .....	5
1.6.1 SFP Configuration .....	5
1.6.2 Genlock Configuration.....	6
1.6.3 I/O Channels .....	7
1.6.4 Administration Panel Footer Tools.....	9
CHAPTER 2 USER INTERFACE .....	11
Section 2.1 The Desktop .....	11
2.1.1 Configure Channels .....	12
Section 2.2 Titlebar & Dashboard .....	17
2.2.1 Titlebar Tools .....	17
2.2.2 Viewport Tools .....	18
2.2.3 Dashboard Tools.....	19
APPENDIX A:  NDI (NETWORK DEVICE INTERFACE) .....	21
APPENDIX B:  DIMENSIONS AND MOUNTING .....	21
APPENDIX C:  ENHANCED SUPPORT (PROTEK) .....	22
APPENDIX D:  RELIABILITY TESTING .....	22
CREDITS.....	23



## Chapter 1 INTRODUCTION AND SETUP



This chapter explains how to connect power, monitors and audio visual devices to your NewTek NC1 Studio Input/Output IP Module. It also reviews the registration process. After completing this short section, you'll be all set to begin using NC1 IO IP.

### SECTION 1.1 WELCOME

Thank you for purchasing this NewTek™ product. As a company, NewTek is extremely proud of its record of innovation and commitments to excellence in design, manufacture, and superb product support. NewTek IP Series products are the most advanced live production tools available, and you will find them exceptionally powerful and versatile.

NewTek's innovative live production systems have repeatedly redefined broadcast workflows, providing new possibilities and economy. The tradition continues with the NewTek NC10 Studio Input/Output IP module. This implementation of NewTek's innovative NDI (Network Device Interface) protocol places your new system squarely in the forefront of IP technology solutions for the video broadcast and production industries.

### SECTION 1.2 OVERVIEW

Commitments and requirements can change from production to production. A powerful, versatile platform for multi-source production and multi-screen delivery workflows, the Studio I/O IP Module quickly pivots to accommodate additional connections.



NC1 IO IP's turnkey installation and operation lets you assemble a network of modules to configure multi-system and multi-site workflows with a minimum of fuss.

Your NewTek NC1 Studio I/O IP Module provides a highly efficient interoperability link between production locations and systems on your network, and is readily adaptable to your needs.

Translate as many as four a/v streams (up to 1080p at 59.94) from SMPTE 2110 input to NDI™ output, and four more from NDI (or other supported source) to SMPTE 2110 output.

Integrate with compatible systems and devices across your network for switching, streaming, display, and delivery. You can stack modules in a single rack, or station them in multiple locations as required to meet the demands of your production environment.

## SECTION 1.3 SETTING UP

### 1.3.1 COMMAND AND CONTROL

*Hint: NC1 IO's interface requires a monitor resolution setting of at least 1280x1024.*

1. Connect an external computer monitor to the HDMI port on the backplane (see Input/Output Connections).
2. Connect the *mouse* and *keyboard* to USB ports also on the backplane.
3. Connect the *power cord* to NC1 IO's backplane
4. Turn on the computer monitor.
5. Press the *Power* switch on NC1 IO's faceplate (behind the drop-down door).

At this point, the Power switch *LED* will illuminate in blue as the device boots up. (If this does not happen, check your connections and retry). By the way, though not a requirement, we strongly encourage the use of an uninterruptable power supply (UPS), as for any 'mission critical' system.

Surge protection is also important in some locales. Likewise, consider A/C "power conditioning", especially in situations where local power is unreliable or 'noisy'. Power conditioners can reduce wear on NC1 IO's power supplies and other electronics, and provide a further measure of protection from surges, spikes, lightning and high voltage.

A word about UPS devices:

'Modified sine wave' UPS devices are popular due to low manufacturing costs. However, such units should generally be viewed as being of low quality and possibly inadequate to fully protect the system from abnormal power events.

For a modest added cost, consider a "pure sine wave" UPS. These units can be relied on to supply very clean power, eliminating potential problems, and are recommended for applications demanding high reliability.

## SECTION 1.4 INPUT/OUTPUT CONNECTIONS

External audio and video sources are connected to the appropriate inputs on NC1 IO's backplane.

1. HDMI - monitor port
2. Ethernet - network connections
3. USB - connect keyboard, mouse and other peripheral devices.



FIGURE 1

4. RESERVED -HD-BNC connector (High Density BNC)
5. SFP A and SFP B
6. Power

## SECTION 1.5 NETWORKING

### 1.5.1 ETHERNET

Generally, simply connecting a suitable cable from one of the two Gigabit Ethernet ports on the backplane is all that is required to add it to a *local area network* (LAN), which typically will serve for NDI i/o connections as well as more mundane networking chores. In some settings, additional steps may be required. You can access the system *Network and Sharing* control panel to accomplish more extensive configuration tasks. If further help connecting is required, please consult your system administrator.

### 1.5.2 SFP A AND B (SMPTE 2110)

The two MSA compatible SFP cages (identified as SFP A and B; see #5 in Figure 1) are provided.

This is where you will plug in your preferred SFP (Small Form-factor Pluggable) transceivers to connect and serve SMPTE 2110 traffic between external systems and your NC1 I/O IP.

Each of the two SFP connection allows two SMPTE 2110 input connections (for a total of four) and two outputs to SMPTE 2110.

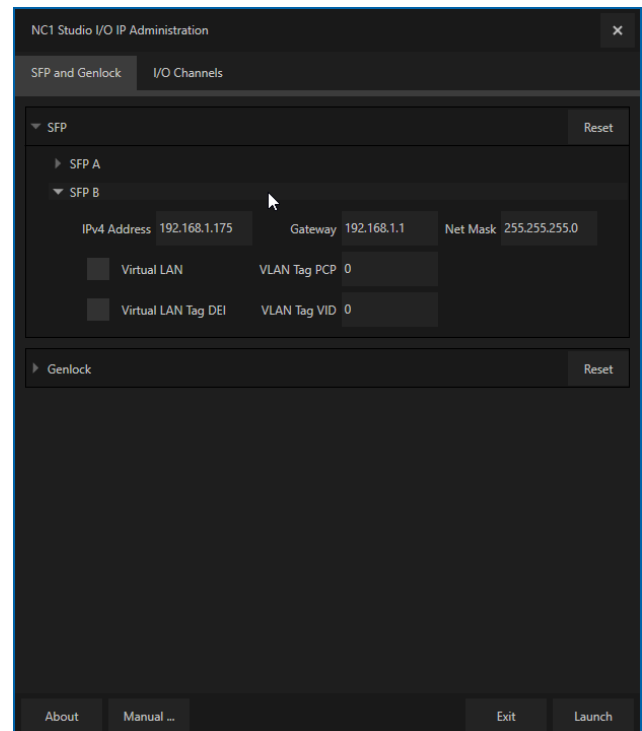

FIGURE 2

## SECTION 1.6 CONFIGURATION (ADMINISTRATION)

The configuration of the two SFP ports, Genlock, and (SMPTE 2110) *I/O Channels* is performed in NC1 Studio I/O IP's *Administration* panel, shown in Figure 2.

This control panel appears on first launch, and thereafter can be accessed by selecting *Exit to Admin* from the *Desktop* (see Section 2.2.1), or from the Windows Start menu.

### 1.6.1 SFP CONFIGURATION

Click the *SFP and Genlock* tab and the header (A or B) for the SFP you wish to configure to expand its settings group.

As a minimum, you will need to supply the following values in order to identify the SFP connection on the network you wish to connect it to:

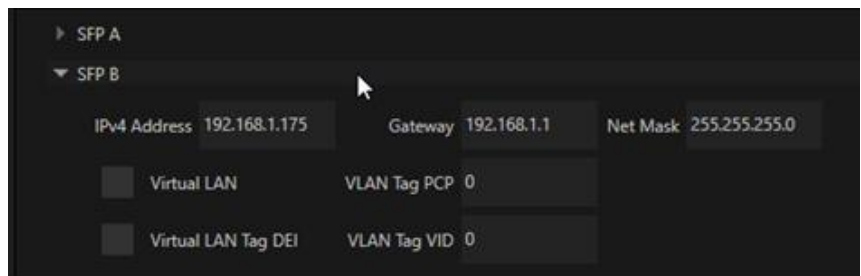

FIGURE 3

- *IPv4Address*
- *Gateway*
- *Net Mask*

Optionally, enable the *Virtual LAN* switch if you these connections to be associated with a VLAN. In this case, continue to configure the following VLAN tags:

- *PCP* – the Priority Code Point refers to the IEEE 802.1p class of service and maps to the frame priority level. PCP values can be used to prioritize traffic.
- *DEI* – Enable the Drop Eligibility Indicator field indicates the frames eligible to be dropped when congestion makes it necessary.
- *VID* – The VLAN IDentifier specifies the VLAN to which the frame belongs.

### 1.6.2 GENLOCK CONFIGURATION

Genlocking provides a mechanism to ensure that your video sources are in sync with one another and other external systems. The *Genlock* tab in the *Administration panel* provides the necessary settings and options.

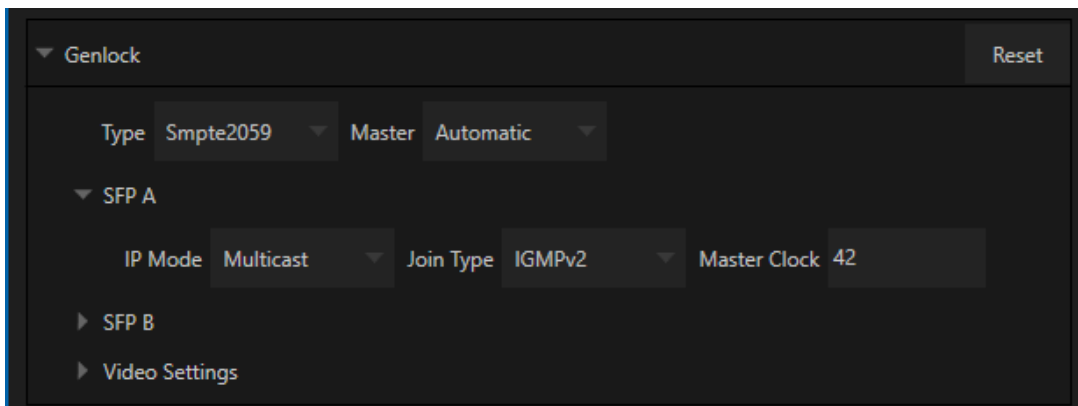

FIGURE 4

- *Type* – Normally, you will select *SMTPE2059* as the method by which timing reference information is supplied to the system. (The other option, *Internal*, uses the system clock for timing (free running) rather than an external reference.)
  - *Master* – Either SFP (A or B) can be designated as the *Genlock* reference source, or you can select *Automatic*.
- *SFP (A/B)* – Configure the SFP you designated as *Master* (unless you selected *Internal* above).
  - *IP Mode* – select the appropriate IP protocol, choosing *Multicast*, *Unicast*, or *Hybrid*.
  - *Join Type* – Choose *None* or *IGMPv2*.
  - *Master Clock* – Specify the for the Master Clock ID for genlock over IP.



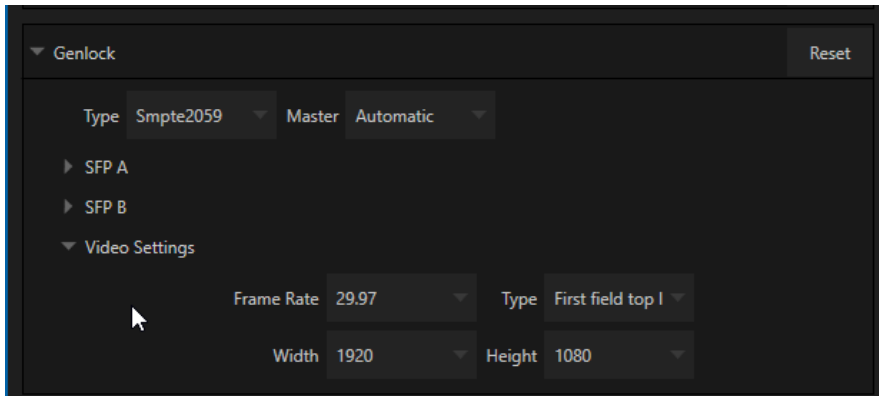

FIGURE 5

- *Video Settings* – Specify the *Frame Rate*, *Type* (choose between fielded and progressive options), *Width* and *Height*.

*Note: The frame rate selected determines which optional formats are shown in the Live Desktop menus. For example selecting 29.97 or 59.94 results in only NTSC format frame rate options being listed.*

### 1.6.3 I/O CHANNELS

As mentioned previously, each SFP transceiver allows two SMTPE 2110 input connections (for a total of four) and two outputs to SMTPE 2110.

Inputs 1 and 2, and outputs 1 and 2 are served by SFP A, while SFP B handles inputs 3 and 4 and outputs 3 and 4.

The settings for each input and output are configured individually in the *I/O Channels* tab of the *Administration* panel, as discussed next.

#### INPUTS

After expanding an input control group, you will typically checkmark the *Enable Video* and *Enable Audio* switches.

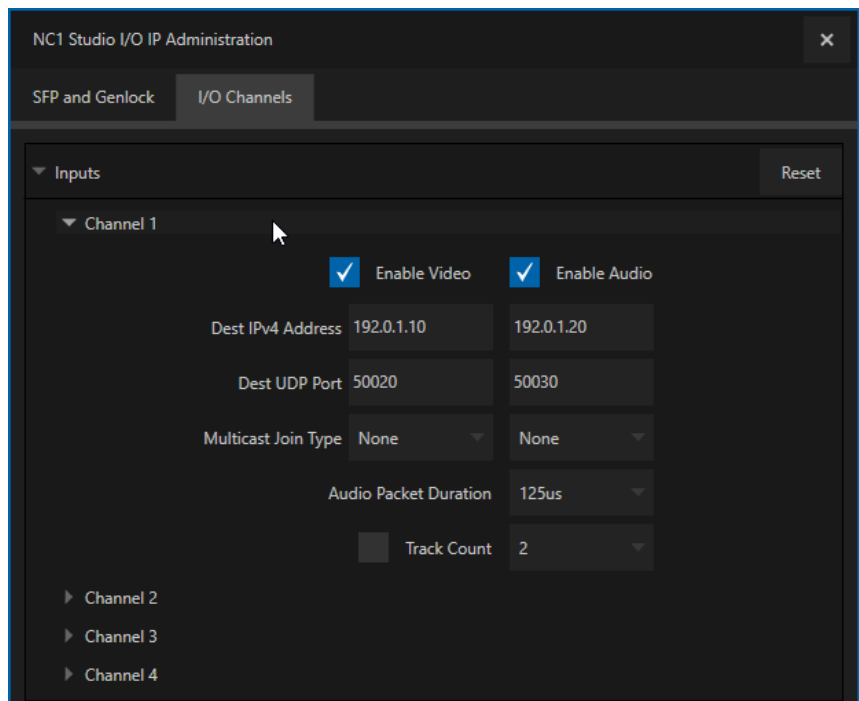

FIGURE 6

Then enter values and choose appropriate settings for the corresponding IP streams in the columns below.

- *Dest(ination) IPv4 Address* – reception multicast IPv4 address
- *Dest(ination) UDP Port* – reception User Datagram Protocol (UDP) port

- *Multicast Join Type* – the membership request type when Dest IPv4 Address is a multicast address
- (Audio column only)
  - *Audio Packet Duration* –the duration of incoming audio packets
  - *Track Count (switch)* – enable this to use a value entered at right to limit the IP stream track count received

## OUTPUTS

Expand the *Outputs* control group, and continue in similar fashion to checkmark *Enable Video* and *Enable Audio* for each SMPTE 2110 output.

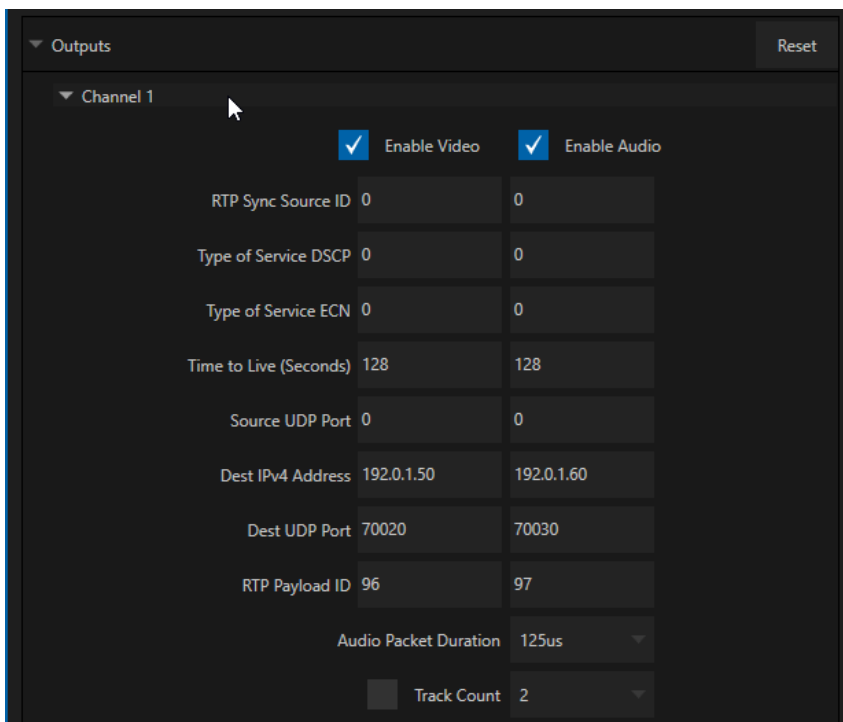

- *RTP Sync Source* – the RTP (Real-time Transfer Protocol) Synchronization Source Identifier (SSRC)
- *Type of Service DSCP* – indicates that the Type of Service (ToS) is Differentiated Service Code Point (DSCP), with a range of [0-63] (6 bits)
- *Type of Service ECN* – indicates that the Type of Service (ToS) is Explicit Congestion Notification (ECN). Range is [0..3] (2 bits)
- *Time to Live (Seconds)* – the time in which packets can be used in seconds. That is, it indicates the packets' Time to live (TTL)
- *Source UDP Port* – the User Datagram Protocol (UDP) port of the sender (i.e., the transmitter)
- *Dest(ination) IPv4 Address* – the UDP port of the destination (i.e., the receiver). Only used in multicast.
- *Dest(ination) UDP Port* – the UDP port of the destination (i.e., the receiver)

- *RTP Payload ID* – the RTP (Real-time Transfer Protocol) payload ID
- (Audio column only)
  - *Audio Packet Duration* –the duration of outgoing audio packets
  - *Track Count (switch)* – enable to use the value entered at right to limit the IP stream track count transmitted

---

#### 1.6.4 ADMINISTRATION PANEL FOOTER TOOLS

---

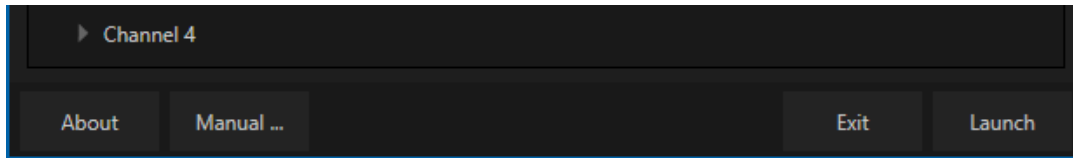

FIGURE 7

At the bottom of the Administration pane, you will see About, Manual, Exit, and Launch buttons.

The operation performed by each of these is obvious, but we would like to highlight the fact that the About panel provides hardware and software version information that may be useful should you require product support situation, along with important licensing information.



## Chapter 2 USER INTERFACE



This chapter explains the layout and options provided in the user interface, and how to configure NC1 IO audio and video input and output. It also introduces the various supplemental video production features NC1 IO provides, including Proc Amps, Scopes and capture.

### SECTION 2.1 THE DESKTOP

The NC1 IO IP default *Desktop* interface provides very useful remote monitoring options in addition to configuration and control features.

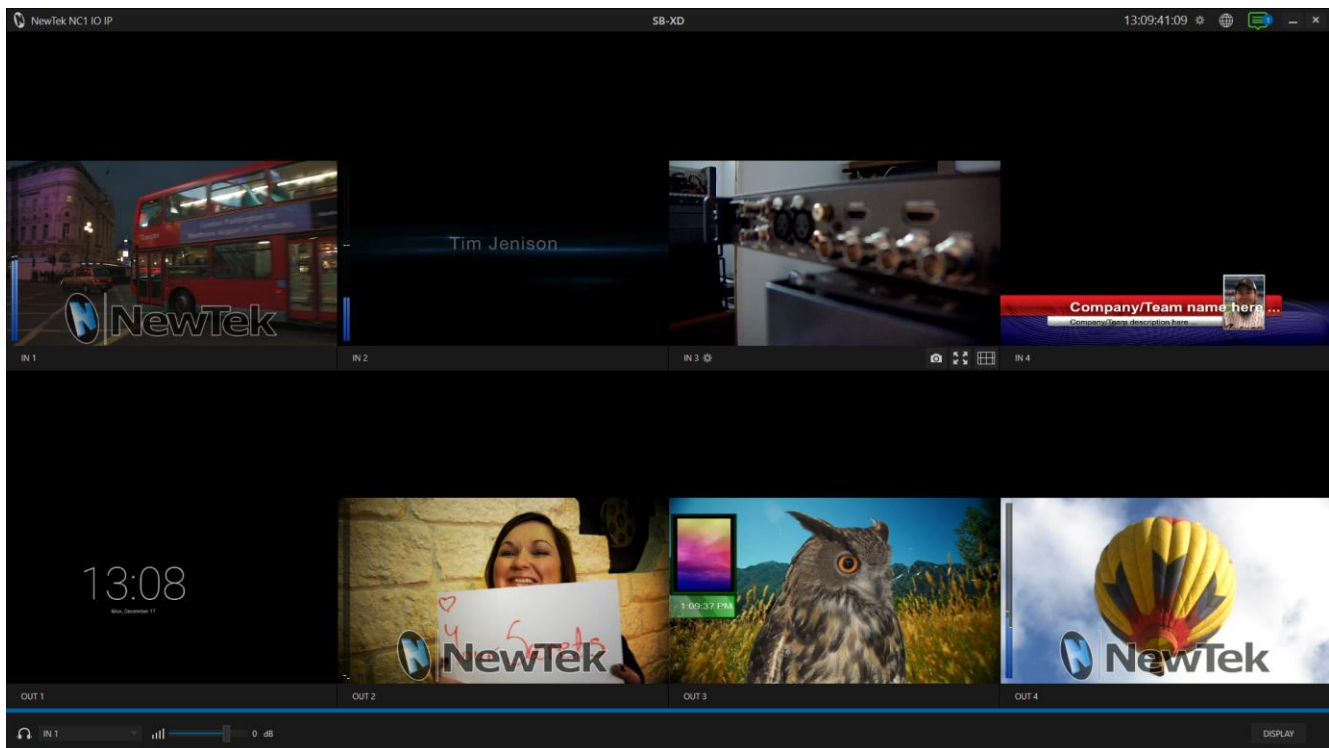
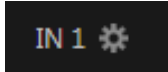

FIGURE 8

The *Desktop* interface includes a *titlebar* running across the top of the screen, and a *Dashboard* at the bottom. By default, the large middle section of the *Desktop* shows eight viewports, each displaying one video 'channel'. Each channel's viewport is labeled in the toolbar beneath. (Note that some viewport toolbar controls are hidden when not in use, or until you move the mouse pointer over a viewport.)

Continue reading for an overview of the NC1 IO IP *Desktop* features.

## 2.1.1 CONFIGURE CHANNELS



NC1 IO IP allows you to select different audio and video sources for each input or channel via the *Configure* panel (Figure 10). Click the gear next to the channel label below a viewport to open its *Configure* panel (Figure 9).

FIGURE 9

*Hint: Alternatively, you can quickly access the Configure Channel pane by double-clicking the viewport.*

The tabs shown in a *Configuration* panel vary according to whether you wish to configure an input (from a SMPTE 2110 source) or an output (sending a SMPTE 2110 stream to a downstream receiver).

### INPUT TAB

Let's consider configuring an input channel first. An input supplied by a SMPTE 2110 source is automatically converted to an NDI stream. The editable *Channel Name* under the viewport identifies output the channel to other NDI-enabled systems on the network.

*Note: NDI Access Manager, included in NDI Tools (available without charge from NDI.newtek.com), can be used to control access to NDI source and output streams.*

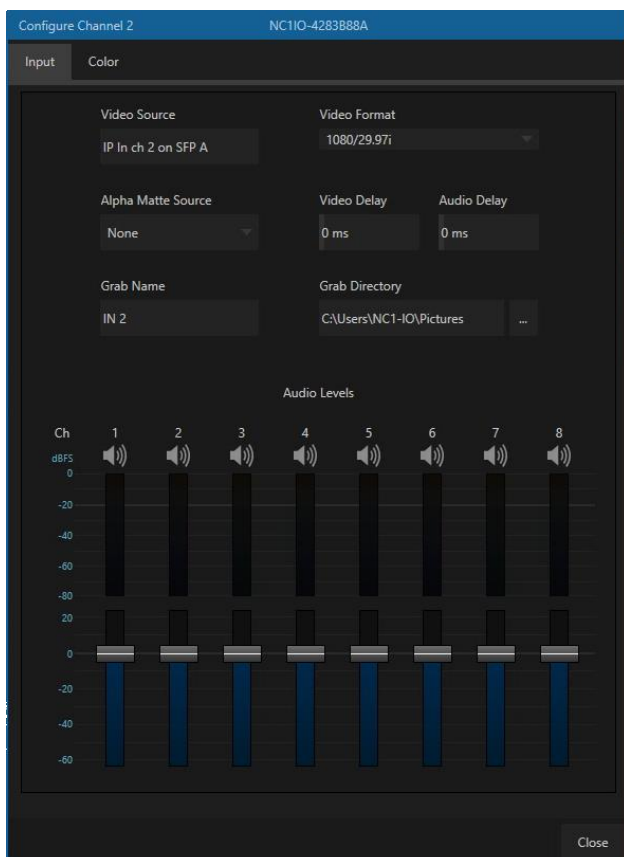

FIGURE 10

The tabbed *Input* pane allows you to the video sources for this channel, and set its format. The *Video Source* information display identifies the specific input you have chosen to configure. The nearby *Video Format* menu allows you to match the input to the format of the incoming SMPTE 2110 video stream.

*Hint: Remember that the video standard selections shown in these menus is determined by the Frame Rate setting in the Administration panel's Genlock options – see Section 1.6.2.*

Note that the *Alpha Matte Source* menu allows you to configure 'key/fill' inputs, where the transparency and fill color information for a 32bit NDI output with embedded alpha are supplied via two separate SMPTE 2110 inputs (the video format of both sources must match).

A *Delay* setting is provided for both audio and video sources, allowing precise A/V synchronization where a/v source timing differs.

#### CAPTURE

This tab is also where you assign the path and filename for captured still images.



FIGURE 11

The initial *Grab Directory* is the default *Pictures* folder on the system, but you can choose to use a network storage volumes or external drive connected to one of the USB ports on your NC1's rear panel instead if you like.

#### AUDIO LEVELS

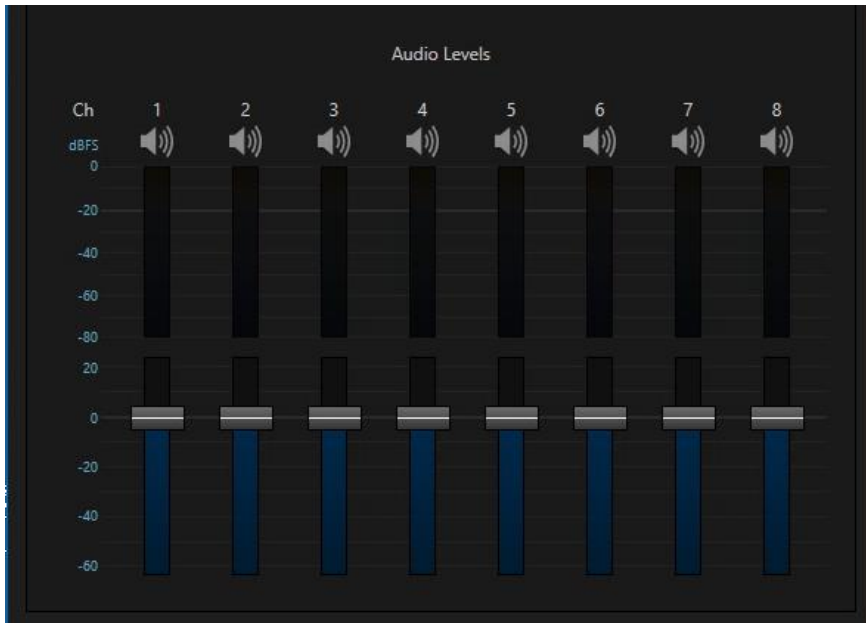

FIGURE 12

Faders in the *Audio Levels* section of the *Configure Channel > Input* tab let you modulate the audio levels for up to eight audio channels incoming from SMPTE 2110. The *VU meters* above the faders are calibrated in dB FS (Full Scale). Click the 'speaker' icon above an audio channel to mute the associated audio stream.

## OUTPUT TAB

If you open the *Configure Channel* pane for an output, instead, you will find settings related to output from the channel to SMPTE 2110.

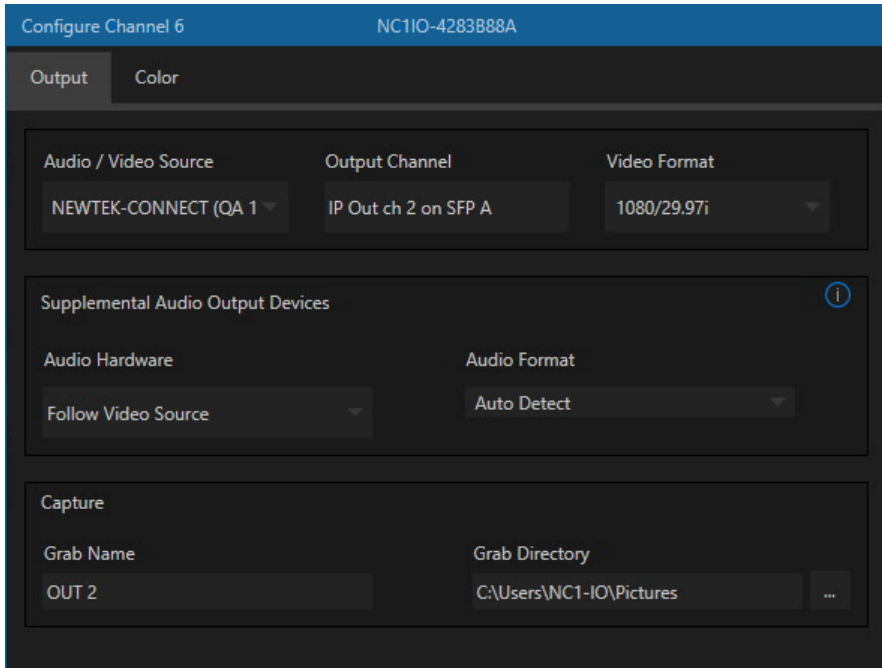

FIGURE 13

The first choice you will usually make is which audio/video source you wish to output as SMPTE 2110. Often, you will simply use the *Audio/Video Source* menu to select an NDI a/v stream from your network, but there are other possibilities, too. Selecting a *Video Format* at right determines the video output format applied.

## CLIPS AND IP SOURCES

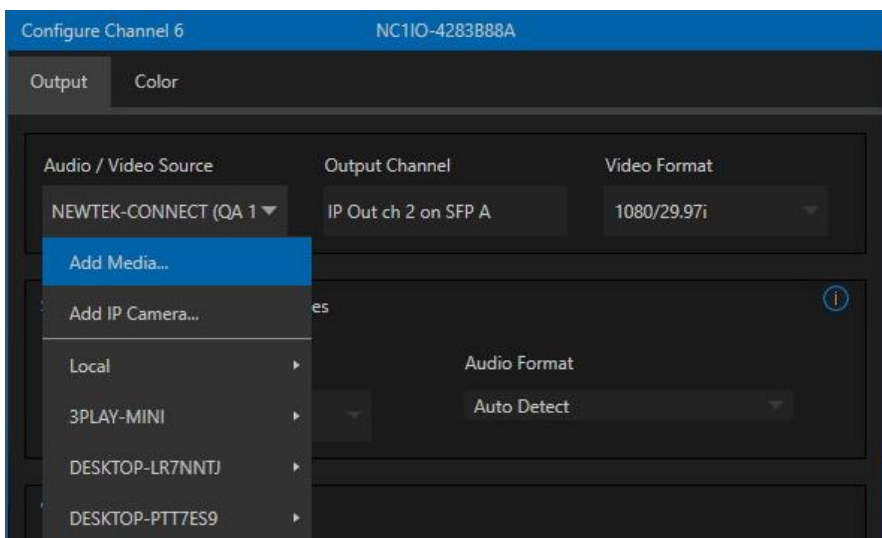

FIGURE 14



As mentioned in the previous section, NDI sources – such as a PTZ camera with NDI network video output – can be directly selected.

The *Video Source* drop down menu also contains an *Add Media* item to let you select a video file to play. The *Add IP Camera* menu item (Figure 14) requires a little more explanation.

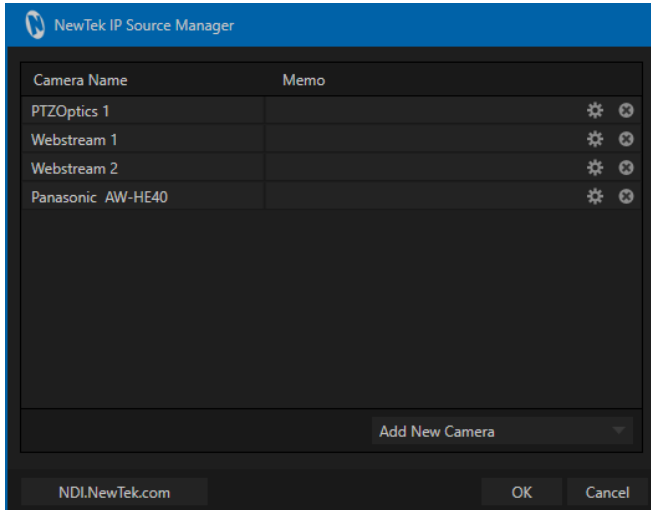

FIGURE 15

Clicking the *Add IP Camera* entry opens the *IP Source Manager*. Adding entries to the list of sources shown in this panel causes corresponding listings to appear in the *Local* group shown in the *Video Source* menu of the *Configure Channel* panel (along with the SMTPE 2110 inputs from SFP A and B).

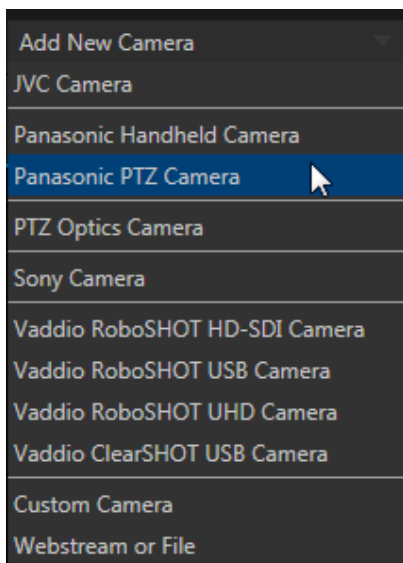

FIGURE 16

To use Click the *Add New Camera* menu, select a source type from the dropdown list provided.

This opens a dialog suited to the particular source device you wish to add, such as one of the numerous supported PTZ camera brands and models.

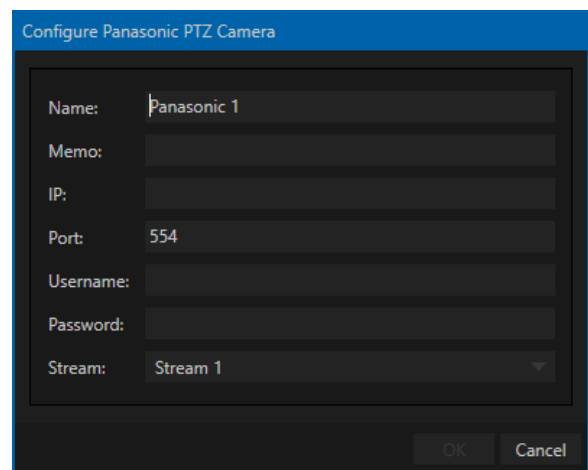

FIGURE 17

**Note:** After adding an IP source, you must exit and restart the software for the new settings to be applied.

## SUPPLEMENTAL AUDIO DEVICE

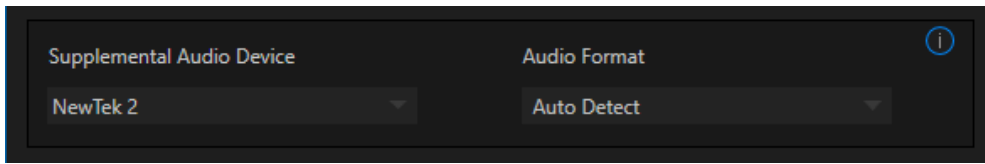

FIGURE 18

The *Supplemental Audio Device* allows you to direct audio output to system sound devices as well as well as any supported third part audio devices you may connect (typically by USB). As required, *Audio Format* options are provided in a menu at right.

## COLOR TAB

Both input and output channels provide a *Color* tab (Figure 19). This panel provides an extensive set of tools for adjusting the color characteristics of each video channel.

Choosing *Auto Color* automatically adapts color balance as lighting conditions change over time.

*Note: Proc Amp adjustments follow Auto Color processing.*

By default, each camera with *Auto Color* enabled is processed by itself. Enable *Multicam* to process multiple cameras as a group.

To apply *Multicam* to a source without its own colors being evaluated, checkmark *Listen Only*.

Typically, you might enable *Listen Only* for all *Multicam* group members except one to make that source the 'master' color reference.

*Note: Custom settings in the Color tab trigger a COLOR notification message that appears in the footer below the viewport of the channel (Figure 20).*

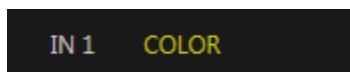

FIGURE 20

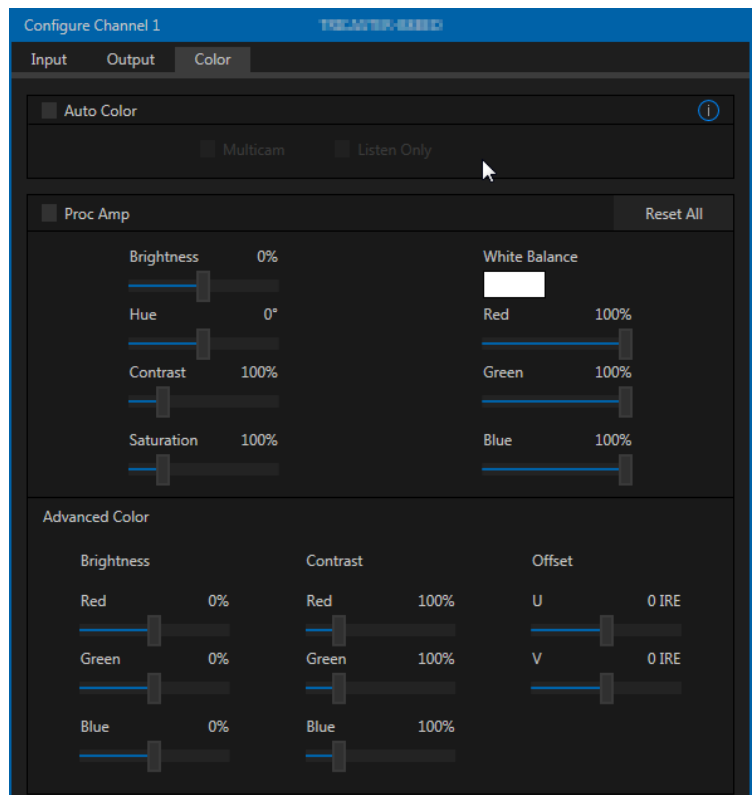
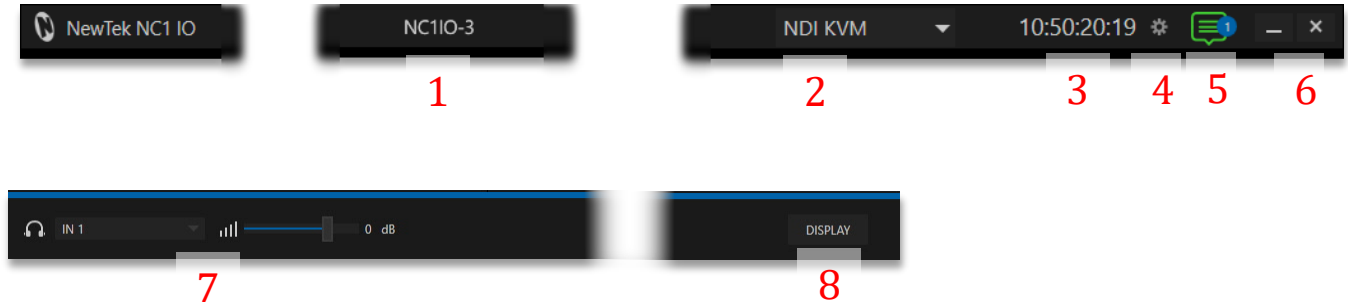

FIGURE 19

## SECTION 2.2 TITLEBAR & DASHBOARD

NC1 IO's *Titlebar* and *Dashboard* are home to a number of important displays, tools and controls. Prominently located at the top and bottom of the *Desktop*, the *Dashboard* occupies the full width of the screen.



The various elements presented in these two bars are listed below (starting from the left):

1. *Machine name* (the system network name supplies the prefix identifying NDI output channels)
2. *NDI KVM menu* – Options to control NC1 IO remotely via NDI connection
3. *Time Display*
4. *Configuration* (see Section 2.2.1)
5. *Notifications Panel*
6. *Minimize and Exit*
7. *Headphones Source and Volume* (see Section 2.2.3)
8. *Display* (see section 2.2.3)

Of these items, some are so important that they rate their own chapters. Others are detailed in various sections of this guide (cross references to the relevant sections of the manual are provided above).

### 2.2.1 TITLEBAR TOOLS

#### NDI KVM

Thanks to NDI®, it is no longer necessary to configure complicated hardware KVM installations to enjoy remote control over your NC1 IO system. The free NDI Studio Monitor application for brings network KVM connectivity to any Windows® system on the same network.

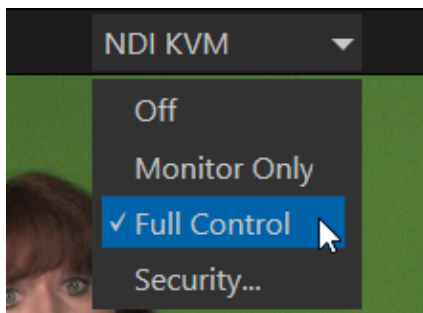

FIGURE 21

To enable NDI KVM, use the titlebar *NDI KVM* menu to select an operating mode, choosing between *Monitor Only* or *Full Control* (which passes mouse and keyboard operations to the remote system). The *Security* option lets you apply *NDI Group* control to limit who can view the *NDI KVM* output from the host system.

To view the output from the remote system and control it, select [Your NC1 IO IP system's Device Name]>*User Interface* in the *Studio Monitor* application supplied with the free NDI Tool pack, and enable the KVM button overlaid at upper-left when you move the mouse over the screen.

**Hint: Note that Studio Monitor's KVM toggle button can be relocated to a more convenient spot by dragging.**

This feature gives you a great way to control the system around your studio or campus. With the User Interface running full-screen in *Studio Monitor* on a receiving system, it's really hard to remember that you're actually controlling a remote system.

Even touch is supported, meaning you can run the *User Interface* output on a Microsoft Surface™ system for portable touch control over your entire live production system.

(Actually, many of the interface screengrabs shown in this manual – including those in this section – were grabbed from *NDI Studio Monitor* while controlling the remote system in the manner described above.)

## SYSTEM CONFIGURATION

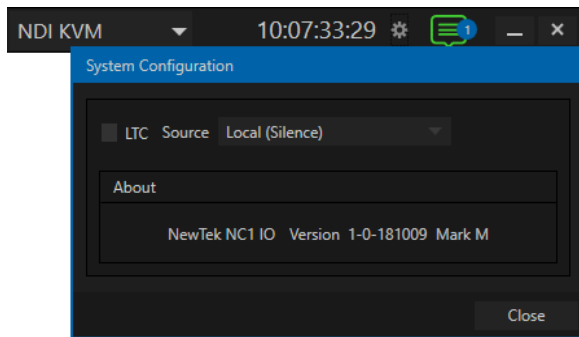

FIGURE 22

The *System Configuration* dialog is opened by clicking the 'gear' gadget next to the *Titlebar* time display, and appears as shown in Figure 22.

### LTC TIMECODE

LTC timecode support can be activated by choosing an input using the *LTC Source* menu to choose almost any audio input to receive the timecode signal over, and enabling the checkbox at left.

## ABOUT

The *About* box displays the current software version and hardware revision of the unit.

## NOTIFICATIONS

The Notifications panel opens when you click the 'text balloon' gadget at right in the *Titlebar*. This panel lists information messages the system provides, including any cautionary alerts.

*Hint: You can clear individual entries using by right-clicking to show the item's context menu, or the Clear All button in the panel's footer.*

## 2.2.2 VIEWPORT TOOLS

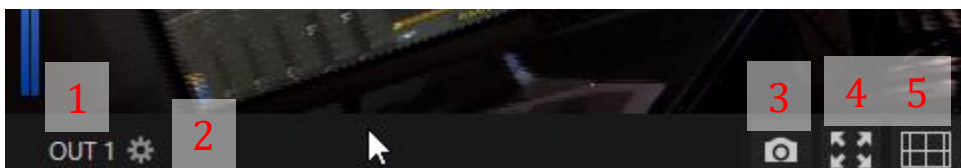

FIGURE 23

NC1 IO's channels each have a toolbar beneath their respective viewports. The various elements comprising the toolbar are listed below from left to right:

1. *Channel name* – Can be changed by clicking on the label, and also in the *Configure Channel* panel.
2. A *Configuration* gadget (gear) pops up next to the channel name when the mouse is over a viewport.

3. *Grab* – the base filename and path for still image grabs are set in the *Configure Channel* panel.
4. *Full screen*
5. *Overlays*

#### GRAB

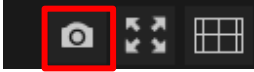

FIGURE 24

A *Grab Input* tool is located in the lower right corner below the monitor for each channel. By default, still image files are stored in the system *Pictures* folder. The path can be modified in the *Output* window for the channel (see the *Output* heading above).

#### FULL SCREEN



FIGURE 25

Clicking this button expands the video display for the selected channel to fill your monitor. Press ESC on your keyboard or click the mouse to return to the standard display.

#### OVERLAY



FIGURE 26

Found in the lower right corner of each channel, *Overlays* can be useful for visualizing safe zones, centering and more. To use an overlay, just click on an icon in the list (see Figure 27); more than one overlay can be active at the same time.

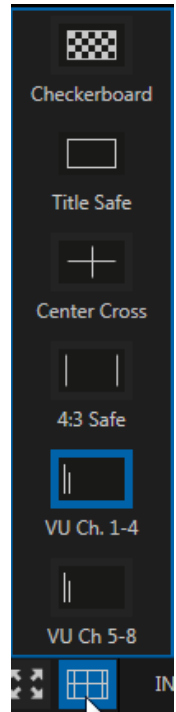

FIGURE 27

### 2.2.3 DASHBOARD TOOLS

#### AUDIO (HEADPHONES)

You can connect a headset to the (green) audio output jack on the rear of NC1 IO's motherboard.

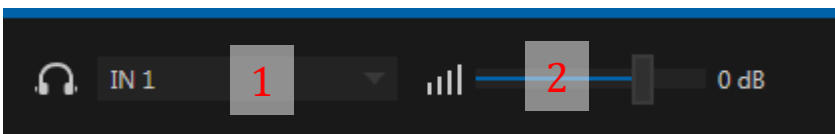

FIGURE 28

Controls for *Headphone audio* are found in the lower-left corner of the dashboard at the bottom of the screen (Figure 28).

1. The audio source supplied to the *Headphone* jack can be selected using the menu next to the *headphone icon* (Figure 29).
2. The *Volume* for the selected source can be adjusted moving the slider provided at right (double-click this control to reset it to the default 0dB value).

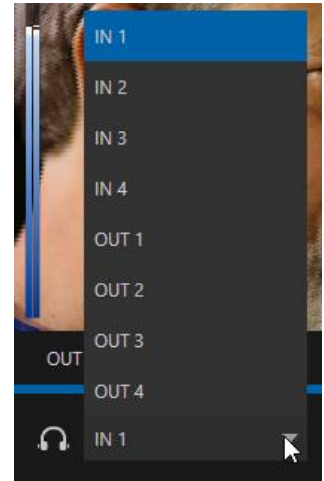

FIGURE 29

## DISPLAY

In the bottom-right corner of the *Dashboard* at the bottom of the (primary) screen, the *Display* widget offers a variety of layout options to let you viewing channels individually or in groups (Figure 30).

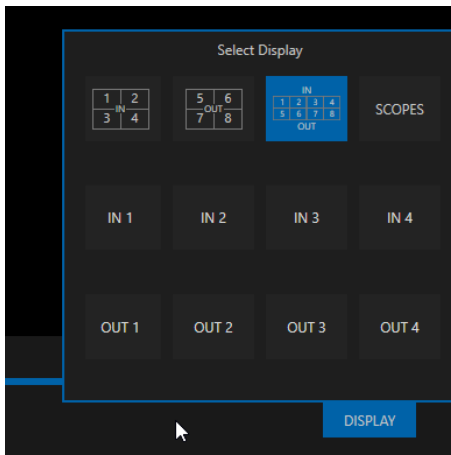

FIGURE 30

*Waveform* and *Vectorscope* features are shown when you select the *SCOPES* option in the *Display* widget (Figure 31).

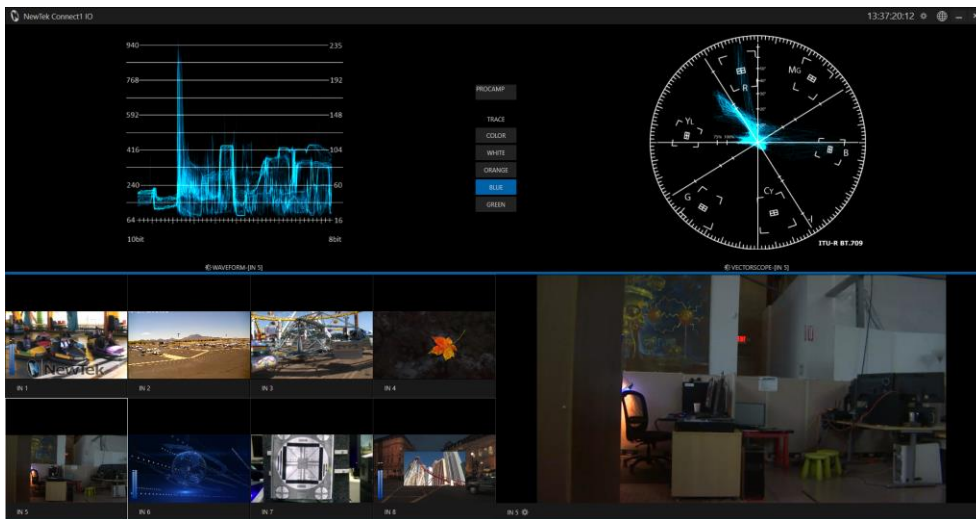

FIGURE 31

## APPENDIX A: NDI (NETWORK DEVICE INTERFACE)

---

“What is NDI?” In a nutshell, NewTek’s Network Device Interface (NDI) technology is the world’s most prolific video over IP protocol for live production. NDI allows systems and devices to identify and communicate with each other, and to encode, transmit, and receive high quality, low latency, frame-accurate video and audio over IP in real time.

NDI enabled-devices and software have the potential to greatly enhance your video production pipeline, by making video input and output available anywhere your network runs. NewTek’s live video production systems and a growing number of third party systems provide direct support for NDI, both for ingest and output. Although NC1 IO provides many other useful features, it is purpose designed primarily to turn SDI sources into NDI signals.

For more extensive details on NDI, please visit <http://www.newtek.com/ndi.html>.

## APPENDIX B: DIMENSIONS AND MOUNTING

---

NC1 IO is designed for convenient mounting in a standard 19” rack (mounting rails are available separately from NewTek Sales). The unit comprises a 1 Rack Unit (RU) chassis supplied with ‘ears’ designed to permit mounting in standard 19” rack architecture.

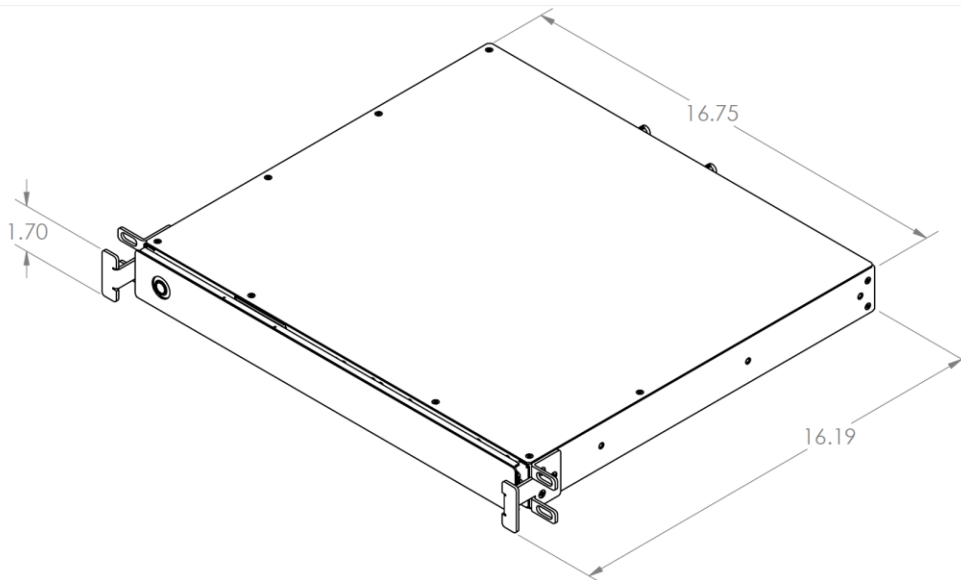

FIGURE 32

The units weigh nearly 14 pounds (6.35 KG). A shelf or rear support will distribute the load more evenly if rack-mounted. Good front and rear access is important for convenience in cabling should be considered.

In view of the top panel vents on the chassis, at least one RU should be allowed above these systems for ventilation and cooling. Please keep in mind that adequate cooling is a very important requirement for virtually all electronic and digital equipment, and this is true of NC1 IO as well. We recommend allowing 1.5 to 2 inches of space on all sides for cool (i.e., comfortable ‘room temperature’) air to circulate around the

chassis. Good ventilation at the front and rear panel is important, and ventilated space above the unit (1RU minimum is recommended).

When designing enclosures or mounting the unit, supplying good free air movement around the chassis as discussed above should be viewed as a critical design consideration. This is especially true in fixed installations where NC1 IO will be installed inside furniture-style enclosures.

---

## APPENDIX C: ENHANCED SUPPORT (PROTEK)

---

NewTek’s optional ProTek<sup>SM</sup> service programs offer renewable (and transferable) coverage and enhanced support service features extending well beyond the standard warranty period.

Please see <http://www.newtek.com/protek.html> or your local authorized NewTek reseller for more details regarding ProTek plan options.

---

## APPENDIX D: RELIABILITY TESTING

---

We know our products play vital roles in the productions of our customers. Durability and consistent, robust performance are much more than just adjectives for your business and ours.

For this reason, all NewTek products undergo rigorous reliability testing to ensure they meet our exacting test standards. For NC1 IO, the following standards are applicable:

Test Parameter	Evaluation Standard
Temperature	Mil-Std-810F Part 2, Sections 501 & 502
Ambient Operating	0°C and +40°C
Ambient Non-Operating	-10°C and +55°C
Humidity	Mil-STD 810, IEC 60068-2-38
Ambient Operating	20% to 90%
Ambient Non-Operating	20% to 95%
Vibration	ASTM D3580-95; Mil-STD 810
Sinusoidal	Exceeds ASTM D3580-95 Paragraph 10.4: 3 Hz to 500 Hz
Random	Mil-Std 810F Part 2.2.2, 60 minutes each axis, Section 514.5 C-VII
Electrostatic Discharge	IEC 61000-4-2
Air Discharge	12K Volts
Contact	8K Volts



## CREDITS

---

**Acknowledgments:** Tim Jenison, Jim Plant

**Engineering:** Andrew Cross, Alvaro Suarez, Brian Brice, Cary Tetrick, Charles Steinkuehler, Dan Fletcher, Gil Triana, James Killian, Jan Uribe, Jarrod Davis, Jeremy Wiseman, John Perkins, Karen Zipper, Kevin Rouviere, Kirk Morger, Mahdi Mohajer, Masaaki Konno, Matt Gerner, Menghua Wang, Michael Joiner, Michael Watkins, Mike Murphy, Nathan Kovner, Naveen Jayakumar, Ryan Hansberger, Shawn Wisniewski, Steve Bowie, Troy Stevenson

**Additional thanks to:** NewTek Marketing, Sales, Business Development, Customer Support, Training and Development, and Operations

Trademarks: NewTek, NewTek VMC1, NewTek VMC1 IN, NewTek VMC1 OUT, NewTek NC1, NewTek NC1 IN, NewTek NC1 I/O, TriCaster, TriCaster TC1, TriCaster Advanced Edition, TriCaster XD, TriCaster 8000, TriCaster TCXD8000, TCXD8000, TriCaster 860, TriCaster TCXD860, TCXD860, TriCaster 460, TriCaster TCXD460, TCXD460, TriCaster 410, TriCaster TCXD410, TCXD410, TriCaster Mini SDI, TriCaster Mini, TriCaster 40, TriCaster TCXD40, TCXD40, TriCaster 855, TriCaster TCXD855, TCXD855, TriCaster 455, TriCaster TCXD455, TCXD455, TriCaster EXTREME, TriCaster 850 EXTREME, TriCaster TCXD850 EXTREME, TCXD850 EXTREME, TriCaster 450 EXTREME, TriCaster TCXD450 EXTREME, TCXD450 EXTREME, TriCaster 850, TriCaster TCXD850, TCXD850, TriCaster 450, TriCaster TCXD450, TCXD450, TriCaster 300, TriCaster TCXD300, TCXD300, TriCaster PRO, TriCaster STUDIO, TriCaster BROADCAST, TriCaster DUO, MediaDS, MDS1, 3PLAY, 3Play, 3Play 3P1, 3Play 4800, 3PXD4800, 3Play 440, 3PXD440, 3Play Mini, 3Play 820, 3PXD820, 3Play 425, 3PXD425 3Play 330, 3PXD330, TalkShow, TalkShow VS 4000, TalkShow VS100, Network Device Interface, NDI, NewTek Connect, NewTek Connect Spark, NewTek IsoCorder, ProTek, ProTek Care, ProTek Elite, iVGA, SpeedEDIT, IsoCorder, LiveText, LiveGraphics Creator, LiveGraphics, DataLink, LiveSet, LiveGraphics, TriCaster Virtual Set Editor, Virtual Set Editor Advanced Edition, TriCaster VSE, TriCaster VSE Advanced Edition, LiveMatte, TimeWarp, VT, VT[3], VT[4], V[T5], Video Toaster, Toaster, Inspire 3D, 3D Arsenal, Aura, LightWave, LightWave 3D and LightWave CORE are trademarks, service marks, and registered trademarks of NewTek. All other brand names, product names, or trademarks belong to their respective holders



**NDI**<sup>™</sup>