

## High Power White LEDs

# SST-12-WxS



### Table of Contents

Ordering Part Numbers . . . . .	2
Binning Information . . . . .	3
Chromaticity Binning Structure . . . . .	4
Product Characteristics . . . . .	6
Soldering Profile . . . . .	9
Precautions for Use . . . . .	10
Mechanical Dimensions . . . . .	11
Tape and Reel . . . . .	12
Packaging and Labeling . . . . .	13

### Features

- Round light emitter delivers superior beam quality and higher optical efficiency than square emitters for collimating optics
- High lumen density of monolithic emitter reduces the optics' size while maximizing the light intensity and beam distance
- Maximum Drive Current: 1.8 A
- Luminous Efficacy: typ. 174 lm/W @ 350 mA, 85°C (6500K)
- Color Temperature: 5000K, 5700K, 6500K
- Color Rendering Index: min. 65, typ. 70
- Low thermal resistance: 4.9°C/W
- ANSI-compatible chromaticity bins
- Electrically isolated thermal path
- 8 kV HBM ESD rating per ANSI/ESDA/JEDEC JS-001
- RoHS and REACH compliant

### Applications

- Compact Portable Lights
- Bicycle Lights
- Automotive Auxiliary Lights
- Stage & Studio Lighting
- Outdoor Lighting
- LED Work Lights

## Ordering Part Numbers

CCT	Minimum Flux Bin <sup>1</sup>	Minimum Flux (lm)	Chromaticity Bin Kit Code <sup>2</sup>	Ordering Part Numbers
5000K	H4	285	501	SST-12-W50S-A120-H4501
			502	SST-12-W50S-A120-H4502
	H5	305	501	SST-12-W50S-A120-H5501
			502	SST-12-W50S-A120-H5502
5700K	H4	285	571	SST-12-W57S-A120-H4571
			572	SST-12-W57S-A120-H4572
	H5	305	571	SST-12-W57S-A120-H5571
			572	SST-12-W57S-A120-H5572
6500K	H4	285	651	SST-12-W65S-A120-H4651
			652	SST-12-W65S-A120-H4652
	H5	305	651	SST-12-W65S-A120-H5651
			652	SST-12-W65S-A120-H5652

### Notes

1. The Ordering Part Number specifies the Minimum Flux Bin in shipment; higher flux bins may be shipped without advance notice. Please refer to 'Luminous Flux Binning' table for details of all flux bins.
2. Shipments always adhere to the color bins specified in each Chromaticity Bin Kit. See 'Chromaticity Bin Kit Codes' table for the color bins included in each Bin Kit.

## Part Number Nomenclature

SST — 12 — W<xx> — <p###> — <ffcc>

Product Family	Light Emission Area	Light Color	Package Configuration	Bin Kit
<b>S:</b> Surface Mount <b>S:</b> Dome Lensed <b>T:</b> Single Emitter	<b>12:</b> 1.2 mm <sup>2</sup>	<b>W:</b> White <b>&lt;xx&gt;</b> Color Temperature <b>50:</b> 5000K <b>65:</b> 6500K <b>&lt;y&gt;</b> CRI Category Code <b>S:</b> CRI>65	<b>&lt;p&gt;</b> Solder Pad Configuration <b>A:</b> type A - see page 11  <b>&lt;###&gt;</b> Viewing angle <b>120:</b> 120°	<b>&lt;ff&gt;</b> Minimum Flux Bin, see 'Luminous Flux Binning' table for details <b>&lt;ccc&gt;</b> Chromaticity Bin Kit, see 'Chromaticity Bin Kit Codes' table for details

## Luminous Flux Binning

Flux Bin Code	Binning @ 700 mA, T <sub>j</sub> =85°C <sup>1</sup>		@ 350 mA, T <sub>j</sub> =25°C <sup>2</sup>	Correlated Minimum Flux (lm) @ T <sub>j</sub> =85°C <sup>2</sup>			
	Minimum Flux (lm)	Maximum Flux (lm)	Minimum Flux (lm)	350 mA	1000 mA	1800mA	2400 mA
H3	267	285	164	147	355	547	657
H4	285	305	176	157	379	584	701
H5	305	324	188	168	406	625	750
J2	324	345	200	178	431	664	797
J3	345	367	213	190	459	707	849

### Notes

- LEDs are measured at 25°C ambient temperature with 700 mA 20ms single pulse. The measured values are correlated to 700 mA at 85°C junction temperature (T<sub>j</sub>). Luminus maintains a ±6% tolerance on flux measurement.
- Flux values at other junction temperature (T<sub>j</sub>) and/or forward current conditions are calculated and for reference only.

## Forward Voltage Binning

Voltage Bin Code	Binning @ 700 mA, T <sub>j</sub> =85°C	
	Minimum Voltage (V)	Maximum Voltage (V)
VH	2.5	2.7
VJ	2.7	2.9
VK	2.9	3.1

Note: Individual voltage bins are not orderable.

**Chromaticity Binning Coordinates**

CCT	Bin Code	CIE <sub>x</sub>	CIE <sub>y</sub>	Bin Code	CIE <sub>x</sub>	CIE <sub>y</sub>	Bin Code	CIE <sub>x</sub>	CIE <sub>y</sub>	Bin Code	CIE <sub>x</sub>	CIE <sub>y</sub>
5000K	DA	0.3371	0.349	DB	0.3376	0.3616	DC	0.3463	0.3687	DD	0.3451	0.3554
		0.3451	0.3554		0.3463	0.3687		0.3551	0.376		0.3533	0.362
		0.344	0.3427		0.3451	0.3554		0.3533	0.362		0.3515	0.3487
		0.3366	0.3369		0.3371	0.349		0.3451	0.3554		0.3440	0.3427
	DH	0.3366	0.3369	DE	0.3381	0.3762	DF	0.348	0.384	DG	0.344	0.3428
		0.344	0.3428		0.348	0.384		0.3571	0.3907		0.3515	0.3487
		0.3429	0.3307		0.3463	0.3687		0.3551	0.376		0.3495	0.3339
		0.3361	0.3245		0.3376	0.3616		0.3463	0.3687		0.3429	0.3307
5700K	CA	0.3215	0.335	CB	0.3207	0.3462	CC	0.329	0.3538	CD	0.329	0.3417
		0.329	0.3417		0.329	0.3538		0.3376	0.3616		0.3371	0.349
		0.329	0.33		0.329	0.3417		0.3371	0.349		0.3366	0.3369
		0.3222	0.3243		0.3215	0.335		0.329	0.3417		0.3290	0.3300
	CH	0.3222	0.3243	CE	0.3196	0.3602	CF	0.329	0.369	CG	0.329	0.33
		0.329	0.33		0.329	0.369		0.3381	0.3762		0.3366	0.3369
		0.329	0.318		0.329	0.3538		0.3376	0.3616		0.3361	0.3245
		0.3231	0.312		0.3207	0.3462		0.329	0.3538		0.3290	0.3180
6500K	BA	0.3048	0.3207	BB	0.3028	0.3304	BC	0.3115	0.3391	BD	0.313	0.329
		0.313	0.329		0.3115	0.3391		0.3205	0.3481		0.3213	0.3373
		0.3144	0.3186		0.313	0.329		0.3213	0.3373		0.3221	0.3261
		0.3068	0.3113		0.3048	0.3207		0.313	0.329		0.3144	0.3186
	BH	0.3068	0.3113	BE	0.3005	0.3415	BF	0.3099	0.3509	BG	0.3144	0.3186
		0.3144	0.3186		0.3099	0.3509		0.3196	0.3602		0.3221	0.3261
		0.3161	0.3059		0.3115	0.3391		0.3205	0.3481		0.3231	0.312
		0.3093	0.2993		0.3028	0.3304		0.3115	0.3391		0.3161	0.3059

## Chromaticity Binning Diagram

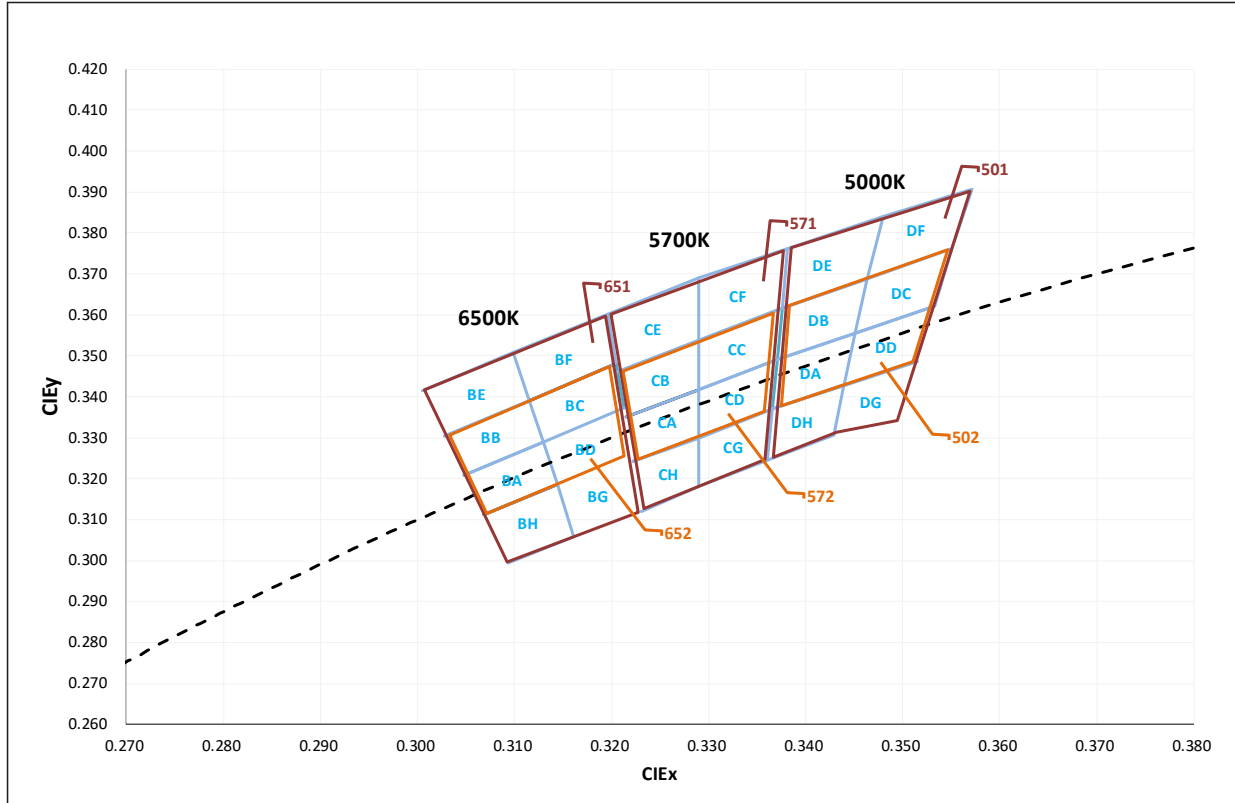

## Chromaticity Bin Kit Codes

CCT	Bin Kit	Chromaticity Bins
5000K	501	DA, DB, DC, DD, DE, DF, DG, DH
	502	DA, DB, DC, DD
5700K	571	CA, CB, CC, CD, CE, CF, CG, CH
	572	CA, CB, CC, CD
6500K	651	BA, BB, BC, BD, BE, BF, BG, BH
	652	BA, BB, BC, BD

Note: Luminus maintains a tolerance of  $\pm 0.005$  on chromaticity (CIE<sub>x</sub>, CIE<sub>y</sub>), and  $\pm 2$  on Color Rendering Index (CRI) measurements.

## Product Characteristics

Parameter	Symbol	Minimum	Typical	Maximum	Unit
Viewing Angle (FWHM)	$2\theta_{1/2}$		120		Degree
Color Rendering Index	CRI	65	70		
Thermal resistance (Electrical) Junction/Solder Point	$R_{thjs-EL}$		4.9		$^{\circ}C/W$
Forward Voltage (@ $I_f=700$ mA, $T_j=85^{\circ}C$ )	$V_f$	2.5	2.9	3.1	V
DC Forward Current (Details refer to Maximum Permissible DC Current vs Junction Temperature)	$I_f$	0.1		2.4   1.8	A
Junction Temperature	$T_j$			130   150	$^{\circ}C$
Power Dissipation	$P_d$			8   6	W
Surge Current ( $t < 10$ ms, Duty Cycle $< 10\%$ )	$I_{s-max}$			3.6   2.5	A
Reverse Voltage ( $I_r=10$ mA)	$V_r$			5	V
Operating Temperature	$T_{opr}$	-40		100	$^{\circ}C$
Storage Temperature	$T_{stg}$	-40		100	$^{\circ}C$
ESD withstand Voltage HBM Per ANSI/ESDA/JEDEC JS-001	$V_{HBM}$	8			kV
ESD withstand Voltage CDM Per ANSI/ESDA/JEDEC JS-002	$V_{CDM}$	1			kV

## Maximum Permissible DC Current vs. Junction Temperature

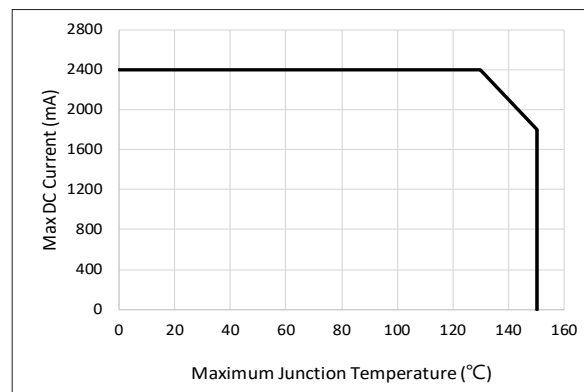

## Optical & Electrical Characteristics

### Relative Luminous Flux vs. Forward Current

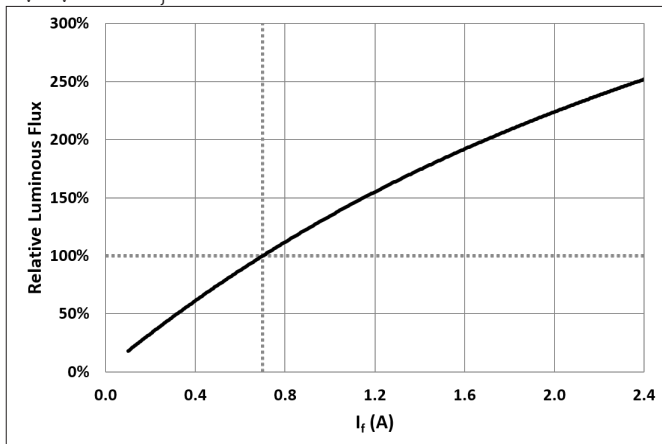
 $\Phi_v/\Phi_v(0.7\text{ A}), T_j = 85^\circ\text{C}$ 

### Relative Luminous Flux vs. Temperature( $T_j$ )

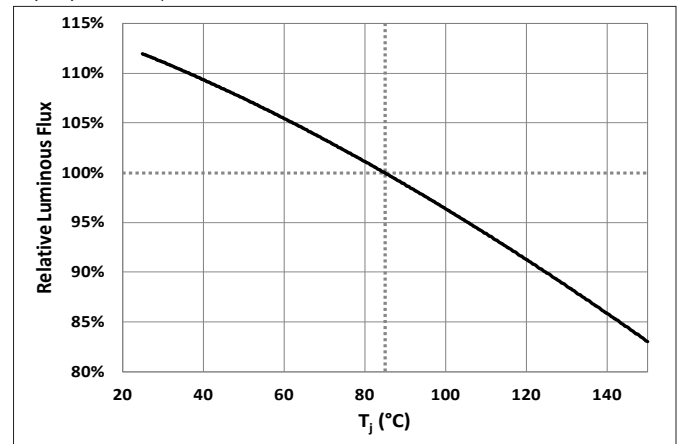
 $\Phi_v/\Phi_v(85^\circ\text{C}), I_f=0.7\text{ A}$ 

### Forward Voltage vs. Forward Current

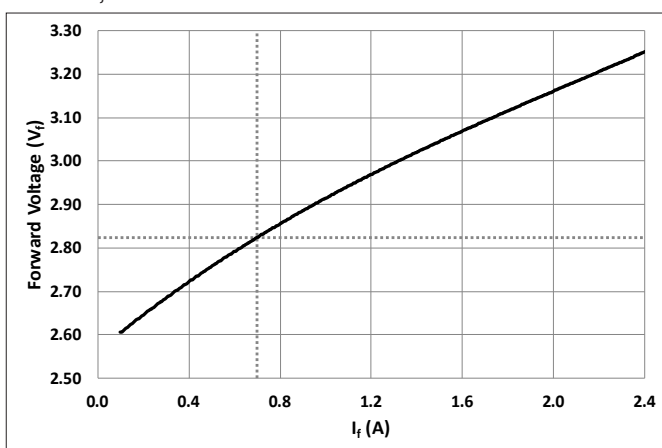
 $V_f=f(I_f), T_j=85^\circ\text{C}$ 

### Relative Forward Voltage vs. Temperature( $T_j$ )

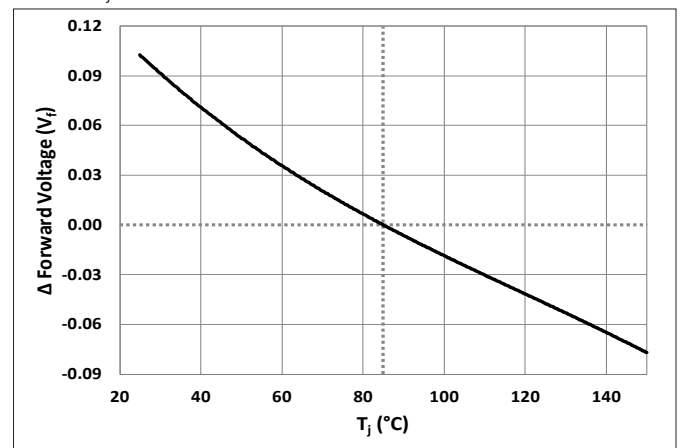
 $\Delta V_f=V_f(T_j)-V_f(85^\circ\text{C}), I_f=0.7\text{ A}$ 

### Relative Chromaticity vs. Forward Current

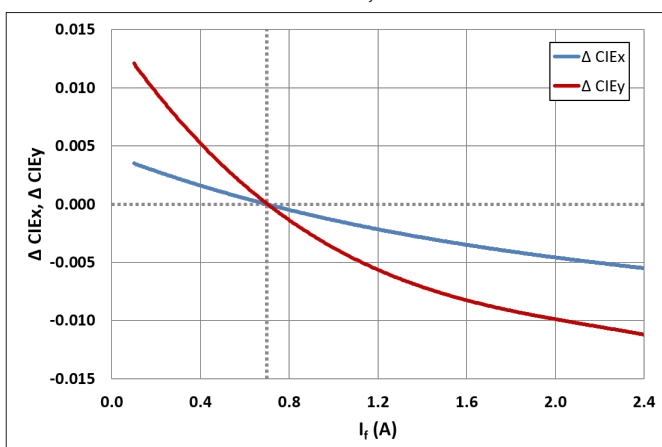
 $\Delta CIE_{x,y}=CIE_{x,y}(I_f)-CIE_{x,y}(0.7\text{ A}), T_j=85^\circ\text{C}$ 

### Relative Chromaticity vs. Temperature( $T_j$ )

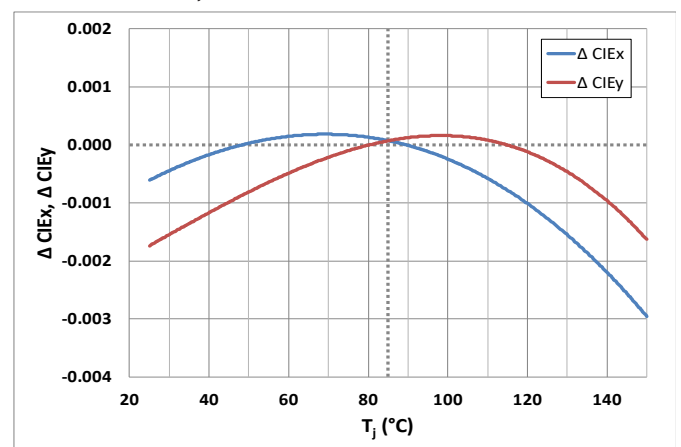
 $\Delta CIE_{x,y}=CIE_{x,y}(T_j)-CIE_{x,y}(85^\circ\text{C}), I_f=0.7\text{ A}$ 

### Relative Spectral Power Distribution

$I_f=0.7\text{ A}, T_j=85^\circ\text{C}$

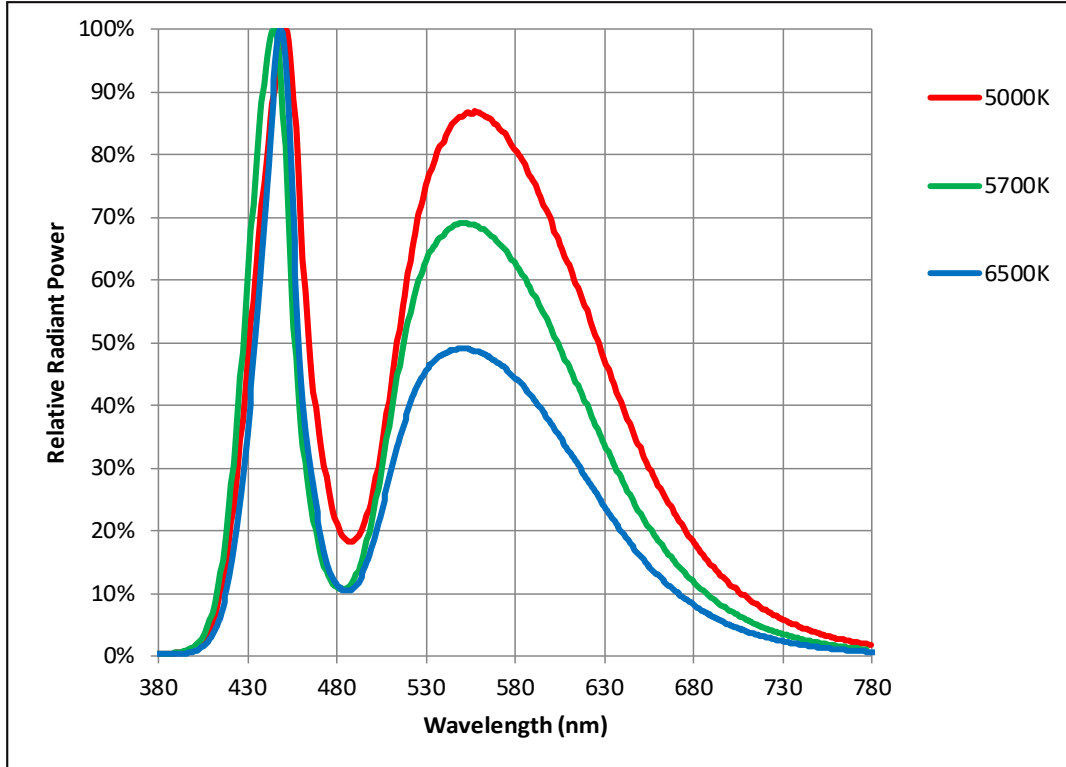

### Typical Radiation Characteristics

$I_f=0.7\text{ A}, T_j=25^\circ\text{C}$

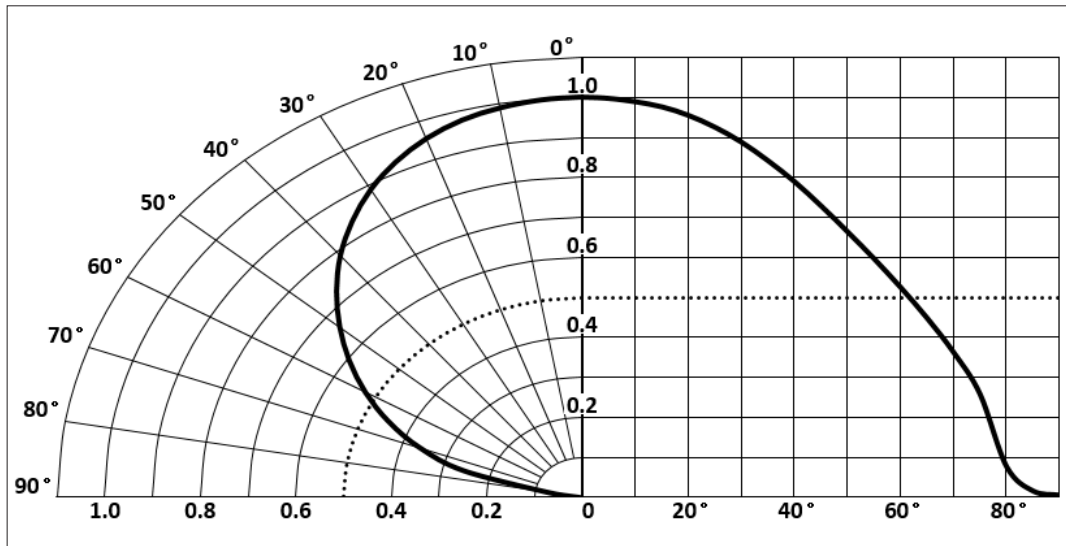



## Soldering Profile

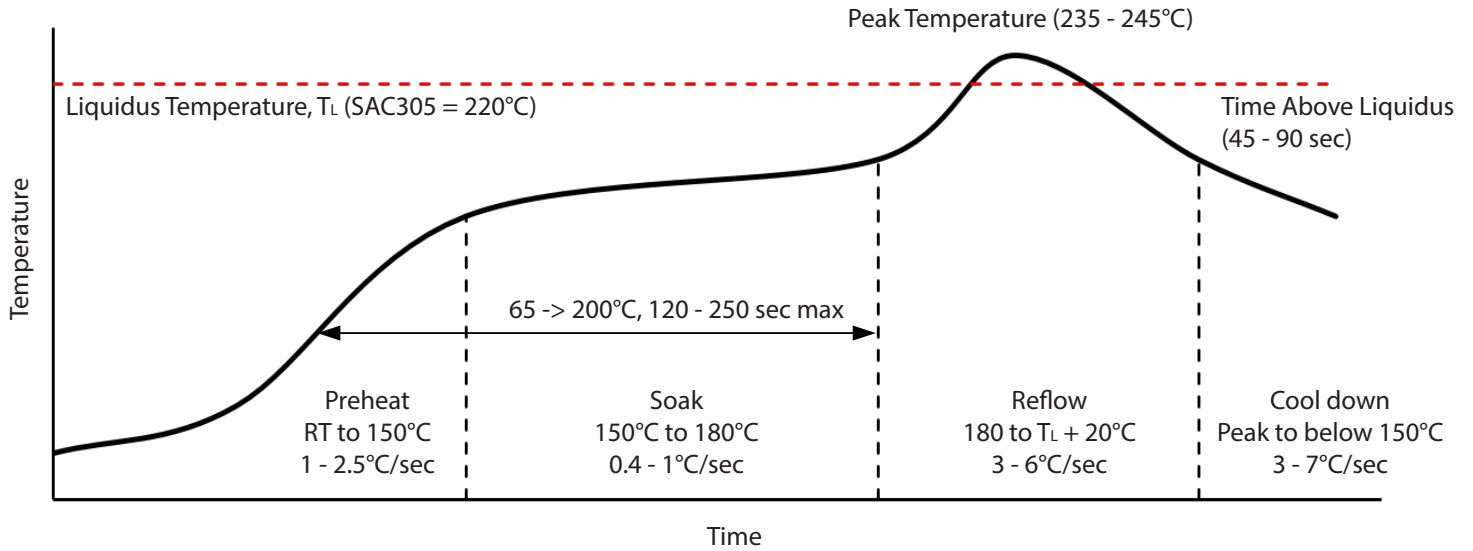

SMT Rework Guideline	Manual Hotplate Reflow	Hot Air Gun Reflow
Heating Time	< 60 sec	
Hotplate Temperature	< 245°C	< 150°C

### Notes

- Product complies to Moisture Sensitivity Level 3 (MSL 3).
- The numbers in the table are specific to SAC305. Luminus recommends using an SAC305 solder paste with a no-clean flux for RoHS compliant products.
- During the pick and place process, axial forces on the dome (or window) should not exceed 0.5 Newtons (N).
- Use of a multi-zone IR reflow oven with a nitrogen blanket is recommended.
- Time-temperature profile of the reflow process showing the four functional profile zones are defined in IPC-7801. Temperature is referenced to the center of the PCB.
- Luminus recommends to use the solder paste data sheet information as a starting point in time-temperature process development.
- These are general guidelines. Consult the solder paste manufacturer's datasheet for guidelines specific to the alloy and flux combination used in your application. For more information, please refer to: <https://luminusdevices.zendesk.com/hc/en-us/articles/360060306692-How-do-I-Reflow-Solder-Luminus-SMD-Components->
- For any technical questions about soldering process, please contact Luminus at techsupport@luminus.com.

## Precautions for Use

### Storage:

#### 1. Before opening the package

The LEDs should be kept at a temperature lower than 40°C and relative humidity lower than 90%. The LEDs should be used within a year. When storing the LEDs, moisture proof package with absorbent material (silica gel) is recommended.

#### 2. After opening the package

The LEDs should be kept at a temperature lower than 30°C and relative humidity lower than 60%. The LEDs should be soldered within 168 hours (7 days) after opening the moisture proof package.

If unused LEDs remain, they should be stored in moisture proof packages, such as sealed containers with moisture absorbent material (silica gel). It is also recommended to return the unused LEDs to the original moisture proof package and to seal it again.

If the moisture absorbent material (silica gel) vaporizes or passes the expiration date, baking treatment should be performed by using the following conditions : 60°C for 20 hours.

The LED's electrode and lead frame comprise a silver plated copper alloy. The silver surface may be affected by environments. Please avoid conditions which may cause the LEDs to corrode or discolor. The corrosion or discoloration might lower solderability or affect optical characteristics.

Please avoid rapid transition in ambient temperature, especially in high humidity environments where condensation can occur.

### Static Electricity:

1. The products are sensitive to static electricity, and care should be taken when handling them.

2. Static electricity or surge voltage will damage the LEDs. It is recommended to wear anti-electrostatic gloves or wristband when handling the LEDs.

3. All devices, equipment and machinery must be properly grounded. It is recommended that measures be taken against surge voltage to the equipment that mounts the LEDs.

## Package Configuration

### Mechanical Dimensions

All dimensions are in millimeter  $\pm 0.13$  mm

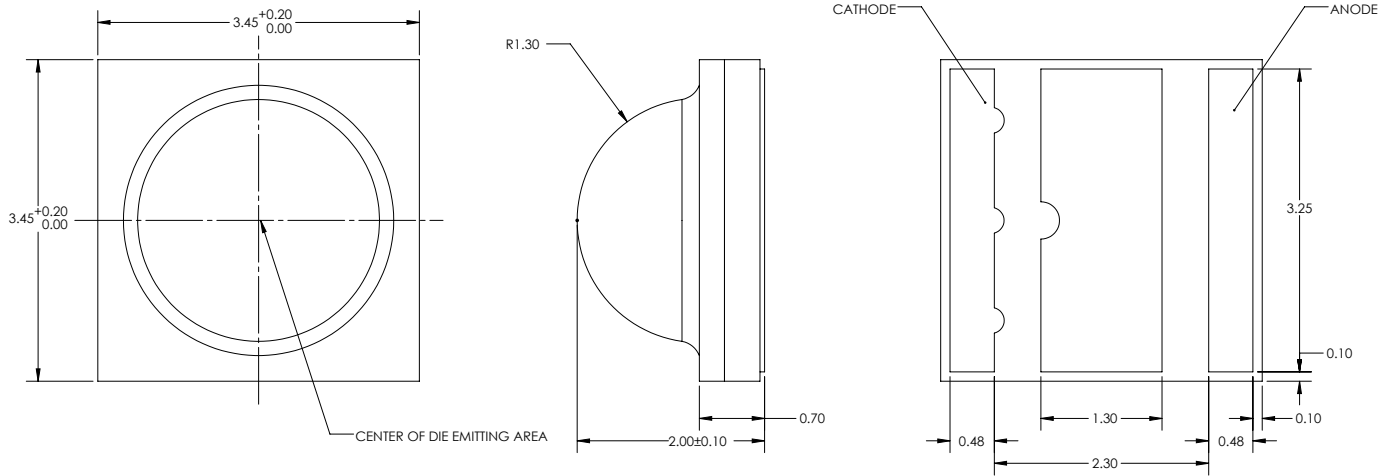

### Recommended PCB Solder Pad and Stencil Pattern

All dimensions are in millimeter  $\pm 0.13$  mm

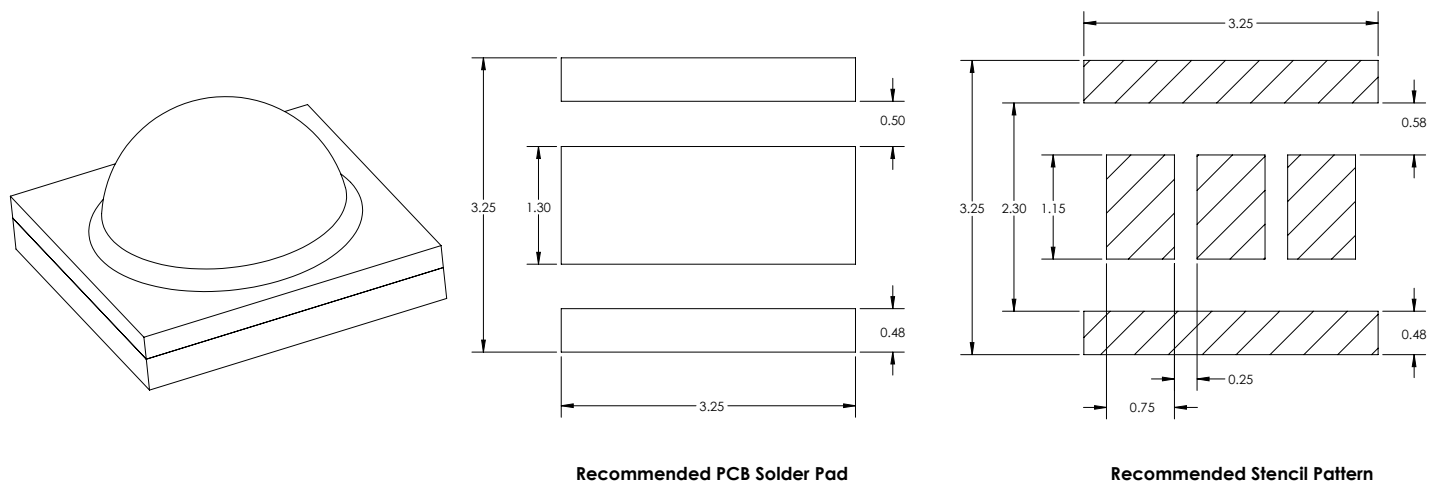

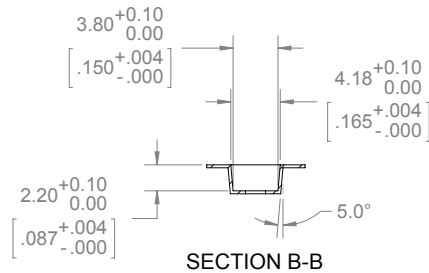
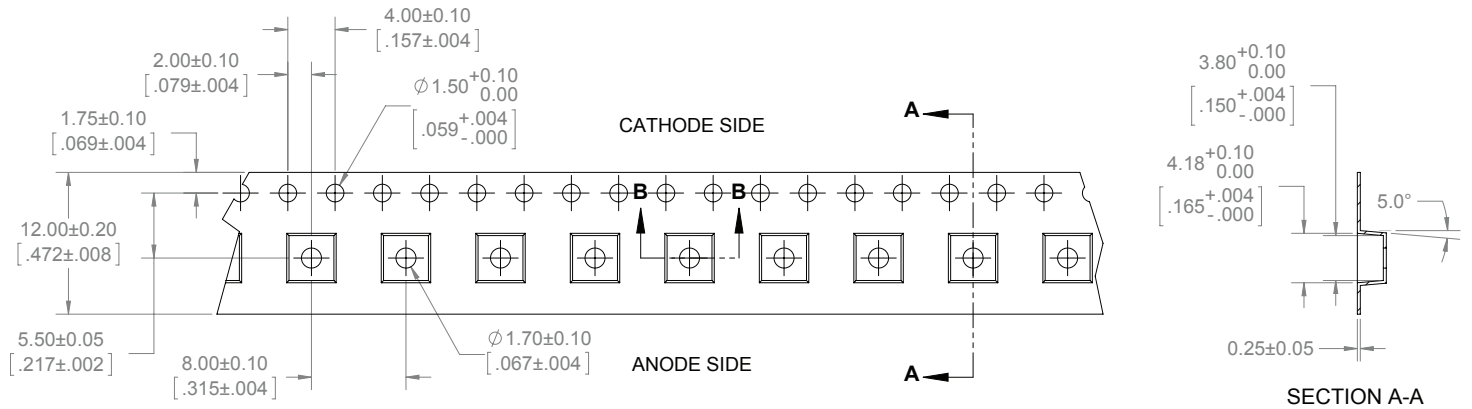
**Tape and Reel**

**Notes:**

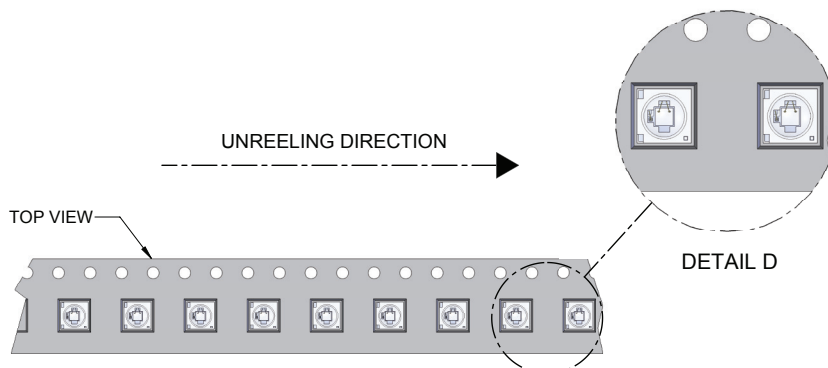
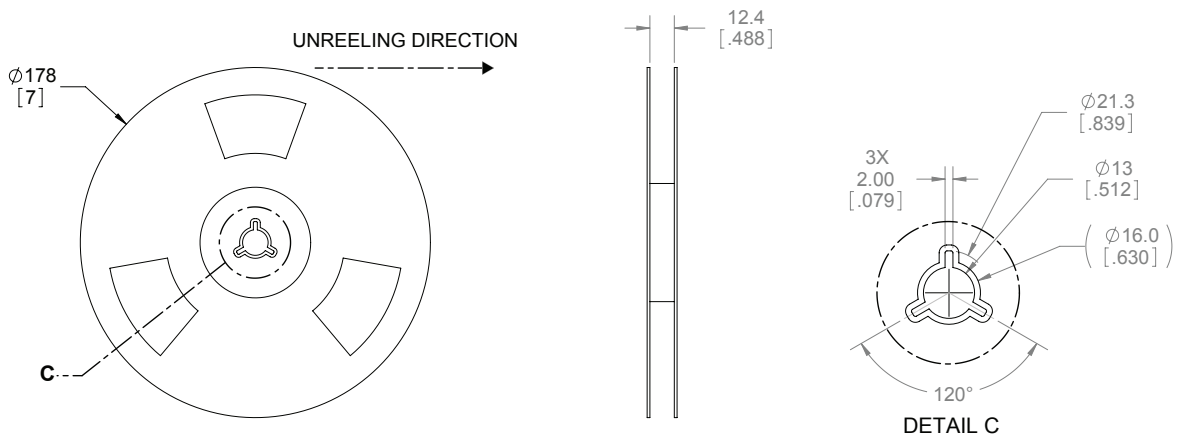
1. Final tape and reel packaging must meet the requirements of JEDEC-STD-033, LEVEL 2A.
2. Leave 304.8 mm [12.00 in] of type empty for lead in (38 empty pockets)
3. Leave 457.2 mm [18.00 in] of type empty for trailer (57 empty pockets)
4. Must comply to EIA-481-C-2003
5. Each reel contains 1,000 units

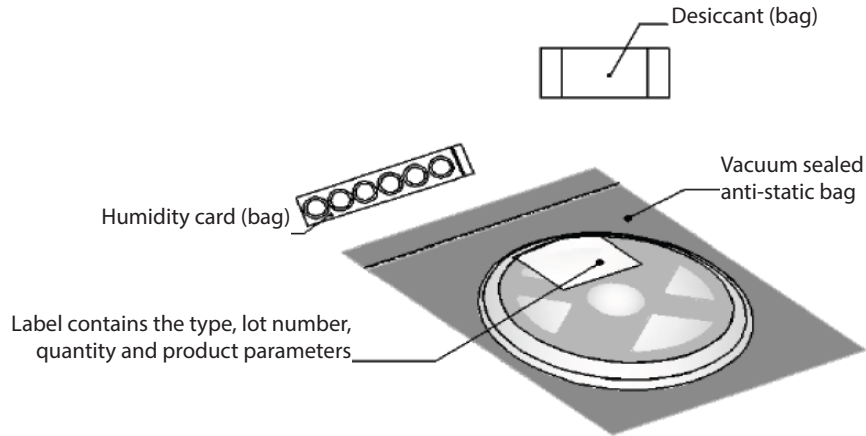

## Packaging and Labeling

### Packaged Reel



### Label on Reel

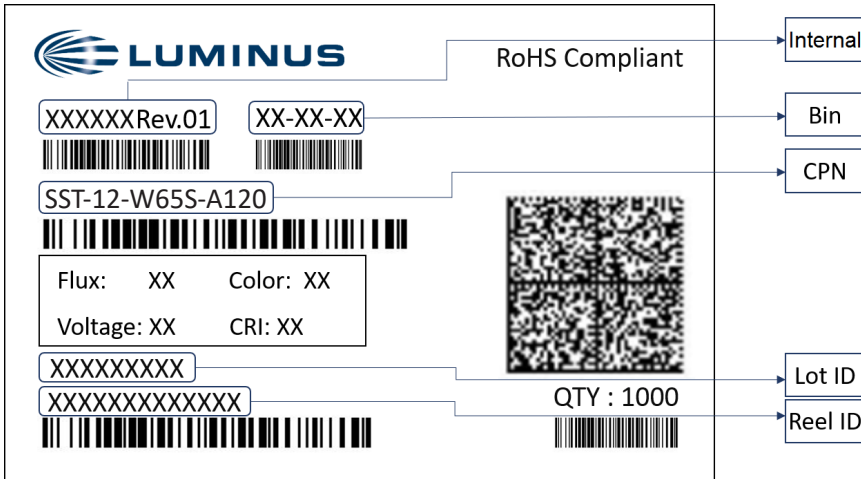

Label Information	
CPN	Luminus ordering part number
MPN	For Luminus internal use
QTY	Quantity of parts per reel
Flux	Single flux bin code (see <i>Luminous Flux Binning</i> table on page 3)
Voltage	Single voltage bin code (see <i>Forward Voltage Binning</i> table on page 3)
Color	Single chromaticity bin code (see <i>Chromaticity Bin Coordinates</i> table on page 4)
CRI	N/A
Lot ID & Reel ID	For Luminus internal use

### Packaging Boxes

**Box Size 1** - 5 reels per box  
 Size: 22.5 x 24.5 x 6.5 cm

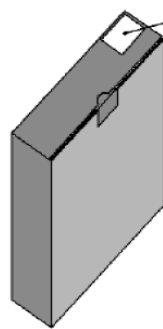
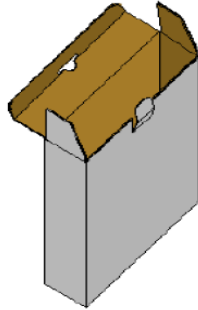

Label contains the type, lot number, quantity and product parameters

**Box Size 2** - 10 reels per box  
 Size: 22.5 x 24.5 x 13 cm

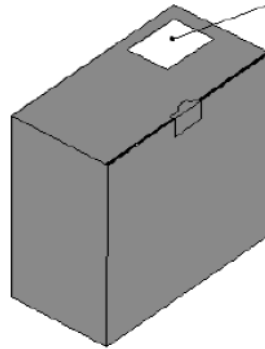
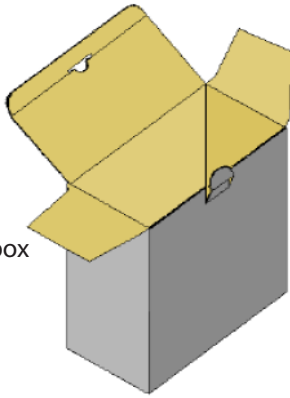

Label contains the type, lot number, quantity and product parameters

### Shipping Label on Packaging Box

Multiple labels are attached to the box (one label per reel inside the box)

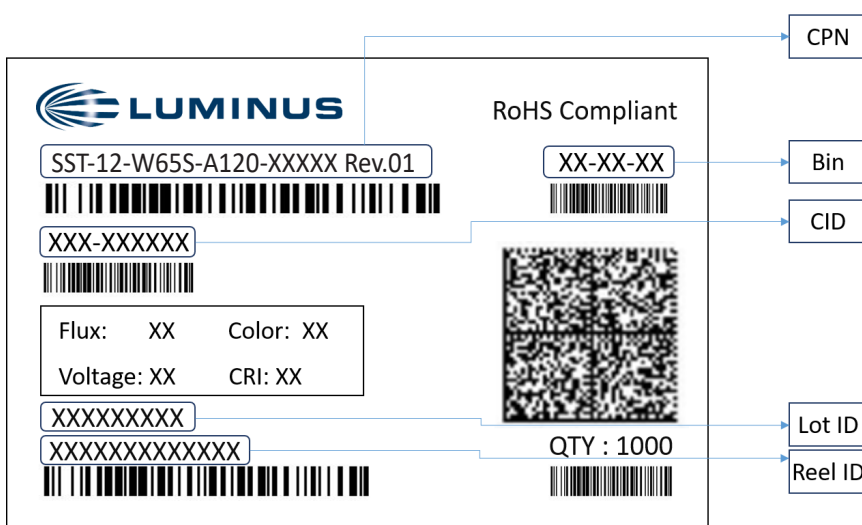

Label Information	
<b>CPN</b>	Luminus ordering part number
<b>CID</b>	Customer ID
<b>QTY</b>	Quantity of parts per reel
<b>Flux</b>	Single flux bin code (see <i>Luminus Flux Binning</i> table on page 3)
<b>Voltage</b>	Single voltage bin code (see <i>Forward Voltage Binning</i> table on page 3)
<b>Color</b>	Single chromaticity bin code (see <i>Chromaticity Bin Coordinates</i> table on page 4)
<b>CRI</b>	N/A
<b>Lot ID &amp; Reel ID</b>	For Luminus internal use