

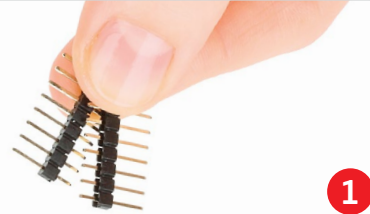

GSM click™

2. Soldering the headers

Before using your click™ board, make sure to solder 1x8 male headers to both left and right side of the board. Two 1x8 male headers are included with the board in the package.



2

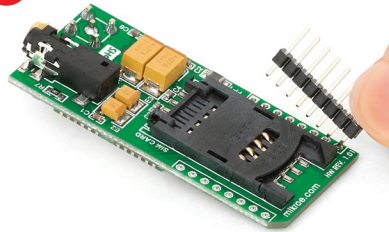

Turn the board upside down so that bottom side is facing you upwards. Place shorter parts of the header pins in both soldering pad locations.

3

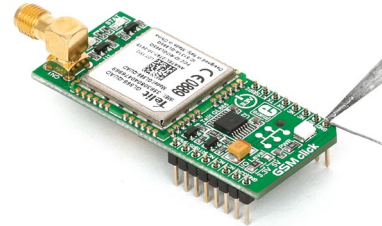

Turn the board upward again. Make sure to align the headers so that they are perpendicular to the board, then solder the pins carefully.

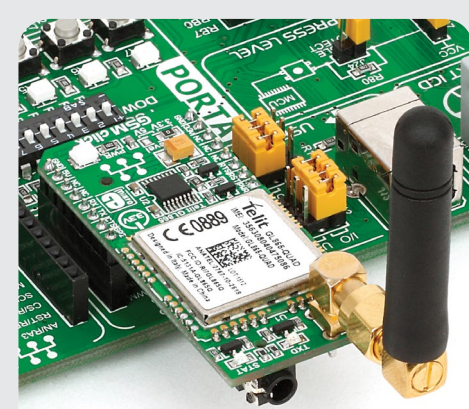

4. Essential features

GSM click™ with its Telit **GL865-QUAD** IC is ideal for mobile devices. It features GSM/GPRS protocol stack 3GPP (release 4 compliant) and supports GSM/GPRS 850/900/1800/ 1900 MHz Quad-band frequency. Additional features such as integrated TCP/IP protocol stack (including UDP, SMTP, ICMP and FTP), serial multiplexer, remote AT commands and many more, extend the functionality of the board.

1. Introduction

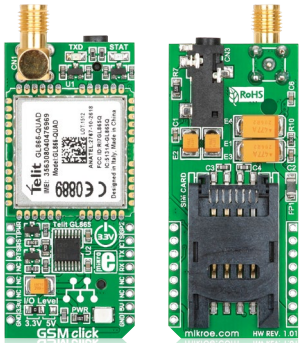

GSM click™ is an add-on board in mikroBUS™ form factor. It's a compact and easy solution for adding GSM/GPRS mobile phones standard to your design. It features a **GL865-QUAD** GSM/GPRS module, a **TXB0106** 6-bit bidirectional voltage-level translator and a SIM CARD socket. GSM click™ communicates with the target board microcontroller via seven mikroBUS™ lines (RX, TX, INT, PWM, CS, RST and AN). The board is designed to use 3.3V and 5V I/O voltage levels. A LED diode indicates the presence of power supply.

3. Plugging the board in

Once you have soldered the headers your board is ready to be placed into desired mikroBUS™ socket. Make sure to align the cut in the lower-right part of the board with the markings on the silkscreen at the mikroBUS™ socket. If all of the pins are aligned correctly, push the board all the way into the socket.

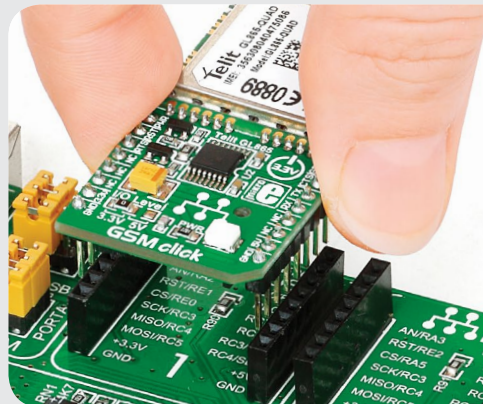

click™
BOARD
www.mikroe.com

GSM click Manual
ver. 1.01c



0 100000 026595

5. GSM click™ board schematic

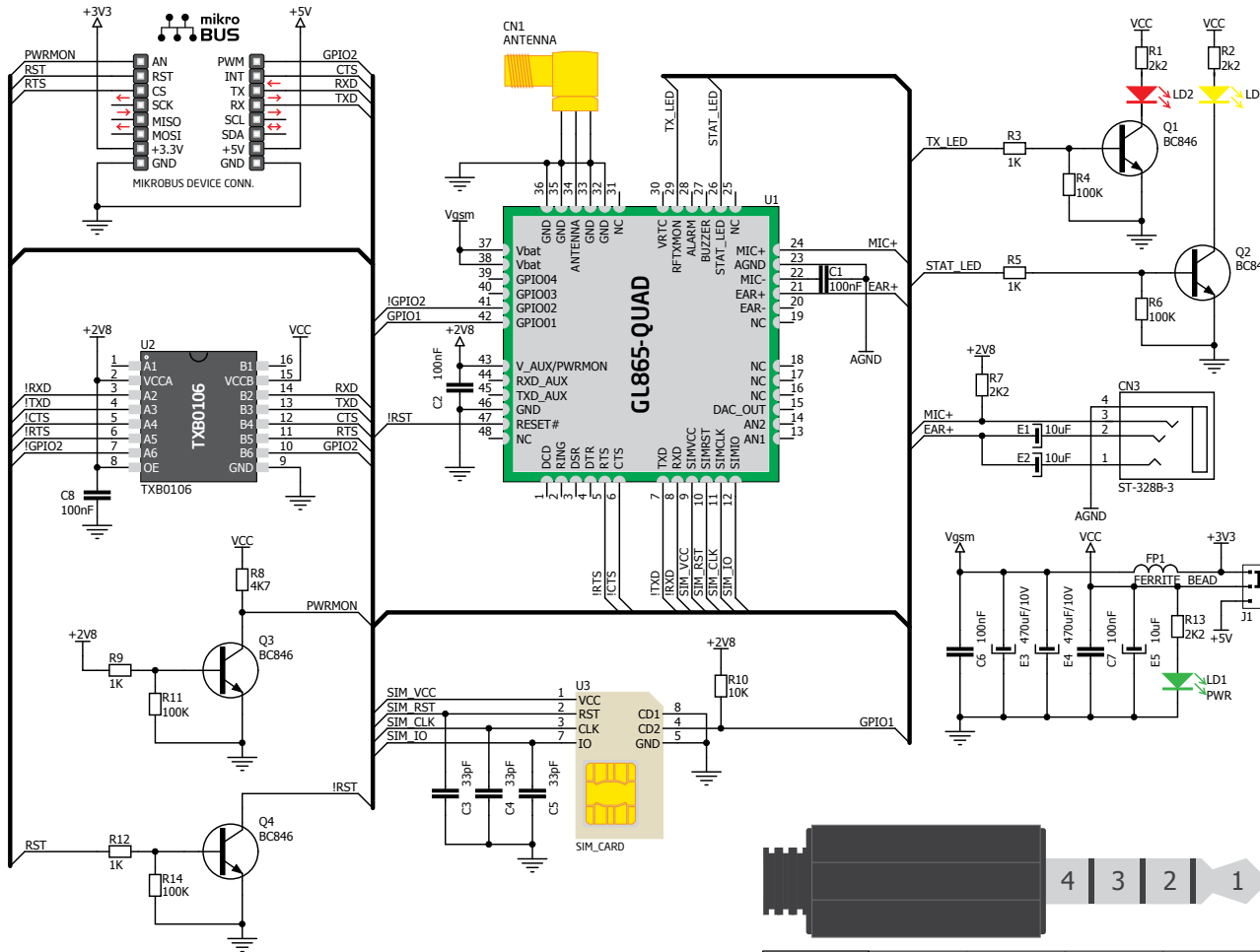

Pin Number	1	2	3	4
Description	Left Audio	Right Audio	Microphone	Common/GND

6. SMD Jumper

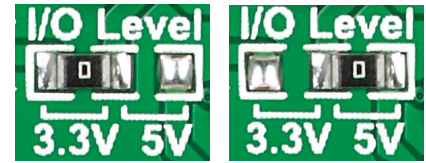

There is one zero-ohm SMD jumper **J1** which is used to select whether 3.3V or 5V I/O voltage level is used. Jumper **J1** is soldered in 3.3V position by default.

7. Code examples

Once you have done all the necessary preparations, it's time to get your click™ board up and running. We have provided examples for mikroC™, mikroBasic™ and mikroPascal™ compilers on our **Libstock** website. Just download them and you are ready to start.



8. Support

MikroElektronika offers **free tech support** (www.mikroe.com/support) until the end of the product's lifetime, so if something goes wrong, we're ready and willing to help!

