



# SL8500 Modular Library System

**Systems Assurance Guide**

MT9229

Revision: K





# SL8500 Modular Library System

---

## Systems Assurance Guide

Sun Microsystems, Inc.  
[www.sun.com](http://www.sun.com)

Part No. MT9229  
August 2006  
Revision: K

Copyright 2004, 2008 Sun Microsystems, Inc., 4150 Network Circle, Santa Clara, California 95054, U.S.A. All rights reserved.

Sun Microsystems, Inc. has intellectual property rights relating to technology that is described in this document. In particular, and without limitation, these intellectual property rights may include one or more of the U.S. patents listed at <http://www.sun.com/patents> and one or more additional patents or pending patent applications in the U.S. and in other countries.

This document and the product to which it pertains are distributed under licenses restricting their use, copying, distribution, and decompilation. No part of the product or of this document may be reproduced in any form by any means without prior written authorization of Sun and its licensors, if any.

Third-party software, including font technology, is copyrighted and licensed from Sun suppliers.

Parts of the product may be derived from Berkeley BSD systems, licensed from the University of California. UNIX is a registered trademark in the U.S. and in other countries, exclusively licensed through X/Open Company, Ltd.

Sun, Sun Microsystems, the Sun logo, Java, AnswerBook2, docs.sun.com, Solaris, and StorageTek, are trademarks or registered trademarks of Sun Microsystems, Inc. in the U.S. and in other countries.

All SPARC trademarks are used under license and are trademarks or registered trademarks of SPARC International, Inc. in the U.S. and in other countries. Products bearing SPARC trademarks are based upon an architecture developed by Sun Microsystems, Inc.

The OPEN LOOK and Sun™ Graphical User Interface was developed by Sun Microsystems, Inc. for its users and licensees. Sun acknowledges the pioneering efforts of Xerox in researching and developing the concept of visual or graphical user interfaces for the computer industry. Sun holds a non-exclusive license from Xerox to the Xerox Graphical User Interface, which license also covers Sun's licensees who implement OPEN LOOK GUIs and otherwise comply with Sun's written license agreements.

U.S. Government Rights—Commercial use. Government users are subject to the Sun Microsystems, Inc. standard license agreement and applicable provisions of the FAR and its supplements.

DOCUMENTATION IS PROVIDED "AS IS" AND ALL EXPRESS OR IMPLIED CONDITIONS, REPRESENTATIONS AND WARRANTIES, INCLUDING ANY IMPLIED WARRANTY OF MERCHANTABILITY, FITNESS FOR A PARTICULAR PURPOSE OR NON-INFRINGEMENT, ARE DISCLAIMED, EXCEPT TO THE EXTENT THAT SUCH DISCLAIMERS ARE HELD TO BE LEGALLY INVALID.

---

Copyright 2004, 2008 Sun Microsystems, Inc., 4150 Network Circle, Santa Clara, Californie 95054, Etats-Unis. Tous droits réservés.

Sun Microsystems, Inc. a les droits de propriété intellectuels relatants à la technologie qui est décrit dans ce document. En particulier, et sans la limitation, ces droits de propriété intellectuels peuvent inclure un ou plus des brevets américains énumérés à <http://www.sun.com/patents> et un ou les brevets plus supplémentaires ou les applications de brevet en attente dans les Etats-Unis et dans les autres pays.

Ce produit ou document est protégé par un copyright et distribué avec des licences qui en restreignent l'utilisation, la copie, la distribution, et la décompilation. Aucune partie de ce produit ou document ne peut être reproduite sous aucune forme, par quelque moyen que ce soit, sans l'autorisation préalable et écrite de Sun et de ses bailleurs de licence, s'il y en a.

Le logiciel détenu par des tiers, et qui comprend la technologie relative aux polices de caractères, est protégé par un copyright et licencié par des fournisseurs de Sun.

Des parties de ce produit pourront être dérivées des systèmes Berkeley BSD licenciés par l'Université de Californie. UNIX est une marque déposée aux Etats-Unis et dans d'autres pays et licenciée exclusivement par X/Open Company, Ltd.

Sun, Sun Microsystems, le logo Sun, Java, AnswerBook2, docs.sun.com, Solaris, et StorageTek sont des marques de fabrique ou des marques déposées de Sun Microsystems, Inc. aux Etats-Unis et dans d'autres pays.

Toutes les marques SPARC sont utilisées sous licence et sont des marques de fabrique ou des marques déposées de SPARC International, Inc. aux Etats-Unis et dans d'autres pays. Les produits portant les marques SPARC sont basés sur une architecture développée par Sun Microsystems, Inc.

L'interface d'utilisation graphique OPEN LOOK et Sun™ a été développée par Sun Microsystems, Inc. pour ses utilisateurs et licenciés. Sun reconnaît les efforts de pionniers de Xerox pour la recherche et le développement du concept des interfaces d'utilisation visuelle ou graphique pour l'industrie de l'informatique. Sun détient une licence non exclusive de Xerox sur l'interface d'utilisation graphique Xerox, cette licence couvrant également les licenciées de Sun qui mettent en place l'interface d'utilisation graphique OPEN LOOK et qui en outre se conforment aux licences écrites de Sun.

LA DOCUMENTATION EST FOURNIE "EN L'ÉTAT" ET TOUTES AUTRES CONDITIONS, DECLARATIONS ET GARANTIES EXPRESSES OU TACITES SONT FORMELLEMENT EXCLUES, DANS LA MESURE AUTORISÉE PAR LA LOI APPLICABLE, Y COMPRIS NOTAMMENT TOUTE GARANTIE IMPLICITE RELATIVE A LA QUALITE MARCHANDE, A L'APTITUDE A UNE UTILISATION PARTICULIERE OU A L'ABSENCE DE CONTREFAÇON.

---

We welcome your feedback. Please contact the Sun Learning Services Feedback System at:

[SLSFS@Sun.com](mailto:SLSFS@Sun.com)

or

Sun Learning Services  
Sun Microsystems, Inc.  
One StorageTek Drive  
Louisville, CO 80028-3256  
USA

Please include the publication name, part number, and edition number in your correspondence if they are available. This will expedite our response.



Please  
Recycle



# Summary of Changes

---

Date	Revision	Description
May 2004	First (A)	Initial release
June 2004	Second (B)	Refer to this revision for the list of changes (artwork change)
July 2004	Third (C)	Refer to this revision for the list of changes (power updates)
October 2004	Fourth (D)	Refer to this revision for the list of changes (specifications)
May 2005	Fifth (E)	Refer to this revision for the list of changes (pass-thru port)
September 2005	Sixth (F)	Refer to this revision for the list of changes (handbots and drives)
March 2006	Seventh (G)	Refer to this revision for the list of changes (features)
September 2006	Eighth (H)	Refer to this revision for the list of changes (SPL, TCP/IP)
March 2007	Ninth (J)	Refer to this revision for the list of changes (SPL, Host connectivity)
January 2008	Tenth (K)	Changes to this revision include: <ul style="list-style-type: none"><li>• Added Multi-Host connectivity information—<a href="#">Appendix I</a> and <a href="#">“Host Interface Connections” in Chapter 1</a>.</li><li>• Updated order numbers—<a href="#">Chapter 5</a>.</li><li>• Removed the Tape Drive and Media order numbers. Refer to the appropriate Systems Assurance Guides for the information.</li><li>• Updated the <a href="#">“Library Comparisons” in Appendix F</a>, and the power comparisons information in <a href="#">Table 29 on page 187</a>.</li></ul>

**Note:** Change bars are included in this revision.

## Summary of Changes

# Contents

---

<b>Summary of Changes</b> .....	<b>iii</b>
<b>Contents</b> .....	<b>v</b>
<b>Figures</b> .....	<b>xiii</b>
<b>Tables</b> .....	<b>xv</b>
<b>Preface</b> .....	<b>xix</b>
SL8500 Site Preparation Kit .....	xix
Terminology and Usage .....	xix
Organization .....	xx
<a href="#">Related Training</a> .....	<a href="#">xxi</a>
<a href="#">Access the Learning Management System</a> .....	<a href="#">xxi</a>
Related Publications .....	xxii
Additional Information .....	xxiii
Sun's External Web Site .....	xxiii
Customer Resource Center .....	xxiii
Sun Partner Advantage Program .....	xxiii
Hardcopy Publications .....	xxiii
<b>1: Introduction</b> .....	<b>1</b>
Library Overview .....	1
Modules .....	2
Library Walls, Arrays, and Slots .....	4
Address Scheme .....	4
Understanding the Address Scheme .....	5
Capacities .....	8
Total Library Capacities .....	8
Partitioned Capacities .....	8
Reserved Slot Capacities .....	8
Power .....	9
N+1 Power Configuration .....	9
2N Power Configuration .....	10
AC Power Options .....	11
Delta or Wye? .....	11
Load Sharing DC Power Supplies .....	12
Power Connections .....	13
Connectors .....	14
Circuit Breaker Ratings .....	14

## Contents

Electronics Control Module .....	15
HBC Card .....	15
HBT Card .....	15
HBK Card .....	15
Firmware .....	16
Audits and Initialization .....	17
Audit Conditions .....	17
Audit Types .....	17
Robotic Rail Assemblies .....	18
Cartridge Access Ports .....	19
Pass-thru Mechanisms .....	20
Elevators .....	20
Pass-thru Ports .....	21
Library Cameras .....	23
Accessory Racks .....	24
Operator Panels .....	25
Keypad .....	25
Remote Operator Panel .....	26
Touch Screen Operator Control Panel .....	26
Service Safety Door and Mode .....	27
Emergency Robotic Stop .....	27
Host Interface Connections .....	28
Network Recommendations .....	29
Fibre Channel .....	29
Host Connectivity Checklist .....	30
Library Complex .....	31
Requirements .....	31
Dual TCP/IP .....	32
Requirements .....	32
Dual TCP/IP Network Entries Worksheet .....	33
Partitioning .....	34
Requirements .....	34
Multi-Host .....	35
Requirements .....	35
Multi-Host Network Entries Work Sheet .....	36
Library Management Software .....	37
Nearline Control Solution .....	37
Client System Component .....	38
Storage Management Component .....	38
HTTP Server .....	38
LibraryStation .....	38
Host Software Component .....	39
HSC 6.1 and Near Continuous Operation .....	39
HSC and Large Capacity Library Support .....	39
Virtual Storage Manager .....	40
Expert Library Manager .....	40



Automated Cartridge System Library Software	.41
SNMP	.42
Management Information Base	.43
Tape Drives	.44
Media and Labels	.45
Safety Features	.46
Emergency Robotic Stop	.46
Door Switches	.46
Smoke Detection	.46
Service Mode	.46
Interlocks	.47
Mechanical Access Door Mechanism	.47
Service Safety Door	.47
Interior Lighting	.47
Fire Suppression	.47
Regulatory Agencies	.48
Safety	.48
Electromagnetic	.48
Fiber-optic	.49
Laser Product Label	.49
Shock, Vibration, and Impact Tests	.49
<b>2: System Assurance</b>	<b>51</b>
System Assurance Planning Meetings	.51
Customer Team Member Contact Sheet	.52
Sun Microsystems Team Member Contact Sheet	.53
Engagement Methodology	.54
<b>3: Site Survey Forms</b>	<b>55</b>
Interoperability	.55
Pre-Sales Technical Qualification	.55
System Configuration	.56
Applications	.58
MVS General Information	.60
ACSLs General Information	.61
Data Bases	.62
Hardware Configurations	.63
Library	.63
Tape Drives	.63
Tape Cartridges	.64
Network	.65
ESCON Directors	.67
FICON Directors	.68
Cables and Connectors	.69
Planning for Content	.70
<b>4: Site Preparation</b>	<b>73</b>
Site Planning Checklist	.73
Physical Planning	.78

## Contents

Environmental Requirements	79
Air Flow Requirements	80
Seismic or Earthquake Ratings	80
Accessory Racks	81
Tape Drive and Cartridge Specifications	82
AC Power Planning	83
Floor Template	84
Floor Requirements	85
Co-planar Requirements	86
Floor Cutouts	87
Cable Routing	88
Ceiling Requirements	89
Height Adjustments	90
Clearances	90
Drive and Electronics Module Planning	91
Electronic Module Planning	92
Tape Drive Cable Planning	93
Pass-thru Port Planning	94
Fire Suppression Planning	95
Obtaining a Password	96
Installing StreamLine Library Console	96
Remote Support	97
Service Delivery Platform	97
Sun Microsystems Technical Excellence Center	97
Preparing for the Installation	98
Personnel	98
Power	98
Floor	99
Raised Floor	99
Weight	99
Co-planar	99
Construction Area	99
Installation Tools	99
Shipping Weights and Dimensions	101
Moving Unpacked Components	103
Adjustable Jacks	106
Moving Libraries	107
<b>5: Ordering Information</b>	<b>109</b>
Feature Codes	110
Library Modules	111
Slot Configurations and Capacities	112
Total Library Capacities	112
Partitioned Capacities	112
Data Cartridge Slots	113
Power	114
HandBots	115

HandBot Power Supplies .....	115
Front Frame Electronics .....	116
Keypad .....	116
Touch Screen Operator Control Panel .....	116
Cartridge Access Ports .....	116
WebCam Monitoring .....	117
Accessory Racks .....	117
Service Safety Door .....	117
Pass-thru Ports .....	118
Tape Drive Power Supplies .....	119
Tape Drives .....	120
Cables .....	121
Ethernet Cables .....	121
Fiber-Optic Cables Work Sheet .....	122
ESCON Cables Work Sheet .....	123
Special Parts .....	124
Order Number Listing .....	125
<b>A: Content Management .....</b>	<b>127</b>
Dedicating Rails .....	128
Managing Cartridges .....	129
Grouping Tape Drives .....	130
Minimizing Elevator and PTP Activity .....	131
Cartridge Access Port Guidelines .....	132
Planning for Content .....	132
<b>B: Software .....</b>	<b>135</b>
From a Software Point of View .....	135
Structural Elements .....	135
Addressing .....	136
Tape Drives .....	137
Cartridge Access Ports .....	138
Elevators .....	139
Auto Clean .....	139
Operational Differences .....	139
Host Software Component .....	140
Automated Cartridge System Library Software .....	141
ACSLs Differences with a SL8500 .....	142
Upgrading ACSLS .....	142
AS/400 Configuration Requirements .....	142
VSM .....	143
Independent Software Vendors .....	143
Tier 1 and 2 Partners .....	143
Software Feature Codes .....	144
ACSLs Feature Codes .....	144
HSC Feature Codes .....	145
<b>C: Tape Drives .....</b>	<b>147</b>

Contents

- T9840 Tape Drives .....148
- T9940 Tape Drives .....149
- T10000 Tape Drive .....150
- HP LTO Specifications .....151
- IBM LTO Specifications .....152
- Quantum LTO Specifications .....153
- Super DLT600 .....154
- Dynamic World Wide Name .....155
  - Arbitrated Loops .....155
- Tape Drive Comparisons .....156
  
- D: Media ..... 157**
  - Disclaimer .....157
  - 9840 Tape Cartridge .....158
    - 9840 Cartridge Specifications .....159
  - 9940 Tape Cartridge .....160
    - 9940 Cartridge Specifications .....161
  - T10000 Tape Cartridges .....162
    - Cleaning Cartridges .....162
    - Data Cartridges .....162
    - VolSafe Cartridges .....162
  - T10000 Cartridge Specifications .....163
  - LTO Tape Cartridges .....164
    - LTO Cartridge Specifications .....165
  - Super DLT Tape Cartridges .....166
    - Super DLTtape Cartridge Specifications .....167
  - VolSafe Cartridges .....168
  - Barcode Labels .....169
    - Barcode Standards .....170
    - Media Domain and ID Labels .....171
    - Media Label Requirements .....171
      - Label Examples .....172
    - Cleaning and Diagnostic Labels .....173
  - Ordering Tape Cartridges and Labels .....174
    - Volume Serial Numbers .....174
    - 9840 and 9940 Cartridge Labels .....174
  - Media Comparisons .....175
  
- E: Electrical Conversions ..... 177**
  - Symbolic .....177
  - To Find Volts, Watts, and Amperes .....177
  - To Find Volt-Amperes (VA) .....178
  - To Find Kilovolt-Amperes (kVA) .....178
  - To Find Kilowatts .....178
  - To Convert Between kW and kVA .....179
  - To Find British Thermal Units From Electrical Values .....179
  
- F: Comparisons ..... 181**

Contrasts Between Libraries .....	181
Capacity Comparison with 9310 Libraries .....	183
Library Comparisons .....	184
<b>G: TCP/IP Connectivity .....</b>	<b>189</b>
Differences, Benefits, and Terminology .....	190
Differences .....	190
Benefits .....	191
Terminology .....	192
Network Addressing .....	193
Subnet Masks .....	194
Netmask Quick Reference .....	196
ACSLs and Dual TCP/IP Support .....	197
HSC and Dual TCP/IP Support .....	198
Multi-Homed Configuration on Two Subnets .....	199
CLI Commands .....	200
Multi-Homed Configuration with Different Subnets .....	201
CLI Commands .....	202
Single Interface Host with Multi-Homed SL8500 .....	203
CLI Commands .....	204
Service Connection .....	205
Potential Problems .....	206
Shared Networks .....	206
Diagnosing TCP/IP Problems .....	207
Solutions .....	207
Gigabit Ethernet Connections .....	207
<b>H: Partitioning .....</b>	<b>209</b>
Purpose .....	209
Guidelines .....	210
Software and Firmware Requirements .....	212
Capacities .....	213
Tasks .....	214
Planning .....	215
<b>I: Multi-Host Connectivity .....</b>	<b>223</b>
Requirements .....	223
Library Management Software .....	224
Specifics for ACSLS .....	224
Specifics for HSC .....	224
Host Connections .....	224
Multi-Host Network Entries Work Sheet .....	225
Configuration Examples .....	226
<b>J: Work Sheets .....</b>	<b>229</b>
Host Selection Checklist .....	230
Network Entries Work Sheet .....	231
Multi-Host Network Entries Work Sheet .....	232

Contents

<b>Glossary</b> .....	<b>241</b>
<b>Index</b> .....	<b>247</b>

# Figures

---

Figure 1. SL8500 Modular Library System	1
Figure 2. Library Modules	2
Figure 3. Panel Numbering	6
Figure 4. Internal Addressing Map	7
Figure 5. N+1 Power Configuration	9
Figure 6. 2N Power Configuration (Optional Feature)	10
Figure 7. Delta or Wye?	13
Figure 8. HandBot and Rail Assembly	18
Figure 9. Cartridge Access Port	19
Figure 10. Elevators	20
Figure 11. Pass-thru Port Mechanism	21
Figure 12. Library Cameras	23
Figure 13. Keypad	25
Figure 14. Touch Screen Operator Control Panel	26
Figure 15. Service Safety Door	27
Figure 16. Emergency Robotic Stop Switch	27
Figure 17. TCP/IP Connections	28
Figure 18. Example: A Nearline Control Solution using HSC, ExLM, and VSM Products	37
Figure 19. ACSLS Example	41
Figure 20. SNMP Block Diagram	42
Figure 21. Management Information Base Hierarchy	43
Figure 22. Content Management Plan	70
Figure 23. Accessory Rack Power	81
Figure 24. Drive Tray	82
Figure 25. PDU Connections	83
Figure 26. Terminal Block	83
Figure 27. Floor Planning Template	84
Figure 28. Weight Distribution Pad Locations	85
Figure 29. Co-planar – Floor Slope Diagram	86
Figure 30. Floor Cutouts for Power and Signal Cables	87
Figure 31. Cabling Routing	88
Figure 32. Upper Module Installation	89
Figure 33. Minimum and Maximum Height Specifications	90
Figure 34. Drive and Electronics Module Planning	91
Figure 35. Electronic Control Module	92

## Figures

Figure 36. Cabling Tape Drives (Example, figure is not exact)	93
Figure 37. Pass-thru Port Planning Example	94
Figure 38. Fire Suppression Ceiling Access	95
Figure 39. Adjustable Jack	106
Figure 40. Jack Positioning	106
Figure 41. Features and Their Locations	110
Figure 42. Fiber Optic Duplex Connectors	122
Figure 43. ESCON Cable Connectors	123
Figure 1. Content Management Example	127
Figure 2. Content Management Work Sheets	133
Figure 3. 9840 Tape Cartridge	158
Figure 4. 9940 Tape Cartridge	160
Figure 5. Tape Cartridge Types	162
Figure 6. LTO Tape Cartridge	164
Figure 7. DLT and SDLT Tape Cartridges	166
Figure 8. VolSafe/WORM Tape Cartridge Example	168
Figure 9. Barcode Label Examples	169
Figure 10. Barcode Design	170
Figure 11. Label Examples	172
Figure 12. Cleaning and Diagnostic Label Examples	173
Figure 13. Multi-Homed Host, Multi-Homed SL8500 on Two Subnets	199
Figure 14. Multi-Homed Host, Multi-Homed SL8500, Interfaces on Different Subnets	201
Figure 15. Single Interface Host and Multi-Homed SL8500	203
Figure 16. Dual TCP/IP Port 2A Service Connection	205
Figure 17. Partition Planning and Capacities	213
Figure 18. Partition Planning Example	216
Figure 19. Base Library Partition Planning	217
Figure 20. One Expansion Module Partition Planning	218
Figure 21. Two Expansion Modules Partition Planning	219
Figure 22. Three Expansion Modules Partition Planning	220
Figure 23. Four Expansion Modules Partition Planning	221
Figure 24. Five Expansion Modules Partition Planning	222
Figure 28. Content Management Work Sheet	233
Figure 29. Partition Planning—Base Library	234
Figure 30. Partition Planning—One Expansion Module	235
Figure 31. Partition Planning—Two Expansion Modules	236
Figure 32. Partition Planning—Three Expansion Modules	237
Figure 33. Partition Planning—Four Expansion Modules	238
Figure 34. Partition Planning—Five Expansion Modules	239



# Tables

---

Table 1. Module Descriptions	3
Table 2. Addressing Descriptions	5
Table 3. Library Data Cartridge Capacity	8
Table 4. Partitioned Capacities	8
Table 5. Reserved Slots	8
Table 6. Load Sharing Power Supplies	12
Table 7. Hubbell Connectors and Plugs (IEC 309)	14
Table 8. Circuit Breaker Ratings	14
Table 9. Accessory Rack Installation Guidelines	24
Table 10. Library Console Remote Operator Panel Requirements	26
Table 11. Host Connection Checklist and Requirements	30
Table 12. HSC Large Library Support	39
Table 13. Supported Tape Drives	44
Table 14. Media	45
Table 15. System Assurance Task Checklist	51
Table 16. Engagement Methodology	54
Table 17. Questions About the Customers Operating Systems	56
Table 18. System Configuration	57
Table 19. Questions About the Customers Applications	58
Table 20. Backup and Archive Software	59
Table 21. Network Management Software	59
Table 22. Library Attachment Software	59
Table 23. MVS Information	60
Table 24. ACSLS Information	61
Table 25. Questions About the Customers Data Base	62
Table 26. Existing Libraries	63
Table 27. Tape Drive Types	63
Table 28. Existing Tape Drives	64
Table 29. Existing Tape Cartridges	64
Table 30. Fibre Channel Switches	65
Table 31. Ethernet Hubs and Switches	65
Table 32. Fibre Channel Switch Connections	66
Table 33. ESCON Directors	67
Table 34. FICON Director Worksheet	68
Table 35. Cables and Connectors	69

Tables

Table 36. Site Planning Checklist . . . . .	73
Table 37. Library Weights and Measures . . . . .	78
Table 38. Environmental Specifications . . . . .	79
Table 39. Environmental Definitions . . . . .	79
Table 40. Air Flow Requirements . . . . .	80
Table 41. Rack Guidelines . . . . .	81
Table 42. Drive Tray Weights and Measures . . . . .	82
Table 43. Tape Drive Weights . . . . .	82
Table 44. Cartridge Tape Weights . . . . .	82
Table 45. Overhead Clearances . . . . .	90
Table 46. Installation Tools . . . . .	100
Table 47. Shipping Pallets – Weights and Dimensions . . . . .	101
Table 48. Total Pallet Weights for a Selected Library Configuration . . . . .	102
Table 49. Component Weights and Dimensions . . . . .	102
Table 50. Unpacked Components . . . . .	103
Table 51. Library Configuration and Additional Features . . . . .	109
Table 52. Library Module Order Numbers . . . . .	111
Table 53. Library Data Cartridge Capacity . . . . .	112
Table 54. Partitioned Capacities . . . . .	112
Table 55. Capacity . . . . .	113
Table 56. Slot Upgrade Order Numbers . . . . .	113
Table 57. Power Distribution Order Numbers . . . . .	114
Table 58. HandBot Order Numbers . . . . .	115
Table 59. HandBot Power Supply Order Numbers . . . . .	115
Table 60. Touch Screen Operator Panel Order Numbers . . . . .	116
Table 61. Cartridge Access Port Order Numbers . . . . .	116
Table 62. WebCam Order Numbers . . . . .	117
Table 63. Accessory Rack Order Numbers . . . . .	117
Table 64. Service Safety Door Order Numbers . . . . .	117
Table 65. Pass-thru Port Order Numbers . . . . .	118
Table 66. Tape Drive Power Supply Order Numbers . . . . .	119
Table 67. Ethernet Cables . . . . .	121
Table 68. Two Gigabit Fiber-Optic Cables . . . . .	122
Table 69. ESCON Cable Part Numbers . . . . .	123
Table 70. Special Parts Order Numbers . . . . .	124
Table 71. Order Number Listing . . . . .	125
Table 1. Slot Addressing . . . . .	136
Table 2. Software Drive Numbering . . . . .	137
Table 3. Physical Drive Numbering . . . . .	137
Table 4. ACSLS Requirements . . . . .	141
Table 5. Supported Independent Software Vendors . . . . .	143
Table 6. Tier 1 and Tier 2 Partners . . . . .	143

Table 7. ACSLS Feature Code Work Sheet . . . . .	144
Table 8. HSC Feature Codes . . . . .	145
Table 9. Supported Tape Drives and Microcode Levels . . . . .	147
Table 10. Library Data Capacity . . . . .	147
Table 11. T9840 Tape Drive Specifications . . . . .	148
Table 12. T9940 Tape Drive Specifications . . . . .	149
Table 13. T10000 Tape Drive Specifications . . . . .	150
Table 14. HP LTO Tape Drive Specifications . . . . .	151
Table 15. IBM LTO Tape Drive Specifications . . . . .	152
Table 16. Quantum LTO Tape Drive Specifications . . . . .	153
Table 17. Super DLT Tape Drive Specifications . . . . .	154
Table 18. Tape Drive Comparisons . . . . .	156
Table 19. 9840 Cartridge Specifications . . . . .	159
Table 20. 9940 Cartridge Specifications . . . . .	161
Table 21. T10000 Cartridge Specifications . . . . .	163
Table 22. LTO Cartridge Specifications . . . . .	165
Table 23. SDLTtape Cartridge Specifications . . . . .	167
Table 24. Media Domain and Media ID Designators . . . . .	172
Table 25. EDP Trioptic Support . . . . .	174
Table 26. Media Comparisons . . . . .	175
Table 27. Old versus New Terminology . . . . .	181
Table 28. Comparisons Between PowderHorn and the SL8500 Library . . . . .	184
Table 29. Power Requirement Comparisons . . . . .	187
Table 30. Network IP Classes and Address Ranges . . . . .	194
Table 31. Netmask Quick Reference . . . . .	196
Table 32. Partitioned Capacities . . . . .	213
Table 33. Steps and Tasks for Partitioning . . . . .	214
Table 34. HSC LMU Path and Address Parameters . . . . .	224
Table 35. Host Selection Checklist and Requirements . . . . .	230

## Tables

# Preface

---

The system assurance process is the exchange of information among team members to ensure that no aspects of the sale, order, and installation of the StreamLine™ SL8500 modular library system are overlooked. This process promotes an error-free installation and contributes to the overall customer satisfaction.

This *System Assurance Guide* is intended for Sun Microsystems and StorageTek account executives, marketing and sales representatives, system engineers, professional services, installation coordinators, service representatives, plus anyone interested in information about the SL8500 modular library system.

**Important:**

Although classified as Sun Confidential—it is intended to be *shared* with customers that are interested in planning for, purchasing, and using the SL8500 modular library system.

## ■ SL8500 Site Preparation Kit

This guide is part of the SL8500 Site Preparation Kit which contains checklists in electronic format that identify the customer configurations and environments. These checklists are a part of the systems assurance process and the exchange of information—feel free to use them.

## ■ Terminology and Usage

The following terminology is used throughout this document and mean the same unless otherwise noted:

- SL8500 modular library system, SL8500 library, SL8500, or just “library”
- Media, cartridges, tape cartridges, volumes, tape volumes, or just “tapes”
- Tape drives, or just “drives”
- Rail (hardware) and library storage module or LSM (software)
- Library complex (hardware) and automated cartridge system ACS (software). An ACS can contain multiple libraries within a complex.
- Slots (hardware) and cells (software)

## ■ Organization

The following lists the organization of this guide.

Chapter	Use this chapter to:
<a href="#">Chapter 1, Introduction</a>	Introduce yourself and your customer to the SL8500 modular library system.
<a href="#">Chapter 2, System Assurance</a>	Help ensure that all aspects of the process are planned carefully and performed efficiently.
<a href="#">Chapter 3, Site Survey Forms</a>	Record information.  This chapter contains a variety of forms to use during the systems assurance process when conducting site surveys, planning, model and feature selections.
<a href="#">Chapter 4, Site Preparation</a>	Prepare for the installation by reviewing the information and completing the Site Planning Checklist.  This chapter includes a site planning checklist, specifications, shipping weights and dimensions, plus other planning topics and requirements to help prepare for an installation of the SL8500 library.
<a href="#">Chapter 5, Ordering Information</a>	Assist with ordering the models, feature codes, cables, and tape cartridges for the SL8500 modular library system.
<a href="#">Appendix A Content Management</a>	Help <i>plan</i> and <i>evaluate</i> the content of an SL8500 library with respect to the physical structure and capacities.  This appendix provides recommendations to help optimize and improve performance for an SL8500.
<a href="#">Appendix B Software</a>	Get a high level overview about the library from a software point of view.
<a href="#">Appendix C Tape Drives</a>	Obtain more information about the tape drives.
<a href="#">Appendix D Media</a>	Get more information about the media.
<a href="#">Appendix E Electrical Conversions</a>	Convert basic electrical values into other types of values.
<a href="#">Appendix F Comparisons</a>	Learn some of the different terms and comparisons between the 9310 PowderHorn library and the SL8500 modular library system.
<a href="#">Appendix G TCP/IP Connectivity</a>	Obtain information about the TCP/IP connectivity of the SL8500, including differences, benefits, terminology, and examples.
<a href="#">Appendix H Partitioning</a>	Plan for Partitioning.  This appendix contains guidelines and essential elements for partitioning the SL8500.
<a href="#">Glossary</a>	Learn the new terms and abbreviations used in this guide.
<a href="#">Index</a>	Locate information in this guide.

## ■ Related Training

Sun Learning Services (SLS) has two tools that employees can use to obtain information about and for training.

1. Learning Management System (LMS) enables you to sign up for classes, access training records, start e-learning courses, and much more.
2. MyLearning Portal allows you to find out about the latest learning offerings, find the right learning for your job, watch training videos, and share and collaborate with peers—all from a single site.

You can access both of these tools through the SunWeb Portal at: <http://sunweb.central.sun.com>.

**Note:** All StorageTek employee technical courses can be accessed from the **MyLearning** website at: <http://mylearning.central.sun.com/>

Old StorageTek Course #	New Sun Course #	Description
CRS-101596	iSTK-1596	SL8500 Field Service and Installation course for employees and partners.

## Access the Learning Management System

See the following for more information:

### Employee Training

Employees can access the LMS by logging into myHR from the SunWeb Portal and myHR, click on the “My Job & Learning” tab and access the new LMS under the “Learning” channel on the page.

### Partner Training

Partner training resources are still available through a version of the Sun Training Access Network (SunTAN), which remains available.

### Customer Training

Customers can review the Training Catalog that is available through the Sun Web site at: <http://www.sun.com>.

Click on the Training link at the top of the page. <http://www.sun.com/training>.

## ■ Related Publications

All publications listed below are available in portable document format (PDF) online at StorageTek's Customer Resource Center (CRC).

<b>Description</b>	<b>Intended Audience</b>	<b>Part Number</b>
<i>Installation Manual</i> This manual describes how to install the library.	<ul style="list-style-type: none"> <li>Professional services</li> <li>Technical specialists</li> <li>Service representatives</li> </ul>	96138
<i>Replaceable Parts Catalog</i> This is a combination of an Illustrated Parts Catalog with removal and replacement procedures on a CD-ROM.	<ul style="list-style-type: none"> <li>Technical specialists</li> <li>Service representatives</li> </ul>	96139
<i>Principles of Operation</i> This document is contained on a CD-ROM and provides information about configurations, modules, contrasts, and descriptions about power, cooling, cell maps, electronics control module, firmware, and logic card functions.	<ul style="list-style-type: none"> <li>Technical specialists</li> <li>Service representatives</li> </ul>	MT9263
<i>User's Guide</i> This guide is intended for users of the library and contains information that can be beneficial to system administrators.	<ul style="list-style-type: none"> <li>Operators</li> <li>System administrators</li> <li>Service representatives</li> </ul>	96154
<i>System Assurance Guide and Site Preparation Kit</i> Provides an overview about the SL8500 library and contains questionnaires and checklists to help prepare for the delivery and installation of the SL8500 library.	<ul style="list-style-type: none"> <li>System engineers</li> <li>Account executives</li> <li>Technical specialists</li> <li>Service representatives</li> <li>Marketing and sales representatives</li> </ul>	Guide: MT9229  Kit: MT9261
<i>Best Practices Guide</i> This guide is intended to help prepare the customer and site workloads to better optimize the SL8500 library.	<ul style="list-style-type: none"> <li>System engineers</li> <li>Account executives</li> <li>Technical specialists</li> <li>System administrators</li> </ul>	TM0017
<i>Cartridge Barcode Label Technical Brief</i>		TT0006
<i>Pass-thru Port Technical Brief</i>		TT0007
<i>Customer Orientation Checklist</i>		TM0005
<i>CSE Operational Checklist</i>		96208
<i>Floor Planning Template</i>		1094936xx
<i>SNMP Reference Guide</i>		SM0015
<i>Dual TCP/IP Technical Brief</i>		TT0019
<i>Partitioning Technical Brief</i>		96269



## ■ Additional Information

Sun Microsystems, Inc. (Sun) offers several methods for you to obtain additional information.

### Sun's External Web Site

The Sun external Web site provides marketing, product, event, corporate, and service information. The external Web site is accessible to anyone with a Web browser and an Internet connection.

The URL for the Sun external Web site is: <http://www.sun.com>

### Customer Resource Center

The Sun StorageTek product Customer Resource Center (CRC) is a Web site that enables members to resolve technical issues by searching code fixes and technical documentation for StorageTek brand products. CRC membership entitles you to other proactive services, such as HIPER subscriptions, technical tips, answers to frequently asked questions, addenda to product documentation books, and online product support contact information. Customers who have a current warranty or a current maintenance service agreement may apply for membership by clicking on the Request Password button on the CRC home page.

- The URL for the CRC is <http://www.support.storagetek.com>
- The CRC is also available through the SunSolve Web site at: <http://sunsolve.central.sun.com>.
- Sun employees may also enter the CRC through the SunWeb PowerPort.

### Sun Partner Advantage Program

The Sun Partner Advantage Program is a new program for all of Sun's partners worldwide. This new program can help align your business with the power of the Sun brand-and serves as your connection to a whole new level of business opportunities. This site provides information about products, services, customer support, upcoming events, training programs, and sales tools to support partners.

The URL for partners is: <http://www.sun.com/partners/>

### Hardcopy Publications

Contact a Sun sales or marketing representative to order additional paper copies of this publication or to order other StorageTek brand product customer publications in paper format.



This chapter provides an overview about the StreamLine™ SL8500 modular library system.

## ■ Library Overview

[Figure 1](#) shows an example of the SL8500 library, which stands 2.37 m (7.76 ft) tall, 1.7 m (5.6 ft) wide, and from 2.76 m (9.1 ft) to 7.5 m (24.7 ft) deep.

**Figure 1. SL8500 Modular Library System**



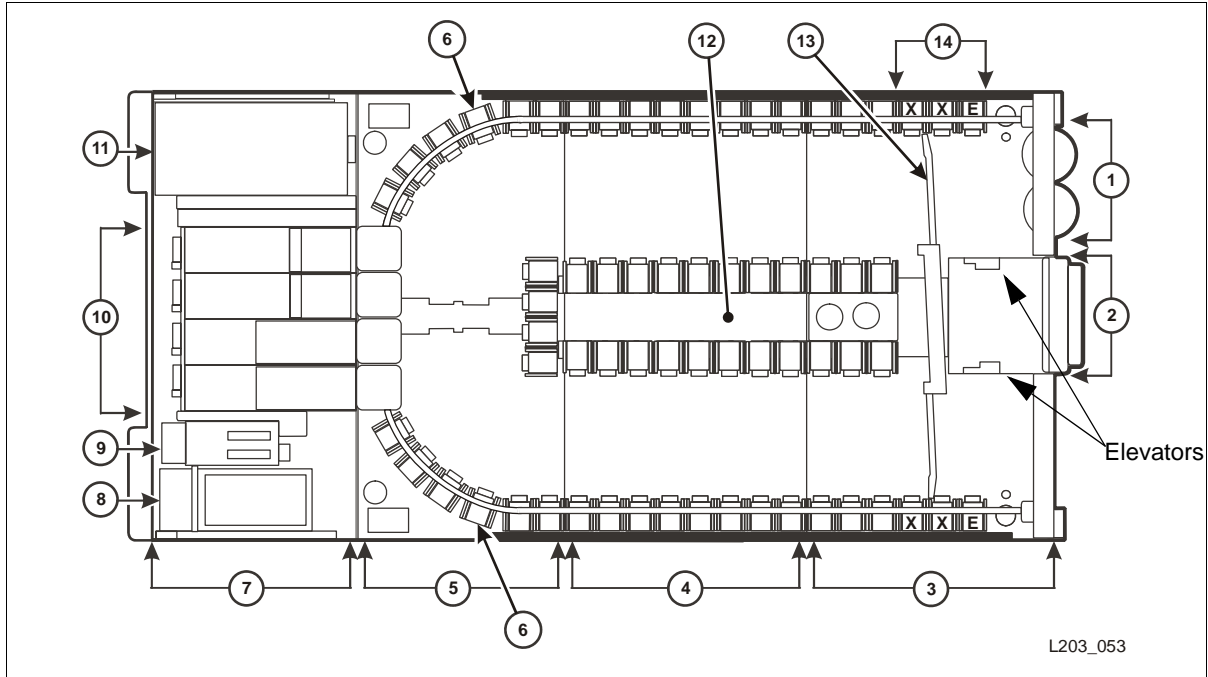
The basic library has slots for 1,448 cartridges and depending on the model and features selected, one SL8500 library can store up to 10,088 tape cartridges with 64 tape drives.

A library complex, which consists of two or more libraries that connect together using pass-thru ports, can store over 320,000 customer usable data tape cartridges with up to 2,048 tape drives.

## Modules

Figure 2 shows a view of the library with an example of each type of module and the location of certain components.

**Figure 2. Library Modules**



1. [“Cartridge Access Ports” on page 19](#)
2. Facade—may contain up to 2 operator panels (Keypad and the StreamLine Library Console)  
The two elevators (vertical pass-thru) are located behind the operator panels).
3. Customer Interface Module (CIM)—only 1 module per library. See [“Capacities” on page 8](#)
4. Storage Expansion Modules (SEM)—up to 5 modules per library. See [“Capacities” on page 8](#)
5. Robotics Interface Module (RIM)—only 1 module per library. See [“Capacities” on page 8](#)
6. Pass-thru Ports—columns 6 and –6. See [“Pass-thru Ports” on page 21](#)
7. Drive and Electronics Module (DEM)—only 1 module per library
8. AC Power and Electronics Control Modules—can have two modules per library
9. DC Power supplies—can have up to 24 modules per library
10. Tape drive bay—holds up to 64 tape drives
11. Accessory racks—may have up to 4 racks that can hold servers, network switches, and the SDP
12. Inner wall cartridge slots
13. [“Service Safety Door and Mode” on page 27](#)
14. [“Reserved Slot Capacities” on page 8](#)
  - E = End stop
  - X = Diagnostic cartridges



Floor labels can be placed inside the library to help identify column numbers and locations. The part number for these labels is: XSL8500-COL-LABEL.

Table 1. Module Descriptions

Module	Description
<b>Customer Interface Module</b>	<p>The customer interface module is the first module in the library and measures 95.25 cm (37.5 in.) deep. This module contains:</p> <ul style="list-style-type: none"> <li>• 648 data cartridge slots (see <a href="#">“Library Walls, Arrays, and Slots” on page 4</a>)</li> <li>• 198 slots for diagnostic and cleaning cartridges (see <a href="#">“Reserved Slot Capacities” on page 8</a>)</li> <li>• 24 end slots (eight 3-slot arrays) for targeting and drop-off cells (see <a href="#">“Reserved Slot Capacities” on page 8</a>)</li> <li>• One LED display and keypad (see <a href="#">“Keypad” on page 25</a>)</li> <li>• Touch screen operator control panel (<i>optional feature</i>) (see <a href="#">“Touch Screen Operator Control Panel” on page 26</a>)</li> <li>• Two <a href="#">“Load Sharing DC Power Supplies” on page 12</a></li> <li>• One service safety door for maintenance activity (<i>optional feature</i>)</li> <li>• One standard <a href="#">“Cartridge Access Ports” on page 19</a></li> <li>• Two elevator assemblies that can transfer up to four cartridges from one rail to another.</li> </ul>
<b>Storage Expansion Modules</b>	<p>The SL8500 library can accommodate up to <i>five</i> storage expansion modules (callout #4). Each expansion module:</p> <ul style="list-style-type: none"> <li>• Increases the depth of the library by 95.25 cm (37.5 in.) (see <a href="#">“Physical Planning” on page 78</a>)</li> <li>• Adds 1,728 customer usable <i>data</i> cartridge slots (see <a href="#">“Library Walls, Arrays, and Slots” on page 4</a>)</li> </ul> <p><b>Note:</b> <i>In the future</i>, the library can have up to <i>five</i> expansion modules.</p>
<b>Robotics Interface Module</b>	<p>The robotics interface module (callout #5) is the next module and measures 76.2 cm (30 in.) deep. This module contains:</p> <ul style="list-style-type: none"> <li>• 800 data cartridge slots (see <a href="#">“Library Walls, Arrays, and Slots” on page 4</a>)</li> <li>• Pass-thru ports (see <a href="#">“Pass-thru Ports” on page 21</a>)</li> <li>• One of two robotic configurations (see <a href="#">“Robotic Rail Assemblies” on page 18</a>)</li> </ul>
<b>Drive and Electronics Module</b>	<p>The drive and electronics module (callout #7) is the last module in the library and measures 76.2 cm (30 in.) deep. This module contains the:</p> <ul style="list-style-type: none"> <li>• AC power distribution units (see <a href="#">“Power” on page 9</a>)</li> <li>• <a href="#">“Electronics Control Module” on page 15</a></li> <li>• <a href="#">“Load Sharing DC Power Supplies” on page 12</a></li> <li>• <a href="#">“Accessory Racks” on page 24</a></li> <li>• Slots for 1 to 64 tape drives (see <a href="#">“Tape Drives” on page 44</a>)</li> </ul>

## Library Walls, Arrays, and Slots

The library has two types of walls with arrays and slots that hold cartridges:

- *Inner* walls—consist of 14-slot arrays
- *Outer* walls—consist of 13-slot arrays with space for the robotic rails

In addition to the 13- and 14-slot arrays, there are:

- 8-slot arrays in the pass-thru port panels
- 8-slot arrays underneath the stop brackets for the service safety door
- 4-slot arrays on the elevators and pass-thru ports
- 3-slot arrays (end stops) at the ends of each HandBot rail

Each array has *two targets* centered vertically with allowances that **[VI]** accommodate the different sizes and depths of the tape cartridges.

Cartridges are placed in slots and lie flat, hub-side down, parallel to the floor. To prevent slippage, cartridges are held within their slots by retainer clips.

Aisle space between the inner and outer walls is limited to 0.5 m (18 in.). Because of this, entry into the library should be limited.

### Address Scheme

Cartridge locations in previous libraries were: ACS, Library, *Panel*, *Row*, and *Column* (HLI-PRC). Cartridge slot designations in an SL8500 library uses five parameters: Library, Rail, Column, Side, Row (L,R,C,S,W):

1. **Library:** Is the number of that library or within a library complex
2. **Rail:** Rails are numbered top down from 1 – 4 with rail 1 being on top.
  - Each rail is considered a separate library storage module (LSM).
  - LSMs are numbered 0 – 3 (top down).
3. **Column:** Indicates the *horizontal* location of a tape cartridge referenced from the center of the drive bay at the rear of the library forward, where:
  - +1 is just *right* of the center of the drive bays and
  - -1 is just to the *left* of the drive bays

Column numbering is consecutive—the first columns that contain tape cartridges are +3 and -3 and continue forward to the front access doors.

4. **Side:** Indicates the inner and outer walls, or left and right HandBots in a redundant configuration.

<i>Walls:</i>	Outer wall = 1	Inner wall = 2
<i>HandBots:</i>	Left HandBot = 1	Right HandBot = 2

5. **Row:** Is the *vertical* location of a tape cartridge and are consecutively numbered from the top (1) down (13 outer wall and 14 inner wall).

## Understanding the Address Scheme

There are differences in the addresses of the SL8500 and other libraries.

- The SL8500 is *one's*-based (1) and uses negative numbers.
- Other libraries use a *zero*-based (0) and *no* negative numbers.
- The SL8500 uses *five* parameters: library, rail, column, side, and row.
- Other libraries use: ACS, LSM, panel, row, and column (HLI-PRC).

**Table 2. Addressing Descriptions**

HLI-PRC	SL8500	Description	
<b>ACS</b>	<b>Library</b>	Number of the specific library in a library complex (ACS). Note: An ACS contains multiple SL8500's in a library complex.	
<b>LSM</b> LSM 0 ⇨ LSM 1 ⇨ LSM 2 ⇨ LSM 3 ⇨	<b>Rail</b> Rail 1 Rail 2 Rail 3 Rail 4	The SL8500 library has four rails that the HandBots travel, which are numbered from top to bottom 1–4 (one's-based).  ACSLs and HSC considers each rail to be a separate LSM, numbered from top to bottom 0–3 (zero-based).	
<b>Panel</b> Panel 0 ⇨ Panel 1 ⇨ Panel 2– <i>n</i> ⇨	<b>Column</b> CAP Drives Storage slots	Columns indicate the <i>horizontal</i> location in the library. As viewed from the front of the library column and panel numbers start at the <i>center</i> of the drive panel (1) and sweep forward with increasing numbers.  <b>Note:</b> See <a href="#">Figure 3 on page 6</a> for an example of a storage <i>panel</i> . The SL8500 does not use panels as an address.  An HLI panel spans across the width of the library to include both sides (left and right) and both walls (inner and outer) for <i>each</i> LSM.	
	<b>Side</b>	Wall location 1. Outer wall 2. Inner wall	HandBot number 1. Left (–) 2. Right (+)
<b>Row</b>	<b>Row</b>	Rows indicate the <i>vertical</i> location of a tape cartridge and are numbered from the top—down.	
<b>Column</b>		Rows for the HLI address are: <ul style="list-style-type: none"><li>• Storage panels start at 2 with Column 0 = left and Column 1 = right</li><li>• Rows 0–12 outer walls</li><li>• Rows 13–26 inner walls</li><li>• Each column in a normal storage panel has 27 rows.</li><li>• For a total capacity of 54 cartridges per panel.</li></ul>	Rows for the SL8500 address are: <ul style="list-style-type: none"><li>• Storage slots start at Column -3 = left Column +3 = right</li><li>• Rows 1–13 outer wall</li><li>• Rows 1–14 inner wall</li></ul>
<ul style="list-style-type: none"> <li>• Zero-based numbering (as with HLI) starts numbering at 0.</li> <li>• One's-based numbering (as with the SL8500) starts numbering at 1.</li> <li>• This is an important difference in the numbering sequences between software (ACSLs or HSC) and hardware (physical SL8500 addresses)</li> </ul>			

A host library interface (HLI) panel spans across the width of the library to include both sides (left and right) and both walls (inner and outer).

Figure 3 shows how panels match-up to the columns in an SL8500 library.

**Figure 3. Panel Numbering**

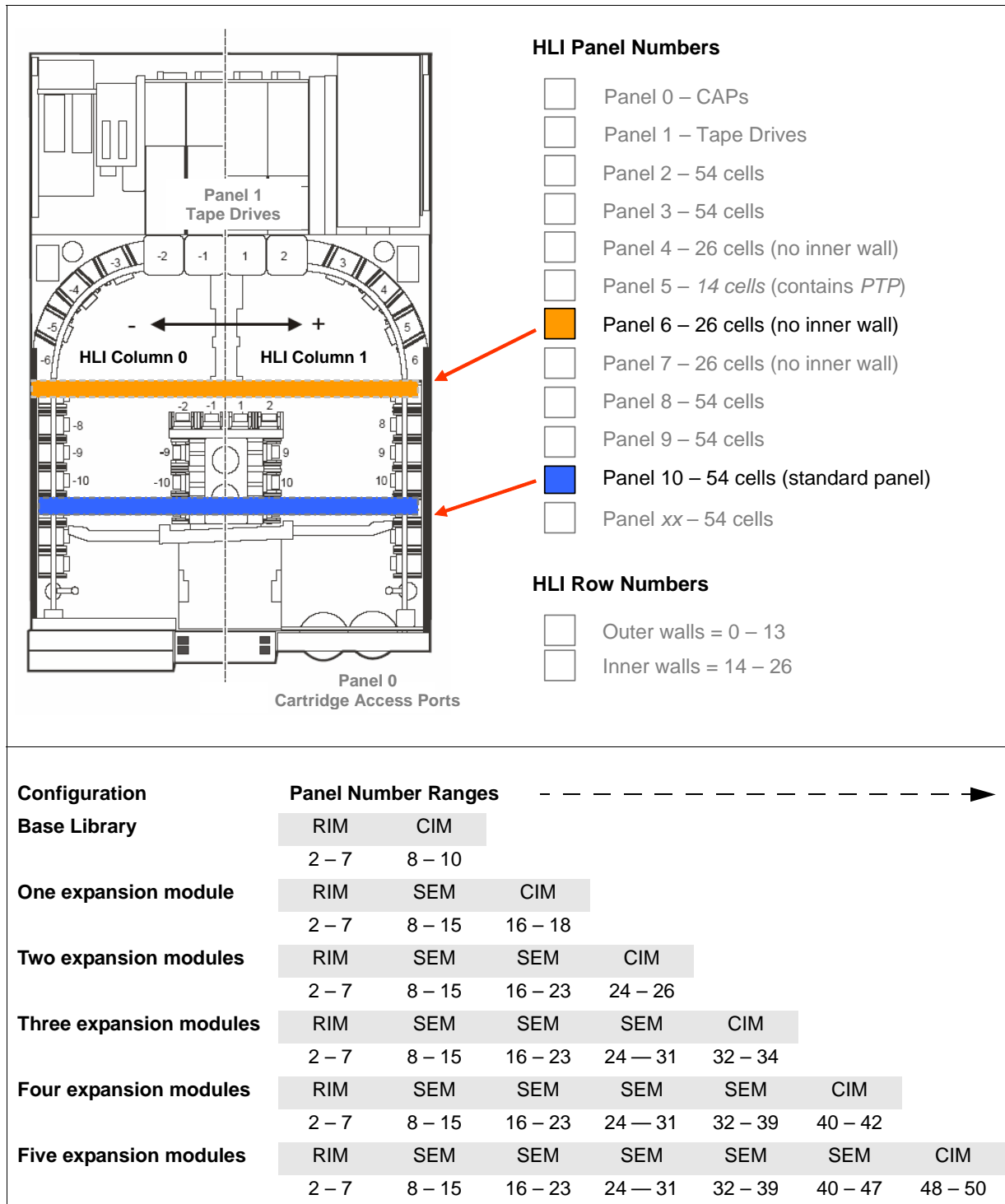
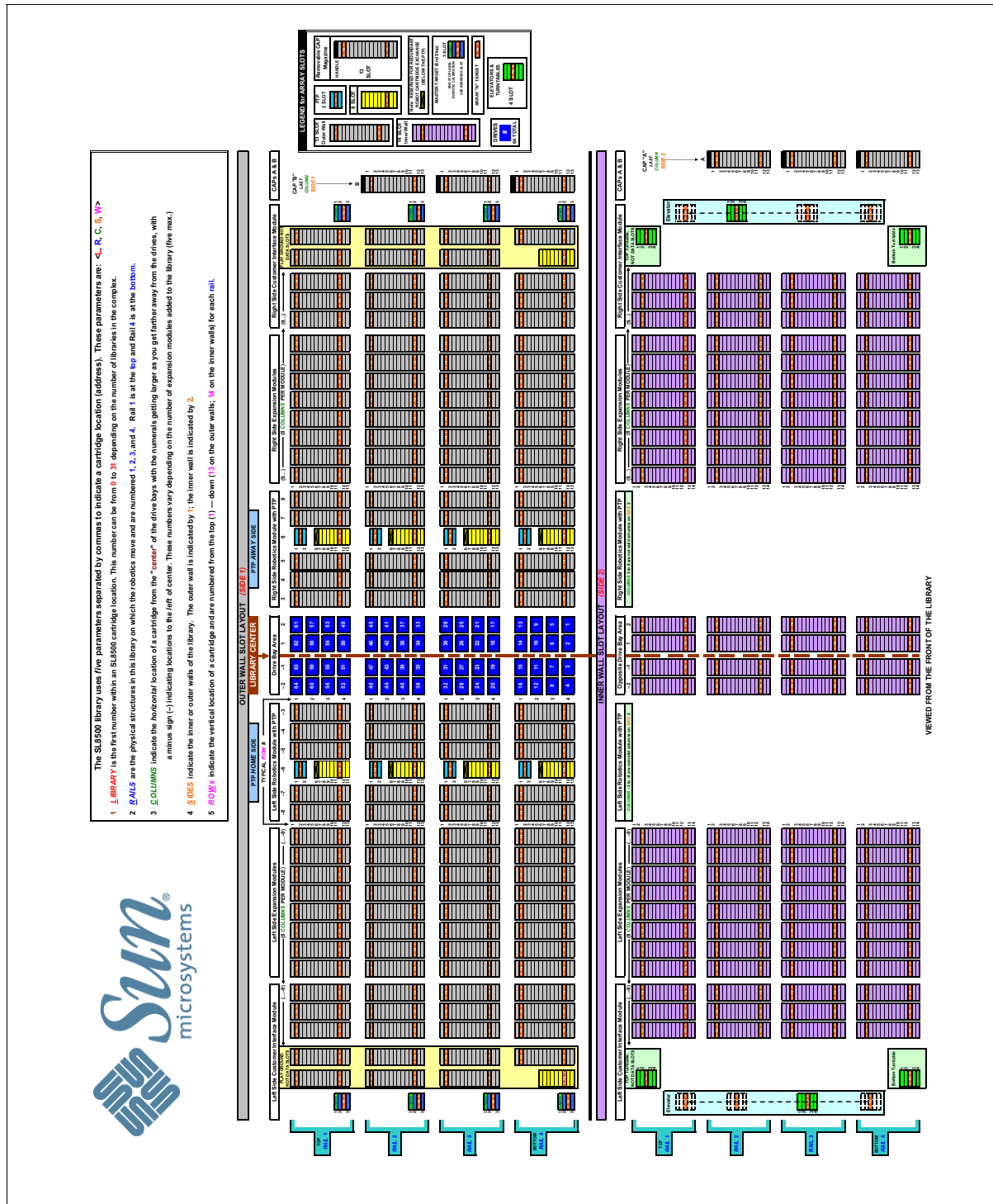




Figure 4. Internal Addressing Map



Poster part number is TP0012, which measure 36-by-24 in. (91-by-61 cm).

## Capacities

### Total Library Capacities

**Table 3. Library Data Cartridge Capacity**

Library Configuration		Cartridge Capacity
	Starting—Base configuration	1,448
Expansion Modules	When adding expansion module, each module adds 1,728 <i>data</i> cartridge slots	
	One expansion module	3,176
	Two expansion modules	4,904
	Three expansion modules	6,632
	Four expansion modules	8,360
	Five expansion modules (maximum)	10,088

### Partitioned Capacities

**Table 4. Partitioned Capacities**

Library Configuration		Partition Capacity per Rail
Basic Library	Drive & Electronics Module	0
	Robotics Interface Module	200
	Customer Interface Module	162
	Base configuration per rail (total)	362
Expansion Modules	When adding expansion module, each rail gets <b>432</b> additional data cartridge slots	
	One expansion module	794
	Two expansion modules	1,226
	Three expansion modules	1,658
	Four expansion modules	2,090
	Five expansion modules (maximum)	2,522

### Reserved Slot Capacities

Note: Reserved slots that *cannot* to be used for data cartridges.

**Table 5. Reserved Slots**

Slots	Usage
198	Diagnostic cartridges
24	Eight 3-cell arrays intended for targeting, proximity sensing, and drop-off.
8	Drop-off slot for the second HandBot

## ■ Power

The SL8500 library has two internal power configurations:

### N+1 Power Configuration

The **N+1** power configuration provides a higher level of DC power redundancy by adding an additional power supply to *each* DC power grid.

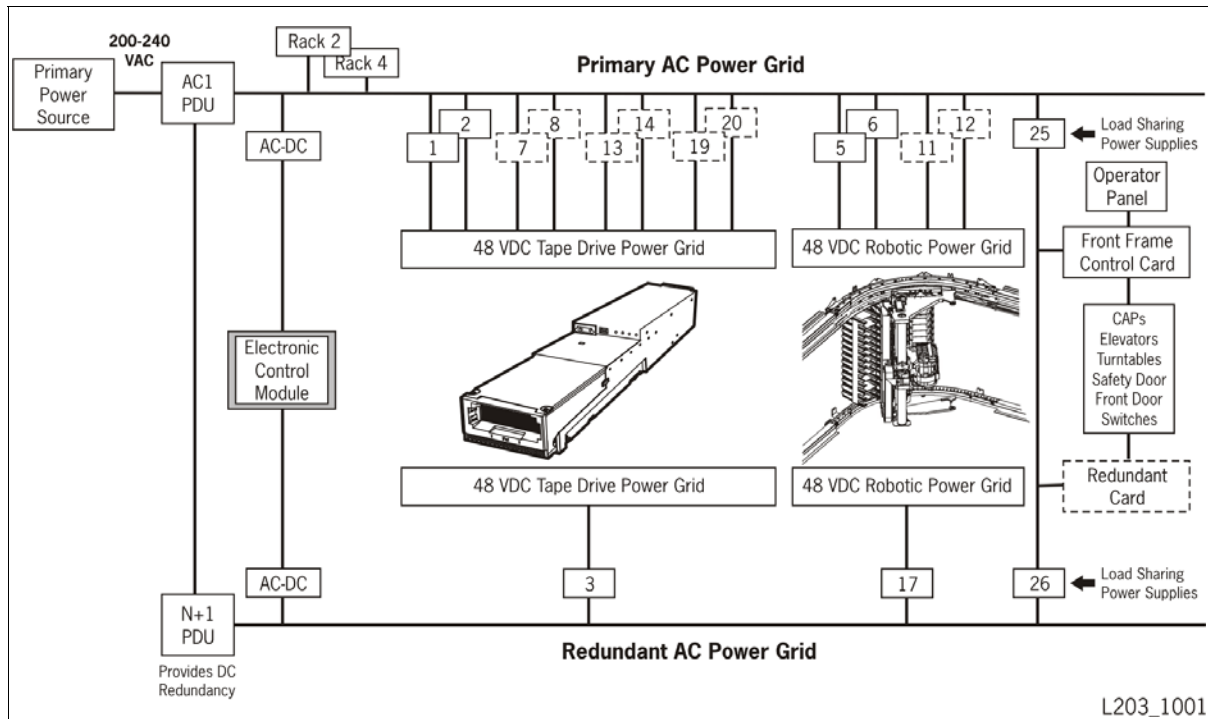
The **N+1** configuration contains *one* “system” power distribution unit (PDU) and *one* N+1 power distribution unit.

- The system PDU accommodates the main power cord and distributes AC power from the customer’s branch circuit to the three DC power grids, the electronics control module, and the N+1 PDU.
- The N+1 PDU provides AC power to an extra 48 VDC load sharing power supply on *each* of the three DC power grids plus an extra AC-to-DC converter for the Electronics Control Module.

If a single power supply fails, there is still enough DC power available on that power grid to keep the entire system operational until the power supply can be replaced.

**Note:** The N+1 power configuration provides only DC power redundancy.

**Figure 5. N+1 Power Configuration**



## 2N Power Configuration

The **2N** power configuration is an *optional feature* that connects another AC power source to a second “system” power distribution unit that should attach to a separate branch circuit.

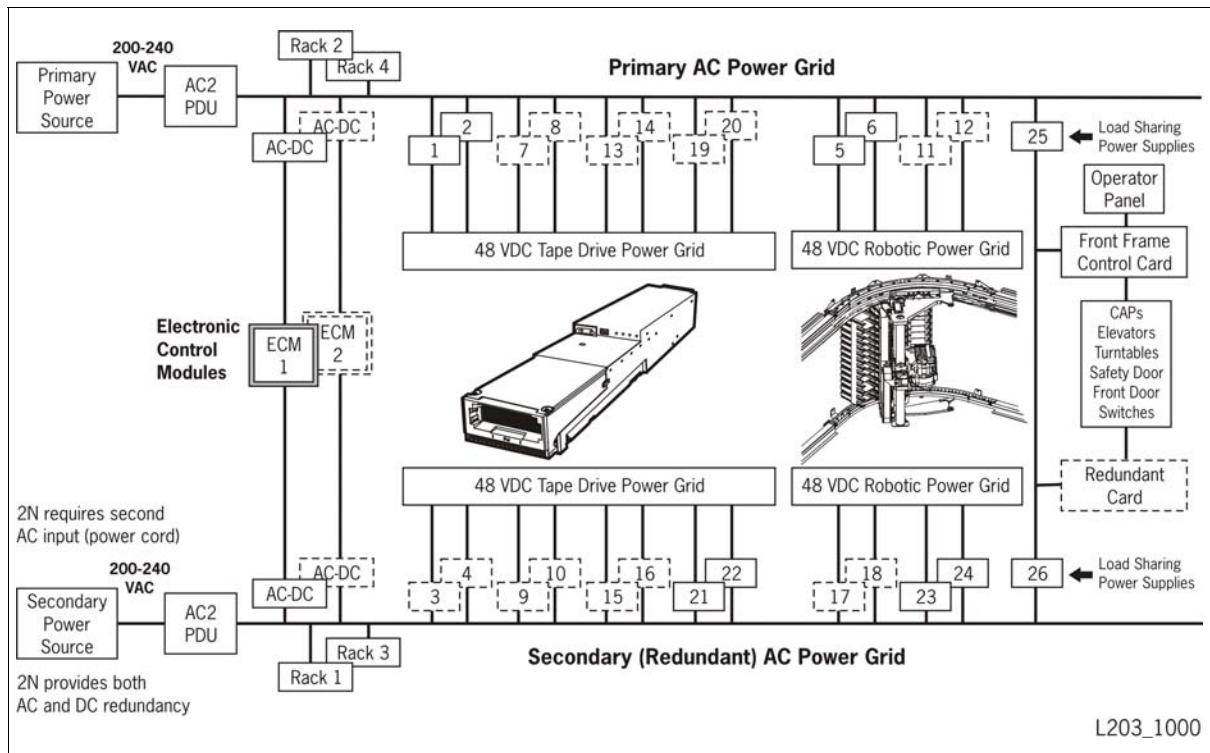
Each system PDU delivers AC power to its own group of load sharing power supplies to provide *both AC and DC* power redundancy.

- If something within an AC power source fails, the second AC power source supplies power to the entire system except the operator panel if AC1 fails.
- If a DC power supply fails, there is still enough power available to keep the entire system operational until the power supply can be replaced.

This configuration provides power to the same components as N+1, *plus*:

- Power for the additional 2N load sharing power supplies (required)
- Power for 2 additional 19-inch racks (1 & 3) each with six outlets
- Power for the redundant AC-to-DC converters for the ECM

**Figure 6. 2N Power Configuration (Optional Feature)**



## AC Power Options

The SL8500 has *four* external AC power options:

- 200–240 VAC, line-to-line, three phase, 40 Amps, 50–60 Hz,  
**Delta:** *mostly* used in the U. S. (One 3-phase input for *each* system PDU)
- 200–240VAC, line-to-neutral, three phase, 24 Amps, 50–60 Hz,  
**Wye:** *mostly* used in Europe (One 3-phase input for *each* system PDU)
- 200–240 VAC, single phase, 24 Amps, 50–60 Hz  
**Three** single-phase inputs are required for *each* system PDU
- ~~200–240 VAC, line-to-neutral, three phase, 24 Amps, 50–60 Hz,  
**SUVA**<sup>1</sup> Wye (One 3-phase input for *each* system PDU)~~  
**Note:** The SUVA power option is no longer an offering.

**Notes:** The following notes are highly recommended.

- Connect to three phase power whenever possible.
- Have a licensed electrician connect the external power cables.

## Delta or Wye?

From the four external AC power options, which one should the customer use? The following are guidelines that may help:

- As stated before, connecting to three phase power is *highly recommended*.  
The single-phase power option requires 3 circuits and uses 6 circuits for a 2N power configuration and redundancy. This power option is provided for customers that do not have access to three phase power.
- There are two three phase power options to choose from: Delta or Wye.

<b>Delta</b>	<b>When the voltage measured from phase-to-phase is 200–240 VAC, use a Delta power distribution unit.</b>  Delta PDUs require <i>four</i> wires (3-phases plus ground). If supplied, Delta PDUs do not use neutral (a fifth wire).
<b>Wye</b>	<b>When the voltage measured from phase-to-phase is 380–415 VAC, use a Wye power distribution unit.</b>  Wye PDUs require <i>five</i> wires (3 phases, ground, and neutral). Neutral (N) is <i>required</i> for Wye PDUs.

---

1. SUVA = Schweizerische Unfallversicherungsanstalt—for use in Switzerland only.

## Load Sharing DC Power Supplies

The SL8500 has *three* DC power grids that supplies 48 VDC to components throughout the library:

- The tape drive power grid supports up to 64 tape drives.
- The robot power grid powers the HandBots and the pass-thru ports.
- The front frame power grid supplies 48 VDC power to the cartridge access ports, elevators, turntables, and the service safety door.

The DC power grids use *load sharing power supplies*. Load sharing allows the output voltage of one supply to be monitored and adjusted by other supplies on the bus.

In effect, each independent output voltage is adjusted so that all of the independent output voltages are the same to evenly distribute the load so if one output fails or is shorted, it will not bring down the bus.

[Table 6](#) explains the quantity of load sharing power supplies required for each power configuration and the number of components they power.

**Table 6. Load Sharing Power Supplies**

Power Supply Type	Quantity	Configuration <sup>1</sup>	
		N+1	2N
Tape drives—from one to:	16	2 + 1 = 3	2 + 2 = 4
	24	3 + 1 = 4	3 + 3 = 6
	32	4 + 1 = 5	4 + 4 = 8
	40	5 + 1 = 6	5 + 5 = 10
	48	6 + 1 = 7	6 + 6 = 12
	56	7 + 1 = 8	7 + 7 = 14
	64	8 + 1 = 9	8 + 8 = 16
This allows one supply for every:		8 tape drives	4 tape drives
Robotics	4	2 + 1 = 3	2 + 2 = 4
	8	4 + 1 = 5	4 + 4 = 8
This allows one supply for every:		2 HandBots	1 HandBot
Front frame components		1 + 1 = 2	1 + 1 = 2
Electronics control module <sup>2</sup>		1 + 1 = 2	2 + 2 = 4
<sup>1</sup> Requires the 2N power configuration and matching DC power feature codes. <sup>2</sup> The electronic control module (ECM) power supplies are AC to DC converters and different from the load sharing power supplies used by the HandBots and tape drives.			

## Power Connections

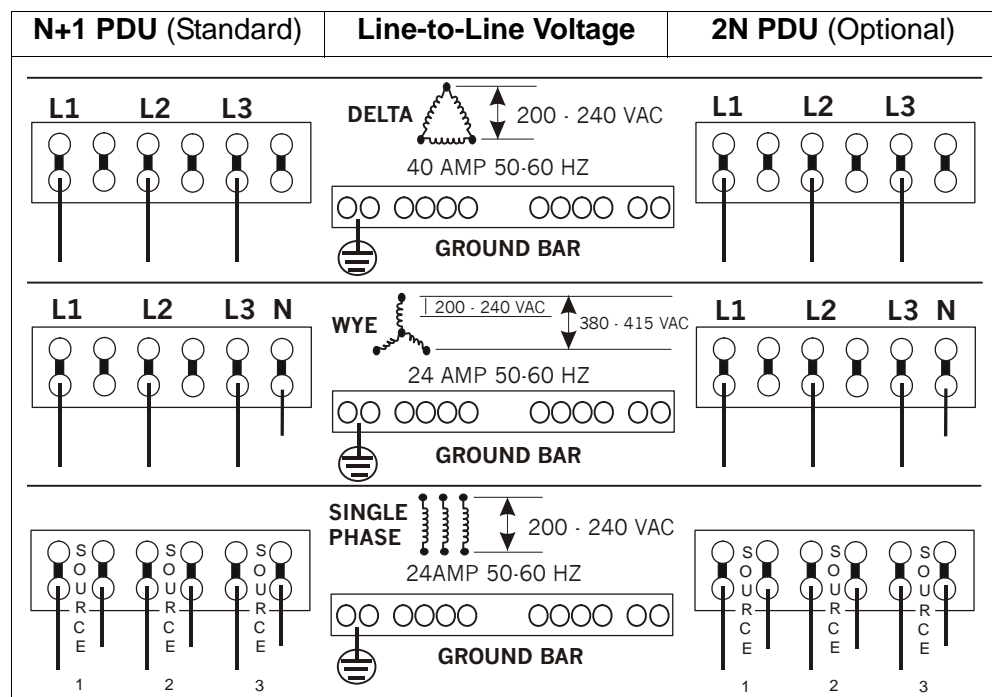
**Warning:** Having a licensed electrician connect the external power cables is highly recommended.

AC wiring from the power source branch circuit must be installed in conduit (flexible or rigid) with a 90-degree elbow-down fitting.

There are six holes provided for the conduit elbows that measure 2.875 cm (1.125 in.) in diameter. The electrician should choose appropriate conduit and fittings for their application that will fit this.

The terminal block hole is 6.35 mm (0.250 in.) in diameter, tin plating over brass, and can accommodate up to #6 wire. Wire Range is 6 mm (14 AWG).

**Figure 7. Delta or Wye?**



**Note:** AC input (cable and wiring) to the 2N PDU is not required if using an N+1 configuration.

## Connectors

When connecting the library to the main power circuits, if plugs and connectors are required instead of using conduit, [Table 7](#) lists the Hubbell part numbers (or equivalent) that can be used.

**Table 7. Hubbell Connectors and Plugs (IEC 309)**

Part Number	Description
HBL330P6W	Single Phase US plug 30 amp
HBL330C6W	Single Phase US connector 30 amp
HBL332P6W	Single Phase Europe plug 32 amp
HBL332C6W	Single Phase Europe connector 32 amp
HBL532P6W	Wye plug 32 amp
HBL532C6W	Wye connector 32 amp
HBL460P9W	Delta plug 60 amp
HBL460C9W	Delta connector 60 amp
L15-50 R	NEMA Delta receptacle (250 V, 50 Amp) **
L15-50 P	NEMA Delta plug (250 V, 50 Amp) **
<ul style="list-style-type: none"> <li>• Single phase minimum current requirement: 24 Amps-RMS</li> <li>• Wye three phase minimum current requirement: 24 Amps-RMS</li> <li>• Delta three phase minimum current requirement: 40 Amps-RMS</li> </ul>	

## Circuit Breaker Ratings

The *minimum* circuit breaker ratings required for the service panel are:

**Table 8. Circuit Breaker Ratings**

Type	Option	Panel Breaker	Service Rating	Connector	PDU Breaker
<b>Conduit</b> (recommended)	Single Ph.	30 Amps	30 Amps	—	30 Amps
	Delta	50 Amps	50 Amps	—	40 Amps
	Wye	30 Amps	30 Amps	—	30 Amps
<b>Connector</b> (US)	Single Ph.	30 Amps	30 Amps	30 Amps	30 Amps
	Delta	50 Amps	50 Amps	50 A - NEMA** 60 A - IEC 309	40 Amps
	Wye	30 Amps	30 Amps	30 Amps	30 Amps
<b>Connector</b> (Europe)	Single Ph.	30 Amps	30 Amps	32 Amps	30 Amps
	Delta	50 Amps	50 Amps	63 Amps	40 Amps
	Wye	30 Amps	30 Amps	32 Amps	30 Amps

**Note:** Wire size should be determined by the electrician.



## ■ Electronics Control Module

Each library has the capability of *two*—redundant—electronics control modules that consist of:

- HBC card—the library controller
- HBT card—the tape drive controller
- HBK card—flash memory

**Note:** Redundant electronics is an optional feature (*check on availability*).

### HBC Card

The HBC card is the library controller, responsible for coordinating all component operations within the library.

This card provides the interface between the host and the library plus:

- Library-to-library LANs
- Tape drive service LAN
- Rail signal interfaces for HandBots
- Environmental monitoring circuits throughout the library

### HBT Card

The HBT card is the tape drive controller, responsible for translating commands from the library controller (HBC card) into unique drive commands that are transferred across differential RS-422 cables to the tape drives (the TTI interface).

### HBK Card

The HBK card contains a flash memory that stores information about the library configuration, passwords, and world wide name.

In the event that you need to replace the HBC controller card, having the information available on the HBK card prevents the need of a reconfiguration to restore the information to the control card.

## Firmware

Library firmware is installed in the factory and resides on the HBC card, which can hold *two* separate versions of code:

- the current activated version
- the previous or a new downloaded version

When installing code, the HBC card transfers the functional code to the different controllers in the library (such as the HBT card for the tape drives and HBB cards for the HandBots).

When upgrading firmware, if for some reason you need to return the library to the previous version of firmware, a service representative can re-activate it for library operation.

### **Firmware Packages:**

There are two types of firmware packages for the library:

- SL8500 code for the library controller and associated library devices
- StreamLine Library Console application firmware (*SLConsole*)

### **Firmware Upgrade:**

Upgrading firmware is a three-step process.

Steps 1 and 2 can be done without interruption to library operation.

Step 3 requires an IPL of the library which may take about *10 minutes*.

1. Download the image file (firmware).
2. Activate the downloaded firmware.
3. Reboot the library to make the firmware operational.

**Note:** *An IPL of the new code only takes about 10 minutes if the front door has not been opened. If you open the front door, both an IPL and Audit are required which will take an additional 15 minutes to 1 hour depending on the capacity.*

For more instructions about upgrading firmware, refer to the online help documentation or user's guide.

## Audits and Initialization

The term *audit* refers to the process of reading and cataloging all cartridges within a library or verifying cartridge locations—the physical inventory.

An SL8500 library is capable of storing all cartridge locations within the library on the HBC card—the library controller. The physical inventory contains:

- Volume serial numbers (VOLSERs) or identification (VOLIDs)
- Internal address locations (library, rail, column, side, and row)
- Verified status (as true or false)

### Audit Conditions

The library audits all cartridge locations in all areas of the library, including the slots in the storage and reserved areas when:

- The library initializes at power-on
- After either one or both access doors are opened and closed
- An audit request is made through StreamLine Library Console

### Audit Types

There are three types of audits that the library performs:

<b>Physical audit</b>	Physical audits are when the HandBots: <ul style="list-style-type: none"> <li>• Scan the cartridge locations in the library</li> <li>• Verify the volumes</li> <li>• Update the HBC card inventory</li> <li>• Set the status of the cartridge location to true</li> </ul>
<b>Verified audit</b>	Verified audits are invoked from the StreamLine Library Console and <i>validate</i> the status of a specific cartridge slot or range of slots.
<b>Virtual audit</b>	Virtual audits are invoked from the StreamLine Library Console and <i>display</i> the cartridge inventory in the console screen.



#### Important:

After the initial audit is complete, audits are then performed as background operations—it is *not* necessary to wait for an entire audit to complete before using the library.

Shortly after the SL8500 begins initialization—after closing the front door or powering-on the library—the SL8500 can begin to perform mount and dismount requests to the tape drives. This is because after the initial audit, the SL8500 uses its existing database from a previous audit to perform any requests.

If cartridges have not been moved, removed, or added, then all subsequent movement requests can proceed without interruption.

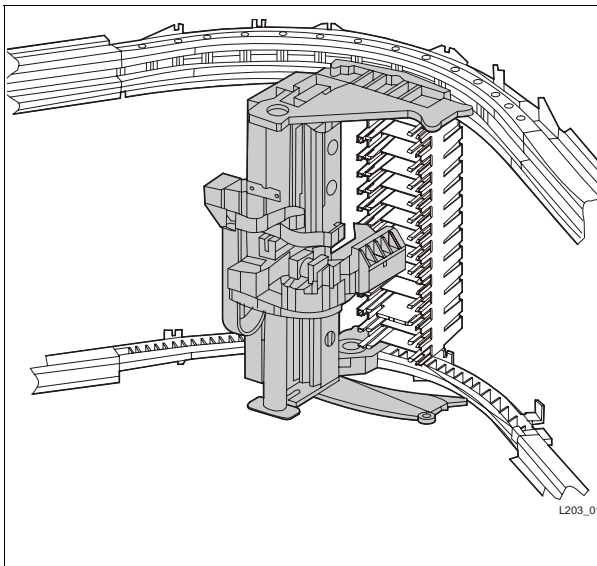
**Note:** Eight HandBots can audit the library quicker than four HandBots.

## ■ Robotic Rail Assemblies

Figure 8 shows an example of the HandBot and rail assembly in the SL8500. When describing the architecture of the SL8500, it may be easiest to think of it as four separate library storage modules (LSMs).

- Each SL8500 has four separate robotic rail assemblies called the StreamLine RaceTrack architecture. These rail assemblies provide both power and communication signals to its own individual robotic system.
- The robotic systems in the SL8500 are called StreamLine HandBot High-Performance Robotics, or HandBot. Each HandBot can service up to 16 tape drives and all of the tape cartridges for that rail.
- Spanning across the four rail assemblies are two elevators. These elevators perform an internal pass-thru port operation that allows any tape cartridge to have access to any tape drive in the SL8500 library and within an SL8500 library complex.

**Figure 8. HandBot and Rail Assembly**



Currently, there are two HandBot configurations:

- 4 HandBots (one per rail)
- 8 HandBots (two per rail)

A HandBot assembly consists of:

- Rail and brush assemblies
- Z-mechanism for vertical motion of the hand
- Wrist-mechanism for horizontal motion
- Digital vision system for targeting
- Barcode scanner for reading VOLID labels
- Proximity sensor for detecting empty cells
- Worm-drive gripper mechanism for gripping the *sides* of the cartridges



### Important:

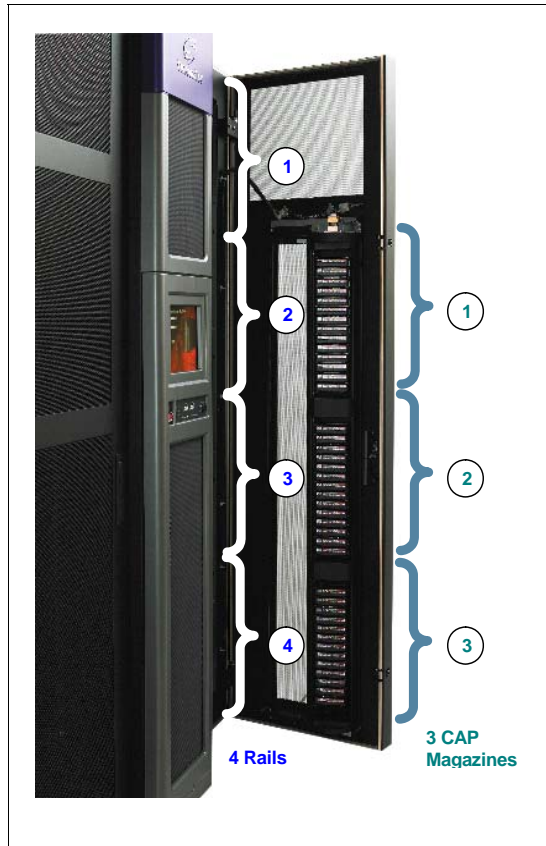
Because of the four individual rails, each robotic assembly is considered a library storage module (LSM). So the architecture of the SL8500 provides four separate and unique LSMs that work in parallel within a single library.

To optimize system performance, the HandBots automatically implement the *Fast Load* capability. Once a HandBot successfully inserts a tape cartridge into a drive, it is immediately available for the next request and does not wait until the drive reports that the cartridge has been loaded. The SL8500 library control electronics waits to return the response to the mount request until it detects that the tape drive has successfully loaded the cartridge tape.

## ■ Cartridge Access Ports

The library comes with one standard, 39-slot, cartridge access port (CAP A), with a future option of an additional 39-slot cartridge access port (CAP B). Both CAPs are located on the right front access door to the library.

**Figure 9. Cartridge Access Port**



### Architecture of the CAP:

- Consists of 39 slots—three magazines with 13 slots each.
- Spans across three rails—2, 3, and 4 (LSMs 1, 2, and 3).
- There is no adjacent CAP section for the top rail (LSM 0)—requires an elevator pass-thru operation to enter or eject cartridges.
- **CAP A** is on the left-side (standard)
  - Comes with the library
  - Software address is 0 or (ACS, LSM, 0)
  - Controls are on the left side of the keypad
- **CAP B** is on the right-side (*optional* feature)
  - Currently not supported
  - Software address is 1 or (ACS, LSM, 1)
  - Controls are on the right side of the keypad

### Addressing scheme:

ACS#	LSM# (per library)	CAP A	CAP B
ACS	1	0	1
ACS	5	0	1
ACS	9	0	1
	and so on...		

**Notes:** Usage considerations for the CAP include:

- When a CAP is in use for enter or eject operations, all 39 slots are reserved for that operation—the CAP cannot be subdivided.
- For addressing purposes, the CAP needs a location (ACS,LSM,CAP#). The LSM address is associated with the second rails in each library because there is no adjacent CAP magazine for the top rail.
- When loading cartridges in the CAP, slots can be skipped.
- Currently, the middle magazine cannot be missing if both the upper and lower or magazines are installed.
- If the HandBot adjacent to the CAP is inoperative, that portion of the CAP is inaccessible.

## ■ Pass-thru Mechanisms

The SL8500 library has two types of pass-thru mechanisms:

**Vertical**      An *elevator* that moves cartridges between rails

**Horizontal**    A *pass-thru port* feature that moves cartridges between libraries

### Elevators

The library comes with *two* four-slot elevators in the front of the library—one on each side of the facade.

**Figure 10. Elevators**



Considerations for the elevators include:

- Elevators provide vertical pass-thru operations between rails within the *same* library.
- Each of the four rails *share* the resources of the two elevators.
- Both elevators are located in the front of the library between the front access doors and the Service Safety Door.
- Because the SL8500 has four rails, system administrators must specify the elevator as:
  - Pass-thru ports to each of the adjacent LSMs in the same library.
  - The lowest numbered LSM (rail) is always the master LSM.
  - Every LSM is adjacent to all other LSMs because of the elevator.



When defining pass-thru ports:

- 0 = Vertical pass-thru components (elevators)
- 1 = Horizontal pass-thru components (pass-thru ports)

## Pass-thru Ports

Connecting libraries together with pass-thru ports creates an SL8500 Library Complex. [Figure 11](#) is an example of a pass-thru port (PTP) mechanism—an electro-mechanical device that allows one library storage module (LSM) to pass a cartridge to another LSM in the same complex.

*For example:* If an operating system issues a mount request, and all of the tape drives are busy in that library, the PTP can pass the cartridge to another library where an idle tape drive can satisfy the mount request.

**Figure 11. Pass-thru Port Mechanism**



The SL8500 pass-thru port feature consists of a separate frame that is installed between the Drive and Electronics Module / Robotics Interface Module of one library with the same modules of an adjacent library.

Each PTP frame has four separate mechanisms that can pass up to two cartridges—per LSM—between the libraries.

There are eight PTP locations in an SL8500 library, two per rail (or LSM). These locations are on the curved portions of the Robotics Interface Module near the tape drives.



### Important:

The need to plan ahead for the addition of pass-thru ports is *extremely important*. The library complex can “grow” in either direction—left or right.

The *preferred* method of installing PTPs to an existing library is to add the new library to the *left* when viewed from the front.

However, the library complex can grow in the other direction—to the right—but this requires a disruption to the system to renumber the LSMs and reconfigure the management software.

The following are highlights about the PTP feature:

- All SL8500 libraries come equipped and ready for the addition of the PTP frame and feature—no additional walls are needed.
- Power for the PTPs comes from the same +48 VDC power bus as the robotic rails. Both the N+1 and 2N power configurations currently support the PTP hardware—no additional power supplies are needed.
- Each PTP frame has four separate mechanisms and can pass up to two cartridges per LSM.

- There are eight PTP locations in an SL8500 library, two per rail (or LSM).
- The PTP locations are on the curved portions of the Robotics Interface Module at columns +6 and –6 near the tape drives for quick access.
- Both ACSLS and HSC support pass-thru port operations—no additional software is needed.
- Existing libraries can remain operational while attaching the PTP frame to them during the installation of an adjacent library.
- If service is required, the pass-thru port mechanism slides out of the frame from the rear of the library—not affecting library operations.
- While the “home” library provides power and communications to the PTP mechanism, either library can initiate a pass-thru operation.

The following terms and definitions apply to SL8500 PTP operations:

<b>Home library</b>	Provides power, signal, and control lines to the PTP mechanisms. This is the library on the right as viewed from the front.
<b>Away library</b>	Always located on the left side of a Home library, as viewed from the front.
<b>Source</b>	Contains the home slot location for the cartridge that will be passed through to an adjacent library.
<b>Destination</b>	Contains the tape drive or slot location in the adjacent library where the cartridge will be mounted or stored.



## ■ Library Cameras

Sun Microsystems offers an Ethernet-based library camera system (WebCam) with monitoring software as an optional feature for the SL8500 modular library system. This feature allows a customer to remotely see the inside of their SL8500 library, which is especially important for those customers who have remote and lights-out data centers.

**Figure 12. Library Cameras**



This is one difference between the 9310 PowderHorn libraries and the SL8500 library—no camera on the hand—that would allow viewing robotic operations and volume serial numbers inside the library.

**Note:** The WebCam feature uses a third party camera designed for the security surveillance market and is subject to change without notice.

The WebCam feature attaches to a 10Base-T, 100Base-T Ethernet connection and provides remote, high-quality, audio and video. This feature contains

- Two cameras that mount in the upper frame of the front access door—one on each side of the library
- Monitoring software

<b>PC requirements</b>	<ul style="list-style-type: none"> <li>• Windows 2000, XP, ME, or 98SE</li> <li>• CPU: Pentium III, 800 MHz or above</li> <li>• Internet Explorer 5.x or above for the Web Browser</li> <li>• ActiveX</li> <li>• Memory Size: 128 MB or above</li> <li>• GA card resolution: 800 x 600 or above</li> </ul>
<b>Dimensions:</b> Length Width Height Weight	Camera dimensions: Length 10.16 cm (4 in.) Width 10.42 cm (4.1 in.) Height 11.18 cm (4.4 in.) Weight 345 g (12.2 oz or 0.75 lb)
<b>Ethernet</b>	10Base-T, 100Base-T, auto-negotiating
<b>Camera</b>	¼ inch CCD color sensor Electronic shutter: 1/60 ~ 1/15000 seconds Fixed focus glass lens F20, 1 LUX
<b>Video</b>	Algorithm: H.263+ (MPEG4 short header mode for streaming) JPEG compression (for still images) Up to 30 frames per second (fps) Built-in motion detector
<b>Audio</b>	24 Kbps Built-in omni-directional microphone
<b>Order Number</b>	XSL8500-WEBCAM-Z

## ■ Accessory Racks

The SL8500 library provides space where up to four standard RETMA<sup>2</sup> 19 inch racks can be installed. These racks are oriented so the components mount vertically instead of horizontally and can hold up to 6Us<sup>3</sup> of equipment, such as switches, hubs, and servers.

There is a six connector PDU that provides 4 amps of AC power for each rack. Two cooling fans provide additional air flow for the installed equipment.

Because of the numerous types of equipment, StorageTek cannot mandate what the customer installs in these racks; therefore, certain guidelines should be followed to prevent voiding the warranty. [Table 9](#) lists these guidelines.

**Table 9. Accessory Rack Installation Guidelines**

Guideline	Specifics
<b>Equipment weight</b>	The accessory rack itself is mounted on slides rated for 80 kg (175 lb). The recommended safe load is 64 kg (140 lb).
<b>Rack mounting</b>	Components must be able to function in a vertical orientation. Heavy components (such as Fibre Channel switches) must have threaded holes in the sides to attach rack slides. Light weight components (such as Ethernet switches) may be mounted with a bracket.
<b>Thermal requirements</b>	Maximum power dissipation is 880 watts (3,000 Btu/hr) per rack module.
<b>Air flow</b>	Generally from non-port end to port end of component. Side to side air flow is acceptable. Maximum Volume per 6u rack module is 241 scfm (standard cubic feet per minute) at 0 inches of water static pressure to a minimum of 0 scfm at 0.60 inches of water static pressure depending upon the devices and equipment installed blocking the fan air flow.
<b>Power cord</b>	Power plug to connect to the rack PDU is: IEC320 C13 shrouded male plug. Minimum cord length is component length <i>plus</i> 46 cm (18 in.) for a service loop.
<b>Regulatory agency compliance</b>	Minimum requirements are: Safety – UL or CSA certification and Electromagnetic – Class A certification from agencies such as the FCC or BSMI.
<b>Dimensional restrictions</b>	Rack module depth is 72 cm (28 in.) Recommended safe length is 66 cm (26 in.)
<b>Maximum power consumption</b>	Per rack module is 4 Amps (maximum) Per outlet strip is 200–240 VAC, 50 to 60 Hz

- Two of the racks (2 and 4) receive power from the primary AC power grid.
- The other two racks (1 and 3) *require* the 2N power configuration.
- When you loose power to a PDU, you also loose power to the associated racks:

---

2. RETMA = Radio Electronics Television Manufacturers Association.  
3. U stands for units. One unit is equal to 4.4 cm (1.75 in.).

## ■ Operator Panels

The SL8500 has three ways the operators can use to access the library:

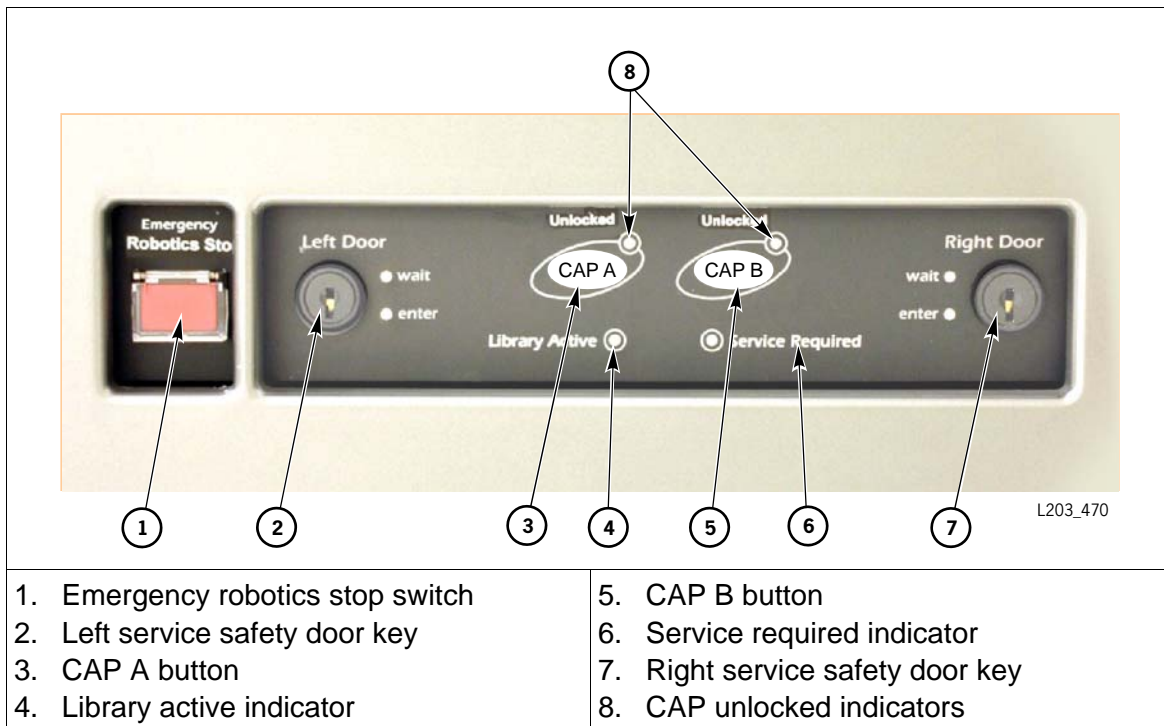
- Keypad
- Remote operator panel
- Touch screen operator panel (an *optional* feature)

### Keypad

The library includes a keypad that has 2 buttons, 8 LEDs, and two locks.

- The two buttons open and close the CAPs.
- The eight LEDs indicate library activity and status.
- The two safety locks allow the service representatives to place the library in maintenance mode.

Figure 13. Keypad



## Remote Operator Panel

A remote operator panel is a standard feature that displays operator functions on a personal computer (PC) that is running the *StreamLine™ Library Console™*.

Library console is a software application that the customer can use to monitor and operate the library. A CD (part number 3139995xx) is supplied with each library that contains this software—requirements are:

**Table 10. Library Console Remote Operator Panel Requirements**

Requirement	Windows 2000	Solaris
Minimum total system RAM	256 MB	256 MB
Minimum additional required disk	64 MB	128 MB

## Touch Screen Operator Control Panel

The touch screen operator control panel—which mounts on the front of the library—is an *optional* feature. This panel consists of a flat screen display, with a touchable interface, and a panel-mounted personal computer. Through this panel, all of the library instructions, diagnostics, library status, library and drive monitoring and functional information can be accessed.

**Figure 14. Touch Screen Operator Control Panel**



The operator panel consists of:

- StreamLine Library Console software
- 12-inch flat screen display (*diagonal* measurement)
- Touch screen interface (no mouse or keypad necessary)
- 20 GB hard drive
- 512 MB memory and 32 MB RAM
- Java applet as the graphical user interface (GUI).

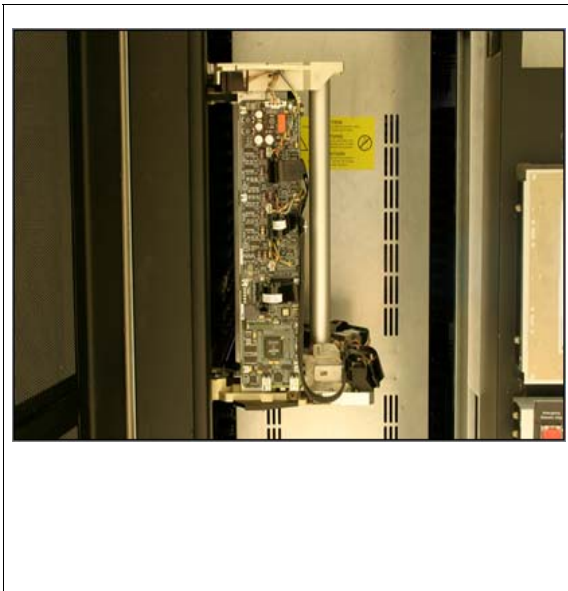


A pen and stylus feature are available for the touch screen interface:

- Pen/Stylus Combo is: XSL-STYLUS-Z
- Holder is: XSL-STYLUSHOLD-Z

## ■ Service Safety Door and Mode

Figure 15. Service Safety Door



The service safety door is a sliding door that moves either to the left or right, depending upon which maintenance lock is opened. This feature is:

- *Optional* with four HandBot configurations
- *Required* with eight HandBot configurations

### Service Mode:

When the maintenance key is inserted into its lock and turned, the safety door separates the forward maintenance area from the library interior.

This feature allows the service representative to safely replace a failing front frame component—such as a HandBot, CAP, or elevator—while the library remains fully operational.

**Important:** Service mode is *not* permitted by an operator. Only qualified service representatives with a service mode key can initiate service.

**Note:** Although *optional*, having a service safety door with a four HandBot configuration also allows the service representative to safely replace a failing front frame component.

## ■ Emergency Robotic Stop

Figure 16. Emergency Robotic Stop Switch



Emergency robotic stop (ERS) is the removal of AC and DC power to the *robotics*—HandBots, pass-thru ports, CAPs, and elevators—the tape drives *are not* affected.

The emergency robotic stop ensures that no robotic motion occurs while someone is inside the library.

The library has two switches:

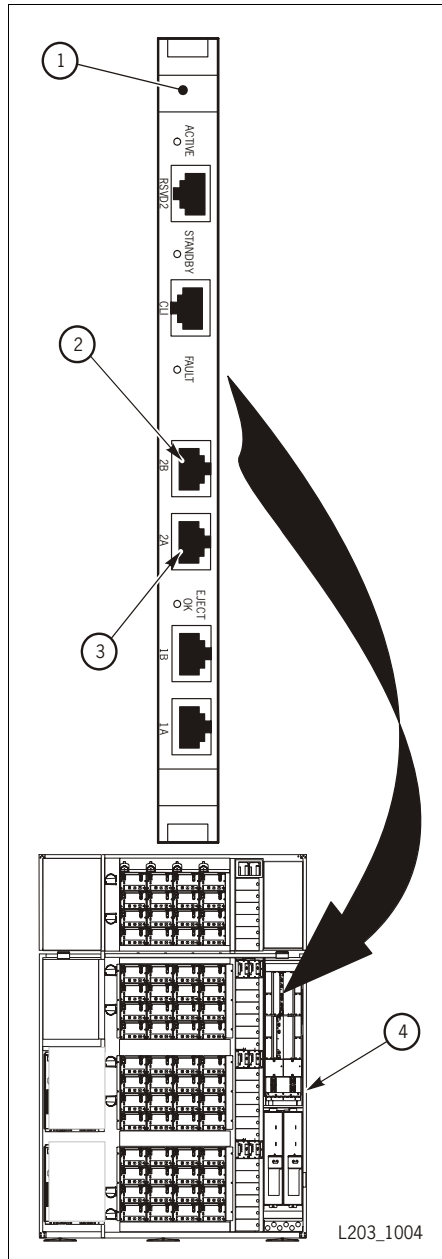
- One interior lighted switch on the left side of the drive bays
- One non-illuminated, covered switch, on the front panel

**Note:** Pressing an ERS switch immediately removes AC and DC power to the robotics (not the entire library). After it is determined that it is safe to restore power, press the switch again to reset it.

## ■ Host Interface Connections

Host interface connections to the library uses **TCP/IP** protocol over an **Ethernet** 10/100-baseT physical interface.

**Figure 17. TCP/IP Connections**



The SL8500 library uses TCP/IP protocol over an Ethernet physical interface to manage and communicate with the host and library management applications. This interface enables both:

- Open system platforms with ACSLS
- Enterprise-level mainframes with HSC

to connect to and communicate with the SL8500.

The HBC card is the library controller responsible for coordinating all component operations within the library and providing the interface connection with the host.

### Connections:

There are two separate Ethernet connections on the HBC card for host to library communications—Ports 2A and 2B.

- Port 2A provides the **Dual TCP/IP** connection—this is an *optional feature* for SL8500 libraries.
- Port 2B provides the primary host connection—this is the standard connection for SL8500 libraries.

Both ports comply with the Institute of Electrical and Electronics Engineers standard—IEEE 802.3—for Ethernet networks.

Both ports are capable of auto-negotiating the:

- Method of transmission
  - Half-duplex: Transmits data in just one direction at a time
  - Full-duplex: Transmits data in two directions simultaneously
- Speed of the transmission
  - 10Base-T: 10 megabits per second (Mbps)
  - 100Base-T: 100 megabits per second (Mbps)

The other two Ethernet connections—Ports 1A and 1B—are for library-to-library communications for the pass-thru ports.

Figure callouts:

1. HBC card (controller card)
2. Port 2B—primary TCP/IP host connection
3. Port 2A—secondary, dual TCP/IP host connection
4. Electronics control module

Refer to the:

- **Dual TCP/IP Technical Brief PN TT0019**,
- **Host Connectivity Technical Brief, PN 316195801**, and
- [Appendix G](#), for more information.

Whenever possible, use a dedicated private network for communication between the host management software (ACSLs, HSC, or other software) and the library.

If a shared network is required, these actions can help with the communication between the host and the library.

1. Directly connect the library to a switch.
2. Place the library on its own subnet.
3. Use a managed switch that can:
  - Set priorities on ports to give the host and library higher priority.
  - Provide dedicated bandwidth between the host and the library.
  - Create a VLAN between the host and the library.
4. Use a virtual private network (VPN) to insulate host to library traffic.

## Network Recommendations

A private network connection to an Ethernet hub or switch is recommended for maximum throughput and minimum resource contention.

When implementing the Dual TCP/IP feature, it is strongly recommended that you and the system administrator work closely together to define the configuration.

The simplest topology (private network connections to a hub or switch) is often the best solution. Simplification will:

- Offer maximum throughput
- Provide minimum resource contention
- Lend itself to higher security for library communication
- Supply the least expensive alternative
- Provide quick identification of any problems within the network

These are only suggestions, however. The customer's network and their desired topology are ultimately the determining factors. For certain topologies, a more complicated setup is required. Many will require consultation between the system administrator and another level of Sun services.

## Fibre Channel



**Note:** Host connections using Fibre Channel is *currently not available*.

## ■ Host Connectivity Checklist

**Table 11. Host Connection Checklist and Requirements**

Configuration	Port	Firmware	Comments
Single See <a href="#">page 28</a>	Port 2B only	All versions	This is the simplest type of host connection to the library.  Supports: Single host/library management software (ACSLs or HSC).
Library Complex See <a href="#">page 31</a>	Port 2B only	FRS_2.00	<i>Optional Feature.</i>  Connects two or more libraries together using pass-thru ports.  Can connect up to 10 libraries together for the complex.  Supports: Single host/library management software (ACSLs or HSC).
Dual TCP/IP See <a href="#">page 32</a>	Port 2B primary Port 2A optional	FRS_3.08	<i>Optional Feature.</i>  Provides <i>two</i> separate paths for host connections to the library or library complex.  Separate, not redundant. Redundancy is provided in the network design.  Supports: Single host/library management software (ACSLs or HSC).
Partitioned See <a href="#">page 34</a>	Port 2B primary Port 2A optional	FRS_3.7x	<i>Optional Feature.</i>  Supports Dual TCP/IP feature.  Supports: Dual host/library management software (ACSLs and/or HSC).
Multi-Host See <a href="#">page 35</a>	Port 2B primary Port 2A optional	FRS_3.95	<i>Optional Feature.</i>  Provides up to <i>four</i> separate paths for host connections to a library complex.  Separate, not redundant. Redundancy is provided in the network design.  Supports: Single host/library management software (ACSLs or HSC).
<p><b>Note:</b> The SL8500 library uses a TCP/IP protocol over an Ethernet physical interface to manage and communicate with the host and library management applications. This interface enables either:</p> <ul style="list-style-type: none"> <li>• Open system platforms with ACSLS or</li> <li>• Enterprise-level mainframes with HSC</li> </ul> <p>to connect to and communicate with the SL8500.</p>			



## Library Complex

The SL8500 Library Complex is created by connecting two or more libraries together with pass-thru ports (PTPs).

The PTP is an electro-mechanical device that allows one library storage module (LSM) to pass up to two tape cartridges to another LSM in the same complex.

SL8500 PTPs consist of a separate frame that is installed between the Drive and Electronics Module and Robotics Interface Module of one library with the same modules of an adjacent library. Each PTP frame has four separate mechanisms that can pass up to *two* cartridges (per LSM) between the libraries at once.



Currently an SL8500 Library Complex can support up to 10 libraries connected together using nine Pass-thru Ports.

## Requirements

The order numbers for a library complex include:

- Order number: X-SL8501P-PTP-Z and XSL8500P-MECH-Z
  - If in the 1st or 6th library: XSL8501P-HUB-Z
  - If 2N power is needed: XSL8500-AC-SW-Z
  - If racks are needed: XSL8500-RACK-Z
  - Frame-only; mechanisms will be added later: X-SL8500P-BLANK-Z

The requirements include the following levels *or higher*:

- Library firmware of **FRS\_2.00**
- StorageTek Library Console: FRS\_2.00
- ACSLS: 7.1 plus PUT0501 for Near Continuous Operation

**or**

- NCS (NearLine Control Solution) Version 6.0 and 6.1
  - HSC: 6.0 plus PTFs (*minimum*) or
  - HSC: 6.1 which added Near Continuous Operation (NCO)

**Note:** Upgrading library firmware can be a disruption to customer operations. You may want to schedule time with the customer to perform this service.

## Dual TCP/IP

The SL8500 library provides two separate Ethernet connections on the HBC card for host to library communications—Ports 2A and 2B.

- Port 2A provides the Dual TCP/IP connection—an *optional feature*
- Port 2B provides the primary connection—the standard connection

The Dual TCP/IP feature provides two public network interfaces to the library and/or library complex.

## Requirements

Order numbers for Dual TCP/IP include:

- Dual TCP/IP Host Interface: XSL8500-DTCPIP

Requirements include the following levels *or higher*:

- Library firmware of **FRS\_3.08**
- StorageTek Library Console: FRS\_x.xx
- ACSLS 7.1

**or**

- NCS 6.0 or 6.1

**Note:** Upgrading library firmware can be a disruption to customer operations. You may want to schedule time with the customer to perform this service.

## Dual TCP/IP Network Entries Worksheet

When preparing the network and connections—as a best practice—complete a network entries worksheet for each port of the SL8500 library.

Description		IP Address
Port 2B	Host name to Port 2B	
	HBC Card Port 2B	
	Gateway Port 2B	
	Netmask	
Port 2A	Host name to Port 2A	
	HBC Card Port 2A	
	Gateway Port 2A	
	Netmask	



### Important:

- When connecting more than one interface to an SL8500 library, the connections should be through **different subnets** for redundancy.  
If one subnet should fail, communications between the hosts and the libraries continue over the other subnet.
- When connecting an interface to Port 2A, a service representative must configure the routing and possibly assign policies for that port (2A) using the command line interface.  
Note: Port 2B is the default port for the library; no routing tables are required when connecting to that port.  
See [“Port Configurations” on page 63](#) for more information.
- **The ports need to be on different Layer 2 broadcast domains<sup>4</sup>.**

4. A broadcast domain is a logical network segment where any computer or other device connected to the network can directly communicate to any other device on that domain without having to go through a routing device, provided they share the same subnet address and are in the same virtual network.

## Partitioning

The Merriam–Webster dictionary defines **partitioning** as to:

- Divide into parts or shares.
- Separate or divide by a partition, such as a wall... or a *rail*.

The architecture of the SL8500 library provides physical boundaries—rails—that make it perfect for partitioning.

## Requirements

The order numbers for partitioning an SL8500 library are:

- Order number: SL8500-UPG-PART
- Upgrade number: XSL8500-UPG-PART

The requirements include the following levels or higher:

- Library firmware **FRS\_3.7x**
- StorageTek Library Console at Version FRS\_3.25
- ACSLS Versions 7.1 and 7.1.1 with PUT0701
- ACSLS HA 2 also requires PTF 6514766  
and
- NCS (NearLine Control Solution) Version 6.1
- HSC (MVS) Version 6.1 with PTF L1H13GW and L1H13JK
- HSC (VM) Version 6.1 with PTF L1H13GX and L1H13JJ

**Note:** Upgrading library firmware can be a disruption to customer operations. You may want to schedule time with the customer to perform this service.



Hosts without the latest level of software (ACSLs or HSC) or without the latest PUTs and PTFs will not be able to bring a partitioned ACS online.

Software and firmware levels can be downloaded and ready in advance of activation. When the time and window is available, these codes can be activated. This preparation can limit down time of the library and operating system.

## Multi-Host

The newest host connectivity feature to an SL8500 Library Complex is Multi-Host. This feature allows up to *four* connections to a library complex that contains 2 or more libraries.

### Requirements

Order numbers for multiple host connections to an SL8500 library are:

- Number: XSL8500-MTCPIP

Requirements include the following levels or *higher*:

- Library firmware **FRS\_3.95**
- StorageTek Library Console at Version FRS\_3.38
- ACSLS Versions 7.1 and 7.1.1 with PUT0701
- ACSLS HA 2 also requires PTF 6514766

or

- NCS (NearLine Control Solution) Version 6.1
- HSC (MVS) Version 6.1 with PTF L1H13GW and L1H13JK
- HSC (VM) Version 6.1 with PTF L1H13GX and L1H13JJ

**Note:** Upgrading library firmware can be a disruption to customer operations. You may want to schedule time with the customer to perform this service.

Hosts without the latest level of software (ACSLs or HSC) or without the latest PUTs and PTFs will not be able to use multiple connections to a library complex.

Software and firmware levels can be downloaded and ready in advance of activation. When the time and window is available, these codes can be activated. This preparation can limit down time of the library and operating system.

## Multi-Host Network Entries Work Sheet

When preparing the network and connections—as a best practice—complete a network entries worksheet for each port of the SL8500 library.

Description		IP Address / Name
Connection 1	HBC Card Port: 2A <input type="checkbox"/> 2B <input type="checkbox"/>	
	Host name	
	Gateway	
	Netmask	
Connection 2	HBC Card Port: 2A <input type="checkbox"/> 2B <input type="checkbox"/>	
	Host name	
	Gateway	
	Netmask	
Connection 3	HBC Card Port: 2A <input type="checkbox"/> 2B <input type="checkbox"/>	
	Host name	
	Gateway	
	Netmask	
Connection 4	HBC Card Port: 2A <input type="checkbox"/> 2B <input type="checkbox"/>	
	Host name	
	Gateway	
	Netmask	



### Important:

- When connecting more than one interface to an SL8500 library or library complex, the connections should be at least two different subnets for redundancy.  
  
If one subnet fails, communications between the hosts and the libraries continue over the other subnets.
- When connecting an interface to Port 2A, a service representative must configure routing and possibly assign policies for that port using the command line interface.  
  
**Port 2B is the preferred port for host attachments to the library,** no routing tables are required when connecting to that port.
- **The ports need to be on different Layer 2 broadcast domains.**

## Library Management Software

Library management software components control the library, manage the volume database—location and attribute information—plus command activities such as mounts, dismounts, enters, and ejects.

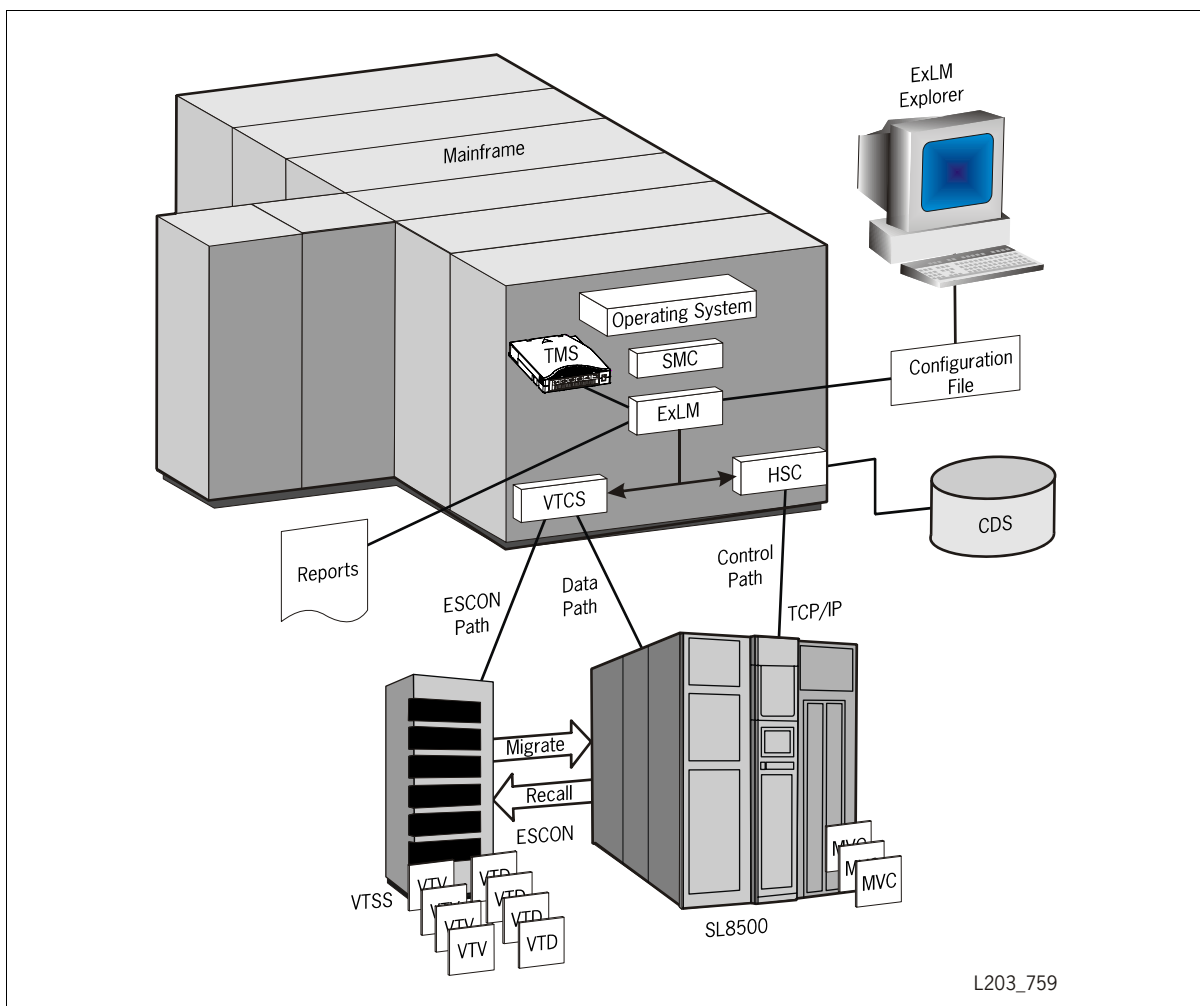
There are several software components depending on the platform, connection type, and operating system that support the SL8500 for both enterprise and open system platforms.

**Note:** The same library management software the customer currently has and is familiar with can be upgraded to support the SL8500 library.

## Nearline Control Solution

Figure 18 shows an example of a library management solution that uses several Nearline Control Solution (NCS) software products.

**Figure 18. Example: A Nearline Control Solution using HSC, ExLM, and VSM Products**



## Client System Component

- MVS/CSC provides client functions and communications between an MVS host and the Library Control System (LCS) on a non-MVS host.
- MVS/CSC allows MVS clients to perform automatic tape handling on a library in addition to sharing multiple host systems (both IBM and non-IBM).
- MVS/CSC communicates with LibraryStation in an MVS-only environment, or the SMC with an HTTP server to provide communication between hosts.

## Storage Management Component

- SMC is the interface between IBM and non-IBM enterprise mainframe operating systems—such as OS/390 and z/OS—and a StorageTek library.
- SMC performs the allocation processing, message handling, and SMS processing for the NCS solution.
- SMC resides on the MVS host system with HSC, MVS/CSC, or on a remote system using the HTTP server to communicate with the HSC.
- SMC communicates with HSC or MVS/CSC to determine policies, volume locations, and drive ownership.
- SMC is a required NCS component.

## HTTP Server

- HTTP Server for OS/390 and z/OS optionally provides the middleware to allow communication between the SMC (client) and a remote HSC subsystem (server).
- HTTP server executes as a separate subsystem on the MVS host where the remote HSC subsystem resides.

## LibraryStation

- LibraryStation provides a communications interface between HSC and a client system running on an open systems platform (either MVS or open systems).
- LibraryStation allows network clients to access the library services of an Automated Cartridge System (ACS) through the MVS host system.
- LibraryStation communicates with the MVS/CSC in an MVS-only environment, or the SMC and the HTTP server to provide communications between MVS hosts.
- LibraryStation executes in the HSC address space on MVS.



## Host Software Component

When an SL8500 library is in a configuration with an MVS host, the host must run a version of the StorageTek Host Software Component (HSC) along with the Storage Management Component (SMC) to:

- Influence allocations
- Intercept mount and dismount messages
- Receive requests from the interface and translates them into commands

### Minimum Level of Support:

**HSC 6.0** with additional PTFs<sup>5</sup> or higher is required for the SL8500 library. However, new tape drive technologies may require higher levels.

## HSC 6.1 and Near Continuous Operation

HSC 6.1 added support for the SL8500 libraries called Near Continuous Operation (NCO). NCO provides users with the ability to modify their hardware configuration dynamically without terminating and restarting HSC.

It is possible to upgrade the SL8500 configuration without performing a LIBGEN, MERGEcds, or stopping and restarting HSC. However, this operation requires assistance from StorageTek. Refer to your Host Software Component Configuration Guide (such as PN 31259710) for more information.

## HSC and Large Capacity Library Support

Table 12. HSC Large Library Support

Support	HSC 6.0.0	HSC 6.1.0
HSC 6.0 and 6.1 currently support 43 panels. The following PTFs are needed to allow support for up to 67 panels (five expansion modules):	SOS6000 - L1H122N	SOS6100 - L1H121Z
	SMS6000 - L1H122M	SMS6100 - L1H121Y
For customers using ExLM to support these configurations, HSC needs these additional PTFs	SOS6000 - L1H12VM	SOS6100 - L1H12VO
	SMS6000 - L1H12VN	SMS6100 - L1H12VP
To correct a problem with the Move utility when accessing over 20 panels, HSC needs these PTFs	SOS6000 - L1H12WR	SOS6100 - L1H12WT



**Note:** Always refer to the Customer Resource Center for the latest updates.

5. PTF is a Program Temporary Fix.

## Virtual Storage Manager

VSM is a virtual tape system that optimizes the tape storage systems for mainframe platforms.

VSM-type solutions consist of a server, disk storage, and front-end software, that complement the physical tape and library products.

The server, disk, and software provide a buffer or cache between the operating systems and the tape drives for storage in a library.

Hardware for a VSM solution consists of:	Software for a VSM solution consists of:
Fault tolerant RAID 6+ disk array	Virtual tape control system ( <b>VTCS</b> ) software resides on the host operating system in the same address space as HSC.
Library and/or library storage modules (LSMs)	
Real (physical) tape drives (RTDs) in a library	VTCS 6.0.0 preferred
Multi-volume cartridges (MVCs)—physical cartridges	HSC 6.0+ minimum

## Expert Library Manager

- Expert Library Manager (ExLM) is a software product that provides content management for *mainframe* automated tape environments.
- ExLM works in combination with:
  - Host Software Component (HSC),
  - Virtual Storage Manager (VSM), and the
  - Customers tape management system (TMS).
- The major considerations for content management and ExLM is to position scratch tapes, non-scratch tapes, and free cells in such a manner to reduce or eliminate pass-thru operations during production cycles.
- The current software level for ExLM to support the SL8500 is 6.0.0.



### Important:

Refer to the **SL8500 Best Practices Guide PN TM0017** for helpful guidelines for the optimization for the SL8500 library along with suggestions about how to improve the performance.

## Automated Cartridge System Library Software

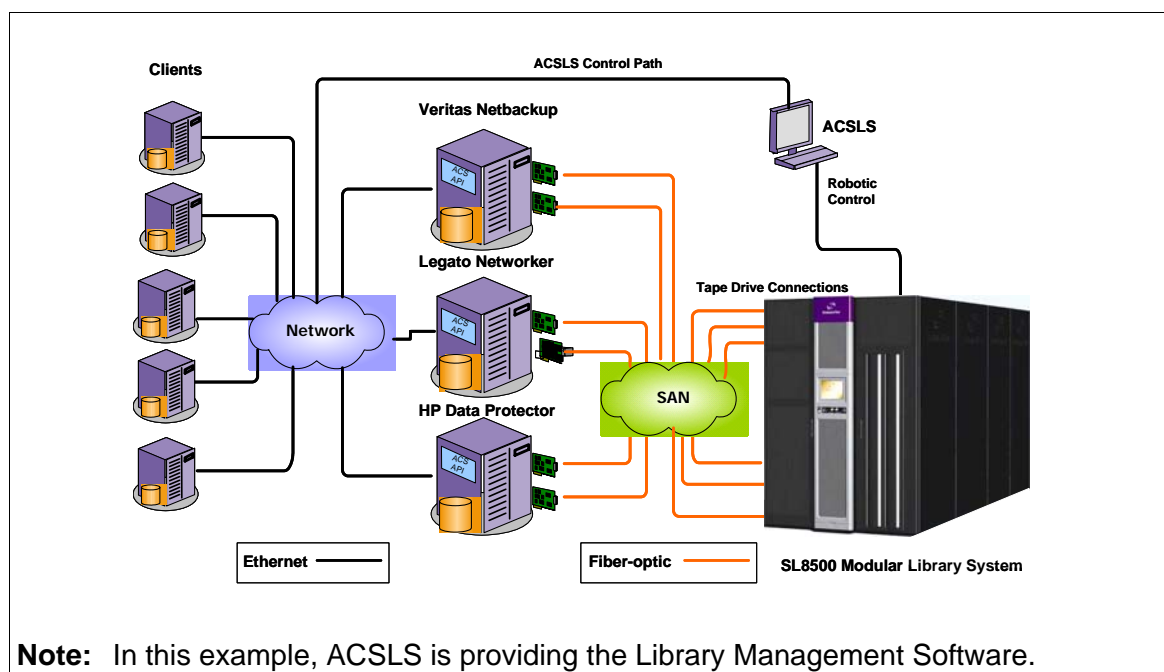
Figure 19 shows an example of an Automated Cartridge System Library Software (ACSL) configuration. ACSL is an open systems software package that manages library contents and controls library hardware to mount and dismount cartridges on tape drives.

This application also provides library management services such as cartridge tracking, pooling, reports, and library control.

**ACSL 7.1** or higher is required. This is the only version of ACSL which currently supports the SL8500 library.

**Note:** Make sure that PTF-809236 is applied.

Figure 19. ACSL Example



**Note:** In this example, ACSL is providing the Library Management Software.

If using ACSL, this application is sold to support a certain number of slots. Make sure to order the appropriate number of slots to match the configuration of the SL8500 library.



### Important:

ACSL 7.1 with PUT0502 has many fixes and enhancements, plus this is a prerequisite for all future maintenance.

This level of software with the SL8500 library firmware of 2.52 is not limited to eight HandBot enhancements—the SL8500 returns “LSM Not Ready” messages when inoperative, degraded, or offline.

**Note:** Check the Customer Resource Center (CRC) for the latest PTF (program temporary fix) and PUT (program update tape) levels.

# SNMP

I



Refer to the **SNMP Reference Guide PN: 316194701** for more information.

Simple Network Management Protocol (SNMP) is an application layer protocol that performs network management operations over an Ethernet connection using a User Datagram Protocol (UDP/IP). SNMP allows:

- Libraries to inform the systems administrator of potential problems.
- Systems administrators to query the library for configuration, operation, and statistical information.

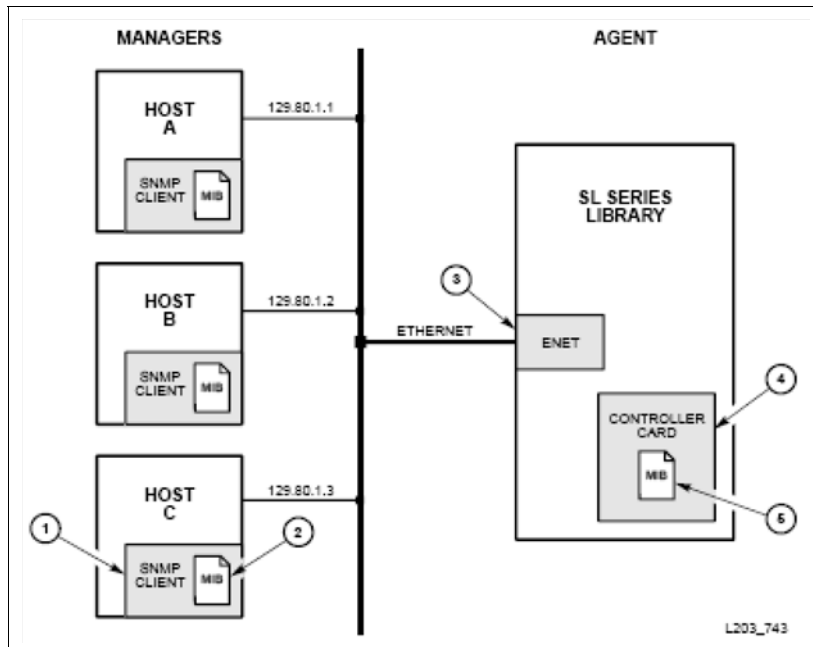
The SL8500 libraries support:

- **SNMPv2c** of the simple network management protocol for machine status queries. Note: with this version, any information transmitted is *not* secure.
- **SNMPv3** of the simple network management protocol is reserved for *proprietary* information. Because this version supports encryption and stronger user identification it is the preferred protocol for proprietary data.

Figure 20 is a simple network block diagram that identifies the locations of the SNMP software application. This figure also identifies examples of:

- IP addresses
- Ethernet connections
- Management Information Base (MIB) locations
- Library controller–HBC card

**Figure 20. SNMP Block Diagram**



1. SNMP software application that implements the role of manager. Examples are Sun Microsystems SunNet Manager, HP OpenView and IBM NetView.
2. The Management Information Base (MIB), copied from the library controller card.
3. Ethernet connection (ENET) for the library (HBC card, port 2B).
4. The SNMP agent is a process running on the library controller card (HBC card).
5. Library MIB data can be:  
Read by v2c users;  
Read/write only by v3 users

**Note:** MIB data can be read through the StreamLine Library Console

**Note:** StreamLine Library Console software must be version 2.91 (2.26.00) or higher.

By default, the SNMP agent is turned off and must be activated by a service representative through the Command Line Interface (CLI).

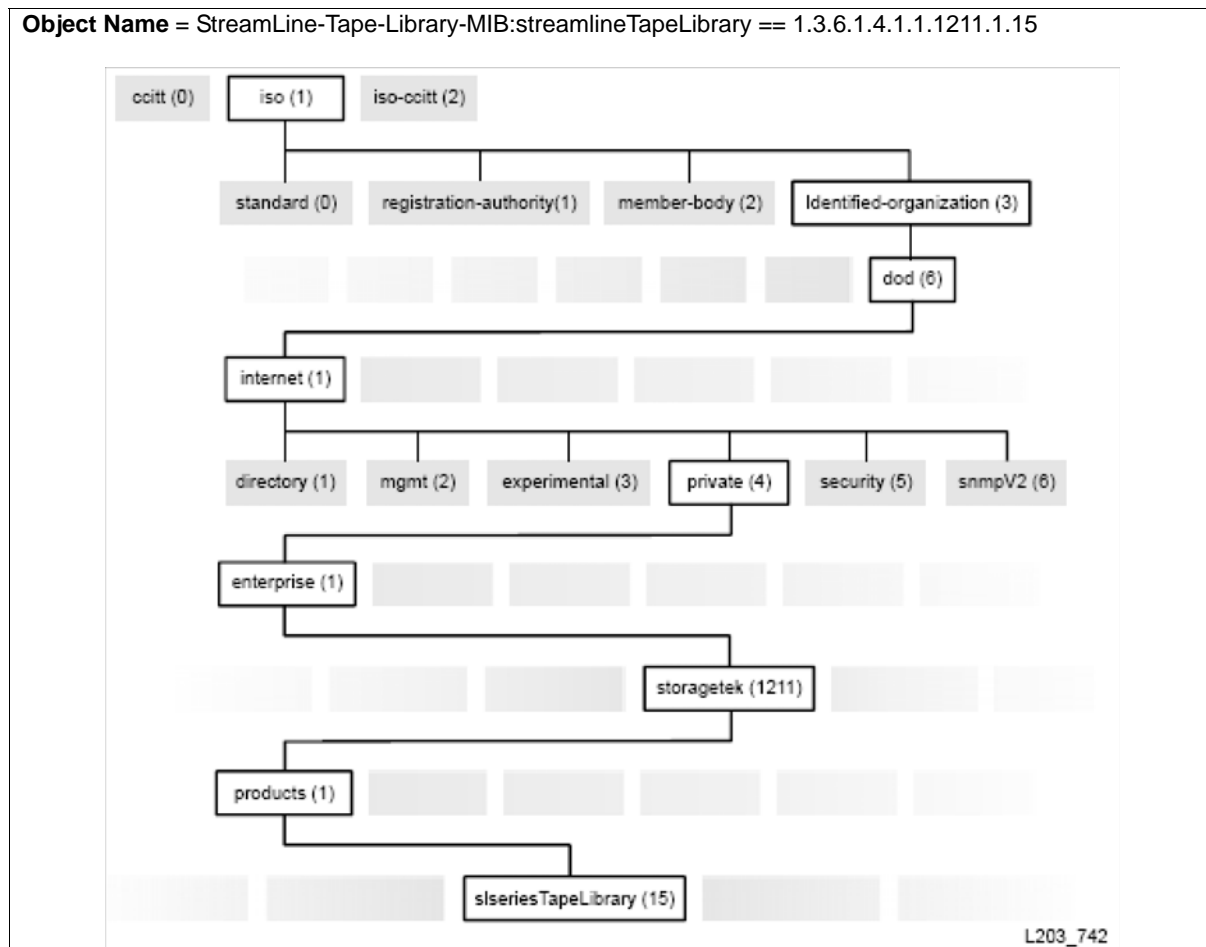
- Future releases will allow the addition or deletion of users or recipients through the SNMP interface (after enabling SNMP through the CLI).
- Because SNMP can only be enabled through the CLI port, *you must work with your customer to setup SNMP.*
- When working with your customer it is important that you keep the security of proprietary information as your first consideration.

## Management Information Base

The MIB is a viewable document that contains descriptions about the characteristics for a managed device. These characteristics are the functional elements for that device which can be monitored using SNMP software.

**Note:** SL8500 libraries implement only MIB extensions defined in the SLSERIES-TAPE-LIBRARY-MIB under the **private (4)** section

**Figure 21. Management Information Base Hierarchy**



## ■ Tape Drives

**Table 13. Supported Tape Drives**

The SL8500 library supports a wide variety of tape drives with one requirement, the interface to these drives must be fiber-optic based, meaning Fibre Channel, FICON<sup>1</sup>, or ESCON<sup>2</sup> attachments.

**Note: SCSI interfaces are not supported.**


See [Appendix C, "Tape Drives"](#) for specific information about the drives.

Drive Type	Vendor	Description	Interface Type
T9840 A, B, C, & D	StorageTek	T9840 are <i>access-centric</i> tape drives that are ideal for applications that demand high data throughput and fast recall.  These drives use a <i>dual-reel</i> cartridge with transfer rates and capacities of: <ul style="list-style-type: none"> <li>• A: 20 GB with rates at 10 MB/s*</li> <li>• B: 20 GB with rates at 19 MB/s</li> <li>• C: 40 GB with rates at 30 MB/s</li> <li>• D: 75 GB with rates at 30 MB/s (encryption-capable)</li> </ul>	Fibre Channel, FICON, ESCON*  * Fibre Channel must be Fabric aware
T9940 B (only)	StorageTek	T9940 are <i>high-capacity</i> tape drives designed for storage applications and use a single reel tape cartridge with transfer rates and capacities of: <ul style="list-style-type: none"> <li>• 200 GB with transfer rates of 30 MB/s</li> </ul> <i>Note: The T9940A tape drive is not supported.</i>	Fibre Channel, FICON, ESCON
T10000 A & B	StorageTek	T10000 are <i>high-capacity, high-performance</i> tape drives that use a single reel tape cartridge with a native storage capacity and transfer rates of: <ul style="list-style-type: none"> <li>• 500 GB native capacity with rates up to 120 MB/s</li> <li>• 1 TB native capacity</li> <li>• Both models are encryption-capable</li> </ul>	Fibre Channel FICON
LTO2 LTO3 LTO4	Hewlett Packard (HP) IBM	Ultrium Linear Tape-Open (LTO) is an "open format" technology, which means that users have multiple sources of product and media. The "open" nature of LTO technology enables compatibility between the two different vendors.  These drives use a single reel tape cartridge with native transfer rates and capacities of: <ul style="list-style-type: none"> <li>• LTO2 drives: 200 GB at 35 MB/s</li> <li>• LTO3 drives: 400 GB at 80 MB/s</li> <li>• LTO4 drives: 800 GB</li> </ul>	Fibre Channel
SDLT 600 DLT-S4	Quantum	Super DLT (SDLT) is a standard for UNIX and Windows platforms. The SDLT 600 use a single reel tape cartridge with native transfer rates and capacities of: <ul style="list-style-type: none"> <li>• SDLT 600: 300 GB, with transfer rates of 36 MB/s</li> <li>• DLT-S4</li> </ul>	Fibre Channel

1. *Fiber Connection, or Fiber Connectivity*—IBM's fiber optic channel technology that extends the capabilities of ESCON. FICON supports full duplex data transfers over longer distances.
2. *Enterprise Systems Connection, or Enterprise Systems Connectivity*—an IBM fiber optic channel technology that supports half duplex data transfers up to 200 Mb/s.

## Media and Labels

Table 14. Media

<b>Tape Cartridges</b>	<p><i>Media Usage:</i> The storage media (tape cartridges) used in a tape drive and/or library can have a <i>significant</i> impact on the overall performance.</p> <p>See <a href="#">Appendix D, “Media”</a> for specific information about the tape cartridges.</p>
<b>Barcode Standards</b>	<p>The SL8500 library requires labels based on the Code 39 barcode standard. This standard uses discrete barcodes, which means that a fixed pattern of bars represents a single character.</p> <p>Each character is made up of 9 bars—5 black bars and 4 white bars—3 of which are wider than the others. This is the reason for the name Code 39 and why some people refer to it as the 3 of 9 Code.</p> <p>These barcode labels are based on the following specifications:</p> <ul style="list-style-type: none"> <li>• AIM Uniform Symbology Specification USS-39</li> <li>• ANSI MH10.8M-1993 Code 39 Barcode Specification</li> <li>• ANSI NCITS 314-199X SCSI 3 Medium Changer Commands (SMC)</li> </ul> <p><i>All labels must conform to these standards when used in the SL8500 library.</i></p>
<b>Labels</b>	<p><b>9x40</b> Uses a <i>six-plus-one</i> label supplied by Engineered Data Products/Colorflex) and American Eagle/Writeline. The plus-one is the required media ID character.</p> <p><b>T10000</b> Uses labels with <i>eight</i> characters, the last two of which are the required Media ID Domain and the Media ID Type characters.</p> <p><b>LTO</b> Uses labels with <i>eight</i> characters, the last two of which are the required Media ID Domain and the Media ID Type characters.</p> <p><b>SDLT</b> Uses labels with <i>seven</i> characters, the last of which is the required media ID character with an implied domain type of 1.</p>
<b>Media ID Labels</b>	<p>The use of <i>media ID</i> labels allows StorageTek libraries to mix tape drive types and media types in a single library or library complex to provide customers with a true <i>mixed media solution</i> called: <i>Any Cartridge, Any Slot™</i></p>
<b>Non-labeled Cartridges</b>  	<p>Non-labeled cartridges are <i>not</i> supported in the SL8500 library. If non-labeled cartridges are left inside the library and a software audit (such as HSC) is initiated, the cartridges will be exported through the CAP.</p> <p><b>Caution:</b>  <b>The SL8500 is able to scan upside-down LTO or SDLT cartridges and insert them into cells. However, mounts of these upside-down cartridges will fail. Currently, the library returns these cartridges back to the cell and does not eject them through the CAP.</b></p>
<b>Upside Down Cartridges</b>	<p>Handling and installing cartridges correctly is very important and must be emphasized to operators. Especially inserting a 9x40 cartridge upside down, this can cause damage to the HandBot and to the cartridge. The behavior for upside down cartridges is explained in the following sections.</p>

## ■ Safety Features

The SL8500 library has a combination of safety features to ensure safety throughout the library.

### Emergency Robotic Stop

Emergency robotic stop (ERS) is the removal of AC and DC power to the *robotics*, such as the HandBots, pass-thru ports, CAPs, and elevators; the library and tape drives *are not* affected. The emergency robotic stop ensures that no robotic motion occurs while someone is inside the library.

The library has two ERS switches:

- One interior lighted switch on the left side of the drive bay area
- One non-illuminated, covered switch, on the front panel

Pressing an ERS switch immediately removes AC and DC power to the robotics (not the entire library). After it is determined that it is safe to restore power, press the switch again to reset it.

### Door Switches

The library has four front door switches on the Customer Interface Module that monitor the state of the front access doors; should a door be opened without using service mode, these switches remove power from the robotics.

### Smoke Detection

In the event of smoke in or around the library, a photo-electric smoke detector mounted in the upper right section of the Drive and Electronics Module, *removes all power from the library*.

Power is restored to the library by resetting the AC circuit breakers.

### Service Mode

Service mode is a method that qualified service representatives can use to access the front service area of the library while the library remains operational. This allows the service representative to perform such operations as HandBot replacement, elevator or turntable motor replacement, or CAP replacement.

**Note:** This mode is not permitted by an operator. Only qualified service representative with a service mode key can initiate service.



## Interlocks

The library features two types of safety interlocks:

- **Door frames:** Two redundant switches behind each front access door of the Customer Interface Module.
- **Service safety door:** Two sets of dual switches located on the upper section of the front frame for the service safety door.

## Mechanical Access Door Mechanism

On the rear section of each door lock, a mechanism is available to mechanically release the door lock from the inside. This is a non-electrical safeguard against someone being locked inside the library. Should an access door be shut and locked from the outside, someone inside the library can push on the mechanism to unlock and open the door.

## Service Safety Door

The optional service safety door is a sliding door that is activated by the maintenance key. This maintenance key is controlled *only* by service representatives and is used when a failing component in the front of the library needs to be replaced.

The service safety door moves either to the left or right, depending upon which maintenance lock is opened. When the maintenance key is inserted into its lock and turned, the safety door separates the forward maintenance area from the library interior. This allows the service representative to safely replace a failing front frame component while the library remains fully operational.

## Interior Lighting

The interior of the library is always illuminated with *white* LEDs on the ceiling.

The ceiling of the Customer Interface Module has *yellow* (hazard) LEDs that flash when the library is in service mode and for approximately 10 seconds when the doors are closed to alert anyone who may still be inside the library.

## Fire Suppression

The library does *not* ship with a Fire Suppression System installed, although features have been incorporated into the library to allow fire suppression systems to be installed.

Professional Services offers fire suppression systems which are installed on site. See [“Fire Suppression Planning” on page 95](#) for more information.

## ■ Regulatory Agencies

The following regulatory agencies have tested and certified the SL8500 library.

### Safety

- Underwriters Laboratories Inc. (UL) - in compliance with UL 60950-1 First Edition, Standard for Information Technology Equipment - Safety Part 1: General Requirements.
- Canadian Standards Association (CSA) - in compliance with CAN/CSA-C22.2 No. 60950-1-03 First Edition, Standard for Information Technology Equipment - Safety - Part 1: General Requirements.
- TUV Rheinland (TUV) - in compliance with EN 60950-1 (IEC 60950-1:2001, modified), Standard for Information Technology Equipment - Safety - Part 1: General Requirements.
- CB Scheme - in compliance to international Certified Body Scheme requirements with all national deviations by TUV Rheinland.

### Electromagnetic

Configuration used for verification and compliance is an SL8500 Modular Library with a TCP/IP connection and 4 to 64 tape drives:

- Federal Communications Commission (FCC) – in compliance to the requirements of FCC 47, Part15, Subpart B and Unintentional Radiators Class A.
- Voluntary Control Council for Interference (VCCI) (Japan) – in compliance to VCCI Class A (Cispr22).
- Australia/New Zealand (C-Tick Mark) – in compliance to requirements of the Australia/New Zealand EMC Framework AS/NZS 3548: 1995 Class A.
- European Community (CE Mark) – in compliance to the requirements of Electromagnetic Compatibility Directive 89/336 (including all amendments).
- Canadian Emissions (ICES) – in compliance to the requirements of Canada's Interference Causing Equipment Standard ICES-003 Class A.
- Taiwan (BSMI) – in compliance to the requirements of Taiwan's requirements, CNS13438 Class A.
- Korea – in compliance to the requirements of Korean EMC Law.

## Fiber-optic

Each fiber-optic interface in this StorageTek Fibre Channel equipment contains a laser transceiver that is a Class 1 Laser Product.

**Note:** Each laser transceiver has an output of less than 70  $\mu$ W.

StorageTek's Class 1 Laser Products comply with EN60825-1:1994+A1+A2 and with sections 21 CFR 1040.10 and 1040.11 of the Food and Drug Administration (FDA) regulations.



**Caution:** Use of controls or adjustment or performance of procedures other than those specified herein might result in hazardous radiation exposure.

## Laser Product Label

In accordance with safety regulations, a label on each StorageTek Fibre Channel product identifies the laser class of the product and the place and date of the manufacturer. The label appears on top of a Fibre Channel tape drive and near the Fibre Channel connectors on a Fibre Channel tape library. A copy of the label is shown here:

<p>CLASS 1 LASER PRODUCT          LASER KLASSE 1          APPAREIL A LASER DE CLASSE 1          COMPLIES WITH 21 CFR 1040.10 AND 1040.11</p>
--

The following translations are for users in Finland and Sweden who wish to identify laser safety and classification:

<p>CLASS 1 LASER          LUOKAN 1 LASERLAITE          KLASSE 1 LASER APPARAT</p>
---

## ■ Shock, Vibration, and Impact Tests

The SL8500 library successfully completed all shock, vibration and impact tests required in Engineering Design Standard 6-1 (EDS 6-1) Environmental Requirements for StorageTek Products.



# System Assurance

## 2

The system assurance process is the exchange of information among team members to ensure that no aspects of the sale, order, installation and implementation for the Sun StorageTek SL8500 Library are overlooked. This process promotes an error-free installation and contributes to the overall customer satisfaction.

The system assurance team members (customer and Sun) ensure that all aspects of the process are planned carefully and performed efficiently. This process begins when the customer accepts the sales proposal. At this time, a Sun representative schedules the system assurance planning meetings.

### ■ System Assurance Planning Meetings

The purpose of the system assurance planning meetings are to:

- Introduce the customer to the SL8500 StreamLine Library
- Explain the system assurance process and establish the team
- Identify and define the customer requirements
- Identify the customer configurations
- Complete the order
- Prepare for the installation and implementation

**Table 15. System Assurance Task Checklist**

Task	Completed?
Introduce the teams to the SL8500 library.	Yes <input type="checkbox"/> No <input type="checkbox"/>
Complete the following Team Member Contact sheets.	Yes <input type="checkbox"/> No <input type="checkbox"/>
Review and complete the <a href="#">“Site Survey Forms” in Chapter 3.</a>	Yes <input type="checkbox"/> No <input type="checkbox"/>
Review and complete <a href="#">“Site Preparation” in Chapter 4.</a>	Yes <input type="checkbox"/> No <input type="checkbox"/>
Review the <a href="#">“Ordering Information” in Chapter 5.</a>	Yes <input type="checkbox"/> No <input type="checkbox"/>
Determine the schedule: Delivery: Date: _____ Time: _____ Installation: Date: _____ Time: _____	Yes <input type="checkbox"/> No <input type="checkbox"/>

## ■ Customer Team Member Contact Sheet

Complete the information for the customer team members:

### Primary Contact:

Name:	
Title:	
Telephone Number:	
FAX Number:	
Cell Phone / Pager:	
E-mail Address:	

### Systems Administrator or other

Name:	
Title:	
Telephone Number:	
FAX Number:	
Cell Phone / Pager:	
E-mail Address:	

### Network Administrator or other

Name:	
Title:	
Telephone Number:	
FAX Number:	
Cell Phone / Pager:	
E-mail Address:	

### Facilities Manager or other

Name:	
Title:	
Telephone Number:	
FAX Number:	
Cell Phone / Pager:	
E-mail Address:	

## ■ Sun Microsystems Team Member Contact Sheet

Complete the information for the Sun StorageTek team members:

### Account Executive or other

Name:	
Title:	
Telephone Number:	
FAX Number:	
Cell Phone / Pager:	
E-mail Address:	

### Systems Engineer or other

Name:	
Title:	
Telephone Number:	
FAX Number:	
Cell Phone / Pager:	
E-mail Address:	

### Installation Coordinator or other

Name:	
Title:	
Telephone Number:	
FAX Number:	
Cell Phone / Pager:	
E-mail Address:	

### Professional Services Representative or other

Name:	
Title:	
Telephone Number:	
FAX Number:	
Cell Phone / Pager:	
E-mail Address:	

## ■ Engagement Methodology

Each individual engagement is different; different customers, different needs, and different requirements.

In addition to system assurance, Sun Microsystems has standardized and implemented a delivery methodology that provides continuity and quality assurance in the engagement and delivery approach. This suggested methodology is called ADIM:

- **A**ssess
- **D**esign
- **I**mplement
- **M**anage

This methodology consists of a defined path of action and a series of templates and checklists for the exchange of information. These templates and checklists document the necessary information to ensure that the proposed solution can be delivered and supported to achieve StorageTek's customer satisfaction requirements.

Designed for Sun StorageTek marketing, sales, and engagement personnel (such as Systems Engineers and Professional Services Engineers, *plus* qualified and approved partners), following this methodology allows us to work together, provide consistent documentation for each engagement and to ensure both customer satisfaction and overall sales success. The information in the following chapters is intended to help you:

**Table 16. Engagement Methodology**

Action:	Refer to:
Ask the right questions	<ul style="list-style-type: none"> <li>• <a href="#">Chapter 3, "Site Survey Forms"</a></li> </ul>
Design the right solution	<ul style="list-style-type: none"> <li>• <a href="#">Appendix A, "Content Management"</a></li> </ul>
Determine if the customer needs assistance migrating currently owned equipment, networks, and media	<ul style="list-style-type: none"> <li>• Best Practices Guide</li> </ul>
Make sure the site is ready to receive the SL8500 library	<ul style="list-style-type: none"> <li>• <a href="#">Chapter 4, "Site Preparation"</a></li> </ul>
Order, install, and implement that solution	<ul style="list-style-type: none"> <li>• <a href="#">Chapter 5, "Ordering Information"</a></li> </ul>
Make sure the customer knows how to use the library	<ul style="list-style-type: none"> <li>• Customer Orientation Checklist</li> <li>• User's Guide</li> </ul>
Provide qualified service and support	<ul style="list-style-type: none"> <li>• Installation Manual</li> <li>• Best Practices Guide</li> <li>• Replaceable Parts Catalog</li> <li>• Troubleshooting Guide</li> </ul>
Follow-up; Make sure the solution meets the customers expectations	<ul style="list-style-type: none"> <li>• Customer Satisfaction</li> </ul>



Use this chapter to record the:

- Different platforms, applications, and hardware configurations
- Workloads for content management planning
- SL8500 configuration

These forms are also in electronic format in the Site Preparation Kit.

## ■ Interoperability



### **Important:**

Not sure if your customer's software of choice supports StorageTek hardware? Do the different network components support each other?

Check out the Interoperability Tool at:

<https://extranet.storitek.com/interop/interop>

The Interop Tool is designed for connectivity information on all supported products sold through Sun Microsystems, Inc. regardless of whether Sun branded or third party branded. The configurations listed are reflective of the most up-to-date information reported from various sources, including Sun testing labs and our technology partners.

The Interop Tool lists configurations with valid connectivity, *it does not validate*.

## ■ Pre-Sales Technical Qualification

Make sure you complete and submit the

- SL8500 Qualification Form, or
- Pre-Sales Technical Qualification Process on the Web

The purpose of this process is to provide the necessary information to ensure that the proposed solution can be delivered and supported error free to achieve StorageTek customer satisfaction requirements.

Send the completed qualification forms to [sales\\_support@storagetek.com](mailto:sales_support@storagetek.com)

## ■ System Configuration

The following two pages provide space where you can record information about the customers operating systems and configurations.

**Table 17. Questions About the Customers Operating Systems**

Question	Answer
<p>1. How many and what types of operating systems or platforms does the customer have?</p> <p>Open-Systems:</p> <ul style="list-style-type: none"> <li>• Windows: 2000, NT... Make &amp; Model: Quantity:</li> <li>• UNIX: Solaris, AIX, HP-UX... Make &amp; Model: Quantity:</li> <li>• Linux... Make &amp; Model: Quantity:</li> </ul> <p>Mainframe:</p> <ul style="list-style-type: none"> <li>• MVS Make &amp; Model: Quantity:</li> <li>• VM Make &amp; Model: Quantity:</li> </ul> <p>Other (Specify): Make &amp; Model: Quantity:</p>	
<p>2. Are there plans for:</p> <ul style="list-style-type: none"> <li>• New purchases?</li> <li>• Future upgrades?</li> <li>• If so, what?</li> </ul>	
<p>3. How many systems/servers are used as:</p> <ul style="list-style-type: none"> <li>• Backup servers?</li> <li>• File servers?</li> <li>• Print servers?</li> <li>• Exchange servers?</li> </ul>	

**Table 18. System Configuration**

<b>System _____</b>	<b>Processor _____</b>	<b>Processor _____</b>
Vendor Make & Model		
Operating System Type		
Version Number & Patch Level		
Number of Channels		
IP Address		
HBA Vendor & Model		
HBA Firmware Versions		
Switch & Port Numbers		
Switch Make & Model		
ESCD and HCD support		
ESCON Director Make & Model		
ESCON Manager		
FICON support		
EREP		
Ports		
<b>System _____</b>	<b>Processor _____</b>	<b>Processor _____</b>
Vendor Make & Model		
Operating System		
Version Number & Patch Level		
Number of Channels		
IP Address		
HBA Vendor & Model		
HBA Firmware Versions		
Switch & Port Numbers		
Switch Make & Model		
ESCD and HCD support		
ESCON Director Make & Model		
ESCON Manager		
FICON support		
EREP		
Ports		

## ■ Applications

The following two pages provide space where you can record information about the customer's applications.

**Table 19. Questions About the Customers Applications**

Question	Answer
1. How many servers or systems perform backups? 2. How are backups performed, manually or automatically?	
3. On what days are backups performed? 4. What types of backups are performed and when? <ul style="list-style-type: none"> <li>• Full:</li> <li>• Incremental:</li> <li>• Differential:</li> </ul> 5. How many hours are available for: <ul style="list-style-type: none"> <li>• Full backups?</li> <li>• Daily Backups?</li> </ul>	
6. How much data is backed up: <ul style="list-style-type: none"> <li>• Per day?</li> <li>• Per week?</li> <li>• Per month?</li> </ul> 7. How much data changes daily (%)?	
8. Are backup windows being met? 9. How long does it actually take? 10. How long should a backup take? 11. Is a different backup schedule needed?	
12. How long does the customer keep the different levels of backed up data? 13. How many copies are made (including the original)? 14. How many copies are archived?	
15. How often are restores necessary? 16. Why are restores necessary? 17. What are the restore requirements? 18. What are the restore objectives?	

**Table 20. Backup and Archive Software**

Selection	Type of Backup and Archive Software	Version
<input type="checkbox"/>	VERITAS NetBackup	
<input type="checkbox"/>	IBM Tivoli Storage Manager (TSM)	
<input type="checkbox"/>	Legato NetWorker	
<input type="checkbox"/>	CA Brightstor	
<input type="checkbox"/>	HP Omniback	
<input type="checkbox"/>	ASM UNIX	
<input type="checkbox"/>	ASM NT	
<input type="checkbox"/>	ASM OS/390	
<input type="checkbox"/>	E-Mail Archive	
<input type="checkbox"/>	Other (Specify)	
<input type="checkbox"/>	Other (Specify)	

**Table 21. Network Management Software**

Selection	Type of Network Management	Version
<input type="checkbox"/>	VERITAS	
<input type="checkbox"/>	IBM Tivoli NetView	
<input type="checkbox"/>	HP OpenView	
<input type="checkbox"/>	HP SUNNet	
<input type="checkbox"/>	Horizon Library Monitor	
<input type="checkbox"/>	RMS/GSM	
<input type="checkbox"/>	Other (Specify)	
<input type="checkbox"/>	Other (Specify)	

**Table 22. Library Attachment Software**

Selection	Type of Library Attachment	Version
<input type="checkbox"/>	HSC	
<input type="checkbox"/>	ACSLs	
<input type="checkbox"/>	ACSLs HA	
<input type="checkbox"/>	Direct SCSI	
<input type="checkbox"/>	Fibre Channel	
<input type="checkbox"/>	Horizon Library Manager	
<input type="checkbox"/>	Other (Specify)	

## MVS General Information

**Table 23. MVS Information**

Yes	No	Question and Response
<input type="checkbox"/>	<input type="checkbox"/>	Does the customer have any software products that modify JES2 allocation (IEFAB421) or the JES3 device scheduler (IATMADL)? If yes, explain:  _____
<input type="checkbox"/>	<input type="checkbox"/>	Does the customer have any software products that modify JES2/JES3 message handling <i>write to operator</i> (WTO Exit)? If yes, explain:  _____
<input type="checkbox"/>	<input type="checkbox"/>	Does the customer use Data Facility/System Managed Storage (DF/SMS)? If yes, explain:  _____
<input type="checkbox"/>	<input type="checkbox"/>	Does the customer use JES3 only?  _____
<input type="checkbox"/>	<input type="checkbox"/>	Will JES3 setup control the tape drives? Refer to the JES3 section in the <i>HSC System Programmers' Guide</i> .  _____
<input type="checkbox"/>	<input type="checkbox"/>	Does the customer have any software products that modify DETACH message, DIAGNOSE, IUCV DASD BLOCKIO, RSCS?  _____

What are the major bottlenecks in their system today?

- |                          |                          |  |
|--------------------------|--------------------------|--|
| <input type="checkbox"/> | <input type="checkbox"/> | Will any JCL changes have to be made to accommodate a library? If yes, explain:<br><br>_____ |
| <input type="checkbox"/> | <input type="checkbox"/> | Does the customer have any special IPL considerations? If yes, explain:<br><br>_____         |

## ACSL S General Information

The ACSLS Product Information Bulletin defines the operating system and hardware requirements for each ACSLS version.

**Table 24. ACSLS Information**

Yes	No	Question & Response
<input type="checkbox"/>	<input type="checkbox"/>	Does this customer have a UNIX-based library control system? If yes, which operating system is installed (example, Solaris 2.6)?  _____  _____  If yes, which release of ACSLS is installed?  _____
<input type="checkbox"/>	<input type="checkbox"/>	Has the library control system been identified as a node on the Ethernet network?  What is the internet (IP) address of the library control system?  _____  _____  What is the network host-name of the library control system?  _____
<input type="checkbox"/>	<input type="checkbox"/>	Does the customer intend to run other applications on the same platform as ACSLS?  _____

**Note:** If the UNIX platform is intended to run co-host applications, the customer should have an experienced system administrator resolve any conflicting resources between applications. StorageTek supports only the ACSLS applications.

## ■ Data Bases

**Table 25. Questions About the Customers Data Base**

Question	Answer
1. How much primary storage exists? Total capacity.	
2. What type and size of disk drives does the customer have?  Make: Model: Capacity: Quantity:	
Make: Model: Capacity: Quantity:	
3. What is the RAID configuration?  4. What type of Failover product and Version is the customer using?	
5. Does all primary storage require backup? If not, how much does?  6. Are additional storage devices needed?	
7. What Data Base Management Systems (DBMS's) does the customer have?  8. What types of databases need backups?  9. What is the size of the smallest database?  10. What is the size of the largest database?  11. How often does the customer backup each database?	
12. What type of data is the customer backing up?  13. How valuable is the data in each database?  14. Do the different databases have different backup requirements?	
15. How is the customer currently protecting the databases (tape backup, mirroring, snapshot)?  16. If mirroring, how many mirrors?  17. Is mirroring installed because failover is required?	



## ■ Hardware Configurations

List any existing hardware the customer currently has:

- Does the customer have any existing libraries?  Yes  No
- Does the customer have any existing tape drives?  Yes  No
- Does the customer have any existing media for reuse?  Yes  No
- Does the customer have an existing storage area network?  Yes  No
- Are migration services required?  Yes  No

### Library

- Will this SL8500 library be replacing existing libraries?  Yes  No
- Replacing existing StorageTek libraries?  Yes  No
- If so, what are the module numbers? \_\_\_\_\_

**Table 26. Existing Libraries**

Libraries	Description	Quantity
Manufacturer		
Make & Model		
Cartridge Capacity		
Manufacturer		
Make & Model		
Cartridge Capacity		

### Tape Drives

See [Appendix C](#) for information about tape drives.

- Does the customer have existing StorageTek tape drives?  Yes  No
- Does the customer need more tape drives?  Yes  No
- What types of drives are needed? \_\_\_\_\_

**Table 27. Tape Drive Types**

Tape Drive Type	Yes	No	Vendor
3480 or 3490-type devices (18/36 track)	<input type="checkbox"/>	<input type="checkbox"/>	
DLT 7000 or 8000	<input type="checkbox"/>	<input type="checkbox"/>	
StorageTek T9840	<input type="checkbox"/>	<input type="checkbox"/>	
StorageTek T9940	<input type="checkbox"/>	<input type="checkbox"/>	
SDLT 320 or 600	<input type="checkbox"/>	<input type="checkbox"/>	
LTO Generation 1, 2, or 3	<input type="checkbox"/>	<input type="checkbox"/>	

**Table 28. Existing Tape Drives**

<b>Tape Drives</b>	<b>Description</b>	<b>Quantity</b>
Manufacturer		
Make & Model		
Manufacturer		
Make & Model		
Manufacturer		
Make & Model		

## Tape Cartridges

See [Appendix D](#) for information about tape cartridges.

- Approximately, how many tape cartridges does the customer have? \_\_\_\_\_
- Does the customer need more tapes?  Yes  No
- Data cartridges?  Yes  No
- Cleaning cartridges?  Yes  No

**Table 29. Existing Tape Cartridges**

<b>Tape Cartridges</b>	<b>Description</b>	<b>Quantity</b>
Data Cartridge Type		
Manufacturer		
Data Cartridge Type		
Manufacturer		
Data Cartridge Type		
Manufacturer		
Data Cartridge Type		
Manufacturer		
Cleaning Cartridge Type		
Manufacturer		
Cleaning Cartridge Type		
Manufacturer		
Cleaning Cartridge Type		
Manufacturer		
Cleaning Cartridge Type		
Manufacturer		

## Network

- Does the customer have an existing storage area network?  Yes  No
- Are additional network devices required?  Yes  No
- What are they? \_\_\_\_\_
- Does the customer use *zones* in the network?  Yes  No
- Are there frequent reconfigurations of the network?  Yes  No
- Are there multiple floors involved with this network?  Yes  No
- Are there inter-connections of hubs and switches?  Yes  No
- Are there remote connections to hubs and switches?  Yes  No
- Is this a campus network?  Yes  No
- Are trunk cables used?  Yes  No
- Are patch panels used?  Yes  No

**Table 30. Fibre Channel Switches**

Information	Switch 1	Switch 2	Switch 3
Manufacturer			
Make & Model			
Software version			
Speed			
Number of Ports			
Port types			
GBIC Module types			
Number of Open Ports			
IP Addresses			
IP Addresses			

**Table 31. Ethernet Hubs and Switches**

Information	Hub/Switch 1	Hub/Switch 2	Hub/Switch 3
Manufacturer			
Make & Model			
Number of Ports			
Software version			
Speed			
Duplex			
Number of Open Ports			
IP Addresses			
IP Addresses			

**Table 32. Fibre Channel Switch Connections**

<b>FC Switch Information</b>	<b>Switch 1</b>	<b>Switch 2</b>	<b>Switch 3</b>
Vendor			
Model Number			
Port 0 Connection and Status			
Port 1 Connection and Status			
Port 2 Connection and Status			
Port 3 Connection and Status			
Port 4 Connection and Status			
Port 5 Connection and Status			
Port 6 Connection and Status			
Port 7 Connection and Status			
Port 8 Connection and Status			
Port 9 Connection and Status			
Port 10 Connection and Status			
Port 11 Connection and Status			
Port 12 Connection and Status			
Port 13 Connection and Status			
Port 14 Connection and Status			
Port 15 Connection and Status			
Port 16 Connection and Status			
Port 17 Connection and Status			
Port 18 Connection and Status			
Port 19 Connection and Status			
Port 20 Connection and Status			
Port 21 Connection and Status			
Port 22 Connection and Status			
Port 23 Connection and Status			
Port 24 Connection and Status			
Port 25 Connection and Status			
Port 26 Connection and Status			
Port 27 Connection and Status			
Port 28 Connection and Status			
Port 29 Connection and Status			
Port 30 Connection and Status			
Port 31 Connection and Status			

## ESCON Directors

- How many ESCON Directors does the customer have? \_\_\_\_\_
- Is an extended distance facility or feature installed?  Yes  No
- Are patch panels used?  Yes  No
- How many ports? \_\_\_\_\_  
(18, 36, 72)
- Are trunk cables used?  Yes  No  
How many? \_\_\_\_\_
- What type of connectors are used? \_\_\_\_\_  
(ST, MTP, ESCON, MTRJ)
- Are couplers used?  Yes  No
- Are adapters used?  Yes  No
- Are standard or custom ESCON jumper cables used?  Std  Custom
- Are there any FICON Bridge Ports?  Yes  No
- Are Fibre Transport Services used with trunk cables?  Yes  No

**Table 33. ESCON Directors**

Information	Director 1	Director 2	Director 3
Manufacturer			
Make & Model			
Software version			
Ports per card			
Number of LED ports			
Number of XDF ports			
Number of FICON ports			
Number of Bridge cards			
Number of Open ports			
Channel Addresses			
Channel Addresses			
IP Addresses			
IP Addresses			

## FICON Directors

FICON products use a mapping layer based on the existing ANSI standards and physical cabling for Fibre Channel but uses different switches called directors similar to ESCON.

- What type of operating system does the customer have? \_\_\_\_\_  
(z/OS, OS/390, 9672 G5/G6, etc.)
- How many FICON Directors does the customer have? \_\_\_\_\_
- Are cascaded directors used to extend distance?  Yes  No
- Are patch panels used?  Yes  No
- How many ports? \_\_\_\_\_
- Are trunk cables used?  Yes  No  
How many? \_\_\_\_\_
- What type of connectors are used? \_\_\_\_\_

**Table 34. FICON Director Worksheet**

FICON Director Worksheet								
Manufacturer:			Type:			Model:		
HCD Switch ID:				Cascaded Directors <input type="checkbox"/> Yes <input type="checkbox"/> No				
Director Domain ID (@)				Fabric Name:				
Director F_Ports				Attached N_Ports or E_Ports				
Slot #	Port #	Port Address	Type (LX/SX)	Port Name	Node (CU/Chnl)	Device Type	Model	ISL CU Intf. CHPID

## Cables and Connectors

**Note:** Plan for 1–2 m (3–7 ft) of slack cable for limited movement and routing.

**Table 35. Cables and Connectors**

Type	Connector	Length	Quantity
9 Micron fiber-optic	LC-to-LC		
	LC-to-SC		
	Other (specify)		
50 Micron fiber-optic	LC-to-LC		
	LC-to-SC		
	LC-to-ST		
	Other (specify)		
62.5 Micron fiber-optic	SC-to-SC		
	Other (specify)		
ESCON	Duplex		
	Duplex -to-ST		
FICON	LC-to-LC		
	LC-to-SC		
	LC-to-ST		
	Other (specify)		
MT-RJ	MT-to-MT		
	MT-to-Duplex		
	MT-to-ST		
	Other (specify)		
Copper	DB-9		
	HSSDC		
Ethernet (CAT5E)	RS-232		
	Other (specify)		

## ■ Planning for Content

When planning the content of an SL8500 library, see:

- [Appendix A, "Content Management"](#) and
- [Appendix H, "Partitioning"](#)

Using [Figure 22](#) as an example, the following pages provide space that you can use to help plan the content of an SL8500 library.

Make additional copies of these sheets as necessary.

**Figure 22. Content Management Plan**

Tape Drives				Storage Cells		Summary				
						Slots	Tapes	Free		
Rail 1LSM 0	0	4	8	12	Workloads: Archive Interactive Volumes	E L E V A T O R S	C	794	200	594
	1	5	9	13						
	2	6	10	14						
	3	7	11	15						
Rail 2LSM 1	0	4	8	12	Workloads: MVCs VSM Physical Volumes Scratch	A	P	794	526	268
	1	5	9	13						
	2	6	10	14						
	3	7	11	15						
Rail 3LSM 2	0	4	8	12	Workloads: Scratch Business Systems	P	C	794	600	194
	1	5	9	13						
	2	6	10	14						
	3	7	11	15						
Rail 4LSM 3	0	4	8	12	Workloads: Payroll Acct. Expenses Scratch	C	A	794	397	397
	1	5	9	13						
	2	6	10	14						
	3	7	11	15						
Total # of Drives: <u>26</u>				Expansion Modules: <u>1</u>		Total Capacity: <u>3,176</u> <u>1,723</u> <u>1,453</u>				
				Performance Zone ⇌ Less active volumes		L203_757				



Figure 22. Content Management Plan

Tape Drives				Storage Cells		Summary			
						Slots	Tapes	Free	
Rail 1\LSM 0	0	4	8	12	Workloads:				
	1	5	9	13					
	2	6	10	14					
	3	7	11	15					
Rail 2\LSM 1	0	4	8	12	Workloads:		C		
	1	5	9	13					
	2	6	10	14					
	3	7	11	15					
Rail 3\LSM 2	0	4	8	12	Workloads:		A		
	1	5	9	13					
	2	6	10	14					
	3	7	11	15					
Rail 4\LSM 3	0	4	8	12	Workloads:		P		
	1	5	9	13					
	2	6	10	14					
	3	7	11	15					
Total # of Drives: _____				Expansion Modules: _____		Total Capacity: _____			
				Performance Zone ⇌ Less active volumes		L203_758			

Tape Drives				Storage Cells		Summary			
						Slots	Tapes	Free	
Rail 1\LSM 0	0	4	8	12	Workloads:				
	1	5	9	13					
	2	6	10	14					
	3	7	11	15					
Rail 2\LSM 1	0	4	8	12	Workloads:		C		
	1	5	9	13					
	2	6	10	14					
	3	7	11	15					
Rail 3\LSM 2	0	4	8	12	Workloads:		A		
	1	5	9	13					
	2	6	10	14					
	3	7	11	15					
Rail 4\LSM 3	0	4	8	12	Workloads:		P		
	1	5	9	13					
	2	6	10	14					
	3	7	11	15					
Total # of Drives: _____				Expansion Modules: _____		Total Capacity: _____			
				Performance Zone ⇌ Less active volumes		L203_758			



# Site Preparation

# 4

Use this chapter to prepare for the installation by reviewing the information and completing the *Site Planning Checklist*.

Other information in this chapter includes planning topics and requirements to help prepare for an installation of the SL8500 modular library system.

## ■ Site Planning Checklist

Use the following checklist to ensure that the customer is ready to receive the library and to ensure that you are ready to start the installation.

**Table 36. Site Planning Checklist**

Question	Answer	Comments
<b>Delivery and Handling</b>		
Does the customer have a delivery dock? If not, where will the equipment be delivered?	Yes <input type="checkbox"/> No <input type="checkbox"/>	
If a delivery dock is available, what are the hours of operation?	_____	
Are there street or alley limitations that may hinder the delivery? (Limited access, one-way traffic, truck size)	Yes <input type="checkbox"/> No <input type="checkbox"/>	
Is the dock close to the computer room where the equipment will be installed?  If no, how far does the equipment need to be moved?	Yes <input type="checkbox"/> No <input type="checkbox"/>  Distance: _____	
Is an elevator required to move the equipment to the appropriate floor?  What type of elevator is being used? (Class A or C, freight, low-rise, passenger, service, hydraulic, pneumatic, etc.)	Yes <input type="checkbox"/> No <input type="checkbox"/>  Description:	
What is the capacity of the elevator? What are the dimensions of the elevator?		
Are there any ramps or slopes that you need to move equipment over to get to the installation site? What is the angle?	Yes <input type="checkbox"/> No <input type="checkbox"/>  Degrees:_____	

**Table 36. Site Planning Checklist (Continued)**

Question	Answer	Comments
<b>Note: See “Shipping Weights and Dimensions” on page 101 for the following questions.</b>		
Will there be people available to handle the number of, size of, and weight of the shipping pallets?	Yes <input type="checkbox"/> No <input type="checkbox"/>	Depending on the configuration, there may be up to 20 pallets.
Will there be equipment available to handle the pallets (forklifts and/or pallet jacks)?	Yes <input type="checkbox"/> No <input type="checkbox"/>	Pallets can be up to 2.4 m (8 ft) long.
Is there a <i>staging area</i> where the pallets can be placed with access to the installation site?	Yes <input type="checkbox"/> No <input type="checkbox"/>	The minimum working area ( <i>not including space for the pallets</i> ) is approximately 56 m <sup>2</sup> (600 ft <sup>2</sup> ).
Are there doorway or hallway height and width limitations that may prevent moving the equipment on the shipping pallets?	Yes <input type="checkbox"/> No <input type="checkbox"/>	
Will you need to <i>unpack</i> the equipment to move it to the installation site?	Yes <input type="checkbox"/> No <input type="checkbox"/>	
<b>Physical Placement (See Table 37 on page 78 for weights and measurements)</b>		
<b>Note:</b> The library does not require raised flooring, <i>but it is highly recommended.</i> Does the site have raised flooring? Has the floor been laser-leveled?	Yes <input type="checkbox"/> No <input type="checkbox"/> Yes <input type="checkbox"/> No <input type="checkbox"/>	It is <i>recommended</i> that the floor be laser-leveled <i>before</i> receiving any equipment.
Does the customer have floor tile cut-outs available for AC power, Interface cables, and vented floor tiles? See “Floor Cutouts” on page 87.	Yes <input type="checkbox"/> No <input type="checkbox"/>	Cutouts are placed at the rear corners of the Drive and Electronics Module. Vented tiles should be placed in <i>front</i> of the library, not under it.
Does the intended site have enough room to install and service the equipment?	Yes <input type="checkbox"/> No <input type="checkbox"/>	See Table 37 on page 78 for clearance specifications
Can the customer’s floor support the weight of the library configuration?	Yes <input type="checkbox"/> No <input type="checkbox"/>	The customer’s floor must be capable of supporting 454 kg (1,000 lb) per distribution pad.
Are there plans for expansion? If so, when?  How many <i>slots</i> does the customer <i>currently</i> have?  How many <i>storage expansion modules</i> does the customer <i>currently</i> have?  Does the customer want to expand with:  • Additional expansion modules? • Pass-thru Ports? • More slots? • ACSLS license keys	Yes <input type="checkbox"/> No <input type="checkbox"/> Date: _____  Slots: _____  SEMs: _____  Yes <input type="checkbox"/> No <input type="checkbox"/> Yes <input type="checkbox"/> No <input type="checkbox"/> Yes <input type="checkbox"/> No <input type="checkbox"/> Slots: _____	
Can the customer’s floor support the weight of future expansions?	Yes <input type="checkbox"/> No <input type="checkbox"/>	See Table 37 on page 78. for weights and measurements

Table 36. Site Planning Checklist (Continued)

Question	Answer	Comments
Is the ceiling above the library clear of obstructions? (smoke detectors, sprinklers, vents, etc.)	Yes <input type="checkbox"/> No <input type="checkbox"/>	See <a href="#">“Ceiling Requirements” on page 89</a> for more information.
Does the equipment need to move over carpet? If so, is there protection from electrostatic discharge (ESD)?	Yes <input type="checkbox"/> No <input type="checkbox"/>	
<b>Environmental (See <a href="#">Table 38 on page 79</a> for specifications)</b>		
Does the site meet the environmental requirements for: <ul style="list-style-type: none"> <li>• Temperature?</li> <li>• Humidity?</li> <li>• Air flow (front and back)?</li> <li>• Cooling requirements?</li> <li>• Heat generated by <i>rack equipment</i>?</li> </ul>	Yes <input type="checkbox"/> No <input type="checkbox"/>	Temperature: 16°–32°C (60°–90°F) Humidity: 20–80%, non-condensing  See <a href="#">“Air Flow Requirements” on page 80</a> See <a href="#">Table 41 on page 81</a>
What is the customer’s computer room: <ul style="list-style-type: none"> <li>• Temperature?</li> <li>• Relative Humidity?</li> </ul>		Current measurements:
Does the site contain features and materials that guard against electrostatic discharge (ESD)?	Yes <input type="checkbox"/> No <input type="checkbox"/>	
Does the customer have a large dumpster and means to dispose of the packing material?  Are there special requirements to dispose of or recycle the packing material, pallets, and cardboard?	Yes <input type="checkbox"/> No <input type="checkbox"/>  Yes <input type="checkbox"/> No <input type="checkbox"/>	Depending on the configuration, there may be up to 20 pallets worth of packing material.
Is there concern about Seismic or Earthquake ratings for the SL8500?	Yes <input type="checkbox"/> No <input type="checkbox"/>	See the statement about <a href="#">“Seismic or Earthquake Ratings” on page 80</a>
<b>Power</b>		
Does the intended site meet the power requirements for of the equipment?	Yes <input type="checkbox"/> No <input type="checkbox"/>	200–240 VAC, 47–63 Hz Three Phase: Delta or Wye Single Phase: <i>if required</i>
<b>Note:</b> Connecting to three phase power is <i>highly recommended</i> . The single phase power option requires 3 circuits for N+1 and 6 circuits for 2N power configurations.		
Have arrangements been made for a licensed electrician to connect power?	Yes <input type="checkbox"/> No <input type="checkbox"/>	See <a href="#">“AC Power Planning” on page 83</a>
Does the site have multiple, separate circuits for power redundancy?	Yes <input type="checkbox"/> No <input type="checkbox"/>	For 2N power configurations only
Does the customer plan to use multiple branch circuits for redundancy?	Yes <input type="checkbox"/> No <input type="checkbox"/>	

**Table 36. Site Planning Checklist (Continued)**

Question	Answer	Comments
<b>Building Codes:</b>		
Because new electrical wiring is necessary, will it require an inspection or an approval?	Yes <input type="checkbox"/> No <input type="checkbox"/>	
Do local, city, state, or federal codes need to be checked and approved for:		Comments:
<ul style="list-style-type: none"> <li>• New wiring configurations?</li> <li>• Fire suppression requirements?</li> <li>• Clearances?</li> <li>• Safety?</li> </ul>	Yes <input type="checkbox"/> No <input type="checkbox"/> Yes <input type="checkbox"/> No <input type="checkbox"/> Yes <input type="checkbox"/> No <input type="checkbox"/> Yes <input type="checkbox"/> No <input type="checkbox"/>	See <a href="#">page 95</a> See <a href="#">page 78</a>
<b>Connectivity .</b>		
Is the customer using an Open Systems or an Enterprise platform or network?	Open <input type="checkbox"/> Enterprise <input type="checkbox"/>	
Have you completed the Site Survey forms in Chapter 4?	Yes <input type="checkbox"/> No <input type="checkbox"/>	
Have you referred to the Interop Tool at <a href="https://extranet.stortek.com/interop/interop?">https://extranet.stortek.com/interop/interop?</a>	Yes <input type="checkbox"/> No <input type="checkbox"/>	
Does the customer want to install equipment in the library rack space?	Yes <input type="checkbox"/> No <input type="checkbox"/>	See <a href="#">Table 41 on page 81</a> for guidelines.
Have you completed a cable plan?	Yes <input type="checkbox"/> No <input type="checkbox"/>	
Have you determined the type of and number of cables required?	Yes <input type="checkbox"/> No <input type="checkbox"/>	Each electronics control module provides <i>two</i> Ethernet connections for host communications <i>Each</i> tape drive <i>needs</i> an interface connection (data path), some can support two connections (dual-port).
Is the customer prepared to supply Ethernet cables for the network?	Yes <input type="checkbox"/> No <input type="checkbox"/>	
Can the customer provide the required number of “static” IP addresses?	Yes <input type="checkbox"/> No <input type="checkbox"/>	
Will interface cables be run from outside the computer room?	Yes <input type="checkbox"/> No <input type="checkbox"/>	Cables that run outside a computer room require flammability ratings of CL2/CL2P.
<b>Remote Support (See the information in “Service Delivery Platform” on page 97)</b>		
Will the customer allow StorageTek to use remote support?	Yes <input type="checkbox"/> No <input type="checkbox"/>	
Has the SDP Systems Assurance Guide been completed?	Yes <input type="checkbox"/> No <input type="checkbox"/>	Provided in the Site Preparation Kit.
Has the SDP appliance and mounting hardware been ordered?	Yes <input type="checkbox"/> No <input type="checkbox"/>	

Table 36. Site Planning Checklist (Continued)

Question	Answer	Comments
<b>Tape Drives (See Appendix C, "Tape Drives" for more information)</b>		
Does the customer have the correct type and number of tape drives?	Yes <input type="checkbox"/> No <input type="checkbox"/>	
Are new or additional drives required? How many? What types?	Yes <input type="checkbox"/> No <input type="checkbox"/> _____ _____	
<b>Media Factors (See Appendix D, "Media" for information about tape cartridges)</b>		
Does the customer have the correct type and number of tape cartridges?	Yes <input type="checkbox"/> No <input type="checkbox"/>	
<ul style="list-style-type: none"> <li>• Are additional cartridges required?</li> <li>• Are cleaning cartridges required?</li> <li>• Are labels required?</li> </ul> How many? What types?	Yes <input type="checkbox"/> No <input type="checkbox"/> Yes <input type="checkbox"/> No <input type="checkbox"/> Yes <input type="checkbox"/> No <input type="checkbox"/> _____ _____	
Does the customer need additional CAP magazines, cartridge racks and furniture?	Yes <input type="checkbox"/> No <input type="checkbox"/>	
<b>Professional Services, Data Center Services, and Data Migration Services</b>		
Does the customer want or need a <b>Fire Suppression</b> system?	Yes <input type="checkbox"/> No <input type="checkbox"/>	For more information, visit: <a href="http://mysales.central/public/clientsolutions">http://mysales.central/public/clientsolutions</a>
For the library?		
For the computer room?	Yes <input type="checkbox"/> No <input type="checkbox"/>	
Are media conversions required? Such as going from an older technology to a newer one?	Yes <input type="checkbox"/> No <input type="checkbox"/>	
Is the customer moving existing products and services to an SL8500 library?	Yes <input type="checkbox"/> No <input type="checkbox"/>	
Are Professional Services required for:		
<ul style="list-style-type: none"> <li>• Assessments and Migration</li> <li>• Conversion services</li> <li>• Drive and media relocations</li> <li>• Training</li> </ul>	Yes <input type="checkbox"/> No <input type="checkbox"/> Yes <input type="checkbox"/> No <input type="checkbox"/> Yes <input type="checkbox"/> No <input type="checkbox"/> Yes <input type="checkbox"/> No <input type="checkbox"/>	
<b>Human Interface</b>		
Are there any issues that may prevent operators from entering the library?  Such as handicapped (wheel-chair), too short to reach drives in the upper bays, too tall to easily enter the library.	Yes <input type="checkbox"/> No <input type="checkbox"/>	The width between the inner and outer walls is 45 cm (18 in.), which may be difficult for some to move freely inside the library.
Where will the remote operator panels be located?	Yes <input type="checkbox"/> No <input type="checkbox"/>	

## Physical Planning

**Table 37. Library Weights and Measures**

Component	Measurement		Weight	
	Meters (cm)	Feet (in.)	Kilograms	Pounds
<ul style="list-style-type: none"> <li>Height</li> <li>Width</li> </ul>	2.37 m (236.6 cm)	7.76 ft (93.15 in.)		
<ul style="list-style-type: none"> <li>Lengths and Weights (<i>full</i>)<sup>1</sup> <ul style="list-style-type: none"> <li>- Base Library</li> <li>- 1 expansion module</li> <li>- 2 expansion modules</li> <li>- 3 expansion modules</li> <li>- 4 expansion modules</li> <li>- 5 expansion modules</li> </ul> </li> </ul>	<i>(with doors/facade)</i> 2.8 m (276.9 cm) 3.7 m (372.1 cm) 4.7 m (467.4 cm) 5.6 m (562.6 cm) 6.6 m (657.8 cm) 7.5 m (753.1 cm)	<i>(with doors/facade)</i> 9.1 ft (109 in.) 12.2 ft (146.5 in.) 15.3 ft (184 in.) 18.5 ft (221.5 in.) 21.6 ft (259 in.) 24.7 ft (296.5 in.)	2835 kg 3640 kg 4445 kg 5250 kg 6055 kg 6860 kg	6,250 lb 8,025 lb 9,800 lb 11,575 lb 13,350 lb 15,125 lb
<ul style="list-style-type: none"> <li>Weights (<i>empty</i>)<sup>2</sup> <ul style="list-style-type: none"> <li>- Base Library</li> <li>- 1 expansion module</li> <li>- 2 expansion modules</li> <li>- 3 expansion modules</li> <li>- 4 expansion modules</li> <li>- 5 expansion modules</li> </ul> </li> </ul>			1497 kg 1883 kg 2268 kg 2654 kg 3039 kg 3425 kg	3,300 lb 4,150 lb 5,000 lb 5,850 lb 6,700 lb 7,550 lb
<ul style="list-style-type: none"> <li>Rear door length</li> <li>Front door/facade length</li> <li>PTP (between covers)</li> </ul>	0.10 m (10.16 cm) 0.19 m (19 cm) 0.14 m (14.07 cm)	0.33 ft (4 in.) 0.625 ft (7.5 in.) 0.46 ft (5.54 in.)		
<ul style="list-style-type: none"> <li>Pass-thru Port               <ul style="list-style-type: none"> <li>- Height:</li> <li>- Width: (between frames)</li> <li>- Depth:</li> <li>- Weight: (<i>with mechanisms</i>)</li> </ul> </li> </ul>	2.31 m (231 cm) 0.17 m (17.17 cm) 1.5 m (150.8 cm)	7.58 ft (91 in.) 0.56 ft (6.76 in.) 4.95 ft (59.4 in.)	121 kg	266 lb
<ul style="list-style-type: none"> <li>Service clearances               <ul style="list-style-type: none"> <li>- Front</li> <li>- Rear</li> </ul> </li> </ul>	0.66 m (66 cm) 0.89 m (89 cm)	2.2 ft (26 in.) 2.9 ft (35 in.)		
<ul style="list-style-type: none"> <li>Individual modules (<i>full</i>)<sup>1</sup> <ul style="list-style-type: none"> <li>- Drive and Electronics<sup>3, 5</sup></li> <li>- Robotics Interface<sup>3</sup></li> <li>- Storage Expansion<sup>3</sup></li> <li>- Customer Interface<sup>4</sup></li> </ul> </li> </ul>	<i>(frames only)</i> 0.76 m (76.2 cm) 0.76 m (76.2 cm) 0.95 m (95.25 cm) 0.95 m (95.25 cm)	<i>(frames only)</i> 2.5 ft (30 in.) 2.5 ft (30 in.) 3.125 ft (37.5 in.) 3.125 ft (37.5 in.)	1236 kg 828 kg 805 kg 771 kg	2,725 lb 1,825 lb 1,775 lb 1,700 lb
<ul style="list-style-type: none"> <li>Individual modules (<i>empty</i>)<sup>2</sup> <ul style="list-style-type: none"> <li>- Drive and Electronics<sup>3, 5</sup></li> <li>- Robotics Interface<sup>3</sup></li> <li>- Storage Expansion<sup>3</sup></li> <li>- Customer Interface<sup>4</sup></li> </ul> </li> </ul>			590 kg 352 kg 386 kg 556 kg	1,300 lb 775 lb 850 lb 1,225 lb

1. Full = All tape drives, DC power supplies, and cartridges, with 2N power, four robots, doors and facade.
2. Empty = Base library configuration with N+1 power and four robots; *without* tape drives or tape cartridges.
3. Engineering lab measurement.
4. Logically calculated (estimated).
5. Without equipment installed in the racks (variable).



## Environmental Requirements

**Note:** Although the SL8500 library will function over a full list of environmental ranges as specified below, *optimal reliability* is achieved if the environment is maintained between the recommended ranges.

**Table 38. Environmental Specifications**

Description	Optimum	Recommended Range	Full Operating Range
<b>Temperature</b> - Operating - Shipping - Storing	22°C (72°F)	20° – 25°C (68° – 77°F)	+16° to 32°C (60° to +90°F) -30° to +49°C (-23° to +120°F) +4.4° to +32°C (+40° to +90°F)
<b>Relative Humidity</b> - Operating - Shipping - Storing	45%	40% – 50%	20% to 80% 5% to 90% 20% to 80%
<b>Wet bulb</b> (operating)	+25.6°C (+78°F) maximum, non-condensing		
<b>Heat Output</b>	44,380 Btu/hr (maximum loading**) The equation for heat output is: 3.41214 x Watts = Btu/hr		
<b>Power Consumption</b>	13.0 kW (maximum loading**) or 13.7 kVA kVA = kWatts ÷ Power factor (Power factor for the SL8500 is 0.95)		
**Maximum loading includes 64 tape drives, 4 fully loaded racks, 8 HandBots, all the front frame components (CAPs, service door, and elevators), plus redundant control modules.			



**Important:** Although this equipment is designed to operate in environmental conditions of 20% to 80% humidity, industry best practices recommends computer rooms maintain a relative humidity of 40% to 50% for best performance.

**Table 39. Environmental Definitions**

<b>British thermal unit (Btu)</b>	A measure of the amount of heat required to raise the temperature of one pound of water one degree Fahrenheit. British thermal units are most commonly associated with power over a unit of time—Btu per hour (Btu/hr).
<b>Relative Humidity</b>	A measure of water vapor in the air.
<b>Temperature</b>	The measurement of hot and cold to specific scales, such as Celsius (also called centigrade) and Fahrenheit.  The Celsius temperature scale uses 0° for the freezing point of water and 100° for the boiling point of water. The Fahrenheit temperature scale uses 32° for the freezing point and 212° for the boiling point.
<b>Watt</b>	A watt is a unit of power or the amount of energy per unit of time. Often the term watt is used for expressing energy consumption as kW (kilo-Watts).
<b>Wet bulb</b>	The difference in temperature between wet bulb (humidity) and dry bulb (temperature) provides a measure of atmospheric humidity.

## Air Flow Requirements

The air flow required to cool the SL8500 depends on the total number of components installed within it, such as tape drives, load sharing DC power supplies, and accessory racks.

Each of these components contribute to the total airflow required.

Calculations (requirements) for these individual components—using standard air conditions at sea level (pressure) and 22°C / 72°F (temperature)—are:

**Table 40. Air Flow Requirements**

Component	Measurement	Quantity
Tape drive	0.57m <sup>3</sup> /min. (20 ft <sup>3</sup> /min.) each	64 possible
DC power supply	0.71m <sup>3</sup> /min. (25 ft <sup>3</sup> /min.) each	24 possible
Rack Modules	13.59m <sup>3</sup> /min. (480 ft <sup>3</sup> /min.) each	4 possible
Electronics Module	4.42m <sup>3</sup> /min. (156ft <sup>3</sup> /min.)	

A maximum configured library with 64 tape drives, 24 DC power supplies, four rack modules, and the electronic control module would require:

112.0m<sup>3</sup>/min. (3956 ft<sup>3</sup>/min.) of supply air to avoid recirculation.

Most configurations are smaller than this and require less air flow.

An example of a smaller configuration is 12 tape drives split between drive bays for redundancy, one robot on each level, one rack module, and the electronic control module.

This would require 33.30m<sup>3</sup>/min. (1176 ft<sup>3</sup>/min.).

The layout of the data center should account for the cooling requirements of SL8500 as well as other equipment in the center—possibly through the concept of having a cool aisle and hot aisle in accordance with environmental best practices and controls.

## Seismic or Earthquake Ratings

The requirements for seismic compatibility vary dramatically throughout the world. As such, StorageTek does not offer a standard “seismic” feature for the SL8500 modular library system.

It is recommended that any customer who has seismic concerns work with local experts who are familiar with the local code and requirements.

Professional Services can also be engaged to help coordinate this activity.

## Accessory Racks

The SL8500 library provides space where up to four standard RETMA 19 inch racks can be installed.

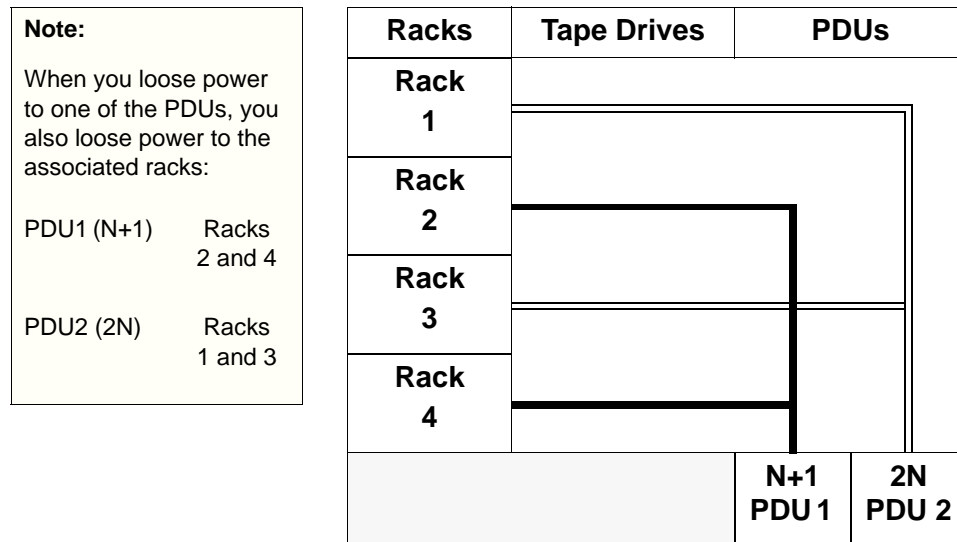
Because of the numerous types of equipment, StorageTek cannot mandate what the customer installs in these racks; therefore, certain guidelines should be followed to prevent voiding the warranty.

**Table 41. Rack Guidelines**

Description	Value / Range
Accessory rack	The accessory rack is mounted on slides rated for 80 kg (175 lb). Safe load is 64 kg (140 lb).
Mounting hardware (equipment in the rack)	Components must function in a <i>vertical</i> position. Rails are not provided; use the mounting hardware supplied by the manufacturer.
<ul style="list-style-type: none"> <li>• Height</li> <li>• Width</li> <li>• Depth</li> <li>• Mount-points</li> </ul>	48.25 cm (19 in.) 27.3 cm (10.75 in.) including power strip 72 cm (28 in.) safe length is 66 cm (26 in.) 72.4 cm (28.5 in.) between mounting points
Thermal requirements	880 watts (3,000 Btu/hr) <i>per rack module</i> .
Power	200–240 VAC, 50 to 60 Hz, 4 Amps Six IEC320 C13 outlet receptacles
See <a href="#">Table 9 on page 24</a> for additional information and guidelines.	

Two of the racks (2 and 4) receive power from the primary AC power grid. The other two racks (1 and 3) *require* the 2N power configuration.

**Figure 23. Accessory Rack Power**



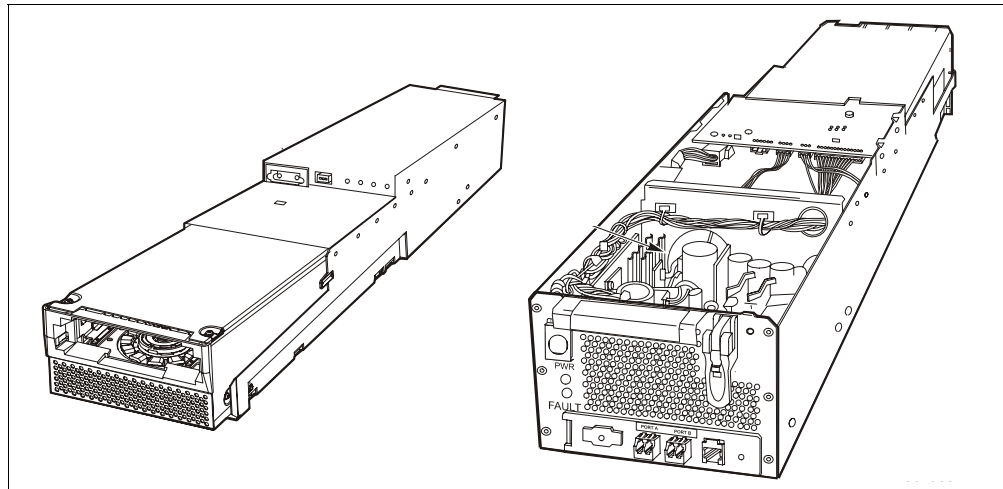
## Tape Drive and Cartridge Specifications

The supported tape drives fit into a drive tray that slides into the slots of the drive bay in the rear of the library.

**Table 42. Drive Tray Weights and Measures**

Drive Tray	Height	Width	Length	Weight
Drive tray <i>only</i>	10.8 cm (4.25 in.)	16.5 cm (6.5 in.)	85 cm (33.5 in.)	4.3 kg (9.5 lb)

**Figure 24. Drive Tray**



**Table 43. Tape Drive Weights**

Drive Type	Tape Drive Weight (with drive tray)
T9840	8.2 kg (18.0 lb)
T9940	11 kg (24.3 lb)
T10000	9.4 kg (20.75 lb)
LTO	6.9 kg (15 lb)
SDLT	6.7 kg (14.8 lb)

**Table 44. Cartridge Tape Weights**

Drive Type	Cartridge Tape Weight	
T9x40	262 g (9.2 oz)	0.26 kg (0.57 lb)
T10000	264 g (9.31 oz)	0.26 kg (0.58 lb)
LTO	210 g (7.4 oz)	0.21 kg (0.46 lb)
SDLT	222.5 g (7.85 oz)	0.22 kg (0.49 lb)

## ■ AC Power Planning

*StorageTek highly recommends connection of the library's AC wiring to be done by a licensed electrician.*

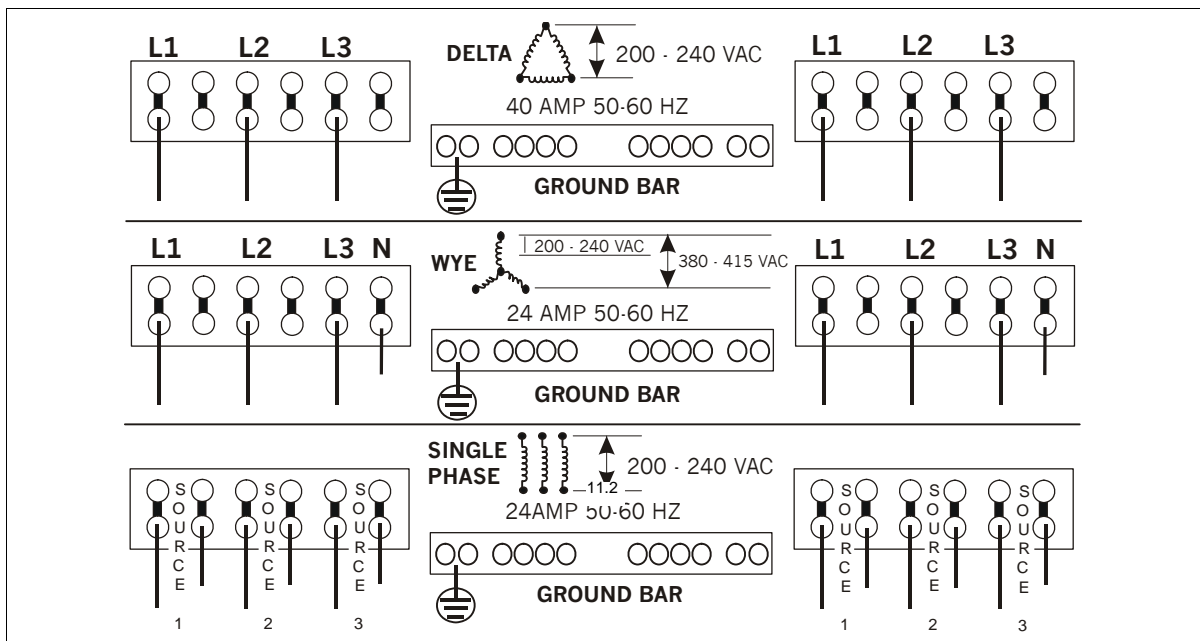
**Note:** AC wiring from the power source branch circuit must be installed in conduit (flexible or rigid) with a 90-degree elbow-down fitting.

There are six holes provided for the conduit elbows that measure 2.875 cm (1.125 in.) in diameter. The electrician should choose appropriate conduit and fittings for their application that will fit this.

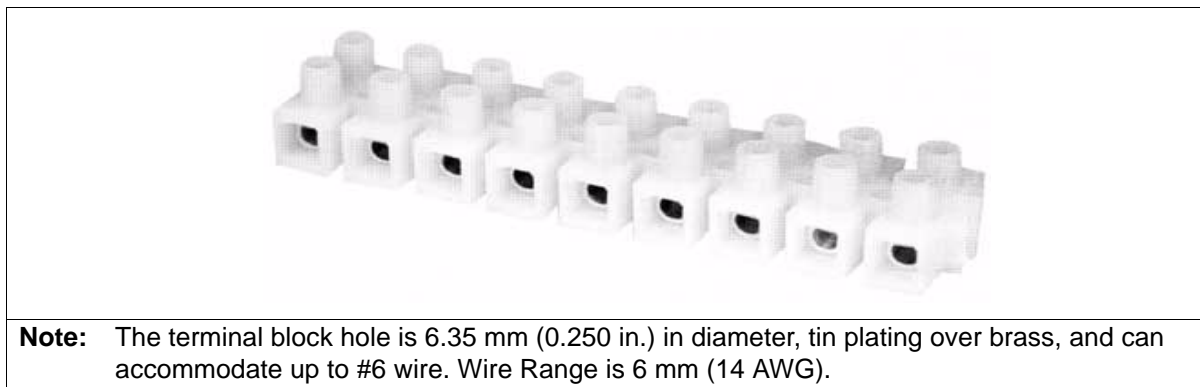
Figure 25 shows the power distribution connections.

Figure 26 shows the type of terminal block used.

**Figure 25. PDU Connections**

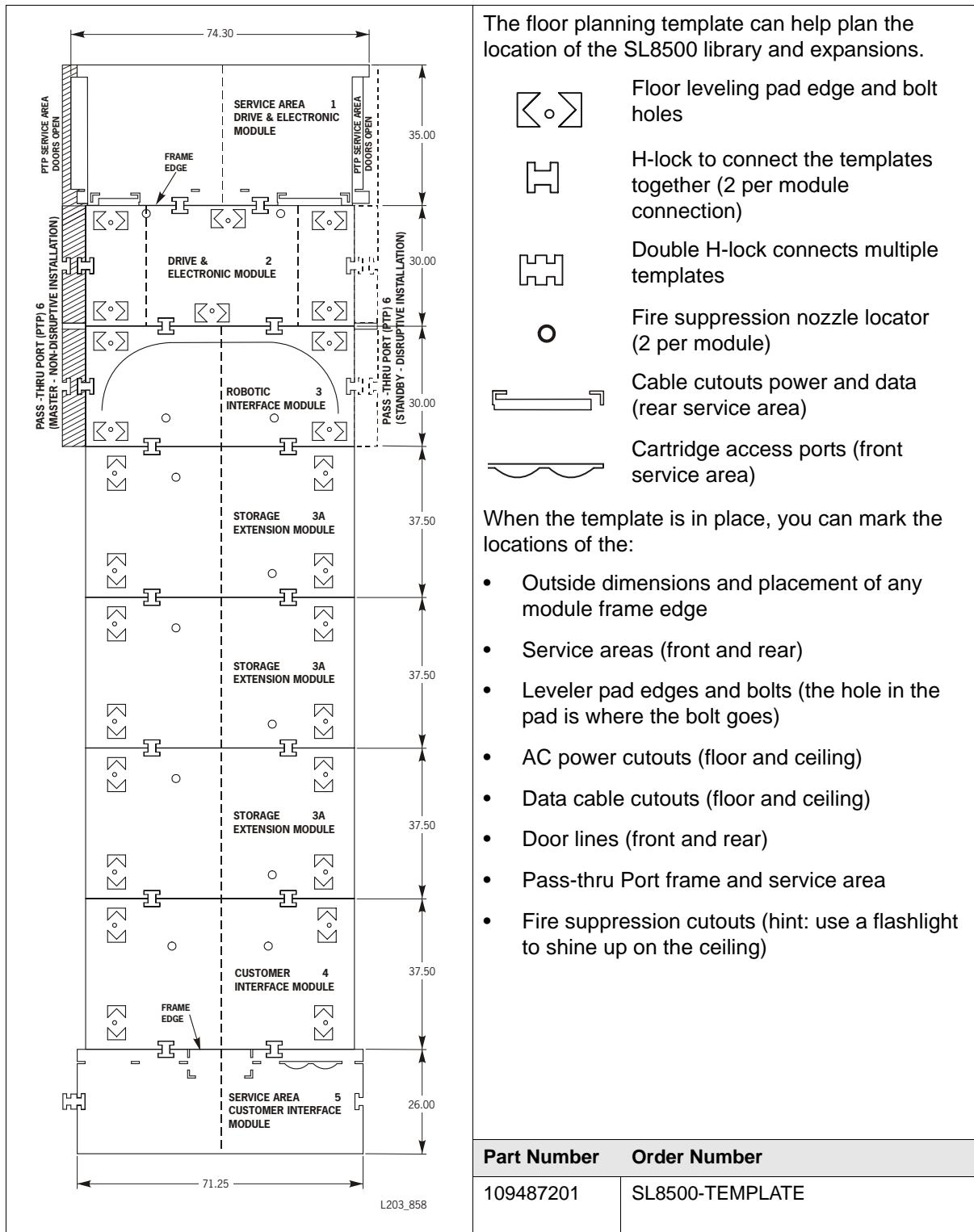


**Figure 26. Terminal Block**



# Floor Template

Figure 27. Floor Planning Template



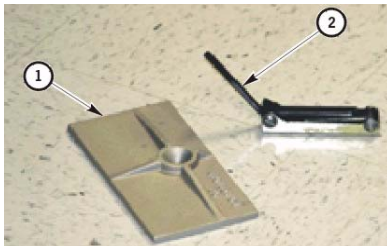
## ■ Floor Requirements



A *Floor Template* is available to help with planning. This template is an actual size, multi-module design made of corrugated plastic—order part number 109487201.

Depending on the number of modules, tape drives, and tape cartridges, the weight of the library can vary. See [Table 37 on page 78](#) for more information. *Make sure the customer's floor will support this weight.*

Additionally, if the equipment must be transported on elevators, the elevator cars must be capable of safely handling the weight. See ["Shipping Weights and Dimensions" on page 101](#) for more information.

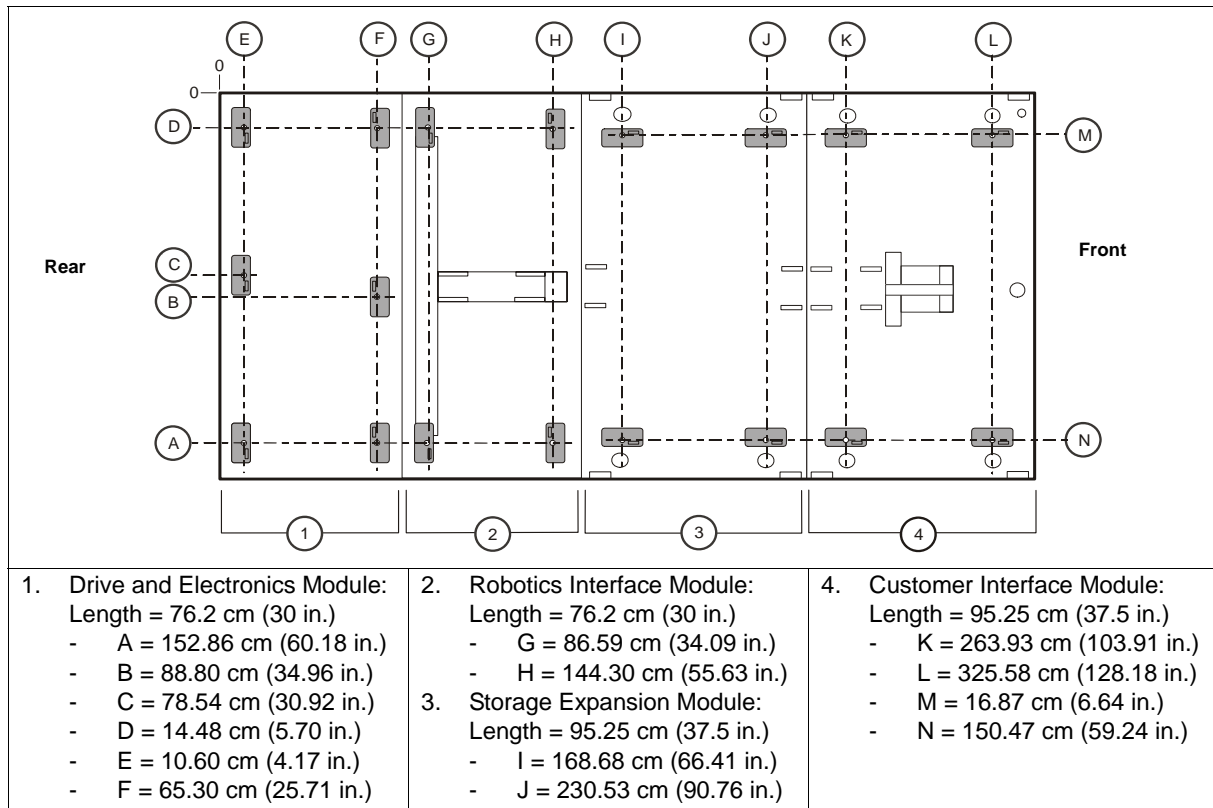


The customer's floor must be capable of supporting 454 kg (1,000 lb) per *each* weight distribution pad. These pads measure 4 inches by 8 inches. The weight represents the modules, plus a *factor of safety* to accommodate torque values, installation procedures, and component variances.)

- (1) Weight distribution pad
- (2) 1/4-in. Allen wrench for height adjustment bolts

[Figure 28](#) shows the weight distribution pad placements for the various modules. **Important:** Notice the placement and direction of the pads.

**Figure 28. Weight Distribution Pad Locations** (Viewed from the top of the library)



## Co-planar Requirements

**Important:**

This is perhaps the most important concept that you must understand or you will experience frame damage, premature wear, and targeting errors.

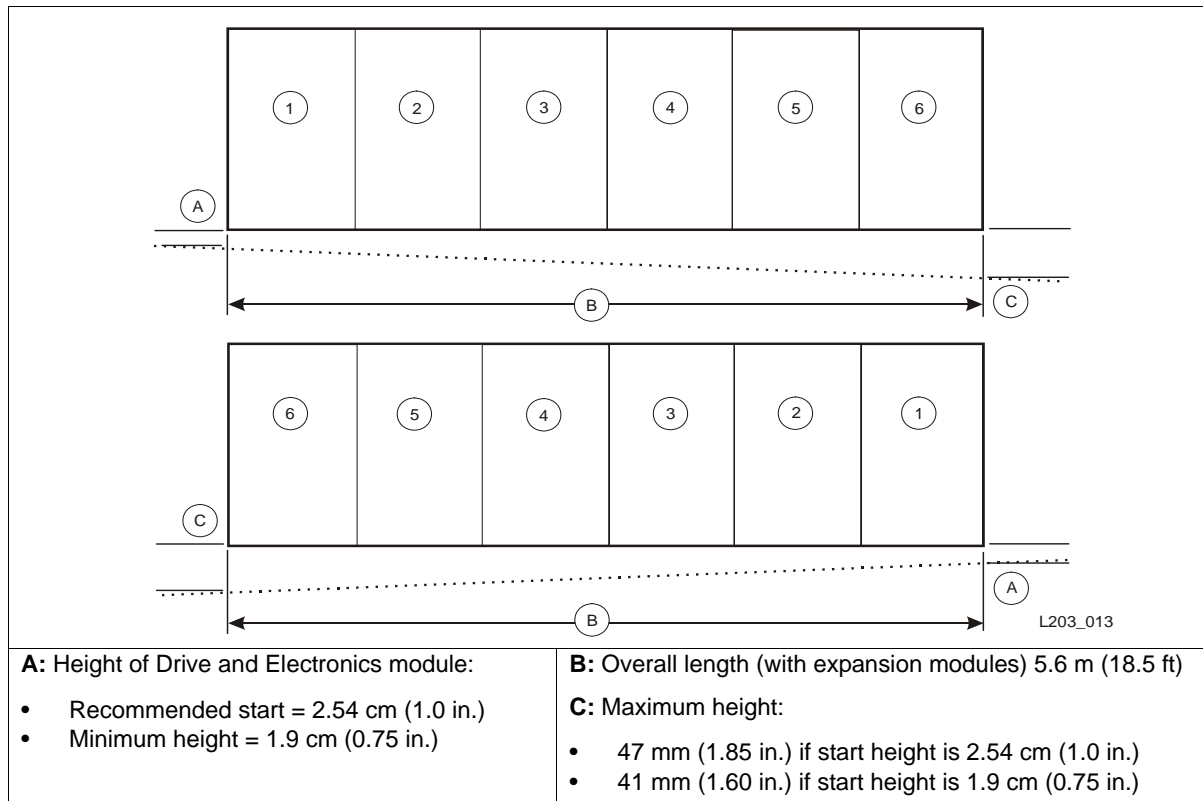
- StorageTek *requires* that the customer’s floor be laser-leveled *before* receiving any equipment.
- StorageTek *requires* that the library modules be *level* across the width (from left to right) and installed on the same horizontal plane to within  $\pm 25$  mm (1 in.) tolerance.

**Note:** For future library complex expansion, you should check the entire floor adjacent to the library for pass-thru port operations or in front of the library for storage expansion modules.

Because the HandBots travel along rails, the library must be adjusted for the rails to be on the same plane (co-planar). Some customer floors may contain *slight* slopes in them (despite the laser leveling requirement) and these variations must be taken into account. These variations *cannot exceed* 28 mm  $\pm 0.8$  mm (1.1 in.  $\pm 0.0325$  in.) throughout the length of the library.

Figure 29 illustrates the maximum *floor-to-module distance* variation, over a distance of 5.6 m (18.5 ft).

**Figure 29. Co-planar – Floor Slope Diagram**





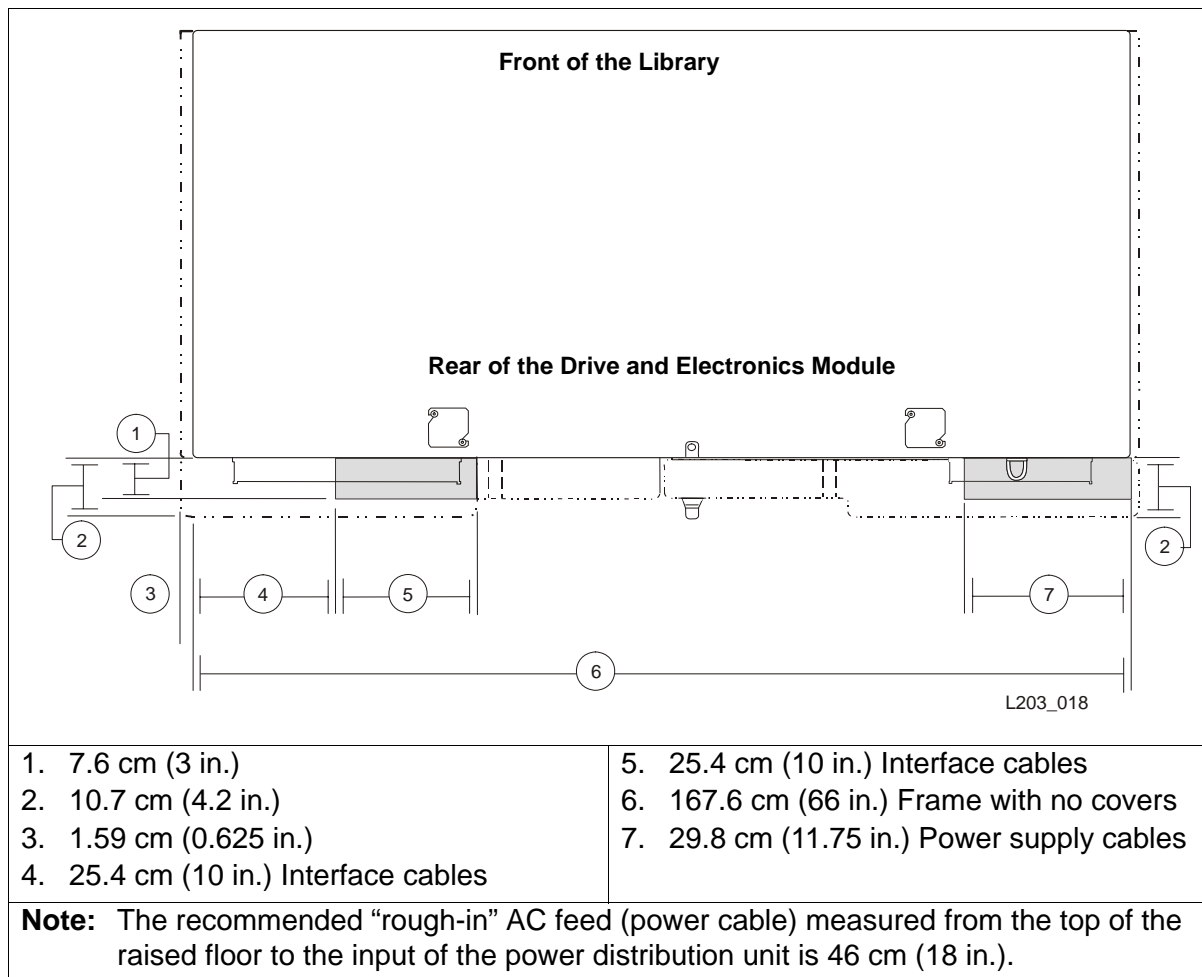
## Floor Cutouts

Floor cutouts for cable routing must be supplied for the library. Cables include:

- Power cables
- Ethernet cables
- Interface cables

Figure 30 shows an example with dimension for the floor cutouts which are placed near the two, rear corners of the Drive and Electronics Module.

**Figure 30. Floor Cutouts for Power and Signal Cables**



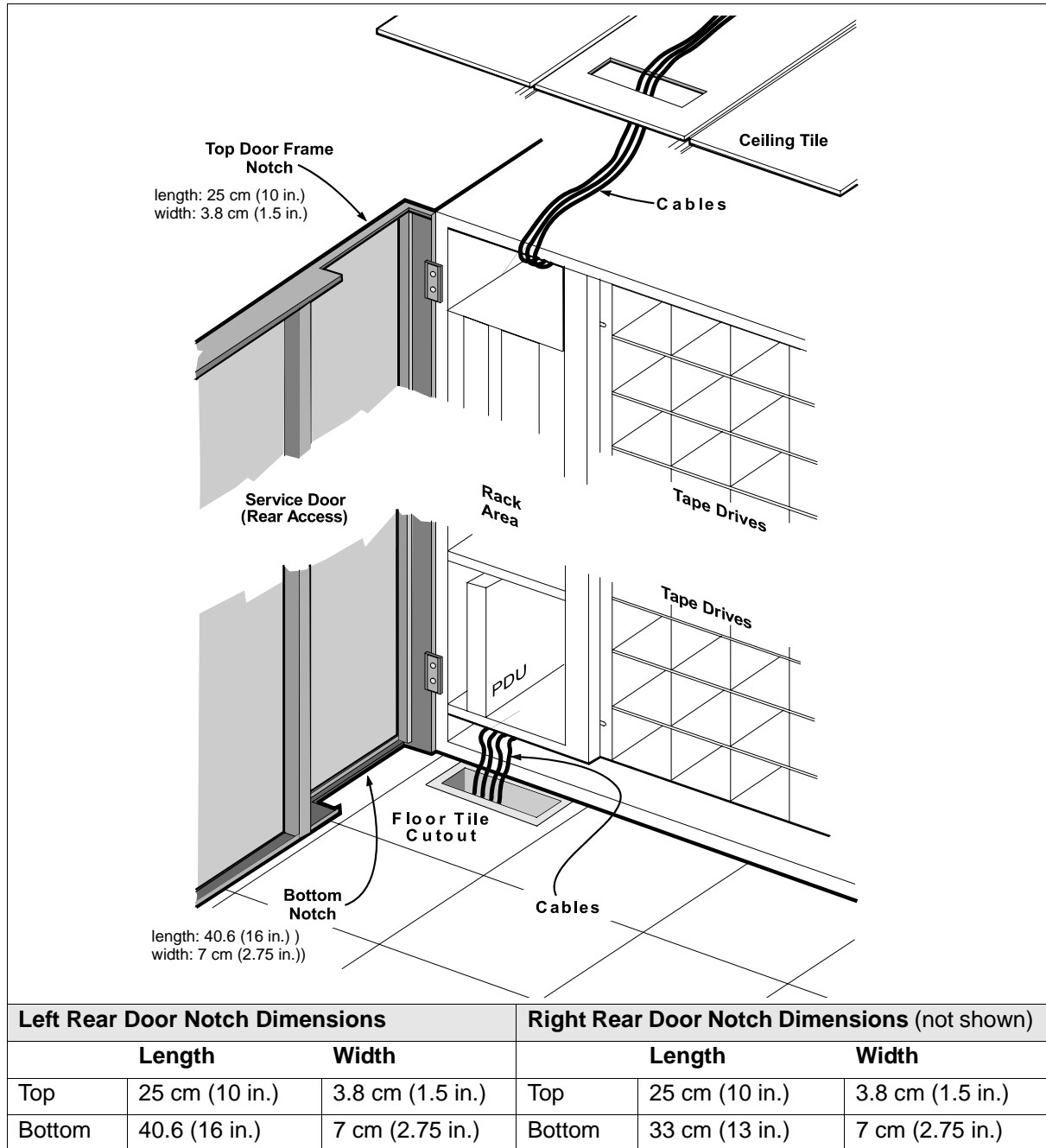
**Note:** You can also route cables from the ceiling.  
See “Cable Routing” on page 88.

## Cable Routing

The library door has four notches for routing interface cables into the rack area and power cables to the Base and 2N PDUs. Two in each left and right door door on the top and bottom.

Figure 31 shows an example of cable routing using interface cables. This figure also provides a good example for floor tile cutouts for the cables.

**Figure 31. Cabling Routing**



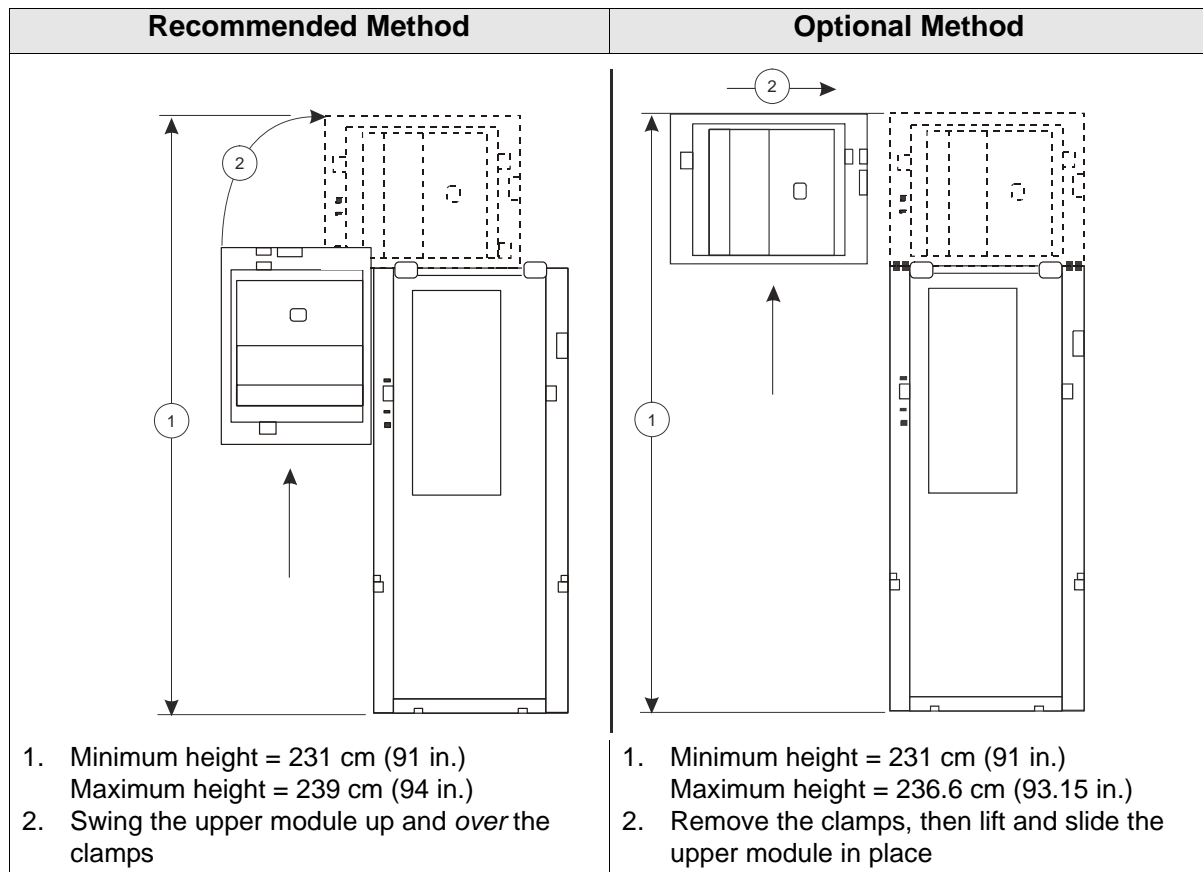
## Ceiling Requirements

Figure 32 shows the upper sections of the Drive and Electronics Module and the Robotics Interface Module. These modules must be installed on top of the lower modules. To install the upper modules:

- The recommended method is to *hang* the modules on the clamps then *swing* the upper modules into place. This method requires at least 239 cm (94 in.) of floor-to-ceiling clearance.
- The optional method is to remove the clamps (for clearance), *lift* the upper modules up and *slide* them over the lower modules. This requires *four* people to accomplish (one person on each corner).

**Caution:** *Overhead hazard:* Make sure that sprinkler heads, sensors, and other equipment that may hang from the ceiling are not interfered with when you install the upper modules.

Figure 32. Upper Module Installation



## Height Adjustments

Figure 33 shows the minimum and maximum library height specifications:

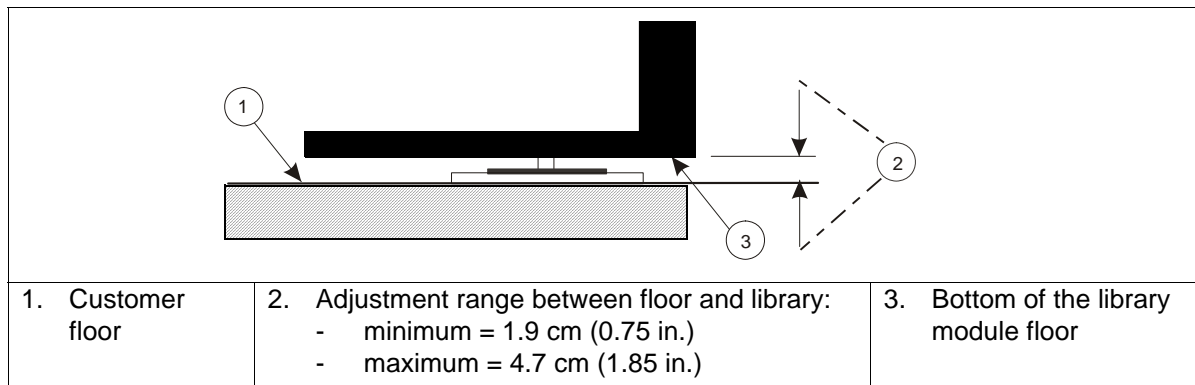
- Minimum height = 231.4 cm (91 in.)
- Maximum height = 236.6 cm (93.15 in.)

On a level floor, the first module's height, between the module and floor, should be adjusted to 25.4 mm ± 0.8 mm (1 in. ± 0.0325 in.).

The absolute minimum module-to-floor height permitted is 19 mm (0.75 in.).

Following these guidelines allows you to adjust the library to meet the “Co-planar Requirements” on page 86.

**Figure 33. Minimum and Maximum Height Specifications**



## Clearances

Table 45 lists the clearances—library to ceiling—required to install side covers, front and rear doors, and the upper modules.

**Table 45. Overhead Clearances**

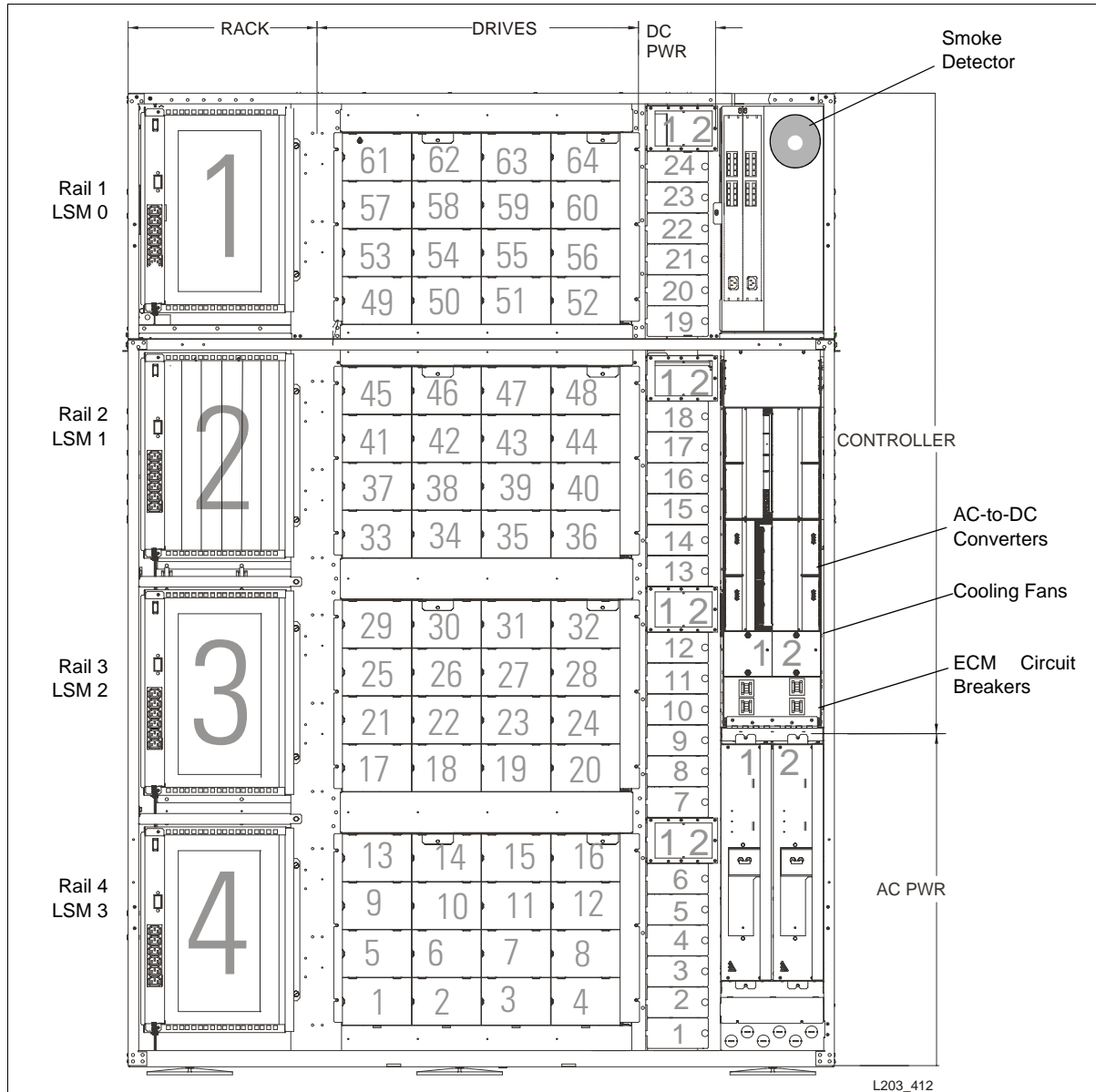
Overhead Clearance	Description
1.9 cm (0.75 in.)	Side cover installation
1.3 cm (0.5 in.)	Upper robotics interface module installation
2.5 cm (1 in.)	Facade installation Hanging the front and rear doors on the hinges Upper drive and electronics module installation
4.5 cm (1.75 in.)	Customer interface module roof installation Storage expansion module roof installation

To calculate maximum height and installation clearances, use the library height range and add the overhead clearance. *For example:* The library is 236.6 cm (93.15 in.) plus the maximum space required for roof installation is 4.5 cm (1.75 in.), so the maximum height—floor to ceiling—is 241 cm (95 in.) *worst case.*

## ■ Drive and Electronics Module Planning

Figure 34 shows the location of components at the rear of the library (the Drive and Electronics Module).

**Figure 34. Drive and Electronics Module Planning**

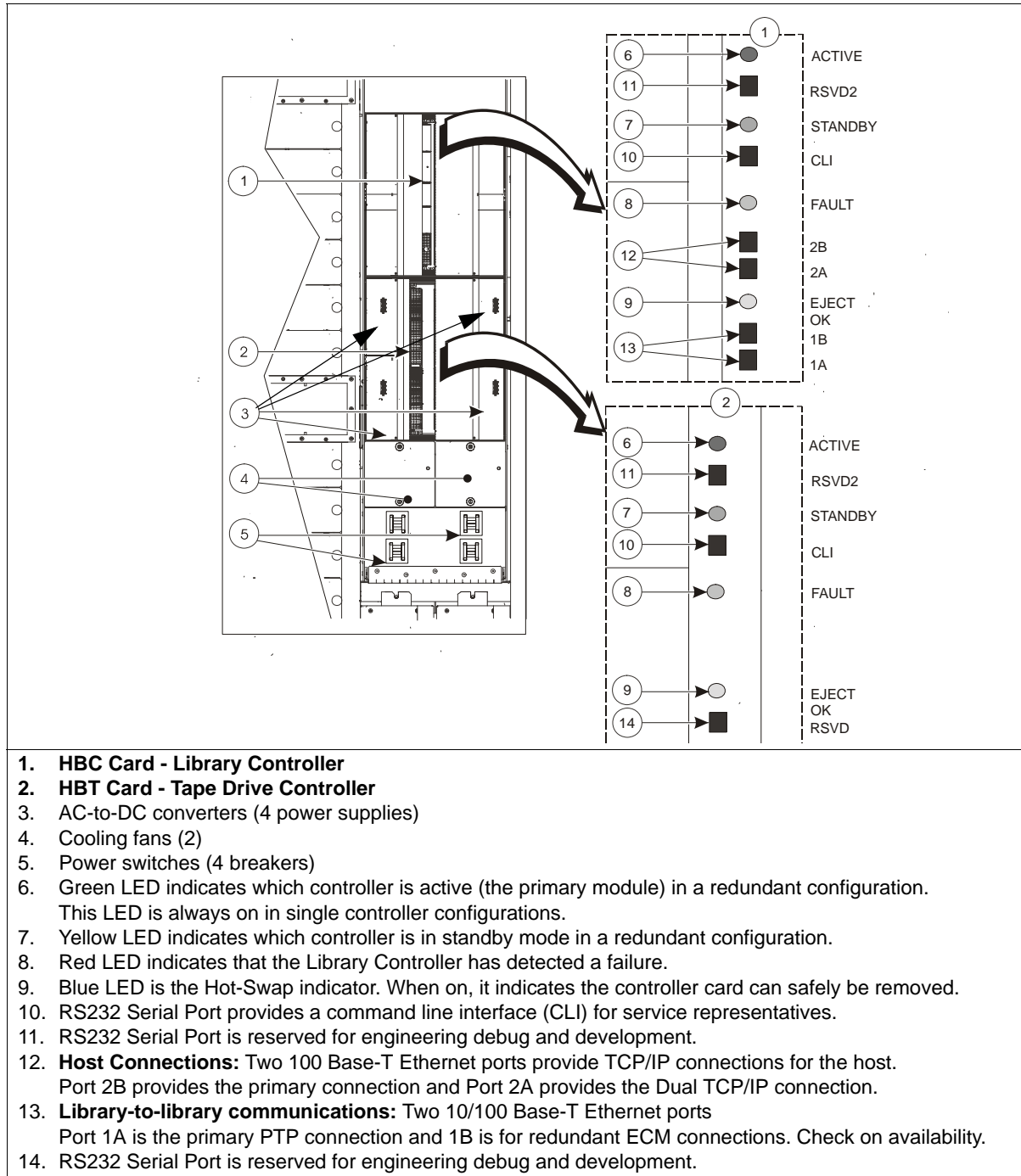


Rack modules 1 to 4	Tape Drives 1 to 64	DC power supplies	AC Power 1 and 2
Racks 2 and 4 get power from PDU 1 Racks 1 and 3 get power from PDU 2 (2N required)	Each rail has 16 drives Each rail is an LSM	Minimum (required) DCPS slots are:   - 1, 2, and 3 for drives - 6 and 17 for the HandBots	1 = Primary PDU 2 = N+1 or 2N PDU  <b>ECM 1 and 2</b> 1 = Primary 2 = Redundant

## Electronic Module Planning

Figure 35 shows the electronics control module (ECM) which resides in a card cage in the rear of the library. The ECM is split into two parts and can hold two independent and redundant card sets and four AC-to-DC converters.

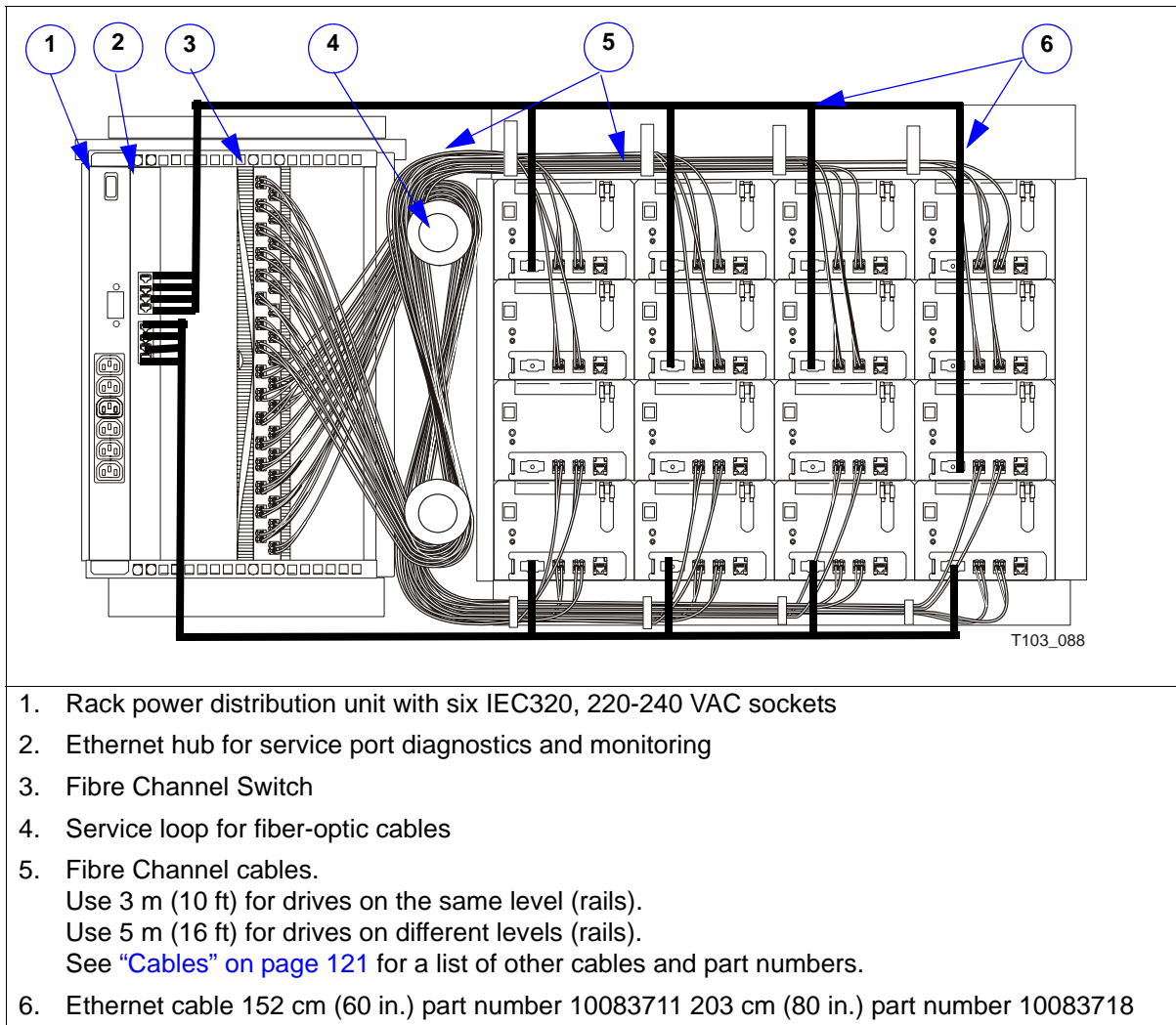
Figure 35. Electronic Control Module



## Tape Drive Cable Planning

By consolidating network components in the SL8500 rack areas, cabling and establishing a storage area network (SAN) is less difficult. [Figure 36](#) shows network components (Fibre Channel switches and Ethernet hubs) in the rack space of the SL8500 library with 16 tape drives.

**Figure 36. Cabling Tape Drives** (Example, figure is not exact)



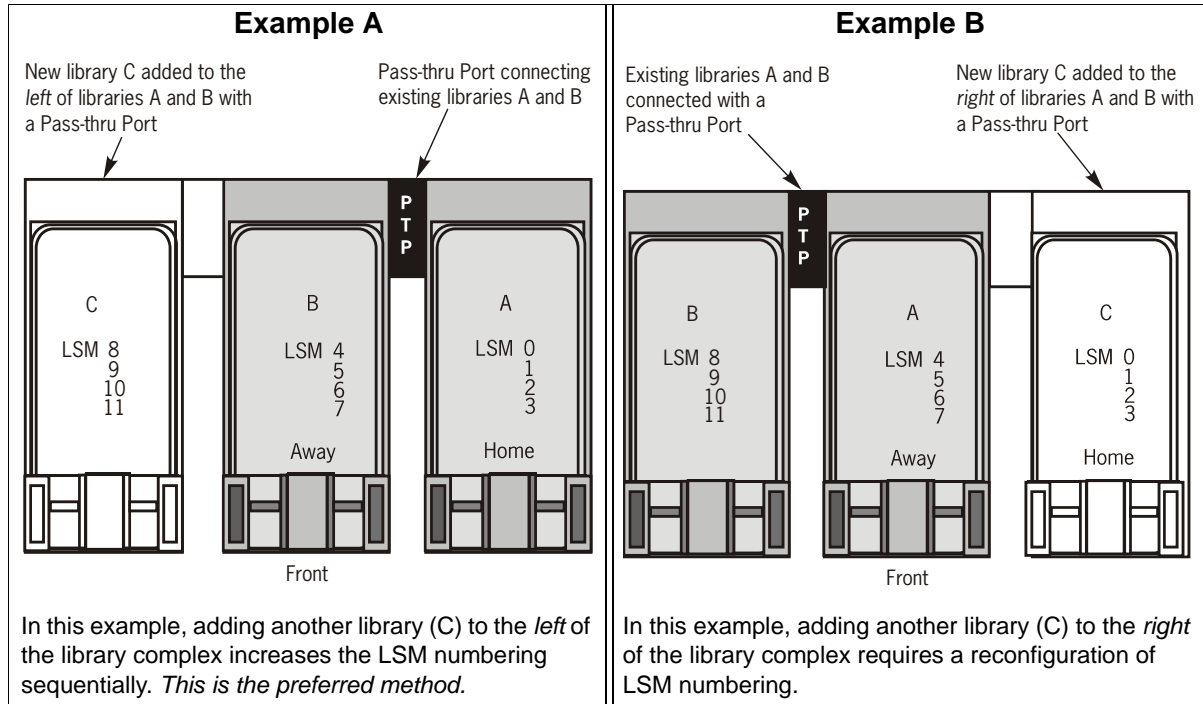
### Remember:

- Every tape drive needs an interface cable
- Not all tape drives require an Ethernet cable
- When ordering cables, plan for 1–2 m (3–7 ft) of slack cable for routing
- Make sure you have the correct tape drive and cartridge tape associated for every LSM in the library to support mixed media Any Cartridge Any Time

## ■ Pass-thru Port Planning

Figure 37 shows two examples of three libraries connected with PTPs. Example A shows the LSM numbering as you add libraries to the left. Example B shows the LSM numbering as you add libraries to the right.

**Figure 37. Pass-thru Port Planning Example**



### Important:

For non-disruptive growth, the preferred method is to add libraries from **right to left**. However, the library can grow in the other direction—from *left to right*—but this requires a disruption to re-configure the system, re-number the LSMs, and re-IPL the library.

To implement the pass-thru port feature, you must have:

- Accessory racks: 1 rack (required) 2 racks for power redundancy
- Inter-library Communications kit (PN 314842401)
- PTP conversion bill and instructions
- Software upgrade and reconfiguration

Make sure these are at the following levels or higher.

- Library firmware: FRS\_1.70 (3.70.00) or higher—current is FRS\_2.52
- StreamLine Library Console: FRS\_2.00 (such as 2.16)
- ACSLS: 7.1 plus PUT0501 for Near Continuous Operation
- HSC: 6.0 plus PTFs (minimum) or HSC: 6.1 which added Near Continuous Operation (NCO).

See the *Pass-thru Port Technical Brief (TT0007x)* for more information.



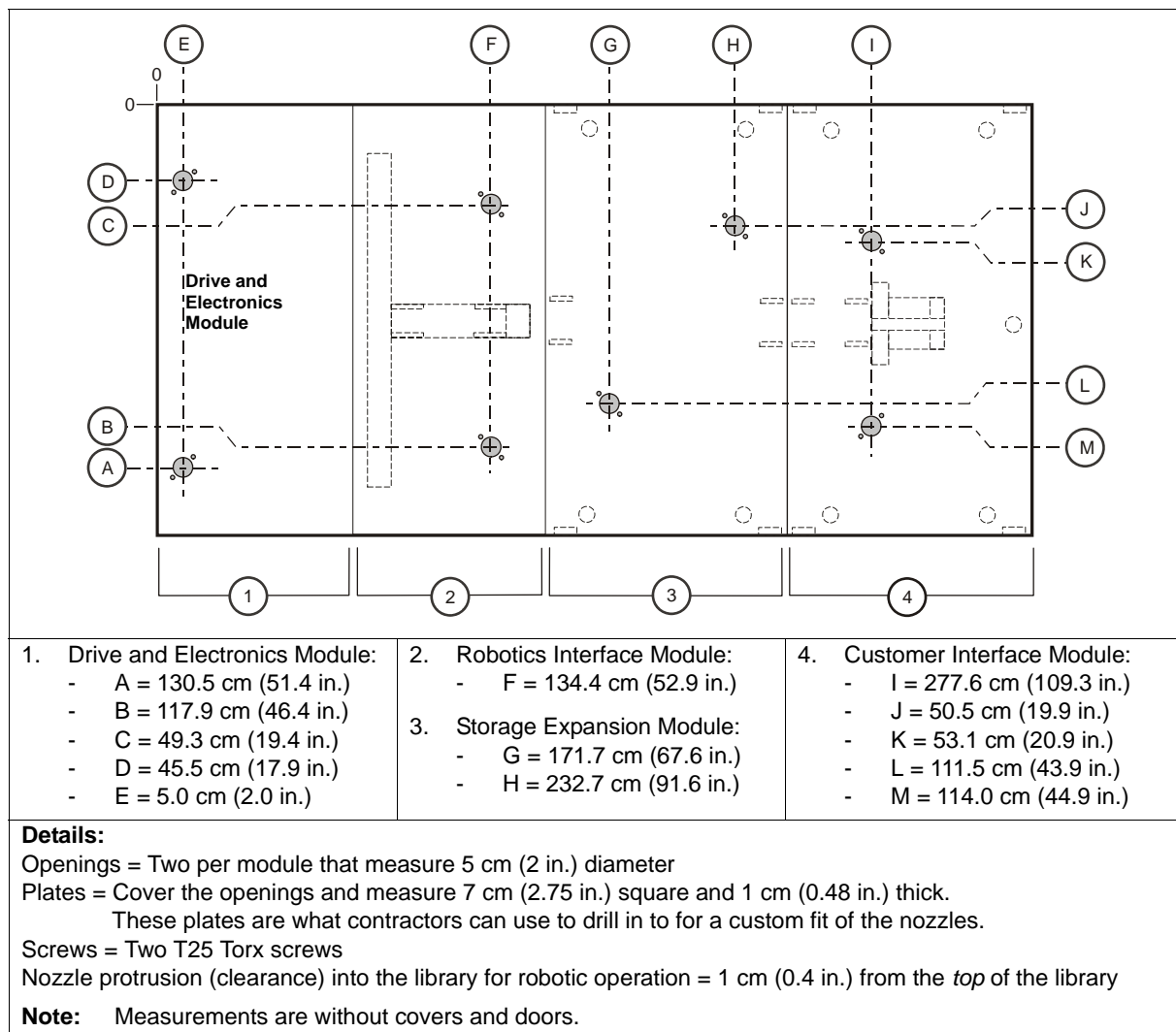
## ■ Fire Suppression Planning

The library does *not* ship with a Fire Suppression System installed, although features have been incorporated into the library to allow for one.

Professional Services offers fire suppression systems which are installed on site. Visit the Professional Services Web site for more information about these services or contact your local Professional Services representative (names are also listed on this Web site).

Figure 38 shows the accesses for fire suppression planning.

**Figure 38. Fire Suppression Ceiling Access** (Viewed from the top of the library)



As a standard safety feature, the library comes equipped with photo-electric smoke detectors that *removes all power from the library* if smoke is detected in and around the library. Power is restored to the library by resetting the AC circuit breakers on the power distribution units.

## ■ Obtaining a Password

The StreamLine Library Console security system (interface with the library) *requires activation* of the site user accounts with a password.

Sun StorageTek representatives (such as installation coordinator, installer, service representative) must obtain a password before any configuration of the library is possible.

To save time, obtain this password *before* beginning the installation.

*Before requesting an activation password:*

- The requestor must have attended the SL8500 training (including training updates and Webinars) and passed all applicable tests.
- The requestor *must* have a valid User ID and password to access the Customer Resource Center (CRC).
- The CRC User ID must be authorized to use the Activation Password application accessible through the CRC.

**Note:** Contact Global Services if you are not able to access the Activation Password application.

Directions for use of the password are supplied in the *StreamLine SL8500 Modular Library System Installation Manual*, PN 96138.



**Important:** Be aware that the Customer Resource Center (CRC) Web site is being migrated into the Sun Microsystems Web structure.

Visit: <http://sunsolve.sun.com> for more information.

## ■ Installing StreamLine Library Console

StreamLine Library Console is a software application that provides all of the functions to test, monitor, and operate the library. You should also obtain and activate this software before installing the library.

StreamLine Library Console is contained on a compact disk (PN 3139995xx). This software is loaded first to your personal computer, then customers must also load this on to their remote personal computer.

Some notes about installing the StreamLine Library Console software:

- For Windows, if the CD does not auto-start, go to the Windows START Menu. Select Run. Then type: `D:\SLConsoleWindows` (where "D" is the letter for your CD-ROM drive). Click OK.
- For Solaris, type `/cdrom/cdrom0/SLConsoleSolaris.bin` and follow the installer instructions.

When downloading the application, make sure to select the remote option.

## ■ Remote Support

Service and support representatives are available to assist **you** and the customer with hardware and software problem resolution.

During the initial order and installation planning, make sure that you inform the customer about the local and remote support options.

## Service Delivery Platform

The Service Delivery Platform (SDP) is a remote support solution for the SL8500 library. The SDP consists of a smart appliance placed at the customer site that connects to the library plus to any StorageTek T-Series tape drives.

If the customer wants remote support as part of the SL8500 library installation, the SDP Systems Assurance Guide needs to be completed.

Visit:

- <https://onestopwiki.sfbay/index> and
- [https://onestopwiki.sfbay/index.php?title=SDP\\_Support\\_Tools](https://onestopwiki.sfbay/index.php?title=SDP_Support_Tools).

This configurator assists you with:

- Creating a Bill of Materials (BOM) that is required for the SDP installation
- Provides you with a link to Software Manufacturing and Distribution
- Lists instructions for locating the SDP Software Kit

Ask your local logistics personnel to order the parts using SAP or ACES.

---

Does the customer want remote support?	Yes <input type="checkbox"/>	No <input type="checkbox"/>
Has the SDP appliance been ordered?	Yes <input type="checkbox"/>	No <input type="checkbox"/>
Has the SDP Systems Assurance Guide been completed?	Yes <input type="checkbox"/>	No <input type="checkbox"/>

---

Refer to the Site Preparation Kit or Web site.

## Sun Microsystems Technical Excellence Center

Customer initiated maintenance begins with a telephone call from you to Sun Microsystems and the Technical Excellence Center (TEC).

You will receive immediate attention from qualified personnel.

To contact the TEC, call:

**800.525.0369** (inside the United States)

**303.673.2778** (outside the United States)

## ■ Preparing for the Installation

The SL8500 library requires extensive site preparation to accomplish an error-free installation. Considerations that you and the customer must make before the equipment arrives are outlined in the following sections.

### Personnel



**Warning:** *Weight of the upper modules:* You need to lift the upper drive bay and robotic rail modules. These modules weigh approximately 40 kg (85 lb) and are raised a height of 1.7 m (5.5 ft).

The estimated time to physically install a library is about 24 person/hours. This is based on *three qualified people working approximately eight hours.*

**Note:** For initial planning, you may want to estimate it as two days to completely install the library. This allows plenty of time to ensure a quality installation and allow for training.

To make the best use of personnel, multiple tasks should be done simultaneously. Time factors to consider include:

- Guiding the pallets from the dock to the computer room
- Removing packaging material when floor space is limited
- Lifting requirements of 40 kg (85 lb) to attach upper frame assemblies
- Configuring the library and up to 64 drives with switches and cables

Installation tips for these situations are supplied in the *Installation Manual.*

### Power

Keep in mind the following power considerations:

1. A *qualified electrician* is required to install the power cable and must:
  - Use flexible or rigid conduit
  - Adhere to the torque specifications; *2 Nm (18 in-lb) torque*
  - Attach a 90-degree elbow-down fitting to the library's PDU or there will be problems attaching the cover and closing the rear door

Make sure time has been scheduled and coordinated with the electrician.

2. Remember that there are two power configurations and four branch circuit options from which the customer can choose.

*Make sure* the correct configuration and branch circuit is selected.

3. Plan the location for the second set of power wiring even if the customer is not purchasing the redundant power feature.

Make sure each power source is on a separate branch circuit; otherwise the redundant power feature is defeated (for 2N power configurations).

## Floor

Several requirements exist for the customer's *floor*:

### Raised Floor

The SL8500 library does not require a raised floor. The primary concern is that the environmental requirements are met. As long as there is adequate airflow and environmental specifications are met, a raised floor is not required.

### Weight

The weight of the library can vary depending on the configuration and number of modules (see [Table 37 on page 78](#) for the listed weights). Make sure the customer's floor has been checked to verify that it will support this weight.

### Co-planar

StorageTek recommends that the customer's floor be laser-leveled prior to receiving any equipment and that the library modules be situated along the same horizontal plane (co-planar<sup>1</sup>) to within  $\pm 25$  mm (1 in.) tolerance.

Co-planer positioning of the library modules is extremely important, because up to six modules may be joined together linearly. If you are not within a 25 mm (1 in.) height condition between the first and second module, this will result in a 152 mm (6 in.) condition at the last module. Out-of-plane conditions will cause binding, premature wear, and damage to the HandBots.

### Construction Area

The minimum working area (not including the space required for the pallets) is approximately 56 m<sup>2</sup> (600 ft<sup>2</sup>).

## Installation Tools

[Table 46](#) lists the tools available in the installation kit (part 24100250) that may be ordered through StorageTek Logistics (if one is *not* available locally).

#### Notes:

- These tools are *not* supplied with each library.
- You should always order the kit instead of ordering the tools separately.
- Separate tool orders are *only* for replacing damaged or missing tools.
- Once used, retain the kit for re-use locally or ship within your region.
- Kit dimensions are: 99 cm (39 in.) long, 71 cm (28 in.) wide, and 51 cm (20 in.) high. The kit comes with an extendable handle and wheels.
- Make sure you order any *additional items* (see the following page)

---

1. Lying or acting in the same plane.

**Table 46. Installation Tools**

<b>Description</b>	<b>StorageTek Part Number</b>
Copper rail connector extraction tool	313921001
Frame jacks with handles (adjustable jack)	313880803
Pawl adjustment tool	314801802
Tool bag	24100254
Torx screwdriver and bits	4850
3/8-in. drive ratchet wrench	3010420130
6 in. extension for 3/8-in. drive ratchet	3010420624
3/4-in. socket for 3/8-in. drive ratchet	24100036
3/8-in. socket for 3/8-in. drive ratchet	24100251
9/16 in. socket for 3/8-in. drive ratchet	3010420467
1/4-in. hex (Allen) on 3/8-in. drive	3010420645
5/16-in. hex (Allen) on 3/8-in. drive	3010420646
3/4-in. combination open end/box end wrench	3010420417
5/8-in. combination open end/box end wrench	24100253
9/16-in. combination open end/box end wrench	3010420476
25 ft tape measure	3010420629
2 ft level	24100252
Utility knife	24100045
Safety glasses	4803
Wire side cutters	24100041
Rubber mallet	3010420627

In addition, these other items may be required:

- Serial cable for laptop (PN 24100134)
- Crossover cable for laptop (PN 24100163)
- *Rack hardware kit* (PN 314837601)
- *Laptop shelf* (PN 313981201)
- *Block kit assembly* (PN 314828101)
- *Tape drive power kit* (PN 314831201)
- *Floor planning template* (PN 109487201)
- Flashlight
- Step stool
- Safety glasses
- Work gloves
- Volt/Ohmmeter
- Optional power drill for tightening nuts and screws

## ■ Shipping Weights and Dimensions

The SL8500 library is delivered on pallets that can measure up to 2.4 m (8 ft) in length and weigh up to 491 kg (1082 lb). Make sure the customer has forklifts or pallet jacks that can handle these pallets. If moving between floors, make sure the customer has an elevator that can operate with these loads.

**Note:** The values listed are estimates and subject to change. Fractions are rounded up to the next whole number. Examples: 13.25 is rounded up to 14 or 23.68 is rounded up to 24.

- [Table 47](#) lists the individual pallet size and weights
- [Table 48](#) lists the total weight of the pallets for a library configuration
- [Table 49](#) lists weights dimensions for additional components

**Table 47. Shipping Pallets – Weights and Dimensions**

Pallet	Description	Weight	Dimensions		
			Height	Width	Length
1	Lower Drive & Electronics Module	491 kg (1082 lb)	196 cm (77 in.)	92 cm (36 in.)	185 cm (73 in.)
2*	Upper Drive & Electronics Module	114 kg (250 lb)	76 cm (30 in.)	92 cm (36 in.)	185 cm (73 in.)
2/4*	Upper Modules	201 kg (443 lb)	137 cm (54 in.)	92 cm (36 in.)	185 cm (73 in.)
3	Lower Robotics Interface Module	241 kg (532 lb)	196 cm (77 in.)	92 cm (36 in.)	185 cm (73 in.)
4*	Upper Robotics Interface Module	91 kg (200 lb)	76 cm (30 in.)	92 cm (36 in.)	185 cm (73 in.)
4a	Storage Expansion Module	327 kg (720 lb)	122 cm (48 in.)	102 cm (40 in.)	246 cm (97 in.)
5	Customer Interface Module	319 kg (703 lb)	122 cm (48 in.)	82 cm (32 in.)	246 cm (97 in.)
6	Z-frame	145 kg (320 lb)	76 cm (30 in.)	64 cm (25 in.)	246 cm (97 in.)
7	Basic library rails	100 kg (220 lb)	33 cm (13 in.)	112 cm (44 in.)	125 cm (49 in.)
7a	Rails 1st expansion module	182 kg (400 lb)	33 cm (13 in.)	112 cm (44 in.)	218 cm (86 in.)
7b	Rails 2nd expansion module	272 kg (600 lb)	33 cm (13 in.)	112 cm (44 in.)	315 cm (124 in.)
7c	Rails 3rd expansion module Stacked and re-packed (114 in.)	372 kg (820 lb)	51 cm (20 in.) 51 cm (20 in.)	112 cm (44 in.) 56 cm (22 in.)	315 cm (124 in.) 315 cm (124 in.)
8	Arrays, basic library (16 boxes)	160 kg (350 lb)	122 cm (48 in.)	115 cm (45 in.)	153 cm (60 in.)
8a	Arrays, expan. mods. (16 boxes)	182 kg (400 lb)	122 cm (48 in.)	115 cm (45 in.)	153 cm (60 in.)
9	Covers and Doors (painted)	356 kg (785 lb)	122 cm (48 in.)	110 cm (43 in.)	254 cm (100 in.)
9c	Covers and Doors with CAP	356 kg (850 lb)	137 cm (54 in.)	110 cm (43 in.)	254 cm (100 in.)
10	4x Robotics (4 boxes)	57 kg (124 lb)	63.5 cm (25 in.)	100 cm (39 in.)	82 cm (60 in.)
10	8x Robotics (8 boxes)	102 kg (224 lb)	115 cm (45 in.)	100 cm (39 in.)	82 cm (60 in.)
–	CAP	22 kg (48 lb)	36 cm (14 in.)	38 cm (15 in.)	229 cm (90 in.)
* When both upper modules are shipped together, labels 2 and 4 are applied to the same pallet = 201 kg (443 lb).					

**Table 48. Total Pallet Weights for a Selected Library Configuration**

Library Configuration	Pallets Needed / Shipped	Total Weight
Basic Library	1, 2, 3, 4, 5, 6, 7, 8, 9, 10	2135 kg (4,716 lb)
<i>Plus First Expansion Module</i>	1, 2, 3, 4, 4a, 5, 6, 7a, 8, 8a, 9, 10	2724 kg (6,016 lb)
<i>Plus Second Expansion Module</i>	1, 2, 3, 4, 4a (x2), 5, 6, 7b, 8, 8a (x2), 9, 10	3323 kg (7,336 lb)
<i>Plus Third Expansion Module</i>	1, 2, 3, 4, 4a (x3), 5, 6, 7b, 7c, 8, 8a (x3), 9, 10	3931 kg (8,676 lb)
The weight of one CAP is included in the total weights listed. If ordering the optional CAP, increase the total weight by 22 kg (48 lb). CAPs are shipped in their own container and usually added to pallet 9.		

**Table 49. Component Weights and Dimensions**

Description	Weight	Packaged Dimensions		
		Height	Width	Length
CAP	22 kg (48 lb)	36 cm (14 in.)	38 cm (15 in.)	229 cm (90 in.)
Façade- Upper and Lower Ships with pallet 9	19 kg (40 lb)	13 cm (5 in.)	49 cm (19 in.)	242 cm (95 in.)
Copper Kit for Rails 76 inch Ships with pallet 7A	9 kg (20 lb)	8 cm (3 in.)	44 cm (17 in.)	196 cm (77 in.)
Copper Kit for Rails 114 inch Ships with pallet 7B	12 kg (25 lb)	8 cm (3 in.)	92 cm (36 in.)	178 cm (70 in.)
Copper Kit for Rails +114inch Ships with pallet 7C	14 kg (30 lb)	8 cm (3 in.)	92 cm (36 in.)	178 cm (70 in.)
Drive Bay Ships on a pallet	37 kg (80 lb)	94 cm (36 in.)	59 cm (23 in.)	83 cm (32 in.)
HBS	5 kg (10 lb)	16 cm (6 in.)	26 cm (10 in.)	61 cm (24 in.)
Op Panel/Display	11 kg (23 lb)	31 cm (12 in.)	41 cm (16 in.)	46 cm (18 in.)
PDU	9 kg (19 lb)	28 cm (11 in.)	74 cm (29 in.)	74 cm (29 in.)
PDU N+1	9 kg (19 lb)	21 cm (8 in.)	61 cm (24 in.)	69 cm (27 in.)
Power Supplies	5 kg (10 lb)	23 cm (9 in.)	26 cm (10 in.)	46 cm (18 in.)
Drive Tray - Common SL8500	14 kg (30 lb)	31 cm (12 in.)	33 cm (13 in.)	102 cm (40 in.)
Drive - Common Ships on a pallet	173 kg (380 lb)	107 cm (42 in.)	107 cm (42 in.)	138 cm (54 in.)
LTO Drive on SL8500 Tray	12 kg (26 lb)	31 cm (12 in.)	33 cm (13 in.)	102 cm (40 in.)
9940 Drive on SL8500 Tray	18 kg (38 lb)	31 cm (12 in.)	33 cm (13 in.)	125 cm (49 in.)
9940 Drive- Pallet Load Ships on a pallet	118 kg (260 lb)	107 cm (42 in.)	72 cm (28 in.)	127 cm (50 in.)
Rack Module (19" Rack)	19 kg (40 lb)	64 cm (25 in.)	51 cm (20 in.)	92 cm (36 in.)
Safety Door Ships on a pallet	20 kg (42 lb)	33 cm (13 in.)	66 cm (26 in.)	229 cm (90 in.)

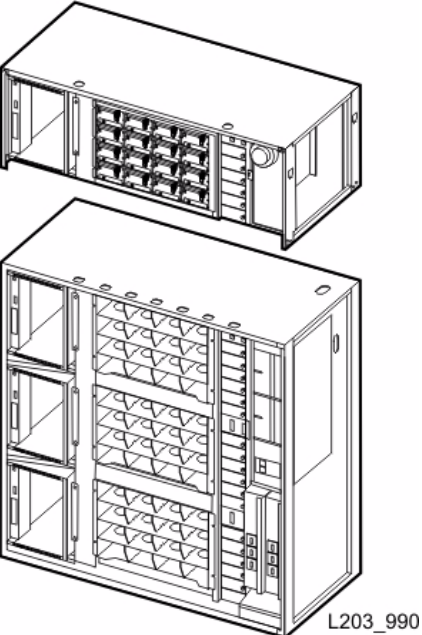
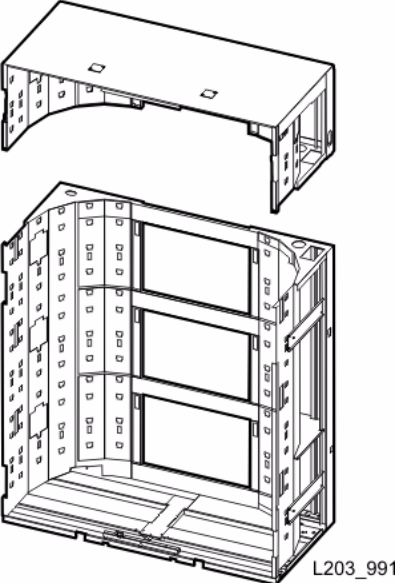


## Moving Unpacked Components

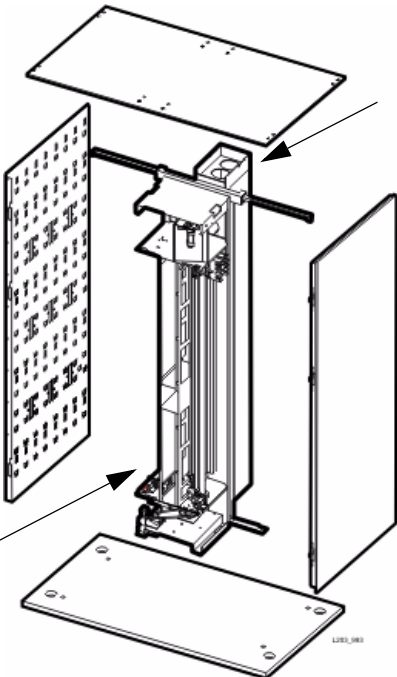
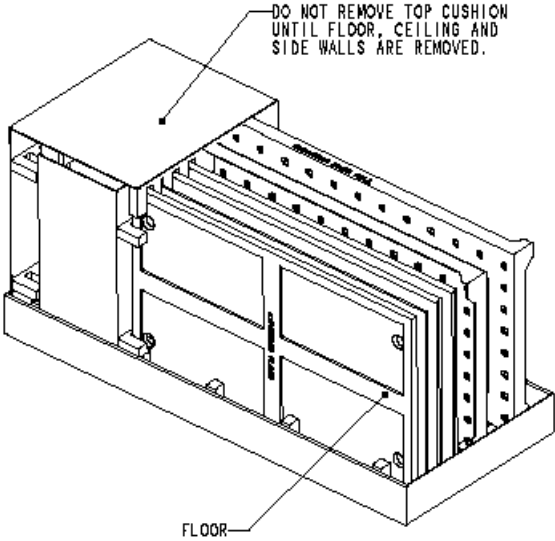
If necessary, you can unpack the library components from the pallets to move them to the installation site. Follow the unpacking instructions on the outside packaging material or installation manual.

Table 50 lists the specifications for the *larger* parts of the library.

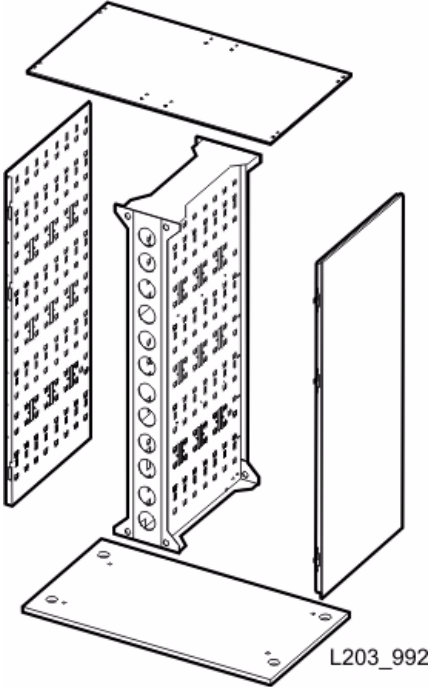
**Table 50. Unpacked Components**

Component	Description
	<p><b>Drive and Electronics Module</b> This module comes in two parts:</p> <p>The upper module specifications are:</p> <ul style="list-style-type: none"> <li>Height: 58.5 cm (23 in.)</li> <li>Width: 168 cm (66 in.)</li> <li>Depth: 76 cm (30 in.)</li> <li>Weight: 37 kg (80 lb)</li> <li>Pallet #: 2</li> </ul> <p><b>Note:</b> Removing the drive bay from the upper module makes it easier to lift and move.</p> <p><b>Caution:</b> The lower module is the heaviest module in the library:</p> <ul style="list-style-type: none"> <li>Height: 173 cm (68 in.)</li> <li>Width: 168 cm (66 in.)</li> <li>Depth: 76 cm (30 in.)</li> <li>Weight: 386 kg (850 lb)</li> <li>Pallet #: 1</li> </ul>
	<p><b>Robotics Interface Module</b> This module comes in two parts:</p> <p>The upper module:</p> <ul style="list-style-type: none"> <li>Height: 54.6 cm (21.5 in.)</li> <li>Width: 168 cm (66 in.)</li> <li>Depth: 76 cm (30 in.)</li> <li>Pallet #: 2</li> </ul> <p>The lower module:</p> <ul style="list-style-type: none"> <li>Height: 176.5 cm (69.5 in.)</li> <li>Width: 168 cm (66 in.)</li> <li>Depth: 76 cm (30 in.)</li> <li>Pallet #: 3</li> </ul> <p><b>Note:</b> Because of the open design of these modules, diagonal stabilizers are attached to help move and handle them.</p>

**Table 50. Unpacked Components**

Component	Description
	<p><b>Customer Interface Module</b> This module is not pre-assembled and must be constructed on-site.</p> <p><u>Customer Module Center Section</u> There are two center sections that must be attached to the floor of this module:</p> <ul style="list-style-type: none"> <li>• A <i>rear</i> section that does <i>not</i> contain components</li> <li>• A <i>front</i> section, called the Z frame, which contains the elevator and turntable assemblies.</li> </ul> <p>The dimensions of the Z frame are:</p> <p>Height: 227.3 cm (89.5 in.) Width: 44.5 cm (17.5 in.) Depth: 51 cm (20 in.) Pallet #: 6</p> <p><b>Caution:</b> The Z frame weighs 77 kg (170 lb).</p> <p><b>Note:</b> Allow 3 m (10 ft) of space at the end of the box or pallet to unpack these components.</p>
	<p><b>Floor:</b> Height: 167.6 cm (66 in.) Width: 94.6 cm (37.25 in.) Depth: 3.8 cm (1.5 in.) Pallet #: 5</p> <p><b>Ceiling (roof):</b> Height: 167 cm (65.75 in.) Width: 95.25 cm (37.5 in.) Depth: 3.8 cm (1.5 in.) Pallet #: 5</p> <p><b>Left and Right Walls:</b> Height: 231 cm (91 in.) Width: 186.7 cm (73.5 in.) Depth: 4.4 cm (1.75 in.) Pallet #: 5</p>

**Table 50. Unpacked Components**

Component	Description
	<p><b>Storage Expansion Module</b>            These modules are <i>not</i> pre-assembled and must be constructed on-site.</p> <p><b>Note:</b> Allow 3 m (10 ft) of space at the end of the box or pallet to unpack these components.</p> <p>Floor:            Height: 167.6 cm (66 in.)            Width: 94.6 cm (37.25 in.)            Depth: 3.8 cm (1.5 in.)            Pallet #: 4</p> <p>Ceiling (roof):            Height: 167 cm (65.75 in.)            Width: 95.25 cm (37.5 in.)            Depth: 3.8 cm (1.5 in.)            Pallet #: 4</p> <p>Center Wall Section            Height: 227.3 cm (89.5 in.)            Width: 44.5 cm (17.5 in.)            Depth: 95.25 cm (37.5 in.)            Pallet #: 4</p> <p>Left and Right Walls:            Height: 231 cm (91 in.)            Width: 186.7 cm (73.5 in.)            Depth: 4.4 cm (1.75 in.)            Pallet #: 4</p>
<p><b>Doors</b>            Pallet #: 9</p> <p>Front:            Height: 231 cm (91 in.)            Width: 61.5 and 66 cm (24.25 and 26 in.)            Depth: 8.25 cm (3.25 in.)</p> <p>Rear access:            Height: 231 cm (91 in.)            Width: 85.7 cm (33.75 in.)            Depth: 10 cm (4 in.)</p> <p><b>Rack assemblies:</b>            Height: 48.26 cm (19 in.)            Width: 33.65/38 cm (13.25/15 in.)            Depth: 72.5 cm (28.5 in.)</p>	<p><b>Rails</b> are composed of five major parts. And depending on the configuration, are the longest parts in the library:</p> <ol style="list-style-type: none"> <li>1. Clamps (installed at the factory)</li> <li>2. Rail extrusions</li> <li>3. Bottom floor extrusion</li> <li>4. Geared tracks</li> <li>5. Power/signal strips</li> </ol> <p>Pallet #: 7 (a, b, or c)</p> <p><u>Extrusion lengths:</u>            1 m (3.3 ft)            2 m (6.4 ft)            3 m (9.5 ft)            3.9 m (12.6 ft)</p>

## Adjustable Jacks

Special jacks (Figure 40) may be needed to assist in unpacking, moving, and positioning the larger modules. This jack is part of the tool kit, which is required for an installation.

See “Installation Tools” on page 99 for a list of tools.

**Figure 39. Adjustable Jack**

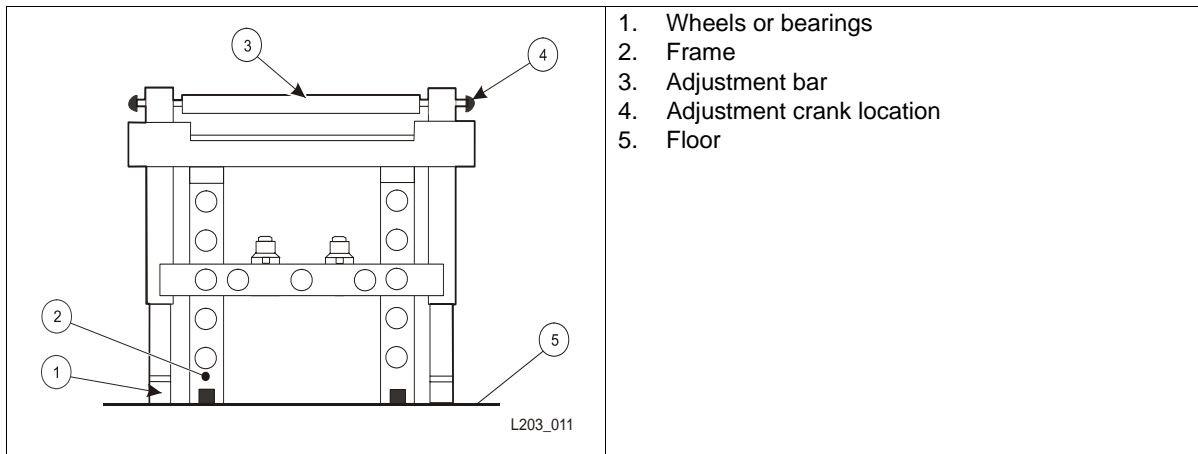
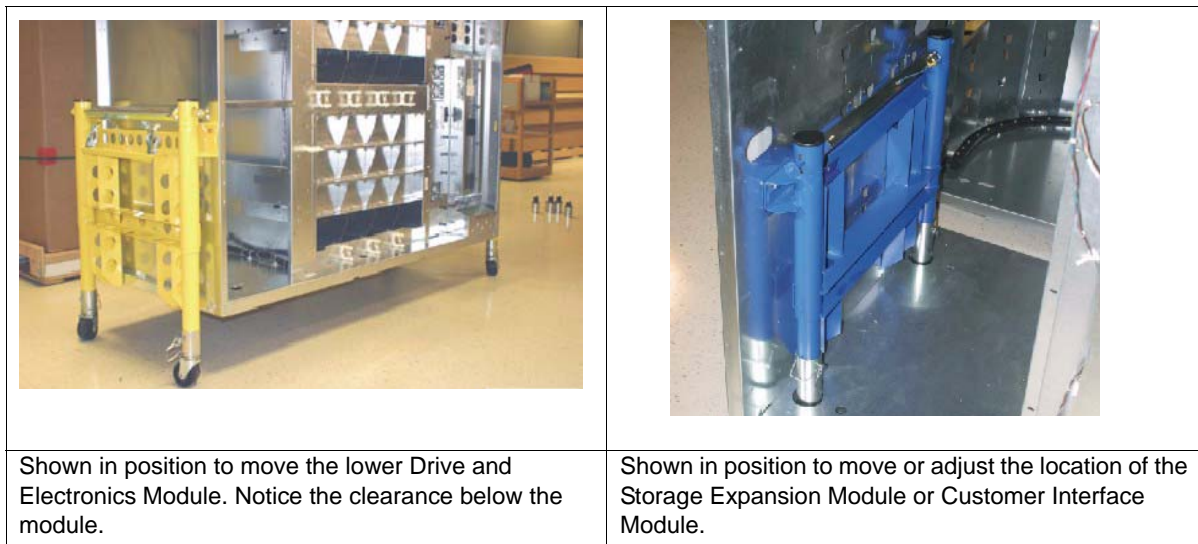


Figure 40 shows two ways to position the adjustable jack.

**Figure 40. Jack Positioning**



## ■ Moving Libraries

Moving an installed library involves extensive work.

Connected library modules can *not* be moved as a unit.

If a library *must be moved*, you must first determine where the library is to be moved. If you need to move the library through a doorway, hallway, or different floor, you must *disassemble* the entire library and re-assemble it.

If the library is to be moved within the room, you must then:

- Disconnect all power and signal cables to the library and drives
- Remove all drives
- Remove all equipment racks
- Remove all arrays and cartridges
- Disconnect all cables between the modules
- Physically separate the modules
- Remove arrays to accommodate inserting the roller assemblies
- Attach roller assemblies to each module to move it to the desired location
- Adjust all modules for co-planar condition
- Re-attach the modules and rails
- Reconnect the library module interconnect cables
- Reconnect all external cables



# Ordering Information

# 5

Use this chapter to help you order the StreamLine SL8500 modular library system, tape drives, media, and external cables.

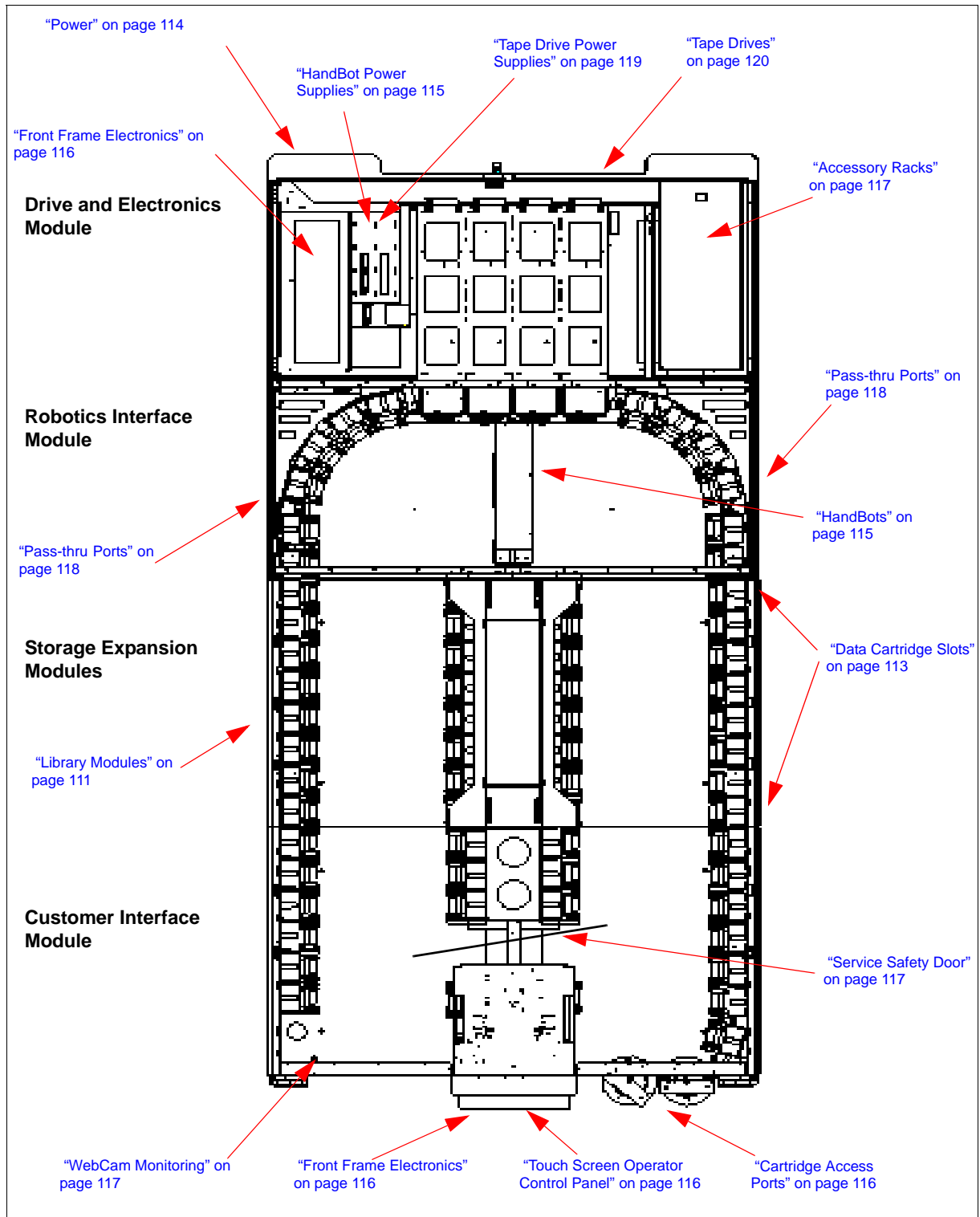
The model number for the SL8500 modular library system is: **SL85-001**, which includes:

**Table 51. Library Configuration and Additional Features**

What the Customer Gets:	Additional Information:
3 Library Modules: <ul style="list-style-type: none"> <li>• Drive &amp; Electronics (DEM)</li> <li>• Robotics Interface (RIM)</li> <li>• Customer Interface (CIM)</li> </ul>	See <a href="#">“Library Modules” on page 111</a> to increase capacity Note: Each storage expansion module adds 1,728 cartridge slots.
1,448 slots (feature L015)	See <a href="#">“Data Cartridge Slots” on page 113</a>
Main AC power distribution ( <i>selectable</i> )	See <a href="#">“Power” on page 114</a>
<i>Robots — none</i> You must select the number of HandBots	See <a href="#">“HandBots” on page 115</a> Also see <a href="#">“HandBot Power Supplies” on page 115</a>
1 Electronics Control Module plus 2 power supplies	See <a href="#">“Front Frame Electronics” on page 116</a>
Front Frame components	See <a href="#">“Front Frame Electronics” on page 116</a>
1 cartridge access port with 39 slots	See <a href="#">“Cartridge Access Ports” on page 116</a>
Optional Features:	<ul style="list-style-type: none"> <li>• <a href="#">“WebCam Monitoring” on page 117</a></li> <li>• <a href="#">“Accessory Racks” on page 117</a></li> <li>• <a href="#">“Accessory Racks” on page 117</a></li> <li>• <a href="#">“Service Safety Door” on page 117</a></li> <li>• <a href="#">“Tape Drive Power Supplies” on page 119</a></li> </ul>
What you might also need to order: <ul style="list-style-type: none"> <li>• Extra CAP magazines</li> <li>• Tape Drives and/or vacancy plates</li> <li>• Media (tape cartridges)</li> <li>• Cables (interface)</li> <li>• Software (ACSLs or HSC)</li> <li>• ACSLS Server</li> <li>• Service Delivery Platform (SDP)</li> </ul>	See <ul style="list-style-type: none"> <li>• <a href="#">“Cartridge Access Ports” on page 116</a></li> <li>• <a href="#">“Tape Drives” on page 120 and Appendix C</a></li> <li>• <a href="#">Appendix D</a></li> <li>• <a href="#">“Cables” on page 121</a></li> <li>• <a href="#">“Software Feature Codes” on page 144</a></li> <li>• <a href="#">“Software Feature Codes” on page 144</a></li> <li>• <a href="#">“Remote Support” on page 97</a></li> </ul>
<p><a href="#">Figure 41 on page 110</a> shows the locations and page numbers of the features for the library.</p>	

## ■ Feature Codes

Figure 41. Features and Their Locations





## Library Modules

Up to *five* additional storage Expansion Modules can be added to increase the size of the library.

**Note:** Use these feature codes in conjunction with the “Data Cartridge Slots” features to increase the cartridge capacity.

**Table 52. Library Module Order Numbers**

Order Number	Description
SL8500-ENTRY-Z	SL8500 Entry Bundle
XSL8500-PKG-1EF	PKG ASSY,DFT,SL8500 1EF
XSL8500-PKG-2EF	PKG ASSY,DFT,SL8500 2EF
XSL8500-PKG-3EF	PKG ASSY,DFT,SL8500 3EF
XSL8500-PKG-FF	PKG ASSY,DFT,SL8500 FF
SL8500-CIM-Z	CIM assembly, StorageTek
SL8500-CVR-Z	Cover group, StorageTek
SL8500-BASEASY-Z	BASE MODULE ASSY
SL8500-ZFRAME-Z	Z FRAME ASSY
SL8500-BSEARRAY-Z	BASE MACHINE ARRAY
SL8500-BASELIB-Z	SL8500 Base Library
XSL8500-EXP-FRZ	Expansion frame
XSL8500-0EF-RAILZ	Rails for 0 Expansion Frame
XSL8500-1EF-RAILZ	Rails for 1 Expansion Frame
XSL8500-2EF-RAILZ	Rails for 2 Expansion Frame
XSL8500-3EF-RAILZ	Rails for 3 Expansion Frames
XSL8500-4EF-RAILZ	Rails for 4 Expansion Frames
XSL8500-5EF-RAILZ	Rails for 5 Expansion Frames



Floor labels can be placed inside the library to help identify column numbers and locations. The part number for these labels is: XSL8500-COL-LABEL.

## Slot Configurations and Capacities

### Total Library Capacities

**Table 53. Library Data Cartridge Capacity**

Library Configuration		Cartridge Capacity
	Starting—Base configuration	1,448
Expansion Modules	When adding expansion module, each module adds 1,728 <i>data</i> cartridge slots	
	One expansion module	3,176
	Two expansion modules	4,904
	Three expansion modules	6,632
	Four expansion modules	8,360
	Five expansion modules (maximum)	10,088

### Partitioned Capacities

**Table 54. Partitioned Capacities**

Library Configuration		Partition Capacity per Rail
Basic Library	Drive & Electronics Module	0
	Robotics Interface Module	200
	Customer Interface Module	162
	Base configuration per rail (total)	362
Expansion Modules	When adding expansion module, each rail gets <b>432</b> additional data cartridge slots	
	One expansion module	794
	Two expansion modules	1,226
	Three expansion modules	1,658
	Four expansion modules	2,090
	Five expansion modules (maximum)	2,522

## Data Cartridge Slots

**Table 55. Capacity**

Order Number	Description
SL8500-ENTRY-Z	SL8500 Entry Bundle
XSL8500-LOADPLATE	SL8500 Load Plate

To increase the cartridge capacity of the library, you can add additional slots with these feature codes:

**Table 56. Slot Upgrade Order Numbers**

Order Number	Description
XSL8500-UPG-1750	Slot upgrade, 1448 to 1750
XSL8500-UPG-2000	Slot upgrade, 1750 to 2000
XSL8500-UPG-2250	Slot upgrade, 2000 to 2250
XSL8500-UPG-2500	Slot upgrade, 2250 to 2500
XSL8500-UPG-3000	Slot upgrade, 2500 to 3000
XSL8500-UPG-3500	Slot upgrade, 3000 to 3500
XSL8500-UPG-4000	Slot upgrade, 3500 to 4000
XSL8500-UPG-4500	Slot upgrade, 4000 to 4500
XSL8500-UPG-5000	Slot upgrade, 4500 to 5000
XSL8500-UPG-5500	Slot upgrade, 5000 to 5500
XSL8500-UPG-6000	Slot upgrade, 5500 to 6000
XSL8500-UPG-6500	Slot upgrade, 6000 to 6500
XSL8500-UPG-1250	Slot upgrade, 1000 to 1250
XSL8500-UPG-1448	Slot upgrade, 1250 to 1448
XSL8500-UPG-7000	Slot upgrade, 6500 to 7000
XSL8500-UPG-7500	Slot upgrade, 7000 to 7500
XSL8500-UPG-8000	Slot upgrade, 7500 to 8000
XSL8500-UPG-8500	Slot upgrade, 8000 to 8500
XSL8500-UPG-9000	Slot upgrade, 8500 to 9000
XSL8500-UPG-9500	Slot upgrade, 9000 to 9500
XSL8500-UPG-10000	Slot upgrade, 9500 to 10000

## Power

There are two possible AC power configurations for the library.

- **N+1 power:** the *standard power configuration* for DC power redundancy.
- **2N power:** an *optional configuration* for AC and DC power redundancy.

**Note:** The 2N power distribution unit must connect to a separate power source to provide *both AC and DC* power redundancy.

There are three possible power options:

- **Delta:** 200–240 VAC, three phase, 50–60 Hz, 40 Amps,
- **Wye:** 200–240VAC, three phase, 50–60 Hz, 24 Amps
- **Single-phase:** 200–240 VAC, 50–60 Hz, 24 Amps (3-separate inputs)

**Note:** The SUVA<sup>1</sup> Wye, 200–240 VAC, three phase, 50–60 Hz, 24 Amps power option is no longer supported.

You must select *one* of these power feature codes from [Table 57](#).

**Table 57. Power Distribution Order Numbers**

Order Number	Description
XSL8500-1PH-Z	N+1 Single Phase Power
XSL8500-AC-ASSY-Z	N+1 ASSY,AC
XSL8500-N1-ASY-SZ	N+1 ASSY,AC,SUVA
XSL8500-DELTAZ	N+1 Delta Power
XSL8500-WYE-Z	N+1 Wye Power
<del>XSL8500-N1-SUVA-Z</del>	<del>N+1 SUVA Power</del>
<b>Note:</b> The SUVA AC power supply and power option is no longer supported.	
XSL8500-AC-SW-Z	AC Transfer Switch
XSL8500-DR-PWR-Z	One Drive Power Supply
XSL8500-RB-PWR-Z	One Robot Power Supply

1. SUVA = Schweizerische Unfallversicherungsanstalt (*Switzerland only*).

## HandBots

[Table 58](#) lists the HandBot features:

**Table 58. HandBot Order Numbers**

Order Number	Description
XSL8500-4BOT-Z	4-HandBots

## HandBot Power Supplies

The HandBot power supplies plug into the Robot and Pass-thru Port Power Grid and provide 48 VDC power to the HandBots and pass-thru ports.

Power supply requirements depends on the number of HandBots and the type of library power configuration (N+1 or 2N).

- The N+1 power configuration provides *two* load sharing power supplies for every four HandBots plus *one* redundant power supply.
- The 2N power configuration provides *one* load sharing power supply for *each* HandBot.

**Note:** A 2N power supply requires a 2N Power Configuration.  
See [Table 57 on page 114](#).

**Table 59. HandBot Power Supply Order Numbers**

Order Number	Description
XSL8500-RB-PWR-Z	One Robotic Power Supply

Guidelines:

- Four HandBot power (*standard* power for 4 robots)  
Order 3 power supplies (2+1 redundant)
- Four HandBot power (*optional* power for 4 robots)  
Order 4 power supplies (2+2 redundant)
- Eight HandBot power (*standard* power for 8 robots)  
Order 5 power supplies (4+1 redundant)
- Eight HandBot power (*optional* power for 8 robots)  
Order 8 power supplies (4+4 redundant)

## Front Frame Electronics

The front frame electronics control the components on the front of the library. These components include the operator panels, two cartridge access ports, two elevators, two library cameras, and the service safety door (if present). It also contains two load sharing power supplies (*as standard features*).

### Keypad

The library includes a keypad that has two buttons, eight LEDs, and two locks. The two buttons open and close the CAPs. The eight LEDs indicate library activity and status. The two safety locks allow the service representatives to place the library in maintenance mode.

### Touch Screen Operator Control Panel

The library supports an *optional* control panel which is actually a computer with a software application referred to as StreamLine Library Console.

- When this feature is ordered, the library gets the Touch Screen Operator Control Panel mounted on the facade.
- When no feature is ordered, the library comes with a decorator panel.

**Table 60. Touch Screen Operator Panel Order Numbers**

Order Number	Description
XSL8500-TSOP-Z	Touchscreen Op Panel
XSL-STYLUS-HOLD-Z	Stylus Holder Spare
XSL-STYLUS-Z	Stylus Spare for Touchscreen

## Cartridge Access Ports

The library includes one 39-slot cartridges access port (CAP) with an *optional* feature to add a second 39-slot CAP to the library. Each CAP contains three removable magazines, each with 13 slots, for a total of 39 cartridges.

**Table 61. Cartridge Access Port Order Numbers**

Order Number	Description
XSL8500-CAP-MAGZ	SL8500 CAP Magazine Assembly

## WebCam Monitoring

Because there is no viewing window for this library, a library camera monitoring system is included. The WebCam feature includes two static cameras, one for each side of the library and monitoring software.

**Table 62. WebCam Order Numbers**

Order Number	Description
XSL8500-WEBCAM-Z	WebCams

## Accessory Racks

The library provides space for up to four traditional 19-inch racks to be installed in the Drive and Electronics Module. These racks are oriented so the components mount vertically instead of horizontally and can hold up to 6Us (1u = 1.75 inches) of equipment, such as switches, hubs, and servers.

**Note:** Equipment must be qualified to be installed in the racks. Follow the guidelines listed in [Table 9 on page 24](#)

**Table 63. Accessory Rack Order Numbers**

Order Number	Description
XSL8500-RACK-Z	6U Accessory Rack
XSL8500-RACK-HW-Z	Rack Component HW Kit
<b>Note:</b> Order up to two racks for an N+1 power configuration or up to four in a 2N power configuration	

## Service Safety Door

The service safety door is a sliding door that is activated by a maintenance key, which is controlled *only* by service representatives, and is used when a failing component in the of front frame needs to be replaced.

The Service Safety Door is *required* to support redundant *eight* HandBots and optional (*although recommended*) to support *four* HandBots.

**Table 64. Service Safety Door Order Numbers**

Order Number	Description
XSL8500-SVDR-Z	Service Safety Door

## Pass-thru Ports

A library complex is created by connecting two or more SL8500 libraries together with pass-thru ports (PTPs). The PTPs are installed between the drive and electronics module and the robotics interface module of one library, and the same modules of an adjacent library.

To order the pass-thru port feature, you need to order:

- Order Number **SL8500P-BLANK-Z** (frame *only*)
- Order Number **SL8501P-PTP-Z** (everything, including the mechanisms)

**Table 65. Pass-thru Port Order Numbers**

Order Number	Description
X-SL8501P-PTP-Z	PTP with mechanisms
X-SL8500P-BLANK-Z	PTP without mechanisms
XSL8500P-MECH-Z	PTP mechanisms for upgrade
XSL8501P-HUB-Z	Hub and ILC kit for PTP

Hub and inter-library communication (ILC) kit guidelines:

Order the hub if:

- You are installing the first PTP between libraries 1–2  
OR if:
- You are connecting libraries 3, 4, or 5 off of the same hub.  
(The same goes for libraries 8, 9, and 10—13, 14, and 15—and so on.)  
OR if:
- You are expanding the complex between libraries 6–7, 11–12, and so on.

This number includes the Ethernet hub and cables to connect up to 5 additional libraries.



## Tape Drive Power Supplies

See [“Tape Drives” on page 120](#) for information about specific drives.

Location and selection of the power supplies depends on the number of tape drives selected and the type of power configuration (N+1 or 2N). Each pair of supplies provides enough power to support up to 16 tape drives regardless of the type of drive.

- The N+1 power configuration provides *two* load sharing power supplies for every 16 drives with *one* redundant power supply.
- The 2N power configuration provides *one* load sharing power supply for every *four* tape drives.

**Note:** The power supplies are hot-pluggable and can be added to the library without any down time.

**Table 66. Tape Drive Power Supply Order Numbers**

Order Number	Description
XSL8500-DR-PWR-Z	One Drive Power Supply

Power supply guidelines:

- Drive power 1–16 drives *standard*  
Order 3 power supplies (2+1 redundant)
- N+1 Drive Power 17–32 drives  
Order 5 power supplies (4+1 redundant)
- N+1 Drive Power 33–48 drives  
Order 7 power supplies (6+1 redundant)
- N+1 Drive Power 49–64 drives  
Order 9 power supplies (8+1 redundant)
- 2N Drive Power 1–16 drives  
Order 4 power supplies (2+2 redundant)
- 2N Drive Power 17–32 drives  
Order 8 power supplies (4+4 redundant)
- 2N Drive Power 33–48 drives  
Order 12 power supplies (6+6 redundant)
- 2N Drive Power 49–64 drives  
Order 16 power supplies (8+8 redundant)

**Note:** The 2N drive power supplies *require* a 2N Power Configuration. See [Table 57 on page 114](#).

## ■ Tape Drives

The minimum number of tape drives the customer needs to order is *one*.

See [Appendix C, "Tape Drives"](#) for information about the specific tape drives.

Tape drives supported in the SL8500 include StorageTek tape drives as well as third party tape drives with Fiber Channel, ESCON and FICON interfaces.

- High voltage differential (HVD) and low voltage differential (LVD) small computer system interface (SCSI) tape drives *are not supported*.

Tape drive ordering guidelines:

- The tape drive *must support* the dynamic World Wide Name feature for the drives to be varied online with the SL8500 library.
- Tape drive configurations do not support Arbitrated Loops.
- *Equipment damage*: In case of a tape drive failure, the drives are removed from their trays which are specific to that drive type.  
*Do not mix tape drives and drive trays.*
- All T9840 tape drives use the same media type, a 9840 tape cartridge. However, the format and data capacity between the T9840 A/B (20 GB) is different than the T9840C (40 GB) and T9840D (80 GB).

When upgrading tape drives from a T9840 A/B to a T9840C, there can be a noticeable increase in the *time-to-ready* for the T9840C drives when reading legacy T9840 A/B written cartridges.

Suggestion for improvement include:

Re-formatting the cartridges to T9840C compatibility and installing uplevel drive firmware (such as 1.35.x07).

- Encryption adds another element to content management. Refer to the Key Management System, Systems Assurance Guide for more information about encryption-capable drives, including:
  - T10000 A
  - T10000 B
  - T9840 D
  - HP LTO4



If a drive slot does not contain a tape drive, it must have a vacancy plate; part number 3139987xx (metal) or 3139987xx (plastic).

The SL8500 Drive Power Up Kit is SL8500-DRPWRUP-KIT

## ■ Cables

The following sections provide information about the different interface cables available through StorageTek. When you order cables, keep this in mind:

- **Riser cables** can be used in computer rooms and are not classified according to flammability or toxic gas emissions.
- **Plenum cables** are designed for installation in air ducts and manufactured to meet UL standards for flammability and produce little smoke.

## Ethernet Cables

The library uses Ethernet cables for TCP/IP connections, which include host and library-to-library communications.

**Table 67. Ethernet Cables**

Description	Order Number
CAT5E, 8 ft, 24 AWG, Shielded	CABLE10187033-Z
CAT5E, 35 ft, 24 AWG, Shielded	CABLE10187034-Z
CAT-5E, 50 IN, 24 AWG, Shielded	CABLE10187035-Z
CAT5E, 35 ft, 24AWG, Shielded, Plenum	CABLE10187039-Z
CAT5E, 55 ft, 24AWG, Shielded, Plenum	CABLE10187040-Z
CAT5E, 100 ft, 24AWG, Shielded, Plenum	CABLE10187041-Z

## Fiber-Optic Cables Work Sheet

**Figure 42. Fiber Optic Duplex Connectors**

<p><b>LC connectors</b> are the industry standard for all 2 Gbps Fibre Channel devices.</p> <p><b>Note:</b> The SL8500 drive tray requires LC plugs for connection on the rear panel.</p> <p><b>SC connectors</b> are the standard for 1 Gbps Fibre Channel devices such as the T9840A tape drive.</p> <p><b>Important:</b> When re-using T9840A tape drives, you will need to use an SC to LC adapter (PN 312105301). The drive tray only supports LC connectors.</p>	
--	--

Table 68 lists the fiber-optic cables with LC connectors.

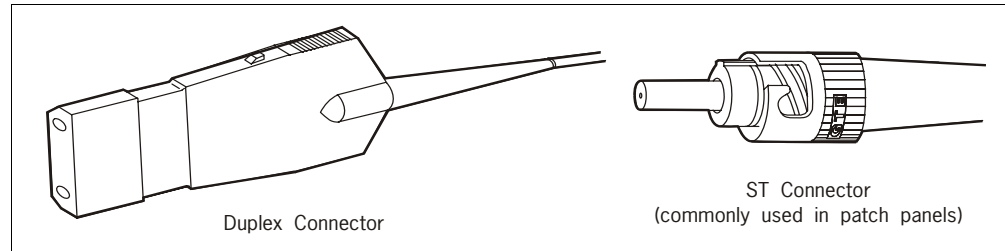
**Table 68. Two Gigabit Fiber-Optic Cables**

Select	Order Number	Description	Quantity
<b>LC to LC, 50/125 Micron</b>			
<input type="checkbox"/>	CABLE10800340-Z	3 m (9.8 ft) Duplex, Riser	
<input type="checkbox"/>	CABLE10800341-Z	5 m (16.4 ft) Duplex, Riser	
<input type="checkbox"/>	CABLE10800310-Z	10 m (32.8 ft) Duplex, Riser	
<input type="checkbox"/>	CABLE10800311-Z	50 m (164 ft) Duplex, Riser	
<input type="checkbox"/>	CABLE10800312-Z	100 m (328 ft) Duplex, Riser	
<input type="checkbox"/>	CABLE10800313-Z	10 m (32.8 ft) Duplex, Plenum	
<input type="checkbox"/>	CABLE10800314-Z	50 m (164 ft) Duplex, Plenum	
<input type="checkbox"/>	CABLE10800315-Z	100 m (328 ft) Duplex, Plenum	
<b>LC to LC, 9/125 Micron</b>			
<input type="checkbox"/>	CABLE10800302-Z	3 m (9.8 ft) Duplex, Riser	
<input type="checkbox"/>	CABLE10800331-Z	10 m (32.8 ft) Duplex, Riser	
<input type="checkbox"/>	CABLE10800333-Z	50 m (164 ft) Duplex, Riser	
<input type="checkbox"/>	CABLE10800306-Z	100 m (328 ft) Duplex, Riser	
<input type="checkbox"/>	CABLE10800330-Z	10 m (32.8 ft) Duplex, Plenum	
<input type="checkbox"/>	CABLE10800332-Z	50 m (164 ft) Duplex, Plenum	
<input type="checkbox"/>	CABLE10800305-Z	100 m (328 ft) Duplex, Plenum	
<p><b>Note:</b> When using cables with SC connectors, you will need to use an SC to LC adapter (part number 315447901).</p> <p>The SL8500 drive tray only supports LC connectors.</p>			

## ESCON Cables Work Sheet

ESCON cables, depending on the platform or network components, can have different types of connectors. [Figure 43](#) shows examples of two styles of ESCON connectors.

**Figure 43. ESCON Cable Connectors**



**Table 69. ESCON Cable Part Numbers**

Select	Order Number	Description	Quantity
<input type="checkbox"/>	CABLE10800289-Z	13 m (4 ft) Riser	
<input type="checkbox"/>	CABLE10800290-Z	31 m (100 ft) Riser	
<input type="checkbox"/>	CABLE10800291-Z	61 m (200 ft) Riser	
<input type="checkbox"/>	CABLE10800292-Z	107 m (350 ft) Riser	
<input type="checkbox"/>	CABLE10800285-Z	13 m (4 ft) Plenum	
<input type="checkbox"/>	CABLE10800286-Z	31 m (100 ft) Plenum	
<input type="checkbox"/>	CABLE10800287-Z	61 m (200 ft) Plenum	
<input type="checkbox"/>	CABLE10800288-Z	107 m (350 ft) Plenum	

## ■ Special Parts

**Table 70. Special Parts Order Numbers**

Description	Order Number	StorageTek PN
PEN/STYLUS COMBO	XSL-STYLUS-Z	11000998
PEN/STYLUS HOLDER	XSL-STYLUS-HOLD-Z	11000999
MAGAZINE ASSEMBLY, CAP	XSL8500-CAP-MAGZ	313927402
LOAD PLATE XSL8500-LOADPLATE		313994503
DLT, 8 CART DIAG KIT, VOLSER 000-007	XDLT-DIAG-KIT	314821901
LTO, 8 CART DIAG KIT, VOLSER 000-007	XLTO-DIAG-KIT	314822001
9840, 8 CART DIAG KIT, VOLSER 000-007	X9840-DIAG-KIT	314822101
9940, 8 CART DIAG KIT, VOLSER 000-007	X9940-DIAG-KIT	314822201
LTO2, 8 CART DIAG KIT, VOLSER 000-019	XLTO2-DIAG-KIT	314831101
RACK COMPONENT HARDWARE KIT	XSL8500-RACK-HW-Z	419649201
COLUMN LABEL SET ASSEMBLY,SL8500	XSL8500-COL-LABEL	314869801
LTO3, 8 CART DIAG KIT, VOLSER 000-027	XLTO3-DIAG-KIT	314872301
SDLT, 8 CART DIAG KIT, VOLSER 000-027	XSDLT-DIAG-KIT	314872401
T10000, 8 CART DIAG KIT, VOLSER 000-019	XT10000-DIAG-KIT	314876501

## ■ Order Number Listing

Table 71 provides a list of order numbers for the SL8500.

**Table 71. Order Number Listing**

Order Number	Description
SL8500-ENTRY-Z	SL8500 Entry Bundle
XSL8500-PKG-1EF	PKG ASSY,DFT,SL8500 1EF
XSL8500-PKG-2EF	PKG ASSY,DFT,SL8500 2EF
XSL8500-PKG-3EF	PKG ASSY,DFT,SL8500 3EF
XSL8500-PKG-FF	PKG ASSY,DFT,SL8500 FF
SL8500-CIM-Z	CIM assembly, StorageTek
SL8500-CVR-Z	Cover group, StorageTek
SL8500-BASEASY-Z	BASE MODULE ASSY
SL8500-ZFRAME-Z	Z FRAME ASSY
SL8500-BSEARRAY-Z	BASE MACHINE ARRAY
SL8500-BASELIB-Z	SL8500 Base Library
XSL8500-EXP-FRZ	Expansion frame
XSL8500-0EF-RAILZ	Rails for 0 Expansion Frame
XSL8500-1EF-RAILZ	Rails for 1 Expansion Frame
XSL8500-2EF-RAILZ	Rails for 2 Expansion Frame
XSL8500-3EF-RAILZ	Rails for 3 Expansion Frames
XSL8500-4EF-RAILZ	Rails for 4 Expansion Frames
XSL8500-5EF-RAILZ	Rails for 5 Expansion Frames
XSL8500-4BOT-Z	4 HandBots
XSL8500-AC-SW-Z	AC Transfer Switch
XSL8500-1PH-Z	N+1 Single Phase Power
XSL8500-AC-ASSY-Z	N+1 ASSY,AC
XSL8500-N1-ASY-SZ	N+1 ASSY,AC,SUVA
XSL8500-DELTAZ	N+1 Delta Power
XSL8500-N1-SUVA-Z	N+1 SUVA Power
XSL8500-WYE-Z	N+1 Wye Power
XSL8500-DR-PWR-Z	One Drive Power Supply
XSL8500-RB-PWR-Z	One Robot Power Supply
XSL8500-RACK-Z	6RU Rack
XSL8500-RACK-HW-Z	Rack Component HW Kit
XSL8500-SVDR-Z	Service Safety Door
XSL8500-TSOP-Z	Touchscreen Op Panel

**Table 71. Order Number Listing**

Order Number	Description
XSL8500-WEBCAM-Z	WebCams
X-SL8501P-PTP-Z	PTP with mechanisms
X-SL8500P-BLANK-Z	PTP without mechanisms
XSL8500P-MECH-Z	PTP mechanisms for upgrade
XSL8501P-HUB-Z	Hub and ILC kit for PTP
XSL8500-UPG-CAP-Z	39 Cartridge CAP
XSL8500-UPG-HBZ-Z	Add a second HBZ for 2nd CAP
XSL8500-DTCPIP	Dual TCPIP Host Interface
XSL8500-UPG-PART	Partitioning
XSL8500-SHELF-Z	Service Shelf for Laptop
XSL8500-MAG13-Z	SL8500 Magazine Assy for CAP
XSL8500-UPG-1750	Slot upgrade, 1448 to 1750
XSL8500-UPG-2000	Slot upgrade, 1750 to 2000
XSL8500-UPG-2250	Slot upgrade, 2000 to 2250
XSL8500-UPG-2500	Slot upgrade, 2250 to 2500
XSL8500-UPG-3000	Slot upgrade, 2500 to 3000
XSL8500-UPG-3500	Slot upgrade, 3000 to 3500
XSL8500-UPG-4000	Slot upgrade, 3500 to 4000
XSL8500-UPG-4500	Slot upgrade, 4000 to 4500
XSL8500-UPG-5000	Slot upgrade, 4500 to 5000
XSL8500-UPG-5500	Slot upgrade, 5000 to 5500
XSL8500-UPG-6000	Slot upgrade, 5500 to 6000
XSL8500-UPG-6500	Slot upgrade, 6000 to 6500
XSL8500-UPG-1250	Slot upgrade, 1000 to 1250
XSL8500-UPG-1448	Slot upgrade, 1250 to 1448
XSL8500-UPG-7000	Slot upgrade, 6500 to 7000
XSL8500-UPG-7500	Slot upgrade, 7000 to 7500
XSL8500-UPG-8000	Slot upgrade, 7500 to 8000
XSL8500-UPG-8500	Slot upgrade, 8000 to 8500
XSL8500-UPG-9000	Slot upgrade, 8500 to 9000
XSL8500-UPG-9500	Slot upgrade, 9000 to 9500
XSL8500-UPG-10000	Slot upgrade, 9500 to 10000
XSL8500-Col-Label	Column Label Set
XSL8500-LOADPLATE	SL8500 Load Plate



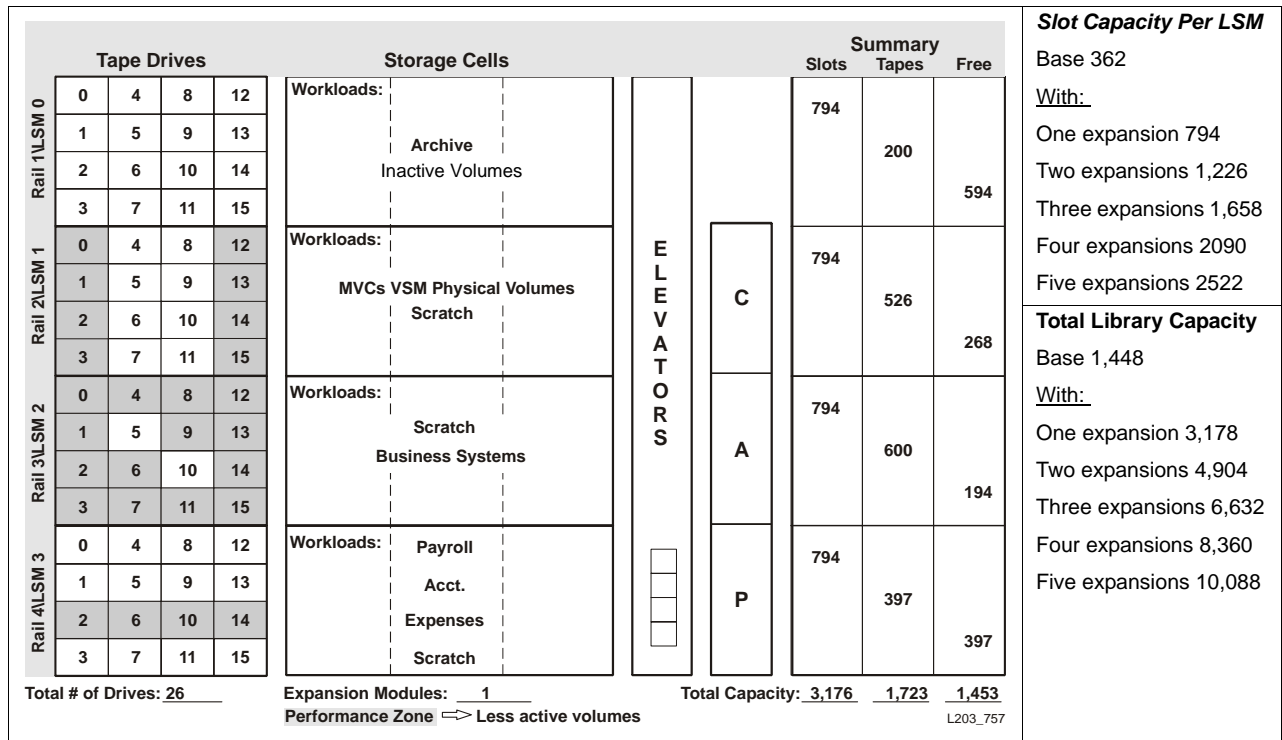
# Content Management



The *most important* aspect of an SL8500 is the need to plan and *evaluate* the content with respect to the physical structure and capacities of an SL8500.

Figure 1 shows an example of how a content management philosophy might look using the information in this chapter.

**Figure 1. Content Management Example**



This chapter provides recommendations when evaluating workloads for an SL8500 library, which include:

- Dedicate rails—separate workloads to specific rails (as in Figure 1)
- Manage cartridges—move inactive cartridges to archival LSMs or eject them
- Group tape drives—logically install drives by type, function, and quantity
- Minimize elevator and pass-thru port activity

Using these recommendations will help to optimize the SL8500 library and enhance performance.

**Note:** Refer to the *SL8500 Best Practices Guide* for more information.

## ■ Dedicating Rails

The SL8500 is not just another library. The SL8500 architecture is *four separate library storage modules* that work together in parallel. This architecture offers extremely flexible and scalable configurations that can *StreamLine* automated tape applications.

*Instead of distributing cartridges and tape drives evenly across all the rails...*

*Look at it from a business perspective and logically plan each individual LSM to meet the customer's specific needs and business requirements. Allocate separate tape application workloads to specific library storage modules.*

Recommendations include:

- 
- |  |  |
|--|--|
| <input type="checkbox"/> <b>Separate rails</b> | <ul style="list-style-type: none"> <li>• Ideally, try to confine each workload to a single LSM to reduce pass-thru activity—this improves performance.</li> <li style="padding-left: 20px;">If this is not possible because the workload is too large, consider breaking the workload into smaller segments that do fit.</li> <li>• Allocate rails to each major application.<br/><i>For example:</i> HSM and VSM both need tape drives and media. Plan separate rails for these types of applications.</li> </ul> |
|--|--|
- 
- |   |   |
|---|---|
| <input type="checkbox"/> <b>Combine workloads</b> | <p>If you are <i>not</i> able to easily separate the workload, consider:</p> <ul style="list-style-type: none"> <li>• Using rails that are adjacent to each other. This provides a shorter distance for the pass-thru operation.</li> <li>• Pass-thru's are either:             <ul style="list-style-type: none"> <li>- <b>Vertical:</b> using the elevator in the same library, or</li> <li>- <b>Horizontal:</b> using pass-thru ports (PTPs) to a different library</li> </ul> </li> </ul> |
|---|---|
- 
- |  |  |             |  |                         |   |                     |  |
|--|--|-------------|--|-------------------------|---|---------------------|--|
| <input type="checkbox"/> <b>Populate the rails</b> | <p>When populating the rails:</p> <table border="0" style="width: 100%;"> <tr> <td style="padding-right: 10px;">Media types</td> <td>• Make sure the rails have compatible cartridges for the tape drives</td> </tr> <tr> <td>Scratch cartridge pools</td> <td>• Make sure the rails have enough <i>scratch</i> cartridges</td> </tr> <tr> <td>Adequate free cells</td> <td>• Make sure there are adequate free cells so cartridges can <b>float</b> upon dismount</td> </tr> </table> | Media types | • Make sure the rails have compatible cartridges for the tape drives | Scratch cartridge pools | • Make sure the rails have enough <i>scratch</i> cartridges | Adequate free cells | • Make sure there are adequate free cells so cartridges can <b>float</b> upon dismount |
| Media types  | • Make sure the rails have compatible cartridges for the tape drives   |             |  |                         |   |                     |  |
| Scratch cartridge pools                            | • Make sure the rails have enough <i>scratch</i> cartridges  |             |  |                         |   |                     |  |
| Adequate free cells                                | • Make sure there are adequate free cells so cartridges can <b>float</b> upon dismount   |             |  |                         |   |                     |  |
- 
- |   |   |
|---|---|
| <input type="checkbox"/> <b>Use of the top rail</b> | <ul style="list-style-type: none"> <li>• Avoid using the top rail to support an application that requires a significant number of ejects and enters. To enter and eject cartridges from LSM 0 requires elevator pass-thru activity.</li> <li>• Consider using the top rail as an archival LSM—one that uses <i>less active</i> tapes; or</li> <li>• Use the top rail as an LSM with <i>very active</i> tapes that requires fast access—using T9840C tape drives, with few enters and ejects.</li> </ul> |
|---|---|
- 
- |   |  |
|---|--|
| <input type="checkbox"/> <b>Enters and Ejects</b> | <ul style="list-style-type: none"> <li>• Whenever possible, enter cartridges through the cartridge access ports (CAPs).</li> <li>• When planning the workloads, place applications that require significant enters and ejects on rails adjacent to CAP magazines.</li> </ul> |
|---|--|
-

## ■ Managing Cartridges

Managing cartridges—how cartridges are entered, ejected, handled, and treated—in the library can have an affect on performance. Some considerations include:

- 
- Use tape management applications (ExLM)** Use a library management application such as ExLM with HSC to keep active volumes on the same LSMs as compatible drives and to migrate less active volumes.

---

  - Use the float option** When *float* is on, ACSLS or HSC selects a new home cell for a cartridge that is in an LSM as close to the drive as possible on a dismount. This option automatically clusters cartridges by the drives for the workload.

Make sure each LSM contains enough free cells to allow selection of a new home cell in that LSM.

---

  - Cluster cartridges** Cluster cartridges by workload on separate rails with enough tape drives to support the maximum activity—peak usage—for the workloads

---

  - Entering cartridges** Enter cartridges through the CAP.

When *manually* placing cartridges in the library with the front access door open, *library operations cease* and the library management software—such as ACSLS or HSC—must perform a *full audit* to update the library database to match the actual contents of the library.

When you enter cartridges through the CAP the library stays online, mounts can continue, and the library management software always tries to move the cartridge to an LSM adjacent to the CAP magazine—minimizing pass-thru activity.

---

  - Ejecting cartridges** *Ordered or Unordered Ejects?*

Specifying ordered ejects places the volume serial numbers (VOLSERs) in a specific sequence. This operation is significantly slower than unordered ejects which allows ACSLS or HSC to eject cartridges to a CAP magazine adjacent to that LSM—minimizing pass-thru activity.

---

  - Archiving cartridges** When using HSC with ExLM, move the *least recently used* (LRU) cartridges farther out on the rail, away from the tape drives and slots in the Performance Zone.

Consider using the *top rail* as an archival LSM if the tape does not require CAP activity—few enters and ejects.

---

  - Managing space**

    - Move *inactive* cartridges out of the library or off of an LSM to ensure there is adequate space for *active* cartridges.
    - Plan for times of *peak activity*.
    - Free cell management:
      - If the same drive-type and media-type are on the same rail for specific applications, fewer free cells are required.
      - If a specific application requires several enters and ejects or pass-thru operations, more free cells are required.

---

  - Supplying scratch cartridges** Make sure each rail has the correct amount and type of data cartridges *plus* enough scratch cartridges to support the workload.
-

## ■ Grouping Tape Drives

During the installation, having an understanding about how to logically group and install the tape drives in an SL8500 can minimize both elevator and PTP activity. Strategies to use when determining where to install the tape drives include:

- 
- |  |   |
|--|---|
| <input type="checkbox"/> <b>Cluster tape drives</b>              | <p>Install tape drives that use the same media types on the same rails.<br/><i>For example:</i> place T9840 drives on one rail and T9940 drives on a different rail with the media to match.</p> <p><i>Potential issues:</i><br/>Clustering tape drives and media on the same rail works well until:</p> <ul style="list-style-type: none"> <li>• The number of mounts exceeds the capacity of the HandBots.</li> <li>• There are too many “active” cartridges to fit on that rail</li> <li>• The number of concurrently mounted tapes exceeds the maximum number of tape drives.</li> </ul> <p><i>Indicating:</i><br/>There are too many active cartridges on that rail for the HandBots to mount (keep up with) or not enough tape drives.</p> <p><i>Recommendations:</i><br/>When resources for a specific workload exceeds the capacity of a rail, spread the cartridges and drives over two or more rails. Some suggestions might be to:</p> <ul style="list-style-type: none"> <li>• Add more tape drives (if possible).</li> <li>• Add expansion modules to increase cartridges for that rail</li> <li>• Use the TLC/FSM tool to model and re-evaluate the content.</li> <li>• Upgrade to an eight HandBot configuration.</li> </ul> |
| <input type="checkbox"/> <b>Use the CAP</b>                      | <p>Enter tape cartridges so compatible media is on the same rail with the tape drives.</p> <p><i>For example:</i> enter cartridges using a CAP magazine adjacent to the desired rail (LSM) where compatible tape drives are located.</p>  |
| <input type="checkbox"/> <b>Try not to exceed limits</b>         | <p>Configure heavy tape applications so they do not exceed the performance limits of that LSM and/or library configuration.<br/><i>For example:</i> limit peak HSM workloads by the number of concurrent recalls in that configuration.</p>   |
| <input type="checkbox"/> <b>Use the TLC/FSM tool</b>             | <p><b>Important:</b><br/>Use the SE tool Tape Library Configurator / Field Simulation Model (TLC/FSM) to determine the optimal drive configurations. When you supply a configuration and a workload (trace file of the mounts), TLC/FSM can output drive utilization statistics and suggestions.</p>  |
| <input type="checkbox"/> <b>Redundant HandBot configurations</b> | <p>When configuring the SL8500 with eight HandBots (two per rail), install drives in the outer two columns first—this allows both HandBots to access drives at the same time.</p>   |
| <input type="checkbox"/> <b>Manage your tapes</b>                | <p>Use ExLM to help manage tape locations to provide quick access to tape drives.</p>   |
-

## ■ Minimizing Elevator and PTP Activity

As pass-thru activity (elevator and pass-thru ports) increases, performance (exchanges per hour) decreases. Here are several things you can do to minimize or improve pass-thru activity.

❑ <b>Mounting cartridges</b>	Mount cartridges in tape drives that are on the same rail (LSM).
❑ <b>Use the float option</b>	<ul style="list-style-type: none"> <li>• Take advantage of the <code>float</code> option to limit pass-thru activity.</li> <li>• Make sure volumes can <i>float</i> to locations in other LSMs—after a pass-thru—by maintaining some free cells within each LSM.</li> <li>• When dismounting cartridges, and <i>float</i> is on, ACSLS and HSC try to avoid an elevator pass-thru among LSMs by assigning a new home cell—if that cartridge's old home slot is in a different LSM.</li> <li>• When float is on ACSLS and HSC attempts to put the cartridge:             <ul style="list-style-type: none"> <li>- In the same LSM as the tape drive</li> <li>- To the closest LSM to the drive with free storage slots</li> </ul> </li> </ul>
❑ <b>Entering cartridges</b>	<p>Enter cartridges into an LSM that has compatible tape drives for that media-type.</p> <p><b>Note:</b> When entering tape cartridges, place them in the CAP magazine adjacent to the LSM where they will reside.</p> <p><i>For example:</i> you only have T9840 drives on LSMs 2 and 3. You should enter 9840 cartridges in to the CAP slots adjacent to these LSMs.</p>
❑ <b>Maintain scratch cartridge levels</b>	<p>Make sure that scratch cartridges are available in sufficient quantity for each tape workload.</p> <p>For an SL8500, this means having scratch cartridges available on each rail (LSM) of the library.</p>
❑ <b>Keep free cells</b>	Make sure there are adequate free cells in each LSM.
❑ <b>Plan pass-thru activity</b>	<p>When planning workloads for a <i>library complex</i> where the workload requires more than one LSM, consider the following:</p> <p><b>Elevators:</b> Use <i>adjacent</i> LSMs in the same library to limit the distance the cartridges must travel. Remember, there is a 50% chance with drive preferencing that the cartridge and drive are on the same rail between two LSMs.</p> <ul style="list-style-type: none"> <li>• Elevators have the capability of passing up to <i>four</i> tapes.</li> <li>• Currently, elevator pass-thru times are faster than the pass-thru ports.</li> </ul> <p><b>PTPs:</b> If the library has high pass-thru activity using the elevator, consider using <i>adjoining</i> LSMs and the pass-thru ports.</p> <ul style="list-style-type: none"> <li>• PTPs have the capability of passing up to <i>two</i> tapes.</li> </ul>
❑ <b>Use ExLM</b>	Use ExLM for mainframe operating systems to manage cartridges.

## ■ Cartridge Access Port Guidelines

Although operation of the cartridge access port does not directly affect the performance of the library, here are some guidelines that can help with its overall operation.

- ❑ **Entering cartridges**
  - Whenever possible, enter cartridges through the CAP.
  - When planning the workloads, place applications that require significant enters and ejects on rails adjacent to CAP magazines.
  - Use the “TLSM” parameter on the HSC enter command to direct cartridges to specific LSMs. This will cause pass-thru activity.
  - An alternative to using the “TLSM” parameter is to load only the magazines adjacent to the desired or specific LSM.
  - Use the *watch\_vols* utility for ACSLS.
  - **Tip:** Place labels outside the CAP indicating which magazine and LSM gets what type of cartridge. *For example:*
    - LSM 1 uses T9840 tape drives, load that magazine with only 9840 tape cartridges
    - LSM 2 uses LTO tape drives, load that magazine with only LTO tape cartridges
    - LSM 3 uses cartridges for a specific application or job, load that magazine with the necessary cartridge types

This will help operators identify what cartridges go to which LSM.

- ❑ **Using the top rail**
  - Avoid using the top rail to support an application that requires a significant number of ejects and enters. To enter and eject cartridges from LSM 0 requires elevator pass-thru activity.
  - Consider using the top rail as an archival LSM—one that uses *less active* tapes; or as an LSM with *very active* tapes that requires fast access, uses T9840C tape drives, with few enters and ejects.

- ❑ **Inserting cartridges** Insert cartridges with the correct orientation:

- Flat in the slots (seated)
- Parallel to the floor
- Hub-side down
- Barcode label pointing out and below the readable characters.

**Note:** You can skip magazine slots, but make sure all magazine arrays are in place.



Hub-side

## ■ Planning for Content

[Figure 2 on page 133](#) provides space that you can use to help plan the content of an SL8500 library.

Figure 2. Content Management Work Sheets

Tape Drives				Storage Cells		Summary			
				Workloads:		Slots	Tapes	Free	
Rail 1LSM 0	0	4	8	12	Workloads:				
	1	5	9	13					
	2	6	10	14					
	3	7	11	15					
Rail 2LSM 1	0	4	8	12	Workloads:		C		
	1	5	9	13					
	2	6	10	14					
	3	7	11	15					
Rail 3LSM 2	0	4	8	12	Workloads:		A		
	1	5	9	13					
	2	6	10	14					
	3	7	11	15					
Rail 4LSM 3	0	4	8	12	Workloads:		P		
	1	5	9	13					
	2	6	10	14					
	3	7	11	15					

Total # of Drives: \_\_\_\_\_ Expansion Modules: \_\_\_\_\_ Total Capacity: \_\_\_\_\_  
 Performance Zone ⇨ Less active volumes L203\_758

Tape Drives				Storage Cells		Summary			
				Workloads:		Slots	Tapes	Free	
Rail 1LSM 0	0	4	8	12	Workloads:				
	1	5	9	13					
	2	6	10	14					
	3	7	11	15					
Rail 2LSM 1	0	4	8	12	Workloads:		C		
	1	5	9	13					
	2	6	10	14					
	3	7	11	15					
Rail 3LSM 2	0	4	8	12	Workloads:		A		
	1	5	9	13					
	2	6	10	14					
	3	7	11	15					
Rail 4LSM 3	0	4	8	12	Workloads:		P		
	1	5	9	13					
	2	6	10	14					
	3	7	11	15					

Total # of Drives: \_\_\_\_\_ Expansion Modules: \_\_\_\_\_ Total Capacity: \_\_\_\_\_  
 Performance Zone ⇨ Less active volumes L203\_758

Tape Drives				Storage Cells			Summary			
	0	4	8	12	Workloads:			Slots	Tapes	Free
Rail 1LSM 0	0	4	8	12	Workloads:					
	1	5	9	13						
	2	6	10	14						
	3	7	11	15						
Rail 2LSM 1	0	4	8	12	Workloads:			C		
	1	5	9	13						
	2	6	10	14						
	3	7	11	15						
Rail 3LSM 2	0	4	8	12	Workloads:			A		
	1	5	9	13						
	2	6	10	14						
	3	7	11	15						
Rail 4LSM 3	0	4	8	12	Workloads:			P		
	1	5	9	13						
	2	6	10	14						
	3	7	11	15						
Total # of Drives: _____				Expansion Modules: _____			Total Capacity: _____			
				Performance Zone ⇨ Less active volumes						

L203\_758

Tape Drives				Storage Cells			Summary			
	0	4	8	12	Workloads:			Slots	Tapes	Free
Rail 1LSM 0	0	4	8	12	Workloads:					
	1	5	9	13						
	2	6	10	14						
	3	7	11	15						
Rail 2LSM 1	0	4	8	12	Workloads:			C		
	1	5	9	13						
	2	6	10	14						
	3	7	11	15						
Rail 3LSM 2	0	4	8	12	Workloads:			A		
	1	5	9	13						
	2	6	10	14						
	3	7	11	15						
Rail 4LSM 3	0	4	8	12	Workloads:			P		
	1	5	9	13						
	2	6	10	14						
	3	7	11	15						
Total # of Drives: _____				Expansion Modules: _____			Total Capacity: _____			
				Performance Zone ⇨ Less active volumes						

L203\_758



This appendix describes the differences and provides information about the library management software, shows some cell mapping examples, and lists the feature codes for ACSLS and HSC products.

## ■ From a Software Point of View

Most of the information in this system assurance guide has been about hardware, site planning, and features; so what about library management software?

Library management software for the SL8500 library includes:

- Host Software Component (HSC)
- Automated Cartridge System Library Software (ACSL)
- VSM 2, 3, and 4
- Independent Software Vendors (ISVs)
- Plus future versions of these

From a software point of view, there are differences between the SL8500 library and other StorageTek automated cartridge subsystems, such as structural elements, addressing, drive numbers, pass-thru ports, and some operational differences.

## Structural Elements

### **Library Storage Module (LSM)**

The SL8500 library has four robotic rails that provide power and communications to the HandBots. Each of these rails is considered an LSM. Because of this, there are four LSMs within each SL8500 library.

### **Panels**

Panel numbering differs from other libraries because it uses positive and negative numbers.

- Panel 0 is the cartridge access port (CAP).
- Panel 1 is the drive panel.
- All other panels start their numbering after the drive bay (Panel 1) forward. Panel 2 is right of the drives and -2 is left of the drives. These are the start of the data cartridges.

- Special panels include:
  - Corners are special because there are no inner wall corner panels
  - Pass-thru ports are special because the top six slots are inaccessible because of the PTPs.
  - Pass-thru port panels are also special because the top cartridge slot (under the port) is reserved as a redundant robotics drop-off slot; two for each rail, one on each side.

## Addressing

Cartridge locations in previous libraries were listed by Panel, Row, and Column. The cartridge slot locations for an SL8500 use five parameters: Library, Rail, Column, Side, and Row.

**Table 1. Slot Addressing**

Parameter	Address	Description	Example	
			Software	Physical
Library	L,0,0,0,0	L = Number of the library in the complex (1 to 31)	1,0,0,0,0	1,0,0,0,0
Rail	L,R,0,0,0	R = Number of the rail in the library (LSM 1 to 4)	1,3,0,0,0	1,3,0,0,0
Column	L,R,C,0,0,	C = Column number (depending on modules in the library)	1,3,-10,0,0	1,3,-11,0,0
Side	L,R,C,S,0	S = Outer wall is 1; Inner wall is 2	1,3,-10,2,0	1,3,-11,2,0
Row	L,R,C,S,W	W = Row: Variable (1 to 14)	1,3,-10,2,5	1,3,-11,2,5

For more information about addressing, see

- [“Library Walls, Arrays, and Slots” on page 4](#)
- [“Address Scheme” on page 4](#)
- [“Understanding the Address Scheme” on page 5](#)

## Tape Drives

All of the tape drives in the SL8500 library are physically located in the Drive and Electronics Module and are identified using the five parameters.

[Table 2](#) shows the *internal—software—mapping* (*inside* the library),

[Table 3](#) shows the *external—physical—numbering* (*outside* the library).

**Table 2. Software Drive Numbering**

LSM	Internal - Software Drives Numbers			
LSM 0	<b>Drive 0</b>	Drive 4	Drive 8	Drive 12
	Drive 1	Drive 5	Drive 9	Drive 13
	Drive 2	Drive 6	Drive 10	Drive 14
	Drive 3	Drive 7	Drive 11	Drive 15
LSM 1	Drive 0	Drive 4	Drive 8	Drive 12
	Drive 1	Drive 5	Drive 9	Drive 13
	Drive 2	Drive 6	Drive 10	Drive 14
	Drive 3	Drive 7	Drive 11	<b>Drive 15</b>
LSM 2	Drive 0	Drive 4	Drive 8	Drive 12
	Drive 1	Drive 5	Drive 9	Drive 13
	Drive 2	Drive 6	Drive 10	Drive 14
	<b>Drive 3</b>	Drive 7	Drive 11	Drive 15
LSM 3	Drive 0	Drive 4	Drive 8	Drive 12
	Drive 1	Drive 5	Drive 9	Drive 13
	Drive 2	Drive 6	Drive 10	Drive 14
	<b>Drive 3</b>	<b>Drive 7</b>	<b>Drive 11</b>	<b>Drive 15</b>

**Table 3. Physical Drive Numbering**

External - Physical Drive Numbers				DC PWR
				24
Drive 61	Drive 62	Drive 63	<b>Drive 64</b>	23
Drive 57	Drive 58	Drive 59	Drive 60	22
Drive 53	Drive 54	Drive 55	Drive 56	21
Drive 49	Drive 50	Drive 51	Drive 52	20
				19
				18
Drive 45	Drive 46	Drive 47	Drive 48	17 (N+1)
Drive 41	Drive 42	Drive 43	Drive 44	16
Drive 37	Drive 38	Drive 39	Drive 40	15
<b>Drive 33</b>	Drive 34	Drive 35	Drive 36	14
				13
				12
Drive 29	Drive 30	Drive 31	Drive 32	11
Drive 25	Drive 26	Drive 27	Drive 28	10
Drive 21	Drive 22	Drive 23	Drive 24	9
Drive 17	Drive 18	Drive 19	<b>Drive 20</b>	8
				7
				6 (robot )
Drive 13	Drive 14	Drive 15	Drive 16	5 (robot )
Drive 9	Drive 10	Drive 11	Drive 12	4
Drive 5	Drive 6	Drive 7	Drive 8	3 (N+1)
<b>Drive 1</b>	<b>Drive 2</b>	<b>Drive 3</b>	<b>Drive 4</b>	2 (DRV)
				1 (DRV)

These tables show a matching of drives (the highlighted drives). *For example:*

- Internal/software LSM 0 Drive 0 matches with external/physical Drive 64.
- Internal LSM 1 Drive 15 matches with external/physical Drive 33.
- Internal LSM 2 Drive 3 matches with external physical Drive 20.

A default behavior of some tape management software (such as ACSLS) is to dismount the drive and leave the cartridge in the same LSM (rail). This depends on software features such as fixed volume location, float/no float, or extended store.



**Important:**

System administrators and the installers of the library need to be in agreement about the placement and location of the tape drives. Placement affects the configuration of the software and the performance of the library.

For example: If a cartridge is in LSM 3 (the bottom rail) and a mount is requested on a drive in a different LSM, the HandBot gets the cartridge, places it in the elevator (a pass-thru operation), another HandBot retrieves the cartridge, and mounts it in the tape drive.

On dismount, if the software is configured for fixed volume location, the HandBot removes the cartridge from the drive, places it in the elevator (a pass-thru operation), the HandBot in LSM 3 retrieves the cartridge, and puts in back in its original slot.

## Cartridge Access Ports

The two CAPs service all the LSMs in the library.

- When a CAP is in use by one LSM, all 39 Slots are reserved for that LSM, and no other LSMs can access it.
- The CAPs cover the size of three LSMs (1,2, and 3); three magazines with 13-Slots each. There is no adjacent section in the CAP for the top LSM (0), which requires a pass-thru operation with the elevator.
- **CAP A** is:
  - Standard CAP (comes with the library)
  - Located on the left, with controls on the left side of the keypad
  - Software address 0 or (ACS, 1, 0)
- **CAP B** is:
  - Optional CAP (must be ordered)
  - Located on the right, with controls on the right side of the keypad
  - Software address 1 or (ACS, 1, 1)
- For addressing purposes, the CAP needs a location (ACS,LSM,CAP#). The LSM of choice is LSM 1, so the CAP addresses are: (ACS, 1, 0) for CAP A and (ACS, 1, 1) for CAP B.
- When loading cartridges in the CAP, slots can be skipped or magazines can be missing.
- If a HandBot is inoperative, that portion of the CAP is inaccessible.

## Elevators

**Elevators** are considered pass-thru ports. Each elevator has three pass-thru operations per rail. Each rail can pass-thru to the other three rails.

## Auto Clean

Auto Clean is a feature of automated libraries that allows the library to clean a tape drive when needed.

**Note:** *Currently, this feature is not supported.*

## Operational Differences

### LSM Prefencing:

Is basically the same as with other libraries and tries to minimize pass-thru operations (elevator, turntable, and pass-thru ports).

- Mount scratch tapes — Selects cartridges based on the LSM (rail)
- Query mount — Orders drives by LSM (rail) proximity
- Query mount scratch — Orders drives by LSM (rail) proximity
- Enter — Enters cartridge from the CAP to the closest LSM with free Slots

### Limits:

- For HSC, the maximum number of libraries is 32 (or 128 LSMs, [0-127]).
- For ACSLS, the maximum number is 31 (or 127 LSMs, [0-126]).
- The maximum number of panels in a library is 60.

### Mount and Dismount Commands:

You or CSC can still specify a cartridge by VOLID or VOLSER and specific drive location. If a cartridge move using a pass-thru operation (elevator) the default behavior is for that cartridge to remain in the drive's LSM.

### Enter (Import) and Eject (Export) Commands:

Library management software normally tries to **Enter/Import** a cartridge to an LSM (rail) adjacent to the CAP.

Currently with HSC, if there are open slots in the top LSM (00), an **Enter** command attempts to place the cartridge in that LSM (00), then work its way down. For example: If a cartridge is entered in the second magazine of a CAP, and there are open slots in LSM 0, the library performs a pass-thru operation with the elevator from the CAP to LSM 0.

For an **Eject/Export** command, the software ejects the cartridge to the CAP magazine adjacent to the LSM. For an **Eject/Export** command from LSM 0, the library performs a pass-thru operation to an open slot in the top magazine of the CAP.

## ■ Host Software Component

The StorageTek Host Software Component (HSC) is one type of management software that can control the SL8500 library. This software resides in the host but is transparent to the operating system.

HSC receives requests from the programmatic interface and translates them into commands that are carried by the control path to the LSM.

The Storage Management Component (SMC) also resides on the MVS host along with HSC and communicates to:

- Influence tape allocation to ensure the correct tape drives are selected
- Intercept mount/dismount and swap messages and translate them to perform tape hardware functions.



### Important:

- **HSC 5.0 and 5.1** are not supported with the SL8500 library.
- **HSC 6.0** with new PTFs is required to support the SL8500 library.
- **HSC 6.1** contains additional support for the SL8500, such as Near Continuous Operation (NCO) that allows the addition and deletion of panels, drives, and LSMs for Capacity on Demand without needing to reconfigure or restart HSC.
- **Large Capacity Library Support**

HSC 6.0 and 6.1 currently support 43 panels. The following PTFs are needed to allow support for up to 67 panels:

Support	HSC 6.0.0	HSC 6.1.0
HSC	SOS6000 - L1H122N	SOS6100 - L1H121Z
	SMS6000 - L1H122M	SMS6100 - L1H121Y
HSC with ExLM needs these additional PTFs	SOS6000 - L1H12VM	SOS6100 - L1H12VO
	SMS6000 - L1H12VN	SMS6100 - L1H12VP
HSC and the Move utility	SOS6000 - L1H12WR	SOS6100 - L1H12WT

**Note:** Always refer to the Customer Resource Center for the latest updates.

## ■ Automated Cartridge System Library Software

The StorageTek Automated Cartridge System Library Software (ACSL) is another type of management software that can control the SL8500 library.

This software is a UNIX-based application for mainframe, AS/400, UNIX, Windows, and Linux platforms.

ACSL functions as the standard in automated library management software for Open Systems environments and efficiently shares library resources with just about any application on almost any platform.



### Important:

**ACSL 7.1** or higher is required for support (with PTF-809236). A TCP/IP connection is needed to connect the server to the library. There are no required configuration changes for ACSL to function.

Because ACSL is sold separately, make sure that the slot count is appropriate and supported by the SL8500 library and application.

To allow for *dynamic* slot upgrades (Capacity on Demand), you can purchase and install the expansion modules, then upgrade as needed to the maximum number of slots for the number of expansion frames installed.

**Table 4. ACSL Requirements**

Specifications	ACSL	ACSL High Availability
Minimum hardware requirements	<ul style="list-style-type: none"> <li>256 MB RAM</li> <li>4 GB of disk space</li> <li>CD-ROM for product installation on Sun or AIX platforms</li> <li>Offline database backup capability (recommended)</li> </ul>	<ul style="list-style-type: none"> <li>44SF-28R Sunfire V240 server or 44SB-02K</li> <li>SunBlade 1500 Workstation</li> <li>44SE-D2A Sun StorEdge D2 disk array</li> <li>SNFCS40 Brocade SilkWorm switch (optional)</li> </ul>
Minimum software requirements	<ul style="list-style-type: none"> <li>ACSL 7.1</li> </ul>	<ul style="list-style-type: none"> <li>ACSL 7.1</li> <li>ACSL HA Agent</li> <li>VERITAS Foundation Suite HA</li> </ul>
Connections	TCP/IP (SCSI <i>not</i> supported)	TCP/IP (SCSI <i>not</i> supported)
Supported operating systems	Sun Solaris 8.0 or 9.0	Sun Solaris 8.0 or 9.0, AIX 4.3.3 and 5.1 and Linux Red Hat 8.0

Presently ACSLS has performance recommendations for utilizing and minimizing pass-thru activities:

- Minimizing pass-thru activity between LSMs
- Floating cartridges during a dismount
- Entering cartridges into a library
- Ejecting cartridges from a library
- Maintaining empty storage cells in a library
- Minimizing pass-thru activity with ACSAPI requests
- Using ACSAPI requests and ACSLS commands

This information is documented in detail in Appendix C “Improving Library Performance,” in the *ACSLS Installation and Configuration Guide*.

## ACSLS Differences with a SL8500

There are several differences about how ACSLS operates with the SL8500 library, these include:

- ACSLS considers each SL8500 rail as a separate LSM.
- ACSLS LSMs are numbered from 0 to 3.
- SL8500 CAPs span three rails (2-4). For ACSLS, this is LSMs 1-3.

## Upgrading ACSLS

You can upgrade directly to ACSLS 7.1 from earlier versions of ACSLS, including: 6.1.1 – 6.1 – 6.0.1 – 6.0 – 5.4 – and 5.3.2.

Refer the *ACSLS Installation, Configuration, and Administration Guide* for upgrade installation procedures and Appendix C “Improving Library Performance.”

## ■ AS/400 Configuration Requirements

Requirements for AS/400 to function as another type of management software to control the SL8500 library include:

- **RMLS/CSC must be at 1.3.0**  
RMLS/CSC is the client component of ACSLS that runs on the AS/400. It performs the mounts, dismounts, enters, and ejects on the AS/400. This product integrates into the tape management systems for the AS/400. The tape management systems that RMLS/CSC integrates with are: IBM/BRMS, HelpSystems/RobotSave, and LXI/MMS.
- **OS/400 must be at V5R2**  
OS/400 is the operating system that runs on an AS/400 and the iSeries platform. (iSeries is interchangeable with AS/400).
- ACSLS only supports TCP/IP communications to RMLS/CSC.
- SNA (Systems Network Architecture) is not supported.



## ■ VSM

There are no required configuration changes for VSM / VTCS to run with the SL8500 library.

## ■ Independent Software Vendors

What independent software vendors (ISVs) will be tested and supported?

**Table 5. Supported Independent Software Vendors**

ISV	Platform Supported
CA BrightStor, Enterprise Backup	Windows, Solaris , AIX, HP-UX
CA BrightStor ARCserve	Windows, Solaris
Legato NetWorker	Windows, SUN, AIX, HP-UX
Tivoli Storage Manager	Windows, AIX
VERITAS NetBackup	Windows, Solaris, AIX, HP-UX

## ■ Tier 1 and 2 Partners

[Table 6](#) lists partners into Tier 1 and Tier 2 groups.

**Table 6. Tier 1 and Tier 2 Partners**

Tier 1	Tier 2
VERITAS NetBackup	CommVault Galaxy
VERITAS Backup Exec	ADIC AMASS/StorNext
Legato NetWorker	BackBone NetVault
Tivoli Storage Manager	Atempo Time Navigator
HP DataProtector	ASM (Windows/Sun)
CA BrightStor, Enterprise Backup	Syncsort Backup Express
CA BrightStor ARCserve (No ACSLS Support)	

## ■ Software Feature Codes

StorageTek continues to expand the capabilities of its industry leading library management software with releases of ACSLS and HSC.

### ACSLS Feature Codes

The model number for ACSLS is: **ACSLS 02**  
 This is the model number which includes ACSLS software with the following feature codes:

**Table 7. ACSLS Feature Code Work Sheet**

Required?	Action	Select	Feature	Description
Yes	Select the a <b>Model</b>	■	0000	ACSLS Base Model
Yes	You <i>must</i> select a <b>Platform</b>	<input type="checkbox"/>	0AIX	ACSLS Software AIX Version
		<input type="checkbox"/>	0LNX	ACSLS Software LINUX Version
		<input type="checkbox"/>	0SLR	ACSLS Software SOLARIS Version
Yes	Select the <b>Level</b> of ACSLS:	<input type="checkbox"/>	L700	ACSLS Level 7.1 or higher
No	Select <b>Options</b>	<input type="checkbox"/>	HA01	High Availability SOLARIS Version
		<input type="checkbox"/>	VSHB	VERITAS High Availability Suite
		<input type="checkbox"/>	OEMS	OEM Software
Yes	You <i>must</i> select one item from the <b>Slot</b> features based on number of slots required.  Make sure to match or exceed the feature code with the number of slots in the SL8500 library	<input type="checkbox"/>	Q001	Up to 100 Slots
		<input type="checkbox"/>	Q002	Up to 200 Slots
		<input type="checkbox"/>	Q003	Up to 300 Slots
		<input type="checkbox"/>	Q004	Up to 400 Slots
		<input type="checkbox"/>	Q005	Up to 500 Slots
		<input type="checkbox"/>	Q006	Up to 600 Slots
		<input type="checkbox"/>	Q007	Up to 700 Slots
		<input type="checkbox"/>	Q008	Up to 800 Slots
		<input type="checkbox"/>	Q009	Up to 900 Slots
		<input type="checkbox"/>	Q010	Up to 1,000 Slots
		<input type="checkbox"/>	Q011	Up to 1,100 Slots
		<input type="checkbox"/>	Q012	Up to 1,200 Slots
		<input type="checkbox"/>	Q013	Up to 1,300 Slots
		<input type="checkbox"/>	Q014	Up to 1,400 Slots
		<input type="checkbox"/>	Q015	Up to 1,500 Slots
<input type="checkbox"/>	Q020	Up to 2,000 Slots		
<input type="checkbox"/>	Q025	Up to 2,500 Slots	<b>First Expansion</b>	

(continued on next page)

**Table 7. ACSLS Feature Code Work Sheet (Continued)**

Required?	Action	Select	Feature	Description
Yes	Select the number of <b>Slots</b> (continued).	<input type="checkbox"/>	Q030	Up to 3,000 Slots
		<input type="checkbox"/>	Q035	Up to 3,500 Slots
		<input type="checkbox"/>	Q040	Up to 4,000 Slots
		<input type="checkbox"/>	Q045	Up to 4,500 Slots <b>Second Expansion</b>
		<input type="checkbox"/>	Q050	Up to 5,000 Slots
		<input type="checkbox"/>	Q055	Up to 5,500 Slots
		<input type="checkbox"/>	Q060	Up to 6,000 Slots <b>Third Expansion</b>
		<input type="checkbox"/>	Q070	Up to 7,000 Slots
		<input type="checkbox"/>	Q080	Up to 8,000 Slots <b>Fourth Expansion</b>
		<input type="checkbox"/>	Q090	Up to 9,000 Slots
		<input type="checkbox"/>	Q100	Up to 10,000 Slots <b>Fifth Expansion</b>
		<input type="checkbox"/>	Q110	Up to 11,000 Slots
		<input type="checkbox"/>	Q165	Up to 16,500 Slots
		<input type="checkbox"/>	Q220	Up to 22,000 Slots
		<input type="checkbox"/>	Q275	Up to 27,500 Slots
		<input type="checkbox"/>	Q500	Up to 50,000 Slots
		<input type="checkbox"/>	Q750	Up to 75,000 Slots
<input type="checkbox"/>	Q751	Up to 99,998 Slots		
<input type="checkbox"/>	Q999	99999+ Slots		

## HSC Feature Codes

**Table 8. HSC Feature Codes**

Description	Code
MVS HSC	1190M30
DSLO License	2902
38,000 Cartridges	2923
Level 6.0	L600

Software

# Tape Drives



The SL8500 library supports a wide variety of tape drives with fiber-optic based interfaces. This appendix provides information about these tape drives.

**Table 9. Supported Tape Drives and Microcode Levels**

Vendor	Drive Type	Firmware*	Latest Level
StorageTek	T9840A	1.34.158	1.35.x07
	T9840B	1.34.358	
	T9840C	1.34.558	
	T9940B	1.34.408	1.35.305
	T10000	(Check on level)	(Check on level)
HP	LTO2	K3A1 EC141048	K541
	LTO3	(Check on level)	L25S
IBM	LTO2	4770 EC141226	53Y2
	LTO3	(Check on level)	57F7
Quantum	SDLT600	(Check on level)	V40
<b>Note:</b> *This is the <i>minimum</i> recommended tape drive firmware level.			

Table 10 lists the *approximate* library capacity with these tape drives

**Table 10. Library Data Capacity**

Tape Drive Type	Cartridge Capacity	No Expansions (1,448 slots)	3 Expansions (6,632 slots)	5 Expansions (10,088 slots)
T9840 A/B	20 GB/cartridge	28.3 TB	130 TB	202 TB
T9840 C	40 GB/cartridge	56.5 TB	259 TB	405 TB
T9940 B	200 GB/cartridge	283 TB	1.26 PB	1.98 PB
T10000	500 GB/cartridge	707 TB	3.16 PB	5.00 PB
LTO Generation 2	200 GB/cartridge	283 TB	1.26 PB	1.98 PB
LTO Generation 3	300 GB/cartridge	424 TB	1.89 PB	2.97 PB
SDLT 600	400 GB/cartridge	565 TB	2.52 PB	4.8 PB



1 PB (Petabyte) = 1024 TB (Terabytes) = 1,048,576 GB (Gigabytes) Binary (base 2)  
 1 PB (Petabyte) = 1000 TB (Terabytes) = 1,000,000 GB (Gigabytes) Decimal (base 10)

## ■ T9840 Tape Drives

**Description** The T9840—models A, B, and C—are **access-centric** tape drives that have an average access time of just 12 seconds. These tape drives are ideal for applications that demand high data throughput and fast recall.

**Read/Write Technology** The T9840C uses a variable rate randomizer, with partial response, maximum likelihood circuitry and LZ1 as the data recording method.

The T9840 models A and B use a StorageTek proprietary recording format.

A 16-channel head reduces the required number of tape passes to record data to tape and also extends media life (few passes).

**Media** These drives obtain their high-performance by using a unique *dual-hub* cartridge design with midpoint load technology. This design enables fast access and reduces latency by positioning the read/write head in the middle of the tape.

With the 9840 unique dual-hub design, the entire tape path is contained within the cartridge, which reduces contamination and enables the drives fast access.

**Connectivity**

Interface	T9840A	T9840B	T9840C
Fibre Channel	1 Gb	2 Gb	2 Gb
ESCON	19 MB/s	19 MB/s	19 MB/s
FICON	N/A	2 Gb	2 Gb

**Operating Systems**

Versions of both enterprise and open system platforms, such as:  
Windows: NT, 2000; UNIX: Solaris, HP-UX, AIX; Linux; MVS, VM, and OS/390

**Table 11. T9840 Tape Drive Specifications**

Specifications	T9840A	T9840B	T9840C
Capacity (native)	20 GB	20 GB	40 GB
Transfer rate (native)	10 MB/s	19 MB/s	30 MB/s
Data Buffer size	8 MB	32 MB	64 MB
Number of tracks	288	288	288
Load to ready	4 sec	4 sec	4 sec
Access time-average (to first file)	8 sec	8 sec	8 sec
Tape speed (meters per second)	2 m/s	4 m/s	3.4 m/s
Rewind time (maximum/average)	16/8 sec	16/8 sec	16/8 sec
Unload time	4 sec	4 sec	4 sec
MTBF (100% duty cycle)	290,000 hrs	290,000 hrs	290,000 hrs
<b>Power</b>			
Auto-ranging / Amperage	100–240 VAC at 50–60 Hz		
Consumption	82 VA	82 VA	82 VA
Operating Heat Output	280 Btu/hrs	280 Btu/hrs	280 Btu/hrs

## ■ T9940 Tape Drives

<b>Description</b>	StorageTek's T9940B tape drive is a <b>capacity-centric</b> tape drive that offers exceptional storage capacity. This tape drive is ideal for applications that demand high throughput and capacity.								
<b>Read/Write Technology</b>	The T9940B use a variable rate randomizer, with partial response, maximum likelihood circuitry and LZ1—an Adaptive Lossless Data Compression technique—as the data recording method.  A 16-channel head reduces the required number of tape passes to record data to tape and also extends media life (few passes).								
<b>Media</b>	The tape cartridge for this drive uses a single-reel hub design—the supply reel is inside the cartridge and the take-up reel is inside the tape drive.								
<b>Connectivity</b>	<table border="1"> <thead> <tr> <th>Interface</th> <th>T9940B</th> </tr> </thead> <tbody> <tr> <td>Fibre Channel</td> <td>2 Gb</td> </tr> <tr> <td>ESCON</td> <td>20 MB/sec</td> </tr> <tr> <td>FICON</td> <td>2 Gb</td> </tr> </tbody> </table>	Interface	T9940B	Fibre Channel	2 Gb	ESCON	20 MB/sec	FICON	2 Gb
Interface	T9940B								
Fibre Channel	2 Gb								
ESCON	20 MB/sec								
FICON	2 Gb								
<b>Operating Systems</b>	Versions of both enterprise and open system platforms, such as: Windows: NT, 2000; UNIX: Solaris, HP-UX, AIX; Linux; MVS, VM, and OS/390								

**Table 12. T9940 Tape Drive Specifications**

Specifications	T9940B
Capacity (native)	200 GB
Transfer rate (native)	30 MB/s
Data Buffer size	64 MB
Number of tracks	576
Load to ready	18 sec
Access time-average (to first file)	59 sec
Tape speed (meters per second)	2.4 m/s
Rewind time (maximum/average)	90/45 sec
Unload time	18 sec
MTBF (100% duty cycle)	290,000 hrs
<b>Power</b>	
Auto-ranging / Amperage	100–240 VAC at 50–60 Hz
Consumption	82 VA
Operating Heat Output	280 Btu/hrs

## ■ T10000 Tape Drive

<b>Description</b>	The T10000 tape drive is a small, modular, high-performance, <b>capacity-centric</b> tape drive that is capable of storing up to 500 GB of uncompressed data on a single cartridge while supporting a throughput rate of 120 MB/s.
<b>Read/Write Technology</b>	The T10000 uses partial response, maximum likelihood (PRML) complemented by dual magneto-resistive (MR) head technologies that provide 32 channels that write data to the tape and read it back. This dual-head technology: <ul style="list-style-type: none"> <li>• Provides the high-density data format</li> <li>• Increases data integrity</li> <li>• Promotes longer media life</li> <li>• Achieves significantly high transfer rates</li> </ul>
<b>Media</b>	The new tape cartridge for this drive uses a single-reel hub design—the supply reel is inside the cartridge and the take-up reel is inside the tape drive.
<b>Connectivity</b>	The interface connections to the T10000 are strictly fiber-optic—either Fibre Channel or FICON ( <i>future offering</i> )—to support the high rate of data transfers.
<b>Operating Systems</b>	The T10000 supports a variety of operating system platforms: <ul style="list-style-type: none"> <li>• Enterprise mainframes (such as z/OS and OS/390) and</li> <li>• Open system platforms (such as Windows, UNIX, and Linux).</li> </ul>

**Table 13. T10000 Tape Drive Specifications**

Physical Specifications	T10000A
Capacity (native)	500 GB
Transfer rate (native)	2 Gbps / 4 Gbps
Throughput	120 MB/s
Data Buffer size	256 MB
Number of tracks	768 tracks (32 channels / 24 wraps)
Load to ready	15 sec
Access time-average (to first file)	16 sec
Tape speed (meters per second)	2.0 to 4.95 m/s
Rewind time (maximum/average)	108 sec
Unload time	23 sec
MTBF (100% duty cycle)	290,000 hrs
<b>Power</b>	
Auto-ranging / Amperage	88–264 VAC, 48–63 Hz
Consumption	90 VA
Operating Heat Output	280 Btu/hrs



## ■ HP LTO Specifications

**Description** Hewlett-Packard LTO tape drives are a small, modular, **capacity-centric** drive. These drives conform to the LTO open standard where drive technology is based on an open standard that provides media compatibility across all brands and manufacturers of LTO Ultrium products.

**Read/Write Technology** LTO drives record data using write-equalized run length limited (RLL) code. LTO2 uses an LZ1-based compression scheme while LTO3 uses PRML and a derivative of the Advanced Lossless Data Compression (ALDC-2) technique.

Data is written in a linear format with a serpentine pattern—the tape reverses direction after each set of tracks is written to the end of tape (EOT).

**Media** The tape cartridge for LTO Ultrium drives is a single-reel hub design—the supply reel is inside the cartridge and the take-up reel is inside the tape drive. The drives require different media and must be labeled as such:

Version (Label)	LTO2 (L2)	LTO3 (L3)
<b>Capacity:</b>	200 GB	400 GB
<b>Tracks:</b>	512	704
<b>Total Length:</b>	609 m (1998 ft)	680 m (2230 ft)

**Note:** HP drives support the LTO standard for backward compatibility, which is to write back one generation and read back two generations.

**Connectivity**

Interface	LTO2	LTO3
<b>Fibre Channel</b>	2 Gb	2 Gb

**Operating Systems**

The target customers for HP LTO drives are mid-range tape automation environments with Windows NT/2000, Netware, Linux, and UNIX (HP-UX).

**Table 14. HP LTO Tape Drive Specifications**

Physical Specifications	LTO2	LTO3
Capacity (native)	200 GB	400 GB
Transfer rate (native)	30 MB/s	80 MB/s
Data Buffer size	64 MB	128 MB
Number of tracks	512	704
Load to ready	15–24 sec	19 sec
Access time-average (to first file)	64–75 sec	72 sec
Tape speed (meters per second)	5.50 m/s	5.32 m/s
Rewind time (maximum/average)	104/52 sec	98/49 sec
Unload time	13–19 sec	19 sec
MTBF (100% duty cycle)	250,000 hrs	250,000 hrs
<b>Power</b>		
Auto-ranging / Amperage	100–240 VAC at 50–60 Hz / 0.8 Amps	
Consumption	38 W	35 W

## ■ IBM LTO Specifications

- Description** IBM TotalStorage 3580 LTO tape drives are small, modular, **capacity-centric** drives and conform to the LTO open standard for compatibility.
- Read/Write Technology** IBM drives use a magneto resistive (MR) head design to help minimize debris and wear. Data is written in a linear format with a serpentine pattern—the tape reverses direction after each set of tracks is written to the end of tape (EOT).  
LTO2 use a LZ1-based data compression scheme while LTO3 uses a derivative of the Advanced Lossless Data Compression (ALDC-2) technique.
- Media** The tape cartridge for LTO Ultrium drives is a single-reel hub design—the supply reel is inside the cartridge and the take-up reel is inside the tape drive.  
The drives require different media and must be labeled as such:

Version (Label)	LTO2 (L2)	LTO3 (L3)
<b>Capacity:</b>	200 GB	400 GB
<b>Tracks:</b>	512	704
<b>Total Length:</b>	609 m (1998 ft)	680 m (2230 ft)

**Note:** IBM drives support the LTO standard for backward compatibility, which is to write back one generation and read back two generations.

**Connectivity**

Interface	LTO2	LTO3
<b>Fibre Channel</b>	2 Gb	2 Gb / 4 Gb

**Operating Systems**

Operating system support is available for: IBM AIX, OS/400 and i5/OS, Microsoft Windows 2000 Server 2003, Sun Solaris 8 and 9; HP-UX 11.0 and 11, and Red Hat Enterprise Linux 3; SUSE LINUX Enterprise Server 8.

**Table 15. IBM LTO Tape Drive Specifications**

Physical Specifications	LTO2	LTO3
Capacity (native)	200 GB	400 GB
Transfer rate (native)	35 MB/s	80 MB/s
Data Buffer size	64 MB	128 MB
Number of tracks	512	704
Load to ready	15 sec	15 sec
Access time-average (to first file)	64 sec	46 sec
Tape speed (meters per second)	6.2 m/s	5.46 m/s
Rewind time (maximum/average)		88 sec
Unload time		
MTBF (100% duty cycle)	250,000 hrs	250,000 hrs
<b>Power</b>		
Auto-ranging / Amperage	100–240 VAC at 50–60 Hz / 0.5–1.0 Amps	
Consumption	29 W	28 W

## ■ Quantum LTO Specifications

<b>Description</b>	Quantum LTO tape drives are small, modular, <b>capacity-centric</b> drives.								
<b>Read/Write Technology</b>	LTO drives record data using write-equalized run length limited (RLL) code. LTO3 uses PRML and derivative of the ALDC-2 technique. Data is written in a linear format with a serpentine pattern—the tape reverses direction after each set of tracks is written to the end of tape (EOT).  Quantum LTO3 uses an exclusive 13-speed transfer feature that maximizes the data transfer rates by adjusting tape streaming automatically to match the host's rate of transfer and speed.								
<b>Media</b>	The tape cartridge for LTO Ultrium drives is a single-reel hub design—the supply reel is inside the cartridge and the take-up reel is inside the tape drive. The drives require different media and must be labeled as such:								
	<table border="1"> <thead> <tr> <th>Version (Label)</th> <th>LTO3 (L3)</th> </tr> </thead> <tbody> <tr> <td><b>Capacity:</b></td> <td>400 GB</td> </tr> <tr> <td><b>Tracks:</b></td> <td>704</td> </tr> <tr> <td><b>Total Length:</b></td> <td>680 m (2230 ft)</td> </tr> </tbody> </table>	Version (Label)	LTO3 (L3)	<b>Capacity:</b>	400 GB	<b>Tracks:</b>	704	<b>Total Length:</b>	680 m (2230 ft)
Version (Label)	LTO3 (L3)								
<b>Capacity:</b>	400 GB								
<b>Tracks:</b>	704								
<b>Total Length:</b>	680 m (2230 ft)								
<b>Connectivity</b>	<b>Note:</b> Because the Quantum supports only SCSI interfaces, it can not be installed in an SL8500 library.								
<b>Operating Systems</b>	Support includes: Windows Desktop, Windows Server, Novell NetWare, Unix, Linux, Mac OS								

**Table 16. Quantum LTO Tape Drive Specifications**

Physical Specifications	LTO3
Capacity (native)	400 GB
Transfer rate (native)	80 MB/s
Data Buffer size	128 MB
Number of tracks	704
Load to ready	15 sec
Access time-average (to first file)	58 sec
Tape speed (meters per second)	5.9 m/s
Rewind time (maximum/average)	115/51 sec
Unload time	30 sec
MTBF (100% duty cycle)	250,000 hrs
<b>Power</b>	
Auto-ranging / Amperage	100–240 VAC at 50–60 Hz / 0.5–1.0 Amps
Consumption	42 W

## ■ Super DLT600

<b>Description</b>	The Super DLT (SDLT) is the next generation of follow-on products to the popular DLT family—once a standard for mid-range UNIX and Windows environments. The SDLT is a modular design, <b>capacity-centric</b> tape drive that supports multiple product generations and consists of both a new drive and a new tape cartridge.
<b>Read/Write Technology</b>	<p>The Super DLT product family incorporates an advanced tape recording technology called Laser Guided Magnetic Recording (LGMR). This technology combines optical and magnetic technologies for higher capacities—data is written on the magnetic side of the tape; servo positioning occurs optically on the other side of the tape.</p> <p>Magnetoresistive Cluster (MRC) heads provide a densely packed array of read/write heads that are precisely positioned using thin-film processing.</p> <p>Partial Response Maximum Likelihood (PRML) technology provides the high-performance required for linear tape products.</p>
<b>Media</b>	<p>The tape cartridge for SDLT drives is a single-reel hub design—the supply reel is inside the cartridge and the take-up reel is inside the tape drive.</p> <p>Two types of tape cartridges exist: SDLTape I and SDLTape II.</p> <p>Read only compatibility with SDLT I and read and write compatibility with SDLT II.</p>
<b>Connectivity</b>	2 Gb Fibre Channel (FC)
<b>Operating Systems</b>	Support includes: Windows NT/2000/2003 Server, Novell NetWare, Unix, and Linux,

**Table 17. Super DLT Tape Drive Specifications**

<b>Physical Specifications</b>	<b>SDLT 600</b>
Capacity (native)	300 GB
Transfer rate (native)	36 MB/s
Data Buffer size	64 MB
Number of tracks	640
Load to ready	18 sec
Access time-average (to first file)	79 sec
Tape speed (meters per second)	2.74 m/s
Rewind time (maximum/average)	156/77 sec
Unload time	19 sec
MTBF (100% duty cycle)	250,000 hrs
<b>Power</b>	
Auto-ranging / Amperage	100–240 VAC at 50–60 Hz /
Consumption	34 W

## ■ Dynamic World Wide Name

Each connection (port) in a Fibre Channel environment must have a unique ID called the World Wide Name (WWN). The WWN is a 64-bit address that identifies each individual device, company, with vendor information.

When a device logs-in to a Fibre Channel network, the WWN is validated for access by comparing Port Name, Node Name, and Port ID. All three of these identifiers must match or this indicates the configuration has changed and the port is blocked from access.

StorageTek uses the IEEE registered format for Name Address Authority (NAA), company ID, and vendor specific identifier for a total of 64 bits for login validation.

StorageTek's company ID is 24 bits consisting of: 500104F (hex)

The SL8500 includes the dynamic World Wide Name (dWWN) feature, that, when enabled, assigns world wide names to the library drive *slots* rather than the drives themselves.

This feature allows you to swap or replace devices, such as tape drives, without bringing down the entire operating system to update a .conf file or GEN file because of a new WWN.

Changing the WWN feature must be coordinated with the system administrator and is usually enabled during installation.

**Note:** Both library and tape drives must have microcode or firmware that supports the dynamic World Wide Naming feature.



**Important:**

Tape drives that are migrated from other libraries *will be assigned a different* WWN when installed in an SL8500 library. The existing network may not associate this new WWN with the originally assigned name.

This will require a reconfiguration of the network for these tape drives.

## Arbitrated Loops



SL8500 tape drive configurations *do not support Arbitrated Loops.*

# ■ Tape Drive Comparisons

Table 18. Tape Drive Comparisons

Comparisons	StorageTek T-Series			HP	IBM	LTO3	Quantum
	T10000	T9940B	T9840C				
<b>Data</b>							
Capacity (native)	500 GB	200 GB	40 GB	LTO3	LTO3	LTO3	SDLT 600
Transfer rates (native)	120 MB/s	30 MB/s	30 MB/s	80 MB/s	80 MB/s	68 MB/s	300 GB
Fibre Channel	2 & 4 Gb/s	2 Gb/s	2 Gb/s	2 Gb/s	2 Gb/s	no	36 MB/s
FICON	2 Gb/s	no	2 Gb/s	no	no	no	2 Gb/s
ESCON	2 Gb/s	18 MB/s	18 MB/s	no	no	no	no
Buffer size	256 MB	64 MB	64 MB	128 MB	128 MB	128 MB	64 MB
Load time (to ready)	15 sec	18 sec	4 sec	19 sec	15 sec	30 sec	12 sec
Access time (to first byte)	16 sec	59 sec	8 sec	71 sec	46 sec	88 sec	93 sec
Search time (file access)	—	—	—	52 sec	54 sec	58 sec	67 sec
Tape speed (meters per sec.)	2–4.95 m/s	2.4 m/s	3.4 m/s	5.32 m/s	5.46 m/s	5.9 m/s	2.7 m/s
Rewind time (max./average)	108 sec	90 / 45 sec	16 / 8 sec	98 / 49 sec	88 sec	115 / 51 sec	156 / 77 sec
Unload time	23 sec	18 sec	4 sec	19 sec	19 sec	19 sec	12 sec
Availability (MTBF)	290,000 hrs	290,000 hrs	290,000 hrs	250,000 hrs	250,000 hrs	250,000 hrs	250,000 hrs
Compatibility	Proprietary Format (same model)			LTO2, LTO3 (r/w) and LTO 1 (r/only)			SDLT II (r/w) SDLT I (r/only)
<b>Media</b>							
Tracks	768	576	288	704	704	704	640
Length—usable	855 m (2805 ft)	650 m (2134 ft)	251 m (889 ft)	651 m (2136 ft)	651 m (2136 ft)	651 m (2136 ft)	596 m (1957 ft)
VolSafe—WORM technology	yes	yes	yes	yes	yes	yes	yes

Tape cartridges are not shipped as part of the SL8500 modular library system and must be ordered separately.

**Notes:**

- The customer can use their existing cartridges as long as they are compatible with the supported tape drives and still within their warranty period.
- Professional Services and Data Center Services offer transition support and services to help migrate media and drives.
- Make sure that the customer orders the cartridge tape labels before the installation.
- Labels cannot be ordered separately from the cartridge tape.

**Note:** For more information and how to order, refer to the *Sun StorageTek Media Catalog* PN TM0007x.

## ■ Disclaimer



**Media Usage:**

The storage media (tape cartridges) used in a tape drive and/or library can have a *significant* impact on the overall performance. The following is a Sun Microsystems StorageTek policy regarding tape storage media:

- Sun Microsystems warrants tape storage media that is branded StorageTek.
- The customer is responsible for all expenses and costs related to the repair or replacement of hardware damaged by non-StorageTek branded tape storage media.
- The customer may be billed for any service provided by Sun StorageTek resulting from or related to problems caused by non-StorageTek branded tape storage media.

This appendix describes the tape cartridges used in the SL8500 library.

**Note:** Contact a Sun StorageTek representative to obtain more information about tape cartridges and labels.

## ■ 9840 Tape Cartridge

The 9840 tape cartridge is a half-inch tape cartridge featuring a self-contained tape path with dual reels for fast midpoint loads, which eliminates the time required to thread tape. The 9840 tape cartridges use high-density advanced metal particle (AMP) media with a back coating that is specially formulated to reduce static and tape compression.

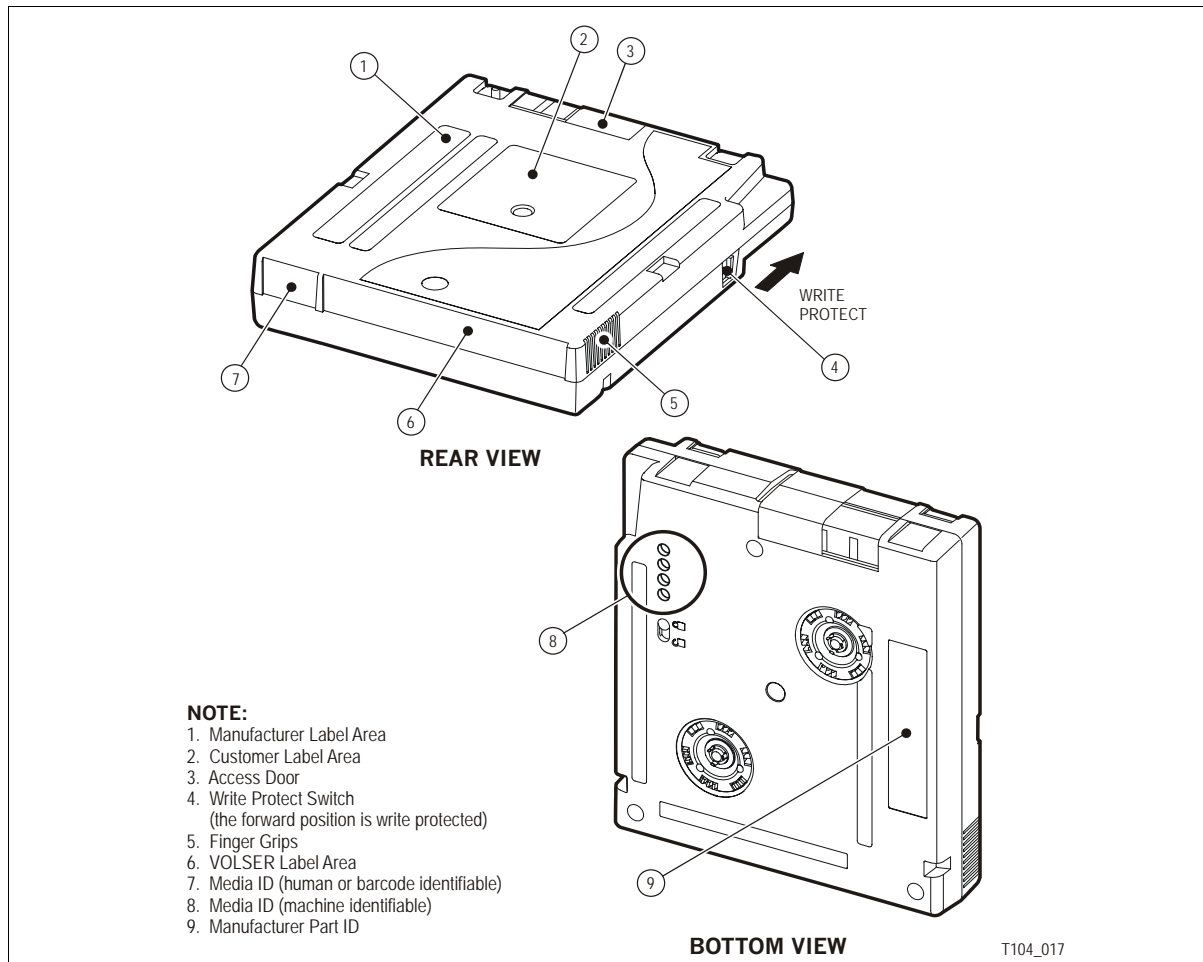
Pre-written servo tracks provide precision head alignment.

These cartridges are used exclusively in T9840A, T9840B and T9840C tape drives.

The media ID labels required for the 9840 tape cartridges are:

- R = data cartridge
- U = Cleaning cartridge

**Figure 3. 9840 Tape Cartridge**





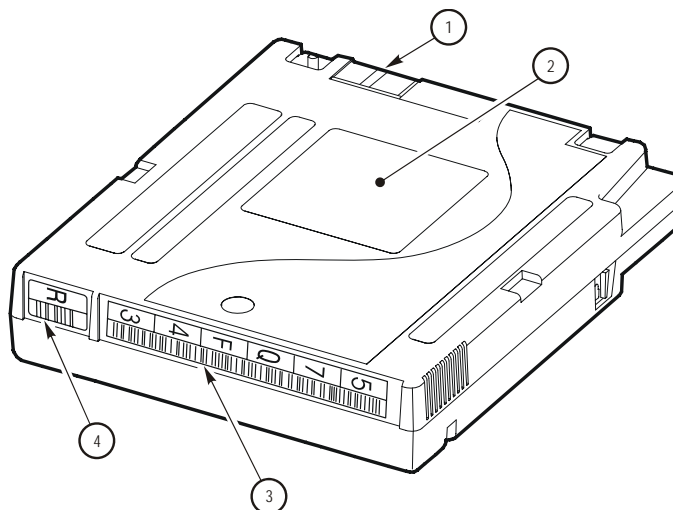
## 9840 Cartridge Specifications

The 9840 tape cartridge was designed concurrently with the T9840 tape drive to provide fast access to data and storage of up to 40 gigabytes on a single cartridge.

One important characteristic is the *midpoint load design* that provides access to data within 12 seconds (on average).

The 9840 design achieves this fast access by having *both* supply and take-up reels inside the cartridge.

1. Write-protect switch
2. Customer label
3. Volume serial number (label)
4. Media ID label



T104\_018

**Table 19. 9840 Cartridge Specifications**

Specifications		Performance	
Capacity, native		Read/Write speed	
• T9840A	20 GB	• T9840A	2.0 m/s (79 ips)
• T9840B	20 GB	• T9840B	4.0 m/s (158 ips)
• T9840C	40 GB	• T9840C	3.4 m/s (134 ips)
		Search/Rewind speed (A,B,C)	11 m/s (440 ips)
Availability		Mechanical	
Archival life	15 – 30 yrs	Height	2.54 cm (1.00 in.)
Load/unloads	10,000	Width	10.9 cm (4.29 in.)
Short-length durability	80,000 r/w passes	Length	12.5 cm (4.92 in.)
Long-length durability	361 full file writes	Weight	262 g (9.17 oz)
Uncorrected bit error rate	$1 \times 10^{-18}$	Drop strength	1.00 m (39.4 in.)
Permanent errors	Zero		
Supported drives (compatibility)	T9840A, B, C		
Format			
Number of tracks	288	Form factor	Half-inch
Physical length	271 m (889 ft)	Formulation	Advanced metal particle (AMP)
Recordable length	251 m (823 ft)	Coercivity	$1625 \pm 75$ Oersteds (130 KA/m)
Recording density	1491cpmm	Substrate	Polyethylene naphthalate (PEN)
Track-following servo	Pre-recorded		

## ■ 9940 Tape Cartridge

The 9940 tape cartridge is a high-capacity, single-reel cartridge with the following characteristics:

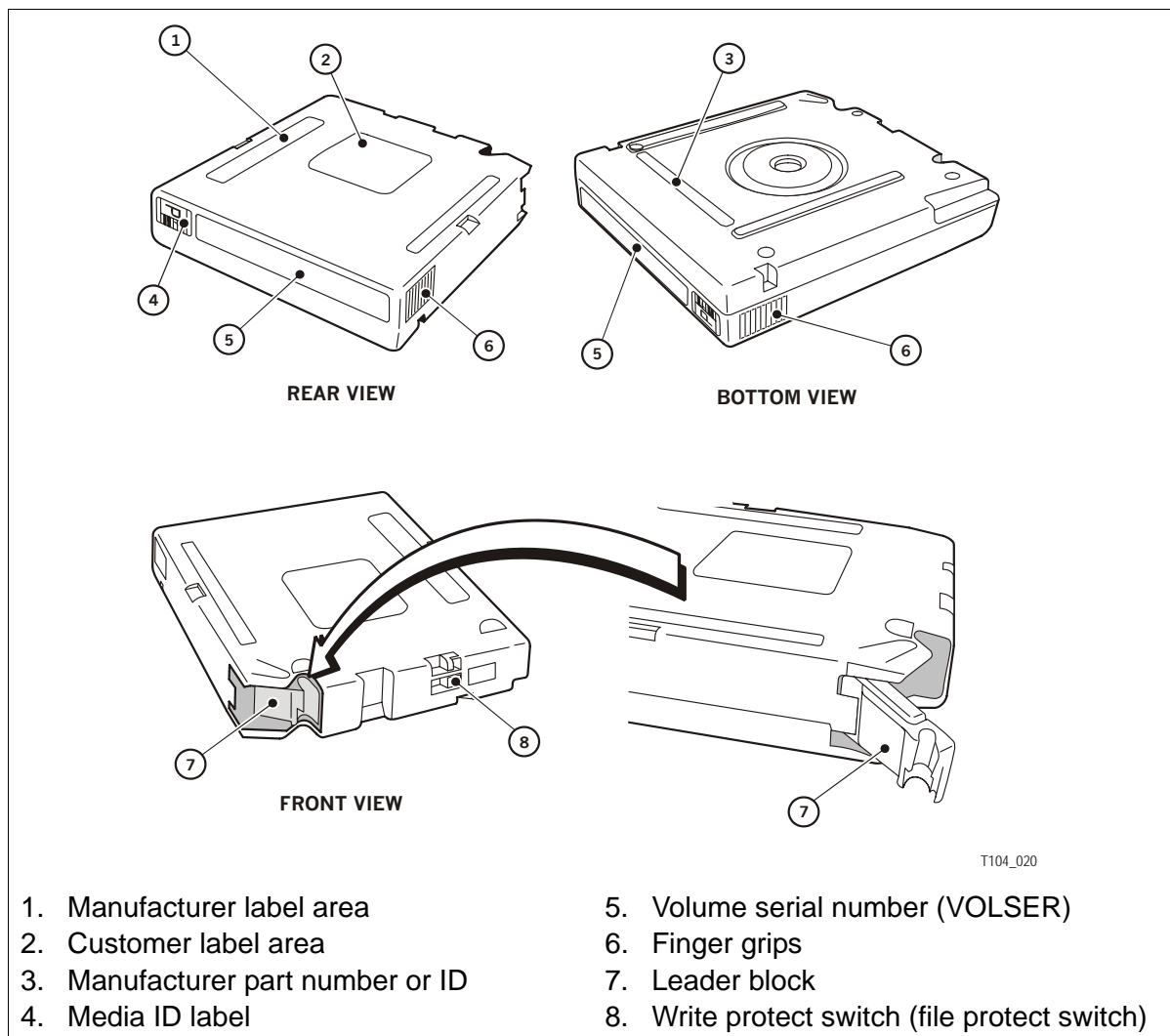
- Advanced metal particle (AMP) tape for higher recording density
- Proprietary back coating reduces static and tape compression
- Pre-written servo tracks provides for precision head alignment
- Half-inch 3480 form-factor tape cartridge.

9940 tape cartridges are used exclusively in T9940A and T9940B tape drives.

The media ID labels required for the 9940 tape cartridges are:

- P = Data cartridge
- W = Cleaning cartridge

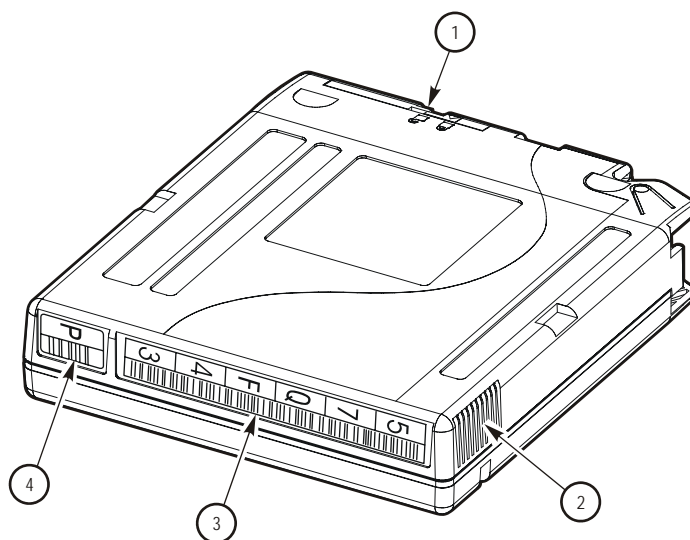
**Figure 4. 9940 Tape Cartridge**



## 9940 Cartridge Specifications

The 9940 tape cartridge is designed to store up to 200 gigabytes of uncompressed data on a single cartridge.

To enable this storage capacity, it contains only the supply reel inside the cartridge. The take-up reel is inside the tape drive.



1. Write protect switch
2. Finger grips
3. Volume serial number
4. Media ID label

T104\_021

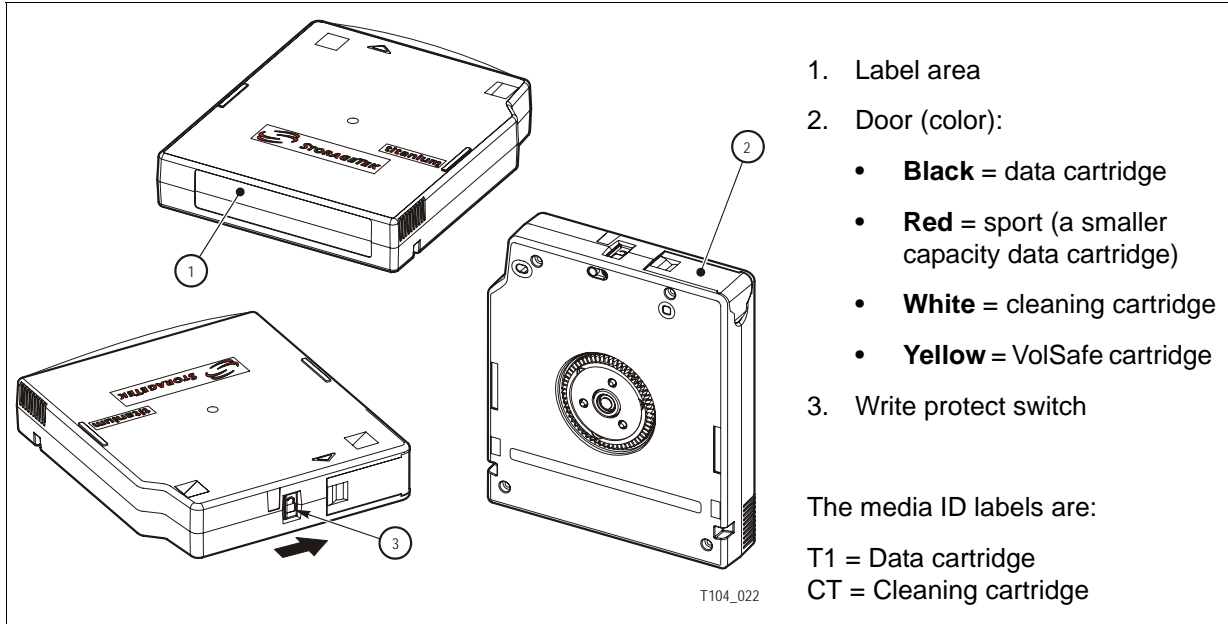
**Table 20. 9940 Cartridge Specifications**

Specifications		Performance	
Capacity, native		Read/Write speed	
• T9940A	60 GB	• T9940A	2.0 m/s (79 ips)
• T9940B	200 GB	• T9940B	2.4 m/s (95 ips)
		Search/Rewind speed (A, B)	11 m/s (440 ips)
Availability		Mechanical	
Archival life	15 – 30 yrs	Height	2.54 cm (1.00 in.)
Load/unloads	10,000	Width	10.9 cm (4.29 in.)
Short-length durability	80,000 r/w passes	Length	12.5 cm (4.92 in.)
Long-length durability	361 full file writes	Weight	262 g (9.17 oz)
Uncorrected bit error rate	$1 \times 10^{-18}$	Drop strength	1.00 m (39.4 in.)
Permanent errors	Zero		
Supported drives (compatibility)	T9940 A and B		
Format			
Number of tracks	288 (T9940A) 576 (T9940B)	Form factor	Half-inch
Physical length	700 m (2,296 ft)	Formulation	Advanced metal particle (AMP)
Recordable length	650 m (2,134 ft)	Coercivity	$1625 \pm 75$ Oersteds (130 KA/m)
Recording density	—	Substrate	Polyethylene naphthalate (PEN)
Track-following servo	Pre-recorded		

## ■ T10000 Tape Cartridges

Optimized for high capacity, the T10000 tape cartridges use a single reel hub to maximize performance. There are four types of tape cartridges:

**Figure 5. Tape Cartridge Types**



### Cleaning Cartridges

Cleaning cartridges clean the tape path and read/write head up to 100 times, after which, the tape drive rejects the cartridge.

### Data Cartridges

There are two types of data cartridges; capacity (500 GB) and sport (120 GB). These cartridges are under warranty for 10,000 (ten-thousand) mounts<sup>1</sup>.

**Important:** After 15,000 mounts, a tape drive *will not* accept the cartridge.

The tape is under warranty for 200 full file writes to the media. *The tape drive issues a warning message when that number is exceeded* giving the customer time to transfer the data.

### VolSafe Cartridges

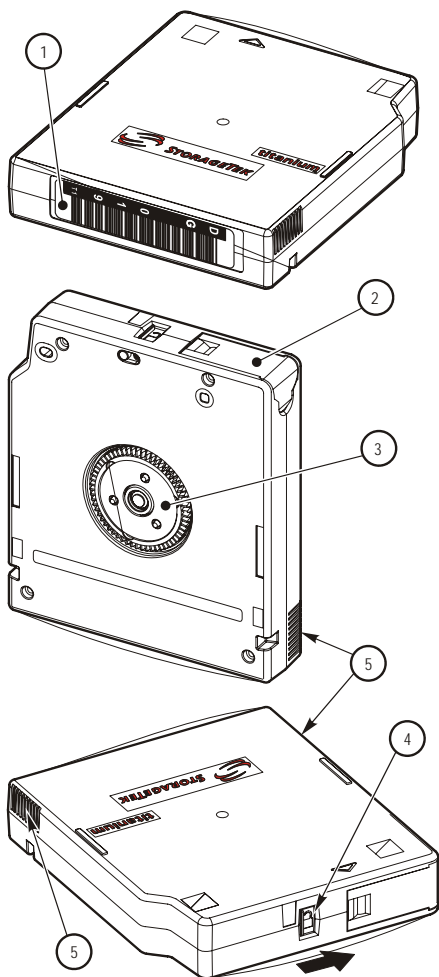
VolSafe is an extension of the write protect function for a StorageTek tape drive. These cartridges are for write once read many (WORM) applications and cannot be erased without destroying the tape itself.

---

1. A mount is defined as the tape drive threads the tape onto the machine reel and goes to load point; just inserting the cartridge into the tape drive does not constitute a mount.

## T10000 Cartridge Specifications

The T10000 tape cartridge is designed to store up to 500 gigabytes of uncompressed data on a single cartridge.



1. Label area
2. Door color identifies the type of cartridge:
  - Black = Data (capacity–500 GB)
  - Red = Data (sport–120 GB)
  - Yellow = VolSafe
  - White = Cleaning
3. Hub
4. Write protect switch
5. Finger grips

### Radio Frequency Identification

Included inside the cartridge is a Radio Frequency Identification (RFID) memory chip. The RFID chip contains information about the cartridge and its performance over time.

The Radio Frequency Identification technology is composed of a:

- Memory chip in the cartridge
- Module in the drive to retrieve information about the tape

### Availability

Archival life	15 – 30 yrs
Load/unloads	10,000
Short-length durability	80,000 r/w passes
Long-length durability	200 full file writes
Uncorrected bit error rate	1 x 10 <sup>-18</sup>
Paramount errors	Zero
Supported drives (compatibility)	Proprietary T10000 A (only)

T104\_023

**Table 21. T10000 Cartridge Specifications**

Specifications		Performance	
Capacity, native		Read/Write speed	
• T10000A	500 GB	• T10000A	2.0 to 4.95 m/s
<b>Format</b>		Search/Rewind speed —	
Number of tracks	768	<b>Mechanical</b>	
Physical length	917 m (3,009 ft)	Height	2.54 cm (1.00 in.)
Recordable length	855 m (2,805 ft)	Width	10.9 cm (4.29 in.)
Form factor	Half-inch	Length	12.5 cm (4.92 in.)
Formulation	Advanced metal particle	Weight	264 g (9.31 oz)
Track-following servo	Pre-recorded	Drop strength	1.00 m (39.4 in.)

## ■ LTO Tape Cartridges

The Linear Tape-Open (LTO) Ultrium family of tape cartridges are optimized for high capacity and performance and are composed of half-inch, high-grade, patented, ceramic-coated metal particle tape.

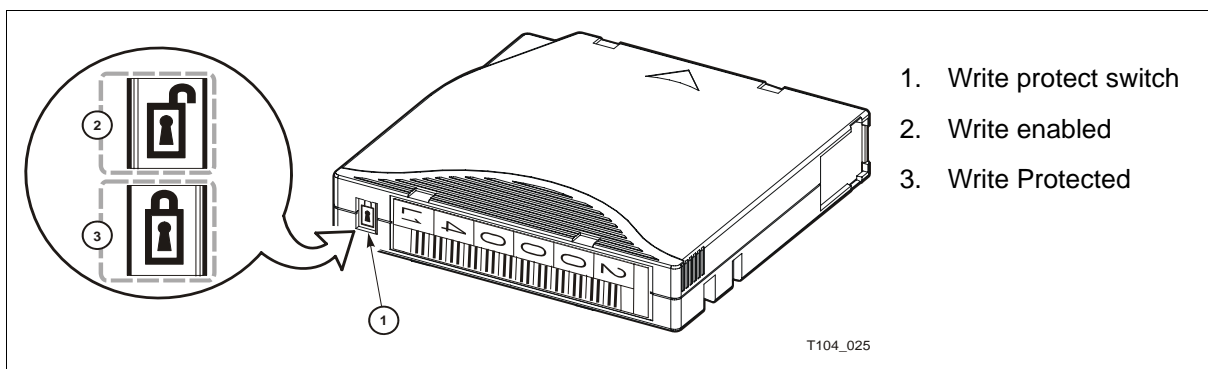
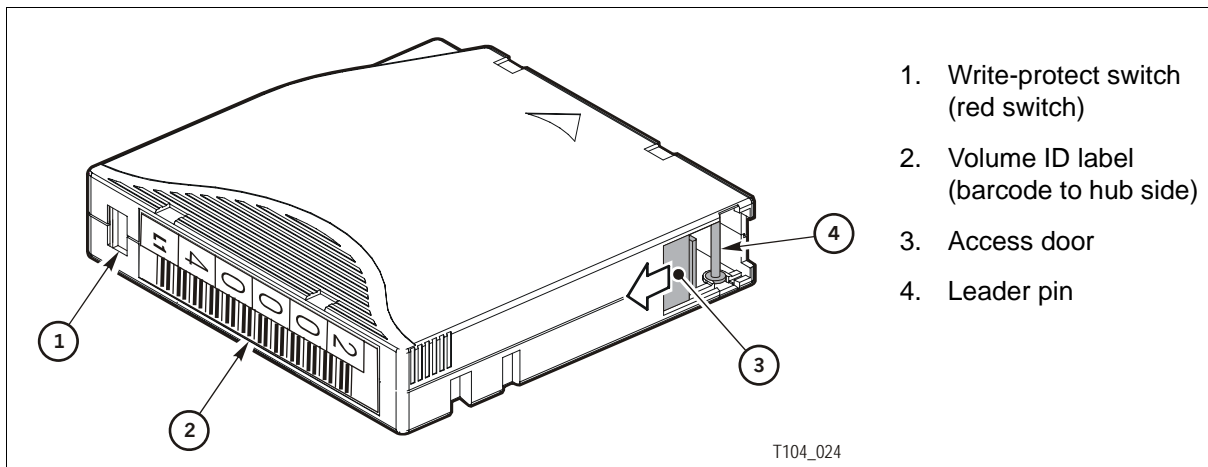
The media ID labels for LTO tape cartridges are:

### LTO data cartridges:

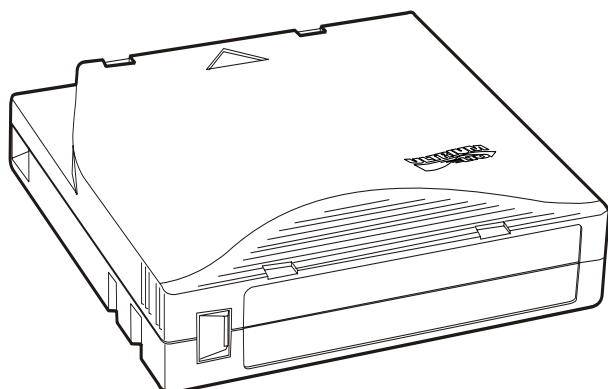
- LT = WORM
- L3 = Generation 3 (400 GB)
- L2 = Generation 2 (200 GB)
- L1 = Generation 1 (100 GB)
- LA = 50 GB
- LB = 30 GB
- LC = 10 GB

**Cleaning cartridge:** CU = Universal

**Figure 6. LTO Tape Cartridge**



## LTO Cartridge Specifications



T104\_029

LTO (Ultraium) cartridges are capacity-centric using single reel cartridges—only the supply reel inside the cartridge—the take-up reel is inside the tape drive.

### Mechanical

Height	2.15 cm (0.85 in.)
Width	10.54 cm (4.15 in.)
Length (depth)	10.20 cm (4.02 in.)
Weight	210 g (0.463 lb)

### Composition

Form factor	Half-inch
Formulation	Metal Particle (MP)
Coercivity	1,850 (147 KA/m)
Substrate	Polyethylene naphthalate
Track-following servo	Factory pre-recorded

**Table 22. LTO Cartridge Specifications**

Specifications	LTO1	LTO2	LTO3
Capacity, native	100 GB	200 GB	400 GB
<b>Performance</b>			
Read/Write speed	4.0 m/s	6.22 m/s	5.46 m/s
Search/Rewind speed	7 m/s	7 m/s	7 m/s
<b>Format</b>			
Recording density (kilobits per inch)	124 kb/in	188 kb/in	245 kb/in
Number of tracks	384	512	704
Tape length (total)	609 m (1998 ft)	609 m (1998 ft)	680 m (2230 ft)
Usable	580 m (1902 ft)	580 m (1902 ft)	651 m (2136 ft)
<b>Availability</b>			
Archival life	15–30 yrs	15–30 yrs	15–30 yrs
Durability	Average 1,000,000+ head passes in an office/computer environment		
Uncorrected bit error rate	$1 \times 10^{-17}$	$1 \times 10^{-17}$	$1 \times 10^{-17}$
Permanent errors	Zero	Zero	Zero
<b>Compatibility</b>			
Read	LTO1	LTO1, LTO2	LTO1, LTO2, LTO3
Write	LTO1	LTO1, LTO2	LTO2, LTO3
Supported tape drives	LTO1	LTO1, LTO2	LTO3

## ■ Super DLT Tape Cartridges

Super DLT (SDLT) tape cartridges are composed of half-inch, patented, ceramic-coated metal particle media.

By transferring the optical servo guide information to the opposite side of the media, the SDLT cartridge enables a higher density of recording tracks on the magnetic surface of the media.

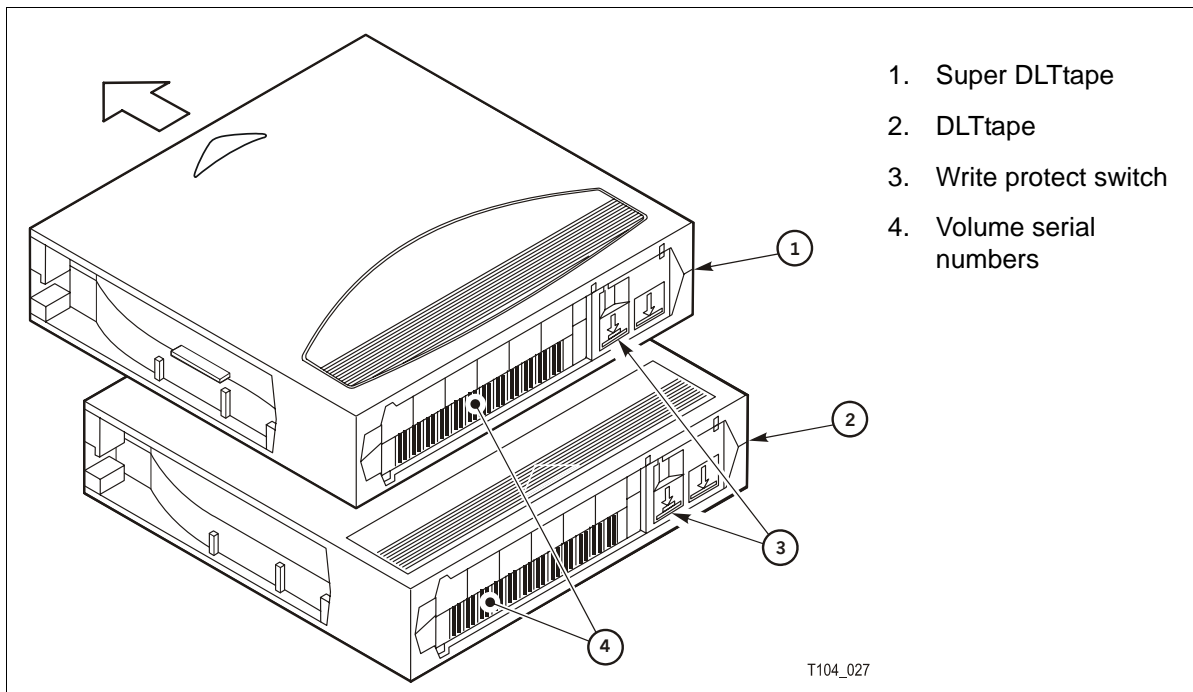
There are two types of SDLT tape cartridges:

- SDLTtape I: for use with SDLT models 220 and 320 (160 GB)
- SDLTtape II: for use with the SDLT 600 (300 GB)

The media ID labels for SDLT tape cartridges are:

- S = SDLTtape I
- 2 = SDLTtape II

**Figure 7. DLT and SDLT Tape Cartridges**

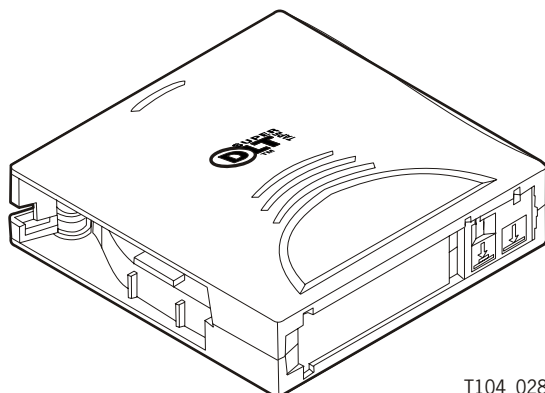


### Notes:

- You cannot insert a Super DLTtape II tape cartridge into an SDLT 220, SLDT 320, or any other earlier model of DLT tape drive.
- Both Super DLTtape cartridges have a keying feature that prevent them from being inserted into the older generation DLT tape drives.



## Super DLTtape Cartridge Specifications



T104\_028

SDLTtape cartridges are capacity-centric cartridges—and come in different colors:

Super DLTtape I data cartridge is dark green.

Super DLTtape II data cartridge is dark blue.

### Mechanical

Height	2.54 cm (1.00 in.)
Width	105.6 cm (4.16 in.)
Length (depth)	105.3 cm (4.15 in.)
Weight	222.5 g (7.85 oz)

### Composition

Form factor	Half-inch
Formulation	Advanced metal particle
Coercivity	2,650 Oersteds
Substrate	Polyethylene naphthalate
Track-following servo	Optical

**Table 23. SDLTtape Cartridge Specifications**

Specifications	SDLTtape I	SDLTtape II
Capacity, native	110 GB (SDLT 220) 160 GB (SDLT320)	300 GB
<b>Performance</b>		
Read/Write speed	3.1 m/s	3.56 m/s
Search/Rewind speed	4.1 m/s	4.83 m/s
<b>Format</b>		
Recording density (kilobits per inch)	193 kb/in (SDLT320)	233 kb/in
Number of tracks	448	640
Tape length (total)	854 m (2800 ft)	630 m (2066 ft)
Usable	538 m (1765 ft)	596 m (1957 ft)
<b>Availability</b>		
Archival life	15–30 yrs	15–30 yrs
Durability	Average 1,000,000+ head passes in an office/computer environment	
Long-length durability (maximum)	260 full media passes	
Uncorrected bit error rate	1 x 10 <sup>-17</sup>	1 x 10 <sup>-17</sup>
Permanent errors	Zero	Zero
<b>Compatibility</b>		
Read	DLT IV, SDLTtape I	SDLTtape I, II
Write	SDLTtape I	SDLTtape II
Supported tape drives	SDLT 220/320	SDLT 320/600

## ■ VolSafe Cartridges

The original write once, read many (WORM) tape-based storage solution, VolSafe secure media can be configured to meet the most stringent storage regulatory requirements, such as:

- Sarbanes-Oxley Act<sup>2</sup>
- Securities Exchange Commission (SEC)
- Health Insurance Portability and Accountability Act (HIPAA)
- Department of Defense Disclaimers

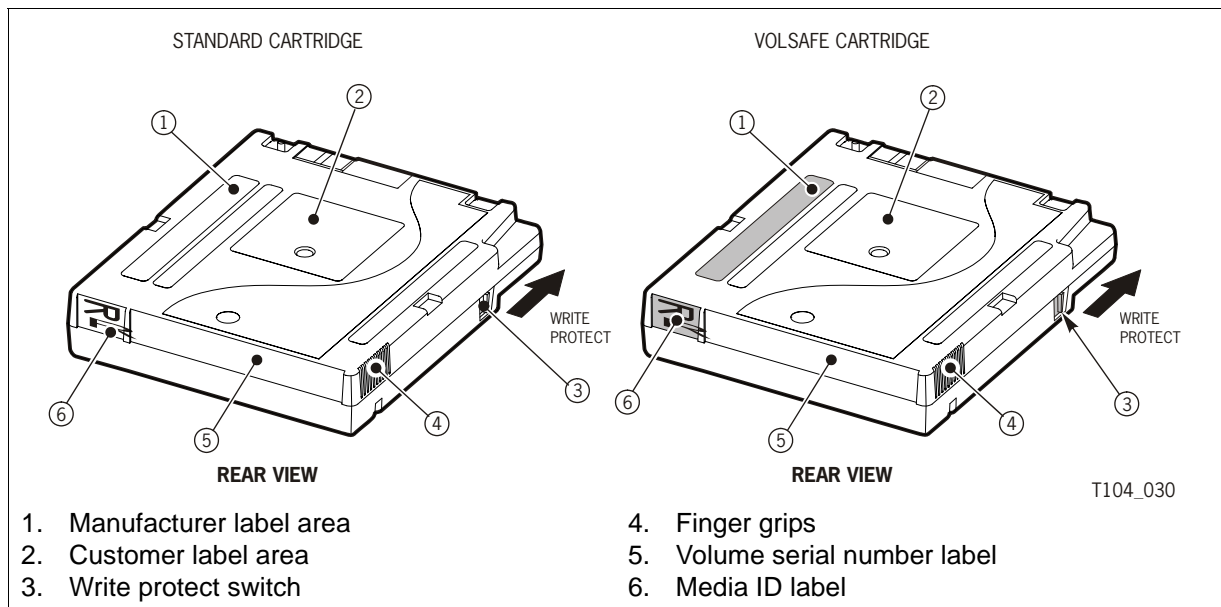
VolSafe- and WORM-enabled tape drives provide fast access and high performance with non-erasable, non-rewritable formats. Data can be written on or appended to a tape cartridge until it is full. This data can not be overwritten or erased without destroying the cartridge.

Unlike many other alternatives, *all* T-Series tape drives are VolSafe-technology-capable allowing the customer to simply purchase the media, not a new drive.

VolSafe and WORM cartridges can often be identified by the color, for example:

- T10000 cartridges use the color yellow to identify VolSafe cartridges
- 9840 cartridges use the color green
- LTO3 technology uses two-tone cartridges to identify WORM cartridges
- SDLT drives can convert *standard data cartridges* into WORM cartridges

**Figure 8. VolSafe/WORM Tape Cartridge Example**




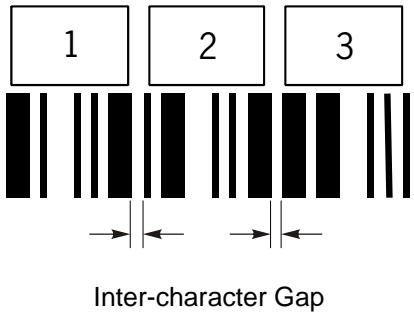

2. The Sarbanes-Oxley Act introduced highly significant legislative changes to financial practice and corporate governance regulations.

## ■ Barcode Labels

The labels used for the tape drives and libraries are based on the Code 39 barcode standard. This standard uses discrete barcodes, which means that a fixed pattern of bars represents a single character.

Each character is made up of *nine* bars—*five* black bars and *four* white bars—*three* of which are wider than the others. This is the reason for the name Code 39 and why some people refer to it as the 3 of 9 Code.

**Figure 9. Barcode Label Examples**

	<p>For example: This barcode represents the letter A, using</p> <ul style="list-style-type: none"> <li>• Six narrow bars and three wide bars</li> <li>• Two wide black bars and one wide white bar</li> </ul>
	<p>When multiple characters are arranged together as a label or volume serial number (VOLSER), a single, narrow white bar is placed between the individual character barcodes.</p> <p>This is called the Inter-character Gap.</p> <p>The Code 39 standard supports 36 unique alpha-numeric characters—the letters A through Z and the numbers 0 through 9—for use in making customer labels. Note that no lower case letters are used.</p> <p>This standard also supports seven special characters ( - . \$ / + % * ), which are not part of the customer label.</p>
	<p>For the decode algorithms to function properly, delimiters or start and stop characters are needed to bind the actual barcode label characters together.</p> <p>One of the most common characters to use for a delimiter is the asterisk (*), one of the seven special characters. The asterisk should never be used in a barcode as part of the customer-defined characters.</p>

Barcode algorithms only decode the characters between the asterisks; they ignore characters outside the asterisks. For example:

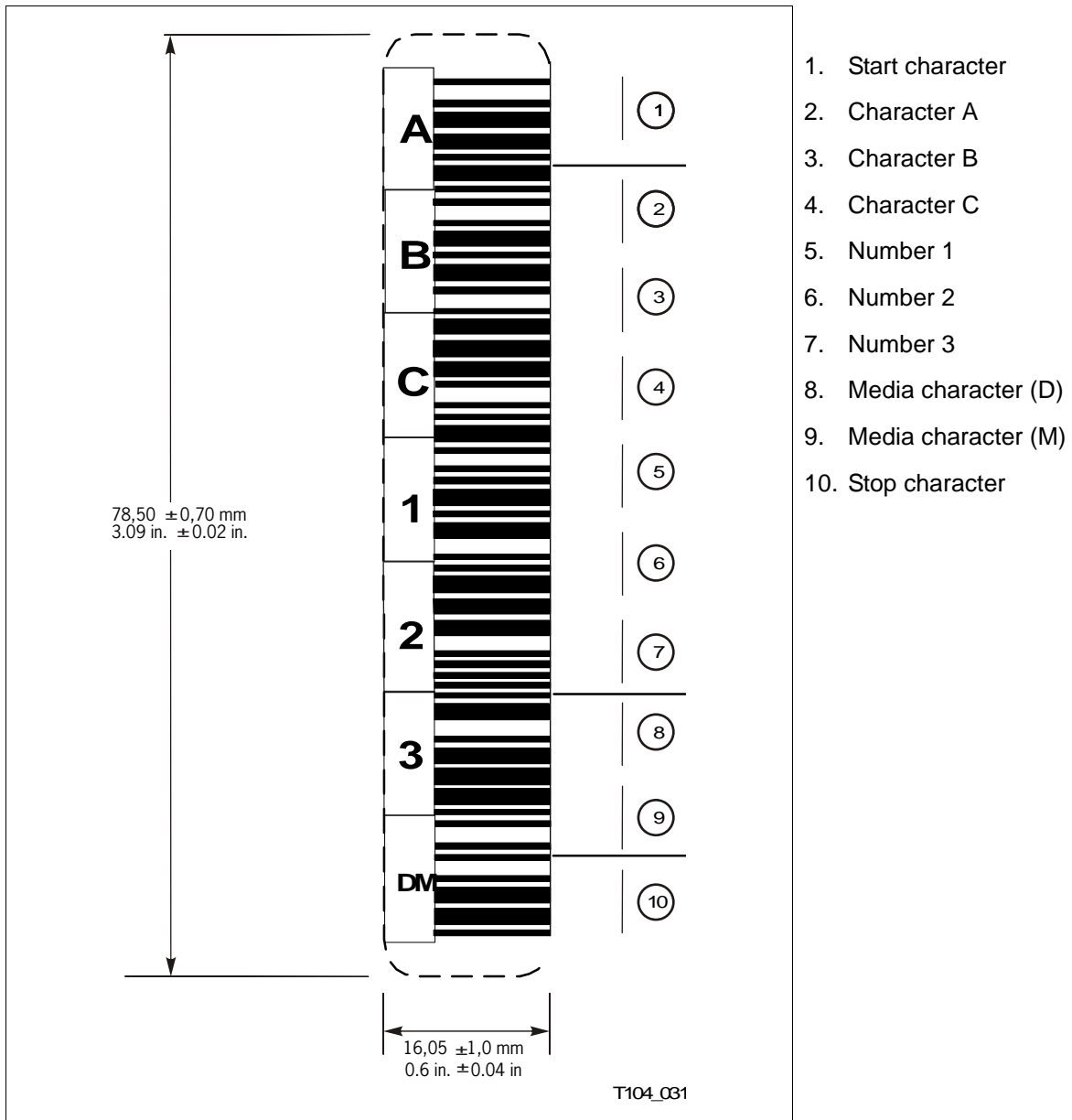
Actual Barcode Label	After Decoding	Comments
*ABC123*	ABC123	Good label
*ABC*23*	ABC	Misplaced stop character
ABC*23*	23	Misplaced start character
*ABC5678	Unreadable	No stop character detected

## Barcode Standards

The SL8500 library reads barcodes of six characters or more that meet the following standards:

- American National Standards Institute (ANSI) MH10.8M-1993 Code 39 Barcode Specification
- Automatic Identification Manufacturers (AIM) Uniform Symbology Specification USS-39

**Figure 10. Barcode Design**



## Media Domain and ID Labels

The media domain and media ID labels are the way a particular type of tape cartridge is identified by a library. This is an important feature called:

### Any Cartridge, Any Slot™

The use of media domain and media ID labels allow customers to mix tape drive types and media types in a single library or library complex—a true mixed media solution.

The structure for the media domain and ID label is, for example:

Cartridge	Label	Media Domain	Media ID
LTO3	L3	L	3
T10000	T1	T	1

[Table 24 on page 172](#) lists the media domain and ID labels.

## Media Label Requirements

The SL8500 supports three types of media and tape drives:

- StorageTek T-Series (T9840 A, B, C, the T9940B, and T10000 series)
- Linear Tape-Open (LTO) generations 2, 3, and WORM technology
- Super DLT (SDLT) drives

Requirements for the media labels—volume serial numbers (VOLSER)—are:

<b>T9x40</b>	The T9x40 tape cartridges require a <i>six plus one-character</i> label that consists of the six-character customer label, then a single media ID character. These labels have a unique barcode format based on the Code 39 standard that use a unique start/stop character—the dollar sign (\$)—and are printed only by EDP/Colorflex or American Eagle Systems/Wrightline for use in StorageTek libraries.
<b>T10000</b>	The T10000 cartridge uses a label similar to the LTO label. This label requires an <i>eight-character</i> label with domain type and media ID. The media domain is a “T” and the media IDs are 2 or 3.  The eight-character label is the future direction for all new tape technologies because of its flexibility to differentiate between tape technologies and it fully meets the ANSI Code 39 specification.
<b>LTO</b>	LTO tape cartridges require an <i>eight-character</i> label. This label consists of a six-character customer defined volume serial number, the domain type (tape technology), and the media ID for that particular technology.
<b>SDLT</b>	SDLT tape cartridges require a <i>seven-character</i> label. The six-character DLT labels do not indicate the media type and is <i>not</i> compatible with the SL8500 libraries. The seven character label has a small identifier <i>next to</i> the sixth character on the label for the media ID (either S or 2).

## Label Examples

Figure 11 shows some examples of labels, media domains and IDs.

Figure 11. Label Examples

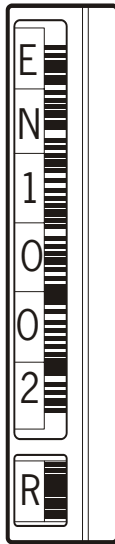
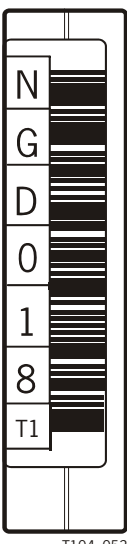
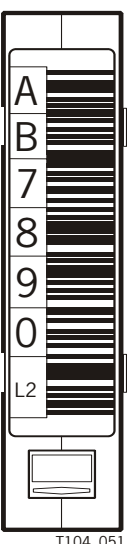
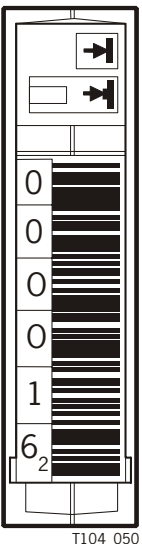
T9x40 Six-plus-one	T10000 Eight-characters	LTO Eight-characters	SDLT Seven-characters
 <p>T104_057</p>	 <p>T104_053</p>	 <p>T104_051</p>	 <p>T104_050</p>

Table 24 lists examples of the media domain and ID designators.

Table 24. Media Domain and Media ID Designators

<p><b>T9940 cartridge:</b> P = T9940 Data W = Cleaning</p> <p><b>T9840 cartridge:</b> R = T9840 Data U = Cleaning</p> <p>Implied domain = 00</p>	<p><b>T10000 cartridge:</b> T1 = T10000 Data CT = Cleaning</p>	<p><b>LTO data cartridge:</b> LT = WORM L3 = Gen 3 (400 GB) L2 = Gen 2 (200 GB) L1 = Gen 1 (100 GB) LA = 50 GB LB = 30 GB LC = 10 GB</p> <p><b>Cleaning cartridge:</b> CU = Universal</p>	<p><b>DLTtape cartridge:</b> B = DLT1 C = DLTtape III D = DLTtape IV E = DLTtape III-XT</p> <p><b>SDLTtape cartridge:</b> S = Super DLTtape I 2 = Super DLTtape II</p> <p>Implied domain = 01</p>
--	--	---	---

**Note:** 9840 and 9940 labels have an implied domain type of 00. SDLT tapes have an implied domain type of 01. These labels do not show the domain types, only the media ID is required.

## Cleaning and Diagnostic Labels

### Description

Cleaning and diagnostic cartridges require different labels to distinguish them from data cartridges.

- As the name implies, cleaning cartridges clean the tape path and read/write heads of the tape drives.
- Diagnostic cartridges are for service representatives to run read and write tests on the tape drive. In general, these tapes are standard data cartridges with a special diagnostic label.

The first three alphanumeric characters in the label sequence determine the type of cartridge being used.

### Cleaning cartridge label format

[ **CLN***vnn* ], where:  
 “**CLN**” is the cleaning cartridge identifier,  
 “*v*” is the drive type identifier, blank or a space, and  
 “*nn*” is a sequence of numbers (such as CLNU01 or CLN 02).

#### Notes:


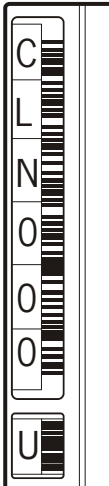


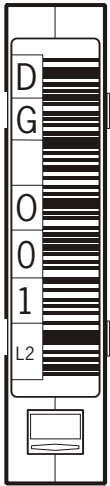
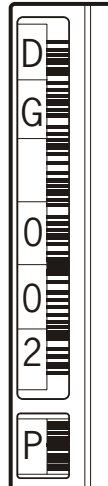

- First generation LTO cleaning cartridge labels also use the media ID type that coincides with the drive type.
- SDLT and 9840/9940 cleaning labels do not include the drive type identifier (“*v*”) as the fourth character. This identifier began with the LTO cleaning cartridges and will continue on future tape technologies.

### Diagnostic cartridge label format

[ **DG**{space}*nnn* ], where  
 “**DG**{space}” is the diagnostic cartridge identifier, and  
 “*nnn*” is a sequence of numbers (such as DG 001, and DG 019).

Diagnostic cartridge labels also require the unique media ID type that coincides with the drive type

Figure 12. Cleaning and Diagnostic Label Examples

Cleaning Labels			Diagnostic Labels			
						
T104_055	T104_057	T104_059	T104_054	T104_056	T104_058	T104_060
LTO	9840	T10000	SDLT	LTO	9940	T10000

## ■ Ordering Tape Cartridges and Labels

Contact your authorized selling agent for approved labeled cartridges.

### Notes:

- You must select the volume serial number (VOLSER) range and other label options when ordering media.
- If you choose to order additional labels, call any authorized Sun Microsystems reseller.
- Labels for media used in libraries vary according to their applicable drive technology.

## Volume Serial Numbers

- The VOLSER has a total of six characters.
  - The first three are the volume and can be either alpha or numeric.
  - The last three are the serial number and are always numeric.
  - Except with the individual color label options for 9x40 cartridges.
- If you choose the individual color label options, all characters can be either alpha, numeric, or any combination of the two. With this label option, you can choose a background color for each of the characters.

**Note:** Most customers use the vibrant color option.

## 9840 and 9940 Cartridge Labels



### Important:

For 9840 and 9940 tape cartridges only. Sun StorageTek and EDP Trioptic hold a patent for the labels and EDP has exclusive rights to distribute (US only) the tri-optic label for these cartridges.

Customers can order these labels over the EDP Web site at:

<http://www.tri-optic.com>

Or by contacting EDP:

**Table 25. EDP Trioptic Support**

<b>Client Support – USA</b>	<b>Client Support – Europe</b>
Monday through Friday 8:00 AM to 5:00 PM Mountain Time Telephone: 888.438.8362 E-mail: Support@Tri-Optic.com	Telephone: (011) +44 (0) 1245 322380 E-Mail: Sales@EDPEurope.com



## Media Comparisons

Table 26 provides a comparison of different (current) media types.

**Table 26. Media Comparisons**

Specifications	9840 (C)	9940 (B)	T10000	LTO2	LTO3	SDLT I	SDLT II
<b>Performance</b>							
Capacity, native	40 GB	200 GB	500 GB	200 GB	400 GB	160 GB	300 GB
Drive transfer rate	30 MB/s	30 MB/s	120 MB/s	30 MB/s	80 MB/s	16 MB/s	36 MB/s
Read/Write speed	3.4 m/s	2.4 m/s	2–4.9 m/s	6.22 m/s	5.46 m/s	3.1 m/s	3.56 m/s
Search/Rewind speed	11 m/s	11 m/s	—	7 m/s	7 m/s	4.1 m/s	4.83 m/s
Recording density	—	—	—	188 kb/in	245 kb/in	193 kb/in	233 kb/in
<b>Format</b>							
Number of tracks	288	576	768	512	704	448	640
Tape length							
Total (meters/feet)	271 m (889 ft)	700m (2296 ft)	917m (3009 ft)	609m (1998 ft)	680m (2230 ft)	854m (2800 ft)	630m (2066 ft)
Usable (meters/feet)	251 m (889 ft)	650m (2134 ft)	855m (2805 ft)	580m (1902 ft)	651m (2136 ft)	538m (1765 ft)	596m (1957 ft)
<b>Availability</b>							
Archival life	15–30 yr	15–30 yr	15–30 yr	15–30 yr	15–30 yr	15–30 yr	15–30 yr
Load/unloads	10,000	10,000	10,000	5,000	5,000	5,000	5,000
Durability (full file writes/passes)	361	361	200	260	260	260	260
Uncorrected bit error rate	1 x 10 <sup>-18</sup>	1 x 10 <sup>-18</sup>	1 x 10 <sup>-18</sup>	1 x 10 <sup>-17</sup>	1 x 10 <sup>-17</sup>	1 x 10 <sup>-17</sup>	1 x 10 <sup>-17</sup>
Permanent errors	Zero	Zero	Zero	Zero	Zero	Zero	Zero
<b>Compatibility</b>							
Read	T9840A,B,C	T9940A,B	T10000	LTO1, 2	LTO 1, 2, 3	DLT IV, SDLT I	SDLTtape I, II
Write	T9840A,B,C	T9940A,B	T10000	LTO1, 2	LTO2, 3	SDLTtape I	SDLTtape II
Supported tape drives	T9840A,B,C	T9940A,B	T10000	LTO1, 2	LTO3	SDLT 220/320	SDLT 320, 600
VolSafe / WORM Technology?	Yes	Yes	Yes	No	Yes	No	Yes
<b>Labels</b>							
Barcode characters	Six plus one media ID	Six plus one media ID	Eight including domain type and media ID	Eight including domain type and media ID	Eight including domain type and media ID	Seven including media ID	Seven including media ID



# Electrical Conversions

# E

It is often necessary take certain electrical values (such as volts, amps, and watts) and convert them into other electrical values (such as kW, kVA and Btu). These values are used to calculate overall power, heating, and cooling requirements for customer sites.

This appendix describes how to take basic electrical values and convert them into these other types of electrical values.

**Note:** Not all of these are conversions, but formulas where using any two known values allow you to calculate a third.

## Symbolic

<b>A</b> = Amperes (Amps)	<b>PF</b> = Power Factor
<b>Btu</b> = British Thermal Unit	<b>V</b> = Volts
<b>kVA</b> = Kilovolt-amperes	<b>VA</b> = Volt-amperes
<b>kW</b> = Kilowatts	<b>W</b> = Watts

## To Find Volts, Watts, and Amperes

When Watts and Amperes are known:

$$\text{Watts divided by Amps} = \text{Volts} \quad \text{or} \quad W \div A = V$$

When Amps and Volts are known:

$$\text{Amps multiplied by Volts} = \text{Watts} \quad \text{or} \quad A \times V = W$$

When Watts and Volts are known:

$$\text{Watts divided by Volts} = \text{Amps} \quad \text{or} \quad W \div V = A$$

*For example:* Given the following values you can use any two values to calculate a third Watts = 2400 (2.4 kW), Volts = 120, Amps = 20.

$$2.4 \text{ kW} \div 20 \text{ A} = 120 \text{ V}$$

$$120 \text{ V} \times 20 \text{ A} = 2,400 \text{ W (or 2.4 kW)}$$

$$2,400 \text{ W} \div 120 \text{ V} = 20 \text{ A}$$

## To Find Volt-Amperes (VA)

When Volts and Amperes are known, you can use the previous example:

$$\begin{aligned} \text{Volts multiplied by Amps} &= \text{Volt-amperes (VA)} \\ \text{Volts [VAC]} \times \text{Amps [A-rms]} &= \text{Volt-amperes [VA]} \end{aligned}$$

*For example:* A small server is plugged into a 120 VAC 60 Hz power source and is rated at 2.5 amps.

$$120 \text{ VAC} \times 2.5 \text{ amps} = 300 \text{ VA}$$

## To Find Kilovolt-Amperes (kVA)

### Single Phase:

Again, using the previous example:

$$\begin{aligned} \text{Volts multiplied by Amps divided by 1,000} &= \text{kilo-volt-amperes [kVA]} \\ \text{Volts [VAC]} \times \text{Amps [A-rms]} \div 1000 &= \text{kilo-volt-amperes [kVA]} \end{aligned}$$

*For example:*  $120 \text{ VAC} \times 2.5 \text{ amps} \div 1000 = 0.3 \text{ kVA}$

### Three Phase:

#### Phase 1

$$\text{Volts [VAC]} \times \text{Amps [A-rms]} \div 1000 = \text{kilo-volt-amperes [kVA]}$$

#### Phase 2

$$\text{Volts [VAC]} \times \text{Amps [A-rms]} \div 1000 = \text{kilo-volt-amperes [kVA]}$$

#### Phase 3

$$\text{Volts [VAC]} \times \text{Amps [A-rms]} \div 1000 = \text{kilo-volt-amperes [kVA]}$$

#### Total kVA

$$\text{kVA (phase 1)} + \text{kVA (phase 2)} + \text{kVA (phase 3)} = \text{kVA (3-phase total)}$$

Using the single phase example above:

$$0.3 \text{ kVA} + 0.3 \text{ kVA} + 0.3 \text{ kVA} = 0.9 \text{ kVA}$$

## To Find Kilowatts

Finding kilowatts is a little more complicated because the formula requires a value for the “power factor.” The power factor (PF) is not a precise value (unless known), but required. This factor can vary from 60–95% and is rarely published on the equipment. For purposes of these calculations a power factor of 0.85 is used.

$$\text{Volts} \times \text{Amps} \times \text{PF} \div 1000 = \text{Kilowatts (kW)}$$

**Single Phase:**

*For example:* A medium-sized server is plugged into a 120 VAC 60 Hz power source and is rated at 6.0 amps.

$$120 \text{ VAC} \times 6 \text{ amps} \times 0.85 \text{ (PF)} = 612 \div 1,000 \text{ is } 0.612 \text{ kW}$$

**208–240 Two Phase:**

*For example:* A server using a 220 VAC power source is rated at 4.7 amps.

$$220 \text{ VAC} \times 4.7 \text{ amps} \times 2 \text{ (phases)} \times 0.85 \text{ (PF)} = 1757.8 \div 1,000 = 1.76 \text{ kW}$$

**Three Phase:**

**Note:** For 3-Phase power configurations you also need to multiply by 1.73.

*For example:* A large disk subsystem has 192 physical volumes, a power source of 208 VAC, and is rated at 22 amps.

$$208 \text{ VAC} \times 22 \text{ amps} \times 1.73 \times 0.85 \text{ (PF)} \div 1000 = 6.729 \text{ kW}$$

**To Convert Between kW and kVA**

The only difference between kW and kVA is the power factor. Once again, the power factor is an approximation (unless already known). For purposes of our calculations, we will use a power factor of 0.85.

**Note:** The kVA value is always higher than the value for kW.

$$\text{kW divided by } 0.85 = \text{kVA}$$

$$\text{kVA multiplied by } 0.85 = \text{kW}$$

**To Find British Thermal Units From Electrical Values**

The commonly used method for converting electrical values to British Thermal Units is:

$$3.41214 \times \text{Watts} = \text{Btu/hr or}$$

$$1 \text{ kW} = 3\,413 \text{ Btus}$$

Many manufacturers publish kW, kVA and Btu in their equipment specifications. Often, dividing the Btu value by 3413 does not equal the published kW value.

- Where the information is provided by the manufacturer, use it.
- Where it is not, use the formula.



# Comparisons



Because the SL8500 is a new library, a comparison between an existing StorageTek library—the 9310 Powderhorn—might help to put things into perspective.

This appendix provides comparisons between these two libraries.

## ■ Contrasts Between Libraries

Many concepts and terms used for earlier libraries apply to SL8500 libraries. However, many terms for the SL8500 have been modified from their original meanings. As the SL8500 library product is substantially different from earlier StorageTek library products, a general list of terms that relate old with new concepts is supplied in [Table 27](#).

**Table 27. Old versus New Terminology**

9310 PowderHorn	SL8500
<b>Automated Cartridge System (ACS):</b> An LMU and its associated LSMs.	<b>Library complex:</b> Two or more libraries joined together with PTPs
<b>Audit:</b> The process of reading and cataloging all cartridges within an LSM or ACS; this is done through the Host Software Component (HSC) and the updated data is sent to the Control Data Set (CDS).	<b>Physical audit:</b> Cartridge volume identifiers (VOLIDs) and locations are stored within the library’s memory—at power-on or when access doors are closed.  <b>Verified audit:</b> By a StreamLine Library Console™ command, cartridge VOLIDs and locations are validated.  <b>Virtual audit:</b> Cartridge database is displayed through StreamLine Library Console.
<b>Cartridge Access Port (CAP):</b> Standard 21-slot or optional 80-slot, access door	<b>CAP:</b> Located on the right access door. CAP A is standard (39-slots); CAP B is optional.
<b>Dual LMU:</b> A master LMU that controls operation of the LSMs and a standby LMU that monitors the master; if a master LMU failure occurs, the standby LMU assumes control.	<b>Library complex:</b> Two or more libraries joined together with PTPs. SL8500 libraries in this configuration operate as peer-to-peer—there are no longer “master” or “standby” designations.
<b>Enter:</b> Enter a cartridge through the CAP	<b>Import:</b> Enter a cartridge through the CAP.
<b>Eject:</b> A specified cartridge is placed into the CAP by the robot for removal by the operator.	<b>Export:</b> A specified cartridge is placed into the CAP by a HandBot for removal by the operator.

**Table 27. Old versus New Terminology (Continued)**

9310 PowderHorn	SL8500
<p><b>Hand:</b> The component that reads cartridge VOLIDs, stores, and retrieves cartridges; cartridge VOLIDs are read before retrieval by the robot.</p>	<p><b>HandBot:</b> The component that stores and retrieves cartridges; it reads cartridge VOLIDs:                      When entered through a CAP                      During an audit                      When retrieved through a PTP                      Since the location and VOLIDs of cataloged cartridges are resident on the HBC card, VOLIDs are not read during normal mount/dismount activities; mounts/dismounts are done by “dead reckoning.”</p>
<p><b>Library:</b> All software and hardware related to Automated Cartridge Systems.</p>	<p><b>SL8500 Modular Library:</b> A single unit composed of at least three modules (drive and electronics module, robotics interface module, customer interface module); up to <i>five</i> storage expansion module may be added.</p>
<p><b>Library Control Unit (LCU):</b> The power source and robotic controller for an LSM.</p>	<p>An LCU is <i>not</i> attached to the library; its function is now contained within library’s HBC and HBT controller cards.</p>
<p><b>Library Management Unit (LMU):</b> The controller of all LSMs connected to it; the interface between the LSMs and the host. The term is still used in relation to addressing.</p>	<p>An LMU is no longer housed in a separate unit; its function is now contained within library HBC (controller) cards. See also “Library Complex”.</p>
<p><b>Library Storage Module (LSM):</b> Storage module, up to sixteen per ACS (LMU).</p>	<p><b>Rail:</b> Each rail within an SL8500 is designated as one LSM (4 LSMs per SL8500 Library) by host software.</p>
<p><b>Master PTP:</b> The controlling PTP; its commands originate from the LCU that contains the LP/LPP card.</p>	<p><b>Home library:</b> <i>Home</i> denotes the library supplying power and communication to the PTP. Power and communication originate from the <i>left</i> side (as viewed from the front) of the home library; either library may initiate a PTP activity.                      Two SL8500 libraries are joined together by <i>four</i> PTPs because there are four rails per library.                      An SL8500 library PTP cannot perform a pass-thru operation to or from a 9310 or L5500 LSM.  <b>Note:</b> Internal racks and Ethernet switches are required for PTP operations.</p>
<p><b>Robot:</b> A component that revolves around a central point in a circular LSM.</p>	<p><b>HandBots:</b> Components that move linearly along rails and vertically along the hand’s Z column. A single library can have from four to eight HandBots.</p>



**Table 27. Old versus New Terminology (Continued)**

<b>9310 PowderHorn</b>	<b>SL8500</b>
<b>Size/capacity:</b> Determined by firmware and number of installed arrays; approximately 6,000 cartridges per LSM.	<b>Size/capacity:</b> Determined by the number of modules installed: three are required (1448 cartridges), but an additional <i>five</i> storage expansion modules can be added (6632 cartridges each). Slots are enabled to allow “capacity on demand.”
<b>Standby PTP:</b> The LSM whose PTP mechanism does not contain the PTP motor or LP/LPP card (LCU).	<b>Away library:</b> <i>Away</i> denotes the library <i>not</i> supplying power or communication to the PTP. <i>Away</i> libraries are on the <i>left</i> side (as viewed from the front) of the home library; either library may initiate a PTP activity.  SL8500 libraries are joined together by four PTPs because there are four rails.  <b>Note:</b> Internal racks and Ethernet switches are required for PTP operations.
<b>Tape drive capacity:</b> Up to 80 (with 9741e cabinets).	<b>Tape drive capacity:</b> From 1 to 64, with 16 per drive array assembly
<b>Theta:</b> Describes the circular path of the robot.	Because the path for the HandBots is no longer circular, the term “theta” motion does not apply.
<b>Wrist:</b> Describes outer-to-inner wall hand motion.	<b>Wrist:</b> Describes outer-to-inner wall HandBot motion.
<b>Z motion:</b> Describes the vertical path of the robot (4410) or hand (9310/L5500)	<b>Z motion:</b> Describes the vertical path of a HandBot hand assembly.

## Capacity Comparison with 9310 Libraries

The advantages of the SL8500 library can be seen when compared to a 9310 ACS that contains three, dense pack library storage modules (LSMs).

Three 9310 LSMs provide storage for 33 cartridges per 0.1 m<sup>2</sup> (1 ft<sup>2</sup>), whereas an SL8500 library complex, composed of three SL8500s provides storage for 59 cartridges per 0.1 m<sup>2</sup> (1 ft<sup>2</sup>).

## ■ Library Comparisons

Because the SL8500 is a new library, a comparison between the existing Powderhorn, 9310 might help to put things into perspective.

- [Table 28](#) compares libraries between weights, measures, and capacities
- [Table 29](#) compares power requirements

**Table 28. Comparisons Between PowderHorn and the SL8500 Library**

9310 PowderHorn		SL8500	
<b>Measurements</b>			
<b>Storage Module (LSM)</b>		<b>Modular Library</b>	
Height	235 cm (92.5 in.)	Height:	236.6 cm (93.15 in.)
Diameter	325 cm (128.0 in.)	Width:	170.8 cm (67.25 in.)
<b>Control Unit (LCU)</b>		Length:	
Height	161 cm (63.5 in.)	Base library	276.9 cm (109 in.)
Width	39.1 cm (15.4 in.)	1 expansion module	372.1 cm (146.5 in.)
Length	58.1 cm (22.9 in.)	2 expansion modules	467.4 cm (184 in.)
<b>Management Unit (LMU)</b>		3 expansion modules	562.6 cm (221.5 in.)
Height	93.0 cm (36.6 in.)	<b>Note:</b> One of the benefits of the SL8500 is the consolidation LMU, LCU, Drive Cabinets, and LSM within the SL8500.	
Width	74.4 cm (29.3 in.)	<i>Plus</i> additional consolidation with internal rack space for network components.	
Length	59.7 cm (23.5 in.)		
<b>Drive Cabinet (9741e)</b>			
Height	183 cm (72.0 in.)		
Width	74.9 cm (29.5 in.)		
Length	58.4 cm (23 in.)		
Drives per cabinet	20 drives		
<b>Total Area (60 drives)</b>	10.3 m <sup>2</sup> (110.8 ft <sup>2</sup> )	<b>Total Area (64 drives)</b>	9.6 m <sup>2</sup> (103.4 ft <sup>2</sup> )
<b>Weight</b>			
<b>LSM</b>		<b>Base library</b>	
Empty	2449 kg (5,400 lb)	Empty	1497 kg (3,300 lb)
Fully Loaded	3810 kg (8,400 lb)	Loaded	2835 kg (6,250 lb)
<b>LCU</b>		1 expansion module	1883 kg (4,150 lb)
<b>LMU</b>		Loaded	3640 kg (8,025 lb)
9741e Drive Cabinet	186 kg (410 lb)	2 expansion modules	2268 kg (5,000 lb)
One T9940 drive	7.7 kg (17 lb)	Loaded	4445 kg (9,800 lb)
9741e with 20 drives	340.2 kg (750 lb)	3 expansion modules	2654 kg (5,850 lb)
9741e with 40 drives	680.3 kg (1,500 lb)	Loaded	5250 kg (11,575 lb)
9741e with 60 drives	1020.5 kg (2,250 lb)	Loaded = All drives, cartridges, and power supplies with 2N power and four robots	
9741e with 80 drives	1361 kg (3,000 lb)		
<b>Total Weight (60 drives)</b>	5420 kg (11,950 lb)	<b>Total Weight (64 drives)</b>	5250 kg (11,575 lb)

Table 28. Comparisons Between PowderHorn and the SL8500 Library (Continued)

9310 PowderHorn		SL8500	
<b>Service Clearances</b>			
LSM (door opening)	86.36 cm (34 in.)	Front	66 cm (26 in.)
LCU	39.0 cm (15.4 in.)	Rear	85 cm (33.5 in.)
LMU	81.3 cm (32.0 in.)	Pass-thru ports	15.25 cm (6 in.)
9741e Drive Cabinet	81.3 cm (32.0 in.)	Door width	10.16 cm (4 in.)
<b>Planning Requirements</b>			
Raised Floor Loading	244-293 kg/m <sup>2</sup> (50-60 lb/ft <sup>2</sup> )	Raised Floor Loading	260 kg/m <sup>2</sup> (120 lb/ft <sup>2</sup> )
Loading per pad	454 kg (1,000 lb)	Loading per pad	454 kg (1,000 lb)
Distribution pads	18 (per library)	Distribution pads	26 (with 3 expansions)
Assembly area	35 m <sup>2</sup> (400 ft <sup>2</sup> )	Assembly area	56 m <sup>2</sup> (600 ft <sup>2</sup> )
<b>Power Requirements</b>			
Voltage (selectable)	200 to 240 VAC	Voltage	200 to 240 VAC
Frequency	47 to 63 Hz	Frequency	47 to 63 Hz
Phases (Current)	Single	Phases (Current)	
LCU/LSM	12 Amps	Single Phase	3 inputs (24 Amps) 6 redundant
LMU	8 Amps	Three Phase:	Delta (40 Amps) Wye (24 Amps) SUVA (24 Amps)
9741e Drive Cabinet	20 Amps	(recommended)	
Power Consumption		Power Consumption	13.0 kW
LCU/LSM	1.5 kW	(maximum loading**)	
LMU	0.126 kW	Heat Output	44,380 Btu/hr
9741e Drive Cabinet	1.47 kW	(maximum loading**)	
Heat Output		** Maximum loading = 64 tape drives, 4 fully loaded racks, 8 HandBots, all front frame components, plus redundant control modules	
LCU/LSM	3,750 Btu/hr		
LMU	2,050 Btu/hr		
9741e Drive Cabinet	8,047 Btu/hr		
Minimum system (16 drives)	3.56 kW 12,140 Btu/hr	Minimum system (16 drives)	3.32 kW 11,320 Btu/hr
Maximum system (60 drives, 3 x 9741E)	10.76 kW 36,700 Btu/hr	Maximum system (64 drives, plus 8 HandBots, 4 racks)	12.27 kW 41,840 Btu/hr
<b>Note:</b> See <a href="#">Table 29 on page 187</a> for additional comparisons for power requirements			

**Table 28. Comparisons Between PowderHorn and the SL8500 Library (Continued)**

9310 PowderHorn		SL8500	
<b>Capacities</b>			
Tape drives (max) single library ACS	80 (four 9741e) 960	Tape drives (max) single library complex	64 2,048
Tape cartridges (max) single library ACSLs managed NCS/HSC managed	6,000 (5,500) 144,000 96,000	Tape cartridges (max) single library complex	6,632 greater than 200,000
Storage Density	33 cartridges per 0.1 m <sup>2</sup> (1 ft <sup>2</sup> )	Storage Density	59 cartridges per 0.1 m <sup>2</sup> (1 ft <sup>2</sup> )
Libraries in an ACS	24 (ACSLs control) 16 (HSC control)	Libraries in a Complex	31 (ACSLs) or 32 (HSC)
Cartridge Access Ports	21-cells standard 80-cells <i>optional</i>	Cartridge Access Ports	39-slots standard 39-slots <i>optional</i> 78 total
<b>Storage (Tape Cartridges)</b>			
<b>Single Library</b>	<u>1,500 cartridges (min.)</u>	<b>Single Library</b>	<u>1,448 cartridges (min.)</u>
T9840 A (20 GB)	30 TB	T9840 A (20 GB)	29 TB
T9840 B (20 GB)	30 TB	T9840 B (20 GB)	29 TB
T9840 C (40 GB)	60 TB	T9840 C (40 GB)	58 TB
T9940 B (200 GB)	300 TB	T9940 B (200 GB)	290 TB
LTO Gen 2 (200 GB)	300 TB	LTO Gen 2 (200 GB)	290 TB
<b>ACS (24 libraries)</b>	<u>84,000 cartridges</u>	<b>Complex (32 libraries)</b>	<u>300,000 cartridges</u>
T9840 A (20 GB)	1.68 PB	T9840 A (20 GB)	6 PB
T9840 B (20 GB)	1.68 PB	T9840 B (20 GB)	6 PB
T9840 C (40 GB)	3.36 PB	T9840 C (40 GB)	12 PB
T9940 B (200 GB)	16.8 PB	T9940 B (200 GB)	60 PB
	<u>132,000 cartridges</u>	LTO Gen 2 (200 GB)	60 PB
LTO Gen 2 (200 GB)	26.4 PB		
<b>Performance (Tape Drives)</b>			
<b>Single Library</b>	<u>80 drives</u>	<b>Single Library</b>	<u>64 drives</u>
T9840 A (10 MB/s)	2.9 TB/hr	T9840 A (10 MB/s)	2.3 TB/hr
T9840 B (19 MB/s)	5.5 TB/hr	T9840 B (19 MB/s)	4.4 TB/hr
T9840 C (30 MB/s)	8.6 TB/hr	T9840 C (30 MB/s)	6.9 TB/hr
T9940 B (30 MB/s)	8.6 TB/hr	T9940 B (30 MB/s)	6.9 TB/hr
LTO Gen 2 (32-35 MB/s)	10 TB/hr	LTO Gen 2 (32-35 MB/s)	8.1 TB/hr
<b>ACS (24 libraries)</b>	<u>960 drives</u>	<b>Complex (32 libraries)</b>	<u>2,048 drives</u>
T9840 A (10 MB/s)	34.56 TB/hr	T9840 A (10 MB/s)	74 TB/hr
T9840 B (19 MB/s)	65.56 TB/hr	T9840 B (19 MB/s)	140 TB/hr
T9840 C (30 MB/s)	103.68 TB/hr	T9840 C (30 MB/s)	221 TB/hr
T9940 B (30 MB/s)	103.68 TB/hr	T9940 B (30 MB/s)	221 TB/hr
LTO Gen 2 (32-35 MB/s)	120.96 TB/hr	LTO Gen 2 (32-35 MB/s)	258 TB/hr

**Table 29. Power Requirement Comparisons**  
Between PowderHorn and the SL8500 ~ A Quick Reference

9310 PowderHorn					SL8500 Library											
2 Hands		Watts			4 Robots		Watts			8 Robots		Watts				
Component	Qty	Idle	Max Cont.	Peak	Component	Qty	Idle	Max Cont.	Peak	Qty	Idle	Max Cont.	Peak			
LCU & LSM	1	200	<b>800</b>	1500	LSM	1	112	<b>220</b>	564	1	224	<b>440</b>	1128			
LMU	1	126	<b>126</b>	126	ECM Control Module	1	100	<b>100</b>	100	1	100	<b>100</b>	100			
Dual LMUs	1	252	252	252												
					Rack space (base)				1440	—	Base		—	1440	—	
Rack space (each 9741)					Rack space (redundant)				2880	—	Redundant		—	2880	—	
<b>Tape Drives:</b>					<b>Tape Drives:</b>											
T9x40 / T10000	4	582	714	770	T9x40 / T10000	4	372	504	560	4	372	504	560			
	16	1690	<b>2226</b>	2450		16	1480	<b>2016</b>	2240		16	1480	<b>2016</b>	2240		
	20	2062	2730	3010		20	1852	2520	2800		20	1852	2520	2800		
	40	4124	5460	6020		40	3704	5040	5600		40	3704	5040	5600		
	64	6582	8694	9590		64	5952	8064	8960		64	5952	8064	8960		
LTO / SDLT	4	386	450	478	LTO / SDLT	4	176	240	268	4	176	240	268			
	16	914	1170	1282		16	704	960	1072		16	704	960	1072		
	20	1090	1410	1550		20	880	1200	1340		20	880	1200	1340		
	40	2180	2820	3100		40	1760	2400	2680		40	1760	2400	2680		
	64	3446	4470	4918		64	2816	3840	4288		64	2816	3840	4288		
					<b>Pass-thru Ports</b>				each	20	22	26	each	20	22	26
Example (max case): For a Powderhorn (2 hands) LCU, LSM with 1 LMU and 16 T9X40 drives: 800 + 126 + 2226 = <b>3152 watts</b> (max)					Example (max continuous case): For a SL8500 (4 robots) LCU, LSM, 1 ECM and 16 T9X40 drives: 220 + 100 + 2016 = <b>2336 watts</b> ( <b>max continuous</b> )					Example (max continuous case): For a SL8500 (8 robots) LCU, LSM, 1 ECM and 16 T9X40 drives: 440 + 100 + 2016 = <b>2556 watts</b> (max)						

## Comparisons

# TCP/IP Connectivity



This appendix provides three network topology examples with routing tables and the CLI commands used to configure each example.

- [“Multi-Homed Configuration on Two Subnets” on page 199](#)
- [“Multi-Homed Configuration with Different Subnets” on page 201](#)
- [“Single Interface Host with Multi-Homed SL8500” on page 203](#)

This appendix also provides a fourth example that can be used as a service configuration.

- [“Service Connection” on page 205](#)

With the Dual TCP/IP feature, if the customer only has one connection into the SL8500, the second port (2A) can be used as a connection for service.

For example, connections to the

## **Service Delivery Platform (SDP)**

In the past, SDP connections to an SL8500 library used the customers public network—which often changed the customers reasoning to have an SDP connection.

With the Dual TCP/IP feature and enabling Port 2A, you can create a separate network for SDP connectivity to the SL8500 and appropriate T-Series tape drives.

## **StreamLine Library Console (SLC)**

With the Dual TCP/IP feature and enabling Port 2A, you can connect and start a remote SLC connection at the *rear* of the library.

## **Laptop Ethernet connections**

With the Dual TCP/IP feature and enabling Port 2A, you can use both the command line interface and Ethernet connection to configure the library (using PuTTY), perform diagnostic functions (load and unload drives), and initiate a cell audit for example.

## ■ Differences, Benefits, and Terminology

The SL8500 now features Dual TCP/IP—which provides two public network interfaces to the library and/or library complex.

This feature requires a library firmware of FRS\_3.08 or higher.

### Differences

#### Important:

There are differences between the terms Dual LMU<sup>1</sup> (from previous libraries) and Dual TCP/IP for the SL8500. Here is an overview between the two.

An overview of Dual LMU (9330 and 4430) and Dual TCP/IP (SL8500).

1. **Dual LMU (9330 and 4430):** Consists of a: 1) Master LMU and a 2) Standby LMU. Each LMU has its own connection to the host.
  - The Dual LMU design is an **active/passive** design—the master LMU handles *all* requests from the host.
  - One Library Control Unit (LCU) is required per library storage module or silo (9310 or 4410).
  - The standby LMU monitors the state of the master LMU through a heartbeat between the two units. If the master fails to respond, the standby takes over.
  - The standby LMU can also take over for the master LMU when it receives a switch transmission command from HSC or ACSLS. Note: ACSLS and HSC **do not** automatically initiate a switch when communications to the master LMU fails.
  - The switch-over process takes about eight minutes and requests in progress may be lost.
  - Both LMUs are capable of being the master, but only one can be the master at a given moment.
2. **Dual TCP/IP (SL8500):** Provides *two separate* host connections between the host software (ACSLs or HSC) and the library controller.
  - Dual TCP/IP is an **active/active** design—when both communication paths are available, ACSLS and HSC use both of them to communicate with the SL8500.
  - In the SL8500, the HBC card provides *all* of the functions of the LMU, the LCU, and the library communications facility (LCF).
  - Currently, there is only one HBC card in the SL8500 library.

---

1. LMU = Library management unit



- HSC uses each path alternately.
- ACSLS continuously monitors both connections using one path as primary and occasionally using the second path.
- This helps ensure that both paths are working properly so that if one fails, there is a high degree of confidence that the other path is operational.
- Both HSC and ACSLS detect when a path is unavailable and automatically re-send transmissions over the other path.
- The SL8500 also re-sends transmissions over the other path when a path becomes unavailable. After retrying for four to five minutes, ACSLS, HSC, and the SL8500 will mark a path as unavailable and just use the remaining path.
- When a path is marked as unavailable, ACSLS, HSC, and the SL8500 continues to monitor the path. When the path becomes available again, ACSLS, HSC, and the SL8500 will automatically re-connect to the path.

## Benefits

### The benefits between Dual TCP/IP and Dual LMU are:

- Dual TCP/IP is **active/active**. ACSLS and HSC use both paths. This helps ensure that both paths are working properly so that if one fails, there is a high degree of confidence that the other path is operational.

Dual LMU is **active/passive**. There is a risk that when the master LMU fails, the standby LMU may not be operational.

- ACSLS and HSC monitor the communication paths and automatically retry communications over the remaining path.
- With Dual LMU, ACSLS and HSC *do not* automatically switch to the standby LMU when they lose communication with the master. An operator must issue a “Switch LMU” command to cause an actual switch from the host software.
- With Dual TCP/IP, ACSLS, HSC or the SL8500 detect a communication path that is unavailable and automatically retry transmissions over the alternate path within seconds. Generally, transactions are not lost.

When the standby LMU detects that the master LMU is not responding to the heartbeat, it takes about eight minutes for the standby LMU to re-IPL and become the master LMU. Transactions in progress may be lost.

- The SL8500 had redundant hot-replaceable power for the electronics. A power supply failure in the 9330 or 4430 LMU will take down that LMU.

**The benefits of Dual LMU verses Dual TCP/IP are:**

- There is only one Library Controller card in the SL8500 at present. If the Library Controller fails, the SL8500 library complex is unavailable.

However, none of the electronics in the Library Control Unit (LCU) on the 9310 and 4410 is redundant either.

**Note:** The Dual TCP/IP feature provides a *dual path* functionality, not redundant functionality. Redundancy with this feature is a function of the *network* to which the library connects.

## Terminology

**ARP**—Short for Address Resolution Protocol, a network layer protocol that converts IP address into physical addresses, like Ethernet addresses. Address Resolution Protocol (ARP) Takeover allows traffic to be redirected from a failing OSA-Express connection to another OSA-Express connection.

**Dual path/Dual TCP/IP**—two distinct physical paths within a network architecture that interconnect two host systems.

**Ethernet**—a local-area network (LAN) architecture that serves as the basis for the IEEE 802.3 standard. Ethernet is one of the most widely implemented LAN standards.

**Gateway**—A node on a network that serves as an *entrance* to another network. A gateway is a device that *routes* traffic from one network to another network.

**MAC address**—Short for media access control.

**Mbps**—spelled this way it is short for megabits per second, a unit of measure for data transfer speed (a megabit is equal to one million bits).

Newer versions of Ethernet, called Gig-E or 1000Base-T support data transfers of 1 gigabit (1,000 Mbps).

**MBps**—Spelled this way it is short for megabytes per second.

**Multi-homed**—more than one network interface (for example, the two SL8500 TCP/IP ports)—this does *not* imply redundancy.

**Netmask**—This entry makes the library accessible through a subnet on a larger network, using a number from 0 to 32; for example, 126.80.70.121/**23**. The number 23 in this example is the netmask.

Network masks—also known as a subnet mask or netmask—use bits to identify the subnetwork, and how many host addresses may access it.

These masks are usually represented by a dotted decimal notation of four numbers from 0 to 255 separated by periods. For example 255.255.254.0 is a subnet mask.

A shorter form of notation—known as Classless Inter-Domain Routing (CIDR)—gives the network number followed by a slash (“/”) and the number of bits in the netmask.

**Redundant TCP/IP**—relates to dynamic routing or switching from a primary interface to a secondary interface in the event of a failure on one interface. *This is not supported.*

**Routing**—is the process of moving a packet of data from a source to a destination. Routing is a key feature in networking because it enables messages to pass from one device to another device, eventually reach its target.

**Static Routing**—routing information in the host system is manually configured by the system administrator. This is the only routing method supported by the SL8500.

**TCP/IP**—Transmission Control Protocol/Internet Protocol

**TCP** is one of the main protocols in networks that enable two hosts to establish a connection and exchange streams of data. TCP guarantees delivery of data and also guarantees that packets are delivered in the order they were sent.

**IP** specifies the format of packets and the addressing scheme.

## ■ Network Addressing

To communicate on a network, each device must have a unique number or “address.”

An Internet Protocol or IP address is a unique number that identifies a device and allows it to communicate on a network. All other IP network devices—including computers, routers, and libraries—must have its own unique address. IP addresses are usually represented by a dotted decimal notation of four numbers from 0 to 255.

For example: 128.80.142.23 is an IP address.

An IP address has two components, the network address and the host address. Assuming this is a Class B network,

- the first two numbers (128.80) represent the network address
- the second two numbers (142.23) identify a particular host or device on this network.

There are five classes of IP ranges: Class A, Class B, Class C, Class D, and Class E—while only A, B and C are commonly used. Each class allows for a range of valid IP addresses. Below is a listing of these addresses.

**Table 30. Network IP Classes and Address Ranges**

Class	Address Range	Supports
<b>Class A</b>	1.0.0.1 to 126.255.255.254	Supports 16 million hosts on each of 127 networks.
<b>Class B</b>	128.1.0.1 to 191.255.255.254	Supports 65,000 hosts on each of 16,000 networks.
<b>Class C</b>	192.0.1.1 to 223.255.254.254	Supports 254 hosts on each of 2 million networks.
<b>Class D</b>	224.0.0.0 to 239.255.255.255	Reserved for multicast groups.
<b>Class E</b>	240.0.0.0 to 254.255.255.254	Reserved.

## ■ Subnet Masks

Definitions:

- **Subnets** allow network administrators to further divide the host part of an IP address into further, smaller, networks—subnets.
- A **mask** is a filter that selectively includes or *excludes* certain values. Values that do not conform to the mask can not access the device.
- A **subnet mask**, or **netmask**, is a 32-bit mask that divides an IP address into subnets and specifies the available hosts on a network.

A subnet mask looks like an IP address and is often seen in 255.255.255.0 notation. It uses a “1” bit to filter, or “mask” allowable addresses in the network.

For example: 255.255.255.0 is a subnet mask.

Where:

- 255 values *mask* the access of an IP address range and
- 0 (or 000) values *allow* the access of an IP address range

When configuring the IP address, including the “slash” notation (for example / 24) is known as Classless Inter-Domain Routing (CIDR<sup>2</sup>) format and indicates the subnet mask for that IP address. While the more conventional notation 255.255.255.0 provides the same information, the subnet mask is more concise using the CIDR notation.

---

2. CIDR is often pronounced as Cedar.

Here is an example of a netmask, binary conversion, and the number of bits masked.

Netmask	First Octet	Second Octet	Third Octet	Fourth Octet
	255.	255.	255.	255
Conversion	11111111	11111111	11111111	11111111
Netmask length (CIDR notation)	/8	/16	/24	/32

The above example is a 32-bit address, which is a broadcast address and does not allow any hosts, computers, or other network devices access.

Commonly used netmasks are the 24-bit mask and 23-bit mask.

Netmask	First Octet	Second Octet	Third Octet	Fourth Octet
	255.	255.	255.	0
Conversion	11111111	11111111	11111111	00000000
Netmask length (CIDR notation)	/8	/16	<b>/24</b>	—
Conversion	11111111	11111111	1111111 <b>0</b>	00000000
Netmask length (CIDR notation)	/8	/16	<b>/23</b>	—

Using a 24-bit netmask would be capable of 2,097,150 networks or 254 different hosts. Below is a breakdown of each of the commonly used network classes:

Class	Netmask length	Networks	Hosts	Netmask
Class A	/8	126	16,777,214	255.0.0.0
Class B	/16	16,382	65,534	255.255.0.0
Class C	/24	2,097,150	254	255.255.255.0

See [Table 31 on page 196](#) for a complete list of netmask values.

## Netmask Quick Reference

**Table 31. Netmask Quick Reference**

Bits	Hosts	Netmask
/8	16777216	255.0.0.0—Class A network
/9	8388608	255.128.0.0
/10	4194304	255.192.0.0
/11	2097152	255.224.0.0
/12	1048576	255.240.0.0
/13	524288	255.248.0.0
/14	262144	255.252.0.0
/15	131072	255.254.0.0
/16	65536	255.255.0.0—Class B network
/17	32768	255.255.128.0
/18	16384	255.255.192.0
/19	8192	255.255.224.0
/20	4096	255.255.240.0
/21	2048	255.255.248.0
/22	1024	255.255.252.0
/23	512	255.255.254.0
/24	256	255.255.255.0—Class C network
/25	128	255.255.255.128
/26	64	255.255.255.192
/27	32	255.255.255.224
/28	16	255.255.255.240
/29	8	255.255.255.248
/30	4	255.255.255.252
/31		
/32	1	255.255.255.255—Single IP address

## ■ ACSLS and Dual TCP/IP Support

The purpose of dual TCP/IP is to automatically recognize and avoid a failing communication path. Since this is automated, there is no need for you to manually switch from an inoperative connection. The best solution is having ACSLS keep two connections to the library open because ACSLS will use all active connections. If one connection is inoperative, ACSLS will just use the remaining operative connection, while continuing to try to re-establish communication on the failing connection.

ACSLs provides the ability to configure two TCP/IP connections to a single library, using “acsss\_config” or the Dynamic Configuration “config.”

When configuring libraries, the user is asked how many connections there are to the library and then the name of the devices (IP addresses).

In order to take full advantage of dual TCP/IP support on the SL8500, the routing tables on the ACSLS server must be manipulated using the “route” command.

### Is there a preferred configuration?

The preferred configuration for dual TCP/IP implementations is two network interfaces on two separate subnets for the ACSLS server. This provides maximum throughput and minimum resource contention with regard to network communications while adding a second physical connection improving reliability.

For more information about ACSLS, the SL8500, and Dual TCP/IP, refer to the: *ACSLs Installation Configuration and Administration Guide (ICAG)*

---

#### Notes:

- Always refer to the Customer Resource Center (CRC) for the latest Tech Tips, code updates, and information.
  - Until the ACSLS ICAG is updated, a Technical Tip will be posted on the CRC with this information.
  - Make sure you reference and use the ACSLS documentation to configure the routing tables on the ACSLS server to support Dual TCP/IP.
- 

The minimum level of software required is:

- ACSLS 7.1 for Solaris on SPARC or AiX.
- Apply PUT0601 and the following PTFs:
- ACSLS 7.1.0 for Solaris on SPARC: PTF849144S
- ACSLS 7.1.0 for AiX:PTF849144A
- ACSLS 7.1.1 for Solaris on X86.
- Apply PTF849144X

For ACSLS HA, see the ACSLS documentation about Dual TCP/IP for more information.

## ■ HSC and Dual TCP/IP Support

HSC provides support to configure two TCP/IP connections using the LMUPATH control statement. This statement allows users to define network LMU attachments in a dual TCP/IP environment for an SL8500.

You must also specify a second LMUADDR parameter to define the dual TCP/IPs. HSC then automatically determines whether the connection is dual TCP/IP or dual LMU.

Once this is completed, vary the ACS offline and back online to pick up the revised LMUPATH statement that includes the second connection.

For more information about HSC, the SL8500, and Dual TCP/IP, refer to the: *HSC Systems Programmer's Guides*

---

**Notes:**

- Always refer to the Customer Resource Center (CRC) for the latest Tech Tips, code updates, and information.
  - Until the HSC Systems Programmer's Guide is updated, a Technical Tip will be posted on the CRC with this information.
  - Make sure you reference and use the HSC Programmer's Guide to configure the routing tables on the system mainframes to support Dual TCP/IP.
- 

The minimum level of software required is:

NCS 6.0 or 6.1 with the appropriate PTFs (below):

**HSC/MVS/VM:**

- SOS600 L1H131L
- SMS600 L1H131K
- SOS610 L1H131N
- SMS610 L1H131M

**MSP:**

- MSP PTF LF61005 includes MVS PTF L1H131N

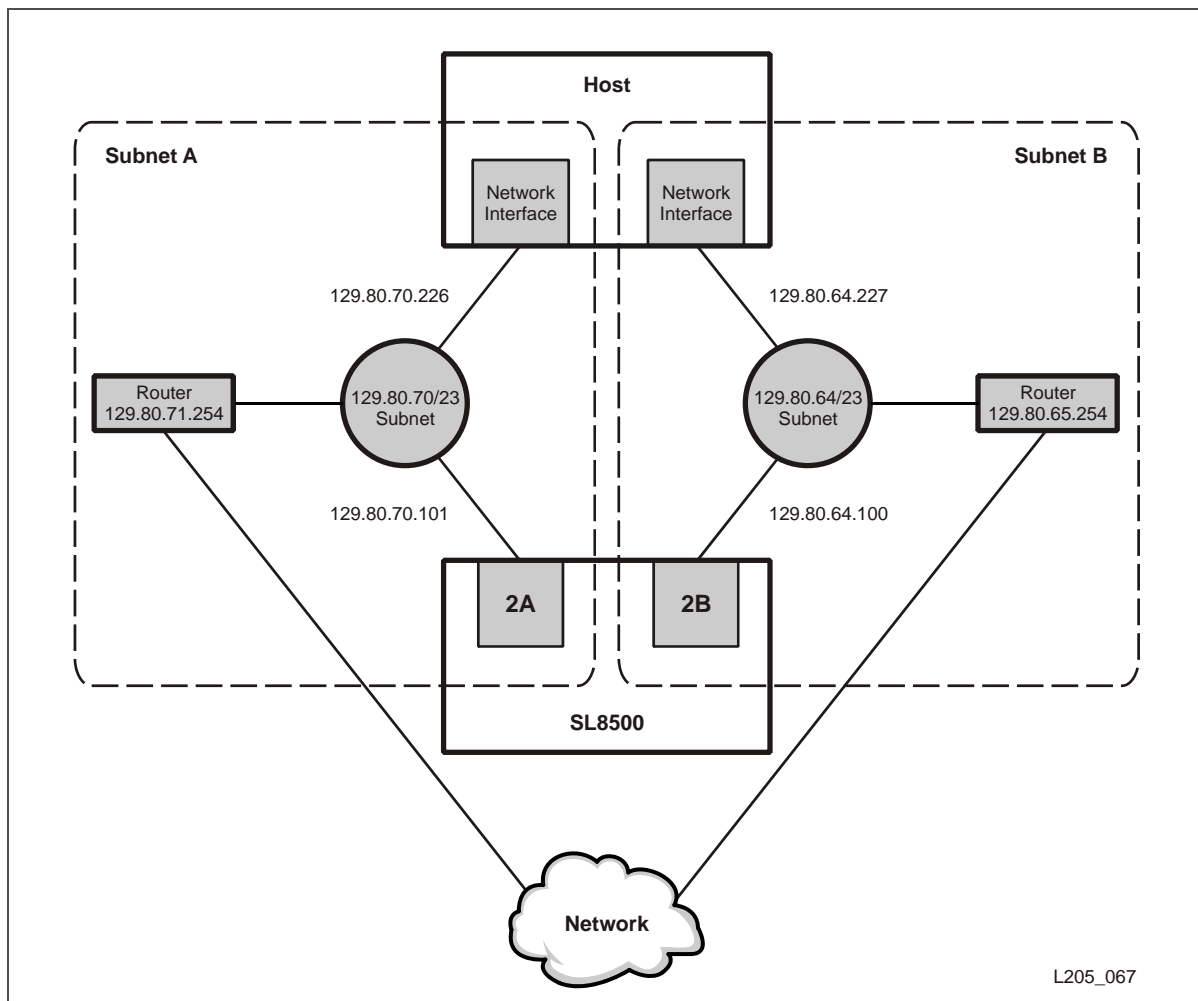


## ■ Multi-Homed Configuration on Two Subnets

Figure 13 illustrates a simple and easy-to-troubleshoot ACSLS/HSC configuration. In this topology, the route required to reach each network interface on the host can be described with a standard, static route.

- In this example, traffic sourced from the host for destination 129.80.70.101 (Port 2A) crosses through subnet A.
- Conditions on subnet B do not impact this path.
- Likewise, conditions on 129.80.64.100 (Port 2B) for subnet B do not impact subnet A.

Figure 13. Multi-Homed Host, Multi-Homed SL8500 on Two Subnets



**SL8500 Routing Table:**

Port	Destination	Gateway	Netmask
2A	129.80.70.0	*	255.255.254.0 (/23)
2B	129.80.64.0	*	255.255.254.0 (/23)

**CLI Commands**

The CLI commands to configure this example are:

**Addresses**

1. Take both ports down.

```
SL8500> network ip link set dev 2A down
SL8500> network ip link set dev 2B down
```

2. Add the **IP addresses** and **subnet masks** for both ports.

```
SL8500> network ip address add 129.80.70.101/23 dev 2A
SL8500> network ip address add 129.80.64.100/23 dev 2B
```

3. Bring both ports back up.

```
SL8500> network ip link set dev 2A up
SL8500> network ip link set dev 2B up
```

**Routing**

In this example, all connections are on the same subnet (129.80), so no special routing requirements are necessary. However, you may want to include a default gateway for the outside network connections.

4. Add a default gateway for network access.

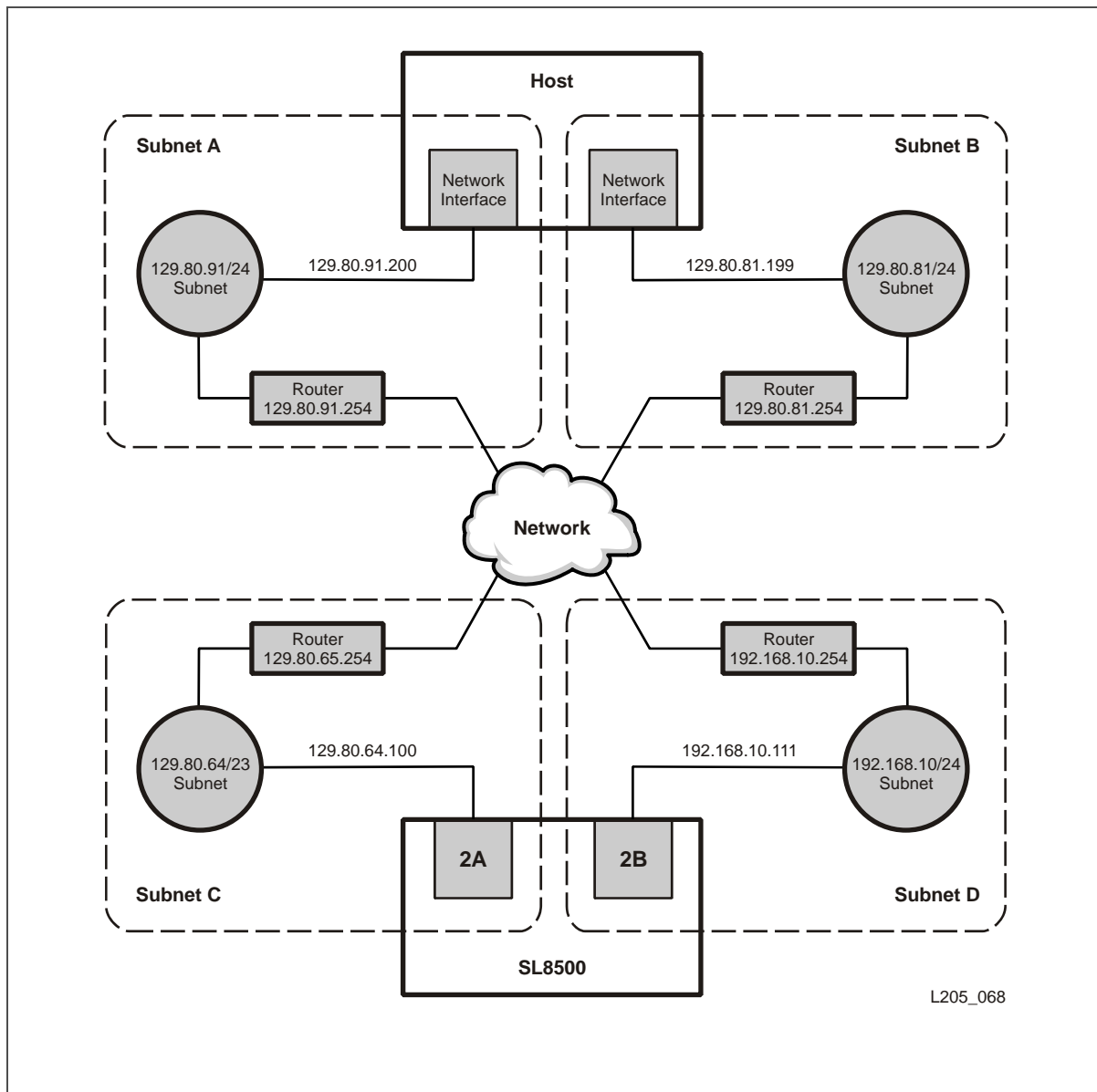
```
network ip route add default via 129.80.65.254
```

You must also configure the routing on the ACSLS server and/or system mainframes. Refer to the appropriate ACSLS or HSC documentation.

## ■ Multi-Homed Configuration with Different Subnets

Figure 14 illustrates distinct network paths within a large network. This is configured through static routing, but each destination route for each network must be defined. In this example, creating an association between destination networks permits us to specify two distinct paths; subnet A can only reach subnet C and subnet B can only reach subnet D.

**Figure 14. Multi-Homed Host, Multi-Homed SL8500, Interfaces on Different Subnets**



**Host and SL8500 Routing Tables:**

Host Routing Table		
Destination	Gateway	Netmask
129.80.91.0	*	255.255.255.0 (/24)
129.80.81.0	*	255.255.255.0 (/24)
129.80.64.0	129.80.91.254	255.255.254.0 (/23)
192.168.10.0	129.80.81.254	255.255.255.0 (/24)

SL8500 Routing Table		
Destination	Gateway	Netmask
192.168.10.0	*	255.255.255.0 (/24)
129.80.64.0	*	255.255.254.0 (/23)
129.80.91.0	129.80.65.254	255.255.255.0 (/24)
129.80.81.0	192.168.10.254	255.255.255.0 (/24)

**CLI Commands**

The CLI commands to configure this example are:

**Addresses**

1. Take both ports down.

```
SL8500> network ip link set dev 2A down
SL8500> network ip link set dev 2B down
```

2. Add the **IP addresses** and **subnet masks** for both ports.

```
SL8500> network ip address add 129.80.64.100/23 dev 2A
SL8500> network ip address add 192.168.10.111/24 dev 2B
```

3. Bring both ports back up.

```
SL8500> network ip link set dev 2A up
SL8500> network ip link set dev 2B up
```

**Routing**

Because this example is using *two* host IP address *into two* SL8500 ports and involves multiple routers, you need to describe the route using the router *closest* to the SL8500 (the format is host router address via SL8500 port router addresses).

4. Add the route for host access through the subnets.

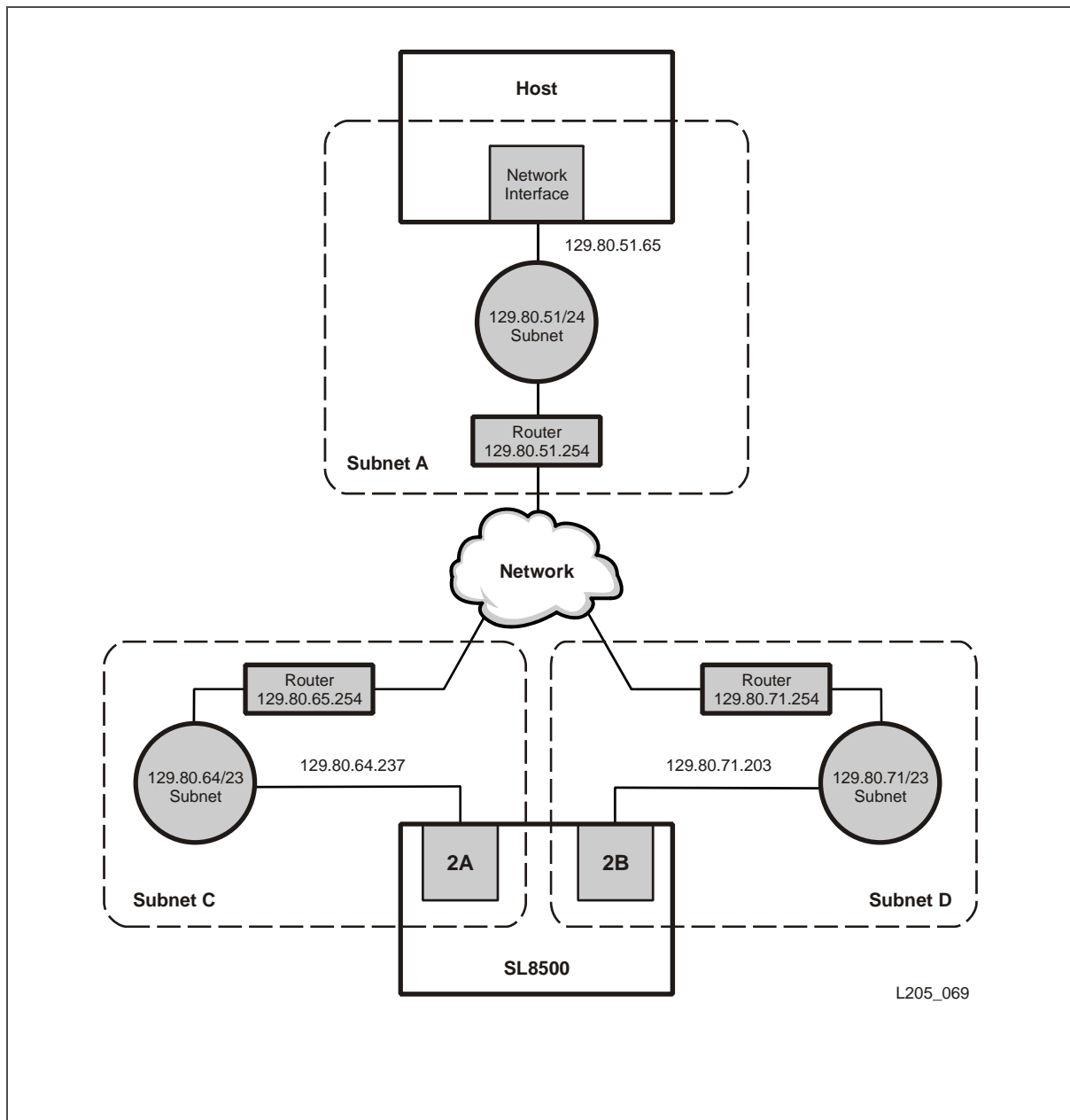
```
network ip route add 129.80.91.200 via 129.80.65.254
network ip route add 129.80.81.199 via 192.168.10.254
```

You must also configure the routing on the ACSLS server and/or system mainframes. Refer to the appropriate ACSLS or HSC documentation.

## ■ Single Interface Host with Multi-Homed SL8500

Figure 15 illustrates a single network interface. If set up incorrectly, loop problems may be encountered with this type of configuration.

Figure 15. Single Interface Host and Multi-Homed SL8500



## Routing Tables (an example of using the policy routing command)

Port 2A Routing Table		
Destination	Gateway	Netmask
129.80.51.65	129.80.65.254	255.255.255.255 (/32)
Port 2B Routing Table		
129.80.51.65	129.80.71.254	255.255.255.255 (/32)
SL8500 Routing Table		
Destination	Gateway	Netmask
129.80.64.0	*	255.255.254.0 (/23)
129.80.71.0	*	255.255.254.0 (/23)
default (2B)	129.80.71.254	0.0.0.0

Notice the netmask for Ports 2A and 2B is /32. This value masks all other bits except the specific destination (host) IP address of 129.80.51.65 through the separate and unique gateway (router) IP addresses.

## CLI Commands

### Addresses

- Take both ports down.
 

```
SL8500> network ip link set dev 2A down
SL8500> network ip link set dev 2B down
```
- Add the **IP addresses** and **subnet masks** for both ports.
 

```
SL8500> network ip address add 129.80.64.237/23 dev 2A
SL8500> network ip address add 129.80.71.203/23 dev 2B
```
- Bring both ports back up.
 

```
SL8500> network ip link set dev 2A up
SL8500> network ip link set dev 2B up
```

### Routing

Because this example is using *one* host IP address *into two* SL8500 ports, you need to use the network ip policy routing commands.

- Add the policy route for both ports.
 

```
SL8500> network ip policy route add 129.80.51.65 via 129.80.65.254 dev 2A
SL8500> network ip policy route add 129.80.51.65 via 129.80.71.254 dev 2B
```
- Enable the policies.
 

```
SL8500> network ip policy enable dev 2A
SL8500> network ip policy enable dev 2B
```

No special routing is needed for this configuration for ACSLS or HSC. Refer to the appropriate ACSLS or HSC documentation for more information.

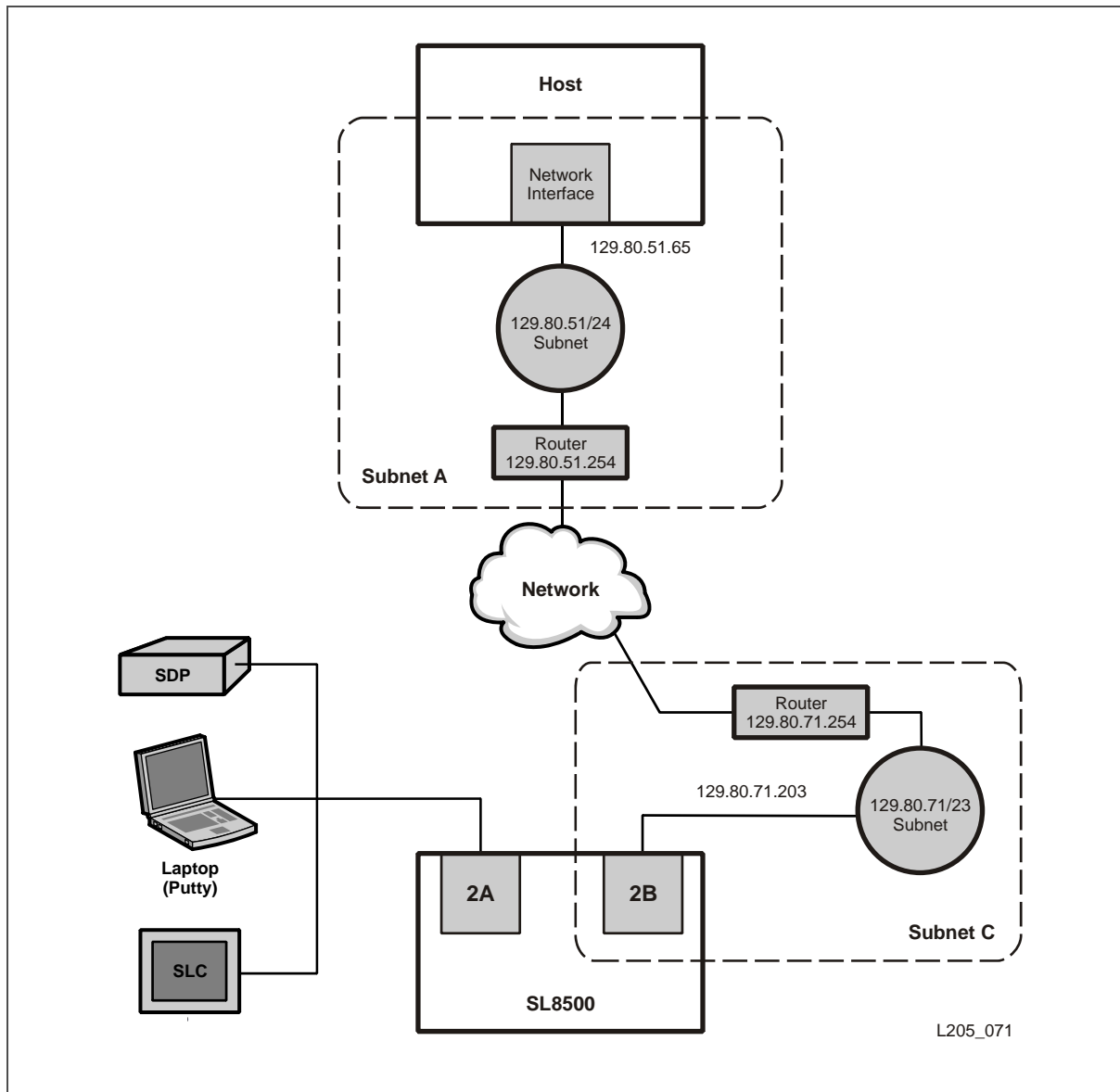
## ■ Service Connection

With the Dual TCP/IP feature, if the customer only has one connection into the SL8500, the second port (2A) can be used as a connection for service.

For example:

- Service Delivery Platform (SDP)
- Laptop (PC)
- StreamLine Library Console (SLC)

**Figure 16. Dual TCP/IP Port 2A Service Connection**



## ■ Potential Problems

While the SL8500's processor can auto-negotiate between 10 and 100 Mbps traffic, floods of address resolution protocol broadcasts (ARP is a network layer protocol that converts IP addresses into physical addresses) can overwhelm the library.

If the SL8500 is connected to shared networks, broadcast messages may be sent to all network nodes. While the library is receiving these irrelevant broadcasts, it cannot receive or reply to requests for library activity to the point that, to its host, it appears that the library's TCP/IP connection has been lost.

Similarly, heavy network traffic can overwhelm the Ethernet controller on the HBC card.

## Shared Networks

The following are some examples of issues that can arise when you connect the SL8500 library to a shared network.

- A TCP/IP-connected library can handle standard host traffic, but it cannot handle floods of *Address Resolution Protocol* (ARP) broadcasts. **For this reason, it is best to attach the library on a controlled network, such as behind a switch or router.**
- Newer generation networks, such as 1000Base-T and Gig-E, support earlier communication modes—such as 10BaseT and 100BaseT. However, devices that are communicating with the library may transmit data at bandwidths that could overwhelm it. Again, for this reason, is best to **attach the library on a controlled network**, such as, with a switch that can isolate the library from network broadcasts.
- When you connect the library on shared networks, and broadcasts are sent to all network nodes, they may also be directed to the library (even though it does not need them). During the time the library is receiving these irrelevant broadcasts, it cannot receive requests or reply to others in a timely fashion. This heavy broadcast traffic on the network can saturate the library to the point that, to the host, it may appear that the TCP/IP connection has been lost.
- Heavy network traffic can also overwhelm the Ethernet controller causing the processor to continuously reset and re-initialize the controller, then recover the host-to-library communications.



## Diagnosing TCP/IP Problems

If communication problems arise, problems can be diagnosed by using the following methods:

1. Use a “sniffer” (a device or program used to trace the network traffic for the library).
2. Display the port statistics on the switch or hub to which the library is connected. Search for any errors that were encountered.
3. Run a trace with the library management software that displays host-to-library packets and transmissions.

## Solutions

If possible, use a dedicated private network for host management software-to-library communication.

If, however, a shared network is required, possible solutions are:

1. Directly connect the library to a switch that filters out undirected (broadcast) traffic.
2. Place the library on its own subnet—this may protect the library from receiving broadcast messages.
3. Use a managed switch—this can:
  - Set priorities on ports to supply the host and library with higher priority
  - Provide dedicated bandwidth between the host and library
  - Create a virtual local area network (VLAN) between the host and library
4. A virtual private network (VPN) can also insulate host-to-library traffic from other interference, such as irrelevant broadcasts.

## Gigabit Ethernet Connections

The SL8500 library does not support native Gigabit Ethernet (Gig-E) connections.

Remember, the SL8500 network is only between the ACSLS server or HSC host and Gig-E communications and speed is not necessary.

When connecting to Gig-E networks, choose a switch or router that can convert to 100 Mbps for the library.

There is not an issue of what the customer puts on the other side of the server, host, or library to their clients.



# Partitioning



The definition of a **partition** according to the Merriam–Webster dictionary is:

1. to divide into parts or shares.
2. to separate or divide by a partition, such as a wall.

In computing, many people are familiar with hard disk drive partitioning to create several logical divisions on the same hard drive. This separation allows administrators to apply different operating system functions, files, and formatting to the same physical hard drive. In layman's terms, partitioning a hard drive makes it appear to be more than one hard drive.

The SL8500 Modular Library System now provides the ability to partition the library—within hardware boundaries—to support from one to four physical partitions.

## ■ Purpose

Partitioning the SL8500 library means the customer can have:

- More than one operating system and application manage the library.
- An improvement in the protection or isolation of files.
- An increase in system and library performance.
- A higher level of data organization.
- An increase in user efficiency.

Partitions may be customized to fit different requirements, for example:

- allowing for special partitions to protect or archive data
- enabling multiple organizations, companies, or departments access
- isolating clients (such as for service centers)
- separating different encryption key groups
- dedicating partitions as test systems for new technologies or data migration to new tape drives

This appendix:

- Contains guidelines and essential elements for SL8500 partitions.
- Provides templates to help plan the partitioning of the library.
- Describes how to license and enable the partitioning feature.
- Shows how to partition the rails in the library.
- Describes how to override reserved cartridge access ports (CAPs)

## ■ Guidelines

Essential elements for understanding partitions are:

- **Clear communication between all parties**, such as system programmers, network administrators, both ACSLS and HSC administrators, and Sun service representatives.
- Only a single library may be partitioned—pass-thru port (PTP) operations are not allowed. However, if libraries are currently connected using PTPs, and you—the customer—what to keep that structure for future development; a service representative can disconnect the local network interface and connections within the library to disable this configuration. *You will not need to disassemble the complex.*
- Customers must be current on maintenance levels of their library management software (ACSLs and HSC).

See the software and firmware requirements on [page 212](#).

- Depending on the library configuration, each rail has:
  - Minimum capacity of 362 cartridges<sup>1</sup>.
  - Maximum capacity of 2,522 cartridges<sup>2</sup>.
  - From 1 to 16 tape drives.
- Each rail is the smallest element of a partition, but partitions may include more than one rail. If a partition includes more than one rail, those rails must be *adjacent*.
- Hosts with a common database—HSC hosts using a common Control Data Set (CDS)—can share a partition; these hosts are called a “host group.”

A single HSC CDS cannot connect to more than one partition within the same SL8500 library; however, you can have one partition from each library in the same CDS. If you have two partitions in a library, you must also have two CDS; three partitions, three CDS.

- When partitioned, the library controller reports rails assigned to another partition within the library as “unallocated” (HSC) or as a new “SL8500\_Unalloc LSM” (ACSLs). This provides two things:
  - It displays the entire library, and
  - If partitioning is changed (rails added to or removed from a partition), cartridge locations remain constant.

---

1. The basic configuration of an SL8500 library is 1,448 cartridges; spread across four LSMs provides 362 cartridges per rail.  
 2. The maximum configuration of an SL8500 library is 10,088 cartridges; spread across four LSMs provides 2,522 cartridges per rail.

**Remember:**

- Partitioned LSMs cannot communicate with other LSMs within the library unless they are in the same partition.
- Elevators and CAPs are *shared resources*—each partition can fully use these resources for enter and eject operations.
- No elevator pass-thru operations will occur between LSMs unless they are defined in the same partition, except when using the CAP to service Rail 1, regardless of its configured partition.
- Elevator operation is under the control of the library controller when CAP operations are issued. The library controller uses the elevators and HandBots to access the entire capacity of the CAPs for enters and ejects without regard for the partitions.
- Partitions can share the ownership of the CAPs. That is, if one host/partition has CAP A reserved, a different host/partition can have CAP B reserved, or one host/partition can have both CAPs reserved.
- Automatic mode is not supported in a partitioned library.
- Duplicate VOLSERS<sup>3</sup> are supported by the library; however, ACSLS and HSC do not, unless:
  - The duplicate VOLSERS are in different partitions.
  - With HSC managed partitions, the duplicate VOLSERS are in different control data sets.
  - With ACSLS managed partitions, the duplicate VOLSERS are on different ACSLS servers.
- All drives, storage slots and cartridges within a partition are solely owned by that host or host group.
- Library complex considerations:  
When breaking apart an established library complex to partition libraries within it, you need to understand the numbering and addressing scheme of the library.
- Rails do not need to be included in a partition, they can remain unassigned to allow for future growth.

---

3. VOLSER = volume serial number—the cartridge tape label.

## Software and Firmware Requirements

Requirements for partitioning the SL8500 library include:

- Order number: SL8500-UPG-PART
- Upgrade number: XSL8500-UPG-PART
- Library firmware FRS\_3.7x or higher
- StreamLine Library Console (SLC) at Version FRS\_3.25 or higher
- ACSLS Versions 7.1 and 7.1.1 with PUT0701
- ACSLS HA 2 also requires PTF 6514766
- NCS (NearLine Control Solution) Version 6.1
- HSC (MVS) Version 6.1 with PTF L1H13GW and L1H13JK
- HSC (VM) Version 6.1 with PTF L1H13GX and L1H13JJ
- VSM (Virtual Storage Module) Versions 3, 4, or 5
- ExPR (Expert Performance Reported) with PTF L1E025H
- ExLM (Expert Library Manager) Version 6.0 with PTF L1L00F6, Version 6.1 (none), Version 6.2 with PTF L1L00F7

Hosts without the latest level of software (ACSLs or HSC) or without the latest PUTs and PTFs will not be able to bring a partitioned ACS online.

Always refer to the Customer Resource Center (CRC) for the latest versions of software, firmware, and documentation.

## Capacities

Figure 17 shows an example of an SL8500 library with the capacities of each module; partition capacities per rail and per library configuration, plus drive modules (from 1 to 16 tape drives) for each rail.

Figure 17. Partition Planning and Capacities

		Base Library				Storage Expansion Modules					Shared Resources				
		DEM				RIM + CIM		SEM 1	SEM 2	SEM 3	SEM 4	SEM 5			
Rail 1/LSM0	1	5	9	13	200	162	432	432	432	432	432	432	E L E V A T O R S  (2)	C	C
	2	6	10	14											
	3	7	11	15											
	4	8	12	16											
Rail 2/LSM1	1	5	9	13	200	162	432	432	432	432	432	432		A	A
	2	6	10	14											
	3	7	11	15											
	4	8	12	16											
Rail 3/LSM2	1	5	9	13	200	162	432	432	432	432	432	432		P <sup>A</sup>	P <sup>B</sup>
	2	6	10	14											
	3	7	11	15											
	4	8	12	16											
Rail 4/LSM3	1	5	9	13	200	162	432	432	432	432	432	432			
	2	6	10	14											
	3	7	11	15											
	4	8	12	16											
Partition Capacities per Rail					362		794	1,226	1,658	2,090	2,522				
Total Library Capacities					1,448		3,176	4,904	6,632	8,360	10,088				

L205\_072

Table 32. Partitioned Capacities

	Library Configuration	Partition Capacity per Rail
Basic Library	Drive & Electronics Module	0
	Robotics Interface Module	200
	Customer Interface Module	162
	Base configuration per rail (total)	362
Expansion Modules	When adding expansion module, each rail gets <b>432</b> additional data cartridge slots	
	One expansion module	794
	Two expansion modules	1,226
	Three expansion modules	1,658
	Four expansion modules	2,090
	Five expansion modules (maximum)	2,522

## ■ Tasks

Use [Table 33](#) to help prepare for partitioning.

**Table 33. Steps and Tasks for Partitioning**

✓	Step	Task	Reference	Responsibility*
<input type="checkbox"/>	1. Team	<p>Create a Team.</p> <p>When planning for partitions, using a process similar to that of the system assurance process, which is the exchange of information among team members. Team members should include representatives from both the customer and Sun Microsystems to ensure that all aspects of the process are planned carefully and performed efficiently.</p>		<ul style="list-style-type: none"> <li>• Customer</li> <li>• Sun SE, PS</li> <li>• Sun Service</li> </ul>
<input type="checkbox"/>	2. Codes	Review the software and firmware requirements. Update as required.	<a href="#">"Software and Firmware Requirements" on page 212</a>	<ul style="list-style-type: none"> <li>• Customer</li> <li>• Sun SE, PS</li> <li>• Sun Service</li> </ul>
<input type="checkbox"/>	3. Planning	<ul style="list-style-type: none"> <li>• Create a planning team</li> <li>• Define the customer expectations</li> <li>• Complete the assessment</li> <li>• Identify the configurations</li> <li>• Complete the planning diagrams</li> </ul>	<a href="#">"Planning" on page 215</a>	<ul style="list-style-type: none"> <li>• Customer</li> <li>• Sun SE, PS</li> <li>• Sun Service</li> </ul>
<input type="checkbox"/>	4. Media	<ul style="list-style-type: none"> <li>• Verify the distribution of cartridges and required tape drives are available and ready.</li> </ul>		<ul style="list-style-type: none"> <li>• Customer</li> </ul>
<input type="checkbox"/>	5. Library	<ul style="list-style-type: none"> <li>• Convert a complex (if necessary).</li> </ul>	SL8500 Partitioning Technical Brief (PN 96269)	<ul style="list-style-type: none"> <li>• Sun Service</li> </ul>
<input type="checkbox"/>	6. License	<ul style="list-style-type: none"> <li>• License the partitioning feature and create the library partitions.</li> </ul>		<ul style="list-style-type: none"> <li>• Sun Service</li> </ul>
<input type="checkbox"/>	7. Hosts	<ul style="list-style-type: none"> <li>• Momentarily stop all host activity.</li> <li>• Make the hosts inaccessible.</li> </ul>		<ul style="list-style-type: none"> <li>• Customer</li> </ul>
<input type="checkbox"/>	8. Use	<p>Instruct the customer how to:</p> <ul style="list-style-type: none"> <li>• Partition and re-partition</li> <li>• Override a CAP reservation</li> </ul>		<ul style="list-style-type: none"> <li>• Customer</li> <li>• Sun Service</li> </ul>
<ul style="list-style-type: none"> <li>• SE = Systems engineer</li> <li>• PS = Professional services representative</li> <li>• Service = Service representative (Svc)</li> <li>• Customer = System administrators, network administrators, system programmers, operators</li> </ul>				

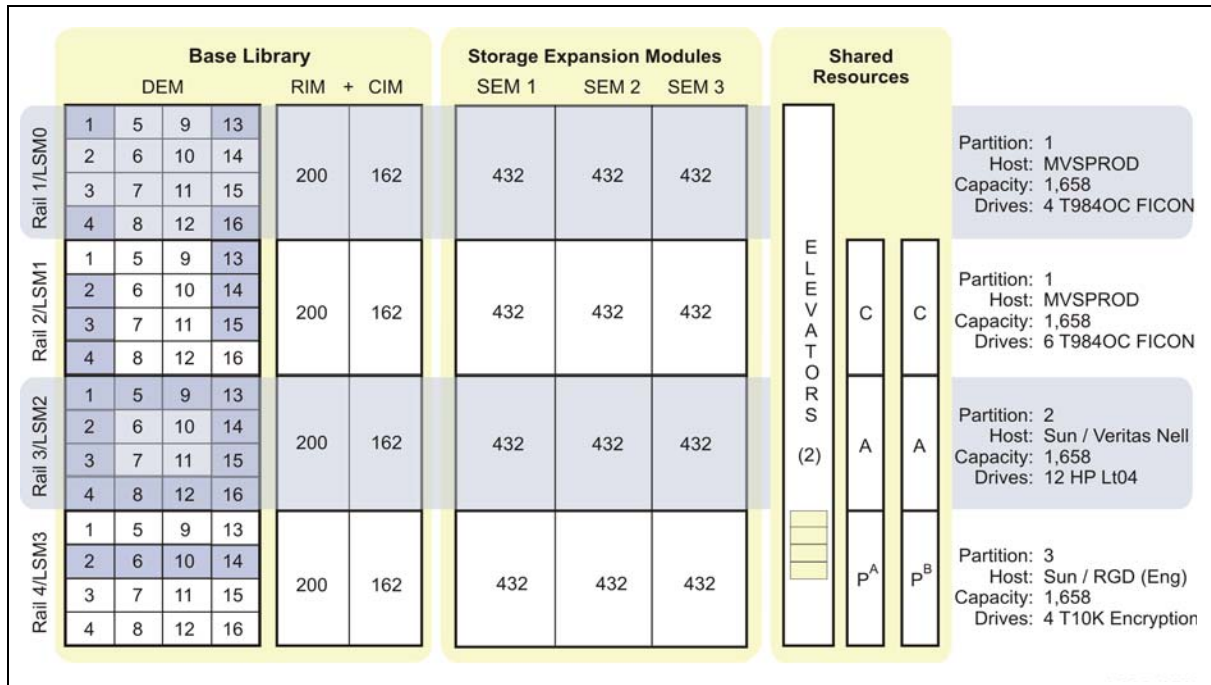


## ■ Planning

Identify and define the customer requirements and expectations	
Identify the proposed configurations	
Complete the following assessment:	
Is this a new installation or an existing installation?	New: <input type="checkbox"/> Existing: <input type="checkbox"/> If existing, cartridge migration may be required to configure the partitions correctly. Cartridge migration required? Yes <input type="checkbox"/> No <input type="checkbox"/>
How many partitions are there going to be in the library?	
How many rails are there going to be for a partition? Remember to configure the elevator for use between partitions.	1. 2. 3. 4.
What is the name and purpose for each partition?	1. 2. 3. 4.
What type of operating systems for each partition?	1. 2. 3. 4.
What type of library management software for each partition? Make sure the customer has the latest versions and updates. See <a href="#">page 212</a> for information.	1. ACSL: <input type="checkbox"/> HSC: <input type="checkbox"/> 2. ACSL: <input type="checkbox"/> HSC: <input type="checkbox"/> 3. ACSL: <input type="checkbox"/> HSC: <input type="checkbox"/> 4. ACSL: <input type="checkbox"/> HSC: <input type="checkbox"/>
What type of applications are being used?	1. 2. 3. 4.
How many cartridges are needed for each partition?	1. 2. 3. 4.
How many free slots are needed for each partition?	1. 2. 3. 4.
What are the tape drive types and quantities?	1. 2. 3. 4.
<ul style="list-style-type: none"> <li>• Complete a plan using the figures in this chapter as an example.</li> <li>• Place this information with the library.</li> </ul>	

Figure 18 provides an example to show the flexibility that partitions provide for host connections, applications, capacities, tape drive types and interfaces.

Figure 18. Partition Planning Example



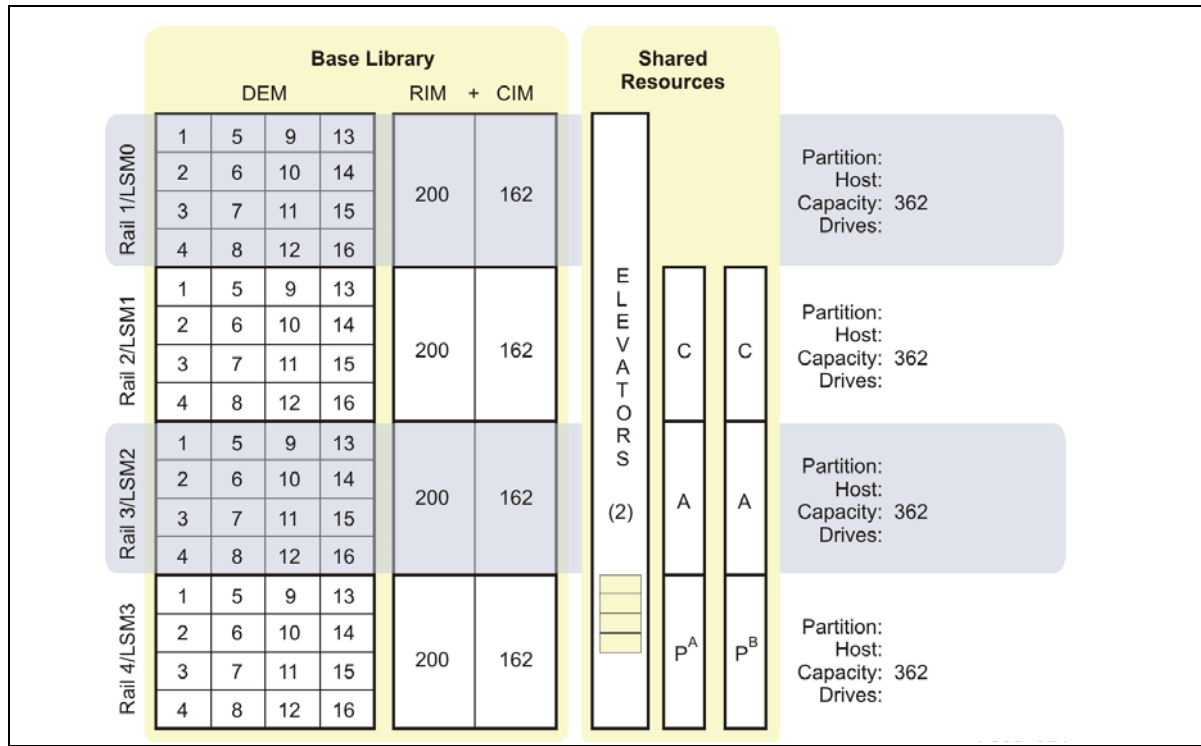
Rail 1 and Rail 2 Combined as one Partition (ACS 0)			
Partition ID	hli1 / MVS combined	Partition ID	hli1 / MVS combined
Hosts	z/OS V1R1	Hosts	z/OS V1R1
ACSLs or HSC	HSC Version 6.1	ACSLs or HSC	HSC Version 6.1
Applications	Tivoli Version 5.3	Applications	Tivoli Version 5.3
Cartridge capacity	1,000	Cartridge capacity	580
Free slots	658	Free slots	1,078
Tape Drive types	4 T9840 C FICON	Tape Drive types	6 T9840 C FICON

Rail 3 (ACS 1)		Rail 4 (ACS 2)	
Partition ID	hli2 / Open Systems	Partition ID	hli3 / Encryption
Hosts	Solaris 9	Hosts	Solaris 10
ACSLs or HSC	ACSLs	ACSLs or HSC	ACSLs
Applications	Veritas NBU 4.5 Media Manager DataCenter	Applications	Oracle, Siebel, SAP, SQL, NetWorker
Cartridge capacity	1106	Cartridge capacity	830
Free slots	552	Free slots	828
Tape Drive types	12 HP LTO 3, 2Gb FC	Tape Drive types	4 T10K, 4Gb FC, Crypto

Figure 19 on page 217 through Figure 24 on page 222 provide work sheets for planning partitions with the six different library configurations.

Make copies as necessary.

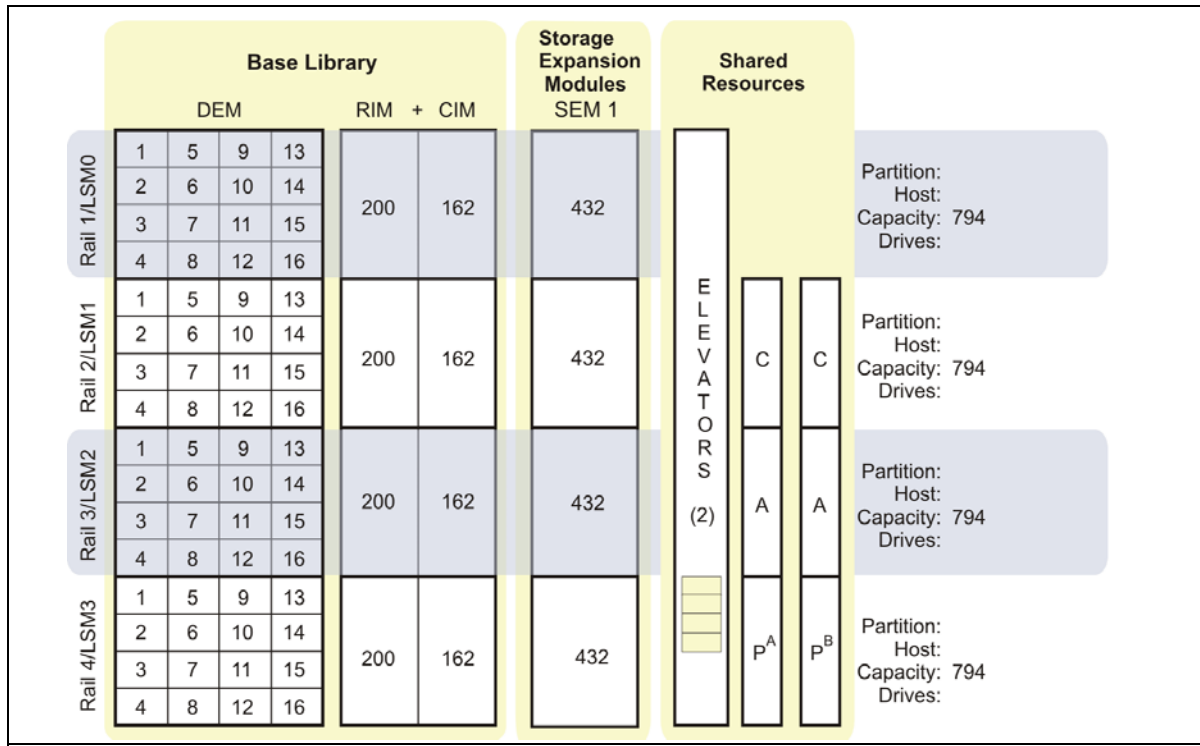
**Figure 19. Base Library Partition Planning**



Rail 1		Rail 2	
Partition ID		Partition ID	
Hosts		Hosts	
ACSLs or HSC		ACSLs or HSC	
ACS, LSM Address		ACS, LSM Address	
Applications		Applications	
Cartridge capacity		Cartridge capacity	
Free slots		Free slots	
Tape Drive types		Tape Drive types	

Rail 3		Rail 4	
Partition ID		Partition ID	
Hosts		Hosts	
ACSLs or HSC		ACSLs or HSC	
ACS, LSM Address		ACS, LSM Address	
Applications		Applications	
Cartridge capacity		Cartridge capacity	
Free slots		Free slots	
Tape Drive types		Tape Drive types	

**Figure 20. One Expansion Module Partition Planning**



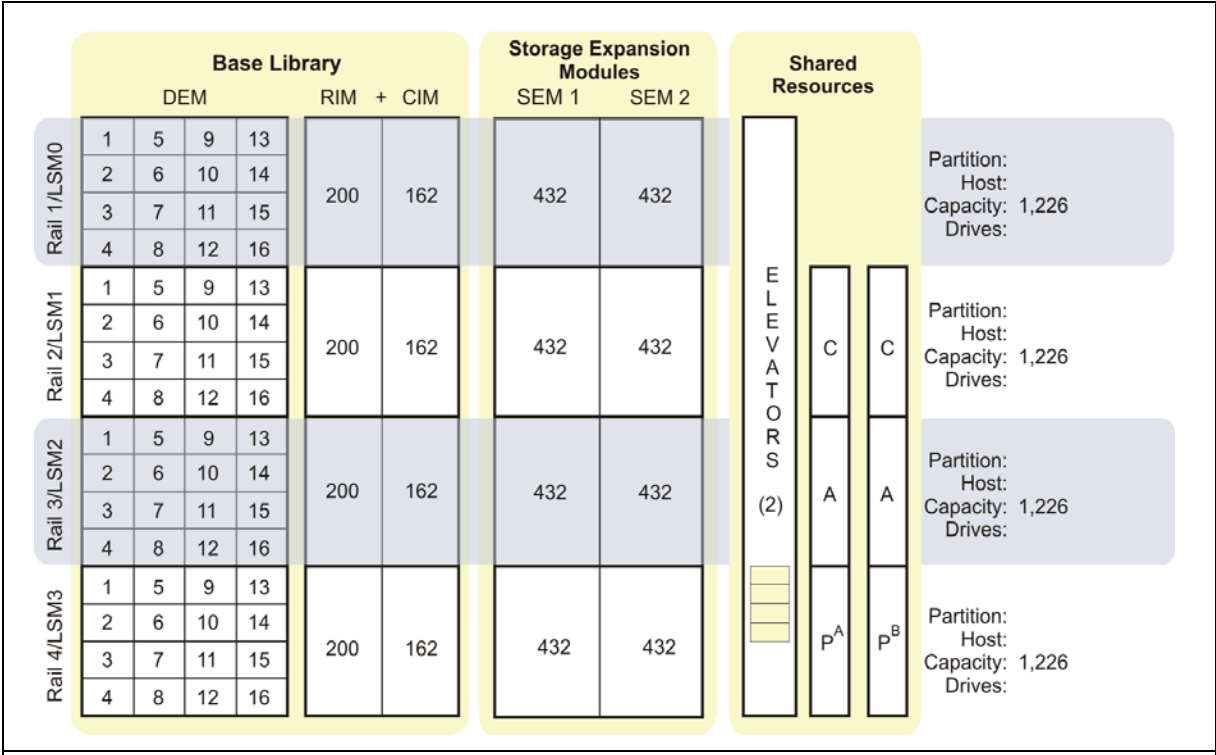
<b>Rail 1</b>	
Partition ID	
Hosts	
ACSLs or HSC	
ACS, LSM Address	
Applications	
Cartridge capacity	
Free slots	
Tape Drive types	

<b>Rail 2</b>	
Partition ID	
Hosts	
ACSLs or HSC	
ACS, LSM Address	
Applications	
Cartridge capacity	
Free slots	
Tape Drive types	

<b>Rail 3</b>	
Partition ID	
Hosts	
ACSLs or HSC	
ACS, LSM Address	
Applications	
Cartridge capacity	
Free slots	
Tape Drive types	

<b>Rail 4</b>	
Partition ID	
Hosts	
ACSLs or HSC	
ACS, LSM Address	
Applications	
Cartridge capacity	
Free slots	
Tape Drive types	

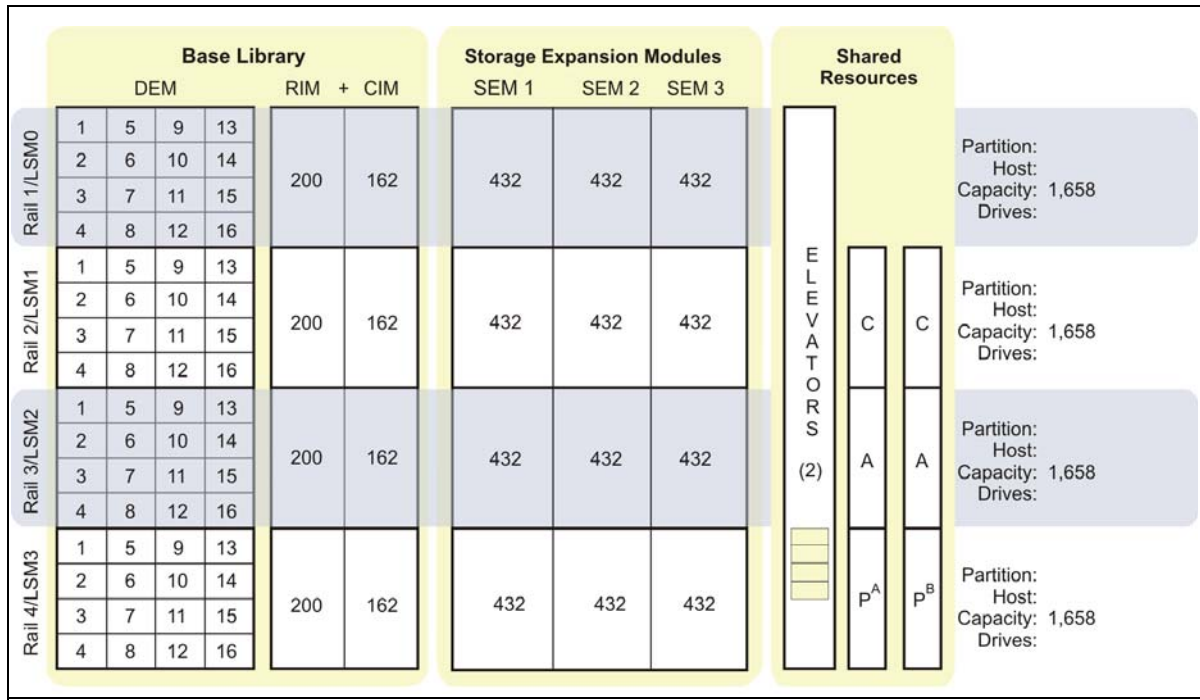
Figure 21. Two Expansion Modules Partition Planning



Rail 1		Rail 2	
Partition ID		Partition ID	
Hosts		Hosts	
ACSLs or HSC		ACSLs or HSC	
ACS, LSM Address		ACS, LSM Address	
Applications		Applications	
Cartridge capacity		Cartridge capacity	
Free slots		Free slots	
Tape Drive types		Tape Drive types	

Rail 3		Rail 4	
Partition ID		Partition ID	
Hosts		Hosts	
ACSLs or HSC		ACSLs or HSC	
ACS, LSM Address		ACS, LSM Address	
Applications		Applications	
Cartridge capacity		Cartridge capacity	
Free slots		Free slots	
Tape Drive types		Tape Drive types	

**Figure 22. Three Expansion Modules Partition Planning**



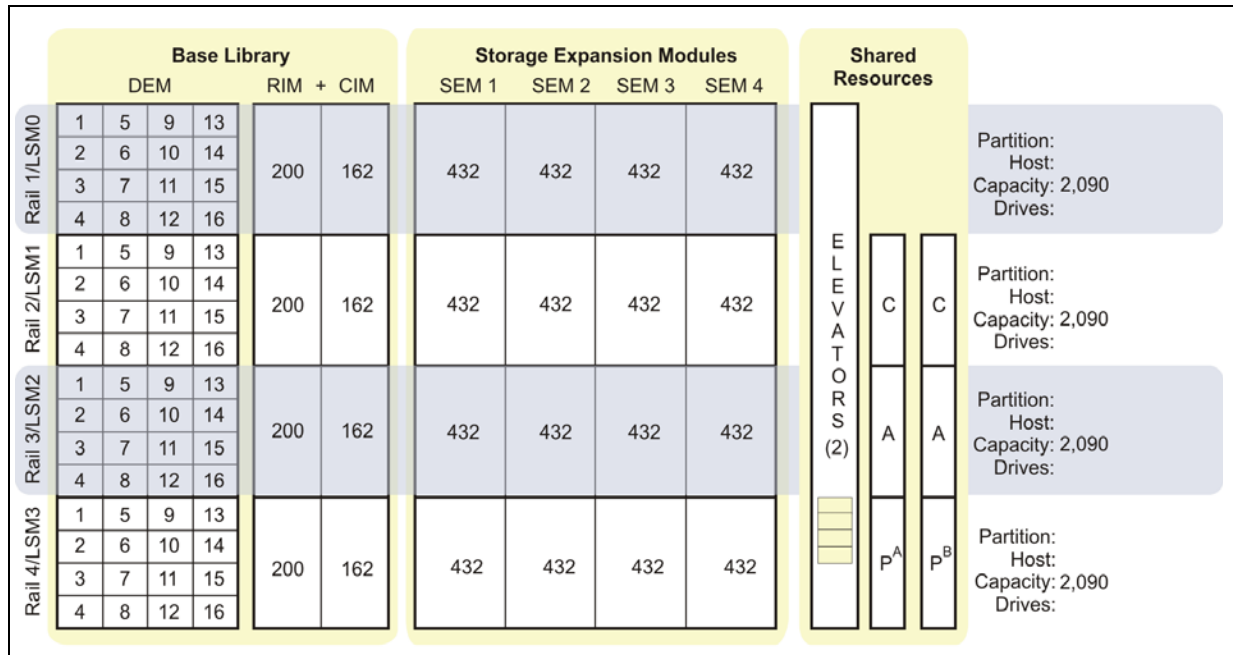
<b>Rail 1</b>	
Partition ID	
Hosts	
ACSLs or HSC	
ACS, LSM Address	
Applications	
Cartridge capacity	
Free slots	
Tape Drive types	

<b>Rail 2</b>	
Partition ID	
Hosts	
ACSLs or HSC	
ACS, LSM Address	
Applications	
Cartridge capacity	
Free slots	
Tape Drive types	

<b>Rail 3</b>	
Partition ID	
Hosts	
ACSLs or HSC	
ACS, LSM Address	
Applications	
Cartridge capacity	
Free slots	
Tape Drive types	

<b>Rail 4</b>	
Partition ID	
Hosts	
ACSLs or HSC	
ACS, LSM Address	
Applications	
Cartridge capacity	
Free slots	
Tape Drive types	

**Figure 23. Four Expansion Modules Partition Planning**



Rail 1	
Partition ID	
Hosts	
ACSLs or HSC	
ACS, LSM Address	
Applications	
Cartridge capacity	
Free slots	
Tape Drive types	

Rail 2	
Partition ID	
Hosts	
ACSLs or HSC	
ACS, LSM Address	
Applications	
Cartridge capacity	
Free slots	
Tape Drive types	

Rail 3	
Partition ID	
Hosts	
ACSLs or HSC	
ACS, LSM Address	
Applications	
Cartridge capacity	
Free slots	
Tape Drive types	

Rail 4	
Partition ID	
Hosts	
ACSLs or HSC	
ACS, LSM Address	
Applications	
Cartridge capacity	
Free slots	
Tape Drive types	

**Figure 24. Five Expansion Modules Partition Planning**

		Base Library				Storage Expansion Modules					Shared Resources				
		DEM		RIM + CIM		SEM 1	SEM 2	SEM 3	SEM 4	SEM 5					
Rail 1/LSM0	1	5	9	13	200	162	432	432	432	432	432	ELEVATORS (2)	C	C	Partition: Host: Capacity: 2,522 Drives:
	2	6	10	14											
	3	7	11	15											
	4	8	12	16											
Rail 2/LSM1	1	5	9	13	200	162	432	432	432	432	432	ELEVATORS (2)	C	C	Partition: Host: Capacity: 2,522 Drives:
	2	6	10	14											
	3	7	11	15											
	4	8	12	16											
Rail 3/LSM2	1	5	9	13	200	162	432	432	432	432	432	ELEVATORS (2)	A	A	Partition: Host: Capacity: 2,522 Drives:
	2	6	10	14											
	3	7	11	15											
	4	8	12	16											
Rail 4/LSM3	1	5	9	13	200	162	432	432	432	432	432	ELEVATORS (2)	P <sup>A</sup>	P <sup>B</sup>	Partition: Host: Capacity: 2,522 Drives:
	2	6	10	14											
	3	7	11	15											
	4	8	12	16											

<b>Rail 1</b>	
Partition ID	
Hosts	
ACSLs or HSC	
ACS, LSM Address	
Applications	
Cartridge capacity	
Free slots	
Tape Drive types	

<b>Rail 2</b>	
Partition ID	
Hosts	
ACSLs or HSC	
ACS, LSM Address	
Applications	
Cartridge capacity	
Free slots	
Tape Drive types	

<b>Rail 3</b>	
Partition ID	
Hosts	
ACSLs or HSC	
ACS, LSM Address	
Applications	
Cartridge capacity	
Free slots	
Tape Drive types	

<b>Rail 4</b>	
Partition ID	
Hosts	
ACSLs or HSC	
ACS, LSM Address	
Applications	
Cartridge capacity	
Free slots	
Tape Drive types	



# Multi-Host Connectivity



The newest host connectivity feature to an SL8500 Library Complex is Multi-Host. This feature allows up to *four* connections to a library complex that contains 2 or more libraries.

## ■ Requirements

Order numbers for multiple host connections to an SL8500 library are:

- Number: XSL8500-MTCPIP

Requirements include the following levels or *higher*:

- Library firmware **FRS\_3.95**
- StorageTek Library Console at Version FRS\_3.38
- ACSLS Versions 7.1 and 7.1.1 with PUT0701
- ACSLS HA 2 also requires PTF 6514766

or

- NCS (NearLine Control Solution) Version 6.1
- HSC (MVS) Version 6.1 with PTF L1H13GW and L1H13JK
- HSC (VM) Version 6.1 with PTF L1H13GX and L1H13JJ

**Note:** Upgrading library firmware can be a disruption to customer operations. You may want to schedule time with the customer to perform this service.

Hosts without the latest level of software (ACSLs or HSC) or without the latest PUTs and PTFs will not be able to use multiple connections to a library complex.

Software and firmware levels can be downloaded and ready in advance of activation. When the time and window is available, these codes can be activated. This preparation can limit down time of the library and operating system.

## Library Management Software

Both ACSLS or HSC can support up to *four* connections to an SL8500 Library Complex, also called an ACS.

### Specifics for ACSLS

When ACSLS has two connections to one SL8500, you must configure the SL8500 and ACSLS server routing tables. Refer to the *ACSLs Installation, Configuration, and Administrator Guide* ⇨ ACSLS Dual TCP/IP Support section for more information.

Make the first connection that you specify in `acsss_config` or `config acs new` to the SL8500 library with the most activity.

### Specifics for HSC

When HSC has two connections to one SL8500, refer to the: *HSC Systems Programmers Guide* ⇨ Appendix A: HSC Support for the SL8500 Library ⇨ TCP/IP Communications ⇨ Important Considerations section for more information.

**Optimization:** HSC will distribute communications to the libraries evenly. Connections to multiple libraries distribute the communication with HSC among all of the connected libraries, as opposed to having one library handle all communication with HSC.

The following example shows multiple LMUADDR parameters consisting of four IP addresses. In this case, the first, second, third, and fourth IP addresses indicate a TCP/IP connection to each of four separate SL8500 libraries connected in ACS 00.

**Table 34. HSC LMU Path and Address Parameters**

LMUPATH ACS(00) LMUADDR(123.456.789.012,123.456.789.013,123.456.789.014,123.456.789.015)
--

## Host Connections

For example, connections can be:

- Four connections to four separate SL8500 libraries ([Figure 25.](#))
- Two connections each of two SL8500 libraries ([Figure 26.](#))
- Two connections to one library plus two other connections ([Figure 27.](#))



**Important:**

To optimize library performance and minimize inter-library communication among the SL8500s, **connect to the libraries with the most activity.**

## Multi-Host Network Entries Work Sheet

When preparing the network and connections—as a best practice—complete a network entries worksheet for each port of the SL8500 library.

Description		IP Address / Name
Connection 1	HBC Card Port: 2A <input type="checkbox"/> 2B <input type="checkbox"/>	
	Host name	
	Gateway	
	Netmask	
Connection 2	HBC Card Port: 2A <input type="checkbox"/> 2B <input type="checkbox"/>	
	Host name	
	Gateway	
	Netmask	
Connection 3	HBC Card Port: 2A <input type="checkbox"/> 2B <input type="checkbox"/>	
	Host name	
	Gateway	
	Netmask	
Connection 4	HBC Card Port: 2A <input type="checkbox"/> 2B <input type="checkbox"/>	
	Host name	
	Gateway	
	Netmask	

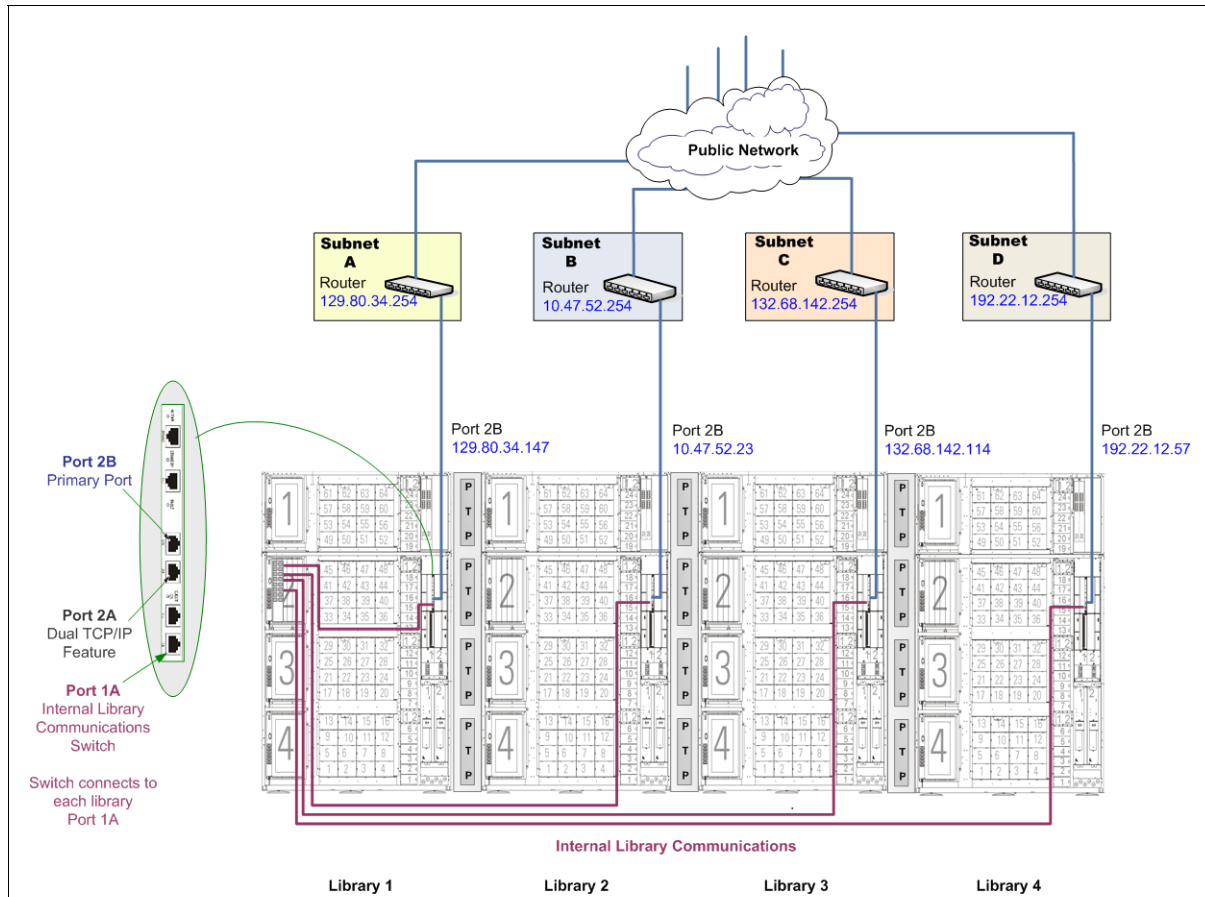


### Important:

- When connecting more than one interface to an SL8500 library or library complex, the connections should be at least two different subnets for redundancy.
  - If one subnet fails, communications between the hosts and the libraries continue over the other subnets.
- When connecting an interface to Port 2A, a service representative must configure routing and possibly assign policies for that port using the command line interface.
  - Port 2B is the default port for the library, no routing tables are required when connecting to that port.
- **The ports need to be on different Layer 2 broadcast domains.**

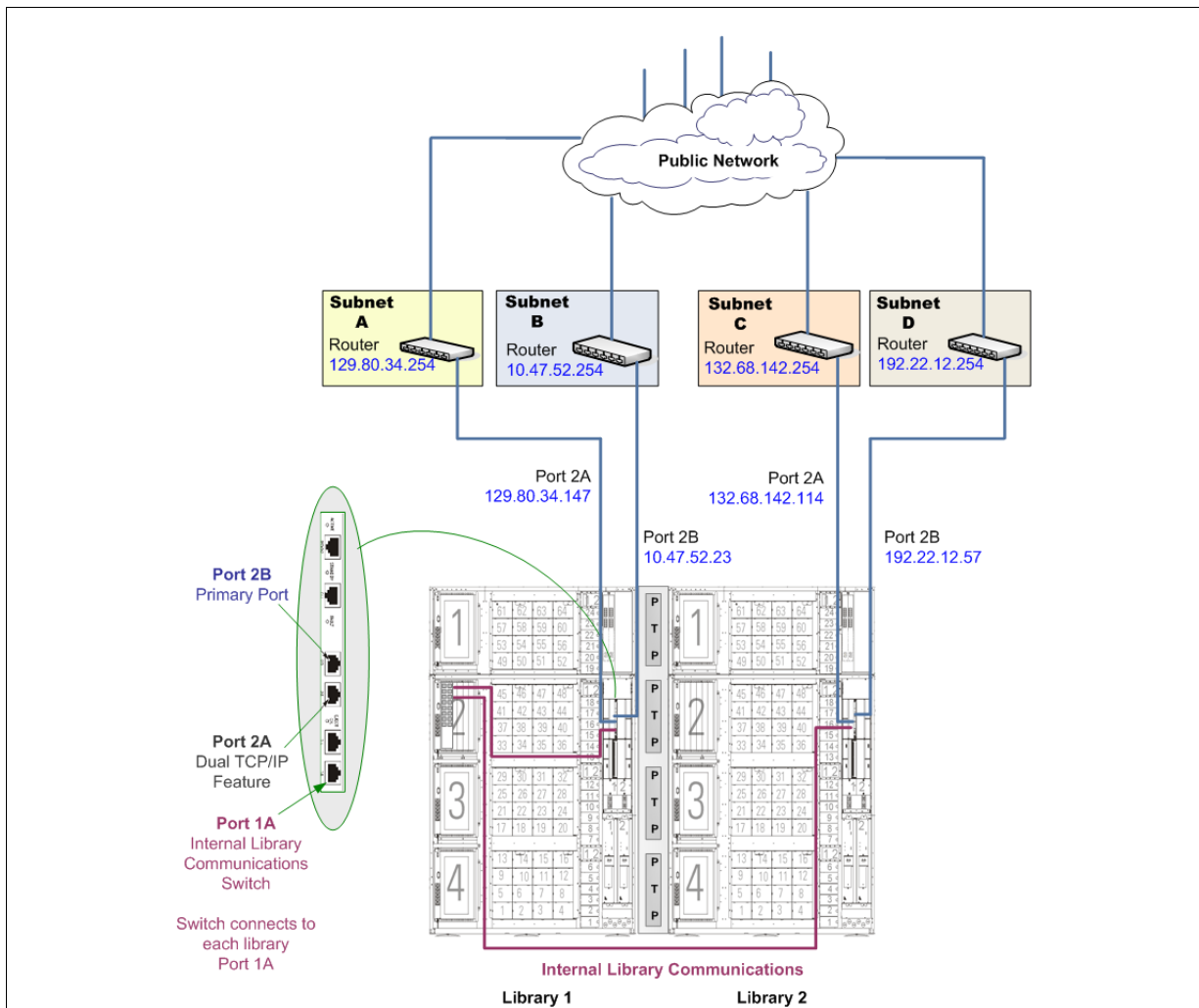
## Configuration Examples

Figure 25. Multi-Host Configuration—Four Libraries with Four Host Connections



Components	Library 1	Library 2	Library 3	Library 4
Expansion Modules	One	Two	Three	Three
Library Firmware	FRS_3.96	FRS_3.96	FRS_3.96	FRS_3.96
Library Console	3.38	3.38	3.38	3.38
Software	ACSLs 7.1 or HSC 6.1	ACSLs 7.1 or HSC 6.1	ACSLs 7.1 or HSC 6.1	ACSLs 7.1 or HSC 6.1
IP Address	129.80.34.147	10.47.52.23	132.68.142.114	192.22.12.57
LSMs	0, 1, 2, 3	4, 5, 6, 7	8, 9, 10, 11	12, 13, 14, 15
<b>Features:</b>				
Pass-thru Port	Yes	Yes	Yes	—
Dual TCP/IP	No — The Multi-Host feature provides this connectivity.			
Partitioning	Not supported	Not supported	Not supported	Not supported
Multi-Host	Yes — Optional feature that supports up to four host connections to a library complex.			

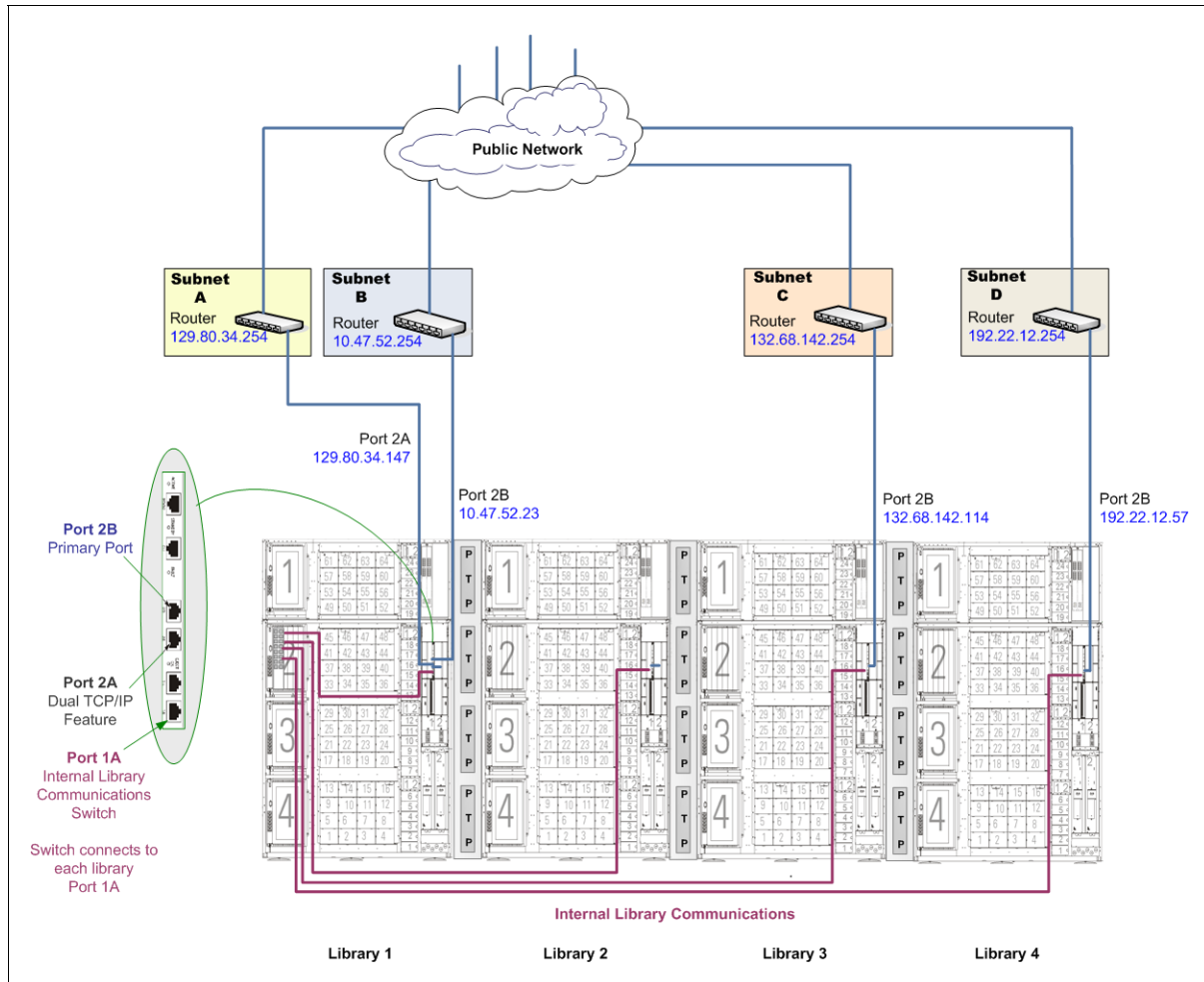
**Figure 26. Multi-Host Configuration—Two Libraries with Four Host Connections**



Components	Library 1		Library 2	
Expansion Modules	One		Two	
Library Firmware	FRS_3.96		FRS_3.96	
Software	ACSLs 7.1 or HSC 6.1		ACSLs 7.1 or HSC 6.1	
<b>Port:</b> IP Address	<b>2A:</b> 129.80.34.147	<b>2B:</b> 10.47.52.23	<b>2A:</b> 132.68.142.114	<b>2B:</b> 192.22.12.57
LSMs	0, 1, 2, 3		4, 5, 6, 7	
<b>Features:</b>				
Pass-thru Port	Yes		—	
Dual TCP/IP	No — The Multi-Host feature provides this connectivity.			
Partitioning	Not supported		Not supported	
Multi-Host	Yes — Optional feature that supports up to four host connections to a library complex.			

- Note: Because both Library 1 and Library 2 have a connection to Port 2A, a service representative must configure routing tables and possibly assign policies for those ports using the command line interface.

**Figure 27. Multi-Host Configuration—with Two Plus Two Host Connections**



Components	Library 1	Library 2	Library 3	Library 4
Expansion Modules	One	Two	Three	Three
Library Firmware	FRS_3.96	FRS_3.96	FRS_3.96	FRS_3.96
Library Console	3.38	3.38	3.38	3.38
Software	ACSLs 7.1 or HSC 6.1	ACSLs 7.1 or HSC 6.1	ACSLs 7.1 or HSC 6.1	ACSLs 7.1 or HSC 6.1
IP Address	129.80.34.147	10.47.52.23	132.68.142.114	192.22.12.57
LSMs	0, 1, 2, 3	4, 5, 6, 7	8, 9, 10, 11	12, 13, 14, 15
<b>Features:</b>				
Pass-thru Port	Yes	Yes	Yes	—
Dual TCP/IP	No — The Multi-Host feature provides this connectivity.			
Partitioning	Not supported	Not supported	Not supported	Not supported
Multi-Host	Yes — Optional feature that supports up to four host connections to a library complex.			

- Note: Because Library 1 has a connection to Port 2A, a service representative must configure routing and possibly assign policies for that port using the command line interface.

---

This appendix provides work sheets to help plan the host connections, content and partition planning for the SL8500 and includes:

- [“Host Selection Checklist” on page 230](#)
- [“Network Entries Work Sheet” on page 231](#)
- [“Multi-Host Network Entries Work Sheet” on page 232](#)
- [“Content Management Work Sheet” on page 233](#)
- [“Partition Planning—Base Library” on page 234](#)
- [“Partition Planning—One Expansion Module” on page 235](#)
- [“Partition Planning—Two Expansion Modules” on page 236](#)
- [“Partition Planning—Three Expansion Modules” on page 237](#)
- [“Partition Planning—Four Expansion Modules” on page 238](#)
- [“Partition Planning—Five Expansion Modules” on page 239](#)

## ■ Host Selection Checklist

**Table 35. Host Selection Checklist and Requirements**

Configuration	Port	Firmware	Comments
Single	Port 2B only	All versions	This is the simplest type of host connection to the library.  Supports: Single host/library management software (ACSLs or HSC).
Library Complex	Port 2B only	FRS_2.00	<i>Optional Feature.</i>  Connects two or more libraries together using pass-thru ports.  Can connect up to 10 libraries together for the complex.  Supports: Single host/library management software (ACSLs or HSC).
Dual TCP/IP	Port 2B primary Port 2A optional	FRS_3.08	<i>Optional Feature.</i>  Provides <i>two</i> separate paths for host connections to the library or library complex.  Separate, not redundant. Redundancy is provided in the network design.  Supports: Single host/library management software (ACSLs or HSC).
Partitioned	Port 2B primary Port 2A optional	FRS_3.7x	<i>Optional Feature.</i>  Supports Dual TCP/IP feature.  Supports: Dual host/library management software (ACSLs and/or HSC).
Multi-Host	Port 2B primary Port 2A optional	FRS_3.95	<i>Optional Feature.</i>  Provides up to <i>four</i> separate paths for host connections to a library complex.  Separate, not redundant. Redundancy is provided in the network design.  Supports: Single host/library management software (ACSLs or HSC).
<p>Note: The SL8500 library uses a TCP/IP protocol over an Ethernet physical interface to manage and communicate with the host and library management applications. This interface enables either:</p> <ul style="list-style-type: none"> <li>- Open system platforms with ACSLS or</li> <li>- Enterprise-level mainframes with HSC</li> </ul> <p>to connect to and communicate with the SL8500.</p>			



## ■ Network Entries Work Sheet

When preparing the network and connections—as a best practice—complete a network entries worksheet for each port of the SL8500 library.

Description		IP Address
Port 2B	Host name to Port 2B	
	HBC Card Port 2B	
	Gateway Port 2B	
	Netmask	
Port 2A	Host name to Port 2A	
	HBC Card Port 2A	
	Gateway Port 2A	
	Netmask	



### Important:

- When connecting more than one interface to an SL8500 library, the connections should be through different subnets for redundancy.  
If one subnet fails, communications between the hosts and the libraries continue over the other subnets.
- When connecting an interface to Port 2A, a service representative must configure routing and possibly assign policies for that port using the command line interface.  
**Port 2B is the preferred port for host attachments to the library, no routing tables are required when connecting to that port.**
- **The ports need to be on different Layer 2 broadcast domains.**

## Multi-Host Network Entries Work Sheet

When preparing the network and connections—as a best practice—complete a network entries worksheet for each port of the SL8500 library.

Description		IP Address / Name
Connection 1	HBC Card Port: 2A <input type="checkbox"/> 2B <input type="checkbox"/>	
	Host name	
	Gateway	
	Netmask	
Connection 2	HBC Card Port: 2A <input type="checkbox"/> 2B <input type="checkbox"/>	
	Host name	
	Gateway	
	Netmask	
Connection 3	HBC Card Port: 2A <input type="checkbox"/> 2B <input type="checkbox"/>	
	Host name	
	Gateway	
	Netmask	
Connection 4	HBC Card Port: 2A <input type="checkbox"/> 2B <input type="checkbox"/>	
	Host name	
	Gateway	
	Netmask	



### Important:

- When connecting more than one interface to an SL8500 library or library complex, the connections should be at least two different subnets for redundancy.

If one subnet fails, communications between the hosts and the libraries continue over the other subnets.

- When connecting an interface to Port 2A, a service representative must configure routing and possibly assign policies for that port using the command line interface.

**Port 2B is the preferred port for host attachments to the library,** no routing tables are required when connecting to that port.

- The ports need to be on different Layer 2 broadcast domains.**

Figure 28. Content Management Work Sheet

DEM				RIM	SEM	CIM	Slots	Carts	Free
61	62	63	64	Contents:					
57	58	59	60						
53	54	55	56						
49	50	51	52						
Rail 1\LSM 0				Contents:					
45	46	47	48						
41	42	43	44						
37	38	39	40						
Rail 2\LSM 1				Contents:					
33	34	35	26						
29	30	30	32						
25	26	27	28						
Rail 3\LSM 2				Contents:					
21	22	23	24						
17	18	19	20						
13	14	15	16						
Rail 4\LSM 3				Contents:					
9	10	11	12						
5	6	7	8						
1	2	3	4						
Rail 4\LSM 3									

<b>ELEVATORS</b>	<b>C</b>	<b>A</b>	<b>P</b>
------------------	----------	----------	----------

--	--	--

--	--	--

**Total # of Drives:** \_\_\_\_\_

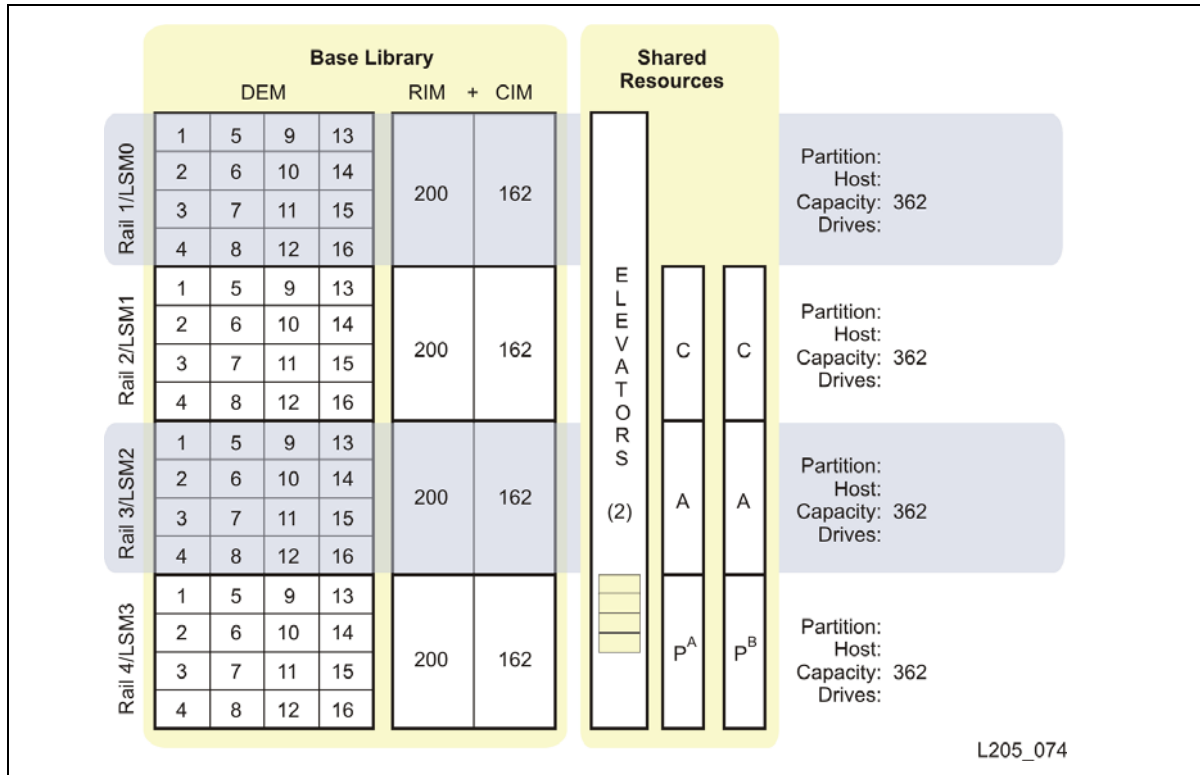
**Expansion Modules:** \_\_\_\_\_

**Performance Zone**   ➤ **Less active volumes**

**Total Capacity:** \_\_\_\_\_

L203\_758

**Figure 29. Partition Planning—Base Library**



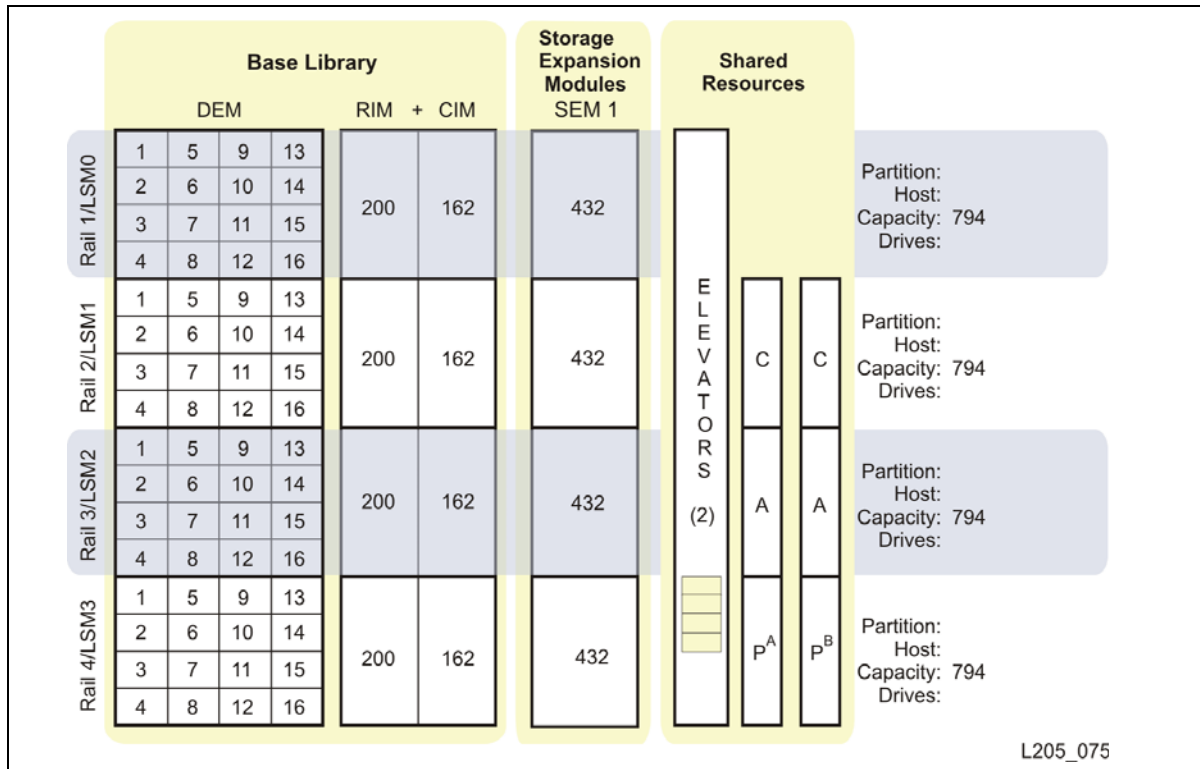
<b>Rail 1</b>
Partition ID
Hosts
ACSLS or HSC
ACS, LSM Address
Applications
Cartridge capacity
Free slots
Tape Drive types

<b>Rail 2</b>
Partition ID
Hosts
ACSLS or HSC
ACS, LSM Address
Applications
Cartridge capacity
Free slots
Tape Drive types

<b>Rail 3</b>
Partition ID
Hosts
ACSLS or HSC
ACS, LSM Address
Applications
Cartridge capacity
Free slots
Tape Drive types

<b>Rail 4</b>
Partition ID
Hosts
ACSLS or HSC
ACS, LSM Address
Applications
Cartridge capacity
Free slots
Tape Drive types

**Figure 30. Partition Planning—One Expansion Module**



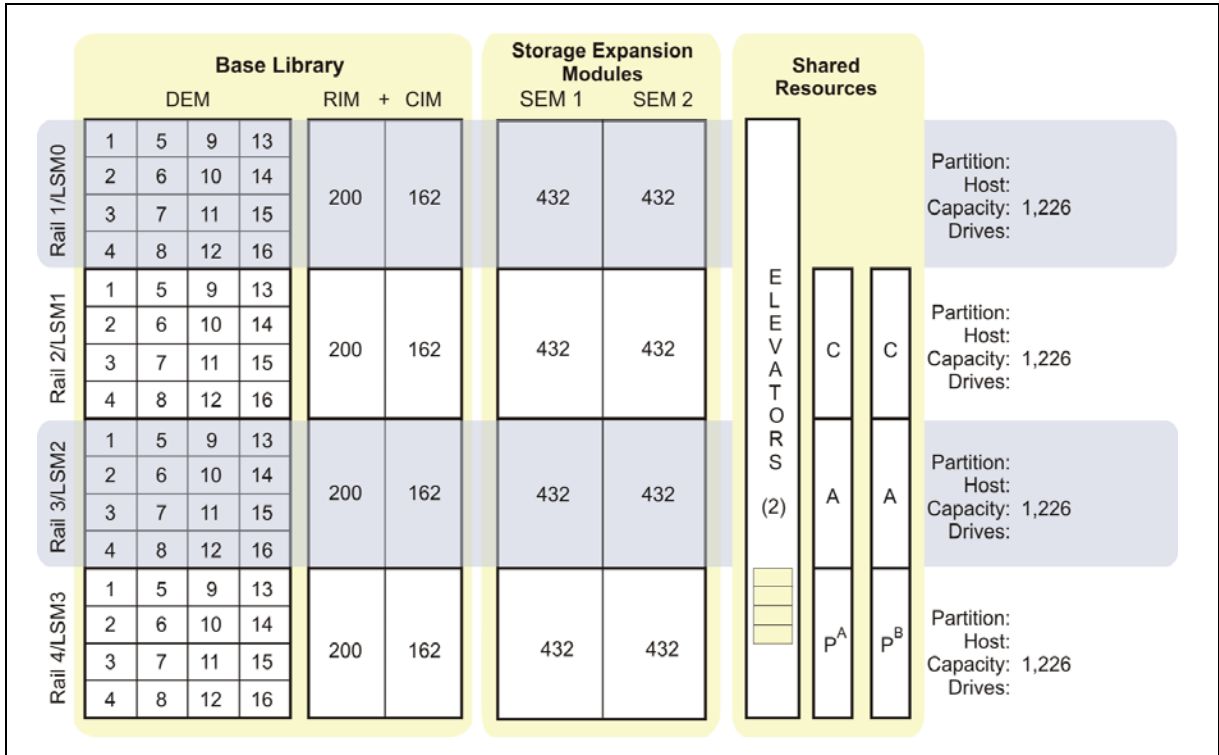
<b>Rail 1</b>
Partition ID
Hosts
ACSLs or HSC
ACS, LSM Address
Applications
Cartridge capacity
Free slots
Tape Drive types

<b>Rail 2</b>
Partition ID
Hosts
ACSLs or HSC
ACS, LSM Address
Applications
Cartridge capacity
Free slots
Tape Drive types

<b>Rail 3</b>
Partition ID
Hosts
ACSLs or HSC
ACS, LSM Address
Applications
Cartridge capacity
Free slots
Tape Drive types

<b>Rail 4</b>
Partition ID
Hosts
ACSLs or HSC
ACS, LSM Address
Applications
Cartridge capacity
Free slots
Tape Drive types

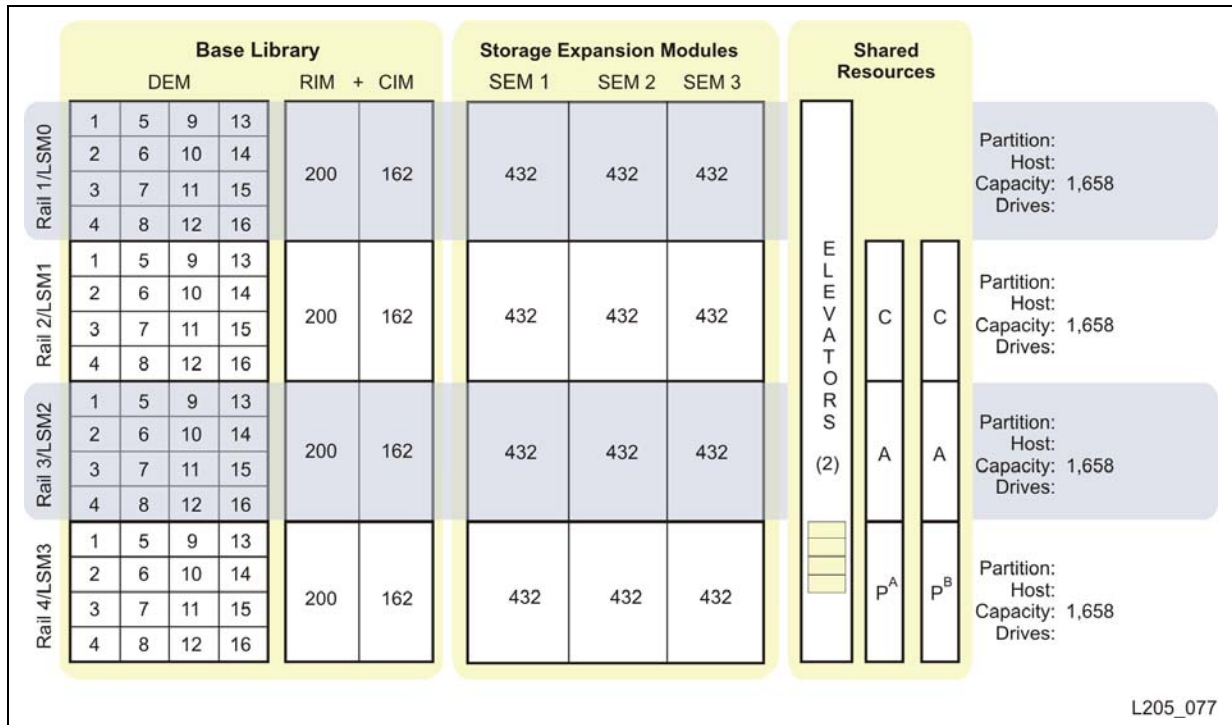
**Figure 31. Partition Planning—Two Expansion Modules**



<b>Rail 1</b>	<b>Rail 2</b>
Partition ID	Partition ID
Hosts	Hosts
ACSLs or HSC	ACSLs or HSC
ACS, LSM Address	ACS, LSM Address
Applications	Applications
Cartridge capacity	Cartridge capacity
Free slots	Free slots
Tape Drive types	Tape Drive types

<b>Rail 3</b>	<b>Rail 4</b>
Partition ID	Partition ID
Hosts	Hosts
ACSLs or HSC	ACSLs or HSC
ACS, LSM Address	ACS, LSM Address
Applications	Applications
Cartridge capacity	Cartridge capacity
Free slots	Free slots
Tape Drive types	Tape Drive types

**Figure 32. Partition Planning—Three Expansion Modules**



L205\_077

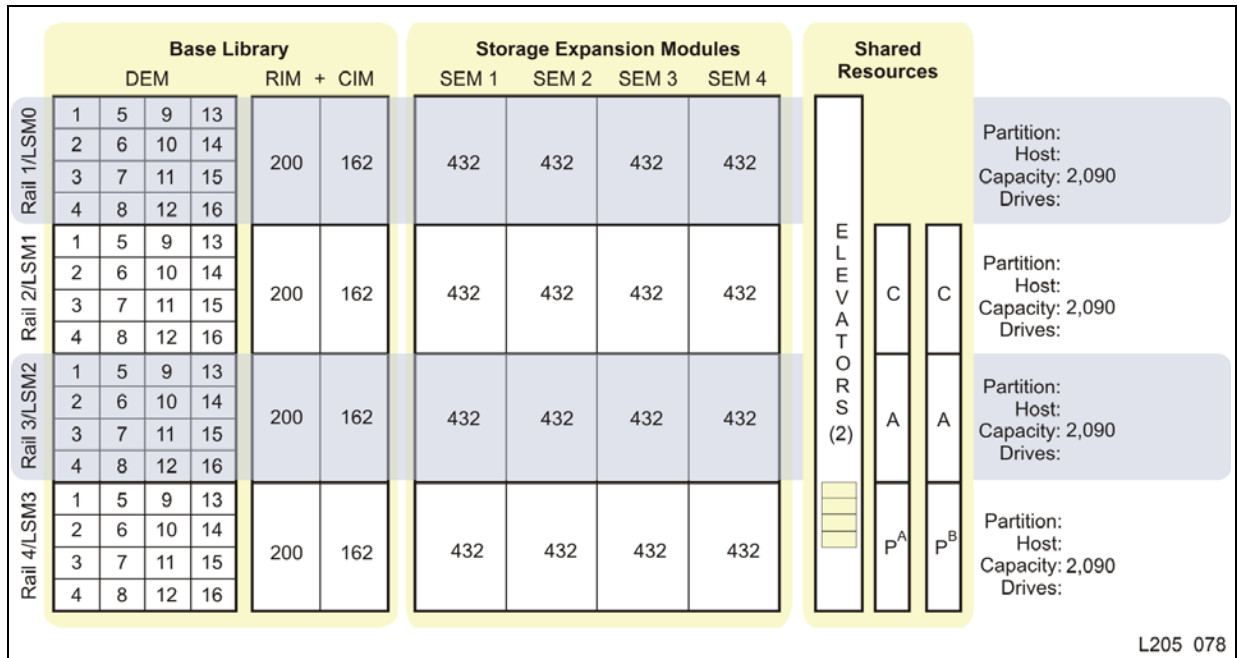
<b>Rail 1</b>
Partition ID
Hosts
ACSLs or HSC
ACS, LSM Address
Applications
Cartridge capacity
Free slots
Tape Drive types

<b>Rail 2</b>
Partition ID
Hosts
ACSLs or HSC
ACS, LSM Address
Applications
Cartridge capacity
Free slots
Tape Drive types

<b>Rail 3</b>
Partition ID
Hosts
ACSLs or HSC
ACS, LSM Address
Applications
Cartridge capacity
Free slots
Tape Drive types

<b>Rail 4</b>
Partition ID
Hosts
ACSLs or HSC
ACS, LSM Address
Applications
Cartridge capacity
Free slots
Tape Drive types

**Figure 33. Partition Planning—Four Expansion Modules**



Rail 1
Partition ID
Hosts
ACSLS or HSC
ACS, LSM Address
Applications
Cartridge capacity
Free slots
Tape Drive types

Rail 2
Partition ID
Hosts
ACSLS or HSC
ACS, LSM Address
Applications
Cartridge capacity
Free slots
Tape Drive types

Rail 3
Partition ID
Hosts
ACSLS or HSC
ACS, LSM Address
Applications
Cartridge capacity
Free slots
Tape Drive types

Rail 4
Partition ID
Hosts
ACSLS or HSC
ACS, LSM Address
Applications
Cartridge capacity
Free slots
Tape Drive types



**Figure 34. Partition Planning—Five Expansion Modules**

		Base Library				Storage Expansion Modules					Shared Resources			
		DEM				RIM	CIM	SEM 1	SEM 2	SEM 3	SEM 4	SEM 5		
Rail 1/LSM0	1	5	9	13	200	162	432	432	432	432	432	ELEVATORS (2)	C	C
	2	6	10	14										
	3	7	11	15										
	4	8	12	16										
Rail 2/LSM1	1	5	9	13	200	162	432	432	432	432	432	A	A	
	2	6	10	14										
	3	7	11	15										
	4	8	12	16										
Rail 3/LSM2	1	5	9	13	200	162	432	432	432	432	432	P <sup>A</sup>	P <sup>B</sup>	
	2	6	10	14										
	3	7	11	15										
	4	8	12	16										
Rail 4/LSM3	1	5	9	13	200	162	432	432	432	432	432			
	2	6	10	14										
	3	7	11	15										
	4	8	12	16										
Partition Capacities per Rail					362		794	1,226	1,658	2,090	2,522			
Total Library Capacities					1,448		3,176	4,904	6,632	8,360	10,088			

L205\_072

Rail 1	Rail 2
Partition ID	Partition ID
Hosts	Hosts
ACSLs or HSC	ACSLs or HSC
ACS, LSM Address	ACS, LSM Address
Applications	Applications
Cartridge capacity	Cartridge capacity
Free slots	Free slots
Tape Drive types	Tape Drive types

Rail 3	Rail 4
Partition ID	Partition ID
Hosts	Hosts
ACSLs or HSC	ACSLs or HSC
ACS, LSM Address	ACS, LSM Address
Applications	Applications
Cartridge capacity	Cartridge capacity
Free slots	Free slots
Tape Drive types	Tape Drive types



# Glossary

---

This glossary defines terms and abbreviations in this and other SL8500 library related publications.

## Numerics

**2N** A power configuration that gives the Product Name library full AC and DC power redundancy. This configuration allows AC line cords on two separate circuits, either of which can power the entire system. *See also* N+1.

## A

**access door** A door on either side of the front facade through which service personnel can enter the library. Optional CAPs are attached to the right access door.

**accessory rack** An area of the drive and electronics module that is used for Product Name library electronic and power equipment and for other standard 19-inch rack-mount electronic equipment. Up to four racks are permitted in the electronics/drive assembly. Rack-mount equipment must be on the approved equipment list.

**ACSLs** *See* Automated Cartridge System Library Software.

**Any Cartridge Any Slot™ technology** The StorageTek technology that allows seamless sharing of different media types and drives without hard partitions.

**array** A partitioned unit that holds multiple objects, such as cartridges or tape drive tray assemblies.

**Automated Cartridge System Library Software (ACSLs)** Software that manages ACS library contents and controls ACS library hardware to mount and dismount cartridges on ACS drives.

## B

**barcode line scan camera** A component of the robot that is used for cartridge identification and position calibration.

## C

**camera** In an Product Name library, one of two types:

- The barcode line scanner that is part of the robot hand assembly.
- The two LibCam monitoring cameras that display activity inside the library on the touch screen operator control panel.

**CAP** *See* cartridge access port.

**cartridge access port (CAP)** A device in the library that allows an operator to insert or remove cartridges during library operations.

**cartridge array** An array that holds multiple cartridges. The SL8500 library contains 8, 13, or 14 slots, depending on their location.

**cartridge tape** A container holding magnetic tape that can be processed without separating the tape from the container.

The library uses data, diagnostic, and cleaning cartridges. These cartridges are not interchangeable.

**cleaning cartridge** A tape cartridge that contains special material to clean the tape path in a transport or drive.

**CLI** Command line interface.

**CompactPCI (cPCI®)** Industry standard bus used for card-to-card bus expansion.

**controller** The module that houses the controls for the elevators, CAPs, turntables, and service safety door.

**cPCI** See CompactPCI.

**customer interface module (CIM)** The front module of the SL8500 library at which the customer has access to the touch screen operator panel and CAPs, and service personnel have access to the library and service bay.

## D

**data cartridge** A term used to distinguish a cartridge onto which a tape drive may write data from a cartridge used for cleaning or diagnostic purposes.

**diagnostic cartridge** A data cartridge with a “DG” label that is used for diagnostic routines.

**drive and electronics module** The module in an Product Name library that contains the electronics control module, power distribution units (PDUs), power supplies, accessory racks and equipment, and tape drives for the library.

**drive bay** A partitioned section of the tape drive array assembly that holds one tape drive tray assembly.

**drop-off slots** Slots used to hold a cartridge in the event of a robot failure that occurs while a cartridge is in the robot hand.

**dWWN** See dynamic World Wide Name.

**dynamic World Wide Name** A feature that applies dynamic names to network devices rather than fixed names. When a dWWN-named device is replaced, it is assigned the same WWN as the one replaced, preventing reconfiguration of the network.

## E

**ECM** See electronics control module.

**electronics control module (ECM)** The assembly that:

- Processes commands from a host system
- Coordinates the activities of robots, elevators, pass-thru ports, and tape drives
- Monitors status inputs from sensors and switches

**elevator** The device that transports cartridges vertically, across rail boundaries.

**emergency power-off (EPO)** (1) A safety scheme that allows a “power down” of a subsystem or a system as a whole instead of powering it down component-by-component.

(2) A safety switch on a machine or in a data center that allows a user to immediately power down a machine or a data center power supply by cutting off the external source power.

**Emergency Robotics Stop** A button on the Customer Interface Module keypad that removes power to the robotics power grid, leaving the remaining library power on.

**Enterprise Systems Connection (ESCON)** A set of fiber-optic based products and services developed by IBM that allows devices within a storage environment to be dynamically configured. A channel-to-control unit I/O interface that uses optical cables as a transmission medium.

**ESCON** See Enterprise Systems Connection.

**Ethernet** A local-area, packet-switched network technology. Originally designed for coaxial cable, it is now found running over shielded, twisted-pair cable. Ethernet is a 10- or 100-megabytes-per-second LAN.

**export** The action in which the library places a cartridge into the cartridge access port so that the operator can remove the cartridge from the library.  
*Synonymous with eject.*

## F

**failover** The act of moving to a secondary or redundant path when the primary path fails.

**Fibre Channel** A bidirectional, full-duplex, point-to-point, serial data channel structured for high performance capacity. The Fibre Channel is an interconnection of multiple communication ports, called N\_Ports. These N\_Ports are interconnected by a switching network, called a fabric, to a point-to-point link, or an arbitrated loop.

Fibre Channel is a generalized transport mechanism with no protocol of its own. A Fibre Channel does not have a native input/output command set, but can transport existing Upper Level Protocols (ULP) such as SCSI and IPI. Fibre Channel operates at speeds of 100 MB per second (full speed), 50 MB per second (half speed), 25 MB (quarter speed), or 12.5 MB (eighth speed). Fibre Channel operates over distances of up to 100 m over copper media or up to 10 km over optical links.

**fibre connection (FICON)** An IBM S/390-based channel architecture that provides up to 256 channels in a single connection, each having a capacity of 100 MB per second.

**FICON** See fibre connection.

## G

**get** An activity in which a robot obtains a cartridge from a slot or drive.

**gripper** (1) The portion of the hand assembly that grasps the cartridge.

## H

**hand assembly** A part of the library robot whose function is to grasp cartridges and move them between storage slots and drives. A bar-code line scan camera on the hand assembly reads cartridge volume labels.

**HandBot™** High performance small robot. Four or eight HandBots are used in an SL8500 library. *Contrast with TallBot™.*

The full name is StreamLine™ HandBot™ high performance robotics.

**HBZ module** See controller.

**HLI-PRC address** A four-digit, comma-separated value (L,P,R,C) that represents LSM, Panel, Row, and Column. This addressing scheme is used by host LMU interface (HLI) clients, including ACSLS and HSC, to represent library components accessible to those HLI clients.

**host audit** The process of updating the cartridge VOLIDs and locations (collected by a security audit) in a host CDS. This audit is initiated by a host command.

**hot swap** Removal and replacement of a system component while system power remains on and system operations continue. *Contrast with cold swap. Contrast with hot-pluggable.*

*Synonymous with online servicing.*

**hot-pluggable** The capability that allows a service representative to replace FRUs while power to the FRU is maintained. This feature allows hardware maintenance

actions and hardware upgrades to proceed without disrupting subsystem availability. *Contrast with* hot swap.

## I

**import** The process of placing a cartridge into the cartridge access port so that the library can insert it into a storage slot. *Synonymous with* enter.

**interlock switch** A switch that disconnects power to library mechanisms, excluding tape drives, when the front door is opened.

**initial program load (IPL)** A process that activates a machine reset and loads system programs to prepare a computer system for operation. Processors having diagnostic programs activate these programs at initial program load execution. Devices running firmware usually reload the functional firmware from a diskette or disk drive at initial program load execution. *Synonymous with* initial microprogram load (IML).

## K

**keypad interface** See membrane keypad.

## L

**LibCam Monitoring** A feature that provides two cameras, one for each leg of the horseshoe, for viewing activity inside the library. The touch screen operator control panel is required. *Not available at this time. Do not use this definition.*

**library camera** See LibCam Monitoring.

**library complex** Two or more Product Name libraries attached to each other with PTPs.

**library console** See Streamline™ Library Console™.

**library controller** The HBC card within the Product Name library that controls

operations and communicates with the operator panel.

**library operator panel** See touch screen operator control panel.

**library storage module (LSM)** A term used to identify each level of the SL8500, including the rail assembly, robotics, tape drives, power supplies, electronics modules, and accessory rack. The LSMs are numbered top-to-bottom, 0–3.

## M

**magazine** A removable array that holds cartridges and is placed into the cartridge access port (CAP). Each SL8500 CAP holds up to three magazines, each of which holds up to 13 cartridges.

**master (pass-thru port)** The side of a pass-thru port (PTP) that contains the electronics that control the actions of the PTP. *See also* standby (pass-thru port).

**membrane keypad** A keypad mounted on the front facade used to monitor the status of the SL8500 library and to operate the CAPs.

## N

**N+1** A power configuration that provides AC power and redundant DC power by adding a second DC power supply to each DC bus. *See also* 2N.

## O

**operator panel** See touch screen operator control panel.

## P

**pass-thru port (PTP)** A mechanism that enables a cartridge to pass through from one library to another in a multiple modular library complex.

**PCI** Peripheral component interconnect.

**PDU** See power distribution unit.

**physical library** A single Product Name library consisting of a customer interface module, robotics interface module, and a drive and electronics module, with one to five storage expansion modules optional. See *also* logical library.

**power distribution unit (PDU)** A device for the distribution of AC line power from one inlet to multiple outlets. Multiple PDUs provide higher availability because the power continues if one PDU (or its alternating current [AC] source if the PDUs use separate AC sources) loses power.

**power grid** A power circuit that minimizes power failures that cause the library to cease operations. An Product Name library has five power grids, two for AC power and three for DC power.

**power/communication bus rail** A rail that sits on the robot track to provide 48 VDC power and communication to the robot.

**primary library interface (PLI)** The communication path between the operator panel and the library controller (the HBC card.) This consists of Ethernet with TCP/IP and XML.

**put** An activity in which a robot places a cartridge into a slot or drive.

## R

**RaceTrack™ architecture** The design and implementation of the SL8500 library's multiple high performance robotics.

**rail** That portion of the upper robot track assembly that provides power and communication to the robot.

**rail assembly** The mechanism on which the robot travels between cartridge arrays and tape drives.

**reach mechanism** A component of the robot that moves the gripper to get or put a cartridge at a designated location.

**RealTime Growth™ capability** The capability to add pass-thru ports dynamically while the library is operating.

**remote operator console** The customer's operator panel that interfaces with the PLI. See *also* security software layer.

**reserved slots** Cartridge slots that are used only for cleaning and diagnostic cartridges and as drop-off slots.

**robot** A mechanism that moves horizontally along a track in the Product Name to transport tape cartridges to and from other locations in the library. *Also called* an HandBot or TallBot.

**robotics interface module (RIM)** The module containing the curved rails and pass-through port (PTP) assemblies. See *also* StreamLine™ RaceTrack™.

## S

**security audit** The process of reading and storing in Product Name library memory the VOLIDs and locations of all cartridges in the library. See *also* host audit.

**service area** An area between the access doors of the customer interface assembly and the service safety door in which an inoperable robot is stored for service and other mechanisms can be repaired or replaced.

**service safety door** A motor-driven barrier that separates the service areas of the front interface assembly from the rest of the library so that service personnel can safely repair or replace failed library mechanisms while the library continues normal operations. *Synonymous with* safety barrier.

**SL8500** See StreamLine™ SL8500 modular library system.

**SL8500 address** A five-digit, comma-separated value (L,C,R,S,W) that represents Library, Rail, Column, Side, and Row. This addressing scheme is used by SL8500 firmware and internal communications to represent all devices and locations within the library.

**slot** Location in the library in which a tape cartridge is stored. *Synonymous with* cell.

**standby (pass-thru port)** The side of a pass-thru port (PTP) that operates in response to actions initiated by the master side of the PTP. *See also* master (pass-thru port).

**storage expansion module** An optional module for the Product Name library that provides up to 1728 additional cartridge storage slots. Up to five modules can be attached to each SL8500 library.

**StreamLine™ Library Console™** The operator panel software application used for the SL8500.

**StreamLine™ RaceTrack™** The design and implementation of the SL8500 library's multiple high performance robotics.

**StreamLine™ RealTime Growth™** The capability to add pass-thru ports dynamically while the library is operating.

**StreamLine™ SL8500 modular library system** An automated tape library comprised of:

- Customer interface module
- Robotics interface module
- Drive and electronics module
- Storage expansion module (optional)

## T

**TallBot™** High capacity tall robot. One or two TallBots are used in an SL8500 library. *Contrast with* HandBot™.

The full name is StreamLine™ TallBot™ high capacity robotics.

**tape drive** An electromechanical device that moves magnetic tape and includes mechanisms for writing and reading data to and from the tape.

**tape drive tray assembly** The mechanical structure that houses a tape drive, fan assembly, power and logic cards, cables, and connectors for data and logic cables. *Synonymous with* drive tray assembly.

**touch screen operator control panel** An optional feature consisting of a flat-panel display with a touch screen interface and a panel mount computer. This feature is attached to the front facade.

**turntable** A mechanism that transfers cartridges between the aisles within a single library.

## U

**U** A standard unit of measurement of vertical space inside a rack-mount cabinet equal to 44.5 mm (1.75 in.).

**unlocked** In the SL8500, status indicating that software has made a CAP available for operator use. An LED is lit when a CAP is unlocked.

## V

**vacancy plate** A plate that covers an unused bay, such as a drive bay or power supply bay.

## W

**World Wide Name** A 64-bit integer that identifies a Fibre Channel port. *See also* dynamic World Wide Name (dWWN).

**wrist** (1) A mechanism in the robot assembly that allows the robot to access the outer and inner storage walls.



# Index

---

## Numerics

- 2N power configuration
  - about the, 10
  - block diagram of, 10
  - feature codes for, 114
- 3 of 9 code, 169
- 39-slot cartridge access port, 19
- 9310
  - library specifications, 184
- 9741e Drive Cabinet, 185
- 9840
  - cartridge specifications, 159
  - tape cartridge, 158
  - tape drive, 148
- 9940
  - cartridge specifications, 161
  - tape cartridge, 160

## A

- AC power
  - connections, 14
  - EPO switches, 27, 46
  - factors and concerns, 75
  - feature codes, 114
  - site planning, 83
- accessory rack
  - about the, 24
  - feature codes, 117
  - planning guidelines, 81
  - power block diagram, 81
- ACSLs
  - feature codes, 144
  - general information gathering, 61
  - introduction to, 41
  - levels, 141
  - versions, 34, 212
- activation password, 96
- address, tape drives
  - dWWN, 120, 155

- addressing
  - poster, 7
  - scheme, 5
- adjustable jacks, 106
- agencies, safety and ESD, 48
- alley limitations, 73
- American Eagle, cartridge labels by, 45
- Amperes, finding values for, 177
- ANSI label specifications, 45
- Any Cartridge, Any Slot, 45, 171
- applications, 58
- archival life, media, 175
- archive software, types of, 59
- archiving cartridges, 129
- ARCserve, 143
- arrays
  - locating the cartridges, 4
  - targets, 4
- ASM, 143
- assessment, 215
- audit
  - time estimates, 17
- auditing and non-labeled cartridges, 45
- Auto Clean, 139
- Automated Cartridge System Library Software
  - feature codes, 144
  - introduction to, 41
  - levels, 141
- Automatic Identification Manufacturers specification, 170
- availability, media specifications, 175

## B

- backup and archive software types of, 59
- barcode labels, 169
- base configuration
  - description of, 1
  - model number for, 109
- bit error rate, 175

## Index

block kit assembly, 100  
Branch Circuit Requirements, 98  
British Thermal Unit, finding values for, 179  
Btu/hr, 79  
building code requirements, 76

## C

CA BrightStor, 143  
cable routing, 88  
cable survey, 69  
cables  
    ESCON, 123  
    Ethernet, 121  
    interface, 121  
    plenum, 121  
    riser, 121  
cabling tape drives, 93  
camera feature, 117  
cameras  
    optional feature code for, 117  
Canadian Emissions, 48  
Canadian Standards Association, 48  
CAP  
    about the, 19  
    feature codes, 116  
    optimization guidelines, 132  
capacity  
    CAP, 19  
    cartridge tapes, 157  
    library, 147  
    tape drives, 147  
Capacity on Demand  
    using ACSLS, 141  
    with HSC, 140  
capacity, media comparisons, 175  
carpet, survey question, 75  
cartridge  
    access port, 19  
    capacity, 113  
    survey, 64  
cartridge access port, 19  
cartridge access ports  
    enter/eject cartridges, 129  
    guidelines, 132  
    optimization, 130  
cartridge management  
    ExLM, 40  
cartridges  
    data locations, 4  
    optimization, 129  
    per square foot/meter, 183  
    placement in cells, 4  
Cartridges Access Port, ordering, 116  
cautions, meaning of, 231, 232  
CB Scheme, 48  
CD, StreamLine Library Console  
    part number for, 26  
CE Mark, 48  
cells  
    capacities, 8, 112  
    locations in a library, 4  
    partitioning, 213  
    planning, 213, 215  
    poster, 7  
    targets, 4  
checklists  
    applications, 58  
    before you install, 73  
    cables and connectors, 69  
    cartridge tapes, 64  
    connectivity, 65  
    data base, 62  
    ESCON, 67  
    existing hardware, 63  
    FICON, 68  
    library, 63  
    media, 64  
    network, 65  
    site planning, 73  
    system assurance, 51  
    system configuration, 56  
    tape drives, 63  
circuit breakers, ratings, 14  
Class 1 Laser Products, 49  
classes, xxi  
cleaning cartridges, 173  
cleaning, auto clean function, 139  
clearances, 90  
CLI, 92  
Client System Component, 38  
clustering  
    cartridges, 129  
    drives, 130  
code, 16  
Code 39 Barcode Specification, 45  
Code 39 label standard, 169  
code, functional, 16

- Colorflex, labels by, 45
  - columns
    - floor labels, 2, 111
  - combining workloads, 128
  - Command Line Interface Port, 92
  - communication
    - HBC controller, 15
  - CommVault Galaxy, 143
  - comparison
    - capacity, 183
    - power requirements, 187
  - comparisons
    - library specifications, 184
    - media, 175
    - tape drives, 156
  - comparisons between libraries, 181, 184
  - compatibility, media specifications, 175
  - components
    - Host Software, 39
    - robotic, 18
    - software, 37
    - Storage Management, 39
  - conduit elbows, 13, 83
  - configuration
    - AC power options, 9
    - flash memory, 15
    - tape drive, 93
  - configuring
    - elevators, 20
    - partitions, 213
  - connections
    - interface cable types, 121
    - power, 14
  - connectivity, 55
    - factors for pre-installation, 76
    - interface cables, 121
  - connectors
    - and power plugs, 14
    - Fibre Channel, 122
    - power, 14
  - console, library, 26
  - content management
    - cartridges, 129
    - drives, 129
    - elevators, 131
    - media, 129
    - pass-thru port, 131
    - philosophy, xx, 127
    - planning, 132, 215
    - rails, 128
    - tape cartridges, 129
    - tape drives, 130
  - contrasts between libraries, 181, 184
  - conversions, of electrical values, 177, 189
  - Cooling Requirements, 80
  - co-planar, 86
  - courses, xxi
  - crossover cable, 100
  - CSA, 48
  - CSC
    - description, 38
    - PTFs, 140
  - C-Tick Mark, 48
  - customer
    - applications, 58
    - contact sheet, 52
    - floor requirements, 99
    - hardware configuration, 63
    - platforms they use, 55
    - satisfaction and the
      - system assurance process, xix, 51
    - software, 58
    - system configuration, 57
  - Customer Interface Module
    - components in, 3
    - length of, 78
  - customer interface module (CIM)
    - capacity, 8, 112, 213
  - Customer Resource Center (CRC), xxiii
  - cut-outs, floor, 74
- ## D
- Data Base Management Systems, types of, 62
  - data base questions, 62
  - data cartridge
    - capacities, 157
    - specifications, 157
  - Data Facility/System Managed Storage, 60
  - DC power
    - feature codes for the handbots, 115
    - grids, 12
  - delivery dock, 73
  - delivery of the hardware, 73
  - Department of Defense Disclaimers, 168
  - depths of the library, 78
  - DF/SMS, 60

## Index

- diagnostic cartridges, 173
  - dimensions
    - for shipping, 101
  - directors, 68
    - ESCON, 67
    - FICON, 68
  - disclaimer, 157
  - distribution pad weight, 85
  - DLT
    - tape cartridges, 166
  - DLTtape, 166
  - dock availability, 73
  - domain, media labels, 171
  - door
    - cutouts, 88
    - lock, 47
    - notches for cable routing, 88
    - safety for, 27, 47
    - switches and safety features, 46
  - doorway, height, 74
  - drive addresses
    - dWWN, 120, 155
  - Drive and Electronics Module, 3
    - length of, 78
    - planning, 91
  - drive and electronics module (DEM)
    - capacity, 8, 112, 213
  - Drive Power Up Kit, 120
  - drive tray, 82
  - drives
    - dWWN requirement, 120
    - models supported, 44, 147
  - duplicate VOLSERs, 211
  - dWWN
    - drive addressing, 120, 155
    - required for drives, 120
  - dynamic slots upgrades, 141
- ## E
- earthquakes, 80
  - ECM, 15, 92
  - EDP Trioptic, 174
  - education, xxi
  - eject
    - cartridges, 129
    - optimization, 129
  - Eject OK LEDs, 92
  - electrical conversions, 177, 189
  - electrician, 98
  - electromagnetic agencies, 48
  - Electronic Control Module
    - planning, 92
  - Electronics Control Module
    - overview, 15
  - elevators, 116, 139
    - configuration, 20
    - content management, 131
    - description, 18
  - elevators, survey question, 73
  - EMC Law, 48
  - emergency robotic stop, 27, 46
  - EN60825-1, 49
  - encryption-capable, 44
  - Engineered Data Products, labels by, 45
  - Engineering Design Standard, 49
  - enter
    - cartridges, 129
    - optimization, 129
  - Enterprise Systems Connection, definition of, 44
  - environmental factors and concerns, 75
  - error rates, media ratings, 175
  - error-free installation, xix, 51
  - ERS, 27, 46
  - ESCON
    - cables, 123
    - definition, 44
    - Director survey, 67
  - Ethernet
    - cables, part number for, 121
    - the physical interface, 28
  - Ethernet hub, 93
  - European Community, 48
  - ExLM
    - overview, 40
  - ExLM version, 212
  - Expansion Module
    - feature codes, 111
  - Expert Library Manager, 40
  - ExPR version, 212
  - extractor tool, used for power rails, 100
- ## F
- Fast Load capability, 18
  - FCC, 48
  - features

- base power codes, 114
- capacity, 8, 112
- cartridge cells, 113
- fire suppression, 47, 95
- lighting, 47
- power supplies, robot, 115
- robots, 115
- safety, 46
- slots, 113
- touch screen pen and stylus, 26
- Federal Communications Commission, 48
- Fiber Connection, definition of, 44
- fiber-optic cables, 93
- Fibre Channel, 44
  - connector, 122
- Fibre Channel switch location, 93
- Fibre Channel switch survey, 66
- FICON
  - definition of, 44
  - survey, 67
- FICON Directors, 68
- Fire Suppression System, comments about, 47, 95
- firmware, 16
  - downloading, 16
  - flash memory versions, 15
- firmware upgrade, 16
- flash memory, 15
- flash memory, discussed, 15
- float
  - enabling, 131
  - optimization, 129
- floor
  - co-planar requirement/tolerance, 86
  - customer, installation requirements, 99
  - variations, 86
  - weight capacity, 85, 99
- floor cutouts, 87
- floor label part numbers, 2, 111
- floor planning template, 100
- floor template, 85
- floor tile cut-outs availability, 74
- floor tile cutouts for routing, 88
- forklifts, 74
- Front Frame Control Electronics, 116
- Front Frame Power Grid, 12
- functional code, 16

## H

- HandBot configurations, 18
- HandBots
  - workload optimization, 130
- handling factors, 73
- hardcopy publications from StorageTek, xxiii
- hardware
  - tools required for installation, 99
- hardware configuration, customers, 63
- HBC Card, 15, 92
- HBK card, 15
- HBT Card, 15, 92
- Health Insurance Portability and Accountability Act, 168
- height of the library, 78
- height, library limits
  - requirement/tolerance, 86
- Hewlett-Packard LTO tape drives, 151
- High Performance Robotics, 18
- HLI-PRC, description of, 5
- horizontal pass-thru operations, 21
- host connections, 92
- host interface connections, 28
- host selection, 30, 230
- Host Software Component, 39
- Hot-Swap indicator, 92
- HP
  - DataProtector, 143
- HP LTO
  - description, 151
  - specifications, 151
- HSC
  - description, 39
  - feature codes, 145
  - PTFs, 140
- HTTP Server, 38
- Hubbell, plugs and connectors, 14
- hubs and switches, 65
- HVD, 120

## I

- IBM LTO
  - description, 152
  - specifications, 152
- IBM TotalStorage 3580 LTO tape drives, 152
- ICES, 48
- IEC320 sockets, 93

## Index

- impact testing, 49
  - inner walls, 4
  - installation
    - preparing for, 98
    - site planning checklist, 73
    - StreamLine Library Console, 96
    - tool kit, 99
  - installing redundant HandBots, 130
  - Inter-character Gap for barcode labels, 169
  - interface
    - cable routing, 88
    - cables, 121
    - connections, 28
    - types supported, 44
  - interior lighting, 47
  - interlocks, 47
  - internal addresses
    - description, 5
    - poster, 7
  - interoperability, 55
- ## J
- jack assembly part number, 99
  - jacks, 106
  - JCL changes, 60
  - JES2, 60
  - JES3, 60
- ## K
- keypad, 25, 116
  - kilowatts, finding values for, 178
  - kit
    - installation tools, 99
  - kVA, finding values for, 178
  - kW, finding values for, 178
- ## L
- label, laser product, 49
  - labels, 169
    - columns, 2, 111
    - ordering, 174
    - requirements for, 171
  - laptop cross-over and serial cables, 100
  - laptop shelf, 100
  - laser product label, 49
  - laser-leveled before receiving, 74
  - LC to SC adapter, 122
  - Legato NetWorker, 143
  - length, tape, 175
  - lengths of modules, 78
  - lengths of the library, 78
  - LibCam feature, 117
  - library
    - capacities, 8, 112
    - capacities, cartridge tapes, 4
    - capacity, amount of data contained, 147
    - codes for ordering, 109
    - console, 26
    - controller, 15
    - features, 109
    - firmware, 34, 212
    - module types, 2
    - moving, 107
    - moving unpacked components, 103
    - optional features, 109
    - ordering, 109
    - planning, 213
    - system assurance, xix, 51, 214
  - library console, 26
  - library management software, types of, 59
  - library specifications, 184
  - library survey, 63
  - library to ceiling clearances, 90
  - library weights and measures, 78
  - LibraryStation
    - description of, 38
    - PTFs for, 140
  - licensed electrician, 98
  - lights, 47
  - Load Sharing Power Supplies
    - about the, 12
    - number required, 12
  - loading per pad, 185
  - logic cards, 15
  - LSM prefencing, 139
  - LTO
    - cartridge types, 164
    - HP drives, 151
    - IBM drives, 152
    - labels, 171
    - media, 164
    - Quantum drives, 153
    - tape cartridges, 164
    - tapes, 164

LVD, 120

## M

Main AC Power Distribution Unit Feature Codes, 114

Management Information Base. *See* MIB  
management software, library management software, 135

managing cartridges

for optimization, 129

mass of the library, 78

master PTP, 94

matrix and sales tools, 55

maximum

height specification, 89

possible configuration, 1

maximum capacity, 210

measurements, library, 78

media, 45, 164

archival life, 175

domain labels, 171

ID labels, 171

Service Center, 174

survey, 64

media optimization, 129

media *See also* tape cartridge

Media Usage Disclaimer, 157

MIB

described

microcode, 16

minimizing pass-thru activity

for optimization, 131

minimum

current requirement, 14

height specification, 89

working area, 99

minimum capacity, 210

mixed media, 171

model number, 109

module

electronic cards, 15

module depths, individual, 78

modules

capacities, 8, 112

Customer Interface, 3

planning, 213

Robotics Interface, 3

Storage Expansion, 3

modules in the library, 2

moving an installed library, 107

moving unpacked components, 103

MVS general information, 60, 61

MVS versions, 34, 212

MVS/CSC, 38

## N

N+1 Power Distribution Unit, 9

NCO, 39, 140

NCS, 37

Near Continuous Operation, 39, 140

Nearline Control Solutions, 37

network

SNMP, 42

survey, 65

network management software, types of, 59

non-labeled cartridges and the audit, 45

numbering, cartridge cell locations, 4

## O

One Gigabit Fiber Optic

Cable Order Worksheet, 122

open systems software package, 41

operating systems and configurations, 56

operator panel

feature codes, 116

types of, 25

optimization guidelines

audits, 17

cartridges, 129

details, 127

elevators, 131

initialization, 17

media, 129

pass-thru ports, 131

planning, 70, 132

rails, 128

tape cartridges, 129

tape drives, 130

top rail, 128

options, AC power configurations, 9

order number, 31, 34, 212

ordering the library, 109

outer walls, 4

overhead clearances, 90  
overview  
    Super DLT, 154

## P

pad, weight per leveling, 85  
pallet jacks, 74  
pallets, 74  
panel numbering, 6  
panel, row, column addressing, 5  
panel, vacancy, 120  
panel. See walls  
panels, 25  
panels, keypad and operator, 116  
part number  
    installation tools, 100  
    StreamLine Library Console CD, 96  
    tool kit, 99  
part numbers  
    1 Gb fiber optic cables, 122  
    Ethernet cables, 121  
    Hubbell plugs and connectors, 14  
    StreamLine Library Console CD, 26  
partitioning  
    capacities, 210  
    definition, 34, 209  
    guidelines, 210  
    requirements, 212  
partner contact sheet, 53  
Partners Web site, xxiii  
pass-thru port  
    feature codes, 118  
    model number, 118  
    requirements, 94  
    specifications, 78  
pass-thru port planning, 94  
Pass-thru Ports  
    configuration, 21  
    content management, 131  
    locations, 2  
pass-thru ports  
    description, 21  
pass-thru ports, optional feature code, 118  
password  
    procedure for obtaining, 96  
PDUs, 9  
pen and stylus, 26

philosophy for content management, xx, 127  
photo-electric smoke detector, 46, 95  
physical  
    concerns for site planning, 74  
    placement factors for site planning, 74  
physical audit, 17  
physical planning, 78  
placement of data cartridges, 4  
planning  
    AC power, 83  
    checklist, 73  
    physical, 78  
    shipping weights and dimensions, 101  
planning for content, 132, 215  
planning meetings, for system assurance, 51  
platform configurations, 55  
plenum cables, 121  
plugs and connectors, 14  
plugs, for power, 14  
populating the rails, 128  
poster, 7  
Powderhorn and SL8500 power requirements, 187  
power  
    AC configurations, 9  
    accessory rack, 81  
    configuration drawing, 9  
    configurations, 9  
    connections, 14  
    connectors, 14  
    distribution units, 9  
    factors for pre-installation planning, 75  
    options, 11  
    planning, 83  
    plugs, 14  
power rails, extractor tool, 100  
pre-installation planning  
    AC power, 83  
    checklist, 73  
    physical, 78  
    shipping weights and dimensions, 101  
preparing for the installation, 98  
Pre-Sales Technical Qualification Process, 55  
process, for system assurance, xix, 51, 214  
PTFs, 140  
PTP  
    installation considerations, 21



- Technical Brief, xxii
- PTP management, 131
- PTPs
  - description, 21
  - requirements, 94

## Q

- Quantum
  - LTO specifications, 153
  - LTO tape drives, 153
  - SDLT specifications, 154

## R

- RaceTrack architecture, 18
- rack
  - descriptions, 24
  - feature codes, 117
- rack hardware kit, 100
- rack power distribution, 93
- rack requirements, 81
- Radio Frequency Identification
  - T10000 cartridge, 163
- RAID configuration, what kind, 62
- rail optimization, 128
- raised floor loading, 185
- ramps or slopes, 73
- Read/Write speeds, 175
- recirculation, 80
- recording densities, 175
- regulatory agencies, 48
- remote console, 26
- remote site planning, 76
- remote support, 97
- replacing existing libraries, 63
- requirements
  - for the system assurance process, 51
- reserved slots
  - capacities, 8
- rewind speeds, 175
- RFID
  - T10000 cartridges, 163
- riser cables, 121
- Robot and Pass-thru Port Power Grid, 12
- robot configurations, 18
- robot feature codes, 115
- robot power supplies, 115

- robotic rail assemblies, descriptions, 18
- Robotics Interface Module
  - length of, 78
- robotics interface module (RIM)
  - capacity, 8, 112, 213
- Robotics Interface Module, components in, 3
- routing for interface cables, 88
- RS232 Serial Port, 92

## S

- safety
  - agencies, 48
  - barrier, 47
  - door, feature code for, 117
  - features, 46
  - laser product label, 49
- sales support, 55
- Sarbanes-Oxley Act, 168
- SC Duplex connectors, 122
- SC to LC adapter, 122
- scratch
  - cartridge optimization, 129
- SCSI tape drives, 120
- SDLT
  - definition of, 44
- SDLT, tape types I and II, 166
- SDP, 97
- Seagate
  - cartridge tape, 164
- Search/Rewind speeds, 175
- Securities Exchange Commission, 168
- security system, 96
- security, obtaining a password, 96
- seismic compatibility, 80
- separating rails, 128
- serial cable, 100
- Service Delivery Platform, 97
- service mode, 27, 46
- service safety door, 47, 117
- shipping
  - dimensions, 101
  - pallets, 74
- shock tests, 49
- Simple Network Management Protocol, 42
- site planning checklist, 73
- SL8500 library complex, 21
- SL8500 Qualification Form, 55

- SLC
    - firmware requirements, 212
  - slopes, 86
  - slot upgrades, 141
  - slots, 113
    - addressing, 5
    - capacities, 8, 112
    - cells, xix
    - partitioning, 213
    - planning, 213, 215
  - SMC, 38, 39
  - smoke detector, 46, 95
  - Smoke Detector location, 91
  - SNMP, 42
  - software components, 37
  - software levels
    - ExLM, 40
  - software, library management, 135
  - Solaris, loading StreamLine Library Console, 96
  - space between the walls, 4
  - specifications, 184
  - sport cartridge, 162
  - square foot/meter of the library, 184
  - ST connectors, 123
  - standby mode, 92
  - stand-by, PTP, 94
  - steps for partitioning, 214
  - storage area network, existing, 65
  - Storage Expansion Module
    - components in, 3
    - length of, 78
    - number of cartridge slots in, 3
  - storage expansion modules (SEM)
    - capacity, 8, 112
  - Storage Management Component, 38, 39
  - storage media, 45
  - StorageTek
    - contact sheet, 53
    - Customer Resource Center (CRC), xxiii
    - hardcopy publications, xxiii
    - HTTP Server, 38
    - Library Communications Facility, 29
    - Partners site, xxiii
    - sales support Web site, 55
    - Technical Excellence Center, 97
    - Web site, xxiii
  - StreamLine Library Console, 26
    - CD part number, 26, 96
    - feature codes, 116
    - loading software, 96
    - memory requirements, 26
    - software application, 96
  - stylus feature, 26
  - Sun
    - Customer Resource Center (CRC), xxiii
    - Partners Web site, xxiii
    - Web site, xxiii
  - Super DLT
    - description, 44, 154
    - drive specifications, 154
    - label requirements, 171
    - overview, 154
    - specifications, 154
    - tape cartridges, 166
  - supply reel, 159
  - supported tape drives, 44
  - survey, 68
  - switches and hubs
    - existing network components, 65
  - Syncsort Backup Express, 143
  - system assurance
    - customer contact sheet, 52
    - planning meeting, 51
    - process overview, xix, 51, 214
    - StorageTek contact sheet, 53
  - system configuration worksheet, 57
  - system power distribution units, 9
- T**
- T10000
    - cartridge specifications, 163
    - cleaning cartridges, 162
    - description, 150
    - labels, 171
    - specifications, 150
    - tape cartridges, 162
  - T9840
    - description, 148
    - specifications, 148
    - tape cartridges, 158
  - T9940
    - description, 149
    - labels, 171
    - specifications, 149

- tape cartridges, 160
  - take-up reels, 159
  - tape cartridge content management, 129
  - tape cartridges
    - 9840, 158
    - 9940, 160
    - Any Cartridge, Any Slot, 171
    - capacity, 175
    - comparisons, 175
    - compatibility, 175
    - DLT, 166
    - labels, 169
    - LTO, 164
    - ordering, 174
    - Super DLT, 166
    - T10000, 162
  - tape drive
    - content management, 130
    - planning, 91
    - survey, 63
  - tape drive controller, 15
  - Tape Drive Power Grid, 12
  - tape drive power kit, 100
  - tape drives
    - comparisons, 156
    - HP LTO, 151
    - HVD, 120
    - IBM LTO, 152
    - LVD, 120
    - model numbers, 120
    - partitioning, 210
    - performance, 147
    - Quantum LTO, 153
    - SCSI, 120
    - specifications, 148
    - supported models, 44
    - T10000, 150
    - T9840, 148
    - T9940, 149
    - vacancy plate, 120
  - tape drives See drives and specific drive manufacturer
  - tape management systems, 40
  - targets, 4
  - targets, firmware loading, 16
  - tasks for partitioning, 214
  - team members, 214
  - TEC, 97
  - technical brief, PTP, xxii
  - Technical Excellence Center, 97
  - terminal block, 83
  - terminology, 181
  - terminology in manual, xix
  - Tivoli Storage Manager, 143
  - TMS, 40
  - tolerance, floor, 86
  - tools
    - required for installation, 99
  - top rail usage, 128, 132
  - topologies, types of Fibre Channel, 29
  - torque specifications, 98
  - total area, area of the library, 184
  - total weight of the library, for comparison, 184
  - TotalStorage 3580, 152
  - Touch Screen Operator Panel, 116
  - tracks, number of, 175
  - training, xxi
  - transfer rates, 175
  - tray, tape drive, 82
  - Tricode, labels by, 45
  - T-Series
    - T10000, 150
    - T9840, 148
    - T9940, 149
  - TUV Rheinland, 48
  - Two Gigabit Fiber Optic Cable Order Worksheet, 122
- ## U
- UL, 48
  - Ultrium cartridges, 164
  - uncorrected bit error rate, 175
  - Underwriters Laboratories, 48
  - Uniform Symbology Specification, 170
  - unpacked components, 103
  - upgrade number, 34, 212
  - upgrades, slots (Capacity on Demand), 141
  - upgrading firmware, 16
  - usable length, 175
- ## V
- VA, finding values for, 178
  - vacancy plate, 120
  - variations, floor, 86

## Index

- verified audit, 17
- VERITAS NetBackup, 143
- vertical pass-thru operations, 20
- vibration testing, 49
- virtual audit, 17
- VLAN, 207
- VM version, 34, 212
- VolSafe, 162, 168
- VOLSER, 169
- VOLSER, description of a volume serial number, 174
- VOLSERs, 211
- Volts, finding values for, 177
- volume serial number, 169
- volume serial numbers, 174
- Voluntary Control Council
  - for Interference, 48
- VPN, 207

## W

- walls, space between, 4
- Watts, 187
- Watts, finding values for, 177
- Web sites
  - sales support, 55
- WebCam feature, 117
- Webinars, xxi
- weight
  - floor capacity, 85, 99
- weights of the individual modules, 78
- weights of the library, 78
- width of the library, 78
- Windows, loading StreamLine
  - Library Console, 96
- working area, 99
- workload optimization, 128
- worksheet
  - 1Gb cables, 122
  - system configuration, 57
- WORM, 168
- write once, read many, 168
- write speeds, comparisons, 175
- Writeline, labels by, 45



Sun Microsystems, Inc. 4150 Network Circle, Santa Clara, CA 95054 USA Phone 1-650-960-1300 or 1-800-555-9SUN Web [sun.com](http://sun.com)



ARGENTINA: 5411-4317-5636 • AUSTRALIA: 1-800-550-786 • AUSTRIA: 43-1-601-26-0 • BALKANS: 301-6188-111 • BELGIUM: 32-2-704 89 83 • BRAZIL: 55-11-51872100 • BRUNEI: 65-216-8333 • CANADA: 1-800-422-8020 (GENERAL); 416-964-2001 (LEARNING MANAGEMENT SYSTEM SALES, TORONTO) • CHILE: 562-372-4500 • COLOMBIA: 571-629-2323  
CZECH REPUBLIC: 420 2 33009311 • DENMARK: 45 4556 5040 • EGYPT: 00 202 570 9442 • FINLAND: 358-9-525-551 • FRANCE: 33-1-41-33-17-17 • GERMANY: 49-89-460-08-2788 • GREECE: 30-01-6188101 • HONG KONG: 852-2877-7077 • HUNGARY: 361-202-4415 • INDIA: 91-80-229-8989 • INDONESIA: 65-216-8333 • IRELAND: 353-1-668-4377  
ISRAEL: 972-9-9710500 • ITALY: 39-02-9259511 • JAPAN: 81-3-5779-1820 • KOREA: 82-2-3453-6602 • MALAYSIA: 603-2116-1887 • MIDDLE EAST: 00 9714 3366333 • MEXICO: 525-261-0344 • NETHERLANDS: 31-33-4515200 • NEW ZEALAND: 0800-786-338 • NORTH WEST AFRICA: 00 9714 3366333 • NORWAY: FROM NORWAY: 47-22023950, TO NORWAY: 47-23369650 • PAKISTAN: 00-9714-3366333 • PEOPLE'S REPUBLIC OF CHINA: 8610-6803-5588 • PHILIPPINES: 632-885-7867 • POLAND: 48-22-8747848 • PORTUGAL: 351-21-413-4000 • RUSSIA: 7-095-935-8411 • SAUDI ARABIA: 00 9714 3366333 • SINGAPORE: 65-216-8300 • SOUTH AFRICA: 27-11-256-6300 • SPAIN: 34-902-210-412 • SRI LANKA: 65-2168333 • SWEDEN: 46-8-631 22 00 • SWITZERLAND: 41-1-908-90-50 (GERMAN) 41-22-999-0444 (FRENCH) • TAIWAN: 886-2-25185735 • THAILAND: 662-344-6855 • TURKEY: 90 212 335 22 00 • UNITED KINGDOM: 44-1276-416-520 • UNITED STATES: 1-800-422-8020 • VENEZUELA: 582-905-3800 • VIETNAM: 65-216-8333 • WORLDWIDE HEADQUARTERS: 1-650-960-1300

**SUN™** THE NETWORK IS THE COMPUTER ©2006 Sun Microsystems, Inc. All rights reserved. Sun, Sun Microsystems, and the Sun logo are trademarks or registered trademarks of Sun Microsystems, Inc. in the United States and other countries.