

PULLING



From simple straight-shot pulls to pulls with multiple bends and offsets, Greenlee cable pulling equipment can help save you time, increase your efficiency and more safely pull cable where you need it to be.

CONTENTS

Cable Feeders	203
Cable Pullers	204
Tugger Accessories	213
Cable Tray Feeder and Accessories	220
Rope.....	225
Swivels & Rope Connectors	226
Grips.....	228
Cable Pulling Lubricants.....	235
Swabs, Brushes, Mandrels	238



CABLE PULLER – SELECTION GUIDE



CAT. NO.	DESCRIPTION	PULLING FORCE			WEIGHT	SPEED									POWER	REQUIRED ROPE
		CONT.	MAX.			NO LOAD	500 LB	800 LB	1000 LB	2000 LB	4000 LB	5000 LB	6000 LB	8000 LB		
UT10-2S	Ultra Tugger® 10 (UT10) Cable Puller	6500 lb	10000 lb		86 lb (puller only)	16 fpm	-	-	-	14.0 fpm	12.0 fpm	-	7.0 fpm	6.0 fpm	1-1/2" HP electric	7/8" double braid
08000	Ultra Tugger® 8 Power Cable Puller	6500 lb	8000 lb		86 lb (puller only)	9 fpm	-	-	-	8.0 fpm	7.5 fpm	-	7.0 fpm	6.0 fpm	1-1/2" HP electric	7/8" double braid
6001	Power Cable Puller	4500 lb	6500 lb		108 lb (puller only)	16.5 fpm	-	-	-	11.0 fpm	7.5 fpm	6.0 fpm	-	-	1-1/2" HP electric	3/4" double braid
G6	G6 Turbo™ 6000 lb Cable Puller	4000 lb	6000 lb		252 lb (with boom)	90 fpm	63 fpm	-	21 fpm	19 fpm	8 fpm	8 fpm	-	-	1-1/2" HP electric	3/4" double braid
G3	G3 Tugger®	1200 lb	2000 lb		123 lb (with boom)	97 fpm	59.0 fpm	-	36.0 fpm	-	-	-	-	-	1" HP electric	1/2" double braid

Weights are approximate.



6810

Ultra Cable Feeder™

- One person set-up and operation
- Accommodates cable ranging in size up to 3.5" (88.9 mm) in diameter
- Feeds cable at variable speeds to match the speed of cable puller
- Tires for improved traction with low friction cable
- Two cable loading methods: Top-loading and End-loading
- Available with pendant and toggle switch

SPECIFICATIONS

Power Supply	115 VAC, 15 amps, 60 Hz 230 VAC, 8 amps, 50/0 Hz
Speed	4-36 feet per minute (1.2-11 meters per minute)
Maximum Tractive Force	Single Cable: 200 lb (.9 kN) All Cables: 800 lb (3.5 kN)
Cable Capacity	(Quantity / Size) 8 x 250 MCM (120 mm ²) 6 x 500 MCM (240 mm ²) 5 x 750 MCM (300 mm ²)
Reel Weight Capacity	25,000 lb total (11,300 kg)
Size	41" L x 27.5" W x 37.5" H (1040 mm x 699 mm x 953 mm)
Weight	285 lb (130 kg)
Tire Pressure	50 psi (2.4 bar)

CAT. NO.	UPC NO.	DESCRIPTION
6810	783310055648	Ultra Cable Feeder™ with Hand Switch 120V
6810-22	783310122937	Ultra Cable Feeder™ with Hand Switch 220V
R 05645	783310056454	Tee (included)
A 19233	783310192336	Tire Kit Upgrade

ULTRA TUGGER® 10

10,000 LB CABLE PULLER



On-Board Storage
Keep the disassembled boom stored on the unit



Hand Crank
Provides assistance when lifting heavy loads with the boom



Handle
Easily push the unit on the job site



Quick-Disconnect System
Allows for 360° of adjustments for the elbow and nose

Extendable Boom
Boom can extend up to 20'



Built-In Storage
Store adapters for 2" – 5" conduit

Solid wheels
Eliminate the risk of getting a flat

Additional Mounting Options
Floor mount and chain mount are also available for the UT10

Swivel Casters
Easily navigate through rough terrain on the construction site



ULTRA TUGGER® 10 PACKAGE COMPONENTS

SPECIFICATIONS

Pulling Force	Maximum: 10,000 lb (44.48 kN) Continuous: 6,500 lb (28.9 kN)	
Dimensions	Length: 11.5" (292 mm) Width: 26" (660 mm)	
Height	120V models: 6.75" (172 mm) 220V models: 10.0" (254 mm)	
Weight	86 lb (39 kg) (Puller only)	
Pulling Speed – Feet (Meters) Per Minute	No Load: 16 fpm/min (4.88 mpm) At 2000 lb (0.9 kN): 14 fpm (4.27 mpm) At 4000 lb (1.8 kN): 12 fpm (3.66 mpm)	At 6000 lb (2.7 kN): 7 fpm (2.13 mpm) At 8000 lb (3.6 kN): 6 fpm (1.8 mpm)
Drive Motor	1-1/2 HP (1.1 kW)	
Power Requirements	UT10-2S, UT10-22, 6900, 6900-22, 6901, 6901-22, 6906, 6906-22, 6706A	
Required Rope	7/8" diameter (22.2 mm); Double-Braided Polyester Composite – Rated at 32,000 lb (142 kN) minimum breaking strength	

KIT OPTIONS

PRODUCTS INCLUDED

CAT. NO.	UPC NO.	DESCRIPTION	UT10 KITS				MOBILE VERSIBOOM II KITS	
			6900	6901	6906	6906A	MVB	MVB-A
B UT10-2S	783310055280	Puller Assembly (UT10)	X	X	X	X	-	-
00865	783310008651	Mount Assy-Floor	X	-	-	-	-	-
02846	783310028468	Chain Mount Ass'y-Pkgd	-	X	-	-	-	-
MVB	783310005537	Mobile VersiBoom™ II	-	-	X	-	X	-
MVB-A	783310086635	Mobile VersiBoom™ II and 6 Adapters	-	-	-	X	-	X
R 00561	783310005612	3' Boom	-	-	X	X	X	X
R 00560	783310005605	4' Boom	-	-	X	X	X	X
R 00563	783310005636	Adapter Weldment, 2"	-	-	-	X	-	X
R 00564	783310005643	Adapter Weldment, 2-1/2"	-	-	X	X	X	X
R 00565	783310005650	Adapter Weldment, 3"	-	-	X	X	X	X
R 00566	783310005667	Adapter Weldment, 3-1/2"	-	-	-	X	-	X
R 00567	783310005674	Adapter Weldment, 4"	-	-	X	X	X	X
R 00610	783310006107	Adapter Weldment, 5"	-	-	-	X	-	X
A 00583	783310005834	Adapter Assembly, 2" Screw-On	-	-	-	-	-	-
A 00584	783310005841	Adapter Assembly, 2-1/2" Screw-On	-	-	-	-	-	-
A 00585	783310005858	Adapter Assembly, 3" Screw-On	-	-	-	-	-	-
A 00586	783310005865	Adapter Assembly, 3-1/2" Screw-On	-	-	-	-	-	-
A 00587	783310005872	Adapter Assembly, 4" Screw-On	-	-	-	-	-	-

CAT NO.	UPC NO.	DESCRIPTION
N 6906A	783310086642	UT10-2S Package with Mobile VersiBoom™ II and 6 Adapters
6906	783310003595	UT10-2S Package with Mobile VersiBoom™ II
6906-22	783310008125	UT10-22 (220 V) Package with Mobile VersiBoom™ II
6900	783310003571	UT10-2S Package with Floor mount
6900-22	783310008149	UT10-22 (220 V) Package with Floor mount
6901	783310003588	UT10-2S Package with Chain mount
6901-22	783310008132	UT10-22 (220 V) Package with Chain mount
UT10-2S	783310055280	Puller Assembly
UT10-22	783310008293	(220 V) Puller Assembly
A FG01	783310060703	Small Part
R 00464	783310004646	Foot switch



Ultra Tugger® 8 (UT8) Cable Puller: 8000 lb (35.8kN) rated

- 8,000 (35.8 kN) lb pulling force to handle most pulling jobs
- Available with Mobile VersiBoom™ for less than 2 minute, one person set-up, & 20' tall
- Available with floor mount & chain mount for tighter spaces

SPECIFICATIONS

Pulling Force	Maximum: 8,000 lb (35.8 kN) Continuous: 6,500 lb (28.9 kN)
Dimensions	Length: 11.5" (292 mm) Width: 26" (660 mm)
Height	120V models: 6.75" (172 mm) 220V models: 10.0" (254 mm)
Weight	86 lb (39 kg) (08000 only)
Pulling Speed – Feet (Meters) Per Minute	No Load: 9 fpm (2.7 mpm) At 2000 lb (0.9 kN): 8 fpm (2.4 mpm) At 4000 lb (1.8 kN): 7.5 fpm (2.3 mpm) At 6000 lb (2.7 kN): 7 fpm (2.1 mpm) At 8000 lb (3.6 kN): 6 fpm (1.8 mpm)
Drive Motor	1-1/2 HP (1.1 kW)
Power Requirements	8000, 6800, 6801 = 120 VAC 60Hz 20A UT8-22, 6800-22 = 220 VAC 50Hz
Required Rope:	7/8" diameter (22.2 mm); Double-Braided Polyester Composite – Rated at 32,000 lb (142 kN) minimum breaking strength

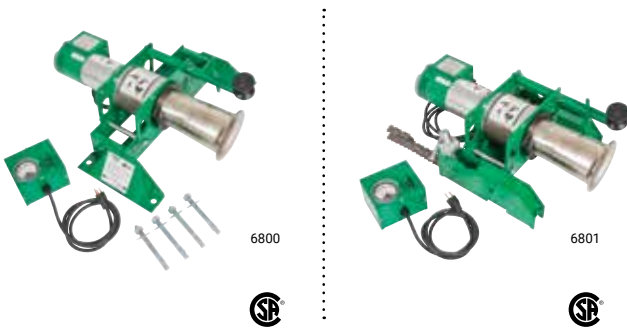

CAT. NO.	UPC NO.	DESCRIPTION
6800	783310009856	Ultra Tugger® 8 Cable Puller with Standard Force Gauge, and Floor Mount
6800-22	783310031963	Same as 6800, except 220 VAC 50 Hz
6801	783310009863	Ultra Tugger® 8 Cable Puller with Standard Force Gauge, and Conduit Chain Mount
6806	783310003625	UT8 Package with Mobile VersiBoom™ II
6806-22	783310003694	UT8-22 (220 V) Package with Mobile VersiBoom™ II
B 08000	783310080008	Cable Puller (6800)
A FG01	783310060703	Smart Pull
A 34136G	783310341369	Pull Rope 7/8" x 300' (22.2 mm x 91 m)
A 34137	783310341376	Pull Rope 7/8" x 600' (22.2 mm x 182 m)
A 34138	783310341383	Pull Rope 7/8" x 1,200' (22.2 mm x 365 m)
A 444	783310018742	Foot Switch Unit (UT8)

NOTE: Properly rated rope is critical to cable pulling. See page 225 for rope selection by rating.

CAT. NO.	UPC NO.	DESCRIPTION	6800	6801	6806
08000	783310080008	Cable Puller (6800)	X	X	X
00865	783310008651	Mount Assy-Floor	X	-	-
02846	783310028468	Chain Mount Ass'y-Pkgd	-	X	-
MVB	783310005537	Mobile VersiBoom™	-	-	X



Mobile VersiBoom™ II shown with Ultra Tugger® 10, sold separately.

Mobile VersiBoom™ II

Quick Set-Up

- One person set-up in less than 2 minutes

Versatile

- Can be extended up to 20'
- Use with one 3' boom for tighter spaces
- Use with 2"–5" slip-on adapters and 2"–4" threaded adapters
- Easy to store and transport
- Can be folded up in less than 2 minutes and can be stored on the back of a pick-up truck
- Fully contained unit

SPECIFICATIONS

Weight	322 lb (146.06 kg)
Length	47" (1193.8mm)
Width	42" (1066.8 mm)
Height	48" (1219.19 mm)

CAT. NO.	UPC NO.	DESCRIPTION
A MVB-A	783310086635	Mobile VersiBoom™ II and 6 Adapters
A MVB	783310005537	Mobile VersiBoom™ II

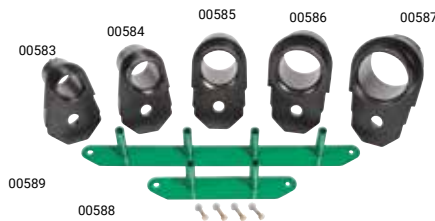

Mobile VersiBoom™ II Components/Accessories

CAT. NO.	UPC NO.	DESCRIPTION	SHIPS WITH MVB II	MVB-A
R 00471	783310004714	Coupling Hanger Kit	–	–
R 00563	783310005636	Adapter Weldment, 2" (UT8)	–	X
R 00564	783310005643	Adapter Weldment, 2-1/2"	X	X
R 00565	783310005650	Adapter Weldment, 3" (UT8)	X	X
R 00566	783310005667	Adapter Weldment, 3-1/2"		X
R 00567	783310005674	Adapter Weldment, 4" (UT8)	X	X
R 00610	783310006107	Adapter Weldment, 5" (UT8)	–	X
A 00583	783310005834	Adapter Assembly, 2" Screw-On	–	–
A 00584	783310005841	Adapter Assembly, 2-1/2" Screw-On	–	–
A 00585	783310005858	Adapter Assembly, 3" Screw-On	–	–
A 00586	783310005865	Adapter Assembly, 3-1/2" Screw-On	–	–
A 00587	783310005872	Adapter Assembly, 4" Screw-On	–	–
R 00588	783310005889	Hanger Weldment, Short	X	X
R 00589	783310005896	Hanger Weldment, Long	X	X
R 00590	783310005902	Screw On Coupling Kit	–	–
R 00561	783310005612	3' Boom	X	X
R 00560	783310005605	4' Boom	X	X

NOTE: Properly rated rope is critical to cable pulling. See page 225 for rope selection by rating.



Super-Tugger® Cable Puller: 6500 lb (28.9 kN) rated

- Pull up to 6,500 lb (28.9 kN) with less than 27 lb (120 N) of operator effort
- Unique floor mounting attachment for quick, reliable setup
- Leaf-type mounting chains won't twist when tightening
- Heat-treated steel serrated gripper feet for secure mounting to conduit
- Right-angle sheave allows the operator to stand out of the direct line of force
- Audio alarm high force warning and circuit breaker shut off at maximum force for added safety
- Tapered capstan and patented rope guidance system for better control of the rope when feeding onto the capstan

SPECIFICATIONS:

Pulling Force	Maximum: 6,500 lb (28.9 kN) Continuous: 4,500 lb (20 kN)
Dimensions	Length: 20-3/4" (527 mm) Width: 22-1/2" (572 mm) Height: 12" (305 mm)
Weight	6001, 6001-22: 108 lb (49 kg) 6003: 454 lb (206 kg) 6000, 6000-22: 550 lb (250 kg) 6006, 6006-22: 612 lb (278 kg)
Pulling Speed – Feet (Meters) Per Minute:	No Load: 16.5 (5) At 2000 lb: (8.8 kN) – 11 (3.4) At 4000 lb: (17.9 kN) – 7.5 (2.3) At 6000 lb: (26.7 kN) – 6 (1.8)
Drive Motor	1-1/2 HP (1.1 kW)
Power Requirements	6001, 6004, 6005: 120 VAC 16Hz 20A 6001-22: 220 VAC 50Hz
Required Rope	3/4" (19.1 mm) Double-Braided Composite – Rated at 26,000 lb (115.6 kN)



CAT. NO.	UPC NO.	DESCRIPTION
6001	783310296270	Super Tugger Cable Puller Power Unit, Includes force gauge and vise chains
6001-22	783310314660	Same as 6001 except 220 VAC 50 HZ
6004	783310563587	Super Tugger Complete Puller Package, Includes 6001 Super Tugger, Floor Mount, Mobile Carriage, Boom Mount, 4' Boom Tube, Nose Unit, 2 1/2", 3", 3 1/2", 4" Slip-in and Screw-On Couplings & Storage Trays
6005	783310563594	Super Tugger Complete Puller Package, Includes 6001 Super Tugger, Floor Mount, Mobile Carriage, Boom Mount, 4' Boom Tube, Nose Unit, 3' Boom Tube, Elbow Unit, 2 1/2", 3", 3 1/2", 4" Slip-in and Screw-On Couplings and Storage Trays
A 35098	783310350989	Double-Braided Composite Rope 3/4" x 300' (19.1 mm x 91 m)
A 35100	783310351009	Double-Braided Composite Rope 3/4" x 600' (19.1 mm x 182 m)
A 35101	783310351016	Double-Braided Composite Rope 3/4" x 1,200' (19.1 mm x 365 m)
A 3048	783310233626	Storage Box
A 11147	783310111474	Ultra Tugger® 640/6001 Adapter Package Includes wheeled carriage, 4 ft (1.2 m) boom, boom adapter, nose unit, 2-1/2", 3" and 4" slip-in couplings and 2", 3" and 4" screw-on couplings



11147

11147 Super-Tugger® 6001 Adapter Package

- Adapt 6001 Super-Tugger to Super-Tugger® with Wheeled Carriage and Boom for faster and easier cable puller setups
- Wheeled carriage and boom provides fast setup with no anchors to set or chains to mount
- Boom uses 3" rigid steel conduit for easy length adjustment to pull 10 feet (3m) of cable out of the box fast and easy
- Optional Elbow Unit and Boom available to reach into manholes or pull up to 20 feet (6 m) of cable out of the box

SPECIFICATIONS:

Weight	198 lb (90 kg)
Length	91-1/2" (232 cm)
Width	27" (69 cm)
Height	38-1/2" (98 cm)
Use With	Greenlee 6001 Cable Pullers
Load Rating	6500 lb (28.9 kN)

CAT. NO.	UPC NO.	DESCRIPTION
11147	783310111474	Super-Tugger® 640/6001 Adapter Package Includes wheeled carriage, 4 ft (1.2 m) boom, boom adapter, nose unit, 2-1/2", 3" and 4" slip-in couplings and 2", 3" and 4" screw-on couplings

NOTE: Properly rated rope is critical to cable pulling. See page 225 for rope selection by rating.

Package Components

CAT. NO.	UPC NO.	DESCRIPTION	SUPER-TUGGER – 6,500 LB			
			110 VAC			
			6001	6004	6005	11147
6001	783310296270	Cable Puller w/Force Gauge 120 VAC, 60 Hz	X	X	X	-
6037	783310356059	Floor Mount	-	X	X	-
29631	783310296317	Vise Chains	X	X	X	-
11145	783310111450	Boom Mount	-	X	X	X
00791	783310007913	4' (1.2 m) Boom Tube	-	X	X	X
00864	783310008644	Nose Unit	-	X	X	X
00863	783310008637	Elbow Unit	-	-	X	X
00835	783310008354	3' (.9 m) Boom Tube	-	-	X	-
03661	783310036616	2" Screw-On Coupling	-	-	-	X
00781	783310007814	2-1/2" Screw-On Coupling	-	X	X	-
00782	783310007821	3" Screw-On Coupling	-	X	X	X
00783	783310007838	3-1/2" Screw-On Coupling	-	X	X	-
00784	783310007845	4" Screw-On Coupling	-	X	X	X
00799	783310007999	Adapter for Screw-On Coupling	-	X	X	-
00804	783310008040	2-1/2" Slip-In Coupling	-	X	X	X
00811	783310008118	3" Slip-In Coupling	-	X	X	X
00815	783310008156	3-1/2" Slip-In Coupling	-	X	X	-
00820	783310008200	4" Slip-In Coupling	-	X	X	X
11152	783310111528	Storage Trays (2)	-	X	X	X
8012	783310008729	12" Hook Sheave	-	-	-	-

G6 TURBO™ 6,000 LB TUGGER

HANDS DOWN FASTER. PERIOD.

No Loose Pieces
Allowing quick changeover for easy transport

Ergonomic Design
Eliminates heavy lifting during setup

Dual Capstans
Increase pulling speeds and maximize efficiency

Built-In Dolly
Fast and easy transport

Patent-Pending Adjustable Clamp
Secures conduit in seconds without any adapters

Circuit Breaker Monitor
Auto shutoff and extends motor life

Two-Speed Motor
Specially designed for 6,000 lb load

Force Indicator
Also helps prevent damage to puller

G6 Floor Mount
Provides ultimate flexibility during a pull in hard to reach areas by allowing for custom set-ups that can create longer tail lengths

08632

G6

SPECIFICATIONS

Pulling Force	4,000 lb (17.800 KN) Continuous 5,000 lb (22.200 KN) Intermittent 6,000 lb (26.700 KN) Momentary
Rope Size	3/4" (19.100 mm) Double-Braided Composite, Rated at 26,000 lb (115.600 kN)
Drive Motor	120V VAC, 50/60 Hz, 12 Amps
NoLoad Main Capstan Speed	High Speed 28 ft/min (8.53 m/min) Low Speed 11 ft/min (3.35 m/min)
No Load Secondary Capstan Speed	High Speed 90 ft/min (27.43 m/min) Low Speed 35 ft/min (10.70 m/min)
Standard Boom Extension	7.5' (2.29 m)
Weight	252 lb (114 kg)

Includes a force indicator and foot switch

CAT. NO.	UPC NO.	DESCRIPTION
G6	783310069546	G6 Turbo™ 6,000-pound Puller with Boom/Dolly Mount
G6-F	783310086314	G6 Turbo™ 6,000-pound Puller with Floor Mount
08632	783310086321	Floor Mount Assembly for G6 Turbo™

G3 TUGGER™ CABLE PULLER

CAN HOOK ON THE BACK OF A TRUCK HITCH

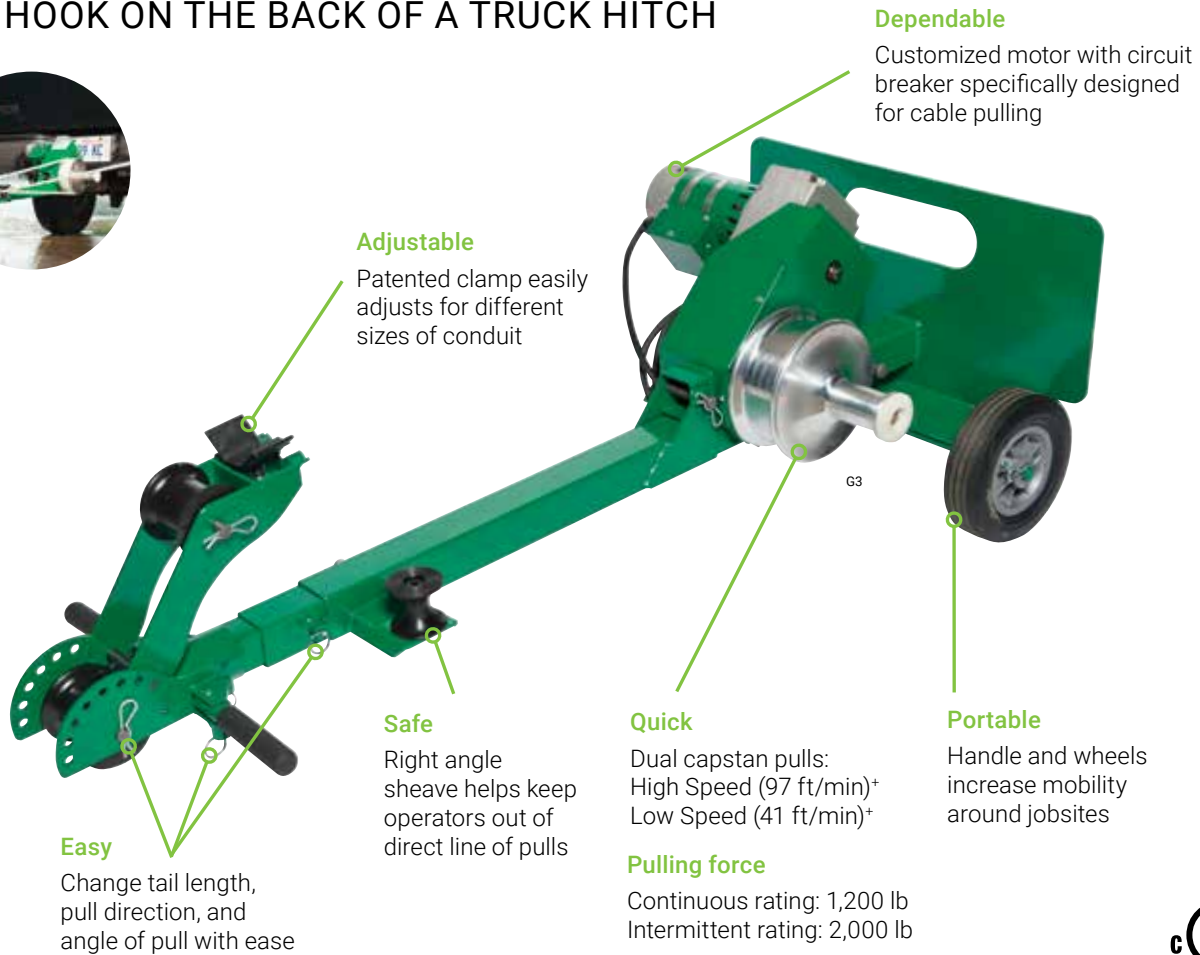

Dependable

Customized motor with circuit breaker specifically designed for cable pulling

Adjustable

Patented clamp easily adjusts for different sizes of conduit

Safe

Right angle sheave helps keep operators out of direct line of pulls

Quick

Dual capstan pulls:
High Speed (97 ft/min)[†]
Low Speed (41 ft/min)[†]

Portable

Handle and wheels increase mobility around jobsites

Easy

Change tail length, pull direction, and angle of pull with ease

Pulling force

Continuous rating: 1,200 lb
Intermittent rating: 2,000 lb



SPECIFICATIONS

Pulling Force	Continuous rating – 1,200 lb Intermittent rating – 2,000 lb
Drive Motor	120 VAC, 50/60 Hz, 12 Amps
Weight	123 lb
Pulling Speeds	High Speed Capstan – No Load: 97 ft/min 500 lb Load (227 kg) 59 ft/min 1,000 lb Load (455 kg) 36 ft/min Low Speed Capstan – No Load: 41 ft/min 1,000 lb Load (455 kg) 21 ft/min 2,000 lb Load (909 kg) 13 ft/min
Rope	1/2" polyester (10,000 lb minimum breaking strength)
Conduit Size	1" or larger
Pulling Capabilities	3 x 500 kcmil cable 500' with 2 x 90° bends 3 x 500 kcmil cable 250' with 4 x 90° bends 8 x 4/0 AWG cable 300' with 3 x 90° bends

- 3X faster set-up than competition – no loose pieces[†]
- 20% faster than competition[†]
- 25% stronger than competition[†]

CAT. NO.	UPC NO.	DESCRIPTION
G3	783310009054	G3 Tugger®

[†]When compared to competitive models

G-SERIES SMART PULL

MONITOR YOUR CABLE PULL



5-Roller Design

Simply lay down rope, replace rollers and start pulling

Touch Screen LCD Display

Real time force, speed and distance display

Alerts user with flashing colored background

Cam-Locking Pin

Easily insert and remove rope with removable roller and retained pin

Compatibility

Use with existing G6 Turbo™, UT10/UT8 Mobile VersiBoom™ II, floor mount and chain mount

Skeletal Frame

Reduces weight for ease of handling

Makita® Battery Platform

Up to 20 hours of battery life with 5Ah battery

Monitor Using Mobile App

Wireless platform with Bluetooth® file transfer
Transfer file from PullCalc App

USB Download

For easy data retrieval
128MB of on-board memory

Roll Cage Handles

Sturdy steel handles protect the electronics
Easy to carry

- Instant early warning alert allows contractor to take timely action, avoiding rework
- Reduce liability by recording information with accuracy of ensuring a healthy pull and peace of mind for the contractor
- Wirelessly monitor force, speed and distance through the pull

PULLCALC APP



SPECIFICATIONS

Max Force	10,000 lb (44.48 kN)
Rope Size	Up to 7/8" diameter
Weight	34.2 lb
Length	25.5"

SUGGESTED TOLERANCE

FG01 LOAD RANGE (LB)	TOLERANCE (LB)
0-1399	± 75
1400-2749	± 95
2750-5599	± 140
5600-10,000	± 235

CAT. NO.	UPC NO.	DESCRIPTION
FG01	783310060703	G-Series Smart Pull

TUGGER ACCESSORIES



Foot Switch for Cable Pullers

- Use with UT2™, 640, 6001, 6500 or 6800 cable pullers to add foot control

SPECIFICATIONS

Power Source	120 VAC
Weight	3.5 lb (1.6 kg)

CAT. NO.	UPC NO.	DESCRIPTION
A 444	783310018742	Foot Switch

PULLING ACCESSORIES

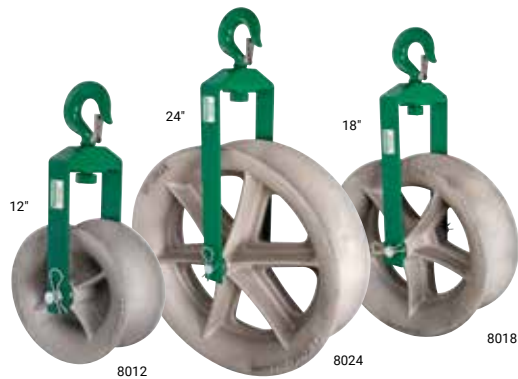

Hook Sheaves – 8,000 lb Capacity

- For use with UT8, UT5, 6001, UT4 and UT2™ cable pullers
- Strong, welded steel frames
- Forged steel closure type hooks with 1" (25.4 mm) opening
- All three sheaves are aluminum alloy with self-lubricating bearings

SHEAVE	8012		8018		8024	
DIAMETER	12" (304.8 mm)		18" (457.2 mm)		24" (609.6 mm)	
DESCRIPTION	CAT. NO.	UPC NO.	CAT. NO.	UPC NO.	CAT. NO.	UPC NO.
Roll Pin	50700	783310507000	50700	783310507000	50700	783310507000
Sheave Pin	00838	783310008385	00838	783310008385	00838	783310008385
Sheave Unit	00843	783310008439	00844	783310008446	00845	783310008453
Yoke Frame	00854	783310008545	00856	783310008569	00856	783310008569

CAT. NO.	UPC NO.	OUTSIDE DIAMETER	INSIDE RADIUS	WIDTH	WEIGHT	MAXIMUM RATED CAPACITY
8012	783310008729	12" (304.8 mm)	3-7/8" (98.4 mm)	5" (127 mm)	28 lb (12.7 kg)	8,000 lb (35.8 kN)
8018	783310008736	18" (457.2 mm)	7" (177.8 mm)	6" (152.4 mm)	44 lb (19.9 kg)	8,000 lb (35.8 kN)
8024	783310008743	24" (609.6 mm)	9-7/8" (250.8 mm)	6-1/2" (165.1 mm)	67 lb (30.3 kg)	8,000 lb (35.8 kN)

Hook-Type Sheaves – 4,000 lb Capacity

- Strong, welded steel frames
- Forged steel closure-type hooks with 1" (25.4 mm) opening
- 5" (127 mm) wide aluminum alloy sheaves with self-lubricating bearings
- Use with cable puller with maximum pulling force of 4,000 lb (17.8 kN) or less



SPECIFICATIONS

Maximum Rated Capacity	4,000 lb (17.8 kN)
Weight	650: 8.8 lb (4 kg) 651: 15 lb (6.8 kg) 652: 25 lb (11.3 kg) 653: 35 lb (15.9 kg)

SHEAVE	650		651		652		653	
DIAMETER	6" (152.4 mm)		12" (304.8 mm)		18" (457.2 mm)		24" (609.6 mm)	
DESCRIPTION	CAT. NO.	UPC NO.	CAT. NO.	UPC NO.	CAT. NO.	UPC NO.	CAT. NO.	UPC NO.
Sheave Pin	16797	783310167976	16797	783310167976	16797	783310167976	16797	783310167976
Sheave	15362	783310153627	15362	783310153627	15363	783310153634	15364	783310153641
Sheave Bushing (2)	16798	783310167983	16798	783310167983	16798	783310167983	16798	783310167983
Yoke Frame	16800	783310168003	16800	783310168003	16802	783310168027	16802	783310168027

CAT. NO.	UPC NO.	DESCRIPTION
650	783310153245	6" (152.4 mm) dia. Hook Sheave with 1-1/2" (38.1 mm) min. radius
651	783310153252	12" (304.8 mm) dia. Hook Sheave with 3-5/16" (84.1 mm) min. radius
652	783310153269	18" (457.2 mm) dia. Hook Sheave with 7" (177.8 mm) min. radius
653	783310153276	24" (609.6 mm) dia. Hook Sheave with 9-13/16" (249.2 mm) min. radius



639

Right-Angle Twin Yoke Sheave – 4,000 lb Capacity

- 9-13/16" (249 mm) minimum radius
- Strong welded steel yokes
- Forged steel closure type hook with 1" (25.4 mm) opening
- 5" (127 mm) wide aluminum alloy sheave with self-lubricating bearings
- Yokes rotate independently to fit various setups
- Use with any cable puller with maximum pulling force of 4,000 lb (17.8 kN) or less

SPECIFICATIONS

Maximum Rated Capacity	4,000 lb (17.8 kN)
Weight	45 lb (20.4 kg)

SHEAVE	6039		
DESCRIPTION	CAT. NO.	UPC NO.	QTY
Sheave Pin	17266	783310172666	1
Sheave	15364	783310153641	1
Sheave Bushing (2)	16798	783310167983	2
Yoke Frame	17299	783310172994	2

CAT. NO.	UPC NO.	DESCRIPTION
639	783310172659	Right Angle Twin Yoke Sheave with 9-13/16" (249 mm) min. radius







Conveyor Sheaves – 4,000 lb Capacity

- Aluminum frame with a series of sheaves to form a large radius
- Yokes with cast steel closure-type hooks with a 1" (25.4 mm) opening
- 5" (127 mm) wide aluminum alloy sheaves
- Use with any cable puller with maximum pulling force of 4,000 lb (17.8 kN) or less

SPECIFICATIONS

Maximum Pulling Force	4,000 lb (17.8 kN)
Weight	4024: 54 lb (24.5 kg) 4036: 60 lb (27 kg) 4048: 83 lb (38 kg)

CAT. NO.	UPC NO.	DESCRIPTION
4024	783310263685	24" (609.6 mm) Conveyor Sheave with 6 sheave wheels
4036	783310263692	36" (914.4 mm) Conveyor Sheave with 8 sheave wheels
4048	783310263708	48" (1219 mm) Conveyor Sheave with 10 sheave wheels
 19185	783310191858	Yoke frame
 15362	783310153627	Sheave w/bearings
 19186	783310191865	Sheave Pin
 31573	783310315735	Sheave Pin



Triple Sheave Cable Guide – 6,500 lb Capacity

- Adjustable center sheave for 19-1/2" (495 mm) or 36" (914 mm) radius
- Forged steel closure type hook with 1-1/2" (38.1 mm) opening
- Aluminum frames for light weight
- Steel yoke is pinned for easy removal
- 21-7/8" (555 mm) high, 24" (610 mm) long, 7-3/8" (187 mm) wide with 5" (127 mm) wide sheaves
- Use with any cable puller with maximum pulling force of 6,500 lb (28.9 kN) or less

SPECIFICATIONS

Maximum Rated Capacity	6,500 lb (28.9 kN)
Weight	28 lb (12.7 kg)

CAT. NO.	UPC NO.	DESCRIPTION
6036	783310315698	Triple Sheave Cable Guide

SHEAVE		6036	
DESCRIPTION	CAT. NO.	UPC NO.	QTY
Sheave Axle	31573	783310315735	3
Sheave Bolt Washer	51434	783310514343	6
Sheave Pin	29600	783310296003	1
Sheave Bushing	16798	783310167983	6
Sheave	15362	783310153627	3

Sheave Bolt is a 3/8"-24 x 3/4" hex head socket head cap screw (grade 5) and is available at most hardware stores.

CABLE PULLING



441-4



441-2

441-2-1/2

441-3

441-3-1/2

441-4

441-5

441-6

Feeding Sheaves

- Yoke frame slides into the end of conduit and holds sheave, allowing the cable being fed into the conduit to smoothly roll over the sheave
- 5" (127 mm) wide aluminum alloy sheave with self-lubricating bearings
- Split tube for easy removal after cable is installed
- See the Capacity Table (below)

CAT. NO.	UPC NO.	DESCRIPTION
441-2	783310301837	Feeding Sheave for 2" conduit
441-2-1/2	783310303589	Feeding Sheave for 2-1/2" conduit
441-3	783310301882	Feeding Sheave for 3" conduit
441-3-1/2	783310303633	Feeding Sheave for 3-1/2" conduit
441-4	783310303473	Feeding Sheave for 4" conduit
441-5	783310301936	Feeding Sheave for 5" conduit
441-6	783310134602	Feeding Sheave for 6" conduit

Weight	Width of Shaft Opening
441-2: 9 lb (4.5 kg)	441-2: 1.24"
441-2-1/2: 11 lb (5 kg)	441-2-1/2: 1.37"
441-3: 14 lb (6.4 kg)	441-3: 1.79"
441-3-1/2: 17 lb (7.7 kg)	441-3-1/2: 1.75"
441-4: 19 lb (8.6 kg)	441-4: 1.99"
441-5: 26 lb (11.8 kg)	441-5: 2.23"
441-6: 28 lb (12.7 kg)	441-6: 2.75"

SHEAVE	441-2		441-2-1/2		441-3	
DIAMETER	2" CONDUIT		2-1/2" CONDUIT		441-3	
DESCRIPTION	CAT. NO.	UPC NO.	CAT. NO.	UPC NO.	CAT. NO.	UPC NO.
Sheave Pin	25160	783310251606	25160	783310251606	25160	783310251606
Sheave	15362	783310153627	15362	783310153627	15362	783310153627

SHEAVE	441-3-1/2		441-4		441-5		441-6	
DIAMETER	3-1/2" CONDUIT		4" CONDUIT		5" CONDUIT		6" CONDUIT	
DESCRIPTION	CAT. NO.	UPC NO.	CAT. NO.	UPC NO.	CAT. NO.	UPC NO.	CAT. NO.	UPC NO.
Sheave Pin	25160	783310251606	25160	783310251606	25160	783310251606	25160	783310251606
Sheave	15362	783310153627	15362	783310153627	15362	783310153627	15362	783310153627

CAPACITY TABLE

Angle of Pull	441-2	441-2-1/2	441-3	441-3-1/2	441-4	441-5
15°	1750 lb 7.7 kN	1900 lb 8.4 kN	6050 lb 26.9 kN	6500 lb 28.9 kN	6500 lb 28.9 kN	6500 lb 28.9 kN
30°	900 lb 4.0 kN	1000 lb 4.4 kN	3150 lb 14.0 kN	5050 lb 22.4 kN	6500 lb 28.9 kN	6500 lb 28.9 kN
45°	650 lb 2.8 kN	700 lb 3.1 kN	2200 lb 9.7 kN	3550 lb 15.7 kN	5200 lb 23.1 kN	6500 lb 28.9 kN
60°	500 lb 2.2 kN	550 lb 2.4 kN	1800 lb 8.0 kN	2900 lb 12.8 kN	4200 lb 18.6 kN	6000 lb 26.6 kN
75°	450 lb 2.0 kN	500 lb 2.2 kN	1600 lb 7.1 kN	2600 lb 11.5 kN	3650 lb 16.2 kN	5500 lb 24.4 kN
90°	450 lb 2.0 kN	500 lb 2.2 kN	1550 lb 6.8 kN	2500 lb 11.1 kN	3500 lb 15.5 kN	5250 lb 23.3 kN

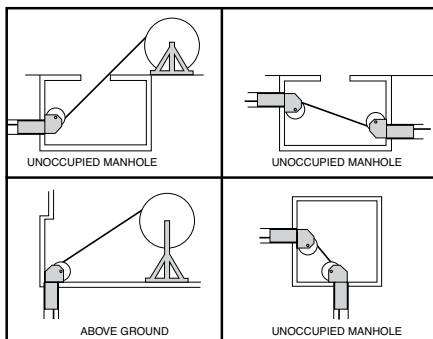



6072

Manhole Sheaves for UT2™, Tugger and Super Tugger®

- High-strength aluminum alloy frame for easy setup
- Adjustable, a full range of sheave pin positions over the frame length to accommodate most manhole setups
- 18" (457 mm) diameter aluminum alloy sheaves with 7" (178 mm) minimum radius and 5" (127 mm) width
- Self-lubricating bearings for easier cable pulling

SPECIFICATIONS

Maximum Rated Capacity	6,500 lb (28.9 kN)
Weight	190 lb (86.2 kN)

CAT. NO.	UPC NO.	DESCRIPTION
6072	783310313953	12' (3.7 m) Manhole Sheave



488-2

Nylon Cable Protector

- Fits in the end of conduit to shield the cable from sharp edges as it is being fed through
- Rugged nylon resists abrasion

SPECIFICATIONS

Weight	488-2: 0.08 lb (36 g) 488-3: 0.2 lb (90 g)
--------	---

CAT. NO.	UPC NO.	DESCRIPTION
488-2	783310329282	Nylon Cable Protector for 2" and 2-1/2" conduit
488-3	783310329299	Nylon Cable Protector for 3" – 6" conduit



489

Cable Guide

- Position where cables are being pulled over sharp edges

SPECIFICATIONS

Weight	5 lb (227 g)
Size	13" L x 3-1/4" W x 12" radius

CAT. NO.	UPC NO.	DESCRIPTION
489	783310329305	Nylon Cable Guide



459

Light Base Sheave

- Mounts directly to existing square light pole bolt patterns
- Slotted mounting holes fit a wide range of bolt circle sizes
- Tall enough to position sheave above most conduits
- Rugged welded steel base structure
- Allows user to install wires into outdoor light bases by pulling horizontally
- Also can be used to feed wires into vertical light base conduit

SPECIFICATIONS

Overall Height	14-1/2" (368 mm)
Weight	18 lb (8.2 kg)
Bolt Circle Capability	7.8" (198 mm) to 14.8" (376 mm) diameter
Maximum Mounting	1" (25 mm) diameter at 7.8" (198 mm) bolt circle 1-1/2" (38 mm) at 14.8" (376 mm) bolt circle
Pulling Capacity	500 lb (227 kg)

CAT. NO.	UPC NO.	DESCRIPTION
459	783310898009	Light Base Sheave

CABLE TRAY FEEDER & ACCESSORIES



CTF-200

CTF-200

- Quick clamping onto cable, can handle up to 2" (50.8 mm) in outer cable diameter
- 360° swivel pins to easily release cable from all sides with no loose pieces
- Designed specifically to handle electrical cable with 5 grooves to grab cable safely and evenly
- Pre set to aid up to 200 lb (90.7 kg) of force to prevent damage to the insulation of the cable
- Quickly adjust legs and feeder into position utilizing no loose pieces
- Control feeder up to 8' (2.4 m) away with pendant
- Quick set up utilizing a ratchet strap to securely mount to tray

CAT. NO.	UPC NO.	DESCRIPTION
CTF-200	783310036449	Cable Tray Feeder

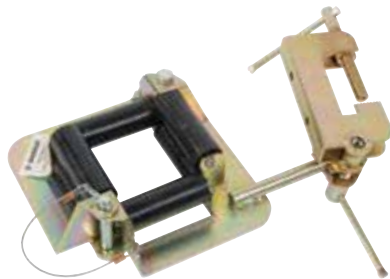

CR25

CR25

- Six nylon rollers provide smooth movement of cable and prevent cable damage
- Pull pin makes opening and closing to insert and remove cables a simple one step operation
- Adjustment clamp allows the CR25 to be swiveled and/or rotated into any position
- Heavy duty 12 gauge cold rolled steel construction for durability and zinc dichromate finish prevents corrosion
- Up to 20 network cables can be pulled at one time
- Easily attaches to wooden framing members using a lag bolt and the hole in the mounting bracket of the CR25
- May also be used with coax, NM, small size THHN, and similar cables

SPECIFICATIONS

Roller Opening Size	3" (76 mm) square
Weight	2 lb (1 kg)

CAT. NO.	UPC NO.	DESCRIPTION
CR25	783310122111	Cable Roller Guide

Tray-Type Sheaves

- Steel frame easily attaches to cable tray up to 2" (50.8 mm) thick
- Helps roll and guide tray pulls
- Make tray pulls easier
- 5" (127 mm) wide aluminum alloy sheaves with self-lubricating bearings



658



659

SPECIFICATIONS

Size	658: 12" (304.8 mm) long 659: 22" (558.8 mm) long
Weight	658: 11 lb (5 kg) 659: 17 lb (7.7 kg)

CAT. NO.	UPC NO.	DESCRIPTION
658	783310153320	Tray-Type Sheave
659	783310190943	Tray-Type Sheave

660QA Quick Adjust Sheave Roller

- Quick and easy adjustment of slide leg
- 7X faster setup and disassembly than competition
- 11" to 20" adjustable sliding leg
- Self-lubricated bearings with aluminum alloy sheave
- Wide edge hook fits on common ladder tray sizes
- One design quickly adjusts to fit common tray configurations
- No loose pieces



660QA

CAT. NO.	UPC NO.	DESCRIPTION
660QA	783310027683	Sheave-Tray, Quick Adjust
 03471	783310034711	Sheave Hardware Kit



CTR100

CTR100 Cable Tray Roller

- 2X faster setup and disassembly than competition
- Rated for 100 lb
- Overlapping roller design prevents rope or cable from potential pinch points
- Compact design fits into tight spaces
- Easy cable release with no loose pieces
- Quick adjust push button for faster setup time and disassembly time

CAT. NO.	UPC NO.	DESCRIPTION
CTR100	783310028109	Roller, Cable
R 03472	783310034728	Roller Replacement Kit
R 03473	783310034735	Frame and Pin Kit
R 03476	783310034766	Handle Assembly Kit

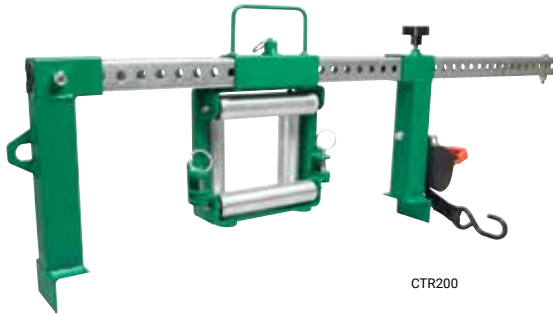

CTR200

CTR200 Cable Tray Roller

- Rated for 200 lb (90 kg)
- Adjustable leg to fit on tray widths of up to 36" (914.4 mm)
- Securely fastens to various types of cable tray rails
- Easy cable release and positioning of roller guide with no loose pieces
- Quickly fastens mounting system to tray with auto retractable ratchet strap
- Roller guide opens from the left to right side allowing the cable release to be easily accessible
- Overlapping roller design prevents rope or cable from potential pinch points

CAT. NO.	UPC NO.	DESCRIPTION
CTR200	783310027973	Roller, Cable
R 03472	783310034728	Roller Replacement Kit
R 03473	783310034735	Frame and Pin Kit
R 03474	783310034742	Ratchet Kit

Cable Tray Rollers

- Installed up through the bottom of the tray for easy removal after the cable is installed
- Individual rollers keep rolling with each cable even after several cables have been installed in the tray
- Steel ball bearing rollers for long life and less friction
- Steel welded frame
- Adjustment slots and universal mounting brackets

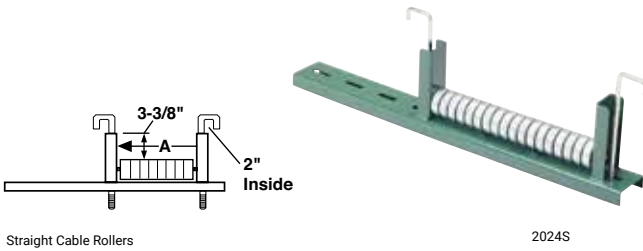

Straight Cable Rollers

2024S

SPECIFICATIONS

Weight	2018S: 8 lb (3.6 kg) 2024S: 10 lb (4.5 kg) 2030S: 13 lb (5.9 kg) 2036S: 15 lb (6.8 kg)	2018R: 11 lb (5 kg) 2024R: 12 lb (5.4 kg) 2030R: 13 lb (5.9 kg) 2036R: 14 lb (6.3 kg) 20249R: 41 lb (18.6 kg) 20369R: 53 lb (24 kg)
--------	---	--

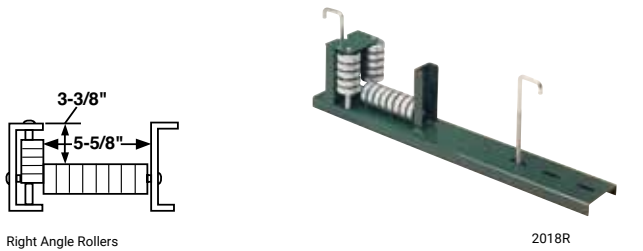

Right Angle Rollers

2018R

CAT. NO.	UPC NO.	DESCRIPTION
R 28170	783310281702	J-Hook

CAT. NO.	UPC NO.	DIMENSION A
2018S	783310273837	6-5/16" (160.3 mm)
2024S	783310273844	12-1/2" (317.5 mm)
2030S	783310273868	18-11/16" (474.7 mm)
2036S	783310273875	24-7/8" (631.8 mm)



Radius Cable Rollers

20249R

CAT. NO.	UPC NO.	DESCRIPTION
----------	---------	-------------

STRAIGHT CABLE ROLLERS

2018S	783310273837	Straight Cable Roller for 12" – 18" (304.8 – 457.2 mm) wide tray
2024S	783310273844	Straight Cable Roller for 20" – 24" (508 – 609.6 mm) wide tray
2030S	783310273868	Straight Cable Roller for 24" – 30" (609.6 – 762 mm) wide tray
2036S	783310273875	Straight Cable Roller for 30" – 36" (762 – 914.4 mm) wide tray

RADIUS CABLE ROLLERS

2018R	783310273882	Radius Cable Roller for 12" – 18" (304.8 – 457.2 mm) wide tray
2024R	783310273899	Radius Cable Roller for 20" – 24" (508 – 609.6 mm) wide tray
2030R	783310273905	Radius Cable Roller for 24" – 30" (609.6 – 762 mm) wide tray
2036R	783310273912	Radius Cable Roller for 30" – 36" (762 – 914.4 mm) wide tray

RIGHT ANGLE CABLE ROLLERS

20249R	783310273929	Right Angle Rollers 24" (609.6 mm) radius 90°
20369R	783310273936	Right Angle Rollers 36" (914.4 mm) radius 90°



31931



31925



31926



31927



31930



31929



Haines Cable Tray Rollers

- Highly economical system of 1-1/2" steel conduit spindles, high impact ABS plastic rollers and simple clips
- Rollers snap in and out of clips fast and easy
- Mounting clips fit onto the top of most I-Beam and C-Channel trays, so existing wire is not disturbed
- 8" (203.2 mm) to 48" (1219.2 mm) wide rollers are available, using expandable roller halves and 3" (76.2 mm) PVC conduit
- Use Greenlee Cable-Cream™ (see p. 236) to lube spindle and roller, this lubricant is compatible with all cable insulation types

CAT. NO.	UPC NO.	DESCRIPTION	SIZE
31931	783310319313	Haines Roller 6" (152.4 mm) dia.	7" (177.8 mm) wide
31925	783310319252	Expandable Roller Half	Used to make 8" (203.2 mm) to 48" (1219.2 mm) wide roller
31926	783310319269	Coupling 3" (76.2 mm) long	3-1/2" (88.9 mm) dia.
31927	783310319276	Mounting Clip Steel Conduit	Use with 1-1/2" Rigid
31930	783310319306	Spindle (includes End Caps)	1-1/2" Rigid Conduit x 40" (1016 mm) long
31929	783310319290	End Cap	Fits 1-1/2" Rigid Conduit

ROPE



35283

Double-Braided Composite Rope for Cable Pullers

- Double-braided inner core with an extra double-braided outer jacket for added strength and less stretch; white with green tracer
- Rot and mildew resistant
- Factory spliced eyes at both ends
- Low stretch
- Properly rated rope is critical to cable pulling

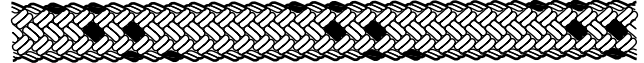

ROPE DIAMETER	ROPE LENGTH		CAT. NO.	UPC NO.	MAXIMUM RATED CAPACITY		AVERAGE BREAKING STRENGTH		WEIGHT		ROPE STAND
									LB	KG	
805 Puller 3/8" (9.5 mm)	300'	91m	450	783310237730	1200 lb	3.6 kN	3700 lb	16.4 kN	14.3	6.5	406
	600'	182m	451	783310237754	1200 lb	3.6 kN	3700 lb	16.4 kN	31.0	14.3	644
	1,200'	365m	452	783310237761	1200 lb	3.6 kN	3700 lb	16.4 kN	60.0	27.2	644
G3 & UT2™ Puller 1/2" (12.7 mm)	300'	91m	455	783310237747	2,200 lb	8.9 kN	10,000 lb	44.4 kN	34	15.4	644
	600'	182m	456	783310237778	2,200 lb	8.9 kN	10,000 lb	44.4 kN	75	34	644
UT4 & 640 Puller 9/16" (14.3 mm)	300'	91m	35283G	783310352839	4,000 lb	17.8 kN	16,000 lb	71.1 kN	28	12.7	644
	600'	182m	35284	783310352846	4,000 lb	17.8 kN	16,000 lb	71.1 kN	63	28.6	644
	1,200'	365m	35285G	783310352853	4,000 lb	17.8 kN	16,000 lb	71.1 kN	130	59	†
6001 & G6 Puller 3/4" (19.1 mm)	300'	91m	35098	783310350989	6,500 lb	28.9 kN	26,000 lb	115.6 kN	58	26.3	644
	600'	182m	35100	783310351009	6,500 lb	28.9 kN	26,000 lb	115.6 kN	113	51.3	654
	1,200'	365m	35101	783310351016	6,500 lb	28.9 kN	26,000 lb	115.6 kN	230	104.3	†
6800 (UT8) Puller & UT10-2S 7/8" (22.2 mm)	300'	91m	34136G	783310341369	8,000 lb	35.6 kN	32,000 lb	142.3 kN	90	40.8	654
	600'	182m	34137	783310341376	8,000 lb	35.6 kN	32,000 lb	142.3 kN	178	80.7	654
	1,200'	365m	34138	783310341383	8,000 lb	35.6 kN	32,000 lb	142.3 kN	359	163.3	†



405 Rope Stand sold separately. See page 513.

Polypro General Purpose Rope

- Highly-visible, bright yellow with green tracer, excellent for roping off areas on construction sites
- Rot and mildew resistant
- Weather resistant
- Economical general purpose rope
- **Not for cable pulling**



ROPE DIAMETER	ROPE LENGTH		CAT. NO.	UPC NO.	BREAKING STRENGTH		AVERAGE WEIGHT	
							LB	KG
3/16" (4.8 mm)	250'	76 m	408	783310214670	720 lb	3.2 kN	3	1.4
	600'	182 m	409	783310214687	720 lb	3.2 kN	6	2.7
1/4" (6.4 mm)	250'	76 m	412	783310214717	1130 lb	5.0 kN	4	1.8
	600'	182 m	413	783310214724	1130 lb	5.0 kN	9	4.1
	1,000'	304 m	414	783310214748	1130 lb	5.0 kN	13	5.9
3/8" (9.5 mm)	250'	76 m	417	783310214779	2430 lb	10.8 kN	9	4.1
	600'	182 m	418	783310215202	2430 lb	10.8 kN	19	8.6
1/2" (12.7 mm)	250'	76 m	421	783310214809	3780 lb	16.8 kN	15	6.8
	600'	182 m	422	783310215219	3780 lb	16.8 kN	35	15.9

SWIVELS & ROPE CONNECTORS



Rope-to-Swivel Connectors

- Rope-to-swivel connectors connect the cable pulling rope, up to 1" (254 mm) in diameter, to the pulling swivel
- Makes connecting the pulling rope and the pulling swivel easier
- Connectors feature a removable sheave for rope eye
- Select the connector with a maximum rated capacity that meets or exceeds the cable puller's maximum pulling force

CAT. NO.	UPC NO.	DESCRIPTION
R 39849	783310398493	Sheave
R 39850	783310398509	Sheave Pin

CAT. NO.	UPC NO.	MAX. RATED CAPACITY IN CONDUIT		MAX. RATED CAPACITY OVERHEAD		DIAMETER		LENGTH		"E"		"F"		USE ON SWIVEL
		LB	KN	LB	KN	IN	mm	IN	mm	IN	mm	IN	mm	
39905	783310399056	5,000	22.2	3,000	13.3	2	50.8	4-11/16	119	7/16	11.12	13/32	10.32	39107
39904	783310399049	7,000	31.1	4,200	18.6	2	50.8	4-11/16	119	1/2	12.7	1/2	12.7	39108
39903	783310399032	10,000	44.4	6,000	26.6	2	50.8	4-11/16	119	9/16	14.3	5/8	15.9	39109
39902G	783310399025	10,000	44.4	6,000	26.6	2	50.8	4-11/16	119	11/16	17.5	11/16	17.5	39110

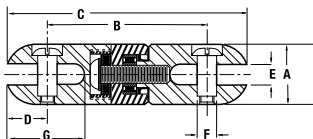
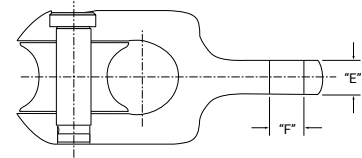

Swivels

- Helps eliminate winding and tangling of rope and cable during pull
- Connects grip and pulling rope
- All stainless steel body construction
- Efficient thrust and roller bearing construction allows smooth rotation, even under full load
- Clevis pins are "shoulder bolt" style, so load on both sides of clevis is taken on the shoulder, not on the thread
- Swivel selection should exceed a maximum rated capacity of pulling force

CAT. NO.	UPC NO.	MAX. RATED CAPACITY		DIAMETER														WEIGHT		REPLACEMENT* PIN KIT UPC NO.
		LB	KN	A		B		C		D		E		F		G		LB	KG	
				IN	mm	IN	mm	IN	mm	IN	mm	IN	mm	IN	mm	IN	mm			
39106	783310391067	2,250	11.1	7/8	22.2	2-5/8	66.7	3-1/2	88.9	7/16	11.1	3/8	9.5	5/16	7.9	31/32	24.6	.4	.16	39112
39107	783310391074	5,000	22.2	1-1/4	31.8	3-1/16	77.8	4-1/8	104.5	17/32	13.5	1/2	12.7	13/32	10.3	1-9/32	32.5	1.0	.45	39112
39108	783310391081	7,000	31.1	1-3/8	34.9	3-9/32	83.3	4-17/32	115.1	5/8	15.9	9/16	14.3	1/2	12.7	1-3/8	34.9	1.0	.45	39114
39109	783310391098	10,000	44.4	1-5/8	41.3	3-15/16	100	5-7/16	138.1	3/4	19.1	5/8	15.9	5/8	15.9	1-23/32	43.7	2.0	.91	39115
39110	783310391104	15,000	66.7	2	50.8	4-11/16	119.1	6-9/16	166.7	15/16	23.8	3/4	19.1	11/16	17.5	2	50.8	4.0	1.81	39116
39111	783310391111	25,000	111.2	2-3/8	60.3	5-11/16	144.5	8-7/16	214.3	1-3/16	30.2	1	25.4	7/8	22.2	2-25/32	70.6	7.0	3.18	39117

*Replacement Pin Kits contain two (2) Replacement Pins

Breakaway Swivels

- Acts as a mechanical fuse, breaking away at a preset load to prevent damage to expensive cable
- Breakaway pins can be replaced to change breakaway values

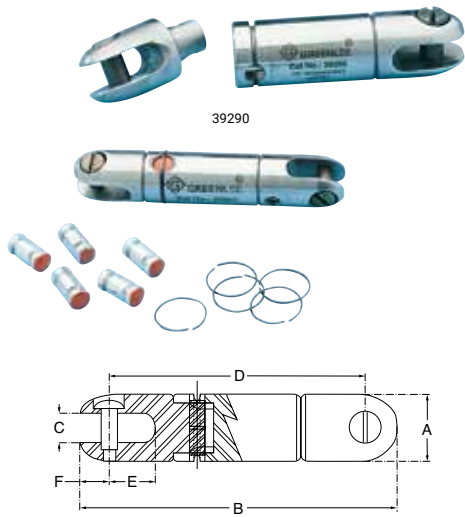

BREAKAWAY PIN KITS

CAT. NO.	UPC NO.	BREAKING POINT	BREAKING POINT	COLOR CODE	USE WITH
39294	783310392941	200 lb	0.9 kN	White	
39295	783310392958	400 lb	1.8 kN	Yellow	39290
39296	783310392965	600 lb	2.7 kN	Orange	5/8" Swivel
39297	783310392972	675 lb	3.0 kN	Black	
39302	783310393023	200 lb	0.9 kN	White	
39303	783310393030	400 lb	1.8 kN	Yellow	39298
39304	783310393047	600 lb	2.7 kN	Orange	7/8" Swivel
39306	783310393061	800 lb	3.6 kN	Grey	
39308	783310393085	1000 lb	4.4 kN	Red	

BREAKAWAY SWIVEL BODY ONLY

CAT. NO.	UPC NO.	A		B		C		D		E		F	
		IN	mm	IN	mm	IN	mm	IN	mm	IN	mm	IN	mm
39290G	783310392903	5/8	15.9	3-7/32	81.8	9/32	7.1	2-23/32	69.1	7/16	11.1	1/4	6.4
39298	783310392989	7/8	22.2	4-7/32	107.2	3/8	9.5	3-11/32	84.9	17/32	13.5	5/16	7.9

For forged eye grips



For forged eye grips



Rope Clevis

- Removable bolt and rope sheave
- Removable grip eye bolt
- Select the clevis with a rating that meets or exceeds the cable puller's maximum pulling force
- Removable sheave for rope eye

For flexible eye grips



CAT. NO.	UPC NO.	DESCRIPTION
578	783310319108	Rope Clevis
579	783310319054	Rope Clevis
678	783310195245	Rope Clevis

MAXIMUM RATED CAPACITY	WEIGHT	LENGTH	WIDTH	INSIDE DIAMETER
578: 6,500 lb (28.9 kN)	0.9 lb (408 g)	3.0" (76 mm)	1.406" (36 mm)	1.25" (32 mm)
579: 10,000 lb (44.4 kN)	1.3 lb (589 g)	3.5" (89 mm)	1.84" (47 mm)	1.5" (38 mm)
678: 6,500 lb (28.9 kN)	1.3 lb (589 g)	3.5" (89 mm)	1.75" (44 mm)	0.94" (24 mm)

GRIPS

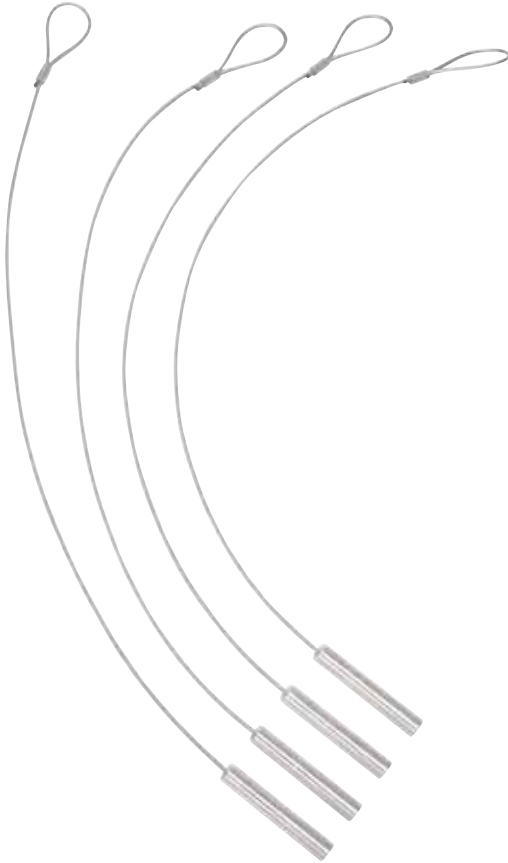

Gator Grips™

- 2 minute set-up
- 6 grips cover the cable size from 1AWG through 1000 MCM
- 5 different harness lengths to prevent overlap during cable pull
- Use Greenlee EK12IDLX or HK12ID to crimp any size without changing dies

CAT. NO.	UPC NO.	DESCRIPTION
GG1-1/0XS	783310054696	Grip Assy, 1-1/0 Extra Short
GG1-1/0S	783310054702	Grip Assy, 1-1/0 Short
GG1-1/0M	783310054719	Grip Assy, 1- 1/0 Medium
GG1-1/0L	783310054726	Grip Assy, 1- 1/0 Long
GG1-1/0XL	783310054733	Grip Assy, 1-1/0 Extra Long
GG2/0-4/0XS	783310054740	Grip Assy, 2/0-4/0 Extra Short
GG2/0-4/0S	783310054771	Grip Assy, 2/0-4/0 Short
GG2/0-4/0M	783310054788	Grip Assy, 2/0-4/0 Medium
GG2/0-4/0L	783310054795	Grip Assy, 2/0-4/0 Long
GG2/0-4/0XL	783310054801	Grip Assy, 2/0-4/0 Extra Long
GG250-350XS	783310055020	Grip Assy, 250-350 Extra Short
GG250-350S	783310055037	Grip Assy, 250-350 Short
GG250-350M	783310055044	Grip Assy, 250-350 Medium
GG250-350L	783310055051	Grip Assy, 250-350 Long
GG250-350XL	783310055068	Grip Assy, 250-350 Extra Long
GG400-500XS	783310055075	Grip Assy, 400-500 Extra Short
GG400-500S	783310055082	Grip Assy, 400-500 Short
GG400-500M	783310055099	Grip Assy, 400-500 Medium
GG400-500L	783310055105	Grip Assy, 400-500 Long
GG400-500XL	783310055112	Grip Assy, 400-500 Extra Long
GG600-750XS	783310055129	Grip Assy, 600-750 Extra Short
GG600-750S	783310055136	Grip Assy, 600-750 Short
GG600-750M	783310055143	Grip Assy, 600-750 Medium
GG600-750L	783310055150	Grip Assy, 600-750 Long
GG600-750XL	783310055167	Grip Assy, 600-750 Extra Long
GG1000XS	783310055174	Grip Assy, 1000 Extra Short
GG1000S	783310055181	Grip Assy, 1000 Short
GG1000M	783310055211	Grip Assy, 1000 Medium
GG1000L	783310055228	Grip Assy, 1000 Long
GG1000XL	783310055235	Grip Assy, 1000 Extra Long

SPECIFICATIONS

Wire Type	1 AWG – 1000 MCM Copper, Aluminum, Compacted and Compact (CU and AL)
-----------	---

GRIP WIRE RANGE	WIRE SIZE	RATED PULLING LOAD FOR REGULAR AND COMPACT STRANDED COPPER CABLE				RATED PULLING LOAD FOR REGULAR AND COMPACT STRANDED ALUMINUM CABLE				MINIMUM CONDUIT SIZE (IN)
		CABLE (LB)	3 CABLES (LB)	4 CABLES (LB)	5 CABLES (LB)	CABLE (LB)	3 CABLES (LB)	4 CABLES (LB)	5 CABLES (LB)	
1 to 1/0	1	1,200	3,600	4,800	6000	500	1500	2000	2500	1-1/4
	1/0	2,000	6,000	8,000	10000	650	1950	2600	3250	1-1/4
2/0 to 4/0	2/0	2,000	6,000	8,000	10000	800	2400	3200	4000	1-1/2
	3/0	2,000	6,000	8,000	10000	900	2700	3600	4500	2
	4/0	2,000	6,000	8,000	10000	1000	3000	4000	5000	2
250-350	250	2,000	6,000	8,000	8000	1600	4800	6400	8000	2
	300	2,000	6,000	8,000	10000	1700	5100	6800	8500	2-1/2
	350	2,500	7,500	10,000	12500	2200	6600	8800	11000	2-1/2
400-500	400	2,500	7,500	10,000	12500	1900	5700	7600	9500	2-1/2
	500	2,500	7,500	10,000	12500	2500	7500	10000	12500	3
600-750	600	2,500	7,500	10,000	9000	1500	4500	6000	7500	3
	750	3,000	9,000	12,000	15000	2300	6900	9200	11500	3-1/2
1000	1,000	3,000	9,000	12,000	15000	3500	10500	14000	17500	3-1/2

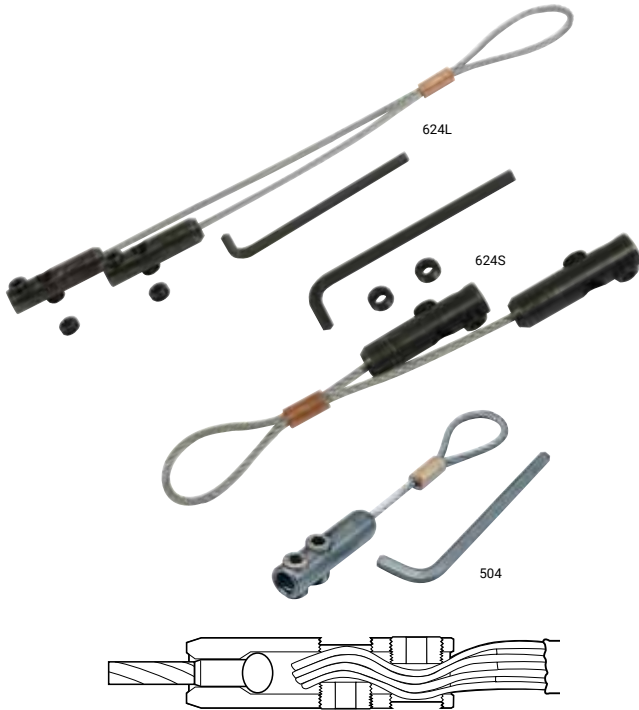

Each grip has two opposed set screws that provide positive locking. Openings in wire grip should be 50% filled with wire to assure slip-proof grip.

Set Screw Clamp Pulling Grips

- Use to pull in 2" (50.8 mm) or larger conduit
- Type of pulls: heavy, long runs (629)
- Type of pull: light and medium (504)
- Type of grip: Flexible eye 1/4" (6.4 mm–629) (6.3 mm–504) diameter galvanized steel aircraft cable connected to 2 cable receptacles with 5/8" (15.9 mm) diameter opening and 2 clamping set screws
- Select pulling grips with a maximum-rated capacity that meets or exceeds the cable puller's maximum pulling force
- Minimum cable diameter is 3/8"

Maximum Rated Capacity	Weight
504: 1750 lb (28.9 kN)	504: 5 lb (2.3 kg)
629: 6,500 lb (28.9 kN)	629: 5 lb (2.3 kg)
624: 6,500 lb (28.9 kN)	624: 3.5 lb (1.5 kg)
624S: 3,250 lb (14.5 kN)	624S: 2 lb (.9 kg)
624L: 3,250 lb (14.5 kN)	624L: 2.1 lb (1 kg)

SPECIFICATIONS

Capacity	1,750 lb (7.7 kN)
Weight	1.2 lb (.5 kg)
Size	Receptacle – 5/8" (15.9 mm)

CAT. NO.	UPC NO.	DESCRIPTION
504	783310236658	Set Screw Clamp-Type Pulling Grip
629	783310318552	Pulling Grip with Clevis includes 624S, 624L and 678 clevis – 4 Clamp
624	783310319085	Pulling Grip includes 624S and 624L – 2 Clamp each
624S	783310318668	Short Pulling Grip – 2 Clamp
R 624L	783310318675	Long Pulling Grip – 2 Clamp
R 51208	783310512080	Grip Allen Wrench
R 52352	783310523529	Grip Set Screw (2 per clamp), 629 and 624 – 8 for each grip 624L and 624S – 4 for each grip.



Cable Preparation Instructions for Set Screw Clamp-Type Pulling Grips

- Strip cable approximately 3" (76 mm) of insulation off the end of the cable to be pulled. **NOTE:** The grip head should not be more than 60% filled nor less than 40% filled to assure that the set screw does not project above the surface of the grip body when the set screws are tightened down
- The central core should be clipped away and the outer strands used in the grip head
- Using the Allen Wrench provided, back out the set screws far enough to accommodate the stripped cables
- Insert the bare wire strands into the grip head as far as they will go
- Tighten both set screws in each grip securely against the conductors
- **CAUTION:** If the set screws extend above the surface of the gripping head, damage to the conduit could result. To prevent this, wrap the head with electrical tape.



PULLING GRIP SELECTION GUIDE

- How to select correct pulling grip:
1. Select the type of grip needed.
 2. Select the size of grip needed (see below).
 3. Select a grip with maximum rated capacity that meets or exceeds the cable puller's maximum pulling force.

1. Select the type of grip needed

GRIP TYPE	DESCRIPTION	TYPE OF EYE	SIZE RANGE DIA. INCHES (mm)	MAX. RATED CAPACITY – LB (KN)	USE TO PULL
Junior Grips	Single weave galvanized steel mesh	Flexible	.19-1.24 (4.8-31.5)	708 (3.5)	In conduit or tray – Building wire by hand.
Light Duty Grips	Single weave galvanized steel mesh	Flexible	.50-3.99 (12.7-101.3)	2940 (13.1)	In conduit or tray – Light-duty applications, short easy runs.
T-Type Grips	Double weave galvanized steel mesh	Flexible	.50-3.99 (12.7-101.3)	6200 (27.6)	In conduit or tray – Medium-duty applications
K-Type Grips	Double weave galvanized steel mesh	Rotating forged	.50-6.99 (12.7-177.5)	9600 (42.7)	In conduit or tray – Heavy-duty applications, long hard runs.
Multiple Strength Grips	Triple to double to single weave galvanized steel mesh	Rotating forged	.25-3.99 (6.4-101.3)	9600 (42.7)	Overhead transmission lines – Bare or insulated conductors, wire rope.
Slack Grips Rod Closing	Double weave galvanized steel mesh– rod closing – offset eye	Flexible	.50-3.99 (12.7-101.3)	2400 (12.7-101.3)	Where end of conductor is not available. Can be pulled straight only, rod will not flex.

2. Select the size of grip needed

After determining the type of grip needed, measure the diameter of the cable being pulled. If pulling more than one cable “of the same diameter,” refer to chart below for required grip diameter range. If pulling more than one cable “of different diameters,” bundle cables together, measure the circumference and refer to the chart on bottom of this page for required grip diameter range. Once the cable diameter or required grip diameter is determined, refer to individual chart for type of grip chosen to locate Catalog/UPC number.

2 CABLES DIA. EACH IN/(mm)	3 CABLES DIA. EACH IN/(mm)	4 CABLES DIA. EACH IN/(mm)	5 CABLES DIA. EACH IN/(mm)	6 & 7 CABLES DIA. EACH IN/(mm)	8 CABLES DIA. EACH IN/(mm)	9 CABLES DIA. EACH IN/(mm)	REQUIRED GRIP DIA. IN/(mm)
.30-.38/(7.6-9.7)	.25-.31/(6.4-7.9)	.22-.27/(5.6-6.9)	.19-.24/(4.8-6.1)	.17-.22/(4.3-5.6)	.15-.19/(3.8-6.1)	.14-.18/(3.6-4.6)	.50-.61/(12.7-15.5)
.38-.44/(9.7-11.2)	.31-.36/(7.9-9.1)	.27-.31/(6.9-7.9)	.24-.29/(6.1-7.4)	.22-.26/(5.6-6.6)	.19-.23/(6.1-5.8)	.18-.21/(4.6-5.3)	.62-.74/(15.7-18.8)
.44-.59/(11.2-15.0)	.36-.49/(9.1-12.4)	.31-.42/(7.9-10.7)	.29-.38/(7.4-9.7)	.26-.34/(6.6-8.6)	.23-.31/(5.8-7.9)	.21-.28/(5.3-7.1)	.75-.99/(19.1-25.1)
.59-.75/(15.0-19.1)	.49-.63/(12.4-16.0)	.42-.54/(10.7-13.7)	.38-.48/(9.7-12.2)	.34-.43/(8.6-10.9)	.31-.39/(7.9-9.9)	.28-.35/(7.1-8.9)	1.00-1.24/(25.4-31.5)
.75-.90/(19.1-22.9)	.63-.76/(16.0-19.3)	.54-.65/(13.7-16.5)	.48-.58/(12.2-14.7)	.43-.52/(10.9-13.2)	.39-.46/(9.9-11.7)	.35-.42/(8.9-10.7)	1.25-1.49/(31.8-37.8)
.90-1.07/(22.9-27.2)	.76-.89/(19.3-22.6)	.65-.77/(16.5-19.6)	.58-.67/(14.7-17.0)	.52-.60/(13.2-15.2)	.46-.54/(11.7-13.7)	.42-.49/(10.7-12.4)	1.50-1.74/(38.1-44.2)
1.07-1.22/(27.2-31.0)	.89-1.02/(22.6-25.9)	.77-.88/(19.6-22.4)	.67-.77/(17.0-19.6)	.60-.69/(15.2-17.5)	.54-.62/(13.7-15.7)	.49-.56/(12.4-14.2)	1.75-1.99/(44.5-50.5)
1.22-1.53/(31.0-39.9)	1.02-1.28/(25.9-32.5)	.88-1.10/(22.4-27.9)	.77-.96/(19.6-24.2)	.69-.86/(17.5-21.8)	.62-.77/(15.7-19.6)	.56-.71/(14.2-18.00)	2.00-2.49/(50.8-63.2)
1.53-1.83 / (38.9-46.5)	1.28-1.53/(32.5-38.9)	1.10-1.32/(27.9-33.5)	.96-1.16/(24.2-29.5)	.86-1.03/(21.8-26.2)	.77-.93/(19.6-23.6)	.71-.85/(18.0-21.6)	2.50-2.99/(63.5-75.9)
1.83-2.14/(46.5-54.4)	1.53-1.79/(38.9-45.5)	1.32-1.54/(33.5-39.1)	1.16-1.35/(29.5-34.3)	1.03-1.20/(26.2-30.5)	.93-1.08/(23.6-27.4)	.85-.99/(21.6-25.1)	3.00-3.49/(76.2-88.6)
2.14-2.44 / (54.4-62.0)	1.79-2.05/(45.5-52.0)	1.54-1.76/(39.1-44.7)	1.35-1.54/(34.3-39.1)	1.20-1.37/(30.5-34.8)	1.08-1.24/(27.4-31.5)	.99-1.13/(25.1-28.7)	3.50-3.99/(88.9-101.3)
2.44-2.75/(62.0-69.9)	2.05-2.30/(52.0-58.4)	1.76-1.98/(44.7-50.3)	1.54-1.74/(39.1-44.2)	1.37-1.55/(34.8-39.4)	1.24-1.39/(31.5-35.3)	1.13-1.27/(28.7-32.3)	4.00-4.49/(101.6-114.0)
2.75-3.06/(69.9-77.7)	2.30-2.56/(58.4-65.0)	1.98-2.20/(50.3-55.9)	1.74-1.93/(44.2-49.0)	1.55-1.72/(39.4-43.7)	1.39-1.55/(35.3-39.4)	1.27-1.41/(32.3-35.8)	4.50-4.99/(114.3-126.7)

* Split grips require the next larger size.

3. Select a grip with maximum rated capacity that meets or exceeds the cable puller's maximum pulling force.

MEASURE THE CIRCUMFERENCE OF THE WIRE BUNDLE

CIRCUMFERENCE RANGE		REQUIRED GRIP DIAMETER	
IN	mm	IN	mm
1.57- 1.95	39.9- 49.5	.50- .61	12.7 - 15.5
1.95- 2.36	49.5- 59.9	.62- .74	15.8 - 18.8
2.36- 3.14	59.9- 79.8	.75- .99	19.1 - 25.1
3.14- 3.93	79.8- 99.8	1.00- 1.24	25.4 - 31.5
3.93- 4.71	99.8- 119.6	1.25- 1.49	31.8 - 37.8
4.71- 5.50	119.6- 139.7	1.50- 1.74	38.1 - 44.2
5.50- 6.28	139.7- 159.5	1.75- 1.99	44.5 - 50.5
6.28- 7.85	159.5- 199.4	2.00- 2.49	50.8 - 63.2
7.85- 9.42	199.4- 239.3	2.50- 2.99	63.5 - 75.9
9.42- 11.00	239.3- 279.4	3.00- 3.49	76.2 - 88.6
11.00- 12.57	279.4- 319.3	3.50- 3.99	88.9 - 101.3
12.57- 14.14	319.3- 359.2	4.00- 4.49	101.6 - 114.0
14.14- 15.71	359.2- 399.0	4.50- 4.99	114.3 - 126.7

NOTE: Properly rated rope is critical to cable pulling. See page 225 for rope selection by rating.



30758

Basket-Type Pulling Grip Sets

- Handy set gives you the size range you need
- Have the correct grip on the job and save time

SPECIFICATIONS

Capacity	30758: (2) #14 to 4-1/0, .25" – 1.24" (6.4 – 31.5 mm) diameter 597: 3-1/0 to 250 MCM, .75" – 1.99" (1.9 – 50.5 mm) diameter 598: 3-350 MCM to 3-750 MCM, 1.50" – 2.99" (38.1 – 75.9 mm) diameter 599: 3-1/0 to 3-750 MCM, .75" – 2.99" (1.9 – 75.9 mm) diameter
Weight	30758: 1.2 lb (.5 kg) 597: 6 lb (2.7 kg); 598: 9.9 lb (4.5 kg) 599: 13 lb (5.9 kg)

CAT. NO.	UPC NO.	DESCRIPTION
30758	783310307587	Building Wire Junior Grip Set: diameter range .25" – 1.24" (6.4 – 31.5 mm). Consists of 30588, 30590, 30592, and 30594, 30584, 30586.
597	783310314820	T-Type Grip Set: diameter range .75" – 1.99" (19 – 50.5 mm). Consists of 30576, 30578, and 31010.
598	783310314837	T-Type Grip Set: diameter range 1.50" – 2.99" (38.1 – 75.9 mm). Consists of 31010, 30580 and 31012.
599	783310314844	T-Type Grip Set: diameter range .75" – 2.99" (19 – 75.9 mm). Consists of 30576, 30578, 31010, 30580 and 31012.

Junior Basket-Type Pulling Grips

- Use to pull in: conduit or tray
- Type of pulls: building wire manually
- Type of grip: single weave galvanized steel mesh with flexible pulling eye
- Select the grip with a maximum rated capacity that meets or exceeds the cable puller's maximum pulling force

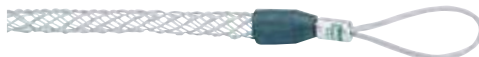

30584

CAT. NO.	UPC NO.	CABLE DIAMETER RANGE		MAXIMUM RATED CAPACITY		EYE LENGTH		MESH LENGTH	
		IN	mm	LB	KN	IN	mm	IN	mm
30596	783310305965	.19 – .24	4.8 – 6.1	80	.3	3-1/4	82.6	4-1/4	108
30584	783310305842	.25 – .36	6.2 – 9.1	90	.4	3-1/4	82.6	4-1/4	108
30586	783310305866	.37 – .49	9.2 – 12.6	180	.8	3-3/4	95.3	7	177.8
30588	783310305880	.50 – .61	12.7 – 15.50	260	1.1	4-1/4	108	8-1/2	215.9
30590	783310305903	.62 – .74	15.6 – 18.9	390	1.7	5	127	10	254
30592	783310305927	.75 – .99	19 – 25.3	560	2.4	5-3/4	146	10	254
30594	783310305941	1.00 – 1.24	25.4 – 31.5	780	3.4	6-1/2	165.1	11-1/2	292.1

Light-Duty Basket-Type Pulling Grips



- Use to pull in: conduit or tray
- Type of pulls: light-duty, short, easy runs
- Type of grip: single weave galvanized steel mesh with flexible pulling eye
- Select the grip with a maximum rated capacity that meets or exceeds the cable puller's maximum pulling force

CAT. NO.	UPC NO.	CABLE DIAMETER RANGE		MAXIMUM RATED CAPACITY		EYE LENGTH		MESH LENGTH	
		IN	mm	LB	KN	IN	mm	IN	mm
30536	783310305361	.50 - .61	12.7 - 15.5	560	2.5	5	127	16	406.4
30538G	783310305385	.62 - .74	15.6 - 18.9	560	2.5	5	127	16	406.4
30540	783310305408	.75 - .99	19.0 - 25.3	800	3.5	6	152.4	20	508
30542	783310305521	1.00 - 1.24	25.4 - 31.5	1360	6	7	177.8	20	508
30544	783310305446	1.25 - 1.49	31.6 - 38	1360	6	7	177.8	21	533.4
30546	783310305460	1.50 - 1.99	38.1 - 50.7	1360	6	8	203.2	23	584.2
30548G	783310305484	2.00 - 2.49	50.8 - 63.4	1700	7.5	9	228.6	25	635
30550	783310305507	2.50 - 2.99	63.5 - 76.1	2120	9.4	9	228.6	27	685.8
30552	783310305521	3.00 - 3.49	76.2 - 88.8	2940	13	10	254	30	762
30554	783310305545	3.50 - 3.99	88.9 - 101.3	2940	13	10	254	32	812.8

NOTE: Properly rated rope is critical to cable pulling. See page 225 for rope selection by rating.

K Basket-Type Pulling Grips



- Use to pull in: conduit or tray
- Type of pulls: heavy-duty, long, hard runs
- Type of grip: double-weave galvanized steel mesh with forged steel swivel eye
- Select the grip with a maximum rated capacity that meets or exceeds the cable puller's maximum pulling force

CAT. NO.	UPC NO.	CABLE DIAMETER RANGE		MAXIMUM RATED CAPACITY		EYE LENGTH		MESH LENGTH		ROTATING EYE DIAMETER	
		IN	mm	LB	KN	IN	mm	IN	mm	IN	mm
STANDARD											
30442	783310304425	.50 - .61	12.7 - 15.5	1120	4.9	5	127	16	406.4	7/8	22.2
30998G	783310309987	.62 - .74	15.6 - 18.9	1360	6	5	127	16	406.4	7/8	22.2
30460	783310304609	.75 - .99	19.0 - 25.3	1920	8.5	6	152.4	32	812.8	1	25.4
31000G	783310310006	1.00 - 1.49	25.4 - 38.0	3280	14.5	7	177.8	33	838.2	1-3/8	34.9
30462	783310304623	1.50 - 1.99	38.1 - 50.7	3280	14.5	7	177.8	34	863.6	1-3/8	34.9
31002	783310310020	2.00 - 2.49	50.8 - 63.3	5440	24.1	9	228.6	36	914.4	1-5/8	41.2
30464	783310304647	2.50 - 2.99	63.5 - 76.1	6600	29.3	10	254	38	965.2	1-7/8	47.6
31004	783310310044	3.00 - 3.49	76.2 - 88.8	8200	36.5	10	254	39	990.6	1-7/8	47.6
30466	783310304661	3.50 - 3.99	88.9 - 101.5	9600	42.7	10	254	41	1041.4	1-7/8	47.6
31006	783310310068	4.00 - 4.49	101.6 - 114.2	9600	42.7	10	254	42	1066.8	1-7/8	47.6
30468G	783310304685	4.50 - 4.99	114.3 - 126	9600	42.7	10	254	58	1473.2	1-7/8	47.6
30470	783310304708	5.00 - 5.99	127 - 152.3	9600	42.7	10	254	60	1524	1-7/8	47.6

NOTE: Properly rated rope is critical to cable pulling. See page 225 for rope selection by rating.

T-Basket-Type Pulling Grips



- Use to pull in: conduit or tray
- Type of pulls: medium-duty
- Type of grip: double weave galvanized steel mesh with flexible pulling eye
- Select the grip with a maximum rated capacity that meets or exceeds the cable puller's maximum pulling force

CAT. NO.	UPC NO.	CABLE DIAMETER RANGE		MAXIMUM RATED CAPACITY		EYE LENGTH		MESH LENGTH	
		IN	mm	LB	KN	IN	mm	IN	mm
SHORT									
30558G	783310305583	.50 - .61	12.7 - 15.5	900	4	8	203.2	21	533.4
30560	783310305606	.62 - .74	15.6 - 18.9	1120	4.9	8	203.2	24	610
30562	783310305620	.75 - .99	19.0 - 25.3	1360	6	9	228.6	24	610
30564	783310305644	1.00 - 1.49	25.4 - 38.0	1920	8.7	9	228.6	24	610
30566	783310305668	1.50 - 1.99	38.1 - 50.7	3280	14.5	11	279.4	24	610
30568	783310305682	2.00 - 2.49	50.8 - 63.3	3700	16.4	12	304.8	24	610
30570	783310305705	2.50 - 2.99	63.5 - 76.1	4900	21.7	12	304.8	24	610
30572	783310305729	3.00 - 3.49	76.2 - 88.8	4900	21.7	14	355.6	24	610
30574	783310305743	3.50 - 3.99	88.9 - 101.3	6200	27.5	14	355.6	26	660.4
STANDARD									
30576	783310305767	.75 - .99	19.0 - 25.3	1360	6	9	228.6	36	914.4
30578	783310305781	1.00 - 1.49	25.4 - 38.0	1920	8.7	9	228.6	36	914.4
31010G	783310310105	1.50 - 1.99	38.1 - 50.7	3280	14.5	11	279.4	36	914.4
30580	783310305804	2.00 - 2.49	50.8 - 63.3	3700	16.4	12	304.8	36	914.4
31012	783310310129	2.50 - 2.99	63.5 - 76.1	4900	21.7	12	304.8	36	914.4
30582	783310305828	3.00 - 3.49	76.2 - 88.8	4900	21.7	14	355.6	36	914.4
31014	783310310143	3.50 - 3.99	88.9 - 101.3	6200	27.5	14	355.6	40	1016

Multiple Strength Basket-Type Pulling Grips with Rotating Forged Eye



- Use to pull overhead transmission lines, bare or insulated conductors and wire rope
- Type of pulls: heavy-duty, long distance
- Triple, to double, to single weave galvanized steel mesh with forged steel swivel eye
- Color coded for easy size identification
- Select the grip with a maximum rated capacity that meets or exceeds the cable puller's maximum pulling force

CAT. NO.	UPC NO.	CABLE DIAMETER RANGE		MAXIMUM RATED CAPACITY		COLOR CODE	EYE LENGTH		MESH LENGTH		ROTATING EYE DIAMETER	
		IN	mm	LB	KN		IN	mm	IN	mm	IN	mm
30474	783310304746	.25 – .49	12.7 – 15.5	1360	6	Dark Green	5	127	26	660.4	7/8	22.3
30476	783310304760	.50 – .74	15.6 – 18.9	2000	8.8	Brown	6	152.4	32	812.8	1	25.4
30478	783310304784	.75 – .99	19.0 – 25.3	2880	12.8	Light Blue	6	152.4	41	1041.4	1	25.4
30480	783310304807	1.00 – 1.24	25.4 – 31.5	4920	21.8	Gold	8	203.2	52	1320.8	1-3/8	34.9
30482	783310304821	1.25 – 1.49	31.6 – 38.0	6120	27.2	Black	8	203.2	56	1422.4	1-5/8	41.2
30484	783310304845	1.50 – 1.74	38.1 – 44.3	6120	27.2	Red	9	228.6	60	1524.0	1-7/8	47.6
30486	783310304869	1.75 – 2.24	44.4 – 56.9	9600	42.7	Dark Blue	10	254	70	1778.0	1-7/8	47.6
30502	783310305026	2.00 – 2.49	50.8 – 63.4	9600	42.7	Yellow	10	254	50	1270	1-7/8	47.6
30504	783310305040	2.50 – 2.99	63.5 – 76.1	9600	42.7	Orange	10	254	52	1320.8	1-7/8	47.6
30506	783310305064	3.00 – 3.49	76.2 – 88.8	9600	42.7	Aluminum	10	254	54	1371.6	1-7/8	47.6
30508	783310305088	3.50 – 3.99	88.9 – 101.3	9600	42.7	Light Green	10	254	56	1422.4	1-7/8	47.6

Split Mesh Rod Closing Basket-Type Slack Pulling Grips

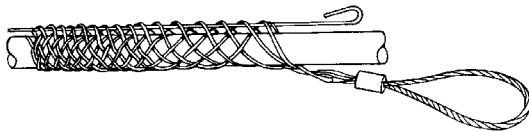

- Use to pull in: conduit or tray
- Type of pulls: medium-duty
- Type of grip: double weave galvanized steel mesh with flexible pulling eye
- Select the grip with a maximum rated capacity that meets or exceeds the cable puller's maximum pulling force

CAT. NO.	UPC NO.	CABLE DIAMETER RANGE		MAXIMUM RATED CAPACITY		EYE LENGTH		MESH LENGTH	
		IN	mm	LB	KN	IN	mm	IN	mm
30658	783310306580	.50 – .61	12.7 – 15.50	300	1.3	7	177.8	6	152.4
31024	783310310242	.62 – .74	15.6 – 18.9	360	1.6	7	177.8	8	203.2
30660	783310306603	.75 – .99	19 – 25.3	440	1.9	7	177.8	10	254
31026	783310310266	1.00 – 1.24	25.4 – 31.5	680	3	8	203.2	12	304.8
30662	783310306627	1.25 – 1.49	31.6 – 38.0	900	4	8	203.2	14	355.6
31028	783310310280	1.50 – 1.74	38.1 – 44.3	1160	5.1	9	228.6	15	381
30664	783310306641	1.75 – 1.99	44.4 – 50.7	1520	6.7	10	254	16	406.4
31030G	783310310303	2.00 – 2.49	50.8 – 63.4	1800	8	10	254	19	482.6
30666	783310306665	2.50 – 2.99	63.5 – 76.1	2200	9.7	10	254	20	508
31032	783310310327	3.00 – 3.49	76.2 – 88.8	2400	10.6	12	304.8	21	533.4
30668	783310306689	3.50 – 3.99	88.9 – 101.3	2400	10.6	12	304.8	24	610

NOTE: Properly rated rope is critical to cable pulling. See page 225 for rope selection by rating.

CABLE PULLING LUBRICANTS

CABLE PULLING LUBRICANT SELECTION GUIDE



Clear Lube™



Cable-Cream™



Cable-Gel™



Winter-Gel™

APPLICATION	Electrical or datacom use. Clear and colorless for easy cleanup.	Electrical use. Heavy-duty lubricant adheres well to cable without messy dripping.	Electrical or datacom use. Cleans up quickly, non-staining. Can be applied by hand or pump.	Electrical or datacom use. Cleans up quickly, non-staining. Can be applied by hand or pump.
Application Temperature Range (°F)	20°F - 190°F	20°F - 190°F	20°F - 190°F	20°F - 190°F
Application Temperature Range (°C)	-6°C - 88°C	-6°C - 88°C	-6°C - 88°C	-6°C - 88°C
Minimum Storage Temperature	30° F/-1 C	30° F/-1 C	30° F/-1 C	30° F/-1 C
Base	Polymer	Wax	Polymer	Polymer
Average Coefficient of Friction*	0.26	0.11	0.18	0.21
Color	Clear	Yellow	Blue/Green	Blue

COMPATIBILITY (CABLE TYPE)

Rubber	X	X	X	X
Neoprene	X	X	X	X
Nylon	X	X	X	X
PVC	X	X	X	X
High-density or cross linked polyethylene	X	X	X	X
Low-density polyethylene	X	X	X	X
Semiconducting jacket	X	X	X	X
Hypalon	X	X	X	X

*(IEEE 375-2 test procedure) kinetic coefficient of friction tested at 300 lb/ft sidewall bearing pressure

Cable Lubricant Quantity Chart

The following equation is a general guideline to determine the amount of cable lubricant to use for an average cable pull.

$$Q = 0.0015 \times L \times D$$

Where:

Q = Quantity of cable lubricant to use in gallons

L = Length of cable pull in feet

D = Diameter of conduit or duct in inches

If the following situations apply, consider using additional lubricant:

- The cable jacket is hard and/or cable is very stiff
- The conduit is rough or dirty
- There are many bends to pull through
- The percentage of conduit filled by the cable is unusually high
- The conduit is water filled

SPECIFICATIONS

Pull Length	1"	2"	3"	4"
200'	0.3 gal	0.6 gal	0.9 gal	1.2 gal
300'	0.5 gal	0.9 gal	1.4 gal	1.8 gal
400'	0.6 gal	1.2 gal	1.8 gal	2.4 gal
600'	0.9 gal	1.8 gal	2.7 gal	3.6 gal
800'	1.2 gal	2.4 gal	3.6 gal	4.8 gal
1000'	1.5 gal	3.0 gal	4.5 gal	6.0 gal



Cable-Cream™ Cable Pulling Lubricant

- Advanced formula, light yellow cream makes pulling faster and easier
- Compatible with all cable insulation types
- Dries slowly to a thin, non-conductive, non-hardening residue
- Adheres well to the cable without messy dripping; Reduces waste
- Cleans up easily and is non-staining
- Won't break down or separate after exposure to freezing cold or blistering heat
- Environmentally friendly and non-corrosive
- Ideal for hot weather environment

SPECIFICATIONS

Weight	CRM-Q: 2.3 lb (1 kg) CRM-5: 42 lb (19.1 kg) CRM-1: 9.5 lb (4.3 kg)
Viscosity	30,000 – 45,000 CPS
PH Range	7.0 – 8.0
Average COF	0.11

CAT. NO.	UPC NO.	DESCRIPTION
CRM-Q	783310352075	Cable-Cream One Quart Squeeze Bottle (.95 l)
CRM-1	783310352082	Cable-Cream One Gallon (3.79 l)
CRM-5	783310352099	Cable-Cream 5 Gallons (18.93 l)



Cable-Gel™ Cable Pulling Lubricant

- Polymer-based, no silicon lubricant offers lower friction and easier pulling
- Compatible with all cable insulation types
- Cleans up quickly. Non-staining
- Higher lubricity than competitive products
- Will not cement itself to the pipe
- Dries slowly
- Can be applied by hand or pump
- Will not break down or separate after exposure to heat or cold
- Environmentally friendly and non-corrosive
- Ideal for indoor environment

SPECIFICATIONS

Weight	GEL-Q: 2.3 lb (1 kg) GEL-1: 8.5 lb (3.9 kg) GEL-5: 45 lb (20.4 kg) GEL-55: 498 lb (225.9 kg)
Viscosity	8,000 – 12,000 CPS
PH Range	7.0 – 8.0
Average COF	0.18

CAT. NO.	UPC NO.	DESCRIPTION
GEL-Q	783310352112	Cable-Gel One Quart Squeeze Bottle (.95 l)
GEL-1	783310352129	Cable-Gel One Gallon (3.79 l)
GEL-5	783310352136	Cable-Gel 5 Gallons (18.93 l)



Winter-Gel™ Cable Pulling Lubricant

- Winter-Gel will not freeze until -25° F (-31° C)
- Reduces friction for easy pulling
- Compatible with all cable insulation types
- Cleans up quickly and easily
- High lubricity
- Can be used all year long
- Environmentally friendly and non-corrosive
- Ideal for cold weather environment

SPECIFICATIONS

Weight	WGEL-Q: 2.3 lb (1 kg) WGEL-1: 9 lb (4.1 kg) WGEL-5: 44 lb (20 kg)
Viscosity	10,000 – 14,000 CPS
PH Range	7.0 – 8.0
Average COF	0.21

CAT. NO.	UPC NO.	DESCRIPTION
WGEL-Q	783310352150	Winter-Gel Pulling Lube One Quart Squeeze Bottle (.95 l)
WGEL-1	783310352167	Winter-Gel Pulling Lube One Gallon (3.79 l)
WGEL-5	783310352174	Winter-Gel Pulling Lube 5 Gallons (18.93 l)



Clear Lube™

- Designed for use within electrical or datacom cable pulls
- Clear and colorless for quick, easy clean-up
- Environmentally friendly and non-corrosive
- Easy to apply either by hand, brush or pump
- Polymer base with no silicon additives
- Three-year shelf life with no deterioration in lubricant

SPECIFICATIONS

Weight	CLR-Q: 2.3 lb (1.0 kg) CLR-1: 7.6 lb (3.5 kg) CLR-5: 44.8 lb (20.4 kg)
Viscosity	10,000 – 20,000 CPS
PH Range	6.0 – 8.0
Average COF	0.26

CAT. NO.	UPC NO.	DESCRIPTION
CLR-Q	783310104377	Clear Lube Pulling Lubricant, One Quart (.95 l)
CLR-1	783310104384	Clear Lube Pulling Lubricant, One Gallon (3.79 l)
CLR-5	783310104391	Clear Lube Pulling Lubricant, 5 Gallons (18.93 l)

SWABS, BRUSHES, MANDRELS



Lube Spreader Swab

- Spreads a coat of wire lubricant in duct before installation of cable
- Cleans mud, dirt, and light debris from duct before pulling
- Tapered shape permits bi-directional use
- Will not damage inner walls of duct

CAT. NO.	UPC NO.	DUCT SIZE		MAXIMUM DISK SIZE		MAXIMUM RATED CAPACITY		WEIGHT	
		IN	mm	IN	mm	LB	KN	LB	KG
16854	783310168546	2	50.8	1.75	44.5	4800	21.3	.5	.23
16856	783310168560	2.5	63.5	2.25	57.2	4800	21.3	.6	.27
16857	783310168577	3	76.2	2.75	69.9	4800	21.3	1.5	.68
16858	783310168584	3.5	88.9	3.25	82.6	4800	21.3	2.0	.91
16859	783310168591	4	102	3.75	95.3	4800	21.3	2.5	1.13
17370	783310173700	5	127	4.75	120.7	4800	21.3	3.5	1.59
17571	783310175711	6	152	5.75	146.1	4800	21.3	4.0	1.81



Wire Duct Brush

- Flat steel bristles for maximum cleaning of sand, grit and light obstructions from duct
- Pulling eye on one end and smaller twisted eye on the other end for tailing line allows bi-directional use
- Can be pulled to loosen dried material before using mandrels or spreader swabs

CAT. NO.	UPC NO.	DUCT SIZE		MAXIMUM DIAMETER		MAXIMUM RATED CAPACITY		WEIGHT	
		IN	mm	IN	mm	LB	KN	LB	KG
39274	783310392743	2	50.8	1.87	47.5	200	.89	.83	.38
39276	783310392767	2.5	63.5	2.38	60.5	200	.89	.83	.38
39278	783310392781	3	76.2	2.87	72.9	200	.89	.83	.38
39280	783310392804	3.5	88.9	3.38	85.9	200	.89	.90	.41
39282	783310392828	4	102	3.87	98.3	200	.89	.95	.43
39284	783310392842	5	127	4.87	123.7	200	.89	1.15	.52
39286	783310392866	6	152	5.87	149.1	200	.89	1.28	.58

Flexible Mandrel

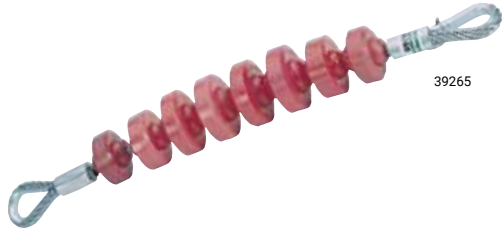

- Useful for cleaning out mud, dirt, and light obstacles from ducts before installation of cable
- Can be used around tight bends due to convex contacts between disks
- Tapered profile allows pulling in either direction and pulling eyes on both ends
- Polyurethane disks do not damage inner walls of duct

CAT. NO.	UPC NO.	DUCT SIZE		MAXIMUM DISK SIZE		MAXIMUM RATED CAPACITY		WEIGHT	
		IN	mm	IN	mm	LB	KN	LB	KG
39265	783310392651	2	50.8	1.88	47.7	2330	10.3	1	.45
39263	783310392637	2.5	63.5	2.19	55.6	2330	10.3	1	.45
39261	783310392613	3	76.2	2.81	71.4	2330	10.3	1.5	.68
39259	783310392590	3.5	88.9	3.25	82.5	4800	21.3	3.5	1.59
39257	783310392576	4	102	3.75	95.3	4800	21.3	4.5	2.04
39255	783310392552	5	127	4.69	119.1	4800	21.3	6	2.72

App Store is a registered trademark of Apple Inc.
 Bluetooth is a registered trademark of Bluetooth SIG, Inc.
 Google Play is a registered trademark of Google Inc.
 Kevlar is a registered trademark of E.I. DuPont de Nemours and Company
 Makita is a registered trademark of MAKITA CORPORATION.