

# Products list



---

# LEGEND

---

## PRODUCT FINISH

- GA** (GA) Hot-dip galvanised.  
Coating thickness according to EN ISO 1461:2010.
- ZN** (ZN) Electrolytic cold-dip galvanised.  
Zinc-coated.
- SM** (SM) Continuous hot-dip galvanised.  
Sendzimir.
- PT** (PT) Paint suitable for use on exteriors.
- WD** (WD) Wood.

## ABOUT THE PRODUCT



On request.

**LOT**

Sale by lots.

*The images and the list of weights shown are for guidance only and are subject to changes in design or used materials.*





---

## INDEX

---

THE COMPANY		2
SCAFFOLDING		4
Modular Scaffolding MEKA 48		4
European Scaffolding DINO 48		10
Façade Scaffolding DUO 45		14
Ladder Frame Scaffolding		18
European Scaffolding FREE 48		20
Steel Rolling Towers		21
Sys-Fast		21
Multipurpose		22
Free 42		22
Aluminium Rolling Towers		23
Alu 50		23
Alu Free		25
Scaffolding Accessories		26
SHORING TOWER D-SYSTEM		28
STAGES, RAMPS AND GRANDSTANDS MF48		30
SAFETY EQUIPMENT		34
Temporary Edge Protection Systems		34
Barriers and Walkways		35
Guardrails, Consoles and Safety Net System		36
LIFTING		38
Buckets		38
Crane Forks		39
Grippers		39
Pallets		40
Mortar Skips		40
Carts		41
Chains and Slings		41
Façade Platforms		41
CONSTRUCTION EQUIPMENT		42
Trestles and Ladders		42
Wall Bars and Squares		43
Cement Carts and Wheel Barrows		44
Plaster Buckets, Debris Chutes and Others		45
FORMWORK		46
Retaining walls		46
Roof		47
PROPS		48



## DACAME

DACAME is a company specialized in the design and manufacturing of scaffolding, safety and construction equipment systems. The company's headquarters are based in Tarragona and cover an area of 70,000m<sup>2</sup>. Our Business System is developed to provide you with an integral solution for your projects, offering the best product and service. This is why if you work with us, you will receive:

- Design and manufacturing adapted to your needs.
- Delivery wherever and whenever you want.
- 5 scaffolding models and compatibility between our certified Modular and Frame Scaffolding Systems\*.
- Excellent price-quality ratio.
- Customized training.

*\* Consult the Technical Department before adapting the two certified Scaffolding Systems.*



## THE COMPANY

DACAME is dedicated to the design, manufacture and marketing of scaffolding, safety and construction equipment systems.

DACAME was born in early 90s as a family company and operated in the local and national market. The company was formed of a young and dynamic team who enjoyed their work and had a perfect knowledge of the product and a great future vision (both in the national and international markets) who established our Corporate Culture.

Nowadays our headquarters covers an area of more than 70,000m<sup>2</sup>, where the various factory departments are situated: the central offices, the technical departments and the manufacturing and logistics areas. Our location between the international ports of Barcelona and Valencia, and the fact that we have our own truck fleet, means excellent logistic optimization and efficiency, enabling us to offer a door-to-door service to all our clients, both European and international.





**SERVICE: as the basis of our Culture.**

Our Corporate Culture is based on constant investment in Research and Development, Manufacturing, and, ultimately, on all the Organizational Areas. It is also based on the continuous training of our team, who work constantly to offer you the best business plan that will provide you with integral solutions for all your projects.

Nowadays we work with over 50 countries, and our philosophy is based on offering the best solutions wherever and whenever you need them. An efficient and flexible structure allows us to adapt to all projects.

In addition, we have a big fleet truck, and can therefore offer a door-to-door service to our clients all over Europe.

For transcontinental services, our location between the international ports of Barcelona and Valencia means excellent logistic optimization and efficiency.



**QUALITY: as the basis of our Products.**

DACAME is synonymous with quality and safety, which means constant investment in Research and Development to ensure that all our products are manufactured according to European Standards and are adapted to new market demands.

In order to adapt to the market's demands, our R&D department invests in new products and offers you a very competitive service. Our quality system is based on the control and exhaustive analysis of all our manufacturing processes. In 2004, we received the Quality Certificate ISO-9001-00, followed by AENOR N certifications for our Modular MEKA 48 and DINO 48 European Frame Scaffolding, our Façade Scaffolding DUO 45 and our Temporary Edge Protection System B35. Following the same Quality Policy, our range of Construction Equipment is guaranteed for CE Marking (where applicable).

*All our certified products are regularly verified by their respective inspection bodies, in accordance with current regulations.*



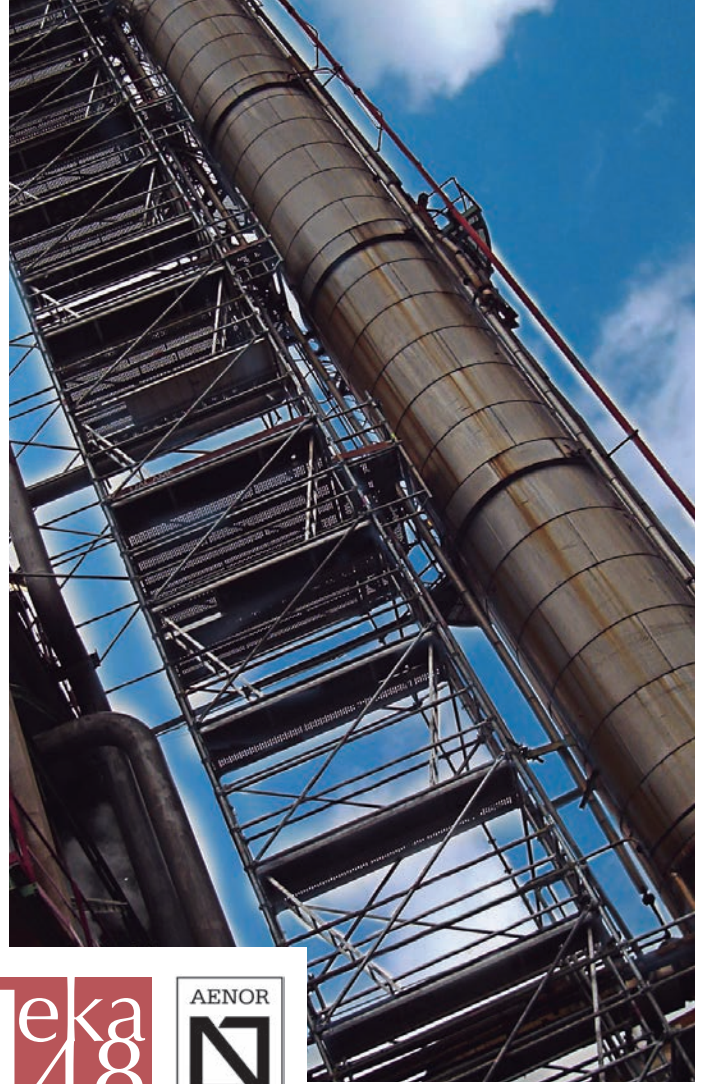

**M**eka  
48  
DACAME

AENOR



Producto  
Certificado  
Andamios



**STARTING ELEMENTS**
**WEIGHT LOT**

	025010108 SCREW JACK BASE Ø 36 ( 500 ) (ZN)	2,80	50
	025020078 SCREW JACK BASE Ø 36 ( 750 ) (ZN)	3,60	50
	025020108 SCREW JACK BASE Ø 36 (1000) (ZN)	4,00	50
	025020118 SCREW JACK BASE Ø 36 (1000) 2 levers (ZN)	3,86	
	219902060 SWIVEL JACK BASE Ø 36 (600) (ZN)	3,00	
	219903130 REINFORCED SIDE BRACKET 1.3 m (GA)	17,00	
	219904050 SCREW JACK 0.5 m CLAMP Ø 48 (ZN)	3,20	
	219900010 BASE COLLAR MEKA 48 (GA)	1,50	

**VERTICAL STANDARDS**
**WEIGHT LOT**

	210100050 VERTICAL STANDARD MEKA 48 500 (GA)	3,00	
	210100100 VERTICAL STANDARD MEKA 48 1000 (GA)	5,20	38
	210100150 VERTICAL STANDARD MEKA 48 1500 (GA)	7,70	38
	210100200 VERTICAL STANDARD MEKA 48 2000 (GA)	9,60	38
	210100300 VERTICAL STANDARD MEKA 48 3000 (GA)	14,20	38
	070300001 SNAP PIN 1u (ZN)	0,08	15/25

**LEDGERS**
**WEIGHT LOT**

	210200042 LEDGER MEKA 48 400 (GA)	1,90	40
	210200072 LEDGER MEKA 48 700 (GA)	2,60	40
	210200102 LEDGER MEKA 48 1000 (GA)	3,30	40
	210200132 LEDGER MEKA 48 1300 (GA)	4,00	40
	210200152 LEDGER MEKA 48 1500 (GA)	4,50	40
	210200202 LEDGER MEKA 48 2000 (GA)	5,70	40
	210200232 LEDGER MEKA 48 2300 (GA)	6,50	40
	210200252 LEDGER MEKA 48 2500 (GA)	7,00	40
	210200302 LEDGER MEKA 48 3000 (GA)	8,20	40

## GUARDRAILS

WEIGHT LOT

	211710200 ASSEMBLY GUARDRAIL MEKA 48 2000 (GA)	12,10	34
	211710250 ASSEMBLY GUARDRAIL MEKA 48 2500 (GA)	13,50	34
	211710300 ASSEMBLY GUARDRAIL MEKA 48 3000 (GA)	14,80	34
	211720130 GUARDRAIL MEKA 48 1300 (GA)	6,00	34
	211720200 GUARDRAIL MEKA 48 2000 (GA)	7,90	34
	211720250 GUARDRAIL MEKA 48 2500 (GA)	9,10	34
	211720300 GUARDRAIL MEKA 48 3000 (GA)	10,60	34
	211730070 SIDE GUARDRAIL MEKA 48 700 (GA)	3,10	
	211730100 SIDE GUARDRAIL MEKA 48 1000 (GA)	3,80	

## DIAGONAL BRACES

WEIGHT LOT

	210315072 DIAGONAL MEKA 48 1500x700 (GA)	5,60	
	210315102 DIAGONAL MEKA 48 1500x1000 (GA)	6,00	
	210320102 DIAGONAL MEKA 48 2000x1000 (GA)	7,10	
	210320132 DIAGONAL MEKA 48 2000x1300 (GA)	7,40	
	210320152 DIAGONAL MEKA 48 2000x1500 (GA)	7,70	
	210320202 DIAGONAL MEKA 48 2000x2000 (GA)	8,50	
	210320252 DIAGONAL MEKA 48 2000x2500 (GA)	9,40	
	210320302 DIAGONAL MEKA 48 2000x3000 (GA)	10,40	

## RUNNERS

WEIGHT LOT

	025029069 RUNNER 700 (GA)	3,40	
	025029079 RUNNER 1000 (GA)	4,80	

## SPIGOT WITH CLAMP

WEIGHT LOT

	219900020 SPIGOT WITH CLAMP MEKA 48 (GA)	1,50	
--	--	------	--

## TRUSS LEDGERS

WEIGHT LOT

	211000100 TRUSS LEDGER MEKA 48 1000 (GA)	7,50	
	211000130 TRUSS LEDGER MEKA 48 1300 (GA)	9,00	
	211000150 TRUSS LEDGER MEKA 48 1500 (GA)	11,50	
	211000200 TRUSS LEDGER MEKA 48 2000 (GA)	15,70	
	211000250 TRUSS LEDGER MEKA 48 2500 (GA)	20,50	
	211000300 TRUSS LEDGER MEKA 48 3000 (GA)	24,50	

## TRUSS LEDGERS WITHOUT END FITTING

WEIGHT LOT

	211010250 TRUSS LEDGER WITHOUT END FITTING 2500 (GA)	14,40	
	211010300 TRUSS LEDGER WITHOUT END FITTING 3000 (GA)	17,40	
	211010350 TRUSS LEDGER WITHOUT END FITTING 3500 (GA)	20,30	
	211010400 TRUSS LEDGER WITHOUT END FITTING 4000 (GA)	23,20	
	211010500 TRUSS LEDGER WITHOUT END FITTING 5000 (GA)	29,00	
	211010600 TRUSS LEDGER WITHOUT END FITTING 6000 (GA)	34,90	



## DOUBLE TRUSS LEDGERS

WEIGHT LOT

	211100200 DOUBLE TRUSS LEDGER MEKA 48 2000 (GA)	29,00	
	211100300 DOUBLE TRUSS LEDGER MEKA 48 3000 (GA)	43,00	
	211100400 DOUBLE TRUSS LEDGER MEKA 48 4000 (GA)	53,00	
	211100500 DOUBLE TRUSS LEDGER MEKA 48 5000 (GA)	69,00	
	211100600 DOUBLE TRUSS LEDGER MEKA 48 6000 (GA)	77,00	

## ALUMINIUM DOUBLE TRUSS LEDGERS

WEIGHT LOT

	241110200 ALUMINIUM DOUBLE TRUSS LEDGER 2000 (AL)	Aluminium Ø 48x4 mm	8,00	
	241110300 ALUMINIUM DOUBLE TRUSS LEDGER 3000 (AL)	Aluminium 48x4 mm	12,00	
	241111080 TRUSS CENTRAL FITTING (GA)		8,10	
	219905320 TRUSS END FITTING MEKA 48 (GA)		4,80	

## FIXED STEEL PLANKS

WEIGHT LOT

	210500070 FIXED PLANK M48/D48 700 C6 H7 (GA)	H: 7 cm	4,70	
	210500100 FIXED PLANK M48/D48 1000 C6 H7 (GA)		6,10	
	210500150 FIXED PLANK M48/D48 1500 C6 H7 (GA)		8,50	28
	210530200 FIXED PLANK M48/D48 2000 C6 H7 (GA)	H: 7 cm	11,00	28/56
	210530250 FIXED PLANK M48/D48 2500 C4 H7 (GA)		13,00	28/56
	210530300 FIXED PLANK M48/D48 3000 C4 H7 (GA)		16,00	28/56
	210500250 FIXED PLANK M48/D48 2500 C6 H8 (GA)	H: 8 cm	18,50	28/56
	210500300 FIXED PLANK M48/D48 3000 C5 H8 (GA)		21,50	28/56

## ACCESS PLANKS

WEIGHT LOT

	210600150 ACCESS PLANK WITH TRAPDOOR M48/D48 1500 C-4	16,00	10
	210600200 ACCESS PLANK WITH TRAPDOOR M48/D48 2000 C-4	18,00	10
	210600250 ACCESS PLANK WITH TRAPDOOR M48/D48 2500 C-4	22,00	10
	210600300 ACCESS PLANK WITH TRAPDOOR M48/D48 3000 C-4	26,00	10
	240920000 ACCESS LADDER (AL)	3,40	
	212390010 LADDER SUPPORT (GA)	4,50	
	240400200 ACCESS PLANK W/TRAPDOOR M48 2 m (AL) W/LADDER	20,00	
	240400300 ACCESS PLANK W/TRAPDOOR M48 3 m (AL) W/LADDER	28,50	

**TOEBOARDS**
**WEIGHT LOT**

	210800070 TOEBOARD M48/D48 700 (WD)	2,10	20
	210800100 TOEBOARD M48/D48 1000 (WD)	2,70	20
	210800130 TOEBOARD M48/D48 1300 (WD)	3,10	20
	210800150 TOEBOARD M48/D48 1500 (WD)	3,50	20
	210800200 TOEBOARD M48/D48 2000 (WD)	4,50	20
	210800230 TOEBOARD M48/D48 2300 (WD)	5,00	20
	210800250 TOEBOARD M48/D48 2500 (WD)	5,70	20
	210800300 TOEBOARD M48/D48 3000 (WD)	6,70	20
	210801070 TOEBOARD MEKA 48 700 (SM)	2,20	20
	210801100 TOEBOARD MEKA 48 1000 (SM)	3,00	20
	210801200 TOEBOARD MEKA 48 2000 (SM)	5,90	20
	210801300 TOEBOARD MEKA 48 3000 (SM)	8,80	20

**PLANK EXTENSION BARS**
**WEIGHT LOT**

	211220080 PLANK EXTENSION 2000x80 MEKA 48 (GA)	6,00	
	211225080 PLANK EXTENSION 2500x80 MEKA 48 (GA)	7,40	
	211230080 PLANK EXTENSION 3000x80 MEKA 48 (GA)	8,80	

**BRACKETS**
**WEIGHT LOT**

	210700030 BRACKET MEKA 48 300 (GA)	4,30	
	210700070 BRACKET MEKA 48 700 (GA)	6,60	
	210700100 BRACKET MEKA 48 1000 (GA)	9,40	

**STABILIZERS**
**WEIGHT LOT**

	211300030 STABILIZER MEKA 48 400 (GA)	4,30	
	211300070 STABILIZER MEKA 48 700 (GA)	6,60	
	211300100 STABILIZER MEKA 48 1000 (GA)	9,40	
	251200500 TELESCOPIC STABILIZER 6000 (GA)	23,00	

**TIE BARS**
**WEIGHT LOT**

	025029089 TIE BAR 500 (GA)	1,50	
	025029099 TIE BAR 1000 (GA)	2,40	
	025029109 TIE BAR 1500 (GA)	3,40	

**JOINING PIPES**
**WEIGHT LOT**

	211600050 JOINING PIPE 500 (GA)	1,80	
	211600100 JOINING PIPE 1000 (GA)	3,50	
	211600150 JOINING PIPE 1500 (GA)	5,30	
	211600200 JOINING PIPE 2000 (GA)	7,00	
	211600250 JOINING PIPE 2500 (GA)	8,80	
	211600300 JOINING PIPE 3000 (GA)	10,50	
	211600400 JOINING PIPE 4000 (GA)	14,00	
	211600500 JOINING PIPE 5000 (GA)	17,50	
211600600 JOINING PIPE 6000 (GA)	21,00		

## PROTECTION AND SECURITY

WEIGHT LOT

	210900000 GUARDRAIL POST MEKA 48 (ZN) (2u)	8,00	
	210900010 PROVISIONAL TELESCOPIC GUARDRAIL M48 (ZN) (2u.)	8,00	
	210900108 PROTECTION FAN 1350 (GA)	10,00	12
	219900040 ROSETTE PROTECTOR (PP)	0,29	

## ACCESS STAIRS

WEIGHT LOT

<p>B: 60 cm</p>	240920200 ACCESS STAIR H:2x2 m x 60 cm (AL)	20,00	
	240920300 ACCESS STAIR H:2x3 m x 60 cm (AL)	24,50	
	212420300 ACCESS STAIR H:2x2 m x 60 cm (GA)	46,00	
<p>B: 90 cm</p>	240920308 ACCESS STAIR H:2x3 m x 90 cm (AL)	32,10	
	211420200 OUTER GUARDRAIL 2x2 MEKA 48 (2u) (GA)	11,00	
	211420300 OUTER GUARDRAIL 3x2 MEKA 48 (2u) (GA)	13,60	
	211520200 INNER/OUTER HANDRAIL 2x2 M48/D48 (GA)	6,00	
	211520300 INNER/OUTER HANDRAIL 3x2 M48/D48 (GA)	7,50	

## SPECIAL PRODUCTS

WEIGHT LOT

<p>150 210</p>	219900031 DOUBLE LOCK MEKA 48 150 (GA)	1,40	
	219900030 DOUBLE LOCK MEKA 48 210 (GA)	1,60	
<p>S.J.</p>	219906050 VERTICAL CONNECTOR M48 (500) (GA)	2,60	
	219906000 VERTICAL CONNECTOR M48 SCREW JACK (GA)	2,00	
	219907350 BASE PLATE ANCHOR HEAD M48 2R-350 (GA)	17,00	

**STARTING ELEMENTS**
**WEIGHT LOT**

	025010108 SCREW JACK BASE Ø 36 ( 500 ) (ZN)	2,80	50
	025020078 SCREW JACK BASE Ø 36 ( 750 ) (ZN)	3,60	50
	025020108 SCREW JACK BASE Ø 36 (1000) (ZN)	4,00	50
	025020118 SCREW JACK BASE Ø 36 (1000) 2 levers (ZN)	3,86	
	219902060 SWIVEL JACK BASE Ø 36 (600) (ZN)	3,00	
	219903130 REINFORCED SIDE BRACKET 1.3 m (GA)	17,00	
	219904050 SCREW JACK 0.5 m CLAMP Ø 48 (ZN)	3,20	

**SCAFFOLD FRAMES**
**WEIGHT LOT**

	020620073 SCAFFOLD FRAME DINO 48 2000x 700 (PT)	19,00	18
	020620079 SCAFFOLD FRAME DINO 48 2000x 700 (GA)	19,00	18
	020620103 SCAFFOLD FRAME DINO 48 2000x1000 (PT)	20,00	18
	020620109 SCAFFOLD FRAME DINO 48 2000x1000 (GA)	20,00	18
	070300001 SNAP PIN 1u (ZN)	0,08	15/25

**WALKTHRU FRAMES**
**WEIGHT LOT**

	020621153 WALKTHRU FRAME DINO 48 2300x1400 (PT)	32,50	
	020621159 WALKTHRU FRAME DINO 48 2300x1400 (GA)	32,50	
	025029123 WALKTHRU FRAME WITH COUPLER SPIGOT D48 (PT)	2,00	
	025029120 WALKTHRU FRAME WITH COUPLER SPIGOT D48 (GA)	2,00	

## GUARDRAIL ACCESSORIES

WEIGHT LOT

	020611703 SUPPLEMENT INNER D48 SIDE 700 (PT)	10,40
	020611709 SUPPLEMENT INNER D48 SIDE 700 (GA)	10,40
	020611003 SUPPLEMENT INNER D48 SIDE 1000 (PT)	11,80
	020611009 SUPPLEMENT INNER D48 SIDE 1000 (GA)	11,80
	020611723 SUPPLEMENT INNER D48 CENTRAL (PT)	3,60
	020611729 SUPPLEMENT INNER D48 CENTRAL (GA)	3,60

## HANDRAILS AND DIAGONAL BRACES

WEIGHT LOT

	021620209 HANDRAIL DINO 48 2000 T4 (SM)	3,00
	021620259 HANDRAIL DINO 48 2500 T4 (SM)	3,60
	021620309 HANDRAIL DINO 48 3000 T4 (SM)	4,40
	022630209 DIAGONAL DINO 48 2000 T4-F (SM) <b>T4-F</b>	3,51
	022630259 DIAGONAL DINO 48 2500 T4-F (SM)	4,12
	022630309 DIAGONAL DINO 48 3000 T4-F (SM)	4,76
	022620209 DIAGONAL DINO 48 2000 T4 (SM) <b>T4</b>	4,11
	022620259 DIAGONAL DINO 48 2500 T4 (SM)	4,64
	022620309 DIAGONAL DINO 48 3000 T4 (SM)	5,22

## INITIATION SUPPORTS

WEIGHT LOT

	025029033 INITIATION SUPPORT FOR PLANK D48 700 (PT)	2,60
	025029039 INITIATION SUPPORT FOR PLANK D48 700 (GA)	2,60
	025029053 INITIATION SUPPORT FOR PLANK D48 1000 (PT)	3,70
	025029059 INITIATION SUPPORT FOR PLANK D48 1000 (GA)	3,70
	025029043 INITIATION SUPPORT FOR DIAGONAL D48 (PT)	0,26
	025029049 INITIATION SUPPORT FOR DIAGONAL D48 (GA)	0,26

## DOUBLE TRUSS LEDGERS

WEIGHT LOT

	025040209 DOUBLE TRUSS LEDGER DINO 48 2000 (GA)	29,00
	025040309 DOUBLE TRUSS LEDGER DINO 48 3000 (GA)	42,00
	025040409 DOUBLE TRUSS LEDGER DINO 48 4000 (GA)	53,00
	025040509 DOUBLE TRUSS LEDGER DINO 48 5000 (GA)	69,00
	025040609 DOUBLE TRUSS LEDGER DINO 48 6000 (GA)	77,00

## ALUMINIUM DOUBLE TRUSS LEDGERS

WEIGHT LOT

	241110200 ALUMINIUM DOUBLE TRUSS LEDGER 2000 (AL) <b>Aluminium Ø 48x4 mm</b>	8,00
	241110300 ALUMINIUM DOUBLE TRUSS LEDGER 3000 (AL) <b>Aluminium 48x4 mm</b>	12,00
	241111080 TRUSS CENTRAL FITTING (GA)	8,10
	251305320 TRUSS END FITTING DUO 45 (GA)	4,80

**GUARDRAILS**
**WEIGHT LOT**

	025012063	TOP GUARDRAIL DINO 48 2000 (PT)	6,00	
	025012069	TOP GUARDRAIL DINO 48 2000 (GA)	6,00	
	025012563	TOP GUARDRAIL DINO 48 2500 (PT)	8,00	
	025012569	TOP GUARDRAIL DINO 48 2500 (GA)	8,00	
	025013063	TOP GUARDRAIL DINO 48 3000 (PT)	9,10	
	025013069	TOP GUARDRAIL DINO 48 3000 (GA)	9,10	
	025010763	SIDE GUARDRAIL DINO 48 700 (PT)	4,20	
	025010769	SIDE GUARDRAIL DINO 48 700 (GA)	4,20	
	025011063	SIDE GUARDRAIL DINO 48 1000 (PT)	5,10	
	025011069	SIDE GUARDRAIL DINO 48 1000 (GA)	5,10	

**RUNNERS**
**WEIGHT LOT**

	025029063	RUNNER 700 (PT)	3,40	
	025029069	RUNNER 700 (GA)	3,40	
	025029073	RUNNER 1000 (PT)	4,80	
	025029079	RUNNER 1000 (GA)	4,80	

**SPIGOT WITH COUPLER FOR FRAMES**
**WEIGHT LOT**

	025029133	SPIGOT WITH COUPLER FOR DINO 48 FRAME (PT)	0,70	
	025029130	SPIGOT WITH COUPLER FOR DINO 48 FRAME (GA)	0,70	

**FIXED STEEL PLANKS**
**WEIGHT LOT**

	210530202	FIXED PLANK M48/D48 2000 C6 H7 (PT)	<i>H: 7 cm</i>	11,00	28/56
	210530252	FIXED PLANK M48/D48 2500 C4 H7 (PT)		13,00	28/56
	210530302	FIXED PLANK M48/D48 3000 C4 H7 (PT)		16,00	28/56
	210530200	FIXED PLANK M48/D48 2000 C6 H7 (GA)	<i>H: 7 cm</i>	11,00	28/56
	210530250	FIXED PLANK M48/D48 2500 C4 H7 (GA)		13,00	28/56
	210530300	FIXED PLANK M48/D48 3000 C4 H7 (GA)		16,00	28/56

**ACCESS PLANKS**
**WEIGHT LOT**

	210600200	ACCESS PLANK WITH TRAPDOOR M48/D48 2000 C-4		18,00	10
	210600250	ACCESS PLANK WITH TRAPDOOR M48/D48 2500 C-4		22,00	10
	210600300	ACCESS PLANK WITH TRAPDOOR M48/D48 3000 C-4		26,00	10
	240920000	ACCESS LADDER (AL)		3,40	
	212390010	LADDER SUPPORT (GA)		4,50	

**TOEBOARDS**
**WEIGHT LOT**

	210800070	TOEBOARD M48/D48 700 (WD)		2,10	20
	210800100	TOEBOARD M48/D48 1000 (WD)		2,70	20
	210800200	TOEBOARD M48/D48 2000 (WD)		4,50	20
	210800250	TOEBOARD M48/D48 2500 (WD)		5,70	20
	210800300	TOEBOARD M48/D48 3000 (WD)		6,70	20
	025030769	TOEBOARD DINO 48 700 (SM)		2,10	
	025031069	TOEBOARD DINO 48 1000 (SM)		2,70	
	251000200	TOEBOARD D45/D49 2000 (SM)		5,90	
	251000250	TOEBOARD D45/D49 2500 (SM)		7,30	
	251000300	TOEBOARD D45/D49 3000 (SM)		8,80	

## TIE BARS

WEIGHT LOT

	025029083 TIE BAR 500 (PT)	1,50	
	025029089 TIE BAR 500 (GA)	1,50	
	025029093 TIE BAR 1000 (PT)	2,40	
	025029099 TIE BAR 1000 (GA)	2,40	
	025029103 TIE BAR 1500 (PT)	3,40	
	025029109 TIE BAR 1500 (GA)	3,40	

## BRACKETS

WEIGHT LOT

	025029013 BRACKET DINO 48 300 (PT)	4,30	
	025029019 BRACKET DINO 48 300 (GA)	4,30	
	025029023 BRACKET DINO 48 700 (PT)	6,60	
	025029029 BRACKET DINO 48 700 (GA)	6,60	
	025029113 BRACKET DINO 48 1000 (PT)	9,40	
	025029119 BRACKET DINO 48 1000 (GA)	9,40	

## STABILIZERS

WEIGHT LOT

	025060700 STABILIZER DINO 48 700 (GA)	7,30	
	025061000 STABILIZER DINO 48 1000 (GA)	10,10	
	251200500 TELESCOPIC STABILIZER 6000 (GA)	23,00	

## PROTECTION AND SECURITY

WEIGHT LOT

	025070000 GUARDRAIL POST DINO 48 (ZN) (2u)	10,00	
	025070010 PROVISIONAL TELESCOPIC GUARDRAIL D48 (ZN) (2u.)	8,00	
	210900108 PROTECTION FAN 1350 (GA)	10,00	12

## ACCESS STAIRS

WEIGHT LOTE

	240920200 ACCESS STAIR H:2x2 m x 60 cm (AL)	Aluminium	20,00
	240920300 ACCESS STAIR H:2x3 m x 60 cm (AL)	Aluminium	24,50
	212420300 ACCESS STAIR H:2x2 m x 60 cm (GA)	STEEL	46,00
	240920308 ACCESS STAIR H:2x3 m x 90 cm (AL)	Aluminium	32,10
	025052020 OUTER GUARDRAIL 2x2 DINO 48 (2u) (GA)		11,00
	025053020 OUTER GUARDRAIL 3x2 DINO 48 (2u) (GA)		13,60
	211520200 INNER/OUTER HANDRAIL 2x2 M48/D48 (GA)		6,00
	211520300 INNER/OUTER HANDRAIL 3x2 M48/D48 (GA)		7,50

## STARTING ELEMENTS

WEIGHT LOT

	025010108 SCREW JACK BASE Ø 36 ( 500) (ZN)	2,80	50
	025020078 SCREW JACK BASE Ø 36 ( 750) (ZN)	3,60	50
	025020108 SCREW JACK BASE Ø 36 (1000) (ZN)	4,00	50
	219902060 SWIVEL JACK BASE Ø 36 (600) (ZN)	3,00	
	219903130 REINFORCED SIDE BRACKET 1.3 m (GA)	17,00	
	219904050 SCREW JACK 0.5 m CLAMP Ø 48 (ZN)	3,20	

## SCAFFOLD FRAMES

WEIGHT LOT

	250120080 SCAFFOLD FRAME DUO 45 HAB 2000x 800 (GA)	13,50	24
	250120085 SCAFFOLD FRAME DUO 45 HBB 2000x 800 (GA)	12,50	24
	250020080 SCAFFOLD FRAME DUO 45 HLA 2000x 800 (GA)	10,00	
	250020180 SCAFFOLD FRAME DUO 45 HLB 2000x 800 (GA)	10,00	
	250110080 SCAFFOLD FRAME DUO 45 UB 1100x 800 (GA)	9,20	
	250112080 SCAFFOLD FRAME DUO 45 HB 1000x 800 (GA)	8,00	



## WALKTHRU FRAMES

WEIGHT LOT

	250020150 WALKTHRU FRAME DUO 45 2000x1300 (GA)	17,40	
	250020900 WALKTHRU FRAME WITH COUPLER SPIGOT D45 (GA)	1,40	

## STARTING KITS

WEIGHT LOT

	250020910 START KIT DUO 45 PM (GA)	18,00	
	250120087 START KIT DUO 45 GM 2 m (GA)	25,00	

## ASSEMBLY GUARDRAILS

WEIGHT LOT

<p>For HAB</p>	250300200 ASSEMBLY GUARDRAIL DUO 45 2000 (A) (GA)	11,00	34
	250300250 ASSEMBLY GUARDRAIL DUO 45 2500 (A) (GA)	13,00	34
	250300300 ASSEMBLY GUARDRAIL DUO 45 3000 (A) (GA)	15,00	34
<p>For HBB</p>	250303200 ASSEMBLY GUARDRAIL DUO 45 2000 (B) (GA)	11,00	34
	250303250 ASSEMBLY GUARDRAIL DUO 45 2500 (B) (GA)	13,00	34
	250303300 ASSEMBLY GUARDRAIL DUO 45 3000 (B) (GA)	15,00	34

## STANDARD GUARDRAILS

WEIGHT LOT

	250301200 STANDARD GUARDRAIL DUO 45 2000 (GA)	8,80	34
	250301250 STANDARD GUARDRAIL DUO 45 2500 (GA)	10,60	34
	250301300 STANDARD GUARDRAIL DUO 45 3000 (GA)	12,40	34

## SIDE GUARDRAILS

WEIGHT LOT

	250200080 SIDE GUARDRAIL DUO 45 AB (GA)	For HAB	3,00
	250200090 SIDE GUARDRAIL DUO 45 AB-BB (GA)	For HAB For HBB	3,00
	250300080 SIDE GUARDRAIL WITH TOEBOARD DUO 45 BB (GA)	For HBB	6,31

**HANDRAILS**

WEIGHT LOT

	250400070 FRONT HANDRAIL DUO 45 800 (SM)	1,30
	250400080 SIDE HANDRAIL DUO 45 800 (SM)	1,40
	250400200 HANDRAIL DUO 45 2000 (SM)	3,00
	250400250 HANDRAIL DUO 45 2500 (SM)	3,60
	250400300 HANDRAIL DUO 45 3000 (SM)	4,20

**EXTENSIBLE HANDRAIL**

WEIGHT LOT

	250419310 EXTENSIBLE HANDRAIL DUO 45 (1900-3100) (GA)	6,90
--	---	------

**DIAGONALS**

WEIGHT LOT

	250500200 DIAGONAL DUO 45 2000 (SM)	4,80
	250500250 DIAGONAL DUO 45 2500 (SM)	5,50
	250500300 DIAGONAL DUO 45 3000 (SM)	5,90

**ALUMINIUM DOUBLE TRUSS LEDGERS**

WEIGHT LOT

	241110200 ALUMINIUM DOUBLE TRUSS LEDGER 2000 (AL)	Aluminium Ø 48x4 mm	8,00
	241110300 ALUMINIUM DOUBLE TRUSS LEDGER 3000 (AL)	Aluminium Ø 48x4 mm	12,00
	241111080 TRUSS CENTRAL FITTING (GA)		8,10
	251305320 TRUSS END FITTING DUO 45 (GA)		4,80

**RUNNERS**

WEIGHT LOT

	250601080 RUNNER DUO 45 800 RD. (ZN)	○	3,06
	250600080 RUNNER DUO 45 800 SQ. (ZN)	□	3,60

**BRACKETS**

WEIGHT LOT

	250900040 BRACKET DUO 45 400 (GA)	4,30
	250900080 BRACKET DUO 45 800 (GA)	6,80

**VERTICAL PIPE**

WEIGHT LOT

	251110100 VERTICAL PIPE DUO 45 1000 MB (GA)	3,30
--	---	------

**FIXED STEEL PLANKS (WIDTH 30 cm)**
**WEIGHT LOT**

	250701200 FIXED PLANK DUO 45 2000 x 300 (SM) <i>H: 7 cm</i>	11,00	28/56
	250701250 FIXED PLANK DUO 45 2500 x 300 (SM)	13,00	28/56
	250701300 FIXED PLANK DUO 45 3000 x 300 (SM)	16,00	28/56

**FIXED STEEL PLANKS (WIDTH 36,5 cm)**
**WEIGHT LOT**

	250700080 FIXED PLANK DUO 45 800x365 (SM) <i>H: 6 cm</i>	6,60	18/45
	250700200 FIXED PLANK DUO 45 2000x365 (SM)	15,20	18/45
	250700250 FIXED PLANK DUO 45 2500x365 (SM)	18,70	18/45
	250700300 FIXED PLANK DUO 45 3000x365 (SM)	21,70	18/45

**FIXED WOOD PLANKS (WIDTH 75 cm)**
**WEIGHT LOT**

	250705200 FIXED PLANK DUO 45 2000x750 FR (WD/AL)	22,50	10
	250705250 FIXED PLANK DUO 45 2500x750 FR (WD/AL)	25,50	10
	250705300 FIXED PLANK DUO 45 3000x750 FR (WD/AL)	29,00	10

**ACCESS PLANKS (WIDTH 75 cm)**
**WEIGHT LOT**

	250802200 ACCESS PLANK WITH TRAPDOOR DUO 45 2000x750 C-4	22,50	10
	250802250 ACCESS PLANK WITH TRAPDOOR DUO 45 2500x750 C-4	25,50	10
	250802300 ACCESS PLANK WITH TRAPDOOR DUO 45 3000x750 C-4	29,00	10
	240920010 PLANK LADDER FR (AL)	3,40	
	212390010 LADDER SUPPORT (GA)	4,50	

**TOEBOARDS**
**WEIGHT LOT**

	251000080 TOEBOARD DUO 45 800 (SM)	1,80	
	251000200 TOEBOARD D45/D49 2000 (SM)	5,90	
	251000250 TOEBOARD D45/D49 2500 (SM)	7,30	
	251000300 TOEBOARD D45/D49 3000 (SM)	8,80	

**TELESCOPIC STABILIZER**
**WEIGHT LOT**

	251200500 TELESCOPIC STABILIZER 6000 (GA)	23,00	
--	---	-------	--

**TIE BARS**
**WEIGHT LOT**

	251200050 TIE BAR DUO 45 500 (GA)	1,50	
	025029099 TIE BAR 1000 (GA)	2,40	
	025029109 TIE BAR 1500 (GA)	3,40	

## SCAFFOLD FRAMES AMM

**WEIGHT**    **LOT**

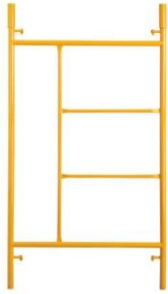
	020110081	SCAFFOLD FRAME (AMM) H:1000 x 800		8,00	
	020110101	SCAFFOLD FRAME (AMM) H:1000 x 1000		8,20	12
	020110151	SCAFFOLD FRAME (AMM) H:1000 x 1500		11,00	
	020115101	SCAFFOLD FRAME (AMM) H:1500 x 1000		11,00	
	020115151	SCAFFOLD FRAME (AMM) H:1500 x 1500		13,50	
	020120081	SCAFFOLD FRAME (AMM) H:2000 x 800		11,50	36
	020120101	SCAFFOLD FRAME (AMM) H:2000 x 1000		13,70	26
	020120151	SCAFFOLD FRAME (AMM) H:2000 x 1500		17,00	26

## SCAFFOLD FRAMES AZZ

**WEIGHT**    **LOT**

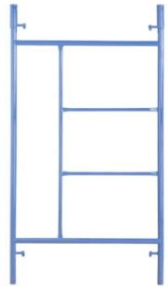
	020210082	SCAFFOLD FRAME (AZZ) H:1000 x 800		8,00	
	020210102	SCAFFOLD FRAME (AZZ) H:1000 x 1000		8,20	12
	020210152	SCAFFOLD FRAME (AZZ) H:1000 x 1500		11,00	
	020215102	SCAFFOLD FRAME (AZZ) H:1500 x 1000		11,00	
	020215152	SCAFFOLD FRAME (AZZ) H:1500 x 1500		13,50	
	020220082	SCAFFOLD FRAME (AZZ) H:2000 x 800		11,50	36
	020220102	SCAFFOLD FRAME (AZZ) H:2000 x 1000		13,70	26
	020220152	SCAFFOLD FRAME (AZZ) H:2000 x 1500		17,00	26

## SCAFFOLD FRAMES RJY

**WEIGHT**    **LOT**

	020310084	SCAFFOLD FRAME (RJY) H:1000 x 800		8,00	
	020310104	SCAFFOLD FRAME (RJY) H:1000 x 1000		8,20	12
	020310154	SCAFFOLD FRAME (RJY) H:1000 x 1500		11,00	
	020315104	SCAFFOLD FRAME (RJY) H:1500 x 1000		11,00	
	020315154	SCAFFOLD FRAME (RJY) H:1500 x 1500		13,50	
	020320084	SCAFFOLD FRAME (RJY) H:2000 x 800		11,50	36
	020420104	SCAFFOLD FRAME (RJY) H:2000 x 1000		14,10	26
	020320154	SCAFFOLD FRAME (RJY) H:2000 x 1500		17,00	26

## WALKTHRU FRAMES

**WEIGHT**    **LOT**

	020121101	WALKTHRU FRAME (AMM) H:2000x1000		16,00	
	020221102	WALKTHRU FRAME (AZZ) H:2000x1000		16,00	
	020321104	WALKTHRU FRAME (RJY) H:2000x1000		16,00	

## HANDRAILS

**WEIGHT**    **LOT**

	AMM	021110202	HANDRAIL (AMM - AZZ) 2000	2,00	32
	AZZ	021110302	HANDRAIL (AMM - AZZ) 3000	3,00	32
		021310204	HANDRAIL (RJY) 2000 (RJY)	2,00	32
	RJY	021410304	HANDRAIL (RJY) 3000	3,00	32

## CROSS BRACES

**WEIGHT**    **LOT**

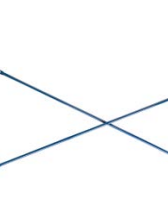
	AMM	022310212	CROSS BRACE (AMM - AZZ) H:1000x2000	4,20	32
	AZZ	022310312	CROSS BRACE (AMM - AZZ) H:1000x3000	6,20	32
		022310222	CROSS BRACE (AMM - AZZ) H:1500x2000	4,20	32
		022310322	CROSS BRACE (AMM - AZZ) H:1500x3000	6,20	32
		022110202	CROSS BRACE (AMM - AZZ) H:2000x2000	4,20	32
		022110302	CROSS BRACE (AMM - AZZ) H:2000x3000	6,20	32

## CROSS BRACES RJY

PT
WEIGHT LOT

	022310214 CROSS BRACE (RJY) H:1000x2000	4,20	32
	022310314 CROSS BRACE (RJY) H:1000x3000	6,20	32
	022310204 CROSS BRACE (RJY) H:2000x2000 (RJJ)	4,20	32
	022410304 CROSS BRACE (RJY) H:2000x3000	6,20	32

## EXTENSIBLE GUARDRAILS

WEIGHT LOT

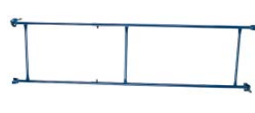
	025012205 EXTENSIBLE GUARDRAIL (CONV) 2000 (PT)	8,50	
	025013302 EXTENSIBLE GUARDRAIL (CONV) 3000 (PT)	10,50	

## EXTENSIBLE PLANKS

WEIGHT LOT

	025020202 EXTENSIBLE PLANK (CONV) 2000 (PT)	<i>H: 7 cm</i>	12,00	28/56
	025020302 EXTENSIBLE PLANK (CONV) 3000 (PT)		17,00	28/56



## FIXED PLANKS

WEIGHT LOT

	025023200 FIXED PLANK (RJY-RJP) 2000 (PT)	<i>H: 7 cm</i>	11,50	28/56
	025023300 FIXED PLANK (RJY-RJP) 3000 (PT)		16,50	28/56

## ACCESS PLANKS

WEIGHT LOT

	025022201 ACCESS PLANK WITH TRAPDOOR (RJY-RJP) 2000	18,50	
	025022301 ACCESS PLANK WITH TRAPDOOR (RJY-RJP) 3000	26,00	10
	240920000 PLANK LADDER (AL)	3,40	

## TOEBOARDS

WEIGHT LOT

	025030201 TOEBOARD (AMM - AZZ) 2000 (PT)	11,00	
	025030301 TOEBOARD (AMM - AZZ) 3000 (PT)	14,00	
	025030204 TOEBOARD (RJY) 2000 (PT)	11,00	
	025030304 TOEBOARD (RJY) 3000 (PT)	14,00	

## TIE BARS

WEIGHT LOT

	025029100 TIE BAR (CONV) 1000 (Ø42) (PT)	2,10	
---	--	------	--

## BRACKETS







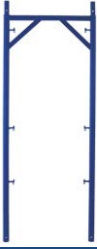
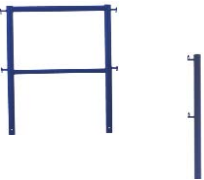

WEIGHT LOT

	022640041 BRACKET (CONV) 400 (PT)	2,90	
	022640071 BRACKET (CONV) 700 (PT)	4,00	

## ACCESS STAIR



WEIGHT LOT

	025000075 ACCESS STAIR (CONV) H:2000x3000 (PT)	49,00	
---	--	-------	--

<b>SCAFFOLD FRAMES</b>		WEIGHT	LOT
	260020070 SCAFFOLD FRAME FREE 48 2000x 650 (PT)	12,00	
<b>GUARDRAIL ACCESSORIES</b>		WEIGHT	LOT
	260050703 SUPPLEMENT INNER FREE 48 SIDE 650 (PT)	7,20	
	260050003 SUPPLEMENT INNER FREE 48 CENTRAL (PT)	2,50	
<b>HANDRAILS AND DIAGONALS</b>		WEIGHT	LOT
	260012000 HANDRAIL FREE 48 2000 (SM)	2,80	
	260012500 HANDRAIL FREE 48 2500 (SM)	3,40	
	260013000 HANDRAIL FREE 48 3000 (SM)	4,10	
	260032000 DIAGONAL FREE 48 2000 TF (SM)	3,30	
	260032500 DIAGONAL FREE 48 2500 TF (SM)	3,90	
	260033000 DIAGONAL FREE 48 3000 TF (SM)	4,40	
<b>GUARDRAILS</b>		WEIGHT	LOT
	025012063 TOP GUARDRAIL DINO/FREE 48 2000 (PT)	6,00	
	025012563 TOP GUARDRAIL DINO/FREE 48 2500 (PT)	8,00	
	025013063 TOP GUARDRAIL DINO/FREE 48 3000 (PT)	9,10	
	260040703 SIDE GUARDRAIL FREE 48 650 (PT)	3,40	
<b>FIXED STEEL PLANKS</b>		WEIGHT	LOT
	210530202 FIXED PLANK M48/D48 2000 C6 H7 (PT) <i>H: 7 cm</i>	11,00	28/56
	210530252 FIXED PLANK M48/D48 2500 C4 H7 (PT)	13,00	28/56
	210530302 FIXED PLANK M48/D48 3000 C4 H7 (PT)	16,00	28/56
<b>ACCESS PLANKS</b>		WEIGHT	LOT
	270900200 ACCESS PLANK WITH TRAPDOOR DCM 2000 C-4 FR	21,50	10
	270900250 ACCESS PLANK WITH TRAPDOOR DCM 2500 C-4 FR	24,50	10
	270900300 ACCESS PLANK WITH TRAPDOOR DCM 3000 C-4 FR	28,00	10
	240920000 PLANK LADDER (AL)	3,40	
	212390010 LADDER SUPPORT (GA)	4,50	
<b>TOEBOARDS</b>		WEIGHT	LOT
	260070650 TOEBOARD FREE 48 650 (WD)	2,00	20
	210800200 TOEBOARD M48/D48 2000 (WD)	4,50	20
	210800250 TOEBOARD M48/D48 2500 (WD)	5,70	20
	210800300 TOEBOARD M48/D48 3000 (WD)	6,70	20
	260070658 TOEBOARD FREE 48 650 (SM)	1,70	
	251000200 TOEBOARD D45/D49 2000 (SM)	5,90	
	251000250 TOEBOARD D45/D49 2500 (SM)	7,30	
	251000300 TOEBOARD D45/D49 3000 (SM)	8,80	



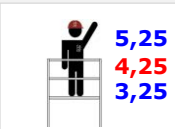

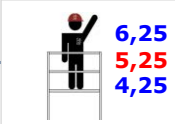



## ROLLING TOWERS SYS-FAST (Working area: 1.35 x 2 m)

WEIGHT LOT

	212104000 ROLLING TOWER SYS-FAST 4 - FREE	 <p>5,25 4,25 3,25</p>	222,00
	212104010 ROLLING TOWER SYS-FAST 4 - ECO		250,00
 <p>ECO</p> <p>PLUS</p>	212105010 ROLLING TOWER SYS-FAST 5 - ECO	 <p>6,25 5,25 4,25</p>	280,00
	212105020 ROLLING TOWER SYS-FAST 5 - PLUS		324,00

### SYS-FAST TOWERS COMPONENTS

4-ECO 5-ECO 5-PLUS

	212213100 SCAFFOLD FRAME MEKA 48 1300X1000 S-F (GA)		2	2
	212213200 SCAFFOLD FRAME MEKA 48 1300X2000 S-F (GA)	4	4	4
	211720200 STANDARD GUARDRAIL MEKA 48 2000 (GA)	2	2	4
	210320202 DIAGONAL MEKA 48 2000x 2000 (GA)	2	2	2
	210200202 LEDGER MEKA 48 2000 (GA)	2	2	2
	210530200 FIXED PLANK M48/D48 2000 C6 H7 (GA)	2	2	4
	210600200 ACCESS PLANK WITH TRAPDOOR M48/D48 2000	1	1	2
	070300001 SNAP PIN 1u (ZN)	4	8	8
	219901008 SCREW JACK HOLDER (ZN)	4	4	4
	210800130 TOEBOARD M48/D48 1300 (WD)	2	2	2
	210800200 TOEBOARD M48/D48 2000 (WD)	2	2	2
	050213505 LADDER WITH HOOKS AND RAILINGS B 3000 (PT)	1		
	050214005 LADDER WITH HOOKS AND RAILINGS B 4000 (PT)		1	
	240920000 ACCESS LADDER (AL)			2
	212390010 LADDER SUPPORT (GA)	1	1	1
	025000200 WHEEL WITH SCREW JACK HE 250 Kg (ZN)	4	4	4



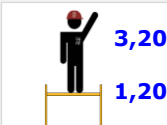

### FOLDABLE MINI-SCAFFOLD (Base 1.05 x 0.4 m)

WEIGHT LOT

	9901B0000 FOLDABLE MINI-SCAFFOLD 1200 (PT)	 <p>3,20 1,20</p>	28,00
---	--	--	-------

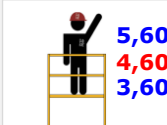
## MULTIPURPOSE TOWER (Working area: 1.8 x 0.7 m)

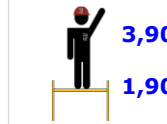
WEIGHT LOT





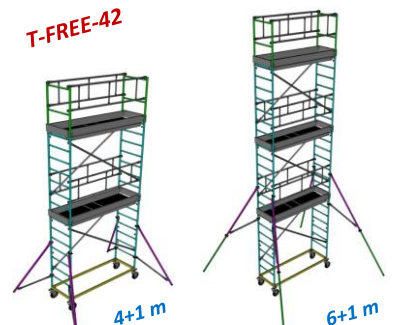
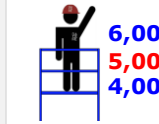
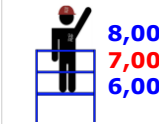

 <p>with trapdoor</p>	<p>9901A0900 MULTIPURPOSE TOWER WORK AT 2 LEV. (PT)</p>		<p>192,00</p>
 <p>with trapdoor</p>	<p>9901A0100 MULTIPURPOSE TOWER (PT)</p>		<p>58,00</p>
	<p>9901A1001 GUARDRAILS SET (PT) (2 u)</p>		<p>30,00</p>
	<p>9901A6001 STABILIZER MULTIPURPOSE TOWER (PT) (4 u)</p>		<p>16,00</p>
	<p>9901A5001 MULTIPURPOSE TOWER CASTER (ZN)</p>		<p>1,50 4</p>

## ROLLING TOWERS FREE 42 (Working area: 2 x 0.65 m)

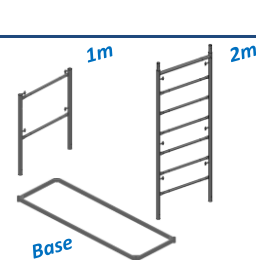
WEIGHT LOT

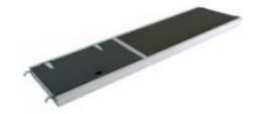
 <p>T-FREE-42</p> <p>4+1 m 6+1 m</p>	<p>ROLLING TOWER FREE 42 H: 4+1 m 520004000</p>		<p>216,00</p>
	<p>ROLLING TOWER FREE 42 H: 6+1 m 520006000</p>		<p>306,00</p>



### FREE 42 TOWERS COMPONENTS

		4+1	6+1
 <p>1m 2m</p> <p>Base</p>	<p>520265200 TOWER FRAME T-FREE-42 2000x650 (GA)</p>	<p>4</p>	<p>6</p>
	<p>520265100 TOWER FRAME T-FREE-42 1000x650 (GA)</p>	<p>2</p>	<p>2</p>
	<p>520165100 FREE TOWER BASE 650x2000 (GA)</p>	<p>1</p>	<p>1</p>
	<p>260032000 DIAGONAL FREE 48 2000 TF (SM)</p>	<p>4</p>	<p>6</p>
	<p>025012069 TOP GUARDRAIL DINO 48 2000 (GA)</p>	<p>4</p>	<p>6</p>
	<p>210600200 ACCESS PLANK WITH TRAPDOOR M48/D48 2000 C-4</p>	<p>2</p>	<p>3</p>
	<p>520800650 TOEBOARD T-FREE-42 650 (SM)</p>	<p>4</p>	<p>6</p>
	<p>520802000 TOEBOARD T-FREE-42 2000 (SM)</p>	<p>4</p>	<p>6</p>
	<p>520910200 TOWER FIXED STABILIZER T-FREE-42 (GA)</p>	<p>4</p>	
	<p>520920340 TOWER ADJUSTABLE STABILIZER T-FREE-42 (GA)</p>		<p>4</p>
	<p>025000200 WHEEL WITH SCREW JACK HE 250 Kg (ZN)</p>	<p>4</p>	<p>4</p>



## FRAMES

WEIGHT SERIE

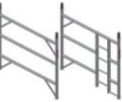
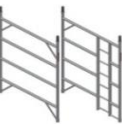
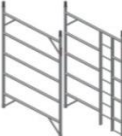
	510075139 FRAME ALU 50 1392x0750	5,50	075
	511075139 LADDER FRAME ALU 50 1392x0750	7,00	075
	510075185 FRAME ALU 50 1856x0750	6,50	075
	511075185 LADDER FRAME ALU 50 1856x0750	8,80	075
	510135139 FRAME ALU 50 1392x1350	6,60	135
	511135139 LADDER FRAME ALU 50 1392x1350	8,50	135
	510135185 FRAME ALU 50 1856x1350	9,00	135
	511135185 LADDER FRAME ALU 50 1856x1350	10,10	135
	510135232 FRAME ALU 50 2320x1350	10,50	135
	511135232 LADDER FRAME ALU 50 2320x1350	13,20	135



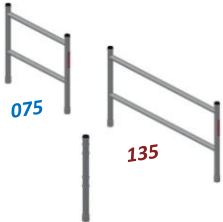

## GUARDRAILS

WEIGHT SERIE

	512007594 GUARDRAIL ALU 50 945x0750	3,10	075
	512013594 GUARDRAIL ALU 50 945x1350	4,00	135
	512075135 GUARDRAIL POST 945 (AL)	1,15	

## HORIZONTALS AND DIAGONALS

WEIGHT SERIE

	513000200 HORIZONTAL BRACE ALU 50 2000		2,35
	513000300 HORIZONTAL BRACE ALU 50 3000		2,97
	514000220 DIAGONAL BRACE ALU 50 2205		2,55
	514000310 DIAGONAL BRACE ALU 50 3140		3,08

## PLANKS

WEIGHT SERIE

	515020061 FIXED PLANK ALU 50 2000X610		14,70
	515030061 FIXED PLANK ALU 50 3000X610		23,29
	515120061 ACCESS PLANK ALU 50 2000 x 610	<i>with trapdoor</i>	15,20
	515130061 ACCESS PLANK ALU 50 3000 x 610		23,50

## TOEBOARDS

WEIGHT SERIE

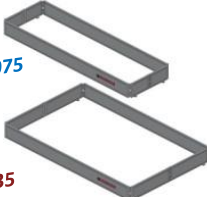
	516061195 TOEBOARD ALU 50 1950x0610	11,00	75
	516061295 TOEBOARD ALU 50 2950x0610	13,90	75
	516122195 TOEBOARD ALU 50 1950x1220	12,80	135
	516122295 TOEBOARD ALU 50 2950x1220	16,10	135

## CASTER

WEIGHT SERIE

	<p>517000155 CASTER ALU 50 Ø150x50</p>	<p>5,00</p>
---	--	-------------

## STABILIZERS

WEIGHT SERIE

	<p>518000257 FIXED STABILIZER ALU 50 2570</p>	<p>5,20</p>
	<p>518260320 ADJUSTABLE STABILIZER ALU 50 2600-3200</p>	<p>6,50</p>



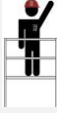
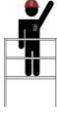
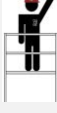

## 075 SERIES CONFIGURATIONS (Working area 0.75 x 2 m)

WEIGHT SERIE

 <p>075 2 m</p>	<p>500075020 ALUMINIUM ROLLING TOWER ALU 50 07502</p>	 <p>4,90 3,90 2,90</p>	<p>122,50 075</p>
	<p>500075030 ALUMINIUM ROLLING TOWER ALU 50 07503</p>	 <p>5,37 4,37 3,37</p>	<p>125,30 075</p>
	<p>500075040 ALUMINIUM ROLLING TOWER ALU 50 07504</p>	 <p>5,84 4,84 3,84</p>	<p>128,10 075</p>

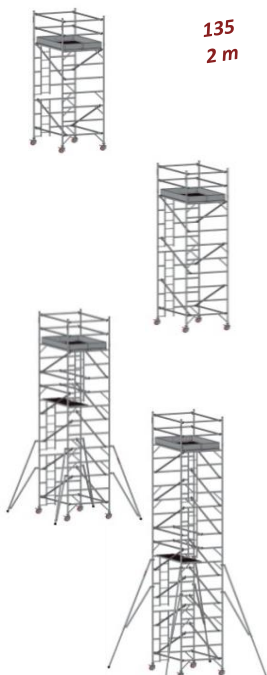
## 135 SERIES CONFIGURATIONS (Working area 1.35 x 2 m)

WEIGHT SERIE

 <p>135 2 m</p>	<p>500135030 ALUMINIUM ROLLING TOWER ALU 50 13503</p>	 <p>5,37 4,37 3,37</p>	<p>129,20 135</p>
	<p>500135050 ALUMINIUM ROLLING TOWER ALU 50 13505</p>	 <p>6,30 5,30 4,30</p>	<p>142,90 135</p>
	<p>500135080 ALUMINIUM ROLLING TOWER ALU 50 13508</p>	 <p>7,70 6,70 5,70</p>	<p>213,00 135</p>
	<p>500135120 ALUMINIUM ROLLING TOWER ALU 50 13512</p>	 <p>9,55 8,55 7,55</p>	<p>247,50 135</p>

## FRAMES

WEIGHT SERIE

	530275090 FRAME ALU FREE 900x750	2,90	075F
	530175200 FRAME ALU FREE 2000x750	5,50	075F

## HORIZONTAL AND DIAGONALS

WEIGHT SERIE

	530315000 HORIZONTAL ALU FREE 1500		1,10	075F
	530416770 DIAGONAL ALU FREE 1677		1,20	075F
	530419530 DIAGONAL ALU FREE 1953		1,30	075F

## PLANKS

WEIGHT SERIE

	530575150 ACCESS PLANK ALU FREE 1500x750 (WD/AL) <i>with trapdoor</i>	12,10	075F
--	---	-------	------

## TOEBOARDS

WEIGHT SERIE

	530675150 TOEBOARD ALU FREE 1500x750 (WD)	4,40	075F
--	---	------	------

## CASTER

WEIGHT SERIE

	530701270 CASTER ALU FREE Ø127x35	2,13	075F
--	-----------------------------------	------	------

## STABILIZERS

WEIGHT SERIE

	530900000 FIXED STABILIZER ALU FREE 2100	2,80	075F
	530800000 ADJUSTABLE STABILIZER ALU FREE 2200-3500	4,00	075F

## 075F SERIES CONFIGURATIONS (Working area 0.75 x 1.5 m)

WEIGHT SERIE

	530075030 ALUMINIUM ROLLING TOWER ALU FREE 07503F	 4 3 2	54,00	075F
	530075050 ALUMINIUM ROLLING TOWER ALU FREE 07505F	 6 5 4	95,00	075F
	530075070 ALUMINIUM ROLLING TOWER ALU FREE 07507F	 8 7 6	130,00	075F
	530075090 ALUMINIUM ROLLING TOWER ALU FREE 07509F	 10 9 8	160,00	075F

<b>STARTING COMPONENTS</b>		WEIGHT	LOT
	025001142 FIXED SCAFFOLD BASE Ø 35 (ZN)	0,70	
	025002001 SCAFFOLD BASE PLATE (PP)	0,18	
	025010108 SCREW JACK BASE Ø 36 ( 500) (ZN)	2,80	50
	025020078 SCREW JACK BASE Ø 36 ( 750) (ZN)	3,60	50
	025020108 SCREW JACK BASE Ø 36 (1000) (ZN)	4,00	50
	025020118 SCREW JACK BASE Ø 36 (1000) 2 levers (ZN)	3,86	
	219902060 SWIVEL JACK BASE Ø 36 (600) (ZN)	3,00	
<b>WHEELS WITH SCREW JACK (wheel Ø 20 cm)</b>		WEIGHT	LOT
	025000200 WHEEL WITH SCREW JACK HE 250 kg (ZN)	5,80	4
	025000210 WHEEL WITH SCREW JACK HR 750 kg (ZN) Nylon	5,40	4
<b>SCAFFOLD WHEELS (wheel Ø 20 cm)</b>		WEIGHT	LOT
	025000100 SCAFFOLD WHEEL EI 250 kg INT. (ZN)	3,90	6
	025000090 SCAFFOLD WHEEL EE 250 kg EXT. (ZN)	4,00	6
	025000110 SCAFFOLD WHEEL RE 600 kg EXT. (ZN) Nylon	3,00	8
<b>OVERLAPPING PLATES</b>		WEIGHT	LOT
	026110060 OVERLAPPING PLATE 1000 x 550 (GA)	10,10	
	026110090 OVERLAPPING PLATE 1000 x 850 (GA)	14,30	
	026115060 OVERLAPPING PLATE 1400 x 550 (GA)	14,50	
	026115090 OVERLAPPING PLATE 1400 x 850 (GA)	21,60	



<b>CLAMPS</b>		WEIGHT	LOT
	025000050 FIXED CLAMP Ø 42 (ZN)	1,30	20
	025000052 FIXED CLAMP Ø 48 (ZN)	1,30	20
	025000060 SWIVEL CLAMP Ø 42 (ZN)	1,40	20
	025000051 SWIVEL CLAMP Ø 48 (ZN)	1,40	20
	025000062 SWIVEL CLAMP WITH WEDGE PIN Ø 45 (GA)	1,20	20
	025000061 SWIVEL CLAMP WITH WEDGE PIN Ø 48 (GA)	1,30	20

<b>CLAMPS WITH ACCESSORIES</b>		WEIGHT	LOT
	219901008 SCREW JACK HOLDER (ZN)	1,10	
	025000031 PLATE CLAMP WITH L-SHAPED BRACKET (PT)	0,50	
	025000032 PLATE CLAMP WITH Ø 14 SECURING PIN (PT)	0,50	
	025000033 PLATE CLAMP WITH Ø 20 SECURING PIN (PT)	0,50	

<b>PULLEYS</b>		WEIGHT	LOT
	025000085 PULLEY (Roller) DCM (PT)	8,40	
	025000088 PULLEY (Roller) DCM (ZN)	8,40	
	219900050 PULLEY (Roller) MEKA 48 (GA)	7,60	

<b>SCAFFOLD NETS</b>		WEIGHT	LOT
	026060100 SCAFFOLD NET 6,0 x 10 m Ht.	5,40	10
	026030200 SCAFFOLD NET 3,0 x 20 m Ht.	5,20	10

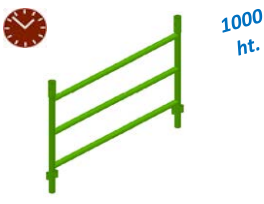
<b>SCAFFOLD TIES</b>		WEIGHT	LOT
	025029148 SCAFFOLD TIE A 12x120 (Øint 23) (ZN)	0,180	50
	025029158 SCAFFOLD TIE B 12x190 (Øint 23) (ZN)	0,230	50
	025029160 SCREW ANCHOR A Ø14x100	0,005	50
	025029170 SCREW ANCHOR B Ø14x135	0,007	50

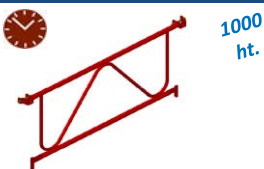
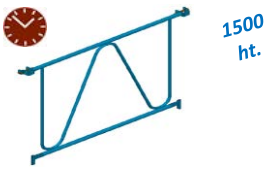
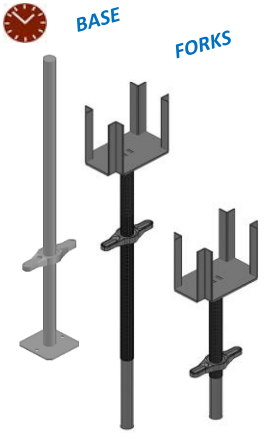
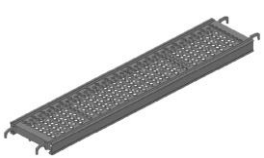
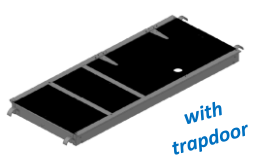
FRAMES		WEIGHT	LOT
	228111000 SHORING TOWER FRAME D-SYSTEM 1300 H:1000 (GA)	15,60	
	228111500 SHORING TOWER FRAME D-SYSTEM 1300 H:1500 (GA)	21,70	
	070300001 SNAP PIN 1u (ZN)	0,08	15/25
GUARDRAILS		WEIGHT	LOT
	228121000 GUARDRAIL D-SYSTEM 1500 H:1000 (GA)	8,00	
	228121500 GUARDRAIL D-SYSTEM 1500 H:1500 (GA)	9,60	
SCREW JACKS		WEIGHT	LOT
	025020128 SCREW JACK BASE Ø 38 (1000) (ZN)	10,80	
	228130050 SCREW JACK FORK HEAD Ø 38 ( 500) (ZN)	7,00	
	228130100 SCREW JACK FORK HEAD Ø 38 (1000) (ZN)	13,00	
PLANKS		WEIGHT	LOT
	210500150 FIXED PLANK M48/D48 1500 C6 H7 (GA)	8,50	28
	210600150 ACCESS PLANK M48/D48 1500 C-4	16,00	10

## ACCESSORIES

WEIGHT LOT

	<p>228191150 FRAME FOR DISPLACEMENT D-SYSTEM (GA)</p>	<p>12,00</p>
	<p>025000052 FIXED CLAMP Ø 48 (ZN)</p>	<p>1,30 20</p>
	<p>025000200 WHEEL WITH SCREW JACK HE 250 kg (ZN)</p>	<p>5,80</p>
	<p>219901008 SCREW JACK HOLDER (ZN)</p>	<p>1,10</p>

## PRODUCT CHARACTERISTICS

### SHORING TOWER D-SYSTEM

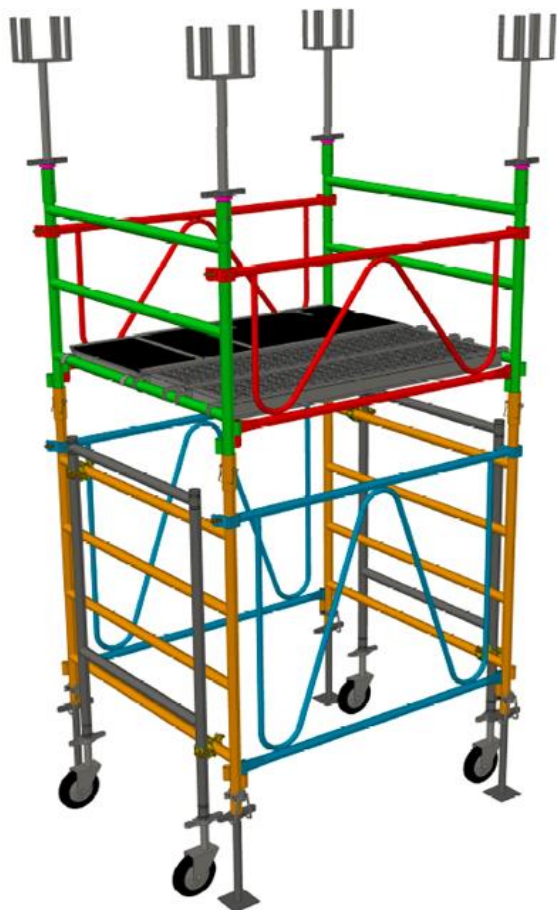

- Designed and manufactured in compliance with standards EN 12812 and EN 12813.
- Dimensions in plant 1.5 m (length) x 1.3m (width).
- Load capacity per foot: 3000 kg (contact our Technical Department for other capacities).
- Settings at different heights.
- Can be lifting using a crane.
- Easy and safe assembly.



## STARTING ELEMENTS

WEIGHT LOT

	025010108 SCREW JACK BASE Ø 36 ( 500 ) (ZN)	2,80	50
	025020078 SCREW JACK BASE Ø 36 ( 750 ) (ZN)	3,60	50
	025020108 SCREW JACK BASE Ø 36 (1000) (ZN)	4,00	50
	219902060 SWIVEL JACK BASE Ø 36 (600) (ZN)	3,00	
	219900010 BASE COLLAR MEKA 48 (GA)	1,50	

## VERTICAL STANDARDS

WEIGHT LOT

	210100050 VERTICAL STANDARD MEKA 48 500 (GA)	3,00	
	210100100 VERTICAL STANDARD MEKA 48 1000 (GA)	5,20	38
	210100150 VERTICAL STANDARD MEKA 48 1500 (GA)	7,70	38
	210100200 VERTICAL STANDARD MEKA 48 2000 (GA)	9,60	38
	210100300 VERTICAL STANDARD MEKA 48 3000 (GA)	14,20	38
	602001000 VERTICAL STANDARD MF48 1000 (GA)	5,00	
	602002000 VERTICAL STANDARD MF48 2000 (GA)	9,40	
	602003000 VERTICAL STANDARD MF48 3000 (GA)	14,00	
	070300001 SNAP PIN 1u (ZN)	0,08	15/25

## LEDGERS

WEIGHT LOT

	210200072 LEDGER MEKA 48 700 (GA)	2,60	40
	210200102 LEDGER MEKA 48 1000 (GA)	3,30	40
	210200132 LEDGER MEKA 48 1300 (GA)	4,00	40
	210200152 LEDGER MEKA 48 1500 (GA)	4,50	40
	210200202 LEDGER MEKA 48 2000 (GA)	5,70	40
	210200232 LEDGER MEKA 48 2300 (GA)	6,50	40
	210200252 LEDGER MEKA 48 2500 (GA)	7,00	40
	210200302 LEDGER MEKA 48 3000 (GA)	8,20	40



## DIAGONALS

WEIGHT LOT

	210315072	DIAGONAL MEKA 48 1500x 700 (GA)	5,60
	210315102	DIAGONAL MEKA 48 1500x 1000 (GA)	6,00
	210320102	DIAGONAL MEKA 48 2000x 1000 (GA)	7,10
	210320132	DIAGONAL MEKA 48 2000x 1300 (GA)	7,40
	210320152	DIAGONAL MEKA 48 2000x 1500 (GA)	7,70
	210320202	DIAGONAL MEKA 48 2000x 2000 (GA)	8,50
	210320252	DIAGONAL MEKA 48 2000x 2500 (GA)	9,40
	210320302	DIAGONAL MEKA 48 2000x 3000 (GA)	10,40

## SPIGOT WITH CLAMP

WEIGHT LOT

	219900020	SPIGOT WITH CLAMP MEKA 48 (GA)	1,50
--	-----------	--------------------------------	------

## TRUSS LEDGERS

WEIGHT LOT

	211000100	TRUSS LEDGER MEKA 48 1000 (GA)	7,50
	211000130	TRUSS LEDGER MEKA 48 1300 (GA)	9,00
	211000150	TRUSS LEDGER MEKA 48 1500 (GA)	11,50
	211000200	TRUSS LEDGER MEKA 48 2000 (GA)	15,70
	211000250	TRUSS LEDGER MEKA 48 2500 (GA)	20,50
	211000300	TRUSS LEDGER MEKA 48 3000 (GA)	24,50

## DOUBLE TRUSS LEDGERS

WEIGHT LOT

	211100200	DOUBLE TRUSS LEDGER MEKA 48 2000 (GA)	29,00
	211100300	DOUBLE TRUSS LEDGER MEKA 48 3000 (GA)	43,00
	211100400	DOUBLE TRUSS LEDGER MEKA 48 4000 (GA)	53,00
	211100500	DOUBLE TRUSS LEDGER MEKA 48 5000 (GA)	69,00
	211100600	DOUBLE TRUSS LEDGER MEKA 48 6000 (GA)	77,00

## BRACKETS

WEIGHT LOT

	210700030	BRACKET MEKA 48 400 (GA)	4,30
	210700070	BRACKET MEKA 48 700 (GA)	6,60
	210700100	BRACKET MEKA 48 1000 (GA)	9,40

## STAGE PLATFORMS

WEIGHT LOT

	600010100	STAGE PLATFORM MF48 1000x1000 (WD/GA)	22,00
	600015100	STAGE PLATFORM MF48 1500x1000 (WD/GA)	30,50
	600015150	STAGE PLATFORM MF48 1500x1500 (WD/GA)	40,00
	600020100	STAGE PLATFORM MF48 2000x1000 (WD/GA)	38,00
	600020150	STAGE PLATFORM MF48 2000x1500 (WD/GA)	54,00

## PASADOR

WEIGHT LOT

	602900100	R SHAPE SPRING LOCK PIN (ZN)	0,05
--	-----------	------------------------------	------



## SUPPORT PLATES

WEIGHT LOT

	602100210	SUPPORT PLATE CORNER (1) MF48 (GA)		0,90
	602100220	SUPPORT PLATE SIDE (2) MF48 (GA)		1,00
	602100240	SUPPORT PLATE INTERIOR (4) MF48 (GA)		1,10

## GUARDRAILS

WEIGHT LOT

 	601000500 GUARDRAIL MF48 500 (GA)	8,10
	601001000 GUARDRAIL MF48 1000 (GA)	13,70
	601001500 GUARDRAIL MF48 1500 (GA)	19,50
	601002000 GUARDRAIL MF48 2000 (GA)	25,00
	601003000 GUARDRAIL MF48 3000 (GA)	36,00

## TRUSS LEDGER LADDERS

WEIGHT LOT

 	212610150 TRUSS LEDGER LADDER MEKA 48 H:1000x1500 (GA)	9,00
	212615230 TRUSS LEDGER LADDER MEKA 48 H:1500x2300 (GA)	13,00
	212620300 TRUSS LEDGER LADDER MEKA 48 H:2000x3000 (GA)	20,00



## GUARDRAILS FOR STAIRS

WEIGHT LOT

 	601515100 GUARDRAIL FOR STAIRS MF48 H:1000 (GA)	20,00
	601523150 GUARDRAIL FOR STAIRS MF48 H:1500 (GA)	30,00
	601530200 GUARDRAIL FOR STAIRS MF48 H:2000 (GA)	38,00
 	601715100 DIAGONAL HANDRAIL FOR STAIRS MF48 1000x1500 (SM)	4,50
	601723150 DIAGONAL HANDRAIL FOR STAIRS MF48 1500x2300 (SM)	5,80
	601730200 DIAGONAL HANDRAIL FOR STAIRS MF48 2000x3000 (SM)	7,00





## STAGE STEPS

WEIGHT LOT

 	600531000 STAGE STEPS MF48 1000 (WD/GA)	8,30
	600531500 STAGE STEPS MF48 1500 (WD/GA)	12,50
	600532000 STAGE STEPS MF48 2000 (WD/GA)	16,80



## FIXING ELEMENTS

WEIGHT LOT

 	602200000 CRAMP IRON WITH BRACKET (ZN)	1,40
	602201110 RUNNER 112 (ZN)	1,60
	602202110 RUNNER 112 90g (ZN)	1,60



## COVER

WEIGHT LOT

 	602900200 COVER MF48 (ZN)	0,10
--	---------------------------	------

## JOINING PIPES

WEIGHT LOT

 	603000050 JOINING PIPE FREE 500 (SM)	1,13
	603000100 JOINING PIPE FREE 1000 (SM)	2,27
	603000150 JOINING PIPE FREE 1500 (SM)	3,40
	603000200 JOINING PIPE FREE 2000 (SM)	4,54
	603000250 JOINING PIPE FREE 2500 (SM)	5,67
	603000300 JOINING PIPE FREE 3000 (SM)	6,81
	603000400 JOINING PIPE FREE 4000 (SM)	9,08
	603000500 JOINING PIPE FREE 5000 (SM)	11,34
	603000600 JOINING PIPE FREE 6000 (SM)	13,61



## TEMPORARY EDGE PROTECTION SYSTEMS (COMPLIANCE WITH EN 13374: 2013)

Assurance of compliance with EN 13374: 2013 by:

- 1) tests at Tecnalía Technology Center, testing laboratory with ENAC accreditation No. 4 / LE024,
- 2) AENOR N Mark of certified product.

### B35

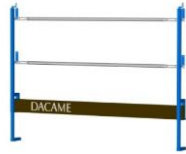

tecnalía

### E-1200



tecnalía

### E-1150-14



## GUARDRAIL POSTS

WEIGHT LOT

	070211002 GUARDRAIL B35 (PT)	6,20	50/100
	070211008 GUARDRAIL B35 (ZN)	6,20	50/100
	070200062 ANCHOR GUARDRAIL E-1200 (PT)	2,20	50/100
	070200069 ANCHOR GUARDRAIL E-1200 (GA)	2,20	50/100
	070200072 ANCHOR GUARDRAIL E-1150-14 (PT)	2,00	50/100
	070200078 ANCHOR GUARDRAIL E-1150-14 (ZN)	2,00	50/100

## SECURITY GUARDRAILS AND TOEBOARDS

WEIGHT LOT

	070212250 SECURITY GUARDRAIL B35 2500 (SM)	4,00	100/200
	070213250 TOEBOARD B35 2500x150x27 (WD)	5,00	50



## PLASTIC COMPONENTS (ANCHOR GUARDRAIL E)

WEIGHT LOT

	070200530 PROTECTION PLASTIC PLUG (ØE 36 / ØI 12-18)	0,021	250
	070200510 ANCHOR CAPSULE FOR E GUARDRAIL (in Ø 40)	0,025	150

## GUARDRAIL SUPPORTS

WEIGHT LOT

	070200912 GUARDRAIL SUPPORT E - Type I (PT)	1,00	
	070200918 GUARDRAIL SUPPORT E - Type I (ZN)	1,00	
	070200922 GUARDRAIL SUPPORT E - Type L (PT)	1,30	
	070200928 GUARDRAIL SUPPORT E - Type L (ZN)	1,30	

## BCN BARRIERS

WEIGHT LOT

	070920111 BARRIER BCN 2100x1000 (Metal Sheet) (PT)	16,00	
	070920119 BARRIER BCN 2100x1000 (Metal Sheet) (GA) <i>Galva</i>	16,00	

## FREE BARRIERS

PT

WEIGHT LOT

	070712301 BARRIER FREE 2300x1000 1 foot (Metal Sheet)	12,50	30/60
	070722301 BARRIER FREE 2300x1000 2 feet (Metal Sheet)	13,00	30/60
	070732301 BARRIER FREE 2300x1000 2 detachable feet (M.S.)	13,00	30
	071600015 COLLAPSIBLE BARRIER FOOT FREE	1,20	

## DCM BARRIERS

PT

WEIGHT LOT

	071521001 BARRIER DCM 1000x1000 2 feet (Metal Sheet)	9,00	25
	070412501 BARRIER DCM 2500x1100 1 foot	14,50	25/50
	070422501 BARRIER DCM 2500x1100 2 feet	15,00	25/50
	070402501 BARRIER DCM 2500x1100 2 detachable feet	15,00	25
	071511001 BARRIER DCM 2500x1100 1 foot (Metal Sheet)	15,00	25/50
	070522501 BARRIER DCM 2500x1100 2 feet (Metal Sheet)	16,00	25/50
	070502501 BARRIER DCM 2500x1100 2 detachable feet (M.S.)	16,00	25
	070522508 BARRIER DCM 2500x1100 2 feet (M.S.) (GA) <i>Galva</i>	16,00	25/50
071600011 COLLAPSIBLE BARRIER FOOT DCM	1,27		

## INCLINED BARRIERS

WEIGHT LOT

	071321181 INCLINED BARRIER 1800 2 feet (CH) (PT)	12,00	
	071321189 INCLINED BARRIER 1800 2 feet (CH) (GA) <i>Galva</i>	12,00	

## PLASTIC BARRIERS

WEIGHT LOT

	072A20101 BARRIER 2000x1000x55 m (Polyethylene) YELLOW	12,20	
	072A20102 BARRIER 2000x1000x55 m (Polyethylene) BLUE <i>blue</i>	12,20	

## MINI BARRIERS

PT

WEIGHT LOT

	072511405 BARRIER MINI 1425x990 1 foot (Metal Sheet) T25	7,00	35
	072511418 BARRIER MINI 1425x990 1 foot (Metal Sheet) T28	8,20	35



## PARKING BARRIER AND SIGNAL SUPPORT

WEIGHT LOT

	071700018 PARKING BARRIER 300x680 (H) (ZN)	4,10	
	900000108 SIGNAL SUPPORT (ZN)	3,20	

## WALKWAYS

WEIGHT LOT

	073170088 WALKWAY W/GUARDRAILS PL-A 1700x 880 (GA/PT)	43,00	
	073200088 WALKWAY W/GUARDRAILS PL-A 2000x 880 (GA/PT)	50,00	
	073170120 WALKWAY W/GUARDRAILS PL-B 1700x1200 (GA/PT)	52,00	
	073200120 WALKWAY W/GUARDRAILS PL-B 2000x1200 (GA/PT)	61,00	
	074120100 REINFORCED WALKWAYS W/GUARDRAILS 2x1 m (GA)	69,00	
	074130100 REINFORCED WALKWAYS W/GUARDRAILS 3x1 m (GA)	109,00	

**VERTICAL GUARDRAILS**
**WEIGHT LOT**

	112100204	VERT. GUARDRAIL 2000 (PT)	5,80	20
	112100209	VERT. GUARDRAIL 2000 (GA)	5,80	20
	112100304	VERT. GUARDRAIL 3000 (PT)	8,30	20
	112100309	VERT. GUARDRAIL 3000 (GA)	8,30	20
	112100404	VERT. GUARDRAIL 4000 (PT)	10,30	20
	112100409	VERT. GUARDRAIL 4000 (GA)	10,30	20
	112101204	VERT. GUARDRAIL 2000 W/CLAMP (PT)	8,00	20
	112101209	VERT. GUARDRAIL 2000 W/CLAMP (GA)	8,00	20
	112101304	VERT. GUARDRAIL 3000 W/CLAMP (PT)	11,20	20
	112101309	VERT. GUARDRAIL 3000 W/CLAMP (GA)	11,20	20
	112101404	VERT. GUARDRAIL 4000 W/CLAMP (PT)	13,20	20
	112101409	VERT. GUARDRAIL 4000 W/CLAMP (GA)	13,20	20

**VERTICAL GUARDRAILS WITH SUPPORTS**
**WEIGHT LOT**

	112210204	VERT. GUARDRAIL W/SUPPORT 2000 (PT)	8,00	20
	112210209	VERT. GUARDRAIL W/SUPPORT 2000 (GA)	8,00	20
	112210304	VERT. GUARDRAIL W/SUPPORT 3000 (PT)	11,20	20
	112210309	VERT. GUARDRAIL W/SUPPORT 3000 (GA)	11,20	20
	112210404	VERT. GUARDRAIL W/SUPPORT 4000 (PT)	13,20	20
	112210409	VERT. GUARDRAIL W/SUPPORT 4000 (GA)	13,20	20
	112211204	VERT. GUARDRAIL W/SUPPORT 2000 W/CLAMP (PT)	12,40	20
	112211209	VERT. GUARDRAIL W/SUPPORT 2000 W/CLAMP (GA)	12,40	20
	112211304	VERT. GUARDRAIL W/SUPPORT 3000 W/CLAMP (PT)	16,00	20
	112211309	VERT. GUARDRAIL W/SUPPORT 3000 W/CLAMP (GA)	16,00	20
	112211404	VERT. GUARDRAIL W/SUPPORT 4000 W/CLAMP (PT)	18,60	20
	112211409	VERT. GUARDRAIL W/SUPPORT 4000 W/CLAMP (GA)	18,60	20

**SUPPORTS**
**WEIGHT LOT**

	112007304	VERTICAL GUARDRAIL SUPPORT (PT)	6,00	20
	112007309	VERTICAL GUARDRAIL SUPPORT (GA)	6,00	20
	111900009	INTERMEDIARY SUPPORT (ZN)	3,00	20

**CONSOLES**
**WEIGHT LOT**

	110000804	WALL CONSOLE H: 800 x 800 (PT)	6,00	
	110000809	WALL CONSOLE H: 800 x 800 (GA)	6,00	
	110001004	WALL CONSOLE H:1000 x1000 (PT)	7,40	
	110001009	WALL CONSOLE H:1000 x1000 (GA)	7,40	
	110001504	WALL CONSOLE H:1000 x1500 (PT)	12,30	
	110001509	WALL CONSOLE H:1000 x1500 (GA)	12,30	
	110011004	WALL CONSOLE H:1000 x1000 (RD) (PT)	7,00	
	110011009	WALL CONSOLE H:1000 x1000 (RD) (GA)	7,00	

SQUARE TUBE

ROUND TUBE

**WINDOW GUARDRAILS**
**WEIGHT LOT**

	112300104	WINDOW GUARDRAIL (ECO) 780-1100 (PT)	1,80	20
	112301104	WINDOW GUARDRAIL (PLUS) 1010-2010 (PT)	3,60	20

**DOUBLE GUARDRAIL SUPPORTS**
**WEIGHT LOT**

	110105004	DOUBLE GUARDRAIL SUPPORT (PT)	5,00	20/40
	110105009	DOUBLE GUARDRAIL SUPPORT (ZN)	5,00	20/40

**PINION GUARDRAILS**

WEIGHT LOT

	110735204 PINION GUARDRAIL (PT)	6,20	
	110735209 PINION GUARDRAIL (GA)	6,20	

**GUARDRAILS - B and E TYPES -**

WEIGHT LOT

	070200025 GUARDRAIL B (PT)	4,30	50/100
	070200028 GUARDRAIL B (ZN)	4,30	50/100
	070200052 GUARDRAIL B - 1300 (PT)	5,46	50/100
	070200082 GUARDRAIL B - 1500 (1+3H) (PT)	6,76	50/100
	070200102 ANCHOR GUARDRAIL E-1500 (1+3H) (PT)	2,15	50/100
	070200410 SECURITY GUARDRAIL (Ø : 35x1,5) 1000 (SM)	1,24	
	070200430 SECURITY GUARDRAIL (Ø : 35x1,5) 1500 (SM)	1,86	
	070200450 SECURITY GUARDRAIL (Ø : 35x1,5) 2000 (SM)	2,48	
	070200500 SECURITY GUARDRAIL (Ø : 35x1,5) 2500 (SM)	3,10	50/100
	070200818 EXTENSIBLE GUARDRAIL EXT. (R:1860-2930) (ZN)	4,30	
	070200670 TOEBOARD 2500x150 (SM)	6,20	

**MODULAR GUARDRAIL SYSTEM**

WEIGHT LOT

	070200210 MODULAR GUARDRAIL 1100 (GA)	4,00	
	070202250 GUARDRAIL WITH PLUG (Ø: 35x2) 2500 (SM)	4,90	
	070213250 TOEBOARD B35 2500x150x27 (WD)	5,00	50
	070200510 ANCHOR CAPSULE FOR E GUARDRAIL (in Ø 40)	0,03	150













**SAFETY NET SYSTEM (H: 8 m - L: 2 m)**

WEIGHT LOT

	070328025 COMPLETE SAFETY NET (60x60x3) (PT)	0,00	15	
	070328020 COMPLETE SAFETY NET (60x60x3) (GA)	Galva	0,00	15
	070324025 SAFETY NET SQUARE 4000 X 2000 (60x60x3) (PT)	37,50		
	070324005 SAFETY NET SQUARE 4000 (60x60x3) (PT)	24,50		
	070300000 SNAP PIN 25u. (kit) (ZN)	2,00		
	070300010 SAFETY NET SUPPORT (PT)	2,00		



<b>PLUS BUCKETS</b>		PT	PLUS	WEIGHT	LOT
 C	010411504	CENTRAL UNLOADING BUCKET PLUS C	150 L	45,00	
	010412004	CENTRAL UNLOADING BUCKET PLUS C	200 L	50,00	
	010418004	CENTRAL UNLOADING BUCKET PLUS C	800 L	140,00	
	010419994	CENTRAL UNLOADING BUCKET PLUS C	1000 L	160,00	
 CL	010421504	SIDE AND CENTRAL UNLOADING BUCKET PLUS CL	150 L	60,00	
	010422004	SIDE AND CENTRAL UNLOADING BUCKET PLUS CL	200 L	65,00	
	010423494	SIDE AND CENTRAL UNLOADING BUCKET PLUS CL	350 L	80,00	
	010424994	SIDE AND CENTRAL UNLOADING BUCKET PLUS CL	500 L	97,00	
	010428004	SIDE AND CENTRAL UNLOADING BUCKET PLUS CL	800 L	150,00	
	010429994	SIDE AND CENTRAL UNLOADING BUCKET PLUS CL	1000 L	170,00	
 CT	010440501	BUCKET PLUS WITH RUBBER HOSE CT	500 L	120,00	
	010441001	BUCKET PLUS WITH RUBBER HOSE CT	1000 L	215,00	
	010441501	BUCKET PLUS WITH RUBBER HOSE CT	1500 L	295,00	
 BCE	010435001	BUCKET PLUS WITH RUBBER HOSE BCE	500 L	230,00	
	010435011	BUCKET PLUS WITH RUBBER HOSE BCE	1000 L	340,00	
	010435021	BUCKET PLUS WITH RUBBER HOSE BCE	1500 L	435,00	
	010435101	RUBBER HOSE Ø 200 BCE (2 m)		4,00	
	010435200	CLAMP FOR RUBBER HOSE		1,00	
 BC+	010450051	BUCKET PLUS WITH RUBBER HOSE BC+	500 L	250,00	
	010450101	BUCKET PLUS WITH RUBBER HOSE BC+	1000 L	365,00	
	010450151	BUCKET PLUS WITH RUBBER HOSE BC+	1500 L	450,00	
 BCF	010455051	LAYDOWN BUCKET PLUS BCF	500 L	160,00	
	010455101	LAYDOWN BUCKET PLUS BCF	1000 L	310,00	
	010455151	LAYDOWN BUCKET PLUS BCF	1500 L	410,00	
<b>DCM BUCKETS</b>		PT	DCM	WEIGHT	LOT
 VF	010412505	CENTRAL UNLOADING BUCKET DCM VF	250 L	64,00	
	010413005	CENTRAL UNLOADING BUCKET DCM VF	300 L	69,00	
	010413505	CENTRAL UNLOADING BUCKET DCM VF	350 L	70,00	
	010415005	CENTRAL UNLOADING BUCKET DCM VF	500 L	77,00	
 DV	010422505	SIDE AND CENTRAL UNLOADING BUCKET DCM DV	250 L	70,00	
	010423005	SIDE AND CENTRAL UNLOADING BUCKET DCM DV	300 L	77,00	
	010423505	SIDE AND CENTRAL UNLOADING BUCKET DCM DV	350 L	79,00	
	010425005	SIDE AND CENTRAL UNLOADING BUCKET DCM DV	500 L	85,00	
<b>CIRCULAR MUCK TIPPING SKIPS</b>				WEIGHT	LOT
	010430655	CIRCULAR MUCK TIPPING SKIP	65 L (PT)	17,50	
	010431005	CIRCULAR MUCK TIPPING SKIP	100 L (PT)	20,50	
	010431505	CIRCULAR MUCK TIPPING SKIP	150 L (PT)	25,50	



<b>PLUS CRANE FORKS</b>		CE	EN 13155	PT	PLUS	WEIGHT	LOT
 MBA	100200031	AUTOMATIC CRANE FORK MBA 1500 kg				130,00	
	100200041	AUTOMATIC CRANE FORK MBA 2000 kg				146,00	
 MBACR	100200051	MANUAL CRANE FORK MBACR 1500 kg				130,00	
 MBR MBRA	100200061	MANUAL TELESCOPIC CRANE FORK MBR 1500 kg				140,00	
	100200071	MANUAL TELESCOPIC CRANE FORK MBR 2000 kg				160,00	
	100200101	TELESCOPIC SELF LEVELLING CRANE FORK MBRA 3000 kg				250,00	
<b>DCM CRANE FORKS</b>		CE	EN 13155	PT	DCM	WEIGHT	LOT
 DCM	100200025	MANUAL CRANE FORK DCM 1500 kg				101,00	
	100200028	MANUAL CRANE FORK DCM FR 1500 kg (H1600)				108,00	
<b>PLUS GRIPPERS</b>		CE	EN 13155	PT	PLUS	WEIGHT	LOT
 PZC	100400011	GRIPPER G 150 kg (A: 50-240) PZC				13,00	
 PZC-L	100400021	MANUAL GRIPPER 200 kg (A:500-1000) PZC-L				12,00	
 PZV-M	100400031	GRIPPER G 500 kg (A: 20-140) PZV-M				9,50	
 PZM-F	100400051	GRIPPER 1200 kg (A: 30-150) PZM-F-15				15,00	
	100400061	GRIPPER 1200 kg (A:150-300) PZM-F-30				22,00	
 PZM-T	100400071	GRIPPER 1200 kg (A: 10-260) PZM-T-26				25,00	
	100400081	GRIPPER 1200 kg (A:200-500) PZM-T-50				28,00	
 PZB 3	100400041	GRIPPER 1500 kg (A: 30-100) PZB 3				48,00	
 PZM-L	100400111	MANUAL GRIPPER (A:200-500) PZM-L				2,00	
<b>LIFTING BEAMS</b>		CE	EN 13155	PT		WEIGHT	LOT
 BIL	100000011	FIXED LIFTING BEAM WITH HOOKS 1500 kg BIL 1 m				10,00	
	100000021	FIXED LIFTING BEAM WITH HOOKS 1500 kg BIL 2 m				20,00	

**KERB-LAYING GRIPPERS**



WEIGHT LOT

 B	105000008 KERB-LAYING GRIPPER B (A:920-1020) (ZN)	6,00	
 C	105000018 KERB-LAYING GRIPPER C (A: 40-360) (ZN)	4,00	

**PALLETS**

EN 13626





WEIGHT LOT

 ECO	010600020 PALLET ECO 400 kg (PT)	ROUND TUBE	27,50	
	010600021 PALLET ECO 400 kg (GA)		27,50	
 DCM	010600025 PROP PALLET DCM 600 kg (PT)	SQUARE TUBE	34,00	6
	010600026 PROP PALLET DCM 600 kg (GA)		34,00	6

**STOCK PALLETS**

EN 13626

WEIGHT LOT

	010612102 STOCK BASE PALLET 1.0x1.2 m 1200 kg (PT)	52,00	
	010612109 STOCK BASE PALLET 1.0x1.2 m 1200 kg (GA)	52,00	
	010631002 STOCK POST PALLET 1.0 m (PT)	5,40	4
	010631202 STOCK POST PALLET 1.2 m (PT)	6,50	4
	010631502 STOCK POST PALLET 1.5 m (PT)	8,10	4
	010632002 STOCK POST PALLET 2.0 m (PT)	10,80	4
	010631009 STOCK POST PALLET 1.0 m (GA)	5,40	4
	010631209 STOCK POST PALLET 1.2 m (GA)	6,50	4
	010631509 STOCK POST PALLET 1.5 m (GA)	8,10	4
	010632009 STOCK POST PALLET 2.0 m (GA)	10,80	4
 KIT	010641002 STOCK PALLET 1.0x1.2 H 1.0 1200 kg (PT) (Kit)	73,60	
	010641202 STOCK PALLET 1.0x1.2 H 1.2 1200 kg (PT) (Kit)	78,00	
	010641502 STOCK PALLET 1.0x1.2 H 1.5 1200 kg (PT) (Kit)	84,40	
	010642002 STOCK PALLET 1.0x1.2 H 2.0 1200 kg (PT) (Kit)	95,20	
 KIT GA	010641009 STOCK PALLET 1.0x1.2 H 1.0 1200 kg (GA) (Kit)	73,60	
	010641209 STOCK PALLET 1.0x1.2 H 1.2 1200 kg (GA) (Kit)	78,00	
	010641509 STOCK PALLET 1.0x1.2 H 1.5 1200 kg (GA) (Kit)	84,40	
	010642009 STOCK PALLET 1.0x1.2 H 2.0 1200 kg (GA) (Kit)	95,20	

**STEEL MORTAR SKIPS**

WEIGHT LOT

 FREE	010100102 STEEL MORTAR SKIP FREE 280 L (PT)	32,00	
 DCM	010100015 STEEL MORTAR SKIP DCM 300 L (PT)	49,00	
	010100085 STEEL MORTAR SKIP DCM 500 L (PT)	70,00	
 FR	010101364 STEEL MORTAR SKIP FR 360 L (PT)	64,00	
	010101504 STEEL MORTAR SKIP FR 500 L (PT)	75,00	
 M50	010100071 STEEL MORTAR SKIP M50 500 L (PT)	70,00	
 A-50D	010100091 BOAT SKIP A-50D 500 L (PT)	100,00	

**PLASTIC MORTAR TUB**

WEIGHT LOT

 CPG	010100311 PLASTIC MORTAR TUB CPG 200 L	14,00	
	010100324 PLASTIC MORTAR TUB BASE CPG (PT)	8,50	

**SKIPS AND TOOL BOX**

WEIGHT LOT

	010600015 DEBRIS SKIP 1.5x1.5x0.3 m 1000 kg (PT)	85,00	
	010600231 FORKLIFT TIPPING SKIP BB 1350 L (2Tn) (PT)	200,00	
	010600261 FORKLIFT TIPPING SKIP BB 1600 L (2Tn) (PT)	215,00	
	010600031 TOOL BOX 650x1800x600 (PT)	82,00	

**CARTS**

PT

WEIGHT LOT

	010200019 CEMENT CART 1 PU Foam Wheel E1 100 L		23,00	4/6/10
	010200029 CEMENT CART 2 PU Foam Wheels E3 100 L		21,00	
	010200059 CEMENT CART 2 PU Foam Wheels R3 125 L		29,00	
	010200065 CEMENT CART 2 Pneumatic Wheels K1 90 L		33,00	
	010300045 BRICK CART 3 PU Foam Wheels L1		40,50	

**CHAINS AND SLINGS**

CE

WEIGHT LOT

	010200510 SET OF 3 HOOK CHAINS 750 kg (ZN)	3 EN 818	1,80	
	010200410 SET OF SLINGS FOR DEBRIS SKIP (2x 2H.) 2200 kg	4 EN 13414-1	4,50	
	010200400 POLYESTER SLING WITH 1 HOOK 3000 kg	1 EN 1492-1	2,70	

**FAÇADE PLATFORMS**

WEIGHT LOT

	100100212 FIXED FAÇADE PLATFORM FREE 1200 kg (PT)		110,00	
	100100222 FAÇADE PLATFORM W/TRAPDOOR FREE 1200 kg (PT)		124,00	
	100100015 FIXED FAÇADE PLATFORM DAC 1500 kg (PT)		181,00	
	100100025 FAÇADE PLATFORM W/TRAPDOOR DAC 1500 kg (PT)		203,00	
	100100112 FIXED FAÇADE PLATFORM DCM 1500 kg (PT)	UNE 180401	195,00	
	100100122 FAÇADE PLATFORM W/TRAPDOOR DCM 1500 kg (PT)		217,00	
	100100129 FAÇADE PLATFORM W/TRAPDOOR DCM 1500 kg (GA)		217,00	



**MAN BASKETS FOR CRANE**

PT



WEIGHT LOT

	100500101 MAN BASKET FOR CRANE CPP-R1G (1 worker)	165,00	
	100500201 MAN BASKET FOR CRANE CPP-G2C (2 workers)	300,00	

## FOLDING TRESTLES

		WEIGHT	LOT
 ROUND TUBE	030110805 TRESTLE RD. BR-A- 800 (PT)	5,70	10/20
	030101005 TRESTLE RD. BR-A-1000 (PT)	6,30	10/20
 ROUND TUBE	030210805 TRESTLE RD. BR-B- 800 (with chain) (PT)	6,40	10/20
	030211005 TRESTLE RD. BR-B-1000 (with chain) (PT)	7,20	10/20
	030211205 TRESTLE RD. BR-B-1200 (with chain) (PT)	8,00	10/20
	030111505 TRESTLE RD. BR-B-1500 (with chain) (PT)	9,40	10/20
 SQUARE TUBE	030410805 TRESTLE SQ. BC-B- 800 (with chain) (PT)	6,80	18
	030411005 TRESTLE SQ. BC-B-1000 (with chain) (PT)	8,80	18
	030411205 TRESTLE SQ. BC-B-1200 (with chain) (PT)	9,80	18
	030411505 TRESTLE SQ. BC-B-1500 (with chain) (PT)	12,80	18



## TRESTLES

		WEIGHT	LOT
 ROUND TUBE	040121455 TRESTLE RD. FIXED FEET CR-F-1450 (PT)	10,40	12
	040122505 TRESTLE RD. FIXED FEET. CR-F-2500 (PT)	17,00	12
 ROUND TUBE	040111208 TRESTLE RD. FOLDING FEET CR-PG-1200 (ZN)	10,40	8
 SQUARE TUBE	040112205 TRESTLE SQ. FIXED FEET CC-F 2200 (PT)	18,00	12
	040212205 TRESTLE SQ. FOLDING FEET CC-P 2200 (PT)	18,50	12

## STEEL STAIR TREAD

		WEIGHT	LOT
	050015212 STEEL STAIR TREAD (PT)	4,20	50

## LADDERS

		WEIGHT	LOT
 B	050212505 LADDER WITH HOOKS B 2500 (PT)	13,20	
	050213505 LADDER WITH HOOKS B 3000 (PT)	16,10	
	050213005 LADDER WITH HOOKS B 3500 (PT)	19,30	
	050214005 LADDER WITH HOOKS B 4000 (PT)	22,50	
	050214505 LADDER WITH HOOKS B 4500 (PT)	25,40	
	050215005 LADDER WITH HOOKS B 5000 (PT)	28,60	
	050216005 LADDER WITH HOOKS B 6000 (PT)	36,60	
 C	050312505 LADDER C 2500 (PT)	13,00	
	050313005 LADDER C 3000 (PT)	15,00	
	050313505 LADDER C 3500 (PT)	17,50	
	050314005 LADDER C 4000 (PT)	20,50	
	050314505 LADDER C 4500 (PT)	24,00	
	050315005 LADDER C 5000 (PT)	27,50	
	050316005 LADDER C 6000 (PT)	34,50	
	050021202 LADDER STABILIZER L: 1200 (PT)	EN 131 3,60	

<b>TELESCOPIC WALL BARS</b>		WEIGHT	LOT
	080611800 TELESCOPIC WALL BAR (40/35) 1150-1800 (PT)	3,74	20/40/100
	080613105 TELESCOPIC WALL BAR (40/35) 1950-3100 (PT)	6,30	20/40/100
	080613605 TELESCOPIC WALL BAR (40/35) 2200-3600 (PT)	7,30	20/40/100
	080615515 TELESCOPIC WALL BAR (40/35) 3100-5100 (PT)	9,80	20/40/100
	080611808 TELESCOPIC WALL BAR (40/35) 1150-1800 (ZN)	3,74	20
	080713108 TELESCOPIC WALL BAR (40/35) 1950-3100 (ZN)	6,30	20/40/100
	080713308 TELESCOPIC WALL BAR (45/40) 1950-3300 (ZN) +	7,15	100
	080713608 TELESCOPIC WALL BAR (40/35) 2200-3600 (ZN)	7,30	20/40/100
	080715108 TELESCOPIC WALL BAR (40/35) 3100-5100 (ZN)	9,80	20

<b>FIXED WALL BARS</b>		WEIGHT	LOT
	080412000 FIXED WALL BAR (40x40x1,2) 2000 (SM)	3,00	40/80
	080412500 FIXED WALL BAR (40x40x1,2) 2500 (SM)	3,70	40/80
	080413000 FIXED WALL BAR (40x40x1,2) 3000 (SM)	4,20	40/80
	080413500 FIXED WALL BAR (40x40x1,2) 3500 (SM)	5,20	40/80
	080414000 FIXED WALL BAR (40x40x1,2) 4000 (SM)	6,00	40/80
	080512000 FIXED WALL BAR (40x40x1,5) 2000 (SM) +	3,80	40/80
	080512500 FIXED WALL BAR (40x40x1,5) 2500 (SM) +	4,80	40/80
	080513000 FIXED WALL BAR (40x40x1,5) 3000 (SM) +	5,70	40/80
	080513500 FIXED WALL BAR (40x40x1,5) 3500 (SM) +	6,70	40/80
	080514000 FIXED WALL BAR (40x40x1,5) 4000 (SM) +	7,70	40/80

<b>ALUMINIUM WALL BARS</b>		WEIGHT	LOT
	080812000 ALUMINIUM WALL BAR (40x40x1,4) 2000	1,10	28
	080812500 ALUMINIUM WALL BAR (40x40x1,4) 2500	1,40	28
	080813000 ALUMINIUM WALL BAR (40x40x1,4) 3000	1,70	28
	080912000 ALUMINIUM WALL BAR (60x30x1,5) 2000	1,40	25
	080912500 ALUMINIUM WALL BAR (60x30x1,5) 2500	1,70	25
	080913000 ALUMINIUM WALL BAR (60x30x1,5) 3000	2,00	25

<b>RULER-HOLDER</b>		WEIGHT	LOT
	900000040 RULER-HOLDER (R:230-295) (ZN)	1,00	10

<b>BUILDERS SQUARES</b>		WEIGHT	LOT
	080110408 BUILDERS SQUARE 400 (ZN)	1,60	6
	080110608 BUILDERS SQUARE 600 (ZN)	2,40	6
	080110808 BUILDERS SQUARE 800 (ZN)	3,20	6
	080111008 BUILDERS SQUARE 1000 (ZN)	4,00	3

<b>WAR-BAR HOLDER</b>		WEIGHT	LOT
	080200018 WAR-BAR HOLDER H: 1160 (ZN)	1,80	6

<b>CEMENT CARTS AND WHEEL BARROWS</b>		PT	WEIGHT	LOT
	010300025 CEMENT CART SQ-M (solid wheel)		11,50	
	010300035 CEMENT CART SQ-N (pneumatic wheel)		11,50	
	010300654 WHEELBARROW CR 65 RED (pneumatic wheel)		12,50	6/12
	010301654 WHEELBARROW CR 65 RED (PU foam wheel)		12,60	
	010300901 WHEELBARROW CA 90 YELLOW (pneumatic wheel)		13,00	6/12
	010301901 WHEELBARROW CA 90 YELLOW (PU foam wheel)		13,10	

<b>PU FOAM WHEELS</b>			WEIGHT	LOT
	010200600 PU FOAM WHEEL NO AXLE RP	E3, R3 y L1	2,50	
	010200622 PU FOAM WHEEL WITH AXLE RPE-220	E1, CR y CA	2,80	
	010200624 PU FOAM WHEEL WITH AXLE RPE-245		2,90	

<b>CEMENT CART WHEELS</b>			WEIGHT	LOT
	010200561 CEMENT CART SOLID WHEEL RSM	SQM	1,45	
	010200560 CEMENT CART PNEUMATIC WHEEL RSN	SQN	1,00	

<b>PNEUMATIC WHEEL RK</b>			WEIGHT	LOT
	010200546 PNEUMATIC WHEEL RK	K1	4,80	

<b>MORTAR SKIPS</b>			WEIGHT	LOT
	010100035 STEEL MORTAR SKIP WITH WHEELS 165 L (PT)		21,00	
	010100025 STEEL MORTAR SKIP WITH STAND 165 L (PT)		18,50	

<b>PLASTER BUCKETS</b>		WEIGHT	LOT
	010510408 PLASTER BUCKET 40 (ZN)	13,00	
	010510508 PLASTER BUCKET 50 (ZN)	14,00	
	040520925 EXTENSIBLE PLASTER BUCKET TRESTLE (PT)	3,70	

<b>DEBRIS CHUTES</b>		WEIGHT	LOT
	010710131 ENTRY DEBRIS CHUTE	12,50	
	010720111 CONSTRUCTION DEBRIS CHUTE	8,00	
	010700000 SUPPORT SYSTEM FOR DEBRIS CHUTE (GA)	13,50	

<b>PORTABLE BATHROOM</b>		WEIGHT	LOT
	9901C0000 PORTABLE BATHROOM EQUIPPED WITH WHEELS	67,00	

<b>SIEVES</b>		WEIGHT	LOT
	100315085 METALLIC SIEVE KB-A 1500x 800 (5x5) (PT)	17,00	
	100320105 METALLIC SIEVE KB-B 2000x1000 (5x5) (PT)	22,00	

<b>MANHOLE COVERS</b>		WEIGHT	LOT
	900001008 MANHOLE COVER 300x300 (2) (ZN)	EN 124-1	3,20 10
	900001018 MANHOLE COVER 400x400 (2) (ZN)		4,20 10
	900001028 MANHOLE COVER 500x500 (2x2) (ZN)		6,10 10
	900001038 MANHOLE COVER 600x600 (2x2) (ZN)		7,60 10
	900001048 MANHOLE COVER 700x700 (3x3) (ZN)		8,90 10
	900001058 MANHOLE COVER 800x800 (3x3) (ZN)		9,60 10
	900001108 MANHOLE COVER W/LOCK 300x300 (2) (ZN)	EN 124-1	3,98 10
	900001118 MANHOLE COVER W/LOCK 400x400 (2) (ZN)		5,73 10
	900001128 MANHOLE COVER W/LOCK 500x500 (4) (ZN)		7,91 10
	900001138 MANHOLE COVER W/LOCK 600x600 (4) (ZN)		10,22 10

<b>CLEANER FOR BRICKWORK</b>		WEIGHT	LOT
	900000010 CLEANER FOR BRICKWORK (ZN)	0,16	25

<b>CAULKER</b>		WEIGHT	LOT
	900000020 CAULKER (SHEET 30 cm.)	0,70	10
	900000030 HANDLE 1190 (WD)	0,90	10

<b>RETAINING WALLS</b>		WEIGHT	LOT
	900003005 RETAINING WALL 1.0 m (PT)	8,70	
	900003015 RETAINING WALL 2.0 m (PT)	16,20	
	900003025 RETAINING WALL 2.5 m (PT)	20,20	
	900003035 RETAINING WALL 3.0 m (PT)	24,60	
	900003045 ANGLE RETAINING WALL 0.5 x 0.5 m (PT)	9,30	
	900003055 COMPENSATORY RETAINING WALL (PT)	6,40	
	900003068 UNION CLAMP (T-P) (ZN)	0,15	

<b>H FORMWORK (for 27 and 32 mm panels)</b>		WEIGHT	LOT
	38ZZ00274 H FORMWORK 27 (PT)	3,10	
	38ZZ00279 H FORMWORK 27 (GA)	3,10	
	38ZZ00324 H FORMWORK 32 (PT)	3,10	
	38ZZ00329 H FORMWORK 32 (GA)	3,10	
	38ZZ00008 H ADJUSTABLE FORMWORK 27 (ZN)	4,80	

<b>HAMMER CLAMPS</b>		WEIGHT	LOT
	070110702 HAMMER CLAMP 700 (PT)	2,70	6/60
	070110902 HAMMER CLAMP 900 (PT)	3,00	6/60

<b>TIE RODS</b>		WEIGHT	LOT
	38ZA17100 TIE ROD Ø:17 1000	1,60	10
	38ZA17108 TIE ROD Ø:17 1000 (ZN)	1,60	10
	070200530 PROTECTION PLASTIC PLUG (ØE 36 / ØI 12-18)	0,021	250

<b>NUTS AND SQUARE WASHER</b>		WEIGHT	LOT
	38ZF17120 ROTATING WING NUT Ø:17 H:75 (115) (ZN)	1,12	
	38ZG17100 TIE NUT Ø:17 H:50 Ø:100 (ZN)	0,51	40
	38ZB17090 WING NUT Ø:17 H:50 (ZN)	0,35	100
	38ZC17050 HEXAGONAL NUT Ø:17 H:50 (ZN)	0,22	100
	38ZE12082 SQUARE WASHER Ø:22 120x120x8 (ZN)	0,85	



**ROOF FORMWORK SYSTEM FOR 0,97 / 1 m PANELS**
**STEEL JOISTS**

WEIGHT LOT

	32CA10009 STEEL JOIST 1 m (GA)	5,60
	32CA20009 STEEL JOIST 2 m (GA)	11,05
	32CA30009 STEEL JOIST 3 m (GA)	16,05
	32CA40009 STEEL JOIST 4 m (GA)	21,00

**STEEL STRINGERS**

WEIGHT LOT

	32PA10008 STEEL STRINGER ( T- 970) 1 m (GA)	4,80
	32PA20008 STEEL STRINGER ( T- 970) 2 m (GA)	8,50
	32PA30008 STEEL STRINGER ( T- 970) 3 m (GA)	12,20
	32PA40008 STEEL STRINGER ( T- 970) 4 m (GA)	16,15
	32PB10008 STEEL STRINGER ( T-1000) 1 m (GA)	4,80
	32PB20008 STEEL STRINGER ( T-1000) 2 m (GA)	8,50
	32PB30008 STEEL STRINGER ( T-1000) 3 m (GA)	12,20
	32PB40008 STEEL STRINGER ( T-1000) 4 m (GA)	16,15

**ROOF FORMWORK SYSTEM FOR 1,97 / 2 m PANELS**
**STEEL JOISTS**

WEIGHT LOT

	32CA10009 STEEL JOIST 1 m (GA)	5,60
	32CA20009 STEEL JOIST 2 m (GA)	11,05
	32CA30009 STEEL JOIST 3 m (GA)	16,05
	32CA40009 STEEL JOIST 4 m (GA)	21,00

**STEEL STRINGERS**

WEIGHT LOT

	32PC20008 STEEL STRINGER ( T-1970) 2 m (GA)	8,50
	32PC40008 STEEL STRINGER ( T-1970) 4 m (GA)	16,15
	32PD20008 STEEL STRINGER ( T-2000) 2 m (GA)	8,50
	32PD40008 STEEL STRINGER ( T-2000) 4 m (GA)	16,15

**INTERMEDIATES**

WEIGHT LOT

	32CX20108 INTERMEDIATE (T-1970/2000) 1 m (GA)	4,00
	32CX20208 INTERMEDIATE (T-1970/2000) 2 m (GA)	8,20
	32CX20308 INTERMEDIATE (T-1970/2000) 3 m (GA)	11,90
	32CX20408 INTERMEDIATE (T-1970/2000) 4 m (GA)	15,60

**JOISTS**

WEIGHT LOT

	32CX01978 JOIST T-1970 (GA)	5,10
	32CX02008 JOIST T-2000 (GA)	5,10

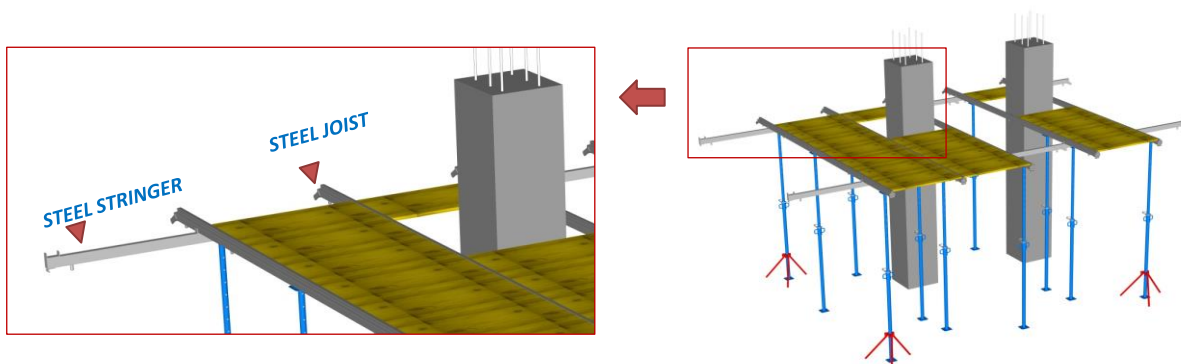

**TELESCOPIC PROPS**

WEIGHT LOT

	090111005 TELESCOPIC PROP 1750 (PT)		5,40	26/65
	090113005 TELESCOPIC PROP 3000 (PT)		7,30	26/65
	090213004 TELESCOPIC PROP 3000 R (PT)		8,50	26/65
	090214004 TELESCOPIC PROP 4000 R (PT)		10,20	26/65
	090115004 TELESCOPIC PROP 5000 (PT)		15,00	50

**KITS**

PT

WEIGHT LOT

	090903630 TELES. PROP 3000 (63u.) + PALLET DCM (kit)		0,00	
	090913630 TELES. PROP 3000 R (63u.) + PALLET DCM (kit)		0,00	
	090904630 TELES. PROP 4000 R (63u.) + PALLET DCM (kit)		0,00	

**PROP COMPONENTS**

WEIGHT LOT

	090300010 PROP WASHER (1750-3000-4000) (ZN)		0,06	
	090300054 PROP WASHER (5000) (PT)		0,05	
	090300025 PROP HOOK (1750-3000-4000) (ZN)		0,18	100
	090300064 PROP HOOK (5000) (PT)		0,40	

**PROP ACCESSORIES**

WEIGHT LOT

	090300035 PROP FORK HEAD (GA)		2,40	
	090301004 PROP SUPPORT (Ø 48 / Ø 56) (PT)		3,40	
	090301009 PROP SUPPORT (Ø 48 / Ø 56) (GA)		3,55	
	090300048 INCLINABLE TERMINAL TOOL FOR PROP (ZN)		0,90	





DACAME, S. L.

[www.dacame.com](http://www.dacame.com)

[dacame@dacame.com](mailto:dacame@dacame.com)

+34 977 717 004

Ctra. Santa Bárbara - La Sénia. km.4,6  
43515 La Galera - Tarragona - SPAIN

