

MC770

RESIDENTIAL ROOFING

DETAIL LIST

00 / 24	COVER SHEET
01 / 24	ROOF RIDGE
02 / 24	SAWTOOTH RIDGE
03 / 24	SAWTOOTH EAVE
04 / 24	ROOF VALLEY
05 / 24	ROOF - CHANGE PITCH
06 / 24	EAVE WITH METALLINE FASCIA
07 / 24	EAVE WITH INTERNAL GUTTER BRACKET
08 / 24	EAVE WITH SNOW STRAP
09 / 24	FLUSH EAVE WITH INTERNAL GUTTER BRACKET
10 / 24	FLUSH EAVE WITH EXTERNAL GUTTER BRACKET
11 / 24	BARGE WITH PROFILED CLADDING
12 / 24	BARGE OVERHANG
13 / 24	PARAPET WITH TRANSVERSE APRON
14 / 24	TRANSVERSE APRON
15 / 24	PARALLEL APRON
16 / 24	MAX. 85mm DIAMETER PIPE PENETRATION
17 / 24	OVER 85mm DIAMETER PIPE PENETRATION
18 / 24	3D-RIDGE TO BARGE JUCTION
19 / 24	3D-DUTCH GABLE
20 / 24	3D-APRON
21 / 24	3D-OVER 85mm DIAMETER PIPE PENETRATION
22 / 24	3D-CHIMNEY PENETRATION
23 / 24	3D-RIDGE/BARGE FLASHINGS
24 / 24	3D-DUTCH GABLE FLASHINGS

RRMC770

0800 ROOFNZ (0800 766 369)
www.metalcraftroofing.co.nz

Architectural / Specification Enquiries

Ph: 09 274 0408

Mobile: 027 603 1096

Email: Frances.charles@unitedindustries.co.nz



Metalcraft
Roofing

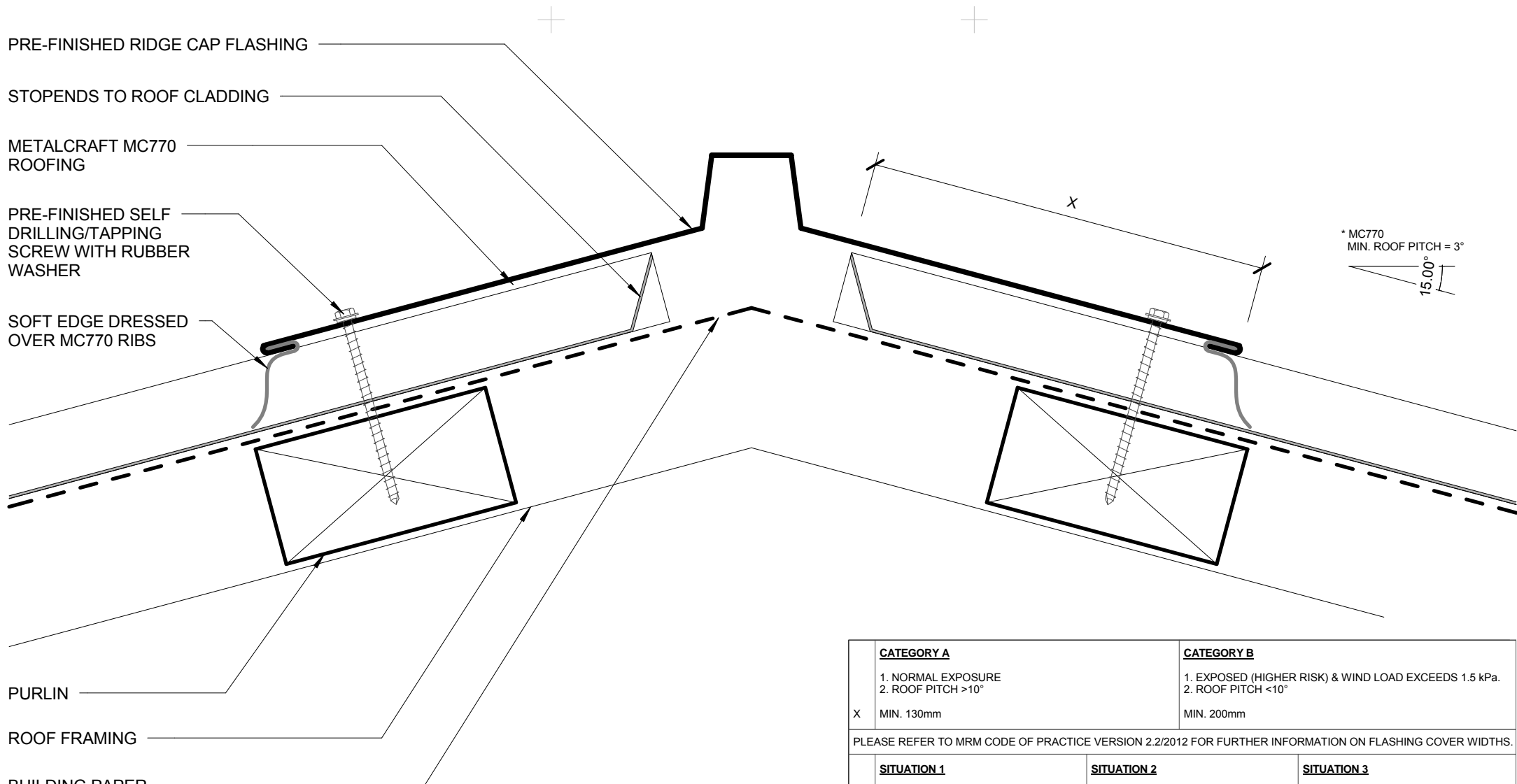

CATEGORY A		CATEGORY B			
1. NORMAL EXPOSURE 2. ROOF PITCH >10°		1. EXPOSED (HIGHER RISK) & WIND LOAD EXCEEDS 1.5 kPa. 2. ROOF PITCH <10°			
X	MIN. 130mm	X	MIN. 200mm		
PLEASE REFER TO MRM CODE OF PRACTICE VERSION 2.2/2012 FOR FURTHER INFORMATION ON FLASHING COVER WIDTHS.					
SITUATION 1		SITUATION 2		SITUATION 3	
1. LOW, MEDIUM, HIGH WIND ZONES 2. ROOF PITCH ≥ 10°		1. VERY HIGH WIND ZONE 2. ALL ROOF PITCHES		1. EXTRA HIGH WIND ZONE 2. ALL ROOF PITCHES	
X	MIN. 130mm (EXCLUDING ANY SOFT EDGE OR TURN-DOWN TO ROOFING)	X	MIN. 200mm (EXCLUDING ANY SOFT EDGE OR TURN-DOWN TO ROOFING)	X	MIN. 200mm
PLEASE REFER TO E2 FOR FURTHER INFORMATION ON FLASHING COVER WIDTHS.					

- BUILDING PAPER IS THE COMMON GENERIC NAME FOR PERMEABLE ROOF AND WALL UNDERLAYS. PLEASE REFER TO NZBC E2/AS1 AND MRM CODE OF PRACTICE VERSION 2.2 /2012.

* - PLEASE REFER TO MRM CODE OF PRACTICE VERSION 2.2 /2012 AS MINIMUM PITCH WILL INCREASE DEPENDING ON SHEET LENGTH.

DISCLAIMER:
All details are to be used for indicative purposes only and the designer should consult both the MRM code of practice version 2.2 /2012, E2 and all other relevant building codes
Details of the supporting mechanisms are indicative only. Compliance of the supporting mechanisms is the responsibility of the designer. Construction detail can vary for wall cladding. The underlay is detailed as a single line for simplicity and is indicative only. Building paper type and method of installation should comply with underlay manufacturers recommendations and NZBC regulations.



MC770

**ROOF RIDGE
RESIDENTIAL ROOFING**

Reference RRM770

Date 2014

Scale 1 : 2

Sheet

01 / 24

PRE-FINISHED SAWTOOTH
RIDGE CAP FLASHING

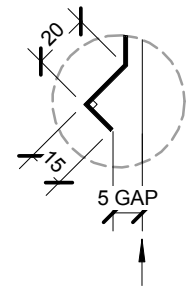

ALTERNATIVE OPTION
BIRDS BEAK EDGE

HEMMED EDGE

PRE-FINISHED 8g WAFER-
TEK SCREW BEDDED IN
SILICONE

TIMBER PACKER

FASCIA BOARD

TIMBER PACKER

WEATHERBOARDS ON CAVITY

BUILDING PAPER SHOWN DASHED

ROOF OR WALL FRAMING

Z

X



STOPENDS TO ROOF CLADDING

SOFT EDGE DRESSED OVER
MC770 RIBS

METALCRAFT MC770 ROOFING

PRE-FINISHED SELF
DRILLING/TAPPING SCREW WITH
RUBBER WASHER

BUILDING PAPER SHOWN
DASHED

PURLIN

CATEGORY A		CATEGORY B			
1. NORMAL EXPOSURE 2. ROOF PITCH >10°		1. EXPOSED (HIGHER RISK) & WIND LOAD EXCEEDS 1.5 kPa. 2. ROOF PITCH <10°			
X	MIN. 130mm	MIN. 200mm			
Z	MIN. 50mm (VERTICALLY DOWN FACE - SMOOTH) MIN. 75mm (VERTICALLY DOWN FACE - PROFILED)	MIN. 75mm (VERTICALLY DOWN FACE - SMOOTH) MIN. 100mm (VERTICALLY DOWN FACE - PROFILED)			
PLEASE REFER TO MRM CODE OF PRACTICE VERSION 2.2/2012 FOR FURTHER INFORMATION ON FLASHING COVER WIDTHS.					
SITUATION 1		SITUATION 2		SITUATION 3	
1. LOW, MEDIUM, HIGH WIND ZONES 2. ROOF PITCH ≥ 10°		1. VERY HIGH WIND ZONE 2. ALL ROOF PITCHES		1. EXTRA HIGH WIND ZONE 2. ALL ROOF PITCHES	
X	MIN. 130mm (EXCLUDING ANY SOFT EDGE OR TURN-DOWN TO ROOFING)	MIN. 200mm (EXCLUDING ANY SOFT EDGE OR TURN-DOWN TO ROOFING)		MIN. 200mm	
Z	MIN. 50mm	MIN. 70mm		MIN. 90mm	
PLEASE REFER TO E2 FOR FURTHER INFORMATION ON FLASHING COVER WIDTHS.					

- BUILDING PAPER IS THE COMMON GENERIC NAME FOR PERMEABLE
ROOF AND WALL UNDERLAYS. PLEASE REFER TO NZBC E2/AS1 AND
MRM CODE OF PRACTICE VERSION 2.2 /2012.

* - PLEASE REFER TO MRM CODE OF PRACTICE VERSION 2.2 /2012 AS
MINIMUM PITCH WILL INCREASE DEPENDING ON SHEET LENGTH.

DISCLAIMER:
All details are to be used for indicative purposes only and the designer should consult both the MRM code
of practice version 2.2 /2012, E2 and all other relevant building codes
Details of the supporting mechanisms are indicative only. Compliance of the supporting mechanisms is the
responsibility of the designer. Construction detail can vary for wall cladding. The underlay is detailed as a
single line for simplicity and is indicative only. Building paper type and method of installation should comply
with underlay manufacturers recommendations and NZBC regulations.

MC770

SAWTOOTH RIDGE
RESIDENTIAL ROOFING

Reference RRM770

Date 2014

Scale 1 : 2

Sheet

02 / 24

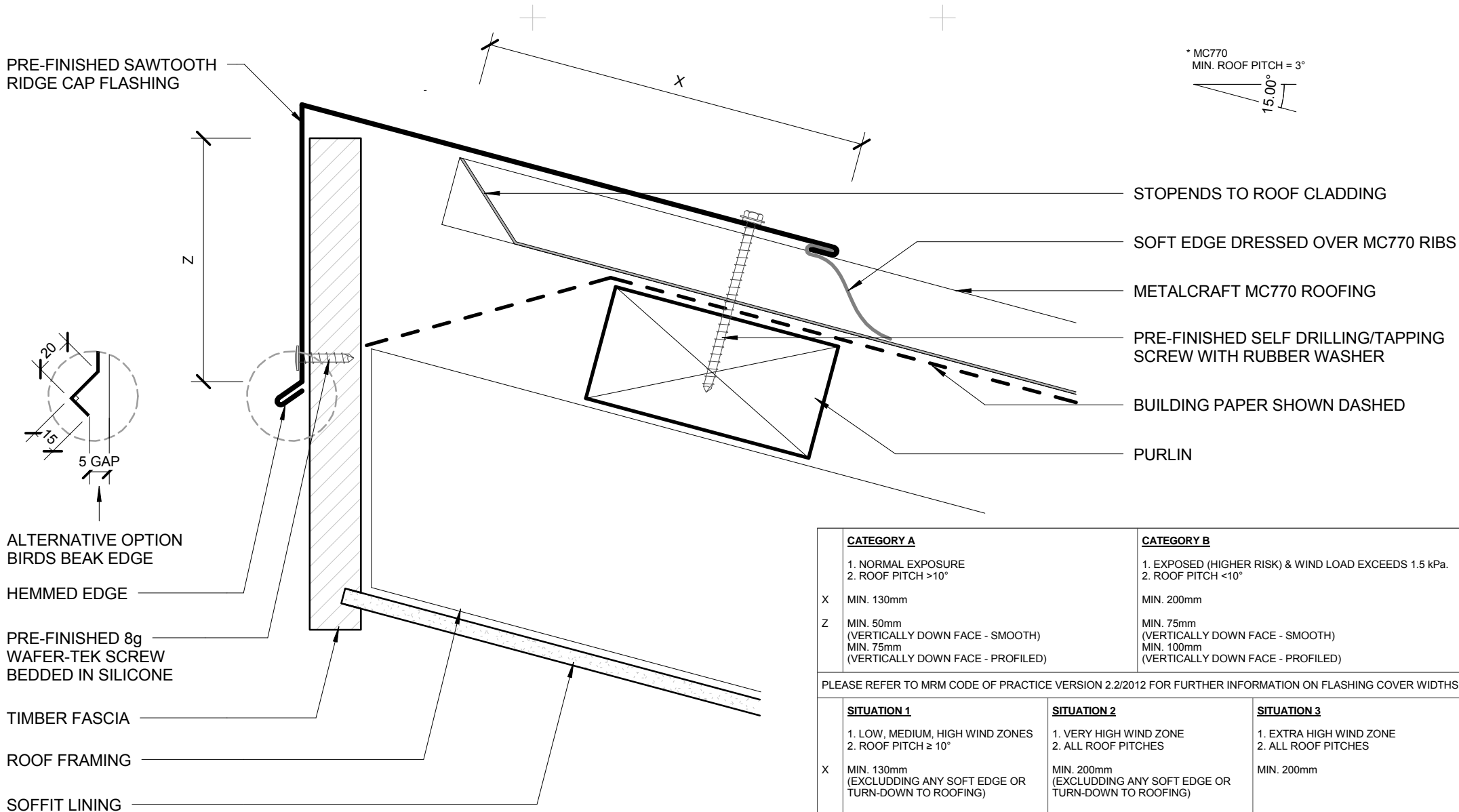

* MC770
MIN. ROOF PITCH = 3°
15.00°

ALTERNATIVE OPTION
BIRDS BEAK EDGE

HEMMED EDGE

PRE-FINISHED 8g
WAFER-TEK SCREW
BEDDED IN SILICONE

TIMBER FASCIA

ROOF FRAMING

SOFFIT LINING

STOPENDS TO ROOF CLADDING

SOFT EDGE DRESSED OVER MC770 RIBS

METALCRAFT MC770 ROOFING

PRE-FINISHED SELF DRILLING/TAPPING
SCREW WITH RUBBER WASHER

BUILDING PAPER SHOWN DASHED

PURLIN

CATEGORY A		CATEGORY B			
1. NORMAL EXPOSURE 2. ROOF PITCH >10°		1. EXPOSED (HIGHER RISK) & WIND LOAD EXCEEDS 1.5 kPa. 2. ROOF PITCH <10°			
X	MIN. 130mm	MIN. 200mm			
Z	MIN. 50mm (VERTICALLY DOWN FACE - SMOOTH) MIN. 75mm (VERTICALLY DOWN FACE - PROFILED)	MIN. 75mm (VERTICALLY DOWN FACE - SMOOTH) MIN. 100mm (VERTICALLY DOWN FACE - PROFILED)			
PLEASE REFER TO MRM CODE OF PRACTICE VERSION 2.2/2012 FOR FURTHER INFORMATION ON FLASHING COVER WIDTHS.					
SITUATION 1		SITUATION 2		SITUATION 3	
1. LOW, MEDIUM, HIGH WIND ZONES 2. ROOF PITCH ≥ 10°		1. VERY HIGH WIND ZONE 2. ALL ROOF PITCHES		1. EXTRA HIGH WIND ZONE 2. ALL ROOF PITCHES	
X	MIN. 130mm (EXCLUDING ANY SOFT EDGE OR TURN-DOWN TO ROOFING)	MIN. 200mm (EXCLUDING ANY SOFT EDGE OR TURN-DOWN TO ROOFING)		MIN. 200mm	
Z	MIN. 50mm	MIN. 70mm		MIN. 90mm	
PLEASE REFER TO E2 FOR FURTHER INFORMATION ON FLASHING COVER WIDTHS.					

- BUILDING PAPER IS THE COMMON GENERIC NAME FOR PERMEABLE ROOF AND WALL UNDERLAYS. PLEASE REFER TO NZBC E2/AS1 AND MRM CODE OF PRACTICE VERSION 2.2 /2012.

* - PLEASE REFER TO MRM CODE OF PRACTICE VERSION 2.2 /2012 AS MINIMUM PITCH WILL INCREASE DEPENDING ON SHEET LENGTH.

DISCLAIMER:
All details are to be used for indicative purposes only and the designer should consult both the MRM code of practice version 2.2 /2012, E2 and all other relevant building codes
Details of the supporting mechanisms are indicative only. Compliance of the supporting mechanisms is the responsibility of the designer. Construction detail can vary for wall cladding. The underlay is detailed as a single line for simplicity and is indicative only. Building paper type and method of installation should comply with underlay manufacturers recommendations and NZBC regulations.

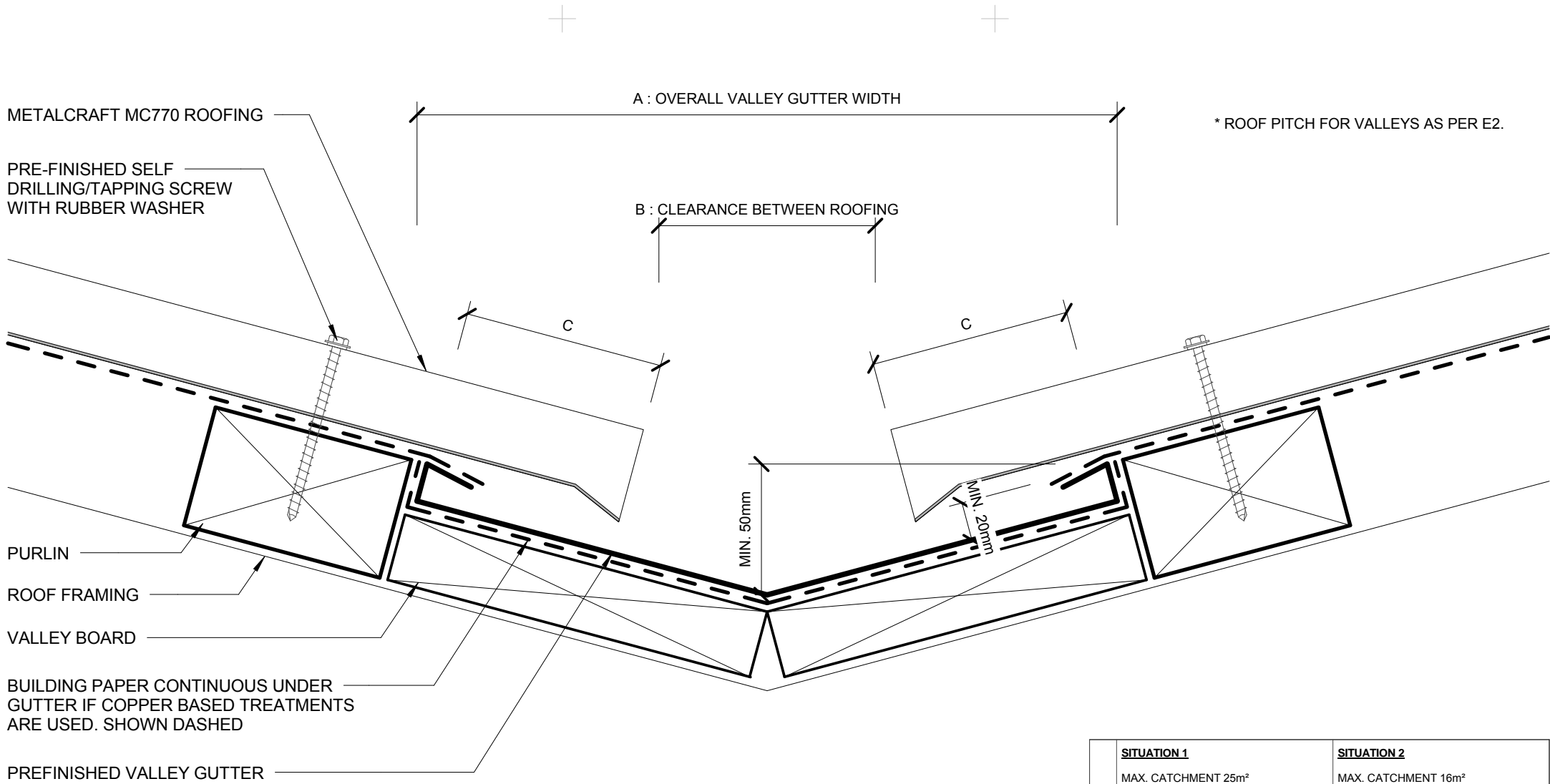

	SITUATION 1	SITUATION 2
	MAX. CATCHMENT 25m ² MIN. ROOF PITCH 8°	MAX. CATCHMENT 16m ² MIN. ROOF PITCH 12.5°
A	MIN. 250mm	160mm - 249mm
B	MIN. 50mm	MIN. 40mm
C	MIN. 80mm	MIN. 60mm
PLEASE REFER TO MRM CODE OF PRACTICE VERSION 2.2/2012 AND E2 FOR FURTHER INFORMATION.		

- BUILDING PAPER IS THE COMMON GENERIC NAME FOR PERMEABLE ROOF AND WALL UNDERLAYS. PLEASE REFER TO NZBC E2/AS1 AND MRM CODE OF PRACTICE VERSION 2.2 /2012.

* - PLEASE REFER TO MRM CODE OF PRACTICE VERSION 2.2 /2012 AS MINIMUM PITCH WILL INCREASE DEPENDING ON SHEET LENGTH.

DISCLAIMER:
All details are to be used for indicative purposes only and the designer should consult both the MRM code of practice version 2.2 /2012, E2 and all other relevant building codes
Details of the supporting mechanisms are indicative only. Compliance of the supporting mechanisms is the responsibility of the designer. Construction detail can vary for wall cladding. The underlay is detailed as a single line for simplicity and is indicative only. Building paper type and method of installation should comply with underlay manufacturers recommendations and NZBC regulations.

MC770

Reference RRM770

Date 2014

Scale 1 : 2

Sheet

**ROOF VALLEY
RESIDENTIAL ROOFING**

04 / 24

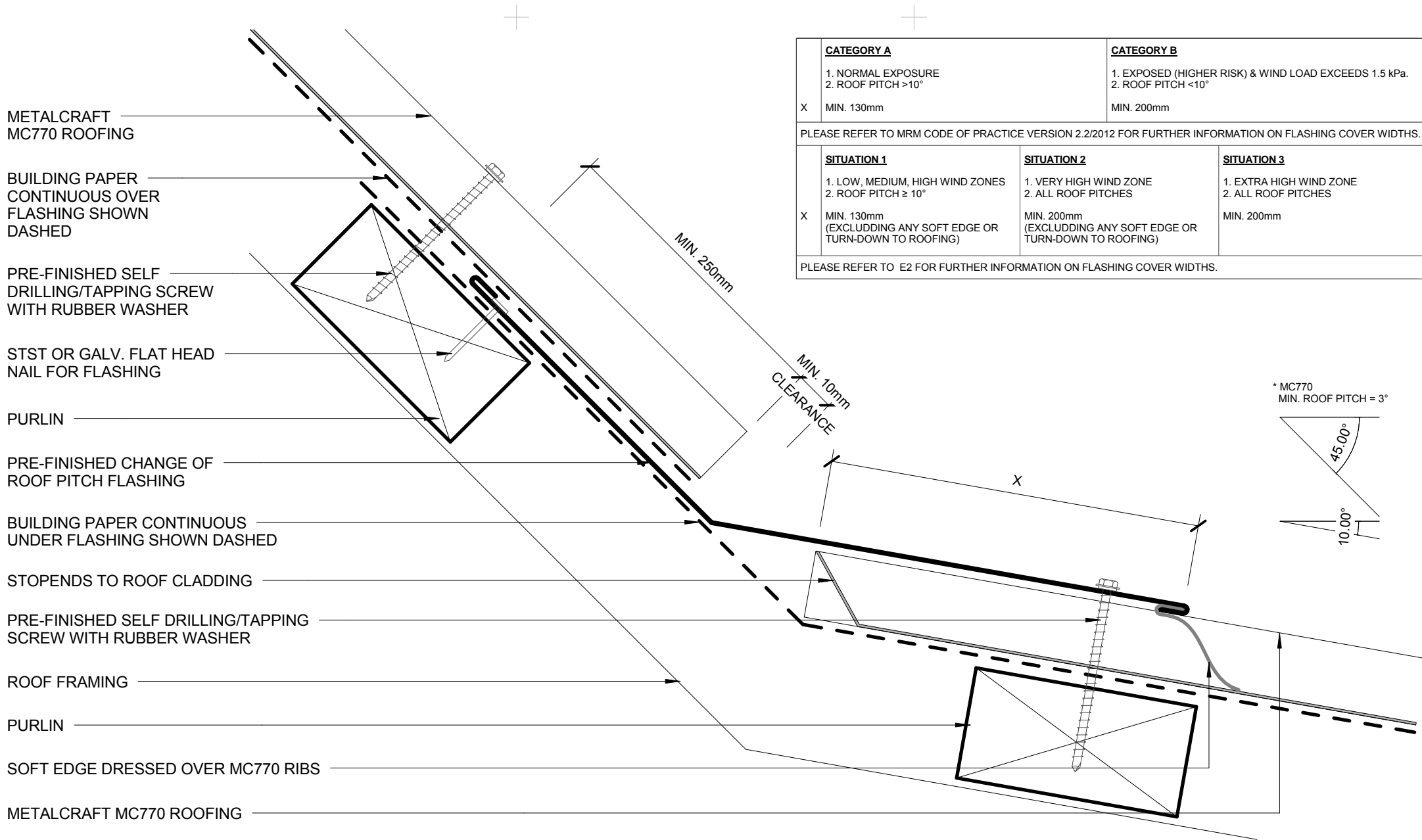

- BUILDING PAPER IS THE COMMON GENERIC NAME FOR PERMEABLE ROOF AND WALL UNDERLAYS. PLEASE REFER TO NZBC E2/AS1 AND MRM CODE OF PRACTICE VERSION 2.2 /2012.

* - PLEASE REFER TO MRM CODE OF PRACTICE VERSION 2.2 /2012 AS MINIMUM PITCH WILL INCREASE DEPENDING ON SHEET LENGTH.

DISCLAIMER:
All details are to be used for indicative purposes only and the designer should consult both the MRM code of practice version 2.2 /2012, E2 and all other relevant building codes
Details of the supporting mechanisms are indicative only. Compliance of the supporting mechanisms is the responsibility of the designer. Construction detail can vary for wall cladding. The underlay is detailed as a single line for simplicity and is indicative only. Building paper type and method of installation should comply with underlay manufacturers recommendations and NZBC regulations.

MC770

Reference RRM770

Date 2014

Scale 1 : 2

Sheet

05 / 24

ROOF - CHANGE PITCH
RESIDENTIAL ROOFING

EAVE FLASHING REQUIRED WHEN
 - ROOF PITCH $\leq 10^\circ$, OR
 - SOFFIT WIDTH $\leq 100\text{mm}$, OR
 - WIND ZONES = VERY HIGH OR EXTRA HIGH OR
 - ENGINEER SPECIFIC DESIGN

* MC770
 MIN. ROOF PITCH = 3°



MIN. 50mm
 OR AS REQUIRED

MIN. 125 mm

MIN. 35mm
 OVERLAP

METALCRAFT MC770 ROOFING

BUILDING PAPER SHOWN DASHED

METALLINE™ QUAD GUTTER

METALLINE™ QUAD GUTTER
 OVERSTRAP

SPRING CLIP

METALLINE™ FASCIA

FASCIA BRACKET

PRE-FINISHED EAVE FLASHING

TIMBER PURLIN

STST OR GALV. FLAT HEAD NAIL
 FOR FLASHING

PRE-FINISHED SELF DRILLING/TAPPING
 SCREW WITH RUBBER WASHER

TIMBER ROOF FRAMING

SOFFIT LINING

- BUILDING PAPER IS THE COMMON GENERIC NAME FOR PERMEABLE
 ROOF AND WALL UNDERLAYS. PLEASE REFER TO NZBC E2/AS1 AND
 MRM CODE OF PRACTICE VERSION 2.2 /2012.

* - PLEASE REFER TO MRM CODE OF PRACTICE VERSION 2.2 /2012 AS
 MINIMUM PITCH WILL INCREASE DEPENDING ON SHEET LENGTH.

DISCLAIMER:
 All details are to be used for indicative purposes only and the designer should consult both the MRM code
 of practice version 2.2 /2012, E2 and all other relevant building codes
 Details of the supporting mechanisms are indicative only. Compliance of the supporting mechanisms is the
 responsibility of the designer. Construction detail can vary for wall cladding. The underlay is detailed as a
 single line for simplicity and is indicative only. Building paper type and method of installation should comply
 with underlay manufacturers recommendations and NZBC regulations.

EAVE WITH METALLINE FASCIA
 RESIDENTIAL ROOFING

MC770

Reference RRM770

Date 2014

Scale 1 : 2

Sheet

06 / 24



EAVE FLASHING REQUIRED WHEN
 - ROOF PITCH $\leq 10^\circ$, OR
 - SOFFIT WIDTH $\leq 100\text{mm}$, OR
 - WIND ZONES = VERY HIGH OR EXTRA HIGH OR
 - ENGINEER SPECIFIC DESIGN

* MC770
 MIN. ROOF PITCH = 3°

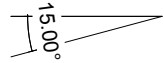

METALCRAFT MC770 ROOFING

BUILDING PAPER SHOWN DASHED

METALLINE™ QUAD GUTTER

METALLINE™ QUAD GUTTER
 INTERNAL BRACKET

PRE-FINISHED 8g WAFER-TEK SCREW

TIMBER FASCIA

MIN. 50mm
 OR AS REQUIRED

MIN. 125 mm

MIN. 35mm
 OVERLAP

PRE-FINISHED EAVE FLASHING

TIMBER PURLIN

STST OR GALV. FLAT HEAD NAIL OR
 FLASHING

PRE-FINISHED SELF DRILLING/TAPPING
 SCREW WITH RUBBER WASHER

TIMBER ROOF FRAMING

SOFFIT LINING

- BUILDING PAPER IS THE COMMON GENERIC NAME FOR PERMEABLE
 ROOF AND WALL UNDERLAYS. PLEASE REFER TO NZBC E2/AS1 AND
 MRM CODE OF PRACTICE VERSION 2.2 /2012.

* - PLEASE REFER TO MRM CODE OF PRACTICE VERSION 2.2 /2012 AS
 MINIMUM PITCH WILL INCREASE DEPENDING ON SHEET LENGTH.

DISCLAIMER:
 All details are to be used for indicative purposes only and the designer should consult both the MRM code
 of practice version 2.2 /2012, E2 and all other relevant building codes
 Details of the supporting mechanisms are indicative only. Compliance of the supporting mechanisms is the
 responsibility of the designer. Construction detail can vary for wall cladding. The underlay is detailed as a
 single line for simplicity and is indicative only. Building paper type and method of installation should comply
 with underlay manufacturers recommendations and NZBC regulations.

EAVE WITH INTERNAL GUTTER BRACKET

RESIDENTIAL ROOFING

MC770

Reference RRM770

Date 2014

Scale 1 : 2

Sheet

07 / 24

EAVE FLASHING REQUIRED WHEN
 - ROOF PITCH $\leq 10^\circ$, OR
 - SOFFIT WIDTH $\leq 100\text{mm}$, OR
 - WIND ZONES = VERY HIGH OR EXTRA HIGH OR
 - ENGINEER SPECIFIC DESIGN

* MC770
 MIN. ROOF PITCH = 3°

15.00°

MIN. 125 mm

MIN. 50mm
 OR AS REQUIRED

METALCRAFT MC770 ROOFING

PRE-FINISHED POP RIVET
 BEDDED IN SILICONE OR PRE-FINISHED 8g WAFER-TEK SCREW

SNOW STRAP AS REQUIRED

METALLINE™ QUAD GUTTER

METALLINE™ QUAD GUTTER
 INTERNAL BRACKET

PRE-FINISHED 8g WAFER-TEK
 SCREW

TIMBER FASCIA

MIN. 35mm
 OVERLAP

BUILDING PAPER SHOWN DASHED

PRE-FINISHED EAVE FLASHING

TIMBER PURLIN

STST OR GALV. FLAT HEAD NAIL FOR
 FLASHING

PRE-FINISHED SELF DRILLING/TAPPING
 SCREW WITH RUBBER WASHER

TIMBER ROOF FRAMING

SOFFIT LINING

- BUILDING PAPER IS THE COMMON GENERIC NAME FOR PERMEABLE
 ROOF AND WALL UNDERLAYS. PLEASE REFER TO NZBC E2/AS1 AND
 MRM CODE OF PRACTICE VERSION 2.2 /2012.

* - PLEASE REFER TO MRM CODE OF PRACTICE VERSION 2.2 /2012 AS
 MINIMUM PITCH WILL INCREASE DEPENDING ON SHEET LENGTH.

DISCLAIMER:
 All details are to be used for indicative purposes only and the designer should consult both the MRM code
 of practice version 2.2 /2012, E2 and all other relevant building codes
 Details of the supporting mechanisms are indicative only. Compliance of the supporting mechanisms is the
 responsibility of the designer. Construction detail can vary for wall cladding. The underlay is detailed as a
 single line for simplicity and is indicative only. Building paper type and method of installation should comply
 with underlay manufacturers recommendations and NZBC regulations.

MC770

Reference RRM770

Date 2014

Scale 1 : 2

Sheet

08 / 24

EAVE WITH SNOW STRAP
 RESIDENTIAL ROOFING

EAVE FLASHING REQUIRED WHEN
 - ROOF PITCH $\leq 10^\circ$, OR
 - SOFFIT WIDTH $\leq 100\text{mm}$, OR
 - WIND ZONES = VERY HIGH OR EXTRA HIGH OR
 - ENGINEER SPECIFIC DESIGN

* MC770
 MIN. ROOF PITCH = 3°

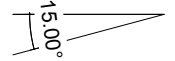

METALCRAFT MC770 ROOFING

BUILDING PAPER SHOWN DASHED

QUARTER ROUND GUTTER

QUARTER ROUND GUTTER
 INTERNAL BRACKET

PRE-FINISHED 8g WAFER-TEK SCREW

FASCIA BOARD

TIMBER PACKER

WEATHERBOARDS ON CAVITY

MIN. 50mm
 OR AS REQUIRED

MIN. 125 mm

MIN. 35mm
 OVERLAP

PRE-FINISHED EAVE FLASHING

TIMBER PURLIN

STST OR GALV. FLAT HEAD NAIL FOR
 FLASHING

PRE-FINISHED SELF DRILLING/TAPPING
 SCREW WITH RUBBER WASHER

TIMBER PACKER

BUILDING PAPER SHOWN DASHED

ROOF FRAMING

- BUILDING PAPER IS THE COMMON GENERIC NAME FOR PERMEABLE
 ROOF AND WALL UNDERLAYS. PLEASE REFER TO NZBC E2/AS1 AND
 MRM CODE OF PRACTICE VERSION 2.2 /2012.

* - PLEASE REFER TO MRM CODE OF PRACTICE VERSION 2.2 /2012 AS
 MINIMUM PITCH WILL INCREASE DEPENDING ON SHEET LENGTH.

DISCLAIMER:
 All details are to be used for indicative purposes only and the designer should consult both the MRM code
 of practice version 2.2 /2012, E2 and all other relevant building codes
 Details of the supporting mechanisms are indicative only. Compliance of the supporting mechanisms is the
 responsibility of the designer. Construction detail can vary for wall cladding. The underlay is detailed as a
 single line for simplicity and is indicative only. Building paper type and method of installation should comply
 with underlay manufacturers recommendations and NZBC regulations.

FLUSH EAVE WITH INTERNAL GUTTER BRACKET

MC770

RESIDENTIAL ROOFING

Reference RRM770

Date 2014

Scale 1 : 2

Sheet

09 / 24

EAVE FLASHING REQUIRED WHEN
 - ROOF PITCH $\leq 10^\circ$, OR
 - SOFFIT WIDTH $\leq 100\text{mm}$, OR
 - WIND ZONES = VERY HIGH OR EXTRA HIGH OR
 - ENGINEER SPECIFIC DESIGN

* MC770
 MIN. ROOF PITCH = 3°

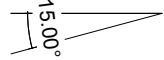

METALCRAFT MC770 ROOFING

BUILDING PAPER SHOWN DASHED

QUARTER ROUND GUTTER

QUARTER ROUND GUTTER
 EXTERNAL BRACKET

PRE-FINISHED 8g WAFER-TEK SCREW

FASCIA BOARD

TIMBER PACKER

WEATHERBOARDS ON CAVITY

MIN. 50mm
 OR AS REQUIRED

MIN. 125 mm

MIN. 35mm
 OVERLAP

PRE-FINISHED EAVE FLASHING

TIMBER PURLIN

STST OR GALV. FLAT HEAD NAIL FOR
 FLASHING

PRE-FINISHED SELF DRILLING/TAPPING
 SCREW WITH RUBBER WASHER

TIMBER PACKER

BUILDING PAPER SHOWN DASHED

ROOF FRAMING

- BUILDING PAPER IS THE COMMON GENERIC NAME FOR PERMEABLE
 ROOF AND WALL UNDERLAYS. PLEASE REFER TO NZBC E2/AS1 AND
 MRM CODE OF PRACTICE VERSION 2.2 /2012.

* - PLEASE REFER TO MRM CODE OF PRACTICE VERSION 2.2 /2012 AS
 MINIMUM PITCH WILL INCREASE DEPENDING ON SHEET LENGTH.

DISCLAIMER:
 All details are to be used for indicative purposes only and the designer should consult both the MRM code
 of practice version 2.2 /2012, E2 and all other relevant building codes
 Details of the supporting mechanisms are indicative only. Compliance of the supporting mechanisms is the
 responsibility of the designer. Construction detail can vary for wall cladding. The underlay is detailed as a
 single line for simplicity and is indicative only. Building paper type and method of installation should comply
 with underlay manufacturers recommendations and NZBC regulations.

FLUSH EAVE WITH EXTERNAL GUTTER BRACKET

MC770

RESIDENTIAL ROOFING

Reference RRM770

Date 2014

Scale 1 : 2

Sheet

10 / 24

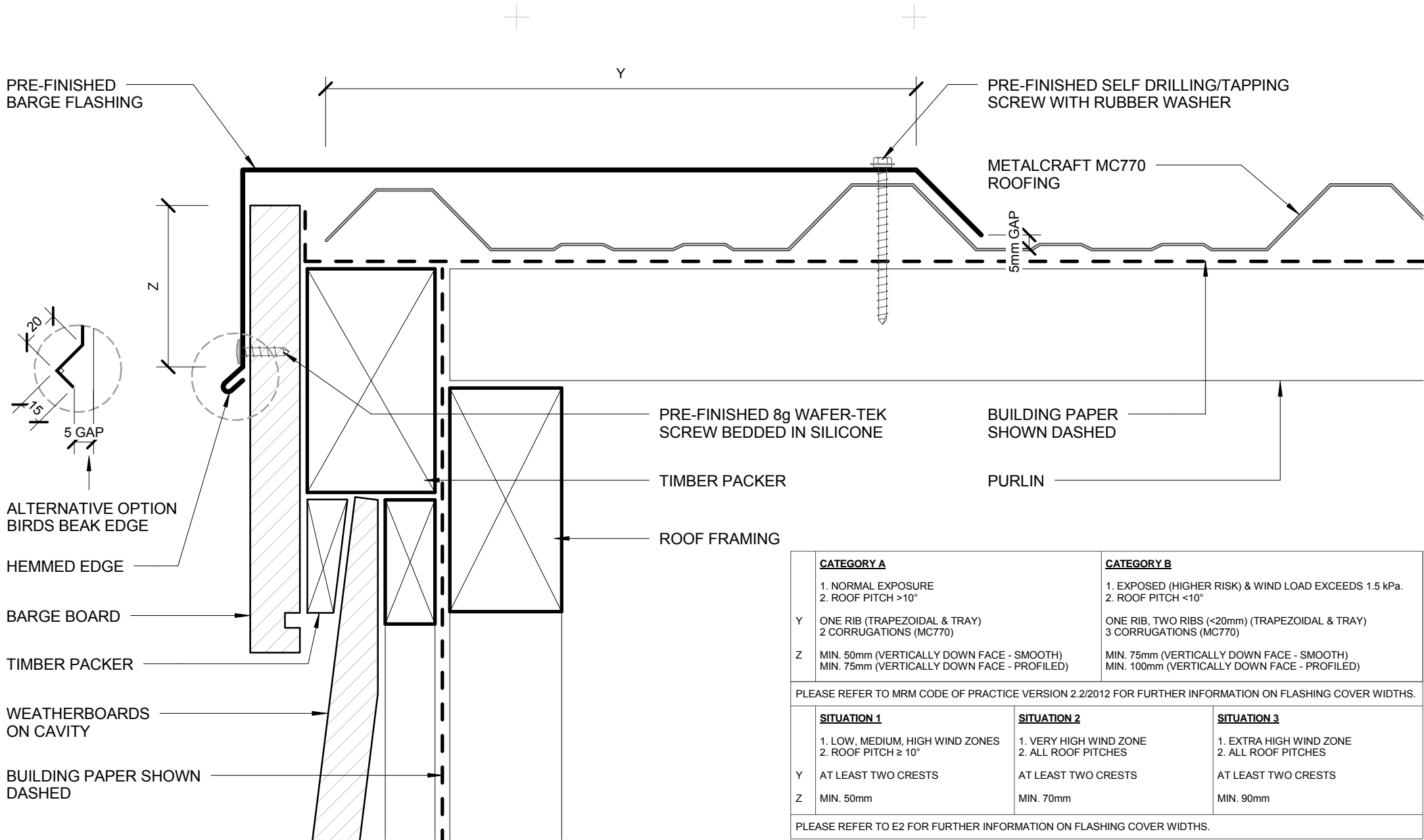

<u>CATEGORY A</u>		<u>CATEGORY B</u>
1. NORMAL EXPOSURE 2. ROOF PITCH >10°		1. EXPOSED (HIGHER RISK) & WIND LOAD EXCEEDS 1.5 kPa. 2. ROOF PITCH <10°
Y	ONE RIB (TRAPEZOIDAL & TRAY) 2 CORRUGATIONS (MC770)	ONE RIB, TWO RIBS (<20mm) (TRAPEZOIDAL & TRAY) 3 CORRUGATIONS (MC770)
Z	MIN. 50mm (VERTICALLY DOWN FACE - SMOOTH) MIN. 75mm (VERTICALLY DOWN FACE - PROFILED)	MIN. 75mm (VERTICALLY DOWN FACE - SMOOTH) MIN. 100mm (VERTICALLY DOWN FACE - PROFILED)
PLEASE REFER TO MRM CODE OF PRACTICE VERSION 2.2/2012 FOR FURTHER INFORMATION ON FLASHING COVER WIDTHS.		
<u>SITUATION 1</u>	<u>SITUATION 2</u>	<u>SITUATION 3</u>
1. LOW, MEDIUM, HIGH WIND ZONES 2. ROOF PITCH ≥ 10°	1. VERY HIGH WIND ZONE 2. ALL ROOF PITCHES	1. EXTRA HIGH WIND ZONE 2. ALL ROOF PITCHES
Y	AT LEAST TWO CRESTS	AT LEAST TWO CRESTS
Z	MIN. 50mm	MIN. 90mm
PLEASE REFER TO E2 FOR FURTHER INFORMATION ON FLASHING COVER WIDTHS.		

- BUILDING PAPER IS THE COMMON GENERIC NAME FOR PERMEABLE ROOF AND WALL UNDERLAYS. PLEASE REFER TO NZBC E2/AS1 AND MRM CODE OF PRACTICE VERSION 2.2 /2012.

DISCLAIMER:
All details are to be used for indicative purposes only and the designer should consult both the MRM code of practice version 2.2 /2012, E2 and all other relevant building codes
Details of the supporting mechanisms are indicative only. Compliance of the supporting mechanisms is the responsibility of the designer. Construction detail can vary for wall cladding. The underlay is detailed as a single line for simplicity and is indicative only. Building paper type and method of installation should comply with underlay manufacturers recommendations and NZBC regulations.

BARGE WITH PROFILED CLADDING RESIDENTIAL ROOFING

MC770

Reference RRM770

Date 2014

Scale 1 : 2

Sheet

11 / 24

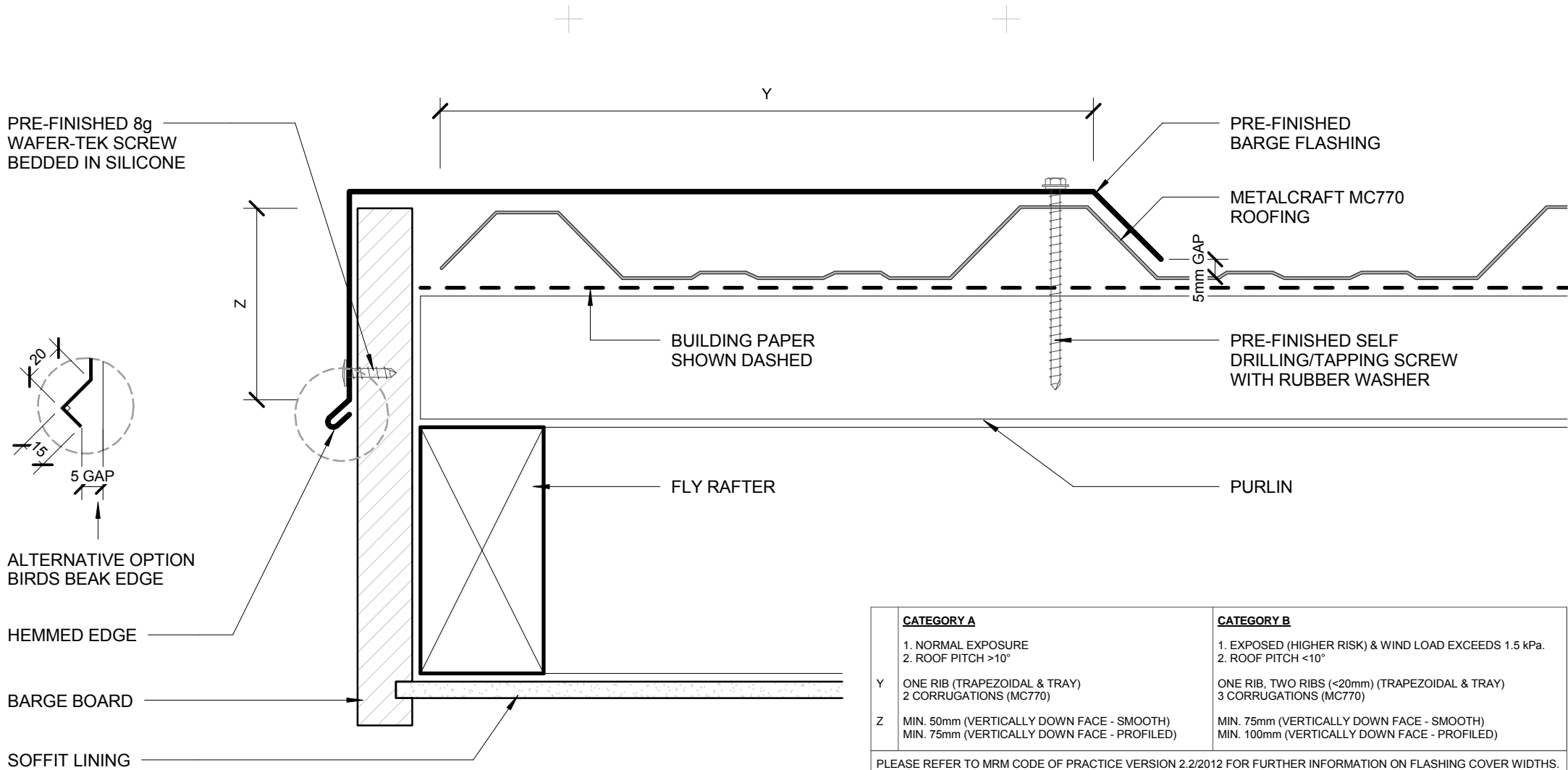

	CATEGORY A	CATEGORY B	
	1. NORMAL EXPOSURE 2. ROOF PITCH >10°	1. EXPOSED (HIGHER RISK) & WIND LOAD EXCEEDS 1.5 kPa. 2. ROOF PITCH <10°	
Y	ONE RIB (TRAPEZOIDAL & TRAY) 2 CORRUGATIONS (MC770)	ONE RIB, TWO RIBS (<20mm) (TRAPEZOIDAL & TRAY) 3 CORRUGATIONS (MC770)	
Z	MIN. 50mm (VERTICALLY DOWN FACE - SMOOTH) MIN. 75mm (VERTICALLY DOWN FACE - PROFILED)	MIN. 75mm (VERTICALLY DOWN FACE - SMOOTH) MIN. 100mm (VERTICALLY DOWN FACE - PROFILED)	
PLEASE REFER TO MRM CODE OF PRACTICE VERSION 2.2/2012 FOR FURTHER INFORMATION ON FLASHING COVER WIDTHS.			
	SITUATION 1	SITUATION 2	SITUATION 3
	1. LOW, MEDIUM, HIGH WIND ZONES 2. ROOF PITCH ≥ 10°	1. VERY HIGH WIND ZONE 2. ALL ROOF PITCHES	1. EXTRA HIGH WIND ZONE 2. ALL ROOF PITCHES
Y	AT LEAST TWO CRESTS	AT LEAST TWO CRESTS	AT LEAST TWO CRESTS
Z	MIN. 50mm	MIN. 70mm	MIN. 90mm
PLEASE REFER TO E2 FOR FURTHER INFORMATION ON FLASHING COVER WIDTHS.			

- BUILDING PAPER IS THE COMMON GENERIC NAME FOR PERMEABLE ROOF AND WALL UNDERLAYS. PLEASE REFER TO NZBC E2/AS1 AND MRM CODE OF PRACTICE VERSION 2.2 /2012.

DISCLAIMER:
All details are to be used for indicative purposes only and the designer should consult both the MRM code of practice version 2.2 /2012, E2 and all other relevant building codes
Details of the supporting mechanisms are indicative only. Compliance of the supporting mechanisms is the responsibility of the designer. Construction detail can vary for wall cladding. The underlay is detailed as a single line for simplicity and is indicative only. Building paper type and method of installation should comply with underlay manufacturers recommendations and NZBC regulations.



MC770

**BARGE OVERHANG
RESIDENTIAL ROOFING**

Reference RRM770

Date 2014

Scale 1 : 2

Sheet

12 / 24

PRE-FINISHED PARAPET CAP FLASHING

TIMBER PACKER

PRE-FINISHED 8g WAFER-TEK SCREW BEDDED IN SILICONE

STST OR GALV. FLAT HEAD NAIL FOR FLASHING

PRE-FINISHED SELF DRILLING / TAPPING SCREW WITH RUBBER WASHER

BARGE BOARD

TIMBER PACKER

WEATHERBOARDS ON CAVITY

BUILDING PAPER SHOWN DASHED

WALL FRAMING

MIN. 5.00°

BUILDING PAPER TO PROVIDE SEPARATION OF METAL CAPPING AND TIMBER SHOWN DASHED

CONTINUOUS TIMBER PACKING

TIMBER NOG FOR FIXING APRON FLASHING

STOPENDS TO ROOF CLADDING

TIMBER PURLIN

ROOF FRAMING

CATEGORY A

- 1. NORMAL EXPOSURE
 - 2. ROOF PITCH >10°
- G 25mm
- N MIN. 50mm + HEM OR 75mm (VERTICALLY UP FACE - SMOOTH)
MIN. 75mm + HEM OR 100mm (VERTICALLY UP FACE - PROFILED)
- L MIN. 150mm
- Z MIN. 50mm (VERTICALLY DOWN FACE - SMOOTH)
MIN. 75mm (VERTICALLY DOWN FACE - PROFILED)

CATEGORY B

- 1. EXPOSED (HIGHER RISK) & WIND LOAD EXCEEDS 1.5 kPa.
 - 2. ROOF PITCH <10°
- G 25mm
- N MIN. 75mm + HEM OR 100mm (VERTICALLY UP FACE - SMOOTH)
MIN. 100mm + HEM OR 125mm (VERTICALLY UP FACE - PROFILED)
- L MIN. 200mm
- Z MIN. 75mm (VERTICALLY DOWN FACE - SMOOTH)
MIN. 100mm (VERTICALLY DOWN FACE - PROFILED)

PLEASE REFER TO MRM CODE OF PRACTICE VERSION 2.2/2012 FOR FURTHER INFORMATION ON FLASHING COVER WIDTHS.

SITUATION 1

- 1. LOW, MEDIUM, HIGH WIND ZONES
 - 2. ROOF PITCH ≥ 10°
- G MIN. 35mm
- N MIN. 75mm
- L MIN. 130mm (EXCLUDING ANY SOFT EDGE OR TURN-DOWN TO ROOFING)
- Z MIN. 50mm

SITUATION 2

- 1. VERY HIGH WIND ZONE
 - 2. ALL ROOF PITCHES
- G MIN. 35mm
- N MIN. 75mm
- L MIN. 200mm (EXCLUDING ANY SOFT EDGE OR TURN-DOWN TO ROOFING)
- Z MIN. 70mm

SITUATION 3

- 1. EXTRA HIGH WIND ZONE
 - 2. ALL ROOF PITCHES
- G MIN. 35mm
- N MIN. 75mm
- L MIN. 200mm
- Z MIN. 90mm

PLEASE REFER TO E2 FOR FURTHER INFORMATION ON FLASHING COVER WIDTHS.

* MC770
MIN. ROOF PITCH = 3°

PRE-FINISHED APRON FLASHING

SOFT EDGE DRESSED OVER MC770 RIBS

METALCRAFT MC770 ROOFING

PRE-FINISHED SELF DRILLING/TAPPING SCREW WITH RUBBER WASHER

BUILDING PAPER SHOWN DASHED

- BUILDING PAPER IS THE COMMON GENERIC NAME FOR PERMEABLE ROOF AND WALL UNDERLAYS. PLEASE REFER TO NZBC E2/AS1 AND MRM CODE OF PRACTICE VERSION 2.2 /2012.

* - PLEASE REFER TO MRM CODE OF PRACTICE VERSION 2.2 /2012 AS MINIMUM PITCH WILL INCREASE DEPENDING ON SHEET LENGTH.

DISCLAIMER:
All details are to be used for indicative purposes only and the designer should consult both the MRM code of practice version 2.2 /2012, E2 and all other relevant building codes
Details of the supporting mechanisms are indicative only. Compliance of the supporting mechanisms is the responsibility of the designer. Construction detail can vary for wall cladding. The underlay is detailed as a single line for simplicity and is indicative only. Building paper type and method of installation should comply with underlay manufacturers recommendations and NZBC regulations.

PARAPET WITH TRANSVERSE APRON
RESIDENTIAL ROOFING

MC770

Reference RRM770

Date 2014

Scale 1 : 2

Sheet

13 / 24

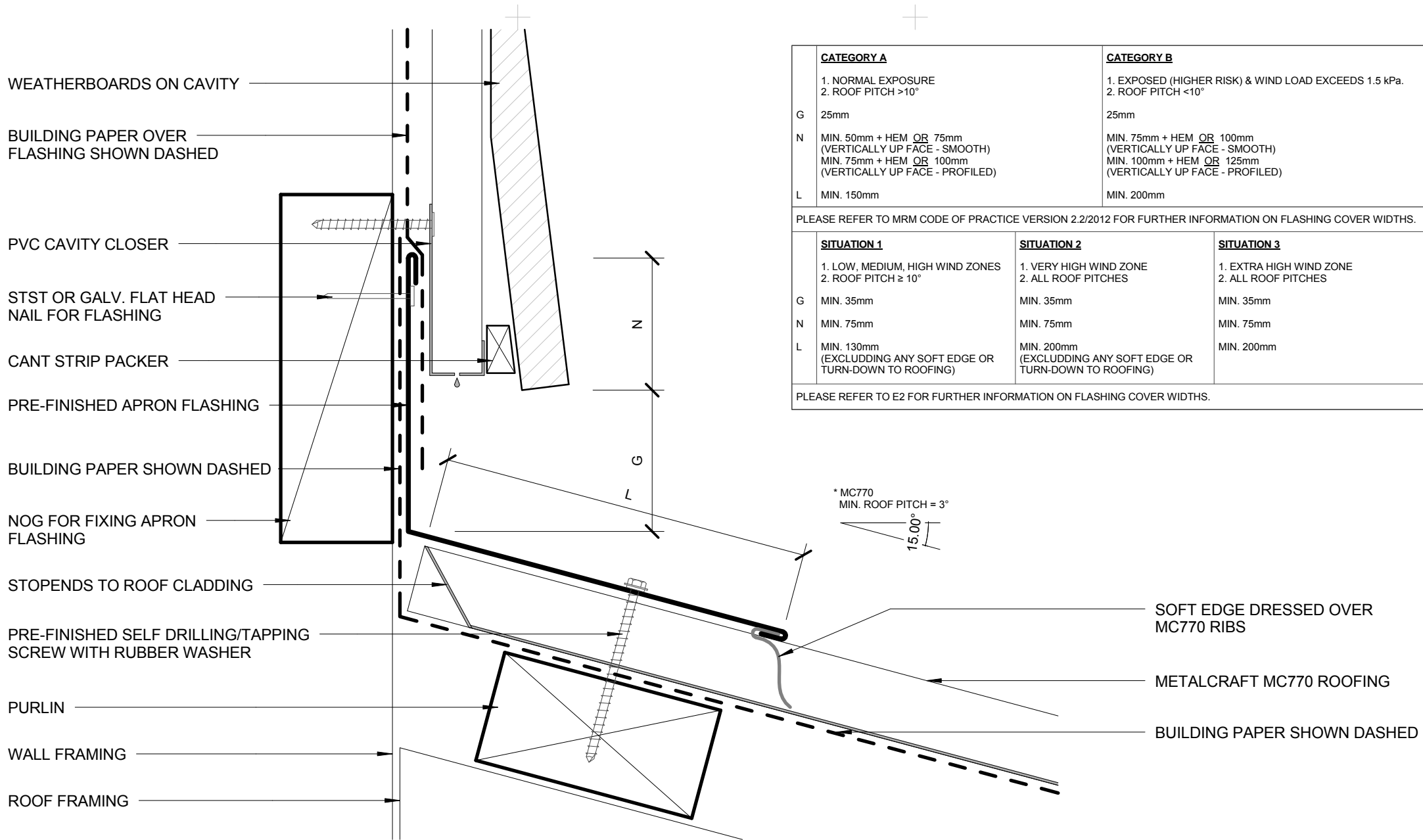

	CATEGORY A	CATEGORY B
	1. NORMAL EXPOSURE 2. ROOF PITCH >10°	1. EXPOSED (HIGHER RISK) & WIND LOAD EXCEEDS 1.5 kPa. 2. ROOF PITCH <10°
G	25mm	25mm
N	MIN. 50mm + HEM OR 75mm (VERTICALLY UP FACE - SMOOTH) MIN. 75mm + HEM OR 100mm (VERTICALLY UP FACE - PROFILED)	MIN. 75mm + HEM OR 100mm (VERTICALLY UP FACE - SMOOTH) MIN. 100mm + HEM OR 125mm (VERTICALLY UP FACE - PROFILED)
L	MIN. 150mm	MIN. 200mm

PLEASE REFER TO MRM CODE OF PRACTICE VERSION 2.2/2012 FOR FURTHER INFORMATION ON FLASHING COVER WIDTHS.

	SITUATION 1	SITUATION 2	SITUATION 3
	1. LOW, MEDIUM, HIGH WIND ZONES 2. ROOF PITCH ≥ 10°	1. VERY HIGH WIND ZONE 2. ALL ROOF PITCHES	1. EXTRA HIGH WIND ZONE 2. ALL ROOF PITCHES
G	MIN. 35mm	MIN. 35mm	MIN. 35mm
N	MIN. 75mm	MIN. 75mm	MIN. 75mm
L	MIN. 130mm (EXCLUDING ANY SOFT EDGE OR TURN-DOWN TO ROOFING)	MIN. 200mm (EXCLUDING ANY SOFT EDGE OR TURN-DOWN TO ROOFING)	MIN. 200mm

PLEASE REFER TO E2 FOR FURTHER INFORMATION ON FLASHING COVER WIDTHS.

- BUILDING PAPER IS THE COMMON GENERIC NAME FOR PERMEABLE ROOF AND WALL UNDERLAYS. PLEASE REFER TO NZBC E2/AS1 AND MRM CODE OF PRACTICE VERSION 2.2 /2012.

* - PLEASE REFER TO MRM CODE OF PRACTICE VERSION 2.2 /2012 AS MINIMUM PITCH WILL INCREASE DEPENDING ON SHEET LENGTH.

DISCLAIMER:
All details are to be used for indicative purposes only and the designer should consult both the MRM code of practice version 2.2 /2012, E2 and all other relevant building codes
Details of the supporting mechanisms are indicative only. Compliance of the supporting mechanisms is the responsibility of the designer. Construction detail can vary for wall cladding. The underlay is detailed as a single line for simplicity and is indicative only. Building paper type and method of installation should comply with underlay manufacturers recommendations and NZBC regulations.

MC770 **TRANSVERSE APRON**
RESIDENTIAL ROOFING



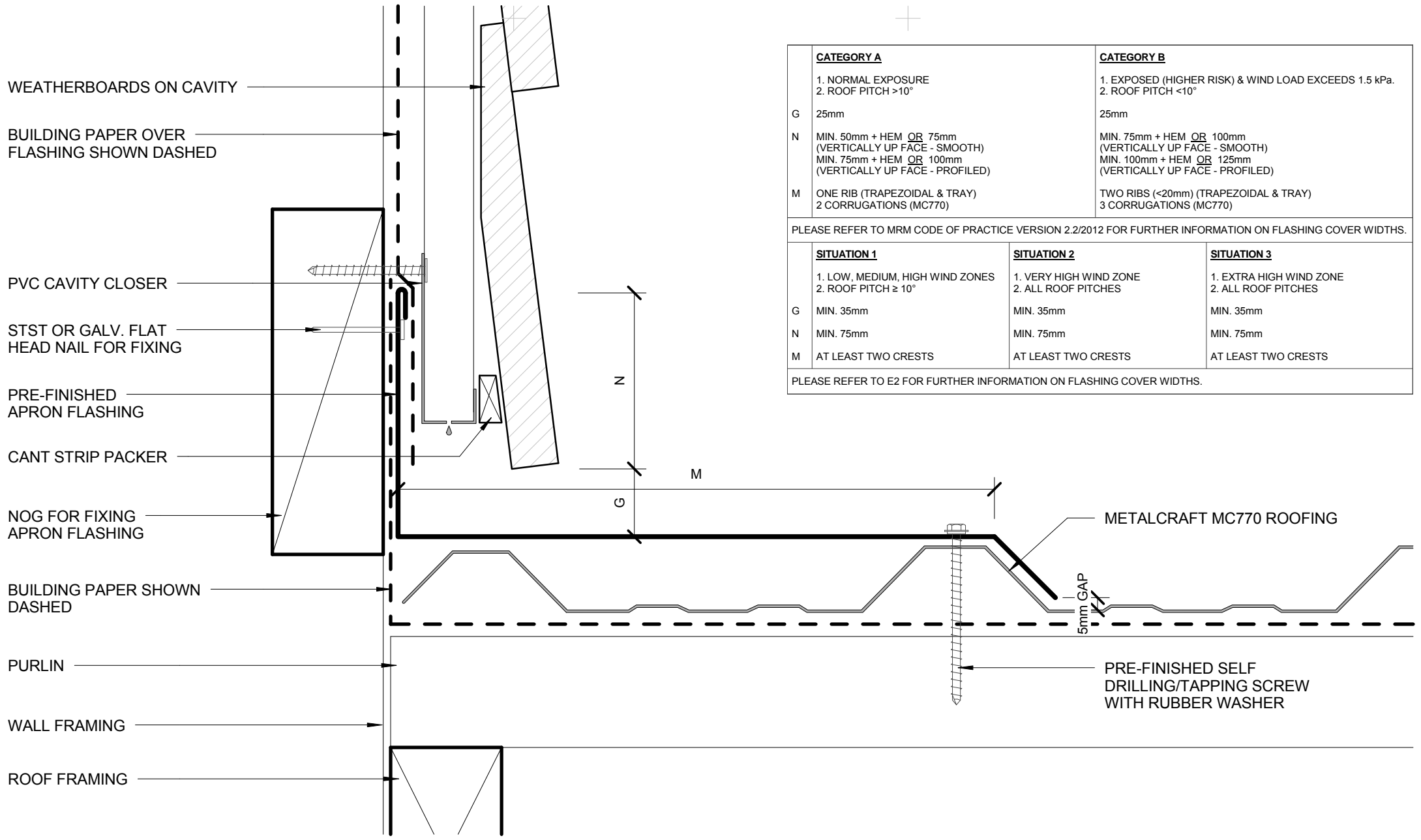

	CATEGORY A	CATEGORY B
	1. NORMAL EXPOSURE 2. ROOF PITCH >10°	1. EXPOSED (HIGHER RISK) & WIND LOAD EXCEEDS 1.5 kPa. 2. ROOF PITCH <10°
G	25mm	25mm
N	MIN. 50mm + HEM OR 75mm (VERTICALLY UP FACE - SMOOTH) MIN. 75mm + HEM OR 100mm (VERTICALLY UP FACE - PROFILED)	MIN. 75mm + HEM OR 100mm (VERTICALLY UP FACE - SMOOTH) MIN. 100mm + HEM OR 125mm (VERTICALLY UP FACE - PROFILED)
M	ONE RIB (TRAPEZOIDAL & TRAY) 2 CORRUGATIONS (MC770)	TWO RIBS (<20mm) (TRAPEZOIDAL & TRAY) 3 CORRUGATIONS (MC770)

PLEASE REFER TO MRM CODE OF PRACTICE VERSION 2.2/2012 FOR FURTHER INFORMATION ON FLASHING COVER WIDTHS.

	SITUATION 1	SITUATION 2	SITUATION 3
	1. LOW, MEDIUM, HIGH WIND ZONES 2. ROOF PITCH ≥ 10°	1. VERY HIGH WIND ZONE 2. ALL ROOF PITCHES	1. EXTRA HIGH WIND ZONE 2. ALL ROOF PITCHES
G	MIN. 35mm	MIN. 35mm	MIN. 35mm
N	MIN. 75mm	MIN. 75mm	MIN. 75mm
M	AT LEAST TWO CRESTS	AT LEAST TWO CRESTS	AT LEAST TWO CRESTS

PLEASE REFER TO E2 FOR FURTHER INFORMATION ON FLASHING COVER WIDTHS.

- BUILDING PAPER IS THE COMMON GENERIC NAME FOR PERMEABLE ROOF AND WALL UNDERLAYS. PLEASE REFER TO NZBC E2/AS1 AND MRM CODE OF PRACTICE VERSION 2.2 /2012.

DISCLAIMER:
All details are to be used for indicative purposes only and the designer should consult both the MRM code of practice version 2.2 /2012, E2 and all other relevant building codes
Details of the supporting mechanisms are indicative only. Compliance of the supporting mechanisms is the responsibility of the designer. Construction detail can vary for wall cladding. The underlay is detailed as a single line for simplicity and is indicative only. Building paper type and method of installation should comply with underlay manufacturers recommendations and NZBC regulations.



MC770

PARALLEL APRON
RESIDENTIAL ROOFING

Reference RRM770

Date 2014

Scale 1 : 2

Sheet

15 / 24

THIS DETAIL IS APPLIED ONLY WHEN
 - ROOF PITCH MIN. 10° and MAX. 45°
 - PIPE DIAMETER MAX. 85mm

* MIN. 10° FOR PIPE PENETRATION

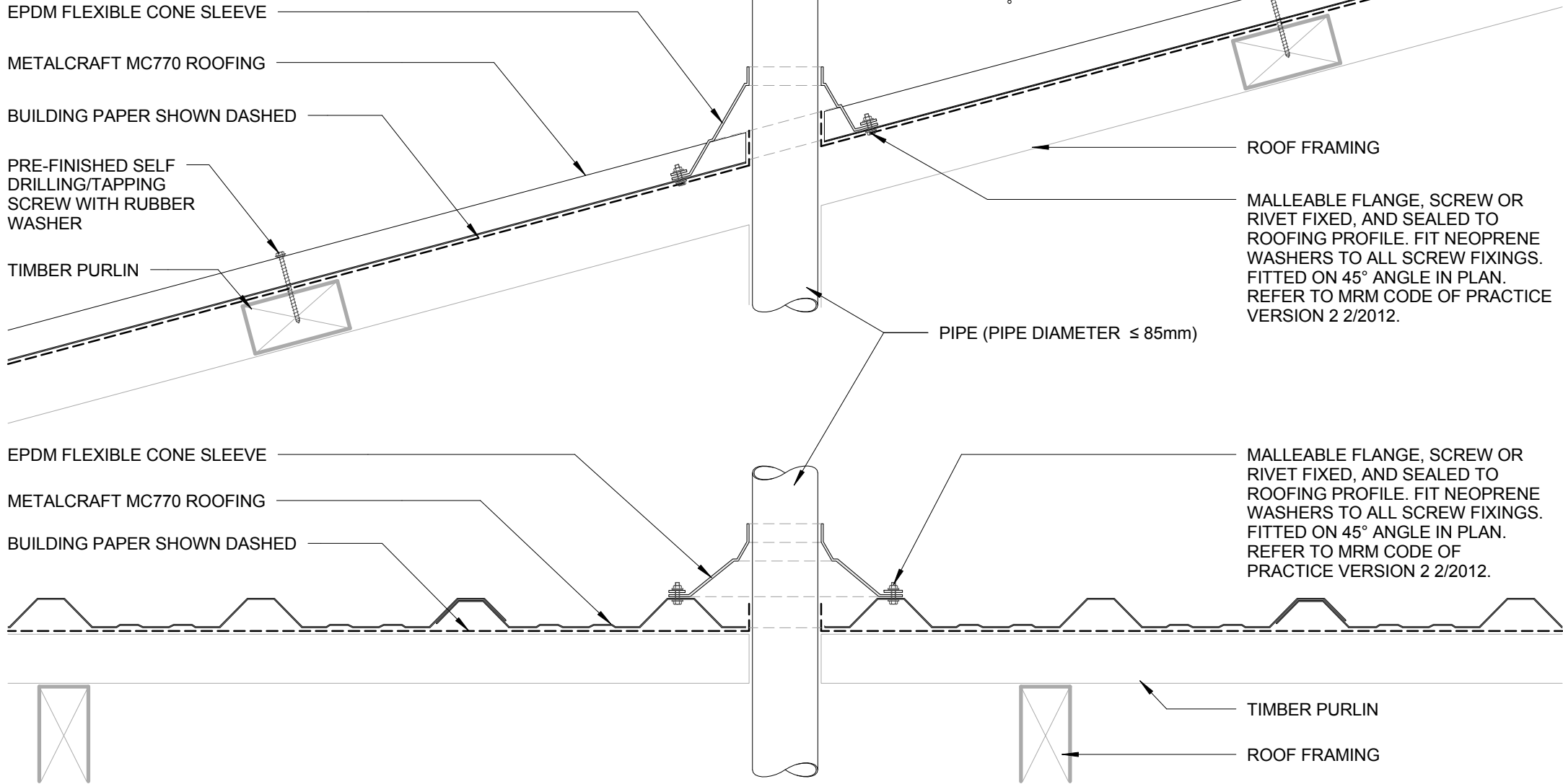
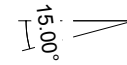

- BUILDING PAPER IS THE COMMON GENERIC NAME FOR PERMEABLE ROOF AND WALL UNDERLAYS. PLEASE REFER TO NZBC E2/AS1 AND MRM CODE OF PRACTICE VERSION 2.2 /2012.

* - PLEASE REFER TO MRM CODE OF PRACTICE VERSION 2.2 /2012 AS MINIMUM PITCH WILL INCREASE DEPENDING ON SHEET LENGTH.

DISCLAIMER:
 All details are to be used for indicative purposes only and the designer should consult both the MRM code of practice version 2.2 /2012, E2 and all other relevant building codes
 Details of the supporting mechanisms are indicative only. Compliance of the supporting mechanisms is the responsibility of the designer. Construction detail can vary for wall cladding. The underlay is detailed as a single line for simplicity and is indicative only. Building paper type and method of installation should comply with underlay manufacturers recommendations and NZBC regulations.

MAX. 85mm DIAMETER PIPE PENETRATION

MC770

RESIDENTIAL ROOFING

Reference RRM770

Date 2014

Scale 1 : 5

Sheet

16 / 24

THIS DETAIL IS APPLIED ONLY WHEN
 - ROOF PITCH MIN. 10°
 - PIPE DIAMETER OVER 85mm AND MAX. 500mm
 - PIPE TO BE POSITIONED AS CLOSE TO ROOF RIDGE AS POSSIBLE

* MIN. 10° FOR PIPE PENETRATION

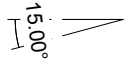

EPDM FLEXIBLE CONE SLEEVE

PRE-FINISHED SELF DRILLING/TAPPING SCREW WITH RUBBER WASHER

METALCRAFT MC770 ROOFING

PURLIN

MALLEABLE FLANGE, SCREW OR RIVET FIXED, AND SEALED TO ROOFING PROFILE. FIT NEOPRENE WASHERS TO ALL SCREW FIXINGS. FITTED ON 45° ANGLE IN PLAN. REFER TO MRM CODE OF PRACTICE VERSION 2.2/2012.

METALCRAFT MC770 ROOFING

5mm GAP

M

NOGS BETWEEN PURLINS FOR PENETRATION

L	REFER TO SHEET NO. 14/24 TRANSVERSE APRON
M	REFER TO SHEET NO. 16/24 PARALLEL APRON
X	REFER TO SHEET NO. 01/24 ROOF RIDGE

- BUILDING PAPER IS THE COMMON GENERIC NAME FOR PERMEABLE ROOF AND WALL UNDERLAYS. PLEASE REFER TO NZBC E2/AS1 AND MRM CODE OF PRACTICE VERSION 2.2 /2012.

* - PLEASE REFER TO MRM CODE OF PRACTICE VERSION 2.2 /2012 AS MINIMUM PITCH WILL INCREASE DEPENDING ON SHEET LENGTH.

DISCLAIMER:
 All details are to be used for indicative purposes only and the designer should consult both the MRM code of practice version 2.2 /2012, E2 and all other relevant building codes
 Details of the supporting mechanisms are indicative only. Compliance of the supporting mechanisms is the responsibility of the designer. Construction detail can vary for wall cladding. The underlay is detailed as a single line for simplicity and is indicative only. Building paper type and method of installation should comply with underlay manufacturers recommendations and NZBC regulations.

PRE-FINISHED ROOF RIDGE CAP FLASHING

X

PRE-FINISHED SOAKER FLASHING UNDER PRE-FINISHED ROOF RIDGE CAP FLASHING

ROOF FRAMING

PIPE (85mm > PIPE DIAMETER ≤ 500mm)

EPDM FLEXIBLE CONE SLEEVE

PRE-FINISHED SOAKER FLASHING WITH PRE-FINISHED POP RIVET BEDDED IN SILICONE OR PRE-FINISHED 8g WAFER-TEK SCREW

5mm GAP

BUILDING PAPER SHOWN DASHED

PURLIN

ROOF FRAMING

OVER 85mm DIAMETER PIPE PENETRATION RESIDENTIAL ROOFING

MC770

Reference RRM770

Date 2014

Scale 1 : 5

Sheet

17 / 24



* PLEASE REFER TO MRM CODE OF PRACTICE VERSION 2.2/2012 AND RANZ HOW TO ON-SITE GUIDE METAL ROOF FLASHINGS FOR FURTHER INFORMATION ON FLASHING COVER WIDTHS.

PRE-FINISHED RIDGE CAP FLASHING

METALCRAFT MC770 ROOFING

PRE-FINISHED BARGE FLASHING

PURLIN

ROOF FRAMING

FASCIA BOARD

WALL FRAMING

WALL CLADDING ON CAVITY

3D-RIDGE TO BARGE JUCTION
RESIDENTIAL ROOFING

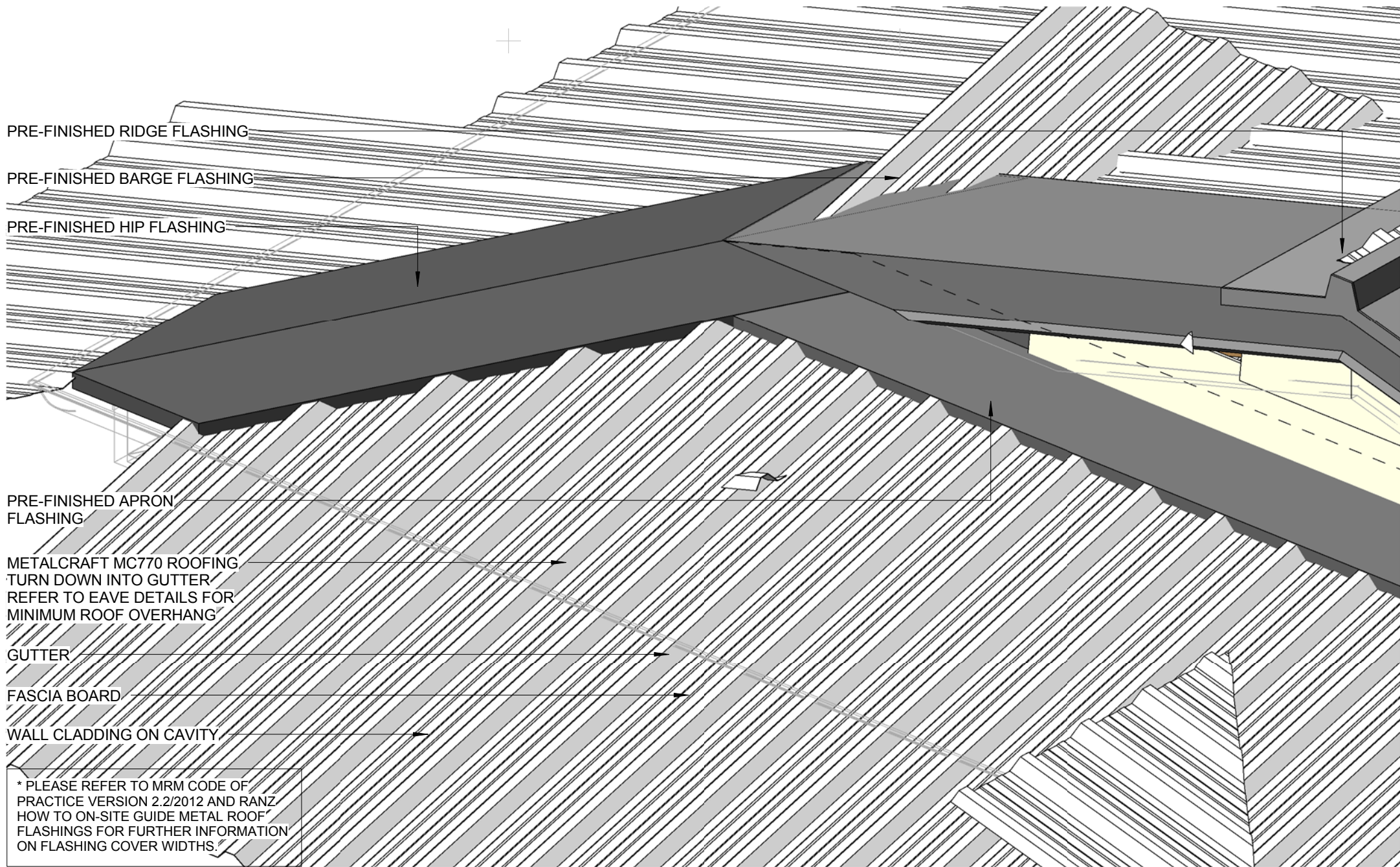

PRE-FINISHED RIDGE FLASHING

PRE-FINISHED BARGE FLASHING

PRE-FINISHED HIP FLASHING

PRE-FINISHED APRON FLASHING

METALCRAFT MC770 ROOFING
TURN DOWN INTO GUTTER
REFER TO EAVE DETAILS FOR
MINIMUM ROOF OVERHANG

GUTTER

FASCIA BOARD

WALL CLADDING ON CAVITY

* PLEASE REFER TO MRM CODE OF PRACTICE VERSION 2.2/2012 AND RANZ HOW TO ON-SITE GUIDE METAL ROOF FLASHINGS FOR FURTHER INFORMATION ON FLASHING COVER WIDTHS.

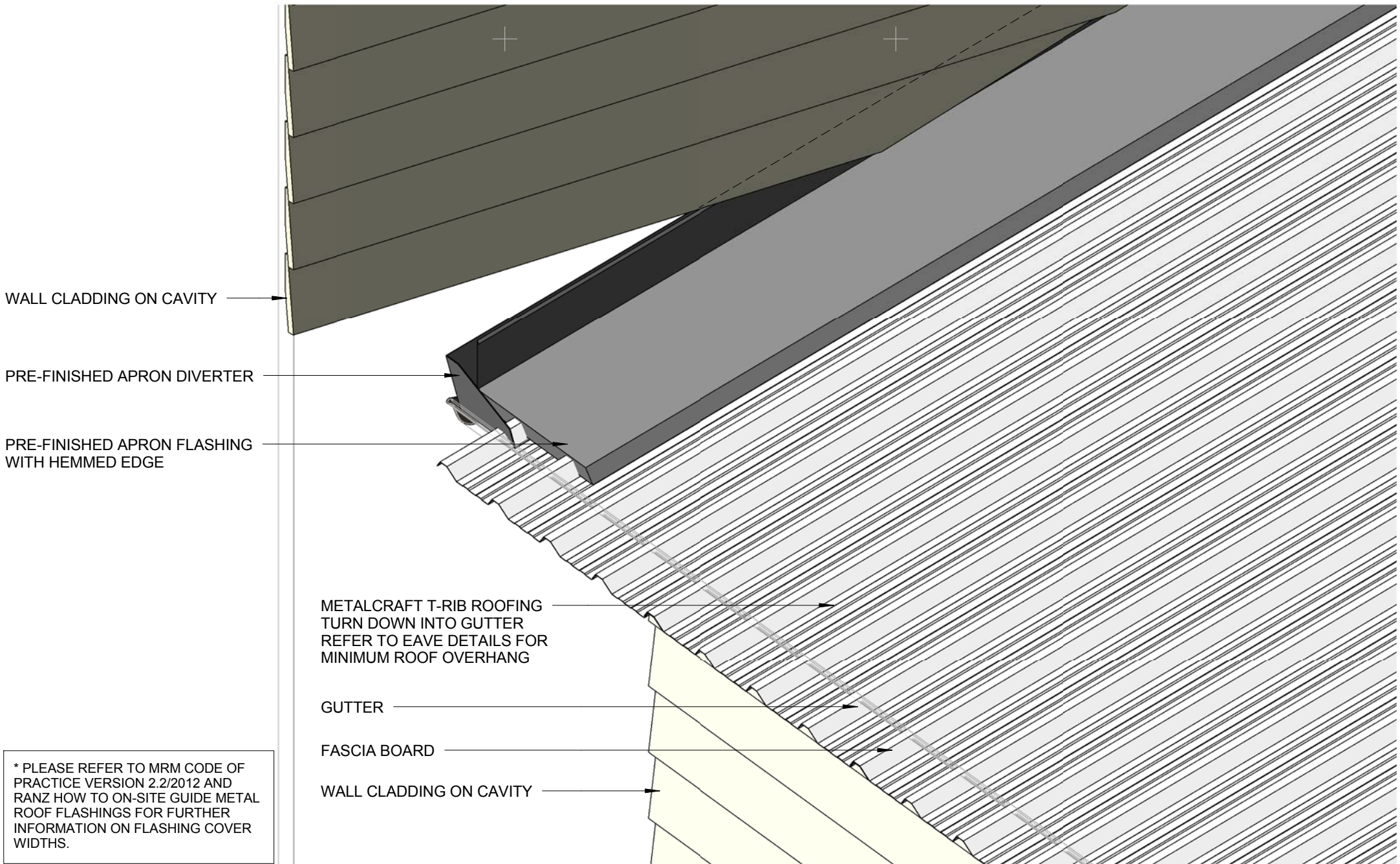

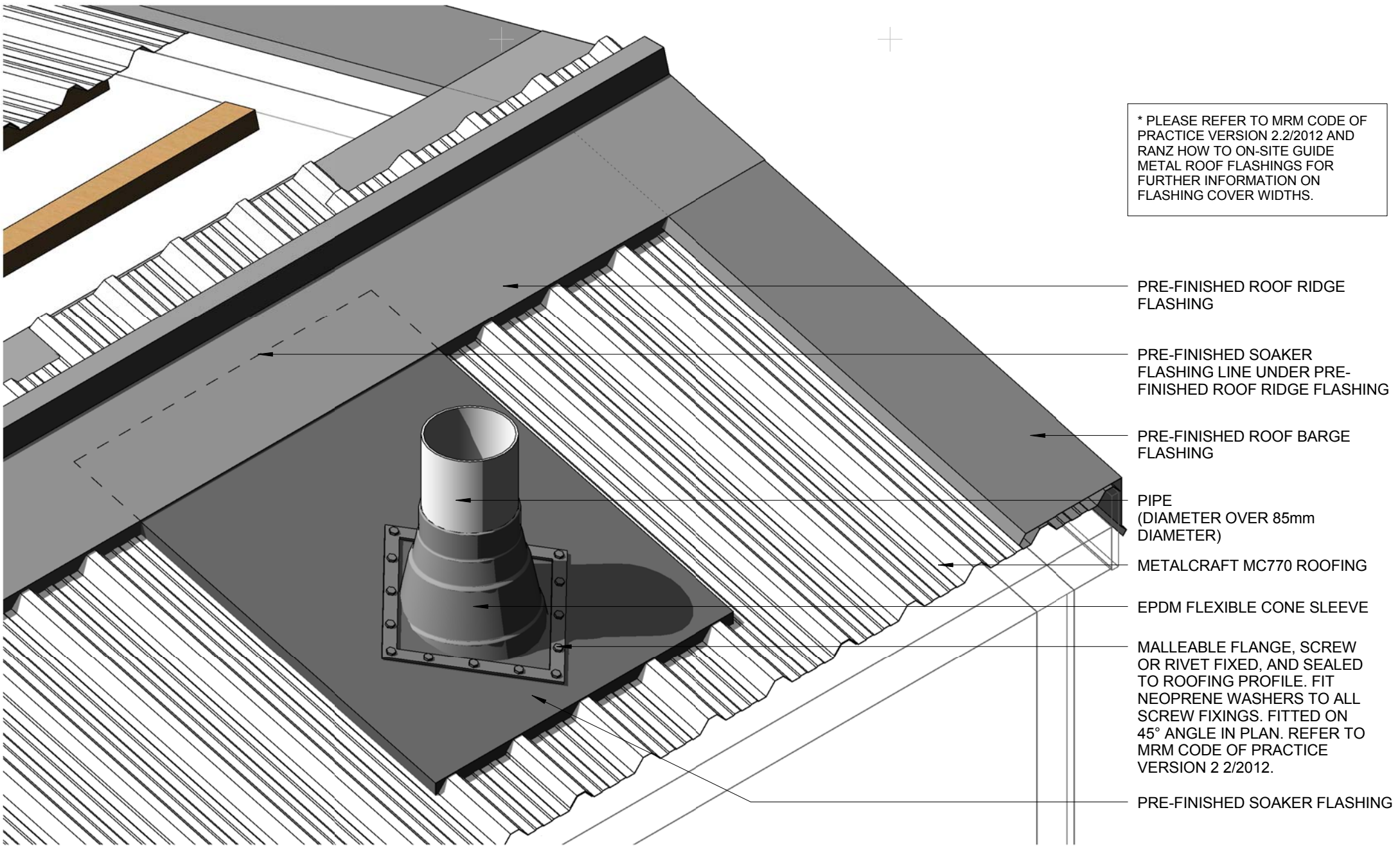

* PLEASE REFER TO MRM CODE OF PRACTICE VERSION 2.2/2012 AND RANZ HOW TO ON-SITE GUIDE METAL ROOF FLASHINGS FOR FURTHER INFORMATION ON FLASHING COVER WIDTHS.

- PRE-FINISHED ROOF RIDGE FLASHING
- PRE-FINISHED SOAKER FLASHING LINE UNDER PRE-FINISHED ROOF RIDGE FLASHING
- PRE-FINISHED ROOF BARGE FLASHING
- PIPE (DIAMETER OVER 85mm DIAMETER)
- METALCRAFT MC770 ROOFING
- EPDM FLEXIBLE CONE SLEEVE
- MALLEABLE FLANGE, SCREW OR RIVET FIXED, AND SEALED TO ROOFING PROFILE. FIT NEOPRENE WASHERS TO ALL SCREW FIXINGS. FITTED ON 45° ANGLE IN PLAN. REFER TO MRM CODE OF PRACTICE VERSION 2 2/2012.
- PRE-FINISHED SOAKER FLASHING

3D-OVER 85mm DIAMETER PIPE PENETRATION
RESIDENTIAL ROOFING



DISCLAIMER:
 All details are to be used for indicative purposes only and the designer should consult both the MRM code of practice version 2.2 /2012, E2 and all other relevant building codes
 Details of the supporting mechanisms are indicative only. Compliance of the supporting mechanisms is the responsibility of the designer. Construction detail can vary for wall cladding. The underlay is detailed as a single line for simplicity and is indicative only. Building paper type and method of installation should comply with underlay manufacturers recommendations and NZBC regulations.

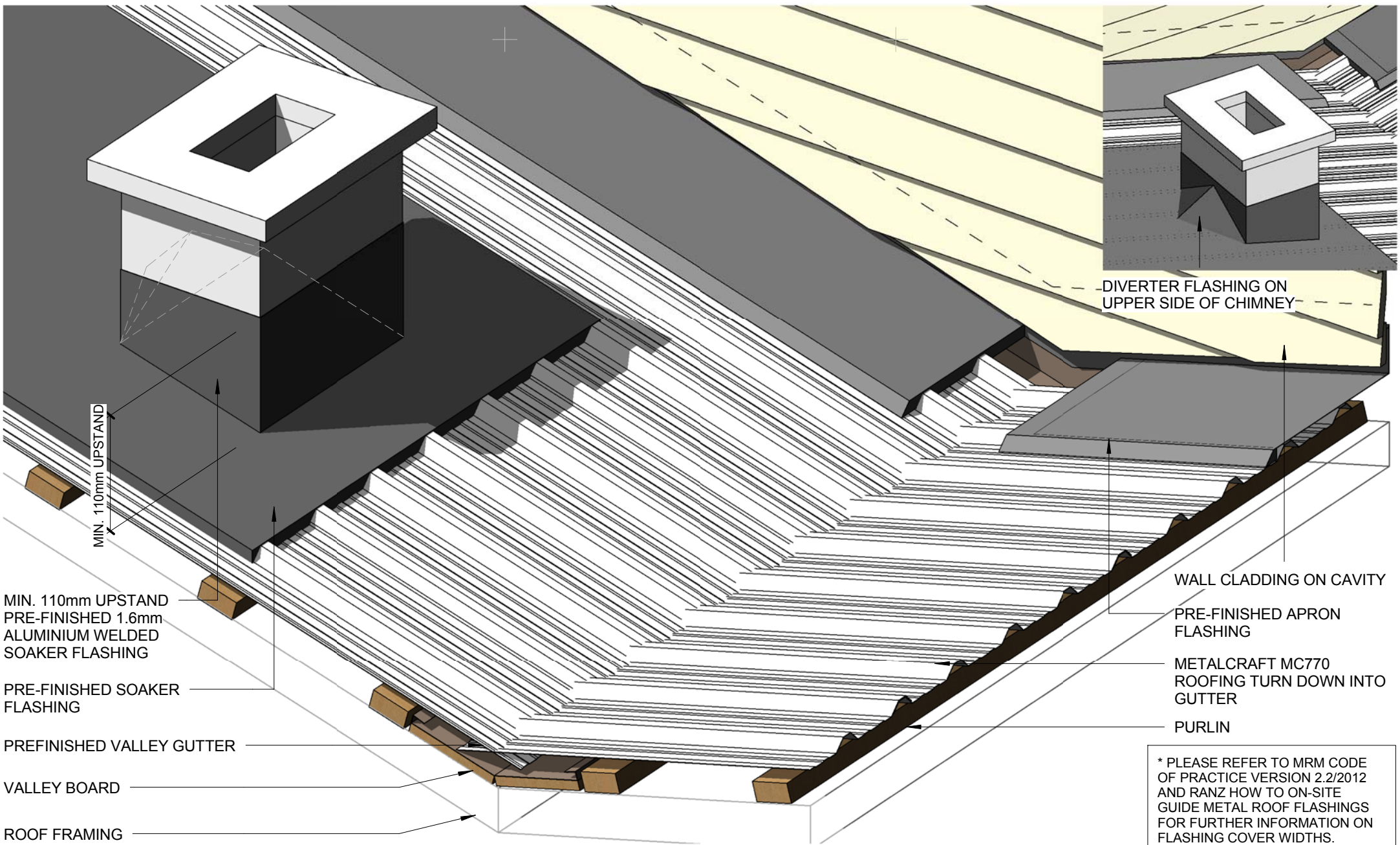

MIN. 110mm UPSTAND
 PRE-FINISHED 1.6mm
 ALUMINIUM WELDED
 SOAKER FLASHING

PRE-FINISHED SOAKER
 FLASHING

PREFINISHED VALLEY GUTTER

VALLEY BOARD

ROOF FRAMING

DIVERTER FLASHING ON
 UPPER SIDE OF CHIMNEY

WALL CLADDING ON CAVITY

PRE-FINISHED APRON
 FLASHING

METALCRAFT MC770
 ROOFING TURN DOWN INTO
 GUTTER

PURLIN

* PLEASE REFER TO MRM CODE
 OF PRACTICE VERSION 2.2/2012
 AND RANZ HOW TO ON-SITE
 GUIDE METAL ROOF FLASHINGS
 FOR FURTHER INFORMATION ON
 FLASHING COVER WIDTHS.

OPTION 1

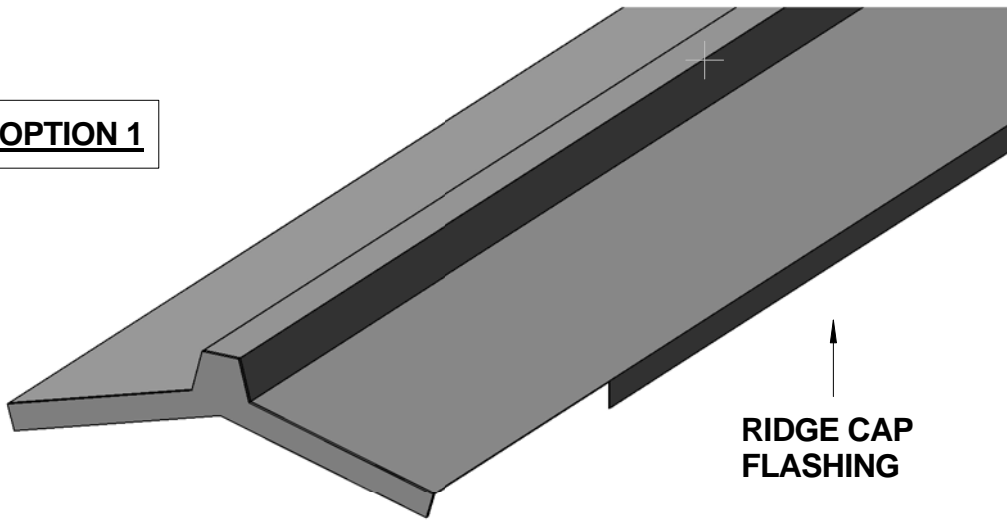

RIDGE CAP FLASHING

OPTION 2

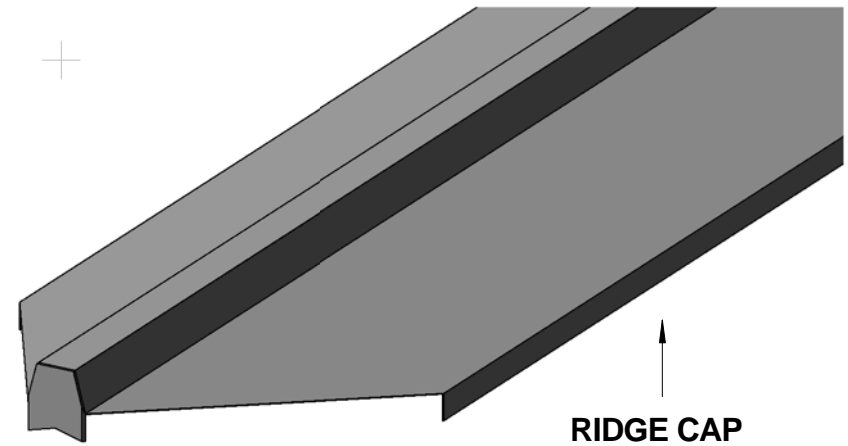

RIDGE CAP FLASHING

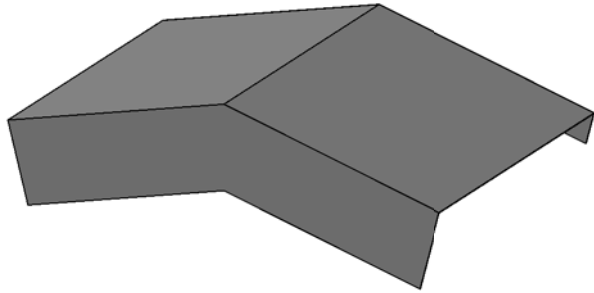

ADDITIONAL SADDLE FLASHING

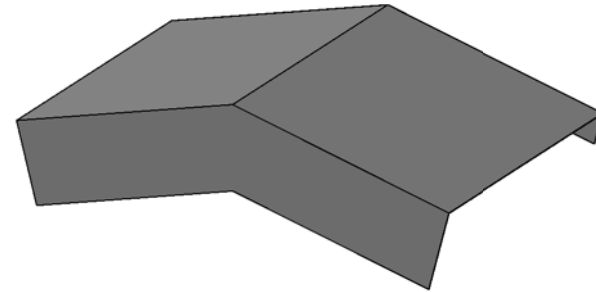

ADDITIONAL SADDLE FLASHING

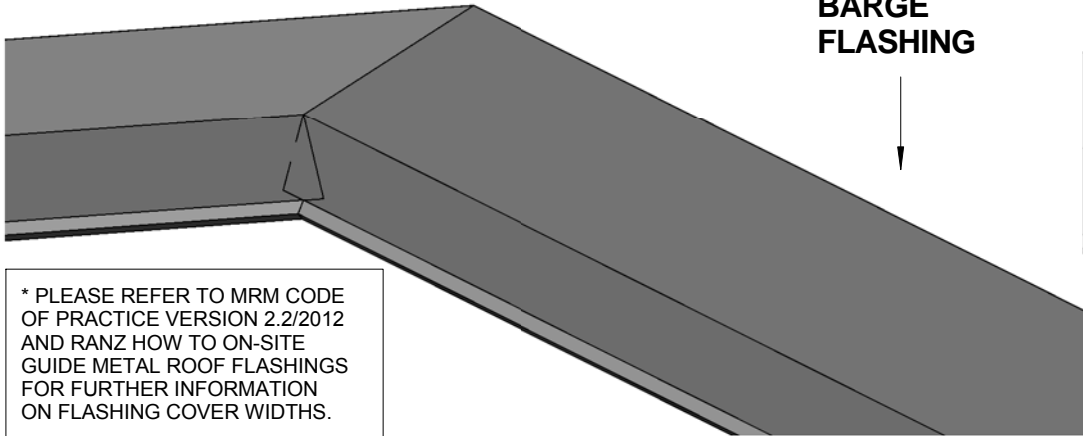

BARGE FLASHING

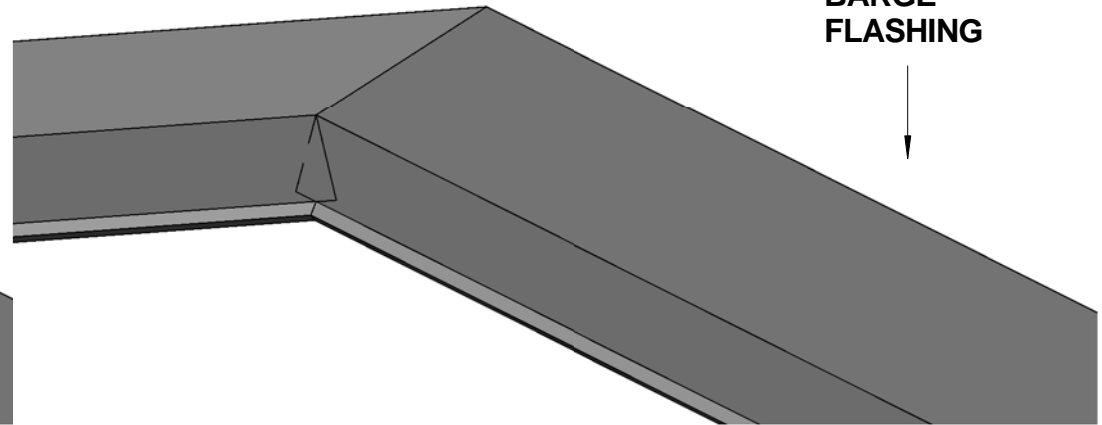

BARGE FLASHING

* PLEASE REFER TO MRM CODE OF PRACTICE VERSION 2.2/2012 AND RANZ HOW TO ON-SITE GUIDE METAL ROOF FLASHINGS FOR FURTHER INFORMATION ON FLASHING COVER WIDTHS.

DISCLAIMER:
All details are to be used for indicative purposes only and the designer should consult both the MRM code of practice version 2.2/2012, E2 and all other relevant building codes
Details of the supporting mechanisms are indicative only. Compliance of the supporting mechanisms is the responsibility of the designer. Construction detail can vary for wall cladding. The underlay is detailed as a single line for simplicity and is indicative only. Building paper type and method of installation should comply with underlay manufacturers recommendations and NZBC regulations.

MC770

3D-RIDGE/BARGE FLASHINGS

RESIDENTIAL ROOFING

**(4) PRE-FINISHED
BARGE FLASHING**

**(3) PRE-FINISHED 3D
SADDLE FLASHING**

**(2) PRE-FINISHED
APRON FLASHING**

(1) PRE-FINISHED HIP FLASHING

* PLEASE REFER TO MRM CODE OF PRACTICE VERSION 2.2/2012 AND RANZ HOW TO ON-SITE GUIDE METAL ROOF FLASHINGS FOR FURTHER INFORMATION ON FLASHING COVER WIDTHS.

3D-DUTCH GABLE FLASHINGS
RESIDENTIAL ROOFING