

BE
AG & INDUSTRIAL

PARTS

CATALOG 2018

40TH
EDITION



PH 604.850.7770 | FAX 604.850.7774
TOLL FREE 1.877.588.3311 | TOLL FREE FAX 1.800.665.7334
WWW.BRABEREQ.COM

WARRANTY COVERAGE

Equipment distributed by Braber Equipment is guaranteed to the extent of the one year warranty from the manufacturer. Proof of purchase must be presented when requesting warranty service. Exceptions to this warranty are Honda and Powerease 7HP and 15HP engines to the extent of two years warranty, Delevan, Shurflo, and Everflo pumps to the extent of two year warranty from date of manufacture or one year from date of invoice (whichever occurs first), and Agriase Rotary Cutter Gearboxes to the extent of 6 years limited warranty. Warranty does not cover freight or labour charges associated with the inspection and testing of products sold by Braber Equipment, which are found not to be a valid warranty claim.

Delevan, Shurflo, and Everflo pumps should be on a dedicated (individual) circuit, protected by the fuse indicated on the motor label. The total current draw on the circuit must not exceed the recommended manufacturer's specifications. If the pump is used in conjunction with other components, overload current protection (fuse or circuit breaker) and wire size must be for the total amp requirement of all devices on the circuit. The pump should not be located in an area less than one cubic foot unless adequate ventilation is provided. Failure to adhere to the above will result in the unit being void of warranty.

Orders received with missing parts need to be reported within 48 hours. All warranty returns require a Braber Equipment pre-approval before returning merchandise for a warranty inspection. Warranty claims without this pre-approval will not receive credit and any freight claims or damages must be reported within 48 hours.

PROCEDURE

1. When a dealer encounters a warranty situation, they must call Braber Equipment and ask for the Warranty Manager.
2. The Warranty manager will provide the dealer with a warranty application.
3. Once the warranty application has been submitted to the Warranty Manager, the Warranty Manager will pre-assess the application taking into consideration the following:
 - a. Warranty coverage outstanding for the unit.
 - b. Recalls related to the unit.
 - c. Proper care and application of the unit.
4. If the application passes the pre-assessment stage, the dealer will be provided with an RGA number. Once they obtain this number, they will have 45 days to return the unit prepaid to Braber Equipment.
5. Based on review of the unit, the final decision of the application will be made resulting in the unit being repaired, credited or rejected for warranty.
6. If the unit has warranty coverage Braber Equipment will order the necessary parts from the manufacturer, repair the unit, and return it to the dealer.
7. If the unit is not covered under warranty- and is repairable, the dealer or customer will be quoted a price including applicable taxes for the cost of repair by Braber Equipment. The unit will then be returned to the dealer via freight collect.

POLICY

The foregoing warranty is exclusive and in lieu of all other conditions or warranties, whether written, oral or implied (including any warranty of merchantability or fitness for purpose). If it appears the specified warranty period stated in section "Warranty Coverage" from the date of delivery by the Dealer to the ultimate Purchaser, that the goods do not meet the warranty specified, Braber Equipment will effect correction of any defects, at Braber Equipment option, either by repairing or replacing parts. Upon expiration of the warranty period, all such liability shall terminate.

This Warranty does not cover depreciation or damage caused by normal wear, accident, improper maintenance, improper protection in storage or improper use. The cost of normal maintenance and normal replacement of service items such as belts, lubricant or oils are the Customer's responsibility. Warranty as set forth in the preceding paragraphs shall not apply to supplier equipment such as tires or tubes, such being the subject to the warranty of their own respective manufacturers. The forgoing shall constitute the sole remedy of the Dealer and the sole liability of Braber Equipment.

LIMITATION OF LIABILITY

Subject to government regulations, Braber Equipment liability of any claim, of any kind, including negligence for any loss or damages arising out of, connected with, or resulting from the order, or from the performance or breach thereof, or from the manufacture, sale, delivery, resale, repair, or use of any goods or parts covered by or furnished under an order, shall in no case exceed the price applicable to the goods or parts thereof which gives rise to the claim. In no event shall Braber Equipment be liable for special or consequential damages, including but not limited to downtime or labour resulting from damage.

TERMS

All parts invoices are due and payable 30 days after invoice date. 2% interest per month will be charged to overdue accounts.

WASHINGTON, OREGON AND CALIFORNIA TOLL-FREE NUMBERS

PHONE: 1-877-588-3311 | FAX: 1-800-665-7334

PRESEASON STOCK ORDER PROGRAMS

Braber Equipment will offer a minimum of 2 booking order programs throughout the year.

The main booking order program will be handed out in the early Fall season and will coincide with the circulation of a new catalogue and price list. Orders will be accepted until Jan 10 of the following year, and terms will be given to June 10 upon acceptance of minimum order criteria. These orders will be shipped prepaid at our discretion.

Braber Equipment will offer a second smaller booking order program in May, with terms given to Oct 10th of that year upon acceptance of qualifying orders. Freight will be prepaid at our discretion for qualifying orders.

Braber Equipment is not obligated to pay for freight on back ordered items from our booking order programs, we will however make every effort to ship these backordered items at our discretion with other goods on our next scheduled truck drops.

New product bulletins and new product specials will take place throughout the year.

MONTHLY STOCK ORDER

- Minimum Order \$1000
- Must be from BE parts Catalog
- 60 day terms
- Order must be **faxed or emailed** and requested as a stock order

BRABER EQUIPMENT FREIGHT POLICY

Braber will prepay freight only on preseason booking orders and specials. Free freight is available at our discretion.

RETURN POLICY FOR BE CATALOG

1. All items in BE parts Catalog are returnable, with proof of purchase, up to one year.
2. All returns are subject to a 15% restocking charge.
3. All returns are to be freight prepaid.
4. Braber Equipment will only accept annual parts returns from September 1 to September 30.

NO EXCEPTIONS.

OEM RETURN POLICY

1. All special order items are 100% nonreturnable.
2. All other returns are subject to a 15% restocking charge.

FOR MORE INFORMATION CALL

604-850-7770

1 HAYING TINES, ACCESSORIES
& BALE FORKS
PAGE 1



2 HAY MOWER BLADES
& HARDWARE
PAGE 17



3 TILLER BLADES
PAGE 27



4 POWER TAKE OFF
SHAFTS & COMPONENTS
PAGE 39



5 CULTIVATOR
& PLOW PARTS
PAGE 67



6 TIRES & TUBES
PAGE 75



7 SPRAYER EQUIPMENT
& ACCESSORIES
PAGE 79



8 POWER PRODUCTS
PAGE 157





**GARDEN EQUIPMENT
& ACCESSORIES**
PAGE 191

9



MATERIAL HANDLING
PAGE 201

10



BLADES & HAMMERS
PAGE 205

11



TRACTOR SEATS
PAGE 229

12



LINKAGE PARTS
PAGE 241

13



**TRAILER, TOWING &
TRACTOR ACCESSORIES**
PAGE 269

14



CHAIN HARDWARE
PAGE 287

15



**DISPLAY RACKS
& PLANOGRAMS**
PAGE 299

16

17

LED LIGHTS
PAGE 313



18

**RANCH HARDWARE
& FENCING**
PAGE 321



19

POWER TRANSMISSION
PAGE 327



20

**SHOP & CLEANING
SUPPLIES**
PAGE 339



21

TOOLS
PAGE 343



22

**TRACTOR ACCESSORIES
& HYDRAULICS**
PAGE 359



23

**TRACTOR ATTACHMENTS
& DIAMOND HARROW**
PAGE 365





1 HAYING TINES, ACCESSORIES & BALE FORKS

BRABER EQUIPMENT

40TH
EDITION

PARTS CATALOG

TEDDER TINES

CLAAS

CLAAS#	BRABER#	FITS MODELS
9568151	45.000.700	670, 770, 870, 640, 1050

45.000.700

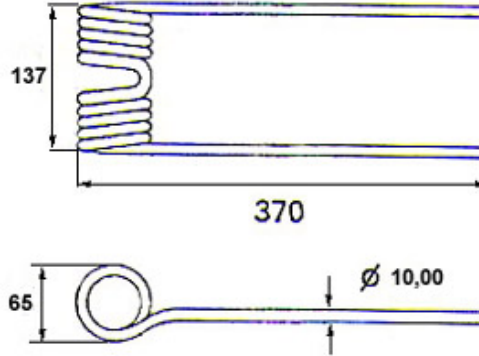

DEUTZ FAHR

DEUTZ FAHR#	BRABER#	FITS MODELS
1.1064.030.129.00, 0658 0647,1650 2741	LH 45.000.014	KV25APOLLO, KV250DN
1.1064.030.130.00, 0658 0648,1650 2742	RH 45.000.015	KV25APOLLO, KV250DN
1.1043.030.107.00, 1650 -2744, 0658-0456	45.000.500*	KH4 S/D, KH400/500/600/700, KH20 (10MM), FANEX 772, 772A KH252, KH276 (10MM TINE)

45.000.014

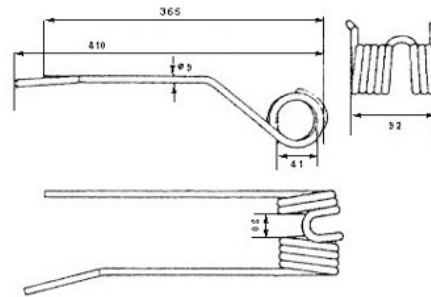

45.000.015

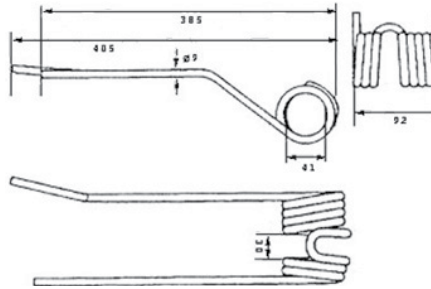

45.000.500

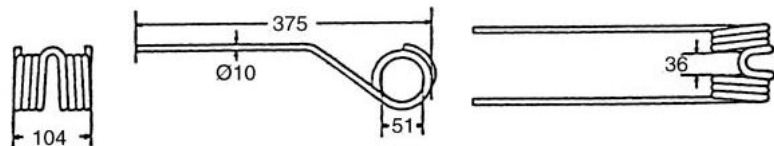

TEDDER TINES

FELLA

FELLA#	BRABER#	FITS MODELS
488.072, 487.922, 150.862	45.000.350	TH440/450,520/D, 530,540,660DHY, 680, 700/D, 790/800/1100/1300

45.000.350

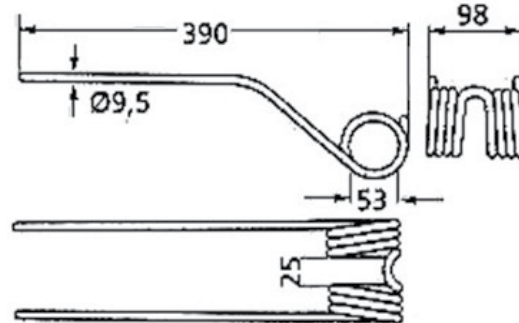

KUHN

KUHN#	BRABER#	FITS MODELS
585-052-14	O/S 45.000.012	GF452/440/452 (BENT)
576-011-00	N/S 45.000.013	GRS21, GRS20, GRS24

45.000.012

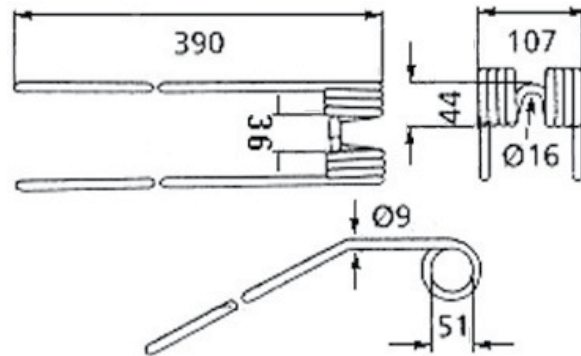

45.000.013

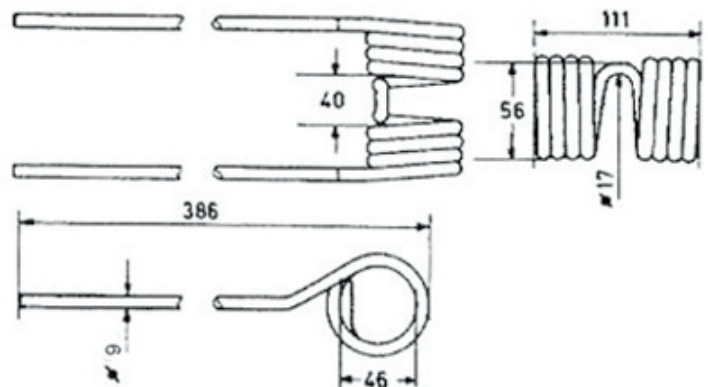

TEDDER TINES

LELY

LELY#	BRABER#	FITS MODELS
4.1015.0058.0	RH 45.000.560	LOTUS 300 80° BENT END
4.1015.0068.0	LH 45.000.561	LOTUS 300 80° BENT END

45.000.560

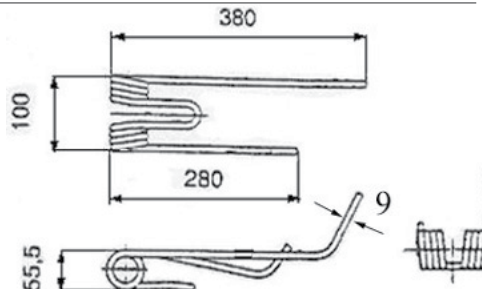

45.000.561

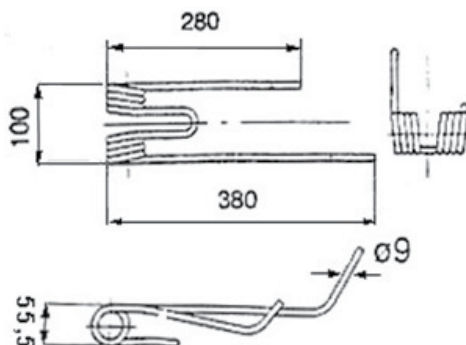

NIEMEYER

NIEMEYER#	BRABER#	FITS MODELS
10501 (GREEN/YELLOW)	LH 45.000.007	HR300/302D/362D/460U/462D/562D/671/70
10502 (RED)	RH 45.000.008	HR300/302D/362D, 460U/462D/ 562D/671/70

45.000.007

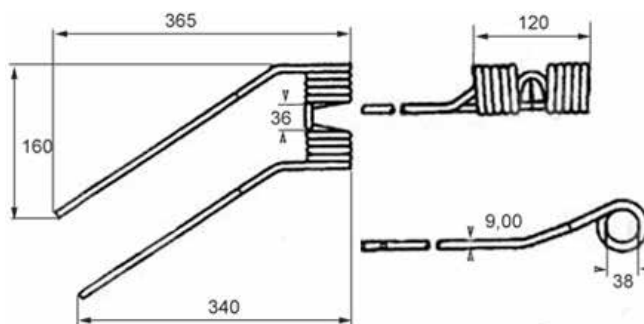

45.000.008

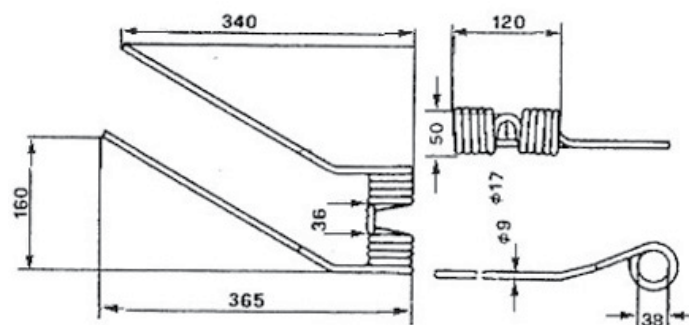

TEDDER TINES

PZ-ZWEEGERS

PZ-ZWEEGERS#	BRABER#	FITS MODELS
PZ-339	LH 45.000.025	FANEX SERIES
PZ-340	RH 45.000.026	FANEX SERIES

45.000.025

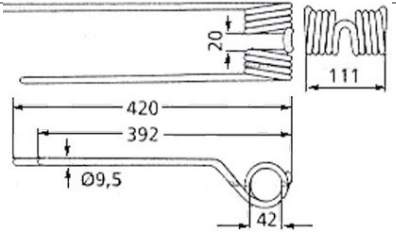

45.000.026

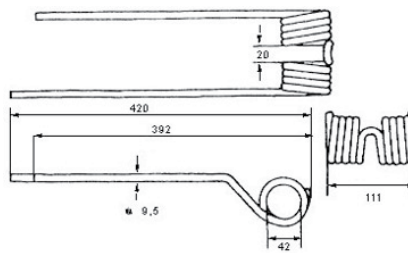

TAARUP/ FARENDLOSE

TAARUP#	FARENDLOSE#	BRABER#	FITS TAARUP MODELS	FITS FARENDLOSE MODELS
66.228.000	511042	LH 45.000.117	725, 725S, 725C, 725CH	RW325
66.229.000	511043	RH 45.000.118	725, 725S, 725C, 725CH	RW325
	5-067	45.000.119		RHT-11, RHT-13 (SWATH TINE)

45.000.117

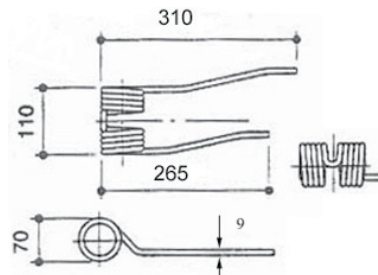

45.000.118

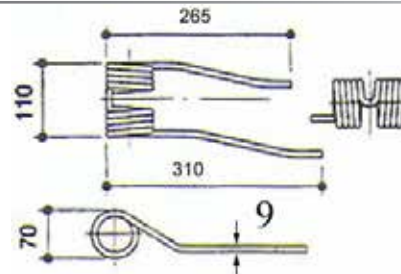
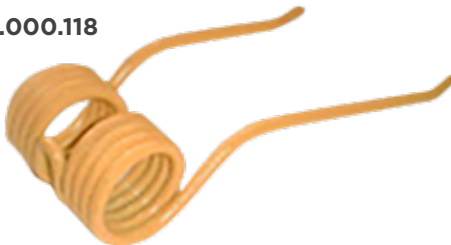

45.000.119



685

RAKE, ROTARY SWATH TURNER TINES

BORELLO/ CESARI

BORELLO#	CESARI#	BRABER#	FITS BORELLO MODELS	FITS CESARI MODELS
BO-86	03.01.063	45.000.430	BRUSH RAKE	RC140/RC170/RC 200 SERIES

45.000.430

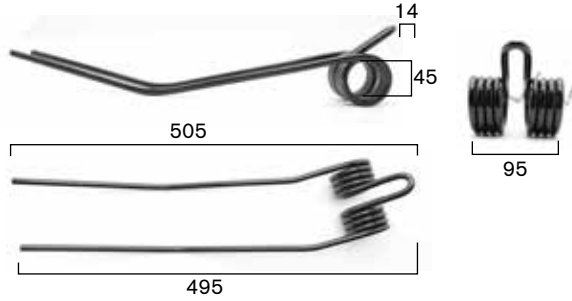

CLAAS

CLAAS#	BRABER#	FITS MODELS
9536290	45.000.750	1500, 3275, 330S, 350S, 350T, 380S, 665L, 390S, 470S, 660HY
955710	45.000.710	LINER TWIN ROTOR 880L 1500 1550 3000

45.000.750

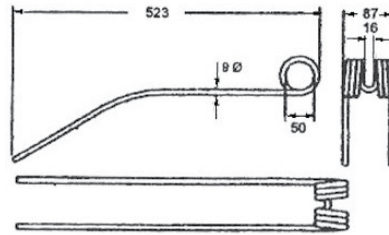

45.000.710

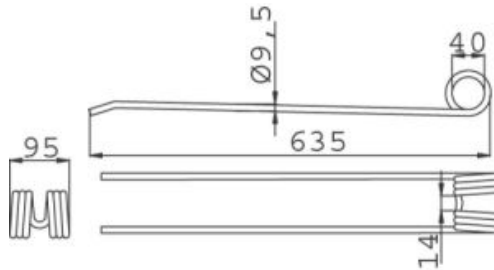
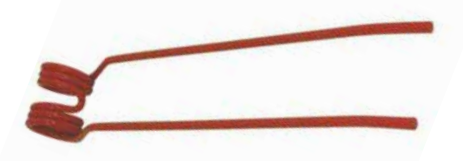

DA ROS

DA ROS	BRABER#	FITS MODELS
69000220	45.000.220	GR300, 330, 380, 410
69000330		GR300DR, 330DR, 410DR

45.000.220

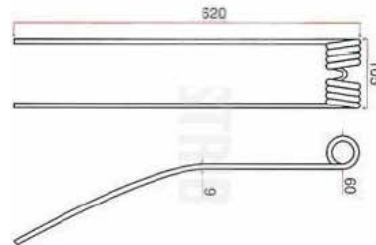

69000330

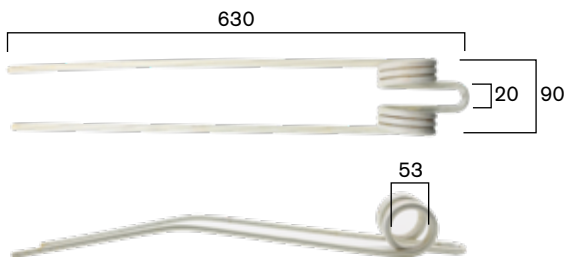

RAKE, ROTARY SWATH TURNER TINES

DEUTZ FAHR

DEUTZ FAHR#	BRABER#	FITS MODELS
1650-0387	45.000.550	KS-345, KS-342, KS-370
1.1089.030.101.00, 0623 1509,1650 2731	45.000.420	KS-85

45.000.550

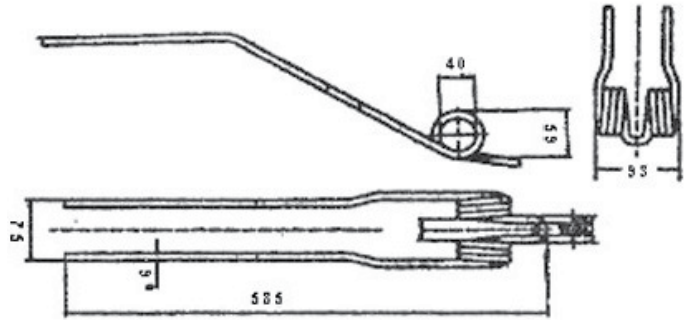

45.000.420

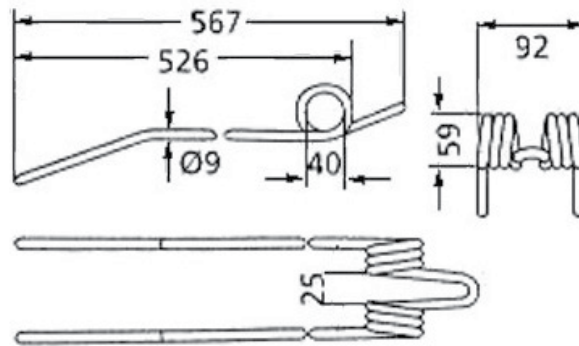

FAZA

FAZA #	BRABER#	FITS MODELS
N/A	88.004.013	FAZA, BE-GR RAKES

88.004.013

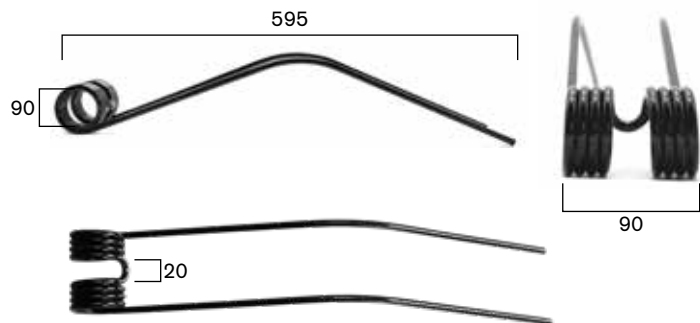

RAKE, ROTARY SWATH TURNER TINES

FELLA/STOLL

FELLA#	STOLL#	BRABER#	FITS FELLA MODELS	FITS STOLL MODELS
497.032/497.031/ 492.816/160.313		45.000.351	TS290/295DS, TS320/330/335DN/ 380DN, TS415DN, TS631	
490.046 GREEN	N/A	RH	TA7/D, TS8/D, UM320	410
491.000 RED	N/A	LH	TA7/D, TS8/D, UM320	410
160.111		45.000.361	TS340/350/390/425/455/670/781/ 16001601/1602/800/1402, 4000	
162.058	N/S	45.000.362	TS1601/1602 N/S (NARROW TAPER)	

45.000.351

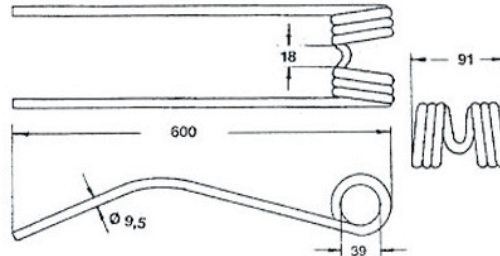

45.000.354

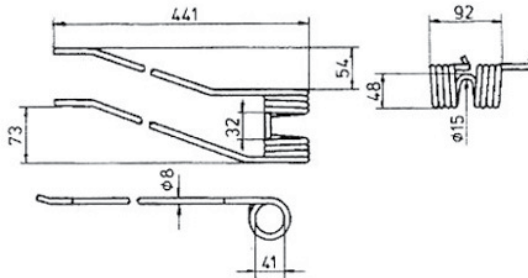

45.000.355

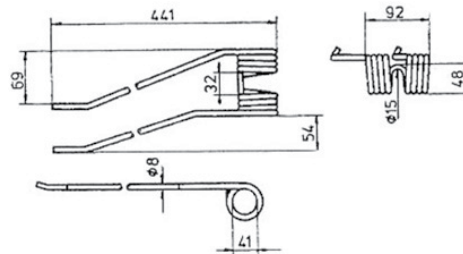

45.000.361

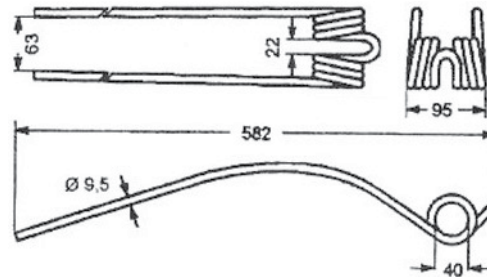

45.000.362

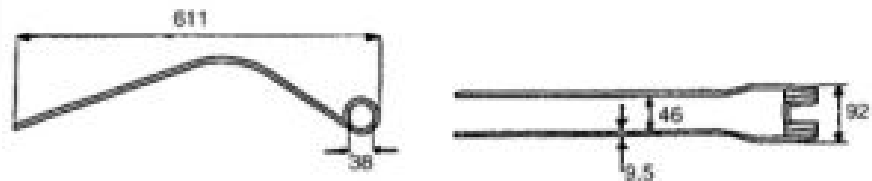

RAKE, ROTARY SWATH TURNER TINES

KUHN

KUHN#	BRABER#	FITS MODELS
577.017.00	45.000.400	GA 230/280/300/402

45.000.400

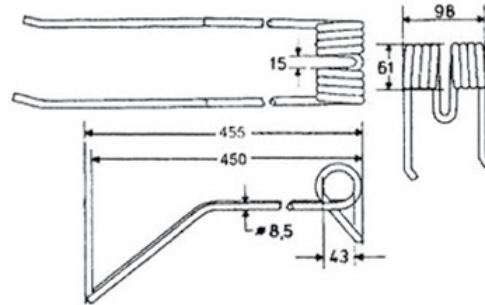

NEW HOLLAND

NEW HOLLAND#	BRABER#	FITS MODELS
539281, GREEN	RH	45.000.354
539330, RED	LH	45.000.355
64562, YELLOW		45.064.562

45.000.354

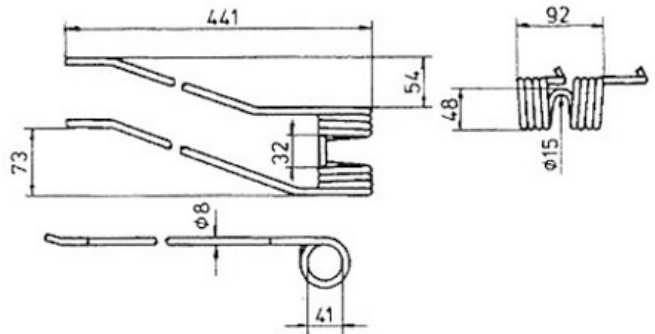

45.000.355

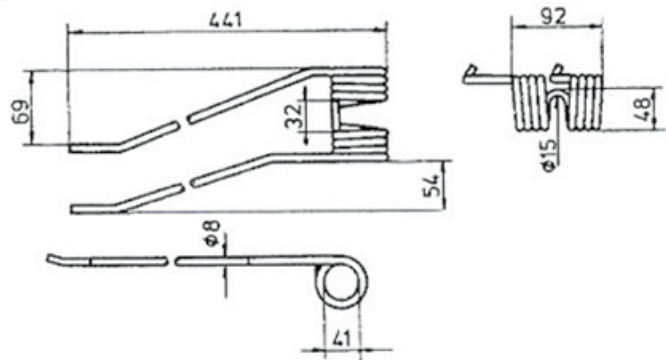

45.064.562

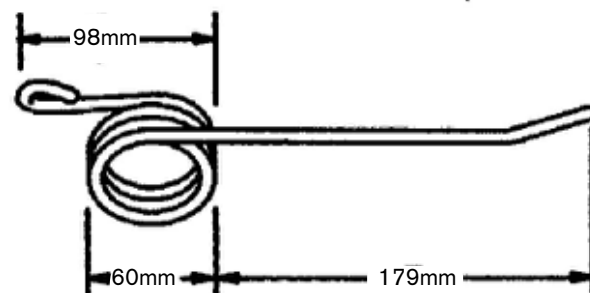

RAKE, ROTARY SWATH TURNER TINES

PZ-ZWEEGERS

PZ-ZWEEGERS#	BRABER#	FITS MODELS
PZ-190 YELLOW	RH	45.000.190
PZ-192 BLUE SPOT	LH	45.000.192
PZ-225 YELLOW	RH	45.000.225

45.000.190

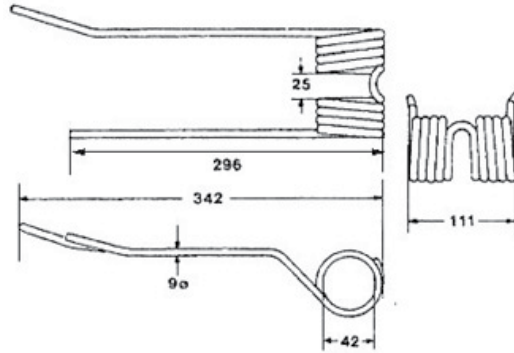

45.000.192

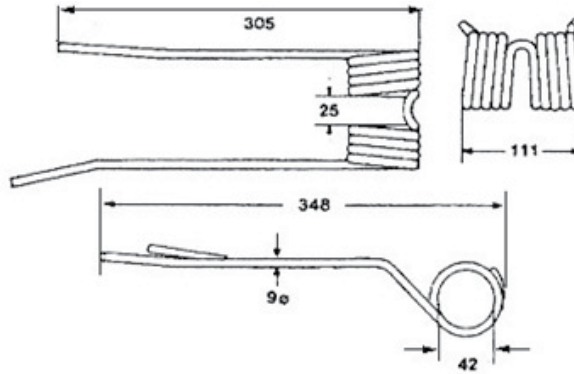
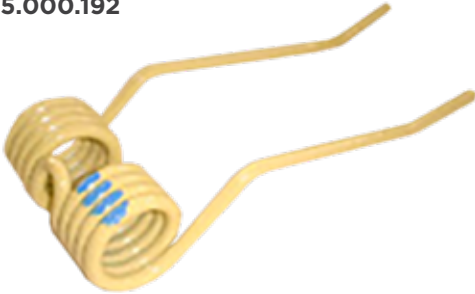

45.000.225

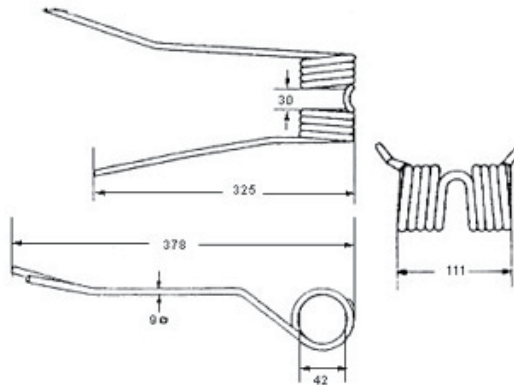
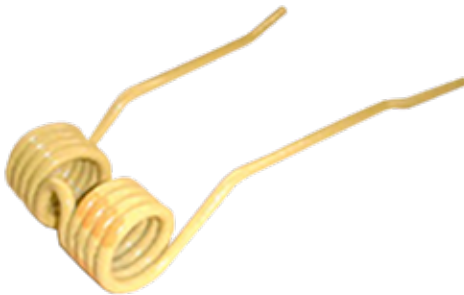

RAKE, ROTARY SWATH TURNER TINES

PZ-ZWEEGERS/ SITREX

PZ-ZWEEGERS#	SITREX#	BRABER#	FITS PZ-ZWEEGERS MODELS	FITS SITREX MODELS
PZ-107 BLUE SPOT	200.285	LH 45.000.107	HAYBOB 300/HS 360 (NARROW)	HM 300 HAYMAKER (NARROW)
PZ-110 BLUE SPOT	200.286	LH 45.000.110	HAYBOB 300/HS 360 (WIDE)	HM 300 HAYMAKER (WIDE)
PZ-111 YELLOW	200.287	RH 45.000.111	HAYBOB 300/HS 360 (WIDE)	HM 300 HAYMAKER (WIDE)
PZ-106 YELLOW	200.284	RH 45.000.106	HAYBOB 300 (NARROW)	HM 300 HAYMAKER (NARROW)
PZ-114		45.000.114	HAYBOB (SWATH TINE)	

45.000.107

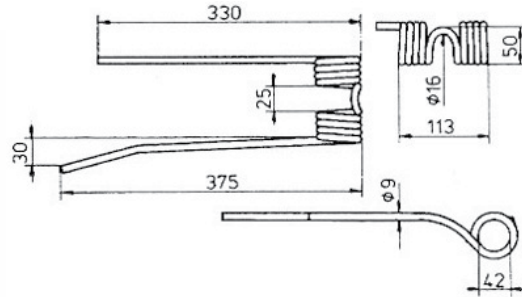

45.000.110

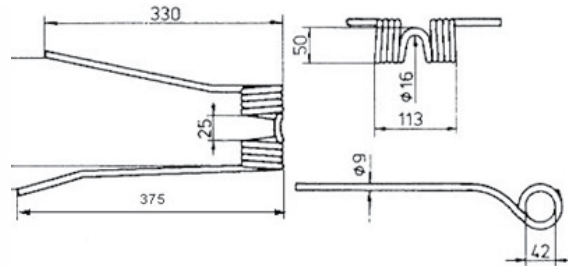
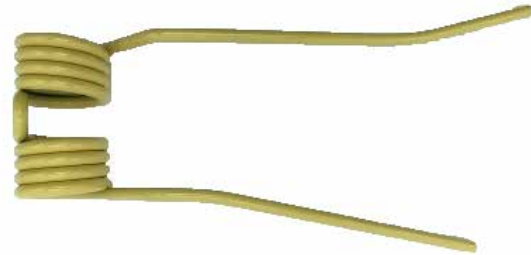

45.000.111

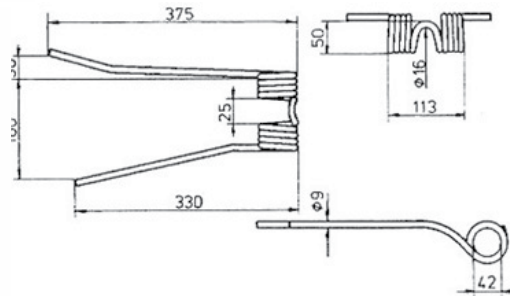

45.000.106

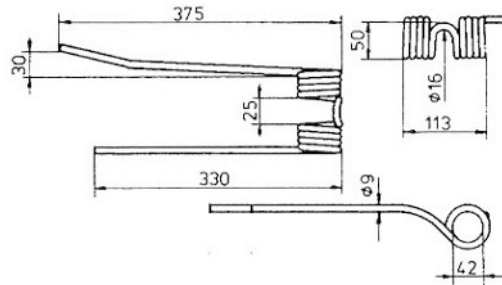

45.000.114

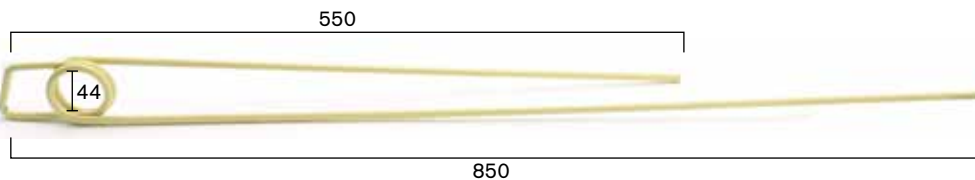

RETURN SPRINGS



PART #	OEM#
58.000.099 (LH)	PZ 99
58.000.100 (RH)	PZ 100
FOR MODELS	HAYBOB/ TR300/ SITREX

RAKE, ROTARY SWATH TURNER TINES

JOHN DEERE

JOHN DEERE#	BRABER#	FITS MODELS
TP257SE	45.000.257	JD 851/894/350/858
186SE	45.160.320	JD 553/594

45.000.257

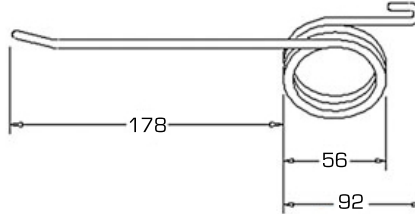

45.160.320

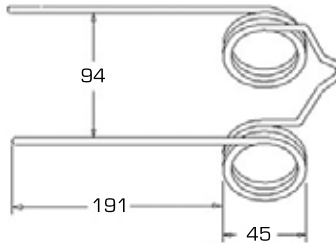

INTERNATIONAL

INTERNATIONAL#	BRABER#	FITS MODELS
457374R1/462978R	45.160.126	3, 4, 8, 9, 11 (1956-LATER), 14, 15 (1956-LATER), 16, 30, 35, 86, 96, 97

45.160.126

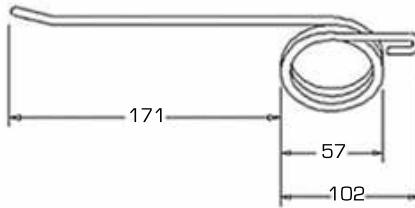

BALER TINE

JOHN DEERE

JOHN DEERE#	BRABER#	FITS MODELS
E61295	45.061.295	JD 553/594

45.061.295

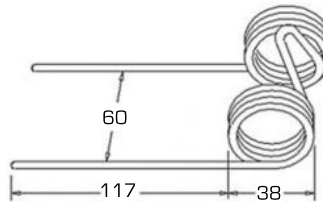

NEW HOLLAND

NEW HOLLAND#	BRABER#	FITS MODELS
131673	45.131.673	87052855/86632007/84822014/ 80916 061/86551419/916061/80131673

45.131.673

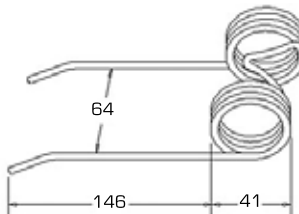

BALER TINES

DEUTZFAHR

DEUTZFAHR#	BRABER#	FITS MODELS
0657-2888	45.000.200	MP SERIES (DEUTZ FAHR BALERS)

45.000.200

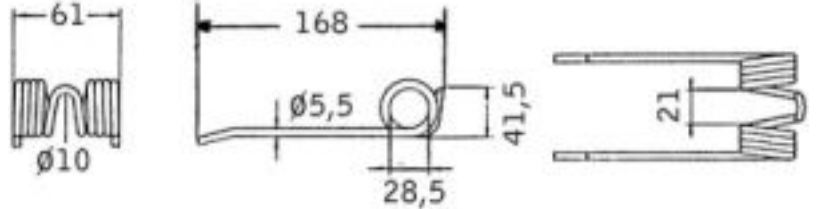

BELT RAKE TINES

DA ROS/MORELATTO

DA ROS#	MERELLATO#	BRABER#	FITS DA ROS MODELS	FITS MORELATTO MODELS
MS-062/6900020	77.000.002	45.000.113	D150/180/210/250	BR 200/220

PZ-ZWEEGERS/ SIP

PZ-ZWEEGERS#	SIP#	BRABER#	FITS PZ-ZWEEGERS MODELS	FITS SIP MODELS
PZ-69	151057705	45.000.113	PZ-2000	BE-3350 SIP 165/180/200/220

45.000.113

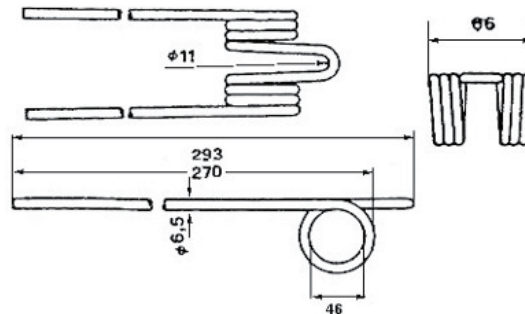

FARENDLOSE

FARENDLOSE#	BRABER#	FITS MODELS
5033	45.000.003	RHT-11, RHT-13 (UNEVEN)
5034	45.000.004	RHT-11, RHT-13 (EVEN)

45.000.003

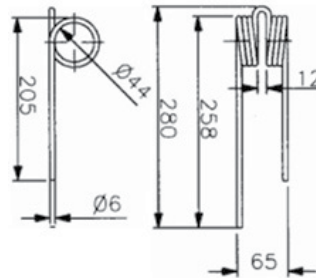

45.000.004

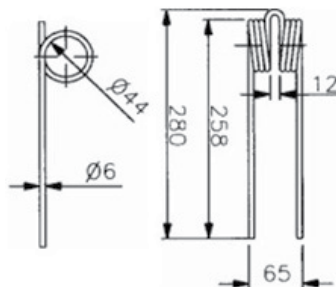

RUBBER RAKE TOOTH TINES

MEASUREMENT LEGEND

- A USABLE LENGTH
- B INSIDE OF MOUNT

RAKES, SIDE DELIVERY

OEM#	BRABER#	FOR MODELS	A	B	HOLES
300411	45.300.411	LOCKWOOD, INNES, PICKETT, FOR BEAN WINDROWERS.	7 ¹ / ₄ "	1 ³ / ₁₆ "	CENTERED

45.300.411

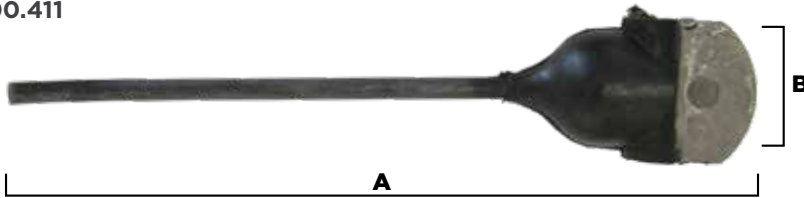

RAKES, SIDE DELIVERY

OEM#	BRABER#	FOR MODELS	A	B	HOLES
300114	LH 45.300.114	NEW HOLLAND/ALLEN, TWIN STAR, NH850613	10"	2"	OFFSET
300213	RH 45.300.213	NEW HOLLAND/ALLEN, TWIN STAR, NH850614	10"	2"	OFFSET

45.300.114

45.300.213

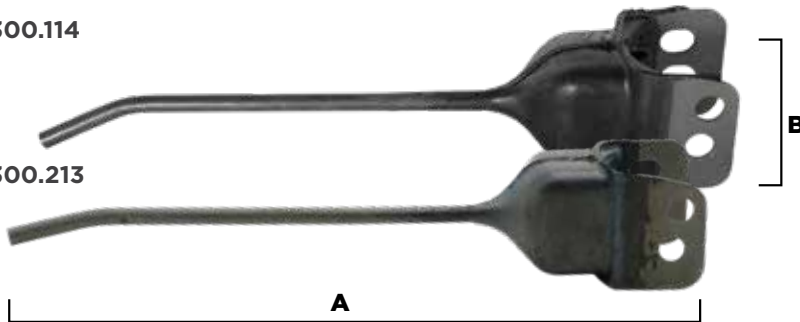

RAKES, SIDE DELIVERY

OEM#	BRABER#	FOR MODELS	HOLE SIZE	A	B	HOLES
300718	45.300.718	VERMEER 2888-001, JOHN DEERE	10MM	9 ³ / ₄ "	1 ³ / ₄ "	CENTERED

45.300.718

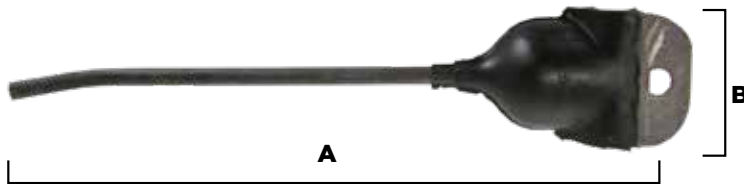

RAKES, SIDE DELIVERY

OEM#	BRABER#	FOR MODELS	A	B	HOLES
300916	45.300.916	JD AE56204, NH 850612 FOR ROUND BAR, PARALLEL BAR RAKES	10"	1 ⁵ / ₈ "	OFFSET

45.300.916

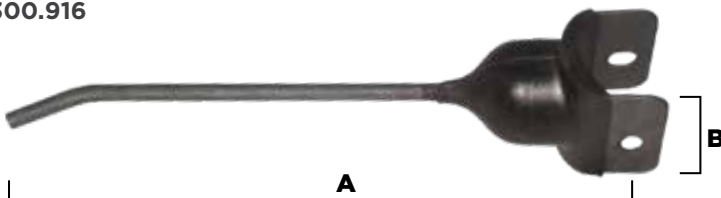

UNIVERSAL TINE!

RUBBER RAKE TOOTH TINES

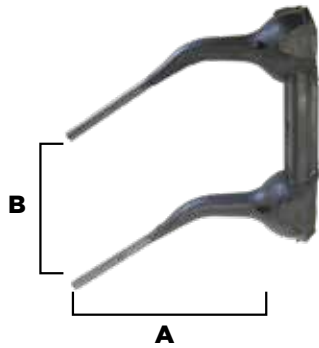

MEASUREMENT LEGEND

- A USABLE LENGTH
- B INSIDE OF MOUNT

RAKES, SIDE DELIVERY

OEM#	BRABER#	FOR MODELS	A	B
300510	45.300.510	DARF, FARMHAND, MORRILL, FOR WHEEL RAKES	6 1/2"	4 1/4"

FINGERWHEEL TINES

VICON/LELY/TONUTTI

VICON/LELY#	BRABER#	FITS MODELS	A	B	C
92611	45.092.611	O/S FINGERWHEEL RAKE	159	318	440
2299139/2299139	45.036.133	N/S FINGERWHEEL RAKE	152	254	440

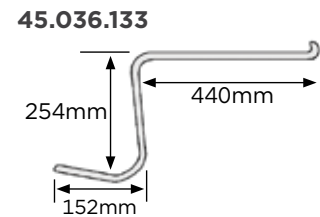
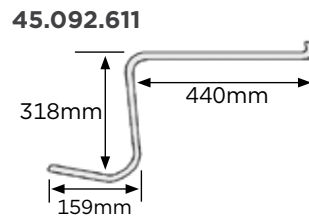

H&S, SITREX, ATLAS

H&S, SITREX, ATLAS#	BRABER#	FITS MODELS
203055	45.000.176	203055/ 3637507/ 3737507/ 96OT1/ OT1/ OT-1/ TEOT1/ TEOT1E/ TES1E

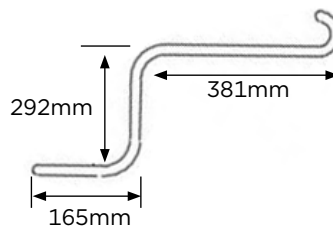

MOUNTING HARDWARE: TINE CLAMPS

SPECIFICATIONS

FELLA #	150.094
FELLA #	160.089
FELLA #	161.379
BE # FAZA/BE GR	88.004.012
DAROS#	3500060
DAROS#	3500220



150.094



160.089



3500060



161.379



88.004.012



3500220

ALL MEASUREMENTS ARE IN MILLIMETERS UNLESS OTHERWISE STATED (1" = 25.4 MM).
THESE ITEMS ARE NOT ORIGINAL EQUIPMENT PARTS.

BALE SPEARS & SLEEVES

SPECIFICATIONS

PART#	DESCRIPTION	MATERIAL	LOAD	LENGTH
60.000.006	CRANKED CONUS I	TEMPERED SPRING STEEL 60517	1800 LBS	910MM (35")
60.000.007	CRANKED CONUS II, STONE FORK	TEMPERED SPRING STEEL 60517	2200 LBS	980MM (39")



LENGTH

SPECIFICATIONS

PART#	DESCRIPTION	MATERIAL	LOAD	LENGTH
60.000.003	CONUS II, WEIGHT 6.8 KGS	TEMPERED SPRING STEEL 60517	2200 LBS	820MM (32")
60.000.004	CONUS II, WEIGHT 8.3 KGS	TEMPERED SPRING STEEL 60517	2200 LBS	980MM (39")
60.000.005	CONUS II, WEIGHT 9.7 KGS	TEMPERED SPRING STEEL 60517	2200 LBS	1,240MM (49")
60.000.009	NUT, CONUS II, NEW STYLE, 30MM THREAD			



LENGTH

SLEEVES

CONUS I SLEEVE



SPECIFICATIONS

PART#	60.000.001
LENGTH	108
OD	50.2
ID	25.45
ID	35.20

CONUS II SLEEVE



SPECIFICATIONS

PART#	60.000.002
LENGTH	117.90
OD	57.30
ID	31.80
ID	44.50



2 HAY MOWER BLADES & HARDWARE

BRABER EQUIPMENT

40TH
EDITION

PARTS CATALOG

SICKLE GUARDS

55.030.001



55.030.004



55.030.005



55.030.006



55.030.013



55.030.014



55.030.015



55.030.017



55.030.018



55.030.106

SICKLE GUARDS

PART #	GUARD TYPE	FITS	OEM REPLACEMENT #
55.030.001	DOUBLE PRONG	BADGET NORTHLAND, CASE IH, HESSTON, MASSEY FERGUSON & NEW HOLLAND	683994M1, 700707147, 70016292, 683476M1, 219191, 858778, 86615982, 86521587, 86553340, BU215-A
55.030.004	TRIPLE PRONG	FORD & JOHN DEERE	H213507, H20547, H213400
55.030.005	DOUBLE PRONG	JOHN DEERE, WHITE, MASSEY FERGUSON, NEW HOLLAND & NEW IDEA	H113571, H145791, H153719, H61954, H75386, 9510220, 228392M1/M2, 134024, 714611, BC240-A
55.030.006	TRIPLE PRONG	JOHN DEERE	H205448, H213398
55.030.013	DOUBLE PRONG	NEW HOLLAND, SAMPO & CLAYSON	RV0498838, 80379720, 379720
55.030.014	DOUBLE PRONG	CLAAS	676235
55.030.015	DOUBLE PRONG	MASSEY FERGUSON & CASE IH	44104500, 44102900
55.030.017	DOUBLE PRONG	JOHN DEERE	H25602, Z11228
55.030.018	DOUBLE PRONG	FORD	34887A1
55.030.106	DOUBLE PRONG	CASE IH, FIELD QUEEN, GEHL, HESSTON, NEW HOLLAND, VERSATILE & J I CASE	700700845, 049239, 748178, 788278, 611179, 911902, 65327, 604884, V94711, 49239

SICKLE SECTION KNIFE KITS & WEAR PLATES



55.211.022



UNDER SERRATED



TOP SERRATED

SICKLE SECTION KNIFE KITS

PART #	DESCRIPTION	SIZE	FITS MODELS	OEM REPLACEMENT #
55.211.001	EXTRA HEAVY, TOP SERRATED, CHROME	3" X 3 1/4"	CASE IH, HESSTON, JOHN DEERE, MASSEY FERGUSON, NEW HOLLAND	596321R3, 700705300, 683936M1, 604921H
55.211.022	HEAVY UNDER SERRATED	3" X 3 1/4"	AGCO-ALLIS MOWERS, JD MOWERS, JD M/C & WINDROWERS, FORD MOWERS, TRIUMPH MOWERS	70802541, E76373, Z7030H, 141198, 646
55.212.012	EXTRA HEAVY, UNDER SERRATED	3" X 3 1/4"	CASE IH MOWERS, WINDROWERS & MOWER CONDITIONERS MASSEY FERGUSON MOWER CONDITIONER HAYTENDER	826722C2, 1036362M1, 29875, 60969, 462381R91, R63159R91, 290627S, 340-32056S, 101988C91
55.204.170	HEAVY TOP SERRATED CHROME	3" X 3 1/4"	CASE IH COMBINE HEADERS, JOHN DEERE, WINDROWERS, MOWER CONDITIONERS, NEW HOLLAND, MACDON MOWERS & CONDITIONERS	84342590, W34620CR, W35888CR, 137448C1CR, 34390CR
55.203.325	HEAVY 7 TOOTH TOP SERRATED SECTION	3" X 3 1/4"	CASE IH MOWERS, M/C, COMBINES 1010 & 1020 HEADERS	112074A1
55.204.268	HEAVY TOP SERRATED CHROME	3" X 3 1/4"	CASE IH, NEW HOLLAND, MASSEY	M333-1/2SCR, 604921H, 683936M1, 596321R1



55.204.210



TOP SERRATED END SECTION

PART #	DESCRIPTION
55.204.210	TOP SERRATED END SECTION FOR ALL MOWERS, MOWER/CONDITIONERS, UNIVERSAL, 3TS



55.440.591



UNIVERSAL WEAR PLATE

PART #	DESCRIPTION
55.440.591	UNIVERSAL WEAR PLATE FOR ALL MOWERS, MOWER/CONDITIONERS, WINDROWERS AND COMBINES, W50

SICKLE SECTION ACCESSORIES



55.450.692

KNIFE/SICKLE CLIP LO-ARCH

PART #	DESCRIPTION
55.450.692	KNIFE/SICKLE CLIP LO-ARCH, FITS MOST MOWER/CONDITIONERS, WINDORWERS AND COMBINES



55.380.560

PITMAN ARM

PART #	DESCRIPTION
55.380.560	PITMAN ARM, UNIVERSAL WOOD



55.904.500

SICKLE SECTION BOLT-ON FASTENERS

PART #	DESCRIPTION	LENGTH	NO. OF PIECES
55.904.500	BOLT W/ LOCKNUT	5/8"	50 PCS
55.550.058	COUNTERSUNK	1"	20 PCS
55.550.085	HEAD BOLTS	1"	15 PCS
55.550.095	HEAD BOLTS	1 5/16"	12 PCS



55.360.462

SICKLE SECTION RIVETS

PART #	DESCRIPTION
55.360.462	RIVETS, SICKLE SECTION 1LB 5/8" LENGTH X 5 1/2" OVAL HEAD, ZINC PLATED



55.360.524

SICKLE SECTION RIVET ASSORTMENT

PART #	DESCRIPTION
55.360.524	SICKLE SECTION RIVET ASSORTMENT, 82 PCS, 3 SIZES

ASSORTMENT CONTENTS

RIVET SIZE	NO. OF PIECES
5/8" X 5 1/2" OVAL HEAD	72
1" X 5 1/2" OVAL HEAD	5
1 1/4" X 5 1/2" OVAL HEAD	5

REVERSIBLE HAY MOWER BLADES

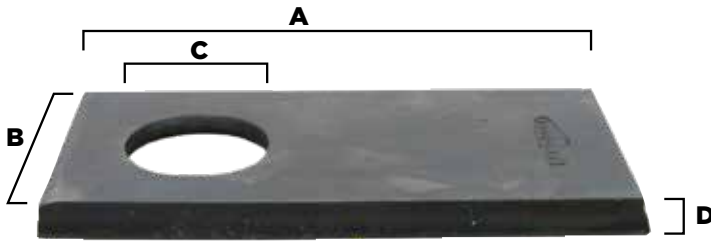

CLAAS

CLAAS#	BRABER#	A	B	C	D
977-516-0	55.000.001	88	40	19	3
978-186-0	55.000.002	96	40	19	3

FAHR

FAHR#	BRABER#	A	B	C	D
1-1019-010-271.20	55.000.001	88	40	19	3
1-1012-030-115.00	55.000.002	96	40	19	3

FELLA

FELLA#	BRABER#	FITS MODELS	A	B	C	D
477.741	55.000.001		88	40	19	3
477.740	55.000.002	KM20, KM21	96	40	19	3

INTERNATIONAL

INTERNATIONAL#	BRABER#	FITS MODELS	A	B	C	D
3164894R4	55.000.002	3104, 3106	96	40	19	3

KRONE

KRONE#	BRABER#	A	B	C	D
7-141-071-0, 4143-149-4	55.000.001	88	40	19	3
1371-24-27	55.000.002	96	40	19	3

NIEMER

NIEMER#	BRABER#	A	B	C	D
570.400	55.000.001	88	40	19	3
570.404/41473021	55.000.002	96	40	19	3

PZ-ZWEEGERS

PZ-ZWEEGER#	BRABER#	FITS MODELS	A	B	C	D
MT52S	55.000.001	230, 265, 275, 320	88	40	19	3
MT452S	55.000.002		96	40	19	3

TARRUP

TARRUP#	BRABER#	A	B	C	D
58.372.200	55.000.005	110	40	20.5	3

REVERSIBLE HAY MOWER BLADES

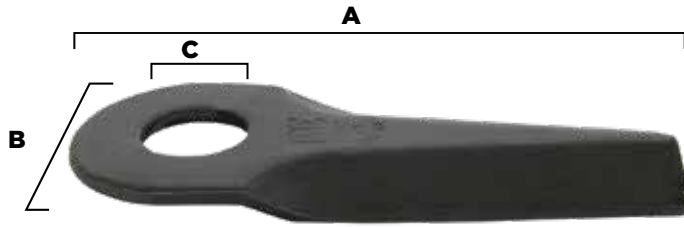

JOHN DEERE

JOHN DEERE#	BRABER#	DESCRIPTION	A	B	C
CC19993	55.000.007	SHORT SPOON	130	49	20.5X22.8 OVAL

NEW HOLLAND

NEW HOLLAND#	BRABER#	DESCRIPTION	FITS MODELS	A	B	C
697551	55.000.007	SHORT SPOON	442, 462	130	49	20.5X22.8 OVAL

TAARUP

TAARUP#	BRABER#	DESCRIPTION	FITS MODELS	A	B	C
56-110-300	55.000.007	SHORT SPOON	204, 205, 206	130	49	20.5X22.8 OVAL

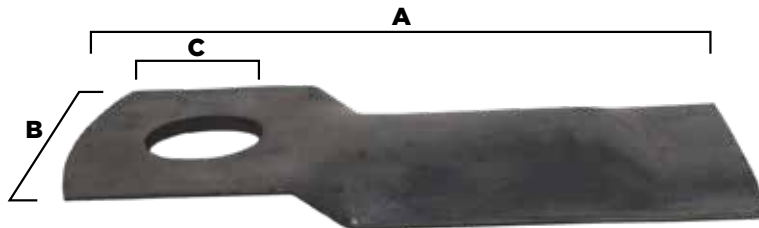

TAARUP

TAARUP#	BRABER#	DESCRIPTION	A	B	C
56-293-100	55.293.100	SHORT SPOON	131	50	20.5X22.8 OVAL

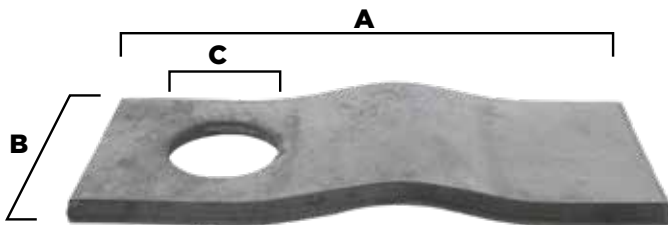

PZ-ZWEEGERS

PZ-ZWEEGERS#	BRABER#	FOR MODELS	A	B	C
CM120	55.000.010	CM 135, CM 165	105	47	21

SIP

SIP#	BRABER#	FOR MODELS	A	B	C
151019702	55.000.010	ROTO 135, 165, 185, RK1650	105	47	21

HAY MOWER BLADES CW & CCW



BUSH HOG

BUSH HOG#	BRABER#	FITS MODELS	A	B	C	D
526215	CCW LH 55.000.011	DM18, DM19, DM7, DM8	120	48	18.5	4
526216	CW RH 55.000.012	DM9, HM5, HM7, HM8	120	48	18.5	4

CASE IH

CASE IH#	BRABER#	FITS MODELS	A	B	C	D
ZA526215	CW RH 55.000.012	3204, 3205, 3206, 3209,	120	48	18.5	4
ZA526215	CCW LH 55.000.011	ALL WITH STANDARD DISK	120	48	18.5	4
700711857	CW RH 55.000.857	8309, 8312, 8315, 8850	108	48	4	18.5
700711858	CCW LH 55.000.858		108	48	4	18.5
952042	CW RH 55.952.420	DISCO 2650, 3050, 3450	115	47.75	19	4
952043	CCW LH 55.952.430		115	47.75	19	4

CLAAS

CLAAS#	BRABER#	FITS MODELS	A	B	C	D
952.042	CW RH 55.952.420	DISCO 2650, 3050, 3450	115	47.75	19	4
952.043	CCW LH 55.952.430		115	47.75	19	4

FELLA

FELLA#	BRABER#	FITS MODELS	A	B	C	D
122.330	CW RH 55.000.104	SM 165, SM 206, SM 216, SM 240, SH 167,	106	48	19	4
122.329	CCW LH 55.000.103	SH 207, SH 247, SM168, SM208	106	48	19	4
131.117	CCW LH 55.000.117	SM 270, SM 210, SM 320,	111	48.75	19	4
131.118	CW RH 55.000.118	SM 350, SM310	111	48.75	19	4
N/A	CW RH 55.000.174	SM 900	118	48.75	19	4
N/A	CCW LH 55.000.175		118	48.75	19	4

GEHL

GEHL#	BRABER#	FITS MODELS	A	B	C	D
604658	CCW LH 55.000.011	2310, 2330, DC1080,	120	48	18.5	4
604659	CW RH 55.000.012	DC2350, DH140, DH160	120	48	18.5	4

HESSTON

HESSTON#	BRABER#	FITS MODELS	A	B	C	D
700712888	CW RH 55.000.015	10° LIFT, 1320, 1340, 1360, 1365	107	45	18	4
700712889	CCW LH 55.000.016		107	45	18	4
700711857	CW RH 55.000.857	11° LIFT, 1320, 1340, 1360, 1365	108	48	4	18.5
700711858	CCW LH 55.000.858		108	48	4	18.5
700715575	CW RH 55.000.575	18° LIFT, 1320, 1340, 1360, 1365	107	45	18	4
700715576	CCW LH 55.000.576		107	45	18	4

HAY MOWER BLADES CW & CCW

INTERNATIONAL

INTERNATIONAL#			BRABER#	FITS MODELS	A	B	C	D
56890	CCW	LH	55.000.011	3204, 3205, 3206	120	48	18.5	4
58700	CW	RH	55.000.012		120	48	18.5	4

JOHN DEERE

JOHN DEERE#			BRABER#	FITS MODELS	A	B	C	D
E80208	CW	RH	55.000.015	920, 930, 1350, 1360, 1460, 1470	107	45	18	4
E80206	CCW	LH	55.000.016		107	45	18	4
20500/44007	CCW	LH	55.000.500	240, 260	95	45	16.25	3.5
20501/44006	CW	RH	55.000.501		95	45	16.25	3.5

KUHN

KUHN#			BRABER#	FITS MODELS	A	B	C	D
564.512.00	CW	RH	55.000.780	GHD44, 44HD, 55, 55HD, 66, 66HD,	122	48	18.5	4
564.513.00	CCW	LH	55.000.781	77, GMD SELECT	122	48	18.5	4
559.033.10	CW	RH	55.000.015	FC252G, 353GC, 350G, 300	107	45	18	4
559.032.10	CCW	LH	55.000.016	GMD500, 700, 600, 602, 702	107	45	18	4
561.513.00	CW	RH	55.000.004	FC 300, 302, 303, 350, 352, 400,	93	40	16.5	3
561.512.00	CCW	LH	55.000.003	500, 4000G, 4000R, 4000RG	93	40	16.5	3

NEW HOLLAND

NEW HOLLAND#			BRABER#	FITS MODELS	A	B	C	D
444 267	CW	RH	55.000.012	408, 411, 412, 415	120	48	18.5	4
444 266	CCW	LH	55.000.011		120	48	18.5	4
853 820	CW	RH	55.000.015	1411, 1412, 1431, 1432, 1441, 1442 & OLDER 600 SERIES	107	45	18	4
853 819	CCW	LH	55.000.016		107	45	18	4
9847683	CW	RH	55.000.683	1411, 1412, 1431, 1432, 1441, 1442 & OLDER 600 SERIES	107	48	22.8	4
9847684	CCW	LH	55.000.684		107	48	22.8	4

NEW IDEA

NEW IDEA#			BRABER#	FITS MODELS	A	B	C	D
526215	CCW	LH	55.000.011	5209, 5212, 526, 527, 528, 5406, 5407, 5408, 5409	120	48	18.5	4
526216	CW	RH	55.000.012		120	48	18.5	4

TAARUP

TAARUP#			BRABER#	FITS MODELS	A	B	C	D
56.110.400	CW	RH	55.110.400	4028, 4032, 4032C, 4040, 4040C	126	48	20.5X23	4
56.110.900	CCW	LH	55.110.900		126	48	20.5X23	4

VICON

VICON#			BRABER#	FITS MODELS	A	B	C	D
900-58-700	CW	RH	55.000.012	CH165, 167, 247, 240, GHR2400, 3200, KH240, 241, 321, KMR, KMT 2400, 300, 3200	120	48	18.5	4
902-58-699	CCW	LH	55.000.011		120	48	18.5	4
902-61-560	CW	RH	55.000.014	AM 2400, 2800, CM144, 216, 217, GMR 2800, KM 281, 391, KMR 2800, KMT 2800	108	48	18.5	4
902-61-559	CCW	LH	55.000.013		108	48	18.5	4

BOLT ASSEMBLIES

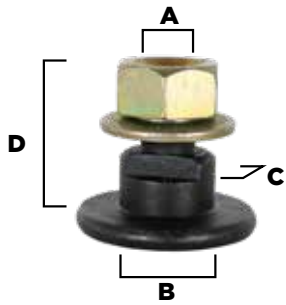

BOLT & NUT
Part# 06.000.003
Part# 06.000.015

KUHN#	BRABER#	A	B	C	D
561.501.00K	06.000.003	10	16	9.75	22
561.158.00K	06.000.015	12	18	12	26

DIMENSIONS LEGEND

A	BOLT WIDTH
B	BLADE SHOULDER
C	LOCK WIDTH
D	USEABLE LENGTH

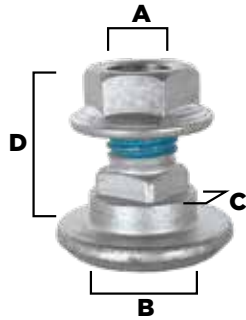

BOLT & NUT
Part# 06.000.016

FELLA#	BRABER#	A	B	C	D
122.181, 426.053	06.000.016	12	18	12	21

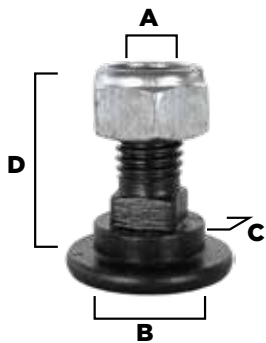

BOLT & NUT
Part# 06.000.018

TAARUP#	BRABER#	A	B	C	D
56.403.000	06.000.018	12	20	12	30

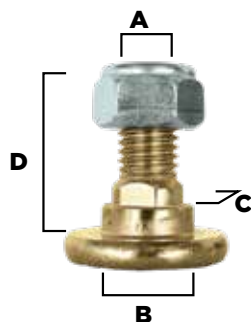
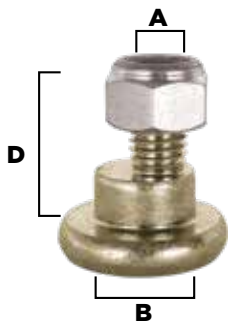

BOLT & NUT
Part# 06.000.017
Part# 06.000.020

VICON#	BRABER#	A	B	C	D
900-81-160	06.000.017	10	18	N/A	25
B13-74-593	06.000.020	12	18	12	29

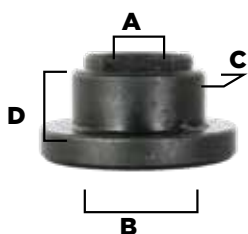

BOLT & NUT
Part# 06.000.021

CNH#	BRABER#	A	B	C	D
700127073	06.000.022	12	21.75	14	11.5

NEW HOLLAND#	BRABER#	A	B	C	D
86515265	06.000.021	12	21.75	14	11.5



3 TILLER BLADES

BRABER EQUIPMENT
40TH
EDITION
PARTS CATALOG

SQUARE BLADES / "L" BLADE

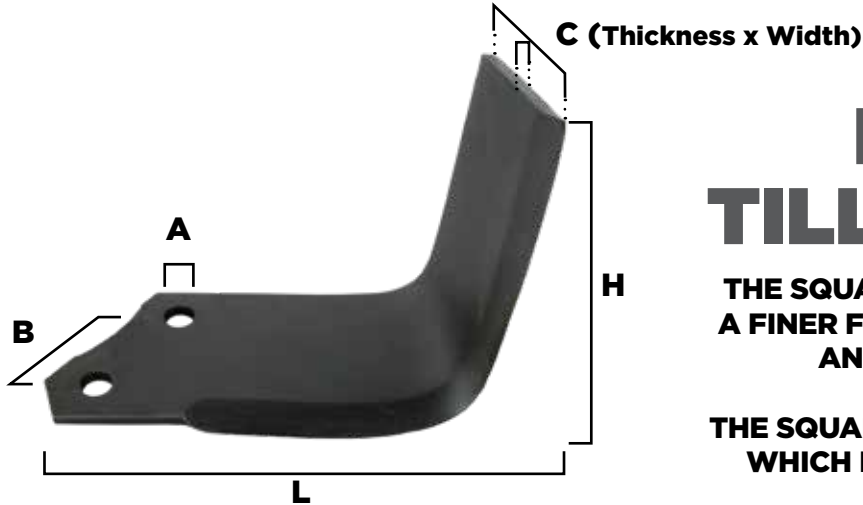

L SHAPED TILLAGE BLADES

THE SQUARE BLADE OR "L" BLADE CREATES
A FINER FINISH FOR SEED BED PREPARATION
AND CREATES MORE HARDPAN.

THE SQUARE BLADE HAS A CHOPPING EFFECT
WHICH IS IDEAL FOR RASPBERRY CANES.

AGRIC

AGRIC#	BRABER#	FITS MODELS	BOLT KIT	A	B	C	L	H
N/A	LH 63.000.009	B	05.000.002	1/2"	57	80X7	180	132
N/A	RH 63.000.010							
36216L	LH 63.000.013	A	05.000.001	7/16"	57	80X6	170	140
36215R	RH 63.000.014							

BREVEGLIERI

BREVEGLIERI #	BRABER#	FITS MODELS	BOLT KIT	A	B	C	L	H
0089275D	RH 63.000.098	BRE-MG	05.000.006	12.5	40	60X6	154	56
	63.000.098HS							
0089275S	LH 63.000.099							
	63.000.099HS							
8300044	RH 63.000.122	BRE-MBE	05.000.005	10.5	35	56X6	113	56
8300043	LH 63.000.133							

CARRARO

CARRARO#	BRABER#	FITS MODELS	BOLT KIT	A	B	C	L	H
98714	LH 63.000.090	28/29 (3 HOLES)	05.000.006	12.5	57-34	80X7	182	130
98715	RH 63.000.091							

FARM KING

FARM KING#	BRABER#	FITS MODELS	BOLT KIT	A	B	C	L	H
91202901LH	LH 63.000.009	HD 50/60 (72"-80")	05.000.002	1/2"	57	80X7	180	132
91202900RH	RH 63.000.010							

FRONTIER

FRONTIER#	BRABER#	FITS MODELS	BOLT KIT	A	B	C	L	H
191-00-422	LH 63.000.047	RT 1260/1360	05.000.006	7/16"	45	70X6	190	115
191-00-421	RH 63.000.046							

HOWARD

HOWARD#	BRABER#	FITS MODELS	BOLT KIT	A	B	C	L	H
3900	LH 63.000.009	E/U/HE/A/H/ST/HR20/HR30	05.000.002	1/2"	57	80X7	180	132
3901	RH 63.000.010							
9900	LH 63.000.013	P/HL/HX/HR8/HR9/HR10/ HR15/HR16/HR20	05.000.001	7/16"	57	80X6	170	140
9901	RH 63.000.014							
9863	LH 63.000.015							
9862	RH 63.000.016	HR40/HR41/HR43, K/S/M	05.000.009 OPT: 05.000.008	16.5	51	80X9	180	138

HS: HARDSURFACED ONE SIDE

TS: HARDSURFACED BOTH SIDES

ALL MEASUREMENTS ARE IN MILLIMETERS UNLESS OTHERWISE STATED (1" = 25.4 MM).
THESE ITEMS ARE NOT ORIGINAL EQUIPMENT PARTS.

SQUARE BLADES / "L" BLADE

JOHN DEERE

JOHN DEERE#	BRABER#	FITS MODELS	BOLT KIT	A	B	C	L	H
N/A	LH 63.000.009	770	05.000.002	1/2"	57	80X7	180	132
N/A	RH 63.000.010							
PT8444	LH 63.000.013	550/660	05.000.001	7/16"	57	80X6	170	140
PT8445	RH 63.000.014							
N/A	LH 63.000.064	RT 1270	05.000.007	14.5	48	80X6	180	135
N/A	RH 63.000.065							

KRONE

KRONE#	BRABER#	FITS MODELS	BOLT KIT	A	B	C	L	H
035-43-0	LH 63.000.001	RE	05.000.007	14.5	35	65X7	190	128
035-268-1	RH 63.000.002							
036-395-0	LH 63.000.005	REVS	05.000.007	14.5	57	80X7	165	138
036-273-0	RH 63.000.006							
107-269-0	LH 63.000.007	RF	05.000.009	16.5	75	110X8	195	140
107-083-0	RH 63.000.008							

KUHN

KUHN#	BRABER#	FITS MODELS	BOLT KIT	A	B	C	L	H
N/A	LH 63.000.009	EL-70/80/120	05.000.002	1/2"	57	80X7	169	130
N/A	RH 63.000.010							
52166400	LH 63.000.013	EL-30/35/45/50/60/71	05.000.001	7/16"	57	80X6	170	140
52106300	RH 63.000.014							
51921500	LH 63.000.082	EL-80N/EL100N	05.000.007	14.5	57	80X7	165	135
51921600	RH 63.000.083							

KUBOTA

KUBOTA#	BRABER#	FITS MODELS	BOLT KIT	A	B	C	L	H
70741-55850	LH 63.000.013	FL 850/1000/1020/ 1021/ 1270/1271	05.000.001	7/16"	57	80X6	170	140
70741-55860	RH 63.000.014							

MASCHIO/TERRANOVA

MASCHIO#	BRABER#	FITS MODELS	BOLT KIT	A	B	C	L	H
021-08-430	RH 63.000.034	NC/PS/Z	05.000.007	14.5	56	80X6	180	135
021-08-431	LH 63.000.035							
011-10-428	RH 63.000.040	BI/B/C/SC	05.000.007	14.5	56	80X8	215	140
011-10-429	LH 63.000.041							
		TBI/TB/TC/TSC						
		63.000.041HS						
191-00-422	RH 63.000.046	A/E/H/KS/W	05.000.006	12.5	44	70X6	190	115
191-00-421	LH 63.000.047							
241-00-404	RH 63.000.056	S	05.000.008	16.5	56	90X8	223	145
241-00-405	LH 63.000.057	TS						
291-00-408	LH 63.000.064	U/US/UZ	05.000.007	14.5	48	80X6	180	135
291-00-407	RH 63.000.065							
201-00-414	RH 63.000.052	G	05.000.009	16.5	68	97X10	225	140
201-00-415	LH 63.000.053							

MEARELLI

MEARELLI#	BRABER#	FITS MODELS	BOLT KIT	A	B	C	L	H
N/A	RH 63.000.132	FP	05.000.005	10.5	35	56X6	113	56
N/A	LH 63.000.133							

HS: HARDSURFACED ONE SIDE

TS: HARDSURFACED BOTH SIDES

ALL MEASUREMENTS ARE IN MILLIMETERS UNLESS OTHERWISE STATED (1" = 25.4 MM).
THESE ITEMS ARE NOT ORIGINAL EQUIPMENT PARTS.

SQUARE BLADES / "L" BLADE

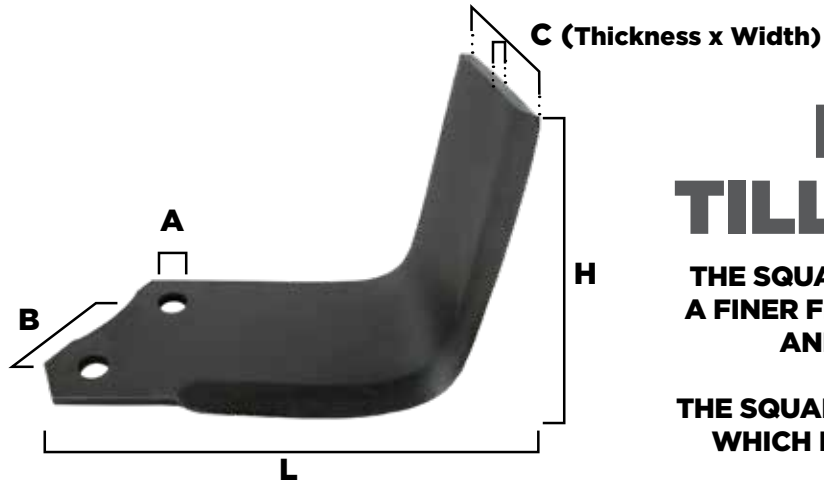

L SHAPED TILLAGE BLADES

THE SQUARE BLADE OR "L" BLADE CREATES
A FINER FINISH FOR SEED BED PREPARATION
AND CREATES MORE HARDPAN.

THE SQUARE BLADE HAS A CHOPPING EFFECT
WHICH IS IDEAL FOR RASPBERRY CANES.

MURATORI

MURATORI#	BRABER#	FITS MODELS	BOLT KIT	A	B	C	L	H	
12.0024.00	LH	63.000.148	MH/MHC/MZ	05.000.007	14.5	57	80X8	170	160
12.0025.00	RH	63.000.149							

NORTHWEST

NORTHWEST#	BRABER#	FITS MODELS	BOLT KIT	A	B	C	L	H	
RB26	LH	63.100.026	05.000.009	16.5	56	3/8"	167	157	
RB26HS		63.100.026HS							
RB27	RH	63.100.027	05.000.009	16.5	56	3/8"	167	123	
RB27HS		63.100.027HS							
RB26SD	LH	63.200.026HS	FOR SOD HARD SURFACED	05.000.009	16.5	56	3/8"	167	123
RB27SD	RH	63.200.027HS							

ORTOLAN

ORTOLAN#	BRABER#	FITS MODELS	BOLT KIT	A	B	C	L	H
466156L	LH	63.000.041	05.000.007	14.5	56	80X8	215	140
		63.000.041HS						
466106R	RH	63.000.040	05.000.007	14.5	56	80X8	215	140
		63.000.040HS						

SOVEMA

SOVEMA#	BRABER#	FITS MODELS	BOLT KIT	A	B	C	L	H
900-11-007	RH	63.000.162	05.000.006	12.5	46	70X7	180	110
900-11-008	LH	63.000.163						
900-11-009	RH	63.000.166	05.000.007	14.5	46	70X7	145	110
900-11-010	LH	63.000.167						

HS: HARDSURFACED ONE SIDE

TS: HARDSURFACED BOTH SIDES

ALL MEASUREMENTS ARE IN MILLIMETERS UNLESS OTHERWISE STATED (1" = 25.4 MM).
THESE ITEMS ARE NOT ORIGINAL EQUIPMENT PARTS.

C BLADES

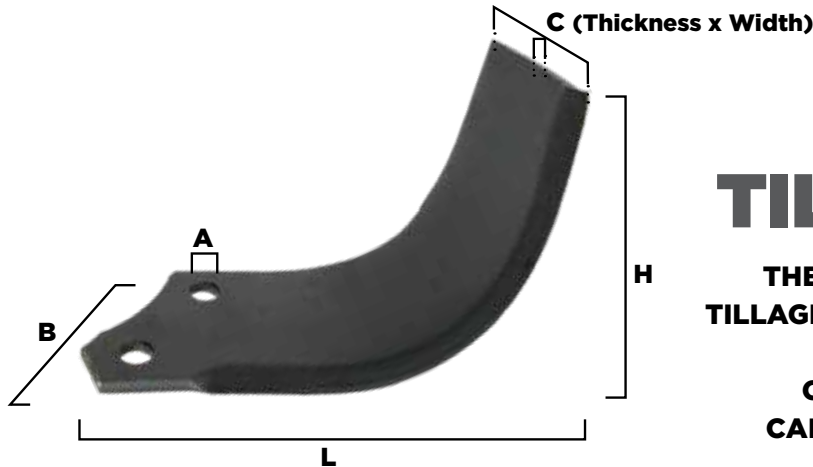

C SHAPED TILLAGE BLADES

THE “C” BLADE IS A GENERAL PURPOSE
TILLAGE BLADE THAT CREATES LESS HARDPAN.

C BLADES HAVE A SELF CLEANING
CAPABILITY DUE TO A WIPING MOTION.

AGRIEASE

AGRIEASE#		FITS MODELS	BOLT KIT	A	B	C	L	H
63.000.019	LH	BE-IGN	05.000.002	1/2"	57	80X7	210	130
63.000.020	RH							
63.000.048	RH	BE-TS	05.000.006	12.5	44	70X6	190	115
63.000.049	LH							
63.000.066	RH	BE-FTL	05.000.006	12.5	45	60X5.5	180	117
63.000.067	LH							
63.000.192	RH	BE-RT/RTM	05.000.006	12.5	44	65X6	165	105
63.000.193	LH							
63.000.194	RH	BE-RT	05.000.006	12.5	44	52X6	165	105
63.000.195	LH							
63.000.196	RH	BE-TXG	05.000.006	12.5	35	60X6	155	130
63.000.197	LH							

AGRIC

AGRIC#	BRABER#	FITS MODELS	BOLT KIT	A	B	C	L	H
N/A	LH 63.000.019	B, BMS	05.000.002	1/2"	57	80X7	210	130
N/A	RH 63.000.020							
N/A	LH 63.000.073	D/AFMJ/AL	05.000.001	7/16"	35	67X6	140	146
N/A	RH 63.000.072							

BEFCO

BEFCO#	BRABER#	FITS MODELS	BOLT KIT	A	B	C	L	H
000-0104D/S	LH 63.000.121	G/1/T30/T40	05.000.002	1/2"	40	60X6	175	110
000-0104D/S	RH 63.000.120							
000-1071D/S	LH 63.000.123	2/3/T50	05.000.002	1/2"	40	70X6	205	110
000-1071D/S	RH 63.000.122							

CARONI

CARONI#	BRABER#	FITS MODELS	BOLT KIT	A	B	C	L	H
FL-17400/500	LH 63.000.073	FL80/90/100/110 /120/130	05.000.001	7/16"	35	67X6	140	146
FL-17400/500	RH 63.000.072							

CELLI

CELLI#	BRABER#	FITS MODELS	BOLT KIT	A	B	C	L	H
722562HS	63.722.562HS	TIGRE		16	57	71X10	176	142
722562TS	63.722.562TS							
722563HS	63.722.563HS	TIGRE		16	57	71X10	176	142
722563TS	63.722.563TS							

HS: HARDSURFACED ONE SIDE

TS: HARDSURFACED BOTH SIDES

ALL MEASUREMENTS ARE IN MILLIMETERS UNLESS OTHERWISE STATED (1" = 25.4 MM).
THESE ITEMS ARE NOT ORIGINAL EQUIPMENT PARTS.

C BLADES

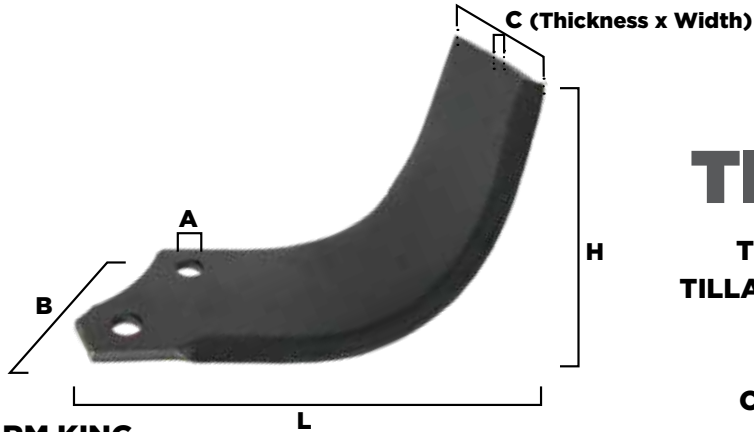

C SHAPED TILLAGE BLADES

THE "C" BLADE IS A GENERAL PURPOSE
TILLAGE BLADE THAT CREATES LESS HARDPAN.

C BLADES HAVE A SELF CLEANING
CAPABILITY DUE TO A WIPING MOTION.

FARM KING

FARM KING#	BRABER#	FITS MODELS	BOLT KIT	A	B	C	L	H
N/A	LH 63.000.019	HD 50/60/72/84/E50	05.000.002	1/2"	57	80X7	210	130
N/A	RH 63.000.020							
N/A	LH 63.000.121	LD 40/48/60	05.000.002	1/2"	40	60X6	175	110
N/A	RH 63.000.120							

FRONTIER

FRONTIER#	BRABER#	FITS MODELS	BOLT KIT	A	B	C	L	H
400-00-405	LH 63.000.069	RT 1140/1150/1160H	05.000.006	12.5	40	60X5	180	110
400-00-404	RH 63.000.068							
480-00-405	LH 63.000.067	RT 1240/1250/1160	05.000.006	12.5	45	60X5.5	180	117
480-00-404	RH 63.000.066							
191-00-424	LH 63.000.049	RT 1260/1360	05.000.006	12.5	44	70X6	190	115
	LH 63.000.049HS							
191-00-423	RH 63.000.048							
	RH 63.000.048HS							

HOWARD

HOWARD#	BRABER#	FITS MODELS	BOLT KIT	A	B	C	L	H
9948	LH 63.000.019	E/U/HE/A/H/ST/HR20/HR30/	05.000.002	1/2"	57	80X7	210	130
9949	RH 63.000.020	E50						
G5149/300	LH 63.000.609	HR7/HR12	05.000.001	7/16"	35	60X6	130	120
D5150/300	RH 63.000.610							

JOHN DEERE

JOHN DEERE#	BRABER#	FITS MODELS	BOLT KIT	A	B	C	L	H
N/A	LH 63.000.019	770	05.000.002	1/2"	57	80X7	210	130
N/A	RH 63.000.020							
N/A	LH 63.000.609	550/660	05.000.001	7/16"	35	60X6	130	120
N/A	RH 63.000.610							

KUHN

KUHN#	BRABER#	FITS MODELS	BOLT KIT	A	B	C	L	H
52359600	RH 63.000.096HS	GL 142/250/300/400	05.000.008	16	75	108X8	225	140
52359700	LH 63.000.097HS							

LANDPRIDE

LANDPRIDE#	BRABER#	FITS MODELS	BOLT KIT	A	B	C	L	H
820-056C	LH 63.000.121	10/15	05.000.002	1/2"	40	60X6	175	110
820-055C	RH 63.000.120							
820-057C	LH 63.000.185	25	05.000.002	1/2"	1-3/4"	60X6	190	115
820-058C	RH 63.000.184							
	LH 63.000.049	34/50	05.000.006	12.5	44	70X6	190	115
	LH 63.000.049HS							
	RH 63.000.048							
	RH 63.000.048HS							

HS: HARDSURFACED ONE SIDE

TS: HARDSURFACED BOTH SIDES

ALL MEASUREMENTS ARE IN MILLIMETERS UNLESS OTHERWISE STATED (1" = 25.4 MM).
THESE ITEMS ARE NOT ORIGINAL EQUIPMENT PARTS.

MALETTI

MALETTI#	BRABER#	FITS MODELS	BOLT KIT	A	B	C	L	H
1300079C	LH 63.000.150	PL	05.000.007	14.5	46	70X8	205	110
1300080C	RH 63.000.151							

MASCHIO/TERRANOVA

MASCHIO#	BRABER#	FITS MODELS	BOLT KIT	A	B	C	L	H
40000404/5	LH 63.000.069	L	05.000.006	12.5	40	60X5	180	110
40000404/5	RH 63.000.068	TL						
005-66-103/153	LH 63.000.033	R/L (OLD STYLE)	05.000.006	12.5	65	60X6	195	83
005-66-103/153	RH 63.000.032							
021-08-433	LH 63.000.037	NC/PS/Z	05.000.007	14.5	56	80X6	192	135
021-08-432	RH 63.000.036	TN/TP/TZ						
201-00-413	LH 63.000.050	G	05.000.009	16	68	90X10	265	145
	63.000.050HS							
201-00-412	RH 63.000.051	TG	05.000.005	10.5	56	60X6	174	57
	63.000.051HS							
211-00-413	LH 63.000.055	K	05.000.005	10.5	56	60X6	174	57
	63.000.055HS							
211-00-412	RH 63.000.054	TK	05.000.007	14.5	48	80X6	160	132
	63.000.054HS							
291-00-405	LH 63.000.062	U/US/UZ	05.000.007	14.5	48	80X6	160	132
291-00-406	RH 63.000.063	TU/TUS/TUZ						
480-00-404	LH 63.000.066	W/TW	05.000.006	12.5	45	60X5.5	180	117
480-00-405	RH 63.000.067	OLDSTYLE						
731-00-404	RH 63.000.068	W/TW	05.000.006	12.5	60	60X6	178	117
731-00-405	LH 63.000.069	NEW STYLE						
191-00-424	LH 63.000.049	A/E/H/KS/AL	05.000.006	12.5	44	70X6	190	115
191-00-423	RH 63.000.048	TA/TE/TKS						
011-10-427	LH 63.000.039	BI/B/C/AS/SC	05.000.007	14.5	56	80X8	215	142
	63.000.039HS							
011-10-426	RH 63.000.038	TBI/TB/TC/TSC	05.000.008	16	56	90X10	175	150
	63.000.038HS							
094-00-414	RH 63.000.414	NEW STYLE PANTERA	05.000.008	16	56	90X10	175	150
094-00-415	LH 63.000.415							
094-00-423	RH 63.000.414TS							
094-00-424	LH 63.000.415TS							

MULTIVATOR

MULTIVATOR#	BRABER#	FITS MODELS	BOLT KIT	A	B	C	L	H
185L / 185LH	LH 63.000.075	FP6	05.000.005	10.5	31.5	55X6	150	54
	63.000.075HS							
184R / 184LH	RH 63.000.074	FP6	05.000.005	10.5	31.5	55X6	150	54
	63.000.074HS							
FPSL / FPSLH	LH 63.000.077	FPSR	05.000.006	12.5	40	65X6	170	70
	63.000.077HS							
FPSR / FPSRH	RH 63.000.078	FPSR	05.000.006	12.5	40	65X6	170	70
	63.000.078HS							

NORTHWEST

NORTHWEST#	BRABER#	FITS MODELS	BOLT KIT	A	B	C	L	H
RB39L	LH 63.100.039HS	SABRE	05.000.011	16.5	56	98X10	130	100
RB40R	RH 63.100.040HS							

HS: HARDSURFACED ONE SIDE

TS: HARDSURFACED BOTH SIDES

ALL MEASUREMENTS ARE IN MILLIMETERS UNLESS OTHERWISE STATED (1" = 25.4 MM).
THESE ITEMS ARE NOT ORIGINAL EQUIPMENT PARTS.

C BLADES

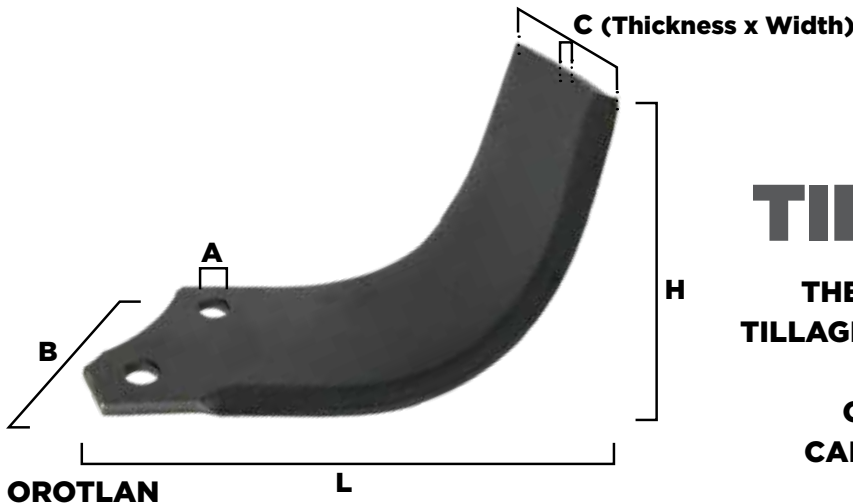

C SHAPED TILLAGE BLADES

**THE "C" BLADE IS A GENERAL PURPOSE
TILLAGE BLADE THAT CREATES LESS HARDPAN.**

**C BLADES HAVE A SELF CLEANING
CAPABILITY DUE TO A WIPING MOTION.**

OROTLAN

OROTLAN#	BRABER#	FITS MODELS	BOLT KIT	A	B	C	L	H
566153	LH 63.000.033	L/S	05.000.006	12.5	65	60X6	195	83
566103	RH 63.000.032							
N/A	LH 63.000.039	H/P	05.000.007	14.5	56	80X8	215	142
N/A	RH 63.000.038							

SICMA

SICMA#	BRABER#	FITS MODELS	BOLT KIT	A	B	C	L	H
4811680	LH 63.000.121	SA	05.000.002	12.5	40	60X6	175	110
4811681	RH 63.000.120							
4814783	LH 63.000.039	SP	05.000.007	14.5	56	80X8	215	142
4814784	RH 63.000.038							

YANMAR

YANMAR#	BRABER#	FITS MODELS	BOLT KIT	A	B	C	L	H
412129	LH 63.000.033	YKT/YHT-60	05.000.006	12.5	65	60X6	195	83
412130	RH 63.000.032							

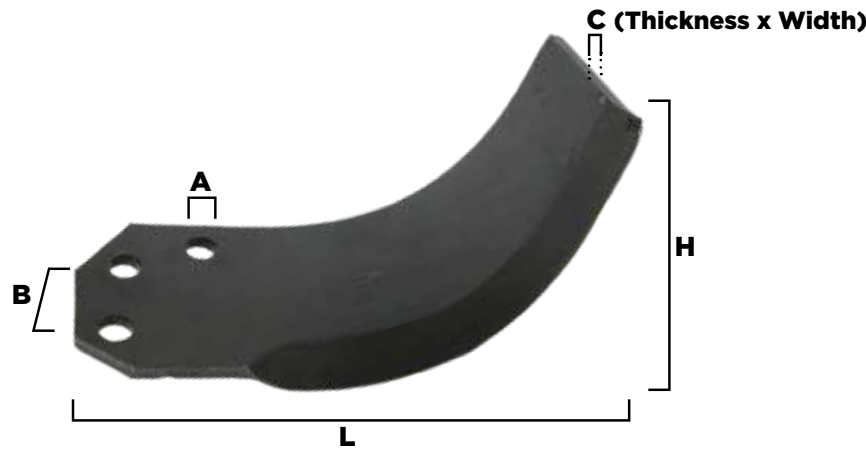

CARRARO

CARRARO#	BRABER#	FITS MODELS	BOLT KIT	A	B	C	L	H
98712	LH 63.000.092	28/29 (3 HOLE)	05.000.006	12.5	57-34	80X7	182	130
98713	RH 63.000.093							

HS: HARDSURFACED ONE SIDE

TS: HARDSURFACED BOTH SIDES

ALL MEASUREMENTS ARE IN MILLIMETERS UNLESS OTHERWISE STATED (1" = 25.4 MM).
THESE ITEMS ARE NOT ORIGINAL EQUIPMENT PARTS.

J BLADES

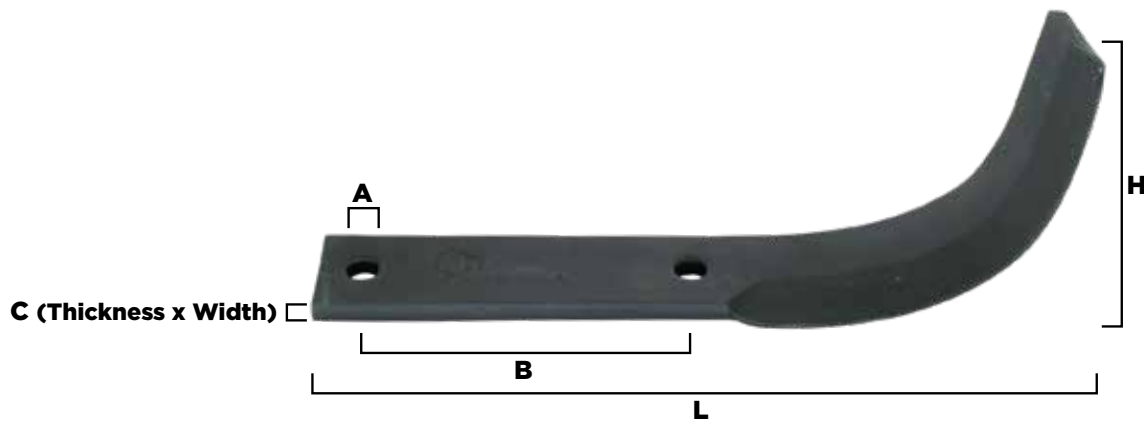

HOWARD

HOWARD#		BRABER#	FITS MODELS	BOLT KIT	A	B	C	L	H
9941	LH	63.000.011	Cadet J/HN/Tillit/John Deere/	05.000.001	7/16"	114	40X8	273	105
9942	RH	63.000.012	Yanmar/Kubota/Kuhn/Woods/HJ						

JOHN DEERE

JOHN DEERE#		BRABER#	FITS MODELS	BOLT KIT	A	B	C	L	H
9941	LH	63.000.011	JOHN DEERE MFG	05.000.001	7/16"	114	40X8	273	105
9942	RH	63.000.012	BY HOWARD						

KRONE

KRONE#		BRABER#	FITS MODELS	BOLT KIT	A	B	C	L	H
034-109-0	LH	63.000.003	RL	05.000.006	12.5	120	40X8	268	102
034-020-0	RH	63.000.004							

MURATORI

MURATORI#		BRABER#	FITS MODELS	BOLT KIT	A	B	C	L	H
57	LH	63.000.140	MA	05.000.006	12.5	123	60X6	275	120
65	RH	60.000.141							

* WHILE SUPPLIES LAST

TILLIT

TILLIT#		BRABER#	FITS MODELS	BOLT KIT	A	B	C	L	H
122491	LH	63.000.011	LDT/MDT	05.000.001	7/16"	114	40X8	273	105
122492	RH	63.000.012							

YANMAR

YANMAR#		BRABER#	FITS MODELS	BOLT KIT	A	B	C	L	H
N/A	LH	63.000.011	YMT/THT-50	05.000.001	7/16"	114	40X8	273	105
N/A	RH	63.000.012							

HS: HARDSURFACED ONE SIDE

TS: HARDSURFACED BOTH SIDES

ALL MEASUREMENTS ARE IN MILLIMETERS UNLESS OTHERWISE STATED (1" = 25.4 MM).
THESE ITEMS ARE NOT ORIGINAL EQUIPMENT PARTS.

ROTO SPIKE BLADES



MASCHIO

MASCHIO#	BRABER#	FITS MODELS	BOLT KIT	A	B	C	L	
261-00-417	LH	63.000.070	MASCHIO COBRA/SUPER COBRA/	05.000.007	14.5	44	80X8	185
261-00-418	RH	63.000.071	FALCON/SUPER FALCON					

POWER HARROW BLADES



MASCHIO

MASCHIO#	BRABER#	FITS MODELS	BOLT KIT	A	B	C	L	H	
101-00-262	LH	CW 63.000.042	HB/HM/HL	05.000.010	12.5	44	60X12	335	60
101-00-263	RH	CCW 63.000.043	TH/TM/TL						
271-00-209	LH	CW 63.000.061	DL/DC/DS/	04.016.050 GRD 10.9	16.5	50	90X10	280	101
271-00-210	RH	CCW 63.000.060	TD/TDL/TDC/TDS						
361-00-210	LH	CW 63.000.170	DM/TDM	04.016.050, 04.016.065SPC OR 04.016.055	16.5	60	100X12	300	101
361-00-211	RH	CCW 63.000.171							
611-00-229	LH	CW 63.000.172	MEGA	04.018.059 GRD 10.9	18.5	70	110X15	320	110
611-00-230	RH	CCW 63.000.173							

QUICK-FIT BLADES



MASCHIO

MASCHIO#	BRABER#	FITS MODELS	A	L	H
361-00-366	LH	CW 63.000.366	15	320	110
361-00-367	RH	CCW 63.000.367			
214-00-322	LH	CW 63.000.322	16	370	100
214-00-323	RH	CCW 63.000.323			

HS: HARDSURFACED ONE SIDE

TS: HARDSURFACED BOTH SIDES

ALL MEASUREMENTS ARE IN MILLIMETERS UNLESS OTHERWISE STATED (1" = 25.4 MM).
THESE ITEMS ARE NOT ORIGINAL EQUIPMENT PARTS.

POWER HARROW SPIKES

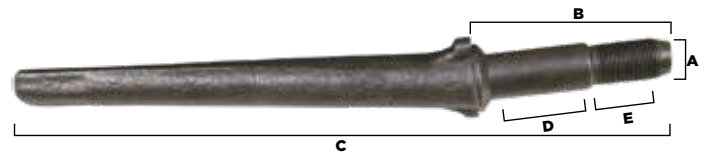

VICON

VICON#	BRABER#	FITS MODELS	NUT	WASHER	A	B	C	D	E
900-44-100	63.000.076	SE2-300/450	305-69-910	314-55-910	20	93	365	48	38

LELY

LELY#	BRABER#	SUPPORTING NUT	SUPPORTING WASHER	A	B	C	D	E
1160603150	63.000.024	305-69-910*	314-55-910*	20X1.5	95	365	60	32

TILLER BOLT ASSEMBLIES

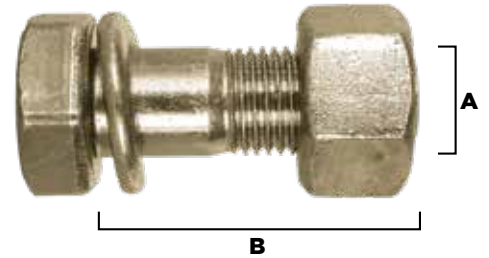

TILLER BOLT ASSEMBLIES

BRABER#	MODELS	A	B	GRADE
05.000.001	HOWARD P, KUHN BL30/35/45, YANMAR YMT/YHT50, AGRIC A, TILLIT LTD/MTD, KUBOTA FL TILLER	7/16"	35	10.9
05.000.002	HOWARD E, DOUGLAS HD 50/60, KUHN EL70/120, LANDPRIDE	1/2"	1½	10.9
05.000.005	MASCHIO K, TERRANOVA TK, CARONI FL, MEARELLI FP, SOVEMA LASER	10	30	8.8
05.000.006	MASCHIO A/E/R/KS/W, TERRANOVA TA/TE/KS/W, MP TL/TLS, PEGORARO TL/TLS MASCHIO BI/B/N/P/Z/C/SC/US/UZ	12	35	10.9
05.000.007	TERRANOVA TB/TN/TP/TZ/TC/TSC/TB1 KUHN EL-80, MALLETTI, ORTOLAN 45H/P, SOVEMA SE/SECS/SE/S, LANDPRIDE 35, PEGORARO DL/LN, MURATORI MH/MHC	14	40	10.9
05.000.008	MASCHIO S/G, TERRANOVA TS/TG, HOWARD S	16	45	8.8
05.000.009	MASCHIO S/G/D, TERRANOVA TS/TG/TD, NORTHWEST MASCHIO L/HB/HM, TERRANOVA TL/TH/TM, KUHN EL25, CARRARO 27/28/29,	16	60	10.9
05.000.010	DOUGLAS LD-40/48/60, YANMAR YKT/YHT-60, MURATOR MA, LANDPRIDE 25/1550, SOVEMA SP/SPS/SE/SEC/SPC	12	45	8.8
05.000.011	NORTHWEST SABRE	16	5	10.9
05.000.012	NORTHWEST SABRE	14	35	8.8

HS: HARDSURFACED ONE SIDE

TS: HARDSURFACED BOTH SIDES

ALL MEASUREMENTS ARE IN MILLIMETERS UNLESS OTHERWISE STATED (1" = 25.4 MM).
THESE ITEMS ARE NOT ORIGINAL EQUIPMENT PARTS.



4 POWER TAKE OFF SHAFTS & COMPONENTS

BRABER EQUIPMENT
40TH
EDITION
PARTS CATALOG

PTO DRIVELINE PLANOGRAM

BY-PY SERIES	MIN HORSE POWER RATING
1	16 HP
2	21 HP
3	30 HP
4	35 HP
5	47 HP
6	64 HP
7	75 HP
8	95 HP
9	120 HP



BY-PY COMPLETE PTO DRIVELINES



L (COLLAPSED LENGTH)



BY-PY STANDARD PTOS

SHAFTING

TRACTOR END



IMPLEMENT END

PART# 69.885.001

SERIES	1	
LENGTH (L)	25"	12502
HP/RPM	16 HP/540 RPM	
TRACTOR END	1-3/8" 6 SPLINE	
IMPLEMENT END	1-3/8" 6 SPLINE	12503





PART# 69.888.001

SERIES	1	
LENGTH (L)	34"	12502
HP/RPM	16 HP/540 RPM	
TRACTOR END	1-3/8" 6 SPLINE	
IMPLEMENT END	1-3/8" 6 SPLINE	12503





PART# 69.888.002

SERIES	2	
LENGTH (L)	34"	12504
HP/RPM	21 HP/540 RPM	
TRACTOR END	1-3/8" 6 SPLINE	
IMPLEMENT END	1-3/8" 6 SPLINE	12505





PART# 69.888.264

SERIES	2	
LENGTH (L)	57"	12504
HP/RPM	21 HP/540 RPM	
TRACTOR END	1-3/8" 6 SPLINE	
IMPLEMENT END	1-3/8" 6 SPLINE	12505



PART# 69.885.004

SERIES	4	
LENGTH (L)	34"	12507
HP/RPM	35 HP/540 RPM	
TRACTOR END	1-3/8" 6 SPLINE	
IMPLEMENT END	1-3/8" 6 SPLINE	12508



BY-PY COMPLETE PTO DRIVELINES



BY-PY STANDARD PTOS

SHAFTING

TRACTOR END



IMPLEMENT END

PART# 69.885.456

SERIES	4	
LENGTH (L)	48"	12507
HP/RPM	35 HP/540 RPM	
TRACTOR END	1-3/8" 6 SPLINE	
IMPLEMENT END	1-3/8" 6 SPLINE	12508





PART# 69.888.464

SERIES	4	
LENGTH (L)	57"	12507
HP/RPM	35 HP/540 RPM	
TRACTOR END	1-3/8" 6 SPLINE	
IMPLEMENT END	1-3/8" 6 SPLINE	12508





PART# 69.888.005

SERIES	5	
LENGTH (L)	34"	12509
HP/RPM	47 HP/540 RPM	
TRACTOR END	1-3/8" 6 SPLINE	
IMPLEMENT END	1-3/8" 6 SPLINE	12510





PART# 69.888.006

SERIES	6	
LENGTH (L)	34"	12509
HP/RPM	64 HP/540 RPM	
TRACTOR END	1-3/8" 6 SPLINE	
IMPLEMENT END	1-3/8" 6 SPLINE	12512



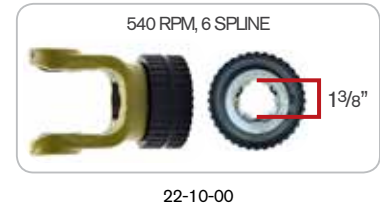

PART# 69.885.664

SERIES	6	
LENGTH (L)	57"	12509
HP/RPM	64 HP/540 RPM	
TRACTOR END	1-3/8" 6 SPLINE	
IMPLEMENT END	1-3/8" 6 SPLINE	12512



PART# 69.575.356

SERIES	6	
LENGTH (L)	22"	12509
HP/RPM	64 HP/540 RPM	
TRACTOR END	1-3/8" 6 SPLINE	
IMPLEMENT END	1-3/8" 21 SPLINE	12512





BY-PY COMPLETE PTO DRIVELINES



BY-PY STANDARD PTOS

SHAFTING

PART# 69.888.007

SERIES	7	
LENGTH (L)	34"	12511
HP/RPM	75 HP/540 RPM	
TRACTOR END	1-3/8" 6 SPLINE	
IMPLEMENT END	1-3/8" 6 SPLINE	12512

PART# 69.888.008

SERIES	8	
LENGTH (L)	34"	12512
HP/RPM	95 HP/540 RPM	
TRACTOR END	1-3/8" 6 SPLINE	
IMPLEMENT END	1-3/8" 6 SPLINE	12522

TRACTOR END

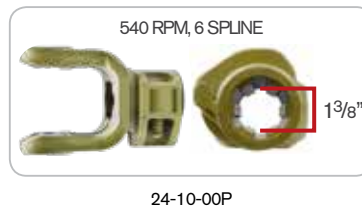



IMPLEMENT END





BY-PY ROUND BORE SHEARBOLT PTOS

SHAFTING



PART# 69.885.260

SERIES	2	
LENGTH (L)	52"	12504
HP/RPM	21 HP/540 RPM	
TRACTOR END	1-3/8" 6 SPLINE	
IMPLEMENT END	1-1/4" ROUND BORE SHEARBOLT	12505

PART# 69.777.053

SERIES	4	
LENGTH (L)	60"	12507
HP/RPM	35 HP/540 RPM	
TRACTOR END	1-3/8" 6 SPLINE	
IMPLEMENT END	1-1/4" ROUND BORE SHEARBOLT	12508

PART# 69.888.049

SERIES	4	
LENGTH (L)	34"	12507
HP/RPM	35 HP/540 RPM	
TRACTOR END	1-3/8" 6 SPLINE	
IMPLEMENT END	1-3/8" ROUND BORE SHEARBOLT	12508

TRACTOR END



IMPLEMENT END



BY-PY COMPLETE PTO DRIVELINES



BY-PY ROUND BORE SHEARBOLT PTOS

SHAFTING

TRACTOR END



IMPLEMENT END

PART# 69.885.049

SERIES	4	
LENGTH (L)	25"	12507
HP/RPM	35 HP/540 RPM	
TRACTOR END	1-3/8" 6 SPLINE	
IMPLEMENT END	1-3/8" ROUND BORE SHEARBOLT	12508



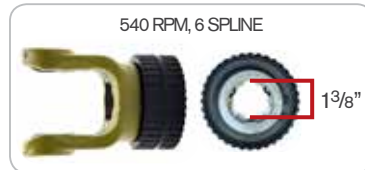

PART# 69.885.051

SERIES	4	
LENGTH (L)	52"	12507
HP/RPM	35 HP/540 RPM	
TRACTOR END	1-3/8" 6 SPLINE	
IMPLEMENT END	1-3/8" ROUND BORE SHEARBOLT	12508





PART# 69.888.059

SERIES	5	
LENGTH (L)	34"	12509
HP/RPM	47 HP/540 RPM	
TRACTOR END	1-3/8" 6 SPLINE	
IMPLEMENT END	1-3/8" ROUND BORE SHEARBOLT	12510



PART# 69.888.069

SERIES	6	
LENGTH (L)	34"	12509
HP/RPM	64 HP/540 RPM	
TRACTOR END	1-3/8" 6 SPLINE	
IMPLEMENT END	1-3/8" ROUND BORE SHEARBOLT	12512





BY-PY ROUND BORE KEYWAY PTOS

SHAFTING

TRACTOR END

IMPLEMENT END

PART# 69.300.461

SERIES	4	
LENGTH (L)	34"	12507
HP/RPM	35 HP/540 RPM	
TRACTOR END	1-3/8" 6 SPLINE	
IMPLEMENT END	1" ROUND BORE 1/4" KEYWAY	12508



BY-PY COMPLETE PTO DRIVELINES



BY-PY ROUND BORE KEYWAY PTOS

SHAFTING

TRACTOR END



IMPLEMENT END

PART# 69.774.125

SERIES	4	
LENGTH (L)	30"	12507
HP/RPM	35 HP/540 RPM	
TRACTOR END	1-3/8" 6 SPLINE	
IMPLEMENT END	1-1/4" ROUND BORE 1/4" KEYWAY	12508



PART# 69.888.825

SERIES	8	
LENGTH (L)	34"	12512
HP/RPM	95 HP/540 RPM	
TRACTOR END	1-3/8" 6 SPLINE	
IMPLEMENT END	1-1/4" ROUND BORE 1/2" KEYWAY	12522





BY-PY ROUND BORE SPECIALTY APPLICATION PTOS

SHAFTING

TRACTOR END



IMPLEMENT END

PART# 69.300.001

SERIES	1	
LENGTH (L)	22"	12502
HP/RPM	16 HP/540 RPM	
TRACTOR END	1-3/8" 6 SPLINE	
IMPLEMENT END	30MM ROUND BORE	12503





PART# 69.000.016

SERIES	2	
LENGTH (L)	34"	12504
HP/RPM	21 HP/540 RPM	
TRACTOR END	1-3/8" 6 SPLINE	
IMPLEMENT END	25MM TAPERED ROUND BORE	12505















PART# 69.000.015

SERIES	2	
LENGTH (L)	34"	12504
HP/RPM	21 HP/540 RPM	
TRACTOR END	1-3/8" 6 SPLINE	
IMPLEMENT END	30MM TAPERED ROUND BORE	12505



BY-PY COMPLETE PTO DRIVELINES

BY-PY SHEARBOLT PTOS

	SHAFTING	TRACTOR END	IMPLEMENT END
PART# 69.888.400			
SERIES	4	540 RPM, 6 SPLINE	540 RPM, 6 SPLINE SHEARBOLT CLUTCH
LENGTH (L)	34"	1 3/8"	1 3/8"
HP/RPM	35 HP/540 RPM	22-10-00P	57-117-18
TRACTOR END	1-3/8" 6 SPLINE		
IMPLEMENT END	1-3/8" 6 SPLINE SHEARBOLT CLUTCH		
	12508		
PART# 69.885.005			
SERIES	5	540 RPM, 6 SPLINE	540 RPM, 6 SPLINE SHEARBOLT CLUTCH
LENGTH (L)	34"	1 3/8"	1 3/8"
HP/RPM	47 HP/540 RPM	507050351	606505001
TRACTOR END	1-3/8" 6 SPLINE		
IMPLEMENT END	1-3/8" 6 SPLINE SHEARBOLT CLUTCH		
	12510		
PART# 69.750.006			
SERIES	6	540 RPM, 6 SPLINE	540 RPM, 6 SPLINE SHEARBOLT CLUTCH
LENGTH (L)	41"	1 3/8"	1 3/8"
HP/RPM	64 HP/540 RPM	22-10-00P	606606001
TRACTOR END	1-3/8" 6 SPLINE		
IMPLEMENT END	1-3/8" 6 SPLINE SHEARBOLT CLUTCH		
	12512		
PART# 69.888.046			
SERIES	8	540 RPM, 6 SPLINE	540 RPM, 6 SPLINE SHEARBOLT CLUTCH
LENGTH (L)	34"	1 3/8"	1 3/8"
HP/RPM	95 HP/540 RPM	24-10-00P	6060M0306G
TRACTOR END	1-3/8" 6 SPLINE		
IMPLEMENT END	1-3/8" 6 SPLINE SHEARBOLT CLUTCH		
	12522		

BY-PY RADIAL PIN PTOS













	SHAFTING	TRACTOR END	IMPLEMENT END
PART# 69.888.013HD			
SERIES	4	540 RPM, 6 SPLINE	540 RPM, 6 SPLINE K33 RADIAL PIN CLUTCH
LENGTH (L)	70"	1 3/8"	1 3/8"
HP/RPM	35 HP/540 RPM	22-10-00P	55-202-03
TRACTOR END	1-3/8" 6 SPLINE		
IMPLEMENT END	1-3/8" 6 SPLINE K33 RADIAL PIN CLUTCH		
	12508		

BY-PY COMPLETE PTO DRIVELINES

BY-PY OVERRUNNING PTOS

	SHAFTING	TRACTOR END	IMPLEMENT END
PART# 69.888.011			
SERIES	5	540 RPM, 6 SPLINE	540 RPM, 6 SPLINE OVERRUNNING CLUTCH
LENGTH (L)	34"	1 3/8"	1 3/8"
HP/RPM	47 HP/540 RPM		
TRACTOR END	1-3/8" 6 SPLINE		
IMPLEMENT END	1-3/8" 6 SPLINE OVERRUNNING CLUTCH		
	12510	507050351P	601205601R

BY-PY SLIP CLUTCH PTOS

	SHAFTING	TRACTOR END	IMPLEMENT END
PART# 69.777.025			
SERIES	4	540 RPM, 6 SPLINE	540 RPM, 6 SPLINE 2 DISC SLIP CLUTCH
LENGTH (L)	40"	1 3/8"	1 3/8"
HP/RPM	35 HP/540 RPM		
TRACTOR END	1-3/8" 6 SPLINE		
IMPLEMENT END	1-3/8" 6 SPLINE 2 DISC SLIP CLUTCH		
	12508	21-10-00P	FKL0438050B
PART# 69.885.446			
SERIES	4	540 RPM, 6 SPLINE	540 RPM, 6 SPLINE 4 DISC SLIP CLUTCH
LENGTH (L)	46"	1 3/8"	1 3/8"
HP/RPM	35 HP/540 RPM		
TRACTOR END	1-3/8" 6 SPLINE		
IMPLEMENT END	1-3/8" 6 SPLINE 4 DISC SLIP CLUTCH		
	12508	21-10-00P	56-064-06B
PART# 69.888.040			
SERIES	6	540 RPM, 6 SPLINE	540 RPM, 6 SPLINE 4 DISC SLIP CLUTCH
LENGTH (L)	42"	1 3/8"	1 3/8"
HP/RPM	64 HP/540 RPM		
TRACTOR END	1-3/8" 6 SPLINE		
IMPLEMENT END	1-3/8" 6 SPLINE 4 DISC SLIP CLUTCH		
	12512	22-10-00P	56-064-06B
PART# 69.777.039			
SERIES	6	540 RPM, 6 SPLINE	540 RPM, 6 SPLINE 2 DISC SLIP CLUTCH
LENGTH (L)	40"	1 3/8"	1 3/8"
HP/RPM	64 HP/540 RPM		
TRACTOR END	1-3/8" 6 SPLINE		
IMPLEMENT END	1-3/8" 6 SPLINE 2 DISC SLIP CLUTCH		
	12512	22-10-00P	56-062-06B

BY-PY COMPLETE PTO DRIVELINES



BY-PY SLIP CLUTCH PTOS

SHAFTING

TRACTOR END



IMPLEMENT END

PART# 69.888.602

SERIES	6	
LENGTH (L)	57"	12509
HP/RPM	64 HP/540 RPM	
TRACTOR END	1-3/8" 6 SPLINE	
IMPLEMENT END	1-3/8" 6 SPLINE 2 DISC SLIP CLUTCH	12512



PART# 69.888.940

SERIES	9	
LENGTH (L)	41"	12513
HP/RPM	120 HP/540 RPM	
TRACTOR END	1-3/8" 6 SPLINE	
IMPLEMENT END	1-3/8" 6 SPLINE 4 DISC SLIP CLUTCH	12522



REPLACEMENT CROSS KITS

BY-PY REPLACEMENT CROSS KITS



PART#	A (mm)	B (mm)	BY-PY SERIES	540 RPM	1000 RPM	LOCKUP
71201	22	54	1	16 HP	25 HP	EXTERNAL
71202	23.8	61.3	2	21 HP	31 HP	EXTERNAL
71203	27	70	3	30 HP	47 HP	EXTERNAL
71204	27	74.6	4	35 HP	55 HP	EXTERNAL
71205	30.2	80	5	47 HP	74 HP	EXTERNAL
71206	30.2	92	6	64 HP	100 HP	EXTERNAL
71207	35	94	7	75 HP	118 HP	EXTERNAL
71208	35	106.5	8	95 HP	150 HP	EXTERNAL



NORTH AMERICAN IMPERIAL REPLACEMENT CROSS KITS



PART#	A	B	SERIES	540 RPM	1000 RPM	LOCKUP
200-06	0.97"	2.28"	6N	14 HP	21 HP	INTERNAL
200-12	1.06"	2.50"	12N	19 HP	29 HP	INTERNAL
200-14	1.13"	2.62"	14N	28 HP	44 HP	EXTERNAL
200-35	1.25"	3.20"	35N	51 HP	79 HP	EXTERNAL
200-55	1.53"	4.30"	55N	106 HP	164 HP	EXTERNAL



ALL MEASUREMENTS ARE IN MILLIMETERS UNLESS OTHERWISE STATED (1" = 25.4 MM).
THESE ITEMS ARE NOT ORIGINAL EQUIPMENT PARTS.

BY-PY REPLACEMENT SHAFTS

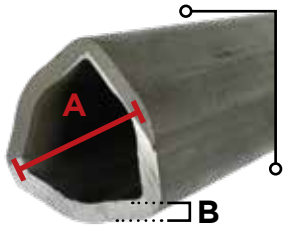

DIMENSION "A" MEASURED AT FLAT TO OPPOSITE END.

SCALE VIEW



PART#	12502
A (mm)	26.5
B (mm)	3.5
SERIES	1
PTO CROSS	71201

1



PART#	12503
A (mm)	32.2
B (mm)	2.6
SERIES	1
PTO CROSS	71201

1



PART#	12504
A (mm)	29
B (mm)	4
SERIES	2
PTO CROSS	71202

2



PART#	12505
A (mm)	36
B (mm)	4.5
SERIES	2, 3
PTO CROSS	71202, 71203

2,3



PART#	12507
A (mm)	36
B (mm)	4.5
SERIES	4
PTO CROSS	71204

4



PART#	12508
A (mm)	43.5
B (mm)	3.4
SERIES	3, 4
PTO CROSS	71203, 71204

3,4



PART#	12509
A (mm)	45
B (mm)	4
SERIES	5, 6
PTO CROSS	71205, 71206

5,6



PART#	12510
A (mm)	51.6
B (mm)	3
SERIES	5
PTO CROSS	71205

5



PART#	12511
A (mm)	45
B (mm)	5.5
SERIES	7
PTO CROSS	71207

7



PART#	12512
A (mm)	54
B (mm)	4
SERIES	6,7,8
PTO CROSS	71206, 71207, 71208

6-8



PART#	12513
A (mm)	54
B (mm)	5
SERIES	9
PTO CROSS	71209

9



PART#	12522
A (mm)	63
B (mm)	4
SERIES	9
PTO CROSS	71209

9



PART#	12514
A (mm)	54
B (mm)	6
SERIES	10
PTO CROSS	71210

10



PART#	12515
A (mm)	66
B (mm)	5.6
SERIES	10
PTO CROSS	71210

10



BY-PY PTO SHIELDS







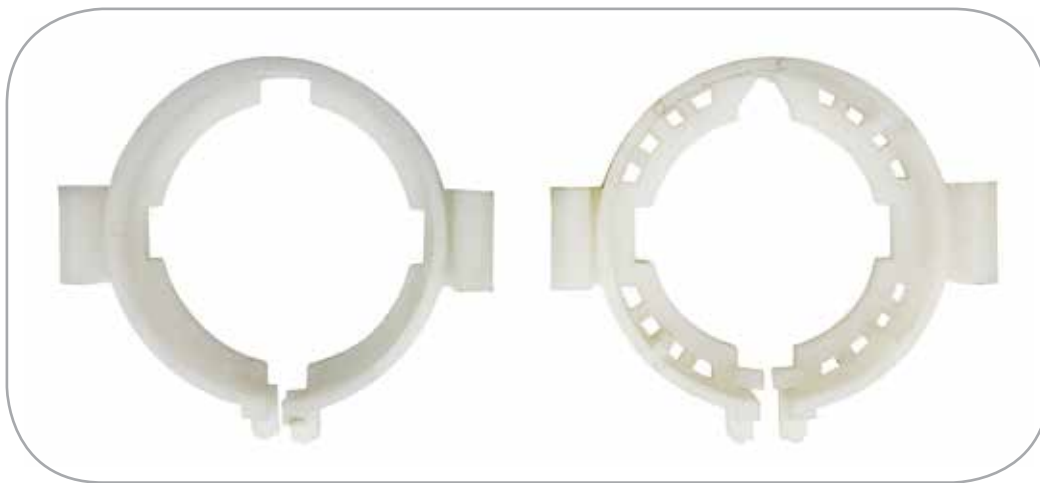

L (COLLAPSED LENGTH)

SERIES	NEW SHIELD COMPLETE	LENGTH (MM)	OUTER BEARING RING	INNER BEARING RING	SAFETY CHAIN
1	69.888.996	1524 MM	69.889.980 SET		69.889.000
2			42 MM	35 MM	
3			69.889.982 SET		
4			47 MM	41 MM	
5	69.889.984 SET				
6	47 MM		41 MM		
7	69.889.984 SET				
8	47 MM		41 MM		
	69.888.997		69.889.986 SET		
		68.5 MM	59.5 MM		
		69.889.986 SET			
		68.5 MM	59.5 MM		
			69.889.986 SET		
			68.5 MM	59.5 MM	
			69.889.988 SET		
			70.2 MM	64.3 MM	



BY-PY REPLACEMENT YOKES

SERIES	DESCRIPTION	CROSS KIT	QD YOKE PIN	QD YOKE COLLAR	ROUND BORE S/B	ROUND BORE KEY	MALE INBOARD	FEMALE INBOARD		
										
1	1 1/8" 6	71201 (22 X 54)	507010351P	507010351			204016852 TUBE OD = 26.5 MM	204016851 TUBE OD = 32.5 MM		
	1 3/8" 6									
	25MM									
	30MM									
	3/4"									
1"	10-22-113	10-22-31								
		10-22-108	10-22-33							
		211018951	212018451							
		10-22-295	10-22-142							
2	1 1/8" 6	71202 (23.8 X 61.3)	507020351P	507020351			204026852 TUBE OD = 29 MM	204026851 TUBE OD = 36 MM		
	1 3/8" 6									
	25MM									
	30MM									
	3/4"									
1"	211024651									
		20-30-03	212026251							
			212028451							
		20-15-156	20-15-162							
		211029151	20-30-128							
3	1 1/8" 6	71203 (27 X 70)	507030351				204036852 TUBE OD = 36 MM	204036851 TUBE OD = 43.5 MM		
	1 3/8" 6									
	25MM									
	30MM									
	35MM									
	1"								211034651	212036151
	211034851	212036251								
	211034951									
	211039051	212038551								
	1 1/4"		211039151							
	1 3/8"			212038751						
4	1 3/8" 6	71204 (27 X 74.6)	21-10-00P	21-10-00			204046852 TUBE OD = 36 MM	204046851 TUBE OD = 43.5 MM		
	1 3/8" 21								21-19-00	
	25MM									
	30MM								211044651	
	1"								211044851	212046251
	1 1/4"									21-24-150
	1 3/8"	21-24-151	21-24-160							
5	1 3/8" 6	71205 (30.2 X 80)	507050351P	507050351			204056861 TUBE OD = 45 MM	204056860 TUBE OD = 51.6 MM		
	1 3/8" 21								572053751	
	30MM									
	1 1/4"								211054851	
	1 3/8"								211059151	
	1 3/8"	211054954	212058751							
6	1 3/8" 6	71206 (30.2 X 92)	22-10-00P	22-10-00			204066852 TUBE OD = 45 MM	204066851 TUBE OD = 54 MM		
	1 3/8" 21								507063751	
	35MM									
	1 1/4"								211064951	
	1 3/8"								211069151	212068651
	1 3/4"	211069251								
7	1 3/8" 6	71207 (35 X 94)	507170351P	507170351			204176852 TUBE OD = 45 MM	204176851 TUBE OD = 54 MM		
	1 3/8" 21								507173751	
	35MM									
	1 1/4"								211174951	
	1 3/8"									
8	1 3/8" 6	71208 (35 X 106.5)	24-10-00P	24-10-00			204086861	204086860		
	1 3/8" 21								24-18-00	
	1 3/4" 20								507083851	
	1 3/8" 6								507190351	
9	1 3/8" 21	41209 (41 X 108)	507193751				204196852	204196851		
	1 3/4" 20									
	1 3/8" 6									
10	1 3/8" 6	41210 (41 X 118)	507100351				TUBE OD = 54MM	TUBE OD = 63 MM		
	1 3/8" 21									

BY-PY REPLACEMENT CLUTCHES & PARTS

SERIES	TYPE	L	D	PART#	DATA
4	K90/2	45	200	FKL0438050B	1 ³ / ₈ " (6) [CLAMP BOLT]
5	K90/2	45	200	56-062-05B	1 ³ / ₈ " (6) [CLAMP BOLT]
6	K90/2	45	200	56-062-06B	1 ³ / ₈ " (6) [CLAMP BOLT]
6	K90/4	65	200	56-064-06B	1 ³ / ₈ " (6) [CLAMP BOLT]
6	K90/4	65	200	56-066-06B	1 ³ / ₄ " (6) [CLAMP BOLT F4L]

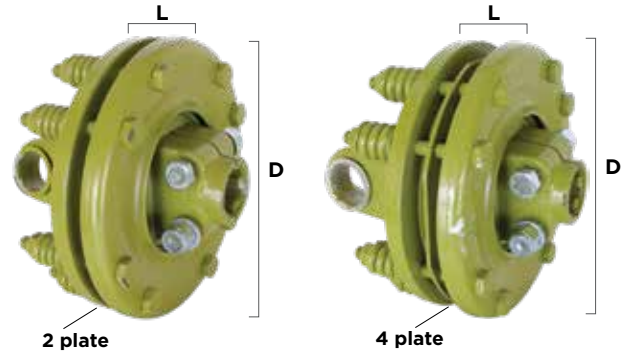

BY-PY SLIP CLUTCH PARTS

SERIES		FF1		FF2		FF4	
NO.	INFO	QTY	PART#	QTY	PART#	QTY	PART#
1	D6	8	351022370	8	351022370	8	351022370
2	SERIES 4	1	21-73-01B				
	SERIES 5						
	SERIES 6	1		1	253062302		253062302
	SERIES 7						
3		1	258005320	1	258005320	1	258005320
4	DIA 140	2	247000054				
	DIA 160			2	247000061	4	247000061
5	1 ³ / ₈ 6 SPLINE	1	515200311	1	515210311		
						1	275230004
6	1 ³ / ₈ 6 SPLINE	2	01.012.070	2	01.012.070		
	3MM					2	248230002
7	3MM	1	248220008	1	248230002		
	1 ³ / ₈ 6 SPLINE					2	01.012.070
8				1	248230006		
	1 ³ / ₈ 6 SPLINE					2	01.012.070
9		8	01.010.100	8	01.010.100	1	248230006
10						8	01.010.100

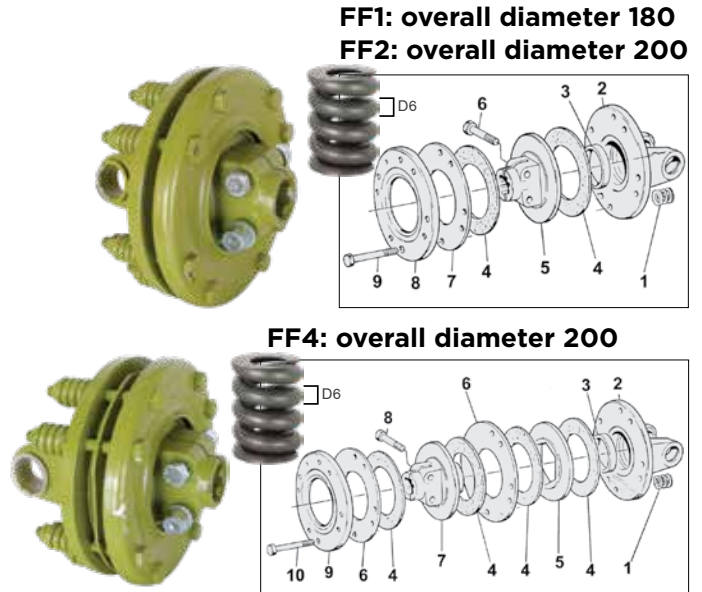

UNIVERSAL 2 PLATE SLIP CLUTCHES

PART# 69.000.100

FEMALE	1 ³ / ₈ " 6 SPLINE
MALE	1 ³ / ₈ " 6 SPLINE

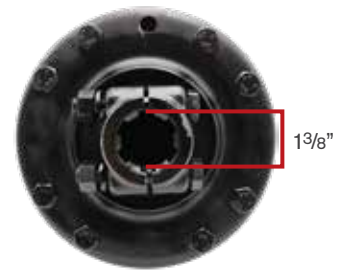
**PART# 69.000.101**

FEMALE	1 ³ / ₈ " RB
MALE	1 ³ / ₈ " 6 SPLINE

**PART# 69.000.102**

FEMALE	1 ³ / ₈ " RB
MALE	1 ³ / ₈ " 6 SPLINE



REPLACEMENT FRICTION DISCS FOR SLIP CLUTCHES



PART#	DESCRIPTION	OD SIZE	ID SIZE
015-019	RINIERI TYPE	142	78
F034S	WALTERSHEID TYPE	130	70
56-73-00	WALTERSHEID TYPE	153	91
56-73-04	WALTERSHEID TYPE	171	102
56-73-07	WALTERSHEID TYPE	90	56
247000061	BY-PY	161	97
247000054*	BY-PY	140	85

*WORKS FOR BE 69.777.025

WALTERSHEID TYPE COMPLETE PTO DRIVELINES



L (COLLAPSED LENGTH)



WALTERSHEID TYPE STANDARD PTOS

SHAFTING

TRACTOR END



IMPLEMENT END

PART# 69.000.010

SERIES	W2500		75-44-00
LENGTH (L)	34"		
HP/RPM	90 HP/540 RPM		
TRACTOR END	1-3/8" 6 SPLINE		75-45-00
IMPLEMENT END	1-3/8" 6 SPLINE		



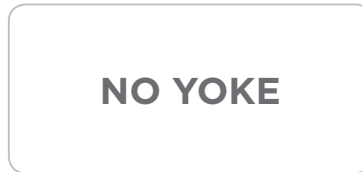

PART# 69.000.018

SERIES	W2500		75-44-00
LENGTH (L)	59"		
HP/RPM	90 HP/540 RPM		
TRACTOR END	NO YOKE		75-45-00
IMPLEMENT END	NO YOKE		



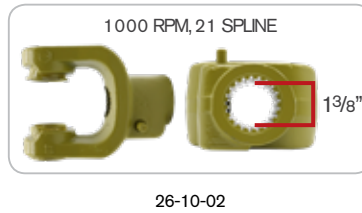

PART# 69.000.030

SERIES	W2600		75-45-00
LENGTH (L)	34"		
HP/RPM	166 HP/1000 RPM		
TRACTOR END	1-3/8" 21 SPLINE		75-46-102
IMPLEMENT END	1-3/4" 20 SPLINE		



PART# 69.100.030

SERIES	W2600		75-45-00
LENGTH (L)	34"		
HP/RPM	166 HP/1000 RPM		
TRACTOR END	1-3/8" 21 SPLINE		75-46-102
IMPLEMENT END	NO YOKE		

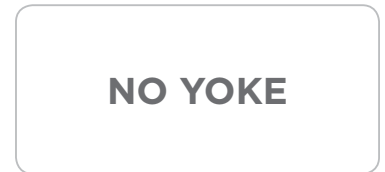
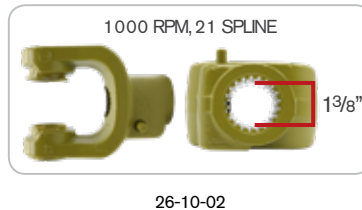

WALTERSHEID TYPE COMPLETE PTO DRIVELINES



WALTERSHEID TYPE SLIP & CAM CLUTCH PTOs

SHAFTING

TRACTOR END



IMPLEMENT END

PART# 69.000.047

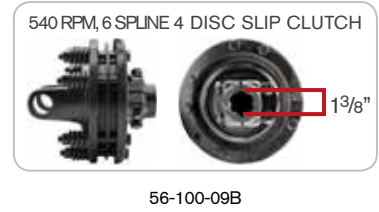
SERIES	W2500	
LENGTH (L)	34"	75-44-00
HP/RPM	90 HP/540 RPM	
TRACTOR END	1-3/8" 6 SPLINE	
IMPLEMENT END	1-3/8" 6 SPLINE 4 DISC SLIP CLUTCH	75-45-00



PART# 69.100.048

SERIES	W2600	
LENGTH (L)	34"	75-45-00
HP/RPM	166 HP/1000 RPM	
TRACTOR END	1-3/4" 20 SPLINE	
IMPLEMENT END	1-3/4" 20 SPLINE CAM CLUTCH	75-46-102

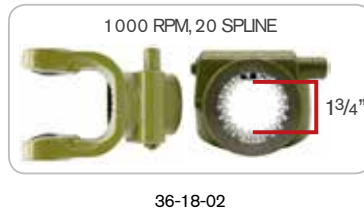



WALTERSHEID TYPE WWE PTOs (CV 1 END)

SHAFTING

TRACTOR END



IMPLEMENT END

PART# 69.000.035

SERIES	WWE2380	
LENGTH (L)	34"	75-11-00
HP/RPM	38 HP/540 RPM	
TRACTOR END	1-3/8" 6 SPLINE CV	
IMPLEMENT END	1-3/8" 6 SPLINE	75-15-00





PART# 69.000.032

SERIES	WWE2480	
LENGTH (L)	34"	75-25-00
HP/RPM	53 HP/540 RPM	
TRACTOR END	1-3/8" 6 SPLINE CV	
IMPLEMENT END	1-3/8" 6 SPLINE	75-35-00



PART# 69.000.043

SERIES	WWE2480	
LENGTH (L)	48"	75-25-00
HP/RPM	53 HP/540 RPM	
TRACTOR END	1-3/8" 6 SPLINE CV	
IMPLEMENT END	1-3/8" 6 SPLINE	75-35-00





WALTERSHEID TYPE COMPLETE PTO DRIVELINES



WALTERSHEID TYPE WWE PTOS (CV 1 END)

SHAFTING



PART# 69.999.001

SERIES	WWE2480	
LENGTH (L)	64"	75-25-00
HP/RPM	53 HP/540 RPM	
TRACTOR END	1-3/8" 6 SPLINE CV	
IMPLEMENT END	1-3/8" 6 SPLINE	
		75-35-00



PART# 69.000.036

SERIES	WWE2580	
LENGTH (L)	34"	75-44-00
HP/RPM	139 HP/1000 RPM	
TRACTOR END	1-3/8" 21 SPLINE CV	
IMPLEMENT END	1-3/8" 6 SPLINE	
		75-45-00

PART# 69.000.042

SERIES	WWE2580	
LENGTH (L)	34"	75-44-00
HP/RPM	90 HP/540 RPM	
TRACTOR END	1-3/8" 6 SPLINE CV	
IMPLEMENT END	1-3/8" 6 SPLINE	
		75-45-00

PART# 69.000.033

SERIES	WWE2580	
LENGTH (L)	48"	75-44-00
HP/RPM	139 HP/1000 RPM	
TRACTOR END	1-3/4" 20 SPLINE CV	
IMPLEMENT END	1-3/4" 20 SPLINE	
		75-45-00

TRACTOR END

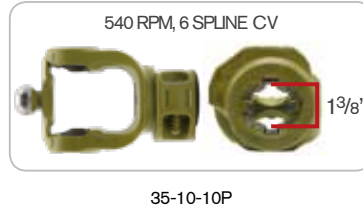



IMPLEMENT END



WALTERSHEID TYPE WWZ PTOS (CV BOTH ENDS)

SHAFTING

PART# 69.000.034

SERIES	WWZ2380	
LENGTH (L)	34"	75-11-00
HP/RPM	38 HP/540 RPM	
TRACTOR END	1-3/8" 6 SPLINE CV	
IMPLEMENT END	1-3/8" 6 SPLINE CV	
		75-15-00

TRACTOR END





IMPLEMENT END



WALTERSHEID TYPE PTOS

WALTERSHEID TYPE WWZ PTOS (CV BOTH ENDS)

PART# 69.000.037

SERIES	WWZ2480	
LENGTH (L)	59"	75-44-00
HP/RPM	53 HP/540 RPM	
TRACTOR END	1-3/8" 6 SPLINE CV	
IMPLEMENT END	1-3/8" 6 SPLINE CV	75-45-00





35-10-12



35-10-12

PART# 69.999.002

SERIES	WWZ2480	
LENGTH (L)	64"	75-25-00
HP/RPM	53 HP/540 RPM	
TRACTOR END	1-3/8" 6 SPLINE CV	
IMPLEMENT END	1-3/8" 6 SPLINE CV	75-35-00



35-10-12



35-10-12

WALTERSHEID TYPE REPLACEMENT CROSS KITS



PART#	A (mm)	B (mm)	SERIES	540 RPM	1000 RPM	LOCKUP
10-01-00	22	55	W2100, W2101	16 HP	24 HP	EXTERNAL
20-00-00	24	61	W2200	27 HP	42 HP	EXTERNAL
21-00-00	27	74.5	W2300	38 HP	60 HP	EXTERNAL
23-00-00	30	106.5	W2300	38 HP	60 HP	EXTERNAL
35-00-00	32	76	W2400	53 HP	83 HP	EXTERNAL
36-00-00	36	89	W2500	90 HP	139 HP	EXTERNAL
26-00-00	42	104	W2600	107 HP	166 HP	EXTERNAL



WALTERSHEID TYPE WIDE ANGLE REPLACEMENT CROSS KITS

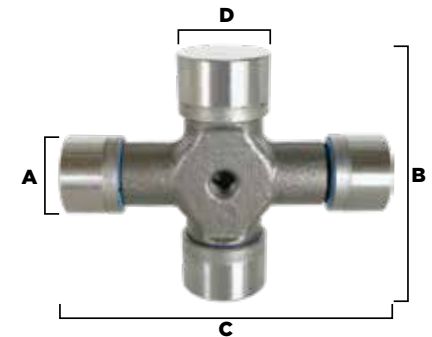

PART#	A (mm)	B (mm)	C (mm)	D (mm)	SERIES	540 RPM	1000 RPM	LOCKUP
20-06-00	22	62	76	24	W2280 WIDE ANGLE	27 HP	42 HP	EXTERNAL
21-06-00	24	75	95	27	W2380 WIDE ANGLE	38 HP	60 HP	EXTERNAL
35-06-00	27	76	98	32	W2480 WIDE ANGLE	53 HP	83 HP	EXTERNAL
36-06-00	32	89	111	36	W2580 WIDE ANGLE	90 HP	139 HP	EXTERNAL

WALTERSHEID TYPE REPLACEMENT SHAFTS

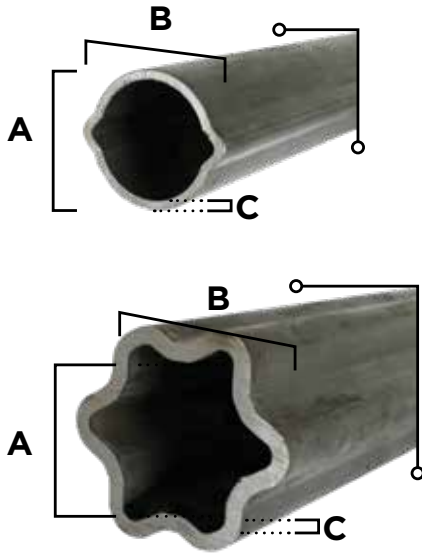

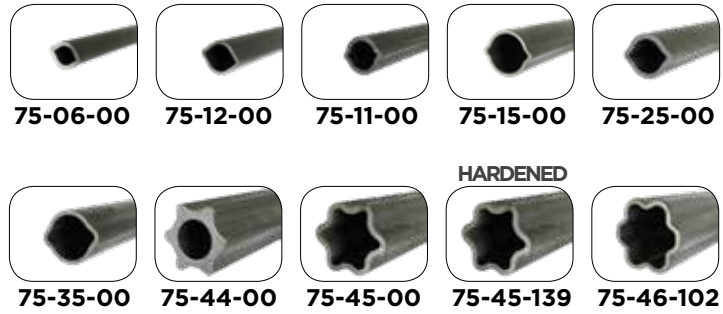

SCALE VIEW





SHAFTING SOLD IN 1 METRE (39.5") INCREMENTS ONLY
DIMENSION "B" MEASURED AT FLAT PEAK ON STAR SHAFTING.

PART#	75-06-00	MALE
SERIES	W2000, W2100, W2200, WWE2200, WWZ2200	
A	23.5	
B	31	WALTERSCHEID TYPE #00A
C	--	

PART#	75-12-00	FEMALE
SERIES	W2000, W2100, W2200, WWE2200, WWZ2200	
A	30	
B	39	WALTERSCHEID TYPE #0A
C	2.8	

PART#	75-11-00	MALE
SERIES	WWE2200, WWZ2200, WWE2300, WWZ2300, W2100, W2200, W2300, W1	
A	34.5	
B	40	WALTERSCHEID TYPE #0V
C	4	

PART#	75-15-00	FEMALE
SERIES	WWE2200, WWZ2200, WWE2300, WWZ2300, W2100, W220, W2300, W1	
A	41	
B	48	WALTERSCHEID TYPE #1
C	3	

PART#	75-25-00	MALE
SERIES	WWE2400, WWZ2400, WWE2300, WWZ2300, W2300, W2400, W2500, W11, W220	
A	39.5	
B	49	WALTERSCHEID TYPE #1B
C	4	

PART#	75-35-00	FEMALE
SERIES	WWE2400, WWZ2400, WWE2300, WWZ2300, W2300, W2400, W2500, W11, W220	
A	48	
B	57.7	WALTERSCHEID TYPE #2A
C	3.8	

PART#	75-44-00	MALE
SERIES	W2500, W2600, W240, W250	
A	37	
B	47	WALTERSCHEID TYPE #S4
C	--	

PART#	75-45-00	FEMALE
SERIES	W2400, W2500, W2600, W240, W250	
A	47	*
B	57	WALTERSCHEID TYPE #S5
C	4.5	

PART#	75-45-139 (HARDENED)	MALE
SERIES	W2400, W2500, W2600, W240, W250	
A	47	*
B	57	WALTERSCHEID TYPE #S5
C	4.5	

PART#	75-46-102	FEMALE
SERIES		
A	57	
B	67	WALTERSCHEID TYPE #S6
C	5	

***Note: 75-45-00 & 75-45-139 are interchangeable.**
All W2600 Series drivelines come standard with 75-45-00 Male profile tubing.

WALTERSHEID TYPE PTO SHIELDS & INBOARD YOKES

WALTERSHEID TYPE PTO SHIELDS

SERIES NEW & OLD	SHIELD COMPLETE	LENGTH	FEMALE BEARING RING	MALE BEARING RING	SAFETY CHAIN
W2000	P22-1000	1,000 MM	G0150	G0150	82-36-03
W2100	P22-1500	1,500 MM	SIZE: 41MM	SIZE: 41MM	
W2100	P34-1000	1,000 MM	G0240-G0240	G0240-G0240	82-36-03
W2200					
W2200	P34-1500	1,500 MM	SIZE: 50MM	SIZE: 50MM	82-36-03
W2300					
W1					
W2300	P67-1000	1,000 MM	G0340-G0340	G0340-G0340	82-36-03
W2400					
W2500	P67-1500	1,500 MM	SIZE: 62MM	SIZE: 62MM	82-36-03
W2400					
W11					
W2200					
W2400	P67-1000	1,000 MM	G0340-G0340	G0340-G0340	82-36-03
W2500					
W2400	P67-1500	1,500 MM	SIZE: 62MM	SIZE: 62MM	82-36-03
W11					
W2200					
	P90-1500	1,500 MM	G0440	G0440	82-36-03
	P67-1500*		SIZE: 81MM	SIZE: 81MM	
W2600	*CUSTOMER MUST MEASURE YOKE	1,500 MM	G0340-G0340	G0340-G0340	82-36-03
			SIZE: 62MM	SIZE: 62MM	



Bearing size is determined by measuring peaks as illustrated. Make sure the bearing is fully closed.

WALTERSHEID TYPE REPLACEMENT INBOARD YOKES

BREAKDOWN DIAGRAM

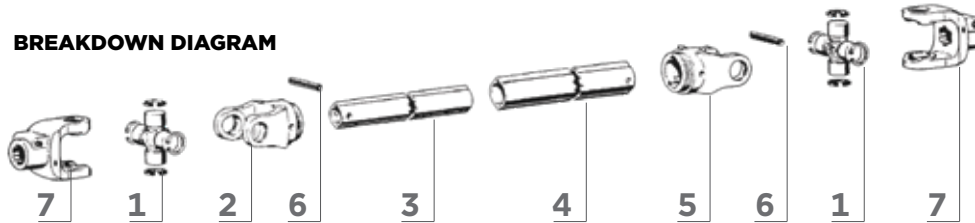

SERIES	CROSS KIT	YOKE	INNER SHAFT	OUTER SHAFT	YOKE	ROLL PIN	END YOKE
NEW	1	2 Male Inboard	3	4	5 Female Inboard	6	7
W2100	10-01-00	10-48-00 10-40-00	75-06-00 75-11-00	75-12-00 75-15-00	10-49-00 10-41-00	15.008.050 15.008.060	SEE PAGE 63
W2200	20-00-00	20-32-00 20-11-00	75-06-00 75-11-00	75-12-00 75-15-00	20-33-00 20-12-00	15.008.060 15.008.060	SEE PAGE 63
W2300	21-00-00	21-11-00 21-22-100	75-11-00 75-25-00	75-15-00 75-35-00	21-12-00 21-22-101	15.010.065 15.010.080	SEE PAGE 63
W2400	35-00-00	35-13-00	75-25-00	75-35-00	35-14-00	15.010.080	SEE PAGE 63
W2500	36-00-00	36-13-00	75-25-00	75-35-00	36-14-00	15.010.080	SEE PAGE 63

SERIES	CROSS KIT	YOKE	INNER SHAFT	OUTER SHAFT	YOKE	ROLL PIN	END YOKE
NEW	1	2 Male Inboard	3	4	5 Female Inboard	6	7
W2400	35-00-00	35-13-100	75-44-00	75-45-00	35-14-100	15.010.080	SEE PAGE 63
W2500	36-00-00	36-13-100* 36-13-100B	75-44-00	75-45-00	36-14-100* 36-14-100B	15.010.080	SEE PAGE 63
W2600	26-00-00	26-13-100 26-13-00	75-44-00 75-45-00	75-45-00 75-46-102	26-14-100 26-14-00	15.013.090 15.013.090	SEE PAGE 63

*PLEASE NOTE: FITS BRABER 69.000.010 AND 69.000.047 ONLY

WALTERSHEID TYPE WIDE ANGLE INBOARD YOKES

80° WIDE ANGLE CONSTANT VELOCITY PTO

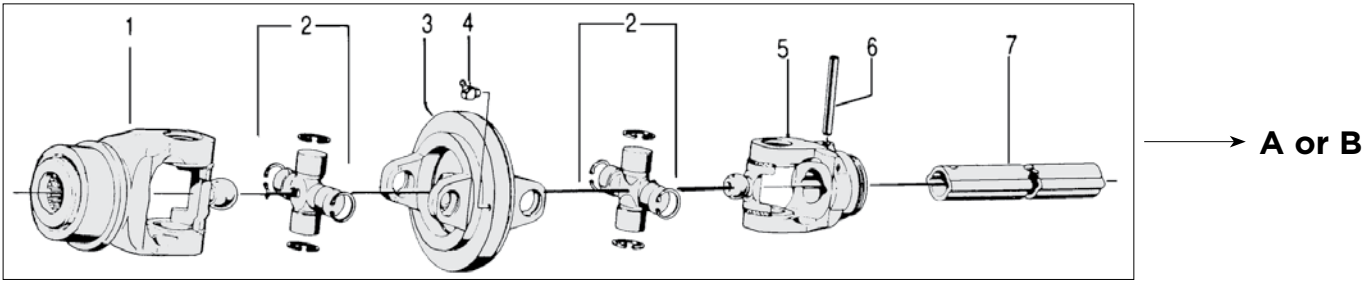

A.
WWE IMPLEMENT HALF
(STANDARD JOINT).

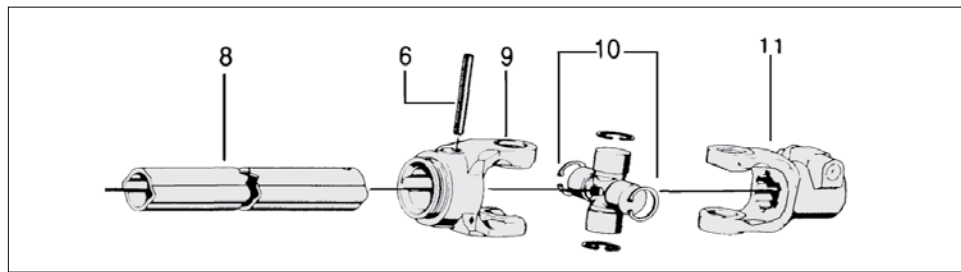
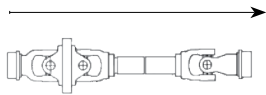



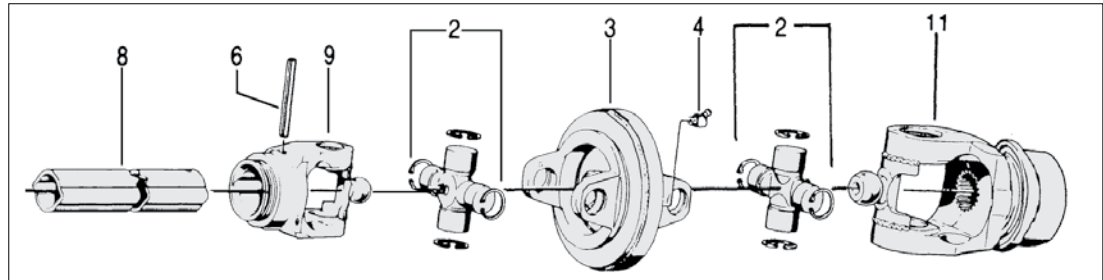
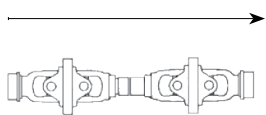

B.
WWZ, TRACTOR END +
IMPLEMENTS END CV



1			AS LOCK	QD LOCK
TRACTOR YOLK	SERIES	SIZE	PART#	PART#
	WW 2280	1 3/8" 6 SPLINE		30-83-910
	WW 2380	1 3/8" 6 SPLINE	21-83-910	21-10-810
	WW 2480	1 3/8" 6 SPLINE		35-10-10
	WW 2480	1 3/8" 21 SPLINE		35-10-12
	WW 2580	1 3/8" 6 SPLINE		36-83-110
	WW 2580	1 3/8" 21 SPLINE		36-83-112
	WW 2580	1 3/4" 20 SPLINE	36-84-112	

	2	3	4	5	6	7	8	A	B	10	11
SERIES	CROSS & BEARING KIT	DOUBLE YOKE	GREASE ZERK	INBOARD YOKE	ROLL PIN	INNER SHAFT	OUTER SHAFT	WWE INBOARD YOKE	WWZ INBOARD YOKE	CROSS & BEARING	END YOKES
2280	20-06-00	20-91-05	49.008.135	20-32-810	15.008.060	75-06-00	75-12-00	20-33-00		20-00-00	
				20-11-810	15.010.065	75-11-00	75-15-00	20-12-00			
2380	21-06-00	21-91-05	49.008.135	21-11-810	15.010.065	75-11-00	75-15-00	21-12-00	21-12-810	21-00-00	REFER BACK TO CHART 1
					15.010.080	75-25-00	75-35-00	21-22-101			
2480	35-06-00	35-41-05	49.008.135	35-13-10	15.010.080	75-25-00	75-35-00	35-14-00	35-14-10	35-00-00	
2580	36-06-00	36-41-05	49.008.135		15.010.080	75-44-00	75-45-00	36-10-100	36-14-830	36-00-00	

WALTERSHEID TYPE REPLACEMENT END YOKES

SERIES	DESCRIPTION	CROSS KIT	Q-D PIN	ROUND BORE SHEAR PIN	ROUND BORE KEY WAY	ROUND BORE CLAMP-ON		
								
W2100	1 1/8" 6 SPLINE	10-01-00	10-11-00					
16HP	1 3/8" 6 SPLINE		10-10-00					
@540	25 MM			10-22-113	10-22-31	10-10-110		
	30 MM			10-22-108	10-22-33			
	1"			10-22-295	10-22-142	010188		
	1 1/4"		10-22-291	10-22-299				
W2200	1 3/8" 6 SPLINE	20-00-00	20-10-00					
27HP	25 MM				20-19-121			
@540	30 MM			20-30-03				
	1"			20-15-156*	20-15-162			
	1 1/4"				20-30-128			
W2300	1 1/8" 6 SPLINE	21-00-00	21-10-00					
38HP	1 3/8" 6 SPLINE		21-10-00P					
@540	1 3/8" 21 SPLINE		21-19-00					
	25 MM				21-15-11			
	30 MM					21-29-02		
	35 MM			21-24-01				
	1"				211048552			
	1 1/8"			21-17-00	21-15-117			
	1 1/4"				21-24-150	21-24-158		
	1 3/8"			21-24-151	21-24-160			
W2400	1 3/8" 6 SPLINE	35-00-00	35-10-00*					
53HP	1 3/8" 21 SPLINE		35-10-02					
	1 1/4"					35-22-115		
	1 3/8"			35-22-101				
	1 1/2"					01055F		
W2500	1 3/8" 6 SPLINE	36-00-00	36-10-00P					
90HP	1 3/8" 21 SPLINE		36-10-02					
@540	1 3/4" 20 SPLINE		36-18-02					
	1 3/4"					36-24-101		
	2"					01675X		
W2600	1 3/8" 6 SPLINE	26-00-00	26-10-00					
107HP	1 3/8" 21 SPLINE		26-10-02					
@540	1 3/4" 20 SPLINE		26-18-02					
	1 3/4" 6 SPLINE		26-18-00					

WALTERSHEID TYPE REPLACEMENT CLUTCHES & PARTS

SIZE	TYPE	L	D	PART#	DATA
W2300	K90	45MM	180MM	56-100-08B	1 3/8" (6) [CLAMP BOLT]
W2400	K90/2	45MM	200MM	56-102-08B	1 3/8" (6) [CLAMP BOLT]
	K90/4	65MM	200MM	56-109-09B	1 3/8" (21) [CLAMP BOLT]
W2500	K90/4	65MM	200MM	56-100-09B	1 3/8" (6) [CLAMP BOLT]
	K90/4	65MM	200MM	56-101-09B	1 3/8" (21) [CLAMP BOLT]
W2600	K90/4	65MM	200MM	56-107-09B	1 3/4" (20) [CLAMP BOLT]
	K90/4	65MM	200MM	33-39-00	1 3/8" (6) [CLAMP BOLT]
	CAM CLUTCH 2900NM RH	75MM	160MM	56-10-048	1 3/4" (20) [CLAMP BOLT]

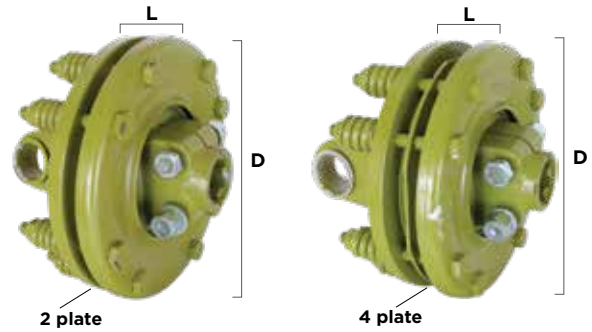

WALTERSHEID TYPE SLIP CLUTCH PARTS

NO.	SERIES	2 PLATE (W2300)		2 PLATE (W2400)		4 PLATE (W2400 & W2500)	
		QTY	PART#	QTY	PART#	QTY	PART#
1	D=6	8	351022370	8	351022370	8	351022370
	W2400			1	35-73-01B	1	35-73-01B
	W2500			1		1	36-73-01B
	W2600					1	26-73-01
3		1	258005320	1	258005320	1	258005320
4	DIA 140	2	247000054				
	DIA 160			2	247000061	4	247000061
5	1 3/8" 6 SPLINE	1	515200311	1	515210311		
						1	275230004
6	1 3/8" 6 SPLINE	2	01.012.070	2	01.012.070		
	3MM					2	248230002
7	3MM			1	248230002		
	1 3/8" Z6					1	515230311
	1 3/8" 21					1	515233711
	1 3/4" 20					1	515233811
8				1	248230006	2	01.012.070
9		8	01.010.100	8	01.010.100	1	248230006
10						8	01.010.100

FF1: overall diameter 180
FF2: overall diameter 200

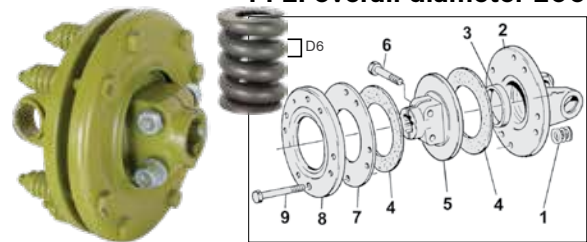

FF4: overall diameter 200

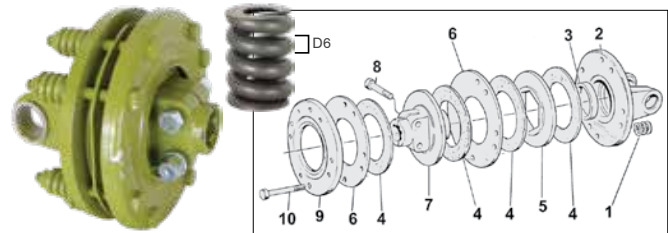

ITEM	PART#	SIZE	TYPE	X MM	TECHNICAL DATA	DESCRIPTION
1	09.000.012				DIN 985-M12 X 1.75	SELF-LOCKING NUT
2	39.000.012				DIN 125-A13	WASHER
3	66-01-53					COMPRESSION SPRING
4	35-73-01	2400		86	10 HOLES	FLANGE YOKE
	36-73-01	2500		100	10 HOLES	FLANGE YOKE
5	56-73-00				91 X 153	FRICTION DISC
6	56-90-04		K90		1 3/8" (6)	HUB
	56-91-00		K90/4		1 3/8" (6)	HUB
	56-91-02		K90/4		1 3/4" (21)	HUB
	56-91-06		K90/4		1 3/4" (20)	HUB
7	09.000.012				DIN 985 - M 12 X 1.75	SELF LOCKING NUT
8	01.012.065				DIN 931 - M 12 X 65 X 1.75	HEXAGON BOLT
9	56-92-00					THRUST FLANGE
10	01.012.090				DIN 960 - M 12 X 90 X 1.75	HEXAGON BOLT
11	56-93-00					DRIVE PLATE
12	56-94-00					DRIVE PLATE
13	01.012.120				DIN 960 - M 12 X 120 X 1.75	HEXAGON BOLT

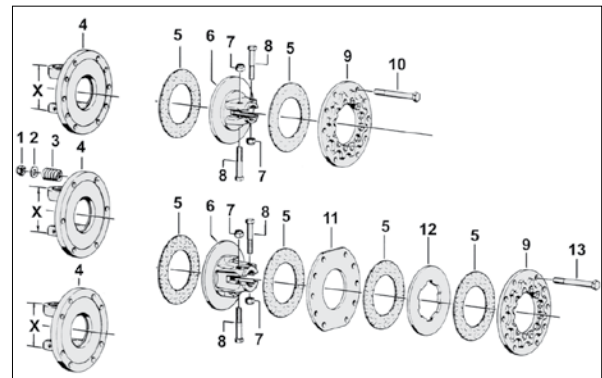

QUICK DISCONNECT YOKE PIN KITS

PART #	65-01-12K		
DESCRIPTION	QUICK DISCONNECT YOKE PIN KIT		
TYPE	WALTERSHEID TYPE		
OEM#	AGRASET 101, TYPE2 (NEW STYLE)		
FOR YOKES	1 1/8" X 6 SPLINE		
	1 3/8" X 6 SPLINE		
	1 3/8" X 21 SPLINE		
DIMENSIONS	L	W	A
	34	13	8

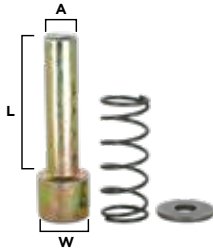

PART #	65-01-13K		
DESCRIPTION	QUICK DISCONNECT YOKE PIN KIT		
TYPE	WALTERSHEID TYPE		
OEM#	AGRASET 102, TYPE2 (NEW STYLE)		
FOR YOKES	1 3/4" X 6 SPLINE		
	1 3/4" X 20 SPLINE		
DIMENSIONS	L	W	A
	42	16	8.8

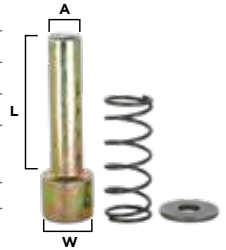

PART #	65-01-00K		
DESCRIPTION	QUICK DISCONNECT YOKE PIN KIT		
TYPE	OLD STYLE WALTERSHEID TYPE		
OEM#	AGRASET 100, TYPE 1 (OLD STYLE)		
	AGRASET 103, TYPE 1 (OLD STYLE)		
FOR YOKES	1 3/4" X 6 SPLINE		
	1 3/8" X 6 SPLINE		
	1 3/8" X 21 SPLINE		
DIMENSIONS	L	W	A
	54	13	15.5

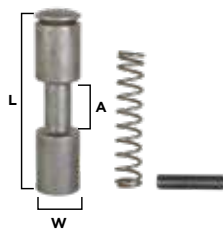

PART #	403000001		
DESCRIPTION	QUICK DISCONNECT YOKE PIN KIT		
STYLE	NEW - FITS BE STYLE PTOS		
DIMENSIONS	L	W	A
	34	13	8

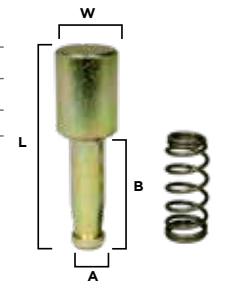

PART #	401000001		
DESCRIPTION	QUICK DISCONNECT YOKE PIN KIT		
STYLE	NEW - FITS BE STYLE PTOS		
DIMENSIONS	L	W	A
	34	13	8

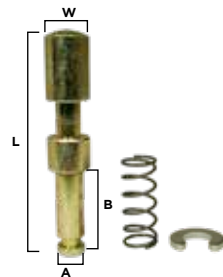

QUICK DISCONNECT COLLAR KITS



PART #	69.888.974		
DESCRIPTION	QUICK DISCONNECT COLLAR KIT		
TYPE	NEW STYLE-FITS BE STYLE PTOS BALL TYPE CPL		



PART #	69.888.975		
DESCRIPTION	QUICK DISCONNECT COLLAR KIT		
TYPE	NEW STYLE-FITS BE SSTYLE PTOS 1/4 TURN BALL TYPE CPL		

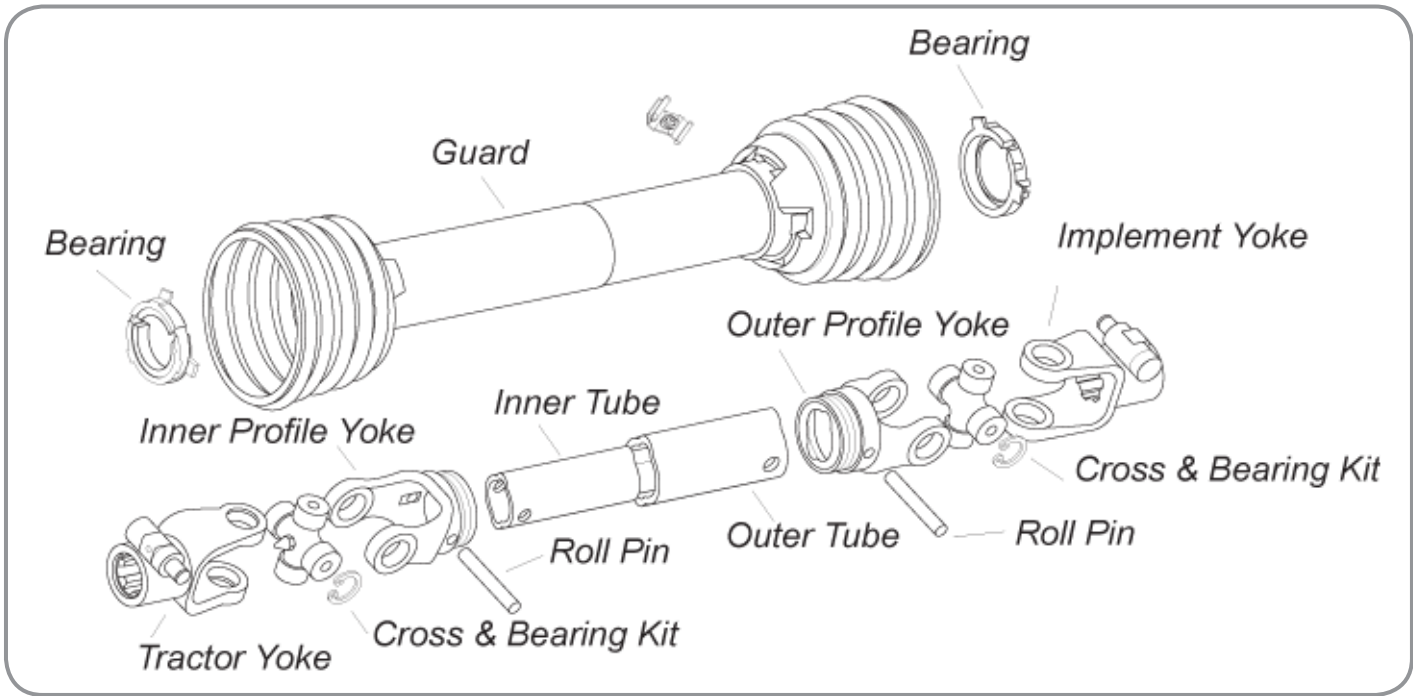

DRIVELINE FAILURES NOT ELIGIBLE FOR WARRANTY

- | | | | | | |
|-----------------|---|--|------------------|---|--|
| <p>1</p> | <p>Extreme torque peak or shock load PTO drive shaft too long. Yoke ear deformation.</p> | | <p>8</p> | <p>Shield interference with implement. Excessive wear of shield bearing.</p> | |
| <p>2</p> | <p>Excessive working angle. Ears worn or pounded.</p> | | <p>9</p> | <p>Incorrect chain mounting. Chains moving or failure.</p> | |
| <p>3</p> | <p>Extreme torque peak or shock load. Cross arms broken.</p> | | <p>10</p> | <p>Inadequate lubrication. Worn centering knobs.</p> | |
| <p>4</p> | <p>Excessive continuous load or excessive working angle. Inadequate greasing. Accelerated wear of cross-kit.</p> | | <p>11</p> | <p>Exceeding joint angle. Broken centering knobs.</p> | |
| <p>5</p> | <p>PTO not cut per operations manual. Pulling apart of telescopic tubes during operation.</p> | | <p>12</p> | <p>One tube spinning and one tube chained. Foreign object contacting tubes. Distorted shield tubes.</p> | |
| <p>6</p> | <p>Extreme torque peak or shock load. Wrong shear pin. Slip clutch not properly adjusted. Telescoping tube failure or twisting.</p> | | <p>13</p> | <p>Excessive end thrust load. Exceeding joint angle. Split central body.</p> | |
| <p>7</p> | <p>Inadequate greasing. Short tube engagement. Accelerated wear of telescoping tubes.</p> | | <p>14</p> | <p>Exceeding joint angle. Split ear on central body.</p> | |



5 CULTIVATOR & PLOW PARTS

BRABER EQUIPMENT
40TH
EDITION
PARTS CATALOG

S TINE - STANDARD



56.000.004



PART# 56.000.001 (STANDARD)

DIMENSION	32 X 10 X 550 (1 1/4" X 3/8" X 22")
BOLT AND NUT	56.000.004 (STANDARD 3/8" X 1 1/4") 56.000.016 (OPTIONAL 3/8" X 1 3/4")

S TINE - HEAVY

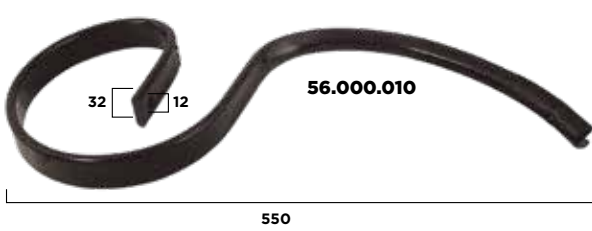

56.000.004



PART# 56.000.010 (HEAVY)

DIMENSION	32 X 12 X 550 (1 1/4" X 1/2" X 22")
BOLT AND NUT	56.000.004 (STANDARD 3/8" X 1 1/4") 56.000.016 (OPTIONAL 3/8" X 1 3/4")

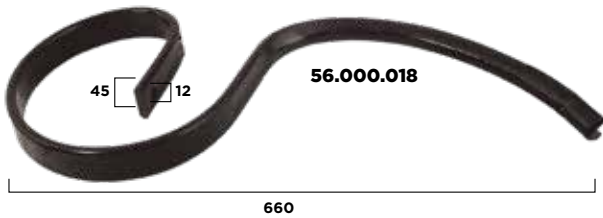

56.000.004



PART# 56.000.018 (HEAVY)

DIMENSION	45 X 12 X 660 (1 3/4" X 1/2" X 26")
BOLT AND NUT	56.000.004 (STANDARD 3/8" X 1 1/4") 56.000.016 (OPTIONAL 3/8" X 1 3/4")

CLAMPS



56.000.005



56.000.002



56.000.021



56.000.022

PART #	FOR TINE	FOR SQUARE BAR	BOLT	NUT
56.000.005	32 X 10 (56.000.010)	50 X 50 (2" X 2")	01.012.090	09.000.012
56.000.002	32 X 10 (56.000.001)	12 X 50 (1/2" X 2")	01.012.045	09.000.012
56.000.021	45 X 12	50 X 50 (2" X 2")	N/A	N/A
56.000.022	45 X 12	63 X 63 (2 1/2" X 2 1/2")	N/A	N/A

REVERSIBLE POINTS



3/8"

PART# 56.000.003

DIMENSION	40 X 6 X 190 (1 1/2" X 1/4" X 8")
	56.000.004 (STANDARD 3/8" X 1 1/4")
BOLT & NUT	56.000.016 (OPTIONAL 3/8" X 1 3/4")



3/8"

PART# 56.000.017

DIMENSION	40 X 6 X 205
	56.000.004 (STANDARD 3/8" X 1 1/4")
BOLT & NUT	56.000.016 (OPTIONAL 3/8" X 1 3/4")



3/8"

PART# 56.000.020

DIMENSION	50 X 6 X 250
	56.000.004 (STANDARD 3/8" X 1 1/4")
BOLT & NUT	56.000.016 (OPTIONAL 3/8" X 1 3/4")



7/16"

PART# ART-460

DIMENSION	50 X 6 X 260 (2" X 11" X 1 3/4")
BOLT & NUT	56.000.027 (7/16" X 2")
REFERENCE	USED ON ALL BE FIELD CULTIVATORS.



7/16"

PART# 56.444.017

DIMENSION	50 X 6 X 215
BOLT & NUT	56.000.027 (7/16" X 2")

SWEEPS



3/8"

PART# 56.000.006

WIDTH	70MM (2 3/4")
THICKNESS	6MM (1/4")
	56.000.004 (STANDARD 3/8" X 1 1/4")
BOLT & NUT	56.000.016 (OPTIONAL 3/8" X 1 3/4")



7/16"

PART# 56.444.006

WIDTH	70MM (2 3/4")
THICKNESS	6MM (1/4")
	56.000.004 (STANDARD 3/8" X 1 1/2")
BOLT & NUT	56.000.034 (OPTIONAL 7/16" x 1 3/4")



3/8"

PART# 56.000.025

WIDTH	100MM (4")
THICKNESS	5MM (3/16")
	56.000.004 (STANDARD 3/8" X 1 1/4")
BOLT & NUT	56.000.016 (OPTIONAL 3/8" X 1 3/4")



3/8"

PART# 56.000.007

WIDTH	100 MM (4")
THICKNESS	6 MM (1/4")
	56.000.004 (STANDARD 3/8" X 1 1/2")
BOLT & NUT	56.000.016 (OPTIONAL 3/8" X 1 3/4")

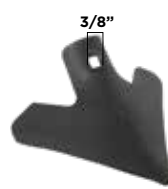

3/8"

PART# 56.000.008

WIDTH	180MM (7")
THICKNESS	6MM (1/4")
	56.000.004 (STANDARD 3/8" X 1 1/2")
BOLT & NUT	56.000.016 (OPTIONAL 3/8" X 1 3/4")

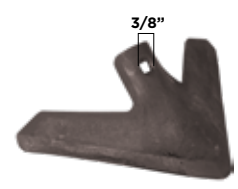

3/8"

PART# 56.000.014

WIDTH	254MM (10")
THICKNESS	6MM (1/4")
	56.000.004 (STANDARD 3/8" X 1 1/2")
BOLT & NUT	56.000.016 (OPTIONAL 3/8" X 1 3/4")

C SHANK SWEEPS



7/16"

PART# 56.000.019

OEM#	C138
WIDTH	70 MM (2 3/4")
THICKNESS	6MM (1/4")
MOUNTING BOLT	56.000.034 (7/16" x 1 3/4")



7/16"

PART# 56.104.247

OEM#	4FCH447
WIDTH	100 MM (4")
THICKNESS	6MM (1/4")
MOUNTING BOLT	56.000.034 (7/16" x 1 3/4")



7/16"

PART# 56.547.097

OEM#	#1547097C2
WIDTH	178 MM (7")
THICKNESS	6MM
MOUNTING BOLT	56.000.034 (7/16" x 1 3/4")



7/11"

PART# 56.372.560

OEM#	#372560A1
WIDTH	178 MM (7")
THICKNESS	6MM
MOUNTING BOLT	56.000.034 (7/16" x 1 3/4")

ALL MEASUREMENTS ARE IN MILLIMETERS UNLESS OTHERWISE STATED (1" = 25.4 MM).
THESE ITEMS ARE NOT ORIGINAL EQUIPMENT PARTS.

FORGED CULTIVATOR POINTS

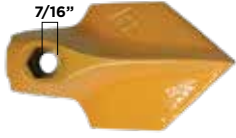

PART# 56.000.011

DESCRIPTION	CAST SWEEP FOR SINGLE HOLE S-TINES
OEM#	CT2083G
WIDTH	3"
BOLT	7/16"



PART# 56.000.012

DESCRIPTION	CAST SWEEP
OEM#	E256
WIDTH	2 1/2"
BOLT	7/16"

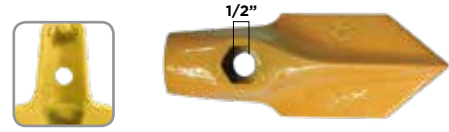

PART# 56.000.013

DESCRIPTION	CAST SWEEP W/ LOCKING NUB
OEM#	D192
WIDTH	2 1/2"
BOLT	1/2"

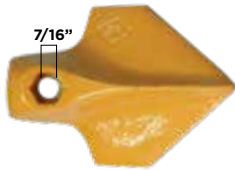

PART# 56.000.028

DESCRIPTION	CAST SWEEP W/ LOCKING NUB
OEM#	D192
WIDTH	2 1/2"
BOLT	7/16"

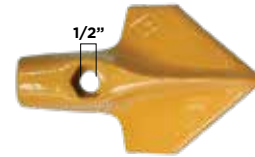

PART# 56.000.029

DESCRIPTION	CAST SWEEP FOR SINGLE HOLE S-TINES
OEM#	MX-4
WIDTH	4"
BOLT	1/2"

PASTURE HARROW PARTS



MOUNTING RINGS

PART #	61.000.002	61.000.003
DIAMETER	4"	2"



DRAW HOOK

PART#	61.200.010
INLAND#	E1587-00
BE-HAR#	40,60



STAR TINE

PART#	61.000.001
DESCRIPTION	PASTURE HARROW STAR TINE

RAKE TINES



ROCK RAKE TINE

YORK OEM#	YORK 657011
BRABER#	57.657.011



LANDSCAPE RAKE TINE

PART #	RRTINEG
DESCRIPTION	REPLACEMENT LANDSCAPE RAKE TINES FOR BE/AGRIEASE RAKES

HARROW TINES

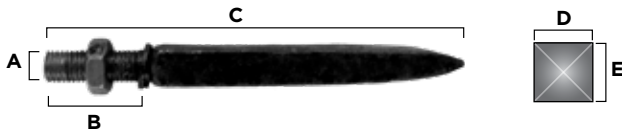

PART#	DESCRIPTION	A	B	C	D	E
61.200.001	TINE, DIAMOND HARROW W/NUT	9/16"	1 1/2"	7"	3/4"	3/4"



PART#	DESCRIPTION	A	B	C	D	E
61.200.002	TINE, DIAMOND HARROW 7"	9/16"	1-7/8"	7"	5/8"	5/8"



PART#	DESCRIPTION	A	B	C	D	E
61.200.004	TINE, DIAMOND HARROW 8"	9/16"	2"	8"	5/8"	5/8"

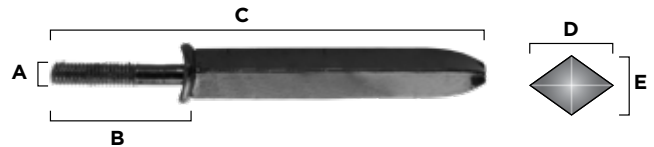

PART#	DESCRIPTION	A	B	C	D	E
61.200.016	TINE, DIAMOND 7/16" THREAD	5/8"	7/8"	8"	7/8"	5/8"
61.200.017	TINE, DIAMOND 1/2" THREAD	5/8"	7/8"	8"	7/8"	5/8"
61.200.018	TINE, DIAMOND 7/16" THREAD	5/8"	7/8"	8 1/2"	7/8"	5/8"
61.200.019	TINE, DIAMOND 1/2" THREAD	5/8"	7/8"	8 1/2"	7/8"	5/8"



PART#	DESCRIPTION	A	B	C	D	E
61.200.020	TINE, DIAMOND W/ HEAD	5/8"	-	8"	7/8"	5/8"



PART#	DESCRIPTION	A	B	C	D	E
61.200.021	TINE, DIAMOND NO HEAD	5/8"	-	8"	7/8"	5/8"



PART#	DESCRIPTION	A	B	C	D	E
61.200.031	TINE, SQUARE NO HEAD	5/8"	-	8"	5/8"	5/8"



PART#	DESCRIPTION	A	B	C	D	E
61.200.032	TINE, SQUARE W/ HEAD	5/8"	-	10"	5/8"	5/8"



PART#	DESCRIPTION	A	B	C	D	E
61.200.040	3/4" x 8" TINE, SQUARE NO HEAD	3/4"	-	8"	3/4"	3/4"



PART#	DESCRIPTION	A	B	C	D	E
61.200.045	3/4" x 10" TINE, SQUARE NO HEAD	3/4"	-	10"	3/4"	3/4"
61.200.047	3/4" x 11" TINE, DIAMOND W/HEAD	3/4"	-	11"	3/4"	3/4"
61.200.049	3/4" x 12" TINE, DIAMOND W/HEAD	3/4"	-	12"	3/4"	3/4"
61.200.051	3/4" x 14" TINE, DIAMOND W/HEAD	3/4"	-	14"	3/4"	3/4"

KVERNELAND REPLACEMENTS



MOULDBOARDS

PART#	DESCRIPTION
063283	MOULDBOARD RIGHT KV #3
063293	MOULDBOARD LEFT KV #3
073286	MOULDBOARD RIGHT KV #6-9
073287	MOULDBOARD LEFT KV #6-9
073290	MOULDBOARD RIGHT KV #6-9
073291	MOULDBOARD LEFT KV #6-9



SHARES

PART#	DESCRIPTION
053087	SHARE F/REVERS. POINT 14" RIGHT
053088	SHARE F/REVERS. POINT 16" RIGHT
063014	EUROSHARE 14" RIGHT KV #3
063015	EUROSHARE 16" RIGHT KV #3
063018	EUROSHARE 16" LEFT KV #3
073004	EUROSHARE 16" RIGHT KV #6-9
073005	EUROSHARE 16" LEFT KV #6-9
073006	EUROSHARE 18" RIGHT KV #6-9
073007	EUROSHARE 18" LEFT KV #6-9



POINTS

PART#	DESCRIPTION
053090	REVERSIBLE POINT R (INCLUDES BOLTS & NUTS)
05309MOLC	EUROPOINT R, CARBIDE COATED
063090	REVERSIBLE POINT L (INCLUDES BOLTS & NUTS)
06309MOLC	EUROPOINT L, CARBIDE COATED
NOTE	BE POINTS COME WITH 1483430 BOLTS AND NUTS.



LANDSLIDES

PART#	DESCRIPTION
053683	LANDSLIDE, LONG RH
053684	LANDSLIDE, SHORT R KV #3
063603	LANDSLIDE, LONG, LOW R KV #3
063605	LANDSLIDE, SHORT, RH, KV #3
063610	LANDSLIDE, SHORT R&L KV #3
073608	LANDSLIDE, SHORT R&L KV #9
073609	LANDSLIDE, LONG R&L KV #9
063604	LANDSLIDE, LONG LOW LH
063606	LANDSLIDE, SHORT LH

DISC COULTER



COVER



HUB

COULTERS & HUBS

PART#	DESCRIPTION
056156	UNIVERSAL COVER FOR HUB R&L
056112	DISC COULTER, 18" R&L
060609	HUB FOR DISC COULTER 034MM R&L
060624	HUB FOR DISC COULTER 030MM R&L



WEARING PLATES

PART#	DESCRIPTION
063600A	WEARING PLATE, REVERSIBLE R&L
063601A	WEARING PLATE, REVERSIBLE R&L



SHINS

PART#	DESCRIPTION
063240	SHIN R
073230	SHIN R
073250	SHIN R
073251	SHIN L
073256	SHIN R KV #6-9
073257	SHIN L KV #6-9
063250	SHIN LH

KONGSKILDE/OVERUM REPLACEMENTS



MOULDBOARDS

PART#	DESCRIPTION
084031	MOULDBOARD R UC "V" BOTTOM
084087	MOULDBOARD L UC "V" BOTTOM
094594	MOULDBOARD R XL
094595	MOULDBOARD L XL
85261	MOULDBOARD L "V"
85262	MOULDBOARD R "V"



SHARES

PART#	DESCRIPTION
074606	SHARE 14" R "SR"
074607	SHARE 16" R "SR"
072633	SHARE 14" R SML
094598	SHARE 14" R "XL"
094602	SHARE 18" R "XL"
094603	SHARE 18" L "XL"



POINTS

PART#	DESCRIPTION
072635	POINT, STEEL CASTING R "SML"
074601	POINT, STEEL CASTING L "SR"



LANDSLIDES

PART#	DESCRIPTION
074602	LANDSLIDE, FRONT R "SR"
080602	LANDSLIDE, FRONT R "SR"
080603	LANDSLIDE, LONG R "SR"
094605	LANDSLIDE L "XL"



WEARING PLATES & BRACKETS

PART#	DESCRIPTION
074612	REVERSIBLE WEARING PLATE R
080601	REVERSIBLE WEARING PLATE R
094612	BRACKET PLATE R
094613	BRACKET PLATE L



SHINS

PART#	DESCRIPTION
83980	SHIN RH
094596	SHIN R "XL"
094597	SHIN L "XL"
80609	SHIN "R"

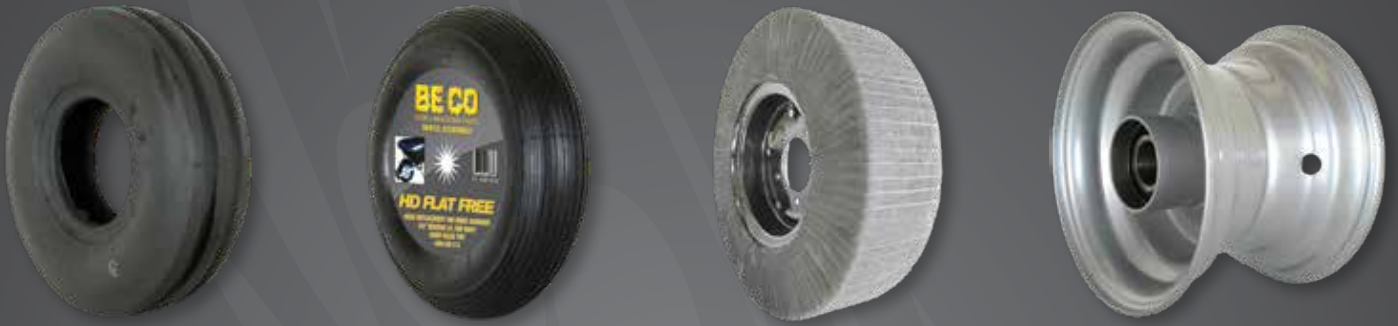

6 TIRES & TUBES

BRABER EQUIPMENT
40TH
EDITION
PARTS CATALOG

RIM ASSEMBLIES & WHEELS

IMPLEMENT TIRES AND TUBES



PART#	TYPE	OEM	DIMENSIONS
51.000.003	TIRE	HF-257 TT	3.50 X 6, 4 PLY
51.000.004	TUBE	TR-87	3.50/4.00 X 6
51.000.005	TIRE	HF-257 TT	4.00 X 4, 4 PLY
51.000.006	TUBE	TR-87	3.50/4.00 X 4
51.000.007	TIRE	HF-257 TT	3.50 X 8, 4 PLY
51.000.008	TUBE	TR-13	3.50/4.00 X 8



PART#	TYPE	OEM	DIMENSIONS
51.000.011	TIRE	HF-217 TT	16 X 6.50 - 8, 4 PLY
51.000.012	TUBE	TR-13	3.50/4.00 X 8
51.000.013	TIRE	HF-217 TT	15 X 6.00 - 6, 4 PLY
51.000.014	TUBE	TR-13	15 X 6.00 - 6

RIM ASSEMBLY WITH BEARINGS



RIM ASSEMBLY WITH BEARINGS - PART# ND-9827

PART#	TYPE	DIMENSIONS
51.000.013	TIRE	15 X 6.00-6, 4 PLY
51.000.014	TUBE	15 X 6.00-6
CAPACITY	250 KG MAX LOAD	250 KG MAX LOAD
BEARING SIZE	25MM ID, 6205 BEARINGS	25MM ID, 6205 BEARINGS

PNEUMATIC & FOAM FILLED WHEEL BARROW WHEELS



51.484.008



51.450.016



51.450.016Y

WHEEL BARROW WHEELS

PART#	DESCRIPTION
51.484.008	WHEEL ASSY 480/400 X 8 PNEUMATIC WHEEL BARROW 3/4" SHAFT
51.450.016	WHEEL ASSY 16" FOAM FILLED HD 3/4" SHAFT
51.450.016Y	WHEEL ASSY 16" FOAM YELLOW FILLED HD 3/4" SHAFT

ROTARY CUTTER WHEELS



294BE



RC20G

ROTARY CUTTER WHEELS

PART#	DESCRIPTION
294BE	TIRE, LAMINATED, 6" X 9", 5 BOLT HOLES ON 5-1/2" CIRCLE, 5-1/4" WIDE, 21" OVERALL DIAMETER, 4" CENTER HOLE
RC20G	TIRE, LAMINATED, 3-1/2" X 9", 4 BOLT HOLES ON 5" CIRCLE, 3-5/8" WIDE, 15" OVERALL DIAMETER, 3-1/2" CENTER HOLE

PNEUMATIC WHEEL ASSEMBLIES

MAG RIM PNEUMATIC WHEEL ASSEMBLY

PART#	85.660.032F
DESCRIPTION	10" PNEUMATIC MAG TIRE
TIRE PRESSURE	30 PSI MAX
RIM	ALUMINUM
BUSHING (AXLE)	PLATED STEEL (3/4"), STEEL BEARING
HUB	PLATED STEEL, 2-1/4" LONG

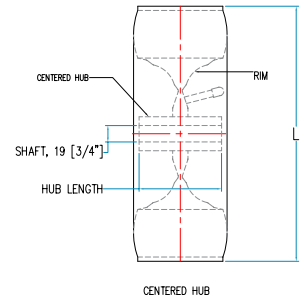

15" PNEUMATIC WHEEL ASSEMBLY

PART#	51.000.017
DESCRIPTION	15" TIRE & WHEEL ASSEMBLY
TIRE PRESSURE	30 PSI MAX
RIM	6" DIAMETER STEEL
BUSHING (AXLE)	STEEL BEARING
HUB	STEEL, 3-1/8" HUB WIDTH



10" PNEUMATIC WHEEL ASSEMBLY

PART#	51.000.018
DESCRIPTION	10" TIRE & WHEEL ASSEMBLY
TIRE PRESSURE	30 PSI MAX
RIM	4" DIAMETER STEEL
BUSHING (AXLE)	STEEL BEARING
HUB	STEEL, 2-1/4" HUB WIDTH



FOAM FILLED WHEEL ASSEMBLIES



FOAM FILLED WHEEL ASSEMBLIES

PART#	DESCRIPTION	RIM	BUSHING (AXLE)	HUB
85.660.004BF	10" FOAM FILLED	STEEL BLACK	3/4" NYLON	STEEL, BLACK, 2-3/8" LONG, 5/8" OFF CENTER
85.660.006BF	12" FOAM FILLED	STEEL BLACK	3/4" NYLON	STEEL, BLACK, 3-7/8" LONG, CENTERED
85.660.050BF	12" FOAM FILLED	METAL BLACK	NYLON (3/4"), BLACK	STEEL, BLACK, 3-7/8" LONG, 5/8" OFF CENTER

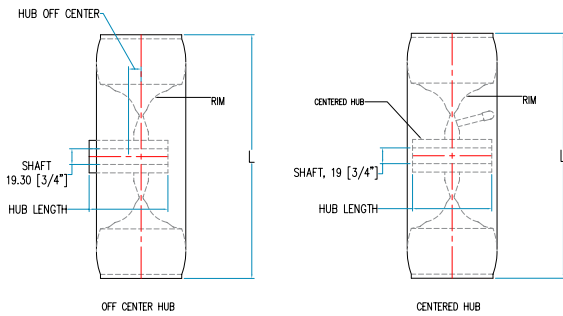

FOAM FILLED MAG WHEEL ASSEMBLIES

PART#	DESCRIPTION	RIM	BUSHING (AXLE)	HUB
85.660.032F	10" FOAM FILLED MAG TIRE	ALUMINUM	PLATED STEEL (3/4"), STEEL BEARING	PLATED STEEL, 2-1/4" LONG, CENTERED
85.660.020F	12" FOAM FILLED MAG TIRE	ALUMINUM	PLATED STEEL (3/4"), STEEL BEARING	PLATED STEEL, 2-1/4" LONG, CENTERED

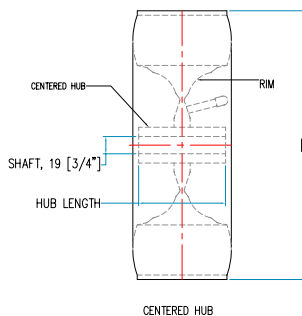



7 SPRAYER EQUIPMENT & ACCESSORIES

BRABER EQUIPMENT

40TH
EDITION

PARTS CATALOG

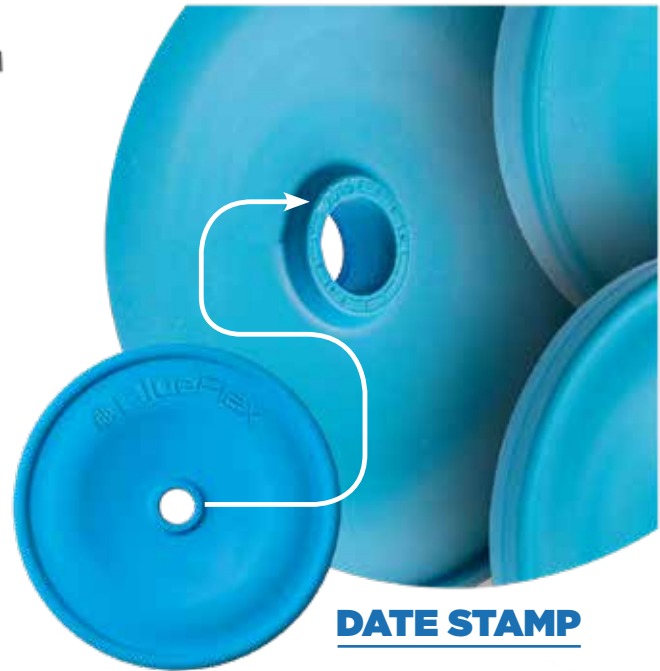
**DATE STAMP**

FEATURES

- ALL BLUEFLEX DIAPHRAGMS HAVE A DATE STAMP
- UNIQUE BLUEFLEX DIAPHRAGM SHAPE & PATENTED DIAPHRAGM PLATE REDUCE MECHANICAL STRESS FOR LONGER LIFE
- EQUAL OR BETTER CHEMICAL RESISTANCE IN A WIDER RANGE OF CHEMICALS

**SPECIAL SHAPE**

CHEMICAL	BUNA (NBR)	BLUEFLEX
SEAWATER	OK	OK
CAUSTIC SODA 50%	OK	OK
AMMONIA	LIMITED	OK
SODIUM HYPOCHLORITE (BLEACH)	NO	OK
SULPHURIC ACID 95%	LIMITED	OK
NITRIC ACID 10%	NO	OK
HYDROCHLORIC ACID 10%	OK	OK
HYDROGEN PEROXIDE	NO	OK
ACETONE	NO	OK
HYDRAULIC FLUID	NO	NO
ALCOHOLS	LIMITED	OK
POTASSIUM SOLUTION	OK	NO
DETERGENT SOLUTION	OK	OK
SOAP SOLUTION	OK	OK

**PATENTED DIAPHRAGM PLATE**

AR LOW PRESSURE PUMPS

AR 202 LOW PRESSURE PUMP

PART#	90.110.202	DIAPHRAGMS	2
PSI	290	INPUT SHAFT	3/4"
GPM	5.3	THRUSHAFT	NO
CONTROLS	VR20	PARTS IN CONTACT W/ PUMPED LIQUIDS	ANODIZED ALUMINUM

NOTE: THIS PUMP COMES WITH A CONTROL VALVE.

PUMP ACCESSORIES

90.200.001	CONTROL UNIT, VR 20
------------	---------------------

PUMP REPAIR PARTS

90.800.080	DIAPHRAGM, BUNA
90.800.082	DIAPHRAGM, BLUEFLEX
90.800.190	DIAPHRAGM, ACCUMULATOR
90.800.192	DIAPHRAGM, ACCUMULATOR BLUEFLEX
800085	DIAPHRAGM, DESMOPAN
2409	O RING KIT

OPTIONS

90.400.004	5HP GEARBOX, 3/4" CRANKSHAFT
------------	------------------------------

OPTIONAL PUMP DESCRIPTION

90.104.202	AR 202 COMES WITH 20 MM INPUT SHAFT GEARBOX ATTACHED
90.100.252	AR 252, 6.6 GPM COMES WITH 30 MM INPUT SHAFT (NO THRU SHAFT)



AR 70 LOW PRESSURE PUMP

PART#	90.100.070	DIAPHRAGMS	2
PSI	290	INPUT SHAFT	NO
GPM	19	THRUSHAFT	NO
INPUT SHAFT	1 3/8" 6 SPLINE	PARTS IN CONTACT W/ PUMPED LIQUIDS	PLASTIC COATED ALUMINUM

PUMP ACCESSORIES

90.200.005	CONTROL VDR20
90.200.887	CONTROL GS20S
2365	O RING KIT

PUMP REPAIR PARTS

90.550.080	DIAPHRAGM, BUNA
90.550.081	DIAPHRAGM, BLUEFLEX
90.550.190	DIAPHRAGM, ACCUMULATOR
90.550.194	DIAPHRAGM, ACCUMULATOR BLUEFLEX
90.650.670	DIAPHRAGM DAMPER
90.650.671	DIAPHRAGM, DAMPER BLUEFLEX

OPTIONAL PUMP DESCRIPTION

90.102.070	AR 70 C/W 35 MM INPUT SHAFT (NO THRU SHAFT)
------------	---



AR 115 LOW PRESSURE PUMP

PART#	90.100.115	DIAPHRAGMS	3
PSI	290	CONTROLS	NO
GPM	30	THRUSHAFT	NO
INPUT SHAFT	1 3/8" 6 SPLINE	PARTS IN CONTACT W/ PUMPED LIQUIDS	PLASTIC COATED ALUMINUM

PUMP ACCESSORIES

90.200.005	CONTROL VDR20
90.200.003	CONTROL RM205

PUMP REPAIR PARTS

90.550.080	DIAPHRAGM, BUNA
90.550.081	DIAPHRAGM, BLUEFLEX
90.550.190	DIAPHRAGM, ACCUMULATOR
90.550.194	DIAPHRAGM, ACCUMULATOR BLUEFLEX
2026	O RING KIT

OPTIONAL PUMP DESCRIPTION

90.102.115	AR 115 C/W 35 MM INPUT SHAFT (NO THRU SHAFT)
------------	--



AR LOW PRESSURE PUMPS

AR 160 LOW PRESSURE PUMP



PART#	90.100.160	DIAPHRAGMS	4
PSI	290	CONTROLS	NO
GPM	42.5	THRUSHAFT	1 ³ / ₈ " 6 SPLINE
INPUT SHAFT	1 ³ / ₈ " SPLINE	PARTS IN CONTACT W/ PUMPED LIQUIDS	PLASTIC COATED ALUMINUM

PUMP REPAIR PARTS	
90.550.080	DIAPHRAGM, BUNA
90.550.081	DIAPHRAGM, BLUEFLEX
90.550.190	DIAPHRAGM, ACCUMULATOR
90.550.194	DIAPHRAGM, ACCUMULATOR BLUEFLEX
1908	O RING KIT

AR 250 LOW PRESSURE PUMP



PART#	90.100.250	DIAPHRAGMS	6
PSI	290	CONTROLS	NO
GPM	66	THRUSHAFT	1 ³ / ₈ " 6 SPLINE
INPUT SHAFT	1 ³ / ₈ " SPLINE	PARTS IN CONTACT W/ PUMPED LIQUIDS	PLASTIC COATED ALUMINUM

PUMP REPAIR PARTS	
90.550.080	DIAPHRAGM, BUNA
550085	DIAPHRAGM, DESMOPAN
90.550.081	DIAPHRAGM, BLUEFLEX
90.550.190	DIAPHRAGM, ACCUMULATOR
90.550.194	DIAPHRAGM, ACCUMULATOR BLUEFLEX
1904	O RING KIT

COMET LOW PRESSURE PUMPS

COMET MC20/20 LOW PRESSURE PUMP

PART#	90.502.020	DIAPHRAGMS	2 (BUNA)
PSI	290	CONTROLS	YES
GPM	5.3	THRUSHAFT	NO
INPUT SHAFT	3/4"	PARTS IN CONTACT W/ PUMPED LIQUIDS	ANODIZED ALUMINUM

PUMP ACCESSORIES

5011000162	FLANGE FOR 4 STROKE ENGINES
1800002000	REPLACEMENT DIAPHRAGMS

ADDITIONAL INFORMATION

PUMP INCLUDES BUILT IN PRESSURE REGULATOR AND GEAR BOX FOR DIRECT ENGINE CONNECTION. REQUIRES 5011000162 FLANGE.

NON-STOCK ITEM, CALL FOR DETAILS.



UDOR LOW PRESSURE PUMPS

UDOR ZETA170 LOW PRESSURE PUMP

PART#	8467.00	DIAPHRAGMS	4
PSI	290	CONTROLS	NO
GPM	45	THRUSHAFT	1 3/8" 6 SPLINE
INPUT SHAFT	1 3/8" 6 SPLINE	PARTS IN CONTACT W/ PUMPED LIQUIDS	PLASTIC COATED ALUMINUM

PUMP ACCESSORIES

8378000	SINGLE LEVER CONTROL
---------	----------------------

PUMP REPAIR PARTS

90.090.302	DIAPHRAGM, BUNA
90.090.314	DIAPHRAGM, ACCUMULATOR
90.090.359	DIAPHRAGM, "UDOR ZETA170 DESMO



AR MEDIUM PRESSURE PUMPS

AR 30 MEDIUM PRESSURE PUMP



3 BOLT
FLANGE INPUT

PART#	90.100.030	DIAPHRAGMS	2
PSI	580	CONTROLS	NO
GPM	9.3	THRUSHAFT	NO
INPUT SHAFT	3 BOLT FLANGE	PARTS IN CONTACT W/ PUMPED LIQUIDS	PLASTIC COATED ALUMINUM

PUMP ACCESSORIES	
5003000700	PTO KIT 1 ³ / ₈ " 6 SPLINE FLANGED
5003004100	PTO KIT 1" ROUND
90.200.900	CONTROL GI40

PUMP REPAIR PARTS	
90.620.080	DIAPHRAGM, BUNA
90.620.082	DIAPHRAGM, BLUEFLEX
90.550.190	DIAPHRAGM, ACCUMULATOR
90.550.194	DIAPHRAGM, ACCUMULATOR BLUEFLEX
90.650.670	DIAPHRAGM, DAMPER
90.650.671	DIAPHRAGM, DAMPER BLUEFLEX
1916	O RING KIT

OPTIONAL PUMP	DESCRIPTION
90.101.030	AR 30 COMES WITH 3 BOLT INPUT SHAFT AND 3/4" THRU SHAFT.
INPUT:	3 BOLT FLANGE
OUTPUT (THRU):	3/4" SHAFT

AR 50 MEDIUM PRESSURE PUMP



3 BOLT
FLANGE INPUT

PART#	90.100.050	DIAPHRAGMS	2
PSI	580	CONTROLS	NO
GPM	13.7	THRUSHAFT	NO
INPUT SHAFT	3 BOLT FLANGE	PARTS IN CONTACT W/ PUMPED LIQUIDS	PLASTIC COATED ALUMINUM

PUMP ACCESSORIES	
5003000700	PTO KIT 1 ³ / ₈ " 6 SPLINE FLANGED
5003004100	PTO KIT 1" ROUND
90.200.900	CONTROL GS40GI

PUMP REPAIR PARTS	
90.650.082	DIAPHRAGM, BUNA
90.650.080	DIAPHRAGM, BLUEFLEX
90.650.520	DIAPHRAGM, ACCUMULATOR
90.650.523	DIAPHRAGM ACCUMULATOR, BLUEFLEX
90.650.670	DIAPHRAGM, DAMPER
90.650.671	DIAPHRAGM, DAMPER BLUEFLEX
1919	O RING KIT

OPTIONAL PUMP	DESCRIPTION
90.101.050	AR 50 COMES WITH 3 BOLT FLANGE INPUT AND 1" THRU SHAFT OUTPUT
INPUT:	3 BOLT FLANGE
OUTPUT (THRU):	1" SHAFT

AR MEDIUM PRESSURE PUMPS

AR 403 MEDIUM PRESSURE PUMP

PART#	90.100.403	DIAPHRAGMS	3
PSI	580	CONTROLS	NO
GPM	10.6	THRUSHAFT	NO
INPUT SHAFT	3 BOLT FLANGE	PARTS IN CONTACT W/ PUMPED LIQUIDS	ANODIZED ALUMINUM

PUMP ACCESSORIES	
5003000700	PTO KIT 1 3/8" 6 SPLINE FLANGED
5003004100	PTO KIT 1" ROUND
90.200.900	CONTROL GS40GI

PUMP REPAIR PARTS	
90.800.080	DIAPHRAGM, BUNA
90.800.082	DIAPHRZAGM, BLUEFLEX
800085	DIAPHRAGM, DESMOPAN
2389	O RING KIT

OPTIONAL PUMP	DESCRIPTION
90.101.403	AR403AP WITH 540 MALE INPUT SHAFT AND 3 BOLT THRU SHAFT (FLANGE)
INPUT:	540 MALE SHAFT
OUTPUT (THRU):	3 BOLT FLANGE



AR 503 MEDIUM PRESSURE PUMP

PART#	90.100.503	DIAPHRAGMS	3
PSI	580	CONTROLS	NO
GPM	14.5	THRUSHAFT	NO
INPUT SHAFT	3 BOLT FLANGE	PARTS IN CONTACT W/ PUMPED LIQUIDS	ANODIZED ALUMINUM

PUMP ACCESSORIES	
5003000700	PTO KIT 1 3/8" 6 SPLINE FLANGED
5003004100	PTO KIT 1" ROUND
90.200.050	CONTROL GS40GI

PUMP REPAIR PARTS	
90.620.080	DIAPHRAGM, BUNA
90.620.082	DIAPHRAGM, BLUEFLEX
620085	DIAPHRAGM, DESMOPAN
1984	O RING KIT

OPTIONAL PUMP	DESCRIPTION
90.101.503	AR 503 AP
INPUT:	540 MALE SHAFT
OUTPUT (THRU)	3 BOLT FLANGE



3 BOLT FLANGE INPUT



COMET MEDIUM PRESSURE PUMPS

MP20 MEDIUM PRESSURE PUMP



PART#	90.500.020	DIAPHRAGMS	2 (BUNA)
PSI	435	CONTROLS	NO
GPM	5.2	THRUSHAFT	NO
INPUT SHAFT	6 BOLT FLANGE	PARTS IN CONTACT W/ PUMPED LIQUIDS	ANODIZED ALUMINUM

PUMP ACCESSORIES

1204004600	CONTROL, SIRIUS
5005002160	GEARBOX
5003000700	PTO KIT, 1 3/8" BOLT ON
5003004100	PTO KIT, 1" SMOOTH

PUMP REPAIR PARTS

1800002000	DIAPHRAGM, BUNA
5026008000*	OVERHAUL KIT, INCLUDES CHECK VALVE KITS & DIAPHRAGMS.*

NOTE : THIS PUMP IS SHIPPED WITHOUT CONTROL VALVE

*NON-STOCK ITEM, CALL FOR DETAILS.

MP30 MEDIUM PRESSURE PUMP



PART#	90.500.030	DIAPHRAGMS	2 (BUNA)
PSI	435	CONTROLS	NO
GPM	7.7	THRUSHAFT	NO
INPUT SHAFT	6 BOLT FLANGE	PARTS IN CONTACT W/ PUMPED LIQUIDS	ANODIZED ALUMINUM

PUMP ACCESSORIES

1204004600	CONTROL, SIRIUS
5005002160	GEARBOX
5003000700	PTO KIT, 1 3/8" BOLT ON
5003004100	PTO KIT, 1" SMOOTH

PUMP REPAIR PARTS

1800002000	DIAPHRAGM, BUNA
5026008000*	OVERHAUL KIT, INCLUDES CHECK VALVE KITS & DIAPHRAGMS.*

NOTE : THIS PUMP IS SHIPPED WITHOUT CONTROL VALVE

*NON-STOCK ITEM, CALL FOR DETAILS.

P48 MEDIUM PRESSURE PUMP



PART#	90.500.048	DIAPHRAGMS	2 (BUNA)
PSI	435	CONTROLS	NO
GPM	14	THRUSHAFT	NO
INPUT SHAFT	6 BOLT FLANGE	PARTS IN CONTACT W/ PUMPED LIQUIDS	PLASTIC COATED ALUMINUM

PUMP ACCESSORIES

5003000700	PTO KIT 1 3/8" 6 SPLINE
5003004100	PTO KIT 1" ROUND

PUMP REPAIR PARTS

1800002000	DIAPHRAGM, BUNA
5005002160	GEARBOX
1204048500	CONTROL 3 LEVER

NOTE : THIS PUMP IS SHIPPED WITHOUT CONTROL VALVE

COMET MEDIUM PRESSURE PUMPS

APS 31 MEDIUM PRESSURE PUMP

PART#	90.500.031	DIAPHRAGMS	3 (BUNA)
PSI 580	580	CONTROLS	NO
GPM 7.4	7.4	THRUSHAFT	NO
INPUT SHAFT	6 BOLT FLANGE	PARTS IN CONTACT W/ PUMPED LIQUIDS	ANODIZED ALUMINUM

PUMP ACCESSORIES	
5003000700	PTO KIT 1 3/8" 6 SPLINE
5003004100	PTO KIT 1" ROUND
1204020500	CONTROL 3 LEVER
1204045700	CONTROL
5005002160	GEARBOX FOR 4 STROKE 3/4 THRU SHAFT FLANGE

PUMP REPAIR PARTS	
1800002000	DIAPHRAGM, BUNA

NOTE : THIS PUMP IS SHIPPED WITHOUT CONTROL VALVE



APS 41 MEDIUM PRESSURE PUMP

PART#	90.500.041	DIAPHRAGMS	3 (BUNA)
PSI	580	CONTROLS	NO
GPM	10.8	THRUSHAFT	NO
INPUT SHAFT	6 BOLT FLANGE	PARTS IN CONTACT W/ PUMPED LIQUIDS	ANODIZED ALUMINUM

PUMP ACCESSORIES	
5003000700	PTO KIT 1 3/8" 6 SPLINE
5003004100	PTO KIT 1" ROUND
1204020500	CONTROL 3 LEVER
1204045700	CONTROL
5005002160	GEARBOX FOR 4 STROKE 3/4 THRU SHAFT FLANGE

PUMP REPAIR PARTS	
1800002000	DIAPHRAGM, BUNA

OPTIONAL PUMP	DESCRIPTION
90.501.041	20MM CONICAL SHAFT VERSION

NOTE : THIS PUMP IS SHIPPED WITHOUT CONTROL VALVE
*NON-STOCK ITEM, CALL FOR DETAILS.



AR HIGH PRESSURE PUMPS

AR 813 HIGH PRESSURE PUMP C/SP FLANGE



PART#	90.100.813	DIAPHRAGMS	3
PSI	725	CONTROLS	NO
GPM	21.4	THRUSHAFT	6 BOLT FLANGE
INPUT SHAFT	1 $\frac{3}{8}$ " 6 SPLINE	PARTS IN CONTACT W/ PUMPED LIQUIDS	PLASTIC COATED ALUMINUM

PUMP ACCESSORIES

90.200.050	CONTROL VALVE
8378000	CONTROL VALVE SINGLE LEVER
5003000700	1 $\frac{3}{8}$ " 6 SPLINE PTO KIT
5003004100	1" RB SHAFT

PUMP REPAIR PARTS

90.104.081	DIAPHRAGM, BUNA
90.104.083	DIAPHRAGM, BLUEFLEX
90.104.240	DIAPHRAGM, ACCUMULATOR
2376	O RING KIT

ADDITIONAL INFORMATION

THE 90.100.813 COMES WITH A C/SP 540 MALE INPUT AND A 6 BOLT FLANGE OUTPUT.

AR 1064 HIGH PRESSURE PUMP



PART#	90.101.064	DIAPHRAGMS	4
PSI	725	CONTROLS	NO
GPM	27.7	THRUSHAFT	1 $\frac{3}{8}$ " 6 SPLINE
INPUT SHAFT	1 $\frac{3}{8}$ " 6 SPLINE	PARTS IN CONTACT W/ PUMPED LIQUIDS	ANODIZED ALUMINUM

PUMP ACCESSORIES

90.200.050	CONTROL VALVE
8378000	CONTROL VALVE SINGLE LEVER

PUMP REPAIR PARTS

90.104.081	DIAPHRAGM, BUNA
90.104.083	DIAPHRAGM, BLUEFLEX
90.104.240	DIAPHRAGM, ACCUMULATOR
2378	O RING KIT

OPTIONAL PUMP DESCRIPTION

90.102.064	1 $\frac{3}{8}$ " MALE INPUT SHAFT AND 6 BOLT FLANGE OUTPUT (THRU)
------------	--

AR 1203 HIGH PRESSURE PUMP



PART#	90.102.203	DIAPHRAGMS	3
PSI	725	CONTROLS	NO
GPM	30.8	THRUSHAFT	1 $\frac{3}{8}$ " 6 SPLINE
INPUT SHAFT	1 $\frac{3}{8}$ " 6 SPLINE	PARTS IN CONTACT W/ PUMPED LIQUIDS	ANODIZED ALUMINUM

PUMP ACCESSORIES

90.200.050	CONTROL VALVE
8378000	CONTROL VALVE SINGLE LEVER

PUMP REPAIR PARTS

90.550.080	DIAPHRAGM, BUNA
90.550.190	DIAPHRAGM, DAMPNER

OPTIONAL PUMP DESCRIPTION

90.101.203	1 $\frac{3}{8}$ " MALE INPUT SHAFT AND 6 BOLT FLANGE OUTPUT (THRU)
------------	--

AR HIGH PRESSURE PUMPS

AR 1604 HIGH PRESSURE PUMP

PART#	90.101.604	DIAPHRAGMS	4
PSI	725	CONTROLS	NO
GPM	40.4	THRUSHAFT	1 ³ / ₈ " 6 SPLINE
INPUT SHAFT	1 ³ / ₈ " 6 SPLINE	PARTS IN CONTACT W/ PUMPED LIQUIDS	ANODIZED ALUMINUM

PUMP ACCESSORIES

8378000	SINGLE LEVER CONTROL
90.200.050	CONTROL VALVE

PUMP REPAIR PARTS

90.550.080	DIAPHRAGM
550085	DIAPHRAGM BUNA
90.550.190	DIAPHRAGM, DAMPNER



AR BHP130 HIGH PRESSURE PUMP

PART#	90.121.130	DIAPHRAGMS	3
PSI	725	CONTROLS	NO
GPM	33.7	THRUSHAFT	1 ³ / ₈ " 6 SPLINE
INPUT SHAFT	1 ³ / ₈ " 6 SPLINE	PARTS IN CONTACT W/ PUMPED LIQUIDS	PLASTIC COATED ALUMINUM

NOTE: SEPARATE MANIFOLD DESIGN

PUMP ACCESSORIES

8378000	CONTROL VALVE SINGLE LEVER
---------	----------------------------

PUMP REPAIR PARTS

224080	DIAPHRAGM
224081	DIAPHRAGM, BLUEFLEX
90.550.190	DIAPHRAGM, ACCUMULATOR
90.550.194	DIAPHRAGM, ACCUMULATOR BLUEFLEX



AR BHP150 HIGH PRESSURE PUMP

PART#	90.121.150	DIAPHRAGMS	3
PSI	725	CONTROLS	NO
GPM	37.7	THRUSHAFT	1 ³ / ₈ " 6 SPLINE
INPUT SHAFT	1 ³ / ₈ " 6 SPLINE	PARTS IN CONTACT W/ PUMPED LIQUIDS	PLASTIC COATED ALUMINUM

NOTE: SEPARATE MANIFOLD DESIGN

PUMP ACCESSORIES

8378000	CONTROL VALVE SINGLE LEVER
---------	----------------------------

PUMP REPAIR PARTS

224080	DIAPHRAGM
224081	DIAPHRAGM, BLUEFLEX
90.550.190	DIAPHRAGM, ACCUMULATOR
90.550.194	DIAPHRAGM, ACCUMULATOR BLUEFLEX



AR HIGH PRESSURE PUMPS

AR BHP170 HIGH PRESSURE PUMP



PART#	90.121.170	DIAPHRAGMS	4
PSI	725	CONTROLS	NO
GPM	42.4	THRUSHAFT	1 ³ / ₈ " 6 SPLINE
INPUT SHAFT	1 ³ / ₈ " 6 SPLINE	PARTS IN CONTACT W/ PUMPED LIQUIDS	PLASTIC COATED ALUMINUM

NOTE: SEPARATE MANIFOLD DESIGN

PUMP ACCESSORIES

8378000 CONTROL VALVE SINGLE LEVER

PUMP REPAIR PARTS

224080	DIAPHRAGM
224081	DIAPHRAGM, BLUEFLEX
90.550.190	DIAPHRAGM, ACCUMULATOR
90.550.194	DIAPHRAGM, ACCUMULATOR BLUEFLEX

AR BHP200 HIGH PRESSURE PUMP



PART#	90.121.200	DIAPHRAGMS	4
PSI	725	CONTROLS	NO
GPM	51.2	THRUSHAFT	1 ³ / ₈ " 6 SPLINE
INPUT SHAFT	1 ³ / ₈ " 6 SPLINE	PARTS IN CONTACT W/ PUMPED LIQUIDS	PLASTIC COATED ALUMINUM

NOTE: SEPARATE MANIFOLD DESIGN

PUMP ACCESSORIES

8378000 CONTROL VALVE SINGLE LEVER

PUMP REPAIR PARTS

224080	DIAPHRAGM
224081	DIAPHRAGM, BLUEFLEX
90.550.190	DIAPHRAGM, ACCUMULATOR
90.550.194	DIAPHRAGM, ACCUMULATOR BLUEFLEX

AR BHA170 HIGH PRESSURE PUMP



PART#	90.101.170	DIAPHRAGMS	4
PSI	725	CONTROLS	NO
GPM	43	THRUSHAFT	1 ³ / ₈ " 6 SPLINE
INPUT SHAFT	1 ³ / ₈ " 6 SPLINE	PARTS IN CONTACT W/ PUMPED LIQUIDS	ANODIZED ALUMINUM

NOTE: SEPARATE MANIFOLD DESIGN

PUMP ACCESSORIES

8378000 CONTROL VALVE SINGLE LEVER

PUMP REPAIR PARTS

2240080	DIAPHRAGM
2240081	DIAPHRAGM, BLUEFLEX
90.550.190	DIAPHRAGM, ACCUMULATOR
2457	O RING KIT

NOTESTHIS PUMP HAS AN ALUMINUM BODY AND ANODIZED HEADS.
THE AR BHA160 PUMP REPLACES THE AR1554.**OPTIONAL PUMP**

90.102.170 BHS160, BRASS HEAD VERSION OF BHA160

AR HIGH PRESSURE PUMPS

AR BHS90 HIGH PRESSURE PUMP

PART#	90.131.090	DIAPHRAGMS	3
PSI	725	CONTROLS	NO
GPM	23.9	THRUSHAFT	1 3/8" 6 SPLINE
INPUT SHAFT	1 3/8" 6 SPLINE	PARTS IN CONTACT W/ PUMPED LIQUIDS	BRASS
NOTE: SEPERATE MANIFOLD DESIGN			
PUMP ACCESSORIES			
8378000			
PUMP REPAIR PARTS			
90.550.080	DIAPHRAGM		
90.550.081	DIAPHRAGM, BLUEFLEX		
90.800.190	DIAPHRAGM, ACCUMULATOR		
90.800.192	DIAPHRAGM, ACCUMULATOR BLUEFLEX		



AR BHS120 HIGH PRESSURE PUMP

PART#	90.131.120	DIAPHRAGMS	3
PSI	725	CONTROLS	NO
GPM	29.8	THRUSHAFT	1 3/8" 6 SPLINE
INPUT SHAFT	1 3/8" 6 SPLINE	PARTS IN CONTACT W/ PUMPED LIQUIDS	BRASS
NOTE: SEPARATE MANIFOLD DESIGN			
PUMP ACCESSORIES			
8378000	CONTROL VALVE SINGLE LEVER		
PUMP REPAIR PARTS			
90.550.080	DIAPHRAGM		
90.550.081	DIAPHRAGM, BLUEFLEX		
90.800.190	DIAPHRAGM, ACCUMULATOR		
90.800.192	DIAPHRAGM, ACCUMULATOR BLUEFLEX		



AR BHS150 HIGH PRESSURE PUMP

PART#	90.131.150	DIAPHRAGMS	3
PSI	725	CONTROLS	NO
GPM	37.7	THRUSHAFT	1 3/8" 6 SPLINE
INPUT SHAFT	1 3/8" 6 SPLINE	PARTS IN CONTACT W/ PUMPED LIQUIDS	BRASS
NOTE: SEPARATE MANIFOLD DESIGN			
PUMP ACCESSORIES			
8378000	CONTROL VALVE SINGLE LEVER		
PUMP REPAIR PARTS			
224080	DIAPHRAGM		
224081	DIAPHRAGM, BLUEFLEX		
90.550.191	DIAPHRAGM, ACCUMULATOR		
90.550.194	DIAPHRAGM, ACCUMULATOR BLUEFLEX		



AR HIGH PRESSURE PUMPS

AR BHS170 HIGH PRESSURE PUMP



PART#	90.131.170	DIAPHRAGMS	4
PSI	725	CONTROLS	NO
GPM	42.4	THRUSHAFT	1 3/8" 6 SPLINE
INPUT SHAFT	1 3/8" 6 SPLINE	PARTS IN CONTACT W/ PUMPED LIQUIDS	BRASS

NOTE: SEPARATE MANIFOLD DESIGN

PUMP ACCESSORIES

8378000 CONTROL VALVE SINGLE LEVER

PUMP REPAIR PARTS

224080	DIAPHRAGM
224081	DIAPHRAGM, BLUEFLEX
90.550.190	DIAPHRAGM, ACCUMULATOR
90.550.194	DIAPHRAGM, ACCUMULATOR BLUEFLEX

AR BHS200 HIGH PRESSURE PUMP



PART#	90.131.200	DIAPHRAGMS	4
PSI	725	CONTROLS	NO
GPM	51.2	THRUSHAFT	1 3/8" 6 SPLINE
INPUT SHAFT	1 3/8" 6 SPLINE	PARTS IN CONTACT W/ PUMPED LIQUIDS	BRASS

NOTE: SEPARATE MANIFOLD DESIGN

PUMP ACCESSORIES

8378000 CONTROL VALVE SINGLE LEVER

PUMP REPAIR PARTS

224080	DIAPHRAGM
224081	DIAPHRAGM, BLUEFLEX
90.550.190	DIAPHRAGM, ACCUMULATOR
90.550.194	DIAPHRAGM, ACCUMULATOR BLUEFLEX

COMET HIGH PRESSURE PUMPS

APS71 HIGH PRESSURE PUMP

PART#	90.501.071	DIAPHRAGMS	3 (BUNA)
PSI	725	CONTROLS	NO
GPM	18.8	THRUSHAFT	1 3/8" 6 SPLINE FEMALE
INPUT SHAFT	1 3/8" 6 SPLINE	PARTS IN CONTACT W/ PUMPED LIQUIDS	ANODIZED ALUMINUM

PUMP ACCESSORIES			
1204020500	CONTROL		
PUMP REPAIR PARTS			
1800008800	DIAPHRAGM, BUNA		
1800003400	ACCUMULATOR DIAPHRAGM		
NOTE: THIS PUMP IS SHIPPED WITHOUT A REGULATOR.			



APS96 HIGH PRESSURE PUMP

PART#	90.500.096	DIAPHRAGMS	4 (BUNA)
PSI	725	CONTROLS	NO
GPM	23.5	THRUSHAFT	1 3/8" 6 SPLINE
INPUT SHAFT	1 3/8" 6 SPLINE	PARTS IN CONTACT W/ PUMPED LIQUIDS	ANODIZED ALUMINUM

PUMP ACCESSORIES			
8378000	SINGLE LEVER CONTROL		
PUMP REPAIR PARTS			
1800008800	DIAPHRAGM, BUNA		
1800009400	DIAPHRAGM, ACCUMULATOR		
NOTE: THIS PUMP IS USED ON SOME FLORIDA PLN SPRAYERS. THIS PUMP IS SHIPPED WITHOUT A REGULATOR.			



APS141 HIGH PRESSURE PUMP

PART#	90.500.141	DIAPHRAGMS	4 (BUNA)
PSI	725	CONTROLS	NO
GPM	37	THRUSHAFT	1 3/8" 6 SPLINE
INPUT SHAFT	1 3/8" 6 SPLINE	PARTS IN CONTACT W/ PUMPED LIQUIDS	ANODIZED ALUMINUM

PUMP ACCESSORIES			
8378000	SINGLE LEVER CONTROL		
PUMP REPAIR PARTS			
1800001200	DIAPHRAGM, BUNA		



LOW/MEDIUM PRESSURE CONTROL

GS20S CONTROL VALVE - LOW



PART#	90.200.887
MODELS	AR70
VALVES	3
GPM	13.2
PSI	290

KITS	
90.201.040	REPAIR KIT
90.200.041	REMOTE KIT
90.200.977	BARB KIT

VDR 20S CONTROL VALVE - LOW



PART#	90.200.005
MODELS	AR70, AR 115, AR135
VALVES	4
GPM	34.3
PSI	290

KITS	
90.201.040	REPAIR KIT
90.200.041	REMOTE KIT
90.200.977	BARB KIT

VR20 CONTROL VALVE - MED



PART#	90.200.001
MODELS	AR19/202
MAX PSI	290
GPM	10.6

GI 40 CONTROL VALVE - MED



Barb Kit Part# **90.200.977**

Remote Kit Part# **90.200.041**

PART#	90.200.900
MODELS	AR 30, AR 50
VALVES	2
PORTS	1 ADDITIONAL
GPM	21.1
PSI	580

KITS	
90.201.040	REPAIR KIT
90.200.041	REMOTE KIT
90.200.977	BARB KIT

HIGH PRESSURE CONTROLS

GS50 VALVE - HIGH

PART#	90.200.962
MODELS	BHA-BHP 130-150-170-200, BHS 90-105-120-130-150-170-200
GPM	52.8
PSI	725



VDR50 CONTROL VALVE - HIGH

PART#	90.200.050
MODELS	BHA-BHP 130, BHS 90-105-110-120, AR 503, AR 30, AR 50, AR 713, AR 813, AR 1064, AR 903, AR 1053, AR 1203
MAX PSI	725
VALVES	2
PORTS	2 ADDITIONAL
GPM	34.3



KIT	
90.200.052	MOUNTING KIT

NOTE
WHEN ORDERING THIS CONTROL VALVE, IT IS RECOMMENDED THAT YOU ALSO ORDER THE MOUNTING KIT 90.200.052



Mounting Part# **90.200.052**

SINGLE LEVER CONTROL VALVE - HIGH

PART#	8378000
MODELS	AR903, AR 1053, AR 1064, AR 1203, AR 1604, BHA SERIES, BHS SERIES, BHP SERIES
MAX PSI	725
MOVING PARTS	BRASS OR STAINLESS STEEL
HOUSING	ANODIZED ALUMINUM

PRESSURE FITTING	
162.604.3A	1/2" BARB
INLET FITTING	
1101.12	O-RING
0604.29	NUT
0202.69	3/4" BARB

KIT	
502201130	REPAIR KIT

NOTE
ADJUSTABLE REGULATOR WORKS WELL AT LOW PRESSURES. 6 POSITION CONTROL LEVER CLICKS INTO POSITION



PRESSURE RELIEF VALVES & PTO ADAPTER KITS

PRESSURE RELIEF VALVES



PRESSURE RELIEF VALVES

PART #	PSI	INLET
90.922.026	150	1/2" MNPT
90.920.026	400	1/2" MNPT
90.920.057	150	3/4" MNPT
90.922.057	250	3/4" MNPT
90.924.057	400	3/4" MNPT

FEATURES

- 3/4" FPT DISCHARGE
- POLYPRO & BRASS CONSTRUCTION



ALUMINUM RELIEF VALVE

PART #	PSI	INLET
90.910.026	300	3/4" M

FEATURES

- 3/4" FPT DISCHARGE
- ALUMINUM BYPASS RELIEF VALVE W/ STAINLESS STEEL BALL



BRASS RELIEF VALVE

PART #	PSI	INLET
90.900.026	300	3/4" M

FEATURES

- 3/4" FPT DISCHARGE
- BRASS BYPASS RELIEF VALVE W/ STAINLESS STEEL BALL

PTO ADAPTER KITS



5003000700

MODELS	ALL AR OR COMET DIAPHRAGM PUMPS WITH 3 OR 6 BOLT FLANGE
SHAFT	13 8" 6 SPLINE, MALE

ADDITIONAL INFORMATION

HARDWARE INCLUDED.



5003004100

MODELS	ALL AR OR COMET DIAPHRAGM PUMPS WITH 3 OR 6 BOLT FLANGE
SHAFT	1" ROUND, KEYED

ADDITIONAL INFORMATION

HARDWARE INCLUDED.



TAV01-A

SIZE	13 8" 6 SPLINE, FEMALE 6 BOLT FLANGE MOUNT
-------------	---

GEARBOXES & PUMP ASSEMBLIES

GEARBOXES

PART#	DESCRIPTION	RATIO	ENGINE SHAFT	USED WITH
90.400.001	AR GEARBOX KIT 1636	1.:5.9	3/4"	AR30
90.400.002	AR GEARBOX KIT 1639	1.:5.9	1"	AR50, 503, 813, 1064, 1203
90.400.004	AR GEARBOX KIT 1613	1:4.3	3/4"	AR 19, 202
90.400.003	COMET GEARBOX KIT 5005002160	1:6.44	3/4"	COMET APS31, 41



PUMP ASSEMBLIES



PART#	PUMP	GPM	PSI	ENGINE	GEARBOX
90.800.001	AR202	5.3	290	HONDA 5HP GC160QHC	1:4.3
90.800.002	AR30	9.3	580	HONDA 5HP GC160	1:5.9
90.800.003	AR50	13.7	580	HONDA 9HP GX270	1:5.9
90.800.004	AR 202	5.3	290	HONDA 6.5HP GX200QX	1:4.3
90.800.005	AR30	9.3	580	HONDA 6.5HP GX200QX	1:5.9
90.800.006	AR1064	27.7	400	HONDA 13HP GX390	1:5.9
90.800.007	AR813	21.4	550	HONDA 13HP GX390	1:5.9
90.800.008	COMET APS31	7.4	580	HONDA 6.5HP GX200QX	1:6.44
90.800.009	COMET APS41	10.8	580	HONDA 6.5HP GX200QX	1:6.44
90.800.014	AR30	9.3	580	HONDA 5.5HP GX160 ELECTRIC START	1:5.9
90.800.016	COMET APS31	7.4	580	POWEREASE 7HP	1:6.44
90.800.018	AR813	21	725	HONDA 13HP GX390KQAE2 ELEC START	1:5.9
90.800.022	AR1064	27	723	HONDA 20HP GX630RQXF6 O/A	1:5.9
90.800.024	AR1203	30	725	HONDA 20HP GX630RQXF6 O/A	1:5.9
90.801.003	AR50(THRU SHAFT)	13.7	580	HONDA 9HP GX270	1:5.9
90.801.005	AR30(THRU SHAFT)	9.3	580	HONDA 6.5HP GX200QX	1:5.9
90.800.015	AR503	14.5	580	HONDA 9HP GX270UQ ELECTRIC START	1:5.9
90.800.019	AR503	14.5	580	HONDA 9HP GX270QA	1:5.9

ALL MEASUREMENTS ARE IN MILLIMETERS UNLESS OTHERWISE STATED (1" = 25.4 MM).
THESE ITEMS ARE NOT ORIGINAL EQUIPMENT PARTS.

PowerFLO™ 2200 SERIES



DELAVAN™ PowerFLO

DIMENSIONS

INCHES (MM)

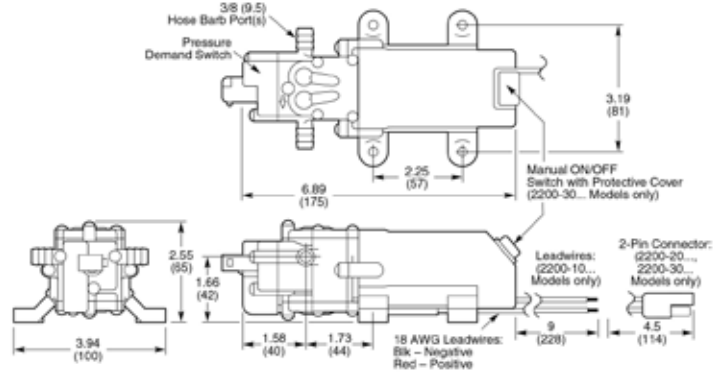

90.220.201

OEM #	2200-201
DESCRIPTION	DELAVAN 12V DEMAND PUMP
FLOW	1.0 GPM (OPEN FLOW)
PRESSURE	40 PSI
AMPS	4.0 MAX
WEIGHT	1.25 LBS (0.57 KG)
ADDITIONAL INFORMATION	3/8" HOSE BARB / DEMAND 1.0 GPM, WITH 2-PIN CONNECTOR

PUMP

TYPE	2-CHAMBER POSITIVE DISPLACEMENT, SELF PRIMING, CAPABLE OF BEING RUN DRY
TEMPERATURE	110°F (43°C) MAX.
PRIMING CAPABILITIES	4 FEET (1.2 M) SUCTION LIFT
MAX PRESSURE	40 PSI (2.8 BAR)
PRESSURE DEMAND SWITCH	SHUT-OFF: 40 ±5 PSI (2.8 ±0.3 BAR) FACTORY SETTING TURN-ON: 25 ±5 PSI (1.7 ±0.3 BAR) FACTORY SETTING
INLET/OUTLET PORTS	3/8" HOSE BARB

MOTOR

TYPE	12 VDC, PERMANENT MAGNET, THERMALLY PROTECTED, SPLASHPROOF
LEADS	2200-1 MODELS: 18 AWG, 9" LONG 2200-2, 2200-3 MODELS: 18 AWG, 4.5" LONG WITH 2-PIN CONNECTOR
DUTY CYCLE	INTERMITTENT

MATERIALS OF CONSTRUCTION

MOTOR HOUSING	NYLON 6/6
PUMP HOUSING	POLYPROPYLENE
VALVES	VITON
DIAPHRAGM	SANTOPRENE
FASTENERS	STAINLESS STEEL AND ZINC PLATED

PERFORMANCE

PRESSURE / FLOW / AMP DRAW

PSI	BAR	GPM	LPM	AMPS
0-3	0.2	1.00	3.7	1.5
10	0.7	0.85	3.1	1.9
20	1.4	0.71	2.6	2.1
30	2.1	0.61	2.3	2.4
40	2.8	0.42	1.6	2.6

PowerFLO™ 7800 SERIES

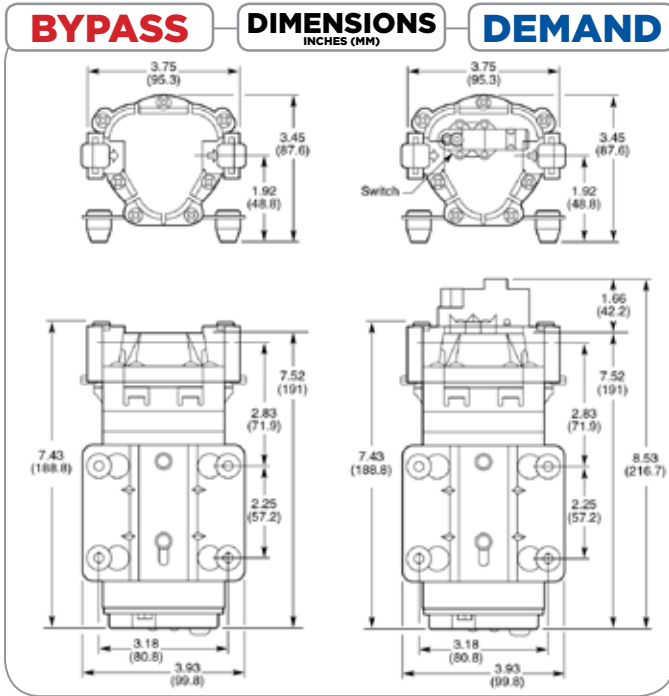

PART#	OEM#	DESCRIPTION	PORT SIZE	MAX GPM	MAX PSI
90.780.230	7812-301	PUMP, DELAVAN 7812-301, 12V, DEMAND	3/8" FNPT	2.0	60
90.780.121	7812-104	PUMP, DELAVAN 7812-104, 115V, DEMAND	3/8" FNPT	2.0	60
90.781.111	7812-111	PUMP, DELAVAN 7812-111, 12V, BYPASS	3/8" FNPT	2.0	60
90.780.122	7812-114	PUMP, DELAVAN 7812-114, 115V, BYPASS	3/8" FNPT	2.0	60

MOTOR

TYPE	12 VDC, PERMANENT MAGNET, TOTALLY ENCLOSED, NON-VENTILATED
LEADS	14 AWG, 12" LONG
DUTY CYCLE	SEE HEAT RISE GRAPH
TEMPERATURE LIMITS	MOTOR IS NOT EQUIPPED WITH THERMAL PROTECTION. FOR USER SAFETY, OPTIMAL PERFORMANCE, AND MAXIMUM MOTOR LIFE, THE MOTOR SURFACE TEMPERATURE SHOULD NOT EXCEED 150°F (66°C) (SEE HEAT RISE GRAPHS).

PUMP

TYPE	3 CHAMBER POSITIVE DISPLACEMENT DIAPHRAGM PUMP, SELF PRIMING, CAPABLE OF BEING RUN DRY, DEMAND OR BYPASS MODEL.
LIQUID TEMPERATURE	140°F (60°C) MAX.
PRIMING CAPABILITIES	14 FEET (4 M)

MATERIALS OF CONSTRUCTION

PUMP HOUSING	POLYPROPYLENE
VALVES	VITON
DIAPHRAGM	SANTOPRENE
FASTENERS	STAINLESS STEEL
MOTOR SHELL	COATED STEEL

HEAT RISE

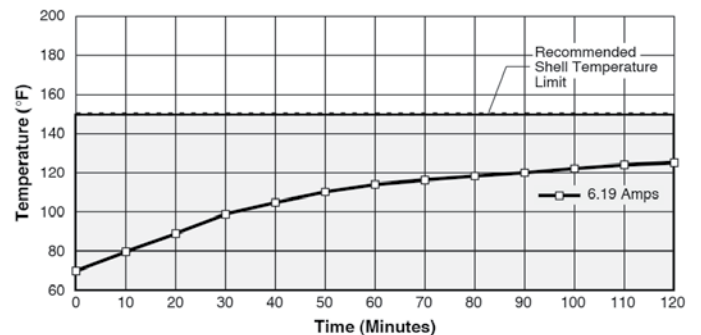

PERFORMANCE

PRESSURE / FLOW / AMP DRAW

PSI	GPM	AMPS
10	2.00	2.8
20	1.70	3.7
30	1.60	4.2
40	1.55	4.7
50	1.25	5.2
60	1.05	5.7

PowerFLO™ 5800 SERIES



DELANVAN™ PowerFLO

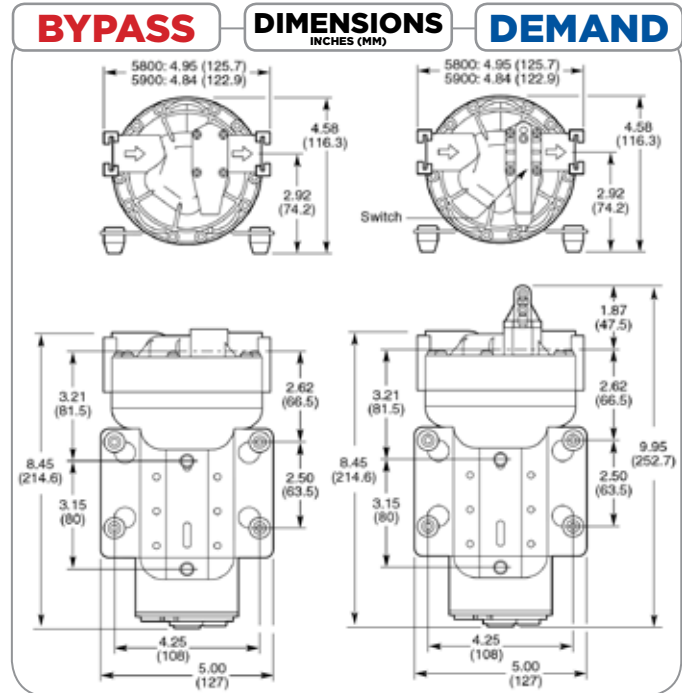

PART#	OEM#	DESCRIPTION	PORT SIZE	MAX GPM	MAX PSI
90.583.301	5830-301C	PUMP, DELAVAN 5830-301C, 12V, DEMAND	½" FNPT	3.0	45
90.583.104	5830-104C	PUMP, DELAVAN 5830-104C, 115V, DEMAND	½" FNPT	3.0	45
90.583.111	5830-111E	PUMP, DELAVAN 5830-111E, 12V, BYPASS	½" FNPT	3.0	60
90.585.101	5850-201C	PUMP, DELAVAN 5850-201C, 12V, DEMAND	½" FNPT	5.0	45
90.585.104	5850-104C	PUMP, DELAVAN 5850-104C, 115V, DEMAND	½" FNPT	5.0	45
90.585.111	5850-111E	PUMP, DELAVAN 5850-111E, 12V, BYPASS	½" FNPT	5.0	60

MOTOR

TYPE	12 VDC, PERMANENT MAGNET, TOTALLY ENCLOSED, NON-VENTILATED
LEADS	14 AWG, 12" LONG
DUTY CYCLE	SEE HEAT RISE GRAPH
TEMPERATURE LIMITS	MOTOR IS NOT EQUIPPED WITH THERMAL PROTECTION. FOR USER SAFETY, OPTIMAL PERFORMANCE, AND MAXIMUM MOTOR LIFE, THE MOTOR SURFACE TEMPERATURE SHOULD NOT EXCEED 180°F (82°C) (SEE HEAT RISE GRAPHS).

PUMP

TYPE	5 CHAMBER POSITIVE DISPLACEMENT DIAPHRAGM PUMP, SELF PRIMING, CAPABLE OF BEING RUN DRY, DEMAND OR BYPASS MODE
LIQUID TEMPERATURE	140°F (60°C) MAX.
PRIMING CAPABILITIES	14 FEET (4 M)

MATERIALS OF CONSTRUCTION

PUMP HOUSING	POLYPROPYLENE
VALVES	VITON
DIAPHRAGM	SANTOPRENE
FASTENERS	STAINLESS STEEL AND ZINC PLATED

HEAT RISE

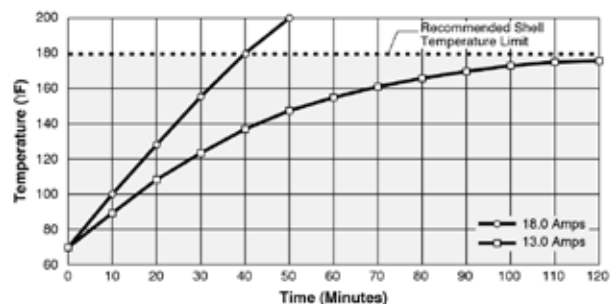

PERFORMANCE

PRESSURE / FLOW / AMP DRAW

5930 - 3 GPM			5850 - 5 GPM		
PSI	GPM	AMPS	PSI	GPM	AMPS
0	3.50	4.0	0	5.80	5.10
10	3.20	3.50	10	5.00	6.00
20	2.80	5.80	20	4.50	9.00
30	2.65	7.20	30	4.10	7.20
40	2.45	8.30	40	3.80	13.00
50	2.20	9.10	50	3.30	14.50
60	2.00	9.90	60	3.00	16.30

PowerFLO™ FB2 SERIES

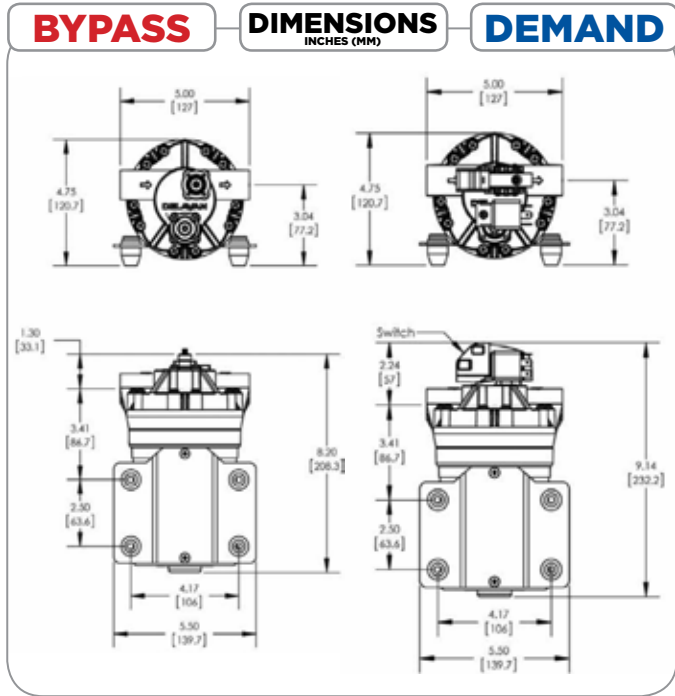

PART#	OEM#	DESCRIPTION	PORT SIZE	MAX GPM	MAX PSI
90.787.101	7870-101E	PUMP, "DEL 12V 7.0@60 DEM	1/2" FNPT	7.0	60
90.787.101Y	7870-101Y	PUMP, "DEL 12V 7.0@100 DEM	1/2" FNPT	7.0	100
90.787.111	7870-111Y	PUMP, "DEL 12V 7.0 /100 BYPASS	1/2" FNPT	7.0	100

MOTOR

TYPE	12 VDC PERMANENT MAGNET, TOTALLY ENCLOSED, NON-VENTILATED
LEADS	12 AWG, 12" LONG
DUTY CYCLE	INTERMITTENT
TEMPERATURE LIMITS	TEMPERATURE LIMITS: MOTOR IS NOT EQUIPPED WITH THERMAL PROTECTION. FOR USER SAFETY, OPTIMAL PERFORMANCE, AND MAXIMUM MOTOR LIFE, THE MOTOR SURFACE TEMPERATURE SHOULD NOT EXCEED 180°F (82°C).

PUMP

TYPE	5 CHAMBER POSITIVE DISPLACEMENT DIAPHRAGM PUMP, SELF PRIMING, CAPABLE OF BEING RUN DRY, DEMAND OR BYPASS MODE
LIQUID TEMPERATURE	140°F (60°C) MAX.
PRIMING CAPABILITIES	14 FEET (4 M)

MATERIALS OF CONSTRUCTION

PUMP HOUSING	POLYPROPYLENE
VALVES	SANTOPRENE
DIAPHRAGM	SANTOPRENE
FASTENERS	STAINLESS STEEL
MOTOR SHELL	COATED STEEL

PERFORMANCE

PRESSURE / FLOW / AMP DRAW

PSI	GPM	AMPS
10	7.00	11.0
20	6.81	12.0
40	5.96	13.0
60	4.98	17.0
80	3.96	21.0
100	2.55	25.0

Everflo EF1000 SERIES



DIMENSIONS INCHES (MM)

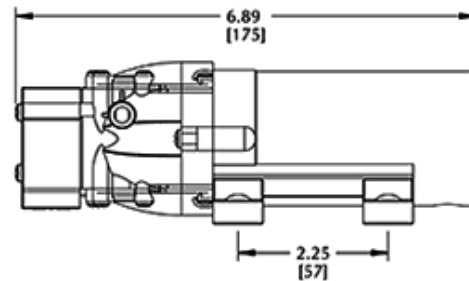
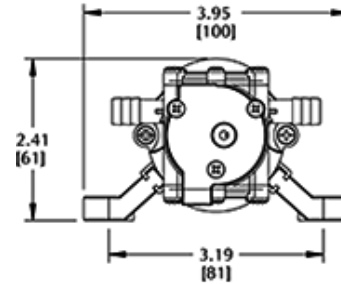

PART#	OEM#	DESCRIPTION	PORT SIZE	MAX GPM	MAX PSI
90.240.100	EF1000	PUMP, DEM 12V EF 1.0 GPM	3/8" HOSE BARB	1.0	40
90.240.100B	EF1000-BOX	PUMP, DEM 12V EF 1.0 GPM BOXED	3/8" HOSE BARB	1.0	40

SPECIFICATIONS

MAX PSI:	40
MAX GPM:	1.0
POWER SUPPLY:	12V
MAX AMPS:	4.0
SELF-PRIMING:	YES (UP TO 4')
PORTS:	3/8" HOSE BARB
MAX FLUID TEMP:	140 DEG F
WEIGHT:	1.3 LBS DRY

MATERIALS OF CONSTRUCTION

PUMP HOUSING:	POLYPOPYLENE
VALVES:	SANTOPRENE
DIAPHRAGM:	SANTOPRENE
FASTENERS:	ZINC PLATED STEEL
MOTOR SHELL:	POLYPOPYLENE

PERFORMANCE PRESSURE / FLOW / AMP DRAW

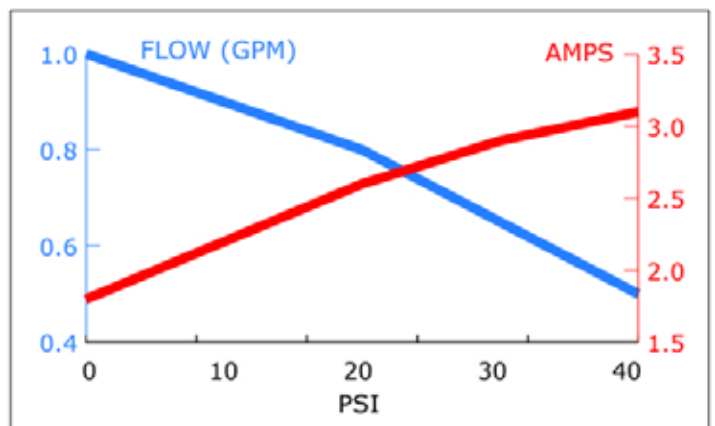

Everflo EF2200 SERIES

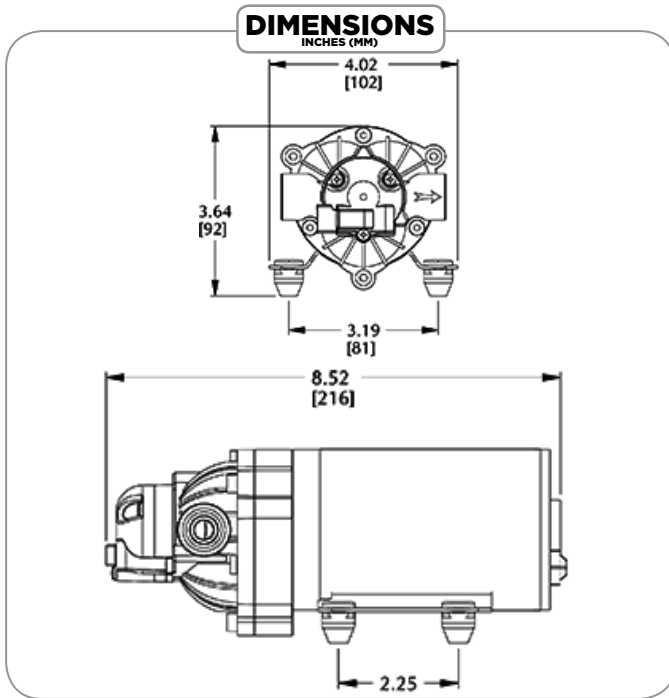

PART#	OEM#	DESCRIPTION	PORT SIZE	MAX GPM	MAX PSI
90.240.220	EF2200	PUMP, DEM 12V EF 2.2 GPM	3/8" NPT PORTS	2.2	70
90.240.220B	EF2200-BOX	PUMP, DEM 12V EF 2.2 GPM BOXED	3/8" NPT PORTS	2.2	70
90.241.220	EF2200-QA	PUMP, DEM 12V EF 2.2 GPM QA	QUICK ATTACH PORTS	2.2	70

SPECIFICATIONS

MAX PSI:	70
MAX GPM:	2.2
POWER SUPPLY:	12V
MAX AMPS:	8.0
SELF-PRIMING:	YES (UP TO 8')
PORTS:	3/8" FPT
MAX FLUID TEMP:	140 DEG F
WEIGHT:	4.8 LBS DRY

PERFORMANCE

PRESSURE / FLOW / AMP DRAW

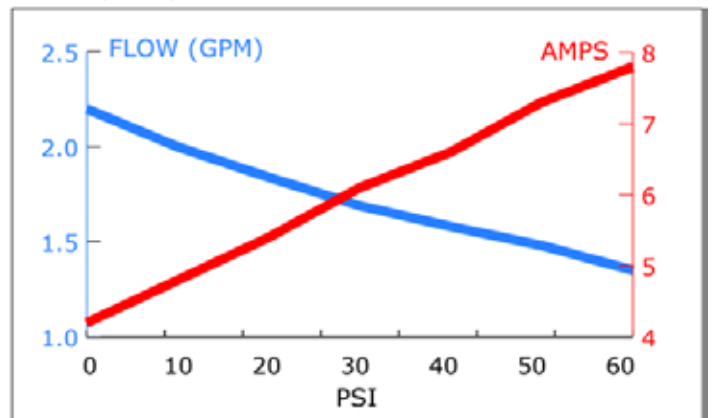

MATERIALS OF CONSTRUCTION

PUMP HOUSING:	POLYPROPYLENE
VALVES:	SANTOPRENE
DIAPHRAGM:	SANTOPRENE
FASTENERS:	ZINC PLATED STEEL
MOTOR SHELL:	POLYPROPYLENE

Everflo EF3000 SERIES

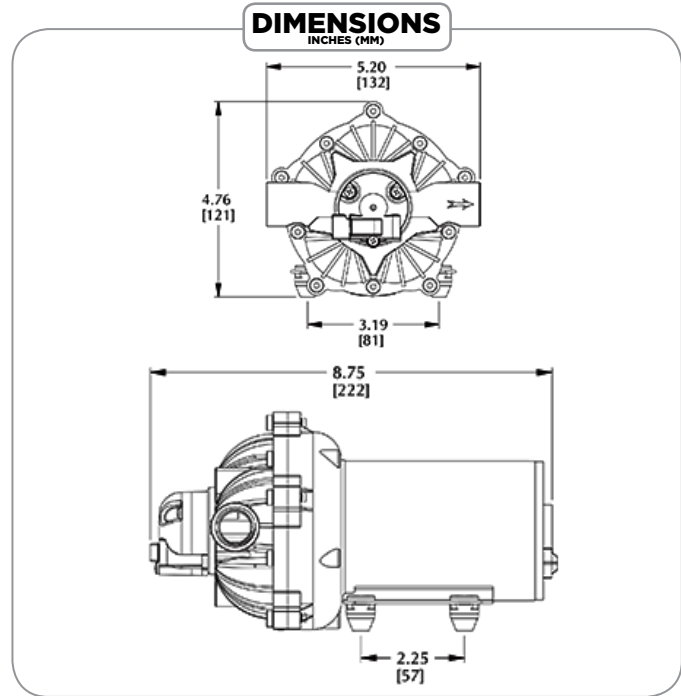

PART#	OEM#	DESCRIPTION	PORT SIZE	MAX GPM	MAX PSI
90.240.300	EF3000	PUMP, DEM 12V EF 3.0 GPM	1/2" FPT	3.0	60
90.240.300B	EF3000-BOX	PUMP, DEM 12V EF 3.0 GPM BOXED	1/2" FPT	3.0	60

SPECIFICATIONS

MAX PSI:	60
MAX GPM:	3.0
POWER SUPPLY:	12V
MAX AMPS:	10.0
SELF-PRIMING:	YES (UP TO 8')
PORTS:	1/2" FPT
MAX FLUID TEMP:	140 DEG F
WEIGHT:	5.6 LBS DRY

MATERIALS OF CONSTRUCTION

PUMP HOUSING:	POLYPROPYLENE
VALVES:	SANTOPRENE
DIAPHRAGM:	SANTOPRENE
FASTENERS:	ZINC PLATED STEEL
MOTOR SHELL:	POLYPROPYLENE

PERFORMANCE

PRESSURE / FLOW / AMP DRAW

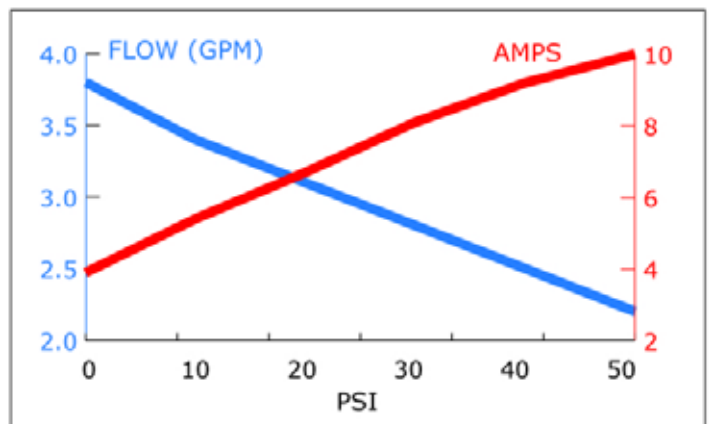

Everflo EF4000 SERIES

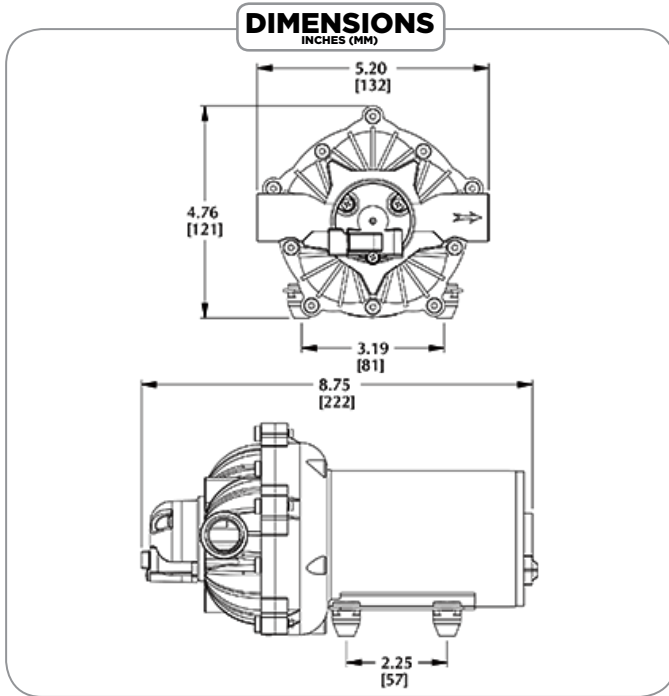

PART#	OEM#	DESCRIPTION	PORT SIZE	MAX GPM	MAX PSI
90.240.400	EF4000	PUMP, DEM 12V EF 4.0 GPM	1/2" FPT	4.0	60
90.240.400B	EF4000-BOX	PUMP, DEM 12V EF 4.0 GPM BOXED	1/2" FPT	4.0	60

SPECIFICATIONS

MAX PSI:	60
MAX GPM:	4.0
POWER SUPPLY:	12V
MAX AMPS:	13.0
SELF-PRIMING:	YES (UP TO 8')
PORTS:	1/2" FPT
MAX FLUID TEMP:	140 DEG F
WEIGHT:	5.6 LBS DRY

MATERIALS OF CONSTRUCTION

PUMP HOUSING:	POLYPROPYLENE
VALVES:	SANTOPRENE
DIAPHRAGM:	SANTOPRENE
FASTENERS:	ZINC PLATED STEEL
MOTOR SHELL:	POLYPROPYLENE

PERFORMANCE

PRESSURE / FLOW / AMP DRAW

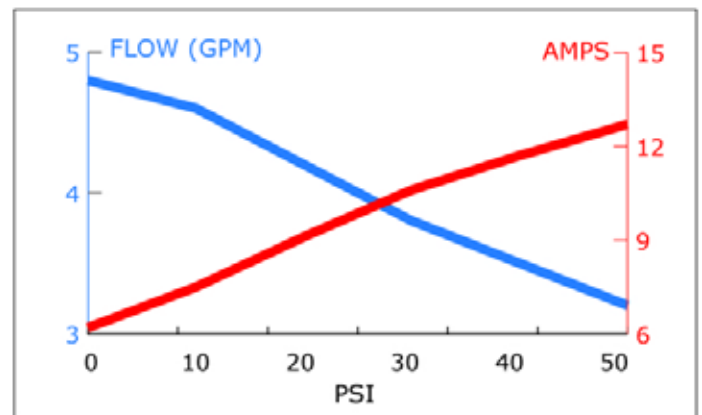

Everflo EF5500 SERIES

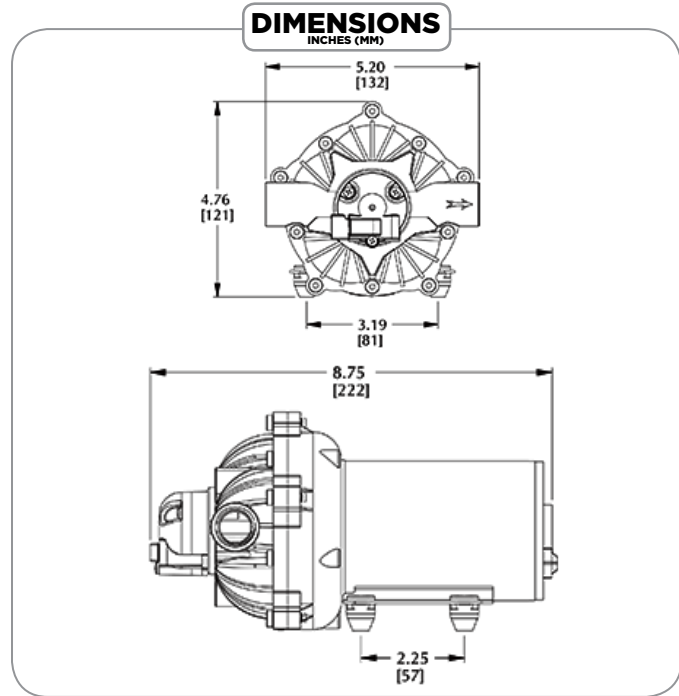

PART#	OEM#	DESCRIPTION	PORT SIZE	MAX GPM	MAX PSI
90.240.550	EF5500	PUMP, DEM 12V EF 5.5 GPM	1/2" FPT	5.5	60
90.240.550B	EF5500-BOX	PUMP, DEM 12V EF 5.5 GPM BOXED	1/2" FPT	5.5	60

SPECIFICATIONS

MAX PSI:	60
MAX GPM:	5.5
POWER SUPPLY:	12V
MAX AMPS:	17.0
SELF-PRIMING:	YES (UP TO 8')
PORTS:	1/2" FPT
MAX FLUID TEMP:	140 DEG F
WEIGHT:	5.6 LBS DRY

MATERIALS OF CONSTRUCTION

PUMP HOUSING:	POLYPROPYLENE
VALVES:	SANTOPRENE
DIAPHRAGM:	SANTOPRENE
FASTENERS:	ZINC PLATED STEEL
MOTOR SHELL:	POLYPROPYLENE

PERFORMANCE

PRESSURE / FLOW / AMP DRAW

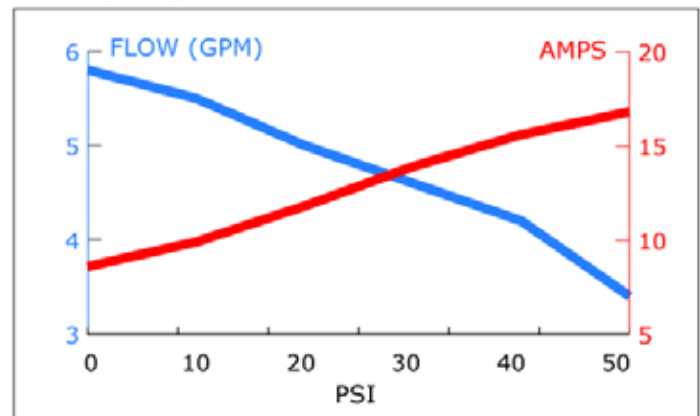

BE 1000 SERIES

90.220.202

DESCRIPTION	PUMP, DEM 12V BE 1.0 GPM
PORT SIZE	3/8" HOSE BARB

SPECIFICATIONS

MAX PSI:	40
MAX GPM:	1.0
POWER SUPPLY:	12V
MAX AMPS:	4.0
SELF-PRIMING:	YES (UP TO 4')
PORTS:	3/8" HOSE BARB
MAX FLUID TEMP:	140 DEG F
WEIGHT:	1.3 LBS DRY

MATERIALS OF CONSTRUCTION

HOUSING	POLYPROPYLENE
VALVES	VITON, POLYPROPYLENE
DIAPHRAGM	SANTOPRENE



COMES FULLY
BOXED



SHURflo® 8000 SERIES

90.543.936

OEM #	8000-543-936
DESCRIPTION	12 VDC DIAPHRAGM PUMP AUTOMATIC DEMAND PUMP W/WIRE HARNESS
FLOW	1.8 GPM (OPEN FLOW)
PRESSURE	150 PSI (10.3 BAR)
AMPS	SEE PERFORMANCE CHART
WEIGHT	
ADDITIONAL INFORMATION	

PERFORMANCE

PRESSURE / FLOW / AMP DRAW

PSI	BAR	GPM	LPM	AMPS
20	1.4	1.26	4.7	5.0
40	2.8	1.14	4.3	6.2
60	4.1	1.02	3.9	7.3

PUMP

TYPE	3 CHAMBER POSITIVE REPLACEMENT DIAPHRAGM PUMP
TEMPERATURE	170°F [76°C]
PRIMING CAPABILITIES	SELF PRIMING UP TO 8 VERTICAL FEET (2.4M)
PRESSURE DEMAND SWITCH	60 PSI DEMAND SWITCH
INLET/OUTLET PORTS	3/8" NPT FEMALE PORTS



SHURflo
First in Fluid Innovation

MATERIALS OF CONSTRUCTION

HOUSING	POLYPOPYLENE
VALVES	VITON
DIAPHRAGM	SANTOPRENE

RollerPRO™ 4900 SERIES



DELAN™ **RollerPRO**
4900 SERIES
Roller Pump

DIMENSIONS

INCHES (MM)

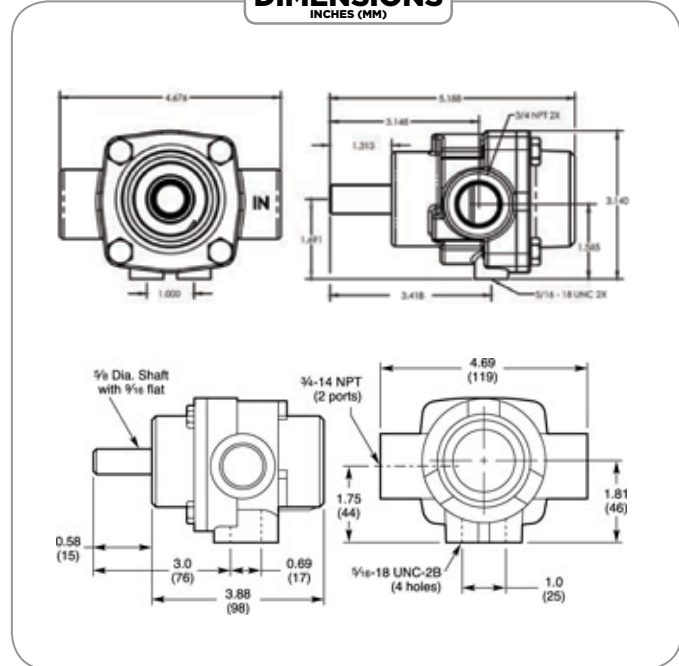

PART#	DESCRIPTION	PORT SIZE	MAX GPM	MAX PSI
4900C	CAST IRON 5/8" SOLID SHAFT, CW ROTATION	3/4" NPT (FEMALE)	9.2	150
4900DSS	STAINLESS STEEL DIAMOND SERIES™ 5/8" SOLID SHAFT, CW ROTATION	3/4" NPT (FEMALE)	9.2	150
4901C	CAST IRON 1/2" HOLLOW SHAFT, CW ROTATION	3/4" NPT (FEMALE)	9.2	150
4901DSS	STAINLESS STEEL DIAMOND SERIES™ 1/2" HOLLOW SHAFT, CW ROTATION	3/4" NPT (FEMALE)	9.2	150

PUMP

TYPE	4-ROLLER DESIGN
MAX PRESSURE	150 PSI (10.5 BAR)
TEMPERATURE	140°F (60°C)
PORT SIZE	3/4" NPT (FEMALE)
MOUNTING	BASE MOUNTED: 5/16 - 18 UNC-2B (2 HOLES)
PTO	USE TORQUE BAR AND CHAIN
SHAFT	SIZE: 4900: 5/8" SOLID SHAFT 4901: 1/2" HOLLOW SHAFT ROTATION: CW (STANDARD) (SHAFT ROTATION IS DETERMINED WHEN LOOKING AT SHAFT END OF PUMP)
WEIGHT	5 LBS (11 KG)

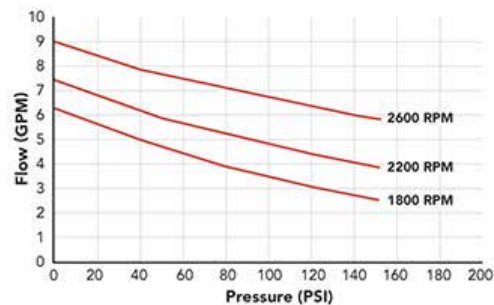

MATERIALS OF CONSTRUCTION

HOUSING	CAST IRON OR DIAMOND SERIES™ STAINLESS STEEL
ROLLERS	1/2" ULTRA ROLLERS (STANDARD) POLYPROPYLENE (OPTIONAL)
SHAFT SEALS	VITON CARTRIDGE TYPE LIP SEALS
SEAL RING	VITON
SHAFT & ROTOR	CAST IRON: EXTRA-FINE FINISH 404 SST DIAMOND SERIES™ STAINLESS STEEL: EXTRA-FINE FINISH 416 SST
BEARINGS	PERMANENTLY-LUBRICATED, HEAVY-DUTY SEALED BEARINGS

PERFORMANCE

PRESSURE / FLOW / AMP DRAW

PSI	1800 RPM	2200 RPM	2600 RPM
0	6.3	7.7	9.2
20	5.8	6.9	8.5
40	5.0	6.2	7.9
60	4.4	5.6	7.5
80	3.8	5.2	7.2
100	3.4	4.8	6.8

RollerPRO™ 6900 SERIES

DIMENSIONS INCHES (MM)

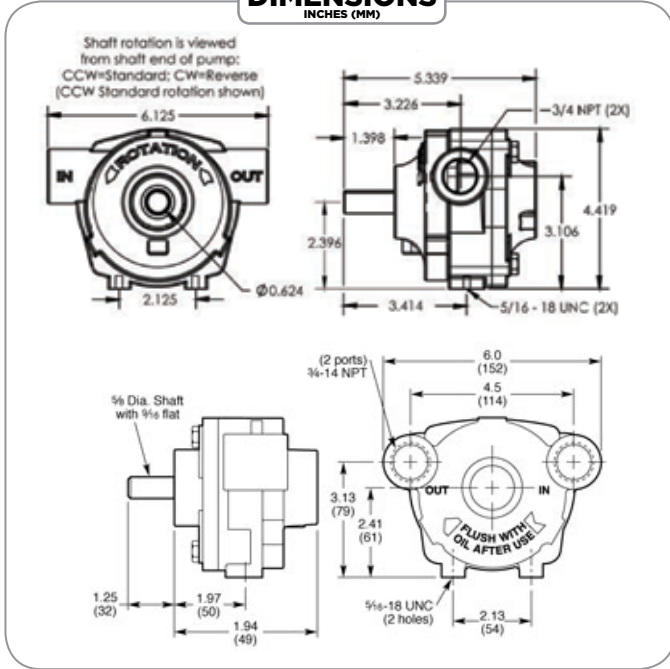

PART#	DESCRIPTION	PORT SIZE	MAX GPM	MAX PSI
6900DSS	STAINLESS STEEL DIAMOND SERIES™ 5/8" SOLID SHAFT, CCW ROTATION	3/4" NPT (FEMALE)	19.6	300
6900DSS-R	STAINLESS STEEL DIAMOND SERIES™ 5/8" SOLID SHAFT, CW/REVERSE ROTATION	3/4" NPT (FEMALE)	19.6	300
6901C	CAST IRON 5/8" SOLID SHAFT, CCW ROTATION, REAR PRT	3/4" NPT (FEMALE)	19.6	300
DPK-6900C	CAST IRON 5/8" SOLID SHAFT, CCW ROTATION PUMP WITH #90200 COUPLER AND TORQUE ARM KIT	3/4" NPT (FEMALE)	19.6	300
DPK-6900DSS	STAINLESS STEEL DIAMOND SERIES™ PUMP WITH #90200 COUPLER AND TORQUE ARM KIT	3/4" NPT (FEMALE)	19.6	300
6900C	CAST IRON 5/8" SOLID SHAFT, CCW ROTATION	3/4" NPT (FEMALE)	19.6	300
6900C-R	CAST IRON 5/8" SOLID SHAFT, CW/REVERSE ROTATION	3/4" NPT (FEMALE)	19.6	300

PUMP

TYPE	6-ROLLER DESIGN
MAX PRESSURE	300 PSI (21 BAR)
TEMPERATURE	140°F (60°C)
PORT SIZE	3/4" NPT (FEMALE) 6900: SIDE PORTS 6901C: REAR PORTS – NON FIELD SERVICEABLE
MOUNTING PTO	BASE MOUNTED: 5/16 - 18 UNC-2B (2 HOLES) USE TORQUE BAR AND CHAIN
SHAFT	SIZE: 5/8" SOLID SHAFT ROTATION: CCW (STANDARD); CW (OPTIONAL) (SHAFT ROTATION IS DETERMINED WHEN LOOKING AT SHAFT END OF PUMP)
WEIGHT	9 LBS (19.8 KG)

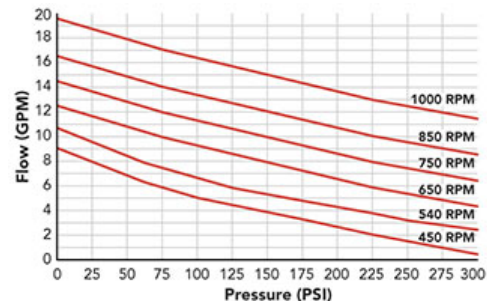

MATERIALS OF CONSTRUCTION

HOUSING	CAST IRON OR DIAMOND SERIES™ STAINLESS STEEL
ROLLERS	3/4" ULTRA ROLLERS (STANDARD) POLYPROPYLENE (OPTIONAL) 6900 SERIES: 3/4" ULTRA ROLLERS (STANDARD) 6901C: 3/4" ULTRA ROLLERS (STANDARD)
SHAFT SEALS	VITON CARTRIDGE TYPE LIP SEALS
SEAL RING	VITON
SHAFT & ROTOR	CAST IRON: EXTRA-FINE FINISH 404 SST. DIAMOND SERIES™ STAINLESS STEEL: EXTRA-FINE FINISH 416 SST
BEARINGS	PERMANENTLY-LUBRICATED, HEAVY-DUTY SEALED BEARINGS

PERFORMANCE

PRESSURE / FLOW / AMP DRAW

PSI	1800 RPM	2200 RPM	2600 RPM
0	6.3	7.7	9.2
20	5.8	6.9	8.5
40	5.0	6.2	7.9
60	4.4	5.6	7.5
80	3.8	5.2	7.2
100	3.4	4.8	6.8

ALL MEASUREMENTS ARE IN MILLIMETERS UNLESS OTHERWISE STATED (1" = 25.4 MM).
THESE ITEMS ARE NOT ORIGINAL EQUIPMENT PARTS.

RollerPRO™ 7900 SERIES



DEHAVAN™ *RollerPRO*
7900 SERIES Roller Pumps

DIMENSIONS INCHES (MM)

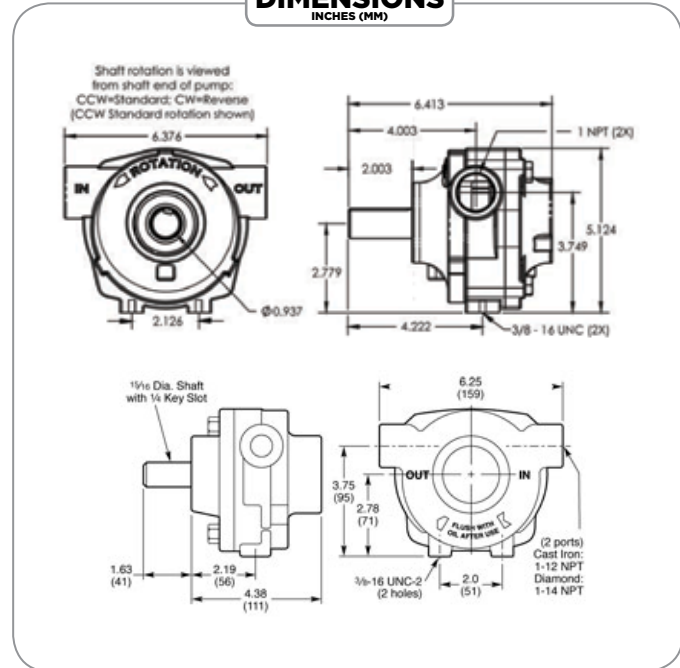

PART#	DESCRIPTION	PORT SIZE	MAX GPM	MAX PSI
7900C	CAST IRON 15/16" SOLID SHAFT, CCW ROTATION	1" NPT (FEMALE)	22.5	200
7900C-R	CAST IRON 15/16" SOLID SHAFT, CW/REVERSE ROTATION	1" NPT (FEMALE)	22.5	200
7900DSS	STAINLESS STEEL DIAMOND SERIES™ 15/16" SOLID SHAFT, CCW ROTATION	1" NPT (FEMALE)	22.5	200
7900DSS-R	STAINLESS STEEL DIAMOND SERIES™ 15/16" SOLID SHAFT, CW/REVERSE ROTATION	1" NPT (FEMALE)	22.5	200

PUMP

TYPE	7-ROLLER DESIGN
MAX PRESSURE	200 PSI (14 BAR)
TEMPERATURE	140°F (60°C)
PORT SIZE	1" NPT (FEMALE)
MOUNTING	BASE MOUNTED: 3/8" -18 UNC-2B (2 HOLES)
PTO	USE TORQUE BAR AND CHAIN
SHAFT	SIZE: 15/16" SOLID SHAFT ROTATION: CCW (STANDARD); CW (OPTIONAL) (SHAFT ROTATION IS DETERMINED WHEN LOOKING AT SHAFT END OF PUMP)
WEIGHT	14 LBS (30.8 KG)

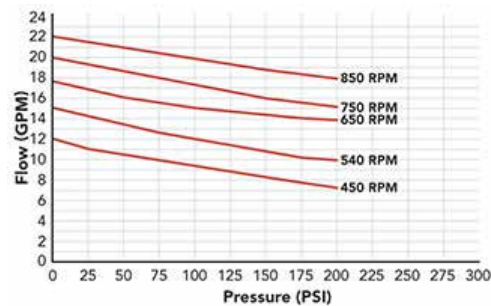

MATERIALS OF CONSTRUCTION

PUMP HOUSING	CAST IRON OR DIAMOND SERIES™ STAINLESS STEEL
ROLLERS	3/4" ULTRA ROLLERS (STANDARD) POLYPROPYLENE (OPTIONAL)
SHAFT SEALS	VITON CARTRIDGE TYPE LIP SEALS
SEAL RING	VITON
SHAFT & ROTOR	CAST IRON: EXTRA-FINE FINISH 404 SST DIAMOND SERIES™ STAINLESS STEEL: EXTRA-FINE FINISH 416 SST
BEARINGS	PERMANENTLY-LUBRICATED, HEAVY-DUTY SEALED BEARINGS

PERFORMANCE

PRESSURE / FLOW / AMP DRAW

PSI	540 RPM	650 RPM	850 RPM
0	15.2	17.7	22.5
20	14.5	17.0	21.8
40	13.6	16.2	21.0
100	12.0	15.0	20.0
200	10.0	13.9	18.0

RollerPRO™ 8900 SERIES

DIMENSIONS INCHES (MM)

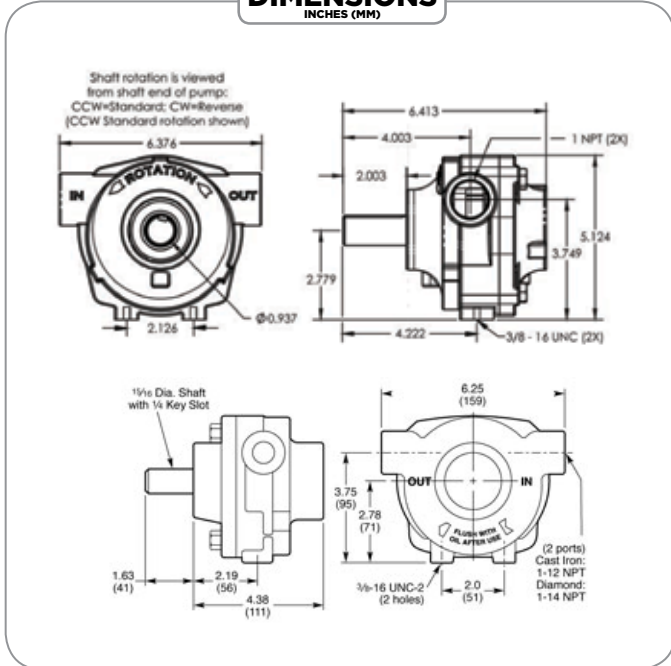

PART#	DESCRIPTION	PORT SIZE	MAX GPM	MAX PSI
8900C-R	CAST IRON 15/16" SOLID SHAFT, CW/REVERSE ROTATION	1" NPT (FEMALE)	24	150
8900DSS	STAINLESS STEEL DIAMOND SERIES™ 15/16" SOLID SHAFT, CCW ROTATION	1" NPT (FEMALE)	24	150
8900DSS-R	STAINLESS STEEL DIAMOND SERIES™ 15/16" SOLID SHAFT, CW/REVERSE ROTATION	1" NPT (FEMALE)	24	150
DPK-8900C	CAST IRON 15/16" SOLID SHAFT, CCW ROTATION PUMP WITH #90300 COUPLER AND TORQUE ARM KIT	1" NPT (FEMALE)	24	150
DPK-8900DSS	STAINLESS STEEL DIAMOND SERIES™ PUMP WITH #90300 COUPLER AND TORQUE ARM KIT	1" NPT (FEMALE)	24	150
8900C	CAST IRON 15/16" SOLID SHAFT, CCW ROTATION	1" NPT (FEMALE)	24	150

PUMP

TYPE	8-ROLLER DESIGN
MAX PRESSURE	150 PSI (10.5 BAR)
TEMPERATURE	140°F (60°C)
PORT SIZE	1" NPT (FEMALE)
MOUNTING	BASE MOUNTED: 3/8 - 18 UNC-2B (2 HOLES)
PTO	USE TORQUE BAR AND CHAIN
SHAFT	SIZE: 15/16" SOLID SHAFT ROTATION: CCW (STANDARD); CW (OPTIONAL) (SHAFT ROTATION IS DETERMINED WHEN LOOKING AT SHAFT END OF PUMP)
WEIGHT	14 LBS (30.8 KG)

MATERIALS OF CONSTRUCTION

PUMP HOUSING	CAST IRON OR DIAMOND SERIES™ STAINLESS STEEL
ROLLERS	3/4" ULTRA ROLLERS (STANDARD) POLYPROPYLENE (OPTIONAL)
SHAFT SEALS	VITON CARTRIDGE TYPE LIP SEALS
SEAL RING	VITON
SHAFT & ROTOR	CAST IRON: EXTRA-FINE FINISH 404 SST DIAMOND SERIES™ STAINLESS STEEL: EXTRA-FINE FINISH 416 SST
BEARINGS	PERMANENTLY-LUBRICATED, HEAVY-DUTY SEALED BEARINGS

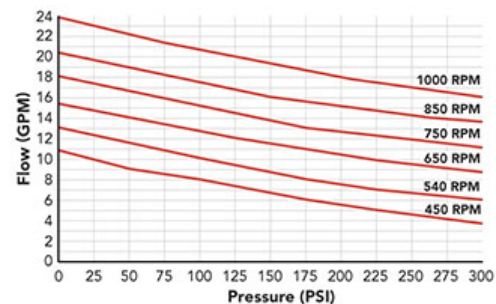

PERFORMANCE

PRESSURE / FLOW / AMP DRAW

PSI	540 RPM	850 RPM	1000 RPM
0	13.0	20.2	24.0
20	12.4	19.8	23.2
40	11.6	19.1	22.4
100	10.6	18.6	21.8
200	8.9	15.7	18.0
300	7.0	14.0	17.1

DELVAN ROLLER PUMP ACCESSORIES

PART#	SERIES	DESCRIPTION
33680	4400, 5500, 6600, 7700, 8800	TORQUE BAR & CHAIN. REQUIRED TO ANCHOR PTO-MOUNTED PUMPS IN ORDER TO KEEP PUMP FROM ROTATING WITH THE SHAFT.
50101	4400	COUPLER FOR 5/8" DIAM ELECTRIC MOTOR OR GAS ENGINE SHAFTS. 2600 RPM MAX OPERATING SPEED, MILD STEEL WITH SET SCREWS.
46814-3	7700, 8800	COUPLER, 1 3/8" DIA. PTO, 15/16" PUMP SHAFT, DUAL SPEED 540-1000 RPM, CORROSION RESISTANT CAST ALUMINUM, NYLON COLLAR.
46814-1	6600	COUPLER, 1 3/8" DIA. PTO, 5/8" PUMP SHAFT, DUAL SPEED 540-1000 RPM, CORROSION RESISTANT CAST ALUMINUM, NYLON COLLAR.
35735	5500, 7700, 8800	COUPLER, 1 3/8" DIA. PTO, 15/16" PUMP SHAFT, 540 RPM, FORGED STEEL BODY, NYLON COLLAR.
35979	5500, 8800	COUPLER, 1 3/8" DIA. PTO, 15/16" PUMP SHAFT, 1000 RPM, FORGED STEEL BODY, NYLON COLLAR.
90800	5500, 8800	COUPLER, 1 3/4" DIA. PTO, 15/16" PUMP SHAFT, 1000 RPM, FORGED STEEL BODY, NYLON COLLAR.

AGITATORS



PART# 163.1.2

MATERIAL	BRASS
NOZZLE	1.5MM TUNGSTEN CARBIDE
COUPLER	1/2" HOSE BARB



PART# 8201005

NOZZLE	1 1/2 MM CERAMIC
REPLACEMENT PARTS	
0604.18	REPLACEMENT NUT

INLINE - MESH FILTERS

PART#	INLET/OUTLET FILTER	GPM	PSI
8105001	1/2" NPT 50 MESH SCREEN ONLY 50 MESH FILTER C00100001	20	290
8105005	3/4" NPT 50 MESH SCREEN ONLY 50 MESH FILTER C00100001	26	290
8105009	1" NPT 50 MESH SCREEN ONLY 50 MESH FILTER C00100005	39	290
REPLACEMENT PARTS			
390291	O-RING FOR 8105001, 8105005, 8105009		



PART#	FILTER	GPM	PSI
8121001	1 1/4" 50 MESH SCREEN ONLY 50 MESH FILTER C00100033	52	220
8121005	1 1/2" 50 MESH	73	220



SUCTION FILTERS WITH VALVES



PART#	FILTER
8091001	2" SUCTION 50 MESH
8092001	2" SUCTION 50 MESH WITH SHUT OFF
ADDITIONAL INFORMATION	
SCREEN ONLY 50 MESH FILTER C00100009.	
SCREEN ONLY 32 MESH FILTER C00100008.	
SCREEN ONLY 16 MESH FILTER C00100056.	
REPLACEMENT PARTS	
316000.050	REPLACEMENT O-RING, BODY
116740-1	90° BARB KIT WITH 2" NUT



PART#	FILTER
125.503.1	1 1/2", 46 MESH FILTER
ADDITIONAL INFORMATION	
INLINE POLYPROPYLENE STRAINER, EXTERNAL MALE PIPE FITTINGS, FOR BOOM AND AIR BLAST SPRAYERS. AUTO SHUT OFF VALVE ALLOWS FILTER CLEANING WHILE TANK IS FULL.	
REPLACEMENT PARTS	
016-C857	REPLACEMENT BOWL
125.203.14	REPLACEMENT 50 MESH SCREEN
26.892.057	REPLACEMENT O-RING



PART#	FILTER
8078001	1 1/4" SUCTION, 50 MESH, SHUT OFF, FITS FLORIDA NAZA 300/400
8082001	1 1/2" SUCTION, 50 MESH, SHUT OFF, FITS FLORIDA PLN SPRAYER
8080001	1 1/2" SUCTION, 50 MESH, SHUT-OFF, FITS FLORIDA NAZA 500/600/800
REPLACEMENT PARTS	
1040060	REPLACEMENT O-RING
C00100012	REPLACEMENT 50 MESH SCREEN FOR 8082001

LOW PROFILE MPT STRAINERS

NYLON LOW PROFILE MPT STRAINERS

NYLON BOWL			
PART#	SIZE	GASKET	MESH
14644	1/4"	EPDM	20
11474	1/4"	EPDM	40
12992	1/4"	EPDM	80
17933	1/4"	VITON	20
11215	1/4"	VITON	40
11043	1/4"	VITON	80
17934	1/2"	EPDM	20
12546	1/2"	EPDM	40
12815	1/2"	EPDM	80
11109	1/2"	VITON	20
12171	1/2"	VITON	40
10923	1/2"	VITON	80

CLEAR BOWL			
PART#	SIZE	GASKET	MESH
14656	1/4"	EPDM	20
11633	1/4"	EPDM	40
11469	1/4"	EPDM	80
10910	1/4"	VITON	20
10911	1/4"	VITON	40
10912	1/4"	VITON	80
12379	1/2"	EPDM	20
11434	1/2"	EPDM	40
13090	1/2"	EPDM	80
10924	1/2"	VITON	20
10925	1/2"	VITON	40
10981	1/2"	VITON	80

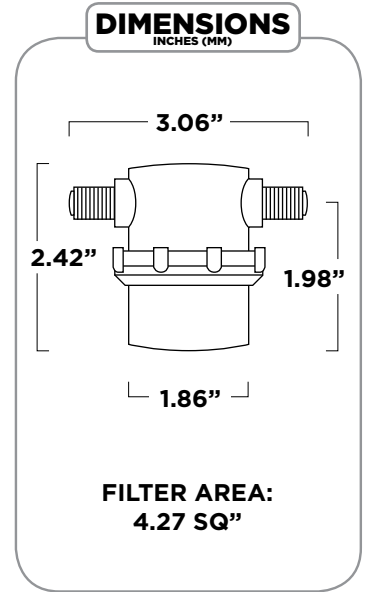

POLYPRO LOW PROFILE MPT STRAINERS

POLYPROPYLENE BOWL			
PART#	SIZE	GASKET	MESH
17912	1/4"	EPDM	20
11642	1/4"	EPDM	40
14591	1/4"	EPDM	80
17913	1/4"	VITON	20
13914	1/4"	VITON	40
13915	1/4"	VITON	80
17917	1/2"	EPDM	20
17918	1/2"	EPDM	40
17919	1/2"	EPDM	80
17920	1/2"	VITON	20
17921	1/2"	VITON	40
17922	1/2"	VITON	80

CLEAR BOWL			
PART#	SIZE	GASKET	MESH
14628	1/4"	EPDM	20
14629	1/4"	EPDM	40
14630	1/4"	EPDM	80
17916	1/4"	VITON	20
12326	1/4"	VITON	40
12678	1/4"	VITON	80
14637	1/2"	EPDM	20
12250	1/2"	EPDM	40
12397	1/2"	EPDM	80
18456	1/2"	VITON	20
17923	1/2"	VITON	40
12410	1/2"	VITON	80

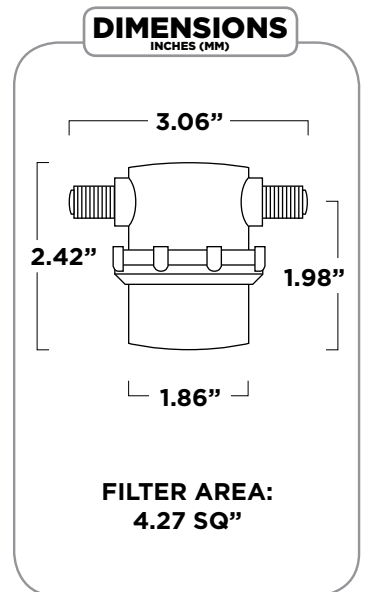

AVAILABLE UPON REQUEST! CALL FOR DETAILS!

STANDARD NYLON/POLYPRO FPT/NPT STRAINERS

STANDARD NYLON FPT STRAINERS

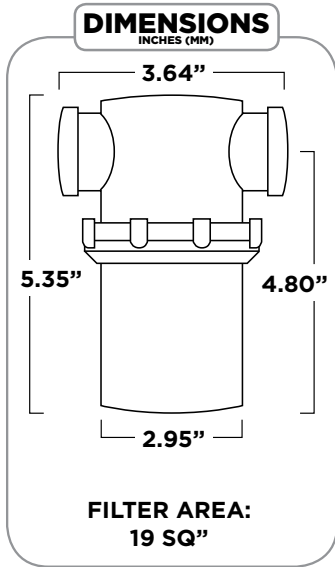

NYLON BOWL			
PART#	SIZE	GASKET	MESH
11407	1/2"	EPDM	40
11297	3/4"	EPDM	20
11298	3/4"	EPDM	40
11300	3/4"	EPDM	80
10962	3/4"	VITON	80

CLEAR BOWL			
PART#	SIZE	GASKET	MESH
17935	1/2"	EPDM	20
17936	1/2"	EPDM	40
12553	1/2"	EPDM	80
10949	1/2"	VITON	40
10946	1/2"	VITON	80
12460	3/4"	EPDM	20
11299	3/4"	EPDM	40
11301	3/4"	EPDM	80
10985	3/4"	VITON	40
10986	3/4"	VITON	80

AVAILABLE UPON REQUEST! CALL FOR DETAILS!

STANDARD POLYPRO NPT STRAINERS

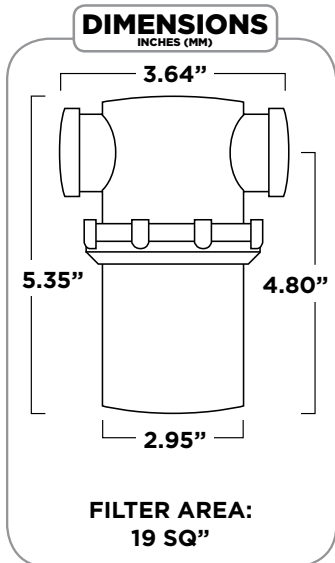

POLYPROPYLENE BOWL			
PART#	SIZE	GASKET	MESH
14577	1/2"	EPDM	20
11354	1/2"	EPDM	40
11385	1/2"	EPDM	80
12375	1/2"	VITON	40
17924	1/2"	VITON	80
11262	3/4"	EPDM	20
11263	3/4"	EPDM	40
11264	3/4"	EPDM	80
12573	3/4"	VITON	20
11376	3/4"	VITON	40
11277	3/4"	VITON	80

CLEAR BOWL			
PART#	SIZE	GASKET	MESH
14687	1/2"	EPDM	20
12356	1/2"	EPDM	40
14688	1/2"	EPDM	80
17925	1/2"	VITON	20
17926	1/2"	VITON	40
13752	1/2"	VITON	80
14689	3/4"	EPDM	20
12262	3/4"	EPDM	40
14466	3/4"	EPDM	80
17927	3/4"	VITON	20
17928	3/4"	VITON	40
14323	3/4"	VITON	80

AVAILABLE UPON REQUEST! CALL FOR DETAILS!

STANDARD NYLON/POLYPRO FPT/NPT STRAINERS

STANDARD NYLON FPT STRAINERS

NYLON BOWL				CLEAR BOWL			
PART#	SIZE	GASKET	MESH	PART#	SIZE	GASKET	MESH
11303	1"	EPDM	20	14674	1"	EPDM	20
11304	1"	EPDM	40	12165	1"	EPDM	40
11305	1"	EPDM	80	12324	1"	EPDM	80
10999	1"	VITON	20	11005	1"	VITON	20
11001	1"	VITON	40	11007	1"	VITON	40
11002	1"	VITON	80	11003	1"	VITON	80
17938	1¼"	EPDM	20	13716	1¼"	EPDM	20
11308	1¼"	EPDM	40	12166	1¼"	EPDM	40
11309	1¼"	EPDM	80	12430	1¼"	EPDM	80
11021	1¼"	VITON	20	11026	1¼"	VITON	20
11023	1¼"	VITON	40	11028	1¼"	VITON	40
11019	1¼"	VITON	80	11024	1¼"	VITON	80
17939	1½"	EPDM	20	11538	1½"	EPDM	20
11606	1½"	EPDM	40	12138	1½"	EPDM	40
11528	1½"	EPDM	80	12325	1½"	EPDM	80
11432	1½"	VITON	20	11145	1½"	VITON	20
11360	1½"	VITON	40	11054	1½"	VITON	40
11518	1½"	VITON	80	11186	1½"	VITON	80

AVAILABLE UPON REQUEST! CALL FOR DETAILS!

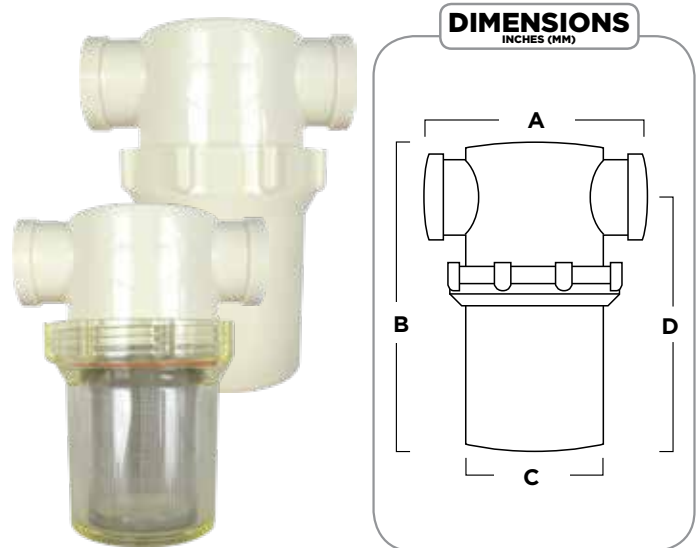

DIMENSIONS

SIZE	A	B	C	D	F.AREA
1"	4.62"	6.36"	4.00"	5.60"	33 SQ"
1¼"	5.00"	7.10"	4.00"	6.10"	36 SQ"
1½"	5.16"	8.10"	4.00"	6.93"	39 SQ"

STANDARD POLYPRO NPT STRAINERS

NYLON BOWL				CLEAR BOWL			
PART#	SIZE	GASKET	MESH	PART#	SIZE	GASKET	MESH
11265	1"	EPDM	20	12943	1"	EPDM	20
11266	1"	EPDM	40	12488	1"	EPDM	40
11267	1"	EPDM	80	12465	1"	EPDM	80
12338	1"	VITON	20	17929	1"	VITON	20
11378	1"	VITON	40	17930	1"	VITON	40
12336	1"	VITON	80	14915	1"	VITON	80
11268	1¼"	EPDM	20	13740	1¼"	EPDM	20
11269	1¼"	EPDM	40	12415	1¼"	EPDM	40
11270	1¼"	EPDM	80	12389	1¼"	EPDM	80
17637	1¼"	VITON	20	17741	1¼"	VITON	20
11379	1¼"	VITON	40	17931	1¼"	VITON	40
12337	1¼"	VITON	80	14916	1¼"	VITON	80
11271	1½"	EPDM	20	13850	1½"	EPDM	20
11272	1½"	EPDM	40	14460	1½"	EPDM	40
11273	1½"	EPDM	80	14464	1½"	EPDM	80
12572	1½"	VITON	20	17932	1½"	VITON	20
11380	1½"	VITON	40	13539	1½"	VITON	40
11381	1½"	VITON	80	13751	1½"	VITON	80

AVAILABLE UPON REQUEST! CALL FOR DETAILS!

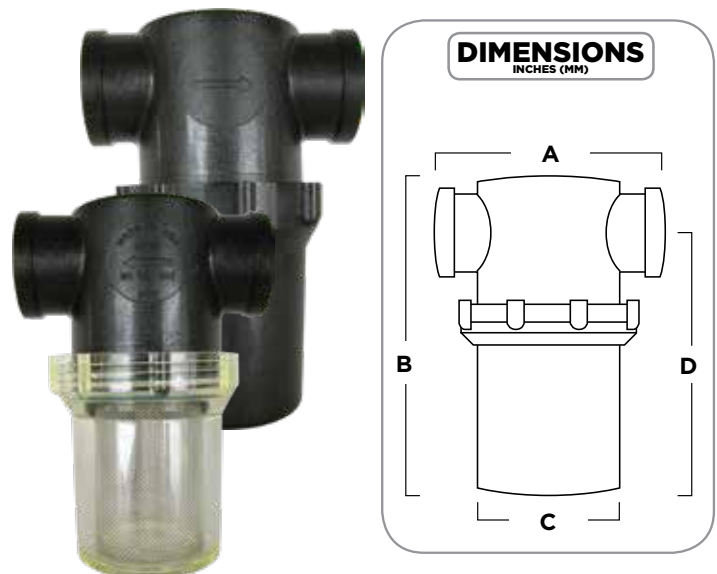

DIMENSIONS

SIZE	A	B	C	D	F.AREA
1"	4.62"	6.36"	4.00"	5.60"	33 SQ"
1¼"	5.00"	7.10"	4.00"	6.10"	36 SQ"
1½"	5.16"	8.10"	4.00"	6.93"	39 SQ"

**SPRAYER TANK LID**

PART#	90.700.030
DESCRIPTION	STANDARD ESTATE SPRAYER LID
SIZE	6" WITH BREATHER
HEIGHT	2.17"
WORKING WIDTH	6.00"
WIDTH	6.77"

90.700.301	EPDM GASKET
------------	-------------

**ANCHOR BRACKET**

PART#	TD200B
DESCRIPTION	2" TANK TIE DOWN ANCHOR BRACKET.
HOLE SIZE	7/16" HOLE

**BULKHEAD FITTINGS**

PART#	NPT	OPENING	GASKET
90.910.012	1/2"	1 3/4"	90.915.134
90.910.034	3/4"	1 3/4"	90.915.134
90.910.100	1"	2 1/8"	90.915.218
90.910.114	1-1/4"	2 5/8"	90.915.258
90.910.112	1-1/2"	2 5/8"	90.915.258
90.910.200	2"	3 1/4"	90.915.314
90.910.300	3"	4 3/8"	90.915.438
90.910.400	4"	5 5/8"	90.915.558

ADDITIONAL INFO

POLYPROPYLENE BULKHEAD FITTINGS
COME COMPLETE WITH GASKET.

SNAPPER HOSE CLAMPS

PART#	MIN DIA	MAX DIA
SHC-A	0.228"	0.356"
SHC-AA	0.256"	0.319"
SHC-BB	0.351"	0.394"
SHC-C	0.402"	0.485"
SHC-D	0.449"	0.511"
SHC-E	0.516"	0.619"
SHC-F	0.616"	0.707"
SHC-G	0.666"	0.784"
SHC-H	0.702"	0.801"
SHC-J	0.779"	0.899"
SHC-L	0.985"	1.135"
SHC-M	1.044"	1.198"
SHC-N	1.123"	1.296"
SHC-R	1.338"	1.566"
SHC-V	1.730"	2.010"

**NOZZLE BODY CLAMPS**

PART#	TUBE DIAMETER
BCR-34	3/4" ROUND
BCS-100	1" SQUARE

AVAILABLE UPON REQUEST. CALL FOR DETAILS.

**USE WITH SCHEDULE 80
POLYPROPYLENE PIPE**

PART#	PIPE ID
CPC-075	3/4"
CPC-100	1"

PIPE CLAMPS AVAILABLE UPON REQUEST!

T-BOLT CLAMPS**PURPOSE**

To provide a quick, yet effective means of clamping a variety of fittings to a wide range of hose. T-Bolts can be applied with a standard socket wrench. They provide 360° sealing surface by using a shoe or formed bridge.

SERVICES

The T-Bolt clamp is a high strength, reliable clamp with numerous applications in both the commercial and industrial markets including hose and duct work connections for air, oil, water and other types of low pressure fluid lines.

**ADDITIONAL INFORMATION**

- 0.025" BAND THICKNESS
- 3/4" WIDE BAND
- 300 SERIES STAINLESS STEEL BAND, BOLT AND NUT MATERIAL
- SELF LOCKING NUTS
- 75 IN/LB TORQUE RATING

PART#	SIZE NOMINAL	O.D. RANGE	
		FROM	TO
TB-840131	1 1/4"	1 5/32"	1-15/32"
TB-840150	1 1/2"	1 3/8"	1-9/16"
TB-840175	1 3/4"	1 5/8"	1-13/16"
TB-840200	2"	1 7/8"	2-1/16"
TB-840225	2 1/4"	2 1/8"	2-5/16"
TB-840238	2 3/8"	2 1/4"	2-7/16"
TB-840250	2 1/2"	2 3/8"	2-9/16"
TB-840256	2 9/16"	2 11/32"	2-5/8"
TB-840275	2 3/4"	2 17/32"	2-13/16"
TB-840300	3"	2 25/32"	3-1/16"
TB-840325	3 1/4"	3 1/32"	3-5/16"
TB0840350	3 1/2"	3 9/32"	3-9/16"
TB-840375	3 3/4"	3 17/32"	3-16/16"
TB-840425	4 1/4"	4 1/32"	4-5/16"
TB-840450	4 1/2"	4 9/32"	4-9/16"
TB-840475	4 3/4"	4 17/32"	4-13/16"

POLYPROPYLENE CAMLOCKS

TYPE A CAMLOCKS

PART#	SIZE	THREAD
90.720.034	¾"	MALE COUPLER X FPT
90.720.100	1"	MALE COUPLER X FPT
90.720.114	1 ¼"	MALE COUPLER X FPT
90.720.112	1 ½"	MALE COUPLER X FPT
90.737.040	2"	MALE COUPLER X FPT
90.720.300	3"	MALE COUPLER X FPT



TYPE E CAMLOCKS

PART#	SIZE	THREAD
90.724.034	¾"	MALE BARB X MALE COUPLER
90.724.100	1"	MALE BARB X MALE COUPLER
90.724.114	1 ¼"	MALE BARB X MALE COUPLER
90.724.112	1 ½"	MALE BARB X MALE COUPLER
90.737.160	2"	MALE BARB X MALE COUPLER
90.724.300	3"	MALE BARB X MALE COUPLER



TYPE B CAMLOCKS

PART#	SIZE	THREAD
90.721.034	¾"	FEMALE COUPLER X MPT
90.721.100	1"	FEMALE COUPLER X MPT
90.721.114	1 ¼"	FEMALE COUPLER X MPT
90.721.112	1 ½"	FEMALE COUPLER X MPT
90.737.300	2"	FEMALE COUPLER X MPT
90.721.300	3"	FEMALE COUPLER X MPT



TYPE F CAMLOCKS

PART#	SIZE	THREAD
90.725.034	¾"	MALE COUPLER X MPT
90.725.100	1"	MALE COUPLER X MPT
90.725.114	1 ¼"	MALE COUPLER X MPT
90.725.112	1 ½"	MALE COUPLER X MPT
90.737.100	2"	MALE COUPLER X MPT
90.725.300	3"	MALE COUPLER X MPT



TYPE C CAMLOCKS

PART#	SIZE	THREAD
90.722.034	¾"	MALE BARB X FEMALE COUPLER
90.722.100	1"	MALE BARB X FEMALE COUPLER
90.722.114	1 ¼"	MALE BARB X FEMALE COUPLER
90.722.112	1 ½"	MALE BARB X FEMALE COUPLER
90.737.360	2"	MALE BARB X FEMALE COUPLER
90.722.300	3"	MALE BARB X FEMALE COUPLER



TYPE DP CAMLOCKS

PART#	SIZE	THREAD
90.726.034	¾"	DUST PLUG
90.726.100	1"	DUST PLUG
90.726.112	1 ½"	DUST PLUG
90.726.114	1 ¼"	DUST PLUG
90.737.440	2"	DUST PLUG
90.397.114	1 ¼"	DUST PLUG
90.726.300	3"	DUST PLUG



TYPE D CAMLOCKS

PART#	SIZE	THREAD
90.723.034	¾"	FEMALE COUPLER X FPT
90.723.100	1"	FEMALE COUPLER X FPT
90.723.114	1 ¼"	FEMALE COUPLER X FPT
90.723.112	1 ½"	FEMALE COUPLER X FPT
90.737.240	2"	FEMALE COUPLER X FPT
90.723.300	3"	FEMALE COUPLER X FPT



TYPE DC CAMLOCKS

PART#	SIZE	THREAD
90.727.034	¾"	DUST CAP
90.727.100	1"	DUST CAP
90.727.112	1 ½"	DUST CAP
90.727.114	1 ¼"	DUST CAP
90.396.114	1 ¼"	DUST CAP
90.737.500	2"	DUST CAP
90.727.300	3"	DUST CAP



ALUMINUM CAMLOCKS

TYPE A CAMLOCKS



PART#	SIZE	THREAD
90.390.034	¾"	MALE COUPLER X FPT
90.390.100	1"	MALE COUPLER X FPT
90.390.114	1¼"	MALE COUPLER X FPT
90.390.112	1½"	MALE COUPLER X FPT
90.390.200	2"	MALE COUPLER X FPT
90.390.300	3"	MALE COUPLER X FPT
90.390.400*	4"	MALE COUPLER X FPT

* PHONE FOR AVAILABILITY.

TYPE B CAMLOCKS



PART#	SIZE	THREAD	GASKET#
90.391.034	¾"	FEMALE COUPLER X MPT	90.399.034
90.391.100	1"	FEMALE COUPLER X MPT	90.399.100
90.391.114	1¼"	FEMALE COUPLER X MPT	90.399.114
90.391.112	1½"	FEMALE COUPLER X MPT	90.399.112
90.391.200	2"	FEMALE COUPLER X MPT	90.399.200
90.391.300	3"	FEMALE COUPLER X MPT	90.399.300
90.391.400*	4"	FEMALE COUPLER X MPT	90.399.400

* PHONE FOR AVAILABILITY

TYPE C CAMLOCKS



PART#	SIZE	THREAD	GASKET#
90.392.034	¾"	MALE BARB X FEMALE COUPLER	90.399.034
90.392.100	1"	MALE BARB X FEMALE COUPLER	90.399.100
90.392.114	1¼"	MALE BARB X FEMALE COUPLER	90.399.114
90.392.112	1½"	MALE BARB X FEMALE COUPLER	90.399.112
90.392.200	2"	MALE BARB X FEMALE COUPLER	90.399.200
90.392.300	3"	MALE BARB X FEMALE COUPLER	90.399.300
90.392.400*	4"	MALE BARB X FEMALE COUPLER	90.399.400

* PHONE FOR AVAILABILITY

TYPE D CAMLOCKS



PART#	SIZE	THREAD	GASKET#
90.393.034	¾"	FEMALE COUPLER X FPT	90.399.034
90.393.100	1"	FEMALE COUPLER X FPT	90.399.100
90.393.114	1¼"	FEMALE COUPLER X FPT	90.399.114
90.393.112	1½"	FEMALE COUPLER X FPT	90.399.112
90.393.200	2"	FEMALE COUPLER X FPT	90.399.200
90.393.300	3"	FEMALE COUPLER X FPT	90.399.300
90.393.400*	4"	FEMALE COUPLER X FPT	90.399.400

* PHONE FOR AVAILABILITY

TYPE E CAMLOCKS



PART#	SIZE	THREAD
90.394.034	¾"	MALE BARB X MALE COUPLER
90.394.100	1"	MALE BARB X MALE COUPLER
90.394.114	1¼"	MALE BARB X MALE COUPLER
90.394.112	1½"	MALE BARB X MALE COUPLER
90.394.200	2"	MALE BARB X MALE COUPLER
90.394.300	3"	MALE BARB X MALE COUPLER
90.394.400*	4"	MALE BARB X MALE COUPLER

* PHONE FOR AVAILABILITY

TYPE F CAMLOCKS



PART#	SIZE	THREAD
90.395.034	¾"	MALE COUPLER X MPT
90.395.100	1"	MALE COUPLER X MPT
90.395.114	1¼"	MALE COUPLER X MPT
90.395.112	1½"	MALE COUPLER X MPT
90.395.200	2"	MALE COUPLER X MPT
90.395.300	3"	MALE COUPLER X MPT
90.395.400*	4"	MALE COUPLER X MPT

* PHONE FOR AVAILABILITY

TYPE DP CAMLOCKS



PART#	SIZE	THREAD
90.397.034	¾"	DUST PLUG
90.397.100	1"	DUST PLUG
90.397.112	1½"	DUST PLUG
90.397.200	2"	DUST PLUG
90.397.300	3"	DUST PLUG
90.397.400*	4"	DUST PLUG

* PHONE FOR AVAILABILITY

TYPE DC CAMLOCKS



PART#	SIZE	THREAD	GASKET#
90.396.034	¾"	DUST CAP	90.399.034
90.396.100	1"	DUST CAP	90.399.100
90.396.112	1½"	DUST CAP	90.399.112
90.396.200	2"	DUST CAP	90.399.200
90.396.300	3"	DUST CAP	90.399.300
90.396.400*	4"	DUST CAP	90.399.400

* PHONE FOR AVAILABILITY

HOSE REELS/WRAPPS

AG SPRAY HOSE REELS & SPRAYER HOSE

PART#	HOSE LENGTH	DIMENSIONS	SPRING LOCKING MECHANISM
85.401.020	200'	3/8" - 1/2"	NO
85.401.040	400'	3/8" - 1/2"	NO
85.410.020	200'	3/8" - 1/2"	YES
85.410.040	400'	3/8" - 1/2"	YES

PART#	DESCRIPTION
85.401.100	SWIVEL, HOSE REEL
MAX PSI	700 PSI
HOSE SIZE	3/8" - 1/2" HIGH PRESSURE
SWIVEL	85.401.100
INLET/OUTLET	3/8" FEMALE PIPE
ADDITIONAL INFO	USED FOR G961-038 AND G961-050 HOSE ON THE SAME PAGE



SWIVEL
85.401.100

Hose Reel With New Spring Locking Mechanism!

SPRAYER HOSE

PART#	SIZE	ROLL QTY
G961-038	3/8"	300 FT.
G961-050	1/2"	300 FT.

ADDITIONAL INFORMATION
YELLOW PVC LINED SPRAYER HOSE, PRESSURE RATING 700 PSI.



HOSE WRAPS

PART#	DESCRIPTION
90.700.001	UNIVERSAL HOSE WRAP WITH 2 BOLT MOUNT

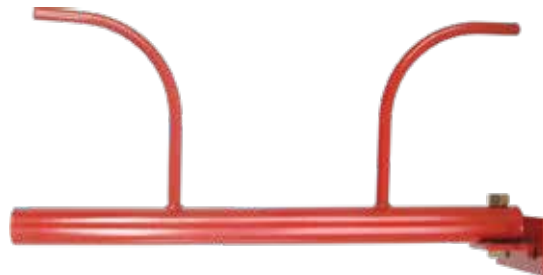

SPOT SPRAY GUNS



U05050001 U04505002



U05050001 U04505002

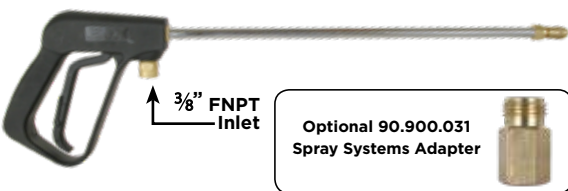

Optional 90.900.031
Spray Systems Adapter



Optional Adapter



90.900.089
1/4" MNPT x F 11/16"
Nozzle Thread

SPOT SPRAYER

PART#	U4505000
DESCRIPTION	LOW PRESSURE GUN TO FIT 3/8" HOSE, WITH CHROMED ALUMINUM SPRAY LANCE
LENGTH	600MM (24")
INLET	3/8" HOSE BARB
ORIFICE	#18 TIP ADJUSTABLE
FEATURES	FILTER IN HANDLE
OPTIONS	
U45050001	CLIP, HOLDS GUN ASSEMBLY TO TANK
U04505002	REPLACEMENT SPRAY TIP

TELESCOPING SPOT SPRAYER

PART#	U45050005
DESCRIPTION	LOW PRESSURE TELESCOPING GUN TO FIT 3/8" HOSE, CHROMED ALUMINUM SPRAY LANCE
LENGTH	1524MM (60")
INLET	3/8" HOSE BARB
ORIFICE	#18 TIP ADJUSTABLE
FEATURES	FILTER IN HANDLE
OPTIONS	
U45050001	CLIP, HOLDS GUN ASSEMBLY TO TANK
U04505002	REPLACEMENT SPRAY TIP

PISTOL GRIP SPRAY GUN

PART#	DESCRIPTION
SG-2218-18	GUN, SPOTSPRAY PISTOL GRIP 18"
SG-2218-24	GUN, SPOTSPRAY PISTOL GRIP 24"
LENGTH	1524MM (60")
MAX PSI	250 PSI
MAX FLOW	8 GPM
INLET	3/8" MNPT
ORIFICE	#18 TIP ADJUSTABLE
FEATURES	FILTER IN HANDLE

PISTOL SPRAY GUN

PART#	DESCRIPTION
90.300.005	9" PISTOL SPRAY GUN, #18 TIP
90.300.105	18" PISTOL SPRAY GUN, #18 TIP
90.300.205	24" PISTOL SPRAY GUN, #18 TIP
OPTIONS	
90.900.154	1/4" ADJUSTABLE SPRAYER NOZZLE (#8 ORIFICE)
90.900.031	SPRAY SYSTEMS ADAPTER

SPRAY SHIELD

PART#	DESCRIPTION
90.900.087	SPRAY SHIELD, 45° 1/4" FNPT CONNECTION
* ADAPTS TO MANY INDUSTRY STANDARD GUNS, USING PART # 90.900.089	

ACCESSORIES

PART#	DESCRIPTION
90.900.089	ADAPTER, 1/4" MNPT X F 11/16" NOZZLE THREAD
90.900.086	REPLACEMENT NOZZLE BODY
90.900.085	REPLACEMENT NOZZLE BODY, TWIST CAP
90.900.084	REPLACEMENT SEAL/ GASKET

ATTACHES DIRECTLY TO

PART#	DESCRIPTION
90.300.005	450 MM (18") LANCE SPOT SPRAYER
90.300.105	600MM (24") LANCE SPOT SPRAYER
90.300.205	760MM (30") LANCE SPOT SPRAYER

SPOT SPRAY GUNS

PISTOL SPRAY GUN

PART#	SG-5524-00
DESCRIPTION	PISTOL SPRAY GUN WITH #24 TIP
OUTLET	#24 TIP
INLET	3/8" MNPT
ORIFICE	#24 TIP ADJUSTABLE
FEATURES	BRASS VALVE, ADJUSTABLE SPRAY NOZZLE, ERGONOMIC FIT, LOCKING SPRAY GRIP



SPRAY GUN W/ALUMINUM BARREL

PART#	90.300.008M		
DESCRIPTION	GUN, SPRAY		
LENGTH	13"		
MAX PSI	900 PSI	MAX FLOW	8GPM
INLET	1/2" NPTF		
ORIFICE	TEEJET D SERIES		
FEATURES	COMMERCIAL SPRAY GUN W/ALUMINUM BARREL		



SPRAY GUN W/ALUMINUM BARREL

PART#	90.300.008		
DESCRIPTION	GUN, SPRAY		
LENGTH	560MM (22")		
MAX PSI	900 PSI	MAX FLOW	8 GPM
INLET	1/2" NPTF		
ORIFICE	TEEJET D SERIES		
FEATURES	COMMERCIAL SPRAY GUN W/ALUMINUM BARREL		



WAND & GUN ASSEMBLY

PART#	90.300.004
DESCRIPTION	GUN, SPRAY
LENGTH	600MM (24")
MAX PSI	600 PSI
INLET	3/8" NPTF CONNECTION
ORIFICE	1.5 MM CERAMIC
FEATURES	HIGH RESISTANCE PLASTIC MATERIALS STAINLESS STEEL BRASS



MULTI PURPOSE AG SPRAY GUNS



90.100.502

WAND & GUN ASSEMBLIES

PART#	DESCRIPTION
90.100.502	ALUMINUM SPRAY GUN, 23"
MAX PSI	400 PSI
INLET	3/4" FHGT
ORIFICE	#5 SS ORIFICE DISC SIZE
FEATURES (MATERIALS)	WAND MATERIAL: ALUMINUM HANDLE ROTATES 360° FOR USE WITH STANDARD GARDEN HOSES



90.300.111



90.300.222

WAND & GUN ASSEMBLIES

PART#	DESCRIPTION
90.300.111	WAND & GUN ASSY, 300MM
90.300.222	WAND & GUN ASSY, 600MM
MAX PSI	580 PSI
INLET	FGHT
ORIFICE	HARDENED ORIFICE D6
FEATURES (MATERIALS)	WAND MATERIAL: BRASS - NICKEL PLATED BRASS - STAINLESS STEEL - HIGH RESISTANCE PLASTIC MATERIALS TRIGGER MATERIAL: ELECTROLESS NICKEL PLATED ALUMINUM BODY - STAINLESS STEEL SEAT AND SHUT OFF PISTON - BRASS - FKM GASKETS - HIGH RESISTANCE PLASTIC MATERIALS

COMPONENTS

PART#	DESCRIPTION
5.901.26	WAND, 300MM
5.901.30	WAND, 600MM
23.1309.11	TRIGGER VALVE
90.300.120	GARDEN HOSE SWIVEL ADAPTER
90.900.002	BRASS NOZZLE CAP
5.1701.8	SPRAY SYSTEMS ADAPTER

REPAIR KITS

23.302.26	TRIGGER VALVE SEAL KIT
5.601.2	ADAPTER GASKET

ADDITIONAL INFORMATION

COMPLETED WITH SPRAYING SYSTEMS END ADAPTER, BRASS CAP, ORIFICE AND GARDEN HOSE ADAPTER.

HARDENED ORIFICE (D6)



90.410.006

SPRAY SYSTEMS ADAPTER



5.1701.8

TRIGGER VALVE



23.1309.11

BRASS NOZZLE CAP



90.900.002

GARDEN HOSE SWIVEL



90.300.120

MULTI PURPOSE AG SPRAY GUNS

WAND & GUN ASSEMBLIES

PART#	DESCRIPTION
90.300.001	WAND & GUN ASSEMBLY, 300MM
90.300.002	WAND & GUN ASSEMBLY, 600MM
90.300.003	WAND & GUN ASSEMBLY, 1000MM

MAX PSI	700 PSI
INLET	1/2" BSPM
ORIFICE	9.801.14 1.5MM DIACERAMIC TIP
FEATURES	BRASS BODY, STAINLESS STEEL PIPE

ADDITIONAL INFORMATION (MATERIALS)
WAND MATERIAL: BRASS - NICKEL PLATED BRASS - STAINLESS STEEL - HIGH RESISTANCE PLASTIC MATERIALS

TRIGGER MATERIAL: ELECTROLESS NICKEL PLATED ALUMINUM BODY - STAINLESS STEEL SEAT AND SHUT OFF PISTON - BRASS - FKM GASKETS - HIGH RESISTANCE PLASTIC MATERIALS

COMPONENTS

PART#	DESCRIPTION	PART#	DESCRIPTION
9.901.42	WAND, 300MM	9.801.12	1.0MM
5.901.48	WAND, 600MM	9.801.12	1.0MM
9.901.42	WAND, 1000M	9.801.14	1.5MM
23.208.84	TRIGGER VALVE	9.801.15	1.8MM
9.1701.5	CONE ADAPTER	9.801.17	2.3MM
9.1305.8	TURBO CONE		
162.609.05	1/2" BSP HEX NIPPLE		

REPLACEMENT DIACERAMIC TIPS

HOLE DIA (MM)	PERFORMANCES	200 PSI		450 PSI		700 PSI	
		CONE	STRAIGHT	CONE	STRAIGHT	CONE	STRAIGHT
Ø 1.0	CAPACITY US/GPM	0.44	0.56	0.71	0.87	0.87	1.05
	SPRAY ANGLE	30°	-	35°	-	40°	-
	MAX. THROW FT.	6.3	15.1	8.1	19.0	8.9	20.0
Ø 1.2	CAPACITY US/GPM	0.58	0.73	0.93	1.15	1.12	1.38
	SPRAY ANGLE	35°	-	40°	-	45°	-
	MAX. THROW FT.	6.9	17.5	9.2	20.7	9.8	21.5
Ø 1.5	CAPACITY US/GPM	0.83	1.10	1.31	1.78	1.59	2.12
	SPRAY ANGLE	40°	-	45°	-	50°	-
	MAX. THROW FT.	7.8	20.0	10.2	23.8	11.1	24.4
Ø 1.8	CAPACITY US/GPM	0.95	1.68	1.50	2.68	1.81	3.24
	SPRAY ANGLE	50°	-	55°	-	60°	-
	MAX. THROW FT.	8.7	21.2	11.2	25.5	12.6	26.3
Ø 2.0	CAPACITY US/GPM	1.10	2.02	1.72	3.20	2.07	3.85
	SPRAY ANGLE	55°	-	60°	-	65°	-
	MAX. THROW FT.	9.4	22.6	11.9	27.2	14.3	28.2
Ø 2.3	CAPACITY US/GPM	1.29	2.77	2.05	4.40	2.47	5.31
	SPRAY ANGLE	60°	-	65°	-	75°	-
	MAX. THROW FT.	10.3	24.1	13.6	28.9	15.3	29.5

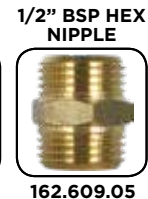
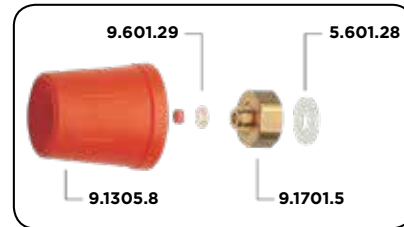

SPRAY SHIELD

PART#	DESCRIPTION
8292004	SHIELD, SPRAY ITAL 12MM FTHD

REPLACEMENT PARTS

PART#	DESCRIPTION
90.900.086	NOZZLE BODY, POLY
90.900.085	NOZZLE CAP, POLY TWIST ON
90.900.084	SEAL, FOR 90.900.085

ATTACHES DIRECTLY TO

PART#	DESCRIPTION
90.300.001	WAND & GUN ASSY, 300MM
90.300.002	WAND & GUN ASSY, 600MM
90.300.003	WAND & GUN ASSY, 1000MM



FLASH SPRAY GUNS

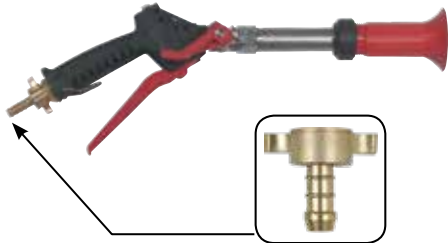

Part# 162.604.2A
Included (3/8")



Part# 162.604.2A (3/8")
Part# 162.604.3A (1/2")

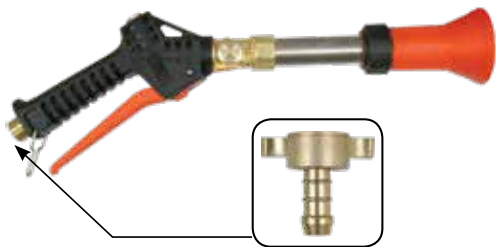

Part# 162.604.2A (3/8")
Part# 162.604.3A (1/2")

FLASH SPRAY GUN

PART#	90.300.006
DESCRIPTION	GUN, GREENHOUSE
LENGTH	400MM (16")
MAX PSI	400 PSI MAX FLOW 15 GPM
INLET	1/2" MBSP
ORIFICE	CERAMIC
FEATURES	ONE-HAND SPRAY PATTERN ADJUSTMENT FROM CONE MIST TO STRAIGHT STREAMS. EXCELLENT FOR VINEYARD, NURSERY, AND GREENHOUSE APPLICATIONS

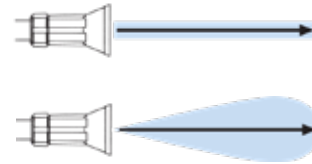

FLASH SPRAY GUN

PART#	26.902.162
DESCRIPTION	GUN, SPRAY FLASH
LENGTH	400MM (16")
MAX PSI	700 PSI MAX FLOW 15 GPM
INLET	1/2" MBSP
ORIFICE	2.0MM HOLLOW CONE
FEATURES	RECOMMENDED FOR TREATMENTS THAT NEED MAXIMUM MIST BLOWING OF THE PRODUCT. GUARANTEE EXCEPTIONAL MICRONISATION. NOZZLE ADJUSTMENT AND RELATIVE LOCKING AND CLOSING CAN BE DONE WITH JUST ONE HAND.

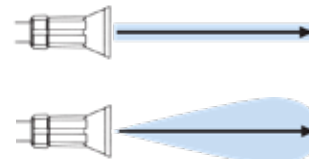

FLASH SPRAY GUN

PART#	26.901.162
DESCRIPTION	GUN, SPRAY GREENHOUSE
LENGTH	400MM (16")
MAX PSI	700 PSI MAX FLOW 15 GPM
INLET	1/2" MBSP
ORIFICE	1.5MM CERAMIC TIP
FEATURES	ADJUSTABLE FROM CONE TO STREAM SPRAY.

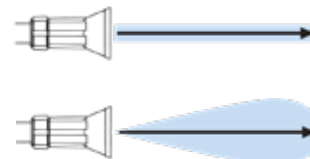

LONG RANGE SPRAY GUNS

TURBINE SPRAY GUN

PART#	7.901.103		
DESCRIPTION	GUN, TURBINE TREE 45'		
LENGTH	431MM (17")		
MAX PSI	850 PSI		
INLET	½" MBSP		
ORIFICE	2.3 MM CERAMIC TIP		
FEATURES	ADJUSTABLE FROM CONE TO STREAM SPRAY. 13.901.151 COMES STANDARD WITH A 2.3MM TIP.		
REPLACEMENT TIPS			
68.1802.51	1.5MM	68.1802.17	3.0MM
68.1802.16	2.5MM	68.1802.18	3.5MM

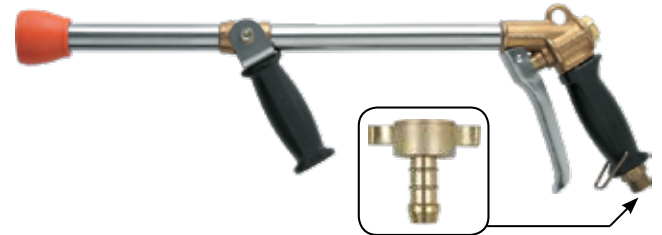

Part# 162.604.2A (3/8")
Part# 162.604.3A (1/2")

LONG RANGE TREE GUN

PART#	90.300.007		
DESCRIPTION	GUN, LONG RANGE		
LENGTH	600MM (24")		
MAX PSI	850 PSI	MAX FLOW	25 GPM
INLET	½" MBSP		
ORIFICE	CERAMIC		
FEATURES	CONTINUOUS SPRAY PATTERN ADJUSTMENT FROM CONE TO MIST TO STRAIGHT STREAM. ERGONOMIC HANDLE WITH HAND GUARD AND TRIGGER LOCK. INCLUDES ½" HOSE BARB INLET.		

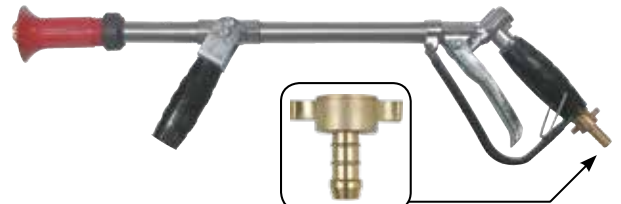

Part# 162.604.3A
Included (1/2")

LONG RANGE SPRAY GUN

PART#	13.902.151		
DESCRIPTION	SPRAYGUN, LONGRANGE 670MM		
LENGTH	600MM (24")		
MAX PSI	850 PSI	MAX FLOW	25 GPM
INLET	½" MBSP		
ORIFICE	2.5MM CERAMIC TIP		
FEATURES	CONTINUOUS SPRAY PATTERN ADJUSTMENT FROM CONE TO MIST TO STRAIGHT STREAM. ERGONOMIC HANDLE WITH HAND GUARD AND TRIGGER LOCK.		

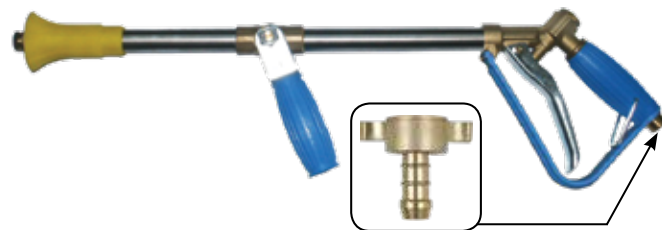
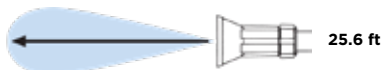

Part# 162.604.2A (3/8")
Part# 162.604.3A (1/2")

20 SERIES DRY GAUGES

DESCRIPTION

1½", 2", 2½", and 4" casing. Center Back, Bottom, Front or Panel Mount. These gauges are designed for use with gas, oil, and water or any medium not corrosive to brass or bronze.

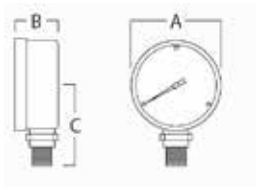

BOTTOM MOUNT

SIZE	A"	B"	C"	D"	E"
1½	6.656	1.000	1.297	N/A	N/A
2	2.016	1.109	1.687	N/A	N/A
2½	2.469	1.187	1.828	N/A	N/A
4	3.969	1.266	2.734	N/A	N/A

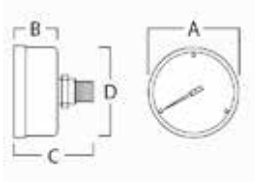

REAR/PANEL MOUNT

SIZE	A"	B"	C"	D"	E"
1½	1.655	0.950	1.600	1.614	N/A
2	2.180	0.900	1.878	2.180	N/A
2½	2.490	1.124	1.912	2.425	N/A
4	3.969	1.266	2.734	N/A	N/A

GENERAL SERVICE GAUGES (DUAL SCALE)

MOVEMENT	BRASS
BOURDON TUBE	C-SHAPED IN COPPER ALLOY UP TO 600 PSI AND HELICAL IN PHOSPHOR BRONZE ABOVE 600 PSI.
POINTER	BLACK ENAMELED ALUMINUM DIAL WHITE ALUMINUM
WINDOW	ACRYLIC
CASE MATERIAL	STEEL, BLACK PAINTED
BEZEL	CHROME PLATED
CONNECTION MATERIAL	BRASS
CONNECTION SIZE	1/8" MNPT ON 1½" SIZE. 1/4" MNPT ON 2", 2½", AND 4 SIZES.
ACCURACY	ASME/ANSI B40.1 GRADE B (3-2-3%)
FILL MATERIAL	DRY ONLY
WETTED PARTS	COPPER ALLOY

1.5" FACE BOTTOM MOUNT

PART #	DESCRIPTION
85.415.015	GAUGE, DRY 0-15 PSI 1½"
85.415.060	GAUGE, DRY 0-60 PSI 1½"
85.415.100	GAUGE, DRY 0-100 PSI 1½"
85.415.160	GAUGE, DRY 0-160 PSI 1½"
85.415.200	GAUGE, DRY 0-200 PSI 1½"

1.5" FACE REAR MOUNT

PART #	DESCRIPTION
85.410.015	GAUGE, DRY 0-15PSI
85.410.060	GAUGE, DRY 0-60 PSI 1½"
85.410.100	GAUGE, DRY 0-100 PSI 1½"
85.410.160	GAUGE, DRY 160 PSI 1½" RMT
85.410.200	GAUGE, DRY 0-200 PSI

1.5" FACE PANEL MOUNT c/w MOUNTING BRACKET

PART #	DESCRIPTION
85.411.015	GAUGE, DRY 0-15PSI
85.411.060	GAUGE, DRY 0-60 PSI 1½"
85.411.100	GAUGE, DRY 100 PSI 1½" RMT
85.411.160	GAUGE, DRY 160 PSI 1½" RMT
85.411.200	GAUGE, DRY 0-200 PSI

2" FACE REAR MOUNT

PART #	DESCRIPTION
85.420.100	GAUGE, DRY 0-100 2" REAR
85.420.200	GAUGE, DRY 0-200 2" REAR
85.420.300	GAUGE, DRY 0-300 2" REAR

4" FACE REAR MOUNT

PART #	DESCRIPTION
85.710.030	GAUGE, DRY 30 PSI 4" RMT
85.710.200	GAUGE, DRY 200 PSI 4¼"

4" BOTTOM MOUNT VACUUM

PART #	DESCRIPTION
85.800.030	GAUGE, DRY VAC 30 PSI 4" DUA

24 SERIES DRY GAUGES

GENERAL SERVICE GAUGES (SINGLE SCALE)

MOVEMENT	BRASS
BOURDON TUBE	C-SHAPED IN COPPER ALLOY UP TO 600 PSI AND HELICAL IN PHOSPHOR BRONZE ABOVE 600 PSI.
POINTER	BLACK ENAMELED ALUMINUM
DIAL	WHITE ALUMINUM
WINDOW	ACRYLIC
CASE MATERIAL	ABS STANDARD, BLACK STEEL OPTIONAL
BEZEL	BLACK
CONNECTION MATERIAL	BRASS
CONNECTION SIZE	1/4" MNPT
ACCURACY	ASME/ANSI B40.1 GRADE B (3- 2-3%)
FILL MATERIAL	DRY ONLY
WETTED PARTS	COPPER ALLOY

2" FACE BOTTOM MOUNT

PART #	DESCRIPTION
85.400.030	GAUGE, DRY 30 PSI 2"
85.401.060	GAUGE, DRY 60 PSI 2"
85.400.100	GAUGE, DRY 100 PSI 2"
85.400.200	GAUGE, DRY 200 PSI 2"
85.400.300	GAUGE, DRY 300 PSI 2"
85.400.400	GAUGE, DRY 400 PSI 2"

2.5" FACE BOTTOM MOUNT

PART #	DESCRIPTION
85.500.030	GAUGE, DRY 30 PSI 2.5" BLACK
85.500.060	GAUGE, DRY 60 PSI 2.5" BLACK
85.500.100	GAUGE, DRY 100 PSI 2.5" BLACK
85.500.160	GAUGE, DRY 160 PSI 2.5" BLACK
85.500.200	GAUGE, DRY 200 PSI 2.5" BLACK
85.500.300	GAUGE, DRY 300 PSI 2.5" BLACK
85.500.400	GAUGE, DRY 400 PSI 2.5" BLACK
85.500.600	GAUGE, DRY 600 PSI 2.5" BLACK

4" BOTTOM MOUNT

PART #	DESCRIPTION
85.700.030	GAUGE, DRY 30 PSI 4"
85.700.060	GAUGE, DRY 60 PSI 4"
85.700.100	GAUGE, DRY 100 PSI 4"
85.700.200	GAUGE, DRY 200 PSI 4"
85.700.300	GAUGE, DRY 300 PSI 4"

DESCRIPTION

2", 2½", and 4" Casing. Bottom Mount only. These gauges are designed for use with gas, oil, and water or any medium not corrosive to brass or bronze.

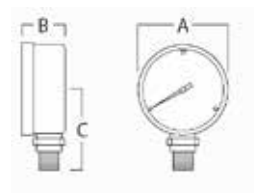

BOTTOM MOUNT

SIZE	A"	B"	C"	D"	E"
2"	2.016	1.109	1.687	N/A	N/A
2.5"	2.469	1.187	1.828	N/A	N/A
4"	3.969	1.266	2.734	N/A	N/A

40 SERIES GLYCERIN FILLED GAUGES

DESCRIPTION

1½", 2", 2½", and 4" casing. Center Back, Bottom, Front or Panel Mount. These gauges are designed for use with any medium not corrosive to brass or bronze. Liquid-filled gauges are recommended for reducing shock caused by pressure fluctuations or vibration (standard). Dry is special order.

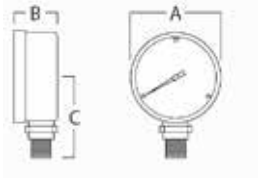

BOTTOM MOUNT

SIZE	A"	B"	C"	D"	E"
1½	1.735	1.075	1.500	1.575	N/A
2	2.102	1.075	1.734	1.970	N/A
2½	2.620	1.165	2.270	2.470	N/A
4	4.200	1.266	2.734	3.969	N/A

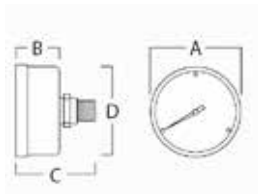

REAR/PANEL MOUNT

SIZE	A"	B"	C"	D"	E"
1½	1.780	0.900	1.600	1.614	N/A
2	2.211	1.090	2.045	2.030	N/A
2½	2.620	1.165	2.270	2.470	N/A
4	4.200	1.265	2.734	3.969	N/A

INDUSTRIAL GAUGES (DUAL SCALE)

BRASS	BRASS
BOURDON TUBE	C-SHAPED IN COPPER ALLOY UP TO 600 PSI AND HELICAL IN PHOSPHOR BRONZE ABOVE 600 PSI.
POINTER	BLACK ENAMELED ALUMINUM
DIAL	WHITE ALUMINUM
WINDOW	POLYCARBONATE – TEMPERATURE COMPENSATING
CASE MATERIAL	304 STAINLESS STEEL
CONNECTION MATERIAL	BRASS
CONNECTION SIZE	1/8" MNPT ON 1½" SIZE. 1/4" MNPT ON 2", 2½", AND 4 SIZES.
ACCURACY	ASME/ANSI B40.1 GRADE A (2-1-2%)
FILL MATERIAL	DRY, GLYCERIN, SILICONE, FLOROLUBE
WETTED PARTS	COPPER ALLOY

4" BOTTOM MOUNT

PART #	DESCRIPTION
84.000.015	GAUGE, GLY 15 PSI 4"
84.000.030	GAUGE, GLY 30 PSI 4"
84.000.060	GAUGE, GLY 60 PSI 4"
84.000.100	GAUGE, GLY 100 PSI 4"
84.000.160	GAUGE, GLY 160 PSI 4"
84.000.200	GAUGE, GLY 200 PSI 4"
84.000.300	GAUGE, GLY 300 PSI 4"
84.000.400	GAUGE, GLY 400 PSI 4"
84.000.600	GAUGE, GLY 600 PSI 4"
84.001.000	GAUGE, GLY 1000 PSI 4"
84.003.000	GAUGE, GLY 3000 PSI 4"
84.005.000	GAUGE, GLY 5000 PSI 4"
84.010.000	GAUGE, GLY 10,000 PSI 4"

4" BOTTOM MOUNT VACCUM

PART #	DESCRIPTION
84.000.006	GAUGE, GLY VAC 60 PSI 4" DUA
84.100.150	GAUGE, GLY VAC 150 PSI 4"

4" FACE REAR MOUNT

PART #	DESCRIPTION
84.910.100	GAUGE, GLY 100 PSI 4" RMT
84.910.160	GAUGE, GLY 160 PSI 4" RMT
84.910.200	GAUGE, GLY 200 PSI 4" RMT
84.910.300	GAUGE, GLY 300 PSI 4" RMT
84.910.600	GAUGE, GLY 600 PSI 4" RMT

41 SERIES GLYCERIN FILLED GAUGES

GENERAL SERVICE GAUGES (DUAL SCALE)

MOVEMENT	BRASS
BOURDON TUBE	C-SHAPED IN COPPER ALLOY UP TO 1000 PSI AND HELICAL IN PHOSPHOR BRONZE ABOVE 1000 PSI.
POINTER	BLACK ENAMELED ALUMINUM
DIAL	WHITE ALUMINUM
WINDOW	ACRYLIC
CASE MATERIAL	304 STAINLESS STEEL
CONNECTION MATERIAL	BRASS
CONNECTION SIZE	1/4 MNPT
ACCURACY	ASME/ANSI B40.1 GRADE B (3-2-3%)
FILL MATERIAL	DRY, GLYCERIN
WETTED PARTS	COPPER ALLOY

2.5" FACE BOTTOM MOUNT

PART #	DESCRIPTION	BLISTER PACK PART #
85.300.015	GAUGE, GLY 15 PSI 2.5"	85.300.015BP
85.300.030	GAUGE, GLY 30 PSI 2.5"	85.300.030BP
85.300.060	GAUGE, GLY 60 PSI 2.5"	85.300.060BP
85.300.100	GAUGE, GLY 100 PSI 2.5"	85.300.100BP
85.300.160	GAUGE, GLY 160 PSI 2.5"	85.300.160BP
85.300.200	GAUGE, GLY 200 PSI 2.5"	85.300.200BP
85.300.300	GAUGE, GLY 300 PSI 2.5"	85.300.300BP
85.300.400	GAUGE, GLY 400 PSI 2.5"	85.300.400BP
85.300.600	GAUGE, GLY 600 PSI 2.5"	85.300.600BP
85.301.000	GAUGE, GLY 1000 PSI 2.5"	85.301.000BP
85.302.000	GAUGE, GLY 2000 PSI 2.5"	85.302.000BP
85.303.000	GAUGE, GLY 3000 PSI 2.5"	85.303.000BP
85.305.000	GAUGE, GLY 5000 PSI 2.5"	85.305.000BP
85.310.000	GAUGE, GLY 10000 PSI 2.5"	85.310.000BP

2.5" FACE BOTTOM MOUNT VACUUM

PART #	DESCRIPTION
85.310.030	GAUGE, GLY VAC 30 PSI 2.5"
85.310.060	GAUGE, GLY VAC 60 PSI 2.5"
85.310.150	GAUGE, GLY VAC 150 PSI 2.5"

2.5" PANEL MOUNT C/W MOUNTING BRACKET

PART #	DESCRIPTION
85.900.030	GAUGE, GLY 30 PSI 2.5" RMT
85.900.060	GAUGE, GLY 60 PSI 2.5" RMT
85.900.100	GAUGE, GLY 100 PSI 2.5" RMT
85.900.160	GAUGE, GLY 160 PSI 2.5" RMT
85.900.200	GAUGE, GLY 200 PSI 2.5" RMT
85.900.300	GAUGE, GLY 300 PSI 2.5" RMT
85.900.400	GAUGE, GLY 400 PSI 2.5" RMT
85.900.600	GAUGE, GLY 600 PSI 2.5" RMT

2.5" FACE REAR MOUNT

PART #	DESCRIPTION
85.910.030	GAUGE, GLY 30 PSI 2.5" RMT
85.910.060	GAUGE, GLY 60 PSI 2.5" RMT
85.910.100	GAUGE, GLY 100 PSI 2.5" RMT
85.910.160	GAUGE, GLY 160 PSI 2.5" RMT
85.910.200	GAUGE, GLY 200 PSI 2.5" RMT
85.910.300	GAUGE, GLY 300 PSI 2.5" RMT
85.910.400	GAUGE, GLY 400 PSI 2.5" RMT
85.910.600	GAUGE, GLY 600 PSI 2.5" RMT

2.5" FACE DUAL SCALE

PART #	DESCRIPTION
85.200.060	GAUGE, GLY 60PSI 2.5" DUAL
85.200.100	GAUGE, GLY 100PSI 2.5" DUAL
85.200.160	GAUGE, GLY 160PSI 2.5" DUAL
85.200.300	GAUGE, GLY 300PSI 2.5" DUAL

DESCRIPTION

2-1/2" casing. Center Back, Bottom, Front or Panel Mount. These gauges are designed for use with any medium not corrosive to brass or bronze. Liquid-filled gauges are recommended for reducing shock caused by pressure fluctuations or vibration. Liquid filled standard.

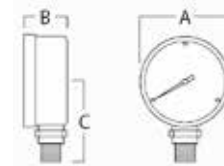

BOTTOM MOUNT

SIZE	A"	B"	C"	D"	E"
2-1/2	2.670	1.100	2.270	2.460	N/A

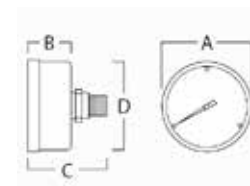

REAR/PANEL MOUNT

SIZE	A"	B"	C"	D"	E"
2-1/2	2.630	1.120	2.214	2.470	N/A

54 SERIES GLYCERIN FILLED GAUGES

DESCRIPTION

2", 2½", and 4" Casing. Center Back, Bottom, Front or Panel Mount. These gauges are designed for use with any medium not corrosive to stainless steel. Liquid-filled gauges are recommended for reducing shock caused by pressure fluctuations or vibration. Liquid filled standard; dry special order.

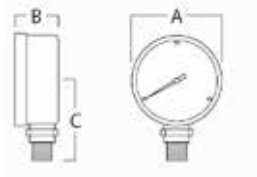
**BOTTOM MOUNT**

SIZE	A"	B"	C"	D"	E"
2½	2.672	1.109	2.250	2.460	N/A
4	4.344	1.828	3.391	3.970	N/A

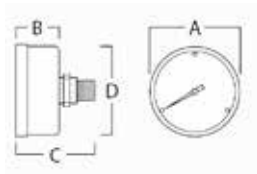
**REAR/PANEL MOUNT**

SIZE	A"	B"	C"	D"	E"
2½	2.672	1.109	2.250	2.460	N/A
4	4.344	1.828	3.391	3.970	N/A

STAINLESS STEEL O.E.M. GAUGES (SINGLE SCALE)

MOVEMENT	BRASS
BOURDON TUBE	C-SHAPED IN COPPER ALLOY UP TO 600 PSI AND HELICAL IN PHOSPHOR BRONZE ABOVE 600 PSI.
POINTER	BLACK ENAMELED ALUMINUM
DIAL	WHITE ALUMINUM
WINDOW	ACRYLIC
CASE MATERIAL	ABS STANDARD, BLACK STEEL OPTIONAL
BEZEL	BLACK
CONNECTION MATERIAL	BRASS
CONNECTION SIZE	¼" MNPT
ACCURACY	ASME/ANSI B40.1 GRADE B (3- 2-3%)
FILL MATERIAL	DRY ONLY
WETTED PARTS	COPPER ALLOY

1.5" FACE BOTTOM MOUNT

PART #	DESCRIPTION
85.350.030	GAUGE, GLY 30 PSI 2.5" SS
85.350.060	GAUGE, GLY 60 PSI 2.5"SS
85.350.100	GAUGE, GLY 100 PSI 2.5" SS
85.350.160	GAUGE, GLY 160 PSI 2.5" SS
85.350.200	GAUGE, GLY 200 PSI 2.5" SS

2.5" FACE BOTTOM MOUNT

PART #	DESCRIPTION
85.355.030	GAUGE, GLY 30 PSI 2.5" SSRM
85.355.060	GAUGE, GLY 60 PSI 2.5" SSRM
85.355.100	GAUGE, GLY 100 PSI 2.5" SSRM
85.355.200	GAUGE, GLY 200 PSI 2.5" SSRM

INDICATOR GAUGES

PART #	DIAMETER	DESCRIPTION
85.410.991	2"	AMPERES GAUGE, NEGATIVE -30/30
85.410.992	2"	OIL PRESSURE GAUGE, 1/8 CBM, 0-80 PSI



85.410.991



85.410.992

ACCESSORIES

PART#	DESCRIPTION
85.140.140	INLINE SNUBBER, 1/4"
85.300.998	BLACK PROTECTIVE GAUGE COVER FOR 2 1/2" FACE
85.300.999	BLUE PROTECTIVE GAUGE COVER FOR 2 1/2" FACE



85.140.140



85.300.999



85.300.998

BRASS NOZZLE BODIES



90.900.003

DESCRIPTION	NOZZLE BODY SWIVEL
FITTING	1/4" FEMALE
OEM#	5000 1/4T
MATERIAL	BRASS



90.900.049

DESCRIPTION	NOZZLE BODY SWIVEL
FITTING	1/4" MALE
OEM#	5540 1/4TT
MATERIAL	BRASS



90.900.004

DESCRIPTION	NOZZLE BODY SWIVEL
FITTING	1/4" FEMALE
OEM#	42022 1/4T
MATERIAL	BRASS



90.900.050

DESCRIPTION	NOZZLE BODY SWIVEL
FITTING	1/4" MALE
OEM#	6240 1/4 TT
MATERIAL	BRASS



**90.900.052 (1/4") 90.901.038 (3/8")
90.900.024 (JAM NUT)**

DESCRIPTION	NOZZLE BODY ELBOWS
FITTING	90° ELBOW BARB (1/2" OR 3/8")
OEM#	919-531TD 1/2"
MATERIAL	BRASS



**90.900.053 (1/4") 90.902.038 (3/8")
90.900.024 (JAM NUT)**

DESCRIPTION	NOZZLE BODY TEES
FITTING	1/2" OR 3/8" BARB
OEM#	9192A-931T 1/2"
MATERIAL	BRASS



90.900.032

DESCRIPTION	NOZZLE BODY
FITTING	1/8" MNPT X 11/16" NOZZLE THREAD
OEM#	1336 1/8 TT
MATERIAL	BRASS



90.900.001 (1/4") 90.900.005 (3/8")

DESCRIPTION	NOZZLE BODY
FITTING	MNPT X 11/16" M NOZZLE THREAD
OEM#	1322 1/4 TT
MATERIAL	BRASS

AVAILABLE IN STAINLESS STEEL. CALL FOR DETAILS



90.900.031

DESCRIPTION	NOZZLE BODY
FITTING	1/4" FNPT X 11/16" M NOZZLE THREAD
OEM#	1321 1/4 T
MATERIAL	BRASS

1/4" or 1/2" FNPT



1/8" F Nozzle Thread

90.900.029 (1/4") 90.900.030 (1/2")

DESCRIPTION	NOZZLE CAP/ADAPTER
FITTING	4676 1/8" MNPT X 11/16" NOZZLE THREAD
FITTING	4676 1/4" MNPT X 11/16" NOZZLE THREAD
MATERIAL	BRASS



90.900.025

DESCRIPTION	QUICK CAP
FITTING	11/16" F NOZZLE THREAD
MATERIAL	BRASS



90.900.016

DESCRIPTION	BLOCKOFF PLATE
OEM#	3942
MATERIAL	BRASS



90.900.002

DESCRIPTION	90.900.002
FITTING	NOZZLE BODY CAP
OEM#	1325
MATERIAL	BRASS

AVAILABLE IN STAINLESS STEEL. CALL FOR DETAILS



90.900.006 (DEEP)

DESCRIPTION	NOZZLE BODY CAP
OEM#	20230
NOTE	USE WITH CERAMIC TIPS
MATERIAL	BRASS



90.900.009



90.900.119

90.900.009 (BRASS) 90.900.119 (NYLON)

DESCRIPTION	(MESH STRAINER) SCREENS
OEM#	4514-32
MATERIAL	BRASS & NYLON

BRASS NOZZLE BODIES



91.900.056

DESCRIPTION	NOZZLE BALL VALVE
FITTING	1/4" FNPT X 11/16" M NOZZLE THREAD
MATERIAL	BRASS
REPLACEMENT PARTS	
91.900.057	HANDLE & HARDWARE

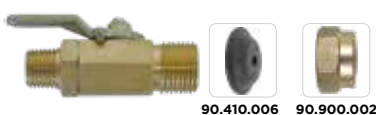

91.900.156

DESCRIPTION	NOZZLE BALL VALVE
FITTING	1/4" MNPT X 11/16" M NOZZLE THREAD
MATERIAL	BRASS
REPLACEMENT PARTS	
91.900.057	HANDLE & HARDWARE



HARDENED ORIFICE

ORIFICE	CONE/STREAM ORIFICE
PART#	90.410.002(#2) 90.410.007(#7)
	90.410.003(#3) 90.410.008(#8)
	90.410.004(#4) 90.410.010(#10)
	90.410.005(#5) 90.410.011(#11)
	90.410.006(#6)
MATERIAL	HARDENED STEEL WITH COATING



90.900.054

ADJUSTABLE NOZZLE

PART#	THREAD	OEM #
90.900.154	1/4" X #18 ORIFICE	5500-18
90.900.054	1/4" X #8 ORIFICE	5500-8
MATERIAL	BRASS	



90.900.040

ADJUSTABLE NOZZLE

PART#	THREAD	OEM #
90.900.140	11/16" X #18 ORIFICE	5500-18
90.900.040	11/16" X #8 ORIFICE	5500-8
MATERIAL	BRASS	



90.409.025



90.409.025

NOZZLE CORES

PART#	SIZE	MATERIAL
90.409.023	#23	BRASS
90.409.025	#25	BRASS
90.409.045	#45	BRASS

ITALIAN MADE BRASS ROLLOVER NOZZLES



73.610.105

INLET	1/4" MALE BSP CONNECTION
INCLUDES	3/8 BSP CAPS (2), NYLON FILTERS (2), 1/4" BSP BRASS JAM NUTS
NOTE	USED ON MOST FLORIDA SPRAYERS. USED WITH STANDARD D-SERIES ORIFICES & CORES.
MATERIAL	QUALITY BRASS CONSTRUCTION
REPLACEMENT PARTS	
256.605.7	REPLACEMENT CAPS



76.617.40

DESCRIPTION	1/4" FEMALE BSP CONNECTION
INCLUDES	POLY SCREEN AND 11/16" BRASS NOZZLE CAP
NOTE	M76 & SINGLE ROLLOVER, ANTI-DRIP
MATERIAL	QUALITY BRASS CONSTRUCTION



76.617.30

DESCRIPTION	1/4" MALE BSP CONNECTION
INCLUDES	POLY SCREEN AND 11/16" BRASS NOZZLE CAP
NOTE	M76 & SINGLE ROLLOVER, ANTI-DRIP
MATERIAL	QUALITY BRASS CONSTRUCTION



73.617.39

DESCRIPTION	1/4" FNPT CONNECTION
DESCRIPTION	COMES WITH 11/16" NOZZLE THREADS CAPS (2) NYLON FILTERS (2), ANTI-DRIP VALVE BUILT-IN
NOTE	USED WITH STANDARD D-SERIES ORIFICES & CORES.
MATERIAL	QUALITY BRASS CONSTRUCTION

BRASS BSP FITTINGS



23.1502.34

DESCRIPTION	FGHT SWIVEL
THREAD	FGHT X 1/2" MBSP
MATERIAL	BRASS



26.1502.45

DESCRIPTION	BSP SWIVEL
FITTING	1/2" FBSP X 1/2" MBSP
MATERIAL	BRASS



162.609.05

DESCRIPTION	HEX, NIPLLE
FITTING	1/2" MBSP
MATERIAL	BRASS



HOSE BARB FITTING

PART#	FITTING
162.604.2A	1/2" FBSP TO 3/8" BARB
162.604.3A	1/2" FBSP TO 1/2" BARB
REPLACEMENT SEAL	1209001300
REPLACEMENT NUT	90.900.013
MATERIAL	BRASS



HOSE BARB FITTING

PART#	FITTING
90.900.043	3/8" BARB X 90° X FBSP
90.900.044	1/2" BARB X 90° X FBSP
SEAL#	1209001300
MATERIAL	BRASS



HOSE BARB FITTING

PART#	FITTING
162.604.9	3/4" FBSP X 3/4" BARB
162.604.10	1" FBSP X 1" BARB
MATERIAL	BRASS



90.900.041

DESCRIPTION	HOSE BARB	
FITTING	1/2" BARB	1/2" FBSP
SEAL#	1209001300	N/A
BRAGLIA#	162.1502.21	N/A
NOTE	90.900.042 USE ON 90.900.041, 043, 044.	
MATERIAL	BRASS	

BRASS NPT FITTINGS



90.900.010

DESCRIPTION	STREET ELBOW
THREAD	3/4" MNPT X 3/4" BARB
MATERIAL	BRASS



90° FEMALE ELBOW

PART#	FNPT	PART#	FNPT
85.704.203	1/8"	85.704.008	3/8"
85.704.204	1/4"	85.704.209	1/2"
MATERIAL	BRASS		



45° FEMALE ELBOWS

PART#	MATERIAL	FNPT
85.704.403	BRASS	1/8"
85.703.404	BRASS	1/4"



90° FEMALE ELBOW

PART#	FNPT	PART#	FNPT
85.704.303	1/8"	85.704.306	3/8"
85.704.304	1/4"		
MATERIAL	BRASS		



SQUARE HEAD PIP PLUGS

PART#	MATERIAL	MNPT
85.718.004	BRASS	1/4"
85.718.006	BRASS	3/8"
85.718.008	BRASS	1/2"



MALE PIPE TEES

PART#	MATERIAL	FNPT
85.701.003	BRASS	1/8"
85.701.004	BRASS	1/4"
85.701.006	BRASS	3/8"
85.701.008	BRASS	1/2"



MALE BRANCH TEES

PART#	MATERIAL	MNPT	FNPT
85.702.003	BRASS	1/8"	1/8"
85.702.004	BRASS	1/4"	1/4"
85.702.006	BRASS	3/8"	3/8"



MALE TEES

PART#	MATERIAL	MNPT
85.703.003	BRASS	1/8"
85.703.004	BRASS	1/4"
85.703.006	BRASS	3/8"

BRASS NPT FITTINGS



STREET TEES

PART#	MATERIAL	MNPT	FNPT
85.714.003	BRASS	1/8"	1/8"
85.714.004	BRASS	1/4"	1/4"
85.702.005	BRASS	3/8"	3/8"
85.714.008	BRASS	1/2"	1/2"



FEMALE COUPLING

PART#	MATERIAL	FNPT
85.713.003	BRASS	1/8"
85.713.004	BRASS	1/4"
85.713.006	BRASS	3/8"
85.713.008	BRASS	1/2"



BRASS CAP

PART#	MATERIAL	FNPT
85.717.003	BRASS	1/8"
85.717.004	BRASS	1/4"
85.717.006	BRASS	3/8"
85.717.008	BRASS	1/2"



CROSS FEMALE PIPE

PART#	MATERIAL	FNPT
85.711.003	BRASS	1/8"
85.711.004	BRASS	1/4"
85.711.006	BRASS	3/8"
85.711.008	BRASS	1/2"



45° STREET ELBOWS

PART#	MATERIAL	MNPT	FNPT
85.704.413	BRASS	1/8"	1/8"
85.704.414	BRASS	1/4"	1/4"
85.704.001	BRASS	3/8"	3/8"
85.704.002	BRASS	1/2"	1/2"



90° STREET ELBOW

PART#	MATERIAL	MNPT	FNPT
85.704.003	BRASS	1/8"	1/8"
85.704.004	BRASS	1/4"	1/4"
85.704.006	BRASS	3/8"	3/8"
85.704.007	BRASS	3/8"	1/4"
85.704.009	BRASS	1/2"	1/2"
85.704.110	BRASS	3/4"	3/4"



LONG NIPPLE

PART#	MNPT	LENGTH
85.715.017	1/8"	1 1/2"
85.715.018	1/8"	2"
85.715.021	1/4"	1 1/2"
85.715.022	1/4"	2"
85.715.025	3/8"	1 1/2"
85.715.026	3/8"	2"
85.715.029	1/2"	1 1/2"
85.715.030	1/2"	2"

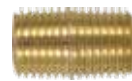

CLOSE NIPPLE

PART#	MNPT
85.716.003	1/8"
85.716.004	1/4"
85.716.006	3/8"
85.716.008	1/2"
85.716.010	3/4"



BUSHINGS

PART#	MATERIAL	MNPT	FNPT
85.709.060	BRASS	1/4"	1/8"
85.709.064	BRASS	3/8"	1/4"
85.709.084	BRASS	1/2"	1/4"
85.709.086	BRASS	1/2"	3/8"
85.709.090	BRASS	3/4"	3/8"
85.709.091	BRASS	3/4"	1/2"



HOSE BARB FITTING

PART#	MATERIAL	FITTING
90.900.037	BRASS	1/4" MNPT X 1/2" X 2"
90.900.036	BRASS	1/4" MNPT X 3/8" X 2"
90.912.038	BRASS	3/8" MNPT X 1/2" X 2"
90.900.033	BRASS	1/2" MNPT X 3/8" X 2"
90.934.012	BRASS	1/2" MNPT X 3/4" X 2"
90.912.158	BRASS	1/2" MNPT X 5/8" X 1 1/2"
90.900.020	BRASS	3/4" MNPT X 3/8" X 2"
90.900.045	BRASS	3/4" MNPT X 1/2" X 2"
90.900.035	BRASS	3/4" MNPT X 3/4" X 2"
90.900.055	BRASS	1" MNPT X 1" X 2"



HEX NIPPLE

PART#	MNPT	MNPT
85.705.003	1/8"	1/8"
85.705.104	1/4"	1/8"
85.705.004	1/4"	1/4"
85.705.105	3/8"	1/8"
85.706.064	3/8"	1/4"
85.705.006	3/8"	3/8"
85.705.108	1/2"	1/4"
85.706.086	1/2"	3/8"
85.705.008	1/2"	1/2"
85.706.087	3/4"	1/2"
85.705.010	3/4"	3/4"



REDUCING ADAPTER

PART#	MNPT	FNPT
85.705.100	1/8"	1/8"
85.705.101	1/8"	1/4"
85.705.102	1/8"	3/8"
85.705.103	1/4"	1/4"
85.705.005	1/4"	3/8"
85.705.106	1/4"	1/2"
85.705.107	3/8"	3/8"
85.707.086	3/8"	1/2"
85.705.109	1/2"	1/2"
85.705.110	1/2"	3/4"

NYLON & POLYPRO FITTINGS



MALE PIPE FITTING

NYLON	POLYPRO	MPTXHB	BAG QTY.
A18316	3A18316	1/8 X 3/16	50
A1814	3A1814	1/8 X 1/4	50
A18516	3A18516	1/8 X 5/16	50
A1838	3A1838	1/8 X 3/8	50
A14316	3A14316	1/4 X 3/16	50
A14	3A14	1/4 X 1/4	50
A14516	3A14516	1/4 X 5/16	50
A1438	3A1438	1/4 X 3/8	50
A1412	3A1412	1/4 X 1/2	50
A3814	3A3814	3/8 X 1/4	50
A38516	3A38516	3/8 X 5/16	50
A38	3A38	3/8 X 3/8	50
A3812	3A3812	3/8 X 1/2	50
A3858	3A3858	3/8 X 5/8	50
A1214	3A1214	1/2 X 1/4	50
A1238	3A1238	1/2 X 3/8	50
A12	3A12	1/2 X 1/2	50
A1258	3A1258	1/2 X 5/8	25
A1234	3A1234	1/2 X 3/4	25
A3414	3A3414	3/4 X 1/4	25
A3438	3A3438	3/4 X 3/8	25
A3412	3A3412	3/4 X 1/2	25
A3458	3A3458	3/4 X 5/8	25
A34	3A34	3/4 X 3/4	25
A34100	3A34100	3/4 X 1	25
A10034	3A10034	1 X 3/4	25
A100	3A100	1 X 1	25
A100114	3A100114	1 X 1 1/4	25
A11434	3A11434	1 1/4 X 3/4	1
A114100	3A114100	1 1/4 X 1	1
A114	3A114	1 1/4 X 1 1/4	1
A114112	3A114112	1 1/4 X 1 1/2	1
A112114	3A112114	1 1/2 X 1 1/4	1
A112	3A112	1 1/2 X 1 1/2	1
A200	3A200	2 X 2	1



MALE ELBOW PIPE FITTING

NYLON	POLYPRO	MPTXHB	BAG QTY.
EL1814	3EL1814	1/8 X 1/4	50
EL1838	3EL1838	1/8 X 3/8	50
EL14316	3EL14316	1/4 X 3/16	50
EL14	3EL14	1/4 X 1/4	50
EL14516	3EL14516	1/4 X 5/16	50
EL1438	3EL1438	1/4 X 3/8	50
EL1412	3EL1412	1/4 X 1/2	50
EL3814	3EL3814	3/8 X 1/4	50
EL38516	3EL38516	3/8 X 5/16	50
EL38	3EL38	3/8 X 3/8	50
EL3812	3EL3812	3/8 X 1/2	50
EL3858	3EL3858	3/8 X 5/8	50
EL1214	3EL1214	1/2 X 1/4	50
EL1238	3EL1238	1/2 X 3/8	50
EL12	3EL12	1/2 X 1/2	50
EL1258	3EL1258	1/2 X 5/8	25
EL1234	3EL1234	1/2 X 3/4	25
EL3414	3EL3414	3/4 X 1/4	25
EL3438	3EL3438	3/4 X 3/8	25
EL3412	3EL3412	3/4 X 1/2	25
EL3458	3EL3458	3/4 X 5/8	25
EL34	3EL34	3/4 X 3/4	25
EL34100	3EL34100	3/4 X 1	25
EL100	3EL100	1 X 1	25



45° STREET ELBOW FITTING

NYLON	POLYPRO	FPTXMPT	BAG QTY.
SE3445	3SE3445	3/4 X 3/4	10



STREET ELBOW FITTING

NYLON	POLYPRO	FPTXMPT	BAG QTY.
SE14	3SE14	1/4 X 1/4	25
SE38	3SE38	3/8 X 3/8	25
SE12	3SE12	1/2 X 1/2	25
SE34	3SE34	3/4 X 3/4	10



FEMALE PIPE FITTING

NYLON	POLYPRO	FNPTXHB	BAG QTY.
A14F	3A14F	1/4 X 1/4	50
A1438F	3A1438F	1/4 X 3/8	50
A3814F	3A3814F	3/8 X 1/4	50
A38F	3A38F	3/8 X 3/8	50
A3812F	3A3812F	3/8 X 1/2	50
A1214F	3A1214F	1/2 X 1/4	50
A1238F	3A1238F	1/2 X 3/8	50
A12F	3A12F	1/2 X 1/2	25
A1258F	3A1258F	1/2 X 5/8	25
A1234F	3A1234F	1/2 X 3/4	25
A3438F	3A3438F	3/4 X 3/8	25
A3412F	3A3412F	3/4 X 1/2	25
A3458F	3A3458F	3/4 X 5/8	25
A34F	3A34F	3/4 X 3/4	25



FEMALE ELBOW PIPE FITTING

NYLON	POLYPRO	FPTXHB	BAG QTY.
EL1814F	3EL1814F	1/8 X 1/4	50
EL1838F	3EL1838F	1/8 X 3/8	50
EL14316F	3EL14316F	1/4 X 3/16	50
EL14F	3EL14F	1/4 X 1/4	50
EL1438F	3EL1438F	1/4 X 3/8	50
EL3814F	3EL3814F	3/8 X 1/4	50
EL38F	3EL38F	3/8 X 3/8	50
EL3812F	3EL3812F	3/8 X 1/2	50
EL1258F	3EL1258F	1/2 X 5/8	25
EL1234F	3EL1234F	1/2 X 3/4	25
EL3412F	3EL3412F	3/4 X 1/2	25
EL3458F	3EL3458F	3/4 X 5/8	25
EL34F	3EL34F	3/4 X 3/4	25



TEES 1/4" GAUGE PORT

NYLON	POLYPRO	FPT	BAG QTY.
GTT1214	3GTT1214	1/2	25
GTT3414	3GTT3414	3/4	1

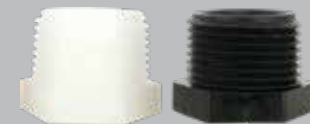

REDUCER BUSHINGS

NYLON	POLYPRO	MPTXFPT	BAG QTY.
RB3818	3RB3818	3/8 X 1/8	50
RB3814	3RB3814	3/8 X 1/4	50
RB1218	3RB1218	1/2 X 1/8	50
RB1214	3RB1214	1/2 X 1/4	50
RB1238	3RB1238	1/2 X 3/8	50
RB3418	3RB3418	3/4 X 1/8	25
RB3414	3RB3414	3/4 X 1/4	25
RB3438	3RB3438	3/4 X 3/8	25
RB3412	3RB3412	3/4 X 1/2	25
RB10012	3RB10012	1 X 1/2	25
RB10034	3RB10034	1 X 3/4	25
RB20034	3RB20034	2 X 3/4	1

NYLON & POLYPRO FITTINGS



NIPPLES

NYLON	POLYPRO	MPTXFPT	BAG QTY.
M18	3M18	1/8 X 1/8	50
M14	3M14	1/4 X 1/4	50
M38	3M38	3/8 X 3/8	50
M12	3M12	1/2 X 1/2	50
M34	3M34	3/4 X 3/4	25
M100	3M100	1 X 1	25
M114	3M114	1 1/4 X 1 1/4	1
M112	3M112	1 1/2 X 1 1/2	1
M200	3M200	2 X 2	1



HOSE MENDERS WITH CENTER STOP

NYLON	POLYPRO	HBXHB	BAG QTY.
SHM14	3SHM14	1/4 X 1/4	50
SHM38	3SHM38	3/8 X 3/8	50
SHM1238	3SHM1238	1/2 X 3/8	50
SHM12	3SHM12	1/2 X 1/2	50
SHM1258	3SHM1258	1/2 X 5/8	25
SHM58	3SHM58	5/8 X 5/8	25
SHM34	3SHM34	3/4 X 3/4	25
SHM100	3SHM100	1 X 1	25
SHM114	3SHM114	1 1/4 X 1 1/4	1
SHM112	3SHM112	1 1/2 X 1 1/2	1



HOSE MENDERS

NYLON	POLYPRO	HBXHB	BAG QTY.
HM14316	3HM14316	1/4 X 3/16	50
HM14	3HM14	1/4 X 1/4	50
HM516	3HM516	5/16 X 5/16	50
HM3814	3HM3814	3/8 X 1/4	50
HM1214	3HM1214	1/2 X 1/4	50
HM1238	3HM1238	1/2 X 3/8	50
HM5838	3HM5838	5/8 X 3/8	25
HM58	3HM58	5/8 X 5/8	25



REDUCER NIPPLES

NYLON	POLYPRO	MPTXFPT	BAG QTY.
M1418	3M1418	1/4 X 1/8	50
M3818	3M3818	3/8 X 1/8	50
M3814	3M3814	3/8 X 1/4	50
M1214	3M1214	1/2 X 1/4	50
M1238	3M1238	1/2 X 3/8	50
M3438	3M3438	3/4 X 3/8	25
M3412	3M3412	3/4 X 1/2	25



COUPLINGS

NYLON	POLYPRO	FPTXFPT	BAG QTY.
FC12	3FC12	1/2 X 1/2	50
FC34	3FC34	3/4 X 3/4	10
FC100	3FC100	1 X 1	10
FC114	3FC114	1 1/4 X 1 1/4	1
FC112	3FC112	1 1/2 X 1 1/2	1
FC200	3FC200	2 X 2	1



HOSE FITTINGS

NYLON	POLYPRO	MGHTXHB	BAG QTY.
D3414	3D3414	3/4 X 1/4	25
D3438	3D3438	3/4 X 3/8	25
D3412	3D3412	3/4 X 1/2	25
D3458	3D3458	3/4 X 5/8	25
D34	3D34	3/4 X 3/4	25

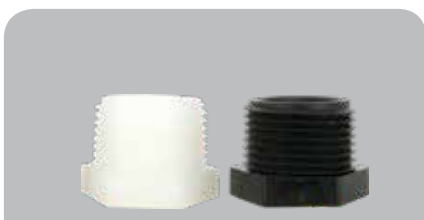

HEX PLUGS

NYLON	POLYPRO	MPT	BAG QTY.
F18	3F18	1/8	50
F14	3F14	1/4	50
F38	3F38	3/8	50
F12	3F12	1/2	50
F34	3F34	3/4	25
F100	3F100	1	25
F114	3F114	1 1/4	1
F112	3F112	1 1/2	1
F200	3F200	2	1



TEES

NYLON	POLYPRO	HB1XHB2/3	BAG QTY.
T14	3T14	1/4 X 1/4	50
T1438	3T1438	1/4 X 3/8	50
T38	3T38	3/8 X 3/8	50
T3812	3T3812	3/8 X 1/2	50
T3858	3T3858	3/8 X 5/8	25
T1238	3T1238	1/2 X 3/8	25
T12	3T12	1/2 X 1/2	1
T58	3T58	5/8 X 5/8	1
T3412	3T3412	3/4 X 1/2	1
T34	3T34	3/4 X 3/4	1



TEES

NYLON	POLYPRO	MPTXHB	BAG QTY.
T1814T	3T1814T	1/8 X 1/4	50
T14T	3T14T	1/4 X 1/4	50
T1438T	3T1438T	1/4 X 3/8	50
T1412T	3T1412T	1/4 X 1/2	50
T3814T	3T3814T	3/8 X 1/4	50
T38T	3T38T	3/8 X 3/8	50
T3812T	3T3812T	3/8 X 1/2	50
T1238T	3T1238T	1/2 X 3/8	50
T12T	3T12T	1/2 X 1/2	50
T1258T	3T1258T	1/2 X 5/8	25
T1234T	3T1234T	1/2 X 3/4	25
T3438T	3T3438T	3/4 X 3/8	25
T3412T	3T3412T	3/4 X 1/2	25
T3458T	3T3458T	3/4 X 5/8	25
T34T	3T34T	3/4 X 3/4	25

NYLON & POLYPRO FITTINGS



ELBOWS

NYLON	POLYPRO	MGHTXHB	BAG QTY.
ELD3414	3ELD3414	3/4 X 1/4	25
ELD3438	3ELD3438	3/4 X 3/8	25
ELD3412	3ELD3412	3/4 X 1/2	25
ELD3458	3ELD3458	3/4 X 5/8	25
ELD34	3ELD34	3/4 X 3/4	25



ELBOWS

NYLON	POLYPRO	MPTXHB	BAG QTY.
EL14HB	3EL14HB	1/4 X 1/4	50
EL3814HB	3EL3814HB	3/8 X 1/4	50
EL38HB	3EL38HB	3/8 X 3/8	50
EL1214HB	3EL1214HB	1/2 X 1/4	50
EL1238HB	3EL1238HB	1/2 X 3/8	50
EL12HB	3EL12HB	1/2 X 1/2	50
EL58HB	3EL58HB	5/8 X 5/8	25
EL3458HB	3EL3458HB	3/4 X 5/8	25
EL34HB	3EL34HB	3/4 X 3/4	25
EL100HB	3EL100HB	1X1	25

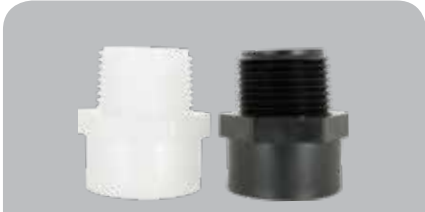

ADAPTERS

NYLON	POLYPRO	FPTXMPT	BAG QTY.
H34	3H34	3/4 X 3/4	25



HEX HEAD BARB FITTING

NYLON	POLYPRO	FPTXHB	BAG QTY.
Q14	3Q14	1/4 X 1/4	50
Q12	3Q12	1/2 X 1/2	25

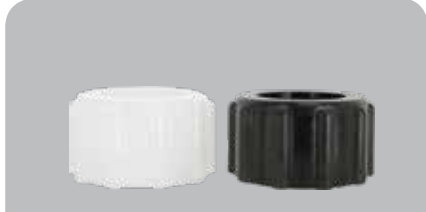

NUT FGHT

NYLON	POLYPRO	FGHT	BAG QTY.
B34	3B34	3/4	25



ADAPTERS

NYLON	POLYPRO	FPTXMPT	BAG QTY.
I34	3I34	3/4 X 3/4	25



FLAT SEAT HOSE BARB

NYLON	POLYPRO	HB	BAG QTY.
C14	3C14	1/4	25
C38	3C38	3/8	25
C12	3C12	1/2	25
C58	3C58	5/8	25
C34	3C34	3/4	25
C100	3C100	1	25



ADAPTERS

NYLON	POLYPRO	MGHTXMPT	BAG QTY.
E3438	3E3438	3/4 X 3/8	25
E3412	3E3412	3/4 X 1/2	25
E34	3E34	3/4 X 3/4	25



NOZZLE RETAINING NUT

NYLON	POLYPRO	FPS	BAG QTY.
B12	3B12	1/16	25



ADAPTERS

NYLON	POLYPRO	FGHTXMPT	BAG QTY.
G3414	3G3414	3/4 X 1/4	25
G3412	3G3412	3/4 X 1/2	25
G34	3G34	3/4 X 3/4	25



NUT HEX SWIVEL

NYLON	POLYPRO	FGHT	BAG QTY.
B100	3B100	1	25

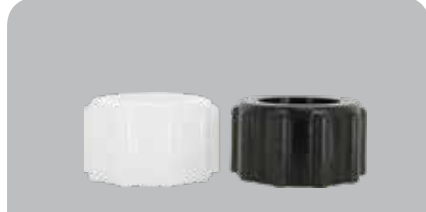

NOZZLE RETAINING NUT

NYLON	POLYPRO	FPS	BAG QTY.
8027	38027	1/16	25



TEES

NYLON	POLYPRO	FPTXMPT	BAG QTY.
T34F	3T34F	3/4 X 3/4	25

NYLON & POLYPRO FITTINGS



CROSSES, INCLUDES B12 NUT

NYLON	POLYPRO	MPSXHB	BAG QTY.
T38C	3T38C	1 ¹ / ₁₆ X 3 ³ / ₈	50
T12C	3T12C	1 ¹ / ₁₆ X 1 ¹ / ₂	50
T34C	3T34C	1 ¹ / ₁₆ X 3 ³ / ₄	50



NIPPLE

NYLON	POLYPRO	MPSXMPT	BAG QTY.
NB1614	3NB1614	1 ¹ / ₁₆ X 1 ¹ / ₄	50
NB1612	3NB1612	1 ¹ / ₁₆ X 1 ¹ / ₂	50



NOZZLE THREAD

NOZZLE CAP, NOZZLE THREAD

NYLON	POLYPRO	FPS	BAG QTY.
3942	33942	1 ¹ / ₁₆	25

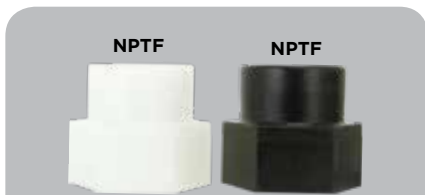

NPTF

NPTF

NOZZLE THREAD

FEMALE SPRAY TIP ADAPTER

NYLON	POLYPRO	FPSXFPT	BAG QTY.
NF1614	3NF1614	1 ¹ / ₁₆ X 1 ¹ / ₄	25



NPTF

GARDEN HOSE
THREAD

CAPS, GARDEN HOSE THREAD

NYLON	POLYPRO	FGHT	BAG QTY.
N34	3N34	3 ³ / ₄	25

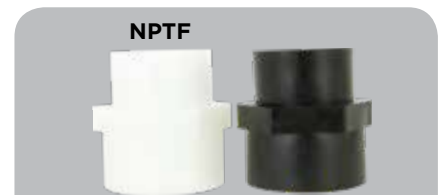

NPTF

FGHT

ADAPTER COUPLINGS

NYLON	POLYPRO	FGHTXNPTF	BAG QTY.
J3412	3J3412	3 ³ / ₄	25



ELBOWS

NYLON	POLYPRO	MPSXHB	BAG QTY.
NTL14	3NTL14	1 ¹ / ₁₆ X 1 ¹ / ₄	50
NTL38	3NTL38	1 ¹ / ₁₆ X 3 ³ / ₈	50
NTL12	3NTL12	1 ¹ / ₁₆ X 1 ¹ / ₂	50
NTL58	3NTL58	1 ¹ / ₁₆ X 5 ⁵ / ₈	25
NTL34	3NTL34	1 ¹ / ₁₆ X 3 ³ / ₄	25



TEES

NYLON	POLYPRO	MPSXHB	BAG QTY.
NTT38	3NTT38	1 ¹ / ₁₆ X 3 ³ / ₈	50
NTT12	3NTT12	1 ¹ / ₁₆ X 1 ¹ / ₂	50
NTT58	3NTT58	1 ¹ / ₁₆ X 5 ⁵ / ₈	50
NTT34	3NTT34	1 ¹ / ₁₆ X 3 ³ / ₄	25



HOSE BARB FOR 8027 NUT

NYLON	POLYPRO	HB	BAG QTY.
K8414	3K8414	1 ¹ / ₄	25
K8438	3K8438	3 ³ / ₈	25
K8412	3K8412	1 ¹ / ₂	25



HOSE BARB WITH NOZZLE THREAD

NYLON	POLYPRO	MPSXHB	BAG QTY.
38D	338D	1 ¹ / ₁₆ X 3 ³ / ₈	50
3812D	33812D	1 ¹ / ₁₆ X 1 ¹ / ₂	50

STAINLESS STEEL FITTINGS



HOSE BARB

PART#	MNPT X HB	PART#	MNPT X HB
90.316.300	1/4" X 1/4"	90.316.307	3/4" X 1"
90.316.301	1/4" X 3/8"	90.316.308	1" X 1"
90.316.302	1/4" X 1/2"	90.316.309	1 1/4" X 1 1/4"
90.316.303	3/8" X 3/8"	90.316.310	1 1/2" X 1 1/2"
90.316.304	3/8" X 1/2"	90.316.311	2" X 2"
90.316.305	1/2" X 1/2"	90.316.312	3" X 3"
90.316.306	3/4" X 3/4"	90.316.313	4" X 4"
MATERIAL 316 STAINLESS STEEL			



NPT CAP

PART#	FNPT	PART#	FNPT
90.304.326	1/8"	90.304.331	1"
90.304.327	1/4"	90.304.332	1 1/4"
90.304.328	3/8"	90.304.333	1 1/2"
90.304.329	1/2"	90.304.334	2"
90.304.330	3/4"	90.304.335	3"
MATERIAL 304 STAINLESS STEEL			



FEMALE PIPE CROSS

PART#	FNPT	PART#	FNPT
90.304.341	1/8"	90.304.346	1"
90.304.342	1/4"	90.304.347	1 1/4"
90.304.343	3/8"	90.304.348	1 1/2"
90.304.344	1/2"	90.304.349	2"
90.304.345	3/4"	90.304.350	3"
MATERIAL 304 STAINLESS STEEL			



HEX PLUG

PART#	MNPT	PART#	MNPT
90.304.356	1/8"	90.304.361	1"
90.304.357	1/4"	90.304.362	1 1/4"
90.304.358	3/8"	90.304.363	1 1/2"
90.304.359	1/2"	90.304.364	2"
90.304.360	3/4"	90.304.365	3"
MATERIAL 304 STAINLESS STEEL			



COUPLING

PART#	FNPT	PART#	FNPT
90.304.371	1/8" X 1/8"	90.304.376	1" X 1"
90.304.372	1/4" X 1/4"	90.304.377	1 1/4" X 1 1/4"
90.304.373	3/8" X 3/8"	90.304.378	1 1/2" X 1 1/2"
90.304.374	1/2" X 1/2"	90.304.379	2" X 2"
90.304.375	3/4" X 3/4"	90.304.380	3" X 3"
MATERIAL 304 STAINLESS STEEL			



90° ELBOWS

PART#	FNPT	PART#	FNPT
90.304.386	1/8" X 1/8"	90.304.391	1" X 1"
90.304.387	1/4" X 1/4"	90.304.392	1 1/4" X 1 1/4"
90.304.388	3/8" X 3/8"	90.304.393	1 1/2" X 1 1/2"
90.304.389	1/2" X 1/2"	90.304.394	2" X 2"
90.304.390	3/4" X 3/4"	90.304.395	3" X 3"
MATERIAL 304 STAINLESS STEEL			



45° ELBOWS

PART#	FNPT	PART#	FNPT
90.304.400	1/8" X 1/8"	90.304.405	1" X 1"
90.304.401	1/4" X 1/4"	90.304.406	1 1/4" X 1 1/4"
90.304.402	3/8" X 3/8"	90.304.407	1 1/2" X 1 1/2"
90.304.403	1/2" X 1/2"	90.304.408	2" X 2"
90.304.404	3/4" X 3/4"	90.304.409	3" X 3"
MATERIAL 304 STAINLESS STEEL			



90° ELBOWS

PART#	FNPT X MNPT	PART#	FNPT X MNPT
90.304.421	1/8" X 1/8"	90.304.426	1" X 1"
90.304.422	1/4" X 1/4"	90.304.427	1 1/4" X 1 1/4"
90.304.423	3/8" X 3/8"	90.304.428	1 1/2" X 1 1/2"
90.304.424	1/2" X 1/2"	90.304.429	2" X 2"
90.304.425	3/4" X 3/4"	90.304.430	3" X 3"
MATERIAL 304 STAINLESS STEEL			



SQUARE HEAD PLUGS

PART#	MNPT	PART#	MNPT
90.304.470	1/8"	90.304.475	1"
90.304.471	1/4"	90.304.476	1 1/4"
90.304.472	3/8"	90.304.477	1 1/2"
90.304.473	1/2"	90.304.478	2"
90.304.474	3/4"	90.304.479	3"
MATERIAL 304 STAINLESS STEEL			



FEMALE TEES

PART#	FNPT	PART#	FNPT
90.304.485	1/8"	90.304.490	1"
90.304.486	1/4"	90.304.491	1 1/4"
90.304.487	3/8"	90.304.492	1 1/2"
90.304.488	1/2"	90.304.493	2"
90.304.489	3/4"	90.304.494	3"
MATERIAL 304 STAINLESS STEEL			



REDUCER BUSHING

PART#	MNPT X FNPT	PART#	MNPT X FNPT
90.304.440	1/4" X 1/8"	90.304.450	1" X 3/4"
90.304.441	3/8" X 1/4"	90.304.451	1 1/4" X 3/4"
90.304.442	1/2" X 1/8"	90.304.452	1 1/4" X 1"
90.304.443	1/2" X 1/4"	90.304.453	1 1/2" X 3/4"
90.304.444	1/2" X 3/8"	90.304.454	1 1/2" X 1"
90.304.445	3/4" X 1/4"	90.304.455	1 1/2" X 1 1/4"
90.304.446	3/4" X 1/2"	90.304.456	2" X 1 1/2"
90.304.449	1" X 1/2"	90.304.457	3" X 2"
MATERIAL 304 STAINLESS STEEL			



UNIONS

MATERIAL 304 STAINLESS STEEL			
AVAILABLE UPON REQUEST			

STAINLESS STEEL FITTINGS & SPRAY BOOMS



NIPPLES

PART#	MNPT	PART#	MNPT	PART#	MNPT
90.304.200	1/8" X 3/4"	90.304.229	1/2" X 2"	90.304.258	1 1/4" X 4"
90.304.201	1/8" X 1 1/2"	90.304.230	1/2" X 2 1/2"	90.304.259	1 1/4" X 5"
90.304.202	1/8" X 2"	90.304.231	1/2" X 3"	90.304.260	1 1/4" X 6"
90.304.203	1/8" X 2 1/2"	90.304.232	1/2" X 3 1/2"	90.304.261	1 1/2" X 1 3/4"
90.304.204	1/8" X 3"	90.304.233	1/2" X 4"	90.304.262	1 1/2" X 2"
90.304.205	1/8" X 3 1/2"	90.304.234	1/2" X 5"	90.304.263	1 1/2" X 2 1/2"
90.304.206	1/8" X 4"	90.304.235	1/2" X 6"	90.304.264	1 1/2" X 3"
90.304.207	1/8" X 5"	90.304.236	3/4" X 1 3/8"	90.304.265	1 1/2" X 3 1/2"
90.304.208	1/8" X 6"	90.304.237	3/4" X 1 1/2"	90.304.266	1 1/2" X 4"
90.304.209	1/4" X 7/8"	90.304.238	3/4" X 2"	90.304.267	1 1/2" X 5"
90.304.210	1/4" X 1 1/2"	90.304.239	3/4" X 2 1/2"	90.304.268	1 1/2" X 6"
90.304.211	1/4" X 2"	90.304.240	3/4" X 3"	90.304.269	2" X 2"
90.304.212	1/4" X 2 1/2"	90.304.241	3/4" X 3 1/2"	90.304.270	2" X 2 1/2"
90.304.213	1/4" X 3"	90.304.242	3/4" X 4"	90.304.271	2" X 3"
90.304.214	1/4" X 3 1/2"	90.304.243	3/4" X 5"	90.304.272	2" X 3 1/2"
90.304.215	1/4" X 4"	90.304.244	3/4" X 6"	90.304.273	2" X 4"
90.304.216	1/4" X 5"	90.304.245	1" X 1 1/2"	90.304.274	2" X 5"
90.304.217	1/4" X 6"	90.304.246	1" X 2"	90.304.275	2" X 6"
90.304.218	3/8" X 1"	90.304.247	1" X 2 1/2"	90.304.276	3" X 2 5/8"
90.304.219	3/8" X 1 1/2"	90.304.248	1" X 3"	90.304.277	3" X 3"
90.304.220	3/8" X 2"	90.304.249	1" X 3 1/2"	90.304.278	3" X 3 1/2"
90.304.221	3/8" X 2 1/2"	90.304.250	1" X 4"	90.304.279	3" X 4"
90.304.222	3/8" X 3"	90.304.251	1" X 5"	90.304.280	3" X 5"
90.304.223	3/8" X 3 1/2"	90.304.252	1" X 6"	90.304.281	3" X 6"
90.304.224	3/8" X 4"	90.304.253	1 1/4" X 1 5/8"	90.304.282	4" X 2 7/8"
90.304.225	3/8" X 5"	90.304.254	1 1/4" X 2"	90.304.283	4" X 4"
90.304.226	3/8" X 6"	90.304.255	1 1/4" X 2 1/2"	90.304.284	4" X 5"
90.304.227	1/2" X 1 1/8"	90.304.256	1 1/4" X 3"	90.304.285	4" X 6"
90.304.228	1/2" X 1 1/2"	90.304.257	1 1/4" X 3 1/2"		

MATERIAL 304 STAINLESS STEEL

STAINLESS SPRAY BOOMS

PART #	DESCRIPTION	A	B	C	D
90.900.083	32" BOOM, WITH OPEN ENDS	1/2" MNPT	1/4" FNPT	N/A	1/2" MNPT
90.900.082	72" BOOM, WITH SEALED END - ONE END	1/2" MNPT	1/4" FNPT	N/A	SEALED
90.900.081	72" BOOM, WITH SEALED ENDS	SEALED	1/4" FNPT	1/2" MNPT	SEALED

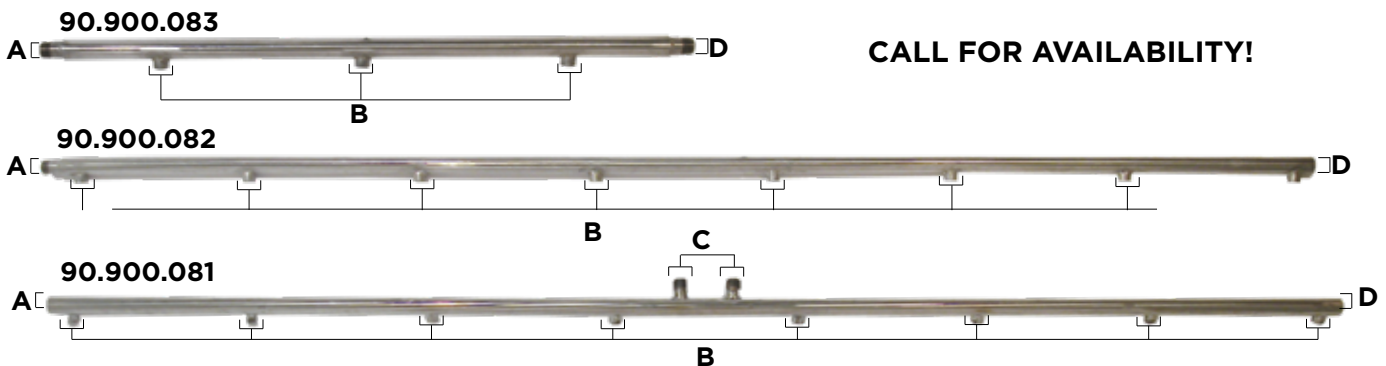

CALL FOR AVAILABILITY!

NOZZLE FITTINGS



HARDENED ORIFICE

ORFICE	CONE/STREAM ORIFICE	
PART#	90.410.001(#1)	90.410.006 (#6)
	90.410.002(#2)	90.410.007(#7)
	90.410.003(#3)	90.410.008 (#8)
	90.410.004(#4)	90.410.010(#10)
	90.410.005(#5)	90.410.011(#11)
MATERIAL	HARDENED STEEL WITH COATING	



90.900.012 90.900.011 90.944.012

SCREEN MESH

PART#	MATERIAL	MESH	CHECK BALL
90.900.011	NYLON	50	NO
90.900.111	NYLON	50	YES
90.900.012	NYLON	100	NO
90.900.112	NYLON	100	YES
90.944.011	BRASS	50	NO
90.944.012	BRASS	100	NO



90.900.009 90.900.119

**90.900.009 (BRASS)
90.900.119 (NYLON)**

DESCRIPTION	(MESH STRAINER) SCREENS
OEM#	4514-32
MATERIAL	BRASS & NYLON



90.900.002

DESCRIPTION	
FITTING	NOZZLE BODY CAP
OEM#	1325
MATERIAL	BRASS

AVAILABLE IN STAINLESS STEEL. CALL FOR DETAILS



90.900.006 (DEEP)

DESCRIPTION	NOZZLE BODY CAP
OEM#	20230
NOTE	USE WITH CERAMIC TIPS
MATERIAL	BRASS



90.900.016

DESCRIPTION	BLOCKOFF PLATE
OEM#	3942
MATERIAL	BRASS

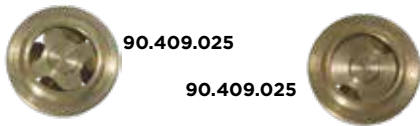

90.409.025

90.409.025

NOZZLE CORES

PART#	SIZE	MATERIAL
90.409.023	#23	BRASS
90.409.025	#25	BRASS
90.409.045	#45	BRASS



90.900.054

ADJUSTABLE NOZZLE

PART#	THREAD	OEM #
90.900.154	1/4" X #18 ORIFICE	5500-18
90.900.054	1/4" X #8 ORIFICE	5500-8
MATERIAL	BRASS	



90.900.040

ADJUSTABLE NOZZLE

PART#	THREAD	OEM #
90.900.140	11/16" X #18 ORIFICE	5500-18
90.900.040	11/16" X #8 ORIFICE	5500-8
MATERIAL	BRASS	



VALVE HANDLE

PART#	90.900.027
FITTING	3/4" FGHT X 1/4" MNPT
OEM#	4754
MATERIAL	BRASS, RUBBER HANDLE



TEFLON TAPE

PART#	85.400.110 (BOX OF 12) 85.400.101 (SINGLE ROLL)
DIMENSIONS	1/2" X 480"
CONTENTS	12/BOX

110° & 80° ISO POLYACETAL FAN NOZZLES

FEATURES

- PRECISION MOLDED IN POLYACETAL
- NARROW ELLIPTICAL SPRAY PATTERN
- 10 TIMES THE WEARABILITY OF BRASS
- AVAILABLE IN TWO SPRAY ANGLES OF 80° AND 110°
- COLOR CODED FOR QUICK IDENTIFICATION OF FLOW RATE
- POLYACETAL HAS UP TO 10 TIMES THE WEARABILITY OF STANDARD BRASS TIPS!
- WHEN BOOM MOUNTED AT 20" SPACING PROVIDE 50% OVERLAP TO GIVE AN OVERALL EVEN DISTRIBUTION

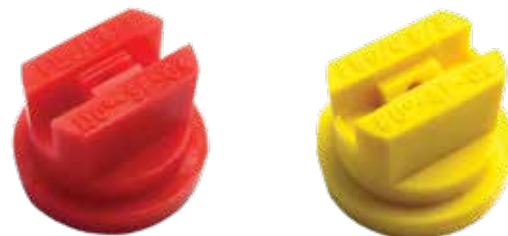

APPLICATIONS

Used for broadcast application of pre and post emergent herbicides, fungicides and insecticides.

NOZZLE SPACING

SPRAY ANGLE	SUGGESTED SPRAY HEIGHTS	
	20" SPACING	30" SPACING
80°	24-26"	NOT SUITABLE
110°	14-16"	20-22"

PART #	SPRAY TIP	SPRAY ANGLE	PSI	GPM	FLOW (OZ/MIN)	GALLONS PER ACRE 20° SPACING								GALLONS PER ACRE 30° SPACING							
						5	6	7	8	10	12	14	16	5	6	7	8	10	12	14	16
						MPH	MPH	MPH	MPH	MPH	MPH	MPH	MPH	MPH	MPH	MPH	MPH	MPH	MPH	MPH	MPH
ORANGE 90.110.001 90.080.001	#1	110°	30	0.09	11	5.2	4.3	3.7	3.3	2.6	2.2	1.8	1.6	3.5	2.9	2.5	2.2	1.7	1.4	1.2	1.1
			40	0.10	13	6.0	5.0	4.3	3.8	3.0	2.5	2.1	1.9	1.9	4.0	3.3	2.9	2.5	2.0	1.7	1.4
		80°	45	0.11	14	6.5	5.3	4.6	4.0	3.2	2.7	2.3	2.0	4.3	3.5	3.0	2.7	2.1	1.8	1.5	1.3
			50	0.11	15	6.7	5.6	4.8	4.2	3.4	2.8	2.4	2.1	4.5	3.7	3.2	2.8	2.2	1.9	1.6	1.4
GREEN 90.110.015 90.080.015	#1.5	110°	30	0.13	16	7.8	7.0	5.6	4.9	3.9	3.2	2.8	2.4	5.2	4.3	3.7	3.2	2.6	2.2	1.8	1.6
			40	0.15	19	9.0	7.5	6.4	5.6	4.5	3.7	3.2	2.8	6.0	5.0	4.3	3.7	3.0	2.5	2.1	1.9
		80°	45	0.16	21	9.6	8.0	6.8	6.0	4.8	4.0	3.4	3.0	6.4	5.3	4.5	4.0	3.2	2.6	2.0	2.0
			50	0.17	22	10.1	8.4	7.2	6.3	5.0	4.2	3.6	3.1	6.7	5.6	4.8	4.2	3.4	2.8	2.4	2.1
YELLOW 90.110.002 90.080.002	#2	110°	30	0.18	22	10.4	8.7	7.4	6.5	5.2	4.3	3.7	3.3	7.0	5.8	5.0	4.3	3.5	2.9	2.5	2.2
			40	0.20	26	12.0	10.0	8.6	7.5	6.0	5.0	4.3	3.8	8.0	6.7	5.7	5.0	4.0	3.3	2.9	2.5
		80°	45	0.21	28	12.8	10.6	9.1	8.0	6.4	5.3	4.6	4.0	8.5	7.1	6.1	5.3	4.3	3.5	3.0	2.7
			50	0.23	29	13.5	11.2	9.6	8.4	6.7	5.6	4.8	4.2	9.0	7.5	6.4	5.6	4.5	3.7	3.2	2.8
BLUE 90.110.003 90.080.003	#3	110°	30	0.26	34	15.6	13.0	11.2	9.8	7.8	6.5	5.6	4.9	10.4	8.7	7.4	6.5	5.2	4.3	3.7	3.3
			40	0.30	39	18.1	15.0	12.9	11.3	9.0	7.5	6.4	5.6	12.0	10.0	8.6	7.5	6.0	5.0	4.3	3.8
		80°	45	0.32	41	19.2	16.0	13.7	12.0	9.6	8.0	6.8	6.0	12.8	10.6	9.1	8.0	6.4	5.3	4.6	4.0
			50	0.34	44	20.2	16.8	14.4	12.6	10.1	8.4	7.2	6.3	13.5	11.2	9.6	8.4	6.7	5.6	4.8	4.2
RED 90.110.004 90.080.004	#4	110°	30	0.35	45	20.9	17.4	14.9	13.0	10.4	8.7	7.4	6.5	13.9	11.6	9.9	8.7	7.0	5.8	5.0	4.3
			40	0.41	52	24.1	20.1	17.2	15.0	12.0	10.0	8.6	7.5	16.1	13.4	11.5	10.0	8.0	6.7	5.7	5.0
		80°	45	0.43	55	25.5	21.3	18.2	16.0	12.8	10.6	9.1	8.0	17.0	14.2	12.2	10.6	8.5	7.1	6.1	5.3
			50	0.45	58	26.9	22.4	19.2	16.8	13.5	11.2	9.5	8.4	17.9	15.0	12.8	11.2	9.0	7.5	6.4	5.6
BROWN 90.110.005 90.080.005	#5	110°	30	0.44	56	26.1	21.7	18.6	16.3	13.0	10.9	9.3	8.1	17.4	14.5	12.4	10.9	8.7	7.2	6.2	5.4
			40	0.51	65	30.1	25.1	21.5	18.8	15.0	12.5	10.7	9.4	20.1	16.7	14.3	12.5	10.0	8.4	7.2	6.3
		80°	45	0.54	69	31.9	26.6	22.8	20.0	16.0	13.3	11.4	10.0	21.3	17.7	15.2	13.3	10.6	8.9	7.6	6.7
			50	0.57	73	33.7	28.0	24.0	21.0	16.8	14.0	12.0	10.5	22.4	18.7	16.0	14.0	11.2	9.3	8.0	7.0
GRAY 90.110.006 90.080.006	#6	110°	30	0.53	67	31.3	26.1	22.3	19.5	15.6	13.0	11.2	9.8	20.9	17.4	14.9	13.0	10.4	8.7	7.4	6.5
			40	0.61	78	36.1	30.1	25.8	22.6	18.1	15.0	12.9	11.3	24.1	20.1	17.2	15.0	12.0	10.0	8.6	7.5
		80°	45	0.64	83	38.3	31.9	27.4	23.9	19.2	16.0	13.7	12.0	25.5	21.3	18.2	16.0	12.8	10.6	9.1	8.0
			50	0.68	87	40.4	33.7	28.8	25.2	20.2	16.8	14.4	12.6	26.9	22.4	19.2	16.8	13.5	11.2	9.6	8.4
WHITE 90.110.008 90.080.008	#8	110°	30	0.70	90	41.7	34.8	29.8	26.1	20.9	17.4	14.9	13.0	27.8	23.2	19.9	17.4	13.9	11.6	9.9	8.7
			40	0.81	104	48.2	40.1	34.4	30.1	24.1	20.1	17.2	15.0	32.1	26.8	22.9	20.1	16.1	13.4	11.5	10.0
		80°	45	0.86	110	51.1	42.6	36.5	31.9	25.5	21.3	18.2	16.0	34.1	28.4	24.3	21.3	17.0	14.2	12.2	10.6
			50	0.91	116	53.8	44.9	38.5	33.7	26.9	22.4	19.2	16.8	35.9	29.9	25.6	22.4	17.9	15.0	12.8	11.2
LIGHT BLUE 90.110.010 90.080.010	#10	110°	30	0.88	112	52.1	43.4	37.2	32.6	26.1	21.7	18.6	16.3	34.8	29.0	24.8	21.7	17.4	14.5	12.4	10.9
			40	1.01	130	60.2	50.2	43.0	37.6	30.1	25.1	21.5	18.8	40.1	33.4	28.7	25.1	20.1	16.7	14.3	12.5
		80°	45	1.07	138	63.8	53.2	45.6	39.9	31.9	26.6	22.8	20.0	42.6	35.5	30.4	26.6	21.3	17.7	15.2	13.3
			50	1.13	145	67.3	56.1	48.1	42.1	33.7	28.0	24.0	21.0	44.9	37.4	32.0	28.0	22.4	18.7	16.0	14.0
60	1.24	159	73.7	61.4	52.7	46.1	36.9	30.7	26.3	23.0	49.1	41.0	35.1	30.7	24.6	20.5	17.6	15.4			

110° ISO FAN NOZZLES, CERAMIC INSERT



FEATURES

- AVAILABLE IN 110° SPRAY ANGLE
- PRECISION MOLDED IN POLYACETAL
- COLOR CODED FOR QUICK IDENTIFICATION OF FLOW RATE
- CERAMIC TIP LASTS 90-100 TIMES LONGER THAN A STANDARD BRASS TIP

NOZZLE SPACING

SPRAY ANGLE	SUGGESTED SPRAY HEIGHTS	
	20" SPACING	30" SPACING
110°	14-16"	20-22"

APPLICATIONS

Used for broadcast application of pre and post emergent herbicides, fungicides and insecticides.

PART #	SPRAY TIP	SPRAY ANGLE	PSI	GPM	FLOW (OZ/MIN)	GALLONS PER ACRE 20° SPACING								GALLONS PER ACRE 30° SPACING							
						5 MPH	6 MPH	7 MPH	8 MPH	10 MPH	12 MPH	14 MPH	16 MPH	5 MPH	6 MPH	7 MPH	8 MPH	10 MPH	12 MPH	14 MPH	16 MPH
GREEN 93.110.015	#1.5	110°	30	0.13	17	7.8	6.5	5.6	4.9	3.9	3.3	2.8	2.4	5.2	4.3	3.7	3.3	2.6	2.2	1.9	1.6
			40	0.15	19	9.0	7.5	6.4	5.6	4.5	3.8	3.2	2.8	6.0	5.0	4.3	3.8	3.0	2.5	2.1	1.9
			45	0.16	21	9.6	8.0	6.8	6.0	4.8	4.0	3.4	3.0	6.4	5.3	4.6	4.0	3.2	2.7	2.3	2.0
			50	0.17	22	10.1	8.4	7.2	6.3	5.0	4.2	3.6	3.2	6.7	5.6	4.8	4.2	3.4	2.8	2.4	2.1
			60	0.19	24	11.1	9.2	7.9	6.9	5.5	4.6	3.9	3.5	7.4	6.1	5.3	4.6	3.7	3.1	2.6	2.3
YELLOW 93.110.002	#2	110°	30	0.18	22	10.4	8.7	7.4	6.5	5.2	4.3	3.7	3.3	7.0	5.8	5.0	4.3	3.5	2.9	2.5	2.2
			40	0.20	26	12.0	10.0	8.6	7.5	6.0	5.0	4.3	3.8	8.0	6.7	5.7	5.0	4.0	3.3	2.9	2.5
			45	0.21	28	12.8	10.6	9.1	8.0	6.4	5.3	4.6	4.0	8.5	7.1	6.1	5.3	4.3	3.5	3.0	2.7
			50	0.23	29	13.5	11.2	9.6	8.4	6.7	5.6	4.8	4.2	9.0	7.5	6.4	5.6	4.5	3.7	3.2	2.8
			60	0.25	32	14.7	12.3	10.5	9.2	7.4	6.1	5.3	4.6	9.8	8.2	7.0	6.1	4.9	4.1	3.5	3.1
BLUE 93.110.003	#3	110°	30	0.26	34	15.6	13.0	11.2	9.8	7.8	6.5	5.6	4.9	10.4	8.7	7.4	6.5	5.2	4.3	3.7	3.3
			40	0.30	39	18.1	15.0	12.9	11.3	9.0	7.5	6.4	5.6	12.0	10.0	8.6	7.5	6.0	5.0	4.3	3.8
			45	0.32	41	19.2	16.0	13.7	12.0	9.6	8.0	6.8	6.0	12.8	10.6	9.1	8.0	6.4	5.3	4.6	4.0
			50	0.34	44	20.2	16.8	14.4	12.6	10.1	8.4	7.2	6.3	13.5	11.2	9.6	8.4	6.7	5.6	4.8	4.2
			60	0.37	48	22.1	18.4	15.8	13.8	11.1	9.2	7.9	6.9	14.7	12.3	10.5	9.2	7.4	6.1	5.3	4.6
RED 93.110.004	#4	110°	30	0.35	45	20.9	17.4	14.9	13.0	10.4	8.7	7.4	6.5	13.9	11.6	9.9	8.7	7.0	5.8	5.0	4.3
			40	0.41	52	24.1	20.1	17.2	15.0	12.0	10.0	8.6	7.5	16.1	13.4	11.5	10.0	8.0	6.7	5.7	5.0
			45	0.43	55	25.5	21.3	18.2	16.0	12.8	10.6	9.1	8.0	17.0	14.2	12.2	10.6	8.5	7.1	6.1	5.3
			50	0.45	58	26.9	22.4	19.2	16.8	13.5	11.2	9.5	8.4	17.9	15.0	12.8	11.2	9.0	7.5	6.4	5.6
			60	0.50	64	29.5	24.6	21.1	18.4	14.7	12.3	10.5	9.2	19.7	16.4	14.0	12.3	9.8	8.2	7.0	6.1
BROWN 93.110.005	#1	110°	30	0.44	56	26.1	21.7	18.6	16.3	13.0	10.9	9.3	8.1	17.4	14.5	12.4	10.9	8.7	7.2	6.2	5.4
			40	0.51	65	30.1	25.1	21.5	18.8	15.0	12.5	10.7	9.4	20.1	16.7	14.3	12.5	10.0	8.4	7.2	6.3
			45	0.54	69	31.9	26.6	22.8	20.0	16.0	13.3	11.4	10.0	21.3	17.7	15.2	13.3	10.6	8.9	7.6	6.7
			50	0.57	73	33.7	28.0	24.0	21.0	16.8	14.0	12.0	10.5	22.4	18.7	16.0	14.0	11.2	9.3	8.0	7.0
			60	0.62	79	36.9	30.7	26.3	23.0	18.4	15.4	13.2	11.5	24.6	20.5	17.6	15.4	12.3	10.2	8.8	7.7
GRAY 93.110.006	#1	110°	30	0.53	67	31.3	26.1	22.3	19.5	15.6	13.0	11.2	9.8	20.9	17.4	14.9	13.0	10.4	8.7	7.4	6.5
			40	0.61	78	36.1	30.1	25.8	22.6	18.1	15.0	12.9	11.3	24.1	20.1	17.2	15.0	12.0	10.0	8.6	7.5
			45	0.64	83	38.3	31.9	27.4	23.9	19.2	16.0	13.7	12.0	25.5	21.3	18.2	16.0	12.8	10.6	9.1	8.0
			50	0.68	87	40.4	33.7	28.8	25.2	20.2	16.8	14.4	12.6	26.9	22.4	19.2	16.8	13.5	11.2	9.6	8.4
			60	0.74	95	44.2	36.9	31.6	27.6	22.1	18.4	15.8	13.8	29.5	24.6	21.1	18.4	14.7	12.3	10.5	9.2

140° DEFLECTOR NOZZLES



FEATURES

- 14 TO 43 PSI
- WIDE SPRAY ANGLE OF 140°
- PRODUCES COARSE DROPLETS
- FITS STANDARD NOZZLE CAPS
- NARROW RECTANGULAR SPRAY PATTERN
- MOLDED IN HIGH PERFORMANCE COLOR CODED POLYACETAL
- SCREWDRIVER SLOT AT FRONT TO ALIGN NOZZLE IN STANDARD CAPS

APPLICATIONS

This nozzle is well suited to broadcast spraying with small boom sprayers fitted to all-terrain vehicles. The wide angle allows the nozzles to be spaced at 40" intervals effectively reducing the number of nozzles required.

Polyacetal has up to 10 times the wearability of standard brass tips!

PART #	SPRAY TIP#	SPRAY ANGLE	PSI	GPM	FLOW (OZ/MIN)	GALLONS PER ACRE 40° SPACING						
						3 MPH	4 MPH	5 MPH	6 MPH	7 MPH	8 MPH	9 MPH
RED 90.140.002	#2	140°	15	0.25	31	12.1	9.1	7.3	6.1	5.2	4.5	4.0
			20	0.28	36	14.0	10.5	8.4	7.0	6.0	5.3	4.7
			25	0.32	40	15.7	11.7	9.4	7.8	6.7	5.9	5.2
			30	0.35	44	17.2	12.9	10.3	8.6	7.4	6.4	5.7
			35	0.37	48	18.5	13.9	11.1	9.3	7.9	6.9	6.2
BROWN 90.140.025	#2.5	140°	15	0.31	39	15.2	11.4	9.1	7.6	6.5	5.7	5.1
			20	0.35	45	17.5	13.1	10.5	8.7	7.5	6.6	5.8
			25	0.40	51	19.6	14.7	11.7	9.8	8.4	7.3	6.5
			30	0.43	55	21.4	16.1	12.9	10.7	9.2	8.0	7.1
			35	0.47	60	23.1	17.4	13.9	11.6	9.9	8.7	7.7
GREY 90.140.003	#3	140°	15	0.37	47	18.2	13.6	10.9	9.1	7.8	6.8	6.1
			20	0.42	54	21.0	15.7	12.6	10.5	9.0	7.9	7.0
			25	0.47	61	23.5	17.6	14.1	11.7	10.1	8.8	7.8
			30	0.52	66	25.7	19.3	15.4	12.9	11.0	9.6	8.6
			35	0.56	72	27.8	20.8	16.7	13.9	11.9	10.4	9.3

HOLLOW CONE CERAMIC NOZZLE

FEATURES

- AVAILABLE IN 80° SPRAY ANGLE
- COMPLETE WITH SWIRL ASSEMBLY
- PRECISION MOLDED IN POLYACETAL
- COLOR CODED FOR QUICK IDENTIFICATION OF FLOW RATE
- CERAMIC TIP LASTS 90-100 TIMES LONGER THAN STANDARD BRASS TIP



Ceramic has up to 100 times the wearability of standard brass tips!

PART #	SPRAY TIP #	SPRAY ANGLE	GALLONS PER MINUTE					
			44 PSI	58 PSI	73 PSI	101 PSI	145 PSI	218 PSI
RED 93.100.001	#1	80°	0.10	0.12	0.13	0.15	0.18	0.22
ORANGE 93.100.002	#2	80°	0.21	0.24	0.27	0.31	0.37	0.46
GRAY 93.100.003	#3	80°	0.31	0.36	0.40	0.46	0.55	0.66
BLACK 93.100.004	#4	80°	0.41	0.47	0.53	0.62	0.73	0.89
BLUE 93.100.005	#5	80°	0.53	0.58	0.63	0.74	0.89	1.07

ALL MEASUREMENTS ARE IN MILLIMETERS UNLESS OTHERWISE STATED (1" = 25.4 MM). THESE ITEMS ARE NOT ORIGINAL EQUIPMENT PARTS.

NOZZLES



Part# 90.900.160

HARDI FAN TIP CONVERSION CAP

FEATURES

- COMPLETE WITH GASKETS
- PRECISION MOLDED IN POLACETAL
- CONVERTS FROM HARDI SYSTEMS TO ISO STANDARD FAN TIPS



Part# 90.900.162

HARDI HOLLOW CONE CONVERSION CAP

FEATURES

- COMPLETE WITH GASKETS
- PRECISION MOLDED IN POLACETAL
- CONVERTS FROM HARDI SYSTEMS TO ISO STANDARD FAN TIPS

ISO STANDARD BAYONET CAPS

PART #	SIZE	COLOR
90.900.170	ISO STANDARD	BLACK
90.900.171	ISO STANDARD	BLUE
90.900.172	ISO STANDARD	RED
90.900.173	ISO STANDARD	YELLOW
90.900.174	ISO STANDARD	GREEN
90.900.175	ISO STANDARD	BROWN

FEATURES

- COMPLETE WITH GASKETS
- PRECISION MOLDED IN POLACETAL
- ISO COLOR CODED FOR EASY IDENTIFICATION



Part# 90.900.171



STANDARD PATTERN BOOMLESS NOZZLES

Standard spray nozzles are available in right or left spray. Nozzle delivers a directional spray pattern with back-spray to ensure overlap coverage when mounted in pairs. Spray distance value at 36" mounted height. Mounting range 24" - 48". All standard pattern boomless nozzles are a two piece construction.

LEFT SPRAY PATTERN	RIGHT SPRAY PATTERN	ORIFICE SIZE	CONSTRUCTION
BN2XP116LSX	BN2XP116RSX	.116	STAINLESS STEEL CAP & POLYPRO BODY
BN2XP120LS-NT	BN2XP120RS-NT	.125	STAINLESS STEEL CAP & POLYPRO BODY
BN2XP125LS	BN2XP125RS	.125	STAINLESS STEEL CAP & POLYPRO BODY
BN2XP140LS-NT	BN2XP140RS-NT	.140	STAINLESS STEEL CAP & POLYPRO BODY
BN2XP152LS	BN2XP152RS	.152	STAINLESS STEEL CAP & POLYPRO BODY
BN2XP187LS	BN2XP187RS	.187	STAINLESS STEEL CAP & POLYPRO BODY

NARROW PATTERN BOOMLESS NOZZLES

Narrow pattern nozzles are available in right or left spray. Nozzle delivers a concentrated pattern for narrow band spray applications. Spray distance value at 18" mounted height. Mounting range 12" - 24". All narrow pattern boomless nozzles are a two piece construction.

LEFT SPRAY PATTERN	ORIFICE SIZE	CONSTRUCTION
BN2XX187LN	.187	STAINLESS STEEL CAP & BODY

WIDE PATTERN BOOMLESS NOZZLES

Wide spray nozzles are available in various spray distance values. Nozzle delivers a full spray pattern. Designed for wide band spray applications from a single mounted nozzle. Spray distance value at 36" mounted height. Mounting height 24" - 48". All wide pattern boomless nozzles are a two piece construction.

FULL SPRAY PATTERN	ORIFICE SIZE	CONSTRUCTION
N2XX152FWX	.152	STAINLESS STEEL CAP & BODY
BN2XX187FW	.187	STAINLESS STEEL CAP & BODY
BN2XP116FW	.116	STAINLESS STEEL CAP & POLYPRO BODY
BN2XP152FW	.152	STAINLESS STEEL CAP & POLYPRO BODY
BN2BP088RSX	.088	
BN2BB088RSX	.088	
BN2BP125FWX	.125	BRASS CAP & POLYPRO BODY
BN2BP125FWX-CS	.125	BRASS CAP & POLYPRO BODY
BN2BP152FWX	.152	BRASS CAP & POLYPRO BODY
BN2BP152FWX-CS	.152	BRASS CAP & POLYPRO BODY
BN2BP187FW30	.187	BRASS CAP & POLYPRO BODY

BALL VALVES



BRASS BALL VALVES

PART#	SIZE	PSI	THREAD
91.000.001	1/4"	600 WOG	FNPT
91.000.002	3/8"	600 WOG	FNPT
91.000.003	1/2"	600 WOG	FNPT
91.000.004	3/4"	600 WOG	FNPT
91.000.005	1"	600 WOG	FNPT
91.000.006	1 1/4"	600 WOG	FNPT
91.000.007	1 1/2"	600 WOG	FNPT
91.000.008	2"	600 WOG	FNPT
91.000.010	3"	600 WOG	FNPT
91.000.012	4"	600 WOG	FNPT

NON-CSA APPROVED



SWEAT BALL VALVES

PART#	SIZE	PSI	THREAD
91.500.003	1/2"	600 WOG	SOLDER
91.500.004	3/4"	600 WOG	SOLDER
91.500.005	1"	600 WOG	SOLDER
91.500.006	1 1/4"	600 WOG	SOLDER
91.500.007	1 1/2"	600 WOG	SOLDER
91.000.008	2"	600 WOG	SOLDER

CSA/UL APPROVED



CARBON STEEL BALL VALVES

PART#	SIZE	PSI	THREAD
91.300.001	1/4"	2,000	FNPT
91.300.002	3/8"	2,000	FNPT
91.300.003	1/2"	2,000	FNPT
91.300.004	3/4"	2,000	FNPT
91.300.005	1"	2,000	FNPT
91.300.006	1 1/4"	2,000	FNPT
91.300.007	1 1/2"	2,000	FNPT
91.300.008	2"	2,000	FNPT

ADDITIONAL INFORMATION
RESTRICTED PORT BALL VALVES WITH CARBON STEEL BODY.



316 STAINLESS STEEL BALL VALVES

PART#	SIZE	PSI	THREAD
91.200.001	1/4"	1000 WOG	FNPT
91.200.002	3/8"	1000 WOG	FNPT
91.200.003	1/2"	1000 WOG	FNPT
91.200.004	3/4"	1000 WOG	FNPT
91.200.005	1"	1000 WOG	FNPT
91.200.006	1 1/4"	1000 WOG	FNPT
91.200.007	1 1/2"	1000 WOG	FNPT
91.200.008	2"	1000 WOG	FNPT
91.200.009	2 1/2"	1000 WOG	FNPT
91.200.010	3"	1000 WOG	FNPT

ADDITIONAL INFORMATION
LOCKING HANDLE



BSP BALL VALVES

PART#	SIZE
91.150.140	3/8" MNPT X 1/2" MBSP
91.150.150	1/2" MNPT X 1/2" MBSP

ADDITIONAL INFORMATION
MNPT TO MBSP NICKEL PLATED BRASS VALVES



CHROME LEVER MINI BALL VALVES

PART#	SIZE	PSI	THREAD
91.400.001	1/4"	200	FNPT X FNPT
91.401.001	1/4"	200	FNPT X MNPT
91.400.002	3/8"	200	FNPT X FNPT
91.401.002	3/8"	200	FNPT X MNPT
91.400.003	1/2"	200	FNPT X FNPT
91.401.003	1/2"	200	FNPT X MNPT

DESCRIPTION
CHROMED BRASS BODY, BALL AND STEM WITH A TEFLON® SEAT AND VITON® SEALS

TEMP RATING
-4° TO 250° F



CHROME T-HANDLE MINI BALL VALVE

PART#	SIZE	PSI	THREAD
91.400.101	1/4"	200	FNPT X FNPT
91.401.101	1/4"	200	FNPT X MNPT
91.400.102	3/8"	200	FNPT X FNPT
91.401.102	3/8"	200	FNPT X MNPT
91.400.103	1/2"	200	FNPT X FNPT
91.401.103	1/2"	200	FNPT X MNPT

DESCRIPTION
CHROMED BRASS BODY, BALL AND STEM WITH A TEFLON® SEAT AND VITON® SEALS

TEMP RATING
-4° TO 250° F



GATE VALVES

PART#	SIZE	PSI	THREAD
92.000.003	1/2"	200	FNPT
92.000.004	3/4"	200	FNPT
92.000.005	1"	200	FNPT
92.000.006	1 1/4"	200	FNPT
92.000.007	1 1/2"	200	FNPT
92.000.008	2"	200	FNPT
92.000.009	2 1/2"	200	FNPT
92.000.010	3"	200	FNPT
92.000.012	4"	200	FNPT

DESCRIPTION
ADJUSTABLE STEM PACKING, MAXIMUM PRESSURE W.O.G. OF 200 PSI

TEMP RATING
-22° F TO 184° F

HANDHELD SPRAYERS



90.702.008
8 LITRE



90.702.006
6 LITRE



90.702.002
2 LITRE



90.702.001
1 LITRE

FEATURES

- LIGHTWEIGHT AND EASY TO USE
- HANDLE ACTION PISTON PUMP
- SINGLE CONICAL SPRAY TIP
- EASY TO USE SPOT SPRAY WAND
- LARGE MOUTH FOR EASY FILLING
- PRESSURE RELIEF VALVE
- ERGONOMIC HANDLE

REPLACEMENT PARTS

PART#	DESCRIPTION
90.709.002	SEAL & REBUILD KIT FOR 90.700.012 & 90.700.002
90.700.066	TRIGGER & HOSE FOR 6.5L & 8L SPRAYERS
90.700.067	LANCE & NUTS FOR 6.5L & 8L SPRAYERS

PORTABLE PULL BEHIND SPRAYER



90.710.016
16 LITRE

FEATURES

- LIGHTWEIGHT AND EASY TO USE
- NO LIFTING REQUIRED, REDUCE BACK PAIN
- HANDLE ACTION PISTON PUMP
- SINGLE CONICAL SPRAY TIP
- EASY TO USE SPOT SPRAY WAND
- LARGE MOUTH FOR EASY FILLING
- PRESSURE RELIEF VALVE
- ERGONOMIC HANDLE
- PULL-TYPE HANDCART DESIGN

REPLACEMENT PARTS

PART#	DESCRIPTION
90.710.117	HANDLE ASSEMBLY
90.710.118	HOSE AND WAND ASSEMBLY
90.710.119	PLUNGER & SEAL KIT ASSEMBLY

IDEAL FOR
INSECTICIDES, FERTILIZERS,
HERBICIDES & DISINFECTANTS
TREES AND SHRUBS
INSECT CONTROL
RANCH AND FARM
HOME AND INDUSTRIAL
LIVESTOCK WEED CONTROL
CONSTRUCTION
MUNICIPALITIES

BACKPACK SPRAYER

FEATURES

- LIGHTWEIGHT & EASY TO USE
- COMES WITH 4 SPRAY TIPS
- QUICK FITTING HARNESS CLIPS
- LEVER ACTION PISTON PUMP
- LARGE OPENING LID
- NEW PADDED STRAPS
- CARRY HANDLE
- LANCE CLIP
- QUALITY SEALS
- BUILT-IN SCREENS

REPLACEMENT PARTS

PART#	DESCRIPTION
90.700.113	LEVER, PUMP W/ GRIP
90.700.112	LID, N/S BACKPACK
90.700.114	PISTON CUP ASSY W/ ROCKER ARM
90.700.115	GUN ASSY

New padded straps and easy clip bottom connection



90.704.016
16 LITRE

ACCESSORIES

PART #	DESCRIPTION
90.700.135	BACKPACK SPRAY HOOD
ADDITIONAL INFO	
PRESS FIT	



4 SPRAY TIPS

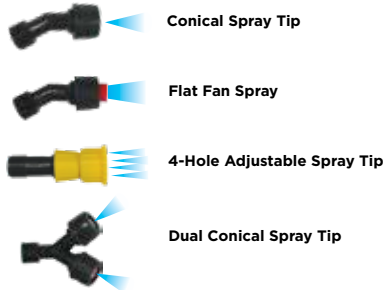

SPOT SPRAYER

FEATURES

- 12V DC PUMP
- REPLACEMENT DRAIN FITTING WITH CAP
- TRIGGER GUN WITH 20" CHROMED LANCE
- NOZZLE ADJUSTS FROM MIST TO SOLID STREAM
- 15' OF 1/4" COILED HOSE
- 5" SCREW ON LID

REPLACEMENT PARTS

PART#	DESCRIPTION
90.240.100	1GPM EVERFLO PUMP
DJ9017	BATTERY
DJ9016	12V 1AMP CHARGER
U45050000	SPOT WAND
DN2014	15' COILED HOSE
DJ2011	REMOTE TOGGLE SWITCH WITH CONNECTION WIRES
3N34	DRAIN PLUG CAP



90.700.100
9 GALLON

PORTABLE SPRAYER



FEATURES

- RECHARGEABLE 12V BATTERY
- 2 HR RUN TIME ON SINGLE CHARGE
- FRONT MOUNTED NOZZLE WITH 50" SWATH
- SPOT SPRAY GUN WITH COILED HOSE
- 18' VERTICAL AND 20' HORIZONTAL SPRAY
- INCLUDES HITCH BAR FOR TOWING
- ADJUSTABLE HANDLE FOR EASY STORAGE
- 12" WHEELS
- 9 GALLON TANK

REPLACEMENT PARTS

PART#	DESCRIPTION
90.240.100	1GPM EVERFLO PUMP
DJ9017	BATTERY
DJ9016	12V 1AMP CHARGER
U45050000	SPOT WAND
DN2014	15' COILED HOSE
DJ2011	REMOTE TOGGLE SWITCH WITH CONNECTION WIRES
3N34	DRAIN PLUG CAP



LITHIUM-ION BATTERY POWERED SPRAYER



90.709.016
16 LITRE

FEATURES

- ON/OFF SWITCH PREVENTS BACK FLOW
- QUICK WAND NOZZLE FOR ANY DIRECTION
- QUICK SPRING HOSE
- QUICK NOZZLE ADJUSTS FROM MIST TO STRAIGHT JET
- ELECTRONIC OVERLOAD PROTECTION
- LITHIUM-ION BATTERY PACK QUICK CHARGER AND
- SLOW CHARGER WITH ELECTRONIC PROTECTION
- THREE PERFECT SPRAYING MODES BY EASY SWITCH
- SAFETY TRIGGER: AVOIDING MISOPERATION
- RUBBER OVER-MOULDED GRIP
- OPERATOR CAN CHOOSE TRACKING (PULLING) OR BACKPACKING

DESCRIPTION

LITHIUM-ION BATTERY POWERED SPRAYER
16L 7.2V LITHIUM BATTERY
BACKPACK OR PULL BEHIND

APPLICATIONS

- GARDENING
- FERTILIZER
- PESTICIDES
- DISINFECTANT
- RINSE
- CLEANING FILTER OF AIR CONDITIONER



FOUR MODES



18V LITHIUM-ION BACKPACK SPRAYER

PART#	DESCRIPTION
90.709.015	18V LITHIUM-ION BACKPACK SPRAYER

FEATURES

- REMOVABLE LITHIUM-ION BATTERY PACK
- INPUT: 18 V, 2.15 AH
- LIQUID FLOW: 1.8 L/MIN
- SPRAY DISTANCE: > 5M
- WORK TIME: 40 MIN
- CHARGE TIME: 2.5 HOURS
- 2 SPEEDS
- BATTERY INDICATOR LIGHT



2 SPEED SWITCH



REMOVABLE LITHIUM-ION BATTERY PACK



LITHIUM-ION DELUXE ROLL & SPRAY

PART#	DESCRIPTION
90.709.030	LITHIUM-ION DELUXE ROLL & SPRAY

FEATURES

- REMOVABLE LITHIUM-ION BATTERY PACK
- INPUT: 18 V, 2.15 AH
- LIQUID FLOW: 2.4 L/MIN
- SPRAY DISTANCE: > 10M
- WORK TIME: 45-65 MIN
- CHARGE TIME: 2.5 HOURS
- 2 SPEEDS
- BATTERY INDICATOR LIGHT



2 SPEED SWITCH



REMOVABLE LITHIUM-ION BATTERY PACK



SPOT SPRAYERS



*NOTE: When adding spray boom kits, must upgrade to a minimum 1.8GPM pump.
*Pump Sold Separately.

PART#	DESCRIPTION
90.700.150	SPRAYER, SPOT 15 GAL 1GPM PUMP
90.700.152	SPRAYER, SPOT 15 GAL 2GPM PUMP
90.700.250	SPRAYER, SPOT 25 GAL 1GPM PUMP
90.700.252	SPRAYER, SPOT 25 GAL 2GPM DELA
90.700.253	SPRAYER, SPOT 25 GAL 2.2GPM EV
90.700.254	SPRAYER, SPOT 25 GAL 1.8GPM SF

REPLACEMENT PARTS

PART#	DESCRIPTION
U45050000	SPOT WAND
90.700.233	WIRE HARNESS WITH SWITCH
3N34	DRAIN PLUG CAP
U45050001	LANCE CLIPS, SINGLE CLIP

FEATURES

- 15' HOSE WITH U45050000 GUN
- CHOICE OF 1.0, 1.8 OR 2GPM 12 VOLT PUMP

ACCESSORIES

PART#	DESCRIPTION
90.700.302	STRAIGHT BOOM, 2 NOZZLES. USE WITH A MIN 1.8GPM PUMP*
90.700.303	BRACKET KIT FOR ATV
90.700.306	BOOMLESS SINGLE NOZZLE KIT, (req. min 2GPM pump)
90.700.307	BOOMLESS DOUBLE NOZZLE KIT (req. min 2GPM pump)
90.700.314	14' FOLDING BOOM KIT (req. min 2GPM pump)
85.400.100	DRY PRESSURE GAUGE, 2" 100 PSI



90.700.303



90.700.302



90.700.306

TRAILER LAWN SPRAYERS



PART#	DESCRIPTION
90.800.150	15 GALLON BE SPOT SPRAYER
90.800.250	25 GALLON BE SPOT SPRAYER

REPLACEMENT PARTS

PART#	DESCRIPTION
90.241.220	EVERFLOW QUICK ATTACHMENT
90.410.003	BOOM SPRAYER TIP, GREY
U4050002	ADJUSTABLE SPRAY TIP, FOR SPOT GUN
U45050006	SPOT WAND WITH HOSE
85.400.100	DRY PRESSURE GAUGE, 2" 100PSI
90.700.233	WIRE HARNESS WITH SWITCH
3N34	DRAIN PLUG CAP
U4050001	LANCE CLIPS, SINGLE CLIP

FEATURES

- 15' HOSE WITH U45050000 GUN
- 2.0 GPM 12 VOLT PUMP
- 72" 2 NOZZLE SPRAY BOOM COVERAGE
- EVERFLOW 2.2 GPM PUMP
- POWDER COATED FRAME
- 10" PNEUMATIC TIRES
- PRESSURE GAUGE

ACCESSORIES

PART#	DESCRIPTION
90.700.314	FOLDING BOOM, 4 NOZZLES, 14' COVERAGE USE W/A MIN 1.8GPM PUMP
90.700.306	BOOMLESS NOZZLE KIT, SINGLE
90.700.307	BOOMLESS NOZZLE KIT, DOUBLE
90.700.304	FOLDING BOOM KIT, 10'
90.700.314	14' FOLDING BOOM KIT (req. min 2GPM pump)
85.400.100	DRY PRESSURE GAUGE, 2" 100 PSI



90.700.307



90.700.304



90.700.306

TRAILER LAWN SPRAYERS

FEATURES

- 2.2 EVERFLO PUMP
- ON-OFF BOOM CONTROL
- GLYPHOSATE COMPATIBLE
- DELUXE HANDGUN OPTION
- 120" BOOM SPRAY COVERAGE
- 18" HANDGUN WITH 15FT OF HOSE
- ADJUSTABLE CONE SPRAY NOZZLE
- 3 SECTION FOLDING BREAKAWAY BOOM
- CHEMICAL RESISTANT POLYETHYLENE TANK
- ADJUSTABLE PRESSURE WITH RETURN TO TANK

REPLACEMENT PARTS

PART#	DESCRIPTION
90.241.220	PUMP, DEM 12V EF 2.2 GPM QA
90.140.025	SPRAY TIPS, BROWN
U45050002	SPRAYTIP, ADJUSTABLE FOR SPOT GUN
U45050006	SPOT WAND WITH HOSE
85.400.100	DRY PRESSURE GAUGE, 2" 100PSI
90.700.233	WIRE HARNESS WITH SWITCH
U45050001	LANCE CLIPS, SINGLE CLIP



90.800.400
40 GALLON

RTV MOUNT SPRAYERS

PART#	DESCRIPTION
BE-RTVSM40	40 GALLONS EVERFLO 12 V PUMP
BE-RTVMS60	60 GALLONS EVERFLO 12 V PUMP

FEATURES

- POLY TANK
- ADJUSTABLE SKID FRAME
- EVERFLO 12 VOLT PUMP 2.2 GPM
- 3 NOZZLES
- ADJUSTABLE RELIEF W/ GAUGE
- 3-PIECE, 80" FOLDING BOOM
- INCLUDES REMOTE SWITCH
- HANDGUN WITH HOSE
- ADJUSTABLE HEIGHT
- RUBBER BUMPERS ENSURE A SNUG FIT OVER THE RTV TAILGATE TO MINIMIZE SLIDING IN BOX

REPLACEMENT PARTS

PART#	DESCRIPTION
90.241.220	PUMP, DEM 12V EF 2.2 GPM QA
90.140.025	BOOM SPRAYER TIP, BROWN
U45050002	ADJUSTABLE SPRAY TIP, FOR SPOT GUN
U45050006	SPOT WAND WITH HOSE
85.400.100	DRY PRESSURE GAUGE, 2" 100PSI
90.700.233	WIRE HARNESS WITH SWITCH
U45050001	LANCE CLIPS, SINGLE CLIP



REAR MOUNT SPRAYERS



All models come with pump, flow control valve, spot gun & boom

3 PT SPRAYERS WITH 12V PUMP

PART#	DESCRIPTION
BE-RMES40	12V 40 GALLON 3 PT, 3 NOZZLE BOOM, 10' SPRAY COVERAGE
BE-RMES60	12V 60 GALLON 3 PT, 3 NOZZLE BOOM, 10' SPRAY COVERAGE

3 PT SPRAYERS, WITH ROLLER PUMP

PART#	DESCRIPTION
BE-RMS40	40 GALLON 3 PT, ROLLER PUMP & CONTROL, 3 NOZZLE BOOM, 10' SPRAY COVERAGE
BE-RMS60	60 GALLON 3 PT, ROLLER PUMP & CONTROL, 3 NOZZLE BOOM, 10' SPRAY COVERAGE

REPLACEMENT PARTS 12V

PART#	DESCRIPTION
90.241.220	2.2 GPM EVERFLO PUMP
90.140.025	SPRAY TIPS, BROWN
U45050006	SPOT WAND WITH HOSE
85.400.100	DRY PRESSURE GAUGE, 2" 100 PSI
90.700.233	WIRE HARNESS WITH SWITCH
U45050001	LANCE CLIPS, SINGLE CLIP

REPLACEMENT PARTS ROLLER PUMP

PART#	DESCRIPTION
6900C	PUMP
90.140.025	SPRAY TIPS, BROWN
U45050006	SPOT WAND WITH HOSE
85.400.100	DRY PRESSURE GAUGE, 2" 100 PSI
U45050001	LANCE CLIPS, SINGLE CLIP

12V SKID MOUNT SPRAYERS



PART#	DESCRIPTION
BE-SMES40-10	40 GALLONS
BE-SMES60-10	60 GALLONS

FEATURES

- PRESSURE CONTROL
- IDEAL FOR APPLYING INSECTICIDES AND HERBICIDES
- CHEMICAL RESISTANT TANK
- 2.2 GPM 12 VOLT EVERFLO PUMP
- 15' OF HOSE WITH HANDGUN
- 3 SECTION BOOM, 10' SPRAY WIDTH

REPLACEMENT PARTS

PART#	DESCRIPTION
90.241.220	2.2 GPM EVERFLO PUMP
90.140.025	SPRAY TIPS, BROWN
U45050006	SPOT WAND WITH HOSE
85.400.100	DRY PRESSURE GAUGE, 2" 100 PSI
90.700.233	WIRE HARNESS WITH SWITCH
U45050001	LANCE CLIPS, SINGLE CLIP
90.700.233	WIRE HARNESS WITH SWITCH
U45050001	LANCE CLIPS, SINGLE CLIP



8 POWER PRODUCTS

BRABER EQUIPMENT

40TH EDITION

PARTS CATALOG

WATER TRANSFER PUMPS

POWERED by
HONDA *PowerEase*
engines◀ SUITABLE FOR
OIL TRANSFER

FEATURES

- VITON® - CHEMICAL RESISTANT SEALS*
- SUITABLE FOR OIL TRANSFER*
- 121FT TOTAL LIFT
- 26FT SUCTION LIFT
- CENTRIFUGAL ALUMINUM PUMP
- HEAVY DUTY ALUMINUM IMPELLER
- RECOIL START

PUMP REPLACEMENT PARTS

- 50.001.022 - COMPLETE SEAL SET
- 50.001.020 - IMPELLER
- 50.001.021 - PLUG SET
- 85.150.301 - 1" COMPLETE PUMP

1" WATER TRANSFER PUMP

PART#	DISPLACEMENT	FUEL TANK CAPACITY	INLET/OUTLET	GPM
WP-1015HT	25CC HONDA GX25 MINI	0.15 GAL (0.58L)	1" MNPT	26
WP1015	38CC POWEREASE	0.5 GAL (2L)	1" MNPT	26
WP1015V	38CC POWEREASE	0.5 GAL (2L)	1" MNPT	26

POWERED by
HONDA

FEATURES

- 82FT TOTAL LIFT
- 26FT SUCTION LIFT
- CENTRIFUGAL ALUMINUM PUMP
- HEAVY DUTY ALUMINUM IMPELLER
- RECOIL START & LOW OIL SHUTDOWN

PUMP REPLACEMENT PARTS

- 50.002.202 - COMPLETE SEAL SET
- 50.002.201 - IMPELLER
- 50.002.203 - PLUG SET
- 85.150.201 - 2" COMPLETE PUMP/FRAME KIT
- 50.002.204 - 2" INLET/OUTLET REPLACEMENT

2" WATER TRANSFER PUMP

PART#	DISPLACEMENT	FUEL TANK CAPACITY	INLET/OUTLET	GPM
WP-2050HL	160CC HONDA GC160	0.5 GAL (1.8L)	2" MNPT	158

POWERED by
HONDA *PowerEase*
engines

FEATURES

- 82FT TOTAL LIFT
- 26FT SUCTION LIFT
- CENTRIFUGAL ALUMINUM PUMP
- HEAVY DUTY ALUMINUM IMPELLER
- RECOIL START & LOW OIL SHUTDOWN

PUMP REPLACEMENT PARTS

- 50.002.202 - COMPLETE SEAL SET
- 50.002.201 - IMPELLER
- 50.002.203 - PLUG SET
- 85.150.201 - 2" COMPLETE PUMP/FRAME KIT
- 50.002.204 - 2" INLET/OUTLET REPLACEMENT

2" WATER TRANSFER PUMP

PART#	DISPLACEMENT	FUEL TANK CAPACITY	INLET/OUTLET	GPM
WP-2065HL	196CC HONDA GX200	0.82 GAL (3.1L)	2" MNPT	158
WP-2070S	210CC POWEREASE	0.95 GAL (3.6L)	2" MNPT	158

WATER TRANSFER PUMPS

FEATURES

- 85FT TOTAL LIFT
- 26FT SUCTION LIFT
- CENTRIFUGAL ALUMINUM PUMP
- HEAVY DUTY ALUMINUM IMPELLER
- RECOIL START & LOW OIL SHUTDOWN

PUMP REPLACEMENT PARTS

- 50.003.202 - COMPLETE SEAL SET
- 50.003.201 - IMPELLER
- 50.002.203 - PLUG SET
- 85.150.203 - 3" COMPLETE PUMP/FRAME KIT
- 50.003.204 - 3" INLET/OUTLET REPLACEMENT

3" WATER TRANSFER PUMP

PART#	DISPLACEMENT	FUEL TANK CAPACITY	INLET/OUTLET	GPM
WP-3065HL	196CC HONDA GX200	0.82 GAL (3.1L)	3" MNPT	264
WP-3070S	210CC POWEREASE 7HP	0.95 GAL (3.6L)	3" MNPT	264



POWERED by **HONDA** *PowerEase* engines

FEATURES

- 98FT TOTAL LIFT
- 26FT SUCTION LIFT
- CENTRIFUGAL ALUMINUM PUMP
- HEAVY DUTY ALUMINUM IMPELLER
- RECOIL START & LOW OIL SHUTDOWN

PUMP REPLACEMENT PARTS

- 50.571.150 - COMPLETE SEAL SET
- 50.571.154 - IMPELLER
- 50.571.152 - PLUG SET
- 85.150.204 - 4" COMPLETE PUMP/FRAME KIT
- 50.571.151 - 4" INLET/OUTLET REPLACEMENT

4" WATER TRANSFER PUMP

PART#	DISPLACEMENT	FUEL TANK CAPACITY	INLET/OUTLET	GPM
WP-4013HR	389CC HONDA GX390	1.8 GAL (6.1L)	4" MNPT	422
WP-4015R	420CC POWEREASE	1.7 GAL (6.5L)	4" MNPT	422



POWERED by **HONDA** *PowerEase* engines

FEATURES

- 100FT TOTAL LIFT
- 16FT SUCTION LIFT
- CENTRIFUGAL ALUMINUM PUMP
- HEAVY DUTY CAST IRON IMPELLER
- ELECTRIC START
- LOW OIL SHUTDOWN
- FLAT FREE TIRES

4" WATER TRANSFER PUMP

PART#	DISPLACEMENT	FUEL TANK CAPACITY	INLET/OUTLET	GPM
WP4015S	459CC POWEREASE	30L, LONG RANGE	4" MNPT	242



PowerEase engines

WATER TRANSFER & HIGH PRESSURE PUMPS

POWERED by
HONDA▲
ELECTRIC START
(WP-6013HER)

FEATURES

- 70FT TOTAL LIFT
- 26FT SUCTION LIFT
- CENTRIFUGAL ALUMINUM PUMP
- HEAVY DUTY CAST IRON IMPELLER
- RECOIL START (WP-6013HR)
- ELECTRIC START (WP-6013HER)
- *BATTERY NOT INCLUDED
- LOW OIL SHUTDOWN
- FLAT FREE TIRES

PUMP REPLACEMENT PARTS

- 50.006.006 - COMPLETE SEAL SET
- 50.006.003 - IMPELLER
- 50.006.007 - PLUG SET
- 85.150.207 - 6" COMPLETE PUMP/FRAME KIT

6" WATER TRANSFER PUMP

PART#	ENGINE	FUEL TANK CAPACITY	INLET/OUTLET	GPM
WP-6013HR	389CC HONDA GX390	1.71 GAL (6.5L)	6" MNPT	620
WP-6013HER	389CC HONDA GX390	1.71 GAL (6.5L)	6" MNPT	620

PowerEase
engines

FEATURES

- 66FT TOTAL LIFT
- 16FT SUCTION LIFT
- CENTRIFUGAL ALUMINUM PUMP
- HEAVY DUTY CAST IRON IMPELLER
- ELECTRIC START
- LOW OIL SHUTDOWN
- FLAT FREE TIRES
- SINGLE CYLINDER

6" WATER TRANSFER PUMP

PART#	DISPLACEMENT	FUEL TANK CAPACITY	INLET/OUTLET	GPM
WP6015S	459CC POWEREASE	30L, LONG RANGE	6" MNPT	528

POWERED by
HONDAPowerEase
engines

FEATURES

- 197FT TOTAL LIFT
- 26FT SUCTION LIFT
- CENTRIFUGAL ALUMINUM PUMP
- ALUMINUM IMPELLER
- RECOIL START & LOW OIL SHUTDOWN

PUMP REPLACEMENT PARTS

- 50.571.143 - COMPLETE SEAL SET
- 50.571.141 - IMPELLER
- 50.571.144 - PLUG SET
- 85.150.205 - 2" COMPLETE PUMP/FRAME KIT
- 85.571.142 - 2" INLET/OUTLET REPLACEMENT

2" HIGH PRESSURE PUMP

PART#	DISPLACEMENT	FUEL TANK CAPACITY	INLET/OUTLET	GPM
HP-2065HR	196CC HONDA GX200	0.82 GAL (3.1L)	2" MNPT	126
HP-2070R	210CC POWEREASE	0.95 GAL (3.6L)	2" MNPT	126

HIGH PRESSURE & TRASH PUMPS

FEATURES

- 330FT TOTAL LIFT
- 26FT SUCTION LIFT
- CENTRIFUGAL CAST IRON PUMP
- HEAVY DUTY CAST IRON IMPELLER
- RECOIL START & LOW OIL SHUTDOWN

PUMP REPLACEMENT PARTS

- 50.002.262 - COMPLETE SEAL SET
- 50.002.261 - IMPELLER
- 50.002.263 - PLUG SET
- 85.150.206 - 2" COMPLETE PUMP/FRAME KIT
- 50.002.264 - 2" INLET/OUTLET REPLACEMENT

2" HIGH PRESSURE PUMP

PART#	DISPLACEMENT	FUEL TANK CAPACITY	INLET/OUTLET	GPM
HP-2013HR	389CC HONDA GX390	1.8 GAL (6.1L)	2" MNPT	140
HP-2015R	420CC POWEREASE	1.71 GAL (6.5L)	2" MNPT	140

POWERED by
HONDA

POWERBASE
engines



FEATURES

- 300FT TOTAL LIFT
- 26FT SUCTION LIFT
- CENTRIFUGAL PUMP
- ALUMINUM TWIN IMPELLER
- RECOIL START & LOW OIL SHUTDOWN

PUMP REPLACEMENT PARTS

- 50.002.262 - COMPLETE SEAL SET
- 50.002.261 - IMPELLER
- 50.002.263 - PLUG SET
- 85.150.206 - 2" COMPLETE PUMP/FRAME KIT
- 50.002.264 - 2" INLET/OUTLET REPLACEMENT

2" ULTRA HIGH PRESSURE PUMP

PART#	DISPLACEMENT	FUEL TANK CAPACITY	INLET/OUTLET	GPM
HP-2065HT-2	196CC HONDA GX200	0.82 GAL (3.1L)	2" MNPT	90

POWERED by
HONDA



FEATURES

- UP TO 5/8" SOLIDS
- 85FT TOTAL LIFT
- 26FT SUCTION LIFT
- CENTRIFUGAL ALUMINUM PUMP
- CAST IRON IMPELLER
- RECOIL START & LOW OIL SHUTDOWN

PUMP REPLACEMENT PARTS

- 50.102.103 - COMPLETE SEAL SET
- 50.102.101 - IMPELLER
- 50.102.102 - PLUG SET
- 85.150.312F - 2" COMPLETE PUMP/FRAME KIT

POWERED by
HONDA

POWERBASE
engines



2" SEMI-TRASH PUMP

PART#	DISPLACEMENT	FUEL TANK CAPACITY	INLET/OUTLET	GPM
TP-2065HT	196CC HONDA GX200	0.82 GAL (3.1L)	2" MNPT	158

TRASH PUMPS

POWERED by
HONDA **Powerbase**
engines

FEATURES

- UP TO 5/8" SOLIDS
- 85FT TOTAL LIFT
- 26FT SUCTION LIFT
- CENTRIFUGAL ALUMINUM PUMP
- CAST IRON IMPELLER
- RECOIL START & LOW OIL SHUTDOWN

PUMP REPLACEMENT PARTS

- 50.103.202 - COMPLETE SEAL SET
- 50.103.201 - IMPELLER
- 50.103.203 - PLUG SET
- 85.150.213 - 3" COMPLETE PUMP/FRAME KIT

3" SEMI-TRASH PUMP

PART#	DISPLACEMENT	FUEL TANK CAPACITY	INLET/OUTLET	GPM
TP-3065HR	196CC HONDA GX200	0.82 GAL (3.1L)	3" MNPT	264
TP-3070R	210CC POWEREASE	0.95 GAL (3.6L)	3" MNPT	264

POWERED by
HONDA **Powerbase**
engines

FEATURES

- UP TO 13/16" SOLIDS
- 88FT TOTAL LIFT
- 26FT SUCTION LIFT
- RECOIL START & LOW OIL SHUTDOWN

PUMP REPLACEMENT PARTS

- 50.102.121 - COMPLETE SEAL SET
- 50.102.122 - IMPELLER
- 50.102.120 - PLUG SET
- 85.150.022 - 2" COMPLETE PUMP/FRAME KIT

2" TRASH PUMP

PART#	DISPLACEMENT	FUEL TANK CAPACITY	INLET/OUTLET	GPM
TP-2065HR	196CC HONDA GX200	0.82 GAL (3.1L)	2" MNPT	180
TP-2070RR	210CC POWEREASE	0.95 GAL (3.6L)	2" MNPT	180

POWERED by
HONDA **Powerbase**
engines

FEATURES

- UP TO 1" SOLIDS
- 98FT TOTAL LIFT
- 26FT SUCTION LIFT
- CENTRIFUGAL ALUMINUM PUMP
- CAST IRON IMPELLER
- RECOIL START & LOW OIL SHUTDOWN

PUMP REPLACEMENT PARTS

- 50.103.033 - COMPLETE SEAL SET
- 50.103.031 - IMPELLER
- 50.103.032 - PLUG SET
- 85.150.423 - 3" COMPLETE PUMP/FRAME KIT

3" TRASH PUMP

PART#	DISPLACEMENT	FUEL TANK CAPACITY	INLET/OUTLET	GPM
TP-3013HM	389CC HONDA GX390	1.8 GAL (6.1L)	3" MNPT	370
TP-3015RM	420CC POWEREASE	1.7 GAL (6.5L)	3" MNPT	370

TRASH & CHEMICAL TRANSFER PUMPS

POWERED by **HONDA** **PowerBase** engines

FEATURES

- UP TO 1" SOLIDS
- 95FT TOTAL LIFT
- 26FT SUCTION LIFT
- CENTRIFUGAL ALUMINUM PUMP
- CAST IRON IMPELLER
- RECOIL START & LOW OIL SHUTDOWN

PUMP REPLACEMENT PARTS

- **85.104.023** - COMPLETE SEAL SET
- **85.104.021** - IMPELLER
- **85.103.032** - PLUG SET
- **85.150.424** - 4" COMPLETE PUMP/FRAME KIT



4" TRASH PUMP

PART#	DISPLACEMENT	FUEL TANK CAPACITY	INLET/OUTLET	GPM
TP-4013HM	389CC HONDA GX390	1.8 GAL (6.1L)	4" MNPT	580
TP-4015RM	420CC POWEREASE	1.7 GAL (6.5L)	4" MNPT	580

POWERED by **HONDA** **PowerBase** engines

FEATURES

- FIBERGLASS REINFORCED POLY PUMP
- FIBERGLASS REINFORCED POLY IMPELLER
- 115FT TOTAL LIFT
- 26FT SUCTION LIFT
- RECOIL START & LOW OIL SHUTDOWN

PUMP REPLACEMENT PARTS

- **85.571.162** - COMPLETE SEAL SET
- **85.571.163** - IMPELLER
- **85.571.160** - PLUG SET
- **85.150.222** - 2" COMPLETE PUMP/FRAME KIT
- **85.571.161** - 2" INLET/OUTLET REPLACEMENT



2" CHEMICAL TRANSFER PUMP

PART#	DISPLACEMENT	FUEL TANK CAPACITY	INLET/OUTLET	GPM
NP-2050HR	160CC HONDA GC160	0.5 GAL (1.8L)	2" MNPT	154
NP-2065HR	196CC HONDA GX200	0.82 GAL (3.1L)	2" MNPT	154
NP-2070R	210CC POWEREASE	0.95 GAL (3.6L)	2" MNPT	154

POWERED by **HONDA** **PowerBase** engines

FEATURES

- FIBERGLASS REINFORCED POLY PUMP
- FIBERGLASS REINFORCED POLY IMPELLER
- 92FT TOTAL LIFT
- 26FT SUCTION LIFT
- RECOIL START & LOW OIL SHUTDOWN

PUMP REPLACEMENT PARTS

- **85.571.175** - COMPLETE SEAL SET
- **85.571.179** - IMPELLER
- **85.571.160** - PLUG SET
- **85.150.223** - 3" COMPLETE PUMP/FRAME KIT
- **85.571.174** - 3" INLET/OUTLET REPLACEMENT



3" CHEMICAL TRANSFER PUMP

PART#	DISPLACEMENT	FUEL TANK CAPACITY	INLET/OUTLET	GPM
NP-3065HR	196CC HONDA GX200	0.82 GAL (3.1L)	3" MNPT	265
NP-3070R	210CC POWEREASE	0.95 GAL (3.6L)	3" MNPT	265

WATER PUMP KITS

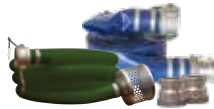
PowerCase
enginesACCESSORIES
INCLUDED ▶

FEATURES

- 82FT TOTAL LIFT
- 26FT SUCTION LIFT
- CENTRIFUGAL ALUMINUM PUMP
- HEAVY DUTY CAST IRON IMPELLER
- RECOIL START & LOW OIL SHUTDOWN

ACCESSORIES INCLUDED

- 12FT (2") SUCTION HOSE W/ CAMLOCKS
- 50FT (2") DISCHARGE HOSE W/ CAMLOCK & STRAINER

2" WATER TRANSFER PUMP KIT

PART#	DISPLACEMENT	FUEL TANK CAPACITY	INLET/OUTLET	GPM
WPK-2065CM	210CC POWEREASE	0.95 GAL (3.6L)	2" MNPT	158

PUMP REPLACEMENT PARTS

- 50.002.202 - COMPLETE SEAL SET
- 50.002.201 - IMPELLER
- 50.002.203 - PLUG SET
- 85.150.201 - 2" COMPLETE PUMP/FRAME KIT
- 50.002.204 - 2" INLET/OUTLET REPLACEMENT
- 85.400.089 - 25FT (2") SUCTION HOSE
- 85.400.097 - 50FT (2") DISCHARGE HOSE
- 90.390.200 - TYPE A CAMLOCKS

POWERED by
HONDAPowerCase
engines◀ SHOOTS WATER
UP TO 85'!ACCESSORIES
INCLUDED ▼

FEATURES

- 197FT TOTAL LIFT
- 26FT SUCTION LIFT
- 85 PSI MAX
- CENTRIFUGAL ALUMINUM PUMP
- HEAVY DUTY ALUMINUM IMPELLER
- FOOT VALVE
- RECOIL START & LOW OIL SHUTDOWN

ACCESSORIES INCLUDED

- FIRE NOZZLE
- PRIMING JUG
- 12FT SUCTION HOSE
- 50FT FIRE HOSE
- FOOT VALVE

2" FIRE CART

PART#	DISPLACEMENT	FUEL TANK CAPACITY	INLET/OUTLET	GPM
HPFC-2065HR	196CC HONDA GX200	0.82 GAL (3.1L)	2" MNPT	126
HPFC-2070R	210CC POWEREASE	0.95 GAL (3.6L)	2" MNPT	126

PUMP REPLACEMENT PARTS

- 85.571.143 - COMPLETE SEAL SET
- 85.571.141 - IMPELLER
- 85.571.144 - PLUG SET
- 85.571.142 - 3" INLET/OUTLET REPLACEMENT
- 85.400.079 - 12FT (2") SUCTION HOSE
- 50.015.001 - 50FT (1.5") FIRE HOSE KIT
- 50.002.301 - FOOT VALVE

POWERED by
HONDAPowerCase
enginesACCESSORIES
INCLUDED ▶

FEATURES

- 197FT TOTAL LIFT
- 26FT SUCTION LIFT
- CENTRIFUGAL ALUMINUM PUMP
- HEAVY DUTY ALUMINUM IMPELLER
- 12FT (2") SUCTION HOSE
- 50FT (2") FIRE HOSE
- FOOT VALVE
- RECOIL START & LOW OIL SHUTDOWN

ACCESSORIES INCLUDED

- FIRE NOZZLE
- PRIMING JUG
- 12FT SUCTION HOSE
- 50FT FIRE HOSE
- FOOT VALVE

2" FIRE FIGHTING PUMP KIT

PART#	DISPLACEMENT	FUEL TANK CAPACITY	INLET/OUTLET	GPM
HPFK-2065HR	196CC HONDA GX200	0.82 GAL (3.1L)	2" MNPT	126
HPFK-2070R	210CC POWEREASE	0.95 GAL (3.6L)	2" MNPT	126

PUMP REPLACEMENT PARTS

- 85.571.143 - COMPLETE SEAL SET
- 85.571.141 - IMPELLER
- 85.571.144 - PLUG SET
- 85.150.205 - 2" COMPLETE PUMP/FRAME KIT
- 85.571.142 - 2" INLET/OUTLET REPLACEMENT
- 85.400.079 - 12FT (2") SUCTION HOSE
- 50.015.001 - 50FT (1.5") FIRE HOSE KIT

HIGH PERFORMANCE CENTRIFUGAL PUMPS

FEATURES

- HONDA GXH50
- RECOIL START & LOW OIL SHUTDOWN
- FUEL TANK CAPACITY, 0.2 GAL (0.77L)
- 50 GPM MAX FLOW
- 120FT TOTAL LIFT
- 26FT SUCTION LIFT
- 1.5" MNPT
- US FORESTRY APPROVED SPARK ARRESTOR

ACCESSORIES INCLUDED

- 1" REDUCER

1.5" PORTABLE WILDLAND SERIES HIGH PRESSURE PUMP

PART#	DISPLACEMENT	FUEL TANK CAPACITY	INLET/OUTLET	GPM
WS1525	53CC POWEREASE	0.2 GAL (0.77L)	1.5" MNPT	50
WS1525H	50CC HONDA GXH50	0.2 GAL (0.77L)	1.5" MNPT	50

Powerbase
engines

POWERED by
HONDA

ULTRA LIGHT WEIGHT
PORTABLE DESIGN

US FORESTRY APPROVED
SPARK ARRESTOR



FEATURES

- HONDA GXH50
- RECOIL START & LOW OIL SHUTDOWN
- FUEL TANK CAPACITY, 0.2 GAL (0.77L)
- 50 GPM MAX FLOW
- 120FT TOTAL LIFT
- 26FT SUCTION LIFT
- 1.5" MNPT
- US FORESTRY APPROVED SPARK ARRESTOR

APPLICATIONS

- ATTACK LINE FIREFIGHTING
- FITS IN THE BACK OF A UTV
- PRESCRIBED BURNS
- REMOTE AREAS
- FARM & RURAL COMMUNITY WORK
- IRRIGATION APPLICATIONS

ACCESSORIES INCLUDED

- 50FT HOSE & REEL
- 125 GALLON TANK

1.5" WILDLAND SERIES SKID UNIT

PART#	DISPLACEMENT	FUEL TANK CAPACITY	INLET/OUTLET	GPM
WS1525SKID	50CC HONDA GXH50	0.2 GAL (0.77L)	1.5" MNPT	50

POWERED by
HONDA

125 GAL. TANK,
50 FT HOSE REEL



FEATURES

- 196CC HONDA GX200 ENGINE
- 3.6 HP
- 22,190 CFM
- PPV AIR FLOW
- WEIGHT (DRY): 59.1 LB
- 16.5" PROPELLER DIAMETER
- 94,8 DB @ 10 FT NOISE LEVEL

APPLICATIONS

- SINGLE DOOR, E.G. HOUSE
- SMALL APARTMENT BLOCK
- FIRE STOKING

POSITIVE PRESSURE FAN (PPV)

PART#	HP	DISPLACEMENT	FUEL TANK CAPACITY	MAX CFM
WS65PPV	3.6 HP	196CC HONDA GX200	0.8 GAL (3.1L)	22,190

FOLDABLE
HANDLE

POWERED by
HONDA



HIGH PERFORMANCE CENTRIFUGAL PUMPS

POWERED by
HONDA▲
ACCESSORIES
INCLUDED**FEATURES**

- 196CC HONDA GX200 ENGINE
- RECOIL START & LOW OIL SHUTDOWN
- 78 GPM MAX FLOW
- 110 PSI MAX
- 120FT TOTAL LIFT
- 26FT SUCTION LIFT
- US FORESTRY APPROVED SPARK ARRESTOR

ACCESSORIES INCLUDED

- FIRE NOZZLE
- PRIMING JUG
- 12FT SUCTION HOSE
- 50FT FIRE HOSE
- FOOT VALVE

2" FIRE CART WILDLAND SERIES

PART#	DISPLACEMENT	FUEL TANK CAPACITY	INLET/OUTLET	OUTLET	GPM
WS1565FC	196CC HONDA GX200	0.82 GAL (3.1L)	1.5" MNPT	1" (2X)	78

POWERED by
HONDA**FEATURES**

- RECOIL START & LOW OIL SHUTDOWN
- 110 PSI MAX
- 120FT TOTAL LIFT
- 26FT SUCTION LIFT
- US FORESTRY APPROVED SPARK ARRESTOR

2" FIRE CART WILDLAND SERIES

PART#	DISPLACEMENT	FUEL TANK CAPACITY	INLET/OUTLET	OUTLET	GPM
WS1565HP	196CC HONDA GX200	0.82 GAL (3.1L)	1.5" MNPT	1" (2X)	78
WS159HP	270CC HONDA GX270	1.4 GAL (5.3L)	1.5" MNPT	1" (2X)	85

POWERED by
HONDA**FEATURES**

- RECOIL START & LOW OIL SHUTDOWN
- 110 PSI MAX
- 120FT TOTAL LIFT
- 26FT SUCTION LIFT
- US FORESTRY APPROVED SPARK ARRESTOR

1.5" PORTABLE HIGH PRESSURE PUMP WILDLAND SERIES

PART#	DISPLACEMENT	FUEL TANK CAPACITY	INLET/OUTLET	OUTLET	GPM
WS1565H	196CC HONDA GX200	0.82 GAL (3.1L)	1.5" MNPT	1" (2X)	78
WS159H	270CC HONDA GX270	1.4 GAL (5.3L)	1.5" MNPT	1" (2X)	85

CENTRIFUGAL & HYDRAULIC PUMPS

FEATURES

- TALL BLADE IMPELLER DESIGN
- HIGHER PRESSURE AT STANDARD ENGINE SPEEDS
- ALL POLYPROPYLENE CORROSION RESISTANT CONSTRUCTION
- IMPELLER ATTACHES DIRECTLY TO 3/4" (1.91CM) KEYED SHAFT ENGINE
- AVAILABLE COMPLETE OR LESS ENGINE
- GRAVITY FED
- NO PRIMING
- RECOIL START & LOW OIL SHUTDOWN

1" CENTRIFUGAL CHEMICAL PUMP POLYPROPYLENE

PART#	DISPLACEMENT	MAX PSI	INLET	OUTLET	GPM
WC1050H	160CC HONDA GC160	65 PSI	1" MNPT	3/4" MNPT	24

POWERED by
HONDA



FEATURES

- RESISTANT ON ALL SURFACES INSIDE & OUT
- ALL IRON CONSTRUCTION
- IMPELLER ATTACHES DIRECTLY TO 3/4" (1.91CM) KEYED SHAFT ENGINE
- AVAILABLE COMPLETE OR LESS ENGINE
- GRAVITY FED
- NO PRIMING
- RECOIL START & LOW OIL SHUTDOWN

1.5" CENTRIFUGAL PUMP

PART#	DISPLACEMENT	MAX PSI	INLET	OUTLET	GPM
WC1565H	196CC HONDA GX200	65 PSI	1-1/2" MNPT	1-1/4" MNPT	110

POWERED by
HONDA



FEATURES

- IMPELLER ATTACHES DIRECTLY TO 1" (2.54CM) KEYED SHAFT
- PULL START ENGINE
- ALL IRON CONSTRUCTION
- AVAILABLE COMPLETE OR LESS ENGINE
- GRAVITY FED
- NO PRIMING
- LOW OIL SHUTDOWN

2" CENTRIFUGAL PUMP

PART#	DISPLACEMENT	MAX PSI	INLET	OUTLET	GPM
WC2090H	270CC HONDA GX270	65 PSI	2" MNPT	1-1/2" MNPT	24

POWERED by
HONDA



FEATURES

- INTEGRAL NEEDLE VALVE BYPASSES UP TO 9 GPM (34 LPM) ON OPEN CENTER SYSTEMS
- STANDARD VITON® CARBON/CERAMIC SEAL OR OPTIONAL SEVERE DUTY SILICON CARBIDE MECHANICAL SEAL
- CHEMICAL RESISTANT VALOX® OR OPTIONAL CAST IRON IMPELLER
- STAINLESS STEEL SHAFT & WEAR RING
- GRAVITY FED
- NO PRIMING
- MADE IN USA

1.5" HYDRAULIC PUMP

PART#	DISPLACEMENT	MAX PSI	INLET	OUTLET	GPM
WC15HYD	HYDRAULIC PUMP	120 PSI	1-1/2" MNPT	1-1/4" MNPT	145

ACE
PUMPS



DIAPHRAGM PUMP

POWERED by
HONDA

FEATURES

- MAXIMUM FLUID TEMPERATURE: 140°F/60°C

EPOXY COATED 2 DIAPHRAGM PUMP

PART#	DISPLACEMENT	PUMP	PSI	GPM	RPM
WD30H	196CC HONDA GX200	AR 30	580	9.5	550

POWERED by
HONDA

FEATURES

- MAXIMUM FLUID TEMPERATURE: 140°F/60°C

EPOXY COATED 2 DIAPHRAGM PUMP

PART#	DISPLACEMENT	PUMP	PSI	GPM	RPM
WD50H	270CC GX270	AR 50	580	14.0	550



FEATURES

- MAXIMUM FLUID TEMPERATURE: 140°F/60°C
- 3 BOLT INPUT - 1 3/8 6 SPLINE THROUGH SHAFT (C/SP)

ANODIZED ALUMINUM 3 DIAPHRAGM PUMP

PART#	PUMP	PSI	GPM	RPM
90.100.813	AR 813	725	21.4	550



FEATURES

- MAXIMUM FLUID TEMPERATURE: 140°F/60°C
- 1 3/8 6 INPUT - 1 3/8 6 SPLINE THROUGH SHAFT (C/C)

ANODIZED ALUMINUM 4 DIAPHRAGM PUMP

PART#	PUMP	PSI	GPM	RPM	MATERIAL
90.101.170	AR BHA/BHS 170	725	39.7	550	ALUMINUM (BHA)
90.131.170	AR BHA/BHS 170	725	39.7	550	BRASS (BHS)

SUBMERSIBLE PUMPS

FEATURES

- MECHANICAL SEAL
- 15FT CORD
- PLASTIC BODY

3/4" TOP DISCHARGE WITHOUT FLOAT

PART#	POWER	GAL/HR CAPACITY	DELIVERY HEIGHT	SUBMERSIBLE DEPTH	SOLID HANDLING
SP-500TD	1/4 HP, 115V, 60HZ	1580	28.5FT MAX	15FT MAX	0.2" MAX



FEATURES

- MECHANICAL SEAL
- 15FT CORD
- PLASTIC BODY

1.5" DISCHARGE WITH FLOAT

PART#	POWER	GAL/HR CAPACITY	DELIVERY HEIGHT	SUBMERSIBLE DEPTH	SOLID HANDLING
SP-650BD	1/3 HP, 115V, 60HZ	3036	20FT MAX	26FT MAX	0.2" MAX



FEATURES

- MECHANICAL SEAL
- 15FT CORD
- VERTICAL FLOAT SWITCH

1.5" DISCHARGE WITH FLOAT

PART#	POWER	GAL/HR CAPACITY	DELIVERY HEIGHT	SUBMERSIBLE DEPTH	SOLID HANDLING
SP-600BD	1/3 HP, 115V, 60HZ	3036	20FT MAX	26FT MAX	0.2" MAX



TETHERED FLOAT SWITCH

PART#	DESCRIPTION	POWER
SPCORD	TETHERED FLOAT SWITCH W/ PIGGY BACK PLUG	115V, 60HZ



SUBMERSIBLE PUMPS



FEATURES

- TETHERED FLOAT SWITCH
- COPPER WINDINGS
- MECHANICAL SEAL
- 25FT CORD
- PLASTIC BODY

1.5" SIDE DISCHARGE WITH FLOAT

PART#	POWER	GAL/HR CAPACITY	DELIVERY HEIGHT	SUBMERSIBLE DEPTH	SOLID HANDLING
SP-550SD	1/2 HP, 115V, 60HZ	2420	28FT MAX	23FT MAX	0.2" MAX



FEATURES

- TETHERED FLOAT SWITCH
- COPPER WINDINGS
- MECHANICAL SEAL
- 25FT CORD
- STAINLESS STEEL BODY

1.5" TOP DISCHARGE WITH FLOAT

PART#	POWER	GAL/HR CAPACITY	DELIVERY HEIGHT	SUBMERSIBLE DEPTH	SOLID HANDLING
SP-750TD	3/4 HP, 115V, 750W	2420	28FT MAX	26FT MAX	0.2" MAX



FEATURES

- TETHERED FLOAT SWITCH
- COPPER WINDINGS
- MECHANICAL SEAL
- 25FT CORD
- STAINLESS STEEL/PLASTIC BODY

1.5" SIDE DISCHARGE WITH FLOAT

PART#	POWER	GAL/HR CAPACITY	DELIVERY HEIGHT	SUBMERSIBLE DEPTH	SOLID HANDLING
SP-900SD	1 HP, 115V, 1100W	3434	29.5FT MAX	26FT MAX	0.2" MAX



FEATURES

- TETHERED FLOAT SWITCH
- COPPER WINDINGS
- MECHANICAL SEAL
- 25FT CORD
- STAINLESS STEEL BODY

1.5" SIDE DISCHARGE WITH VERTICAL FLOAT

PART#	POWER	GAL/HR CAPACITY	DELIVERY HEIGHT	SUBMERSIBLE DEPTH	SOLID HANDLING
ST-900SD	1-1/4 HP, 115V, 1100W	3410	36FT MAX	16FT MAX	1.4" MAX

WATER PUMP ACCESSORIES

FIRE HOSE

PART#	SIZE	LENGTH	MAX PRESSURE
50.015.001	1.5"	50FT	190 PSI



FEATURES

- ADJUSTABLE SPRAY PATTERN
- USED WITH HIGH PRESSURE PUMP

FIRE NOZZLE

PART#	SIZE	FITTING
50.015.002	1.5"	FNPT



FEATURES

- SCREEN AROUND FOOT KEEPS OUT DEBRIS
- LEAK PROOF TO MAINTAIN CONSTANT PRIMING



FOOT VALVE

PART#
50.002.301

REDUCING ADAPTER

PART#	SIZE
50.015.007	2" FNPSH X 1.5" MNPSH



ADAPTERS

PART#	SIZE
50.015.003	FIRE HOSE X 1.5" MNPT
50.015.004	FIRE HOSE X 1.5" FNPSH



GASKETS

PART#	USED WITH
50.015.005	USE WITH 50.015.004
50.015.006	USE IN 50.015.003/004/001



WATER PUMP ACCESSORIES



WATER PUMP DISCHARGE HOSE KITS (BLUE)

PART#	SIZE	LENGTH	TEMP	PRESSURE
85.400.084	1"	50FT	150°F	80 PSI
85.400.085	2"	50FT	150°F	80 PSI
85.400.086	3"	50FT	150°F	65 PSI
85.400.087	4"	50FT	150°F	55 PSI
85.400.094	6"	50FT	150°F	55 PSI



WATER PUMP DISCHARGE HOSE KITS (RED)

PART#	SIZE	LENGTH	TEMP	PRESSURE
85.400.097	2"	50FT	150°F	150 PSI
85.400.098	3"	50FT	150°F	150 PSI



SUCTION HOSE KITS

PART#	SIZE	LENGTH	CAMLOCK	STRAINER
85.400.088	1"	25FT	ALUMINUM	NYLON
85.400.089	2"	25FT	ALUMINUM	STEEL
85.400.090	3"	25FT	ALUMINUM	STEEL
85.400.091	4"	25FT	ALUMINUM	NYLON
85.400.093	6"	25FT	ALUMINUM	NYLON



FEATURES

- INCLUDES SLUDGE PUMP, DISCHARGE HOSE, SUCTION HOSE & HOSE CLAMPS
- ATTACH TO A PRESSURE WASHER QUICK CONNECT LANCE

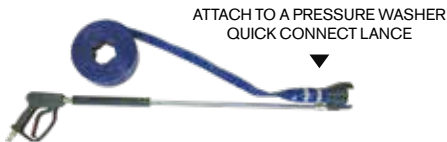

SLUDGE PUMP KIT

PART#	SIZE	DISCHARGE HOSE	SUCTION HOSE
85.400.018	2"	25FT	18"



WATER PUMP REPLACEMENT STRAINERS

PART#	SIZE	MATERIAL
50.002.400	2"	PLASTIC
50.002.012	2"	METAL
50.003.400	3"	PLASTIC
50.004.400	4"	PLASTIC
50.006.008	6"	PLASTIC
50.006.008S	6"	METAL



TRASH PUMP REPLACEMENT STRAINERS

PART#	SIZE	MATERIAL
50.002.014	2"	METAL
50.103.018	3"	PLASTIC
50.104.005	4"	PLASTIC

ALUMINUM CAMLOCKS

TYPE A CAMLOCKS

PART#	SIZE	THREAD
90.390.034	¾"	MALE COUPLER X FPT
90.390.100	1"	MALE COUPLER X FPT
90.390.114	1 ¼"	MALE COUPLER X FPT
90.390.112	1 ½"	MALE COUPLER X FPT
90.390.200	2"	MALE COUPLER X FPT
90.390.300	3"	MALE COUPLER X FPT
90.390.400*	4"	MALE COUPLER X FPT

* PHONE FOR AVAILABILITY.



TYPE E CAMLOCKS

PART#	SIZE	THREAD
90.394.034	¾"	MALE BARB X MALE COUPLER
90.394.100	1"	MALE BARB X MALE COUPLER
90.394.114	1 ¼"	MALE BARB X MALE COUPLER
90.394.112	1 ½"	MALE BARB X MALE COUPLER
90.394.200	2"	MALE BARB X MALE COUPLER
90.394.300	3"	MALE BARB X MALE COUPLER
90.394.400*	4"	MALE BARB X MALE COUPLER

* PHONE FOR AVAILABILITY



TYPE B CAMLOCKS

PART#	SIZE	THREAD	GASKET#
90.391.034	¾"	FEMALE COUPLER X MPT	90.399.034
90.391.100	1"	FEMALE COUPLER X MPT	90.399.100
90.391.114	1 ¼"	FEMALE COUPLER X MPT	90.399.114
90.391.112	1 ½"	FEMALE COUPLER X MPT	90.399.112
90.391.200	2"	FEMALE COUPLER X MPT	90.399.200
90.391.300	3"	FEMALE COUPLER X MPT	90.399.300
90.391.400*	4"	FEMALE COUPLER X MPT	90.399.400

* PHONE FOR AVAILABILITY



TYPE F CAMLOCKS

PART#	SIZE	THREAD
90.395.034	¾"	MALE COUPLER X MPT
90.395.100	1"	MALE COUPLER X MPT
90.395.114	1 ¼"	MALE COUPLER X MPT
90.395.112	1 ½"	MALE COUPLER X MPT
90.395.200	2"	MALE COUPLER X MPT
90.395.300	3"	MALE COUPLER X MPT
90.395.400*	4"	MALE COUPLER X MPT

* PHONE FOR AVAILABILITY



TYPE C CAMLOCKS

PART#	SIZE	THREAD	GASKET#
90.392.034	¾"	MALE BARB X FEMALE COUPLER	90.399.034
90.392.100	1"	MALE BARB X FEMALE COUPLER	90.399.100
90.392.114	1 ¼"	MALE BARB X FEMALE COUPLER	90.399.114
90.392.112	1 ½"	MALE BARB X FEMALE COUPLER	90.399.112
90.392.200	2"	MALE BARB X FEMALE COUPLER	90.399.200
90.392.300	3"	MALE BARB X FEMALE COUPLER	90.399.300
90.392.400*	4"	MALE BARB X FEMALE COUPLER	90.399.400

* PHONE FOR AVAILABILITY



TYPE DP CAMLOCKS

PART#	SIZE	THREAD
90.397.034	¾"	DUST PLUG
90.397.100	1"	DUST PLUG
90.397.112	1 ½"	DUST PLUG
90.397.200	2"	DUST PLUG
90.397.300	3"	DUST PLUG
90.397.400*	4"	DUST PLUG

* PHONE FOR AVAILABILITY



TYPE D CAMLOCKS

PART#	SIZE	THREAD	GASKET#
90.393.034	¾"	FEMALE COUPLER X FPT	90.399.034
90.393.100	1"	FEMALE COUPLER X FPT	90.399.100
90.393.114	1 ¼"	FEMALE COUPLER X FPT	90.399.114
90.393.112	1 ½"	FEMALE COUPLER X FPT	90.399.112
90.393.200	2"	FEMALE COUPLER X FPT	90.399.200
90.393.300	3"	FEMALE COUPLER X FPT	90.399.300
90.393.400*	4"	FEMALE COUPLER X FPT	90.399.400

* PHONE FOR AVAILABILITY



TYPE DC CAMLOCKS

PART#	SIZE	THREAD	GASKET#
90.396.034	¾"	DUST CAP	90.399.034
90.396.100	1"	DUST CAP	90.399.100
90.396.112	1 ½"	DUST CAP	90.399.112
90.396.200	2"	DUST CAP	90.399.200
90.396.300	3"	DUST CAP	90.399.300
90.396.400*	4"	DUST CAP	90.399.400

* PHONE FOR AVAILABILITY



POLYPROPYLENE CAMLOCKS

TYPE A CAMLOCKS



PART#	SIZE	THREAD
90.720.034	3/4"	MALE COUPLER X FPT
90.720.100	1"	MALE COUPLER X FPT
90.720.114	1 1/4"	MALE COUPLER X FPT
90.720.112	1 1/2"	MALE COUPLER X FPT
90.737.040	2"	MALE COUPLER X FPT
90.720.300	3"	MALE COUPLER X FPT

TYPE E CAMLOCKS



PART#	SIZE	THREAD
90.724.034	3/4"	MALE BARB X MALE COUPLER
90.724.100	1"	MALE BARB X MALE COUPLER
90.724.114	1 1/4"	MALE BARB X MALE COUPLER
90.724.112	1 1/2"	MALE BARB X MALE COUPLER
90.737.160	2"	MALE BARB X MALE COUPLER
90.724.300	3"	MALE BARB X MALE COUPLER

TYPE B CAMLOCKS



PART#	SIZE	THREAD
90.721.034	3/4"	FEMALE COUPLER X MPT
90.721.100	1"	FEMALE COUPLER X MPT
90.721.114	1 1/4"	FEMALE COUPLER X MPT
90.721.112	1 1/2"	FEMALE COUPLER X MPT
90.737.300	2"	FEMALE COUPLER X MPT
90.721.300	3"	FEMALE COUPLER X MPT

TYPE F CAMLOCKS



PART#	SIZE	THREAD
90.725.034	3/4"	MALE COUPLER X MPT
90.725.100	1"	MALE COUPLER X MPT
90.725.114	1 1/4"	MALE COUPLER X MPT
90.725.112	1 1/2"	MALE COUPLER X MPT
90.737.100	2"	MALE COUPLER X MPT
90.725.300	3"	MALE COUPLER X MPT

TYPE C CAMLOCKS



PART#	SIZE	THREAD
90.722.034	3/4"	MALE BARB X FEMALE COUPLER
90.722.100	1"	MALE BARB X FEMALE COUPLER
90.722.114	1 1/4"	MALE BARB X FEMALE COUPLER
90.722.112	1 1/2"	MALE BARB X FEMALE COUPLER
90.737.360	2"	MALE BARB X FEMALE COUPLER
90.722.300	3"	MALE BARB X FEMALE COUPLER

TYPE DP CAMLOCKS



PART#	SIZE	THREAD
90.726.034	3/4"	DUST PLUG
90.726.100	1"	DUST PLUG
90.726.112	1 1/2"	DUST PLUG
90.726.114	1 1/4"	DUST PLUG
90.737.440	2"	DUST PLUG
90.397.114	1 1/4"	DUST PLUG
90.726.300	3"	DUST PLUG

TYPE D CAMLOCKS



PART#	SIZE	THREAD
90.723.034	3/4"	FEMALE COUPLER X FPT
90.723.100	1"	FEMALE COUPLER X FPT
90.723.114	1 1/4"	FEMALE COUPLER X FPT
90.723.112	1 1/2"	FEMALE COUPLER X FPT
90.737.240	2"	FEMALE COUPLER X FPT
90.723.300	3"	FEMALE COUPLER X FPT

TYPE DC CAMLOCKS



PART#	SIZE	THREAD
90.727.034	3/4"	DUST CAP
90.727.100	1"	DUST CAP
90.727.112	1 1/2"	DUST CAP
90.727.114	1 1/4"	DUST CAP
90.396.114	1 1/4"	DUST CAP
90.737.500	2"	DUST CAP
90.727.300	3"	DUST CAP

GENERATOR INVERTERS

1200 WATT INVERTER

BE1200I

NEW

- 60CC POWEREASE
- RECOIL START
- 1200 RUNNING WATT OUTPUT
- 12V DC
- 1 × 120V DUPLEX (20A)
- RATED AMP: 8.3A
- MAX AMP: 9.16A
- BREAKER: 8A
- ULTRA QUIET-RUNNING
- 2 USB PORTS
- AUTOMATIC THROTTLE SAVES FUEL
- PARALLEL CAPABILITY
- DECIBEL RATING: 57DB @ RATED LOAD
64DB @ FULL LOAD



PowerEase engines

2100 WATT INVERTER

BE2100I

NEW

- 79CC POWEREASE
- RECOIL START
- 1800 RUNNING WATT OUTPUT
- 1 × 120V DUPLEX (20A)
- 1 X 12V DC 8.3A DC
- RATED AMP: 13.3A
- ULTRA QUIET-RUNNING
- 2 USB PORTS
- AUTOMATIC THROTTLE SAVES FUEL
- 4.2/1.1 GAL FUEL TANK CAPACITY
- PARALLEL CAPABILITY
- DECIBEL RATING: 59DB @ RATED LOAD
53DB @ 1/4 LOAD



PARALLEL CAPABILITY



PARALLEL KIT PART #: 85.571.902



PARALLEL CORD PART #: 85.591.902

PowerEase engines

3500 WATT INVERTER

BE3500IP

NEW

- 212CC POWEREASE
- RECOIL START
- 3000 RUNNING WATT OUTPUT
- 2X USB PORTS
- 1 X 120V 20A DUPLEX
- 1 X 120V 20A TWISTLOCK
- 12V DC 8.3A
- RATED AMP: 13.3A
- ULTRA QUIET-RUNNING
- AUTOMATIC THROTTLE SAVES FUEL
- 4.2/1.1 GAL FUEL TANK CAPACITY
- PARALLEL CAPABILITY
- DECIBEL RATING: 59DB @ RATED LOAD
53DB @ 1/4 LOAD



PARALLEL CAPABILITY



PARALLEL KIT PART #: 85.571.903

PowerEase engines

GENERATOR INVERTERS & GENERATORS

3600 WATT INVERTER

BE3600IE

NEW

- 212CC POWEREASE
- ELECTRIC START
- 3000 RUNNING WATT OUTPUT
- 2X USB PORTS
- LED CONTROL PANEL
- 1 X 120V 20A DUPLEX
- 1 X 120V 20A TWISTLOCK
- 12V DC 8.3A
- RATED AMP: 13.3A
- ULTRA QUIET-RUNNING
- AUTOMATIC THROTTLE SAVES FUEL
- 4.2/1.1 GAL FUEL TANK CAPACITY
- PARALLEL CAPABILITY
- DECIBEL RATING: 59DB @ RATED LOAD
53DB @ 1/4 LOAD

**PARALLEL
CAPABILITY**

PARALLEL KIT PART #: 85.571.903

Powerbase
engines**3500 WATT INVERTER**

BE3500L

- 212CC POWEREASE
- ELECTRIC START
- 3000 RUNNING WATT OUTPUT
- 1 x 120V DUPLEX (20A)
- 1 x 120V TWISTLOCK (30A)
- 12V 8.3A
- RATED AMP: 25A
- MAX AMP: 29.1A
- BREAKER: 23A
- RUNS MOST 13,500 BTU RV AC UNITS AND MORE
- PARALLEL CAPABILITY
- DECIBEL RATING: 60DB @ RATED LOAD
50DB @ 1/4 LOAD
- AUTO THROTTLE
- DIGITAL DISPLAY METER
- LOCKING WHEEL SYSTEM

**PARALLEL
CAPABILITY
WHEN USING EXTERNAL
PARALLEL BOX**

PARALLEL KIT PART #: 85.591.901

Powerbase
engines**3500 WATT GENERATOR**

BE3500PS

- 208CC POWEREASE
- RECOIL START
- LOW OIL SHUTDOWN
- 3500 MAX WATT OUTPUT
- 2800 RUNNING WATT OUTPUT
- FUEL GAUGE
- 2 X 120V 20A DUPLEX
- 1 X 120V 30A TWISTLOCK
- RATED AMP: 23.3A
- MAX AMP: 29.1A
- BREAKER: 24A

Powerbase
engines

4200 WATT GENERATOR

BE4200PS

- 223CC POWEREASE
- RECOIL START
- LOW OIL SHUTDOWN
- 4200 MAX WATT OUTPUT
- 3500 RUNNING WATT OUTPUT
- FUEL GAUGE
- 9" FLAT FREE TIRES
- VOLTAGE SELECTOR
- 2 X 120V 20A DUPLEX
- 1 X 120V/240V 4 PRONG TWISTLOCK
- RATED AMP: 29.1A/14.6A
- MAX AMP: 35A/17.5A
- BREAKER: 18.9A



6500 WATT GENERATOR ELECTRIC START

BE-6500ER

- 389CC POWEREASE
- ELECTRIC START
- 6500 MAX AC OUTPUT
- 5500 MAX AC CONTINUOUS OUTPUT
- 2 X 120V 20A DUPLEX
- 1 X 120V TWISTLOCK
- 1 X 240V TWISTLOCK
- 12V DC 8.3A
- RATED AMP: 45.8A/22.9A
- MAX AMP: 54.1A/27A
- BREAKER: 23.3A
- LOW OIL SHUTDOWN
- AUTOMATIC VOLTAGE REGULATOR (AVR)
- 9" FLAT FREE TIRES

FEATURES

- NOISE LEVEL @ 7M: 74DB
- FUEL TANK CAPACITY: 25 L/ 6.6 GAL
- RUN TIME PER TANK: 7H @ FULL LOAD
- VOLT METER
- FUEL GAUGE
- CIRCUIT BREAKERS
- FLAT FREE TIRES INCLUDED
- BATTERY INCLUDED
- AUTOMATIC IDLE DOWN



9000 WATT GENERATOR ELECTRIC START

BE-9000ER

- 420CC POWEREASE
- ELECTRIC START
- 9000 MAX AC OUTPUT
- 7100 MAX AC CONTINUOUS OUTPUT
- 3 X 120V 20A DUPLEX
- 1 X 120V TWISTLOCK
- 1 X 240V TWISTLOCK
- 12V DC 8.3A
- RATED AMP: 59.2A/29.6A
- MAX AMP: 75A/37.5A
- BREAKER: 27A
- LOW OIL SHUTDOWN
- AUTOMATIC VOLTAGE REGULATOR (AVR)
- 9" FLAT FREE TIRES

FEATURES

- NOISE LEVEL @ 7M: 78DB
- FUEL TANK CAPACITY: 25 L/ 6.6 GAL
- RUN TIME PER TANK: 6.5H @ FULL LOAD
- VOLT METER
- FUEL GAUGE
- CIRCUIT BREAKERS
- FLAT FREE TIRES INCLUDED
- BATTERY INCLUDED
- AUTOMATIC IDLE DOWN



GENERATORS

9400 WATT GENERATOR DUAL FUEL

BE9400DFS

- GAS & PROPANE
- 459CC POWEREASE
- ELECTRIC START
- 9400 MAX WATT OUTPUT (GAS)
- 9000 MAX WATT OUTPUT (LPG)
- 7500 RUNNING WATT OUTPUT (GAS)
- 7000 RUNNING WATT OUTPUT (LPG)
- RATED AMP (GASOLINE): 62.5A/31.3A
- MAX AMP (GASOLINE): 66.6A/33.3A
- RATED AMP (LPG): 58.3A/29.2A
- MAX AMP (LPG): 62.5A/31.3A
- MAIN BREAKER: 32A
- RECEPTACLES:
 - 4 X 120V 20A DUPLEX
 - 1 X 120V 30A TWISTLOCK
 - 1 X 120/240V 50A

FEATURES

- FUEL TANK CAPACITY: 26.5L / 7 GAL
- LOW OIL SHUTDOWN
- AUTOMATIC VOLTAGE REGULATOR (AVR)
- 9" FLAT FREE TIRES
- BATTERY INCLUDED
- HOUR METER
- RUN TIME PER TANK:
 - 8H @ FULL LOAD (GAS)
 - 12H @ 1/2 LOAD (GAS)

NEW

Powerbase
engines

*TANK NOT INCLUDED



EPA C US

12000 WATT GENERATOR ELECTRIC START

BE-12000ES

- 459CC POWEREASE
- ELECTRIC START
- LOW OIL SHUTDOWN
- 12000 MAX OUTPUT
- 9000 RUNNING OUTPUT
- RECEPTACLES:
 - 1 X 120V/240V RATED VOLTAGE

FEATURES

- 26.5L/7 GAL FUEL TANK CAPACITY
- RUN TIME PER TANK: 7H @ FULL LOAD
- HOUR METER
- FUEL GAUGE
- CIRCUIT BREAKERS
- 9" FLAT FREE TIRES INCLUDED
- LOW OIL SHUTDOWN
- 14A BATTERY INCLUDED

NEW

Powerbase
engines

EPA C US

12000 WATT GENERATOR ELECTRIC START

BE-12000ER

- 622CC POWEREASE
- ELECTRIC START
- 12000 MAX AC OUTPUT
- 9500 MAX AC CONTINUOUS OUTPUT
- 12V DC 8.3A
- RATED AMP: 79.2A/39.6A
- MAX AMP: 87.5A/43.8A
- BREAKER: 44A
- RECEPTACLES:
 - 2 X 120V 20A DUPLEX
 - 1 X 120V 30A TWISTLOCK
 - 1 X 120V/240V 30A TWISTLOCK
 - 1 X 120V/240V 50A

FEATURES

- FUEL TANK CAPACITY: 40 L / 11 GAL
- RUN TIME PER TANK: 6H @ FULL LOAD
- HOUR METER
- FUEL GAUGE
- CIRCUIT BREAKERS
- 9" FLAT FREE TIRES INCLUDED
- LOW OIL SHUTDOWN
- BATTERY INCLUDED

Powerbase
engines

EPA C US

GENERATOR ACCESSORIES

EXTENSION CORD 85.508.010

- 75 FT
- LIGHT SINGLE END
- STANDARD 15A 120V
- 12/3 SJTW CABLE



Receptacle
x1

EXTENSION CORD 85.508.013

- 75 FT
- LIGHT SINGLE END
- STANDARD 15A 120V
- 14/3 SJTW CABLE



Receptacle
x1

HD EXTENSION CORD 85.508.006

- 50 FT
- LIGHT TRIPLE END
- STANDARD 15A 120V
- 10/3 SJTW CABLE



Receptacle
x3

HD EXTENSION CORD 85.508.007

- 100 FT
- LIGHT SINGLE END
- STANDARD 15A 120V
- 10/3 SJTW CABLE



Receptacle
x1

25FT, 3750 WATT GENERATOR CORD 85.508.001

- MAX 30 AMPS, 125V
- PLUG TYPE: (1) NEMA L5-30P
- RECEPTACLE TYPE: (3) NEMA 5-15R
- 10 GAUGE AWG
- SJTW INSULATION
- OUTLETS EQUIPPED WITH WEATHER GAURD FOR OUTDOOR USE



Plug
x1



Receptacle
x3

25FT, 7500 WATT GENERATOR CORD 85.508.002

- MAX 30 AMPS, 250V
- PLUG TYPE: (1) NEMA L14-30P
- RECEPTACLE TYPE: (4) NEMA 5-20R
- 10 GAUGE AWG
- SJTW INSULATION
- OUTLETS EQUIPPED WITH WEATHER GAURD FOR OUTDOOR USE



Plug
x1



Receptacle
x4

25FT, 7500 WATT GENERATOR CORD 85.508.003

- MAX 30 AMPS, 250V
- PLUG TYPE: (1) NEMA L14-30P
- RECEPTACLE TYPE: (4) NEMA 5-20R
- 10 GAUGE AWG
- SJTW INSULATION
- OUTLETS EQUIPPED WITH WEATHER GAURD FOR OUTDOOR USE



Plug
x1



Receptacle
x4

3FT GENERATOR Y ADAPTER 85.508.004

- MAX 30 AMPS, 250V
- 10 GAUGE AWG, SJTW
- PLUG TYPE: (1) NEMA L14-30P
- RECEPTACLE TYPE: (2) NEMA 5-20R
- CONVERT 240 TWIST-LOCK INTO (2) STANDARD HOME OUTLETS
- WEATHER RESISTANT, THERMO-VINYL JACKET



Plug
x1



Receptacle
x2

25FT GENERATOR CORD REEL 85.508.025

- 360 TOP-SWIVEL HOOK
- CASE PROVIDES EXTRA DURABILITY
- 5-15P PLUG
- 3 OUTLET 5-15R RECEPTACLE
- 16/3 SJTW CORD



Receptacle
x1

50FT GENERATOR CORD REEL 85.508.050

- 360 TOP-SWIVEL HOOK
- CASE PROVIDES EXTRA DURABILITY
- 5-15P PLUG
- 1 OUTLET 5-15R RECEPTACLE
- 16/3 SJTW CORD



Receptacle
x3

GENERATOR ACCESSORIES

RV PLUG ADAPTER

85.508.005

- 12V NEMA L5-30P PLUG
- CONNECT YOUR RV'S 30A PLUG TO YOUR GENERATOR'S 30A TWIST-LOCK OUTLET
- CONVERTS L5-30P TO AN RV TT-30R
- DURABLE - UL LISTED FOR OUTDOOR USE
- COMPACT RV ADAPTER PLUG

Plug
x1Receptacle
x1**PARALLEL BOX**

85.571.902

- FOR I2000L

**PARALLEL BOX**

85.571.903

- FOR I3000R

**PARALLEL CABLE**

85.591.902

- FOR I2000L & BE2100I
- CONNECT 2 INVERTERS TOGETHER
- ALLOWS UP TO 20A DRAW FROM OUTLET

**PARALLEL KIT**

85.591.901

- CONNECT 2 3500W

**GENERATOR COVERS**

- MADE FROM DURABLE, WATER RESISTANT VINYL
- ADJUSTABLE DRAWSTRING FOR A SECURE FIT
- PROTECT YOUR GENERATOR FROM THE ELEMENTS

PART # 85.508.008
FITS 3100-4200 WATT
GENERATORPART # 85.508.009
FITS 5200-10000 WATT
GENERATOR**INVERTER COVER**

- MADE FROM DURABLE, WATER RESISTANT VINYL BACKED POLYESTER
- ADJUSTABLE DRAWSTRING FOR A SECURE FIT
- PROTECT YOUR GENERATOR FROM THE ELEMENTS

PART # 85.508.015
FITS 3500 WATT
INVERTER

FORCED AIR HEATERS

FEATURES

- ADJUSTABLE HEIGHT ANGLE
- 10 FT HOSE & REGULATOR INCLUDED
- OVER-HEAT SHUT-OFF
- FULLY ENCLOSED GAS CONTROLS
- CONTINUOUS ELECTRONIC IGNITION
- VARIABLE HEAT SETTINGS

60,000 BTU LPG FORCED AIR HEATER

PART#	BTU	HEAT CAPACITY	POWER	MAX OPERATING HOURS
HL060F	60,000	1500 SQ.FT	120V	14 H



FEATURES

- ADJUSTABLE HEIGHT ANGLE
- 10 FT HOSE & REGULATOR INCLUDED
- OVER-HEAT SHUT-OFF
- FULLY ENCLOSED GAS CONTROLS
- CONTINUOUS ELECTRONIC IGNITION
- VARIABLE HEAT SETTINGS

125,000 BTU LPG FORCED AIR HEATER

PART#	BTU	HEAT CAPACITY	POWER	MAX OPERATING HOURS
HL125F	125,000	3100 SQ.FT	120V	30 H



FEATURES

- ADJUSTABLE HEIGHT ANGLE
- 10 FT HOSE & REGULATOR INCLUDED
- OVER-HEAT SHUT-OFF
- FULLY ENCLOSED GAS CONTROLS
- VARIABLE HEAT SETTINGS

150,000 BTU LPG FORCED AIR HEATER

PART#	BTU	HEAT CAPACITY	POWER	MAX OPERATING HOURS
HL150F	150,000	3800 SQ.FT	120V	30 H



FORCED AIR HEATERS



FEATURES

- FORCED AIR
- BUILT-IN THERMOSTAT
- BUILT-IN CALIBRATED AIR PRESSURE GAUGE
- EASY-LIFT HANDLES
- AUTOMATIC SAFETY SHUT-OFF SYSTEM
- POWER ON/OFF SWITCH
- FUEL GAUGE
- EXTENSION CORD WRAP

70,000 BTU KEROSENE/DIESEL FORCED AIR HEATER

PART#	BTU	HEAT CAPACITY	POWER	FUEL TANK	MAX OPERATING HOURS
HK070F	70,000	1700 SQ.FT	120V	5 GAL	9 H



FEATURES

- FORCED AIR
- BUILT-IN THERMOSTAT
- DIGITAL TEMPERATURE READ OUT & LED DIAGNOSTICS
- FLAT FREE TIRES
- BUILT-IN CALIBRATED AIR PRESSURE GAUGE
- EASY-LIFT HANDLES
- AUTOMATIC SAFETY SHUT-OFF SYSTEM
- POWER ON/OFF SWITCH
- FUEL GAUGE
- EXTENSION CORD WRAP

125,000 BTU KEROSENE/DIESEL FORCED AIR HEATER

PART#	BTU	HEAT CAPACITY	POWER	FUEL TANK	MAX OPERATING HOURS
HK125FW	125,000	3100 SQ.FT	120V	10 GAL	10 H



FEATURES

- FORCED AIR
- BUILT-IN THERMOSTAT
- DIGITAL TEMPERATURE READ OUT & LED DIAGNOSTICS
- FLAT FREE TIRES
- BUILT-IN CALIBRATED AIR PRESSURE GAUGE
- EASY-LIFT HANDLES
- AUTOMATIC SAFETY SHUT-OFF SYSTEM
- POWER ON/OFF SWITCH
- FUEL GAUGE
- EXTENSION CORD WRAP

175,000 BTU KEROSENE/DIESEL FORCED AIR HEATER

PART#	BTU	HEAT CAPACITY	POWER	FUEL TANK	MAX OPERATING HOURS
HK175FW	175,000	4300 SQ.FT	120V	13 GAL	9 H

FORCED AIR HEATERS

FEATURES

- FORCED AIR
- BUILT-IN THERMOSTAT
- BUILT-IN CALIBRATED AIR PRESSURE GAUGE
- DIGITAL TEMPERATURE READ OUT & LED DIAGNOSTICS
- FLAT FREE TIRES
- EASY-LIFT HANDLES
- AUTOMATIC SAFETY SHUT-OFF SYSTEM
- POWER ON/OFF SWITCH
- FUEL GAUGE
- EXTENSION CORD WRAP

215,000 BTU KEROSENE/DIESEL FORCED AIR HEATER

PART#	BTU	HEAT CAPACITY	POWER	FUEL TANK	MAX OPERATING HOURS
HK215FW	215,000	5300 SQ FT	120V	13 GAL	8 H



FEATURES

- FORCED AIR
- BUILT-IN THERMOSTAT
- BUILT-IN CALIBRATED AIR PRESSURE GAUGE
- DIGITAL TEMPERATURE READ OUT & LED DIAGNOSTICS
- FLAT FREE TIRES
- EASY-LIFT HANDLES
- AUTOMATIC SAFETY SHUT-OFF SYSTEM
- POWER ON/OFF SWITCH
- FUEL GAUGE
- EXTENSION CORD WRAP

400,000 BTU KEROSENE/DIESEL FORCED AIR HEATER

PART#	BTU	HEAT CAPACITY	POWER	FUEL TANK	MAX OPERATING HOURS
HK400FW	400,000	10,000 SQ FT	120V	24 GAL	8 H



FEATURES

- FORCED AIR
- BUILT-IN THERMOSTAT
- BUILT-IN CALIBRATED AIR PRESSURE GAUGE
- DIGITAL TEMPERATURE READ OUT & LED DIAGNOSTICS
- FLAT FREE TIRES
- EASY-LIFT HANDLES
- AUTOMATIC SAFETY SHUT-OFF SYSTEM
- POWER ON/OFF SWITCH
- FUEL GAUGE
- EXTENSION CORD WRAP

600,000 BTU KEROSENE/DIESEL FORCED AIR HEATER

PART#	BTU	HEAT CAPACITY	POWER	FUEL TANK	MAX OPERATING HOURS
HK600FW	600,000	15,000 SQ FT	120V	40 GAL	9 H



ELECTRIC FAN HEATERS



FEATURES

- PORTABLE HEAT FOR ANY ROOM WITH ADJUSTABLE THERMOSTAT
- WITH IT'S 2 HEAT SETTINGS, FAN ONLY SETTING, SWIVEL FEATURES, & STURDY HANDLE, THE ROBUST FAN HEATER CAN BE PLACED IN ANY ROOM FOR INSTANT COMFORT
- 120V

5,100 BTU ELECTRIC FAN HEATER

PART#	BTU	WATTS	HEAT STYLE	HEAT CAPACITY
HE15	5,100	1.5 KW	FORCED AIR	165 SQ FT



FEATURES

- PORTABLE HEAT FOR ANY ROOM WITH ADJUSTABLE THERMOSTAT
- WITH IT'S 2 HEAT SETTINGS, FAN ONLY SETTING, SWIVEL FEATURES, & STURDY HANDLE, THE ROBUST FAN HEATER CAN BE PLACED IN ANY ROOM FOR INSTANT COMFORT
- 230V

10,200 BTU ELECTRIC FAN HEATER

PART#	BTU	WATTS	HEAT STYLE	HEAT CAPACITY
HE30	10,200	3.3 KW	FORCED AIR	320 SQ FT



FEATURES

- WIRED REMOTE CONTROL FOR EASY TEMPERATURE & FAN CONTROL
- WITH IT'S 2 HEAT SETTINGS, FAN ONLY SETTING, SWIVEL FEATURES, & STURDY HANDLE, THE ROBUST FAN HEATER CAN BE PLACED IN ANY ROOM FOR INSTANT COMFORT
- 230V

17,000 BTU ELECTRIC FAN HEATER W/ CONTROL BOX

PART#	BTU	WATTS	HEAT STYLE	HEAT CAPACITY
HED50	17,000	5.0 KW	FORCED AIR	540 SQ FT

TORCHES & TANK TOP HEATERS

FEATURES

- FOR PLUMBING & HOUSEHOLD USE
- ADJUSTABLE FLAME CONTROL
- FOR SOLDERING & BRAZING
- SOLID BRASS CONSTRUCTION FOR DURABILITY

SOLID BRASS TORCH

PART#	START	FLAME TYPE	FUEL TYPE
HLT010	MANUAL	PENCIL FLAME	PROPANE



FEATURES

- CONTINUOUS RUN-LOCK
- HIGH TEMPERATURE
- FOR SOLDERING & BRAZING
- LOCK BUTTON
- PRESSURE REGULATED
- CAST ALUMINUM BODY
- ADJUSTMENT KNOB

TRIGGER START TORCH

PART#	START	FLAME TYPE	FUEL TYPE
HLT020	TRIGGER ON/OFF	SWIRL FLAME	PROPANE



FEATURES

- WIND RESISTANT
- MATCH LIGHT IGNITION
- SAFETY TIP-OVER SWITCH
- REAR BURNER SAFETY GUARD
- HOSE & REGULATOR INCLUDED
- RUST PROOF CHROME EMITTER GUARD

16,000 BTU LPG TANK TOP HEATER

PART#	BTU	HEAT STYLE	HEAT CAPACITY
HLTT16	16,000	RADIANT	400 SQ. FT.



FEATURES

- SWIVEL & TILT BURNER HEAD
- WIND RESISTANT
- MATCH LIGHT IGNITION
- SAFETY TIP-OVER SWITCH
- REAR BURNER SAFETY GUARD
- HOSE & REGULATOR INCLUDED
- RUST PROOF CHROME EMITTER GUARD

32,000 BTU LPG TANK TOP HEATER

PART#	BTU	HEAT STYLE	HEAT CAPACITY
HLTT32	32,000'	RADIANT	800 SQ. FT.



CARPET BLOWERS & AXIAL VANE FANS

**FEATURES**

- TILTING MECHANISM TO HELP YOU DIRECT AIR FLOW AT 45° OR 90° FOR VENTILATION OR DRYING

6" CARPET BLOWER

PART#	RPM	AMPS	CFM	CORD	SPEED
FC6	1300	10.8	300	25FT	1

**FEATURES**

- TILTING MECHANISM TO HELP YOU DIRECT AIR FLOW AT 45° OR 90° FOR VENTILATION OR DRYING

10" CARPET BLOWER

PART#	RPM	AMPS	CFM	CORD	SPEED
FC10	1300	10.8	1200	25FT	2

**FEATURES**

- PERFECT FOR COOLING, EXHAUSTING, VENTILATING & DRYING
- AUTO-RESET THERMAL PROTECTION
- COMES WITH ACCORDIAN STYLE EXHAUST HOSE

8" AXIAL VANE FAN WITH DUCTING HOSE

PART#	SIZE	RPM	AMPS	WATTS	CFM
FV8	8"	3400	1.8A	200	2100

**FEATURES**

- PERFECT FOR COOLING, EXHAUSTING, VENTILATING & DRYING
- AUTO-RESET THERMAL PROTECTION
- COMES WITH ACCORDIAN STYLE EXHAUST HOSE

12" AXIAL VANE FAN WITH DUCTING HOSE

PART#	SIZE	RPM	AMPS	WATTS	CFM
FV12	12"	3000	4.2A	500	3100

WALL MOUNT & PEDESTAL FANS

FEATURES

- 120 VOLTS, 60HZ
- RUGGED HANGING BAR
- POWDER COATED STEEL FRAME
- 3 BLADE PULL CHAIN
- OSCILLATING
- 10FT GROUNDED
- THREE-PRONG POWER CORD
- ENCLOSED, DUST PROOF, ENERGY EFFICIENT MOTOR

18" WALL MOUNT FAN

PART#	AMPS	BLADES	WHEELS	MAX CFM
FW18	7 A	3	NO	3853



FEATURES

- DIRECT DRIVE
- DURABLE POWDER COATED FRAME
- 6FT CORD LENGTH

REPLACEMENT PARTS

- 43.030.000 - FAN BLADE ASSEMBLY
- FP30-M - MOTOR

30" PEDESTAL FAN

PART#	HP	WATTS	AMPS	BLADES	SPEED	WHEELS	MAX CFM
FP30	0.2	226	1.9A (110V)	3	2 SPEED	NO	8750



DRUM FANS



FEATURES

- DIRECT DRIVE
- DURABLE POWDER COATED FRAME
- HEAVY DUTY COLD ROLLED STEEL BARREL
- 6FT CORD LENGTH

REPLACEMENT PARTS

- 43.024.000 - FAN BLADE ASSEMBLY
- 43.024.001 - 4" WHEEL
- 43.024.002 - AXLE
- FD24-M - MOTOR

24" DRUM FAN

PART#	HP	WATTS	AMPS	BLADES	SPEED	WHEELS	MAX CFM
FD24	0.17	220	1.96 (110V)	3	2 SPEED	YES	7700



◀ HANDLES



FEATURES

- DIRECT DRIVE
- DURABLE POWDER COATED FRAME
- HEAVY DUTY COLD ROLLED STEEL BARREL
- 6FT CORD LENGTH

REPLACEMENT PARTS

- 43.036.000 - FAN BLADE ASSEMBLY
- 43.036.001 - 6" WHEEL
- 43.036.002 - AXLE
- FD36-M - MOTOR

36" DRUM FAN

PART#	HP	WATTS	AMPS	BLADES	SPEED	WHEELS	MAX CFM
FD36	0.33	423	8.8A (110V)	3	2 SPEED	YES + HANDLE	11,200



◀ HANDLES



FEATURES

- DIRECT DRIVE
- DURABLE POWDER COATED FRAME
- HEAVY DUTY COLD ROLLED STEEL BARREL
- 8FT CORD LENGTH

REPLACEMENT PARTS

- 43.042.000 - FAN BLADE ASSEMBLY
- 43.042.001 - 6" WHEEL
- 43.036.002 - AXLE
- FD42-M - MOTOR

42" DRUM FAN

PART#	HP	WATTS	AMPS	BLADES	SPEED	WHEELS	MAX CFM
FD42	0.5	586	5.5A (110V)	4	2 SPEED	YES + HANDLE	15,400

BELT DRIVE DRUM FANS

FEATURES

- FOUR BLADE DESIGN FOR EVEN AIR FLOW
- DURABLE RUBBER WHEELS
- BELT DRIVE
- DURABLE POWDER COATED FRAME
- HEAVY DUTY COLD ROLLED STEEL BARREL
- 8FT CORD LENGTH

REPLACEMENT PARTS

- 43.042.000 - FAN BLADE ASSEMBLY
- 43.048.001 - 8" WHEEL
- 43.042.001 - AXLE
- 43.042.002 - BELT ASSEMBLY
- FD42B-M - MOTOR

42" BELT DRIVE DRUM FAN

PART#	HP	WATTS	AMPS	BLADES	SPEED	WHEELS	MAX CFM
FD42B	1.0	735	6.0A (110V)	4	2 SPEED	YES	17,700



FEATURES

- FOUR BLADE DESIGN FOR EVEN AIR FLOW
- DURABLE RUBBER WHEELS
- BELT DRIVE
- DURABLE POWDER COATED FRAME
- HEAVY DUTY COLD ROLLED STEEL BARREL
- 8FT CORD LENGTH

REPLACEMENT PARTS

- 43.048.000 - FAN BLADE ASSEMBLY
- 43.048.001 - 8" WHEEL
- 43.042.001 - AXLE
- 43.042.002 - BELT ASSEMBLY
- FD48B-M - MOTOR

48" BELT DRIVE DRUM FAN

PART#	HP	WATTS	AMPS	BLADES	SPEED	WHEELS	MAX CFM
FD48B	1.5	1120	9.0A (110V)	4	2 SPEED	YES	19,500





9 LAWN & GARDEN EQUIPMENT & ACCESSORIES

BRABER EQUIPMENT

40TH
EDITION

PARTS CATALOG

GARDEN HOSES



HD GARDEN HOSE

PART#	DIAMETER	LENGTH
90.358.050	5/8"	50 FT
90.358.100	5/8"	100 FT
90.375.050	3/4"	50 FT
90.375.100	3/4"	100 FT

FEATURES

145 MAX PSI
3.75 MM WALL THICKNESS
580 MAX BURST PSI
THERMOPLASTIC MATERIAL (BLEND OF RUBBER & PVC)
PREMIUM BLUE HOSE RESISTS KINKING
HEAVY DUTY BRASS ENDS



HIGH FLEXIBILITY GARDEN HOSE

PART#	DIAMETER	LENGTH
90.358.051	5/8"	50 FT
90.358.101	5/8"	100 FT
90.375.051	3/4"	50 FT
90.375.101	3/4"	100 FT

FEATURES

150 MAX PSI
5/8" OR 3/4" HIGH FLEX POLYMER
NYLON BRAID
NICKEL PLATED BRASS FITTINGS
BEND RESTRICTORS
SMOOTH COVER

WATER INLET FILTERS & WASHERS



BLUE INLET FILTER

PART#	85.300.058
MAX PSI	170 PSI
MAX TEMP	180° F
MAX FLOW	10.0 GPM
INLET	3/4" FGHT
OUTLET	1/2" MNPT
PORTS/PLUGS	DUAL 1/4" FNPT W/ PLUGS

COMPONENTS

85.309.051	PLASTIC BLUE CAP
90.300.120	GARDEN HOSE ADAPTER

ADDITIONAL INFORMATION

PROTECTS THE PUMP FROM CONTAMINANTS IN THE WATER. CAP EASILY UNSCREWS WITH AN ALLEN KEY TO CLEAN OUT SCREEN.



CLEAR INLET FILTER

PART#	85.300.055
PORT	YES
MAX TEMP	175° F
MAX FLOW	8.0 GPM
INLET	3/4" FGHT
OUTLET	1/2" MNPT

ADDITIONAL INFORMATION

PROTECTS THE PUMP FROM CONTAMINANTS IN THE WATER. CLEAR GLASS BOWL ALLOWS FOR VIEWING WHEN SCREEN NEEDS CLEANING.



GARDEN HOSE WASHER

PART#	85.308.121
SIZE	1" OD X 5/8" ID



FILTER WASHER

PART#	85.308.120
SIZE	1" OD (60 MESH)

ADDITIONAL INFORMATION

USE ON PUMPS W/ SHALLOW INLETS

ADAPTER STRAINER

PART#	90.300.119	90.300.120
DESCRIPTION	FGHT X 3/8" MNPT	FGHT X 1/2" MNPT
FILTER	STAINLESS STEEL MESH #60	
MATERIAL	BRASS	



GARDEN HOSE VALVES

**NYLON INLINE SHUTOFF**

PART# GHV-1	
DESCRIPTION	NYLON INLINE SHUTOFF
MAX PSI	60
MATERIAL	PLASTIC
SPECIFICATIONS	FGHT X MGHT

**BRASS VALVE W/ THUMB SHUTOFF**

PART# 91.900.074	
DESCRIPTION	BRASS INLINE SHUTOFF
MAX PSI	100
INLET	MGHT
OUTLET	FGHT

**DUAL NYLON INLINE SHUTOFF**

PART# GHV-2	
DESCRIPTION	NYLON INLINE SHUTOFF
MAX PSI	60
MATERIAL	PLASTIC
SPECIFICATIONS	FGHT X MGHT (2)

**DUAL BRASS SHUTOFF**

PART# 91.900.073	
DESCRIPTION	BRASS GARDEN HOSE VALVE, Y SHUTOFF, SWIVEL
MAX PSI	60
SPECIFICATIONS	FGHT X MGHT (2)

**DUAL BRASS SHUTOFF**

PART# 90.303.001	
DESCRIPTION	BRASS DUAL SHUTOFF

**BRASS 4 WAY MANIFOLD**

PART# 90.303.000	
DESCRIPTION	BRASS 4 WAY MANIFOLD

**BRASS VALVE W/ LOCKNUT**

PART# 91.900.075	
DESCRIPTION	BRASS INLINE SHUTOFF
MAX PSI	100
INLET	MGHT
OUTLET	FGHT

GARDEN HOSE ACCESSORIES

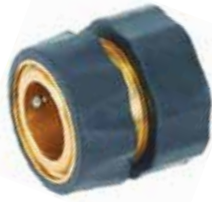

FEMALE QUICK CONNECT

PART# 90.303.002

DESCRIPTION	FEMALE QUICK CONNECT
-------------	----------------------



QUICK CONNECT SET

PART# 90.300.025

DESCRIPTION	5 PIECE QUICK CONNECT SET
-------------	---------------------------

90.303.003



90.303.005



MALE COUPLERS

PART# 90.303.003

DESCRIPTION	BRASS MALE COUPLER
-------------	--------------------

DIAMETER	5/8"
----------	------

PART# 90.303.005

DESCRIPTION	BRASS MALE COUPLER
-------------	--------------------

DIAMETER	3/4"
----------	------

90.303.004



90.303.006



FEMALE COUPLERS

PART# 90.303.004

DESCRIPTION	BRASS FEMALE COUPLER
-------------	----------------------

DIAMETER	5/8"
----------	------

PART# 90.303.006

DESCRIPTION	BRASS FEMALE COUPLER
-------------	----------------------

DIAMETER	3/4"
----------	------

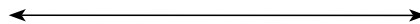

GARDEN HOSE COUPLER

PART# 90.900.138

DESCRIPTION	GARDEN HOSE COUPLER
-------------	---------------------

THREAD	3/4" FGHT
--------	-----------

SIZE	3/4" X 1/2" (MATES W/ 90.900.137)
------	-----------------------------------

COLLAR	1/2" W/ QUICK COLLAR
--------	----------------------

MATERIAL	BRASS
----------	-------

QUICK CONNECT ADAPTER

PART# 90.900.137

DESCRIPTION	QUICK CONNECT ADAPTER
-------------	-----------------------

THREAD	3/4" MGHT
--------	-----------

PLUG	1/2"
------	------

MATERIAL	BRASS
----------	-------

BRASS GARDEN HOSE FITTINGS**BUSHING**

PART#	SIZE	MATERIAL
90.300.130	MGHT X 1/2" FNPT	BRASS

**HEX COUPLER**

PART#	SIZE	MATERIAL
90.900.022	FGHT X 3/4" FNPT	BRASS

**HEX NIPPLE**

PART#	SIZE	MATERIAL
90.900.018	3/4" MGHT X 3/4" MNPT	BRASS

**HEX NUT**

PART#	SIZE	MATERIAL
90.900.038	FGHT BARB NUT	BRASS

**HOSE BARB**

PART#	SIZE	MATERIAL
90.900.019	MGHT X 3/8" X 2"	BRASS
90.900.047	MGHT X 1/2" X 2"	BRASS
90.900.048	MGHT X 3/4" X 2"	BRASS

**HOSE BARB SWIVEL**

PART#	SIZE	MATERIAL
90.900.046	FGHT X 3/8" X 2"	BRASS
90.900.021	FGHT X 1/2" X 2"	BRASS
90.900.034	FGHT X 3/4" X 2"	BRASS

GARDEN HOSE GUNS & NOZZLES



90.300.020



90.300.022



90.300.023



90.300.024



90.300.026



85.205.020

PART#	DESCRIPTION
90.300.020	PROFESSIONAL IND PISTOL NOZZLE
90.300.022	ADJUSTABLE TIP REAR TRIGGER NOZZLE
90.300.023	10 PATTERN POWERSPRAY NOZZLE
90.300.024	ADJUSTABLE POWERSPRAY NOZZLE
90.300.026	POWER PRO FIREMAN'S NOZZLE

PART# 85.205.020	
DESCRIPTION	LOW PRESSURE HIGH VOLUME SPRAY GUN
MAX PRESSURE	350 PSI
MAX FLOW	26 GPM
MAX TEMP	195° F
INLET	1/2" FGHT WITH 1/2" FGHT SWIVEL FITTING
NOTE	HIGH QUALITY HEAVY DUTY INSULATED HIGH VOLUME GUN.
COMPONENTS	90.300.120 SWIVEL REQUIRED.



90.300.010



90.300.011



90.300.012

PART#	DESCRIPTION	INLET	NOTE
90.300.010	PREMIUM GARDEN HOSE GUN W/ ADJUSTABLE BRASS TIP, PLUNGER AND NUT. ZINC ALLOY BODY AND COMFORTABLE SOFT GRIP.	FGHT CONNECTION	CARDED FOR CONVENIENT DISPLAY
90.300.011	PREMIUM GARDEN HOSE GUN W/ ADJUSTABLE 8 FUNCTION SPRAY HEAD. ZINC ALLOY BODY AND COMFORTABLE SOFT GRIP.	FGHT CONNECTION	CARDED FOR CONVENIENT DISPLAY
90.300.012	4" GARDEN HOSE NOZZLE MADE OF QUALITY BRASS W/ AN INSULATED GRIP. TWIST OPERATION FROM CONE TO STREAM.	FGHT CONNECTION	COMES IN DISPLAY PACK

LAWN & GARDEN EQUIPMENT

**ROLLERS**

PART#	81.200.020
WIDTH	48"

PART#	81.200.021
WIDTH	60"

**DRUM SPIKE AERATOR**

PART#	81.200.040
WIDTH	48"

PART#	81.200.041
WIDTH	60"



*Boxed Items
Require Assembly*

40" TRAIL AERATOR

PART#	81.200.004
WIDTH	40"

**40" TINE DETHATCHER**

PART#	81.200.001
WIDTH	40"

**SALT SPREADER**

PART#	PFSS60P
DESCRIPTION	SALT SPREADER

**250 LB SPREADER**

PART#	PFS105T
DESCRIPTION	250 LB SPREADER

**ATV SPREADER**

PART#	MFS350T
DESCRIPTION	ATV PULL TYPE FERTILIZER SPREADER
CAPACITY	350LB/160L
COVERAGE	17,500 SQUARE FT

FEATURES

- PNEUMATIC TIRE 14"/600-6
- STEEL SQUARE HOPPER
- IDEAL FOR USE WHEN A PTO IS NOT AVAILABLE
- SPREADS SEED, FERTILIZER, SAND & SALT
- ADJUSTABLE TOWBAR WITH 2" BALL HITCH
- HEAVY DUTY CAST IRON, OIL BATH GEARBOX

LAWN & GARDEN EQUIPMENT



TRAILER DOLLY

PART#	81.200.600
DESCRIPTION	TRAILER DOLLY
CAPACITY	200LB



LIVESTOCK WATERER

PART#	81.000.015
DESCRIPTION	5 GAL LIVESTOCK WATERER



MINI DRAG HARROW

PART#	81.200.060
DESCRIPTION	MINI DRAG HARROW



42" SWEEPER

PART#	SW42T
DESCRIPTION	42" SWEEPER



5/8" X 7"
REPLACEABLE
TEETH

DIAMOND HARROW

PART#	HAR40S	HAR60S
WORKING WIDTH	40"	60"
LENGTH	52"	52"
WEIGHT	62 LB	98 LB



PART#	TC5017HD
DESCRIPTION	DUMP CART
SIZE	17FT ²



PART#	TC5010
DESCRIPTION	DUMP CART
SIZE	9.9FT ²



PART#	TC5014HD
DESCRIPTION	HD DUMP CART
SIZE	14FT ²

POLY DUMP CARTS



TCP600



TCP12004W



TCP1000



TCP1500



TCP1200



TCP15004W



FEATURES

- TOW BAR SWIVEL, EASY TILT
- QUICK RELEASE TIPPER LATCH MAKES LOADING AND UNLOADING CONVENIENT AND EASY
- ALL STEEL TUBULAR FRAME WITH POWDER COAT
- PIN STYLE HITCH FOR USE WITH BOTH ATV'S AND LAWN TRACTORS
- STEEL RIMS

POLY DUMP CARTS

PART#	CAPACITY	TIRE SIZE	HEAPED LOAD SIZE	LEVEL LOAD SIZE	OVERALL DIMENSIONS	BODY DIMENSIONS
TCP600	600LB	16"	10FT ³	7FT ³	65" X 36" X 26"	43.3" X 32.9" X 10.5"
TCP1000	1000LB	16"	18FT ³	14FT ³	83" X 50" X 27"	58.9" X 38.0" X 15.0"
TCP1200	1200LB	18"	19FT ³	15FT ³	85" X 47" X 31"	61.4" X 31.0" X 18.1"
TCP12004W	1200LB	18"	19FT ³	15FT ³	85" X 50" X 31"	61.4" X 31.0" X 18.1"
TCP1500	1500LB	18"	28FT ³	22FT ³	97" X 55" X 31"	69.1" X 39.8" X 17.9"
TCP15004W	1500LB	18"	28FT ³	22FT ³	97" X 58" X 31"	69.1" X 39.8" X 17.9"

ALL MEASUREMENTS ARE IN MILLIMETERS UNLESS OTHERWISE STATED (1" = 25.4 MM).
THESE ITEMS ARE NOT ORIGINAL EQUIPMENT PARTS.



10 MATERIAL HANDLING

BRABER EQUIPMENT

40TH
EDITION

PARTS CATALOG

BIN FORKS & PALLET FORKS



ABF TUBED TINES



ABFHD SOLID TINES

PALLET & BIN FORK

PART#	ABFG
CAPACITY	1200 LB
HITCH	CAT 1, 3 PT HITCH
SIZE	L41" X 25" CENTER
FORK SIZE	2"X4" TUBE
WEIGHT	90 LB

HEAVY DUTY PALLET & BIN FORK

PART#	ABFHDG
CAPACITY	2000 LB
HITCH	CAT 1, 3 PT HITCH
SIZE	L41" X 25" CENTER
FORK SIZE	1 1/4"X4" SOLID
WEIGHT	174 LB



BUCKET PALLET FORK

PART#	BFT2000G
CAPACITY	2000 LB EACH

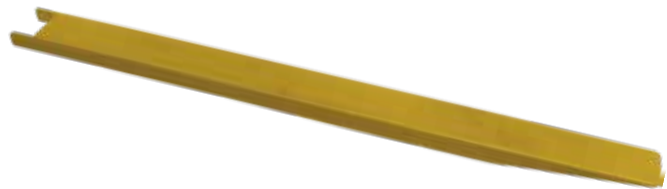

FORK EXTENSION

PART#	BE-EXT3T2M
DESCRIPTION	2 METERS, 6.6', 100LB



BUCKET PALLET FORK

PART#	BFT1000G
CAPACITY	1000 LB EACH



PALLET JACKS

NARROW PALLET JACK

PART#	B27001
DESCRIPTION	NARROW PALLET JACK
CAPACITY	5,500 LB
OVERALL HEIGHT	64"
FORK LENGTH	48"
OVERALL FORK WIDTH	21.5"
WEIGHT	143 LB
LOWERED FORK HEIGHT	2.95"
MAX LIFTING HEIGHT	7.28"
GROUND CLEARANCE	0.87"
TURNING RADIUS	53"
SERVICE WEIGHT	143.3 LB



WIDE PALLET JACK

PART#	B27002
DESCRIPTION	WIDE PALLET JACK
CAPACITY	5,500 LB
OVERALL HEIGHT	64"
FORK LENGTH	48"
OVERALL FORK WIDTH	27"
WEIGHT	154 LB
LOWERED FORK HEIGHT	2.95"
MAX LIFTING HEIGHT	7.28"
GROUND CLEARANCE	0.87"
TURNING RADIUS	53"
SERVICE WEIGHT	154.32 LB





11 BLADES & HAMMERS

BRABER EQUIPMENT

40TH
EDITION

PARTS CATALOG

ROTARY BLADES



PART #	OEM #	TYPE	SIZE	BOLT#	D	W	L
55.000.402	BRABER, TAYLOR PITTSBURGH	CCW	48"	55.007.919	38.1 (1½")	76.25 (3")	450 (17¾")
55.000.502	BRABER, TAYLOR PITTSBURGH	CCW	60"	55.007.919	38.1 (1½")	76.25 (3")	625 (24⅝")
55.000.602	BRABER, TAYLOR PITTSBURGH	CCW	72"	55.007.919	38.1 (1½")	76.25 (3")	800 (31½")
PART #	OEM #	TYPE			D	W	L
55.000.096	BUSH HOG 7828	CCW			38.1 (1½")	100 (4")	490 (19⅜")
55.000.097	BUSH HOG 7829	CW			38.1 (1½")	100 (4")	490 (19⅜")
PART #	OEM #	TYPE			D	W	L
55.007.555	BUSH HOG 7555	CCW UPLIFT			38.1 (1½")	100 (4")	630 (24¾")
55.007.556	BUSH HOG 7556	CCW UPLIFT			38.1 (1½")	100 (4")	705 (27¾")
55.007.557	BUSH HOG 7557	CCW UPLIFT			38.1 (1½")	100 (4")	775 (30½")
PART #	OEM #	TYPE			D	W	L
55.090.014	BUSH HOG 90014	CW			38.1 (1½")	100 (4")	610 (24")
55.090.015	BUSH HOG 90015	CCW			38.1 (1½")	100 (4")	610 (24")
PART #	OEM #	TYPE			D	W	L
55.067.743	BUSH HOG 67743	CW			38.1 (1½")	100 (4")	432 (17⅞")
55.067.744	BUSH HOG 67744	CCW			38.1 (1½")	100 (4")	432 (17⅞")
PART #	OEM #	TYPE			D	W	L
55.820.198	LANDPRIDE 820198C	CCW			38.1 (1½")	76.25 (3")	635 (25")
55.820.137	LANDPRIDE 820137C	CCW			38.1 (1½")	100 (4")	635 (25")
PART#	OEM	TYPE			D	W	L
55.311.428	PERFECT 3.11428 CCW	LF SERIES 215			1"	3"	324 (12 ¾")
55.311.427	PERFECT 3.11427 CCW	LF SERIES 245			1"	3"	372 (14 ⅝")
55.313.924	PERFECT 3.13924 CCW	LF SERIES 275			1"	3"	413 (16 ⅜")
PART#	OEM	TYPE			D	W	L
55.401.046	SCHULTE 401046	CW			38.1 (1½")	100 (4")	635 (25")
55.401.047	SCHULTE 401047	CCW			38.1 (1½")	100 (4")	635 (25")
55.401.048	SCHULTE 401048	CCW			38.1 (1½")	100 (4")	711 (28")
PART#	OEM	TYPE	FITS		D	W	L
55.000.092	WOODS 3900	CCW	C80, C080, D80, D080		23 (⅞")	76.25 (3")	470 (18½")
55.000.789	WOODS 15789	CCW	MD-080-2		39 (1½")	76.25 (3")	470 (18½")

ROTARY BLADES & SIDE SLICER BLADES

ROTARY BLADES



PART#	OEM	TYPE	FITS	D	W	C	L
55.000.095	WOODS 3955	CCW	C80, C080, D80, D080	23 (7/8")	75.5 (3")	10 (3/8")	472 (18 1/2")
55.000.790	WOODS	CCW	C80, C080, D80, D080	39 (1 1/2")	32 (1 1/4")	10 (3/8")	472 (18 1/2")

SIDE SLICER BLADES



PART#	OEM	FITS	D	W	L	C	F
55.620.080	CARONI, NEW HOLLAND		14	44	124	5	40
55.000.051	CARONI 050 01200 LONG	TL900/1200/1500	10.5	44	124	5	40
55.000.056	COSMAG 860-559, RINIERI 159-06	COSMAG-TM, RINIERI-LTE,TRC	25.5	71	145	8	61
55.000.086	DANDL SA-2027, FL960, CD-2100	DANDLE ORCHARD MODEL I SERIES	16	53	87	4	48
55.000.086HS	DANDL SA-2027, FL960, CD-2100 HARD SURFACE VERSION	DANDLE ORCHARD MODEL I SERIES	16	53	87	4	48
55.000.087	DANDL RA-2039	ROW CROP	16	51	172	4	48
55.000.207	LOFTNESS 8021, VRISIMO	HARD SURFACED FLAIL, VRISIMO	24	65	173	8.5	60
55.000.053	NOBILI, VRISIMO	C BLADE MODEL: BMG, VRISIMO	25.5	74	203	10	55
55.000.090	REARS FL 940/LOFTNESS 8023	JOHN DEERE MODEL 27	20.25	66	140	8.3	52
55.000.090HS	REARS FL 946, HARD SURFACED	JOHN DEERE MODEL 27	20.25	66	140	8.3	52
55.505.301	ALLOWAY 505-3-001		16	50.75	193	6.4	48
55.000.038	CARONI 100 07400 SHORT	TM 1300/1600/1900	13X27	44	87	5	38
55.000.038	MOTT 105319M	FLAIL	13X27	44	87	5	38
55.000.030	MOTT 100761, MASCHIO 404-00-416	MAS-G	13X27	44	86	3.5	32

BLADES & HAMMERS

SIDE SLICER BLADE (FINE)



PART#	OEM	FITS	D	W	L	C	F
55.000.035	MOTT 102086, MASCHIO 403-00-412	MAS-G	9	32	126	2	18
55.000.036	MOTT 101993, MASCHIO 403-00-429	ALL MOTT, MAS-G	9	32	77	2	15

HAMMERS

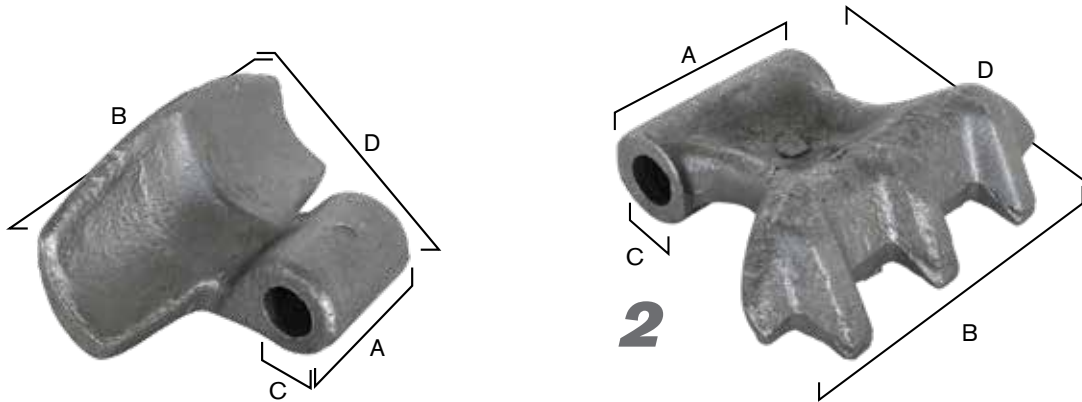

PART#	OEM	FITS MODELS	A	B	C	D
55.000.060	COSMAG 473-061	COSMAG-TUF, RINIERI LTC, TRP	60	150	20	106
55.000.021	RINIERI 137-16	TRX, LTA, LTB, LTM	75	200	20	118
55.000.020	PERFECT 11624		75	200	20	118
55.000.020	RINIERI 137-27, SEPPI 83130000, AGRICOM A2500MF3	#SMO, SOME MODELS, LONG SHANK, NEW STYLE RINIERI TRC, TRS	40	115	16	126
55.000.098*	REARS FL948H, WOODS 'OF'	HEAVY DUTY, AGRICOM EVG	38	118	16	116
<i>*TAKES 5/8 X 4 BOLT AND BUSHINGS, NOT SOLD BY BRABER EQUIPMENT</i>						
55.000.099	REARS FL948H, 750 OM	HEAVY DUTY	38	118	3/4"	116
55.000.022, BERTI MODEL TA 135	SEPPI, KUHN 6061700	#SMW, SHORT SHANK, BERTI 135	40	115	16	107
55.000.277		RINIERI TRB	12.5	78	14	85
55.128.000	PROMAC PBC 12800		58.44	71	31	110
EFAG140.103	HAMMER, AGRIEASE		40	138	16	120
EFGC120.104A	HAMMER, AGRIEASE		40	90	16	110
55.000.019	WILLIBAUGH 230-40-068	USE BOLT 01.020.140S	90	160	20	125
55.000.150**	VOTEX 73.31.147		70	156	16.5	107

**TAKES 16 X 140MM BOLT BE# 01.016.140, OEM# 251127 GRD 10.9

KNIVES & PINS

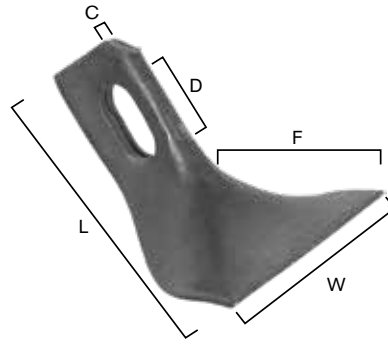

PART #	DANDL#	SA-2042	MODELS "I" SERIES	D	W	L	C	F
55.000.080	JOHN DEERE#	E31900	MODELS 25/A. 26/A	26X14.5	72	86	6	65
	REARS	FL920						
	VRISIMO	CD2110						

MATHEWS

PART#	55.000.071
MC BLADE#	0015208
C	5
H	110
W	161
D	10 X 11.50MM

ADDITIONAL INFORMATION

ROTARY SCYTHE MODELS: 7E, 9E.
MC MODELS: 10/S, 12/S, 144S/B, 180S/B, 2408S/B.

MATHEWS ROW CROP SHREDDER KNIFE

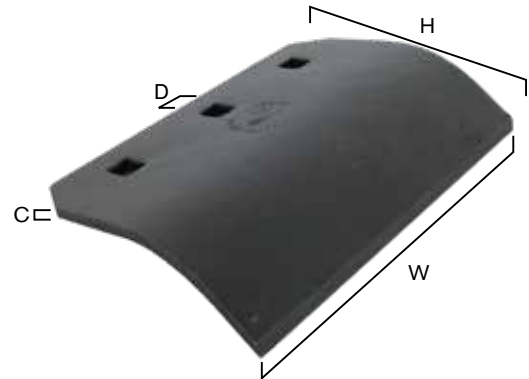

PART#	55.000.037
MOTT#	101034
FOR FLAIL	55.000.035
A	7.75
B	22

PART#	55.000.032
MOTT#	102670
TIGER#	TS-1021
MASCHIO#	404-00-417
FOR CLEVIS	55.000.024
A	11
B	72

PART #	55.100.032
OEM	NUMAC PIN
A	11
B	76

PINS

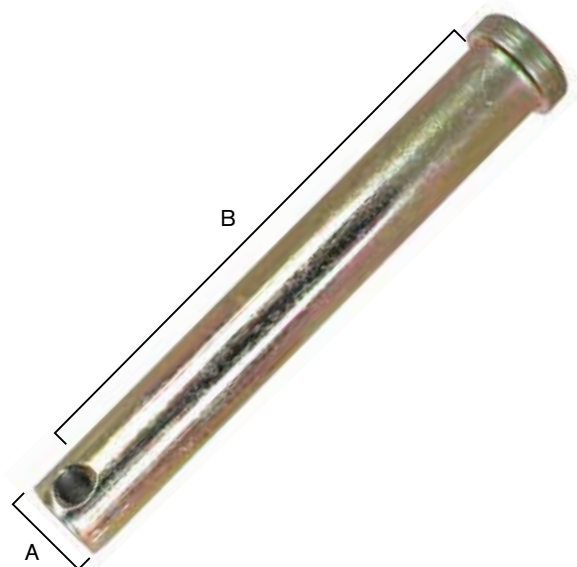

D RINGS, SHACKLES, CLIPS & HANGERS

D RINGS

PART#	OEM	TYPE	A	B
55.000.084	VRISIMO CD-2130		10.5	57
55.000.031	MOTT 101991	FINE CUT	8	20
55.000.082	VRISIMO CD-2135	D-RING		

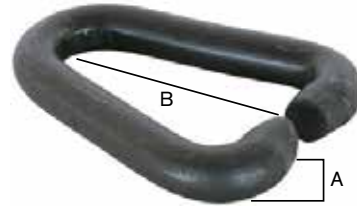

SHACKLES

PART# 55.000.052				
CARONI#	2000700			
USE WITH	SIDE SLICER BLADE 55.000.038			
A	10	B	34	

PART# 55.000.024				
MOTT#	100761			
TIGER#	TS-1020			
MASCHIO#	404-00-415			
A	11.5	B	42	C 26

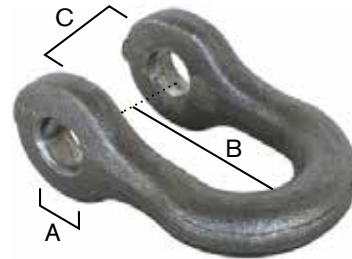

D RING CLIP

PART# 55.000.081				
CARONI#	2000700			
A	10	B	31	C 38

FOR D RING	55.000.031			
PART#	55.000.033 (OEM# MOTT 101992)			
PART#	55.100.033 (OEM# 102650) FLAT EDGE			
A	8	B	25	C 43

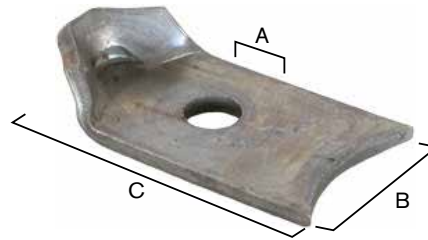

OVAL HANGER

OEM	DANDL, VRISIMO CD-2125			
PART#	55.000.083			
A	41X19	B	30	C 3.5

A = INSIDE DIAMETER

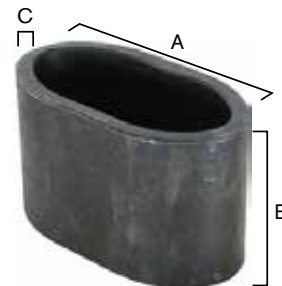

BOLTS & BOLT ASSEMBLIES



PART#	01.020.140S
DIMENSIONS	20MM X 140MM
ADDITIONAL INFORMATION	
USES CASTLE NUT 10.000.020 OR 09.000.020 NYLON LOCK NUT	

BOLT PART#	860-229
DIMENSIONS	20MM X 150MM
CASTLE NUT	BRABER# 10.000.020
NYLOCK NUT	BRABER# 09.000.020
ADDITIONAL INFORMATION	
FITS NEW STYLE RINIERI TRP/TRX SHREDDER.	



PART #	55.007.919
DIMENSIONS	1 1/8 NF WITH 6MM KEY WAY
ADDITIONAL INFORMATION	
FITS BE MOWER, TAYLOR PITTSBURGH & ALAMO GRASS MOWER	

PART #	55.047.919
DIMENSIONS	1 1/8 NF WITH 4MM KEY WAY.
ADDITIONAL INFORMATION	
FITS BUSH HOG MOWERS, OEM PART # 7919	

PART #	55.000.055
DIMENSIONS	1 1/8 NF WITH 4.5MM KEY WAY.
ADDITIONAL INFORMATION	
FITS BE ROTARY CUTTERS	



PART #	DESCRIPTION
064-56	
DRILLED HOLE:	USE 10.000.020 CASTLE NUT
NO DRILLED HOLE:	USE 09.000.020 NYLOCK NUT (NEW)
DIMENSIONS	20MM X 115MM SPECIAL
FITS MODELS	TRP SHREDDER
RINIERI #	OEM# 0643020115
NUT CASTLE	BRABER# 10.000.020
NUT NYLOCK	BRABER# 09.000.020
ADDITIONAL INFORMATION	
NEW STYLE BOLT DOES NOT REQUIRE A LOCKING PIN. PLEASE STATE WHETHER OR NOT A LOCKING PIN IS REQUIRED.	



PART#	55.132.075
DIMENSIONS	26.75 X 16 X 90MM
RINIERI#	0642016090
SEPPI#	1320075
NUT	BRABER# 11.000.016
ADDITIONAL INFORMATION	
GRD 10.9.	

FLAIL SETS

ALAMO FLAIL SETS

ALAMO

PIC	ALAMO#	BRABER#	DESCRIPTION
A	09.528.01	55.095.280	GRASS FLAIL
B	09.517.01	55.095.701	SHACKLE
C	41.167.01	55.411.670	BOLT KIT (10 PCE)



BOMFORD FLAIL SETS

BOMFORD

PIC	BOMFORD#	BRABER#	DESCRIPTION
A	02-812-01	55.100.034	GRASS FLAIL
B	02-959-01	55.000.026	BRUSH FLAIL (0.9LB)
	42750.01	N/A	BRUSH FLAIL (0.7LB)



BOMFORD

PIC	BOMFORD#	BRABER#	DESCRIPTION
A	05-895-01	55.000.063	SHACKLE
B	02-807-01	55.000.064	SPACER
C	02-801-01	55.000.065	COLLAR
D	03-675-25	55.000.069	BOLT ASSEMBLY

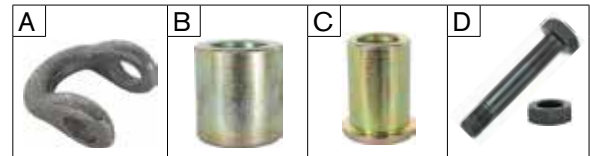

BOMFORD

PIC	BOMFORD#	BRABER#	DESCRIPTION
A	09-528-01	55.095.280	GRASS FLAIL
B	09-517-01	55.095.701	SHACKLE
C	41-167-01	55.411.670	BOLT KIT (10 PCE)



BOMFORD

PIC	BOMFORD#	BRABER#	DESCRIPTION
A	MC-7191320	55.719.132	HAMMER FLAIL
B		55.425.981	BUSHING (2 REQ PER KIT)
C	41-167-01	55.411.670	BOLT KIT (10 PCE)



BOMFORD

PIC	BOMFORD#	BRABER#	DESCRIPTION
A	03-958-01	55.000.068	BUSHMASTER FLAIL
B	03-437-01	55.000.066	LONG BUSHING
C	03-675-26	55.000.075	BOLT ASSEMBLY



BOMFORD

PIC	BOMFORD#	BRABER#	DESCRIPTION
A	01-474-01	55.195.300	BUSHWACKER FLAIL
B	03-437-01	55.000.066	LONG BUSHING
C	03-675-26	55.000.075	BOLT ASSEMBLY



FLAIL SETS

BOMFORD FLAIL SETS

BOMFORD

PIC	BOMFORD#	BRABER#	DESCRIPTION
A	43594-01	55.425.941*	FLAIL
B	42598-01	55.425.980	COLLAR, 14MM HOLE
C	41-725-01	55.417.251	SPACER
D	41535-01	55.415.351	COLLAR, 16MM HOLE
E	05.775.13	55.577.513	BOLT & NUT 14MM 1.5 X 140MM



***NOTE:** BUSHMASTER 46402.01 OPEN FLAIL AND BOMFORD 46401.01 CAN BE REPLACED BY BE 55.425.941 FLAIL.

CARONI FLAIL SETS

CARONI

PIC	CARONI#	BRABER#	DESCRIPTION
A	10007400	55.000.038	SHORT FLAIL
B	20000700	55.000.052	SHACKLE
C		01.010.080	BOLT
D		09.000.010	LOCK NUT (NYLOCK)



CARONI

PIC	CARONI#	BRABER#	DESCRIPTION
A	05001200	55.000.051	LONG FLAIL, 10MM HOLE
		55.620.080	LONG FLAIL, 14MM HOLE



COSMAG FLAIL SETS

COSMAG/RINIERI

PIC	COS/RIN#	BRABER#	DESCRIPTION
A	860-559	55.000.056	FLAIL



COSMAG/RINIERI

PIC	COS/RIN#	BRABER#	DESCRIPTION
A	473-061	55.000.060	HAMMER FLAIL



FLAIL SETS

DANDL FLAIL SETS

DANDL

PIC	DANDL#	BRABER#	DESCRIPTION
A	SA-2027	55.000.086	FLAIL
B		55.000.083	OVAL HANGER
C		55.000.084	D-RING



DANDL

PIC	DANDL#	BRABER#	DESCRIPTION
A	SA-2042	55.000.080	CUP FLAIL
B		55.000.083	OVAL HANGER
C		55.000.084	D-RING



DANDL

PIC	DANDL#	BRABER#	DESCRIPTION
A	DMF-1A2016	55.000.038	FLAIL
B	DFM-1A2096	55.209.600	HANGER
C	DFM-1A2098	55.209.800	CLIP
D		55.209.500	PIN

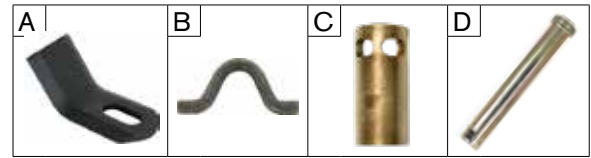

DIAMOND MOWERS FLAIL SETS

DIAMOND MOWERS

PIC	DIAMOND MOWERS#	BRABER#	DESCRIPTION
A	22-1017	55.000.053	FLAIL
B	11-0757	55.110.757	BOLT
C	11-056	55.110.056	WASHER
D	11-1054	55.111.054	NUT
E	11-2005	55.112.005	ROLL PIN
F		55.000.054	STRAIGHT FLAIL

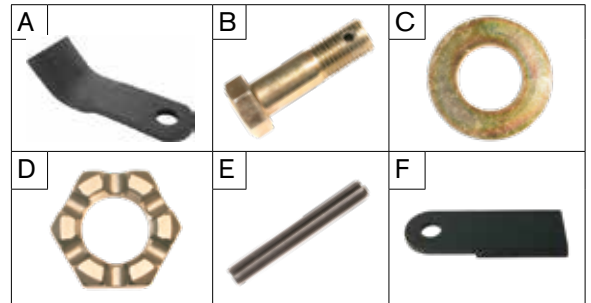

DIAMOND MOWERS

PIC	DIAMOND MOWERS#	BRABER#	DESCRIPTION
A	22-1016	55.221.016	FLAIL
B	11-1501	55.111.501 OR 55.000.024	CLEVIS



DIAMOND MOWERS

PIC	DIAMOND MOWERS#	BRABER#	DESCRIPTION
A	22-1005 (ALT. 22-1015)	55.221.005	FLAIL
B	11-0506	55.110.506	BOLT
C	11-1003	55.111.003	NUT



FLAIL SETS

EDWARDS FLAIL SETS

EDWARDS

PIC	EDWARDS#	BRABER#	DESCRIPTION
A	HMB-217H	55.000.034	FLAIL H.D.
B	9041	55.000.028	PIN
C	HMB-815	55.000.029	SHACKLE

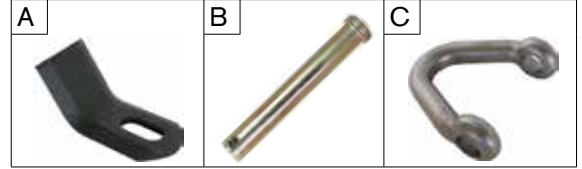

FERRI FLAIL SETS

FERRI

PIC	FERRI#	BRABER#	DESCRIPTION
A	0901049	55.901.049	FLAIL



FERRI

PIC	FERRI#	BRABER#	DESCRIPTION
A	0901133	55.000.038	FLAIL
B	0901118	59.901.118	CLEVIS
C	0931855	01.008.055	BOLT
D		09.000.008	NUT



JACOBSEN FLAIL SETS

JACOBSEN

PIC	JACOBSEN#	BRABER#	DESCRIPTION
A	337599	55.337.599	FLAIL
B	362226	55.362.226	SHACKLE



JOHN DEERE FLAIL SETS

JOHN DEERE

PIC	JOHN DEERE#	BRABER#	DESCRIPTION
A	E31900	55.000.080	CUP FLAIL
B	E31905	55.000.081	CLIP
C	E31903	55.000.082	D-RING



JOHN DEERE

PIC	JOHN DEERE#	BRABER#	DESCRIPTION
A	P-57928	55.579.280	FLAIL
B	P-57926	55.579.260	CLIP
C	P-57925	55.579.250	D-RING



JOHN DEERE

PIC	JOHN DEERE#	BRABER#	DESCRIPTION
A	FL940	55.000.090	FLAIL
B		55.000.090HS	HARD SURFACE FLAIL

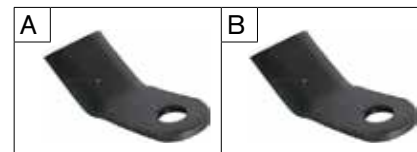

FLAIL SETS

LITTLE INDUSTRIES FLAIL SETS

LITTLE INDUSTRIES

PIC	LITTLE INDUSTRIES#	BRABER#	DESCRIPTION
A	NW1	55.000.068	DROP FORGED "T" FLAIL
B	NW1 H.D.	55.000.023	DROP FORGED "T" FLAIL 1/4" THICKER CUTTING EDGE
C	NW2	55.195.300	HD DROP FORGED "T" FLAIL
D	NW	55.000.066	LONG BUSHING
E	BT .5 X 5.25	55.000.076	BOLT & NYLOCK ASSEMBLY
F		55.000.077	BOLT & NYLOCK ASSEMBLY 3/4" N.F.

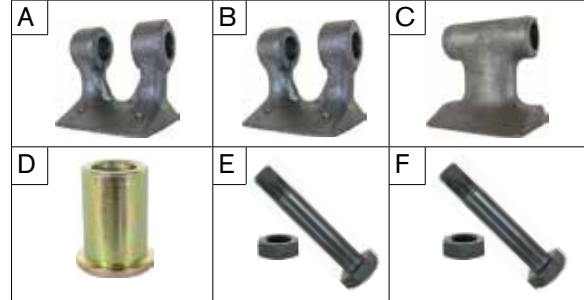

MASCHIO FLAIL SETS

MASCHIO

PIC	MASCHIO#	BRABER#	DESCRIPTION
A	403-00-429	55.000.036	FLAIL
B	403-00-412	55.000.035	FLAIL

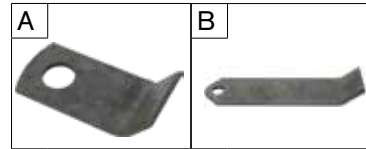

MASCHIO

PIC	MASCHIO#	BRABER#	DESCRIPTION
A	404-00-416	55.000.030	FLAIL
B	404-00-415	55.000.024	SHACKLE
C	404-00-417	55.000.032	PIN

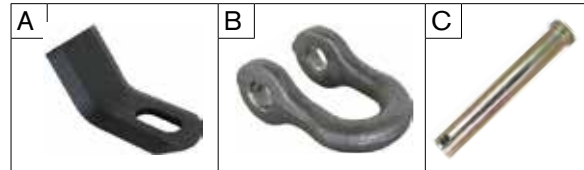

MATHEWS FLAIL SETS

MATHEWS

PIC	MATHEWS#	BRABER#	DESCRIPTION
A	0015208	55.000.071	BLADE



MCCONNELL FLAIL SETS

MCCONNELL

PIC	MCCONNELL#	BRABER#	DESCRIPTION
A	73 14 366	55.500.000	HAMMER FLAIL

BOMFORD 41.391.01



MOTT FLAIL SETS

MOTT

PIC	MOTT#	BRABER#	DESCRIPTION
A	101993	55.000.036	FLAIL
B	101991	55.000.031	D-RING
C	101992	55.000.033	CLIP
D	102650	55.100.033	CLIP



FLAIL SETS

MOTT/ALAMO FLAIL SETS

MOTT/ALAMO

PIC	MOTT#	BRABER#	DESCRIPTION
A	000032	55.032.000	BOLT
B	000210	55.210.000	NUT
C	102086	55.000.035	FLAIL
D	101034	55.000.037	PIN

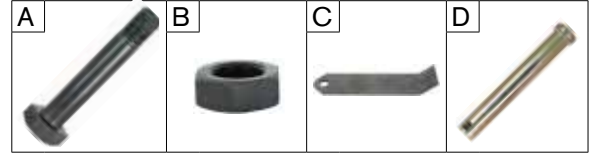

MOTT/ALAMO

PIC	MOTT#	BRABER#	DESCRIPTION
A	100759	55.000.030	FLAIL 3MM THICK
B	100761	55.000.024	SHACKLE
C	102670	55.000.032	PIN



MOTT/ALAMO

PIC	MOTT#	BRABER#	DESCRIPTION
A	105319M	55.000.038	FLAIL 4.5MM THICK
B	100761	55.000.024	SHACKLE
C	102670	55.000.032	PIN
D		17.004.025	COTTER PIN



MULAG FLAIL SETS

MULAG

PIC	MULAG#	BRABER#	DESCRIPTION
A	TM-60-07-0340	55.070.340	LARGE FLAIL
B	TM-60-07-0451	55.070.451	LARGE PIN
C	TM-60-07-0452	55.070.452	LARGE COLLAR
D	TM-60-07-0453	55.070.453	LARGE SPRING PIN

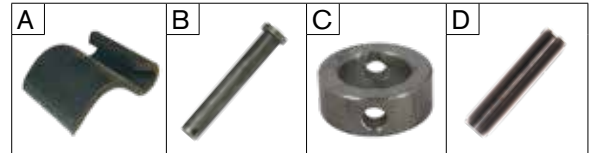

MULAG

PIC	MULAG#	BRABER#	DESCRIPTION
A	173 679	55.173.679	SMALL FLAIL
B	103 643	55.103.643	SMALL FLAIL WASHER
C	173 680	55.173.680	SMALL FLAIL BUSHING
D	174 491	55.174.491	SMALL FLAIL BOLT
E	102 266	55.102.266	SMALL FLAIL NUT

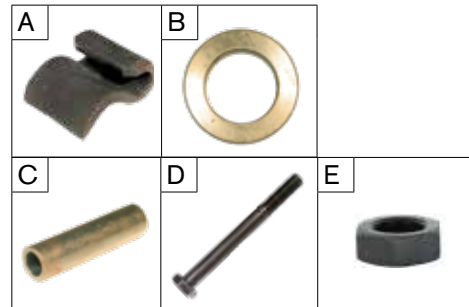

NEW HOLLAND FLAIL SETS

NEW HOLLAND

PIC	NEW HOLLAND#	BRABER#	DESCRIPTION
A	6200080	55.620.080	FLAIL ME6200080 14MM HOLE



FLAIL SETS

NOBILI FLAIL SETS

NOBILI

PIC	NOBILI#	BRABER#	DESCRIPTION
A		55.000.053	GRASS BLADE



NUMAC FLAIL SETS

NUMAC/US MOWERS

PIC	NUMAC#	BRABER#	DESCRIPTION
A		55.000.030	FLAIL 3.0MM THICK
B		55.000.038	FLAIL 4.5MM THICK
D		55.100.032	PIN
E		55.000.024	SHACKLE

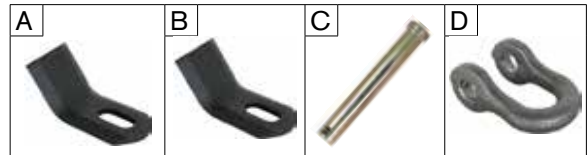

NUMAC/US MOWERS

PIC	NUMAC#	BRABER#	DESCRIPTION
A		55.195.300	BRUSH FLAIL
B		55.000.066	LONG BUSHING
C		55.000.075	BOLT AND NUT ASSEMBLY, 1/2" N.F.



PROMAC FLAIL SETS

PROMAC

PIC	PROMAC#	BRABER#	DESCRIPTION
A	PBC128000	55.128.000	FLAIL
B	PBC128110	55.128.110	BOLT/NUT
C	PBC128112	55.128.112	SPACER



REARS FLAIL SETS

REARS

PIC	REARS#	BRABER#	DESCRIPTION
A	FL948H	55.000.098	HEAVY DUTY BRUSH HAMMER. TAKES 3/8" X 4" BOLT AND BUSHINGS, NOT SOLD BY BRABER EQUIPMENT.
B	FL940	55.000.090	FLAIL
C	FL946	55.000.090HS	FLAIL (HARD SURFACED)
D		55.000.099	FLAIL 3/4" HOLE

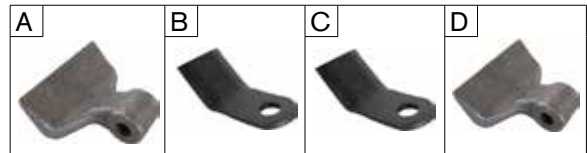

SEPPI FLAIL SETS

SEPPI

PIC	SEPPI#	BRABER#	DESCRIPTION
A	83130000SMO	55.000.020	LONG FLAIL
B	SMW	55.000.022	SHORT FLAIL

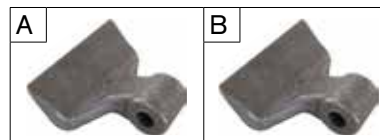

FLAIL SETS

TERRAIN KING FLAIL SETS/ALAMO BRUSH AXE

TERRAIN KING/ALAMO BRUSH AXE

PIC	TERRAIN KING#	BRABER#	DESCRIPTION
A	02956707	55.000.300	FLAIL AXE
B	02956943	55.295.694	BUSHING
C	02956949	55.295.949	BOLT
D	02956948	55.295.948	NUT

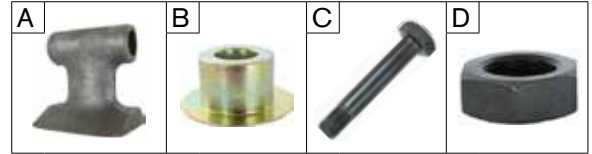

TIGER FLAIL SETS

TIGER

PIC	TIGER#	BRABER#	DESCRIPTION
A	TF3220A	55.000.049	CUP FLAIL
B	TF3222A	55.003.222	BRACKET
C	TF32221	55.003.221	D-RING
D	TF3219	55.003.219	SPLIT D RING (OPTIONAL FOR GRASS FLAIL)
E	TF3223A	55.003.223	BRACKET
F		55.100.034	GRASS FLAIL

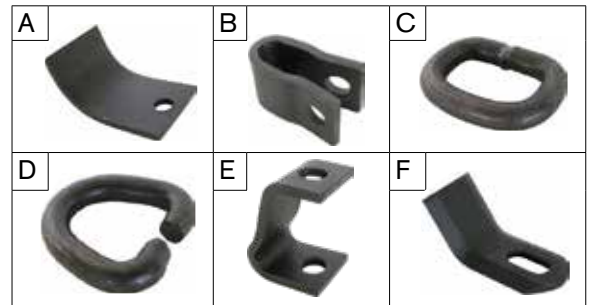

TIGER

PIC	TIGER#	BRABER#	DESCRIPTION
A	TF1019	55.000.048	FLAIL, REPLACED BY 55.337.140
B	33714	55.337.140	FLAIL, HEAVY
C	TF1020	55.000.024	SHACKLE
D	TF1021	55.000.032	PIN
E	TF1021B	55.001.021	BOLT ASSEMBLY (OPTIONAL) 34011 BOLT, 21677 NUT
F	TF-1019F	55.100.080	TIGER CUP FLAIL
G	33713	55.337.130	FLAIL
H		17.004.025	COTTER PIN

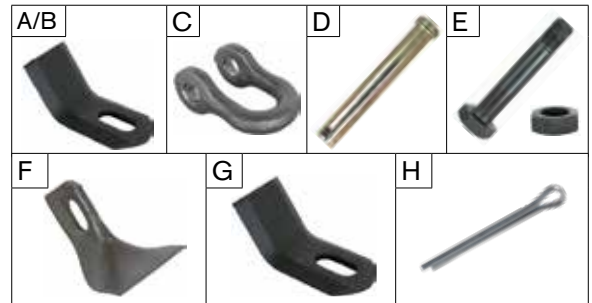

TIGER

PIC	TIGER#	BRABER#	DESCRIPTION
A	33622	55.296.763	SABER TOOTH FLAIL
B	33854	55.338.540	BOLT
C	33621	55.336.210	BUSHING
D	32676	55.295.948	NUT

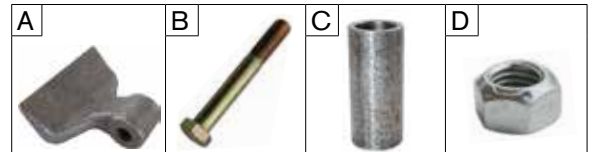

TIGER

PIC	TIGER#	BRABER#	DESCRIPTION
A	34780	55.347.800	BRUSH FLAIL
B	34782	55.347.820	TWISTED SHACKLE
C	34786	55.347.860	BOLT
D	33719	55.417.251	SPACER
E	6T2419	55.620.419	NUT



FLAIL SETS

TIGER FLAIL SETS

TIGER MBG ASSEMBLY

PIC	TIGER#	BRABER#	DESCRIPTION
A	06521007	55.652.107	FLAIL
B	34786	55.347.860	BOLT
C	6T2419	55.620.419	NUT
D	41725001	55.417.252	SPACER
E	06430122	55.643.122	SPACER



NEW TYPE

PIC	TIGER#	BRABER#	DESCRIPTION
A	06420182	55.642.182	SHOULDER BUSHING
B	06420183	55.642.183	SPACER COLLAR

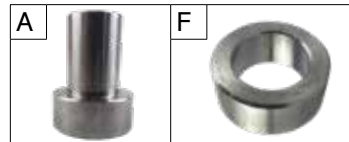

TIGER HDB ASSEMBLY

PIC	TIGER#	BRABER#	DESCRIPTION
A	46399.01	55.463.901	FLAIL HAMMER
B	33857	55.338.570	SHOULDER BUSHING
C	33858	55.338.580	SPACER COLLAR
D	33854	55.338.540	BOLT
E	32674	55.295.948	NUT



TRACKLESS FLAIL SETS

TRACKLESS

PIC	TRACKLESS#	BRABER#	DESCRIPTION
A		55.000.082	SHORT D RING
B		55.000.081	CLIP
C		55.000.030	3MM THICK FLAIL
D	FL29	55.000.084	LONG D RING
E	FL30	55.100.085	H.D.CLIP
F	FL28	55.000.080	CUP FLAIL

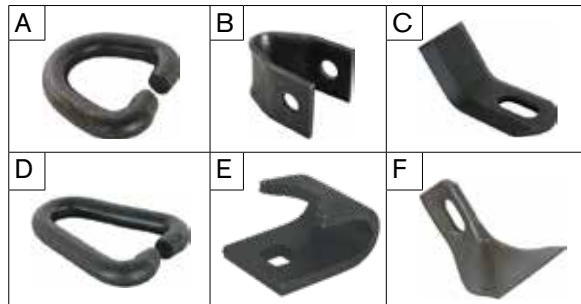

US MOWERS FLAIL SETS

US MOWERS

PIC	US MOWERS#	BRABER#	DESCRIPTION
A	2558468	55.000.053	SAMURAI FLAIL
B	2558544	2558544	SAMURAI BOLT
C	2558107	55.111.054	SAMURAI LOCK NUT
D	2558352	55.110.056	WASHER (2 PER)
E	2558863	55.000.090	FLAIL 1 LB
F		55.112.005	SPRING PIN
G	2558974	2558974	BOLT
H	2558107	25589107	NUT
I	2560622	55.000.054	STRAIGHT FLAIL

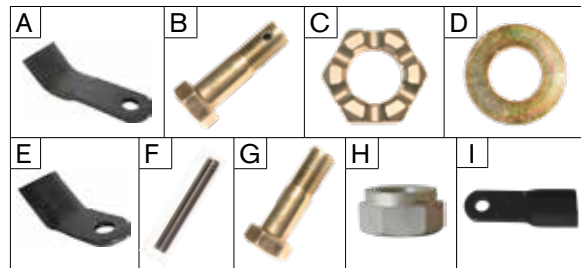

FLAIL SETS

WILLIBAUGH FLAIL SETS

WILLIBAUGH

PIC	WILLIBAUGH#	BRABER#	DESCRIPTION
A	230-40-068	55.000.019	HAMMER FLAIL



VALLEY TOOL/VRISIMO FLAIL SETS

VALLEY TOOL/VRISIMO

PIC	VALLEY TOOL#	BRABER#	DESCRIPTION
A	CD2300	55.000.019	FLAIL
B	CD2600	55.000.020	FLAIL
C	CD2105	55.000.026	FLAIL
D	CD2500	55.000.053	FLAIL
E	CD2106	55.000.063	SHACKLE
F	CD2105A	55.100.034	FLAIL
G	CD2200	55.000.087	FLAIL
H	CD2540	55.195.300	FLAIL
I	CD2185	55.000.207	FLAIL HARD FACED
J	CD2530	55.652.107	FLAIL



VOTEX FLAIL SETS

VOTEX

PIC	VOTEX#	BRABER#	DESCRIPTION
A	45.03.190	55.453.190	GRASS FLAIL
B	45.03.200	55.453.200	SHACKLE

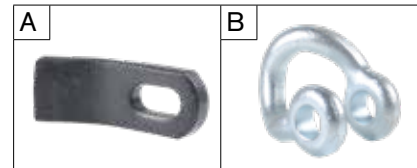

ROTARY SETS

ALAMO/BOMFORD ROTARY SETS

ALAMO/BOMFORD

PIC	ALAMO/BOMFORD#	BRABER#	DESCRIPTION
A	SPECIAL	55.100.201	GRASS ROTARY BLADE
B	USE WITH SPECIAL	55.201.360	GRASS BLADE SHIM
C	USE WITH SPECIAL	55.201.361	GRASS BLADE SHIM

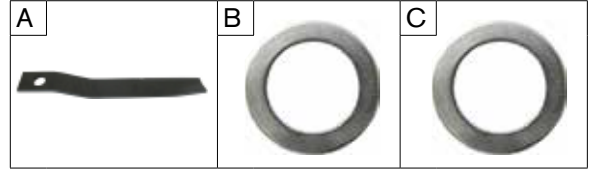

A (CLOSE UP)



BLACKIE MACHINERY ROTARY SETS

BLACKIE MACHINREY

PIC	BLACKIE#	BRABER#	DESCRIPTION
A	BM1024	55.000.093	BRUSH BLADE
B	BM1024HL	55.000.203	HIGH LIFT GRASS BLADE
C	BM1025	55.061.022	BOLT
D	BM1026	55.061.023	NUT
E		55.000.201	SINGLE HEAD GRASS BLADE

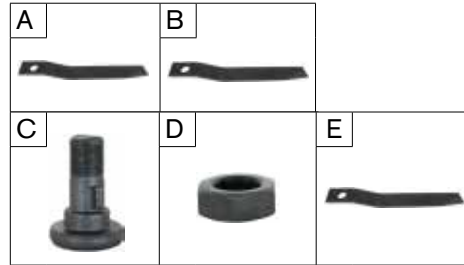

A (CLOSE UP)



BUSH HOG ROTARY SETS

BUSH HOG

PIC	BUSHHOG#	BRABER#	DESCRIPTION
A	7828	55.000.096	ROTARY BLADE (CCW)
B	7919	55.007.919	BLADE PIN ASSEMBLY
C	7829	55.000.097	ROTARY BLADE (CW)
D	11150	55.011.150	ROTARY BLADE (CW)



DEWEZE ROTARY SETS

DEWEZE

PIC	DEWEZE#	BRABER#	DESCRIPTION
A	500268	55.500.268	BLADE KIT L.H. (2PER)
B	500269	55.500.269	BLADE KIT R.H. (2PER)
C	500319	55.500.319	BOLT KIT (2PER)



ROTARY SETS

DIAMOND ROTARY SETS

DIAMOND

PIC	DIAMOND #	BRABER#	DESCRIPTION
A	22-0001	55.220.001	ROTARY BLADE 72" CUT
B	11-2005	55.112.005	ROLL PIN
C	11-0759	55.110.759	HEX SHANK BOLT
D	11-1050	55.111.050	NUT
E	11-0057	55.110.057	WASHER

A (CLOSE UP)

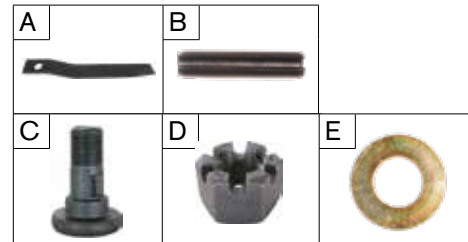

DIAMOND

PIC	DIAMOND #	BRABER#	DESCRIPTION
A	22-0010-C	55.220.010	BRUSH BLADE (3/4")
B	11-0628B	55.336.350	BOLT (1 2/4" - 12 THREAD)
C	11-1060	55.338.600	NUT
D	11-2046	55.112.046	ROLL PIN
E	37-0023	55.000.209	KEY



DIAMOND

PIC	DIAMOND #	BRABER#	DESCRIPTION
A	22-0003	55.000.093	BLADE 50" TRI-HEX
B	11-0759	55.110.759	HEX SHANK BOLT
C	11-1050	55.061.023	HD NYLOCK
D	11-0057	55.110.057	HD WASHER
E	11-2005	55.112.005	ROLL PIN



DIAMOND

PIC	DIAMOND #	BRABER#	DESCRIPTION
A	22-0005	55.220.005	1/2" GRASS BLADE 50"
B	22-0006	55.220.006	5/8" THICK BRUSH BLADE 50"
C	11-0503	55.161.022	BOLT
D	11-1008	55.061.023	HD NYLOCK
E	22-0004	55.000.097	GRASS 60"
F	22-0002	55.223.100	BRUSH 60"

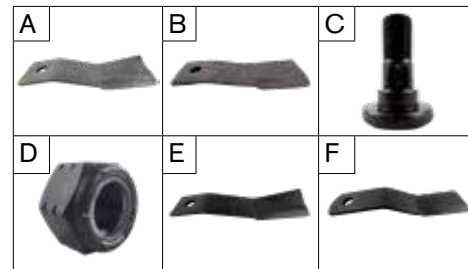

LITTLE INDUSTRIES ROTARY SETS

LITTLE INDUSTRIES

PIC	LITTLE INDUSTRIES#	BRABER#	DESCRIPTION
A	34-9-15	55.034.915	ROTARY BLADE (CENTER OF HOLE TO END OF BLADE = 12 1/2")
B	2BLM-BLTC	55.300.100	BOLT KIT (BOLT, SPACER WASHER, NYLOCK NUT & WOODRUFF KEY)
C		55.134.915	ROTARY BLADE (CENTER OF HOLE TO END OF BLADE = 11")

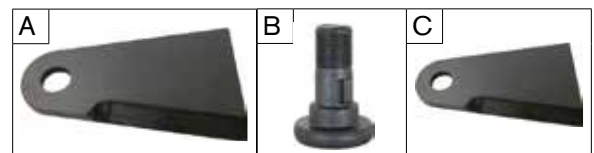

ROTARY SETS

NUMAC/US MOWERS ROTARY SETS

NUMAC/US MOWERS

PIC	NUMAC#	BRABER#	DESCRIPTION
A	NMAX103	55.103.000	GRASS BLADE, 2 ¹ / ₂ " HOLE, 1/2" THICK
B	NMAX101	55.272.691	BRUSH BLADE, 5/8" THICK, 14 ¹ / ₂ " LONG
C		55.223.100	BLADE, USES 55.000.088 BOLT
D	BB100	55.200.100D	BLADE BOLT, LONG
E		55.000.088	BLADE BOLT, 1" N.F.
F		55.000.089	NUT 1"
G		15.006.040	PIN
H	NBB100	55.100.100	SLOTTED NUT 1 1/4" N.F.
I		38.000.125	1 1/4" LOCK WASHER
J	6 X 50	15.006.050	ROLL PIN (6MM X 50MM)
K		55.103.048	GRASS BLADE SHIM
L	BB100A	55.400.100A	BOLT SHORT 2 7/8
M		55.272.692	BRUSH BLADE (MACHINE BEVELLED), 5/8" THICK
N		55.272.693	BRUSH BLADE (FORGED), 5/8" THICK, 5" LONG

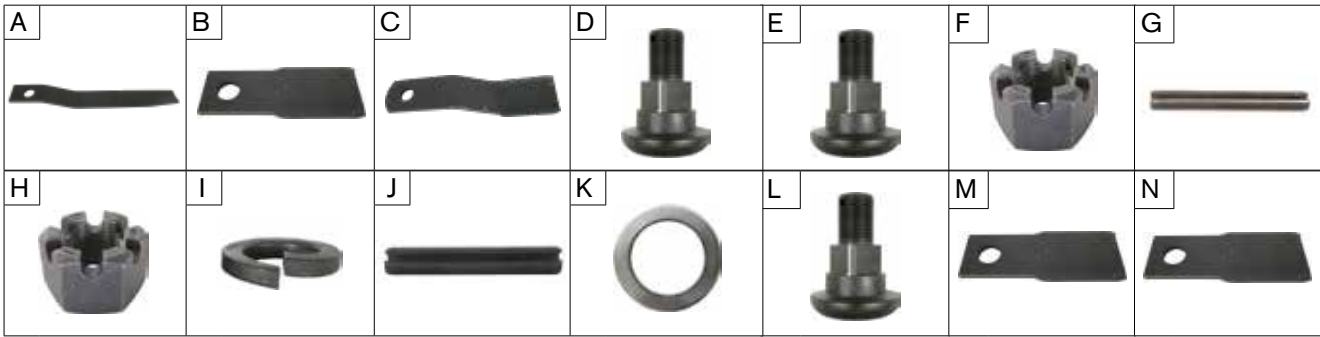

A (CLOSE UP)



PROMAC ROTARY SETS

PROMAC

PIC	PROMAC#	BRABER#	DESCRIPTION
A	B350-1	55.350.001	BLADE
B	B351-1	55.351.001	BOLT
C	B351-2	55.351.002	WASHER
D	B351-3	55.351.003	NUT

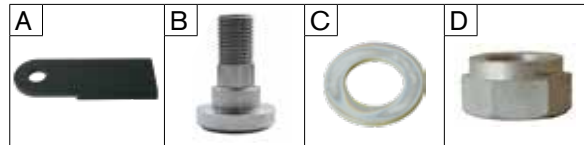

ROANOKE ROTARY SETS

ROANOKE

PIC	ROANOKE#	BRABER#	DESCRIPTION
A	2231	55.223.100	DOUBLE SIDED BLADE



ROTARY SETS

RHINO ROTARY SETS

RHINO

PIC	RHINO#	BRABER#	DESCRIPTION
A	47-7520	55.007.557	BLADE
B		55.007.919	BOLT ASSEMBLY

A (CLOSE UP)

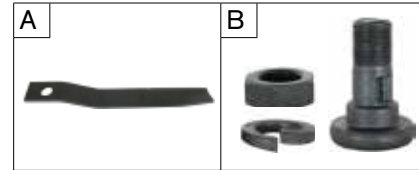

TERRAIN KING/ALAMO

PIC	TERRAIN KING#	BRABER#	DESCRIPTION
A	02962635	55.000.635	BRUSH AXE BLADE, 13½" LONG
B	02726900	55.272.690	BRUSH AXE BLADE, 14½" LONG (SET OF 2, 02761500)
C	02782900	55.278.290	BOLT, 3" LONG
D	02964330	55.296.433	BOLT, 3¾" LONG
E	00748000	55.748.000	BOLT H.D. LOCK WASHER
F	0020900	55.209.000	SLOTTED NUT
G	0020900	15.005.045	PIN

TERRAIN KING/ALAMO ROTARY SETS



TERRAIN KING/ALAMO

PIC	TERRAIN KING#	BRABER#	DESCRIPTION
A	02886200	55.000.097	GRASS BLADE 60"
B	7917	55.007.919	BOLT ASSEMBLY

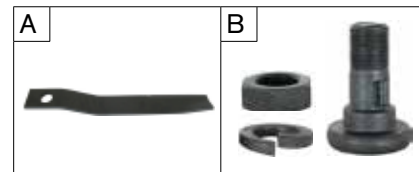

TIGER ROTARY SETS

TIGER

PIC	TIGER#	BRABER#	DESCRIPTION
A	6T1021R	55.000.097	GRASS BLADE 60", PLUS DIAMOND22-0004
B	TM-21251	55.021.251	GRASS BLADE 72"
C	6T1022R	55.061.022	BOLT, 2⅞"
D		55.161.022	BOLT, 3¼"
E	6T1023R	55.061.023	NUT (NYLOCK)

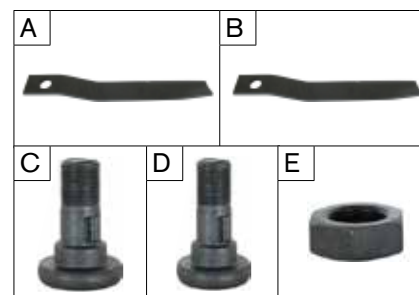

TIGER

PIC	TIGER#	BRABER#	DESCRIPTION
A	TB2031S	55.000.201	ROTARY GRASS BLADE 50" (½" THICK)
B	TB2031SHS	55.000.203	ROTARY HI-LIFT GRASS BLADE 50"
C	6T1022R	55.061.022	BOLT, 2⅞" (FOR 1 ½" BOLT HOLE)
D		55.161.022	BOLT, 3¼" (FOR 1 ½" BOLT HOLE)
E	6T1023R	55.061.023	NUT NYLOCK
F	TB2031A	55.000.093	ROTARY BRUSH BLADE 50"

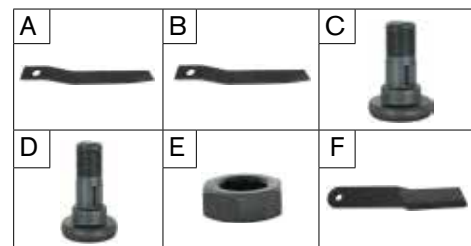

ROTARY SETS

TIGER ROTARY SETS

TIGER

PIC	TIGER#	BRABER#	DESCRIPTION
A	33203	55.220.010	SABERTOOTH BLADE, 3/4" THICK, 2 1/4" BOLT HOLE
B	33635	55.336.350	BOLT
C	33860	55.338.600	NUT
D	33859	55.338.590	WASHER
E	PT209	55.000.209	KEY
F	11-2046	55.112.046	ROLL PIN



TIGER

PIC	TIGER#	BRABER#	DESCRIPTION
A	065221001	55.652.101	BLADE, BRUSH, 5/8" THICK, 1 3/4" BOLT HOLE ("50" CUT)
B	06538000	55.653.800	BOLT, 5/8" BLADE SHOULDER (50" CUT)
C	06521002	55.652.102	BLADE GRASS, 5/8" THICK, 1-3/4" BOLT HOLE

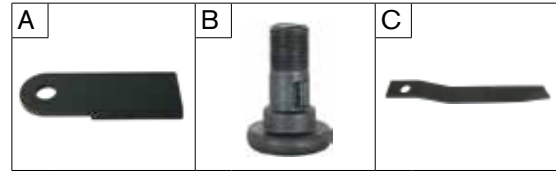

TIGER

PIC	TIGER#	BRABER#	DESCRIPTION
A	34584	55.346.840	ROTARY BLADE, 1/2" THICK, 1 3/4" HOLE
B	34497	55.344.970	BOLT
C	34585	55.346.850	ROTARY BLADE, 1/2" THICK, 1 3/4" HOLE



WOODS ROTARY SETS

WOODS

PIC	WOODS#	BRABER#	DESCRIPTION
A	3900	55.000.092	ROTARY BLADE
B	3955	55.000.095	ROTARY BLADE
C	15789	55.000.789	ROTARY BLADE MD080
D	15790	55.000.790	ROTARY BLADE MD080 39MM HOLE
E	32606	55.326.060	PIN KIT (PIN, LOCK)

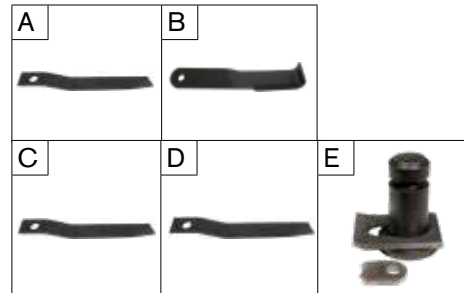

BLADES & TINES

EDGER & OVERSEEDER BLADES



OEM#	BRABER#	DESCRIPTION
LITTLE WONDER 129	55.129.000	EDGER BLADE
TANAKA 435-33110200	55.435.331	EDGER BLADE
JOHN DEERE PT13745	55.137.450	EDGER BLADE
	55.373.241*	OVERSEEDER BLADE, RYAN, BLUEBIRD P18 OVERSEEDER

* COMES IN A SET OF 20.

CORE TYPE AERATOR TINES



OEM#	BRABER#	DESCRIPTION
RYAN 545364	55.545.364	1/2" CORE TYPE AERATOR TINE
RANSOMES 515196	55.545.364	1/2" CORE TYPE AERATOR TINE
373017/522361	55.373.017	FITS MODELS RYAN, CLASSEN, BLUEBIRD H530A
	55.311.719	3/4" X 6
JD ET16863	55.168.630	3/4" X 6 CLOSED
	55.153.000	1" HOLLOW (FITS VERTI-DRAIN)
	55.201.106	3/4" SIDE EJECT TWINE TINE (FITS RYAN)
	55.110.000	18" SOLID TINE (FITS VERTI-DRAIN)

ROTARY BLADES

FINISH CUT ROTARY BLADES



A-K

OEM	OEM#	# PCS	BRABER#	MODEL
CUB CADET	759-3820		55.759.382	
EXMARK	323515		55.323.515	
EXMARK	613112		55.613.112	
EXMARK	613250		55.613.250	
FARMKING	966719, 966273		55.966.719	16 FT
FARMKING	966738		55.966.738	19 FT
FARMKING	966167		55.966.167	
FORD/NH	160191		55.160.191	
GRAVELY	25124		55.251.240	
HAUL-ALL	990-6788		55.996.788	
HAUL-ALL	990-6789		55.996.789	
HAUL-ALL	990-6790		55.996.790	
HAUL-ALL	990-7101		55.997.101	
HUSTLER/EXCEL	754853		55.754.853	
HUSTLER/EXCEL	015651		55.015.651	
JACOBSEN	3007759/2810030		55.307.759	HR9016
JACOBSEN	390515		55.390.515	
JACOBSEN	390514		55.390.514	
JACOBSEN	554589		55.554.589	
JACOBSEN	391040	3 PER	55.391.040	R311T
JACOBSEN	391039	4 PER	55.391.039	R311T
JACOBSEN	4163101		55.416.310	
JACOBSEN			55.722.598	HR6010
JACOBSEN	MULCHER BLADE		55.112.244	
JOHN DEERE	EPC201693		55.807.830	
JOHN DEERE	M128485		55.128.485	
JOHN DEERE	M115496		55.115.496	
JOHN DEERE	M86209/AM39966		55.862.090	
JOHN DEERE	M82408/AM100946		V55.824.080	
JOHN DEERE	M141785		55.403.330	
JOHN DEERE	M87622/AM100538		55.876.220	
JOHN DEERE	M74175		55.741.750	
JOHN DEERE	M115495		55.115.495	
JOHN DEERE	M80783/AM102401		55.807.830	
JOHN DEERE	M125413		55.125.413	
JOHN DEERE	M76466		55.764.660	
JOHN DEERE	M41967		55.041.967	
JOHN DEERE	TCU51118/M144935		55.511.180	
JOHN DEERE	TCU15882 72"		55.158.820	FASTBCK
JOHN DEERE	MULCHER 72"		55.258.820	
JOHN DEERE	M144935 TCU15881 60"		55.158.810	
KUBOTA	7654034330		55.403.330	
KUBOTA	7655034330		55.503.433	
KUBOTA	7653934330		55.393.433	
KUBOTA	70722-34330		55.707.330	
KUBOTA	76553-34330/ 7000025002 72"		55.533.433	
KUBOTA F3680	K5677-97530 72"		55.975.300	

K-Z

OEM	OEM#	# PCS	BRABER#	MODEL
KUBOTA	K5371-34340		55.537.134	
KUBOTA	K5647-34340/ 6025080280		55.343.400	
LAWN BOY	612543		55.612.543	
LAND PRIDE	890-325C		55.890.325	
LAND PRIDE	890-326C		55.890.326	
NUNES	438828		55.438.828	
NUNES	438815		55.438.815	
NUNES	438815 MULCHER		55.538.815	
PROGRESSIVE	521308		55.521.308	
RANSOMES	112111-04		55.112.111	
RANSOMES	112111-02		55.112.112	
RANSOMES	112111-03		55.112.113	
RANSOMES	112243-03	7 PER	55.112.243	951D/ JACHR6010
RANSOMES	112111-01		55.112.110	
RANSOMES	219252-03		55.219.250	
RANSOMES	112243-05		55.122.435	
SCAG	A48111		55.481.110	
SCAG	A48110		55.048.110	
STIENER	79-053		55.079.053	
TORO	85-6040		55.856.040	
TORO	29-5530		55.295.530	
TORO	BLACK		55.395.530	
TORO	86-0010		55.860.010	4100
TORO	69-6920		55.696.920	580D
TORO	MULCHER		55.796.920	580D
TORO	85-6040		55.856.040	
TORO	29-5530		55.295.530	
TORO	107-0235-03 MULCHER		55.107.023	4700D
TORO	26-5790.5-4012		55.265.790	
TORO	29-5530 MULCHERHD		55.295.532	
TORO	8-5230		55.852.300	
TORO	92-5608		55.925.608	4000D
TORO	107-0214-03 MULCHER		55.925.708	4000D
TORO	MULCHER BLADE		55.110.594	5910/5900
TORO	110-5946-03		55.594.603	5900/5910
TRACKLESS	M4005		55.295.530	
TRACKLESS	MULCHER BLADE		55.295.531	
TRACKLESS	MULCHER BLADE HD		55.295.532	
WALKER	5705-03		55.570.503	
WALKER	7705-1		55.770.510	
WALKER	7705-2		55.770.520	
WOODS	38175KT (3PC)		55.381.750	
WOODS	38151		55.382.510	
WOODS	1008199KT (3PC)		55.108.199	
VENTRAC	79-0038 72"		55.079.038	



12 TRACTOR SEATS

BRABER EQUIPMENT
40TH
EDITION
PARTS CATALOG

ALL **BECO** TRACTOR SEATS COME FULLY PACKAGED IN HIGH QUALITY RETAIL BOXES



EXTRA THICK CARDBOARD
FOR A DURABLE, LONG LASTING BOX

COLOR & NUMBERING SYSTEM
TO MAKE FINDING THE RIGHT SEAT EASY

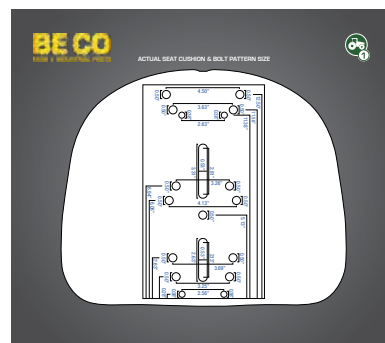

ACTUAL SIZE SEAT CUSHION & DETAILED BOLT PATTERN
ON THE LID OF THE BOX



AGRICULTURAL SEATS

AGRICULTURAL UNIVERSAL SUSPENSION SEAT

PART #	DESCRIPTION
SEA-300RMBE	UNIVERSAL SUSPENSION SEAT

- ADJUSTABLE BASE W/ 5 MOUNTING ANGLES
- WEIGHT ADJUSTABLE SUSPENSION
- LEATHERETTE UPHOLSTERY
- FORE/AFT ADJUSTMENT
- BLACK

REPLACEMENTS

PART #	DESCRIPTION
ACC402CBEBLK	BOTTOM SEAT CUSHION
ACC402SBEBLK	BACK SEAT CUSHION
ACC404	LOAD SPRING

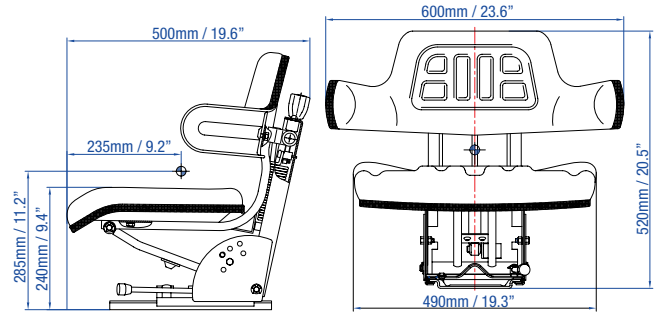

AGRICULTURAL UNIVERSAL SUSPENSION SEAT

PART #	DESCRIPTION
SEA-300RMBLUE	UNIVERSAL SUSPENSION SEAT

- ADJUSTABLE BASE W/ 5 MOUNTING ANGLES
- WEIGHT ADJUSTABLE SUSPENSION
- LEATHERETTE UPHOLSTERY
- FORE/AFT ADJUSTMENT
- BLUE

REPLACEMENTS

PART #	DESCRIPTION
ACC402CBEBLU	BOTTOM SEAT CUSHION
ACC402SBEBLU	BACK SEAT CUSHION
ACC404	LOAD SPRING

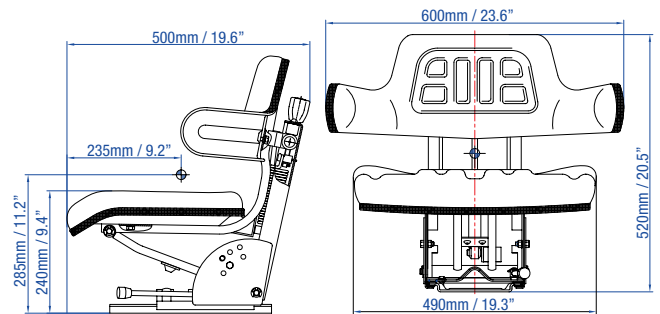

AGRICULTURAL UNIVERSAL SUSPENSION SEAT

PART #	DESCRIPTION
SEA-300RMYEBE	UNIVERSAL SUSPENSION SEAT

- ADJUSTABLE BASE W/ 5 MOUNTING ANGLES
- WEIGHT ADJUSTABLE SUSPENSION
- LEATHERETTE UPHOLSTERY
- FORE/AFT ADJUSTMENT
- YELLOW

REPLACEMENTS

PART #	DESCRIPTION
ACC402CYE	BOTTOM SEAT CUSHION
ACC402SYE	BACK SEAT CUSHION
ACC404	LOAD SPRING

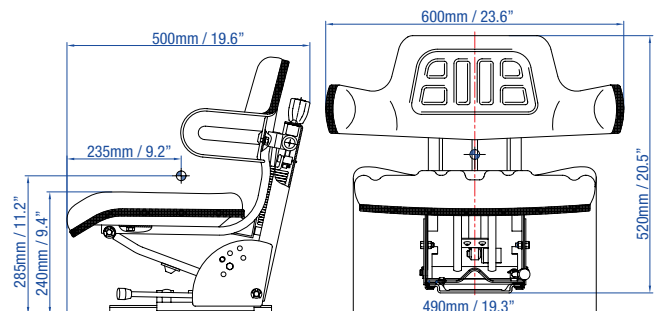

AGRICULTURAL SEATS

**AGRICULTURAL
UNIVERSAL SUSPENSION SEAT**

PART #	DESCRIPTION
SEA-ECO2100BE	UNIVERSAL SUSPENSION SEAT

- ADJUSTABLE BASE W/ 5 MOUNTING ANGLES
- LEATHERETTE UPHOLSTERY
- FORE/AFT ADJUSTMENT
- WEIGHT ADJUSTABLE SUSPENSION
- BLACK



REPLACEMENTS

PART #	DESCRIPTION
ACC402CBELK	BOTTOM SEAT CUSHION

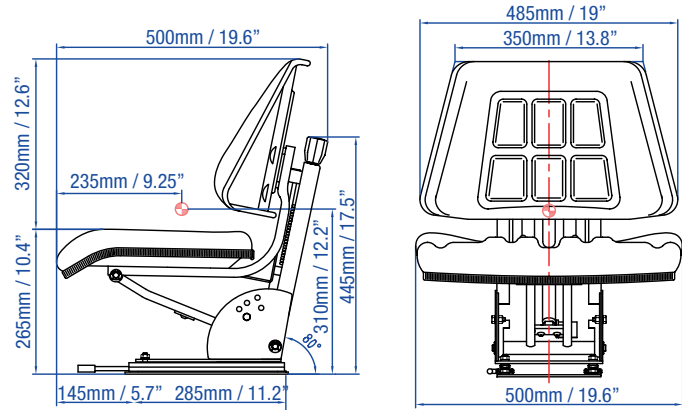

**AGRICULTURAL
UNIVERSAL SUSPENSION SEAT**

PART #	DESCRIPTION
SEA-ECO2100BLUBE	UNIVERSAL SUSPENSION SEAT

- ADJUSTABLE BASE W/ 5 MOUNTING ANGLES
- LEATHERETTE UPHOLSTERY
- FORE/AFT ADJUSTMENT
- WEIGHT ADJUSTABLE SUSPENSION
- BLUE

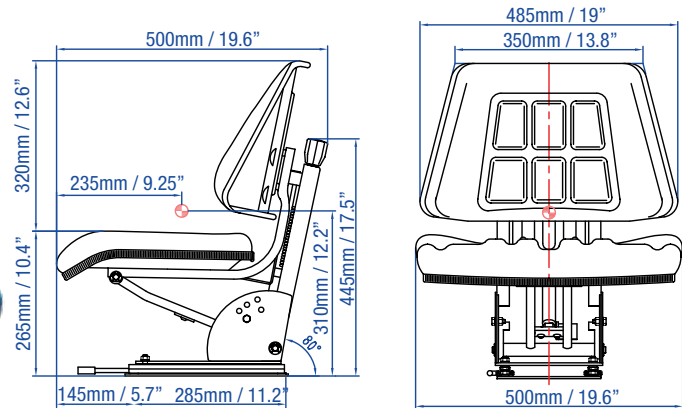

**AGRICULTURAL
UNIVERSAL SUSPENSION SEAT**

PART #	DESCRIPTION
SEA-12USSBE	UNIVERSAL SUSPENSION SEAT

- WEIGHT ADJUSTABLE SUSPENSION
- LEATHERETTE UPHOLSTERY
- FORE/AFT ADJUSTMENT
- BLACK

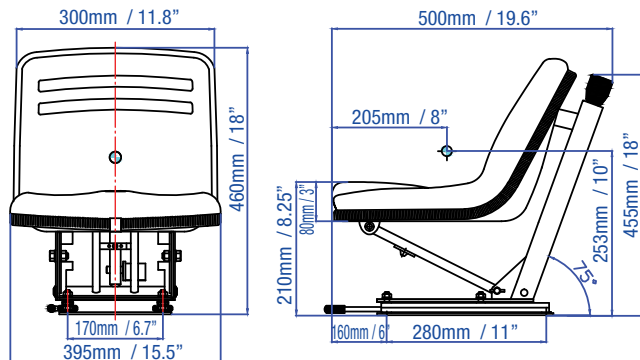

AGRICULTURAL SEATS

AGRICULTURAL NARROW DELUXE SUSPENSION

PART #	DESCRIPTION
SEA-COM2210	NARROW DELUXE SEAT

- WEIGHT ADJUSTABLE SUSPENSION
- LEATHERETTE UPHOLSTERY
- FORE/AFT ADJUSTMENT
- NARROW

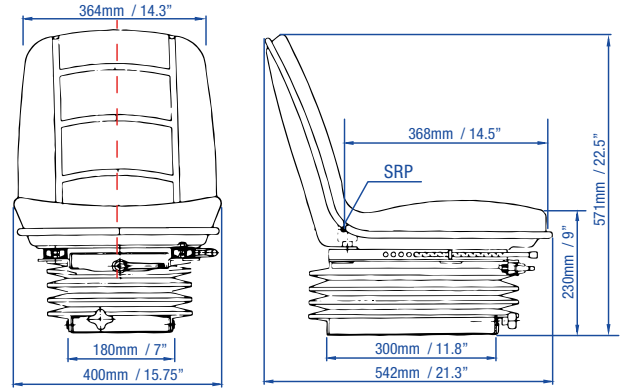

REPLACEMENTS

PART #	DESCRIPTION
COM001	SEAT CUSHION

AGRICULTURAL ECONOMY CAB SUSPENSION SEAT

PART #	DESCRIPTION
SEA-SC253000	ECONOMY CAB SUSPENSION SEAT

- PREMIUM BLACK CLOTH
- MECHANICAL SUSPENSION
- FORE/AFT ADJUSTMENT
- ADJUSTABLE ARM RESTS
- ADJUSTABLE HEAD REST
- SEAT BELT

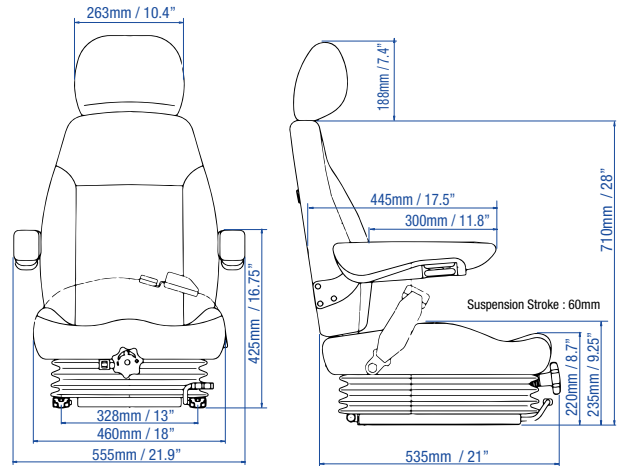

AGRICULTURAL DELUXE CAB AIR SUSPENSION SEAT

PART #	DESCRIPTION
SEA-18DCSBE	DELUXE CAB AIR SUSPENSION SEAT

- PREMIUM GREY CLOTH
- AIR SUSPENSION
- SEAT BELT
- FORE/AFT ADJUSTMENT
- ADJUSTABLE ARM RESTS
- ADJUSTABLE HEAD REST

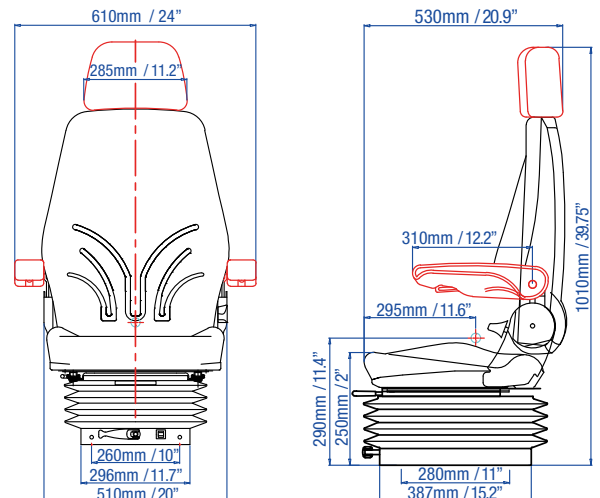

AGRICULTURAL SEATS

**AGRICULTURAL
UNIVERSAL NON SUSPENSION SEAT**

PART #	DESCRIPTION
SEA-508BE	UNIVERSAL NON SUSPENSION SEAT

- LEATHERETTE UPHOLSTERY
- SLIDE TRACK
- NON SUSPENSION
- BLACK

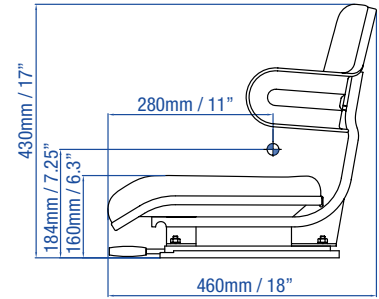
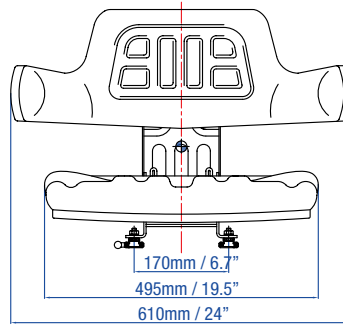

**AGRICULTURAL
UNIVERSAL SLIDE SEAT**

PART #	DESCRIPTION
SEA-8WSBE	UNIVERSAL SLIDE SEAT

- PVC COVER
- SLIDE TRACK
- NON SUSPENSION
- BLACK

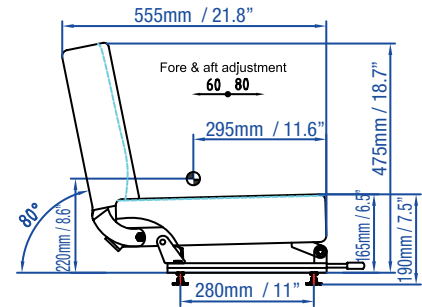
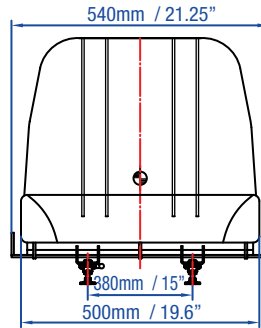

**AGRICULTURAL
UNIVERSAL SLIDE SEAT**

PART #	DESCRIPTION
SEA-5USBE	UNIVERSAL SLIDE SEAT

- PVC COVER
- SLIDE TRACK
- NON SUSPENSION
- BLACK

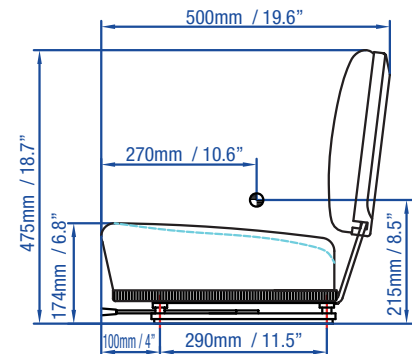
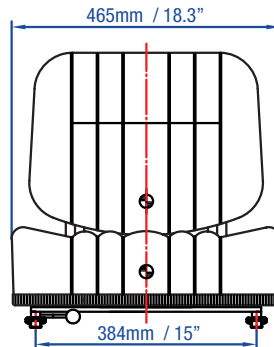

AGRICULTURAL SEATS

AGRICULTURAL UNIVERSAL NARROW SEAT

PART #	DESCRIPTION
SEA-11NBE	SEAT

- LEATHERETTE UPHOLSTERY
- FORE/AFT ADJUSTMENT
- SLIDE TRACK
- NON SUSPENSION
- BLACK

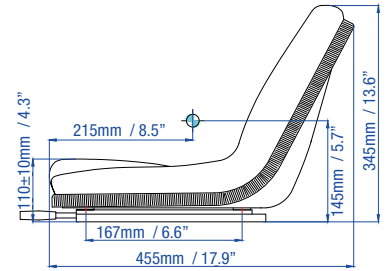
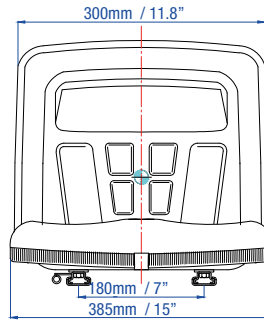

AGRICULTURAL UNIVERSAL NARROW SEAT

PART #	DESCRIPTION
CMP3100	UNIVERSAL NARROW SEAT

- NARROW SEAT
- STEEL BACK
- BLACK

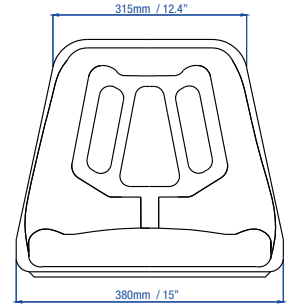
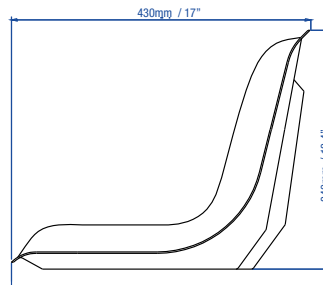

AGRICULTURAL UNIVERSAL WIDE SEAT

PART #	DESCRIPTION
CMP6100	UNIVERSAL WIDE SEAT

- STEEL BACK
- WIDE SEAT
- NON ADJUSTABLE
- BLACK

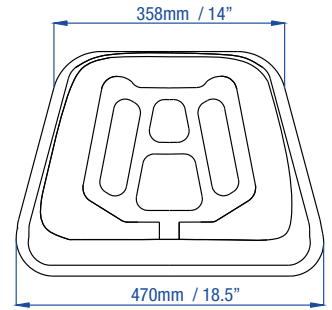
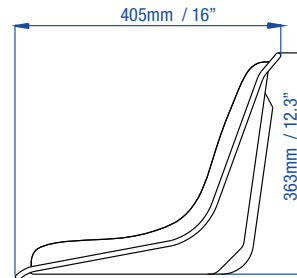

AGRICULTURAL DELUXE CONTOURED SEAT

PART #	DESCRIPTION
SEA-450BE	DELUXE CONTOURED SEAT

- HIGH BACK
- NON ADJUSTABLE
- BLACK

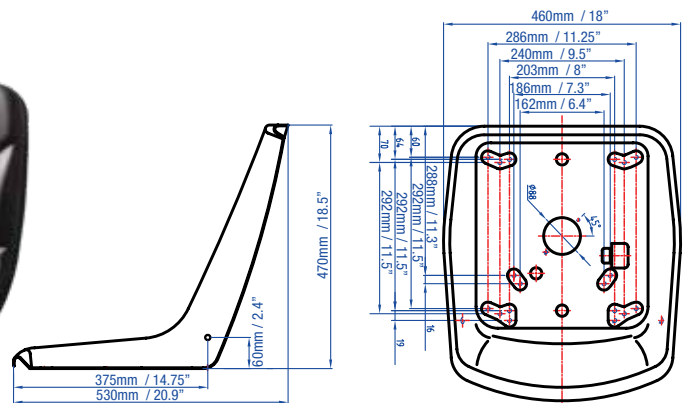

AGRICULTURAL SEATS

AGRICULTURAL GREY/BLACK SLIDE SEAT

PART #	DESCRIPTION
SEA-23UGBE	GREY/BLACK SLIDE SEAT

- GREY PLASTIC BACK
- BLACK PVC COVER
- FORE/AFT ADJUSTMENTS
- ADJUSTABLE ARM RESTS
- DOCUMENT HOLDER IN SEAT BACK

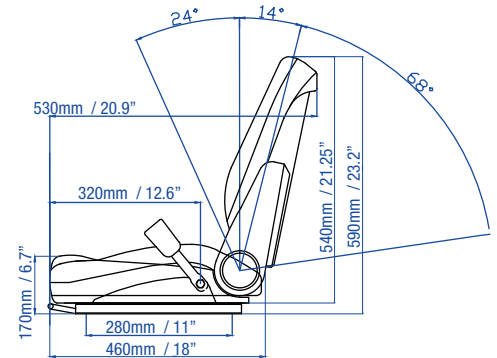
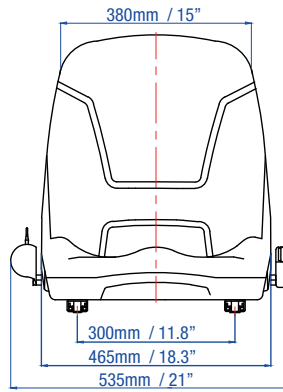

AGRICULTURAL BLACK/WHITE IH SEAT

PART #	DESCRIPTION
SEA-IH6012BE	BLACK/WHITE IH SEAT

- 3 PIECE CUSHION SET
- IH BLACK/WHITE
- HARDWARE NOT INCLUDED
- SEE SEA-JZS561 FOR HARDWARE

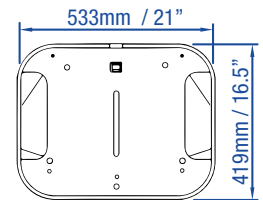
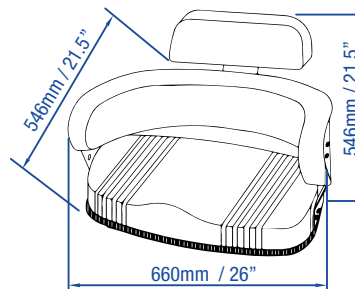

AGRICULTURAL YELLOW SEAT

PART #	DESCRIPTION
SEA-JD0550YE	YELLOW SEAT

- 3 PIECE CUSHION SET
- YELLOW
- HARDWARE NOT INCLUDED
- SEE SEA-JZS551 FOR HARDWARE

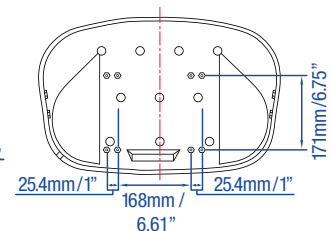
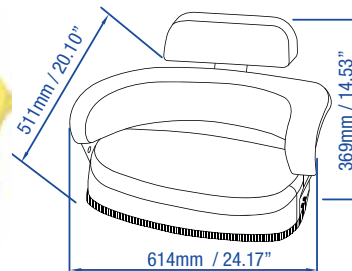

AGRICULTURAL SEAT MOUNTING HARDWARE

PART #	DESCRIPTION
SEA-JZS561	MOUNTING HARDWARE FOR IH6012BE
SEA-JZS551	MOUNTING HARDWARE FOR JD0550YE



SEA-JZS561



SEA-JZS551

ALL MEASUREMENTS ARE IN MILLIMETERS UNLESS OTHERWISE STATED (1" = 25.4 MM). THESE ITEMS ARE NOT ORIGINAL EQUIPMENT PARTS.

INDUSTRIAL SEATS

INDUSTRIAL UNIVERSAL FORKLIFT SEAT

PART #	DESCRIPTION
SEA-300INDBE	UNIVERSAL FORKLIFT SEAT

- LEATHERETTE UPHOLSTERY
- INDUSTRIAL APPLICATION
- NON FOLDING SEAT BACK
- FORE/AFT ADJUSTMENT
- BLACK

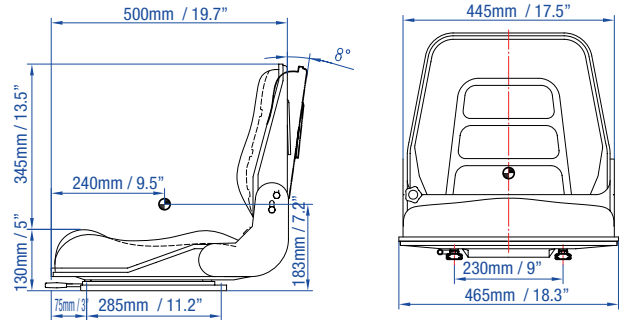

INDUSTRIAL UNIVERSAL FOLD SEAT

PART #	DESCRIPTION
SEA-35500BE	UNIVERSAL FOLD SEAT W/ ARMRESTS

- LEATHERETTE UPHOLSTERY
- INDUSTRIAL APPLICATION
- FOLDING SEAT BACK
- FORE/AFT ADJUSTMENT
- ADJUSTABLE ARM RESTS
- BLACK

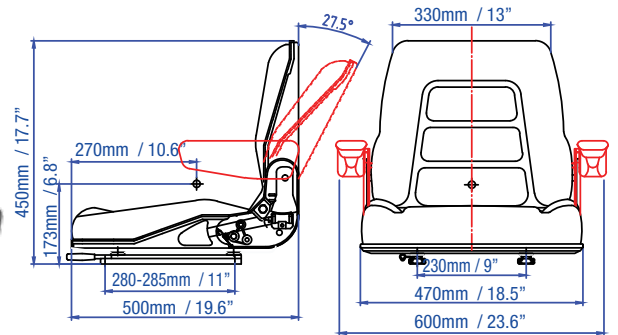

INDUSTRIAL UNIVERSAL SUSPENSION SEAT

PART #	DESCRIPTION
SEA-SU35500BE	UNIVERSAL SUSPENSION SEAT

- LEATHERETTE UPHOLSTERY
- INDUSTRIAL APPLICATION
- FOLDING SEAT BACK
- FORE/AFT ADJUSTMENT
- WEIGHT ADJUSTABLE SUSPENSION
- BLACK

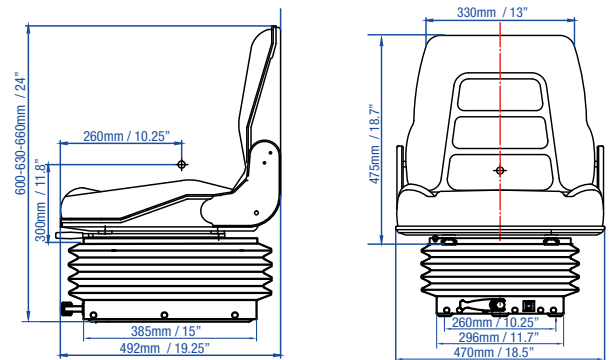

INDUSTRIAL DELUXE SUSPENSION SEAT

PART #	DESCRIPTION
SEA-SHA35500BE	DELUXE SUSPENSION SEAT

- LEATHERETTE UPHOLSTERY
- INDUSTRIAL APPLICATION
- FOLDING SEAT BACK
- FORE/AFT ADJUSTMENT
- WEIGHT ADJUSTABLE SUSPENSION
- ADJUSTABLE ARM RESTS
- ADJUSTABLE HEAD REST
- BLACK

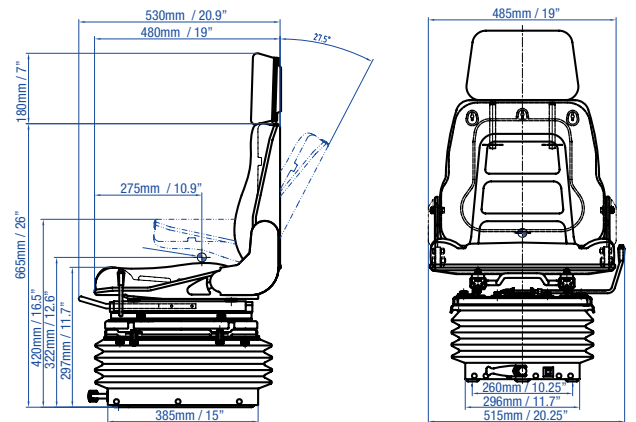

INDUSTRIAL SEATS

**INDUSTRIAL
UNIVERSAL SLIDE SEAT**

PART #	DESCRIPTION
SEA-MUL002BE	UNIVERSAL SLIDE SEAT

- PVC COVER
- FORE/AFT ADJUSTMENT

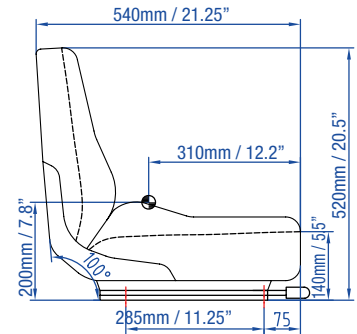
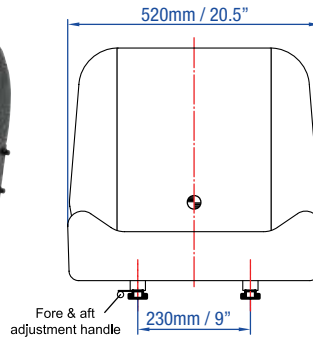

**INDUSTRIAL
UNIVERSAL WRAP SEAT**

PART #	DESCRIPTION
SEA-50DIBE	UNIVERSAL WRAP SEAT

- INDUSTRIAL WRAP
- FORE/AFT ADJUSTMENT
- DOCUMENT POCKET IN SEAT BACK

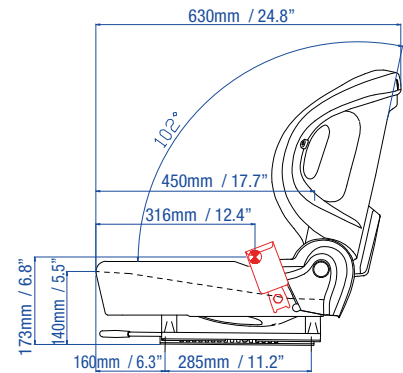
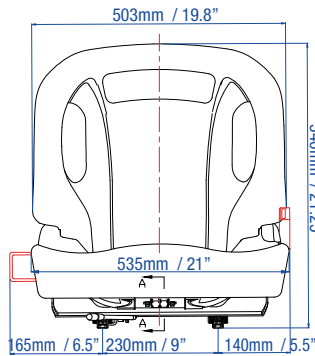

**INDUSTRIAL
UNIVERSAL WRAP SUSPENSION SEAT**

PART #	DESCRIPTION
SEA-509SDIBE	UNIVERSAL WRAP SUSP. SEAT

- INDUSTRIAL WRAP
- FORE/AFT ADJUSTMENT
- SUSPENSION
- WEIGHT ADJUSTABLE
- ADJUSTABLE BACKREST
- DOCUMENT POCKET IN SEAT BACK

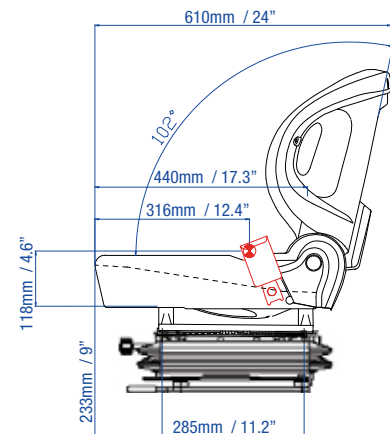
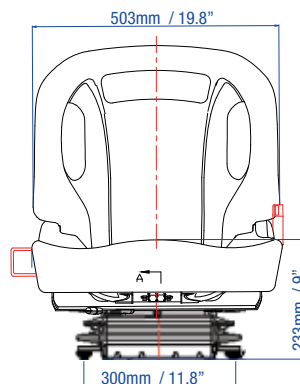

LAWN & GARDEN SEATS

LAWN & GARDEN BLACK UNIVERSAL SEAT

PART #	DESCRIPTION
SEA-LG6BE	UNIVERSAL SEAT

- LAWN & GARDEN
- WITH DRAIN HOLE
- ALL WEATHER
- BLACK

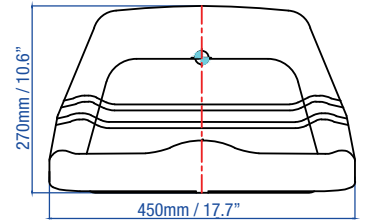
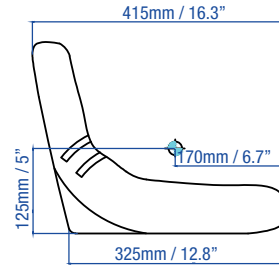

LAWN & GARDEN YELLOW UNIVERSAL SEAT

PART #	DESCRIPTION
SEA-LG6YBE	UNIVERSAL SEAT

- LAWN & GARDEN
- WITH DRAIN HOLE
- ALL WEATHER
- YELLOW

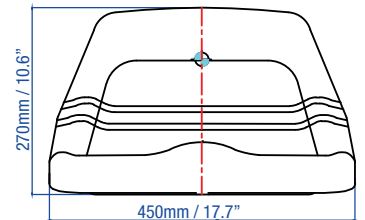
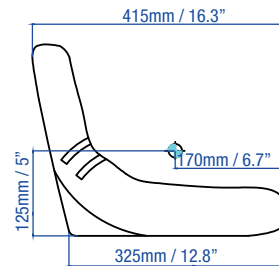

LAWN & GARDEN LOW BACK SEAT

PART #	DESCRIPTION
SEA-INI054	LOW BACK SEAT

- LAWN & GARDEN
- WITH DRAIN HOLE
- ALL WEATHER
- BLACK

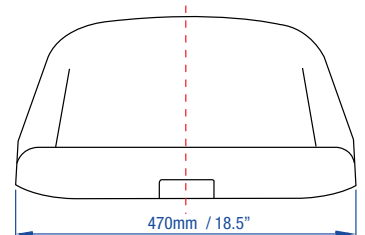
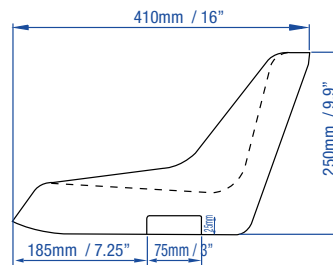

PADDED PAN SEAT

PART #	DESCRIPTION
SEA-100BE	PADDED PAN SEAT

- PAN SEAT
- WITH DRAIN HOLES
- ALL WEATHER
- BLACK

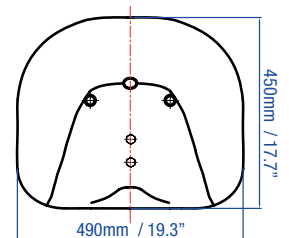
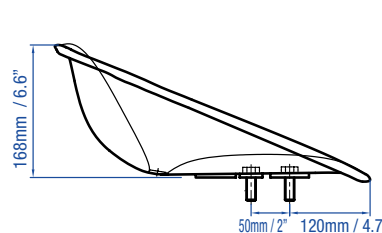

LAWN & GARDEN SEATS

LAWN & GARDEN
DELUXE HIGH STEEL BACK SEAT

PART #	DESCRIPTION
SEA-135BE	DELUXE HIGH STEEL BACK SEAT

- LAWN & GARDEN
- HIGH STEEL BACK
- ALL WEATHER
- BLACK

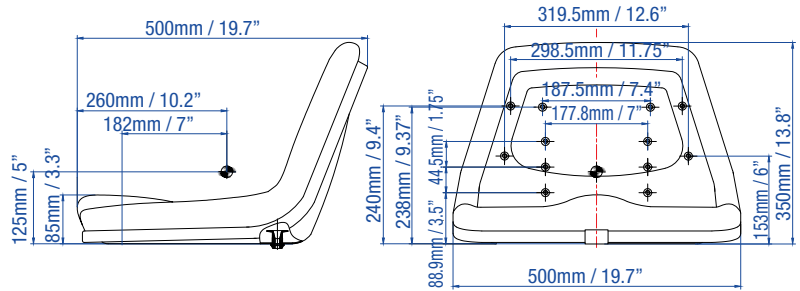

LAWN & GARDEN
LOW BACK PAN SEAT

PART #	DESCRIPTION
SEA-7PNBE	LOW BACK PAN SEAT

- PAN SEAT
- WITH DRAIN HOLE
- ALL WEATHER
- BLACK

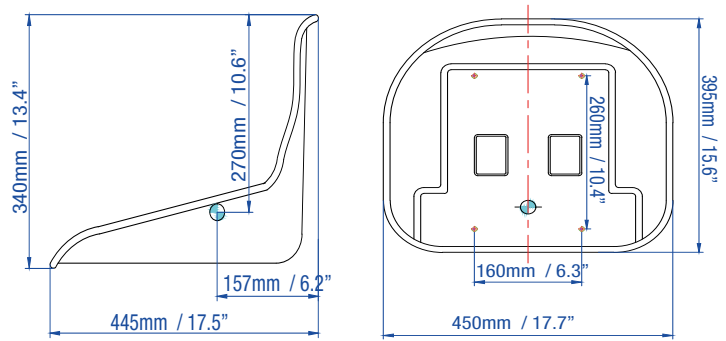

LAWN & GARDEN
BLACK SEAT

PART #	DESCRIPTION
SEA-800007	BLACK LAWN & GARDEN SEAT

- LAWN & GARDEN
- WITH DRAIN HOLE
- ALL WEATHER
- BLACK

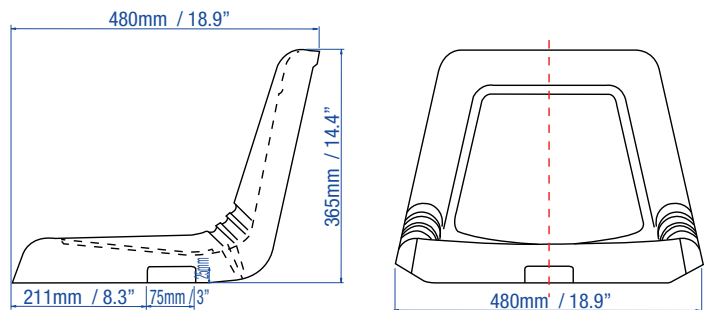



13 LINKAGE PARTS

BRABER EQUIPMENT

40TH EDITION

PARTS CATALOG

FORGED TOP LINKS

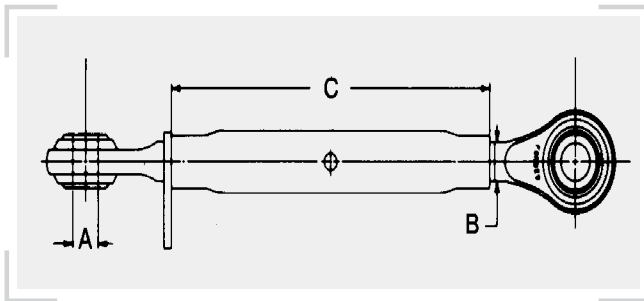

- QUALITY FORGED TOP LINKS AVAILABLE IN CATEGORY 0, 1, 1 & 2 COMBINATION, 2 AND 3 SIZES
- ALL TOP LINKS ARE YELLOW ZINC PLATED UNLESS OTHERWISE SPECIFIED
- THE ENDS ARE CLEAR ZINC PLATED

PART#	CATEGORY	A: PIN HOLE SIZE	B: THREADS	C: BODY LENGTH	CLOSED LENGTH	OPEN LENGTH	COLOR	PACK QTY	WEIGHT
204TL	0	5/8"	3/4" NC	7-5/8"	11"	16"	PLATED	1	2.5 LB
205TL	1	3/4"	1-1/8" NC	13-1/4"	17"	26"	PLATED	1	7.4 LB
206TLB	1	3/4"	1-1/8" NC	16"	21"	31"	BLUE	1	7.6 LB
206TL	1	3/4"	1-1/8" NC	16"	21"	31"	PLATED	1	7.6 LB
207TLB	1	3/4"	1-1/8" NC	20"	25"	35"	BLUE	1	9.1 LB
207TL	1	3/4"	1-1/8" NC	20"	25"	35"	PLATED	1	9.1 LB
212TL	1	3/4"	1-1/8" NC	24"	29"	39"	PLATED	1	8.9 LB
208TLB	1 & 2	3/4" & 1"	1-1/8" NC	16"	21"	32"	BLUE	1	9.1 LB
208TL	1 & 2	3/4" & 1"	1-1/8" NC	16"	21"	32"	PLATED	1	9.1 LB
213TL	1 & 2	3/4" & 1"	1-1/8" NC	20"	25"	35"	PLATED	1	10.1 LB
209TL	2	1"	1-1/8" NC	16"	21"	31"	PLATED	1	10 LB
210TL	2	1"	1-1/8" NC	20"	25"	37"	PLATED	1	10 LB
209TLHD	2	1"	1-1/4" NC	15-3/4"	20"	30"	PLATED	1	10.7 LB
209TLHDB	2	1"	1-1/4" NC	16"	23"	32"	BLUE	1	12 LB
210TLHD	2	1"	1-1/4" NC	20"	27"	37"	PLATED	1	12.6 LB
250TLA	3	1-1/4"	1-3/8" NC	19-1/2"	25-1/2"	37"	BLACK	1	20 LB

ALL MEASUREMENTS ARE IN MILLIMETERS UNLESS OTHERWISE STATED (1" = 25.4 MM).
THESE ITEMS ARE NOT ORIGINAL EQUIPMENT PARTS.

TOP LINK REPAIR ENDS & 3PT HITCH ASSEMBLIES

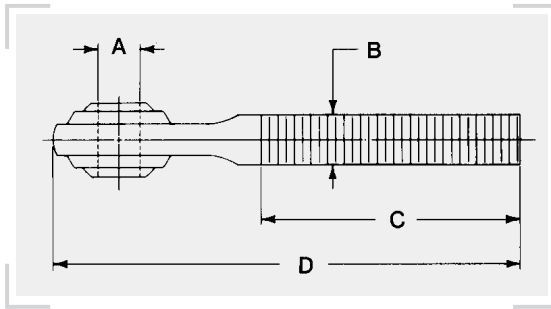

- FORGED AND WELDED SCREW-IN REPAIR ENDS
- FOR CATEGORY 0, 1, 2 AND 3 TOP LINKS
- CLEAR ZINC PLATED

PART#	CATEGORY	TYPE	A: PIN HOLE SIZE	B: THREAD DIAMETER	C: THREAD LENGTH	D: OVERALL LENGTH	PACK QTY	WEIGHT
400BE	1	FORGED	3/4"	1-1/8" NC (LH)	6"	10"	1	2.4 LB
401BE	1	FORGED	3/4"	1-1/8" NC (RH)	6"	10"	1	2.4 LB
406BE	2	FORGED	1"	1-1/4" NC (LH)	5-1/2"	10"	1	3 LB
407BE	2	FORGED	1"	1-1/4" NC (RH)	5-1/2"	10"	1	3 LB
403BE	2	FORGED	1"	1-1/8" NC (RH)	6-1/2"	11"	1	3 LB
402BE	2	FORGED	1"	1-1/8" NC (LH)	6-1/2"	11"	1	8 LB
405BE	3	FORGED	1-1/4"	1-3/8" NC (RH)	7-1/4"	12-1/8"	1	8 LB
404BE	3	FORGED	1-1/4"	1-3/8" NC (LH)	7-1/4"	12-1/8"	1	8 LB



3PT HITCH ASSEMBLY

PART#	CATEGORY	DESCRIPTION
10003PT	1	COMPLETE 3 PT HITCH ASSEMBLY

BALL SOCKETS

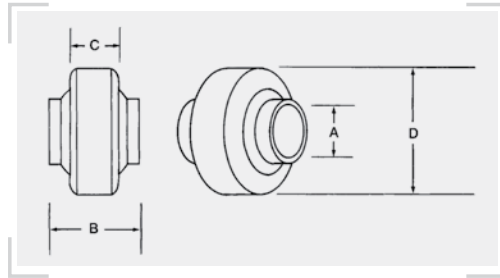

- WELD-ON TOP LINK BALL SOCKETS TO FIT CATEGORY 0 THROUGH CATEGORY 3 TRACTORS
- AVAILABLE IN BLACK OXIDE & YELLOW ZINC DICHROMATE PLATED VERSIONS

PART#	CAT.	DESCRIPTION	A: PIN HOLE SIZE	B: LENGTH THRU BORE	C: SLEEVE WIDTH	D: SLEEVE O.D.	PACK QTY	WEIGHT
B-213B	1	STANDARD DUTY, BLACK OXIDE	3/4"	1-5/8"	3/4"	2"	2	0.6 LB
B-214B	2	STANDARD DUTY, BLACK OXIDE	1"	1-3/4"	7/8"	2-3/8"	2	0.8 LB
B-2219	2	HEAVY DUTY, BLACK OXIDE	1"	1-3/4"	1-3/16"	2-3/4"	2	1.8 LB
B-2229	3	STANDARD DUTY, BLACK OXIDE	1-1/4"	1-3/4"	1-9/32"	3-1/8"	2	1.8 LB
B-214	2	STANDARD DUTY, PLATED	1"	1-3/4"	7/8"	2-3/8"	2	0.8 LB
B-212	1	HEAVY DUTY, PLATED	3/4"	1-5/8"	7/8"	2-1/8"	2	0.7 LB
B-213	1	STANDARD DUTY, PLATED	3/4"	1-5/8"	3/4"	2"	2	0.6 LB
B-228	2	STANDARD DUTY, PLATED	1"	1-1/4"	7/8"	2-3/8"	2	0.8 LB
B-235	1 & 2	STANDARD DUTY, BLACK OXIDE	3/4" & 1"	1-1/2" & 1-1/4"	7/8"	2-3/8"	2	0.6 LB



- WELD-ON LIFT ARM BALL SOCKETS TO FIT CATEGORY 0 THROUGH CATEGORY 3 TRACTORS
- AVAILABLE IN BLACK OXIDE & YELLOW ZINC DICHROMATE PLATED VERSIONS

PART#	CAT.	DESCRIPTION	PIN HOLE SIZE	LENGTH THRU BORE	SLEEVE WIDTH	SLEEVE O.D.	WEIGHT
B-221B	1	STANDARD DUTY, BLACK OXIDE	7/8"	1-3/8"	7/8"	2-3/8"	0.9 LB
B-2215	2	EXTRA HEAVY DUTY, BLACK OXIDE	1-1/8"	1-3/4"	1-3/8"	3-1/8"	1.9 LB
B-2231	3	STANDARD DUTY, BLACK OXIDE	1-7/16"	1-3/4"	1-11/32"	3-1/2"	2.4 LB
B-221	1	STANDARD DUTY, PLATED	7/8"	1-3/8"	7/8"	2-3/8"	0.9 LB
B-222	2	STANDARD DUTY, PLATED	1-1/8"	1-5/16"	15/16"	2-3/8"	0.8 LB
B-2216	2	EXTRA HEAVY DUTY, PLATED	1-1/8"	1-3/4"	1-3/8"	3-1/8"	1.9 LB

TOP & LIFT ARM ENDS

TOP LINK END



STRAIGHT LIFT ARM END



- HIGH-QUALITY, WELD-ON TOP LINK AND LIFT ARM BALL SOCKETS IN CATEGORY 1, 2, AND 3 SIZES
- LIFT ARM ENDS ARE AVAILABLE IN STRAIGHT AND BENT STYLES



BENT LIFT ARM END

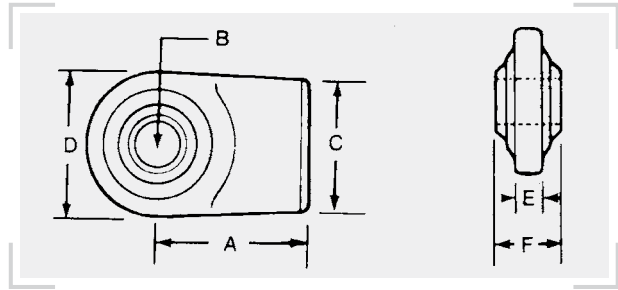
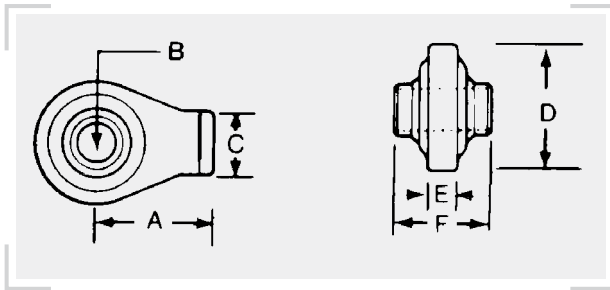

PART#	CAT.	DESCRIPTION	A	B	C	D	E	F	PACK QTY
480E	1	TOP LINK END	2"	3/4"	1-1/8"	2-1/4"	1/2"	1-3/4"	1
481E	2	TOP LINK END	2-3/8"	1"	1-1/8"	2-5/8"	1/2"	2"	1
482E	1	LIFT ARM END, STRAIGHT	2-3/4"	7/8"	2-3/8"	2-5/8"	5/8"	1-3/8"	1
483E	2	LIFT ARM END, STRAIGHT	3-1/8"	1-1/8"	2-3/4"	3-1/8"	3/4"	1-3/4"	1
485E	1	LIFT ARM END, BENT	4"	7/8"	1-7/8"	2-5/8"	5/8"	1-3/8"	1
484E	2	LIFT ARM END, BENT	4"	1-1/8"	1-7/8"	3-1/8"	5/8"	1-3/4"	1
487E	3	LIFT ARM END, STRAIGHT	3-3/8"	1-7/16"	3"	3-1/2"	3/4"	1-3/4"	1

TOP & LIFT ARM BALLS

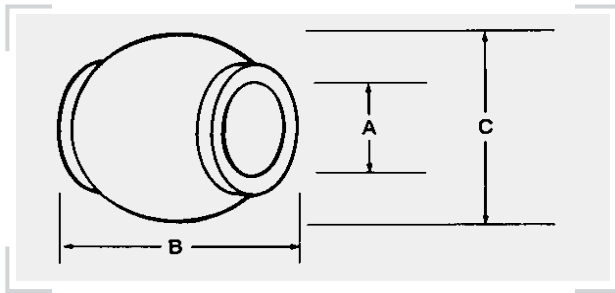

- TOP LINK AND LIFT ARM BALLS FOR FORD, JOHN DEERE, OLIVER & OTHER TRACTORS
- DESIGNED TO REPLACE ORIGINAL BALLS
- YELLOW ZINC DICHROMATE PLATING

PART#	CAT.	DESCRIPTION	A: PIN HOLE SIZE	B: LENGTH THRU BORE	C: BALL DIAMETER	PACK QTY
B-241	1	JOHN DEERE & OLIVER TOP LINK BALL; REPLACES DEERE F2680, OLIVER 105968A	3/4"	1-3/4"	2"	1
B-242	2	JOHN DEERE & OLIVER TOP LINK BALL; REPLACES DEERE F2681, OLIVER 104585A	1"	1-3/4"	2"	1
450B	1	FORD LIFT ARM BALL; REPLACES FORD DDN995233; FITS FORD 3000 AND 4000	7/8"	1-3/8"	2-1/4"	1
452B	2	FORD LIFT ARM BALL; REPLACES FORD C5NN557A; FITS FORD 5000	1-1/8"	1-3/4"	2-1/4"	1
454B	1	OLIVER LIFT ARM BALL; REPLACES OLIVER 105967A; FITS MODELS WITH CLAW-TYPE LIFT ARM	7/8"	1-3/8"	2"	1
453B	2	OLIVER LIFT ARM BALL; REPLACES OLIVER 104591A; FITS ALL MODELS WITH CLAW-TYPE LIFT ARM	1-1/8"	1-3/4"	2"	1
451B	2	FORD LIFT ARM BALL; NARROW WIDTH; REPLACES C5NN557B	1-1/8"	1-3/8"	2-1/4"	1
451BH	2	FORD LIFT ARM BALL; HEAT TREATED; REPLACES C5NN557BDS	1-1/8"	1-3/8"	2-1/4"	1

ALL MEASUREMENTS ARE IN MILLIMETERS UNLESS OTHERWISE STATED (1" = 25.4 MM).
THESE ITEMS ARE NOT ORIGINAL EQUIPMENT PARTS.

REDUCER BUSHINGS



- USED IN THE PIN HOLE OF A TOP LINK TO ALLOW A SMALLER CATEGORY PIN TO FIT.
- YELLOW ZINC DICHROMATE PLATING.

TOP LINK REDUCER BUSHINGS

PART #	CAT.	DESCRIPTION	OUTSIDE DIAMETER	INSIDE DIAMETER	LENGTH	PACK QTY
474RB	0-1	FITS ALL CATEGORY 0 TOP LINK PINS	3/4"	5/8"	1-5/8"	5
476RB	3-2	BUSHING, TOPLINK	1-1/4"	1"	1-3/4"	5
478RB	1-2	FITS ALL CATEGORY 1 TOP LINK PINS; REPLACES FORD C7NN6993A	1"	3/4"	1-15/16"	5
478SRB	1-2	FITS ALL CATEGORY 1 TOP LINK PINS; SHORT	1"	3/4"	1-5/8"	5
480RB	2-3	FITS ALL CATEGORY 2 TOP LINK PINS	1-1/4"	1"	1-15/16"	5



- USED IN THE PIN HOLE OF A LIFT ARM TO ALLOW A SMALLER CATEGORY PIN TO FIT.
- YELLOW ZINC DICHROMATE PLATING.

LIFT ARM REDUCER BUSHINGS

PART #	CAT.	DESCRIPTION	OUTSIDE DIAMETER	INSIDE DIAMETER	LENGTH	PACK QTY
475RB	0-1	FITS ALL CATEGORY 0 LIFT ARM PINS	7/8"	5/8"	1-3/8"	5
477RB	1-2	FITS ALL CATEGORY 1 LIFT ARM PINS; FORD C7NN6992A	1-1/8"	7/8"	1-3/4"	5
477SRB	1-2	FITS ALL CATEGORY 1 LIFT ARM PINS; REPLACES JOHN DEERE F2684	1-1/8"	7/8"	1-3/8"	5
479RB	2-3	FITS ALL CATEGORY 2 LIFT ARM PINS	1-7/16"	1-1/8"	1-3/4"	5
483RB	2-3	FITS ALL CATEGORY 2 LIFT ARM PINS; EXTRA LONG	1-7/16"	1-1/8"	3-1/4"	5
481RB	2-3	FITS ALL CATEGORY 2 LIFT ARM PINS; 15/32" LYNCH PIN HOLE	1-7/16"	1-1/8"	2-1/2"	5
482RB	2-3	FITS ALL CATEGORY 2 LIFT ARM PINS	1-7/16"	1-1/8"	2-3/4"	5



BUSHING HITCH

PART #	DESCRIPTION
473RB	BUSHING HITCH, CAT 2, 3 REDUCER

ADDITIONAL INFORMATION
MOUNTS ON HITCH PIN

DRAW PINS (LIFT ARM PINS)



CATEGORY 1 & 2
FORGED IMPLEMENT PIN



CATEGORY 2



CATEGORY 1

- FORGED AND ADJUSTABLE CATEGORY 0 THROUGH 3 DRAW PINS FOR A VARIETY OF APPLICATIONS
- ALL PINS ARE YELLOW ZINC DICHROMATE PLATED

PART #	CAT.	DESCRIPTION	PIN DIAM.	USABLE LENGTH	OVERALL LENGTH	THREAD DIAM.	PACK QTY
149IP	0	ADJUSTABLE	5/8"	ADJUSTABLE	3-7/8"	5/8" NF	1
150IP	1	ADJUSTABLE	7/8"	ADJUSTABLE	4-5/8"	7/8" NF	1
151IP	1	ADJUSTABLE	7/8"	ADJUSTABLE	5"	7/8" NF	1
152IP	1	FORGED	7/8"	1-3/4"	5-1/2"	7/8" NF	1
159IP	1	ADJUSTABLE; EXTRA LONG	7/8"	ADJUSTABLE	6-1/4"	7/8" NF	1
153IP	1	FORGED; EXTRA LONG	7/8"	2-1/4"	6-1/2"	7/8" NF	1
164IP	1	FORGED	7/8"	2"	5"	5/8" NF	1
163IP	1	FORGED	7/8"	1-3/4"	4-1/2"	5/8" NF	1
156IP	1 TO 2	FORGED	1-1/8"	2-1/4"	6-5/16"	7/8" NF	1
154IP	1 TO 2	ADJUSTABLE	1-1/8"	ADJUSTABLE	5-1/4"	7/8" NF	1
155IP	1 TO 2	FORGED	1-1/8"	1-13/16"	5-1/4"	7/8" NF	1
162IP	1 & 2	FORGED	1-1/8" & 7/8"	2-1/16" BOTH	8"	1" NF	1
160IP	2	ADJUSTABLE	1-1/8"	ADJUSTABLE	6-1/8"	1-1/8" NF	1
157IP	2	FORGED	1-1/8"	1-3/4"	6-1/8"	1-1/8" NF	1
165IP	2 TO 1	FORGED	7/8"	1-3/4"	5-3/4"	1-1/8" NF	1
167IP	2 TO 3	ADJUSTABLE	1-7/16"	ADJUSTABLE	6-1/2"	1-1/8" NF	3
166IP	2 TO 3	FORGED	1-7/16"	1-7/8"	5-3/4"	1-1/8" NF	1
168IP	3	FORGED	1-7/16"	2"	5-7/8"	1-3/8" NF	1

DRAWBARS

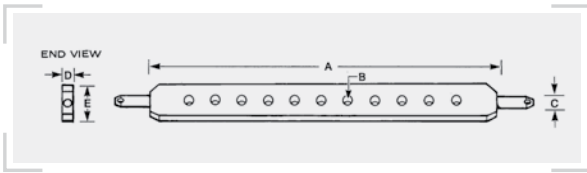

- ONE-PIECE 3PT HITCH CROSS DRAWBARS
- FITS CAT. 0 THROUGH CAT. 3 TRACTORS



- DO NOT EXCEED WORKING LOAD LIMIT.
- FARM HARDWARE IS NOT FOR LIFTING.

PART #	CAT.	NO. OF HOLES	LIFT ARM SPACING	HOLE DIA	PIN DIA	THICKNESS	WIDTH	COLOR	PKG. QTY.	WEIGHT (LB.)
1005DB	0	7	20"	5/8"	3/4"	5/8"	2"	BLACK	1	13.5
1000DB	0/1	7	20"	3/4"	7/8"	1"	2-1/2"	BLACK	1	13.5
1002DBB	1	11	26"	3/4"	7/8"	1"	2-1/2"	BLUE	1	16.4
1002DB	1	11	26"	3/4"	7/8"	1"	2-1/2"	BLACK	1	16.4
1004DB	1	11	26"	3/4"	7/8"	1-1/8"	2-1/2"	BLACK	1	18.25
1003DBB	2	11	26"	3/4"	1-1/8"	1-1/4"	3"	BLUE	1	27
1003DB	2	11	26"	3/4"	1-1/8"	1-1/4"	3"	BLACK	1	27
1001DBB	2	13	32"	3/4"	1-1/8"	1-1/4"	3"	BLUE	1	33
1001DB	2	13	32"	3/4"	1-1/8"	1-1/4"	3"	BLACK	1	33
1008DB	3	5	38"	1-1/4"	1-7/16"	1-3/4"	3-1/2"	BLACK	1	65

SB-631



BEDBL2



SD-921



PART #	DESCRIPTION	WORKING LOAD LIMIT	PACK QTY
64.038.002	DRAWBAR HOOK FOR ALL TRACTOR DRAWBARS UP TO 1-5/8" THICK; FOR USE WITH 5/16" TO 1/2" CHAIN	9,000 LBS	1
SD-921	DRAWBAR, SWINGING, FITS ALL TRACTOR MODELS		1
SB-631	BRACKET, STABILIZER, UNIVERSAL LH & RH. 5/8" X 1" SLOTTED HOLE, 4-5/8" MOUNTING HOLES		1
BEDBL2	DRAWBAR LOCK		1



64.038.002

STABILIZER ARMS

UNIVERSAL STABILIZER ARM
302S



ADJUSTABLE FORGED STABILIZER ARM
300S



STAY STRAP
304S



LIFT ARM
486E



LIFT ARM LEVELING ASSEMBLY
351JA



STABILIZER CHAIN
310S



PART #	DESCRIPTION	PACK QTY	WEIGHT (LB.)
304S	UPPER STAY STRAP FOR CATEGORY 1; FITS ALL FERGUSON MODELS, FORD 2N, 8N, 9N, NAA, 600, 700, 800, 900, OLIVER 550 & ALL OLIVER 3-POINT CONVERSIONS, MASSEY-FERGUSON 35 & 50	1	2.8
303S	LOWER STAY STRAP FOR CATEGORY 1; FITS ALL FERGUSON MODELS. FORD 2N, 8N, 9N, NAA, 600, 700, 800, 900, OLIVER 550 & ALL OLIVER 3-POINT CONVERSIONS, MASSEY-FERGUSON 35 & 50	1	2.4
301S	RIGHT OR LEFT UNIVERSAL STABILIZER ARM; 7/8" PIN HOLES ON 31-9/16" CENTERS	1	6
302S	RIGHT OR LEFT UNIVERSAL STABILIZER ARM; REPLACES MASSEY-FERGUSON ST96362358; 7/8" PIN HOLES ON 33-1/8" CENTERS	1	6.4
300S	HEAVY-DUTY ADJUSTABLE FORGED STABILIZER ARM; FITS ALL FERGUSON MODELS, FORD 2N, 8N, 9N, NAA, 600, MASSEY-FERGUSON 35, 50, 175, 65, 135, 150, 165, 180; ADJUSTABLE FROM 28-1/2" TO 36" ; 7/8" PIN HOLES; 7/8" NF THREADS	1	6
309S	UNIVERSAL STABILIZER ARM; 7/8" PIN HOLES ON 31-9/16" AND 33-1/8" CENTERS; 3 HOLE	1	6.1
310S	PAIR OF UNIVERSAL STABILIZER CHAINS FOR MOST CATEGORY 1 APPLICATIONS; YELLOW ZINC PLATED	1	14
486E	CATEGORY 1 RIGHT- OR LEFT-HAND FORGED LIFT ARM; FITS ALL FERGUSON MODELS, FORD 2N, 8N, 9N, NAA, MASSEY-FERGUSON 35, 50, OLIVER 550 & OLIVER 3PT CONVERSION, JOHN DEERE 1010; 7/8" PIN HOLES; 31-3/4" BALL CENTERS; 34-1/2" OVERALL LENGTH	1	11.7
351JA	CATEGORY 1 LIFT ARM LEVELING ASSEMBLY; 18-1/2" CLOSED; 25" OPEN LENGTH; 7/8" NF THREAD DIAMETER; REPLACES FORD NCA577A	1	6

STABILIZER PINS

- STABILIZER STUB PINS FOR FORD, FERGUSON AND OTHER STABILIZER KITS
- YELLOW ZINC DICROMATE PLATED

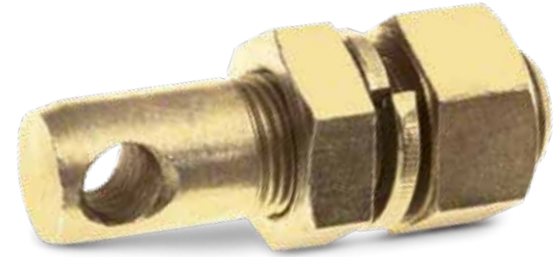

PART #	DESCRIPTION	PIN DIAM.	USABLE LENGTH	OVERALL LENGTH	THREAD DIAM.	PACK QTY
780P	STABILIZER STUB PIN	7/8"	1/2"	3-3/8"	5/8" NF	5
781P	REPLACES FORD 230044, MASSEY-FERGUSON 18177M1	7/8"	3/8"	2-5/8"	5/8" NF	5
785P	REPLACES FORD 141185, MASSEY-FERGUSON MF668154M1	7/8"	1-1/4"	3-1/8"	5/8" NF	5
787P	STABILIZER STUB PIN	7/8"	1/2"	2-5/8"	5/8" NF	5
788P	REPLACES MF186802M1	7/8"	11/16"	3-1/8"	3/4" NF	5

ROLL PIN TYPE



HEAD TYPE



116P CATEGORIES 2 & 3

- FOR USE WITH IMPLEMENTS WITH YOLK TYPE MOUNTINGS
- ALL PINS ARE YELLOW ZINC DICHROMATE PLATED

PART #	CAT.	TYPE	PIN DIAM.	USABLE LENGTH	OVERALL LENGTH	PACK QTY
170IP	1	ROLL PIN	7/8"	4-1/2"	6"	1
171IP	2	ROLL PIN	1-1/8"	3-5/16"	4-3/4"	2
172IP	2	ROLL PIN	1-1/8"	4-3/4"	6-1/2"	1
173IP	2	ROLL PIN	1-1/8"	5-3/8"	7"	2
174IP	2	ROLL PIN	1-1/8"	7-3/8"	9"	1
175IP	2	ROLL PIN	1-1/8"	9"	10-3/4"	2
169IP	3	HEAD	1-7/16"	4-11/16"	6"	1
176IP	3	ROLL PIN	1-7/16"	6-1/4"	8-1/2"	2
116P	2 & 3	HEAD	1-1/8" & 1-7/16"	3-5/8" & 4-1/4"	9-1/4"	1

TOP LINK PINS

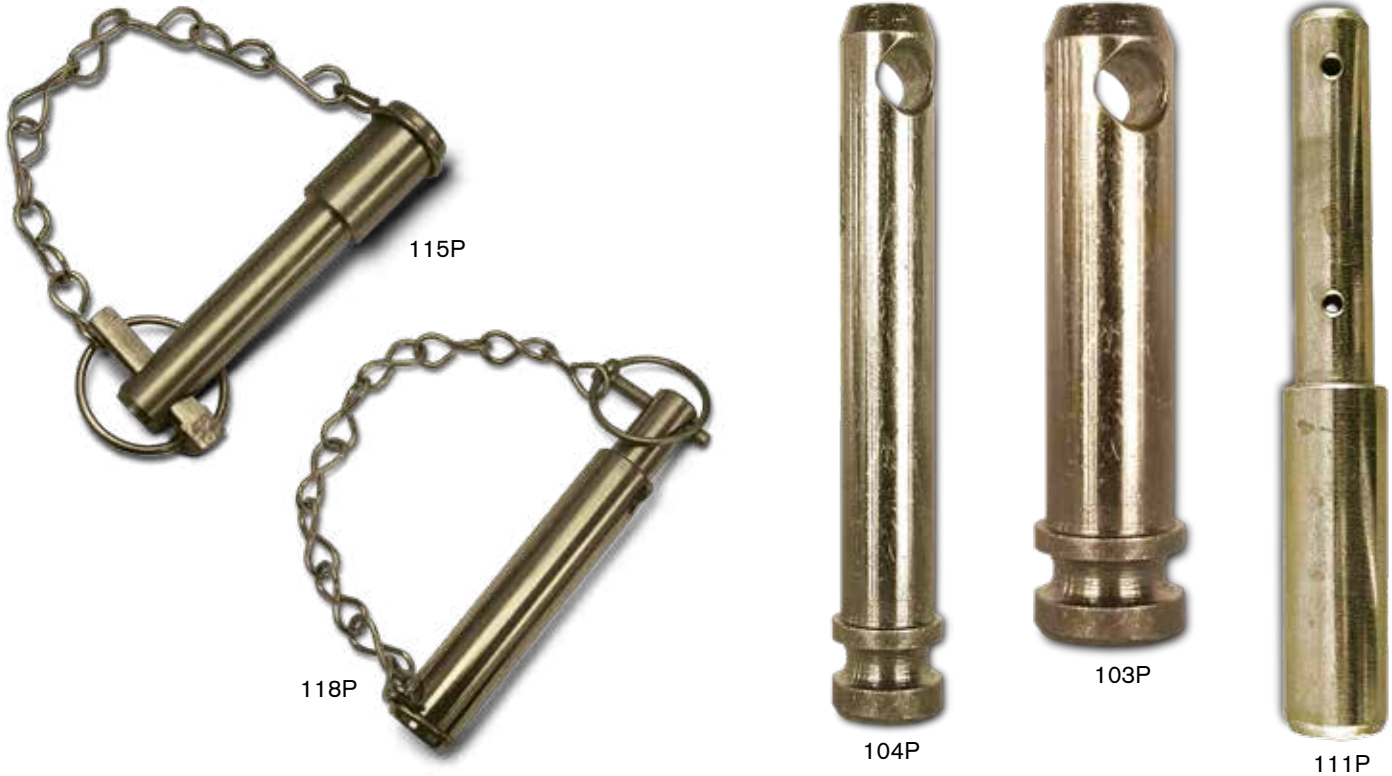

- SIZES AND STYLES FOR CATEGORY 0 THROUGH 3 TRACTORS
- YELLOW ZINC DICHROMATE PLATED

PART #	CAT.	DESCRIPTION	PIN DIAM.	OVERALL LENGTH	USABLE LENGTH	PACK QTY
104P	0	TOP LINK PIN	5/8"	4-7/16"	3"	1
105P	1	REPLACES FORD 9N-560, FERGUSON 195647M1	3/4"	4-1/2"	2-3/4"	1
115P	1	TOP LINK PIN	3/4"	5-1/4"	3"	1
107P	1	LONG TOP LINK PIN; REPLACES FERGUSON 195589M1, AC339942	3/4"	5-1/2"	3-7/8"	1
110P	1	EXTRA-LONG TOP LINK PIN; REPLACES FORD E381T9	3/4"	6-3/8"	4-3/4"	1
106P	2	REPLACES FORD C5NN560A, MF185873M91, AC2090149/239888	1"	5-1/4"	3-9/16"	1
103P	2	REPLACES FORD E27N995272	1"	4-3/4"	3"	1
108P	2	REPLACES FORD C5NN486A	1"	6"	4-3/8"	1
117P	2	REPLACES FORD E2016F9, AC345552	1"	7-1/16"	5-3/8"	1
118P	2	TOP LINK PIN	1"	6-1/8"	4-1/4"	1
109P	3	TOP LINK PIN	1-1/4"	6-1/2"	4-5/8"	1
111P	1-2	TOP LINK STEPPED	3/4"-1"	6-3/4"	3-9/16"	1
112P	1-2	BOTTOM LINK STEPPED	7/8"-1-1/8"	7-1/2"	3"	1
113P	1-2-1	BOTTOM LINK STEPPED	7/8"-1-1/8"	8-3/8"	2-7/8"	1

HITCH PINS

- AN ECONOMY HITCH PIN (CLEVIS PIN) FOR NUMEROUS APPLICATIONS
- YELLOW ZINC DICHROMATE PLATED

CLEVIS PINS

PART #	PIN DIAM.	USABLE LENGTH	OVERALL LENGTH	PACK QTY
6036	1/2"	5"	6-3/8"	1
6037	5/8"	5"	6-3/8"	1
6038	3/4"	5"	6-3/8"	1
6039	7/8"	5"	6-3/8"	1
6040	1"	5"	6-3/8"	1
6041	1-1/8"	5"	6-3/8"	1



- FORGED-HEAD HITCH PIN WITH FIXED HANDLE AND ZINC PLATED "R" CLIP PIN
- OVER 25% STRONGER THAN GRADE 2
- YELLOW ZINC DICHROMATE PLATED

FIXED-HANDLE HITCH PINS

PART #	PIN DIAM.	USABLE LENGTH	OVERALL LENGTH	PACK QTY
705HPF	1/2"	4-1/4"	5-1/4"	1
702HPF	5/8"	4-1/4"	5-1/4"	1
704HPF	5/8"	6-1/4"	7-1/4"	1
703HPF	3/4"	4-1/4"	5-1/2"	1
700HPF	3/4"	6-1/4"	7-1/4"	1
709HPF	7/8"	4-1/4"	5-1/4"	1
701HPF	7/8"	6-1/4"	7-1/4"	1
706HPF	1"	6-1/4"	7-1/4"	1
707HPF	1-1/8"	6-1/4"	7-1/4"	1



SWIVEL-HANDLE FORGED HITCH PINS



- FORGED-HEAD HITCH PIN WITH SWIVEL HANDLE
- ZINC PLATED "R" CLIP PIN OR CHAIN AND 1/4" LYNCH PIN
- MORE THAN 25% STRONGER THAN GRADE 2
- YELLOW ZINC DICHROMATE PLATED

HITCH PINS WITH CLIP

PART #	PIN DIAM.	USABLE LENGTH	OVERALL LENGTH	PACK QTY
715HPC	3/8"	4-1/4"	4-3/4"	1
705HPC	1/2"	4-1/4"	5-3/4"	1
712HPC	1/2"	6-1/4"	7-3/4"	1
702HPC	5/8"	4-1/4"	5-3/4"	1
704HPC	5/8"	6-1/4"	7-3/4"	1
703HPC	3/4"	4-1/4"	5-3/4"	1
700HPC	3/4"	6-1/4"	7-3/4"	1
709HPC	7/8"	4-1/4"	5-3/4"	1
701HPC	7/8"	6-1/4"	7-3/4"	1
714HPC	1"	4-1/4"	5-3/4"	1
706HPC	1"	6-1/4"	7-3/4"	1
707HPC	1-1/8"	6-1/4"	7-3/4"	1
708HPC	1-1/4"	6-1/4"	7-3/4"	1



HITCH PINS WITH CHAIN

PART #	PIN DIAM.	USABLE LENGTH	OVERALL LENGTH	PACK QTY
705HP	1/2"	4-1/4"	5-3/4"	1
712HP	1/2"	6-1/4"	7-3/4"	1
702HP	5/8"	4-1/4"	5-3/4"	1
704HP	5/8"	6-1/4"	7-3/4"	1
703HP	3/4"	4-1/4"	5-3/4"	1
700HP	3/4"	6-1/4"	7-3/4"	1
701HP	7/8"	6-1/4"	7-3/4"	1
706HP	1"	6-1/4"	7-3/4"	1
707HP	1-1/8"	6-1/4"	7-3/4"	1
708HP	1-1/4"	6-1/4"	7-3/4"	1
709HP	7/8"	4-1/4"	7-1/4"	1
730HP	3/4"	8-1/2"	10"	1

DROP-FORGED HITCH PINS

- ONE-PIECE, DROP-FORGED
- GRADE 5 PERFORMANCE HITCH PINS
- MADE FROM HIGH-STRENGTH STEEL AND HEAT TREATED
- ZINC PLATED "R" CLIP PIN INCLUDED
- YELLOW ZINC DICHROMATE PLATED



706FFHP

PART #	PIN DIAM.	USABLE LENGTH	OVERALL LENGTH	HANDLE	PACK QTY
705FFHP	1/2"	3-1/2"	5-11/32"	WIRE	1
704FFHP	5/8"	6"	9-3/16"	SOLID	1
703FFHP	3/4"	4"	7-7/16"	SOLID	1
700FFHP	3/4"	6-1/4"	9-7/16"	SOLID	1
709FFHP	7/8"	4-1/4"	7-3/4"	SOLID	1
701FFHP	7/8"	6-1/2"	10-11/16"	SOLID	1
714FFHP	1"	4-3/4"	8-17/32"	SOLID	1
706FFHP	1"	6-3/4"	10-17/32"	SOLID	1
707FFHP	1-1/8"	7"	11"	SOLID	1
708FFHP	1-1/4"	7"	11-1/8"	SOLID	1
716FFHP	1-3/8"	7"	11-27/32"	SOLID	1
719FFHP	1-1/2"	8"	12-23/32"	SOLID	1

PART #	PIN DIAM.	USABLE LENGTH	PACK QTY
705FHP	1/2"	3-1/2"	1
702FHP	5/8"	3-5/8"	1
703FHP	3/4"	4"	1
700FHP	3/4"	6-1/4"	1
701FHP	7/8"	6-1/2"	1
706FHP	1"	6-3/4"	1
707FHP	1-1/8"	7"	1
708FHP	1-1/4"	7"	1



HITCH PINS - BLUE/GRAY HEAD



- HEAT TREATED, MADE FROM ALLOY STEEL
- GRADE 8 PERFORMANCE
- PIN HAS BLACK POWDER COATING
- BLUE OR GRAY VINYL COATED HEAD/HANDLE
- ZINC PLATED "R" CLIP PIN INCLUDED

PART #	PIN DIAM.	USABLE LENGTH	OVERALL LENGTH	PACK QTY
705HPBLU	1/2"	3-5/8"	6-5/8"	1
702HPBLU	5/8"	4"	7"	1
704HPBLU	5/8"	6"	9"	1
703HPBLU	3/4"	4"	7"	1
700HPBLU	3/4"	6-1/2"	9-1/2"	1
709HPBLU	7/8"	4-1/4"	7-1/4"	1
701HPBLU	7/8"	6-1/2"	9-1/2"	1
714HPBLU	1"	4-3/4"	7-3/4"	1
706HPBLU	1"	7"	10"	1
707HPBLU	1-1/8"	7"	10"	1
708HPBLU	1-1/4"	7"	10"	1
719HPBLU	1-1/2"	8-1/2"	11-1/2"	1



PART #	PIN DIAM.	USABLE LENGTH	OVERALL LENGTH	PACK QTY
705HPG	1/2"	3-5/8"	6-5/8"	1
702HPG	5/8"	4"	7"	1
704HPG	5/8"	6"	9"	1
703HPG	3/4"	4"	7"	1
700HPG	3/4"	6-1/2"	9-1/2"	1
709HPG	7/8"	4-1/4"	7-1/4"	1
701HPG	7/8"	6-1/2"	9-1/2"	1
714HPG	1"	4-3/4"	7-3/4"	1
706HPG	1"	7"	10"	1
707HPG	1-1/8"	7"	10"	1
708HPG	1-1/4"	7"	10"	1
719HPG	1-1/2"	8-1/2"	11-1/2"	1

RED HEAD & DOUBLE LOCK HITCH PINS

RED HEAD HITCH PINS

PART #	PIN DIAM.	USABLE LENGTH	OVERALL LENGTH	PACK QTY
705HPR	1/2"	3-5/8"	6-5/8"	1
702HPR	5/8"	4"	7"	1
704HPR	5/8"	5-3/4"	9"	1
703HPR	3/4"	4"	7"	1
700HPR	3/4"	6-1/2"	9-1/2"	1
709HPR	7/8"	4-1/4"	7-1/4"	1
701HPR	7/8"	6-1/2"	9-1/2"	1
714HPR	1"	4-3/4"	7-3/4"	1
706HPR	1"	7-1/2"	10"	1
707HPR	1-1/8"	8-1/2"	11-1/2"	1
708HPR	1-1/4"	8-1/2"	11-1/2"	1
719HPR	1-1/2"	8-1/2"	11-1/2"	1
731HPR	1-3/4"	8-1/2"	12"	1
732HPR	2"	8-1/2"	12"	1
712HPR	1"	12"	15"	1
713HPR	1-1/4"	12"	15"	1
717HPR	1-1/2"	13"	16"	1



- GRADE 5 PERFORMANCE, FORGED HITCH PINS
- MADE FROM HIGH-STRENGTH STEEL AND HEAT TREATED
- PIN HAS BLACK POWDER COATING WITH A RED VINYL COATED HEAD AND HANDLE
- ZINC PLATED "R" CLIP PIN INCLUDED

DOUBLE LOCK HITCH PINS

PART #	PIN DIAM.	USABLE LENGTH	PACK QTY
702HPDL	5/8"	4-1/2"	1
703HPDL	3/4"	4-1/2"	1
700HPDL	3/4"	6"	1
709HPDL	7/8"	4-1/2"	1
701HPDL	7/8"	6"	1
706HPDL	1"	6"	1
707HPDL	1-1/8"	7"	1
708HPDL	1-1/4"	7"	1
719HPDL	1-1/2"	8"	1



- GRADE 5 PERFORMANCE HITCH PINS
- DESIGNED WITH A QUICK-RELEASE HANDLE TO ALLOW EASY REMOVAL
- DOUBLE-LOCK MECHANISM ENSURING THE PIN WILL REMAIN IN PLACE
- THE PIN AND HANDLE ARE POWDER COATED WITH ZINC-PLATED LOCKS

LOCKING PINS

- NUMEROUS FARM, LAWN AND GARDEN, AND INDUSTRIAL APPLICATIONS
- ROUND- AND SQUARE-LOOP STYLES
- YELLOW ZINC DICHROMATE PLATED.



PART #	DIAM.	USABLE LENGTH	WIRE LOOP	PACK QTY
913PA	1/4"	1-3/8"	ROUND	10
908PA	1/4"	1-3/4"	ROUND	10
910PA	1/4"	2-1/4"	SQUARE	10
909PA	1/4"	2-1/2"	SQUARE	10
903PA	1/4"	2-1/2"	ROUND	10
919PA	5/16"	1-3/8"	ROUND	10
921PA	5/16"	1-3/4"	ROUND	10
904PA	5/16"	2-1/4"	SQUARE	10
900PA	5/16"	2-1/4"	ROUND	10
918PA	5/16"	2-1/2"	ROUND	10
915PA	5/16"	2-1/2"	SQUARE	10
922PA	5/16"	3-1/2"	SQUARE	10
920PA	5/16"	3-15/16"	SQUARE	10
917PA	3/8"	1-1/2"	ROUND	10
906PA	3/8"	2-1/4"	ROUND	10
905PA	3/8"	2-1/4"	SQUARE	10
911PA	3/8"	2-1/2"	ROUND	10
907PA	3/8"	2-1/2"	SQUARE	10
916PA	3/8"	3"	SQUARE	10
914PA	3/8"	3-7/16"	SQUARE	10

HITCH PINS - SAFETY LOCK & BENT

- SPRING STEEL WIRE FITS IN THE GROOVE ON THE PIN TO SECURE IT
- YELLOW ZINC DICHROMATE PLATED

PART #	PIN DIAM.	USABLE LENGTH	OVERALL LENGTH	PACK QTY
710HPW	1/2"	4"	5-1/2"	1
711HPW	5/8"	4"	5-1/2"	1
700HPW	3/4"	6"	7-1/2"	1
701HPW	7/8"	6"	7-1/2"	1
706HPW	1"	6"	7-1/2"	1



- THESE PINS HAVE NUMEROUS FARM, LAWN AND GARDEN, AND INDUSTRIAL APPLICATIONS
- COMPLETE WITH ZINC-PLATED "R" CLIP PIN
- YELLOW ZINC DICHROMATE PLATED

PART #	PIN DIAM.	USABLE LENGTH	PACK QTY
725HP	5/16"	3"	1
723HP	3/8"	3"	1
720HPS	1/2"	2-1/2"	1
720HP	1/2"	3"	1
721HP	3/4"	3-1/2"	1
720HPL	1/2"	4"	1
722HPL	5/8"	3.5"	1
720HPXL	1/2"	5"	1
722HP	5/8"	3"	1
722HPEL	5/8"	4"	1
722HPXL	5/8"	5"	1
721HPXL	3/4"	4-1/2"	1



“R” CLIP PINS

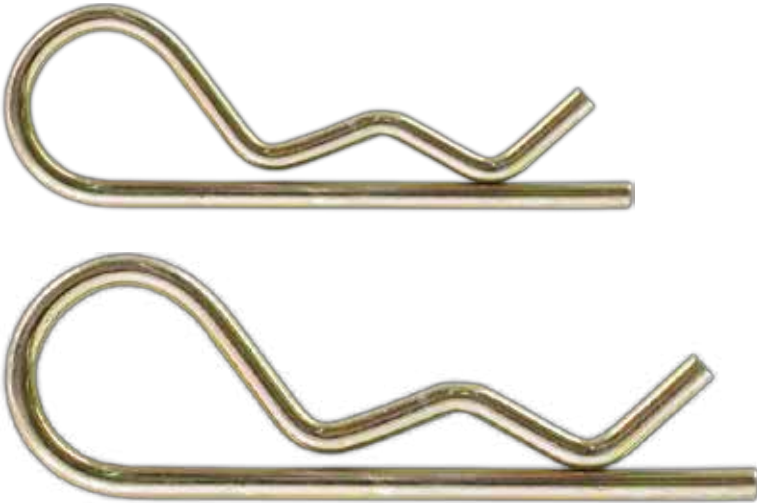

- AVAILABLE IN THE MOST POPULAR SIZES FOR FARM AND OTHER APPLICATIONS.
- YELLOW ZINC DICHROMATE PLATED SPRING WIRE.

BULK PART #	WIRE DIAM.	OVERALL LENGTH	FITS PIN DIAM.	RETAIL BAG PART #	BULK PACK QTY	PACK QTY
P-7922	1/16"	1-9/16"	3/8" TO 1/2"	-	100	1
P-7923	3/32"	1-5/8"	1/4" TO 1/2"	P-7923B12 (12)	100	1
P-7924	1/8"	1-15/16"	1/2" TO 3/4"	P-7924B8 (8)	100	1
P-7925	5/32"	2-15/16"	5/8" TO 1"	P-7925B7 (7)	100	1
P-7927	3/16"	3-3/4"	7/8" TO 1-1/4"	P-7927B3 (3)	25	1
P-7928	1/4"	4"	3/4" TO 1"	P-7928BP2 (2)	25	1
P-7929	5/16"	5-15/16"	1" TO 1-7/16"	-	5	1
P-7929S	5/16"	4-1/8"	1" TO 1-7/16"	P-7929SB2 (2)	5	1
P-7940	5/16"	3-1/2"	1" TO 1-7/16"	-	5	1
P-7995	1/8"	2-1/2"	1/2" TO 3/4"	-	25	1
P-7997	3/16"	4-3/32"	7/8" TO 1-1/4"	-	5	1
67.700.366				HAIR PIN CLIP, 1/16 X 1-3/8		
67.700.367				HAIR PIN CLIP, 3/32 X 1-11/16		
67.700.368				HAIR PIN CLIP, 3/16 X 3-1/4		
67.700.369				HAIR PIN CLIP, 3/32 X 2-5/16		
67.700.371				HAIR PIN CLIP, 5/32 X 3-5/16		
67.700.372				HAIR PIN CLIP, 1/8 X 2-5/8		
67.700.373				HAIR PIN CLIP, 1/8 X 2		
67.700.374				HAIR PIN CLIP, 1/4 X 4-1/4		
67.700.375				HAIR PIN CLIP, 7/64 X 2-1/16		
67.700.376				HAIR PIN CLIP, 11/64 X 2-5/8		
67.700.377				HAIR PIN CLIP, 3/16 X 3-3/4		

NOTE: NUMBER IN PARENTHESIS IN RETAIL BAG PART NUMBER COLUMN INDICATES BAG QUANTITIES.

LYNCH PINS

- FASTENERS FOR NUMEROUS FARM AND OTHER APPLICATIONS.
- YELLOW ZINC DICHROMATE PLATED EXCEPT FOR BLACK POWDER COATED FINISH.



801LP



803LP



806LP

BULK PART #	DESCRIPTION	PIN DIAM.	USABLE LENGTH	RETAIL BAG PART NO.	BULK PKG. QTY.	PACK QTY
804LP	STANDARD	3/16"	1"	804LPB2 (2)	100	1
804LPC	804LP (SPC7919DS, B500168) WITH CHAIN AND COTTER PIN	3/16"	1"	-	25	-
801LP	STANDARD	7/16"	1-1/4"	801LPB2 (2)	100	1
806LP	801LP (2N609DS, B500170) WITH CHAIN AND COTTER PIN	7/16"	1-1/4"	-	25	-
800LP	STANDARD	1/4"	1-1/4"	800LPB2 (2)	100	1
810LP	SHORT SHANK	7/16"	1-1/4"	-	100	-
803LP	HEAVY DUTY; FITS CATEGORY 1, 2 AND 3 PINS; BLACK POWDER COAT	7/16"	1-1/2"	803LPB2 (2)	100	1
803LPC	803LP (251387DS, B500171) WITH CHAIN AND COTTER PIN; BLACK POWDER COAT	7/16"	1-1/2"	-	25	-
802LP	STANDARD	5/16"	1-1/4"	802LPB2 (2)	100	1
805LP	STANDARD	3/8"	1-1/4"	-	100	-
811LP	LONG; FITS CATEGORY 1, 2 AND 3 PINS	7/16"	1-3/4"	-	100	-
809LP	LONG SHANK	7/16"	1-1/4"	-	100	-
808LP	LYNCH PIN	7/16"	1-7/8"	-	-	-

NOTE: NUMBER IN PARENTHESIS IN RETAIL BAG PART NUMBER COLUMN INDICATES BAG QUANTITIES.

DETENT & COTTER PINS

- BALL DETENT ALLOWS FOR FAST AND EASY INSERTION AND REMOVAL OF PIN
- REPLACES PINS THAT REQUIRE A COTTER PIN
- AVAILABLE IN MOST POPULAR SIZES
- ZINC PLATED CARBON STEEL



PART #	PIN DIAM.	USABLE LENGTH	OVERALL LENGTH	PACK QTY
65.500.000	3/16"	1"	1-3/8"	5
65.500.005	1/4"	3"	3-7/16"	5
65.500.016	3/8"	4"	4-5/8"	5
65.500.024	1/2"	2-1/2"	3-9/32"	5

COTTER PINS - BAGGED

PART #	DESCRIPTION	BAG QTY
67.700.380	COTTER PIN PACK 1/16X1	110
67.700.381	COTTER PIN PACK 3/32X1	100
67.700.382	COTTER PIN PACK 1/8X1	100
67.700.383	COTTER PIN PACK 1/8X1-1/2	75
67.700.384	COTTER PIN PACK 5/32X1	75
67.700.387	COTTER PIN PACK 3/16X1-1/2	35
67.700.388	COTTER PIN PACK 3/16X2	30
67.700.389	COTTER PIN PACK 1/4X1-1/2	20
67.700.390	COTTER PIN PACK 1/4X2	17
67.700.391	COTTER PIN PACK 5/16X2	10



COTTER PIN KIT

PART #	PACK QTY
68.000.100	100



HYDRAULIC CYLINDER PINS & RATCHET JACKS

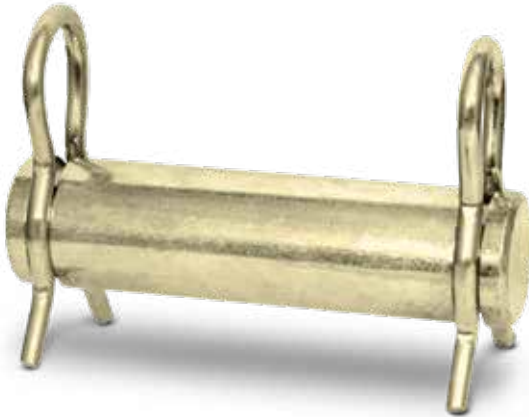

- PINS FOR HYDRAULIC CYLINDERS AND JACKS IN POPULAR SIZES
- STANDARD CYLINDER CLIPS INCLUDED
- WILL ACCOMMODATE "R" CLIP PIN
- YELLOW ZINC DICHROMATE PLATED

HYDRAULIC CYLINDER PINS

PART #	DIAM.	USABLE LENGTH	OVERALL LENGTH	PACK QTY
P-7712	1"	2"	2-3/4"	1
P-7729	1"	2-3/4"	3-9/16"	1
P-7743	1"	2-7/8"	3-11/16"	5
P-7744	1"	3"	3-13/16"	1
P-7746	1"	3-1/4"	4-1/16"	1
P-7750	1-1/4"	3-1/4"	4-1/16"	5



- MULTIPLE USES - ADJUSTMENT OF IMPLEMENTS AND EQUIPMENT
- REPLACE HYDRAULIC CYLINDERS OR OLD SCREW JACKS
- APPLICATIONS WHERE INFREQUENT ADJUSTMENT IS NEEDED

RATCHET JACKS

PART #	DESCRIPTION	PACK QTY	WEIGHT (LB.)
350JA	HEAVY-DUTY RATCHET JACK WITH 1-1/4" ACME THREADS AND GREASE ZERKS; ADJUSTABLE FROM 20" CLOSED TO 28" OPEN; 1" CLEVIS PINS, CLIP PINS AND HANDLE INCLUDED; BLACK POWDER-COAT FINISH	1	15

MISCELLANEOUS FARM ACCESSORIES

1641K

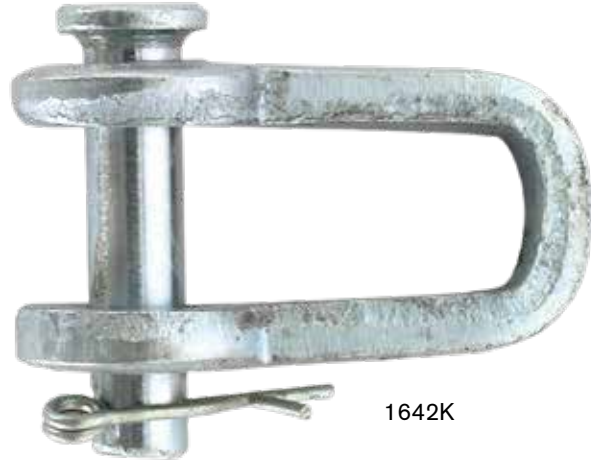

1642K

100901MC



2582AD

PART #	DESCRIPTION	PACK QTY	WEIGHT (LB.)
1641K	CHECK-CHAIN CLEVIS EYE BOLT; USED TO FASTEN CHECK-CHAIN TO LIFT ARMS; REPLACES FORD NCB660A; FITS FERGUSON 20 & 30; ASSEMBLED WITH 9/16" NF HEX NUT	1	0.4
1642K	CHECK-CHAIN CLEVIS; USED TO FASTEN CHECK-CHAIN TO TRACTOR; REPLACES FORD 9N582; FITS MF 20, 30, 35, 40 AND 50	1	0.1
100901MC	MUFFLER CLAMP ASSEMBLY; REPLACES FORD 9N5251; FITS FORD 2N, 8N, 9N, MF 20, 30, 40 AND 50	1	0.6
2582AD	DRILL DRAG CHAIN; 3-1/2" RING DIAMETER; 1/2" RING THICKNESS; FITS MOST STANDARD SEED DRILLS	1	2.1

CLEVIS - T-HANDLE, UTILITY & GENERAL

PART #	DIAM.	USABLE LENGTH	PACK QTY
6070	1/2"	2-1/4"	1
6071	5/8"	3-1/8"	1
6072	3/4"	3-1/4"	1



PART #	BODY DIAM.	CLEVIS OPENING	USABLE LENGTH	PIN DIAM.	WORKING LOAD LIMIT (LB.)	PACK QTY
64.401.025	1/4"	15/32"	7/8"	5/16"	1,000	1
64.400.516	5/16"	17/32"	1"	3/8"	1,500	1
64.400.038	3/8"	21/32"	1-1/4"	7/16"	2,000	1
64.400.716	7/16"	23/32"	1-1/2"	1/2"	3,000	1
64.401.050	1/2"	13/16"	1-11/16"	5/8"	6,000	1
64.400.058	5/8"	1-1/16"	2"	3/4"	9,000	1



PART #	BODY DIAM.	CLEVIS OPENING	USABLE LENGTH	PIN DIAM.	WORKING LOAD LIMIT (LB.)	PACK QTY
64.405.075	3/4"	2-1/2"	6-3/16"	3/4"	10,000	1



CLEVIS - STRAIGHT & TWISTED



- DESIGNED AND ENGINEERED STRAIGHT, TWISTED, UTILITY AND FARM CLEVISES
- HEAT-TREATED PINS
- TOTALLY FORGED
- BETTER GRAIN STRUCTURE ALIGNMENT WITHOUT BUILT-IN STRESS
- MORE CONSISTENCY IN STRENGTH, QUALITY AND CONFORMITY
- CLEVISES, MID-LINKS AND DRAWBAR HOOK HAVE BLACK POWDER COATED FINISH
- PINS ARE YELLOW ZINC DICHROMATE PLATED
- DO NOT EXCEED WORKING LOAD LIMIT
- FARM HARDWARE IS NOT FOR LIFTING 

PART #	BODY DIAM.	CLEVIS OPENING	USABLE LENGTH	PIN DIAM.	WORKING LOAD LIMIT (LB.)	PACK QTY
64.300.058	5/8"	7/8"	3-1/4"	1/2"	6,000	1
64.300.075	3/4"	1-5/16"	3-3/4"	5/8"	12,000	1
64.300.078	7/8"	1-5/16"	3-1/4"	3/4"	16,000	1
64.301.078	7/8"	1-5/16"	4-1/4"	3/4"	16,000	1
64.301.516	15/16"	1-7/16"	4-5/8"	7/8"	20,000	1
64.300.001	1"	2-1/8"	5-5/16"	1"	25,000	1



PART #	BODY DIAM.	CLEVIS OPENING	USABLE LENGTH	PIN DIAM.	WORKING LOAD LIMIT (LB.)	PACK QTY
64.200.058	5/8"	7/8"	3"	1/2"	6,000	1
64.200.075	3/4"	1-5/16"	3-1/2"	5/8"	12,000	1
64.201.078	7/8"	1-5/16"	3"	3/4"	16,000	1
64.200.078	7/8"	1-5/16"	3-7/8"	3/4"	16,000	1
64.201.516	15/16"	1-7/16"	4-1/4"	7/8"	20,000	1
64.200.001	1"	2-1/8"	5"	1"	25,000	1

FARM CLEVISES & MID LINKS



- SCREW PIN SHACKLE TYPE USED FOR MULTIPLE HITCHES & CRAWLER TRACTORS
- DO NOT EXCEED WORKING LOAD LIMIT
- FARM HARDWARE IS NOT FOR LIFTING



PART #	BODY DIAM.	CLEVIS OPENING	USABLE LENGTH	PIN DIAM.	WORKING LOAD LIMIT (LB.)	PACK QTY
64.350.025	1/4"	15/32"	1-1/8"	5/16"	1,000	1
64.350.516	5/16"	17/32"	1-1/4"	3/8"	2,000	1
64.350.038	3/8"	23/32"	1-7/16"	7/16"	3,000	1
64.350.716	7/16"	3/4"	1-11/16"	1/2"	4,000	1
64.350.050	1/2"	13/16"	1-15/16"	5/8"	6,500	1
64.350.058	5/8"	1-1/16"	2-1/2"	3/4"	9,000	1
64.350.075	3/4"	1-1/4"	3"	7/8"	13,000	1
64.350.078	7/8"	1-7/16"	3-1/4"	1"	15,000	1
64.350.001	1"	1-11/16"	3-3/4"	1-1/8"	17,000	1
64.350.118	1-1/8"	1-13/16"	4-1/4"	1-1/4"	24,000	1
64.300.114	1-1/4"	2"	4-1/2"	1-3/8"	28,000	1

- DO NOT EXCEED WORKING LOAD LIMIT
- FARM HARDWARE IS NOT FOR LIFTING



PART #	CHAIN SIZE	WORKING LOAD LIMIT (LB.)	PACKAGE QTY.
64.000.004	1/4" OR 5/16"	4,700	1
64.000.003	3/8"	6,600	1
64.000.005	7/16" OR 1/2"	11,300	1

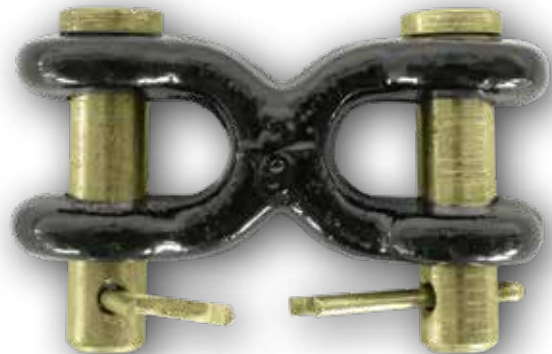



14 TRAILER, TOWING & TRACTOR ACCESSORIES

BRABER EQUIPMENT

40TH
EDITION

PARTS CATALOG

FARM JACKS



FJ-48



FJ-60

FEATURES

- FARM, LIFT, HOIST, PULL OR PUSH
- TOP WINCH-CONNECTOR CLAMP
- SAFE USE INFORMATION AFFIXED TO JACK HANDLE TUBE FOR EASY REFERENCE

APPLICATIONS

- MULTI-PURPOSE JACK FOR OFF-ROAD, WINCHING, PULLING/CLAMPING & AGRICULTURAL APPLICATIONS

FARM JACKS

PART#	RATED CAPACITY	TESTED CAPACITY	HEIGHT	LIFT RANGE	CLAMPING CAPACITY	WINCHING CAPACITY
FJ-48	4660 LBS	7000 LBS	48"	4-1/2" - 37"	750 LBS	5,000 LBS
FJ-60	4660 LBS	7000 LBS	60"	4-1/2" - 48-1/4"	750 LBS	5,000 LBS

ACCESSORIES AVAILABLE

PART#	DESCRIPTION
FJ-FP	FARM JACK FOOT PLATE

FEATURES

- REDUCES JACK SINKAGE ON SOFT GROUND
- CONVENIENT TO USE, EASY TO STORE
- CAN BE USED WITH FJ-48 & FJ-60
- DURABLE FOOT PLATE INCREASES SUPPORT SURFACE AREA AND GIVES THE JACK MORE VERSATILITY



WELD COLLAR JACKS



BE DIAMOND SERIES JACKS

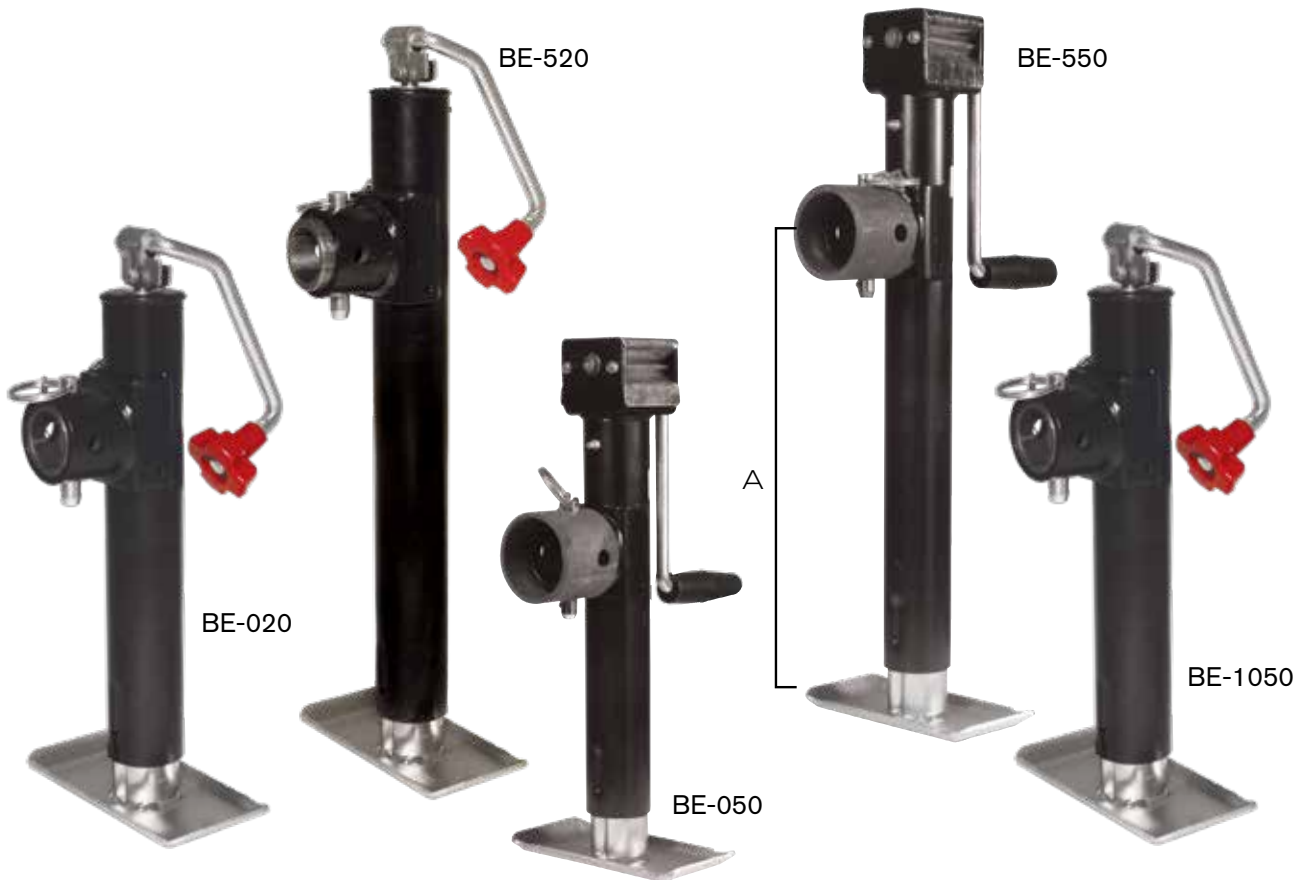

PART#	OEM #	DESCRIPTION	MAX LIFT	MAX LOAD (STATIC)	LIFT	A (HEIGHT)
BE-020	TISCO# ASJ210TH15 BULLDOG# BD158451	TOP WIND 10" WELD COLLAR	2000 LBS	2600 LBS	10"	11 1/4"
BE-050	BULLDOG# BD178201	SIDE WIND 10" WELD COLLAR	5000 LBS	6000 LBS	10"	10"
BE-520	TISCO# ASJ215TH20 BULLDOG# BD158452	TOP WIND 15" WELD COLLAR	2000 LBS	2600 LBS	15"	15 5/8"
BE-550	TISCO# ASJ5155TH20 BULLDOG# BD178203	SIDE WIND 15" WELD COLLAR	5000 LBS	6000 LBS	15"	15"
BE-1050		TOP WIND 10" WELD COLLAR	5000LBS		10"	10.5"

REPLACEMENT PARTS

64.002.000	PIN# BE-025-CA MOUNTING PIPE (BE-020/520)
64.003.000	MOUNTING PIPE (BE-050/550)
XA-003-999	REPLACEMENT TOP WIND HANDLE ASSY WITH KNOB (BE-020/520)
BE-702	REPLACEMENT SIDE WIND HANDLE GRIP AND RETAINING CLIP (BE-050/550/1050)
BE-703	REPLACEMENT SIDE WIND HANDLE ASSY INCLUDING ARM, GRIP, CLIP, WASHER, & PIN

GREASE NIPPLE
ON ALL JACKS
(BE EXCLUSIVE)

WELD FLANGE JACKS



BE DIAMOND SERIES JACKS



PART#	DESCRIPTION	MAX LIFT	MAX LOAD (STATIC)	LIFT	A (HEIGHT)
BE-120	JACK, TOP WIND, A FRAME	2000 LBS	2600 LBS	13½"	
BE-130	JACK, SIDE WIND, A FRAME	2000 LBS	2600 LBS	13½"	
BE-140	JACK, TOP WIND, A FRAME	5000 LBS	6000 LBS	13½"	
FJ-020	JACK, TOP WIND, FLANGE STYLE	2000 LBS	2600 LBS	10"	11"
FJ-530	JACK, TOP WIND, FLANGE STYLE	2000 LBS	2600 LBS	15"	15"
FJ-540	JACK, SIDE WIND, FLANGE STYLE	2000 LBS	2600 LBS	15"	15"
FJ-02-20B	FLANGE KIT, FLANGE, PIN, SPRING & CLIPS				

REPLACEMENT PARTS

TJ-06-05	STEEL WHEEL ASSY WITH FORK FOR BE-120 (1000 LBS MAX)
TJ-06-02	WHEEL ASSY WITH FORK FOR BE-120 (1000 LBS MAX)
TJ-06-03	BASE WITH SNAP PIN FOR BE-120
XA-003-999	TOP WIND HANDLE ASSEMBLY (BE-120/FJ-020)
BE-702	REPLACEMENT SIDE WIND HANDLE GRIP AND RETAINING CLIP (BE-130/540)
BE-703	REPLACEMENT SIDE WIND HANDLE ASSY INCLUDES ARM, GRIP, CLIP, WASHER, & PIN

TRAILER JACKS WITH WHEELS



BE DIAMOND SERIES JACKS

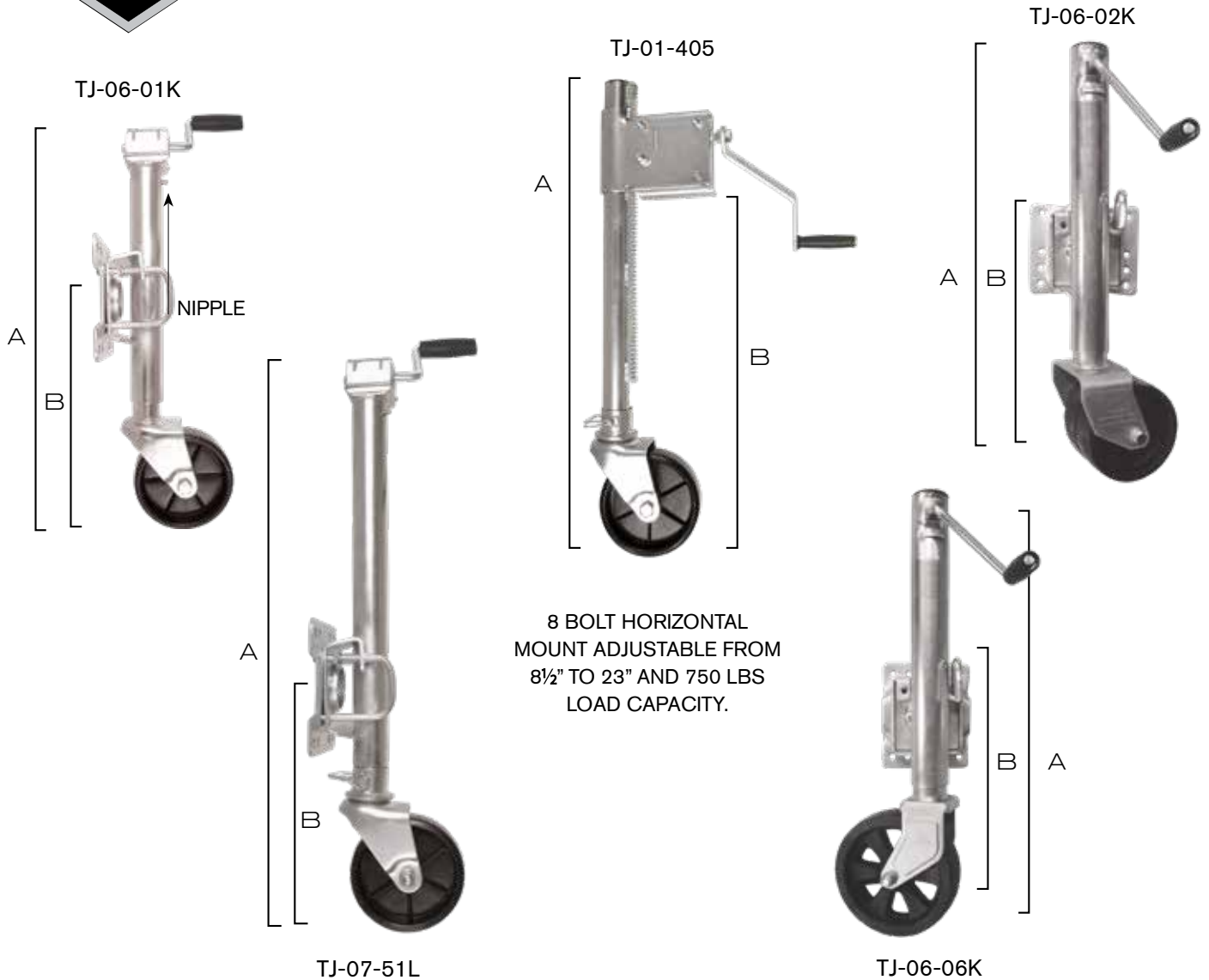

PART#	MAX LIFT	MAX LOAD (STATIC)	LIFT	A (RETRACTED HEIGHT)	B (RETRACTED MOUNT HEIGHT)
TJ-06-01K	1,000 LBS	1300 LBS	10"	24"	14"
TJ-06-02K	1,500LBS	1500 LBS	10"	26"	14"
TJ-06-06K	1,500LBS	1500 LBS	10"	28"	14"
TJ-01-405	750 LBS	1000 LBS	14"	29"	8½" - 23"
TJ-07-51L	1,000	1300 LBS	15"	30"	12½"

ADDITIONAL INFORMATION

TRAILER JACKS COME WITH WHEEL AND 4 POSITION MOUNTING BRACKET. WHEEL SIZE 6" X 2".

REPLACEMENT PARTS

TJ-06-04	6" POLY WHEEL, 1000 LBS MAX 2" WIDE
BE-702	REPLACEMENT SIDE WIND HANDLE GRIP AND RETAINING CLIP (BE-050/550)
BE-703	REPLACEMENT SIDE WIND HANDLE ASSY INCLUDES ARM, GRIP, CLIP, WASHER, AND PIN

TAILGATE JACKS



BE DIAMOND SERIES JACKS



BE-1020S



BE-1010S



BE-1520S

PART#	DESCRIPTION	MAX LIFT	LIFT	MAX LOAD (STATIC)
BE-1010S	TAILGATE JACK, SIDE WIND, NO BASE (REMOVABLE HANDLE)	2000 LBS	10"	2600
BE-1020S	JACK, SIDE WIND	2000 LBS	10"	2600
BE-1520S	JACK, SIDE WIND (NO MOUNTING TUBE)	2000 LBS	15"	2600

REPLACEMENT PARTS

BE-702	REPLACEMENT SIDE WIND HANDLE GRIP AND RETAINING CLIP (BE-BE-050/550)
BE-703	REPLACEMENT SIDE WIND HANDLE ASSY INCLUDES ARM, GRIP, CLIP, WASHER, AND PIN
BE-1011	REPLACEMENT SIDE WIND HANDLE FOR BE-1010S

ZINC PLATED JACKS



BE ZINC & SPECIALTY JACKS



PART#	DESCRIPTION	MAX LIFT	MAX LOAD (STATIC)	LIFT	A (HEIGHT)
BE-555	TOP WIND, ZINC FINISH	5000 LB	6000 LB	15"	15 1/2"
ST-2104	TOP WIND, ZINC FINISH	2000 LBS	2600 LBS	10"	11"
ST-2154	TOP WIND, ZINC FINISH	2000 LBS	2600 LBS	15"	16"
LT-5103	SIDE WIND, ZINC FINISH, EXTRA WIDE BASE	7000 LBS	8000 LBS	10"	11"
LT-5153	SIDE WIND, ZINC FINISH, EXTRA WIDE BASE	7000 LBS	8000 LBS	15"	16"
BE-5015	SIDE WIND, ZINC FINISH, FIXED MOUNT BOLT ON		5000LBS	15" TRAVEL	

REPLACEMENT PARTS

64.003.000	MOUNTING PIPE (LT-5103/5153)
64.002.000	MOUNTING PIPE (ST-2104/2154)
BE-702	REPLACEMENT SIDE WIND HANDLE GRIP AND RETAINING CLIP (BE-050/050)
BE-703	REPLACEMENT SIDE WIND HANDLE ASSY INCLUDES ARM, GRIP, CLIP, WASHER, AND PIN
XA-003-099	TOP WIND HANDLE ASSEMBLY
BE-025	REPLACEMENT PIN AND CHAIN

HEAVY DUTY JACKS



BE INDUSTRIAL JACKS



BE-500



BE-720



BE-700



HANDLE INCLUDED!

BE-1200

PART#	DESCRIPTION	MAX WEIGHT	LIFT
BE-500	JACK, 5000 LBS 15" SIDE WIND, SQUARE TUBING	5000 LBS	15" LIFT
BE-720	JACK, HD SQUARE TUBING, WITH TELESCOPING LEG, TOP WIND	7000 LBS	26" LIFT
BE-700	JACK, HD SQUARE TUBING, WITH TELESCOPING LEG, SIDE WIND	7000 LBS	26" LIFT
BE-1200	JACK, 12000 LBS W/ SPRING RETURN DROP LEG, 12.5" TRAVEL & 13.5" DROP LEG, INCLUDES HANDLE!	12,000 LBS	26" LIFT
BE-1200Z	JACK, ZINC PLATED, 1200LBS W/ 13.5" SPRING RETURN DROP LEG AND 12.5" TRAVEL, INCLUDES HANDLE!	12,000 LBS	26" LIFT

REPLACEMENT PARTS

BE-703	REPLACEMENT SIDE WIND HANDLE ASSY INCLUDES ARM, GRIP, CLIP, WASHER, AND PIN (BE-700)
BE-1201	REPLACEMENT HANDLE FOR BE-1200 & BE1200Z
BE-1202	RETAINING CLIP FOR BE1202
BE-704	REPLACEMENT TOP WIND HANDLE ASSY (BE-720)
BE-705	REPLACEMENT DROP LEG (BE-700, BE-720)

JACK ACCESSORIES



MOUNTING PIPES

PART#	FITS	A	B	C	D	SIZE
64.002.000	BE-020/520, LT-5103-5153	38 (1.5")	48 (1.89")	50.8 (2")	9/16"	SMALL
64.001.000	BE-701	50.8 (2")	65 (2.55")	63.5 (2.5")	9/16"	MEDIUM
64.001.058		50.8 (2")	65 (2.55")	63.5 (2.5")	5/8"	LARGE
64.003.000	BE-050/550, ST-2104/2154	63.5 (2.5")	65 (2.55")	76 (3")	9/16"	LARGE
64.003.058		63.5 (2.5")	65 (2.55")	76 (3")	5/8"	LARGE

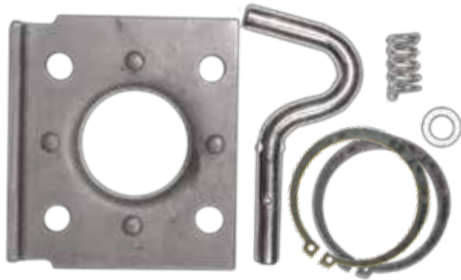

FLANGE KIT

PART#	FITS	DESCRIPTION
FJ-02-20B	FJ-020, FJ-530/540	FLANGE KIT, INCLD. FLANGE, PIN, SPRINGS & CLIP



HAND WINCHES

PART#	DESCRIPTION
64.500.253	HAND WINCH 1400 LB CAPACITY
64.500.254	HAND WINCH 2000 LB CAPACITY



TJ-06-04



TJ-06-08



TJ-06-02



TJ-07-02

WHEELS

PART#	FITS	DESCRIPTION
TJ-06-04	TJ-06-01K, TJ-01-405, TJ-07-51L	REPLACEMENT TRAILER JACK WHEEL
TJ-06-08	TJ-06-06K	REPLACEMENT POLY WHEEL

WHEEL ASSEMBLIES

PART#	FITS	DESCRIPTION
TJ-06-02	BE-120	WHEEL ASSY WITH FORK, 1000LBS MAX
TJ-06-05	BE-120	STEEL WHEEL ASSY WITH FORK, 1000LBS MAX
TJ-07-02	TJ-07-51L	REPLACEMENT WHEEL ASSY

JACK ACCESSORIES

WIND HANDLES

PART#	FITS	DESCRIPTION
XA-003-099	BE-020/520, BE-555, ST-2104/2154	TOP WIND HANDLE ASSY
BE-704	BE-702	TOP WIND HANDLE ASSY
BE-702	BE-050/550, TJ-06-01K, TJ-01-405,	REPLACEMENT SIDE WIND HANDLE GRIP & RETAINING CLIP
BE-703	TJ-07-51L, BE-1010S, BE-1020S, BE-1520S	REPLACEMENT SIDE WIND HANDLE ASSY INCLUDES ARM, GRIP, CLIP, WASHER & PIN
BE-1201	BE-1200/BE-1200Z	REPLACEMENT HANDLE

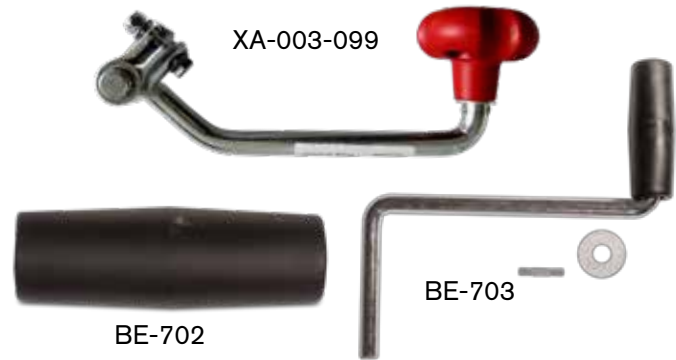

WELD-ON JACK COLLAR

PART#	A	B	C	D
BE-701	63.5 (2.5")	50.8 (2")	63.5 (2.5")	114.3 (4.5")

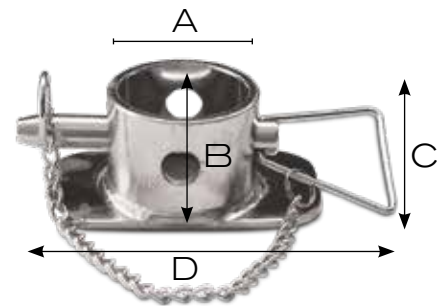

BASE WITH SNAP PIN

PART#	FITS	DESCRIPTION
TJ-06-03	BE-120	BASE WITH SNAP PIN



REPLACEMENT DROP LEG

PART#	FITS	DESCRIPTION
BE-705	BE-700/720	REPLACEMENT DROP LEG



REPLACEMENT PIN AND CHAIN

PART#	
BE-027	5/8" X 3.5"
BE-025-CA-1	9/16" X 3.5"

TRAILER COUPLERS & HITCH BALLS



TRAILER COUPLERS

PART#	DESCRIPTION	CHANNEL SIZE	BALL SIZE	MAX LOAD
64.500.003	COUPLER, ZINC FINISH	2" CHANNEL	1 7/8" BALL	3500 LBS
64.500.004	COUPLER, ZINC FINISH	2" CHANNEL	2" BALL	3500 LBS
64.500.005	COUPLER, ZINC FINISH	2.5" CHANNEL	2" BALL	3500 LBS
64.500.006	COUPLER, ZINC FINISH	3" CHANNEL	2" BALL	3500 LBS
64.500.007	COUPLER, ZINC FINISH	2.5" CHANNEL	1 7/8" BALL	3500 LBS
64.500.008	COUPLER, ZINC FINISH	3" CHANNEL	1 7/8" BALL	3500 LBS



64.800.726



64.819.117

A-FRAME COUPLERS

PART#	DESCRIPTION	BALL SIZE	MAX LOAD	GROSS WEIGHT	MAX TONGUE WEIGHT	NOTE
64.800.726	A-FRAME COUPLER	2" BALL	5000 LBS	5000 LBS	700 LBS	SAE CLASS III
64.819.117	A-FRAME COUPLER	2 5/16" BALL	5000 LBS	10,000 LBS	1500 LBS	SAE/CSA CLASS IV

TRAILER BALLS

PART#	DESCRIPTION	WEIGHT	BALL SIZE	THREAD SIZE
64.500.345	TRAILER BALL	3,500 LBS	1-7/8"	1" EXTERNAL THREAD
64.500.346	TRAILER BALL	2,000 LBS	1-7/8"	3/4" INTERNAL THREAD
64.500.347	TRAILER BALL	3,500 LBS	2"	3/4" INT THREAD
64.500.348	TRAILER BALL	2,000 LBS	1-7/8"	3/4" EXT THREAD
64.500.349	TRAILER BALL	3,500 LBS	2"	3/4" EXT THREAD
64.500.350	TRAILER BALL	5,000 LBS	2"	1" EXT THREAD
64.500.351	TRAILER BALL	6,000 LBS	2-5/16"	1" EXT THREAD
64.500.352	TRAILER BALL	7,500 LBS	2-5/16"	1-1/4" EXT THREAD
64.500.353	TRAILER BALL HD	10,000 LBS	2-5/16"	1-1/4" EXT THREAD
64.500.354	TRAILER BALL HD	12,000 LBS	2-5/16"	1-1/4" EXT THREAD
64.500.355	TRAILER BALL	2,000 LBS	1-7/8"	3/4" EXT THREAD - LONG
64.500.356	TRAILER BALL	3,500 LBS	2"	3/4" EXT THREAD - LONG
64.500.357	TRAILER BALL	5,000 LBS	2"	1" EXT THREAD - LONG
64.500.358	TRAILER BALL	8,000 LBS	2"	1-1/4" EXT THREAD



TRAILER BALL MOUNTS



64.500.320



64.500.321

64.500.323



64.500.330



64.500.325



64.500.326



64.500.332

PART#	DESCRIPTION
64.500.320	MOUNT, CLASS 4, 2" DROP, 1" HOLE
64.500.321	MOUNT, CLASS 4, 4" DROP, 1" HOLE
64.500.323	MOUNT, CLASS 3, 1" HOLE STRAIGHT
64.500.325	HD TRIPLE TYPE MOUNT
64.500.326	HD TRIPLE TYPE MOUNT CHROME PLATED BALLS
64.500.330	CLEVIS TYPE MOUNT
64.500.332	MOUNT, CLASS 4, 6" DROP, 1" HOLE

SAFETY CHAINS, TRAILER PINS & TOW LIGHTS

SAFETY CHAINS

PART#	DESCRIPTION	SIZE
64.325.024	G43 LIGHT DUTY SAFETY CHAIN WITH OPEN S-HOOK (FOR SMALL TRAILERS)	24"
64.303.516	G43 5/16" PLATED CHAIN G43 5/16" SLIP HOOK WITH SAFETY LATCH	36"
64.303.038	G43 3/8" PLATED CHAIN G43 3/8" SLIP HOOK WITH SAFETY LATCH	36"

G70 SAFETY ASSEMBLIES AVAILABLE UPON REQUEST.



BENT TRAILER HITCH PINS

PART#	SPEECO#	A: USEABLE LENGTH	B: PIN DIA.
720HP	P71111	3"	1/2"
722HP	P71112	3"	5/8"
721HP	P71113	3 1/2"	3/4"
720HPS	P71120	2 1/2"	1/2"
720HPXL	P71123	5"	1/2"
721HPXL	P71129	4 1/2"	3/4"
722HPEL	P71126	4"	5/8"
722HPL		3 1/2"	5/8"
722HPXL	P71127	5"	5/8"
723HP	P71118	3"	3/8"
725HP	P71115	3"	5/16"

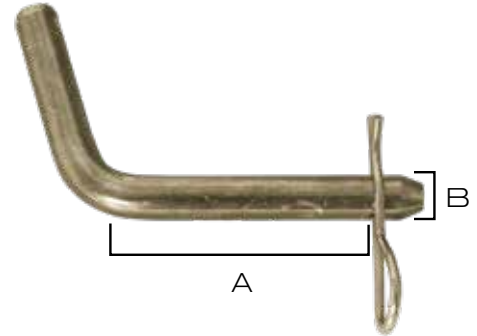

ROAD READY TOW LIGHTS

PART#	DESCRIPTION
64.500.002	UNIVERSAL MAGNETIC TOW LIGHTS

FEATURES

- MAGNETIC BASE W/ SCRATCH RESISTANT BOTTOMS
- 4 PIN CONNECTIONS
- UP TO 80" WIDE
- 30 FT CORD



COMMERCIAL GRADE LED TOWING LIGHTS

PART#	DESCRIPTION
LTHD1230	12V COMMERCIAL GRADE LED TOWING LIGHT KIT

FEATURES

- CARRYING CASE INCLUDED
- 30FT WIRING HARNESS INCLUDED
- 7FT SPAN BETWEEN TWO LIGHTS
- 60LB ROUND PULL MAGNETS



LED TOWING LIGHT KIT

PART#	DESCRIPTION
LT1230	12V LED TOWING LIGHT KIT

FEATURES

- 24 LEDS (12 ON EACH SIDE)
- 30 FT WIRING HARNESS INCLUDED
- MAGNETIC BASE
- 100,000 HOURS LIFE TIME



SUBMERSIBLE LED TRAILER LIGHT KIT

PART#	DESCRIPTION
LST1222	12V SUBMERSIBLE LED TRAILER LIGHT KIT

FEATURES

- MOUNTING HARDWARE
- LICENSE PLATE BRACKET
- 22FT WIRING HARNESS INCLUDED
- FOR TRAILERS UP TO 80" WIDE



VEHICLE SAFETY SIGNS & RATCHET TIE DOWNS



67.003.020



67.003.010



67.003.030



67.003.040

SLOW MOVING VEHICLE SIGNS

PART#	DESCRIPTION
67.003.010	0.04" THICK ALUMINUM, S276.6, 14" H X 16" W
67.003.020	0.80" THICK PLASTIC, S276.6, 14" H X 16" W
67.003.030	SMV EMBLEM DECAL, S276.6
67.003.040	HARDWARE KIT (MOUNTING HARDWARE FOR ALUMINUM & PLASTIC)

FEATURES

- SMV EMBLEMS REQUIRED FOR SLOW MOVING VEHICLES ON PUBLIC ROADS
- IDEAL FOR TRACTORS, COMBINES, FLOWS, MOVING CREWS, TOW MOTORS & OTHER VEHICLES
- ASAE (S276.6) APPROVED AND STATE OF ILLINOIS COMPLIANT
- MADE W/ HIGH INTENSITY, MICRO-PRISMATIC REFLECTIVE & FLUORESCENT MATERIALS
- HARDWARE KIT AVAILABLE FOR MOUNTING SIGNS ON YOUR VEHICLE

RATCHET TIE DOWNS



64.720.060



64.700.001



64.700.002



64.700.005



64.730.001



64.700.006



64.720.001



64.700.050



64.720.050



64.710.002



64.795.001



64.795.002



64.710.003

PART#	SIZE	SWLL	MAX LOAD	COLOR	DESCRIPTION
64.700.001	1"X15'	400LB	1200LB	BLUE	RATCHET STRAP, VINYL COATED STEEL HOOKS
64.700.002	1"X15'	400LB	1200LB	RED	RATCHET STRAP, VINYL COATED STEEL HOOKS
64.700.005	1"X15'	650LB	2000LB	BLACK	RATCHET STRAP, VINYL COATED STEEL HOOKS
64.700.006	1"X15'	650LB	2000LB	CAMO	RATCHET STRAP, VINYL COATED STEEL HOOKS
64.700.050	1"X15'	400LB	1200LB	BLACK	RATCHET STRAP, MEDIUM DUTY IN FOUR PACK BLISTER
64.720.001	1"X10'	400LB	1200LB	RED	CAM STRAP, VINYL COATED HEAT TREATED STEEL HOOKS, DIE CAST CAMBUCKLE
64.720.050	1"X6'	400LB	1200LB	RED	CAM STRAP, FOUR PACK BLISTER
64.720.060	1"X10'1"X15'	400LB	1200LB	BLACK	CAM & RATCHET STRAP COMBO, FOUR PACK BLISTER
64.730.001	1"X15'	650LB	2000LB	RED	RATCHET STRAP, SOFT GRIP WITH DOUBLE J-HOOKS
64.795.001	1/4"	150LB	N/A	BLACK	RATCHET ROPE TIE DOWN
64.795.002	3/8"	250LB	N/A	BLACK	RACHET ROPE TIE DOWN
64.710.002	1"X15'	1000LB	3000LB	YELLOW	RATCHET STRAP WITH DOUBLE J-HOOKS
64.710.003	2"X15'	1250LB	4000LB	YELLOW	RATCHET STRAP WITH J-HOOKS

RATCHET STRAPS

HD RATCHET STRAP WITH JJ HOOKS



64.703.000

HD RATCHET STRAP WITH FLAT HOOK



64.703.100

PATENTED STEP-RELEASE MECHANISM FOR CONTROLLED RELEASE WHEN EXCESSIVE LOAD HAS BEEN APPLIED DURING LOAD SHIFT

RATCHET STRAP WITH J HOOK 2 PACK



64.703.400

BUILT-IN HOOK LOOPS ADD AN ADDITIONAL ANCHOR POINT WHEN HOOKS CANNOT BE USED DUE TO LARGER DIAMETER TUBING

HD RATCHET STRAP WITH JJ HOOKS



64.703.200

RATCHET STRAP WITH J HOOK



64.703.300

RATCHET STRAP WITH JJ HOOKS



64.703.500

RATCHET STRAPS

PART#	SIZE	WORK LOAD	COLOR	DESCRIPTION
64.703.000	2"X27'	3,300 LB	BLACK	HD RATCHET STRAP WITH JJ HOOKS, CONTROLLED RELEASE
64.703.100	2"X27'	3,300 LB	BLACK	HD RATCHET STRAP WITH FLAT HOOK, CONTROLLED RELEASE
64.703.200	2"X40'	3,300 LB	BLACK	HD RATCHET STRAP W/ JJ HOOKS
64.703.300	1"X16'	500 LB	BLACK	RATCHET STRAP WITH J HOOK
64.703.400	1"X6'	600 LB	BLACK	RATCHET STRAP WITH J HOOK, BUILT IN HOOK LOOPS, 2 PACK
64.703.500	1 1/4"X16'	830 LB	BLACK	RATCHET STRAP WITH JJ HOOKS
64.703.600	1 1/2"X16'	1,665 LB	BLACK	RATCHET STRAP WITH JJ HOOKS

RATCHET STRAP WITH JJ HOOKS



64.703.600

RECOVERY STRAPS AND LIFT SLINGS

RECOVERY STRAPS

PART#	SIZE	MAX LOAD	COLOR	DESCRIPTION
64.151.520	2"X20'	15,000 LB	YELLOW	RECOVERY STRAP WITH LOOPS
64.152.020	2"X20'	20,000 LB	YELLOW	RECOVERY STRAP WITH LOOPS
64.152.030	2"X30'	15,000 LB	YELLOW	RECOVERY STRAP WITH LOOPS
64.006.502	3"X20'	27,000 LB	YELLOW	HD RECOVERY STRAP WITH LOOPS
64.156.030	6"X30'	54,000 LB	YELLOW	HD RECOVERY STRAP WITH LOOPS
64.006.602	3"X30'	27,000 LB	YELLOW	HD RECOVERY STRAP WITH LOOPS
64.153.630	4"X30'	36,000 LB	YELLOW	HD RECOVERY STRAP WITH LOOPS
64.153.620	4"X20'	36,000 LB	YELLOW	RECOVERY STRAP EYE TO EYE
64.156.620	6"X20'	54,000 LB	YELLOW	RECOVERY STRAP EYE TO EYE
64.161.250	6"X50'	120,000 LB	ORANGE	RECOVERY STRAP W/ MASTERLINK
64.161.650	8"X50'	160,000 LB	ORANGE	RECOVERY STRAP W/ MASTERLINK
64.162.050	10"X50'	200,000 LB	ORANGE	RECOVERY STRAP W/ MASTERLINK
64.162.450	12"X50'	240,000 LB	ORANGE	RECOVERY STRAP W/ MASTERLINK

SMALL EYE TO EYE RECOVERY STRAP



64.153.620

2" X 20' RECOVERY STRAP WITH LOOPS



64.151.520

RECOVERY STRAP WITH MASTERLINK



64.161.250

3" X 20' HD RECOVERY STRAP WITH LOOPS



64.006.502

2" X 6' 2 PLY LIFT SLING



64.156.206

LIFT SLINGS

PART#	SIZE	SWLL	COLOR	DESCRIPTION
64.156.206	2"X6'	6,200 LB	YELLOW	LIFT SLING, 2 PLY
64.156.208	2"X8'	6,200 LB	YELLOW	LIFT SLING, 2 PLY
64.156.210	2"X10'	6,200 LB	YELLOW	LIFT SLING, 2 PLY

TARP STRAPS, TRUCK TIE DOWNS & WINCHES

TARP STRAPS & S HOOKS

PART#	SIZE	DESCRIPTION
64.701.500	15"	TARP STRAP WITH S HOOKS
64.702.100	21"	TARP STRAP WITH S HOOKS
64.702.400	24"	TARP STRAP WITH S HOOKS, ADJUSTABLE LENGTH
64.713.100	31"	TARP STRAP WITH S HOOKS, ADJUSTABLE LENGTH
64.714.100	41"	TARP STRAP WITH S HOOKS
64.700.900	9"	TARP STRAP WITH S HOOKS
64.710.040	5MM	REPLACEMENT S HOOKS

15" TARP STRAP WITH S HOOKS



64.701.500

24" ADJUSTABLE TARP STRAP WITH S HOOKS



64.702.400

REPLACEMENT STRAP WITH JJ HOOKS



64.320.881

REPLACEMENT STRAP WITH FLAT HOOK



64.705.344

REPLACEMENT STRAP WITH JJ HOOKS



64.705.354

REPLACEMENT S HOOKS, 5MM



64.710.040

TRUCK TIE DOWN WITH DELTA RING



64.704.603

TRUCK TIE DOWN WITH FLAT HOOK



64.703.603

STANDARD WINCH BAR



64.705.304

4" STANDARD WELD ON WINCH



64.705.314

TRUCK TIE DOWNS & WINCHES

PART#	SIZE	COLOR	DESCRIPTION
64.320.881	4"X25'	YELLOW	REPLACEMENT STRAP WITH JJ HOOKS
64.705.344	2"X30'	YELLOW	REPLACEMENT STRAP WITH FLAT HOOKS
64.705.354	2"X30'	YELLOW	REPLACEMENT STRAP WITH JJ HOOKS
64.704.603	4"X30'	YELLOW	TRUCK TIE DOWN WITH DELTA RING
64.703.603	4"X30'	YELLOW	TRUCK TIE DOWN WITH FLAT HOOK
64.705.324	4"	BLACK	PORTABLE BOLT ON 4" WINCH
64.705.314	4"	BLACK	STANDARD WELD ON 4" WINCH
64.705.304		BLACK	STANDARD WINCH BAR

4" PORTABLE BOLT ON WINCH



64.705.324

BE COMPLETE TRAILER TOW KIT



1x
STRAIGHT
CLEVIS
Part# 64.300.058

- Body Diameter: 5/8"
- Clevis Opening: 7/8"
- Usable Length: 3-1/4"
- Pin Diameter: 1/2"
- Working Load Limit: 6000LB



2x
G70 CHAIN
ASSEMBLY
Part# 64.016.516

- 5/16"
- 16'
- Grade 70
- Transport Grade
- Gold Zinc Plated
- With Hooks



2x
D-Ring
Part# 64.000.888

- D-Ring
- Comes with forged pin



1x **1x**
31" TARP 24" TARP
STRAP STRAP
Part# 64.702.400
Part# 64.713.100

- Tarp Strap with S Hooks
- Synthetic EPDM Rubber
- Resistant to heat, ozone, sunlight and corrosives
- Adjustable Length



2x
LOAD
BINDER
Part# 64.100.002

- 5/16" - 3/8"
- Forged
- Fits 5/16" to 3/8" Chain
- Red Powder Coated



2x
27' x 2" HD
RATCHET TIE DOWN
Part# 64.703.000

- Flat Hooks, Bar Handle
- Break strength 10,000 lbs
- Work load 3,300 lbs
- Thermo-plastic rubber handles
- Weather & corrosion-resistant hardware
- Cut & abrasion-resistant webbing is woven from high tensile strength polyester



15 CHAIN HARDWARE

BRABER EQUIPMENT

40TH
EDITION

PARTS CATALOG

HD CHAIN DISPLAY

BULK CHAIN IN BUCKETS

PART#	CHAIN	WIDTH	LENGTH
64.263.190	G30	3/16" (5.5MM)	190FT
64.214.110	G30	1/4" (7.0MM)	110FT
64.251.670	G30	5/16" (8.0MM)	70FT
64.238.050	G30	3/8" (10.0MM)	50FT
67.914.110	G30	1/4" (7.0MM)	110FT
64.951.670	G30	5/16" (8.0MM)	70FT
64.938.050	G30	3/8" (10.0M)	50FT
64.114.110	G30	1/4" (7.0MM)	110FT
64.151.670	G30	5/16" (8.0MM)	70FT
64.138.050	G30	3/8" (10.0MM)	50FT

35 KG BUCKETS



ALL MEASUREMENTS ARE IN MILLIMETERS UNLESS OTHERWISE STATED (1" = 25.4 MM).
THESE ITEMS ARE NOT ORIGINAL EQUIPMENT PARTS.

BULK CHAIN



- ZINC PLATED
ELECTRO GALVANIZED
- SHORT LOOP STYLE

PART#	CHAIN	WORKING LBS (WLL)	WIDTH	LENGTH	BUCKET
64.200.018	G30 (SYSTEM 3)	375	1/8" (4MM)	400FT	P4
64.200.316	G30 (SYSTEM 3)	750	3/16" (5.5MM)	190FT	P4
64.200.025	G30 (SYSTEM 3)	1,250	1/4" (7.0MM)	400FT	P14
64.200.516	G30 (SYSTEM 3)	1,900	5/16" (8.0MM)	550FT	P15
64.200.038	G30 (SYSTEM 3)	2,650	3/8" (10.00MM)	400FT	P15
64.200.050	G30 (SYSTEM 3)	4,500	1/2" (13.5MM)	400FT	P16
64.300.025	G43 (SYSTEM 4)	2,600	1/4" (7.0MM)	400FT	P14
64.300.516	G43 (SYSTEM 4)	3,250	5/16" (8.0MM)	275FT	P14
64.300.038	G43 (SYSTEM 4)	5,400	3/8" (10.00MM)	200FT	P14
64.300.050	G43 (SYSTEM 4)	9,200	1/2" (13.5MM)	100FT	P14
64.100.025	G70 (SYSTEM 7)	3,150	1/4" (7.0MM)	164FT	P14
64.100.516	G70 (SYSTEM 7)	4,700	5/16" (8.0MM)	164FT	P14
64.100.038	G70 (SYSTEM 7)	6,600	3/8" (10.0MM)	200FT	P14
64.100.050	G70 (SYSTEM 7)	11,300	1/2" (13.5MM)	200FT	P15

HOT DIPPED GALVANIZED CHAIN

P15 DRUM
250 KGS



PART#	CHAIN	WIDTH	LENGTH
64.900.316	G30	3/16" (5.5MM)	750FT
64.900.025	G30	1/4" (7.0MM)	800FT
64.900.516	G30	5/16" (8.0MM)	550FT
64.900.038	G30	3/8" (10.0MM)	400FT
64.900.050	G30	1/2" (13.5MM)	200FT

P14 DRUM
125 KGS



P4 BUCKET
35 KGS



CHAIN ASSEMBLIES & LOAD BINDERS



G70 CHAIN ASSEMBLIES

PART#	CHAIN	WORKING LBS.	SIZE
64.016.516	G70	4,700	5/16" X 16 FT WITH HOOKS
64.016.038	G70	6,600	3/8" X 16 FT WITH HOOKS
64.020.516	G70	4,700	5/16" X 20 FT WITH HOOKS
64.020.038	G70	6,600	3/8" X 20 FT WITH HOOKS
64.025.038	G70	6,600	3/8" X 25 FT WITH HOOKS
64.020.005	G70	11,300	1/2" X 20 FT WITH HOOKS

▪ SYSTEM 7 TRANSPORT GRADE (G70)



AGRICULTURAL SAFETY CHAIN

PART#	CHAIN	WORKING LBS.	DESCRIPTION
64.358.014	G70	10,000	CHAIN, SFTY 58" WITH HOOK 1/4"
64.367.516	G70	16,100	CHAIN, SFTY 67" WITH HOOK 5/16"
64.362.038	G70	20,000	CHAIN, SFTY 62" WITH HOOK 3/8"
64.362.012	G70	40,000	CHAIN, SFTY 62" WITH HOOK 1/2"



LOAD BINDERS

PART#	HOOK	SIZE	WLL	MBS
64.100.000	G70 FORGED	FORGED 3/16" - 1/4"	250 LBS	800 LBS
64.100.001	G70 RATED	FORGED 1/4" - 5/16"	2,600 LBS	7,800 LBS
64.100.002	G70 RATED	FORGED 5/16" - 3/8"	5,400 LBS	19,000 LBS
64.101.002	INDIRECT LOAD BINDER		5,400 LBS	19,000 LBS
64.100.003	G70 RATED	FORGED 3/8" - 1/2"	9,200 LBS	28,000 LBS



RATCHET LOAD BINDERS

PART#	SIZE	WLL	MBS
64.199.002	FORGED 5/16" - 3/8"	5,400 LBS	19,000 LBS
64.199.003	FORGED 3/8" - 1/2"	12,000 LBS	33,000 LBS

CLEVISSES & SHACKLES

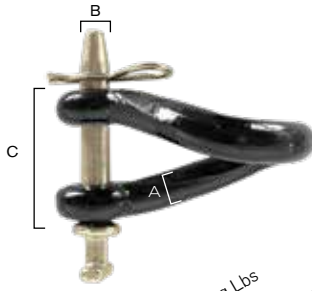

TWISTED CLEVIS

PART#	SPECO#	LBS	A	B	C
64.200.058	CL490203	6,000	5/8"	1/2"	2 1/4"
64.200.075	CL490204	12,000	3/4"	5/8"	3"
64.200.078	CL490206	16,000	7/8"	3/4"	3 1/4"
64.201.078		16,000	7/8"	3/4"	3"
64.201.516	CL490207	20,000	15/16"	7/8"	3 3/4"
64.200.001	CL490208	25,000	1"	1"	4 1/4"

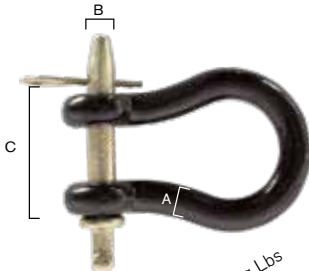

STRAIGHT CLEVIS

PART#	SPECO#	LBS	A	B	C
64.300.058	CL490103	6,000	5/8"	1/2"	2 1/4"
64.300.075	CL490104	12,000	3/4"	5/8"	3"
64.300.078	CL490106	16,000	7/8"	3/4"	3 1/4"
64.301.078		16,000	7/8"	3/4"	4 1/4"
64.301.516	CL490107	20,000	15/16"	7/8"	3 3/4"
64.300.001	CL490108	25,000	1"	1"	4 1/4"
64.300.114		28,000	1 1/4"	1 3/8"	4 1/2"

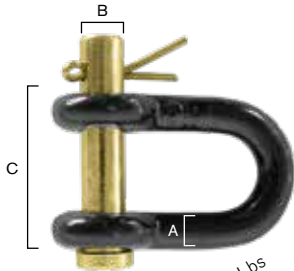

UTILITY CLEVIS

PART#	SPECO#	LBS	A	B	C
64.401.025		1,000	1/4"	15/16"	7/8"
64.400.516		1,500	15/16"	3/8"	1"
64.400.038	CL490303	2,000	3/8"	7/16"	1 1/4"
64.400.716	CL490304	3,000	7/16"	1/2"	1 1/2"
64.401.050		6,000	1/2"	5/8"	1 11/16"
64.400.058	CL490306	9,000	5/8"	3/4"	2"



SHACKLE ANCHORS

PART#	SIZE
64.400.020	1/4"
64.400.021	5/16"
64.400.022	3/8"
64.400.024	1/2"
64.400.025	5/8"
64.400.026	3/4"
64.400.027	7/8"
64.400.028	1"

NOTE: COMES WITH GALVANIZED SCREW



COMMERCIAL SHACKLE ANCHORS

PART#	SIZE
64.398.020	1/4"
64.398.021	5/16"
64.398.022	3/8"
64.398.023	7/16"
64.398.024	1/2"
64.398.025	5/8"



CHAIN SHACKLES

PART#	SIZE
64.400.001	1/4"
64.400.002	5/16"
64.400.003	3/8"
64.400.004	7/16"
64.400.005	1/2"

NOTE: COMES WITH GALVANIZED SCREW

CHAIN HOOKS



GRAB HOOKS

PART#	CHAIN	SIZE
64.000.009	G43	1/4" HOOK
64.000.010	G43	5/16" HOOK
64.000.011	G43	3/8" HOOK
64.100.009	G70	1/4" HOOK
64.100.010	G70	5/16" HOOK
64.100.011	G70	3/8" HOOK
64.100.014	G70	1/2" HOOK



SLIP HOOKS

PART#	CHAIN	SIZE
64.100.006	G70	1/4" HOOK
64.100.007	G70	5/16" HOOK
64.100.008	G70	3/8" HOOK
64.100.013	G70	1/2" HOOK



GRAB HOOKS WITH SAFETY LOCKS

PART#	CHAIN	SIZE
64.311.009	G43	1/4" HOOK
64.311.010	G43	5/16" HOOK
64.311.011	G43	3/8" HOOK
64.111.009	G70	1/4" HOOK
64.111.010	G70	5/16" HOOK
64.111.011	G70	3/8" HOOK
64.111.012	G70	1/2" HOOK



SLIP HOOKS WITH SAFETY LOCKS

PART#	CHAIN	SIZE
64.310.006	G43	1/4" HOOK
64.310.007	G43	5/16" HOOK
64.310.008	G43	3/8" HOOK
64.110.006	G70	1/4" HOOK
64.110.007	G70	5/16" HOOK
64.110.008	G70	3/8" HOOK
64.110.009	G70	1/2" HOOK



EYE SLIP HOOKS

PART#	DESCRIPTION	SIZE
64.600.006	EYE SLIP CARBON ZP	1/4" HOOK
64.600.007	EYE SLIP CARBON ZP	5/16" HOOK
64.600.008	EYE SLIP CARBON ZP	3/8" HOOK



EYE GRAB HOOKS

PART#	DESCRIPTION	SIZE
64.611.006	EYE GRAB CARBON ZP	1/4" HOOK
64.611.007	EYE GRAB CARBON ZP	5/16" HOOK
64.611.008	EYE GRAB CARBON ZP	3/8" HOOK

CHAIN HOOKS & CONNECTORS



CLEVIS SLIP HOOKS

PART#	CHAIN	SIZE
64.307.006	G43	1/4" HOOK
64.307.007	G43	5/16" HOOK
64.307.008	G43	3/8" HOOK



LANYARD/WINCH HOOKS

PART#	DESCRIPTION	SIZE
64.612.136	HOOK, SAFETY WINCH	1/4" HOOK
64.612.137	LANYARD SNAP, SINGLE	3/4" HOOK
64.612.138	LANYARD SNAP, DOUBLE	1" HOOK



WELD-ON BUCKET HOOK

PART#	CHAIN
64.500.516	5/16"
64.500.038	3/8"
64.500.076	7/16"
64.500.012	1/2"



HOOK EYES & LATCHES

PART#	CAPACITY	SIZE
64.600.010	3/4 TON	
64.600.011	1 TON	5/16" HOOK
64.600.012	1 1/2 TON	3/8" HOOK
64.600.014	3 TON	1/2" HOOK



CHAIN CONNECTORS

PART#	CHAIN	SIZE
64.777.516	G43	1/4"-5/16" PLATED
64.777.003	G43	3/8" PLATED
64.777.038	G70	3/8" PLATED
64.777.050	G70	1/2" PLATED
64.000.003	G70	3/8" BLACK
64.000.004	G70	1/4" - 5/16" BLACK
64.000.005	G70	7/16" - 1/2" BLACK



DRAW BAR HOOK

PART#	WORKING LOAD LIMIT (LBS)
64.038.002	9,500 LBS

CLIPS, PINS & LINKS



SPRING CLIPS

PART#	SIZE	FINISH
65.500.071	3/16" X 2"	ZINC PLATED
65.500.072	1/4" X 2 2/8"	ZINC PLATED
65.500.074	5/16" X 3 3/8"	ZINC PLATED
65.500.075	3/4" X 4"	ZINC PLATED

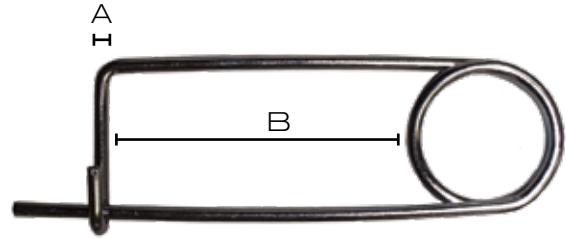

INDUSTRIAL SAFETY PIN

PART#	A	B
68.100.001	1/8"	3 1/8"
68.100.002	3/16"	3 3/8"
68.100.003	1/4"	5 1/4"



QUICK LINKS

PART#	SIZE	FINISH
64.600.030	1/8"	BRIGHT ZINC
64.600.031	3/16"	BRIGHT ZINC
64.600.032	1/4"	BRIGHT ZINC
64.600.033	5/16"	BRIGHT ZINC
64.600.034	3/8"	BRIGHT ZINC
64.600.035	7/16"	BRIGHT ZINC
64.600.036	1/2"	BRIGHT ZINC



QUICK RELEASE PINS

PART#	SIZE	
65.500.001	1/4" X 1"	5PCS
65.500.002	1/4" X 1 1/2"	5PCS
65.500.003	1/4" X 2"	5PCS
65.500.004	1/4" X 2 1/2"	5PCS
65.500.005	1/4" X 3"	5PCS
65.500.006	5/16" X 1"	5PCS
65.500.007	5/16" X 1 1/2"	5PCS
65.500.008	5/16" X 2"	5PCS
65.500.009	5/16" X 2 1/2"	5PCS
65.500.010	5/16" X 3"	5PCS
65.500.011	3/8" X 1"	5 PCS
65.500.013	3/8" X 2"	5 PCS
65.500.015	3/8" X 3"	5 PCS



LINK LAP

PART#	SIZE	FINISH
64.600.000	1/8"	BRIGHT ZINC
64.600.002	1/4"	BRIGHT ZINC
64.600.003	5/16"	BRIGHT ZINC
64.600.004	2/8"	BRIGHT ZINC



DOUBLE CHAIN SWIVEL

PART#	SIZE
64.400.444	1/4"



68.500.001



68.500.030



68.500.061



68.500.011



68.500.040



68.500.071



68.500.020



68.500.050



68.500.081

SNAPS

PART#	DESCRIPTION
68.500.001	ROUND SWIVEL SNAP 3/8", 14 KG WLL; MALLEABLE; NICKEL PLATED
68.500.002	ROUND SWIVEL SNAP 1/2", 16 KG WLL; MALLEABLE; NICKEL PLATED
68.500.003	ROUND SWIVEL SNAP 5/8", 16 KG WLL; MALLEABLE; NICKEL PLATED
68.500.004	ROUND SWIVEL SNAP 3/4", 24 KG WLL; MALLEABLE; NICKEL PLATED
68.500.011	1" SQUARE SWIVEL SNAP, 16 KG WLL; MALLEABLE
68.500.020	3 1/2" OPEN EYE SNAP, 30 KG WLL; MALLEABLE
68.500.030	3 1/2" DOUBLE BOLT SNAP, 19 KG WLL; MALLEABLE
68.500.040	5/8" SOLID SNAP, 16 KG WLL; MALLEABLE
68.500.050	SCISSOR SNAP ROUND SWIVEL 1/2", 18 KG WLL; MALLEABLE
68.500.051	SCISSOR SNAP ROUND SWIVEL 5/8", 20 KG WLL; MALLEABLE
68.500.061	PANIC SNAP FIXED EYE 1/2", 24 KG WLL; MALLEABLE
68.500.062	PANIC SNAP SWIVEL EYE 3/4", 24 KG WLL; MALLEABLE
68.500.071	1" SECURITY SNAP, 27 KG WLL; MALLEABLE
68.500.081	3/4" SWIVEL EYE LEVER SNAP, 24 KG WLL; NICKEL PLATED
68.500.090	2 7/8" ROPE SNAP, STEEL
68.500.100	3/8" X 2 1/2" SPRING SNAP, ALLOY STEEL
68.500.200	3/8" X 2 1/2" BABY SPRING SNAP



68.500.090



68.500.100



68.500.200

EYEBOLTS, KEYSTOCKS & HOOKS



LAG SCREW EYEBOLTS

PART#	DESCRIPTION
68.300.001	1/4" X 3 3/4", ZINC PLATED; WITH LABEL
68.300.002	1/4" X 5", ZINC PLATED; WITH LABEL
68.300.003	5/16" X 4", ZINC PLATED; WITH LABEL
68.300.004	5/16" X 6", ZINC PLATED; WITH LABEL
68.300.005	3/8" X 4 1/2", ZINC PLATED; WITH LABEL
68.300.006	3/8" X 8", ZINC PLATED; WITH LABEL



S-HOOKS

PART#	DESCRIPTION
65.600.001	S-HOOK, 1/8", WLL 10 KG
65.600.002	S-HOOK, 5/32", WLL 16 KG
65.600.003	S-HOOK, 3/16", WLL 25 KG
65.600.004	S-HOOK, 1/4", WLL 35 KG
65.600.005	S-HOOK, 5/16", WLL 58 KG



ROPE HOOK

PART#	DESCRIPTION
68.114.010	3/8" X 3 1/2" ROPE HOOK



WIRE FORMED EYEBOLTS

PART#	DESCRIPTION
68.400.001	EYEBOLT 3/16" X 2"; ZINC PLATED
68.400.002	EYEBOLT 3/16" X 2 1/2"; ZINC PLATED
68.400.003	EYEBOLT 1/4" X 2"; ZINC PLATED
68.400.004	EYEBOLT 1/4" X 2 1/2"; ZINC PLATED
68.400.005	EYEBOLT 1/4" X 3"; ZINC PLATED
68.400.006	EYEBOLT 1/4" X 4"; ZINC PLATED
68.400.009	EYEBOLT 5/16" X 3 1/4"; ZINC PLATED
68.400.010	EYEBOLT 5/16" X 4"; ZINC PLATED
68.400.011	EYEBOLT 5/16" X 5"; ZINC PLATED
68.400.012	EYEBOLT 5/16" X 6"; ZINC PLATED
68.400.013	EYEBOLT 3/8" X 4"; ZINC PLATED
68.400.014	EYEBOLT 3/8" X 5"; ZINC PLATED
68.400.015	EYEBOLT 3/8" X 6"; ZINC PLATED
68.400.016	EYEBOLT 3/8" X 8"; ZINC PLATED
68.400.017	EYEBOLT 1/2" X 6"; ZINC PLATED
68.400.018	EYEBOLT 1/2" X 8"; ZINC PLATED



KEYSTOCKS

PART#	DESCRIPTION
68.100.201	KEY, ZINC PLATED, 3/16" X 3/16" X 12
68.100.202	KEY, ZINC PLATED, 1/4" X 1/2" X 12
68.100.203	KEY, ZINC PLATED, 5/16" X 5/16" X 12



D RINGS

PART#	DESCRIPTION
68.650.001	3/4", NICKEL PLATED; 1/8" WIRE DIAMETER
68.650.003	1", NICKEL PLATED; 1/8" WIRE DIAMETER
68.650.005	1 5/16", NICKEL PLATED; 5/32" WIRE DIAMETER
68.650.006	1 5/8" IN, NICKEL PLATED; 5/32" WIRE DIAMETER
68.650.007	2", NICKEL PLATED; 11/64" WIRE DIAMETER



SPLIT RINGS

PART#	DESCRIPTION
68.650.034	LIGHT SPLIT RING 3/4", ROUND EDGE
68.650.035	LIGHT SPLIT RING 1" ROUND EDGE
68.650.036	SPLIT RING 1 1/4", ANGLE EDGE



RING AND BOLT

PART#	DESCRIPTION
68.300.290	RING & EYE BOLT 2", ZINC PLATED; 2 1/2" BOLT
68.300.295	RING & LAG EYE BOLT 2", ZINC PLATED; 4 1/2" IN LAGSCREW BOLT



HARNESS RINGS

PART#	DESCRIPTION
68.650.002	HARNESS RING 1 1/4", NICKEL PLATED; W/LABEL
68.650.004	HARNESS RING 1 1/2", NICKEL PLATED; W/LABEL
68.154.580	RING, STEEL HARNESS, 1/4" X 1"



MOUNTING RING & BRACKET

PART#	DESCRIPTION
68.600.995	2" MOUNTING RING AND BRACKET 2" ID X 1-15/16"; 14" MNT HOLE

PULLEYS



SWIVEL PULLEY BLOCKS

PART#	DESCRIPTION
68.300.021	PULLEY BLOCK, 2" SWIVEL EYE, 460 LB WLL; MAX CBL DIA: 3/16"
68.300.023	PULLEY BLOCK, 3" SWIVEL EYE, 650 LB WLL; MAX CBL DIA: 1/4"



FIXED PULLEY BLOCKS

PART#	DESCRIPTION
68.300.061	PULLEY BLOCK, 2" FIXED EYE, 480 LB WLL; MAX CBL DIA: 3/16"
68.300.062	PULLEY BLOCK, 2.5" FIXED EYE, 550 LB WLL; MAX CBL DIA: 1/4"
68.300.063	PULLEY BLOCK, 3" FIXED EYE, 650 LB WLL; MAX CBL DIA: 1/4"



DOUBLE SCISSOR BLOCKS

PART#	DESCRIPTION
68.300.041	2" DBL SCISSOR PULLEY BLOCK, 480 LB WLL; MAX CBL DIA: 3/16"
68.300.042	2.5" DBL SCISSOR PULLEY BLOCK, 550 LB WLL; MAX CBL DIA: 1/4"
68.300.043	3" DBL SCISSOR PULLEY BLOCK, 650 LB WLL; MAX CBL DIA: 1/4"



SINGLE SCISSOR BLOCKS

PART#	DESCRIPTION
68.300.051	2" SCISSOR PULLEY BLOCK, 480 LB WLL; MAX CBL DIA: 3/16"
68.300.052	2.5" SCISSOR PULLEY BLOCK, 550 LB WLL; MAX CBL DIA: 1/4"
68.300.053	3" SCISSOR PULLEY BLOCK, 650 LB WLL; MAX CBL DIA: 1/4"



SWIVEL EYE PULLEYS

PART#	DESCRIPTION
68.300.015	SINGLE SWIVEL PULLEY 3/4", 40 KG WLL
68.300.016	SINGLE SWIVEL PULLEY 1", 40 KG WLL
68.300.017	SINGLE SWIVEL PULLEY 1 1/4", 40 KG WLL
68.300.018	SINGLE SWIVEL PULLEY 1 1/2", 40 KG WLL
68.300.019	SINGLE SWIVEL PULLEY 2", 40 KG WLL



SINGLE FIXED PULLEYS

PART#	DESCRIPTION
68.300.010	SINGLE FIXED PULLEY 3/4", 50 KG WLL
68.300.011	SINGLE FIXED PULLEY 1", 50 KG WLL
68.300.012	SINGLE FIXED PULLEY 1 1/4", 80 KG WLL
68.300.013	SINGLE FIXED PULLEY 1 1/2", 80 KG WLL
68.300.014	SINGLE FIXED PULLEY 2", 80 KG WLL



16 RETAIL DISPLAY RACKS & PLANOGRAMS

BRABER EQUIPMENT

40TH
EDITION

PARTS CATALOG

RETAIL DISPLAY BOARDS

PART#	DESCRIPTION
67.900.002	VERTICAL TOWER
67.900.003	BOARD WITH HOLES
67.900.005	PEG, STEEL WITH NUT
67.600.001	TRAILER BALLS
67.600.002	HITCH COUPLERS
67.600.003	TURNBUCKLES
67.600.004	CLEVIS & SHACKLES
67.600.005	FARM LOOSE PINS
67.600.006	CHAIN HOOKS
67.600.007	3PT IMP PINS & BUSHINGS

PART#	DESCRIPTION
67.600.008	FARM BLISTER PACK PINS
67.600.009	FOLD OVER HITCH PINS
67.600.010	RED HITCH PINS
67.600.011	WIRE ROPE ACCY'S
67.600.012	SMALL ACCESSORY KITS
67.600.013	GREASE PACKS & ACCESSORIES
67.600.014	RATCHET TIE DOWNS BOARD #1
67.600.015	RATCHET TIE DOWNS BOARD #2
67.600.016	U-BOLTS

ALL ITEMS LABELED WITH UPC CODES



TRAILER BALLS

PART # 67.600.001



HITCH COUPLERS

PART # 67.600.002



TURNBUCKLES

PART # 67.600.003



CLEVIS & SHACKLES

PART # 67.600.004



RETAIL DISPLAY BOARDS

FARM LOOSE PINS

PART # 67.600.005



CHAIN HOOKS

PART # 67.600.006



3PT IMP PINS & BUSHINGS

PART # 67.600.007

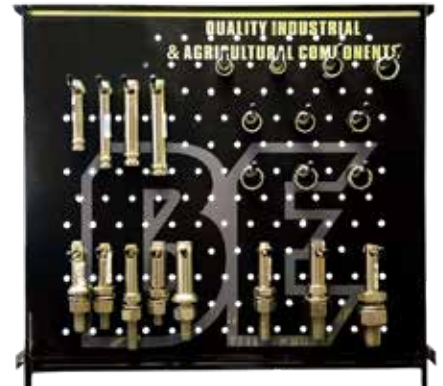

FARM BLISTER PACK PINS

PART # 67.600.008



FOLD OVER HITCH PINS

PART # 67.600.009



RED HITCH PINS

PART # 67.600.010



WIRE ROPE ACCESSORIES

PART # 67.600.011



RATCHET TIE DOWNS #1

PART # 67.600.014



RATCHET TIE DOWNS #2

PART # 67.600.015



SMALL ACCESSORY KITS

SMALL ACCESSORY KITS RETAIL DISPLAY

PART#	DESCRIPTION
67.700.300	KIT, FUSES ATO STD PLUG , 50PCS
67.700.301	KIT, FUSES ATO MINI PLUG, 50PCS
67.700.302	KIT, COTTER PINS SMALL, 215PCS
67.700.303	KIT, COTTER PINS LARGE, 40PCS
67.700.304	KIT, GREASE FITTINGS S.A.E. STD, 40PCS
67.700.305	KIT, HAIR PINS, 28PCS
67.700.306	KIT, SOCKET SET SCREWS STD, 65PCS
67.700.307	KIT, SPRING PINS, METRIC, 62PCS
67.700.308	KIT, WOODRUFF KEYS, METRIC, 40PCS
67.700.309	KIT, "E" RETAINER RINGS, METRIC, 70PCS
67.700.310	KIT, INTERNAL RETAINER RINGS, 55PCS
67.700.311	KIT, EXTERNAL RETAINER RINGS, 70PCS
67.700.312	KIT, CLEVIS PINS STD, 23PCS
67.700.313	KIT, KEYSTOCK, STD, 30PCS
67.700.314	KIT, METRIC GREASE FITTINGS, 50PCS
67.700.315	KIT, DRIVE-IN GREASE FITTINGS STD, 50PCS
67.999.005	UNIVERSAL BATTERY TERMINAL, ZINC, 2 PACK
67.999.006	UNIVERSAL BATTERY TERMINAL, LEAD, 2 PACK



67.600.012



67.700.300



67.700.301



67.700.302



67.700.303



67.700.304



67.700.305



67.700.306



67.700.307



67.700.308



67.700.309



67.700.310



67.700.311



67.700.312



67.700.313



67.700.314



67.700.315

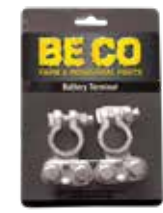

67.999.005

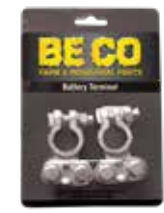

67.999.006

LARGE ACCESSORIES



HAIR PIN ASSORTMENT

PART #	DESCRIPTION
67.100.150	150 PIECES



E-CLIP ASSORTMENT

PART #	DESCRIPTION
67.300.300	300 PIECES



COPPER WASHER SET

PART #	DESCRIPTION
67.000.110	METRIC, 110 PIECES



WIRE TERMINAL KIT

PART #	DESCRIPTION
67.000.360	360 PIECES



WIRE TERMINAL & CRIMPER KIT

PART #	DESCRIPTION
67.999.175	175 PIECES



WOODRUFF KEY SET

PART #	DESCRIPTION
67.200.080	METRIC, 80 PIECES



O-RING ASSORTMENT KITS

PART #	DESCRIPTION
67.444.225	METRIC 225 PCS
67.100.225	IMP 225 PCS
67.444.407	METRIC 407 PCS
67.100.407	IMP 407 PCS



UNIVERSAL CLEVIS PIN KIT

PART #	DESCRIPTION
67.000.060	CLEVIS PIN ASSOR, 60 PCS
67.700.201	UNIVERSAL CLEVIS PIN KIT 37 PCS
67.999.071	UNIVERSAL CLEVIS PIN KIT 71 PCS



COTTER PIN ASSORTMENTS

PART #	DESCRIPTION
67.100.555	555 PIECES
67.100.144	144 PIECES (LARGE SIZES)
68.000.215	215 PCS, COTTER PIN KIT
68.000.050	COTTER PIN PACK - 50PCS
68.000.100	COTTER PIN PACK - 100PCS

LARGE ACCESSORIES



ALLIGATOR CLIP KIT

PART #	DESCRIPTION
67.999.060	60 PIECES



LYNCH PIN KIT

PART #	DESCRIPTION
67.700.200	50 PIECES



HEX DRIVER BIT KIT

PART #	DESCRIPTION
67.999.114	114 PIECES



HEAT SHRINK TUBING BLACK

PART #	DESCRIPTION
67.999.127	127 PIECES



1156/1157 BULB KIT

PART #	DESCRIPTION
67.999.017	17 PIECES



FUSE KIT

PART #	DESCRIPTION
67.999.147	ATO, MINI, MAXI & BOSCH, 147 PCS



ROLL PIN ASSORTMENT KITS

PART #	DESCRIPTION
67.444.120	METRIC 120 PIECES
67.100.120	IMP 120 PIECES



GREASE NIPPLE KIT

PART #	DESCRIPTION
67.444.110	METRIC, 110 PIECES
67.100.110	IMP, 110 PIECES



SPRING ASSORTMENTS

PART #	DESCRIPTION
67.000.200	200 PIECES

LARGE ACCESSORIES



RETAINING RING ASSORTMENTS

PART #	DESCRIPTION
67.100.300	EXTERNAL SIZES, 300 PCS
67.100.285	INTERNAL SIZES, 285 PCS



SHACKLE & WIRE ROPE KIT

PART #	DESCRIPTION
67.999.030	30 PIECES



HOSE CLAMP KIT

PART #	DESCRIPTION
67.999.026	HOSE CLAMP KIT, 26 PCS



FUSE KIT

PART #	DESCRIPTION
67.999.080	FUSE KIT, ATO STYLE, 80 PCS



FUSE KIT

PART #	DESCRIPTION
67.999.121	FUSE KIT, 121PCS

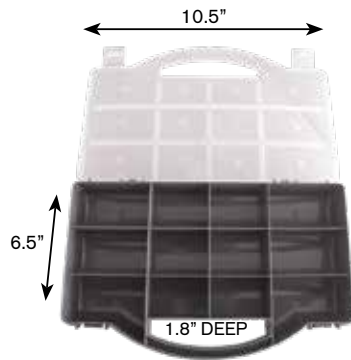

HD POLYMER ACCESSORY CASE

PART #
85.600.103



NYLON LOCKNUTS

PART #	DESCRIPTION
67.700.070	LOCKNUTS, NYLON, 40PCS

GREASE PACKS & ACCESSORIES



67.600.013



67.000.013 67.000.026 67.000.022



67.000.024 67.000.025 67.000.023



67.000.028



67.000.021



67.000.019

GREASE PACKS & ACCESSORIES RETAIL DISPLAY

PART#	DESCRIPTION	TECH INFO	PACKING
67.000.013	GREASE COUPLER, 4 JAW	1/8 NPT	CLAMSHELL
67.000.021	NEEDLE NOSE DISPENSER	LENGTH:1-1/2"	BLISTER
67.000.022	90 DEG ANGLE GREASE COUPLER		BLISTER
67.000.023	GREASE INJECTORS 18GA	18GA X1-1/2"	3 IN ONE BLISTER
67.000.024	GREASE INJECTOR 18GA	18GA X1-1/2"	1 IN ONE BLISTER
67.000.025	GREASE INJECTORS (18GA & 21GA)		2 IN ONE BLISTER
67.000.026	GREASE COUPLERS, HD, 10,000 PSI	1/8" NPT	BLISTER
67.000.027	GREASE HOSE, PLASTIC, 12", 1/8" NPT	MAX: 3500 PSI	POLYBAGGED
67.000.028	GREASE HOSE, PLASTIC, 18", 1/8" NPT	MAX: 3500 PSI	POLYBAGGED
67.000.011	GREASE HOSE, RUBBER, 18"	1/8 NPT	POLYBAGGED
67.000.019	GREASE GUN HOLDER BRACKET		LOOSE
67.700.030	SAE GREASE FITTINGS BE KIT	1/8 NPT STRAIGHT	10 PCS
67.700.039	SAE GREASE FITTINGS BE KIT	1/8 NPT 45 DEG	5 PCS
67.700.037	SAE GREASE FITTINGS BE KIT	1/8 NPT 95 DEG	10 PCS
67.700.031	SAE GREASE FITTINGS BE KIT	1/4-28 STRAIGHT	10 PCS
67.700.040	SAE GREASE FITTINGS BE KIT	1/4-28 STR - LONG	10 PCS
67.700.032	SAE GREASE FITTINGS BE KIT, 45 DEG	1/4-28 TAPER	5 PCS
67.700.033	SAE GREASE FITTINGS BE KIT, 90 DEG	1/4-28 TAPER	5 PCS
67.700.038	SAE GREASE FITTINGS BE KIT	1/4 NPT STRAIGHT	5 PCS
67.700.041	SAE GREASE FITTINGS BE KIT	5/16-24 STRAIGHT	5 PCS
67.700.042	SAE GREASE FITTINGS BE KIT	3/8-24 STRAIGHT	5 PCS
67.700.036	SAE GREASE FITTINGS BE KIT	6MM STRAIGHT	5 PCS
67.700.034	SAE GREASE FITTINGS BE KIT	6MM 45 DEG	5 PCS
67.700.035	SAE GREASE FITTINGS BE KIT	6MM 90 DEG	5 PCS
67.700.043	SAE GREASE FITTINGS BE KIT	8MM STRAIGHT	5 PCS
67.700.044	SAE GREASE FITTINGS BE KIT	8MM 45 DEG	5 PCS
67.700.046	SAE GREASE FITTINGS BE KIT	10MM STRAIGHT	5 PCS
67.700.050	DRIVE IN GREASE FITTINGS BE KIT	3/16 STRAIGHT	5 PCS
67.700.052	DRIVE IN GREASE FITTINGS BE KIT	1/4 STRAIGHT	5 PCS
67.700.045	GREASE FITTINGS	8MM X 90°	6 PCS
67.700.055	GREASE FITTINGS	ASSORTED DRIVE IN	50 PCS
67.700.051	GREASE FITTINGS	5/16" DRIVE IN	5 PCS
67.700.053	GREASE FITTINGS	3/8" DRIVE IN	5 PCS

U-BOLTS & SAFETY GLASSES



67.600.016

U-BOLTS RETAIL DISPLAY

PART#	SIZE	PART#	SIZE
ROUND U-BOLTS W/ PLATE & NUTS		SQUARE U-BOLTS W/ NUTS	
66.200.001	1/4"X1-1/8"	66.200.020	3/8"X3-1/2"
66.200.002	1/4"X1-3/8"	66.200.021	3/8"X2"X3"
66.200.003	1/4"X2"	66.200.022	3/8"X2"X5"
66.200.004	5/16"X1-3/8"	66.200.023	3/8"X4"X3"
66.200.005	5/16"X1-3/8"	66.200.024	3/8"X4"X5"
66.200.006	5/16"X1-3/4"	66.200.025	3/8"X6"X5"
66.200.007	5/16"X1-3/4"	66.200.026	3/8"X6"X7"
66.200.008	5/16"X2"	ALL ITEMS LABELED WITH UPC CODES	
66.200.009	5/16"X2"		
66.200.010	5/16"X2-1/2"		
66.200.011	5/16"X2-1/2"		
66.200.012	3/8"X2-1/2"		
66.200.013	3/8"X3"		

SAFETY GLASSES



CLEAR LENS & FRAME EYEWEAR

PART#	DESCRIPTION
1209C	20 PACK, CLEAR LENS, CLEAR FRAME
1209C-P	240 PACK, CLEAR LENS, CLEAR FRAME

FEATURES

- ECONOMIC EYEWEAR, IDEAL FOR SERVICE CENTERS, REPAIR SHOPS, FARMS & OTHER APPLICATIONS
- MEETS ANSI SAFETY RATINGS



MIRROR LENS & BLACK FRAME EYEWEAR

PART#	DESCRIPTION
1209B	20 PACK, MIRROR LENS, BLACK FRAME
1209B-P	240 PACK, MIRROR LENS, BLACK FRAME

FEATURES

- ECONOMIC EYEWEAR, TINTED TO REDUCE EYESTRAIN IN BRIGHT CONDITIONS, 99% UV PROTECTION
- IDEAL FOR OUTDOOR FARM AND INDUSTRIAL ACTIVITIES
- MEETS ANSI SAFETY RATINGS



CLEAR LENS & BLACK FRAME EYEWEAR

PART#	DESCRIPTION
1204C	20 PACK, CLEAR LENS, BLACK FRAME
1204C-P	240 PACK, CLEAR LENS, BLACK FRAME

FEATURES

- ECONOMIC STYLIZED EYEWEAR WITH SOFT FLEX EAR PIECES
- IDEAL FOR SERVICE CENTERS, REPAIR SHOPS, FARMS AND OTHER APPLICATIONS
- MEETS ANSI SAFETY RATINGS



TINTED LENS & BLACK FRAME EYEWEAR

PART#	DESCRIPTION
1204M	20 PACK, TINTED LENS, BLACK FRAME
1204M-P	240 PACK, TINTED LENS, BLACK FRAME

FEATURES

- ECONOMIC STYLIZED EYEWEAR WITH SOFT FLEX EAR PIECES
- TINTED TO REDUCE EYESTRAIN, 99% UV PROTECTION
- IDEAL FOR OUTDOOR FARM AND INDUSTRIAL ACTIVITIES
- MEETS ANSI SAFETY RATINGS

PLANOGRAMS

3' WHEEL & GATE PLAN-O-GRAM



4' TRAILER & TOWING PLAN-O-GRAM





**8' HYDRAULIC
CENTER
PLAN-O-GRAM**

**8' DRIVETRAIN
PLAN-O-GRAM**

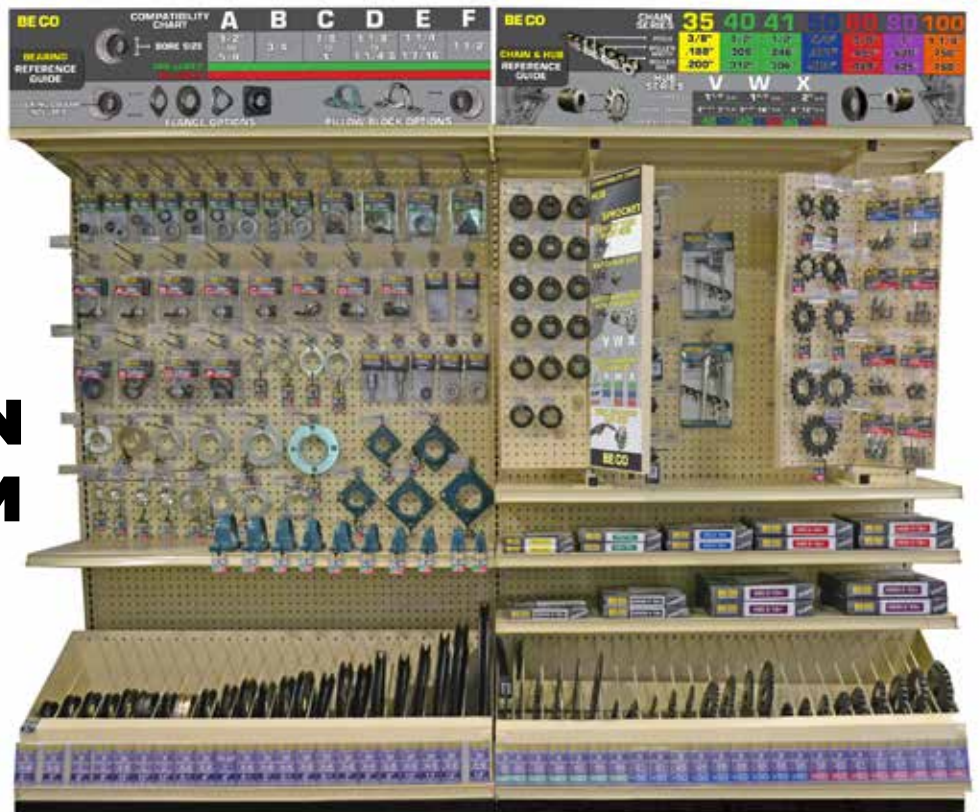

PLANOGRAMS

12' SEAT PLAN-O-GRAM



8' HITCH PLAN-O-GRAM



4' PTO PLAN-O-GRAM



4' HAY PLAN-O-GRAM





17 LED
LIGHTS

BRABER EQUIPMENT
40TH
EDITION
PARTS CATALOG

ALL **BECO** LED LIGHTS SHARE THE SAME GREAT QUALITY BUILD AND COMPONENTS.



CAN BE USED ANYWHERE, ANYTIME

WORKING TEMP: -45°F TO 130°F

DIECAST ALUMINUM HOUSING

INCREASED DURABILITY & HEAT REDUCTION

LIFESPAN: 50,000 HOURS

LONG LASTING INVESTMENT

POLYCARBONATE LENS

HIGH IMPACT RESISTANT

LOW AMP DRAW

CREATING LOW VEHICLE DEMAND

IP 67 WEATHER RATING

SEALED AGAINST DUST & WATER

LIGHT COLOR: 6000°K WHITE

PROVIDES A NATURAL LIGHT

MOUNTING BRACKETS

MAKES INSTALLATION EASY



HANG TAB



INNOVATIVE RETAIL
PACKAGING WITH
BUILT-IN WINDOW
TO VIEW PRODUCT
AND **HANG TABS**
FOR EASY DISPLAY



BUILT IN WINDOW



HOUSING W/O HARDWARE

**PART NO. LF1801
FLOOD LIGHT - 6 EPISTAR LEDS**

18W **1200 LUMENS**

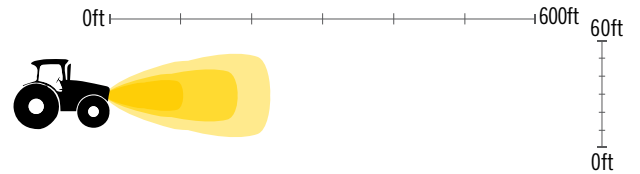

HOUSING W/O HARDWARE

**PART NO. LF1803
FLOOD LIGHT - 6 CREE LEDS**

18W **2160 LUMENS**

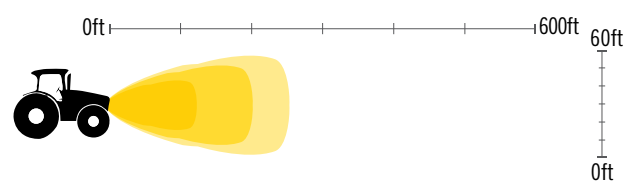

HOUSING W/O HARDWARE

**Part No. LF4201
FLOOD LIGHT - 14 EPISTAR LEDS**

42W **3000 LUMENS**

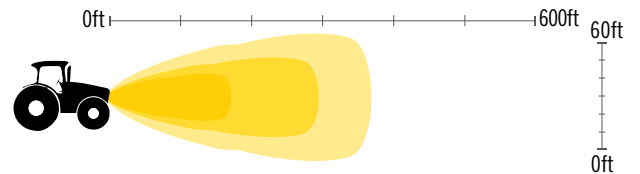

HOUSING W/O HARDWARE

**Part No. LF4801
FLOOD LIGHT - 16 EPISTAR LEDS**

48W **3300 LUMENS**

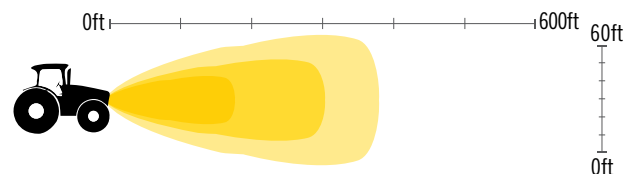

LED WORK LIGHTS



HOUSING W/O HARDWARE

Part No. LF5101
FLOOD LIGHT - 17 EPISTAR LEDS

51W **3825 LUMENS**

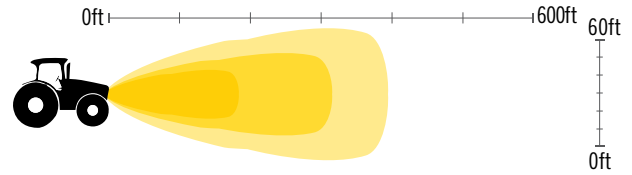

HOUSING W/O HARDWARE

Part No. LF6001
FLOOD LIGHT - 6 CREE LEDS

60W **7800 LUMENS**

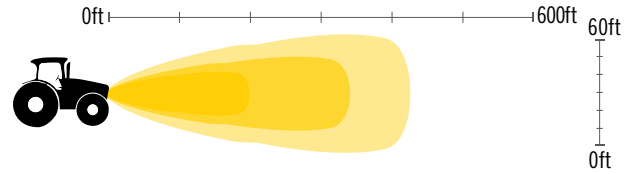

HOUSING W/O HARDWARE

Part No. LF1501
PORTABLE FLOOD LIGHT - 5 EPISTAR LEDS

15W **1125 LUMENS**



HOUSING W/O HARDWARE

Part No. LF1802
FLOOD LIGHT - 6 EPISTAR LEDS

18W **1350 LUMENS**

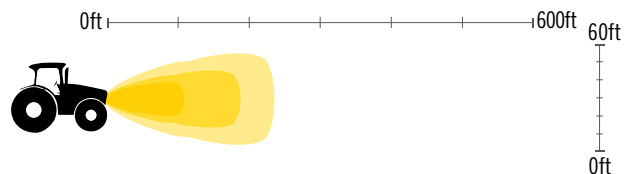

LED WORK LIGHTS & LIGHT BARS



HOUSING W/O HARDWARE

Part No. LS6001
SPOT LIGHT - 6 CREE LEDS

60W **7800 LUMENS**

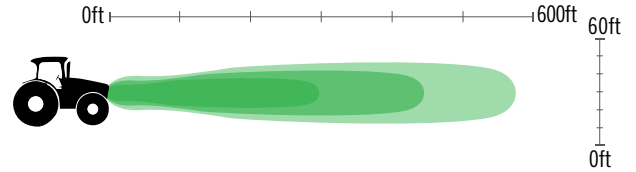

HOUSING W/O HARDWARE

Part No. LS2701
SPOT LIGHT - 9 EPISTAR LEDS

27W **1755 LUMENS**

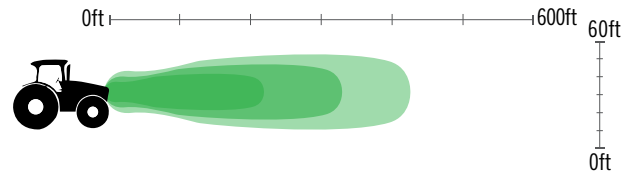

HOUSING W/O HARDWARE

Part No. LF4001
COMBO FLOOD/SPOT LIGHT BAR - 10"

40W **5000 LUMENS**

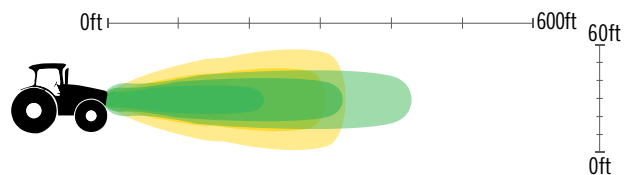

HOUSING W/O HARDWARE

Part No. LB22120
COMBO FLOOD/SPOT LIGHT BAR - 22"

120W **9600 LUMENS**

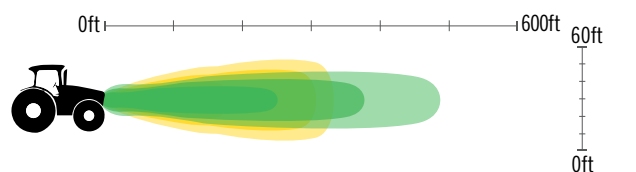

LED LIGHT BARS



Part No. LB32180
COMBO FLOOD/SPOT LIGHT BAR - 32"

180W 14400 LUMENS

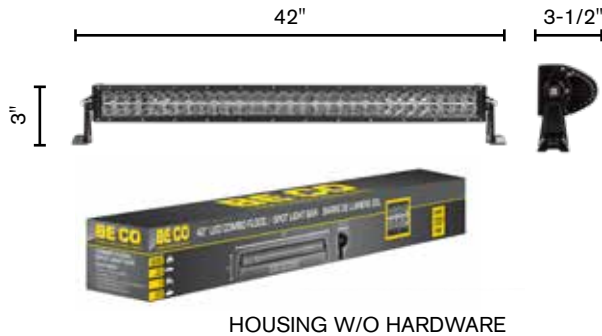
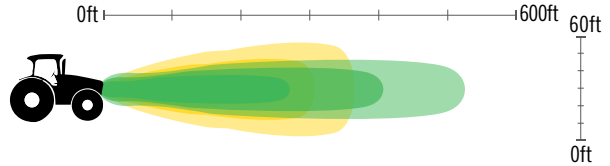

Part No. LB42240
COMBO FLOOD/SPOT LIGHT BAR - 42"

240W 19200 LUMENS

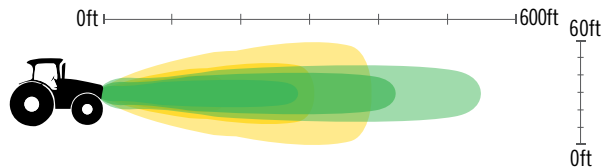

Part No. LB50288
COMBO FLOOD/SPOT LIGHT BAR - 50"

288W 23040 LUMENS

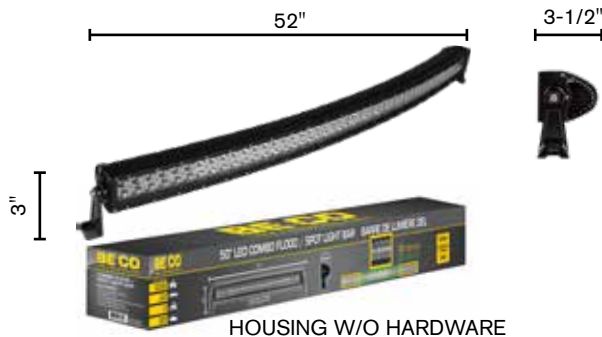
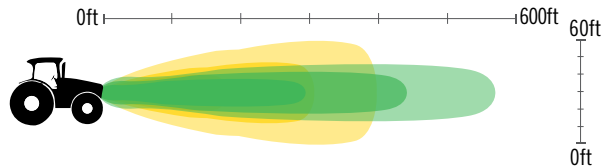

Part No. LB52300
COMBO FLOOD/SPOT LIGHT BAR - 52"

300W 28800 LUMENS CURVED

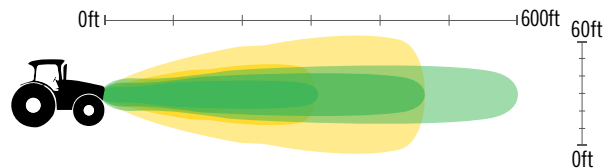

Part No. LEDWH01
LED LIGHT WIRING HARNESS

- 30 FT WIRING HARNESS
- 2 SETS OF DT CONNECTORS
- 30A RELAY / UP TO 360W
- PLUG & PLAY - EASY INSTALLATION OF ANY BECO LED LIGHTS

VEHICLE SAFETY LIGHTS

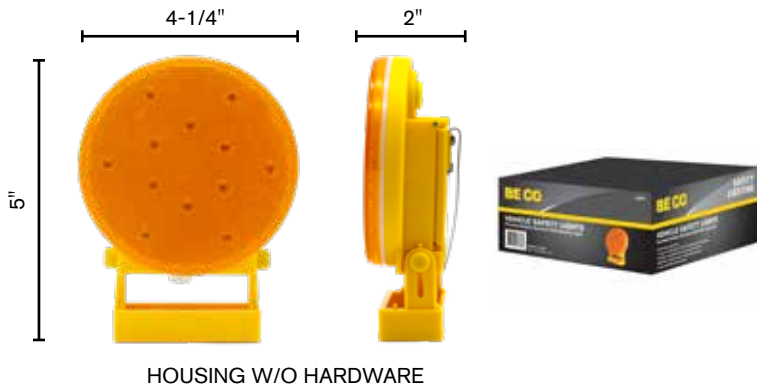

HOUSING W/O HARDWARE

Part No. LS001
PORTABLE SAFETY LIGHT -
BATTERY OPERATED

- PUSH BUTTON OPERATION
- 3 USER-SELECTABLE FLASH PATTERNS
- MAGNETIC BASE AND 180° ADJUSTABLE
- 72 HRS OF OPERATION ON 2X AA BATTERIES (NOT INCLUDED)



HOUSING W/O HARDWARE

Part No. LS002
360° SAFETY LIGHT -
BATTERY OPERATED

- 24 ULTRA-BRIGHT LEDS
- MAGNETIC BASE
- 60 TRIPLE FLASHES PER MINUTE
- 300-400 HRS OF OPERATION ON 2X D BATTERIES (NOT INCLUDED)



HOUSING W/O HARDWARE

Part No. LS003
LED SAFETY LIGHT -
12V

- 36W, 1800 LUMENS
- CONNECTS TO A 12V CAR OUTLET
- MAGNETIC BASE
- 50,000 HOURS LIFE TIME



HOUSING W/O HARDWARE

Part No. BL01
360° BEACON LIGHT -
HIGH PIPE MOUNT

- DC 12-24V
- MEETS IP56 PROTECTION STANDARDS
- -30°C TO + 50°C TEMPERATURE RANGE
- 80 SMD5050 360° REVOLVING FLASH / INTERMITTENT FLASH

VEHICLE SAFETY LIGHTS & TOWING LIGHT KITS



HOUSING W/O HARDWARE

Part No. BL02
360° BEACON LIGHT -
LOW PIPE MOUNT

- DC 12-24V
- MEETS IP56 PROTECTION STANDARDS
- -30°C TO + 50°C TEMPERATURE RANGE
- 80 SMD5050 360° REVOLVING FLASH / INTERMITTENT FLASH



BLB901
SIDE MOUNT



BLB903
TOP FLUSH



BLB902
TOP MOUNT



BLB904
SIDE L-SHAPED

Part No. BLB901/BLB902/BLB903/BLB904
BRACKETS FOR
BEACON LIGHTS

- COPPER AND RUBBER
- FITS ANY BECO BEACON LIGHTS



HOUSING W/O HARDWARE

Part No. LT1230
LED TOWING LIGHT KIT -
12V

- 24 LEDS (12 ON EACH SIDE)
- 30 FT WIRING HARNESS INCLUDED
- MAGNETIC BASE
- 100,000 HOURS LIFE TIME



Part No. LTHD1230
COMMERCIAL GRADE
LED TOWING LIGHT KIT - 12V

- CARRYING CASE INCLUDED
- 30 FT WIRING HARNESS INCLUDED
- 7 FT SPAN BETWEEN TWO LIGHTS
- 60 LB ROUND PULL MAGNETS



Part No. LST1222
SUBMERSIBLE
LED TRAILER LIGHT KIT - 12V

- 22 FT WIRING HARNESS INCLUDED
- FOR TRAILERS UNDER 80" WIDE
- MOUNTING HARDWARE & LICENSE PLATE BRACKET
- DOT CERTIFIED



18 RANCH HARDWARE & FENCE PRODUCT

BRABER EQUIPMENT

40TH
EDITION

PARTS CATALOG

FENCE PRODUCT



GATE CLOSER

PART#	DESCRIPTION
71.000.010	HD CABLE

FEATURES

- QUICK & EFFECTIVE WAY TO OPEN/CLOSE GATES
- ADJUSTABLE CABLE CAN FIT AROUND MOST SIZE POSTS
- EASY & QUICK TO INSTALL ON ANY WOODEN FENCE POST



GATE HINGES

PART#	DESCRIPTION
71.002.001	1-5/8" - 1-3/4" TUBE GATES
71.002.002	2" TUBE GATES

FEATURES

- INCLUDES BOTH UPPER AND LOWER MOUNTING HARDWARE
- SIMPLE TO INSTALL AND RELIABLE QUALITY



STANDARD GATE CLOSER

PART#	DESCRIPTION
71.000.008	STANDARD GATE CLOSER

FEATURES

- LIGHT DUTY
- 630MM



STAKE POCKETS

PART#	DESCRIPTION
71.000.014	STEEL STAKE POCKETS

FEATURES

- 1-1/2" X 3-1/4" OPENING, 2-1/2" HIGH
- BLACK POWDER COATED FINISH



BARBED WIRE CARRIERS

PART#	DESCRIPTION
71.000.012	BARBED WIRE CARRIERS

FEATURES

- GRIP/CARRY ROLLS OF BARBED WIRE SAFELY
- CAN BE USED TO EASILY UNROLL BARBED WIRE WITH ITS FREE SPINNING DESIGN



GATE LATCHES

PART#	DESCRIPTION
71.002.010	1-5/8" - 2" TUBE; TWO WAY LOCKABLE
71.002.007	1-5/8" - 2" TUBE; ONE WAY LOCKABLE

FEATURES

- REDUCES STRESS ON GATE HINGE
- PREVENTS SAGGING & SWINGING
- QUICKLY OPEN LATCH WITH ONLY ONE HAND
- LOCKABLE FOR EXTRA SECURITY



GATE ANCHOR

PART#	DESCRIPTION
71.000.005	FITS 1-3/4" - 2" TUBE

FEATURES

- DROP DOWN ANCHOR WHEN GATE IS IN ANY POSITION TO KEEP FROM MOVING
- PREVENTS SAGGING AND SWINGING
- EASY TO INSTALL

FENCE PRODUCT



71.004.000



71.004.001

T-POST PULLERS

PART#	DESCRIPTION
71.004.000	T-POST PULLER
71.004.001	METAL T-POST PULLER

FEATURES

- PULL T-POSTS OUT OF THE GROUND AND KEEP THEM STRAIGHT AND IN RE-USABLE CONDITION
- **71.004.000** - LONG HANDLE GIVES EXTRA LEVERAGE & MAKES FOR A SIMPLE & EFFECTIVE ONE MAN OPERATION
- **71.004.001** - CAN BE USED WITH FARM JACK OR CHAIN WITH HOOK

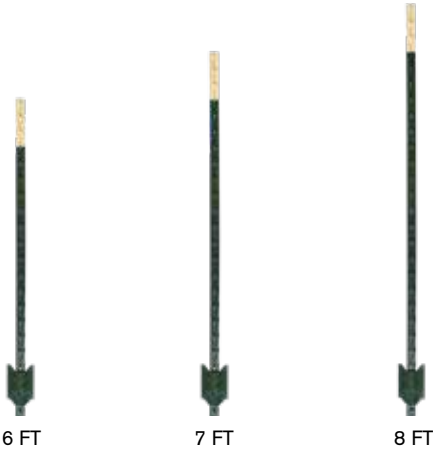

6 FT

7 FT

8 FT

STUDED T-POSTS

PART#	DESCRIPTION
71.004.006	T-POST, STUDED 6'
71.004.007	T-POST, STUDED 7'
71.004.008	T-POST, STUDED 8'

WIRE GRIPPER

PART#	DESCRIPTION
71.000.011	WIRE GRIPPER

FEATURES

- SAFELY GRIP BARBED WIRE WHEN DOING MAINTENANCE
- WORKS WITH OTHER SMALL CABLES OR WIRES
- FOR USE WITH A COME-ALONG



71.000.015



71.000.020

WIRE STRETCHERS

PART#	DESCRIPTION
71.000.015	WIRE STRETCHER
71.000.020	WIRE STRETCHER W/ RATCHET CONTROL

FEATURES

- SAFELY HOLD AND KEEP TENSION ON WIRE WHEN CONNECTING
- WORKS WITH BARBED WIRE, SMOOTH AND HIGH TENSILE WIRE
- **71.000.020** - HAS RATCHET CONTROL FOR RELEASE OF WIRE TENSION

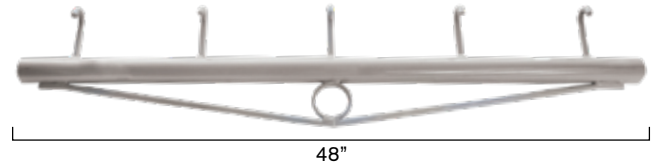

48"

WIRE STRETCHER

PART#	DESCRIPTION
71.000.017	48" WOVEN WIRE STRETCHER

FEATURES

- A SIMPLE AND EFFICIENT TOOL TO HELP YOU STRETCH WOVEN AND WELDED WIRE FENCE
- JUST ATTACH HOOKS TO FENCE AND CABLE PULLER TO LOOP TO START STRETCHING

POST POUNDER

PART#	DESCRIPTION
71.004.002	POST POUNDER, 16.5 LB

FEATURES

- DRIVE STEEL FENCE POSTS INTO THE GROUND WITH EASE
- HEAVY DUTY STEEL AND POWDER COATED FINISH MAKE FOR A LONG LASTING LIFE



GATE WHEELS



FOAM FILLED, FLAT FREE GATE WHEEL

PART#	DESCRIPTION
71.003.100	FOAM FILLED, FLAT FREE GATE WHEEL

FEATURES

- SPRING LOADED DESIGN PROVIDES SHOCK ABSORPTION
- U-BOLTS (INCLUDED) ATTACH WHEEL TO 1-5/8" - 2" TUBE
- CASTORS ARE DESIGNED TO MAKE GATE OPENING & CLOSING EASY
- INTEGRATED EXTENDED GATE MOUNT ALLOWS FULL 360° ROTATION OF WHEEL



TALL GATE WHEEL

PART#	DESCRIPTION
71.003.000	FITS 1-5/8" - 2" TUBE

FEATURES

- REDUCE STRESS ON GATE HINGE & BOLTS AND ALLOW THE GATE TO OPEN WITH EASE
- HEIGHT ADJUSTABLE MOUNTING SYSTEM FOR DIFFERENT HEIGHT GATES
- EASY TO INSTALL



FOAM FILLED, FLAT FREE GATE WHEEL

PART#	DESCRIPTION
71.003.200	FOAM FILLED, FLAT FREE GATE WHEEL

FEATURES

- CONSTRUCTED OF ZINC PLATED, RUST RESISTANT STEEL
- TWO FOAM FILLED, FLAT FREE TIRES PREVENT SAGGING OR DRAGGING WHEN THE GATE ROLLS OPEN
- U-BOLTS ATTACH WHEELS TO 2" - 3" TUBE



GATE WHEEL

PART#	DESCRIPTION
71.003.400	GATE WHEEL

FEATURES

- FITS ROUND TUBE 1-5/8" - 2" O.D.
- PREVENTS GATE FROM SWINGING AND SAGGING
- ALLOWS GATE TO OPEN AND CLOSE EASILY IN EITHER DIRECTION

XTRAC FLOATING GATE WHEEL

PART#	DESCRIPTION
71.003.300	XTRAC PLASTIC GATE WHEEL

FEATURES

- DUAL MOUNTING POSITIONS TO ACCOMMODATE HIGH OR LOW GATES
- INCLUDES HEAVY DUTY AXLE BOLT WITH LOCKING NUT AND 3 U-BOLTS WITH NUTS
- LARGE WHEEL ALLOWS GATE TO SWING OVER ROUGH, MUDDY OR UNEVEN ENTRIES AND HELPS GATE FLOAT ACROSS ROUGH OR WET DRIVEWAYS
- SUPPORTS UP TO A 300LB GATE
- BLACK POWDER COAT FINISH PREVENTS RUST AND WEATHERING

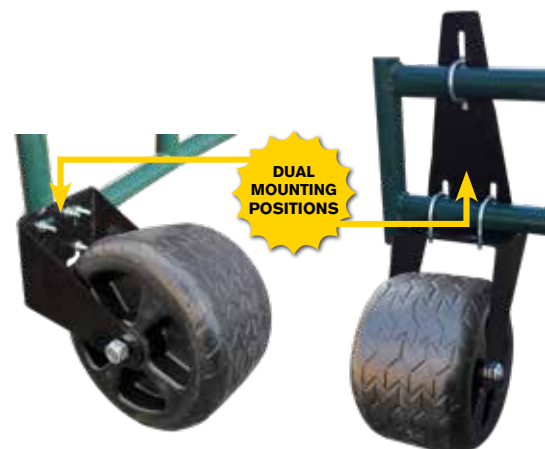

HAY HOOKS & COW BELLS

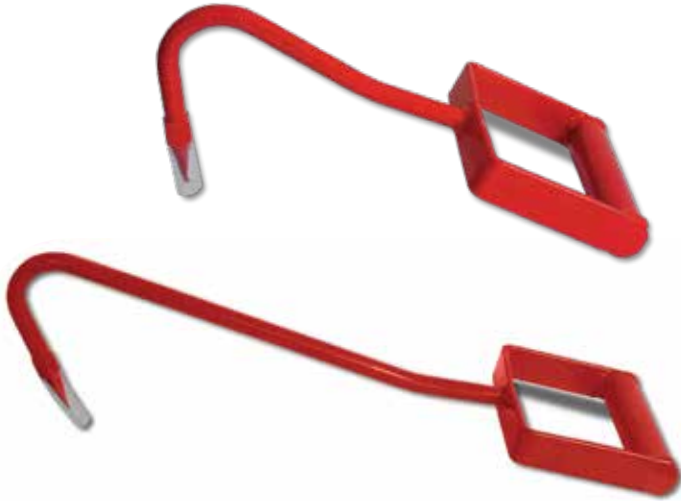

HAY HOOKS

PART#	DESCRIPTION
71.000.013	11" HAY HOOK, RED
71.000.016	17" HAY HOOK, RED

FEATURES

- ALLOWS YOU TO MOVE AND SECURE HAY EASIER
- WIDE HANDLE MAKES THIS THE IDEAL HAY BUCKING TOOL



SPORTSMAN COW BELL

PART#	DESCRIPTION
71.500.000	COW BELL W/ RED HANDLE

FEATURES

- POWDER COATED FINISH FOR LONG LIFE
- GREAT FOR SPORTING EVENTS



LONG DISTANCE COW BELL

PART#	DESCRIPTION
71.500.001	4" LONG DISTANCE COW BELL

FEATURES

- LONG DISTANCE COWBELLS PRODUCE A SHARP TONE THAT CAN BE HEARD AT LONG DISTANCES



KENTUCKY COW BELLS

PART#	DESCRIPTION
71.500.004	4" KENTUCKY COW BELL
71.500.003	4-7/8" KENTUCKY COW BELL
71.500.005	1-5/8" KENTUCKY COW BELL

FEATURES

- KENTUCKY COW BELLS PRODUCE A DULL TONE THAT CAN BE HEARD AT LONG DISTANCES

EARTH ANCHORS

**HOT DIPPED GALVANIZED
EARTH ANCHORS**

PART#	A	B	C
62.000.004	48"	5/8"	6"
62.000.006	48"	5/8"	4 1/2"
62.000.007	36"	1/2"	4 1/2"
62.000.008	36"	5/8"	6"
62.000.009	28"	1/2"	3"
62.000.010	15 1/2"	1/2"	3"

FEATURES

- ORCHARD AND VINEYARD ANCHORS
- HOT DIPPED ELECTRO GALVANIZED FINISH

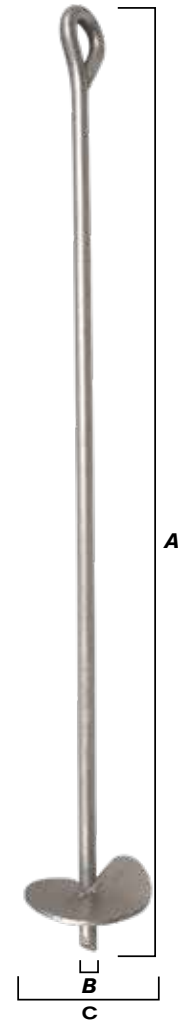
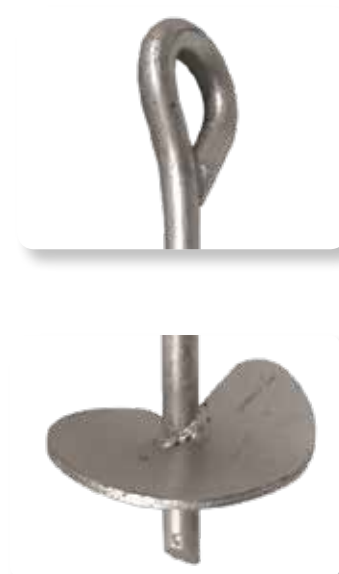
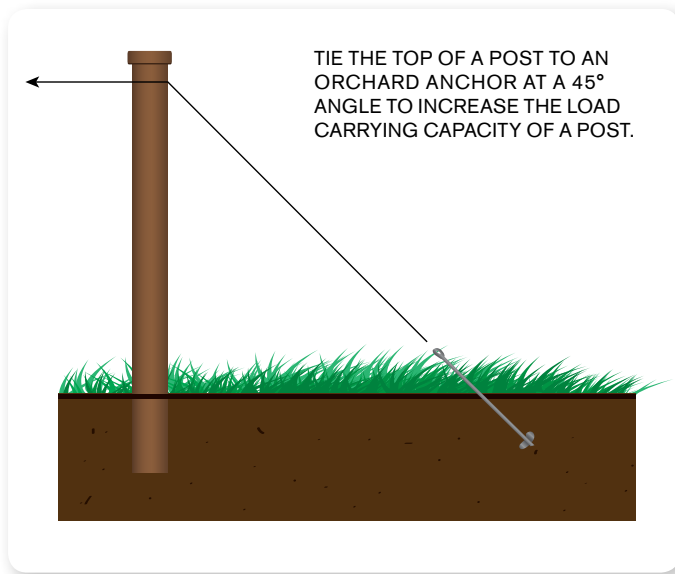

**STEEL
EARTH ANCHOR**

PART#	LENGTH	THICKNESS	WEIGHT
62.000.011	480MM	8MM	0.3KG

FEATURES

- MADE WITH STEEL
- ELECTRO GALVANIZED PLATING



**PLASTIC
HAY ANCHOR**

PART#	LENGTH	WIDTH
62.000.020	7 2/3"	3 3/16"

FEATURES

- MADE OF POLYPROPELENE TO PREVENT RUSTING
- INSERT HAY ANCHOR BY HAND OR BY 3/4 SOCKET
- CONVENIENT TIE POINTS FOR USE WITH ROPE OR "S" HOOKS





19 POWER TRANSMISSION

BRABER EQUIPMENT

40TH
EDITION

PARTS CATALOG

PLAN-O-GRAMS

BE CO

POWER TRANSMISSION PRODUCT



POP-MERCH CONSISTS OF:

- 2 SPINNER ASSEMBLIES
- 112 HOOKS
- 2 ADJUSTABLE LOWER SHELVING UNITS
- ALL POINT OF PURCHASE MATERIAL
- DESIGNED TO WORK WITH STANDARD LOZIER SHELVING UNITS
- COLOR CODING & ALPHABETICAL SYSTEM SIMPLIFIES & MAKES PROGRAM CONSUMER FRIENDLY

DRIVE PRODUCT - SPROCKETS

IDLER SPROCKETS

PART#	CHAIN	BORE SIZE	TEETH
74.401.217	#40/41	0.5"	17
74.405.817	#40/41	0.625"	17
74.501.213	#50	0.5"	13
74.505.813	#50	0.625"	13
74.501.215	#50	0.5"	15
74.505.815	#50	0.625"	15
74.501.217	#50	.5"	17
74.505.817	#50	.625"	17
74.601.211	#60	.5"	11
74.605.811	#60	.625"	11
74.601.213	#60	.5"	13
74.605.813	#60	.625"	13
74.601.215	#60	.5"	15
74.605.815	#60	.625"	15

PART # 74.605.813



#40 SPROCKETS 1/2" PITCH

PART#	CHAIN	O.D.	HUB	TEETH
74.040.012	# 40	2-3/16	V	12
74.040.013	# 40	2-1/4	V	13
74.040.014	# 40	2-7/16	V	14
74.040.015	# 40	2-5/8	V	15
74.040.016	# 40	2-13/16	W	16
74.040.017	# 40	3	W	17
74.040.018	# 40	3-1/8	W	18
74.040.019	# 40	3-5/16	W	19
74.040.020	# 40	3-7/16	X	20
74.040.021	# 40	3-5/8	X	21
74.040.022	# 40	3-3/4	X	22
74.040.023	# 40	4	X	23
74.040.024	# 40	4-1/6	X	24
74.040.026	# 40	4-3/8	X	26
74.040.028	# 40	4-11/16	X	28
74.040.030	# 40	5-1/16	X	30
74.040.032	# 40	5-3/8	X	32
74.040.036	# 40	6	X	36
74.040.040	# 40	6-5/8	X	40
74.040.042	# 40	7	X	42
74.040.045	# 40	7-3/8	X	45
74.040.048	# 40	7-7/8	X	48

PART # 74.040.015



- MADE OF HIGH QUALITY, PRECISION MACHINED STEEL FOR LONG LASTING PERFORMANCE
- OFFERED IN A FULL LINE OF WELD-ON OR IDLER SPROCKETS
- WELD-ON SPROCKETS TO BE USED IN COMBINATION WITH MULTIPLE SIZES OF WELD-ON HUBS

DRIVE PRODUCT - SPROCKETS

PART # 74.050.016



#50 SPROCKETS 5/8" PITCH

PART#	CHAIN	O.D.	HUB	TEETH
74.050.010	#50	2-1/4	V	10
74.050.011	#50	2-1/2	V	11
74.050.012	#50	2-3/4	W	12
74.050.013	#50	3-7/8	W	13
74.050.014	#50	3-1/16	W	14
74.050.015	#50	3-1/4	W	15
74.050.016	#50	3-7/16	W	16
74.050.017	#50	3-11/16	X	17
74.050.018	#50	3-7/8	X	18
74.050.019	#50	4-1/8	X	19
74.050.020	#50	4-3/8	X	20
74.050.021	#50	4-9/16	X	21
74.050.022	#50	4-3/4	X	22
74.050.024	#50	5-1/8	X	24
74.050.026	#50	5-1/2	X	26
74.050.028	#50	5-7/8	X	28
74.050.030	#50	6-5/16	X	30
74.050.032	#50	6-3/4	X	32
74.050.034	#50	7-1/16	X	34
74.050.036	#50	7-9/16	X	36

PART # 74.060.026



#60 SPROCKETS 3/4" PITCH

PART#	CHAIN	O.D.	HUB	TEETH
74.060.009	#60	2 1/2	V	9
74.060.010	#60	2 3/4	V	10
74.060.011	#60	3	W	11
74.060.012	#60	3-1/4	W	12
74.060.013	#60	3-1/2	W	13
74.060.014	#60	3-3/4	W	14
74.060.015	#60	4	X	15
74.060.016	#60	4-1/4	X	16
74.060.017	#60	4-1/2	X	17
74.060.018	#60	4-11/16	X	18
74.060.019	#60	5	X	19
74.060.020	#60	5-1/8	X	20
74.060.021	#60	5-1/2	X	21
74.060.022	#60	5-11/16	X	22
74.060.024	#60	6-1/8	X	24
74.060.026	#60	6-5/8	X	26
74.060.028	#60	7-1/8	X	28
74.060.030	#60	7-5/8	X	30

DRIVE PRODUCT - CHAIN

65.040.001



65.050.002



65.050.010



- HIGH QUALITY AND PRECISION MACHINED STEEL TO MEET OR EXCEED ANSI SPECIFIED STANDARDS
- OFFERED IN BAGGED QUANTITIES FOR CONVENIENCE

- HIGH QUALITY AND PRECISION MACHINED STEEL TO MEET OR EXCEED ANSI SPECIFIED STANDARDS
- SOLID ROLLERS, SOLID BUSHINGS
- OFFERED IN A COMPLETE LINE OF SIZES TO SUIT ALL NEEDS

CONNECTING LINKS

PART#	TYPE	BAG QTY	PITCH
65.204.001	A2040	4	1"
65.205.001	A2050	3	1-1/4"
65.206.001	A2060	3	1-1/2"
65.035.001	35	4	3/8"
65.035.201	35-2	4	3/8"
65.040.001	40	4	1/2"
65.041.001	41	4	1/2"
65.050.001	50	4	5/8"
65.050.201	50-2	4	5/8"
65.050.501	50H	4	5/8"
65.060.001	60R	3	3/4"
65.060.201	60-2	3	3/4"
65.060.501	60H	3	3/4"
65.080.001	80	2	1"
65.080.201	80-2	2	1"
65.080.501	80H	2	1"
65.100.001	100	2	1-1/4"
65.120.001	120	2	1-1/2"

OFFSET LINKS

PART#	TYPE	BAG QTY	PITCH
65.204.002	A2040	4	1"
65.205.002	A2050	3	1-1/4"
65.206.002	A2060	3	1-1/2"
65.035.002	35	4	3/8"
65.035.202	35-2	4	3/8"
65.040.002	40	4	1/2"
65.041.002	41	4	1/2"
65.050.002	50	3	5/8"
65.050.202	50-2	3	5/8"
65.050.502	50H	3	5/8"
65.060.002	60R	3	3/4"
65.060.202	60-2	3	3/4"
65.060.502	60	3	3/4"
65.080.002	80	2	1"
65.080.202	80-2	2	1"
65.080.502	80	2	1"
65.100.002	100R	2	1-1/4"
65.120.002	120R	2	1-1/2"

ROLLER CHAIN

PART#	TYPE	LENGTH	PITCH
65.204.010	2040	10FT	1"
65.205.010	2050	10FT	1-1/4"
65.206.010	2060	10FT	1-1/2"
65.035.010	35	10FT	3/8"
65.035.210	35-2	10FT	3/8"
65.040.010	40	10FT	1/2"
65.041.010	41	10FT	1/2"
65.050.010	50	10FT	5/8"
65.050.210	50-2	10FT	5/8"
65.050.510	50H	10FT	5/8"
65.060.010	60R	10FT	3/4"
65.060.210	60-2	10FT	3/4"
65.060.510	60H	10FT	3/4"
65.080.010	80R	10FT	1"
65.100.010	100	10FT	1-1/4"
65.120.010	120	10FT	1-1/2"

ROLLER CHAIN BREAKERS

PART#	DESCRIPTION
67.005.050	PIN BREAKER #25 - #60 CHAIN
67.005.051	PIN BREAKER #60 - #100 CHAIN

67.005.050



67.005.051



STEEL ROLLER CHAIN BREAKER

PART#	DESCRIPTION
67.005.055	STEEL ROLLER CHAIN BREAKER, HEAVY DUTY CAST IRON

- HANDY & USEFUL, THIS CAST IRON STEEL ROLLER CHAIN DETACHER CAN BE KEPT IN THE TRACTOR TOOL BOX
- ACTS AS A LINK DETACHER FOR VARIOUS CHAINS & HAS A RIVET KNOCKOUT HOLE FOR REPAIRING ROLLER CHAINS
- MADE OUT OF HEAVY DUTY CAST IRON TO WITH STAND PLENTY OF WEAR AND ABUSE



DRIVE PRODUCT - HUBS & BORES

HUB W
72.200.034



- AVAILABLE IN V, W, OR X SERIES
- OFFERED WITH ROUND, SPLINE, SQUARE, OR HEXAGONAL BORES
- HIGH QUALITY AND PRECISION MACHINED
- TO BE USED IN COMBINATION WITH SPROCKETS OR PULLEYS

SPLINED BORE W

PART#	BORE SIZE	HUB TYPE
72.206.118	1-1/8 X 6SP	W
72.206.138	1-3/8 X 6SP	W

HEX BORE W

PART#	BORE SIZE	HUB TYPE
72.220.078	7/8	W
72.220.100	1	W

X-SERIES HUB ROUND BORE

PART#	BORE SIZE	HUB TYPE
72.300.058	5/8	X
72.301.116	11/16	X
72.300.034	3/4	X
72.301.316	13/16	X
72.300.078	7/8	X
72.301.516	15/16	X
72.310.000	1	X
72.310.116	1-1/16	X
72.310.118	1-1/8	X
72.310.316	1-3/16	X
72.310.014	1-1/4	X
72.311.516	1-5/16	X
72.310.038	1-3/8	X
72.310.716	1-7/16	X
72.310.012	1-1/2	X

IDLER HUB
72.212.058



BORE W
72.206.138



HEX BORE X

PART#	BORE SIZE	HUB TYPE
72.320.078	7/8	X
72.320.100	1	X
72.320.118	1-1/8	X

SPLINED BORE X

PART#	BORE SIZE	HUB TYPE
72.306.118	1-1/8 X 6SP	X
72.321.138	1-3/8 X 21SP	X
72.306.138	1-3/8 X 6SP	X

SQUARE BORE

PART#	BORE SIZE	HUB TYPE
72.330.058	5/8"	X
72.330.078	7/8"	X
72.330.118	1-1/8"	X
72.331.316	1-3/16"	X
72.330.114	1-1/4"	X

IDLER HUBS

PART#	BORE SIZE	HUB TYPE
72.212.058	5/8" - 1/2"	W
72.312.058	5/8" - 1/2"	X

V-SERIES HUB

PART#	BORE SIZE	HUB TYPE
72.100.012	1/2	V
72.100.916	9/16	V
72.100.058	5/8	V
72.100.034	3/4	V
72.100.078	7/8	V

W-SERIES HUB

PART#	BORE SIZE	HUB TYPE
72.200.012	1/2	W
72.200.916	9/16	W
72.200.058	5/8	W
72.201.116	11/16	W
72.200.034	3/4	W
72.201.316	13/16	W
72.200.078	7/8	W
72.201.516	15/16	W
72.210.000	1	W
72.210.116	1-1/16	W
72.210.018	1-1/8	W
72.210.316	1-3/16	W
72.210.014	1-1/4	W

SQUARE HUB W

PART#	BORE SIZE	HUB TYPE
72.230.012	1/2	W
72.230.034	3/4	W

DRIVE PRODUCT - PULLEYS

STANDARD PULLEYS

PART#	O.D. (")	V TYPE STYLE	HUB TYPE
75.100.212	2 1/2	A OR B	V
75.100.003	3	A OR B	V
75.200.312	3 1/2	A OR B	W
75.200.004	4	A OR B	W
75.200.412	4 1/2	A OR B	W
75.200.005	5	A OR B	W
75.200.512	1/2	A OR B	W
75.200.006	6	A OR B	W
75.200.612	6 1/2	A OR B	W
75.200.007	7	A OR B	W
75.200.008	8	A OR B	W
75.200.009	9	A OR B	W
75.200.010	10	A OR B	W
75.200.011	11	A OR B	W
75.200.012	12	A OR B	W
75.200.014	14	A OR B	W
75.200.016	16	A OR B	W
75.300.006	6	C	X
75.300.008	8	C	X
75.300.010	10	C	X
75.300.012	12	C	X

PART # 75.200.005



PART # 75.300.008



FLAT TYPE IDLER PULLEYS

PART#	O.D. (")	BORE SIZE	INSIDE WIDTH
75.850.307	3 1/2	5/8	1
75.850.308	4	5/8	3/4
75.850.301	4	1/2	1
75.850.302	4	5/8	1

PART #75.850.302



- FULL RANGE OF SIZES TO SUIT MOST INDUSTRY NEEDS
- HIGH QUALITY AND PRECISION MACHINED
- WELD-ON PULLEYS TO BE USED IN COMBINATION WITH MULTIPLE SIZES OF WELD-ON HUBS

DRIVE PRODUCT - HOUSING

PART # 33.207.000FS



4 BOLT FLANGE HOUSINGS

PART#	DESCRIPTION
33.207.000FS	FLANGE HOUSING 4 HOLE 1 1/4 1 7/16
33.208.000FS	FLANGE HOUSING 4 HOLE 1 1/2 1 9/16
33.204.000FS	FLANGE HOUSING 4 HOLE 1/2 - 3/4
33.205.000FS	FLANGE HOUSING 4 HOLE 7/8 - 1
33.206.000FS	FLANGE HOUSING 4 HOLE 1-1/8 1-1/4S

PART # 33.204.000LP



LOW PROFILE PILLOW BLOCK HOUSINGS

PART#	DESCRIPTION
33.204.000LP	PILLOW BLOCK HOUSING BORE 3/4
33.205.000LP	PILLOW BLOCK HOUSING BORE 7/8 - 1
33.206.000LP	PILLOW BLK HOUSING 1-1/8 1-1/4
33.207.000LP	PILLOW BLK HOUSNG 1 1/4 1 7/16

PART # 33.203.000P



PILLOW BLOCK HOUSING

PART#	DESCRIPTION
33.203.000P	PILLOW BLOCK HOUSING 1/2 - 11/16
33.204.000P	PILLOW BLOCK HOUSING BORE 3/4
33.205.000P	PILLOW BLOCK HOUSING BORE 7/8 - 1
33.206.000P	PILLOW BLOCK HOUSING ORE S 1-1/8 1-1/4
33.207.000P	PILLOW BLK HOUSING 1-1/4H 1-7/16
33.208.000P	PILLOW BLK HOUSING BORE 1-1/2 1-9/16

STAMPED STEEL 3 & 4 BOLT FLANGES

PART#	DESCRIPTION
33.203.000PF	FLANGE 3 HOLE ROUND BORE 1/2 1 1/16
33.204.000PF	FLANGE 3 HOLE ROUND BORE 3/4
33.205.000PF	FLANGE 3 HOLE ROUND BORE 7/8-1
33.206.000PF	FLANGE 3 HOLE ROUND BORE 1-1/8 1-1/4S
33.207.000PF	FLANGE 3 HOLE ROUND BORE 1-1/4H 1-7/16
33.208.004PF	FLANGE 4 HOLE ROUND 1-1/2 1-9/16
33.209.004PF	FLANGE 4 HOLE ROUND BORE 1-5/8 1-3/4

PART # 33.203.000PF



STAMPED STEEL 2 BOLT FLANGES

PART#	DESCRIPTION
33.203.000PFL	FLANGE 2 HOLE BORE 1/2 1 1/16
33.204.000PFL	FLANGE 2 HOLE BORE 3/4
33.205.000PFL	FLANGE 2 HOLE BORE 7/8-1
33.206.000PFL	FLANGE 2 HOLE BORE 1-11/8 1-1/4S

PART # 33.203.000PFL



STAMPED STEEL 3 BOLT FLANGES

PART#	DESCRIPTION
33.204.000GPFL	FLANGE 3 HOLE TRIANGLE BORE 3/4
33.205.000GPFL	FLANGE 3 HOLE TRIANGLE BORE 7/8-1
33.206.000GPFL	FLANGE 3 HOLE TRIANGLE BORE 1-1/8 1-1/4S

PART # 33.204.000GPFL



STAMPED STEEL PILLOW BLOCK FLANGES

PART#	DESCRIPTION
33.203.000PP	PILLOW BLK FLANGE BORE 1/2 1 1/16
33.204.000PP	PILLOW BLOCK FLANGE BORE 3/4
33.205.000PP	PILLOW BLOCK FLANGE BORE 7/8-1
33.206.000PP	PILLOW BLOCK FLANGE BORE 1-1/8 1-1/4S
33.207.000PP	PILLOW BLOCK FLANGE BORE 1-14H 1-7/16

PART # 33.203.000PP



BEARINGS

PART # 33.007.032RS



PART # 29.062.002BP



PART # 33.201.008SA



PART # 33.201.008HC



CULTIVATOR & PUMP BEARINGS

PART#	DESCRIPTION
33.007.032RS	PRESS WHEEL BEARING
29.062.002BP	PUMP BEARING 15MM .5906
29.062.003BP	PUMP BEARING 17MM .6693
29.062.004BP	PUMP BEARING 20MM .7874
29.062.005BP	PUMP BEARING 25MM .9843
33.885.151E	BEARING IHC CULTIVATOR GUAGE WHEEL
33.885.154B	CULT GAUGE WHEEL BEARING
33.099.502H	BEARING FOR ACE PUMP 15.88MM 5/8

PRE-LUBED BEARINGS

PART#	DESCRIPTION
33.201.008SA	BEARING PRE-LUBE BORE 1/2
33.202.010SA	BEARING PRE-LUBE BORE 5/8
33.204.012SA	BEARING PRE-LUBE BORE 3/4
33.205.014SA	BEARING PRE-LUBE BORE 7/8
33.205.015SA	BEARING PRE-LUBE BORE 15/16
33.205.016SA	BEARING PRE-LUBE BORE 1
33.206.018SA	BEARING PRE-LUBE BORE 1-1/8
33.206.019SA	BEARING PRE-LUBE BORE 1-3/16
33.206.020SA	BEARING PRE-LUBE BORE 1-1/4S
33.207.020SA	BEARING PRE-LUBE BORE 1-1/4
33.207.022SA	BEARING PRE-LUBE BORE 1-3/8
33.207.023SA	BEARING PRE-LUBE BORE 1-7/16
33.208.024CSA	BEARING PRE-LUBE BORE 1 1/2

RE-LUBED BEARINGS

PART#	DESCRIPTION
33.201.008HC	BEARING RE-LUBE BORE 1/2
33.202.010HC	BEARING RE-LUBE BORE 5/8
33.204.012HC	BEARING RE-LUBE BORE 3/4
33.205.014HC	BEARING RE-LUBE BORE 7/8
33.205.015HC	BEARING RE-LUBE BORE 15/16
33.205.016HC	BEARING RE-LUBE BEAR 1
33.206.018HC	BEARING RE-LUBE BORE 1-1/8
33.206.019HC	BEARING RE-LUBE BORE 1-3/16
33.206.020HC	BEARING RE-LUBE BORE S 1-1/4
33.207.022HC	BEARING RE-LUBE BORE 1-3/8
33.207.023HC	BEARING RE-LUBE BORE 1-7/16
33.208.024HC	BEARING RE-LUBE BORE 1-1/2

JAW COUPLINGS



JAW COUPLERS

PART#	DESCRIPTION	BORE SIZE	OUTSIDE DIAMETER	KEYWAY SIZE	TYPE
72.075.012	COUPLER, SHAFT 1/2" L075	1/2"	1.75"	1/8" X 1/16"	L075
72.075.058	COUPLER, SHAFT 5/8" L075	5/8"	1.75"	3/16" X 3/32"	L075
72.075.034	COUPLER, SHAFT 3/4" L075	3/4"	1.75"	3/16" X 3/32"	L075
72.095.012	COUPLER, SHAFT 1/2" L095	1/2"	2.11"	1/8" X 1/16"	L095
72.095.058	COUPLER, SHAFT 5/8" L095	5/8"	2.11"	3/16" X 3/32"	L095
72.095.034	COUPLER, SHAFT 3/4" L095	3/4"	2.11"	3/16" X 3/32"	L095
72.095.078	COUPLER, SHAFT 7/8" L095	7/8"	2.11"	3/16" X 3/32"	L095
72.095.100	COUPLER, SHAFT 1" L095	1"	2.11"	1/4" X 1/8"	L095
72.095.118	COUPLER, SHAFT 1-1/8" L095	1-1/8"	2.11"	1/4" X 1/8"	L095
72.075.000	INSERT, RUBBER COUPLER L075	SOLID		SOB (NBR)	L075
72.095.000	INSERT, RUBBER COUPLER L095	SOLID		SOB (NBR)	L095





20 SHOP & CLEANING SUPPLIES

BRABER EQUIPMENT

40TH EDITION

PARTS CATALOG

GENERAL SHOP SUPPLIES



PART # B55207



PART # B55208



PART # B5440030



PART # B5025001



PART # B5520201



PART # B1488



PART # B1400



PART # B1475



PART # B1450



PART # B1405



PART # B1495

PART#	QUANTITY	DESCRIPTION
B55207	6 BOXES/CASE	TOWELS, SHOP BUCKET
B55208	2 BUCKETS/CASE	TOWELS, SHOP BUCKET, RE-FILL
B5440030	30 ROLLS/CASE	SHOP TOWELS, HD, 64 TOWEL BOX
B5025001	8 BOXES/CASE	SHOP TOWELS, HD
B5520201	6 BOXES/CASE	SHOP TOWELS, HD, 200 TOWEL BOX
B1488	10 PADS/BOX	DRUM TOPPER, UNIVERSAL 2" & 3/4" OPENINGS
B1400	100 PADS/BOX	PAD, 15" X 18" UNIVERSAL SORBENT
B1475	200 PADS/BAG 1 BAG/BOX	PAD, SINGLE OIL ONLY, 16" X 20" X 3/16"
B1450	100 PADS/BAG 1 BAG/BOX	PAD, OIL ONLY, HD, 16" X 20" X 3/8"
B1405	40 SOCKS/CASE	SOCK, UNIVERSAL, CHEMSORB 3" X 48"
B1495	40 SOCKS/CASE	SOCK, OIL ONLY 3" X 48"

HAND CLEANERS



PART # B27128
PART # B28128
PART # B28128HD



PART # B29129NUT
PART # B29130CP
PART # B29131HD



PART # B27015
PART # B28015



PART # B28045B



PART # B27290



PART # B28128SBR



PART # B28014
PART # B28045

PART#	QUANTITY	DESCRIPTION
B27128	4/BOX	HAND CLEANER, 1 GALLON, CITRUS
B28128	4/BOX	HAND CLEANER, 1 GALLON, PUMICE CITRUS
B28128HD	4/BOX	HEAVY DUTY HAND CLEANER, 1 GALLON, PUMICE
B29129NUT	4/BOX	HAND CLEANER NUT SHELL, 1 GALLON,
B29130CP	4/BOX	HAND CLEANER CITRUS PUMICE 1 GALLON,
B29131HD	4/BOX	HAND CLEANER HEAVY DUTY, 1 GALLON,
B27015	12/BOX	HAND CLEANER, 15 OZ, CITRUS
B28015	12/BOX	HAND CLEANER, GEL 15 OZ, PUMICE CITRUS
B28045B	1/BOX	HAND CLEANER WALL MOUNT DISPENSER, 1 GALLON, PUMICE
B27290	6/BOX	HAND SCRUBBER WIPES, 90 COUNT
B28128SBR	1/BOX	HAND CLEANER WALL MOUNT DISPENSER, 1 GALLON, PUMICE
B28014	12/BOX	HAND CLEANER, GEL, 4.5 OZ PUMICE
B28045	6/BOX	HAND CLEANER, GEL, 4.5 LB CARTRIDGE, PUMICE

POLYETHYLENE FUNNELS

POLYETHYLENE FUNNEL

1 PINT

PART # B1503

- 1 PINT CAPACITY
- TOP ID 4-1/2"
- SPOUT OD 1/2"
- HEIGHT 6"
- INCLUDES AN IN-SPOUT SCREEN TO REDUCE CONTAMINATION



POLYETHYLENE FUNNEL

1-1/4 QUART, CAPPED

PART # B1505

- 1-1/4 QUART CAPACITY
- TOP ID 4"
- SPOUT OD 5/8"
- HEIGHT 10-1/2"
- INCLUDES A CAP TO PREVENT FUNNEL FROM COLLECTING DIRT, ENGINE GRIME AND OTHER CONTAMINANTS



POLYETHYLENE FUNNEL

2 QUART

PART # B1501

- 2 QUART CAPACITY
- TOP ID 6-1/2"
- SPOUT OD 1-1/16"
- HEIGHT 8-1/2"
- INCLUDES AN IN-SPOUT SCREEN TO REDUCE CONTAMINATION



POLYETHYLENE FUNNEL

1-1/2 QUART, CAPPED

PART # B1507

- 1-1/2 QUART CAPACITY
- TOP ID 4"
- SPOUT OD 1-1/8"
- HEIGHT 13-1/4"
- INCLUDES A CAP TO PREVENT FUNNEL FROM COLLECTING DIRT, ENGINE GRIME AND OTHER CONTAMINANTS



POLYETHYLENE FUNNEL

6 QUART

PART # B1502

- 6 QUART CAPACITY
- TOP ID 8-1/2"
- SPOUT OD 1-5/6"
- HEIGHT 10-1/2"
- INCLUDES AN IN-SPOUT SCREEN TO REDUCE CONTAMINATION



POLYETHYLENE FUNNEL

1 PINT

PART # B1506

- 1-1/2 QUART CAPACITY
- TOP ID 4"
- SPOUT OD 5/8"
- HEIGHT 17"
- INCLUDES A CAP TO PREVENT FUNNEL FROM COLLECTING DIRT, ENGINE GRIME AND OTHER CONTAMINANTS



POLYETHYLENE FUNNEL

1 PINT, CAPPED

PART # B1504

- 1 PINT CAPACITY
- TOP ID 3"
- SPOUT OD 1/2"
- HEIGHT 9-1/2"
- INCLUDES A CAP TO PREVENT FUNNEL FROM COLLECTING DIRT, ENGINE GRIME AND OTHER CONTAMINANTS



POLYETHYLENE FUNNEL

4 QUART

PART # B1509

- 4 QUART CAPACITY
- TOP ID 9-1/2"
- SPOUT OD 1-1/2"
- HEIGHT 8-1/2"
- SPOUT LENGTH 1-1/4"
- THREAD 2"
- COMES WITH SCREEN AND LID TO REDUCE CONTAMINATION





21 TOOLS

BRABER EQUIPMENT
40TH
EDITION
PARTS CATALOG

BOOSTER CABLES



15 FT BOOSTER CABLE

PART # BE154BC

- COPPER/ALUMINUM CLAMPS
- 4 GAUGE
- COMES IN ROUND ZIPPER BAG



30 FT BOOSTER CABLE

PART # BE302BC

- COPPER/ALUMINUM CLAMPS
- 2 GAUGE
- COMES IN ROUND ZIPPER BAG



15 FT BOOSTER CABLE

PART # BE152BC

- COPPER/ALUMINUM CLAMPS
- 2 GAUGE
- COMES IN ROUND ZIPPER BAG



BOOSTER CABLES

15 FT BOOSTER CABLE

PART # BE15BCCA1GA

30 FT BOOSTER CABLE

PART # BE30BCCA1GA

- 0.30 X 707 CCA WIRES X O.D. 14MM
- SOLID COPPER ALLIGATOR CLAMPS
- 1 GAUGE
- USE WITH MEDIUM DUTY EQUIPMENT
- 900 AMP CLAMPS



15 FT HEAVY DUTY BOOSTER CABLE

PART # BE15BCHDC1GA

30 FT HEAVY DUTY BOOSTER CABLE

PART # BE30BCHDC1GA

- 0.32 X 537 COPPER WIRES X O.D. 14MM
- SOLID COPPER ALLIGATOR CLAMPS
- 1 GAUGE
- USE WITH HEAVY DUTY EQUIPMENT
- 900 AMP CLAMPS
- FINE-STRANDED COPPER CONDUCTOR FOR MAXIMUM CONDUCTIVITY AND FLEXIBILITY



COMMERCIAL PORTABLE JUMP STARTER

PART # 67.999.464

- 12V
- 1100A CRANKING AMP
- 2200A PEAK AMP
- 2 X 20AH SEALED LEAD-ACID BATTERY
- 1 X 12V POWER OUTLET
- BUILT IN HIGH BRIGHTNESS LED WORKLIGHT
- ON/OFF SWITCH FOR SAFETY
- AUTOMATIC CIRCUIT OVERLOAD PROTECTION
- REVERSE HOOK-UP ALARM AND INDICATION
- USB PORT



AIR COMPRESSOR JUMP STARTER

PART # 67.999.474

- 12V
- 500A CRANKING AMP
- 1200A PEAK AMP
- 20AH SEALED LEAD-ACID BATTERY
- AIR COMPRESSOR
- 1 X 12V POWER OUTLET
- BUILT IN HIGH BRIGHTNESS LED WORKLIGHT
- ON/OFF SWITCH FOR SAFETY
- AUTOMATIC CIRCUIT OVERLOAD PROTECTION
- REVERSE HOOK-UP ALARM AND INDICATION
- USB PORT



AIR STORAGE TANKS & BLOW GUNS

AIR STORAGE TANKS



PART #	CAPACITY	MAX PRESSURE
67.000.500	5 GALLONS	125 PSI
67.000.700	7 GALLONS	125 PSI
67.001.100	11 GALLONS	125 PSI

- LIGHT-WEIGHT, PORTABLE TANK WITH CARRY HANDLE FOR EASY TRANSPORT
- PERFECT FOR FILLING TIRES AND SPORTS EQUIPMENT
- CONNECTS TO STANDARD COMPRESSED AIR SOURCE
- INCLUDES PRESSURE GAUGE & REGULATOR, AIR FILLER & CHUCK HOSE, AIR BLOW GUN, AIR BLEED VALVE AND REGULATOR PROTECTION



AIR BLOW GUN



PART #	DESCRIPTION
67.000.582	AIR BLOW GUN

ROTARY HAND PUMP



PART #	DESCRIPTION
67.500.250	ROTARY HAND PUMP, OIL DRUM PUMP

DIGITAL CALIPERS & DRAWING HOLDERS

DIGITAL CALIPERS

PART#	76.100.000
SIZE	100MM/4"
BUTTONS	3
MEASUREMENTS	METRIC/STANDARD

ADDITIONAL INFORMATION	
COMES WITH CASE AND BATTERY	

PART#	76.150.000
SIZE	150MM/6"
BUTTONS	3
MEASUREMENTS	METRIC/STANDARD

ADDITIONAL INFORMATION	
COMES WITH CASE AND EXTRA BATTERY	



DRAWING HOLDERS

PART#	67.000.999
DESCRIPTION	PROTECTS/HOLDS OPERATORS MANUAL
TOTAL TUBE LENGTH	13"
INSIDE DIAMETER	2-1/4"
MOUNTING HOLE SPACING	9-1/2"



PART#	67.221.000
DESCRIPTION	HD MANUAL & DRAWING HOLDER W/ RUBBER GASKET & VENTING HOLES PROTECTS/HOLDS OPERATORS MANUAL
TOTAL TUBE LENGTH	12"
INSIDE DIAMETER	2"
MOUNTING HOLE SPACING	10-1/2"



PART#	67.222.000
DESCRIPTION	HD MANUAL & DRAWING HOLDER W/ RUBBER GASKET & VENTING HOLES PROTECTS/HOLDS OPERATORS MANUAL
TOTAL TUBE LENGTH	13-1/2"
INSIDE DIAMETER	3-1/4"
MOUNTING HOLE SPACING	12-1/2"



GREASE GUNS



LEVER ACTION GREASE GUN

PART#	67.212.000
PSI	10,000
CAPACITY	14 OZ

- HEAVY DUTY DIE CAST ALUMINUM HEAD
- AIR VENT (BLEEDER VALVE)
- 3 WAY LOADING
- 18" HIGH PRESSURE FLEX HOSE W/ COUPLER INCLUDED.
- SURE GRIP VINYL HANDLE COVER
- DELIVERS APPROXIMATELY 3 OZ IN 40 STROKES



PISTOL GRIP GREASE GUN

PART#	67.208.000
PSI	7000
CAPACITY	14 OZ

- HEAVY DUTY DIE CAST ALUMINUM HEAD
- AIR VENT (BLEEDER VALVE)
- 3 WAY LOADING
- 18" HIGH PRESSURE FLEX HOSE W/ COUPLER INCLUDED.
- SURE GRIP VINYL HANDLE COVER
- DELIVERS APPROXIMATELY 1 OZ IN 33 STROKES



SINGLE SHOT AIR GREASE GUN

PART#	67.000.116
PSI	3,600
CAPACITY	14 OZ

- IDEAL FOR MAINTAINING AUTOMOBILES FARM EQUIPMENT & MACHINERY
- 9" FLEXIBLE HOSE
- FOR HARD TO REACH FITTINGS
- 40:1 RATIO AIR MOTOR
- 3 WAY LOADING
- AIR VENT VALVE FOR PURGING REMAINING AIR
- LIGHTWEIGHT 1.6KG REDUCES OPERATOR FATIGUE



ELECTRIC GREASE GUN

PART#	67.018.200
PSI	9,500
CAPACITY	14 OZ

- 18 V OUTPUT
- 2 SPEED
- 2 BATTERIES
- CORDLESS
- CARRYING CASE INCLUDED
- 42" HYDRAULIC WHIP HOSE

GREASE GUN ACCESSORIES



PART #	DESCRIPTION	TECHNICAL INFO	PACKING
67.000.013	GREASE COUPLER, 4 JAW	1/8 NPT	CLAMSHELL
67.000.021	NEEDLE NOSE DISPENSER	LENGTH: 1-1/2"	BLISTER
67.000.022	90° ANGLE GREASE COUPLER		BLISTER
67.000.023	GREASE INJECTORS 18GA, 3PCS	18GA X1-1/2"	3 IN 1 BLISTER
67.000.024	GREASE INJECTOR 18GA, 1PC	18GA X1-1/2"	BLISTER
67.000.025	GREASE INJECTORS 18GA & 21GA, 2PCS		2 IN 1 BLISTER
67.000.026	GREASE COUPLERS, HD 10,000 PSI	1/8" NPT	BLISTER
67.000.027	GREASE HOSE, PLASTIC, 12", 1/8" NPT	MAX 3500 PSI	POLYBAGGED
67.000.028	GREASE HOSE, PLASTIC, 18", 1/8" NPT	MAX 3500 PSI	POLYBAGGED
67.000.011	GREASE HOSE, 18" W/ COUPLER	1/8" NPT	POLYBAGGED



OIL SUCTION GUN

PART#	67.000.100
CAPACITY	16 OZ

- NO PUMP PRIMING NEEDED
- FOR USE WITH ANY TYPE OF NON-CORROSIVE LUBRICANT
- SPECIALLY DESIGNED LIP SEAL PROVIDES MAXIMUM SUCTION
- 12" PVC HOSE
- IDEAL FOR ADDING/REMOVING OIL FROM GEAR CASES



GREASE GUN HOLDERS

PART #	DESCRIPTION
67.000.119	HD GREASE GUN HOLDER
67.000.019	GREASE GUN HOLDER



AIR GREASE LUBRICATORS

AIR GREASE LUBRICATOR

CASE IH, 5 GALLONS
PRESSURE RATIO 50:1
PART # 5705AGD



OIL CANS, RED

PART # 67.700.320



PART#	DESCRIPTION
67.700.320	OIL CAN, PUMP STYLE, 200ML
67.700.330	OIL CAN, PUMP STYLE, 300ML
67.700.350	OIL CAN, PUMP STYLE, 500ML

AIR GREASE LUBRICATOR

CASE IH, 15 GALLONS
PRESSURE RATIO 55:1
PART # 5715AGD



- ALL KITS INCLUDE A 50FT HOSE, AIR REGULATOR & GREASE VALVE
- WORKING PRESSURE 70-115 PSI

OIL CANS, BLUE

PART # 67.700.100



PART#	DESCRIPTION
67.700.100	OIL CAN, PUMP STYLE, 300ML
67.700.107	OIL CAN, PUMP STYLE, 500ML
67.700.124	OIL CAN, PUMP STYLE, 700ML

AIR GREASE LUBRICATOR

CASE IH, 55 GALLONS
PRESSURE RATIO 55:1
PART # 5755AGD



GREASE DISPENSE VALVE

PART # 57GUNAGD

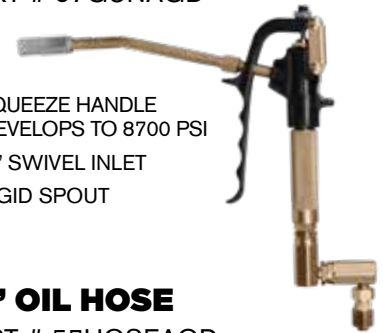

- SQUEEZE HANDLE DEVELOPS TO 8700 PSI
- 1/4" SWIVEL INLET
- RIGID SPOUT

50' OIL HOSE

PART # 57HOSEAGD

- REPLACEMENT HOSE FOR MOBILE OIL DISPENSERS
- 1/2" FITTINGS
- 3190 PSI RATING



OIL DISPENSERS

MOBILE OIL DISPENSER

CASE IH, 5 GALLONS
PRESSURE RATIO 3:1
PART # 5710MOD



- CAN BE USED WITH ENGINE OIL, ATF OIL, HYDRAULIC OIL, AUTOMATIC TRANSMISSION OIL, ANTI-FREEZE & ALLIED PRODUCTS
- WORKING PRESSURE 70-115 PSI, MAX FREE FLOW RATE 4G/MIN
- LCD CONTROL VALVE SHOWS FLOWS IN GALLONS OR LITERS
- ALL KITS INCLUDE 50FT HOSE & AIR REGULATOR

MOBILE OIL DISPENSER

CASE IH, 15 GALLONS
PRESSURE RATIO 5:1
PART # 5715MOD



50' OIL HOSE

PART # 57HOSEMOD



- REPLACEMENT HOSE FOR MOBILE OIL DISPENSERS
- 1/2" FITTINGS
- 3190 PSI RATING

MOBILE OIL DISPENSER

CASE IH, 55 GALLONS
PRESSURE RATIO 5:1
PART # 5755MOD



DIGITAL CONTROL VALVE

PART # 57GUNMOD



- 5 DIGIT LCD DISPLAY
- BATTERY POWERED WITH AUTO POWER SAVING MODE
- SHOWS FLOW IN LITERS OR GALLONS
- ANTI-DRIP MUZZLE

INTERNATIONAL HARVESTER AIR GUNS



1/2" COMPOSITE IMPACT WRENCH
PART # IHIW12700C



1/2" DRIVE AIR IMPACT WRENCH
PART # IHIW12600



3/4" DRIVE AIR IMPACT WRENCH
PART # IHIW341100



**1" IMPACT WRENCH
W/ 6" EXTENDED ANVIL**
PART # IHIW11600



90° AIR DIE GRINDER, MINI
PART # IHDGA



**1/4" AIR DYE GRINDER
STRAIGHT, MEDIUM**
PART # IHDGS

INTERNATIONAL HARVESTER AIR GUNS



3/8" AIR RATCHET WRENCH
PART # IHR3850



LONG BARREL AIR HAMMER KIT
PART # IHAHL



3/8" IMPACT WRENCH
200FT/LB
PART # IHIW38200



CLEAR DISPLAY STAND
FOR AIR TOOLS
PART # IHDSATC

INTERNATIONAL HARVESTER AIR TOOLS

PART#	DRIVE	DESCRIPTION
IHIW12700C	1/2"	700 FT/LB MAX TORQUE, 8,000 RPM FREE SPEED, 4.74LB/2.15KG
IHIW12600	1/2"	600 FT/LB MAX TORQUE, 8,000 RPM FREE SPEED, 5.95LB/2.70KG
IHIW38200	3/8"	200 FT/LB MAX TORQUE, 10,000 RPM FREE SPEED, 2.98LB/1.35KG
IHIW341100	3/4"	1,100 FT/LB MAX TORQUE, 5,500 RPM FREE SPEED, 12.35LB/5.60KG
IHIW11600	1"	1,600 FT/LB MAX TORQUE, 150 RPM FREE SPEED, 12.35LB/5.60KG
IHR3850	3/8"	50 FT/LB MAX TORQUE, 5,500 RPM FREE SPEED, 2.58LB/1.17KG
IHDGA	1/4", 90°	20,000 RPM FREE SPEED, 1.24 LB/.56KG 1/4" COLLET ACCEPTS ALL STANDARD ACCESSORIES
IHDGS	1/4", 90°	20,000 RPM FREE SPEED, 1.24 LB/.56KG, 1/4" COLLET ACCEPTS ALL STANDARD ACCESSORIES
IHAHL		2,000 BPM, 3-1/2" LONG STROKE, INCLUDES 4 PIECE HAMMER BIT KIT, STANDARD .401 SHANK, 4.5LB/2.04KG
IHDSATC		DISPLAY STAND, AIR TOOLS CLEAR

- STEEL NOSE, ALUMINUM HOUSING & COMPOSITE BODY FOR LIGHTWEIGHT & DURABILITY
- FORWARD/REVERSE REAR DIAL ON BACK
- ALL METAL BALL BEARINGS & GEARS
- VARIABLE SPEED TRIGGER

INTERNATIONAL HARVESTER SOCKET KITS & SCREWDRIVER SETS



13 PIECE IMPACT SOCKETS

PART # IHDS1213S



7 PIECE NUT DRIVER SET

PART # IHDS7M



6-IN-1 SCREW DRIVER

PART # IHSD61K

7 PIECE SCREWDRIVER SET

PART # IHSD7R



8 PIECE IMPACT SOCKETS

PART # IHDS3408M

SOCKET SETS

PART#	DRIVE	DESCRIPTION, SOCKET SIZE SAE OR METRIC (IN OR MM)
IHDS1213S	1/2"	13PC, DEEP WELL - 9/16, 1/2, 7/16, 5/8, 11/16, 3/4, 13/16, 7/8, 15/16, 1, 1-1/16, 1-1/8, 1-1/4
IHS1213S	1/2"	13PC - 7/16, 1/2, 9/16, 5/8, 11/16, 3/4, 13/16, 7/8, 15/16, 1, 1-1/16, 1-1/8, 1-1/4
IHDS1214M	1/2"	14PC, DEEP WELL - 10, 11, 12, 13, 14, 15, 16, 17, 18, 19, 21, 22, 26, 27
IHS214M	1/2"	14PC - 10, 11, 12, 13, 14, 15, 16, 17, 18, 19, 21, 22, 26, 27
IHDS388S	3/8"	8PC - 5/16, 3/8, 7/16, 1/2, 9/16, 5/8, 11/16, 3/4
IH388S	3/8"	8PC - DEEP WELL - 5/16, 3/8, 7/16, 1/2, 9/16, 5/8, 11/16, 3/4
IHDS388M	3/8"	8PC - DEEP WELL - 9, 10, 11, 13, 14, 15, 17, 19
IH388M	3/8"	8PC - 9, 10, 11, 13, 14, 15, 17, 19
IHDS3408S	3/4"	8PC - DEEP WELL - 1, 1-1/16, 1-1/8, 1-1/4, 1-5/16, 1-3/8, 1-7/16, 1-1/2
IHS3408S	3/4"	8PC, 1, 1-1/16, 1-1/8, 1-1/4, 1-5/16, 1-3/8, 1-7/16, 1-1/2
IHDS3408M	3/4"	8PC, DEEP WELL - 21 BUDD WHEEL, 24, 26, 27, 29, 30, 32, 38
IHS3408M	3/4"	8PC - 21 BUDD WHEEL, 24, 26, 27, 29, 30, 32, 38

ADDITIONAL INFORMATION

CHROME MOLYBDENUM STEEL
BLOW-MOLDED CASE

SCREWDRIVER SETS

PART#	SIZE
IHDS7M	7PC METRIC - INCLUDES ALL SIZES FROM 6MM TO 12MM
IHDS7S	7PC SAE - 3/16", 1/4", 5/16", 11/32", 3/8", 7/16", 1/2"
IHSD61K	6 IN 1 - SLOTTED 3/16", 1/4"; PHILLIPS #1(1/4"), #2(5/16"); NUT DRIVER 1/4", 5/16"
IHSD4R	4PC - SLOTTED 3/16" X 3", 1/4" X 4"; PHILLIPS: #1 X 3", #2 X 4"
IHSD7H	7PC - SLOTTED 3/16" X 3", 1/4" X 4", 5/16" X 6", 3/8" X 8"; PHILLIPS #1 X 3", #2 X 4", #3 X 6"
IHSD7R	7PC - SLOTTED 3/16 X 4", 1/4 X 6", 5/16 X 6", 3/8 X 8"; PHILLIPS #1 X 3", #2 X 4", #3 X 6"

ADDITIONAL INFORMATION

CONTOURED ERGONOMIC HANDLES
OIL AND SOLVENT RESISTANT
RUST RESISTANT CHROME PLATED FINISH

INTERNATIONAL HARVESTER TOOL STORAGE



36" TOP CHEST
PORTABLE
PART # IH36TT

- 16 GAL STEEL CONSTRUCTIONS ON TOP CHEST WITH WELDED SEAMS - NO SPOT WELDING
- TOP CHEST HOLDS BOTH METRIC AND SAE TOOLS
- WEATHER STRIPPING CREATES A TIGHT SEAL AGAINST DUST AND MOISTURE
- LOCKING LATCH IN TOP CHEST SECURES TOOLS FROM UNAUTHORIZED USE
- 21.5 X 36.85 X 17.52"



48" TOOL BOX
JOB SITE
PART # IH48JB

- HEAVY GAUGE STEEL WITH POWDER COATED FINISH
- FOUR WAY ENTRY SKID FOR EASY HANDLING
- RECESSED LOCKING ARE PROTECTING CONTENTS
- REINFORCED OVERLAPPING LID PROVIDES PROTECTION FOR WEATHER
- 48-1/8" W X 24-1/8" D X 28-3/8" H
- MANUFACTURER'S LIMITED WARRANTY



20" TOOL BOX
PORTABLE
PART # IHTB20

- POWDERED COATED RED FINISH
- REMOVABLE METAL TRAY
- HEAVY-DUTY RUST RESISTANT LATCHES



16" TRACTOR TOOL BOX
PART # IHTB016

20" TRACTOR TOOL BOX
PART # IHTB020



41" CHEST
8 DRAWER
PART # IH41TCT

- CODED TUBULAR LOCK & KEYS
- FULL EXTENSION BALL BEARING DRAWER SLIDES WILL STORE UP TO 100 LB
- DRAWER LINERS ARE PROVIDED TO PROTECT BOTH YOUR TOOLS AND DRAWERS
- GAS SPRINGS IN CHEST LID FOR EASY OPENING
- 21.26 X 40.94 X 17.72"

41" CABINET
11 DRAWER
PART # IH41BCT

- CODED TUBULAR LOCK & KEYS
- FULL EXTENSION BALL BEARING DRAWER SLIDES WILL STORE UP TO 100 LB
- DRAWER LINERS ARE PROVIDED TO PROTECT BOTH YOUR TOOLS AND DRAWERS
- 40.87 X 41.57 X 18.11"



21" HAND TOOL BOX
3 DRAWER
PART # IHTB213

- BALL BEARING DRAWER SLIDES
- HEAVY DUTY LATCHES & CARRYING HANDLE PROVIDE SECURITY & PORTABILITY
- MANUFACTURER'S LIMITED WARRANTY

TOOLS

PART# IHUS3



PART# IHSSMT



PART# IHOP12



PART# IHFRSS1



PART# IHSC10041



PART# IHOPSW



PART# IHTM125



PART# IHOP18



PART# IHSD50



PART# IHOW2



PART# IHWL1



PART# IHFLM2



PART# IHFLP1



PART# IHFLF3



PART#	DESCRIPTION
IHUS3	3-PIECE UTILITY TOOL SET, 4" MAGNETIC TRAY, TELESCOPIC PICK AND MIRROR
IHSSMT	9-3/8" X 5-3/8" STAINLESS STEEL TRAY WITH 2 PVC COATED MAGNETS
IHSD50	50 PACK POCKET SCREWDRIVERS REVERSIBLE - FLAT TIP BLADE, VALVE TURNER
IHTM125	1" X 27' TAPE MEASURE - ENGLISH/METRIC SCALE
IHFLP1	IH PEN LIGHT 3W/1 CREE LED BULB
IHFLM2	IH MINI FLASHLIGHT (BLACK) 3W / CREE LED BULB
IHFLF3	IH SPOT FLOOD LIGHT (RED)
IHWL1	IH COMPACT ALL-PURPOSE LED WORK LIGHT, INCLUDES 110-240V AC ADAPTOR & 12V DC PLUG-IN VEHICLE CHARGER, 2 IN 1: 30-LED WORK LIGHT AND 5-LED FLASHLIGHT, 15 000-16 000 LED RATING
IHOP12	IH 2-1/4" - 4" OIL FILTER PLIERS, 12" LONG
IHOPSW	IH 4-1/4" - 7" OIL FILTER PLIERS, SWIVEL
IHOP18	IH 4-1/4" - 7" OIL FILTER PLIERS, 18" LONG
IHOW2	OIL FILTER WRENCH, BAND W/HANDLES (2-7/8" - 3-1/4" FILTER DIAMETER)
IHOW3	OIL FILTER WRENCH, BAND W/HANDLES (3-1/2" - 3-7/8" FILTER DIAMETER)
IHOW4	OIL FILTER WRENCH, BAND W/HANDLES (4-1/8" - 4-7/16" FILTER DIAMETER)
IHFRSS1	24-PIECE FLEX RATCHET & SPLINE SOCKET SET
IHSC10041	39-PIECE RATCHET BIT SET

PART# IHPK01



PART# IHPK02



PART# IHPK03



PART# IHPKMT



PART# IH5401



PART# IH6825M



PART# IH6070M



PART# IH6000M



PART# C000SS



PART#	SIZE	DESCRIPTION
IHPK01		KNIFE, CENTOFANTE TRIBUTE WITH MICARTA HANDLE
IHPK02		KNIFE, POCKET CLASSIC "STOCKMAN" JIG BONE
IHPK03		KNIFE, IGNITOR ASSISTED OPENING
IHPKMT		MULTI-TOOL WITH LED LIGHT
IH30LTR	24" X 16" X 16.25"	VINTAGE COOLER, ALUMINUM BODY, DRAIN VALVE, SECURE SEAL, SOLID STEEL LATCH
IH6825M	MEDIUM	A/B GRADE COW LEATHER GLOVE, TAILORED KEYSTONE THUMB' FULL LINING INSIDE
IH6825L	LARGE	
IH6825XL	X-LARGE	
IH6070M	MEDIUM	BREATHABLE FORM-FITTING SPANDEX BACK
IH6070L	LARGE	VIBRATION RESISTANT TPR ON KNUCKLE
IH6070XL	X-LARGE	ABRASION-RESISTANT NON-SLIP PALM PATCHES
IH6070XXL	XX-LARGE	TERRY CLOTH SWEAT WIPE ON THUMBS
IH6070XXL	XX-LARGE	ADJUSTABLE WRIST CLOSURE LOCKS OUT DIRT & DEBRIS
IH6070XXL	XX-LARGE	MACHINE WASH, AIR DRY
IH6000M	MEDIUM	DURABLE SYNTHETIC LEATHER PALM BREATHABLE FORM-FITTING SPANDEX BACK ADJUSTABLE WRIST CLOSURE LOCKS OUT DIRT & DEBRIS
IH6000L	LARGE	
IH6000XL	X-LARGE	
C000SS		SPOT SPRAYER, 80-150 PSI, REFILLABLE, NOT FOR USE WITH PAINT PRODUCTS OR FLAMMABLE PROPELLANTS, 32 OZ MAXIMUM LIQUID CAPACITY, ECO FRIENDLY
IH5401		GREASE GUN LEVER ACTION 10000P

PART# IH30LTR





22 HYDRAULICS & TRACTOR ACCESSORIES

BRABER EQUIPMENT

40TH
EDITION

PARTS CATALOG

RATCHET JACKS, PINS & O-RINGS

HEAVY DUTY RATCHET JACK



* COMES WITH HANDLE

PART#	PIN SIZE	MINIMUM LENGTH	MAXIMUM LENGTH	TENSION (PULL)	MAXIMUM CAPACITY (PUSH)
350JA	1"	20"	28"	15,000 LBS	10,000 LBS

PINS



SECURING PIN

PART #	DESCRIPTION
P-7910	SECURING PIN

ADDITIONAL INFORMATION
FITS P-7712, P-7713 AND 1" CYLINDER PINS



REPLACEMENT PINS

PART #	SIZE	OEM #
P-7712	2 3/4"	CASE -B504952, FARMEX - 1544, TISCO P7712
P-7713	3 15/16"	TISCO P7713
P-7729	1" X 2 3/4"	
P-7750	1 1/4" X 3 1/4"	

ADDITIONAL INFORMATION

P-7712 FITS BE350JA, P-7713 FITS MOST 3/8" HYD, P-7729 FITS MOST HYDRAULIC CYLINDERS, P-7750 FITS 46.003.016 AND 46.035.016

O-RINGS



26.000.007

PART #	THICKNESS	INSIDE DIAMETER	OUTSIDE DIAMETER	NO. OF PIECES	ISO 3601 SIZE REFERENCE
26.000.007	1/16"	5/32"	9/32"	10	-007
26.000.010	1/16"	1/4"	3/8"	10	-010
26.000.011	1/16"	5/16"	7/16"	8	-011
26.000.110	3/32"	3/8"	9/16"	8	-110
26.000.111	3/32"	7/16"	5/8"	8	-111
26.000.112	3/32"	1/2"	11/16"	7	-112
26.000.113	3/32"	9/16"	3/4"	7	-113
26.000.115	3/32"	11/16"	7/8"	6	-115
26.000.116	3/32"	3/4"	15/16"	6	-116
26.000.214	1/8"	1"	1-1/4"	3	-214



67.100.072

O-RING ASSORTMENT

PART #	NO. OF PIECES
67.100.072	72 PCS, 6 SIZES

KIT CONTENTS

THICKNESS	INSIDE DIAMETER	OUTSIDE DIAMETER	NO. OF PIECES	ISO 3601 SIZE REFERENCE
1/16"	5/32"	9/32"	20	-007
1/16"	1/4"	3/8"	15	-010
3/32"	7/16"	5/8"	10	-111
3/32"	9/16"	3/4"	10	-113
3/32"	3/4"	15/16"	10	-116
1/8"	1"	1-1/4"	7	-214

ALL MEASUREMENTS ARE IN MILLIMETERS UNLESS OTHERWISE STATED (1" = 25.4 MM). THESE ITEMS ARE NOT ORIGINAL EQUIPMENT PARTS.

HYDRAULIC TIPS, VALVES & STROKE CONTROLS

HYDRAULIC TIPS

PART#	DESCRIPTION
8010-4P	PIONEER STYLE 1/2" FNPT (POPPET TIP)
8010-F	PIONEER STYLE HYD COUPLER 1/2" FNPT (4050 TYPE)
8010-4PKIT	HYDRAULIC COUPLER KIT, 1 X 8010-4P, 1 X 8010-F



8010-4P

8010-F

8010-4PKIT

HYDRAULIC VALVES

PART#	DESCRIPTION
46.333.002	CLOSED CENTER CONVERSION KIT, A8032
LSTL13	HYDRAULIC VALVE W/ CONTROL HANDLE



PART#	DESCRIPTION
46.333.008	BE 2 STAGE GEAR PUMP, 11 GPM, CW ROTATION, 0.50" SHAFT, 1/8" SQUARE KEY
46.333.009	BE 2 STAGE GEAR PUMP, 16 GPM, CW ROTATION, 0.50" SHAFT, 1/8" SQUARE KEY



STROKE CONTROLS



PART#	DESCRIPTION
46.888.100	STROKE CONTROL KIT, FITS 1 1/8" TO 1 1/4" RODS
46.888.101	STROKE CONTROL KIT, FITS 1 3/8" TO 1 1/2" RODS
46.888.102	STROKE CONTROL KIT FITS 1 1/8" TO 1 1/2" RODS, W/ FINGER TABS
46.888.103	STROKE CONTROL KIT FITS 1 3/8" TO 2" RODS, W/ FINGER TABS



PART#	DESCRIPTION
46.888.006	FITS 1 3/8" TO 1 1/2" ROD, 1" WIDE
46.888.010	FITS 1 3/8" TO 1 1/2" RODS, 1 1/2" WIDE
46.888.011	1" WIDE FOR 2" DIA
46.888.013	2" WIDE FOR 2" DIA

HYDRAULIC CYLINDERS



DESCRIPTION	PRESSURE	PORT SIZE
TIE ROD HYD CYLINDER	2500 PSI	3/8" NPTF (2" & 2.5") 1/2" NPTF (3" & 4")

PART #	SHAFT #	DESCRIPTION
46.020.112	1.125"	SEAL KIT FOR 2" HYDRAULIC CYLINDER
46.025.112	1.125"	SEAL KIT FOR 2.5" HYDRAULIC CYLINDER
46.030.125	1.125"	SEAL KIT FOR 3" HYDRAULIC CYLINDER
46.030.150	1.5"	SEAL KIT FOR 3" HYDRAULIC CYLINDER
46.035.125	1.25"	SEAL KIT FOR 3.5" HYDRAULIC CYLINDER
46.035.150	1.5"	SEAL KIT FOR 3.5" HYDRAULIC CYLINDER
46.040.125	1.25"	SEAL KIT FOR 4" HYDRAULIC CYLINDER
46.040.175	1.75"	SEAL KIT FOR 4" HYDRAULIC CYLINDER

BORE SIZE	PART #	BORE X STROKE	RETRACT LENGTH	ROD DIA.	CLEVIS PIN DIA.	WT. (KG)
2"	46.002.008	2" X 8"	20.25"	1.125"	1"	8.50
	46.002.010	2" X 10"	20.25"	1.125"	1"	9.07
	46.002.012	2" X 12"	22.25"	1.125"	1"	9.53
	46.002.018	2" X 18"	28.25"	1.125"	1"	
	46.002.024	2" X 24"	34.25"	1.125"	1"	
	46.002.048	2" X 48"	58.25"	1.125"	1"	
2.5"	46.025.008	2.5" X 8"A	20.25"	1.125"	1"	9.98
	46.025.010	2.5" X 10"	20.25"	1.125"	1"	10.00
	46.025.012	2.5" X 12"	22.25"	1.125"	1"	
	46.025.016	2.5" X 16"	26.25"	1.125"	1"	
	46.025.020	2.5" X 20"	30.25"	1.125"	1"	
3"	46.003.008	3" X 8"A	20.25"	1.25"	1"	13.00
	46.003.010	3" X 10"	20.25"	1.25"	1"	13.70
	46.003.012	3" X 12"	22.25"	1.25"	1"	14.00
	46.003.016	3" X 16"A		1.25"	1"	
	46.003.020	3" X 20"A	30.25"	1.25"	1"	
3.5"	46.035.008	3.5" X 8"A	20.25"	1.125"	1.25"	
	46.035.016	3.5" X 16"A	28.25"	1.125"	1.25"	
4"	46.004.008	4" X 8"A	20.25	1.25"	1.25"	17.50

* WELDED CYLINDERS AVAILABLE FOR SPECIAL ORDER.

* FULL LINE OF HYDRAULIC CYLINDERS AVAILABLE FOR SPECIAL ORDER, INCLUDING CUSTOM MADE FOR MANUFACTURING PURPOSES.

A=ASAE ROD LENGTH.

CYLINDER SIZE CHARTS

TIE ROD CYLINDER SIZE CHART

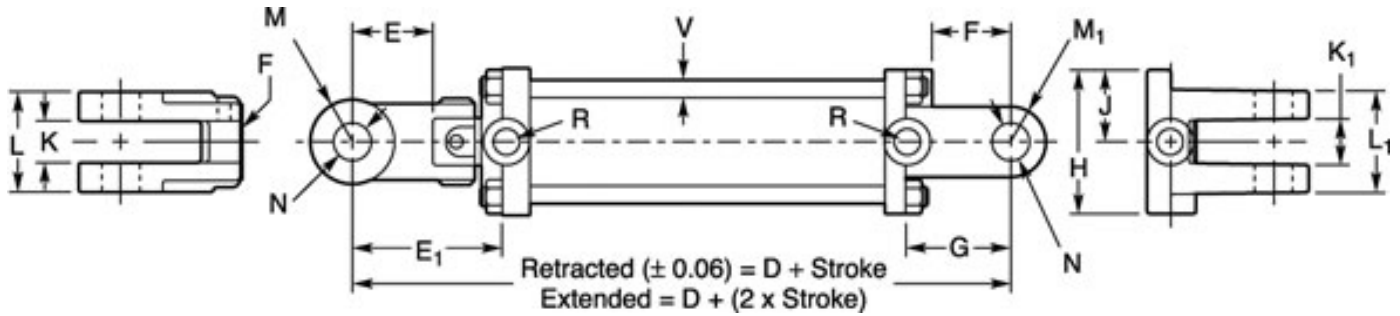

DIMENSION	2"	2.5"	3"	3.5"	4"
D	10 ¹ / ₄	10 ¹ / ₄	10 ¹ / ₄	10 ¹ / ₄	10 ¹ / ₄
E	2 ¹ / ₈	2 ¹ / ₈	2 ¹ / ₈	2 ¹ / ₈	2 ¹ / ₈
E 1	4 ⁷ / ₁₆	4 ⁷ / ₁₆	4 ⁷ / ₁₆	4 ⁷ / ₁₆	4 ⁷ / ₁₆
F	1 ⁵ / ₈	1 ⁵ / ₈	2	2	2
G	2 ³ / ₈	2 ³ / ₈	2 ¹ / ₄	2 ¹ / ₄	2 ¹ / ₄
H	2 ³ / ₄	3 ¹ / ₈	3 ³ / ₄	4 ¹ / ₄	4 ⁷ / ₈
J	1 ³ / ₈	1 ⁹ / ₁₆	1 ¹ / ₈	2 ¹ / ₈	2 ⁷ / ₁₆
K	1 ¹ / ₈	1 ¹ / ₈	1 ¹ / ₈	1 ¹ / ₈	1 ¹ / ₈
K 1	1 ¹ / ₈	1 ¹ / ₈	1 ¹ / ₈	1 ¹ / ₈	1 ¹ / ₄
L	2 ³ / ₄	2 ³ / ₄	2 ³ / ₄	2 ³ / ₄	2 ³ / ₄
L 1	2 ¹ / ₂	2 ¹ / ₂	2 ⁹ / ₁₆	1 ³ / ₄	3
M	1 ¹ / ₈	1 ¹ / ₈	1 ¹ / ₈	1 ¹ / ₈	1 ¹ / ₈
M 1	1	1	1	1 ¹ / ₈	1 ¹ / ₈
N PML	1 ¹ / ₆₄	1 ¹ / ₆₄	1 ¹ / ₆₄	1 ¹ / ₆₄	1 ¹ / ₆₄
N PMH	1 ¹ / ₆₄	1 ¹ / ₆₄	1 ¹ / ₆₄	1 ¹ / ₆₄	1 ¹ / ₆₄
P	1 ¹ / ₈ - 12	1 ¹ / ₈ - 12	1 ¹ / ₄ - 12	1 ¹ / ₄ - 12	1 ¹ / ₄ - 12
R PML	³ / ₈	³ / ₈	¹ / ₂	¹ / ₂	¹ / ₂
R PMH	³ / ₄ - 16	³ / ₄ - 16	³ / ₄ - 16	³ / ₄ - 16	³ / ₄ - 16
V	³ / ₈	³ / ₈	¹ / ₂	⁵ / ₈	⁵ / ₈

ASAE CYLINDER SIZE CHART

DIMENSION	2"	2.5"	3"	3.5"	4"
D ASAE-8	12 ¹ / ₄	12 ¹ / ₄	12 ¹ / ₄	12 ¹ / ₄	12 ¹ / ₄
D ASAE-16	15 ¹ / ₂	15 ¹ / ₂	15 ¹ / ₂	15 ¹ / ₂	15 ¹ / ₂
E 1 ASAE-8	6 ³ / ₁₆	6 ³ / ₁₆	5 ¹⁵ / ₁₆	5 ¹⁵ / ₁₆	5 ⁷ / ₈
E 1 ASAE-16	9 ⁷ / ₁₆	9 ⁷ / ₁₆	9 ⁹ / ₁₆	9 ⁹ / ₁₆	9 ⁷ / ₈
N 1 ASAE-8	1 ¹ / ₆₄	1 ¹ / ₆₄	1 ¹ / ₆₄	1 ¹ / ₆₄	1 ¹ / ₆₄
N 1 ASAE-16	1 ¹⁷ / ₆₄	1 ¹⁷ / ₆₄	1 ¹⁷ / ₆₄	1 ¹⁷ / ₆₄	1 ¹⁷ / ₆₄

MUFFLER CLAMPS & HANGERS, RAIN CAPS & STEERING WHEEL SPINNERS

MUFFLER CLAMPS

PART#	DESCRIPTION
66.100.001	MUFFLER CLAMP, 1 1/2"
66.100.002	MUFFLER CLAMP, 1 3/4"
66.100.003	MUFFLER CLAMP, 1 7/8"
66.100.004	MUFFLER CLAMP, 2"
66.100.005	MUFFLER CLAMP, 2 1/4"
66.100.006	MUFFLER CLAMP, 2 1/2"
66.100.007	MUFFLER CLAMP, 2 3/4"
66.100.008	MUFFLER CLAMP, 3"
66.100.009	MUFFLER CLAMP, 3 1/2"
66.100.010	MUFFLER CLAMP, 4"
66.100.011	MUFFLER CLAMP, 5"



MUFFLER HANGER

PART#	DESCRIPTION
66.100.015	MUFFLER HANGER



RAIN CAPS

PART#	ADJUSTABLE LENGTH
66.000.150	1 1/2" - 1 1/16"
66.000.175	1 3/4" - 1 5/16"
66.000.002	2" - 2 3/16"
66.000.225	2 1/4" - 2 1/16"
66.000.250	2 1/2" - 2 1/16"
66.000.275	2 3/4" - 2 5/16"
66.000.003	3" - 3 3/16"
66.000.350	3 1/2" - 3 1/16"
66.000.375	3 3/4" - 3 5/16"
66.000.004	4" - 4 3/16"



STEERING WHEEL SPINNERS

PART#	DESCRIPTION
67.094.060	BALL BEARING STYLE SPINNER, W/ MOUNTING BRACKET
67.096.060	BLACK SPINNER W/ MOUNTING BRACKET
67.097.060	ALUMINUM SPINNER W/ MOUNTING BRACKET
67.099.060	DELUXE STEERING WHEEL SPINNER



67.099.060



67.094.060



67.096.060



67.097.060



23 TRACTOR ATTACHMENTS

BRABER EQUIPMENT

40TH EDITION

PARTS CATALOG

SOIL BUSTERS, HARROW & WELD-ON MOUNTS



BUCKET BALL MOUNT

PART#	64.500.342
DESCRIPTION	BUCKET BALL MOUNT



WELD-ON SKID STEER PLATE

PART#	ABSS
DESCRIPTION	WELD-ON SKID STEER ADAPTER PLATE
HEIGHT	18 7/8"
WIDTH	47 1/4"
DEPTH	3 1/8"



HILLER/MIDDLEBUSTER

PART#	BE-MB15G
HP RATING	UP TO 40 HP
WEIGHT	110 LB



SUBSOILER

PART#	SS1RG
HP RATING	UP TO 40 HP
WEIGHT	98 LB
DEPTH	22" PENETRATION



5/8" X 7"
REPLACEABLE
TEETH

DIAMOND HARROW

PART#	HAR40S	HAR60S
WORKING WIDTH	40"	60"
LENGTH	52"	52"
WEIGHT	62 LB	98 LB



EURO WELD-ON MOUNT

PART#	WOKAO600
DESCRIPTION	ALO & EURO ATTACHMENT
WEIGHT	36 LB

QUICK HITCHES & ACCESSORIES

3 PT QUICK HITCHES

PART #	WEIGHT	WIDTH	HP RATING	HITCH
QH1G	72 LB	29"	UP TO 50 HP	CAT 1
QH2G	139 LB	36"	UP TO 100 HP	CAT 2
QH2HDG	163 LB	36" HD	UP TO 130 HP	CAT 2
QH2-3G	197 LB	42"	UP TO 225 HP	CAT 2-3
QH3NG	176 LB	37"	UP TO 225 HP	CAT 3 NARROW
QH3G	184 LB	42"	UP TO 225 HP	CAT 3



FULLY BOXED

3 PT HITCH ACCESSORIES

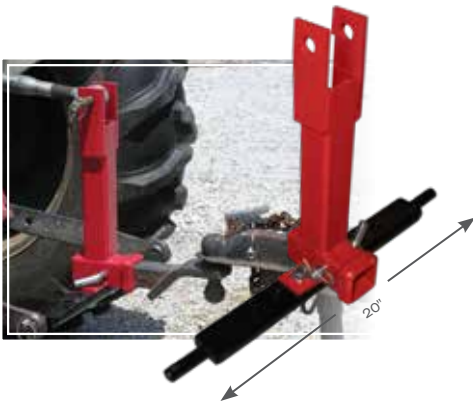

3 PT TOW HOOK

PART#	64.500.340KITM
DESCRIPTION	LOWER CONNECTION TOW HITCH
CATEGORY	CAT I



3 PT TOW HOOK

PART#	64.500.341KITM
DESCRIPTION	UPPER & LOWER CONNECTION
CATEGORY	CAT I



3 PT TOW HOOK, HD

PART#	64.500.343KITM
DESCRIPTION	UPPER & LOWER CONNECTION
CATEGORY	CAT II

**NEW INNOVATIVE,
CONSUMER FRIENDLY
RETAIL PACKAGING**





MANUFACTURING FACILITIES

1 Abbotsford, BC, Canada

34425 McConnell Rd
Abbotsford BC, V2S 7P1

TF 1.877.588.3311
Fax 1.604.850.7774

5 Shakopee, MN, USA

4301 - 12th Avenue E
Shakopee MN, 55379

TF 1.877.588.3311
Fax 1.952.426.3695

14 Sydney, Australia

15 Hudson Place
Mulgrave, NSW, 2756

TF 1.877.588.3311
Fax +61 (2) 4577 3184

11 Chongqing, China

Buying Office

12 Shanghai, China

Distribution & Manufacturing

SALES & DISTRIBUTION

6 Kitchener, ON, Canada

45 Washburn Dr Unit B
Kitchener ON, N2R 1S1

TF 1.877.588.3311
Fax 1.519.624.7510

2 Centralia, WA, USA

1709 Mildmay Court
Centralia WA, 98531

TF 1.877.588.3311
Fax 1.604.850.7774

3 Portland, OR, USA

29121 Kinsman Road
Wilsonville OR, 97070

TF 1.877.588.3311
Fax 1.604.850.7774

15 Hamilton, New Zealand

8 Perclo Place, Te Rapa
Hamilton, 3200

TF 1.877.588.3311
Fax +64 (7) 849 4894

9 United Kingdom

Isaac Way, London Road
Pembroke Dock
SA72 4RW, UK

TF 1.877.588.3311
Fax +64 (7) 849 4894

7 Fredrick, MD, USA

#4 4780 Winchester Blvd
Fredrick MD, 21703

TF 1.877.588.3311
Fax 1.240.699.0338

8 West Palm Beach, FL, USA

5483 Leeper Drive, West
Palm Beach FL, 33407

TF 1.877.588.3311
Fax 1.561.688.9247

13 Perth, West Australia

Unit 1-37 Harlond Ave
Malaga WA, 6090

TF 1.877.588.3311
Fax +61 (8) 9467 0508

4 Wildomar, CA, USA

2430 Priellip Rd
Bldg. 5 #101
Wildomar CA, 92595

TF 1.877.588.3311
Fax 1.951.677.2148

SALES OFFICE

10 Reggio Emilia, Italy