

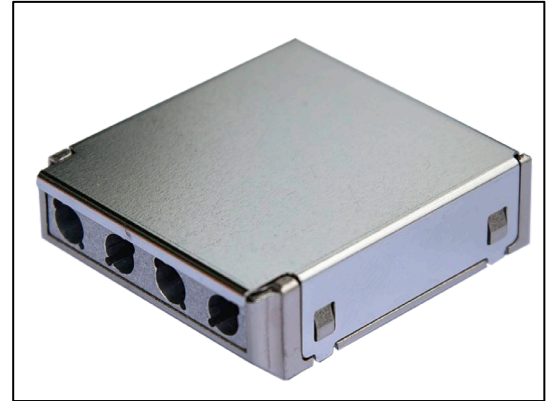

Features:

- Four independent optical channels
 - DX: 2 Transmitters, 2 Receivers
 - TX: 4 Transmitters
 - RX: 4 Receivers
- Supports data rates of 6 to 10.3125Gbps including
 - IEEE 802.3ae 10GBASE-SR/SW and
 - 10G Fibre Channel 1200-Mx-SN-I4
- 850nm VCSEL transmitters and PIN receivers
- IEC-60825-1 Class 1 eye safety compliant
- Option for RoHS 6/6 compliant and lead free per Directive 2011/65/EU
- Separable electrical interface with pluggable connector and screws
- ARINC 801 fiber interface
- Enhanced status and diagnostics monitor interface
- -40 to +85°C operating temperature standard, -40 to +95°C option
- -55 to +100°C storage temperature
- Parylene conformal coating option



The RCP-10G-SX is ideal for harsh environment connectivity because of its low cost, availability, and wide operating parameters



COMMERCIAL AEROSPACE



MILITARY AEROSPACE



MILITARY TACTICAL

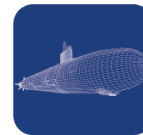

SUBSEA NETWORKING

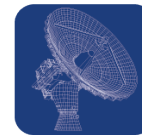

RADAR & SENSING



OIL & EXPLORATION

Absolute Maximum Ratings

Parameter	Symbol	Min.	Max.	Unit	Note
Maximum Supply Voltage	VCC	-0.3	4.0	V	
Electrostatic Discharge, Data I/O pins	ESD		500	V	(1)
Storage Temperature	T _{STO}	-55	100	°C	
Relative Humidity	RH	0	95	%	Based on conformal coating
Conformal Coating		0.8	1.2	mil	See ruggedization notes, page 8

Notes:

- 1) Proper ESD conditions should be employed while attaching RCP to the host board.

General Specifications

Parameter	Symbol	Min.	Typ.	Max.	Unit	Notes
Supply Voltage	VCC	3.14	3.3	3.47	V	+/- 5%
Supply Voltage Rise Time to 1.8V	t _{VCC}			1	ms	Required if no ext. supervisor reset
Data Rate	BR	6		10.3125	Gbps	Balanced NRZ data protocols
Operating Temperature	TOP	-40		85	°C	



Electrical Specifications ($T_{OP} = -40$ to 85°C , $V_{CC} = 3.135$ to 3.465 Volts, Data Rate = 10.3125 Gbps unless specified otherwise)

Parameter	Symbol	Min.	Typ.	Max.	Unit	Notes
Total Module Power Dissipation (DX)	$P_{DISS(DX)}$			1.53	W	DX: 0°C to $+85^{\circ}\text{C}$
	$P_{DISS(DX_cold)}$			2.57	W	DX: -40°C to 0°C (1)
Total Module Power Dissipation (TX)	$P_{DISS(TX)}$			1.39	W	TX: 0°C to $+85^{\circ}\text{C}$
	$P_{DISS(TX_cold)}$			3.47	W	TX: -40°C to 0°C (1)
Total Module Power Dissipation (RX)	$P_{DISS(RX)}$			1.66	W	
Transmitter						
Supply Current (Per TX Channel)	I_{CC}			100	mA	0°C to $+85^{\circ}\text{C}$
	$I_{CC(TX_cold)}$			250	mA	-40°C to 0°C (1)
Input differential impedance	R_{in}	90	100	110	Ω	
TX Single-Ended Input Voltage Swing	V_{in}	100		600	mV	
TX Fault Assert Output Voltage	V_{FH}	2.4			V	LVTTTL
TX Fault De-Assert Output Voltage	V_{FL}			0.4	V	LVTTTL
TX Disable Input Voltage	V_{DIS}	2.0			V	LVTTTL
TX Enable Input Voltage	V_{EN}			0.8	V	LVTTTL
Receiver						
Supply Current (Per RX Channel)	I_{CC}			120	mA	
Rx Single-Ended Output Voltage Swing	V_O	125		400	mV	
Data Output Rise Time	t_r		35	45	ps	(2)
Data Output Fall Time	t_f		35	45	ps	(2)
Loss of Signal De-Assert	V_{LOSD}	2.4			V	(3)
Loss of Signal Assert	V_{LOSA}			0.4	V	(3)
Loss of Signal De-Assert Time	t_d	2.5	10	80	μs	
Loss of Signal Assert Time	t_a	2.5	10	80	μs	
Serial Bus						
Data, Clock Input Low Voltage	V_{IL}	-0.5		0.8	V	
Data, Clock Input High Voltage	V_{IH}	2.1		V_{CC}	V	
Data, Clock Output Low Voltage	V_{OL}			0.4	V	
Notes:						
1) Heater used for transmitter optical sub-assembly (TOSA), resulting in additional current draw.						
2) 20% to 80%						
3) LOS is LVTTTL. Logic 0 indicates normal operation; logic 1 indicates no signal is detected.						



Optical Characteristics (T_{OP} = -40 to 85°C, V_{CC} = 3.135 to 3.465 Volts, Data Rate = 10.3125 Gbps unless specified otherwise)

Parameter	Symbol	Min.	Typ.	Max.	Unit	Notes
Transmitter						
Output Optical Power	P _{OUT}	-5	-1.5	-0.8	dBm	(1)
Optical Wavelength	λ		850		nm	
Extinction ratio	ER	3	5		dB	
Relative Intensity Noise	RIN			-130	dB/Hz	
TX Mask Compliance	See TX Compliance Mask					(2)
Receiver						
Receiver Sensitivity	RX _{SENS}			-12	dBm	(3)
Receiver Overload	RX _{MAX}	0			dBm	
Optical Center Wavelength	λ _C		850		nm	
Return Loss	RL	12			dB	
Loss of Signal Assert	LOS _A	-25			dBm	
Loss of Signal De-Assert	LOS _D			-9	dBm	
Loss of Signal Hysteresis	LOS _D -LOS _A	1		5	dBm	
Notes:						
1) Class 1 Laser Safety per FDA/CDRH and IEC-60825-1 regulations.						
2) Measured with 2-5 meter patch cord consisting of laser optimized OM3 or OM4 fiber.						
3) Measured using PRBS 2 ³¹ -1 pattern.						

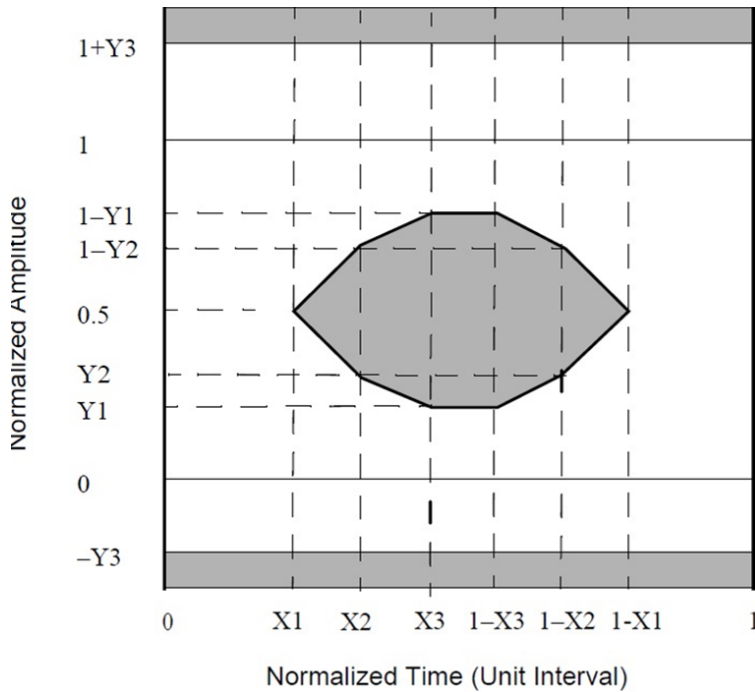

TX Compliance Mask

Coordinate	Value
X1	0.25
X2	0.40
X3	0.45
Y1	0.25
Y2	0.28
Y3	0.40





Pin Configuration

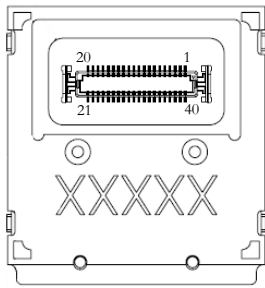

RCP Bottom View

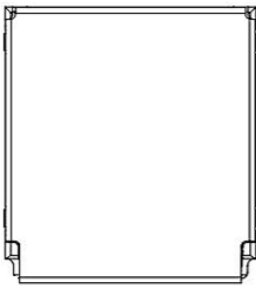

RCP Top View

GND_1	G3	G2	GND_1
GND_1	21	20	VCC_1
D1-	22	19	/RST
D1+	23	18	N/C
GND_1	24	17	CH1_DIS
FLT1/LOS1	25	16	CTRL_INT
GND_2	26	15	VCC_2
D2-	27	14	GND_2
D2+	28	13	GND_2
GND_2	29	12	CH2_DIS
FLT2/LOS2	30	11	SCL
FLT3/LOS3	31	10	SDA
GND_3	32	9	CH3_DIS
D3-	33	8	GND_3
D3+	34	7	GND_3
GND_3	35	6	VCC_3
FLT4/LOS4	36	5	N/C
GND_4	37	4	CH4_DIS
D4-	38	3	GND_4
D4+	39	2	GND_4
GND_4	40	1	VCC_4
GND_4	G4	G1	GND_4

Host Connector view

Notes:

- Pin 19 is connected to the /RST pin of the microcontroller. See Application schematics for recommended connection.
- Channels 1 & 4 are TX circuits and Channels 2 & 3 are RX circuits in DX transceiver configuration.
- Data lines for all channels are AC coupled.

Pin	Symbol	Description	Logic/Protocol
1	VCC_4	Channel 4 VCC	+3.3V
2	GND_4	Channel 4 Signal Ground	0V
3	GND_4	Channel 4 Signal Ground	0V
4	CH4_DIS	Channel 4 Disable	LVTTTL
5	N/C	Do Not Connect	No Connect
6	VCC_3	Channel 3 VCC	+3.3V
7	GND_3	Channel 3 Signal Ground	0V
8	GND_3	Channel 3 Signal Ground	0V
9	CH3_DIS	Channel 3 Disable	LVTTTL
10	SDA	2-Wire Bus Data	I2C
11	SCL	2-Wire Bus Clock	I2C
12	CH2_DIS	Channel 2 Disable	LVTTTL
13	GND_2	Channel 2 Signal Ground	0V
14	GND_2	Channel 2 Signal Ground	0V
15	VCC_2	Channel 2 VCC	+3.3V
16	CTRL_INT	Controller Interrupt	LVTTTL
17	CH1_DIS	Channel 1 Disable	LVTTTL
18	N/C	Do Not Connect, Internal Use Only	No Connect
19	/RST	Controller /RST	Note 1
20	VCC_1	Channel 1 VCC	+3.3V
21	GND_1	Channel 1 Signal Ground	0V
22	D1-	Channel 1 Data Negative	CML
23	D1+	Channel 1 Data Positive	CML
24	GND_1	Channel 1 Signal Ground	0V
25	FLT1/LOS1	Fault for Tx Channel 1 or Loss of Signal for Rx Channel 1	LVTTTL
26	GND_2	Channel 2 Signal Ground	0V
27	D2-	Channel 2 Data Negative	CML
28	D2+	Channel 2 Data Positive	CML
29	GND_2	Channel 2 Signal Ground	0V
30	FLT2/LOS2	Fault for Tx Channel 2 or Loss of Signal for Rx Channel 2	LVTTTL
31	FLT3/LOS3	Fault for Tx Channel 3 or Loss of Signal for Rx Channel 3	LVTTTL
32	GND_3	Channel 3 Signal Ground	0V
33	D3-	Channel 3 Data Negative	CML
34	D3+	Channel 3 Data Positive	CML
35	GND_3	Channel 3 Signal Ground	0V
36	FLT4/LOS4	Fault for Tx Channel 4 or Loss of Signal for Rx Channel 4	LVTTTL
37	GND_4	Channel 4 Signal Ground	0V
38	D4-	Channel 4 Data Negative	CML
39	D4+	Channel 4 Data Positive	CML
40	GND_4	Channel 4 Signal Ground	0V
G1-4	GND	Mounting Ground Pads for Connector	0V





PCB Design Guidelines

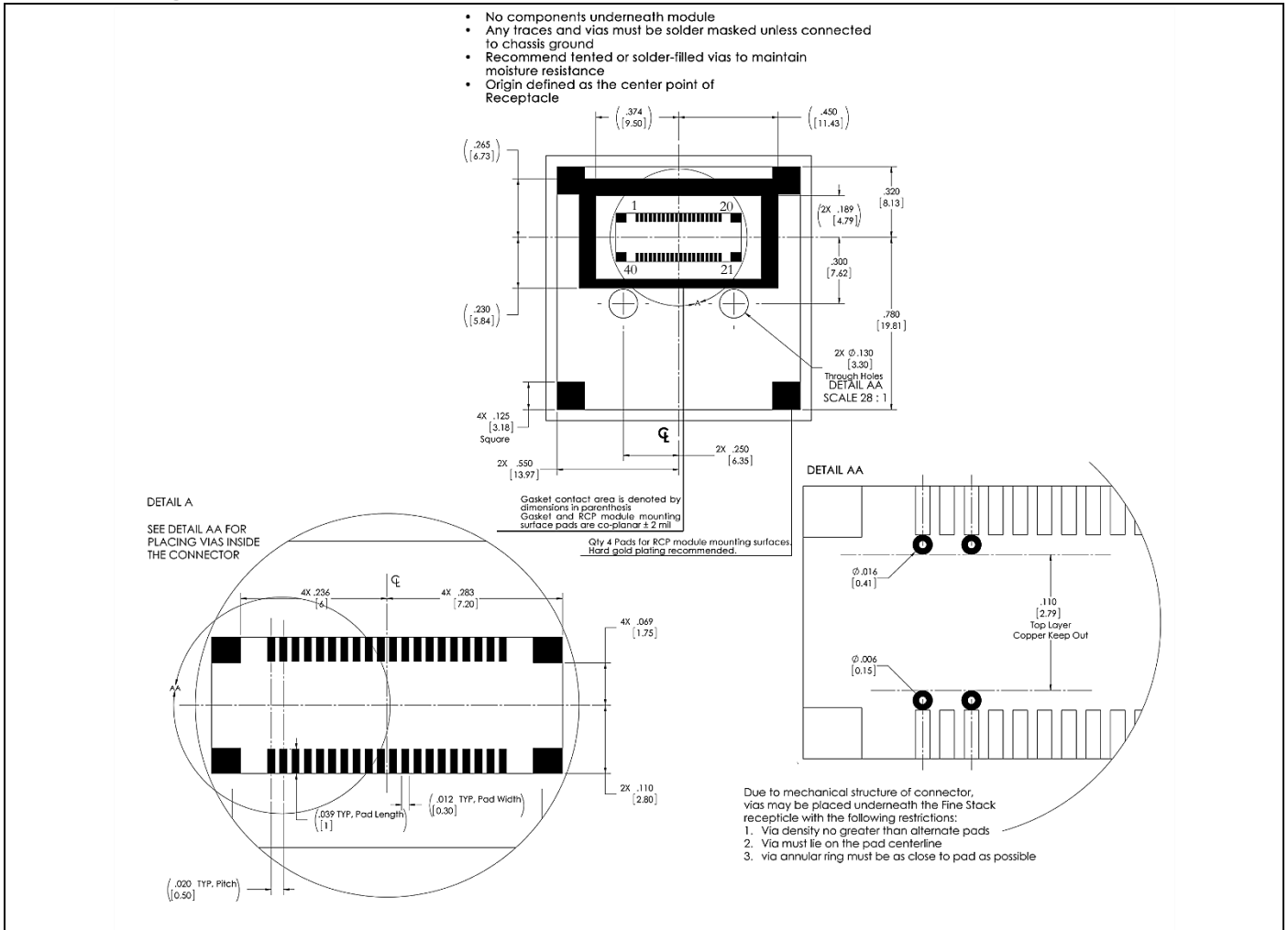

Notes:

- 1) Case Grounding**
 - a. Chassis (case) ground is isolated from data ground.
 - b. The method of terminating chassis ground is application dependent.
 - i. The method chosen is usually based on EMI requirements of the end application.
 - c. The RCP is design to operate with chassis ground either floating or tied to data ground.
- 2) 40 Pin Connector Composition**
 - a. Contact: Copper Alloy (t=0.15) with Gold Plating
 - b. Solder Peg: Copper Alloy with Tin Plating
 - c. Contact: Gold Plating (0.00076 mm)
- 3) Orientation**
 - a. PCB guideline diagrams are shown from the top view of a host PCB that is to be connected to an RCP module.

Ordering Information for 40 Pin Board-Mount Receptacle

COTSWORKS Part Number

110-00047



Application Schematics

Transmitter Application Schematic

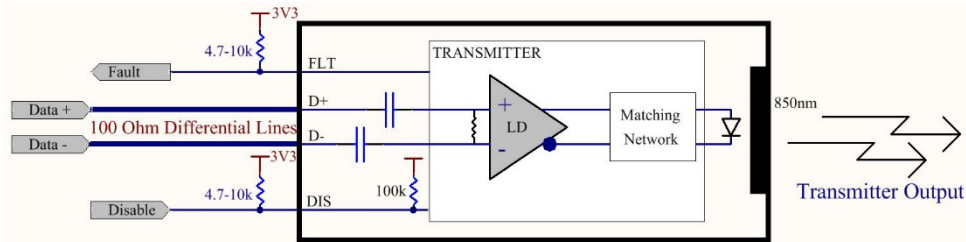

- Channels 1 & 4 are Transmitter Circuits in the standard DX version of the transceiver
 - Check Pinout on page 3 for pin assignments based on transceiver configuration
 - Capacitors connected to data lines for AC coupling.

Receiver Application Schematic

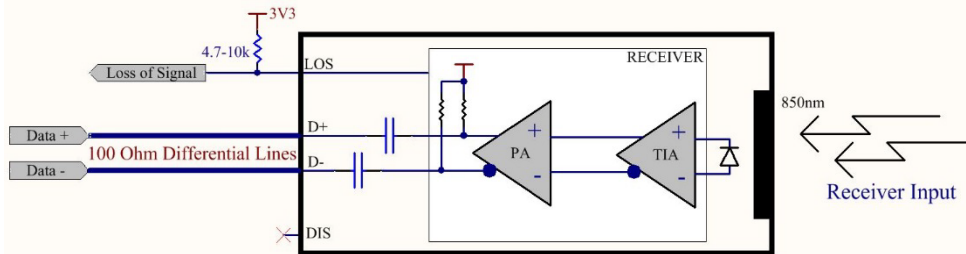

- Channels 2 & 3 are Receiver Circuits in the standard DX version of the transceiver
 - Check Pinout on page 3 for pin assignments based on transceiver configuration
 - Capacitors connected to data lines for AC coupling.

Controller Application Schematic

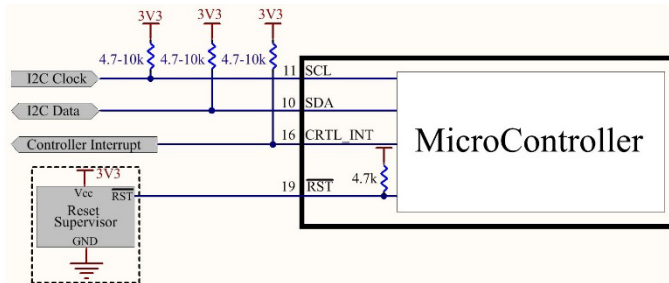

- Pin allocation and connections to the microcontroller are common to all variations of the RCP module.
- Reset supervisor shown is optional
 - Open collector reset supervisor circuit with a hold down time of 10ms or greater should be chosen
 - COTSWORKS did testing with the MAX803 Reset Supervisor
- In the absence of the reset supervisor, the power to the transceiver module must reach 1.8V in 1ms or less for a valid POR on the microcontroller

Power Filtering Circuit Application Schematic

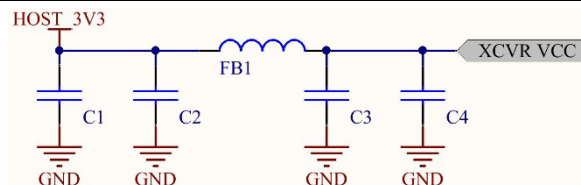

- All four channels must be powered for proper operation of the RCP module
- Recommend host routes separate supply voltages and filtering for each channel as shown above and implemented in the Host Board Application Schematic
 - FB1 ferrite bead for power supply noise suppression; Murata BLM18KG601SN1, 0603, 600Ω @ 100MHz, 1300mA
 - C1/C4 bulk capacitance; Murata GRM21BR61C106KE15L, 0805, 10μF, 16V
 - C2/C3 de-coupling capacitors; Murata GRM155R71C104KA88D, 0402, 0.1μF, 16V



Mechanical Specifications

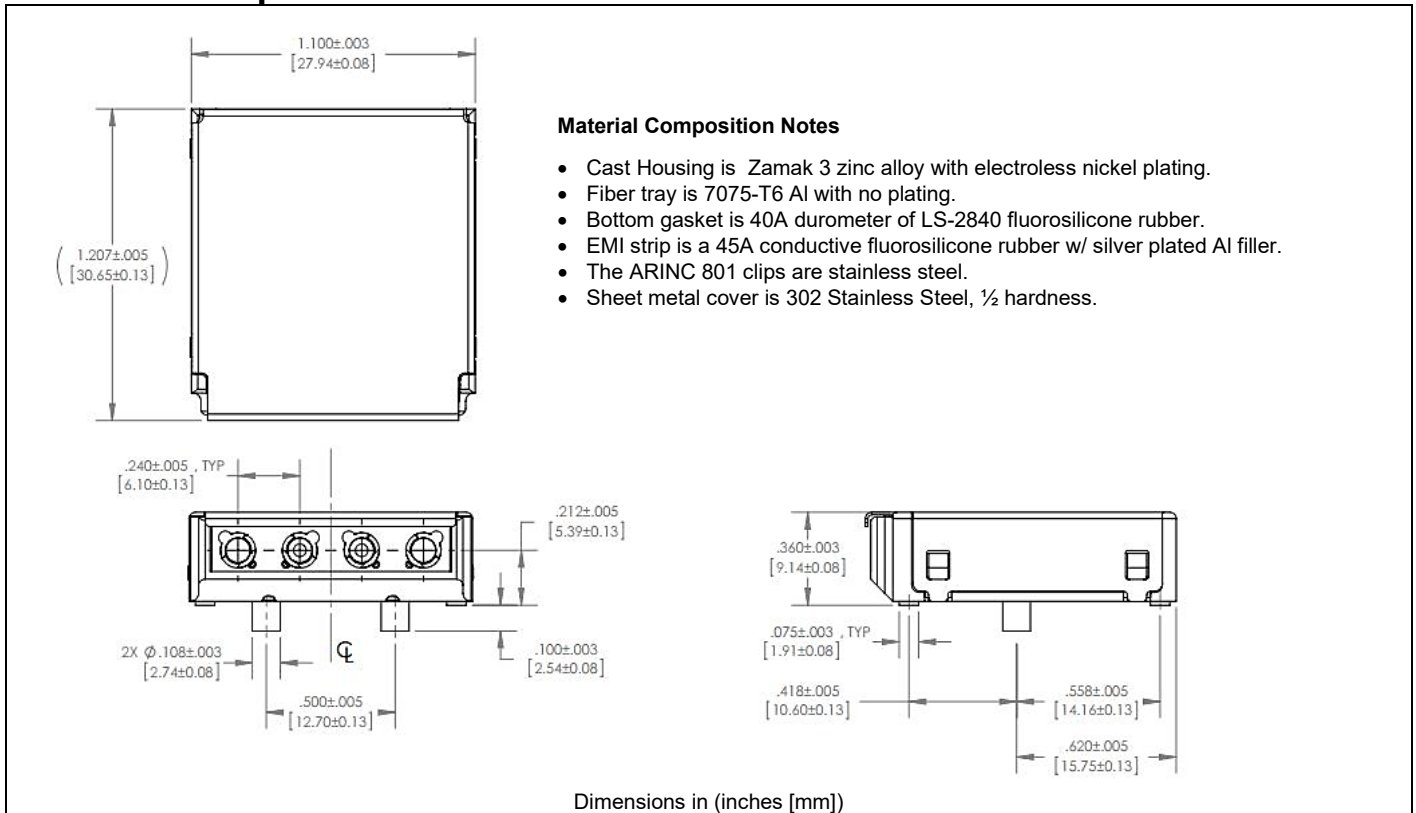

Mounting Hardware Guidelines

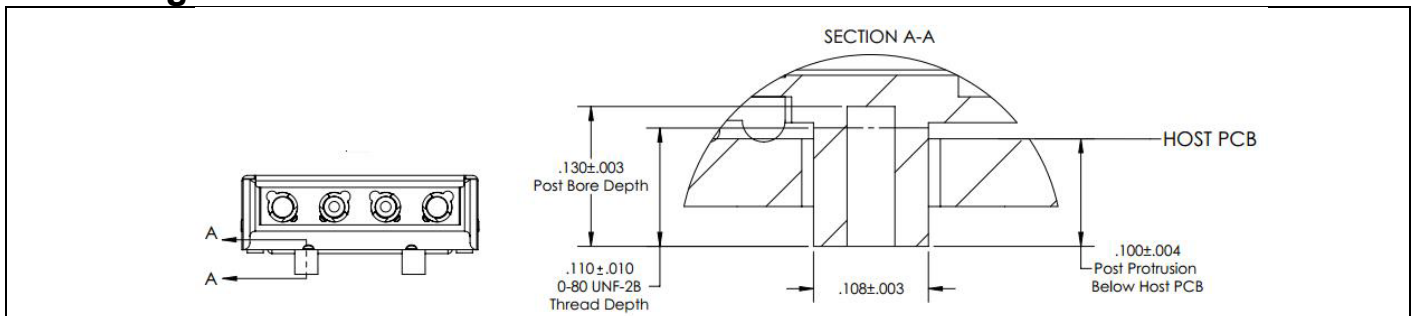

Mounting hardware shown for standard 0.0625" PCB thickness. Please contact COTSWORKS for other board thicknesses.

Recommended Torque	12 in-oz.
Recommended Minimum Thread Engagement	0.07 inches





Ruggedization Notes

- Parylene C coating can be used for conformal coating with a 1.0 mil ± 0.2 mil thickness through a deposition process.
- Parylene Type C has a 5600 VPM rating, withstands high temperatures, and extremely resistant to oil/dirt, and object impact.
- Contact COTSWORKS for all MSDS, case composition, and burn analysis.

Installation of Fiber Optic Termini

- Industry standard size 16 tooling should be used to insert/extract the ARINC 801 termini from the RCP module.
- Please contact COTSWORKS for additional support if required.

Reference Information

- 1) IEEE Standard 802.3-2008
- 2) Directive 2011/65/EU of the European Parliament and of the Council, “on the restriction of the use of certain hazardous substances in electrical and electronic equipment.” June 8th, 2011

Regulatory Compliance

- COTSWORKS transceivers are Class 1 Laser Products and comply with US FDA regulations.
- These products are designed to comply with the Class 1 eye safety requirements of EN (IEC) 60825 and the electrical safety requirements of EN (IEC) 60950.
- This part has an option for compliance with Directive 2011/65/EU covering restriction on certain hazardous substances (RoHS)
 - Contact COTSWORKS support for a product compliance matrix

Warnings

Handling Precautions: This device is susceptible to damage as a result of electrostatic discharge (ESD). A static free environment is highly recommended.

Laser Safety: Radiation emitted by laser devices can be dangerous to human eyes. Avoid eye exposure to direct or indirect radiation.

Labeling Specifications

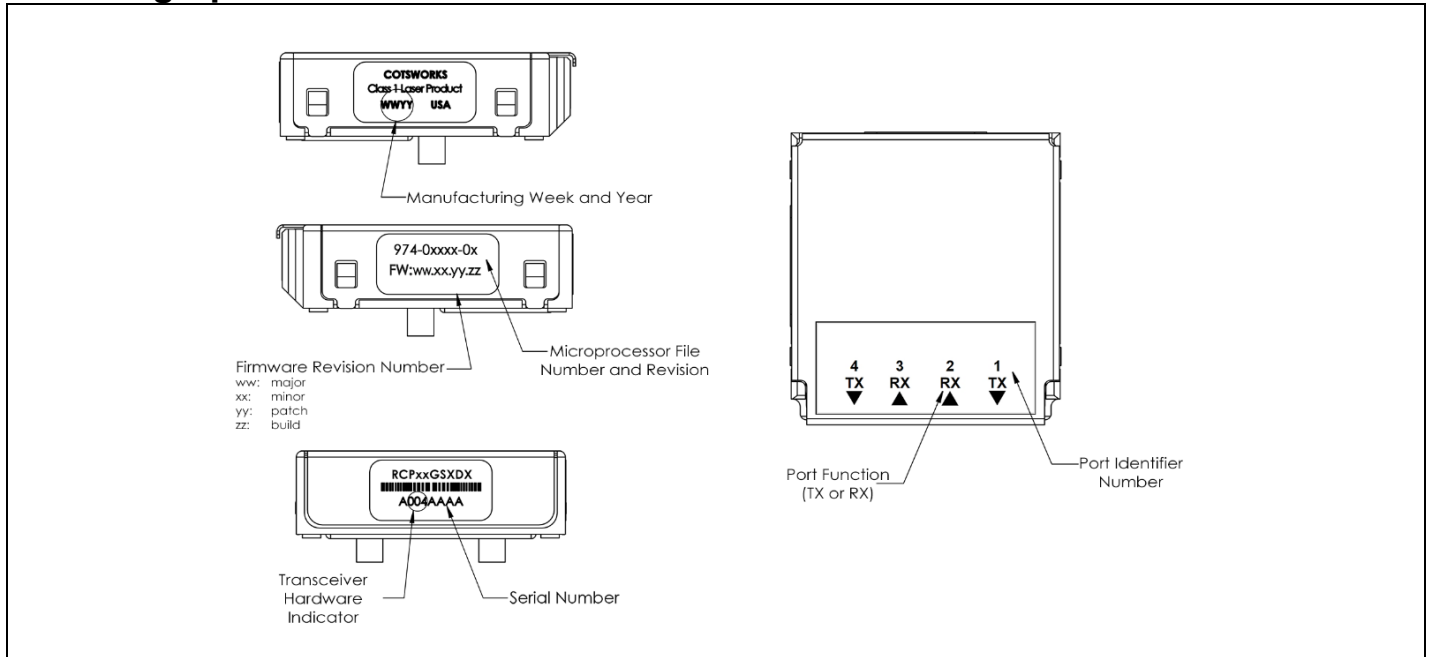



Ordering Information

RCP-10G-SX	-DX	-LX	-x	-x	-xx	-x	-x
	Channel Configuration	Fiber Interface	Ruggedized Coating	Operating Temp Range	Module Serial Bus Address (leave blank for default of C4)	RoHS Level	Screw Thread Type
RCP Form Factor	DX: 2 RX + 2 TX		(): Non-coated	A: -40 to 85 °C		(): Lvl 5	(): Imperial
10Gbps Max Data Rate	RX: 4 RX	ARINC-801 Receptacles	R: Parylene	M: -40 to 95 °C	C0, C2, C6, C8, CA, CC, CE, D0, D2, D4, D6, D8, DA, DC or DE	6: Lvl 6	U: Metric
Short Reach (MMF)	TX: 4 TX						

Example part number: RCP-10G-SX-RX-LX-R-A-C0-U

[10Gbps 850nm-based Rugged Chip-scale Pluggable, Quad Receivers, ARINC 801 Interfaces, Parylene-coated, Industrial operating temp range, C0 Serial Bus Address, Metric Screw Threads]

Contact COTSWORKS for mechanical dimensional information and other configuration options.

RCP, RCP+, COTSWORKS, and the COTSWORKS logo are trademarks of COTSWORKS,INC. COTSWORKS reserves the right to change, alter, or revise this document without notice unless otherwise agreed to. All rights reserved. Designed, manufactured, and created in the USA.

