



**TWO-STAGE FAN
III. DATA AND PERFORMANCE WITH ROTOR TIP CASING TREATMENT
UNIFORM AND DISTORTED INLET FLOWS**

by
G. D. Burger, T. R. Hodges,
M. J. Keenan

**PRATT & WHITNEY AIRCRAFT DIVISION
UNITED AIRCRAFT CORPORATION**

March 1975

(NASA-CR-134722) TWO-STAGE FAN. 3: DATA N75-21278
AND PERFORMANCE WITH ROTOR TIP CASING
TREATMENT, UNIFORM AND DISTORTED INLET FLOWS
(Pratt and Whitney Aircraft) 187 p HC \$7.00 Unclas
CSCL 21E G3/07 18605

prepared for

**NATIONAL AERONAUTICS AND SPACE ADMINISTRATION
NASA LEWIS RESEARCH CENTER
CONTRACT NAS3-13494**

1. Report No. NASA CR-134722		2. Government Accession No.		3. Recipient's Catalog No.	
4. Title and Subtitle Two Stage Fan III. Data and Performance with Rotor Tip Casing Treatment, Uniform and Distorted Inlet Flows				5. Report Date March 1975	
7. Author(s) G. D. Burger T. R. Hodges, M. J. Keenan				6. Performing Organization Code	
9. Performing Organization Name and Address Pratt & Whitney Aircraft Division United Aircraft Corporation East Hartford, CT 06108				8. Performing Organization Report No. PWA-5239	
12. Sponsoring Agency Name and Address National Aeronautics and Space Administration Washington, D. C. 20546				10. Work Unit No.	
				11. Contract or Grant No. NAS3-13494	
				13. Type of Report and Period Covered Contractor Report	
				14. Sponsoring Agency Code	
15. Supplementary Notes Project Manager, R. S. Ruggeri, Fluid System Components Division, NASA-Lewis Research Center, Cleveland, Ohio 44135					
16. Abstract <p>A two-stage fan with a 1st-stage rotor design tip speed of 1450 ft/sec [442 m/sec], a design pressure ratio of 2.8, and corrected flow of 184.2 lbm/sec [83.55 kg/sec] was tested with axial skewed slots in the casings over the tips of both rotors. The variable-stagger stators were set in the nominal positions.</p> <p>Casing treatment improved stall margin by nine percentage points at 70 percent speed, but decreased stall margin, efficiency, and flow by small amounts at design speed. Treatment improved first-stage performance at low speed only and decreased second-stage performance at all operating conditions.</p> <p>Casing treatment did not affect the stall line with tip radially distorted flow but improved stall margin with circumferentially distorted flow. Casing treatment increased the attenuation for both types of inlet flow distortion.</p>					
17. Key Words (Suggested by Author(s)) Two-Stage Fan Axial Skewed Slots, Casing Treatment, Uniform & Distorted Inlet Flow			18. Distribution Statement Unclassified - Unlimited		
19. Security Classif. (of this report) Unclassified		20. Security Classif. (of this page) Unclassified		21. No. of Pages 188	22. Price*

* For sale by the National Technical Information Service, Springfield, Virginia 22151

FOREWORD

This report was prepared for the National Aeronautics and Space Administration, Lewis Research Center, under Contract NAS3-13494 to present data and performance of a two-stage fan tested with a redesigned 2nd-stage rotor, axial skewed slots in the casings over the tips of both rotors, and with the resettable stators in their nominal positions. Mr. R. S. Ruggeri was the NASA Project Manager for this effort, and Mr. H. V. Marman was the P&WA Program Manager. This report was prepared by G. D. Burger, T. R. Hodges, and M. J. Keenan with contributions from B. Gray, A. Finke, J. Rawlins, A. Mellow, C. Klein and other P&WA personnel.

TABLE OF CONTENTS

	Page
SUMMARY	1
INTRODUCTION	2
APPARATUS	3
Aerodynamic Design	3
Rotor Tip Casing Treatment	5
Mechanical Design	6
Test Facility	6
Instrumentation and Calibration	7
PROCEDURES	10
Test Procedures	10
Data Reduction Techniques	10
Data Correction and Averaging	10
Performance Parameter Calculations	12
RESULTS AND DISCUSSION	15
Uniform Inlet Flow	15
Fan Overall Performance	15
Overall Performance of the First-Stage Rotor and First Stage	17
Overall Performance of the Second-Stage Rotor and Second Stage	17
Blade-Element Performance	18
Tip Radially Distorted Inlet Flow	21
Overall Performance	21
Blade-Element Performance	22
Circumferentially Distorted Inlet Flow	24
Fan Overall Performance	25
Circumferential Distributions of Flowfield Parameters	26
Attenuation of Circumferential Distortion	26
SUMMARY OF RESULTS	27
LIST OF REFERENCES	29
APPENDIX	
A – Symbols and Performance Parameters	121
B – Blade Spans and Diameters and Column Heading Identifications	127
C – Overall Performance and Blade-Element Data for Uniform Inlet Flow	131
D – Overall Performance and Blade-Element Data for Tip Radially Distorted Inlet Flow	161
E – Overall Performance and Velocity Vector Parameters for Circumferentially Distorted Inlet Flow	169
DISTRIBUTION LIST	181

LIST OF ILLUSTRATIONS

Figure	Title	Page
1	Schematic of Two-Stage Fan Test Arrangement	31
2	Fan Flowpath	32
3	Blades and Vanes Employed in the Two-Stage Fan	33
4	Sketch of Rotor Tip Casing Treatments	34
5	Schematic of Compressor Test Facility	34
6	Sketch of Distortion Screens	35
7	Typical Instrumentation Employed in Two-Stage Fan Tests	36
8	Axial Locations of Instrumentation	37
9	Circumferential Locations of Instrumentation	38
10	Correlation Used for Radial Distortion Streamline Analysis	39
11	Fan Overall Performance With Uniform Inlet Flow With Casing Treatment – Performance With Solid Casings Shown for Comparison	40
12	Fan Overall Total Temperature Ratio Data Versus Corrected Flow With Casing Treatment for Uniform Inlet Flow – Solid Casing Curves Shown for Comparison	41
13	Fan Overall Total Pressure Recovery Versus Corrected Flow at Design Speed for Uniform Inlet Flow With Casing Treatment and With Solid Casings	42
14	Rotor 1 Performance With Uniform Inlet Flow and Casing Treatment – Performance With Solid Casing Shown for Comparison	43
15	Rotor 1 Pressure Coefficient and Adiabatic Efficiency Versus Flow Coefficient for Uniform Inlet Flow With Casing Treatment – Solid Casing Data Shown for Comparison	44
16	Rotor 1 Total Temperature Ratio Versus Corrected Flow at Design Speed for Uniform Inlet Flow With Casing Treatment and Solid Casings	44

LIST OF ILLUSTRATIONS (Cont'd)

Figure	Title	Page
17	First-Stage Pressure Coefficient and Adiabatic Efficiency Versus Flow Coefficient for Uniform Inlet Flow With Casing Treatment and With Solid Casings	45
18	First-Stage Performance for Uniform Inlet Flow and Casing Treatment – Performance With Solid Casings Shown for Comparison	46
19	Rotor 2 Pressure Coefficient and Adiabatic Efficiency Versus Flow Coefficient for Uniform Inlet Flow With Casing Treatment and With Solid Casings	47
20	Second-Stage Pressure Coefficient and Adiabatic Efficiency Versus Flow Coefficient for Uniform Inlet Flow With Casing Treatment and With Solid Casings	48
21	Fan, Rotor 1, and Rotor 2 Total Temperature Ratio Versus Span at Design Speed for Uniform Inlet Flow With Casing Treatment and With Solid Casings	49
22	Fan, Rotor 1, and Rotor 2 Total Pressure Ratio Versus Span at Design Speed for Uniform Inlet Flow With Casing Treatment and With Solid Casings	50
23	Comparison of Radial Profiles of Meridional Velocity Entering Rotor 2 With Casing Treatment and With Solid Casings for Near-Stall Data Points at Design Speed for Uniform Inlet Flow	51
24	Fan, Rotor 1, and Rotor 2 Adiabatic Efficiency Versus Span at Design Speed With Casing Treatment and With Solid Casings	52
25	Fan, Rotor 1, and Rotor 2 Adiabatic Efficiency Versus Span at 85 Percent Speed for Uniform Inlet Flow at Near-Stall Data Points With Casing Treatment and With Solid Casings	53
26	Fan, Rotor 1, and Rotor 2 Adiabatic Efficiency Versus Span at 70 Percent Speed for Uniform Inlet Flow at Peak Efficiency Data Points With Casing Treatment and With Solid Casings	54
27	Rotor 1 Blade-Element Performance Data for Uniform and Tip Radially Distorted Inlet Flow With Casing Treatment – Solid Casing Curves Shown for Comparison	55

LIST OF ILLUSTRATIONS (Cont'd)

Figure	Title	Page
28	Stator 1 Blade-Element Performance Data for Uniform and Tip Radially Distorted Inlet Flow With Casing Treatment – Solid Casing Curves Shown for Comparison	66
29	Rotor 2 Blade-Element Performance Data for Uniform and Tip Radially Distorted Inlet Flow With Casing Treatment – Solid Casing Curves Shown for Comparison	77
30	Stator 2 Blade-Element Performance Data for Uniform and Tip Radially Distorted Inlet Flow With Casing Treatment – Solid Casing Curves Shown for Comparison	88
31	Rotor 1 Inlet Total Pressure Ratio Versus Span for Tip Radially Distorted Inlet Flow at Design Speed With Casing Treatment	99
32	Fan Overall Performance for Tip Radially Distorted Inlet Flow With Casing Treatment – Performance With Uniform Inlet Flow and With Solid Casings Shown for Comparison	100
33	First-Stage Performance for Tip Radially Distorted Inlet Flow With Casing Treatment – Performance With Uniform Inlet Flow and With Solid Casings Shown for Comparison	101
34	Rotor 1 Performance for Tip Radially Distorted Inlet Flow With Casing Treatment – Performance With Uniform Inlet Flow and With Solid Casings Shown for Comparison	102
35	Radial Distribution of Total Pressure Ratio for Near-Stall Conditions for Tip Radially Distorted and Uniform Inlet Flow, at Design Speed With Casing Treatment – Data With Solid Casings and Tip Radially Distorted Flow Shown for Comparison	103
36	Total Pressure Ratio Versus Span at Fan Inlet, First-Stage Exit, and Fan Exit for Tip Radially Distorted and Uniform Inlet Flow at Design Speed With Casing Treatment – Data with Solid Casings and Tip Radially Distorted Flow Shown for Comparison	104
37	Circumferential Distribution of Total Pressure at Fan Inlet for Circumferentially Distorted Inlet Flow at a Near-Design Data Point With Casing Treatment	105

LIST OF ILLUSTRATIONS (Cont'd)

Figure	Title	Page
38	Fan Overall Performance for Circumferentially Distorted Inlet Flow With Casing Treatment -- Performance With Uniform Inlet Flow and With Solid Casings Shown for Comparison	106
39	Circumferential Distributions of Rotor 1 Inlet Static Pressure at the Tip for Tests at Design Speed for Circumferentially Distorted Inlet Flow With Casing Treatment	107
40	Circumferential Distributions of Rotor 1 Inlet Static Pressure at the Root for Tests at Design Speed for Circumferentially Distorted Inlet Flow With Casing Treatment	108
41	Circumferential Distributions of Fan Inlet Total Pressure, Static Pressure, Absolute Mach Number, Relative Flow Angle, Absolute Flow Angle, and Meridional Velocity for Circumferentially Distorted Inlet Flow at Design Speed With Casing Treatment	109
42	Circumferential Distributions of Fan Exit Total Pressure, Static Pressure, Absolute Mach Number, Relative Flow Angle, Absolute Flow Angle, and Meridional Velocity for Circumferentially Distorted Inlet Flow at Design Speed With Casing Treatment	115

LIST OF TABLES

Table	Title	Page
I	Design Overall Performance Parameters	3
II	Blade and Vane Geometric Parameters	5
III	Casing Treatment Design Parameters	6
IV	Performance and Blade Element Instrumentation	8
V	Stall Transient Instrumentation	9
VI	Input Parameters to Flowfield Program	13
VII	Annulus Blockages	14
VIII	Comparison of Performance Parameters With Rotor Tip Casing Treatment and Solid Casing for Uniform Inlet Flow	15
IX	Attenuation Parameter at Design Speed for Tip Radially Distorted Inlet Flow	24
X	Comparison of Performance Obtained With the Twelve-Location and Four-Location Data Acquisition Methods	25
XI	Attenuation Parameters for Circumferentially Distorted Inlet Flow	27
XII	Spans and Diameters for the Blade-Element Data	127
XIII	Identification of Overall Performance and Blade-Element Data Column Headings	128
XIV	Overall-Performance and Stall Data Summary With Uniform Inlet Flow	131
XV	Overall Performance and Blade-Element Data (Uniform Inlet Flow, 70 Percent Speed)	132
XVI	Overall Performance and Blade-Element Data (Uniform Inlet Flow, 85 Percent Speed)	140
XVII	Overall Performance and Blade-Element Data (Uniform Inlet Flow, 100 Percent Speed)	148

LIST OF TABLES (Cont'd)

Table	Title	Page
XVIII	Overall Performance and Stall Data Summary With Tip-Radial Inlet Flow Distortion	161
XIX	Overall Performance and Blade-Element Data (Tip Radially Distorted Inlet Flow, 70 Percent Speed)	162
XX	Overall Performance and Blade-Element Data (Tip Radially Distorted Inlet Flow, 100 Percent Speed)	165
XXI	Overall Performance and Stall Data Summary With Circumferential Inlet Flow Distortion	169
XXII	Velocity Vector Parameters at Fan Inlet (Circumferentially Distorted Inlet Flow)	170
XXIII	Velocity Vector Parameter at Fan Exit (Circumferentially Distorted Inlet Flow)	174
XXIV	Circumferential Distributions of Total Pressure Ratio and Total Temperature Ratio at 2nd-Stage Stator Exit (Circumferentially Distorted Inlet Flow)	178

TWO-STAGE FAN
III. DATA AND PERFORMANCE WITH ROTOR TIP CASING TREATMENT,
UNIFORM AND DISTORTED INLET FLOW

G. D. Burger, T. R. Hodges and M. J. Keenan
Pratt & Whitney Aircraft

SUMMARY

Tests were conducted on a highly loaded, two-stage fan designed for a tip speed of 1450 ft/sec [442 m/sec] and an overall pressure ratio of 2.8. The purpose of the tests was to determine detailed aerodynamic performance of the fan with rotor tip casing treatment. The casing treatment consisted of axial skewed slots located over the tips of both rotors. Fan performance data were obtained for uniform and for distorted inlet flows. The data obtained in a previous test of the fan without casing treatment was used for determining the effects of the casing treatment.

With uniform inlet flow, casing treatment improved stall margin at part speed without reducing efficiency or flow; at 70 percent of design speed stall margin increased from 17% with the solid casing to 26%. At design speed, stall margin decreased from 12% with the solid casing to 10%. The adiabatic efficiency on the operating line was 82.2% at design speed with casing treatment, which is 1.5 percentage points less than the design value and 2.8 percentage points below the value obtained with solid casing. At design speed and pressure ratio, the fan achieved a corrected flow of 183.5 lbm/sec [83.3 kg/sec] which is 0.4% below the design value of 184.2 lbm/sec [83.55 kg/sec].

First-stage pressure ratio and efficiency were increased by casing treatment at 70 percent of design speed but were decreased at design speed. Second-stage pressure ratio and efficiency were decreased by casing treatment at all speeds. These results indicate that better overall fan performance would probably have been achieved with casing treatment over the 1st-stage rotor and a solid casing over the 2nd-stage rotor.

Casing treatment caused significant differences in radial profiles of pressure and temperature ratios. These profiles resulted in unusual radial patterns of blade-element performance parameters, particularly for the 2nd-stage rotor in which loss apparently decreased between 85 percent span and the tip.

A screen-generated, tip-radial distortion, covering approximately the outer 40 percent of the inlet annulus area and with a distortion parameter, $(P_{\max} - P_{\min})/P_{\max}$, of 0.14 at design corrected flow, increased stall margin at design speed from 10% with undistorted flow to 16%. At 70 percent of design speed, distortions generated by the same screen reduced stall margin from 26% to 15%; efficiency levels were the same as with undistorted flow. The distortion was completely attenuated at design speed for near-stall and midrange data points, and approximately half of the distortion was attenuated at wide-open throttle.

A circumferentially distorted inlet flow, covering approximately a 90-degree segment of the fan inlet annulus area and with a peak distortion parameter of 0.13 at 99 percent of design corrected flow, increased stall margin by two percentage points at design speed and did not change overall performance at 70 percent of design speed. Stall pressure ratio at design speed was lower with the distortion, but the fan could be throttled to a lower flow before stalling.

In general, casing treatment improved stall margin relative to the solid casing in operating regimes where rotor tip loadings caused stall. Thus, at low speed where the 1st-stage rotor tip was highly loaded, casing treatment increased the stall margin, but no benefit was obtained at design speed where loadings at the hub of the second stage caused stall.

INTRODUCTION

An extensive program has been conducted by NASA on high speed, highly loaded, single-stage fans. Based on demonstrations of good performance at high speeds and loadings in single stages, a two-stage, highly loaded, high-speed fan was designed, fabricated, and tested. The objectives of the two-stage fan program were to evaluate the stage matching problems, distortion tolerance, response to stator adjustment, and effectiveness of casing treatment for such a fan. Design tip speed for the two-stage fan was 1450 ft/sec [442 m/sec]; design pressure ratio was 2.8; tip diameter was 31.0 in. [0.787m], and the hub-tip ratio at the inlet to the 1st-stage rotor was 0.4. Design corrected flow per unit annulus area at the 1st-stage rotor leading edge was 42.0 lbm/sec-ft² [205 kg/sec-m²], giving a design corrected flow of 184.2 lbm/sec [83.55 kg/sec]. Details of the aerodynamic and mechanical designs are given in Reference 1.

Good aerodynamic performance was documented during the first test of this two-stage fan. However, this first test was abbreviated due to flutter on the 2nd-stage rotor blades and cracking of the root leading edges of some stator vanes. Results of the first test are reported in detail in Reference 2.

The 2nd-stage rotor blades were redesigned with partspan shrouds to eliminate flutter, and the fan was rebuilt with these redesigned blades. A radially skewed pressure ratio profile was also incorporated into this redesign with the objective of increasing stall margin. Hub pressure ratio was raised to increase flow velocities at the hub, thereby reducing critical blade-element loadings. Steps were also taken to eliminate stator cracking. Additional 1st-stage stator vanes were fabricated to insure that all vanes in the rebuild would meet the design thickness specifications. Stator leading edge pressure sensors were not used on either stator in the rebuild to avoid stress concentrations, since the data from the first build had shown that stator discharge instrumentation provides the same information as the leading edge sensors with good accuracy. Design details of the 2nd-stage rotor with the partspan shroud are given in Reference 3.

The modified two-stage fan was tested with solid casings to document performance with stators set at their design stagger angles. Tests were run with uniform inlet flow and with tip-radial, hub-radial, and circumferential inlet distortions. Results of these tests are reported in detail in Reference 3.

Stator stagger angle optimization tests with solid casings were conducted at 70 percent, 100 percent, and 105 percent of design speed with uniform inlet flow to obtain increased overall fan efficiency and stall margin. Results of these tests are reported in detail in Reference 4.

Axial skewed slots in the casings over the rotor tips have been shown to be an effective means of improving stall margin when critical loadings occur at rotor blade tips, while causing only a small penalty in operating line efficiency. Casing treatment can be particularly beneficial when inlet flow distortions are present. Casing inserts with axial skewed slots were therefore designed to replace the smooth casings over the rotor tips. Slot configurations were based on designs used successfully in previous NASA test programs (ref. 5 and 6). Casing treatment tests were conducted with uniform inlet flow at 70 percent, 85 percent, and 100 percent of design speed and with tip-radial and circumferential inlet distortions at 70 percent and 100 percent of design speed.

This report presents the test results obtained with the modified two-stage fan with stators set at their design stagger angles and with casing treatment consisting of axial skewed slots over both rotors.

The symbols used in this report and performance parameters are defined in Appendix A.

APPARATUS

AERODYNAMIC DESIGN

The two-stage fan test arrangement is shown schematically in Figure 1, and a detailed description of the aerodynamic and mechanical design of the fan is given in Reference 1. A detailed description of the redesigned 2nd-stage rotor used in this test is given in Reference 3.

Design performance parameters at the design point are summarized in Table I.

TABLE I – DESIGN OVERALL PERFORMANCE PARAMETERS

Corrected Speed: $N\sqrt{\theta} = 10720$ rpm - Corrected Flow: $W\sqrt{\theta/\delta} = 184.20$ lbm/sec
 [83.55 kg/sec]

	PRESSURE RATIO		ADIABATIC EFFICIENCY (%)	
	Local	Cumulative	Local	Cumulative
Rotor 1	1.786	1.786	89.4	89.4
Stator 1	.976	1.742	–	85.3
Rotor 2	1.655	2.884	89.9	86.5
Stator 2	.971	2.80	–	83.7

The fan was designed without inlet-guide-vanes (IGV) but with the provision for adding a variable camber IGV at a later date. Stators were designed with the ability for resetting at different stagger angles without requiring removal of the fan from the test stand. Both stators were designed to turn the flow to the axial direction (design position). The tip diameter of the 1st-stage rotor inlet was selected as 31 inches [0.787 m] to permit use of existing hardware and to allow adequate horsepower margin for the drive engine. With a required 1st-stage rotor tip speed of 1450 ft/sec [442 m/sec], the design speed corrected to standard inlet conditions was 10,720 rpm. The inlet inner case diameter was held at a minimum of 10 inches [0.254 m] to provide clearance for the front bearing compartment. The specific flow at the inlet to the 1st-stage rotor was set at 42.0 lbm/sec-ft² [205 kg/sec-m²], consistent with advanced fan technology. This, with the specified hub-tip ratio of 0.4 and the chosen tip diameter, yielded a design inlet corrected flow of 184.2 lbm/sec [83.55 kg/sec].

The average Mach number at the fan exit was approximately 0.5, a practical value for thrust augmentation.

Flowpath convergence and wall curvature between inlet and exit were used to control velocity profiles and blade aerodynamic loadings (diffusion factors) near the walls. Design loadings were similar to those for which good single-stage performance has been obtained, as explained in Reference 1.

Blockages were included in the aerodynamic design to account for boundary layer growth on the casing walls and for presence of the rotor partspan shrouds. Boundary layer displacement thickness at the 1st-stage rotor inlet was assumed equal to that measured downstream of inlet bellmouths used in research programs at Pratt & Whitney Aircraft. Growth of the wall displacement thickness through the blade rows of the two-stage fan was estimated using a correlation developed by W. T. Hanley (ref. 7) wherein growth along the casing walls is chiefly a function of wall static pressure gradient. To account for the presence of partspan shrouds, a blockage equal to the percent of total annulus area occupied by the shroud was applied at the exit of each rotor and the inlet of the following stator, and half this amount was used at the inlet of each rotor. No allowance for shroud blockage was applied at the 1st-stage or 2nd-stage stator exits. Total blockage inputs to the streamline analysis calculation at various axial locations were computed as the sum of end-wall blockages and shroud blockages and were applied equally to all stream tubes.

The axial spacings between rotor and stator of both the 1st-stage and 2nd-stage were held to a minimum, as shown in the flowpath drawing in Figure 2, which is in line with actual engine design practice. A spacing of slightly more than one inch [0.0254 m] was allowed between stages to provide room for radial and tangential traverse instrumentation at the exit of the 1st-stage stator. Coordinates of blade edges at the hub and tip are given in Figure 2. The differences between the coordinates of the original and redesigned 2nd-stage rotor are due to changes in blade edge location. Flowpath walls were not changed.

Rotor and stator blade sections for both stages of the fan were multiple-circular-arc (MCA) airfoils designed on conical surfaces which approximate stream surfaces of revolution. Blade setting angles were determined from design flow angles and incidence and deviation angle criteria described in Reference 1. Blade chords were chosen to be consistent with moderate axial lengths, acceptable loadings, and structural requirements. Airfoil leading and trailing edge radii and blade thicknesses were chosen to provide mechanical integrity while maintaining adequate flow area. A partspan shroud was located at 61 percent span on the 1st-stage rotor and at 60 percent span on the redesigned 2nd-stage rotor. A view of a rotor and stator for each blade row of the two-stage fan is shown in Figure 3.

Design details of the 1st-stage rotor, the 1st-stage stator, the original 2nd-stage rotor, and the 2nd-stage stator, including manufacturing sections defined on planes normal to the stacking line, are given in Reference 1. Details of the redesigned 2nd-stage rotor are given in Reference 3. A summary of important design parameters of blades and vanes is given in Table II. Stator velocity vectors calculated for the negatively sloped total pressure profile of the redesigned 2nd-stage rotor showed that both stators would be satisfactory for tests with the redesigned rotor.

TABLE II — BLADE AND VANE GEOMETRIC PARAMETERS

	FIRST-STAGE		SECOND-STAGE	
	Rotor	Stator	Rotor (Redesign)	Stator
Number of airfoils	28	46	60	59
Aspect ratio ¹	2.48	2.75	2.63	2.20
Hub chord, inch [meter]	3.62 [0.092]	2.75 [0.070]	2.10 [0.053]	2.22 [0.056]
Tip chord, inch [meter]	4.55 [0.116]	3.10 [0.079]	1.89 [0.048]	2.45 [0.062]
Hub solidity	2.38	2.52	2.24	2.25
Tip solidity	1.33	1.55	1.27	1.66

¹ Average length/axially projected hub chord

ROTOR TIP CASING TREATMENT

Rotor tip casing treatment, consisting of axial skewed slots partitioned into front and rear sections of equal length, was used over each rotor. The casing treatment design is shown schematically in Figure 4, and the geometric design parameters are listed in Table III. The slot partitions were centered on the blade stacking line of each rotor.

TABLE III – CASING TREATMENT DESIGN PARAMETERS

	Rotor 1	Rotor 2
Number of slots ¹	252	476
<u>Slot Width</u> Land width (Circumferential)	2.0	2.083
<u>Slot Width</u> <u>Slot depth</u> ²	5.0	10.
Axial Projected Chord		
slot leading edge (%)	19.2	16.8
slot trailing edge (%)	82.1	85.5
<u>Width of Axial Partition</u> <u>Total Axial Length</u>	0.1147	0.1067
<u>Slot Area</u> <u>Total Area</u>	0.5902	0.6036

1 Each slot divided into equal front and rear sections

2 Width measured normal to direction of slot sides, depth measured in direction of slot sides.

MECHANICAL DESIGN

Predicted rotor and stator stresses due to static and dynamic loads are well within the capabilities of the materials selected. Rotor blades were fabricated from AMS 4928 (titanium alloy); stator vanes were fabricated from AMS 5613 (stainless steel); and disks, spacers, and hubs were fabricated from AMS 6415 (low alloy steel). The 1st-stage rotor blades have partspan shrouds at 61 percent span from the hub to avoid resonances, and the redesigned 2nd-stage rotor blades, used in the test described herein, have partspan shrouds at 60 percent span from the hub to avoid flutter. An oil damped front bearing was incorporated as a result of the initial tests which revealed incipient critical speed problems. Mechanical design of the original fan configuration is described in detail in Reference 1, and details of the rotor redesign and oil damped bearing design are given in Reference 3.

TEST FACILITY

The test program was carried out in a sea-level compressor test stand (Figure 5) that was equipped with a gas turbine drive engine with a 2.1:1 gearbox to provide speed-range capability. Airflow entered the rig through a calibrated nozzle. A 72 ft [21.9 m] straight section of 42 in. [1.07 m] diameter pipe ran from the nozzle to a 90 in. [2.29 m] diameter inlet plenum. A wire mesh screen and an "egg crate" structure located in the plenum provided a uniform total pressure profile to the compressor. The airflow was exhausted from the compressor into a toroidal collector and then into a 6 ft [1.83 m] diameter discharge stack. The stack contained a 6 ft [1.83 m] diameter valve to provide back pressure, or throttling, for the test compressor. Two smaller valves, a 24 in. [0.61 m] and a 12 in. [0.305 m], located in the bypass lines provided fine adjustment of back pressure.

The desired inlet distortion patterns were generated by means of screens attached to a 1 in. x 1 in. [0.0254 m x 0.0254 m] mesh base-screen of 1/8 inch [0.0032 m] diameter wire. A rotatable case with 12 struts located 33 in. [0.84 m] upstream of the rotor leading edge was used to support the base screen. Sketches of the tip-radial and circumferential distortion screens are shown in Figure 6. These screens are identical to those used during the distortion studies reported in Reference 3.

Rotor strain-gage and inlet hub static pressure instrumentation leads were routed through the nonrotating nose fairing. Ten struts, 14 inches [0.356 meters] upstream of the rotor leading edge, supported the forward bearing and the assembly for the strain-gage slip-ring. Eight struts located 11 inches [0.28 meters] downstream of the stator trailing edge supported the rear bearing.

INSTRUMENTATION AND CALIBRATION

Airflow to the compressor was measured by means of a calibrated nozzle designed to the standards of the ISO (International Organization for Standards). Airflow measurements were within one percent accuracy. The compressor speed was measured by means of an impulse type pickup. The pickup was an electromagnetic device which counted the number of gear teeth that passed within an interval of time and converted the count to RPM. Between 4,000 rpm and 12,000 rpm, accuracy was within 0.2%.

All temperatures were measured using chromel-alumel, type K thermocouples and were recorded in millivolts by means of an automatic data acquisition system. Temperature elements were calibrated for Mach number over their full operating range. Effects of total pressure level on temperature recovery were accounted for by using the corrections found in Reference 8. The thermocouple leads were calibrated for each temperature element. Overall rms temperature accuracy was estimated to be $\pm 1.0^\circ\text{F}$ [$\pm 0.56^\circ\text{K}$].

Wedge probes which measured total pressure, static pressure, and air angle and combination probes which measured total pressure, total temperature, static pressure, and air angle were calibrated for Mach number as a function of indicated static-to-total pressure ratio, with pitch angle as a parameter. Total pressure recovery and yaw angle deviation were calibrated as functions of Mach number and pitch angle. Accuracy of the measured air angles was within 1.0 degree.

All pressures from probes, fixed rakes, and static taps were measured with transducers and recorded in millivolts by an automatic data acquisition system. The accuracy of the pressure was ± 0.1 of the full scale value. All pressures from instrument locations upstream of the 1st-stage rotor trailing edge were measured using 15 lbf/in.² [$1.033 \times 10^5 \text{ N/m}^2$] full-scale transducers. Pressures from the trailing edge of the 1st-stage rotor and from all downstream locations were measured using 50 lbf/in.² [$3.46 \times 10^5 \text{ N/m}^2$] full-scale transducers. Two proximity detectors, located over the tips of each rotor blade at midchord, were used to monitor blade tip clearance.

Photographs of typical instrumentation are shown in Figure 7, and the axial and circumferential positions of the instrumentation are shown in Figures 8 and 9, respectively. Instrumentation for measuring overall and blade element performance data is listed in Table IV.

TABLE IV – PERFORMANCE AND BLADE ELEMENT INSTRUMENTATION

INSTRUMENT PLANE LOCATION	PARAMETER	TYPE AND QUANTITY
Sta. 0 - - Inlet Plenum Chamber	p	6 pressure taps on plenum wall
	T	6 bare wire chromel-alumel thermocouples
Sta. 6 - - Rotor 1 Inlet (2.25 in. [0.0673 m] upstream of Rotor 1)	p	6 O.D. and I.D. wall static taps.
	†P, p & air angle β	2 wedge radial traverse probes spaced 180° apart circumferentially.
	P	two radial rakes with sensors at 10, 30, 50, 70, and 90 percent span (distortion tests only)
Sta. 8 - - Rotor 1 Exit (approx. halfway between Rotor 1 T.E. and Stator 1 L.E.)	††p	4 O.D. wall static taps approximately equally spaced circumferentially.
Sta. 11 - - Stator 1 Exit (halfway between T.E. of Stator 1 and L.E. of Rotor 2)	††p	4 O.D. and 4 I.D. wall static taps, approximately equally spaced circumferentially.
	†T, P, p, & air angle β	Two NASA combination probes - one with circumferential traverse of one vane gap, plus radial traverse, and second probe with radial traverse at midgap.
Sta. 14 - - Rotor 2 Exit	††p	4 O.D. and I.D. wall static taps, approximately equally spaced circumferentially.
Sta. 16 - - Fan Discharge (within ½ chord downstream of Stator 2)	††p	4 O.D. and 4 I.D. wall static taps approximately equally spaced circumferentially.
	†P, p, & air angle β	2 wedge probes, radial traverse, approximately 180° apart and located at vane midchannel.
	†T	2 wake rakes located approximately 180° apart, radially traversed; 10 elements across stator gap.
	†p	2 wake rakes located approximately 180° apart, radially traversed; 13 elements across stator gaps.
Sta. 17 - - Rig Exit	P	One circumferential P rake, 5 elements located at 50 percent span (used for setting points).

† 11 radial locations for uniform inlet flow tests (5, 10, 15, 30, 50, 60, 65, 70, 85, 90, and 95% of passage height); 5 radial locations for distorted inlet flow tests (10, 30, 50, 70, and 90% of passage height).

†† Static pressure taps ahead of and behind stators are located on approximate extensions of mean channel streamlines.

The eleven radial positions at each axial station were defined by the intersection of the axial station and the streamlines for the redesigned fan which passed through 5, 10, 15, 30, 50, 60, 65, 70, 85, 90, and 95 percent of the passage height at the 1st-stage rotor trailing edge. Five radial positions were used for the radial distortion tests. These five positions were located on the streamlines which passed through 10, 30, 50, 70, and 90 percent of the passage height at the trailing edge of the 1st-stage rotor. The radial locations at which these streamlines passed the leading and trailing edges of each blade row are given in Table XII of Appendix B.

The parameters listed in Table V were used to detect and evaluate rotating stall and were recorded continually during excursions into stall. When operating near or within the stall region, two hot-film probes, located at the fan inlet and exit (Stations 6 and 16) with sensors at 25, 50, and 85 percent of passage height from the hub, were used to record velocity fluctuations continuously on a multichannel tape recorder.

TABLE V – STALL TRANSIENT INSTRUMENTATION

INSTRUMENTATION PLANE LOCATION	PARAMETER	TYPE AND QUANTITY
Inlet Nozzle	p	1 static tap downstream and 1 static tap upstream of inlet nozzle
	Δp	A Δp transducer sensing the differential pressure between the upstream and downstream nozzle static pressures
	T	One nozzle temperature
Sta. 0 – Plenum	p	One plenum static tap
	T	One plenum temperature
Sta. 6 – Rotor Inlet	V	One hot-film probe
Rotor 1, Stator 1, and Rotor 2 Exit	p	One O.D. static tap each location
Rotor Blades	Stress	Strain-gages
Stator Blades	Stress	Strain-gages
Sta. 16 – Fan Discharge	p	One O.D. static tap
	V	One hot-film probe
Sta. 17 – Fan Discharge	P	One circumferential pressure rake at 50 percent span
Gearbox	N	Impulse pick-up

Accelerometers were used to measure shaft vibration and stationary and rotating critical parts were instrumented with strain-gages to determine levels of vibratory stress over the operating range of the compressor.

PROCEDURES

TEST PROCEDURES

The mechanical integrity of the test compressor had been established during extensive shakedown tests conducted with solid casings (ref. 3), and no flutter limits or shaft vibration problems were encountered over the full operating range. A brief shakedown test was conducted with uniform inlet flow after installation of the casing treatment, and no excessive stresses or flutter limits were encountered.

Rotating stall surveys were conducted at 70 percent, 85 percent, and 100 percent of design speed. Data from the hot-film probes and selected rotor and stator strain-gages along with a speed signal and stator exit O.D. static pressure were recorded simultaneously by a multi-channel tape recorder. The other transient parameters shown in Table V were recorded at 1.5 second intervals as the fan stage was throttled toward stall; approximately 100 scans were made by the automatic recording system from wide-open throttle to the minimum flow condition.

Fan overall and blade-element performance was obtained for 14 data points with uniform inlet flow at 70 percent, 85 percent, and 100 percent of design speed and for six data points at 70 percent and 100 percent of design speed with tip-radial distortion. At each speed, data points were taken between the maximum flow attainable and the low-flow stability limit. Hub distortion tests were not conducted because rotor tip casing treatment is not likely to improve performance with a hub distortion. Also, the 2nd-stage rotor strain-gages had become inoperable, and indications of a resonance (at low stress levels) had been detected with hub distortion during the solid-casing tests. With circumferential inlet distortion, three data points at 70 percent of design speed and three data-points at design speed were taken to determine overall performance and velocity distribution data at the fan inlet and fan exit. Measurements were made at approximately 30-degree increments around the circumference for three data-points (one at 70 percent speed and two at design speed) and at approximately 90-degree increments for the remaining three points.

DATA REDUCTION TECHNIQUES

All steady-state performance data were automatically recorded in millivolts on computer cards and then converted to engineering units, corrected, and used to calculate overall and blade element parameters as described in the following sections.

Data Correction and Averaging

The data obtained from impact tube type total pressure probes (fixed radial rakes and traversing wake rakes) located in supersonic flow were corrected for shock loss.

Wedge probes were used to measure total pressure, air angle, and static pressure. Mach number was determined from calibrations of measured total and static pressure. The measured total pressure and flow angle from these probes were corrected using Mach number calibration curves for individual probes. The resulting calibrated Mach number and corrected total pressure were then used in conjunction with standard air-property tables to calculate static pressure.

Combination probes were used to measure total pressure, air angle, static pressure, and total temperature. Corrections were based on probe calibrations similar to those previously described for wedge probes but with an additional calibration of total temperature recovery versus Mach number.

All thermocouple signals were converted to temperature measurements using wire calibrations for individual sensors. These temperature measurements were converted into total temperature using calibrations of total-temperature recovery versus Mach number for individual sensors and the pressure-level correction given in Reference 8.

The total pressure impact tube on the NASA combination probe used to traverse the first-stage exit failed during testing, indicating a sudden deterioration in first-stage performance. The probe was recalibrated before being repaired so that the data taken with the damaged probe could be corrected. Some difficulty was experienced in obtaining a satisfactory calibration of the damaged probe. This questionable recalibration affected all blade-element performance parameters and the first-stage overall performance for those data points taken with the damaged probe. Performance parameter tabulations are marked for data points taken with the damaged probe. Fan overall performance measurements were not affected.

For tests with uniform inlet flow, circumferential total pressure distributions obtained at the exits of the 1st-stage and 2nd-stage stators were mass-flow averaged at each radial position using the corresponding measured distribution of total temperature and a constant circumferential static pressure determined by linearly interpolating between static pressure measurements from wall static taps or from wedge probe traverses. The arithmetic average of the three highest values from the circumferential total pressure distribution measured across the passage between adjacent stator vanes at each radial location was chosen to represent the free-stream or stator inlet pressure at the appropriate percent of span. A circumferentially mass-flow averaged total temperature was also calculated at each radial position using measured circumferential distributions of total temperature and pressure and static pressure linearly interpolated between wedge probe or inner and outer wall static tap measurements. Circumferentially mass-flow averaged temperatures from the two temperature wake rakes at the 2nd-stage stator exit were arithmetically averaged for each radial location. During tests with solid casings, one pressure wake rake did not traverse properly for some data points. Comparison of measurements made when both rakes were functioning properly showed excellent agreement. This agreement was also obtained in tests with casing treatments. On the basis of this, only data from the pressure rake that worked consistently for all tests were used in the calculation of performance parameters for points tested with uniform and radially distorted inlet flows.

Air angles measured by circumferential traverses at the exit of the 1st-stage stator were mass flow averaged at each radial location. Air angles measured by the two wedge-probes at the exit of the 2nd-stage stator were arithmetically averaged at each radial location.

For tests with tip radially distorted inlet flow, radial traverses at the exit of the 1st-stage stator were made at midgap – combined circumferential and radial traverses were used for the uniform inlet flow tests. Ratios of midgap measurements to gapwise mass-flow averaged total pressure and temperature and free-stream total pressure were correlated for uniform inlet flow data. These correlations were then used to calculate overall performance and blade-element parameters for the 1st-stage rotor and stator with radially distorted inlet flow. An example of one of the pressure correlations is shown in Figure 10. This technique was also used in the analysis of tests with inlet distortions conducted with solid casings (ref. 3). The major disadvantage of this method is that the calculated stator 1 total pressure loss does not vary with incidence angle. The resulting error is largest for open-throttle and near-stall data points. Fan overall performance data were not affected by inaccuracies inherent in this method.

For tests with circumferentially distorted inlet flow, fan inlet total pressure was calculated by radially mass-flow averaging the measurements made by each fixed rake and arithmetically averaging these radial mass-flow averages. This arithmetic average included inlet rake measurements made at all rotations of the circumferential inlet distortion screen. First-stage and 1st-stage rotor performance with circumferentially distorted flow is not presented. It was not possible to check measurements made by the damaged probe since the “redundant” probe was in a different flow region. Fan exit total pressures and temperatures were measured by means of wake-rake traverses at all rotations of the distortion screen. Total pressures and temperatures were each circumferentially mass-flow averaged for each rake at each radial location. These values were radially mass-flow averaged at each rake position relative to the screen. Overall average total pressure and temperature were calculated by arithmetically averaging the circumferentially and radially mass-flow averaged values for each wake rake position.

Performance Parameter Calculations

Overall and blade element performance parameters were calculated for uniform and radially distorted inlet flows by means of a flowfield analysis computer program. All parameters were corrected to standard day conditions. Inputs to the flowfield program are listed in Table VI.

Total pressures and temperatures were ratioed to compressor inlet values (Station 6). Compressor inlet total pressure was assumed equal to the inlet plenum pressure for tests with uniform inlet flow. For tests with distorted inlet flows, overall pressures were ratioed to the mass-flow average of the total pressures measured by the rakes at the fan inlet. Temperatures were always ratioed to the inlet plenum temperature.

TABLE VI – INPUT PARAMETERS TO FLOWFIELD PROGRAM

LOCATION	PARAMETER
Compressor Inlet (Station 0, Figure 6)	1) Corrected mass flow
	2) Corrected rotor speed
Rotor 1 Inlet Instrument Plane (Station 6)	1) Total pressure ratio ¹ versus radius
	2) Constant radial blockage factor
Stator 1 Inlet (Station 9)	1) Total pressure ratio versus radius
	2) Constant radial blockage factor
Stator 1 Exit Instrument Plane (Station 11)	1) Total temperature ratio versus radius
	2) Total pressure ratio versus radius
	3) Constant radial blockage factor
	4) Absolute air angle versus radius
Stator 2 Inlet (Station 14)	1) Total pressure ratio versus radius
	2) Constant radial blockage factor
Stator 2 Exit Instrument Plane (Station 16)	1) Total temperature ratio versus radius
	2) Total pressure ratio versus radius
	3) Constant radial blockage factor
	4) Absolute air angle versus radius

¹Ratio = 1.0 for uniform inlet flow. For radial distortions, ratio is local value of total pressure divided by mass-flow average of total pressure at Station 6.

A blockage factor was used at each axial location to improve the accuracy of the static pressure and velocity calculations of the flowfield program. Blockages were applied equally to all stream-tubes at each of the axial locations. Axial distributions of flow blockage factors were selected so that the hub and tip static pressures obtained from the flowfield calculations gave the best agreement with the wall average pressure for a representative midthrottle operating point at design speed. As shown in Table VII, the flow blockage factors used in the data reduction flowfield calculation were the same as those used in the redesign of the 2nd-stage rotor except at the trailing edge of the 2nd-stage stator where three percent blockage was added to the calculation for data reduction. These values are the same as those that had been used to reduce the data from the design stator-setting test reported in Reference 3 — details of the blockage selection and static pressure comparisons are given in that reference.

TABLE VII – ANNULUS BLOCKAGES

STATION	DATA REDUCTION (%)	REDESIGN (%)
Rotor 1 Leading Edge	2.4	2.4
Rotor 1 Trailing Edge	4.1	4.1
Stator 1 Leading Edge	4.1	4.1
Stator 1 Trailing Edge	2.8	2.8
Rotor 2 Leading Edge	2.8	2.8
Rotor 2 Trailing Edge	5.3	5.3
Stator 2 Leading Edge	5.3	5.3
Stator 2 Trailing Edge and Downstream	6.5	3.5

All static pressure distributions and air angles behind the rotor were calculated by the streamline flowfield computer program, assuming axisymmetric flow and using mass flow continuity, radial equilibrium, and energy equations. Curvature, enthalpy, and entropy gradient terms were included in the equilibrium calculations. Aerodynamic conditions at the blade edges were calculated by translating the measured data from the instrument plane along streamlines to the blade edges. Blade element parameters were calculated for airfoil sections lying on conical surfaces defined by the intersections of design streamlines and the blade edges. Calculations were made on design streamlines passing through the 1st-stage rotor trailing edge at 5, 10, 15, 30, 50, 60, 65, 70, 85, 90, and 95 percent of the passage height for uniform inlet flow and at 10, 30, 50, 70, and 90 percent for radially distorted inlet flow. Blade-edge stations were input to the flowfield calculation as slanted straight lines which closely approximated the meridional profiles of the manufactured blade edges. In addition to the blade element parameters, the output of the flowfield analysis program also includes overall performance of the 1st-stage rotor blade row, the first stage, the first stage plus the 2nd-stage rotor, the 2nd-stage rotor, and the complete two-stage fan. Blade-element performance data for uniform and radially distorted flow tests are tabulated in Appendixes C and D. Accumulated overall performance to the exit of each blade row is tabulated at the bottom of the blade element data sheet for that blade row.

RESULTS AND DISCUSSION

UNIFORM INLET FLOW

Fan Overall Performance

An overall performance map for the two-stage fan with uniform inlet flow is shown in Figure 11 for the configuration with casing treatment (axial skewed slots) over both rotors. For comparison, fan performance with solid rotor-casings has been included as dashed lines. As shown in the figure, the rotor casing treatment improved stall margin at 70 percent of design speed; however, at design speed there were significant performance penalties in terms of fan pressure ratio, efficiency, flow, and stall margin. There were also performance penalties at 85 percent of design speed but to a lesser degree than at design. Performance parameters at 70 percent, 85 percent, and 100 percent of design speed are compared in Table VIII.

TABLE VIII – COMPARISON OF PERFORMANCE PARAMETERS WITH ROTOR TIP CASING TREATMENT AND SOLID CASING FOR UNIFORM INLET FLOW

	CASING TREATMENT	SOLID CASING
DESIGN SPEED		
Peak Efficiency (%)	82.3	85.4
Peak Pressure Ratio	2.947	3.043 (at stall)
Maximum Inlet Corrected Airflow (% Design)	99.9	100.8
Stall Margin (%)	10	12
85% OF DESIGN SPEED		
Peak Efficiency (%)	84.7	85.5
Peak Pressure Ratio	2.255	2.269 (at stall)
Maximum Inlet Corrected Airflow (% Design)	83.7	84.4
Stall Margin (%)	16	16
70% OF DESIGN SPEED		
Peak Efficiency (%)	84.2	84.9
Peak Pressure Ratio	1.735 (at stall)	1.735 (at stall)
Maximum Inlet Corrected Airflow (% Design)	67.3	67.7
Stall Margin (%)	26	17

At 70 percent of design speed where the most probable cause of stall was high aerodynamic loading in the tip region of the 1st-stage rotor, as explained in Reference 3, the flow range was extended by the use of rotor casing treatment, resulting in a higher value of stall margin. At design speed where the most probable cause of stall was high loadings on the rotor and stator hubs of the 2nd-stage, casing treatment had an adverse effect on stall margin. The reduction in stall pressure ratio at design speed was due to increased losses with casing treatment and not to a reduction in work input. Figure 12 shows that work input (temperature rise) was increased by casing treatment for near-stall conditions over the entire speed range tested. Stalls at all speeds were abrupt, appearing as cyclic surges. At design speed the surge cycle period was 2.0 seconds. At 70 percent of design speed the period was 0.9 seconds.

Stall margin values were calculated for all speeds using the constant throttle operating line shown in Figure 11. This operating line passes through the design point and corresponds to a fixed-area fan nozzle. Nozzle Mach numbers were determined by a ratio of static pressure to total pressure equal to the reciprocal of the fan overall total pressure ratio. The nozzle flow was corrected to inlet conditions based on the selected pressure ratio and a temperature ratio derived from test efficiencies. Stall flows, pressure ratios, and calculated stall margins for uniform inlet flow are listed in Table XIV of Appendix C. Flow capacity was not affected by casing treatment at 70 percent of design speed but was reduced at higher speeds. At design speed and pressure ratio, the corrected air flow was 183.5 lbm/sec [83.3 kg/sec], which is approximately 0.6% below the design flow of 184.2 lbm/sec [83.22 kg/sec] and 1% below the flow of 185.3 lbm/sec [83.72 kg/sec] obtained with solid casings. Maximum flow at design speed was also reduced by approximately 1%. At 85 percent of design speed, operating line flow was reduced by 0.6% and maximum flow by approximately 1%.

Efficiency on the operating line was unchanged by casing treatment at 70 percent of design speed but was reduced by 0.7 percentage points at 85 percent of design speed. At design speed and pressure ratio, adiabatic efficiency was 82.2% which is 1.5 percentage points below the design goal and 2.8 percentage points below the efficiency obtained with solid casings. Peak efficiency at design speed was 82.3% at a pressure ratio of 2.93. With solid casings the peak efficiency was 85.4% at a pressure ratio of 2.86.

Fan total pressure recovery ratio, defined as the ratio of actual fan pressure ratio to the ideal fan pressure ratio derived from the measured total temperature ratio, was lower with casing treatment than with solid casings, as shown by Figure 13. Overall temperature ratio was also lower with casing treatment, except near stall, as shown by a comparison of temperature ratio versus corrected flow at design speed (Figure 12). The combination of lower total pressure recovery (higher loss) and lower temperature ratio (less work input) explains the loss in pressure ratio with casing treatment. The lower efficiency at design speed is due to the increased loss.

Overall Performance of the First-Stage Rotor and First Stage

The 1st-stage rotor had a higher pressure ratio and efficiency with casing treatment than with solid casings at 70 percent and 85 percent of design speed, as shown by the overall performance data presented in Figure 14. Casing treatment improved adiabatic efficiency by approximately 10 percentage points at 70 percent of design speed when the rotor was near stall, decreasing to no benefit at wide-open throttle. At design speed, pressure ratio near stall was reduced from 1.86 with solid casings to 1.84 with casing treatment, and adiabatic efficiency was reduced approximately 1.5 percentage points at the design pressure ratio. Nondimensional plots of pressure coefficient and efficiency versus flow coefficient (Figure 15) illustrate more clearly the trend of higher pressure ratios and efficiencies at low speed and lower pressure ratios and efficiencies at high speed.

At design speed 1st-stage rotor work input was not changed by casing treatment, as shown by the plot of rotor total temperature ratio versus corrected flow for solid and treated rotor casings (Figure 16). Hence, the efficiency drop with treatment at design speed was caused by higher 1st-stage rotor losses; the magnitude of the peak efficiency loss was approximately 1.5 percentage points.

The first-stage pressure coefficients at 70 percent and 85 percent of design speed were higher with casing treatment than with solid casings despite higher stator losses with the casing treatment. This difference between stator loss levels can be seen by comparing the nondimensional performance plot for the 1st-stage rotor (Figure 15) with the first-stage performance plot (Figure 17). The improvement in first-stage efficiency with casing treatment at 70 percent of design speed was smaller than for the rotor alone but near stall it was still approximately 7 percentage points. Casing treatment reduced first-stage pressure ratio and adiabatic efficiency at design speed due to increased losses in both the rotor and stator; adiabatic efficiency was reduced by approximately 2.5 percentage points. Pressure ratio differences at part speed were small, as shown by the first-stage overall performance data presented in Figure 18.

Overall Performance of the Second-Stage Rotor and Second Stage

Nondimensional performance plots for the 2nd-stage rotor and second stage (Figures 19 and 20) show that pressure coefficients with casing treatment for both the rotor and stage were lower than those obtained without casing treatment although casing treatment did provide slightly lower values of flow coefficient. The corresponding lower second-stage pressure ratios caused a small reduction in fan overall pressure ratio with casing treatment at 85 percent of design speed and no change at 70 percent of design speed although the first-stage pressure coefficients increased for both speeds. The general lack of improvement in second-stage pressure ratio and efficiency is probably due to the fact that critical loadings at the tip of the 2nd-stage rotor were not reached with solid casings. Since the improvement in first-stage pressure coefficient was not accompanied by any benefit in overall performance, the fan overall performance data indicates that better fan performance would have been obtained with casing treatment only over the 1st-stage rotor.

Blade-Element Performance

Spanwise Comparisons

Temperature ratio and pressure ratio versus span are presented in Figures 21 and 22 for the 1st-stage and 2nd-stage rotors and for the overall fan at near-stall and peak-efficiency points at design speed with and without casing treatment. Casing treatment caused an apparent redistribution of work input (temperature rise) such that the total-temperature ratio for the 1st-stage rotor increased from about 70 percent span to the tip. The temperature ratio of the 2nd-stage rotor with casing treatment increased in the region between 50 percent and 85 percent of span but decreased in the region from 85 percent span to the tip.

For the near-stall points (Figure 22), the 1st-stage pressure ratio with casing treatment was lower from the hub to about 85 percent span than without casing treatment and higher from there to the tip. For the 2nd-stage rotor, casing treatment reduced the pressure ratio from 50 percent to 90 percent span; however, at 90 percent span the pressure ratio with casing treatment increased sharply and exceeded the solid casing values from 95 percent span to the tip. This increase in pressure ratio near the tip is believed to be primarily the result of radial mixing (particle paths crossing streamlines). The combined effect of casing treatment on overall fan pressure ratio, as shown by the near-stall points, dropped the level of pressure ratio over the entire span but reduced the gradient of decreasing pressure ratio from 90 percent span to the tip.

Meridional velocity profiles at the second-stage inlet for design speed, near-stall data points (Figure 23) have a higher velocity near the tip with casing treatment, consistent with the reduced work input at the tip of the 2nd-stage rotor. The velocity profiles between 50 percent and 85 percent span are nearly identical, however, and do not explain how casing treatment caused higher work input in this region. The change in work input distribution is also believed to be primarily the result of increased radial mixing and to a lesser extent to the change in axial velocity distribution. Casing treatment increased the rise in overall fan temperature in the tip region.

The efficiency profiles that resulted from the measured pressure and temperature distributions are shown in Figure 24. These profiles show a drop in 1st-stage rotor efficiency with casing treatment for the outer 30 percent of span. The profiles for the 2nd-stage rotor with casing treatment show an efficiency deficit starting at approximately midspan; however, the efficiency increases sharply in the tip region due to the pressure increase and temperature decrease in this region. The improbable rise in efficiency outboard of 70 percent span is a strong indication that flow was transported radially across streamlines. The region of low efficiency between 60 percent and 95 percent span at the fan exit resulted in the loss in fan average overall-efficiency with casing treatment.

The large differences in temperature and pressure profiles in the tip region between the solid and treated casings at design speed are less evident at 85 percent and 70 percent speed. Figures 25 and 26 show the resulting radial profiles of efficiency for similar solid casing and casing treatment points at 85 percent and 70 percent speeds, respectively, showing smaller differences in the efficiency profiles of both rotors and of profiles at the fan exit.

Variations of Blade-Element Parameters with Incidence Angle

Blade-element plots of deviation angle, diffusion factor, and deviation angle versus suction surface incidence angle at 11 radial locations for rotor 1, stator 1, rotor 2, and stator 2 are presented in Figures 27 through 30, respectively. The solid line represents design speed performance for solid casings and is based on data given in Reference 3. (Radial distortion blade element data on parts b, d, e, h, and j of these figures are discussed in the Tip Radially Distorted Inlet Flow section of this report.) Although radial mixing of the flow was indicated in spanwise profiles of pressure and temperature (Figures 21 and 22), blade-element performance parameters were calculated assuming no mixing. Tabulations of blade-element data are given in Appendix C.

Rotor 1: The blade-element data for the 1st-stage rotor (Figure 27) shows that the narrow range of incidence angles at design speed was extended about one degree on the stall side (higher incidence) with casing treatment. Increased flow range provided a wider range of blade-element incidence angles which gave a better definition of increasing loss at extremes of high and low incidence angles. At design speed with casing treatment, losses increased with both low and high incidence angles, whereas with solid casings the losses increased only at low incidence angles. At 85 percent to 95 percent of span, losses were higher and deviations lower with casing treatment over the entire design speed incidence angle range, causing the rise in tip temperature ratio seen in Figure 21 and the corresponding efficiency penalty. The range of incidence angles increased with decreasing speed and the level of minimum loss decreased, both with casing treatment and with solid casings. The near-stall values of tip loading were higher with casing treatment, especially at 70 percent speed. Casing treatment raised the level of critical tip-loading, allowing the fan to operate at lower flows at 70 percent speed.

The calculated loss coefficients were negative for blade elements near the hub for certain data points with casing treatment, similar to those calculated with solid casings. These negative losses are attributed to two causes: 1) low temperature rise at low speeds magnified the effect of any temperature measurement errors and 2) temperature and pressure sensors were offset radially and the interpolations in regions of steep radial gradients may not have matched temperatures and pressures accurately. Distribution of loss between rotors and stators is not believed to be the source of the problem since stator losses appear to be reasonable for these points.

Stator 1: The blade-element data for the 1st-stage stator (Figure 28) shows that loss coefficients were relatively insensitive to incidence angle or speed near the hub with levels generally higher with casing treatment than with the solid casing. At design speed the portion of the span influenced by the 1st-stage rotor partspan shroud had lower losses with casing treatment than with the solid casings and shifted to higher incidences, indicating a decrease in flow through this region. At part speeds, stator loss patterns were nearly identical with treated and solid casings.

Diffusion factor levels were essentially the same for solid and treated casings except from 90 percent to 95 percent of span where near-stall values were higher at all speeds with tip treatment. At 70 percent speed where the levels of the stator 1 tip diffusion factor may have initiated fan stall, with casing treatment a diffusion factor of 0.663 was attained at 90 percent span at an incidence of 18.3 degrees compared to the solid casing test value of 0.580 at an incidence angle of 16.7 degrees.

Deviation angles were slightly higher with casing treatment than with solid casings at design speed. Agreement with design values of deviation angle was generally within about two degrees.

Rotor 2: Blade-element data for the 2nd-stage rotor (Figure 29) shows that the hub loadings at design speed with casing treatment did not reach as high a level as with the solid casings. The maximum diffusion factor with casing treatment was 0.59 near the hub and partspan shroud but with solid casing it was 0.64. Since a diffusion factor value of about 0.65 is associated with stall, with solid casing the hub of the 2nd-stage rotor was a probable cause of stall. It is not clear which blade element(s) initiated stall at design speed with casing treatment. There is evidence of choking at design speed with treated casings, similar to trends with solid casings, as shown by the sharp increase in loss with decreasing incidence near the hub. This choking evidence suggests that the 2nd-stage rotor limited the fan flow. Loss levels with casing treatment were slightly higher at the hub and significantly higher from midspan to 88 percent of span, dropping to below the solid casing losses at 94 percent of span.

Deviation angles with casing treatment were approximately two degrees lower over the entire span than with solid casings. The most probable explanation for this apparent change in deviation angle level is insufficient blockage assumed in the streamline calculation of blade-element velocity vectors for the casing treatment test points. For consistency, the same blockages were used for solid and treated casing data analysis. The reduced level of deviation angles with treatment is an indication that effective blockage was higher with casing treatment. A second indication of increased blockage is the incidence angle at which the 2nd-stage stator choked. Figure 30b shows that at design speed, the 2nd-stage stator hub (7 percent span) choked at approximately 1.5 degrees higher incidence angle in the casing treatment test.

Stator 2: The blade-element data for the 2nd-stage stator (Figure 30) shows an abrupt rise in loss with increasing negative incidence angle over the inner half of the vane span. This abrupt rise in loss indicates choke, and it occurred at all speeds. Blade elements in the outer half of the vane span did not have these abruptly changing losses; instead, the losses increased steadily as the incidence angles decreased below design values. This loss pattern is similar to that observed with the solid casings.

An abrupt decrease in deviation accompanied the rises in loss with decreasing incidence angle. The deviation angle changes may be a result of large stator wakes reaching the gap-wise location of the probe and affecting the angle measurement. Loss and loading levels at design speed were generally in good agreement over most of the span both for treated and untreated casings. A shift to lower incidence near the tip occurred with treated casings with a corresponding rise in losses on the choke side.

TIP RADIALLY DISTORTED INLET FLOW

The radial-distortion screen shown schematically in Figure 6 was used to generate an axisymmetric total pressure defect that covered approximately 40 percent of the annulus area at the fan inlet. At design speed the distortion parameter, $(P_{\max} - P_{\min})/P_{\max}$, was 0.15 with maximum flow and 0.13 with near-stall flow. Figure 31 shows the spanwise distribution of total pressure at the fan inlet for the flow range from wide-open throttle to near-stall flows at design speed.

Overall Performance

Overall performance for the fan, the first stage, and the 1st-stage rotor is shown in Figures 32, 33, and 34, respectively. Fan performance with tip radially distorted inlet flow and casing treatment is compared to the uniform inlet flow performance with casing treatment and to the solid casing performance with tip radially distorted inlet flow. At design speed, tip radially distorted flow increased stall margin from 10% with uniform inlet flow to 16%. At 70 percent of design speed, the tip distortion reduced stall margin from 23% to 15%.

Comparison of performance curves for tip radially distorted flow with treated and solid rotor casings shows that the stall lines are nearly the same. At design speed, casing treatment decreased flow so that the operating-line pressure ratio was 2.79 compared to 2.82 without casing treatment. The operating-line efficiency with casing treatment decreased from 84.7% for solid casings to 82.0%. Casing treatment increased stall margin slightly from 15% to 16%. At 70 percent of design speed, flow increased slightly so that the pressure ratio on the operating line increased from 1.69 with solid casings to 1.71 with casing treatment. The pressure ratio at stall was also higher with casing treatment, but stall occurred at a higher flow to give approximately the same stall line. Stall margin based on the operating line decreased from 18% with the solid casing to 15% with casing treatment. The operating-line efficiency decreased from 84.1% with solid casings to 83.8% with casing treatment.

Performance of the first stage and the 1st-stage rotor with uniform and with tip radially distorted inlet flows with and without casing treatment are compared in Figures 33 and 34. At design speed with casing treatment, a higher pressure ratio was obtained at stall with this distortion than with the undistorted flow; however, the pressure ratio was no higher than that obtained with solid casings. The solid casings gave a higher efficiency and flow capacity than the treated casings. The distortion reduced stall pressure ratio at 70 percent speed, but the pressure ratios were higher for the entire 70 percent speed line with casing treatment than with solid casings with the same distortion. The increases in first-stage pressure ratio and efficiency at 70 percent speed with casing treatment and the reduction at design speed are consistent with observed effects of casing treatment on fan overall performance.

Blade-Element Performance

Spanwise Comparison

Spanwise profiles of stage total pressure ratio for near-stall conditions at design speed with uniform and tip radially distorted flow are compared in Figure 35. Each value of pressure ratio in Figure 35 is equal to a local value of exit total pressure divided by a local value of inlet total pressure, where both pressures lie on the same streamline. The resulting pressure ratio profile does not represent a profile of absolute total pressure. The spanwise profile for tip radially distorted flow with solid rotor casings (ref. 3) is also shown. The figure shows that the outer portion of the span of the first stage with casing treatment had a higher pressure ratio with the distortion. It also shows that for the same tip distortion, the radial gradient of first-stage pressure ratio was steeper from midspan to the tip with casing treatment.

The total-pressure defect at the 1st-stage hub with tip radially distorted flow with casing treatment was not seen in tests with solid casings nor with undistorted flow with casing treatment. An incorrect value of total pressure may be the reason for this apparent defect. Total pressures at the inlet and exit of the 1st-stage stator were based on midgap measurements at the stator exit, corrected using the correlation of gap-averaged and free-stream total pressures versus midgap total pressures, as explained in the section Data Correction and Averaging (pg. 10). The correlation may be inaccurate for this operating condition. A local high-pressure ratio at the 2nd-stage hub apparently compensated for this defect.

Variations of Blade Element Parameters With Incidence Angle

Deviation angle, diffusion factor, and loss coefficient versus incidence angle are plotted in Figures 27 through 30 for each blade row at five radial positions together with data from uniform inlet-flow tests. Complete tabulations of blade element data are given in Appendix D.

Rotor 1: At design speed the 1st-stage rotor operated at lower incidence angles from 10 percent to 70 percent of span with tip radially distorted flow than with undistorted flow (Figure 27). The data shows that losses increased sharply at these lower incidence angles. This sharp increase in losses indicates that tip distortion forced flow towards the hub which tended to choke this region. This flow shift also resulted in higher positive incidences with distortion at 90 percent of span for both 70 percent and 100 percent of design speed. The highest diffusion factor reached was 0.6 at 90 percent span for the 70 percent speed near-stall point, much lower than the 0.71 value obtained with uniform inlet flow. This indicates that the reduction in stall margin at 70 percent of design speed with distortion was not due to 1st-stage rotor stall.

Stator 1: Blade element data (Figure 28) with distortion shows that the 1st-stage stator had the highest diffusion factors near stall of any blade row at both 70 percent and 100 percent of design speed. At design speed the diffusion factor at 9 percent span was 0.65. This loading occurred at an incidence angle that was two degrees higher than at the near-stall uniform-inlet-flow point which had a diffusion factor of 0.55. At 70 percent of design

speed the 1st-stage stator tip reached a diffusion factor of 0.67, the same high loading value as with uniform inlet flow (Figure 28j). The distortion caused the diffusion factor to reach its loading limit at a higher flow (lower incidence), causing the loss in fan stall margin.

Losses were in good agreement with uniform inlet flow values across the span for both speeds tested.

Rotor 2: The blade-element data for the 2nd-stage rotor (Figure 29) shows an unusual amount of scatter. This is particularly true of loss coefficient data at 8 percent and 25 percent of span. This scatter and the negative losses calculated at these spans for both speeds do not appear to have resulted from an improper division of loss between rotor 2 and stator 2 but is more likely associated with temperatures or pressures from correlated first-stage exit data, as explained in the section Data Correction and Averaging (pg. 10). Design speed loadings were much lower with distortion at all spans while loadings were essentially the same at 70 percent of design speed. A maximum diffusion factor of 0.59 occurred at 88 percent span for the 70 percent speed near-stall point.

Stator 2: The blade element loss and deviation data for the 2nd-stage stator (Figure 30) agree very well with data from undistorted flow tests at both speeds. However, design speed loadings were much lower, never exceeding a value of 0.5.

Attenuation of Radial Distortion

Attenuations of tip-radial distortion through the two-stage fan with casing treatment were calculated for the three data points at design speed. Due to radial variations in total pressure present in the design profiles (uniform inlet flow) at the first-stage exit and at the fan exit, an attenuation parameter, $A_{r,x}$, at a given station x was defined

$$A_{r,x} = 1 - \frac{(\Delta P/P)_{test,x} - (\Delta P/P)_{design,x}}{(\Delta P/P)_{test,inlet}}$$

where $\Delta P/P = (P_{max} - P_{min})/P_{max}$

The minimum pressure is determined by the local minimum in the distorted region. A negative sign is attached to each $\Delta P/P$ for which the pressure in the hub region exceeds the pressure in the tip region. Thus the design $\Delta P/P$ at the fan exit is negative since the design exit total pressure is higher at the hub than at the tip. The $\Delta P/P$ at the inlet is negative for the tip distortion. Any time the test $\Delta P/P$ at the first-stage or fan exit matches the design $\Delta P/P$, the distortion is considered fully attenuated and the value of $A_r = 100$. Negative values of A_r represent amplified distortions, values of A_r between 0 and 100 represent the percentages of attenuation, and values greater than 100 represent over-attenuated distortions. Table IX presents a summary of attenuation parameters calculated at design speed for tip radially distorted inlet flow. Figure 36 compares spanwise total pressure profiles at the fan inlet, first-stage exit, and fan exit for these data points with the profiles for undistorted flow and

with the profiles for tip radially distorted flow and solid casings. Pressures were ratioed to the average fan inlet total pressure. The figure shows profiles of absolute pressure, not profiles of pressure ratio along streamlines. The shapes of the total pressure profiles at the first-stage exit and fan exit are not markedly different for uniform and distorted inlet flow. At the first-stage exit, the total pressures at the hub with tip distortion were generally higher with solid casings than with casing treatment. This difference was smaller at the fan exit than at the first-stage exit. Pressure differences at the tip were small for all three fan configurations. The combination of lower pressure at the hub and normal pressure at the tip resulted in attenuation parameters over 100 percent for the midrange and near-stall data points. Casing treatment increased the amount of attenuation at the near-stall design speed data point to 103.7% compared to 86.7% with solid casings. At wide-open throttle, attenuation was approximately the same as with solid casings.

It should be noted that the first-stage data for all radial distortion tests were affected by a damaged combination probe at the first-stage exit. Although the recalibration of the probe in its damaged condition was used to reduce these data, first-stage performance and all blade-element data must be treated with some caution.

TABLE IX – ATTENUATION PARAMETERS AT DESIGN SPEED FOR TIP RADIALLY DISTORTED INLET FLOW

THROTTLE SETTING	$(\Delta P/P)_{\text{test}, x}$	$(\Delta P/P)_{\text{design}, x}$	$A_{r,x}$
ROTOR 1, INLET (x = 6)			
Wide-open	-0.141	0	0%
Midrange	-0.140	0	0%
Near stall	-0.134	0	0%
FIRST-STAGE EXIT (x = 11)			
Wide-open	-0.126	0.021	-4.2%
Midrange	-0.113	0.021	4.2%
Near stall	-0.041	0.021	53.8%
FAN EXIT (x = 16)			
Wide-open	-0.157	-0.092	53.9%
Midrange	-0.04	-0.092	137.2%
Near stall	-0.087	-0.092	103.7%

CIRCUMFERENTIALLY DISTORTED INLET FLOW

The circumferential inlet-distortion was generated by means of the screen shown schematically in Figure 6. A distortion pattern was generated which covered approximately a 90-degree segment of the annulus area at the inlet of the 1st-stage rotor. At a near operating-line data point at design speed, the screen provided distortion parameters, $(P_{\text{max}} - P_{\text{min}})/P_{\text{max}}$, of 0.115 at 10 percent span, 0.136 at 50 percent span, and 0.135 at 90 percent span. Inlet, total pressure profiles for this data point are shown in Figure 37.

Fan Overall Performance

Overall performance for the fan with circumferentially distorted inlet flow with and without casing treatment is shown in Figure 38; performance with casing treatment and uniform flow is also shown. At design speed, the stall margin was about 12% with treated casings and circumferentially distorted inlet flow; with uniform inlet flow, the stall margin was 10%. With solid casings, stall margin with circumferentially distorted flow was about 10%; it was 12% with uniform flow – indicating that at design speed casing treatment reduced the sensitivity to circumferential distortion. Peak adiabatic efficiency with treated casings was 81.6% with circumferentially distorted flow; it was 82.3% with uniform flow. With solid casings, efficiency was 81.8% with circumferential distortion and 85.4% with uniform flow.

At 70 percent of design speed, stall margin with circumferentially distorted inlet flow was approximately 25% with casing treatment and 17% with solid casings, about the same values attained with uniform flow. Peak adiabatic efficiency with circumferentially distorted inlet flow was 81.4% with casing treatment and 80.9% with solid casings; efficiency with uniform flow was 84.0% with casing treatment and 84.5% with solid casings.

The overall performance presented in Figure 38 is based on data from two different sets of screen rotation[†]. The solid symbols in the figure are points with data from 12 circumferential locations (30-degree intervals) relative to the screen while the open symbols are points with only four circumferential locations (90-degree intervals) relative to the screen. To evaluate the effects of using four locations instead of 12, four sets of performance parameters were calculated from a 12-location point (a near-design point). One set of calculations used data from all 12-locations, and three sets of calculations used data from only four of the 12 locations; each set utilized a different group. The results of these calculations are present in Table X. The four-location points are labeled A, B, or C for identification purposes. The maximum difference between fan overall pressure ratios was approximately 0.01, and the maximum difference between efficiencies was approximately three percentage points. The four-location data points (open symbols) shown in Figure 38 used the combination identified in Table X as “A”.

TABLE X – COMPARISON OF PERFORMANCE OBTAINED WITH THE TWELVE-LOCATION AND FOUR-LOCATION DATA ACQUISITION METHODS

	Fan Pressure Ratio	Fan Adiabatic Efficiency (%)
12-Location	2.819	81.56
4-Location A	2.817	80.15
B	2.814	80.97
C	2.827	83.32

[†] Only two probes were used, and these probes were held in a circumferentially fixed location relative to the case. To obtain the additional measurements, the screen was rotated relative to the fixed probes.

Overall performance parameters for circumferential distortion data points are based on averages of measurements obtained at different circumferential positions relative to the distortion screen and not on the axisymmetric streamline calculating procedures used for uniform and radial-distortion flow data points. The two methods for calculating overall performance are described in the Data Correction and Averaging section of this report (pg. 10). The difference in performance obtained with the two methods is small. To determine representative differences, pressure ratio and efficiency for the near-design data point with uniform inlet flow were calculated using both techniques. With the method employed for circumferentially distorted flow, the pressure ratio was 0.006 higher and efficiency was 0.12 percentage points higher.

Circumferential Distributions of Flowfield Parameters

Circumferential distributions of static pressures at design speed are shown in Figures 39 and 40. The static pressures were measured by means of taps on the outer case and inner hub at five axial locations between the distortion screen and the 1st-stage rotor inlet. The profiles show regions of lower static pressure behind the screen. The reversed pattern on the outer wall approximately midway between the screen and the rotor inlet was probably due to the support strut immediately downstream of this axial location (Figure 8). No pattern reversal was seen at the hub at any axial location (Figure 40). Static pressure patterns were nearly identical to the patterns caused by the circumferential distortion in tests with solid casings (ref. 3).

Circumferential distributions of total pressure ratio, static pressure ratio, absolute Mach number, relative flow angle, absolute flow angle, and velocity components at the fan inlet and fan exit are presented in Appendix E, Tables XXII and XXIII; circumferential distributions of total temperature ratio for the fan exit are presented in Appendix E, Table XXIV. Figures 41 and 42 show distributions for all these parameters at 10 percent, 50 percent, and 90 percent of span at design speed. Of interest in these plots is the almost complete attenuation of total pressure distortion at 50 percent and 90 percent of span and the apparent amplification at the hub. The attenuation of the pressure distortion was accompanied by the generation of a temperature distortion. At the fan exit, the temperature downstream of the inlet pressure distortion was locally higher than the average for all spanwise positions (Figure 42). These figures also show the possibility of inaccuracies in performance parameters based on measurements at four circumferential positions compared to twelve.

The circumferential patterns of total temperature and pressure were similar in shape to those obtained in tests with solid casings (ref. 3).

Attenuation of Circumferential Distortion

Distortion attenuation is summarized in Table XI for data points obtained with the 12-location method. The attenuation parameter for circumferential distortion, $A_{c, x}$, at station x is defined

$$\frac{A_{c, x}}{100} = 1 - \frac{(\Delta P/P)_x}{(\Delta P/P)_{inlet}}$$

$$\text{where } \Delta P/P = \frac{P_{max} - P_{min}}{P_{max}}$$

Negative values for A_c represent amplified distortions, and positive values represent percent attenuation. The values of A_c in Table XI indicate that a sizeable net attenuation occurred through the fan, except near the hub. The value of $\Delta P/P$ at 10 percent span at the fan exit is approximately twice the fan inlet value at design speed and approximately 2.5 times the fan inlet value at 70 percent speed.

TABLE XI – ATTENUATION PARAMETERS FOR CIRCUMFERENTIALLY DISTORTED INLET FLOW

	SPAN (%)	$(\Delta P/P)_{inlet}$	$A_{c,16}$
70 PERCENT DESIGN SPEED (Near Stall)			
$W\sqrt{\theta}/\delta = 96.0 \text{ lbm/sec}$	10	0.032	-166
[43.5 kg/sec]	50	0.036	25
$P_r = 1.713$	90	0.033	23
DESIGN SPEED (Midrange)			
$W\sqrt{\theta}/\delta = 180.6 \text{ lbm/sec}$	10	0.113	-110
[81.9 kg/sec]	50	0.136	74
$P_r = 2.819$	90	0.134	57
DESIGN SPEED (Near Stall)			
$W\sqrt{\theta}/\delta = 177.4 \text{ lbm/sec}$	10	0.112	-107
[80.5 kg/sec]	50	0.131	75
$P_r = 2.847$	90	0.130	55

SUMMARY OF RESULTS

Tests of a two-stage fan having a 1st-stage rotor tip speed of 1450 ft/sec [442 m/sec] and casing treatment consisting of axial skewed slots over the tip of both rotors produced the following significant results:

1. With uniform inlet flow, casing treatment over the rotor tips decreased stall margin from 12% to 10% at design speed, caused negligible change at 85 percent speed, and increased stall margin from 17% to 25% at 70 percent of design speed.
2. Operating-line adiabatic efficiency at design speed was reduced from 85% with the solid casing to 82.2% with casing treatment. At 85 percent speed, efficiency dropped from 85.5% to 84.7% with casing treatment. The 70 percent of design speed efficiency was essentially unchanged.

3. Operating-line flow capacity was reduced with casing treatment approximately 1.0% at design speed and 0.6% at 85 percent of design speed. No change occurred at 70 percent of design speed.
4. Casing treatment increased first-stage pressure ratio and efficiency at 70 percent and 85 percent of design speed at low flow coefficients. Second-stage efficiency was reduced by casing treatment for all operating conditions. Better overall fan performance would likely have been achieved with casing treatment over the 1st-stage rotor and solid casing over the 2nd-stage rotor.
5. Significant differences in radial profiles of pressure and temperature ratios were measured with casing treatment as compared to those obtained with solid casings.
6. With tip radially distorted inlet flow and casing treatment, the fan maintained the same efficiency levels as with uniform inlet flow but with a six percentage point increase in stall margin at design speed and an eight percentage point decrease at 70 percent of design speed. The stall line was approximately the same as that obtained with tip distortion and solid casings. The tip-radial distortion was attenuated for all operating conditions. Distortion was attenuated to a greater degree with casing treatment than with solid casings.
7. With circumferentially distorted inlet flow and casing treatment, design speed stall margin was 2.3 percentage points greater than with uniform inlet flow, but little change occurred at 70 percent of design speed. Casing treatment improved stall margin by 1.5 percentage points at design speed and 10 percentage points at 70 percent of design speed with this distortion, while efficiencies and pressure ratios remained essentially the same as with solid casings. Casing treatment increased attenuation of circumferential distortions at the tip and midspan but increased distortion amplification at the hub.

LIST OF REFERENCES

1. Messenger, H. E. and Kennedy, E. E.: "Two-Stage Fan I. Aerodynamic and Mechanical Design", NASA CR-120859, PWA-4148, 1972.
2. Ruggeri, R. S. and Benser, W. A.: "Performance of a Highly Loaded Two-Stage Axial Flow Fan", NASA TMX-3076, August, 1974.
3. Messenger, H. E. and Keenan, M. J.: "Two-Stage Fan II. Data and Performance With Redesigned Second Stage Rotor Uniform and Distorted Inlet Flows", NASA CR-134F10, PWA-5087, 1974.
4. Burger, G. D. and Keenan, M. J.: "Two-Stage Fan IV. Data and Performance for Stator Stagger Angle Optimization", NASA CR-134717, PWA-5225, 1975.
5. Osborn, W. M., Lewis, G. W. Jr., and Heidelberg, L. J.: "Effect of Several Porous Casing Treatments on Stall Limit and on Overall Performance of an Axial Flow Compressor Rotor", NASA TN D6537, 1971.
6. Moorc, R. D., Kovich, G., and Blade, R. J.: "Effect of Casing Treatment on Overall Blade-Element Performance of a Compressor Rotor", NASA TN D6538, 1971.
7. Hanley, W. T.: "A Correlation of Endwall Losses in Plane Compressor Cascades", *Journal of Engineering for Power*, Trans. ASME, Vol. 90, Series A, No. 3, July 1968, pp. 251-257.
8. Glawe, G. E., Simms, F. S., and Stickney, T. N.: "Radiation and Recovery Corrections and Time Constants of Several Chromel-Alumel Thermocouple Probes at High Temperatures in High Velocity Gas Streams", NACA TN-3766, October 1956.

ORIGINAL PAGE IS
OF POOR QUALITY

PRECEDING PAGE BLANK NOT FILMED

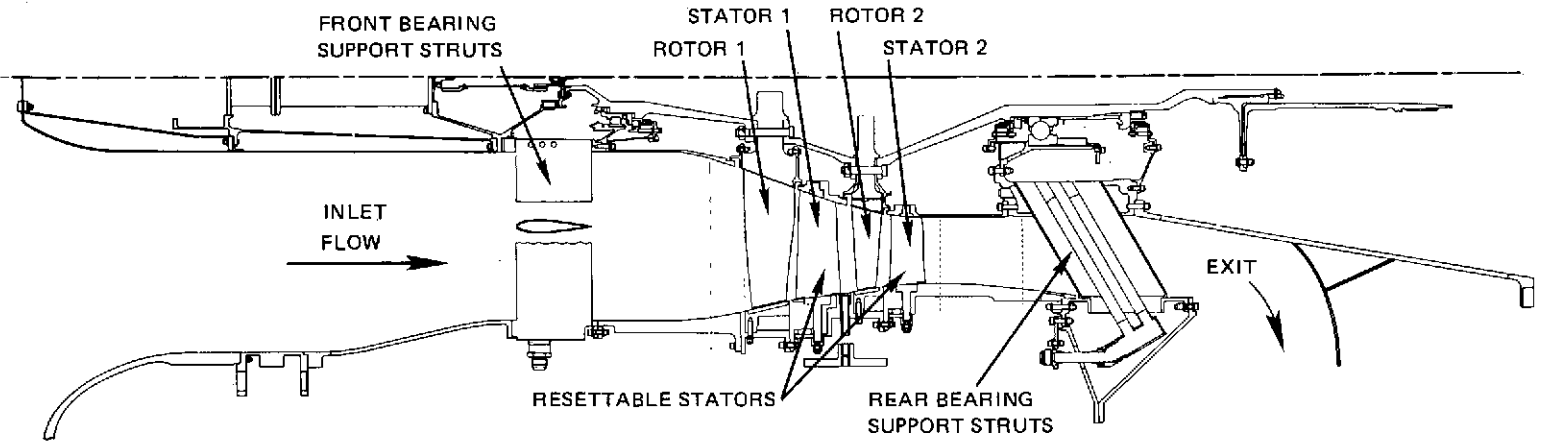

Figure 1 Schematic of Two-Stage Fan Test Arrangement

DIMENSION IN INCHES.
(METERS)

STA	DIAMETER		AXIAL DISTANCE FROM ROTOR 1 LEADING EDGE	
	I.D.	O.D.	z - I.D.	z - O.D.
4	10.00 (0.254)	32.48 (0.825)	-5.20 (-0.132)	-5.20 (-0.132)
5	10.26 (0.261)	32.33 (0.821)	-3.70 (-0.094)	-3.70 (-0.094)
6	10.94 (0.278)	31.96 (0.811)	-2.245 (-0.057)	-2.245 (-0.057)
7	12.40 (0.315)	31.00 (0.787)	0.0 (0.0)	0.42 (0.011)
8	14.84 (0.377)	29.93 (0.760)	3.30 (0.084)	2.75 (0.070)
9	15.22 (0.387)	29.67 (0.754)	3.80 (0.097)	3.45 (0.088)
10	16.85 (0.428)	28.96 (0.736)	6.15 (0.156)	6.33 (0.161)
11	17.18 (0.436)	28.82 (0.752)	6.75 (0.172)	6.75 (0.172)
*12	17.39 (0.442)	28.58 (0.726)	7.23 (0.184)	7.57 (0.192)
** 12	17.39 (0.442)	28.55 (0.725)	7.23 (0.184)	7.65 (0.194)
*13	18.35 (0.467)	28.12 (0.714)	9.20 (0.234)	8.82 (0.224)
** 13	18.37 (0.467)	28.14 (0.715)	9.27 (0.236)	8.76 (0.223)
14	18.58 (0.472)	27.90 (0.709)	9.80 (0.249)	9.59 (0.244)
15	18.90 (0.480)	27.60 (0.701)	11.85 (0.301)	11.93 (0.303)
16	18.90 (0.480)	27.60 (0.701)	13.50 (0.343)	13.50 (0.343)

*ORIGINAL } DENOTES CHANGES IN
**REDESIGN } AXIAL POSITION DUE TO REDESIGN

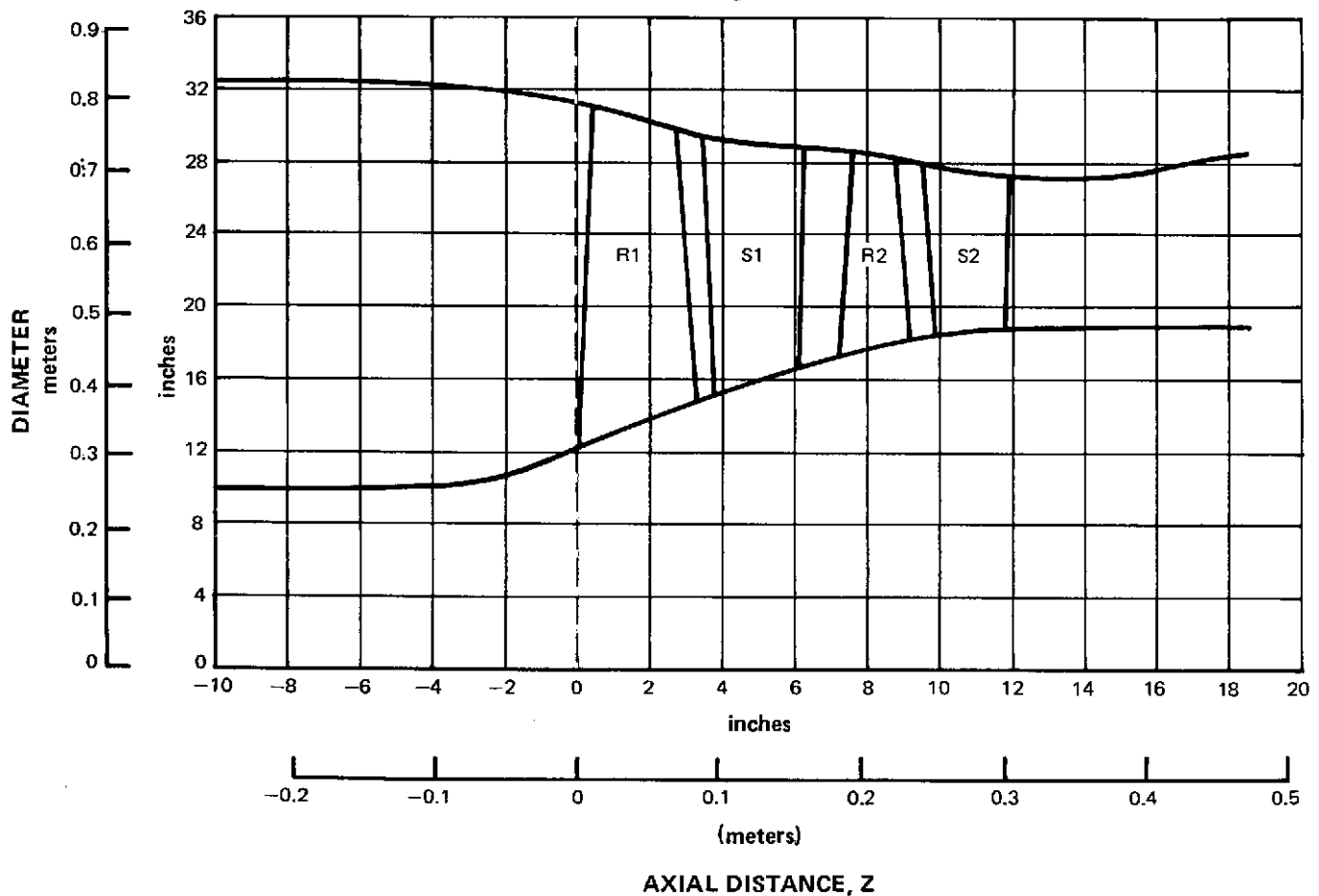
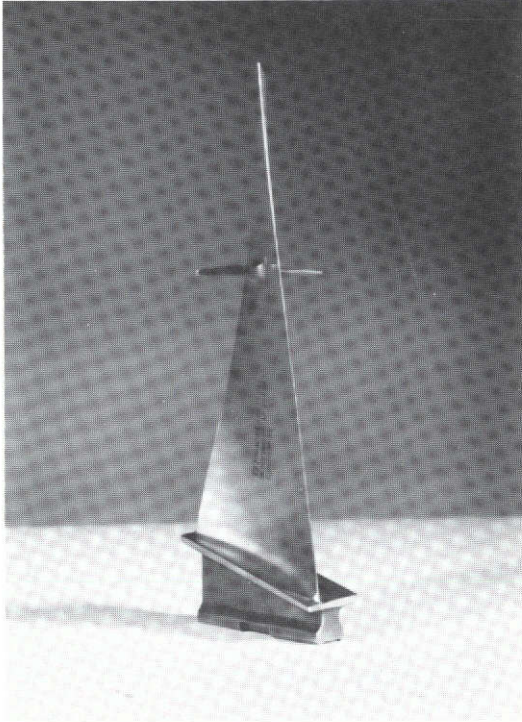
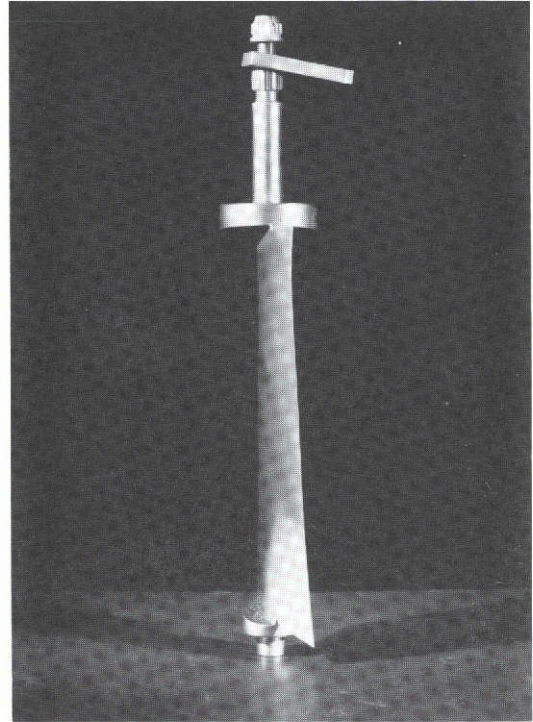

Figure 2 Fan Flowpath



First-Stage Blade



First-Stage Vane

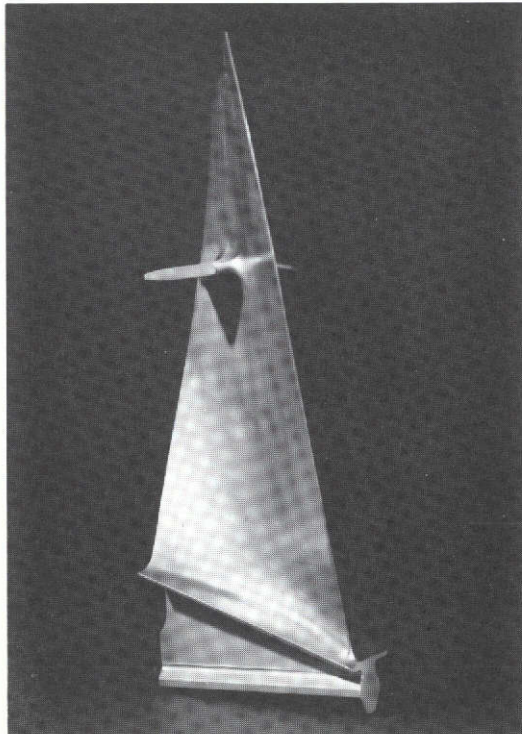

Second-Stage Redesigned Blade

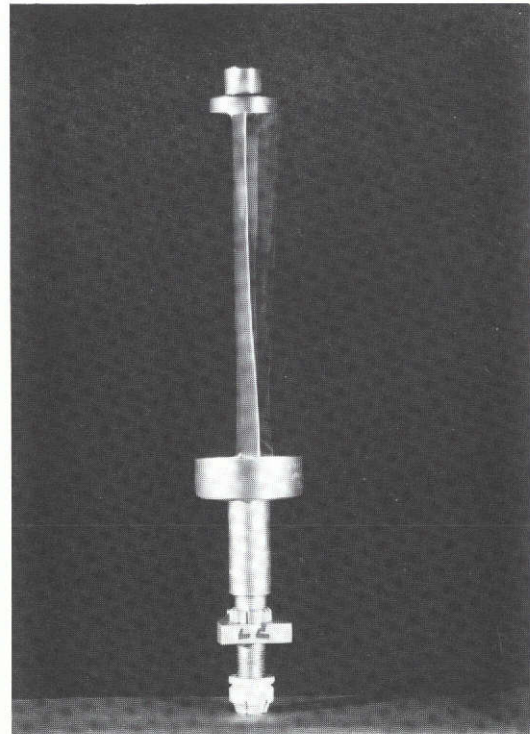

Second-Stage Vane

Figure 3 Blades and Vanes Employed in the Two-Stage Fan

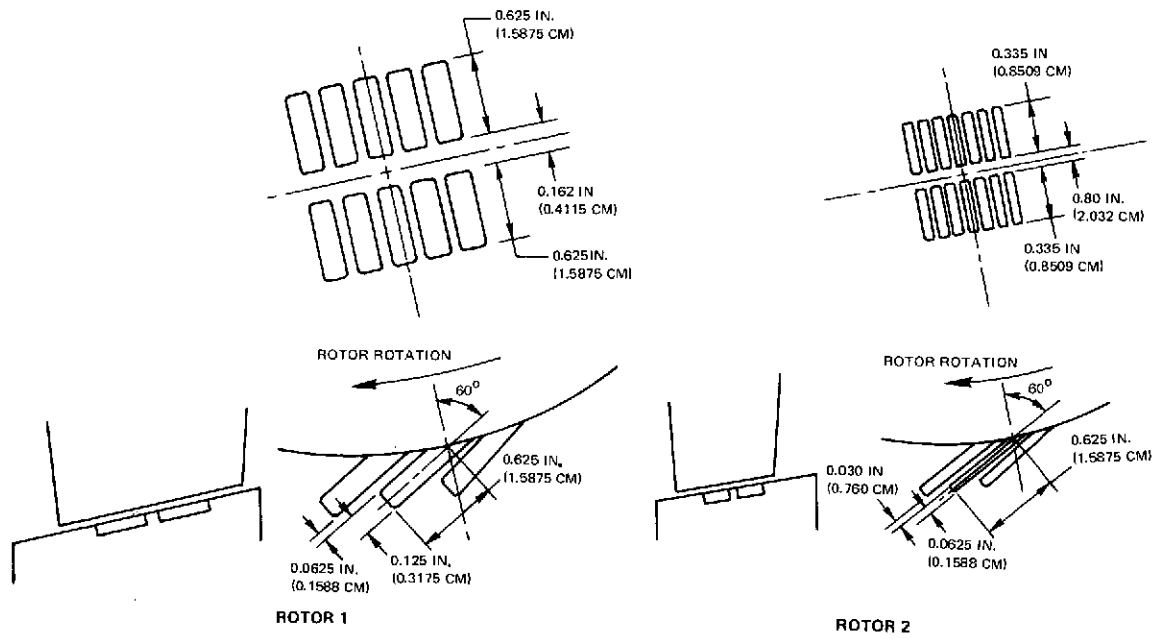

Figure 4 Sketch of Rotor Tip Casing Treatments

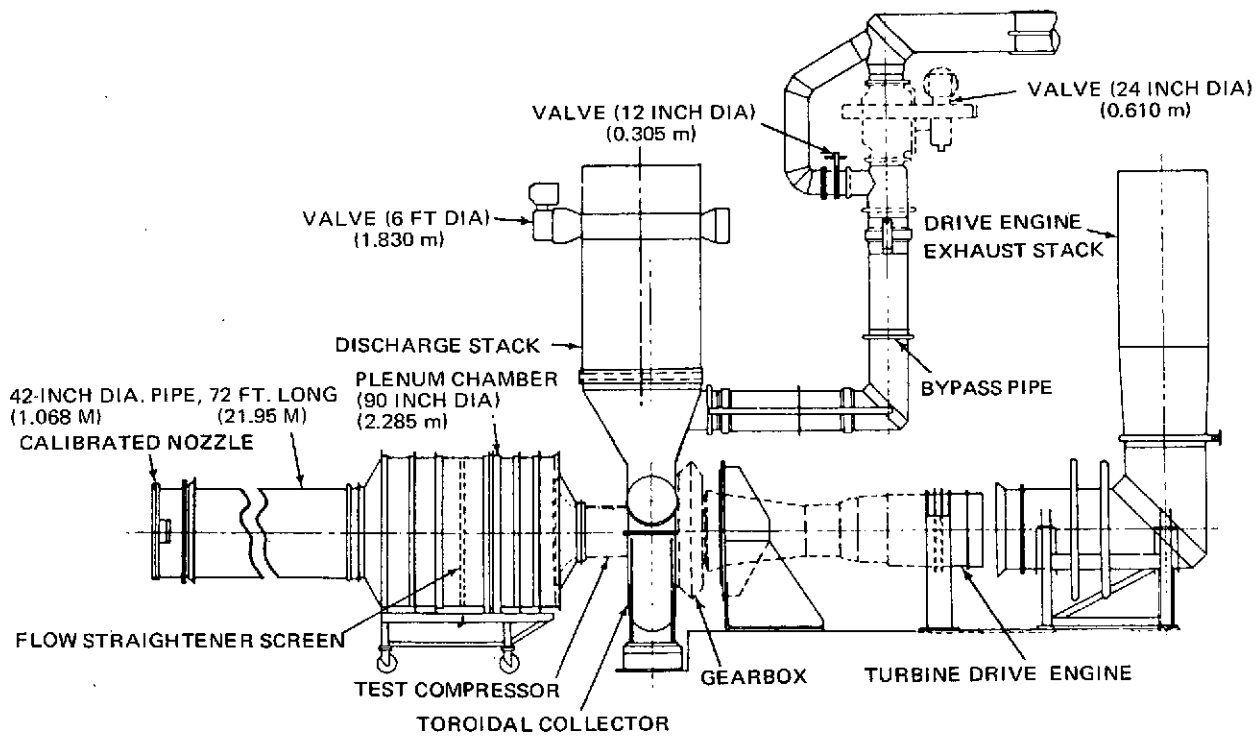
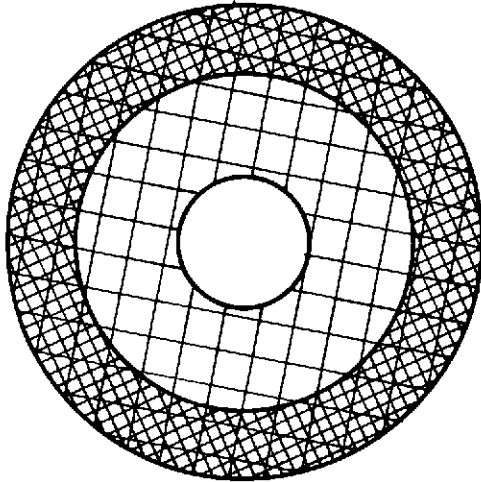

Figure 5 Schematic of Compressor Test Facility

**ORIGINAL PAGE IS
OF POOR QUALITY**



TIP-RADIAL SCREEN

- 39.8 PERCENT OF ANNULUS AREA COVERED
- 1 0.5 X 0.5 X 0.062 IN. (.0127 X .0127 X .0016 m)
 - 1 0.25 X 0.25 X 0.062 in. (.0064 X .0064 X .0016 m)
 - 2 .0625 X .0625 X .017 in. (.0016 X .0016 X .0004 m)
 - BASE 1 X 1 X .125 IN. (.0254 X .0254 X .0032 m)

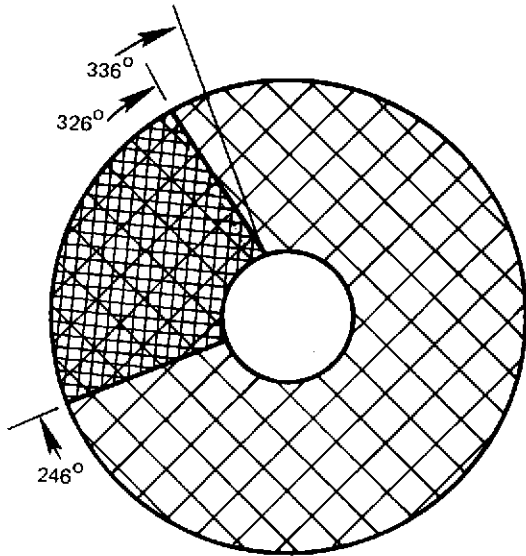

CIRCUMFERENTIAL SCREEN

- 22.9 PERCENT OF ANNULUS AREA COVERED
- 1 .5 X .5 X .062 IN. (.0127 X .0127 X .0016 m)
 - 1 .25 X .25 X .062 IN. (.0064 X .0064 X .0016 m)
 - 4 .0625 X .0625 X .017 IN. (.0016 X .0016 X .0004 m)
 - 2 .0625 X .0625 X .017 IN. (.0016 X .0016 X .0004 m)
(COVERS 0 - 20% SPAN)
 - BASE 1 X 1 X .125 IN. (.0254 X .0254 X .0032 m)

Figure 6 Sketch of Distortion Screens

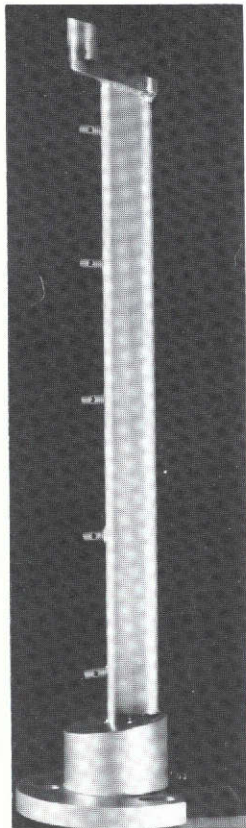

A. Fan Inlet
Total Pressure
Rake Probe

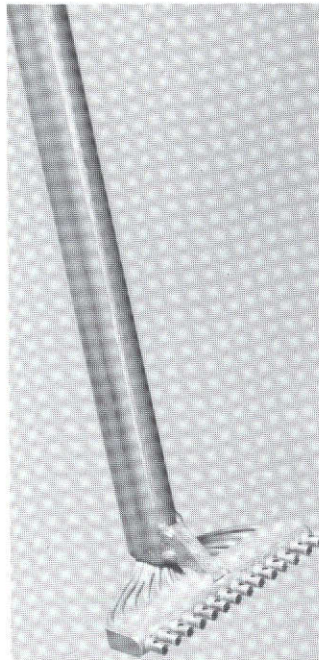

B. Stator 2 Exit Total Pressure
Wake Probe

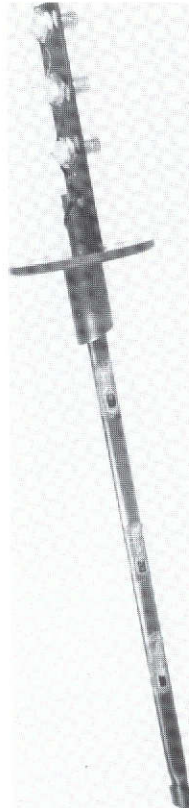

C. Fan Inlet
Hot Film
Probe

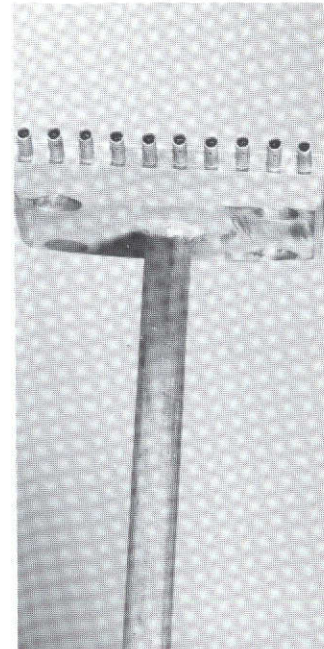

D. Stator 2 Exit Total Temperature
Wake Rake

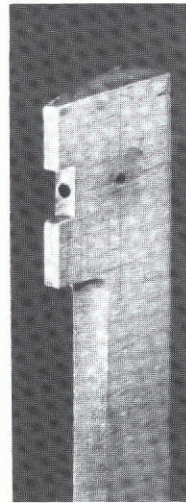
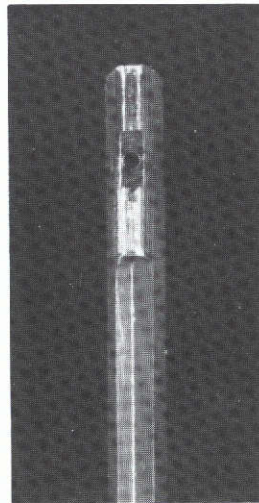
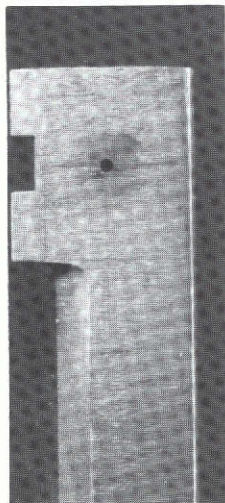

E. Fan Inlet & Static Exit Traverse Wedge Probes

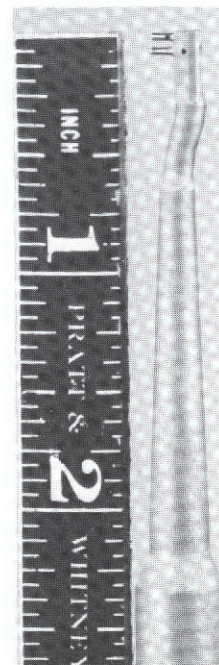

F. Stator 1 Exit
NASA Combination Probe

Figure 7 Typical Instrumentation Employed in Two-Stage Fan Tests

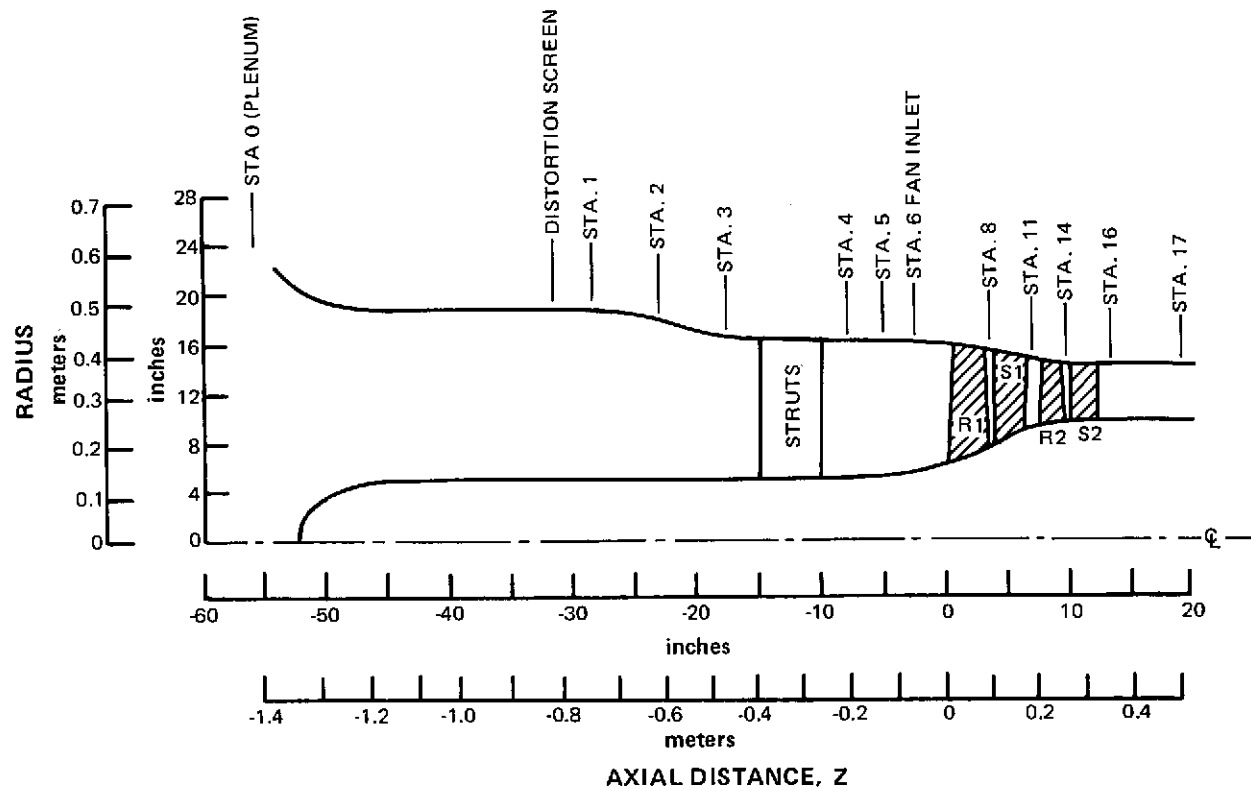

Figure 8 Axial Locations of Instrumentation

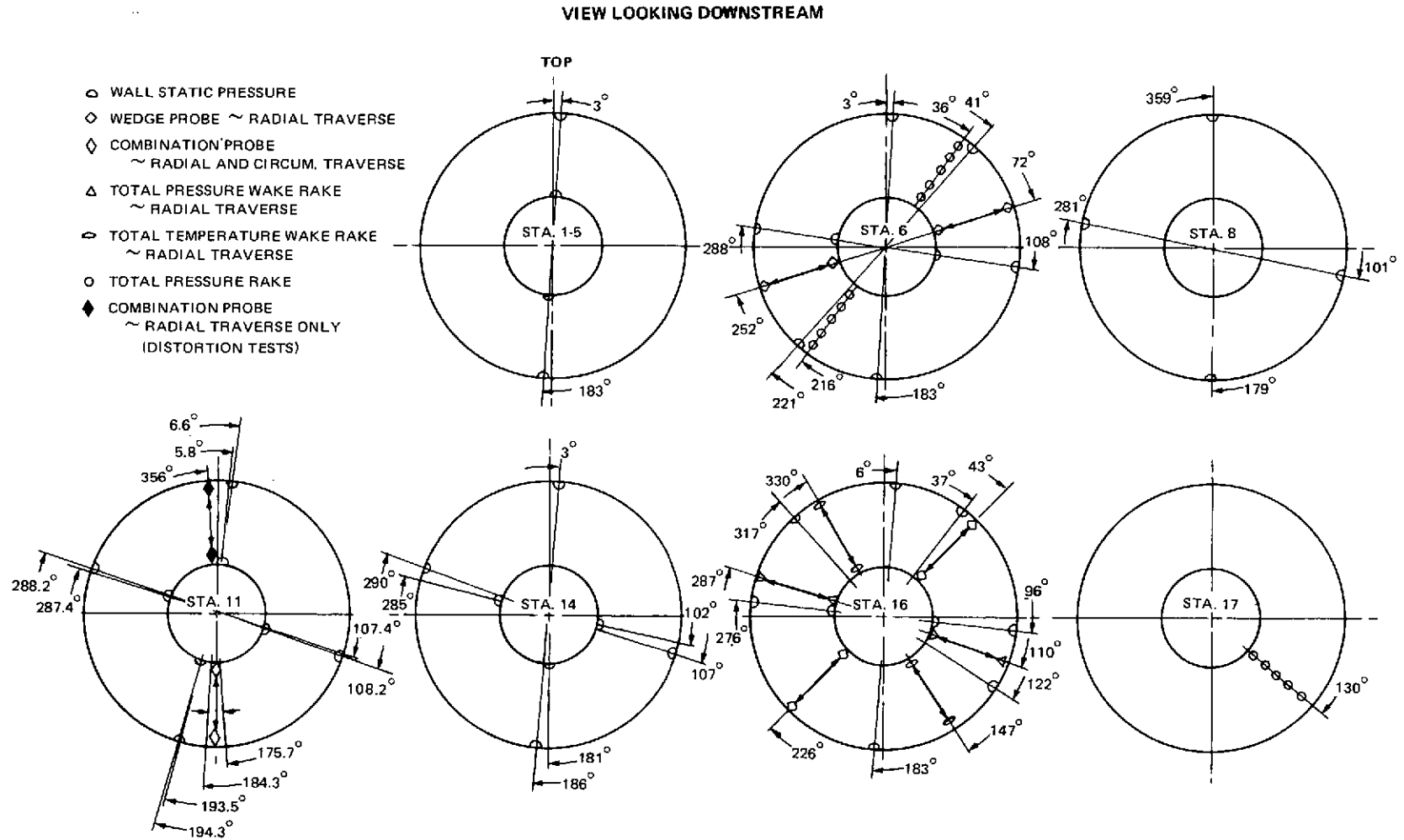

Figure 9 Circumferential Locations of Instrumentation

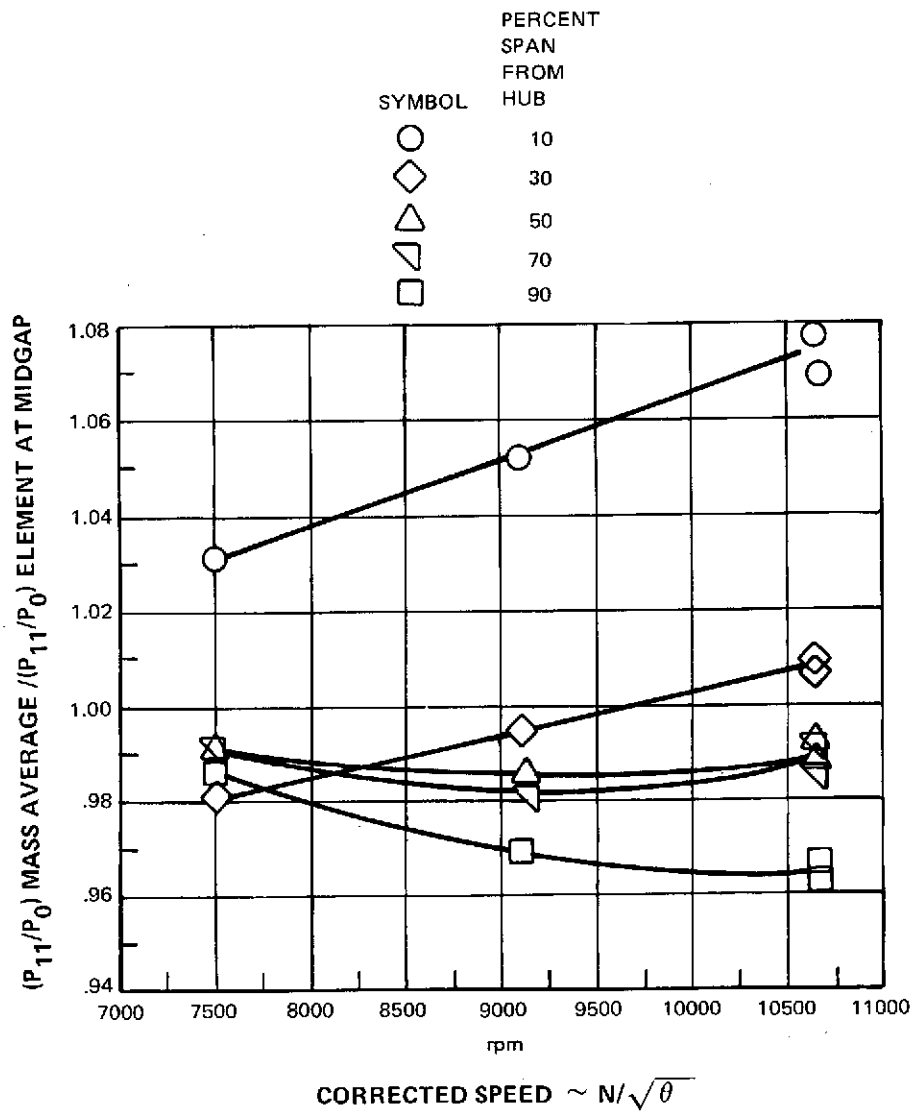

Figure 10 Correlation Used for Radial Distortion Streamline Analysis

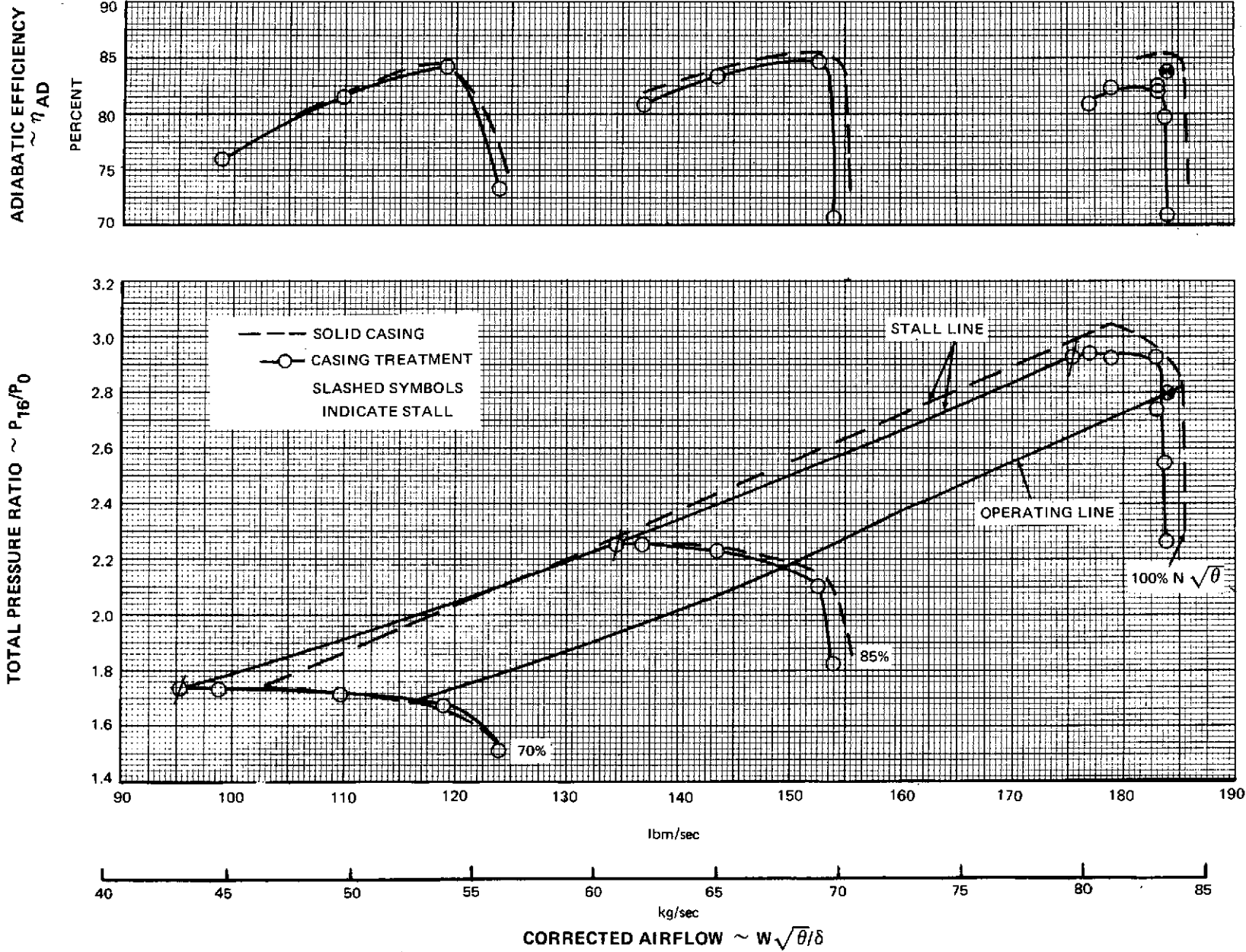

Figure 11 Fan Overall Performance With Uniform Inlet Flow With Casing Treatment – Performance With Solid Casings Shown for Comparison

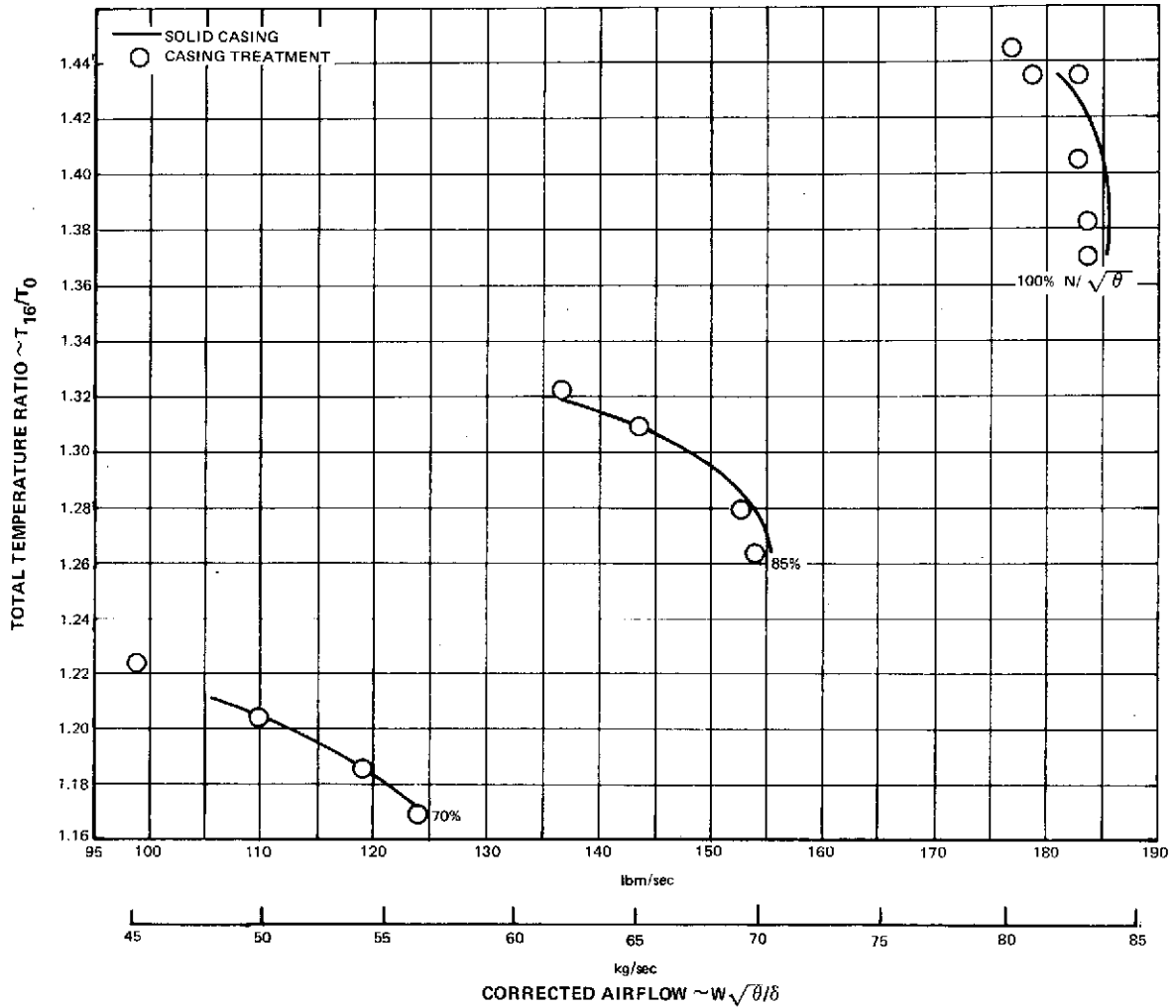

Figure 12 Fan Overall Total Temperature Ratio Data Versus Corrected Flow With Casing Treatment for Uniform Inlet Flow -- Solid Casing Curves Shown for Comparison

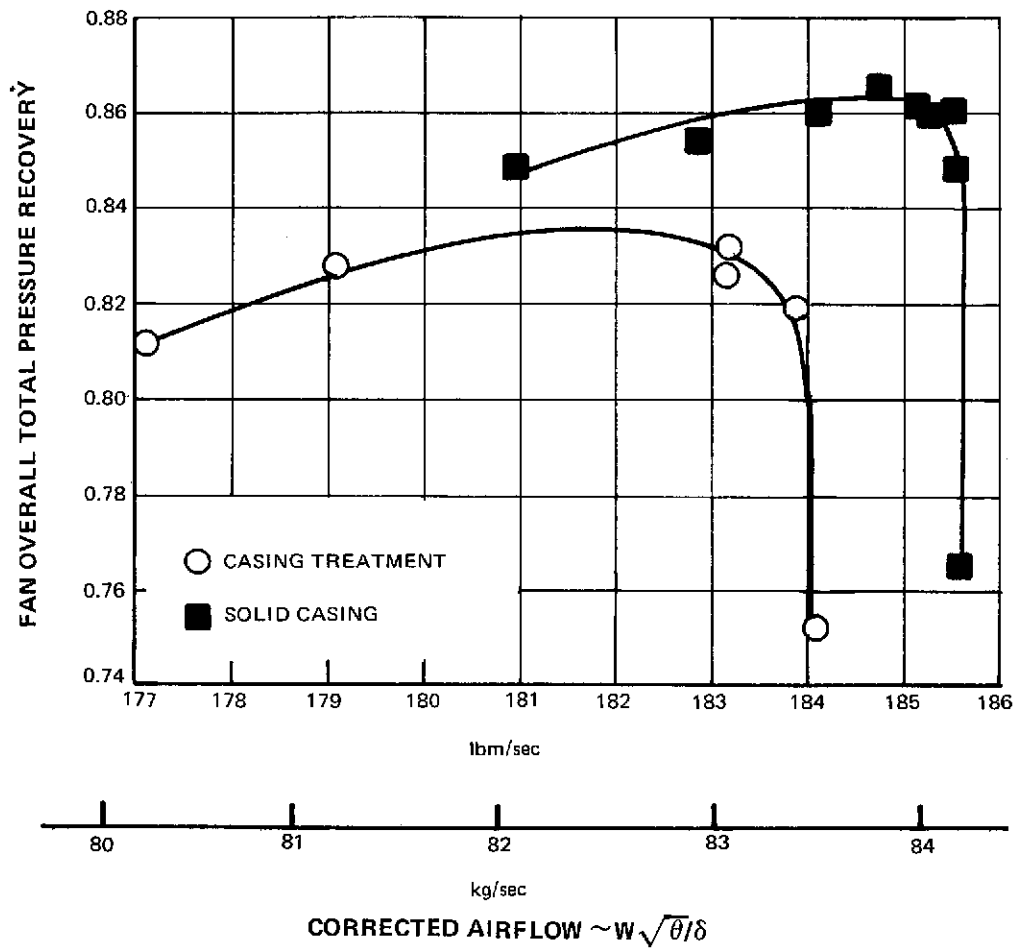

Figure 13 Fan Overall Total Pressure Recovery Versus Corrected Flow at Design Speed for Uniform Inlet Flow With Casing Treatment and With Solid Casings

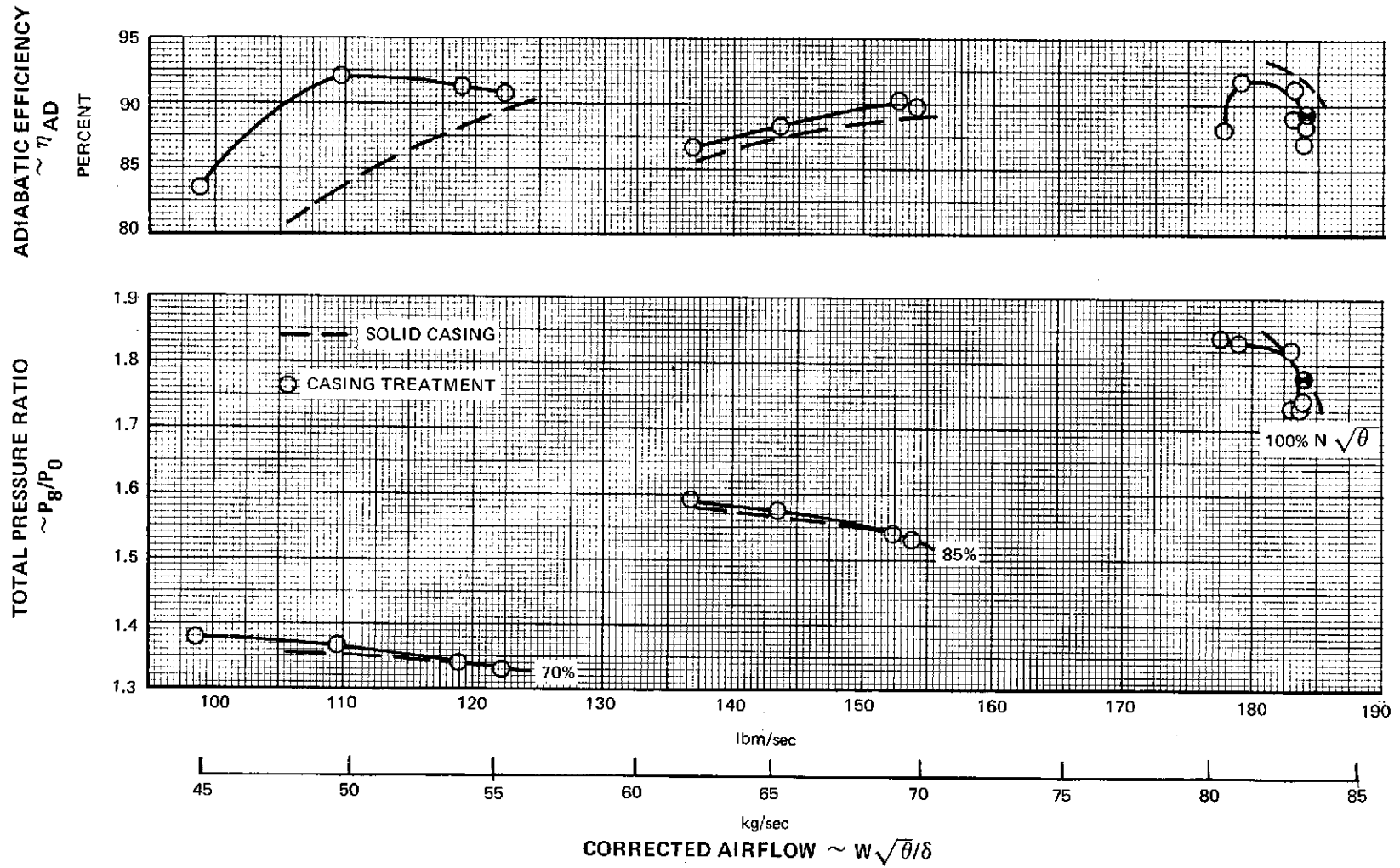

Figure 14 Rotor 1 Performance With Uniform Inlet Flow and Casing Treatment – Performance With Solid Casing Shown for Comparison

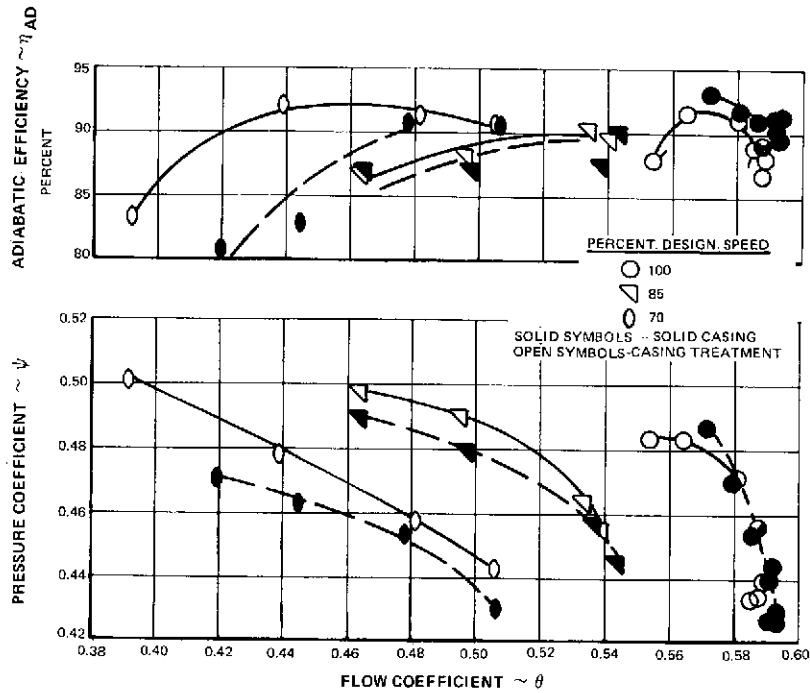

Figure 15 Rotor 1 Pressure Coefficient and Adiabatic Efficiency Versus Flow Coefficient for Uniform Inlet Flow With Casing Treatment – Solid Casing Shown for Comparison

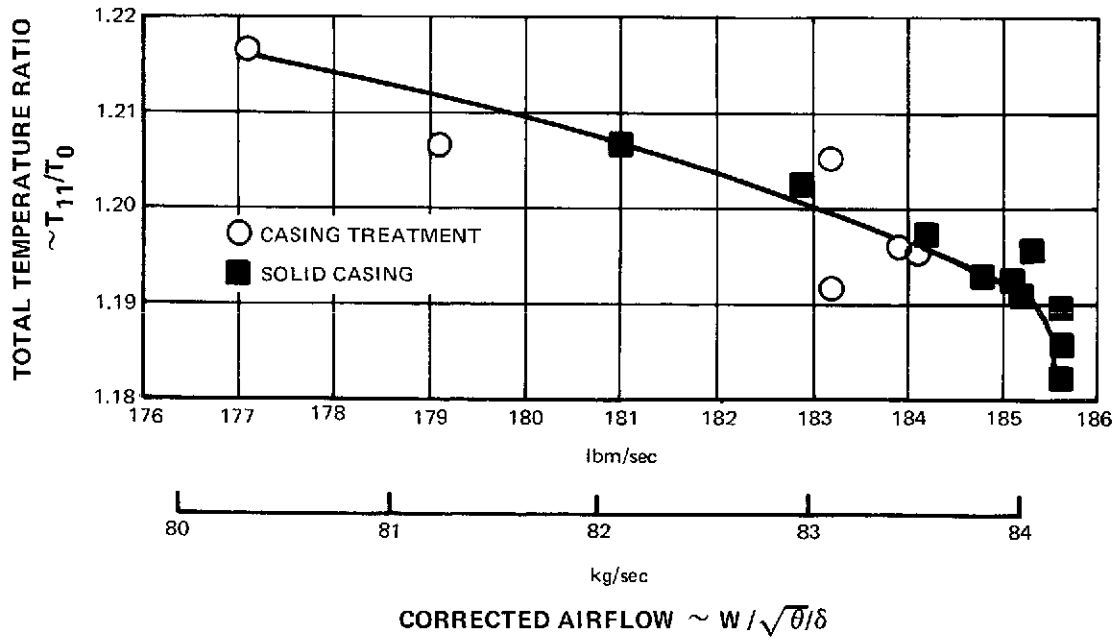

Figure 16 Rotor 1 Total Temperature Ratio Versus Corrected Flow at Design Speed for Uniform Inlet Flow With Casing Treatment and Solid Casings

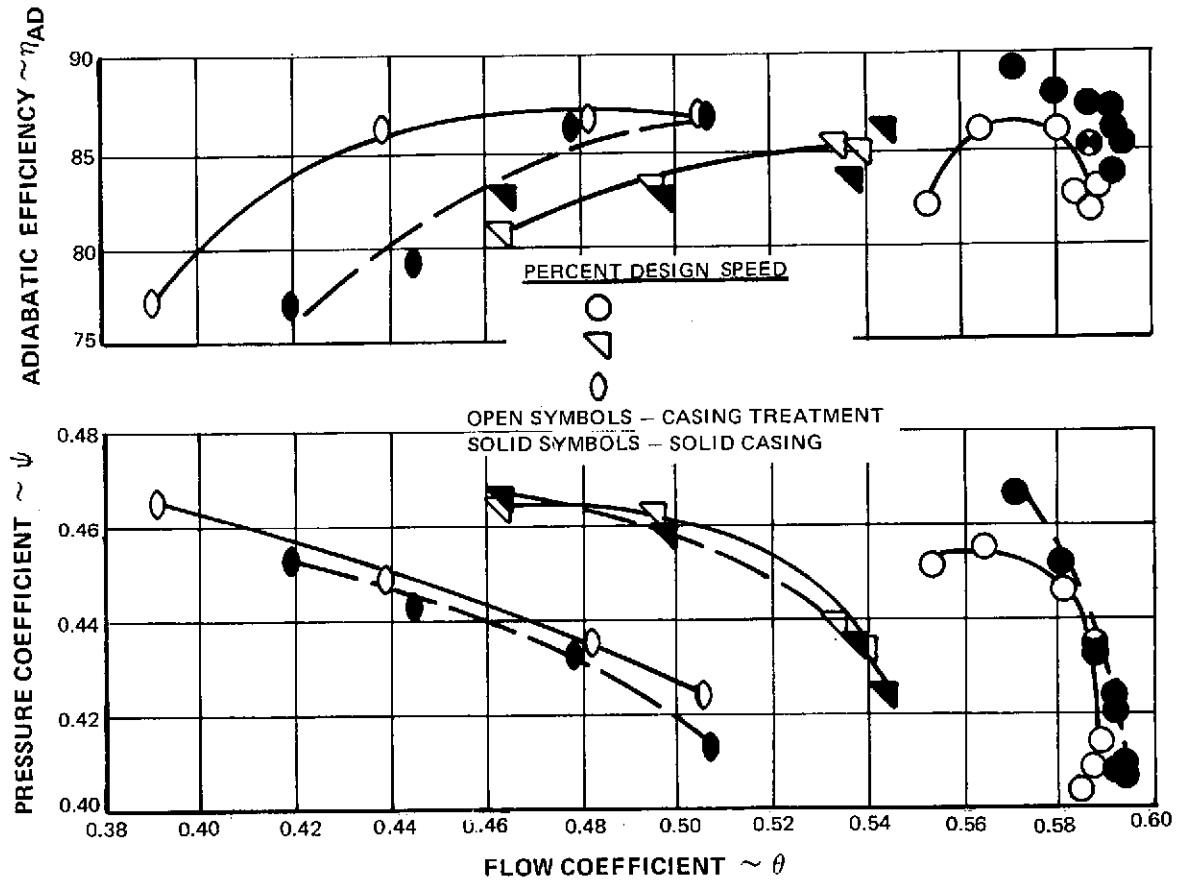

Figure 17 First-Stage Pressure Coefficient and Adiabatic Efficiency Versus Flow Coefficient for Uniform Inlet Flow With Casing Treatment and With Solid Casings

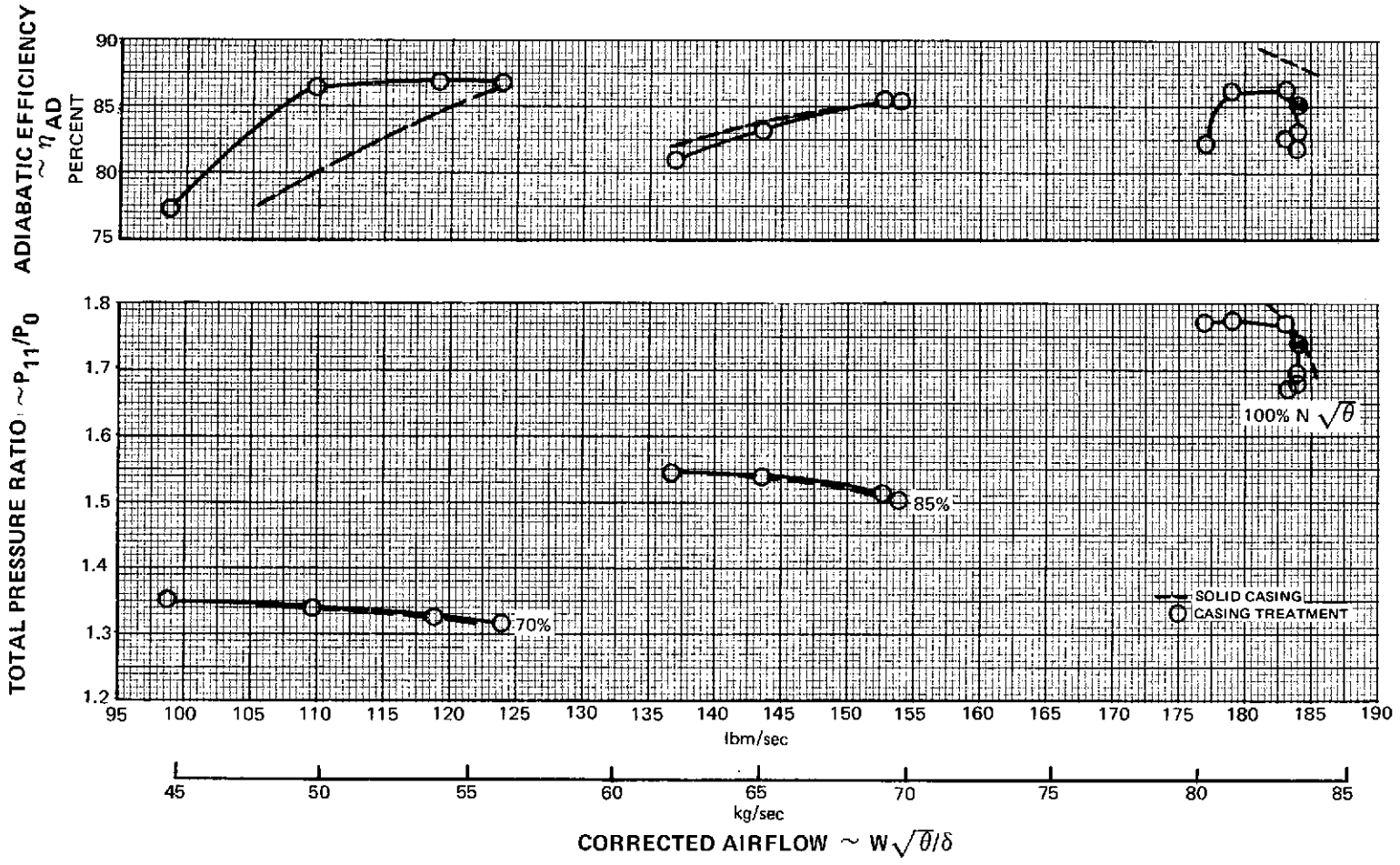

Figure 18 First-Stage Performance for Uniform Inlet Flow and Casing Treatment – Performance With Solid Casings Shown for Comparison

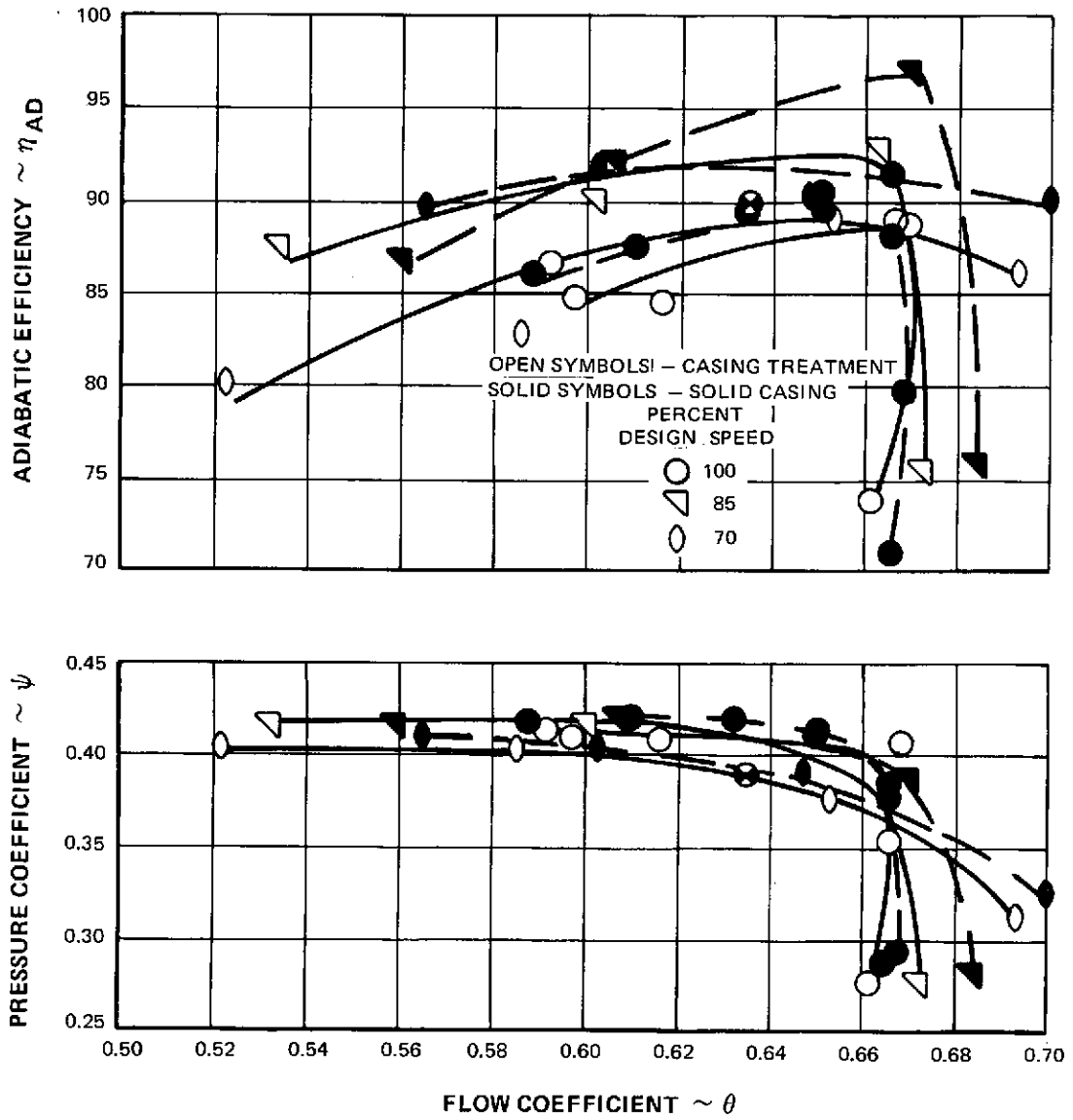

Figure 19 Rotor 2 Pressure Coefficient and Adiabatic Efficiency Versus Flow Coefficient for Uniform Inlet Flow With Casing Treatment and With Solid Casing

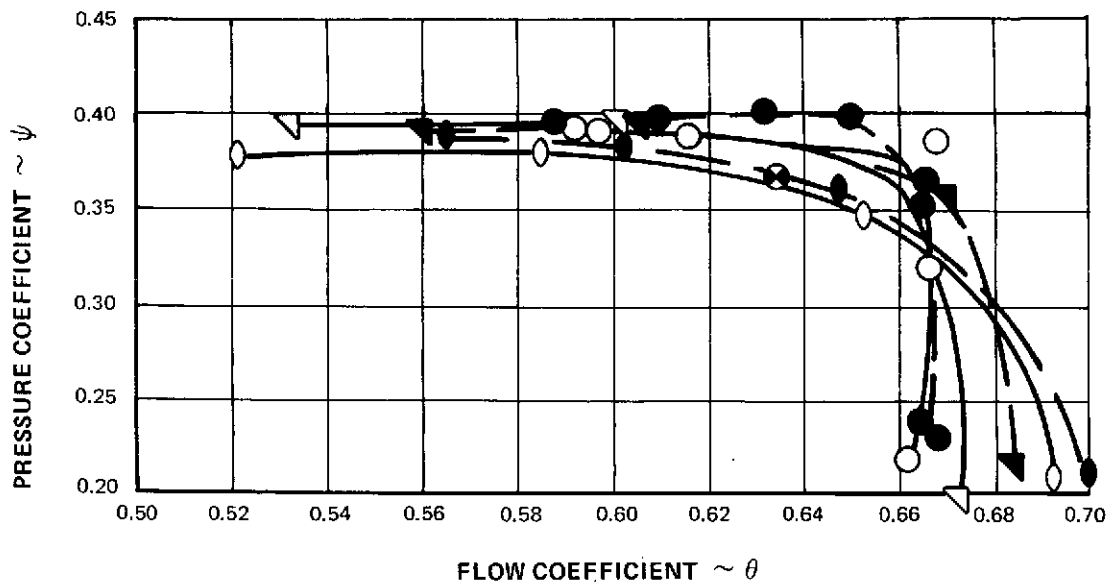
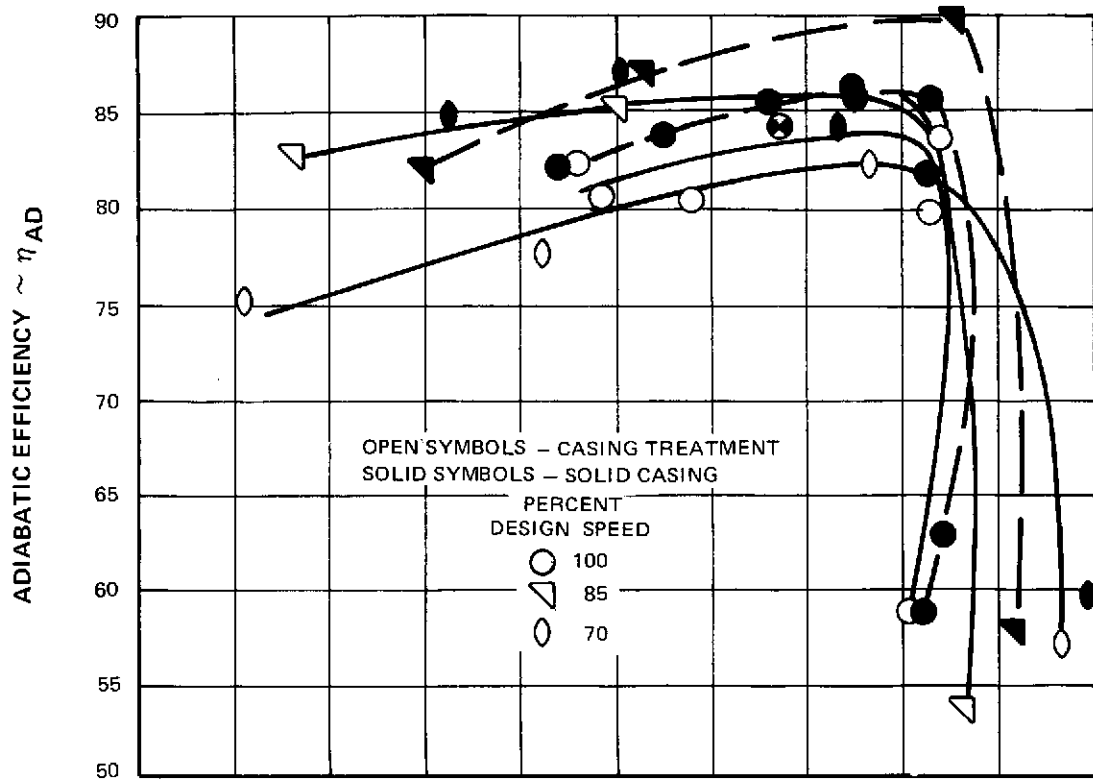

Figure 20 Second-Stage Pressure Coefficient and Adiabatic Efficiency Versus Flow Coefficient for Uniform Inlet Flow With Casing Treatment and With Solid Casing

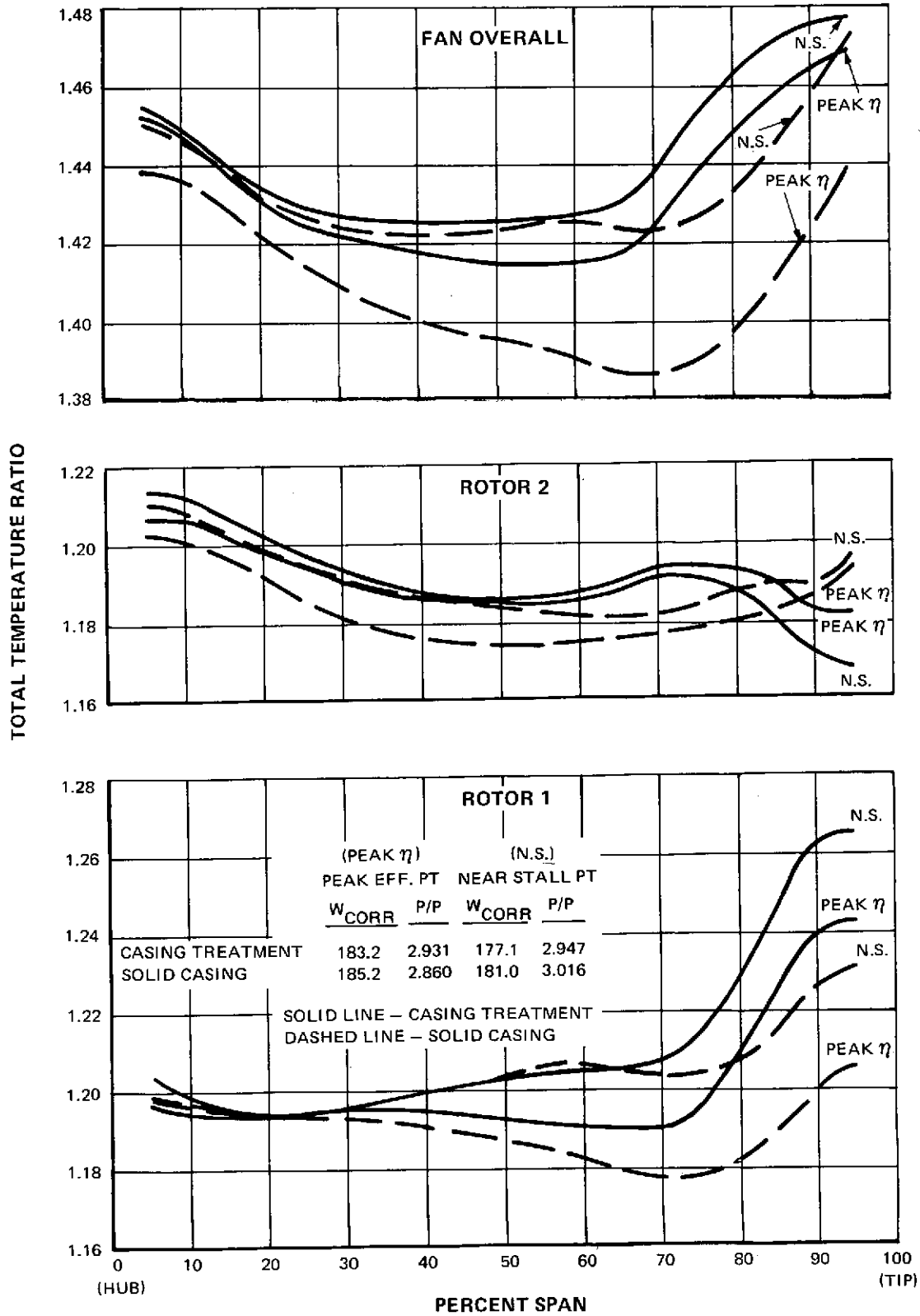

Figure 21 Fan, Rotor 1, and Rotor 2 Total Temperature Ratio Versus Span at Design Speed for Uniform Inlet Flow With Casing Treatment and With Solid Casings

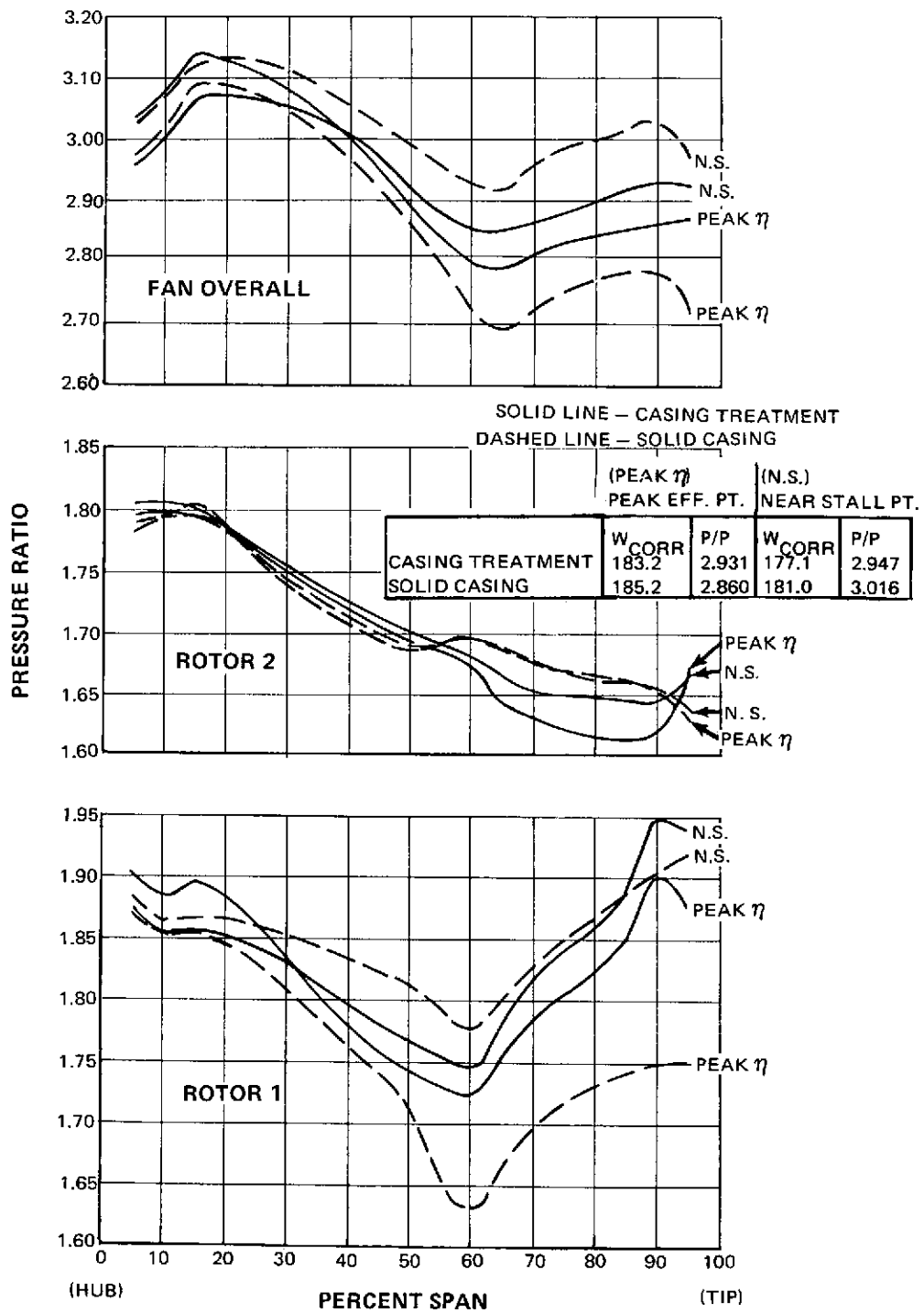

Figure 22 Fan, Rotor 1, and Rotor 2 Total Pressure Ratio Versus Span at Design Speed for Uniform Inlet Flow With Casing Treatment and With Solid Casings

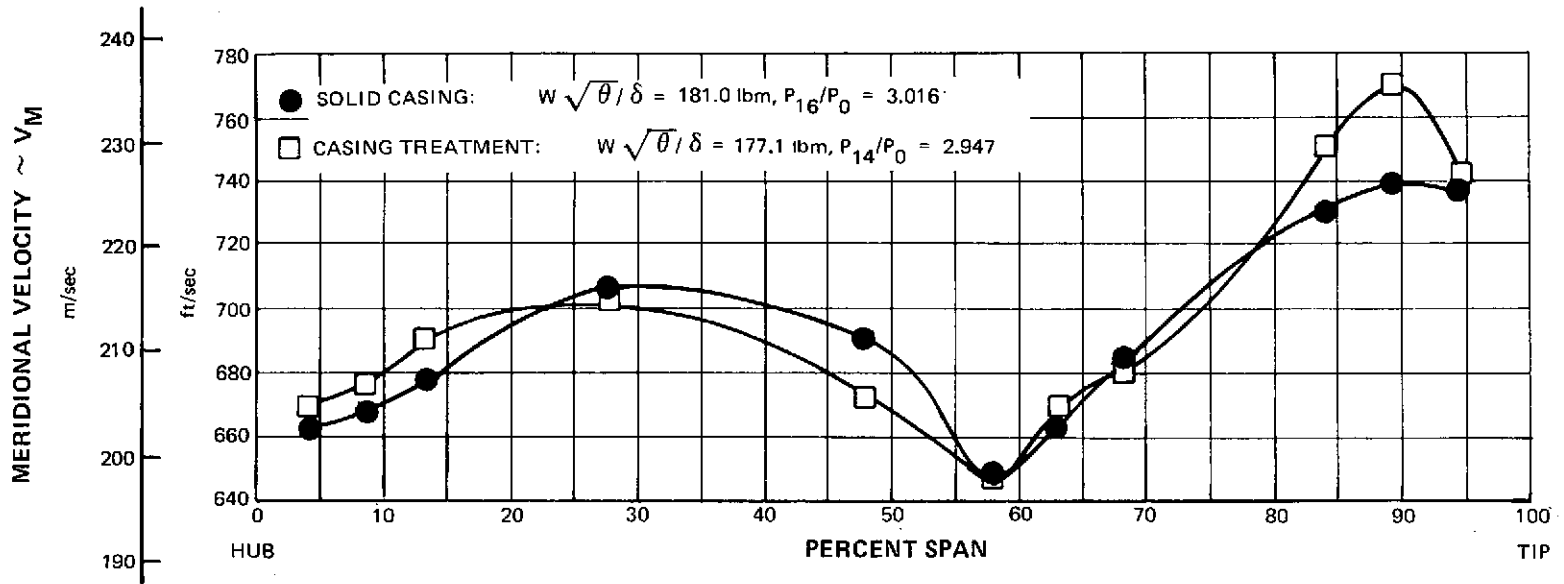

Figure 23 Comparison of Radial Profiles of Meridional Velocity Entering Rotor 2, With Casing Treatment and With Solid Casings for Near-Stall Data Points at Design Speed for Uniform Inlet Flow

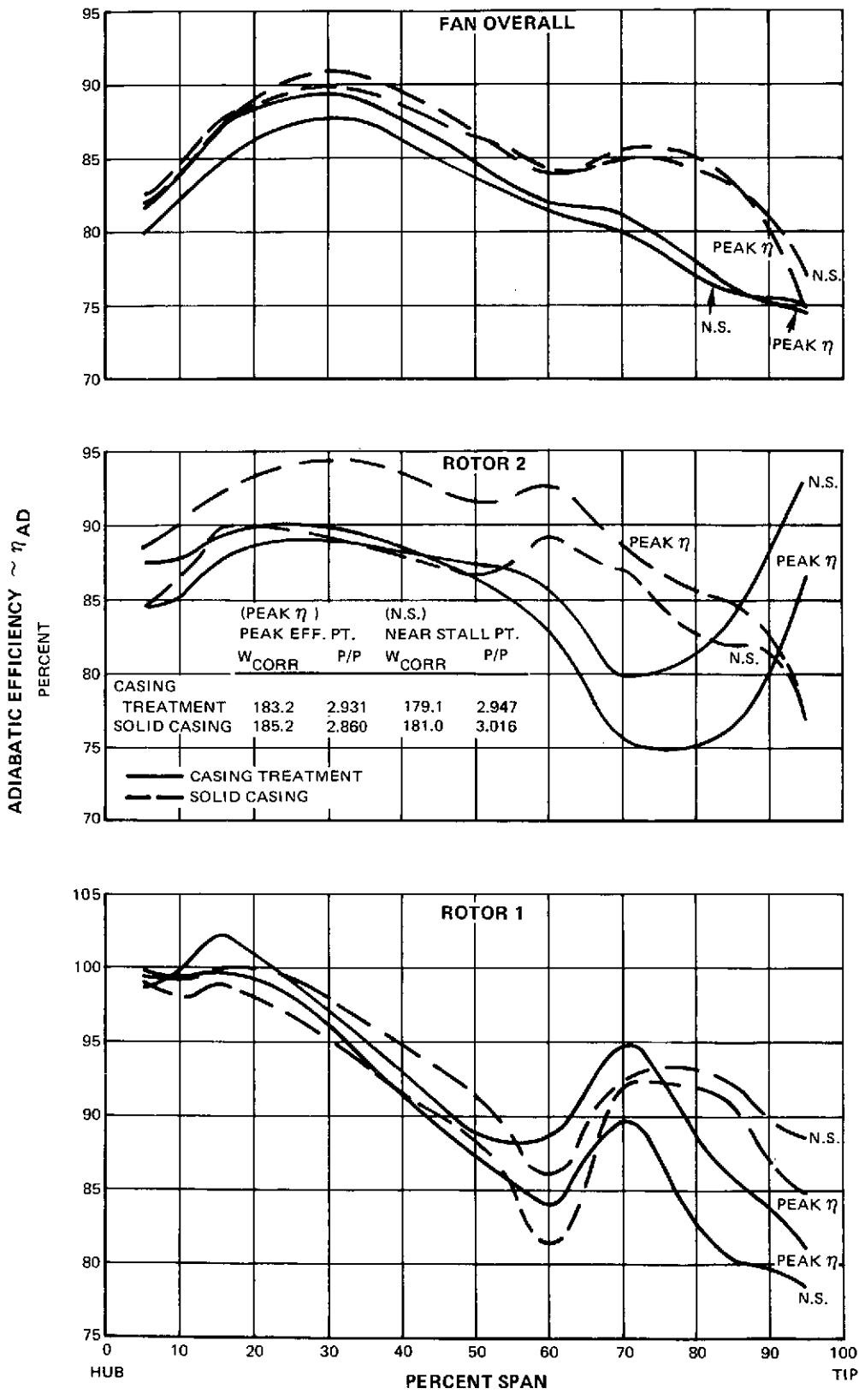

Figure 24 Fan, Rotor 1, and Rotor 2 Adiabatic Efficiency Versus Span at Design Speed With Casing Treatment and With Solid Casings

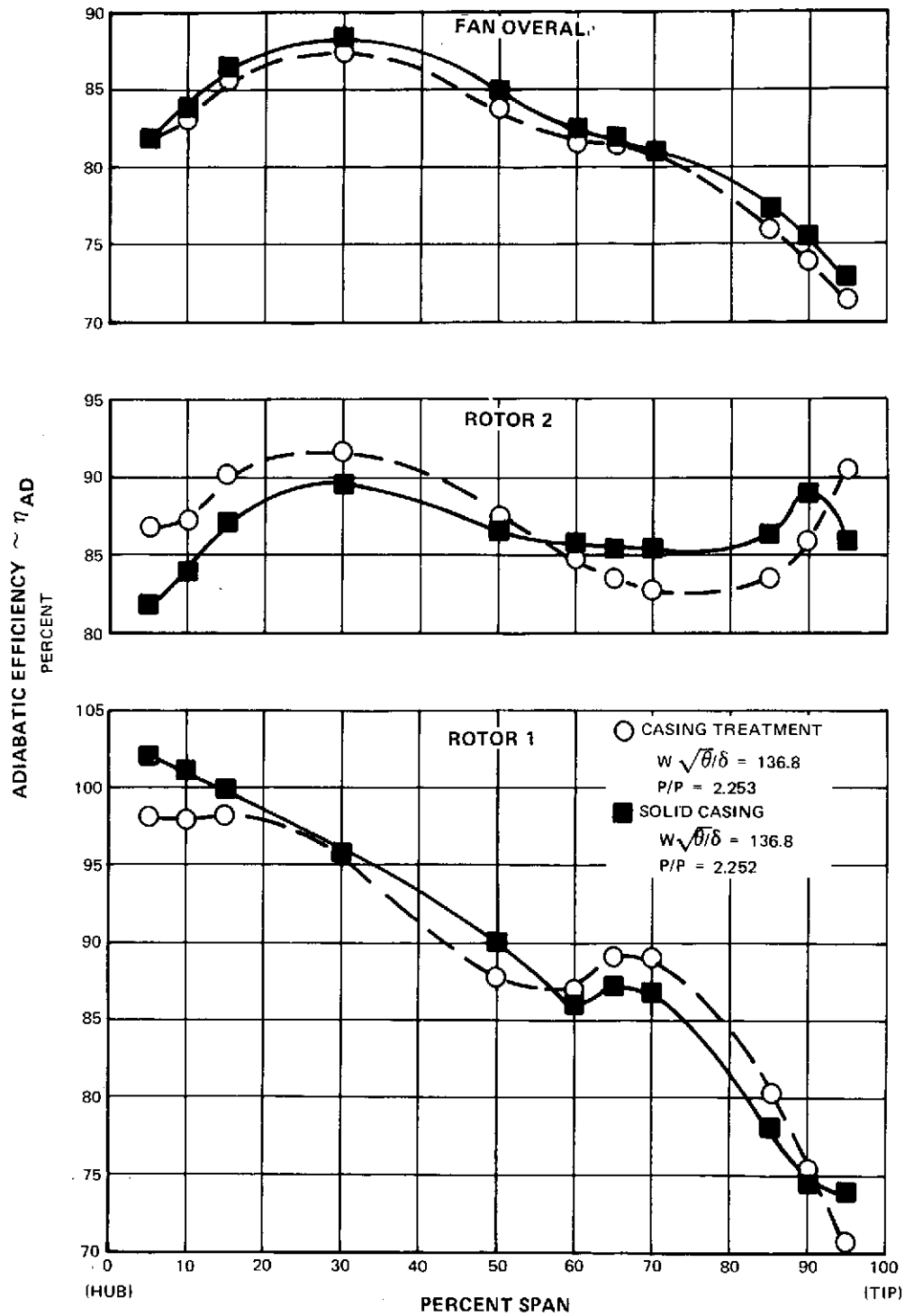

Figure 25 Fan, Rotor 1, and Rotor 2 Adiabatic Efficiency Versus Span at 85 Percent Speed for Uniform Inlet Flow at Near-Stall Data Points With Casing Treatment and With Solid Casings

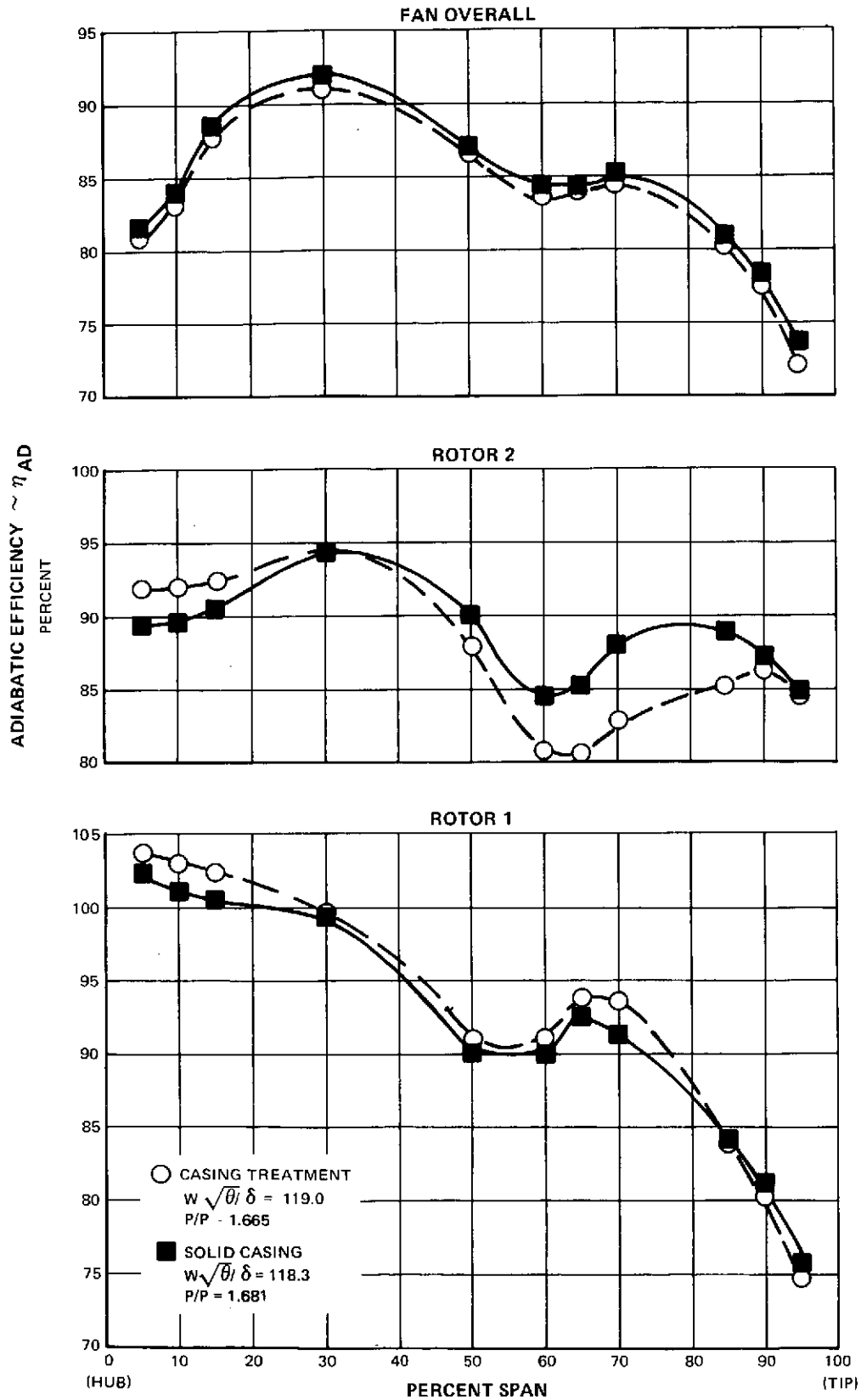

Figure 26 Fan, Rotor 1, and Rotor 2 Adiabatic Efficiency Versus Span at 70 Percent Speed for Uniform Inlet Flow at Peak Efficiency Data Points With Casing Treatment and With Solid Casings

SOLID CURVES INDICATES SOLID CASING PERFORMANCE

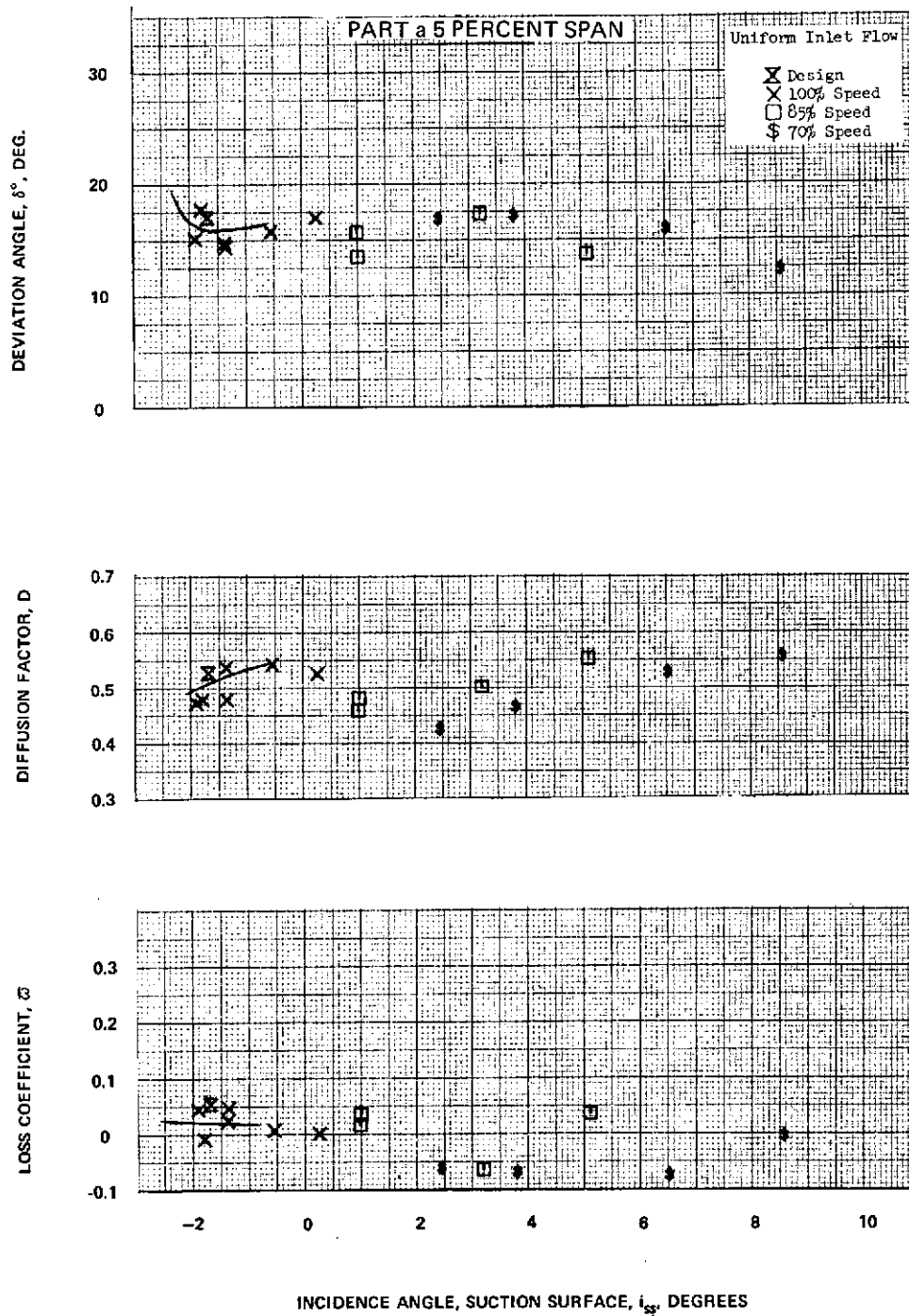

Figure 27 Rotor 1 Blade-Element Performance Data for Uniform and Tip Radially Distorted Inlet Flow With Casing Treatment – Solid Casing Curves Shown for Comparison

SOLID CURVES INDICATES SOLID CASING PERFORMANCE

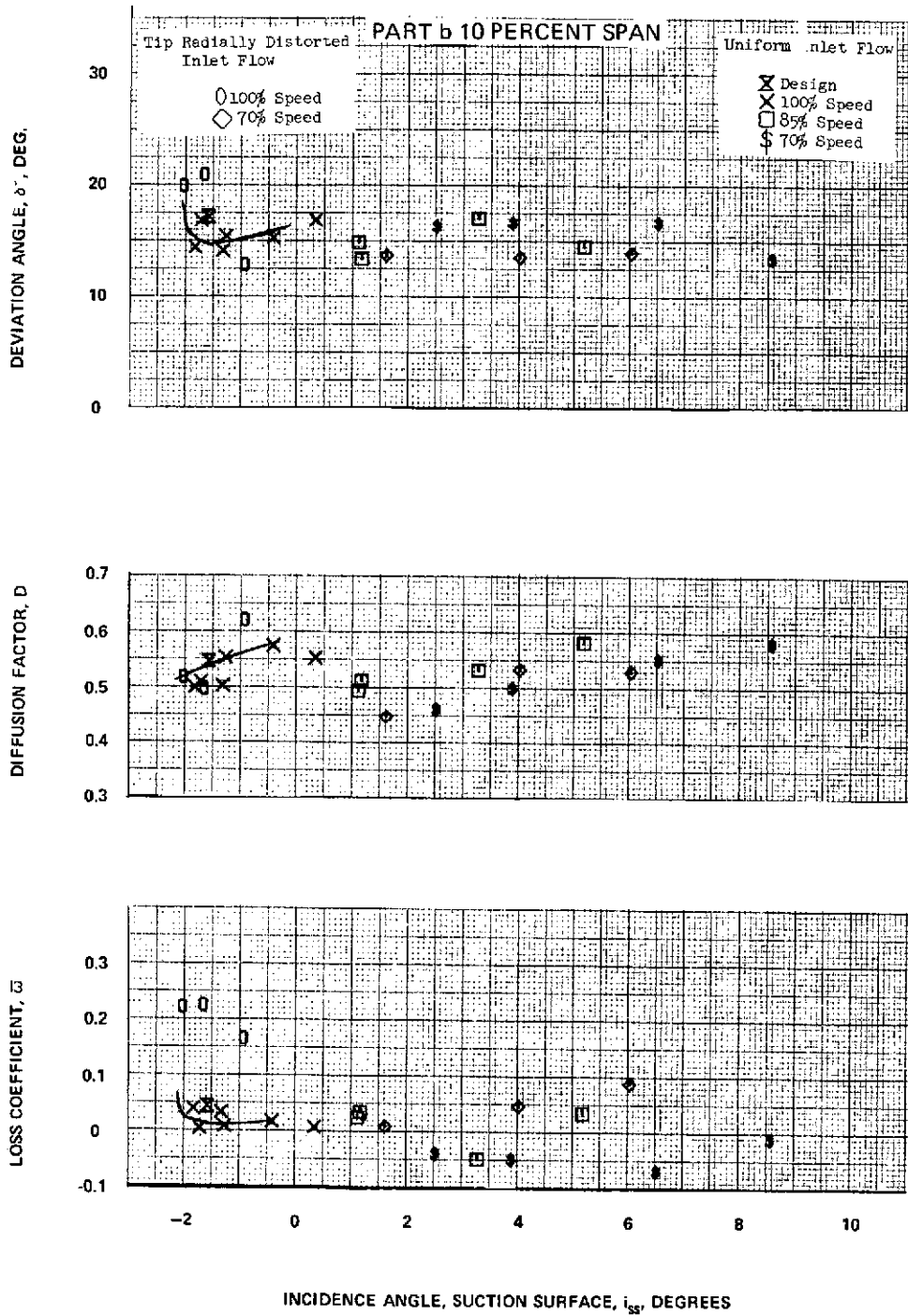

Figure 27 (Cont'd) Rotor 1 Blade-Element Performance Data for Uniform and Tip Radially Distorted Inlet Flow With Casing Treatment – Solid Casing Curves Shown for Comparison

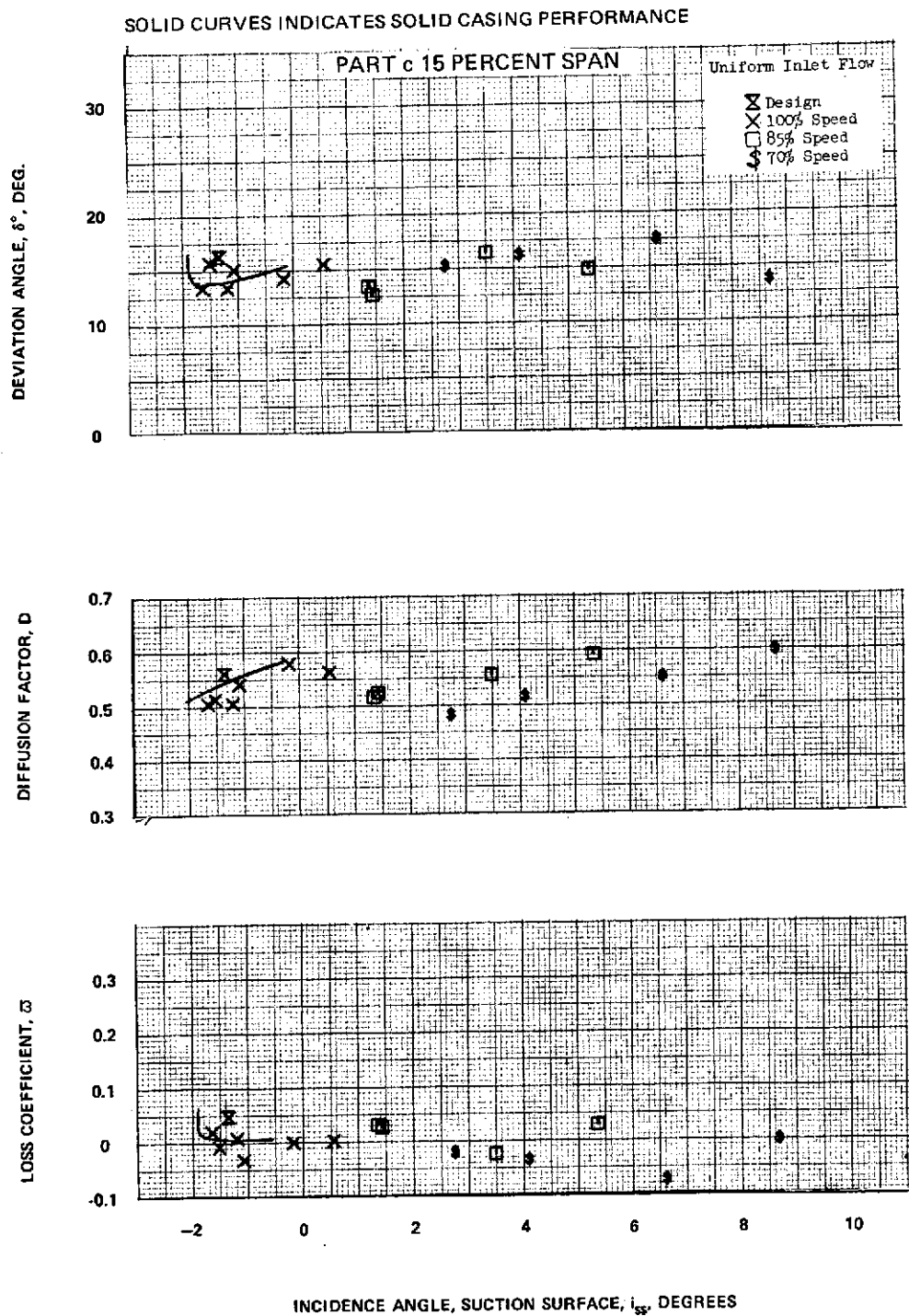

Figure 27 (Cont'd) Rotor 1 Blade-Element Performance Data for Uniform and Tip Radially Distorted Inlet Flow With Casing Treatment – Solid Casing Curves Shown for Comparison

SOLID CURVES INDICATES SOLID CASING PERFORMANCE

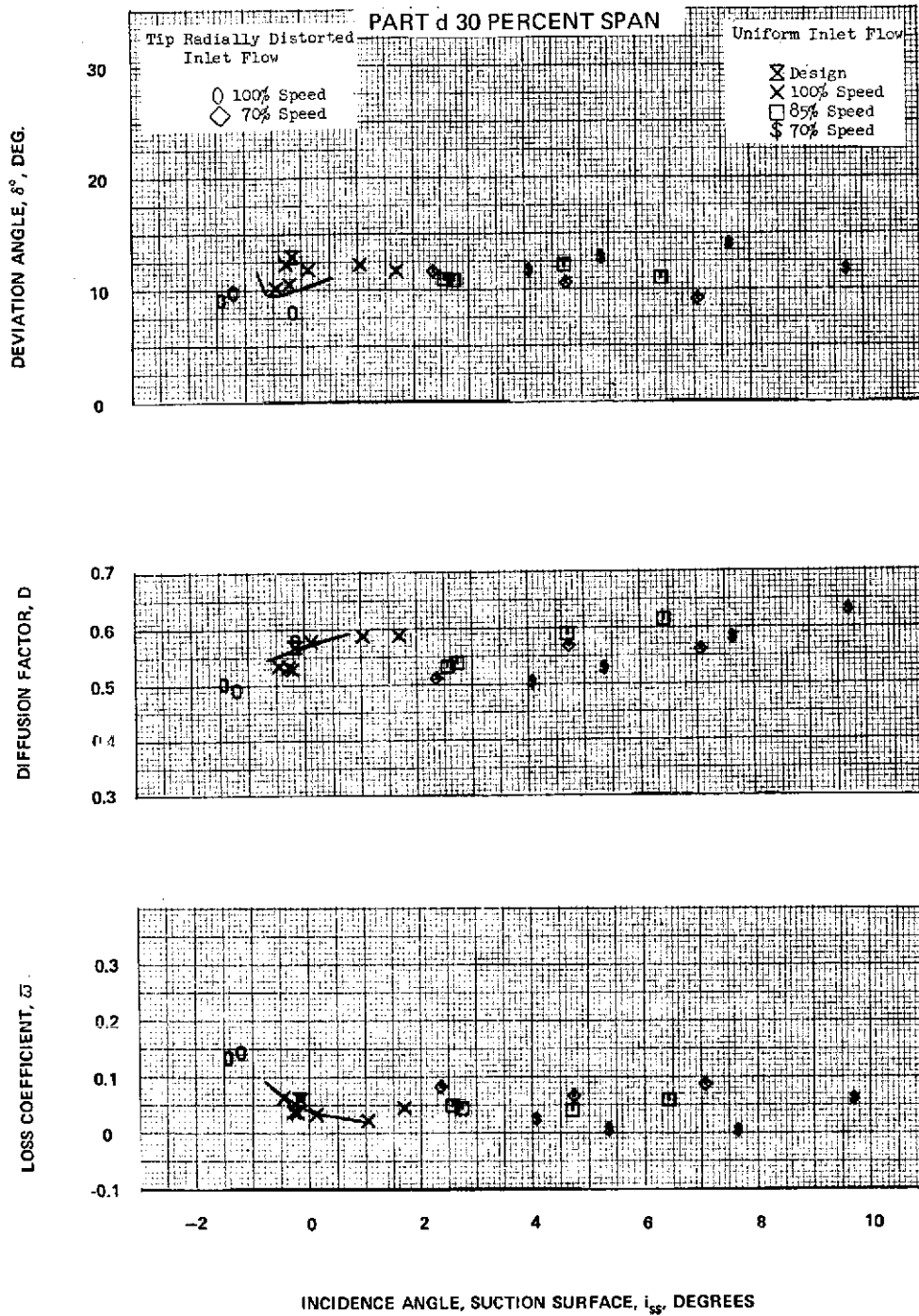

Figure 27 (Cont'd) Rotor 1 Blade-Element Performance Data for Uniform and Tip Radially Distorted Inlet Flow With Casing Treatment – Solid Casing Curves Shown for Comparison

SOLID CURVES INDICATES SOLID CASING PERFORMANCE

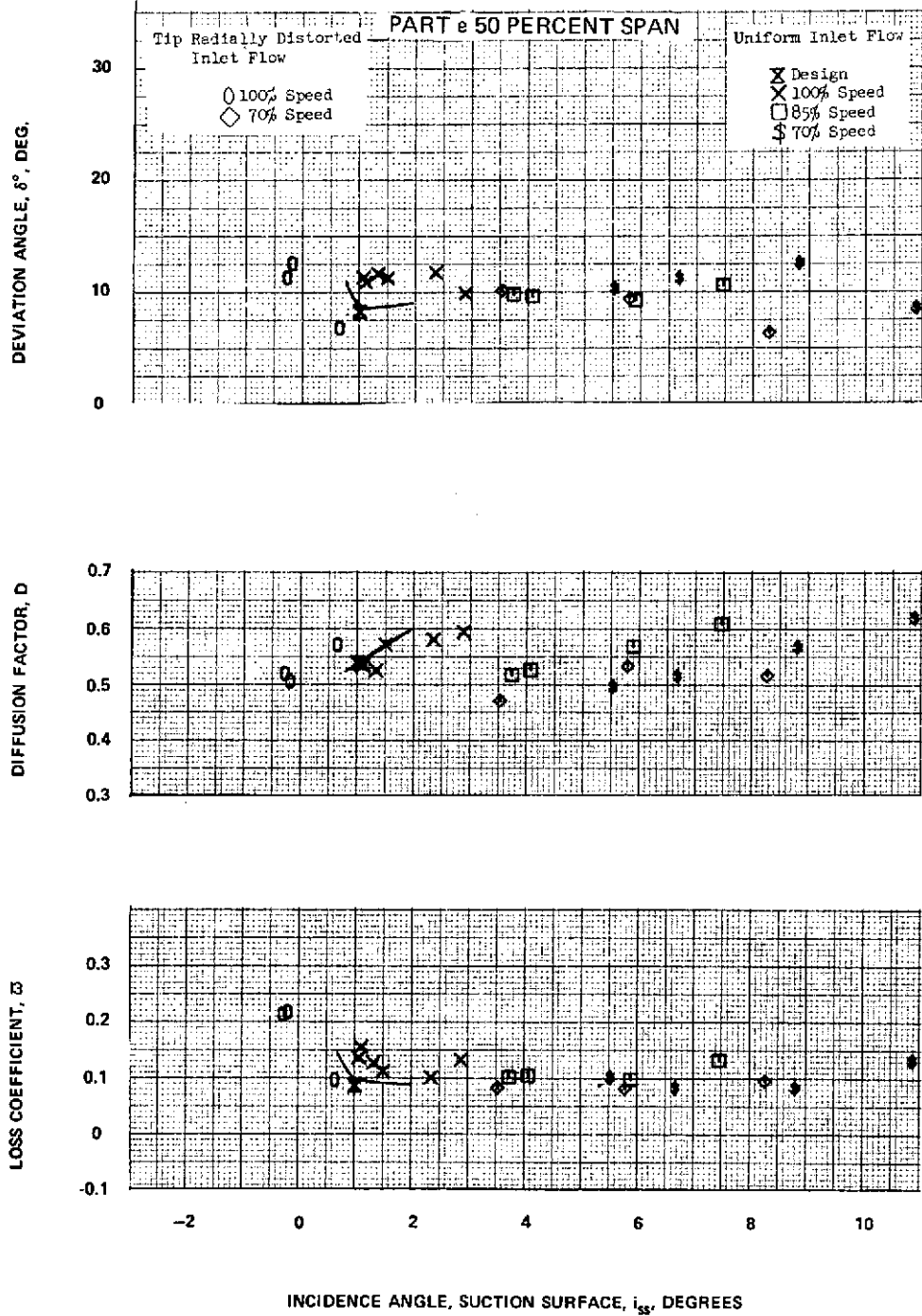

Figure 27 (Cont'd) Rotor 1 Blade-Element Performance Data for Uniform and Tip Radially Distorted Inlet Flow With Casing Treatment – Solid Casing Curves Shown for Comparison

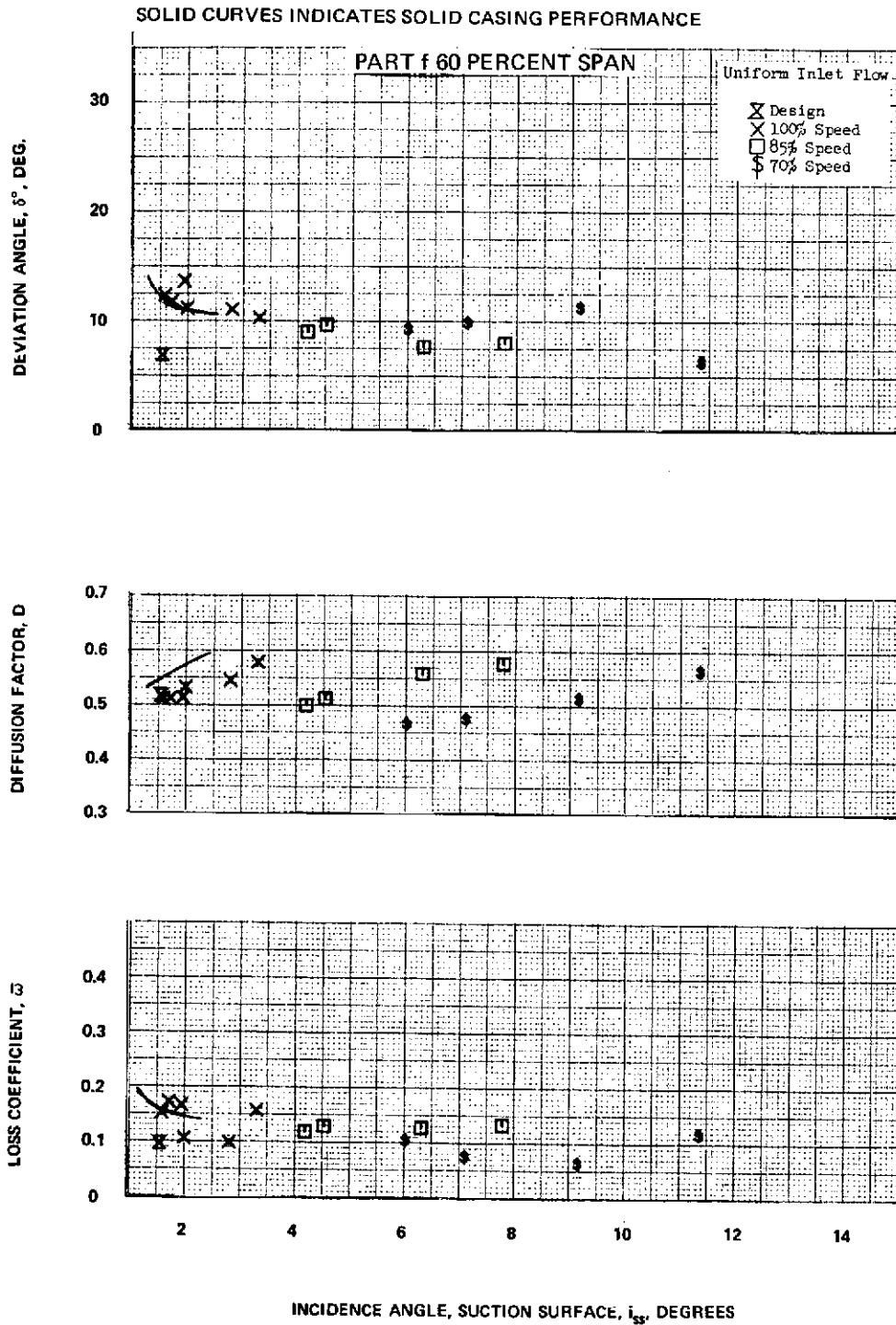

Figure 27 (Cont'd) Rotor 1 Blade-Element Performance Data for Uniform and Tip Radially Distorted Inlet Flow With Casing Treatment – Solid Casing Curves Shown for Comparison

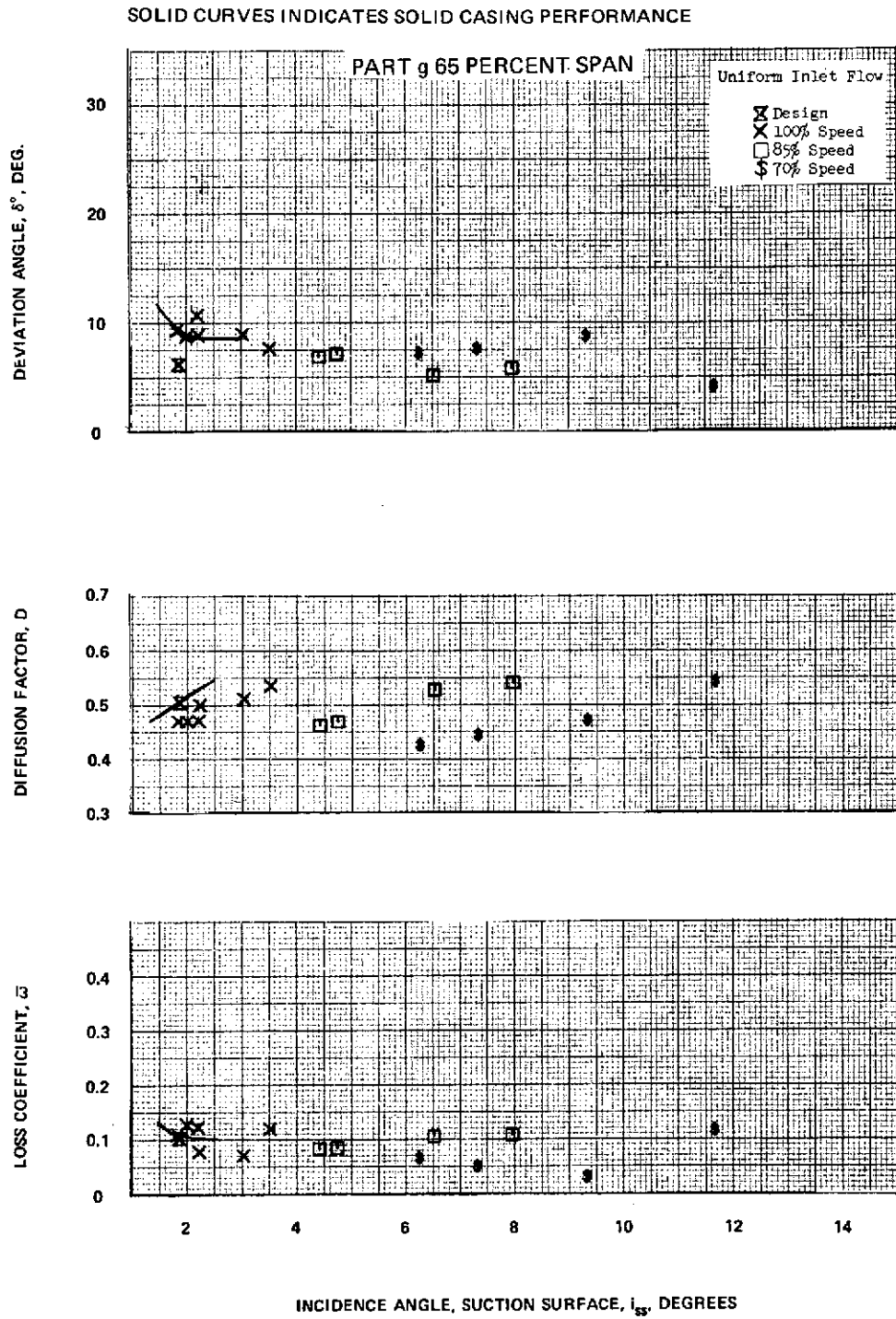

Figure 27 (Cont'd) Rotor 1 Blade-Element Performance Data for Uniform and Tip Radially Distorted Inlet Flow With Casing Treatment – Solid Casing Curves Shown for Comparison

SOLID CURVES INDICATES SOLID CASING PERFORMANCE

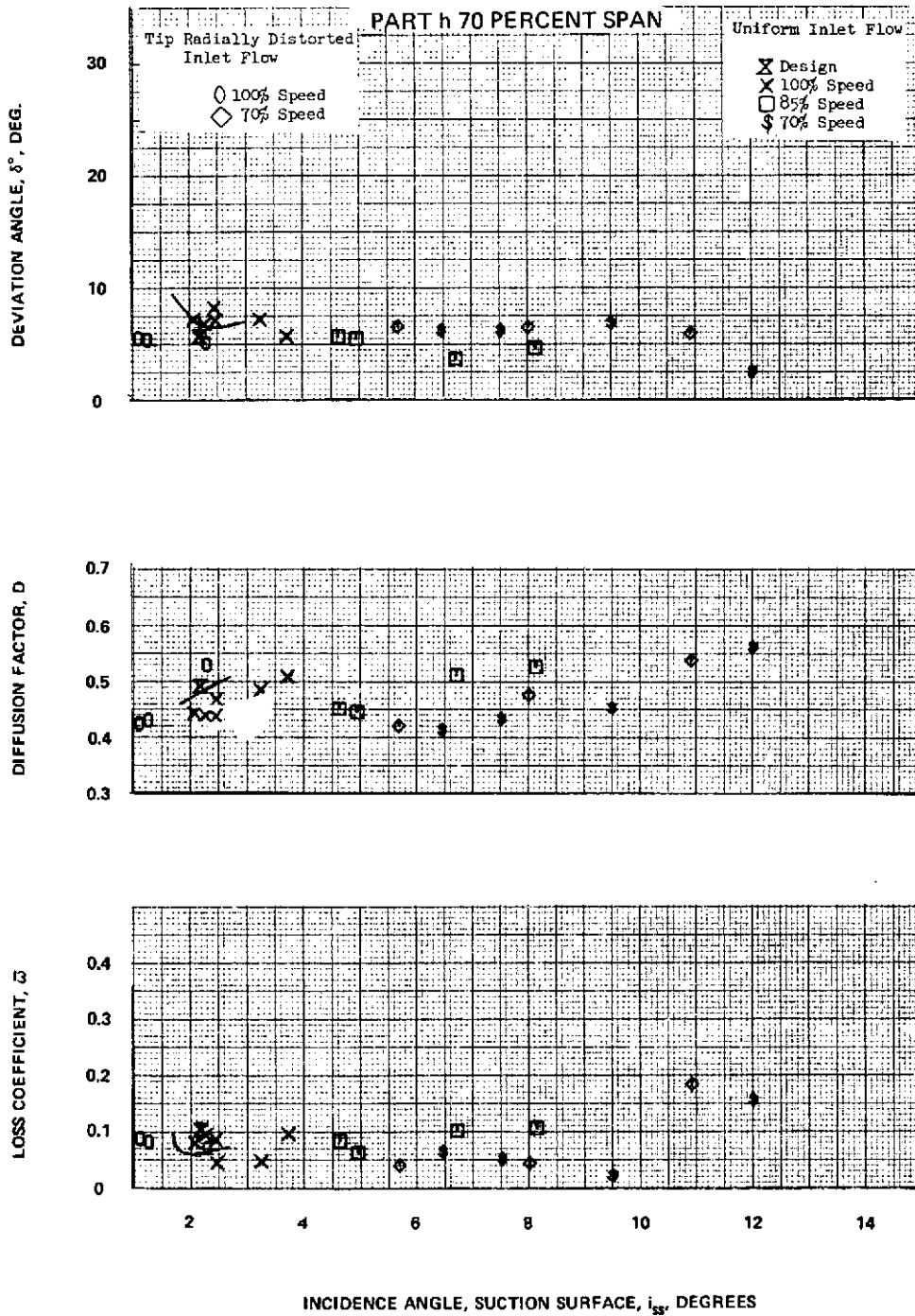

Figure 27 (Cont'd) Rotor 1 Blade-Element Performance Data for Uniform and Tip Radially Distorted Inlet Flow With Casing Treatment – Solid Casing Curves Shown for Comparison

SOLID CURVES INDICATES SOLID CASING PERFORMANCE

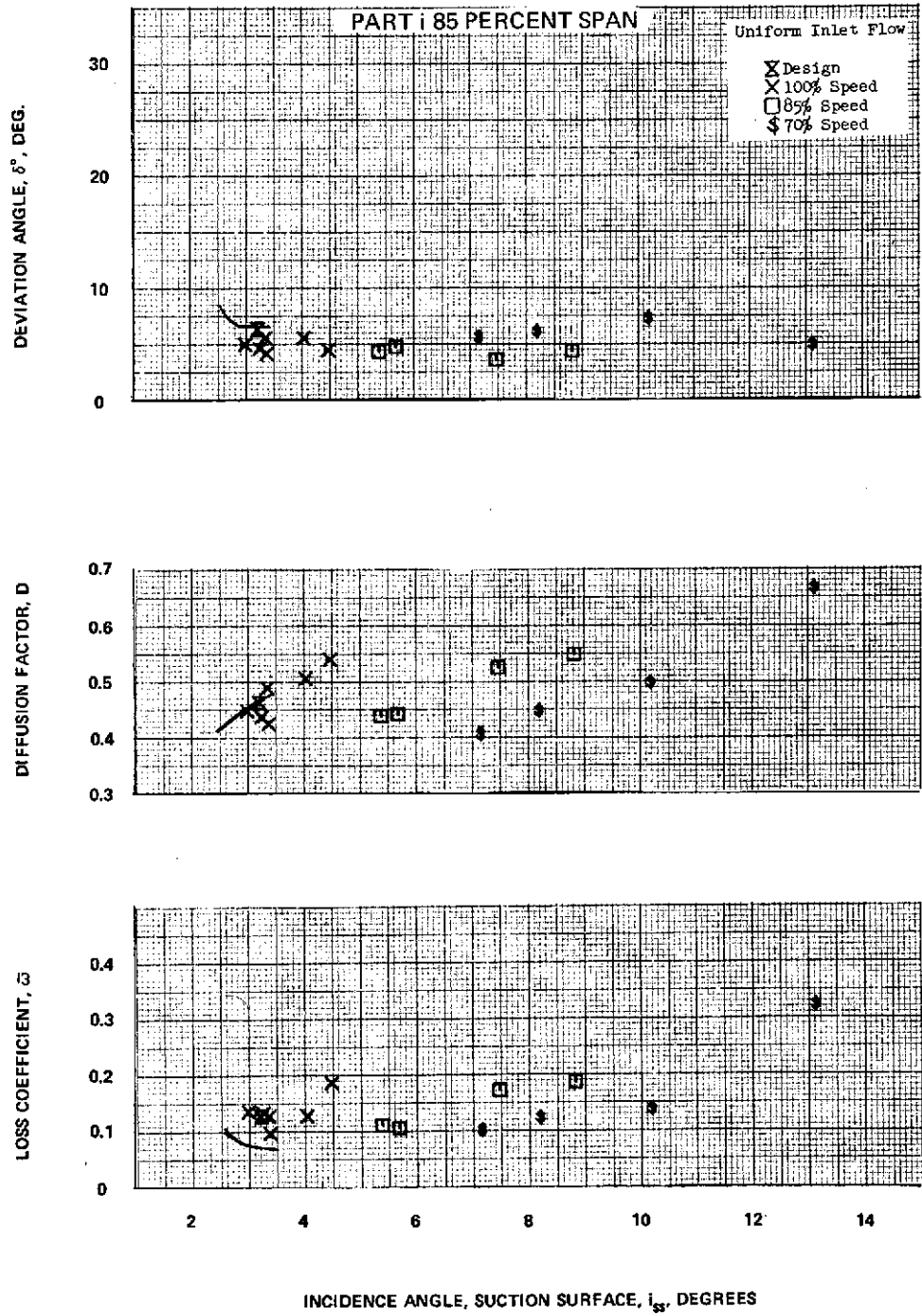

Figure 27 (Cont'd) Rotor 1 Blade-Element Performance Data for Uniform and Tip Radially Distorted Inlet Flow With Casing Treatment – Solid Casing Curves Shown for Comparison

SOLID CURVES INDICATES SOLID CASING PERFORMANCE

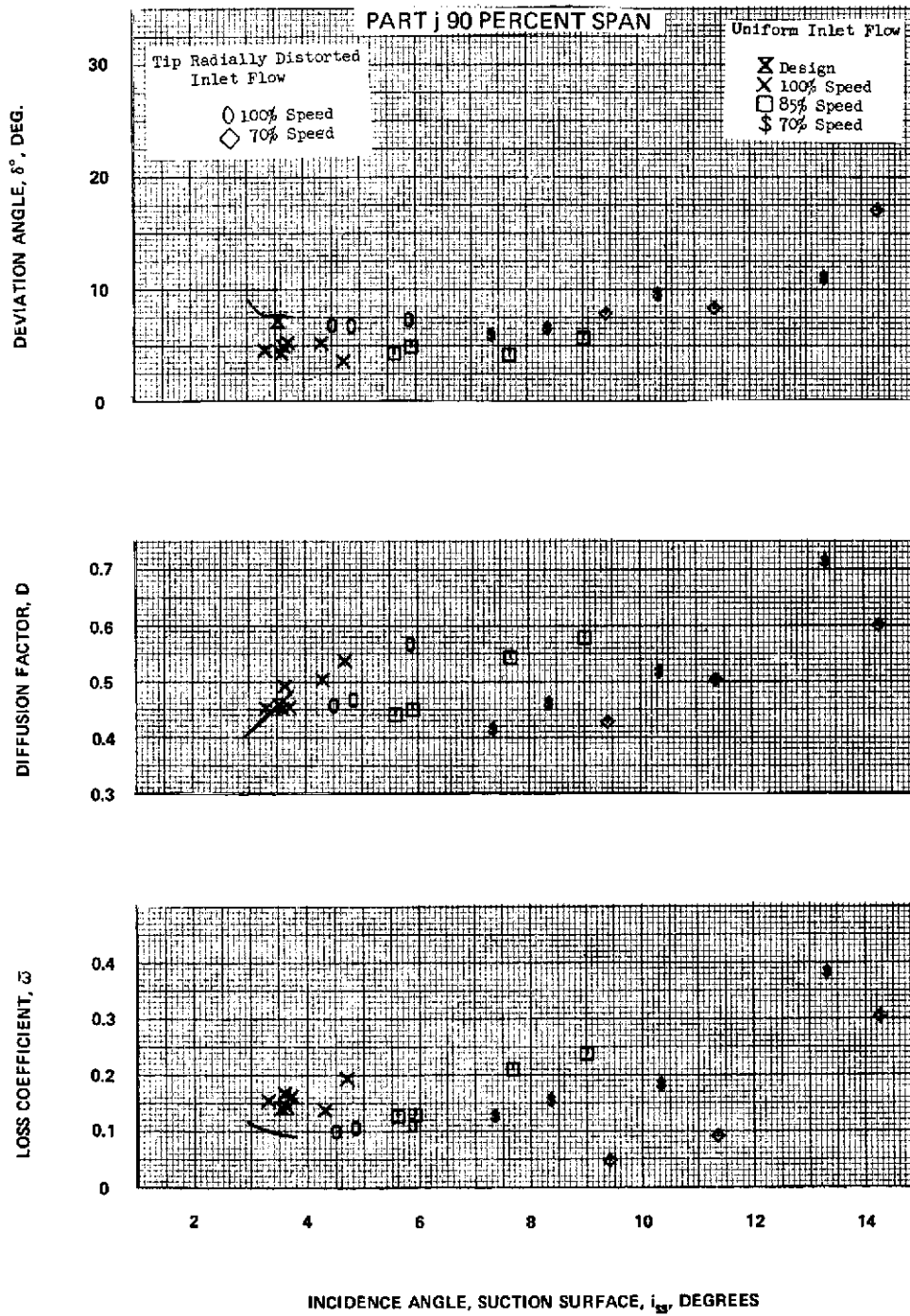

Figure 27 (Cont'd) Rotor 1 Blade-Element Performance Data for Uniform and Tip Radially Distorted Inlet Flow With Casing Treatment – Solid Casing Curves Shown for Comparison

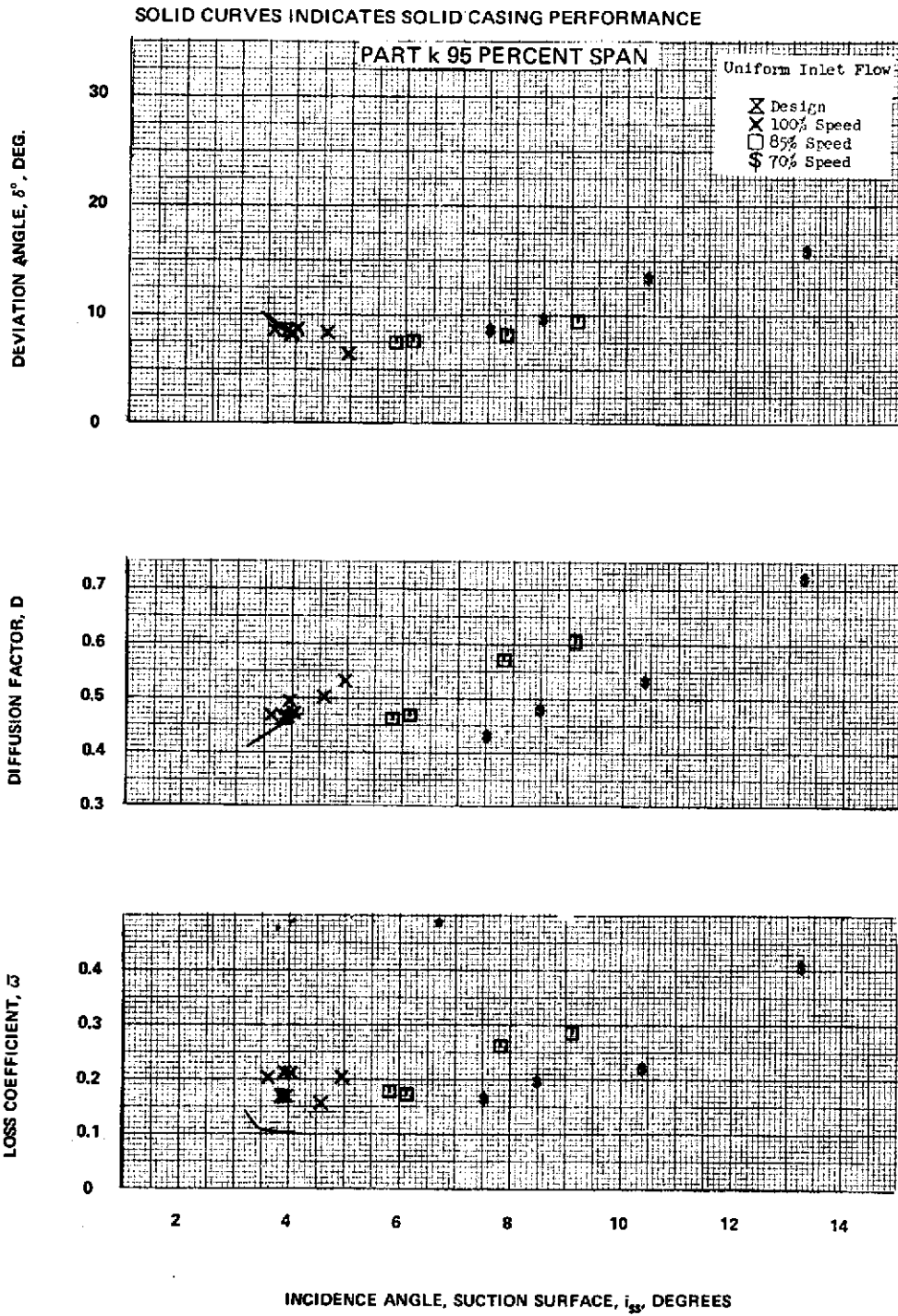

Figure 27 (Cont'd) Rotor 1 Blade-Element Performance Data for Uniform and Tip Radially Distorted Inlet Flow With Casing Treatment – Solid Casing Curves Shown for Comparison

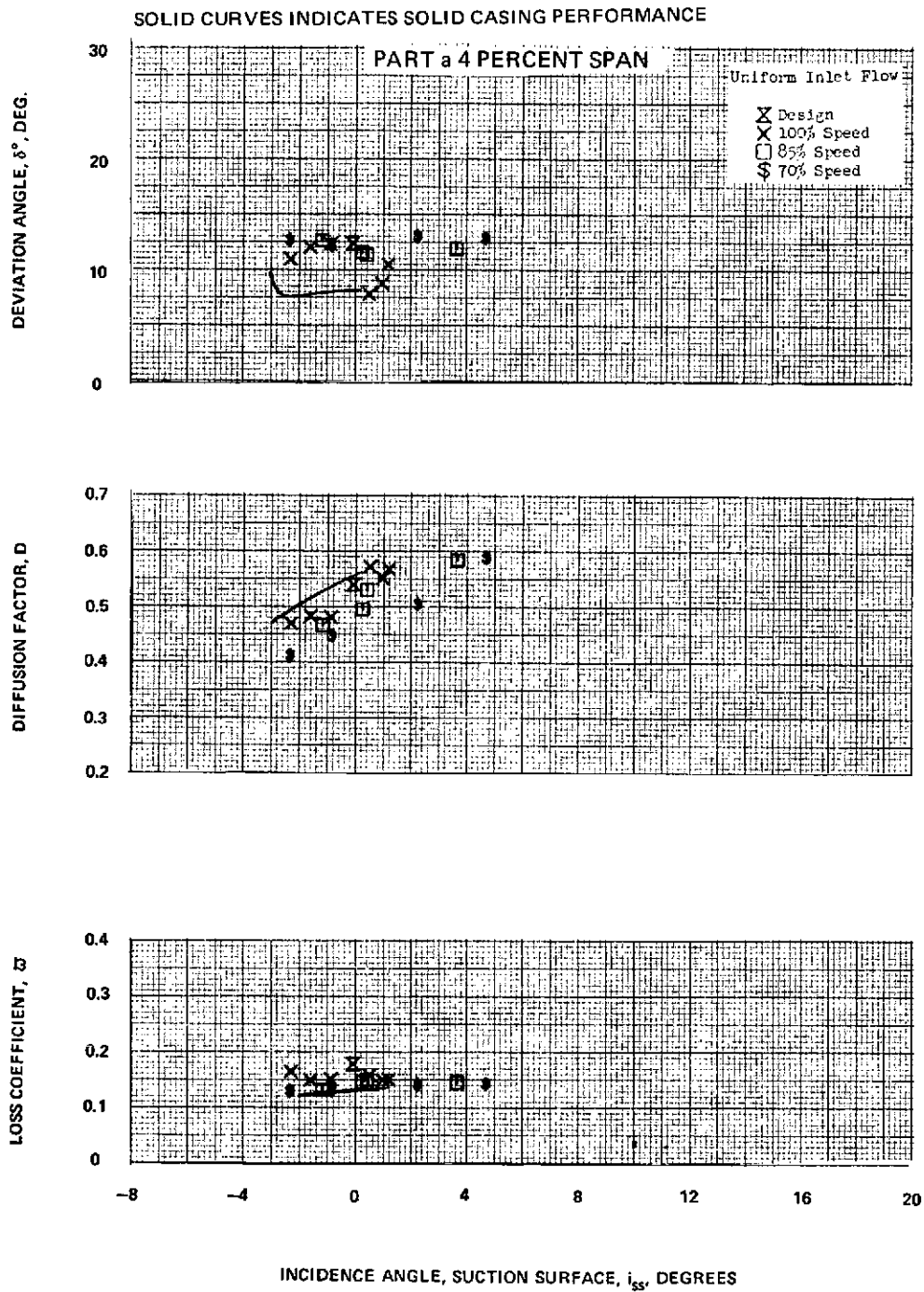

Figure 28 Stator 1 Blade-Element Performance Data for Uniform and Tip Radially Distorted Inlet Flow With Casing Treatment – Solid Casing Curves Shown for Comparison

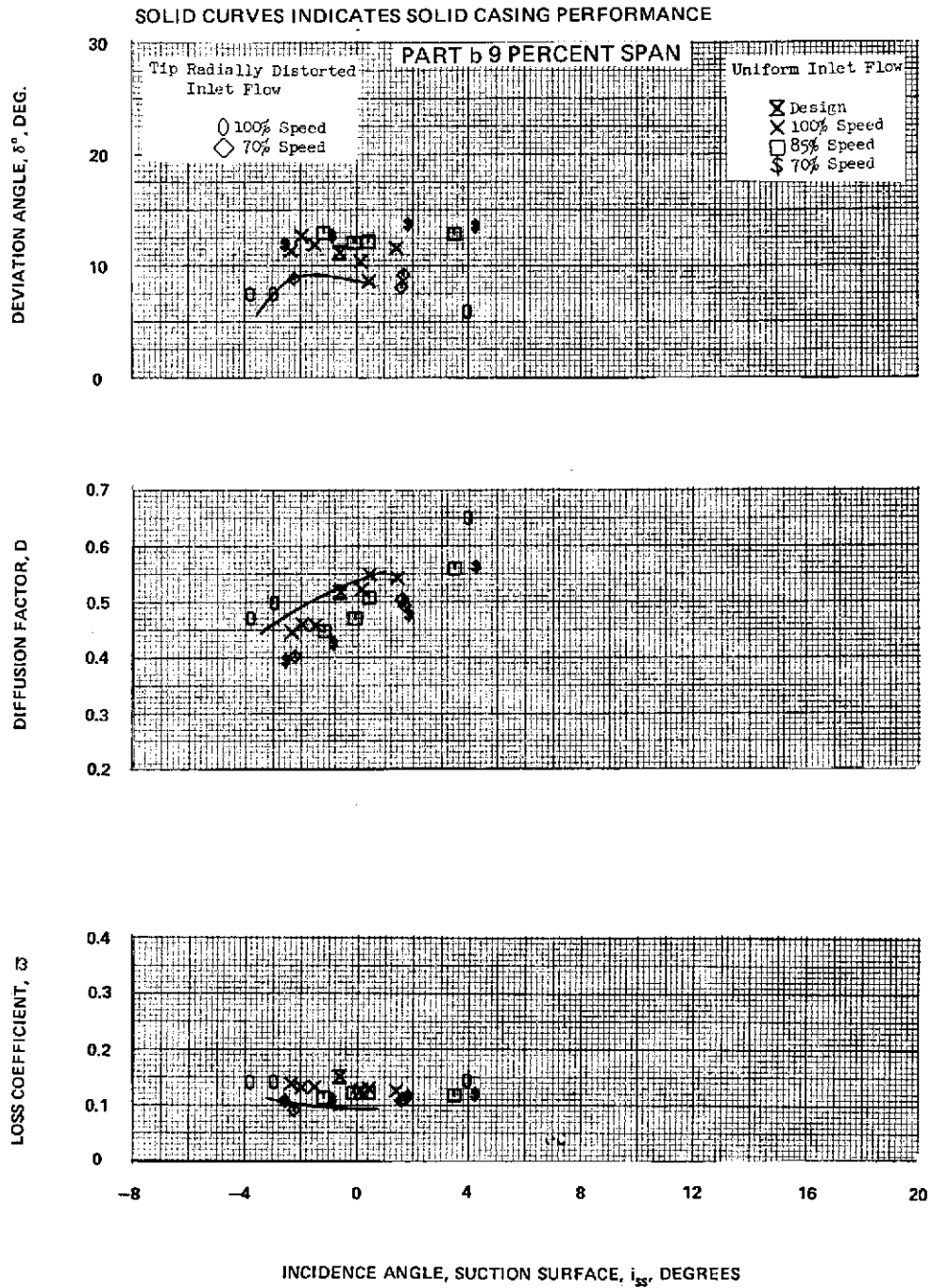

Figure 28 (Cont'd) Stator 1 Blade-Element Performance Data for Uniform and Tip Radially Distorted Inlet Flow With Casing Treatment – Solid Casing Curves Shown for Comparison

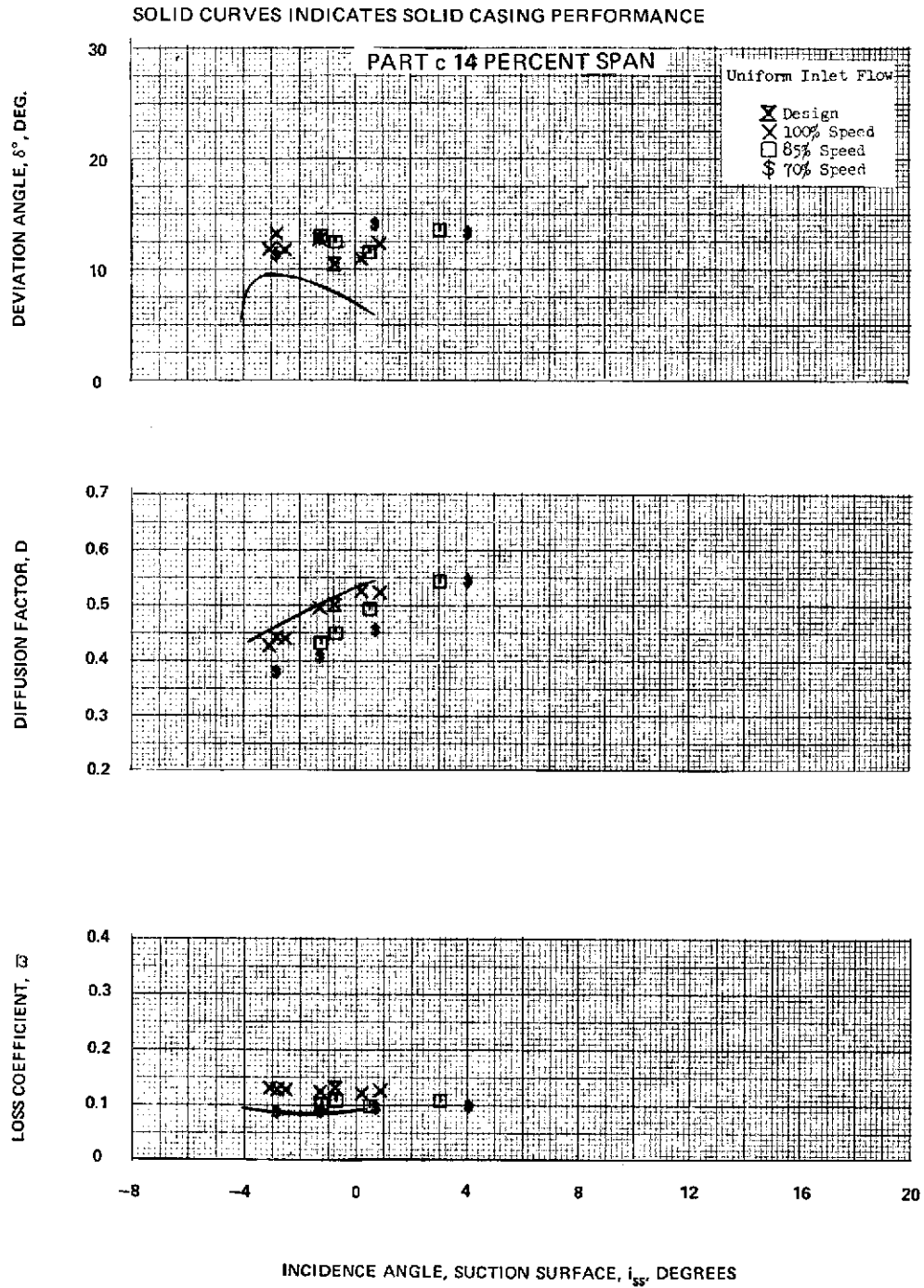

Figure 28 (Cont'd) Stator 1 Blade-Element Performance Data for Uniform and Tip Radially Distorted Inlet Flow With Casing Treatment – Solid Casing Curves Shown for Comparison

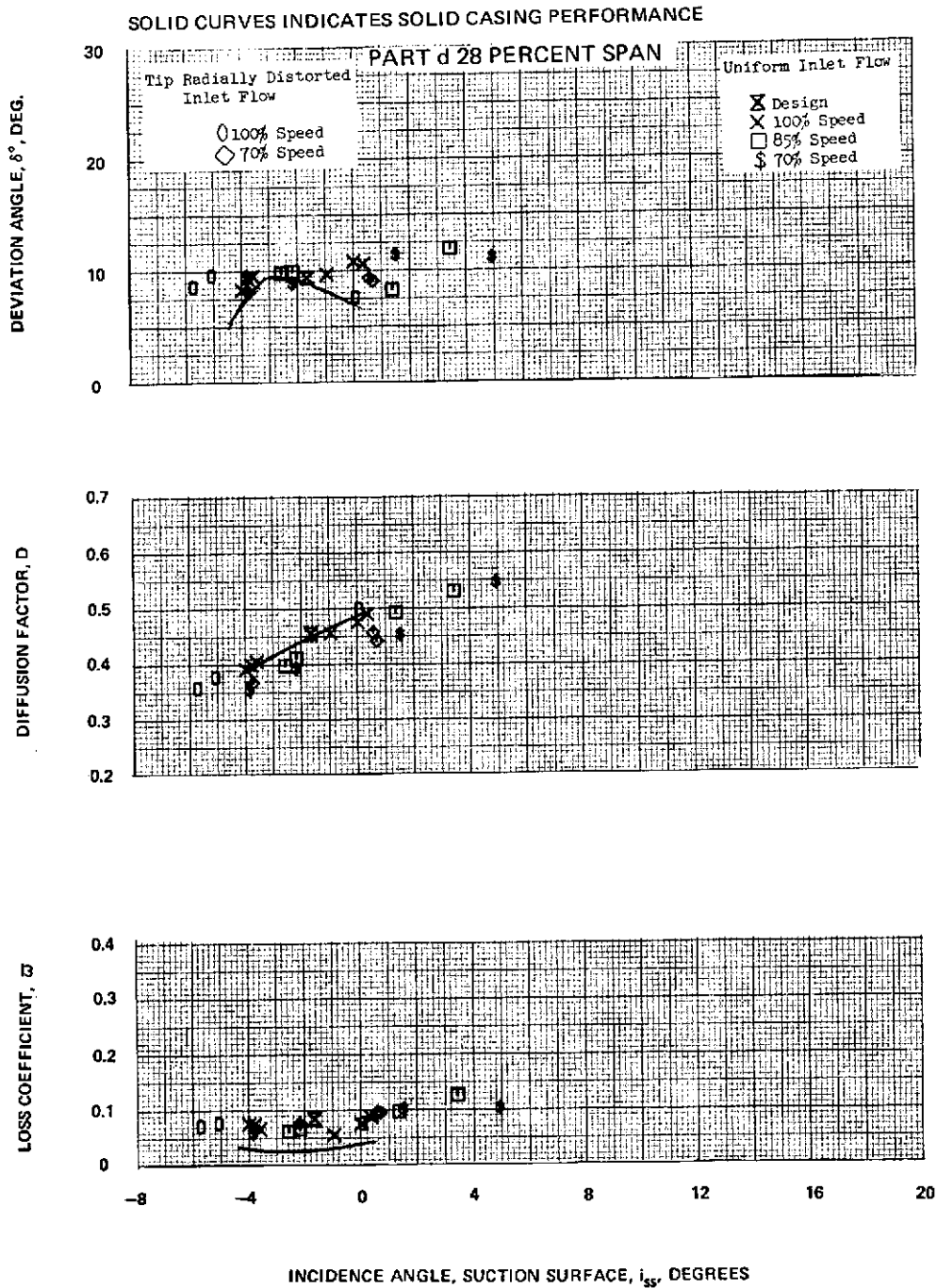

Figure 28 (Cont'd) Stator 1 Blade-Element Performance Data for Uniform and Tip Radially Distorted Inlet Flow With Casing Treatment – Solid Casing Curves Shown for Comparison

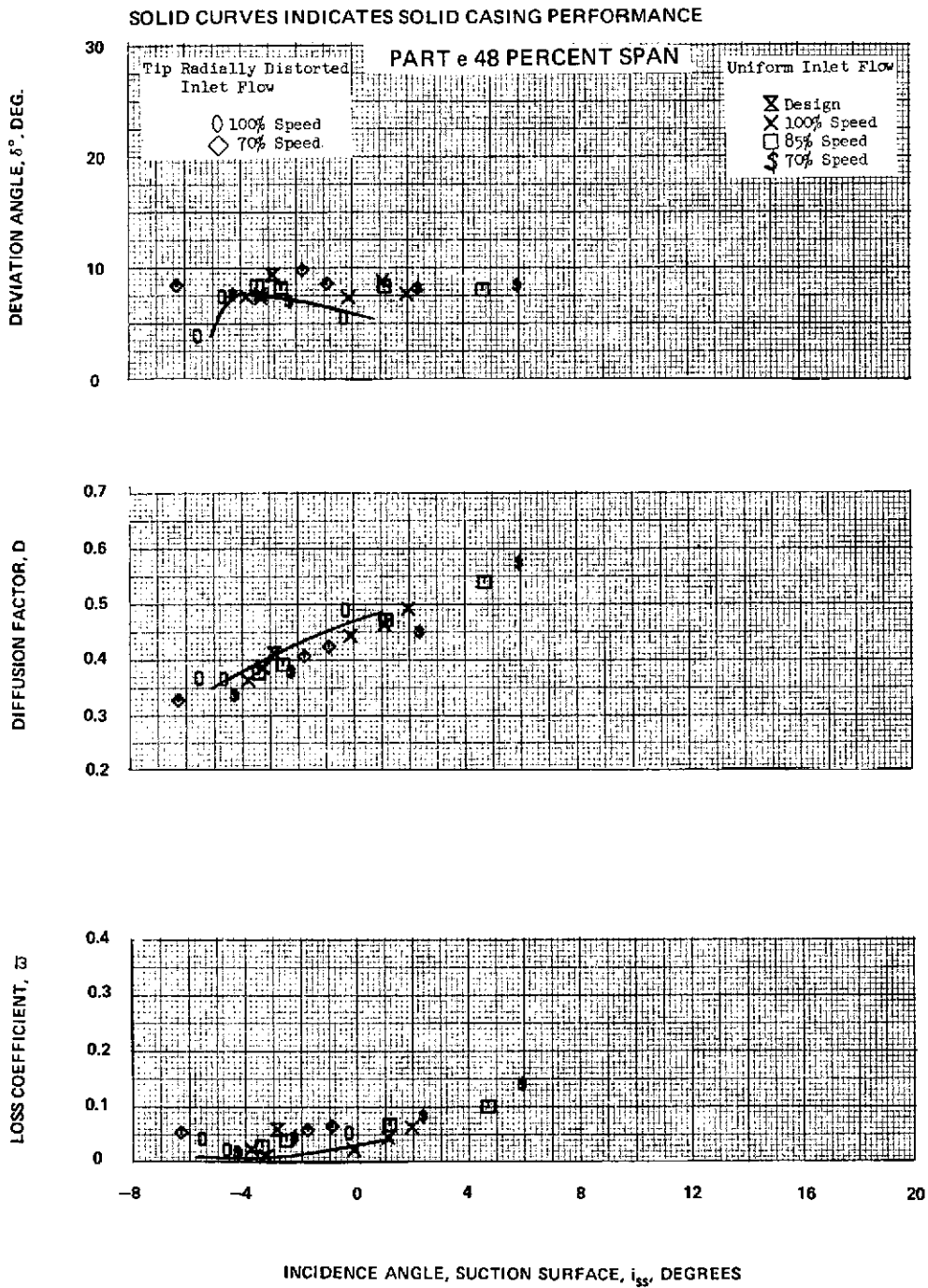

Figure 28 (Cont'd) Stator 1 Blade-Element Performance Data for Uniform and Tip Radially Distorted Inlet Flow With Casing Treatment – Solid Casing Curves Shown for Comparison

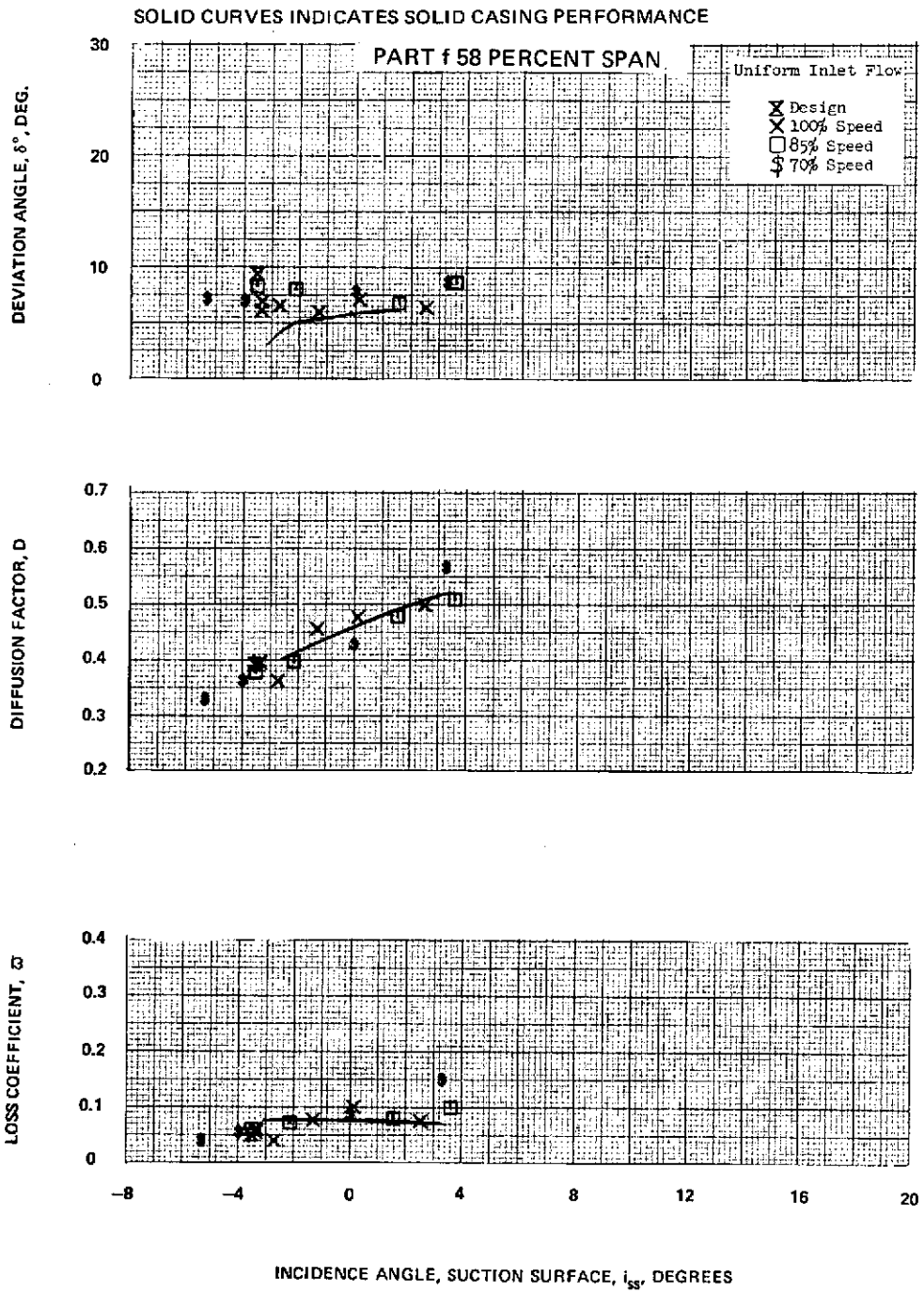

Figure 28 (Cont'd) Stator 1 Blade-Element Performance Data for Uniform and Tip Radially Distorted Inlet Flow With Casing Treatment – Solid Casing Curves Shown for Comparison

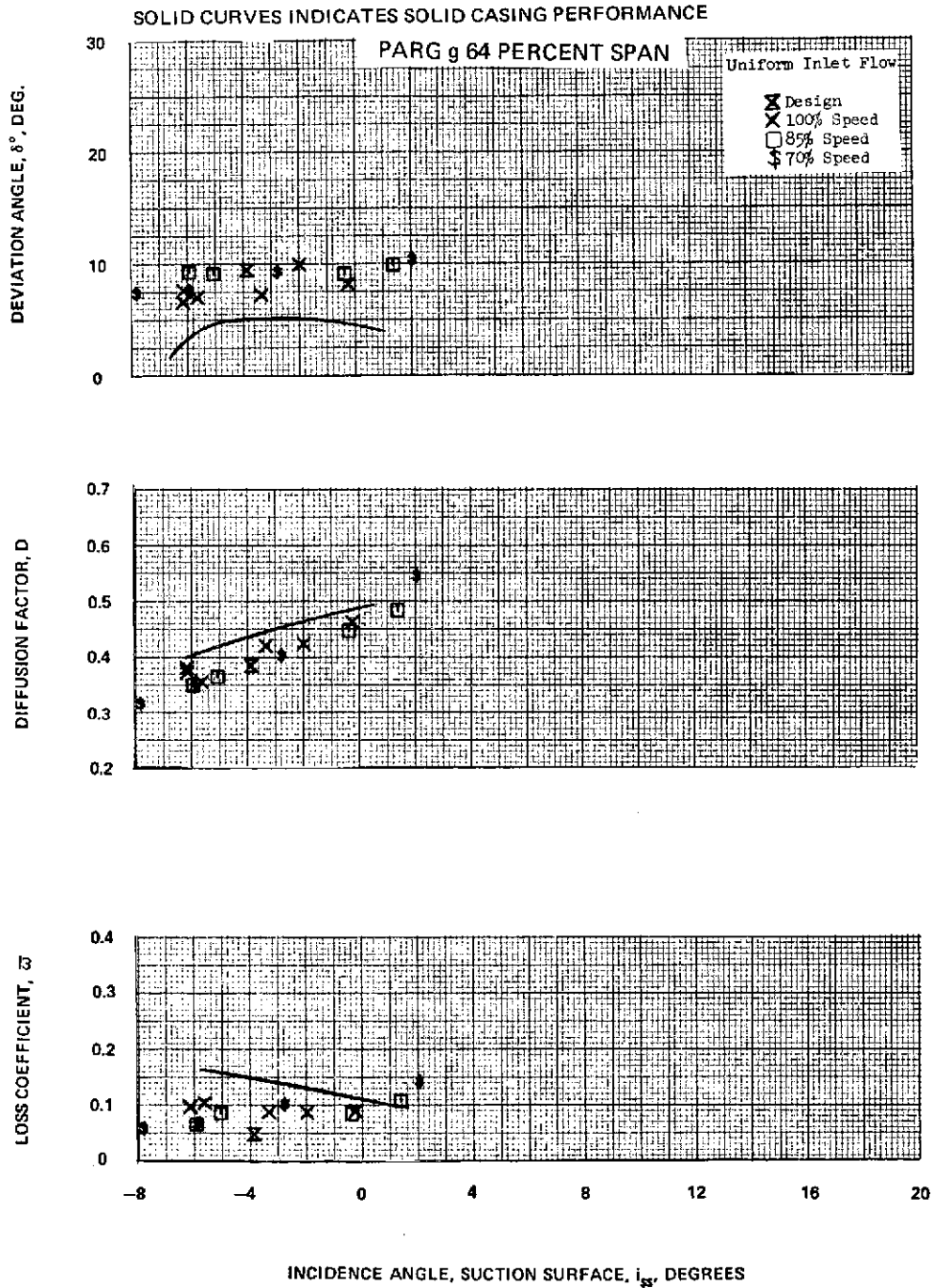

Figure 28 (Cont'd) Stator 1 Blade-Element Performance Data for Uniform and Tip Radially Distorted Inlet Flow With Casing Treatment – Solid Casing Curves Shown for Comparison

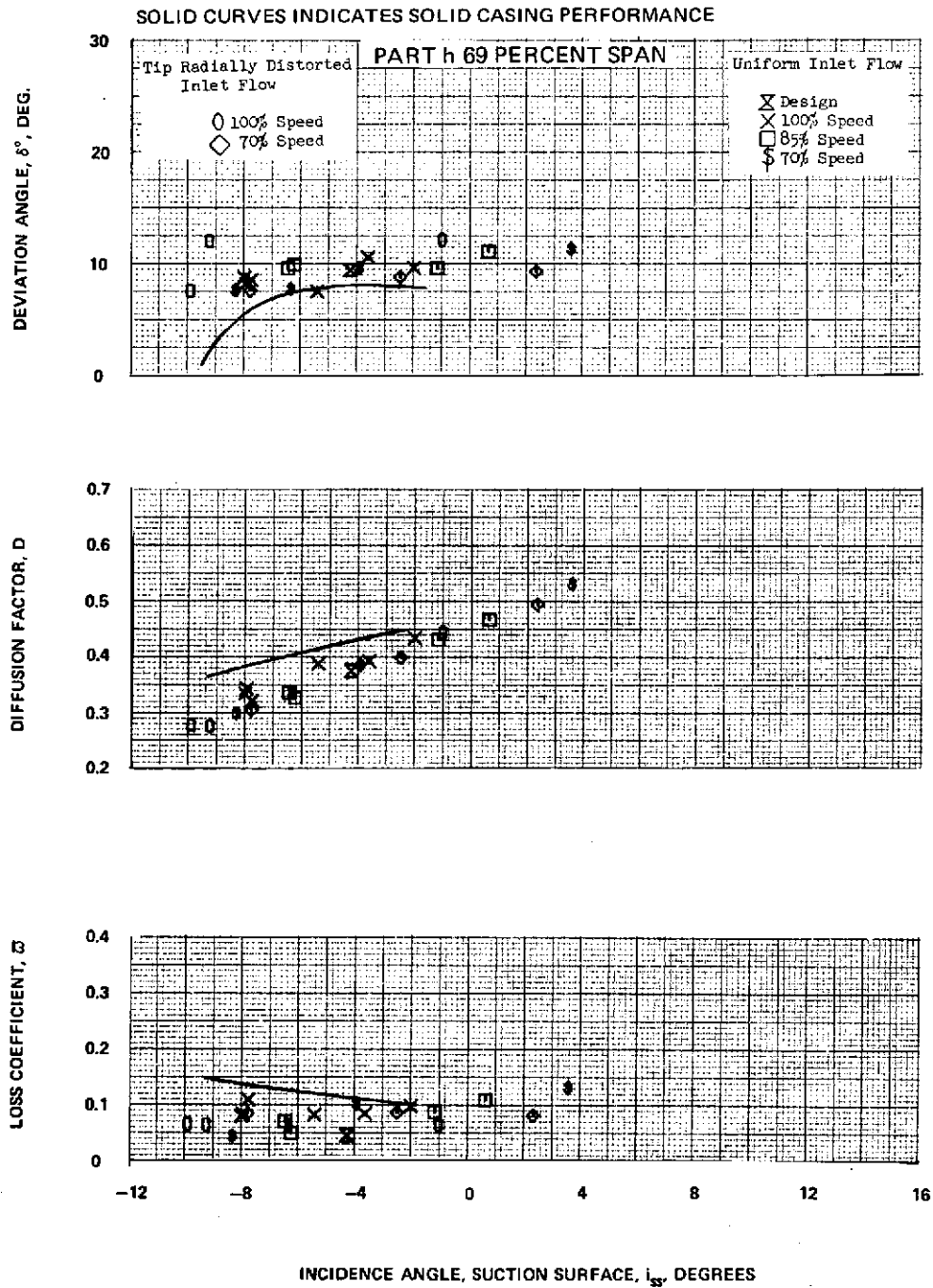

Figure 28 (Cont'd) Stator 1 Blade-Element Performance Data for Uniform and Tip Radially Distorted Inlet Flow With Casing Treatment – Solid Casing Curves Shown for Comparison

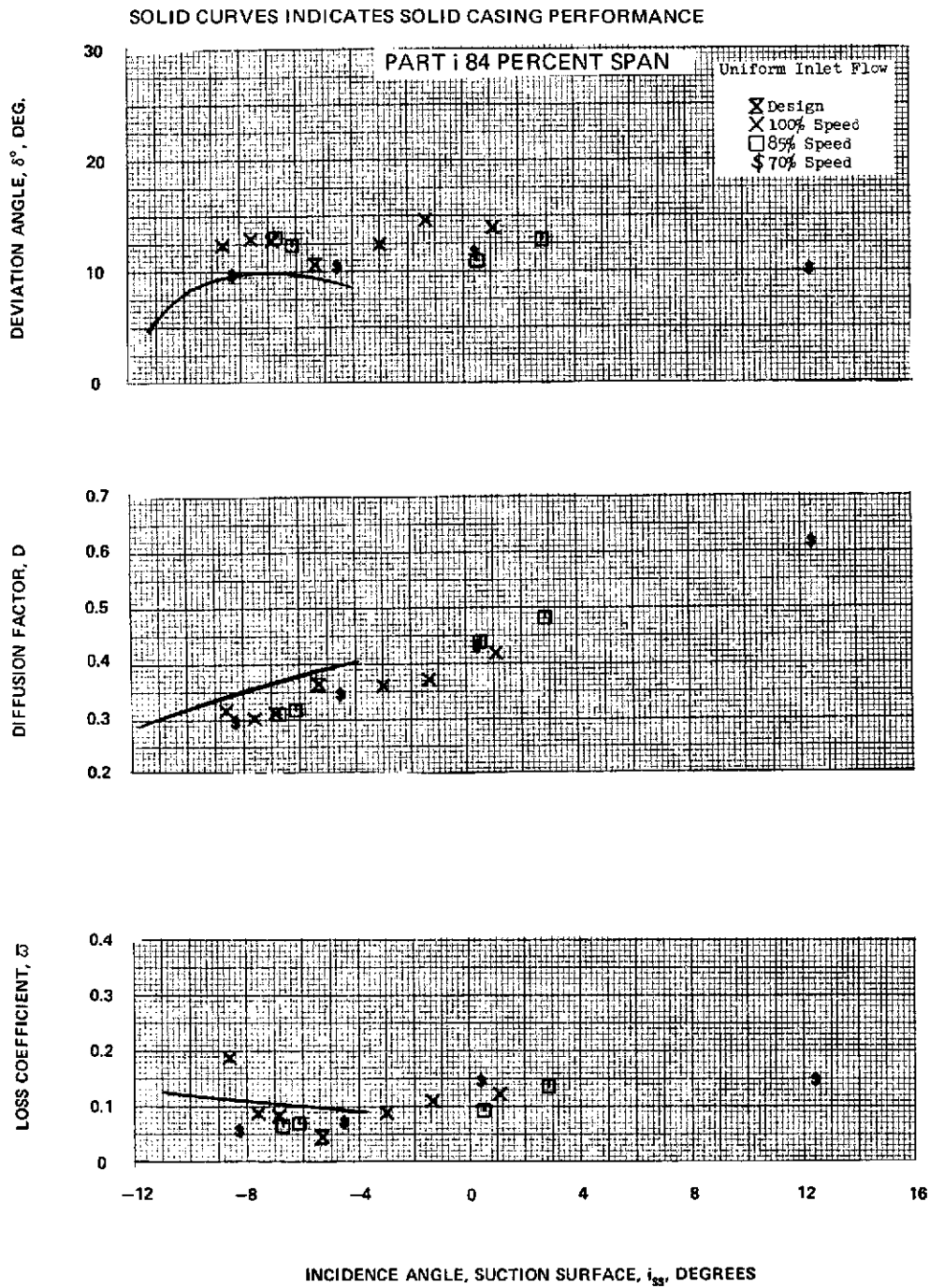

Figure 28 (Cont'd) Stator 1 Blade-Element Performance Data for Uniform and Tip Radially Distorted Inlet Flow With Casing Treatment – Solid Casing Curves Shown for Comparison

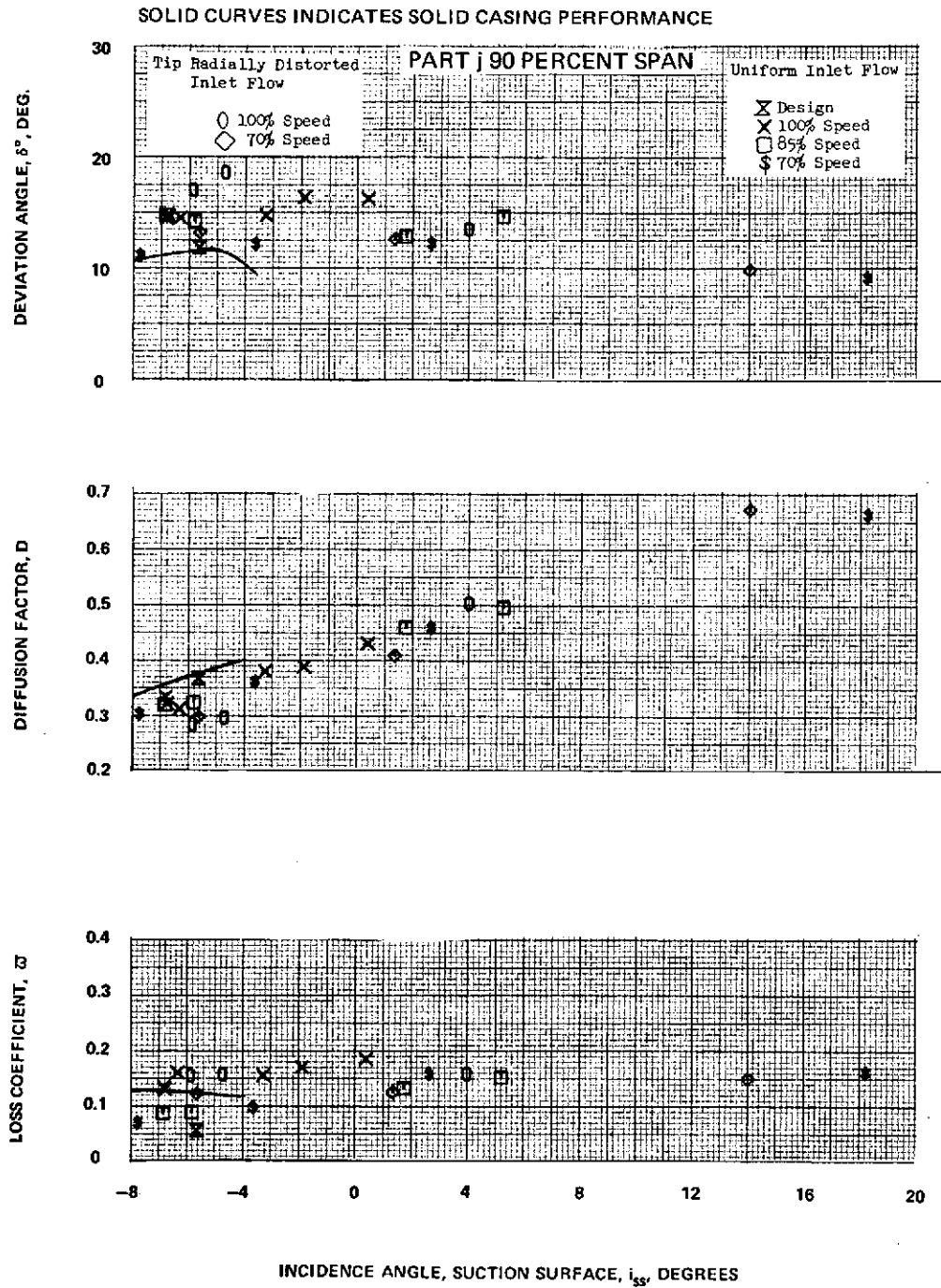

Figure 28 (Cont'd) Stator 1 Blade-Element Performance Data for Uniform and Tip Radially Distorted Inlet Flow With Casing Treatment – Solid Casing Curves Shown for Comparison

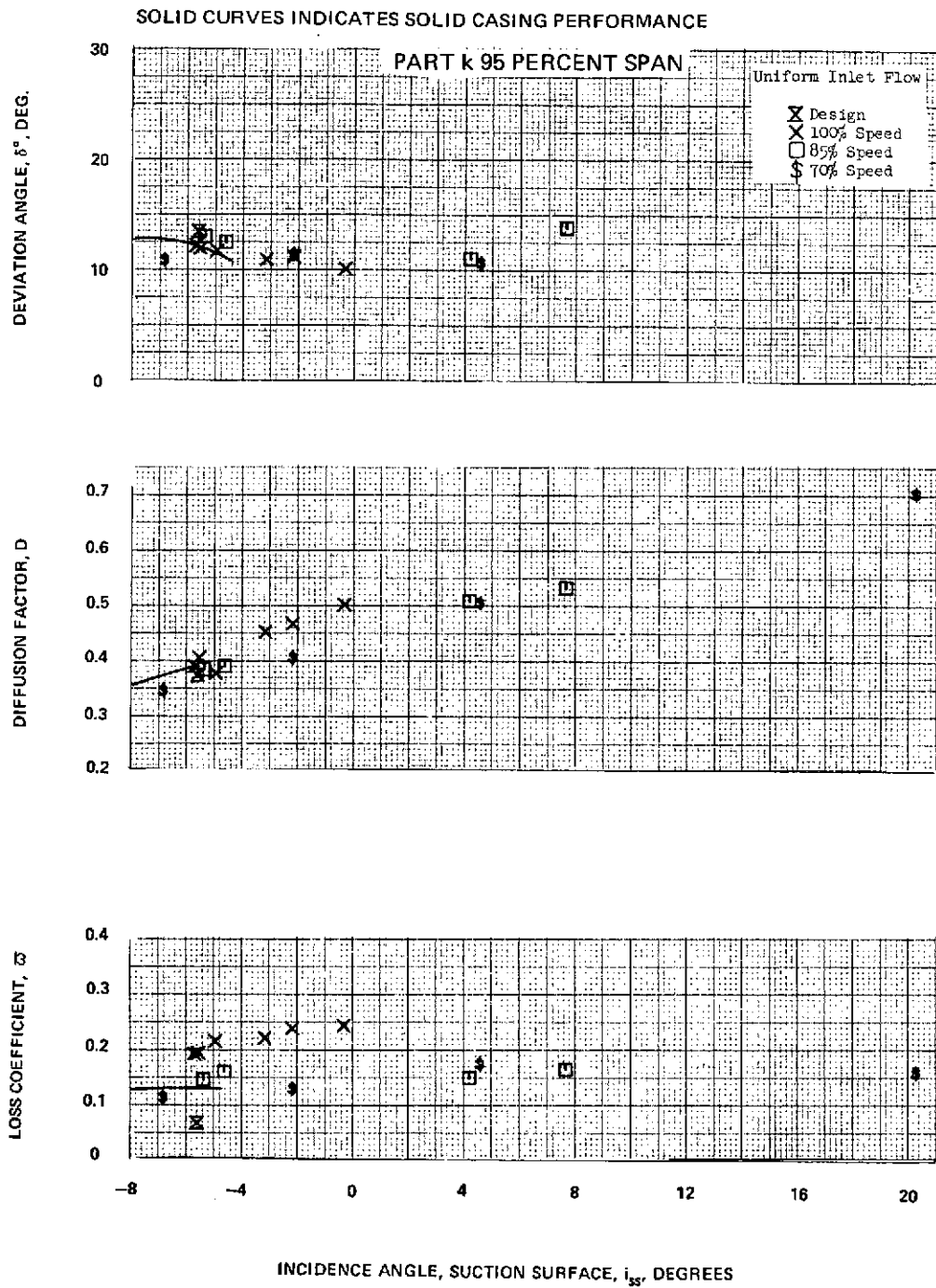

Figure 28 (Cont'd) Stator 1 Blade-Element Performance Data for Uniform and Tip Radially Distorted Inlet Flow With Casing Treatment – Solid Casing Curves Shown for Comparison

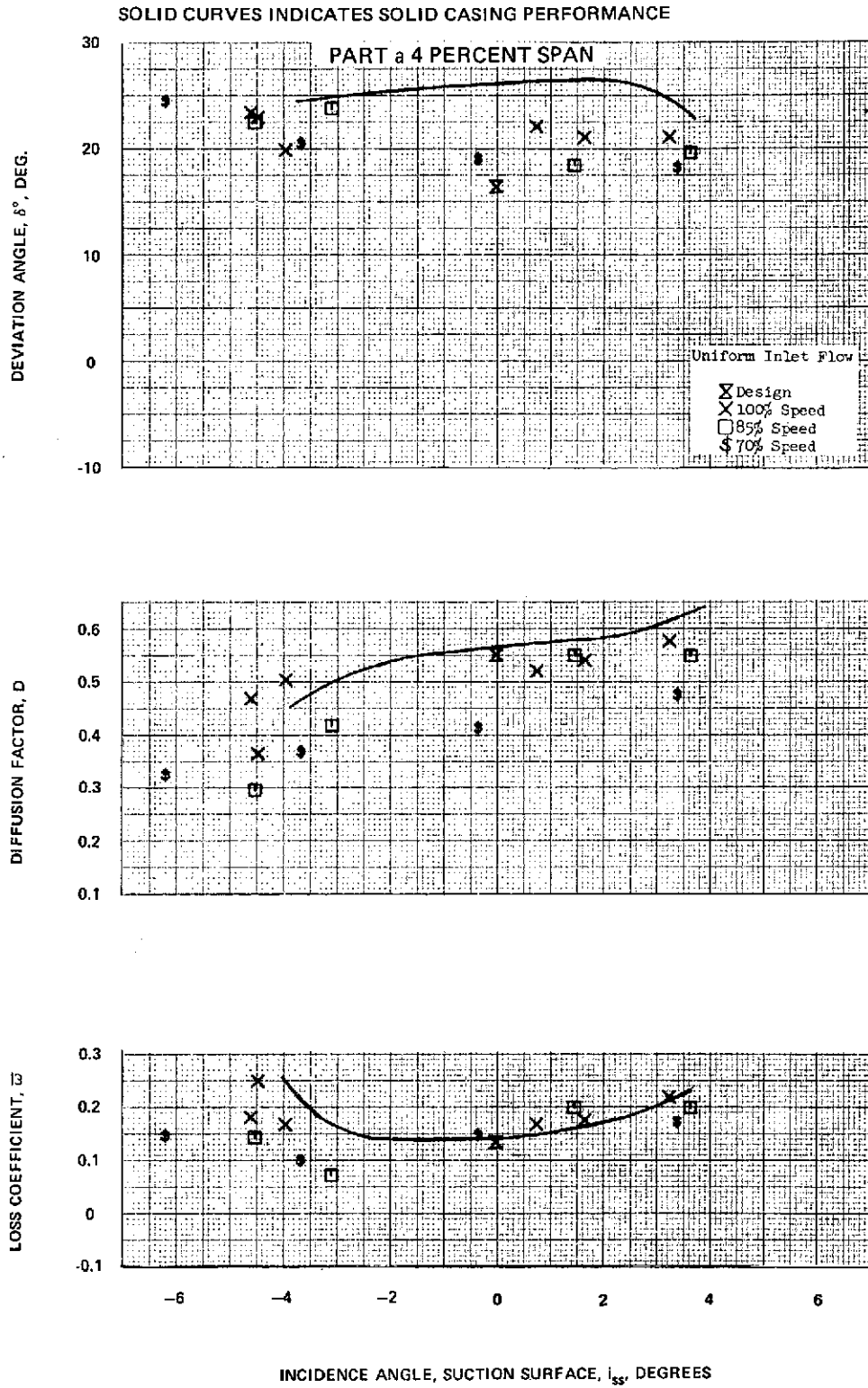

Figure 29 Rotor 2 Blade-Element Performance Data for Uniform and Tip Radially Distorted Inlet Flow With Casing Treatment – Solid Casing Curves Shown for Comparison

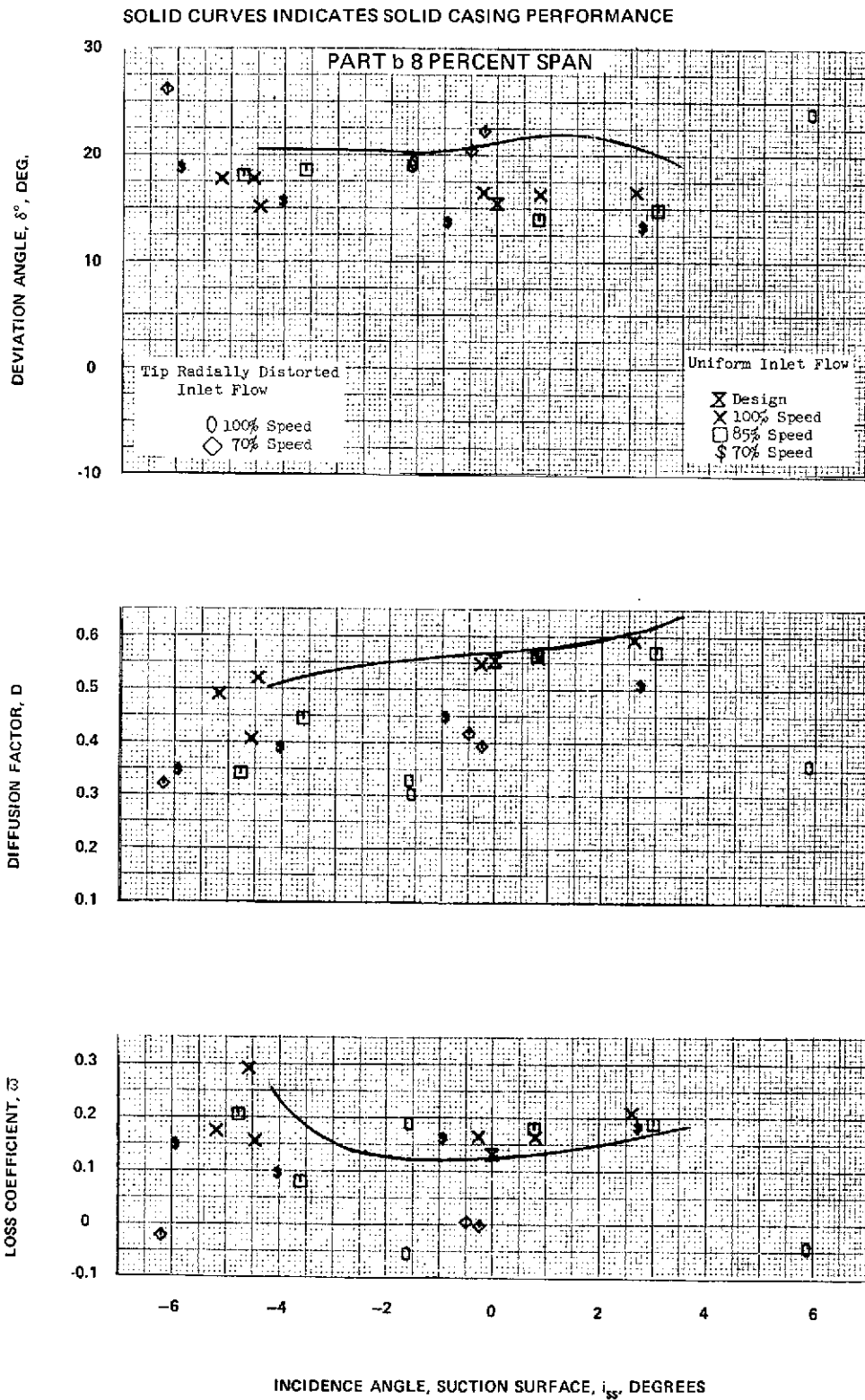

Figure 29 (Cont'd) Rotor 2 Blade-Element Performance Data for Uniform and Tip Radially Distorted Inlet Flow With Casing Treatment – Solid Casing Curves Shown for Comparison

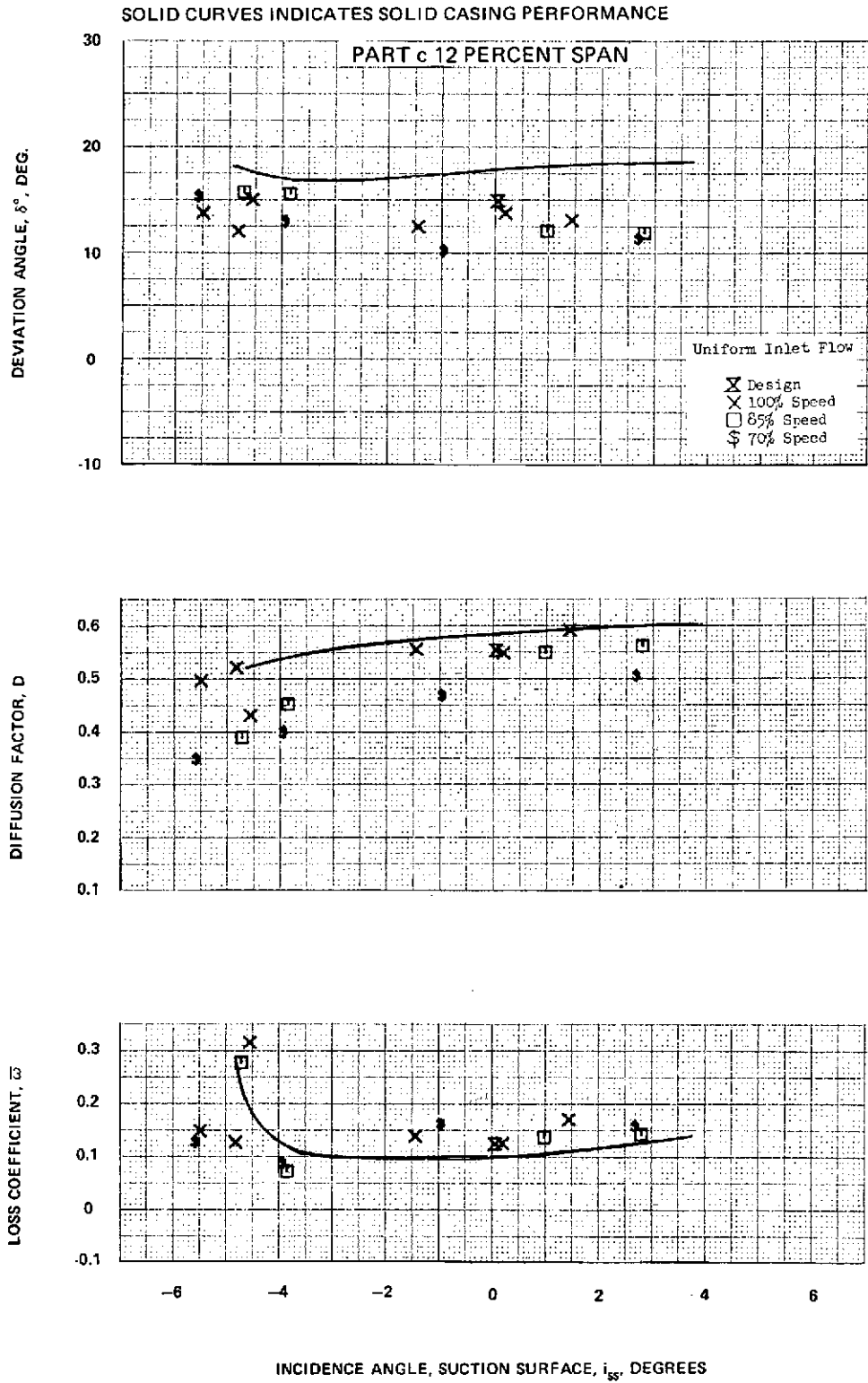

Figure 29 (Cont'd) Rotor 2 Blade-Element Performance Data for Uniform and Tip Radially Distorted Inlet Flow With Casing Treatment – Solid Casing Curves Shown for Comparison

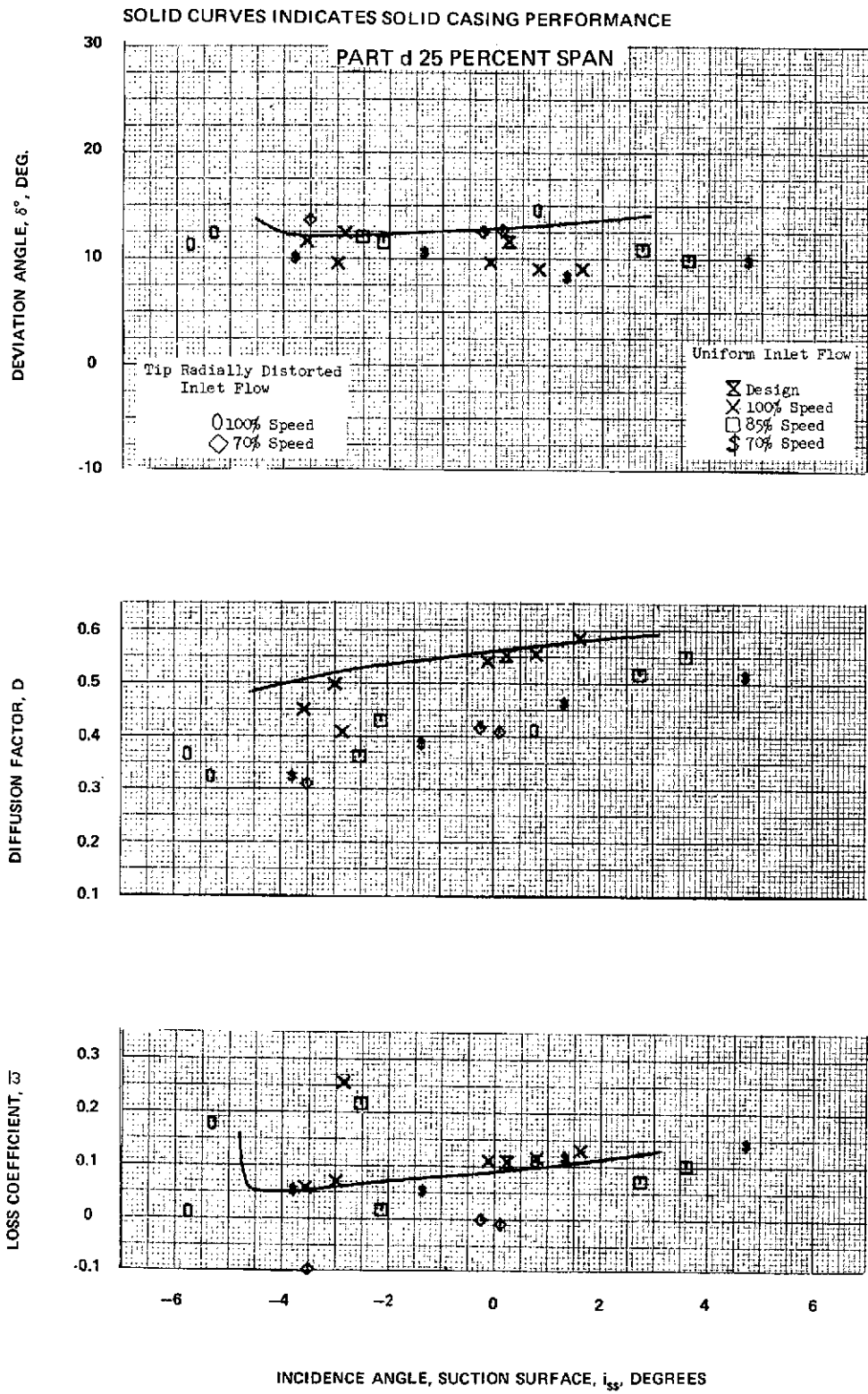

Figure 29 (Cont'd) Rotor 2 Blade-Element Performance Data for Uniform and Tip Radially Distorted Inlet Flow With Casing Treatment – Solid Casing Curves Shown for Comparison

SOLID CURVES INDICATES SOLID CASING PERFORMANCE

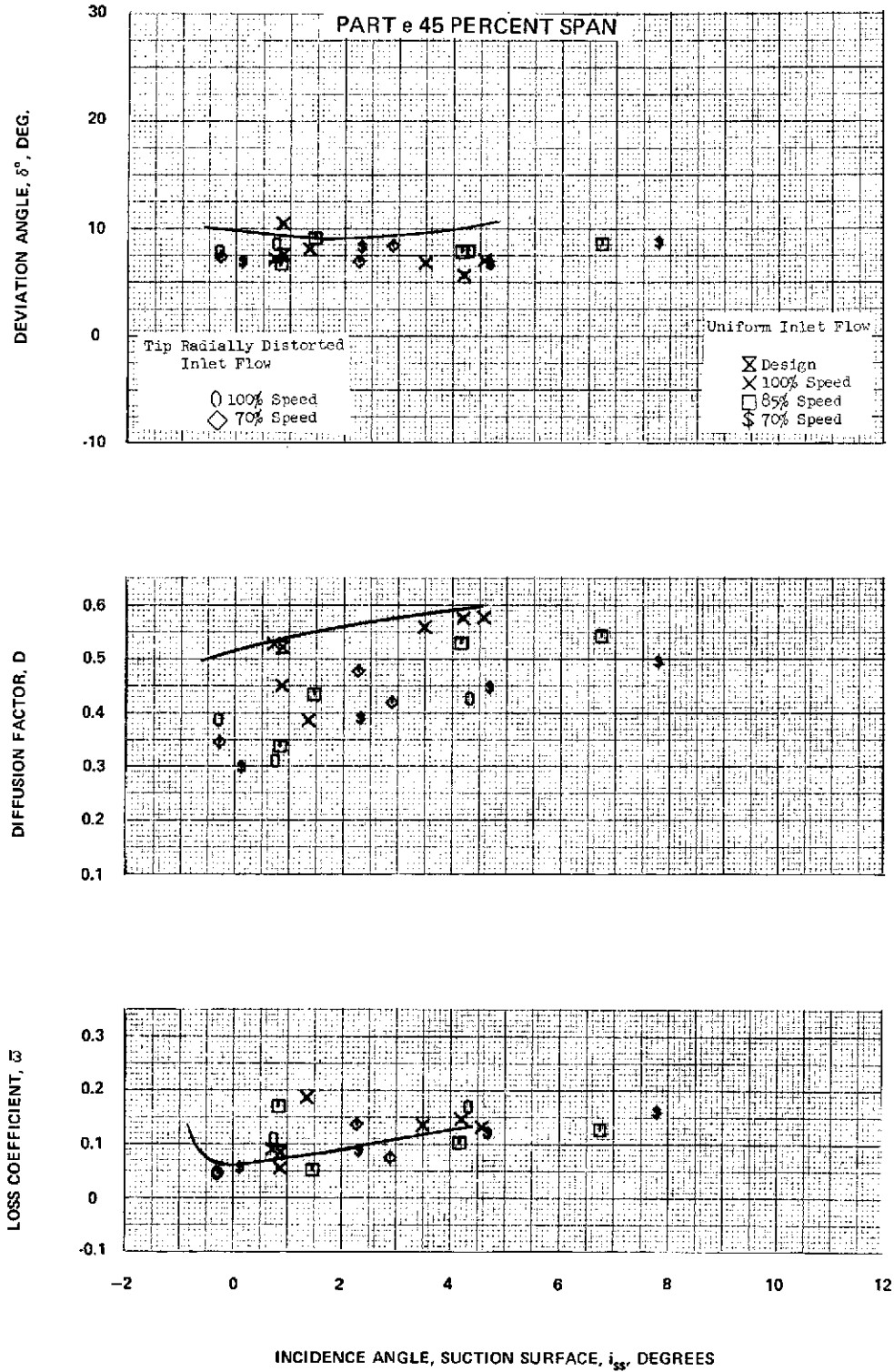

Figure 29 (Cont'd) Rotor 2 Blade-Element Performance Data for Uniform and Tip Radially Distorted Inlet Flow With Casing Treatment – Solid Casing Curves Shown for Comparison

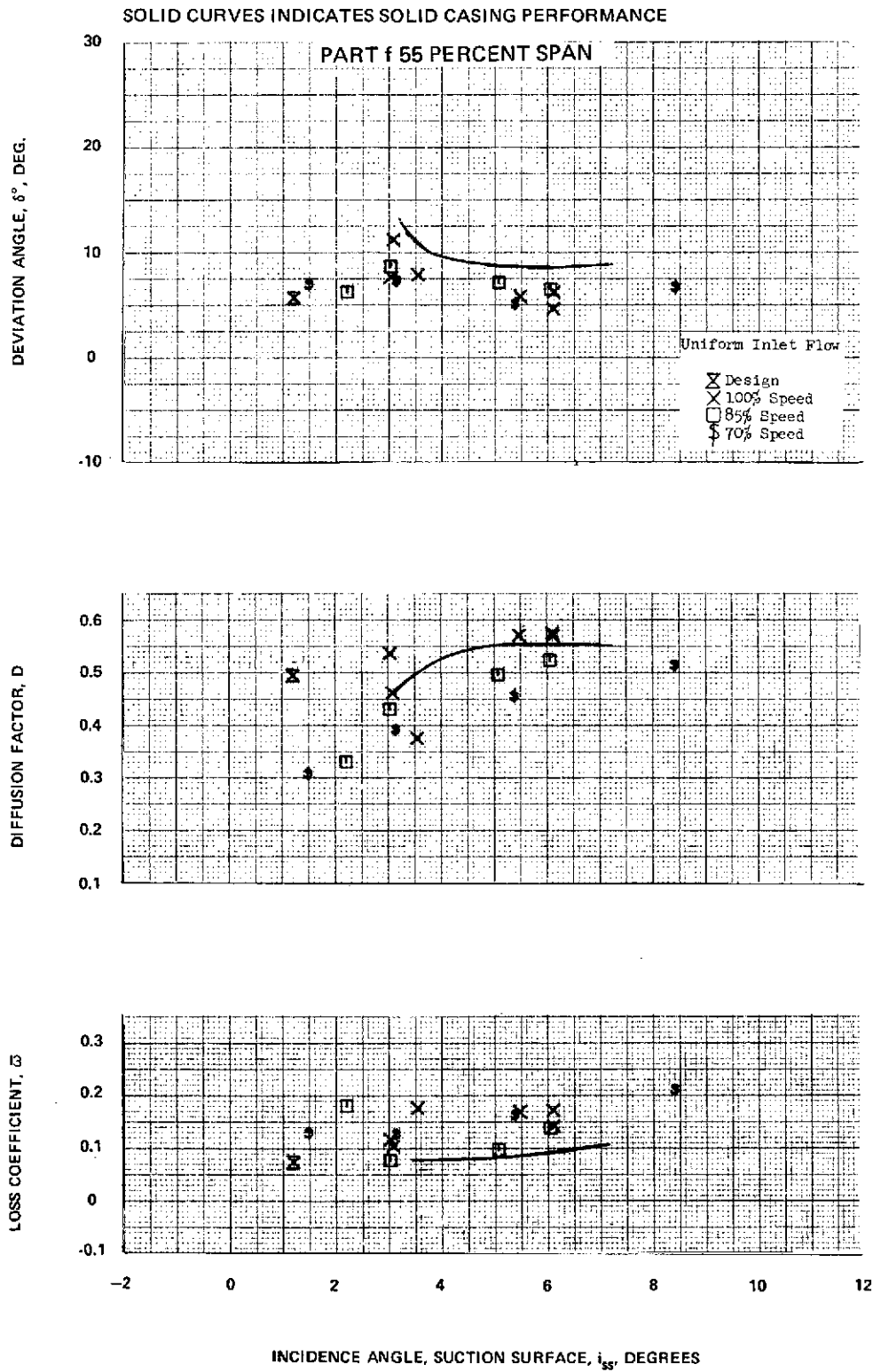

Figure 29 (Cont'd) Rotor 2 Blade-Element Performance Data for Uniform and Tip Radially Distorted Inlet Flow With Casing Treatment – Solid Casing Curves Shown for Comparison

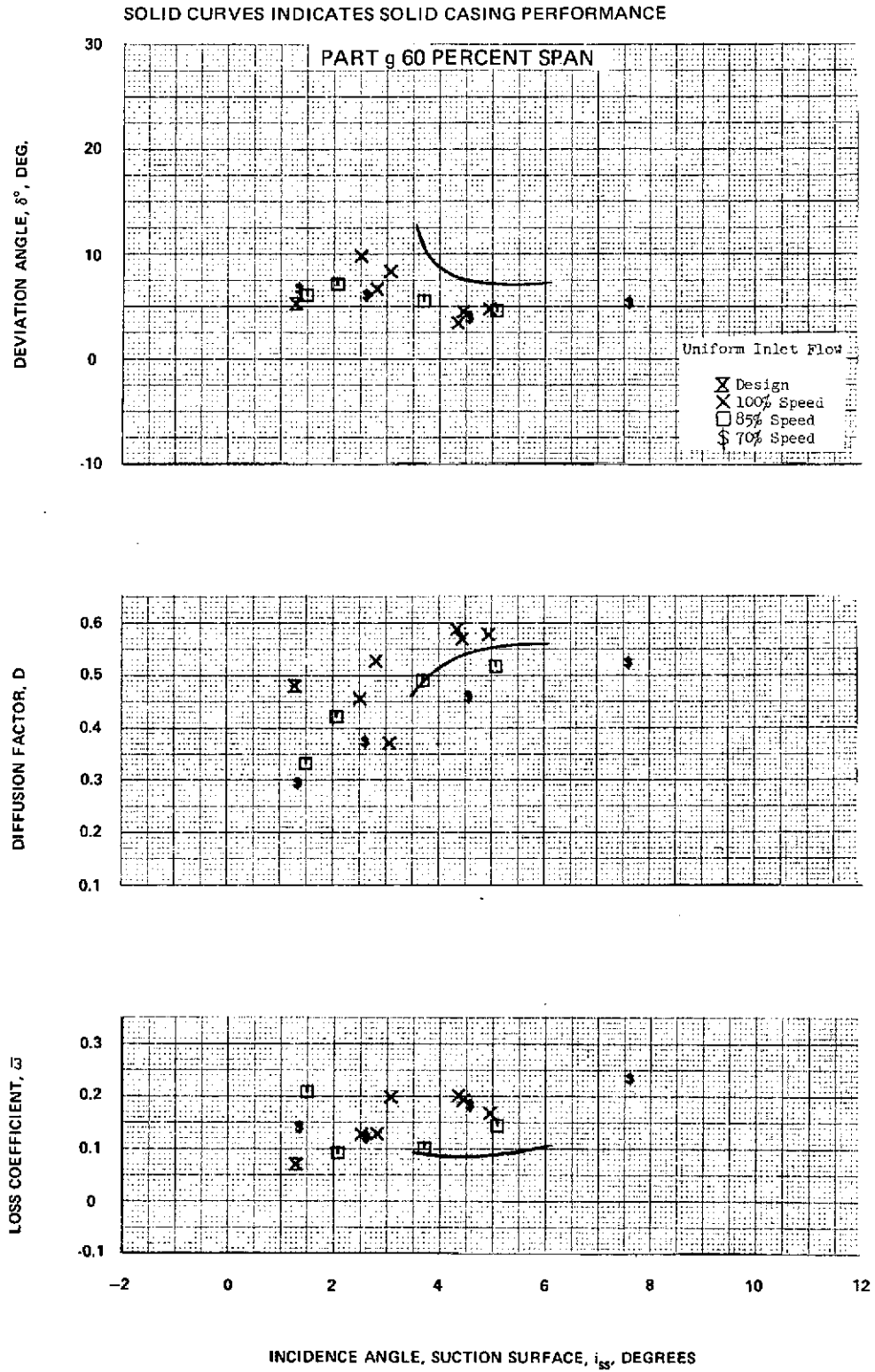

Figure 29 (Cont'd) Rotor 2 Blade-Element Performance Data for Uniform and Tip Radially Distorted Inlet Flow With Casing Treatment – Solid Casing Curves Shown for Comparison

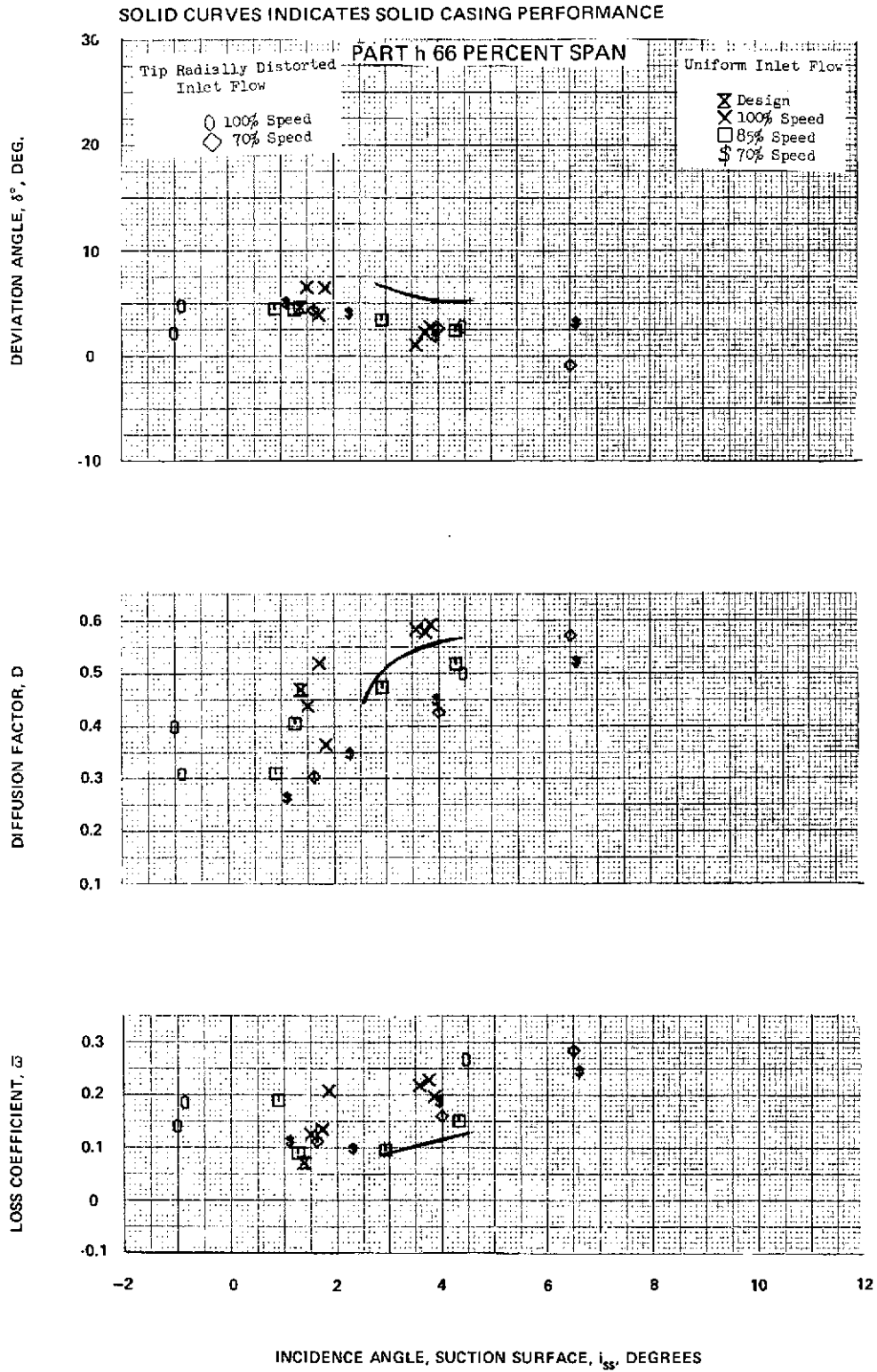

Figure 29 (Cont'd) Rotor 2 Blade-Element Performance Data for Uniform and Tip Radially Distorted Inlet Flow With Casing Treatment – Solid Casing Curves Shown for Comparison

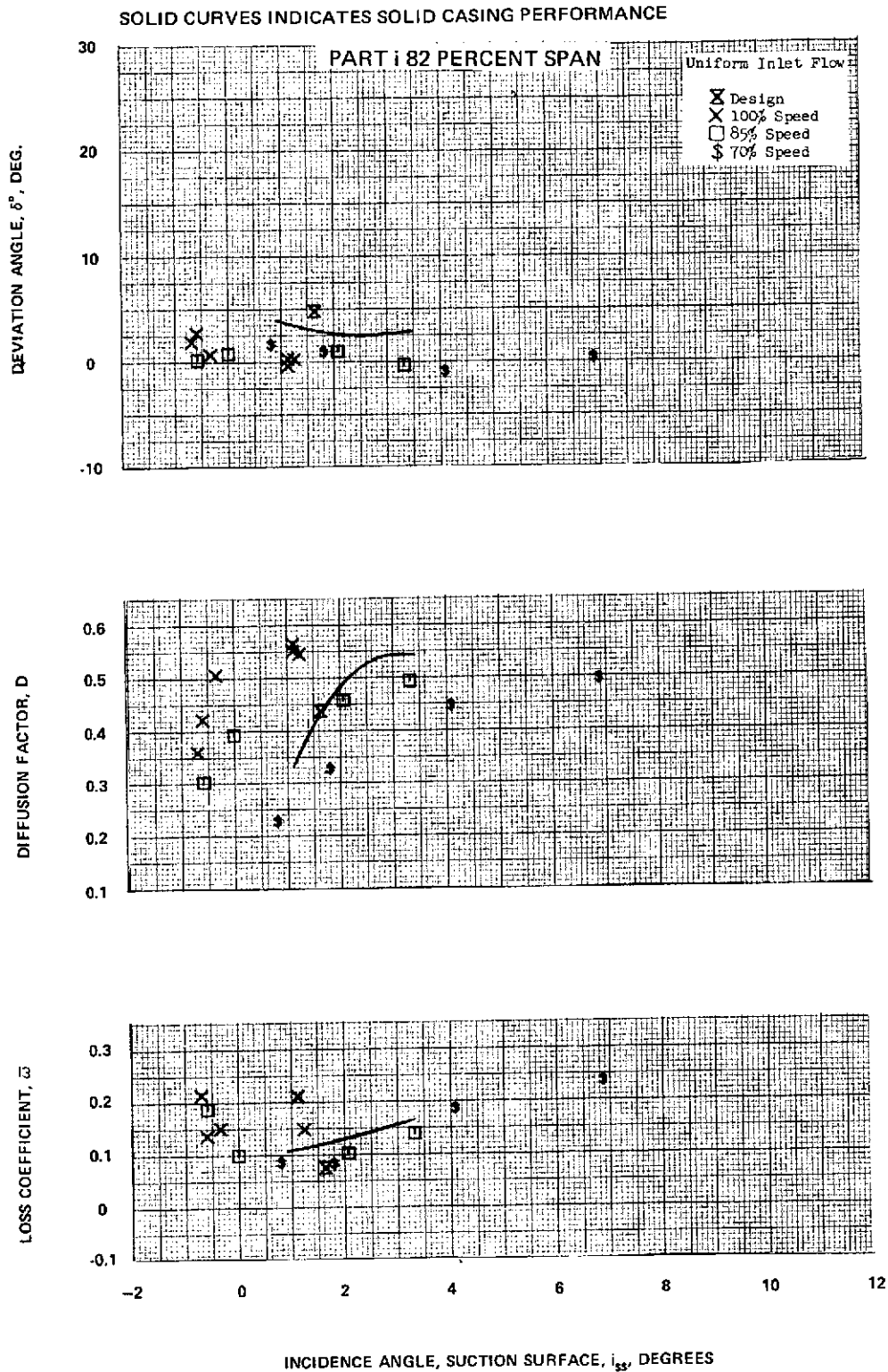

Figure 29 (Cont'd) Rotor 2 Blade-Element Performance Data for Uniform and Tip Radially Distorted Inlet Flow With Casing Treatment – Solid Casing Curves Shown for Comparison

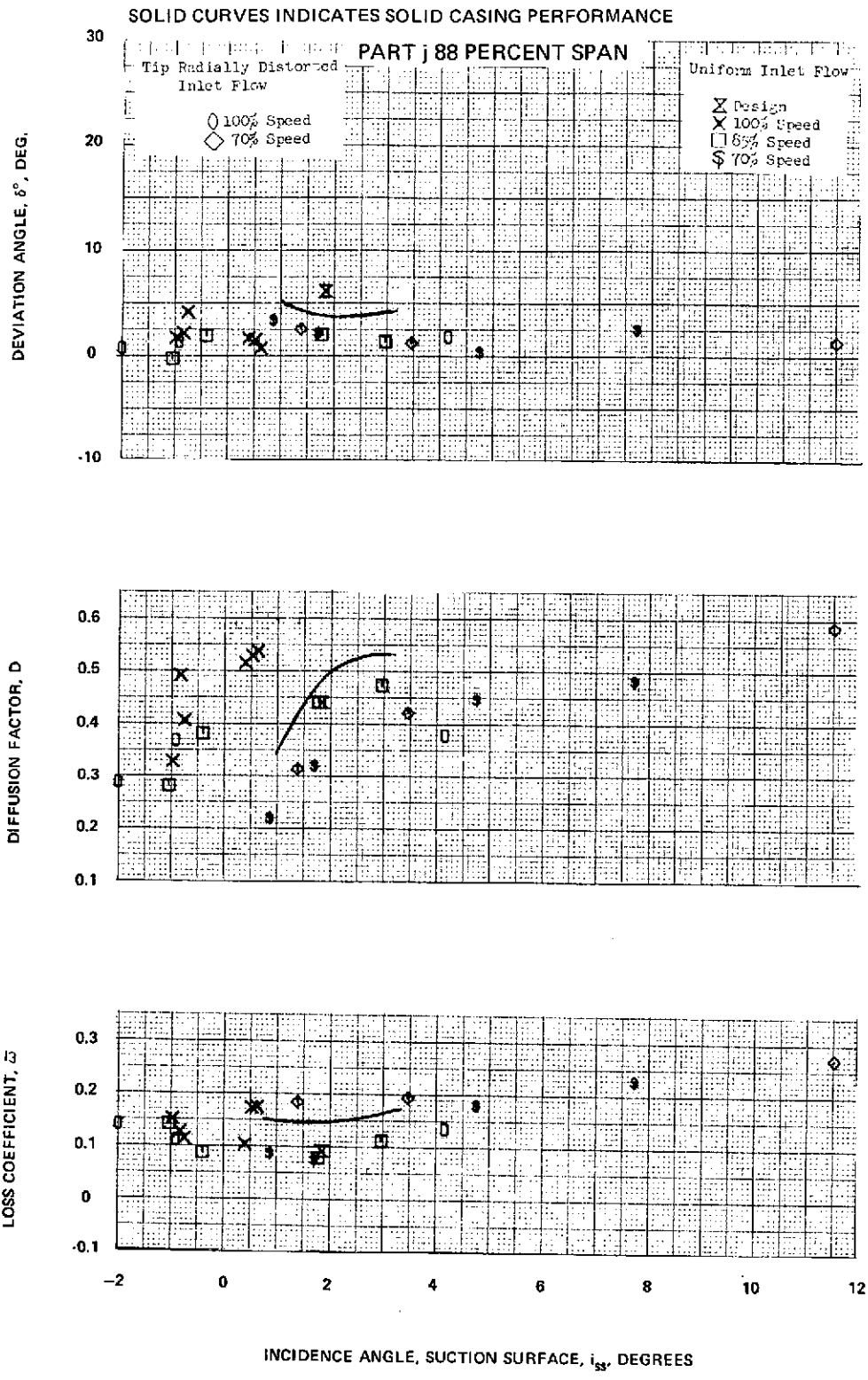

Figure 29 (Cont'd) Rotor 2 Blade-Element Performance Data for Uniform and Tip Radially Distorted Inlet Flow With Casing Treatment – Solid Casing Curves Shown for Comparison

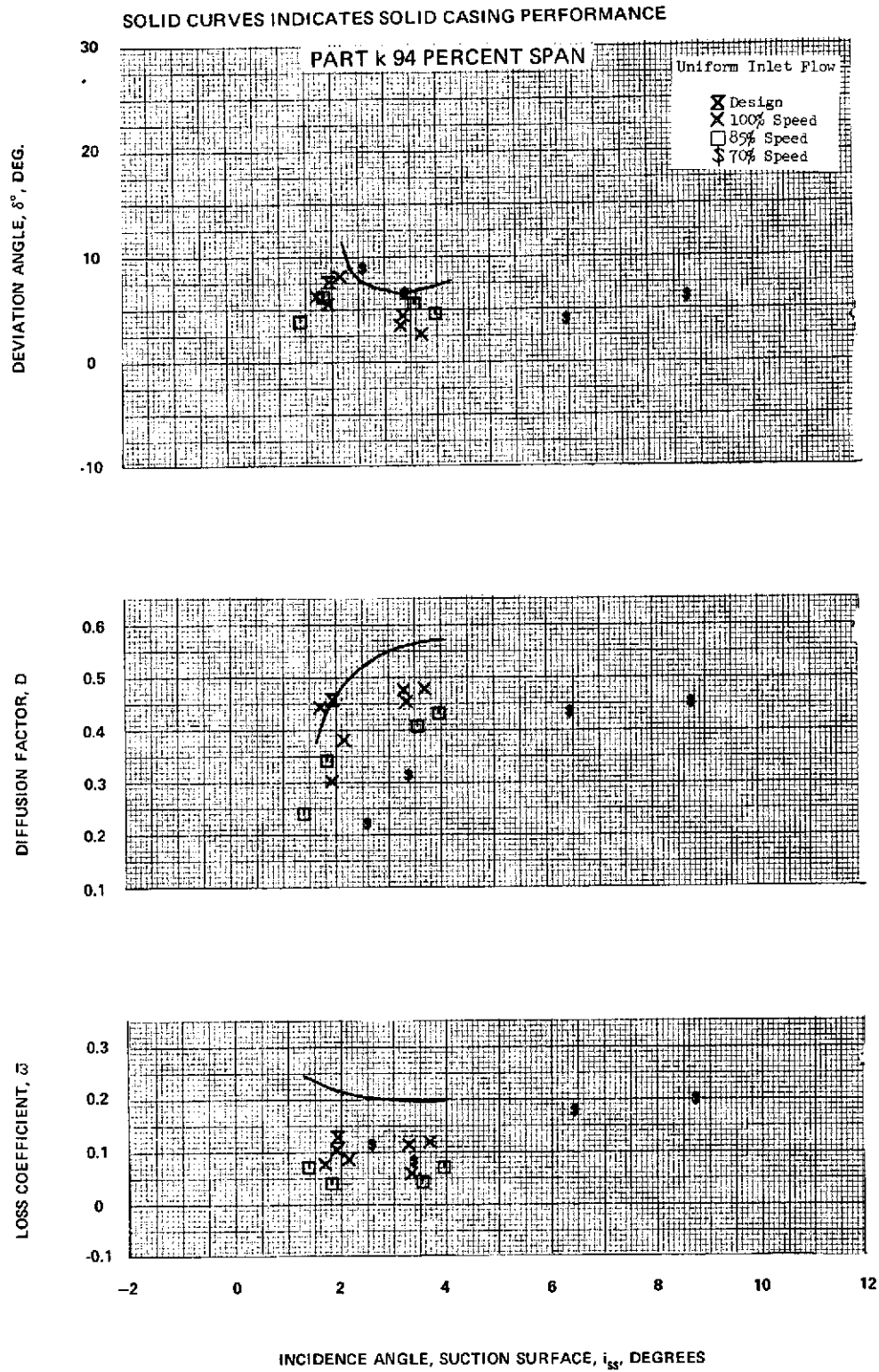

Figure 29 (Cont'd) Rotor 2 Blade-Element Performance Data for Uniform and Tip Radially Distorted Inlet Flow With Casing Treatment – Solid Casing Curves Shown for Comparison

SOLID CURVES INDICATES SOLID CASING PERFORMANCE

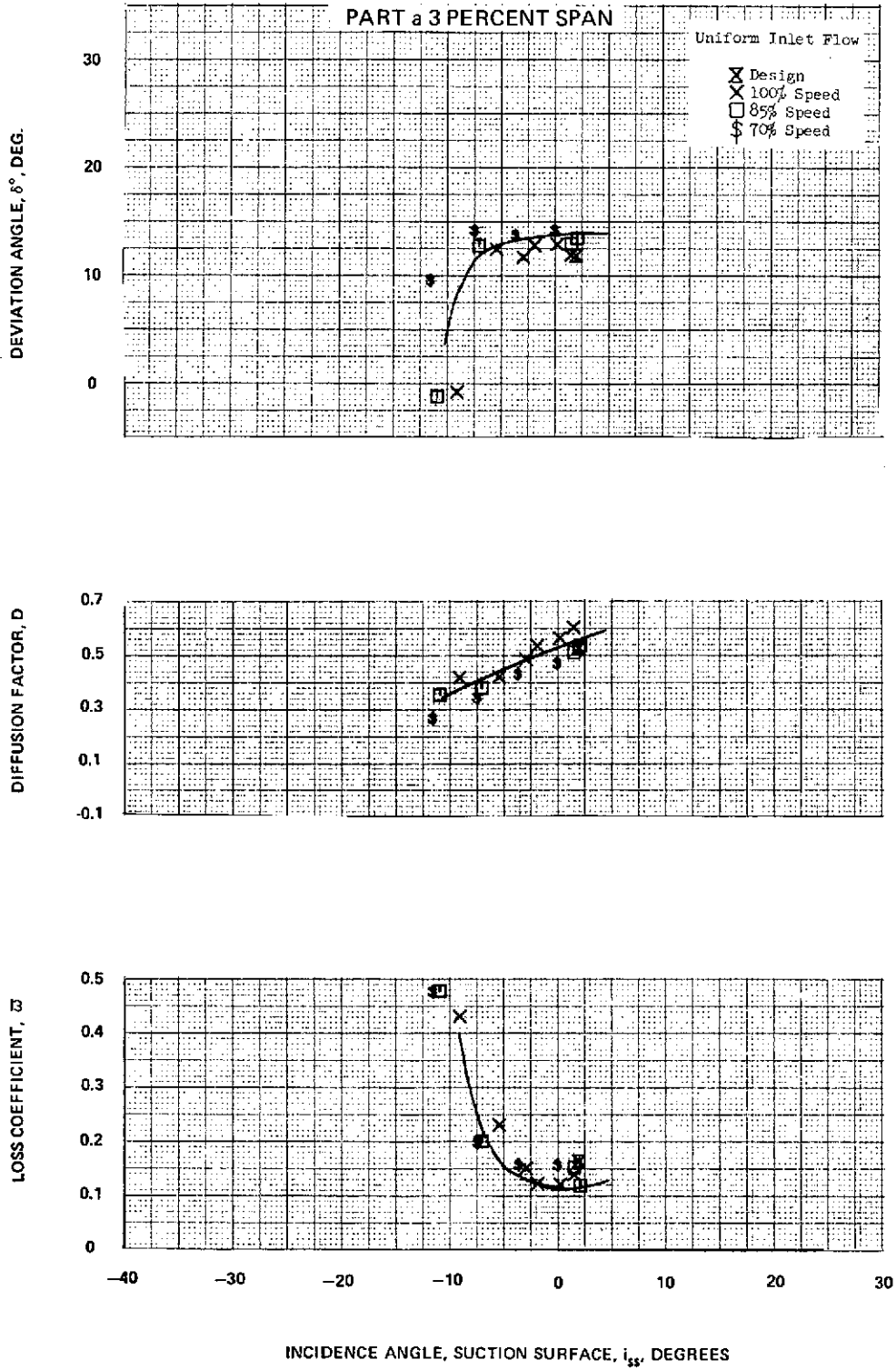

Figure 30 Stator 2 Blade-Element Performance Data for Uniform and Tip Radially Distorted Inlet Flow With Casing Treatment – Solid Casing Curves Shown for Comparison

SOLID CURVES INDICATES SOLID CASING PERFORMANCE

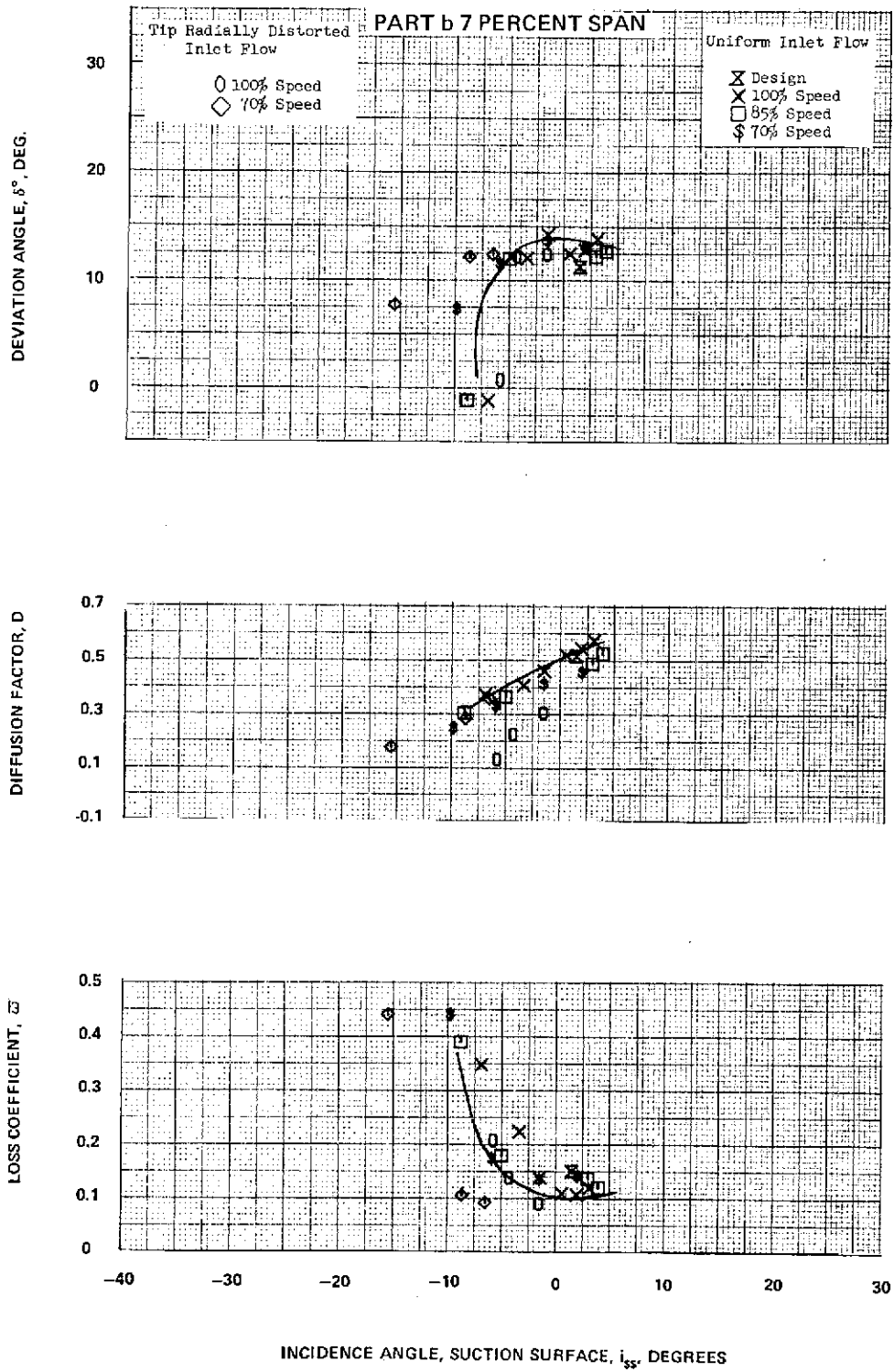

Figure 30 (Cont'd) Stator 2 Blade-Element Performance Data for Uniform and Tip Radially Distorted Inlet Flow With Casing Treatment – Solid Casing Curves Shown for Comparison

C-2

SOLID CURVES INDICATES SOLID CASING PERFORMANCE

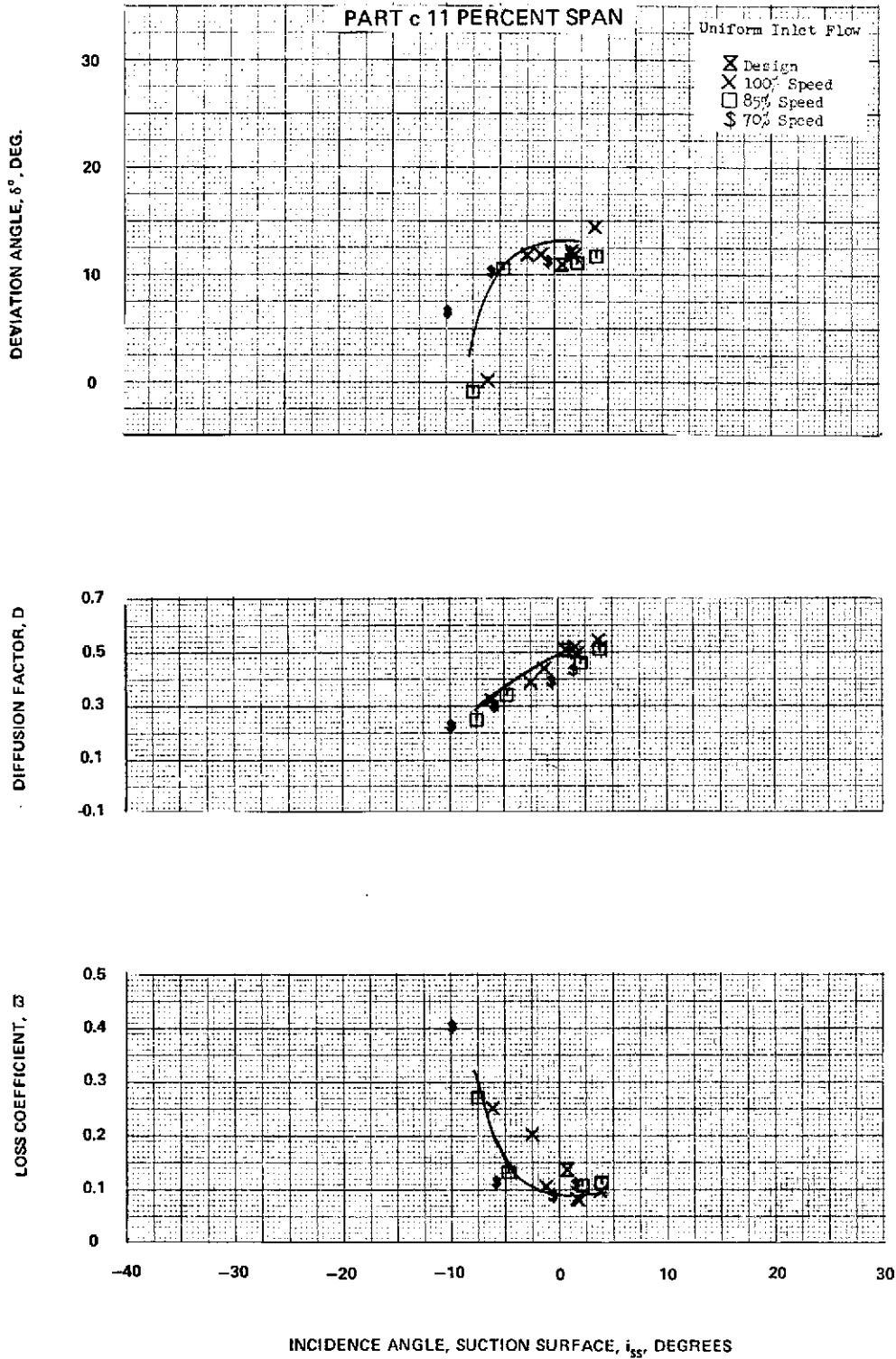

Figure 30 (Cont'd) Stator 2 Blade-Element Performance Data for Uniform and Tip Radially Distorted Inlet Flow With Casing Treatment – Solid Casing Curves Shown for Comparison

SOLID CURVES INDICATES SOLID CASING PERFORMANCE

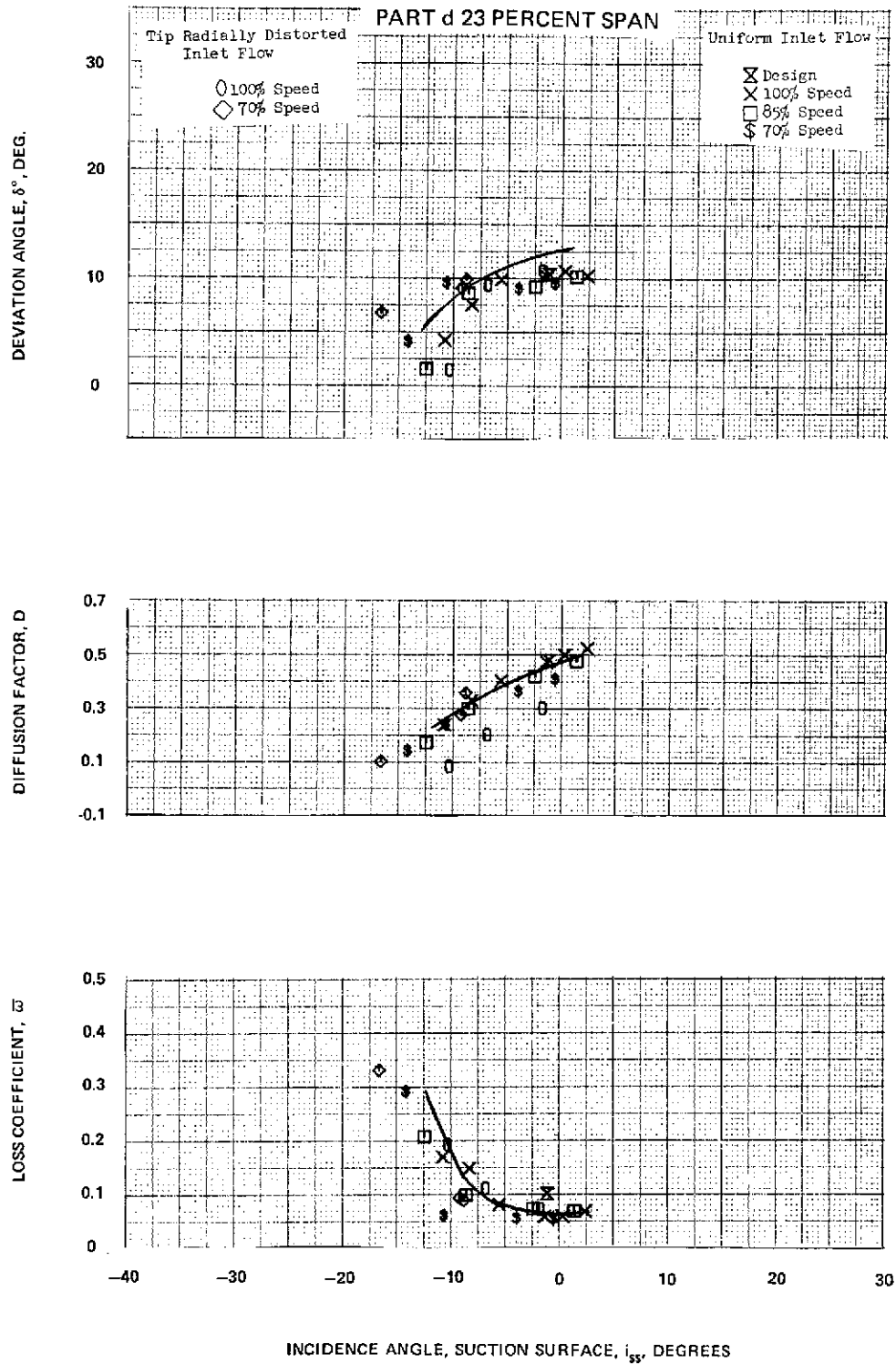

Figure 30 (Cont'd) Stator 2 Blade-Element Performance Data for Uniform and Tip Radially Distorted Inlet Flow With Casing Treatment – Solid Casing Curves Shown for Comparison

SOLID CURVES INDICATES SOLID CASING PERFORMANCE

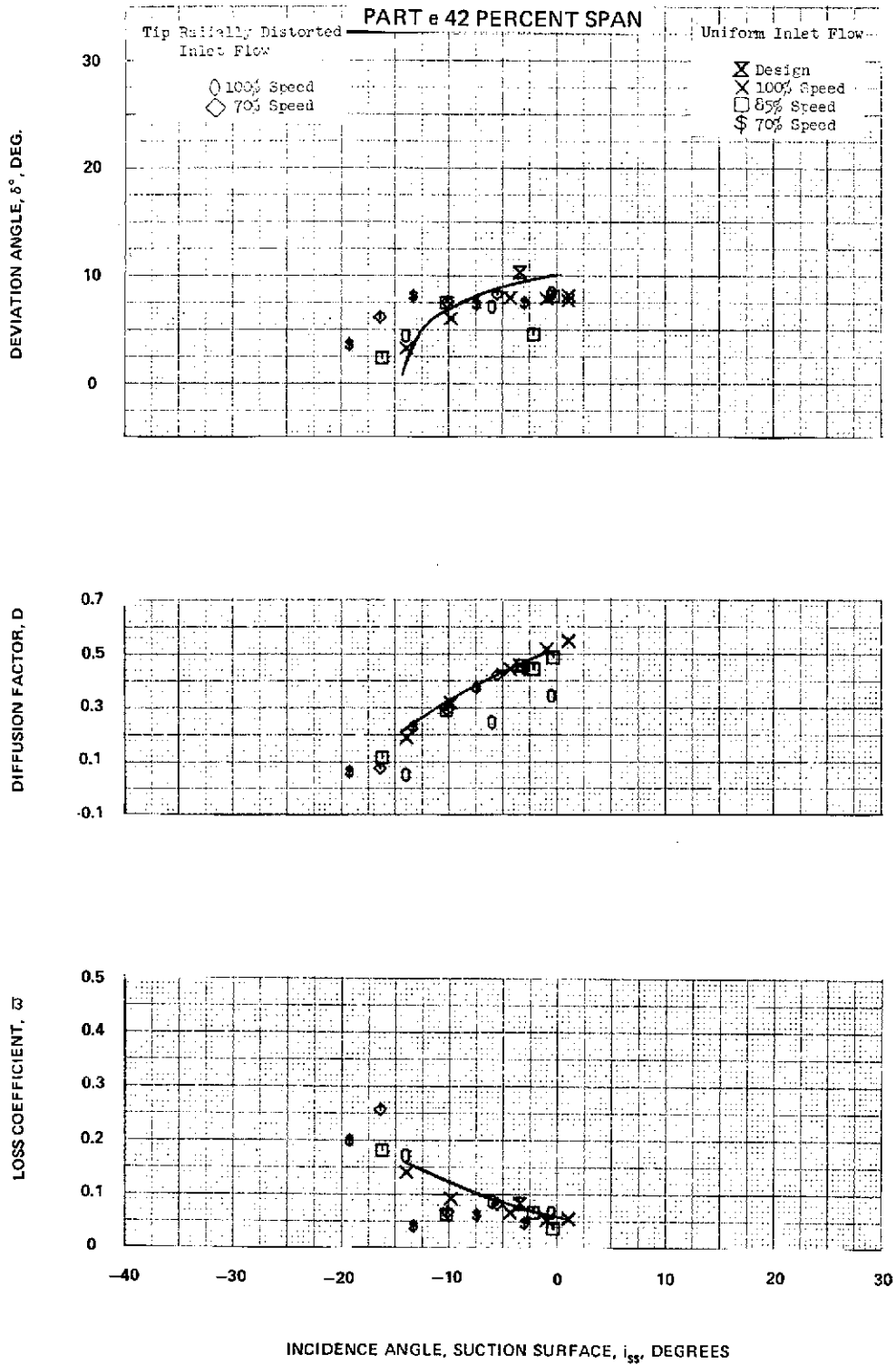

Figure 30 (Cont'd) Stator 2 Blade-Element Performance Data for Uniform and Tip Radially Distorted Inlet Flow With Casing Treatment – Solid Casing Curves Shown for Comparison

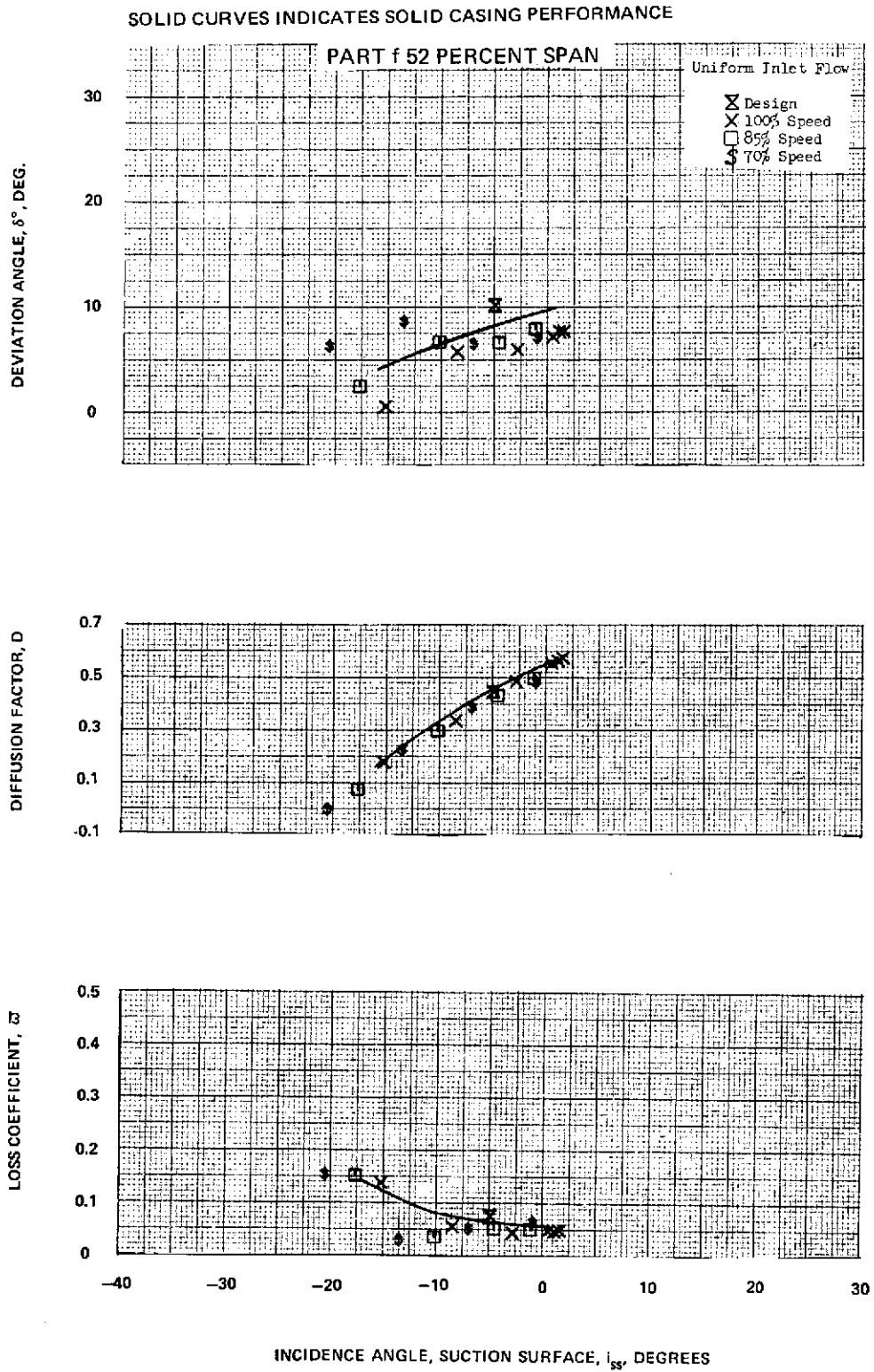

Figure 30 (Cont'd) Stator 2 Blade-Element Performance Data for Uniform and Tip Radially Distorted Inlet Flow With Casing Treatment – Solid Casing Curves Shown for Comparison

SOLID CURVES INDICATES SOLID CASING PERFORMANCE

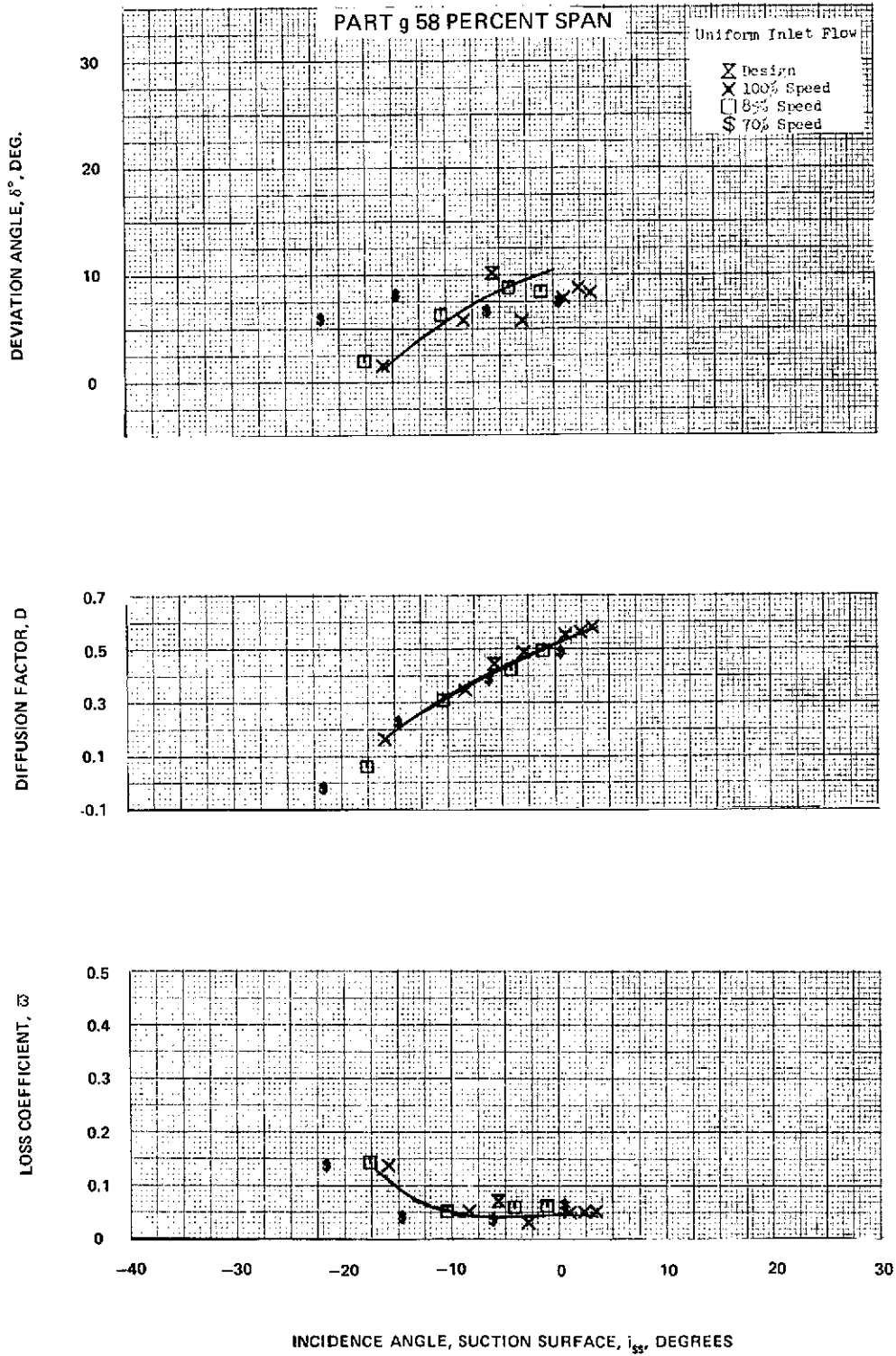

Figure 30 (Cont'd) Stator 2 Blade-Element Performance Data for Uniform and Tip Radially Distorted Inlet Flow With Casing Treatment – Solid Casing Curves Shown for Comparison

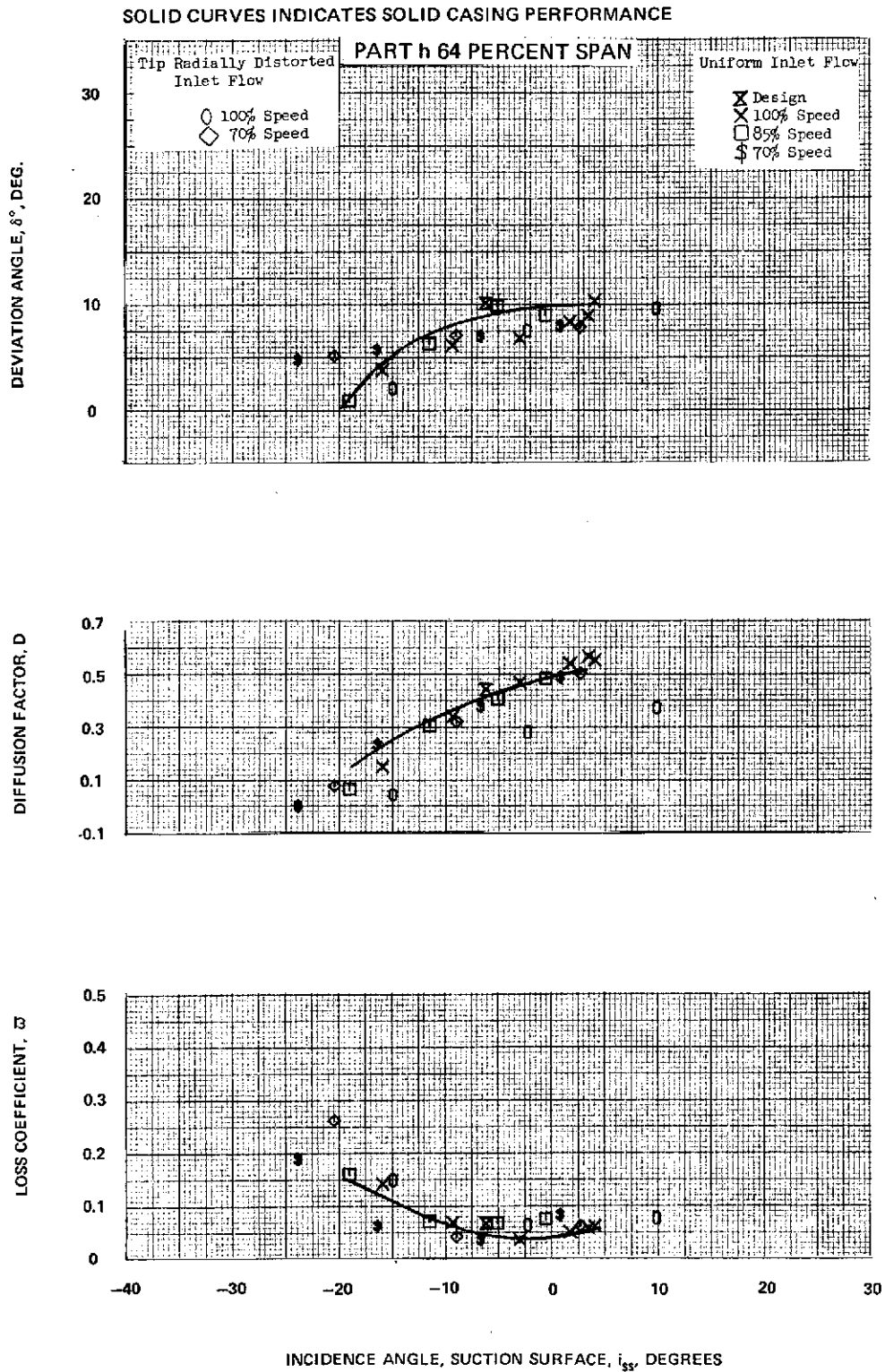

Figure 30 (Cont'd) Stator 2 Blade-Element Performance Data for Uniform and Tip Radially Distorted Inlet Flow With Casing Treatment – Solid Casing Curves Shown for Comparison

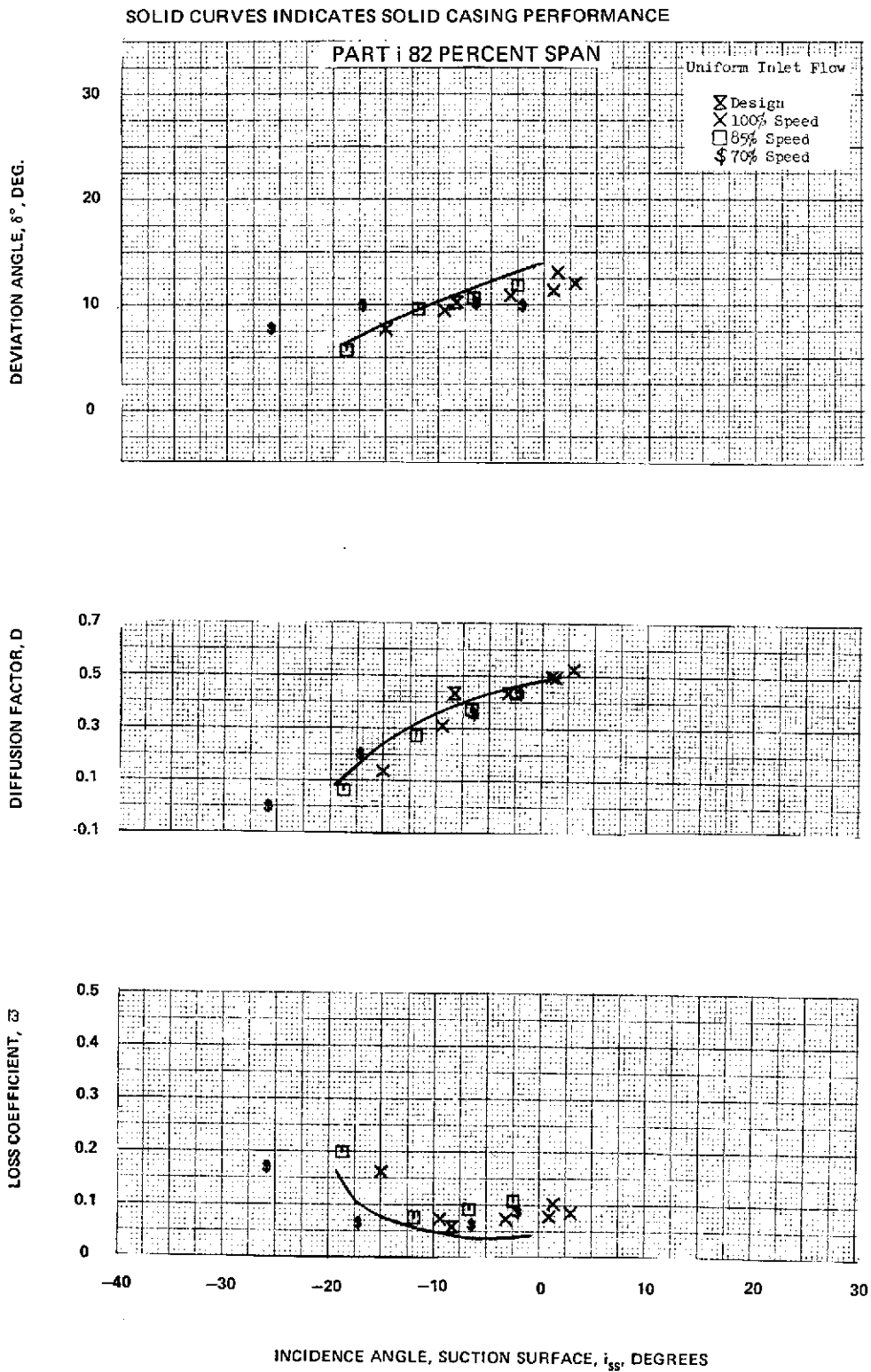

Figure 30 (Cont'd) Stator 2 Blade-Element Performance Data for Uniform and Tip Radially Distorted Inlet Flow With Casing Treatment – Solid Casing Curves Shown for Comparison

SOLID CURVES INDICATES SOLID CASING PERFORMANCE

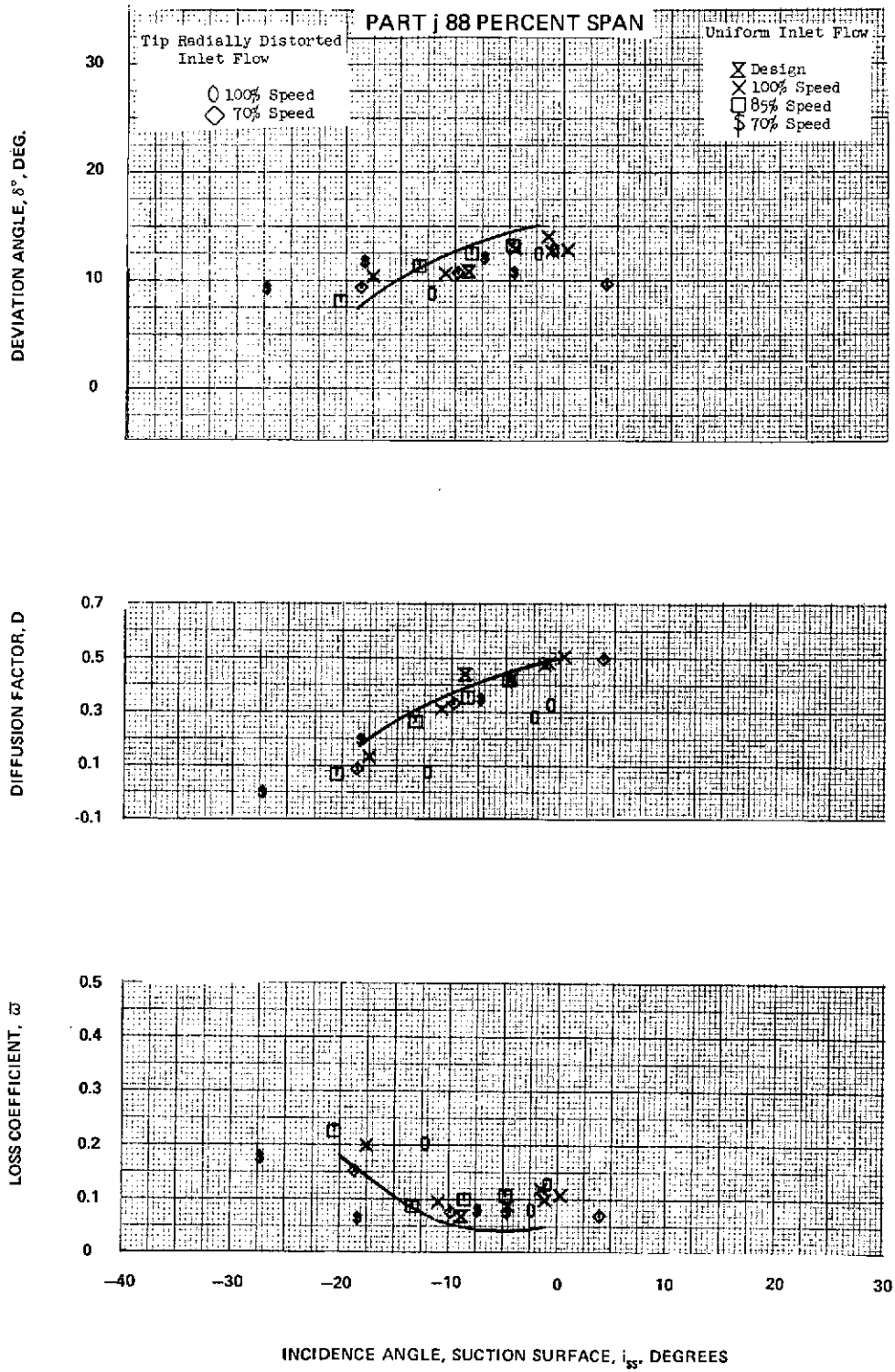

Figure 30 (Cont'd) Stator 2 Blade-Element Performance Data for Uniform and Tip Radially Distorted Inlet Flow With Casing Treatment – Solid Casing Curves Shown for Comparison

SOLID CURVES INDICATES SOLID CASING PERFORMANCE

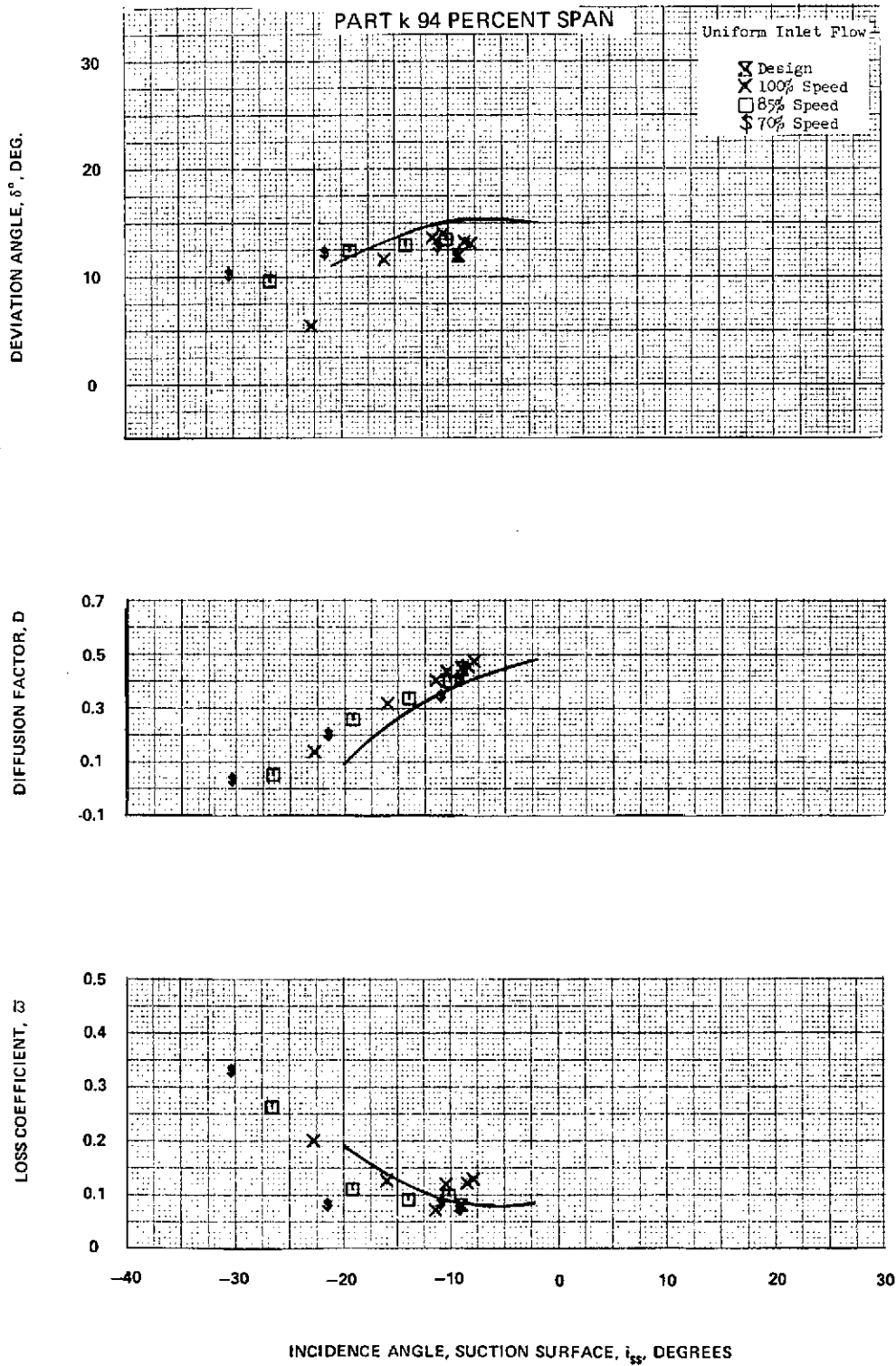

Figure 30 (Cont'd) Stator 2 Blade-Element Performance Data for Uniform and Tip Radially Distorted Inlet Flow With Casing Treatment – Solid Casing Curves Shown for Comparison

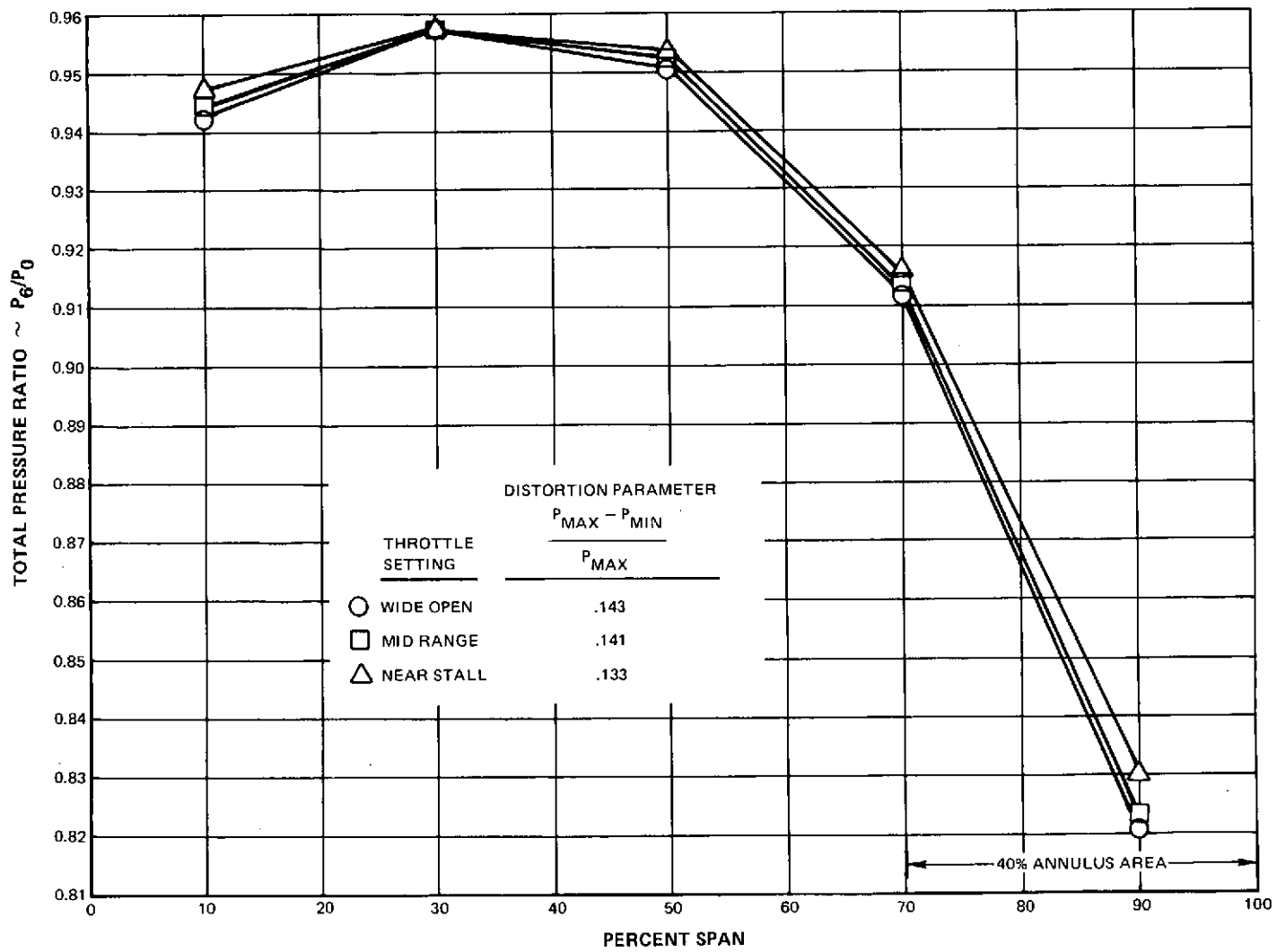

Figure 31 Rotor 1 Inlet Total Pressure Ratio Versus Span for Tip Radially Distorted Inlet Flow at Design Speed With Casing Treatment

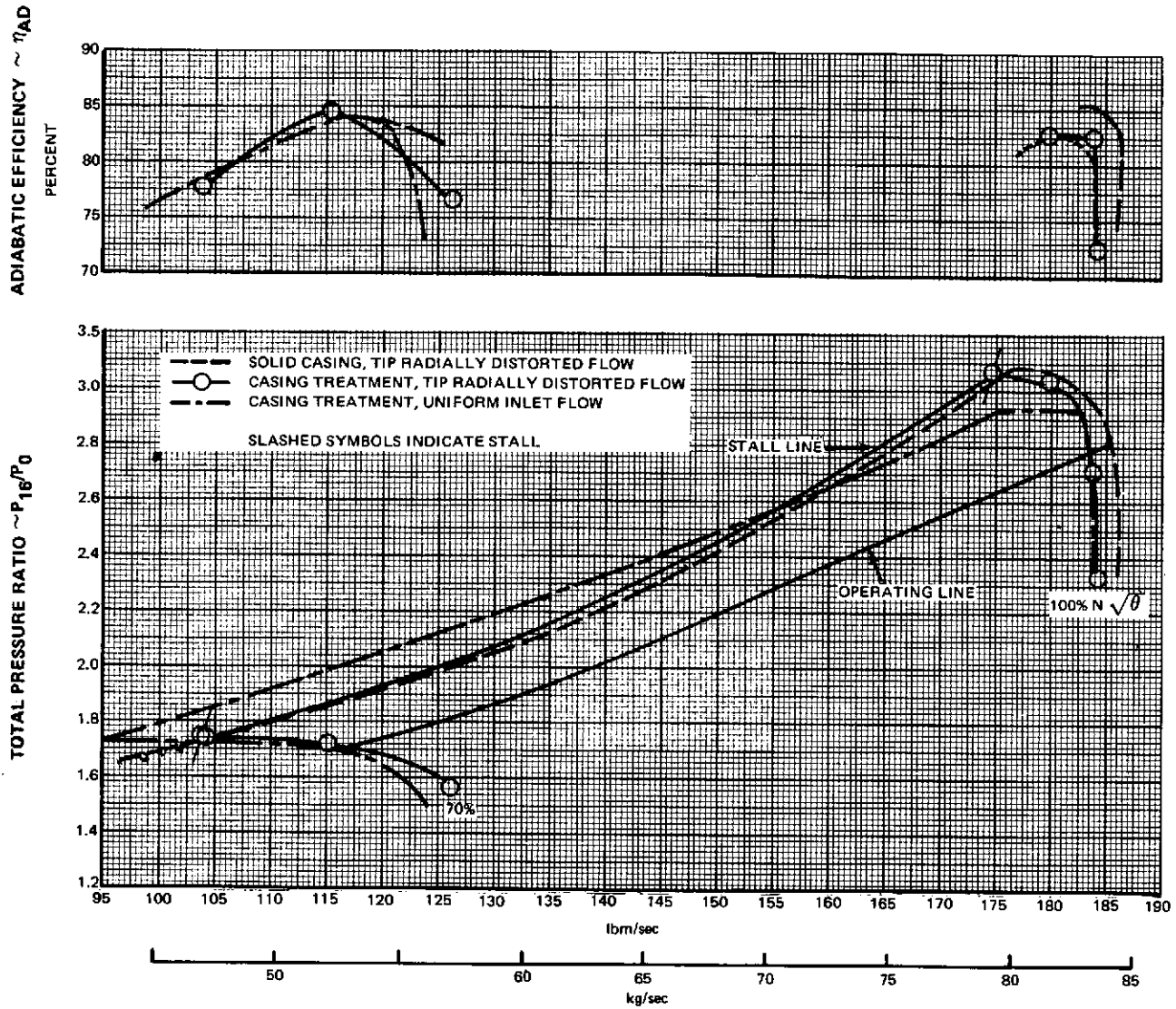

Figure 32 Fan Overall Performance for Tip Radially Distorted Inlet Flow With Casing Treatment – Performance With Uniform Inlet Flow and With Solid Casings Shown for Comparison

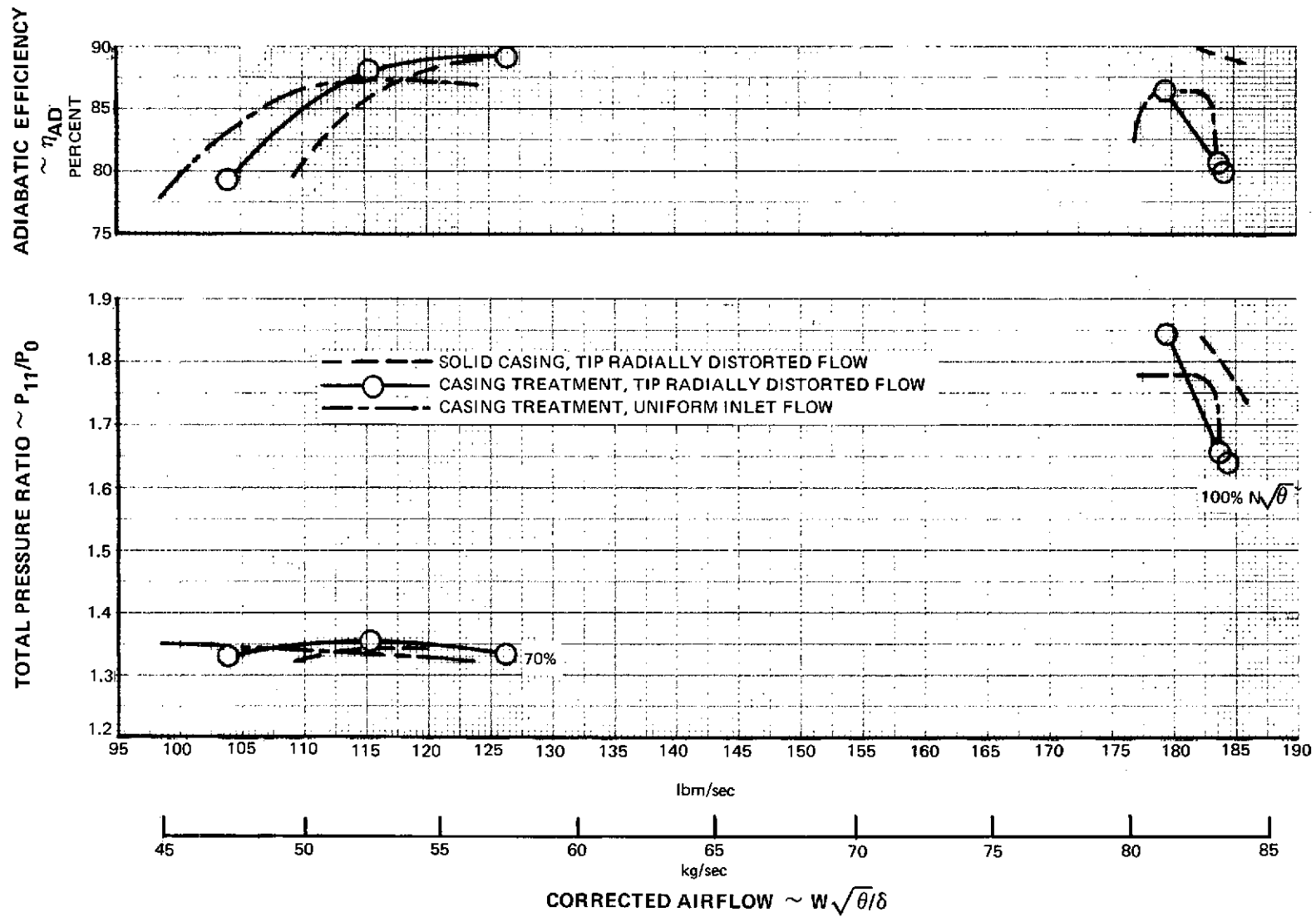

Figure 33 First-Stage Performance for Tip Radially Distorted Inlet Flow With Casing Treatment – Performance With Uniform Inlet Flow and With Solid Casings Shown for Comparison

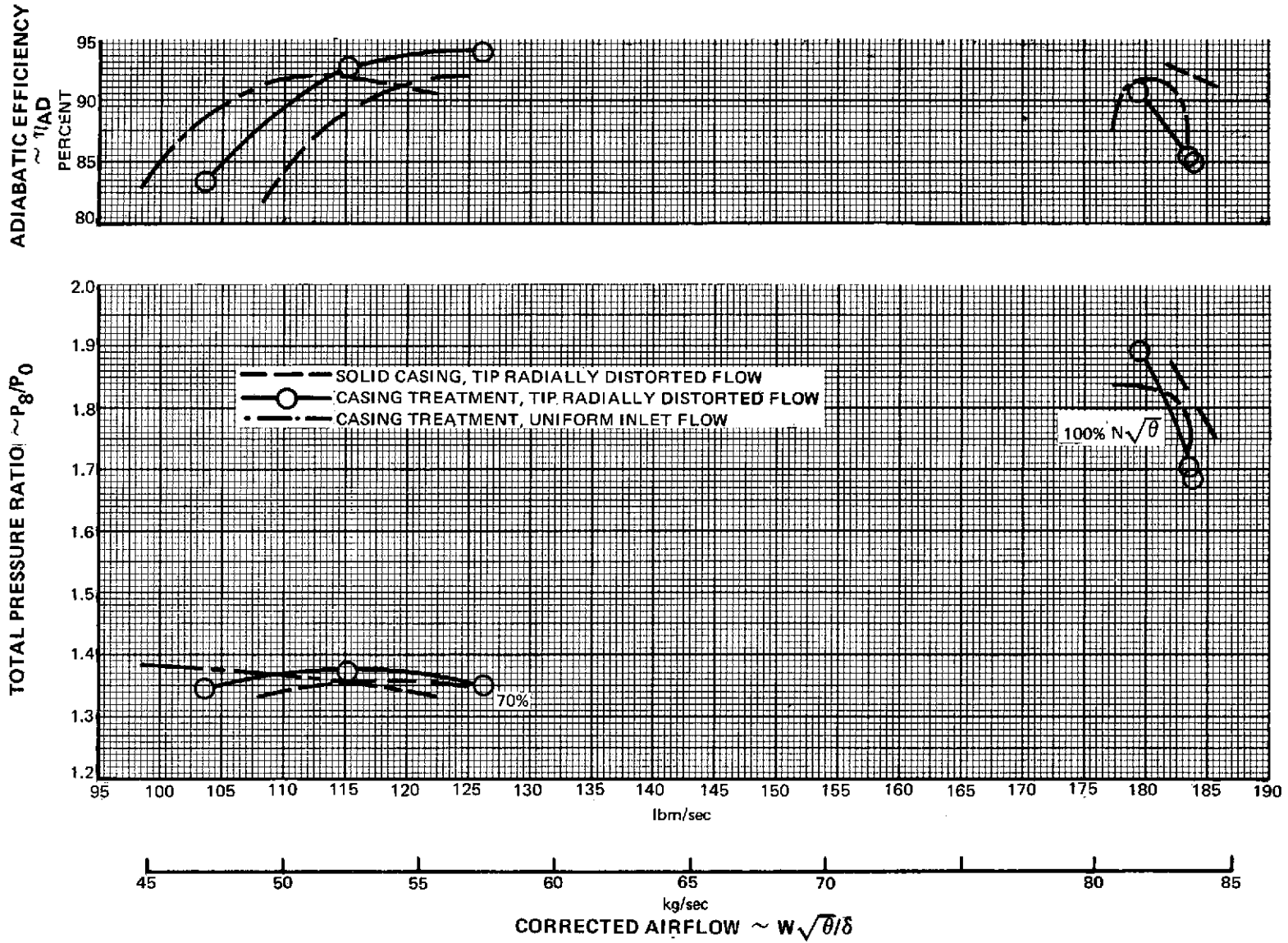

Figure 34 Rotor 1 Performance for Tip Radially Distorted Inlet Flow With Casing Treatment – Performance With Uniform Inlet Flow and With Solid Casings Shown for Comparison

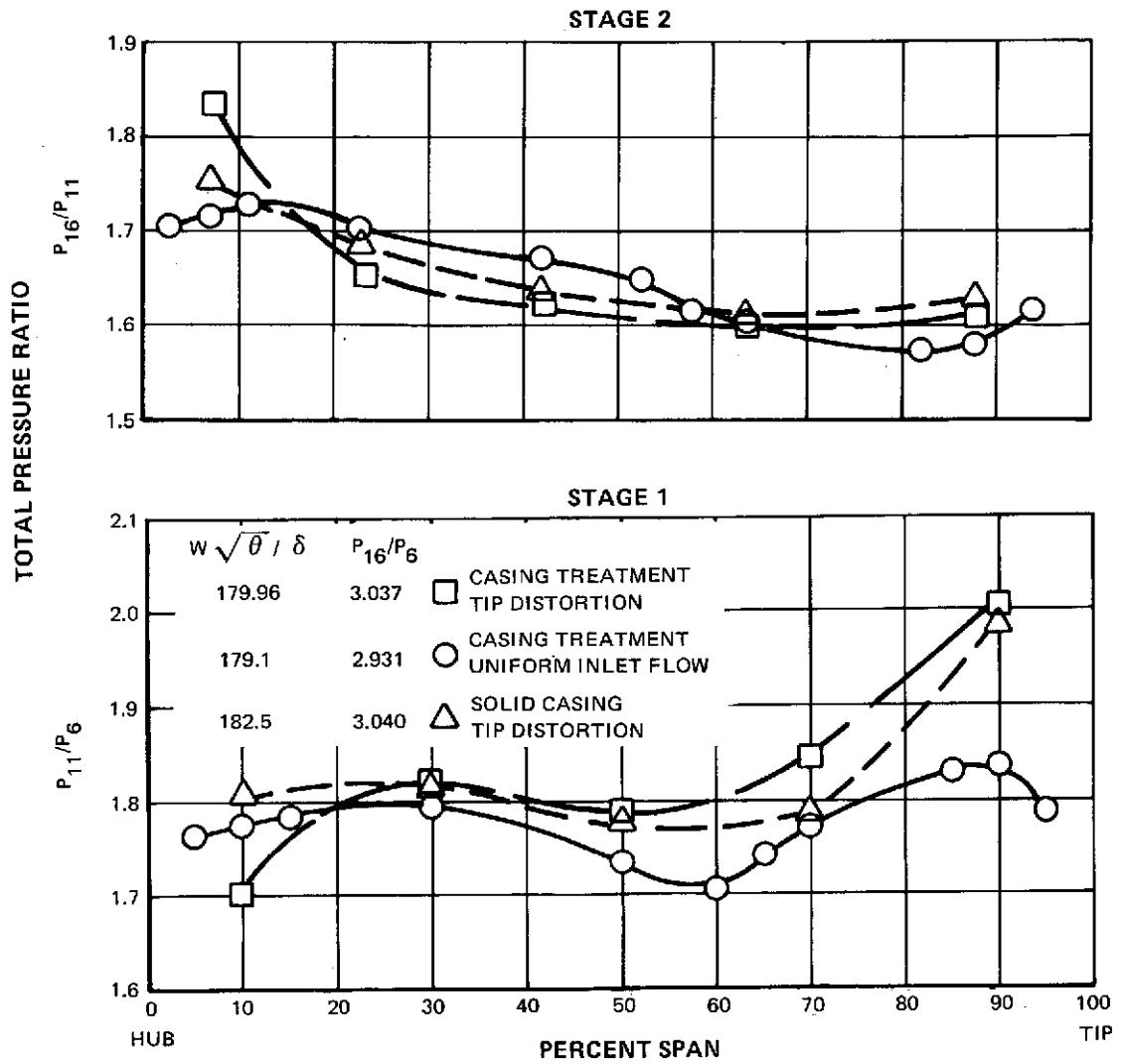

Figure 35 Radial Distribution of Total Pressure Ratio for Near-Stall Conditions for Tip Radially Distorted and Uniform Inlet Flow at Design Speed With Casing Treatment – Data With Solid Casings and Tip Radially Distorted Flow Shown for Comparison

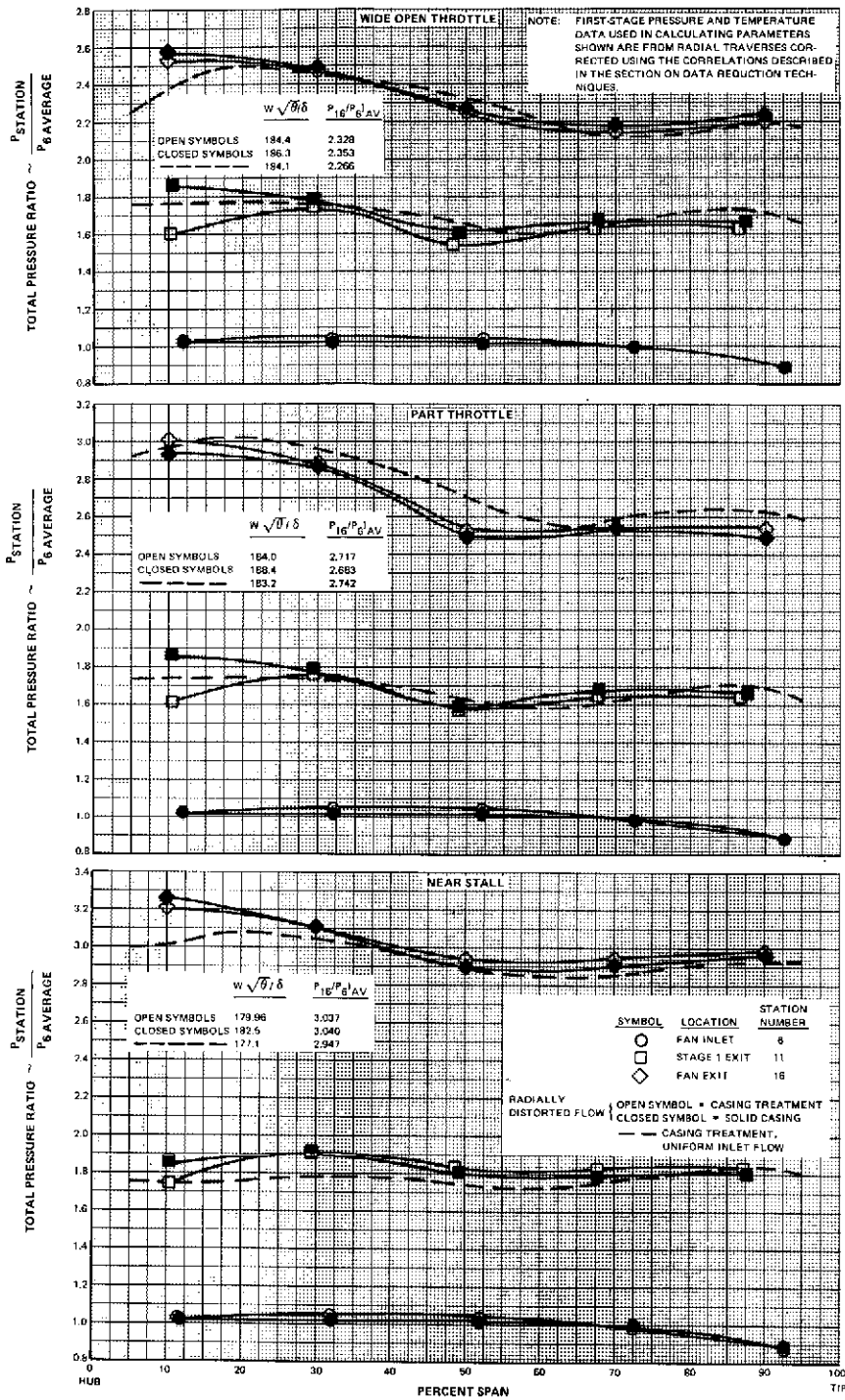

Figure 36 Total Pressure Ratio Versus Span at Fan Inlet, First-Stage Exit, and Fan Exit for Tip Radially Distorted and Uniform Inlet Flow at Design Speed With Casing Treatment – Data With Solid Casing and Tip Radially Distorted Flow Shown for Comparison

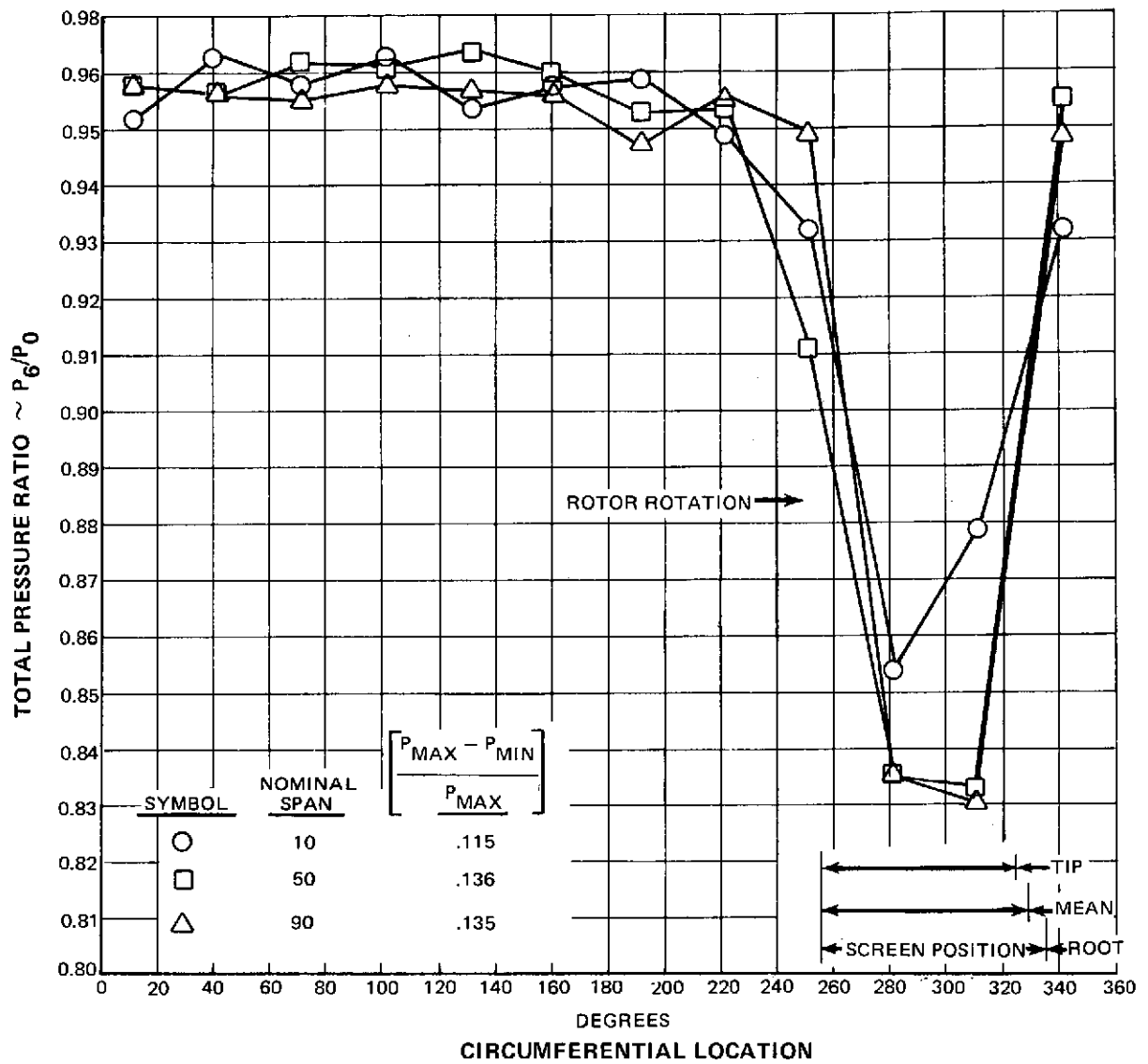

Figure 37 Circumferential Distribution of Total Pressure at Fan Inlet for Circumferentially Distorted Inlet Flow at a Near-Design Data Point With Casing Treatment

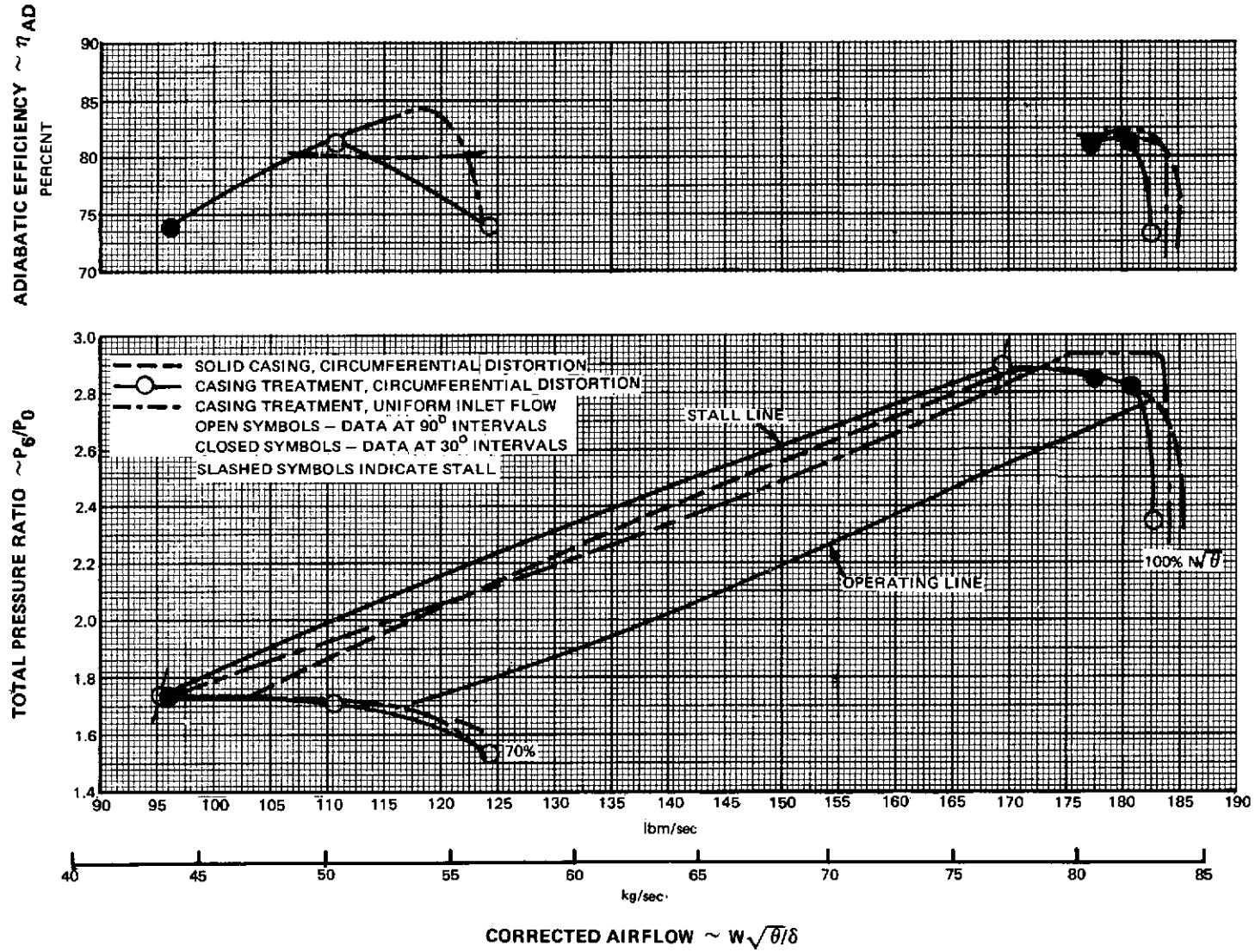

Figure 38 Fan Overall Performance for Circumferentially Distorted Inlet Flow With Casing Treatment – Performance with Uniform Inlet Flow and With Solid Casings Shown for Comparison

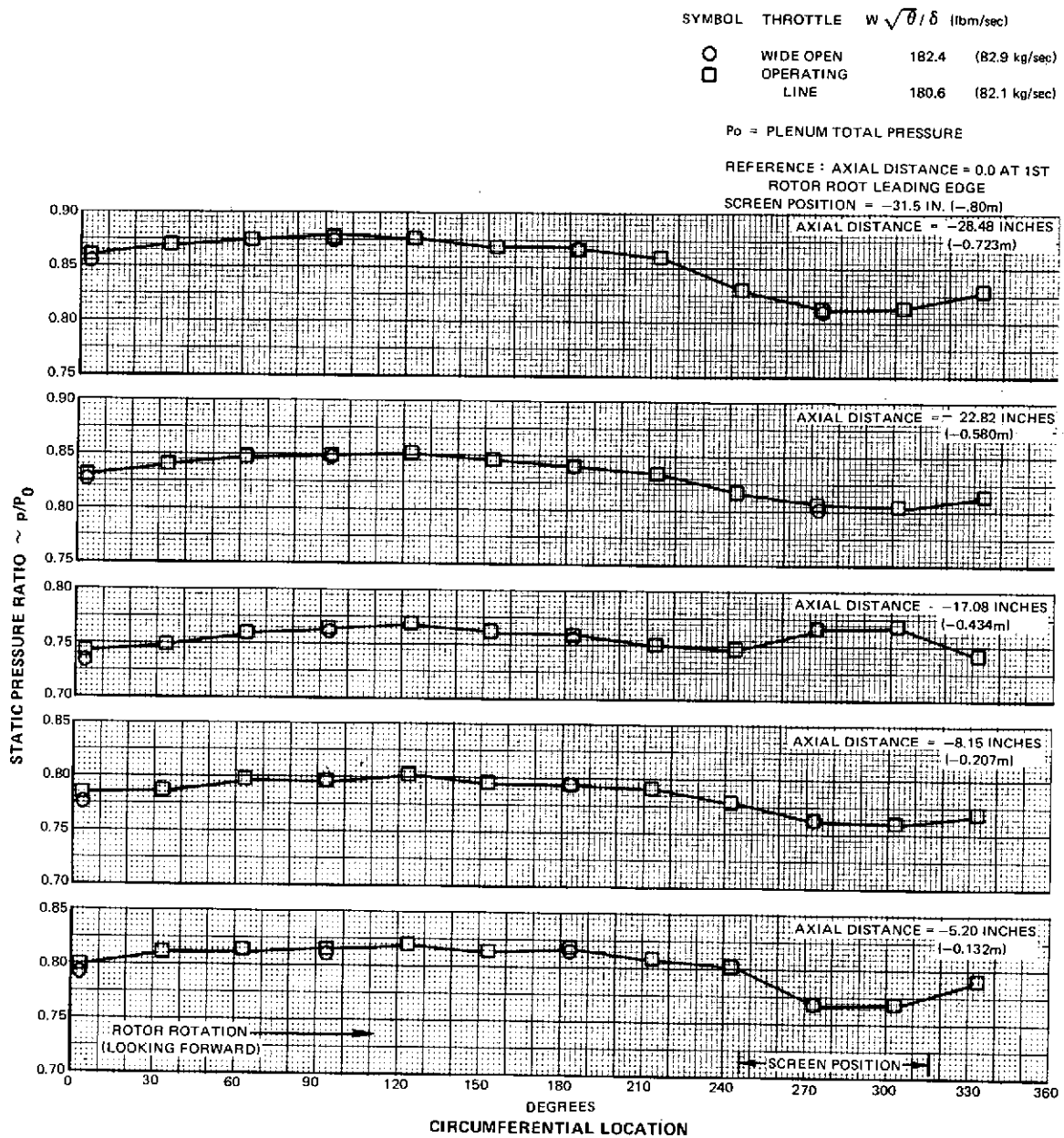

Figure 39 Circumferential Distributions of Rotor 1 Inlet Static Pressure at the Tip for Tests at Design Speed for Circumferentially Distorted Inlet Flow With Casing Treatment

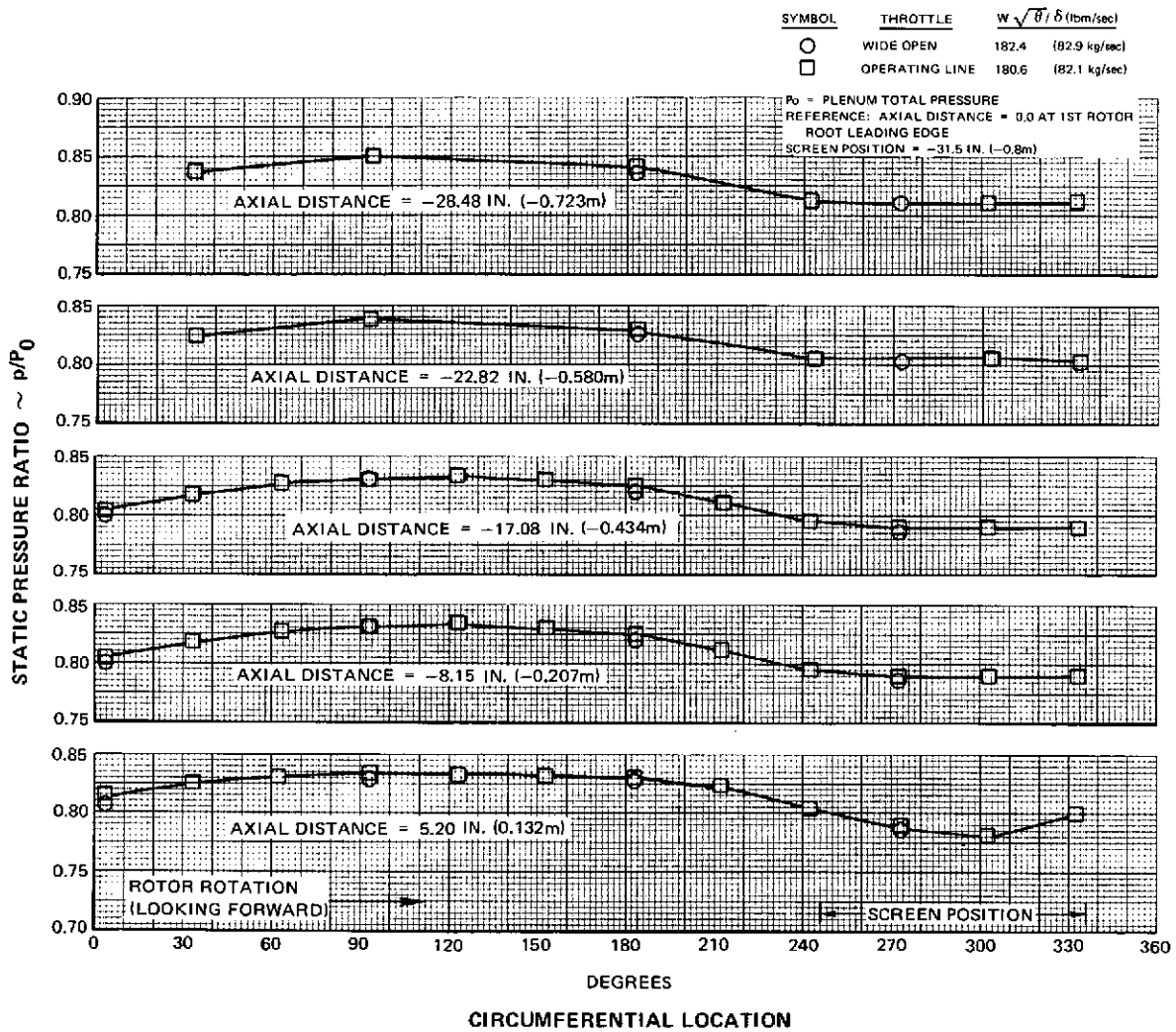

Figure 40 Circumferential Distributions of Rotor 1 Inlet Static Pressure at the Root for Tests at Design Speed for Circumferentially Distorted Inlet Flow With Casing Treatment

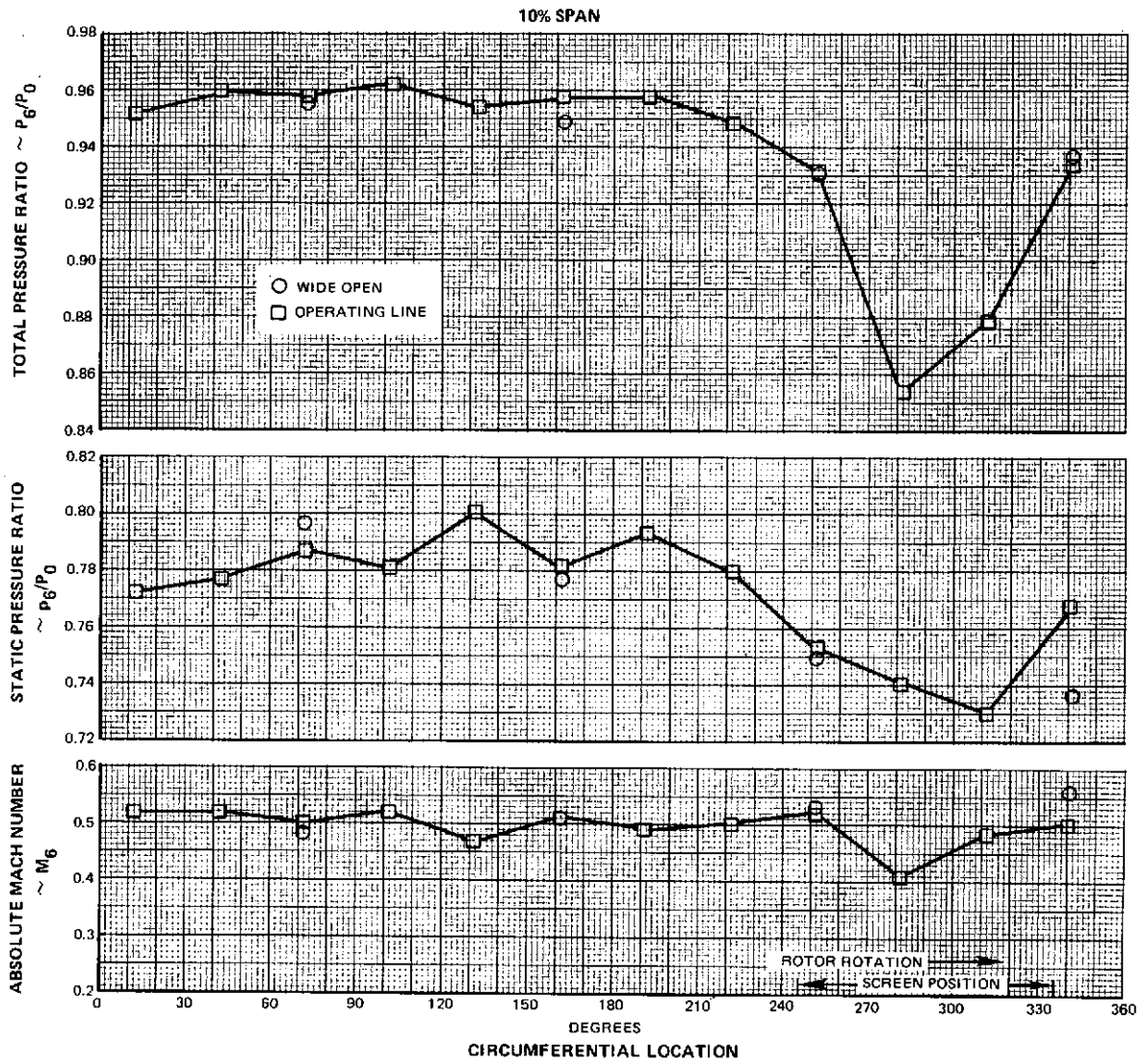

Figure 41 Circumferential Distributions of Fan Inlet Total Pressure, Static Pressure, Absolute Mach Number, Relative Flow Angle, Absolute Flow Angle, and Meridional Velocity for Circumferentially Distorted Inlet Flow at Design Speed With Casing Treatment

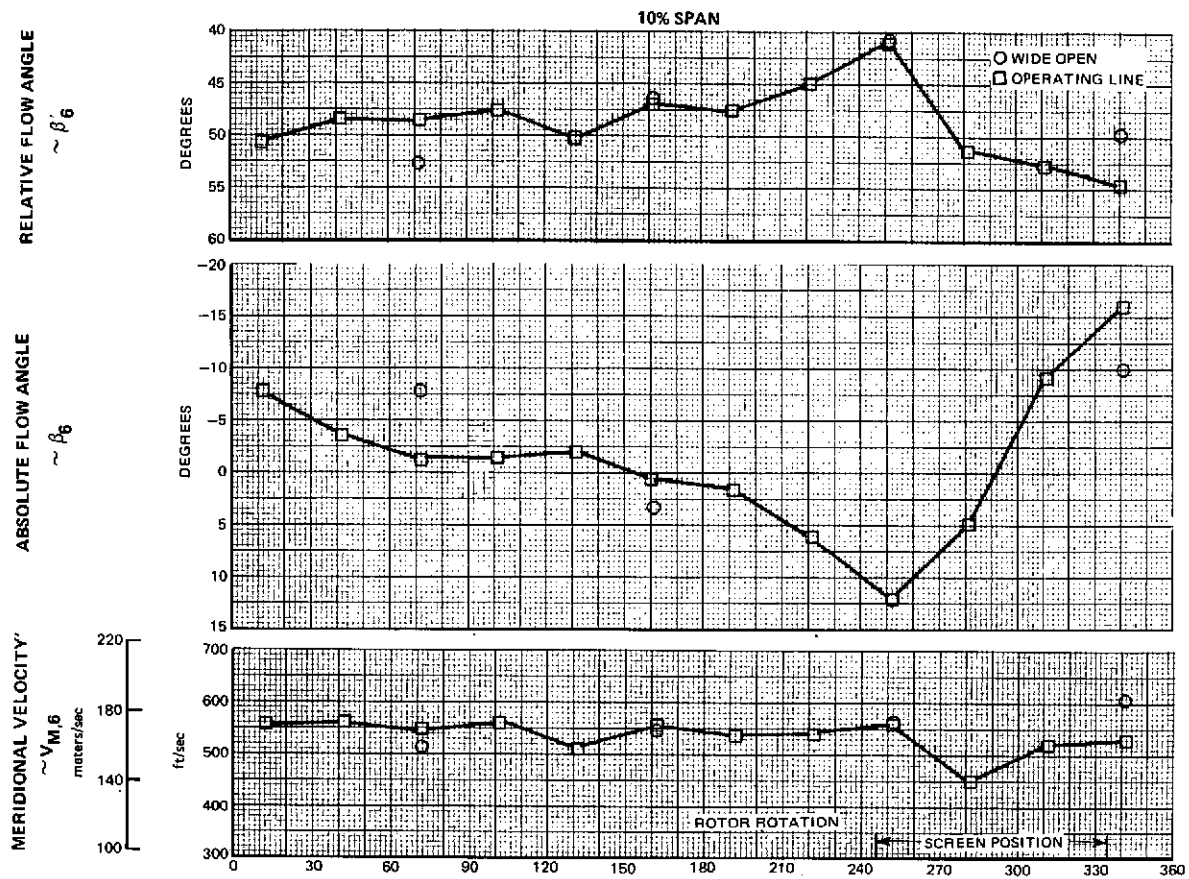

Figure 41 (Cont'd) Circumferential Distributions of Fan Inlet Total Pressure, Static Pressure, Absolute Mach Number, Relative Flow Angle, Absolute Flow Angle, and Meridional Velocity for Circumferentially Distorted Inlet Flow at Design Speed With Casing Treatment

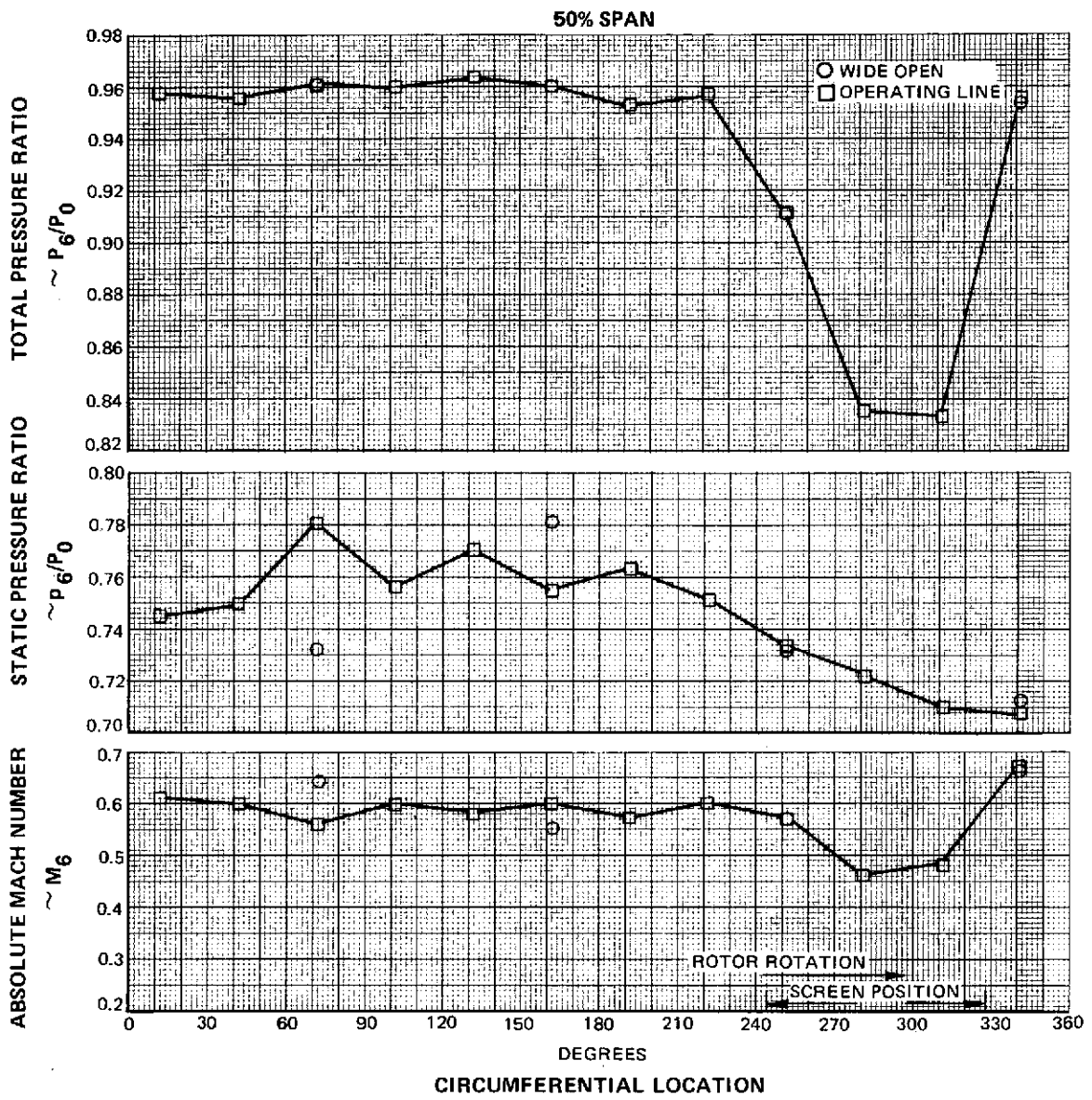

Figure 41 (Cont'd) Circumferential Distributions of Fan Inlet Total Pressure, Static Pressure, Absolute Mach Number, Relative Flow Angle, Absolute Flow Angle, and Meridional Velocity for Circumferentially Distorted Inlet Flow at Design Speed With Casing Treatment

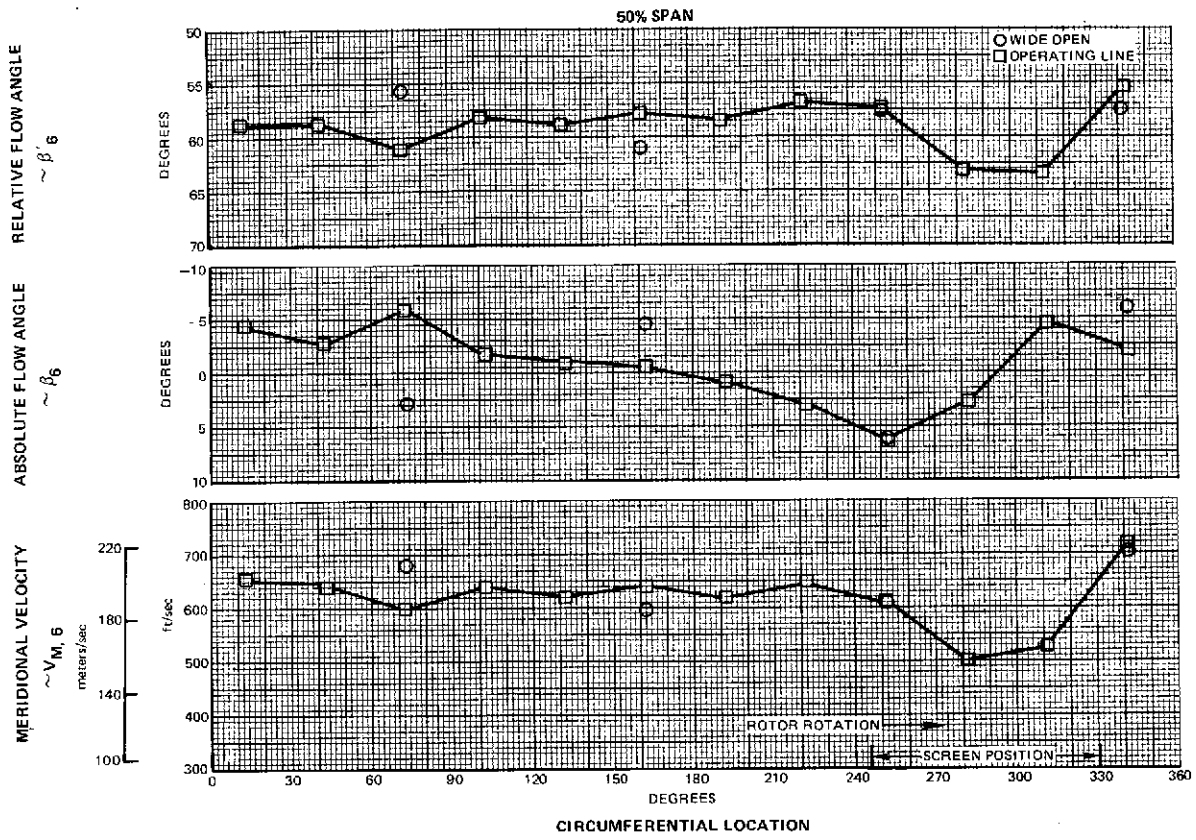

Figure 41 (Cont'd) Circumferential Distributions of Fan Inlet Total Pressure, Static Pressure, Absolute Mach Number, Relative Flow Angle, Absolute Flow Angle, and Meridional Velocity for Circumferentially Distorted Inlet Flow at Design Speed With Casing Treatment

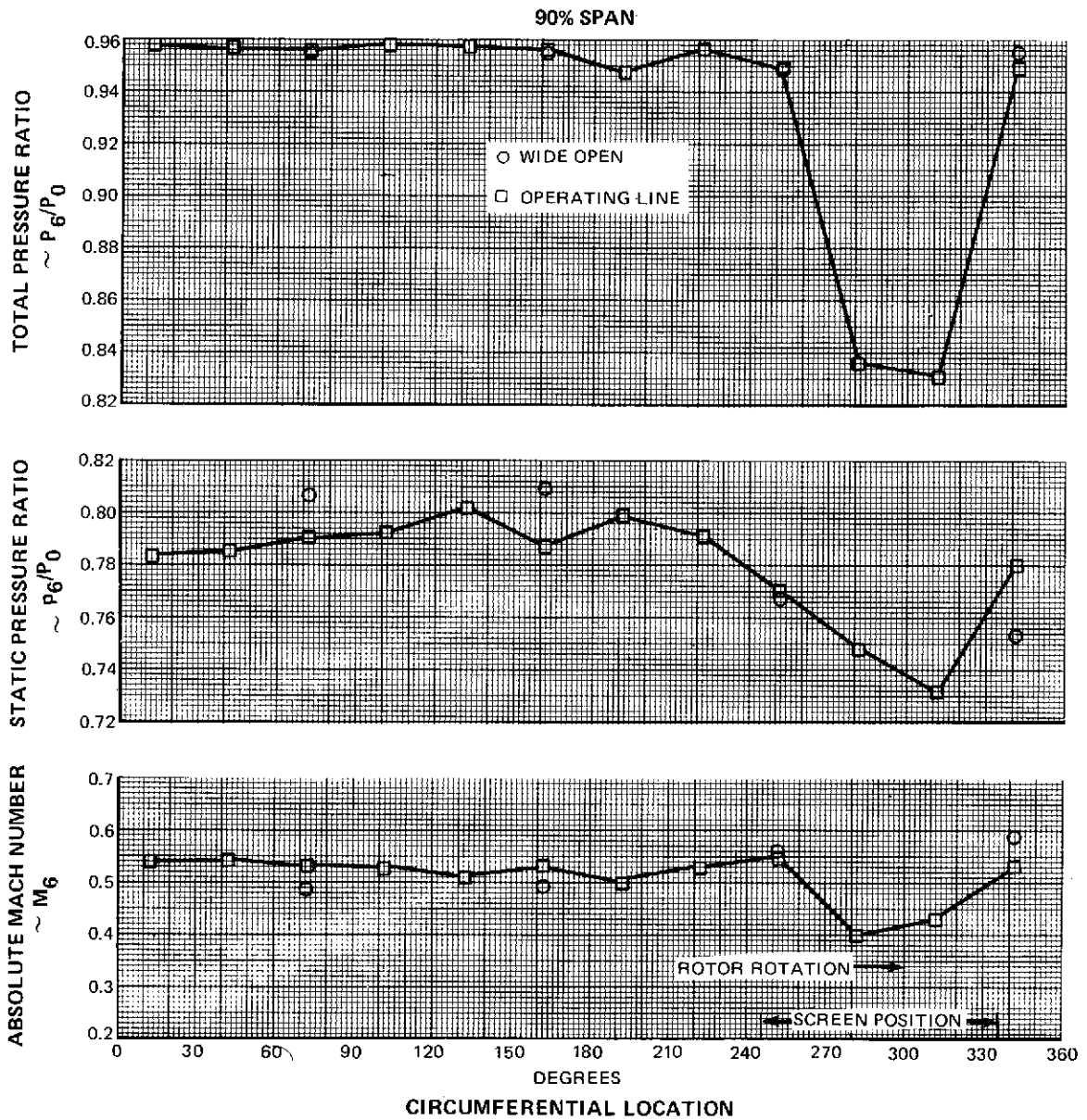

Figure 41 (Cont'd) Circumferential Distributions of Fan Inlet Total Pressure, Static Pressure, Absolute Mach Number, Relative Flow Angle, Absolute Flow Angle, and Meridional Velocity for Circumferentially Distorted Inlet Flow at Design Speed With Casing Treatment

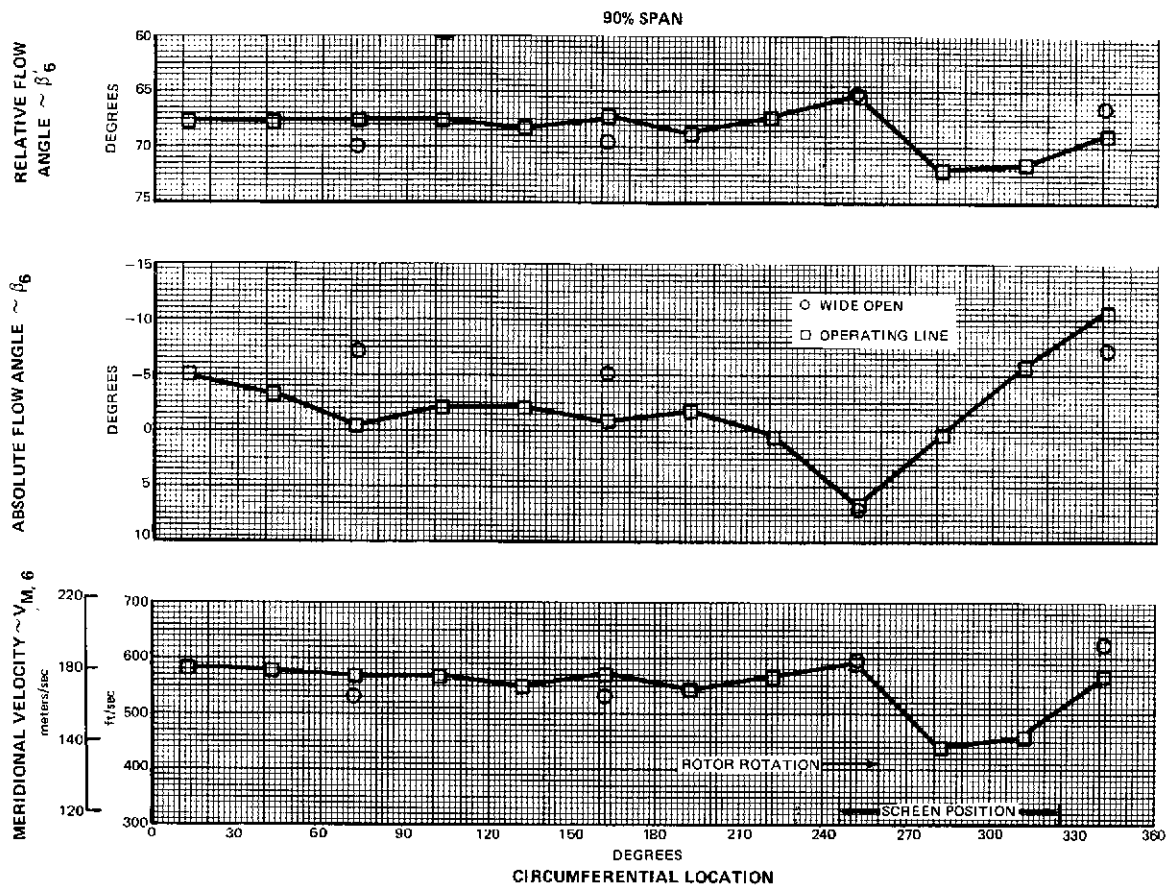

Figure 41 (Cont'd) Circumferential Distributions of Fan Inlet Total Pressure, Static Pressure, Absolute Mach Number, Relative Flow Angle, Absolute Flow Angle, and Meridional Velocity for Circumferentially Distorted Inlet Flow at Design Speed With Casing Treatment

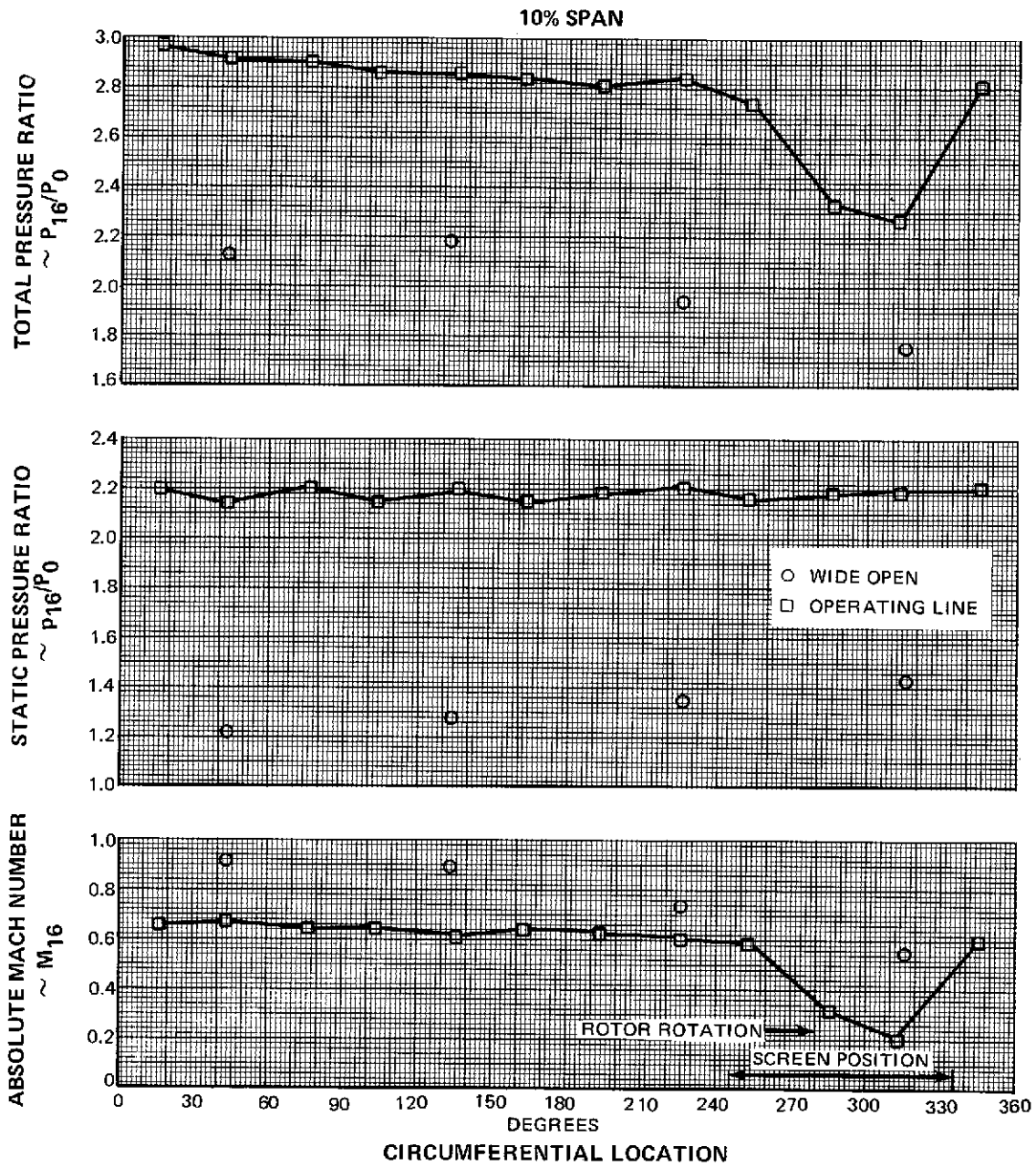

Figure 42 Circumferential Distributions of Fan Exit Total Pressure, Static Pressure, Absolute Mach Number, Relative Flow Angle, Absolute Flow Angle, and Meridional Velocity for Circumferentially Distorted Inlet Flow at Design Speed With Casing Treatment

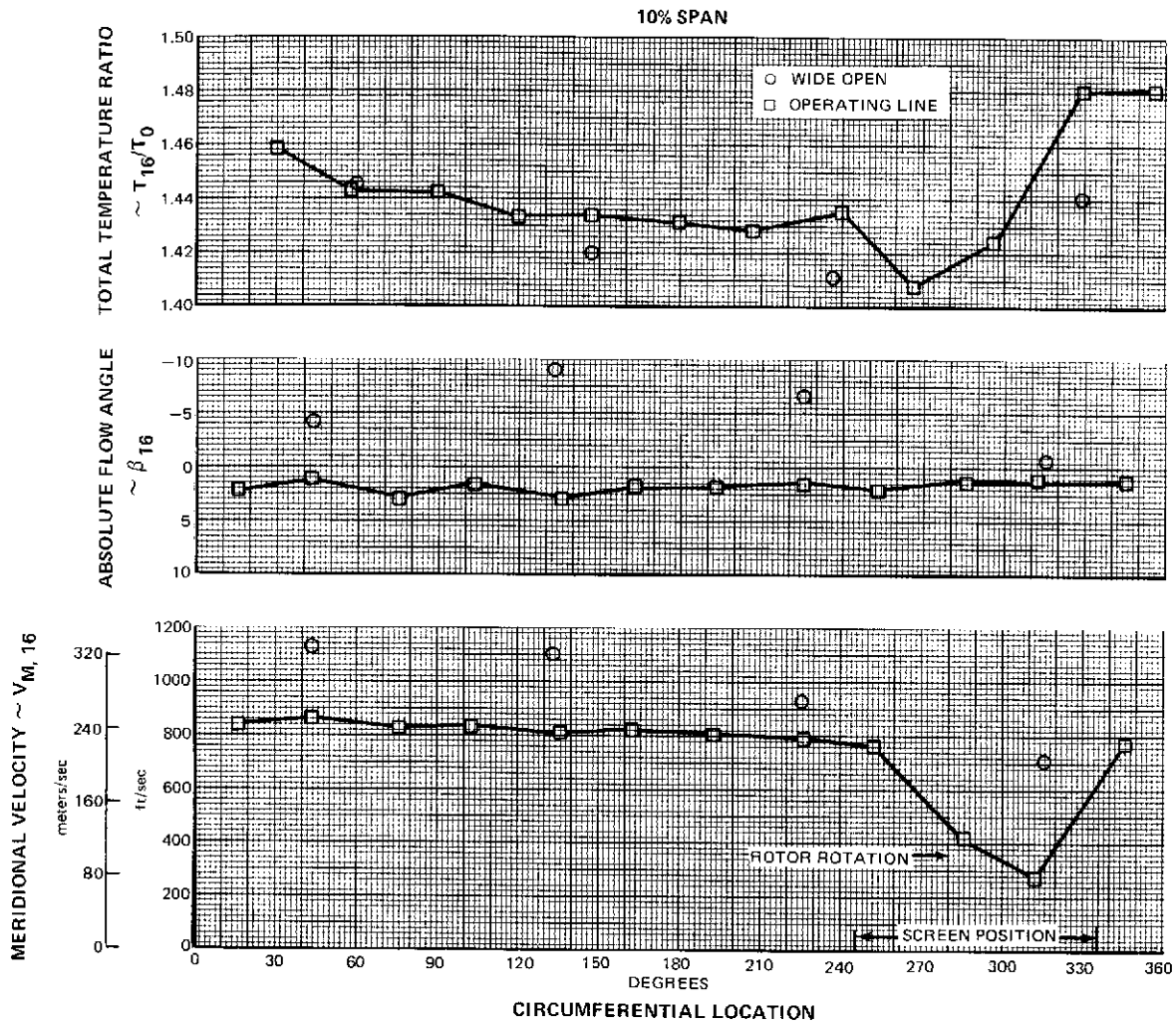

Figure 42 (Cont'd) Circumferential Distributions of Fan Exit Total Pressure, Static Pressure, Absolute Mach Number, Relative Flow Angle, Absolute Flow Angle, and Meridional Velocity for Circumferentially Distorted Inlet Flow at Design Speed With Casing Treatment

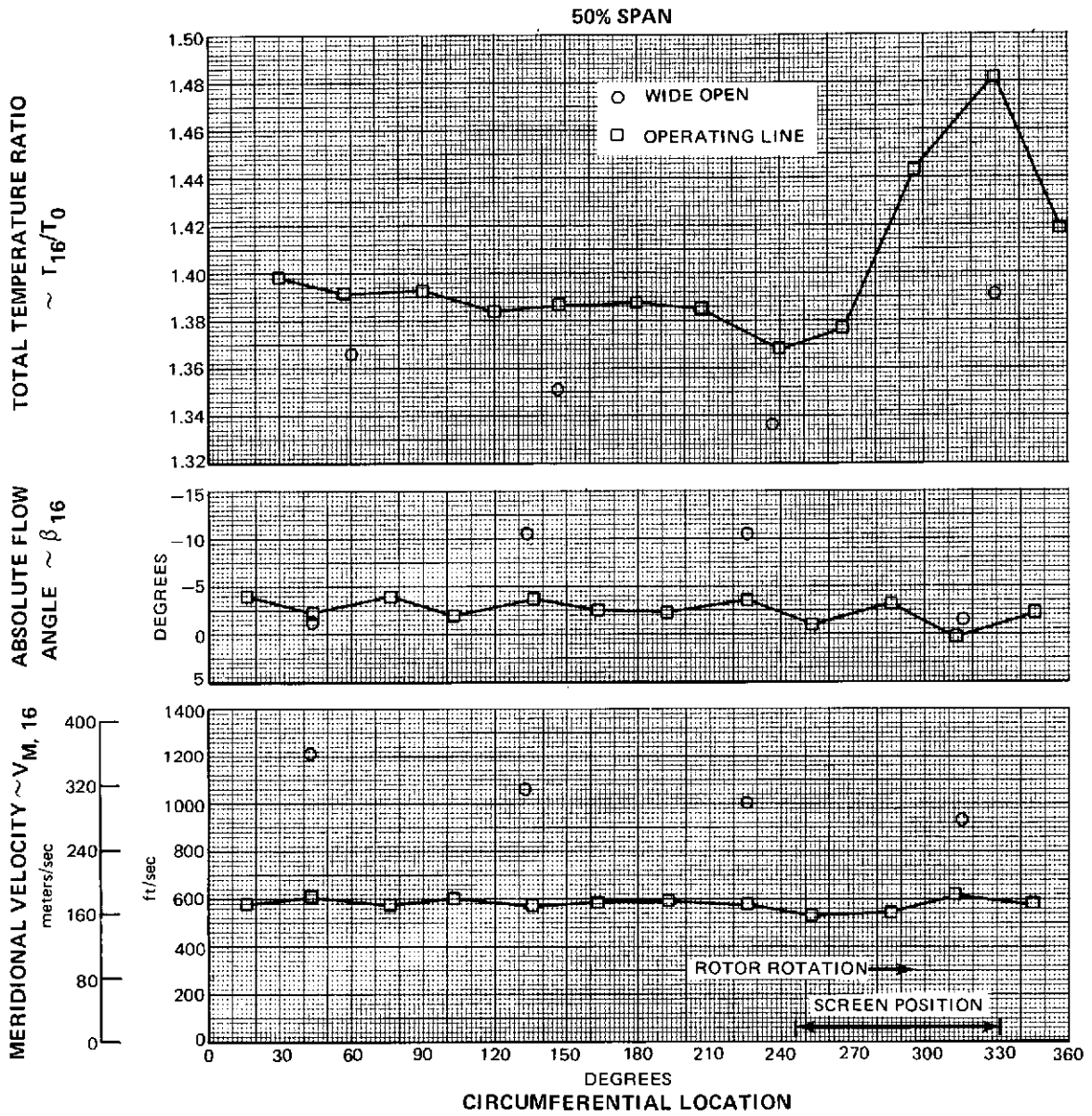

Figure 42 (Cont'd) Circumferential Distributions of Fan Exit Total Pressure, Static Pressure, Absolute Mach Number, Relative Flow Angle, Absolute Flow Angle, and Meridional Velocity for Circumferentially Distorted Inlet Flow At Design Speed With Casing Treatment

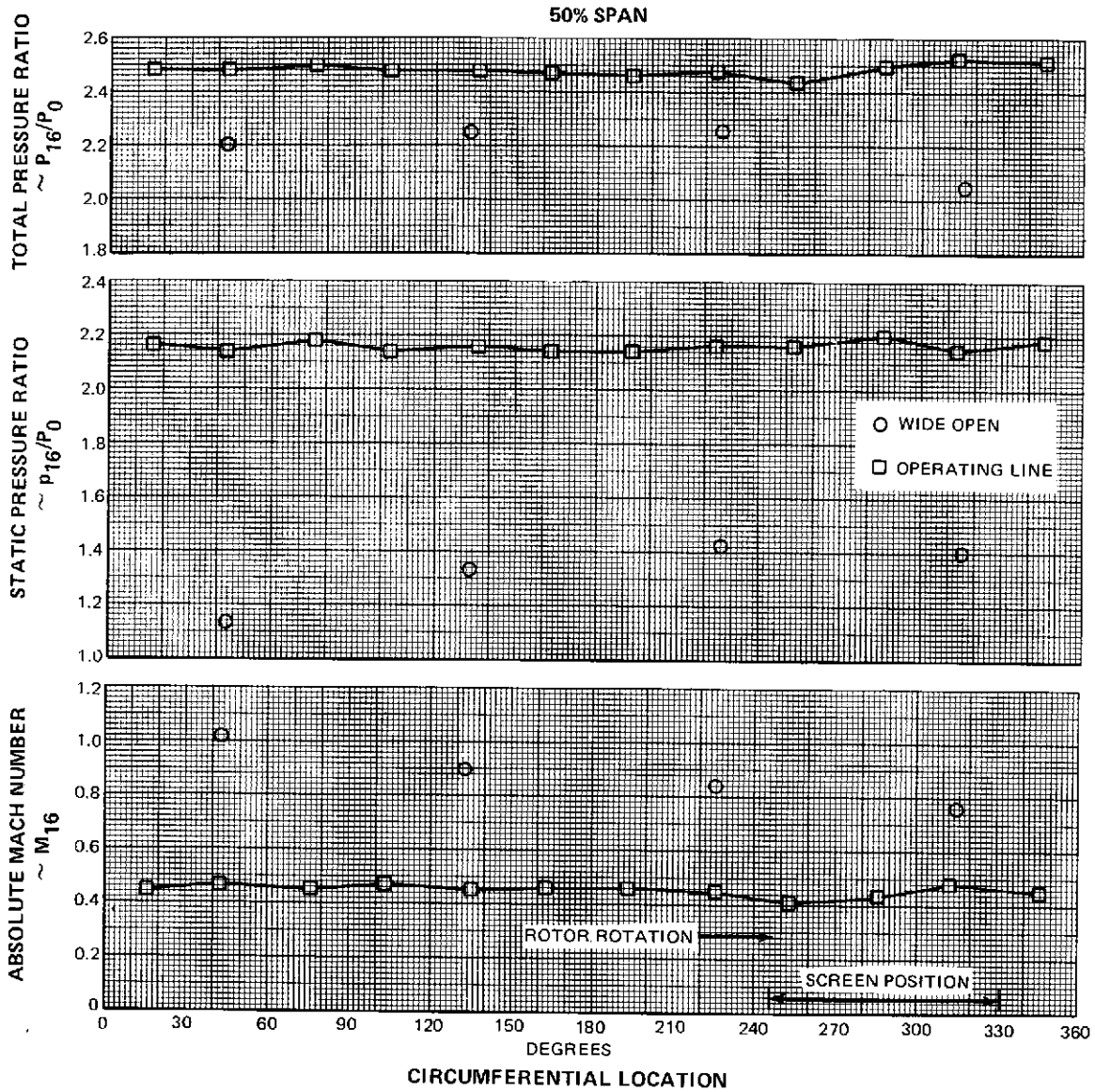

Figure 42 (Cont'd) Circumferential Distributions of Fan Exit Total Pressure, Static Pressure, Absolute Mach Number, Relative Flow Angle, Absolute Flow Angle, and Meridional Velocity for Circumferentially Distorted Inlet Flow at Design Speed With Casing Treatment

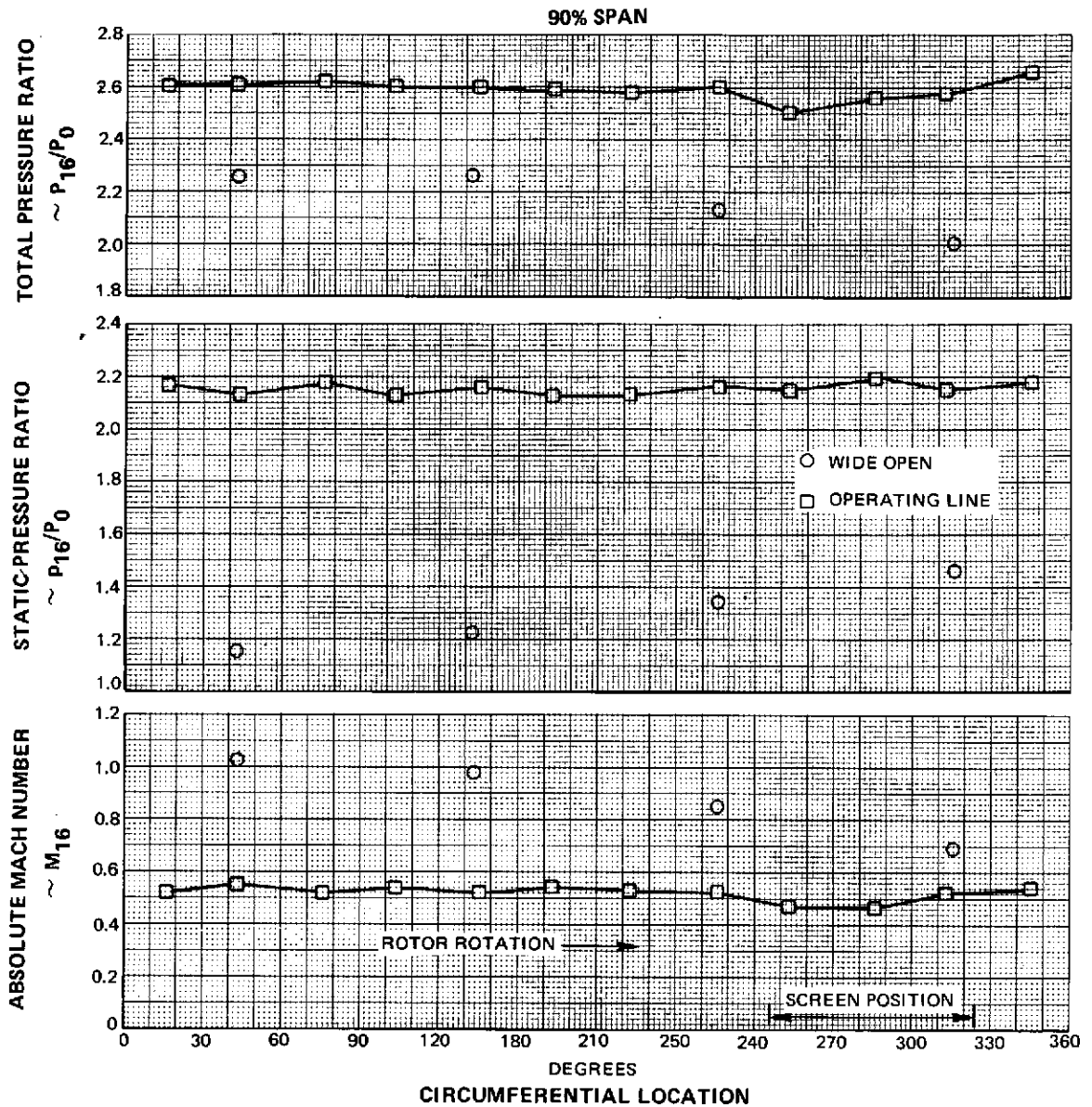

Figure 42 (Cont'd) Circumferential Distributions of Fan Exit Total Pressure, Static Pressure, Absolute Mach Number, Relative Flow Angle, Absolute Flow Angle, and Meridional Velocity for Circumferentially Distorted Inlet Flow at Design Speed With Casing Treatment

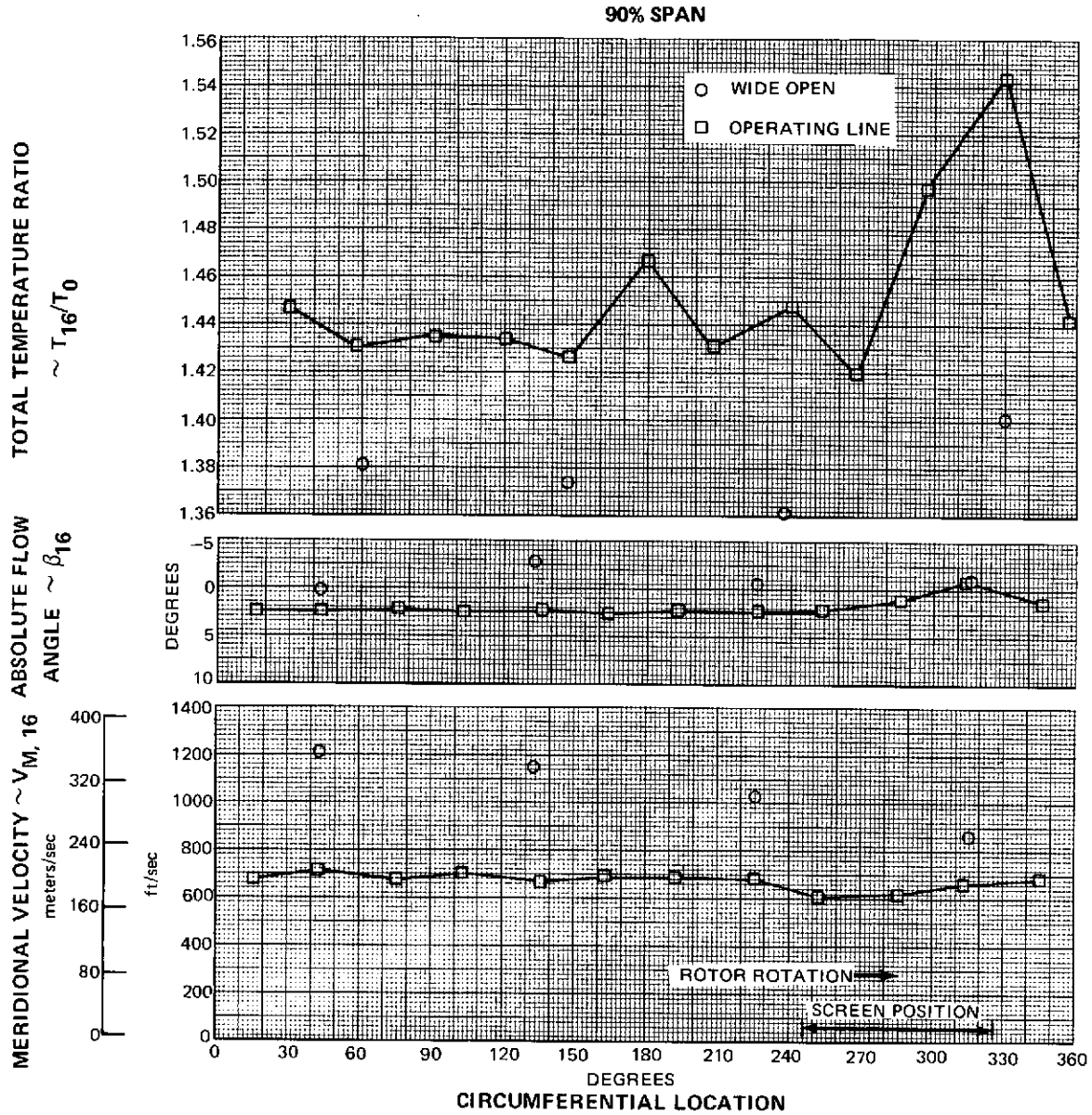

Figure 42 (Cont'd) Circumferential Distributions of Fan Exit Total Pressure, Static Pressure, Absolute Mach Number, Relative Flow Angle, Absolute Flow Angle, and Meridional Velocity for Circumferentially Distorted Inlet Flow at Design Speed With Casing Treatment

APPENDIX A
SYMBOLS AND PERFORMANCE PARAMETERS

SYMBOLS

A	—	area, inches ² [meters ²]
C _p	—	ratio of specific heats, Btu/lbm-°R [joule/kg-°k]
D	—	diffusion factor
g _c	—	conversion factor, 32.17 lbm-ft/lbf-sec ²
i _m	—	incidence angle, angle between inlet air direction and line tangent to blade mean camber line at leading edge, degrees (labelled INCM, Table XIII)
i _{ss}	—	incidence angle, angle between inlet air direction and line tangent to blade suction surface at leading edge, degrees (labelled INCS, Table XIII)
J	—	conversion factor, 778 ft-lbf/Btu [1.00m-kj/joule]
N	—	rotor speed, rpm
P	—	total pressure, lbf/ft ² or n/m ²
p	—	static pressure, lbf/ft ² or n/m ²
R	—	gas constant for air
r	—	radius measured from rig centerline - inches [meters]
SL	—	streamline number
T	—	total temperature, °R [°K]
t	—	static temperature, °R [°K]
	—	blade maximum thickness, inches [meters]
U	—	rotor speed, ft/sec [meters/sec]
V	—	air velocity, ft/sec [meters/sec]

APPENDIX A

V_m	– meridional velocity $(V_r^2 + V_z^2)^{1/2}$, ft/sec [m/sec] labelled VM, Table XIII)
V_θ	– longitudinal velocity, ft/sec [m/sec]
W	– mass flow rate, lbm/sec [kg/sec]
z	– axial distance - inches [meters]
β	– absolute air angle, $\cot^{-1}(V_m/V_\theta)$, degrees (labelled B, Table XIII)
β'	– relative air angle, $\cot^{-1}(V_m/V_\theta')$, degrees (labelled B', Table XIII)
$\Delta\beta$	– air turning angle, degrees
γ	– ratio of specific heats for air
δ	– ratio of total pressure to standard pressure of 2116 lbf/ft ² [1.0125×10^5 N/M ²]
δ°	– deviation angle, exit air angle minus tangent to blade mean camber line at trailing edge - degrees (labelled DEV, Table XIII)
ϵ	– angle between tangent to streamline projected on meridional plane and axial direction - degrees (labelled EPSI, Table XIII)
η	– efficiency
θ	– ratio of total temperature to standard temperature of 518.7°R [288.16°K]
ρ	– mass density - lbm/ft ³ [kg/meters ³]
σ	– solidity, ratio of aerodynamic chord to gap between blades
ϕ	– flow coefficient
ψ	– pressure coefficient
ω	– angular velocity of rotor, radians/sec
$\bar{\omega}$	– total press loss coefficient

Superscripts

'	– relative to rotor
*	– blade metal angle

Subscripts

ad	–	adiabatic
des.	–	design
in	–	inlet
m	–	meridional direction
n	–	selected operating point
p	–	polytropic or profile
r	–	radial direction
	–	ratio (e.g. P_r = total pressure ratio)
ss	–	suction surface
z	–	axial component
θ	–	tangential component
o	–	plenum camber
6	–	instrument plane upstream of rotor 1
7	–	station at rotor 1 leading edge
8	–	station at rotor 1 trailing edge
9	–	station at stator 1 leading edge
10	–	station at stator 1 trailing edge
11	–	instrument plane downstream stator 1

- 12 – station at rotor 2 leading edge
- 13 – station at rotor 2 trailing edge
- 14 – station at stator 2 leading edge
- 15 – station at stator 2 trailing edge
- 16 – instrument plane downstream stator 2

PERFORMANCE PARAMETERS

a) Relative total temperature

$$T'_7 = t_7 + \left[1 + \frac{\gamma - 1}{2} (M'_7)^2 \right] \quad \text{(rotor 1) IN}$$

$$T'_8 = T'_7 + \left[\frac{(\omega r_8)^2 - (\omega r_7)^2}{\frac{2\gamma}{\gamma - 1} R_{g_c}} \right] \quad \text{(rotor 1) OUT}$$

b) Incidence angle based on mean camber line

$$i_m = \beta'_7 - \beta'^*_7 \quad \text{(rotor 1)}$$

$$i_m = \beta_9 - \beta^*_9 \quad \text{(stator 1)}$$

Incidence angle based on suction surface metal angle

$$i_{ss} = \beta'_7 - \beta^*_{ss7} \quad \text{(rotor 1)}$$

$$i_{ss} = \beta_9 - \beta^*_{ss9} \quad \text{(stator 1)}$$

c) Deviation angle

$$\delta^\circ = \beta'_8 - \beta'^*_8 \quad \text{(rotor 1)}$$

$$\delta^\circ = \beta_{10} - \beta^*_{10} \quad \text{(stator 1)}$$

d) Diffusion factor

$$D = 1 - \frac{V'_8}{V'_7} + \frac{r_8 V_{\theta 8} - r_7 V_{\theta 7}}{(r_8 + r_7) \sigma V'_7} \quad (\text{rotor 1})$$

$$D = 1 - \frac{V_{10}}{V_9} + \frac{r_9 V_{\theta 9} - r_{10} V_{\theta 10}}{(r_9 + r_{10}) \sigma V_9} \quad (\text{stator 1})$$

e) Loss coefficient

$$\bar{\omega} = \frac{P'_7 \left[\frac{T'_8}{T'_7} \right]^{\frac{\gamma}{\gamma-1}} - P'_8}{P'_7 - p_7} \quad (\text{rotor 1})$$

$$\bar{\omega} = \frac{P_9 - P_{10}}{P_9 - p_9} \quad (\text{stator 1})$$

f) Loss parameter

$$\frac{\bar{\omega} \cos \beta'_8}{2\sigma} \quad (\text{rotor 1})$$

$$\frac{\bar{\omega} \cos \beta_{10}}{2\sigma} \quad (\text{stator 1})$$

g) Polytropic efficiency

$$\eta_p = \frac{\frac{\gamma-1}{\gamma} \ln \left[\frac{P_8}{P_7} \right]}{\ln \left[\frac{T_8}{T_0} \right]} \quad (\text{rotor 1})$$

h) Adiabatic efficiency

$$\eta_{ad} = \frac{\left[\frac{P_8}{P_7} \right]^{\frac{\gamma-1}{\gamma}} - 1}{\left[\frac{T_{10}}{T_0} \right] - 1} \quad \text{(rotor 1)}$$

$$\eta_{ad} = \frac{\left[\frac{P_{10}}{P_6} \right]^{\frac{\gamma-1}{\gamma}} - 1}{\left[\frac{T_{10}}{T_0} \right] - 1} \quad \text{(stage 1)}$$

i) Stall margin

$$SM = \left[\left(\frac{P_{16}/P_6}{W\sqrt{\theta_6}/\delta_6} \right)_{\text{Stall}} \left(\frac{W\sqrt{\theta_6}/\delta_6}{P_{16}/P_6} \right)_{\text{Reference Point or Operating Point}} - 1 \right] 100$$

j) Flow coefficient $\phi = \frac{V_z}{U_{\text{mean flow}}}$

k) Pressure coefficient $\psi = \frac{\Delta H_{id}}{U_{\text{mean flow}}^2}$
 $= \frac{\eta_{ad} \Delta T_{\text{actual}} c_p J g_c}{U_{\text{mean flow}}^2}$

l) Total Pressure Recovery $= \frac{P_{16}/P_6}{(T_{16}/T_6)^{\frac{\gamma}{\gamma-1}}}$

APPENDIX B

BLADE SPANS AND DIAMETERS AND COLUMN HEADING IDENTIFICATIONS

This appendix provides the spans and diameters (Table XII) for the blade elements and column heading identifications (Table XIII) for the computer printouts presented in Appendixes C and D.

TABLE XII – SPANS AND DIAMETERS FOR THE BLADE-ELEMENT DATA

SL	Rotor 1 Inlet Diameter Span (inches) (%)		Rotor 1 Exit Diameter Span (inches) (%)		Stator 1 Inlet Diameter Span (inches) (%)		Stator 1 Exit Diameter Span (inches) (%)	
1	13.47	5.8	15.59	5.0	15.93	4.9	17.38	4.3
2	14.52	11.4	16.35	10.0	16.64	9.9	17.93	8.9
3	15.56	17.0	17.10	15.0	17.36	14.8	18.49	13.6
4	18.52	32.9	19.37	30.0	19.53	29.8	20.26	28.1
5	22.22	52.8	22.38	50.0	22.42	49.8	22.69	48.2
6	24.00	62.4	23.89	60.0	23.87	59.9	23.93	58.4
7	24.88	67.1	24.65	65.0	24.60	64.9	24.55	63.6
8	25.76	71.8	25.40	70.0	25.33	69.9	25.18	68.8
9	28.38	85.9	27.67	85.0	27.50	85.0	27.07	84.4
10	29.26	90.6	28.42	90.0	28.23	90.0	27.70	89.6
11	30.13	95.3	29.18	95.0	28.95	95.0	28.34	94.8

SL	Rotor 2 Inlet Diameter Span (inches) (%)		Rotor 2 Exit Diameter Span (inches) (%)		Stator 2 Inlet Diameter Span (inches) (%)		Stator 2 Exit Diameter Span (inches) (%)	
1	17.87	4.3	18.74	3.8	18.93	3.8	19.18	3.2
2	18.38	8.8	19.14	7.8	19.30	7.8	19.49	6.8
3	18.90	13.5	19.54	12.0	19.69	11.9	19.82	10.6
4	20.51	28.0	20.84	25.3	20.94	25.3	20.91	23.2
5	22.74	48.0	22.73	44.6	22.75	44.8	22.58	42.2
6	23.88	58.1	23.73	54.9	23.72	55.1	23.49	52.8
7	24.45	63.3	24.25	60.2	24.22	60.5	23.97	58.2
8	25.03	68.4	24.78	65.6	24.72	65.9	24.46	63.9
9	26.78	84.2	26.42	82.4	26.29	82.7	26.00	81.7
10	27.37	89.4	26.98	88.1	26.82	88.4	26.53	87.8
11	27.96	94.7	27.55	94.0	27.36	94.2	27.07	93.9

TABLE XIII — IDENTIFICATION OF OVERALL PERFORMANCE AND BLADE-ELEMENT DATA TABLE COLUMN HEADINGS

ORIGINAL PAGE IS OF POOR QUALITY

ROTOR 1

SL	EPSI-1 DEGREE	EPSI-2 DEGREE	V-1 FT/SEC	V-2 FT/SEC	VM-1 FT/SEC	VM-2 FT/SEC	Vθ-1 FT/SEC	Vθ-2 FT/SEC	B-1 DEGREE	B-2 DEGREE	M-1	M-2	U-1 FT/SEC	U-2 FT/SEC	M'-1	M'-2	V'-1 FT/SEC	V'-2 FT/SEC
•	ϵ_7	ϵ_8	V_7	V_8	V_{m7}	V_{m8}	$V_{\theta 7}$	$V_{\theta 8}$	β_7	β_8	M_7	M_8	U_7	U_8	M'_7	M'_8	V'_7	V'_8
SL	INCS DEGREE	INCM DEGREE	DEV DEGREE	TURN DEGREE	RHOVM-1	RHOVM-2	D-FAC	OMEGA-B TOTAL	LOSS-P TOTAL	PO2/ PO1	%EFF-P TOT	%EFF-A TOT	B'-1 DEGREE	B'-2 DEGREE	Vθ'-1 FT/SEC	Vθ'-2 FT/SEC	PO/PO INLET	
•	i_{m7}	i_{m8}	δ_8^o	$\Delta\beta$	$\rho_7 V_{m7}$	$\rho_8 V_{m8}$	D	$\bar{\omega}$	$\frac{\bar{\omega} \cos \beta_8}{20}$	$\frac{P_8}{P_7}$	η_p	η_{ad}	β'_7	β'_8	$V'_{\theta 7}$	$V'_{\theta 8}$	$\frac{P_8}{P_0}$	
			TO/TO INLET	PO/PO INLET	EFF-AD INLET %	EFF-P INLET %	WC1/A1 LBM/SEC SQFT		TO2/TO1	PO2/PO1	EFF-AD ROTOR %	EFF-P ROTOR %						
			$\frac{T_8}{T_0}$	$\frac{P_8}{P_0}$	η_{ad}	η_p	$\frac{W\sqrt{\beta_7}}{\delta_7 A_7}$		$\frac{T_8}{T_7}$	$\frac{P_8}{P_7}$	η_{adB}	η_{pB}						

STATOR 1

SL	EPSI-1 DEGREE	EPSI-2 DEGREE	V-1 FT/SEC	V-2 FT/SEC	VM-1 FT/SEC	VM-2 FT/SEC	Vθ-1 FT/SEC	Vθ-2 FT/SEC	B-1 DEGREE	B-2 DEGREE	M-1	M-2	PO/PO INLET	TO/TO INLET	PO/PO STAGE	TO2/ TO1
•	ϵ_9	ϵ_{10}	V_9	V_{10}	V_{m9}	V_{m10}	$V_{\theta 9}$	$V_{\theta 10}$	β_9	β_{10}	M_9	M_{10}	$\frac{P_{10}}{P_0}$	$\frac{T_{10}}{T_0}$	$\frac{P_{10}}{P_7}$	$\frac{T_{10}}{T_7}$
SL	INCS DEGREE	INCM DEGREE	DEV DEGREE	TURN DEGREE	RHOVM-1	RHOVM-2	D-FAC	OMEGA-B TOTAL	LOSS-P TOTAL	PO2/ PO1	%EFF-A TOT-INLET	%EFF-P TOT-INLET	%EFF-A TOT-STG	%EFF-P TOT-STG		
•	i_{m9}	i_{m9}	δ_{10}^o	$\Delta\beta$	$\rho_9 V_{m9}$	$\rho_{10} V_{m10}$	D	$\bar{\omega}$	$\frac{\bar{\omega} \cos \beta_{10}}{20}$	$\frac{P_{10}}{P_9}$	η_{ad}	η_p	η_{ad-st}	η_{p-st}		
		NCORR INLET RPM	WCORR INLET LBM/SEC	TO/TO INLET	PO/PO INLET	EFF-AD INLET %	EFF-P INLET %		TO2/TO1	PO2/PO1	EFF-AD STAGE %					
		$\frac{N}{\sqrt{\beta_7}}$	$\frac{W\sqrt{\beta_7}}{\delta_7}$	$\frac{T_{10}}{T_0}$	$\frac{P_{10}}{P_0}$	η_{ad}	η_p		$\frac{T_{10}}{T_7}$	$\frac{P_{10}}{P_9}$	η_{ad-st}					

ORIGINAL PAGE IS
OF POOR QUALITY

ROTOR 2

SL	EPSI-1 DEGREE	EPSI-2 DEGREE	V-1 FT/SEC	V-2 FT/SEC	VM-1 FT/SEC	VM-2 FT/SEC	Vθ-1 FT/SEC	Vθ-2 FT/SEC	B-1 DEGREE	B-2 DEGREE	M-1	M-2	U-1 FT/SEC	U-2 FT/SEC	M'-1	M'-1	V'-1 FT/SEC	V'-2 FT/SEC
*	ϵ_{12}	ϵ_{13}	V_{12}	V_{13}	V_{m12}	V_{m13}	$V_{\theta 12}$	$V_{\theta 13}$	β_{12}	β_{13}	M_{12}	M_{13}	U_{12}	U_{13}	M'_{12}	M'_{13}	V'_{12}	V'_{13}
SL	INCS DEGREE	INCM DEGREE	DEV DEGREE	TURN DEGREE	RHOVM-1	RHOVM-2	D-FAC	OMEGA-B TOTAL	LOSS-P TOTAL	PO2/ PO1	%EFF-P TOT	%EFF-A TOT	B'-1 DEGREE	B'-2 DEGREE	Vθ'-1 FT/SEC	Vθ'-2 FT/SEC	PO/PO INLET	
*	i_{m12}	i_{m12}	δ_{13}°	$\Delta\beta$	$\rho_{12} y_{m12}$	$\rho_{13} y_{m13}$	D	$\bar{\omega}$	$\frac{\bar{\omega} \cos \beta'_{13}}{20}$	$\frac{P_{13}}{P_{12}}$	η_p	η_{ad}	β'_{12}	β'_{13}	$V_{\theta 12}$	$V_{\theta 13}$	$\frac{P_{13}}{P_0}$	
			TO/TO INLET	PO/PO INLET	EFF-AD INLET %	EFF-P INLET %	WC1/A1 LBM/SEC SQFT		TO2/TO1	PO2/PO1	EFF-AD ROTOR %	EFF-P ROTOR %						
			$\frac{T_{13}}{T_0}$	$\frac{P_{13}}{P_0}$	η_{ad}	η_p	$\frac{W\sqrt{\beta'_{12}}}{\delta_{12}^A}$		$\frac{T_{13}}{T_{12}}$	$\frac{P_{13}}{P_{12}}$	η_{ad13}	η_{p13}						

STATOR 2

SL	EPSI-1 DEGREE	EPSI-2 DEGREE	V-1 FT/SEC	V-2 FT/SEC	VM-1 FT/SEC	VM-2 FT/SEC	Vθ-1 FT/SEC	Vθ-2 FT/SEC	B-1 DEGREE	B-2 DEGREE	M-1	M-2	PO/PO INLET	TO/TO INLET	PO/PO STAGE	TO2/ TO1
*	ϵ_{14}	ϵ_{15}	V_{14}	V_{15}	V_{m14}	V_{m15}	$V_{\theta 14}$	$V_{\theta 15}$	β_{14}	β_{15}	M_{14}	M_{15}	$\frac{P_{15}}{P_0}$	$\frac{T_{15}}{T_0}$	$\frac{P_{16}}{P_{12}}$	$\frac{T_{15}}{T_{12}}$
SL	INCS DEGREE	INCM DEGREE	DEV DEGREE	TURN DEGREE	RHOVM-1	RHOVM-2	D-FAC	OMEGA-B TOTAL	LOSS-P TOTAL	PO2/ PO1	%EFF-A TOT-INLET	%EFF-P TOT-INLET	%EFF-A TOT-STG	%EFF-P TOT-STG		
*	i_{m14}	i_{m14}	δ_{15}	$\Delta\beta$	$\rho_{14} y_{m14}$	$\rho_{15} y_{m15}$	D	$\bar{\omega}$	$\frac{\bar{\omega} \cos \beta_{15}}{20}$	$\frac{P_{15}}{P_{14}}$	η_{ad}	η_p	η_{ad-st}	η_{p-st}		
		NCORR INLET RPM	WCORR INLET LBM/SEC	TO/TO INLET	PO/PO INLET	EFF-AD INLET %	EFF-P INLET %		TO2/TO1	PO2/PO1	EFF-AD STAGE %					
		$\frac{N}{\sqrt{\beta_{12}}}$	$\frac{W\sqrt{\beta_{12}}}{\delta_{12}}$	$\frac{T_{16}}{T_0}$	$\frac{P_{16}}{P_0}$	η_{ad}	η_p		$\frac{T_{15}}{T_{12}}$	$\frac{P_{15}}{P_{14}}$	η_{ad-st}					

* SEE TABLE XII
SUBSCRIPTS REFER TO CALCULATION STATIONS

APPENDIX C

OVERALL PERFORMANCE AND BLADE-ELEMENT DATA FOR UNIFORM INLET FLOW

This appendix provides test overall performance and blade-element data for uniform inlet flow with casing treatment and design stator settings. The data is presented for 70 percent, 85 percent, and 100 percent of design speed. An overall-performance and stall data summary is given in Table XIV, and the complete overall performance and blade-element data are given in Tables XV, XVII, and XVIII. The column headings for Tables XV, XVI, and XVIII are identified in Table XIII of Appendix B.

TABLE XIV – OVERALL-PERFORMANCE AND STALL DATA SUMMARY
WITH UNIFORM INLET FLOW

PERFORMANCE

Reference Table ¹	Percent of Design Speed	Corrected Flow ² (lbm/sec)	P_{11}/P_0	$\eta_{ad,11}$ (%)	P_{16}/P_0	$\eta_{ad,16}$ (%)
XV(a)	70	123.9	1.315	87.03	1.508	73.24
XV(b)	70	119.0	1.326	86.90	1.665	84.23
XV(c)	70	109.7	1.339	86.41	1.717	81.44
XV(d)	70	98.7	1.350	77.28	1.728	75.46
XVI(a)	85	154.1	1.504	85.48	1.822	70.64
XVI(b)	85	152.7	1.508	85.51	2.105	84.72
XVI(c)	85	143.6	1.540	83.26	2.232	83.22
XVI(d)	85	136.8	1.549	80.95	2.253	80.76
XVII(a)	100	184.1	1.695	83.19	2.266	70.87
XVII(b)	100	183.9	1.685	81.96	2.550	79.83
XVII(c)	100	183.2	1.673	82.63	2.742	82.02
XVII(d)	100	183.2	1.771	86.28	2.931	82.24
XVII(e)	100	179.1	1.777	86.28	2.931	82.32
XVII(f)	100	177.1	1.776	82.29	2.947	80.98

STALL POINT DATA

Percent of Design Speed	Corrected Flow ² (lbm/sec)	P_{16}/P_0	Stall Margin (%)
70	95.3	1.735	25.9
85	134.5	2.255	15.8
100	175.6	2.935	9.7

- Notes: (1) Refers to remaining Appendix C tables.
 (2) Corrected flow = $W\sqrt{\theta/\delta}$.

TABLE XV(a) — OVERALL PERFORMANCE AND BLADE-ELEMENT DATA
(Uniform Inlet Flow, 70 Percent Speed)

U. S. CUSTOMARY UNITS

ROTOR 1

SL	EPS1-1	EPS1-2	V-1	V-2	VN-1	VN-2	V0-1	V0-2	B-1	B-2	M-1	M-2	RUN NO	9, SPEED	CGDE	70, POINT NO	1	V*-1	V*-2
	DEGREE	DEGREE	FT/SEC	FT/SEC	FT/SEC	FT/SEC	FT/SEC	FT/SEC	DEGREE	DEGREE								FT/SEC	FT/SEC
1	16.400	18.124	380.0	761.1	380.0	468.1	0.0	600.1	0.0	52.0	0.3443	0.6800	438.5	508.1	0.5260	0.4262	580.6	477.1	
2	13.690	15.592	388.1	730.2	388.1	468.3	0.0	560.2	0.0	50.1	0.3518	0.6507	473.3	532.7	0.5568	0.4180	612.1	469.1	
3	11.240	13.253	395.4	704.2	395.4	466.8	0.0	527.2	0.0	48.4	0.3586	0.6261	507.0	557.3	0.5831	0.4159	643.0	467.8	
4	5.077	7.162	410.8	642.5	410.8	455.9	0.0	452.8	0.0	44.8	0.3730	0.5683	603.6	631.1	0.6629	0.4329	730.2	489.5	
5	-0.460	0.605	416.8	557.9	416.8	409.7	0.0	378.7	0.0	42.7	0.3786	0.4902	724.2	725.4	0.7589	0.4739	835.0	539.3	
6	-2.121	-2.090	416.5	536.1	416.5	403.8	0.0	352.7	0.0	41.2	0.3783	0.4704	782.2	778.6	0.8048	0.5149	886.2	586.8	
7	-3.114	-3.304	416.0	545.1	416.0	429.2	0.0	336.1	0.0	38.1	0.3778	0.4190	810.9	803.2	0.8276	0.5573	911.4	634.3	
8	-4.361	-4.478	415.0	544.5	415.0	433.2	0.0	330.0	0.0	37.3	0.3768	0.4782	839.3	827.8	0.8503	0.5794	936.4	659.8	
9	-8.393	-7.949	407.5	550.6	407.5	438.4	0.0	333.0	0.0	37.2	0.3698	0.4817	924.9	901.5	0.9173	0.6282	1010.7	717.9	
10	-9.842	-9.153	403.4	558.3	403.4	439.8	0.0	343.9	0.0	38.0	0.3661	0.4875	953.4	926.1	0.9393	0.6370	1035.2	729.6	
11	-11.176	-10.377	358.8	547.3	358.8	420.7	0.0	330.0	0.0	39.7	0.3617	0.4764	981.8	950.7	0.9613	0.6383	1059.7	733.3	

SL	INCS	INCH	DEV	TURN	RHOVM-1	RHOVM-2	D-FAC	OMEGA-B	LOSS-P	P02/	EFF-P	EFF-A	B*-1	B*-2	V0*-1	V0*-2	PC/PC
	DEGREE	DEGREE	DEGREE	DEGREE				TOTAL	TOTAL	P01	TOT	TOT	DEGREE	DEGREE	FT/SEC	FT/SEC	INLET
1	2.47	7.07	16.84	59.97	27.41	36.61	0.4249	-0.0611	-0.0132	1.4007	103.12	103.29	48.85	-11.12	-438.9	92.0	1.4007
2	2.54	6.84	16.25	53.71	27.92	37.01	0.4602	-0.0403	-0.0093	1.3877	102.32	102.46	50.36	-3.35	-473.3	27.5	1.3877
3	2.77	6.88	19.22	48.09	28.32	37.19	0.4822	-0.0223	-0.0053	1.3770	101.42	101.52	51.78	3.68	-507.0	-30.1	1.3770
4	4.10	7.57	11.64	34.28	29.34	36.88	0.5027	0.0236	0.0059	1.3511	97.94	97.89	55.60	21.32	-603.6	-178.3	1.3511
5	5.55	8.23	10.29	19.51	29.70	33.34	0.4939	0.0999	0.0228	1.3030	89.03	88.65	60.07	40.56	-724.2	-350.8	1.3030
6	6.04	8.32	9.20	15.44	29.68	32.99	0.4645	0.1029	0.0224	1.2957	87.64	87.21	61.98	46.54	-782.2	-425.9	1.2957
7	6.27	8.37	7.13	15.41	29.65	35.28	0.4233	0.0628	0.0138	1.3069	92.03	91.74	62.85	47.44	-810.9	-467.1	1.3069
8	6.49	8.44	6.13	14.72	29.59	35.67	0.4117	0.0629	0.0137	1.3098	91.76	91.47	63.71	48.95	-835.0	-497.7	1.3098
9	7.18	8.61	5.54	13.85	29.13	36.06	0.4052	0.0998	0.0216	1.3207	86.41	85.89	66.23	52.34	-924.9	-568.5	1.3207
10	7.39	8.68	5.88	14.19	28.88	36.06	0.4140	0.1253	0.0274	1.3274	83.13	82.48	67.07	52.86	-953.4	-582.2	1.3274
11	7.55	8.70	6.96	12.98	28.59	34.33	0.4281	0.1626	0.0345	1.3194	78.04	77.19	67.88	54.50	-981.8	-600.6	1.3194

TO/TO	PO/PO	EFF-AD	EFF-P	WCI/AL	T02/T01	P02/P01	EFF-AD	EFF-P
INLET	INLET	INLET	INLET	LBW/SEC			RTOR	RTOR
%	%	%	%	SQFT			%	%
1.0936	1.3306	90.92	91.25	28.14	1.0936	1.3306	90.92	91.25

STATOR 1

SL	EPS1-1	EPS1-2	V-1	V-2	VN-1	VN-2	V0-1	V0-2	B-1	B-2	M-1	M-2	RUN NO	9, SPEED	CGDE	70, POINT NO	1	TC2/
	DEGREE	DEGREE	FT/SEC	FT/SEC	FT/SEC	FT/SEC	FT/SEC	FT/SEC	DEGREE	DEGREE								TC1
1	18.099	14.832	766.1	544.3	491.8	564.3	587.4	3.3	50.2	0.3	0.6849	0.4940	1.3513	1.0979	1.3513	1.3513	1.0979	
2	15.716	13.031	737.9	556.4	491.7	556.4	550.3	7.4	48.3	0.8	0.6582	0.4873	1.3452	1.0958	1.3452	1.3452	1.0958	
3	13.528	11.316	713.9	552.4	490.0	552.3	519.3	8.4	46.7	0.9	0.6355	0.4839	1.3488	1.0943	1.3488	1.3488	1.0943	
4	7.863	6.468	655.8	530.5	477.8	530.5	449.1	0.9	43.2	0.1	0.5808	0.4645	1.3341	1.0917	1.3341	1.3341	1.0917	
5	1.478	0.211	573.0	486.5	430.6	486.3	378.0	-15.0	41.3	-1.8	0.5042	0.4251	1.2990	1.0887	1.2990	1.2990	1.0887	
6	-1.437	-2.636	550.2	477.1	424.5	476.7	352.8	-18.7	39.7	-2.2	0.4849	0.4167	1.2900	1.0879	1.2900	1.2900	1.0879	
7	-2.605	-3.775	552.0	486.9	447.5	486.6	336.9	-17.6	37.0	-2.1	0.4928	0.4258	1.2957	1.0868	1.2957	1.2957	1.0868	
8	-3.590	-4.719	559.6	496.5	451.1	496.2	331.3	-15.7	36.3	-1.8	0.4921	0.4342	1.3016	1.0880	1.3016	1.3016	1.0880	
9	-6.353	-7.163	566.4	508.4	456.6	508.3	335.2	-8.2	36.4	-0.9	0.4963	0.4433	1.3058	1.0967	1.3058	1.3058	1.0967	
10	-7.239	-7.880	574.2	513.3	458.0	513.2	346.4	-6.2	37.2	-0.7	0.5020	0.4465	1.3127	1.1025	1.3127	1.3127	1.1025	
11	-8.188	-8.558	564.1	491.3	440.2	490.8	352.8	-22.0	38.8	-2.6	0.4917	0.4257	1.2969	1.1068	1.2969	1.2969	1.1068	

SL	INCS	INCH	DEV	TURN	RHOVM-1	RHOVM-2	D-FAC	OMEGA-B	LOSS-P	P02/	EFF-A	EFF-P	EFF-A	EFF-P
	DEGREE	DEGREE	DEGREE	DEGREE				TOTAL	TOTAL	P01	TOT-INLET	TOT-INLET	TOT-STG	TOT-STG
1	-2.31	-0.20	12.66	49.91	38.35	47.15	0.4122	0.1303	0.0267	0.9649	91.85	92.16	91.85	92.16
2	-2.52	-0.12	11.99	47.56	38.68	46.65	0.3954	0.1084	0.0230	0.9726	93.38	93.62	93.38	93.62
3	-2.81	-0.03	11.25	45.85	38.82	46.43	0.3779	0.0844	0.0186	0.9799	94.72	94.91	94.72	94.91
4	-3.81	-0.09	9.37	43.09	38.40	44.61	0.3528	0.0564	0.0138	0.9884	93.71	93.93	93.71	93.93
5	-4.25	0.80	7.55	43.01	34.81	40.60	0.3355	0.0163	0.0045	0.9974	87.59	88.01	87.59	88.01
6	-5.28	0.33	7.12	41.58	34.47	39.69	0.3294	0.0396	0.0113	0.9940	85.96	86.42	85.96	86.42
7	-7.80	-1.93	7.30	39.08	36.56	40.58	0.3156	0.0581	0.0169	0.9911	88.57	88.94	88.57	88.94
8	-8.26	-2.12	7.62	38.15	36.91	41.38	0.2981	0.0431	0.0128	0.9934	88.96	89.33	88.96	89.33
9	-8.24	-1.36	9.62	37.31	37.30	42.16	0.2940	0.0556	0.0173	0.9914	82.93	83.54	82.93	83.54
10	-7.73	-0.68	11.08	37.90	37.29	42.38	0.3021	0.0683	0.0216	0.9892	79.72	79.72	79.72	79.72
11	-6.80	0.35	10.74	41.41	35.66	40.23	0.3437	0.1117	0.0358	0.9830	72.21	73.16	72.21	73.16

NCORR	WCORR	TO/TO	PO/PO	EFF-AD	EFF-P	T02/T01	P02/P01	EFF-AD
INLET	INLET	INLET	INLET	INLET	INLET			STAGE
RPM	LBW/SEC	%	%	%	%			%
7468.	123.90	1.0936	1.3151	87.03	87.49	1.0936	0.9883	87.03

ORIGINAL PAGE IS
OF POOR QUALITY

ROTOR 2

SL	EPSI-1	EPSI-2	V-1	V-2	VM-1	VM-2	V0-1	V0-2	B-1	B-2	M-1	M-2	RUN NO	9, SPEED	CGDE	TO, POINT	NG 1	V'-1	V'-2
	DEGREE	DEGREE	FT/SEC	FT/SEC	FT/SEC	FT/SEC	FT/SEC	FT/SEC	DEGREE	DEGREE								FT/SEC	FT/SEC
1	11.560	11.126	612.6	855.1	612.6	697.5	3.2	561.0	0.3	38.7	0.5386	0.7721	582.3	610.8	0.7412	0.6032	843.0	699.3	
2	10.696	9.910	610.7	888.1	610.7	685.9	7.3	564.1	0.7	39.3	0.5374	0.7653	598.8	623.6	0.7482	0.5933	850.2	688.5	
3	9.669	8.750	611.9	874.6	611.9	685.5	8.2	543.3	0.8	38.3	0.5389	0.7537	615.8	636.8	0.7594	0.5961	862.3	691.8	
4	5.780	5.423	601.6	810.2	601.6	681.9	0.9	437.5	0.1	32.7	0.5300	0.6979	668.5	679.2	0.7917	0.6232	898.7	723.5	
5	-0.564	0.644	554.5	687.7	556.7	614.6	-15.1	308.5	-1.6	26.7	0.4894	0.5902	741.1	740.6	0.8251	0.6447	939.0	751.3	
6	-3.456	-1.680	540.2	606.4	539.9	548.2	-18.7	259.3	-2.0	25.3	0.4742	0.5186	778.1	773.3	0.8449	0.6426	962.5	751.5	
7	-4.453	-2.613	544.5	584.0	544.2	534.1	-17.6	236.0	-1.9	23.8	0.4784	0.4995	796.8	790.1	0.8605	0.6584	979.5	769.6	
8	-5.229	-3.456	549.9	586.4	549.7	546.1	-15.6	213.5	-1.6	21.3	0.4830	0.5025	815.6	807.4	0.8753	0.6814	996.5	806.8	
9	-7.723	-6.505	557.2	612.2	557.2	578.8	-8.1	199.5	-0.8	18.9	0.4877	0.5242	872.7	860.8	0.9122	0.7525	1042.3	878.8	
10	-8.594	-7.694	558.3	607.7	558.3	577.2	-6.7	190.0	-0.7	18.2	0.4874	0.5192	891.9	879.2	0.9235	0.7680	1057.9	898.9	
11	-9.234	-8.847	555.2	549.4	534.7	526.4	-22.3	157.1	-2.4	16.6	0.4653	0.4670	911.2	857.8	0.9355	0.7726	1075.8	908.8	

SL	INCS	INCM	DEV	TURN	RHOVM-1	RHOVM-2	O-FAC	OMEGA-B	LOSS-P	PO2/	EFF-P	EFF-A	B'-1	B'-2	V0'-1	V0'-2	PC/PO
	DEGREE	DEGREE	DEGREE	DEGREE				TOTAL	TOTAL	PO1	TOT	TOT	DEGREE	DEGREE	FT/SEC	FT/SEC	INLET
1	-6.17	-1.85	24.46	39.25	50.08	60.08	0.3249	0.1459	0.0332	1.3335	86.51	85.98	43.31	4.07	-579.1	-49.8	1.8019
2	-5.89	-1.44	18.76	39.12	49.97	59.61	0.3462	0.1472	0.0343	1.3410	84.44	85.90	44.06	4.94	-591.5	-59.5	1.8094
3	-5.54	-0.97	15.29	37.05	50.08	60.17	0.3479	0.1270	0.0301	1.3407	87.85	87.36	44.81	7.76	-607.8	-93.6	1.8081
4	-3.75	1.04	9.96	28.48	49.04	61.16	0.3204	0.0519	0.0126	1.3169	94.08	93.87	48.00	19.53	-667.0	-241.7	1.8156
5	0.17	4.75	6.89	18.53	45.17	54.99	0.2979	0.0557	0.0129	1.2451	91.18	90.95	53.64	35.11	-756.2	-432.1	1.6154
6	1.53	5.86	6.92	12.76	43.88	48.45	0.3067	0.1286	0.0278	1.1800	76.99	76.10	53.90	43.13	-796.8	-514.0	1.5240
7	1.39	5.47	6.76	10.23	44.38	47.11	0.2951	0.1411	0.0299	1.1561	72.22	71.69	56.26	46.01	-814.4	-554.1	1.4998
8	1.15	4.56	5.02	5.19	44.87	48.21	0.2637	0.1119	0.0238	1.1510	75.69	75.25	56.53	47.34	-831.2	-593.8	1.4988
9	0.82	3.53	1.61	8.95	45.30	50.64	0.2264	0.0850	0.0196	1.1526	79.98	79.21	57.66	48.70	-880.9	-661.4	1.5101
10	0.91	3.09	3.27	8.16	45.24	50.17	0.2179	0.0852	0.0199	1.1451	78.30	77.93	58.11	49.94	-898.6	-689.1	1.5020
11	2.63	4.32	8.85	5.63	43.09	45.20	0.2183	0.1122	0.0246	1.1165	68.68	68.24	60.14	54.51	-933.5	-740.8	1.4476

TO/TO	PO/PO	EFF-AD	EFF-P	WCI/AL	TO2/TO1	PO2/PO1	EFF-AD	EFF-P
INLET	INLET	%	INLET	LB/SEC			%	ROTOR
1.1701	1.6142	86.17	87.05	35.23	1.0699	1.2275	86.12	86.48

STATOR 2

SL	EPSI-1	EPSI-2	V-1	V-2	VM-1	VM-2	V0-1	V0-2	B-1	B-2	M-1	M-2	RUN NO	9, SPEED	CGDE	TO, POINT	NG 1	PC/PO	TC2/	
	DEGREE	DEGREE	FT/SEC	FT/SEC	FT/SEC	FT/SEC	FT/SEC	FT/SEC	DEGREE	DEGREE								INLET	STAGE	TO1
1	8.867	1.147	928.3	814.0	744.0	813.3	555.2	-32.5	37.0	-2.3	0.8043	0.6949	1.5020	1.2070	1.1114	1.0992				
2	8.023	1.366	919.1	833.6	729.3	831.6	559.2	-57.2	37.7	-3.9	0.7932	0.7132	1.5333	1.2075	1.1358	1.1012				
3	7.186	1.473	904.6	853.0	725.6	850.5	540.2	-65.5	36.9	-4.4	0.7825	0.7321	1.5668	1.2058	1.1621	1.1013				
4	5.086	1.388	838.5	805.7	715.8	860.6	436.7	-93.9	31.5	-6.2	0.7247	0.7497	1.6125	1.1902	1.2041	1.0897				
5	2.692	0.645	718.1	808.0	648.0	802.4	309.6	-95.0	25.5	-6.7	0.6181	0.7016	1.5651	1.1687	1.2026	1.0735				
6	1.080	0.080	639.2	747.2	584.0	785.5	259.9	-50.5	24.0	-3.9	0.5482	0.6474	1.5007	1.1583	1.1642	1.0644				
7	-0.003	-0.266	615.3	713.2	567.7	711.3	237.2	-52.8	22.6	-4.2	0.5277	0.6170	1.4656	1.1536	1.1317	1.0615				
8	-1.061	-0.562	617.1	655.7	578.6	692.7	214.1	-64.6	20.3	-5.3	0.5303	0.6024	1.4450	1.1477	1.1134	1.0550				
9	-3.638	-1.093	645.5	714.6	613.6	713.9	200.4	-30.4	18.1	-2.4	0.5544	0.6181	1.4617	1.1541	1.1160	1.0523				
10	-4.446	-1.251	645.7	711.0	616.6	710.7	191.6	-19.1	17.3	-1.5	0.5536	0.6136	1.4543	1.1585	1.1085	1.0505				
11	-5.445	-1.270	595.6	628.7	574.2	628.9	158.3	-18.8	15.5	-1.7	0.5083	0.5381	1.3702	1.1586	1.0570	1.0468				

SL	INCS	INCM	DEV	TURN	RHOVM-1	RHOVM-2	O-FAC	OMEGA-B	LOSS-P	PO2/	EFF-A	EFF-P	EFF-A	EFF-P
	DEGREE	DEGREE	DEGREE	DEGREE				TOTAL	TOTAL	PO1	TOT-INLET	TOT-INLET	TOT-STG	TOT-STG
1	-11.44	-9.88	9.53	39.25	62.65	61.46	0.2667	0.4767	0.1076	0.8340	59.51	61.72	30.84	31.83
2	-9.70	-7.68	7.32	41.66	62.06	63.38	0.2487	0.4413	0.1013	0.8486	62.56	64.70	36.51	37.60
3	-9.78	-7.28	6.44	41.27	62.46	65.51	0.2232	0.4016	0.0939	0.8644	66.48	68.49	43.22	44.37
4	-14.07	-10.20	4.09	37.72	63.12	68.32	0.1418	0.2920	0.0721	0.9115	76.91	78.38	60.80	61.78
5	-19.17	-13.86	3.55	32.25	57.15	64.98	0.0588	0.1988	0.0528	0.9324	80.91	82.05	73.58	74.23
6	-20.43	-14.64	6.35	27.83	50.92	60.39	0.0015	0.1547	0.0427	0.9697	77.67	78.88	68.79	69.41
7	-15.17	-15.59	5.53	26.89	49.38	57.52	0.0210	0.1373	0.0384	0.9763	75.14	76.42	58.42	59.10
8	-23.78	-17.57	4.79	25.59	50.40	56.14	0.0007	0.1887	0.0534	0.9673	75.70	76.91	56.62	57.23
9	-25.71	-19.01	7.73	20.53	52.87	57.52	0.0026	0.1696	0.0497	0.9681	74.33	75.64	60.86	61.41
10	-27.18	-20.31	9.24	18.81	52.70	56.87	0.0039	0.1745	0.0516	0.9678	71.24	72.67	58.73	59.26
11	-30.28	-23.18	10.23	17.16	48.38	49.35	0.0316	0.3305	0.0986	0.9471	59.33	61.06	34.01	34.46

NCORR	WCORR	TO/TO	PO/PO	EFF-AD	EFF-P	TO2/TO1	PO2/PO1	EFF-AD	EFF-P
INLET	INLET	INLET	INLET	%	INLET			%	STAGE
RPM	LB/SEC								
7466	123.90	1.1701	1.5083	73.24	74.72	1.0699	0.9344	57.06	

ORIGINAL PAGE IS
OF POOR QUALITY

TABLE XV(b) — OVERALL PERFORMANCE AND BLADE-ELEMENT DATA
(Uniform Inlet Flow, 70 Percent Speed)

U. S. CUSTOMARY UNITS

ROTOR 1

SL	EPI-1		EPI-2		V-1	V-2	VM-1		VM-2		V0-1	V0-2	B-1	B-2	M-1	M-2	RUN NO	9. SPEED CODE		TO, POINT NO 2		V1-1	V1-2
	DEGREE	DEGREE	FT/SEC	FT/SEC			FT/SEC	FT/SEC	FT/SEC	FT/SEC								DEGREE	DEGREE	U-1	U-2		
1	16.440	18.116	362.9	737.3	362.9	438.5	0.0	592.7	0.0	53.5	0.3284	0.6572	435.8	509.1	0.5160	0.3979	570.1	446.4					
2	13.779	15.574	370.5	768.7	370.5	438.3	0.0	596.9	0.0	51.7	0.3354	0.6301	474.2	533.8	0.5449	0.3902	601.8	438.9					
3	11.382	13.290	377.6	682.3	377.6	438.4	0.0	522.8	0.0	49.9	0.3420	0.6054	508.0	558.4	0.5794	0.3903	632.9	439.9					
4	5.249	7.181	392.4	626.0	392.4	431.5	0.0	453.5	0.0	46.4	0.3558	0.5526	404.6	632.3	0.6537	0.4124	720.9	467.1					
5	-0.329	0.773	398.3	546.7	398.3	390.0	0.0	386.0	0.0	44.7	0.3613	0.4814	725.6	736.8	0.7508	0.4567	827.7	520.6					
6	-2.201	-1.848	398.4	531.0	398.4	392.5	0.0	357.7	0.0	42.4	0.3613	0.4654	783.7	780.1	0.7974	0.5053	879.1	576.6					
7	-3.342	-3.056	397.5	540.8	397.9	414.4	0.0	347.2	0.0	40.0	0.3609	0.4741	812.4	804.7	0.8205	0.5414	904.6	617.3					
8	-4.731	-4.256	396.7	544.4	396.7	421.7	0.0	344.3	0.0	39.2	0.3598	0.4772	841.1	829.3	0.8434	0.5633	929.9	642.7					
9	-8.924	-7.890	388.9	546.5	388.9	412.1	0.0	359.0	0.0	41.0	0.3525	0.4763	926.7	903.2	0.9110	0.5949	1005.0	682.7					
10	-10.282	-9.137	385.0	554.5	385.0	410.2	0.0	373.1	0.0	42.2	0.3489	0.4820	955.2	927.9	0.9333	0.5997	1029.9	690.0					
11	-11.447	-10.386	380.6	542.2	380.6	386.3	0.0	380.4	0.0	44.5	0.3448	0.4696	983.7	952.5	0.9556	0.5979	1054.8	690.3					

SL	INCS		INCM	DEV DEGREE	TURN DEGREE	RHOVM-1	RHOVM-2	D-FAC	MEGA-B	LOSS-P	PO2/PO1	%EFF-P	%EFF-A	B-1	B-2	V0-1	V0-2	PO/PG
	DEGREE	DEGREE																
1	3.83	8.44	17.16	11.02	26.31	34.73	0.4646	-0.0691	-0.0190	1.3975	103.44	103.63	50.22	-10.80	-439.8	83.6	1.3975	
2	3.91	8.21	16.59	54.74	26.80	35.08	0.4990	-0.0494	-0.0114	1.3879	102.77	102.93	51.73	-3.01	-474.2	23.1	1.3879	
3	4.12	8.22	16.16	48.49	27.25	35.39	0.5154	-0.0362	-0.0086	1.3779	102.27	102.41	53.12	4.63	-508.0	-35.6	1.3779	
4	5.38	8.84	12.79	34.41	28.19	35.40	0.5270	0.0046	0.0011	1.3591	99.56	99.57	56.88	22.47	-604.8	-178.8	1.3591	
5	6.71	9.39	11.20	15.95	28.56	32.23	0.5141	0.0811	0.0182	1.3199	91.48	91.18	61.22	41.47	-725.6	-344.8	1.3199	
6	7.13	9.41	9.77	15.95	28.56	32.60	0.4736	0.0734	0.0158	1.3160	91.48	91.17	63.07	47.12	-783.7	-422.4	1.3160	
7	7.34	9.44	7.53	18.68	28.53	34.58	0.4421	0.0476	0.0104	1.3274	94.23	94.03	63.92	47.84	-812.4	-457.5	1.3274	
8	7.55	9.51	6.15	15.76	28.46	35.24	0.4317	0.0502	0.0109	1.3334	93.76	93.54	64.77	49.01	-861.1	-485.0	1.3334	
9	8.24	9.65	6.05	14.43	27.97	34.24	0.4468	0.1221	0.0262	1.3402	84.54	83.92	67.27	52.84	-926.7	-544.3	1.3402	
10	8.40	9.69	6.47	14.61	27.72	33.95	0.4601	0.1537	0.0331	1.3473	80.86	80.06	68.08	53.47	-955.2	-554.8	1.3473	
11	8.52	9.67	9.54	12.57	27.44	31.81	0.4771	0.1940	0.0401	1.3389	75.78	74.79	68.86	55.88	-983.7	-572.0	1.3389	

TO/TO INLET	PO/PG INLET	EFF-AD INLET	EFF-P INLET	WCL/AL LBM/SEC	T02/T01	PO2/PO1	EFF-AD ROTOR	EFF-P ROTOR
1.0568	1.3449	91.35	91.68	27.03	1.0968	1.3449	91.35	91.68

STATOR 1

SL	EPI-1		EPI-2		V-1	V-2	VM-1		VM-2		V0-1	V0-2	B-1	B-2	M-1	M-2	RUN NO	9. SPEED CODE		TO, POINT NO 2		V1-1	V1-2
	DEGREE	DEGREE	FT/SEC	FT/SEC			FT/SEC	FT/SEC	FT/SEC	FT/SEC								DEGREE	DEGREE	U-1	U-2		
1	18.090	14.792	740.8	522.5	460.5	522.5	580.2	-1.3	51.7	-0.1	0.6605	0.4560	1.3508	1.0969	1.3508	1.0969	1.3508	1.0969					
2	15.687	12.941	714.8	517.9	460.2	517.7	546.9	14.0	50.0	1.5	0.6360	0.4522	1.3508	1.0954	1.3508	1.0954	1.3508	1.0954					
3	13.483	11.232	690.3	514.7	459.8	514.3	514.9	20.9	48.3	2.3	0.6130	0.4496	1.3507	1.0937	1.3507	1.0937	1.3507	1.0937					
4	7.922	6.459	637.3	456.2	451.5	496.2	449.8	-4.3	44.9	-0.5	0.5633	0.4332	1.3387	1.0920	1.3387	1.0920	1.3387	1.0920					
5	-1.712	0.817	561.6	459.5	408.9	459.1	385.3	-19.6	43.3	-2.4	0.4935	0.4004	1.3107	1.0905	1.3107	1.0905	1.3107	1.0905					
6	-1.041	-1.685	544.7	455.1	410.6	454.7	358.0	-19.2	41.1	-2.4	0.4779	0.3966	1.3065	1.0896	1.3065	1.0896	1.3065	1.0896					
7	-2.147	-2.889	594.0	468.4	431.1	468.2	348.0	-15.1	38.9	-1.8	0.4864	0.4085	1.3148	1.0898	1.3148	1.0898	1.3148	1.0898					
8	-3.095	-3.769	557.9	477.1	438.0	476.9	345.6	-14.0	38.3	-1.7	0.4895	0.4160	1.3207	1.0918	1.3207	1.0918	1.3207	1.0918					
9	-5.928	-6.326	561.2	481.5	429.6	481.9	361.1	-1.7	40.1	-0.2	0.4897	0.4179	1.3257	1.1040	1.3257	1.1040	1.3257	1.1040					
10	-6.923	-7.210	569.6	483.7	428.1	483.7	375.7	2.8	41.4	0.3	0.4957	0.4181	1.3275	1.1111	1.3275	1.1111	1.3275	1.1111					
11	-8.013	-8.150	558.2	462.0	405.6	461.7	383.4	-16.2	43.5	-2.0	0.4841	0.3978	1.3137	1.1163	1.3137	1.1163	1.3137	1.1163					

SL	INCS		INCM	DEV DEGREE	TURN DEGREE	RHOVM-1	RHOVM-2	D-FAC	MEGA-B	LOSS-P	PO2/PO1	%EFF-P	%EFF-A	B-1	B-2	V0-1	V0-2	PO/PG
	DEGREE	DEGREE																
1	-0.81	1.30	12.19	51.84	36.40	44.44	0.4481	0.1312	0.0268	0.9667	92.67	92.95	92.67	92.67	92.67	92.67	92.67	92.67
2	-0.82	1.58	12.76	48.45	36.70	44.17	0.4270	0.1110	0.0236	0.9735	94.13	94.34	94.13	94.13	94.13	94.13	94.13	94.13
3	-1.25	1.54	12.71	45.56	36.94	43.99	0.4060	0.0869	0.0192	0.9805	95.84	95.98	95.84	95.84	95.84	95.84	95.84	95.84
4	-2.14	1.58	8.78	45.34	36.83	42.42	0.3912	0.0746	0.0182	0.9855	94.50	94.69	94.50	94.50	94.50	94.50	94.50	94.50
5	-2.23	2.82	6.87	45.71	33.60	34.00	0.3772	0.0440	0.0120	0.9933	88.85	89.24	88.85	88.85	88.85	88.85	88.85	88.85
6	-3.93	1.68	6.94	43.51	33.92	38.59	0.3633	0.0548	0.0157	0.9920	88.69	89.07	88.69	88.69	88.69	88.69	88.69	88.69
7	-5.87	0.00	7.54	40.78	35.78	38.79	0.3463	0.0654	0.0191	0.9902	90.63	90.96	90.63	90.63	90.63	90.63	90.63	90.63
8	-6.30	-0.16	7.74	39.99	36.39	40.52	0.3368	0.0633	0.0188	0.9904	90.21	90.56	90.21	90.21	90.21	90.21	90.21	90.21
9	-4.50	2.38	10.35	40.32	35.47	40.61	0.3440	0.0712	0.0222	0.9892	80.75	81.47	80.75	80.75	80.75	80.75	80.75	80.75
10	-3.59	3.46	12.10	41.02	35.21	40.55	0.3600	0.0963	0.0305	0.9851	75.93	76.85	75.93	75.93	75.93	75.93	75.93	75.93
11	-2.13	9.02	11.30	45.52	33.18	38.43	0.4038	0.1272	0.0407	0.9812	69.73	70.84	69.73	69.73	69.73	69.73	69.73	69.73

NCCORR INLET RPM	NCCORR INLET LBM/SEC	TO/TO INLET	PO/PG INLET	EFF-AD INLET	EFF-P INLET	T02/T01	PO2/PO1	EFF-AD STAGE	EFF-P STAGE
7482	119.00	1.0468	1.3263	86.90	87.38	1.0968	0.9842	86.90	87.38

ROTOR 2

SL	EPSI-1	EPSI-2	V-1	V-2	VM-1	VM-2	V0-1	V0-2	B-1	B-2	M-1	M-2	RUN NO	% SPEED	CODE	TO	POINT NO 2	V*-1	V*-2	
DEGREE	DEGREE	FT/SEC	FT/SEC	FT/SEC	FT/SEC	FT/SEC	FT/SEC	FT/SEC	DEGREE	DEGREE								FT/SEC	FT/SEC	
1	11.534	11.033	566.2	896.4	566.2	655.9	-1.3	611.0	-0.1	42.8	0.4959	0.7659					0.7129	0.5633	813.9	655.9
2	10.637	9.724	566.5	879.1	566.3	638.1	13.7	604.6	1.4	43.3	0.4966	0.7344					0.7145	0.5479	815.1	638.4
3	9.594	8.486	567.5	854.5	567.1	628.4	20.4	579.1	2.1	42.6	0.4979	0.7330					0.7222	0.5414	823.1	631.2
4	5.710	4.983	557.3	767.7	557.3	610.2	-4.3	455.1	-0.4	36.3	0.4889	0.6565					0.7673	0.5627	874.6	658.0
5	-0.143	0.349	517.7	637.3	517.4	535.3	-19.6	345.9	-2.2	32.9	0.4531	0.5414					0.8061	0.5657	921.1	665.9
6	-2.593	-1.679	507.8	579.2	507.4	488.9	-19.0	310.6	-2.1	32.4	0.4442	0.4908					0.8277	0.5713	946.2	674.1
7	-3.441	-2.517	517.4	571.6	517.2	489.9	-15.1	294.5	-1.7	31.0	0.4529	0.4647					0.8438	0.5918	963.9	698.0
8	-4.206	-3.326	524.6	576.8	524.4	505.0	-14.0	278.7	-1.5	28.8	0.4590	0.4895					0.8599	0.6213	982.8	732.2
9	-6.741	-6.075	531.9	593.3	531.9	524.5	-1.8	277.3	-0.2	27.7	0.4630	0.5013					0.8625	0.6640	1025.0	785.9
10	-7.046	-7.171	534.3	596.6	534.3	528.7	3.0	275.1	0.3	27.4	0.4637	0.5022					0.9013	0.6775	1038.6	804.0
11	-8.528	-8.398	514.3	562.6	514.1	506.6	-16.3	244.7	-1.8	25.7	0.4445	0.4719					0.9178	0.6945	1061.9	828.0

SL	INCS	INCM	DEV	TURN	RHOVM-1	RHOVM-2	O-FAC	MEGA-B	LOSS-P	PO2/	%EFF-P	%EFF-A	B*-1	B*-2	V0*-1	V0*-2	PO/PO
DEGREE	DEGREE	INCH	DEGREE	DEGREE				TOTAL	TOTAL	TOT	TOT	DEGREE	DEGREE	FT/SEC	FT/SEC	INLET	
1	-3.64	0.68	20.48	45.76	47.29	58.86	0.3696	0.0994	0.0227	1.3988	92.17	91.81	45.84	0.08	-584.7	-0.9	1.8894
2	-3.99	0.46	15.42	44.16	47.35	57.84	0.3893	0.0948	0.0221	1.3943	92.41	92.06	45.96	1.80	-596.2	-20.1	1.8834
3	-3.90	0.68	12.88	41.11	47.46	57.53	0.3989	0.0871	0.0208	1.3822	92.66	92.33	46.45	5.35	-596.5	-59.0	1.8670
4	-1.31	3.46	10.46	30.42	46.48	57.73	0.3836	0.0513	0.0124	1.3385	94.65	94.45	50.44	20.02	-674.0	-225.4	1.7912
5	2.36	6.93	8.28	19.33	43.00	50.08	0.3896	0.0876	0.0200	1.2686	88.26	87.90	55.83	34.50	-762.1	-396.1	1.6619
6	3.19	7.53	7.29	14.07	42.25	45.61	0.3918	0.1268	0.0273	1.2292	81.30	80.78	57.57	43.50	-798.6	-464.2	1.6075
7	2.66	6.74	6.12	12.16	43.16	45.80	0.3743	0.1219	0.0261	1.2183	80.89	80.38	57.54	45.38	-813.4	-497.1	1.6024
8	2.34	6.15	4.01	11.39	43.75	47.31	0.3480	0.0986	0.0213	1.2179	83.58	83.15	57.72	46.33	-831.2	-530.2	1.6084
9	1.85	4.53	0.90	10.66	43.97	48.82	0.3272	0.0822	0.0192	1.2256	85.68	85.30	58.66	48.00	-876.2	-585.2	1.6243
10	1.74	3.92	2.06	10.20	43.94	48.98	0.3189	0.0738	0.0177	1.2245	86.74	86.39	58.94	48.74	-890.6	-605.7	1.6266
11	3.43	5.13	6.49	8.80	41.99	46.53	0.3118	0.0800	0.0185	1.2141	84.91	84.52	60.95	52.15	-929.2	-654.9	1.5955

TO/TD	PO/PO	EFF-AD	EFF-P	WCI/A1	TO2/T01	P02/P01	EFF-AD	EFF-P
INLET	INLET	INLET	INLET	LBM/SEC			ROTOR	ROTOR
%	%	%	%	%			%	%
1.1860	1.6931	87.44	88.32	33.60	1.0814	1.2780	89.07	89.42

STATOR 2

SL	EPSI-1	EPSI-2	V-1	V-2	VM-1	VM-2	V0-1	V0-2	B-1	B-2	M-1	M-2	RUN NO	% SPEED	CODE	TO	POINT NO 2	PO/PO	TO/TD	PO/PO	TE2/
DEGREE	DEGREE	FT/SEC	FT/SEC	FT/SEC	FT/SEC	FT/SEC	FT/SEC	FT/SEC	DEGREE	DEGREE								INLET	INLET	STAGE	T01
1	8.086	0.852	925.5	138.0	700.5	737.4	604.9	30.1	41.1	2.3	0.7980	0.6220					1.7614	1.2171	1.3040	1.1095	
2	7.652	0.767	906.8	145.1	680.4	745.1	599.5	3.9	41.6	0.3	0.7810	0.6292					1.7765	1.2146	1.3152	1.1086	
3	6.592	0.546	881.4	161.3	667.8	761.3	575.3	-8.6	40.9	-0.7	0.7586	0.6455					1.8052	1.2092	1.3364	1.1055	
4	3.933	-0.310	792.8	120.3	650.1	720.3	455.7	-9.7	35.0	-0.8	0.6798	0.6126					1.7661	1.1931	1.3188	1.0925	
5	1.159	-0.976	661.5	614.4	583.9	613.9	345.8	-23.7	31.5	-2.2	0.5632	0.5207					1.6533	1.1779	1.2615	1.0801	
6	-0.526	-1.230	603.2	558.8	517.0	558.6	310.8	-14.9	31.0	-1.5	0.5122	0.4727					1.6065	1.1716	1.2245	1.0753	
7	-1.441	-1.310	595.5	549.0	517.4	548.6	294.8	-19.7	29.6	-2.1	0.5059	0.4646					1.5915	1.1687	1.2103	1.0723	
8	-2.256	-1.333	600.4	551.2	531.5	569.6	279.3	-42.0	27.7	-4.4	0.5105	0.4668					1.5920	1.1677	1.2055	1.0696	
9	-4.321	-1.329	620.7	578.3	554.6	578.3	270.6	-2.9	26.7	-0.3	0.5256	0.4880					1.6064	1.1807	1.2120	1.0700	
10	-5.024	-1.339	626.6	585.0	562.2	584.9	276.7	9.6	26.2	0.9	0.5294	0.4925					1.6081	1.1872	1.2109	1.0688	
11	-5.830	-1.262	599.9	551.5	546.9	551.5	246.4	2.3	24.3	0.2	0.5047	0.4622					1.5742	1.1915	1.1981	1.0673	

SL	INCS	INCM	DEV	TURN	RHOVM-1	RHOVM-2	O-FAC	MEGA-B	LOSS-P	PO2/	%EFF-A	%EFF-P	%EFF-A	%EFF-P
DEGREE	DEGREE	INCH	DEGREE	DEGREE				TOTAL	TOTAL	P01	TOT-INLET	TOT-INLET	TOT-STG	TOT-STG
1	-7.37	-5.81	14.15	34.75	61.64	67.73	0.3431	0.1979	0.0447	0.9320	80.80	82.24	71.81	72.83
2	-5.81	-3.79	11.35	41.31	60.55	68.88	0.3317	0.1732	0.0399	0.9421	83.09	84.38	74.87	75.80
3	-5.73	-3.22	10.19	41.57	60.10	71.14	0.2976	0.1116	0.0262	0.9642	87.79	88.74	81.73	82.44
4	-10.50	-6.71	9.55	35.75	59.84	68.03	0.2419	0.0608	0.0151	0.9837	91.30	91.95	88.78	89.18
5	-13.21	-7.40	8.09	33.71	52.18	57.73	0.2271	0.0403	0.0108	0.9920	86.78	87.66	85.46	85.89
6	-13.42	-7.63	8.49	32.51	47.73	52.31	0.2254	0.0303	0.0084	0.9950	83.76	84.78	78.95	79.51
7	-14.50	-8.59	8.11	31.70	47.88	51.40	0.2268	0.0412	0.0115	0.9934	84.15	85.13	77.40	77.97
8	-16.34	-10.14	5.74	32.07	49.30	51.50	0.2342	0.0623	0.0176	0.9899	84.71	85.66	78.70	79.22
9	-17.10	-10.41	5.88	26.98	51.00	53.56	0.2020	0.0645	0.0189	0.9889	80.21	81.46	80.50	80.99
10	-18.21	-11.33	11.71	25.31	51.39	53.82	0.1924	0.0631	0.0187	0.9891	77.61	79.03	81.52	81.98
11	-21.41	-14.31	12.17	24.09	49.47	50.18	0.2023	0.0822	0.0246	0.9869	72.25	73.94	78.58	79.09

NCORR	WCORR	TO/TD	PO/PO	EFF-AD	EFF-P	TO2/T01	P02/P01	EFF-AD
INLET	INLET	INLET	INLET	INLET	INLET			STAGE
RPM	LBM/SEC	%	%	%	%			%
7482	119.00	1.1860	1.6648	84.23	85.30	1.0814	0.9822	82.33

ORIGINAL PAGE IS
OF POOR QUALITY

TABLE XV(c) — OVERALL PERFORMANCE AND BLADE-ELEMENT DATA
(Uniform Inlet Flow, 70 Percent Speed)

U. S. CUSTOMARY UNITS

ROTOR 1

SL	Epsi-1		Epsi-2		V-1		V-2		VM-1		VM-2		V0-1		V0-2		B-1		B-2		M-1		M-2		RUN NO	9, SPEED	CODE 70,	POINT NO 3		V1-1	V1-2
	DEGREE	DEGREE	FT/SEC	FT/SEC	FT/SEC	FT/SEC	FT/SEC	FT/SEC	FT/SEC	FT/SEC	FT/SEC	FT/SEC	FT/SEC	FT/SEC	FT/SEC	FT/SEC	FT/SEC	DEGREE	DEGREE	DEGREE	DEGREE	DEGREE	DEGREE	DEGREE				DEGREE	FT/SEC		
1	16.577	18.063	330.1	711.9	330.1	392.6	0.0	593.8	0.0	56.5	0.2982	0.6326	440.8	510.3	0.4975	0.3567	550.7	401.4													
2	14.007	15.491	337.7	683.5	337.7	398.1	0.0	555.7	0.0	54.3	0.3052	0.6060	475.3	535.0	0.5269	0.3534	583.1	398.6													
3	11.603	13.162	345.0	657.5	345.0	406.0	0.0	517.1	0.0	51.8	0.3119	0.5820	509.2	559.7	0.5561	0.3614	615.0	408.2													
4	5.123	7.238	359.7	604.7	359.7	388.5	0.0	463.4	0.0	50.0	0.3255	0.5323	606.2	633.8	0.6379	0.3734	704.9	424.2													
5	-0.307	0.942	364.6	537.9	364.6	350.6	0.0	407.9	0.0	49.3	0.3300	0.4703	727.3	732.5	0.7364	0.4177	813.6	477.8													
6	-2.202	-1.637	364.5	519.4	364.5	359.2	0.0	375.7	0.0	46.3	0.3299	0.4541	785.6	781.9	0.7838	0.4738	866.0	542.3													
7	-3.494	-2.852	364.0	529.4	364.0	387.3	0.0	361.6	0.0	43.0	0.3295	0.4634	814.3	806.6	0.8073	0.5160	892.0	590.0													
8	-5.173	-4.108	362.7	538.4	362.7	402.9	0.0	357.1	0.0	41.6	0.3283	0.4708	843.0	831.3	0.8306	0.5442	917.8	622.3													
9	-10.115	-8.017	359.4	540.1	353.4	375.2	0.0	388.6	0.0	46.0	0.3196	0.4685	928.9	905.4	0.8985	0.5539	995.8	638.6													
10	-11.380	-9.300	349.1	531.3	349.1	350.9	0.0	399.0	0.0	48.6	0.3157	0.4592	957.5	930.1	0.9216	0.5502	1019.1	638.6													
11	-12.103	-10.511	349.0	516.0	345.0	322.2	0.0	403.1	0.0	51.3	0.3120	0.4446	986.0	954.7	0.9445	0.5504	1044.8	638.9													

SL	INCS	INCM	DEV	TURN	RHOVM-1	RHOVM-2	D-FAC	OMEGA-B	LOSS-P	P02/	%EFF-P	%EFF-A	B1-1	B1-2	V01-1	V01-2	PG/PO
DEGREE	DEGREE	DEGREE	DEGREE	DEGREE	TOTAL	TOTAL	TOTAL	TOTAL	TOTAL	P01	TOT	TOT	DEGREE	DEGREE	FT/SEC	FT/SEC	INLET
1	6.55	11.16	15.95	64.94	24.14	31.59	0.5274	-0.0746	-0.0161	1.3995	103.46	103.66	52.94	-12.00	-440.8	83.5	1.3995
2	6.55	10.85	16.64	57.33	24.66	32.39	0.5510	-0.0694	-0.0160	1.3920	103.68	103.68	54.37	-2.96	-475.3	20.7	1.3920
3	6.65	10.75	17.50	49.68	25.14	33.36	0.5503	-0.0744	-0.0177	1.3837	104.47	104.71	53.65	5.97	-509.2	-42.6	1.3837
4	7.67	11.14	13.96	35.53	26.10	32.39	0.5807	0.0031	0.0007	1.3693	99.69	99.71	59.17	23.64	-606.2	-170.4	1.3693
5	8.85	11.53	12.52	20.58	26.42	29.50	0.5660	0.0815	0.0180	1.3437	92.17	91.86	63.37	42.75	-727.3	-324.6	1.3437
6	9.19	11.47	11.18	16.40	26.41	30.43	0.5115	0.0426	0.0131	1.3420	93.30	93.04	65.12	46.52	-785.5	-406.2	1.3420
7	9.35	11.46	8.66	16.96	26.38	33.03	0.4701	0.0274	0.0058	1.3546	96.92	96.81	65.93	48.97	-814.3	-445.0	1.3546
8	9.54	11.49	6.80	17.10	26.30	34.44	0.4515	0.0200	0.0043	1.3648	97.66	97.58	66.76	49.66	-843.0	-474.2	1.3648
9	10.22	11.65	7.21	15.27	25.69	31.71	0.4970	0.1367	0.0285	1.3697	84.08	83.39	69.27	54.00	-928.8	-516.8	1.3697
10	10.38	11.67	9.51	13.59	25.41	29.50	0.5171	0.1814	0.0362	1.3642	78.90	77.99	70.08	56.51	-957.5	-531.1	1.3642
11	10.43	11.58	13.30	11.12	25.14	26.97	0.5299	0.2178	0.0406	1.3547	74.47	73.39	70.76	59.64	-986.0	-551.7	1.3547

TO/T0	PO/PO	EFF-AD	EFF-P	WCI/41	LOSS-P	P02/P01	%EFF-A	%EFF-P	
INLET	INLET	INLET	INLET	LBM/SEC	%	%	%	%	
1.1008	1.3643	92.11	92.42	24.92		1.1008	1.3643	92.11	92.42

STATOR 1

SL	Epsi-1		Epsi-2		V-1		V-2		VM-1		VM-2		V0-1		V0-2		B-1		B-2		M-1		M-2		RUN NO	9, SPEED	CODE 70,	POINT NO 3		TO2/	TO1
DEGREE	DEGREE	FT/SEC	FT/SEC	FT/SEC	FT/SEC	FT/SEC	FT/SEC	FT/SEC	FT/SEC	FT/SEC	FT/SEC	FT/SEC	FT/SEC	FT/SEC	FT/SEC	FT/SEC	DEGREE	DEGREE	DEGREE	DEGREE	DEGREE	DEGREE	DEGREE	DEGREE				FT/SEC	FT/SEC		
1	18.029	14.809	712.4	444.8	411.9	464.7	581.2	5.8	54.8	0.7	0.6331	0.4038	1.3523	1.0973	1.3523	1.0973															
2	15.606	13.027	686.7	465.3	416.8	464.9	545.7	20.9	52.7	2.6	0.6090	0.4047	1.3555	1.0954	1.3555	1.0954															
3	13.481	11.384	662.6	464.0	423.8	463.1	509.3	29.5	50.3	3.6	0.5869	0.4040	1.3568	1.0929	1.3568	1.0929															
4	8.231	6.826	613.1	442.7	405.7	442.4	459.7	15.6	48.6	2.0	0.5401	0.3846	1.3449	1.0943	1.3449	1.0943															
5	1.887	0.977	548.4	415.4	367.3	415.3	407.2	-8.8	47.9	-1.2	0.4798	0.3599	1.3275	1.0959	1.3275	1.0959															
6	-0.887	-1.563	531.0	414.8	375.0	414.6	376.0	-11.3	45.1	-1.6	0.4644	0.3597	1.3266	1.0943	1.3266	1.0943															
7	-1.923	-2.540	541.0	429.9	401.7	429.9	362.3	-1.3	42.1	-0.2	0.4736	0.3733	1.3354	1.0936	1.3354	1.0936															
8	-2.736	-3.329	545.3	444.0	416.4	444.0	358.2	1.4	40.7	0.2	0.4808	0.3856	1.3443	1.0952	1.3443	1.0952															
9	-5.272	-5.642	552.0	435.5	350.1	435.4	390.6	8.2	45.1	1.1	0.4793	0.3750	1.3412	1.1122	1.3412	1.1122															
10	-6.385	-6.608	543.9	422.6	366.9	422.6	401.5	3.0	47.6	0.4	0.4706	0.3625	1.3348	1.1186	1.3348	1.1186															
11	-7.725	-7.784	529.1	401.0	339.0	400.5	406.2	-19.6	50.2	-2.8	0.4563	0.3428	1.3238	1.1235	1.3238	1.1235															

SL	INCS	INCM	DEV	TURN	RHOVM-1	RHOVM-2	D-FAC	OMEGA-B	LOSS-P	P02/	%EFF-A	%EFF-P	%EFF-A	%EFF-P
DEGREE	DEGREE	DEGREE	DEGREE	DEGREE	TOTAL	TOTAL	TOTAL	TOTAL	TOTAL	P01	TOT	TOT	TOT	TOT
1	2.29	4.40	13.04	54.13	33.13	40.42	0.5054	0.1422	0.0291	0.9664	92.65	92.93	92.65	92.93
2	1.87	4.27	13.78	50.16	33.86	40.59	0.4776	0.1170	0.0248	0.9740	95.29	95.46	95.29	95.46
3	0.75	3.54	14.01	46.65	34.74	40.57	0.4534	0.0930	0.0205	0.9807	98.15	98.20	98.15	98.20
4	1.56	5.28	11.28	46.55	33.65	38.66	0.4517	0.0989	0.0241	0.9822	93.76	93.99	93.76	93.99
5	2.42	7.47	8.10	49.13	30.77	26.09	0.4485	0.0821	0.0224	0.9880	87.98	88.42	87.98	88.42
6	0.05	5.67	7.80	46.63	31.63	36.06	0.4279	0.0869	0.0249	0.9880	89.28	89.67	89.28	89.67
7	-2.74	3.14	9.22	42.23	34.10	37.48	0.4019	0.1009	0.0295	0.9856	92.05	92.34	92.05	92.34
8	-3.88	2.27	9.61	40.54	35.43	38.73	0.3848	0.1010	0.0300	0.9852	92.83	93.09	92.83	93.09
9	0.46	7.34	11.63	43.11	32.81	37.46	0.4284	0.1447	0.0451	0.9789	78.05	78.91	78.05	78.91
10	2.69	9.74	12.18	47.23	30.69	36.14	0.4579	0.1573	0.0498	0.9778	72.60	73.66	72.60	73.66
11	4.62	11.77	10.51	53.05	28.23	34.05	0.3028	0.1725	0.0552	0.9770	67.59	68.81	67.59	68.81

WCI/41	LOSS-P	P02/P01	%EFF-A	%EFF-P
LBM/SEC	%	%	%	%
7500.	109.70	1.1008	1.3643	86.41

ROTOR 2

SL	EPS1-1	EPS1-2	V-1	V-2	VM-1	VM-2	V0-1	V0-2	B-1	B-2	M-1	M-2	9, SPEED	CODE	TO, POINT NO 3	V*-1	V*-2	
DEGREE	DEGREE	FT/SEC	FT/SEC	FT/SEC	FT/SEC	FT/SEC	FT/SEC	FT/SEC	DEGREE	DEGREE						FT/SEC	FT/SEC	
1	11.546	10.582	495.6	863.5	499.5	593.0	5.6	627.7	0.6	46.5	0.4352	0.7376	584.8	613.4	0.6663	0.5067	764.9	593.1
2	10.670	9.651	503.8	847.6	503.4	569.6	20.3	627.6	2.3	47.7	0.4394	0.7234	601.3	626.2	0.6705	0.4862	768.8	569.6
3	9.683	8.419	505.7	827.8	504.9	555.4	29.0	613.8	3.3	47.8	0.4416	0.7062	618.4	639.6	0.6778	0.4743	776.1	556.0
4	5.935	4.946	492.9	743.5	452.6	542.9	15.4	508.0	1.8	43.1	0.4297	0.6313	671.3	682.1	0.7152	0.4841	820.3	570.1
5	0.137	0.401	466.8	636.0	466.7	496.6	-8.8	397.3	-1.1	38.7	0.4059	0.5365	744.3	743.8	0.7704	0.5108	886.0	605.5
6	-2.491	-1.781	461.2	592.1	461.1	460.6	-11.0	372.1	-1.4	38.9	0.4012	0.4984	781.4	776.6	0.7975	0.5159	916.8	613.0
7	-3.410	-2.662	471.9	582.5	471.9	449.0	-1.2	371.2	-0.1	39.5	0.4110	0.4901	800.2	793.5	0.8099	0.5186	930.0	616.4
8	-4.062	-3.400	483.2	545.4	483.2	455.9	1.4	367.2	0.2	38.8	0.4208	0.4922	819.1	810.8	0.8271	0.5349	949.7	636.2
9	-6.042	-5.680	480.0	599.6	479.9	466.5	8.3	376.6	1.0	38.8	0.4146	0.4997	876.5	864.5	0.8569	0.5627	991.9	675.1
10	-6.911	-6.647	471.5	602.2	471.4	469.5	4.1	377.1	0.5	38.6	0.4058	0.5001	895.7	882.9	0.8682	0.5731	1008.6	690.2
11	-8.024	-7.575	453.5	583.5	453.1	468.6	-19.4	347.7	-2.4	36.4	0.3890	0.4823	915.1	901.7	0.8908	0.5998	1038.6	725.6

SL	INCS	INCM	DEV	TURN	RHOVM-1	RHOVM-2	D-FAC	OMEGA-B	LOSS-P	P02/	%EFF-P	%EFF-A	B*-1	B*-2	V0*-1	V0*-2	PG/PO
DEGREE	DEGREE	DEGREE	DEGREE					TOTAL	TOTAL	P01	TOT	TOT	DEGREE	DEGREE	FT/SEC	FT/SEC	INLET
1	-0.33	3.98	19.03	50.52	42.90	54.16	0.4144	0.1473	0.0336	1.3943	89.73	89.26	49.15	-1.37	-574.2	14.3	1.8856
2	-0.89	3.56	13.68	49.21	43.33	52.52	0.4475	0.1605	0.0375	1.3881	88.63	88.11	49.07	-0.14	-581.0	1.4	1.8819
3	-0.92	3.65	10.17	46.75	43.58	51.72	0.4677	0.1612	0.0386	1.3811	88.23	87.70	49.43	2.64	-589.4	-25.7	1.8737
4	1.37	6.16	8.21	35.35	42.29	51.51	0.4603	0.1158	0.0284	1.3441	89.73	89.32	53.12	17.77	-655.9	-174.1	1.8074
5	4.74	5.32	6.68	23.31	39.87	47.49	0.4471	0.1208	0.0281	1.2928	88.39	85.91	58.21	34.90	-753.1	-346.4	1.7160
6	5.43	9.77	5.06	18.53	39.50	44.05	0.4553	0.1622	0.0362	1.2643	80.27	79.64	59.80	41.27	-792.4	-404.5	1.6787
7	4.62	8.70	3.96	16.28	40.56	42.96	0.4995	0.1830	0.0407	1.2514	77.04	76.33	59.49	43.21	-801.4	-422.3	1.6722
8	4.00	7.81	1.83	15.23	41.58	43.65	0.4903	0.1874	0.0421	1.2477	75.82	75.08	59.38	44.15	-817.6	-443.6	1.6773
9	4.14	6.82	-0.96	14.82	40.68	44.17	0.4469	0.1856	0.0449	1.2640	76.06	75.29	60.95	46.13	-868.1	-487.9	1.6964
10	4.80	6.98	0.28	15.05	39.69	44.25	0.4453	0.1797	0.0446	1.2726	76.87	76.09	62.00	46.96	-891.7	-505.8	1.7015
11	6.50	8.19	3.96	14.39	37.90	43.88	0.4320	0.1759	0.0431	1.2733	76.57	75.78	64.01	49.62	-934.5	-554.0	1.6865

TO/TO	PO/PO	EFF-AD	EFF-P	WCI/ A1	T02/T01	P02/P01	EFF-AD	EFF-P
INLET	INLET	INLET	INLET	LBM/SEC	%	%	ROTOR	ROTOR
		%	%	SQFT			%	%
1.2049	1.7436	83.93	85.12	30.73	1.0946	1.3018	82.58	83.20

STATOR 2

SL	EPS1-1	EPS1-2	V-1	V-2	VM-1	VM-2	V0-1	V0-2	B-1	B-2	M-1	M-2	9, SPEED	CODE	TO, POINT NO 3	PG/PG	TO/TO	PG/PG	TO/TO
DEGREE	DEGREE	FT/SEC	FT/SEC	FT/SEC	FT/SEC	FT/SEC	FT/SEC	FT/SEC	DEGREE	DEGREE						INLET	INLET	STAGE	TO/TO
1	8.689	0.847	884.5	639.2	429.5	638.9	621.3	21.4	44.9	1.9	0.7576	0.5331	1.7920	1.2196	1.3254	1.1114	1.1114	1.1114	
2	7.631	0.743	867.5	646.8	654.7	646.2	622.1	27.2	46.0	2.4	0.7423	0.5403	1.8048	1.2177	1.3318	1.1114	1.1114	1.1114	
3	6.495	0.465	847.2	662.7	588.4	662.7	609.5	3.5	46.2	0.3	0.7243	0.5553	1.8279	1.2138	1.3467	1.1104	1.1104	1.1104	
4	3.627	-0.508	762.0	618.6	589.6	616.4	506.1	-14.1	41.7	-1.3	0.6482	0.5171	1.7847	1.2024	1.3269	1.0988	1.0988	1.0988	
5	0.920	-0.953	653.7	525.8	519.4	525.1	397.0	-27.2	37.4	-3.0	0.5524	0.4396	1.6989	1.1929	1.2797	1.0886	1.0886	1.0886	
6	-0.337	-0.903	610.3	486.3	483.6	485.3	372.3	-30.9	37.5	-3.6	0.5145	0.4060	1.6660	1.1895	1.2561	1.0870	1.0870	1.0870	
7	-1.120	-0.882	601.0	480.9	472.3	480.0	371.6	-30.1	38.2	-3.6	0.5064	0.4016	1.6616	1.1882	1.2452	1.0866	1.0866	1.0866	
8	-1.970	-0.903	604.3	488.3	479.3	487.6	368.0	-26.4	37.5	-3.1	0.5089	0.4078	1.6667	1.1891	1.2399	1.0866	1.0866	1.0866	
9	-4.399	-1.094	422.3	314.6	433.9	514.0	378.5	-0.9	37.5	-0.1	0.5196	0.4257	1.6784	1.2125	1.2504	1.0917	1.0917	1.0917	
10	-5.217	-1.181	627.6	520.2	500.0	520.0	379.2	12.0	37.2	1.3	0.5222	0.4293	1.6752	1.2220	1.2558	1.0935	1.0935	1.0935	
11	-6.005	-1.177	614.1	505.5	504.5	505.5	350.1	7.7	34.9	0.9	0.5089	0.4155	1.6632	1.2291	1.2558	1.0941	1.0941	1.0941	

SL	INCS	INCM	DEV	TURN	RHOVM-1	RHOVM-2	D-FAC	OMEGA-B	LOSS-P	P02/	%EFF-A	%EFF-P	%EFF-A	%EFF-P	%EFF-A	%EFF-P
DEGREE	DEGREE	DEGREE	DEGREE					TOTAL	TOTAL	P01	TOT-INLET	TOT-INLET	TOT-STG	TOT-STG	TOT-STG	TOT-STG
1	-3.95	-1.99	13.73	42.98	56.73	62.52	0.4302	0.1569	0.0354	0.9502	82.52	83.87	75.11	76.06	76.06	76.06
2	-1.38	0.64	13.66	43.63	55.06	63.56	0.4131	0.1348	0.0310	0.9584	84.34	85.56	76.43	77.35	77.35	77.35
3	-0.46	2.04	11.19	45.88	54.15	65.71	0.3887	0.0857	0.0201	0.9745	87.91	88.87	80.22	81.01	81.01	81.01
4	-3.08	-0.02	9.01	42.99	53.51	61.44	0.3628	0.0554	0.0138	0.9863	88.84	89.69	85.01	85.57	85.57	85.57
5	-7.34	-2.03	7.34	40.33	49.27	52.01	0.3732	0.0610	0.0163	0.9885	84.87	85.75	82.29	82.87	82.87	82.87
6	-6.85	-1.06	6.58	41.19	45.89	47.94	0.3882	0.0522	0.0144	0.9913	82.83	84.00	77.29	77.98	77.98	77.98
7	-6.07	-0.08	6.59	41.74	44.85	47.41	0.3874	0.0360	0.0101	0.9942	82.80	84.06	74.58	75.32	75.32	75.32
8	-6.56	-0.36	7.01	40.58	45.53	48.16	0.3766	0.0353	0.0100	0.9943	83.04	84.19	73.07	73.84	73.84	73.84
9	-6.31	0.39	10.07	37.59	46.32	49.78	0.3932	0.0620	0.0182	0.9894	75.00	76.72	71.78	72.63	72.63	72.63
10	-7.22	-0.35	12.09	33.92	46.62	49.92	0.3456	0.0777	0.0236	0.9868	71.84	73.78	71.77	72.64	72.64	72.64
11	-10.87	-3.78	12.60	33.99	46.66	48.05	0.3439	0.0847	0.0253	0.9863	68.21	70.37	71.31	72.19	72.19	72.19

MCORR	MCORR	TO/TO	PO/PO	EFF-AD	EFF-P	T02/T01	P02/P01	EFF-AD	EFF-P
INLET	INLET	INLET	INLET	INLET	INLET	%	%	STAGE	STAGE
RPM	LBM/SEC			%	%			%	%
7500	109.70	1.2049	1.7170	81.44	82.77	1.0946	0.9848	77.61	77.61

ORIGINAL PAGE IS
OF POOR QUALITY

TABLE XV(d) — OVERALL PERFORMANCE AND BLADE-ELEMENT DATA
(Uniform Inlet Flow, 70 Percent Speed)

U. S. CUSTOMARY UNITS

ROTOR 1

SL	EPI-1		EPI-2		V-1		V-2		VM-1		VM-2		V0-1		V0-2		B-1		B-2		M-1		M-2		U-1		U-2		M'-1		M'-2		V'-1		V'-2			
	DEGREE	DEGREE	FT/SEC	FT/SEC	FT/SEC	FT/SEC	FT/SEC	FT/SEC	FT/SEC	FT/SEC	FT/SEC	FT/SEC	FT/SEC	DEGREE	DEGREE	DEGREE	DEGREE	DEGREE	DEGREE	DEGREE	DEGREE	DEGREE	DEGREE	DEGREE	DEGREE	DEGREE	DEGREE	DEGREE	DEGREE	DEGREE	DEGREE	DEGREE	DEGREE	DEGREE	DEGREE	DEGREE		
1	16.421	17.488	305.5	715.5	305.5	349.2	0.0	613.4	0.0	58.9	0.2757	0.6355	440.1	509.4	0.4834	0.3404	535.7	383.5																				
2	13.671	15.383	311.4	688.2	311.8	377.6	0.0	575.4	0.0	56.7	0.2814	0.6096	474.5	534.1	0.5125	0.3364	567.8	379.8																				
3	11.102	13.035	317.8	663.2	317.8	378.8	0.0	544.3	0.0	55.1	0.2869	0.5861	508.3	558.7	0.5412	0.3350	599.5	379.1																				
4	4.367	7.078	329.8	610.5	329.8	364.4	0.0	489.9	0.0	53.3	0.2979	0.5363	605.2	632.7	0.6226	0.3438	689.2	391.4																				
5	-2.032	0.760	331.9	570.4	331.9	346.7	0.0	452.9	0.0	52.6	0.2998	0.4974	724.1	731.3	0.7213	0.3879	798.3	444.7																				
6	-4.930	-1.990	328.8	566.4	328.8	370.4	0.0	428.4	0.0	49.2	0.2970	0.4937	784.2	780.6	0.7681	0.4455	850.4	511.1																				
7	-6.695	-3.365	325.8	576.4	325.8	389.2	0.0	425.2	0.0	47.6	0.2943	0.5023	812.9	805.2	0.7910	0.4750	875.8	543.9																				
8	-8.646	-4.850	321.9	585.6	321.5	384.7	0.0	441.5	0.0	49.0	0.2903	0.5088	841.6	829.9	0.8135	0.4750	901.0	546.7																				
9	-13.884	-9.190	303.4	556.3	303.4	316.3	0.0	505.5	0.0	58.0	0.2737	0.5116	927.3	903.8	0.8802	0.4365	975.7	508.7																				
10	-14.757	-10.271	297.1	582.9	297.1	252.8	0.0	525.2	0.0	64.3	0.2679	0.4974	955.6	928.5	0.9027	0.4061	1000.9	476.0																				
11	-14.270	-11.066	292.4	573.0	292.4	225.4	0.0	526.8	0.0	66.8	0.2636	0.4875	984.4	953.1	0.9259	0.4102	1026.9	482.2																				

SL	INCS		INCM		DEV		TURN		RHOVM-1		RHOVM-2		D-FAC		OMEGA-B		LOSS-P		PO2/		XEFF-P		XEFF-A		B'-1		B'-2		V0'-1		V0'-2		PC/PO						
	DEGREE	DEGREE	DEGREE	DEGREE	DEGREE	DEGREE	DEGREE	DEGREE	TOTAL	TOTAL	TOTAL	TOTAL	TOTAL	TOTAL	TOTAL	TOTAL	TOTAL	TOTAL	TOTAL	TOTAL	TOTAL	TOTAL	TOTAL	TOTAL	TOTAL	TOTAL	TOTAL	TOTAL	TOTAL	TOTAL	TOTAL	TOTAL	TOTAL	TOTAL	TOTAL	TOTAL	TOTAL		
1	8.60	13.20	12.24	70.69	22.50	29.54	0.5561	-0.0042	-0.0009	1.3981	100.19	100.22	54.98	-15.71	-440.1	103.9	1.3981																						
2	8.60	12.90	13.30	62.64	22.93	30.59	0.5804	-0.0110	-0.0025	1.3924	100.54	100.59	54.42	-6.23	-474.5	61.3	1.3924																						
3	8.71	12.82	13.70	55.55	23.33	30.97	0.5986	-0.0015	-0.0004	1.3857	100.06	100.05	57.72	2.17	-508.3	-14.4	1.3857																						
4	9.74	13.21	11.69	39.80	24.13	30.27	0.6293	0.0596	0.0148	1.3739	95.72	95.55	61.22	21.37	-605.2	-142.9	1.3739																						
5	10.93	13.61	8.48	26.65	24.27	29.07	0.6183	0.1303	0.0305	1.3688	88.78	88.30	63.44	38.75	-726.1	-278.4	1.3688																						
6	11.39	13.67	6.23	23.76	24.07	31.20	0.5628	0.1194	0.0265	1.3740	89.03	88.56	67.33	43.57	-814.2	-352.2	1.3740																						
7	11.69	13.79	4.03	23.94	23.87	32.80	0.5417	0.1129	0.0262	1.3833	88.91	88.42	68.27	44.34	-812.9	-380.0	1.3833																						
8	12.05	14.00	2.45	23.56	23.58	32.23	0.5605	0.1553	0.0363	1.3892	84.77	84.08	69.26	45.31	-841.6	-388.4	1.3892																						
9	13.16	14.58	4.82	20.58	22.36	25.87	0.6657	0.3228	0.0711	1.3931	69.24	67.80	72.20	51.62	-927.3	-398.4	1.3931																						
10	13.36	14.65	10.96	15.08	21.92	20.52	0.7134	0.3814	0.0732	1.3858	64.21	62.56	73.04	51.96	-955.8	-403.3	1.3858																						
11	13.30	14.46	15.77	11.53	21.60	18.27	0.7188	0.4065	0.0698	1.3823	61.89	60.15	73.64	62.11	-984.4	-426.3	1.3823																						

TO/TO	PO/PO	EFF-AD	EFF-P	WCI/A1	T02/T01	P02/P01	EFF-AD	EFF-P
INLET	INLET	%	%	LBM/SEC			%	%
1.1160	1.3819	83.53	84.24	22.42	1.1160	1.3819	83.53	84.24

STATOR 1

SL	EPI-1		EPI-2		V-1		V-2		VM-1		VM-2		V0-1		V0-2		B-1		B-2		M-1		M-2		U-1		U-2		PC/PO		TC2/							
	DEGREE	DEGREE	FT/SEC	FT/SEC	FT/SEC	FT/SEC	FT/SEC	FT/SEC	FT/SEC	FT/SEC	FT/SEC	FT/SEC	FT/SEC	DEGREE	DEGREE	DEGREE	DEGREE	DEGREE	DEGREE	DEGREE	DEGREE	DEGREE	DEGREE	DEGREE	DEGREE	DEGREE	DEGREE	DEGREE	DEGREE	DEGREE	DEGREE	DEGREE	DEGREE	DEGREE				
1	18.075	14.926	714.8	410.8	388.0	410.8	600.4	4.0	57.3	0.5	0.6345	0.3552	1.3506	1.1004	1.3506	1.1004	1.3506																					
2	15.768	13.245	689.7	413.5	355.4	413.2	565.2	17.4	55.1	2.4	0.6110	0.3579	1.3549	1.0987	1.3549	1.0987	1.3549																					
3	13.731	11.665	666.5	415.2	395.9	414.7	536.2	20.7	53.6	2.8	0.5893	0.3595	1.3576	1.0977	1.3576	1.0977	1.3576																					
4	8.619	7.242	617.0	395.0	380.2	394.8	485.9	12.2	52.0	1.8	0.5423	0.3414	1.3489	1.0993	1.3489	1.0993	1.3489																					
5	3.135	2.063	578.0	372.7	360.1	372.6	452.2	-6.4	51.5	-1.0	0.5046	0.3206	1.3382	1.1063	1.3382	1.1063	1.3382																					
6	1.134	0.071	573.7	371.2	381.1	371.2	428.7	-4.6	48.4	-0.7	0.5003	0.3193	1.3389	1.1089	1.3389	1.1089	1.3389																					
7	0.446	-0.445	583.2	384.2	398.5	384.1	425.8	6.4	46.9	1.0	0.5085	0.3304	1.3470	1.1083	1.3470	1.1083	1.3470																					
8	-0.220	-1.255	592.3	358.3	394.3	398.1	442.0	13.4	48.3	1.9	0.5150	0.3422	1.3567	1.1123	1.3567	1.1123	1.3567																					
9	-2.924	-3.629	603.6	386.2	327.6	386.2	507.1	-3.5	57.1	-0.5	0.5183	0.3276	1.3590	1.1393	1.3590	1.1393	1.3590																					
10	-4.749	-6.998	591.1	370.4	265.4	370.1	527.9	-17.6	63.2	-2.7	0.5048	0.3125	1.3539	1.1504	1.3539	1.1504	1.3539																					
11	-6.910	-6.861	581.3	355.0	236.8	353.7	530.9	-30.7	66.0	-5.0	0.4949	0.2977	1.3487	1.1609	1.3487	1.1609	1.3487																					

ROTOR 2

SL	EPSI-1	EPSI-2	V-1	V-2	VM-1	VM-2	VO-1	VO-2	B-1	B-2	M-1	M-2	RUN NO	9, SPEED	CODE 70,	POINT NO 4	V*-1	V*-2	
	DEGREE	DEGREE	FT/SEC	FT/SEC	FT/SEC	FT/SEC	FT/SEC	FT/SEC	DEGREE	DEGREE							FT/SEC	FT/SEC	
1	11.598	10.913	437.6	423.0	437.6	526.6	3.7	632.5	0.5	30.1	0.3790	0.6984		583.8	612.4	0.6293	0.4472	726.7	527.0
2	10.758	9.526	444.1	408.8	443.8	506.9	16.8	630.2	2.2	31.1	0.3851	0.6858		600.3	625.2	0.6356	0.4299	733.1	507.0
3	9.769	8.234	449.1	752.1	448.6	512.4	20.6	604.8	2.6	49.6	0.3897	0.6721		617.4	638.5	0.6479	0.4354	740.6	513.6
4	5.780	4.534	435.4	105.0	435.3	486.0	12.0	510.8	1.8	46.4	0.3773	0.5946		670.2	681.0	0.6836	0.4343	789.1	514.9
5	0.069	-0.084	410.1	402.8	410.0	440.3	-6.4	411.7	-0.9	43.1	0.3536	0.5042		743.0	742.5	0.7365	0.4606	854.3	550.7
6	-2.443	-2.291	402.8	568.4	402.8	402.2	-5.0	401.6	-0.7	44.9	0.3470	0.4737		780.1	775.3	0.7603	0.4576	882.4	549.0
7	-3.266	-3.131	412.0	563.9	412.0	389.7	5.8	407.5	0.8	46.3	0.3550	0.4693		768.8	792.2	0.7699	0.4557	893.6	547.6
8	-3.734	-3.774	426.0	568.0	425.8	391.9	13.7	411.2	1.8	46.3	0.3659	0.4719		817.7	809.5	0.7832	0.4641	909.8	558.7
9	-5.383	-5.643	430.1	582.2	430.1	424.0	-1.8	399.0	-0.2	43.1	0.3659	0.4778		875.0	863.1	0.8305	0.5158	976.6	628.5
10	-6.429	-6.609	422.5	574.5	422.2	430.5	-16.2	380.3	-2.2	41.3	0.3575	0.4688		894.2	881.4	0.8492	0.5391	1003.6	660.7
11	-7.808	-7.985	413.0	559.2	411.9	435.6	-30.8	344.3	-4.3	38.2	0.3473	0.4506		913.5	900.1	0.8668	0.5732	1030.3	706.2

SL	INCS	INCM	DEVE	TURN	RHOVM-1	RHOVM-2	D-FAC	OMEGA-B	LOSS-P	P02/	WFF-P	WFF-A	B-1	B-2	VO-1	VO-2	PC/PC
	DEGREE	DEGREE	DEGREE	DEGREE				TOTAL	TOTAL	P01	TOT	TOT	DEGREE	DEGREE	FT/SEC	FT/SEC	INLET
1	3.42	7.73	18.22	55.08	38.27	49.10	0.4767	0.1722	0.0392	1.3936	89.11	88.61	52.90	-2.18	-580.1	20.1	1.8826
2	2.77	7.22	13.25	53.30	38.90	47.69	0.5083	0.1817	0.0425	1.3883	88.25	87.71	52.73	-0.57	-583.5	5.1	1.8815
3	2.73	7.31	11.27	49.34	39.38	48.70	0.5047	0.1573	0.0376	1.3841	89.29	88.81	53.08	3.74	-596.8	-33.6	1.8792
4	4.79	9.59	9.72	37.27	38.08	46.82	0.5115	0.1412	0.0343	1.3402	88.29	87.62	56.54	19.28	-658.1	-170.2	1.8071
5	7.45	12.42	8.70	24.40	35.66	42.44	0.4953	0.1604	0.0364	1.2640	83.29	82.71	61.32	36.92	-749.4	-330.8	1.7210
6	8.47	12.80	6.67	19.95	35.10	38.67	0.5146	0.2110	0.0459	1.2555	73.98	74.18	62.84	42.88	-785.1	-373.7	1.6940
7	7.66	11.74	5.34	17.93	35.97	37.43	0.5244	0.2346	0.0509	1.2524	72.37	71.50	62.05	45.41	-804.0	-398.2	1.6991
8	6.67	10.48	3.09	16.64	37.18	37.58	0.5228	0.2453	0.0539	1.2446	72.24	71.33	63.74	47.43	-876.8	-464.0	1.7201
9	6.93	9.61	0.33	16.31	36.78	40.02	0.4956	0.2366	0.0559	1.2659	72.53	71.62	64.58	49.16	-910.4	-501.1	1.7158
10	7.78	9.96	2.48	15.82	35.73	40.31	0.4809	0.2267	0.0538	1.2613	74.30	73.46	66.31	51.76	-944.4	-555.9	1.7016
11	8.80	10.49	6.10	14.95	34.48	40.40	0.4495	0.1981	0.0463								

TO/TO	PO/PC	EFF-AD	EFF-P	WCI/AI	T02/T01	P02/P01	EFF-AD	EFF-P
INLET	INLET	INLET	INLET	LBM/SEC	%	%	ROTOR	ROTOR
%	%	%	%	SOFT	%	%	%	%
1.2240	1.7551	77.75	79.41	27.62	1.0968	1.2998	80.15	80.85

STATOR 2

SL	EPSI-1	EPSI-2	V-1	V-2	VM-1	VM-2	VO-1	VO-2	B-1	B-2	M-1	M-2	RUN NO	9, SPEED	CODE 70,	POINT NO 4	TC2/
	DEGREE	DEGREE	FT/SEC	FT/SEC	FT/SEC	FT/SEC	FT/SEC	FT/SEC	DEGREE	DEGREE							TC1
1	8.642	0.809	838.9	380.7	558.3	580.2	626.1	24.1	48.6	2.4	0.7132	0.4811		1.7977	1.2236	1.3311	1.1120
2	7.539	0.657	823.9	547.1	537.1	586.6	624.8	19.0	49.5	1.9	0.6998	0.4871		1.8076	1.2219	1.3343	1.1120
3	6.441	0.371	807.4	600.2	539.5	600.1	600.6	12.0	48.2	1.1	0.6856	0.4952		1.8247	1.2182	1.3437	1.1098
4	3.921	-0.478	719.3	555.5	508.3	555.4	508.9	-8.0	45.1	-0.8	0.6075	0.4623		1.7874	1.2087	1.3253	1.0994
5	1.114	-1.119	616.3	461.3	459.0	460.7	411.2	-22.9	41.8	-2.8	0.5161	0.3819		1.7092	1.2058	1.2773	1.0899
6	-0.159	-1.061	582.2	418.6	421.5	418.0	401.7	-22.5	43.6	-3.1	0.4858	0.3454		1.6782	1.2072	1.2530	1.0906
7	-0.997	-1.038	578.1	415.4	409.5	415.2	408.1	-19.2	44.9	-2.6	0.4816	0.3426		1.6758	1.2096	1.2444	1.0915
8	-1.952	-1.072	562.8	420.2	412.1	419.9	412.1	-15.5	45.0	-2.1	0.4897	0.3458		1.6719	1.2141	1.2371	1.0926
9	-4.621	-1.297	600.9	460.3	447.5	460.3	401.0	-2.1	41.9	-0.3	0.4938	0.3743		1.6974	1.2466	1.2479	1.0970
10	-5.380	-1.350	596.2	464.5	457.3	464.5	382.5	-0.6	40.0	-0.1	0.4873	0.3762		1.6965	1.2590	1.2519	1.0969
11	-6.073	-1.268	582.1	450.7	467.6	450.7	346.7	-0.7	36.7	-0.1	0.4734	0.3633		1.6832	1.2686	1.2479	1.0929

SL	INCS	INCM	DEVE	TURN	RHOVM-1	RHOVM-2	D-FAC	OMEGA-B	LOSS-P	P02/	WFF-P	WFF-A	B-1	B-2	VO-1	VO-2	TC2/
	DEGREE	DEGREE	DEGREE	DEGREE				TOTAL	TOTAL	P01	TOT	TOT	DEGREE	DEGREE	FT/SEC	FT/SEC	TC1
1	0.10	1.66	14.19	46.18	51.54	58.21	0.4693	0.1566	0.0354	0.9549	81.49	81.49	82.97	84.30	75.89	76.82	
2	2.11	4.13	13.10	47.68	50.08	59.12	0.4570	0.1408	0.0324	0.9604	82.97	82.97	84.30	76.51	77.42	80.84	
3	1.59	4.09	11.99	47.06	50.83	60.86	0.4297	0.1077	0.0253	0.9708	85.84	85.84	86.97	80.05	80.84	84.72	
4	-0.46	3.41	9.50	45.92	48.63	56.56	0.4087	0.0539	0.0134	0.9878	86.39	86.39	87.44	84.12	84.72	81.01	
5	-2.87	2.44	7.46	44.68	44.00	46.47	0.4423	0.0460	0.0123	0.9924	80.36	80.36	81.75	80.37	74.14	71.17	
6	-0.81	4.98	7.14	46.67	40.29	41.89	0.4833	0.0652	0.0180	0.9902	76.84	76.84	78.46	73.33	68.49	68.14	
7	0.63	6.43	7.52	47.50	39.10	41.51	0.4879	0.0637	0.0178	0.9907	75.78	75.78	77.45	70.30	68.49	68.14	
8	0.92	7.13	7.99	47.09	39.29	41.83	0.4877	0.0812	0.0230	0.9880	76.16	76.16	78.16	67.15	68.14	69.15	
9	-1.90	4.80	9.90	42.16	41.93	44.72	0.4320	0.0863	0.0253	0.9868	68.09	68.09	68.48	65.47	68.14	69.15	
10	-4.48	2.40	10.71	40.05	42.44	44.64	0.4113	0.0738	0.0218	0.9890	62.86	62.86	65.47	68.17	69.15	70.96	
11	-9.08	-1.98	11.85	36.74	43.00	42.85	0.4038	0.0742	0.0221	0.9895	55.64	55.64	62.43	70.06	70.96		

MCORR	MCORR	TO/TO	PO/PC	EFF-AD	EFF-P	T02/T01	P02/P01	EFF-AD	EFF-P
INLET	INLET	INLET	INLET	INLET	INLET	%	%	STAGE	STAGE
RPM	LBM/SEC	%	%	%	%	%	%	%	%
7487.	98.70	1.2240	1.7283	75.46	77.24	1.0968	0.9848	75.29	

ORIGINAL PAGE IS
OF POOR QUALITY

TABLE XVI(a) — OVERALL PERFORMANCE AND BLADE-ELEMENT DATA
(Uniform Inlet Flow, 85 Percent Speed)

U. S. CUSTOMARY UNITS

ROTOR 1

SL	EPI-1		EPI-2		V-1		V-2		VM-1		VM-2		V0-1		V0-2		B-1		B-2		M-1		M-2		RUN NO	9, SPEED	CODE 85,	POINT NO 21	V*-1	V*-2
	DEGREE	DEGREE	FT/SEC	FT/SEC	FT/SEC	FT/SEC	FT/SEC	FT/SEC	FT/SEC	FT/SEC	FT/SEC	FT/SEC	FT/SEC	FT/SEC	FT/SEC	FT/SEC	FT/SEC	CEGREE	CEGREE	M-1	M-2	U-1	U-2	M*-1						
1	16.641	18.437	467.8	524.0	467.8	554.4	0.0	739.2	0.0	53.2	0.4454	0.8237	534.3	618.5	0.6605	0.5058	723.5	567.4												
2	14.129	16.166	497.7	899.0	457.7	554.4	0.0	655.0	0.0	51.5	0.4548	0.7893	576.1	648.4	0.6956	0.4939	761.3	556.3												
3	11.838	14.035	507.2	661.9	572.2	553.9	0.0	660.3	0.0	50.0	0.4639	0.7627	617.1	678.3	0.7305	0.4904	798.8	554.2												
4	5.978	8.256	530.1	784.1	530.1	564.0	0.0	564.7	0.0	46.1	0.4857	0.6885	734.7	768.2	0.8302	0.5100	906.0	580.8												
5	0.114	1.811	544.5	684.4	544.9	495.5	0.0	472.1	0.0	43.6	0.4959	0.5956	881.5	887.8	0.9509	0.5629	1036.3	646.8												
6	-1.962	-1.021	547.1	655.6	547.1	479.8	0.0	446.8	0.0	43.0	0.5021	0.5685	952.1	947.7	1.0078	0.6015	1098.1	693.6												
7	-3.027	-2.378	547.3	666.4	547.3	509.8	0.0	429.0	0.0	40.1	0.5023	0.5788	987.0	977.6	1.0357	0.6505	1128.6	748.9												
8	-4.259	-3.689	546.7	666.4	546.7	515.7	0.0	425.1	0.0	39.5	0.5017	0.5759	1021.8	1007.5	1.0635	0.6749	1158.8	777.9												
9	-8.286	-7.529	538.7	685.2	538.7	536.3	0.0	432.9	0.0	38.9	0.4940	0.5951	1125.8	1097.3	1.1445	0.7372	1248.0	853.9												
10	-9.775	-8.856	533.6	704.9	533.6	547.2	0.0	444.3	0.0	39.0	0.4891	0.6073	1160.4	1127.2	1.1707	0.7539	1277.2	875.1												
11	-11.163	-10.220	527.4	685.6	527.4	513.7	0.0	454.1	0.0	41.4	0.4832	0.5873	1195.1	1157.2	1.1967	0.7459	1306.3	870.7												

SL	INCS DEGREE	INCH	DEV DEGREE	TURN DEGREE	RHCVM-1	RHCVM-2	D-FAC	MEGA-B	LOSS-P	PO2/	%EFF-P	%EFF-A	B*-1	B*-2	V0*-1	V0*-2	PC/PO	TOTAL		TOTAL		TOTAL		TOTAL		PC2/P01	%EFF-P	%EFF-A	%EFF-P	%EFF-A
																		PO1	TOT	PO1	TOT	PO1	TOT	PO1	TOT					
1	0.99	5.60	15.65	55.66	33.85	43.27	0.4583	0.0157	0.0034	1.6088	99.20	99.16	47.37	-12.31	-534.3	120.7	1.6088													
2	1.12	5.42	14.80	53.74	34.39	44.02	0.4935	0.0245	0.0056	1.5941	98.61	96.53	48.94	-4.80	-576.1	44.5	1.5941													
3	1.36	5.47	13.39	48.50	34.91	44.61	0.5155	0.0298	0.0071	1.5845	98.14	98.04	50.37	1.86	-617.1	-18.0	1.5845													
4	2.57	6.04	10.84	33.55	36.12	45.15	0.5311	0.0472	0.0118	1.5513	96.21	95.99	54.07	20.52	-734.7	-203.5	1.5513													
5	3.75	6.43	5.73	18.27	36.88	41.83	0.5151	0.0999	0.0230	1.4865	89.72	89.16	58.27	40.00	-881.5	-415.8	1.4865													
6	4.19	6.47	8.89	13.89	37.00	40.72	0.4978	0.1171	0.0256	1.4743	87.02	86.32	60.12	46.23	-952.1	-500.9	1.4743													
7	4.42	6.52	6.78	13.51	37.01	43.65	0.4596	0.0799	0.0177	1.4939	90.79	90.28	61.00	47.09	-987.0	-548.6	1.4939													
8	4.64	6.60	5.61	13.40	36.98	44.28	0.4500	0.0825	0.0182	1.5026	90.31	89.76	61.86	48.47	-1021.8	-582.4	1.5026													
9	5.38	6.81	4.24	13.39	36.57	46.19	0.4374	0.1094	0.0244	1.5401	86.93	86.13	64.43	51.04	-1125.8	-664.4	1.5401													
10	5.62	6.92	4.22	14.05	36.31	47.09	0.4392	0.1249	0.0283	1.5602	85.24	84.31	65.31	51.22	-1160.4	-682.9	1.5602													
11	5.84	6.99	7.40	12.43	35.96	43.84	0.4598	0.1752	0.0382	1.5409	79.24	77.97	66.17	53.74	-1195.1	-703.1	1.5409													

TC/T0	PD/PC	EFF-AD	EFF-P	W1/A1	T02/T01	PC2/P01	EFF-AD	EFF-P
INLET	INLET	INLET	INLET	LBM/SEC	%	%	ROTOR	ROTOR
%	%	%	%	SCFT	%	%	%	%
1.1446	1.5328	89.75	90.33	35.00	1.1446	1.5328	89.75	90.33

STATOR 1

SL	EPI-1		EPI-2		V-1		V-2		VM-1		VM-2		V0-1		V0-2		B-1		B-2		M-1		M-2		RUN NO	9, SPEED	CODE 85,	POINT NO 21	V*-1	V*-2
	DEGREE	DEGREE	FT/SEC	FT/SEC	FT/SEC	FT/SEC	FT/SEC	FT/SEC	FT/SEC	FT/SEC	FT/SEC	FT/SEC	FT/SEC	FT/SEC	FT/SEC	FT/SEC	FT/SEC	CEGREE	CEGREE	M-1	M-2	U-1	U-2	M*-1						
1	18.309	14.590	929.0	634.4	582.6	636.3	723.7	3.5	51.4	0.3	0.8288	0.5481	1.5319	1.1467	1.5319	1.1467	1.5319													
2	16.091	13.250	857.5	630.1	582.6	629.8	682.7	19.7	49.7	1.8	0.7978	0.5429	1.5316	1.1446	1.5316	1.1446	1.5316													
3	14.028	11.668	873.0	625.2	582.1	628.5	650.5	28.1	48.3	2.5	0.7737	0.5422	1.5343	1.1437	1.5343	1.1437	1.5343													
4	8.554	7.267	800.0	614.5	571.1	614.5	560.2	4.2	44.5	0.4	0.7039	0.5300	1.5236	1.1391	1.5236	1.1391	1.5236													
5	2.351	1.711	702.9	545.1	521.6	569.0	471.3	-10.2	42.1	-1.0	0.6129	0.4899	1.4768	1.1346	1.4768	1.1346	1.4768													
6	-0.501	-0.875	674.6	552.1	505.1	552.0	447.2	-11.0	41.5	-1.1	0.5861	0.4744	1.4582	1.1357	1.4582	1.1357	1.4582													
7	-1.800	-1.992	685.0	572.4	533.4	572.4	429.9	-1.9	38.9	-0.2	0.5961	0.4929	1.4742	1.1349	1.4742	1.1349	1.4742													
8	-2.974	-2.582	687.2	585.5	538.9	589.5	426.4	4.9	38.4	0.5	0.5974	0.5076	1.4883	1.1379	1.4883	1.1379	1.4883													
9	-6.174	-5.508	710.0	620.9	560.8	620.4	435.5	26.2	37.9	2.4	0.6144	0.5324	1.5192	1.1530	1.5192	1.1530	1.5192													
10	-7.143	-6.901	726.7	628.4	572.8	627.5	447.3	32.1	36.1	2.9	0.6275	0.5372	1.5282	1.1612	1.5282	1.1612	1.5282													
11	-8.139	-7.582	709.7	576.6	542.4	587.5	457.6	-4.7	40.3	-0.5	0.6095	0.4988	1.4915	1.1686	1.4915	1.1686	1.4915													

SL	INCS DEGREE	INCH	DEV DEGREE	TURN DEGREE	RHCVM-1	RHCVM-2	D-FAC	MEGA-B	LOSS-P	PO2/	%EFF-P	%EFF-A	B*-1	B*-2	V0*-1	V0*-2	PC/PO	TOTAL		TOTAL		TOTAL		TOTAL		PC2/P01	%EFF-P	%EFF-A	%EFF-P	%EFF-A	
																		PO1	TOT	PO1	TOT	PO1	TOT	PO1	TOT						
1	-1.17	0.94	12.64	51.07	45.30	56.19	0.4664	0.1315	0.0269	0.9523	88.34	89.00	88.34	89.00	88.34	89.00	88.34														
2	-1.16	1.24	13.01	47.90	45.99	55.85	0.4481	0.1142	0.0242	0.9609	89.58	90.16	89.58	90.16	89.58	90.16	89.58														
3	-1.24	1.54	12.54	45.74	46.54	55.90	0.4302	0.0999	0.0220	0.9674	90.52	91.05	90.52	91.05	90.52	91.05	90.52														
4	-2.54	1.18	9.66	44.07	46.96	54.83	0.3962	0.0598	0.0146	0.9831	91.91	92.36	91.91	92.36	91.91	92.36	91.91														
5	-3.42	1.63	8.28	43.12	43.60	50.37	0.3749	0.0270	0.0074	0.9941	87.55	88.19	87.55	88.19	87.55	88.19	87.55														
6	-3.50	2.12	8.22	42.66	42.45	48.55	0.3768	0.0603	0.0172	0.9874	83.84	84.66	83.84	84.66	83.84	84.66	83.84														
7	-5.92	-0.04	9.20	39.07	45.23	50.50	0.3491	0.0646	0.0188	0.9862	86.93	87.66	86.93	87.66	86.93	87.66	86.93														
8	-6.22	-0.08	9.90	37.91	45.82	52.00	0.3260	0.0478	0.0142	0.9897	87.25	87.93	87.25	87.93	87.25	87.93	87.25														
9	-6.71	0.17	12.97	35.45	47.78	54.46																									

ROTOR 2

SL	EPSI-1	EPSI-2	V-1	V-2	VM-1	VM-2	V0-1	V0-2	B-1	B-2	M-1	M-2	U-1	U-2	M'-1	M'-2	V'-1	V'-2
DEGREE	DEGREE	FT/SEC	FT/SEC	FT/SEC	FT/SEC	FT/SEC	FT/SEC	FT/SEC	DEGREE	DEGREE			FT/SEC	FT/SEC			FT/SEC	FT/SEC
1	11.437	11.154	704.4	1122.3	704.4	867.0	3.3	712.5	0.3	39.3	0.6108	0.9529	708.8	743.4	0.8645	0.7367	997.0	867.6
2	10.521	9.952	703.5	1075.5	703.3	817.6	19.1	698.8	1.6	40.4	0.6106	0.9089	728.8	759.0	0.8672	0.6928	999.2	819.8
3	9.546	8.837	705.8	1013.1	705.3	763.6	27.7	665.8	2.2	41.0	0.6130	0.8511	749.5	775.2	0.8764	0.6480	1009.2	771.4
4	6.369	5.711	658.7	526.8	658.6	762.3	4.3	527.1	0.4	34.7	0.6078	0.7778	813.6	826.7	0.9298	0.6874	1069.2	819.1
5	1.277	1.362	654.7	616.9	654.7	707.4	-10.2	408.5	-0.9	30.0	0.5681	0.6830	902.0	901.5	0.9742	0.7210	1122.8	862.3
6	-1.385	-0.869	631.4	735.6	621.3	646.7	-11.3	350.5	-1.0	28.4	0.5463	0.6124	947.1	941.2	0.9929	0.7292	1147.6	875.9
7	-2.547	-1.890	644.9	702.4	644.9	617.5	-2.1	334.6	-0.2	28.4	0.5589	0.5845	969.8	961.7	1.0109	0.7324	1166.4	880.1
8	-3.471	-2.825	657.5	701.3	657.5	626.2	4.7	315.8	0.4	26.7	0.5698	0.5843	992.7	982.7	1.0284	0.7621	1186.8	914.8
9	-5.824	-5.577	689.4	737.3	666.5	658.4	26.1	331.9	2.2	26.6	0.5548	0.6114	1062.3	1047.8	1.0740	0.8066	1244.1	972.7
10	-6.706	-6.615	701.0	714.7	700.2	699.1	33.7	333.8	2.7	25.4	0.6036	0.6429	1085.6	1070.1	1.0881	0.8426	1263.6	1015.3
11	-7.905	-7.557	666.9	753.7	666.8	705.4	-4.4	265.6	-0.4	20.5	0.5702	0.6244	1109.1	1092.8	1.1098	0.9005	1297.9	1087.1

SL	INCS	INCM	DEV	TURN	RHCVM-1	RHCVM-2	D-FAC	MEGA-B	LOSS-P	PO2/	%EFF-P	%EFF-A	B'-1	B'-2	V0'-1	V0'-2	PC/PC
DEGREE	DEGREE	DEGREE	DEGREE	DEGREE				TOTAL	TOTAL	P01	TOT	TOT	DEGREE	DEGREE	FT/SEC	FT/SEC	INLET
1	-4.52	-0.21	22.43	42.92	60.11	77.97	0.2958	0.1425	0.0325	1.5326	88.54	87.84	44.96	2.03	-705.5	-30.9	2.3479
2	-4.73	-0.28	18.02	41.02	60.12	73.89	0.3416	0.2035	0.0474	1.4819	82.95	82.00	45.22	4.22	-709.8	-60.2	2.2696
3	-4.69	-0.11	15.66	37.53	60.36	69.12	0.3891	0.2761	0.0655	1.4094	75.22	74.01	45.66	8.13	-721.8	-109.3	2.1623
4	-2.50	2.30	11.91	27.78	59.81	71.10	0.3592	0.2151	0.0515	1.3595	76.39	75.36	45.25	21.47	-809.3	-299.7	2.0735
5	0.87	5.45	6.66	15.46	55.75	67.10	0.3367	0.1694	0.0394	1.3167	77.41	76.54	44.34	34.88	-912.2	-493.0	1.9467
6	2.23	6.57	6.17	14.23	53.60	61.04	0.3295	0.1798	0.0394	1.2641	72.66	71.76	44.60	42.38	-958.4	-590.7	1.8415
7	1.53	5.60	6.13	11.61	55.04	58.27	0.3325	0.2084	0.0446	1.2238	65.70	64.74	44.40	45.39	-971.9	-627.1	1.8026
8	0.92	4.73	4.41	5.56	56.19	59.25	0.3100	0.1894	0.0407	1.2127	66.38	65.48	44.30	46.73	-988.0	-666.9	1.8031
9	-0.55	2.13	0.15	5.02	58.47	62.04	0.3017	0.1859	0.0441	1.2204	66.24	65.30	44.26	47.24	-1036.2	-716.0	1.8513
10	-1.01	1.17	-0.37	5.85	59.16	66.22	0.2795	0.1405	0.0352	1.2467	74.11	73.32	44.19	46.31	-1051.9	-736.3	1.9067
11	1.42	3.12	3.73	9.55	55.62	66.84	0.2371	0.0687	0.0169	1.2606	86.02	85.57	44.94	49.39	-1113.4	-827.2	1.8855

TO/TO	PO/PC	EFF-AD	EFF-P	M1/A1	T02/T01	PO2/P01	EFF-AD	EFF-P
INLET	INLET	%	%	LBM/SEC			%	%
1.2643	1.9633	80.29	82.04	39.21	1.1046	1.3057	75.43	76.32

STATOR 2

SL	EPSI-1	EPSI-2	V-1	V-2	VM-1	VM-2	V0-1	V0-2	B-1	B-2	M-1	M-2	PO/PO	TO/TO	PC/PC	TC/TC
DEGREE	DEGREE	FT/SEC	FT/SEC	FT/SEC	FT/SEC	FT/SEC	FT/SEC	FT/SEC	DEGREE	DEGREE			INLET	INLET	STAGE	T01
1	9.017	1.078	1162.6	964.5	925.4	939.5	705.4	-218.2	37.6	-13.1	0.9948	0.8000	1.8241	1.3158	1.1907	1.1473
2	8.256	1.217	1116.2	997.4	874.9	974.0	693.1	-214.9	38.7	-12.4	0.9491	0.8323	1.8972	1.3122	1.2388	1.1457
3	7.371	1.211	1052.3	1020.4	819.0	998.8	662.3	-209.0	39.2	-11.8	0.8899	0.8566	1.9578	1.3060	1.2774	1.1414
4	4.674	0.818	963.9	975.5	808.0	968.0	525.7	-149.7	33.1	-8.8	0.8129	0.8261	1.9283	1.2822	1.2611	1.1244
5	1.821	0.213	856.2	920.5	752.4	911.6	408.8	-127.6	28.5	-8.0	0.7192	0.7785	1.8630	1.2580	1.2536	1.1085
6	0.382	-0.174	775.3	869.4	655.8	861.6	351.0	-116.2	26.7	-7.7	0.6517	0.7339	1.7922	1.2478	1.2275	1.0987
7	-0.474	-0.393	747.7	842.5	668.3	833.9	335.3	-120.3	26.6	-8.2	0.6245	0.7108	1.7563	1.2413	1.1981	1.0935
8	-1.541	-0.593	747.3	827.0	676.9	816.4	316.5	-132.4	25.0	-9.2	0.6254	0.6980	1.7361	1.2365	1.1714	1.0881
9	-4.660	-0.586	782.1	855.5	713.9	852.9	333.9	-67.2	25.1	-4.5	0.6570	0.7189	1.7574	1.2539	1.1592	1.0891
10	-5.548	-1.069	828.7	884.4	757.6	883.4	336.0	-42.0	24.0	-2.7	0.6918	0.7433	1.7887	1.2619	1.1698	1.0884
11	-6.214	-1.090	816.1	866.5	771.3	866.2	266.6	-35.4	19.1	-2.3	0.6806	0.7272	1.7531	1.2610	1.1724	1.0796

SL	INCS	INCM	DEV	TURN	RHCVM-1	RHCVM-2	D-FAC	MEGA-B	LOSS-P	PO2/	%EFF-A	%EFF-P	%EFF-A	%EFF-P
DEGREE	DEGREE	DEGREE	DEGREE	DEGREE				TOTAL	TOTAL	P01	TOT-INLET	TOT-INLET	TOT-STG	TCT-STG
1	-10.84	-9.28	-1.24	50.66	80.46	73.70	0.3531	0.4775	0.1051	0.7746	59.21	62.43	34.58	36.14
2	-8.77	-6.75	-1.18	51.09	76.70	77.82	0.3050	0.3900	0.0877	0.8234	64.18	67.19	43.13	44.77
3	-7.47	-4.96	-0.97	50.99	72.06	81.30	0.2460	0.2688	0.0617	0.8864	69.04	71.76	51.07	52.70
4	-12.42	-8.55	1.52	41.93	73.54	80.84	0.1722	0.2067	0.0507	0.9257	73.04	75.38	55.00	56.42
5	-16.20	-10.89	2.34	36.47	69.80	77.54	0.1131	0.1814	0.0481	0.9454	75.29	77.32	61.32	62.51
6	-17.66	-11.87	2.55	34.41	64.21	73.26	0.0744	0.1536	0.0421	0.9601	73.09	75.17	60.90	61.99
7	-17.62	-11.63	1.97	34.80	61.63	70.92	0.0615	0.1433	0.0398	0.9659	72.27	74.34	56.39	57.46
8	-19.02	-12.81	0.91	34.23	62.58	69.47	0.0661	0.1601	0.0449	0.9629	72.09	74.14	52.33	53.35
9	-18.71	-12.01	5.67	29.59	65.50	71.47	0.0613	0.1987	0.0581	0.9502	68.77	71.10	48.21	49.25
10	-20.48	-13.60	8.06	26.69	69.66	73.69	0.0660	0.2241	0.0662	0.9388	68.92	71.31	51.66	52.69
11	-26.60	-19.50	4.60	21.47	70.64	71.62	0.0491	0.2629	0.0784	0.9299	66.55	69.04	58.20	59.11

NCQRR	WCQRR	TO/TO	PO/PC	EFF-AD	EFF-P	T02/T01	PO2/P01	EFF-AD
INLET	INLET	INLET	INLET	INLET	INLET			STAGE
RPM	LBM/SEC			%	%			%
9090	154.10	1.2643	1.8222	70.64	72.97	1.1046	0.9281	53.77

ORIGINAL PAGE IS
OF POOR QUALITY

TABLE XVI(b) — OVERALL PERFORMANCE AND BLADE-ELEMENT DATA
(Uniform Inlet Flow, 85 Percent Speed)

U. S. CUSTOMARY UNITS

ROTOR 1

SL	E PSI-1		E PSI-2		V-1		V-2		VM-1		VM-2		Vθ-1		Vθ-2		B-1		B-2		M-1		M-2		9, SPEED CODE 85, POINT NO 12		V*-1		V*-2	
	DEGREE	DEGREE	FT/SEC	FT/SEC	FT/SEC	FT/SEC	FT/SEC	FT/SEC	FT/SEC	FT/SEC	FT/SEC	FT/SEC	DEGREE	DEGREE	DEGREE	DEGREE	DEGREE	DEGREE	FT/SEC	FT/SEC	FT/SEC	FT/SEC	FT/SEC	FT/SEC	FT/SEC	FT/SEC	FT/SEC	FT/SEC	FT/SEC	FT/SEC
1	16.661	18.193	487.3	928.2	487.3	537.4	0.0	756.8	0.0	54.6	0.4449	0.8265	533.8	618.0	0.6599	0.4942	722.8	555.0												
2	14.183	15.714	496.5	891.1	496.5	541.4	0.0	707.8	0.0	52.6	0.4537	0.7904	575.6	647.9	0.6946	0.4831	760.2	544.7												
3	11.686	13.426	505.4	863.2	505.4	547.8	0.0	667.1	0.0	50.6	0.4621	0.7635	616.7	677.8	0.7290	0.4847	797.3	547.9												
4	5.954	7.466	526.1	781.6	526.1	538.0	0.0	567.0	0.0	46.5	0.4819	0.6860	734.2	767.6	0.8274	0.5039	903.2	574.2												
5	0.326	1.049	537.4	684.4	537.4	488.5	0.0	479.3	0.0	44.4	0.4928	0.5950	880.8	887.1	0.9461	0.5533	1031.8	636.4												
6	-1.282	-1.612	538.9	647.3	538.9	462.8	0.0	452.6	0.0	44.4	0.4942	0.5604	951.3	946.9	1.0027	0.5863	1093.4	677.2												
7	-2.226	-2.813	539.1	661.8	539.1	499.6	0.0	434.1	0.0	41.0	0.4944	0.5742	986.2	976.8	1.0307	0.6000	1123.9	737.7												
8	-3.554	-3.989	538.7	670.9	538.7	519.7	0.0	424.2	0.0	39.2	0.4940	0.5823	1021.0	1006.8	1.0586	0.6776	1154.4	780.7												
9	-8.016	-7.579	530.7	682.2	530.7	526.4	0.0	434.0	0.0	39.5	0.4863	0.5886	1124.9	1096.4	1.1398	0.7300	1243.8	846.2												
10	-9.596	-8.859	525.5	695.4	525.5	531.6	0.0	448.3	0.0	40.1	0.4813	0.5981	1159.5	1126.4	1.1640	0.7410	1273.0	861.6												
11	-11.059	-10.204	519.1	683.9	519.1	506.8	0.0	459.3	0.0	42.1	0.4752	0.5853	1194.1	1156.2	1.1920	0.7375	1302.1	861.7												

SL	INCS DEGREE	INCM DEGREE	DEV DEGREE	TURN DEGREE	RHOVM-1	RHOVM-2	D-FAC	OMEGA-B	LOSS-P	PO2/PO1	%EFF-P	%EFF-A	B*-1	B*-2	Vθ-1	Vθ-2	PO/PO	TOT		EFF-AD	EFF-P	
																		TOT	INLET			ROTOR
1	1.00	5.60	13.46	61.88	33.82	41.97	0.4804	0.0344	0.0073	1.6182	98.29	98.19	47.38	-14.49	-533.8	138.8	1.6182	1.6182				
2	1.17	5.47	13.30	55.29	34.33	43.08	0.5116	0.0346	0.0079	1.6024	98.09	97.97	48.99	-6.30	-575.6	59.8	1.6024	1.6024				
3	1.44	5.55	12.45	49.33	34.81	44.30	0.5239	0.0249	0.0060	1.5954	98.47	98.39	50.45	1.12	-616.7	-10.7	1.5954	1.5954				
4	2.75	6.22	10.74	33.83	35.92	44.86	0.5373	0.0425	0.0106	1.5563	96.63	96.43	54.25	20.42	-734.2	-200.6	1.5563	1.5563				
5	4.08	6.77	9.58	18.75	36.50	41.40	0.5242	0.1025	0.0236	1.4445	89.72	89.15	58.60	39.85	-880.8	-407.9	1.4445	1.4445				
6	4.54	6.82	9.56	13.58	36.58	39.42	0.5104	0.1272	0.0275	1.4755	86.23	85.48	60.47	46.90	-951.3	-494.4	1.4755	1.4755				
7	4.75	6.85	7.06	13.95	36.59	43.01	0.4669	0.0816	0.0179	1.5006	90.87	90.36	61.33	47.38	-986.2	-542.8	1.5006	1.5006				
8	4.96	6.91	5.41	13.91	36.57	45.05	0.4434	0.0616	0.0136	1.5185	92.90	92.49	62.17	48.26	-1021.0	-582.5	1.5185	1.5185				
9	5.68	7.11	4.68	13.25	36.15	45.71	0.4413	0.1037	0.0229	1.5475	87.77	87.01	64.73	51.48	-1124.9	-662.5	1.5475	1.5475				
10	5.93	7.22	4.83	13.78	35.88	46.06	0.4487	0.1276	0.0285	1.5648	85.14	84.20	65.61	51.83	-1159.5	-678.0	1.5648	1.5648				
11	6.15	7.30	7.53	12.61	35.55	43.62	0.4662	0.1711	0.0372	1.5546	80.07	78.82	66.48	53.87	-1194.1	-696.9	1.5546	1.5546				

TO/TO	PO/PO	EFF-AD	EFF-P	WCL/A1	T02/T01	PO2/PO1	EFF-AD	EFF-P
INLET	INLET	INLET	INLET	LBM/SEC	%	%	ROTOR	ROTOR
%	%	%	%	SOFT	%	%	%	%
1.1457	1.5412	90.27	90.83	34.68	1.1457	1.5412	90.27	90.83

STATOR 1

SL	E PSI-1		E PSI-2		V-1		V-2		VM-1		VM-2		Vθ-1		Vθ-2		B-1		B-2		M-1		M-2		9, SPEED CODE 85, POINT NO 12		V*-1		V*-2	
	DEGREE	DEGREE	FT/SEC	FT/SEC	FT/SEC	FT/SEC	FT/SEC	FT/SEC	FT/SEC	FT/SEC	FT/SEC	FT/SEC	DEGREE	DEGREE	DEGREE	DEGREE	DEGREE	DEGREE	FT/SEC	FT/SEC	FT/SEC	FT/SEC	FT/SEC	FT/SEC	FT/SEC	FT/SEC	FT/SEC	FT/SEC	FT/SEC	FT/SEC
1	18.013	14.709	932.0	616.4	565.4	616.3	740.8	-8.6	52.8	-0.8	0.8303	0.5291	1.5320	1.1500	1.5320	1.1500	1.5320	1.1500												
2	15.561	12.803	898.6	614.4	569.4	614.3	695.2	9.9	50.8	0.9	0.7979	0.5280	1.5348	1.1470	1.5348	1.1470	1.5348	1.1470												
3	13.355	11.023	873.4	616.3	575.4	615.9	657.1	21.6	48.8	2.0	0.7736	0.5302	1.5396	1.1450	1.5396	1.1450	1.5396	1.1450												
4	7.783	6.153	796.8	601.8	564.4	601.8	562.4	5.9	44.9	0.6	0.7006	0.5184	1.5267	1.1395	1.5267	1.1395	1.5267	1.1395												
5	1.602	0.247	701.8	560.0	513.4	559.9	478.5	-12.0	43.0	-1.2	0.6113	0.4813	1.4805	1.1365	1.4805	1.1365	1.4805	1.1365												
6	-1.319	-2.389	665.4	535.5	487.4	535.4	453.0	-13.1	42.9	-1.4	0.5771	0.4592	1.4559	1.1374	1.4559	1.1374	1.4559	1.1374												
7	-2.534	-3.451	680.4	561.7	523.4	561.7	434.8	-3.1	39.7	-0.3	0.5915	0.4830	1.4769	1.1359	1.4769	1.1359	1.4769	1.1359												
8	-3.522	-4.307	689.3	585.0	542.3	585.0	425.6	1.9	38.2	0.2	0.5995	0.5037	1.4972	1.1372	1.4972	1.1372	1.4972	1.1372												
9	-6.282	-6.645	702.8	613.0	550.7	612.8	436.6	18.4	38.5	1.7	0.6076	0.5253	1.5247	1.1531	1.5247	1.1531	1.5247	1.1531												
10	-7.200	-7.406	716.7	621.7	556.7	621.2	451.4	25.8	39.1	2.4	0.6179	0.5309	1.5334	1.1625	1.5334	1.1625	1.5334	1.1625												
11	-8.175	-8.236	707.1	585.4	534.6	585.3	462.9	-9.8	41.0	-1.0	0.6066	0.4965	1.5002	1.1704	1.5002	1.1704	1.5002	1.1704												

SL	INCS DEGREE	INCM DEGREE	DEV DEGREE	TURN DEGREE	RHOVM-1	RHOVM-2	D-FAC	OMEGA-B	LOSS-P	PO2/PO1	%EFF-A	%EFF-P	B*-1	B*-2	Vθ-1	Vθ-2	PO/PO	TOT		EFF-AD	EFF-P	
																		TOT	INLET			STAGE
1	0.26	2.37	11.54	53.60	44.04	54.79	0.4955	0.1457	0.0298	0.9471	86.40	87.17	86.40	87.17								
2	-0.08	2.32	12.14	49.85	45.07	54.88	0.4710	0.1225	0.0260	0.9581	88.56	89.20	88.56	89.20								
3	-0.71	2.08	12.38	46.82	46.21	55.24	0.4481	0.1056	0.0233	0.9656	90.50	91.04	90.50	91.04								
4	-2.15	1.57	9.83	44.30	46.63	54.09	0.4099	0.0638	0.0156	0.9822	92.09	92.52	92.09	92.52								
5	-2.54	2.51	8.08	44.19	43.11	49.80	0.3901	0.0386	0.0105	0.9915	86.90	87.58	86.90	87.58								
6	-2.11	3.50	7.96	44.31	41.14	47.26	0.3960	0.0715	0.0205	0.9855	82.44	83.32	82.44	83.32								
7	-5.06	0.82	9.07	40.07	44.66	49.83	0.3639	0.0848	0.0248	0.9820	86.71	87.40	86.71	87.40								
8	-6.43	-0.29	9.61	37.99	46.57	52.04	0.3351	0.0698	0.0207	0.9849	89.09	89.67	89.09	89.67								
9	-6.12	0.76	12.27	36.77	47.32	54.17	0.3159	0.0688	0.0215	0.9848	83.66	84.58	83.66	84.58								
10	-5.80	1.25	14.16	36.75	47.70	54.63	0.3226	0.0873	0.0276	0.9802	79.95	81.10	79.95	81.10								
11	-4.61	2.54	12.35	41.98	45.47	50.87	0.3882	0.1587	0.0508	0.9651	72.09	73.61	72.09	73.61								

NCORR	WCORR	TO/TO	PO/PO	EFF-AD	EFF-P	T02/T01	PO2/PO1	EFF-AD
INLET	INLET	INLET	INLET	INLET	INLET	%	%	STAGE
RPM	LBM/SEC	%	%	%	%	%	%	%
9083	152.70	1.1457	1.5084	85.51	86.31			

ROTOR 2

SL	EPSI-1	EPSI-2	V-1	V-2	VM-1	VM-2	V0-1	V0-2	B-1	B-2	M-1	M-2	U-1	U-2	M'-1	M'-2	V'-1	V'-2
DEGREE	DEGREE	FT/SEC	FT/SEC	FT/SEC	FT/SEC	FT/SEC	FT/SEC	FT/SEC	DEGREE	DEGREE			FT/SEC	FT/SEC			FT/SEC	FT/SEC
1	11.450	11.066	680.2	1016.7	680.2	737.9	-8.3	699.4	-0.7	43.3	0.5874	0.8487	708.2	742.8	0.8532	0.6171	987.9	739.2
2	10.502	9.783	683.6	558.9	683.6	713.1	9.9	699.4	0.8	44.3	0.5914	0.8331	728.3	758.4	0.8579	0.5968	991.6	715.5
3	9.448	8.568	690.1	974.7	689.8	702.8	20.9	675.4	1.7	43.8	0.5980	0.8127	748.9	774.6	0.8690	0.5918	1002.9	709.7
4	5.601	5.092	686.3	895.6	686.3	701.3	5.7	557.0	0.5	38.5	0.5960	0.7463	813.0	826.1	0.9201	0.6259	1059.6	751.1
5	-0.363	0.370	640.7	748.0	640.6	604.6	-12.0	440.4	-1.1	36.1	0.5546	0.6178	901.3	900.7	0.9657	0.6276	1115.6	759.9
6	-2.967	-1.816	612.5	675.3	612.3	546.4	-12.4	396.7	-1.2	36.0	0.5286	0.5555	946.4	940.5	0.9818	0.6341	1137.6	770.9
7	-3.923	-2.761	631.8	668.7	631.8	544.4	-2.8	388.3	-0.3	35.5	0.5466	0.5505	969.1	961.0	1.0028	0.6506	1159.2	790.2
8	-4.654	-3.606	650.5	682.2	650.5	565.0	2.2	382.4	0.2	34.0	0.5634	0.5622	991.9	981.9	1.0258	0.6789	1184.4	823.8
9	-6.700	-6.113	679.3	709.5	679.1	592.6	18.7	390.3	1.6	33.3	0.5858	0.5813	1061.4	1047.0	1.0730	0.7246	1244.4	884.5
10	-7.358	-6.991	689.4	715.1	688.9	602.0	26.2	386.0	2.2	32.5	0.5925	0.5845	1084.8	1069.2	1.0855	0.7442	1263.0	910.6
11	-8.222	-8.154	658.6	683.9	658.5	603.4	-9.8	321.8	-0.8	27.9	0.5622	0.5571	1108.2	1092.0	1.1077	0.7970	1297.5	978.4

SL	INCS	INCM	DEV	TURN	RHOVM-1	RHOVM-2	D-FAC	OMEGA-8	LOSS-P	P02/	%EFF-P	%EFF-A	B'-1	B'-2	V0'-1	V0'-2	PO/PO
DEGREE	DEGREE	DEGREE	DEGREE	DEGREE	TOTAL	TOTAL	TOTAL	TOTAL	P01	TOT	TOT	DEGREE	DEGREE	DEGREE	FT/SEC	FT/SEC	INLET
1	-3.08	1.24	23.76	43.04	58.64	73.67	0.4188	0.0710	0.0162	1.5722	94.44	94.08	46.40	3.36	-716.5	-43.5	2.4087
2	-3.57	0.88	18.53	41.67	59.07	72.07	0.4442	0.0786	0.0183	1.5659	93.76	93.36	46.38	4.71	-718.4	-59.0	2.4039
3	-3.82	0.76	15.54	38.52	59.68	71.96	0.4516	0.0710	0.0168	1.5508	94.11	93.74	46.54	8.01	-728.0	-99.2	2.3878
4	-2.10	2.69	11.42	28.67	59.22	74.15	0.4261	0.0150	0.0036	1.5173	98.57	98.48	49.65	20.98	-807.3	-269.0	2.3151
5	1.49	6.06	9.06	17.67	54.93	64.11	0.4337	0.0515	0.0116	1.4309	93.76	93.46	54.96	37.28	-913.4	-460.3	2.1138
6	3.07	7.41	8.63	12.60	52.37	57.67	0.4301	0.0756	0.0159	1.3829	90.00	89.55	57.44	44.84	-958.8	-543.7	2.0196
7	2.10	6.18	7.16	10.55	54.38	57.62	0.4219	0.0916	0.0192	1.3610	87.30	86.76	56.97	46.42	-971.9	-572.7	2.0146
8	1.29	5.10	4.32	10.02	56.17	59.99	0.4049	0.0890	0.0191	1.3578	87.23	86.68	56.67	46.64	-989.7	-599.6	2.0343
9	0.03	2.71	0.72	9.03	58.17	62.48	0.3920	0.0985	0.0231	1.3608	85.40	84.76	56.84	47.81	-1042.7	-656.7	2.0739
10	-0.37	1.81	1.79	8.36	58.65	63.33	0.3799	0.0858	0.0207	1.3581	86.85	86.28	56.83	48.46	-1058.6	-683.2	2.0841
11	1.86	3.56	6.12	7.60	55.38	63.22	0.3398	0.0376	0.0088	1.3623	93.78	93.51	59.38	51.78	-1118.0	-770.2	2.0467

TO/TO	PO/PO	EFF-AD	EFF-P	WCI/AL	T02/T01	P02/P01	EFF-AD	EFF-P
INLET	INLET	INLET	INLET	LBM/SEC	%	%	ROTOR	ROTOR
		%	%	SQFT			%	%
1.2793	2.1633	88.16	89.35	38.75	1.1165	1.4341	92.75	93.10

STATOR 2

SL	EPSI-1	EPSI-2	V-1	V-2	VM-1	VM-2	V0-1	V0-2	B-1	B-2	M-1	M-2	PO/PO	TO/TO	PO/PO	T02/T01
DEGREE	DEGREE	FT/SEC	FT/SEC	FT/SEC	FT/SEC	FT/SEC	FT/SEC	FT/SEC	DEGREE	DEGREE			INLET	INLET	STAGE	T01
1	8.720	0.851	1051.6	806.1	791.6	806.0	692.2	13.2	41.4	0.9	0.8823	0.6556	2.2170	1.3181	1.4473	1.1460
2	7.705	0.773	1032.0	814.5	764.4	814.4	693.4	10.1	42.4	0.7	0.8648	0.6638	2.2393	1.3153	1.4596	1.1463
3	6.653	0.575	1006.8	830.9	750.6	830.9	671.0	-5.7	42.0	-0.4	0.8431	0.6802	2.2776	1.3092	1.4798	1.1432
4	4.076	-0.180	924.8	798.5	739.6	798.2	555.2	-24.2	37.0	-1.7	0.7734	0.6575	2.2469	1.2867	1.4707	1.1290
5	1.427	-0.810	776.9	685.8	640.0	685.0	440.4	-33.8	34.5	-2.8	0.6435	0.5628	2.0922	1.2680	1.4135	1.1156
6	-0.260	-1.047	704.5	615.5	582.1	614.4	397.0	-37.3	34.3	-3.5	0.5811	0.5036	2.0064	1.2606	1.3768	1.1084
7	-1.231	-1.122	697.8	602.0	579.5	600.6	388.8	-41.1	33.8	-3.9	0.5761	0.4928	1.9914	1.2563	1.3474	1.1059
8	-2.161	-1.153	711.0	614.2	598.9	612.8	383.3	-41.2	32.6	-3.8	0.5875	0.5033	2.0035	1.2566	1.3380	1.1050
9	-4.606	-1.295	742.3	658.5	630.0	658.5	392.5	-6.9	32.0	-0.6	0.6100	0.5370	2.0398	1.2774	1.3383	1.1082
10	-5.420	-1.353	751.0	668.6	642.8	668.5	388.4	6.3	31.2	0.5	0.6159	0.5440	2.0447	1.2845	1.3320	1.1053
11	-6.148	-1.277	726.5	634.0	650.4	634.0	323.6	4.5	26.5	0.4	0.5941	0.5142	1.9969	1.2852	1.3306	1.0981

SL	INCS	INCM	DEV	TURN	RHOVM-1	RHOVM-2	D-FAC	OMEGA-8	LOSS-P	P02/	%EFF-A	%EFF-P	%EFF-A	%EFF-P
DEGREE	DEGREE	DEGREE	DEGREE	DEGREE	TOTAL	TOTAL	TOTAL	TOTAL	P01	TOT	TOT	TOT	TOT	
					INLET	INLET	INLET	INLET	STAGE	STAGE	STAGE	STAGE	STAGE	
					%	%	%	%	%	%	%	%	%	
1	-7.01	-5.45	12.75	40.51	77.06	84.35	0.3792	0.2001	0.0452	0.9203	80.10	82.17	75.98	77.19
2	-4.98	-2.96	11.96	41.73	75.46	85.85	0.3649	0.1785	0.0411	0.9307	81.97	83.86	77.63	78.78
3	-4.67	-2.17	10.45	42.37	75.19	88.60	0.3379	0.1299	0.0305	0.9512	85.55	87.10	82.39	83.33
4	-8.59	-4.73	8.58	38.70	76.79	86.63	0.2975	0.0979	0.0243	0.9677	90.60	91.59	90.00	90.53
5	-10.19	-4.89	7.48	37.34	66.90	74.10	0.2894	0.0625	0.0167	0.9844	87.45	88.66	89.54	90.02
6	-10.14	-4.35	6.75	37.73	60.60	66.08	0.2992	0.0360	0.0099	0.9926	84.35	85.78	87.96	88.47
7	-10.41	-4.41	6.26	37.73	60.52	64.66	0.3091	0.0516	0.0144	0.9897	84.74	86.13	83.71	84.37
8	-11.46	-5.25	6.27	36.43	62.72	66.04	0.3053	0.0702	0.0199	0.9854	85.46	86.79	82.37	83.06
9	-11.84	-5.15	9.56	32.56	65.38	69.90	0.2715	0.0745	0.0219	0.9835	81.30	83.05	79.97	80.76
10	-13.25	-6.37	11.31	30.67	66.45	70.48	0.2614	0.0847	0.0251	0.9809	79.55	81.47	80.71	81.46
11	-19.20	-12.10	12.34	26.13	66.78	66.22	0.2575	0.1110	0.0331	0.9765	76.46	78.60	86.32	86.85

NCORR	WCORR	TO/TO	PD/PO	EFF-AD	EFF-P	T02/T01	P02/P01	EFF-AD
INLET	INLET	INLET	INLET	INLET	INLET	STAGE	STAGE	STAGE
RPM	LBM/SEC			%	%	%	%	%
9083	152.70	1.2793	2.1054	84.72	86.21	1.1165	0.9732	85.44

ORIGINAL PAGE IS
OF POOR QUALITY

TABLE XVI(c) - OVERALL PERFORMANCE AND BLADE-ELEMENT DATA
(Uniform Inlet Flow, 85 Percent Speed)

U. S. CUSTOMARY UNITS

ROTOR 1

SL	EPSI-1	EPSI-2	V-1	V-2	VM-1	VM-2	V0-1	V0-2	B-1	B-2	M-1	M-2	KUN NU	9, SPEED	CODE	85, POINT	NU 33	V'-1	V'-2
	DEGREE	DEGREE	FT/SEC	FT/SEC	FT/SEC	FT/SEC	FT/SEC	FT/SEC	DEGREE	DEGREE				U-1	U-2	M*-1	M*-1	FT/SEC	FT/SEC
1	16.500	18.354	449.9	875.3	449.9	507.8	0.0	712.9	0.0	54.0	0.4096	0.7770	533.2	617.2	0.6351	0.4587	697.7	518.8	
2	13.861	16.029	459.5	841.4	459.5	508.7	0.0	679.2	0.0	52.8	0.4186	0.7442	574.9	647.1	0.6705	0.4504	736.0	509.2	
3	11.473	13.866	468.3	809.6	468.3	503.4	0.0	634.1	0.0	51.6	0.4269	0.7137	615.9	677.0	0.7053	0.4453	773.7	505.2	
4	5.616	8.108	487.9	750.3	487.9	483.8	0.0	573.5	0.0	49.9	0.4453	0.6556	733.3	766.6	0.8042	0.4552	880.8	520.9	
5	-0.053	1.716	499.0	684.9	499.0	458.3	0.0	509.1	0.0	48.0	0.4560	0.5933	879.7	886.0	0.9243	0.5140	1011.4	593.4	
6	-2.217	-1.027	500.1	670.6	500.1	449.7	0.0	497.5	0.0	47.9	0.4571	0.5783	950.2	945.8	0.9814	0.5476	1073.7	634.9	
7	-3.389	-2.329	499.9	685.1	499.9	479.7	0.0	489.2	0.0	45.6	0.4569	0.5911	985.0	975.6	1.0095	0.5894	1104.5	683.1	
8	-4.787	-3.650	498.6	692.7	498.6	493.9	0.0	485.8	0.0	44.5	0.4558	0.5971	1019.7	1005.5	1.0374	0.6180	1135.2	717.0	
9	-9.132	-7.602	489.0	703.2	489.0	486.2	0.0	508.0	0.0	46.2	0.4465	0.6008	1123.5	1095.1	1.1188	0.6512	1225.3	762.2	
10	-10.542	-8.951	483.6	713.7	483.6	478.8	0.0	529.2	0.0	47.8	0.4414	0.6069	1198.1	1125.0	1.1455	0.6500	1255.0	764.3	
11	-11.654	-10.293	477.8	695.8	477.8	436.2	0.0	542.1	0.0	51.1	0.4359	0.5881	1192.6	1154.8	1.1721	0.6357	1284.8	752.1	

SL	INCS	INCM	DEV	TURN	RHOVM-1	RHOVM-2	D-FAC	OMEGA-B	LOSS-P	PO2/	%EFF-P	%EFF-A	B*-1	B*-2	V0'-1	V0'-2	PO/PO
	DEGREE	DEGREE	DEGREE	DEGREE				TOTAL	TOTAL	P01	TOT	TOT	DEGREE	DEGREE	FT/SEC	FT/SEC	INLET
1	3.21	7.81	17.27	60.28	31.68	61.23	0.5021	-0.0642	-0.0139	1.6112	103.14	103.37	49.59	-10.69	-533.2	95.7	1.6112
2	3.28	7.58	17.40	53.70	32.24	41.95	0.5321	-0.0493	-0.0113	1.3976	102.69	102.90	51.10	-2.60	-874.9	23.1	1.5976
3	3.50	7.60	16.00	47.63	32.75	42.00	0.5549	-0.0257	-0.0061	1.3822	101.53	101.67	52.50	4.87	-615.9	42.9	1.5822
4	4.72	8.19	12.09	34.46	33.85	41.30	0.5882	0.0391	0.0097	1.5657	97.04	96.86	56.23	21.77	-733.3	-193.2	1.5657
5	5.91	8.59	9.17	20.98	34.46	39.75	0.5666	0.0961	0.0223	1.5393	91.13	90.62	60.43	39.44	-879.7	-377.0	1.5393
6	6.32	8.60	7.57	17.34	34.53	39.17	0.5559	0.1249	0.0280	1.3414	87.87	87.13	62.25	44.91	-950.2	-448.3	1.5414
7	6.53	8.63	5.08	17.71	34.51	44.06	0.5252	0.1023	0.0233	1.5655	89.83	89.19	63.11	43.40	-985.0	-486.4	1.5655
8	6.74	8.70	3.60	17.51	34.45	43.45	0.5103	0.1001	0.0229	1.3808	89.85	89.19	65.96	46.45	-1019.7	-519.7	1.5808
9	7.48	8.91	3.53	16.21	33.91	42.55	0.5243	0.1715	0.0388	1.6056	82.34	81.15	66.53	50.32	-1123.5	-587.0	1.6056
10	7.70	8.99	4.14	16.24	33.61	41.69	0.5424	0.2088	0.0474	1.6200	78.83	77.38	67.38	51.14	-1154.1	-595.7	1.6200
11	7.85	9.00	8.11	13.73	33.29	37.68	0.5685	0.2595	0.0556	1.6032	73.43	71.86	68.19	54.46	-1192.6	-612.7	1.6032

TO/TO	PO/PO	EFF-AD	EFF-P	WCI/AL	PO2/T01	P02/P01	EFF-AD	EFF-P
INLET	INLET	INLET	INLET	LBM/SEC	%	%	ROTOR	ROTOR
1.1576	1.5780	88.30	89.00	32.62	1.1576	1.5780	88.30	89.00

STATOR 1

SL	EPSI-1	EPSI-2	V-1	V-2	VM-1	VM-2	V0-1	V0-2	B-1	B-2	M-1	M-2	RUN NO	9, SPEED	CODE	85, POINT	NU 33	PO/PO	TO/TU	PU/PU	TO2/
	DEGREE	DEGREE	FT/SEC	FT/SEC	FT/SEC	FT/SEC	FT/SEC	FT/SEC	DEGREE	DEGREE				PG/PG				INLET	INLET	STAGE	Tu1
1	18.347	15.111	876.7	550.7	550.6	590.6	697.9	-9.9	53.0	-1.0	0.7784	0.4719	1.5315	1.5315	1.1413	1.5315	1.5315	1.5315	1.5315	1.5315	1.5315
2	16.195	13.544	845.9	550.0	531.1	549.9	658.4	9.5	51.3	1.0	0.7486	0.4717	1.5369	1.5369	1.1393	1.5369	1.5369	1.5369	1.5369	1.5369	1.5369
3	14.200	12.023	816.4	546.5	523.7	546.4	624.6	10.3	50.0	1.1	0.7202	0.4689	1.5385	1.5385	1.1377	1.5385	1.5385	1.5385	1.5385	1.5385	1.5385
4	8.929	7.628	761.2	526.9	505.9	526.8	568.8	-10.3	48.4	-1.1	0.6660	0.4507	1.5281	1.5281	1.1410	1.5281	1.5281	1.5281	1.5281	1.5281	1.5281
5	2.914	2.194	698.6	511.4	479.5	511.3	508.1	-9.8	46.7	-1.1	0.6060	0.4363	1.5172	1.5172	1.1444	1.5172	1.5172	1.5172	1.5172	1.5172	1.5172
6	0.161	-0.304	685.1	505.9	470.7	505.3	497.9	-23.1	46.6	-2.0	0.5917	0.4302	1.5132	1.5132	1.1507	1.5132	1.5132	1.5132	1.5132	1.5132	1.5132
7	-1.081	-1.401	693.8	531.2	499.5	531.2	490.0	-3.4	44.5	-0.4	0.6047	0.4322	1.5346	1.5346	1.1528	1.5346	1.5346	1.5346	1.5346	1.5346	1.5346
8	-2.192	-2.405	707.9	546.8	513.8	546.8	487.0	2.1	43.5	0.2	0.6112	0.4653	1.5493	1.5493	1.1560	1.5493	1.5493	1.5493	1.5493	1.5493	1.5493
9	-5.350	-5.495	720.6	563.6	508.6	563.6	510.5	2.8	43.1	0.3	0.6168	0.4758	1.5702	1.5702	1.1771	1.5702	1.5702	1.5702	1.5702	1.5702	1.5702
10	-6.449	-6.589	732.4	564.1	503.0	564.0	532.4	9.6	46.7	1.0	0.6242	0.4735	1.5722	1.5722	1.1900	1.5722	1.5722	1.5722	1.5722	1.5722	1.5722
11	-7.713	-7.810	715.9	537.5	462.6	537.1	546.3	-22.5	49.8	-2.4	0.6063	0.4482	1.5515	1.5515	1.2008	1.5515	1.5515	1.5515	1.5515	1.5515	1.5515

SL	INCS	INCM	DEV	TURN	RHOVM-1	RHOVM-2	D-FAC	OMEGA-B	LOSS-P	PO2/	%EFF-P	%EFF-A	%EFF-A	%EFF-P
	DEGREE	DEGREE	DEGREE	DEGREE				TOTAL	TOTAL	P01	TOT-INLET	TOT-INLET	TOT-STG	TOT-STG
1	0.42	2.53	11.31	54.00	43.04	50.67	0.5306	0.1502	0.0307	0.9503	91.67	92.14	91.67	92.14
2	0.48	2.84	12.21	50.29	43.67	50.87	0.5074	0.1235	0.0262	0.9615	93.80	94.14	93.80	94.14
3	0.52	3.30	11.47	48.97	43.68	50.74	0.4819	0.0952	0.0210	0.9721	95.09	95.36	95.09	95.36
4	1.39	5.11	8.15	49.51	42.92	48.84	0.4812	0.0945	0.0231	0.9756	91.34	91.82	91.34	91.82
5	1.15	6.20	8.22	47.75	41.31	47.21	0.4697	0.0655	0.0179	0.9856	87.62	88.30	87.62	88.30
6	1.58	7.20	6.74	49.22	40.89	46.40	0.4780	0.0793	0.0227	0.9833	83.35	84.27	83.35	84.27
7	-0.35	5.53	9.02	44.82	43.47	48.92	0.4458	0.0837	0.0244	0.9817	86.02	86.17	86.02	86.17
8	-1.13	5.01	9.65	43.25	44.85	50.40	0.4304	0.0859	0.0255	0.9809	85.41	86.26	85.41	86.26
9	0.53	7.41	10.83	44.86	44.11	51.47	0.4347	0.0916	0.0286	0.9793	77.69	79.04	77.69	79.04
10	1.75	8.80	12.76	43.71	43.38	51.06	0.4582	0.1314	0.0416	0.9695	72.61	74.27	72.61	74.27
11	4.21	11.36	10.90	52.25	39.56	48.09	0.5066	0.1475	0.0472	0.9675	66.55	68.51	66.55	68.51

MCORR	MCORR	TO/TO	PO/PO	EFF-AD	EFF-P	TO2/T01	P02/P01	EFF-AD	EFF-P
INLET	INLET	INLET	INLET	INLET	INLET	%	%	STAGE	%
9072	148460	1.1576	1.5398	83.26	84.22	1.1576	0.9758	83.26	

ROTOR 2

SL	EPSI-1	EPSI-2	V-1	V-2	VM-1	VM-2	V0-1	V0-2	B-1	B-2	M-1	M-2	9, SPEED	CODE	BS, POINT	NO 35	V ¹ -1	V ¹ -2
	DEGREE	DEGREE	FT/SEC	FT/SEC	FT/SEC	FT/SEC	FT/SEC	FT/SEC	DEGREE	DEGREE			U-1	U-2	M ¹ -1	M ¹ -2	FT/SEC	FT/SEC
1	11.733	11.094	580.9	967.2	580.8	594.9	-10.0	762.6	-1.0	51.9	0.4991	0.7997	707.4	741.9	0.7930	0.4922	923.0	595.3
2	11.060	9.852	586.8	955.0	586.8	582.9	9.2	756.4	0.9	52.3	0.5049	0.7896	727.4	757.4	0.7979	0.4962	927.4	582.9
3	10.211	8.678	590.4	940.1	590.3	596.6	10.9	726.6	1.1	50.5	0.5085	0.7780	748.0	773.0	0.8133	0.4952	944.3	588.4
4	6.612	5.162	587.3	854.5	587.2	608.7	-10.1	599.7	-1.0	44.6	0.5049	0.7036	812.0	825.0	0.8660	0.5344	1010.3	649.1
5	1.152	0.811	576.0	739.0	575.9	530.4	-9.4	514.5	-0.9	44.1	0.4940	0.6027	900.2	899.6	0.9233	0.5346	1076.6	655.5
6	-1.217	-1.163	570.5	686.0	570.0	514.1	-22.8	454.1	-2.3	41.4	0.4876	0.5570	945.2	939.3	0.9602	0.5740	1123.4	706.9
7	-2.262	-2.078	592.1	661.6	592.4	509.4	-4.3	452.9	-0.4	41.6	0.5006	0.5533	967.9	959.8	0.9728	0.5635	1136.3	718.6
8	-3.174	-2.939	607.9	685.0	607.9	521.6	1.9	444.9	0.2	40.4	0.5200	0.5564	950.7	980.7	0.9929	0.6069	1160.7	747.8
9	-5.820	-5.646	634.4	698.3	634.4	545.5	2.6	435.8	0.2	38.5	0.5389	0.5615	1060.1	1045.7	1.0475	0.6560	1233.2	810.5
10	-6.746	-6.673	640.6	705.0	640.5	560.0	11.2	429.4	1.0	37.3	0.5414	0.5655	1089.4	1067.9	1.0554	0.6806	1249.0	849.3
11	-7.936	-8.018	620.3	684.7	619.9	571.2	-22.5	377.5	-2.1	33.3	0.5206	0.5461	1106.8	1090.6	1.0814	0.7267	1288.2	915.7

SL	INCS	INCM	DEV	TURN	RHOVM-1	RHOVM-2	D-FAC	OMEGA-B	LOSS-P	PO2/P01	XEFF-P	XEFF-A	B ¹ -1	B ¹ -2	V0 ¹ -1	V0 ¹ -2	PO/PO
	DEGREE	DEGREE	DEGREE	DEGREE				TOTAL	TOTAL	P01	TOT	TOT	DEGREE	DEGREE	FT/SEC	FT/SEC	INLET
1	1.47	5.78	18.42	52.92	52.78	61.38	0.5504	0.1987	0.0453	1.5772	87.00	86.15	50.94	-1.98	-717.3	20.6	2.4151
2	0.81	5.26	13.92	50.66	53.45	61.07	0.5632	0.1783	0.0417	1.5800	88.15	87.37	50.76	0.10	-718.2	-1.0	2.4277
3	1.01	5.59	12.02	46.87	53.82	63.56	0.5487	0.1360	0.0325	1.5835	90.57	89.95	51.37	4.49	-737.1	-47.0	2.4371
4	2.78	7.57	10.75	34.22	53.11	66.76	0.5134	0.0708	0.0171	1.5468	94.06	93.69	54.53	20.31	-822.4	-225.3	2.3642
5	4.20	8.77	7.76	21.68	51.84	58.95	0.5289	0.1022	0.0235	1.4781	89.83	89.27	57.67	35.98	-909.6	-385.1	2.2427
6	5.11	9.45	7.10	16.17	51.04	57.20	0.4955	0.0958	0.0207	1.4458	89.37	88.81	59.48	43.31	-968.0	-485.2	2.1800
7	3.74	7.82	5.35	13.81	53.16	56.87	0.4905	0.1016	0.0220	1.4302	88.27	87.67	56.61	44.81	-972.1	-506.9	2.1908
8	2.97	6.78	3.37	12.66	54.60	58.45	0.4738	0.0947	0.0207	1.4253	88.66	88.08	56.36	45.69	-988.8	-535.8	2.2048
9	2.10	4.78	0.94	10.88	56.21	60.74	0.4563	0.1021	0.0238	1.4272	87.09	86.43	58.91	48.03	-1057.5	-609.9	2.2394
10	1.80	3.98	1.90	10.42	56.18	62.16	0.4398	0.0769	0.0185	1.4340	90.03	89.52	59.00	48.58	-1072.2	-638.5	2.2552
11	3.59	5.28	5.49	9.95	53.68	63.04	0.4043	0.0410	0.0097	1.4365	94.36	94.07	61.10	51.15	-1129.3	-713.1	2.2321
	TO/TO	PO/PO	EFF-AD	EFF-P	WCI/AL					TO2/T01	PO2/P01	EFF-AD	EFF-P				
	INLET	INLET	%	%	SQFT							%	%				
	1.3092	2.2803	85.69	87.23	35.88					1.1309	1.4809	90.27	90.78				

STATOR 2

SL	EPSI-1	EPSI-2	V-1	V-2	VM-1	VM-2	V0-1	V0-2	B-1	B-2	M-1	M-2	9, SPEED	CODE	BS, POINT	NO 35	V ¹ -1	V ¹ -2
	DEGREE	DEGREE	FT/SEC	FT/SEC	FT/SEC	FT/SEC	FT/SEC	FT/SEC	DEGREE	DEGREE			U-1	U-2	M ¹ -1	M ¹ -2	FT/SEC	FT/SEC
1	8.47	0.763	988.6	651.7	838.3	651.6	755.0	12.8	50.0	1.1	0.6197	0.5211	INLET	INLET	2.2831	1.3248	1.4911	1.1607
2	7.242	0.593	975.6	668.2	624.1	688.1	749.8	11.2	50.4	1.0	0.6089	0.5358	2.3106	1.3212	1.5044	1.1593		
3	6.066	0.336	960.1	690.7	633.9	690.7	721.1	2.0	48.8	0.2	0.7966	0.5562	2.3482	1.3153	1.5260	1.1558		
4	3.466	-0.388	873.8	662.5	637.9	662.4	597.2	-13.2	43.2	-1.1	0.7211	0.5350	2.3179	1.3023	1.5164	1.1417		
5	0.627	-1.059	759.1	578.3	558.6	575.4	514.0	-58.0	42.6	-5.7	0.6203	0.4652	2.2130	1.2951	1.4501	1.1320		
6	-0.859	-1.223	707.3	539.4	542.1	538.4	454.3	-33.4	39.9	-3.5	0.5754	0.4330	2.1683	1.2938	1.4325	1.1250		
7	-1.645	-1.258	703.5	537.0	537.7	536.8	453.6	-12.9	40.1	-1.4	0.5722	0.4310	2.1641	1.2935	1.4150	1.1225		
8	-2.459	-1.273	708.1	548.8	550.1	546.8	445.9	-2.6	39.0	-0.3	0.5759	0.4407	2.1741	1.2945	1.4066	1.1206		
9	-4.171	-1.308	726.1	585.0	578.9	584.9	438.2	4.4	37.2	0.4	0.5853	0.4661	2.1975	1.3201	1.4004	1.1232		
10	-5.840	-1.300	737.0	601.7	597.1	601.4	431.9	17.8	36.0	1.7	0.5922	0.4780	2.2090	1.3309	1.4046	1.1205		
11	-6.206	-1.221	722.3	591.0	614.5	590.9	379.6	9.7	31.8	0.9	0.5780	0.4678	2.1898	1.3382	1.4100	1.1151		
	INCS	INCM	DEV	TURN	RHOVM-1	RHOVM-2	D-FAC	OMEGA-B	LOSS-P	PO2/P01	XEFF-P	XEFF-A	B ¹ -1	B ¹ -2	V0 ¹ -1	V0 ¹ -2	PO/PO	
	DEGREE	DEGREE	DEGREE	DEGREE				TOTAL	TOTAL	P01	TGT-INLET	TGT-INLET	DEGREE	DEGREE	FT/SEC	FT/SEC	STAGE	
	1.59	3.15	12.94	48.92	64.92	75.24	0.5099	0.1328	0.0345	0.9454	81.69	83.66	74.94	78.27				
	3.00	5.02	12.21	49.46	64.80	77.71	0.4890	0.1360	0.0313	0.9523	83.95	85.70	77.36	78.01				
	2.18	4.69	11.01	48.67	66.86	81.15	0.4571	0.1051	0.0246	0.9640	87.41	88.80	82.05	83.07				
	-2.40	1.47	9.18	44.30	69.18	78.44	0.4189	0.0727	0.0180	0.9786	89.60	90.74	84.75	89.38				
	-2.11	3.19	4.55	48.35	61.47	67.62	0.4437	0.0661	0.0176	0.9848	86.16	87.59	85.84	86.56				
	-4.47	1.32	6.68	43.47	58.72	62.93	0.4325	0.0521	0.0144	0.9894	84.06	85.68	84.15	86.24				
	-4.11	1.88	6.79	41.50	59.44	62.70	0.4229	0.0596	0.0167	0.9881	83.91	85.54	84.75	85.47				
	-5.05	1.16	9.84	39.27	61.02	64.08	0.4054	0.0662	0.0188	0.9867	84.18	85.78	84.53	85.24				
	-6.64	0.06	10.60	36.73	63.63	66.94	0.3704	0.0908	0.0266	0.9812	78.62	80.82	81.61	82.46				
	-8.50	-1.63	12.46	34.27	65.33	68.26	0.3510	0.0981	0.0290	0.9793	76.60	79.02	84.15	84.92				
	-13.92	-6.82	12.87	30.87	66.67	66.43	0.3347	0.0913	0.0273	0.9815	74.02	76.67	82.15	89.66				
	MCORR	MCORR	TO/TO	PO/PO	EFF-AD	EFF-P				TO2/T01	PO2/P01	EFF-AD	EFF-P					
	INLET	INLET	INLET	INLET	%	%						%	%					
	9072.	143.60	1.3092	2.2323	83.22	84.98				1.1309	0.9790	85.12						

ORIGINAL PAGE IS
OF POOR QUALITY.

TABLE XVI(d) — OVERALL PERFORMANCE AND BLADE-ELEMENT DATA
(Uniform Inlet Flow, 85 Percent Speed)

U. S. CUSTOMARY UNITS

ROTOR 1

SL	EPI-1		EPI-2		V-1		V-2		VM-1		VM-2		V0-1		V0-2		B-1	B-2	M-1	M-2	RUN NO		9, SPEED		CODE 85, POINT NO		4	
	DEGREE	DEGREE	FT/SEC	FT/SEC	FT/SEC	FT/SEC	FT/SEC	FT/SEC	DEGREE	DEGREE	FT/SEC	FT/SEC	FT/SEC	FT/SEC	DEGREE	DEGREE					U-1	U-2	M'-1	M'-2	FT/SEC	FT/SEC	FT/SEC	FT/SEC
1	10.015	10.338	423.4	874.3	423.4	874.3	466.2	0.0	739.6	0.0	57.8	0.3847	0.7736	536.8	621.2	0.6210	0.4256	683.5	481.0									
2	14.040	16.006	432.2	837.6	432.2	470.0	0.0	693.2	0.0	55.9	0.3929	0.7384	578.6	651.3	0.6566	0.4160	722.2	471.9										
3	11.775	13.850	440.6	809.0	440.6	475.1	0.0	654.7	0.0	54.0	0.4009	0.7112	619.5	681.3	0.6519	0.4183	760.5	475.9										
4	5.806	8.117	460.0	757.9	460.0	468.1	0.0	595.5	0.0	51.8	0.4190	0.6605	738.4	771.6	0.7922	0.4361	869.6	500.1										
5	0.174	1.782	470.6	615.2	470.6	419.5	0.0	529.0	0.0	51.6	0.4291	0.5824	885.4	891.8	0.9142	0.4784	1002.7	594.6										
6	-1.967	-0.919	472.0	672.6	472.0	433.5	0.0	514.3	0.0	49.9	0.4305	0.5786	956.3	951.9	0.9725	0.5298	1066.5	616.0										
7	-3.254	-2.241	471.9	683.1	471.9	463.8	0.0	501.6	0.0	47.2	0.4303	0.5879	991.3	981.9	1.0012	0.5747	1097.9	667.7										
8	-4.762	-3.580	470.9	685.9	470.9	473.8	0.0	495.9	0.0	46.3	0.4294	0.5856	1026.3	1012.0	1.0296	0.6023	1129.2	700.6										
9	-9.350	-7.626	460.8	702.3	460.8	463.9	0.0	527.2	0.0	48.6	0.4199	0.5978	1130.8	1102.2	1.1125	0.6289	1221.1	738.8										
10	10.764	8.968	455.5	707.8	455.5	441.2	0.0	553.4	0.0	51.4	0.4149	0.5989	1165.6	1132.2	1.1397	0.6158	1251.4	727.8										
11	11.764	10.318	450.0	698.1	450.0	403.3	0.0	569.8	0.0	54.6	0.4096	0.5871	1200.4	1162.3	1.1670	0.6028	1281.9	716.7										

SL	INCS	INCM	DEV	TURN	RHOVM-1	RHOVM-2	D-FAC	OMEGA-B		LOSS-P	PO2/	XEFF-P	XEFF-A	B'-1	B'-2	VB'-1	VB'-2	PC/PC
								TOTAL	TOTAL									
1	5.12	5.73	13.69	65.77	30.10	37.61	0.5526	0.0358	0.0076	1.6060	98.37	98.28	51.50	-14.27	-536.6	118.4	1.6060	
2	5.19	9.49	14.50	58.11	30.63	36.60	0.5815	0.0341	0.0078	1.5928	98.25	98.15	53.01	-3.10	-578.6	41.9	1.5928	
3	5.37	5.48	14.74	51.17	31.14	39.61	0.5913	0.0272	0.0085	1.5859	98.45	98.36	54.38	3.21	-619.5	-26.6	1.5859	
4	6.44	5.91	10.93	37.33	32.27	40.18	0.6130	0.0568	0.0142	1.5876	95.98	95.73	57.95	20.61	-738.0	-170.0	1.5876	
5	7.48	10.17	10.58	21.15	32.88	36.62	0.6070	0.1308	0.0297	1.5485	88.60	87.89	62.00	40.85	-865.4	-362.8	1.5485	
6	7.80	10.08	7.92	18.47	32.96	38.17	0.5749	0.1314	0.0293	1.5667	87.88	87.11	62.74	45.26	-956.3	-437.6	1.5667	
7	7.97	10.08	5.69	18.56	32.95	41.15	0.5396	0.1047	0.0236	1.5881	90.02	89.37	64.56	46.00	-991.3	-480.3	1.5881	
8	8.10	10.11	4.58	17.94	32.89	42.18	0.5250	0.1044	0.0235	1.5988	89.77	89.05	65.38	47.44	-1026.3	-516.1	1.5988	
9	8.84	10.26	4.26	16.83	32.32	41.02	0.5475	0.1852	0.0413	1.6303	81.69	80.41	67.89	51.06	-1130.8	-574.9	1.6303	
10	9.03	10.32	5.62	16.10	32.01	38.72	0.5772	0.2361	0.0519	1.6389	77.05	75.43	68.71	52.62	-1165.6	-578.8	1.6389	
11	9.14	10.30	9.32	13.81	31.68	35.14	0.6030	0.2827	0.0588	1.6322	72.60	70.68	69.48	55.66	-1200.4	-592.5	1.6322	

TD/TO	PO/PO	EFF-AD	EFF-P	WCI/AI	PO2/T01	PG2/P01	EFF-AD	EFF-P
INLET	INLET	INLET	INLET	LBM/SEC	%	%	ROTOR	ROTOR
1.1644	1.5951	86.75	87.61	31.07	1.1644	1.5951	86.75	87.61

STATOR 1

SL	EPI-1		EPI-2		V-1		V-2		VM-1		VM-2		V0-1		V0-2		B-1	B-2	M-1	M-2	RUN NO		9, SPEED		CODE 85, POINT NO		4	
	DEGREE	DEGREE	FT/SEC	FT/SEC	FT/SEC	FT/SEC	FT/SEC	FT/SEC	DEGREE	DEGREE	FT/SEC	FT/SEC	FT/SEC	FT/SEC	DEGREE	DEGREE					U-1	U-2	M'-1	M'-2	FT/SEC	FT/SEC	FT/SEC	FT/SEC
1	18.244	15.027	873.4	903.3	487.7	505.3	724.1	-3.8	56.2	-0.4	0.7723	0.4303	1.5302	1.1475	1.5302	1.1475	1.5302	1.1475										
2	16.012	13.396	839.5	505.6	490.9	505.4	681.0	14.9	54.4	1.7	0.7403	0.4311	1.5351	1.1450	1.5351	1.1450	1.5351	1.1450										
3	14.003	11.845	813.3	504.4	495.4	503.6	645.0	27.1	52.6	3.1	0.7154	0.4304	1.5376	1.1432	1.5376	1.1432	1.5376	1.1432										
4	8.908	7.547	766.3	498.1	488.1	497.6	590.7	22.1	50.5	2.5	0.6688	0.4240	1.5375	1.1473	1.5375	1.1473	1.5375	1.1473										
5	2.980	2.163	687.1	464.1	439.7	464.0	528.0	-11.1	50.2	-1.4	0.5934	0.3935	1.5152	1.1510	1.5152	1.1510	1.5152	1.1510										
6	0.234	-0.295	685.5	485.4	492.8	485.4	514.7	-6.3	48.7	-0.7	0.5904	0.4111	1.5320	1.1567	1.5320	1.1567	1.5320	1.1567										
7	-0.960	-1.371	696.4	505.1	482.2	505.1	502.5	3.6	46.2	0.4	0.6002	0.4281	1.5486	1.1578	1.5486	1.1578	1.5486	1.1578										
8	-2.010	-2.360	699.7	516.5	492.5	516.3	497.0	15.4	45.3	1.7	0.6024	0.4378	1.5596	1.1601	1.5596	1.1601	1.5596	1.1601										
9	-5.028	-5.404	718.4	531.5	485.6	531.1	529.5	20.2	47.5	2.2	0.6127	0.4462	1.5789	1.1837	1.5789	1.1837	1.5789	1.1837										
10	-6.166	-6.517	725.3	535.4	465.0	534.7	556.6	26.2	40.2	2.8	0.6149	0.4467	1.5841	1.1988	1.5841	1.1988	1.5841	1.1988										
11	-7.561	-7.779	718.6	521.5	428.8	521.5	574.2	3.6	53.3	0.4	0.6039	0.4321	1.5746	1.2124	1.5746	1.2124	1.5746	1.2124										

SL	INCS	INCM	DEV	TURN	RHOVM-1	RHOVM-2	D-FAC	OMEGA-B		LOSS-P	PO2/	XEFF-A	XEFF-P	XEFF-A	XEFF-P
								TOTAL	TOTAL						
1	3.68	5.79	11.91	54.45	39.38	47.05	0.5847	0.1449	0.0296	0.9927	87.62	88.32	87.62	88.32	
2	3.51	5.91	12.50	52.68	40.26	47.30	0.5601	0.1189	0.0252	0.9637	89.86	90.43	89.86	90.43	
3	3.05	5.91	13.46	49.51	41.20	47.30	0.5421	0.1052	0.0232	0.9696	91.37	91.66	91.37	91.86	
4	3.47	7.19	11.80	47.94	41.69	46.69	0.5287	0.1233	0.0301	0.9679	88.75	89.39	88.75	89.39	
5	4.71	9.76	7.94	31.58	38.14	43.28	0.5379	0.0987	0.0270	0.9790	83.50	84.41	83.50	84.41	
6	3.64	5.29	8.62	45.40	39.61	45.24	0.5086	0.0992	0.0284	0.9792	82.70	83.60	82.70	83.60	
7	1.38	7.26	9.80	45.77	42.49	47.21	0.4830	0.1067	0.0312	0.9770	84.21	85.23	84.21	85.23	
8	0.67	6.81	11.14	43.56	43.33	48.31	0.4654	0.1074	0.0319	0.9767	84.53	85.45	84.53	85.45	
9	2.88	9.76	12.73	41.32	42.59	49.14	0.4793	0.1391	0.0421	0.9698	77.33	77.33	77.33	77.33	
10	5.23	12.27	14.58	47.36	40.45	49.00	0.4946	0.1510	0.0478	0.9658	70.60	72.41	70.60	72.41	
11	7.71	14.86	13.71	52.43	37.02	47.26	0.5309	0.1622	0.0520	0.9645	65.16	67.28	65.16	67.28	

NCORR	WCI/AI	TD/TO	PO/PO	EFF-AD	EFF-P	PO2/T01	PO2/P01	EFF-AD	EFF-P
INLET	INLET	INLET	INLET	INLET	INLET	%	%	STAGE	STAGE
9130.	136.80	1.1644	1.5487	80.95	82.07	1.1644	0.9709	80.95	82.07

ROTOR 2

SL	EPSI-1	EPSI-2	V-1	V-2	VM-1	VM-2	V0-1	V0-2	B-1	B-2	M-1	M-2	9. SPEED	CODE	85. POINT	NO. 4	V-1	V-2
DEGREE	DEGREE	FT/SEC	FT/SEC	FT/SEC	FT/SEC	FT/SEC	FT/SEC	FT/SEC	DEGREE	DEGREE			FT/SEC	FT/SEC			FT/SEC	FT/SEC
1	11.057	11.055	535.4	551.8	535.4	579.8	-3.9	754.9	-0.4	52.3	0.4570	0.7841	711.9	746.7	G.7630	0.4777	894.9	579.9
2	10.897	9.771	540.9	935.7	540.7	562.6	14.2	752.7	1.5	53.1	0.4624	0.7740	732.1	762.3	0.7683	0.4635	898.7	562.7
3	9.979	8.549	544.8	930.1	544.2	569.2	26.6	735.5	2.8	52.2	0.4663	0.7669	752.8	778.6	0.7767	0.4707	907.5	576.9
4	6.295	5.028	550.0	846.6	549.6	561.9	22.0	633.3	2.3	48.4	0.4700	0.6942	817.2	830.4	0.8261	0.4882	966.6	595.4
5	1.079	0.725	523.9	731.2	523.7	508.5	-10.7	525.4	-1.2	45.9	0.4460	0.5932	906.0	905.4	0.8990	0.5150	1055.8	634.8
6	-1.394	-1.321	542.2	695.6	542.2	493.2	-6.4	490.5	-0.7	44.8	0.4611	0.5623	551.3	945.4	0.9359	0.5424	1100.5	670.9
7	-2.436	-2.254	559.7	655.8	559.6	495.0	3.2	489.0	0.3	44.6	0.4764	0.5622	574.1	966.0	0.9539	0.5554	1120.6	687.4
8	-3.324	-3.103	571.6	701.2	571.4	495.6	15.0	496.1	1.5	45.0	0.4866	0.5660	593.1	987.1	0.9672	0.5631	1136.3	697.7
9	-5.885	-5.720	597.6	719.3	597.2	527.0	20.4	489.6	1.9	42.7	0.5045	0.5751	1067.0	1052.4	1.0173	0.6165	1205.0	771.1
10	-6.854	-6.768	606.7	718.2	606.1	539.2	26.2	474.5	2.5	41.2	0.5092	0.5718	1090.4	1074.8	1.0279	0.6424	1224.7	806.9
11	-6.026	-8.101	599.0	701.1	599.0	557.8	4.1	426.7	0.4	37.1	0.4994	0.5557	1114.0	1097.7	1.0515	0.6928	1261.3	874.1

SL	INCS	INCM	DEV	TURN	RHOVM-1	RHOVM-2	D-FAC	OMEGA-B	LOSS-P	PO2/	TEFF-P	TEFF-A	B-1	B-2	V0-1	V0-2	PC/PC
DEGREE	DEGREE	DEGREE	DEGREE					TOTAL	TOTAL	P01	TOT	TOT	DEGREE	DEGREE	FT/SEC	FT/SEC	INLET
1	3.66	7.98	19.60	53.94	45.29	60.01	0.5494	0.1981	0.0452	1.5706	87.60	86.80	53.14	-0.80	-715.8	8.2	2.4033
2	3.05	7.50	14.80	52.02	49.93	59.05	0.5699	0.1875	0.0438	1.5727	88.11	87.33	53.00	0.58	-717.8	9.7	2.4141
3	2.84	7.41	11.85	48.47	50.33	60.74	0.5609	0.1421	0.0339	1.5817	90.73	90.12	53.19	4.32	-726.2	-43.1	2.4323
4	3.65	8.45	9.76	36.08	50.56	61.54	0.5479	0.1007	0.0244	1.5355	92.14	91.65	55.41	19.32	-795.2	-197.1	2.3612
5	6.79	11.37	8.55	23.49	47.84	56.31	0.5425	0.1264	0.0287	1.4797	88.09	87.43	60.26	36.78	-916.7	-380.0	2.2426
6	0.09	10.43	6.45	17.01	49.48	54.81	0.5236	0.1366	0.0298	1.4456	85.79	85.04	60.46	42.66	-957.7	-454.9	2.2138
7	5.13	9.21	4.63	16.11	51.21	55.21	0.5178	0.1439	0.0316	1.4374	84.58	83.78	60.00	43.89	-976.9	-477.0	2.2235
8	4.37	8.18	2.34	15.09	52.32	55.40	0.5177	0.1503	0.0335	1.4374	83.71	82.87	59.75	44.66	-982.1	-491.0	2.2398
9	3.36	6.04	-0.36	13.43	53.82	58.63	0.4933	0.1381	0.0330	1.4498	84.27	83.44	60.17	46.72	-1046.6	-562.9	2.2874
10	3.00	5.18	1.23	12.29	53.99	59.76	0.4719	0.1113	0.0271	1.4482	86.81	86.11	60.20	47.51	-1064.2	-600.4	2.2926
11	4.00	5.70	4.54	11.32	52.69	61.55	0.4297	0.0679	0.0164	1.4441	91.32	90.86	61.51	50.19	-1109.5	-672.9	2.2755

TO/TO	PO/PO	EFF-AD	EFF-P	WCI/A1	TO2/TO1	PC2/PO1	EFF-AD	EFF-P
INLET	INLET	INLET	INLET	LBM/SEC			ROTOR	ROTOR
		%	%	SOFT			%	%
1.3226	2.2988	83.01	84.85	34.09	1.1359	1.4843	87.50	88.17

STATOR 2

SL	EPSI-1	EPSI-2	V-1	V-2	VM-1	VM-2	V0-1	V0-2	B-1	B-2	M-1	M-2	9. SPEED	CODE	85. POINT	NO. 4	TC2/
DEGREE	DEGREE	FT/SEC	FT/SEC	FT/SEC	FT/SEC	FT/SEC	FT/SEC	FT/SEC	DEGREE	DEGREE			FT/SEC	FT/SEC			TO1
1	6.557	0.777	970.7	616.4	615.4	616.2	747.3	17.8	50.6	1.7	0.8016	0.4908	2.3047	1.3288	1.5063	1.1579	
2	7.410	0.637	557.7	621.0	600.3	620.8	746.2	15.7	51.4	1.5	0.7908	0.4951	2.3149	1.3258	1.5088	1.1575	
3	8.244	0.426	947.4	636.7	603.8	636.6	730.1	8.7	50.6	0.8	0.7830	0.5053	2.3462	1.3267	1.5223	1.1551	
4	3.016	-0.266	863.7	614.7	550.2	614.7	630.7	-1.8	47.0	-0.2	0.7096	0.4929	2.3206	1.3102	1.5082	1.1423	
5	0.590	-1.061	749.2	534.3	534.7	533.9	524.9	-20.8	44.4	-2.2	0.6089	0.4266	2.2284	1.3062	1.4695	1.1350	
6	-0.821	-1.106	714.7	501.3	519.6	500.9	490.8	-19.9	43.3	-2.3	0.5788	0.3993	2.1528	1.3068	1.4329	1.1303	
7	-1.563	-1.163	715.5	503.8	521.6	503.6	489.8	-15.3	43.2	-1.7	0.5752	0.4012	2.1536	1.3078	1.4201	1.1298	
8	-2.357	-1.165	721.7	516.5	522.9	516.4	497.5	-10.3	43.5	-1.1	0.5836	0.4111	2.2038	1.3114	1.4153	1.1310	
9	-4.783	-1.287	745.0	560.8	555.3	560.5	492.1	16.0	41.4	1.6	0.5969	0.4427	2.2351	1.3397	1.4167	1.1334	
10	-5.545	-1.300	747.2	572.8	575.1	572.3	477.1	24.6	39.8	2.5	0.5964	0.4508	2.2415	1.3504	1.4258	1.1287	
11	-6.199	-1.225	736.0	546.3	599.3	566.2	427.2	14.4	35.6	1.5	0.5852	0.4442	2.2283	1.3577	1.4145	1.1208	

SL	INCS	INCM	DEV	TURN	RHOVM-1	RHOVM-2	D-FAC	OMEGA-B	LOSS-P	PO2/	TEFF-A	TEFF-P	TEFF-A	TEFF-P
DEGREE	DEGREE	DEGREE	DEGREE					TOTAL	TOTAL	P01	TOT-INLET	TOT-INLET	TOT-STG	TC1-STG
1	2.16	3.72	13.47	48.55	63.32	72.66	0.5342	0.1184	0.0267	0.9591	81.73	83.71	78.28	79.49
2	3.97	5.98	12.70	49.94	62.28	73.54	0.5267	0.1193	0.0275	0.9596	82.57	84.83	78.80	79.98
3	3.92	6.42	11.63	45.78	63.72	76.01	0.5068	0.1102	0.0258	0.9632	85.53	87.13	81.90	82.92
4	1.40	5.26	10.15	47.12	64.02	73.95	0.4742	0.0674	0.0187	0.9805	87.47	88.84	87.35	88.05
5	-0.26	5.04	8.67	46.68	58.70	63.69	0.4857	0.0356	0.0095	0.9921	83.82	85.51	85.72	86.47
6	-1.07	4.72	7.95	45.55	57.23	59.42	0.4991	0.0509	0.0141	0.9896	81.78	83.65	82.68	83.53
7	-1.07	4.93	8.42	44.50	57.65	59.67	0.4937	0.0620	0.0174	0.9874	81.56	83.45	80.88	81.79
8	-0.50	5.70	8.97	44.65	57.90	61.07	0.4896	0.0740	0.0210	0.9848	81.14	83.09	79.29	80.26
9	-2.41	4.29	11.80	41.47	64.96	64.96	0.4356	0.1066	0.0313	0.9772	79.86	78.39	78.00	79.04
10	-4.70	2.17	13.23	37.30	62.88	65.76	0.4137	0.1045	0.0309	0.9777	73.81	76.56	80.70	81.62
11	-10.14	-3.05	13.39	34.13	65.08	64.50	0.3982	0.0986	0.0294	0.9796	71.70	74.65	85.71	86.39

NCORR	WCORR	TO/TO	PO/PO	EFF-AD	EFF-P	TO2/TO1	PO2/PO1	EFF-AD
INLET	INLET	INLET	INLET	INLET	INLET			STAGE
RPM	LBM/SEC			%	%			%
9130	136.80	1.3226	2.2529	80.76	82.80	1.1359	0.9800	82.80

ORIGINAL PAGE IS
OF POOR QUALITY

TABLE XVII(a) — OVERALL PERFORMANCE AND BLADE-ELEMENT DATA
(Uniform Inlet Flow, 100 Percent Speed)

U. S. CUSTOMARY UNITS

ROTOR 1

SL	CPJ1-1	EPJ1-2	V-1	V-2	VM-1	VM-2	V0-1	V0-2	B-1	B-2	M-1	M-2	U-1	U-2	M'-1	M'-2	V'-1	V'-2
DEGREE	DEGREE	FT/SEC	FT/SEC	FT/SEC	FT/SEC	FT/SEC	FT/SEC	FT/SEC	DEGREE	DEGREE			FT/SEC	FT/SEC			FT/SEC	FT/SEC
1	14.744	14.382	622.5	1098.0	622.5	652.1	0.0	884.6	0.0	53.6	0.5755	0.9784	627.7	726.7	0.8173	0.5973	604.0	670.9
2	4.278	10.065	637.4	1058.6	637.4	662.2	0.0	825.9	0.0	51.3	0.5903	0.9380	676.9	761.9	0.8610	0.5895	929.7	667.3
3	11.928	13.910	652.3	1029.8	652.3	677.7	0.0	775.4	0.0	48.9	0.6051	0.9098	725.1	797.0	0.9047	0.5991	975.3	678.4
4	3.503	4.130	688.3	934.8	688.3	662.0	0.0	660.0	0.0	44.9	0.6411	0.8170	863.3	902.5	1.0284	0.6161	1104.1	753.0
5	0.537	1.031	708.9	783.3	708.9	563.7	0.0	543.9	0.0	44.0	0.6621	0.6741	1035.7	1043.1	1.1721	0.6480	1255.1	753.0
6	2.037	1.262	712.2	723.2	712.2	565.1	0.0	497.3	0.0	43.4	0.6654	0.6194	1118.6	1113.4	1.2389	0.6934	1320.1	809.6
7	2.821	2.587	713.2	745.4	713.2	570.6	0.0	479.6	0.0	40.1	0.6664	0.6402	1159.6	1148.6	1.2720	0.7552	1361.3	879.3
8	0.005	3.865	713.0	761.6	713.0	601.3	0.0	467.8	0.0	37.9	0.6662	0.6552	1200.5	1183.8	1.3046	0.8027	1396.3	935.0
9	0.200	7.570	702.1	758.2	702.1	621.3	0.0	501.2	0.0	38.8	0.6551	0.6802	1322.7	1289.2	1.3972	0.8551	1497.5	1003.5
10	0.843	8.863	694.7	823.1	694.7	637.7	0.0	520.4	0.0	39.1	0.6476	0.6991	1363.4	1324.4	1.4265	0.8716	1530.2	1026.3
11	11.202	10.212	685.8	785.6	685.8	588.3	0.0	520.5	0.0	41.4	0.6386	0.6626	1404.1	1359.5	1.4551	0.8643	1562.6	1024.7

SL	INCS	INCM	DEV	TURN	RHOVM-1	RHOVM-2	D-FAC	OMEGA-B	LCSS-P	P02/	%EFF-P	%EFF-A	B'-1	B'-2	V0'-1	V0'-2	PO/PO
DEGREE	DEGREE	DEGREE	DEGREE					TOTAL	TOTAL	P01	TGT	TGT	DEGREE	DEGREE	FT/SEC	FT/SEC	INLET
1	-1.30	3.25	14.32	58.66	40.55	50.65	0.4782	0.0464	0.0099	1.8987	97.03	97.42	45.03	-13.64	-627.7	157.9	1.8987
2	-1.32	2.96	14.08	52.03	41.19	52.86	0.5022	0.0329	0.0075	1.8815	98.14	97.98	46.50	-5.53	-676.9	64.0	1.8815
3	-1.17	2.91	13.36	45.99	41.80	55.41	0.5000	0.0067	0.0016	1.8752	99.58	99.56	47.82	1.83	-725.1	-21.6	1.8792
4	-0.44	3.26	10.44	31.47	43.20	56.31	0.5274	0.0351	0.0088	1.8433	97.13	96.89	51.29	20.12	-863.3	-242.5	1.8133
5	1.00	3.76	11.26	14.67	43.94	48.59	0.5333	0.1342	0.0302	1.6566	86.16	85.17	55.60	41.53	-1035.7	-499.2	1.6566
6	1.59	3.87	12.22	7.56	44.06	45.58	0.5090	0.1511	0.0310	1.6083	82.97	81.82	57.53	49.57	-1118.6	-616.2	1.6083
7	1.03	3.93	9.23	6.87	44.09	50.19	0.4680	0.1072	0.0226	1.6566	87.68	86.80	58.41	49.54	-1159.6	-669.0	1.6566
8	2.00	4.03	7.12	9.32	44.08	53.43	0.4407	0.0793	0.0109	1.6813	90.72	90.04	59.29	49.98	-1200.5	-716.0	1.6813
9	2.97	4.42	4.90	10.34	43.70	55.18	0.4471	0.1344	0.0295	1.7493	84.76	83.53	62.04	51.70	-1322.7	-788.1	1.7493
10	3.32	4.61	4.51	11.50	43.44	56.55	0.4509	0.1531	0.0345	1.7877	83.03	81.61	63.00	51.51	-1363.4	-804.0	1.7877
11	3.63	4.78	8.51	9.10	43.11	51.68	0.4654	0.2011	0.0427	1.7392	77.22	75.41	63.96	54.86	-1404.1	-839.0	1.7392

TO/TD	PO/PO	EFF-AD	EFF-P	MC1/A1	TQ2/T01	P02/P01	EFF-AD	EFF-P
INLET	INLET	INLET	INLET	LBM/SEC	INLET	INLET	ROTOR	ROTOR
%	%	%	%	SQFT	%	%	%	%
1.1955	1.7476	88.41	89.26	41.81	1.1955	1.7476	88.41	89.26

STATOR 1

SL	EPJ1-1	EPJ1-2	V-1	V-2	VM-1	VM-2	V0-1	V0-2	B-1	B-2	M-1	M-2	U-1	U-2	M'-1	M'-2	V'-1	V'-2
DEGREE	DEGREE	FT/SEC	FT/SEC	FT/SEC	FT/SEC	FT/SEC	FT/SEC	FT/SEC	DEGREE	DEGREE			FT/SEC	FT/SEC			FT/SEC	FT/SEC
1	14.124	14.885	1106.6	742.7	688.9	742.7	866.0	-0.7	51.7	-0.1	0.9865	0.6294	1.7651	1.2060	1.7651	1.2060	1.7651	1.2060
2	15.762	13.136	1070.9	741.6	699.0	741.5	811.3	9.3	49.4	0.7	0.9508	0.6296	1.7710	1.2015	1.7710	1.2015	1.7710	1.2015
3	13.702	11.521	1045.4	744.0	713.7	743.8	763.8	17.1	47.0	1.3	0.9259	0.6329	1.7784	1.1979	1.7784	1.1979	1.7784	1.1979
4	8.430	7.188	956.1	729.0	696.7	729.0	654.8	-0.9	43.2	-0.1	0.8381	0.6211	1.7563	1.1907	1.7563	1.1907	1.7563	1.1907
5	2.144	1.646	807.8	647.4	598.0	647.0	543.0	-23.8	42.2	-2.1	0.6971	0.5495	1.6462	1.1815	1.6462	1.1815	1.6462	1.1815
6	-1.037	-1.185	748.7	607.2	559.3	606.2	497.7	-34.9	41.7	-3.3	0.6430	0.5144	1.5958	1.1774	1.5958	1.1774	1.5958	1.1774
7	-2.376	-3.383	769.9	628.7	601.5	628.0	480.6	-31.2	38.6	-2.8	0.6631	0.5338	1.6143	1.1769	1.6143	1.1769	1.6143	1.1769
8	-3.450	-3.363	786.0	663.2	630.6	663.0	469.2	-14.2	36.7	-1.2	0.6780	0.5643	1.6483	1.1790	1.6483	1.1790	1.6483	1.1790
9	-0.329	-6.066	824.8	721.9	652.8	721.4	504.2	26.9	37.8	2.1	0.7050	0.6097	1.7122	1.2088	1.7122	1.2088	1.7122	1.2088
10	-7.226	-8.962	850.7	722.6	670.3	721.9	523.9	33.4	38.1	4.7	0.7250	0.6069	1.7141	1.2216	1.7141	1.2216	1.7141	1.2216
11	-4.161	-7.983	816.5	662.0	625.7	661.8	524.6	-17.5	40.1	-1.5	0.6911	0.5514	1.6671	1.2270	1.6671	1.2270	1.6671	1.2270

SL	INCS	INCM	DEV	TURN	RHOVM-1	RHOVM-2	D-FAC	OMEGA-B	LCSS-P	P02/	%EFF-A	%EFF-P	B'-1	B'-2	V0'-1	V0'-2	PO/PO
DEGREE	DEGREE	DEGREE	DEGREE					TOTAL	TOTAL	P01	TGT-INLET	TGT-INLET	DEGREE	DEGREE	FT/SEC	FT/SEC	INLET
1	-0.87	1.24	12.27	51.74	33.16	68.70	0.4810	0.1511	0.0309	0.9301	85.52	86.61	85.52	86.61	85.52	86.61	85.52
2	-1.48	0.93	11.94	48.45	35.22	69.07	0.4590	0.1334	0.0283	0.9413	87.99	88.90	87.99	88.90	87.99	88.90	87.99
3	-2.51	0.27	11.70	45.70	37.63	69.65	0.4386	0.1248	0.0273	0.9472	90.26	91.00	90.26	91.00	90.26	91.00	90.26
4	-3.77	-0.05	9.20	43.30	38.37	68.35	0.3977	0.0730	0.0178	0.9730	91.64	92.28	91.64	92.28	91.64	92.28	91.64
5	-3.28	1.77	7.20	44.33	30.81	59.51	0.3834	0.0108	0.0030	0.9973	84.23	85.27	84.23	85.27	84.23	85.27	84.23
6	-3.36	2.26	6.06	44.96	47.89	55.23	0.3961	0.0544	0.0135	0.9865	80.49	81.71	80.49	81.71	80.49	81.71	80.49
7	-6.15	-0.26	6.94	41.49	32.19	57.33	0.3803	0.0963	0.0281	0.9752	82.83	83.93	82.83	83.93	82.83	83.93	82.83
8	-7.91	-1.77	8.20	37.92	35.27	60.74	0.3424	0.0826	0.0245	0.9780	86.67	87.72	86.67	87.72	86.67	87.72	86.67
9	-8.85	0.03	12.69	35.63	37.07	65.32	0.3106	0.0831	0.0259	0.9763	79.52	80.99	79.52	80.99	79.52	80.99	79.52
10	-6.82	0.23	14.43	35.46	38.46	64.82	0.3328	0.1325	0.0419	0.9613	75.06	76.85	75.06	76.85	75.06	76.85	75.06
11	-5.53	1.62	11.80	41.62	33.99	58.61	0.4032	0.1923	0.0416	0.9476	67.46	69.62	67.46	69.62	67.46	69.62	67.46

NCORR	WCORR	TO/TD	PO/PO	EFF-AD	EFF-P	TQ2/T01	P02/P01	EFF-AD
INLET	INLET	INLET	INLET	INLET	INLET	INLET	INLET	STAGE
RPM	LBM/SEC	%	%	%	%	%	%	%
10680	184.10	1.1955	1.6950	83.19	84.37	1.1955	0.9699	83.19

ROTOR 2

SL	EPSI-1	EPSI-2	V-1	V-2	VM-1	VM-2	VO-1	VO-2	B-1	B-2	M-1	M-2	PG/PO	U-1	U-2	10	POINT	NG	V'-1	V'-2
DEGREE	DEGREE	FT/SEC	FT/SEC	FT/SEC	FT/SEC	FT/SEC	FT/SEC	FT/SEC	DEGREE	DEGREE			FT/SEC	FT/SEC					FT/SEC	FT/SEC
1	11.490	11.263	830.6	1255.1	830.6	939.7	-0.8	831.9	-0.1	41.4	0.7110	1.0329	832.8	873.5	1.0072	0.7742			1176.8	940.6
2	10.844	10.163	834.2	1224.1	834.2	899.0	9.0	829.9	0.0	42.0	0.7158	1.0034	856.3	891.7	1.0203	0.7393			1189.1	902.0
3	9.749	9.132	840.1	1178.5	839.9	867.7	16.8	797.5	1.1	42.0	0.7225	0.9832	880.6	910.7	1.0362	0.7151			1208.8	875.0
4	8.763	8.188	835.8	1059.1	835.8	851.1	-0.6	830.3	-0.0	36.0	0.7208	0.8640	955.9	971.3	1.0955	0.7480			1270.2	916.8
5	1.770	2.000	763.2	916.3	762.8	772.0	-23.4	492.3	-1.8	32.5	0.6554	0.7431	1059.8	1059.1	1.1377	0.7772			1324.8	958.4
6	-1.180	-0.817	718.6	822.3	717.8	704.4	-34.9	424.3	-2.8	31.0	0.6153	0.6641	1112.7	1105.8	1.1590	0.7916			1353.7	980.2
7	-2.564	-1.607	731.7	777.7	731.1	670.8	-31.6	393.5	-2.5	30.3	0.6275	0.6275	1139.4	1129.9	1.1839	0.8037			1380.5	996.2
8	-3.594	-2.676	758.2	775.1	758.1	670.2	-14.5	389.5	-1.1	30.1	0.6515	0.6260	1166.3	1154.6	1.2058	0.8215			1403.2	1017.1
9	-4.710	-3.401	813.4	816.5	815.0	703.2	26.7	418.7	1.9	30.6	0.6959	0.6552	1248.1	1231.1	1.2531	0.8600			1468.3	1074.4
10	-6.487	-6.376	823.6	854.9	822.8	750.0	35.7	410.3	2.5	28.5	0.6995	0.6850	1275.5	1257.3	1.2638	0.9065			1488.0	1131.3
11	-7.710	-7.791	774.0	828.0	773.8	752.1	-16.8	346.2	-1.2	24.0	0.6520	0.6603	1303.1	1284.0	1.2888	0.9587			1530.0	1202.1

SL	INCS	INCM	DEV	TURN	RHOVM-1	RHOVM-2	D-FAC	OMEGA-B	LOSS-P	PO2/	XEFF-P	XEFF-A	B'-1	B'-2	VO'-1	VO'-2	PO/PO
DEGREE	DEGREE	DEGREE	DEGREE					TOTAL	TOTAL	P01	TOT	DEGREE	FT/SEC	FT/SEC			INLET
1	-4.448	-0.15	22.92	42.49	73.08	89.48	0.3658	0.2480	0.0566	1.6437	80.35	78.91	45.02	2.52	-833.6	-41.5	2.9048
2	-4.54	-0.09	17.74	41.50	73.07	86.63	0.4058	0.2906	0.0677	1.6151	76.50	74.88	45.42	3.92	-847.3	-61.8	2.8596
3	-4.53	0.04	14.95	38.40	74.38	84.58	0.4302	0.3188	0.0748	1.5441	73.16	71.44	45.82	7.42	-863.8	-113.2	2.7812
4	-2.02	1.97	12.30	27.07	73.74	86.56	0.4047	0.2542	0.0607	1.4820	73.60	72.11	48.93	21.87	-956.5	-341.0	2.6128
5	1.39	5.96	8.05	18.58	66.19	80.71	0.3852	0.1899	0.0425	1.4557	77.68	76.48	54.86	36.27	-1083.2	-566.8	2.4080
6	3.58	7.92	7.81	13.93	61.97	73.59	0.3749	0.1753	0.0374	1.4191	76.95	75.80	57.95	44.02	-1147.7	-681.6	2.2620
7	3.11	7.19	8.36	10.38	63.41	70.06	0.3715	0.1982	0.0407	1.3639	71.68	70.43	57.99	47.61	-1171.0	-736.4	2.1971
8	1.47	5.68	6.39	8.54	66.10	70.23	0.3644	0.2075	0.0429	1.3351	68.69	67.41	57.25	48.70	-1180.9	-765.1	2.1974
9	-0.66	2.02	1.86	7.15	70.07	72.97	0.3594	0.2136	0.0490	1.3279	66.60	65.25	56.15	48.95	-1221.3	-812.3	2.2691
10	-0.94	1.24	1.81	7.98	70.01	78.39	0.3270	0.1499	0.0362	1.3597	75.75	74.68	56.26	48.28	-1239.9	-846.9	2.3407
11	1.95	3.64	5.44	8.36	64.82	78.31	0.2994	0.1012	0.0240	1.3913	83.14	82.34	59.46	51.10	-1319.9	-937.7	2.3042

TO/TG	PO/PO	EFF-AD	EFF-P	W/L/A1	TO2/T01	PO2/P01	EFF-AD	EFF-P
INLET	INLET	INLET	INLET	LBM/SEC	%	%	ROTOR	ROTOR
%	%	%	%	%	%	%	%	%
1.3703	2.4347	77.93	80.47	42.47	1.1462	1.4364	74.10	75.38

STATOR 2

SL	EPSI-1	EPSI-2	V-1	V-2	VM-1	VM-2	VO-1	VO-2	B-1	B-2	M-1	M-2	PG/PO	IG/TG	PD/PO	T02/
DEGREE	DEGREE	FT/SEC	FT/SEC	FT/SEC	FT/SEC	FT/SEC	FT/SEC	FT/SEC	DEGREE	DEGREE			INLET	INLET	STAGE	TOL
1	9.022	1.066	1304.8	991.8	1012.3	973.6	823.3	-218.5	39.4	-12.6	1.0831	0.7908	2.2514	1.4382	1.2759	1.1921
2	4.298	1.181	1272.4	1046.0	970.5	1021.3	823.0	-225.8	40.6	-12.5	1.0514	0.8346	2.3688	1.4371	1.3396	1.1943
3	7.334	1.128	1226.5	1082.8	935.1	1063.6	793.7	-202.6	40.5	-10.8	1.0098	0.8705	2.4737	1.4306	1.3935	1.1925
4	4.681	0.588	1104.3	1042.7	907.6	1036.8	629.1	-111.4	34.8	-6.1	0.9066	0.8467	2.4479	1.3925	1.3838	1.1676
5	0.811	-0.135	962.3	963.8	826.4	956.5	493.0	-118.8	30.8	-7.1	0.7847	0.7850	2.3217	1.3596	1.3891	1.1490
6	0.450	-0.461	872.2	893.5	761.3	880.9	425.6	-149.3	29.2	-9.6	0.7081	0.7262	2.2007	1.3437	1.3755	1.1404
7	-0.365	-0.610	828.3	852.3	728.7	842.6	393.9	-128.3	28.4	-8.6	0.6718	0.6922	2.1351	1.3340	1.3323	1.1334
8	-1.411	-0.727	825.9	839.4	728.1	834.3	390.0	-92.4	28.1	-6.3	0.6706	0.6623	2.1158	1.3264	1.2941	1.1282
9	-4.666	-1.037	873.5	888.4	765.2	847.6	421.2	-39.0	28.9	-2.5	0.7033	0.7170	2.1649	1.3596	1.2679	1.1284
10	-5.584	-1.105	912.7	916.8	814.0	916.8	412.7	-6.9	27.0	-0.4	0.7361	0.7398	2.1999	1.3682	1.2780	1.1223
11	-6.253	-1.102	895.1	907.6	824.7	901.7	348.0	-103.9	23.0	-6.6	0.7191	0.7302	2.1690	1.3730	1.3104	1.1194

SL	INCS	INCM	DEV	TURN	RHOVM-1	RHOVM-2	D-FAC	OMEGA-B	LOSS-P	PO2/	XEFF-A	XEFF-P	XEFF-A	XEFF-P
DEGREE	DEGREE	DEGREE	DEGREE					TOTAL	TOTAL	P01	TOT-INLET	TOT-INLET	TOT-STG	TOT-STG
%	%	%	%					%	%	%	%	%	%	%
1	-3.03	-7.47	-0.81	52.05	92.32	86.80	0.4170	0.4307	0.0950	0.7741	59.31	63.56	37.25	39.33
2	-6.86	-4.84	-1.21	53.02	89.77	92.84	0.3724	0.3473	0.0781	0.8226	63.64	67.05	44.44	46.63
3	-6.10	-3.60	0.06	51.32	87.78	98.79	0.3197	0.2489	0.0573	0.8779	68.33	72.00	51.32	53.51
4	-10.74	-6.88	4.19	40.95	89.42	99.69	0.2373	0.1690	0.0417	0.9285	74.04	77.03	57.72	59.59
5	-13.90	-8.59	3.22	37.88	84.00	93.39	0.1864	0.1401	0.0372	0.9519	75.45	75.00	65.73	67.26
6	-15.22	-9.43	0.61	38.78	77.46	85.83	0.1786	0.1388	0.0378	0.9392	73.32	76.05	67.59	68.99
7	-15.87	-5.88	1.52	37.00	74.11	82.02	0.1631	0.1372	0.0380	0.9633	72.26	75.00	63.64	65.06
8	-15.91	-9.70	3.79	34.46	74.28	81.33	0.1300	0.1413	0.0399	0.9632	72.53	75.22	59.30	60.73
9	-16.94	-8.24	7.65	31.38	77.06	84.61	0.1360	0.1611	0.0473	0.9548	68.44	71.61	54.36	55.85
10	-17.51	-10.63	10.34	27.38	82.37	86.93	0.1311	0.1978	0.0585	0.9403	68.41	71.64	59.05	60.43
11	-22.77	-15.67	5.37	29.52	82.72	84.53	0.1368	0.2066	0.0595	0.9416	66.18	69.58	66.84	68.07

MCORR	MCORR	TO/TG	PO/PO	EFF-AD	EFF-P	TO2/T01	PO2/P01	EFF-AD
INLET	INLET	INLET	INLET	INLET	INLET	%	%	STAGE
RPM	LBM/SEC	%	%	%	%	%	%	%
10680	184.10	1.3703	2.2657	70.87	73.96	1.1462	0.9306	58.77

ORIGINAL PAGE IS
OF POOR QUALITY

TABLE XVII(b) — OVERALL PERFORMANCE AND BLADE-ELEMENT DATA
(Uniform Inlet Flow, 100 Percent Speed)

U. S. CUSTOMARY UNITS

ROTOR 1

SL	EP51-1	EP51-2	V-1	V-2	VN-1	VN-2	V0-1	V0-2	B-1	B-2	M-1	M-2	RUN NO	B, SPEED	CODE	10, POINT	NO 2	V'-1	V'-2
	DEGREE	DEGREE	FT/SEC	FT/SEC	FT/SEC	FT/SEC	FT/SEC	FT/SEC	DEGREE	DEGREE								FT/SEC	FT/SEC
1	16.704	18.206	634.0	1099.7	634.0	662.7	0.0	877.7	0.0	53.0	0.5869	0.9800						892.0	679.7
2	14.214	15.848	648.2	1060.2	648.2	666.7	0.0	822.7	0.0	50.9	0.6010	0.9401						937.1	671.5
3	11.847	13.010	662.3	1032.2	662.3	682.0	0.0	774.8	0.0	48.6	0.6150	0.9124						981.9	682.4
4	9.508	7.648	693.8	936.8	693.8	659.7	0.0	665.1	0.0	45.2	0.6467	0.8183						1107.3	701.0
5	-0.263	-1.018	707.7	788.7	707.7	567.2	0.0	548.0	0.0	44.0	0.6608	0.6787						1254.1	752.8
6	-1.550	-1.843	708.2	731.0	708.2	530.1	0.0	503.4	0.0	43.5	0.6613	0.6261						1323.7	808.0
7	-2.311	-3.088	708.1	753.7	708.1	576.4	0.0	485.6	0.0	40.1	0.6611	0.6475						1358.4	878.3
8	-3.541	-4.262	707.0	768.0	707.0	606.7	0.0	470.9	0.0	37.8	0.6601	0.6607						1392.9	935.8
9	-4.060	-7.758	693.8	804.6	693.8	633.7	0.0	495.8	0.0	38.0	0.6467	0.6889						1493.3	1025.2
10	-4.726	-8.993	685.8	827.9	685.8	641.6	0.0	523.2	0.0	39.1	0.6386	0.7032						1525.8	1026.2
11	-11.192	-10.280	676.3	792.0	676.3	595.6	0.0	522.0	0.0	41.1	0.6291	0.6663						1556.1	1027.4

SL	INCS	INCM	DEV	TURN	RHOVN-1	RHOVN-2	D-FAC	OMEGA-B	LOSS-P	PO2/	TEFF-P	TEFF-A	B'-1	B'-2	V0'-1	V0'-2	PO/PO
	DEGREE	DEGREE	DEGREE	DEGREE				TOTAL	TOTAL	P01	T01	T01	DEGREE	DEGREE	FT/SEC	FT/SEC	INLET
1	-1.90	2.71	15.09	57.35	41.05	51.26	0.4715	0.0439	0.0094	1.8907	97.71	97.50	44.43	-12.87	-627.5	151.2	1.8907
2	-1.02	2.48	14.39	51.22	41.64	53.06	0.4990	0.0393	0.0090	1.8722	97.74	97.54	46.00	-5.22	-676.7	61.1	1.8722
3	-1.04	2.47	13.38	45.52	42.21	55.36	0.5050	0.0187	0.0045	1.8690	98.81	98.72	47.37	1.84	-724.9	-22.0	1.8690
4	-0.45	3.02	10.00	31.30	43.40	55.47	0.5336	0.0622	0.0156	1.7964	94.95	94.54	51.06	19.78	-663.0	-237.2	1.7964
5	1.12	3.80	10.82	14.54	43.90	48.33	0.5336	0.1534	0.0347	1.6438	84.28	83.17	55.64	41.10	-1035.4	-494.9	1.6438
6	1.72	4.00	11.67	8.65	43.92	45.49	0.5098	0.1705	0.0354	1.5986	81.03	79.76	57.66	49.01	-1118.3	-609.8	1.5986
7	2.03	4.10	8.68	9.58	43.91	50.15	0.4681	0.1248	0.0266	1.6404	85.86	84.18	58.58	49.00	-1159.3	-662.7	1.6404
8	2.27	4.22	6.74	9.89	43.88	53.37	0.4386	0.0935	0.0201	1.6716	89.18	88.39	59.49	49.60	-1200.2	-712.5	1.6716
9	3.25	4.68	4.54	10.96	43.41	55.91	0.4361	0.1324	0.0293	1.7417	84.94	83.74	62.30	51.34	-1322.3	-793.1	1.7417
10	3.61	4.90	4.23	12.05	43.11	56.31	0.4499	0.1660	0.0376	1.7756	81.67	80.18	63.29	51.23	-1363.0	-800.9	1.7756
11	3.93	5.08	8.13	9.79	42.75	51.80	0.4624	0.2104	0.0451	1.7291	76.23	74.36	64.26	54.47	-1403.7	-837.2	1.7291

T0/T0	PO/PO	EFF-AD	EFF-P	WCL/R1	T02/T01	P02/P01	EFF-AD	EFF-P
INLET	INLET	INLET	INLET	LBM/SEC			ROTOR	ROTOR
%	%	%	%	SOFT			%	%
1.1960	1.7369	87.09	88.04	41.77	1.1960	1.7369	87.09	88.04

STATOR 1

SL	EP51-1	EP51-2	V-1	V-2	VN-1	VN-2	V0-1	V0-2	B-1	B-2	M-1	M-2	RUN NO	B, SPEED	CODE	10, POINT	NO 2	PO/PO	T02/
	DEGREE	DEGREE	FT/SEC	FT/SEC	FT/SEC	FT/SEC	FT/SEC	FT/SEC	DEGREE	DEGREE								INLET	INLET
1	18.048	19.790	1108.8	741.3	701.0	741.3	859.2	-4.2	51.0	-0.3	0.9897	0.6286					1.7584	1.2043	1.7584
2	15.644	12.947	1074.1	739.0	707.6	738.8	808.1	19.4	48.9	1.5	0.9546	0.6275					1.7625	1.2007	1.7625
3	13.513	11.224	1049.5	739.8	720.4	738.9	763.2	36.1	46.7	2.8	0.9303	0.6290					1.7676	1.1978	1.7676
4	11.118	8.470	959.6	726.1	696.8	726.1	659.7	2.1	43.4	0.2	0.8410	0.6180					1.7475	1.1922	1.7475
5	1.565	0.343	813.7	645.8	602.4	649.5	547.0	-19.8	42.2	-1.7	0.7024	0.5513					1.6348	1.1829	1.6348
6	-1.049	-2.633	737.0	613.5	565.9	612.9	503.7	-28.5	41.7	-2.5	0.6507	0.5195					1.5850	1.1795	1.5850
7	-2.926	-3.792	779.2	638.7	608.6	638.4	486.5	-28.0	38.7	-1.8	0.6711	0.5423					1.6064	1.1788	1.6064
8	-3.910	-4.678	792.6	673.2	636.5	673.1	472.3	-7.6	36.6	-0.7	0.6838	0.5732					1.6407	1.1796	1.6407
9	-4.496	-6.937	830.6	731.5	663.9	730.9	499.0	29.4	37.0	2.3	0.7112	0.6189					1.7016	1.2067	1.7016
10	-7.313	-7.602	854.5	735.4	672.8	734.6	526.8	37.5	38.2	2.9	0.7281	0.6183					1.7040	1.2227	1.7040
11	-8.209	-8.335	821.5	677.6	631.0	677.5	526.1	-18.3	39.9	-1.3	0.6956	0.5651					1.6375	1.2275	1.6375

SL	INCS	INCM	DEV	TURN	RHOVN-1	RHOVN-2	D-FAC	OMEGA-B	LOSS-P	PO2/	TEFF-A	TEFF-P	B'-1	B'-2	V0'-1	V0'-2	PO/PO		
	DEGREE	DEGREE	DEGREE	DEGREE				TOTAL	TOTAL	P01	T01-INLET	T01-INLET	DEGREE	DEGREE	FT/SEC	FT/SEC	STAGE		
1	-1.59	0.52	12.01	51.28	53.80	68.44	0.4830	0.1495	0.0306	0.9306	85.58	86.60	85.58	86.66			86.66		
2	-1.95	0.45	12.72	47.40	55.49	68.61	0.4605	0.1323	0.0281	0.9415	87.51	88.45	87.51	88.45			88.45		
3	-2.82	-0.04	13.17	43.92	57.63	68.93	0.4408	0.1252	0.0276	0.9466	89.28	90.09	89.28	90.09			90.09		
4	-3.29	1.76	7.57	43.95	57.63	67.70	0.4039	0.0641	0.0156	0.9761	89.89	90.64	89.89	90.64			90.64		
5	-3.44	2.28	4.88	44.16	47.89	59.21	0.3854	0.0089	0.0024	0.9978	82.35	83.50	82.35	83.50			83.50		
6	-6.13	-0.25	7.59	40.47	52.24	55.22	0.3942	0.0601	0.0172	0.9848	78.31	79.64	78.31	79.64			79.64		
7	-7.97	-1.83	8.78	37.28	55.23	57.66	0.3724	0.0968	0.0282	0.9746	81.06	82.25	81.06	82.25			82.25		
8	-7.53	-6.71	12.84	34.71	57.68	61.06	0.3334	0.0791	0.0235	0.9787	84.57	84.57	84.57	85.59			85.59		
9	-6.77	0.28	14.71	35.23	58.09	65.53	0.3007	0.0869	0.0271	0.9750	79.31	80.77	79.31	80.77			80.77		
10	-7.313	-7.602	854.5	735.4	672.8	734.6	526.8	37.5	38.2	2.9	0.7281	0.6183					73.81	75.66	73.81
11	-5.68	1.47	12.02	41.24	53.95	59.19	0.3877	0.1307	0.0611	0.9474	86.44	88.65	86.44	88.65			88.65		

NCORR	NCORR	T0/T0	PO/PO	EFF-AD	EFF-P	T02/T01	P02/P01	EFF-AD	EFF-P
INLET	INLET	INLET	INLET	INLET	INLET			STAGE	STAGE
RPM	LBM/SEC	%	%	%	%			%	%
10677	183.90	1.1960	1.6852	81.96	83.22	1.1960	0.9702	81.96	83.22

ROTOR 2

SL	E PSI-1		E PSI-2		V-1		V-2		VM-1		VM-2		V0-1		V0-2		B-1		B-2		M-1		M-2		B, SPEED CODE 10, POINT NO 2		V1-1		V1-2			
	DEGREE	DEGREE	FT/SEC	FT/SEC	FT/SEC	FT/SEC	FT/SEC	FT/SEC	FT/SEC	FT/SEC	FT/SEC	FT/SEC	FT/SEC	FT/SEC	FT/SEC	FT/SEC	FT/SEC	DEGREE	DEGREE	DEGREE	DEGREE	DEGREE	DEGREE	FT/SEC	FT/SEC	FT/SEC	FT/SEC	FT/SEC	FT/SEC	FT/SEC	FT/SEC	
1	11.214	11.214	837.4	1108.2	837.4	821.8	-4.0	830.2	-0.3	43.2	0.7179	0.9486	832.8	873.2	1.0147	0.6683	1183.7	823.0														
2	10.057	10.057	841.9	1127.1	841.7	799.4	19.0	836.6	1.3	46.2	0.7233	0.9391	850.1	891.5	1.0199	0.6503	1187.1	801.2														
3	8.939	8.939	849.2	1142.2	848.3	789.4	35.4	825.0	2.4	46.2	0.7313	0.9274	880.4	910.5	1.0312	0.6451	1197.5	794.5														
4	5.959	5.959	853.7	1046.4	853.7	817.5	2.1	856.3	0.1	38.8	0.7375	0.8512	955.7	971.1	1.1057	0.7113	1279.9	876.0														
5	0.017	0.017	773.9	855.1	773.7	686.7	-19.9	509.6	-1.5	36.6	0.6651	0.6672	1099.5	1058.8	1.1412	0.7066	1328.1	879.1														
6	-1.623	-1.623	726.4	751.0	726.0	592.0	-26.2	462.1	-2.1	38.0	0.6219	0.5994	1112.5	1105.6	1.1561	0.6979	1350.4	874.4														
7	-2.652	-2.652	740.7	740.4	740.4	584.7	-19.1	454.2	-1.5	37.8	0.6353	0.5910	1139.1	1129.6	1.1791	0.7130	1374.7	893.3														
8	-3.583	-3.583	764.2	762.3	764.1	612.8	-6.8	453.5	-0.5	36.4	0.6567	0.6094	1166.0	1154.3	1.2029	0.7443	1399.8	930.9														
9	-4.185	-4.185	811.9	794.7	811.3	642.9	30.1	467.2	2.1	35.9	0.6930	0.6304	1247.7	1230.7	1.2489	0.7917	1463.2	998.1														
10	-7.009	-7.009	816.8	794.9	815.9	649.4	37.9	458.3	2.6	35.1	0.6927	0.6260	1275.2	1256.9	1.2570	0.8132	1482.1	1029.3														
11	-8.116	-8.116	766.6	759.2	766.5	647.7	-15.2	396.0	-1.1	31.3	0.6451	0.5963	1302.7	1283.6	1.2829	0.8630	1524.6	1098.8														

SL	INCS	INCM	DEV	TURN	RHOVM-1	RHOVM-2	D-FAC	OMEGA-B	LOSS-P	PO1	%EFF-P	%EFF-A	B1-1	B1-2	V01-1	V01-2	PO/PO
DEGREE	DEGREE	DEGREE	DEGREE	TOTAL	TOTAL	TOTAL	TOTAL	TOTAL	TOTAL	TOTAL	TOTAL	TOTAL	DEGREE	DEGREE	FT/SEC	FT/SEC	INLET
1	-4.59	-0.27	23.38	41.91	73.16	86.74	0.4493	0.1803	0.0411	1.7061	85.88	84.78	44.89	2.98	-836.6	-43.0	3.0000
2	-5.14	-0.69	17.73	40.90	73.67	85.91	0.4896	0.1729	0.0403	1.7169	86.43	85.37	44.82	3.92	-837.1	-54.9	3.0256
3	-1.46	-0.88	13.49	38.73	74.27	86.65	0.4956	0.1478	0.0352	1.7237	88.19	87.25	44.90	6.16	-845.0	-85.5	3.0465
4	-3.56	1.25	11.51	27.14	73.92	94.19	0.4489	0.0562	0.0135	1.6871	94.63	94.21	48.21	21.07	-953.6	-314.7	2.9501
5	0.90	5.47	10.43	15.71	66.09	79.75	0.4499	0.0567	0.0121	1.5940	93.71	93.29	54.37	38.66	-1079.4	-549.2	2.5971
6	3.12	1.45	11.14	10.12	61.97	68.04	0.4609	0.1027	0.0206	1.5205	87.30	86.54	57.49	47.37	-1138.7	-643.5	2.4169
7	2.35	6.63	9.82	6.34	63.65	67.24	0.4560	0.1270	0.0254	1.4883	83.75	82.82	57.42	49.08	-1158.3	-675.4	2.4424
8	1.53	5.34	6.46	8.13	66.12	70.75	0.4382	0.1247	0.0257	1.4835	83.60	82.67	56.91	48.78	-1172.8	-700.8	2.4388
9	-0.56	2.12	2.69	6.47	69.55	73.38	0.4212	0.1358	0.0306	1.4640	81.21	80.18	56.25	49.78	-1217.6	-763.5	2.4907
10	-0.72	1.44	4.05	5.75	69.12	73.73	0.4048	0.1124	0.0258	1.4575	83.79	82.91	56.48	50.73	-1237.3	-798.6	2.4926
11	2.13	3.87	8.08	5.95	64.03	72.89	0.3786	0.0838	0.0167	1.4850	87.77	87.07	59.69	53.74	-1317.9	-887.6	2.4373

TO/TO	PO/PO	EFF-AD	EFF-P	WCL/A1	TO2/T01	P02/P01	EFF-AD	EFF-P
INLET	INLET	INLET	INLET	LBM/SEC			ROTOR	ROTOR
		%	%	SQFT			%	%
1.3829	2.6612	83.98	86.00	42.68	1.1562	1.5792	88.71	89.41

STATOR 2

SL	E PSI-1		E PSI-2		V-1		V-2		VM-1		VM-2		V0-1		V0-2		B-1		B-2		M-1		M-2		B, SPEED CODE 10, POINT NO 2		TO2/					
	DEGREE	DEGREE	FT/SEC	FT/SEC	FT/SEC	FT/SEC	FT/SEC	FT/SEC	FT/SEC	FT/SEC	FT/SEC	FT/SEC	FT/SEC	FT/SEC	FT/SEC	FT/SEC	FT/SEC	DEGREE	DEGREE	DEGREE	DEGREE	DEGREE	DEGREE	FT/SEC	FT/SEC	FT/SEC	FT/SEC	TO1	TO1			
1	8.689	0.827	1209.6	884.7	887.6	884.7	821.7	9.7	43.1	0.6	0.9886	0.6925	2.6768	1.4371	1.5226	1.1929																
2	7.649	0.741	1196.3	856.9	862.4	896.8	829.1	12.6	44.1	0.8	0.9768	0.7035	2.7120	1.4350	1.5398	1.1943																
3	6.587	0.560	1179.9	919.2	848.6	919.1	819.7	14.0	44.2	0.9	0.9635	0.7243	2.7716	1.4296	1.5687	1.1929																
4	4.178	-0.101	1082.7	908.5	862.3	907.4	654.7	-45.3	37.3	-2.9	0.8831	0.7240	2.7875	1.3978	1.5897	1.1718																
5	1.994	-0.674	890.2	773.9	729.7	771.7	509.9	-58.1	34.9	-4.3	0.7181	0.6162	2.5562	1.3639	1.5591	1.1527																
6	0.531	-0.885	786.8	670.2	636.6	668.1	462.4	-52.0	36.0	-4.4	0.6302	0.5309	2.3993	1.3525	1.5142	1.1466																
7	-0.466	-0.952	774.4	643.9	626.9	642.0	454.6	-49.1	35.9	-4.4	0.6201	0.5096	2.3646	1.3495	1.4718	1.1447																
8	-1.513	-0.991	795.6	667.3	653.2	665.7	454.3	-46.2	34.8	-4.0	0.6382	0.5292	2.3960	1.3490	1.4606	1.1437																
9	-4.366	-1.250	831.1	715.6	685.8	715.0	469.5	-9.3	34.4	-0.7	0.6617	0.5636	2.4448	1.3781	1.4371	1.1427																
10	-5.288	-1.326	834.3	713.9	695.7	713.9	460.5	-2.0	33.6	-0.2	0.6617	0.5598	2.4315	1.3889	1.4243	1.1426																
11	-6.120	-1.264	866.2	672.2	700.7	672.2	398.7	-4.7	29.7	-0.4	0.6360	0.5240	2.3630	1.3990	1.4417	1.1364																

SL	INCS	INCM	DEV	TURN	RHOVM-1	RHOVM-2	D-FAC	OMEGA-B	LOSS-P	PO1	%EFF-A	%EFF-P	B1-1	B1-2	V01-1	V01-2	PO/PO
DEGREE	DEGREE	DEGREE	DEGREE	TOTAL	TOTAL	TOTAL	TOTAL	TOTAL	TOTAL	TOTAL	TOTAL	TOTAL	DEGREE	DEGREE	FT/SEC	FT/SEC	INLET
1	-5.33	-3.82	12.44	42.44	90.67	100.22	0.4197	0.2303	0.0520	0.8925	74.01	77.28	65.67	67.62			
2	-3.33	-1.31	12.05	43.29	89.88	102.36	0.4071	0.2229	0.0513	0.8979	75.51	78.63	67.06	68.98			
3	-2.40	0.04	11.72	43.31	90.44	106.17	0.3843	0.2003	0.0470	0.9096	78.39	81.20	70.68	72.46			
4	-8.28	-4.61	7.46	40.14	97.03	107.85	0.3285	0.1481	0.0367	0.9404	85.24	87.18	81.93	83.07			
5	-9.77	-4.46	6.00	39.24	83.24	92.04	0.3155	0.0914	0.0244	0.9723	84.21	86.12	86.06	88.78			
6	-8.44	-2.65	5.77	40.40	71.95	79.02	0.3370	0.0362	0.0153	0.9865	80.36	82.58	85.32	86.15			
7	-8.32	-2.33	5.79	40.28	70.89	75.79	0.3472	0.0519	0.0145	0.9883	79.54	81.82	80.23	81.27			
8	-9.27	-3.06	6.14	38.75	74.17	78.89	0.3385	0.0679	0.0192	0.9838	81.03	83.48	79.14	80.22			
9	-9.38	-2.68	9.42	35.16	76.83	83.23	0.3089	0.0724	0.0213	0.9816	76.72	79.41	77.43	77.22			
10	-10.90	-4.02	10.61	33.72	77.39	82.10	0.3079	0.0931	0.0216	0.9764	74.67	77.04	77.56	78.65			
11	-10.00	-8.91	11.33	30.13	77.07	76.17	0.3195	0.1264	0.0377	0.9699	70.26	73.56	80.19	81.18			

TABLE XVII(c) - OVERALL PERFORMANCE AND BLADE-ELEMENT DATA
(Uniform Inlet Flow, 100 Percent Speed)

U. S. CUSTOMARY UNITS

ROTOR 1

SL	EPSI-1	EPSI-2	V-1	V-2	VM-1	VM-2	V0-1	V0-2	B-1	B-2	M-1	M-2	RUN NO	9. SPEED	CODE	10. POINT	NO 23	V1-1	V1-2
	DEGREE	DEGREE	FT/SEC	FT/SEC	FT/SEC	FT/SEC	FT/SEC	FT/SEC	DEGREE	DEGREE				%				FT/SEC	FT/SEC
1	16.637	18.257	631.1	1068.3	631.1	654.4	0.0	844.4	0.0	52.2	0.5841	0.9505		627.4	724.3	0.8236	0.5917	689.9	665.0
2	14.109	15.635	645.3	1028.0	645.3	653.7	0.0	793.5	0.0	50.5	0.5981	0.9100		676.5	764.4	0.8665	0.5793	934.9	654.4
3	11.745	13.587	658.8	1001.1	658.8	664.6	0.0	748.5	0.0	48.4	0.6116	0.8835		724.7	796.6	0.9092	0.5682	979.4	666.0
4	5.441	7.619	689.1	910.7	689.1	645.9	0.0	642.1	0.0	44.8	0.6420	0.7952		862.8	902.0	1.0287	0.6079	1104.2	896.2
5	-0.480	1.039	701.7	778.8	701.7	565.9	0.0	535.1	0.0	43.4	0.6547	0.6709		1035.1	1042.6	1.1668	0.6547	1250.5	760.0
6	-1.668	-1.803	701.8	704.8	701.8	505.2	0.0	491.5	0.0	44.2	0.6548	0.6032		1118.0	1112.8	1.1216	0.6853	1320.0	800.8
7	-2.219	-3.015	702.0	723.9	702.0	549.1	0.0	471.6	0.0	40.7	0.6550	0.6212		1158.9	1148.0	1.1243	0.7476	1355.0	871.2
8	-3.321	-4.154	701.7	744.1	701.7	585.9	0.0	458.8	0.0	38.1	0.6547	0.6398		1199.6	1183.1	1.2969	0.8010	1390.0	931.0
9	-8.101	-7.604	690.3	812.8	690.3	649.6	0.0	488.5	0.0	36.9	0.6432	0.6955		1322.0	1288.5	1.3890	0.8818	1491.3	1030.5
10	-9.551	-8.969	682.1	810.5	682.1	623.5	0.0	517.9	0.0	39.6	0.6349	0.6877		1362.7	1323.7	1.4184	0.8645	1523.8	1018.8
11	-11.243	-10.272	672.6	784.0	672.6	582.1	0.0	525.2	0.0	42.0	0.6253	0.6606		1403.3	1358.8	1.4469	0.8567	1556.2	1016.8

SL	INCS	INCM	DEV	TURN	RHOVM-1	RHOVM-2	D-FAC	OMEGA-B	LOSS-P	PO2/	EFF-P	EFF-A	B-1	B-2	V0-1	V0-2	PO/PO
	DEGREE	DEGREE	DEGREE	DEGREE				TOTAL	TOTAL	P01	TOT	TOT	DEGREE	DEGREE	FT/SEC	FT/SEC	INLET
1	-1.79	2.82	17.72	54.83	40.92	51.94	0.4781	0.0091	-0.0020	1.8816	100.48	100.54	44.60	-10.24	-627.4	118.1	1.8816
2	-1.71	2.59	16.80	48.92	41.52	53.01	0.5088	0.0041	0.0009	1.8573	99.77	99.76	46.11	-2.81	-676.5	32.1	1.8573
3	-1.51	2.60	15.66	43.37	42.07	55.01	0.5134	0.0089	-0.0021	1.8525	100.57	100.64	47.50	4.13	-724.7	-48.1	1.8525
4	-0.27	3.20	12.22	29.33	43.23	55.15	0.5313	0.0362	0.0090	1.7843	96.97	94.73	51.24	21.90	-862.8	-259.9	1.7843
5	1.34	4.02	11.60	13.98	43.69	48.65	0.5233	0.1251	0.0280	1.6518	86.99	86.06	55.86	41.88	-1035.1	-507.6	1.6518
6	1.95	4.23	13.55	6.99	43.69	43.71	0.5113	0.1645	0.0328	1.5832	81.37	80.15	57.89	50.89	-1118.0	-621.4	1.5832
7	2.21	4.31	10.63	7.85	43.70	48.16	0.4685	0.1197	0.0245	1.6212	86.15	85.20	58.79	50.94	-1158.9	-676.4	1.6212
8	2.45	4.40	8.18	8.62	43.69	52.00	0.4371	0.0844	0.0176	1.6594	90.07	89.36	59.66	51.04	-1199.6	-724.3	1.6594
9	3.37	4.79	4.09	11.53	43.28	58.24	0.4235	0.0958	0.0214	1.7756	89.11	88.22	62.42	50.88	-1322.0	-800.0	1.7756
10	3.73	5.02	5.20	11.21	42.97	55.24	0.4529	0.1608	0.0357	1.7716	82.13	80.66	63.41	52.20	-1362.7	-805.8	1.7716
11	4.05	5.20	6.63	9.41	42.61	51.05	0.4694	0.2096	0.0444	1.7371	76.47	74.61	64.38	54.98	-1403.3	-833.6	1.7371

TO/TO	PO/PO	EFF-AD	EFF-P	WCL/A1	TO2/TO1	PO2/PO1	EFF-AD	EFF-P
INLET	INLET	%	%	INLET	INLET	INLET	INLET	INLET
1.1916	1.7358	89.01	89.81	41.61	1.1916	1.7358	89.01	89.81

STATOR 1

SL	EPSI-1	EPSI-2	V-1	V-2	VM-1	VM-2	V0-1	V0-2	B-1	B-2	M-1	M-2	RUN NO	9. SPEED	CODE	10. POINT	NO 23	PO/PO	TO/TO	PU/PO	TO2/
	DEGREE	DEGREE	FT/SEC	FT/SEC	FT/SEC	FT/SEC	FT/SEC	FT/SEC	DEGREE	DEGREE				%				INLET	INLET	STAGE	TO1
1	18.116	14.827	1078.0	736.9	692.0	736.7	826.6	-18.2	50.2	-1.4	0.9608	0.6267		1.7420		1.1966	1.7420	1.1966	1.1966	1.1966	
2	15.751	12.998	1042.3	735.3	692.0	735.3	779.4	1.8	48.5	0.1	0.9247	0.6261		1.7472		1.1936	1.7472	1.1936	1.1936	1.1936	
3	13.617	11.274	1018.4	737.7	702.6	737.5	737.3	17.7	46.4	1.4	0.9012	0.6294		1.7546		1.1911	1.7546	1.1911	1.1911	1.1911	
4	8.184	6.526	933.2	722.6	682.0	722.4	636.9	-13.4	45.0	-1.1	0.8174	0.6167		1.7332		1.1856	1.7332	1.1856	1.1856	1.1856	
5	1.736	0.528	802.6	657.7	599.1	657.3	534.2	-22.9	41.7	-2.0	0.6933	0.5594		1.6338		1.1786	1.6338	1.1786	1.1786	1.1786	
6	-1.653	-2.400	730.5	618.0	540.2	617.2	491.8	-39.7	42.3	-2.8	0.6259	0.5246		1.5802		1.1750	1.5802	1.1750	1.1750	1.1750	
7	-3.086	-3.614	748.5	632.1	580.8	631.5	472.4	-26.7	39.2	-2.4	0.6441	0.5376		1.5903		1.1737	1.5903	1.1737	1.1737	1.1737	
8	-4.132	-4.540	768.1	645.6	614.9	645.5	460.2	-19.2	36.9	-0.9	0.6622	0.5674		1.6219		1.1753	1.6219	1.1753	1.1753	1.1753	
9	-6.409	-6.767	837.6	723.0	678.2	722.6	491.6	22.1	36.0	1.8	0.7189	0.6120		1.6793		1.2036	1.6793	1.2036	1.2036	1.2036	
10	-7.149	-7.444	837.5	732.2	655.3	731.4	521.4	34.5	36.6	2.7	0.7129	0.6158		1.6890		1.2204	1.6890	1.2204	1.2204	1.2204	
11	-8.124	-8.238	813.7	685.7	618.1	685.4	529.3	-20.8	40.7	-1.7	0.6879	0.5720		1.6364		1.2288	1.6364	1.2288	1.2288	1.2288	

SL	INCS	INCM	DEV	TURN	RHOVM-1	RHOVM-2	D-FAC	OMEGA-B	LOSS-P	PO2/	EFF-A	EFF-P	EFF-A	EFF-P	EFF-A	EFF-P
	DEGREE	DEGREE	DEGREE	DEGREE				TOTAL	TOTAL	P01	TOT-INLET	TOT-INLET	TOT-STG	TOT-STG	TOT-STG	TOT-STG
1	-2.30	-0.19	10.93	51.65	54.47	87.89	0.4694	0.1649	0.0337	0.9263	87.34	86.27	87.34	86.27	86.27	86.27
2	-2.33	0.07	11.37	48.37	55.47	88.15	0.4462	0.1395	0.0296	0.9409	89.20	90.00	89.20	90.00	90.00	90.00
3	-3.08	-0.30	11.75	45.08	57.34	88.69	0.4250	0.1277	0.0282	0.9478	91.15	91.81	91.15	91.81	91.81	91.81
4	-3.97	-0.25	8.21	44.09	57.33	87.24	0.3899	0.0734	0.0179	0.9738	91.62	92.23	91.62	92.23	92.23	92.23
5	-3.80	1.24	7.32	43.49	50.98	59.84	0.3625	0.0226	0.0062	0.9938	84.23	85.25	84.23	85.25	85.25	85.25
6	-2.70	2.92	6.51	45.17	46.14	55.52	0.3621	0.0395	0.0113	0.9905	79.80	81.03	79.80	81.03	81.03	81.03
7	-5.63	0.25	6.96	41.60	50.29	56.85	0.3545	0.1034	0.0302	0.9745	81.57	82.71	81.57	82.71	82.71	82.71
8	-7.73	-1.58	8.55	37.75	53.89	60.09	0.3208	0.1084	0.0322	0.9720	84.50	85.50	84.50	85.50	85.50	85.50
9	-8.59	-1.71	12.31	34.27	59.92	64.36	0.3149	0.1869	0.0583	0.9456	78.39	79.89	78.39	79.89	79.89	79.89
10	-6.33	0.72	14.49	35.90	57.14	64.46	0.3109	0.1591	0.0503	0.9545	73.25	75.11	73.25	75.11	75.11	75.11
11	-4.93	2.22	11.57	42.44	53.30	58.57	0.3756	0.2133	0.0683	0.9422	65.97	68.20	65.97	68.20	68.20	68.20

MCORR	MCORR	TO/TO	PO/PO	EFF-AD	EFF-P	TO2/TO1	PO2/PO1	EFF-AD	EFF-P
INLET	INLET	INLET	INLET	INLET	INLET	INLET	INLET	INLET	INLET
10674	18320	1.1916	1.6731	82.63	83.82	1.1916	0.9639	82.63	83.82

ROTOR 2

SL	EPSI-1	EPSI-2	V-1	V-2	VM-1	VM-2	V0-1	V0-2	B-1	B-2	M-1	M-2	RUN NO	% SPEED	CODE 10	POINT NO 23	V'-1	V'-2	
	DEGREE	DEGREE	FT/SEC	FT/SEC	FT/SEC	FT/SEC	FT/SEC	FT/SEC	DEGREE	DEGREE				U-1	U-2	M'-1	M'-2	FT/SEC	FT/SEC
1	11.532	11.185	831.9	1189.1	831.7	798.5	-17.7	881.1	-1.2	47.7	0.7152	0.9648		832.3	873.0	1.0224	0.8479	1189.3	798.5
2	10.700	10.001	837.5	1172.7	837.5	782.0	1.8	873.9	0.1	48.1	0.7215	0.9509		855.8	891.2	1.0305	0.8343	1196.2	782.0
3	9.757	8.861	846.8	1152.3	846.6	778.5	17.3	849.6	1.2	47.4	0.7312	0.9350		880.1	910.2	1.0438	0.8336	1208.8	780.6
4	6.155	5.492	849.6	1054.0	849.5	788.9	-13.2	698.9	-0.9	41.6	0.7358	0.8526		955.4	970.8	1.1158	0.8750	1288.4	834.6
5	0.266	0.811	780.2	884.2	779.9	655.6	-22.9	593.3	-1.7	42.1	0.6722	0.7057	1059.2	1058.5	1.1493	0.8417	1333.9	803.9	
6	-2.597	-1.447	730.4	797.6	729.8	578.0	-30.7	549.6	-2.4	43.5	0.6269	0.6326	1112.1	1105.2	1.1638	0.6555	1356.0	801.8	
7	-3.793	-2.496	736.1	784.7	735.6	571.2	-25.9	538.1	-2.0	43.2	0.6325	0.6222	1138.8	1129.3	1.1837	0.6519	1377.6	822.1	
8	-4.698	-3.455	759.0	798.9	758.9	585.7	-9.6	543.3	-0.7	42.6	0.6532	0.6336	1165.7	1154.0	1.2040	0.6711	1399.0	846.1	
9	-6.577	-5.978	807.9	825.3	807.6	610.3	22.0	585.6	1.6	42.2	0.6903	0.6481	1247.4	1230.4	1.2535	0.7145	1467.0	909.8	
10	-7.105	-6.778	820.3	826.1	819.5	617.0	35.1	549.4	2.4	41.5	0.6967	0.6462	1274.8	1256.6	1.2622	0.7361	1486.1	938.5	
11	-7.979	-7.945	783.2	791.2	782.9	639.8	-20.7	465.5	-1.5	35.9	0.6599	0.6461	1302.4	1283.3	1.2953	0.8085	1537.4	1038.3	

SL	INCS	INCM	DEV	TURN	RHOVM-1	RHOVM-2	D-FAC	OMEGA-B	LOSS-P	PO2/	EFF-P	EFF-A	B'-1	B'-2	V0'-1	V0'-2	PO/PL
	DEGREE	DEGREE	DEGREE	DEGREE				TOTAL	TOTAL	PO1	TOT	DEGREE	DEGREE	DEGREE	FT/SEC	FT/SEC	INLET
1	-3.94	0.38	19.82	46.13	72.58	86.30	0.5048	0.1668	0.0380	1.7992	87.78	86.73	45.54	-0.58	-850.1	8.2	3.1342
2	-4.42	0.03	15.09	44.27	73.19	86.17	0.5199	0.1546	0.0361	1.8029	88.51	87.52	45.54	1.27	-854.1	-17.3	3.1494
3	-4.79	-0.22	11.96	41.11	73.99	87.69	0.5206	0.1260	0.0301	1.8006	90.34	89.51	45.56	4.45	-862.8	-60.7	3.1599
4	-2.96	1.83	9.46	29.77	73.45	93.08	0.4947	0.0679	0.0165	1.7579	93.90	93.39	48.79	19.02	-986.6	-271.8	3.0482
5	0.75	5.33	7.14	18.85	66.54	76.20	0.5273	0.0894	0.0207	1.6856	91.00	90.32	54.22	35.37	-1082.1	-465.3	2.7470
6	3.07	7.40	7.63	13.59	62.13	68.70	0.5362	0.1156	0.0247	1.6445	87.85	86.97	57.44	43.84	-1142.9	-555.7	2.5998
7	2.85	6.92	6.09	11.77	62.95	68.09	0.5280	0.1282	0.0272	1.6214	86.09	85.11	57.72	45.95	-1164.7	-591.3	2.5864
8	1.75	5.56	3.82	11.00	65.28	70.09	0.5189	0.1351	0.0293	1.6129	85.04	84.01	57.13	46.13	-1175.3	-610.6	2.6192
9	-0.31	2.37	0.64	8.76	68.63	72.48	0.5056	0.1493	0.0351	1.5991	82.77	81.60	56.50	47.74	-1224.7	-676.8	2.6832
10	-0.80	1.38	2.05	7.67	68.80	73.07	0.4900	0.1253	0.0300	1.5901	85.01	84.00	56.40	48.73	-1239.7	-707.2	2.6930
11	1.73	3.43	6.15	7.44	64.72	75.47	0.4404	0.0742	0.0173	1.6094	90.68	90.03	59.24	51.81	-1323.1	-817.7	2.6413

TO/TO	PO/PO	EFF-AD	EFF-P	WCI/A1	T02/T01	P02/P01	EFF-AD	EFF-P
INLET	INLET	INLET	INLET	LBM/SEC			ROTOR	ROTOR
		%	%	%			%	%
1.4057	2.8160	84.52	86.57	42.74	1.1797	1.6031	88.67	89.47

STATOR 2

SL	EPSI-1	EPSI-2	V-1	V-2	VM-1	VM-2	V0-1	V0-2	B-1	B-2	M-1	M-2	RUN NO	% SPEED	CODE 10	POINT NO 23	V'-1	V'-2	
	DEGREE	DEGREE	FT/SEC	FT/SEC	FT/SEC	FT/SEC	FT/SEC	FT/SEC	DEGREE	DEGREE				U-1	U-2	M'-1	M'-2	FT/SEC	FT/SEC
1	8.596	0.729	1226.8	828.5	862.7	828.5	872.3	-2.1	45.6	-0.1	1.0013	0.8424		2.9104	INLET	1.4472	1.6711	1.2091	1.2091
2	7.483	0.542	1208.7	841.3	842.8	840.1	866.3	43.5	46.0	3.0	0.9856	0.8541		2.9468	1.4432	1.6678	1.2086	1.2086	1.2086
3	6.384	0.258	1186.8	865.9	834.6	865.8	843.8	14.1	45.5	0.9	0.9681	0.8773		3.0123	1.4343	1.7175	1.2038	1.2038	1.2038
4	3.853	-0.606	1085.0	827.0	831.8	827.0	896.7	-7.2	40.0	-0.5	0.8813	0.6510		2.9568	1.4072	1.7033	1.1886	1.1886	1.1886
5	1.500	-1.111	913.8	681.8	695.3	681.2	593.0	-28.2	40.4	-2.4	0.7318	0.5336		2.7065	1.3875	1.6598	1.1771	1.1771	1.1771
6	0.057	-1.169	827.3	592.0	617.8	590.4	550.2	-43.6	41.6	-4.2	0.6580	0.4613		2.5777	1.3806	1.6313	1.1750	1.1750	1.1750
7	-0.824	-1.137	813.5	578.6	609.7	576.8	538.5	-44.9	41.4	-4.4	0.6469	0.4511		2.5612	1.3766	1.6109	1.1729	1.1729	1.1729
8	-1.764	-1.109	827.6	604.8	623.3	603.8	544.5	-34.8	41.1	-3.3	0.6583	0.4721		2.5922	1.3784	1.5990	1.1731	1.1731	1.1731
9	-4.607	-1.304	857.4	648.7	650.7	648.6	558.4	7.4	40.7	0.1	0.6755	0.5016		2.6319	1.4122	1.5684	1.1746	1.1746	1.1746
10	-5.544	-1.358	861.5	655.2	660.8	654.8	552.7	26.1	40.0	2.7	0.6762	0.5048		2.6311	1.4234	1.5540	1.1670	1.1670	1.1670
11	-6.294	-1.275	832.9	632.4	659.0	632.1	468.0	18.1	34.3	1.6	0.6512	0.4860		2.5919	1.4257	1.5623	1.1602	1.1602	1.1602

SL	INCS	INCM	DEV	TURN	RHOVM-1	RHOVM-2	D-FAC	OMEGA-B	LOSS-P	PO2/	EFF-A	EFF-P	EFF-A	EFF-P
	DEGREE	DEGREE	DEGREE	DEGREE				TOTAL	TOTAL	PO1	TOT-INLET	TOT-INLET	TOT-STG	TOT-STG
1	-2.86	-1.30	11.67	45.73	90.46	104.49	0.4851	0.1503	0.0340	0.9289	79.45	82.25	75.00	76.72
2	-1.42	0.60	14.21	43.04	90.27	106.83	0.4608	0.1377	0.0317	0.9362	81.27	83.84	76.77	78.41
3	-1.17	1.33	11.78	44.54	91.54	111.64	0.4361	0.1036	0.0243	0.9530	84.90	87.02	81.40	82.76
4	-5.55	-1.68	9.82	40.51	96.07	108.41	0.4013	0.0802	0.0199	0.9681	88.82	90.37	87.49	88.39
5	-4.26	1.04	7.93	42.82	81.64	88.40	0.4418	0.0654	0.0175	0.9800	84.59	86.56	86.84	87.73
6	-2.75	3.04	6.00	43.86	72.33	75.95	0.4869	0.0444	0.0122	0.9886	81.36	83.63	85.24	86.22
7	-2.82	3.18	5.72	45.86	71.62	74.27	0.4885	0.0305	0.0085	0.9926	81.57	83.80	83.89	84.93
8	-2.95	3.26	6.81	44.40	73.50	77.89	0.4673	0.0349	0.0099	0.9912	82.42	84.58	82.49	83.60
9	-3.13	3.57	10.82	40.02	75.99	81.76	0.4331	0.0728	0.0214	0.9808	76.97	79.82	78.04	79.38
10	-4.47	2.41	12.88	37.89	76.83	81.73	0.4212	0.0864	0.0255	0.9773	74.89	78.00	79.78	81.00
11	-11.43	-4.34	13.57	32.66	79.61	78.30	0.4010	0.0716	0.0214	0.9823	73.16	76.44	66.75	87.58

NCORR	MCORR	TO/TO	PO/PO	EFF-AD	EFF-P	T02/T01	P02/P01	EFF-AD	EFF-P
INLET	INLET	INLET	INLET	INLET	INLET			STAGE	STAGE
RPM	LBM/SEC			%	%			%	%
10674	183.20	1.4057	2.7418	82.02	84.34	1.1797	0.9737	83.80	

ORIGINAL PAGE IS
OF POOR QUALITY

TABLE XVII(d) — OVERALL PERFORMANCE AND BLADE-ELEMENT DATA
(Uniform Inlet Flow, 100 Percent Speed)

U. S. CUSTOMARY UNITS

ROTOR 1

SL	EPSI-1	EPSI-2	V-1	V-2	VM-1	VM-2	V0-1	V0-2	B-1	B-2	M-1	M-2	RUN NU	B. SPEED	CODE 10	POINT NO 3	V'-1	V'-2
	DEGREE	DEGREE	FT/SEC	FT/SEC	FT/SEC	FT/SEC	FT/SEC	FT/SEC	DEGREE	DEGREE							FT/SEC	FT/SEC
1	10.353	18.251	626.6	1059.6	626.6	601.6	0.0	872.2	0.0	55.4	0.5796	0.9378	631.2	730.8	0.8227	0.5470	889.4	618.0
2	14.487	15.841	640.2	1018.1	640.2	614.7	0.0	811.6	0.0	52.9	0.5931	0.8972	680.7	766.1	0.8656	0.5432	934.4	616.3
3	2.183	13.628	653.7	995.6	653.7	640.2	0.0	762.4	0.0	50.0	0.6065	0.8758	729.2	801.5	0.9086	0.5662	979.3	641.4
4	0.009	7.818	684.4	903.7	684.4	607.4	0.0	669.2	0.0	47.8	0.6373	0.7849	868.1	907.6	1.0293	0.5668	1105.5	652.6
5	0.722	1.388	701.5	786.2	701.5	535.4	0.0	575.7	0.0	47.1	0.6545	0.6731	1041.5	1049.0	1.1716	0.6118	1255.7	714.6
6	-0.890	-1.359	704.8	744.9	704.8	523.9	0.0	529.6	0.0	45.3	0.6578	0.6359	1124.9	1119.7	1.2390	0.6736	1327.5	789.4
7	-1.902	-2.614	705.7	756.7	705.7	554.9	0.0	514.5	0.0	42.8	0.6587	0.6467	1166.1	1155.1	1.2723	0.7242	1363.0	847.5
8	-3.277	-3.828	705.4	766.7	705.4	584.0	0.0	496.9	0.0	40.4	0.6585	0.6562	1207.3	1190.4	1.3052	0.7760	1398.3	906.7
9	-7.786	-7.460	694.7	795.2	694.7	583.2	0.0	540.6	0.0	42.8	0.6476	0.6721	1330.1	1296.4	1.3989	0.8069	1500.6	954.7
10	-9.361	-8.736	687.7	823.5	687.7	604.0	0.0	599.7	0.0	42.7	0.6405	0.6939	1371.1	1331.9	1.4287	0.8260	1533.9	980.3
11	-10.951	-10.122	678.9	800.5	678.9	577.5	0.0	554.4	0.0	43.7	0.6317	0.6716	1412.0	1367.2	1.4578	0.8364	1566.7	997.0

SL	INCS	INCM	DEV	TURN	RHOVM-1	RHOVM-2	D-FAC	OMEGA-B	LOSS-P	PO2/	EFF-P	EFF-A	B'-1	B'-2	V0'-1	V0'-2	PO/PO
	DEGREE	DEGREE	DEGREE	DEGREE				TOTAL	TOTAL	PO1	TOT	TOT	DEGREE	DEGREE	FT/SEC	FT/SEC	INLET
1	-1.37	3.24	14.71	55.26	40.73	48.49	0.5371	0.0233	0.0050	1.9038	98.80	98.49	45.01	-13.25	-651.2	141.5	1.9038
2	-1.26	3.04	15.38	50.79	41.31	50.88	0.5525	0.0074	0.0017	1.8859	99.58	99.55	46.56	-4.23	-660.7	45.4	1.8859
3	-1.07	3.04	15.62	44.45	41.86	54.33	0.5610	-0.0331	-0.0079	1.8965	102.07	102.27	47.94	3.49	-729.2	-39.0	1.8965
4	0.13	3.60	11.74	30.21	43.06	53.38	0.5762	0.0323	0.0080	1.8363	97.47	97.26	51.63	21.43	-868.1	-238.5	1.8363
5	1.31	4.20	11.20	14.58	43.68	48.12	0.5696	0.1101	0.0248	1.7429	89.56	88.73	56.03	41.48	-1041.5	-473.3	1.7429
6	2.00	4.28	11.06	9.53	43.80	47.78	0.5302	0.1040	0.0218	1.7243	89.32	88.49	57.93	48.40	-1124.9	-590.1	1.7243
7	2.23	4.33	8.79	9.71	43.83	51.21	0.4984	0.0748	0.0159	1.7566	92.16	91.54	58.81	49.10	-1166.1	-640.5	1.7566
8	2.47	4.42	7.04	9.78	43.82	54.53	0.4671	0.0434	0.0093	1.7865	95.33	94.95	59.68	49.90	-1207.3	-693.6	1.7865
9	3.35	4.77	5.50	10.10	43.44	54.34	0.4891	0.1263	0.0274	1.8524	86.79	85.62	62.40	52.30	-1330.1	-755.9	1.8524
10	3.65	4.95	4.88	11.45	43.18	56.33	0.4908	0.1411	0.0315	1.9015	85.56	84.22	63.34	51.88	-1371.1	-772.1	1.9015
11	3.96	5.11	8.15	9.80	42.85	53.72	0.4919	0.1664	0.0356	1.8767	82.56	80.97	64.29	54.49	-1412.0	-812.8	1.8767

TO/TO	PO/PO	EFF-AD	EFF-P	WCI/A1	PO2/PO1	EFF-A	EFF-P
INLET	INLET	INLET	INLET	LBM/SEC	%	STAGE	STAGE
1.2054	1.8251	91.24	91.94	41.61	1.2054	1.8251	91.24
				SOFT			

STATOR 1

SL	EPSI-1	EPSI-2	V-1	V-2	VM-1	VM-2	V0-1	V0-2	B-1	B-2	M-1	M-2	RUN NU	B. SPEED	CODE 10	POINT NO 3	PO/PO	TO/TO	PO/PO	TO2/
	DEGREE	DEGREE	FT/SEC	FT/SEC	FT/SEC	FT/SEC	FT/SEC	FT/SEC	DEGREE	DEGREE							INLET	INLET	STAGE	TO1
1	17.999	14.740	1064.0	652.7	635.0	651.4	853.8	-41.6	53.5	-3.6	0.9425	0.5487	1.7794	1.2043	1.7794	1.2043	1.2043	1.2043	1.2043	
2	15.588	12.873	1027.1	654.5	647.6	654.4	797.1	-9.4	51.0	-0.8	0.9064	0.5515	1.7882	1.1992	1.7882	1.1992	1.1992	1.1992	1.1992	
3	13.507	11.184	1007.6	663.7	671.7	663.2	751.1	26.1	48.2	2.2	0.8880	0.5605	1.8033	1.1960	1.8033	1.1960	1.1960	1.1960	1.1960	
4	8.193	6.463	921.4	660.1	639.1	660.0	663.7	3.4	46.1	0.3	0.8022	0.5575	1.8008	1.1948	1.8008	1.1948	1.1948	1.1948	1.1948	
5	1.605	0.573	807.0	610.2	566.6	609.8	574.7	-22.1	45.4	-2.1	0.6927	0.5134	1.7313	1.1934	1.7313	1.1934	1.1934	1.1934	1.1934	
6	-1.390	-2.098	766.7	578.3	554.1	577.3	530.0	-34.7	43.7	-3.4	0.6561	0.4860	1.6925	1.1901	1.6925	1.1901	1.1901	1.1901	1.1901	
7	-2.602	-3.164	779.0	611.5	584.0	611.0	515.6	-23.7	41.5	-2.2	0.6674	0.5152	1.7231	1.1908	1.7231	1.1908	1.1908	1.1908	1.1908	
8	-3.597	-4.004	788.9	638.2	611.6	637.9	498.3	-21.1	39.2	-1.9	0.6769	0.5393	1.7514	1.1896	1.7514	1.1896	1.1896	1.1896	1.1896	
9	-6.443	-6.318	820.2	692.1	613.9	691.8	543.9	21.6	41.6	1.8	0.6952	0.5784	1.8099	1.2261	1.8099	1.2261	1.2261	1.2261	1.2261	
10	-7.388	-7.105	849.4	664.8	635.5	695.9	563.6	35.3	41.7	2.9	0.7179	0.5791	1.8171	1.2399	1.8171	1.2399	1.2399	1.2399	1.2399	
11	-8.284	-8.036	829.4	643.2	612.9	644.6	558.8	-28.2	42.5	-2.5	0.6981	0.5330	1.7620	1.2431	1.7620	1.2431	1.2431	1.2431	1.2431	

SL	INCS	INCM	DEV	TURN	RHOVM-1	RHOVM-2	D-FAC	OMEGA-B	LOSS-P	PO2/	EFF-A	EFF-P	EFF-A	EFF-P
	DEGREE	DEGREE	DEGREE	DEGREE				TOTAL	TOTAL	PO1	TOT-INLET	TOT-INLET	TOT-STG	TOT-STG
1	0.97	3.08	8.71	57.14	51.00	63.39	0.5512	0.1495	0.0305	0.9350	87.55	88.50	87.55	88.50
2	0.15	2.55	10.41	51.81	53.23	64.38	0.5227	0.1265	0.0249	0.9478	90.60	91.32	90.60	91.32
3	-1.29	1.50	12.63	46.00	56.47	65.66	0.4938	0.1217	0.0268	0.9513	93.56	94.06	93.56	94.06
4	-0.93	2.79	9.56	45.79	55.48	65.42	0.4539	0.0528	0.0129	0.9817	93.87	94.34	93.87	94.34
5	-0.12	4.92	7.24	47.45	50.31	59.49	0.4422	0.0213	0.0058	0.9943	87.72	88.61	87.72	88.61
6	-1.29	4.33	5.92	47.17	49.93	55.94	0.4354	0.0768	0.0219	0.9808	85.31	86.33	85.31	86.33
7	-3.33	2.54	7.18	43.69	53.24	59.42	0.4192	0.0867	0.0233	0.9775	88.12	88.97	88.12	88.97
8	-5.39	0.76	7.53	41.12	56.41	62.35	0.3876	0.0809	0.0240	0.9786	91.53	92.15	91.53	92.15
9	-2.98	3.90	12.36	39.83	56.38	66.42	0.3587	0.0878	0.0274	0.9757	81.63	83.07	81.63	83.07
10	-3.25	3.80	14.49	38.77	58.36	66.29	0.3793	0.1543	0.0488	0.9552	77.48	79.26	77.48	79.26
11	-3.14	4.01	10.80	45.00	56.09	60.85	0.4503	0.2191	0.0701	0.9392	72.17	74.26	72.17	74.26

NCORA	NCORR	TO/TO	PO/PO	EFF-AD	EFF-P	TO2/TO1	PO2/PO1	EFF-AD	EFF-P
INLET	INLET	INLET	INLET	INLET	INLET	%	%	STAGE	STAGE
10740.	183.20	1.2054	1.7708	86.28	87.32	1.2054	0.9702	86.28	

ROTOR 2

SL	EPSI-1	EPSI-2	V-1	V-2	VM-1	VM-2	VB-1	VB-2	B-1	B-2	M-1	M-2	U-1	U-2	M'-1	M'-2	V'-1	V'-2
DEGREE	DEGREE	FT/SEC	FT/SEC	FT/SEC	FT/SEC	FT/SEC	FT/SEC	FT/SEC	DEGREE	DEGREE			FT/SEC	FT/SEC			FT/SEC	FT/SEC
1	88.442	11.067	729.1	1141.4	728.0	754.2	-40.3	856.3	-3.2	48.5	0.6175	0.9164	837.5	678.4	0.9658	0.6059	1140.4	754.5
2	30.502	9.704	736.1	1126.3	736.1	723.3	-8.7	863.4	-0.7	49.9	0.6253	0.9050	841.1	696.8	0.9679	0.5818	1139.5	724.1
3	3.484	8.580	749.4	1110.0	748.9	707.4	25.5	855.3	1.9	50.3	0.6384	0.8932	845.6	915.9	0.9715	0.5714	1140.5	710.2
4	5.882	5.189	758.4	1019.3	758.4	710.8	3.2	730.4	0.2	45.8	0.6470	0.8157	841.3	976.8	1.0425	0.6019	1121.9	752.2
5	0.221	0.625	707.0	884.8	706.6	620.7	-22.2	630.5	-1.8	45.4	0.6003	0.6985	1065.8	1065.1	1.1015	0.5982	1297.3	757.7
6	-2.562	-1.679	669.7	869.7	668.9	566.5	-34.3	602.3	-2.9	46.7	0.5674	0.6487	1119.0	1112.1	1.1295	0.5978	1333.2	762.1
7	-3.699	-2.737	692.9	820.4	692.5	559.2	-23.7	608.2	-2.0	47.0	0.5882	0.6428	1145.9	1136.3	1.1538	0.6071	1359.2	774.7
8	-4.488	-3.623	712.4	827.9	712.1	558.6	-21.2	611.0	-1.7	47.5	0.6062	0.6475	1172.9	1161.1	1.1831	0.6132	1390.3	784.0
9	-5.834	-5.622	767.9	838.8	767.5	577.7	-21.9	608.1	1.6	46.3	0.6467	0.6489	1255.1	1238.0	1.2234	0.6612	1452.6	854.7
10	-6.279	-6.269	781.2	842.6	780.3	594.8	-37.2	596.8	2.7	44.9	0.6549	0.6504	1282.7	1264.3	1.2322	0.6902	1469.7	694.1
11	-7.440	-7.499	742.1	843.7	741.5	656.3	-28.0	530.2	-2.1	38.7	0.6186	0.6502	1310.4	1291.2	1.2755	0.7743	1530.1	1004.9

SL	INCS	INCM	DEV	TURN	RHOVM-1	RHOVM-2	O-FAC	OMEGA-B	LGSS-P	PO2/	%EFF-P	%EFF-A	B'-1	B'-2	VO'-1	VO'-2	PO/PO
DEGREE	DEGREE	DEGREE	DEGREE	DEGREE	TOTAL	TOTAL	TOTAL	TOTAL	TOTAL	P01	TOT	TOT	DEGREE	DEGREE	FT/SEC	FT/SEC	INLET
1	0.76	5.08	22.07	48.57	68.45	86.35	0.5213	0.1671	0.0381	1.8045	88.61	87.63	50.24	1.67	-677.8	-22.0	3.2114
2	-0.23	4.22	16.45	47.05	69.54	84.41	0.5466	0.1628	0.0380	1.8051	88.83	87.86	49.72	2.63	-869.9	-33.4	3.2293
3	-1.41	3.17	12.41	44.06	71.00	84.34	0.5547	0.1379	0.0329	1.8006	90.31	89.48	48.95	4.68	-860.1	-60.6	3.2476
4	-3.08	4.71	9.54	32.57	71.48	87.93	0.5384	0.1065	0.0264	1.7466	91.06	90.33	51.67	19.10	-958.1	-246.2	3.1445
5	3.53	6.10	6.77	22.00	65.85	77.74	0.5386	0.1349	0.0313	1.6932	87.55	86.60	57.00	35.00	-1084.0	-434.6	2.9270
6	5.51	9.85	5.75	17.93	62.20	70.90	0.5704	0.1685	0.0372	1.6709	83.94	82.74	59.88	41.96	-1153.3	-509.7	2.8358
7	4.49	8.57	4.50	15.61	64.88	70.17	0.5701	0.1936	0.0426	1.6422	80.94	79.58	59.36	43.75	-1169.5	-536.1	2.8356
8	3.73	7.60	2.18	14.67	67.18	70.16	0.5780	0.2283	0.0510	1.6319	77.36	75.77	59.17	44.50	-1194.1	-550.1	2.8606
9	1.16	3.84	0.22	10.66	70.89	72.27	0.5511	0.2089	0.0495	1.6138	77.97	76.44	57.97	47.32	-1233.2	-629.9	2.9156
10	0.56	2.74	1.42	9.66	71.23	74.66	0.5272	0.1715	0.0416	1.6179	81.36	80.05	57.76	48.10	-1245.5	-667.5	2.9416
11	3.33	5.03	3.38	11.81	66.86	82.73	0.4740	0.1116	0.0277	1.6740	87.60	86.67	60.84	49.03	-1338.4	-760.9	2.9657

TO/TO	PO/PO	EFF-AD	EFF-P	WCI/A1	T02/T01	P02/P01	EFF-AD	EFF-P
INLET	INLET	%	%	SQFT	%	%	%	%
1.4355	3.0008	84.32	86.51	40.62	1.1909	1.6945	84.55	85.65

STATOR 2

SL	EPSI-1	EPSI-2	V-1	V-2	VM-1	VM-2	VB-1	VB-2	B-1	B-2	M-1	M-2	PO/PO	T0/T0	PO/PO	EFF-AD	EFF-P	EFF-AD	EFF-P
DEGREE	DEGREE	FT/SEC	FT/SEC	FT/SEC	FT/SEC	FT/SEC	FT/SEC	FT/SEC	DEGREE	DEGREE			INLET	INLET	STAGE	TOT-INLET	TOT-INLET	TOT-STG	TOT-STG
1	88.691	0.820	1170.9	733.0	807.9	733.5	847.6	12.45	46.7	1.0	0.5445	0.5624	3.0384	1.4550	1.7079	1.2080	1.2080	1.2080	
2	7.047	0.704	1154.5	748.9	775.1	748.4	855.6	15.7	48.1	1.2	0.9314	0.5757	3.0757	1.4496	1.7216	1.2082	1.2082	1.2082	
3	0.519	0.442	1137.1	776.3	756.2	776.2	849.2	11.4	48.5	0.8	0.9185	0.6007	3.1418	1.4400	1.7435	1.2038	1.2038	1.2038	
4	3.761	-0.485	1044.5	735.9	749.1	735.9	727.8	-2.4	44.2	-0.2	0.8386	0.5711	3.0830	1.4222	1.7109	1.1903	1.1903	1.1903	
5	4.133	-0.979	908.9	618.9	655.3	618.4	629.9	-26.6	43.9	-2.5	0.7194	0.4771	2.8908	1.4153	1.6688	1.1859	1.1859	1.1859	
6	-0.234	-0.982	851.6	554.1	601.8	553.3	602.6	-29.4	45.0	-3.0	0.6698	0.4252	2.6003	1.4158	1.6555	1.1897	1.1897	1.1897	
7	-1.037	-0.938	845.6	551.5	594.8	551.0	601.0	-22.5	45.3	-2.3	0.6643	0.4234	2.7963	1.4160	1.6245	1.1892	1.1892	1.1892	
8	-1.977	-0.944	853.7	572.2	594.8	571.9	612.4	-17.4	45.8	-1.7	0.6694	0.4384	2.8202	1.4228	1.6128	1.1959	1.1959	1.1959	
9	-5.097	-1.243	869.0	614.8	617.4	614.7	611.5	12.1	44.8	1.1	0.6742	0.4668	2.8568	1.4563	1.5809	1.1900	1.1900	1.1900	
10	-6.079	-1.311	875.5	629.4	637.2	629.0	600.3	20.8	43.4	1.9	0.6780	0.4772	2.8682	1.4632	1.5767	1.1819	1.1819	1.1819	
11	-6.670	-1.244	882.1	638.0	703.0	637.9	532.7	13.8	37.3	1.2	0.6823	0.4831	2.8709	1.4684	1.6247	1.1814	1.1814	1.1814	

SL	INCS	INCM	DEV	TURN	RHOVM-1	RHOVM-2	O-FAC	OMEGA-B	LOSS-P	PO2/	%EFF-A	%EFF-P	%EFF-A	%EFF-P
DEGREE	DEGREE	DEGREE	DEGREE	DEGREE	TOTAL	TOTAL	TOTAL	TOTAL	TOTAL	P01	TOT-INLET	TOT-INLET	TOT-STG	TOT-STG
1	-1.80	-0.24	12.79	45.67	90.46	100.48	0.5339	0.1222	0.0276	0.9465	81.75	84.33	78.84	80.36
2	0.63	2.65	12.45	46.86	88.97	103.42	0.5188	0.1082	0.0249	0.9535	83.81	86.12	80.03	81.49
3	1.84	4.34	11.69	47.44	88.37	108.80	0.4918	0.0774	0.0181	0.9672	87.55	89.36	83.82	85.03
4	-1.32	2.54	10.13	44.42	91.17	104.15	0.4715	0.0578	0.0144	0.9786	89.50	91.00	86.54	87.52
5	-0.86	4.45	7.84	46.32	81.00	86.39	0.5159	0.0519	0.0139	0.9847	84.96	87.00	84.18	85.27
6	0.60	6.39	7.19	48.03	74.36	76.58	0.5556	0.0492	0.0136	0.9872	81.94	84.31	81.10	82.39
7	1.03	7.02	7.83	47.99	73.67	76.21	0.5540	0.0501	0.0140	0.9872	81.76	84.16	78.06	79.49
8	1.76	7.96	8.37	47.54	73.72	78.88	0.5385	0.0493	0.0140	0.9872	81.21	83.70	74.18	75.84
9	0.98	7.68	11.30	43.65	76.05	82.88	0.4960	0.0775	0.0227	0.9797	76.30	79.46	72.97	74.65
10	-1.06	5.82	12.67	41.50	78.66	84.36	0.4783	0.0971	0.0287	0.9743	75.48	78.76	75.76	77.26
11	-8.45	-1.35	13.17	36.05	86.91	85.09	0.4526	0.1215	0.0362	0.9675	74.72	78.11	81.27	82.50

NCORR	WCI/A1	TO/TO	PO/PO	EFF-AD	EFF-P	T02/T01	P02/P01	EFF-AD	EFF-P
RPM	LBM/SEC	INLET	INLET	%	%	%	%	%	%
10740	183.20	1.4355	2.9314	82.24	84.67	1.1909	0.9769	80.53	80.53

ORIGINAL PAGE IS
OF POOR QUALITY

ROTOR 2

SL	EPSI-1	EPSI-2	V-1	V-2	VM-1	VM-2	V8-1	V8-2	B-1	B-2	M-1	RUN NO	B, SPEED	CODE	10, POINT NO	4	V1-1	V1-2
	DEGREE	DEGREE	FT/SEC	FT/SEC	FT/SEC	FT/SEC	FT/SEC	FT/SEC	DEGREE	DEGREE		M-2	U-1	U-2	M-1	M-1	FT/SEC	FT/SEC
1	11.471	11.037	684.9	1117.6	684.6	707.6	-19.8	865.1	-1.7	50.6	0.5789	0.8980	832.4	873.1	0.9239	0.5680	1093.2	707.0
2	13.563	9.728	691.7	1103.3	693.7	688.9	4.3	861.8	0.4	51.3	0.5873	0.8861	850.0	891.4	0.9299	0.5538	1079.4	689.5
3	9.485	6.467	707.6	1088.6	707.3	698.6	19.8	834.9	1.6	50.0	0.6000	0.8752	880.2	910.4	0.9445	0.5649	1113.8	702.7
4	3.620	4.955	719.9	1008.1	719.7	682.1	15.5	742.4	1.2	47.4	0.6122	0.8666	955.6	970.9	1.0068	0.5755	1103.9	719.3
5	0.007	0.446	673.5	889.9	673.5	602.2	-6.3	655.2	-0.5	47.4	0.5700	0.7024	1659.4	1058.7	1.0000	0.5721	1260.6	724.9
6	-2.780	-1.893	642.3	837.0	641.9	563.0	-22.8	619.3	-2.0	47.7	0.5421	0.6567	1112.3	1105.4	1.1004	0.5836	1304.0	743.6
7	-3.843	-2.926	673.5	830.7	673.4	539.1	6.5	632.0	0.6	49.5	0.5701	0.6514	1139.0	1129.5	1.1154	0.5753	1317.0	733.6
8	-4.543	-3.740	692.5	839.9	692.4	548.4	12.9	636.1	1.1	49.2	0.5870	0.6578	1165.4	1154.1	1.1399	0.5908	1344.9	754.4
9	-5.738	-5.612	748.4	845.7	746.9	560.1	47.1	633.7	3.6	48.4	0.6277	0.6539	1247.6	1230.6	1.1859	0.6329	1413.9	818.5
10	-6.127	-6.198	762.3	851.3	760.2	585.6	56.6	617.9	4.2	46.3	0.6371	0.6572	1275.0	1236.8	1.2002	0.6690	1436.2	866.6
11	-7.364	-7.430	723.7	852.3	723.2	657.8	-24.9	541.9	-2.0	39.3	0.6019	0.6569	1302.5	1283.4	1.2572	0.7641	1511.7	991.3

SL	INCS	INCM	DEV	TURN	RHOVM-1	RHOVM-2	D-FAC	OMEGA-B	LOSS-P	P02/	%EFF-P	%EFF-A	B*-1	B*-2	V8*-1	V8*-2	PG/PG
	DEGREE	DEGREE	DEGREE	DEGREE				TOTAL	TOTAL	P01	TOT	TOT	DEGREE	DEGREE	FT/SEC	FT/SEC	INLET
1	1.00	3.97	21.05	50.49	65.51	81.48	0.5414	0.1745	0.0398	1.7924	88.67	87.71	51.14	0.65	-852.3	-6.0	3.1620
2	0.94	3.29	16.27	46.35	66.52	80.70	0.5584	0.1617	0.0377	1.7924	89.35	88.42	50.60	2.45	-854.4	-29.6	3.1790
3	0.22	4.80	13.68	44.42	67.88	83.45	0.5476	0.1245	0.0296	1.7900	91.43	90.70	50.57	6.15	-800.4	-75.5	3.1985
4	0.03	5.62	8.95	34.06	68.98	84.41	0.5520	0.1138	0.0278	1.7413	90.56	90.22	52.58	18.52	-940.2	-228.5	3.1174
5	4.24	8.81	3.60	23.88	63.94	75.38	0.5745	0.1459	0.0344	1.6948	87.09	86.10	57.71	33.82	-1065.6	-403.5	2.9361
6	6.14	10.48	4.50	19.72	60.82	70.48	0.5749	0.1712	0.0385	1.6091	84.12	82.94	60.51	40.79	-1135.1	-486.1	2.8852
7	4.33	6.47	3.41	16.59	64.34	67.78	0.5877	0.2013	0.0451	1.6348	80.80	79.43	59.26	42.67	-1132.5	-497.5	2.8574
8	3.01	7.42	1.00	15.68	66.45	69.14	0.5838	0.2175	0.0498	1.6306	78.98	77.49	58.59	43.32	-1152.9	-516.0	2.8883
9	1.40	3.84	-0.42	11.31	70.16	70.20	0.5639	0.2109	0.0505	1.6098	78.35	76.86	57.57	46.67	-1200.5	-596.9	2.9360
10	0.00	2.83	0.61	10.54	70.70	73.76	0.5359	0.1732	0.0427	1.6183	81.69	80.41	57.86	47.29	-1218.5	-638.8	2.9609
11	3.73	5.43	2.57	13.02	66.52	83.31	0.4766	0.1168	0.0294	1.6716	87.26	86.31	61.25	48.23	-1327.4	-741.5	2.9938

	TO/TO	PG/PG	EFF-AD	EFF-P	WCI/A1		TO2/T01	P02/P01	EFF-AD	EFF-P
	INLET	INLET	INLET	INLET	LBM/SEC				ROTOR	ROTOR
					1				1	1
	1.4350	3.0026	84.46	86.64	39.60		1.1893	1.6901	84.82	85.89

STATOR 2

SL	EPSI-1	EPSI-2	V-1	V-2	VM-1	VM-2	V8-1	V8-2	B-1	B-2	M-1	RUN NO	B, SPEED	CODE	10, POINT NO	4	PG/PG	TO/TO	PG/PG
	DEGREE	DEGREE	FT/SEC	FT/SEC	FT/SEC	FT/SEC	FT/SEC	FT/SEC	DEGREE	DEGREE		M-2	U-1	U-2	M-1	M-1	INLET	INLET	STAGE
1	8.622	0.839	1144.3	689.5	758.9	689.3	856.4	12.8	48.7	1.1	0.9229	0.5286	3.0003	3.0003	1.4451	1.7006	1.2054	1.2054	
2	7.535	0.744	1128.6	705.8	737.5	705.6	854.4	18.5	49.4	1.5	0.9098	0.5425	3.0359	3.0359	1.4417	1.7135	1.2042	1.2042	
3	0.474	0.538	1113.0	731.2	742.7	731.0	828.9	16.4	48.3	1.3	0.8977	0.5646	3.0908	3.0908	1.4349	1.7316	1.1992	1.1992	
4	3.988	-0.185	1030.8	703.8	718.2	703.8	739.4	4.0	45.9	0.3	0.8271	0.5454	3.0600	3.0600	1.4189	1.7071	1.1834	1.1834	
5	1.184	-0.814	912.1	595.8	635.2	599.3	654.6	-22.6	45.8	-2.2	0.7216	0.4614	2.8977	2.8977	1.4173	1.6699	1.1675	1.1675	
6	0.187	-0.837	860.1	542.6	596.7	542.1	619.3	-23.7	46.0	-2.5	0.6764	0.4157	2.8207	2.8207	1.4184	1.6532	1.1667	1.1667	
7	-1.009	-0.817	854.5	540.0	574.1	539.7	632.9	-17.4	47.7	-1.8	0.6717	0.4137	2.8172	2.8172	1.4175	1.6180	1.1683	1.1683	
8	-2.037	-0.664	664.4	559.4	583.4	559.2	637.8	-11.5	47.5	-1.2	0.6786	0.4283	2.8356	2.8356	1.4226	1.6069	1.1915	1.1915	
9	3.220	-1.249	874.5	599.0	598.9	598.7	637.3	19.3	46.8	1.8	0.6761	0.4538	2.8708	2.8708	1.4559	1.5735	1.1800	1.1800	
10	-0.228	-1.335	882.9	618.1	627.3	617.7	621.3	21.8	44.8	2.0	0.6837	0.4679	2.8885	2.8885	1.4655	1.5738	1.1811	1.1811	
11	-0.769	-1.266	889.2	627.9	703.4	627.8	544.0	11.6	37.9	1.1	0.6879	0.4748	2.8928	2.8928	1.4702	1.6187	1.1817	1.1817	

SL	INCS	INCM	DEV	TURN	RHOVM-1	RHOVM-2	D-FAC	OMEGA-B	LOSS-P	P02/	%EFF-A	%EFF-P	B*-1	B*-2	V8*-1	V8*-2	PG/PG
	DEGREE	DEGREE	DEGREE	DEGREE				TOTAL	TOTAL	P01	TOT-INLET	TOT-INLET	DEGREE	DEGREE	FT/SEC	FT/SEC	INLET
1	0.27	1.83	12.88	47.66	85.70	95.53	0.5634	0.1204	0.0272	0.9490	82.48	84.93	75.20	80.69			
2	1.497	4.01	12.76	47.91	84.82	98.48	0.5450	0.1059	0.0244	0.9559	84.16	86.40	80.85	82.23			
3	1.07	4.17	12.13	47.03	87.19	103.10	0.5158	0.0808	0.0189	0.9670	87.09	86.94	84.65	85.79			
4	0.34	4.21	10.64	45.58	87.61	100.45	0.4976	0.0582	0.0144	0.9788	89.50	90.99	86.55	87.55			
5	1.14	6.45	8.14	48.01	78.54	84.43	0.5449	0.0541	0.0145	0.9840	84.79	86.85	83.56	84.70			
6	1.64	7.43	7.72	48.54	73.79	75.73	0.5772	0.0495	0.0137	0.9869	82.09	84.46	81.27	82.55			
7	3.52	9.51	8.32	49.60	71.29	75.41	0.5810	0.0517	0.0145	0.9865	82.14	84.51	77.77	79.21			
8	3.47	5.67	8.93	48.69	72.63	78.01	0.5654	0.0568	0.0161	0.9850	81.88	84.29	75.27	76.85			
9	3.04	9.74	12.01	45.00	73.95	81.41	0.5235	0.0846	0.0248	0.9776	76.18	79.37	72.96	74.62			
10	0.38	7.26	12.79	42.83	77.76	83.66	0.5023	0.1055	0.0312	0.9717	75.71	78.98	72.75	77.24			
11	-7.87	-0.78	12.99	36.80	87.40	84.60	0.4725	0.1289	0.0385	0.9650	75.04	78.41	80.47	81.74			

	NCORR	WCORR	TO/TO	PG/PG	EFF-AD	EFF-P		TO2/T01	P02/P01	EFF-AD	EFF-P
	INLET	INLET	INLET	INLET	1	1				STAGE	STAGE
	KPM	LBM/SEC									
	10676	179.10	1.4350	2.9313	82.32	84.74		1.1893	0.9763	80.65	80.65

ORIGINAL PAGE IS
OF POOR QUALITY

TABLE XVII(f) – OVERALL PERFORMANCE AND BLADE-ELEMENT DATA
(Uniform Inlet Flow, 100 Percent Speed)

U. S. CUSTOMARY UNITS

ROTOR 1

SL	EPSI-1	EPSI-2	Y-1	Y-2	VM-1	VM-2	V0-1	V0-2	B-1	B-2	M-1	M-2	RUN NO	9, SPEED	CODE 10,	POINT NO 14	V1-1	V1-2
	DEGREE	DEGREE	FT/SEC	FT/SEC	FT/SEC	FT/SEC	FT/SEC	FT/SEC	DEGREE	DEGREE							FT/SEC	FT/SEC
1	16.688	18.441	589.2	1034.0	589.2	597.5	0.0	843.9	0.0	24.8	0.5429	0.9147					628.9	728.0
2	14.208	16.180	602.1	993.2	602.1	599.0	0.0	792.3	0.0	52.9	0.5555	0.8743					678.1	763.3
3	11.919	14.062	614.5	969.0	614.5	606.4	0.0	756.5	0.0	51.4	0.5677	0.8499					726.5	798.5
4	5.979	8.409	644.1	895.5	644.1	588.4	0.0	675.0	0.0	48.9	0.5970	0.7765					864.9	904.2
5	0.213	2.062	663.2	799.7	663.2	524.1	0.0	604.0	0.0	49.1	0.6160	0.6831					1037.6	1045.1
6	-1.643	-0.719	667.0	758.2	667.0	495.4	0.0	574.0	0.0	49.2	0.6198	0.6438					1120.7	1113.6
7	-2.639	-2.079	666.1	773.0	666.1	538.1	0.0	555.0	0.0	45.9	0.6209	0.4574					1161.8	1150.8
8	-3.929	-3.418	668.1	786.1	668.1	567.5	0.0	544.0	0.0	43.8	0.6209	0.6691					1186.0	1180.0
9	-7.985	-7.350	659.6	816.6	659.6	556.8	0.0	597.3	0.0	46.9	0.6124	0.6850					1325.2	1251.7
10	-9.402	-8.703	653.7	848.1	653.7	583.7	0.0	615.3	0.0	46.4	0.6063	0.7096					1366.0	1326.9
11	-10.899	-10.126	645.9	835.1	645.9	573.6	0.0	607.0	0.0	46.5	0.5987	0.6967					1406.7	1362.1

SL	INCS	INCM	DEV	TURN	RHOVM-1	RHOVM-2	D-FAC	OMEGA-B	LOSS-P	PO2/	KEFF-P	KEFF-A	B*-1	B*-2	V0-1	V0-2	PO/PO
	DEGREE	DEGREE	DEGREE	DEGREE				TOTAL	TOTAL	P01	TOT	TOT	DEGREE	DEGREE	FT/SEC	FT/SEC	INLET
1	0.26	4.87	16.96	57.04	39.05	48.67	0.5257	0.0004	0.0001	1.8776	99.97	99.97	48.64	-11.00	-628.9	115.9	1.8776
2	0.35	4.45	16.83	50.94	39.64	49.91	0.5525	0.0067	0.0015	1.8566	99.63	99.61	48.17	-2.77	-678.1	29.0	1.8566
3	0.56	4.46	15.50	45.59	40.20	51.44	0.5625	0.0013	0.0003	1.8588	99.92	99.92	49.56	3.97	-726.5	-24.0	1.8588
4	1.70	5.17	11.62	31.90	41.47	51.87	0.5864	0.0436	0.0108	1.8327	96.72	96.44	53.20	21.31	-864.9	-22.2	1.8327
5	2.89	5.57	9.82	17.31	42.24	47.16	0.5925	0.1308	0.0300	1.7686	88.28	87.32	57.41	40.09	-1037.6	-44.1	1.7686
6	3.31	5.59	10.20	11.70	42.39	44.96	0.5760	0.1555	0.0332	1.7454	85.12	83.93	59.25	47.56	-1120.7	-54.0	1.7454
7	3.52	5.42	7.59	12.20	42.44	49.48	0.5341	0.1168	0.0254	1.7828	88.56	87.61	60.10	47.90	-1161.8	-59.8	1.7828
8	3.73	5.48	5.65	12.44	42.44	52.70	0.5071	0.0947	0.0208	1.8162	90.56	89.75	60.95	48.51	-1202.8	-64.0	1.8162
9	4.48	5.90	4.41	12.31	42.10	51.53	0.5395	0.1854	0.0412	1.8489	82.10	80.45	63.52	51.21	-1325.2	-69.3	1.8489
10	4.72	6.01	3.55	13.85	41.86	54.20	0.5368	0.1923	0.0442	1.9473	81.77	80.01	64.40	50.55	-1366.0	-71.6	1.9473
11	4.97	6.12	6.32	12.64	41.54	53.36	0.5295	0.2022	0.0452	1.9399	80.40	78.52	65.30	52.67	-1406.7	-75.1	1.9399

TO/T0	PO/PO	EFF-AD	EFF-P	WCI/A1	TO2/T01	PO2/PO1	EFF-AD	EFF-P
INLET	INLET	%	INLET	LBM/SEC			ROTOR	ROTOR
			%	SOFT			%	%
1.2164	1.8430	88.10	89.07	40.22	1.2164	1.8430	88.10	89.07

STATOR 1

SL	EPSI-1	EPSI-2	Y-1	Y-2	VM-1	VM-2	V0-1	V0-2	B-1	B-2	M-1	M-2	RUN NO	9, SPEED	CODE 10,	POINT NO 14	TO2/
	DEGREE	DEGREE	FT/SEC	FT/SEC	FT/SEC	FT/SEC	FT/SEC	FT/SEC	DEGREE	DEGREE							T02/
			INLET	INLET	INLET	INLET	INLET	INLET									STAGE
1	18.335	15.043	1036.6	616.0	626.1	614.0	826.2	-49.6	53.1	-4.6	0.9173	0.5178					1.7527
2	16.160	13.410	995.6	615.8	627.4	615.1	778.2	-27.8	51.3	-2.6	0.8808	0.5183					1.7605
3	14.152	11.859	978.2	624.2	633.7	624.2	745.2	5.2	49.7	0.5	0.8592	0.5258					1.7746
4	8.895	7.535	910.3	625.0	616.8	622.9	669.4	13.1	47.4	1.2	0.7910	0.5243					1.7807
5	2.750	2.098	816.2	585.5	583.1	585.2	602.9	-17.7	47.5	-1.7	0.7004	0.4897					1.7380
6	-0.247	-0.519	778.2	567.2	525.1	561.9	574.4	-25.6	47.6	-3.0	0.6822	0.4892					1.7131
7	-1.632	-1.637	792.6	593.3	564.7	593.2	596.1	-13.5	44.6	-1.3	0.6757	0.4961					1.7424
8	-2.822	-2.619	806.0	618.8	593.2	618.8	545.6	2.5	42.6	0.2	0.6876	0.5180					1.7692
9	-6.185	-5.652	840.2	668.1	587.4	667.0	600.6	38.0	45.7	3.3	0.7068	0.5519					1.8250
10	-7.277	-6.724	872.6	680.7	614.4	678.8	619.5	52.4	45.3	4.4	0.7323	0.5595					1.8421
11	-8.259	-7.684	862.2	641.1	607.5	640.0	611.7	-37.5	45.3	-3.4	0.7215	0.5245					1.8026

SL	INCS	INCM	DEV	TURN	RHOVM-1	RHOVM-2	D-FAC	OMEGA-B	LOSS-P	PO2/	KEFF-A	KEFF-P	KEFF-A	KEFF-P
	DEGREE	DEGREE	DEGREE	DEGREE				TOTAL	TOTAL	P01	TOT-INLET	TOT-INLET	TOT-STG	TOT-STG
1	0.51	2.62	7.75	57.64	50.89	60.33	0.5722	0.1587	0.0323	0.9333	88.15	89.03	86.15	89.03
2	0.45	2.85	8.66	53.86	52.01	60.85	0.5494	0.1306	0.0277	0.9482	90.33	91.05	90.33	91.05
3	0.22	3.00	10.87	49.27	53.48	62.02	0.5236	0.1184	0.0261	0.9547	91.84	92.46	91.84	92.46
4	0.38	4.10	10.48	46.18	53.84	62.05	0.4884	0.0844	0.0206	0.9714	91.49	92.14	91.49	92.14
5	1.96	7.01	7.58	49.19	49.24	57.53	0.4904	0.0620	0.0169	0.9827	84.43	85.58	84.43	85.58
6	2.55	8.16	6.34	50.59	47.13	54.83	0.4989	0.0747	0.0214	0.9809	80.89	82.26	80.89	82.26
7	-0.23	5.64	8.08	45.87	51.35	58.17	0.4619	0.0885	0.0258	0.9766	83.87	85.06	83.87	85.06
8	-1.97	4.17	9.66	42.39	54.46	60.86	0.4332	0.0968	0.0287	0.9737	85.46	86.56	85.46	86.56
9	1.11	7.99	13.81	42.46	53.61	64.34	0.4168	0.1212	0.0378	0.9656	75.51	77.46	75.51	77.46
10	0.40	7.45	16.20	40.91	54.22	65.06	0.4294	0.1838	0.0580	0.9448	72.56	74.78	72.56	74.78
11	-0.30	6.85	9.95	48.70	55.62	60.90	0.4996	0.2414	0.0772	0.9294	69.06	71.47	69.06	71.47

NCORR	WCI/A1	TO/T0	PO/PO	EFF-AD	EFF-P	TO2/T01	PO2/PO1	EFF-AD
INLET	INLET	INLET	INLET	%	%			%
RPM	LBM/SEC							
10700	177.10	1.2164	1.7757	82.29	83.64	1.2164	0.9634	82.29

ROTOR 2

SL	EPSI-1	EPSI-2	V-1	V-2	VM-1	VM-2	VO-1	VO-2	B-1	B-2	M-1	M-2	RUN NO	% SPEED	CODE	10' POINT	NO 14	V'-1	V'-2
DEGREE	DEGREE	FT/SEC	FT/SEC	FT/SEC	FT/SEC	FT/SEC	FT/SEC	FT/SEC	DEGREE	DEGREE				U-1	U-2	M'-1	M'-1	FT/SEC	FT/SEC
1	11.581	11.097	671.5	1102.4	669.8	681.3	-48.4	866.7	-4.1	51.7	0.5672	0.8814		834.4	875.1	0.9361	0.5447	1106.1	681.3
2	10.769	9.841	677.4	1088.8	676.8	665.3	-27.7	861.9	-2.3	52.2	0.5733	0.8705		857.9	893.4	0.9434	0.5325	1114.6	666.1
3	9.832	8.655	690.7	1075.2	690.7	659.8	4.6	848.9	0.4	52.1	0.5855	0.8606		882.3	912.5	0.9467	0.5306	1118.9	662.9
4	6.563	5.362	703.1	996.1	702.9	647.8	13.3	756.6	1.1	49.4	0.5961	0.7933		957.7	973.2	0.9983	0.5446	1177.4	683.9
5	1.545	1.117	672.4	813.8	672.2	592.1	-17.2	642.6	-1.5	47.3	0.5668	0.6863		1061.8	1061.1	1.0715	0.5095	1271.3	725.0
6	-1.078	-1.070	647.2	818.2	646.5	555.1	-30.0	601.1	-2.7	47.2	0.5435	0.6383		1114.9	1107.9	1.1041	0.5864	1314.8	751.7
7	-2.266	-2.088	670.2	813.9	670.0	546.6	-14.2	608.4	-1.2	48.3	0.5641	0.6342		1141.6	1132.1	1.1266	0.5665	1336.0	752.7
8	-3.177	-2.945	691.8	820.0	691.8	527.6	1.9	627.7	0.2	49.9	0.5830	0.6374		1168.5	1136.8	1.1431	0.5806	1356.3	747.2
9	-5.313	-5.293	751.5	836.1	750.6	571.5	37.9	610.3	2.9	46.7	0.6260	0.6434		1250.4	1233.4	1.1878	0.6506	1426.0	645.5
10	-6.182	-6.248	772.0	836.9	770.1	593.8	54.3	589.7	4.0	44.6	0.6404	0.6429		1277.9	1259.6	1.1995	0.6677	1445.8	695.2
11	-7.518	-7.657	743.7	824.8	742.7	656.4	-37.2	496.9	-2.9	36.9	0.6143	0.6324		1305.5	1286.4	1.2675	0.7882	1534.5	1026.0

SL	INCS	INCM	DEV	TURN	RHOVM-1	RHOVM-2	O-FAC	OMEGA-B	LOSS-P	PO2/	SEFF-P	SEFF-A	B'-1	B'-2	VO'-1	VO'-2	PO/PO
DEGREE	DEGREE	DEGREE	DEGREE	DEGREE				TOTAL	TOTAL	POL	TOT	TOT	DEGREE	DEGREE	FT/SEC	FT/SEC	INLET
1	3.26	7.58	21.10	52.04	64.16	78.59	0.5774	0.2186	0.0498	1.7937	85.89	84.68	52.74	0.70	-882.8	-8.4	3.1436
2	2.64	7.09	18.52	49.89	65.07	78.11	0.5925	0.2073	0.0484	1.7973	86.43	85.27	52.59	2.70	-885.6	-31.5	3.1628
3	1.47	6.04	13.02	46.33	66.52	79.02	0.5906	0.1694	0.0404	1.7959	88.63	87.65	51.82	5.49	-877.7	-65.5	3.1857
4	1.65	6.45	8.92	34.92	67.44	80.61	0.5826	0.1280	0.0312	1.7320	90.19	89.38	53.41	18.48	-944.5	-210.5	3.1218
5	4.62	9.19	7.03	22.83	63.62	74.99	0.5759	0.1314	0.0304	1.6994	88.37	87.48	58.09	35.26	-1079.0	-418.5	2.9570
6	6.15	10.49	6.16	18.15	60.85	70.40	0.5694	0.1409	0.0309	1.6816	86.89	85.90	60.52	42.37	-1144.8	-506.9	2.8817
7	4.99	9.07	4.78	15.82	63.46	68.85	0.5778	0.1672	0.0366	1.6626	84.10	82.93	59.86	44.04	-1155.8	-523.7	2.8903
8	3.89	7.70	2.69	14.27	65.75	67.31	0.5926	0.1965	0.0435	1.6532	81.21	79.65	59.27	45.01	-1166.7	-529.1	2.9173
9	1.28	3.96	0.21	10.79	69.51	73.08	0.5449	0.1469	0.0348	1.6477	84.79	83.68	58.09	47.30	-1212.5	-623.1	2.9985
10	0.43	2.61	1.57	9.38	70.59	76.29	0.5134	0.1023	0.0247	1.6443	88.90	88.09	57.63	48.25	-1223.6	-669.9	3.0222
11	3.38	5.07	4.34	10.89	67.49	84.90	0.4516	0.0565	0.0137	1.6694	93.49	92.99	60.89	50.00	-1342.6	-789.5	3.0214

TO/TO	PO/PO	EFF-AD	EFF-P	WCL/A1	TO2/TO1	PO2/PO1	EFF-AD	EFF-P
INLET	INLET	INLET	INLET	LBM/SEC			ROTOR	ROTOR
		%	%	SOFT			%	%
1.4447	3.0215	83.17	85.53	39.34	1.1877	1.7016	86.72	87.67

STATOR 2

SL	EPSI-1	EPSI-2	V-1	V-2	VM-1	VM-2	VO-1	VO-2	B-1	B-2	M-1	M-2	RUN NO	% SPEED	CODE	10' POINT	NO 14	TU2/	TU1/
DEGREE	DEGREE	FT/SEC	FT/SEC	FT/SEC	FT/SEC	FT/SEC	FT/SEC	FT/SEC	DEGREE	DEGREE				INLET	INLET	INLET	STAGE	TOI	TOI
1	8.680	0.882	1124.3	840.0	726.6	840.0	858.0	0.9	50.0	0.1	0.9016	0.4875		2.9636	1.4522	1.6912	1.2124	1.2124	
2	7.650	0.836	1109.6	663.2	708.1	662.6	854.4	29.8	50.6	2.6	0.8897	0.5068		3.0073	1.4488	1.6717	1.2126	1.2126	
3	6.605	0.686	1095.3	691.0	699.7	689.7	842.7	41.9	50.5	3.5	0.8790	0.5305		3.0617	1.4419	1.6727	1.2079	1.2079	
4	3.778	-0.022	1015.7	677.9	681.1	677.9	753.5	-1.5	48.0	-0.1	0.8110	0.5227		3.0562	1.4271	1.6747	1.1938	1.1938	
5	0.803	-0.736	894.9	590.0	623.4	589.4	642.0	-27.0	45.8	-2.6	0.7045	0.4543		3.9221	1.4252	1.6766	1.1859	1.1859	
6	-0.537	-0.857	841.3	542.8	588.3	542.2	601.4	-23.6	45.6	-2.5	0.6579	0.4144		2.8565	1.4278	1.6635	1.1851	1.1851	
7	-1.294	-0.890	837.9	539.5	575.1	539.3	609.4	-13.2	46.6	-1.4	0.6545	0.4115		2.8503	1.4298	1.6465	1.1865	1.1865	
8	-2.248	-0.951	845.1	555.8	563.7	555.8	629.6	2.0	48.1	0.2	0.6585	0.4232		2.8673	1.4365	1.6298	1.1909	1.1909	
9	-5.314	-1.282	866.0	611.9	611.4	611.2	613.3	30.8	45.2	2.9	0.6083	0.4623		2.9204	1.4699	1.6063	1.1816	1.1816	
10	-6.181	-1.311	809.9	626.2	636.7	625.2	592.7	35.5	43.1	3.2	0.6704	0.4727		2.9317	1.4750	1.5939	1.1710	1.1710	
11	-6.647	-1.228	864.1	629.7	706.2	629.3	498.0	22.2	35.3	2.0	0.6651	0.4751		2.9261	1.4772	1.6205	1.1679	1.1679	

SL	INCS	INCM	DEV	TURN	RHOVM-1	RHOVM-2	O-FAC	OMEGA-B	LOSS-P	PO2/	SEFF-A	SEFF-P	SEFF-A	SEFF-P
DEGREE	DEGREE	DEGREE	DEGREE	DEGREE				TOTAL	TOTAL	POL	TOT-INLET	TOT-INLET	TOT-INLET	TOT-INLET
1	1.56	3.12	11.89	49.94	82.51	88.92	0.6027	0.1390	0.0314	0.9429	80.12	82.86	75.50	77.23
2	3.15	5.17	13.83	48.00	81.91	92.79	0.5730	0.1185	0.0273	0.9522	82.03	84.54	77.41	79.04
3	3.83	6.33	14.32	47.00	82.63	97.66	0.5412	0.0937	0.0219	0.9628	84.87	87.02	80.94	82.34
4	2.39	6.26	10.19	46.08	83.71	97.18	0.5219	0.0672	0.0167	0.9761	87.67	89.43	85.32	86.59
5	1.11	6.42	7.88	46.45	78.06	83.58	0.5466	0.0550	0.0147	0.9843	83.96	86.15	86.49	85.95
6	1.20	6.99	7.73	48.08	73.75	78.23	0.5657	0.0473	0.0131	0.9879	81.39	83.88	83.94	85.05
7	2.39	6.38	8.77	48.02	72.36	75.65	0.5637	0.0507	0.0142	0.9873	80.83	83.39	81.45	82.74
8	4.09	10.29	10.31	47.93	71.02	77.66	0.5512	0.0400	0.0170	0.9849	80.11	82.78	77.88	79.34
9	1.36	8.05	13.81	42.28	77.03	83.63	0.4919	0.1020	0.0299	0.9736	75.87	79.15	78.95	80.30
10	-1.40	5.48	14.02	39.81	80.47	85.18	0.4709	0.1172	0.0346	0.9695	75.36	78.72	82.58	83.68
11	-10.41	-3.31	13.95	33.31	89.30	85.42	0.4386	0.1196	0.0357	0.9693	74.92	78.33	87.26	88.10

NCORR	NCORR	TO/TO	PO/PO	EFF-AD	EFF-P	TO2/TO1	PO2/PO1	EFF-AD	EFF-P
INLET	INLET	INLET	INLET	INLET	INLET			STAGE	STAGE
RPM	LBM/SEC			%	%			%	%
10700	177.10	1.4447	2.9666	80.98	83.59	1.1877	0.9752	82.33	82.33

ORIGINAL PAGE IS
OF POOR QUALITY

APPENDIX D

OVERALL PERFORMANCE AND BLADE-ELEMENT DATA FOR TIP RADially DISTORTED INLET FLOW

This appendix provides test overall performance and blade-element data for tip radially distorted inlet flow with casing treatment and design stator-settings. The data is present for 70 percent and 100 percent of design speed. An overall-performance and stall data summary is given in Table XVIII, and the complete overall performance and blade-element data are given in Tables XIX and XX. The column headings for Tables XIX and XX are identified in Table XIII of Appendix B.

TABLE XVIII – OVERALL PERFORMANCE AND STALL DATA SUMMARY
WITH TIP-RADIAL INLET FLOW DISTORTION

PERFORMANCE

Reference Table ¹	Percent of Design Speed	Corrected Flow ² lbm/sec	P_{11}/P_0	$\eta_{ad,11}$ (%)	P_{16}/P_0	$\eta_{ad,16}$ (%)
XIX (a)	70	126.4	1.332	89.13	1.563	76.85
XIX (b)	70	115.4	1.353	87.99	1.722	84.76
XIX (c)	70	103.9	1.326	79.19	1.734	77.98
XX(a)	100	184.4	1.638	79.87	2.328	72.62
XX(b)	100	184.0	1.657	80.45	2.717	82.71
XX(c)	100	180.0	1.842	86.36	3.037	82.91

STALL POINT DATA

Percent of Design Speed	Corrected Flow ² (lbm/sec)	P_6/P_0	Stall Margin %
70	174.7	3.072	15.6
100	103.8	1.735	15.3

- Notes: (1) Refers to remaining Appendix D tables.
(2) Corrected flow = $W\sqrt{\theta/\delta}$

PRECEDING PAGE BLANK NOT FILMED

**ORIGINAL PAGE IS
OF POOR QUALITY**

TABLE XIX(a) – OVERALL PERFORMANCE AND BLADE-ELEMENT DATA
(Tip Radially Distorted Inlet Flow, 70 Percent Speed)

U. S. CUSTOMARY UNITS

ROTOR 1

SL	EPISI-1	EPISI-2	V-1	V-2	VM-1	VM-2	V0-1	V0-2	B-1	B-2	M-1	M-2	U-1	U-2	M'-1	M'-2	V'-1	V'-2
DEGREE	DEGREE	FT/SEC	FT/SEC	FT/SEC	FT/SEC	FT/SEC	FT/SEC	FT/SEC	DEGREE	DEGREE			FT/SEC	FT/SEC			FT/SEC	FT/SEC
1	14.003	15.903	405.6	766.0	405.6	489.4	0.0	589.3	0.0	50.3	0.3681	0.0835	478.1	538.1	0.5689	0.4390	626.9	492.0
2	6.646	8.025	443.7	649.9	443.7	461.1	0.0	458.0	0.0	44.8	0.4037	0.5747	609.7	637.4	0.681	0.4375	754.1	494.8
3	2.926	2.092	456.5	568.8	456.5	432.7	0.0	369.1	0.0	40.5	0.4158	0.5006	731.5	736.7	0.7853	0.4998	862.2	567.8
4	-0.452	-2.709	472.6	545.3	432.6	430.0	0.0	335.3	0.0	37.9	0.3933	0.4783	847.9	836.1	0.8654	0.5790	951.9	660.0
5	-6.910	-7.996	384.6	539.9	364.6	409.7	0.0	351.7	0.0	40.5	0.3300	0.4699	963.0	935.4	0.9320	0.6207	1029.6	713.1

SL	INCS	INCM	DEV	TURN	RHOVM-1	RHOVM-2	D-FAC	OMEGA-B	LOSS-P	PO2/	EFF-P	EFF-A	B'-1	B'-2	V0'-1	V0'-2	PO/PO
DEGREE	DEGREE	DEGREE	DEGREE							P01	TOT	TOT	DEGREE	DEGREE	FT/SEC	FT/SEC	INLET
1	1.62	5.91	13.63	55.41	29.48	38.69	0.4467	0.0084	0.0019	1.4015	99.50	99.50	49.44	-5.98	-478.1	51.2	1.4243
2	2.27	5.84	11.26	32.61	31.95	37.51	0.5100	0.0807	0.0200	1.3387	92.02	92.76	52.87	21.26	-609.7	-179.4	1.3657
3	3.54	6.22	10.08	17.70	32.59	35.72	0.4690	0.0808	0.0185	1.3046	90.79	90.47	58.06	40.35	-731.5	-367.6	1.3266
4	5.70	7.65	6.46	13.60	30.50	35.83	0.4191	0.0388	0.0064	1.3317	95.02	94.84	62.92	49.31	-847.9	-500.8	1.3285
5	9.44	10.73	7.81	14.32	25.39	34.10	0.4266	0.0461	0.0096	1.3925	94.24	94.00	69.12	54.81	-963.0	-583.7	1.3406

TD/TO	PD/PO	EFF-AD	EFF-P	WC1/A1	TO2/TO1	PO2/PO1	EFF-AD	EFF-P
INLET	INLET	INLET	INLET	LBM/SEC			ROTOR	ROTOR
1.0957	1.3525	94.13	94.35	28.70	1.0957	1.3525	94.17	94.39

STATOR 1

SL	EPISI-1	EPISI-2	V-1	V-2	VM-1	VM-2	V0-1	V0-2	B-1	B-2	M-1	M-2	U-1	U-2	M'-1	M'-2	V'-1	V'-2
DEGREE	DEGREE	FT/SEC	FT/SEC	FT/SEC	FT/SEC	FT/SEC	FT/SEC	FT/SEC	DEGREE	DEGREE			FT/SEC	FT/SEC			FT/SEC	FT/SEC
1	15.911	12.766	773.0	583.9	512.3	583.4	578.9	-23.9	48.6	-2.3	0.6903	0.5111	1.3880	1.1017	1.3657	1.1017	1.0934	1.0934
2	8.207	5.675	862.6	530.0	482.2	529.8	454.4	-12.1	43.3	-1.3	0.5866	0.4636	1.3460	1.0934	1.3195	1.0934	1.0934	1.0934
3	2.425	-0.721	582.8	494.5	451.5	494.4	368.5	-8.3	39.2	-1.0	0.5136	0.4326	1.3151	1.0873	1.2938	1.0873	1.0873	1.0873
4	-2.122	-5.405	560.2	494.6	448.3	494.4	336.0	-15.8	36.9	-1.8	0.4921	0.4322	1.3115	1.0899	1.3146	1.0899	1.0899	1.0899
5	-6.736	-8.166	559.7	503.0	435.5	502.8	354.1	12.1	39.3	1.4	0.4880	0.4365	1.3162	1.1056	1.3670	1.1056	1.1056	1.1056

SL	INCS	INCM	DEV	TURN	RHOVM-1	RHOVM-2	D-FAC	OMEGA-B	LOSS-P	PO2/	EFF-P	EFF-A	B'-1	B'-2	V0'-1	V0'-2	PO/PO
DEGREE	DEGREE	DEGREE	DEGREE							P01	TOT	TOT	DEGREE	DEGREE	FT/SEC	FT/SEC	INLET
1	-2.22	0.19	8.90	50.95	40.33	49.49	0.4031	0.0918	0.0195	0.9750	88.25	88.67	87.55	87.95	90.87	90.81	88.51
2	-3.72	0.00	7.97	44.59	38.97	44.89	0.3655	0.0640	0.0156	0.9868	88.25	88.67	87.55	87.95	90.87	90.81	88.51
3	-6.29	-1.24	8.35	40.17	37.04	41.72	0.3263	0.0528	0.0144	0.9914	88.25	88.67	87.55	87.95	90.87	90.81	88.51
4	-7.75	-1.60	7.59	38.70	37.12	41.51	0.3041	0.0832	0.0247	0.9873	88.25	88.67	87.55	87.95	90.87	90.81	88.51
5	-5.62	1.43	13.17	37.93	35.78	41.69	0.2967	0.1211	0.0383	0.9818	88.25	88.67	87.55	87.95	90.87	90.81	88.51

NCORR	WCORR	TO/TO	PD/PO	EFF-AD	EFF-P	TO2/TO1	PO2/PO1	EFF-AD	EFF-P
INLET	INLET	INLET	INLET	INLET	INLET			STAGE	
7543.	126.36	1.0957	1.3315	89.09	89.49	1.0957	0.9846	89.13	

ROTOR 2

SL	EPISI-1	EPISI-2	V-1	V-2	VM-1	VM-2	V0-1	V0-2	B-1	B-2	M-1	M-2	U-1	U-2	M'-1	M'-2	V'-1	V'-2
DEGREE	DEGREE	FT/SEC	FT/SEC	FT/SEC	FT/SEC	FT/SEC	FT/SEC	FT/SEC	DEGREE	DEGREE			FT/SEC	FT/SEC			FT/SEC	FT/SEC
1	10.396	9.888	654.7	859.2	654.3	717.7	-23.3	472.4	-2.0	33.3	0.5769	0.7396	604.8	629.8	0.7993	0.6324	907.0	734.7
2	4.758	5.052	612.4	785.4	612.3	683.7	-11.8	394.7	-1.1	30.0	0.5396	0.6798	675.2	686.0	0.8108	0.6399	920.2	743.2
3	-1.662	0.157	566.3	671.1	566.2	583.8	-8.5	331.1	-0.9	29.6	0.4963	0.5741	748.5	748.0	0.8319	0.6137	945.4	717.4
4	-6.477	-4.069	545.7	590.7	545.5	536.2	-15.0	247.8	-1.6	24.8	0.4784	0.5037	823.8	815.5	0.8776	0.6658	1000.6	780.9
5	-8.778	-7.917	541.6	596.4	541.4	529.7	12.3	274.1	1.3	27.3	0.4714	0.5041	900.9	888.0	0.9058	0.6824	1040.5	810.8

SL	INCS	INCM	DEV	TURN	RHOVM-1	RHOVM-2	D-FAC	OMEGA-B	LOSS-P	PO2/	EFF-P	EFF-A	B'-1	B'-2	V0'-1	V0'-2	PO/PO
DEGREE	DEGREE	DEGREE	DEGREE							P01	TOT	TOT	DEGREE	DEGREE	FT/SEC	FT/SEC	INLET
1	-0.17	-1.72	26.15	31.45	53.65	66.83	0.3203	0.0235	-0.0054	1.3666	102.61	102.75	43.78	12.33	-628.1	-157.4	1.8966
2	-3.48	1.31	13.51	25.19	50.01	64.84	0.3071	0.0973	-0.0231	1.3618	112.21	112.78	46.27	23.08	-681.0	-251.4	1.9292
3	-0.25	4.33	7.31	17.69	46.38	54.14	0.3447	0.0450	0.0104	1.2673	92.90	92.73	53.22	35.54	-757.1	-416.9	1.6649
4	1.65	5.46	4.27	10.44	44.80	48.45	0.3031	0.1114	0.0240	1.1822	78.52	78.05	57.03	46.59	-838.8	-567.6	1.5510
5	1.42	3.60	2.44	9.50	44.21	46.33	0.3120	0.1831	0.0435	1.1607	65.20	64.49	58.62	49.12	-888.6	-613.9	1.5277

TO/TO	PD/PO	EFF-AD	EFF-P	WC1/A1	TO2/TO1	PO2/PO1	EFF-AD	EFF-P
INLET	INLET	INLET	INLET	LBM/SEC			ROTOR	ROTOR
1.1771	1.6791	90.10	90.77	35.53	1.0742	1.2611	92.18	92.40

STATOR 2

SL	EPISI-1	EPISI-2	V-1	V-2	VM-1	VM-2	V0-1	V0-2	B-1	B-2	M-1	M-2	U-1	U-2	M'-1	M'-2	V'-1	V'-2
DEGREE	DEGREE	FT/SEC	FT/SEC	FT/SEC	FT/SEC	FT/SEC	FT/SEC	FT/SEC	DEGREE	DEGREE			FT/SEC	FT/SEC			FT/SEC	FT/SEC
1	8.243	1.362	892.0	857.3	759.1	855.6	468.5	-53.1	31.9	-3.5	0.7710	0.7375	1.6230	1.2021	1.1668	1.0908	1.0908	1.0908
2	5.914	1.915	816.6	859.5	715.5	857.8	393.6	-59.6	28.9	-3.6	0.7054	0.7451	1.6695	1.1861	1.2346	1.0835	1.0835	1.0835
3	3.656	1.389	699.8	782.8	616.1	780.7	331.8	-56.9	26.3	-4.2	0.6004	0.6769	1.6042	1.1714	1.2169	1.0773	1.0773	1.0773
4	0.207	0.384	618.8	661.4	566.7	659.0	248.5	-57.2	23.6	-5.0	0.5289	0.5678	1.4876	1.1589	1.1344	1.0639	1.0639	1.0639
5	-4.123	-0.465	632.1	663.6	568.8	662.6	275.7	-17.0	25.9	-1.5	0.5360	0.5646	1.4870	1.1795	1.1258	1.0669	1.0669	1.0669

SL	INCS	INCM	DEV	TURN	RHOVM-1	RHOVM-2	D-FAC	OMEGA-B	LOSS-P	PO2/	EFF-P	EFF-A	B'-1	B'-2	V0'-1	V0'-2	PO/PO
DEGREE	DEGREE	DEGREE	DEGREE							P01	TOT	TOT	DEGREE	DEGREE	FT/SEC	FT/SEC	INLET
1	-15.50	-13.48	7.70	35.47	69.19	68.24	0.1772	0.4404	0.1012	0.8557	50.09	51.15	74.22	74.94	75.15	75.80	57.35
2	-16.62	-12.75	6.74	32.52	66.81	70.96	0.1008	0.3311	0.0821	0.9039	50.09	51.15	74.22	74.94	75.15	75.80	57.35
3	-16.38	-11.07	6.13	32.50	56.45	65.66	0.0717	0.2561	0.0683	0.9405	50.09	51.15	74.22	74.94	75.15	75.80	57.35
4	-20.41	-14.21	5.15	28.59	50.60	55.33	0.0776	0.2616	0.0740	0.9541	50.09	51.15	74.22	74.94	75.15	75.80	57.35
5	-18.59																

TABLE XIX(b) — OVERALL PERFORMANCE AND BLADE-ELEMENT DATA
(Tip Radially Distorted Inlet Flow, 70 Percent Speed)

U. S. CUSTOMARY UNITS

ROTOR 1

															RUN NO 11, SPEED CODE 70, POINT NO 3			
SL	EPSI-1	EPSI-2	V-1	V-2	VM-1	VM-2	V0-1	V0-2	B-1	B-2	M-1	M-2	U-1	U-2	M-1	M-1	V*-1	V*-2
	DEGREE	DEGREE	FT/SEC	FT/SEC	FT/SEC	FT/SEC	FT/SEC	FT/SEC	DEGREE	DEGREE			FT/SEC	FT/SEC			FT/SEC	FT/SEC
1	14.512	15.913	369.0	714.4	369.6	419.7	0.0	578.1	0.0	54.0	0.3347	0.6345	473.7	533.2	0.5440	0.3749	600.8	422.1
2	7.376	8.093	403.0	634.4	403.0	416.6	0.0	478.5	0.0	49.0	0.3657	0.5592	604.1	631.6	0.6589	0.3913	726.2	453.9
3	3.217	2.434	413.5	504.6	413.5	393.0	0.0	404.6	0.0	45.8	0.3755	0.4950	724.8	730.0	0.7577	0.4479	834.4	510.9
4	-0.710	-2.297	386.5	540.6	386.5	393.6	0.0	370.5	0.0	43.2	0.3503	0.4721	840.1	828.4	0.8382	0.5274	924.7	603.9
5	-7.150	-7.831	325.2	540.0	325.2	363.6	0.0	399.3	0.0	67.5	0.2937	0.4671	954.1	926.8	0.9104	0.5542	1008.0	640.7

SL	INCS	INCM	DEV	TURN	RHOVM-1	RHOVM-2	D-FAC	OMEGA-B	LOSS-P	PO2/	%EFF-P	%EFF-A	B*-1	B*-2	V0*-1	V0*-2	PO/PO
DEGREE	DEGREE	DEGREE	DEGREE	DEGREE	TOTAL	TOTAL	TOTAL	TOTAL	PO1	TGT	TOT	DEGREE	DEGREE	FT/SEC	FT/SEC	INLET	
1	4.03	0.33	13.49	57.96	27.13	33.66	0.5325	0.0458	0.0105	1.3799	97.52	97.43	51.85	-6.12	-473.7	45.0	1.3997
2	4.75	8.22	10.50	30.06	29.34	34.52	0.5671	0.0645	0.0161	1.3605	95.01	94.81	56.25	20.19	-604.1	-153.2	1.3836
3	5.61	8.49	9.31	20.74	29.90	33.15	0.5313	0.0799	0.0185	1.3390	92.09	91.79	60.32	39.58	-724.8	-328.4	1.3582
4	8.03	9.98	6.42	15.97	27.66	33.49	0.4750	0.0425	0.0092	1.3675	95.25	95.06	65.25	49.27	-840.1	-457.9	1.3628
5	11.38	12.67	8.28	15.77	23.06	30.85	0.5033	0.0897	0.0185	1.4254	90.23	89.75	71.06	59.28	-954.1	-527.5	1.3812

TO/TO	PO/PO	EFF-AD	EFF-P	MC1/A1	TO2/TO1	PO2/PO1	EFF-AD	EFF-P
INLET	INLET	%	%	SOFT			%	%
1.1025	1.3755	93.06	93.34	26.21	1.1025	1.3757	93.09	93.37

STATOR 1

															RUN NO 11, SPEED CODE 70, POINT NO 3			
SL	EPST-1	EPST-2	V-1	V-2	VM-1	VM-2	V0-1	V0-2	B-1	B-2	M-1	M-2	U-1	U-2	M-1	M-1	V*-1	V*-2
	DEGREE	DEGREE	FT/SEC	FT/SEC	FT/SEC	FT/SEC	FT/SEC	FT/SEC	DEGREE	DEGREE			INLET	INLET	STAGE	STAGE	FT/SEC	FT/SEC
1	15.935	12.660	717.5	476.6	438.6	475.9	567.9	-26.1	52.5	-3.1	0.6375	0.4141	1.3631	1.0990	1.3438	1.0990		
2	8.528	5.667	643.1	464.5	433.9	464.5	474.6	-0.6	47.6	-0.1	0.5673	0.4036	1.3583	1.0970	1.3356	1.0970		
3	2.962	-0.247	575.1	443.8	409.4	443.7	403.9	-6.3	44.6	-0.8	0.5046	0.3855	1.3444	1.0948	1.3249	1.0948		
4	-1.450	-4.473	552.5	442.8	409.7	442.7	370.8	-4.6	42.1	-0.6	0.4831	0.3841	1.3447	1.0973	1.3476	1.0973		
5	-6.427	-7.650	556.7	456.3	385.0	456.3	402.0	6.0	46.3	0.6	0.4822	0.3923	1.3560	1.1188	1.3566	1.1188		

SL	INCS	INCM	DEV	TURN	RHOVM-1	RHOVM-2	D-FAC	OMEGA-B	LOSS-P	PO2/	%EFF-P	%EFF-A	B*-1	B*-2	V0*-1	V0*-2	PO/PO
DEGREE	DEGREE	DEGREE	DEGREE	DEGREE	TOTAL	TOTAL	TOTAL	TOTAL	PO1	TGT	TOT	DEGREE	DEGREE	FT/SEC	FT/SEC	INLET	
1	1.61	4.01	8.11	59.57	35.14	41.49	0.5056	0.1092	0.0232	0.9739	89.08	89.49					
2	0.58	4.30	9.20	47.66	35.80	40.59	0.4554	0.0935	0.0228	0.9816	88.08	89.29					
3	-0.89	4.16	8.50	45.42	34.30	38.73	0.4227	0.0633	0.0173	0.9899	86.36	88.78					
4	-2.46	3.68	8.83	42.74	34.68	38.58	0.3986	0.0845	0.0251	0.9875	91.57	91.89					
5	1.36	8.41	12.54	45.54	32.44	39.20	0.4082	0.1238	0.0392	0.9818	84.70	85.38					

NCORR	WCORR	TO/TO	PO/PO	EFF-AD	EFF-P	TO2/TO1	PO2/PO1	EFF-AD	EFF-P
INLET	INLET	INLET	INLET	%	%			%	%
747.4	115.37	1.1025	1.3526	87.96	88.43	1.1025	0.9834	87.99	

ROTOR 2

															RUN NO 11, SPEED CODE 70, POINT NO 3			
SL	EPSI-1	EPSI-2	V-1	V-2	VM-1	VM-2	V0-1	V0-2	B-1	B-2	M-1	M-2	U-1	U-2	M-1	M-1	V*-1	V*-2
	DEGREE	DEGREE	FT/SEC	FT/SEC	FT/SEC	FT/SEC	FT/SEC	FT/SEC	DEGREE	DEGREE			FT/SEC	FT/SEC			FT/SEC	FT/SEC
1	10.227	9.490	524.4	819.4	527.8	623.6	-25.4	531.5	-2.8	40.3	0.4609	0.6992	599.3	624.0	0.7134	0.5380	817.6	630.5
2	4.357	4.276	524.2	727.7	524.2	575.9	-0.5	446.9	-0.1	37.6	0.4576	0.6192	669.0	679.7	0.7422	0.5292	850.3	621.9
3	-1.653	-0.433	497.2	624.0	497.2	505.4	-6.3	365.9	-0.7	35.9	0.4335	0.5280	741.7	741.2	0.7831	0.5327	898.1	629.5
4	-5.667	-4.215	485.4	578.9	485.4	405.8	-4.4	343.7	-0.5	36.4	0.4223	0.4868	816.2	808.0	0.8294	0.5590	953.4	657.7
5	-6.412	-7.621	496.4	552.9	496.4	478.6	6.1	350.0	0.7	30.1	0.4280	0.4933	692.6	679.8	0.8760	0.5940	1016.0	713.9

SL	INCS	INCM	DEV	TURN	RHOVM-1	RHOVM-2	D-FAC	OMEGA-B	LOSS-P	PO2/	%EFF-P	%EFF-A	B*-1	B*-2	V0*-1	V0*-2	PO/PO
DEGREE	DEGREE	DEGREE	DEGREE	DEGREE	TOTAL	TOTAL	TOTAL	TOTAL	PO1	TGT	TOT	DEGREE	DEGREE	FT/SEC	FT/SEC	INLET	
1	-0.21	4.24	22.22	41.34	45.12	59.73	0.3923	0.0046	-0.0011	1.4038	100.38	100.42	49.74	8.40	-624.7	-91.5	1.9134
2	0.15	4.39	12.60	29.75	44.79	56.18	0.4060	0.0108	-0.0026	1.3506	101.14	101.21	51.90	22.16	-669.5	-23.5	1.8326
3	2.95	7.51	8.37	19.81	42.57	49.04	0.4188	0.0744	0.0169	1.2801	90.49	90.19	56.40	36.59	-748.0	-37.2	1.7205
4	4.04	7.85	2.55	14.55	41.66	44.55	0.4261	0.1594	0.0354	1.2409	78.14	77.49	59.42	44.67	-820.6	-46.3	1.6695
5	5.50	5.68	1.13	12.90	42.05	44.80	0.4195	0.1927	0.0470	1.2359	72.66	71.66	60.71	47.81	-886.5	-52.8	1.6759

TO/TO	PO/PO	EFF-AD	EFF-P	MC1/A1	TO2/TO1	PO2/PO1	EFF-AD	EFF-P
INLET	INLET	%	%	SOFT			%	%
1.1981	1.7504	87.50	88.43	32.03	1.0867	1.2941	88.02	88.43

STATOR 2

															RUN NO 11, SPEED CODE 70, POINT NO 3			
SL	EPST-1	EPST-2	V-1	V-2	VM-1	VM-2	V0-1	V0-2	B-1	B-2	M-1	M-2	U-1	U-2	M-1	M-1	V*-1	V*-2
	DEGREE	DEGREE	FT/SEC	FT/SEC	FT/SEC	FT/SEC	FT/SEC	FT/SEC	DEGREE	DEGREE			INLET	INLET	STAGE	STAGE	FT/SEC	FT/SEC
1	7.757	0.655	845.4	724.7	661.2	724.6	526.9	11.3	38.8	0.9	0.7236	0.6119	1.8543	1.2100	1.3603	1.1011		
2	4.503	0.005	749.6	662.1	604.3	661.9	443.5	-14.8	36.4	-1.3	0.6392	0.5593	1.7967	1.1949	1.3234	1.0893		
3	1.773	-0.442	643.7	566.2	529.7	565.5	365.7	-27.3	34.6	-2.8	0.5456	0.4767	1.7060	1.1837	1.2691	1.0812		
4	-1.467	-0.762	598.1	513.1	489.0	512.4	344.4	-27.2	35.1	-3.0	0.5038	0.4294	1.6588	1.1882	1.2333	1.0821		
5	-4.750	-1.004	618.8	520.2	508.8	520.2	352.2	-1.0	34.7	-0.1	0.5159	0.4305	1.6552	1.2156	1.2206	1.0865		

SL	INCS	INCM	DEV	TURN	RHOVM-1	RHOVM-2	D-FAC	OMEGA-B	LOSS-P	PO2/	%EFF-P	%EFF-A	B*-1	B*-2	V0*-1	V0*-2	PO/PO
DEGREE	DEGREE	DEGREE	DEGREE	DEGREE	TOTAL	TOTAL	TOTAL	TOTAL	PO1	TGT	TOT	DEGREE	DEGREE	FT/SEC	FT/SEC	INLET	
1	-8.84	-6.62	12.15	37.88	62.33	70.89	0.2836	0.1048	0.0241	0.9691	90.75	91.12					
2	-9.20	-5.33	9.04	37.64	58.29	65.39	0.2753	0.0932	0.0231	0.9773	93.14	93.38					
3	-10.09	-4.79	7.54	37.38	50.96	55.76	0.2919	0.0658	0.0176	0.9877	86.61	87.02					
4	-8.93	-2.73	7.07	38.16	46.40	49.97	0.3196	0.0411	0.0117	0.9935	75.04	75.74					
5	-9.73	-2.85	10.67	34.84	47.11	49.46	0.3286	0.0743	0.0220	0.9877	67.61	68.48					

NCORR	WCORR	TO/TO	PO/PO	EFF-AD	EFF-P	TO2/TO1	PO2/PO1	EFF-AD	EFF-P

TABLE XIX(c) — OVERALL PERFORMANCE AND BLADE-ELEMENT DATA
(Tip Radially Distorted Inlet Flow, 70 Percent Speed)

U. S. CUSTOMARY UNITS

ROTOR 1

SL		EPI-1		EPI-2		V-1		V-2		VM-1		VM-2		V0-1		V0-2		B-1		B-2		M-1		M-2		U-1		U-2		M'-1		M'-2		V'-1		V'-2		
DEGREE		DEGREE		FT/SEC		FT/SEC		FT/SEC		FT/SEC		FT/SEC		FT/SEC		FT/SEC		DEGREE		DEGREE		M-1		M-2		FT/SEC		FT/SEC		M'-1		M'-2		FT/SEC		FT/SEC		
1	13.913	15.652	343.4	710.3	343.4	415.6	0.0	576.0	0.0	54.2	0.3104	0.6306	474.8	534.4	0.5297	0.3708	585.9	417.7																				
2	5.778	7.455	368.0	647.3	368.0	424.4	0.0	488.7	0.0	49.0	0.3332	0.5707	605.5	633.1	0.6415	0.3953	708.6	448.3																				
3	-0.384	1.477	372.9	594.9	372.9	424.0	0.0	417.4	0.0	44.5	0.3377	0.5222	726.5	731.7	0.7395	0.4632	816.6	527.8																				
4	-6.585	-3.573	338.5	551.1	338.9	370.1	0.0	408.4	0.0	47.8	0.3063	0.4794	842.1	830.3	0.8204	0.4882	907.7	561.3																				
5	-11.426	-6.775	276.0	495.6	276.0	242.0	0.0	429.8	0.0	60.5	0.2487	0.4236	956.4	929.0	0.8988	0.4764	995.4	555.1																				

SL	INCS	INCH	DEV	TURN	RHOVM-1	RHOVM-2	D-FAC	OMEGA-B	LOSS-P	PO2/	EFF-P	EFF-A	B'-1	B'-2	V0'-1	V0'-2	PO/PO
DEGREE		DEGREE	DEGREE	DEGREE	TOTAL		TOTAL	TOTAL	PO1	TOT	TOT	DEGREE	DEGREE	FT/SEC	FT/SEC	INLET	
1	6.05	10.35	13.89	59.58	25.34	33.12	0.5292	0.0870	0.0199	1.3699	95.44	95.26	53.87	-5.71	-474.8	41.0	1.3868
2	7.07	10.56	9.08	39.83	27.00	34.85	0.5553	0.0851	0.0215	1.3639	93.64	93.38	58.59	18.76	-605.5	-144.3	1.3823
3	8.30	10.98	6.28	26.27	27.23	35.11	0.5143	0.0934	0.0225	1.3464	90.88	90.52	62.82	36.55	-726.5	-314.3	1.3582
4	10.95	12.90	5.88	19.43	24.59	30.19	0.5369	0.1825	0.0400	1.3361	80.25	79.46	68.16	48.74	-842.1	-422.0	1.3237
5	14.30	15.59	17.01	9.97	19.92	19.43	0.5995	0.3033	0.0481	1.3280	67.21	65.90	73.98	64.01	-956.4	-499.2	1.2905

TO/TO	PO/PO	EFF-AD	EFF-P	WC1/A1	TO2/T01	PO2/PO1	EFF-AD	EFF-P
INLET	INLET	INLET	INLET	LBM/SEC			ROTOR	ROTOR
		%	%	SQFT			%	%
1.1062	1.3481	83.97	84.60	23.60	1.1062	1.3482	83.99	84.63

STATOR 1

SL		EPI-1		EPI-2		V-1		V-2		VM-1		VM-2		V0-1		V0-2		B-1		B-2		M-1		M-2		U-1		U-2		M'-1		M'-2		V'-1		V'-2		
DEGREE		DEGREE		FT/SEC		FT/SEC		FT/SEC		FT/SEC		FT/SEC		FT/SEC		FT/SEC		DEGREE		DEGREE		M-1		M-2		FT/SEC		FT/SEC		M'-1		M'-2		FT/SEC		FT/SEC		
1	15.826	12.848	713.9	480.2	435.4	479.9	565.8	-16.8	52.5	-2.0	0.6341	0.4173	1.3503	1.0988	1.3338	1.0988																						
2	8.565	6.430	655.5	484.0	441.3	484.0	484.8	-2.8	47.7	-0.3	0.5784	0.4207	1.3561	1.0993	1.3381	1.0993																						
3	3.819	1.980	602.9	471.0	435.8	471.0	416.6	3.3	43.7	0.4	0.5296	0.4093	1.3451	1.0980	1.3332	1.0980																						
4	0.321	-0.305	559.0	412.4	381.9	412.0	408.3	-18.0	46.9	-2.5	0.4867	0.3553	1.3099	1.1080	1.3309	1.1080																						
5	-5.328	-4.816	504.3	312.6	259.1	296.4	432.6	-99.3	59.1	-16.5	0.4331	0.2655	1.2676	1.1281	1.3040	1.1281																						

SL	INCS	INCH	DEV	TURN	RHOVM-1	RHOVM-2	D-FAC	OMEGA-B	LOSS-P	PO2/	EFF-P	EFF-A	B'-1	B'-2	V0'-1	V0'-2	PO/PO
DEGREE		DEGREE	DEGREE	DEGREE	TOTAL		TOTAL	TOTAL	PO1	TOT	TOT	DEGREE	DEGREE	FT/SEC	FT/SEC	INLET	
1	1.89	4.10	9.24	54.53	34.63	41.39	0.4946	0.1110	0.0236	0.9737							
2	0.71	4.42	8.95	48.03	36.08	41.85	0.4399	0.0925	0.0226	0.9812							
3	-1.77	3.28	9.71	43.34	35.97	40.64	0.4053	0.0566	0.0155	0.9901							
4	2.30	8.44	6.92	49.41	31.08	34.99	0.4901	0.0788	0.0234	0.9882							
5	-14.14	21.19	-6.74	77.59	20.68	24.59	0.7163	0.1483	0.0445	0.9820							

NCORR	WCORR	TO/TO	PO/PO	EFF-AD	EFF-P	TO2/T01	PO2/PO1	EFF-AD	EFF-P
INLET	INLET	INLET	INLET	INLET	INLET			STAGE	
RPM		LBM/SEC							
7491.	103.91	1.1062	1.3261	79.16	79.95	1.1062	0.9837	79.19	

ROTOR 2

SL		EPI-1		EPI-2		V-1		V-2		VM-1		VM-2		V0-1		V0-2		B-1		B-2		M-1		M-2		U-1		U-2		M'-1		M'-2		V'-1		V'-2	
DEGREE		DEGREE		FT/SEC		FT/SEC		FT/SEC		FT/SEC		FT/SEC		FT/SEC		FT/SEC		DEGREE		DEGREE		M-1		M-2		FT/SEC		FT/SEC		M'-1		M'-2		FT/SEC		FT/SEC	
1	10.387	9.646	526.4	822.0	526.2	606.1	-16.4	559.4	-1.8	42.4	0.4592	0.7006	600.7	625.5	0.7073	0.5200	810.9	610.1																			
2	5.047	4.801	534.8	730.3	534.7	576.7	-2.6	448.1	-0.3	37.8	0.4666	0.6205	670.5	681.3	0.7502	0.5285	859.7	622.0																			
3	0.292	0.870	503.7	627.2	503.7	476.5	3.2	407.8	0.4	40.6	0.4387	0.5283	743.4	742.9	0.7798	0.4507	895.3	582.5																			
4	-0.803	-1.212	438.6	580.4	438.5	379.8	-15.5	438.9	-2.0	49.0	0.3788	0.4811	818.1	809.9	0.8132	0.4401	941.9	530.9																			
5	-4.619	-4.412	366.4	553.1	352.7	410.6	-99.3	370.6	-15.6	41.8	0.3120	0.4504	694.7	881.9	0.8982	0.5339	1054.6	655.7																			

SL	INCS	INCH	DEV	TURN	RHOVM-1	RHOVM-2	D-FAC	OMEGA-B	LOSS-P	PO2/	EFF-P	EFF-A	B'-1	B'-2	V0'-1	V0'-2	PO/PO
DEGREE		DEGREE	DEGREE	DEGREE	TOTAL		TOTAL	TOTAL	PO1	TOT	TOT	DEGREE	DEGREE	FT/SEC	FT/SEC	INLET	
1	-0.46	3.49	20.39	42.52	44.59	57.73	0.4164	0.0032	0.0008	1.4144	99.74	99.74	49.49	6.57	-617.1	-70.1	1.9099
2	-0.22	4.57	12.44	29.52	45.35	56.04	0.4129	0.0022	-0.0005	1.3513	100.25	100.28	51.53	22.01	-673.2	-233.2	1.8326
3	2.30	6.87	6.90	20.65	42.93	45.90	0.4767	0.1362	0.0316	1.2821	84.24	83.72	55.77	35.12	-740.2	-335.1	1.7242
4	6.78	10.59	1.90	17.94	37.01	35.80	0.5814	0.2793	0.0627	1.2825	70.81	69.79	62.16	44.22	-833.6	-371.0	1.6872
5	13.09	15.27	4.28	19.33	28.90	38.13	0.5336	0.2442	0.0559	1.3301	73.30	72.23	70.29	50.96	-994.3	-511.3	1.6893

TO/TO	PO/PO	EFF-AD	EFF-P	WC1/A1	TO2/T01	PO2/PO1	EFF-AD	EFF-P
INLET	INLET	INLET	INLET	LBM/SEC			ROTOR	ROTOR
		%	%	SQFT			%	%
1.2182	1.7628	80.52	81.98	29.47	1.1013	1.3293	83.48	84.10

STATOR 2

SL		EPI-1		EPI-2		V-1		V-2		VM-1		VM-2		V0-1		V0-2		B-1		B-2		M-1		M-2		U-1		U-2		M'-1		M'-2		V'-1		V'-2	
DEGREE		DEGREE		FT/SEC		FT/SEC		FT/SEC		FT/SEC		FT/SEC		FT/SEC		FT/SEC		DEGREE		DEGREE		M-1		M-2		FT/SEC		FT/SEC		M'-1		M'-2		FT/SEC		FT/SEC	
1	7.791	0.746	844.1	666.7	639.8	666.5	550.6	13.0	40.9	1.1	0.7213	0.5590	1.8585	1.2133	1.3704	1.1042																					
2	4.903	0.483	748.4	601.8	600.3	601.8	447.0</																														

TABLE XX(a) — OVERALL PERFORMANCE AND BLADE-ELEMENT DATA
(Tip Radially Distorted Inlet Flow, 100 Percent Speed)

U. S. CUSTOMARY UNITS

ROTOR 1

RUN NO 11, SPEED CODE 10, POINT NO 21																			
SL	EPSI-1	EPSI-2	V-1	V-2	VM-1	VM-2	V0-1	V0-2	B-1	B-2	M-1	M-2	U-1	U-2	M'-1	M'-2	V'-1	V'-2	
DEGREE	DEGREE	FT/SEC	FT/SEC	FT/SEC	FT/SEC	FT/SEC	FT/SEC	FT/SEC	DEGREE	DEGREE			FT/SEC	FT/SEC			FT/SEC	FT/SEC	
1	14.061	10.187	643.4	991.4	645.4	851.8	0.0	746.9	0.0	48.9	0.5982	0.8772	676.6	761.6	0.8667	0.8667	576.9	935.1	652.0
2	7.556	8.782	715.1	962.4	715.1	705.5	0.0	654.7	0.0	42.9	0.6684	0.8451	862.9	902.2	1.0474	1.0474	655.5	1120.8	747.6
3	4.138	3.006	744.3	769.0	744.3	574.6	0.0	511.1	0.0	41.7	0.6982	0.6640	1035.3	1042.8	1.1961	1.1961	676.0	1275.1	782.8
4	0.546	-2.066	756.5	785.4	738.3	637.8	0.0	405.2	0.0	36.1	0.6920	0.6815	1200.1	1183.3	1.3207	1.3207	829.2	1409.0	960.5
5	-6.645	-7.793	653.2	783.4	653.2	591.3	0.0	513.4	0.0	40.8	0.6060	0.6631	1362.9	1323.9	1.4021	1.4021	648.9	1511.4	1002.9

SL	INCS	INCM	DEV	TURN	RHOVM-1	RHOVM-2	D-FAC	OMEGA-B	LOSS-P	PO2/	%EFF-P	%EFF-A	B'-1	B'-2	V0'-1	V0'-2	PO/PO	
DEGREE	DEGREE	DEGREE	DEGREE	DEGREE				TOTAL	TOTAL	P01	TOT	TOT	DEGREE	DEGREE	FT/SEC	FT/SEC	INLET	
1	-1.64	2.66	20.89	44.89	42.81	50.21	0.4960	0.2250	0.0518	1.6525	85.56	84.52	46.18	1.29	-676.6	-14.6	1.7036	
2	-1.18	2.29	9.69	30.95	46.20	58.12	0.4902	0.1420	0.0357	1.7107	88.30	87.41	50.32	19.37	-862.9	-247.5	1.7901	
3	-0.17	2.51	12.93	11.54	46.78	48.15	0.5037	0.2153	0.0474	1.5251	76.33	74.92	54.35	42.80	-1035.3	-531.7	1.5851	
4	1.12	3.08	5.48	10.00	44.71	55.59	0.4227	0.0857	0.0189	1.6697	90.02	89.29	58.34	48.34	-1200.1	-718.2	1.6742	
5	4.53	5.62	6.73	10.49	38.16	51.21	0.4557	0.0975	0.0209	1.8590	89.65	88.73	64.21	53.73	-1362.9	-810.0	1.7033	

TO/TQ	PG/PU	EFF-AD	EFF-P	WC1/A1	TQ2/TQ1	P02/P01	EFF-AD	EFF-P
INLET	INLET	INLET	INLET	LBM/SEC	ROTOR	ROTOR	ROTOR	ROTOR
1.1895	1.6894	85.25	86.28	41.89	1.1895	1.6894	85.26	86.28

STATOR 1

RUN NO 11, SPEED CODE 10, POINT NO 21																			
SL	EPSI-1	EPSI-2	V-1	V-2	VM-1	VM-2	V0-1	V0-2	B-1	B-2	M-1	M-2	U-1	U-2	M'-1	M'-2	V'-1	V'-2	
DEGREE	DEGREE	FT/SEC	FT/SEC	FT/SEC	FT/SEC	FT/SEC	FT/SEC	FT/SEC	DEGREE	DEGREE			FT/SEC	FT/SEC			FT/SEC	FT/SEC	
1	15.967	12.763	1004.4	690.7	685.9	889.2	733.7	-45.4	47.1	-3.7	0.8905	0.5883	1.6062	1.1825	1.5581	1.1825	1.5581	1.1825	
2	8.900	6.260	983.4	791.2	738.2	791.1	649.7	-10.5	41.4	-0.8	0.8661	0.6791	1.7422	1.1896	1.6649	1.1896	1.6649	1.1896	
3	2.751	0.286	794.0	659.6	608.4	656.6	510.2	-63.2	40.0	-5.5	0.6876	0.5631	1.5693	1.1710	1.5106	1.1710	1.5106	1.1710	
4	-1.838	-4.534	816.6	736.8	671.0	736.8	405.3	-23.8	34.7	-1.9	0.7073	0.6324	1.6433	1.1761	1.6378	1.1761	1.6378	1.1761	
5	-6.536	-7.660	821.2	733.7	637.7	730.7	517.5	66.3	39.1	5.2	0.6981	0.6178	1.6305	1.2182	1.7791	1.2182	1.7791	1.2182	

SL	INCS	INCM	DEV	TURN	RHOVM-1	RHOVM-2	D-FAC	OMEGA-B	LOSS-P	PO2/	%EFF-P	%EFF-A	B'-1	B'-2	V0'-1	V0'-2	PO/PO	
DEGREE	DEGREE	DEGREE	DEGREE	DEGREE				TOTAL	TOTAL	P01	TOT	TOT	DEGREE	DEGREE	FT/SEC	FT/SEC	INLET	
1	-3.77	-1.37	7.49	50.81	52.30	60.56	0.4718	0.1419	0.0301	0.9428	78.96	75.53			78.96	75.53		
2	-5.61	-1.89	8.51	42.15	59.91	71.06	0.3564	0.0697	0.0170	0.9728	82.66	83.83			82.66	83.83		
3	-5.52	-0.47	3.81	45.48	50.22	57.70	0.3663	0.0410	0.0111	0.9888	73.16	74.04			73.16	74.04		
4	-9.86	-3.72	7.57	36.60	37.54	64.91	0.2760	0.0643	0.0191	0.9818	85.92	86.84			85.92	86.84		
5	-5.82	1.23	16.98	33.91	54.03	62.23	0.2825	0.1536	0.0465	0.9573	81.92	83.30			81.92	83.30		

NCORR	WCORR	TO/TQ	PO/PU	EFF-AD	EFF-P	TQ2/TQ1	P02/P01	EFF-AD	EFF-P
INLET	INLET	INLET	INLET	INLET	INLET	ROTOR	ROTOR	ROTOR	ROTOR
10676	184.43	1.1895	1.6379	79.86	81.19	1.1895	0.9695	79.87	

ROTOR 2

RUN NO 11, SPEED CODE 10, POINT NO 21																			
SL	EPSI-1	EPSI-2	V-1	V-2	VM-1	VM-2	V0-1	V0-2	B-1	B-2	M-1	M-2	U-1	U-2	M'-1	M'-2	V'-1	V'-2	
DEGREE	DEGREE	FT/SEC	FT/SEC	FT/SEC	FT/SEC	FT/SEC	FT/SEC	FT/SEC	DEGREE	DEGREE			FT/SEC	FT/SEC			FT/SEC	FT/SEC	
1	10.244	5.776	798.1	1166.4	796.9	838.0	-44.3	811.4	-3.2	44.0	0.6678	0.9513	856.0	891.4	1.0362	0.6865	1202.4	841.8	
2	5.647	5.254	918.3	1053.3	918.2	841.2	-10.7	633.8	-0.7	37.0	0.8011	0.8577	955.6	971.0	1.1629	0.7580	1333.0	906.2	
3	-0.111	0.704	810.0	907.8	807.6	766.8	-62.9	406.0	-4.5	32.4	0.7028	0.7353	1059.4	1058.7	1.1997	0.7752	1382.7	957.1	
4	-5.154	-3.709	846.1	862.6	845.6	667.3	-22.3	414.9	-1.5	31.1	0.7354	0.6473	1165.9	1154.2	1.2677	0.8139	1458.6	1009.4	
5	-7.881	-7.406	838.2	850.7	835.5	708.8	67.1	464.8	4.6	34.2	0.7140	0.6837	1275.1	1256.8	1.2512	0.8344	1468.7	1048.1	

SL	INCS	INCM	DEV	TURN	RHOVM-1	RHOVM-2	D-FAC	OMEGA-B	LOSS-P	PO2/	%EFF-P	%EFF-A	B'-1	B'-2	V0'-1	V0'-2	PO/PO	
DEGREE	DEGREE	DEGREE	DEGREE	DEGREE				TOTAL	TOTAL	P01	TOT	TOT	DEGREE	DEGREE	FT/SEC	FT/SEC	INLET	
1	-1.53	2.92	19.25	42.59	66.06	83.76	0.3011	0.1869	0.0435	1.7589	85.64	84.46	48.42	5.43	-900.4	-80.0	2.8248	
2	-5.27	-0.46	12.28	44.64	76.00	89.04	0.3202	0.1753	0.0419	1.5587	81.12	79.91	46.48	21.84	-968.3	-337.1	2.7113	
3	0.79	5.37	8.53	17.51	65.42	62.43	0.3089	0.1091	0.0248	1.5697	86.97	86.14	54.26	36.76	-1122.4	-572.7	2.4667	
4	-0.82	2.99	4.71	7.53	69.85	72.93	0.3080	0.1850	0.0395	1.3830	72.36	71.09	54.56	47.03	-1188.2	-739.2	2.2717	
5	-1.96	0.22	0.64	7.92	67.05	73.31	0.2860	0.1387	0.0341	1.4369	80.02	78.97	55.24	47.32	-1208.0	-772.1	2.3429	

TO/TQ	PG/PU	EFF-AD	EFF-P	WC1/A1	TQ2/TQ1	P02/P01	EFF-AD	EFF-P
INLET	INLET	INLET	INLET	LBM/SEC	ROTOR	ROTOR	ROTOR	ROTOR
1.3749	2.4887	79.11	81.57	43.92	1.1559	1.5195	80.94	82.03

STATOR 2

RUN NO 11, SPEED CODE 10, POINT NO 21																			
SL	EPSI-1	EPSI-2	V-1	V-2	VM-1	VM-2	V0-1	V0-2	B-1	B-2	M-1	M-2	U-1	U-2	M'-1	M'-2	V'-1	V'-2	
DEGREE	DEGREE	FT/SEC	FT/SEC	FT/SEC	FT/SEC	FT/SEC	FT/SEC	FT/SEC	DEGREE	DEGREE			FT/SEC	FT/SEC			FT/SEC	FT/SEC	
1	7.593	0.441	1214.3	1055.4	909.6	1037.7	804.5	-192.6	41.7	-10.5	0.9979	0.8470	2.5498	1.4257	1.5875	1.5875	1.5875	1.2057	
2	4.200	-0.255	1095.4	1009.1	894.6	997.0	632.1	-155.8	35.3	-8.4	0.8971	0.8160	2.5067	1.3915	1.4380	1.4380	1.4380	1.1693	
3	1.909	-0.616	945.1	913.5	815.1	908.6	486.1	-94.3	30.6	-5.9	0.7725	0.7398	2.3461	1.3585	1.4465	1.4465	1.4465	1.1601	
4	-1.091	-0.631	845.7	809.0	736.5	801.0	415.7	-113.4	29.4	-8.0	0.6851	0.6531	2.1816	1.3375	1.3274	1.3274	1.3274	1.1375	
5	-4.795	-0.943	911.2	842.7	769.6	842.1	487.7	-30.0	32.4	-2.0	0.7297	0.6700	2.2005	1.3844	1.3445	1.3445	1.3445	1.1366	

SL	INCS	INCM	DEV	TURN	RHOVM-1	RHOVM-2	D-FAC	OMEGA-B	LOSS-P	PO2/	%EFF-P	%EFF-A	B'-1	B'-2	V0'-1	V0'-2	PO/PO	
DEGREE	DEGREE	DEGREE	DEGREE	DEGREE				TOTAL	TOTAL	P01	TOT	TOT	DEGREE	DEGREE	FT/SEC	FT/SEC	INLET	
1	-5.71	-3.69	0.75	52.22	87.52	101.50	0.1322	0.2071	0.0469	0.9024	88.17	70.15			88.17	70.15		
2	-10.24	-6.37	1.44	44.20	91.93	100.47	0.0841	0.1924	0.0472	0.9211	63.95	85.72			63.95	85.72		
3	-13.90	-8.60	4.38	36.72	85.54	92.54	0.0469	0.1709	0.0455	0.9434	75.30	77.12			75.30	77.12		
4	-14.65	-8.44	2.06	37.44	76.38	81.43	0.											

TABLE XX(b) — OVERALL PERFORMANCE AND BLADE-ELEMENT DATA
(Tip Radially Distorted Inlet Flow, 100 Percent Speed)

U. S. CUSTOMARY UNITS

ROTOR 1

SL	EPSSI-1	EPSSI-2	V-1	V-2	VM-1	VM-2	V0-1	V0-2	B-1	B-2	M-1	M-2	U-1	U-2	M'-1	M'-2	V'-1	V'-2
1	14.825	15.908	653.3	989.3	653.3	653.6	0.0	757.2	0.0	49.9	0.6061	0.8741	675.5	760.3	0.8718	0.5625	939.7	630.6
2	7.783	8.184	719.9	963.8	719.9	698.3	0.0	664.3	0.0	43.6	0.6732	0.8454	861.5	900.7	1.0498	0.6667	1122.4	737.2
3	4.117	2.320	745.5	783.9	745.5	577.2	0.0	530.3	0.0	42.6	0.6995	0.6761	1033.5	1041.0	1.1957	0.6647	1274.4	770.7
4	0.368	-2.598	732.5	790.2	732.5	634.2	0.0	471.4	0.0	36.6	0.6861	0.6816	1198.0	1181.3	1.3152	0.8211	1404.2	951.9
5	-6.752	-8.004	642.2	784.2	642.2	583.2	0.0	524.2	0.0	41.8	0.5950	0.6026	1360.6	1321.7	1.3941	0.8368	1504.5	987.9

SL	INCS	INCM	DEV	TURN	RHOVM-1	RHOVM-2	D-FAC	OMEGA-B	LOSS-P	PO2/	PO1	TOT	DEGREE	DEGREE	FT/SEC	FT/SEC	PO/PO	TO2/
1	-2.01	2.29	19.86	45.53	43.17	49.45	0.5167	0.2216	0.0510	1.6649	85.87	84.85	45.81	0.27	-675.5	-3.1	1.7172	INLET
2	-1.40	2.06	9.03	31.39	46.53	58.07	0.5020	0.1326	0.0335	1.7318	89.27	88.43	50.10	18.71	-861.5	-236.4	1.8108	INLET
3	-0.26	2.42	11.24	12.74	46.81	48.76	0.5175	0.2120	0.0477	1.5569	77.52	76.10	54.25	41.51	-1033.5	-510.6	1.6184	INLET
4	1.28	3.23	5.33	10.31	44.50	55.67	0.4285	0.0808	0.0179	1.6860	90.75	90.07	58.50	48.18	-1198.0	-709.9	1.6893	INLET
5	4.88	6.17	6.69	10.87	37.76	50.71	0.4657	0.1041	0.0223	1.8719	89.17	88.19	64.56	53.69	-1360.6	-797.4	1.7153	INLET

TO/TO	PO/PO	EFF-AD	EFF-P	WCI/A1	T02/T01	P02/P01	EFF-AD	EFF-P
INLET	INLET	INLET	INLET	LBM/SEC			ROTOR	ROTOR
		%	%	SQFT			%	%
1.1928	1.7079	65.64	86.66	41.80			85.65	86.67

STATOR 1

SL	EPSSI-1	EPSSI-2	V-1	V-2	VM-1	VM-2	V0-1	V0-2	B-1	B-2	M-1	M-2	U-1	U-2	M'-1	M'-2	V'-1	V'-2
1	15.736	12.278	1003.9	665.1	674.3	663.7	743.8	-43.4	47.9	-3.7	0.8891	0.5646	1.6190	1.1847	1.5697	1.1847	1.1847	INLET
2	8.451	4.916	985.5	773.5	732.6	773.5	658.9	3.2	42.0	0.2	0.8672	0.6618	1.7599	1.1920	1.6830	1.1920	1.1920	INLET
3	2.289	-1.415	808.9	664.1	611.5	663.7	529.4	-22.9	40.9	-2.0	0.6997	0.5656	1.6102	1.1770	1.6553	1.1770	1.1770	INLET
4	-2.219	-5.851	815.1	722.2	664.4	721.5	472.2	32.3	35.4	2.6	0.7052	0.6183	1.6592	1.1784	1.6553	1.1784	1.1784	INLET
5	-6.660	-8.229	617.6	718.8	624.4	713.8	527.9	84.5	40.3	0.8	0.6936	0.6033	1.6420	1.2222	1.7915	1.2222	1.2222	INLET

SL	INCS	INCM	DEV	TURN	RHOVM-1	RHOVM-2	D-FAC	OMEGA-B	LOSS-P	PO2/	PO1	TOT	DEGREE	DEGREE	FT/SEC	FT/SEC	PO/PO	TO2/
1	-2.93	-0.53	7.52	51.62	51.78	59.43	0.4989	0.1422	0.0301	0.9428								TOT-STG
2	-1.03	-1.31	9.51	41.73	59.96	70.75	0.3755	0.0742	0.0181	0.9710								TOT-STG
3	-4.63	0.42	7.34	42.84	50.89	59.46	0.3646	0.0213	0.0058	0.9940								TOT-STG
4	-9.19	-3.05	12.01	32.83	57.46	64.61	0.2747	0.0629	0.0186	0.9822								TOT-STG
5	-4.66	2.39	18.56	33.49	53.27	61.53	0.2947	0.1554	0.0489	0.9573								TOT-STG

NCORR	WCORR	TO/TO	PO/PO	EFF-AD	EFF-P	T02/T01	P02/P01	EFF-AD
INLET	INLET	INLET	INLET	INLET	INLET			STAGE
RPM	LBM/SEC			%	%			%
10658	184.01	1.1928	1.6569	80.43	81.75	1.1928	0.9701	80.45

ROTOR 2

SL	EPSSI-1	EPSSI-2	V-1	V-2	VM-1	VM-2	V0-1	V0-2	B-1	B-2	M-1	M-2	U-1	U-2	M'-1	M'-2	V'-1	V'-2
1	9.635	9.416	794.7	1148.1	793.5	806.9	-42.4	816.7	-3.0	45.2	0.6838	0.9327	854.5	889.9	1.0305	0.6582	1197.5	810.2
2	3.858	4.238	915.4	1035.7	915.4	789.8	2.7	670.0	0.2	40.3	0.7975	0.8388	954.0	969.3	1.1501	0.8840	1320.2	844.6
3	-2.471	-0.772	607.9	875.0	807.6	669.5	-21.4	509.7	-1.5	40.4	0.6989	0.7048	1057.6	1056.9	1.1659	0.6639	1347.8	828.0
4	-6.660	-4.585	810.6	822.9	810.1	597.3	34.9	566.0	2.5	43.4	0.7005	0.6548	1163.9	1152.2	1.2006	0.6659	1389.6	836.9
5	-8.194	-7.975	794.4	840.5	769.8	605.0	85.6	583.5	6.2	43.9	0.6721	0.6588	1272.4	1254.7	1.2064	0.7083	1428.0	903.6

SL	INCS	INCM	DEV	TURN	RHOVM-1	RHOVM-2	D-FAC	OMEGA-B	LOSS-P	PO2/	PO1	TOT	DEGREE	DEGREE	FT/SEC	FT/SEC	PO/PO	TO2/
1	-1.57	2.89	19.97	43.23	66.33	93.19	0.3276	-0.0564	-0.0131	1.9823	104.08	104.45	46.38	5.15	-896.9	-73.1	3.2220	INLET
2	-2.71	-0.92	11.16	25.52	76.50	94.94	0.3620	0.0097	0.0023	1.7494	99.09	99.01	46.04	-20.73	-951.2	-299.3	3.0543	INLET
3	-0.76	4.32	7.83	17.16	66.96	79.66	0.3866	0.0445	0.0102	1.6835	95.00	94.66	53.21	36.05	-1079.0	-487.3	2.7140	INLET
4	-0.58	2.85	2.12	9.98	68.87	69.84	0.3988	0.1398	0.0313	1.5617	83.70	82.65	54.42	44.44	-1129.8	-586.2	2.5879	INLET
5	-0.87	1.31	1.21	8.45	65.37	68.96	0.3668	0.1096	0.0267	1.5884	87.13	86.27	56.33	47.88	-1187.8	-671.2	2.6081	INLET

TO/TO	PO/PO	EFF-AD	EFF-P	WCI/A1	T02/T01	P02/P01	EFF-AD	EFF-P
INLET	INLET	INLET	INLET	LBM/SEC			ROTOR	ROTOR
		%	%	SQFT			%	%
1.3982	2.8094	85.89	87.76	43.38			93.96	94.40

STATOR 2

SL	EPSSI-1	EPSSI-2	V-1	V-2	VM-1	VM-2	V0-1	V0-2	B-1	B-2	M-1	M-2	U-1	U-2	M'-1	M'-2	V'-1	V'-2
1	7.733	0.345	1187.3	920.1	868.4	920.0	809.7	14.7	43.2	0.9	0.9705	0.7256	3.0222	1.4283	1.8614	1.2053	1.2053	INLET
2	4.583	-0.562	1068.2	854.5	833.4	854.4	665.1	-14.9	38.6	-1.0	0.8687	0.6768	2.9277	1.3983	1.6744	1.1745	1.1745	INLET
3	2.351	-0.680	908.0	692.2	707.7	691.2	569.0	-38.5	38.8	-3.2	0.7304	0.5449	2.6620	1.3749	1.6518	1.1686	1.1686	INLET
4	-0.979	-0.690	846.4	610.5	630.9	609.9	567.2	-27.5	41.9	-2.6	0.6769	0.4771	2.5454	1.3765	1.5353	1.1648	1.1648	INLET
5	-4.554	-0.870	874.1	629.9	647.6	629.7	587.0	18.5	42.2	1.7	0.6875	0.4849	2.5523	1.4206	1.5544	1.1623	1.1623	INLET

SL	INCS	INCM	DEV	TURN	RHOVM-1	RHOVM-2	D-FAC	OMEGA-B	LOSS-P	PO2/	PO1	TOT	DEGREE	DEGREE	FT/SEC	FT/SEC	PO/PO	TO2/
1	-4.20	-2.18	12.17	42.31	97.30	115.89	0.2257	0.1369	0.0315	0.9379								TOT-STG
2	-6.75	-2.89	9.32	39.80	98.01	109.85	0.2021	0.1108	0.0275	0.9567								TOT-STG
3	-9.91	-0.60	7.12	41.99	82.84	88.43	0.2451	0.0859	0.0230	0.9741								TOT-STG
4	-2.14	4.07	7.53	44.49	72.78	77.16	0.2803	0.0624	0.0177	0.9835								TOT-STG
5	-2.24	4.64	12.45	40.54	72.52	77.12	0.2791	0.0787	0.0233	0.9787								TOT-STG

NCORR	WCORR	TO/TO	PO/PO	EFF-AD	EFF-P	T02/T01	P02/P01	EFF-AD
INLET	INLET	INLET	INLET	INLET	INLET			STAGE
RPM	LBM/SEC			%	%			%
10658	184.01	1.3982	2.7172	82.71	84.92	1.1722	0.9672	87.60

TABLE XX(c) — OVERALL PERFORMANCE AND BLADE-ELEMENT DATA
(Tip Radially Distorted Inlet Flow, 100 Percent Speed)

U. S. CUSTOMARY UNITS

ROTOR 1

SL		EPI-1		EPI-2		V-1		V-2		VM-1		VM-2		V0-1		V0-2		B-1		B-2		M-1		M-2		U-1		U-2		M'-1		M'-2		V'-1		V'-2		
DEGREE		DEGREE		FT/SEC		FT/SEC		FT/SEC		FT/SEC		FT/SEC		FT/SEC		FT/SEC		DEGREE		DEGREE		FT/SEC		FT/SEC		FT/SEC		FT/SEC		FT/SEC		FT/SEC		FT/SEC		FT/SEC		
1	15.246	16.032	632.0	592.0	632.0	546.4	0.0	827.9	0.0	56.6	0.5850	0.8694	677.8	762.9	0.8578	0.4823	926.8	550.3																				
2	8.565	8.487	691.9	942.8	691.9	625.1	0.0	705.7	0.0	48.5	0.6447	0.8195	864.5	903.8	1.0318	0.5700	1107.2	655.7																				
3	3.595	2.751	722.0	839.9	722.0	578.9	0.0	608.6	0.0	46.5	0.6753	0.7204	1037.1	1044.6	1.1820	0.6216	1263.7	724.7																				
4	-0.897	-2.311	705.6	794.3	705.6	562.5	0.0	560.7	0.0	44.9	0.6587	0.6747	1202.2	1185.4	1.3013	0.7141	1394.0	840.6																				
5	-7.236	-7.974	615.7	800.5	615.7	506.9	0.0	619.5	0.0	50.6	0.5689	0.6656	1365.3	1326.3	1.3838	0.7232	1497.7	869.7																				

L		INCS		INCM		DEV		TURN		RHOVM-1		RHOVM-2		D-FAC		OMEGA-B		LOSS-P		P02/		%EFF-P		%EFF-A		B'-1		B'-2		V0'-1		V0'-2		PG/PO			
DEGREE		DEGREE		DEGREE		DEGREE		DEGREE		TOTAL		TOTAL		TOTAL		TOTAL		TOTAL		P01		TOT		TOT		DEGREE		DEGREE		FT/SEC		FT/SEC		INLET			
1	-0.91	3.39	12.82	53.69	42.27	45.31	0.6204	0.1861	0.0380	1.7971	90.70	89.92	46.91	-6.78	-677.8	65.0	1.8541																				
2	-0.14	3.33	7.92	33.77	45.17	56.48	0.5776	0.0545	0.0139	1.8712	96.08	95.73	51.37	17.60	-866.5	-198.1	1.9506																				
3	0.68	3.36	6.73	18.19	45.96	54.04	0.5694	0.0943	0.0226	1.8139	91.59	90.87	55.20	37.01	-1037.1	-436.0	1.8813																				
4	2.32	4.27	5.10	11.58	43.58	53.45	0.5276	0.0700	0.0156	1.8790	93.22	92.60	59.53	47.95	-1202.2	-624.7	1.8744																				
5	5.90	7.19	7.22	11.37	36.91	47.78	0.5658	0.1097	0.0232	2.0947	90.21	89.15	65.58	54.22	-1365.3	-706.7	1.9256																				

TO/TO		PO/PO		EFF-AD		EFF-P		WCI/A1		TO2/TO1		P02/P01		EFF-AD		EFF-P	
INLET		INLET		INLET		INLET		LBM/SEC		%		%		%		%	
1.2206	1.8990	91.06	91.82	40.89	1.2206	1.8996	91.11	91.86									

STATOR 1

SL		EPI-1		EPI-2		V-1		V-2		VM-1		VM-2		V0-1		V0-2		B-1		B-2		M-1		M-2		U-1		U-2		M'-1		M'-2		V'-1		V'-2		
DEGREE		DEGREE		FT/SEC		FT/SEC		FT/SEC		FT/SEC		FT/SEC		FT/SEC		FT/SEC		DEGREE		DEGREE		FT/SEC		FT/SEC		FT/SEC		FT/SEC		FT/SEC		FT/SEC		FT/SEC		FT/SEC		
1	15.798	12.292	996.1	525.7	575.2	523.4	813.2	-48.9	54.8	-5.3	0.8735	0.4376	1.7481	1.2026	1.4944	1.2026																						
2	8.617	5.231	955.6	652.7	650.6	652.4	700.0	-20.3	47.1	-1.8	0.8322	0.5486	1.8957	1.2045	1.8190	1.2045																						
3	3.308	-0.246	855.8	615.5	602.8	614.0	607.5	-42.1	45.2	-3.9	0.7355	0.5158	1.8522	1.2038	1.7844	1.2038																						
4	-1.123	-3.903	811.8	609.0	587.4	608.3	560.4	29.1	43.7	2.7	0.6913	0.5085	1.8401	1.2108	1.8393	1.2108																						
5	-6.317	-7.041	827.4	605.8	543.6	605.5	623.8	17.5	49.0	1.7	0.6901	0.4945	1.8433	1.2634	2.0030	1.2634																						

SL		INCS		INCM		DEV		TURN		RHOVM-1		RHOVM-2		D-FAC		OMEGA-B		LOSS-P		P02/		%EFF-P		%EFF-A		B'-1		B'-2		V0'-1		V0'-2		PG/PO			
DEGREE		DEGREE		DEGREE		DEGREE		DEGREE		TOTAL		TOTAL		TOTAL		TOTAL		TOTAL		P01		TOT		TOT		DEGREE		DEGREE		FT/SEC		FT/SEC		INLET			
1	4.00	6.40	5.95	60.11	47.54	52.96	0.6508	0.1455	0.0308	0.9428	80.20	81.59																									
2	0.12	3.83	7.50	48.89	58.24	67.83	0.4981	0.0732	0.0179	0.9732	91.06	91.76																									
3	-0.27	4.77	5.39	49.15	55.72	63.46	0.4877	0.0518	0.0141	0.9843	88.20	89.11																									
4	-0.95	5.19	12.17	40.91	55.25	62.32	0.4429	0.0624	0.0185	0.9829	90.20	90.99																									
5	4.04	11.09	13.43	47.32	50.47	59.96	0.5024	0.1566	0.0496	0.9573	83.21	84.74																									

NCDRR		WCDRR		TO/TO		PO/PO		EFF-AD		EFF-P		TO2/TO1		P02/P01		EFF-AD	
INLET		INLET		INLET		INLET		INLET		INLET		%		%		%	
10695.	179.96	1.2206	1.8415	86.31	87.42	1.2206	0.9697	86.36									

ROTOR 2

SL		EPI-1		EPI-2		V-1		V-2		VM-1		VM-2		V0-1		V0-2		B-1		B-2		M-1		M-2		U-1		U-2		M'-1		M'-2		V'-1		V'-2	
DEGREE		DEGREE		FT/SEC		FT/SEC		FT/SEC		FT/SEC		FT/SEC		FT/SEC		FT/SEC		DEGREE		DEGREE		FT/SEC		FT/SEC		FT/SEC		FT/SEC		FT/SEC		FT/SEC		FT/SEC		FT/SEC	
1	9.513	9.114	612.2	1036.9	610.3	696.5	-47.8	768.2	-4.5	47.6	0.5131	0.8275	857.5	893.0	0.9151	0.5647	1091.8	707.6																			
2	3.496	3.841	745.7	949.2	745.5	667.8	-18.9	674.5	-1.5	45.2	0.6326	0.7534	957.3	972.7	1.0420	0.5805	1228.3	731.4																			
3	-1.792	-0.588	694.1	866.1	693.0	604.6	-40.3	620.2	-3.3	45.7	0.5859	0.6797	1061.3	1060.6	1.0985	0.5870	1301.5	748.0																			
4	-4.732	-3.670	660.8	831.4	660.2	466.0	29.2	688.5	2.5	55.9	0.5541	0.6429	1168.0	1156.2	1.1038	0.5106	1316.3	660.2																			
5	-6.972	-6.639	683.0	835.1	682.8	588.9	17.7	592.1	1.5	45.0	0.5613	0.6372	1277.3	1259.0	1.1774	0.6789	1432.8	889.7																			

SL		INCS		INCM		DEV		TURN		RHOVM-1		RHOVM-2		D-FAC		OMEGA-B		LOSS-P		P02/		%EFF-P		%EFF-A		B'-1		B'-2		V0'-1		V0'-2		PG/PO		
DEGREE		DEGREE		DEGREE		DEGREE		DEGREE		TOTAL		TOTAL		TOTAL		TOTAL		TOTAL		P01		TOT		TOT		DEGREE		DEGREE		FT/SEC		FT/SEC		INLET		
1	5.94	10.39	23.92	45.79	59.67	89.62	0.3578	-0.0454	-0.0104	1.8958	102.98	103.24	55.89	10.10	-905.3	-124.8	3.3272																			
2	0.82	5.61	14.46	28.55	74.24	88.16	0.4091	0.1093	0.0257	1.6899	90.30	89.56	52.57	24.02	-976.2	-298.2	3.2099																			
3	4.37	8.95	7.85	21.77	69.03	79.20	0.4254	0.1691	0.0388	1.6478	84.02	82.87	57.84	36.07	-1101.6	-440.4	3.0477																			
4	4.51	8.32	2.73	14.83	66.07	60.19	0.4996	0.																												

APPENDIX E

OVERALL PERFORMANCE AND VELOCITY VECTOR PARAMETERS FOR CIRCUMFERENTIALLY DISTORTED INLET FLOW

This appendix provides overall performance and velocity vector parameters for distorted inlet flow with casing treatment and design stator-settings. The data is presented at 70 percent and 100 percent of design speed. An overall-performance and stall data summary is given in Table XXI. Velocity vector parameters at the fan inlet and exit are given in Tables XXII and XXIII. Circumferential distributions of total pressure ratio and total temperature ratio are given in Table XXIV. The velocity vector parameters (V , V_m , and V_θ) are presented in feet per second and are based on standard day, inlet plenum conditions. The circumferential reference position is TDC looking forward. The relative position of the circumferential-distortion screen is $246^\circ - 336^\circ$ (hub) and $246^\circ - 326^\circ$ (tip)—tip is 100 percent span. β° is defined as $\tan^{-1}(\tan\beta/\cos\epsilon)$, where ϵ is the design value.

TABLE XXI— OVERALL PERFORMANCE AND STALL DATA SUMMARY
WITH CIRCUMFERENTIAL INLET FLOW DISTORTION

PERFORMANCE

Ref. Code	Percent of Design Speed	Number of Screen Location Points ¹	Corrected Flow ² (lbm/sec)	P_{16}/P_6	$\eta_{ad, 16}$ (%)
10-70-21	70	4	124.2	1.526	73.98
10-70-22	70	4	110.5	1.713	81.43
10-70-23	70	12	96.0	1.735	73.98
10-10-1	100	4	182.4	2.352	73.77
10-10-22	100	12	180.6	2.819	81.56
10-10-2	100	12	177.4	2.847	81.22

STALL POINT DATA

Percent of Design Speed	Corrected Flow ² (lbm/sec)	P_{16}/P_6	Stall Margin (%)
70	95.1	1.740	25.4
100	169.2	2.888	12.0

- Notes: (1) See page 25
(2) Corrected flow = $W\sqrt{\theta/\delta}$

PRECEDING PAGE BLANK NOT FILMED

TABLE XXII(a) — VELOCITY VECTOR PARAMETERS AT FAN INLET
(Circumferentially Distorted Inlet Flow)

Ref. Code 10-70-21
 $W\sqrt{\theta/\delta} = 124.2 \text{ lbm/sec}$
 $P_{16}/P_6 = 1.526$
 $P_0 = 2009 \text{ lbf/ft}^2$
 $T_0 = 515.4^\circ\text{R}$

Ref. Code 10-70-22
 $W\sqrt{\theta/\delta} = 110.5 \text{ lbm/sec}$
 $P_{16}/P_6 = 1.713$
 $P_0 = 2021 \text{ lbf/ft}^2$
 $T_0 = 516.2^\circ\text{R}$

Ref. Code 10-10-1
 $W\sqrt{\theta/\delta} = 182.4 \text{ lbm/sec}$
 $P_{16}/P_0 = 2.352$
 $P_0 = 1445 \text{ lbf/ft}^2$
 $T_0 = 514.5^\circ\text{R}$

%	72°						72°						72°											
	P_6/P_0	p_6/P_0	90- β '	M	V	V_m	V_0	90- β '	P_6/P_0	p_6/P_0	90- β '	M	V	V_m	V_0	90- β '	P_6/P_0	p_6/P_0	90- β '	M	V	V_m	V_0	90- β '
10	.979	.926	33.1	128	311	314	17	35.6	.984	.945	31.9	124	267	267	9	31.5	.986	.946	37.8	148	524	519	17	37.4
30	.982	.908	32.0	134	371	372	13	32.3	.986	.931	30.8	129	321	320	5	29.4	.989	.946	37.7	151	558	557	16	30.2
50	.983	.902	31.6	135	389	389	11	28.1	.987	.924	31.0	131	342	342	6	25.3	.988	.932	37.4	154	584	583	18	29.4
70	.982	.904	31.6	135	382	382	10	24.3	.987	.927	30.8	130	332	332	1	21.6	.988	.937	36.6	152	571	570	19	20.1
90	.979	.919	31.6	130	332	332	9	18.7	.985	.940	30.8	128	286	286	8	16.3	.984	.947	37.2	149	560	559	18	20.2
MR	.981	.910	31.8	133	363	363	11		.986	.932	30.7	128	315	314	4		.988	.943	30.8	148	564	564	19	
162°																								
10	.979	.928	55.4	128	310	310	8	36.6	.983	.945	55.3	128	262	262	8	32.1	.989	.977	56.6	151	551	550	13	43.3
30	.980	.909	57.4	133	364	364	10	33.6	.984	.931	55.1	128	311	311	10	29.3	.983	.970	55.2	158	628	623	15	39.4
50	.983	.904	58.6	135	384	384	9	28.5	.986	.925	55.0	131	338	338	9	25.8	.981	.971	56.5	158	600	595	16	29.3
70	.982	.905	58.6	134	380	380	10	24.7	.985	.927	55.0	130	330	329	9	21.7	.987	.978	56.7	159	630	629	17	25.1
90	.981	.920	59.1	130	338	338	8	19.2	.985	.941	55.7	128	288	288	6	14.4	.985	.970	56.2	149	636	634	16	20.8
MR	.981	.912	58.6	133	360	360	9		.985	.933	55.9	129	311	311	9		.986	.978	56.1	152	629	628	17	21.1
252°																								
10	.970	.896	75.2	134	373	361	9	47.6	.977	.929	75.3	127	298	290	7	39.2	.981	.949	77.0	153	575	562	12	49.8
30	.984	.867	78.7	133	363	356	7	36.0	.966	.921	79.6	126	291	286	5	29.4	.980	.944	82.1	153	581	575	10	38.6
50	.987	.881	81.2	134	380	375	8	29.7	.967	.913	81.8	129	319	316	4	25.2	.981	.971	83.9	157	618	612	10	38.6
70	.986	.884	81.4	135	391	384	8	24.4	.974	.913	81.8	131	339	335	4	23.0	.982	.975	83.9	158	628	621	11	34.7
90	.977	.897	80.7	135	388	382	6	22.8	.983	.925	81.8	130	327	323	4	19.2	.985	.978	82.8	156	604	599	7	24.6
MR	.986	.889	80.0	135	381	378	6		.974	.920	80.8	129	320	316	5		.985	.979	82.6	156	604	599	7	
342°																								
10	.974	.894	101.9	135	388	380	6	37.0	.980	.927	101.6	128	312	306	6	32.1	.988	.976	99.9	156	612	603	10	40.4
30	.978	.882	100.0	139	426	419	7	32.4	.982	.911	100.3	133	362	356	7	29.4	.984	.971	97.2	148	622	617	10	37.8
50	.980	.877	98.2	140	441	437	4	29.8	.984	.909	98.8	134	374	370	8	25.5	.984	.972	98.1	148	708	704	7	32.8
70	.982	.880	98.2	140	437	433	6	25.6	.985	.912	98.8	133	369	365	5	22.3	.985	.977	96.0	146	704	700	6	29.1
90	.981	.894	97.6	137	405	401	8	21.3	.985	.930	98.2	129	318	318	4	17.1	.985	.978	96.9	149	638	633	7	23.5
MR	.980	.885	98.8	138	422	417	6		.984	.917	99.2	132	351	346	6		.984	.971	96.9	143	675	670	8	

ORIGINAL PAGE IS
OF POOR QUALITY

TABLE XXII(b) — VELOCITY VECTOR PARAMETERS AT FAN INLET
(Circumferentially Distorted Inlet Flow)

Ref. Code 10-10-2
 $W\sqrt{\theta/\delta} = 177.4 \text{ lbf/sec}$
 $P_{16}/P_6 = 2.847$
 $P_0 = 1501 \text{ lbf/ft}^2$
 $T_0 = 504.0^\circ\text{R}$

% span	12°						42°						72°											
	P ₆ /P ₀	p ₆ /P ₀	90-β°	M	V	V _m	V _θ	90-β'	P ₆ /P ₀	p ₆ /P ₀	90-β°	M	V	V _m	V _θ	90-β'	P ₆ /P ₀	p ₆ /P ₀	90-β°	M	V	V _m	V _θ	90-β'
10	.950	.803	98.1	.50	501.	526.	.778	38.4	.987	.807	93.4	.50	505.	544.	.732	40.7	.959	.825	92.8	.47	512.	511.	.820	39.3
30	.960	.778	95.8	.55	603.	600.	.558	35.2	.981	.779	92.3	.55	603.	402.	.724	36.3	.962	.792	91.4	.54	582.	481.	.515	38.7
50	.980	.767	94.5	.57	617.	618.	.493	30.2	.961	.771	92.0	.57	618.	417.	.721	36.9	.965	.783	91.2	.56	608.	602.	.820	30.8
70	.956	.773	94.4	.56	604.	604.	.47	28.3	.960	.777	92.0	.56	604.	604.	.721	36.7	.960	.785	91.7	.54	590.	590.	.517	30.8
90	.954	.797	95.1	.52	562.	560.	.50	21.5	.966	.803	92.9	.51	553.	552.	.721	21.8	.967	.811	92.3	.49	536.	536.	.521	21.0
MR	.956	.782	95.2	.54	589.	587.	.54		.960	.787	92.5	.54	587.	586.	.724		.961	.787	91.9	.48	569.	568.	.513	
102°																								
10	.965	.809	90.7	.51	559.	559.	.7	42.3	.954	.823	90.9	.46	546.	566.	.6	39.7	.987	.806	89.0	.50	547.	547.	.10	42.8
30	.964	.779	91.2	.54	609.	609.	.43	37.1	.960	.787	89.4	.54	586.	586.	.7	36.7	.966	.777	89.3	.55	599.	599.	.7	37.6
50	.964	.766	91.3	.58	629.	629.	.44	31.8	.966	.776	90.2	.57	614.	614.	.2	31.8	.962	.780	89.8	.69	639.	639.	.2	32.3
70	.963	.771	91.2	.57	618.	618.	.43	27.4	.963	.782	90.5	.55	600.	600.	.8	28.9	.962	.771	90.1	.57	617.	617.	.91	27.6
90	.960	.797	91.7	.52	568.	568.	.47	22.2	.968	.808	91.4	.55	644.	644.	.13	21.4	.961	.798	90.3	.52	567.	567.	.8	22.4
MR	.963	.783	91.3	.55	598.	598.	.51		.991	.793	90.5	.53	576.	576.	.6		.960	.781	89.8	.55	597.	597.	.8	
162°																								
10	.984	.812	87.9	.49	530.	530.	.20	49.4	.948	.801	83.4	.50	542.	538.	.40	45.0	.934	.780	78.6	.51	560.	569.	.11	48.3
30	.981	.780	87.8	.54	587.	586.	.25	37.4	.947	.775	84.3	.54	589.	586.	.59	38.6	.903	.784	82.9	.51	560.	586.	.80	37.6
50	.983	.764	88.9	.57	619.	619.	.12	31.8	.965	.759	87.2	.59	642.	641.	.31	33.2	.911	.782	80.9	.55	596.	593.	.60	32.0
70	.980	.773	89.8	.56	611.	611.	.2	27.4	.961	.764	87.9	.58	625.	628.	.25	28.8	.924	.785	84.3	.55	609.	606.	.80	28.4
90	.950	.789	90.6	.50	549.	549.	.8	21.7	.969	.797	89.2	.52	546.	565.	.8	22.5	.960	.777	82.6	.54	599.	586.	.64	24.1
MR	.954	.784	89.2	.54	584.	583.	.8		.967	.778	87.0	.55	592.	597.	.32		.927	.789	83.1	.54	587.	582.	.72	
192°																								
10	.984	.812	87.9	.49	530.	530.	.20	49.4	.948	.801	83.4	.50	542.	538.	.40	45.0	.934	.780	78.6	.51	560.	569.	.11	48.3
30	.981	.780	87.8	.54	587.	586.	.25	37.4	.947	.775	84.3	.54	589.	586.	.59	38.6	.903	.784	82.9	.51	560.	586.	.80	37.6
50	.983	.764	88.9	.57	619.	619.	.12	31.8	.965	.759	87.2	.59	642.	641.	.31	33.2	.911	.782	80.9	.55	596.	593.	.60	32.0
70	.980	.773	89.8	.56	611.	611.	.2	27.4	.961	.764	87.9	.58	625.	628.	.25	28.8	.924	.785	84.3	.55	609.	606.	.80	28.4
90	.950	.789	90.6	.50	549.	549.	.8	21.7	.969	.797	89.2	.52	546.	565.	.8	22.5	.960	.777	82.6	.54	599.	586.	.64	24.1
MR	.954	.784	89.2	.54	584.	583.	.8		.967	.778	87.0	.55	592.	597.	.32		.927	.789	83.1	.54	587.	582.	.72	
252°																								
10	.984	.812	87.9	.49	530.	530.	.20	49.4	.948	.801	83.4	.50	542.	538.	.40	45.0	.934	.780	78.6	.51	560.	569.	.11	48.3
30	.981	.780	87.8	.54	587.	586.	.25	37.4	.947	.775	84.3	.54	589.	586.	.59	38.6	.903	.784	82.9	.51	560.	586.	.80	37.6
50	.983	.764	88.9	.57	619.	619.	.12	31.8	.965	.759	87.2	.59	642.	641.	.31	33.2	.911	.782	80.9	.55	596.	593.	.60	32.0
70	.980	.773	89.8	.56	611.	611.	.2	27.4	.961	.764	87.9	.58	625.	628.	.25	28.8	.924	.785	84.3	.55	609.	606.	.80	28.4
90	.950	.789	90.6	.50	549.	549.	.8	21.7	.969	.797	89.2	.52	546.	565.	.8	22.5	.960	.777	82.6	.54	599.	586.	.64	24.1
MR	.954	.784	89.2	.54	584.	583.	.8		.967	.778	87.0	.55	592.	597.	.32		.927	.789	83.1	.54	587.	582.	.72	
282°																								
10	.987	.767	87.4	.40	440.	440.	.80	37.1	.994	.757	101.8	.49	538.	527.	.107	36.7	.943	.784	100.6	.52	547.	587.	.10	36.8
30	.989	.747	91.0	.41	452.	452.	.85	29.4	.987	.728	97.3	.49	532.	528.	.88	31.8	.953	.781	98.9	.59	640.	636.	.07	35.1
50	.989	.739	90.8	.45	489.	489.	.94	25.7	.983	.722	96.6	.47	519.	514.	.89	28.7	.962	.784	101.0	.58	630.	618.	.10	35.0
70	.985	.727	90.6	.43	474.	474.	.85	21.8	.984	.724	96.4	.45	481.	488.	.84	21.6	.959	.771	100.7	.57	614.	603.	.11	34.0
90	.986	.750	90.8	.40	435.	435.	.44	17.8	.980	.729	99.3	.48	496.	489.	.80	18.6	.959	.776	99.9	.56	606.	603.	.04	33.0
MR	.984	.748	90.3	.42	489.	489.	.20		.982	.733	99.1	.47	511.	506.	.72		.987	.769	98.1	.57	616.	608.	.08	
342°																								
10	.987	.767	87.4	.40	440.	440.	.80	37.1	.994	.757	101.8	.49	538.	527.	.107	36.7	.943	.784	100.6	.52	547.	587.	.10	36.8
30	.989	.747	91.0	.41	452.	452.	.85	29.4	.987	.728	97.3	.49	532.	528.	.88	31.8	.953	.781	98.9	.59	640.	636.	.07	35.1
50	.989	.739	90.8	.45	489.	489.	.94	25.7	.983	.722	96.6	.47	519.	514.	.89	28.7	.962	.784	101.0	.58	630.	618.	.10	35.0
70	.985	.727	90.6	.43	474.	474.	.85	21.8	.984	.724	96.4	.45	481.	488.	.84	21.6	.959	.771	100.7	.57	614.	603.	.11	34.0
90	.986	.750	90.8	.40	435.	435.	.44	17.8	.980	.729	99.3	.48	496.	489.	.80	18.6	.959	.776	99.9	.56	606.	603.	.04	33.0
MR	.984	.748	90.3	.42	489.	489.	.20		.982	.733	99.1	.47	511.	506.	.72		.987	.769	98.1	.57	616.	608.	.08	

TABLE XXII(c) — VELOCITY VECTOR PARAMETERS AT FAN INLET
(Circumferentially Distorted Inlet Flow)

Ref. Code 10-10-22
 $W\sqrt{\theta}/\delta = 180.6 \text{ lbf}/\text{ft}^2$
 $P_{16}/P_6 = 2.819$
 $P_0 = 1491 \text{ lbf}/\text{ft}^2$
 $T_0 = 500.8^\circ\text{R}$

β span	12°								42°								72°								
	P_6/P_0	p_6/P_0	$90-\beta^\circ$	M	V	V_m	V_0	$90-\beta'$	P_6/P_0	p_6/P_0	$90-\beta'$	M	V	V_m	V_0	$90-\beta'$	P_6/P_0	p_6/P_0	$90-\beta^\circ$	M	V	V_m	V_0	$90-\beta'$	
10	.952	.792	98.1	.52	565	559	780	39.8	.960	.797	99.7	.52	568	567	437	41.7	.958	78.7	91.6	.50	565	565	714	41.6	
30	.961	.758	95.7	.59	629	636	643	36.6	.960	.764	98.9	.58	628	627	448	36.9	.962	.770	90.1	.57	619	619	711	38.0	
50	.968	.746	94.6	.61	647	655	653	31.6	.956	.749	92.9	.60	647	646	493	31.8	.962	.780	98.0	.56	603	600	643	29.2	
70	.985	.748	92.8	.60	649	647	643	27.9	.956	.754	92.9	.59	640	640	26	28.0	.960	.784	95.2	.55	592	592	638	28.6	
90	.968	.784	95.1	.54	688	686	682	22.4	.956	.786	93.4	.54	681	680	135	22.4	.956	.791	90.8	.53	671	671	68	22.8	
MR	.957	.764	96.1	.58	624	621	626		.957	.768	93.2	.57	616	615	384		.959	.785	92.7	.54	609	608	681		
102°																									
10	.963	.801	91.6	.52	565	565	716	40.7	.954	.800	92.0	.47	514	514	118	39.9	.958	80.1	89.4	.51	558	558	51	43.2	
30	.964	.770	92.1	.56	623	622	623	37.5	.957	.780	90.1	.55	594	594	11	37.0	.949	.787	89.6	.56	606	606	61	37.6	
50	.961	.756	91.8	.60	643	642	640	32.0	.964	.770	91.2	.58	623	623	113	31.4	.960	.795	90.6	.60	644	644	64	32.4	
70	.962	.763	91.7	.59	632	632	619	27.9	.961	.772	90.9	.67	615	615	9	27.8	.959	.781	90.1	.58	630	630	61	28.1	
90	.965	.793	92.2	.53	573	573	622	22.4	.957	.803	92.2	.51	552	552	21	21.7	.956	.788	90.8	.53	575	575	6	22.7	
MR	.961	.775	91.9	.56	610	609	601		.959	.786	91.2	.54	586	586	113		.956	.773	90.2	.56	607	607	22		
132°																									
162°																									
192°																									
10	.959	.812	88.4	.45	535	535	15	42.5	.949	.800	83.8	.50	545	542	88	45.0	.932	.773	77.8	.42	470	558	120	49.4	
30	.956	.776	87.6	.55	598	598	85	37.9	.949	.788	84.1	.55	605	602	62	39.4	.905	.748	82.5	.53	575	570	75	38.6	
50	.953	.763	89.2	.57	620	620	9	31.8	.957	.781	87.2	.60	646	646	32	32.4	.911	.723	83.6	.57	613	610	68	32.9	
70	.959	.770	89.7	.57	617	616	3	27.7	.959	.761	88.5	.58	632	632	17	28.5	.926	.740	84.0	.58	622	619	65	29.1	
90	.947	.799	91.6	.50	545	545	15	21.4	.956	.792	89.8	.53	571	571	2	22.6	.949	.771	83.9	.55	599	595	69	24.8	
MR	.954	.782	89.5	.54	587	587	6		.956	.773	87.3	.56	605	604	28		.927	.753	82.8	.55	600	598	78		
222°																									
252°																									
282°																									
10	.854	.761	85.1	.41	450	448	39	38.7	.879	.750	99.0	.48	525	519	482	37.6	.925	.788	105.8	.50	587	524	149	38.1	
30	.831	.728	88.8	.41	450	450	11	31.3	.841	.720	94.7	.48	519	518	449	31.9	.946	.721	94.2	.64	685	683	80	38.0	
50	.835	.722	87.2	.42	544	509	24	27.1	.833	.710	94.5	.48	527	526	41	29.7	.955	.701	92.0	.67	716	716	28	34.0	
70	.835	.733	89.3	.43	476	476	6	22.1	.829	.714	94.3	.47	509	508	38	22.8	.957	.715	91.9	.66	705	705	23	30.4	
90	.835	.748	89.5	.40	440	440	4	17.9	.830	.732	95.8	.43	469	466	48	18.3	.949	.781	100.7	.53	581	571	107	21.1	
MR	.836	.739	88.3	.42	465	465	13		.836	.724	95.4	.46	506	504	48		.951	.739	96.0	.61	689	685	48		
312°																									
342°																									

TABLE XXII(d) - VELOCITY VECTOR PARAMETERS AT FAN INLET
(Circumferentially Distorted Inlet Flow)

Ref. Code 10-70-23
 $W\sqrt{\theta/\delta} = 96.0 \text{ lbm/sec}$
 $P_{16}/P_0 = 1.735$
 $P_0 = 2041 \text{ lbf/ft}^2$
 $T_0 = 514.3^\circ\text{R}$

ORIGINAL PAGE IS
OF POOR QUALITY

ϕ	12°						42°						72°											
	P_6/P_0	p_6/p_0	$90-\beta^*$	M	V	V_m	V_0	$90-\beta^*$	P_6/P_0	p_6/p_0	$90-\beta^*$	M	V	V_m	V_0	$90-\beta^*$	P_6/P_0	p_6/p_0	$90-\beta^*$	M	V	V_m	V_0	$90-\beta^*$
10	.987	.988	96.9	.21	230.	226.	286.	24.7	.989	.981	93.2	.20	223.	223.	213.	27.0	.987	.981	91.0	.20	221.	221.	24.	27.2
30	.990	.989	96.6	.25	272.	270.	311.	28.5	.989	.981	93.3	.24	265.	265.	215.	24.8	.989	.982	90.1	.23	220.	220.	20.	24.8
50	.988	.980	96.0	.34	268.	266.	288.	19.7	.989	.981	93.4	.34	264.	264.	218.	19.8	.989	.980	90.1	.24	270.	270.	21.	20.8
70	.989	.986	95.8	.42	246.	245.	222.	13.9	.989	.985	92.6	.42	246.	246.	211.	14.3	.990	.985	89.5	.23	252.	252.	0.	16.8
90	.988	.987	95.0	.48	199.	198.	117.	11.3	.989	.986	92.4	.48	202.	202.	218.	11.6	.988	.986	90.1	.24	261.	261.	20.	11.9
MR	.989	.986	95.8	.42	245.	243.	225.		.989	.987	92.9	.42	249.	242.	212.		.989	.986	90.1	.22	244.	244.		
102°																								
10	.989	.981	90.8	.20	227.	223.	28.	27.6	.986	.981	89.8	.19	213.	212.	3.	26.7	.990	.981	88.5	.20	227.	227.	8.	28.4
30	.990	.980	90.8	.24	270.	270.	11.	28.6	.987	.982	88.6	.23	253.	253.	8.	24.6	.987	.980	88.2	.23	259.	259.	8.	28.1
50	.989	.980	91.0	.34	270.	270.	28.	20.8	.989	.984	88.6	.34	271.	271.	7.	20.9	.989	.985	89.0	.25	280.	280.	8.	21.8
70	.990	.988	91.0	.42	254.	254.	44.	14.8	.989	.984	88.6	.42	256.	256.	6.	17.1	.989	.981	89.0	.24	263.	263.	8.	17.8
90	.988	.988	91.0	.49	206.	204.	24.	11.9	.988	.983	88.7	.49	211.	211.	8.	12.3	.988	.982	89.0	.20	220.	220.	4.	12.8
MR	.989	.986	90.8	.42	247.	247.	44.		.988	.986	88.7	.42	244.	244.	6.		.989	.984	88.8	.23	262.	262.	8.	
162°																								
10	.987	.988	88.8	.21	229.	229.	18.	29.3	.985	.985	81.9	.21	236.	234.	32.	30.8	.981	.980	78.1	.22	240.	236.	49.	32.0
30	.989	.980	88.0	.24	268.	267.	19.	24.1	.988	.986	81.2	.25	275.	272.	42.	27.6	.972	.983	80.5	.21	234.	231.	39.	23.9
50	.987	.980	88.8	.34	279.	279.	17.	21.2	.989	.984	88.0	.34	288.	287.	25.	22.5	.973	.989	88.3	.21	257.	250.	34.	20.2
70	.989	.980	88.8	.42	266.	266.	18.	17.9	.990	.986	85.4	.42	284.	283.	23.	19.2	.980	.981	82.3	.24	268.	266.	36.	18.4
90	.986	.989	87.3	.40	217.	217.	10.	12.7	.989	.987	86.0	.42	242.	241.	17.	14.2	.987	.982	82.3	.23	253.	251.	34.	18.0
MR	.988	.982	88.6	.43	253.	253.	18.		.989	.989	84.3	.42	262.	267.	27.		.980	.986	81.5	.23	262.	249.	37.	
192°																								
10	.987	.988	88.8	.21	229.	229.	18.	29.3	.985	.985	81.9	.21	236.	234.	32.	30.8	.981	.980	78.1	.22	240.	236.	49.	32.0
30	.989	.980	88.0	.24	268.	267.	19.	24.1	.988	.986	81.2	.25	275.	272.	42.	27.6	.972	.983	80.5	.21	234.	231.	39.	23.9
50	.987	.980	88.8	.34	279.	279.	17.	21.2	.989	.984	88.0	.34	288.	287.	25.	22.5	.973	.989	88.3	.21	257.	250.	34.	20.2
70	.989	.980	88.8	.42	266.	266.	18.	17.9	.990	.986	85.4	.42	284.	283.	23.	19.2	.980	.981	82.3	.24	268.	266.	36.	18.4
90	.986	.989	87.3	.40	217.	217.	10.	12.7	.989	.987	86.0	.42	242.	241.	17.	14.2	.987	.982	82.3	.23	253.	251.	34.	18.0
MR	.988	.982	88.6	.43	253.	253.	18.		.989	.989	84.3	.42	262.	267.	27.		.980	.986	81.5	.23	262.	249.	37.	
222°																								
10	.988	.983	88.4	.18	168.	164.	13.	21.7	.987	.984	101.1	.19	204.	202.	24.	23.8	.985	.981	102.2	.22	250.	244.	53.	27.1
30	.983	.937	87.4	.16	176.	176.	8.	17.6	.989	.939	100.4	.17	191.	185.	26.	17.5	.988	.941	98.9	.25	278.	275.	48.	24.1
50	.984	.935	87.8	.17	190.	190.	7.	18.0	.984	.939	99.7	.18	170.	168.	22.	12.7	.988	.942	97.9	.26	291.	285.	40.	20.8
70	.984	.936	87.7	.18	183.	182.	7.	12.4	.983	.941	99.6	.13	150.	148.	22.	9.7	.988	.949	97.7	.24	269.	266.	38.	17.0
90	.984	.942	87.5	.13	150.	150.	7.	8.8	.989	.948	103.9	.14	167.	162.	22.	8.6	.984	.961	96.4	.20	220.	217.	32.	12.8
MR	.984	.938	87.4	.16	174.	173.	8.		.988	.942	101.1	.16	179.	170.	23.		.987	.949	98.6	.24	263.	260.	42.	
282°																								
10	.988	.983	88.4	.18	168.	164.	13.	21.7	.987	.984	101.1	.19	204.	202.	24.	23.8	.985	.981	102.2	.22	250.	244.	53.	27.1
30	.983	.937	87.4	.16	176.	176.	8.	17.6	.989	.939	100.4	.17	191.	185.	26.	17.5	.988	.941	98.9	.25	278.	275.	48.	24.1
50	.984	.935	87.8	.17	190.	190.	7.	18.0	.984	.939	99.7	.18	170.	168.	22.	12.7	.988	.942	97.9	.26	291.	285.	40.	20.8
70	.984	.936	87.7	.18	183.	182.	7.	12.4	.983	.941	99.6	.13	150.	148.	22.	9.7	.988	.949	97.7	.24	269.	266.	38.	17.0
90	.984	.942	87.5	.13	150.	150.	7.	8.8	.989	.948	103.9	.14	167.	162.	22.	8.6	.984	.961	96.4	.20	220.	217.	32.	12.8
MR	.984	.938	87.4	.16	174.	173.	8.		.988	.942	101.1	.16	179.	170.	23.		.987	.949	98.6	.24	263.	260.	42.	

TABLE XXIII(a) — VELOCITY VECTOR PARAMETERS AT FAN EXIT
(Circumferentially Distorted Inlet Flow)

Ref. Code 10-70-21
 $W\sqrt{\theta/\delta} = 124.2 \text{ lbm/sec}$
 $P_{16}/P_6 = 1.526$
 $P_0 = 2009 \text{ lbf/ft}^2$
 $T_0 = 515.4^\circ\text{R}$

Ref. Code 10-70-22
 $W\sqrt{\theta/\delta} = 110.5 \text{ lbm/sec}$
 $P_{16}/P_6 = 1.713$
 $P_0 = 2021 \text{ lbf/ft}^2$
 $T_0 = 516.2^\circ\text{R}$

Ref. Code 10-10-1
 $W\sqrt{\theta/\delta} = 182.4 \text{ lbm/sec}$
 $P_{16}/P_0 = 2.352$
 $P_0 = 1445 \text{ lbf/ft}^2$
 $T_0 = 514.5^\circ\text{R}$

43°

r/r _{span}	P ₁₆ /P ₀		90-β*	M	V	V _m	V _θ	90-β*
	P ₁₆ /P ₀	p ₁₆ /P ₀						
10	1.7274	.970	94.1	.38	466.	465.	-33.	34.8
30	1.625	.910	92.7	.38	1068.	1067.	-50.	54.9
50	1.539	.826	90.9	.38	993.	992.	-14.	52.1
70	1.490	.867	95.0	.79	894.	891.	-78.	45.0
90	1.501	.960	91.8	.40	912.	912.	-24.	45.6
HR	1.501	.823	92.7	.97	1075.	1074.	-51.	

43°

r/r _{span}	P ₁₆ /P ₀		90-β*	M	V	V _m	V _θ	90-β*
	P ₁₆ /P ₀	p ₁₆ /P ₀						
10	1.815	1.435	88.0	.59	703.	702.	24.	48.8
30	1.729	1.426	90.7	.59	838.	832.	-8.	41.7
50	1.617	1.430	91.6	.42	800.	800.	-14.	33.2
70	1.622	1.428	90.9	.42	800.	800.	-8.	32.8
90	1.630	1.428	88.2	.44	830.	830.	17.	31.8
HR	1.687	1.429	89.8	.49	890.	890.	2.	

43°

r/r _{span}	P ₁₆ /P ₀		90-β*	M	V	V _m	V _θ	90-β*
	P ₁₆ /P ₀	p ₁₆ /P ₀						
10	2.127	1.224	94.3	.98	1142.	1139.	-26.	48.6
30	2.012	1.195	91.7	1.09	1291.	1290.	-38.	51.2
50	2.014	1.136	91.8	1.02	1218.	1218.	-32.	47.6
70	2.188	1.164	92.9	.99	1180.	1178.	-40.	44.0
90	2.266	1.198	89.9	1.03	1229.	1223.	2.	44.8
HR	2.270	1.174	91.9	1.02	1217.	1217.	-41.	

133°

r/r _{span}	P ₁₆ /P ₀		90-β*	M	V	V _m	V _θ	90-β*
	P ₁₆ /P ₀	p ₁₆ /P ₀						
10	1.084	.979	93.8	.38	464.	463.	-28.	34.8
30	1.619	.876	90.6	.38	1088.	1088.	-11.	56.8
50	1.530	.913	90.1	.38	994.	994.	-2.	52.6
70	1.478	1.001	95.3	.77	865.	861.	-80.	43.9
90	1.487	.980	91.4	.40	897.	897.	-22.	45.1
HR	1.491	.808	92.1	.98	1075.	1077.	-39.	

133°

r/r _{span}	P ₁₆ /P ₀		90-β*	M	V	V _m	V _θ	90-β*
	P ₁₆ /P ₀	p ₁₆ /P ₀						
10	1.810	1.433	88.0	.59	698.	698.	24.	48.2
30	1.722	1.426	90.7	.53	824.	824.	-8.	41.3
50	1.619	1.432	91.6	.42	804.	804.	-14.	33.1
70	1.626	1.430	91.3	.42	817.	817.	-11.	32.0
90	1.637	1.429	88.1	.48	834.	834.	18.	32.0
HR	1.686	1.430	89.8	.49	886.	886.	2.	

133°

r/r _{span}	P ₁₆ /P ₀		90-β*	M	V	V _m	V _θ	90-β*
	P ₁₆ /P ₀	p ₁₆ /P ₀						
10	2.181	1.288	99.2	.90	1116.	1101.	-178.	48.2
30	2.018	1.388	100.0	.98	1100.	1142.	-201.	43.7
50	2.025	1.337	100.7	.90	1030.	1041.	-201.	33.4
70	2.178	1.342	100.3	.84	1030.	1016.	-185.	37.8
90	2.266	1.425	93.0	.98	1163.	1161.	-41.	41.8
HR	2.280	1.315	98.4	.93	1144.	1102.	-168.	

226°

r/r _{span}	P ₁₆ /P ₀		90-β*	M	V	V _m	V _θ	90-β*
	P ₁₆ /P ₀	p ₁₆ /P ₀						
10	1.155	1.035	94.1	.46	553.	552.	-40.	39.2
30	1.637	1.038	94.4	.44	957.	954.	-73.	51.9
50	1.532	1.042	94.7	.75	859.	857.	-70.	46.2
70	1.438	1.055	95.7	.68	781.	777.	-77.	41.3
90	1.454	1.064	91.6	.68	790.	790.	-21.	41.6
HR	1.485	1.068	94.0	.72	834.	832.	-58.	

226°

r/r _{span}	P ₁₆ /P ₀		90-β*	M	V	V _m	V _θ	90-β*
	P ₁₆ /P ₀	p ₁₆ /P ₀						
10	1.794	1.461	88.8	.55	689.	689.	14.	44.7
30	1.704	1.446	92.0	.49	877.	886.	-21.	39.4
50	1.623	1.446	93.3	.41	899.	892.	-23.	32.8
70	1.619	1.443	93.3	.41	892.	891.	-23.	30.3
90	1.643	1.443	88.8	.43	828.	828.	11.	31.6
HR	1.673	1.447	91.2	.46	853.	853.	-18.	

226°

r/r _{span}	P ₁₆ /P ₀		90-β*	M	V	V _m	V _θ	90-β*
	P ₁₆ /P ₀	p ₁₆ /P ₀						
10	1.940	1.350	96.6	.74	940.	934.	-108.	42.7
30	2.446	1.402	99.6	.93	1134.	1118.	-189.	42.8
50	2.254	1.423	100.8	.84	1032.	1041.	-193.	38.7
70	2.110	1.419	98.9	.79	892.	901.	-181.	36.4
90	2.138	1.420	90.6	.85	1029.	1039.	-111.	39.8
HR	2.214	1.289	97.1	.84	1028.	1030.	-129.	

316°

r/r _{span}	P ₁₆ /P ₀		90-β*	M	V	V _m	V _θ	90-β*
	P ₁₆ /P ₀	p ₁₆ /P ₀						
10	1.210	1.047	90.9	.44	551.	551.	-9.	40.4
30	1.612	1.050	92.9	.41	922.	921.	-47.	51.9
50	1.642	1.066	93.1	.78	860.	859.	-47.	47.1
70	1.499	1.061	93.9	.72	818.	816.	-86.	43.4
90	1.492	1.069	90.8	.71	810.	810.	-7.	42.8
HR	1.508	1.068	92.4	.73	838.	838.	-35.	

316°

r/r _{span}	P ₁₆ /P ₀		90-β*	M	V	V _m	V _θ	90-β*
	P ₁₆ /P ₀	p ₁₆ /P ₀						
10	1.728	1.453	88.3	.50	606.	606.	18.	44.4
30	1.668	1.453	92.2	.45	836.	836.	-21.	36.9
50	1.622	1.453	93.0	.40	879.	879.	-25.	31.6
70	1.638	1.451	93.0	.42	801.	801.	-27.	30.9
90	1.661	1.450	88.8	.45	837.	837.	11.	32.0
HR	1.661	1.452	91.1	.44	831.	831.	-10.	

316°

r/r _{span}	P ₁₆ /P ₀		90-β*	M	V	V _m	V _θ	90-β*
	P ₁₆ /P ₀	p ₁₆ /P ₀						
10	1.754	1.432	90.4	.55	710.	710.	-5.	38.0
30	2.309	1.370	88.6	.90	1034.	1034.	5.	45.3
50	2.039	1.402	91.8	.76	927.	937.	-24.	40.7
70	2.064	1.441	94.3	.7.	865.	860.	-94.	36.7
90	2.011	1.462	91.0	.69	862.	862.	-95.	36.7
HR	2.079	1.429	91.9	.78	930.	930.	-91.	

TABLE XXIII(b) — VELOCITY VECTOR PARAMETERS AT FAN EXIT
(Circumferentially Distorted Inlet Flow)

Ref. Code 10-10-2
 $W\sqrt{\theta/\delta} = 177.4$ lbm/sec
 $P_{16}/P_6 = 2.847$
 $P_0 = 1501$ lbf/ft²
 $T_0 = 504.0^\circ R$

%	16°							43°							76°									
	P_{16}/P_0	p_{16}/P_0	$90-\beta^*$	M	V	V_m	V_0	$90-\beta^*$	P_{16}/P_0	p_{16}/P_0	$90-\beta^*$	M	V	V_m	V_0	$90-\beta^*$	P_{16}/P_0	p_{16}/P_0	$90-\beta^*$	M	V	V_m	V_0	$90-\beta^*$
10	2.940	2.277	89.2	.62	794.	794.	11.	42.0	2.915	2.208	88.6	.64	833.	833.	21.	43.1	2.947	2.288	89.0	.61	800.	800.	14.	42.2
30	2.717	2.244	90.2	.53	685.	688.	10.	34.8	2.786	2.208	89.9	.69	788.	788.	1.	37.5	2.766	2.206	90.2	.55	710.	710.	3.	36.9
50	2.582	2.238	93.6	.43	644.	663.	10.	27.2	2.543	2.205	91.2	.46	696.	696.	13.	28.8	2.561	2.244	93.4	.44	678.	671.	16.	27.8
70	2.595	2.226	91.3	.47	622.	622.	14.	28.3	2.578	2.195	89.3	.49	639.	639.	8.	29.2	2.603	2.240	91.7	.47	613.	613.	18.	27.8
90	2.667	2.230	87.9	.51	677.	677.	24.	29.4	2.610	2.193	88.7	.51	668.	668.	18.	28.8	2.689	2.243	87.6	.52	678.	675.	28.	29.4
MR	2.688	2.241	90.4	.58	675.	675.	45.		2.636	2.202	89.6	.55	713.	713.	7.		2.710	2.282	90.2	.52	679.	679.	28.	
103°																								
10	2.850	2.211	88.6	.63	813.	813.	20.	42.8	2.916	2.275	88.5	.61	784.	784.	21.	41.8	2.868	2.201	88.8	.63	802.	801.	22.	42.1
30	2.814	2.211	89.3	.60	784.	784.	8.	37.3	2.784	2.251	90.5	.55	766.	766.	6.	38.6	2.818	2.200	89.5	.61	769.	769.	7.	36.1
50	2.841	2.208	91.0	.48	686.	685.	15.	28.4	2.854	2.237	93.7	.44	569.	568.	37.	27.3	2.823	2.197	91.8	.45	641.	640.	13.	28.1
70	2.893	2.195	89.8	.49	640.	640.	8.	29.2	2.894	2.230	91.5	.47	612.	611.	16.	27.8	2.864	2.187	89.8	.49	638.	638.	6.	29.2
90	2.688	2.194	88.3	.52	663.	663.	20.	29.0	2.674	2.234	87.6	.52	674.	673.	28.	29.3	2.629	2.186	88.2	.52	674.	673.	21.	29.2
MR	2.701	2.204	89.3	.55	708.	708.	8.		2.692	2.244	90.2	.52	674.	674.	2.		2.692	2.194	89.4	.55	705.	705.	8.	
136°																								
10	2.850	2.213	88.4	.64	787.	787.	29.	41.6	2.884	2.289	88.6	.69	768.	768.	18.	41.2	2.744	2.220	87.5	.65	724.	723.	31.	39.4
30	2.829	2.213	89.2	.60	778.	772.	11.	38.3	2.793	2.241	90.3	.54	763.	763.	4.	38.6	2.896	2.234	87.6	.63	681.	681.	28.	38.3
50	2.838	2.212	91.7	.48	685.	685.	17.	28.3	2.831	2.227	93.3	.43	666.	666.	33.	27.3	2.807	2.242	90.6	.49	688.	688.	46.	28.1
70	2.889	2.199	89.2	.49	637.	637.	8.	29.2	2.878	2.227	91.7	.46	607.	607.	18.	27.6	2.831	2.236	89.1	.43	658.	658.	9.	29.9
90	2.626	2.198	88.2	.51	671.	671.	21.	29.1	2.682	2.228	87.6	.51	673.	672.	28.	29.3	2.850	2.230	87.8	.45	687.	686.	26.	29.0
MR	2.692	2.207	89.2	.54	703.	703.	10.		2.667	2.235	90.1	.51	669.	669.	28.		2.612	2.234	88.3	.48	624.	623.	18.	
193°																								
10	2.834	2.210	89.8	.61	786.	786.	11.	37.8	2.886	2.267	93.2	.41	142.	142.	4.	38.8	2.865	2.228	89.2	.68	892.	892.	8.	33.7
30	2.852	2.248	88.8	.56	644.	644.	10.	28.6	2.863	2.238	88.0	.28	37.	37.	13.	20.8	2.866	2.234	91.0	.44	670.	670.	16.	29.9
50	2.857	2.282	93.0	.43	688.	688.	30.	27.1	2.880	2.225	87.7	.47	601.	601.	24.	29.9	2.894	2.234	93.0	.40	618.	617.	27.	28.5
70	2.893	2.282	91.0	.48	689.	689.	11.	27.1	2.861	2.205	89.5	.52	670.	670.	6.	30.4	2.832	2.224	91.9	.50	641.	641.	21.	28.9
90	2.630	2.247	89.3	.48	630.	630.	8.	27.4	2.721	2.213	91.3	.55	713.	713.	14.	29.8	2.682	2.229	89.7	.52	681.	680.	4.	29.1
MR	2.854	2.280	90.4	.43	661.	661.	44.		2.899	2.298	89.6	.50	644.	644.	4.		2.600	2.230	91.0	.47	618.	618.	11.	
286°																								
10	2.834	2.210	89.8	.61	786.	786.	11.	37.8	2.886	2.267	93.2	.41	142.	142.	4.	38.8	2.865	2.228	89.2	.68	892.	892.	8.	33.7
30	2.852	2.248	88.8	.56	644.	644.	10.	28.6	2.863	2.238	88.0	.28	37.	37.	13.	20.8	2.866	2.234	91.0	.44	670.	670.	16.	29.9
50	2.857	2.282	93.0	.43	688.	688.	30.	27.1	2.880	2.225	87.7	.47	601.	601.	24.	29.9	2.894	2.234	93.0	.40	618.	617.	27.	28.5
70	2.893	2.282	91.0	.48	689.	689.	11.	27.1	2.861	2.205	89.5	.52	670.	670.	6.	30.4	2.832	2.224	91.9	.50	641.	641.	21.	28.9
90	2.630	2.247	89.3	.48	630.	630.	8.	27.4	2.721	2.213	91.3	.55	713.	713.	14.	29.8	2.682	2.229	89.7	.52	681.	680.	4.	29.1
MR	2.854	2.280	90.4	.43	661.	661.	44.		2.899	2.298	89.6	.50	644.	644.	4.		2.600	2.230	91.0	.47	618.	618.	11.	

TABLE XXIII(c) — VELOCITY VECTOR PARAMETERS AT FAN EXIT
(Circumferentially Distorted Inlet Flow)

Ref. Code 10-10-22
 $W\sqrt{\theta/\delta} = 180.6 \text{ lbm/sec}$
 $P_{16}/P_6 = 2.819$
 $P_0 = 1491 \text{ lbf/ft}^2$
 $T_0 = 500.8^\circ\text{R}$

%	16°								43°								76°							
	P_{16}/P_0	p_{10}/P_0	$90-\beta^*$	M	V	V_m	V_θ	$90-\beta^*$	P_{16}/P_0	p_{10}/P_0	$90-\beta^*$	M	V	V_m	V_θ	$90-\beta^*$	P_{16}/P_0	p_{10}/P_0	$90-\beta^*$	M	V	V_m	V_θ	$90-\beta^*$
10	2.965	2.205	87.5	.66	84.5	84.8	32	44.5	2.918	2.154	88.4	.67	86.9	86.9	18	44.3	2.907	2.206	87.1	.64	83.1	83.0	43	44.4
30	2.713	2.192	91.7	.56	72.1	72.1	21	35.8	2.819	2.154	90.0	.64	81.7	81.7	0	39.6	2.744	2.193	89.8	.58	74.2	74.2	3	37.4
50	2.493	2.173	94.0	.48	63.3	63.2	11	27.8	2.492	2.158	92.4	.47	64.2	64.1	-26	29.2	2.502	2.181	94.0	.45	58.0	57.9	41	27.8
70	2.545	2.166	92.2	.49	63.6	63.6	22	28.6	2.583	2.136	89.6	.51	67.0	67.0	5	30.4	2.555	2.172	92.0	.49	63.2	63.2	22	28.6
90	2.619	2.174	87.7	.52	68.8	68.7	21	29.9	2.618	2.138	87.6	.55	72.1	72.0	3	31.1	2.622	2.160	87.6	.52	68.1	68.1	27	29.9
MR	2.664	2.182	90.5	.54	70.3	70.3	21	30.0	2.632	2.144	89.5	.58	75.6	75.6	7	31.1	2.653	2.166	90.0	.54	69.9	69.9	0	30.0

%	103°								136°								163°							
	P_{16}/P_0	p_{10}/P_0	$90-\beta^*$	M	V	V_m	V_θ	$90-\beta^*$	P_{16}/P_0	p_{10}/P_0	$90-\beta^*$	M	V	V_m	V_θ	$90-\beta^*$	P_{16}/P_0	p_{10}/P_0	$90-\beta^*$	M	V	V_m	V_θ	$90-\beta^*$
10	2.882	2.154	88.4	.65	83.8	83.7	24	43.6	2.855	2.197	87.2	.62	80.6	80.5	39	43.3	2.842	2.151	88.2	.64	82.4	82.3	24	43.1
30	2.809	2.144	89.8	.63	80.6	80.6	3	39.4	2.743	2.167	90.5	.58	73.8	73.8	46	37.0	2.812	2.147	89.8	.63	80.1	80.1	3	39.2
50	2.486	2.141	92.1	.47	60.2	60.2	22	29.0	2.486	2.165	93.9	.45	57.8	57.7	-20	27.7	2.475	2.142	91.6	.46	59.1	59.1	47	28.3
70	2.548	2.132	89.7	.51	65.9	65.9	3	30.0	2.547	2.162	91.8	.49	62.9	62.9	-20	28.5	2.536	2.129	89.6	.51	65.0	65.0	5	29.6
90	2.608	2.134	87.6	.54	70.3	70.2	29	30.6	2.604	2.168	87.8	.52	67.5	67.4	28	29.4	2.598	2.135	87.4	.54	69.1	69.1	31	30.0
MR	2.672	2.141	89.4	.57	73.5	73.5	8	30.6	2.644	2.178	90.2	.54	69.0	69.0	2	30.6	2.662	2.141	89.3	.57	72.6	72.6	8	30.6

%	193°								226°								253°							
	P_{16}/P_0	p_{10}/P_0	$90-\beta^*$	M	V	V_m	V_θ	$90-\beta^*$	P_{16}/P_0	p_{10}/P_0	$90-\beta^*$	M	V	V_m	V_θ	$90-\beta^*$	P_{16}/P_0	p_{10}/P_0	$90-\beta^*$	M	V	V_m	V_θ	$90-\beta^*$
10	2.813	2.150	88.2	.63	81.2	81.1	26	42.4	2.844	2.214	85.6	.61	79.3	79.3	20	42.2	2.740	2.163	87.9	.59	77.0	76.9	28	41.2
30	2.807	2.134	89.1	.64	81.4	81.3	13	39.8	2.712	2.192	90.6	.56	72.6	72.6	-7	38.4	2.705	2.169	87.9	.57	73.8	73.8	27	37.6
50	2.470	2.141	92.4	.46	59.4	59.3	25	28.5	2.442	2.173	93.8	.44	57.6	57.5	-34	27.7	2.434	2.169	91.2	.41	53.2	53.2	11	26.3
70	2.526	2.129	89.6	.50	65.2	65.2	8	29.7	2.536	2.170	91.8	.48	62.5	62.5	-20	28.3	2.574	2.163	89.5	.44	57.4	57.4	5	26.8
90	2.580	2.133	87.8	.53	69.0	69.0	26	29.8	2.565	2.178	87.6	.52	68.2	68.1	28	29.7	2.510	2.157	87.7	.47	61.3	61.3	24	27.0
MR	2.650	2.137	89.2	.56	72.8	72.8	10	29.8	2.623	2.184	90.2	.52	68.6	68.6	-9	29.8	2.582	2.164	88.7	.51	66.0	66.0	15	27.0

%	285°								313°								346°							
	P_{16}/P_0	p_{10}/P_0	$90-\beta^*$	M	V	V_m	V_θ	$90-\beta^*$	P_{16}/P_0	p_{10}/P_0	$90-\beta^*$	M	V	V_m	V_θ	$90-\beta^*$	P_{16}/P_0	p_{10}/P_0	$90-\beta^*$	M	V	V_m	V_θ	$90-\beta^*$
10	2.433	2.164	88.9	.51	61.8	61.8	8	28.4	2.426	2.193	86.6	.51	67.9	67.8	7	17.2	2.812	2.205	88.7	.60	77.4	77.3	18	41.4
30	2.444	2.160	88.7	.41	62.9	62.9	2	28.8	2.475	2.189	86.4	.44	66.6	66.4	36	30.7	2.628	2.187	91.1	.52	66.6	66.6	13	33.9
52	2.500	2.203	93.3	.43	65.5	65.4	-3	27.0	2.523	2.184	89.7	.48	61.8	61.8	4	30.2	2.515	2.183	92.3	.45	68.5	68.4	-24	28.4
70	2.522	2.180	88.9	.47	62.1	62.1	-7	27.3	2.531	2.145	89.3	.42	62.9	62.9	8	28.9	2.578	2.171	92.3	.45	64.4	64.4	-26	28.9
90	2.580	2.182	88.9	.47	62.1	62.1	12	27.3	2.583	2.151	90.9	.42	66.8	66.8	11	28.4	2.663	2.186	88.6	.54	69.8	69.8	17	30.1
MR	2.601	2.198	90.2	.43	66.4	66.4	21	27.3	2.514	2.135	89.2	.49	68.0	68.0	3	28.4	2.638	2.188	90.5	.52	67.6	67.6	6	28.4

ORIGINAL PAGE IS
OF POOR QUALITY

TABLE XXIII(d) — VELOCITY VECTOR PARAMETERS AT FAN EXIT
(Circumferentially Distorted Inlet Flow)

Ref. Code 10-70-23
 $W\sqrt{\theta/\delta} = 96.0 \text{ lbm/sec}$
 $P_{16}/P_0 = 1.735$
 $P_0 = 204 \text{ lbf/ft}^2$
 $T_0 = 514.3^\circ\text{R}$

%	16°							43°							76°									
	P16/P0	p16/P0	90-β°	M	V	Vm	Vθ	90-β°	P16/P0	p16/P0	90-β°	M	V	Vm	Vθ	90-β°	P16/P0	p16/P0	90-β°	M	V	Vm	Vθ	90-β°
10	1.838	1.835	88.1	0.51	612	612	20	44.9	1.823	1.819	87.6	0.52	622	621	20	45.1	1.843	1.846	88.0	0.51	612	612	21	44.9
30	1.732	1.837	90.8	0.42	603	603	0	38.6	1.741	1.826	89.8	0.44	628	628	0	37.1	1.723	1.839	91.3	0.41	630	630	21	34.8
50	1.647	1.822	91.1	0.32	393	392	0	27.1	1.672	1.827	89.9	0.36	440	440	0	30.2	1.644	1.832	92.6	0.32	389	389	24	26.9
70	1.634	1.823	91.8	0.31	381	381	0	26.9	1.666	1.825	89.9	0.36	438	438	0	28.6	1.642	1.830	91.8	0.32	393	393	24	26.6
90	1.638	1.823	91.8	0.31	381	381	0	26.9	1.643	1.824	90.2	0.34	414	414	0	25.6	1.647	1.832	90.4	0.32	404	404	20	24.9
MR	1.698	1.833	90.6	0.38	459	459	0	30	1.713	1.824	89.3	0.41	503	503	0	30	1.700	1.836	90.8	0.38	459	459	0	27
103°							136°							163°										
10	1.821	1.819	87.8	0.52	621	620	20	45.0	1.816	1.837	88.1	0.49	594	594	20	44.1	1.816	1.820	87.8	0.51	613	612	23	44.6
30	1.750	1.823	89.9	0.45	642	642	0	27.4	1.719	1.836	91.4	0.40	484	484	0	34.8	1.759	1.820	89.8	0.45	643	643	0	37.8
50	1.676	1.827	90.8	0.37	446	446	0	30.4	1.648	1.832	92.7	0.32	390	390	0	28.9	1.680	1.826	90.8	0.37	481	481	0	30.4
70	1.667	1.825	89.9	0.34	440	440	0	28.4	1.652	1.831	92.0	0.33	408	408	0	26.2	1.664	1.826	90.8	0.35	433	433	0	27.9
90	1.661	1.823	90.0	0.34	423	423	0	28.9	1.662	1.832	90.0	0.34	427	427	0	28.1	1.663	1.825	90.1	0.35	436	436	0	26.6
MR	1.718	1.823	89.8	0.42	508	508	0	30	1.697	1.834	91.0	0.36	467	467	0	28	1.673	1.824	89.7	0.42	507	507	0	27
193°							226°							253°										
10	1.811	1.821	87.8	0.51	607	606	20	44.3	1.790	1.831	88.3	0.47	589	589	17	42.7	1.776	1.823	87.8	0.44	600	600	20	42.0
30	1.754	1.826	89.7	0.45	642	642	0	37.8	1.715	1.836	91.3	0.40	483	483	0	34.6	1.714	1.832	89.7	0.40	488	488	0	38.1
50	1.680	1.827	90.9	0.37	450	450	0	30.8	1.641	1.829	92.8	0.32	389	389	0	28.8	1.688	1.828	90.9	0.36	432	432	0	27.6
70	1.660	1.826	91.0	0.35	429	429	0	27.6	1.657	1.829	91.9	0.34	418	418	0	26.9	1.654	1.827	90.4	0.34	416	416	0	27.0
90	1.666	1.825	89.3	0.36	441	441	0	27.0	1.660	1.835	90.2	0.36	450	450	0	27.4	1.659	1.826	89.8	0.34	426	426	0	26.1
MR	1.718	1.825	89.7	0.42	505	505	0	30	1.695	1.834	90.9	0.38	464	464	0	27.4	1.696	1.830	89.4	0.39	471	471	0	26
286°							313°							346°										
10	1.890	1.838	88.8	0.37	450	450	10	35.8	1.687	1.831	87.3	0.38	456	456	22	36.3	1.720	1.835	87.6	0.41	491	491	20	36.6
30	1.694	1.839	90.0	0.37	448	448	0	33.0	1.666	1.832	89.7	0.35	422	422	0	31.2	1.701	1.838	91.1	0.38	462	461	0	33.3
50	1.638	1.831	92.8	0.31	374	374	0	24.0	1.672	1.832	89.7	0.36	432	432	0	29.8	1.636	1.830	93.4	0.31	376	376	0	26.9
70	1.644	1.833	91.7	0.32	390	390	0	28.4	1.673	1.827	89.7	0.36	443	443	0	28.7	1.640	1.831	91.9	0.32	386	386	0	28.1
90	1.653	1.834	89.9	0.32	411	411	0	28.4	1.666	1.828	90.4	0.35	436	436	0	26.6	1.662	1.834	90.0	0.34	429	429	0	26.6
MR	1.682	1.835	90.5	0.34	416	416	0	28	1.672	1.830	89.4	0.36	438	438	0	26	1.671	1.834	90.8	0.35	430	430	0	26.0

TABLE XXIV(a) — CIRCUMFERENTIAL DISTRIBUTIONS OF TOTAL PRESSURE RATIO AND TOTAL TEMPERATURE RATIO AT 2ND-STAGE STATOR EXIT (Circumferentially Distorted Inlet Flow)

Ref. Code 10-70-21

$$W\sqrt{\theta/\delta} = 124.2 \text{ lbm/sec}$$

$$P_{16}/P_6 = 1.526$$

$$P_0 = 2009 \text{ lbf/ft}^2$$

$$T_0 = 515.4^\circ\text{R}$$

Pressure Data

<u>% Span</u>	<u>17°</u>	<u>110°</u>	<u>200°</u>	<u>287°</u>
10	1.5914	1.5363	1.5250	1.4602
30	1.6457	1.5973	1.5902	1.5303
50	1.5301	1.4781	1.4654	1.3899
70	1.4368	1.4099	1.3984	1.3357
90	1.4632	1.4347	1.4255	1.3829
MR	1.531	1.490	1.479	1.420

Temperature Data

<u>% Span</u>	<u>60°</u>	<u>147°</u>	<u>237°</u>	<u>330°</u>
10	1.2106	1.2091	1.2009	1.2207
30	1.1887	1.1798	1.1692	1.2044
50	1.1614	1.1603	1.1484	1.1839
70	1.1472	1.1433	1.1340	1.1690
90	1.1622	1.1629	1.1551	1.1838
MR	1.1729	1.1699	1.1604	1.1916

Ref. Code 10-70-22

$$W\sqrt{\theta/\delta} = 110.5 \text{ lbm/sec}$$

$$P_{16}/P_6 = 1.713$$

$$P_0 = 2021 \text{ lbf/ft}^2$$

$$T_0 = 516.2^\circ\text{R}$$

Pressure Data

<u>% Span</u>	<u>17°</u>	<u>110°</u>	<u>200°</u>	<u>287°</u>
10	1.8387	1.8097	1.7889	1.7096
30	1.7153	1.7282	1.7202	1.6604
50	1.6269	1.6283	1.6250	1.5905
70	1.6232	1.6206	1.6160	1.5976
90	1.6249	1.6281	1.6267	1.6140
MR	1.690	1.686	1.678	1.635

Temperature Data

<u>% Span</u>	<u>60°</u>	<u>147°</u>	<u>237°</u>	<u>330°</u>
10	1.2166	1.2169	1.2096	1.2198
30	1.1967	1.1942	1.1880	1.2065
50	1.1878	1.1877	1.1811	1.2047
70	1.1845	1.1898	1.1850	1.2094
90	1.2176	1.2175	1.2128	1.2144
MR	1.2015	1.2018	1.1960	1.2179

Ref. Code 10-10-1

$$W\sqrt{\theta/\delta} = 182.4 \text{ lbm/sec}$$

$$P_{16}/P_0 = 2.352$$

$$P_0 = 1445 \text{ lbf/ft}^2$$

$$T_0 = 514.5^\circ\text{R}$$

Pressure Data

<u>% Span</u>	<u>17°</u>	<u>110°</u>	<u>200°</u>	<u>287°</u>
10	2.4129	2.4610	2.4214	2.1136
30	2.4255	2.3706	2.3797	2.1860
50	2.3044	2.2310	2.2196	1.9210
70	2.1586	2.1252	2.0993	1.8828
90	2.1405	2.0975	2.0771	1.9067
MR	2.282	2.250	2.233	2.001

Temperature Data

<u>% Span</u>	<u>60°</u>	<u>147°</u>	<u>237°</u>	<u>330°</u>
10	1.4452	1.4206	1.4104	1.4409
30	1.3944	1.3744	1.3583	1.4119
50	1.3660	1.3517	1.3361	1.3912
70	1.3320	1.3296	1.3187	1.3777
90	1.3810	1.3740	1.3610	1.4016
MR	1.3616	1.3690	1.3559	1.4039

ORIGINAL PAGE IS
OF POOR QUALITY

TABLE XXIV(b) - CIRCUMFERENTIAL DISTRIBUTION OF TOTAL PRESSURE RATIO
AND TOTAL TEMPERATURE RATIO AT 2ND-STAGE STATOR EXIT
(Circumferentially Distorted Inlet Flow)

Ref. Code 10-70-23
 $W\sqrt{\theta/\delta} = 96.0$ lbf/sec
 $P_{16}/P_0 = 1.735$
 $P_0 = 2041$ lbf/ft²
 $T_0 = 514.3^\circ\text{R}$

Pressure Data

<u>% Span</u>	<u>20°</u>	<u>47°</u>	<u>77°</u>	<u>110°</u>	<u>137°</u>	<u>170°</u>	<u>197°</u>	<u>230°</u>	<u>260°</u>	<u>287°</u>	<u>320°</u>	<u>347°</u>
10	1.8402	1.8361	1.8250	1.8278	1.8188	1.8175	1.8020	1.8090	1.7579	1.7280	1.7720	1.7828
30	1.7282	1.7403	1.7421	1.7332	1.7405	1.7299	1.7379	1.7216	1.6915	1.7089	1.7063	1.7145
50	1.6632	1.6531	1.6559	1.6721	1.6600	1.6744	1.6587	1.6739	1.6485	1.6522	1.6620	1.6482
70	1.6597	1.6490	1.6521	1.6728	1.6543	1.6750	1.6613	1.6750	1.6645	1.6488	1.6728	1.6454
90	1.6589	1.6437	1.6493	1.6661	1.6607	1.6678	1.6657	1.6727	1.6652	1.6552	1.6766	1.6549
MR	1.716	1.713	1.711	1.718	1.712	1.716	1.709	1.713	1.687	1.679	1.699	1.693

Temperature Data

<u>% Span</u>	<u>30°</u>	<u>57°</u>	<u>90°</u>	<u>120°</u>	<u>147°</u>	<u>180°</u>	<u>207°</u>	<u>240°</u>	<u>269°</u>	<u>297°</u>	<u>330°</u>	<u>357°</u>
10	1.2276	1.2258	1.2193	1.2163	1.2182	1.2160	1.2189	1.2123	1.2105	1.2146	1.2229	1.2298
30	1.2139	1.2134	1.2038	1.2023	1.2064	1.2006	1.2063	1.1984	1.2025	1.2151	1.2126	1.2164
50	1.2196	1.2158	1.2107	1.2072	1.2052	1.2058	1.2027	1.2026	1.2028	1.2173	1.2202	1.2191
70	1.2530	1.2421	1.2415	1.2345	1.2257	1.2261	1.2194	1.2194	1.2175	1.2319	1.2448	1.2456
90	1.2973	1.2862	1.2889	1.2812	1.2687	1.2702	1.2618	1.2608	1.2584	1.2649	1.2839	1.2910
MR	1.2430	1.2367	1.2322	1.2280	1.2253	1.2240	1.2224	1.2193	1.2189	1.2297	1.2378	1.2418

TABLE XXIV(c) — CIRCUMFERENTIAL DISTRIBUTION OF TOTAL PRESSURE RATIO AND TOTAL TEMPERATURE RATIO AT 2ND-STAGE STATOR EXIT (Circumferentially Distorted Inlet Flow)

Ref. Code 10-10-2

 $W\sqrt{\theta/\delta} = 177.4$ lbm/sec $P_0 = 1501$ lbf/ft² $P_{16}/P_6 = 2.847$ $T_0 = 504.0^\circ\text{R}$ Pressure Data

% Span	20°	47°	77°	110°	137°	170°	197°	230°	260°	287°	320°	347°
10	2.9446	2.9045	2.9430	2.9190	2.9304	2.9009	2.8910	2.8521	2.6888	2.5220	2.5946	2.7918
30	2.7488	2.7625	2.7891	2.7783	2.8116	2.7778	2.7896	2.7452	2.6201	2.5979	2.6657	2.6871
50	2.5723	2.5574	2.5564	2.5464	2.5718	2.5480	2.5598	2.5270	2.4965	2.5437	2.6371	2.5316
70	2.5986	2.5783	2.5876	2.5746	2.6003	2.5735	2.5833	2.5501	2.5156	2.5528	2.6509	2.6464
90	2.6332	2.6221	2.6221	2.5950	2.6317	2.5958	2.6160	2.5772	2.5578	2.5990	2.7021	2.6866
MR	2.705	2.691	2.707	2.690	2.717	2.686	2.694	2.657	2.577	2.567	2.656	2.674

Temperature Data

% Span	30°	57°	90°	120°	147°	180°	207°	240°	267°	297°	330°	357°
10	1.4471	1.4413	1.4316	1.4341	1.4327	1.4290	1.4297	1.4249	1.4093	1.4344	1.4857	1.4877
30	1.4443	1.4083	1.3992	1.3948	1.3993	1.3921	1.3949	1.3848	1.3795	1.4296	1.4677	1.4500
50	1.4090	1.4038	1.3962	1.3938	1.3915	1.3925	1.3921	1.3882	1.3895	1.4640	1.4685	1.4329
70	1.4199		1.4027	1.4035	1.4039	1.4007	1.4048	1.4010	1.4050	1.4930	1.5114	1.4264
90	1.4661		1.4450	1.4386	1.4340	1.4446	1.4368	1.4404	1.4365	1.5173	1.5341	1.4572
MR	1.4334	1.4230	1.4163	1.4142	1.4135	1.4129	1.4123	1.4089	1.4046	1.4692	1.4965	1.4490

Ref. Code 10-10-22

 $W\sqrt{\theta/\delta} = 180.6$ lbm/sec $P_0 = 1491$ lbf/ft² $P_{16}/P_6 = 2.819$ $T_0 = 500.8^\circ\text{R}$ Pressure Data

% Span	20°	47°	77°	110°	137°	170°	197°	230°	260°	287°	320°	347°
10	2.9754	2.9449	2.9246	2.9157	2.9070	2.8862	2.8661	2.8527	2.6903	2.5212	2.5511	2.8522
30	2.7870	2.7803	2.7803	2.7836	2.7893	2.7649	2.7582	2.7334	2.5843	2.5728	2.6311	2.6744
50	2.5234	2.5208	2.5159	2.5074	2.5201	2.4994	2.5034	2.4854	2.4261	2.4843	2.5435	2.5378
70	2.5467	2.5457	2.5416	2.5380	2.5423	2.5260	2.5275	2.5097	2.4404	2.4881	2.5536	2.5892
90	2.5657	2.5807	2.5675	2.5284	2.5689	2.5268	2.5544	2.5202	2.4783	2.5354	2.6100	2.6358
MR	2.690	2.683	2.674	2.664	2.675	2.650	2.649	2.628	2.528	2.521	2.581	2.661

Temperature Data

% Span	30°	57°	90°	120°	147°	180°	207°	240°	267°	297°	330°	357°
10	1.4598	1.4429	1.4423	1.4335	1.4340	1.4314	1.4288	1.4352	1.4083	1.4247	1.4813	1.4813
30	1.4179	1.4042	1.4025	1.3984	1.3967	1.3929	1.3914	1.3655	1.3718	1.4222	1.4601	1.4382
50	1.3988	1.3918	1.3935	1.3848	1.3864	1.3874	1.3854	1.3682	1.3772	1.4440	1.4823	1.4193
70	1.4094	1.3917	1.3890	1.3881	1.3915	1.4009	1.3957	1.3812	1.3884	1.4772	1.4996	1.4032
90	1.4477	1.4302	1.4352	1.4341	1.4264	1.4676	1.4308	1.4486	1.4198	1.4983	1.5447	1.4425
MR	1.4282	1.4134	1.4138	1.4091	1.4079	1.4175	1.4074	1.4072	1.3937	1.4540	1.4961	1.4349

ORIGINAL PAGE IS
OF POOR QUALITY

DISTRIBUTION LIST

1. NASA-Lewis Research Center
 21000 Brookpark Road
 Cleveland, Ohio 44135
 Attention:

Report Control Office	MS 5-5	1
Technical Utilization Office	MS 3-19	1
Library	MS 60-3	2
Fluid System Components		
Division	MS 5-3	1
Compressor Branch	MS 5-9	5
W. L. Stewart	MS 3-5	1
R. S. Ruggeri	MS 5-9	1
M. J. Hartmann	MS 5-9	1
W. A. Benser	MS 5-9	1
D. M. Sandercock	MS 5-9	1
L. J. Herrig	MS 501-4	1
T. F. Gelder	MS 5-9	1
C. L. Ball	MS 5-9	1
L. Reid	MS 5-9	1
L. W. Schopen	MS 500-206	1
C. L. Meyer	MS 60-4	1
W. L. Beede	MS 5-3	1
D. W. Drier	MS 21-4	1
E. E. Bailey (AAMRDL)	MS 77-5	1
N. T. Musial	MS 500-311	1
C. H. Winzig	MS 5-3	1

2. NASA Scientific and Technical Information Facility
 P. O. Box 33
 College Park, Maryland 20740
 Attention: Acquisitions Branch 10

3. NASA Headquarters
 Washington, D. C. 20546
 Attention: N. F. Rekos (RLC) 1

DISTRIBUTION LIST (Cont'd)

4. U. S. Army Aviation Material Laboratory
Fort Eustis, Virginia 23604
Attention: John White 1

5. Headquarters
Wright-Patterson AFB, Ohio 45433
Attention: A. J. Wennerstrom ARL/LF 1
 S. Kobelak, AFAPL/TBP 1
 R. P. Carmichael, ASD/XRHP 1

6. Department of the Navy
Naval Air Systems Command
Propulsion Division, AIR 536
Washington, D. C. 20360 1

7. Department of Navy
Bureau of Ships
Washington, D. C. 20360
Attention: G. L. Graves 1

8. NASA-Langley Research Center
Technical Library
Hampton, Virginia 23365
Attention: Mark R. Nichols 1
 John V. Becker 1

9. The Boeing Company
Commercial Airplane Group
P. O. Box 3707
Seattle, Washington 98124
Attention: G. J. Schott, G-8410, MS 73-24 1

DISTRIBUTION LIST (Cont'd)

10. Douglas Aircraft Company
3855 Lakewood Boulevard
Long Beach, California 90801
Attention: J. E. Merriman |
 Technical Information Ctr. CI-250
11. Pratt & Whitney Aircraft
Florida Research & Development Center
P. O. Box 2691
West Palm Beach, Florida 33402
Attention: J. Brent |
 H. D. Stetson |
 W. R. Alley |
 R. E. Davis |
 R. W. Rockenbach |
 B. A. Jones |
 J. A. Fligg |
12. Pratt & Whitney Aircraft
400 Main Street
East Hartford, Connecticut 06108
Attention: R. E. Palatine |
 T. G. Slaiby |
 H. V. Marman |
 M. J. Keenan |
 B. B. Smyth |
 A. A. Mikołajczak |
 Library (UARL) |
 W. M. Foley (UARL) |
13. Allison Division, GMC
Department 8894, Plant 8
P. O. Box 894
Indianapolis, Indiana 46206
Attention: J. N. Barney U-26 |
 G. E. Holbrook T-22 |
 J. A. Korn T-26 |
 R. F. Alverson U-28 |
 Library S-5 |
 A. Medlock U-28 |
 P. Tramm U-23 |

DISTRIBUTION LIST (Cont'd)

- | | | |
|-----|---|--------------------------------------|
| 14. | Northern Research and Engineering
219 Vassar Street
Cambridge, Massachusetts 02139
Attention: K. Ginwala | 1 |
| | | |
| 15. | General Electric Company
Flight Propulsion Division
Cincinnati, Ohio 45215
Attention: D. Prince H-79
J. F. Klapproth H-42
J. W. McBride H-44
L. H. Smith H-50
J. B. Taylor J-168
Technical Information CTR. N-32
Marlen Miller H-50
C. C. Koch H-79 | 1
1
1
1
1
1
1
1 |
| | | |
| 16. | General Electric Company
1000 Western Avenue
Lynn, Massachusetts 01910
Attention: D. P. Edkins - Bldg. 2-40
F. F. Ehrich - Bldg. 2-40
L. H. King - Bldg. 2-40
R. E. Neitzel- Bldg. 2-40
Dr. C. W. Smith - Library
Bldg. 2-40M | 1
1
1
1
1 |
| | | |
| 17. | Curtiss-Wright Corporation
Wright Aeronautical
Wood-Ridge, New Jersey 07075
Attention: S. Lombardo
G. Provenzale | 1
1 |

DISTRIBUTION LIST (Cont'd)

18. AiResearch Manufacturing Company
402 South 36th Street
Phoenix, Arizona 85034
Attention: Robert O. Bullock |
 W. F. Waterman |
 Jack Erwin |
 Don Seyler |
 Jack Switzer |
 G. L. Perrone |
19. AiResearch Manufacturing Company
2525 West 190th Street
Torrance, California 90509
Attention: R. Kobayashi |
 Bob Carmody |
 Library |
 R. Jackson |
20. Union Carbide Corporation
Nuclear Division
Oak Ridge Gaseous Diffusion Plant
P. O. Box "P"
Oak Ridge, Tennessee 37830
Attention: R. G. Jordan |
 D. W. Burton, K-1001, K-25 |
21. Avco Corporation
Lycoming Division
550 South Main Street
Stratford, Connecticut 06497
Attention: Clause W. Bolton |
22. Teledyne CAE
1330 Laskey Road
Toledo, Ohio 43601
Attention: Eli H. Benstein |
 Howard C. Walch |

DISTRIBUTION LIST (Cont'd)

23. Solar
San Diego, California 92112
Attention: P. A. Pitt
 J. Watkins
1
1
24. Goodyear Atomic Corporation
Box 628
Piketon, Ohio 45661
Attention: C. O. Langebrake
2
25. Iowa State University of Science & Tech.
Ames, Iowa 50010
Attention: Professor George K. Serovy
 Dept. of Mechanical Engineering
1
26. Hamilton Standard Division of United
Aircraft Corporation
Windsor Locks, Connecticut 06096
Attention: Mr. Carl Rohrbach
 Head of Aerodynamics and
 Hydrodynamics
1
27. Westinghouse Electric Corporation
Small Steam and Gas Turbine Engineering B-4
Lester Branch
P. O. Box 9175
Philadelphia, Pennsylvania 19113
Attention: Mr. S. M. DeCorso
1
28. Williams Research Corporation
P. O. Box 95
Walled Lake, Michigan 48088
Attention: J. Richard Joy
 Supervisor, Analytical Section
1

DISTRIBUTION LIST (Cont'd)

29. Lockheed Missile and Space Company
P. O. Box 879
Mountain View, California 94040
Attention: Technical Library 1
30. Eaton Research Center
26201 Northwestern Highway
Southfield, Michigan 48076
ATTN: Librarian 1
31. Chrysler Corporation
Research Office
Dept. 9000
P. O. Box 1118
Detroit, Michigan 48231
Attention: James Furlong (418-19-40)
Ronald Pampreen (418-38-31) 1
32. Elliott Company
Jeannette, Pennsylvania 15644
Attention: J. Rodger Schields
Director-Engineering 1
33. California Institute of Technology
Pasadena, California 91109
ATTN: Prof. Duncan Rannie 1

DISTRIBUTION LIST (Cont'd)

34. Massachusetts Institute of Technology
Cambridge, Massachusetts 02139
Attention: Dr. J. L. Kerrebrock 1
35. Caterpillar Tractor Company
Peoria, Illinois 61601
Attention: J. Wiggins 1
36. Penn State University
Department of Aerospace Engineering
233 Hammond Building
University Park, Pennsylvania 16802
Attention: Prof. B. Lakshminarayana 1
37. Texas A&M University
Department of Mechanical Engineering
College Station, Texas 77843
Attention: Dr. Meherwan P. Boyce P.E. 1