

LMSC-HREC TR D496555-II



147532

# SUPERSONIC FLOW OF CHEMICALLY REACTING GAS-PARTICLE MIXTURES

Volume II

## RAMP -- A Computer Code for Analysis of Chemically Reacting Gas-Particle Flows

Morris M. Penny  
Sheldon D. Smith  
Peter G. Anderson  
Peter R. Sulyma  
Marcus L. Pearson

Lockheed Missiles & Space Company, Inc.  
Huntsville Research & Engineering Center  
4800 Bradford Drive, Huntsville, AL 35807

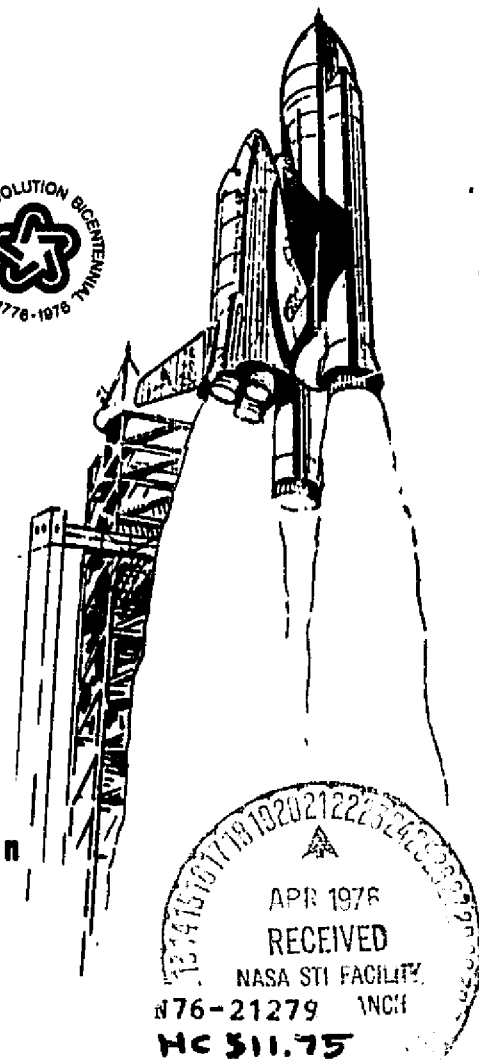

January 1976

Contract NAS9-14517

Prepared for

National Aeronautics and Space Administration  
Johnson Space Center  
Houston, TX 77058

(NASA-CR-147532) SUPERSONIC FLOW OF  
CHEMICALLY REACTING GAS-PARTICLE MIXTURES.  
VOLUME 2: RAMP, A COMPUTER CODE FOR  
ANALYSIS OF CHEMICALLY REACTING GAS-PARTICLE  
FLOWS (Lockheed Missiles and Space Co.)

G3/20

Unclass  
21586

**Page intentionally left blank**

## FOREWORD

This document is Volume II of a two volume report describing the Reacting and Multi-Phase (RAMP) Computer Code developed by the Advanced Technology Systems Section of Lockheed's Huntsville Research & Engineering Center. Volume II addresses the computer code along with the program input and output. Volume I deals with the theory and numerical solution for the computer code.

Documentation of the computer code was prepared in partial fulfillment of contract requirements (Contract NAS9-14517) with the NASA-Johnson Space Flight Center, Houston, Texas, in support of Space Shuttle related exhaust plume applications. The contracting officer's technical representative for this study was Mr. Barney B. Roberts of the Aerodynamics Systems Analysis Section.

The authors acknowledge the efforts of a number of individuals who contributed to the development of the RAMP code. These include Dr. Terry F. Greenwood and Mr. David C. Seymour of the NASA-Marshall Space Flight Center; and Messrs. Robert J. Prozan, Jon A. Freeman, L. Ray Baker and A. W. Ratliff of Lockheed-Huntsville. Ideas and suggestions for improvement of the analysis are reflected by frequent consultation with these individuals.

Companion documents to this report include a theory and numerical solution document for the RAMP computer code; a report which describes the modifications made to the NASA-Lewis TRAN72 computer code; and documentation of a one-dimensional solution which provides a supersonic startline for the RAMP code. These documentation are, respectively:

- "Supersonic Flow of Chemically Reacting Gas-Particle Mixtures - Volume I - A Theoretical Analysis and Development of the Numerical Solution," LMSC-HREC TR D496555-I.
- "User's Guide for TRAN72 Computer Code Modified for use with RAMP and VOFMOC Flowfield Codes," LMSC-HREC TM D390409.
- "General One-Dimensional Flow of Gas-Particle System," LMSC-HREC TM 390876.



## CONTENTS

Section		Page
	FOREWORD	
1	INTRODUCTION AND SUMMARY	1-1
2	USER'S INPUT/OUTPUT GUIDE FOR THE MODIFIED TRAN72 COMPUTER CODE	2-1
	2.1 User of the Modified TRAN72 Program with the RAMP Program	2-1
	2.2 Use of the Modified TRAN72 Program with the VOFMOC Program	2-6
3	REACTING AND MULTIPHASE (RAMP) COMPUTER PROGRAM	3-1
	3.1 Capabilities and Limitations	3-15
	3.2 User's Input Guide for the RAMP Program	3-19
	3.2.1 RAMP Program Input Information	3-19
	3.2.2 Control Card Set-Up for Univac 1108 Exec 8 and Program Overlay Structures	3-47
	3.3 Output Format	3-51
	3.3.1 Description of Printed Output	3-51
	3.3.2 Description of Unformatted Binary Output	3-91
	3.4 Program Utilization Comments	3-96
	3.4.1 Mesh Control Variables	3-96
	3.4.2 Explanation of Error Messages and Other Messages	3-103
	3.4.3 Problems Commonly Encountered and Suggested Fixes	3-107
	3.5 Brief Description of Routines in Functional Groupings	3-114
	3.5.1 General Flow Properties Routines	3-114
	3.5.2 Shock Calculation Routines	3-117
	3.5.3 Input Routines	3-117
	3.5.4 Logic Control Routines	3-118
	3.5.5 Free Molecular Routines	3-119
	3.5.6 Output Routines	3-119
	3.5.7 Transonic Routines	3-120
	3.5.8 Startline Routines	3-120

Section		Page
3	3.5.9 Boundary and Problem Limit Routines	3-121
	3.5.10 Interpolation and Iteration Routines	3-122
	3.5.11 Property Retrieval Routines	3-122
	3.5.12 Chemistry Routines	3-123
	3.5.13 Compatibility Equation Coefficient Routines	3-124
	3.5.14 Corner Point Solution Routines	3-124
	3.5.15 Initialization Routines	3-125
	3.5.16 Performance Calculation Routines	3-125
	3.5.17 Characteristic Routines	3-126
	3.5.18 Miscellaneous Routines	3-126
	3.6 Detailed Discussion of the Individual Routines	3-128
	3.7 Example Problems	3-250
4	CONCLUSIONS	4-1
5	REFERENCES	5-1
 Appendixes		
A	User's Input Guide for the RAMP Radial Lookup Program	A-1
B	On the Accuracy of Predicted Exhaust Plume Flowfield Variables	B-1
C	Empirical Input Data and Input Data Suggestions	C-1

Section 1  
INTRODUCTION AND SUMMARY

Most solid rocket motor propellants contain metal additives which increase the energy content of the system and also suppress combustion pressure instabilities. The presence of these metal additives, however, results in condensed products in the exhaust which can do no expansion work and thereby reduce the effectiveness of the nozzle. Also, the presence of liquid or solid particles in the exhaust will contribute significantly to radiation and plume impingement heating on structures which are either immersed or in proximity to the exhaust plume. It is therefore important to know the physical properties of both the solids and gases throughout the nozzle and exhaust plumes.

This report describes two computer programs which are applicable to the analysis of chemically reacting gas-particle flow fields. The programs are:

- The NASA-Lewis FORTRAN IV Computer Program for Calculation of Thermodynamic and Transport Properties of Complex Chemical Systems (TRAN72)
- The Lockheed Reacting and Multi-Phase Computer Program (RAMP).

These programs are currently operational on the CDC, Univac and IBM computers. To facilitate the use of the codes, they are constructed such that automatic transmission of data to other computer programs is possible via magnetic tapes.

Section 2 presents a description of the modifications made to the TRAN72 computer program to meet the general requirements of Lockheed's RAMP program and provides instructions for operating the modified TRAN72 program. Four example cases are presented which show the required input format

and resultant output for creation of thermodynamic data for typical rocket performance problems. No attempt is made here to report on the program itself since this information is documented in Refs. 1 and 2.

Section 3 of this report discusses the RAMP program. Included are:

- A discussion of the basic capabilities and limitations of the program.
- A user's input guide for the RAMP program.
- A description of the typical input/output for a two-phase chemical equilibrium flow problem; a single phase chemical equilibrium flow problem with free molecular considerations and a single phase finite rate chemistry flow problem.
- A discussion of typical user problems and possible fixes.
- A list of helpful hints and a presentation of example deck set-ups.
- A brief description of each of the basic routines in functional groupings.
- A detailed discussion of each individual routine used in the program.
- Program overlay structure.
- A section of typical example problems including a statement of the problem, accompanying figure and sample input and output.

The gas-particle capability has been incorporated into a streamline-normal method of characteristics computer program (Ref. 3). Choosing this technique provides several important advantages in describing flowfields which contain a gas-particle mixture not found in conventional method of characteristics program (Ref. 4), and at the same time, retains the same sophistication and capabilities of these programs. First, the streamline-normal method allows a data point on a particle limiting streamline to be treated in the same fashion as a data point on a gas streamline. This greatly simplifies the tracing of particle trajectories through the flow field. Also, another important feature is the reduction in computer storage requirement to identify the particle locations. Flow fields containing shock waves (both

right-running and left-running or in combination) can be analyzed in one continuous operation, hence expediting the flowfield description of nozzles and plumes or other complicated geometries.

These computer programs are extremely large and complex so that a complete description of them is not feasible in this report. It is possible, however, to utilize the programs with the information contained herein while total understanding of the methods is made possible by study of the supporting documentation.

The computer programs are available for external distribution. Further information on obtaining the programs is available from the authors.

## Section 2

### USER'S INPUT/OUTPUT GUIDE FOR THE MODIFIED TRAN72 COMPUTER CODE

The TRAN72 computer program (developed by NASA-Lewis Research Center (Ref. 1)) was synthesized by combining a program for the transport properties calculation with the CEC 71 program (Ref. 2) for the thermodynamic properties calculation. The TRAN72 program was subsequently modified to meet the requirements of Lockheed's reacting and Multi-Phase (RAMP) Computer Program (Ref. 5). The requirements satisfied were: (1) calculation of the theoretical rocket performance (for both equilibrium and frozen compositions) during a "gaseous-only" expansion, after a two-phase combustion chamber calculation; and (2) automated communication of these properties to the RAMP program.

#### 2.1 USE OF THE MODIFIED TRAN72 PROGRAM WITH THE RAMP PROGRAM

Modifications were made to the TRAN72 chemical equilibrium calculational scheme in order to generate thermochemical data consistent with the assumptions utilized in the RAMP program formulation. The assumptions being addressed in the RAMP program are:

- The total mass of the mixture is constant.
- The total energy of the mixture is constant.
- The gas obeys the perfect gas law and is either chemically frozen, in chemical non-equilibrium or in chemical equilibrium.
- There is no mass exchange between the phases.
- The particles are inert.

In the modified TRAN72 calculational scheme, the chamber calculations are performed initially with the condensed species considered. The total mass and total enthalpy of the mixture are then adjusted by removing the mass and

enthalpy associated with the condensed species predicted to exist in the chamber after combustion. The total mass adjustment is made by removing the appropriate amount of mass of each of the elements which comprise the condensed species that exist in the chamber. The total enthalpy is adjusted by removing the enthalpy associated with the condensed species that exist in the chamber. Next, the adjusted elemental mass balance relationships and the adjusted total enthalpy are referenced to the adjusted total mass of the mixture. All condensed species are then removed from the list of possible products being considered by the program. The chamber calculations and subsequent equilibrium chemistry expansion are then made with a gaseous-only composition. When the thermodynamic calculations are completed, the transport properties are calculated in the manner described in Ref. 1. The resultant equilibrium chemistry expansion and corresponding transport properties data are for the case in which there is no heat transfer between the condensed and gaseous species during the equilibrium chemistry expansion process. To account for the effects of the heat transfer that does take place between the condensed and gaseous species during the flowfield calculations, additional thermochemical data are required. To generate the required data, the total enthalpy of the gaseous-only mixture is perturbed (mass is held constant) and the thermochemical data calculational scheme is repeated. The total enthalpy is repeatedly perturbed; the result being an array of equilibrium expansion processes and corresponding transport properties, each with a different degree of heat transfer between the two phases.

Experience in thermodynamical modeling of rocket exhaust flows has indicated that many chemical systems experience a transition from equilibrium to frozen chemistry during the expansion process. The standard TRAN72 program has an option to treat this problem. Under the pressure freeze option the chamber and initial expansion calculations are made assuming equilibrium chemistry. At a predetermined pressure ratio (chamber to local static), the chemistry of the system is frozen and the remainder of the expansion is completed with frozen chemistry. With this option, the transport properties are calculated as outlined in Ref. 1.

The thermochemical and transport data are communicated to the RAMP computer program automatically through the use of a magnetic tape (or rapid access storage, i.e., disk, FASTRAN, etc.). Creation of the data tape (or file) is accomplished by means of an additional subroutine (MOCDAT) added to the TRAN72 program. Logic is provided in this routine for creation of a new data tape (or file) and adding data to an existing Master data list. Each data case must be identified with a unique case name which is subsequently used by the RAMP (see card 8 of RAMP input guide) program to determine if thermodynamic data are available. An additional namelist has been added to the run stream to control use of the options available in the MOCDAT subroutine.

The modified TRAN72 program is used to generate thermodynamic and transport properties of the gaseous phase of the products of combustion being considered in a two-phase flow analysis. Control of the program function for this application is handled through three input groups: the reactant data cards, the \$INPT2 namelist, and the \$RKTINP namelist. A detailed description of the standard TRAN72 program input is given in Ref. 1. Thermodynamic data required for this application are calculated using the RKT option under the \$INPT2 namelist. Selection of this option permits calculation of theoretical rocket performance for both equilibrium and frozen compositions during expansions. The variables MOC2P, PARTHT, QDOTP and NQI have been added to the \$INPT2 namelist. The MOC2P variable controls the selection of the two-phase flow analysis option (MOC2P=T). The variables PARTHT, QDOTP and NQI control the selection (PARTHT=T) and use of the variable total enthalpy option when the effects of heat transfer between the condensed and gaseous species are to be determined in a two-phase flow analysis. When PARTHT=T, QDOTP is set equal to the amount by which the total enthalpy of the gaseous only mixture is to be perturbed. NQI is set equal to the number of QDOTP values input. The specific values of the ratio of chamber to local static pressures ( $P_c/P$ ) at which thermodynamic and transport data are generated are input to the program in the \$RKTINP namelist. The pressure freeze option is activated by setting the variable NFZ under the \$RKTINP namelist



equal to the number of the pressure ratio at which transition from equilibrium to frozen chemistry is to occur. (The chamber is considered to be number one, the throat number two, etc.). Freeze pressures may be the chamber value or any supersonic pressure. No provision is made for freeze pressures between chamber and throat. The parameters which are generally utilized by the RAMP program are local Mach number, static pressure and temperature, isentropic coefficient ( $\gamma$ ), molecular weight, entropy, Prandtl number, viscosity, specific heat at constant pressure and the total enthalpy (gas only). These parameters, with the exception of the total enthalpy, are calculated for each value of  $(P_c/P)$  ratio by the program. A detailed description of the logic involved in the standard TRAN72 program computation is presented in flow chart form in Ref. 1. This information can be consulted for an in-depth understanding of the calculational scheme.

To automatically create a tape for communication with the RAMP program requires that one of the two tape-write options be selected (MOCT=T, or MOCTF=T) under the \$INPT2 namelist. The MOCT variable is utilized when the thermochem data are to be run completely under the equilibrium assumption. The MOCTF variable is utilized when the thermochem data are to be run completely or partially frozen. If one of these options is selected an additional namelist, \$TAPGEN, must be input to control the tape-write function and the input of the case name card. The \$TAPGEN data are input after the \$INPT2 data but prior to the case name card and \$RKTINP namelist inputs. Table 2-1 summarizes the program variables added to the modified TRAN72 program.

Four example cases showing the required input format and resultant output for creation of thermodynamic data for typical rocket performance problems are presented in Table 2-2. Case 1 is the required input to perform a calculation of theoretical rocket performance for both the equilibrium and frozen composition assumptions during an isentropic expansion. (No tape is generated.) Case 2 is the same as Case 1 except that a tape for communication with other programs is generated for the frozen composition assumption

Table 2-1

## ADDITIONAL INPUT VARIABLES FOR MODIFIED\* TRAN72 PROGRAM

\$INPT2 NAMELIST					
Variable	Dimension	Type	Common Label	Value Before Read	Comment
MOCT	1	L	HREC	F	Selects tape-write option if true for equil. run.
MOC2P	1	L	HREC	F	Selects two-phase flow analysis option if true.
MOCTF	1	L	HREC	F	Selects tape-write option if true for frozen and pressure freeze options.
PARTHT	1	L	TWOPAS	F	Selects variable total enthalpy option if true for two-phase analysis run.
QDOTP**	26	R	TWOPAS	0.0	Set equal to the amount by which the total enthalpy of the gaseous-only mixture is to be perturbed.
NQI	1	I	TWOPAS	0	Set equal to the number of QDOTP values input.
\$TAPGEN NAMELIST					
IREAD	1	I	-	1	If equal 0, new data added to master data tape list; if equal 1 data written on new data tape.
IO	1	I	-	8	Tape unit of old master tape list.
IN***	1	I	-	10	Tape unit of new data tape.
Case Name Card Format: 6A4					

\* Routines modified from the original TRAN72 program are: LINK, MAIN1 REACT, SEARCH, EQLBRM, ROCKET, RKTOUT, OUT1, TRANSP, OUT.

\*\* The values of QDOTP must always be input in ascending order (from the most negative to the most positive).

\*\*\* When running multiple cases, the data of the last case must always be placed on tape unit 10 if it is to be communicated automatically to the RAMP or VOFMOC programs.

during expansion (MOCTF=T). Case 3 is the required input format for creation of thermodynamic data for use with the RAMP program (MOC2P=T); a tape is generated for the equilibrium composition assumption during the isentropic expansion (MOCT=T). (The effects of heat transfer between the condensed and gaseous species are not determined.) Finally, Case 4 is the same as Case 3 except that the effects of heat transfer between the condensed and gaseous species are determined (PARTHT=T).

## 2.2 USE OF THE MODIFIED TRAN72 PROGRAM WITH THE VOFMOC PROGRAM

The TRAN72 program has been modified to meet the requirements of the RAMP computer program. The data tape (or file) created for communication with the RAMP program contains additional data not required by the VOFMOC program (Ref. 6). For that reason, the tape read statement and format statement in subroutines GASTAP and GASRD, respectively, must be modified to read the additional data as "dummy" variables. The following statements must be changed in the above subroutines before the data tape generated by the TRAN72 program can be read correctly by the VOFMOC program.

- Subroutine GASRD

Old Statement: 1 FORMAT(4A6,5X,A3,6X,12,3X,12)

New Statement: 1 FORMAT(6A4,5X,A3,6X,12,3X,12)

- Subroutine GASTAP

Old Statement: 10 READ(10)(BETA(I),I=1,4),IOF,IS

New Statement: 10 READ(10)(BETA(I),I=1,4),DU,DU,IOF,IS

No other limitations are placed on the use of the modified TRAN72 program.

Table 2-2

EXAMPLE CASES SHOWING THE REQUIRED INPUT FORMAT  
FOR CREATION OF THERMODYNAMIC DATA FOR TYPICAL  
ROCKET PERFORMANCE PROBLEMS

Case 1: Required input to perform a calculation of theoretical rocket  
performance for both the equilibrium and frozen composition  
assumptions during expansion. (No tape is generated.)

REACTANTS

H 2.00	1.00	0.0	6298.15	F
O 2.00	1.00	0.0	6298.15	O

(Insert Blank Card)

NAMELISTS

\$INPT2

RKT=T,PSIA=T,KAASE=C0001,P=200.00,OF=T,MIX=6.0

\$END

\$RKTINP

PLP=10.,30.,50.,100.,500.,1000.,5000.,50000.,100000.,500000.

\$END



Resultant Output for Case 1 (Cont'd)

SHOCK = F  
METN = F  
UITO = F  
CR = .0000000E+00  
SD = .0000000E+00  
SU = .0000000E+00  
IONS = F  
IDEBUG = 0  
TRACE = .0000000E+00  
SIUNIT = F  
EUNITS = F  
TRANST = T  
FROZN = F  
PUNLH = T  
NOVATA = T  
DIF = 1  
MOLP = F  
MOLCT = F  
MUCTF = F  
MOLZF = F  
PARTH = F  
WOUTP = .0000000E+00, .0000000E+00, .0000000E+00, .0000000E+00,  
.0000000E+00, .0000000E+00, .0000000E+00, .0000000E+00,  
.0000000E+00, .0000000E+00, .0000000E+00, .0000000E+00,  
.0000000E+00, .0000000E+00, .0000000E+00, .0000000E+00,  
.0000000E+00, .0000000E+00, .0000000E+00, .0000000E+00,  
END

SPECIES BEING CONSIDERED IN THIS SYSTEM

J 7/65 H J 3/64 H02 J 3/61 H2 L11/65 H20(S) L 1/65 H20(L)  
J 3/61 H20 L 2/69 H20 J 6/62 0 J12/70 0H J 9/65 02  
J 07/61 02

LIST OF CONDENSED SPECIES FROM SEARCH

H20(S) H20(L)  
SHEATNP  
EQL = T  
FROZ = T  
SUBAN = .0000000E+00, .0000000E+00, .0000000E+00, .0000000E+00,  
.0000000E+00, .0000000E+00, .0000000E+00, .0000000E+00,  
.0000000E+00, .0000000E+00, .0000000E+00, .0000000E+00,  
SUPAX = .0000000E+00, .0000000E+00, .0000000E+00, .0000000E+00,  
.0000000E+00, .0000000E+00, .0000000E+00, .0000000E+00,  
PLP = .1000000E+02, .3000000E+02, .5000000E+02, .1000000E+03,  
.5000000E+03, .1000000E+04, .5000000E+04, .1000000E+05,  
.1000000E+06, .5000000E+06, .1000000E+07, .1000000E+08,  
.1000000E+09, .1000000E+10, .1000000E+11, .1000000E+12,  
.1000000E+13

LOCKHEED - HUNTSVILLE RESEARCH & ENGINEERING CENTER

X 2-9

Resultant Output for Case 1 (Cont'd)

NF4	=	+1	
SEND			
OF	=	6.000000	
		EFFECTIVE FUEL	EFFECTIVE OXIDANT
ENTHALPY		HPP(2)	HPP(1)
(KG-MOL) / (SEC K) / KG		.00000000	.00000000
		MIXTURE	
KG-ATOMS/SEC		HQP(1,2)	BQP(1,1)
H		.99209301+00	.00000000
O		.00650000	.14172757+00
			.53573937-01
PT	H	Q	
1	-10.018	-16.435	9.000
2	-10.212	-16.722	3.000
PC/PT	1.728076	T	3229.03
2	-10.212	-16.722	2.000
PC/PT	1.726726	T	.229.25
3	-10.827	-17.881	4.000
4	-11.180	-18.963	4.000
5	-11.328	-19.042	4.000
6	-11.509	-20.021	4.000
7	-11.888	-21.883	4.000
8	-12.034	-27.470	3.000
9	-12.378	-35.461	3.000
10	-12.985	-65.534	2.000
11	-13.208	-64.648	2.000
12	-13.822	-93.855	2.000

REPRODUCIBILITY OF THE ORIGINAL PAGE IS POOR

### Resultant Output for Case 1 (Cont'd)

THEORETICAL ROCKET PERFORMANCE ASSUMING EQUILIBRIUM COMPOSITION DURING EXPANSION

PC = 200.0 PSIA  
CASE NO. = 1

CHEMICAL FORMULA	WT FRACTION (SEE NOTE)	ENERGY CAL/MOL	STATE	TEMP DEG K	DENSITY G/CC
FUEL H <sub>2</sub> O <sub>2</sub>	1.00000	.000	G	298.15	.0000
OXIDANT O <sub>2</sub>	1.00000	.000	G	298.15	.0000
O/F = 6.0000 PERCENT FUEL = 14.2857 EQUIVALENCE RATIO = 1.3227 REACTANT DENSITY = .0000					

	CHAMBER	INNOAT	EXIT	EXIT	EXIT	EXIT	EXIT	EXIT	EXIT	EXIT	EXIT	EXIT
PC/P	1.0000	1.7267	10.000	30.000	50.000	100.00	500.00	1000.00	5000.00	50000.0	100000.0	500000.0
PC/ATM	13.689	7.0815	1.3689	4.636	2.722	1.361	0.272	0.136	0.027	0.003	0.001	0.000
T, DEG K	3387	3229	2756	2458	2306	2089	1582	1385	995	587	495	331
HMU G/CC	6.2506e-4	3.9127e-4	2.2354e-5	3.1358e-5	2.0152e-5	1.1171e-5	2.9587e-6	1.6896e-6	4.7056e-7	7.9798e-8	3.7254e-8	1.4162e-8
H* CAL/G	.3	-274.9	-1852.4	-1464.6	-1637.6	-1853.3	-2268.9	-2413.0	-2681.5	-2933.3	-2986.0	-3078.5
S* CAL/(G*IN)	4.5711	4.5711	4.5711	4.5711	4.5711	4.5711	4.5711	4.5711	4.5711	4.5711	4.5711	4.5711
H* MOL AT	12.969	13.155	13.686	13.911	14.009	14.079	14.111	14.111	14.112	14.112	14.112	14.112
(DLV/DLPT)	-1.04518	-1.03821	-1.01687	-1.00603	-1.00379	-1.00135	-1.00054	-1.00000	-1.00000	-1.00000	-1.00000	-1.00000
(DLV/DLTP)	1.0198	1.2271	1.3744	1.4602	1.6982	1.8380	1.6013	1.0002	1.0000	1.0000	1.0000	1.0000
CP* CAL/(G*IN)	3.1839	2.9874	2.0739	1.4322	1.1889	.9561	.7528	.7193	.6516	.5839	.5711	.5520
GAMMA (S)	1.1209	1.1209	1.1364	1.1402	1.1629	1.1873	1.2300	1.2435	1.2757	1.3178	1.3273	1.3425
SUM VEL/IN/SEC	1565.7	1516.6	1375.0	1297.3	1261.6	1210.6	1071.1	1007.4	864.7	674.9	622.4	511.3
WAVE NUMBER	622	1.000	2.157	2.679	2.934	3.253	4.068	4.461	5.478	7.341	8.032	9.926
AL/AL		1.0000	2.4280	5.4053	7.9544	13.489	46.028	78.146	266.21	1500.93	2512.17	6255.61
CSTAR FT/SEC		7624	7624	7624	7624	7624	7624	7624	7624	7624	7624	7624
CF		.053	1.277	1.506	1.593	1.645	1.675	1.694	2.038	2.132	2.151	2.184
IVAC LB-SEC/LB		291.9	360.1	399.7	415.2	433.5	466.1	476.0	495.7	512.3	515.7	521.5
ISF LB-SEC/LB		151.6	302.6	337.6	377.5	401.6	444.3	458.3	483.0	505.2	509.7	517.6

**MOLE FRACTIONS**

H	.06144	.05369	.02922	.01492	.00933	.00387	.00013	.00002	.00000	.00000	.00000	.00000
H <sub>2</sub> O	.00002	.00001	.00000	.00000	.00000	.00000	.00000	.00000	.00000	.00000	.00000	.00000
H <sub>2</sub>	.25264	.24870	.23976	.23729	.24033	.24216	.24392	.24398	.24399	.24399	.24399	.24399
H <sub>2</sub> O	.60366	.62983	.70389	.73601	.74540	.75254	.75593	.75600	.75601	.75601	.75601	.75601
H <sub>2</sub> O <sub>2</sub>	.00001	.00000	.00000	.00000	.00000	.00000	.00000	.00000	.00000	.00000	.00000	.00000
O	.00000	.00000	.00000	.00000	.00000	.00000	.00000	.00000	.00000	.00000	.00000	.00000
OH	.00007	.00001	.00000	.00000	.00000	.00000	.00000	.00000	.00000	.00000	.00000	.00000
O <sub>2</sub>	.00000	.00000	.00000	.00000	.00000	.00000	.00000	.00000	.00000	.00000	.00000	.00000

ADDITIONAL PRODUCTS WHICH WERE CONSIDERED BUT WHOSE MOLE FRACTIONS WERE LESS THAN .50000-05 FOR ALL ASSIGNED CONDITIONS

H<sub>2</sub>O(2) H<sub>2</sub>O(1) O<sub>3</sub>

NOTE: WEIGHT FRACTION OF FUEL IN TOTAL FUELS AND OF OXIDANT IN TOTAL OXIDANTS.



Resultant Output for Case 1 (Cont'd)

TRANSPORT PROPERTIES OF ROCKET EXHAUST ASSUMING EQUILIBRIUM COMPOSITION DURING EXPANSION

O/F = 4.2000 PERCENT FUEL = 14.2057 EQUIVALENCE RATIO = 1.3227 CHAMBER PRESSURE = 13.609 ATM

TEMP	VISCOSITY	MONATOMIC COND	INTERNAL COND	FROZEN COND	REACTION COND	EQUILIBRIUM COND	CP FROZ	CP EQ	PRANDTL FROZ	PRANDTL EQ	LE#15 NUMBER
DEG K	POISE	CAL/(CM)(SEC)(K)				CAL/(G)(K)		DIMENSIONLESS			
3387	1027. x10 <sup>-6</sup>	721. x10 <sup>-6</sup>	804. x10 <sup>-6</sup>	1525. x10 <sup>-6</sup>	5248. x10 <sup>-6</sup>	6773. x10 <sup>-6</sup>	.8857	3.1839	.5965	.4827	1.3266
3224	894.	641.	722.	1452.	4703.	6156.	.8793	2.9874	.6227	.4831	1.3506
2756	493.	567.	666.	1233.	2440.	3873.	.8550	2.0739	.6193	.4763	1.5017
2450	419.	533.	593.	1093.	1345.	2438.	.8348	1.4322	.6257	.4813	1.7195
2306	779.	475.	548.	1023.	847.	1870.	.8230	1.1889	.6273	.4955	1.8642
2264	719.	436.	485.	921.	364.	1285.	.8038	.9561	.6277	.5353	2.0634
1562	567.	349.	331.	680.	15.	495.	.7462	.7528	.6216	.6135	2.5203
1365	503.	314.	272.	686.	2.	547.	.7183	.7193	.6172	.6158	2.6309
1195	371.	242.	160.	400.	0.	400.	.6516	.6516	.6045	.6045	
567	215.	151.	70.	221.	0.	221.	.5839	.5839	.5702	.5702	
475	100.	129.	54.	184.	0.	184.	.5711	.5711	.5580	.5580	
331	113.	83.	31.	114.	0.	114.	.5526	.5526	.5253	.5253	

2-12

Resultant Output for Case 1 (Cont'd)

THEORETICAL ROCKET PERFORMANCE ASSUMING FROZEN COMPOSITION DURING EXPANSION

PC = 200.0 PSIA  
CASE NO. 1

CHEMICAL FORMULA	WT FRACTION (SEE NOTE)	ENERGY CAL/MOL	STATE	TEMP DEG K	DENSITY G/CC
FUEL H 2.00000	1.00000	.000	g	298.15	.0000
Oxidant O 2.00000	1.00000	.000	g	298.15	.0000
O/F = 6.0000 PERCENT FUEL = 14.2857 EQUIVALENCE RATIO = 1.3227 REACTANT DENSITY = .0000					

	CHAMBER	THROAT	EXIT	EXIT	EXIT	EXIT	EXIT	EXIT	EXIT	EXIT	EXIT	EXIT
PC/P	1.0000	1.7797	10.000	30.000	50.000	100.00	500.00	1000.00	5000.00	50000.0	100000.0	500000.0
P/ATM	13.609	7.0467	1.3609	.4536	.2722	.1361	.0272	.0136	.0027	.0003	.0001	.0000
TEMP K	3287	1003	2243	1819	1665	1426	1000	854	674	515	362	170
MMOL/GCC	6.3506E-4	3.9453E-4	9.5894E-5	3.9420E-5	2.6172E-5	1.5000E-5	4.2805E-6	2.5197E-6	7.4888E-7	1.3646E-7	2.0600E-8	2.5309E-8
H CAL/G	.03	-284.7	-981.8	-1322.7	-1458.2	-1621.3	-1918.4	-2016.8	-2191.0	-2343.0	-2574.4	-2926.8
S CAL/(G/1K)	4.5711	4.5711	4.5711	4.5711	4.5711	4.5711	4.5711	4.5711	4.5711	4.5711	4.5711	4.5711
MMOL WT	12.969	12.969	12.969	12.969	12.969	12.969	12.969	12.969	12.969	12.969	12.969	12.969
CP CAL/(G/1K)	.8857	.8720	.8224	.7829	.7630	.7361	.6608	.6048	.5292	.4705	.4220	.3670
GAMMA (S)	1.2092	1.2130	1.2290	1.2403	1.2513	1.2633	1.2772	1.3117	1.3397	1.3619	1.3653	1.3677
SUN VEL/SEC	1620.3	1543.4	1324.4	1204.1	1140.3	1074.0	913.0	647.3	702.4	221.0	470.9	306.3
MACR NUMBER	.000	1.000	2.156	2.703	3.042	3.427	4.386	4.849	6.096	6.441	9.307	11.664
AE/AI	1.0000	2.2154	4.6430	6.6605	10.964	35.455	58.827	109.90	1007.07	1664.19	5330.95	
CSIA VEL/SEC		743	743	743	743	743	743	743	743	743	743	743
CF	.682	1.200	1.469	1.543	1.620	1.769	1.814	1.891	1.956	1.960	1.990	
TVAC LB-SEC/LB	207.1	343.4	375.0	387.0	400.9	424.9	432.5	445.4	456.2	456.5	462.0	
ISF LB-SEC/LB	157.4	292.3	339.3	356.2	375.0	418.9	430.6	436.6	451.6	454.5	459.0	

MOLE FRACTIONS

H	.06144	HU2	.00002	H2	.25264	H2O	.60366
H2O2	.00001	O	.00930	OH	.06437	O2	.00007

ADDITIONAL PRODUCTS WHICH WERE CONSIDERED BUT WHOSE MOLE FRACTIONS WERE LESS THAN .50000E-05 FOR ALL ASSIGNED CONDITIONS

H2O(L) H2O(L) O3

NOTE: WEIGHT FRACTION OF FUEL IN TOTAL FUELS AND OF OXIDANT IN TOTAL OXIDANTS

LOCKHEED - HUNTSVILLE RESEARCH & ENGINEERING CENTER

2-13

REPRODUCTION OF THIS ORIGINAL PAGE IS POOR

Resultant Output for Case 1 (Cont'd)

TRANSPORT PROPERTIES OF ROCKET EXHAUST ASSUMING FROZEN COMPOSITION DURING EXPANSION

O/F = 6.2500 PERCENT FUEL = 14.2657 EQUIVALENCE RATIO = 1.3227 CHAMBER PRESSURE = 13.009 ATM

TEMP	VISCOSITY	MONATOMIC	INTERNAL	FROZEN	CP	PRANDTL
DEG K	POISE	COND	COND	COND	FROZ	FROZ
		---- CAL/(CM)(SEC)(K)	---- CAL/(CM)(SEC)(K)	---- CAL/(G)(K)		
3387	1327. x 10 <sup>-6</sup>	721. x 10 <sup>-6</sup>	854. x 10 <sup>-6</sup>	1525. x 10 <sup>-6</sup>	.8857	.5705
3053	982.	669.	723.	1391.	.8726	.5709
2243	746.	529.	563.	1031.	.8224	.5749
1819	628.	455.	382.	832.	.7829	.5716
1644	576.	416.	332.	740.	.7633	.5682
1426	510.	372.	271.	642.	.7351	.5635
1304	372.	283.	157.	437.	.6888	.5711
854	318.	244.	122.	366.	.6448	.5669
574	214.	172.	69.	245.	.6142	.5368
315	111.	98.	31.	129.	.5765	.4964
262	89.	82.	24.	100.	.5720	.4865
170	50.	53.	13.	60.	.5076	.4355

Table 2-2 (Continued)

Case 2: Same as Case 1 except that a tape for communication with other programs is generated for the frozen composition assumption during expansion (MOCTF=T).

REACTANTS				
H 2.00	1.00	0.0	G298.15	F
O 2.00	1.00	0.0	G298.15	O

(Insert Blank Card)

NAMELISTS

\$INPT2

RKT=T,PSIA=T,KASE=00001,P=200.00,OF=T,MIX=6.0,MOCTF=T

\$END

\$STAGEN

IREAD=1,I0=8,IN=10

\$END

CASE 2

\$RKTINP

PCP=10.,30.,50.,100.,500.,1000.,5000.,50000.,100000.,500000.

\$END

The resultant output for Case 2 is identical to that of Case 1 except for a listing of the data placed on tape for communication with other programs. The following is a listing of that data.

Resultant Output for Case 2

CASE 2

14 15

	13.6	0	0	0	0	0
	M	M02	M2	M20	M202	0
	02					0M
	0	0	0	0	0	0
.5000000+01	.1360914+02	.3387107+04	.4571126+01	.1296948+02	.1289164+01	.8888888
.5964648+00	.1026803+02	.8857473+00	.1524797+02	.1071697+03	.0000000	
.6143522-01	.2074548-04	.2526378+00	.6036585+00	.6700844+05	.9304747-02	.6407105-01
.8865255-02						
.6000000+01	.7846660+01	.3963393+04	.4571126+01	.1296948+02	.1212994+01	.1000001+01
.5968520+00	.9517980+03	.8725738+00	.1391499-02	.2846713+03	.0000000	
.6143522-01	.2074548-04	.2526378+00	.6036585+00	.6700844+05	.9304747-02	.6407105-01
.8865255-02						
.6000000+01	.1360914+01	.2241120+04	.4571126+01	.1296948+02	.1228950+01	.2156171+01
.5949376+00	.7459975+03	.8224411+00	.1031266-02	.9818261+03	.0000000	
.6143522-01	.2074548-04	.2526378+00	.6036585+00	.6700844+05	.9304747-02	.6407105-01
.8865255-02						
.6000000+01	.4536380+00	.1818886+04	.4571126+01	.1296948+02	.1243327+01	.2743136+01
.5910147+00	.6287030+03	.7829015+00	.8318989-03	.1322747+04	.0000000	
.6143522-01	.2074548-04	.2526378+00	.6036585+00	.6700844+05	.9304747-02	.6407105-01
.8865255-02						
.6000000+01	.2721828+00	.1443734+04	.4571126+01	.1296948+02	.1251253+01	.3042108+01
.5881605+00	.5764133+03	.7830368+00	.7478279-03	.1458166+04	.0000001	
.6143522-01	.2074548-04	.2526378+00	.6036585+00	.6700844+05	.9304747-02	.6407105-01
.8865255-02						
.6000000+01	.1360914+00	.1424448+04	.4571126+01	.1296948+02	.1263319+01	.3826420+01
.5835169+00	.5098191+03	.7350936+00	.6422518+03	.1620997+04	.0000000	
.6143522-01	.2074548-04	.2526378+00	.6036585+00	.6700844+05	.9304747-02	.6407105-01
.8865255-02						
.6000000+01	.2721828+01	.1003621+04	.4571126+01	.1296948+02	.1297168+01	.4385761+01
.5700932+00	.3722229+03	.6698142+00	.4365774-03	.1918392+04	.0000000	
.6143522-01	.2074548-04	.2526378+00	.6036585+00	.6700844+05	.9304747-02	.6407105-01
.8865255-02						
.6000000+01	.1360914+01	.8536904+03	.4571126+01	.1296948+02	.1311706+01	.4848728+01
.5608789+00	.3182571+03	.6447665+00	.3658572+03	.2018852+04	.0000000	
.6143522-01	.2074548-04	.2526378+00	.6036585+00	.6700844+05	.9304747-02	.6407105-01
.8865255-02						
.6000000+01	.2721828+02	.6784616+03	.4571126+01	.1296948+02	.1329747+01	.6025976+01
.5368147+00	.2136717+03	.6041972+00	.2404924+03	.2191046+04	.0000000	
.6143522-01	.2074548-04	.2526378+00	.6036585+00	.6700844+05	.9304747-02	.6407105-01
.8865255-02						
.6000000+01	.2721828+03	.3152506+03	.4571126+01	.1296948+02	.1361947+01	.8511343+01
.4463528+00	.1109285+03	.5765364+00	.1288253+03	.2343800+04	.0000000	
.6143522-01	.2074548-04	.2526378+00	.6036585+00	.6700844+05	.9304747-02	.6407105-01
.8865255-02						
.6000000+01	.1360914+03	.7620391+03	.4571126+01	.1296948+02	.1365323+01	.9307494+01
.4805352+00	.8887161+04	.5726242+00	.1058432+03	.7374371+04	.0000000	
.6143522-01	.2074548-04	.2526378+00	.6036585+00	.6700844+05	.9304747-02	.6407105-01
.8865255-02						
.6000000+01	.2721828+04	.1429792+03	.4571126+01	.1296948+02	.1369790+01	.1166891+02
.4105298+00	.4990455+04	.5676137+00	.6590659+04	.226898+04	.0000000	
.6143522-01	.2074548-04	.2526378+00	.6036585+00	.6700844+05	.9304747-02	.6407105-01
.8865255-02						

LOCKHEED - HUNTSVILLE RESEARCH & ENGINEERING CENTER

2-17

REPRODUCIBILITY OF THIS ORIGINAL PAGE IS POOR

Table 2-2 (Cont'd)

Case 3: Required input for creation of thermodynamic data for use with the RAMP program (MOC2P=T); a tape is generated for the equilibrium composition assumption during expansion (MOCT=T). (The effects of heat transfer between the condensed and gaseous species are not determined.)

```

REACTANTS
AL 1.0
C 6.884 H 10.089 O .278 N .264
FE2.0 O 3.0
C 6.15 H 6.97 O 1.17 N .03
N 1.0 H 4.0 O 4.0 CL 1.0
      (Insert Blank Card)
OMIT      AL(S)      AL(L)      ALCL3(S)      ALCL3(L)
OMIT      ALN(S)     ALN      AL2CL6      AL2O2
OMIT      CCL3      CCL4      CH          CH2
OMIT      CH3      CH4      COCL2      C2CL2
OMIT      C2H6     C3O2     C4          C5
OMIT      FE(S)     FE(L)     FECL2(S)    FECL2(L)
OMIT      H2O(S)    H2O(L)

NAMELISTS
$INPT2
      NKT=T,PSIA=T,KASL=00001,P=554.00,MOC2P=T,MOCT=T
$END
$TAPGEN
      IREAD=1,IO=8,IN=10
$END
CASE 3
$KTI=
      PCP=10.,30.,50.,100.,500.,1000.,5000.,50000.,100000.,500000.
$END

```

### Resultant Output for Case 3

UNIT	AL(1)	AL(1)	ALCL3(1)	ALCL3(L)
UNIT	AL(5)	AL(1)	ALCL6	AL2(2)
UNIT	CCL3	CCL4	CH	CH2
UNIT	CH3	CH4	CCL2	C2CL2
UNIT	C2H1	C302	C4	C5
UNIT	FE(1)	FE(1)	FECL2(1)	FECL2(L)
UNIT	H20(1)	H20(L)		

UNIT	AL(1)	AL(1)	ALCL3(1)	ALCL3(L)
UNIT	AL(5)	AL(1)	ALCL6	AL2(2)
UNIT	CCL3	CCL4	CH	CH2
UNIT	CH3	CH4	CCL2	C2CL2
UNIT	C2H1	C302	C4	C5
UNIT	FE(1)	FE(1)	FECL2(1)	FECL2(L)
UNIT	H20(1)	H20(L)		

UNIT	AL(1)	AL(1)	ALCL3(1)	ALCL3(L)
UNIT	AL(5)	AL(1)	ALCL6	AL2(2)
UNIT	CCL3	CCL4	CH	CH2
UNIT	CH3	CH4	CCL2	C2CL2
UNIT	C2H1	C302	C4	C5
UNIT	FE(1)	FE(1)	FECL2(1)	FECL2(L)
UNIT	H20(1)	H20(L)		

UNIT	AL(1)	AL(1)	ALCL3(1)	ALCL3(L)
UNIT	AL(5)	AL(1)	ALCL6	AL2(2)
UNIT	CCL3	CCL4	CH	CH2
UNIT	CH3	CH4	CCL2	C2CL2
UNIT	C2H1	C302	C4	C5
UNIT	FE(1)	FE(1)	FECL2(1)	FECL2(L)
UNIT	H20(1)	H20(L)		



Resultant Output for Case 3 (Cont'd)

```

      .0000000E+00.  .0000000E+00.  .0000000E+00.  .0000000E+00.
      .0000000E+00.  .0000000E+00.  .0000000E+00.  .0000000E+00.
      .0000000E+00.  .0000000E+00.  .0000000E+00.
TP      *   F
HP      *   F
SP      *   F
TV      *   F
LV      *   F
SV      *   F
KKT     *   T
SHOCK   *   F
DETN    *   F
DTI     *   F
CX      *   .0000000E+00
SO      *   .0000000E+00
SO      *   .0000000E+00
IQES    *   F
IDEUG   *   +0
TYARE   *   .0000000E+00
SIUNIT  *   F
EUNITS  *   F
TRANSP  *   T
FRUZZ   *   F
PUACH   *   F
NOBATA  *   T
DIF     *   F
HGPC    *   F
MCT     *   T
MCTE    *   F
MCCP    *   T
PACTHT  *   F
OOGTF   *   .0000000E+00.  .0000000E+00.  .0000000E+00.  .0000000E+00.
          .0000000E+00.  .0000000E+00.  .0000000E+00.  .0000000E+00.
          .0000000E+00.  .0000000E+00.  .0000000E+00.  .0000000E+00.
          .0000000E+00.  .0000000E+00.  .0000000E+00.  .0000000E+00.
          .0000000E+00.  .0000000E+00.  .0000000E+00.  .0000000E+00.
          .0000000E+00.  .0000000E+00.  .0000000E+00.  .0000000E+00.
          .0000000E+00.  .0000000E+00.
          *   +0
  
```

```

SEND
NO INPTZ VALUE GIVEN FOR OF, EORAT, FA, OR FCCT
STAGEN
IREAD   *   +1
IO      *   +8
IHL     *   +10
  
```

SPECIES BEING CONSIDERED IN THIS SYSTEM

J 6770 AL	J 6763 ALH	J 6770 ALCL	J 6772 ALCL2	J 6770 ALCL3
J 6773 AL0	J 9765 AL0LL	J 12767 AL0H	J 12768 AL02	J 12768 AL02H
J 6772 AL20	J 6772 AL20315)	J 6772 AL2031L)	J 3761 C15)	J 3761 C
J 12769 CCL	J 12768 CCL2	J 3761 C120	J 6767 C1	J 6766 C1H
J 12770 C02	J 9765 C0	J 12765 C0LL	J 9765 C02	J 12767 C2

LOCKHEED - HUNTSVILLE RESEARCH & ENGINEERING CENTER

Resultant Output for Case 3 (Cont'd)

J 3/67 C2H	J 3/61 C2H2	J 9/65 C2H4	J 3/67 C2H	J 3/61 C2H2
J 9/66 C2O	J 12/69 C3	J 6/72 CL	J 6/66 CLCN	J 6/61 CLO
J 3/61 CL02	J 9/65 CL2	J 12/65 CL2O	J 3/65 FE	J 6/65 FECL
J 12/70 FECL2	J 6/65 FECL3(S)	J 6/65 FECL3(L)	J 6/65 FECL3	J 6/65 FE0(S)
J 6/65 FE0(L)	J 9/66 FE0	J 6/66 FE02H2(S)	J 12/66 FE02H2	J 6/66 FE03H3(S)
J 12/70 FE2CL4	J 6/65 FE2O3(S)	J 6/65 FE3O4(S)	J 9/65 H	J 3/64 HALO
J 9/64 HCL	J 12/69 HCN	J 12/70 HCU	J 12/70 HNC0	J 3/63 HNO
J 6/63 HNO2	J 6/63 HNO3	J 3/64 H02	J 3/61 H2	J 3/61 H2O
J 7/69 H2O2	J 3/61 N	J 12/70 NCO	J 12/71 NH	J 12/65 NH2
J 9/65 NH3	J 6/63 NO	J 12/65 NOCL	J 9/64 NO2	J 12/65 NO2CL
J 12/64 NO3	J 9/65 N2	J 12/65 N2H4	J 12/64 N2O	J 9/64 N2O4
J 12/70 N3	J 6/62 O	J 12/70 OH	J 9/65 O2	J 6/61 O3

LIST OF CONDENSED SPECIES FROM SEARCH

AL2O3(S)	AL2O3(L)	C(S)	FECL3(S)	FECL3(L)
FE0(S)	FE0(L)	FE02H2(S)	FE03H3(S)	FE2O3(S)
FE3O4(S)				
CRYTNP				
F0L	= T			
F007	= T			
SUFAR	.0000000E+00	.0000000E+00	.0000000E+00	.0000000E+00
	.0000000E+00	.0000000E+00	.0000000E+00	.0000000E+00
	.0000000E+00	.0000000E+00	.0000000E+00	.0000000E+00
	.0000000E+00	.0000000E+00	.0000000E+00	.0000000E+00
SUFAR	.0000000E+00	.0000000E+00	.0000000E+00	.0000000E+00
	.0000000E+00	.0000000E+00	.0000000E+00	.0000000E+00
	.0000000E+00	.0000000E+00	.0000000E+00	.0000000E+00
	.0000000E+00	.0000000E+00	.0000000E+00	.0000000E+00
PCF	.1000000E+02	.3000000E+02	.5000000E+02	.1000000E+03
	.5000000E+03	.1000000E+04	.5000000E+04	.5000000E+05
	.1000000E+06	.5000000E+06	.0000000E+00	.0000000E+00
	.0000000E+00	.0000000E+00	.0000000E+00	.0000000E+00
	.0000000E+00	.0000000E+00	.0000000E+00	.0000000E+00
	.0000000E+00	.0000000E+00	.0000000E+00	.0000000E+00
HEZ	+1			

SEND

OF .000000

ENTHALPY	EFFECTIVE FUEL	EFFECTIVE OXIDANT	MIXTURE
(KG-MOL/DEG K)/KG	HPP(2)	HPP(1)	HSUBT
	.22321037+03	.00000000	.22321037+03
KG-ATOMS/KG	BOP(1,2)	BOP(1,1)	B0(1)
AL	.59299890-02	.00000000	.59299890-02
C	.94112869-02	.00000000	.94112869-02
H	.37086374-01	.00000000	.37086374-01
O	.24331585-01	.00000000	.24331585-01
N	.62445374-02	.00000000	.62445374-02
FE	.50796372-04	.00000000	.50796372-04
CL	.59239498-02	.00000000	.59239498-02

T	AL	C	H	O	N	FE	CL	
	-17.240	-11.960	-9.065	-19.774	-13.305	-11.197	-21.957	12.000
	-17.488	-13.390	-9.465	-17.874	-13.815	-15.216	-20.292	2.000

LOCKHEED - HUNTSVILLE RESEARCH & ENGINEERING CENTER

2-21

### Resultant Output for Case 3 (Cont'd)

THEORETICAL ROCKET PERFORMANCE ASSUMING EQUILIBRIUM COMPOSITION DURING EXPANSION

PC = 554.0 PSIA

CASE NO. 1

CHEMICAL FORMULA						WT FRACTION (SEE NOTE)	ENERGY CAL/MOL	STATE	TEMP DEG K	DENSITY G/CC
FUEL	AL	1.00000				.16000	.000	S	298.15	.0000
FUEL	C	6.88400	H	10.08900	O	.27800	N	.26400		
FUEL	FE	2.00000	O	3.00000						
FUEL	C	6.15000	H	6.97000	O	1.17000	N	.03000		
FUEL	N	1.00000	H	4.00000	O	4.00000	CL	1.00000		
D/F = .0000						PERCENT FUEL = 100.0000	EQUIVALENCE RATIO = 1.6977	REACTANT DENSITY = .0000		

	CHAMBER	THROAT	EXIT
PC/P	1.0000		
P, ATM	37.697		
T, DEG K	3391		
rho, G/CC	3.039e-3		
M, CAL/G	443.6		
S, CAL/(G)(K)	2.3005		
M, MOL WT	28.304		
(DLV/DEL)T	1.01875		
(V/DL)T	1.3231		
CP, CAL/(G)(K)	.8897		
MA (S)	1.1383		
VEL, M/SEC	1064.8		

**MOLE FRACTIONS**

AL	.00019
ALH	.00001
ALCL	.00406
ALCL2	.00140
ALCL3	.00012
ALC	.00011
ALOCL	.00192
ALO4	.00037
ALO2	.00003
ALO2H	.00062
AL2O	.00001
AL2O3(L)	.07356
CO	.23061
COCL	.00001
CO2	.01614
Cl	.01744
ClO	.00001
Cl2	.00007
Cl3	.00047

LOCKHEED-HUNTSVILLE RESEARCH & ENGINEERING CENTER

2-22

REPRODUCIBILITY OF THIS ORIGINAL PAGE IS POOR

Resultant Output for Case 3 (Cont'd)

FECL .00005  
 FECL2 .00072  
 FECL3 .00001  
 FECL3H2 .00002  
 H .0311  
 HCL .13260  
 HCO .00002  
 H2 .26637  
 H2O .19065  
 N .00001  
 NH2 .00001  
 NH3 .00001  
 NO .00067  
 N2 .08152  
 O .00073  
 OH .00847  
 O2 .00016

MASS OF ELEMENTS BEING REMOVED FOR TWO PHASE CALCULATION (KG OF SPECIE/KG OF MIXTURE)

AL .15136+00 .15136+00  
 C .00000 .15136+00  
 H .00000 .15136+00  
 O .13465+00 .28603+00  
 N .00000 .28603+00  
 FE .00000 .28603+00  
 CL .00000 .28603+00

ADDITIONAL PRODUCTS WHICH WERE CONSIDERED BUT WHOSE MOLE FRACTIONS WERE LESS THAN .5000E-05 FOR ALL ASSIGNED CONDITIONS

AL2O3(S)	C(S)	C	CCL	CCL2	CH2O	CN	CNN	CN2	C2
C2H	C2H2	C2H4	C2H6	C2H2	C2O	C3	CLCN	CLO2	CL2O
FECL3(S)	FECL3(L)	FECL3	FECL3(S)	FECL3(L)	FECL3H2(S)	FECL3H3(S)	FECL4	FE2O3(S)	FE3O4(S)
HALO	HEN	HNLO	HNO	HNH2	HNH3	H2	H2O2	HCO	NH
HOCL	NO2	NO2CL	NO3	N2H4	N2O	N2O4	N3	O3	

NOTED WEIGHT FRACTION OF FUEL IN TOTAL FUELS AND OF OXIDANT IN TOTAL OXIDANTS

ADJUSTED VALUE OF MSURO = .21937+03 (KG-MOL)(MOL K)/KG

EMPIRICAL MASS VALUES AFTER TWO PHASE CONNECTION

AL .4473149-03  
 C .1310168-01

Resultant Output for Case 3 (Cont'd)

H .5194689-01  
 O .2229186-01  
 N .8776253-02  
 FE .7016621-04  
 CL .8297230-02

AL20(1S) HAS BEEN OMITTED FROM PRODUCTS LIST FOR TWO PHASE CALCULATIONS

AL20(1L) HAS BEEN OMITTED FROM PRODUCTS LIST FOR TWO PHASE CALCULATIONS

(1S) HAS BEEN OMITTED FROM PRODUCTS LIST FOR TWO PHASE CALCULATIONS

FECL3(1S) HAS BEEN OMITTED FROM PRODUCTS LIST FOR TWO PHASE CALCULATIONS

FECL3(1L) HAS BEEN OMITTED FROM PRODUCTS LIST FOR TWO PHASE CALCULATIONS

FEO(1S) HAS BEEN OMITTED FROM PRODUCTS LIST FOR TWO PHASE CALCULATIONS

FEO(1L) HAS BEEN OMITTED FROM PRODUCTS LIST FOR TWO PHASE CALCULATIONS

FEO2H2(1S) HAS BEEN OMITTED FROM PRODUCTS LIST FOR TWO PHASE CALCULATIONS

FEO3H3(1S) HAS BEEN OMITTED FROM PRODUCTS LIST FOR TWO PHASE CALCULATIONS

FE2O3(1S) HAS BEEN OMITTED FROM PRODUCTS LIST FOR TWO PHASE CALCULATIONS

FE3O4(1S) HAS BEEN OMITTED FROM PRODUCTS LIST FOR TWO PHASE CALCULATIONS

ADJUSTED LIST OF SPECIES TO BE CONSIDERED IN TWO PHASE SYSTEM

AL	ALH	ALCL	ALCL2	ALCL3
ALO	ALOCL	ALOH	ALO2	ALO2H
AL2O	C	CCL	CCL2	CH2O
CN	CNN	CN2	CO	COCL
CO2	C2	C2H	C2H2	C2H4
C2N	C2N2	C2O	C3	CL
CLCN	CLO	CLO2	CL2	CL2O
FE	FECL	FECL2	FECL3	FEO
FEO2H2	FE2CL4	H	HALO	NCL
HCN	HCO	HNGO	HNO	HN02
HNO3	HO2	H2	H2O	H2O2
N	NO	NH	NH2	NH3
NO	NOCL	NO2	NO2CL	NO3
N2	N2H4	N2O	N2O4	N3
O	OH	O2	O3	

PT	AL	C	H	O	N	FE	CL	
1	-17.488	-13.390	-9.465	-17.899	-13.815	-15.216	-20.292	12.000

PT	AL	C	H	O	N	FE	CL	
1	-17.488	-13.390	-9.465	-17.899	-13.815	-15.216	-20.292	12.000
2	-17.528	-13.424	-9.599	-18.444	-13.947	-14.688	-20.666	4.000

PC/PT= 1.759309 T = 3141.91

PT	AL	C	H	O	N	FE	CL	
2	-17.528	-13.424	-9.599	-18.444	-13.944	-14.666	-20.667	2.000
PC/PT= 1.763161 T = 3140.94								
3	-17.680	-12.951	-9.968	-20.974	-14.307	-12.950	-22.119	4.000
4	-18.384	-12.965	-10.168	-23.494	-14.505	-11.696	-23.406	5.000
5	-19.300	-11.520	-10.261	-24.980	-14.597	-11.058	-24.118	4.000

Resultant Output for Case 3 (Cont'd)

6	-21.406	-10.502	-10.381	-27.398	-14.717	-10.135	-25.220	4.000
7	-29.265	-6.980	-10.564	-35.203	-16.022	-7.681	-24.591	4.000
8	-33.709	-4.995	-10.602	-39.505	-15.180	-6.507	-30.313	4.000
9	-46.524	.788	-11.187	-51.778	-15.626	-3.956	-35.216	5.000
10	-69.801	11.113	-11.989	-73.344	-16.451	-3.945	-43.520	9.000
11	-73.702	12.186	-12.294	-77.133	-16.754	-4.010	-45.216	5.000
12	-88.629	14.662	-13.032	-89.118	-17.461	-4.402	-50.640	5.000

### Resultant Output for Case 3 (Cont'd)

THEORETICAL ROCKET PERFORMANCE ASSUMING EQUILIBRIUM COMPOSITION DURING EXPANSION FOR TWO PHASE HOC CALCULATIONS

PC = 554.0 PSIA  
 CASE NO. 1

CHEMICAL FORMULA		BY FRACTION (SEE NOTE)	ENERGY CAL/MOL	STATE	TEMP DEG K	DENSITY G/CC
FUEL	AL 1.00000	.16000	.000	S	298.15	.0000
FUEL	C 6.88400 H 10.08900 O .27800 N .26900	.12090	-12000.000	S	298.15	.0000
FUEL	FF 2.00000 O 3.00000	.00400	-197300.000	S	298.15	.0000
FUEL	C 6.15000 H 6.97000 O 1.17000 N .03000	.01760	-28300.000	S	298.15	.0000
FUEL	N 1.00000 H 4.00000 O 4.00000 CL 1.00000	.69600	-70690.000	S	298.15	.0000
O/F = .0000		PERCENT FUEL = 100.0000	EQUIVALENCE RATIO = 1.6977	REACTANT DENSITY = .0000		

	CHAMBER	THROAT	EXIT	EXIT	EXIT	EXIT	EXIT	EXIT	EXIT	EXIT	EXIT	EXIT
PC/P	1.0000	1.7632	10.000	30.000	50.000	100.00	500.00	1000.00	5000.00	50000.00	100000.00	500000.00
P. CTM	37.697	21.381	3.7697	1.2566	.7539	.3770	.0759	.0377	.0075	.0008	.0004	.0001
T. DEG K	3391	3141	2392	1924	1771	1537	1089	943	687	470	454	373
HOC G/CC	2.7379-3	1.4949-3	4.0075-4	1.6455-4	1.0917-4	6.2983-5	1.7778-5	1.0272-5	2.8208-6	4.1999-7	2.2630-7	5.5653-8
H. CAL/G	435.9	294.8	-204.9	-432.6	-522.5	-630.6	-827.9	-894.2	-1016.5	-1137.4	-1160.4	-1225.6
S. CAL/(G)K	2.8416	2.8416	2.8416	2.8416	2.8416	2.8416	2.8416	2.8416	2.8416	2.8416	2.8416	2.8416
M. MOL WT	20.208	20.431	20.863	20.997	21.042	21.068	21.073	21.073	21.079	21.491	21.867	22.595
IDLV/DIPIT	-1.01730	-1.01197	-1.00280	-1.00167	-1.00087	-1.00015	-1.00000	-1.00000	-1.00013	-1.00226	-1.00213	-1.00415
IDLV/DITIP	1.2902	1.2133	1.0556	1.0361	1.0204	1.0042	1.0000	1.0001	1.0032	1.5814	1.8495	1.1275
SP. CAL/(G)K	.7641	.6497	.5682	.5186	.4884	.4491	.4455	.4599	.4962	1.6848	1.6836	.6206
WALLA (S)	1.1799	1.1854	1.2255	1.2404	1.2607	1.2684	1.2685	1.2580	1.2362	1.1247	1.1212	1.2107
SON VEL. M/SEC	1283.0	1241.0	1080.8	979.7	938.5	877.1	738.3	684.0	578.6	452.3	434.9	407.7
MACH. NUMBER	.000	1.000	2.195	2.752	3.027	3.406	4.405	4.878	6.025	8.022	8.419	9.147
AE/AT		1.0000	2.2454	4.7030	6.7483	11.089	36.087	60.883	212.18	1369.11	2516.98	10054.3
CSIA. FL/SEC		.0006	.0006	.0006	.0006	.0006	.0006	.0006	.0006	.0006	.0006	.0006
CF		.672	1.267	1.473	1.547	1.632	1.774	1.822	1.904	1.982	2.000	2.037
IVAC. LB-SEC/LB		231.4	278.4	304.2	314.0	325.3	345.1	351.6	363.4	375.1	378.1	384.0
ISP. LB-SEC/LB		125.5	236.4	274.9	288.8	304.6	331.4	340.2	355.5	370.0	373.4	380.2

**MOLE FRACTIONS**

AL	.00011	.00004	.00000	.00000	.00000	.00000	.00000	.00000	.00000	.00000	.00000	.00000
ALH	.00002	.00001	.00000	.00000	.00000	.00000	.00000	.00000	.00000	.00000	.00000	.00000
ALCL	.00438	.00429	.00302	.00100	.00032	.00003	.00000	.00000	.00000	.00000	.00000	.00000
ALCL2	.00151	.00148	.00248	.00234	.00135	.00032	.00000	.00000	.00000	.00000	.00000	.00000
ALCL3	.00013	.00019	.00123	.00503	.00737	.00903	.00942	.00943	.00943	.00941	.00978	.01011
ALO	.00012	.00008	.00000	.00000	.00000	.00000	.00000	.00000	.00000	.00000	.00000	.00000
ALOCL	.00165	.00178	.00160	.00065	.00033	.00004	.00000	.00000	.00000	.00000	.00000	.00000
ALOH	.00040	.00037	.00019	.00005	.00001	.00000	.00000	.00000	.00000	.00000	.00000	.00000
AL2	.00113	.00002	.00000	.00000	.00000	.00000	.00000	.00000	.00000	.00000	.00000	.00000
AL2H	.00013	.00005	.00000	.00000	.00000	.00000	.00000	.00000	.00000	.00000	.00000	.00000
AL2O	.00011	.00001	.00000	.00000	.00000	.00000	.00000	.00000	.00000	.00000	.00000	.00000
AL2O2	.00002	.00007	.00126	.00433	.00802	.00760	.00597	.00563	.00483	.00477	.00413	.00413

Resultant Output for Case 3 (Cont'd)

CCL	.00001	.00000	.00000	.00000	.00000	.00000	.00000	.00000	.00000	.00000	.00000	.00000
C2	.01747	.01872	.02373	.02745	.03335	.04071	.07181	.07216	.14702	.20294	.21692	.24618
C2H4	.00000	.00000	.00000	.00000	.00000	.00000	.00000	.00000	.00000	.00000	.00000	.00000
CL	.01343	.00944	.00158	.00021	.00006	.00001	.00000	.00000	.00000	.00000	.00000	.00000
CL2	.00001	.00000	.00000	.00000	.00000	.00000	.00000	.00000	.00000	.00000	.00000	.00000
CL7	.00001	.00001	.00000	.00000	.00000	.00000	.00000	.00000	.00000	.00000	.00000	.00000
FE	.00053	.00040	.00004	.00000	.00000	.00000	.00000	.00000	.00000	.00000	.00000	.00000
FECL	.00005	.00004	.00000	.00000	.00000	.00000	.00000	.00000	.00000	.00000	.00000	.00000
FECL2	.00078	.00095	.00141	.00147	.00148	.00148	.00148	.00147	.00100	.00001	.00001	.00000
FEH	.00004	.00003	.00000	.00000	.00000	.00000	.00000	.00000	.00000	.00000	.00000	.00000
FE2H2	.00002	.00001	.00000	.00000	.00000	.00000	.00000	.00000	.00000	.00000	.00000	.00000
FE2CL4	.00000	.00000	.00000	.00000	.00000	.00000	.00000	.00000	.00000	.00000	.00000	.00000
H	.03891	.02730	.00428	.00058	.00018	.00002	.00000	.00000	.00000	.00000	.00000	.00000
H2	.14313	.14788	.15483	.14945	.14812	.14403	.14362	.14361	.14365	.14646	.14902	.15398
H2O	.00002	.00001	.00000	.00000	.00000	.00000	.00000	.00000	.00000	.00000	.00000	.00000
H2O2	.27673	.28240	.29874	.30759	.31542	.32400	.35537	.37572	.43644	.48670	.48398	.45497
H2O3	.15182	.15731	.16306	.16066	.15793	.15118	.12317	.09982	.09501	.06551	.06485	.00719
N	.00001	.00000	.00000	.00000	.00000	.00000	.00000	.00000	.00000	.00000	.00000	.00000
N2	.00001	.00000	.00000	.00000	.00000	.00000	.00000	.00000	.00000	.00000	.00000	.00000
NH3	.00001	.00001	.00000	.00000	.00000	.00000	.00000	.00000	.00000	.00000	.00000	.00000
NO	.00072	.00037	.00001	.00000	.00000	.00000	.00000	.00000	.00001	.00005	.00005	.00012
NO2	.08800	.08915	.09123	.09182	.09202	.09213	.09216	.09216	.09218	.09396	.09560	.09475
NO3	.00079	.00033	.00000	.00000	.00000	.00000	.00000	.00000	.00000	.00000	.00000	.00000
OH	.00934	.00544	.00042	.00003	.00001	.00000	.00000	.00000	.00000	.00000	.00000	.00000
O2	.00017	.00007	.00000	.00000	.00000	.00000	.00000	.00000	.00000	.00000	.00000	.00000

ADDITIONAL PRODUCTS WHICH WERE CONSIDERED BUT WHOSE MOLE FRACTIONS WERE LESS THAN .0000005 FOR ALL ASSIGNED CONDITIONS

C	CCL	CCL2	CH2O	CN	C4N	CN2	C2	C2H	C2H2
C2H	C2H2	C2H4	C3	CLCN	CLO2	CL2O	FECL3	HALO	HCN
HNO2	HNO	HNO2	HNO3	HO2	H2O2	HCO	NH	NOCL	NO2
H2CL	NO3	N2H4	N2O	N2O4	N3	O3			

NOTE: WEIGHT FRACTION OF FUEL IN TOTAL FUELS AND OF OXIDANT IN TOTAL OXIDANTS



### Resultant Output for Case 3 (Cont'd)

TRANSPORT PROPERTIES OF ROCKET EXHAUST ASSUMING EQUILIBRIUM COMPOSITION DURING EXPANSION

O/F = .0000 PERCENT FUEL = 100.0000 EQUIVALENCE RATIO = 1.6977 CHAMBER PRESSURE = 37.697 ATM

TEMP DEG K	VISCOSITY POISE	MONATOMIC COND	INTERNAL COND	FROZEN COND	REACTION COND	EQUILIBRIUM COND	CP FROZ	CP EQ	PRANDTL FROZ	PRANDTL EQ	LEWIS NUMBER
		CAL/(CM)(SEC)(K)				CAL/(G)(K)		--- DIMENSIONLESS ---			
3221	931. x10 <sup>-4</sup>	989. x10 <sup>-4</sup>	434. x10 <sup>-4</sup>	923. x10 <sup>-6</sup>	1809. x10 <sup>-6</sup>	2812. x10 <sup>-6</sup>	.4745	.9560	.4802	.3143	2.0328
3193	841.	450.	404.	856.	1723.	2280.	.4723	.8937	.4859	.3260	2.1195
3172	723.	352.	312.	664.	309.	973.	.4553	.5670	.4960	.4214	1.8954
3154	476.	305.	252.	558.	84.	642.	.4415	.5177	.4959	.5053	.8732
3171	584.	287.	227.	514.	44.	598.	.4346	.4882	.4943	.5113	.6970
1537	528.	242.	193.	456.	17.	473.	.4249	.4490	.4920	.5019	.6399
1089	413.	213.	131.	344.	25.	349.	.4013	.4555	.4819	.4980	.6724
943	172.	197.	113.	310.	36.	345.	.3935	.4599	.4728	.4957	.6788
687	295.	147.	87.	254.	49.	303.	.3815	.4962	.4932	.4840	.6356
470	220.	131.	64.	195.	378.	572.	.3669	1.6048	.4155	.6489	.6401
274	210.	124.	60.	184.	385.	569.	.3622	1.6035	.4124	.6207	.6725
100	180.	105.	50.	155.	71.	225.	.3485	.6206	.4049	.6449	.6881

LOCKHEED - HUNTSVILLE RESEARCH & ENGINEERING CENTER

2-28

REPRODUCIBILITY OF ORIGINAL PAGE IS POOR

### Resultant Output for Case 3 (Cont'd)

CASE 3	1	1					1	1
14 44	37.7	.0	.0	.0	.0	.0	.0	
AL	ALM	ALCL	ALCL	ALCL	ALCL	ALO	ALOC	
ALQM	ALQZ	ALQZ	ALQZ	ALQZ	ALQZ	CO	COCL	
C2M4	CL	CL	CL	CL	CL	FE	FECL	
FEO	FLQZ	FLQZ	FLQZ	FLQZ	FLQZ	H	HCL	
H2O	N	NH2	NH3	NH3	NH3	NO	N2	
OH	OZ						O	
.0	.0	.0	.0	.0	.0	.0	.0	
	1	H	2	3	4	5	6	
	M2	L4					2	
.4359247+03	.3749732+02	.3390819+04	.2841598+01	.2020825+02	.1179931+01	.0000000		
.3143401+00	.9305036+03	.9500249+00	.2812115+02	.4366309+03	.4359248+03			
.1130123+03	.1502017+04	.4379596+02	.1507849+02	.1333928+03	.1187501+03	.1445857+02		
.4039977+03	.3112202+04	.6672308+03	.1156688+04	.2489219+00	.9362504+05	.1742090+01		
.0000000	.1342891+01	.4598271+05	.2274880+04	.5295636+03	.5374999+04	.7756356+03		
.4156609+04	.1687344+04	.0000000	.3898058+01	.1431325+00	.1986204+04	.2767278+00		
.1518157+00	.4230479+05	.1002542+04	.8944617+05	.7181847+03	.8299679+01	.7647242+03		
.9355125+02	.1720780+03							
.4359247+03	.2134053+02	.3140957+04	.2841598+01	.2020825+02	.1185590+01	.9999910+00		
.3259634+00	.6807139+03	.8136736+00	.2279505+02	.2558245+03	.4359248+03			
.6403018+04	.7911510+05	.4293953+02	.1682685+02	.1925566+03	.6466427+04	.1740385+02		
.3672678+03	.1789324+04	.8473545+03	.1005036+04	.2505720+00	.4775126+05	.1872234+01		
.0000000	.9433804+02	.3314582+05	.1361009+04	.4011297+03	.3900843+04	.9529531+03		
.2590958+04	.1402724+04	.0000000	.2729937+01	.1474759+00	.9815456+05	.2823984+00		
.1573068+00	.2130557+05	.4938447+05	.6054651+05	.3701068+03	.8915276+01	.2334942+03		
.5637358+02	.7476523+04							
.4359247+03	.3749732+01	.2391724+04	.2841598+01	.2020825+02	.1225498+01	.2145372+01		
.4216390+00	.7234367+03	.5669803+00	.9727776+03	.2065394+03	.4359248+03			
.3487803+05	.4170096+06	.3014870+02	.2676543+02	.1231939+02	.2773990+05	.1800881+02		
.1663053+03	.8735849+04	.4042951+03	.3451480+05	.2512822+00	.3487737+06	.2373073+01		
.0000000	.1581708+02	.3528984+07	.1422971+05	.2411977+04	.4502560+05	.1489896+02		
.1108446+05	.3873267+05	.0000000	.4282138+02	.1548307+00	.6745071+06	.2987367+00		
.1630945+00	.1386114+07	.3230590+06	.2203549+05	.1428510+04	.9122957+01	.4120998+05		
.4216771+03	.9446268+06							
.4359247+03	.1246577+01	.1954021+04	.2841598+01	.2020825+02	.1240437+01	.2751845+01		
.5053196+00	.6262552+03	.5177159+00	.6416247+03	.4326721+03	.4359248+03			
.8201461+07	.1297154+07	.1001870+02	.2341220+02	.5030172+02	.5698880+07	.8455597+03		
.4740944+04	.1906093+07	.1250767+03	.3015580+06	.2472266+00	.3610233+07	.2945263+01		
.0000000	.1188551+03	.0000000	.1486380+06	.2626275+05	.3346853+08	.1469125+04		
.2574562+07	.9247254+06	.0000000	.5827758+03	.1494562+00	.6996303+07	.3095920+00		
.1606644+00	.0000000	.3167069+07	.1541540+05	.4986179+06	.9182347+01	.3865033+07		
.2720610+04	.0000000							
.4359247+03	.7537463+00	.1770947+04	.2841598+01	.2104202+02	.1250728+01	.3027195+01		
.5113286+00	.5840872+03	.4881955+00	.5576625+03	.5225386+03	.4359248+03			
.0000000	.6804000	.3154707+03	.1346578+02	.7374045+02	.0000000	.3254011+03		
.138595+04	.0000000	.3741842+04	.2616568+07	.2440227+00	.1056706+07	.3374641+01		
.0000000	.480951+04	.0000000	.4136380+07	.465910+06	.7074326+07	.1475293+02		
.0000000	.4833001+06	.1196570+07	.1748900+03	.1461190+00	.2650243+07	.3154241+00		

2-29

Resultant Output for Case 3 (Cont'd)

.157295+00	.0000000	.0000000	.1247434-05	.7043415-07	.9201040-01	.0000000
.5438638-05	.0000000					
.357247+03	.3769732+00	.1536754+04	.2641598+01	.2106825+02	.1268444+01	.3406137+01
.5018912+00	.5281424-03	.4490495+00	.4725368-03	.6306132+03	.4359240+03	
.0000000	.0000000	.2570578-04	.3235579-03	.7034011-02	.0000000	.3712637-04
.8271648-04	.0000000	.2832338-05	.0000000	.2370037+00	.0000000	.4071111-01
.0000000	.8685673-05	.0000000	.0000000	.2270020-07	.0000000	.1477923-02
.0000000	.1008712-04	.2517974-07	.2479550-04	.1440307+00	.0000000	.3240030+00
.1511802+00	.0000000	.4000000	.1181820-05	.0000000	.9213397-01	.0000000
.3659424-04	.0000000					
.357247+03	.7539464-01	.1089147+04	.2841598+01	.2107342+02	.1268522+01	.4404774+01
.4900459+00	.4130490-03	.4454895+00	.3694017-03	.8279437+03	.4359240+03	
.0000000	.0000000	.0000000	.1440776-05	.9424992-02	.0000000	.1100151-07
.0000000	.0000000	.0000000	.0000000	.2059731+00	.0000000	.7181003-01
.0000000	.1591519-071	.0000000	.0000000	.0000000	.0000000	.1477579-02
.0000000	.0000000	.4667004-04	.4383272-07	.1436157+00	.0000000	.3553664+00
.1201725+00	.0000000	.0000000	.1643690-05	.0000000	.9215589-01	.0000000
.0000000	.0000000					
.357247+03	.3769732-01	.9425276+04	.2841598+01	.2107350+02	.1257964+01	.4677887+01
.4900459+00	.3721051-03	.4594075+00	.3451980-03	.8942021+03	.4359240+03	
.0000000	.0000000	.0000000	.7020767-07	.9424992-02	.0000000	.0000000
.0000000	.0000000	.0000000	.0000000	.1856253+00	.0000000	.9215887-01
.0000000	.0000000	.0000000	.0000000	.0000000	.0000000	.1477133-02
.0000000	.0000000	.2699683-05	.0000000	.1436149+00	.0000000	.3757150+03
.9442451-01	.0000000	.0000000	.2303133-05	.0000000	.9215590-01	.0000000
.0000000	.0000000					
.357247+03	.7539463-02	.4666498+03	.2841598+01	.2107801+02	.1236233+01	.4024976+01
.4834733+00	.2950800-03	.4941691+00	.3025158-03	.1016549+04	.4359240+03	
.0000000	.0000000	.0000000	.0000000	.9428008-02	.0000000	.0000000
.0000000	.0000000	.0000000	.0000000	.1308335+00	.0000000	.1470181+00
.0000000	.0000000	.0000000	.0000000	.0000000	.0000000	.9478110-03
.0000000	.0000000	.2405620-03	.0000000	.1436446+00	.0000000	.4306365+00
.4501195-01	.0000000	.0000000	.7234770-05	.0000000	.9217527-01	.0000000
.0000000	.0000000					
.357247+03	.7539463-03	.4701619+03	.2841598+01	.2149107+02	.1124659+01	.8022327+01
.4489061+00	.2204004-03	.1664817+01	.5722468-03	.1137387+04	.4359240+03	
.0000000	.0000000	.0000000	.0000000	.9613277-02	.0000000	.0000000
.0000000	.0000000	.0000000	.0000000	.4764866-01	.0000000	.2029571+00
.6141365-02	.0000000	.0000000	.0000000	.0000000	.0000000	.1495356-04
.0000000	.0000000	.7464974-03	.0000000	.1464066+00	.0000000	.4666964+00
.5513151-02	.0000000	.0000000	.4970333-04	.0000000	.9495832-01	.0000000
.0000000	.0000000					
.357247+03	.3769732-03	.4437693+03	.2841598+01	.2186680+02	.1121163+01	.8418098+01
.6206756+00	.2096421-03	.1663544+01	.5686409-03	.1166417+04	.4359240+03	
.0000000	.0000000	.0000000	.0000000	.7281362-02	.0000000	.0000000
.0000000	.0000000	.0000000	.0000000	.4476555-01	.0000000	.2189200+00
.1227795-01	.0000000	.0000000	.0000000	.0000000	.0000000	.8950650-05
.0000000	.0000000	.7636803-03	.0000000	.1490312+00	.0000000	.4639442+00
.4646620-02	.0000000	.0000000	.5246236-04	.0000000	.9440003-01	.0000000
.0000000	.0000000					
.357247+03	.7539464+04	.3730917+03	.2841598+01	.2259505+02	.1219653+01	.9146678+01
.4948571+00	.1798001-03	.6206307+00	.2254447-03	.1225552+04	.4359240+03	
.0000000	.0000000	.0000000	.0000000	.1410710-01	.0000000	.0000000
.0000000	.0000000	.0000000	.0000000	.4130927-02	.0000000	.2461793+00
.2374401-01	.0000000	.0000000	.0000000	.0000000	.0000000	.3504441-00
.0000000	.0000000	.7425304-03	.0000000	.1539840+00	.0000000	.4549721+00
.7194228-02	.0000000	.0000000	.1329851-03	.0000000	.9674946-01	.0000000
.0000000	.0000000					

LOCKHEED - HUNTSVILLE RESEARCH & ENGINEERING CENTER

2-30

Table 2-2 (Continued)

Case 4: Same as Case 3 except that the effects of heat transfer between the condensed and gaseous species are determined (PARTHT=T).

REACTANTS							
AL 1.0				16.	0.0	\$298.15	F
C 6.004	H 10.084	O .278	N .264	12.04	-1200.	\$298.15	F
FE2.0	O 3.0			.4	-197300.	\$298.15	F
C 6.15	H 6.97	O 1.17	N .03	1.96	-26300.	\$298.15	F
N 1.0	H 4.0	O 4.0	CL 1.0	69.60	-70690.	\$298.15	F
(Insert Blank Card)							
OMIT	AL(S)	AL(L)		ALL3(S)	ALCL3(L)		
OMIT	ALN(S)	ALN		AL2CL6	AL202		
OMIT	CCL3	CCL4		CH	CH2		
OMIT	CH3	CH4		COCL2	C2CL2		
OMIT	C2H6	C3O2		C4	C5		
OMIT	FE(S)	FE(L)		FECL2(S)	FECL2(L)		
OMIT	H2O(S)	H2O(L)					
NAMELISTS							
SINPT2							
NKT=T,P=I,A=T,KAJE=0000,P=554.00,MOC2P=I,MUCT=T,PARTHT=T,							
QUOTP=-600.0,-300.0,0.0,100.0,NUI*4							
SEND							
\$TAPGEN							
IHEAD=1.10*8,IN=10							
SEND							
QUOTP TEST CASE							
SRKTINP							
PCP=10.,30.,50.,100.,500.,1000.,5000.,50000.,100000.,500000.							
SEND							

Resultant Output for Case 4

REACTANTS

AL	1.0000														
C	4.4840	H	18.0890	O	.2700	H	.2640		.0000	12.0400	+12000.00	S	298.150	F	.00000
FE	2.0000	O	3.0000		.0000		.0000		.0000	.4000	-19700.00	S	298.150	F	.00000
C	4.1500	H	4.9700	O	1.1700	H	.0300		.0000	1.9400	-28300.00	S	298.150	F	.00000
N	1.0000	H	4.0000	O	4.0000	CL	1.0000		.0000	49.6000	-76690.00	S	298.150	F	.00000
OMIT			AL(S)		AL(L)		ALCL(S)			ALCL(L)					
OMIT			ALM(S)		ALM		ALCL			ALCL					
OMIT			CCL3		CCL4		CM			CM2					
OMIT			CH3		CH4		COCL2			C2CL2					
OMIT			C2M6		C3O2		C4			C5					
OMIT			FE(S)		FE(L)		FECL2(S)			FECL2(L)					
OMIT			M2O(S)		M2O(L)										

NAMELISTS

SINPT2

KASE

T		.00000000E+00,	.00000000E+00,	.00000000E+00,	.00000000E+00,
		.00000000E+00,	.00000000E+00,	.00000000E+00,	.00000000E+00,
		.00000000E+00,	.00000000E+00,	.00000000E+00,	.00000000E+00,
		.00000000E+00,	.00000000E+00,	.00000000E+00,	.00000000E+00,
		.00000000E+00,	.00000000E+00,	.00000000E+00,	.00000000E+00,
		.00000000E+00,	.00000000E+00,	.00000000E+00,	.00000000E+00,
		.00000000E+00,	.00000000E+00,	.00000000E+00,	.00000000E+00,
		.00000000E+00,	.00000000E+00,	.00000000E+00,	.00000000E+00,
		.00000000E+00,	.00000000E+00,	.00000000E+00,	.00000000E+00,
		.00000000E+00,	.00000000E+00,	.00000000E+00,	.00000000E+00,
		.00000000E+00,	.00000000E+00,	.00000000E+00,	.00000000E+00,
		.00000000E+00,	.00000000E+00,	.00000000E+00,	.00000000E+00,
		.00000000E+00,	.00000000E+00,	.00000000E+00,	.00000000E+00,
		.00000000E+00,	.00000000E+00,	.00000000E+00,	.00000000E+00,
		.00000000E+00,	.00000000E+00,	.00000000E+00,	.00000000E+00,
		.00000000E+00,	.00000000E+00,	.00000000E+00,	.00000000E+00,
		.00000000E+00,	.00000000E+00,	.00000000E+00,	.00000000E+00,
		.00000000E+00,	.00000000E+00,	.00000000E+00,	.00000000E+00,
		.00000000E+00,	.00000000E+00,	.00000000E+00,	.00000000E+00,
		.00000000E+00,	.00000000E+00,	.00000000E+00,	.00000000E+00,
		.00000000E+00,	.00000000E+00,	.00000000E+00,	.00000000E+00,
		.00000000E+00,	.00000000E+00,	.00000000E+00,	.00000000E+00,
		.00000000E+00,	.00000000E+00,	.00000000E+00,	.00000000E+00,
		.00000000E+00,	.00000000E+00,	.00000000E+00,	.00000000E+00,
		.00000000E+00,	.00000000E+00,	.00000000E+00,	.00000000E+00,
		.00000000E+00,	.00000000E+00,	.00000000E+00,	.00000000E+00,
		.00000000E+00,	.00000000E+00,	.00000000E+00,	.00000000E+00,
		.00000000E+00,	.00000000E+00,	.00000000E+00,	.00000000E+00,

PSIA = T

MMHG = F

NSQM = F

V		.00000000E+00,	.00000000E+00,	.00000000E+00,	.00000000E+00,
		.00000000E+00,	.00000000E+00,	.00000000E+00,	.00000000E+00,
		.00000000E+00,	.00000000E+00,	.00000000E+00,	.00000000E+00,
		.00000000E+00,	.00000000E+00,	.00000000E+00,	.00000000E+00,
		.00000000E+00,	.00000000E+00,	.00000000E+00,	.00000000E+00,
		.00000000E+00,	.00000000E+00,	.00000000E+00,	.00000000E+00,
		.00000000E+00,	.00000000E+00,	.00000000E+00,	.00000000E+00,
		.00000000E+00,	.00000000E+00,	.00000000E+00,	.00000000E+00,
		.00000000E+00,	.00000000E+00,	.00000000E+00,	.00000000E+00,
		.00000000E+00,	.00000000E+00,	.00000000E+00,	.00000000E+00,
		.00000000E+00,	.00000000E+00,	.00000000E+00,	.00000000E+00,
		.00000000E+00,	.00000000E+00,	.00000000E+00,	.00000000E+00,
		.00000000E+00,	.00000000E+00,	.00000000E+00,	.00000000E+00,
		.00000000E+00,	.00000000E+00,	.00000000E+00,	.00000000E+00,
		.00000000E+00,	.00000000E+00,	.00000000E+00,	.00000000E+00,
		.00000000E+00,	.00000000E+00,	.00000000E+00,	.00000000E+00,
		.00000000E+00,	.00000000E+00,	.00000000E+00,	.00000000E+00,
		.00000000E+00,	.00000000E+00,	.00000000E+00,	.00000000E+00,
		.00000000E+00,	.00000000E+00,	.00000000E+00,	.00000000E+00,
		.00000000E+00,	.00000000E+00,	.00000000E+00,	.00000000E+00,
		.00000000E+00,	.00000000E+00,	.00000000E+00,	.00000000E+00,
		.00000000E+00,	.00000000E+00,	.00000000E+00,	.00000000E+00,
		.00000000E+00,	.00000000E+00,	.00000000E+00,	.00000000E+00,
		.00000000E+00,	.00000000E+00,	.00000000E+00,	.00000000E+00,
		.00000000E+00,	.00000000E+00,	.00000000E+00,	.00000000E+00,
		.00000000E+00,	.00000000E+00,	.00000000E+00,	.00000000E+00,
		.00000000E+00,	.00000000E+00,	.00000000E+00,	.00000000E+00,

ATIO = F

= F

= F

= F

		.00000000E+00,	.00000000E+00,	.00000000E+00,	.00000000E+00,
--	--	----------------	----------------	----------------	----------------

LOCKHEED - HUNTSVILLE RESEARCH & ENGINEERING CENTER

2-32

Resultant Output for Case 4 (Cont'd)

		.0000000E+00	.0000000E+00	.0000000E+00	.0000000E+00
		.0000000E+00	.0000000E+00	.0000000E+00	.0000000E+00
		.0000000E+00	.0000000E+00	.0000000E+00	.0000000E+00
TP	= F				
NP	= F				
SP	= F				
TV	= F				
LV	= F				
SV	= F				
NKT	= T				
SHOCK	= F				
DETN	= F				
QTTO	= F				
CR	=	.0000000E+00			
SO	=	.0000000E+00			
SO	=	.0000000E+00			
IONS	= F				
IDEBUG	=		0		
TRACE	=	.0000000E+00			
SUNIT	= F				
EUNITS	= F				
TRNSPT	= T				
FROZM	= F				
PUNCH	= F				
NOJATA	= T				
DIF	= F				
HOCP	= F				
HOCT	= T				
HUCT?	= F				
HOC2P	= T				
PARTHT	= T				
GDCTH	=	.0000000E+03	.3000000E+03	.0000000E+00	.1000000E+03
		.0000000E+00	.0000000E+00	.0000000E+00	.0000000E+00
		.0000000E+00	.0000000E+00	.0000000E+00	.0000000E+00
		.0000000E+00	.0000000E+00	.0000000E+00	.0000000E+00
		.0000000E+00	.0000000E+00	.0000000E+00	.0000000E+00
		.0000000E+00	.0000000E+00	.0000000E+00	.0000000E+00
		.0000000E+00	.0000000E+00	.0000000E+00	.0000000E+00
		.0000000E+00	.0000000E+00	.0000000E+00	.0000000E+00
NIJ	=	4			

SEND

NG INPI2 VALUE GIVEN FOR OF, EQRAT, FA, DR ERECT

STAPGEN

IREAD = 1

IO = 8

IN = 10

SEND

SPECIES BEING CONSIDERED IN THIS SYSTEM

J12/65 AL	J 6/63 ALH	J 6/70 ALCL	J 6/72 ALCL2	J 6/70 ALCL3
J 6/70 ALD	J 9/64 ALOCL	J12/67 ALOM	J12/68 ALO2	J12/68 ALC24
J 6/72 AL20	J 6/72 AL203(S)	J 6/72 AL203(L)	J 3/61 C(S)	J 3/61 C
J 6/69 CCL	J12/68 CCL2	J 3/61 CH2O	J 6/69 CN	J 6/66 CNH
J 6/70 CN2	J 9/65 CO	J12/65 COCL	J 9/65 CO2	J12/69 C2

Resultant Output for Case 4 (Cont'd)

J 3/67 C2H	J 3/61 C2H2	J 9/65 C2H4	J 3/67 C2N	J 3/61 C2N2
J 9/65 C2O	J 2/69 C3	J 6/72 CL	J 6/66 CLCN	J 6/61 CLD
J 3/61 CLD2	J 9/65 CL2	J 17/65 CL2O	J 3/65 FE	J 6/65 FECL
J 12/70 FECL2	J 6/65 FECL3(S)	J 6/65 FECL3(L)	J 6/65 FECL3	J 6/65 FE01(S)
J 6/65 FE01(L)	J 9/66 FE0	J 6/66 FE02H2(S)	J 12/66 FE02H2	J 6/66 FE03H3(S)
J 12/70 FE2CL4	J 6/65 FE2O3(S)	J 6/65 FE3O4(S)	J 9/65 H	J 3/64 HALO
J 9/64 HCL	J 12/69 HCN	J 12/70 HCO	J 12/70 HNC0	J 3/63 HNO
J 6/63 HN02	J 6/63 HN03	J 3/64 H02	J 3/61 H2	J 3/61 H2O
J 2/69 H2O?	J 3/61 H	J 12/70 HCO	J 12/71 NH	J 12/65 NH2
J 9/65 NH3	J 6/63 NO	J 12/65 NOCL	J 9/64 NO2	J 12/65 NO2CL
J 12/64 N03	J 9/65 N2	J 12/65 N2H4	J 12/64 N2O	J 9/64 N2O4
J 12/70 N3	J 6/62 O	J 12/70 OH	J 9/65 O2	J 6/61 O3

LIST OF CONDENSED SPECIES FROM SEARCH

AL2O3(S)	AL2O3(L)	C(S)	FECL3(S)	FECL3(L)
FE01(S)	FE01(L)	FE02H2(S)	FE03H3(S)	FE2O3(S)
FE3O4(S)				
SRKTINP				
EDL = T				
FR02 = T				
SUBA	.0000000E+00	.0000000E+00	.0000000E+00	.0000000E+00
	.0000000E+00	.0000000E+00	.0000000E+00	.0000000E+00
	.0000000E+00	.0000000E+00	.0000000E+00	.0000000E+00
	.0000000E+00	.0000000E+00	.0000000E+00	.0000000E+00
SUBB	.0000000E+00	.0000000E+00	.0000000E+00	.0000000E+00
	.0000000E+00	.0000000E+00	.0000000E+00	.0000000E+00
	.0000000E+00	.0000000E+00	.0000000E+00	.0000000E+00
FCF	.1000000E+02	.3000000E+02	.5000000E+02	.1000000E+03
	.5000000E+03	.1000000E+04	.5000000E+04	.5000000E+05
	.1000000E+06	.5000000E+06	.0000000E+00	.0000000E+00
	.0000000E+00	.0000000E+00	.0000000E+00	.0000000E+00
	.0000000E+00	.0000000E+00	.0000000E+00	.0000000E+00
NFZ	.0000000E+00	.0000000E+00	.0000000E+00	.0000000E+00
	+1			
SEND				

OF = .000000			
ENTHALPY (KG-MOL)(DEG K)/KG	EFFECTIVE FUEL HPP(2)	EFFECTIVE OXIDANT HPP(1)	MIXTURE HSUB0
	.22321037+03	.00000000	.22321037+03
KG-ATOMS/KG	BP(1,2)	BP(1,1)	BP(1)
AL	.59239998-02	.00000000	.59239998-02
C	.94112869-02	.00000000	.94112869-02
H	.37088374-01	.00000000	.37088374-01
O	.24331585-01	.00000000	.24331585-01
N	.62445374-02	.00000000	.62445374-02
FE	.50096372-04	.00000000	.50096372-04
CL	.59239998-02	.00000000	.59239998-02

PT	AL	C	H	O	N	FE	CL	
1	-13.240	-11.960	-9.063	-19.674	-13.305	-11.197	-21.957	12.000
1	-17.488	-13.370	-9.465	-17.899	-13.815	-15.216	-20.292	8.000

LOCKHEED-HUNTSVILLE RESEARCH & ENGINEERING CENTER

2-34

REPRODUCIBILITY OF THE ORIGINAL PAGE IS POOR

## Resultant Output for Case 4 (Cont'd)

THEORETICAL ROCKET PERFORMANCE ASSUMING EQUILIBRIUM COMPOSITION DURING EXPANSION

PC = 554.0 PSIA  
CASE NO. 1

CHEMICAL FORMULA		WT FRACTION (SEE NOTE)		ENERGY CAL/MOL	STATE	TEMP DEG K	DENSITY G/CC
FUEL	AL 1.00000			.000	S	298.15	.0000
FUEL	C 6.88900 H 10.08900 O .27800 N .26400			-12000.000	S	298.15	.0000
FUEL	FE 2.00000 O 3.00000			-197300.000	S	298.15	.0000
FUEL	C 6.15000 H 6.97000 O 1.17000 N .03000			-28300.000	S	298.15	.0000
FUEL	N 1.00000 H 4.00000 O 4.00000 CL 1.00000			-70490.000	S	298.15	.0000
O/F = .0000		PERCENT FUEL = 100.0000		EQUIVALENCE RATIO = 1.6977	REACTANT DENSITY = .0000		

	CHAMBER	THROAT	EXIT
PC/P	1.0000		
P, ATM	37.497		
T, DEG K	3391		
RHO, G/CC	3.8348-3		
H, CAL/G	-443.6		
S, CAL/(G)(K)	2.3005		
M, MOL WT	28.334		
(DLV/DLP)T	-1.01875		
(DLV/DLT)P	1.3331		
CP, CAL/(G)(K)	.8897		
GAMMA (S)	1.1383		
SON VEL, M/SEC	1064.8		

### MOLE FRACTIONS

AL	.00010
ALH	.00001
ALCL	.00406
ALCL2	.00140
ALCL3	.00012
ALO	.00011
ALOCL	.00152
ALOH	.00037
ALO2	.00003
ALO2H	.00062
AL2O	.00001
AL2O3(L)	.07356
CO	.23061
COCL	.00001
CO2	.01614
CL	.01244
CLO	.00001
CL2	.00002
FC	.00049



Resultant Output for Case 4 (Cont'd)

FECL .00026  
 FECL2 .00072  
 FEO .00004  
 FE02H2 .00002  
 H .03611  
 HCL .13260  
 HCO .00002  
 H2 .25637  
 H2O .14868  
 N .00001  
 NH2 .00001  
 NH3 .00001  
 NO .00047  
 N2 .00152  
 O .00073  
 OH .00867  
 O2 .00016

MASS OF ELEMENTS BEING REMOVED FOR TWO PHASE CALCULATION (KG OF SPECIE/KG OF MIXTURE)

AL	.15138+00	.15138+00
C	.00000	.15138+00
H	.00000	.15138+00
O	.13965+00	.28603+00
N	.00000	.28603+00
FE	.00000	.28603+00
CL	.00000	.28603+00

ADDITIONAL PRODUCTS WHICH WERE CONSIDERED BUT WHOSE MOLE FRACTIONS WERE LESS THAN .60000-05 FOR ALL ASSIGNED CONDITIONS

AL2O3(S)	C(S)	C	CCL	CCL2	CH2O	CH	CNN	CH2	C2
CSH	C2H2	C2H4	C2H	C2N2	C2O	Cl	CLCN	CLO2	CL2O
FECL3(S)	FECL3(L)	FECL3	FEO(S)	FEO(L)	FE02H2(S)	FE03H3(S)	FE2CL4	FE2O3(S)	FE3O4(S)
HALO	HCN	HCO	HNO	HNO2	HNO3	H2O2	H2O	H2O	NH
NOCL	NO2	NO2CL	NO3	N2H4	N2O	N2O4	N3	O3	

NOTE. WEIGHT FRACTION OF FUEL IN TOTAL FUELS AND OF OXIDANT IN TOTAL OXIDANTS

ADJUSTED VALUE OF NSUB0 = .21932+03 (KG-MOL/DEG K/KG

ELEMENTAL MASS VALUES AFTER TWO PHASE CORRECTION

AL	.4973149-03
C	.1318168-01

Resultant Output for Case 4 (Cont'd)

H .5194689-01  
 O .2229186-01  
 N .8746253-03  
 FE .7016621-04  
 CL .#297230-82

AL203(S) HAS BEEN OMITTED FROM PRODUCTS LIST FOR TWO PHASE CALCULATIONS

AL203(L) HAS BEEN OMITTED FROM PRODUCTS LIST FOR TWO PHASE CALCULATIONS

C(S) HAS BEEN OMITTED FROM PRODUCTS LIST FOR TWO PHASE CALCULATIONS

FECL3(S) HAS BEEN OMITTED FROM PRODUCTS LIST FOR TWO PHASE CALCULATIONS

FECL3(L) HAS BEEN OMITTED FROM PRODUCTS LIST FOR TWO PHASE CALCULATIONS

FE0(S) HAS BEEN OMITTED FROM PRODUCTS LIST FOR TWO PHASE CALCULATIONS

FE0(L) HAS BEEN OMITTED FROM PRODUCTS LIST FOR TWO PHASE CALCULATIONS

FE02H2(S) HAS BEEN OMITTED FROM PRODUCTS LIST FOR TWO PHASE CALCULATIONS

FE03H3(S) HAS BEEN OMITTED FROM PRODUCTS LIST FOR TWO PHASE CALCULATIONS

FE203(S) HAS BEEN OMITTED FROM PRODUCTS LIST FOR TWO PHASE CALCULATIONS

FE304(S) HAS BEEN OMITTED FROM PRODUCTS LIST FOR TWO PHASE CALCULATIONS

ADJUSTED LIST OF SPECIES TO BE CONSIDERED IN TWO PHASE SYSTEM

AL	ALM	ALCL	ALCL2	ALCL3
ALO	ALOCL	ALOH	ALO2	ALO2H
AL2O	C	CCL	CCL2	CH2O
CN	CNN	CN2	CO	COCL
CO2	C2	C2H	C2H2	C2H4
C2N	C2N2	C2O	C3	CL
CLCN	CLO	CLO2	CL2	CL2O
FE	FECL	FECL2	FECL3	FEO
FE02H2	FE2CL4	H	HALO	HCL
HCN	HCO	HNCO	HNO	HNO2
HN03	H02	H2	H2O	H2O2
N	NCO	NH	NH2	NH3
NO	NOCL	NO2	NO2CL	NO3
N2	N2H4	N2O	N2O4	N3
O	OH	O2	O3	

PT	AL	C	H	O	N	FE	CL	
1	-17.488	-13.390	+9.465	-17.899	-13.815	-15.216	-20.272	12.000

PT	AL	C	H	O	N	FE	CL	
1	-28.435	+3.033	-7.764	-31.668	-12.109	+8.769	-24.279	14.000
2	-31.712	-1.571	-7.873	-34.874	-12.230	-7.897	-25.623	4.000
PC/PT=	1.814574	T =	1102.32					
2	-31.699	-1.576	-7.873	-34.862	-12.229	-7.900	-25.618	2.000
PC/PT=	1.812748	T =	1102.81					
2	-31.700	-1.576	-7.973	-34.863	-12.229	-7.900	-25.618	1.000
PC/PT=	1.812791	T =	1102.81					
3	-43.156	3.450	-8.257	-45.883	-12.665	-6.358	-30.144	6.000

LOCKHEED - HUNTSVILLE RESEARCH & ENGINEERING CENTER

2-37

Resultant Output for Case 4 (Cont'd)

4	-49.569	5.640	-8.642	-51.839	-13.050	-6.097	-32.721	5.000
5	-52.281	6.369	-8.843	-54.292	-13.244	-6.025	-33.830	4.000
6	-54.101	7.277	-9.125	-57.674	-13.516	-5.920	-35.372	4.000
7	-67.538	9.411	-9.803	-67.225	-14.153	-6.154	-39.700	5.000
8	-74.692	10.534	-10.110	-72.848	-14.430	-6.489	-42.202	5.000
9	-94.390	13.416	-10.919	-87.949	-15.124	-7.777	-48.840	4.000
10	-123.358	17.210	-12.291	-109.998	-16.278	-10.128	-58.422	5.000
THE TEMPERATURE= .2821+03 IS OUT OF RANGE FOR POINT 10								
11	-132.355	19.060	-12.748	-116.779	-16.658	-10.947	-61.351	4.000
THE TEMPERATURE= .2640+03 IS OUT OF RANGE FOR POINT 11								
12	-159.745	22.434	-13.914	-133.466	-17.612	-13.184	-68.920	4.000
THE TEMPERATURE= .2281+03 IS OUT OF RANGE FOR POINT 12								

### Resultant Output for Case 4 (Cont'd)

REPRODUCIBILITY OF THE  
ORIGINAL PAGE IS POOR

THEORETICAL ROCKET PERFORMANCE ASSUMING EQUILIBRIUM COMPOSITION DURING EXPANSION FOR TWO PHASE NOC CALCULATIONS

PC = 554.0 PSIA

QDOTP = 400.0 (KG-MOL/(DEG K)/KG

CASE NO. 1

CHEMICAL FORMULA					WT FRACTION (SEE NOTE)	ENERGY CAL/MOL	STATE	TEMP DEG K	DENSITY G/CC
FUEL	AL	1.00000			.14000	.000	S	298.15	.0000
FUEL	C	6.88400	H	18.88900	.12040	-12000.000	S	298.15	.0000
FUEL	FE	2.00000	O	3.00000	.00400	-197300.000	S	298.15	.0000
FUEL	C	6.15000	H	4.97000	.01960	-28300.000	S	298.15	.0000
FUEL	N	1.00000	H	4.00000	.03800	-70490.000	S	298.15	.0000
			O	4.00000	.69400				
			CL	1.00000					

O/F = .0000    PERCENT FUEL = 100.0000    EQUIVALENCE RATIO = 1.4977    REACTANT DENSITY = .0000

	CHAMBER	THROAT	EXIT	EXIT	EXIT	EXIT	EXIT	EXIT	EXIT	EXIT	EXIT	EXIT
P, ATM	1.0000	1.8128	10.000	30.000	50.000	100.00	500.00	1000.00	5000.00	50000.0	100000.0	500000.0
T, DEG K	37.697	20.795	3.7677	1.2566	.7539	.3770	.0754	.0377	.0075	.0008	.0004	.0001
RHO, G/CC	7.7355E-3	4.8452E-3	1.2353E-3	4.8714E-4	3.1309E-4	1.7140E-4	4.2894E-5	2.4039E-5	6.3015E-6	8.7581E-7	4.7836E-7	1.1817E-7
H, CAL/G	-756.4	-822.3	-972.0	-1044.5	-1077.3	-1116.0	-1193.0	-1220.9	-1274.4	-1330.9	-1344.0	-1372.7
S, CAL/(G)(K)	2.3169	2.3169	2.3169	2.3169	2.3169	2.3169	2.3169	2.3169	2.3169	2.3169	2.3169	2.3169
H, MOL WT	21.082	21.084	21.181	21.687	21.989	22.404	23.329	23.735	24.909	26.890	27.492	28.833
(DLV/DLP)T	1.00039	1.00051	1.01053	1.04025	1.05385	1.04139	1.02848	1.02881	1.03815	1.03961	1.03643	1.02558
(DLV/DLP)P	1.0024	1.0040	1.0357	1.0613	1.0785	1.0553	1.03986	1.03786	1.04557	1.03773	1.02269	1.00903
CP, CAL/(G)(K)	.4377	.4477	.4678	.4897	.4948	.49141	.49040	.49448	.49963	1.03124	1.03346	1.02172
GAMMA (S)	1.2739	1.2684	1.2140	1.1598	1.1523	1.1500	1.1846	1.2048	1.1878	1.1496	1.1427	1.1333
SON VEL, M/SEC	793.1	742.7	612.7	560.4	530.3	506.3	459.3	437.9	378.5	315.7	302.1	273.0
MACH NUMBER	.000	1.000	2.193	2.830	3.091	3.427	4.162	4.503	5.487	6.924	7.346	8.318
AE/AT		1.0000	2.1686	4.7410	7.0134	12.103	43.889	75.923	274.29	1073.87	3390.26	13641.2
CSTAR, FT/SEC		3482	3482	3482	3482	3482	3482	3482	3482	3482	3482	3482
CF		.700	1.266	1.468	1.544	1.634	1.801	1.858	1.961	2.066	2.090	2.139
IVAC, LB-SEC/LB		135.4	148.5	174.0	182.3	190.0	204.4	209.3	218.2	227.7	229.9	238.5
ISP, LB-SEC/LB		75.7	139.0	158.9	167.1	176.9	194.9	201.1	212.3	223.6	226.3	231.6

**MOLE FRACTIONS**

ALCL3	.00943	.00943	.00947	.00970	.00984	.01002	.01044	.01062	.01114	.01203	.01230	.01290
CO	.22132	.20755	.15253	.10712	.08587	.05865	.01166	.00334	.00010	.00000	.00000	.00000
CO2	.05656	.07037	.12432	.14062	.17634	.19592	.22632	.22789	.21452	.19771	.19500	.20029
C2H4	.00000	.00000	.00117	.00907	.01383	.02039	.03477	.04081	.05686	.07837	.08316	.08989
FECL3	.00142	.00131	.00035	.00013	.00008	.00004	.00000	.00000	.00000	.00000	.00000	.00000
FE2CL4	.00003	.00008	.00057	.00070	.00073	.00077	.00082	.00083	.00067	.00094	.00096	.00101
HCL	.14367	.14369	.14634	.14780	.14984	.15249	.15899	.16175	.16975	.18325	.18736	.19450
HCN	.00001	.00000	.00000	.00000	.00000	.00000	.00000	.00000	.00000	.00000	.00000	.00000
N2	.33970	.35343	.40313	.41932	.41503	.41392	.39827	.37949	.30643	.18611	.15214	.04238
O2	.13550	.12173	.07099	.05509	.05145	.04898	.05574	.06996	.12613	.20402	.22069	.24214

LOCKHEED - HUNTSVILLE RESEARCH & ENGINEERING CENTER

2-39

Resultant Output for Case 4 (Cont'd)

NH3	.00034	.00042	.00049	.00123	.00125	.00129	.00192	.00301	.01054	.03995	.05416	.09755
N2	.09202	.09199	.09113	.09423	.09554	.09734	.10106	.10229	.10346	.09762	.09315	.07732

ADDITIONAL PRODUCTS WHICH WERE CONSIDERED BUT WHOSE MOLE FRACTIONS WERE LESS THAN .50000-05 FOR ALL ASSIGNED CONDITIONS

AL	ALH	ALCL	ALCL2	ALO	ALOC	ALOH	ALO2	ALO2H	AL2O
C	CCL	CCL2	CH2O	CN	CNN	CN2	COCL	C2	C2H
CSH2	CSH	CSH2	C2O	C3	CL	CLCN	CLO	CLO2	CL2
CL2O	FE	FECL	FECL3	FEO	FEO2H2	H	HALD	HCO	HNCO
HNO	HNO2	HNO3	HO2	H2O2	H	NCO	NH	NH2	NO
HOCL	HO2	HO2CL	HO3	H2H9	H2O	N2O4	N3	O	OH
O2	O3								

NOTE: WEIGHT FRACTION OF FUEL IN TOTAL FUELS AND OF OXIDANT IN TOTAL OXIDANTS

Resultant Output for Case 4 (Cont'd)

TRANSPORT PROPERTIES OF ROCKET EXHAUST ASSUMING EQUILIBRIUM COMPOSITION DURING EXPANSION

O/P# .0000 PERCENT FUEL=100.0000 EQUIVALENCE RATIO= 1.6977 CHAMBER PRESSURE= 37.697 ATM

TEMP DEG K	VISCOSITY POISE	MONATOMIC COND	INTERNAL COND	FROZEN COND	REACTION COND	EQUILIBRIUM COND	CP PROZ	CP EQ	PRANDTL PROZ	PRANDTL EQ	LEWIS NUMBER
				CAL/(CM)(SEC)(K)			CAL/(G)(K)		DIMENSIONLESS		
1252	456.X10-6	231.X10-6	153.X10-6	384.X10-6	18.X10-6	702.X10-6	.4102	.4376	.4876	.4990	.6580
1103	417.	219.	133.	347.	24.	373.	.4021	.4477	.4826	.4999	.6621
788	326.	179.	96.	275.	104.	379.	.3857	.4478	.4579	.5576	.5579
682	293.	161.	86.	248.	352.	599.	.3792	1.3197	.4471	.6454	.5731
645	281.	154.	82.	237.	402.	439.	.3762	1.4468	.4466	.6368	.6076
401	265.	145.	77.	222.	390.	612.	.3716	1.4911	.4436	.6127	.6257
500	227.	121.	44.	189.	191.	376.	.3574	.7040	.4403	.5466	.6785
454	209.	108.	56.	164.	149.	313.	.3486	.7948	.4435	.5303	.7087
362	188.	79.	28.	117.	204.	323.	.3251	.9263	.4684	.5198	.8631
282	126.	69.	21.	69.	317.	387.	.2949	1.3126	.5369	.4290	1.3242
264	117.	62.	12.	59.	334.	374.	.2871	1.3346	.5650	.3952	1.5477
228	97.	30.	11.	41.	315.	355.	.2706	1.2172	.6431	.3325	2.2014

CASE FOR QDOT = 400.0 AND PC = 37.7 HAS BEEN COMPLETED AND WRITTEN ON TAPE UNIT 10

Resultant Output for Case 4 (Cont'd)

THEORETICAL ROCKET PERFORMANCE ASSUMING EQUILIBRIUM COMPOSITION DURING EXPANSION FOR TWO PHASE MOC CALCULATIONS

PC = 559.0 PSIA

GDOTP = -300.0 (KG-MOL)/(DEG K)/KG

CASE NO. 1

CHEMICAL FORMULA		WT FRACTION (SEE NOTE)		ENERGY CAL/MOL	STATE	TEMP DEG K	DENSITY G/CC
FUEL	AL 1.00000			.16000		298.15	.0000
FUEL	C 6.88400 H 10.08900 O .27800 N .26400			.12040	S	298.15	.0000
FUEL	FE 2.00000 O 3.00000			.00400	S	298.15	.0000
FUEL	C 6.15000 H 6.97000 O 1.17000 N .03000			.01960	S	298.15	.0000
FUEL	N 1.00000 H 4.00000 O 4.00000 CL 1.00000			.69600	S	298.15	.0000

O/F = .0000 PERCENT FUEL = 100.0000 EQUIVALENCE RATIO = 1.6977 REACTANT DENSITY = .0000

PC/P	CHAMBER	THROAT	EXIT	EXIT	EXIT	EXIT	EXIT	EXIT	EXIT	EXIT	EXIT	EXIT
P, ATM	37.697	20.974	3.7697	1.2566	.7539	.3770	.0754	.0377	.0075	.0008	.0004	.0001
T, DEG K	2524	2261	1699	1263	1132	978	712	623	510	393	351	285
RHO, G/CC	3.8111E-3	2.3735E-3	6.0540E-4	2.5558E-4	1.7109E-4	9.8961E-5	2.7224E-5	1.5546E-5	3.9161E-6	5.3507E-7	8.0400E-7	7.8424E-8
H, CAL/G	7140.2	293.1	603.8	751.4	809.0	877.8	1004.7	1048.2	1131.7	1225.0	1297.2	1299.7
S, CAL/(G)(K)	2.6415	2.6415	2.6415	2.6415	2.6415	2.6415	2.6415	2.6415	2.6415	2.6415	2.6415	2.6415
M, MOL WT	20.934	20.995	21.871	21.074	21.074	21.074	21.083	21.092	21.732	22.869	23.208	24.336
(DLV/DLP)T	1.00291	1.00170	1.00008	1.00001	1.00002	1.00003	1.00017	1.00064	1.02757	1.01204	1.01777	1.03450
(DLV/DLP)P	1.0427	1.0318	1.0020	1.0001	1.0001	1.0004	1.0035	1.0110	1.5899	1.1884	1.2714	1.6242
CP, CAL/(G)(K)	5364	5133	4448	4382	4429	4560	4955	5004	1.6026	6352	6974	1.2406
GAMMA (S)	1.2345	1.2416	1.2709	1.2743	1.2706	1.2609	1.2367	1.2373	1.1319	1.2212	1.2197	1.1416
SON VEL, M/SEC	1112.3	1054.4	895.6	796.8	753.2	697.4	589.1	551.4	469.9	417.6	391.5	336.4
TECH NUMBER	.000	1.000	2.152	2.792	3.094	3.513	4.513	4.944	6.068	7.149	7.704	9.139
VELOC		1.0000	2.1454	4.4022	6.2775	10.319	34.580	59.053	224.13	1566.81	2729.48	10379.7
CDSTAR, FT/SEC		5008	5008	5008	5008	5008	5008	5008	5008	5008	5008	5008
CD		.691	1.262	1.457	1.527	1.605	1.742	1.784	1.868	1.956	1.976	2.014
CD* LB*SEC/LB		194.1	229.9	249.4	257.1	265.9	281.8	287.2	297.7	309.3	311.8	316.7
ISPL, LB*SEC/LB		107.5	196.5	226.8	237.6	249.9	271.1	278.0	290.7	304.4	307.5	313.5

MOLE FRACTIONS

ALCL	.00174	.00092	.00001	.00000	.00000	.00000	.00000	.00000	.00000	.00000	.00000	.00000
ALCL2	.00335	.00275	.00319	.00001	.00000	.00000	.00000	.00000	.00000	.00000	.00000	.00000
ALCL3	.00290	.00493	.00922	.00942	.00943	.00943	.00943	.00943	.00972	.01023	.01036	.01089
ALDCL	.00097	.00060	.00001	.00000	.00000	.00000	.00000	.00000	.00000	.00000	.00000	.00000
ALUM	.00012	.00004	.00000	.00000	.00000	.00000	.00000	.00000	.00000	.00000	.00000	.00000
ALPH	.00025	.00013	.00000	.00000	.00000	.00000	.00000	.00000	.00000	.00000	.00000	.00000
CO	.25314	.25151	.22934	.22209	.21061	.19130	.13704	.11526	.06135	.00257	.00030	.00000
CO2	.02279	.02523	.03642	.05569	.06718	.08649	.14087	.16244	.20493	.24298	.23959	.27374
CO3	.00000	.00000	.00000	.00000	.00000	.00000	.00000	.00000	.01011	.03295	.03307	.04852
CL	.00008	.00013	.00001	.00000	.00000	.00000	.00000	.00000	.00000	.00000	.00000	.00000

LOCKHEED - HUNTSVILLE RESEARCH & ENGINEERING CENTER

2-42

Resultant Output for Case 4 (Cont'd)

FE	.00001	.00000	.00000	.00000	.00000	.00000	.00000	.00000	.00000	.00000	.00000	.00000
FECL2	.00145	.00144	.00140	.00140	.00147	.00145	.00065	.00020	.00002	.00000	.00000	.00000
FEOPM2	.00001	.00000	.00000	.00000	.00000	.00000	.00000	.00000	.00000	.00000	.00000	.00000
FE2CL4	.00000	.00000	.00000	.00000	.00000	.00001	.00042	.00044	.00075	.00080	.00081	.00085
H	.00247	.00095	.00002	.00000	.00000	.00000	.00000	.00000	.00000	.00000	.00000	.00000
HCL	.15177	.14910	.14382	.14342	.14342	.14362	.14368	.14374	.14810	.15585	.15814	.16585
H2	.30023	.30508	.32182	.33724	.35072	.37003	.42449	.44611	.45641	.43808	.41765	.34453
H2O	.14601	.16504	.15353	.13629	.12481	.10550	.05120	.02960	.01331	.02124	.03787	.09501
NH3	.00002	.00001	.00001	.00001	.00001	.00002	.00005	.00010	.00018	.00054	.00144	.00339
NO	.00001	.00000	.00000	.00000	.00000	.00000	.00000	.00000	.00000	.00000	.00000	.00000
N2	.09153	.09180	.09214	.09215	.09215	.09215	.09217	.09219	.09495	.09974	.10077	.10223
OH	.00029	.00088	.00000	.00000	.00000	.00000	.00000	.00000	.00000	.00000	.00000	.00000

ADDITIONAL PRODUCTS WHICH WERE CONSIDERED BUT WHOSE MOLE FRACTIONS WERE LESS THAN .0000005 FOR ALL ASSIGNED CONDITIONS

AL	ALM	ALC	AL02	AL20	C	CCL	CCL2	CH20	CN
CNN	CN2	COCL	C2	C2H	C2H2	C2N	C2N2	C20	C3
CLCN	CL0	CL02	CL2	CL20	FECL	FECL3	FE0	HAL0	MEN
HCO	MNCO	MNO	MNO2	MNO3	HO2	H202	N	NCO	NH
NH2	NOCL	NO2	NO2CL	NO3	N2H4	N20	N204	N3	O
O2	O3								

NOTE: WEIGHT FRACTION OF FUEL IN TOTAL FUELS AND OF OXIDANT IN TOTAL OXIDANTS



Resultant Output for Case 4 (Cont'd)

TRANSPORT PROPERTIES OF ROCKET EXHAUST ASSUMING EQUILIBRIUM COMPOSITION DURING EXPANSION

O/F = .0000 PERCENT FUEL = 100.0000 EQUIVALENCE RATIO = 1.6977 CHAMBER PRESSURE = 37.697 ATM

TEMP DEG K	VISCOSITY POISE	MONATOMIC COND	INTERNAL COND	FROZEN COND	REACTION COND	EQUILIBRIUM COND	CP FROZ	CP EQ	PRANDTL FROZ	PRANDTL EQ	LEWIS NUMBER
				CAL/(CM)(SEC)(K)			CAL/(G)(K)				
									DIMENSIONS UNLESS NOTED		
2524	753.X10-6	364.X10-6	333.X10-6	698.X10-6	181.X10-6	879.X10-6	.4586	.5352	.4945	.4582	1.5592
2261	694.	538.	297.	635.	94.	729.	.4516	.5124	.4948	.4888	1.1024
1599	543.	249.	202.	471.	12.	483.	.4273	.4440	.4924	.4989	.6525
1243	459.	232.	154.	387.	17.	404.	.4107	.4381	.4877	.4982	.6614
1132	425.	218.	137.	354.	23.	377.	.4037	.4428	.4837	.4882	.6691
978	382.	201.	117.	318.	33.	351.	.3954	.4559	.4754	.4970	.6766
712	303.	171.	89.	240.	49.	309.	.3824	.4955	.4466	.4861	.6435
623	275.	159.	81.	239.	47.	286.	.3786	.5004	.4342	.4799	.6087
510	234.	137.	69.	205.	38.	594.	.3689	1.4024	.4214	.6324	.6443
393	187.	104.	51.	158.	76.	234.	.3486	.6352	.4130	.5086	.5834
303	169.	94.	44.	137.	83.	221.	.3391	.6994	.4158	.5342	.6696
285	136.	49.	30.	99.	194.	293.	.3172	1.2406	.4371	.5760	.6759

CASE FOR GOOTR = 300.0 AND PC = 37.7 HAS BEEN COMPLETED AND WRITTEN ON TAPE UNIT 10

LOCKHEED - HUNTSVILLE RESEARCH & ENGINEERING CENTER

2-44

Resultant Output for Case 4 (Cont'd)

REPRODUCIBILITY OF THE ORIGINAL PAGE IS POOR

THEORETICAL ROCKET PERFORMANCE ASSUMING EQUILIBRIUM COMPOSITION DURING EXPANSION FOR TWO PHASE NOC CALCULATIONS

PC = 554.0 PSIA

QDOTP = 0 (KG-MOL)(DEG K)/KG

CASE NO. 3

CHEMICAL FORMULA		WT FRACTION (SEE NOTE)		ENERGY CAL/MOL	STATE	TEMP DEG K	DENSITY G/CC
FUEL	AL 1.00000			.16000			
FUEL	C 6.88400 H 10.08900 O .27800 N .24400			.12040	S	298.15	.0000
FUEL	FE 2.00000 O 3.00000			.00400	S	298.15	.0000
FUEL	C 6.15000 H 4.97000 O 1.17000 N .03000			.01960	S	298.15	.0000
FUEL	N 1.00000 H 4.00000 O 4.00000 CL 1.00000			.69600	S	298.15	.0000
O/F = .0000		PERCENT FUEL = 100.0000		EQUIVALENCE RATIO = 1.6977		REACTANT DENSITY = .0000	

	CHAMBER	THROAT	EXIT	EXIT	EXIT	EXIT	EXIT	EXIT	EXIT	EXIT	EXIT	EXIT
PC/P	1.0000	1.7431	10.000	30.000	50.000	100.00	500.00	1000.00	5000.00	10000.00	100000.00	500000.00
P, ATM	37.697	21.381	3.7697	1.2566	.7539	.3770	.0754	.0377	.0075	.0008	.0004	.0001
T, DEG K	3391	3141	2392	1954	1771	1537	1089	943	687	470	444	373
RHO, G/CC	2.7379-3	1.6749-3	4.0075-4	1.6455-4	1.0917-4	6.2983-5	1.7778-5	1.0272-5	2.8206-6	4.2000-7	2.2637-7	5.5653-8
H, CAL/G	435.9	254.8	-206.5	-432.6	-522.5	-630.6	-827.9	-894.2	-1016.5	-1137.4	-1166.4	-1225.6
S, CAL/(G)(K)	2.8416	2.8416	2.8416	2.8416	2.8416	2.8416	2.8416	2.8416	2.8416	2.8416	2.8416	2.8416
M, MOL WT	20.208	20.431	20.663	20.997	21.042	21.068	21.073	21.073	21.079	21.491	21.867	22.595
(DLV/DLP)T	-1.01730	-1.01197	-1.00280	-1.00167	-1.00088	-1.00015	-1.00000	-1.00000	-1.00013	-1.02296	-1.02153	-1.00615
(DLV/DLP)P	1.2902	1.2133	1.0556	1.0351	1.0204	1.0042	1.0000	1.0001	1.0032	1.5614	1.5495	1.1275
CP, CAL/(G)(K)	.9641	.8497	.5682	.5186	.4884	.4491	.4455	.4599	.4762	1.6848	1.6436	.6206
GAMMA (S)	1.1799	1.1856	1.2255	1.2404	1.2507	1.2684	1.2685	1.2580	1.2362	1.1247	1.1212	1.2107
SON. VEL. M/SEC	1283.0	1231.0	1080.8	979.7	935.5	877.1	738.3	684.0	578.4	352.3	338.9	272.7
MACH NUMBER	.000	1.000	2.145	2.752	3.027	3.406	4.405	4.878	6.025	8.022	8.419	9.197
AE/AT		1.0000	2.2454	4.7030	6.7483	11.089	36.007	60.883	212.17	1349.10	2516.99	10054.2
CSTAR, FT/SEC		6006	6006	6006	6006	6006	6006	6006	6006	6006	6006	6006
CF		.672	1.266	1.473	1.547	1.632	1.776	1.822	1.904	1.982	2.000	2.037
IVAC, LB-SEC/LB		231.4	278.4	304.2	314.0	325.3	345.1	351.6	363.4	375.1	378.1	384.0
ISP, LB-SEC/LB		125.5	236.4	274.9	268.8	304.6	331.6	340.2	355.5	370.0	373.4	380.2

MOLE FRACTIONS

AL	.00011	.00006	.00000	.00000	.00000	.00000	.00000	.00000	.00000	.00000	.00000	.00000
ALH	.00002	.00001	.00000	.00000	.00000	.00000	.00000	.00000	.00000	.00000	.00000	.00000
ALCL	.00438	.00429	.00362	.00180	.00032	.00003	.00000	.00000	.00000	.00000	.00000	.00000
ALCL	.00151	.00168	.00268	.00234	.00135	.00032	.00000	.00000	.00000	.00000	.00000	.00000
ALCL3	.00013	.00019	.00123	.00503	.00737	.00903	.00342	.00943	.00943	.00943	.00974	.01011
ALO	.00012	.00006	.00030	.00000	.00000	.00003	.00000	.00000	.00000	.00000	.00000	.00000
ALOC	.00165	.00178	.00180	.00095	.00033	.00024	.00000	.00000	.00000	.00000	.00000	.00000
ALOH	.00040	.00017	.00019	.00005	.00001	.00000	.00000	.00000	.00000	.00000	.00000	.00000
ALC	.00003	.00002	.00000	.00000	.00000	.00000	.00000	.00000	.00000	.00000	.00000	.00000
ALC2H	.00067	.00045	.00040	.00013	.00004	.00000	.00000	.00000	.00000	.00000	.00000	.00000

LOCKHEED HUNTSVILLE RESEARCH & ENGINEERING CENTER

2-45

Resultant Output for Case 4 (Cont'd)

CO	.00001	.00001	.00000	.00000	.00000	.00000	.00000	.00000	.00000	.00000	.00000	.00000
CO2	.24892	.25057	.25128	.24733	.24902	.23700	.20597	.18545	.13083	.04745	.04477	.00000
C2H4	.00001	.00000	.00000	.00000	.00000	.00000	.00000	.00000	.00000	.00000	.00000	.00000
CL	.01742	.01872	.02373	.02745	.03335	.04071	.07181	.09216	.14702	.20294	.21892	.24612
CL2	.00000	.00000	.00000	.00000	.00000	.00000	.00000	.00000	.00000	.00000	.01228	.02176
CLO	.01343	.00764	.00158	.00021	.00004	.00001	.00000	.00000	.00000	.00000	.00000	.00000
CL2O	.00001	.00000	.00000	.00000	.00000	.00000	.00000	.00000	.00000	.00000	.00000	.00000
CL2O2	.00002	.00001	.00000	.00000	.00000	.00000	.00000	.00000	.00000	.00000	.00000	.00000
FE	.00053	.00040	.00000	.00000	.00000	.00000	.00000	.00000	.00000	.00000	.00000	.00000
FECL	.00005	.00004	.00000	.00000	.00000	.00000	.00000	.00000	.00000	.00000	.00000	.00000
FECL2	.00078	.00095	.00141	.00147	.00148	.00148	.00148	.00147	.00100	.00091	.00001	.00000
FE2O3	.00004	.00003	.00000	.00000	.00000	.00000	.00000	.00000	.00000	.00000	.00000	.00000
FE2O4	.00002	.00001	.00000	.00000	.00000	.00000	.00000	.00000	.00000	.00000	.00000	.00000
FE2O5	.00000	.00000	.00000	.00000	.00000	.00000	.00000	.00000	.00000	.00000	.00000	.00000
H	.03898	.02710	.00428	.00058	.00018	.00002	.00000	.00000	.00000	.00000	.00000	.00000
HCL	.14313	.14788	.15483	.14945	.14612	.14903	.14362	.14361	.14365	.14446	.14902	.15398
HCO	.00002	.00001	.00000	.00000	.00000	.00000	.00000	.00000	.00000	.00000	.00000	.00000
H2	.27673	.28240	.29874	.30959	.31542	.32450	.35537	.37572	.43064	.46670	.46396	.45497
H2O	.15182	.15731	.16308	.16044	.15793	.15118	.12917	.09982	.04501	.00551	.00485	.00719
H2O2	.00001	.00000	.00000	.00000	.00000	.00000	.00000	.00000	.00000	.00000	.00000	.00000
NH2	.01061	.00000	.00000	.00000	.00000	.00000	.00000	.00000	.00000	.00000	.00000	.00000
NH3	.00001	.00001	.00000	.00000	.00000	.00000	.00000	.00000	.00000	.00000	.00000	.00000
NO	.00072	.00037	.00001	.00000	.00000	.00000	.00000	.00000	.00000	.00000	.00000	.00000
N2	.08800	.08715	.09123	.09182	.09202	.09213	.09214	.09214	.09218	.09394	.09560	.09875
O	.00079	.00033	.00000	.00000	.00000	.00000	.00000	.00000	.00000	.00000	.00000	.00000
OH	.00934	.00544	.00042	.00003	.00001	.00000	.00000	.00000	.00000	.00000	.00000	.00000
O2	.00017	.00007	.00000	.00000	.00000	.00000	.00000	.00000	.00000	.00000	.00000	.00000

ADDITIONAL PRODUCTS WHICH WERE CONSIDERED BUT WHOSE MOLE FRACTIONS WERE LESS THAN .0000005 FOR ALL ASSIGNED CONDITIONS

C	CCL	CCL2	CH2O	CN	CNM	CN2	C2	C2H	C2-2
C2H4	C2H2	C2O	C3	CLEN	CLO2	CL2O	FECL3	H2LO	HCN
H2CO	HNO	HNO2	HNO3	H2	H2O2	HCO	NH	NOCL	N2
H2CCL	NO3	N2H4	N2O	N2O4	N3	O3			

NOTE: WEIGHT FRACTION OF FUEL IN TOTAL FUELS AND OF OXIDANT IN TOTAL OXIDANTS

### Resultant Output for Case 4 (Cont'd)

TRANSPORT PROPERTIES OF ROCKET EXHAUST ASSUMING EQUILIBRIUM COMPOSITION DURING EXPANSION

O/F = .0000    PERCENT FUEL = 100.0000    EQUIVALENCE RATIO = 1.6977    CHAMBER PRESSURE = 37.697 ATM

TEMP DEG K	VISCOSITY POISE	MONATOMIC	INTERNAL	FROZEN	REACTION	EQUILIBRIUM	CP	CP	PRANDTL	PRANDTL	LEWIS NUMBER
		COND	COND	COND	COND	COND	FROZ	EQ	FROZ	EQ	
		CAL/(CM)(SEC)(K)					CAL/(G)(K)		DIMENSIONLESS		
3391	931.X10-6	489.X10-6	434.X10-6	923.X10-6	1889.X10-6	2612.X10-6	.4745	.9549	.4802	.3163	2.0328
3141	881.	450.	406.	856.	1423.	2280.	.4723	.9437	.4859	.3240	2.1145
2392	723.	352.	312.	644.	389.	973.	.4663	.8670	.4960	.4216	1.8958
1954	626.	305.	252.	558.	84.	642.	.4415	.5177	.4959	.5093	.8732
1771	584.	287.	227.	514.	44.	558.	.4346	.4882	.4943	.5113	.6978
1537	528.	262.	193.	456.	17.	473.	.4244	.4490	.4920	.5019	.6399
1089	413.	213.	131.	344.	25.	349.	.4013	.4455	.4819	.4980	.6726
943	372.	197.	113.	310.	35.	345.	.3935	.4599	.4728	.4957	.6788
687	385.	147.	87.	254.	49.	303.	.3815	.4842	.4433	.4848	.6356
470	220.	131.	44.	195.	378.	572.	.3469	1.6849	.4355	.6489	.5401
444	210.	124.	40.	184.	385.	569.	.3622	1.6836	.4414	.6207	.5725
373	180.	105.	50.	155.	71.	225.	.3485	.6206	.4049	.4949	.5851

CASE FOR 00078    O AND PC    37.7 HAS BEEN COMPLETED AND WRITTEN ON TAPE UNIT 10

Resultant Output for Case 4 (Cont'd)

THEORETICAL ROCKET PERFORMANCE ASSUMING EQUILIBRIUM COMPOSITION DURING EXPANSION FOR TWO PHASE HOC CALCULATIONS

PC = 554.0 PSIA

WOTP = 100.0 (KG-MOL)(DEG K)/KG

CASE-NO. 1

CHEMICAL FORMULA	WT FRACTION (SEE NOTE)	ENERGY CAL/MOL	STATE	TEMP DEG K	DENSITY G/CC
FUEL AL 1.00000	.16000	.000	5	298.15	.0000
FUEL C 6.88400 H 10.08900 O 3.7800 N .26400	.12040	-12000.000	5	298.15	.0000
FUEL FE 2.00000 O 3.00000	.00400	-197300.000	5	298.15	.0000
FUEL C 4.15000 H 6.97000 O 1.17000 N .03000	.01960	-20300.000	5	298.15	.0000
FUEL H 1.00000 H 4.00000 O 4.00000 CL 1.00000	.49600	-70690.000	5	298.15	.0000
O/F = .0000 PERCENT FUEL=100.0000 EQUIVALENCE RATIO= 1.6977 REACTANT DENSITY= .0000					

	CHAMBER	THROAT	EXIT	EXIT	EXIT	EXIT	EXIT	EXIT	EXIT	EXIT	EXIT	EXIT
PC/P	1.0000	1.7556	18.000	30.000	50.000	100.00	500.00	1000.00	5000.00	50000.0	100000.0	500000.0
P, ATM	37.697	21.474	3.7697	1.2566	.7539	.3770	.0754	.0377	.0075	.0008	.0004	.0001
T, DEG K	3577	3538	2624	2175	1979	1736	1239	1049	771	492	458	400
RHO, G/CC	2.5464-3	1.8758-3	3.6245-4	1.4719-4	9.7326-5	5.5685-5	1.5626-5	9.0572-6	2.5109-6	3.9434-7	2.1508-7	5.1266-8
H, CAL/G	434.4	441.0	43.6	315.0	416.7	537.4	761.7	837.0	975.1	1110.1	1140.7	1203.5
S, CAL/(G)(K)	2.8986	2.8986	2.8986	2.8986	2.8986	2.8986	2.8986	2.8986	2.8986	2.8986	2.8986	2.8986
M, MJL WT	19.829	20.098	20.715	20.906	20.968	21.038	21.073	21.073	21.074	21.134	21.461	22.291
(DLV/DLP)T	-1.02630	-1.01978	-1.00532	-1.00226	-1.00194	-1.00099	-1.00001	-1.00000	-1.00003	-1.00568	-1.02206	-1.01153
(DLV/DLP)P	1.4236	1.3380	1.1077	1.0459	1.0404	1.0234	1.0002	1.0000	1.0006	1.1334	1.5582	1.3120
CP, CAL/(G)(K)	1.1737	1.0562	.6778	.5466	.5298	.4949	.4392	.4470	.4846	.7153	1.7138	1.1485
GAMMA (S)	1.1720	1.1735	1.2024	1.2320	1.2371	1.2483	1.2735	1.2674	1.2419	1.1950	1.1225	1.1391
SON. VEL. M/SEC	1325.9	1272.9	1125.4	1032.4	985.4	925.4	789.1	731.1	614.7	481.1	444.5	412.0
MACH NUMBER	.000	1.000	2.148	2.731	3.008	3.384	4.332	4.800	5.971	7.941	8.633	9.519
AE/AT		1.0000	2.2884	4.6343	6.9518	11.502	37.553	63.109	217.66	1331.23	2419.62	9976.24
CSTAR, FT/SEC		.6248	.6248	.6248	.6248	.6248	.6248	.6248	.6248	.6248	.6248	.6248
CF		.668	1.269	1.480	1.557	1.645	1.795	1.843	1.927	2.006	2.024	2.060
IVAC, LB-SEC/LB		240.4	290.9	318.7	329.3	341.7	363.2	370.1	382.7	394.8	397.7	403.8
ISP, LB-SEC/LB		129.8	246.5	287.5	302.3	319.3	348.6	357.8	374.3	389.6	393.0	399.9

MOLE FRACTIONS

AL	.00021	.00013	.00002	.00000	.00000	.00000	.00000	.00000	.00000	.00000	.00000	.00000
ALH	.00002	.00001	.00000	.00000	.00000	.00000	.00000	.00000	.00000	.00000	.00000	.00000
ALCL	.00447	.00451	.00400	.00240	.00155	.00038	.00000	.00000	.00000	.00000	.00000	.00000
ALCL2	.00115	.00125	.00192	.00266	.00254	.00141	.00002	.00000	.00000	.00000	.00000	.00000
ALCL3	.00087	.00089	.00038	.00181	.00173	.00141	.00141	.00143	.00143	.00145	.00148	.00147
ALO	.00022	.00019	.00001	.00000	.00000	.00000	.00000	.00000	.00000	.00000	.00000	.00000
ALOC	.00154	.00171	.00209	.00181	.00128	.00041	.00000	.00000	.00000	.00000	.00000	.00000
ALOH	.00043	.00041	.00028	.00214	.00087	.00002	.00000	.00000	.00000	.00000	.00000	.00000
ALO2	.00005	.00004	.00000	.00000	.00000	.00000	.00000	.00000	.00000	.00000	.00000	.00000
ALO2H	.00066	.00068	.00056	.00033	.00019	.00005	.00000	.00000	.00000	.00000	.00000	.00000

Resultant Output for Case 4 (Cont'd)

AL2O3	.00001	.00001	.00001	.00000	.00000	.00000	.00000	.00000	.00000	.00000	.00000	.00000	.00000
CO	.24530	.24753	.25130	.24954	.24744	.24308	.22029	.20359	.15134	.08938	.06614	.01858	
COCL	.00001	.00001	.00000	.00000	.00000	.00000	.00000	.00000	.00000	.00000	.00000	.00000	.00000
CO2	.01404	.01737	.02175	.02403	.02895	.03423	.05749	.07419	.12645	.18779	.20302	.23729	
C2H4	.00000	.00000	.00000	.00000	.00000	.00000	.00000	.00000	.00000	.00000	.00000	.00000	.00000
CL	.01959	.01560	.00431	.00089	.00033	.00007	.00000	.00000	.00000	.00000	.00000	.00000	.00000
CLO	.00002	.00001	.00000	.00000	.00000	.00000	.00000	.00000	.00000	.00000	.00000	.00000	.00000
CL2	.00003	.00002	.00000	.00000	.00000	.00000	.00000	.00000	.00000	.00000	.00000	.00000	.00000
FE	.00074	.00065	.00019	.00002	.00001	.00000	.00000	.00000	.00000	.00000	.00000	.00000	.00000
FECL	.00006	.00005	.00001	.00000	.00000	.00000	.00000	.00000	.00000	.00000	.00000	.00000	.00000
FECL2	.00051	.00045	.00124	.00144	.00146	.00148	.00148	.00148	.00142	.00063	.00001	.00000	.00000
FEO	.00006	.00005	.00001	.00000	.00000	.00000	.00000	.00000	.00000	.00000	.00000	.00000	.00000
FE2H2	.00001	.00001	.00001	.00000	.00000	.00000	.00000	.00000	.00000	.00000	.00000	.00000	.00000
FE2CL4	.00000	.00000	.00000	.00000	.00000	.00000	.00000	.00000	.00000	.00000	.00000	.00000	.00000
H	.35861	.04513	.01172	.00238	.00090	.00019	.00003	.00000	.00000	.00000	.00000	.00000	.00000
HCL	.13522	.14086	.15400	.15454	.15160	.14650	.14363	.14362	.14362	.14403	.14625	.15191	
HCO	.00003	.00001	.00000	.00000	.00000	.00000	.00000	.00000	.00000	.00000	.00000	.00000	.00000
H2	.24816	.27394	.29220	.30257	.30791	.31614	.34103	.35775	.41001	.46928	.46828	.46125	
H2O	.14167	.14928	.16178	.16163	.16029	.15690	.13449	.11779	.04554	.00417	.00422	.00373	
N	.00002	.00001	.00000	.00000	.00000	.00000	.00000	.00000	.00000	.00000	.00000	.00000	.00000
NN	.00001	.00000	.00000	.00000	.00000	.00000	.00000	.00000	.00000	.00000	.00000	.00000	.00000
NN2	.00001	.00001	.00000	.00000	.00000	.00000	.00000	.00000	.00000	.00000	.00000	.00000	.00000
NN3	.00001	.00001	.00000	.00000	.00000	.00000	.00000	.00000	.00000	.00000	.00000	.00000	.00000
NO	.00129	.00078	.00007	.00000	.00000	.00000	.00000	.00000	.00000	.00000	.00003	.00003	.00004
N2	.08405	.08749	.09055	.09142	.09149	.09200	.09216	.09216	.09216	.09241	.09383	.09746	
O	.00195	.00103	.00004	.00000	.00000	.00000	.00000	.00000	.00000	.00000	.00000	.00000	.00000
OH	.01514	.01041	.00163	.00017	.00004	.00001	.00000	.00000	.00000	.00000	.00000	.00000	.00000
O2	.00041	.00022	.00001	.00000	.00000	.00000	.00000	.00000	.00000	.00000	.00000	.00000	.00000

ADDITIONAL PRODUCTS WHICH WERE CONSIDERED BUT WHOSE MOLE FRACTIONS WERE LESS THAN .50000-05 FOR ALL ASSIGNED CONDITIONS

	CCL	CCL2	CH2O	CN	CNN	CN2	C2	CCN	CCN2
C2H	C2H2	C2O	C3	CLCN	CLO2	CL2O	FECL3	HALO	HCN
HNCO	HNO	HNO2	HNO3	H02	H2O2	HCO	NOCL	NO2	NO2EL
H03	H2H4	H2O	H2O4	H3	O3				

NOTE. WEIGHT FRACTION OF FUEL IN TOTAL FUELS AND OF OXIDANT IN TOTAL OXIDANTS

REPRODUCIBILITY OF THE  
ORIGINAL PAGE IS POOR

Resultant Output for Case 4 (Cont'd)

TRANSPORT PROPERTIES OF ROCKET EXHAUST ASSUMING EQUILIBRIUM COMPOSITION DURING EXPANSION

O/F = .0000 PERCENT FUEL = 100.0000 EQUIVALENC RATIO = 1.6777 CHAMBER PRESSURE = 87.697 ATM

TEMP DEG K	VISCOSITY POISE	MONATOMIC COND	INTERNAL COND	FROZEN COND	REACTION COND	EQUILIBRIUM COND	CP FROZ	CP EQ	PRANDTL FROZ	PRANDTL EQ	LEWIS NUMBER
				CAL/(CM)(SEC)(K)			CAL/(G)(K)			DIMENSIONLESS	
3577	966.X10-6	535.X10-6	448.X10-6	983.X10-6	2701.X10-6	3689.X10-6	.4797	1.1615	.4718	.3047	1.9347
3338	920.	491.	424.	915.	2216.	3131.	.4759	1.0448	.4783	.3075	2.0181
2624	773.	381.	342.	723.	733.	1456.	.4613	.6748	.4934	.3584	2.1906
2175	676.	328.	282.	610.	204.	814.	.4489	.5447	.4971	.4521	1.5662
1979	632.	308.	255.	563.	110.	473.	.4424	.5283	.4867	.4463	1.0851
1736	576.	283.	221.	504.	49.	553.	.4331	.4947	.4944	.5147	.4827
1239	453.	230.	151.	381.	18.	399.	.4095	.4392	.4871	.4985	.6610
1069	408.	211.	128.	339.	27.	366.	.4002	.4470	.4810	.4979	.6739
771	321.	178.	95.	272.	47.	319.	.3852	.4846	.4544	.4881	.6460
492	229.	137.	66.	203.	93.	297.	.3706	.7153	.4177	.5530	.4923
458	216.	129.	62.	191.	377.	567.	.3660	1.7139	.4141	.4525	.5354
400	191.	113.	54.	167.	222.	389.	.3544	1.1485	.4069	.5655	.5942

LOCKHEED - HUNTSVILLE RESEARCH & ENGINEERING CENTER

2-50

Resultant Output for Case 4 (Cont'd)

COOP TEST CASE

4 1

14 19

ALCL HCN	CO H2	CO2 H2O	C2H4 NH3	FECL N2	FE2C	HCL
.0	.0	.0	.0	.0	.0	.0
-.7563738+03	.3769732+02	.1252025+04	.2316876+01	.2108151+02	.1273913+01	.0000000
.4989933+00	.4563408-03	.4396469+00	.4020671-03	.7563768+03	.4359248+03	
.9428998-02	.2213171+00	.5656125-01	.6356326-04	.1420590+02	.2818051-04	.1436682+00
.7031177-05	.3396975+00	.1355033+00	.3444960-03	.9201622-01		
.7563738+03	.2679518+02	.1102804+04	.2316876+01	.2108151+02	.1273913+01	.0000000
.4999204+00	.4167851-03	.4478937+00	.3734105-03	.8222937+03	.4359248+03	
.9431178-02	.2075478+00	.7036607-01	.2886612-05	.1310753+02	.8339599-04	.1436685+00
.4465831-05	.3534276+00	.1217255+00	.4163899-03	.9199340-01		
.7563738+03	.3769732+01	.7877338+03	.2316876+01	.2108151+02	.1273913+01	.2192553+01
.5575984+03	.3264648+03	.6477590+00	.3792524-03	.9720358+03	.4359248+03	
.9474387-02	.1525256+00	.1243209+00	.1723180-03	.3685663-03	.5675932-03	.1443448+00
.1370478-05	.4031337+00	.7098577-01	.9949192-03	.9212702-01		
.7563738+03	.1256577+01	.6817608+03	.2316876+01	.2108151+02	.1273913+01	.2830043+01
.6454377+00	.2931151-03	.1319709+01	.5993245-03	.1046507+04	.4359248+03	
.9701081-02	.1071182+00	.1606201+00	.908843-02	.1203598+03	.7006136-03	.1477084+00
.4477561-06	.4143225+00	.5509359-01	.1228891-02	.9222703-01		
.7563738+03	.7539463+00	.6453291+03	.2316876+01	.2108151+02	.1273913+01	.3690746+01
.6359320+00	.2808524-03	.1446776+01	.6389527-03	.1077336+04	.4359248+03	
.9836150-02	.8586683-01	.1763356+00	.1382713-01	.7687923+04	.7329794-03	.1498565+00
.2334862-06	.4150332+00	.5164609-01	.1252018-02	.9553624+01		
.7563738+03	.3769732+00	.6005654+03	.2316876+01	.2240571+02	.1150021+03	.3426542+01
.6127097+00	.2651319-03	.1414120+01	.6119196+03	.1115978+04	.4359248+03	
.1002243-01	.5864641-03	.1959202+00	.2038877-01	.4025138+04	.7659185-03	.1524938+00
.8484318-07	.4139165+00	.4897683-01	.1290444-02	.9733774-01		
.7563738+03	.7539464-01	.4997360+03	.2316876+01	.232924+02	.1184618+01	.4161616+01
.5465525+00	.2272465-03	.9039898+00	.3758624-03	.1193036+04	.4359248+03	
.1043554-01	.1165654-01	.2263195+00	.3477145-01	.4775039+05	.8160768-03	.1589878+00
.0000000	.3982703+00	.5575718-01	.1917929-02	.1010628+00		
.7563738+03	.3769732-01	.4535921+03	.2316876+01	.232454+02	.1206837+01	.4802552+01
.5302512+00	.2086584-03	.7948053+00	.3127628-03	.1220947+05	.4359248+03	
.1061480-01	.3344559-02	.2278921+00	.4081220-01	.1119464-05	.8321213-03	.1617497+00
.0000000	.3794934+00	.6995832-01	.3011109-02	.1022885+00		
.7563738+03	.7539463+02	.3631953+03	.2316876+01	.2490873+02	.1187839+01	.5486519+01
.5198346+00	.1682996-03	.9963067+00	.3225603-03	.1274390+04	.4359248+03	
.1114206-01	.9685249-04	.2145187+00	.5684166-01	.1924629-07	.8738680-03	.1692518+00
.0000000	.3064283+00	.1261278+00	.1054005-01	.1036589+00		
.7563738+03	.7539463-03	.2821073+03	.2316876+01	.2689000+02	.1149841+01	.6823687+01
.4290227+00	.1264152-03	.1312575+01	.3867612-03	.1330938+04	.4359248+03	
.1202837-01	.6724682-00	.1977058+00	.7837445-01	.0000000	.9433831-03	.1832539+00
.0000000	.1841087+00	.2040166+00	.3994983-01	.9761839-01		
.7563738+03	.3769732+03	.2440324+03	.2316876+01	.2749220+02	.1142715+01	.7345274+01
.1951660+00	.1165517-03	.1334568+01	.3936224-03	.1344762+04	.4359248+03	
.1229770-01	.1513244+00	.1960788+00	.8315707-01	.0000000	.9445144-03	.1873580+00
.0000000	.1521438+00	.2204946+00	.5415713-01	.9314826-01		
.7563738+03	.7539464-04	.2280598+03	.2316876+01	.283328+02	.1133297+01	.8318345+01
.3324584+00	.9707645-04	.1217187+01	.3554134-03	.1372651+04	.4359248+03	
.1287755-01	.0000000	.2002919+00	.8988949-01	.0000000	.1011566-02	.1964977+00
.0000000	.8238127-01	.2421631+00	.9755169+01	.7731578-01		

LOCKHEED - HUNTSVILLE RESEARCH & ENGINEERING CENTER

2-51



Resultant Output for Case 4 (Cont'd)

14 29

37.7 ALCL C02 H OH	.0 ALCL C2H4 HCL	.0 ALCL CL H2	.0 ALOC FC H2O	.0 ALOH FECL NH3	.0 AL02 FE02 NO	.0 CO FE2C N2
2	3	L	2	H	L4	
.1602248+03	.3769732+02	.2523549+04	.2641502+01	.2093427+02	.1234515+01	.0000000
.4582123+00	.7526580-03	.5351739+00	.8790749-03	-.1402746+03	.4359248+03	
.1760368-02	.3348199-02	.2703079+02	.9751932-03	.1206483-03	.2517351-03	.2531436+00
.2279352-01	.0000000	.8806887-03	.1216908-04	.1445723-02	.6134732-05	.3642480-07
.2473379-02	.1517709+00	.3002301+00	.1460090+00	.1931272-04	.1127495-04	.9152944+01
.2693930-03						
.1602248+03	.3769732+02	.2523549+04	.2641502+01	.2093427+02	.1234515+01	.0000000
.4888490+03	.6955243-03	.5124021+00	.7290353-03	-.2930988+03	.4359248+03	
.9205383-03	.2751438-02	.4934754-02	.6011832-03	.5550546-04	.1266052-03	.2515054+00
.2523193-01	.0000000	.3335506-03	.3181922-05	.1464880+02	.2993611-05	.4391096-07
.9452136-03	.1490980+00	.3050812+00	.1650383+00	.1486029-04	.2222073-05	.9180136-01
.7716545-04						
.1602248+03	.3769732+02	.2523549+04	.2641502+01	.2093427+02	.1234515+01	.0000000
.4989496+00	.5432992-03	.4439481+00	.8834306-03	-.6038541+03	.4359248+03	
.7261824-05	.1882156-03	.9219356-02	.9476257-05	.2519392-06	.8251240-06	.2393355+00
.3841538-01	.0000000	.5523370-05	.0000000	.1477434-02	.1540916-06	.1647993-06
.1563639-04	.1438173+00	.3218208+00	.1535342+00	.9859068-05	.0000000	.9214110-01
.2839749-06						
.1602248+03	.3769732+02	.2523549+04	.2641502+01	.2093427+02	.1234515+01	.0000000
.4982400+00	.4590785-03	.4381370+00	.4036996-03	-.7514287+03	.4359248+03	
.2813667-07	.6870379-05	.9419553-02	.7030968-07	.0000000	.0000000	.2220989+00
.5569395-01	.0000000	.1117824-06	.0000000	.1476419-02	.0000000	.9052662-06
.3101619-06	.1436219+00	.3392353+00	.1362902+00	.1096029-04	.0000000	.9215180-01
.0000000						
.1602248+03	.3769732+02	.2523549+04	.2641502+01	.2093427+02	.1234515+01	.0000000
.4982418+00	.4245533-03	.4428848+00	.3773834-03	-.8090325+03	.4359248+03	
.0000000	.1033837-05	.9425557-02	.0000000	.0000000	.0000000	.2106087+00
.6717794-01	.0000000	.1260983-07	.0000000	.1473142-02	.0000000	.2569584-05
.3478363-07	.1436169+00	.3507217+00	.1248074+00	.1279010-04	.0000000	.9215155-01
.0000000						
.1602248+03	.3769732+02	.2523549+04	.2641502+01	.2093427+02	.1234515+01	.0000000
.4769834+00	.3823293-03	.4559489+00	.3507614-03	-.8778451+03	.4359248+03	
.0000000	.5565892-07	.9426679-02	.0000000	.0000000	.0000000	.1913016+00
.8648955-01	.0000000	.0000000	.0000000	.1451504-02	.0000000	.1342216-04
.0000000	.1436184+00	.3700315+00	.1354988+00	.1742310-04	.0000000	.9215072-01
.0000000						
.1602248+03	.3769732+02	.2523549+04	.2641502+01	.2093427+02	.1234515+01	.0000000
.4860838+00	.3029659-03	.4954813+00	.3088231-03	-.1004693+04	.4359248+03	
.0000000	.0000000	.9430871-02	.0000000	.0000000	.0000000	.1370387+00
.1408727+00	.7589053-06	.0000000	.0000000	.6480552-03	.0000000	.4155835-03
.0000000	.1436814+00	.4244850+00	.5120124-01	.5126752-04	.0000000	.9217421-01
.0000000						

LOCKHEED - HUNTSVILLE RESEARCH & ENGINEERING CENTER

2-52

Resultant Output for Case 4 (Cont'd)

.1602248+03	.3749732-01	.6233164+03	.2641502+01	.2109246+02	.1237317+01	.4953952+01
.4798761+00	.2745319-03	.5004125+00	.2862806-03	-.1048229+04	.4359248+03	
.0000000	.0000000	.934967-02	.0000000	.0000000	.0000000	.1162581+00
.1624640+00	.5602065-04	.0000000	.0000000	.1987182-03	.0000000	.6406098-03
.0000000	.1437441+00	.4461110+00	.2960416-01	.740264-04	.0000000	.9219179-01
.0000000						
.1602248+03	.7539463-02	.5098975+03	.2641502+01	.2173222+02	.1131861+01	.6067823+01
.6325566+00	.2344632-03	.1602553+01	.5940016-03	-.1131658+04	.4359248+03	
.0000000	.0000000	.7721170-02	.0000000	.0000000	.0000000	.6134843-01
.2048976+00	.1011067-01	.0000000	.0000000	.2063838-04	.0000000	.7521168-03
.0000000	.1481041+00	.4566094+00	.1330836-01	.1796001-03	.0000000	.9494796-01
.0000000						
.1602248-03	.7539463-03	.3927007+03	.2641502+01	.2284879+02	.1221243+01	.7148683+01
.5085582+00	.1869840-03	.6351563+00	.2335309-03	-.1225045+04	.4359248+03	
.0000000	.0000000	.1022956-01	.0000000	.0000000	.0000000	.2545656-02
.2429807+00	.2795156-01	.0000000	.0000000	.3700813-06	.0000000	.8021237-03
.0000000	.1558497+00	.4300803+00	.2126156-01	.5407849-03	.0000000	.9973768-01
.0000000						
.1602248+03	.3749732-03	.3507314+03	.2641502+01	.2320816+02	.1219744+01	.7703991+01
.5342084+00	.1685633-03	.6793554+00	.2208735-03	-.1247245+04	.4359248+03	
.0000000	.0000000	.1638139-01	.0000000	.0000000	.0000000	.3634368-03
.2395880+00	.3301573-01	.0000000	.0000000	.3462150-07	.0000000	.8141979-03
.0000000	.1581625+00	.4172481+00	.3787433-01	.1440391-02	.0000000	.1007720+00
.0000000						
.1602248+03	.7539464+04	.2851196+03	.2641502+01	.2433566+02	.1141424+01	.9139187+01
.5760464+00	.1358459-03	.1240641+01	.2925737-03	-.1289680+04	.4359248+03	
.0000000	.0000000	.1688580-01	.0000000	.0000000	.0000000	.3442064-05
.2237378+00	.4852166-01	.0000000	.0000000	.0000000	.0000000	.8537706-03
.0000000	.1658463+00	.3445272+00	.9500789-01	.8306153-02	.0000000	.1022298+00
.0000000						

LOCKHEED - HUNTSVILLE RESEARCH & ENGINEERING CENTER

Resultant Output for Case 4 (Cont'd)

14

37.7	.0	.0	.0	.0	.0	.0
AL	ALM	ALCL	ALCL	ALCL	ALO	ALOC
ALOH	ALOZ	ALOZ	ALZ0	CO	COCL	COZ
C244	CL	CL0	CL2	FE	FECL	FECL
FEO	FEOZ	FEOZ	H	HCL	HCO	HZ
H20	H	NH2	NH3	NO	NZ	C
OH	OZ					
.0	.0	.0	.0	.0	.0	.0
			2	3		1
			H			
	H2	L4				
.9359247+03	.3749732+02	.3397819+04	.2891597+01	.2020825+02	.1179931+01	.0000000
.3163401+00	.9305038-03	.9580250+00	.2812115-02	.4366310+03	.4359248+03	
.1130123-03	.3507067-04	.4373597-02	.1507848-02	.1233928-03	.1127501-03	.1446857-02
.9039975-03	.3112200-04	.5672310-03	.1156668-04	.2489219+00	.9362496-05	.1742090-01
.0000000	.1342840-01	.8596264-05	.2276880-04	.5295637-03	.5377000-04	.7754351-03
.4156608-04	.1687343-04	.0000000	.3898058-01	.1431325+00	.1980203-04	.2767278+00
.2515197+00	.6230678-05	.1003542-04	.8944619-05	.7181845-03	.8799682-01	.7867240-03
.9359124-02	.1720780-03					
.4359247+03	.2138367+02	.3140941+04	.2841597+01	.2043883+02	.1185590+01	.9998833+00
.3259631+00	.8807145-03	.8436760+00	.2279514-02	.2558272+03	.4359248+03	
.0403087-04	.7911599-05	.4293953-02	.1682681-02	.1925652-03	.6466498-04	.1780386-02
.3672683-03	.1789343-04	.6473550-03	.1005038-04	.2505720+00	.4775170-05	.1872230-01
.0000000	.9643867-02	.3314617-05	.1381921-04	.4011326-03	.3900870-04	.9529499-03
.2595987-04	.1402728-04	.0000000	.2729957-01	.1478758+00	.9815555-05	.2823984+00
.1573067+00	.2130597-05	.4938507-05	.6856679-05	.1701121-03	.6915273-01	.3334988-03
.5637412-02	.7476643-04					
.4359247+03	.3749732+01	.2391724+04	.2841597+01	.2086339+02	.1225498+01	.2145373+01
.4216390+00	.7234387-03	.5669603+00	.9727776-03	.2065395+03	.4359248+03	
.3387878-05	.4170093-06	.3018671-02	.2676543-02	.1231441-02	.2793984-05	.1800880-02
.1863053-03	.8735825-06	.4042947-03	.3451480-05	.2512822+00	.3487733-06	.2373070-01
.0000000	.1581906-02	.3528476-07	.1427468-05	.4411977-04	.4502559-05	.1409876-02
.1108444-05	.3873278-05	.0000000	.4282134-02	.1548307+00	.6745069-06	.2987388+00
.1630845+00	.1586111-07	.3230539-04	.2203550-05	.1428507-04	.9122957-01	.4120485-05
.4215762-03	.9446231-06					
.4359247+03	.1256577+01	.1954051+04	.2841597+01	.2099744+02	.1240437+01	.2751845+01
.5053146+00	.6262552-03	.5177160+00	.6916247-03	.4326720+03	.4359248+03	
.8201477-07	.1299156-07	.1001870-02	.2341220-02	.5030146-02	.5498891-07	.2454401-03
.4790967-04	.1906095-07	.1250767-03	.3015537-06	.2473286+00	.3610234-07	.2945281-01
.0000000	.2105451-03	.0000000	.1486360-06	.2626279+05	.3346854-06	.1469126-02
.2574568-07	.9247267-06	.0000000	.5827741-03	.1494502+00	.6996306-07	.3095920+00
.1606644+00	.0000000	.3167089-07	.1441540+05	.4988180+06	.9122346-01	.3885035-07
.2720610-04	.0000000					
.4359247+03	.7539463+00	.1709970+04	.2841597+01	.2104202+02	.1250728+01	.3021191+01
.5113287+00	.5840877-03	.4881963+00	.5574637-03	.5225373+03	.4359248+03	
.0000000	.0000000	.3152790-03	.1346595-02	.7374008-02	.0000000	.3254089-03
.1386632-04	.0000000	.3791142-04	.2616711-07	.2440227+00	.1056719-07	.3334634-01
.0000000	.6401682-04	.0000000	.4136392-07	.4657069-06	.7074523-07	.1475244-02
.0000000	.4063055-06	.1196556-07	.1798937-03	.1461190+00	.2050271-07	.3154241+00

2-54

LOCKHEED - HUNTSVILLE RESEARCH & ENGINEERING CENTER

Resultant Output for Case 4 (Cont'd)

.1579295+00	.0000000	.0000000	.1264929-05	.7033640-07	.9291869-01	.0000000
.5438782-05	.0000000					
.4359247+03	.3769732+00	.1536754+04	.2841597+01	.2107342+02	.1248522+01	.4404798+01
.5018911+00	.5281425+03	.4490495+00	.4725370-03	.6306133+03	.4359248+03	
.0000000	.0000000	.2578890-04	.3235589-03	.9034002-02	.0000000	.3713656-04
.8221727-06	.0000000	.2832357-05	.0000000	.2370036+00	.0000000	.4071113-01
.0000000	.8885716-05	.0000000	.0000000	.2278034-07	.0000000	.1477921+02
.0000000	.1008717-06	.2517944-07	.2499562-04	.1440307+00	.0000000	.3240029+00
.1511803+00	.0000000	.0000000	.1181819-05	.0000000	.9213347-01	.0000000
.3659447-06	.0000000					
.4359247+03	.7539464-01	.1089138+04	.2841597+01	.2107342+02	.1248522+01	.4404798+01
.4980458+00	.4130485-03	.4454896+00	.3694616-02	.8279443+03	.4359248+03	
.0000000	.0000000	.0000000	.1448731-05	.9424993-02	.0000000	.1180094-07
.0000000	.0000000	.0000000	.0000000	.2059728+00	.0000000	.7181018-01
.0000000	.1591343-07	.0000000	.0000000	.0000000	.0000000	.1477921+02
.0000000	.0000000	.4667770-06	.4383116-07	.1436157+00	.0000000	.3553667+00
.1201724+00	.0000000	.0000000	.1643713-05	.0000000	.9215591-01	.0000000
.0000000	.0000000					
.4359247+03	.3769732+01	.9425273+03	.2841597+01	.2107350+02	.1257965+01	.4877687+01
.4957344+00	.3721050-03	.4598876+00	.3451979-03	.8942023+03	.4359248+03	
.0000000	.0000000	.0000000	.7020718-07	.9426439-02	.0000000	.0000000
.0000000	.0000000	.0000000	.0000000	.1856252+00	.0000000	.9215891-01
.0000000	.0000000	.0000000	.0000000	.0000000	.0000000	.1473133-02
.0000000	.0000000	.2699704-05	.0000000	.1436149+00	.0000000	.3757159+00
.9982447-07	.0000000	.0000000	.2303138-05	.0000000	.9215589-01	.0000000
.0000000	.0000000					
.4359247+03	.7539463-02	.6846479+03	.2841597+01	.2107861+02	.1236233+01	.6024905+01
.4839732+00	.2950794-03	.4961691+00	.3025153-03	.1016549+04	.4359248+03	
.0000000	.0000000	.0000000	.0000000	.9428790-02	.0000000	.0000000
.0000000	.0000000	.0000000	.0000000	.1308331+00	.0000000	.1470185+00
.0000000	.0000000	.0000000	.0000000	.0000000	.0000000	.9977943-03
.0000000	.0000000	.2405710-03	.0000000	.1436497+00	.0000000	.4306370+00
.4501143-01	.0000000	.0000000	.7234971-05	.0000000	.9217582-01	.0000000
.0000000	.0000000					
.4359247+03	.7539463-03	.4701601+03	.2841597+01	.2149112+02	.1124657+01	.8022363+01
.6489039+00	.2203997-03	.1684853+01	.5722589-03	.1137390+04	.4359248+03	
.0000000	.0000000	.0000000	.0000000	.9613291-02	.0000000	.0000000
.0000000	.0000000	.0000000	.0000000	.4764592-01	.0000000	.2029589+00
.4342102-02	.0000000	.0000000	.0000000	.0000000	.0000000	.1495248-04
.0000000	.0000000	.7464991-03	.0000000	.1464609+00	.0000000	.4666960+00
.5513191-02	.0000000	.0000000	.4970577-04	.0000000	.9395854-01	.0000000
.0000000	.0000000					
.4359247+03	.3769732-03	.4437711+03	.2841597+01	.2186676+02	.1121162+01	.8418862+01
.6206803+00	.2096428-03	.1683582+01	.5686518-03	.1166413+04	.4359248+03	
.0000000	.0000000	.0000000	.0000000	.9781344-02	.0000000	.0000000
.0000000	.0000000	.0000000	.0000000	.4476821-01	.0000000	.2189178+00
.1227722-01	.0000000	.0000000	.0000000	.0000000	.0000000	.6951192-05
.0000000	.0000000	.7636795-03	.0000000	.1490210+00	.0000000	.4639450+00
.4846502-02	.0000000	.0000000	.5244972-04	.0000000	.9559991-01	.0000000
.0000000	.0000000					
.4359247+03	.7539463-04	.3730398+03	.2841597+01	.2259504+02	.1210657+01	.9146692+01
.4948838+00	.1798073-03	.6206124+00	.2254884-03	.1225553+04	.4359248+03	
.0000000	.0000000	.0000000	.0000000	.1010714-01	.0000000	.0000000
.0000000	.0000000	.0000000	.0000000	.4133430-02	.0000000	.2461793+00
.2376425-04	.0000000	.0000000	.0000000	.0000000	.0000000	.3509000-04
.0000000	.0000000	.7925300-03	.0000000	.1539842+00	.0000000	.4549714+00
.0000000	.0000000					
.7194600-02	.0000000	.0000000	.1229947-03	.0000000	.9874951-01	.0000000
.0000000	.0000000					

Resultant Output for Case 4 (Cont'd)

14 45

37.7	.0	.0	.0	.0	.0	.0
AL	ALH	ALCL	ALCL	ALCL	ALCL	ALC
ALOH	AL02	AL02	AL20	CO	COCL	CO2
C2H4	CL	CLO	CL2	CE	FECL	FECL
FE0	FE02	FE2C	H	HCL	HCO	H2
H20	H	NH	NH2	NH3	NO	N2
0	OH	O2				
.0	.0	.0	.0	.0	.0	.0
		H				
	H2	L4				
.6346412+03	.3769732+02	.3577445+04	.2898596+01	.1982914+02	.1171983+01	.0000000
.3046845+00	.9464744+03	.1161364+01	.3683903+02	.6350372+03	.4359248+03	
.2053037-03	.2367840-04	.4488698-02	.1148701-02	.4957333-04	.2160268-03	.1541295-02
.4310749-03	.5305787-04	.6641428-03	.1330929-04	.2452998+00	.1166047-04	.1603791-01
.0000000	.1958877-01	.1833198-04	.3000517-04	.7366891-03	.6207950-04	.5143088-03
.6376191-04	.1417380-04	.0000000	.5880807-01	.1352194+00	.2556314-04	.2681632+00
.1416669+00	.1507846-04	.5275324-05	.1293186-04	.7713723-05	.1290547-02	.8404562-01
.1950378-02	.1513511-01	.4083972-03				
.6346412+03	.2147409+02	.3337834+04	.2898596+01	.2009782+02	.1173463+01	.1000002+01
.3075168+00	.9197014+03	.1046784+01	.3130653+02	.4414487+03	.4359248+03	
.1325271-03	.1380414-04	.4506430-02	.1252088-02	.9167631-04	.1367536-03	.1709850-02
.4088302-03	.3588662-04	.6772983-03	.1225823-04	.2475255+00	.6392512-05	.1737388-01
.0000000	.1549566-01	.8677156-05	.1997896-04	.6492262+03	.5141590-04	.6476467+03
.4855352-04	.1299312-04	.0000000	.4513150-01	.1408622+00	.1355632-04	.2739400+00
.1492786+03	.6270197-05	.2157114-05	.683132-05	.6144375-05	.2768574-03	.8740957-01
.1028954-02	.1041049-01	.2239626-03				
.6346412+03	.3769732+01	.2624198+04	.2898596+01	.2071496+02	.1202397+01	.2147775+01
.3584012+00	.7734172+03	.6747985+00	.1456191-02	.76362667+02	.4359248+03	
.1597068-04	.1425760-05	.3997242-02	.1917626-02	.3836486-03	.1417762-04	.2085972-02
.2758803-03	.4278858-05	.5562425-03	.6806218-05	.2513011+00	.6756059-06	.2175425-01
.0000000	.4314948-02	.2677630-06	.3393257-05	.1896533-03	.1355449-04	.1236444-02
.6840326-05	.6223044-05	.0000000	.1172147-01	.1539968+00	.1319798-05	.2922049+00
.1617807+00	.1348413-06	.5587857-07	.6442764-06	.1673633-05	.6646672-04	.9055438-01
.4029394-04	.1533840-02	.9219790-05				
.6346412+03	.1256577+01	.2175088+04	.2898596+01	.2090659+02	.1232027+01	.2730635+01
.4521157+00	.6756653+03	.5446834+00	.8140033-03	.3149984+03	.4359248+03	
.1217303-05	.1233652-06	.2602509-02	.2655842-02	.1808182-02	.9268012-06	.1805881-02
.1407762-03	.2990067-04	.3311282+03	.2244446-05	.2495366+00	.9511653-07	.2603372-01
.0000000	.6875517-03	.0000000	.8379880-06	.2259043-04	.1907144-05	.1429758-02
.3743496-06	.1778275-05	.0000000	.2384555-02	.1545429+00	.1810615-06	.3025738+00
.1616284+00	.0000000	.0000000	.8450266-07	.9841773-06	.4358066-05	.9141998-01
.9497780-06	.1689164-03	.2169419-06				
.6346412+03	.7539463+00	.1979481+04	.2898596+01	.2096765+02	.1237149+01	.2688478+01
.4962928+00	.6318374+03	.5283412+00	.6726386-03	.4157422+03	.4359248+03	
.2021826-06	.6341599-07	.1552376-02	.2559092-02	.4723212-02	.1419706-06	.1276696-02
.7439706-04	.4724370-07	.1915195-03	.7161949-06	.2474420+00	.3194120-07	.2894670-01
.0000000	.3296726-03	.0000000	.1788665-06	.5613426-05	.5320516-04	.1463813-02
.5678256-07	.9899146-06	.0000000	.8976531-03	.1515976+00	.6098909-07	.3079069+00

LOCKHEED - HUNTSVILLE RESEARCH & ENGINEERING CENTER

2-56

Resultant Output for Case 4 (Cont'd)

.1602902+00	.0000000	.0000000	.2769061-07	.8204827-06	.8460498-06	.9169325-01
.9647754-07	.4416059-04	.2190551-07				
.6346412+03	.3769732+00	.1735652+04	.2898594+01	.2103770+02	.1248329+01	.3388292+01
.5146682+00	.5757205-03	.4946593+00	.5533381-03	-.5373824+03	.4359248+03	
.0000000	.0000000	.3842927-03	.1410561+02	.7140359-02	.0000000	.9145248-03
.1529001-04	.0000000	.4538077-04	.3712160-07	.2430831+00	.0000000	.3422911-01
.0000000	.6671202-04	.0000000	.3186651-07	.5419659-04	.6663587-07	.1475007-02
.0000000	.3331265-06	.0000000	.1863991-03	.1464963+00	.1171992-07	.3161441+00
.1549016+00	.0000000	.0000000	.0000000	.6880289-04	.6175149-07	.9200010-01
.0000000	.5120585-05	.0000000				
.6346412+03	.7539464-01	.1239137+04	.2898594+01	.2107317+02	.1273544+01	.4332024+01
.4985357+00	.4529474-03	.4391854+00	.3990244-03	-.7616922+03	.4359248+03	
.0000000	.0000000	.255190-06	.1969111-04	.7405684-02	.0000000	.6724893-06
.0000000	.0000000	.2273234-07	.0000000	.2202908+00	.0000000	.5748000-01
.0000000	.3858016-06	.0000000	.0000000	.0000000	.0000000	.1476328-02
.0000000	.0000000	.7028104-07	.8474228-06	.1436339+00	.0000000	.3910337+00
.1344906+00	.0000000	.0000000	.0000000	.7334871-06	.0000000	.9215527-01
.0000000	.0000000	.0000000				
.6346412+03	.3769732-01	.1068909+04	.2898594+01	.2107340+02	.1247394+01	.4799935+01
.4979248+00	.4075329-03	.4464675+00	.3658262-03	-.8369689+03	.4359248+03	
.0000000	.0000000	.0000000	.1368478-05	.9425047-02	.0000000	.1244697-07
.0000000	.0000000	.0000000	.0000000	.2035910+00	.0000000	.7419186-01
.0000000	.1418848-07	.0000000	.0000000	.0000000	.0000000	.1477919-02
.0000000	.0000000	.3143899-06	.3905330-07	.1436155+00	.0000000	.3577492+00
.1177905+00	.0000000	.0000000	.0000000	.9321324-06	.0000000	.9215621-01
.0000000	.0000000	.0000000				
.6346412+03	.7539463-02	.7711565+03	.2898594+01	.2107467+02	.1241948+01	.5478672+01
.4880897+00	.3213768-03	.4845871+00	.3190706-03	-.9750578+03	.4359248+03	
.0000000	.0000000	.0000000	.0000000	.9426750-02	.0000000	.0000000
.0000000	.0000000	.0000000	.0000000	.1513421+00	.0000000	.1264495+00
.0000000	.0000000	.0000000	.0000000	.0000000	.0000000	.1418700-02
.0000000	.0000000	.2991052-04	.0000000	.1436188+00	.0000000	.4100142-00
.6553967-01	.0000000	.0000000	.0000000	.2432948-05	.0000000	.9215830-01
.0000000	.0000000	.0000000				
.6346412+03	.7539463-03	.4924284+03	.2898594+01	.2113407+02	.1195000+01	.7941334+01
.5530473+00	.2292583-03	.7153479+00	.2965378-03	-.1110051+04	.4359248+03	
.0000000	.0000000	.0000000	.0000000	.9453577-02	.0000000	.0000000
.0000000	.0000000	.0000000	.0000000	.8937745-01	.0000000	.1877870+00
.7090097-03	.0000000	.0000000	.0000000	.0000000	.0000000	.3457142-04
.0000000	.0000000	.7241634-03	.0000000	.1440277+00	.0000000	.4692845+00
.6166081-02	.0000000	.0000000	.0000000	.2802303-04	.0000000	.9240794-01
.0000000	.0000000	.0000000				
.6346412+03	.3769732-03	.4584027+03	.2898594+01	.2146061+02	.1122473+01	.8632748+01
.6525379+00	.2160765-03	.1713851+01	.5474959-03	-.1140703+04	.4359248+03	
.0000000	.0000000	.0000000	.0000000	.7599661-02	.0000000	.0000000
.0000000	.0000000	.0000000	.0000000	.6813972-01	.0000000	.2030182+00
.5844667-02	.0000000	.0000000	.0000000	.0000000	.0000000	.1302474-04
.0000000	.0000000	.7463916-03	.0000000	.1462531+00	.0000000	.4682766+00
.9221504-02	.0000000	.0000000	.0000000	.9448310-04	.0000000	.9383248-01
.0000000	.0000000	.0000000				
.6346412+03	.7539464-04	.3925016+03	.2898594+01	.2229051+02	.1139060+01	.9519825+01
.5655087+00	.1913325-03	.1148547+01	.3885459-03	-.1203464+04	.4359248+03	
.0000000	.0000000	.0000000	.0000000	.9970897-02	.0000000	.0000000
.0000000	.0000000	.0000000	.0000000	.1858052-01	.0000000	.2372927+00
.1897670-01	.0000000	.0000000	.0000000	.0000000	.0000000	.1700275-05
.0000000	.0000000	.7811895-03	.0000000	.1519087+00	.0000000	.4612544+00
.3731504-02	.0000000	.0000000	.0000000	.9497508+04	.0000000	.9745668-01
.0000000	.0000000	.0000000				

LOCKHEED - HUNTSVILLE RESEARCH & ENGINEERING CENTER

2-57

Section 3

REACTING AND MULTIPHASE (RAMP) COMPUTER PROGRAM

A precise knowledge of local flow properties in nozzles and exhaust plumes is necessary for performance, radiation, attenuation, heat transfer and impingement analyses. The reacting and multiphase (RAMP) computer program is designed to give detailed flowfield information in the supersonic region of a reacting multiphase two-dimensional or axisymmetric flow field. The boundaries of the flow field may be solid such as in a nozzle or "free" such as in a plume. The analysis may be utilized therefore to predict performances as well as plume characteristics of a given engine system. A printed record of the program results is given for user inspection while a binary tape is provided for subsequent manipulation by other analyses. A transonic solution taken from Ref. 7 is also provided internal to the program.

The flow of a gas-particle mixture is described by the equations for conservation of mass, conservation of momentum and conservation of energy. In the gaseous phase the state variables  $P$ ,  $\rho$ ,  $R$  and  $T$  are related by the equation of state while for the particulate phase the equations are for the particle drag, particle heat balance and the particle equation of state. Development of these equations is based on the following assumptions:

1. The particles are spherical in shape.
2. The particle internal temperature is uniform.
3. The gas and particles exchange thermal energy by convection and radiation (optional).
4. The gas obeys the perfect gas law and is either frozen and/or in chemical equilibrium, or is in chemical non-equilibrium.
5. The pressure of the gas and the drag of the particles contribute to the force acting on the control volume.

6. The gas is inviscid except for the drag it exerts on the particles.
7. There are no particle interactions.
8. The volume occupied by the particles is negligible.
9. There is no mass exchange between the phases.
10. A discrete number of particles, each of different size or chemical species, is chosen to represent the actual continuous particle distribution.
11. The particles are inert.

The supersonic two-phase solution accepts the starting line provided by the internally calculated transonic solution as well as other pertinent data supplied through the read function. The equations of motion under the assumptions just listed are hyperbolic and permit the use of a forward marching scheme; a streamline/normal grid structure is employed where the step lengths in the axial and radial directions are under program control. Both BCD (printer) and unformatted binary output tapes are produced. A Prandtl-Meyer expansion of the gas phase and a free boundary calculation are employed to treat the plume flow solution. The run is terminated when prespecified problem limits are reached.

The two-phase flow analysis will treat an extremely wide range of operating conditions. With few exceptions the limitations are imposed by the theory rather than numerical considerations. In this discussion dimension statement sizes which are arbitrarily set are not considered a limitation. The true limitations are:

- Supersonic regions influenced by embedded subsonic regions.
- Vacuum or limiting expansion limitation - a small region of the expansion fan for a vacuum expansion cannot be treated where the Mach number is so large that treatment by continuous flow assumptions becomes meaningless (this limitation is both numerical and theoretical).



- For two-phase flow the lower boundary can only be horizontal (i.e., nozzle centerline).

A complete derivation of the governing equations are available in Volume I of this report. The characteristic equations employed in this analysis are given in Table 3-1a and 3-1b, and a list of symbols is provided in Table 3-2.

A free molecular flow calculation has been provided as an option which permits treatment of the rarefied regions of the plume. As the gas expands it first freezes out the vibrational and rotational modes. During this transition the characteristic equations continue to be employed but the equation of state is modified. At translational freezing, however, the solution switches to an effective source solution. The stream lines are considered straight and the velocity constant. Conservation of mass then determines the density while other properties are found from the equation of state.

Each of the subroutines comprising the RAMP program is listed in Table 3-3. The subroutines which call and are called by the particular routine as well as a brief statement regarding the function of the routine are also included in the table. Routines which have an asterisk in the description column are taken from the Ref. 7 analysis.

Tables 3-4a and 3-4b present a flow chart of the main routines in functional groupings for the equilibrium and finite rate versions. To attempt to completely flow chart the entire program would probably transmit less information than that given in Table 3-4 since it would be extremely complex and bulky. The functional flow chart in conjunction with Table 3-3 and the program listing is felt to be the most appropriate method for presenting the information.

Table 3-1a

**ENTHALPY-ENTROPY-VELOCITY FORM OF THE COMPATIBILITY EQUATIONS FOR GAS-PARTICLE FLOW (FOR CHEMICAL EQUILIBRIUM AND/OR FROZEN FLOW APPLICATIONS)**

- The variables  $q, \theta, H, S, \rho^j, u^j, v^j, h^j$  completely define the gas-particle flow at a given location in the flow field.
- The slope of the gas streamline,  $\theta$ , is given by

$$\frac{dy}{dx} = \tan \theta \quad (3.1)$$

and the compatibility equations which apply along gas streamlines are:

$$dH - T dS + \frac{1}{\rho} \sum_{j=1}^{NP} \rho^j A^j [(u - u^j) + \tan \theta (v - v^j)] dx = 0 \quad (3.2)$$

$$T dS - \frac{(C_p - R)}{q \cos \theta} \sum_{j=1}^{NP} \rho^j A^j B_1^j dx = 0 \quad (3.3)$$

where

$$B_1^j = \frac{1}{C_p/R - 1} \left[ \bar{q} \cdot \Delta \bar{q}^j - \bar{q}^j \cdot \Delta \bar{q} + \frac{2}{3} C^j (T^j - T) + \frac{3\sigma}{A^j m^j r^j} \left[ e^j (T^j)^4 - \alpha^j T^4 \right] \right] \quad (3.4)$$

$$A^j = \frac{\rho^j}{2} \left[ \frac{v^j}{m^j r^j} \right] \quad (3.5)$$

and

$$C^j = \frac{k G^j}{v^j} \quad (3.6)$$

- The slope of the Mach lines is given by

$$\frac{dy}{dx} = \tan(\theta \mp \alpha) \quad (3.7)$$

and the compatibility equations which apply along each Mach line are:

$$d\theta \pm \frac{\cot \alpha}{q} dq \pm \frac{\sin \alpha \cos \alpha}{\gamma R} dS \mp \frac{\cot \alpha}{q^2} dH \mp \frac{\delta \sin \theta \sin \alpha}{\gamma \cos(\theta \mp \alpha)} dx$$

$$\pm \frac{dx}{\rho q^2 \cos(\theta \mp \alpha)} \sum_{j=1}^{NP} \rho^j A^j \left[ \pm (v - v^j) \cos(\theta \mp \alpha) \mp (u - u^j) \sin(\theta \mp \alpha) + \frac{B_1^j}{q \sin \alpha} \right] = 0 \quad (3.8)$$

- The particle streamline direction,  $\theta^j$ , is given by

$$\frac{dy}{dx} = \frac{v^j}{u^j} = \tan \theta^j \quad j = 1, NP \quad (3.9)$$

and the compatibility equations which apply along particle streamlines are:

$$u^j du^j = A^j (u - u^j) dx \quad j = 1, NP \quad (3.10)$$

$$u^j dv^j = A^j (v - v^j) dx \quad j = 1, NP \quad (3.11)$$

$$u^j dh^j = - \left[ \frac{2}{3} A^j C^j (T^j - T) + \frac{3\sigma}{m^j r^j} \left[ e^j (T^j)^4 - \alpha^j T^4 \right] \right] dx \quad j = 1, NP \quad (3.12)$$

- One additional equation for particle density is derived using the integral equation for particle mass conservation

$$dm^j = (2\pi)^\delta \rho^j \left\{ u^j (y^j)^\delta dy^j - v^j (y^j)^\delta dx^j \right\} \quad (3.13)$$

and  $\delta$  takes on the values

$$\delta = 0 \quad \text{for 2 dimensional flow}$$

$$1 \quad \text{for axisymmetric flow}$$

Table 3-1b

PRESSURE-DENSITY-VELOCITY FORM OF THE COMPATIBILITY EQUATIONS FOR GAS-PARTICLE  
FLOW (FOR CHEMICAL NON-EQUILIBRIUM AND TRANSITION FLOW APPLICATIONS)

- The variables  $q, \theta, P, \rho, \rho^j, u^j, v^j, h^j$  completely define the gas-particle flow at a given location in the flow field
- The slope of the gas streamline,  $\theta$ , is given by

$$\frac{dy}{dx} = \tan \theta \quad (3.1)$$

and the compatibility equations which apply along gas streamlines are:

$$q \, dq + \frac{dP}{\rho} + \frac{1}{\rho} \sum_{j=1}^{NP} \rho^j A^j \left[ (u - u^j) + \frac{v}{u} (v - v^j) \right] dx = 0$$

$$dP - a^2 d\rho + \frac{\psi}{u} dx - \frac{1}{u} \sum_{j=1}^{NP} \rho^j A^j B_1^j dx = 0 \quad (3.14)$$

and

$$\rho u \, dX_i - \dot{w}_i \, dx = 0 \quad i = 1, NG \quad (3.15)$$

- The slope of the Mach lines (left running characteristics and right running characteristics) is given by

$$\frac{dy}{dx} = \tan(\theta \mp \alpha) \quad (3.7)$$

and the compatibility equations which apply along each Mach line are:

$$d\theta \mp \cot \alpha \frac{dP}{\rho q^2} \mp \frac{\delta \sin \theta \sin \alpha}{y \cos(\theta \mp \alpha)} \frac{dx}{\rho q^2 \cos(\theta \mp \alpha)} \sum_{j=1}^{NP} \rho^j A^j \left[ \pm (v - v^j) \cos(\theta \mp \alpha) \right. \\ \left. \mp (u - u^j) \sin(\theta \mp \alpha) + \frac{B_1^j}{q \sin \alpha} \right] \mp \frac{\frac{dx}{C_p/R - 1} \sum_{l=1}^{NG} \mu_l X_l}{q^3 \sin \alpha \cos(\theta \mp \alpha)} = 0$$

- The particle streamline direction,  $\theta^j$ , is given by

$$\frac{dy}{dx} = \frac{v^j}{u^j} = \tan \theta^j \quad j = 1, NP \quad (3.9)$$

and the compatibility equations which apply along particle streamlines are:

$$u^j \, du^j = A^j (u - u^j) \, dx \quad j = 1, NP \quad (3.10)$$

$$u^j \, dv^j = A^j (v - v^j) \, dx \quad j = 1, NP \quad (3.11)$$

$$u^j \, dh^j = - \left[ \frac{2}{3} A^j C^j (T^j - T) + \frac{3\sigma}{m^j r^j} \left[ \rho^j (T^j)^4 - \alpha^j T^4 \right] \right] dx \quad j = 1, NP \quad (3.12)$$

- One additional equation for particle density is derived using the integral equation for particle mass conservation

$$d\bar{m}^j = (2\pi)^\delta \rho^j \left[ u^j (y^j)^\delta \, dy^j - v^j (x^j)^\delta \, dx^j \right] \quad (3.13)$$

and  $\delta$  takes on the values

$$\delta = 0 \quad \text{for 2 dimensional flow}$$

$$1 \quad \text{for axisymmetric flow}$$

Table 3-2  
LIST OF SYMBOLS

<u>Symbol</u>	<u>English</u>	<u>Metric</u>	<u>Description</u>
$A^j$	1/sec	1/sec	Defined in Table 3-1
$B_1^j$	$\text{ft}^2/\text{sec}^2$	$\text{m}^2/\text{sec}^2$	Defined in Table 3-1
$C^j$	$\text{ft}^2/\text{sec}^2/^\circ\text{R}$	$\text{m}^2/\text{sec}^2/^\circ\text{K}$	Defined in Table 3-1
$C_p$	$\text{ft}^2/\text{sec}^2/^\circ\text{R}$	$\text{m}^2/\text{sec}^2/^\circ\text{K}$	Gas specific heat at constant pressure
$\epsilon^j$	None	None	Emissivity
$f^j$	None	None	Drag coefficient parameter ( $C_D/C_{D\text{Stokes}}$ )
$G^j$	None	None	Nusselt number parameter ( $\text{Nu}/\text{Nu}_{\text{Stokes}}$ )
H	$\text{ft}^2/\text{sec}^2$	$\text{m}^2/\text{sec}^2$	Total Enthalpy
$h^j$	$\text{ft}^2/\text{sec}^2$	$\text{m}^2/\text{sec}^2$	Particle enthalpy
$m^j$	slug/ $\text{ft}^3$	$\text{kg}/\text{m}^3$	Mass density of a $j^{\text{th}}$ particle
NP, NG	None	None	Number of particle sizes, number of gaseous species
Pr	None	None	Prandtl number
q	ft/sec	m/sec	Velocity
R	$\text{ft}^2/\text{sec}^2/^\circ\text{R}$	$\text{m}^2/\text{sec}^2/^\circ\text{K}$	Gas "constant" (universal gas constant/molecular weight)
$r^j$	ft	m	Radius of a $j^{\text{th}}$ particle
S	$\text{ft}^2/\text{sec}^2/^\circ\text{R}$	$\text{m}^2/\text{sec}^2/^\circ\text{K}$	Entropy
T	$^\circ\text{R}$	$^\circ\text{K}$	Static temperature
$T^j$	$^\circ\text{R}$	$^\circ\text{K}$	Particle temperature
u	ft/sec	m/sec	Gas axial velocity component
v	ft/sec	m/sec	Gas radial velocity component
$u^j$	ft/sec	m/sec	Particle axial velocity
$v^j$	ft/sec	m/sec	Particle radial velocity
y, x	ft	m	Radial, axial coordinates

LIST OF SYMBOLS (Continued)

<u>Symbol</u>	<u>English</u>	<u>Metric</u>	<u>Description</u>
$T_o$	$^{\circ}R$	$^{\circ}K$	Local total temperature
$T_o_R$	$^{\circ}R$	$^{\circ}K$	Reference total temperature
$\alpha$	rad	rad	Mach angle
$\tilde{\alpha}^j$	None	None	Accommodation coefficient
$\gamma$	None	None	Isentropic exponent
$\Delta \bar{q}^j$	ft/sec	m/sec	$\bar{q} - \bar{q}_j$
$\delta$	None	None	0 - two-dimensional, 1 - axisymmetric
$\theta$	rad	rad	Flow Angle
$\nu$	lbf-sec/ft <sup>2</sup>	kg/m sec	Gas viscosity
$\rho$	slug/ft <sup>3</sup>	kg/m <sup>3</sup>	Density
$\rho^j$	slug/ft <sup>3</sup>	kg/m <sup>3</sup>	Particle density ( $j^{\text{th}}$ particle size)
$\sigma$	ft <sup>2</sup> /sec <sup>3</sup>	m <sup>2</sup> /sec <sup>3</sup>	Stefan-Boltzmann constant
$\mu_i$	Not used	cal/gm	Chemical potential of specie i
$\chi_i$	Not used	gm/gm	Mass fraction of specie i

Table 3-3  
RAMP PROGRAM SUBROUTINE LIST

Subroutines No.	Name	Calls Following Routine(s)	Called by Following Routine(s)	Description
1	ABCALC	-	27	*
2	ALGINT	-	18, 31	log-log interpolation routine
3	AOASTR	82, 98, 116, 44, 22	74	iterative solution of area ratio as a function of Mach number
4	AVERAG	98, 21, 106, 83, 94	95	determines flow regime from Knudsen number
5	BLKDAT	-	-	block data routine
6	BOUND	47	7, 30, 49, 55, 70, 71, 74, 95	provides radial dimension and angle of bounding wall at given axial station
7	BOUNDA	41, 6, 23, 46	70, 72, 92	locates wall point when a shock wave is near a wall
8	CARCTR	77, 98, 12, 84, 111	72, 89, 91, 92	solves an interior point compatibility equation for a downstream shock wave point
9	CCALC	-	27	*
10	CHECK	93, 69, 35, 31	70, 95	adds points to or deletes points from the solution as necessary
11	CHEM	102, 85, 88	56	computes the species net rates of production as functions of temperature, density and gas composition
12	COEFEQ	-	8, 55, 95	computes coefficients used in solution of the two-phase compatibility equations
13	COEFF3	35, 69, 41, 77, 31	55, 95	computes the particle flow properties
14	DELTA F	-	24, 115	computes the turning angle through an oblique shock wave
15	DMDXSI	-	-	dummy routine not presently used
16	DOTPRD	-	112	computes the dot product of two vectors
17	DRAGCP	-	31, 77	computes the drag coefficient for the solid particle using Kliegel
18	DRAGMR	2	31, 60, 65, 77, 107	computes the drag coefficient for the solid particle using Crowe
19	DRIVER	40, 74, 108, 70	51	driving routine for main program flow
20	EMOFF	-	81	calculates Mach number from pressure and entropy
21	EMOFV	106	4, 24, 26, 31, 34, 52, 63, 65, 70, 73, 77, 78, 81, 82, 87, 89, 91, 109, 111, 115	computes Mach number from velocity
22	ENTROP	-	3, 24, 115	computes entropy rise across gas shock wave
23	ERRORS	-	7, 33, 34, 41, 52, 55, 70, 72, 81, 82, 89, 90, 91, 92, 100, 106, 109, 110	routine prints various error messages as for the appropriate flag from the calling routine
24	ESHOCK	98, 21, 75, 83, 22, 14, 115	61, 63, 90, 91, 92, 109	computes properties downstream of shock wave
25	EXPCOR	55, 41, 93, 77, 61	70	computes the flowfield points near an expansion corner
26	FABLE	96, 118, 106, 75, 21	98	routine used in determination of local dependent state properties
27	FCALC	1, 9, 68	45	*
28	FIND11	-	60, 65, 107	*
29	FNEWTN	-	34, 55, 95	determines the Newtonian impact pressure on plume free boundary
30	FREEMC	6, 43, 41, 117, 35, 69, 61, 62	70	computes flowfield properties in the free molecular flow regime
31	GAPPBI	2, 69, 98, 111, 106, 21, 75, 97, 18, 17	10, 13, 71, 95	interpolates for flow properties between two data points
32	GASRD	33, 37, 38, 36, 96, 118	74	subroutine which reads gas properties from cards

Table 3-3 (Continued)

Subroutines No. Name	Calls Following Routine(s)	Called by Following Routine(s)	Description
33 GASTAP	36, 23, 39	32	subroutine which reads gas properties from tape and outputs on tape
34 HYPER	98, 75, 21, 29, 63, 44, 100, 105, 23	70	determines hypersonic back pressure at corner
35 IDMPFP	85	10, 13, 30, 55, 66, 70, 78, 79, 95	function to compute the particle storage location within the PFPARY array
36 IDMTAB	-	32, 33, 73	function to compute gas property storage locations within the TABB array
37 IDMXSI	-	32	function to compute gas interpolation parameter storage locations within XSIDIM array
38 IDTAPE	96	32	writes ideal gas properties on data tape
39 IMPUT	93	33	reads chemistry input data for finite rate case
40 INITP	-	40	initializes data arrays and control variables, sets convergent criterion
41 INRSCT	23	7, 13, 25, 30, 55, 70, 71, 72, 79, 89, 91, 92, 95	solves for the intersection of two straight lines
42 INTEGR	69, 112	53	integrates conservation equations along normal
43 ITERM	-	30, 70	decides whether line should be terminated due to problem limits being exceeded
44 ITSUB	-	3, 34, 52, 58, 63, 71, 76, 81, 82, 87, 89, 90, 91, 92, 100, 104, 105, 109	general purpose iteration control routine solves function of one variable
45 JAMES	27, 57	65	*
46 KIKOFF	-	7, 106, 110	provides proper termination - card reads, tape writes for internally detected errors
47 LAGRNG	-	6	interpolates for r, $\theta$ as a function of x when wall points are input
48 LEGS	-	57	*
49 LIMITS	6	70	determines whether current boundary equation still applicable
50 LIPIN	82, 111, 98	74	prepares initial data surface for simple options
51 MAIN	19	-	driver program
52 MASCON	82, 21, 83, 44, 23	74	determines streamline data from mass conservation, linear Mach number variation
53 MASSCK	42, 69	70	integrates mass flow, determines cumulative error in mass flow
54 MAXTIM	-	62, 70	Univac 1108 system routine for checking run time against input variable for cutting off run before maxtime is reached
55 MOC SOL	77, 69, 35, 105, 75, 41, 6, 84, 13, 56, 29, 81, 113, 12, 111, 23, 93	25	solves the characteristic equations in continuous regions, calling arguments control type of solution i.e., upper boundary, lower boundary, interior, single phase only
56 NEWENT	11	55, 95	computes entropy and enthalpy/O <sub>F</sub> change along a streamline
57 NEWT	48	45	*
58 NORSCK	104, 44	61	calculates pitot total pressure for finite rate case
59 NUSNUP	-	-	dummy routine presently not used
60 ONED	28, 18	65	*
61 OUT	64, 58, 24, 98, 75, 77, 112, 69, 93	25, 30, 70, 91	performs bulk of printed output function; outputs are flowfield data points
62 OUTBIN	54, 69, 97	30, 70	performs unformatted binary output of flowfield data on a magnetic tape

REPRODUCIBILITY OF THE  
ORIGINAL PAGE IS POOR

Table 3-3 (Continued)

Subroutines No. Name	Calls Following Routine(s)	Called by Following Routine(s)	Description
63 OVEREX	98, 21, 24, 75, 44, 111, 69, 35	34	computes corner condition for over-expanded flow situation
64 PAGE	-	61, 65, 67, 73	writes page headings
65 PARTIL	60, 45, 80, 28, 18, 114, 107, 64, 93, 98, 21, 106	108	*
66 PARTIN	82, 110, 103, 75, 93, 98, 35, 69	74	reads gas and particle flow properties from tape or cards
67 PARTPH	64	74	reads input and sets up data table of particle T versus h
68 PCALC	-	27	*
69 PFP	85	10, 13, 30, 31, 42, 53, 55, 61, 62, 63, 66, 70, 71, 73, 77, 78, 79, 95, 101	computes the particle property data storage location and retrieves data from the PFPARY array
70 PHASE1	93, 77, 61, 53, 101, 62, 6, 109, 21, 103, 75, 92, 95, 54, 49, 7, 69, 35, 41, 91, 10, 30, 98, 111, 43, 79, 78, 25, 34, 81, 113, 100, 23	19	this subroutine performs the overall control for the entire flowfield solution, selectively calling those calculations which are pertinent to the particular mesh construction as well as the highest level logic routine combining point or limited region solutions into an entire field solution
71 PHYSOL	69, 46, 98, 44, 31, 77, 6, 111	89, 91, 92, 95	computes intersection of physical characteristics with a "normal" data line
72 PHYZOL	7, 41, 23, 98, 111, 8	92	computes intersection of characteristics with "normal" at a downstream shock point
73 PLMOUT	64, 96, 36, 98, 21, 69	74	this routine outputs the input data
74 PLUMIN	73, 32, 86, 6, 3, 52, 50, 66, 67	19	this routine provides the control for all input functions by selectively calling pertinent input routines and/or calls transonic solution
75 POFEM	-	24, 26, 31, 34, 55, 61, 63, 66, 70, 77, 78, 81, 83, 87, 89, 91, 115	computes pressure as a function of Mach number and entropy
76 POFH	44	105	computes pressure as a function of velocity and enthalpy
77 PPATPT	98, 106, 21, 75, 69, 97, 17, 18	8, 13, 25, 55, 61, 70, 71, 79, 92, 95	calculates and stores gas and particle dependent variables as a function of the independent flow variables
78 PRANDT	98, 100, 111, 21, 106, 75, 105, 93, 69, 35	70	provides overall control of Prandtl-Meyer corner calculation
79 PRFRBD	69, 41, 35, 77	70	computes flow properties at a particle limiting intersection with a plume boundary
80 PROP	-	65, 107, 114	*
81 RGMOPF	98, 96, 113, 20, 75, 21, 44, 23	55, 70, 95	iterative solution for Mach number as a function of pressure
82 RGVOFM	98, 96, 113, 21, 44, 23	3, 50, 52, 66	iterative solution velocity as a function of Mach number
83 RHOFEM	75	4, 24, 52, 115	density as a function of Mach number
84 ROTERM	-	8, 55, 95	rotational term in method of characteristics equation
85 RWU	-	11, 35, 69, 93	Univac 1108 machine language routine to access temporary storage
86 SETHTG	102, 98	74	computes 1-dimensional startline properties for a constant startline property finite rate case
87 SITER	98, 21, 75, 44	65	computes entropy as a function of pressure, total enthalpy and velocity
88 SLDP	-	11	solves a set of N simultaneous linear equations using the Gauss-Gordan reduction algorithm with the diagonal pivot strategy
89 SLPLIN	1, 71, 8, 75, 21, 44, 23	91, 95	performs the slip line calculations



Table 3-3 (Continued)

Subroutines No. Name	Calls Following Routine(s)	Called by Following Routine(s)	Description
90 SOKFLX	24, 44, 23, 98, 111	-	computes the flow properties downstream of a reflected shock
91 SOKINT	21, 41, 95, 23, 61, 24, 111, 109, 75, 44, 71, 8, 89, 98	70	computes the flow properties at the intersection of shock waves of the opposite family
92 SOKSOL	41, 95, 111, 24, 98, 72, 71, 8, 44, 7, 23, 77	70	provides control for a shock point solution
93 SPCTX	85	10, 25, 39, 55, 61, 65, 66, 70, 78, 95	reads from or writes on data files the species mole fraction for each point (finite rate version only)
94 STGMOD	-	4	computes gas thermodynamic properties in the transition flow regime
95 STRNOR	93, 69, 35, 77, 111, 41, 89, 71, 31, 13, 84, 56, 12, 29, 4, 81, 113, 10, 6	70, 91, 92	this subroutine provides the regional control for the streamline/normal solution. It has a lower level of logical control than PHASE1 (70) being interested only in determining the location and flow properties of a single new mesh point
96 TAB	-	26, 32, 38, 73, 81, 82, 98, 108	computes the thermodynamic data storage location and retrieves data from the TABB array
97 TEMTAB	-	31, 62, 77	performs table lookup for particle T = f(h) or h = f(T)
98 THERMO	96, 26, 99	3, 4, 8, 24, 31, 34, 50, 61, 63, 65, 66, 70, 71, 72, 73, 77, 78, 81, 82, 86, 87, 90, 91, 92, 100, 109, 115	provides control of interpolation of gas thermodynamic and transport properties
99 THERM1	102, 105	98	computes gas properties as a function of total enthalpy, velocity, temperature and species mole fractions
100 THETPM	98, 106, 105, 44, 23	34, 70, 78	this subroutine evaluates Prandtl-Meyer equation
101 THRUST	69, 112	70	starting line integration and wall pressure integration are performed here
102 TKEY	-	11, 86, 99, 104, 105	computes and interpolates thermodynamic properties from thermodynamic tables which are input
103 TOFEM	-	66, 70, 113	computes temperature as a function of Mach number
104 TOFENH	102, 44	58	computes temperature as a function of total enthalpy and velocity
105 TOFH	102, 44, 76	35, 55, 78, 99, 100	computes temperature as a function of total enthalpy, velocity and species mole fractions
106 TOFV	23, 46	4, 21, 26, 31, 65, 77, 78, 100	computes temperature as a function of velocity
107 TRACE	80, 28, 18	65	*
108 TRANS	96, 35	19	*
109 TURN	98, 21, 110, 24, 44, 111, 23	70, 91	computes shock angle and downstream properties for known turning angle
110 UOFEM	23, 46	66, 109, 111	Mach angle as a function of Mach number
111 UOFV	110, 21	8, 31, 50, 55, 63, 70, 71, 72, 78, 90, 91, 92, 95, 109	Mach angle as a function of velocity
112 VEMAG	16	42, 61, 101	computes magnitude of a vector
113 VOFEM	103	55, 70, 81, 82, 95	computes velocity as a function of Mach number
114 WDGI	80	65	*
115 WEAK	98, 21, 75, 83, 22, 14	24	computes properties downstream of an ideal gas shock wave

Table 3-3 (Concluded)

Subroutines No. Name	Calls Following Routine(s)	Called by Following Routine(s)	Description
116 WOFA	-	3, 24	one-dimensional mass flow as a function of area relation
117 WTFLOW	-	30	computes area bounded by two data points
118 XSI	-	26, 32	computes storage location and retrieves data from the XSIDIM array

\*Reference 7

Table 3-4a

BASIC RAMP FLOW CHART BROKEN DOWN INTO FUNCTIONAL GROUPINGS  
FOR THE EQUILIBRIUM CHEMISTRY VERSION

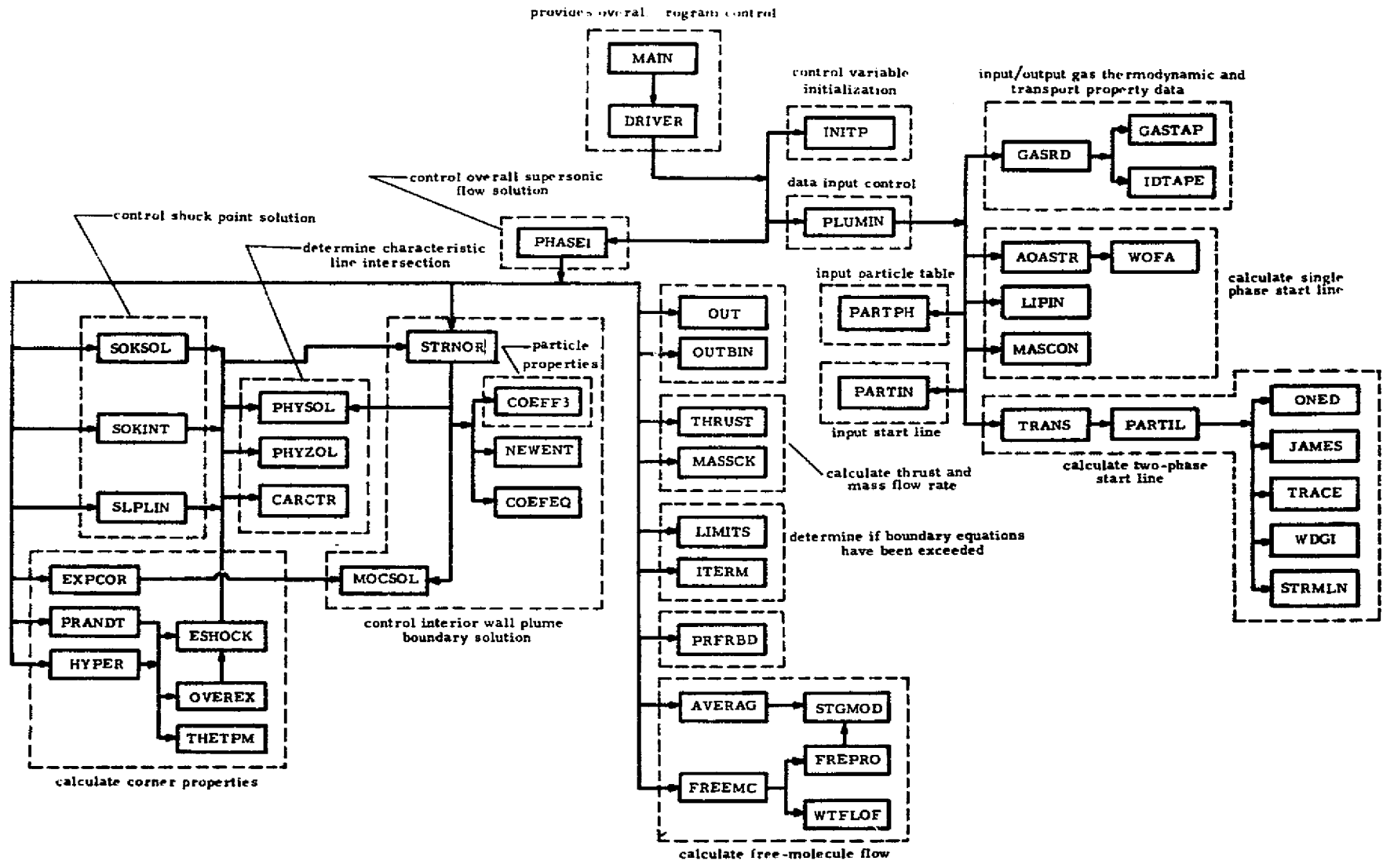

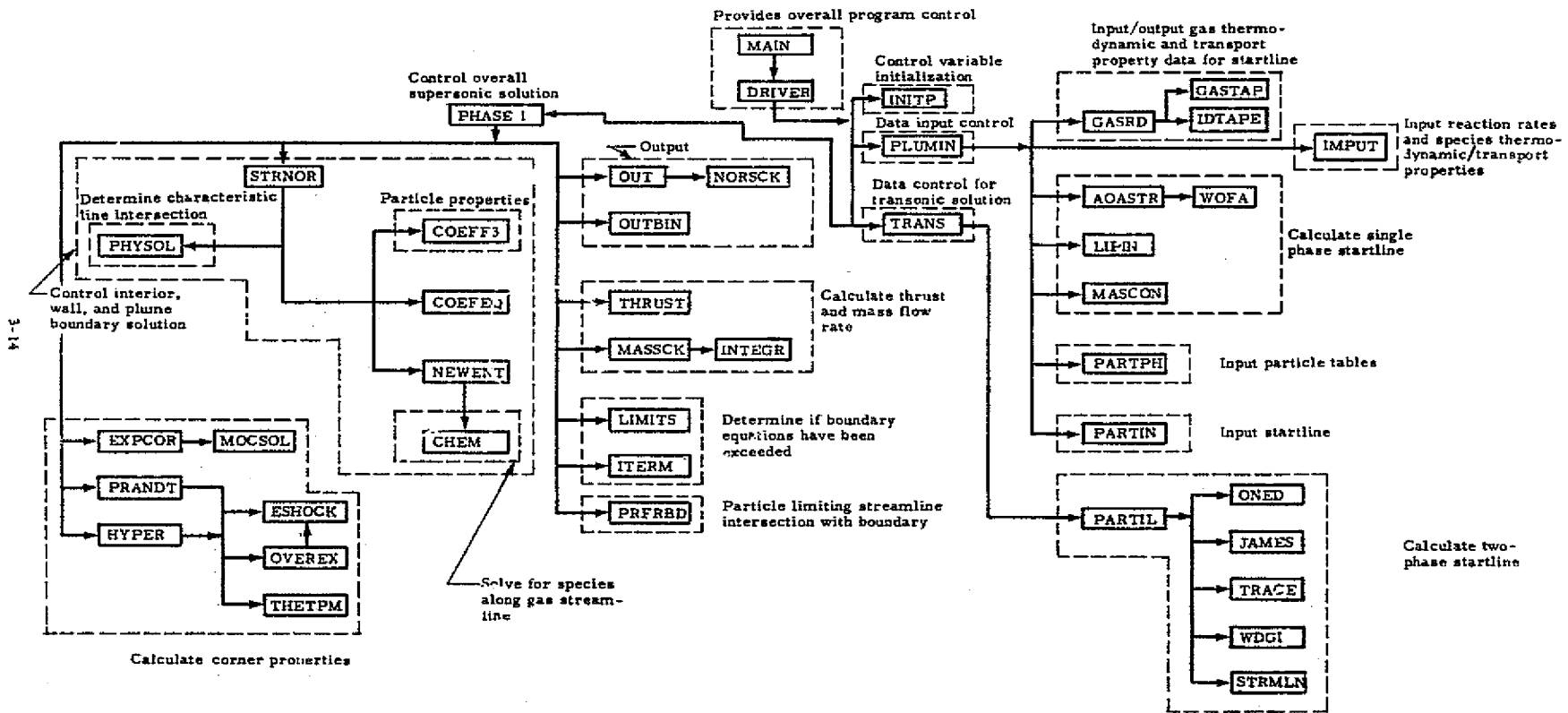

Table 3-4b - Basic RAMP Flow Chart Broken Down into Functional Groupings for the Finite Rate Chemistry Version

### 3.1 CAPABILITIES AND LIMITATIONS

The RAMP computer program described in this document can be used to solve a wide variety of problems associated with real gas, supersonic, compressible flow. Some of the more important, basic capabilities of the existing program are outlined below:

- The gas may be ideal or real. If the gas is real; frozen, equilibrium, or non-equilibrium chemistry assumptions can be made. The effects of oxidizer/fuel gradients may be considered.
- Two-dimensional or axisymmetric flow problem geometries can be used.
- Both upper and lower boundaries can be solid or free. (A solid boundary can be approximated by either a conic or polynomial equation.) (Two-phase problems require the nozzle centerline as a lower boundary).
- A nozzle wall may be curve fit with discrete points.
- Compression corners on the upper wall can be calculated.
- Any number of expansion corners can be considered on either the upper or lower wall.
- Various methods for obtaining an initial start line are utilized.
  1. The program will calculate a one-dimensional start line anywhere in the nozzle.
  2. The program will calculate a start line at points within the nozzle necessary to conserve mass.
  3. Data on a normal surface can be input at points across the flow field within the nozzle or in the plume.
  4. An exit plane startline can be punched.
  5. The program can be restarted from the startline punched in 4 above.
- Hypersonic or quiescent approach flow options may be used.
- Exit to ambient pressure ratios from over-expanded to highly under-expanded are possible.
- Displacement of the axis of symmetry from the center of flow (i.e., the plug nozzle flow field) is possible (for gas only cases).

- Due to computer core size limitations the code presently consists of two versions: (1) an equilibrium chemistry version, and (2) a finite rate chemistry version. The finite rate version has all the capabilities of the equilibrium programs with the following exceptions:

1. Free molecular flow
2. Shock Waves

It is anticipated that one version will be released at a later date.

- The equilibrium version which accompanies this documentation will handle only attached (over-expanded nozzles or compression corners) right-running shocks (see sketch below). The logic for calculating left-running shocks, and coalescing shocks is in the code but has not been thoroughly checked out. When check out is completed, the program modifications will be forwarded to users.

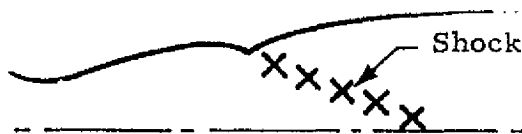

Over-Expanded Nozzle with Right-Running Shock

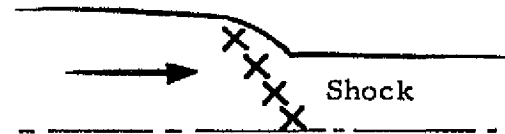

Attached Right-Running Shock

- There is presently a maximum of 100 points on a normal and 50 input points.
- Reacting gas solutions which are in chemical equilibrium have been facilitated by modifying the TRAN72 computer program as described in Section 2 to provide binary tape and punched output of its equilibrium or frozen real gas calculations at any desired O/F ratio(s). The RAMP program has the capability for selecting the proper case from a large set of real gas properties cases stored on a master tape. The method of generating this master tape is outlined in Table 3-5. Cases stored are uniquely identified by some characteristic of the particular gas under consideration. For example, a LOX/LH<sub>2</sub> system may be identified by the following:

<u>Gas Type</u>	<u>Mixture Ratio</u>	<u>Chamber Pressure</u>
O <sub>2</sub> /H <sub>2</sub>	O/F = 1.5 - 8.0	PC = 546.0

New cases of general interest may be added to the master tape; however, ad hoc cases should be prepared on a separate tape. Tape preparation sequence and communication with the RAMP program is diagrammed in Table 3-5.

- Once the gas-particle flowfield solution has been obtained, the output tape may be used by the RAMP Radial Lookup Program (described in Appendix A) which determines the radial variations of flowfield properties across the nozzle and plume flowfields at constant axial stations. The Plume Impingement Program (PLIMP) (Ref. 9) may also be run to determine the effects of the rocket exhaust plume on objects immersed in the plume. Sequencing and communication of auxiliary programs with the RAMP program is shown in Table 3-5.
- Two-dimensional or axisymmetric solutions are selected by simply loading a control word in the program input data. This integer (0 or 1) is then multiplied by the term containing  $(1/r)$  in the governing differential equation. By appropriate description of the flow boundaries, it is possible to change from a solid to free boundary on either the upper or lower walls. Conversely, it is not possible to change from a free to a solid boundary on either wall.

Table 3-5  
 SEQUENCING AND COMMUNICATION OF AUXILIARY PROGRAMS WITH THE RAMP PROGRAM

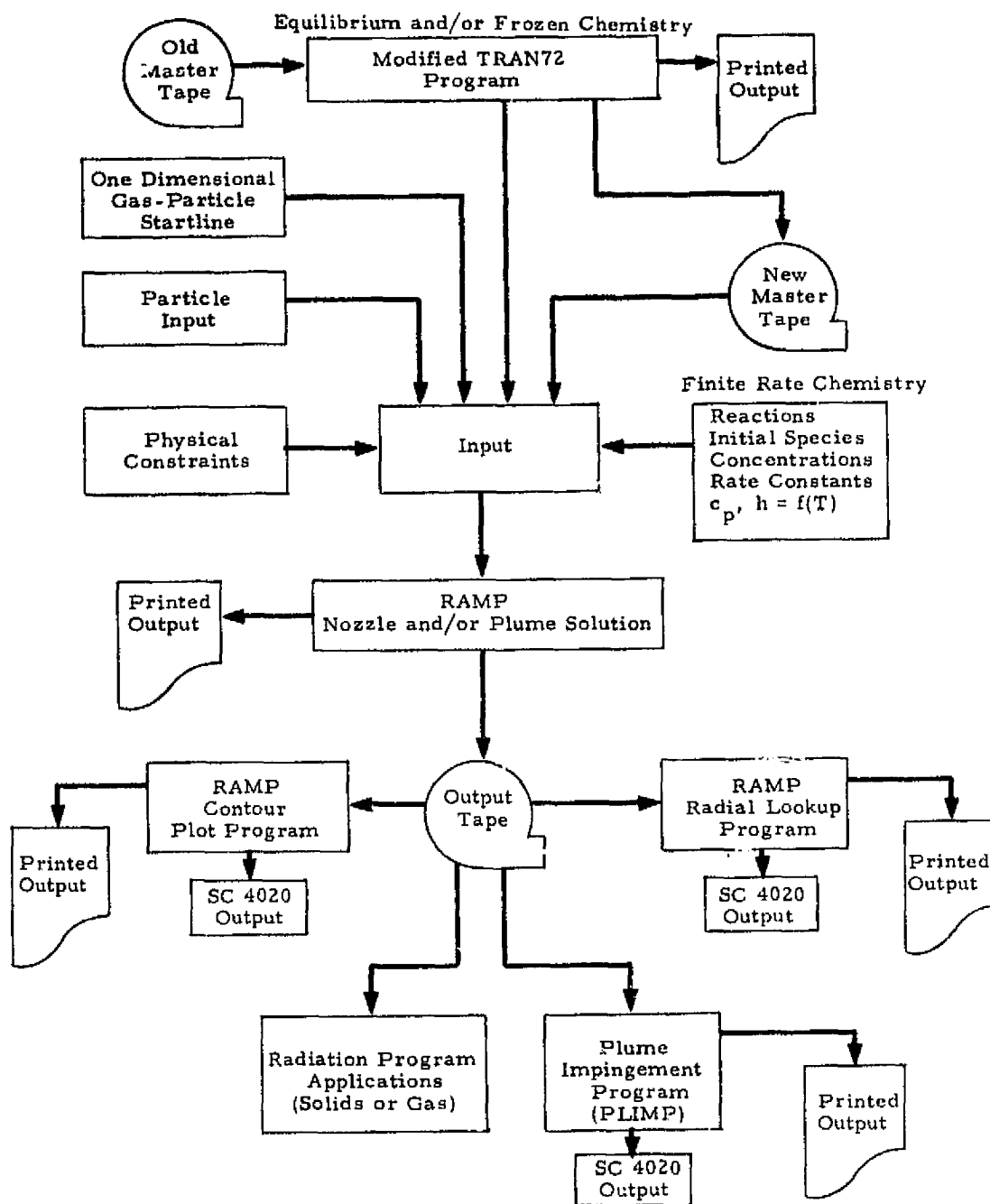



## 3.2 USER'S INPUT GUIDE FOR THE RAMP PROGRAM

This section outlines in detail the procedures for using the Reacting and Multi-Phase (RAMP) Computer Program. Each card and its use is explained in Section 3.2.1. The program magnetic tape assignments are given in Table 3-6.

### 3.2.1 RAMP Program Input Information

The input data are organized into sections determined by their use. The description of these cards is given below.

#### RAMP Computer Program Input Instructions

Cards 1-3	Problem Description Required		Format 3(20A4)
<u>Column</u>	<u>Parameter</u>		<u>Description</u>
1-240	HEADER		Problem description may be put on three cards; however only the first 120 columns will be printed while all 240 characters will be written on the data tape. All three cards must be present even if blank.
Card 4	Run Control Card Required Parameter	<u>Value</u>	Format 16I5 (Right Adjusted) <u>Description</u>
<u>Column</u>			
5	ICON(1) Gaseous thermo- dynamic data con- trol parameter	1	The gas composition is either chemically frozen and/or in chemical equilibrium. The gas properties are read directly from cards 8, 9, 10 and 11.
		2	Same as ICON(1)=1 except gas properties are read directly from a data tape mounted on FORTRAN unit 10.
		3	The gas composition is in chemical non-equilibrium. The gas properties are determined, as a function of temperature in thermodynamic data tables input on cards 13.

Card 4

<u>Column</u>	<u>Parameter</u>	<u>Value</u>	<u>Description</u>
5	ICON(1)	4	Same as ICON(1)=3 except gas composition is chemically frozen.
8-9	NTAPE	N	If ICON(2)=2, tape unit number for startline if not input from cards. The program defaults to unit 5 (read cards) for ICON(2)=2. If ICON(2)≠2 and a two-phase transonic solution is being performed NTAPE is the unit on which the transonic startline will be written. In this case the program defaults to unit 8.
10	ICON(2) Start line control parameter for gas only solution	0	Generate straight startline with Mach number given.
		1	Generate source startline with A/A* given
		2	Startline input from cards or tape.
		3	Generate startline by conservation of mass using a linear Mach number distribution.
	or	0	Generate startline using transonic approximation.
		2	Startline input from cards.
13	ICON(3) Control manner in which points along the startline are spaced	0	Points are spaced according to a sine distribution.
		1	Points are evenly spaced (recommended)
		2	Points are evenly spaced on a circular arc based on the input value of the upper limit of the startline (card 18, CORLIP(2))
			NOTE: This option is necessary only if program is to set up its own gaseous startline.
14, 15	ICON(3)		Number of startline points. ** Maximum of 50 (right adjust)

\*\*NOTE: If particles are present and supersonic startline is generated by transonic approximation then total number of points on startline may be adjusted by transonic program depending on particle distributions.

Card 4 (Continued)

<u>Column</u>	<u>Parameter</u>	<u>Value</u>	<u>Description</u>
16-20	ICON(4) Number of upper boundary equations		Upper boundary specification indicator. If specifying upper boundary by equations, set equal to number of equations to be used. Maximum of 100. Right adjust.

Option for ICON(4) when upper boundary is described by individual points and slopes

ICON(4)	1N000 + Number of discrete points (no boundary equation following last point) (slope at each point in radians)		
	2N000 + Number of discrete points + 1 (an upper boundary equation follows last point) (slope at each point in radians)		
	3N000 + Number of discrete points (no boundary equation following last point) (slope at each point in degrees)		
	4N000 + Number of discrete points + 1 (an upper boundary equation follows last point) (slope at each point in degrees)		

N ~ number of points to use for Lagrangian Integration (5 max).

If N is set to zero, a linear assumption will be made.

NOTE: If a nozzle is being run the throat must also be specified by discrete points.

<u>Column</u>	<u>Parameter</u>	<u>Value</u>	<u>Description</u>
21-25	ICON(5) Number of lower boundary equations		Lower boundary specification indicator. Same description and option as ICON(+).
30	ICON(6)	0	Not presently used
35	ICON(7) Flow type option	0	Two-dimensional flow problem geometry.
		1	Axisymmetric flow problem geometry.
38	INOZ	2	Calculations terminated at nozzle exit.
39	ICON(8) Data output con- trol, used in con- junction with ICON(16)	0	Full printout
		1	Print only boundary, shock, input Prandtl-Meyer, and particle limit- ing streamline points.

Card 4 (Continued)

<u>Column</u>	<u>Parameter</u>	<u>Value</u>	<u>Description</u>
40	ICON(8)	1	Print 1 line (R, X, M, $\theta$ , S and shock angle)
		2	Print above plus Mach angle, P, $\rho$ , T, V.
		3	Print all of above plus MWT, $\gamma$ , $TO^*$ , $PO^*$ , $S^*$ .
42	MORFT Compliments ICON(9)	0	For English system of units. Dimensions are in feet.
		1	Dimensions are in inches. For metric system of units.
		2	Dimensions are in centimeters.
		3	Dimensions are in meters
		4	System of units specified by user.
43	ICON(9) Units indicator	0	Use English system of units.
		1	Use metric system of units.  This option controls the units in which the flow field is calculated. The program assumes that the boundary equations are input in the same units as the units indicator (ICON(9)). This option will not override the units specification on cards 8 and 30 but will convert the units of the gas and particle thermodynamics to correspond to the units of this indicator.
44-45	ISPECS		Number of discrete particle sizes used to represent particle distribution (10 max). If gaseous only flow set equal to 0 (right adjust).
48-50	ICON(10)		Maximum iterations allowable for each point in flow field. If set to 0 program assumes value of 100. Right adjust.
51-55	ICON(11)		Case number printed at top of each page.
60	ICON(12)	0	Calculate shock wave.
		1	No rotation option.
61	ICON(13)	0	Flowfield data will be output on FORTRAN unit 3.
		1	Data will not be written on tape.

Card 4 (Concluded)

<u>Column</u>	<u>Parameter</u>	<u>Value</u>	<u>Description</u>
65	ICON(13)	0	Free molecular calculations will not be considered.
		1	Free molecular calculations will be considered.
68-70	ICON(14)	0	No intermediate printout in solution iteration.
		N	Print intermediate results for N <sup>th</sup> line. Right adjust.
71-75	ICON(15)	0	No intermediate printout.
		M	Print intermediate results from M <sup>th</sup> point on each line from the N <sup>th</sup> (ICON(14)) line on. Right adjust.
76	ICON(16)	0	No punched cards output.
		1	Punch data line at nozzle exit
77-78	ICON(16)	0	Print every line.
		N	Print every N <sup>th</sup> line (use with ICON(8)). Put 0 in column 77 if N < 10.
79-80	ICON(16)*		Time (SEC) before end of allotted run time when new startline is to be punched. Put 0 in column 79 if time less than 10 seconds.

Card 5

Finite Rate Chemistry  
Run Control Card (Re-  
quired if ICON(1)>2)

Format 815 (Right Adjusted)

<u>Column</u>	<u>Parameter</u>	<u>Value</u>	<u>Description</u>
1-5	NT		Number of temperature points in thermodynamic data tables.
6-10	NS		Number of gaseous species (excluding 3rd bodies)
11-15	NM		Number of 3rd bodies.
16-20	NR		Number of reactions specified.
25	NPRINT	0	No intermediate printout in chemistry calculations.
		1	Echo print of input data.
		2	Print intermediate results of chemistry calculations.

\*NOTE: Applicable for Univac 1108 only.

Card 5 (Continued)

<u>Column</u>	<u>Parameter</u>	<u>Value</u>	<u>Description</u>
30	ICTAPE	0	Species concentrations for start-line read directly from cards.
		1	Species concentrations read directly from a data tape mounted on FORTRAN unit 10.
35	KGUP	$\geq 2$	Number of normals calculated before finite rate chemistry contributes to dS and dH.
40	IDIDO	0	Uniform species concentrations along startline.
		1	Non-uniform species concentrations along startline.

Card 6 Upper Boundary Description Required

If ICON(4) < 10000 use following format (I1, 3X, I1, 5X, 6E10.6).

<u>Column</u>	<u>Parameter</u>	<u>Value</u>	<u>Description</u>		
1	IWALL(K, 2)	1	Conic equation $R = A[(B+CX+DX^2)^{1/2} + E]$ Represents throat region. (See page 3-27 for an example and description.)		
		2	Polynomial equation $R = AX^4 + BX^3 + CX^2 + DX + E$		
		3	Free boundary equation $P = P_{\infty} (1 + E_{\infty} X) (1 + \gamma_{\infty} (M_{\infty} \sin(\theta_B - \theta_{\infty}))^2)$ (See page 3-27 for an example and description.)		
		6	Same as IWALL=3 except oblique shock solution for plume boundary. Use if $1.5 < M_{\infty} < 5.5$ .		
		5	ITRAN(K, 2)	0	No discontinuity follows this equation.
				1	Expansion corner follows.
2	Compression corner follows.				

Card 6 (Continued)

<u>Column</u>	<u>Parameter</u>	<u>Value</u>	<u>Description</u>
11-20	WALLCO(K, 1, 2)		Coefficient A or $P_{\infty}$ (psfa or $N/m^2$ ). (Units must be consistent with R in ft or m.)
21-30	WALLCO(K, 2, 2)		B or $\gamma_{\infty}$
31-40	WALLCO(K, 3, 2)		C or $M_{\infty}$
41-50	WALLCO(K, 4, 2)		D or $\theta_{\infty}$ (deg)
51-60	WALLCO(K, 5, 2)		E or $E_{\infty}$
61-70	WALLCO(K, 6, 2)		Maximum value of X applicable to equation (feet if ICON(9)=0 meters if ICON(9)=1).
71-80	RSTAR		Throat radius (ft or m) required only on card for last equation. This is required for two-phase transonic solution only.

If  $10000 < \text{ICON}(4) < 20000$  use following format (15, 5X, 3E10.6, 15, 5X, 3E10.6).

<u>Column</u>	<u>Parameter</u>	<u>Value</u>	<u>Description</u>
5	ITRANS(K, 2)		Same as before.
11-20	WALLCO(K, 3, 2)		Axial displacement (X) of point K (ft or m).
21-30	WALLCO(K, 1, 2)		Radial displacement (R) of point K (ft or m).
31-40	WALLCO(K, 2, 2)		Wall angle ( $\theta$ ) at point K (rad).
45	ITRANS(K+1, 2)		Same as before.
51-60	WALLCO(K+1, 3, 2)		X at point K+1 (ft or m).
61-70	WALLCO(K+1, 1, 2)		R at point K+1 (ft or m).
71-80	WALLCO(K+1, 2, 2)		$\theta$ at point K+1 (rad).

NOTE: Card 6, in the above format, is repeated for each equation until all necessary equations have been input. That is, repeat Card 6, in succession in order of increasing XMAX, for  $K=1, 2, \dots, \text{ICON}(4)$ . All units for lengths for two-phase calculations are consistent with ICON(9), otherwise units for lengths are input at user's discretion.

REPRODUCIBILITY OF THE  
ORIGINAL PAGE IS POOR

Repeat Card 6, in above format, in succession, and in order of increasing X, until all required points have been input.

If  $20000 < \text{ICON}(4) < 30000$  the above format is used except the last segment of the upper boundary is input via an equation. The equation is input with the format for  $\text{ICON}(4) < 10000$  except the throat radius RSTAR is not required.

If  $40000 < \text{ICON}(4) < 50000$ , the format for  $20000 < \text{ICON}(4) < 30000$  is used except  $\theta$  is input in dimension of degrees.

Card 6a

Format E10.6

Card 6a is used only when running a two-phase case where the upper boundary (nozzle wall) is specified by discrete points ( $\text{ICON}(4) > 10000$ ). Do not input this card for any other cases.

<u>Column</u>	<u>Parameter</u>	<u>Value</u>	<u>Description</u>
1-10	RSTAR		Throat radius (ft or m).

Card 7            Lower Boundary Description  
                      Required

The formats and options for Card 7 are controlled by  $\text{ICON}(5)$  and are the same as for Card 6 (Upper Boundary) with the following exceptions: (1) the distance from the nozzle throat to the center ( $X=0$ ) of the coordinate system for the wall equations is read in place of RSTAR. This is only necessary for two-phase cases where a transonic solution is desired and where  $X \neq 0$  at the nozzle throat. This distance is positive if the center of the coordinate system is downstream of the throat and negative if the center of the coordinate system is upstream of the throat. It is not possible to run a two-phase case with the lower boundary specified by points, therefore there is no Card 7a; (2) the indices of the parameters are  $(-, -, 1)$  instead of  $(-, -, 2)$ , e.g., WALLCO(K, 1, 1) instead of WALLCO(K, 1, 2). A nozzle throat region showing the coefficients of a circular throat and free boundary are shown in the sketch on the following page.



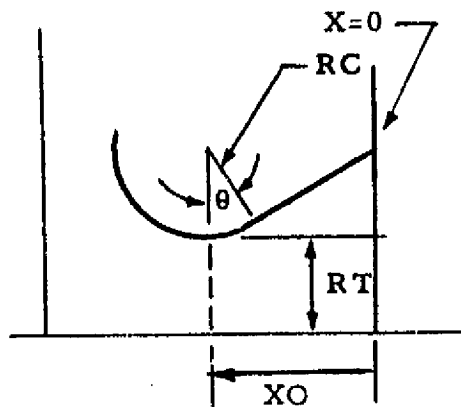

$RC$  = radius of curvature of the circular arc of the throat  
 $RT$  = throat radius  
 $XO$  = axial distance from the origin of the coordinate system to the throat  
 $\theta$  = throat divergence angle corresponding to the maximum value for which the throat conic equation applies

The conic equation for this case would have the following form:

$$\begin{aligned}
 A &= -1 \text{ for an upper equation, } +1 \text{ for a lower equation } (-1 \text{ for this case}) \\
 B &= RC^2 - XO^2 \\
 C &= 2XO \\
 D &= -1 \\
 E &= -(RC + RT) \\
 X_{max} &= RC \sin\theta + XO
 \end{aligned}$$

An example of a free boundary is shown in the sketch below.

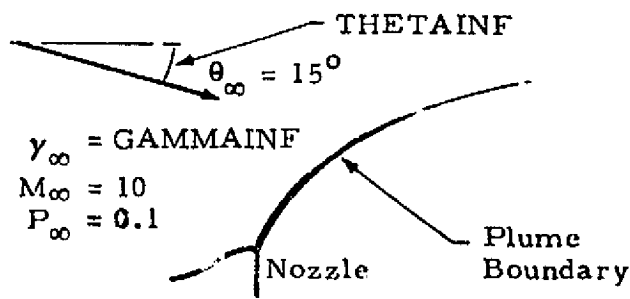

The freestream approach flow is inclined at 15 deg to the plume with a gamma ( $\gamma$ ) of 1.4, a Mach number of 10, and a static pressure of 0.1 psfa.

$$\begin{aligned}
 P_{INF} &= 0.1 \text{ (psfa)} \\
 E &= 0 \text{ (No pressure variation with axial distance)} \\
 \text{GAMMAINF} &= 1.4 \\
 M_{INF} &= 10 \\
 \text{THETA}_{INF} &= -15^{\circ}
 \end{aligned}$$

Card 8

Gas Property Control

Format 6A4, 5X, A3, 6X, 12, 3X, 12

This card is required whether gas data input by cards or tape.

<u>Column</u>	<u>Parameter</u>	<u>Description</u>
1-24	ALPHA(I)	Gas name for real gas on tape (see Section 2, page 3). If inputting gas data via cards, may be any name.
30-32	UNITS (Independent of ICON(9))	ENG Input gas data with English units (cards only). MKS Metric units (cards or tape).
39-40	IOF	Number of O/F tables for gaseous only solution or number of gas total enthalpy tables for two-phase solution
44-45	IS	Number of entropy tables per IOF entry, 1 for gas, 2 maximum for gas chemical equilibrium solution.

Card 9

Mixture Ratio or Total Enthalpy (This card is not used if ICON(1) > 2)

Format E10.6, 8X, 12

<u>Column</u>	<u>Parameter</u>	<u>Description</u>
1-10	OFRAT(M)	For gaseous only flow input O/F ratio, for particle flow input gas total enthalpy (cal/gm for metric, Btu/lbm for English, units specified by Card 8).

Card 10

Entropy (This card is not used if ICON(1) > 2)

Format E10.6, 8X, 12

<u>Column</u>	<u>Parameter</u>	<u>Description</u>
1-10	STAB(M, I)	Entropy of gas (cal/gm-°K or Btu/lbm-°R, units specified by Card 8).
19-20	IVTAB(M, I)	Number of Mach numbers for this entropy value (13 max).

Card 11

Gas Properties  
(This card is not used if  
ICON(1)>2; units specified  
by Card 8)

Format 8E10.6

<u>Column</u>	<u>Parameter</u>	<u>Description</u>
1-10	XSIDIM(1)	Mach number associated with above entropy.
11-20	XSIDIM(2)	Molecular weight of gas (gm/g-mole or lbm/lb-mole).
21-30	XSIDIM(3)	Gamma ( $C_p/C_v$ )
31-40	XSIDIM(4)	Temperature ( $^{\circ}$ K or $^{\circ}$ R)
41-50	XSIDIM(5)	Pressure (atm)
51-60	XSIDIM(6)	Prandtl number (dimensionless)
61-70	XSIDIM(7)	Absolute viscosity (poise)
71-80	XSIDIM(8)	Ideal gas (1 velocity cut per table) - viscosity temperature exponent. Real gas - $C_p$ (cal/gm- $^{\circ}$ K or Btu/lbm- $^{\circ}$ R).

To illustrate the arrangement of Cards 9, 10 and 11, let IOF=2 and IS=2; then the proper arrangement is:

```

Card 9
  10
  11 (1-13 such cards)
  10
  11 (1-13 such cards)
   9
  10
  11 (1-13 such cards)
  10
  11 (1-13 such cards)
  
```

Card 12

Gas Properties  
(This card is required  
if ICON(1)>2)

Format 3E10.6

<u>Column</u>	<u>Parameter</u>	<u>Default Value</u>	<u>Description</u>
1-10	PR	0.7	Prandtl number (dimensionless).
11-20	VISO	1.0E-04	Absolute Viscosity (poise).

Card 12 (Continued)

<u>Column</u>	<u>Parameter</u>	<u>Default Value</u>	<u>Description</u>
21-30	EX	0.6	Viscosity temperature exponent.

Cards 13 Gas Thermodynamic Data  
(The following cards are required if ICON(1)>2)

The following set of cards contain species thermodynamic data. The first card contains the species name, molecular weight and heat of formation. The second and remaining cards contain the temperature and corresponding specific heat, entropy and enthalpy for that species. Two temperatures and corresponding thermodynamic data are placed on each card. The input table can contain up to a maximum of 30 temperature points. The data are input exactly as presented in the JANAF tables (Ref. 10) with the temperature points being the same for all species. Cards 13.1, 13.2, 13.3, etc., are repeated for each species.

<u>Card</u>	<u>Column</u>	<u>Description</u>	<u>Format</u>
13.1	1-6	Name of first species	A6
	7-16	Molecular weight	E10.3
	17-26	Heat of formation, $h_{298_i}$ (kcal/mole)	E10.3
13.2	1-10	First temperature point ( $^{\circ}$ K)	F10.4
	11-20	$c_{p_i}$ (cal/mole- $^{\circ}$ K)	F10.4
	21-30	$S_i$ (cal/mole- $^{\circ}$ K)	F10.4
	31-40	$h_i - h_{298_i}$ (kcal/mole)	F10.4
	41-50	Second temperature point ( $^{\circ}$ K)	F10.4
	51-60	$c_{p_i}$ (cal/mole- $^{\circ}$ K)	F10.4
	61-70	$S_i$ (cal/mole- $^{\circ}$ K)	F10.4
	71-80	$h_i - h_{298_i}$ (kcal/mole)	F10.4
13.3	1-10	Third temperature point	F10.4
		⋮	
		etc.	

**Cards 14 Catalytic Species Weighting Factor Data**  
 (The following cards are required if  
 ICON(1)>2 and NM>0)

The following set of cards specify the catalytic species (M1, M2, M3, ...) and their respective composition in terms of the species participating in the reactions. Weighting factors must be read in the same order in which the thermodynamic data sets are read.

<u>Card</u>	<u>Column</u>	<u>Description</u>	<u>Format</u>
14.1.1	1-6	AID(NS+1) - Name of first catalytic species (e.g., M1)	A6
14.1.2	1-5	WF(1, 1) - Weighting factor of first species (for first catalytic species). Set weighting factor to zero for any reactant which does not contribute to the respective catalytic species.	16F5.2
	6-10	WF(1, 2) - Weighting factor of second species contributing to first catalytic species.	
	⋮		
	75-80	WF(1, 16) - Weighting factor of 16th species contributing to first catalytic species.	
14.1.3	1-5	WF(1, 17) - Weighting factor of 17th species contributing to first catalytic species, etc.	16F5.2
14.2.1	1-6	AID(NS+2) - Name of second catalytic	A6
14.2.2	1-5	WF(2, 1) - Weighting factor of first species contributing to second catalytic species, etc.	16F5.2
14.NM.1	1-6	AID(NS+NM) - Name of last catalytic species, etc.	A6

**Cards 15 Chemical Reaction Mechanisms**  
 (The following cards are required  
 if ICON(1)>2 and NR>2)

The following set of cards specifies the chemical reaction mechanisms for a particular problem, one card for each reaction. No particular order is required.

<u>Card</u>	<u>Column</u>	<u>Description</u>	<u>Format</u>
15.1	1-6	Species A	A6
	7	+ sign	
	8-13	Species B (or M)	A6

Cards 15 (Continued)

<u>Card</u>	<u>Column</u>	<u>Description</u>	<u>Format</u>
15.1	14	+ sign	
	15-20	Blank (or M)	6x(A6)
	21	= sign	
	22-27	Species C	A6
	28	+ sign (if needed)	
	29-34	Species D (or M)	A6
	35	+ sign (if needed)	
	36-41	Species E (or M)	A6
	42-48	Blank	
	49-50	Reaction type, 1 to 12	I2
	51	Rate constant type, 1 to 5	I1
	52-59	A, pre-exponential factor (cm-particle-sec units)	E8.2
	60-64	N, temperature exponent	F5.2
	65-74	B, activation energy (cal/mole)	F10.1
	75-80	M, temperature exponent	F6.2
15.2		Next reaction	
15.NR		Last reaction	

Cards 16      Startline Data      Format 7E10.3  
 (The following cards are required  
 if ICON(1)>2 and ICTAPE=0)

The following cards contain the species mole fractions on the startline. Mole fractions must be read in the same order in which the thermodynamic sets are read.

<u>Card</u>	<u>Column</u>	<u>Description</u>
16.1	1-10	Mole fraction of first species at the first point on the startline.
	⋮	
	61-70	Mole fraction of seventh species at the first point on the startline.

2-2

Cards 16 (Continued)

<u>Card</u>	<u>Column</u>	<u>Description</u>
16.2	1-10	Mole fraction of eighth species at the first point on the startline.
	⋮	
	61-70	Mole fraction of the fourteenth species at the first point on the startline.
	⋮	
		etc.

Cards 16.1 and 16.2, etc., are repeated for each point on the startline. For a uniform startline (IDIDO=0), mole fractions are read for 1 point only.

Card 17 Chamber Condition Data Format 2E10.3  
(This card is used if ICON(1)>2 and ICTAPE=0)

<u>Column</u>	<u>Parameter</u>	<u>Description</u>
1-10	PC	Chamber pressure (atm)
11-20	TC	Chamber temperature ( <sup>o</sup> K)

Card 18 Startline Data Format 8E10.6  
(This card is not used if ICON(2)=2 or for gas particle flow).

Use Card 18a if ICON(1) ≤ 2. Use Card 18b if ICON(1) > 2.

<u>Card</u>	<u>Column</u>	<u>Parameter</u>	<u>Description</u>
18a*	1-10	CORLIP(2)	Axial coordinate of upper limit of startline (ft or m, see Fig. 3-1a)
	11-20	CORLIP(6)	Axial coordinate of lower limit of startline (ft or m, see Fig. 3-1a). (If ICON(3) point spacing option = 2 this value is recalculated using CORLIP(2)).
	21-30	CORLIP(4)	Mach number (ICON(2)=0) or A/A* (ICON(2)=1) for startline
	31-40	CORLIP(5)	Entropy of startline (cal/gm/ <sup>o</sup> K or Btu/lbm/ <sup>o</sup> R)
	41-50	CORLIP(8)	Mixture ratio (O/F) of startline

\*Card 18a is used to input the gas startline information when the gas chemical equilibrium, frozen or ideal gas option is utilized in the solution.

Card 18 (Continued)

<u>Card</u>	<u>Column</u>	<u>Parameter</u>	<u>Description</u>
18b*	1-10	CORLIP(2)	Axial coordinate of upper limit of startline (ft or m, see Fig. 3-1a)
	11-20	CORLIP(6)	Axial coordinate of lower limit of startline (ft or m, see Fig. 3-1a)
	21-30	CORLIP(4)	Mach number (ICON(2)=0) or A/A* (ICON(2)=1) for startline
	31-40	P	Pressure for startline (atm)
	41-50	T	Temperature for startline ( $^{\circ}$ R or $^{\circ}$ K)

Card 19                      Startline Data                      Format 6E13.7

Do not use this card if ICON(2)  $\neq$  2 or for gas-particle flow. Use feet if ICON(9)=0, meters if ICON(9)=1. Use Card 19a if ICON(1)  $\leq$  2. Use Card 19b if ICON(1)  $>$  2.

Repeat this card in succession and in order of increasing R for I=1, 2, ..., ICON(3).

<u>Card</u>	<u>Column</u>	<u>Parameter</u>	<u>Description</u>
19a**	1-13	R	Radial coordinate (R) of point I on startline (ft or m)
	14-26	X	Axial coordinate (X) of point I (ft or m)
	27-39	EM	Mach number at point I (dimensionless)
	40-52	THETA	Flow angle at point I (deg)
	53-65	S	Entropy at point I (cal/gm/ $^{\circ}$ K or Btu/lbm/ $^{\circ}$ R)
	66-78	OF	Mixture ratio at point I (O/F)
19b*	1-13	R	Radial coordinate (R) of point I on startline (ft or m)
	14-26	X	Axial coordinate (X) of point I (ft or m)
	27-39	EM	Mach number at point I (dimensionless)
	40-52	THETA	Flow angle at point I (deg)
	53-65	T	Temperature at point I ( $^{\circ}$ R or $^{\circ}$ K)
	66-78	P	Pressure at point I (atm)

\* This card is used to input the gas startline information when the gas chemical non-equilibrium option is utilized in the solution.

\*\* See footnote on previous page.



Card 20	Cutoff Limits Data	Format 8E10.6
<u>Column</u>	<u>Parameter</u>	<u>Description</u>
1-10	CUTDAT(1)	Radial coordinate defining upper limit of calculation regime (ft or m)
11-20	CUTDAT(2)	Axial coordinate defining upstream cutoff limit (ft or m)
21-30	CUTDAT(3)	Angle upper limit of calculation regime makes with horizontal (deg)
31-40	CUTDAT(4)	Radial coordinate defining downstream cutoff limit (ft or m)
41-50	CUTDAT(5)	Axial coordinate defining downstream cutoff limit (ft or m)
51-60	CUTDAT(6)	Angle downstream cutoff line makes with horizontal (deg)

Card 21	Mesh Control	Format 8E10.6
<u>Column</u>	<u>Parameter</u>	<u>Description</u>
1-10	STEP(3)	Interior point insertion criteria (ft or m). See Section 3.5.1.
11-20	STEP(6)	Axis point insertion criteria (ft or m). See Section 3.5.1.
21-30	STEP(9)	Particle limiting streamline insertion criteria.
31-40	STEP(7)	Point deletion criteria.
41-50	STEP(1)	Prandtl-Meyer integration step size (deg).
51-60	STEP(8)	Interpolation factor for calculating lower wall.

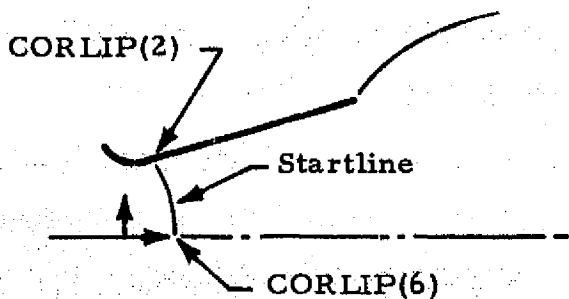
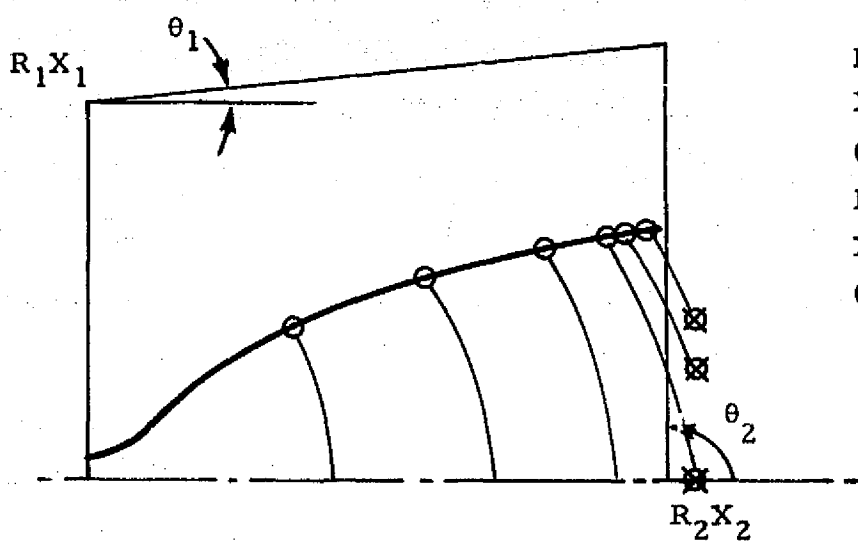

Fig. 3-1a - Startline Geometric Set-Up



- $R_1$  CUTDAT(1)
  - $X_1$  CUTDAT(2)
  - $\theta_1$  CUTDAT(3)
  - $R_2$  CUTDAT(4)
  - $X_2$  CUTDAT(5)
  - $\theta_2$  CUTDAT(6)
- ⊗ Normal terminated by downstream cutoffs.
- ⊙ Normal terminated by plume boundary.

NOTE: The normals must terminate on an upper boundary. Therefore,  $R_1, X_1, \theta_1$  must have values such that the cutoff box will always be above the plume or solid boundary. The code will attempt to fill up the cutoff box with normals until fewer than six points remain on the normal.

Fig. 3-1b - Cutoff Limits

Card 22 Free-Molecular Control Variables Format 6E10.6  
 (This card is not used if ICON(13)=0)

<u>Column</u>	<u>Parameter</u>	<u>Description</u>
1-10	VIBNO	Reciprocal of the Knudsen number at which the vibrational energy mode thermally freezes.
11-20	ROTNO	Reciprocal of the Knudsen number at which the rotational energy mode thermally freezes.
21-30	TRANNO	Reciprocal of the Knudsen number at which the translational energy mode thermally freezes.
31-40	CHARL	Characteristic length used in the Knudsen number calculation (nomally the nozzle exit radius).
41-50	VISCC	Reference viscosity (poise) if not input in thermo tables.
51-60	CONMM	Viscosity relation temperature exponent if not input in thermo tables.

Cards 23 through 35 are input only for two-phase solution.

Card 23 Particle Solution Control Format 1615  
 (Use only if ISPECS > 0)

<u>Column</u>	<u>Parameter</u>	<u>Value</u>	<u>Description</u>
4	IZO	0	Nozzle wall equations are referenced to the nozzle throat.
		1	Nozzle wall equations are referenced to the nozzle exit plane.
5	IWRITE (particle print flag)	0	1 line of print for each particle (V, $\theta$ , $\Delta M$ , h, P, T)
		1	Above plus Re, $\Delta V$ , $\Delta T$ , viscosity, $C_p$ , Pr
		2	All of above plus $T_o$ , $P_o$ , $C_D/C_{DS}$ , Nu/Nus, A, B
6-10	IDRAG	0	Use drag table coded in Kliegel program (Ref. 7).
		1	Use C. J. Crowe drag table coded internal to program (Ref. 11).

Card 23 (Continued)

<u>Column</u>	<u>Parameter</u>	<u>Value</u>	<u>Description</u>
14-15	NSETS	0	Startline calculated by program (ICON(2)≠2)
		N	Number of startline points at which particles are present for given startline. ICON(2)=2, N ≤ ICON(3). Right adjust.
18	IPCHS	0	No punch.
		1	Punch startline from transonic program.
24	JTEM(1)		The elements of the JTEM(M) array indicate which temperature/enthalpy table is to be used for particle species M. The value of JTEM(1) is always set equal to 1 for particle species 1.
25, 30	JTEM(M) M = 2, ISPECS	0	Indicates that the particle species M temperature/enthalpy table will be the same as that for particle species 1. Cards 30, 31 and 32 are not required for particle species M.
.			
.			
65		M	Indicates that the particle species M temperature/enthalpy table will be input on Cards 30, 31 and 32 as Table M.
		N	Indicates that the particle species N temperature/enthalpy table will be the same as that for particle species M. (N < M). Cards 30, 31 and 32 are not required for particle species N.

Card 24      Particle      Format 8E10.6

<u>Column</u>	<u>Parameter</u>	<u>Description</u>
1-10	XMASSP	Ratio of particle total mass flow rate to gas mass flow rate.

Card 25      Particle Mass Flow Rate Fractions (Use only if ISPECS > 0)      Format 8E10.6

<u>Column</u>	<u>Parameter</u>	<u>Description</u>
1-10	PERTG(1)	Ratio of particle No. 1 mass flow rate to total particle mass flow rate.

Card 25 (Continued)

<u>Column</u>	<u>Parameter</u>	<u>Description</u>
11-20	PERTG(2)	Ratio of particle No. 2 mass flow rate to total particle mass flow rate.
.	.	.
.	PERTG(ISPECS)	Ratio of particle No. ISPECS mass flow rate to total particle mass flow rate.

Card 26 Particle Size Data. Format 8E10.6  
(Use only if ISPECS > 0)

<u>Column</u>	<u>Parameter</u>	<u>Description</u>
1-10	PSP(2, 1)	Radius of particle No. 1 (microns).
.	.	.
.	PSP(2, ISPECS)	Radius of particle No. ISPECS (microns).

Card 27 Particle Mass Density. Format 8E10.6  
(Use only if ISPECS > 0)

<u>Column</u>	<u>Parameter</u>	<u>Description</u>
1-10	PSP(1, 1)	Mass density of particle No. 1 (lbm/ft <sup>3</sup> , or kg/m <sup>3</sup> ).
.	.	.
.	PSP(1, ISPECS)	Mass density of particle No. ISPECS (lbm/ft <sup>3</sup> , or kg/m <sup>3</sup> ).

Card 28 Emissivity Data\* Format 8E10.6  
(Use only if ISPECS > 0)  
( $\epsilon$  in Eq. (3.6))

<u>Column</u>	<u>Parameter</u>	<u>Description</u>
1-10	EMISS(1)	Emissivity of particle No. 1.
.	.	.
.	EMISS(ISPECS)	Emissivity of particle No. ISPECS

\*The emissivity and accommodation coefficients are used to determine the local energy exchange between the gas and particles via radiation. They normally produce negligible effects on solution and usually are set to 0 (zero).

Card 29 Accommodation Coefficients\* Format 8E10.6  
 (Use only if ISPECS>0)  
 ( $\alpha$  in Eq. (3.6))

<u>Column</u>	<u>Parameter</u>	<u>Description</u>
1-10	ACC(I)	Accommodation coefficient of particle No. 1.
.	.	.
.	.	.
.	ACC(ISPECS)	Accommodation coefficient of particle No. 1 ISPECS.

Card 30 Particle Equation of State Format 4A6, I3, A6  
 (Use only if ISPECS>0)

<u>Column</u>	<u>Parameter</u>	<u>Description</u>
1-24	ALPHA	Particle name (any name).
28-33	UNIT (Independent of ICON(9))	ENG Data input in English units MKS Use metric units

Card 31 Particle Data Format I3, 12A6  
 (Use only if ISPECS>0)

<u>Column</u>	<u>Parameter</u>	<u>Description</u>
1-3	NPTM(I)	Number of temperature-enthalpy data points for this particle. If equal to 1, input liquid and solid heat capacities (see Card 32). Right adjust.

Card 32 Particle Enthalpy Data Format 7E10.6  
 (Use only if ISPECS>0;  
 units specified by Card 30).

<u>Column</u>	<u>Parameter</u>	<u>Description</u>
1-10	TM(I)	Melting point temperature of particle No.1 ( $^{\circ}$ R in English units, $^{\circ}$ K in MKS units).

\*The emissivity and accommodation coefficients are used to determine the local energy exchange between the gas and particles via radiation. They normally produce negligible affects on solution and usually are set to 0 (zero).

Card 32 (Continued)

<u>Column</u>	<u>Parameter</u>	<u>Description</u>
11-20	HS(I)	Enthalpy of solid phase of particle No. I at melting point temperature (Btu/lbm or cal/gm).
21-30	HM(I)	Enthalpy of liquid phase of particle No. I at melting point temperature (Btu/lbm or cal/gm)
	If NPTM(I)=1, use following format.	
31-40	APHO(1, 1, I)	Heat capacity of liquid phase of particle No. I (Btu/lbm-°R or cal/gm-°K).
41-50	APHO(1, 2, I)	Heat capacity of solid phase of particle No. I (Btu/lbm-°R or cal/gm-°K).
	If NPTM(I) > 1 use following format.	
31-40	APHO(1, 1, I)	Temperature for T-H table for particle No. I (°R or °K).
41-51	APHO(1, 2, I)	Enthalpy for T-H table for particle No. I (Btu/lbm or cal/gm).
51-60	APHO(2, 1, I)	Second temperature in T-H table for particle No. I (°R or °K).
61-70	APHO(2, 2, I)	Second enthalpy in T-H table for particle No. I.

The above format (APHO(J, 1, I), APHO(J, 2, I)) is continued on successive cards of format 7E10.6 for J=1, 2, ..., NPTM(I).

There are as many sets of cards 30, 31, 32 as there are different chemical species.

Card 33      Input Startline      Format 6E13.7  
 (The following cards are required  
 if ICON(2)=2 and ISPECS>0).

Use Card 33a if ICON(1) ≤ 2. Use Card 33b if ICON(1) > 2.  
 Repeat this card for I=1, 2, ..., ICON(3) starting at point on nozzle axis.

Card 33a\*

<u>Column</u>	<u>Parameter</u>	<u>Description</u>
1-13	R	Radial coordinate of startline point I (ft or m).
14-26	X	Axial coordinate of startline point I (ft or m).

\*This card is used when gas chemical equilibrium, frozen or ideal gas option is selected.

Card 33a (Continued)

<u>Column</u>	<u>Parameter</u>	<u>Description</u>
27-39	EM	Mach number at point I.
40-52	THETA	Flow angle at point I (deg).
53-65	S	Entropy at point I (Btu/lbm-°R or cal/gm-°K).
66-78	OF	Gas total enthalpy (Btu/lbm or cal/gm).

Card 33b \*

<u>Column</u>	<u>Parameter</u>	<u>Description</u>
1-13	R	Radial coordinate of startline point I (ft or m).
14-26	X	Axial coordinate of startline point I (ft or m).
27-39	EM	Mach number at point I.
40-52	THETA	Flow angle at point I (deg).
53-65	T	Temperature at point I (°R or °K)
66-78	P	Pressure at point I (atm).

Card 34 Startline Particulate Data Format I5, 5X, 4E13.7  
 (The following cards are required if ICON(2)=2 and ISPECS>0).

Use Card 34a if ICON(1) ≤ 2. Use Card 34b if ICON(1) > 2.

Card 34a

<u>Column</u>	<u>Parameter</u>	<u>Description</u>
5	J1	Particle number
11-23	H1	Particle enthalpy at point I (Btu/lbm or cal/gm).
14-36	RHO1	Particle density at point I (slug/ft <sup>3</sup> or kg/m <sup>3</sup> ).
37-49	U1	Particle axial velocity at point I (ft/sec or m/sec).
50-62	V1	Particle radial velocity at point I (ft/sec or m/sec).

\* This card is used when the gas chemical non-equilibrium option is selected.



Card 34b

<u>Column</u>	<u>Parameter</u>	<u>Description</u>
5	J1	Particle number.
11-23	H1	Particle enthalpy at point I (Btu/lbm or cal/gm).
14-36	RHO1	Particle density at point I (slug/ft <sup>3</sup> or kg/m <sup>3</sup> ).
37-49	V <sub>p</sub>	Particle velocity at point (I) (ft/sec or m/sec).
50-62	Θ <sub>p</sub>	Particle flow angle at point I (deg).

Card 34 is repeated for each discrete particle size at each point on the start line where particles are present, starting at the nozzle wall and going toward the axis (reverse order of Card 33).

Card 35      Transonic Flow Data                      Format: Namelist  
 (Use only if ISPEC > 0  
 and ICON(2) ≠ 2)

Although there are many parameters that may be input via the namelist DATA, most of these have already been assigned values in the previous 32 input cards; and some of the parameters do not apply to the transonic calculation. Only those namelist parameters that could have a significant effect on the program are included below. The namelist data begins in Column 2 with \$DATA. The last card begins in Column 2 and contains only \$END.

<u>Parameter</u>		<u>Assumed Value</u>
THID	Throat inlet half angle (deg)	None
THFD	Fairing angle (deg) (If THFD > THID no fairing)	5.0
THJD	Angle defining farthest downstream none in transonic region (deg)	9.0
THIW	Angle where start line intersects nozzle wall (deg)	12.0
RRT	Throat wall radius of curvature divided by throat radius (> 2.0)	None

Card 35 (Continued)

<u>Parameter</u>		<u>Assumed Value</u>
ZAX	Value of X where startline intersects nozzle axis, normalized by throat radius (If ZAX is not input the program will calculate a value.)	None
(See Fig. 3-2 for an illustration of above parameters.)		
ZI	Number of zones into which the upstream portion of transonic zone is divided*	3.0
ZJ	Number of zones into which the downstream portion of transonic zone is divided*	2.0

\*See Ref. 7.

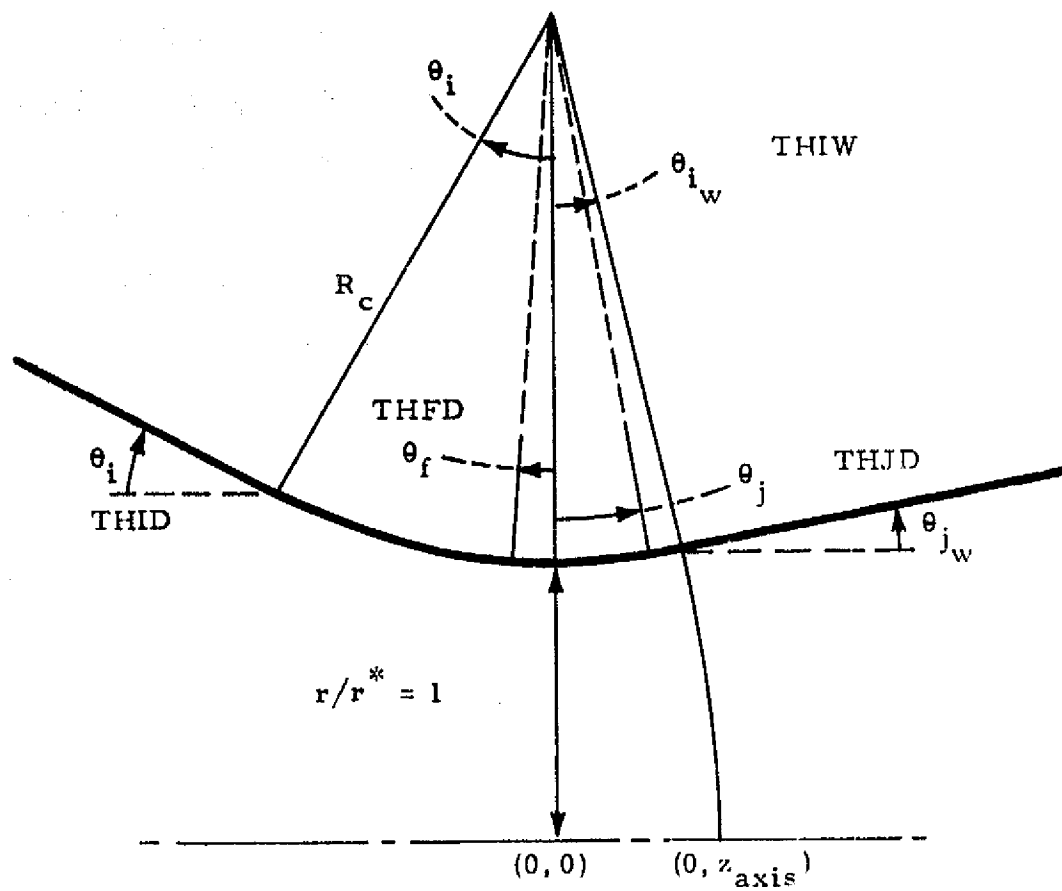

Fig. 3-2 - Inlet and Throat Parameters for a Gas-Particle Transonic Solution (see Ref. 7)

Table 3-6  
MAGNETIC TAPE ASSIGNMENTS FOR THE RAMP PROGRAM

Where Required	Tape Units U-1108	Tape Unit Function
GASTAP - Uses TRAN72 data to set up equilibrium thermodynamic data tables or uses TRAN72 data to get species distribution on startline if finite rate option is selected.	10	Gas properties data generated by the TRAN72 program (input data)
GASTAP, IDTAPE and OUTBIN - Outputs input data and flowfield results on unit 3 for use with other auxiliary programs	3	Flowfield data generated by the RAMP program (output data)
PARTIL - Arranges two phase transonic solution output in the form used by the data acquisition routines.	NTAPE*	Ordered startline data generated internally by the two-phase transonic solution (input data)
PARTIN - Reads startline information necessary to initiate a flowfield solution.	NTAPE*	Variable tape unit number on which startline data calculated external to program is stored (input data).
IDMPFP and PFP - Store and retrieve particle data for each point in the flow field.	2	Stores particle data calculated internally by the RAMP program at each point in the flow field.
SPCTX - Stores and retrieves chemical species data for each point in the flow field.	1	Stores chemical species data calculated internally by the RAMP program at each point in the flow field.

\* Set internally to 8 if ICON(2) = 0, NSPECS > 0 and not input on card 4. Set internally to 5 if ICON(2) = 2 (start line data read from cards) and not input on card 4.

### 3.2.2 Control Card Set-Up for Univac 1108 Exec 8 and Program Overlay Structures

A typical run stream set-up for the Univac 1108 Exec 8 computer is presented in this section. Also included are two tables which give the overlay structures for the two versions of the RAMP program.

#### Control Card Set-Up for the Univac 1108 Exec 8

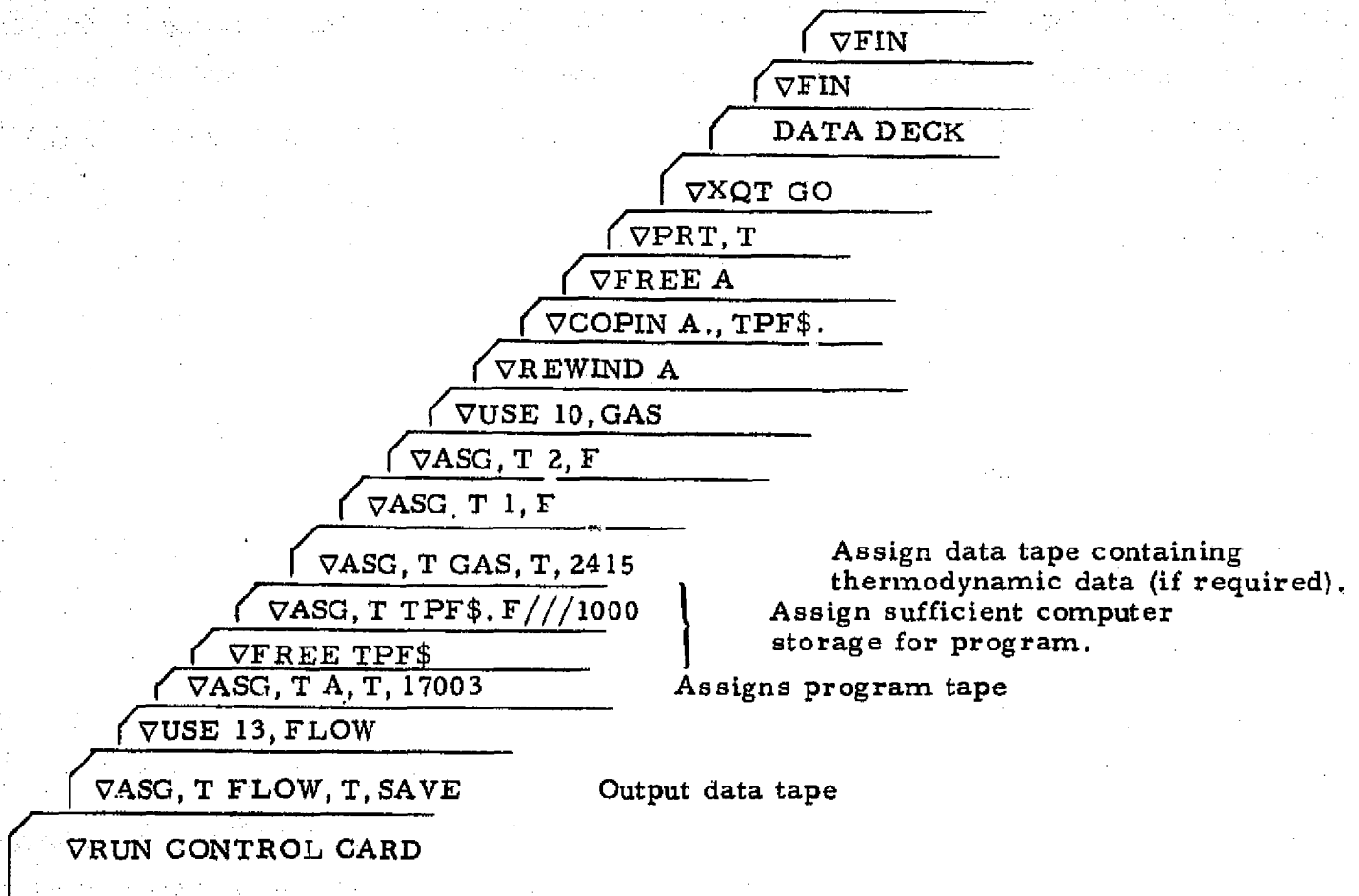

NOTE: This schematic is typical of a run control scheme for the Univac 1108 Exec 8 computer. It is presented to acquaint the user with magnetic tape and scratch area assignments.

The data deck has been described in Section 3.2.1 and will be presented first in flow chart form and the listed for several example problems in Section 3.7.

Tables 3-7a and 3-7b give the program overlay structure for the equilibrium and finite rate chemistry versions of the RAMP program. The equilibrium version requires 63.3K octal storage locations while the finite rate version requires 62.4K octal storage locations.

Table 3-7a

RAMP OVERLAY STRUCTURE FOR EQUILIBRIUM CHEMISTRY VERSION OF PROGRAM

DRIVER	
ALGINT	PFP
BOUND	POFEM
BLKDAT	REPEAT
DRAGMR	RHOFEM
EMOFV	RITE
ERRORS	TAB
FABLE	THERMO
IDMPFP	TOFEM
INITP	TOFV
ITSUB	UOFEM
KIKOFF	UOFV
LAGRNG	VOFEM
PAGE	XSI

PLUMIN	
ABCALC	NEWT
AOASTR	ONED
CCALC	PARTIL
DCALC	PARTIN
FCALC	PARTPH
FINDII	PCALC
GASRD	PLMOUT
GASTAP	PROP
IDMTAB	RGVOFM
IDMXSI	SITER
IDIAPE	STRMLN
JAMES	TRACE
LEGS	TRANS
LIPIN	WDGI
MASCON	WOFA

PHASE1	
AVERAG	ITERM
BOUNDA	LIMITS
CHECK	MAXTIM
COEFEQ	NEWENT
COEFF3	OUT
DELTA	PPATPT
DOTPRD	RGMOFP
DRAGCP	ROTERM
EMOFP	SOKINT
ENTROP	STGMOD
ESHOCK	TEMTAB
FNEWTN	TURN
GAPPBI	VEMAG
INRSCT	WEAK

CARCTR
PHYSOL
PHYZOL
SLPLIN
SOKSOL
STRNOR

EXPCOR	OVEREX
FREEMC	PRANDT
HYP	PRFRBD
INTEGR	THETPM
MASSCK	THRUST
MOCOSOL	WTFLOF
OUTBIN	

Table 3-7b

RAMP OVERLAY STRUCTURE FOR FINITE RATE VERSION OF PROGRAM

REPRODUCIBILITY OF THE ORIGINAL PAGE IS POOR

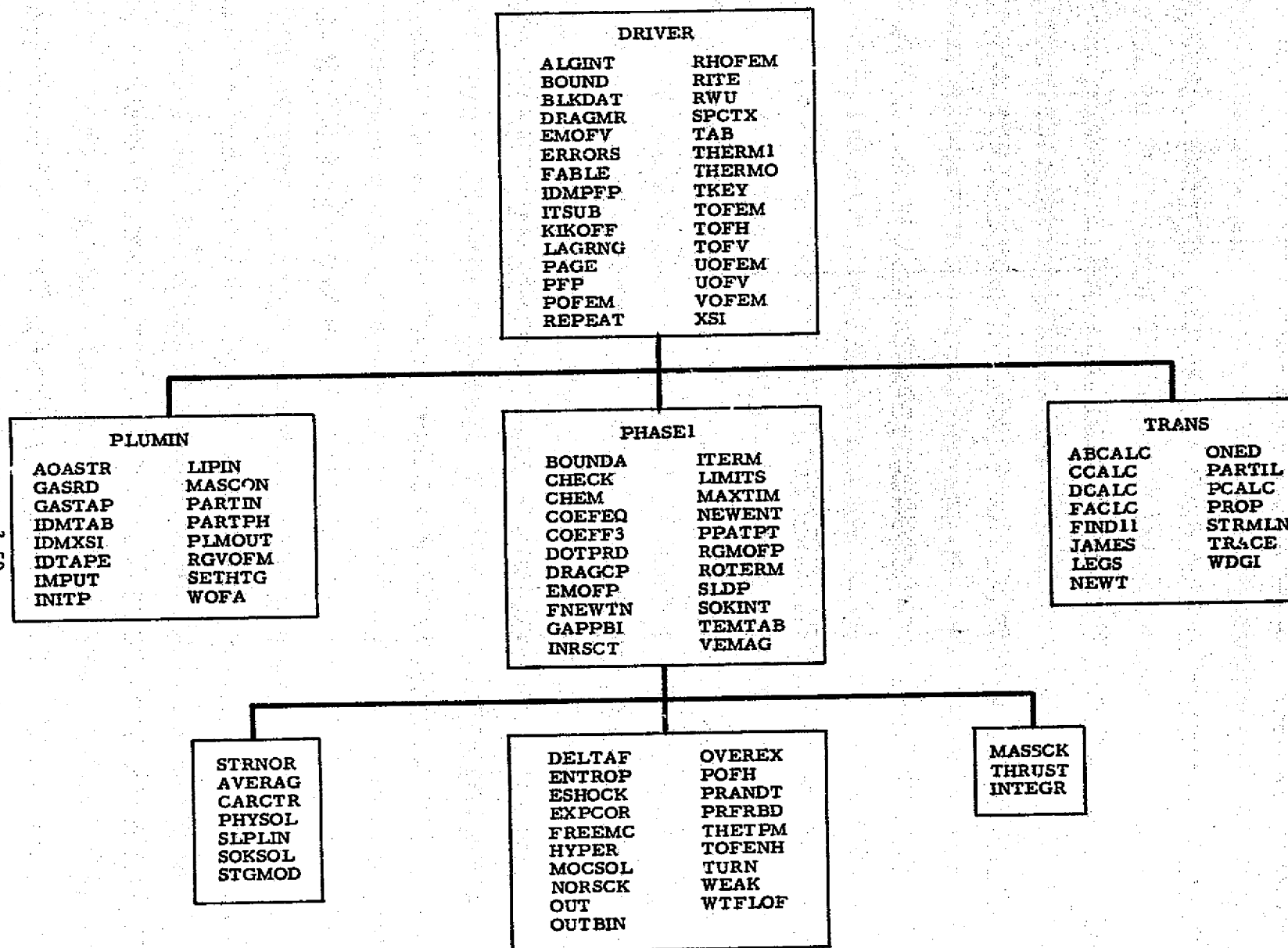



### 3.3 OUTPUT FORMAT

This section describes the printed output as well as the binary tape output for the RAMP code.

#### 3.3.1 Description of Printed Output

The program output is organized so that the initial pages contain the input data and the initial data surface. Each data surface thereafter is constructed along a "normal" to the streamlines which have been chosen to represent the flow expansion of the nozzle and exhaust plume. The computer code will treat a chemical equilibrium and/or frozen or chemical non-equilibrium flow expansion with or without the presence of particles; consequently typical printouts for each case are presented to demonstrate the output for each case. Numbered flags on the example printout sheets correspond to the numbered comments in the following description of the printout. The calculations are performed in either the English or metric system of units; hence units for both are given.

#### GROUP 1 - IDENTIFICATION

- ① Computer code identification
- ② Identifies gas-particle flow solution; does not occur for gaseous only case.
- ③ Case Number: Appears on each page - may be a maximum of five digits.
- ④ Problem Title: Identifies particular solution, appears on each page and may be 120 spaces.

#### GROUP 2 - PROGRAM CONTROL

- ⑤ These 16 parameters control the execution of program according to the options selected. (See Card 4 of the Input Guide for an explanation of the individual parameters.)

#### GROUP 3 - BOUNDARY EQUATIONS (See input guide for a detailed description)

- ⑥ Type Equation: Identifies the type of boundary equation selected.
- ⑦ ITRANS: Indicates whether a discontinuity follows this equation.

- ⑧ Equation Coefficients: Apply to upper and lower boundary equations.
- ⑨ MAX: Maximum value of  $x$  for which this equation applies.

#### GROUP 4 - GAS-PARTICLE MIXTURE IDENTIFICATION

- ⑩ Total Enthalpy (appears for gas-particle flow): Gas total enthalpy before it is perturbed (see page 2-2).
- ⑪ Indicates number of discrete particles used to represent the particle distribution.
- ⑫ Gas Identification: Name (24 characteristics max.) which identifies the gas. If the gas data is stored on a magnetic tape, this is the name which is used to locate the gas data on the data tape (see Card 8 of the Input Guide).

#### GROUP 5 - GAS PROPERTIES

- ⑬ Total Enthalpy (appears for gas-particle flow): Gas total enthalpy for this table.
- ⑬ O/F Ratio (appears for gaseous only solution): O/F for this table.
- ⑭ Entropy: May be two maximum for each O/F or total enthalpy.
- ⑮ Gas Thermodynamics Data Velocity: May be 13 maximum for each entropy (ft/sec or m/sec).
- ⑯ Gas Constant: Value associated with particular velocity, etc., (ft<sup>2</sup>/sec<sup>2</sup>/°R or m<sup>2</sup>/sec<sup>2</sup>/°K).
- ⑰ Isentropic Exponent: Value associated with particular velocity, etc.
- ⑱ Temperature: Value associated with particular velocity, etc., (°R or °K).
- ⑲ Pressure: Value associated with particular velocity, etc., (lbf/ft<sup>2</sup> or N/m<sup>2</sup>).
- Gas Transport Data: (does not appear for gaseous only solution).
- ⑳ Prandtl Number: Value associated with particular value of velocity, etc.
- ㉑ Viscosity: Value associated with particular value of velocity, etc.
- ㉒ Specific Heat at Constant Pressure: This parameter appears for real gas with multiple velocity values. If only one velocity is used the parameter printed is the viscosity exponent for the equation  $\mu = \mu_0 (T/T_0)^{\text{exp}}$ .

GROUP 6 - PROBLEM LIMIT INFORMATION (see input guide)

- (23) R: Radial coordinate of upper cutoff (units consistent with boundary equations).
- (24) X: Axial coordinate of upper cutoff (units consistent with boundary equations).
- (25) THETA: Angle of upper cutoff line (deg)
- (26) R: Radial coordinate of lower cutoff (units consistent with boundary equations).
- (27) X: Axial coordinate of lower cutoff (units consistent with boundary equations).
- (28) Theta: Angle of lower cutoff line (deg).

GROUP 7 - PARTICLE DESCRIPTION (does not appear for gaseous only solution)

- (29) Particle Number: Number assigned to particular particle (10 max).
- (30) Particle Radius: Radius of the particle in microns.
- (31) Mass Density: Particle density ( $\text{lbm}/\text{ft}^3$  or  $\text{kg}_m/\text{m}^3$ ).
- (32) Emissivity: Coefficient of emissivity for particle radiation to the surrounding medium.
- (33) Accommodation Coefficient: Accommodation coefficient for radiation from the surrounding medium to the particle.
- (34)  $\sum_{j=1}^N \dot{\omega}_p^j / \dot{\omega}_g$ : Particle percent loading relative to the gas.
- (35)  $\dot{\omega}_p^j / \sum_{j=1}^N \dot{\omega}_p^j$ : Individual particle percentage relative to the total mass flow rate
- (36) UNITS: Units with which the particle temperature-enthalpy table will be input (see the input guide).
- (37) TMELT: Temperature of the particle during the phase change from liquid to solid ( $^{\circ}\text{R}$  or  $^{\circ}\text{K}$ ).
- (38) HSOLID: Value of enthalpy at which the particle becomes a solid ( $\text{ft}^2/\text{sec}^2$  or  $\text{M}^2/\text{sec}^2$ ).
- (39) HLIQUID: Value of enthalpy at which the particle begins the transition from liquid to solid phase ( $\text{ft}^2/\text{sec}^2$  or  $\text{M}^2/\text{sec}^2$ ) constant specific heat analysis.

- ④① CPMELT: Value of the specific heat at constant pressure for the particle in the liquid state ( $\text{ft}^2/\text{sec}^2/^\circ\text{R}$  or  $\text{m}^2/\text{sec}^2/^\circ\text{K}$ ).
- ④① CPSOLID: Value of the specific heat at constant pressure for the particle in the solid state ( $\text{ft}^2/\text{sec}^2/^\circ\text{R}$  or  $\text{m}^2/\text{sec}^2/^\circ\text{K}$ ).
- ④① TP: Value of the particle temperature ( $^\circ\text{R}$  or  $^\circ\text{K}$ ) (50 max.).
- ④① HP: Value of particle enthalpy corresponding to ④① (50 max.)
- ④② Re: Particle Reynolds number (28 max.).
- ④③ DRAG COEF: Particle drag coefficient parameter,  $f^j$ , corresponding to ④②.

#### GROUP 8 - GAS START LINE INFORMATION

- ④④ R: Radial coordinate of the data point (units consistent with boundary equations).
- ④⑤ X: Axial coordinate of the data point (units consistent with boundary equations).
- ④⑥ M: Local value of the Mach number (must be  $> 1.0$ ).
- ④⑦ THETA: Local flow deflection angle (deg).
- ④⑧ S: Local value of entropy level ( $\text{ft}^2/\text{sec}^2/^\circ\text{R}$  or  $\text{m}^2/\text{sec}^2/^\circ\text{K}$ ).
- ④⑨ MACH ANGLE: Local value corresponding to M (deg).
- ⑤① Shock Angle: Local value of shock angle if point is a downstream shock point (deg).
- ⑤① H-TOTAL (gas-particle flow): Gas total enthalpy level ( $\text{ft}^2/\text{sec}^2$  or  $\text{m}^2/\text{sec}^2$ ).
- ⑤① O/F (gas only flow): local value of O/F.

#### GROUP 9 - PARTICLE START LINE INFORMATION (does not appear for gaseous only solution)

- ⑤② POINT: Data point at which this particle is present.
- ⑤③ SPECIE: Particle number for this data point.
- ⑤④ u: Particle axial component of velocity ( $\text{ft}/\text{sec}$  or  $\text{m}/\text{sec}$ ).
- ⑤⑤ v: Particle radial component of velocity ( $\text{ft}/\text{sec}$  or  $\text{m}/\text{sec}$ ).
- ⑤⑥  $\theta$ : Particle streamline deflection angle (rad)
- ⑤⑦ h: Particle enthalpy level ( $\text{ft}^2/\text{sec}^2$  or  $\text{m}^2/\text{sec}^2$ )
- ⑤⑧  $\rho$ : Local particle concentration ( $\text{slug}/\text{ft}^3$  or  $\text{kg}_m/\text{m}^3$ )

GROUP 10 - MESH CONTROL CRITERIA (see input guide)

- ⑤⑨ DLI: Point insert criteria for the nozzle-plume interior solution (units consistent with boundary equations).
- ⑥⑩ DXA: Line insert criteria along the axis (units consistent with boundary equations).
- ⑥⑪ DLM: Insert criteria near a particle limiting streamline (units consistent with the boundary equations).
- ⑥⑫ DLD: Point delete criteria (units consistent with the boundary equations).
- ⑥⑬ DEGPM: Incremental angle to be used in the numerical integration to define the Prandtl-Meyer expansion fan (deg).
- ⑥⑭ F: Interpolation factor used in the axis point solution.

GROUP 11 - DATA LINE FLOW PROPERTIES

NOTE: The output format for all data surfaces are the same with each point type on the line being identified. Several different lines are shown to indicate typical line constructions.

- ⑥⑮ Line: Line number; lines are numbered in ascending order.
- ⑥⑯ Point: Indicates point number on the line.
- ⑥⑰ Description: Indicates point type and flow regime. These options are:

Point Type	Output Format	Flow Regime	Output Format
a. Input	INPUT POINT	a. Continuum	CONTIN
b. Interior	INTER	b. Vibrationally Frozen	VIBFRZ
c. Wall	WALL	c. Rotationally Frozen	ROTFRZ
d. Free Boundary	FREEBD	d. Transitionally Frozen	TRNFRZ
e. Prandtl-Meyer	PRN-MR		
f. Upstream	UP-SHK		
g. Downstream Shock	DWNSHK		
h. Shock Interaction	SOKINT		
i. Slipline	SLIP		

NOTES: The point type and flow regime will appear in the appropriate combination to completely describe the data point.

Items (70) through (81) refer to gas conditions.

- (68) R: Radial coordinate of the data point (units consistent with the boundary equations)
- (69) X: Axial coordinate of the data point (units consistent with the boundary equations)
- (70) M: Local value of the Mach number
- (71) θ: Local flow deflection angle of the gas streamline (deg)
- (72) S: Local entropy level of the gas ( $\text{ft}^2/\text{sec}^2/^\circ\text{R}$  or  $\text{m}^2/\text{sec}^2/^\circ\text{K}$ )
- (73) V: Local magnitude of the velocity ( $\text{ft}/\text{sec}$  or  $\text{m}/\text{sec}$ )
- (74) H-TOTAL (gas-particle flow): Gas total enthalpy level ( $\text{ft}^2/\text{sec}^2$  or  $\text{m}^2/\text{sec}^2$ )
- (74) O/F (gas only flow): Local value of O/F
- (75) Mach Angle: Mach angle corresponding to the Mach number (deg)
- (76) P: Local pressure ( $\text{lb}_f/\text{in}^2$  or  $\text{N}/\text{m}^2$ )
- (77) ρ: Local density ( $\text{slug}/\text{ft}^3$  or  $\text{kgm}/\text{m}^3$ )
- (78) T: Local static temperature ( $^\circ\text{R}$  or  $^\circ\text{K}$ )
- (79) GAS CONST: Local value of the gas constant ( $\text{ft}^2/\text{sec}^2/^\circ\text{R}$  or  $\text{m}^2/\text{sec}^2/^\circ\text{K}$ )
- (80) LOCAL GAMMA: Local value of the isentropic exponent
- (81) SHOCK ANGLE: Local value of the downstream shockwave angle (deg)

NOTE: Items (82) through (87) refer to the particle properties. This print-out does not appear for gas only flow.

- (82) V: Local magnitude of particle velocity ( $\text{ft}/\text{sec}$  or  $\text{m}/\text{sec}$ )
- (83) θ: Local particle streamline deflection angle (deg)
- (84) DM: Difference in Mach number between the gas and particle
- (85) h: Local particle enthalpy level ( $\text{ft}^2/\text{sec}^2$  or  $\text{m}^2/\text{sec}^2$ )
- (86) ρ: Local particle concentration ( $\text{slug}/\text{ft}^3$  or  $\text{kgm}/\text{m}^3$ )
- (87) T: Local particle temperature ( $^\circ\text{R}$  or  $^\circ\text{K}$ )
- (88) Indicates the data point is on a particle limiting streamline

## GROUP 12 - INTEGRATED GAS AND PARTICLE MASS FLOW RATES

NOTE: The units of the flow rates depend on the units of the boundary equation. For the following units perform the indicated operation.

<u>Units</u>	<u>Factor</u>	<u><math>\dot{w}</math></u>
in.	1/144	slug/sec
ft	1	slug/sec
M	1	kg <sub>m</sub> /sec
None	(Ref. length) <sup>2</sup>	slug/sec or kg <sub>m</sub> /sec

- ⑧9 Gas mass flow rate
- ⑨0 Particle total mass flow rate
- ⑨1 Sum of the gas and particle mass flow rate
- ⑨2 Particle percent loading relative to the gas (numerical integration results)
- ⑨3 Particle percent loading relative to mixture

## GROUP 13 - MOMENTUM INTEGRATION RESULTS

- ⑨4 This is a calculation of the component of the net thrust due to the gas and particle momentum across the starting line.  
FORCEX, FORCEY: Net axial and radial component of the thrust vector (lb<sub>f</sub> or N)  
TORQZ: Net torque resulting from the thrust (ft-lb<sub>f</sub> or m-N)  
ISP: Specific impulse corresponding to FORCEX (lb<sub>f</sub>-sec/lb<sub>m</sub>)
- ⑨5 This is the incremental gas and particle contribution to the thrust and torque vector  
DELFXG, DELFYG: Net gaseous axial and radial component of the thrust vector (lb<sub>f</sub> or N)  
TORQZG: Net torque resulting from the gaseous contribution to the thrust vector (ft-lb<sub>f</sub> or m-N)  
DELFXP, DELFYP: Particle momentum contribution to the thrust vector (lb<sub>f</sub> or N)  
TORQZP: Net torque resulting from the particle contribution to the thrust vector (ft-lb<sub>f</sub> or m-N)

### Problem Solution Iteration Control

- ⑨6 ITR: Number of iterations required for this point to converge within the convergence criteria

### GROUP 14 - PRESSURE INTEGRATION RESULTS

- ⑨7 This calculation is the thrust and torque resulting from the gas pressure acting on the nozzle wall.
- FORCEX, FORCEY: Axial and radial component of the thrust ( $lb_f$  or N). This thrust vector includes the momentum and pressure contribution.
- TORQZ: Net torque resulting from the thrust ( $ft-lb_f$  or  $m-N$ )
- DELFX, DELFY: Incremental force in the axial and radial directions resulting from the pressure acting on the nozzle wall ( $lb_f$  or N)
- ISP: Specific impulse corresponding to FORCEX ( $lb_f\text{-sec}/lb_m$ )

### GROUP 15 - PERCENT CHANGE IN MASS FLOW RATE, MOMENTUM, ENERGY, AND ISP

NOTE: This is a comparison of the mass flow rate, momentum, energy and ISP relative to the mass flow rate, momentum, energy and ISP through the input (starting line) surface. The percent change should be near zero; any variation from zero is an indication of accumulated error in the numerical solution.

- ⑨8 Percent change in the mass flow rate of the gas
- ⑨9 Percent change in the mass flow rate of the particles
- ⑩0 Percent change in the mass flow rate of the mixture
- ⑩1 Percent change in the momentum of the gas
- ⑩2 Percent change in the momentum of the particles
- ⑩3 Percent change in the momentum of the mixture
- ⑩4 Percent change in  $I_{sp}$
- ⑩5 Percent change in the energy of the gas
- ⑩6 Percent change in the energy of the particles
- ⑩7 Percent change in the energy of the mixture.



## GROUP 16 - FREE MOLECULAR CONTROL PARAMETERS

- ⑩⑧ VIBNO: Reciprocal of the Knudsen number at which the vibrational energy mode thermally freezes.
- ⑩⑨ ROTNO: Reciprocal of the Knudsen number at which the rotational energy mode thermally freezes.
- ⑩⑩ TRANNO: Reciprocal of the Knudsen number at which translational energy mode thermally freezes.
- ⑩⑪ CHARL: Characteristic length used in the mean free path calculation used to compute the local value of the Knudsen number (units consistent with the boundary equations).
- ⑩⑫ GAMV: Value of the isentropic exponent to be used in the vibrationally frozen flow calculations.
- ⑩⑬ GAMR: Value of the isentropic exponent to be used in the rotationally frozen flow calculations.

NOTE: Items 112 and 113 are the gas species data to be used in the calculation of parameters used in the Knudsen number calculation (10 max. may be used).

## GROUP 17 - SPECIES THERMODYNAMIC AND REACTION DATA

- ⑩⑭ These 7 parameters control the execution of the finite rate chemistry calculations according to the options selected. (See Card 5 of the Input Guide for an explanation of the individual parameters.)
- ⑩⑮ Prandtl number of the gas (dimensionless)
- ⑩⑯ Absolute viscosity of the gas (poise)
- ⑩⑰ Viscosity temperature exponent
- ⑩⑱ Reaction number
- ⑩⑲ Reaction being considered
- ⑩⑳ A: Pre-exponential factor (cm-particle-sec)
- ⑩㉑ N: Temperature exponent
- ⑩㉒ B: Activation energy (cal/mole)
- ⑩㉓ M: Temperature exponent
- ⑩㉔ R-Type: Reaction type

(125) K-Type: Rate constant type

(126) Catalytic species being considered. (See Card(s) 14 for an explanation.)

**GROUP 18 - SPECIES MOLE FRACTIONS ON THE STARTLINE**

(127) Point: Indicates the point number on the startline

(128) Corresponding species mole fractions at the point (127)

(129) Chamber pressure (atm)

(130) Chamber temperature ( $^{\circ}$ K)

(131) Species mole fractions at a point on the data surface

**Sample Printout  
for Two-Phase Chemical Equilibrium Flow**

3-61

REPRODUCIBILITY OF THE ORIGINAL PAGE IS POOR

Sample Printout for Two-Phase Chemical Equilibrium Flow

SUPERSONIC FLOW ANALYSIS USING THE LOCKHEED-HUNTSVILLE MULTIPLE SHOCK COMPUTER PROGRAM (1)

GAS-PARTICLE FLOW SOLUTION (2)

CASE NO. 1 (3)

PAGE 1

SPACE SHUTTLE SEP MOTOR NOZZLE (4)

Group 1

RUN CONTROL PARAMETERS (5)

ICON(1)	ICON(2)	ICON(3)	ICON(4)	ICON(5)	ICON(6)	ICON(7)	ICON(8)
2	0	25	3		0	1	
ICON(9)	ICON(10)	ICON(11)	ICON(12)	ICON(13)	ICON(14)	ICON(15)	ICON(16)
0	25	1	1	0	0	0	11510

Group 2

FLOW CALCULATIONS ARE IN ENGLISH UNITS WITH THE X COORDINATES IN FEET  
THE PLI FIELD DATA WILL BE WRITTEN ON TAPE

UPPER BOUNDARY

(6) TYPE	(7) ITRANS	(8) A	(8) B	(8) C	(8) D	(8) E	(9) MAX
1	0	-.19000+01	.15340+00	.00000	-.10000+01	-.52225+00	.14672+00
1	1	.10000+01	.51561+01	.21824+01	-.10000+01	-.21796+01	.74059+00
3	0	.45290+01	.00000	.00000	.00000	.00000	.10000+04

Group 3

LOWER BOUNDARY

TYPE	ITRANS	A	B	C	D	E	MAX
2	0	.00000	.00000	.00000	.00000	.00000	.10000+04

CHAMBER ENTHALPY = -.19619+08 (10)

THERE ARE 6 PARTICLE SPECIES PRESENT IN THE GAS-PARTICLE MIXTURE (11)

THE FOLLOWING GAS PROPERTIES IN ENGLISH UNITS ARE FOR SEP PROP PC=1800 (12)  
REAL GAS PROPERTIES

Group 4

H-TOTAL (13)  
-.28631+04

(14) S	(15) V	(16) R	(17) GAMMA	(18) T	(19) P	(20) PR	(21) VIS	(22) CP
-.17515+04	.00000	.19861+04	.12039+01	.94098+04	.10000+04	.57034+00	.17410+05	.12302+05
	.32374+04	.19835+04	.12134+01	.94603+04	.10111+04	.58520+00	.16373+05	.11552+05
	.51771+04	.19815+04	.12260+01	.96228+04	.36000+03	.60100+00	.14258+05	.10005+05
	.64117+04	.19812+04	.12316+01	.97844+04	.10000+03	.50332+00	.12734+05	.10554+05
	.66587+04	.19811+04	.12365+01	.97927+04	.90000+02	.60147+00	.11702+05	.10404+05
	.71778+04	.19811+04	.12376+01	.974457+04	.45000+02	.59727+00	.10564+05	.10327+05
	.77242+04	.19811+04	.12377+01	.970511+04	.19000+02	.58936+00	.92142+06	.10343+05
	.82731+04	.19811+04	.12452+01	.96175+04	.80000+01	.58769+00	.76436+06	.09126+04

Group 5

LOCKHEED-HUNTSVILLE RESEARCH & ENGINEERING CENTER

3-62

Sample Printout for Two-Phase Chemical Equilibrium Flow

SUPERSONIC FLOW ANALYSIS USING THE LOCKHEED-HUNTSVILLE MULTIPLE SHOCK COMPUTER PROGRAM

GAS-PARTICLE FLOW SOLUTION

CASE NO. 1

PAGE 3

SPACE SHUTTLE SEP MOTOR NOZZLE

REAL GAS PROPERTIES

H-TOTAL		REAL GAS PROPERTIES							
S	V	R	GAMMA	T	P	PR	VIS	CP	
= .17515+04									
	.84091+04	.19811+04	.12942+01	.14422+04	.36000+01	.58760+00	.69560-06	.87208+04	
	.86241+04	.19811+04	.13062+01	.12289+04	.12500+01	.58584+00	.60805-05	.84559+04	
	.89932+04	.19811+04	.13317+01	.83245+03	.36000+00	.58277+00	.42702-06	.79585+04	
	.91091+04	.19811+04	.13413+01	.69912+03	.18000+00	.58035+00	.36311-06	.77937+04	
	.93072+04	.19811+04	.13600+01	.46019+03	.36000+01	.57207+00	.23588-06	.74839+04	
.44545+04									
	.80000	.19995+04	.11754+01	.48839+04	.80000+02	.50737+00	.17256-05	.15844+05	
	.31969+04	.19905+04	.11920+01	.43074+04	.45254+02	.53093+00	.16219-05	.13464+05	
	.51556+04	.19831+04	.12182+01	.36197+04	.16000+02	.58140+00	.14247-05	.11313+05	
	.52941+04	.19816+04	.12286+01	.31911+04	.80000+01	.59755+00	.12954-05	.10726+05	
	.66445+04	.19812+04	.12347+01	.28012+04	.40000+01	.60024+00	.11729-05	.10443+05	
	.71663+04	.19811+04	.12374+01	.24537+04	.20000+01	.59719+00	.16791-05	.10334+05	
	.77152+04	.19811+04	.12372+01	.20579+04	.80000+00	.58942+00	.92375-06	.10342+05	
	.82163+04	.19811+04	.12850+01	.16730+04	.26667+00	.58798+00	.76549-08	.89381+04	
	.84831+04	.19811+04	.12940+01	.14472+04	.16000+00	.58792+00	.69760-06	.57256+04	
	.86189+04	.19811+04	.13060+01	.12333+04	.80000+01	.58718+00	.60989-08	.64608+04	
	.89896+04	.19811+04	.13316+01	.83555+03	.16000+01	.58320+00	.43049-06	.79616+04	
	.91060+04	.19811+04	.13412+01	.70177+03	.80000+02	.58081+00	.36443-06	.77534+04	
	.93050+04	.19811+04	.13599+01	.46199+03	.16000+02	.57264+00	.23686-06	.74911+04	

REAL GAS PROPERTIES

H-TOTAL  
= .24125+08

S	V	R	GAMMA	T	P	PR	VIS	CP
= .24769+03								
	.00000	.19923+04	.11919+01	.51581+04	.18000+04	.55000+00	.18540-05	.13625+05
	.33540+04	.19867+04	.12032+01	.47959+04	.10145+04	.54677+00	.17326-05	.12372+05
	.53837+04	.19823+04	.12201+01	.39342+04	.36000+03	.59339+00	.15166-05	.11133+05
	.62562+04	.19814+04	.12277+01	.34668+04	.18000+03	.60145+00	.13793-05	.10729+05
	.69335+04	.19812+04	.12330+01	.30450+04	.90000+02	.60279+00	.12501-05	.10497+05
	.74773+04	.19811+04	.12364+01	.26696+04	.45000+02	.60017+00	.11302-05	.10370+05
	.80496+04	.19811+04	.12378+01	.22387+04	.18000+02	.59362+00	.98632-06	.10319+05
	.85730+04	.19811+04	.12791+01	.17727+04	.80000+01	.59495+00	.82327-06	.90864+04
	.87647+04	.19811+04	.12880+01	.15835+04	.36000+01	.59551+00	.75144-06	.88498+04
	.89553+04	.19811+04	.13004+01	.13527+04	.18000+01	.59562+00	.65929-06	.85428+04
	.91957+04	.19811+04	.13269+01	.92084+03	.36000+00	.59368+00	.47031-06	.80459+04
	.93447+04	.19811+04	.13471+01	.77473+03	.18000+00	.59212+00	.40013-06	.78660+04

Group 5  
(Cont'd)

LOCKHEED - HUNTSVILLE RESEARCH & ENGINEERING CENTER

3-63

Sample Printout for Two-Phase Chemical Equilibrium Flow

SUPERSONIC FLOW ANALYSIS USING THE LOCKHEED-HUNTSVILLE MULTIPLE SHOCK COMPUTER PROGRAM  
 GAS-PARTICLE FLOW SOLUTION  
 CASE NO. 1

SPACE SHUTTLE SEP MOTOR NOZZLE

REAL GAS PROPERTIES

H-TOTAL

S	V	R	GAMMA	T	P	PR	VIS	CP
.53902+04	.00000	.20148+04	.11587+01	.49404+04	.80000+02	.48389+00	.17940-05	.14517+05
.37826+04	.20006+04	.11725+01	.45937+04	.45564+02	.49992+00	.17007-05	.12272+05	
.53419+04	.19862+04	.12045+01	.39195+04	.16000+02	.55086+00	.15120-05	.12284+05	
.62212+04	.19824+04	.12205+01	.34742+04	.80000+01	.58410+00	.13820-05	.11105+05	
.69048+04	.19815+04	.12303+01	.30614+04	.40000+01	.59829+00	.12552-05	.10648+05	
.74538+04	.19812+04	.12357+01	.26856+04	.20000+01	.59940+00	.11355-05	.10402+05	
.80313+04	.19811+04	.12375+01	.22530+04	.80000+00	.59379+00	.99120-06	.10320+05	
.85592+04	.19811+04	.12786+01	.17844+04	.26667+00	.59542+00	.82766-06	.98780+04	
.87565+04	.19811+04	.12876+01	.15943+04	.16000+00	.59607+00	.75563-06	.88758+04	
.89449+04	.19811+04	.12999+01	.13821+04	.80000+01	.59619+00	.66313-06	.85926+04	
.91745+04	.19811+04	.13266+01	.97762+03	.18000+01	.59440+00	.47343-06	.80527+04	
.95025+04	.19811+04	.13366+01	.78054+03	.80000+02	.59291+00	.40294-06	.78718+04	
.97148+04	.19811+04	.13560+01	.51575+03	.16000+02	.58770+00	.26575-06	.75514+04	

REAL GAS PROPERTIES

H-TOTAL  
 =.21872+04

S	V	R	GAMMA	T	P	PR	VIS	CP
-.41765+03	.00000	.19965+04	.11858+01	.53183+04	.18000+04	.54000+00	.18960-05	.14867+05
.34056+04	.19897+04	.11973+01	.48697+04	.10166+04	.55602+00	.17769-05	.12938+05	
.54008+04	.19830+04	.12164+01	.40875+04	.36000+03	.58723+00	.15604-05	.11371+05	
.61721+04	.19816+04	.12253+01	.36078+04	.18000+03	.59908+00	.14214-05	.10592+05	
.70643+04	.19812+04	.12315+01	.31720+04	.90000+02	.60269+00	.12696-05	.10504+05	
.74209+04	.19812+04	.12354+01	.27819+04	.45000+02	.60123+00	.11667-05	.10403+05	
.82057+04	.19811+04	.12378+01	.23740+04	.18000+02	.59537+00	.10188-05	.10318+05	
.87414+04	.19811+04	.12760+01	.18517+04	.60000+01	.59771+00	.85239-06	.91645+04	
.89420+04	.19811+04	.12650+01	.16557+04	.36000+01	.59875+00	.77938-06	.99388+04	
.91745+04	.19811+04	.12974+01	.14161+04	.18000+01	.59925+00	.68499-06	.86491+04	
.90756+04	.19811+04	.13245+01	.96651+03	.36000+00	.59877+00	.49122-06	.80917+04	
.97022+04	.19811+04	.13347+01	.81389+03	.18000+00	.59714+00	.41696-06	.79048+04	
.95192+04	.19811+04	.13544+01	.53859+03	.36000+01	.59299+00	.29988-06	.75755+04	
.58411+04	.20241+04	.11523+01	.58500+04	.80000+02	.47482+00	.18275-05	.21634+05	
.12700+04	.20076+04	.11637+01	.47181+04	.45709+02	.48755+00	.17343-05	.18058+05	
.54260+04	.19880+04	.11957+01	.40610+04	.16000+02	.53284+00	.15529-05	.13986+05	
.63753+04	.19838+04	.12149+01	.36169+04	.80000+01	.57163+00	.14238-05	.11537+05	

Group 5  
 (Cont'd)

LOCKHEED - HUNTSVILLE RESEARCH & ENGINEERING CENTER  
 3-64

Sample Printout for Two-Phase Chemical Equilibrium Flow

SUPERSONIC FLOW ANALYSIS USING THE LOCKHEED-HUNTSVILLE MULTIPLE SHOCK COMPUTER PROGRAM  
 GAS-PARTICLE FLOW SOLUTION  
 CASE NO. 1

PAGE 4

SPACE SHUTTLE SEP MOTOR NOZZLE

REAL GAS PROPERTIES

H-TOTAL

S	V	R	GAMMA	T	P	PR	VJS	CP
.58411+04	.70757+04	.19818+04	.12271+01	.31928+04	.40000+01	.59459+00	.12957+05	.70816+05
	.75987+04	.19813+04	.12342+01	.28041+04	.20000+01	.59463+00	.10738+05	.710467+05
	.81810+04	.19811+04	.12377+01	.23536+04	.80000+00	.59558+00	.10254+05	.110324+05
	.87227+04	.19811+04	.12754+01	.18680+04	.26667+00	.59820+00	.08829+06	.91805+04
	.89755+04	.19811+04	.12844+01	.16706+04	.16000+00	.59934+00	.078508+06	.82541+04
	.91805+04	.19811+04	.12968+01	.14292+04	.80000-01	.59994+00	.069025+06	.86628+04
	.95660+04	.19811+04	.13240+01	.97594+03	.16000-01	.59915+00	.049550+06	.81012+04
	.96939+04	.19811+04	.13343+01	.82199+03	.80000-02	.59810+00	.042283+06	.79129+04
	.98133+04	.19811+04	.13541+01	.54415+03	.16000-02	.59420+00	.028081+06	.75812+04

REAL GAS PROPERTIES

H-TOTAL

.19619+08

S	V	R	GAMMA	T	P	PR	VJS	CP
.00000	.00000	.20017+04	.11798+01	.54684+04	.18000+04	.53040+00	.19346+05	.15475+05
	.34537+04	.19925+04	.11911+01	.50261+04	.10187+04	.54593+00	.18186+05	.13715+05
	.55738+04	.19840+04	.12121+01	.42383+04	.36000+03	.57942+00	.16030+05	.11671+05
	.64935+04	.19820+04	.12224+01	.37483+04	.18000+03	.59535+00	.14627+05	.11008+05
	.71907+04	.19813+04	.12297+01	.37994+04	.90000+02	.60190+00	.13287+05	.10643+05
	.77591+04	.19812+04	.12344+01	.28956+04	.45000+02	.60196+00	.12030+05	.10444+05
	.83575+04	.19811+04	.12376+01	.24304+04	.18000+02	.59704+00	.10513+05	.10327+05
	.89057+04	.19811+04	.12731+01	.19319+04	.60000+01	.60000+00	.088132+06	.92428+04
	.91111+04	.19811+04	.12819+01	.17290+04	.36000+01	.60158+00	.08732+06	.90137+04
	.93475+04	.19811+04	.12944+01	.14807+04	.18000+01	.60246+00	.071089+06	.87172+04
	.97416+04	.19811+04	.13220+01	.10132+04	.36000+00	.60236+00	.051232+06	.81391+04
	.9918+04	.19811+04	.13325+01	.85401+03	.18000+00	.60163+00	.043803+06	.79447+04
	.10115+05	.19811+04	.13527+01	.54614+03	.36000-01	.59865+00	.029237+06	.76017+04
.62828+04	.31100	.20345+04	.11470+01	.51490+04	.80000+02	.46684+00	.18478+05	.23657+05
	.37550+04	.20157+04	.11560+01	.48304+04	.45836+02	.47734+00	.17643+05	.20071+05
	.56345+04	.19924+04	.11861+01	.41947+04	.16000+02	.51537+00	.15901+05	.14185+05
	.61232+04	.19853+04	.12080+01	.37551+04	.80000+01	.55559+00	.14643+05	.12023+05
	.71405+04	.19824+04	.12332+01	.33245+04	.40000+01	.50776+00	.13362+05	.11038+05
	.77177+04	.19814+04	.12322+01	.29245+04	.20000+01	.59866+00	.12122+05	.10565+05
	.81752+04	.19812+04	.12373+01	.24564+04	.80000+00	.59708+00	.10600+05	.10337+05
	.84812+04	.19812+04	.12723+01	.19535+04	.26667+00	.60056+00	.088905+06	.92616+04
	.93995+04	.19812+04	.12811+01	.17488+04	.16667+00	.60228+00	.07480+06	.90359+04

Group 5  
(Cont'd)

Sample Printout for Two-Phase Chemical Equilibrium Flow

SUPERSONIC FLOW ANALYSIS USING THE LOCKHEED-HUNTSVILLE MULTIPLE SHOCK COMPUTER PROGRAM  
GAS-PARTICLE FLOW SOLUTION

CASE NO. 1

PAGE 5

SPACE SHUTTLE SEP MOTOR NOZZLE

REAL GAS PROPERTIES

H-TOTAL

S	V	R	GAMMA	T	P	PR	VLS	CP
.62828+04	.93112+04	.19812+04	.12936+01	.14981+04	.80000+01	.60325+00	.71786+06	.87357+04
.97489+04	.19812+04	.13213+01	.10259+04	.16000+01	.60338+00	.51801+06	.81521+04	
.98309+04	.19812+04	.13319+01	.86491+03	.80000+02	.60275+00	.44317+06	.79557+04	
.15108+05	.19812+04	.13522+01	.57364+03	.16000+02	.60006+00	.29629+06	.76113+04	

Group 5  
(Cont'd)

RUN CUTOFF INFORMATION

(23)	UPPER BOUNDARY			(25)	LOWER BOUNDARY			(28)
R*	X*	THETA*	R*	X*	THETA*	R*	THETA*	
.10000+04	.10000+04	.00000	.00000	.10000+03	.00000+02			

Group 6

PARTICLE PHYSICAL DATA

SPECIE	RADIUS	MASS DENSITY	EMISSIVITY (32)	ACCH. COEFF. (33)
1	.11000+01	.25000+03	.00000	.00000
2	.17000+01	.25000+03	.00000	.00000
3	.25000+01	.25000+03	.00000	.00000
4	.32000+01	.25000+03	.00000	.00000
5	.45000+01	.25000+03	.00000	.00000
6	.65000+01	.25000+03	.00000	.00000

Group 7

THE PARTICLES CONSTITUTE 3.91 PERCENT BY WEIGHT FLOW OF THE GAS-PARTICLE MIXTURE

THE INDIVIDUAL PERCENTAGES ARE .10 .20 .20 .20 .20 .10

THE PARTICLE TEMPERATURE-ENTHALPY TABLE WILL BE READ IN WITH ENGLISH UNITS (35)

PARTICLE TEMPERATURE-ENTHALPY TABLE (37)

PHASE CHANGE DATA \*\*\* THERM = .418853+04 H SOLID = .346107+08 H LIQUID = .465207+08 (39)

CPHELT = .85100+04 CP SOLID = .81199+04

(40) (41)

LOCKHEED - HUNTSVILLE RESEARCH & ENGINEERING CENTER

3-66



Sample Printout for Two-Phase Chemical Equilibrium Flow

SUPERSONIC FLOW ANALYSIS USING THE LOCKHEED-HUNTSVILLE MULTIPLE SHOCK COMPUTER PROGRAM  
 GAS-PARTICLE FLOW SOLUTION  
 CASE NO. 1

PAGE 6

SPACE SHUTTLE SEP MOTOR NOZZLE

PARTICLE DRAG TABLE

I	RE (42)	DRAG COEF. (43)
1	.00003	.10000+01
2	.12500+01	.10000+01
3	.12550+01	.10000+01
4	.12600+01	.10010+01
5	.12650+01	.10020+01
6	.15820+01	.10630+01
7	.19950+01	.11410+01
8	.25100+01	.12240+01
9	.31600+01	.13150+01
10	.39800+01	.14120+01
11	.50100+01	.15170+01
12	.63100+01	.16250+01
13	.79500+01	.17450+01
14	.10000+02	.18740+01
15	.12600+02	.20260+01
16	.15920+02	.21840+01
17	.19950+02	.23640+01
18	.25100+02	.25550+01
19	.31600+02	.27600+01
20	.39800+02	.30000+01
21	.50100+02	.32520+01
22	.63100+02	.35200+01
23	.79500+02	.38250+01
24	.10000+03	.41550+01
25	.12600+03	.45000+01
26	.15920+03	.48000+02
27	.19950+03	.50000+02
28	.25100+03	.50000+02

Group 7  
(Cont'd)

3-67

Sample Printout for Two-Phase Chemical Equilibrium Flow

SUPERSONIC FLOW ANALYSIS USING THE LOCKHEED-HUNTSVILLE MULTIPLE SHOCK COMPUTER PROGRAM  
 GAS-PARTICLE FLOW SOLUTION  
 CASE NO. 1

SPACE SHUTTLE SEP MOTOR NOZZLE

(44)	(45)	(46)	GASEOUS STARTING LINE INFO			(49)	(50)	(51)
R	X	M	THETA (47)	S (48)	MACH ANGLE	SHOCK ANGLE	H-TOTAL	
.00000	.12847+00	.14166+01	.00000	.57051+02	.44904+02	.00000	-.19706+08	
.58304-02	.12843+00	.14169+01	.45764+00	.57068+02	.44891+02	.00000	-.19707+08	
.11661-01	.12833+00	.14178+01	.91650+00	.57170+02	.44853+02	.00000	-.19707+08	
.17491-01	.12917+00	.14194+01	.13778+01	.57205+02	.44789+02	.00000	-.19707+08	
.23321-01	.12794+00	.14217+01	.18428+01	.57325+02	.44700+02	.00000	-.19707+08	
.29152-01	.12765+00	.14246+01	.23128+01	.57479+02	.44685+02	.00000	-.19707+08	
.34982-01	.12729+00	.14281+01	.27897+01	.57670+02	.44645+02	.00000	-.19708+08	
.40813-01	.12686+00	.14323+01	.32737+01	.57895+02	.44579+02	.00000	-.19708+08	
.46643-01	.12637+00	.14373+01	.37678+01	.58157+02	.44507+02	.00000	-.19709+08	
.52473-01	.12581+00	.14430+01	.42733+01	.58457+02	.44469+02	.00000	-.19709+08	
.58304-01	.12519+00	.14494+01	.47920+01	.58795+02	.44362+02	.00000	-.19710+08	
.64134-01	.12450+00	.14567+01	.53262+01	.59177+02	.44352+02	.00000	-.19711+08	
.69964-01	.12375+00	.14648+01	.58781+01	.59591+02	.44353+02	.00000	-.19712+08	
.75795-01	.12293+00	.14738+01	.64501+01	.60052+02	.44276+02	.00000	-.19712+08	
.81625-01	.12204+00	.14839+01	.70449+01	.60558+02	.44269+02	.00000	-.19714+08	
.87455-01	.12109+00	.14950+01	.76654+01	.61112+02	.44192+02	.00000	-.19715+08	
.93286-01	.12008+00	.15073+01	.83145+01	.61715+02	.44154+02	.00000	-.19716+08	
.10150+00	.11853+00	.15267+01	.92834+01	.62654+02	.44091+02	.00000	-.19718+08	
.10995+00	.11785+00	.15358+01	.97115+01	.63082+02	.44062+02	.00000	-.19719+08	
.10816+00	.11719+00	.15447+01	.10122+02	.63498+02	.44034+02	.00000	-.19720+08	
.11497+00	.11572+00	.15654+01	.11034+02	.64441+02	.43970+02	.00000	-.19722+08	
.12001+00	.11457+00	.15825+01	.11752+02	.65198+02	.43919+02	.00000	-.19724+08	
.12732+00	.11284+00	.16100+01	.12849+02	.66371+02	.43898+02	.00000	-.19727+08	
.13357+00	.11126+00	.16368+01	.13856+02	.67459+02	.43765+02	.00000	-.19730+08	
.13991+00	.10959+00	.16675+01	.14943+02	.68637+02	.43848+02	.00000	-.19733+08	
.14574+00	.10790+00	.16993+01	.16003+02	.69773+02	.43649+02	.00000	-.19737+08	

Group 8

(52)	POINT	SPECIE (53)	U (54)	V (55)	THETA (56)	ENTHALPY (57)	DENSITY (58)
1	1	1	.43867+04	.00000	.00000	.50821+08	.41806-04
1	1	2	.41994+04	.00000	.00000	.51228+08	.94862-04
1	1	3	.39460+04	.00000	.00000	.51674+08	.11244-03
1	1	4	.37884+04	.00000	.00000	.52027+08	.12661-03
1	1	5	.35389+04	.00000	.00000	.52563+08	.15268-03
1	1	6	.32769+04	.00000	.00000	.53218+08	.93531-04
2	2	1	.43873+04	.27314+02	.35670+00	.50019+08	.41787-04
2	2	2	.42800+04	.22707+02	.30288+00	.51229+08	.94817-04
2	2	3	.39465+04	.16040+02	.23287+00	.51677+08	.11238-03
2	2	4	.37889+04	.12562+02	.18995+00	.52033+08	.12653-03
2	2	5	.35393+04	.74544+01	.12068+00	.52571+08	.15248-03
2	2	6	.32773+04	.25470+01	.45528-01	.53233+08	.93430-04

Group 9

LOCKHEED-HUNTSVILLE RESEARCH & ENGINEERING CENTER

3-68

REPRODUCIBILITY OF THE ORIGINAL PAGE IS POOR

Sample Printout for Two-Phase Chemical Equilibrium Flow

SUPERSONIC FLOW ANALYSIS USING THE LOCKHEED-HUNTSVILLE MULTIPLE SHOCK COMPUTER PROGRAM  
 GAS-PARTICLE FLOW SOLUTION  
 CASE NO. 1

SPACE-SHUTTLE SEP MOTOR NOZZLE

POINT	SPECIE	U	V	THETA	ENTHALPY	DENSITY
3	1	.43891+04	.54725+02	.71435+00	.50815+08	.41730-04
3	2	.42018+04	.44489+02	.60664+00	.51229+08	.44683-04
3	3	.39481+04	.32146+02	.46649+00	.51685+08	.45220-03
3	4	.37905+04	.25174+02	.38053+00	.52048+08	.42630-03
3	5	.35404+04	.19941+02	.24179+00	.52601+08	.45214-03
3	6	.32786+04	.51141+01	.89371-01	.53277+08	.43137-04
4	1	.43921+04	.82332+02	.10739+01	.50908+08	.41637-04
4	2	.42047+04	.66947+02	.91217+00	.51228+08	.44465-04
4	3	.39509+04	.48382+02	.70159+00	.51698+08	.41192-03
4	4	.37930+04	.37890+02	.57233+00	.52071+08	.42595-03
4	5	.35427+04	.22491+02	.36374+00	.52644+08	.45161-03
4	6	.32808+04	.77209+01	.13484+00	.53342+08	.42682-04
5	1	.43963+04	.11024+03	.14364+01	.50797+08	.41510-04
5	2	.42089+04	.89060+02	.12204+01	.51227+08	.44173-04
5	3	.39548+04	.64815+02	.93895+00	.51712+08	.41154-03
5	4	.37966+04	.50758+02	.76596+00	.52098+08	.42548-03
5	5	.35458+04	.30138+02	.48699+00	.52696+08	.45092-03
5	6	.32838+04	.10384+02	.18122+00	.53420+08	.42133-04
6	1	.44019+04	.13854+03	.18029+01	.50782+08	.41354-04
6	2	.42143+04	.11272+03	.15321+01	.51223+08	.43817-04
6	3	.39598+04	.81516+02	.11793+01	.51726+08	.41109-03
6	4	.38011+04	.63827+02	.96200+00	.52126+08	.42495-03
6	5	.35498+04	.37916+02	.61198+00	.52748+08	.45015-03
6	6	.32877+04	.13127+02	.22876+00	.53497+08	.41793-04
7	1	.44088+04	.16740+03	.21744+01	.50763+08	.41171-04
7	2	.42209+04	.13627+03	.13984+01	.51219+08	.43418-04
7	3	.39660+04	.98557+02	.14235+01	.51736+08	.41040-03
7	4	.38067+04	.77147+02	.11610+01	.52149+08	.42439-03
7	5	.35549+04	.45062+02	.73917+00	.52791+08	.44937-03
7	6	.32924+04	.15958+02	.27771+00	.53559+08	.40893-04
8	1	.44171+04	.19489+03	.25523+01	.50738+08	.40968-04
8	2	.42288+04	.16024+03	.21701+01	.51200+08	.42984-04
8	3	.39735+04	.11482+03	.16724+01	.51738+08	.41009-03
8	4	.38137+04	.90765+02	.13635+01	.52160+08	.42382-03
8	5	.35608+04	.54014+02	.86906+00	.52815+08	.44965-03
8	6	.32980+04	.18894+02	.32824+00	.53589+08	.40393-04
9	1	.44269+04	.22718+03	.29376+01	.50708+08	.40748-04
9	2	.42380+04	.18490+03	.24982+01	.51179+08	.42535-04
9	3	.39822+04	.13397+03	.19269+01	.51727+08	.40960-03
9	4	.38207+04	.10473+03	.15702+01	.52155+08	.42332-03
9	5	.35680+04	.62415+02	.10022+01	.52810+08	.44807-03
9	6	.33044+04	.21945+02	.38050+00	.53574+08	.40070-04
10	1	.44383+04	.25840+03	.33320+01	.50670+08	.40515-04
10	2	.42484+04	.21030+03	.28337+01	.51148+08	.42086-04
10	3	.39923+04	.15257+03	.21878+01	.51701+08	.40915-03
10	4	.38291+04	.11909+03	.17814+01	.52128+08	.42292-03
10	5	.35784+04	.71108+02	.11390+01	.52768+08	.44771-03
10	6	.33117+04	.25119+02	.43959+00	.53502+08	.40991-04

Group 9  
(Cont'd)

LOCKHEED-HUNTSVILLE RESEARCH & ENGINEERING CENTER

3-69

# Sample Printout for Two-Phase Chemical Equilibrium Flow

SUPERSONIC FLOW ANALYSIS USING THE LOCKHEED-HUNTSVILLE MULTIPLE SHOCK COMPUTER PROGRAM

GAS-PARTICLE FLOW SOLUTION  
CASE NO. 1

PAGE 14

SPACE SHUTTLE SEP MOTOR NOZZLE

POINT	SPECIE	U	V	THETA	ENTHALPY	DENSITY
11	1	.44514+04	.29073+03	.37368+01	.50624+08	.40275-04
11	2	.42805+04	.23655+03	.31778+01	.51108+08	.91649-04
11	3	.40038+04	.17175+03	.24563+01	.51456+08	.10876-03
11	4	.38386+04	.13391+03	.19980+01	.52073+08	.12264-03
11	5	.35861+04	.80143+02	.12803+01	.52681+08	.14763-03
11	6	.33198+04	.28426+02	.49658+00	.53367+08	.90207+04
12	1	.44661+04	.32434+03	.41537+01	.50569+08	.40030-04
12	2	.42739+04	.26377+03	.35316+01	.51051+08	.91235-04
12	3	.40167+04	.19177+03	.27334+01	.51588+08	.10844-03
12	4	.38491+04	.14925+03	.22205+01	.51988+08	.12255-03
12	5	.35976+04	.89572+02	.14265+01	.52949+08	.14787-03
12	6	.33789+04	.31869+02	.54849+00	.53169+08	.90741-04
13	1	.44827+04	.35944+03	.46844+01	.51505+08	.39780-04
13	2	.42887+04	.29711+03	.38964+01	.50983+08	.90847-04
13	3	.40312+04	.21770+03	.30204+01	.51498+08	.10821-03
13	4	.38606+04	.16516+03	.24499+01	.51773+08	.12262-03
13	5	.36091+04	.99453+02	.15784+01	.52373+08	.14942-03
13	6	.33391+04	.35456+02	.60836+00	.52924+08	.91581-04
14	1	.45011+04	.39623+03	.50307+01	.50430+08	.39525-04
14	2	.43051+04	.32171+03	.42736+01	.50931+08	.90481-04
14	3	.40472+04	.23468+03	.33187+01	.51385+08	.10806-03
14	4	.38734+04	.18180+03	.26873+01	.51731+08	.12284-03
14	5	.36229+04	.10985+03	.17367+01	.52166+08	.14925-03
14	6	.33504+04	.39193+02	.67020+00	.52661+08	.92662-04
15	1	.45214+04	.43094+03	.54946+01	.50345+08	.39263-04
15	2	.43231+04	.35275+03	.46648+01	.50804+08	.90133-04
15	3	.40649+04	.25764+03	.36298+01	.51253+08	.10796-03
15	4	.38875+04	.19225+03	.29340+01	.51568+08	.12319-03
15	5	.36378+04	.12082+03	.19022+01	.51950+08	.15028-03
15	6	.33631+04	.43091+02	.73407+00	.52431+08	.93861-04
16	1	.45437+04	.47531+03	.59782+01	.50250+08	.38987-04
16	2	.43426+04	.38542+03	.50718+01	.50695+08	.89772-04
16	3	.40840+04	.28240+03	.39556+01	.51109+08	.10786-03
16	4	.39031+04	.21760+03	.31921+01	.51401+08	.12359-03
16	5	.36538+04	.13244+03	.20759+01	.51760+08	.15136-03
16	6	.33774+04	.47167+02	.80011+00	.52310+08	.94983-04
17	1	.45678+04	.51911+03	.64835+01	.50144+08	.38687-04
17	2	.43639+04	.41945+03	.54968+01	.50577+08	.89367-04
17	3	.41049+04	.30857+03	.42982+01	.50953+08	.10770-03
17	4	.39205+04	.23737+03	.34640+01	.51249+08	.12394-03
17	5	.36709+04	.14479+03	.22587+01	.51551+08	.15225-03
17	6	.33911+04	.51499+02	.88959+00	.52410+08	.95744-04
18	1	.45911+04	.56441+03	.71000+01	.50000+08	.38171-04
18	2	.43872+04	.46472+03	.61100+01	.50400+08	.89000-04
18	3	.41272+04	.35401+03	.49100+01	.50800+08	.10700-03
18	4	.39486+04	.26763+03	.38774+01	.51126+08	.12405-03
18	5	.36963+04	.16757+03	.25337+01	.51782+08	.15259-03
18	6	.34201+04	.59014+02	.97013+00	.52330+08	.95488-04

Group 9  
(Cont'd)

Sample Printout for Two-Phase Chemical Equilibrium Flow

SUPERSONIC FLOW ANALYSIS USING THE LOCKHEED-HUNTSVILLE MULTIPLE SHOCK COMPUTER PROGRAM  
 GAS-PARTICLE FLOW SOLUTION  
 CASE NO. 1

PAGE 15

SPACE SHUTTLE SEP MOTOR NOZZLE

POINT	SPECIE	U	V	THETA	ENTHALPY	DENSITY
19	1	.46217+04	.61405+03	.75681+01	.49906+08	.37957-04
19	2	.44116+04	.49568+03	.64108+01	.50332+08	.88214-04
19	3	.41517+04	.36642+03	.50437+01	.50739+08	.10679-03
19	4	.39620+04	.28153+03	.40646+01	.51132+08	.12385-03
19	5	.37073+04	.17199+03	.26561+01	.51998+08	.15217-03
20	1	.46378+04	.64738+03	.78859+01	.49836+08	.37709-04
20	2	.44260+04	.51839+03	.66802+01	.50770+08	.87757-04
20	3	.41657+04	.38193+03	.52658+01	.50716+08	.10628-03
20	4	.39753+04	.29525+03	.42476+01	.51185+08	.12345-03
20	5	.37175+04	.18013+03	.27741+01	.52322+08	.15135-03
21	1	.46733+04	.70565+03	.85890+01	.49685+08	.37084-04
21	2	.44584+04	.56764+03	.72813+01	.50150+08	.88472-04
21	3	.41969+04	.42377+03	.57651+01	.50769+08	.10463-03
21	4	.40070+04	.32728+03	.46699+01	.51507+08	.12174-03
22	1	.47009+04	.75631+03	.91398+01	.49574+08	.36507-04
22	2	.44841+04	.61697+03	.77589+01	.50110+08	.85149-04
22	3	.42214+04	.45601+03	.61655+01	.50938+08	.10272-03
23	1	.47417+04	.83396+03	.99750+01	.49325+08	.35456-04
23	2	.45235+04	.67601+03	.84997+01	.50120+08	.82500-04
24	1	.47771+04	.90564+03	.10734+02	.49320+08	.34286-04

Group 9  
(Cont'd)

THE MESH CONSTRUCTION WILL BE CONTROLLED BY THE FOLLOWING VARIABLES

DI INTERIOR=	.300-01 DX AXIS=	.200-01 DL LIM=	.150+00 DL DELETE=	.100-02 DEG P.H.=	.600+01 F=	.650+00
(59)	(60)	(61)	(62)	(63)	(64)	Group 10

LOCKHEED-HUNTSVILLE RESEARCH & ENGINEERING CENTER

3-71

Sample Printout for Two-Phase Chemical Equilibrium Flow

SUPERSONIC FLOW ANALYSIS USING THE LOCKHEED-HUNTSVILLE MULTIPLE SHOCK COMPUTER PROGRAM  
 GAS-PARTICLE FLOW SOLUTION  
 CASE NO. 1

PAGE 21

SPACE SHUTTLE SEP MOTOR NOZZLE											
LINE POINT	OSCRIP	REGIME	R (68)	X (69)	N (70)	THETA (71)	ENTROPY (72)	VELOCITY (73)	N-TOTAL	ITR	(74)
PARTICLE DATA		MACH ANGLE (75)	PRESSURE (76)	DENSITY (77)	TEMPERATURE (78)	GAS CONST (79)	LOCAL GAMMA (80)	SHOCK ANGLE (81)			
SPECIF POINT DESCRIPTION		V (82)	THETA (83)	D W (84)	ENTHALPY (85)	DENSITY (86)	TEMPERATURE (87)				
1	24	INPUT - CONTIN	.13357+00	.31124+00	.16368+01	.13856+02	.87997+02	.52119+04	.19973+00	0	
PARTICLE DATA											
24 LIMIT STREAMLINE		.98624+04	.10739+02	.13289+00	.49320+08	.34286+04	.46174+04				
-----											
1	25	INPUT - CONTIN	.13393+00	.31095+00	.16675+01	.14443+02	.88637+02	.53708+04	.19733+00	0	
PARTICLE DATA											
NO PARTICLES ARE PRESENT AT THIS POINT											
-----											
1	26	INPUT - CONTIN	.14578+00	.31079+00	.16993+01	.14003+02	.87773+02	.54325+04	.19737+00	0	
PARTICLE DATA											
NO PARTICLES ARE PRESENT AT THIS POINT											
-----											
GAS MASS FLOW RATE =		.85715+02	PARTICLE MASS FLOW RATE =		.32352+02	MIXTURE MASS FLOW RATE =		.48950+02			
		(89)	PARTICLE PERCENT LOADINGS		(90)	MIXTURE PERCENT LOADINGS		(91)			
			RADIUS			LOADING					
			.11000+01			.44998+05					
			.17000+01			.28000+02					
			.26000+01			.28000+02					
			.32000+01			.20000+02					
			.45500+01			.20000+02					
			.65000+01			.44998+05					
PARTICLE PERCENT LOADING RELATIVE TO THE GAS =		.37744+01	PARTICLE PERCENT LOADING RELATIVE TO THE MIXTURE =		.33871+01						
		(92)			(93)						
-----											
MOMENTUM INTEGRATION RESULTS											
FORCE X		.16212+05	FORCE Y		.00000	TORQ Z		.20474+03			
DELFX		.33778+03	DELFY		.30000	TORQ X		.00000	DELFP		.40847+03
									DELFP		.00000
									TORQ Y		.00000
									(94)		(95)

Group 11

Group 12

Group 13

NOTES: (1) Typical printout for the startline data surface.  
 (2) Some points have been omitted for demonstration purposes.

LOCKHEED-HUNTSVILLE RESEARCH & ENGINEERING CENTER

3-72

Sample Printout for Two-Phase Chemical Equilibrium Flow

SUPERSONIC FLOW ANALYSIS USING THE LOCKHEED-HUNTSVILLE MULTIPLE SHOCK COMPUTER PROGRAM  
GAS-PARTICLE FLOW SOLUTION  
CASE NO. 1

PAGE 27

SPACE SHUTTLE SEP MOTOR NOZZLE

LINE POINT	DESCRIP - RESINE	R MACH ANGLE	X PRESSURE	H DENSITY	THETA TEMPERATURE	ENTROPY GAS CONST.	VELOCITY LOCAL GAMMA	H-TOTAL SHOCK ANGLE	ITR
PARTICLE DATA									
2	23 INTER - CONTIN	.12853+00	.12060+00	.14501+01	.13627+02	.67476+02	.53263+00	.19725+00	96
		.37303+02	.40274+03	.47329+02	.43394+04	.19850+04	.12098+01		
PARTICLE DATA									
1	23	.491253+04	.10722+02	.12820+00	.49070+08	.55249+04	.49880+03		
2	23 LIMIT STREAMLINE	.466776+04	.92340+01	.28903+00	.49791+08	.78835+04	.45728+04		
2	24 INTER - CONTIN	.13512+00	.11912+00	.14794+01	.14224+02	.67880+02	.49014+04	.19730+00	
		.36594+02	.38418+03	.44733+02	.43061+04	.19897+04	.12104+01		
PARTICLE DATA									
1	24 LIMIT STREAMLINE	.44489+04	.11591+02	.13444+00	.48920+08	.32544+04	.49704+04		
2	25 INTER - CONTIN	.14204+00	.11722+00	.17128+01	.16001+02	.68831+02	.49856+04	.19735+00	
		.34722+02	.36379+03	.41865+02	.42680+04	.19893+04	.12112+01		
PARTICLE DATA									
NO PARTICLES ARE PRESENT AT THIS POINT									
2	26 WALL - CONTIN	.14794+00	.11545+00	.17447+01	.17144+02	.69773+02	.49852+04	.19737+00	
		.34971+02	.34499+03	.59177+02	.42312+04	.14890+04	.12130+01		
PARTICLE DATA									
NO PARTICLES ARE PRESENT AT THIS POINT									

PRESSURE INTEGRATION RESULTS

FORCE	FORCE	TORQUE	DELFX	DELFY	ISP
.1818+04	.00000	.00000	.10595+05	.00000	.20593903

Group 14

PERCENT CHANGE IN MASS, MOMENTUM AND ENERGY NUMERICAL INTEGRATION FOR LINE 2 RELATIVE TO THE START LINE

PERCENT CHANGE IN MASS FLOW, GAS	PERCENT CHANGE IN MASS FLOW, PARTICLE	PERCENT CHANGE IN MASS FLOW, MIXTURE	PERCENT CHANGE IN MOMENTUM, GAS	PERCENT CHANGE IN MOMENTUM, PARTICLE	PERCENT CHANGE IN MOMENTUM, MIXTURE	PERCENT CHANGE IN ENERGY, GAS	PERCENT CHANGE IN ENERGY, PARTICLE	PERCENT CHANGE IN ENERGY, MIXTURE
.00000	.00000	.00000	.75299+04	.07987+00	.12303+01	.28241+02	.49037+00	.42229+02

Group 15

NOTES: (1) Typical printout for a data surface inside the nozzle.  
(2) Some points have been omitted for demonstration purposes.

REPRODUCIBILITY OF THE ORIGINAL PAGE IS POOR

Sample Printout for Two-Phase Chemical Equilibrium Flow

SUPERSONIC FLOW ANALYSIS USING THE LOCKHEED-HUNTSVILLE MULTIPLE SPEC. COMPUTER PROGRAM										
GAS-PARTICLE FLOW SOLUTION										
CASE NO. 1										
SPACE SHUTTLE SEP MOTOR NOZZLE										
LINE	POINT	DESCRIP - REGIME	R	X	H	THETA	ENTROPY	VELOCITY	H-TOTAL	ITER
			RACH ANGLE	PRESSURE	DENSITY	TEMPERATURE	GAS CONST.	LOCAL GAMMA	SHOCK ANGLE	
PARTICLE DATA			V	THETA	D H	ENTHALPY	DENSITY	TEMPERATURE		
SPECIE	POINT	DESCRIPTION								
40	43	PRN-HR - CONTIN	.31517+00 .13582+02	.74059+00 .39810+01	.42582+01 .14253+03	.43440+02 .17803+04	.89773+02 .19811+04	.70987+04 .12798+01	.119737+08	2
PARTICLE DATA NO PARTICLES ARE PRESENT AT THIS POINT										
40	44	PRN-HR - CONTIN	.31517+00 .12935+02	.74059+00 .21759+01	.46440+01 .10161+03	.49346+02 .16545+04	.89773+02 .19811+04	.72647+04 .12907+01	.119737+08	2
PARTICLE DATA NO PARTICLES ARE PRESENT AT THIS POINT										
40	45	PRN-HR - CONTIN	.31517+00 .11308+02	.74059+00 .11210+01	.40997+01 .61027+04	.56253+02 .13361+04	.89773+02 .19811+04	.74677+04 .13031+01	.119737+08	2
PARTICLE DATA NO PARTICLES ARE PRESENT AT THIS POINT										
40	46	PRN-HR - CONTIN	.31517+00 .10204+02	.74059+00 .53735+00	.46440+01 .39801+04	.48115+02 .11223+04	.89773+02 .19811+04	.76849+04 .13157+01	.119737+08	2
PARTICLE DATA NO PARTICLES ARE PRESENT AT THIS POINT										
40	47	PRN-HR - CONTIN	.31517+00 .91130+01	.74059+00 .23595+00	.63139+01 .18833+04	.47066+02 .92042+03	.89773+02 .19811+04	.78259+04 .13282+01	.119737+08	2
PARTICLE DATA NO PARTICLES ARE PRESENT AT THIS POINT										
40	48	PRN-HR - CONTIN	.31517+00 .80059+01	.74059+00 .92585+01	.71804+01 .92546+05	.42973+02 .72700+03	.89773+02 .19811+04	.79995+04 .13912+01	.119737+08	2
PARTICLE DATA NO PARTICLES ARE PRESENT AT THIS POINT										
40	49	PRN-HR - CONTIN	.31517+00 .64903+01	.74059+00 .31429+01	.43201+01 .41421+05	.47807+02 .55161+03	.89773+02 .19811+04	.70115+04 .13527+01	.119737+08	2
PARTICLE DATA NO PARTICLES ARE PRESENT AT THIS POINT										

NOTES: (1) Typical printout for a data surface containing a Prandtl-Meyer Expansion.  
 (2) Some points have been omitted for demonstration purposes.

LOCKHEED-HUNTSVILLE RESEARCH & ENGINEERING CENTER

3-74



Sample Printout for Two-Phase Chemical Equilibrium Flow

SUPERSONIC FLOW ANALYSIS USING THE LOCKHEED-HUNTSVILLE MULTIPLE SHOCK COMPUTER PROGRAM  
GAS-PARTICLE FLOW SOLUTION  
CASE NO. 1

PAGE 149

SPACE SHUTTLE SEP MOTOR NOZZLE

LINE	POINT	DESCRIP - REGIME	MACH	ANGLE	PRESSURE	DENSITY	TEMPERATURE	ENTROPY	VELOCITY	H-TOTAL	SHOCK ANGLE	ITEM
PARTICLE DATA			V	THETA	D	H	ENTHALPY	DENSITY	TEMPERATURE			
116	1	WALL - CONTIN	.00000	.1675E+01	.3234E+01	.00000	.00000	.66197E+03	.0160E+04	.1126E+08		3
PARTICLE DATA			.1806E+02	.1806E+02	.5064E+03	.2592E+04	.1981E+04	.1236E+01				
1	1		.79467E+04	.00000	.8079E+01	.2243E+08	.2107E+05	.2742E+04				
2	1		.76916E+04	.00000	.1028E+00	.3996E+05	.3996E+05	.2840E+04				
3	1		.77602E+04	.00000	.1547E+00	.2547E+08	.4374E+05	.3137E+04				
4	1		.76095E+04	.00000	.2147E+00	.2823E+08	.4924E+05	.3470E+04				
5	1		.72750E+04	.00000	.3471E+00	.3334E+08	.6404E+05	.4106E+04				
6	1		.67531E+04	.00000	.5544E+00	.3987E+08	.9532E+05	.4188E+04				
117	77	FREED - CONTIN	.1012E+01	.9507E+00	.8319E+01	.6900E+02	.6977E+02	.1011E+05	.1197E+08			2
PARTICLE DATA			.4903E+01	.3144E+01	.4142E+05	.5514E+03	.1981E+04	.1352E+01				
NO PARTICLES ARE PRESENT AT THIS POINT												
A NEW STREAMLINE HAS BEEN INSERTED ON LINE 117 BETWEEN POINTS 25 AND 26												
117	1	WALL - CONTIN	.00000	.1694E+01	.3264E+01	.00000	.00000	.6642E+03	.0184E+04	.1196E+08		3
PARTICLE DATA			.1783E+02	.1707E+02	.4839E+03	.2565E+04	.1981E+04	.1236E+01				
1	1		.79478E+04	.00000	.8647E+01	.2232E+08	.2053E+05	.2749E+04				
2	1		.79031E+04	.00000	.1122E+00	.2290E+08	.3936E+05	.2830E+04				
3	1		.77724E+04	.00000	.1444E+00	.2539E+08	.4318E+05	.3124E+04				
4	1		.76208E+04	.00000	.2248E+00	.2810E+08	.4897E+05	.3461E+04				
5	1		.72680E+04	.00000	.3574E+00	.3319E+08	.6319E+05	.4088E+04				
6	1		.67467E+04	.00000	.5654E+00	.3874E+08	.9464E+05	.4188E+04				
118	73	FREED - CONTIN	.1026E+01	.9540E+00	.8319E+01	.6874E+02	.6977E+02	.1011E+05	.1197E+08			2
PARTICLE DATA			.4903E+01	.3144E+01	.4142E+05	.5514E+03	.1981E+04	.1352E+01				
NO PARTICLES ARE PRESENT AT THIS POINT												
POINT NO. 21 ON LINE 117 HAS BEEN DELETED												
A NEW STREAMLINE HAS BEEN INSERTED ON LINE 116 BETWEEN POINTS 51 AND 52												
A NEW STREAMLINE HAS BEEN INSERTED ON LINE 116 BETWEEN POINTS 53 AND 54												

NOTES: (1) Typical printout for a data surface in the exhaust plume.  
(2) Some points have been omitted for demonstration purposes.

LOCKHEED-HUNTSVILLE RESEARCH & ENGINEERING CENTER

3-75

**Sample Printout for Single-Phase Chemical Equilibrium  
Flow with Free Molecular Considerations**

Sample Printout for Single-Phase Chemical Equilibrium Flow With Free Molecular Considerations

SUPERSONIC FLOW ANALYSIS USING THE LOCKHEED-HUNTSVILLE MULTIPLE SHOCK COMPUTER PROGRAM

CASE NO. 1

PAGE 1

GASEOUS CHECK CASE WITH FREE MOLECULAR CALCULATIONS CONSIDERED

RUN CONTROL PARAMETERS							
ICON(1)	ICON(2)	ICON(3)	ICON(4)	ICON(5)	ICON(6)	ICON(7)	ICON(8)
1	2	21	2	1	0	1	2
ICON(9)	ICON(10)	ICON(11)	ICON(12)	ICON(13)	ICON(14)	ICON(15)	ICON(16)
0	99	1	1	1	0	0	100

FLOW CALCULATIONS ARE IN ENGLISH UNITS WITH THE X,Y COORDINATES IN FEET

THE FLOW FIELD DATA WILL NOT BE WRITTEN ON TAPE

UPPER BOUNDARY							
TYPE	ITRANS	A	B	C	D	E	MAX
2	1	.00000	.00000	.00000	+26795+00	.16969+00	.30969+01
3	0	.20000-02	.00000	.00000	.00000	.00000	.10000+04
LOWER BOUNDARY							
TYPE	ITRANS	A	B	C	D	E	MAX
2	0	.30000	.00000	.00000	.00000	.00000	.10000+04

THERE ARE 0 PARTICLE SPECIES PRESENT IN THE GAS-PARTICLE MIXTURE

THE FOLLOWING GAS PROPERTIES IN ENGLISH UNITS ARE FOR IDEAL GAS  
REAL GAS PROPERTIES

O/F	S	V	R	GAMMA	T	P	PR	VIS	CP
.00000	.00000	.00000	.20016+04	.11793+01	.54684+04	.18000+04	.00000	.00000	.00000
		.34536+04	.19925+04	.11911+01	.60256+04	.10187+04	.00000	.00000	.00000
		.55746+04	.19840+04	.12121+01	.42190+04	.35999+03	.00000	.00000	.00000
		.64915+04	.19820+04	.12224+01	.37476+04	.18000+03	.00000	.00000	.00000
		.71902+04	.19813+04	.12297+01	.32994+04	.90000+02	.00000	.00000	.00000
		.77605+04	.19811+04	.12344+01	.28962+04	.45001+02	.00000	.00000	.00000
		.83577+04	.19811+04	.12376+01	.24300+04	.18000+02	.00000	.00000	.00000
		.89543+04	.19811+04	.12331+01	.19319+04	.60004+01	.00000	.00000	.00000
		.91468+04	.19811+04	.12317+01	.17298+04	.36005+01	.00000	.00000	.00000

Sample Printout for Single-Phase Chemical Equilibrium Flow With Free Molecular Considerations

SUPERSONIC FLOW ANALYSIS USING THE LOCKHEED-HUNTSVILLE MULTIPLE SHOCK COMPUTER PROGRAM

CASE NO. 1

PAGE 2

GASEOUS CHECK CASE WITH FREE MOLECULAR CALCULATIONS CONSIDERED  
REAL GAS PROPERTIES

H-TOTAL

S	V	R	GAMMA	T	P	PR	VIS	CP
.00000	.93361+04	.19811+04	.12944+01	.14814+04	.18003+01	.00000	.00000	.00000

STARTING LINE INFO

R	V	M	THETA	S	MACH ANGLE	SHOCK ANGLE	O/F
.00000	.32324+01	.42555+n1	.00000	.00000	.13591+02	.00000	.00000
.51977-01	.32320+01	.42541+n1	.82494+0n	.00000	.13595+02	.00000	.00000
.10396+00	.32309+01	.42533+n1	.16503+01	.00000	.13598+02	.00000	.00000
.15590+00	.32290+01	.42524+n1	.24726+01	.00000	.13601+02	.00000	.00000
.20777+00	.32284+01	.42513+n1	.32907+01	.00000	.13605+02	.00000	.00000
.25955+00	.32230+01	.42498+n1	.41031+01	.00000	.13609+02	.00000	.00000
.31122+00	.32190+n1	.42479+n1	.49070+01	.00000	.13616+02	.00000	.00000
.36271+00	.32142+01	.42454+n1	.56994+01	.00000	.13624+02	.00000	.00000
.41401+00	.32087+n1	.42420+n1	.64770+01	.00000	.13635+02	.00000	.00000
.46505+00	.32026+n1	.42376+n1	.72345+01	.00000	.13649+02	.00000	.00000
.51577+00	.31958+01	.42317+n1	.79646+01	.00000	.13669+02	.00000	.00000
.56608+00	.31865+01	.42239+n1	.86586+01	.00000	.13695+02	.00000	.00000
.61587+00	.31806+n1	.42141+n1	.93123+01	.00000	.13727+02	.00000	.00000
.66508+00	.31723+01	.42031+n1	.99397+01	.00000	.13764+02	.00000	.00000
.71372+00	.31635+01	.41931+n1	.10576+02	.00000	.13797+02	.00000	.00000
.76189+00	.31542+01	.41858+n1	.11251+02	.00000	.13822+02	.00000	.00000
.80975+00	.31443+01	.41812+n1	.11967+02	.00000	.13837+02	.00000	.00000
.85742+00	.31319+01	.41785+n1	.12710+02	.00000	.13846+02	.00000	.00000
.90499+00	.31228+n1	.41770+n1	.13467+02	.00000	.13851+02	.00000	.00000
.95246+00	.31111+01	.41763+n1	.14232+02	.00000	.13854+02	.00000	.00000
.10000+01	.30987+01	.41757+n1	.15000+02	.00000	.13856+02	.00000	.00000

51

RUN CUTOFF INFORMATION

R=	.10000+03	X=	.10000+03	THETA=	.00000	R=	.00000	X=	.20000+02	THETA=	.90000+02
VIBNO	108	ROTN0	109	TRANNO	110	CHARL	111	GAMV	112	GAMR	113
	.10000+03		.50000+07		.20000+02		.10000+01		.00000		.00000

} Group 16\*

THE MESH CONSTRUCTION WILL BE CONTROLLED BY THE FOLLOWING VARIABLES

DL INTERIOR= .300+01 OX AXIS= .100+01 DL LIM= .100+01 DL DELETE= .500-02 DEG P.H.= .500+01 F= .500+00

\*NOTE: Free molecular flow calculations can also be included in the gas-particle flow.

LOCKHEED - HUNTSVILLE RESEARCH & ENGINEERING CENTER

3-78

REPRODUCIBILITY OF THE ORIGINAL PAGE IS POOR

# Sample Printout for Single-Phase Chemical Equilibrium Flow With Free Molecular Considerations

SUPERSONIC FLOW ANALYSIS USING THE LOCKHEED-HUNTSVILLE MULTIPLE SHOCK COMPUTER PROGRAM

CASE NO. 1

PAGE 8

(74)

GASEOUS CHECK CASE WITH FREE MOLECULAR CALCULATIONS CONSIDERED

LINE	POINT	DESCRIP	REGIME	R MACH	X ANGLE	M PRESSURE	M DENSITY	THETA TEMPERATURE	ENTROPY GAS CONST.	VELOCITY LOCAL GAMMA	SHOCK ANGLE	ITER
1	14	INPUT	CONTIN	.64508+00 .13764+02	.31723+01 .46950+01	.42031+01 .18630-03	.99397+01 .18318+04	.00000 .19811+04	.90499+04 .12775+01	.00000	0	
1	15	INPUT	CONTIN	.71372+00 .13797+02	.31435+01 .47737+01	.41931+01 .18874-03	.10576+02 .18384+04	.00000 .19811+04	.90436+04 .12772+01	.00000	0	
1	16	INPUT	CONTIN	.74189+00 .13822+02	.31442+01 .48127+01	.41856+01 .19057-03	.11251+02 .18433+04	.00000 .19811+04	.90389+04 .12770+01	.00000	0	
1	17	INPUT	CONTIN	.80975+00 .13837+02	.31443+01 .48701+01	.41812+01 .19172-03	.11967+02 .18463+04	.00000 .19811+04	.90360+04 .12768+01	.00000	0	
1	18	INPUT	CONTIN	.85742+00 .13846+02	.31439+01 .48917+01	.41785+01 .19239-03	.12710+02 .18481+04	.00000 .19811+04	.90343+04 .12768+01	.00000	0	
1	19	INPUT	CONTIN	.90499+00 .13851+02	.31428+01 .49038+01	.41770+01 .19276-03	.13467+02 .18491+04	.00000 .19811+04	.90334+04 .12767+01	.00000	0	
1	20	INPUT	CONTIN	.95246+00 .13854+02	.31411+01 .49100+01	.41760+01 .19295-03	.14232+02 .18496+04	.00000 .19811+04	.90329+04 .12767+01	.00000	0	
1	21	INPUT	CONTIN	1.0000+01 .13856+02	.30989+01 .49144+01	.41757+01 .19309-03	.15000+02 .18499+04	.00000 .19811+04	.90325+04 .12767+01	.00000	0	
1	22	PRN=NR	CONTIN	1.0000+01 .12812+02	.30989+01 .28278+01	.45091+01 .12547-03	.19869+02 .18388+04	.00000 .19811+04	.92165+04 .12865+01	.00000	0	
1	23	PRN=NR	CONTIN	1.0000+01 .11747+02	.30989+01 .15766+01	.49115+01 .77372-04	.24750+02 .14247+04	.00000 .19811+04	.93888+04 .12944+01	.00000	0	
1	24	PRN=NR	CONTIN	1.0000+01 .10807+02	.30989+01 .85363+00	.53333+01 .49631-04	.29624+02 .12502+04	.00000 .19811+04	.95494+04 .12944+01	.00000	0	
1	25	PRN=NR	CONTIN	1.0000+01 .99024+01	.30989+01 .45765+00	.58146+01 .30661-04	.34499+02 .10849+04	.00000 .19811+04	.96989+04 .12944+01	.00000	0	
1	26	PRN=NR	CONTIN	1.0000+01 .90295+01	.30989+01 .23197+00	.63717+01 .18139-04	.39374+02 .92955+03	.00000 .19811+04	.98375+04 .12944+01	.00000	0	

3-79

LOCKHEED-HUNTSVILLE RESEARCH & ENGINEERING CENTER

NOTES: (1) Typical printout for a startline data surface containing a Prandtl-Meyer Expansion.  
 (2) Some points have been omitted for demonstration purposes.

# Sample Printout for Single-Phase Chemical Equilibrium Flow With Free Molecular Considerations

SUPERSONIC FLOW ANALYSIS USING THE LOCKHEED-HUNTSVILLE MULTIPLE SHOCK COMPUTER PROGRAM

CASE NO. 1

PAGE 12

GASEOUS CHECK CASE WITH FREE MOLECULAR CALCULATIONS CONSIDERED

LINE	POINT	DESCRIP	REGIME	R MACH	X ANGLE	M PRESSURE	M DENSITY	THETA TEMPERATURE	ENTROPY GAS CONST.	VELOCITY LOCAL GAMMA	SHOCK ANGLE	ITER
2	27	INTER	CONTIN.	.10613+01 .80887+01	.31227+01 .10268+00	.71067+01 .95186-05	.44254+02 .76883+03	.00000 .19811+04	.79788+04 .12944+01	.00000	4	
2	28	INTER	CONTIN	.10686+01 .72641+01	.31756+01 .43634-01	.79005+01 .49804-05	.49073+02 .63535+03	.00000 .19811+04	.10095+05 .12944+01	.00000	4	
2	29	INTER	CONTIN	.10753+01 .64628+01	.31480+01 .17134-01	.88839+01 .24233-05	.53898+02 .51393+03	.00000 .19811+04	.10199+05 .12944+01	.00000	4	
2	30	INTER	CONTIN	.10812+01 .56815+01	.31599+01 .60227-02	.10100+02 .10777-05	.58729+02 .40486+03	.00000 .19811+04	.10292+05 .12944+01	.00000	4	
2	31	INTER	CONTIN	.10864+01 .49174+01	.31515+01 .18136-02	.11665+02 .42748-06	.63566+02 .30837+03	.00000 .19811+04	.10373+05 .12944+01	.00000	4	
2	32	INTER	CONTIN	.10908+01 .41677+01	.31427+01 .45095-03	.13757+02 .14587-06	.68408+02 .22470+03	.00000 .19811+04	.10443+05 .12944+01	.00000	5	
2	33	INTER	CONTIN	.10946+01 .34302+01	.31136+01 .85775-04	.14708+02 .40470-07	.73254+02 .15406+03	.00000 .19811+04	.10502+05 .12944+01	.00000	5	
2	34	INTER	CONTIN	.10976+01 .27032+01	.31244+01 .11044-04	.21190+02 .83055-08	.78110+02 .96649+02	.00000 .19811+04	.10549+05 .12944+01	.00000	4	
2	35	FREEFB	CONTIN	.10987+01 .27780+01	.31201+01 .13007-04	.20603+02 .99245-08	.77877+02 .10185+03	.00000 .19811+04	.10545+05 .12944+01	.00000	4	

POINT NO. 34 ON LINE 2 HAS BEEN DELETED

PERCENT CHANGE IN MASS, MOMENTUM AND ENERGY NUMERICAL INTEGRATION FOR LINE 2 RELATIVE TO THE START LINE  
 THE PERCENT CHANGE IN MASS FLOW IS = -.220844+00  
 PERCENT CHANGE IN MOMENTUM IS = .18840+04 ISP = -.19527+01  
 PERCENT CHANGE IN ENERGY IS = .00000

NOTES: (1) Typical printout for a data surface in the exhaust plume.  
 (2) Some points have been omitted for demonstration purposes.

LOCKHEED - HUNTSVILLE RESEARCH & ENGINEERING CENTER

3-80

# Sample Printout for Single-Phase Chemical Equilibrium Flow With Free Molecular Considerations

SUPERSONIC FLOW ANALYSIS USING THE LOCKHEED-HUNTSVILLE MULTIPLE SHOCK COMPUTER PROGRAM

CASE NO. 1

PAGE 23

GASEOUS CHECK CASE WITH FREE MOLECULAR CALCULATIONS CONSIDERED

LINE	POINT	DESCRIP	REGIME	R MACH	X ANGLE	P PRESSURE	H DENSITY	THETA TEMPERATURE	ENTROPY GAS CONST.	VELOCITY LOCAL GAMMA	D/F SHOCK ANGLE	ITR
6	29	INTER	CONTIN	.11712+01 .57651+01	.32324+01 .67428-02	.99553+01 .11817-05	.57858+02 .41599+03	.00000 .19811+04	.10282+05 .12944+01	.00000	5	
6	30	INTER	CONTIN	.11808+01 .50786+01	.32158+01 .23711-02	.11297+02 .52584-06	.62206+02 .32776+03	.00000 .19811+04	.10357+05 .12944+01	.00000	5	
6	31	INTER	CONTIN	.11890+01 .43988+01	.31987+01 .71057-03	.13032+02 .20727-06	.66612+02 .24919+03	.00000 .19811+04	.10423+05 .12944+01	.00000	4	
6	32	INTER	FREE M	.11956+01 .45607+01	.31824+01 .21450-03	.12576+02 .75136-07	.69344+02 .20930+03	.00000 .19811+04	.10455+05 .16670+01	.00000	1	
6	33	INTER	FREE M	.12013+01 .30782+01	.31656+01 .43479-04	.14735+02 .20778-07	.73346+02 .15280+03	.00000 .19811+04	.10503+05 .16670+01	.00000	1	
6	34	INTER	FREE M	.12073+01 .31529+01	.31415+01 .72497-05	.18137+02 .5173-07	.78371+02 .10185+03	.00000 .19811+04	.10545+05 .16670+01	.00000	1	

3-81

LOCKHEED-HUNTSVILLE RESEARCH & ENGINEERING CENTER

PERCENT CHANGE IN MASS, MOMENTUM AND ENERGY NUMERICAL INTEGRATION FOR LINE 6 RELATIVE TO THE START LINE  
 THE PERCENT CHANGE IN MASS FLOW IS = -.161987+01  
 PERCENT CHANGE IN MOMENTUM IS = .18485+04 ISP = .23162+01  
 PERCENT CHANGE IN ENERGY IS = .00000

- NOTES: (1) Typical printout for a data surface containing free molecular points.  
 (2) Some points have been omitted for demonstration purposes.

**Sample Printout for Single-Phase  
Finite Rate Chemistry Flow**



## Sample Printout for Single-Phase Finite Rate Chemistry Flow

SUPERSONIC FLOW ANALYSIS USING THE LOCKHEED-HUNTSVILLE MULTIPLE SHOCK COMPUTER PROGRAM

GAS-PARTICLE FLOW SOLUTION

CASE NO. 21

PAGE 1

CASE 2) - SODLR6 6/1 CONE, D/F=2.2, FINITE RATE, INVISCID, VAR D/F

PIN CONTROL PARAMETERS

ICON(1)	ICON(2)	ICON(3)	ICON(4)	ICON(5)	ICON(6)	ICON(7)	ICON(8)
3	2	21	2	1	0	1	3
ICON(9)	ICON(10)	ICON(11)	ICON(12)	ICON(13)	ICON(14)	ICON(15)	ICON(16)
0	50	21	1	0	0	0	3010

FLOW CALCULATIONS ARE IN ENGLISH UNITS WITH THE R,X COORDINATES IN FEET

THE FLOW FIELD DATA WILL BE WRITTEN ON TAPE

1

UPPER BOUNDARY

TYPE	ITRANS	A	B	C	D	E	MAX
2	1	.00000	.00000	.00000	.26795+00	.36781-01	.20517+00
3	0	.19400+02	.14000+01	.00000	.00000	.00000	.83333+01

LOWER BOUNDARY

TYPE	ITRANS	A	B	C	D	E	MAX
2	0	.00000	.00000	.00000	.00000	.00000	.83333+01

3-83

Sample Printout for Single-Phase Finite Rate Chemistry Flow

SPECIE THERMODYNAMIC AND REACTION DATA

NT,NS,NR,NN,ICTAPE,KGUP,IOJOO = 115 16 23 3 0 1 114

PRANDTL NUMBER = .70000000+00  
 BASE VISCOSITY = .1845198-05  
 EXPONENT = .80000000+00

REACTIONS BEING CONSIDERED	KR=A*EXP(B/RT+C*LN(T)+D)	A	B	C	D	R-TYPE	K-TYPE
1 H + OH = H2O + H	2.21E+22	2.0	.0	.0	.0	2	2
2 O + H = OH	7.26E+15	.0	.0	.0	.0	2	1
3 H + O = OH	1.37E+18	1.0	-340.0	.0	.0	2	4
4 H + H = H2	1.02E+18	1.0	.0	.0	.0	2	2
5 CO + O = CO2	7.26E+14	.0	-4000.0	.0	.0	2	3
6 OH + H = H2O	8.43E+09	-1.0	-7000.0	.0	.0	1	4
7 OH + O = OH2	2.41E+13	.0	.0	.0	.0	1	1
8 OH + H2 = H2O + H	4.02E+08	-2.0	-2900.0	.0	.0	1	4
9 OH + CO = CH2O + H	4.62E+04	-2.0	1400.0	.0	.0	1	4
10 OH + OH = H2O + O	4.02E+12	.0	-1100.0	.0	.0	1	3
11 CH4 + OH = CH3 + H2O	2.83E+13	.0	-5000.0	.0	.0	1	3
12 CH4 + H = CH3 + H2	1.94E+13	.0	-5000.0	.0	.0	1	3
13 CH4 + O = CH3 + OH	7.10E+13	.0	-9100.0	.0	.0	1	3
14 CH3 + O = CH2O + H	4.62E+13	.0	.0	.0	.0	1	1
15 CH2O + OH = CHO + H2O	5.42E+11	-1.5	.0	.0	.0	1	2
16 CH2O + H = CHO + H2	1.32E+13	.0	-3800.0	.0	.0	1	3
17 CH2O + O = CHO + OH	9.64E+10	.0	.0	.0	.0	1	3
18 CH2O + H2 = CO + H2O	2.10E+16	.0	-35000.0	.0	.0	5	3
19 CHO + OH = CO + H2O	1.26E+14	.0	.0	.0	.0	1	1
20 CHO + H = CO + H2	5.001E+13	.0	-10000.0	.0	.0	1	3
21 CHO + O = CO + OH	1.28E+14	.0	.0	.0	.0	1	1
22 CHO + O2 = CO + H	5.001E+13	.0	-1400.0	.0	.0	7	3
23 CHO + H2 = CO + H	7.23E+13	.0	-15000.0	.0	.0	5	3

CATALYTIC SPECIES BEING CONSIDERED 126

M1 = 1.00 C	1.00 CH4	1.00 CO	1.00 H2	10.00 H2O	1.00 NH3	1.00 N2
2.00 CO2	1.00 H	1.00 NO	1.00 OH	1.00 O	1.00 O2	1.00 CH3
1.00 CH2O	1.00 CHO					
M2 = 1.00 C	1.00 CH4	1.00 CO	1.00 H2	10.00 H2O	1.00 NH3	1.00 N2
3.00 CO2	1.00 H	1.00 NO	2.00 OH	1.00 O	1.00 O2	1.00 CH3
1.00 CH2O	1.00 CHO					
M3 = 1.00 C	1.00 CH4	1.50 CO	1.00 H2	10.00 H2O	1.00 NH3	1.00 N2
3.00 CO2	1.00 H	1.00 NO	1.00 OH	1.00 O	20.00 O2	1.00 CH3
1.00 CH2O	1.00 CHO					

Group 17

LOCKHEED-HUNTSVILLE RESEARCH & ENGINEERING CENTER

Sample Printout for Single-Phase Finite Rate Chemistry Flow

SPECIE MOLE FRACTIONS ON THE START LINE ARE READ FROM CARDS

POINT	C	CH4	CO	H2	H2O	NH3	N2	CO2	H	NO
1	.74780-01	.20780+00	.43820-03	.43150+00	.85700-03	.12570-02	.28310+00	.56340-06	.00000	.00000
1	OH	O	O2	CH3	CH2O	CHO				
	.00000	.00000	.00000	.00000	.00000	.00000				
2	.79100-01	.18990+00	.61360-02	.43860+00	.69990-02	.11890-02	.27820+00	.18310-03	.00000	.00000
2	OH	O	O2	CH3	CH2O	CHO				
	.00000	.00000	.00000	.00000	.00000	.00000				
3	.57070-01	.12470+00	.62990-01	.97090+00	.16650-01	.88890-03	.26610+00	.16870-02	.00000	.00000
3	OH	O	O2	CH3	CH2O	CHO				
	.00000	.00000	.00000	.00000	.00000	.00000				
4	.00000	.22430-01	.16690+00	.98510+00	.80060-01	.35010-03	.25730+00	.79110-02	.12170-03	.28950-06
4	OH	O	O2	CH3	CH2O	CHO				
	.73240-05	.00000	.00000	.00000	.00000	.00000				
5	.00000	.32460-06	.15790+00	.31630+00	.21750+00	.28520-04	.78330+00	.21290-01	.29960+02	.12450-03
5	OH	O	O2	CH3	CH2O	CHO				
	.11610-02	.27660-04	.17390-04	.00000	.00000	.00000				
6	.00000	.00000	.12350+00	.15270+00	.34160+00	.45090-05	.31050+00	.94860-01	.10100-01	.29970-02
6	OH	O	O2	CH3	CH2O	CHO				
	.11410-01	.10340-02	.18890-02	.00000	.00000	.00000				
7	.00000	.00000	.81030-01	.45810-01	.38490+00	.00000	.32900+00	.71660-01	.12700-01	.81070-02
7	OH	O	O2	CH3	CH2O	CHO				
	.29160-01	.39190-02	.12170-01	.00000	.00000	.00000				
8	.00000	.00000	.56790-01	.39920-01	.38490+00	.00000	.32950+00	.89300-01	.96300-02	.14290-01
8	OH	O	O2	CH3	CH2O	CHO				
	.39140-01	.47750-02	.35730-01	.00000	.00000	.00000				

NOTE: Some points have been omitted for demonstration purposes.

Sample Printout for Single-Phase Finite Rate Chemistry Flow

20	OH	O	O2	CH3	CH2O	CHO				
	.17030-02	.33800-04	.21280-04	.00000	.00000	.00000				
21	C	CH4	CO	H2	H2O	NH3	N2	CO2	H	NO
	.00000	.74950-07	.14080+00	.21720+00	.30120+00	.62950-05	.30130+00	.33010-01	.45300-02	.17100-03
21	OH	O	O2	CH3	CH2O	CHO				
	.17030-02	.33800-04	.21280-04	.00000	.00000	.00000				

CHAMBER PRESSURE (ATM) = .34014+02 CHAMBER TEMPERATURE (DEG.K) = .32361+04

Group 18  
(Cont'd)

129

130

THERE ARE 0 PARTICLE SPECIES PRESENT IN THE GAS-PARTICLE MIXTURE

RUN CUTOFF INFORMATION

UPPER BOUNDARY LOWER BOUNDARY  
 R = .25000+01 X = .00000 THETA = .00000 R = .00000 X = .60000+00 THETA = .90000+02

THE MESH CONSTRUCTION WILL BE CONTROLLED BY THE FOLLOWING VARIABLES

DL INTERIOR = .150-01 DX AXIS = .150-01 DL LIM = .000 DL DELETE = .100-04 DEG P.H. = .400+01 F = .375+00

LOCKHEED - HUNTSVILLE RESEARCH & ENGINEERING CENTER

3-86

## Sample Printout for Single-Phase Finite Rate Chemistry Flow

SUPERSONIC FLOW ANALYSIS USING THE LOCKHEED-HUNTSVILLE MULTIPLE SHOCK COMPUTER PROGRAM

GAS-PARTICLE FLOW SOLUTION

CASE NO. 21

PAGE 2

CASE 21 - 500LAF 6/1 CONE, O/F=2.2, FINITE RATE, INVISCID, VAR O/F

LOCKHEED-HUNTSVILLE RESEARCH & ENGINEERING CENTER

LINE	POINT	DESCRIP	REGIME	R MACH	X ANGLE TO*	P PRESSURE PO*	M DENSITY S*	THETA TEMPERATURE	ENTROPY GAS CONST.	VELOCITY LOCAL GAMMA	M-TOTAL SHOCK ANGLE	ITR	
1	1	INPUT	CONTIN	.00000		.84167-02	.10274+01	.00000	.00000	.31052+04	.13224+08	0	
				.76745+02		.27517+03	.54912-02	.18993+04	.37993+04	.12660+01			
				.21660+04		.51429+03	.00000						
CHEMICAL SPECIE MOLE FRACTIONS													
C	7.4785-02	CH4	2.0781-01	CO	6.3874-04	H2	4.3153-01	H2O	8.5705-04	NH3	1.2571-03	N2	2.8312-01
CO2	5.6364-06	H	0.0000	NO	0.0000	OH	0.0000	0	0.0000	O2	0.0000	CH3	0.0000
CH2O	0.0000	CHO	0.0000										
1	2	INPUT	CONTIN	.19561-02		.84167-02	.10291+01	.74624+04	.00000	.31113+04	.12984+08	0	
				.76336+02		.27440+03	.53672-02	.19242+04	.38260+04	.1212+01			
				.22006+04		.51479+03	.00000						
CHEMICAL SPECIE MOLE FRACTIONS													
C	7.9104-02	CH4	1.8991-01	CO	6.3363-03	H2	4.3862-01	H2O	6.4493-03	NH3	1.1841-02	N2	2.7821-01
CO2	1.8311-04	H	0.0000	NO	0.0000	OH	0.0000	0	0.0000	O2	0.0000	CH3	0.0000
CH2O	0.0000	CHO	0.0000										
1	3	INPUT	CONTIN	.39122-02		.84167-02	.10238+01	.15011+01	.00000	.32426+04	.11265+09	0	
				.77629+02		.27475+03	.50759-02	.20735+04	.37591+04	.12870+01			
				.23854+04		.51502+03	.00000						
CHEMICAL SPECIE MOLE FRACTIONS													
C	5.7074-02	CH4	1.2471-01	CO	6.2444-02	H2	4.7043-01	H2O	1.6651-02	NH3	8.8846-04	N2	2.5612-01
CO2	1.6871-03	H	0.0000	NO	0.0000	OH	0.0000	0	0.0000	O2	0.0000	CH3	0.0000
CH2O	0.0000	CHO	0.0000										
1	4	INPUT	CONTIN	.58682-02		.84167-02	.10214+01	.22464+01	.00000	.35142+04	.69241+07	0	
				.74256+02		.27276+03	.43259-02	.26733+04	.33964+04	.13038+01			
				.30969+04		.51283+03	.00000						
CHEMICAL SPECIE MOLE FRACTIONS													
C	0.0000	CH4	2.2633-02	CO	1.6692-01	H2	4.8516-01	H2O	6.0067-02	NH3	3.5014-04	N2	2.5733-01
CO2	7.4119-03	H	1.2171-04	NO	2.8453-07	OH	7.0268-06	0	0.0000	O2	0.0000	CH3	0.0000
CH2O	0.0000	CHO	0.0000										

NOTES: (1) Typical printout for the startline data surface.  
 (2) Some points have been omitted for demonstration purposes.

Sample Printout for Single-Phase Finite Rate Chemistry Flow

SUPERSONIC FLOW ANALYSIS USING THE LOCKHEED-HUNTSVILLE MULTIPLE SHOCK COMPUTER PROGRAM

GAS-PARTICLE FLOW SOLUTION

CASE NO. 21

PAGE 45

CASE 21 - 500LDF 6/1 CONE, O/F=2.7, FINITE RATE, INVISCID, VAR O/F

LINE	POINT	DESCRIP - REGIME	R RACH ANGLE TO*	X PRESSURE PO*	M DENSITY S*	THETA TEMPERATURE	ENTROPY GAS CONST.	VELOCITY LOCAL GAMMA	H-TOTAL SHOCK ANGLE	ITP
60	1	WALL - CONTIN	.00000 .29896+02 .22201+04	.62272-01 .65120+02 .35364+03	.20063+01 .17854-02 .00000	.00000 .13825+04	.91272-05 .37993+04	.52447+04 .13011+01	.13194+09	3

CHEMICAL SPECIE MOLE FRACTIONS

(131)

C	7.4785-02	CH4	2.3781-01	CO	6.3824-04	H2	4.3153-01	H2O	8.5705-04	NH3	1.2571-03	N2	2.8312-01
CO2	5.6364-06	H	3.4528-19	NO	0.0000	OH	1.7397-25	O	3.9207-35	O2	0.0000	CH3	3.0251-18
CH2O	5.1725-10	CHO	1.1351-18										

60	21	WALL - CONTIN	.51639-01 .30733+02 .56034+04	.55452-01 .70385+02 .35518+03	.19568+01 .10656-02 .00000	.15000+02 .37867+04	.77017+02 .25158+04	.67522+04 .12518+01	.36075+07	3
----	----	---------------	-------------------------------------	-------------------------------------	----------------------------------	------------------------	------------------------	------------------------	-----------	---

CHEMICAL SPECIE MOLE FRACTIONS

C	0.0000	CH4	4.9604-08	CO	1.4019-01	H2	2.1814-01	H2O	3.0192-01	NH3	8.3046-06	N2	3.0145-01
CO2	3.3906-02	H	3.4555-03	NO	1.7120-04	OH	6.3044-04	O	6.4868-06	O2	4.3406-06	CH3	1.9276-08
CH2O	9.5135-08	CHO	1.4114-05										

3-88

PRESSURE INTEGRATION RESULTS

FORCEX	FORCEY	TORQZ	DELFX	DELFY	ISP
-.47885+03	.00000	.00000	-.14807+01	.00000	.24229+03

61	1	WALL - CONTIN	.00000 .29606+02 .22220+04	.64003-01 .63188+02 .34987+03	.20242+01 .17445-02 .00000	.00000 .13728+04	.91334-05 .37993+04	.52747+04 .13019+01	.13195+09	3
----	---	---------------	----------------------------------	-------------------------------------	----------------------------------	---------------------	------------------------	------------------------	-----------	---

CHEMICAL SPECIE MOLE FRACTIONS

C	7.4785-02	CH4	2.0781-01	CO	6.3824-04	H2	4.3153-01	H2O	8.5705-04	NH3	1.2571-03	N2	2.8312-01
CO2	5.6364-06	H	3.3760-19	NO	0.0000	OH	1.5902-25	O	2.5212-35	O2	0.0000	CH3	2.9582-18
CH2O	5.1736-10	CHO	1.2096-18										

61	21	WALL - CONTIN	.52095-01 .30445+02 .56055+04	.57151-01 .68429+02 .35064+03	.19735+01 .10418-02 .00000	.15000+02 .37597+04	.78910+02 .25158+04	.67916+04 .12521+01	.36068+07	3
----	----	---------------	-------------------------------------	-------------------------------------	----------------------------------	------------------------	------------------------	------------------------	-----------	---

CHEMICAL SPECIE MOLE FRACTIONS

C	0.0000	CH4	4.9635-08	CO	1.4015-01	H2	2.1819-01	H2O	3.0190-01	NH3	8.3047-06	N2	3.0165-01
CO2	3.3845-02	H	3.4303-03	NO	1.7120-04	OH	6.1685-04	O	6.3040-06	O2	4.2352-06	CH3	1.9187-08
CH2O	9.2748-08	CHO	1.4215-05										

PRESSURE INTEGRATION RESULTS

FORCEX	FORCEY	TORQZ	DELFX	DELFY	ISP
-.48033+03	.00000	.00000	-.14831+01	.00000	.24304+03

NOTES: (1) Typical printout for a data surface inside the nozzle.  
(2) Some points have been omitted for demonstration purposes.

LOCKHEED - HUNTSVILLE RESEARCH & ENGINEERING CENTER

Sample Printout for Single-Phase Finite Rate Chemistry Flow

SUPERSONIC FLOW ANALYSIS USING THE LOCKHEED-HUNTSVILLE MULTIPLE SHOCK COMPUTER PROGRAM

GAS-PARTICLE FLOW SOLUTION

CASE NO. 21

PAGE 89

CASE 21 - 500LRF 4/1 CONE, O/F=2.2, FINITE RATE, INVISCID, VAR O/F

LINE	POINT	DESCRIP - REGIME	R MACH ANGLE TO*	X PRESSURE PO*	M DENSITY S*	THETA TEMPERATURE	ENTROPY GAS CONST.	VELOCITY LOCAL GAMMA	H-TOTAL SHOCK ANGLE	ITR			
114	25	PRN-HR - CONTIN	.91755-01 .16222+02 .66307+04	.20517+00 .39106+01 .63180+02	.35807+01 .10798-03 .00000	.29767+02 .20740+04	.12437+03 .25145+04	.93012+04 .12938+01	.36189+07	5			
CHEMICAL SPECIE MOLE FRACTIONS													
C	0.0000	CH4	5.0639-08	CO	1.3896-01	H2	2.1947-01	H2O	3.0133-01	NH3	8.3088-06	N2	3.0180-01
CO2	3.5089-02	H	2.9945-03	NO	1.7129-04	OH	1.1603-04	O	1.3375-06	O2	1.6412-06	CH3	1.7015-08
CH2O	2.2823-08	CHO	4.9038-05										
114	26	PRN-HR - CONTIN	.91755-01 .15372+02 .66307+04	.20517+00 .27979+01 .50267+02	.37735+01 .83120-04 .00000	.33459+02 .19277+04	.12437+03 .25145+04	.94722+04 .12999+01	.36189+07	5			
CHEMICAL SPECIE MOLE FRACTIONS													
C	0.0000	CH4	5.0639-08	CO	1.3896-01	H2	2.1947-01	H2O	3.0133-01	NH3	8.3088-06	N2	3.0180-01
CO2	3.5089-02	H	2.9945-03	NO	1.7129-04	OH	1.1603-04	O	1.3375-06	O2	1.6412-06	CH3	1.7015-08
CH2O	2.2823-08	CHO	4.9038-05										
114	27	PRN-HR - CONTIN	.91755-01 .14553+02 .66307+04	.20517+00 .19633+01 .39331+02	.39812+01 .63034-04 .00000	.37150+02 .17837+04	.12437+03 .25145+04	.96366+04 .13063+01	.36189+07	5			
CHEMICAL SPECIE MOLE FRACTIONS													
C	0.0000	CH4	5.0639-08	CO	1.3896-01	H2	2.1947-01	H2O	3.0133-01	NH3	8.3088-06	N2	3.0180-01
CO2	3.5089-02	H	2.9945-03	NO	1.7129-04	OH	1.1603-04	O	1.3375-06	O2	1.6412-06	CH3	1.7015-08
CH2O	2.2823-08	CHO	4.9038-05										
114	28	PRN-HR - CONTIN	.91755-01 .13743+02 .66307+04	.20517+00 .13481+01 .30288+02	.42109+01 .47135-04 .00000	.40842+02 .16380+04	.12437+03 .25145+04	.97943+04 .13135+01	.36189+07	5			
CHEMICAL SPECIE MOLE FRACTIONS													
C	0.0000	CH4	5.0639-08	CO	1.3896-01	H2	2.1947-01	H2O	3.0133-01	NH3	8.3088-06	N2	3.0180-01
CO2	3.5089-02	H	2.9945-03	NO	1.7129-04	OH	1.1603-04	O	1.3375-06	O2	1.6412-06	CH3	1.7015-08
CH2O	2.2823-08	CHO	4.9038-05										

NOTES: (1) Typical printout for a data surface containing a Prandtl-Meyer Expansion.

(2) Some points have been omitted for demonstration purposes.

Sample Printout for Single-Phase Finite Rate Chemistry Flow

SUPERSONIC FLOW ANALYSIS USING THE LOCKHEED-HUNTSVILLE MULTIPLE SHOCK COMPUTER PROGRAM  
GAS-PARTICLE FLOW SOLUTION

CASE NO. 21

PAGE 115

CASE 21 - SOOLRF 6/1 CONE, O/F=2.2, FINITE RATE, INVISCID, VAR O/F

LINE	POINT	DESCRIP - REGIME	R MACH	ANGLE TO*	X PRESSURE PO*	M DENSITY S*	THETA TEMPERATURE	ENTROPY GAS CONST.	VELOCITY LOCAL GAMMA	N-TOTAL SHOCK ANGLE	ITR
129	1	WALL - CONTIN	.00000		.22341+00	.29826+01	.00000	.91677-05	.64753+04	.13187+08	2
			.19590+02		.12303+02	.50779-03	.91833+03	.37993+04	.13509+01		
			.23518+04		.14467+03	.00000					

CHEMICAL SPECIE MOLE FRACTIONS

C	7.4785-02	CH4	2.0781-01	CO	6.3824-04	H2	4.3153-01	H2O	8.5705-04	NH3	1.2571-03	N2	2.8312-01
CO2	5.6364-06	H	1.2664-21	NO	0.0000	OH	5.3647-29	O	0.0000	O2	0.0000	CH3	1.4675-17
CH2O	5.1793-10	CHO	4.3574-18										

129	34	FREEBD - CONTIN	.95802-01		.20754+00	.58115+01	.60194+02	.13845+03	.10475+05	.36062+07	2
			.99084+01		.13472+00	.80696-05	.95627+03	.25140+04	.13514+01		
			.66307+04		.58590+01	.00000					

CHEMICAL SPECIE MOLE FRACTIONS

C	0.0000	CH4	5.0650-08	CO	1.3879-01	H2	2.1951-01	H2O	3.0140-01	NH3	8.3105-06	N2	3.0186-01
CO2	3.5096-02	H	2.7946-03	NO	1.7132-04	OH	1.1569-04	O	1.3377-06	O2	1.6416-06	CH3	1.7018-08
CH2O	2.2825-08	CHO	2.4958-04										

POINT NO. 32 ON LINE 129 HAS BEEN DELETED

130	1	WALL - CONTIN	.00000		.22400+00	.29853+01	.00000	.91677-05	.64778+04	.13186+08	2
			.19571+02		.12248+02	.50609-03	.91725+03	.37993+04	.13511+01		
			.23522+04		.14428+03	.00000					

CHEMICAL SPECIE MOLE FRACTIONS

C	7.4785-02	CH4	2.0781-01	CO	6.3824-04	H2	4.3153-01	H2O	8.5705-04	NH3	1.2571-03	N2	2.8312-01
CO2	5.6364-06	H	1.2617-21	NO	0.0000	OH	5.2150-29	O	0.0000	O2	0.0000	CH3	1.4575-19
CH2O	5.1793-10	CHO	4.3589-18										

130	33	FREEBD - CONTIN	.96187-01		.20776+00	.58109+01	.60318+02	.14056+03	.10475+05	.36064+07	2
			.99094+01		.13472+00	.80679-05	.95660+03	.25139+04	.13514+01		
			.66308+04		.58578+01	.00000					

CHEMICAL SPECIE MOLE FRACTIONS

C	0.0000	CH4	5.0652-08	CO	1.3878-01	H2	2.1952-01	H2O	3.0140-01	NH3	8.3107-06	N2	3.0187-01
CO2	3.5097-02	H	2.7646-03	NO	1.7132-04	OH	1.1562-04	O	1.3376-06	O2	1.6416-06	CH3	1.7018-08
CH2O	2.2825-08	CHO	2.7967-04										

- NOTES: (1) Typical printout for a data surface in the exhaust plume.  
(2) Some points have been omitted for demonstration purposes.



### 3.3.2 Description of Unformatted Binary Output

The binary tape output on unit 13 is described in this section. Initial input data are written on the first part of the data tape and gaseous and particle data are written out for each data point in the flow field. This tape is formatted so that it may be used by other auxiliary routines (plot, plume impingement or radiation).

#### GROUP I - General Information

Number of Records = 1

Write ( ) (HEADER(I), I=1, 60), ISPECS, IMETRIC

- HEADER
  - run identification (2A4)
  - date (3A4)
  - description (55A4)
- ISPECS = number of particle species to be considered
- IMETRIC\* = 0 English flowfield units  
= 1 Metric flowfield units

#### GROUP II - Gas Data

Number of Records = 1 + IOF\*IS

Write ( ) (BETA(I), I=1, 6), IOF, IS

- BETA is gas identification name (6A4)
- IOF number of total enthalpy cuts through "Mollier chart" (max = 10)
- IS number of entropy cuts (max = 2)

DO M=1, IOF  
DO I=1, IS

Write ( ) IV, IDATA, ((TEMP(J, K), K=1, IDATA), J=1, IV), IVT,  
((CPM(J, K), K=1, 3), J=1, IVT), RSTAR, PINF, EMINF,  
GAMINF, FINF, EXINF, XSHIFT

\*Determined from ICON(9).

- IV number of velocity cuts through "Mollier chart" for this total enthalpy and entropy + 2 (max = 15)
- IDATA number of gaseous species present for this total enthalpy and entropy (max = 98)
- GAMINF freestream isentropic exponent
- IVT = IV-2
- RSTAR throat radius (ft or meters)
- PINF ambient pressure (psf or Newtons/m<sup>2</sup>)
- EMINF freestream or external stream Mach number
- EXINF limit to which equation applies
- FINF linear static pressure gradient (slope)  $\theta$  approach
- TEMP contains the following information for each value of IOF, IS
- XSHIFT nozzle length (ft or meters)

	1	2	3	4	5	6	7	8	9	. . . . . IDATA			
1		P <sub>f</sub>					(A <sub>4</sub> )	(A <sub>4</sub> )	(A <sub>4</sub> )	. . . . .	(A <sub>4</sub> )	( )	Species
2							(A <sub>4</sub> )	(A <sub>4</sub> )	(A <sub>4</sub> )	. . . . .	(A <sub>4</sub> )	( )	Name
3	Htg	P	T	S	$\psi$	$\gamma$	M <sub>c</sub>	X <sub>1</sub>		. . . . .	X <sub>F</sub>		
4							M*						
5													
.	c												
.	o												
.	n												
.	s									Mole			
.	t									Fractions			
.	a												
.	n												
.	t												
.	t												
.	I												
IV	Htg	P	T	S	$\psi$	$\gamma$	M	X <sub>1</sub>			X <sub>F</sub>		

- P<sub>f</sub> freeze pressure (atm)
- Htg total enthalpy of the gas (cal/gm)
- P pressure (atm)
- T temperature (°K)
- S entropy (cal/gm-°K)
- $\psi$  molecular weight (gm/gm-mole)

- $\gamma$  isentropic exponent
- $M_c$  chamber Mach number = 0
- $M^*$  throat Mach number = 1
- $M$  Mach number for this table entry
- CPM contains the following information

	1	2	3
	Pr	$\mu$	$C_p$
1			
2			
3			
⋮			
⋮			
IVT			

- Pr Prandtl number
- $\mu$  viscosity (poise)
- $C_p$  specific heat at constant pressure (cal/gm-°K)

### GROUP III - Gas Partical Data

Number of Records = ISPECS+1

Write ( ) IDUM, ((PSP(I, J), I=1, 2), J=1, ISPECS)

- IDUM dummy word
- PSP(1, J) mass density of  $j^{\text{th}}$  particle (slug/ft<sup>3</sup> or kg<sub>m</sub>/m<sup>3</sup>)
- PSP(2, J) radius (ft or m)

DO I=1, ISPECS

Write ( ) NTAB1, TMELT, HSOL, HLIQ, (HFIT(N, 1, I), HFIT(N, 2, I),  
N=1, NTAB)

- NTAB1 number of table entries for this species
- TMELT melt temperature (°R or °K)
- HSOL enthalpy before phase change (ft<sup>2</sup>/sec<sup>2</sup>-°R or m<sup>2</sup>/sec<sup>2</sup>-°K)
- HLIQ enthalpy after phase change (ft<sup>2</sup>/sec<sup>2</sup>-°R or m<sup>2</sup>/sec<sup>2</sup>-°K)
- HFIT(N, 1, I) temperature (°R or °K)
- HFIT(N, 2, I) enthalpy (ft<sup>2</sup>/sec<sup>2</sup> or m<sup>2</sup>/sec<sup>2</sup>)
- NTAB number of table entries for this species

Note that if NTAB=1 species is ideal and HFIT(1, 1, I) =  $C_{PL}$  (specific heat of liquid) and HFIT(1, 2, I) =  $C_{PS}$  (specific heat of the solid).

GROUP IV - Flowfield Data

Number of Records = 1 + 2 \* ILAST

Write ( ) (ILAST, I=1, 7), THRUST, AEXIT, IEXIT

- ILAST            number of data points on the following normal surface. If ILAST = 0 there is no information to follow
- THRUST          thrust ( $lb_f$  or Newtons)
- AEXIT            exit plane area ( $ft^2$  or  $m^2$ )
- IEXIT            exit flag     $\begin{cases} 0 & \text{if no exit} \\ 1 & \text{if exit} \end{cases}$

Write ( ) ((ITYPE, R, X, M,  $\theta$ , S,  $\mu$ ,  $\delta$ , Htg), I=1, ILAST), (V, I=1, ILAST), ( $\dot{W}_g$ , I=1, ILAST), ( $\rho$ , P, T,  $\gamma$ ,  $\hat{R}$ ), I=1, ILAST)

- ITYPE            identifies type of point (wall, shock, interior, etc.)
  - 0            input point
  - 1            interior point
  - 2            wall point
  - 3            free boundary
  - 4            upstream shock point
  - 5            Prandtl-Meyer point
  - 6            downstream shock point
  - 7            slip line
  - 8            shock intersection point
  - 9            vibrational mode frozen
  - 10          rotational mode frozen
  - 11          translational mode frozen
- R                radial coordinate (ft or m)
- X                axial coordinate (ft or m)
- M                Mach number
- $\theta$              flow angle (rad)
- S                entropy ( $ft^2/sec^2-^{\circ}R$  or  $m^2/sec^2-^{\circ}K$ )
- $\mu$              Mach angle (rad)
- $\delta$             shock angle (rad)
- Htg             gas total enthalpy ( $ft^2/sec^2$  or  $m^2/sec^2$ )

- V velocity (ft/sec or m/sec)
- $\dot{W}_g$  mass flow between this streamline and axis (slug/sec or  $\text{kg}_m/\text{sec}$ )
- $\rho$  gas density (slug/ft<sup>3</sup> or  $\text{kg}_m/\text{m}^3$ )
- P pressure ( $\text{lb}_f\text{-ft}^2$  or  $\text{N}/\text{m}^2$ )
- T temperature ( $^\circ\text{R}$  or  $^\circ\text{K}$ )
- $\gamma$  isentropic exponent
- R universal gas constant divided by molecular weight ( $\text{ft}^2/\text{sec}^2\text{-}^\circ\text{R}$  or  $\text{m}^2/\text{sec}^2\text{-}^\circ\text{K}$ )

DOI = 1, ILAST

Write ( ) ISP, ((U, V, T, H,  $\rho$ ), J=1, ISP), ILIMIT

- ISP number of particle sizes at this point
- U axial velocity component (ft/sec or m/sec)
- V radial velocity component (ft/sec or m/sec)
- T temperature ( $^\circ\text{R}$  or  $^\circ\text{K}$ )
- H enthalpy ( $\text{ft}^2/\text{sec}^2$  or  $\text{m}^2/\text{sec}^2$ )
- $\rho$  particle density (slug/ft<sup>3</sup> or  $\text{kg}_m/\text{m}^3$ )
- ILIMIT 0 } not a limiting streamline  
1 } is a limiting streamline

NOTE: The flowfield data are repetitively stored on tape as indicated above - normal surface after normal surface. When ILAST = 0 the end of the data has been reached.

### 3.4 PROGRAM UTILIZATION COMMENTS

The primary purpose of this section is to provide the prospective user of Lockheed's RAMP program backup information for inputting and troubleshooting the code. This section also presents the authors' experience on what to look for and what to do if certain problems are encountered while using the program. Included in the discussion are:

1. A description of each mesh control parameter and some suggested values
2. An explanation of "error" messages and other diagnostics, and
3. Problems commonly encountered and suggestions to correct them.

It is envisioned that this section will aid the user in becoming familiar with the use of the code. However, only experience in utilizing the code will provide knowledge for applying the code.

#### 3.4.1 Mesh Control Variables

This subsection discusses each of the mesh control parameters which the program utilizes. The function of each of these parameters is discussed in relation to potential mesh control problems in construction of a typical flow solution.

Control of the insertion of interior points and the deletion of points on a known data surface is the function of subroutine CHECK. CHECK is normally called from subroutine PHASE1 after a line has been completed unless a special circumstance is encountered where a point needs to be inserted or deleted due to streamline crossings. The axial step control is performed by PHASE1.

##### 3.4.1.1 Lower Wall Interpolation Factor (STEP(8))

Characteristic theory governs the construction of the initial data point on a new surface. The maximum axial step at the lower boundary is determined by the intersection of the right-running characteristic (RRC) emanating

from the first interior point on the normal and the lower boundary. The RRC is inclined at the local characteristic angle  $(\theta - \mu)$  toward the lower boundary. The axial step downstream of the known data surface is determined by the intersection of the RRC line (which is located a factor of STEP(8) ( $\leq 1.0$ ) of the distance between the axis point and first interior point) with the lower boundary. Details of this construction are noted in the sketch below.

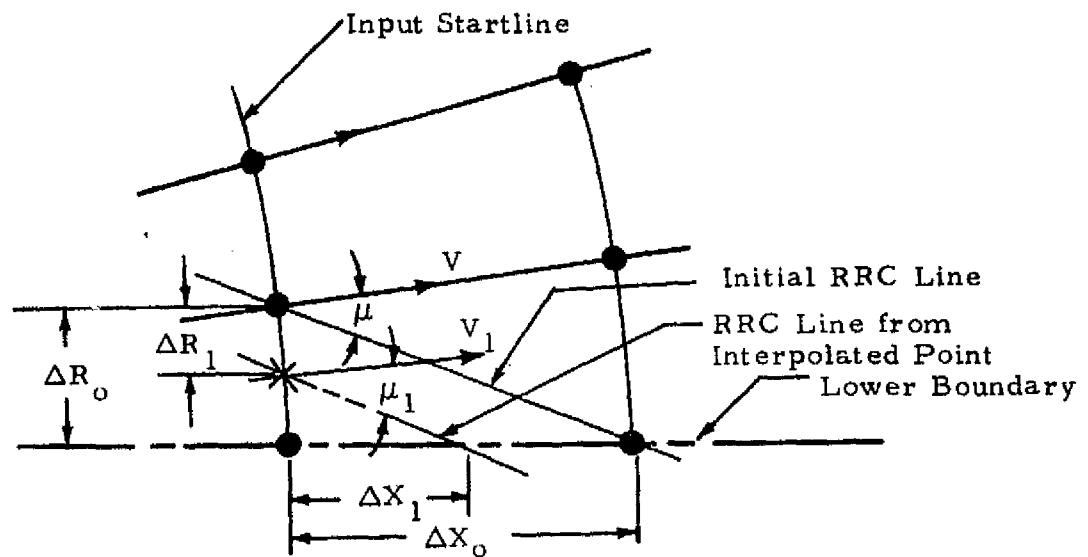

- $\Delta X_1$  = Initial Axial Step
- $\Delta R_0$  = Initial Radial Point Spacing
- $\Delta X_0$  = Maximum Initial Axial Step
- $\mu$  = Local Characteristic Angle
- $V$  = Local Velocity

The  $\Delta RRC$  Step  $\Delta X_1$  is given by:

$$\Delta R_1 = \Delta R_0 [1 - \text{STEP}(8)]$$

$$\Delta X_1 \cong \Delta R_0 * \text{STEP}(8) * \tan(\pi/2 - \mu_1)$$

Consequently, STEP(8) is the primary parameter which controls the mesh construction and also has a significant impact on program run time. The radial point spacing on the start or previous line also helps to determine the initial axial step. The closer the point spacing the smaller the axial step.

Step size also affects the conservation of mass flow, momentum and energy. Most cases will maintain good mass flow conservation. However, there can be cases where poor mass flow conservation is observed. In these instances, normally there is an error in some of the input data. If no error is detected it may be necessary to take smaller step sizes to maintain the particle mass flow conservation. Gaseous cases with larger gradients across the flow field may also require smaller steps and more mesh points in order to conserve mass flow.

#### 3.4.1.2 Axis Point Insertion Criteria (STEP(6))

The axis point insertion control parameter, STEP(6), limits the maximum axial step between data surfaces. If the data surface location between axis points for any reason exceeds STEP(6), the interpolation factor for the lower wall solution (STEP(8)) will be multiplied by 0.8. This results in a smaller axial step. The new axis point will be recomputed until it is less than a distance of STEP(6) away from the known axis point.

Typical values for STEP(6) are: 0.1 throat radii for two-phase nozzle flow problems, 0.1 exit radii for two-phase plume flow problems and 0.2 throat/radius for gas only nozzle solution and 0.2 exit radius for gas only plume flows.

#### 3.4.1.3 Interior Point Insertion Criteria (STEP(3))

The purpose of the point insertion capability is to provide control of the streamline spacing in a rapidly expanding flow. Insertion of a streamline is accomplished in the following manner. The distance along a normal line between two grid points is computed in subroutine CHECK. If this distance exceeds STEP(3) a new streamline will be inserted midway between the two existing points. The new streamline point will be retained as the solution progresses.



#### 3.4.1.4 Particle Limiting Streamline Insertion Criteria (STEP(9))

This parameter provides for control of streamline spacing on a data surface based on the entropy difference between two streamlines. This option is only used for two-phase flow cases and then only between a particle limiting streamline and the adjoint gas streamline. STEP(9) is the maximum allowable percentage change in entropy near a particle limiting streamline. The procedure is to first calculate the entropy difference ( $\Delta S$ ) between the particle limiting streamline and the adjacent streamline, above or below the particle limiting streamline. If  $\Delta S$  is greater than STEP(9) times the entropy level of the limiting streamline then a new streamline point will be inserted midway between the two points. The procedure is identical to the interior point insertion scheme once the program has determined that a point should be added.

This mesh control parameter is utilized to avoid large entropy gradients near limiting streamlines. There will naturally be an entropy gradient across a limiting streamline, from a region where particles are present to a gas-only region. However, use of the STEP(9) control can minimize the chance of encountering numerical difficulties near limiting streamlines in two-phase flow problems.

#### 3.4.1.5 Prandtl-Meyer Integration, (STEP(1))

This parameter controls the number of mesh points which are distributed through the Prandtl-Meyer expansion. STEP(1) is the size of the integration step in degrees that is used to numerically integrate the Prandtl-Meyer function. STEP(1) then becomes the number of degrees between mesh points in the expansion fan.

#### 3.4.1.6 Point Deletion Criteria (STEP(7))

The purpose of this mesh control parameter is to limit the spacing of adjacent streamline points on a normal to a minimum value. When streamlines begin to converge the solution can encounter numerical difficulty when computing locations of intersections of characteristic lines with normals to streamlines.

The procedure is to determine the radial and axial spacing, the Mach number difference and flow angle differences between two consecutive points on a normal ( $\Delta R, \Delta X, \Delta M, \Delta \theta$ ). The average  $R, X$ , Mach number and flow angle for the two points are calculated ( $\bar{R}, \bar{X}, \bar{M}, \bar{\theta}$ ).  $\bar{R}$  and  $\bar{X}$  are multiplied by STEP(7) and  $\bar{M}$  and  $\bar{\theta}$  are multiplied by built in values. If  $\Delta R$  and  $\Delta X$  are less than the average locations ( $\bar{R}$  and  $\bar{X}$ ) times STEP(7) and  $\Delta M$  and  $\Delta \theta$  are less than the average values ( $\bar{M}$  and  $\bar{\theta}$ ) times the built-in values then one of the two points will be deleted. This procedure is shown in the sketch on the following page.

The program will not delete the following types of points: upper or lower boundary, free boundary, Prandtl-Meyer, shock, slipline or limiting streamlines. Normally, the I point is deleted.

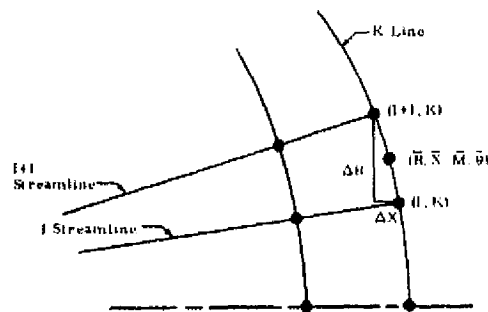

$$\begin{aligned} \Delta M &= |M(I, K) - M(II, K)| \\ \Delta \theta &= |\theta(I, K) - \theta(II, K)| \\ \Delta R &= |R(I, K) - R(II, K)| \\ \Delta X &= |X(I, K) - X(II, K)| \\ \bar{\theta} &= (1/2)[\theta(I, K) + \theta(II, K)] \\ \bar{X} &= (1/2)[X(I, K) + X(II, K)] \\ \bar{R} &= (1/2)[R(I, K) + R(II, K)] \\ \bar{M} &= (1/2)[M(I, K) + M(II, K)] \\ \bar{X} &= \bar{X} \cdot \text{STEP}(7) \\ \bar{R} &= \bar{R} \cdot \text{STEP}(7) \\ \bar{M} &= \bar{M} \cdot 0.2 \\ \bar{\theta} &= \bar{\theta} \cdot 0.1 \end{aligned}$$

IF  $(\Delta R < \bar{R} \cdot \text{STEP}(7))$  AND  $(\Delta X < \bar{X} \cdot \text{STEP}(7))$  AND  $(\Delta M < \bar{M} \cdot 0.2)$  AND  $(\Delta \theta < \bar{\theta} \cdot 0.1)$   
Then the point (I, K) will be deleted  
where  $M$  is the local Mach number and  $\theta$  is the local flow angle.

#### 3.4.1.7 Finite Rate Chemistry Mesh Controls

The mesh control parameters for a finite rate chemistry case are the same as in the previous sections with the following exception.

The lower wall interpolation factor, STEP(8), is overridden by the "CFL" condition which requires that the Mach lines from any new point must intersect the base line between the base point and either of its neighboring points. This condition is assured by the equation

$$CFL = \Delta_N \sqrt{M^2 - 1}$$

where  $\Delta_N$  is the normal distance between any 2 adjacent points on the base line and  $M$  is the Mach number. CFL is the maximum distance along the streamline through the base point the new point may extend and still ensure that the Mach lines intersect the adjacent points. This distance is calculated for each point on the base line and the minimum distance is used for the entire new line.

#### 3.4.1.8 Recommended Mesh Control Variables

Table 3-8 presents a set of recommended values for the mesh control variables. This set of mesh control values has been found by the authors to be general for most of the cases which have been run. However, there probably will be cases where the run time or conservation of mass flow, energy and momentum will be unsatisfactory and adjustments to the mesh will be required. As the user becomes familiar with the code and runs more cases, changes in the mesh control variables and the resulting effect on the flow solution will become apparent.

#### 3.4.1.9 Mesh Spacing Effect on Run Time and Conservation Equations

Run time is significantly affected by the point density for two reasons: (1) the computer run time is a direct function of the number of points on the

Table 3-8  
RECOMMENDED MESH CONTROL VALUES

	Nozzle-Gas	Nozzle-Two-Phase	Plume - Low Altitude Two-Phase	Plume - Low Altitude Gas Only	Plume - High Altitude Two-Phase	Plume - High Altitude Gas Only
STEP(1), Prandtl-Meyer Control	4.0	4.0	4.0	4.0	6.0	6.0
STEP(3), Interior Insertion	$0.1 R_T$	$0.1 R_T$	$0.1 R_E$	$0.2 R_E$	$0.3 R_E$	$0.5 R_E$
STEP(6), Axis Insertion	$0.2 R_T$	$0.1 R_T$	$0.1 R_E$	$0.2 R_E$	$0.2 R_E$	$0.3 R_E$
STEP(7), Delete Criteria	0.001	0.001	0.005	0.005	0.005	0.005
STEP(8), Axis Point Interpolation	0.9	0.7	0.5	0.7	0.7	0.8
STEP(9), Limiting Streamline	1000.0	0.2	0.2	1000.0	0.2	1000.0

$R_T$  = Throat Radius

$R_E$  = Exit Radius

NOTE: If no limiting streamline, axis insertion, or interior insertion control is desired input a large number (~ 1000). If no deletion is desired use an extremely small number (1.E-5).

normals, i.e., for the same number of normal surfaces and twice the number of points on each normal there will be a factor of two difference in run time, (2) the more points on a given normal, the smaller will be the step size which will result in more execution time, i.e., twice as many points on a surface will result in the maximum axial step having one-half the length. This coupled with twice the points on the normal will result in four times as much computer time.

Coupled with conserving run time is the necessity that the solution be numerically valid, i.e., conserve mass, momentum and energy. The conservation functions for numerical solutions of the type employed by the RAMP program are somewhat controlled by the mesh spacing. For flows which contain large gradients in flow properties it is desirable to have more mesh points to avoid any large errors in mass flow, system energy and momentum. Thus there is some happy median between run time and system conservation.

#### 3.4.1.10 Point Spacing

The type of solution which the RAMP code employs lends itself to uniformly spaced points on each data surface. However, particular flow solutions which have large radial gradients require close point spacing in the region of the large gradients. For these cases, smaller axial steps are necessary.

#### 3.4.2 Explanation of Error Messages and Other Messages

1. Previously noted errors have propagated to lower boundary or problem limits have been reached. Case terminated.

The program has terminated properly, the problem limits set by the user have been reached or another error which has been identified via a message has been encountered.

2. Lower boundary solution will not converge.

The program is unable to obtain a solution at the lower boundary within the user specified number of iterations. The code will back up the line a maximum of 10 times in order to try to obtain a solution. If no solution is reached then the execution will terminate.

3. Interior solution will not converge.

The program is unable to obtain a solution for an interior point within the user specified number of iterations. The code will backup and take a smaller step. If the point still will not converge after backing up ten times then the solution will be terminated.

Possible causes of this problem are:

- Input error in boundary equations
- Numerical difficulties due to large point spacing in regions of steep gradients. Use more points or take smaller steps.
- If this occurs early in the solution, the startline may not be physically or numerically suited to the problem. Check the startline.
- Check for obvious errors in thermodynamic data.

4. Upper boundary solution will not converge

The program is unable to obtain a solution at the upper boundary. Causes and fixes are same as item 3.

5. Shock solution will not converge. Line terminated.

The code is unable to obtain a solution for a shock point within the user specified number of iterations. If this occurs early in solution it could be due to an inconsistency of the startline and boundary equations. May be taking too large a step - decrease step size.

6. ITSUB will not converge in RGMOFP

Real gas solution of Mach number as a function of pressure will not converge within preset number of iterations. Check the thermodynamic tables for errors and also the plume boundary conditions.

7. ITSUB will not converge in RGVOFM

Real gas solution of velocity as a function of Mach number will not converge within preset number of iterations. Check the thermodynamic tables for errors. For two-phase, real gas cases with a startline input from cards, be sure all the input Mach numbers fall within the thermodynamic table entries.

8. ITSUB WNC in THETPM

Unable to balance the last Prandtl-Meyer point pressure with the back pressure at the free boundary or flow angle

at a solid boundary, within the preset number of iterations. This can be caused by poor thermodynamic table construction or incompatible plume boundary conditions.

9. ITSUB WNC in AOASTR

Unable to balance the mass flow at input  $A/A^*$  with mass flow at throat within the preset number of iterations. Check thermodynamic tables.

10. ITSUB WNC in TURN

Unable to turn the flow through a specified turning angle within the preset number of iterations. Usually caused by flow going subsonic.

11. ITSUB WNC in OVEREX

Unable to turn the flow through a specified turning angle to match the plume boundary pressure within the preset number of iterations. Usually caused by the flow going subsonic.

12. The following case cannot be found on the master tape.

The program is unable to find the desired gas case among the cases present on the master tape. This is usually caused by the gas header card not matching any of the header cards which appear on the tape or the wrong tape was mounted.

13. ITSUB WNC in HYPER

Program is unable to find a velocity which will give the ambient boundary conditions within the number of preset iterations. Can be caused by trying to expand the flow too far or bad thermodynamic tables.

14. Subsonic Mach number encountered in TOFV

The characteristic theory utilizes Mach number in the definition of Mach angle ( $\sqrt{M^2 - 1}$ ) and is limited to supersonic flow. Possible causes for this message are:

- Flow went subsonic
- Error in boundary equations
- Error in other input data
- A situation is encountered which the code is unable to handle.

15. Negative velocity encountered in TOFV

Something has happened during the solution which has resulted in a negative velocity being calculated. Probable causes are:

- Error in boundary equations
- Error in gas thermodynamic data
- Mesh problem caused by too large a step in a region of steep gradients. Try taking smaller steps.
- Program limitation.

16. ITSUB does not converge in PHYSOL

Subroutine PHYSOL is unable to determine the characteristic intersection with the known data surface within the preset number of iterations. This is usually caused by too small a mesh size or a data surface that has been input, which is not a true normal.

17. Two straight lines in INRSCT are parallel

Subroutine INRSCT's function is to determine the intersection of two straight lines. If two lines are found to be parallel this message is printed out. Usually caused by some inconsistency in the input data.

18. Slipline computation does not converge in SLPLIN

The program is unable to converge on the slipline points (i.e., match flow angle and pressure) within the preset number of iterations. Usually caused by taking too large a step.

19. Characteristic lines diverge, last P-M point set free molecular

Subroutine MOCSOL is unable to intersect right and left running lines while constructing the normal around a Prandtl-Meyer expansion. This is usually caused by trying to take too large a step past an expansion corner.

20. MOCSOL would not converge

MOCSOL is unable to find the intersection of two characteristic lines within the preset number of iterations.

21. A problem with a RRC intersection with line X has been encountered. The line will be recalculated.

This is the result of either an interior solution taking too many iterations or a situation where the program is unable to intersect the right running characteristic from the new point to the known data surface. The program will back up and take a smaller step for a maximum of ten iterations. If the same problem is still encountered the case will be terminated. This is usually caused by an error in a boundary equation, a startline which is not a normal, a poor point spacing.



22. Particle limiting streamline intersection with the boundary

This message occurs whenever a particle limiting streamline intersects a boundary (solid or free). The solution proceeds while assuming all mass which intersects the boundary passes on through.

23. Point number X on line Y has been deleted

This message is printed whenever a point is thrown out because it did not satisfy the mesh control criteria or whenever a gas and particle streamline cross.

24. A new streamline has been inserted on line Y between points X and Z.

This message will appear each time a point is added on a line due to mesh control criteria being exceeded between two points.

25. Due to gas-particle streamline crossing the point X has been replaced

This message occurs for two-phase cases whenever a gas and particle limiting streamline cross. The gas streamline is thrown out.

26. You are trying to throw out point X, the point is a wall, limiting streamline or free boundary point. You probably have an error in your input.

This error message is usually due to an error in the startline or an error in the boundary equations. Check your input data.

### 3.4.3 Problems Commonly Encountered and Suggested Fixes

This section is intended to aid the user in utilizing the program and avoiding some common problems. Also included are some general comments on inputting the code.

The following is a list of hints to the user:

- The numerical scheme which the program utilizes lends itself to evenly spaced points. Therefore, when setting up a startline try to insure that the points are as evenly spaced as possible. The only exception to this rule is in the vicinity of large gradients in flow properties, (e.g., Prandtl-Meyer corners). The points in this region should be closer together and smaller axial steps should be taken.

- In the region immediately downstream of a Prandtl-Meyer expansion it is necessary for the program to patch together a characteristic mesh with the streamline normal mesh (Section 6.9, Vol.I). This mesh construction can result in two unique problems. First, if the first normal beyond the corner is too far downstream of expansion, it is possible for the code to be unable to intersect characteristic lines. This normally will only occur for high altitude cases. To fix this take a small step. If too large a step is taken at lower altitudes, streamlines may cross which can result in a subsonic Mach number or negative velocity message. To correct, take smaller steps. On the other hand, if the first normal downstream of the corner is too close to the lip the points in the fan may be too close together. This may cause problems with characteristic line intersections with previous data surfaces and result in excessive iterations or no convergence of points in this region. It may also result in the necessity to take too small a step in order to proceed with the solution. To correct this problem, a slightly larger step must be taken so that the first normal is further downstream of the corner. Below are sketches of normals which are too close and too far from expansion corners.

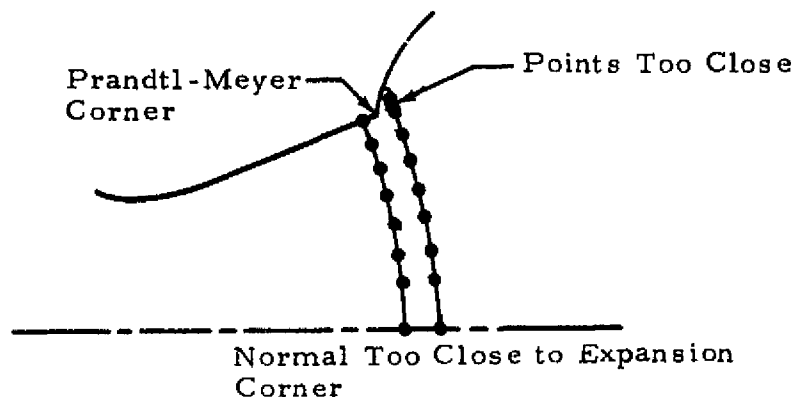
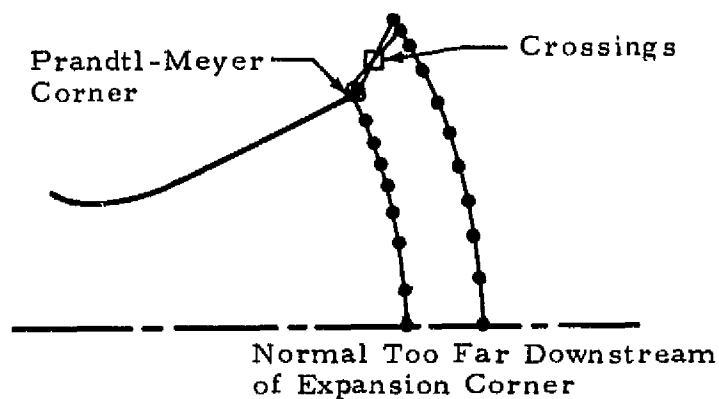

- The transonic solution requires the location of the intersection of the startline with the axis (ZAX) and the nozzle wall (THIW). There is an option in the code to let the program calculate a ZAX based on the input THIW. This is accomplished by not inputting a value on the transonic namelist. The value of ZAX which the code computes will result in a near normal startline. It should also be noted that the startline must be supersonic so if a subsonic Mach number is encountered from the transonic solution the startline must be moved further downstream (Card 36).
- Since the program uses streamlines and normals to streamlines to construct the mesh it is always assumed that each data surface is a true normal. If a startline is input which is not a normal, it is possible to encounter difficulties in getting the solution started. Below are three sketches of candidate initial data surfaces. Sketch A

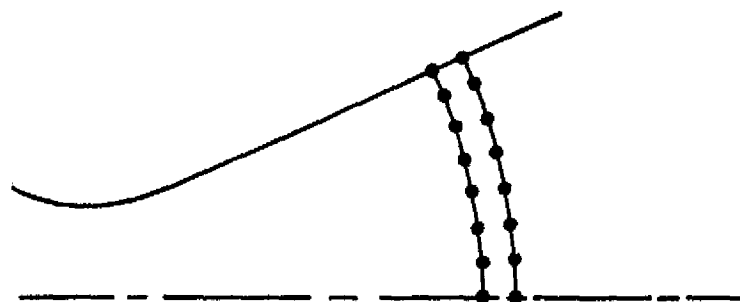

Sketch A - True Normal

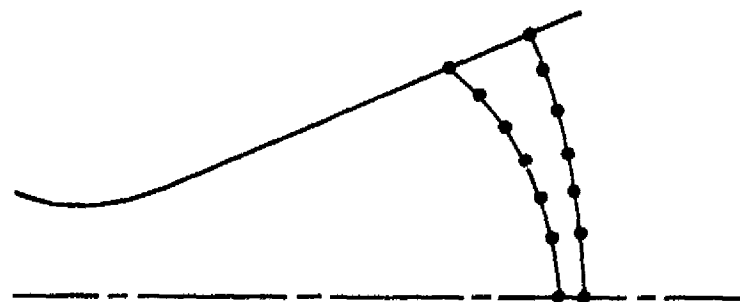

Sketch B - Normal Inclined Too Much

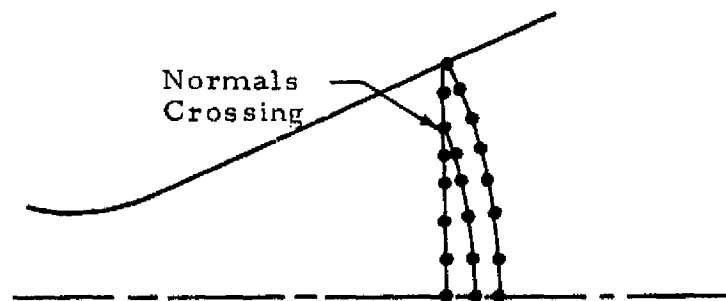

Sketch C - Normal Not Inclined Enough

is a true normal, Sketch B is inclined too much and Sketch C is not inclined enough. In the case of the data surface which is inclined too much the code will probably have trouble finding the characteristic line intersections with this surface during the next line's solution. When the code is unable to obtain an intersection, the new data surface is backed up until a solution is reached or if no solution is reached after backing up ten times the case is terminated. A normal which is not inclined enough will result in normal lines crossing as shown in Sketch C. The solution will usually have no trouble in obtaining a solution for the new data surface although several lines may overlap. To fix both of these cases, regenerate the startline so the normal line is a true normal.

- A large percentage of problems encountered are due to errors in the boundary equations. These errors can result in messages being printed out such as; subsonic Mach number, negative velocity or possible systems error messages due to bad interpolation factors. If any anomalies are encountered while the code is solving an upper boundary point, the following are some of the errors to look for:
  - a. A discontinuity in boundary equations where they are supposed to match
  - b. The boundary equations are not in the same units as the startline
  - c. The startline does not fall on the first boundary equation
  - d. For two-phase cases the input throat radius is not consistent with the throat equation
  - e. There is an error in the equation itself.
- Care should be taken in selecting the particle size distribution for any particular case. If the particle sizes are too large for the motor being analyzed then the lags are too great, thereby compromising the results. If the sizes are too small then the particles may try to thermally and translationally equilibrate with the gas which may result in numerical problems. A discussion on how the authors determine mean sizes and distributions is contained in Appendix C of this volume.
- If the user is only interested in such things as nozzle wall pressure and initial plume expansion angle then a single particle size having the mean size for the motor is sufficient for good results. However, if the user is interested in two-phase impingement, then a good distribution is necessary in order to get satisfactory impingement results. Appendix C contains a discussion of particle distribution.
- There are some specific dos and don'ts associated with inputting a startline with cards. The following hints are what to be careful of when setting up a case where the startline is read from cards.

- a. Make sure that the number of gaseous startline points corresponds to the value input on Card 4 (ICON(3)).
- b. The gaseous startline points should be input starting from the nozzle centerline and proceeding to the upper boundary. The particle properties should be input starting with the first point nearest the upper boundary which has particles present and inputting the particle data down to the nozzle centerline. For each point the particles should be input from the smallest size (particle 1) up to the largest size (particle 6). The same particle number must always be used for each specific size.
- c. A common mistake users make is to forget to input the number of gas points (NSETS, Card 23) which have particles present. This only applies to two-phase cases.
- d. Whenever a restart is used it is necessary that the last point on the startline (upper boundary point) be a point on the first boundary equation. The first boundary equation must also be a type 1 or 2 boundary (conic or polynomial). Therefore, all boundary equations prior to the one which applies at the boundary startline point, must be removed and ICON(4) adjusted accordingly. Cases which are trying to be restarted in the plume require a fictitious boundary for the first equation. This equation consists of a straight line which passes through the boundary point and has the same slope. The next boundary equation should be the original free boundary equation. A sketch describing this requirement is shown below.

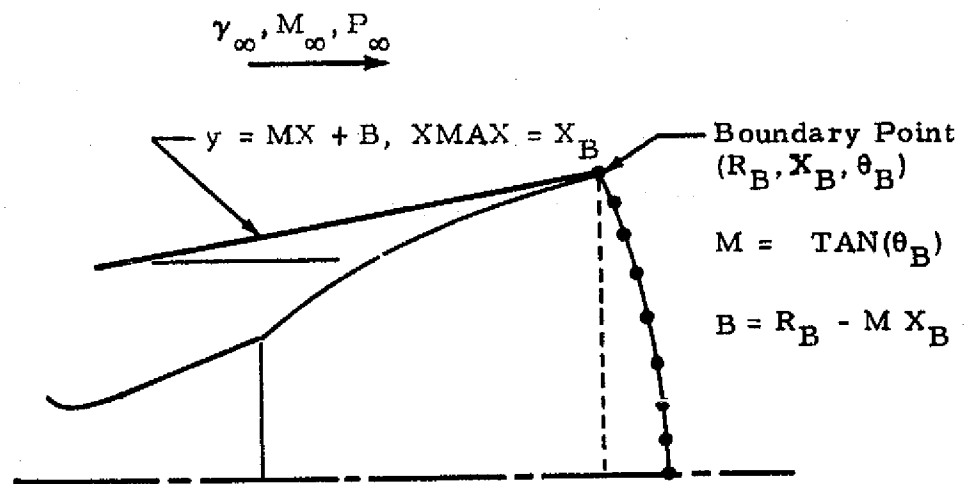

Fictitious Boundary for Plume Restart

REPRODUCIBILITY OF THE  
ORIGINAL PAGE IS POOR

- e. The code presently has a limit of 50 startline points. If a line has been punched which has more than 50 points, omit enough points to obtain 50 maximum.
  - f. The Mach number which is input on the startline cards must be within the thermodynamic table entries for two-phase cases which utilize equilibrium tables with multiple enthalpy and entropy tables. This is normally a problem only for high altitude plume restarts. If this is ever encountered contact the authors for a temporary change to the program so that gas velocity may be read in instead of Mach number.
- If gas thermodynamic data is coming from tape be sure to set ICON(1) = 2 (Card 4) and also use exactly the same gas header card (Card 8) as was used by the TRAN72 program to generate the tape.
  - For gas data coming from cards be sure that the units of the gas properties are consistent with the units identifier on the gas header card (Card 9).
  - The entropy and total enthalpy levels of any startlines input into the program must be consistent with the gas thermodynamic tables. This is generally only important in two-phase cases. If the startline was punched by the program on a previous run and the same gas thermodynamic tables are used then the gas entropy and total enthalpy levels are consistent. However, if the startline is generated by some other code, care should be taken to enter the entropy and total enthalpy to obtain the correct static gas properties (P,  $\rho$ , T). For ideal gas two-phase cases the total enthalpy is calculated as follows:

$$H_T = C_p T_{OL}$$

where  $C_p$  is the ideal gas  $C_p$  defined as  $C_p = \gamma R / (\gamma - 1)$  and  $T_{OL}$  is the local total temperature including any two-phase losses.  $T_O$  and  $P_O$  are the combustion chamber total temperature and pressure. The static pressure is calculated via the following relationship:

$$P = \frac{P_O (T_{OL}/T_O)^{\gamma/\gamma-1}}{e^{S/R} \left(1 + \frac{\gamma-1}{2} M^2\right)^{\gamma/\gamma-1}}$$

The local static temperature is calculated using the local total temperature.

For equilibrium chemistry two-phase cases, the head loss due to the difference in total temperature between local and chamber conditions is accounted for by the change in entropy level between the total enthalpy tables. It is therefore necessary to use 2 entropy tables and more than one total enthalpy table for two-phase equilibrium cases. The user must also be sure that the gas total enthalpy at any point in the plume will never exceed that of the highest total enthalpy table ( $\Delta H = 0$ ) or be less than the lowest total enthalpy table ( $\Delta H_T = -\Delta H_{\max}$ ). A  $\Delta H_T$  of  $-300$  cal/gm is probably the largest heat loss that need be used in the modified TRAN72 program for two-phase cases.

- For finite rate chemistry cases the following precautions should be taken
  1. Be sure that the order in which the chemical species names appear are the same for the thermodynamic data tables, the startline mole fractions and the catalytic species.
  2. Be sure that the temperatures in the data tables are the same for each species and that the number of temperatures are the same.
  3. Be sure that the enthalpies and entropies are referenced to the same temperature for each species.
  4. The program is set up to "freeze" the chemistry on the startline and will keep the chemistry frozen until a complete normal has been computed. It is recommended that the startline should be as near to a normal as possible.
  5. The run time for a finite rate chemistry case is much longer than for an equilibrium case.

### 3.5 BRIEF DESCRIPTION OF ROUTINES IN FUNCTIONAL GROUPINGS

The following subsection contains a brief description of the individual routines which comprise the RAMP program. The basic flow of the program is presented in Table 3-8. The routines are grouped and presented as indicated below:

- General flow properties routines
- Shock calculation routines
- Input routines
- Logic control routines
- Free molecular routines
- Output routines
- Transonic routines
- Startline routines
- Boundary and problem limits routines
- Interpolation and iteration routines
- Property retrieval routines
- Chemistry routines
- Compatibility equation coefficient routines
- Corner point routines
- Initialization routines
- Performance calculation routines
- Characteristic routines
- Miscellaneous routines

#### 3.5.1 General Flow Properties Routines

<u>Routine</u>	<u>Description</u>
EMOFP	This function computes the local Mach number as a function of local pressure (static) and local entropy.
EMOFV	This function computes the Mach number as a function of local velocity.
GAPPBI	This subroutine interpolates for the gas and particle properties between two known data points.



Table 3-8

SCHEMATIC OF BASIC SOLUTION FOR VARIOUS TYPES OF POINTS

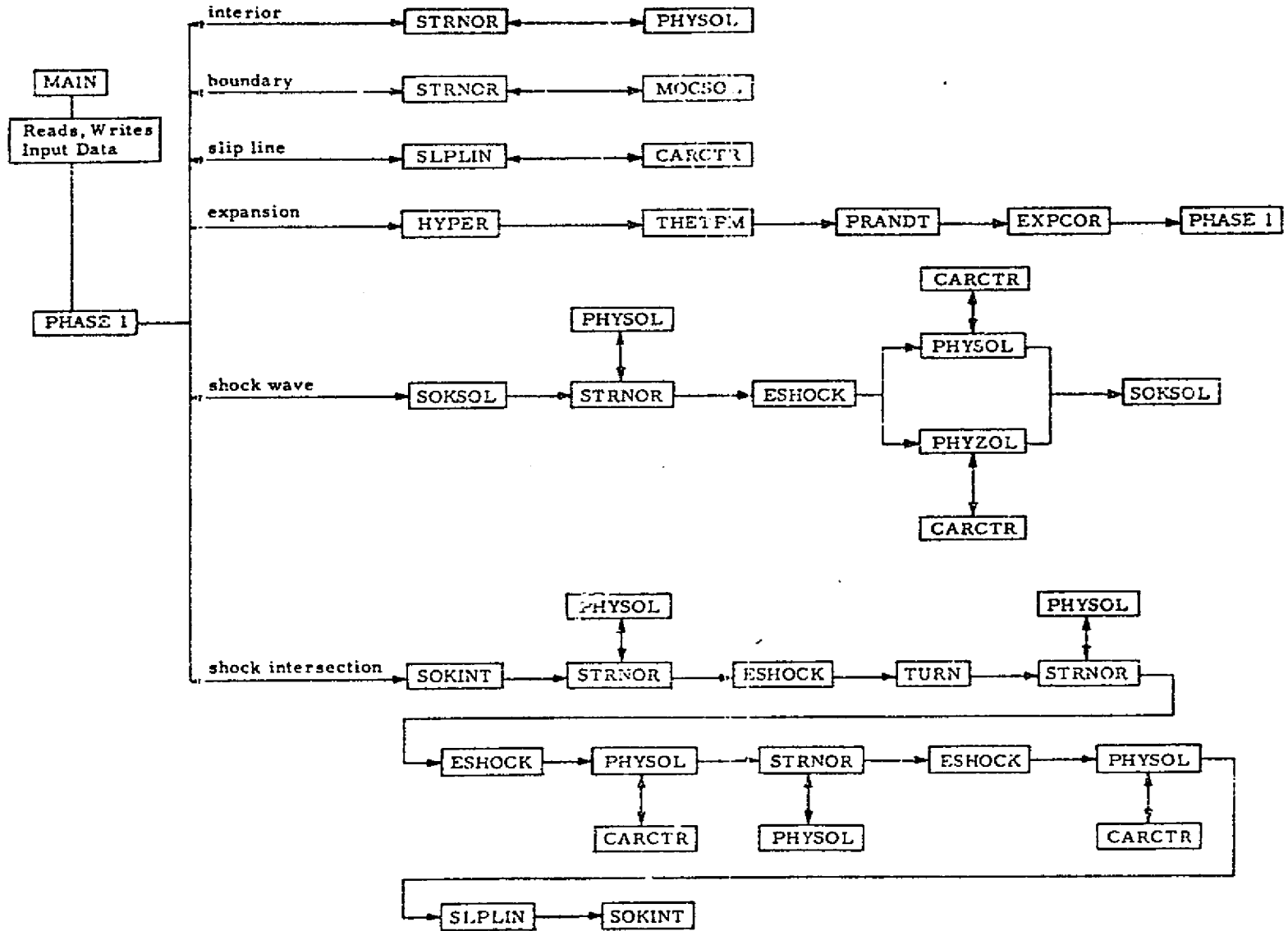

3-115

<u>Routine</u>	<u>Description</u>
POFEM	This function computes static pressure as a function of Mach number and entropy and total temperature (ideal gas two-phase only).
POFH	This routine utilizes the tabulated data of enthalpy and specific heat as functions of temperature for each species of a finite rate chemistry case to calculate pressure, as a function of enthalpy for a real gas, in a Prandtl-Meyer expansion.
PPATPT	This routine calculates and stores gas and particle dependent variables as a function of the independent flow properties.
RGMOFP	This subroutine finds Mach number as a function of pressure, O/F ratio (or total enthalpy) and entropy. The difference between this routine and EMOFP is that in this case the gas properties are not known prior to entry.
RGVOFM	This function computes velocity as a function of Mach number, entropy and O/F ratio (or total enthalpy). The difference between this routine and VOFEM is that the gas properties are not known prior to entry.
RHOFEM	This function computes the local density as a function of Mach number and entropy.
TOFEM	This function computes the local static temperature as a function of Mach number. TOFEM and TOFV are quite similar; the difference being if Mach number or velocity is the known quantity.
TOFENH	This function calculates the temperature as a function of enthalpy for a finite-rate chemistry case.
TOFH	This function calculates the temperature as a function of enthalpy for a finite-rate chemistry case during a Prandtl-Meyer expansion.
TOFV	This function computes the local static temperature as a function of velocity. TOFV and TOFEM are quite similar; the difference being if Mach number or velocity is the known variable.
UOFEM	This function computes the local Mach angle as a function of local Mach number. Prior to the calculation, a test is made to ensure that the Mach number is greater than one.
UOFV	This function computes the local Mach angle as a function of local velocity.
VOFEM	This function computes velocity as a function of Mach number.

### 3.5.2 Shock Calculation Routines

<u>Routine</u>	<u>Description</u>
DELTA $\delta$	This function computes the turning angle through an oblique shock wave knowing the shock angle and the upstream Mach number.
ENTROP	This function utilizes the oblique shock relations to find the entropy rise across a shock as a function of the shock angle and the upstream Mach number.
ESHOCK	This subroutine employs an iterative solution to perform the equilibrium shock calculations for a real or ideal gas. The real and ideal gas calculations are similar, the difference being that an ideal gas case converges on the first iteration.
NORSCK	This routine uses local flow properties to calculate properties downstream of a normal shock to obtain pitot pressure. This routine is used only for finite-rate chemistry, real gas cases.
SLPLIN	This subroutine handles the calculation of the points on the slipline. Two points are assigned to every slipline.
SOKINT	This subroutine computes the flow properties at the intersection of shock waves of the opposite family.
SOKSOL	This subroutine provides control for a shock point solution.
TURN	This subroutine solves for a shock wave which has a known turning angle ( $\delta$ ). A condition of known turning angle exists when the flow is turned through a compression corner on a solid boundary. Real gas effects are considered in calculating conditions downstream of the shock.
WEAK	This subroutine determines the independent variables, entropy and velocity, SD, VD, downstream of a weak oblique shock. The gas properties upstream of the shock are known prior to entry.

### 3.5.3 Input Routines

<u>Routine</u>	<u>Description</u>
GASRD	This subroutine reads in the gas properties. These properties may be real or ideal and read in via cards or tape. The routine also converts input gas properties from MKS units to English (ENG) units if necessary.

<u>Routine</u>	<u>Description</u>
GASTAP	This subroutine reads the real gas properties from the thermochemical data tape generated by the modified TRAN72 computer program and writes this same data on a flowfield tape for communication with other programs.
IMPUT	This routine reads the input cards or tape for the chemistry package. The reaction rate equations, rate constants, and startline species concentrations are read in and the appropriate conversions, if any, are performed. Tables of enthalpy, entropy and specific heats for each species are also input.
PARTIN	This subroutine reads in gas and particle property startline data. Data is read in from cards or tape.
PARTPH	This subroutine reads and sets up the data table of particle temperature versus enthalpy. This routine also prints out the particle drag tables as well as the temperature versus enthalpy tables.
PLUMIN	This subroutine reads in the input data (input via cards) necessary to perform the streamline-normal solution. This routine provides control for all input functions by selectively calling pertinent input routines and/or the transonic solution.

#### 3.5.4 Logic Control Routines

<u>Routine</u>	<u>Description</u>
DRIVER	This subroutine provides the highest order control for program execution. The initialization and logic subroutines are called from here. Most of the common storage needed in the remainder of the program is specified in DRIVER.
MAIN	This subroutine drives the program.
MOC SOL	This subroutine solves the characteristic equations for gas only flow in the region around and downstream of an expansion corner.
PHASE I	This subroutine performs the overall control for the entire flowfield solution, selectively calling those calculations which are pertinent to the particular mesh construction as well as the highest level logic routine combining point or limited region solutions into an entire field solution.

<u>Routine</u>	<u>Description</u>
PLUMIN	This subroutine reads in the input data (input via cards) necessary to perform the streamline/normal solution. This routine provides control for all input functions by selectively calling pertinent input routines and/or the transonic solution.
STRNOR	This subroutine provides the regional control for the streamline/normal solution. It has a lower level of logical control than PHASE1 being interested only in determining the location and flow properties of a single new mesh point.
TRANS	This subroutine provides overall control for initializing the data and reading the namelist data for the Kliegel two-phase transonic solution of a supersonic gas particle startline.

### 3.5.5 Free Molecular Routines

<u>Routine</u>	<u>Description</u>
AVERAG	This subroutine determines the appropriate flow regime based on Knudsen number for non-continuum flow and sets the appropriate gas total conditions.
FREEMC	This subroutine computes flowfield properties in the free molecular regime.
STGMOD	This subroutine computes the gas thermodynamic properties in the transition flow regime.
WTFLOF	This function computes the area normal to the flow which is bounded by two streamline points.

### 3.5.6 Output Routines

<u>Routine</u>	<u>Description</u>
ERRORS	This subroutine contains print messages for various errors which may occur. This is an open ended routine in that it can easily be extended to handle more print messages.
IDTAPE	This subroutine writes the gas properties which were input via cards on the flowfield program tape. The format used to write them on tape is compatible with that used for a real gas.

<u>Routine</u>	<u>Description</u>
OUT	This subroutine writes the calculated data for data points along with the corresponding title and headings.
OUTBIN	This subroutine writes the calculated normal data on the binary output tape. This is done for any number of data points.
PAGE	This subroutine page ejects and writes the header comments and page number on each page of the printout.
PLMOUT	This subroutine prints the data read by PLUMIN.
RITE	This subroutine tells the program user (in no uncertain terms) that he has made a "fatal" error. The next executable statement is a STOP.

### 3.5.7 Transonic Routines

<u>Routine</u>	<u>Description</u>
ABCALC	A complete description of each of these routines is contained in Ref. 7.
CCALC	
DCALC	
FCALC	
FIND11	
JAMES	
LEGS	
NEWT	
ONED	
PARTIL	
PCALC	
PROP	
STRMLN	
TRACE	
TRANS	
WDGI	

### 3.5.8 Startline Routines

<u>Routine</u>	<u>Description</u>
AOASTR	This function finds the Mach number corresponding to a given area ratio by one-dimensional theory. Real gas effects are considered in this calculation.
LIPIN	This subroutine calculates information for the starting line points when the simplified straight start line option is used (i.e., when $ICON(2) \neq 2$ ).

<u>Routine</u>	<u>Description</u>
MASCON	This subroutine calculates the Mach number distribution at an area downstream of the throat such that total mass flow is conserved. Mass flow, calculated at the throat, is used as the constant for comparison.
SEHTG	This subroutine computes the gas total enthalpy for a case when finite-rate chemistry is being used and the startline is to be generated by the program for gaseous flows only.
WOFA	This subroutine computes the weight flow per unit area as a function of Mach number. This calculation is only used in function AOASTR.

### 3.5.9 Boundary and Problem Limit Routines

<u>Routine</u>	<u>Description</u>
BOUND	This subroutine finds the radial coordinate and flow angle (radians) for a given axial coordinate on an upper or lower solid boundary.
FNEWTN	This function solves for the Newtonian impact pressure along the plume boundary. The calculation is applicable for all free stream velocities including quiescent conditions (i.e., $M_\infty = 0$ ).
ITERM	This function tests each normal lower wall point to determine if it is within the predefined problem limits. If the point falls outside the limits, the case is terminated.
LAGRNG	This subroutine determines the radial location and flow angle for solid boundaries which are input as tables of R, X and flow angle.
LIMITS	This subroutine tests the new boundary point to determine if it is within the limits of the current boundary equation.
PRFRBD	This subroutine calculates the flow properties at the intersection of a particle limiting streamline and a plume boundary.

### 3.5.10 Interpolation and Iteration Routines

<u>Routine</u>	<u>Description</u>
ALGINT	This routine does a log interpolation between two values of a variable.
DRAGCP	This routine determines the drag coefficient $F (C_D/C_{D_{Stokes}})$ as a function of Reynolds number.
DRAGMR	This subroutine determines the local drag coefficient $(C_D/C_{D_{Stokes}})$ as a function of particle Reynolds number and particle Mach number.
GAPPBI	This subroutine interpolates for the gas and particle properties between two known data points.
ITSUB	This subroutine controls the iterative solution of any set of equations which can ultimately be expressed as a function of one variable; it can also be used to control an integration loop.
SITER	This subroutine computes entropy as a function of pressure, total enthalpy and velocity.
TEMTAB	This subroutine will perform a table lookup for particle temperature as a function of enthalpy or for particle enthalpy as a function of temperature.
TKEY	This routine determines the proper index to be used in the enthalpy and specific heat tables and calculates interpolation factors.

### 3.5.11 Property Retrieval Routines

<u>Routine</u>	<u>Description</u>
IDMPFP	This function computes the particle storage location within the PFPARY array.
IDMTAB	This function computes the gas property storage location within the TABB array.
IDMXSI	This function computes the gas interpolation parameter storage location within the XSIDIM array.



<u>Routine</u>	<u>Description</u>
PFP	This function computes the particle property data storage location and retrieves data from the PFPARY array.
RWU	This routine is a MSFC Univac 1108 system routine used to read and write from FASTRAN files.
SPCTX	This routine controls the input and output from a FASTRAN file of the chemical species in a finite-rate chemistry case.
TAB	This function computes the thermodynamic data storage location and retrieves data from the TABB array.
XSI	This function computes the storage location for the nonlinear interpolation weighting functions required for thermodynamic property look-up and retrieves data from XSIDIM.

### 3.5.12 Chemistry Routines

<u>Routine</u>	<u>Description</u>
CHEM	This routine evaluates the chemical reaction-rate equations to determine the new chemical species concentrations.
FABLE	This subroutine utilizes real or ideal gas information obtained from a master tape or input cards to calculate properties locally in the flow. The maximum size of the array used by FABLE is limited to eight gas properties ( $V$ , $R$ , $\gamma$ , $T_o$ , $P_o$ , $\mu$ , $Pr$ , $C_p$ ) at 13 velocity "cuts" for each of two entropy cuts and 10 O/F or total enthalpy cuts.
THERMO	This subroutine utilizes real or ideal gas information obtained from the flowfield tape (or tables) and a local O/F ratio (or total enthalpy) to call subroutine FABLE to calculate thermodynamic gas properties locally in the flow.
THERM1	This routine determines the gas thermodynamic properties for a finite-rate chemistry case.

### 3.5.13 Compatibility Equation Coefficient Routines

<u>Routine</u>	<u>Description</u>
COEFEQ	This subroutine calculates the coefficients CI and CIJ for use in the gas-particle system compatibility equation along the gas Mach lines. CI is the gas total enthalpy term and CIJ is the particle contribution to the equation.
COEFF3	This subroutine calculates the new particle properties at the point under consideration, and the intersection of the particle streamlines through this point with the J-line.
NEWENT	This subroutine calculates the change in entropy and gas total enthalpy along a gas streamline for gas particle flows.
ROTERM	This function computes the geometrical factor, $F_I, F_{II}$ , used in the axisymmetric term of the compatibility equation and as an interpolation parameter.

### 3.5.14 Corner Point Solution Routines

<u>Routine</u>	<u>Description</u>
EXPCOR	This subroutine calculates the flow properties of those field points near an expansion corner.
HYPER	This subroutine calculates the balanced pressure at a corner point (i.e., at the intersection of a solid boundary and the pressure boundary). The pressure balance is determined for either the overexpanded or underexpanded case with impact or ambient free-stream pressure.
OVEREX	This subroutine solves for the shock angle at the nozzle lip when the flow is over expanded. Provisions are made to calculate the shock angle for an upper or lower lip point. Real gas effects are considered in calculating flow properties downstream of the shock.
PRANDT	This subroutine computes the Prandtl-Meyer expansion angle for a given boundary angle and divides this angle into a series of expansion "rays" (unless the number of rays has been specified in the input). The flow properties at each angular increment are set and stored in the PHO array.

<u>Routine</u>	<u>Description</u>
THETPM	This subroutine performs a numerical integration to calculate properties through a Prandtl-Meyer expansion. Either the case of known final velocity or known final expansion angle may be handled.

### 3.5.15 Initialization Routines

<u>Routine</u>	<u>Description</u>
BLKDAT	This routine initializes the Kliegel (Ref.7) and Crowe (Ref. 11) gas-particle drag coefficients which are used by the code.
INITP	This subroutine initializes the values of various control parameters, thereby providing for proper operation of the program. These initial values include: <ol style="list-style-type: none"> <li>1. The counter for the upper and lower boundary equations,</li> <li>2. The counter for the first characteristic line,</li> <li>3. The initial number of degrees per Prandtl-Meyer ray,</li> <li>4. Convergence criteria, and</li> <li>5. Maximum number of iterations.</li> </ol>
SEHTG	This subroutine computes the gas total enthalpy for a case when finite-rate chemistry is being used and the startline is to be generated by the program for gaseous flows only.

### 3.5.16 Performance Calculation Routines

<u>Routine</u>	<u>Description</u>
INTEGR	This subroutine calculates the incremental force and energy between two adjacent points in the flow field.
MASSCK	This subroutine keeps a running check on the mass flow. Mass flow at the starting line is calculated and compared with that crossing each normal line downstream.

<u>Routine</u>	<u>Description</u>
THRUST	This subroutine computes the vacuum thrust produced by a two-dimensional or axisymmetric nozzle. Addition of the thrust at the throat and the integrated pressure along the nozzle wall yields the final thrust.

### 3.5.17 Characteristic Routines

<u>Routine</u>	<u>Description</u>
BOUNDA	This subroutine finds the radial and axial coordinates as well as flow angle at the intersection of a straight line with a solid boundary.
CARCTR	This subroutine calculates velocity along either a I or II characteristic line with a known or assumed flow angle.
MOCSOL	This subroutine solves the characteristic equations for gas only flow in the region around and downstream of an expansion corner.
PHYSOL	This subroutine computes the intersection of physical characteristics with a "normal" data line.

### 3.5.18 Miscellaneous Routines

<u>Routine</u>	<u>Description</u>
CHECK	This subroutine determines whether or not to add or delete streamline points based on user input mesh controls.
DOTPRD	This function calculates the dot product of two vectors and returns the result to the calling routine.
INRSCT	This subroutine finds the intersection of two straight lines.
KIKOFF	This subroutine terminates the use if an error in the calculation is encountered.
MAXTIM	This subroutine is a Univac 1108 machine language routine that checks a user input time (seconds) against the remaining CPU time before run termination and returns to a specified label in the calling routine.

<u>Routine</u>	<u>Description</u>
SLDP	This subroutine finds the solutions to a set of N simultaneous linear equations.
VEMAG	This function determines the magnitude of a vector.

### 3.6 DETAILED DISCUSSION OF THE INDIVIDUAL ROUTINES

This subsection contains a detailed description of each routine used in the program.

Described are:

- Function (if applicable) of each routine
- Calling sequence
- Common blocks and other routines used, and
- The method used in performing the routine functions

For your convenience, the routines are organized alphabetically.

NOTE: The following routines are not included in this section as they comprise the two-phase transonic solution of Kliegel which is incorporated in the RAMP code. A complete description of each of these routines is contained in Ref. 7.

ABCALC	JAMES	PARTIL
CCALC	LEGS	PCALC
FCALC	NEWT	PROP
FIND11	ONED	TRACE
		WDGI

FUNCTION NAME: ALGINT

DESCRIPTION

This routine does a log interpolation between two values of a variable.

CALLING SEQUENCE

= ALGINT (H, R1, R2)

where H is the interpolation factor and R1 and R2 are the values of the variables between which the interpolation is being made.

UTILITY ROUTINES AND COMMON REFERENCES

COMMON - None

UTILITY - None

METHOD OF SOLUTION

$$A = \ln (R1) + H * (\ln (R2) - \ln R1)$$

$$\text{ALGINT} = e^A$$

23  
FUNCTION NAME: AOASTR

DESCRIPTION

This function finds the Mach number corresponding to a given area ratio by one-dimensional theory. Real gas effects are considered in this calculation.

CALLING SEQUENCE

EM = AOASTR (OF, S, AOA, K1W1, K2W2)

where EM is the Mach number which exists, one-dimensionally, at an area ratio of AOA, an entropy S, and at an O/F ratio or total enthalpy, OF.

UTILITY ROUTINES AND COMMON REFERENCES

COMMON - None

ERRORS

ITSUB

RGVOFM

THERMO

WOFA

METHOD OF SOLUTION

The weight flow per unit area at Mach one is evaluated. An initial guess for the desired Mach number is made and ITSUB is initialized. An iterative solution of the equation  $FOFEM = AOA - WOFA1/WOFA(EM)$ , driving FOFEM to zero, is performed with the aid of ITSUB.



SUBROUTINE NAME: AVERAG

DESCRIPTION

This subroutine determines the appropriate flow regime based on Knudsen number for non-continuum flow and sets the appropriate gas total conditions.

CALLING SEQUENCE

CALL AVERAG(IS, J, N, K, ITYPE)

where IS is the base point streamline number on the J data surface, N is the streamline point on the K line for which the flow regime is to be determined and ITYPE is a flag which is returned to the calling routine to indicate the flow regime.

<u>ITYPE</u>	<u>Flow Regime</u>
1	Continuum
2	Vibrationally frozen
3	Rotationally frozen
4	Translationally frozen

UTILITY ROUTINES AND COMMON REFERENCES

COMMON/TOTAL/	TOFV
COMMON/GSV/	RHOFEM
COMMON/GAPPA/	STGMOD
COMMON/GASCON/	
COMMON/CONTRL/	
COMMON/FREE/	
COMMON/FSTAG/	
COMMON/DATAR/	
COMMON/MOL/	
COMMON/TEMPER/	
THERMO	
EMOFV	

### METHOD OF SOLUTION

The average Knudsen number between the old streamline base point is calculated via the following equation:

$$Kn = .788539 \bar{\gamma} (\bar{M}^2 / \bar{R}_E) |\ln T_1 - \ln T_2| / dS$$

where the  $(-)$  properties are averaged between the old (1) and new (2) streamline points. The flow regime is determined by checking the calculated Knudsen number against the input Knudsen number criteria for vibrational, rotational or translational freezing. Once the flow regime has been determined the appropriate specific heat ratio ( $\gamma$ ) and total conditions are calculated.

SUBROUTINE NAME: BLKDAT

DESCRIPTION

This routine initializes the Kliegel (Ref. 7) and Crowe (Ref. 11) gas-particle drag coefficients which are used by the code.

CALLING SEQUENCE

None

UTILITY ROUTINES AND COMMON REFERENCES

COMMON/DRAGCF/

COMMON/DRUG/

UTILITY - None

METHOD OF SOLUTION

Not applicable

SUBROUTINE NAME: BOUND

DESCRIPTION

This subroutine finds the radial coordinate and flow angle (radians) for a given axial coordinate on an upper or lower solid boundary.

CALLING SEQUENCE

CALL BOUND (R, X, THETA, ITYPE, K1W1, K1W2)

where R is the radial coordinate, X is the known axial coordinate, THETA is the wall angle and ITYPE indicates whether upper or lower boundary equations are to be used.

UTILITY ROUTINES AND COMMON REFERENCES

COMMON/DATAR/  
COMMON/WAFT/  
LAGRNG

METHOD OF SOLUTION

The common block region DATAR contains boundary equations or wall coordinates necessary to evaluate R and THETA. The two types of equations used are:

$$r = a \left[ \sqrt{b + cx + dx^2} + e \right] \quad \text{Conic Type 1}$$

$$r = ax^4 + bx^3 + cx^2 + dx + e \quad \text{Polynomial Type 2}$$

When the upper or lower boundary is described by discrete points (R, X, THETA) subroutine LAGRNG is called to interpolate for the R and THETA of the point. The input fixed point variable ITYPE has a one or a two in the units position which selects the upper (2) or lower (1) coefficients or points and control information. IEQNOW contains the number of the equation to be used.

SUBROUTINE NAME: BOUNDA

DESCRIPTION

This subroutine finds the radial and axial coordinates as well as flow angle at the intersection of a straight line with a solid boundary.

CALLING SEQUENCE

CALL BOUNDA (PL, PM, RB, XB, AB, ITYPE, KIWI, KIWI2)

where

PL(8) is the storage array for the known boundary point

PM(8) is the storage array for the known field point  
where the straight line passes through

RB and XB are the radial and axial coordinates of the point  
of intersection

AB is the angle of the solid boundary at the point of  
intersection

ITYPE denotes the type of combination being considered

<u>ITYPE</u>	<u>Type of Straight Line</u>	<u>Boundary</u>
51	normal	lower
52	normal	upper
61	II-characteristic	lower
62	I-characteristic	upper
121	right-running shock wave	lower
122	left-running shock wave	upper

UTILITY ROUTINES AND COMMON REFERENCES

COMMON/CONTRL/

COMMON/DATAR/

COMMON/TEMPO1/

BOUND

ERRORS

INRSCT

KIKOFF

CONTRL

TEMPO1

### METHOD OF SOLUTION

Intersection of the straight line from PM and the tangent from PL is found first with the aid of subroutine INRSCT. The radial coordinate and the flow angle on the boundary at this given axial coordinate of the intersection just found can be calculated from the solid boundary equation by using subroutine BOUND. Then, if the boundary is not a straight line, the newly found point on the boundary is used to repeat the same process until the exact intersection is found.

SUBROUTINE NAME: CARCTR

DESCRIPTION

This subroutine calculates velocity along either a I or II characteristic line with a known or assumed flow angle.

CALLING SEQUENCE

CALL CARCTR (LOORUP, P3I, KIWI, KIW2)

where

LOORUP = 1 for a I characteristic  
          = 2 for a II characteristic  
P3i(8) is the storage array for the point  
under consideration

UTILITY ROUTINES AND COMMON REFERENCES

COMMON/CONTROL/  
COMMON/CRITER/  
COMMON/DATAR/  
COMMON/GASCON/  
COMMON/SLIPPT/  
COMMON/PARTP2/  
COMMON/GAPPA/  
ROTERM  
UOFV  
PPATPT  
THERMO  
COEFEQ

METHOD OF SOLUTION

For the first pass of the solution the flow properties, except the flow angle, at the point under consideration are assumed to be identical to those of the upstream point on the same streamline. Equation (3.3) is then used to calculate the "updated" velocity. Other properties are calculated according to the new velocity. This routine is used in the iteration for a shock point solution.

SUBROUTINE NAME: CHECK

DESCRIPTION

This subroutine determines whether or not to add or delete streamline points based on user input mesh controls.

CALLING SEQUENCE

CALL CHECK (I, K, IS, J, IGO, ITOTK, ITOTJ)

where (I, K) and (IS, J) are the two points the program is checking the mesh control constraints against. IGO = -1 for checking deletion and greater than zero for inserting points. ITOTK and ITOTJ are the total number of points on the J and K normals.

UTILITY ROUTINES AND COMMON REFERENCES

COMMON/POINTC/	COMMON/CHEMXX/
COMMON/DATAR/	SPCTX
COMMON/GLOBAL/	PFP
COMMON/PARTP1/	IDMPFP
COMMON/PARTP2/	GAPPBI
COMMON/STEP/	
COMMON/CONTRL/	
COMMON/GAPPA/	
COMMON/FSTAG/	
COMMON/DROP/	
COMMON/CHEMCN/	

METHOD OF SOLUTION

See Section 3.5.1 for a description of mesh control parameters.



SUBROUTINE NAME: CHEM

DESCRIPTION

This routine evaluates the chemical reaction-rate equations to determine the new chemical species concentrations.

CALLING SEQUENCE

CALL CHEM (DXX, RHO, U, T)

where DXX is the distance along the gas streamline from the base point to the new point

RHO = gas density

U = gas velocity

T = gas temperature

UTILITY ROUTINES AND COMMON REFERENCES

COMMON/CRITER/

COMMON/RUE/

COMMON/CONTRL/

COMMON/CHEMCN/

COMMON/GASDAT/

COMMON/CHEMXX/

COMMON/CHEMY/

TKEY

RWU

SLDP

METHOD OF SOLUTION

The reaction rate equations for the various chemical reactions are solved simultaneously using an implicit finite differencing scheme.

SUBROUTINE NAME: COEFEQ

DESCRIPTION

This subroutine calculates the coefficients CI and CIJ for use in the gas-particle system compatibility equation along the gas Mach lines. CI is the gas total enthalpy term and CIJ is the particle contribution to the equation.

CALLING SEQUENCE

CALL COEFEQ (M, IPA, IPB, IPC)

where M is equal to 1 for limiting streamlines, IPA is the base point number for the RRC, IPB is the base point number of the LRC and IPC is the new point number.

UTILITY ROUTINES AND COMMON REFERENCES

COMMON/SLIPPT/  
COMMON/DATAR/  
COMMON/GAPPA/  
COMMON/ONTSPPT/  
COMMON/AVPROP/  
COMMON/CONTRL/  
COMMON/CHEMXX/  
COMMON/CHEMCN/  
UTILITY - None

METHOD OF SOLUTION

The following finite difference relations are used to solve for the coefficients:

$$CI_{1,2} = \frac{\cos \bar{\alpha}_{1,2}}{\sin \bar{\alpha}_{1,2} \bar{q}_{1,2}^2}$$

and

$$C_{1J_{1,2}} = \left[ \sum_{j=1}^{NP} \bar{\rho}_{1,2}^j \bar{A}_{1,2}^j \left[ \pm (\bar{v}_{1,2} - \bar{v}_{1,2}^j) \cos \bar{\beta}_{1,2} \mp (\bar{u}_{1,2} - \bar{u}_{1,2}^j) \sin \bar{\beta}_{1,2} \right. \right. \\ \left. \left. + \frac{\bar{B}_{1,2}^j}{\bar{q}_{1,2} \sin \bar{\alpha}_{1,2}} \right] \right] \frac{\Delta x_{1,2}}{\bar{\rho}_{1,2} \bar{q}_{1,2}^2 \cos \bar{\beta}_{1,2}}$$

For a detailed description of the calculation procedure, see Volume I, Section 3.3.

SUBROUTINE NAME: COEFF3

DESCRIPTION

This subroutine calculates the new particle properties at the point under consideration, and the intersection of the particle streamlines through this point with the J-line.

CALLING SEQUENCE

CALL COEFF3 (KP, M, VERT, IH, KH, I8, K8, I9, K9,  
I7, K7, ITYPE, IPA, IPB, IPC, P3, PG)

UTILITY ROUTINES AND COMMON REFERENCES

COMMON/CONTRL/	COMMON/PSEC/
COMMON/DATAR/	COMMON/PSLD/
COMMON/TOTAL/	COMMON/XXSH/
COMMON/PARTPI/	COMMON/GASCON/
COMMON/GAPPA/	COMMON/CPMUK/
COMMON/ONTSPT/	COMMON/SLIPPT/
COMMON/POINTC/	IDMPFP
COMMON/PARSTU/	PFP
COMMON/CRITER/	INRSCT
	PPATPT
	GAPPBI

METHOD OF SOLUTION

For a detailed description of the calculation procedure, see Volume I, Section 6.1.

FUNCTION NAME: DELTAF

DESCRIPTION

This function computes the turning angle through an oblique shock wave knowing the shock angle and the upstream Mach number.

CALLING SEQUENCE

DELTA = DELTAF (EPS, EM, K1W1, K1W2)

where DELTA, the turning angle is found from the shock angle, EPS, and the upstream Mach number, EM. NOTE: The appropriate values of gas properties must be stored in common upon entry to this routine.

UTILITY ROUTINES AND COMMON REFERENCES

COMMON/GASCON/

UTILITY - None

METHOD OF SOLUTION

The oblique shock relationships are used to determine the turning angle through an oblique shock wave.

$$\delta = \epsilon - \tan^{-1} \left\{ \tan \epsilon \left( \frac{1}{M^2 \sin^2 \epsilon} + \frac{\gamma - 1}{2} \right) \left( \frac{2}{\gamma + 1} \right) \right\}$$

FUNCTION NAME: DOTPRD

DESCRIPTION

This function calculates the dot product of two vectors and returns the result to the calling routine.

CALLING SEQUENCE

= DOTPRD(V1, V2)

where V1 and V2 are any two vectors.

UTILITY ROUTINES AND COMMON REFERENCES

None

METHOD OF SOLUTION

Vector V1 is dotted into vector V2. The resultant is a scalar returned as DOTPRD.

FUNCTION NAME: DRAGCP

DESCRIPTION

This routine determines the drag coefficient  $F (C_D/C_{D_{Stokes}})$  as a function of Reynolds number.

CALLING SEQUENCE

= DRAGCP (RE)

where

RE is the particle Reynolds number.

UTILITY ROUTINES AND COMMON REFERENCES

COMMON/DRAGCF/

UTILITY - None

METHOD OF SOLUTION

$C_D/C_{D_{Stokes}}$  is tabulated as a function of particle Reynolds number and a linear interpolation is performed based on Reynolds number to obtain  $C_D/C_{D_{Stokes}}$ . This tabulation is that of Kliegel (Ref. 7).

FUNCTION NAME: DRACMR

DESCRIPTION

This subroutine determines the local drag coefficient ( $C_D/C_{D_{Stokes}}$ ) as a function of particle Reynolds number and particle Mach number.

CALLING SEQUENCE

= DRAGMR (EM, RE)

where

EM is the particle Mach number

RE is the particle Reynolds number.

UTILITY ROUTINES AND COMMON REFERENCES

COMMON/DRUG/

ALGINT

METHOD OF SOLUTION

$C_D/C_{D_{Stokes}}$  as presented by Crowe (Ref. 11) is tabulated as a function of particle Reynolds number and Mach number. A logarithmic interpolation is performed based on RE and EM to obtain the appropriate value of  $C_D/C_{D_{Stokes}}$ .



SUBROUTINE NAME: DRIVER

DESCRIPTION

DRIVER provides the highest order control for program execution. The initialization and logic subroutines are called from here. Most of the common storage needed in the remainder of the program is specified here.

CALLING SEQUENCE

CALL DRIVER (K, K1W1, K1W2)

where K is a control constant indicating whether or not errors exist in the execution of the program. (K = 1 for a detected error, K = 0 for no errors.) K1W1 and K1W2 are flags which have various uses in the code.

UTILITY ROUTINES AND COMMON REFERENCES

COMMON/AUX/	COMMON/TPEH/
COMMON/CONTRL/	COMMON/WAFT/
COMMON/CRITER/	COMMON/NSF/
COMMON/DRAGCF/	COMMON/XSICOM/
COMMON/CUTFO/	COMMON/GAPPA/
COMMON/DATAR/	COMMON/DISCOM/
COMMON/XXSH/	COMMON/GRINT/
COMMON/FREE/	COMMON/TFLAG/
COMMON/FORCE/	COMMON/TEMPER/
COMMON/GASCON/	COMMON/ONTSPT/
COMMON/HEAD/	COMMON/WRITPT/
COMMON/SIGNAL/	COMMON/PSLD/
COMMON/INPUT/	COMMON/CPMUK/
COMMON/MASSC/	COMMON/MOL/
COMMON/STPC/	COMMON/FAB/
COMMON/TAPRIT/	COMMON/WT/
COMMON/PARTP1/	INITP
COMMON/PARTP2/	PLUMIN
COMMON/GASDAT/	PHASE 1

METHOD OF SOLUTION: Not applicable.

FUNCTION NAME: EMOFP

DESCRIPTION

This routine computes the local Mach number as a function of local pressure (static) and local entropy.

CALLING SEQUENCE

$$EM = EMOFP (P, S, K1W1, K1W2)$$

where EM is the resultant Mach number found from the pressure, P, and entropy, S. NOTE: The appropriate values of the gas properties must be stored in common upon entry to this routine.

UTILITY ROUTINES AND COMMON REFERENCES

COMMON/TEMPER/

COMMON/GASCON/

UTILITY - None

METHOD OF SOLUTION

Thermally perfect gas relationships are used to find the Mach number.

$$M = \sqrt{\left[ \left( \frac{P_o e^{-S/R} (T_o/T_c)^{\gamma/\gamma-1}}{P} \right)^{\gamma-1/\gamma} - 1 \right] \frac{2}{\gamma-1}}$$

FUNCTION NAME: EMOFV

DESCRIPTION

This routine finds Mach number as a function of local velocity.

CALLING SEQUENCE

EM = EMOFV (V, K1W1, K1W2)

where EM is the local Mach number found as a function of the local velocity, V.

NOTE: The appropriate values of the gas properties must be stored in common upon entry to this routine.

UTILITY ROUTINES AND COMMON REFERENCES

COMMON/GASCON/

TOFV

METHOD OF SOLUTION

Thermally perfect gas relationships are used to find the Mach number.

$$M = \sqrt{\left(\frac{T_o}{T} - 1\right) \left(\frac{2}{\gamma - 1}\right)}$$

FUNCTION NAME: ENTROP

DESCRIPTION

This routine utilizes the oblique shock relations to find the entropy rise across a shock as a function of the shock angle and the upstream Mach number.

CALLING SEQUENCE

SD = ENTROP (EPS, EMU, K1W1, K1W2)

where SD is the entropy rise across the shock and is a function of the shock angle, EPS, and the upstream Mach number, EMU. NOTE: The appropriate values of the gas properties must be stored in common upon entry to this routine.

UTILITY ROUTINES AND COMMON REFERENCES

COMMON/GASCON/

UTILITY - None

METHOD OF SOLUTION

The oblique shock relations are employed to find the entropy rise across the shock.

$$ds = \frac{R}{\gamma-1} \left\{ \ln \left[ \frac{(2\gamma M^2 \sin^2 \epsilon - (\gamma-1))}{\gamma+1} \right] + \gamma \ln \left[ \frac{\tan(\epsilon - \delta)}{\tan \epsilon} \right] \right\}$$

SUBROUTINE NAME: ERRORS

DESCRIPTION

ERRORS contains print messages for various errors which may occur. This is an open ended routine in that it can easily be extended to handle more print messages.

CALLING SEQUENCE

CALL ERRORS (I, K1W1, K1W2)

where I selects the message to be printed.

UTILITY ROUTINES AND COMMON REFERENCES

COMMON/CONTRL/

UTILITY - None

METHOD OF SOLUTION

Not applicable.

SUBROUTINE NAME: ESHOCK

DESCRIPTION

This subroutine employs an iterative solution to perform the equilibrium shock calculations for a real or ideal gas. The real and ideal gas calculations are similar, the difference being that an ideal gas case converges on the first iteration.

CALLING SEQUENCE

CALL ESHOCK (OF, S1, V1, EP, DELTA, S2, V2, K2W, K1W)

where the input properties are, OF, the upstream O/F ratio or total enthalpy, S1, V1, the upstream entropy and velocity and, EP, the shock angle. The subroutine returns with DELTA, the turning angle and S2, V2, the downstream entropy and velocity.

UTILITY ROUTINES AND COMMON REFERENCES

COMMON/CONTRL/  
COMMON/GASCON/  
EMOFV  
THERMO  
POFEM  
DELTA F  
ENTROP  
RHOFEM  
WEAK

METHOD OF SOLUTION

The continuity equation coupled with the equations for conservation of normal and tangential momentum are solved in an iterative manner utilizing thermochemical property data to satisfy the conservation of energy equation. This set of four equations is expressed in terms of the four unknown quantities:

$\epsilon$  = shock angle  
 $\delta$  = turning angle  
 $S_2$  = entropy downstream of shock  
 $V_2$  = velocity downstream of shock

SUBROUTINE NAME: EXPCOR

DESCRIPTION

EXPCOR calculates the flow properties of those field points near an expansion corner.

CALLING SEQUENCE

CALL EXPCOR (NPM, J, K, ITOTJ, ITOTK, IPNT, K2W, K1W)

where

NPM = number of Prandtl-Meyer expansion rays emanating from the expansion corner

J = known normal line upstream of the expansion corner

K = the normal line under consideration downstream of the expansion corner

ITOTJ = adjusted total number of points on the J-line, not including the Prandtl-Meyer expansion points NPM

ITOTK = number of points on K-line before the Prandtl-Meyer expansion points are added; returns to the calling routine with the total number of points on K-line including Prandtl-Meyer expansion points

IPNT indicates if an upper (=2) or lower (=1) boundary is being considered.

UTILITY ROUTINES AND COMMON REFERENCES

COMMON/CHEMXX/

COMMON/FSTAG/

COMMON/GLOBAL/

COMMON/GAPPA/

COMMON/CONTRL/

INRSC T

COMMON/DATAR/

MOCSOL

COMMON/INPUT/

OUT

COMMON/STEP C/

SPCTX

COMMON/AUX/

PPATPT

## METHOD OF SOLUTION

Flow properties at the expansion corner points are known (from PRANDT). Calculation starts from one of the corner points which have zero turning angle and proceeds toward the point with an increasing turning angle. Subroutine MOCSOL is used to solve for the flow properties of the intersection of the characteristic lines from two known points. The properties of the intersection of the normal from the known point on the new line (K-line, normal to the streamlines), with the characteristic of the corresponding point at the corner, are then interpolated. This point is then used along with another point at the expansion corner to find another new point, and so forth. The last of the expansion corner points is used twice in the calculation to find two points on the new normal - one on the characteristic line, the other on the streamline.

A weak shock is then initialized at the point on this last characteristic line and a mesh point is inserted between this point and the point on the last expansion ray which is a streamline rather than a characteristic line.

For a detailed description of the calculation procedure, see Volume I, Section 6.9.



SUBROUTINE NAME: FABLE

DESCRIPTION

This subroutine utilizes real or ideal gas information obtained from a master tape or input cards to calculate properties locally in the flow. The maximum size of the array used by FABLE is limited to eight gas properties ( $V, R, \gamma, T_o, P_o, \mu, Pr, C_p$ ) at 13 velocity "cuts" for each of two entropy cuts and 10 O/F or total enthalpy cuts.

CALLING SEQUENCE

CALL TABLE (SS, VV, IF)

where SS is the local entropy, IF is the O/F or enthalpy table of interest and VV is the local velocity at the point of interest.

UTILITY ROUTINES AND COMMON REFERENCES

COMMON/XSICOM/	COMMON/GASDAT/
COMMON/CONTRL/	COMMON/MOL/
COMMON/GASCON/	COMMON/FILIT/
COMMON/FAB/	TOFV
COMMON/GRINT/	POFEM
COMMON/TEMPER/	EMOFV
COMMON/CPMUK/	XSI
COMMON/PARTFP/	TAB

METHOD OF SOLUTION

The routine is entered with an O/F or enthalpy table, IF, the local entropy, SS, and velocity, VV. A test is then made to determine if the gas is real or ideal. If the test indicates an ideal gas, the local properties are set to those stored in the TABB common array. If the test indicates real gas, a double interpolation scheme is utilized to locate gas properties between tabulated values of velocity and entropy. In the case of an entry beyond the range of the tables, an ideal gas extrapolation from the last table value is made to determine the gas properties.

FUNCTION NAME: FNEWTN

DESCRIPTION

This function solves for the Newtonian impact pressure along the plume boundary. The calculation is applicable for all free stream velocities including quiescent conditions (i.e.,  $M_\infty = 0$ ).

CALLING SEQUENCE

$$P_{IM} = \text{FNEWTN}(\text{THETA3}, X, \text{ITYPE1}, K1W1, K1W2)$$

where  $P_{IM}$  is the hypersonic Newtonian impact pressure at the plume boundary, THETA3 is the local flow angle at the boundary, X is the axial coordinate of the boundary point, and ITYPE indicates if an upper (=2) or lower (=1) boundary is being considered.

UTILITY ROUTINES AND COMMON REFERENCES

COMMON/DATAR/

UTILITY - None

METHOD OF SOLUTION

The common block region WALLCO contains the necessary information to evaluate the freestream gas properties at the plume boundary point. The impact pressure is then calculated using the following equation

$$P = P_\infty (1 + eX) \left[ 1 + \gamma_\infty M_\infty^2 \sin^2(\theta_B - \theta_\infty) \right]$$

SUBROUTINE NAME: FREEMC

DESCRIPTION

This subroutine computes flowfield properties in the free molecular regime.

CALLING SEQUENCE

CALL FREEMC (I1, J1, K1, ITOT, IOO, IOUT, IMOD)

where I1 is the point number for the first free molecular point on a normal, J1 is the old data surface, K1 is the new data surface, ITOT is the total number of points on the line, IOO is the line number for which a complete line is to be printed, IOUT is the total number of lines to skip between complete printout and IMOD is the number of points to shift on the old data surface to locate each base point streamline.

UTILITY ROUTINES AND COMMON REFERENCES

COMMON/CONTRL/	COMMON/GLOBAL/
COMMON/DATAR/	BOUND
COMMON/PARTP1/	ITERM
COMMON/PARTP2/	INRSCT
COMMON/FREE/	WTFLOF
COMMON/GASCON/	IDMPFP
COMMON/FSTAG/	PFP
COMMON/CUTFO/	OUT
COMMON/STEP/	OUTBIN
COMMON/CRITER/	

METHOD OF SOLUTION

Once it has been determined that a point is free molecular all successive calculations of the particular streamline point are made via FREEMC. The point properties are determined assuming that temperature, gas velocity, flow angle, gas constant and specific heat ratio ( $\gamma$ ) are constant along a streamline. The gas density is determined from a source flow calculation (i.e., conservation of mass between streamlines).

$$\rho_2 = \frac{\rho_1 u_1 A_1}{u_2 A_2}$$

where subscript 1 is the old data surface properties and subscript 2 is the new data surface properties. The pressure at the new point is then determined from the equation of state.

SUBROUTINE NAME: GAPPBI

DESCRIPTION

This subroutine interpolates for the gas and particle properties between two known data points.

CALLING SEQUENCE

CALL GAPPBI (I8, JU, I9, KU, JB, M, ISKIPG, PG, FACTOR, M1)

where I8 is the base point number, JU is the base point line number, I9 is the second point number, KU is the second point line number, JP is the temporary location in the IPFP array to store the interpolated data, M is the number of particles present, ISKIPG is a flag used to determine what arrays to use to do the interpolation, PG is the array in which the interpolated point properties are stored, FACTOR is the interpolation factor, and M1 = 0 gas only, M1 = 1 particles present.

UTILITY ROUTINES AND COMMON REFERENCES

COMMON/TFLAG/	COMMON/DRAGCF/
COMMON/DATAR/	COMMON/PCTC/
COMMON/PARTP1/	COMMON/WISEX/
COMMON/PARTP2/	ALGINT
COMMON/GAPPA/	PFP
COMMON/GASCON/	THERMO
COMMON/POINTC/	UOFV
COMMON/CPMUK/	TOFV
COMMON/CONTRL/	EMOFV
COMMON/FSTAG/	POFEM
COMMON/TEMPER/	TEMTAB
COMMON/CRITER/	DRAGMR
COMMON/PSLD/	DRAGCP
COMMON/XXSH/	

### METHOD OF SOLUTION

The routine performs a linear interpolation between the properties of two known points and stores the results in temporary arrays which are used in other parts of the program during the calculation. ISKIPG is a flag which tells GAPPBI which arrays to use for the interpolation and whether or not to interpolate on particle properties.

SUBROUTINE NAME: GASRD

DESCRIPTION

This subroutine reads in the gas properties. These properties may be real or ideal and read in via cards or tape. The routine also converts input gas properties from MKS units to English (ENG) units if necessary.

CALLING SEQUENCE

CALL GASRD (IPAR)

where IPAR is a 1 for two-phase flow and a zero for gas-only flow.

UTILITY ROUTINES AND COMMON REFERENCES

COMMON/XSICOM/  
COMMON/CONTRL/  
COMMON/INTCR/  
COMMON/GASCON/  
COMMON/GASDAT/  
COMMON/MOI./  
COMMON/FSTAG/  
XSI  
GASTAP  
IDMXSI  
IDTAPE  
IDMTAB  
TAB

METHOD OF SOLUTION

The gas name, ALPHA(I), type units, number of O/F tables and number of entropy cuts are read in from an input card. If the gas properties are on cards, this subroutine reads the cards. If the gas properties are on tape, control of the reading of properties is given to GASTAP. In either case, the properties are converted from MKS to English (ENG) units by this subroutine if necessary.

SUBROUTINE NAME: GASTAP

DESCRIPTION

GASTAP reads the real gas properties from the thermochemical data tape generated by the modified TRAN72 computer program and writes this same data on a flowfield tape for communication with other programs.

CALLING SEQUENCE

CALL GASTAP

UTILITY ROUTINES AND COMMON REFERENCES

COMMON/GASDAT/	COMMON/XXSH/
COMMON/CONTRL/	COMMON/BPRESW/
COMMON/DATAR/	COMMON/TAPRIT/
COMMON/HEAD/	COMMON/SIGMB/
COMMON/PARTP2/	IDMTAB
COMMON/CHEMCN/	ERRORS
COMMON/PCTC/	IMPUT

METHOD OF SOLUTION

The gas name, ALPHA(I), specified on the input data is compared with available cases on the TRAN72 thermochemical data tape until a match is found. This particular case is then read, stored in core, arranged in a form such that automatic transmission of data to other programs is possible, and then written on the RAMP flowfield tape.



SUBROUTINE NAME: HYPER

DESCRIPTION

This subroutine calculates the balanced pressure at a corner point (i.e., at the intersection of a solid boundary and the pressure boundary). The pressure balance is determined for either the overexpanded or under-expanded case with impact or ambient freestream pressure.

CALLING SEQUENCE

CALL HYPER (PB, I, K, ITYPE1, K1W1, K1W2)

where PB is the boundary pressure, I, K locates the boundary point, and ITYPE1 indicates if an upper (=2) or lower (=1) boundary is being considered.

UTILITY ROUTINES AND COMMON REFERENCES

COMMON/CONTRL/	FNEWTN
COMMON/DATAR/	OVEREX
COMMON/PCTC/	ITSUB
COMMON/FSTAG/	THETPM
THERMO	TOFH
POFEM	ERRORS
EMOFV	

METHOD OF SOLUTION

The boundary pressure (may be impact or ambient) is compared to the static pressure at the corner point. Depending on whether the comparison indicates the flow is overexpanded or underexpanded, a branch is made to OVEREX or THETPM. In either of these routines an iterative process balances the boundary pressure with the flowfield pressure at the boundary.

FUNCTION NAME: IDMPFP

DESCRIPTION

This function computes the particle storage location within the PFPARY array.

CALLING SEQUENCE

= IDMPFP (I, J, K, L)

where I, J, K, L are indices used to determine the storage location.

UTILITY ROUTINES AND COMMON REFERENCES

COMMON/PARTP1/

COMMON/PARTP2/

COMMON/PARTP3/

RWU

METHOD OF SOLUTION

The particle storage location is computed using the following relation

$$\text{IDMPFP} = I + 5 * (J - 1 + 10 * (K - 1 + 100 * (L - 1)))$$

FUNCTION NAME: IDMTAB

DESCRIPTION

This function computes the gas property storage location within the TABB array.

CALLING SEQUENCE

= IDMTAB (I, J, K, L)

where I, J, K, L are indices used to determine the storage location.

UTILITY ROUTINES AND COMMON REFERENCES

None

METHOD OF SOLUTION

The gas property storage location, is computed using the following relation

$$\text{IDMTAB} = I + 10 * (J - 1 + 2 * (K - 1 + 13 * (L - 1)))$$

FUNCTION NAME: IDMXSI

DESCRIPTION

This function computes the gas interpolation parameter storage location within the XSIDIM array.

CALLING SEQUENCE

= IDMXSI (I, J, K, L)

where I, J, K, L are indices used to determine the storage location.

UTILITY ROUTINES AND COMMON REFERENCES

None

METHOD OF SOLUTION

The gas interpolation parameter storage location is computed using the following relation

$$\text{IDMXSI} = 1 + 10 * (\text{J}-1 + 2 * (\text{K}-1 + 13 * (\text{L}-1)))$$

SUBROUTINE NAME: IDTAPE

DESCRIPTION

This subroutine writes the gas properties which were input via cards on the flowfield program tape. The format used to write them on tape is compatible with that used for a real gas.

CALLING SEQUENCE

CALL IDTAPE (UNITS, K1W1, K1W2)

where UNITS indicates whether the gas properties are being read in with English (ENG) or MKS units.

UTILITY ROUTINES AND COMMON REFERENCES

COMMON/XXSH/	COMMON/BPRESW/
COMMON/TAPRIT/	COMMON/PARTP2/
COMMON/CONTRL/	COMMON/GASDAT/
COMMON/HEAD/	TAB

METHOD OF SOLUTION

Gas property data are read in from cards. If not already in MKS units, the data are converted. These converted data are then written on the flowfield tape.

SUBROUTINE NAME: IMPUT

DESCRIPTION

This routine reads the input cards or tape for the chemistry package. The reaction rate equations, rate constants, and startline species concentrations are read in and the appropriate conversions, if any, are performed. Tables of enthalpy, entropy, and specific heats for each species are also input.

CALLING SEQUENCE

CALL IMPUT (IDATA)

where IDATA specifies the proper index of the array being input from a CEC data tape from which species concentrations are being extracted.

UTILITY ROUTINES AND COMMON REFERENCES

COMMON/CONTRL/  
COMMON/CHEMCN/  
COMMON/DATAR/  
COMMON/GASDAT/  
COMMON/CHEMXX/  
COMMON/CPMUK/  
COMMON/WISEX/  
COMMON/PCTC/  
COMMON/GASCON/  
COMMON/VARSL/  
SPCTX

METHOD OF SOLUTION

The routine reads species thermodynamic data and constructs a Gibbs free energy array to replace the entropy array. The reaction rate constant data, reactions, and third body data are input and stored. Finally the startline species concentrations are input via cards or tape and converted to mole/mass ratios.

SUBROUTINE NAME: INITP

DESCRIPTION

This subroutine initializes the values of various control parameters, thereby providing for proper operation of the program. These initial values include:

1. The counter for the upper and lower boundary equations,
2. The counter for the first characteristic line,
3. The initial number of degrees per Prandtl-Meyer ray,
4. Convergence criteria, and
5. Maximum number of iterations.

CALLING SEQUENCE

CALL INITP (KIW1,KIW2)

UTILITY ROUTINES AND COMMON REFERENCES

COMMON/CONTRL/  
COMMON/CRITER/  
COMMON/DATAR/  
COMMON/DISCOM/  
COMMON/HEAD/  
COMMON/STEP/PC/  
UTILITY - None

METHOD OF SOLUTION

Not applicable.

SUBROUTINE NAME: INRSCT

DESCRIPTION

INRSCT finds the intersection of two straight lines.

CALLING SEQUENCE

CALL INRSCT (T1, T2, T3, T4, T5, T6, R3, X3, K1W1, K1W2)

where T1, T2, T3 and T4, T5, T6 define the equations of the two straight lines which intersect at R3, X3.

UTILITY ROUTINES AND COMMON REFERENCES

COMMON - None

ERRORS

METHOD OF SOLUTION

The equations of the straight lines are written

$$r = \tan T3 (x - T2) + T1$$

and

$$x = \cot T6 (r - T4) + T5$$

These equations are solved for x, but a test on the slopes is made to prevent indeterminate forms. If an indeterminate form is possible, the points are mapped one onto another, thus precluding the possibility of indeterminacy except when the lines are parallel.



SUBROUTINE NAME: INTEGR

DESCRIPTION

This subroutine calculates the incremental force and energy between two adjacent points in the flow field.

CALLING SEQUENCE

CALL INTEGR (DELX, DELY, THTBR, R, DA, V,  
RHO, P, X, I, K, FXP, FYP, TRP, FXG, FYG, TRG,  
AXO2D, ENU, EG, EP, EM, DW)

where

DELX = difference in axial position between the two points  
DELY = difference in radial position between the two points  
THTBR = average flow angle of the two points  
R = average radial position of the two points  
DA = absolute distance between the two points  
V = average gas velocity of the two points  
RHO = average gas density of the two points  
P = average gas pressure of the two points  
X = average axial position of the two points  
I = point number of the base point  
K = line number of the base point  
FXP = incremental force in axial direction due to the particle  
momentum  
FYP = incremental force in radial direction due to the particle  
momentum  
TRP = incremental torque due to particle momentum  
FXG = incremental force in axial direction due to gas  
FYG = incremental force in radial direction due to gas  
TRG = incremental torque due to gas axial and radial forces  
AXO2D = geometric term for axisymmetric or 2-D flow  
ENU = angle the line connecting the two points has referenced  
to horizontal  
EG = incremental gas energy

EP = incremental particle energy  
EM = sum of incremental particle and gas energy (i.e., mixture)  
DW = incremental gas mass flow between the two points.

UTILITY ROUTINES AND COMMON REFERENCE

COMMON/CONTRL/  
COMMON/PARTP1/  
COMMON/PARTP2/  
COMMON/DATAR/  
COMMON/FSTAG/  
COMMON/INTCR/  
PFP  
VEMAG

METHOD OF SOLUTION

This subroutine calculates the mass flow, energy, momentum and thrust produced by the particles and gas contained in each streamtube bounded by two streamline points on a normal. The resulting values are integrated along each normal and compared to the initial data surface to determine how well the solution is conserving the conservation equations.

FUNCTION NAME: ITERM

DESCRIPTION

ITERM tests each normal lower wall point to determine if it is within the predefined problem limits. If the point falls outside the limits, the case is terminated.

CALLING SEQUENCE

FUNCTION = ITERM (IP, K, K1W1, K1W2)

where IP identifies the characteristic point on the new K line.

UTILITY ROUTINES AND COMMON REFERENCES

COMMON/CUTFO/

COMMON/DATAR/

UTILITY - None

METHOD OF SOLUTION

The angular orientation of a line drawn from the upper or lower cutoff coordinates to the characteristic point is determined. Comparing this angle to the angle of the upper or lower cutoff line determines if the point is inside or outside the problem limits.

SUBROUTINE NAME: ITSUB

DESCRIPTION

This subroutine controls the iterative solution of any set of equations which can ultimately be expressed as a function of one variable; it can also be used to control an integration loop.

CALLING SEQUENCE

CALL ITSUB (FOFY, Y, SAVE, CONV, NTIMES, K1W1, K1W2)

where

FOFY is the function of Y which is driven to zero

Y is the variable which is iteratively solved for

SAVE is the program control array, i.e., SAVE(1) is a control counter,  
SAVE(2) is the Y increment

CONV is the convergence criteria for FOFY

NTIMES = maximum number of iterations to be performed

UTILITY ROUTINES AND COMMON REFERENCES

None

METHOD OF SOLUTION

ITSUB modifies Y in the proper direction by the increment value SAVE(2) until the root has been bracketed. The method of false position is then used to modify Y until the solution is reached. Immediately after entering ITSUB each time, the function is inspected for convergence. If the function has converged, a program control is set, and computer control is transferred to the calling routine.

SUBROUTINE NAME: KIKOFF

DESCRIPTION

This subroutine terminates the use if an error in the calculation is encountered.

CALLING SEQUENCE

CALL KIKOFF (K1W1, K2W2)

UTILITY ROUTINES AND COMMON REFERENCES

COMMON/CONTRL/

UTILITY - None

METHOD OF SOLUTION

Not applicable.

SUBROUTINE NAME: LAGRNG

DESCRIPTION

This subroutine determines the radial location and flow angle for solid boundaries which are input as tables of R, X and flow angle.

CALLING SEQUENCE

CALL LAGRNG (IER, ID, ARG, R, THETA, ITYPE)

where

IER is an error flag, ID is a table location,

ARG is the axial value for which the radial coordinate, R, of the wall and flow angle, THETA, at the wall are desired,

ITYPE indicates if an upper (= 2) or lower (= 1) boundary is being considered.

UTILITY ROUTINES AND COMMON REFERENCES

COMMON/DATAR/

COMMON/CONTRL/

COMMON/WAFT/

UTILITY - None

METHOD OF SOLUTION

The routine uses the Lagrange interpolation formula to solve for R and flow angle as a function of axial position, X, from a set of tabular points describing a solid boundary. The routine uses the three closest points to the desired X to solve the interpolation formula. In the vicinity of large nonlinear variations in R and flow angle the points should be placed close together.

SUBROUTINE NAME: LIMITS

DESCRIPTION

This subroutine tests the new boundary point to determine if it is within the limits of the current boundary equation. Depending on the test, the options are:

1. use the current boundary equation,
2. advance to the next boundary equation, or
3. the current equation is the last one specified.

CALLING SEQUENCE

CALL LIMITS (I, K, ITYPE, IOK, K1W1, K1W2)

where I, K represents the location of the boundary point in the PHO array, ITYPE indicates if an upper or lower boundary is being considered, and IOK is a control indicating if option 1, 2 or 3 is to be used.

UTILITY ROUTINES AND COMMON REFERENCES

COMMON/CONTRL/  
COMMON/DATAR/  
BOUND

METHOD OF SOLUTION

The radius, RMAX, and boundary angle, THETAMAX, at the limiting axial value XMAX is calculated in BOUND. RMAX or XMAX is compared to R or X for the point in question. The results of the comparison determine which of options 1, 2 or 3 is to be used.

SUBROUTINE NAME: LIPIN

DESCRIPTION

LIPIN calculates information for the starting line points when the simplified straight start line option is used (i.e., when  $ICON(2) \neq 2$ ).

CALLING SEQUENCE

CALL LIPIN (COOR, S, INTOT, DELM, KIWI, KIW2)

where COOR is the starting line information array, S is the entropy level of the start line, INTOT is the total number of input points specified (50 Max), DELM is Mach number gradient along the startline, and KIWI is a flag which determines the type of startline point distribution.

UTILITY ROUTINES AND COMMON REFERENCES

COMMON/INPUT/  
COMMON/CONTRL/  
COMMON/PCTC/  
COMMON/FSTAG/  
COMMON/GASCON/  
RGVOFM  
UOFV  
THERMO

METHOD OF SOLUTION

The startline input data are divided into the specified number of increments. Radial gradients in Mach number, X and  $\theta$ , are calculated.

KIWI = 0 The startline points are concentrated near the upper boundary  
KIWI = 1 The startline points are evenly spaced  
KIWI = 2 The startline points are evenly spaced on a source line



SUBROUTINE NAME: MASCON

DESCRIPTION

MASCON calculates the Mach number distribution at an area downstream of the throat such that total mass flow is conserved. Mass flow, calculated at the throat, is used as the constant for comparison.

CALLING SEQUENCE

CALL MASCON (F, SE, DELM, K1W1, K1W2)

where E is the input line array CORLIP, SE is the input line entropy level, and DELM is the Mach number gradient along the startline.

UTILITY ROUTINES AND COMMON REFERENCES

COMMON/CONTRL/

RGVOFM

ERRORS

EMOFV

ITSUB

RHOFEM

METHOD OF SOLUTION

The mass flow rate at the throat,  $\dot{m}^*$ , is calculated. This  $\dot{m}^*$  is compared to that at the input line location for an initial Mach number distribution. The Mach number distribution is then perturbed until mass flow is conserved.

SUBROUTINE NAME: MASSCK

DESCRIPTION

This subroutine keeps a running check on the mass flow. Mass flow at the starting line is calculated and compared with that crossing each normal line downstream.

CALLING SEQUENCE

CALL MASSCK (ILAST, ISTART, K, K1W1, K1W2)

where ILAST is the last point on the normal line, ISTART is a number of the first point on the normal and K represents the normal line under consideration.

UTILITY ROUTINES AND COMMON REFERENCES

COMMON/DATAR/	COMMON/FORCE/
COMMON/MASSC/	COMMON/WT/
COMMON/INPUT/	COMMON/PARTP1/
COMMON/PSLD/	COMMON/PARTP2/
COMMON/CONTRL/	COMMON/INTCR/
COMMON/NSF/	COMMON/FSTAG/
COMMON/STEP/	INTEGR
COMMON/SIGNAL/	PFP

METHOD OF SOLUTION

The mass flow through the startline is calculated and stored. Mass flow through lines downstream is calculated and these values compared with the initial value. A percent change in mass flow is printed for each normal line. The total mass flow passing under each point on a characteristic line is stored so the mass flow can be written on the output tape to permit stream-line tracing.

SUBROUTINE NAME: MAXTIM

DESCRIPTION

This subroutine is a Univac 1108 machine language routine that checks a user input time (seconds) against the remaining CPU time before run termination and returns to a specified label in the calling routine.

CALLING SEQUENCE

CALL MAXTIM (\$LABEL, TIME)

where

LABEL = the statement number in the calling routine where execution is sent if TIME is greater than the remaining CPU time for the run.

TIME = time in seconds before CPU maximum time when the run is to be terminated normally.

UTILITY ROUTINES AND COMMON BLOCKS

None

METHOD OF SOLUTION

TIME is checked against the remaining CPU time for the particular run. If the remaining CPU time is less than TIME then control of program execution is returned to statement LABEL in the calling routine.

SUBROUTINE NAME: MOCSOL

DESCRIPTION

This subroutine solves the characteristic equations for gas only flow in the region around and downstream of an expansion corner.

CALLING SEQUENCE

CALL MOCSOL (IN,KN,IN1,KN1,IN2,KN2,IFLAG,ITYPE,K1W1,K1W2

where IN,KN identifies the storage location for the new point to be computed, IN1,KN1 identifies the right running known point, and IN2,KN2 identifies the left running known point. IFLAG is an error indicator and ITYPE selects the type calculation.

UTILITY ROUTINES AND COMMON REFERENCES

COMMON/PARTP1/	COEFF3
COMMON/PARTP2/	INRSCT
COMMON/GAPPA/	POFEM
COMMON/ONTSPT/	COEFEQ
COMMON/AVPROP/	PPATPT
COMMON/SLIPPT/	PFP
COMMON/GLOBAL/	IDMPFP
COMMON/FSTAG/	BOUND
COMMON/FREE/	ROTERM
COMMON/STEP/	VOFEM
COMMON/CPMUK/	RGMOFF
COMMON/PCTC/	FNEWTN
COMMON/CONTRL/	TOFH
COMMON/CRITER/	UOFV
COMMON/DATAR/	NEWENT
COMMON/GASCON/	ERRORS
	SPCTX

## METHOD OF SOLUTION

The four characteristic equations are written as a function of five variables,  $R$ ,  $X$ ,  $\theta$ ,  $V$  and  $S$ . An additional relationship is obtained by assuming the entropy,  $S$ , varies linearly between known data points. Using these characteristic equations in finite difference form, the routine solves for a new mesh point, knowing two mesh points of an opposite family.

The solution is begun by setting the average values of properties over the step length equal to the known values at the base points. Subsequent passes in the iterative solution result in "updated" average values. The iterative solution is continued until the desired convergence on velocity or flow angle is reached or until the maximum number of iterations is exceeded.

MOSCOL is utilized by subroutine EXPCOR to solve the normal line immediately downstream of any expansion corner.

SUBROUTINE NAME: NEWENT

DESCRIPTION

This subroutine calculates the change in entropy and gas total enthalpy along a gas streamline for gas particle flows.

CALLING SEQUENCE

CALL NEWENT (NP, IT1, IT2, S3, H3, K, PB)

where

- NP = number of particles present on streamline
- IT1 = 1 for interior point  
2 for wall point
- IT2 = 1 for interior or lower wall point  
= 2 for upper wall point
- S3 = entropy at new point
- H3 = total enthalpy at new point
- K = 5 gas only streamline  
7 gas and particles present on streamline
- PB = array containing streamline base point properties (upstream)

UTILITY ROUTINES AND COMMON REFERENCES

COMMON/CONTRL/	COMMON/CHEMXX/
COMMON/CHEMXY/	COMMON/CHEMCN/
COMMON/AVPROP/	COMMON/WISEX/
COMMON/GAPPA/	CHEM
COMMON/SLIPPT/	

METHOD OF SOLUTION

The compatibility relations for gas total enthalpy and entropy (Eqs. (3.2), and (3.1) of Table 3-1) are solved at the new streamline point knowing the gas and particle properties at the new and base streamline points. For gas only flows (and streamlines not crossing a shock) the gas total enthalpy and entropy are held constant along a given streamline.

REPRODUCIBILITY OF THE  
ORIGINAL PAGE IS POOR

SUBROUTINE NAME: NORSCK

DESCRIPTION

This routine uses local flow properties to calculate properties downstream of a normal shock to obtain pitot pressure. This routine is used only for finite rate chemistry, real gas cases.

CALLING SEQUENCE

CALL NORSCK (VI, PI, EMI, TI, GMI, RI, HI, POSTR)

where

VI, PI, . . . , HI are the local values of velocity, pressure, Mach number, temperature, gamma, gas constant and enthalpy

POSTR is the pitot pressure.

UTILITY ROUTINES AND COMMON REFERENCES

COMMON/GASCON/

COMMON/PCTC/

TOFENH

ITSUB

METHOD OF SOLUTION

The downstream conditions are first estimated using ideal gas relations. The routine then performs an iteration as follows:

1. Calculate downstream static enthalpy from energy equation.
2. Iterate in subroutine TOFENH for temperature, gamma and gas constant.
3. Calculate downstream pressure from continuity and equation of state.
4. Check to see if resultant pressure satisfies the Rayleigh line equation. If not, increment the downstream velocity and repeat steps 1 through 4.
5. When the iteration is complete, the pitot pressure is determined from the downstream conditions.

SUBROUTINE NAME: OUT

DESCRIPTION

OUT writes the calculated data for data points along with the corresponding title and headings.

CALLING SEQUENCE

CALL OUT (I1, I2, K, K1W1, K1W2)

where I1, I2 refer to the point numbers of the points to be output (any number of points may be output at one time. K represents the current normal line (takes on the value 1 or 2).

UTILITY ROUTINES AND COMMON REFERENCES

COMMON/CONTRL/	COMMON/CHEMCN/
COMMON/DATAR/	COMMON/CHEMXX/
COMMON/GASCON/	COMMON/GASDAT/
COMMON/HEAD/	POFEM
COMMON/PARTP1/	PAGE
COMMON/PARTP2/	PF P
COMMON/GAPPA/	THERMO
COMMON/WRITPT/	PPATPT
COMMON/TEMPER/	NORSCK
COMMON/FSTAG/	VEMAG
COMMON/CRITER/	SPCTX
COMMON/TOTAL/	ESHOCK

METHOD OF SOLUTION

Not applicable.



SUBROUTINE NAME: OUTBIN

DESCRIPTION

This subroutine writes the calculated normal data on the binary output tape. This is done for any number of data points.

CALLING SEQUENCE

CALL OUTBIN (I1, I2, JK, K1W1, K1W2)

where I1, I2 identifies the range of points to be written on tape (I1 is first point, I2 is last). JK represents the current characteristic line (1 or 2).

UTILITY ROUTINES AND COMMON REFERENCES

COMMON/TAPRIT/  
COMMON/DATAR/  
COMMON/FORCE/  
COMMON/GAPPA/  
COMMON/PARTP1/  
COMMON/PARTP2/  
COMMON/CONTRL/  
COMMON/GLOBAL/  
COMMON/AUX/  
MAXTIM  
PFP  
TEMTAB

METHOD OF SOLUTION

Not applicable.

SUBROUTINE NAME: OVEREX

DESCRIPTION

OVEREX solves for the shock angle at the nozzle lip when the flow is over expanded. Provisions are made to calculate the shock angle for an upper or lower lip point. Real gas effects are considered in calculating flow properties downstream of the shock.

CALLING SEQUENCE

CALL OVEREX (PB, I, K, ITYPE1, K1W1, K1W2)

where PB is the freestream pressure at the boundary; I, K defines the location of the lip point in the characteristic data (PHO) array and ITYPE1 indicates whether an upper (=2) or lower (=1) boundary is to be considered.

UTILITY ROUTINES AND COMMON REFERENCES

COMMON/DATAR/  
COMMON/PARTP1/  
COMMON/PARTP2/  
EMOFV  
ESHOCK  
THERMO  
POFEM  
ITSUB  
PFP  
UOFV  
IDMPFP  
ERRORS

METHOD OF SOLUTION

For the first pass through the solution, an initial shock angle is assumed. This shock angle is perturbed in ITSUB and the result used to calculate flow properties including static pressure downstream of the shock. The calculated static pressure is compared with the boundary pressure to determine if the desired convergence has been obtained. If the solution has not converged ITSUB is called again and the above procedure is repeated.

SUBROUTINE NAME: PAGE

DESCRIPTION

This subroutine page ejects and writes the header comments and page number on each page of printout.

CALLING SEQUENCE

CALL PAGE (LCNT, K1W1, K1W2)

where LCNT is a counter which monitors the number of lines of printed output per page. LCNT is reinitialized in PAGE.

UTILITY ROUTINES AND COMMON REFERENCES

COMMON/HEAD/  
COMMON/CONTRL/  
UTILITY - None

METHOD OF SOLUTION

When the maximum number of lines per page (55) have been output, PAGE is called to page eject. It then prints the identifying information and the page number, increments the page number and reinitializes the line counter.

SUBROUTINE NAME: PARTIN

DESCRIPTION

This subroutine reads in gas and particle property startline data. Data is read in from cards or tape.

CALLING SEQUENCE

CALL PARTIN (NSETS,NTAPE)

where

NSETS is the number of startline points where particles are present

NTAPE is the FORTRAN unit to read the startline data from (=7 for cards)

UTILITY ROUTINES AND COMMON REFERENCES

COMMON/PARTP1/	COMMON/PCTC/
COMMON/PARTP2/	COMMON/GASDAT/
COMMON/INPUT/	COMMON/WISEX/
COMMON/CONTRL/	COMMON/FSTAG/
COMMON/MASSC/	RGVOFM
COMMON/WT/	UOFEM
COMMON/PSLD/	TOFEM
COMMON/ONTSPT/	POFEM
COMMON/GASCON/	SPCTX
COMMON/TEMPER/	THERMO
COMMON/NSF/	IDMPFP
COMMON/LIPCOM/	PFP

METHOD OF SOLUTION

The gas startline points are read starting with the axis point and input up to the boundary, while the particle startline data is input starting with the last limiting streamline or last gas startline point and input down to the axis.

SUBROUTINE NAME: PARTPH

DESCRIPTION

This subroutine reads and sets up the data table of particle temperature versus enthalpy. This routine also prints out the particle drag tables as well as the temperature versus enthalpy tables.

CALLING SEQUENCE

CALL PARTPH (IPFTOC, LCT, NGS)

where

IPFTOC = zero for two phase case  
          = 10000 for gas only case  
LCT = line counter for printout purposes  
NGS is a dummy variable

UTILITY ROUTINES AND COMMON REFERENCES

COMMON/GASTPE/  
COMMON/CONTRL/  
COMMON/TPEH/  
COMMON/GASDAT/  
COMMON/DRAGCF/  
COMMON/PARTP2/  
COMMON/DATAR/  
COMMON/TFLAG/  
PAGE

METHOD OF SOLUTION

Not applicable.

FUNCTION NAME: PFP

DESCRIPTION

This function computes the particle property data storage location and retrieves data from the PFPARY array.

CALLING SEQUENCE

= PFP(I, J, K, L)

where

I, J, K, L are indices used to determine the storage location.

UTILITY ROUTINES AND COMMON REFERENCES

COMMON/PARTP1/  
COMMON/PARTP2/  
COMMON/PARTP3/  
RWU

METHOD OF SOLUTION

The particle property data storage location is computed using the following relation

$$IX = I + 5 * (J - 1 + 10 * (K - 1 + 100 * (L - 1)))$$

and retrieved using the relation

$$PFP = PFPARY(IX).$$

SUBROUTINE NAME: PHASE1

DESCRIPTION

This subroutine provides the necessary controlling logic for the complete flowfield calculation. Proper subroutines are called to handle different kinds of calculation.

CALLING SEQUENCE

Call PHASE1 (IFINIS, K2W1, K2W2)

where IFINIS is set to zero.

UTILITY ROUTINES AND COMMON REFERENCES

COMMON/CONTRL/	OUTBIN
COMMON/DROP/	SPCTX
COMMON/GASCON/	PPATPT
COMMON/NSF/	LIMITS
COMMON/DATAR/	BOUND
COMMON/GAPPA/	BOUNDA
COMMON/INPUT/	PRANDT
COMMON/GLOBAL/	UOFV
COMMON/STEP/	ITERM
COMMON/PARTP1/	TURN
COMMON/TEMPO1/	HYPER
COMMON/TEMPO2/	POFEM
COMMON/TOTAL/	EMOFV
COMMON/OVERLA/	RGMOFP
COMMON/CRITER/	VOFEM
COMMON/INTEU/	THETPM
COMMON/PSEC/	TOFEM
COMMON/TEMPO3/	SOKSOL
COMMON/FREE/	STRNOR
COMMON/XXSH/	ERRORS
COMMON/BPRESW/	MAXTIM
COMMON/PCTC/	MASSCK
COMMON/CHEMXX/	CHECK
COMMON/WISEX/	PFP
COMMON/EXPER/	IDMPFP
COMMON/GASDAT/	INRSCT
COMMON/FSTAG/	SOKINT
OUT	FREEMC
THRUST	THERMO
	PRFRBD
	EXPCOR

## METHOD OF SOLUTION

This subroutine makes most of the tests to determine what kind of calculation should be carried out for the point under consideration. The point may be a regular field point, solid or free boundary point, left- or right-running shock points, incident shock points or reflected shock points on the solid boundary, attached shock points on the solid boundary, shock wave intersection points (opposite family), slipline points, incident shock points and expansion corner points at the free boundary, expansion corner points at solid boundary, etc.



SUBROUTINE NAME: PHYSOL

DESCRIPTION

This subroutine finds the reference properties on the characteristic line so that the compatibility equations can be used to calculate the flow velocity and angle of a point downstream of the known reference normal line (or surface).

CALLING SEQUENCE

CALL PHYSOL (PRET, IS, JS, IN, KN, IDIR, IFLAG, KIWI, KIW2, PIS, PIN, PM, PM1, IPM, IPM1, KPM, JAG, P, ARGN, ISLIP, KSLIP, IFIX, I141, IQUAD, H, SAVE, DP)

where

PRET(8)	is the storage array of reference properties found
(IS, JS)	is the point on the reference normal line (J-line), normally on the same streamline as the one under consideration
(IN, KN)	is a known point just below the point under consideration on the new normal line (K-line)
IDIR	indicates if a I-characteristic (=+1) or a II-characteristic (= -1) is being considered
IFLAG	is a control indicator to return the proper message to the calling subroutine in order that a proper measure can be taken
PIS(8)	array containing the flow properties of the streamline base point
PIN(8)	array containing the new flow properties of the streamline point
PM(8)	array containing the flow properties of point IPM which brackets the characteristic intersection
PM1(8)	array containing the flow properties of point IPM1 which brackets the characteristic intersection
IPM, IPM1	the point numbers of the two adjacent points on the old data surface which brackets the characteristic intersection

KPM           if the characteristic line intersects a boundary, shock or slipline KPM is the point number on the new data surface which bounds the intersection

JAG           the point immediately above or below the streamline base point. This point is used to detect the presence of a slipline.

P(8)          array in which the characteristic intersection flow properties are stored

ARGN         the angle of the normal

ISLIP         flag which indicates if not enough data is known to obtain the characteristic intersection

KSLIP         if KSLIP is a 1 the characteristic has intersected a slipline

IFIX         index used within PHYSOL which indicates if the two points which bracket the characteristic intersection have been found

I141         flag which indicates if the characteristic intersection is below the first point or above the last point on the old data surface

IQUAD         1 - interpolation is being made on R  
2 - interpolation is being made on X

H             interpolation factor between point IPM and IPM1 necessary to obtain the characteristic intersection

SAVE(8)      array which is used to retain data from previous intersections

DP(8)         array which contains the flow property differences between points IPM and IPM1.

#### UTILITY ROUTINES AND COMMON REFERENCES

COMMON/POINTC/	COMMON/PARTP2/
COMMON/GASCON/	COMMON/GAPPA/
COMMON/TEMPER/	COMMON/DROP/
COMMON/FSTAG/	COMMON/CRITER/
COMMON/CHEMXX/	BOUND
COMMON/CONTRL/	THERMO
COMMON/DATAR/	INRSCT
COMMON/SLIPPT/	ITSUB
COMMON/TEMPO2/	PFP
COMMON/PARTP1/	UOFV
	GAPPBI
	PPATPT

## METHOD OF SOLUTION

The characteristic line is drawn from the point under consideration to intersect the known upstream reference normal line. The reference properties of this intersection are interpolated from the two known points on the reference normal line. Subroutine ITSUB and the average quantities are used to obtain a better approximation of the reference properties.

If the reference properties are not readily available, IFLAG is set to 2, and the reference properties are then assumed to enable the calculation to be continued. Normally, the calculation of this point is repeated afterward to obtain the correct reference properties for the calculation of the new point under consideration.

SUBROUTINE NAME: PHYZOL

DESCRIPTION

This subroutine handles the downstream shock points and wall point near the corner of a reflected or an attached shock wave.

CALLING SEQUENCE

CALL PHYZOL (P5I, P6I, P4I, KANT, IS, JS, IN, KN, ANGLE,  
IFLAG, ITYPE, K1W1, K1W2)

where

P5I(8) is the storage array of the shock downstream point near the corner where the shock reflected or attached

P6I(8) is the storage array of the shock downstream point at the point where shock reflected or attached

P4I(8) is the storage array of the intersection of the wall with the average normal drawn from point P5I

KANT 1. first time calculation  
2. iterative calculation

(IS, JS) denotes the storage location of point P6I

(IN, KN) denotes the storage location of the shock upstream point opposite of point P5I

ANGLE is the angle between the shock wave and the axial coordinate

IFLAG is a control indicator for sending in and out the proper information in order that corresponding measures can be taken

ITYPE indicates if a strong or weak shock is being considered and where the shock is reflected or attached

strong shock 51 (lower wall) 52 (upper wall)  
weak shock 151 (lower wall) 152 (upper wall)

UTILITY ROUTINES AND COMMON REFERENCES

COMMON/DATAR/	BOUNDA
COMMON/PHISOL/	CARCTR
COMMON/SLIPPT/	ERRORS
COMMON/TEMPO1/	INRSCT
COMMON/CONTRL/	THERMO
	UOFV

## METHOD OF SOLUTION

The shock points at the wall (where the shock reflected or attached) are known. The shock upstream point slightly downstream of the shock attachment point is also calculated, though the results may not be the final ones. The oblique shock relations are used to calculate the downstream point P5I. Through this point an average normal line is drawn to intersect the wall (BOUND A). The flow properties of this point P4I are initially assumed to be the same as those of point P6I. Point P4I is treated as a wall point. The velocity of point P5I is then recalculated with the shock downstream properties; this newly calculated velocity is then compared with the velocity calculated with the oblique shock relations. Shock strength is adjusted until the velocity of point P5I calculated by both methods converge to the same value. The final results of the shock points, as well as the wall point downstream of the attached or reflected shock, are then returned to the calling subroutine. See Volume I, Section 6.8 for the details of calculation.

SUBROUTINE NAME: PLMOUT

DESCRIPTION

PLMOUT prints the data read by PLUMIN.

CALLING SEQUENCE

CALL PLMOUT (KP, LCNT, K1W1, K1W2)

where KP is a control parameter set in PLUMIN, and LCNT is the printed line counter.

UTILITY ROUTINES AND COMMON REFERENCES

COMMON/CONTRL/	COMMON/WT/
COMMON/CUTFO/	COMMON/STPC/
COMMON/GASDAT/	COMMON/WAFT/
COMMON/DATAR/	COMMON/FREE/
COMMON/GASCON/	COMMON/MOL/
COMMON/HEAD/	COMMON/TAPRIT/
COMMON/INPUT/	COMMON/FSTAG/
COMMON/GAPPA/	PAGE
COMMON/PARTP1/	TAB
COMMON/PARTP2/	IDMTAB
COMMON/MASSC/	EMOV
COMMON/PARTTP/	THERMO
COMMON/PSLD/	PFP
COMMON/DRAGCF/	

METHOD OF SOLUTION

Not applicable.

SUBROUTINE NAME: PLUMIN

DESCRIPTION

PLUMIN reads in the input data (input via cards) necessary to perform the streamline-normal solution. This routine provides control for all input functions by selectively calling pertinent input routines and/or the transonic solution.

CALLING SEQUENCE

CALL PLUMIN (K1W1, K1W2, NTAPE, NSETS, RRT, XSHSV, ITRS)

UTILITY ROUTINES AND COMMON REFERENCES

COMMON/CONTRL/	COMMON/LIPCOM/
COMMON/CUTFO/	COMMON/DRAGCF/
COMMON/DATAR/	COMMON/PSLD/
COMMON/GASCON/	COMMON/CRITLR/
COMMON/HEAD/	COMMON/WAFT/
COMMON/INPUT/	COMMON/XXSH/
COMMON/STEPG/	COMMON/FREE/
COMMON/TFLAG/	COMMON/MOL/
COMMON/SIGMB/	COMMON/TAPRIT/
COMMON/VISEX/	COMMON/CHEMCN/
COMMON/VARSL/	GASRD
COMMON/PARTTP/	BOUND
COMMON/PARTP1/	LIPIN
COMMON/PARTP2/	AOASTR
COMMON/GAPPA/	MASCON
COMMON/WRITPT/	SETHTG
COMMON/MASSC/	PARTIN
COMMON/BPRESW/	PARTPH
COMMON/SIGNAL/	PLMOUT

METHOD OF SOLUTION

Not applicable.

FUNCTION NAME: POFEM

DESCRIPTION

This function computes the local static pressure as a function of Mach number, entropy and total temperature (ideal gas, two phase only).

CALLING SEQUENCE

$$P = \text{POFEM} (\text{EM}, \text{S}, \text{K1W1}, \text{K1W2})$$

where P is the resultant static pressure found from the Mach number, EM, and entropy, S. NOTE: The appropriate values of the gas properties must be stored in common upon entry to this routine.

UTILITY ROUTINES AND COMMON REFERENCES

COMMON/GASCON/  
COMMON/TEMPER/  
UTILITY - None

METHOD OF SOLUTION

Thermally perfect gas relationships are used to find the pressure.

$$p = p_o e^{-S/R} \left(1 + \frac{\gamma-1}{2} M^2\right)^{-\gamma/\gamma-1} \left(\frac{T_o}{T_c}\right)^{-\gamma/\gamma-1}$$



SUBROUTINE NAME: POFH

DESCRIPTION

This routine utilizes the tabulated data of enthalpy and specific heat as functions of temperature for each species of a finite rate chemistry case to calculate pressure, as a function of enthalpy for a real gas, in a Prandtl-Meyer expansion.

CALLING SEQUENCE

CALL POFH (VF, HT, DELTA)

where

VF is the final velocity

HT is the total enthalpy

DELTA is the flow deflection angle.

UTILITY ROUTINES AND COMMON REFERENCES

COMMON/GASCON/

COMMON/PCTC/

COMMON/EXPER/

COMMON/CPMUK/

ITSUB

METHOD OF SOLUTION

The routine solves for pressure by incrementally changing the flow angle until the final flow angle is obtained. At each increment the routine determines new gas properties from the tables on enthalpy and specific heat as functions of temperature, then uses these properties for the next increment. The result is an integration of the flow properties through the angular change, DELTA.

SUBROUTINE NAME: PPATPT

DESCRIPTION

This subroutine calculates and stores gas and particle dependent variables as a function of the independent flow properties.

CALLING SEQUENCE

CALL PPATPT (M, IC, KC, VG, THETA, SG, K2W1, K2W2, KP, ISKIP, PG)

where

- M is the number of particle sizes present at the point
- IC is the point number for which particle and gas flow properties are to be calculated
- KC is the line identification flag
- VG is the gas velocity at the point
- THETA is the gas flow angle at the point
- SG is the gas entropy at the point
- K2W1 is a dummy variable
- K2W2 is a dummy variable
- KP is the temporary array storage location for the particle and gas flow properties
- ISKIP = 0 calculate particle properties only  
= 20 calculate gas and particle properties  
= 40 calculate gas properties only
- PG array containing the point independent flow properties

UTILITY ROUTINES AND COMMON REFERENCES

- |                |                |
|----------------|----------------|
| COMMON/TFLAG/  | COMMON/WISEX/  |
| COMMON/PARTP1/ | COMMON/TEMPER/ |
| COMMON/PARTP2/ | COMMON/FSTAG/  |
| COMMON/GAPPA/  | COMMON/DATAR/  |
| COMMON/ONTSPT/ | COMMON/FREE/   |
| COMMON/GASCON/ | COMMON/CRITER/ |
| COMMON/CONTRL/ | COMMON/PSLD/   |
| COMMON/CPMUK/  | COMMON/XXSH/   |

COMMON/DRAGCF/  
COMMON/PCTC/  
THERMO  
TOFV  
EMOFV

POFEM  
PFP  
TEMTAB  
DRAGMR  
DRAGCP

#### METHOD OF SOLUTION

The routine is entered knowing the gas independent variables ( $V$ ,  $S$ ,  $OF$  or  $H_T$ ) and particle independent variables ( $u$ ,  $v$ ,  $\rho$ ,  $h$ ). The gas dependent variables ( $T$ ,  $P$ ,  $\rho$ ,  $\mu$ ,  $C_p$ ,  $Pr$ ) and particle dependent variables ( $R_E$ , drag and heat transfer terms) are calculated and stored for use in other parts of the code.

SUBROUTINE NAME: PRANDT

DESCRIPTION

This subroutine computes the Prandtl-Meyer expansion angle for a given boundary angle and divides this angle into a series of expansion "rays" (unless the number of rays has been specified in the input). The flow properties at each angular increment are set and stored in the PHO array.

CALLING SEQUENCE

CALL PRANDT (I, J, THETAB, NPM, IFLAG, ITYPE, K1W1, K1W2)

where

I represents the corner point

J indicates a characteristic line

THETAB is the boundary angle

NPM = number of Prandtl-Meyer increments  
(calculated in PRANDT)

IFLAG is an error flag

ITYPE indicates if upper (2) or lower (1) boundary  
is being considered

UTILITY ROUTINES AND COMMON REFERENCES

COMMON/CRITER/	THERMO
COMMON/DATAR/	THETPM
COMMON/GASCON/	UOFV
COMMON/STEP/	EMOFV
COMMON/CONTRL/	TOFV
COMMON/PCTC/	POFEM
COMMON/CPMUK/	TOFH
COMMON/PARTP1/	SPCTX
COMMON/PARTP2/	PFP
COMMON/FSTAG/	IDMPFP
COMMON/CHEMXX/	

### METHOD OF SOLUTION

The routine is entered with known flow properties at the point of discontinuity along with the known corner and boundary flow angles. From the known angles and the preset number of degrees per ray, the number of increments is calculated. The distribution of P-M rays is then adjusted by a weighting function. Subroutine THETPM is entered with known initial conditions and the number of degrees per ray and returns with a velocity. These new conditions are then set into the PHO array. See Volume I, Sections 5 and 6.9, for the details of calculation.

SUBROUTINE NAME: PRFRBD

DESCRIPTION

This subroutine calculates the flow properties at the intersection of a particle limiting streamline and a plume boundary.

CALLING SEQUENCE

CALL PRFRBD (IS, JS, IN, KN, I, K)

where

- IS = point number of the old (J) data surface plume boundary
- JS = line indicator of the old data surface
- IN = point number of the old (J) data surface limiting streamline
- KN = line indicator of the old data surface
- I = point number of the new (K) data surface limiting streamline
- K = line indicator of the new data surface.

UTILITY ROUTINES AND COMMON REFERENCES

COMMON/DATAR/	COMMON/CONTRL/
COMMON/PARTP1/	COMMON/FSTAG/
COMMON/PARTP2/	PFP
COMMON/GAPPA/	INRST
COMMON/SLIPPT/	IDMPFP
COMMON/ONTSPT/	PPATPT

METHOD OF SOLUTION

Once the new data surface has been completed and it has been determined that a particle limiting streamline has crossed the plume boundary, the location of the intersection is determined by the intersection of a line passing through the old and new limiting streamline points. This establishes two interpolation factors. One along the limiting streamline and one along the plume boundary. Gas properties at the intersection point are interpolated for between the two plume boundary points and particle properties are interpolated for between the two limiting streamline points. The interpolated point and properties are then used as the plume boundary point for the new line and the calculation for the next line is then initiated.

FUNCTION NAME: RGMOFP

DESCRIPTION

This subroutine finds Mach number as a function of pressure, O/F ratio (or total enthalpy) and entropy. The difference between this routine and EMOFP is that in this case the gas properties are not known prior to entry.

CALLING SEQUENCE

EM = RGMOFP (OF, S, P, K2W1, K1W1)

where EM is the resultant Mach number, P is the local static pressure, S is the local entropy, and OF is the local O/F ratio (or total enthalpy).

UTILITY ROUTINES AND COMMON REFERENCES

COMMON/CONTRL/  
COMMON/GASCON/  
COMMON/ISEA/  
COMMON/GASDAT/  
POFEM  
EMOFV  
ITSUB  
VOFEM  
EMOFP  
ERRORS  
TAB  
THERMO

METHOD OF SOLUTION

The real gas tables have, as independent variables, OF ratio (total enthalpy), entropy and velocity. If the velocity is not known, an iterative solution must be employed to find Mach number from pressure, entropy, and OF ratio (or total enthalpy).

FUNCTION NAME: RGVOFM

DESCRIPTION

This subroutine finds velocity as a function of Mach number, entropy and O/F ratio (or total enthalpy). The difference between this routine and VOFEM is that the gas properties are not known prior to entry.

CALLING SEQUENCE

V = RGVOFM (OF, S, EM, K2W, K1W)

where V is the resultant velocity computed from O/F ratio or total enthalpy, OF, entropy, S, and Mach number, EM.

UTILITY ROUTINES AND COMMON REFERENCES

COMMON/CONTRL/  
COMMON/CHEMCN/  
COMMON/GASDAT/  
COMMON/GASCON/  
THERMO  
TAB  
VOFEM  
EMOFV  
ITSUB  
ERRORS

METHOD OF SOLUTION

The real gas tables have, as independent variables, OF ratio (or total enthalpy), entropy and velocity. If the velocity is not known, an iterative solution must be employed to find the velocity from Mach number, OF ratio (or total enthalpy) and entropy.



FUNCTION NAME: RHOFEM

DESCRIPTION

RHOFEM computes the local density as a function of Mach number and entropy.

CALLING SEQUENCE

RHO = RHOFEM (EM,S,K1W1,K1W2)

where RHO is the resultant density found from local Mach number and local entropy. NOTE: The appropriate values of the gas properties must be stored in common upon entry to this routine.

UTILITY ROUTINES AND COMMON REFERENCES

COMMON/GASCON/  
POFEM

METHOD OF SOLUTION

Thermally perfect gas relationships are used to find the density.

$$\rho = \rho_o \left( 1 + \frac{\gamma-1}{2} M^2 \right)^{-(1/\gamma-1)}$$

SUBROUTINE NAME: RITE

DESCRIPTION

This subroutine tells the program user (in no uncertain terms) that he has made a fatal error. The next executable statement is a STOP.

CALLING SEQUENCE

CALL RITE(I)

UTILITY ROUTINES AND COMMON REFERENCES

None

METHOD OF SOLUTION

Not applicable.

FUNCTION NAME: ROTERM

DESCRIPTION

ROTERM computes the geometrical factor,  $F_I, F_{II}$ , used in the axisymmetric term of the compatibility equation and as an interpolation parameter.

CALLING SEQUENCE

$F = \text{ROTERM} (\text{THETA}, \text{DELTA}, \text{EMU}, \text{R3}, \text{RI}, \text{K2W1}, \text{K2W2})$

where

THETA is the flow angles of the known points ( $\bar{\theta}_I$  or  $\bar{\theta}_{II}$ )

DELTA defines the quadrant being considered

EMU is the Mach angles of the known points ( $\bar{\mu}_I$  or  $\bar{\mu}_{II}$ )

R3 is the coordinates of the new point ( $\bar{r}_{III}$  or  $\bar{x}_{III}$ )

RI is the coordinates of the known point ( $r_I$  or  $x_I$ )

UTILITY ROUTINES AND COMMON REFERENCES

None

METHOD OF SOLUTION

The method-of-characteristics solution uses this routine to determine a coefficient needed in its solution. This term (see Eq. (6.29), Section 6 of Ref. 4) can be written as:

$$F = \frac{|\sin \mu| (d_{III} - d)}{\sin(\pi/4 + \delta(\bar{\theta} + \bar{\mu} - \pi/4))}$$

By the proper choice of  $d$  ( $r$  or  $x$ ),  $\delta$  and the sign of  $\mu$ , indeterminate forms are eliminated in the evaluation.

SUBROUTINE NAME: RWU

DESCRIPTION

This routine is a MSFC Univac 1108 system routine used to read and write from FASTRAN files.

CALLING SEQUENCE

CALL RWU (KSUNIT, A(I, J), NS, KSEC, IFCN, ISTAT, NWT)

where

KSUNIT is the unit number of the FASTRAN file

A(I, J) is the array being read or written

NS is the number of entries in the array

KSEC is the location in the file of the required data

IFCN indicates to read data (=16) or write data (=8)

ISTAT is a status indicator

NWT is an output indicator

UTILITY ROUTINES

None

METHOD OF SOLUTION

Not applicable.

SUBROUTINE NAME: SETHTG

DESCRIPTION

This routine computes the gas total enthalpy for a case when finite rate chemistry is being used and the startline is to be generated by the program for gaseous flows only.

CALLING SEQUENCE

CALL SETHTG

UTILITY ROUTINES AND COMMON REFERENCES

COMMON/WISEX/  
COMMON/PCTC/  
COMMON/GASCON/  
COMMON/CHEMCN/  
COMMON/CHEMXX/  
COMMON/LIPCOM/  
COMMON/SIGMB/  
COMMON/GASDAT/  
TKEY  
THERMO

METHOD OF SOLUTION

The routine interpolates for the flow properties at the specified startline Mach number using the equilibrium thermodynamic data tables. The resultant temperature and velocity are then used to obtain the flow properties from the species enthalpy and specific heat tables. The total enthalpy is calculated from the static enthalpy and velocity. This procedure is used to ensure property compatibility when transferring from the equilibrium tables to the species finite rate tables.

SUBROUTINE NAME: SITER

DESCRIPTION

This routine determines the entropy of the gas knowing the velocity, static pressure and total enthalpy or O/F ratio.

CALLING SEQUENCE

CALL SITER(HG, S, EM, V, PC, PL)

where

HG is the known total enthalpy or O/F ratio

S is the gas entropy

EM is the gas Mach number

V is the known gas velocity

PC is the gas total pressure

PL is the known gas static pressure

UTILITY ROUTINES AND COMMON REFERENCES

COMMON/GASCON/  
EMOFV  
ITSUB  
POFEM  
THERMO

METHOD OF SOLUTION

This subroutine iterates on the gas entropy until the guessed entropy, known velocity and enthalpy results in a static pressure which is within the convergence criteria of the known static pressure.

SUBROUTINE NAME: SLDP

DESCRIPTION

This subroutine finds the solutions to a set of N simultaneous linear equations.

CALLING SEQUENCE

CALL SLDP(X, A, N)

where

X is the solution matrix

A is the coefficient matrix

N is the order of the coefficient matrix

UTILITY ROUTINES AND COMMON REFERENCES

None

METHOD OF SOLUTION

The set of N simultaneous equations are solved using a Gauss-Jordan reduction scheme with the diagonal pivot strategy.

SUBROUTINE NAME: SLPLIN

DESCRIPTION

This subroutine handles the calculation of the points on the slip line. Two points are assigned to every slip line.

CALLING SEQUENCE

CALL SLPLIN (IS, JS, IN, KN, IFLAG, ICAUNT, K1W2, K2W2)

where

IS, JS is the storage array of the known point on the lower side of the slip line of the reference normal line (J-line)

IN, KN is the storage array of the known point below the slip line on the current normal (K-line)

IFLAG is a control indicator for sending in and out necessary messages

ICAUNT indicates the status of the iterative solution

0 - first time calculation of a particular slip line

1 - calculated results converged

2 - calculation completed but not final

UTILITY ROUTINES AND COMMON REFERENCES

COMMON/CONTRL/	EMOFV
COMMON/CRITER/	ERRORS
COMMON/DATAR/	INRSCT
COMMON/DROP/	ITSUB
COMMON/GASCON/	PHYSOL
COMMON/SLIPPT	POFEM
CARCTR	

METHOD OF SOLUTION

The slipline points location is found by the usual manner as one of the interior points, and their flow properties are assumed initially to be identical to those of the corresponding points on the reference normal line. The velocity of the lower side point of the slipline is calculated with the aid of subroutines PHYSOL and CARCTR by using the II-characteristic. Pressure is then calculated with subroutine POFEM.



Letting the upper side point of the slipline have the same flow angle as the lower side point; the velocity of the upper side point can be calculated with the I-characteristic. Pressure is then calculated.

The pressure calculated for the slipline points is compared. The flow angle is adjusted, if necessary, until identical pressure is attained on both sides of the slipline.

See Volume I, Section 6.10 for the details of the calculation.

SUBROUTINE NAME: SOKFLX

DESCRIPTION

This subroutine solves for the flow properties downstream of a reflected shock knowing the turning angle and the reflected shock upstream flow properties. Real gas effects are considered in the calculations.

CALLING SEQUENCE

CALL SOKFLX (PD, PU, J, K, ITYPE, K1W1, K2W2)

where

PD is the array containing the downstream flow properties

PU is the array containing the upstream flow properties

J is the line identifier for the upstream flow properties

K is a dummy variable

K1W1 is a dummy variable

K2W2 is a dummy variable

UTILITY ROUTINES AND COMMON REFERENCES

COMMON/CRITER/

COMMON/GASCON/

COMMON/DATAR/

COMMON/CONTRL/

ESHOCK

ITSUB

ERRORS

THERMO

UOFV

METHOD OF SOLUTION

The routine is entered with the flow properties, PU, downstream of the incident shock and a known flow angle downstream of the reflected shock. An initial shock angle is assumed and a flow angle is calculated. The calculated flow angle is compared to the known flow angle and successive iterations on shock angle are performed until the flow angle difference is sufficiently close to zero.

SUBROUTINE NAME: SOKSOL

DESCRIPTION

This subroutine handles the calculation of different types of shock wave points. The following cases are considered:

- |                                                             |               |
|-------------------------------------------------------------|---------------|
| 1. Right-running shock                                      | (ITYPE = 111) |
| 2. Left-running shock                                       | (ITYPE = 112) |
| 3. Right-running shock incident on a lower boundary         | (ITYPE = 121) |
| 4. Left-running shock incident on an upper boundary         | (ITYPE = 122) |
| 5. Right-running shock attached at upper compression corner | (ITYPE = 131) |
| 6. Left-running shock attached at lower compression corner  | (ITYPE = 132) |
| 7. Right-running shock reflected from the upper boundary    | (ITYPE = 141) |
| 8. Left-running shock reflected from the lower boundary     | (ITYPE = 142) |
| 9. Right-running weak shock at the upper wall               | (ITYPE = 151) |
| 10. Left-running weak shock at the lower wall               | (ITYPE = 152) |

CALLING SEQUENCE

CALL SOKSOL (IN, KN, IS, J, ITOTK, IFLAG, ITYPE, K2W1, K2W2)

where

- (IN, KN): storage location in PHO array for the shock upstream point on the new normal (KN-line)
- (IS, J): storage location in PHO array for a reference point on the known normal (J-line)
- ITOTK: total number of the KN-line; this is corrected according to the type of shock point
- IFLAG: for sending in and out necessary messages
- ITYPE: denotes type of shock points to be calculated

## UTILITY ROUTINES AND COMMON REFERENCES

COMMON/CRITER/	BOUNDA
COMMON/GASCON/	CARCTR
COMMON/DATAR/	ERRORS
COMMON/CONTRL/	ESHOCK
COMMON/SLIPPT/	INRSCT
COMMON/PHISOL/	ITSUB
COMMON/TEMPO1/	PHYSOL
COMMON/TEMPO2/	PHYZOL
COMMON/DROP/	PPATPT
COMMON/GLOBAL/	STRNOR
COMMON/GAPPA/	THERMO
COMMON/FSTAG/	STRNOR
COMMON/PARTFP/	

## METHOD OF SOLUTION

The general technique for handling shock wave points is: (1) find the location of the shock points and the flow properties of the shock upstream point, (2) calculate the flow properties of the shock downstream point with the oblique shock relation by using the shock upstream properties, (3) calculate the flow velocity of the shock downstream point with one characteristic line by using the shock downstream properties, (4) compare the velocity calculated from Steps 2 and 3, and (5) if the velocity is not the same, adjust the shock strength and repeat the process from Step 1.

For each individual case, see Vol. I of this report for detail.

SUBROUTINE NAME: SPCTX

DESCRIPTION

This routine controls the input and output from a FASTRAN file of the chemical species in a finite rate chemistry case.

CALLING SEQUENCE

CALL SPCTX (IFCN, IPT, ILINE, JLINE)

where

IFCN indicates to write (=1) on drum or to read (=2) from drum

IPT is the flowfield point number

ILINE is the flowfield line number (one or two)

JLINE specifies to store the data in SPCT(I, 1) or SPCT(I, 2)

UTILITY ROUTINES AND COMMON REFERENCES

COMMON/CHEMXX/

COMMON/CHEMCN/

COMMON/CONTRL/

RWU

METHOD OF SOLUTION

The routine calculates the location in the FASTRAN file where the desired data are read from or stored in. Subroutine RWU is then called to perform the indicated operation.

SUBROUTINE NAME: STGMOD

DESCRIPTION

This subroutine computes the gas thermodynamic properties in the transition flow regime.

CALLING SEQUENCE

CALL STGMOD(I, K)

where

I = the point number

K = the line number

UTILITY ROUTINES AND COMMON REFERENCES

COMMON/GASCON/

COMMON/FREE/

COMMON/GSV/

COMMON/FSTAG/

COMMON/DATAR/

UTILITY - None

METHOD OF SOLUTION

The routine is entered knowing the flow regime, Knudsen number and flow properties ( $M_w$ , T, P, V,  $\gamma$ , S, H,  $\rho$ ) of the (I, K) point. The specific heat ratio is then determined based on the flow regime.

Continuum -  $\gamma$  is same as entered

Vibrational mode frozen -  $\gamma$  is set to 1.4

Rotational mode frozen -  $\gamma$  is set based on a curve fit of gamma from 1.4 (vibrationally frozen) to 1.667 (free molecular) based on Knudsen number

Translationally frozen (free molecular) -  $\gamma = 1.667$

Once the local gamma is determined then the local static properties, T, P and V, are used to determine the local total conditions ( $T_o$ ,  $P_o$ ) and Mach number.

SUBROUTINE NAME: STRNOR

DESCRIPTION

This subroutine handles the calculation of the flow properties of the point in question. The following cases are considered:

1. Interior point, uses I- and II-characteristic (ITYPE = 11)
2. Lower solid boundary point, uses I-characteristic (ITYPE = 21)
3. Upper solid boundary point, uses II-characteristic (ITYPE = 22)
4. Lower free boundary point, uses I-characteristic (ITYPE = 31)
5. Upper free boundary point, uses II-characteristic (ITYPE = 32)

Except those ITYPE numbers shown above, sometimes, one of the following numbers (500, 600, 700, 800, 900) is added to the original number to transmit more information to this subroutine.

CALLING SEQUENCE

CALL STRNOR (I1, K1, IS1, JS1, IN1, KN1, IFLAG, ITYPE, K1W1, K1W2)

where

- I1, K1 is the storage location in the PHO array for the point in question on the new normal (K-line)
- IS1 JS1 is the storage location in the PHO array for the known reference point on the old normal (J-line); normally this point is on the same streamline as the point I1, K1
- IN1, KN1 is the storage location in the PHO array for the known point I1, K1 on the new normal (K-line)
- IFLAG is a control indicator for sending in and out necessary messages
- ITYPE denotes the type of point to be calculated

UTILITY ROUTINES AND COMMON REFERENCES

COMMON/FREE/	COMMON/CPMUK/
COMMON/ISEA/	COMMON/RUE/
COMMON/CHEMCN/	COMMON/CHEMXX/
COMMON/CHEMXY/	COMMON/TUIPA/

COMMON/CONTRL/	COMMON/PARSTU/
COMMON/CRITER/	COMMON/FSTAG/
COMMON/DATAR/	BOUND
COMMON/DROP/	IDMPFP
COMMON/GASCON/	PPATPT
COMMON/PHISOL/	FNEWTN
COMMON/SLIPPT/	INRSCT
COMMON/TEMPO2/	GAPPBI
COMMON/TOTAL/	PHYSOL
COMMON/CROSS/	SPCTX
COMMON/STEP/	FFP
COMMON/AVPROP/	RGMOFP
COMMON/PARTP1/	COEFF3
COMMON/PARTP2/	ROTERM
COMMON/GAPPA/	SLPLIN
COMMON/ONTSPT/	NEWENT
COMMON/POINTC/	UOFV
COMMON/NSF/	VOFEM
COMMON/OVERLA/	COEFEQ
COMMON/GLOBAL/	AVERAG
COMMON/PSEC/	CHECK
COMMON/INTEU/	

### METHOD OF SOLUTION

Initially, the flow properties of the point in question are assumed to be the same as those of the known upstream point on the same streamline, and its location is found by intersecting the average streamline from the reference point (IS1, JS1) on the J-line and the average normal from the known point (IN1, KN1) on the K-line. Subroutine PHYSOL is used to find the reference properties for the characteristic lines and Eq. (3.3) is then used to calculate velocity and flow angle for the new point. Under normal conditions, the mass flow rate between two streamlines is conserved, but when the streamline meets a shock wave, no attempt is made to conserve the mass flow rate, because the streamline



24

is terminated at the shock upstream region and a new streamline is generated from the shock downstream point.

The iterative method is employed to find the velocity and the flow angle until they do not change appreciably between the successive iterations. During this iteration, the location of the new point is perturbed.

FUNCTION NAME: TAB

DESCRIPTION

This function computes the thermodynamic data storage location and retrieves data from the TABB array.

CALLING SEQUENCE

= TAB (I, J, K, L)

where

I, J, K, L are indices which are used to determine the storage location

UTILITY ROUTINES AND COMMON REFERENCES

COMMON/GASDAT/

UTILITY - None

METHOD OF SOLUTION

The thermodynamic data storage location is computed using the following relation

$$IX = I + 10 * (J - 1 + 2 * (K - 1 + 13 * (L - 1))),$$

and retrieved using the relation

$$TABB = TABB(IX)$$

SUBROUTINE NAME: TEMTAB

DESCRIPTION

This subroutine will perform a table lookup for particle temperature as a function of enthalpy or for particle enthalpy as a function of temperature.

CALLING SEQUENCE

CALL TEMTAB(X, Y, WHICH)

where

X is the unknown variable

Y is the known variable

WHICH is the lookup control variable  
indicating to lookup temperature (=1)  
or enthalpy (=2)

UTILITY ROUTINES AND COMMON REFERENCES

COMMON/CONTRL/

COMMON/TPEH/

COMMON/TFLAG/

UTILITY - None

METHOD OF SOLUTION

The unknown variable (particle temperature or enthalpy) is calculated by either assuming constant heat capacities or by applying linear interpolation techniques to the tabulated data input on cards 32.

SUBROUTINE NAME: THERMO

DESCRIPTION

This subroutine utilizes real or ideal gas information obtained from the flowfield tape (or tables) and a local O/F ratio (or total enthalpy) to call subroutine FABLE to calculate thermodynamic gas properties locally in the flow.

CALLING SEQUENCE

CALL THERMO (OF, SS, VV)

where

OF = gas total enthalpy or O/F ratio  
SS = gas entropy  
VV = gas velocity

UTILITY ROUTINES AND COMMON REFERENCES

COMMON/GASCON/	COMMON/GASDAT/
COMMON/CPMUK/	COMMON/FAB/
COMMON/GRINT/	COMMON/CONTRL/
COMMON/PARTP1/	TAB
COMMON/PARTP2/	FABLE
COMMON/TEMPER/	THERM1

METHOD OF SOLUTION

The routine is entered with the local O/F ratio (or total enthalpy), OF, entropy, SS, and velocity, VV. The local ratio is used to determine which set of thermodynamic tables that subroutine FABLE should use to perform table lookup of the local thermodynamic gas properties. Subroutine THERMO then uses the local thermodynamic gas properties obtained from FABLE to perform an interpolation between the O/F (or total enthalpy) tables based on the local O/F ratio (or total enthalpy).

SUBROUTINE NAME: THERM1

DESCRIPTION

This routine determines the gas thermodynamic properties for a finite rate chemistry case.

CALLING SEQUENCE

CALL THERM1(HT, V)

where

HT is the gas total enthalpy

V is the gas velocity

UTILITY ROUTINES AND COMMON REFERENCES

COMMON/TEMPER/

COMMON/GASCON/

COMMON/PCTC/

COMMON/CPMUK/

COMMON/CONTRL/

COMMON/WISEX/

COMMON/CHEMCN/

COMMON/CHEMXX/

COMMON/GASDAT/

TKEY

TOFH

METHOD OF SOLUTION

The routine looks up enthalpy and specific heats from tabulated data of enthalpy and specific heats as functions of temperature. The enthalpy, specific heats and molecular weights of each species are used, along with species concentrations, to calculate the mixture gas constant, gamma, enthalpy, specific heat, and total pressure and temperature. These properties, along with velocity are used to calculate total enthalpy and Mach number.

SUBROUTINE NAME: THETPM

DESCRIPTION

THETPM performs a numerical integration to calculate properties through a Prandtl-Meyer expansion. Either the case of known final velocity or known final expansion angle may be handled.

CALLING SEQUENCE

CALL THETPM (OF, S, DELTA, VF, VI, IT, ITYPE, KIW, K2W)

where

OF is the local O/F ratio or total enthalpy  
S is the local entropy level  
DELTA is the total expansion angle  
VF is the final velocity downstream of the expansion  
VI is the initial velocity upstream of the expansion  
IT is a control parameter indicating if expansion to a solid wall or free boundary is taking place  
ITYPE indicates if an upper (2) or lower (1) boundary is being considered.

UTILITY ROUTINES AND COMMON REFERENCES

COMMON/GASCON/  
COMMON/STPC/  
COMMON/CONTRL/  
THERMO  
TOFH  
ITSUB  
TOFV  
ERRORS

METHOD OF SOLUTION

The integral equation

$$\int_{V_1}^{V_F} \sqrt{M^2 - 1} \frac{dV}{V} - \Delta\theta = f(V_F) = 0$$

where  $M^2 = V^2/\gamma RT$  is solved knowing either the final velocity,  $V_F$ , or the expansion angle ( $\Delta\theta$ ). As can be seen, if the final velocity,  $V_F$ , is known, the integration progresses straightforwardly to a solution. However, if the expansion angle is known, an iterative procedure must be employed to pick the velocity which produces the desired expansion angle.

SUBROUTINE NAME: THRUST

DESCRIPTION

THRUST computes the vacuum thrust produced by a two-dimensional or axisymmetric nozzle. Addition of the thrust at the throat and the integrated pressure along the nozzle wall yields the final thrust.

CALLING SEQUENCE

CALL THRUST (L, K, I1, J1, ITYPE, ICALC, K1W1, K1W2)

where L, K designates the unknown characteristic point and I1, J1 is the known characteristic point. ITYPE specifies if the point is on the upper or lower boundary and ICALC is a counter with the values of 1, 2 or 3. (1 specifies integration at the throat, 2 - along the nozzle and 3 - at the exit.)

UTILITY ROUTINES AND COMMON REFERENCES

COMMON/CONTRL/

COMMON/DATAR/

COMMON/FORCE/

COMMON/INPUT/

COMMON/PARTP1/

COMMON/PARTP2/

COMMON/FSTAG/

COMMON/WT/

COMMON/PSLD/

COMMON/INTCR/

PFP

VEMAG

METHOD OF SOLUTION

Thrust is found by first computing the momentum thrust in the sonic area or throat of the nozzle. The static pressure is then integrated along the nozzle wall and the total thrust found by summation of the pressure and momentum terms (both gas and particle). Inclusion of a factor in the incremental force term accounts for either two-dimensional or axisymmetric flow.



SUBROUTINE NAME: TKEY

DESCRIPTION

This routine determines the proper index to be used in the enthalpy and specific heat tables and calculates interpolation factors.

CALLING SEQUENCE

CALL TKEY (T, TTB, ITKEY, SDT, HDT, NT)

where

T = the temperature

TTB = the temperature tables used as independent variables

ITKEY = the resultant index

SDT and HDT = interpolation factors

NT = number of entries in the temperature table.

UTILITY ROUTINES AND COMMON REFERENCES

None

METHOD OF SOLUTION

The routine searches the temperature table until the input temperature is bounded. The index of the lower bound is stored in ITKEY and the interpolation factors are calculated by the equations

$$SDT = \frac{T - TTB (ITKEY)}{TTB (ITKEY + 1) - TTB (ITKEY)}$$

and

$$HDT = \frac{TTB (ITKEY + 1) - T}{TTB (ITKEY + 1) - TTB (ITKEY)}$$

FUNCTION NAME: TOFEM

DESCRIPTION

TOFEM computes the local static temperature as a function of Mach number. TOFEM and TOFV are quite similar; the difference being if Mach number or velocity is the known quantity.

CALLING SEQUENCE

T = TOFEM (EM, K1W1, K1W2)

where T is the one-dimensionally calculated local static temperature which exists at the Mach number, EM. NOTE: The appropriate values of the gas properties must be stored in common upon entry to this routine.

UTILITY ROUTINES AND COMMON REFERENCES

COMMON/GASCON/

UTILITY - None

METHOD OF SOLUTION

The thermally perfect gas relationships are used to find the static temperature at the local Mach number.

$$T = \frac{T_o}{1 + \frac{\gamma-1}{2} M^2}$$

FUNCTION NAME: TOFENH

DESCRIPTION

This routine calculates the temperature as a function of enthalpy for a finite-rate chemistry case.

CALLING SEQUENCE

= TOFENH(HU)

where HU is the static enthalpy

UTILITY ROUTINES AND COMMON REFERENCES

COMMON/GASCON/

COMMON/PCTC/

COMMON/CPMUK/

COMMON/WISEX/

COMMON/CHEMCN/

COMMON/CHEMXX/

COMMON/GASDAT/

TKEY

ITSUB

METHOD OF SOLUTION

The temperature is estimated initially and this temperature is used to calculate an enthalpy from the temperature-enthalpy tables. If the resultant enthalpy does not match HU, the temperature is incremented and the process repeated until the enthalpies converge.

FUNCTION NAME: TOFH

DESCRIPTION

This routine calculates the temperature as a function of enthalpy for a finite rate chemistry case during a Prandtl-Meyer expansion.

CALLING SEQUENCE

= TOFH (HU, V)

where

HU is the enthalpy

V is the velocity

UTILITY ROUTINES AND COMMON REFERENCES

COMMON/TEMPER/

COMMON/GASCON/

COMMON/PCTC/

COMMON/CPMUK/

COMMON/WISEX/

COMMON/CHEMCN/

COMMON/CHEMXX/

COMMON/GASDAT/

TKEY

ITSUB

POFH

METHOD OF SOLUTION

The methodology is the same as for TOFENH except that the gas constant, molecular weight, gamma and Mach number are also computed.

FUNCTION NAME: TOFV

DESCRIPTION

This function computes the local static temperature as a function of velocity. TOFV and TOFEM are quite similar; the difference being if Mach number or velocity is the known variable.

CALLING SEQUENCE

$$T = \text{TOFV}(V, K1W1, K1W2)$$

where T is the local static temperature which exists at the velocity, V.  
NOTE: The appropriate values of the gas properties must be stored in common upon entry to this routine.

UTILITY ROUTINES AND COMMON REFERENCES

COMMON/GASCON/  
RITE  
ERRORS  
KIKOFF

METHOD OF SOLUTION

The thermally perfect gas relationships are used to find the static temperature at the local velocity.

$$T = T_o - \frac{V^2}{2R} \left( \frac{\gamma - 1}{\gamma} \right)$$

SUBROUTINE NAME: TRANS

DESCRIPTION

This subroutine provides overall control for initializing the data and reading the namelist data for the Kliegel two-phase transonic solution of a supersonic gas particle startline.

CALLING SEQUENCE

CALL TRANS (NTAPE, NSETS, RUT)

where

NTAPE = FORTRAN unit on which the startline is written  
NSETS = number of startline points where particles are present  
RUT = throat radius (ft)

UTILITY ROUTINES AND COMMON REFERENCES

COMMON/CONTRL/	COMMON/PARTP2/
COMMON/GASDAT/	COMMON/ERR/
COMMON/GASCON/	COMMON/NAMEA/
COMMON/CPMUK/	COMMON/NAMEI/
COMMON/TPEH/	COMMON/NAMEW/
COMMON/MASSC/	TAB
COMMON/DRAGCF/	PARTIL
COMMON/TRANS1/	

METHOD OF SOLUTION

Not applicable.

SUBROUTINE NAME: TURN

DESCRIPTION

TURN solves for a shock wave which has a known turning angle ( $\delta$ ). A condition of known turning angle exists when the flow is turned through a compression corner on a solid boundary. Real gas effects are considered in calculating conditions downstream of the shock.

CALLING SEQUENCE

CALL TURN (PU, PD, DELTA, IFLAG, KIW1, KIW2)

where PU, PD represent flow conditions upstream and downstream of the shock, DELTA is the turning angle, and IFLAG indicates if the solution will or will not converge.

UTILITY ROUTINES AND COMMON REFERENCES

COMMON/CRITER/  
COMMON/CONTRL/  
THERMO  
EMOFV  
UOFEM  
ESHOCK  
ITSUB  
ERRORS  
UOFV

METHOD OF SOLUTION

An initial shock angle is assumed. This shock angle is used to calculate a turning angle. The calculated turning angle is compared to the known turning angle and successive iterations on shock angle are performed until the turning angle difference is sufficiently close to zero.

FUNCTION NAME: UOFEM

DESCRIPTION

This function computes the local Mach angle as a function of local Mach number. Prior to the calculation a test is made to ensure that the Mach number is greater than one.

CALLING SEQUENCE

EMU = UOFEM (EM, K1W1, K1W2)

where EMU is the Mach angle which exists at the local Mach number, EM.

UTILITY ROUTINES AND COMMON REFERENCES

COMMON -- None

ERRORS

KIKOFF

RITE

METHOD OF SOLUTION

The following equation is solved for the local Mach angle.

$$\mu = \tan^{-1} \left( \frac{1}{\sqrt{M^2 - 1}} \right)$$



FUNCTION NAME: UOFV

DESCRIPTION

This function computes the local Mach angle as a function of local velocity.

CALLING SEQUENCE

EMU = UOFV (V, K1W1, K1W2)

where EMU is the Mach angle which exists at the local velocity, V.

UTILITY ROUTINES AND COMMON REFERENCES

COMMON - None

UOFEM

EMOFV

METHOD OF SOLUTION

The local velocity is converted into a Mach number using EMOFV. Function UOFEM is then entered with the calculated Mach number. The Mach angle is obtained from the following equation.

$$\mu = \tan^{-1} \left( \frac{1}{\sqrt{M^2 - 1}} \right)$$

FUNCTION NAME: VEMAG

DESCRIPTION

VEMAG determines the magnitude of a vector.

CALLING SEQUENCE

= VEMAG(V)

where V is any vector.

UTILITY ROUTINES AND COMMON REFERENCES

COMMON - None

DOTPRD

METHOD OF SOLUTION

The following equation is solved for the magnitude of a vector

$$\text{VEMAG} = \sqrt{V(1)^2 + V(2)^2}$$

where

$$\vec{V} = V(1)\vec{i} + V(2)\vec{j}$$

FUNCTION NAME: VOFEM

DESCRIPTION

This function computes velocity as a function of Mach number.

CALLING SEQUENCE

$$V = \text{VOFEM} (\text{EM}, \text{K1W1}, \text{K1W2})$$

where V is the local velocity which corresponds to the local Mach number, EM. NOTE: The appropriate values of the gas properties must be stored in common upon entry to this routine.

UTILITY ROUTINES AND COMMON REFERENCES

COMMON/GASCON/  
TOFEM

METHOD OF SOLUTION

The thermally perfect gas relationship

$$V = \sqrt{\frac{R\gamma(T_o - T)}{\left(\frac{\gamma-1}{2}\right)}}$$

is solved for velocity. Local static temperature, T, is obtained from the input Mach number.

SUBROUTINE NAME: WEAK

DESCRIPTION

This subroutine determines the independent variables, entropy and velocity, SD, VD, downstream of a weak oblique shock. The gas properties upstream of the shock are known prior to entry.

CALLING SEQUENCE

CALL WEAK (OF, SU, VU, EPS, DELTA, SD, VD, K1W, K2W)

where OF is the upstream O/F ratio (or total enthalpy), SU, VU are the upstream entropy and velocity, EPS, DELTA are the shock angle and turning angle, and SD, VD are the downstream entropy and velocity.

UTILITY ROUTINES AND COMMON REFERENCES

COMMON/GASCON/  
THERMO  
EMOFV  
POFEM,  
RHOPEM  
ENTROP  
DELTA F

METHOD OF SOLUTION

From the known upstream entropy and velocity, the local gas properties, pressure, density, and upstream Mach number are calculated. The entropy rise across the shock is added to the upstream entropy to get total downstream entropy. Downstream velocity is calculated from the following relationship.

$$V_D = \frac{V_U \cos(\xi)}{\cos(\xi - \delta)}$$

FUNCTION NAME: WOFA

DESCRIPTION

WOFA computes the weight flow per unit area as a function of Mach number. This calculation is only used in function AOASTR.

CALLING SEQUENCE

Weight Flow = WOFA (EM, K1W1, K1W2)

where EM is the local Mach number. NOTE: The appropriate values of the gas properties must be stored in common upon entry to this routine.

UTILITY ROUTINES AND COMMON REFERENCES

COMMON/GASCON/

UTILITY - None

METHOD OF SOLUTION

Weight flow per unit area,  $\dot{W}/A$ , is calculated from the thermally perfect gas relation.

$$\frac{\dot{W}}{A} = \sqrt{\frac{\gamma}{RT_0}} \left\{ \frac{P_0 M}{\left[ 1 + \frac{\gamma-1}{2} M^2 \right]^{\frac{\gamma+1}{2(\gamma-1)}}} \right\}$$

FUNCTION NAME: WTFLOF

DESCRIPTION

This function computes the area normal to the flow which is bounded by two streamline points.

CALLING SEQUENCE

= WTFLOF (M, N, K, A)

where

- M = the point number of the lower streamline point
- N = the point number of the upper streamline point
- K = the line number
- A = a 1 for axisymmetric flow and a 0 for two-dimensional flow.

UTILITY ROUTINES AND COMMON REFERENCES

COMMON/DATAR/  
COMMON/CONTRL/  
UTILITY - None

METHOD OF SOLUTION

The area bounded by two points and normal to the average local flow vector is calculated via geometric relations

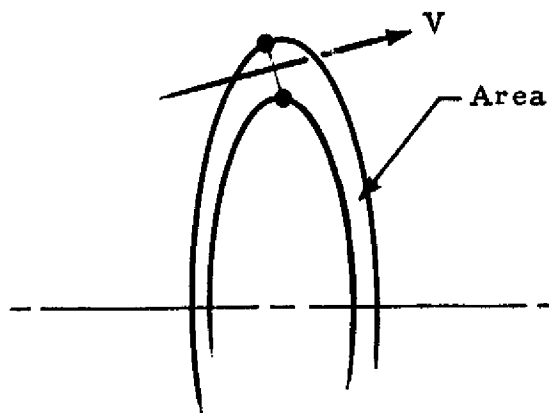

FUNCTION NAME: XSI

DESCRIPTION

This function computes the storage location for the nonlinear interpolation weighting functions required for thermodynamic property lookup and retrieves data from XSIDIM.

CALLING SEQUENCE

= XSI (I, J, K, L)

where

I, J, K, L are indices used to determine the storage location.

UTILITY ROUTINES AND COMMON REFERENCES

COMMON/XSICOM/

UTILITY - None

METHOD OF SOLUTION

The storage location is computed using the following relation

$$IX = I + 10 * (J - 1 + 2 * (K - 1 + 13 * (L - 1)))$$

and retrieved using the relation

$$XSI = XSIDIM(IX)$$

### 3.7 EXAMPLE PROBLEMS

To familiarize the user with the operation of the RAMP computer program several sample cases are presented. Each sample case will consist of a description of the problem, a listing of the input data for the problem and a listing of the pertinent solution.

#### Example Problem 1

This problem analyzes a single phase chemical equilibrium flow field with the following stipulations:

1. Generate a startline at the nozzle exit plane for example problem 2,
2. The gas properties are to be read from cards, and
3. The startline at the nozzle throat is to be calculated internal to the program.

Figure 3-4 presents a schematic of a typical nozzle plume flow field. Table 3-7 presents first a flow chart and then a listing of the input data for the specified problem; some of these cards are indicated in Fig. 3-4. Table 3-8 presents a listing of the pertinent solution.



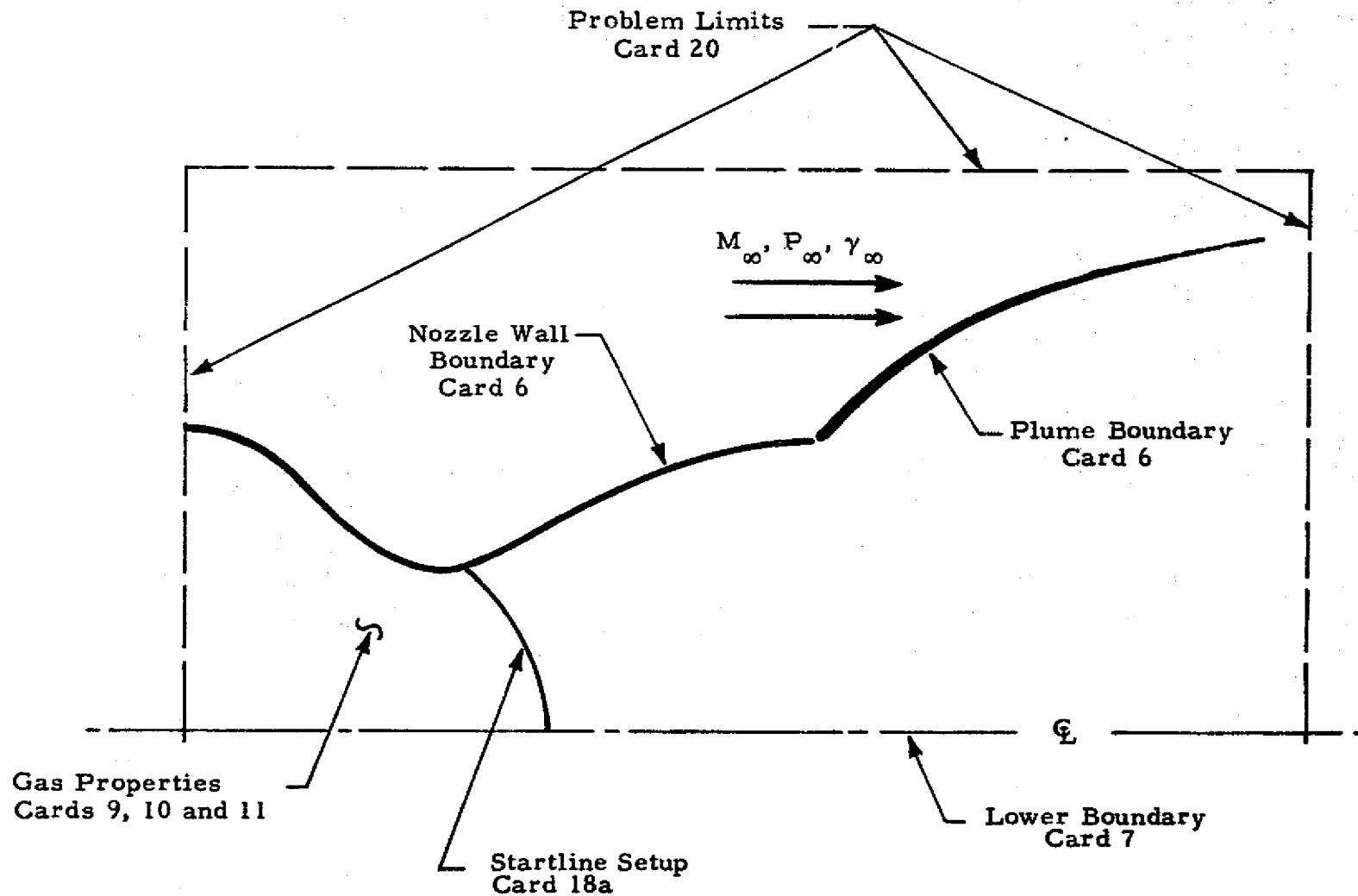
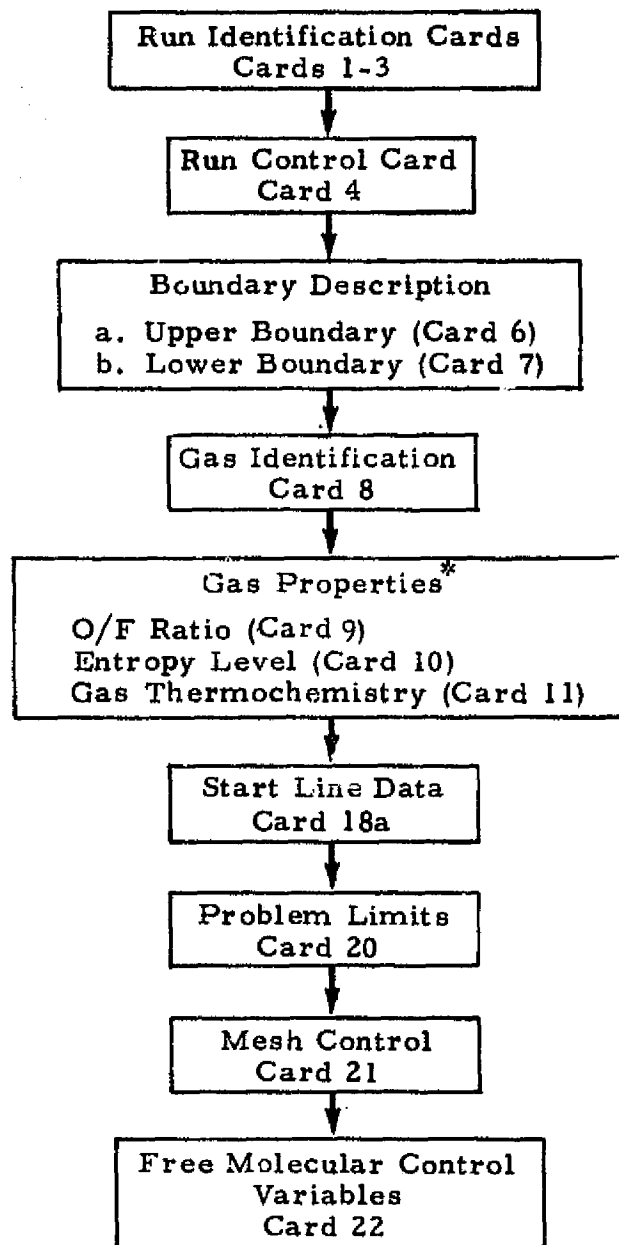

Fig. 3-4 - Schematic of a Typical Nozzle-Plume Flow Field with Control Cards Indicated

Table 3-7  
REQUIRED INPUT FORMAT FOR EXAMPLE PROBLEM 1



\*If gas properties are input on tape (ICON(1)=2) Cards 9, 10 and 11 are not required.

Table 3-7 (Concluded)

Cards 1-3		GASEOUS CHECK CASE WITH FREE MOLECULAR CALCULATIONS CONSIDERED									
Card 4		1	1	1	1	2	15	1	11	1	1200
Cards 6	1		-1.	.133333	0.0	-1.0	-.547722	.09490723			
	2	1				.26794919	.1690930613	.09074760			
	3		.0100					1000.			
Card 7	2							1000.			
Card 8	IDEAL GAS			ENG		1	1				
Card 9	.0										
Card 10	.0			15							
Cards 11	.0		24.054	1.1790	5468.4	122.48					
	1.0		24.946	1.1911	5025.0	69.321					
	1.740		25.055	1.2121	4209.0	24.496					
	2.151		25.080	1.2224	3747.6	12.248					
	2.550		25.007	1.2297	3299.4	6.1241					
	2.916		25.091	1.2344	2896.2	3.0621					
	3.424		25.091	1.2376	2450.0	1.2248					
	4.057		25.091	1.2751	1951.4	.4085					
	4.504		25.091	1.2619	1729.8	.2450					
	4.790		25.091	1.2944	1461.4	.1225					
	5.014		25.091	1.3220	1013.4	.0445					
6.279		25.091	1.3525	555.2	.0122						
7.000		25.091	1.3527	507.0	.0024						
Card 18a	.0	0.0	1.51								
Card 20	100.	-100.	0.0	0.0	5.0	90.					
Card 21	.50	.20	1.	.005	5.	.90					
Card 22	100.0	10.0	.10	1.0		1.0E-04.60					

3-253

Table 3-8  
EXAMPLE PROBLEM 1 PERTINENT SOLUTION

II  
SUPERSONIC FLOW ANALYSIS USING THE LOCKHEED-HUNTSVILLE MULTIPLE SHOCK COMPUTER PROGRAM

CASE NO. 1

PAGE 1

GASEOUS CHECK CASE WITH FREE MOLECULAR CALCULATIONS CONSIDERED

RUN CONTROL PARAMETERS

ICON(1)	ICON(2)	ICON(3)	ICON(4)	ICON(5)	ICON(6)	ICON(7)	ICON(8)
1	0	21	3	1	0	1	2
ICON(9)	ICON(10)	ICON(11)	ICON(12)	ICON(13)	ICON(14)	ICON(15)	ICON(16)
0	15	1	1	1	0	0	12000

FLOW CALCULATIONS ARE IN ENGLISH UNITS WITH THE R,X COORDINATES IN FEET

THE FLOW FIELD DATA WILL NOT BE WRITTEN ON TAPE

UPPER BOUNDARY

TYPE	TRANS	A	B	C	D	E	MAX
1	0	-.10000+01	.13333+00	.00000	-.10000+01	-.54772+00	.94507+01
2	1	.00000	.00000	.00000	.26795+00	.16749+00	.30967+01
3	0	.10000+01	.00000	.00000	.00000	.00000	.10000+01

LOWER BOUNDARY

TYPE	TRANS	A	B	C	D	E	MAX
2	0	.00000	.00000	.00000	.00000	.00000	.10000+01

THERE ARE 0 PARTICLE SPECIES PRESENT IN THE GAS-PARTICLE MIXTURE

THE FOLLOWING GAS PROPERTIES IN ENGLISH UNITS ARE FOR IDEAL GAS  
REAL GAS PROPERTIES

O/F	S	V	R	GAMMA	T	P	PR	VIS	CP
.00000	.00000	.00000	.20014+04	.11798+01	.54684+04	.18000+04	.00000	.00000	.00000
	.34536+04	.19225+04	.11911+01	.50256+04	.10187+05	.00000	.00000	.00000	.00000
	.55746+04	.19840+04	.12121+01	.42390+04	.35999+03	.00000	.00000	.00000	.00000
	.64815+04	.19820+04	.12224+01	.37476+04	.18000+03	.00000	.00000	.00000	.00000
	.71902+04	.19813+04	.12297+01	.32994+04	.90000+02	.00000	.00000	.00000	.00000
	.77605+04	.19811+04	.12344+01	.28962+04	.45001+02	.00000	.00000	.00000	.00000
	.83577+04	.19811+04	.12376+01	.24300+04	.18000+02	.00000	.00000	.00000	.00000
	.89543+04	.19811+04	.12731+01	.19314+04	.60004+01	.00000	.00000	.00000	.00000

Table 3-8 (Continued)

SUPERSONIC FLOW ANALYSIS USING THE LOCKHEED-HUNTSVILLE MULTIPLE SHOCK COMPUTER PROGRAM

CASE NO. 1

PAGE 2

GASEOUS CHECK CASE WITH FREE MOLECULAR CALCULATIONS CONSIDERED  
REAL GAS PROPERTIES

H-TOTAL

S	V	R	GAMMA	T	P	PR	VIS	CP
.00000	.91468+04	.19811+04	.12819+01	.17298+04	.36005+01	.00000	.00000	.00000
	.93361+04	.19811+04	.12944+01	.14814+04	.18003+01	.00000	.00000	.00000
	.94719+04	.19811+04	.13220+01	.10134+04	.36005+00	.00000	.00000	.00000
	.94234+04	.19811+04	.13325+01	.85320+03	.17929+00	.00000	.00000	.00000
	.94670+04	.19811+04	.13527+01	.56700+03	.35270-11	.00000	.00000	.00000

STARTING LINE INFO

R	X	H	THETA	S	MACH ANGLE	SHOCK ANGLE	D/F
.00000	.00000	.10100+01	.00000	.00000	.81931+02	.00000	.00000
.91287-02	.00000	.10100+01	.00000	.00000	.81931+02	.00000	.00000
.16257-01	.00000	.10100+01	.00000	.00000	.81931+02	.00000	.00000
.27386-01	.00000	.10100+01	.00000	.00000	.81931+02	.00000	.00000
.36515-01	.00000	.10100+01	.00000	.00000	.81931+02	.00000	.00000
.45644-01	.00000	.10100+01	.00000	.00000	.81931+02	.00000	.00000
.54772-01	.00000	.10100+01	.00000	.00000	.81931+02	.00000	.00000
.63901-01	.00000	.10100+01	.00000	.00000	.81931+02	.00000	.00000
.73030-01	.00000	.10100+01	.00000	.00000	.81931+02	.00000	.00000
.82158-01	.00000	.10100+01	.00000	.00000	.81931+02	.00000	.00000
.91287-01	.00000	.10100+01	.00000	.00000	.81931+02	.00000	.00000
.10042+00	.00000	.10100+01	.00000	.00000	.81931+02	.00000	.00000
.10954+00	.00000	.10100+01	.00000	.00000	.81931+02	.00000	.00000
.11867+00	.00000	.10100+01	.00000	.00000	.81931+02	.00000	.00000
.12780+00	.00000	.10100+01	.00000	.00000	.81931+02	.00000	.00000
.13693+00	.00000	.10100+01	.00000	.00000	.81931+02	.00000	.00000
.14606+00	.00000	.10100+01	.00000	.00000	.81931+02	.00000	.00000
.15519+00	.00000	.10100+01	.00000	.00000	.81931+02	.00000	.00000
.16432+00	.00000	.10100+01	.00000	.00000	.81931+02	.00000	.00000
.17345+00	.00000	.10100+01	.00000	.00000	.81931+02	.00000	.00000
.18257+00	.00000	.10100+01	.00000	.00000	.81931+02	.00000	.00000

RUN CUTOFF INFORMATION

UPPER BOUNDARY			LOWER BOUNDARY								
R=	.10000+03	X=	-.10000+03	THETA=	.00000	R=	.00000	X=	.50000+01	THETA=	.99000+02

LOCKHEED-HUNTSVILLE RESEARCH & ENGINEERING CENTER

3-255

Table 3-8 (Continued)

SUPERSONIC FLOW ANALYSIS USING THE LOCKHEED-HUNTSVILLE MULTIPLE SHOCK COMPUTER PROGRAM						
CASE NO. 1						PAGE 3
GASEOUS CHECK CASE WITH FREE MOLECULAR CALCULATIONS CONSIDERED						
VIBNO	ROTNO	TRANNO	CHARL	GAMV	GAMR	
.10000+03	.10000+02	.10000+00	.10000+01	.00000	.00000	
THE MESH CONSTRUCTION WILL BE CONTROLLED BY THE FOLLOWING VARIABLES						
DL INTERIOR=	.500+00 DX AXIS=	.200+00 DL LIN=	.100+01 DL DELETE=	.500-02 DEG P.M.=	.500+01 P=	.100+00

LOCKHEED-HUNTSVILLE RESEARCH & ENGINEERING CENTER

3-256

Table 3-8 (Continued)

SUPERSONIC FLOW ANALYSIS USING THE LOCKHEED-HUNTSVILLE MULTIPLE SHOCK COMPUTER PROGRAM

CASE NO. 1

PAGE 2

GASEOUS CHECK CASE WITH FREE MOLECULAR CALCULATIONS CONSIDERED

LINE	POINT	DESCRIP - REGIME	R MACH ANGLE	X PRESSURE	M DENSITY	THETA TEMPERATURE	ENTROPY GAS CONST.	VELOCITY LOCAL GAMMA	O/F SHOCK ANGLE	ITR
1	14	INPUT - CONTIN	.11867+00 .81931+02	.00000 .10076+04	.10100+01 .14517-01	.00000 .50166+04	.00000 .19924+04	.34853+04 .11914+01	.00000	0
1	15	INPUT - CONTIN	.12780+00 .81931+02	.00000 .10076+04	.10100+01 .14517-01	.00000 .50166+04	.00000 .19924+04	.34853+04 .11914+01	.00000	0
1	16	INPUT - CONTIN	.13693+00 .81931+02	.00000 .10076+04	.10100+01 .14517-01	.00000 .50166+04	.00000 .19924+04	.34853+04 .11914+01	.00000	0
1	17	INPUT - CONTIN	.14606+00 .81931+02	.00000 .10076+04	.10100+01 .14517-01	.00000 .50166+04	.00000 .19924+04	.34853+04 .11914+01	.00000	0
1	18	INPUT - CONTIN	.15519+00 .81931+02	.00000 .10076+04	.10100+01 .14517-01	.00000 .50166+04	.00000 .19924+04	.34853+04 .11914+01	.00000	0
1	19	INPUT - CONTIN	.16432+00 .81931+02	.00000 .10076+04	.10100+01 .14517-01	.00000 .50166+04	.00000 .19924+04	.34853+04 .11914+01	.00000	0
1	20	INPUT - CONTIN	.17345+00 .81931+02	.00000 .10076+04	.10100+01 .14517-01	.00000 .50166+04	.00000 .19924+04	.34853+04 .11914+01	.00000	0
1	21	INPUT - CONTIN	.18257+00 .81931+02	.00000 .10076+04	.10100+01 .14517-01	.00000 .50166+04	.00000 .19924+04	.34853+04 .11914+01	.00000	0
THE MASS FLOW RATE IS =			.170473+03							

MOMENTUM INTEGRATION RESULTS

FORCEX	FORCEY	TORQZ	ISP
.33661+05	.00000	.00000	.19746+03

NOTES: (1) Typical printout for the nozzle throat startline data surface.  
 (2) Some points have been omitted for demonstration purposes.

LOCKHEED-HUNTSVILLE RESEARCH & ENGINEERING CENTER  
 3-257

Table 3-8 (Continued)

## SUPERSONIC FLOW ANALYSIS USING THE LOCKHEED-HUNTSVILLE MULTIPLE SHOCK COMPUTER PROGRAM

CASE NO. 1

PAGE 9

GASEOUS CHECK CASE WITH FREE MOLECULAR CALCULATIONS CONSIDERED

LINE	POINT	DESCRIP	REGIME	H MACH ANGLE	X PRESSURE	M DENSITY	THETA TEMPERATURE	ENTROPY GAS CONST.	VELOCITY LOCAL GAMMA	O/P SHOCK ANGLE	ITER
10	21	WALL	- CONTIN	.18271+00 .64542+02	.99155-02 .90099+03	.11075+01 .13229-01	.15560+01 .49256+04	.00000 .19911+04	.37906+04 .11944+01	.00000	3
11	1	WALL	- CONTIN	.00000 .81931+02	.11647-01 .10076+04	.10100+01 .14517-01	.00000 .50166+04	.00000 .19924+04	.34853+04 .11914+01	.00000	1
11	21	WALL	- CONTIN	.18274+00 .63705+02	.10972-01 .89256+03	.11154+01 .13126-01	.17219+01 .49180+04	.00000 .19910+04	.38149+04 .11947+01	.00000	3
12	1	WALL	- CONTIN	.00000 .81931+02	.12812-01 .10076+04	.10100+01 .14517-01	.00000 .50166+04	.00000 .19924+04	.34853+04 .11914+01	.00000	1
3-12 258	21	WALL	- CONTIN	.18277+00 .62925+02	.12022-01 .88438+03	.11230+01 .13026-01	.18867+01 .49106+04	.00000 .19910+04	.38385+04 .11949+01	.00000	3
13	1	WALL	- CONTIN	.00000 .81931+02	.13977-01 .10076+04	.10100+01 .14517-01	.00000 .50166+04	.00000 .19924+04	.34853+04 .11914+01	.00000	1
13	21	WALL	- CONTIN	.18281+00 .62194+02	.13045-01 .87644+03	.11305+01 .12928-01	.20905+01 .49034+04	.00000 .19909+04	.38615+04 .11951+01	.00000	3
14	1	WALL	- CONTIN	.00000 .81931+02	.15141-01 .10076+04	.10100+01 .14517-01	.00000 .50166+04	.00000 .19924+04	.34853+04 .11914+01	.00000	1
14	21	WALL	- CONTIN	.18285+00 .61505+02	.14102-01 .86870+03	.11378+01 .12834-01	.22133+01 .48963+04	.00000 .19908+04	.38838+04 .11954+01	.00000	3
15	1	WALL	- CONTIN	.00000 .81931+02	.16306-01 .10076+04	.10100+01 .14517-01	.00000 .50166+04	.00000 .19924+04	.34853+04 .11914+01	.00000	1
15	21	WALL	- CONTIN	.18289+00 .60852+02	.15132-01 .86115+03	.11450+01 .12741-01	.23751+01 .48893+04	.00000 .19907+04	.39057+04 .11956+01	.00000	3
16	1	WALL	- CONTIN	.00000 .81931+02	.17471-01 .10076+04	.10100+01 .14517-01	.00000 .50166+04	.00000 .19924+04	.34853+04 .11914+01	.00000	1
16	21	WALL	- CONTIN	.18293+00 .60233+02	.16156-01 .85378+03	.11520+01 .12650-01	.25360+01 .48824+04	.00000 .19906+04	.39272+04 .11958+01	.00000	3

NOTES: (1) Typical printout for a data surface inside the nozzles.  
 (2) Some points have been omitted for demonstration purposes.



Table 3-8 (Continued)

SUPERSONIC FLOW ANALYSIS USING THE LOCKHEED-HUNTSVILLE MULTIPLE SHOCK COMPUTER PROGRAM

CASE NO. 1

PAGE 33

GASEOUS CHECK CASE WITH FREE MOLECULAR CALCULATIONS CONSIDERED

LINE	POINT	DESCRIP	REGIME	R		X		M		THETA		ENTROPY		VELOCITY		O/F		ITR
				MACH	ANGLE	PRESSURE	DENSITY	TEMPERATURE	GAS CON.	LOCAL	GAMMA	SHOCK	ANGLE					
106	1	WALL	CONTIN	.00000		.30400+01	.41903+01	.00000		.00000		.90418+04	.00000					5
				.13752+02		.47962+01	.18944-03	.18402+04		.19811+04		.12771+01						
106	2	INTER	CONTIN	.49924-01		.30896+01	.41890+01	.82763+00		.00000		.90410+04	.00000					5
				.13756+02		.48068+01	.18977-03	.18411+04		.19811+04		.12771+01						
106	3	INTER	CONTIN	.99857-01		.30885+01	.41883+01	.16556+01		.00000		.90405+04	.00000					5
				.13759+02		.48124+01	.18994-03	.18416+04		.19811+04		.12770+01						
106	4	INTER	CONTIN	.14975+00		.30867+01	.41876+01	.24810+01		.00000		.90401+04	.00000					5
				.13761+02		.48183+01	.19012-03	.18421+04		.19811+04		.12770+01						
106	5	INTER	CONTIN	.19958+00		.30842+01	.41867+01	.33027+01		.00000		.90395+04	.00000					5
				.13765+02		.48255+01	.19035-03	.18427+04		.19811+04		.12770+01						
106	6	INTER	CONTIN	.24935+00		.30810+01	.41855+01	.41195+01		.00000		.90388+04	.00000					5
				.13769+02		.48348+01	.19063-03	.18434+04		.19811+04		.12770+01						
106	7	INTER	CONTIN	.29901+00		.30770+01	.41840+01	.49296+01		.00000		.90378+04	.00000					5
				.13774+02		.48470+01	.19101-03	.18444+04		.19811+04		.12769+01						
106	8	INTER	CONTIN	.34854+00		.30724+01	.41820+01	.57300+01		.00000		.90365+04	.00000					5
				.13781+02		.48632+01	.19151-03	.18458+04		.19811+04		.12769+01						
106	9	INTER	CONTIN	.39790+00		.30671+01	.41794+01	.65178+01		.00000		.90349+04	.00000					5
				.13790+02		.48847+01	.19217-03	.18475+04		.19811+04		.12768+01						
106	10	INTER	CONTIN	.44705+00		.30612+01	.41759+01	.72691+01		.00000		.90326+04	.00000					5
				.13803+02		.49131+01	.19305-03	.18498+04		.19811+04		.12767+01						
106	11	INTER	CONTIN	.49595+00		.30546+01	.41713+01	.80382+01		.00000		.90297+04	.00000					5
				.13819+02		.49509+01	.19422-03	.18529+04		.19811+04		.12765+01						
106	12	INTER	CONTIN	.54451+00		.30474+01	.41652+01	.87570+01		.00000		.90258+04	.00000					5
				.13841+02		.50017+01	.19572-03	.18570+04		.19811+04		.12764+01						
106	13	INTER	CONTIN	.59266+00		.30397+01	.41571+01	.94370+01		.00000		.90206+04	.00000					5
				.13870+02		.50696+01	.19786-03	.18624+04		.19811+04		.12761+01						

NOTES: (1) Typical printout for a data surface at the nozzle exit plane.  
(2) Some points have been omitted for demonstration purposes.

Table 3-8 (Concluded)

SUPERSONIC FLOW ANALYSIS USING THE LOCKHEED-HUNTSVILLE MULTIPLE SHOCK COMPUTER PROGRAM

CASE NO. 1

PAGE 34

GASEOUS CHECK CASE WITH FREE MOLECULAR CALCULATIONS CONSIDERED

LOCKHEED-HUNTSVILLE RESEARCH & ENGINEERING CENTER  
3-260

LINE	POINT	DSCHP - REGIME	R MACH ANGLE	X PRESSURE	M DENSITY	THETA TEMPERATURE	ENTROPY GAS CONST.	VELOCITY LOCAL GAMMA	O/F SHOCK ANGLE	ITR
106	22	PRN-MR - CONTIN	.10000+01 .12876+02	.30987+01 .29328+01	.44874+01 .12902-03	.19590+02 .16522+04	.00000 .19811+04	.92063+04 .12858+01	.00000	5
106	23	PRN-MR - CONTIN	.10000+01 .11567+02	.30987+01 .12807+01	.49873+01 .68419+04	.24180+02 .13691+04	.00000 .19811+04	.93689+04 .13011+01	.00000	5
106	24	PRN-MR - CONTIN	.10000+01 .97053+01	.30987+01 .31681+00	.59319+01 .23452-04	.28773+02 .98188+03	.00000 .19811+04	.95089+04 .13210+01	.00000	5
106	25	PRN-MR - CONTIN	.10000+01 .88272+01	.30987+01 .16273+00	.65165+01 .19163-04	.33360+02 .83512+03	.00000 .19811+04	.96339+04 .13210+01	.00000	5
106	26	PRN-MR - CONTIN	.10000+01 .79743+01	.30987+01 .78183-01	.72083+01 .81314-05	.37951+02 .69887+03	.00000 .19811+04	.97485+04 .13210+01	.00000	5
106	27	PRN-MR - CONTIN	.10000+01 .71438+01	.30987+01 .34692-01	.80412+01 .43957-05	.42541+02 .57365+03	.00000 .19811+04	.98527+04 .13210+01	.00000	5
106	28	PRN-MR - CONTIN	.10000+01 .63327+01	.30987+01 .13972-01	.90661+01 .22081-05	.47131+02 .45991+03	.00000 .19811+04	.99463+04 .13210+01	.00000	5
106	29	PRN-MR - CONTIN	.10000+01 .55383+01	.30987+01 .49846-02	.10361+02 .10120-05	.51721+02 .35802+03	.00000 .19811+04	.10030+05 .13210+01	.00000	5
106	30	PRN-MR - CONTIN	.10000+01 .47583+01	.30987+01 .15215-02	.12055+02 .41215-06	.56311+02 .26833+03	.00000 .19811+04	.10102+05 .13210+01	.00000	5
106	31	PRN-MR - CONTIN	.10000+01 .39904+01	.30987+01 .37697-03	.14370+02 .14332-06	.60901+02 .19117+03	.00000 .19811+04	.10164+05 .13210+01	.00000	5
106	32	PRN-MR - CONTIN	.10000+01 .32325+01	.30987+01 .69551-04	.17735+02 .39873-07	.65491+02 .12679+03	.00000 .19811+04	.10216+05 .13210+01	.00000	5

NOTES: (1) Typical printout for a data surface containing a Prandtl-Meyer Expansion.  
(2) Some points have been omitted for demonstration purposes.

## Example Problem 2

Example problem 2 is a continuation of the flowfield analysis begun in example problem 1 and is subject to the following stipulations:

1. The analysis is to begin at the nozzle exit plane and is to utilize the startline generated by example problem 1.
2. Free molecular calculations are to be considered, and
3. The gas properties are to be read from cards.

Table 3-9 presents first a flow chart and then a listing of the input data for the specified problem. Table 3-9a presents a listing of the pertinent solution.

Table 3-9  
REQUIRED INPUT FORMAT FOR EXAMPLE PROBLEM .

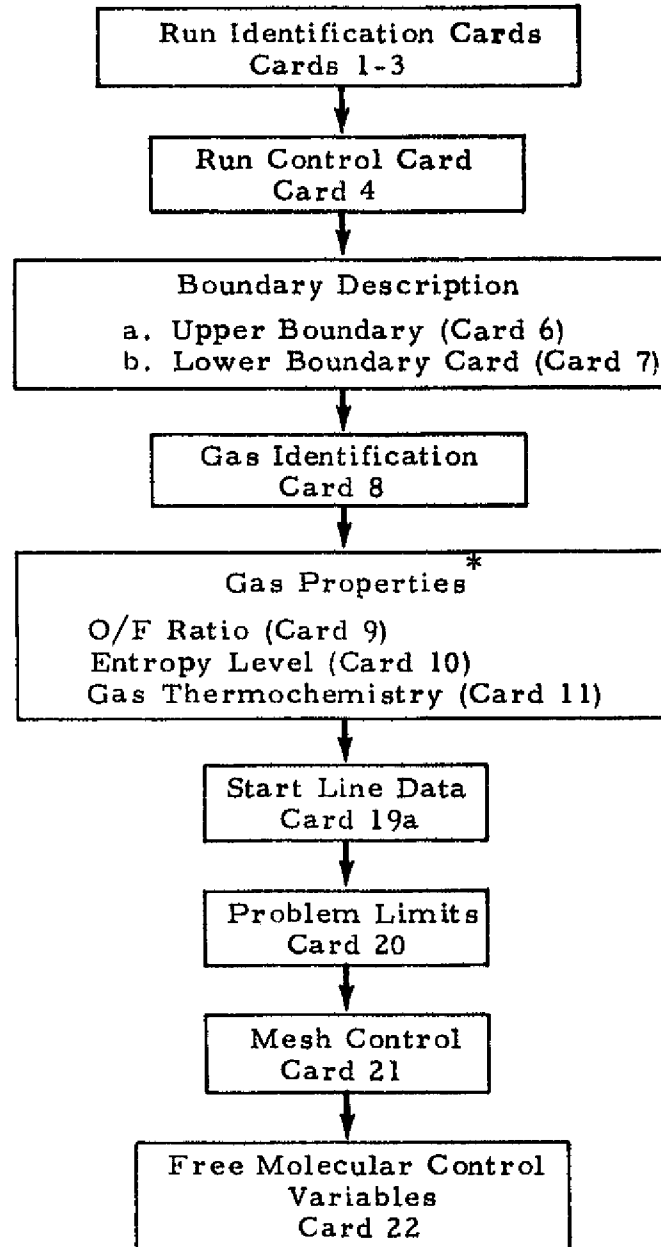

\*If gas properties are input on tape (ICON(1)=2) Cards 9, 10 and 11 are not required.

Table 3-9 - (Concluded)

GASEOUS CHECK CASE WITH FREE MOLECULAR CALCULATIONS CONSIDERED

Cards 1-3											00100
Card 4	1	2	21	2	1	1	2	99	1	11	1
Cards 6	2	1						.26794919	.1696930613	.096885	
	3		.0020							1000.	
Card 7	2									1000.	
Card 8	IDEAL GAS			ENG			1	1			
Card 9	.0										
Card 10	.0										
			10								
	.0	24.634	1.1798	5468.4	122.48						
	1.0	24.948	1.1911	5025.6	69.321						
	1.746	25.055	1.2121	4239.0	24.496						
	2.151	25.080	1.2224	3747.6	12.248						
	2.536	25.089	1.2297	3299.4	6.1241						
	2.916	25.091	1.2344	2896.2	3.0621						
	3.424	25.091	1.2376	2430.0	1.2248						
	4.057	25.091	1.2731	1931.4	.4083						
	4.364	25.091	1.2819	1729.8	.2450						
	4.790	25.091	1.2944	1481.4	.1225						
	.000000	.3232306+01	.4255560+01	.0000000	.0000000	.0000000	.0000000	.0000000	.0000000	.0000000	.0000000
	.5197684-01	.3231992+01	.4254146+01	.8249443+00	.0000000	.0000000	.0000000	.0000000	.0000000	.0000000	.0000000
	.1039027+00	.3230809+01	.4253355+01	.1630313+01	.0000000	.0000000	.0000000	.0000000	.0000000	.0000000	.0000000
	.1558985+00	.3229000+01	.4252460+01	.2472640+01	.0000000	.0000000	.0000000	.0000000	.0000000	.0000000	.0000000
	.2077669+00	.3228389+01	.4251346+01	.3290727+01	.0000000	.0000000	.0000000	.0000000	.0000000	.0000000	.0000000
	.2595539+00	.3227045+01	.4249891+01	.4103095+01	.0000000	.0000000	.0000000	.0000000	.0000000	.0000000	.0000000
	.3112162+00	.3216973+01	.4247967+01	.4907012+01	.0000000	.0000000	.0000000	.0000000	.0000000	.0000000	.0000000
	.3627149+00	.3214193+01	.4245415+01	.5699432+01	.0000000	.0000000	.0000000	.0000000	.0000000	.0000000	.0000000
	.4140085+00	.3206722+01	.4242050+01	.6476959+01	.0000000	.0000000	.0000000	.0000000	.0000000	.0000000	.0000000
	.4650489+00	.3202555+01	.4237622+01	.7234458+01	.0000000	.0000000	.0000000	.0000000	.0000000	.0000000	.0000000
	.5157675+00	.3195820+01	.4231737+01	.7964599+01	.0000000	.0000000	.0000000	.0000000	.0000000	.0000000	.0000000
	.5660755+00	.3188471+01	.4225951+01	.8658559+01	.0000000	.0000000	.0000000	.0000000	.0000000	.0000000	.0000000
	.6158719+00	.3180593+01	.4214127+01	.9312345+01	.0000000	.0000000	.0000000	.0000000	.0000000	.0000000	.0000000
	.6650621+00	.3172253+01	.4203152+01	.9939677+01	.0000000	.0000000	.0000000	.0000000	.0000000	.0000000	.0000000
	.7137183+00	.3163453+01	.4193167+01	.1057622+02	.0000000	.0000000	.0000000	.0000000	.0000000	.0000000	.0000000
	.7618934+00	.3154165+01	.4185807+01	.1125106+02	.0000000	.0000000	.0000000	.0000000	.0000000	.0000000	.0000000
	.8097548+00	.3144333+01	.4181180+01	.1196677+02	.0000000	.0000000	.0000000	.0000000	.0000000	.0000000	.0000000
	.8574228+00	.3133907+01	.4178534+01	.1270982+02	.0000000	.0000000	.0000000	.0000000	.0000000	.0000000	.0000000
	.9049870+00	.3122849+01	.4177059+01	.1346748+02	.0000000	.0000000	.0000000	.0000000	.0000000	.0000000	.0000000
	.9524623+00	.3111144+01	.4176303+01	.1423154+02	.0000000	.0000000	.0000000	.0000000	.0000000	.0000000	.0000000
	1.000000+01	.3098748+01	.4175701+01	.1500000+02	.0000000	.0000000	.0000000	.0000000	.0000000	.0000000	.0000000
Card 20	100.	-100.	0.0	0.0	20.	90.					
Card 21	3.0	1.	1.	.005	5.	.5					
Card 22	100.0	50.	20.	1.0	8.0E-04.	.7					

LOCKHEED - HUNTSVILLE RESEARCH & ENGINEERING CENTER

3-263

Table 3-9a  
EXAMPLE PROBLEM 2 PERTINENT SOLUTION

SUPERSONIC FLOW ANALYSIS USING THE LOCKHEED-HUNTSVILLE MULTIPLE SHOCK COMPUTER PROGRAM

CASE NO. 1

PAGE 1

GASEOUS CHECK CASE WITH FREE MOLECULAR CALCULATIONS CONSIDERED

RUN CONTROL PARAMETERS							
ICON(1)	ICON(2)	ICON(3)	ICON(4)	ICON(5)	ICON(6)	ICON(7)	ICON(8)
1	2	21	2	1	0	1	2
ICON(9)	ICON(10)	ICON(11)	ICON(12)	ICON(13)	ICON(14)	ICON(15)	ICON(16)
0	99	1	1	1	0	0	100

FLOW CALCULATIONS ARE IN ENGLISH UNITS WITH THE X,Y COORDINATES IN FEET

THE FLOW FIELD DATA WILL NOT BE WRITTEN ON TAPE

UPPER BOUNDARY							
TYPE	ITRANS	A	B	C	D	E	MAX
2	1	.00000	.00000	.00000	.26795+00	.16969+00	.30989+01
3	0	.20000+02	.00000	.00000	.00000	.00000	.10000+04
LOWER BOUNDARY							
TYPE	ITRANS	A	B	C	D	E	MAX
2	0	.00000	.00000	.00000	.00000	.00000	.10000+04

THERE ARE 0 PARTICLE SPECIES PRESENT IN THE GAS-PARTICLE MIXTURE

THE FOLLOWING GAS PROPERTIES IN ENGLISH UNITS ARE FOR IDEAL GAS  
REAL GAS PROPERTIES

O/F	S	V	R	GAMMA	T	P	PR	VIS	CP
.00000	.00000	.00000	.70016+04	.17798+01	.54684+04	.18000+04	.00000	.00000	.00000
	.34536+04	.14925+04	.11911+01	.50250+04	.10187+04	.00000	.00000	.00000	.00000
	.55746+04	.19040+04	.12121+01	.42390+04	.35999+03	.00000	.00000	.00000	.00000
	.64815+04	.19820+04	.12224+01	.37476+04	.18000+03	.00000	.00000	.00000	.00000
	.71902+04	.19813+04	.12297+01	.32994+04	.90000+02	.00000	.00000	.00000	.00000
	.77605+04	.19811+04	.12344+01	.28962+04	.45001+02	.00000	.00000	.00000	.00000
	.83577+04	.19811+04	.12376+01	.24300+04	.18000+02	.00000	.00000	.00000	.00000
	.89543+04	.19811+04	.12731+01	.19314+04	.60004+01	.00000	.00000	.00000	.00000
	.91468+04	.19811+04	.12811+01	.17298+04	.36005+01	.00000	.00000	.00000	.00000

Table 3-9a (Continued)

SUPERSONIC FLOW ANALYSIS USING THE LOCKHEED-HUNTSVILLE MULTIPLE SHOCK COMPUTER PROGRAM

CASE NO. 1

PAGE 2

GASEOUS CHECK CASE WITH FREE MOLECULAR CALCULATIONS CONSIDERED  
REAL GAS PROPERTIES

M-TOTAL

S	V	R	GAMMA	T	P	PR	VIS	CP
.00000	.93361+04	.19811+04	.12944+01	.14814+04	.18003+01	.00000	.00000	.00000

STARTING LINE INFO

R	H	THETA	S	MACH ANGLE	SHOCK ANGLE	OFF
.00000	.32324+01	.42555+n1	.00000	.13591+02	.00000	.00000
.61977-01	.32320+01	.42541+n1	.82494+00	.13595+02	.00000	.00000
.10396+00	.32309+01	.42533+n1	.16503+01	.13598+02	.00000	.00000
.15590+00	.32290+01	.42524+n1	.24726+01	.13601+02	.00000	.00000
.20777+00	.32284+01	.42513+n1	.32907+01	.13605+02	.00000	.00000
.25955+00	.32230+01	.42498+n1	.41031+01	.13609+02	.00000	.00000
.31122+00	.32190+01	.42479+n1	.49070+01	.13616+02	.00000	.00000
.36271+00	.32142+01	.42454+n1	.56994+01	.13624+02	.00000	.00000
.41401+00	.32087+01	.42420+n1	.64770+01	.13635+02	.00000	.00000
.46505+00	.32076+n1	.42376+n1	.72345+01	.13649+02	.00000	.00000
.51577+03	.31950+01	.42317+n1	.79846+01	.13669+02	.00000	.00000
.56608+00	.31885+01	.42239+n1	.86586+01	.13695+02	.00000	.00000
.61587+00	.31808+01	.42141+n1	.93123+01	.13727+02	.00000	.00000
.66508+00	.31723+01	.42031+n1	.99397+01	.13764+02	.00000	.00000
.71372+00	.31635+01	.41931+n1	.10576+02	.13797+02	.00000	.00000
.76189+00	.31542+01	.41858+n1	.11251+02	.13822+02	.00000	.00000
.80975+03	.31443+01	.41812+n1	.11967+02	.13837+02	.00000	.00000
.85742+00	.31319+01	.41785+n1	.12710+02	.13846+02	.00000	.00000
.90499+00	.31228+01	.41770+n1	.13467+02	.13851+02	.00000	.00000
.95246+00	.31111+01	.41763+n1	.14232+02	.13854+02	.00000	.00000
.10000+01	.30987+01	.41757+n1	.15000+02	.13856+02	.00000	.00000

RUN CUTOFF INFORMATION

UPPER BOUNDARY			LOWER BOUNDARY		
R=	X=	THETA=	R=	X=	THETA=
.10000+03	-.10000+03	.00000	.00000	.20000+02	.90000+02
VIBNO	ROTHO	TRANNO	CHARL	GAMV	GAMR
.10000+03	.50000+02	.20000+02	.10000+01	.00000	.00000

THE MESH CONSTRUCTION WILL BE CONTROLLED BY THE FOLLOWING VARIABLES

DL INTERIOR= .300+01 OX AXIS= .100+01 NL LIM= .100+01 DL DELETE= .500+02 DEG P.M.= .500+01 P= .500+00

LOCKHEED-HUNTSVILLE RESEARCH & ENGINEERING CENTER

3-265

Table 3-9a (Continued)

SUPERSONIC FLOW ANALYSIS USING THE LOCKHEED-HUNTSVILLE MULTIPLE SHOCK COMPUTER PROGRAM

CASE NO. 1

PAGE 8

GASEOUS CHECK CASE WITH FREE MOLECULAR CALCULATIONS CONSIDERED

LINE	POINT	DESCRIP	REGIME	R MACH ANGLE	X PRESSURE	M DENSITY	THETA TEMPERATURE	ENTROPY GAS CONST.	VELOCITY LOCAL GAMMA	θ SHOCK ANGLE	ITR
1	14	INPUT	CONTIN	.66508+00 .17744+02	.31723+01 .46950+01	.42031+01 .18630-03	.99397+01 .18318+04	.00000 .19811+04	.90499+04 .12775+01	.00000	0
1	15	INPUT	CONTIN	.71372+00 .13797+02	.31435+01 .47737+01	.41931+01 .18874-03	.10576+02 .18384+04	.00000 .19811+04	.90436+04 .12772+01	.00000	0
1	16	INPUT	CONTIN	.74189+00 .11822+02	.31542+01 .48127+01	.41858+01 .19057-03	.11251+02 .18433+04	.00000 .19811+04	.90389+04 .12770+01	.00000	0
1	17	INPUT	CONTIN	.80975+00 .13837+02	.31443+01 .48701+01	.41812+01 .19172-03	.11967+02 .18463+04	.00000 .19811+04	.90360+04 .12768+01	.00000	0
1	18	INPUT	CONTIN	.85742+00 .11846+02	.31139+01 .48917+01	.41785+01 .19239-03	.12710+02 .18481+04	.00000 .19811+04	.90343+04 .12768+01	.00000	0
1	19	INPUT	CONTIN	.90499+00 .11851+02	.31228+01 .49038+01	.41770+01 .19276-03	.13467+02 .18491+04	.00000 .19811+04	.90334+04 .12767+01	.00000	0
1	20	INPUT	CONTIN	.95246+00 .11854+02	.31111+01 .49700+01	.41763+01 .19295-03	.14232+02 .18496+04	.00000 .19811+04	.90329+04 .12767+01	.00000	0
1	21	INPUT	CONTIN	.10000+01 .11856+02	.30989+01 .49144+01	.41757+01 .19309-03	.15000+02 .18499+04	.00000 .19811+04	.90325+04 .12767+01	.00000	0
1	22	PRN*MR	CONTIN	.10000+01 .12812+02	.30989+01 .28778+01	.45096+01 .12542-03	.19869+02 .16388+04	.00000 .19811+04	.92165+04 .12865+01	.00000	0
1	23	PRN*MR	CONTIN	.10000+01 .11747+02	.30989+01 .15166+01	.49119+01 .77372-04	.24750+02 .14247+04	.00000 .19811+04	.93888+04 .12944+01	.00000	0
1	24	PRN*MR	CONTIN	.10000+01 .10807+02	.30989+01 .85163+00	.53333+01 .49631-04	.29624+02 .12502+04	.00000 .19811+04	.95494+04 .12944+01	.00000	0
1	25	PRN*MR	CONTIN	.10000+01 .99026+01	.30989+01 .45765+00	.58148+01 .30661-04	.34499+02 .10849+04	.00000 .19811+04	.96989+04 .12944+01	.00000	0
1	26	PRN*MR	CONTIN	.10000+01 .90295+01	.30989+01 .23197+00	.63717+01 .18139-04	.39374+02 .92955+03	.00000 .19811+04	.98375+04 .12944+01	.00000	0

NOTES: (1) Typical printout for a startline data surface containing a Prandtl-Meyer Expansion.  
 (2) Some points have been omitted for demonstration purposes.



Table 3-9a (Continued)

SUPERSONIC FLOW ANALYSIS USING THE LOCKHEED-HUNTSVILLE MULTIPLE SHOCK COMPUTER PROGRAM

CASE NO. 1

PAGE 12

GASEOUS CHECK CASE WITH FREE MOLECULAR CALCULATIONS CONSIDERED

LINE	POINT	DESCRIP	REGIME	R MACH	X ANGLE	P PRESSURE	M DENSITY	THETA TEMPERATURE	ENTROPY GAS CONST.	VELOCITY LOCAL GAMMA	SHOCK ANGLE	ITER
2	27	INTER	- CONTIN	.10613+01 .80889+01	.31227+01 .10068+00	.71067+01 .95186+05	.44254+02 .76883+03	.00000 .19811+04	.79788+04 .12944+01	.00000	4	
2	28	INTER	- CONTIN	.10686+01 .72641+01	.31756+01 .43639+01	.79085+01 .49804+05	.49073+02 .63535+03	.00000 .19811+04	.10095+05 .12944+01	.00000	4	
2	29	INTER	- CONTIN	.10753+01 .64628+01	.31680+01 .17134+01	.80839+01 .24233+05	.53898+02 .51393+03	.00000 .19811+04	.10199+05 .12944+01	.00000	4	
2	30	INTER	- CONTIN	.10812+01 .56815+01	.31699+01 .60027+02	.10100+02 .10777+05	.58729+02 .40486+03	.00000 .19811+04	.10292+05 .12944+01	.00000	4	
2	31	INTER	- CONTIN	.10864+01 .49174+01	.31515+01 .18136+02	.11625+02 .42748+06	.63566+02 .30837+03	.00000 .19811+04	.10373+05 .12944+01	.00000	4	
2	32	INTER	- CONTIN	.10908+01 .41677+01	.31427+01 .45095+03	.13757+02 .14587+06	.68408+02 .22470+03	.00000 .19811+04	.10443+05 .12944+01	.00000	5	
2	33	INTER	- CONTIN	.10946+01 .34302+01	.31336+01 .85775+04	.16708+02 .40470+07	.73254+02 .15406+03	.00000 .19811+04	.10502+05 .12944+01	.00000	5	
2	34	INTER	- CONTIN	.10976+01 .27032+01	.31244+01 .11044+04	.21190+02 .83055+08	.78110+02 .96649+02	.00000 .19811+04	.10549+05 .12944+01	.00000	6	
2	35	FREED	- CONTIN	.10987+01 .27780+01	.31201+01 .13907+04	.20633+02 .99245+08	.77877+02 .10185+03	.00000 .19811+04	.10545+05 .12944+01	.00000	4	

POINT NO. 34 ON LINE 2 HAS BEEN DELETED

PERCENT CHANGE IN MASS, MOMENTUM AND ENERGY NUMERICAL INTEGRATION FOR LINE 2 RELATIVE TO THE START LINE

THE PERCENT CHANGE IN MASS FLOW IS = -.220844+00  
 PERCENT CHANGE IN MOMENTUM IS = .18840+04 ISP = -.19527+01  
 PERCENT CHANGE IN ENERGY IS = .00000

- NOTES: (1) Typical printout for a data surface in the exhaust plume.  
 (2) Some points have been omitted for demonstration purposes.

Table 3-9a (Concluded)

SUPERSONIC FLOW ANALYSIS USING THE LOCKHEED-HUNTSVILLE MULTIPLE SHOCK COMPUTER PROGRAM

CASE NO. 1

PAGE 23

GASEOUS CHECK CASE WITH FREE MOLECULAR CALCULATIONS CONSIDERED

LINE	POINT	DESCRIP - REGIME	R MACH ANGLE	X PRESSURE	H DENSITY	THETA TEMPERATURE	ENTROPY GAS CONST.	VELOCITY LOCAL GAMMA	SHOCK ANGLE	ITR
6	29	INTER - CONTIN	.11712+01 .57651+01	.32124+01 .67428-02	.99553+01 .11817-05	.57858+02 .41599+03	.00000 .19811+04	.10282+05 .12944+01	.00000	5
6	30	INTER - CONTIN	.11808+01 .50786+01	.32158+01 .23711-02	.11297+02 .52584-06	.62206+02 .32776+03	.00000 .19811+04	.10357+05 .12944+01	.00000	5
6	31	INTER - CONTIN	.11890+01 .43988+01	.31987+01 .71057-03	.13038+02 .20727-06	.66612+02 .24919+03	.00000 .19811+04	.10423+05 .12944+01	.00000	4
6	32	INTER - FREE M	.11956+01 .45607+01	.31824+01 .21450-03	.12576+02 .75186-07	.69344+02 .20930+03	.00000 .19811+04	.10456+05 .16670+01	.00000	1
6	33	INTER - FREE M	.12013+01 .38782+01	.31456+01 .43479-04	.14785+02 .20778-07	.73346+02 .15280+03	.00000 .19811+04	.10503+05 .16670+01	.00000	1
6	34	INTER - FREE M	.12073+01 .31529+01	.31416+01 .72497-05	.18182+02 .51737-08	.78371+02 .10185+03	.00000 .19811+04	.10545+05 .16670+01	.00000	1

PERCENT CHANGE IN MASS, MOMENTUM AND ENERGY NUMERICAL INTEGRATION FOR LINE 6 RELATIVE TO THE START LINE  
 THE PERCENT CHANGE IN MASS FLOW IS = .161987+01  
 PERCENT CHANGE IN MOMENTUM IS = .18485+04 ISP = -.23162+01  
 PERCENT CHANGE IN ENERGY IS = .00000

NOTES: (1) Typical data surface containing points in the free molecular regime.  
 (2) Some points have been omitted for demonstration purposes.

### Example Problem 3

This problem analyzes a two-phase chemical equilibrium flow field with the following stipulations:

1. Free molecular flow calculations are not to be considered.
2. The gas properties are to be read directly from a data tape mounted on FORTRAN unit 10.
3. The start line is to be calculated internal to the program.

Table 3-10 presents first a flow chart and then a listing of the input data for the specified problem. Table 3-11 presents a listing of the pertinent solution. Table 3-12 presents a listing of the input data required for creation of the thermodynamic gaseous properties data tape using the modified TRAN72 computer program (see Section 2 for details).

Table 3-10  
REQUIRED INPUT FORMAT FOR EXAMPLE PROBLEM 3

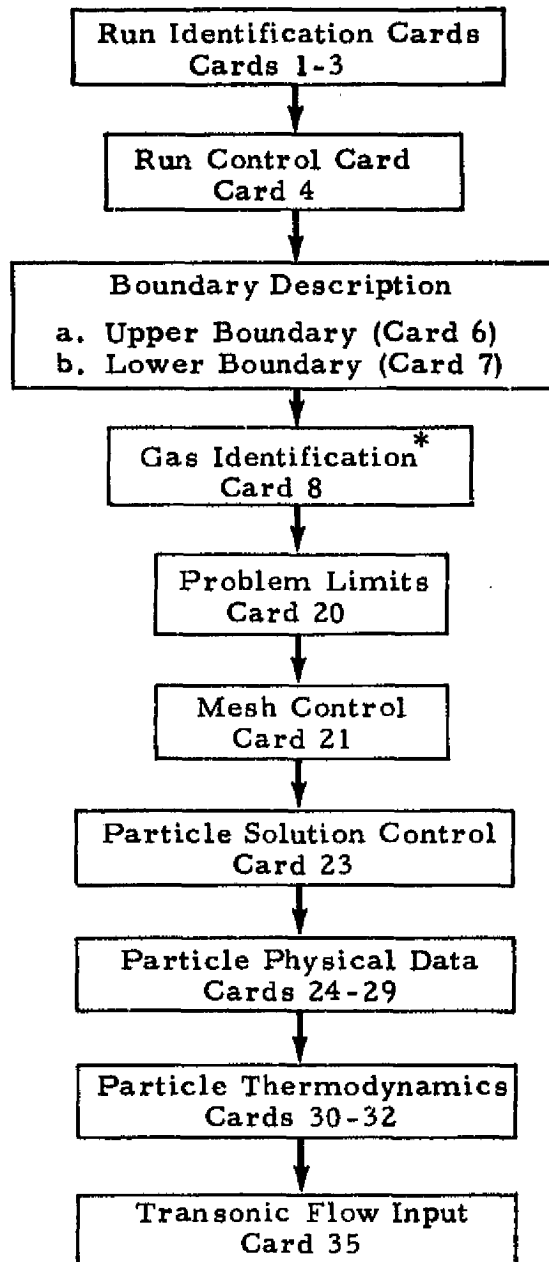

\*The gas properties are input on tape. Therefore, Cards 9, 10 and 11 are not required.

Table 3-10 (Concluded)

Cards	SPACE SHUTTLE SEP MOTOR NOZZLE										
1-3											
Card 4	2	25	3	1	1	2	6	25	1	1	11510
Card 4	1	0	-1.0	.15340277	0.0	-1.0		-.52224999	.14672105		
Card 6	1	1	1.0	5.1560945	2.1824232	-1.0		-2.1796085	.74059416		
Card 6	3	0	4.529							1000.	.13058333
Card 7	2	0								1000.	
Card 8	SEP PROP PC=1800			MKS		4	2				
Card 20	1000.	-1000.	0.0	0.0		100.		90.			
Card 21	.03	.02	.15	.001		6.		.65			
Card 23				1							
Card 24	.03805										
Card 25	.1	.2	.2	.2		.2		.1			
Card 26	1.1	1.7	2.5	3.2		4.5		6.5			
Card 27	250.	250.	250.	250.		250.		250.			
Card 28											
Card 29											
Card 30	AL203 EQ. OF STATE			1ENG							
Card 31	1										
Card 32	4188.5	1358.89	1858.72688	.340016		.32443					
Card 32	\$DATA THID=30. THFD=7. THJD=10. THIW=16. RRT=3. CAPN=.75										
Card 35	\$END										

3-271

Table 3-11

## EXAMPLE PROBLEM 3 PERTINENT SOLUTION

SUPERSONIC FLOW ANALYSIS USING THE LOCKHEED-HUNTSVILLE MULTIPLE SHOCK COMPUTER PROGRAM  
 GAS-PARTICLE FLOW SOLUTION  
 CASE NO. 1

PAGE 1

SPACE SHUTTLE SEP MOTOR NOZZLE

## RUN CONTROL PARAMETERS

ICON(1)	ICON(2)	ICON(3)	ICON(4)	ICON(5)	ICON(6)	ICON(7)	ICON(8)
2	0	25	3	1	0	1	1
ICON(9)	ICON(10)	ICON(11)	ICON(12)	ICON(13)	ICON(14)	ICON(15)	ICON(16)
0	25	1	1	0	0	0	11510

FLOW CALCULATIONS ARE IN ENGLISH UNITS WITH THE X COORDINATES IN FEET

THE FLOW FIELD DATA WILL BE WRITTEN ON TAPE

## UPPER BOUNDARY

TYPE	ITRANS	A	B	C	D	E	HAX
1	0	-0.10000+01	.15340+00	.00000	-0.10000+01	-0.52225+00	.14672+00
1	1	.10000+01	.51541+01	.21924+01	-0.10000+01	-0.21796+01	.74059+00
3	0	.45290+01	.00000	.00000	.00000	.00000	.10000+04

## LOWER BOUNDARY

TYPE	ITRANS	A	B	C	D	E	HAX
2	0	.03000	.00000	.00000	.00000	.00000	.10000+04

CHAMBER ENTHALPY = -0.19619+08

THERE ARE 6 PARTICLE SPECIES PRESENT IN THE GAS-PARTICLE MIXTURE

THE FOLLOWING GAS PROPERTIES IN ENGLISH UNITS ARE FOR SEP PROP PC=1800  
 REAL GAS PROPERTIES

H-TOTAL  
 =0.20631+08

S	V	R	GAMMA	T	P	PR	VIS	CP
-0.17515+04	.00000	.19864+04	.12039+01	.49098+04	.18000+04	.57034+00	.17610-05	.12302+05
	.32194+04	.19835+04	.12134+01	.49363+04	.10111+04	.58520+00	.16373-05	.11552+05
	.51771+04	.19815+04	.12260+01	.36228+04	.36000+03	.60100+00	.14258-05	.10005+05
	.68112+04	.19812+04	.12316+01	.31814+04	.10000+03	.50332+00	.12734-05	.10554+05
	.66507+04	.19811+04	.12345+01	.27927+04	.90000+02	.60147+00	.11702-05	.10404+05
	.71778+04	.19811+04	.12376+01	.24457+04	.45000+02	.59727+00	.10564-05	.10327+05
	.77242+04	.19811+04	.12377+01	.20511+04	.18000+02	.58936+00	.92142-06	.10343+05
	.82231+04	.19811+04	.12457+01	.16175+04	.60000+01	.58769+00	.76436-06	.89326+04

Table 3-11 (Continued)

1. SUPERSONIC FLOW ANALYSIS USING THE LOCKHEED-HUNTSVILLE MULTIPLE SHOCK COMPUTER PROGRAM  
 GAS-PARTICLE FLOW SOLUTION  
 CASE NO. 1

SPACE SHUTTLE SEP MOTOR NOZZLE

REAL GAS PROPERTIES

H-TOTAL	S	V	R	GAMMA	T	P	PR	VIS	CP
.17515+04									
	.84091+04	.19811+04	.12942+01	.14923+04	.36000+01	.58760+00	.69560-06	.57209+04	
	.86241+04	.19811+04	.13062+01	.12289+04	.18000+01	.58584+00	.60605-06	.87537+04	
	.89932+04	.19811+04	.13317+01	.83245+03	.36000+00	.58277+00	.42702-06	.77555+04	
	.91891+04	.19811+04	.13413+01	.69912+03	.18000+00	.58035+00	.36311-06	.77907+04	
	.93772+04	.19811+04	.13607+01	.46019+03	.36000-01	.57207+00	.23588-06	.74889+04	
.44545+04									
	.81920	.19995+04	.11754+01	.48839+04	.80000+02	.50737+00	.17256-05	.15844+05	
	.31967+04	.19905+04	.11920+01	.43074+04	.45254+02	.53093+00	.16219-05	.13454+05	
	.51556+04	.19831+04	.12187+01	.36197+04	.16000+02	.58140+00	.14247-05	.11313+05	
	.59941+04	.19816+04	.12286+01	.31911+04	.80000+01	.59755+00	.12954-05	.10726+05	
	.68445+04	.19812+04	.12347+01	.28012+04	.40000+01	.60024+00	.11729-05	.10453+05	
	.71867+04	.19811+04	.12374+01	.24537+04	.20000+01	.59719+00	.10591-05	.10334+05	
	.77152+04	.19811+04	.12372+01	.20574+04	.80000+00	.58942+00	.92375-04	.10342+05	
	.82163+04	.19811+04	.12850+01	.17230+04	.26667+00	.58798+00	.72544-06	.89321+04	
	.84131+04	.19811+04	.12940+01	.14472+04	.16000+00	.58792+00	.69760-06	.87256+04	
	.86159+04	.19811+04	.13060+01	.12333+04	.80000-01	.58718+00	.60989-06	.84606+04	
	.88096+04	.19811+04	.13316+01	.83555+03	.16000-01	.58320+00	.43049-06	.79616+04	
	.91060+04	.19811+04	.13412+01	.70177+03	.80000-02	.58081+00	.36443-06	.77934+04	
	.93750+04	.19811+04	.13599+01	.46197+03	.16000-02	.57264+00	.23686-06	.74511+04	

REAL GAS PROPERTIES

H-TOTAL	S	V	R	GAMMA	T	P	PR	VIS	CP
.24125+08									
.04769+03									
	.00350	.19923+04	.11919+01	.51581+04	.18000+04	.55000+00	.18540-05	.13825+05	
	.33540+04	.19867+04	.12032+01	.47059+04	.10145+04	.56677+00	.17326-05	.12372+05	
	.51937+04	.19823+04	.12201+01	.39342+04	.36000+03	.59339+00	.15166-05	.11133+05	
	.62562+04	.19814+04	.12277+01	.34663+04	.18000+03	.60145+00	.13793-05	.10729+05	
	.69135+04	.19817+04	.12330+01	.30450+04	.90000+02	.60279+00	.12501-05	.10497+05	
	.74723+04	.19811+04	.12364+01	.26693+04	.45000+02	.60017+00	.11302-05	.10370+05	
	.80496+04	.19811+04	.12378+01	.22387+04	.18000+02	.59362+00	.98632-06	.10319+05	
	.86730+04	.19811+04	.12791+01	.17727+04	.60000+01	.59495+00	.82327-06	.98854+04	
	.87647+04	.19811+04	.12880+01	.15935+04	.36000+01	.59551+00	.75144-06	.88448+04	
	.90953+04	.19811+04	.13004+01	.13527+04	.18000+01	.59562+00	.65929-06	.85428+04	
	.93057+04	.19811+04	.13269+01	.92084+03	.36000+00	.59368+00	.47031-06	.80459+04	
	.94042+04	.19811+04	.13362+01	.77471+03	.18000+00	.59217+00	.40013-06	.78660+04	

LOCKHEED - HUNTSVILLE RESEARCH & ENGINEERING CENTER

3-273

REPRODUCIBILITY OF THIS ORIGINAL PAGE IS POOR

Table 3-11 (Continued)

SUPERSONIC FLOW ANALYSIS USING THE LOCKHEED-HUNTSVILLE MULTIPLE SHOCK COMPUTER PROGRAM

GAS-PARTICLE FLOW SOLUTION

CASE NO. 1

PAGE 3

SPACE SHUTTLE SEP MOTOR NOZZLE

REAL GAS PROPERTIES

H-TOTAL		REAL GAS PROPERTIES						
S	V	R	GAMMA	T	P	PR	VIS	CP
.5390+04	.00000	.20140+04	.11597+01	.49404+04	.80000+02	.48389+00	.17940-05	.14517+05
	.32826+04	.20006+04	.11725+01	.45737+04	.45564+02	.49992+00	.17007-05	.16272+05
	.51419+04	.19862+04	.12045+01	.39195+04	.16000+02	.55086+00	.15120-05	.12284+05
	.67212+04	.19828+04	.12205+01	.34762+04	.80000+01	.58410+00	.13820-05	.11105+05
	.69048+04	.19815+04	.12303+01	.30614+04	.40000+01	.59829+00	.12552-05	.10448+05
	.74538+04	.19812+04	.12357+01	.26855+04	.20000+01	.59949+00	.11355-05	.10402+05
	.80113+04	.19811+04	.12378+01	.22530+04	.80000+00	.59379+00	.99120-06	.10320+05
	.85592+04	.19811+04	.12786+01	.17844+04	.26667+00	.59547+00	.82766-06	.90760+04
	.87565+04	.19811+04	.12876+01	.15943+04	.16000+00	.59607+00	.75563-06	.88758+04
	.89849+04	.19811+04	.12999+01	.13621+04	.80000-01	.59619+00	.66313-06	.85926+04
	.91785+04	.19811+04	.13266+01	.97762+03	.16000-01	.59440+00	.47343-06	.80527+04
	.95025+04	.19811+04	.13366+01	.78054+03	.80000-02	.59291+00	.40294-06	.78718+04
	.97148+04	.19811+04	.13560+01	.51575+03	.16000-02	.58770+00	.26575-06	.75514+04
H-TOTAL		REAL GAS PROPERTIES						
.21872+04								
S	V	R	GAMMA	T	P	PR	VIS	CP
.41765+03	.00000	.19965+04	.11858+01	.53183+04	.18000+04	.57000+00	.18960-05	.14407+05
	.34056+04	.19992+04	.11973+01	.48697+04	.10166+04	.55602+00	.17769-05	.12938+05
	.54008+04	.19830+04	.12164+01	.40875+04	.36000+03	.58723+00	.15604-05	.11371+05
	.61721+04	.19816+04	.12253+01	.36079+04	.18000+03	.59908+00	.14214-05	.10652+05
	.70443+04	.19812+04	.12315+01	.31720+04	.70000+02	.60269+00	.12896-05	.10564+05
	.76204+04	.19812+04	.12355+01	.27819+04	.45000+02	.60123+00	.11667-05	.10403+05
	.82057+04	.19811+04	.12378+01	.23743+04	.18000+02	.59537+00	.10188-05	.10318+05
	.87414+04	.19811+04	.12760+01	.18517+04	.60000+01	.59771+00	.85239-06	.91645+04
	.89420+04	.19811+04	.12650+01	.16557+04	.36000+01	.59875+00	.77938-06	.89388+04
	.91745+04	.19811+04	.12974+01	.14161+04	.18000+01	.59925+00	.68499-06	.86491+04
	.95756+04	.19811+04	.13245+01	.96651+03	.36000+00	.59827+00	.49122-06	.80917+04
	.97022+04	.19811+04	.13347+01	.81389+03	.18000+00	.59714+00	.41696-06	.79048+04
	.99192+04	.19811+04	.13544+01	.53057+03	.36000-01	.59299+00	.29788-06	.75955+04
.5841+04	.00000	.20241+04	.11523+01	.50600+04	.80000+02	.47482+00	.18225-05	.21634+05
	.33200+04	.20076+04	.11637+01	.47101+04	.45709+02	.48755+00	.17343-05	.18050+05
	.54260+04	.19886+04	.11957+01	.40610+04	.16000+02	.53284+00	.15524-05	.13686+05
	.61293+04	.19830+04	.12149+01	.36169+04	.80000+01	.57163+00	.14238-05	.11537+05

LOCKHEED - HUNTSVILLE RESEARCH & ENGINEERING CENTER

3-274



Table 3-11 (Continued)

SUPERSONIC FLOW ANALYSIS USING THE LOCKHEED-HUNTSVILLE MULTIPLE SHOCK COMPUTER PROGRAM

GAS-PARTICLES FLOW SOLUTION  
CASE NO. 1

PAGE 4

SPACE SHUTTLE SEP MOTOR NOZZLE

REAL GAS PROPERTIES

H-TOTAL

S	V	R	GAMMA	T	P	PR	VJS	CP
.58411+04	.70757+04	.19810+04	.12271+01	.31728+04	.40000+01	.59459+00	.12957-05	.70816+05
.75887+04	.19813+04	.12342+01	.28941+04	.20000+01	.59963+00	.10730-05	.710467+05	
.81810+04	.19811+04	.12377+01	.23536+04	.80000+00	.59558+00	.10254-05	.710324+05	
.87227+04	.19811+04	.12754+01	.18580+04	.26667+00	.59820+00	.85829-05	.71805+04	
.89255+04	.19811+04	.12844+01	.14706+04	.16000+00	.59934+00	.78508-05	.89541+04	
.91605+04	.19811+04	.12968+01	.14292+04	.80000-01	.59994+00	.69025-05	.86628+04	
.95660+04	.19811+04	.13240+01	.97544+03	.16000-01	.59915+00	.49550-05	.81012+04	
.96939+04	.19811+04	.13343+01	.82199+03	.80000-02	.59810+00	.42283-05	.79129+04	
.99133+04	.19811+04	.13641+01	.54415+03	.16000-02	.59420+00	.28081-05	.75812+04	

REAL GAS PROPERTIES

H-TOTAL

S	V	R	GAMMA	T	P	PR	VJS	CP
.00000	.00000	.20017+04	.11798+01	.54086+04	.18000+04	.53040+00	.19346-05	.15475+05
.34537+04	.19925+04	.11911+01	.50261+04	.10187+04	.54593+00	.18188-05	.13715+05	
.55738+04	.19840+04	.12121+01	.42383+04	.36000+03	.57942+00	.16030-05	.11671+05	
.64835+04	.19820+04	.12224+01	.37483+04	.18000+03	.59535+00	.14627-05	.11008+05	
.71907+04	.19813+04	.12297+01	.32494+04	.90000+02	.60190+00	.13287-05	.10643+05	
.77591+04	.19812+04	.12344+01	.28956+04	.45000+02	.60196+00	.12030-05	.10444+05	
.83575+04	.19811+04	.12376+01	.24304+04	.18000+02	.59704+00	.10513-05	.10327+05	
.89557+04	.19811+04	.12731+01	.19319+04	.60000+01	.60000+00	.88132-05	.92428+04	
.91111+04	.19811+04	.12819+01	.17290+04	.36000+01	.60158+00	.80732-05	.90137+04	
.93495+04	.19811+04	.12744+01	.14807+04	.18000+01	.60246+00	.71089-05	.87172+04	
.97616+04	.19811+04	.13220+01	.10132+04	.36000+00	.60238+00	.51232-05	.81391+04	
.99180+04	.19811+04	.13325+01	.85401+03	.18000+00	.60163+00	.43803-05	.79447+04	
.10115+05	.19811+04	.13527+01	.56614+03	.36000-01	.59865+00	.29237-05	.76037+04	
.62828+04	.70345+04	.11478+01	.51490+04	.80000+02	.46684+00	.18478-05	.23857+05	
.73550+04	.20157+04	.11560+01	.48304+04	.45836+02	.47734+00	.17643-05	.20071+05	
.55045+04	.19924+04	.11861+01	.41947+04	.16000+02	.51537+00	.15901-05	.14185+05	
.64232+04	.19853+04	.12080+01	.37551+04	.80000+01	.55559+00	.14643-05	.12023+05	
.71405+04	.19824+04	.12332+01	.33245+04	.40000+01	.58776+00	.13362-05	.11038+05	
.77177+04	.19814+04	.12327+01	.29745+04	.20000+01	.59886+00	.12122-05	.10565+05	
.81252+04	.19812+04	.12373+01	.24564+04	.80000+00	.59708+00	.10600-05	.10339+05	
.84812+04	.19812+04	.12723+01	.19535+04	.26667+00	.60056+00	.80905-05	.92636+04	
.93495+04	.19812+04	.12811+01	.17488+04	.16000+00	.60228+00	.81980-05	.90339+04	

LOCKHEED-HUNTSVILLE RESEARCH & ENGINEERING CENTER

3-275

Table 3-11 (Continued)

SUPERSONIC FLOW ANALYSIS USING THE LOCKHEED-HUNTSVILLE MULTIPLE SHOCK COMPUTER PROGRAM  
 GAS-PARTICLE FLOW SOLUTION  
 CASE NO. 1

SPACE SHUTTLE SEP MOTOR NOZZLE

REAL GAS PROPERTIES

H-TOTAL		REAL GAS PROPERTIES							
S	V	R	GAMMA	T	P	PR	VIS	CP	
.62928+04	.93312+04	.19812+04	.12936+01	.14901+04	.80000-01	.60325+00	.71786+06	.87357+04	
	.97489+04	.19812+04	.13213+01	.10259+04	.16000-01	.50336+00	.51601+06	.81521+04	
	.98909+04	.19812+04	.13319+01	.86491+03	.80000-02	.60275+00	.44317+06	.79557+04	
	.10108+05	.19812+04	.13527+01	.57364+03	.16000-02	.60006+00	.29629+06	.74113+04	

RUN CUTOFF INFORMATION

UPPER BOUNDARY				LOWER BOUNDARY							
R*	.10003+04	X*	-.10000+04	THEYA*	.00000	R*	.60000	X*	.10000+03	THEYA*	.90000+02

PARTICLE PHYSICAL DATA

SPECIE	RADIUS	MASS DENSITY	EMISSIVITY	ACCM. COEFF.
1	.11000+01	.25000+03	.00300	.00000
2	.17000+01	.25000+03	.00300	.00000
3	.25000+01	.25000+03	.00300	.00000
4	.32000+01	.25000+03	.00300	.00000
5	.45000+01	.25000+03	.00300	.00000
6	.65000+01	.25000+03	.00300	.00000

THE PARTICLES CONSTITUTE 3.81 PERCENT BY WEIGHT FLOW OF THE GAS-PARTICLE MIXTURE

THE INDIVIDUAL PERCENTAGES ARE .10 .20 .20 .20 .20 .10

THE PARTICLE TEMPERATURE-ENTHALPY TABLE WILL BE READ IN WITH ENGLISH UNITS

PARTICLE TEMPERATURE-ENTHALPY TABLE

PHASE CHANGE DATA \*\*\* THCLT= .418953+04 HSLID= .340107+08 HLIQUID= .465207+08  
 CPHELY= .8510 CPSOLID= .81199+04

LOCKHEED-HUNTSVILLE RESEARCH & ENGINEERING CENTER

3-276

Table 3-11 (Continued)

SUPERSONIC FLOW ANALYSIS USING THE LOCKHEED-HUNTSVILLE MULTIPLE SHOCK COMPUTER PROGRAM  
 GAS-PARTICLE FLOW SOLUTION  
 CASE NO. 1

PAGE 6

SPACE SHUTTLE SEI MOTOR NOZZLE

## PARTICLE DRAG TABLE

I	RE	DRAG COEF.
1	.00000	.10000+01
2	.12500+01	.10000+01
3	.12550+01	.10000+01
4	.12600+01	.10010+01
5	.12650+01	.10020+01
6	.15820+01	.10470+01
7	.19950+01	.11410+01
8	.25100+01	.12240+01
9	.31500+01	.13150+01
10	.39000+01	.14120+01
11	.50100+01	.15170+01
12	.63100+01	.16250+01
13	.79500+01	.17450+01
14	.10000+02	.18740+01
15	.12500+02	.20260+01
16	.15820+02	.21840+01
17	.19950+02	.23640+01
18	.25100+02	.25550+01
19	.31600+02	.27600+01
20	.39000+02	.30000+01
21	.50100+02	.32520+01
22	.63100+02	.35200+01
23	.79500+02	.38250+01
24	.10000+03	.41550+01
25	.31600+03	.79000+01
26	.10000+04	.20000+02
27	.10010+04	.20020+02
28	.10000+04	.20000+02

3-277

Table 3-11 (Continued)

SUPERSONIC FLOW ANALYSIS USING THE LOCKHEED-HUNTSVILLE MULTIPLE SHOCK COMPUTER PROGRAM

GAS-PARTICLE FLOW SOLUTION

CASE NO. 1

SPACE SHUTTLE SEP MOTOR NOZZLE

GASEOUS STARTING LINE INFO

R	X	M	THETA	S	MACH ANGLE	SHOCK ANGLE	H-TOTAL
.00000	.12847+00	.14166+01	.00000	.57051+02	.44904+02	.00000	-.19706+08
.51304-02	.12843+00	.14167+01	.45764+00	.57068+02	.44891+02	.00000	-.19707+08
.11661-01	.12833+00	.14178+01	.91650+00	.57120+02	.44853+02	.00000	-.19707+08
.17491-01	.12917+00	.14194+01	.13778+01	.57205+02	.44789+02	.00000	-.19707+08
.23371-01	.12794+00	.14217+01	.18428+01	.57325+02	.44700+02	.00000	-.19707+08
.29152-01	.12785+00	.14246+01	.23128+01	.57479+02	.44685+02	.00000	-.19707+08
.34982-01	.12729+00	.14291+01	.27897+01	.57670+02	.44445+02	.00000	-.19708+08
.40813-01	.12686+00	.14323+01	.32737+01	.57895+02	.44279+02	.00000	-.19708+08
.46643-01	.12637+00	.14373+01	.37678+01	.58157+02	.44087+02	.00000	-.19709+08
.52473-01	.12581+00	.14430+01	.42733+01	.58457+02	.43849+02	.00000	-.19709+08
.58304-01	.12519+00	.14494+01	.47920+01	.58795+02	.43624+02	.00000	-.19710+08
.64134-01	.12450+00	.14567+01	.53262+01	.59172+02	.43352+02	.00000	-.19711+08
.69964-01	.12375+00	.14648+01	.58781+01	.59591+02	.43053+02	.00000	-.19712+08
.75795-01	.12293+00	.14738+01	.64501+01	.60052+02	.42726+02	.00000	-.19712+08
.81625-01	.12204+00	.14839+01	.70449+01	.60558+02	.42369+02	.00000	-.19714+08
.87455-01	.12109+00	.14950+01	.76654+01	.61112+02	.41982+02	.00000	-.19715+08
.93286-01	.12008+00	.15073+01	.83145+01	.61715+02	.41544+02	.00000	-.19716+08
.99116+00	.11853+00	.15217+01	.92834+01	.62654+02	.40918+02	.00000	-.19718+08
1.04945+00	.11785+00	.15358+01	.97115+01	.63082+02	.40626+02	.00000	-.19719+08
1.10774+00	.11719+00	.15497+01	1.03122+02	.63498+02	.40343+02	.00000	-.19720+08
1.16603+00	.11652+00	.15634+01	1.1034+02	.64441+02	.39703+02	.00000	-.19722+08
1.22432+00	.11577+00	.15775+01	1.1757+02	.65198+02	.39192+02	.00000	-.19724+08
1.28261+00	.11494+00	.15920+01	1.2849+02	.66371+02	.38398+02	.00000	-.19727+08
1.34090+00	.11405+00	.16068+01	1.3856+02	.67459+02	.37658+02	.00000	-.19730+08
1.39919+00	.10959+00	.16219+01	1.4943+02	.68637+02	.36848+02	.00000	-.19733+08
1.45748+00	.10790+00	.16373+01	1.6003+02	.69773+02	.36049+02	.00000	-.19737+08

PARTICLE START LINE PROPERTIES

POINT	SPECIE	U	V	THETA	ENTHALPY	DENSITY
1	1	.43867+04	.00000	.00000	.50821+08	.41806-04
1	2	.41994+04	.00000	.00000	.51228+08	.94862-04
1	3	.39460+04	.00000	.00000	.51674+08	.11244-03
1	4	.37884+04	.00000	.00000	.52027+08	.12661-03
1	5	.35109+04	.00000	.00000	.52563+08	.15260-03
1	6	.32769+04	.00000	.00000	.53218+08	.93531-04
2	1	.43873+04	.77314+02	.35670+00	.50819+08	.41787-04
2	2	.42000+04	.72707+02	.30288+00	.51229+08	.94817-04
2	3	.39465+04	.16040+02	.23287+00	.51677+08	.11238-03
2	4	.37889+04	.12562+02	.18995+00	.52033+08	.12653-03
2	5	.35393+04	.74549+01	.12068+00	.52573+08	.15248-03
2	6	.32773+04	.75470+01	.44528-01	.53233+08	.93430-04

LOCKHEED-HUNTSVILLE RESEARCH & ENGINEERING CENTER

3-278

Table 3-11 (Continued)

SUPERSONIC FLOW ANALYSIS USING THE LOCKHEED-HUNTSVILLE MULTIPLE SHOCK COMPUTER PROGRAM  
 GAS-PARTICLE FLOW SOLUTION  
 CASE NO. 1

PAGE 13

SPACE SHUTTLE SPP MOTOR NOZZLE

POINT	SPECTR	U	V	THETA	ENTHALPY	DENSITY
3	1	.43891+04	.54725+02	.71435+00	.50815+08	.91730-04
3	2	.42018+04	.44489+02	.60664+00	.51229+08	.94683-04
3	3	.39481+04	.32146+02	.46649+00	.51685+08	.1220-03
3	4	.37995+04	.25174+02	.30053+00	.52048+08	.12630-03
3	5	.35406+04	.14941+02	.24179+00	.52601+08	.15214-03
3	6	.32786+04	.51141+01	.89371-01	.53277+08	.93137-04
4	1	.43921+04	.82322+02	.19739+01	.50908+08	.91637-04
4	2	.42047+04	.66947+02	.91217+00	.51228+08	.94965-04
4	3	.39509+04	.48387+02	.70159+00	.51698+08	.11192-03
4	4	.37930+04	.37890+02	.57233+00	.52071+08	.12575-03
4	5	.35427+04	.22471+02	.36374+00	.52644+08	.15161-03
4	6	.32800+04	.77209+01	.13984+00	.53342+08	.92682-04
5	1	.43963+04	.11024+03	.14364+01	.50797+08	.91510-04
5	2	.42009+04	.89660+02	.12204+01	.51227+08	.94173-04
5	3	.39548+04	.64015+02	.93895+00	.51712+08	.11154-03
5	4	.37968+04	.50758+02	.76596+00	.52098+08	.12548-03
5	5	.35458+04	.30138+02	.48699+00	.52696+08	.15092-03
5	6	.32838+04	.10788+02	.18122+00	.53427+08	.92173-04
6	1	.44019+04	.13456+03	.18029+01	.50782+08	.91354-04
6	2	.42143+04	.11272+03	.15321+01	.51223+08	.93019-04
6	3	.39590+04	.80516+02	.11793+01	.51726+08	.11109-03
6	4	.38011+04	.63027+02	.96200+00	.52126+08	.12495-03
6	5	.35498+04	.37916+02	.61198+00	.52748+08	.15015-03
6	6	.32877+04	.13127+03	.22878+00	.53497+08	.91493-04
7	1	.44088+04	.16740+03	.21744+01	.50763+08	.91171-04
7	2	.42209+04	.13622+03	.13984+01	.51214+08	.93510-04
7	3	.39660+04	.98557+02	.14235+01	.51736+08	.11060-03
7	4	.38067+04	.77147+02	.11610+01	.52149+08	.12433-03
7	5	.35548+04	.45867+02	.73917+00	.52791+08	.14937-03
7	6	.32924+04	.15958+02	.27771+00	.53559+08	.90893-04
8	1	.44171+04	.19689+03	.25523+01	.50738+08	.90968-04
8	2	.42280+04	.16024+03	.21701+01	.51200+08	.92784-04
8	3	.39735+04	.11402+03	.14724+01	.51738+08	.11009-03
8	4	.38132+04	.90765+02	.13635+01	.52160+08	.12382-03
8	5	.35608+04	.54014+02	.86904+00	.52815+08	.14965-03
8	6	.32980+04	.18094+02	.32824+00	.53589+08	.90393-04
9	1	.44269+04	.22714+03	.29376+01	.50708+08	.90748-04
9	2	.42390+04	.18490+03	.24982+01	.51179+08	.92535-04
9	3	.39872+04	.13397+03	.19269+01	.51727+08	.10960-03
9	4	.38207+04	.10473+03	.15702+01	.52155+08	.12332-03
9	5	.35780+04	.62415+02	.10022+01	.52810+08	.14807-03
9	6	.33044+04	.21545+02	.38050+00	.53574+08	.90070-04
10	1	.44383+04	.25840+03	.31320+01	.50670+08	.90515-04
10	2	.42484+04	.21030+03	.24137+01	.51148+08	.92086-04
10	3	.39923+04	.15252+03	.21878+01	.51701+08	.10915-03
10	4	.38291+04	.11709+03	.17814+01	.52128+08	.12292-03
10	5	.35744+04	.71100+02	.11390+01	.52768+08	.14771-03
10	6	.33117+04	.25119+02	.43959+00	.53502+08	.89991-04

Table 3-11 (Continued)

SUPERSONIC FLOW ANALYSIS USING THE LOCKHEED-HUNTSVILLE MULTIPLE SHOCK COMPUTER PROGRAM  
GAS-PARTICLE FLOW SOLUTION

CASE NO. 1

PAGE 14

## SPACE SHUTTLE SEP MOTOR NOZZLE

POINT	SPECTE	U	V	THETA	ENTHALPY	DENSITY
11	1	.44514+04	.29073-03	.37368+01	.50624+08	.40275-04
11	2	.42605+04	.23655-03	.31778+01	.51106+08	.91649-04
11	3	.40038+04	.17175+03	.24563+01	.51656+08	.10876-03
11	4	.38386+04	.13391+03	.19986+01	.52073+08	.12266-03
11	5	.35861+04	.50143-02	.12403+01	.52681+08	.14761-03
11	6	.33198+04	.78426+02	.42658+00	.53367+08	.90207-04
12	1	.44661+04	.32434+03	.41537+01	.50569+08	.40030-04
12	2	.42739+04	.26377+03	.35316+01	.51051+08	.91235-04
12	3	.40167+04	.19177+03	.27334+01	.51588+08	.10844-03
12	4	.38491+04	.14925+03	.22205+01	.51988+08	.12255-03
12	5	.35976+04	.89572-02	.14265+01	.52549+08	.14787-03
12	6	.33789+04	.31869+02	.54849+00	.53169+08	.90741-04
13	1	.44877+04	.35944+03	.45844+01	.50505+08	.39750-04
13	2	.42887+04	.29211+03	.38964+01	.50983+08	.90847-04
13	3	.40312+04	.21770+03	.30704+01	.51498+08	.10821-03
13	4	.38608+04	.16518+03	.24499+01	.51973+08	.12262-03
13	5	.36097+04	.99453-02	.15784+01	.52373+08	.14842-03
13	6	.33391+04	.35456-02	.60836+00	.52924+08	.91521-04
14	1	.45011+04	.39623+03	.50307+01	.50430+08	.39525-04
14	2	.43051+04	.32171-03	.42736+01	.50911+08	.90484-04
14	3	.40472+04	.23468+03	.33187+01	.51385+08	.10806-03
14	4	.38734+04	.18180+03	.26873+01	.51731+08	.12284-03
14	5	.36229+04	.10985-03	.17367+01	.52166+08	.14925-03
14	6	.33504+04	.39193-02	.67020+00	.52661+08	.92667-04
15	1	.45214+04	.43494+03	.54946+01	.50345+08	.39263-04
15	2	.43231+04	.35275+03	.46648+01	.50804+08	.90133-04
15	3	.40648+04	.25784-03	.36298+01	.51253+08	.10796-03
15	4	.38875+04	.19925-03	.29340+01	.51568+08	.12319-03
15	5	.36378+04	.12082-03	.19022+01	.51950+08	.15028-03
15	6	.33631+04	.43091-02	.73407+00	.52431+08	.93861-04
16	1	.45437+04	.47581+03	.59782+01	.50250+08	.38987-04
16	2	.43426+04	.38547+03	.50718+01	.50695+08	.89772-04
16	3	.40840+04	.28740-03	.39566+01	.51109+08	.10786-03
16	4	.39031+04	.21768-03	.31921+01	.51401+08	.12359-03
16	5	.36538+04	.13248+03	.20759+01	.51760+08	.15136-03
16	6	.33774+04	.47167-02	.80011+00	.52310+08	.94983-04
17	1	.45678+04	.51911+03	.64835+01	.50144+08	.38687-04
17	2	.43639+04	.41945+03	.54968+01	.50577+08	.89367-04
17	3	.41049+04	.30857+03	.42982+01	.50963+08	.10770-03
17	4	.39205+04	.23737+03	.34640+01	.51249+08	.12394-03
17	5	.36709+04	.14479+03	.22587+01	.51651+08	.15225-03
17	6	.33915+04	.47149-02	.64859+00	.52416+08	.95744-04
18	1	.45911+04	.55911+03	.70711+01	.50077+08	.38177-04
18	2	.43872+04	.45945+03	.61305+01	.50511+08	.88725-04
18	3	.41372+04	.34841+03	.48138+01	.50766+08	.10718-03
18	4	.39486+04	.26765+03	.38774+01	.51126+08	.12405-03
18	5	.36963+04	.16757+03	.25337+01	.51782+08	.15259-03
18	6	.34201+04	.57914+02	.97013+00	.52330+08	.95448-04

Table 3-11 (Continued)

SUPERSONIC FLOW ANALYSIS USING THE LOCKHEED-HUNTSVILLE MULTIPLE SHOCK COMPUTER PROGRAM							PAGE	15
GAS-PARTICLE FLOW SOLUTION								
CASE NO. 1								
SPACE SHUTTLE SEP MOTOR NOZZLE								
POINT	SPECIE	U	V	THETA	ENTHALPY	DENSITY		
19	1	.46217+04	.61405+03	.75681+01	.49906+08	.37957-04		
19	2	.44116+04	.49568+03	.64108+01	.50332+08	.88214-04		
19	3	.41517+04	.36647+03	.50437+01	.50739+08	.10679-03		
19	4	.39620+04	.28153+03	.40646+01	.51132+08	.12385-03		
19	5	.37073+04	.17199+03	.26561+01	.51998+08	.15217-03		
20	1	.46378+04	.64738+03	.78859+01	.49836+08	.37739-04		
20	2	.44260+04	.51839+03	.66802+01	.50270+08	.7757-04		
20	3	.41657+04	.38193+03	.52658+01	.50716+08	.10629-03		
20	4	.39753+04	.29575+03	.42476+01	.51185+08	.12345-03		
20	5	.37175+04	.18013+03	.27741+01	.52322+08	.15135-03		
21	1	.46733+04	.70565+03	.85690+01	.49685+08	.37054-04		
21	2	.44580+04	.56764+03	.72813+01	.50760+08	.86572-04		
21	3	.41969+04	.42372+03	.57651+01	.50769+08	.10463-03		
21	4	.40070+04	.32720+03	.46694+01	.51507+08	.12174-03		
22	1	.47009+04	.75631+03	.91398+01	.49574+08	.36507-04		
22	2	.44841+04	.61097+03	.77589+01	.50110+08	.85149-04		
22	3	.42214+04	.45801+03	.61655+01	.50938+08	.10272-03		
23	1	.47417+04	.83398+03	.99750+01	.49425+08	.35556-04		
23	2	.45235+04	.67601+03	.84997+01	.50120+08	.82500-04		
24	1	.47771+04	.90564+03	.10734+02	.49320+08	.34286-04		

THE MESH CONSTRUCTION WILL BE CONTROLLED BY THE FOLLOWING VARIABLES

DL INTERIOR= .300-01 DX AXIS= .200-01 DL LIM= .150+00 DL DELETE= .100-02 DEG P.H.= .600+01 F= .650+00

LOCKHEED-HUNTSVILLE RESEARCH & ENGINEERING CENTER

3-281

REPRODUCIBILITY OF THE ORIGINAL PAGE IS POOR

Table 3-11 (Continued)

SUPERSONIC FLOW ANALYSIS USING THE LOCKHEED-HUNTSVILLE MULTIPLE SHOCK COMPUTER PROGRAM  
 GAS-PARTICLE FLOW SOLUTION  
 CASE NO. 1

SPACE SHUTTLE SEP MOTOR NOZZLE

LINE	POINT	DESCRIP	REGIME	R	X	H	THETA	ENTROPY	VELOCITY	H-TOTAL	ITR												
				MACH	ANGLE	PRESSURE	TEMPERATURE	GAS CONST.	LOCAL GAMMA	SHOCK ANGLE													
PARTICLE DATA				V	THETA	D	H	ENTHALPY	DENSITY	TEMPERATURE													
SPECIF POINT	DESCRIPTION																						
1	24	INPUT - CONTIN		.13157+00	.1112+00	.1636R+01	.13856+02	.67459+02	.52917+04	.19730+08	0												
				.3765R+02	.41134+03	.68525+02	.43544+04	.19851+04	.12093+01														
PARTICLE DATA																							
1	24	LIMIT STREAMLINE		.486242+04	.10734+02	.13284+00	.49320+08	.34286+04	.45174+04														
1	25	INPUT - CONTIN		.13993+00	.10957+00	.16675+01	.14943+02	.68637+02	.53708+04	.19733+08	0												
				.36848+02	.39136+03	.65735+02	.43194+04	.19848+04	.12101+01														
PARTICLE DATA																							
NO PARTICLES ARE PRESENT AT THIS POINT																							
3-282	24	INPUT - CONTIN		.14576+00	.1079R+00	.16993+01	.16003+02	.69773+02	.54515+04	.19737+08	0												
				.36049+02	.37152+03	.62942+02	.42811+04	.19845+04	.12109+01														
PARTICLE DATA																							
NO PARTICLES ARE PRESENT AT THIS POINT																							
GAS MASS FLOW RATE =				.00715+02		PARTICLE MASS FLOW RATE =				.37352+01		MIXTURE MASS FLOW RATE =		.08950+02									
PARTICLE PERCENT LOADINGS																							
RADIUS      LOADING																							
.11000+01    .96948+01																							
.17000+01    .20000+02																							
.25000+01    .20000+02																							
.32000+01    .20001+02																							
.45000+01    .20001+02																							
.65000+01    .99989+01																							
PARTICLE PERCENT LOADING RELATIVE TO THE GAS =						.37744+01						PARTICLE PERCENT LOADING RELATIVE TO THE MIXTURE =						.30571+01					
MOMENTUM INTEGRATION RESULTS																							
FORCFX			FORCEY			TORQZ			ISP														
.1A212+05			.00000			.00000			.20474+03														
DELFX6			DELFG6			TORQZ6			DELFXP			DELFGP			TORQZP								
.33778+03			.00000			.00000			.40047+03			.00000			.00000								

NOTES: (1) Typical printout for the startline data surface.  
 (2) Some points have been omitted for demonstration purposes.

LOCKHEED-HUNTSVILLE RESEARCH & ENGINEERING CENTER



Table 3-11 (Continued)

SUPERSONIC FLOW ANALYSIS USING THE LOCKHEED-HUNTSVILLE MULTIPLE SHOCK COMPUTER PROGRAM  
 GAS-PARTICLE FLOW SOLUTION  
 CASE NO. 1

SPACE SHUTTLE SEP MOTOR NOZZLE

LINE	POINT	DESCRIP - REGIME	R MACH ANGLE	X PRESSURE	M DENSITY	THETA TEMPERATURE	ENTROPY GAS CONST.	VELOCITY LOCAL GAMMA	H-TOTAL SHOCK ANGLE	STR
PARTICLE DATA										
2	23	INTER - CONTIN	.12853+00	.12060+00	.16501+01	.13627+02	.67676+02	.53263+04	.19728+08	6
			.37303+02	.40274+03	.67329+02	.43394+04	.19850+04	.12096+01		
PARTICLE DATA										
1	23	LIMIT STREAMLINE	.491253+04	.10722+02	.12820+00	.49070+08	.33899+04	.44480+04		
			.466776+08	.92340+01	.20403+00	.49791+08	.78835+04	.45725+03		
-----										
2	24	INTER - CONTIN	.13512+00	.11912+00	.16794+01	.14769+02	.67880+02	.54019+04	.19730+08	6
			.36544+02	.38418+03	.64733+02	.43061+04	.19847+04	.12104+01		
PARTICLE DATA										
1	24	LIMIT STREAMLINE	.494040+04	.11591+02	.13464+00	.48920+08	.32546+04	.44705+04		
-----										
2	25	INTER - CONTIN	.14204+00	.11722+00	.17128+01	.16001+02	.68637+02	.54856+04	.19735+08	4
			.35722+02	.36379+03	.61855+02	.42680+04	.19843+04	.12112+01		
PARTICLE DATA										
NO PARTICLES ARE PRESENT AT THIS POINT										
-----										
2	26	WALL - CONTIN	.14799+00	.11545+00	.17447+01	.17144+02	.69773+02	.55652+04	.19737+08	4
			.34971+02	.34499+03	.59177+02	.42312+04	.19840+04	.12120+01		
PARTICLE DATA										
NO PARTICLES ARE PRESENT AT THIS POINT										
-----										
PRESSURE INTEGRATION RESULTS										
		FORCEY	FORCEY	TORQZ	DELFX	DELFY	ISP			
		.10718+05	.00000	.00000	.10595+03	.00000	.20593+03			
-----										
PERCENT CHANGE IN MASS, MOMENTUM AND ENERGY NUMERICAL INTEGRATION FOR LINE 2 RELATIVE TO THE START LINE										
PERCENT CHANGE IN MASS FLOW, GAS = .14895+01 PARTICLE = .36259+01 MIXTURE = .15672+01										
PERCENT CHANGE IN MOMENTUM, GAS = .75294+04 PARTICLE = .87987+00 MIXTURE = .12303+01 ISP = .12198+01										
PERCENT CHANGE IN ENERGY, GAS = .27691+02 PARTICLE = .98037+00 MIXTURE = .62289+02										

NOTES: (1) Typical printout for a data surface inside the nozzle.  
 (2) Some points have been omitted for demonstration purposes.

LOCKHEED - HUNTSVILLE RESEARCH & ENGINEERING CENTER  
 3-283

Table 3-11 (Continued)

SUPERSONIC FLOW ANALYSIS USING THE LOCKHEED-HUNTSVILLE MULTIPLE SHOCK COMPUTER PROGRAM  
 GAS-PARTICLE FLOW SOLUTION  
 CASE NO. 1

SPACE SHUTTLE SEP MOTOR NOZZLE

LINE POINT	OSCRIP	REGIME	R	X	R	THETA	ENTROPY	VELOCITY	H-TOTAL	ITR
			MACH ANGLE	PRESSURE	DENSITY	TEMPERATURE	GAS CONST.	LOCAL GAMMA	SHOCK ANGLE	
PARTICLE DATA										
SPECIE POINT	DESCRIPTION	V	THETA	D	H	ENTHALPY	DENSITY	TEMPERATURE		
60	43	PRN-MR - CONTIN	.31517+00 .13502+02	.74059+00 .39810+01	.42502+01 .16253-03	.43440+02 .17863+04	.69773+02 .19811+04	.90467+04 .12798+01	.19737+00	
PARTICLE DATA NO PARTICLES ARE PRESENT AT THIS POINT										
60	44	PRN-MR - CONTIN	.31517+00 .12435+02	.74059+00 .21750+01	.46440+01 .10161-03	.49346+02 .15665+04	.69773+02 .19811+04	.92647+04 .12907+01	.19737+00	2
PARTICLE DATA NO PARTICLES ARE PRESENT AT THIS POINT										
60	45	PRN-MR - CONTIN	.31517+00 .11300+02	.74059+00 .11210+01	.50997+01 .61027-04	.55253+02 .13351+04	.69773+02 .19811+04	.94677+04 .13031+01	.19737+00	2
PARTICLE DATA NO PARTICLES ARE PRESENT AT THIS POINT										
60	46	PRN-MR - CONTIN	.31517+00 .10704+02	.74059+00 .53735+00	.56950+01 .34801-04	.61159+02 .11223+04	.69773+02 .19811+04	.96549+04 .13157+01	.19737+00	2
PARTICLE DATA NO PARTICLES ARE PRESENT AT THIS POINT										
60	47	PRN-MR - CONTIN	.31517+00 .91130+01	.74059+00 .23595+00	.63139+01 .58633-04	.67066+02 .92082+03	.69773+02 .19811+04	.96259+04 .13282+01	.19737+00	2
PARTICLE DATA NO PARTICLES ARE PRESENT AT THIS POINT										
60	48	PRN-MR - CONTIN	.31517+00 .80055+01	.74059+00 .92505-01	.71804+01 .92566-05	.72973+02 .72700+03	.69773+02 .19811+04	.97795+04 .13412+01	.19737+00	2
PARTICLE DATA NO PARTICLES ARE PRESENT AT THIS POINT										
60	49	PRN-MR - CONTIN	.31517+00 .69031+01	.74059+00 .31429+01	.83201+01 .41421-05	.78879+02 .55151+03	.69773+02 .19811+04	.10115+05 .13527+01	.19737+00	2
PARTICLE DATA NO PARTICLES ARE PRESENT AT THIS POINT										

NOTES: (1) Typical printout for a data surface containing a Prandtl-Meyer Expansion.  
 (2) Some points have been omitted for demonstration purposes.

LOCKHEED-HUNTSVILLE RESEARCH & ENGINEERING CENTER

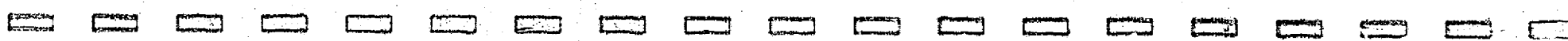

Table 3-11 (Concluded)

SUPERSONIC FLOW ANALYSIS USING THE LOCKHEED-HUNTSVILLE MULTIPLE SHOCK COMPUTER PROGRAM  
 GAS-PARTICLE FLOW SOLUTION  
 CASE NO. 1

SPACE SHUTTLE SEP MOTOR NOZZLE

LINE POINT	DESCRIP - REGIME	R MACH ANGLE	X PRESSURE	M DENSITY	THETA TEMPERATURE	ENTROPY GAS CONST.	VELOCITY LOCAL GAMMA	H-TOTAL SHOCK ANGLE	ITR
PARTICLE DATA		V	THETA	D	M	ENTHALPY	DENSITY	TEMPERATURE	
SPECIF POINT	DESCRIPTION								
114	1 WALL - CONTIN	.00000 .18009+02	.16750+01 .18060+02	.32345+01 .50643-03	.00000 .25920+04	.58197+03 .19812+04	.81502+04 .12365+01	.17954+03	3
PARTICLE DATA									
1	1	.794475+04	.00000	.80755-01	.22432+08	.21071-05	.27626+04		
2	1	.789100+04	.00000	.10288+00	.23066+08	.39966-05	.28107+04		
3	1	.776127+04	.00000	.15476+00	.25476+08	.43749-05	.31375+04		
4	1	.760955+04	.00000	.21457+00	.28232+08	.49649-05	.34769+04		
5	1	.727590+04	.00000	.34715+00	.33341+08	.64048-05	.41061+04		
6	1	.675315+04	.00000	.55444+00	.38867+08	.45327-05	.41885+04		
118	72 FREEBD - CONTIN	.10128+01 .69037+01	.95075+00 .31449-01	.83194-01 .41442-05	.69000+02 .55160+03	.69773+02 .19811+04	.10115+05 .13527+01	.19737+08	2
PARTICLE DATA									
NO PARTICLES ARE PRESENT AT THIS POINT									
A NEW STREAMLINE HAS BEEN INSERTED ON LINE 117 BETWEEN POINTS 25 AND 26									
117	1 WALL - CONTIN	.00000 .17036+02	.16944+01 .17019+02	.32648-01 .48396-03	.00000 .25651+04	.66428+03 .19912+04	.81845+04 .12367+01	.19653+08	3
PARTICLE DATA									
1	1	.796704+04	.00000	.86441-01	.22329+08	.20538-05	.27499+04		
2	1	.790113+04	.00000	.11225+00	.22983+08	.39363-05	.28305+04		
3	1	.777124+04	.00000	.16486+00	.25369+08	.43166-05	.31244+04		
4	1	.762389+04	.00000	.22484+00	.28107+08	.48977-05	.34614+04		
5	1	.728036+04	.00000	.35760+00	.33198+08	.63193-05	.40245+04		
6	1	.676694+04	.00000	.56548+00	.38764+08	.44644-05	.41885+04		
119	73 FREEBD - CONTIN	.10267+01 .69037+01	.95606+00 .31449-01	.83194-01 .41442-05	.68960+02 .55160+03	.69773+02 .19811+04	.10115+05 .13527+01	.19737+08	2
PARTICLE DATA									
NO PARTICLES ARE PRESENT AT THIS POINT									
POINT NO. 21 ON LINE 117 HAS BEEN DELETED									
A NEW STREAMLINE HAS BEEN INSERTED ON LINE 118 BETWEEN POINTS 51 AND 52									
A NEW STREAMLINE HAS BEEN INSERTED ON LINE 118 BETWEEN POINTS 53 AND 54									

LOCKHEED - HUNTSVILLE RESEARCH & ENGINEERING CENTER

3-285

NOTES: (1) Typical printout for a data surface in the exhaust plume.  
 (2) Some points have been omitted for demonstration purposes.

Table 3-12

INPUT DATA REQUIRED FOR CREATION OF THE THERMODYNAMIC  
GASEOUS PROPERTIES DATA TAPE

REACTANTS				
H	3.40424N .85106	O 3.40424CL.85106	.8375	-60200. S 298.15 F
H	10.3357C 7.3165	O .10630	.1091	1200. S 298.15 F
H	11.3337C 5.9366	O 1.07940	.0200	-65000. S 298.15 F
H	8.09750C 5.3983	N .8997 O .8997	.0109	-21000. S 298.15 F
	AL3.7064		.02	0.0 S 298.15 F
O	1.8787	FE1.2523	.0025	-123000. S 298.15 F

OMIT	AL(S)	AL(L)	ALCL3(S)	ALCL3(L)
OMIT	ALN(S)	ALN	AL2CL6	AL2O2
OMIT	CCL3	CCL4	CH	CH2
OMIT	CH3	CH4	COCL2	C2CL2
OMIT	C2H6	C3O2	C4	C5
OMIT	FE(S)	FE(L)	FECL2(S)	FECL2(L)
OMIT	H2O(S)	H2O(L)		

NAMELISTS

```

$INPT2
  RKT=T,PSIA=T,KASE=1,P=1800.,80.,MOC2P=T,MOCTF=T,PARTHT=T,
  QDOTP=-200.,-100.,-50.,0.0,NQI=4,NODATA=T
$END
$TAGEN
  IREAD=1,IO=8,IN=10
$END
SEP PROP PC=1800          MKS          4          2
SRKTINP
  PCP=5.,10.,20.,40.,100.,300.,500.,1000.,5000.,10000.,50000.,NFZ=7
$END
STOP
  
```

#### Example Problem 4

Example problem 4 is the same as example problem 3 except that the start line is input on cards. Table 3-13 presents a flow chart of the input data for the specified problem. Note that Card 35 has been replaced by Cards 33a and 34a. A listing of the pertinent solution is omitted as it is basically the same as for example problem 3.

Table 3-13

REQUIRED INPUT FORMAT FOR EXAMPLE PROBLEM 4

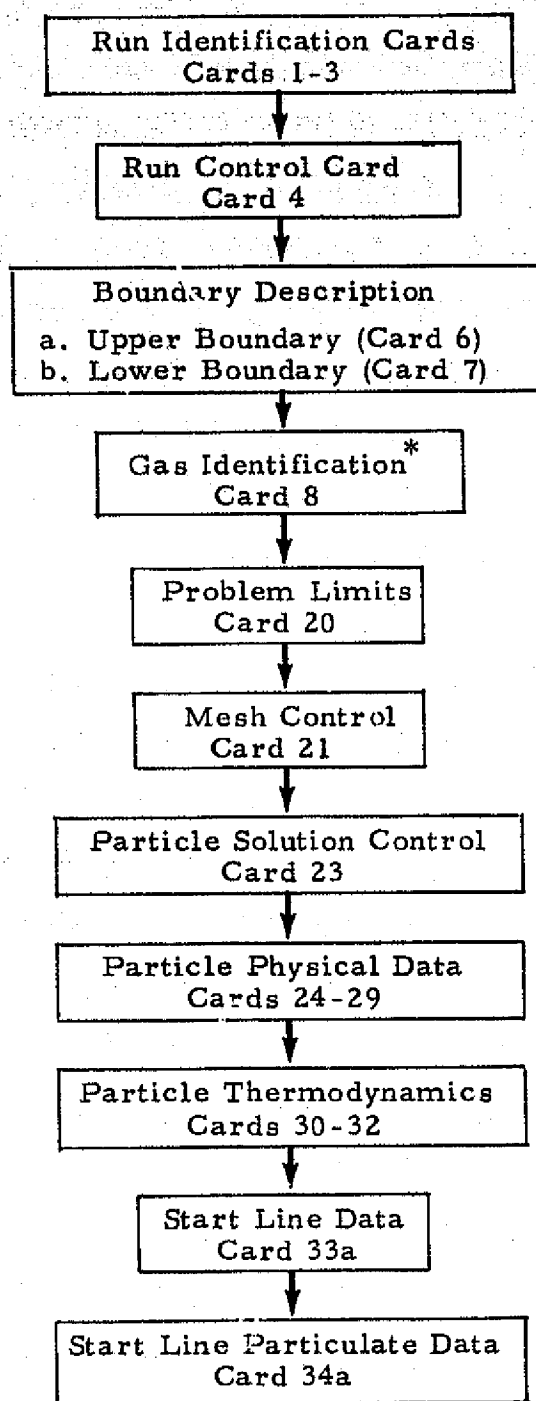

\*The gas properties are input on tape. Therefore, Cards 9, 10 and 11 are not required.

Example Problem 5

This problem analyzes a single phase finite rate chemistry flow field with the following stipulations:

1. Free molecular calculations are not to be considered,
2. Species mole fractions on the start line are to be read from cards, and
3. The start line is to be input on cards.

Table 3-14 presents first a flow chart and then a listing of the input data for the specified problem. Table 3-15 presents a listing of the pertinent solution.

Table 3-14  
REQUIRED INPUT FORMAT FOR EXAMPLE PROBLEM 5

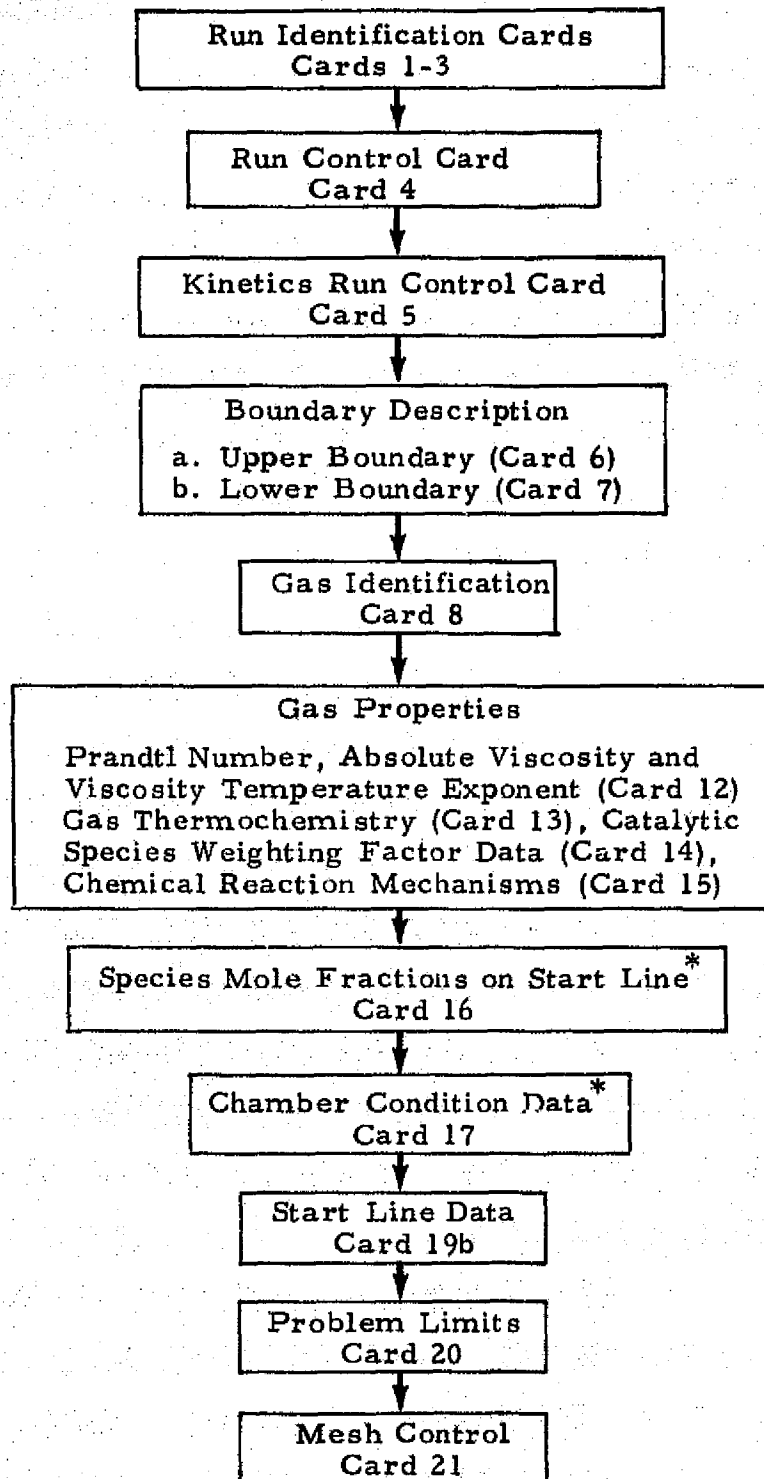

\*If species mole fractions are input on tape (ICTAPE=1) Cards 16 and 17 are not required.



REPRODUCIBILITY OF THE ORIGINAL PAGE IS POOR

Table 3-14 (Continued)

Cards	1	2	21	2	1	0	1	03	50	21	10	0	0	000000
Card 1-3														
Card 4	3	2	21	2	1	0	1	03						
Card 5	24	16	3	23	0	0	2	1						
Card 6									.2679492	.03678118	.20516667	.037375		
Card 7			17.00		1.4							8.3333	.037375	
Card 8												8.3333		
Card 12														
	0	12.001	0.0											
0	0.0	0.0	0.0											
100.	.395	.210	-.252	50.	.1975	.105	-.245							
200.	1.202	.720	-.238	150.	.7465	.465	-.179							
300.	2.054	1.372	-.160	250.	1.628	1.046	-.078							
400.	3.496	2.764	.004	400.	2.851	2.075	.250							
500.	5.440	4.126	.569	600.	4.038	3.471	.947							
700.	5.149	5.844	1.370	800.	4.740	4.739	1.831							
1000.	5.605	7.661	2.828	1200.	5.430	6.809	3.683							
1500.	5.903	9.096	4.905	1600.	5.721	8.417	6.112							
2000.	5.936	10.536	7.275	2000.	5.865	9.711	8.442							
3000.	6.097	12.129	10.212	2600.	5.992	11.267	12.303							
4000.	6.150	13.241	14.412	3000.	6.103	12.708	16.236							
4000.	6.150	13.241	18.074	4000.	6.213	13.893	20.468							
CHA	16.043	-17.895												
0	0.0	0.0	-2.396	50.	3.9745	17.655	-1.9765							
100.	7.949	33.706	-1.601	150.	7.975	38.464	-1.200							
200.	8.001	61.221	-.609	250.	8.268	42.852	-.300							
300.	8.535	44.543	.016	400.	9.600	47.164	.423							
500.	11.076	49.483	1.950	600.	12.483	51.597	3.153							
700.	13.813	53.622	4.430	800.	15.041	55.548	5.647							
1000.	17.150	57.141	6.150	1000.	18.842	62.424	12.732							
1400.	20.150	65.431	10.037	1600.	21.161	68.191	20.772							
1800.	21.947	70.770	15.036	2000.	22.562	73.076	29.540							
2200.	23.256	75.279	20.418	2600.	23.758	79.162	43.478							
3000.	24.233	87.597	25.079	3000.	24.493	84.920	60.369							
3800.	24.695	87.060	37.758	4000.	24.901	89.673	77.690							
0	26.010	-26.42												
0	6.956	39.613	-1.373	50.	6.956	39.613	-1.379							
100.	6.956	37.613	-1.373	150.	6.956	42.024	-1.031							
200.	6.997	44.635	-0.683	250.	6.961	45.846	-0.335							
300.	6.965	47.257	0.013	400.	7.013	49.265	0.711							
500.	7.121	50.841	1.417	600.	7.276	52.152	2.137							
700.	7.450	53.237	2.873	800.	7.624	54.293	3.627							
1000.	7.931	56.028	5.183	1200.	8.168	57.496	6.794							
1400.	8.346	58.759	8.446	1600.	8.460	59.893	10.130							
1800.	8.581	60.899	11.830	2000.	8.664	61.807	13.561							
2200.	8.756	63.024	16.175	2600.	8.827	64.102	18.813							
3000.	8.897	65.370	22.357	3000.	8.937	66.220	25.032							
3800.	8.971	66.999	27.719	4000.	9.014	67.946	31.316							
0	26.010	0.												
0	5.493	26.649	-1.804	50.	5.393	26.649	-1.535							
100.	5.375	24.357	-1.265	150.	5.453	26.586	-0.994							
200.	5.116	20.520	-0.667	250.	5.706	29.995	-0.331							
300.	5.854	31.251	0.013	400.	6.975	33.247	0.707							
500.	6.993	34.586	1.450	600.	7.007	36.682	2.106							
700.	7.636	37.165	2.903	800.	7.347	38.107	3.514							
1000.	7.217	34.702	5.294	1200.	7.700	41.533	6.404							
1400.	7.600	32.187	7.901	1600.	7.800	42.217	9.445							

Table 3-14 (Continued)

1800.	8.016	44.140	11.030	2000.	8.195	45.004	12.651
2300.	8.432	46.180	15.157	2600.	8.639	47.213	17.705
3000.	8.859	48.465	21.210	3300.	9.0	49.6	23.000
3600.	9.3	50.8	25.00	4000.	9.4	53.0	28.000
M2U	18.016	-57.798					
0	0.0	0.0	-2.367	50.	3.9505	18.198	-1.974
100.	7.961	36.396	-1.581	150.	7.965	39.156	-1.18
200.	7.969	41.916	- .784	250.	7.978	43.535	- .384
300.	8.027	45.155	.015	400.	8.186	47.483	.425
500.	8.415	49.334	1.654	600.	8.676	50.891	2.509
700.	8.934	52.249	3.390	800.	9.246	53.464	4.300
1000.	9.451	55.591	6.209	1200.	10.444	57.440	8.240
1400.	10.987	59.092	10.384	1600.	11.462	60.591	12.630
1800.	11.869	61.965	14.964	2000.	12.214	63.254	17.373
2300.	12.654	64.971	21.103	2600.	12.965	66.540	24.945
3000.	13.304	68.420	30.201	3300.	13.503	69.698	34.223
3600.	13.869	70.800	38.300	4000.	13.850	72.330	43.805
NH3	17.03061	-10.97					
0	0.0	0.0	-2.404	50.	3.975	18.604	-2.006
100.	7.950	37.210	-1.609	150.	8.007	39.975	-1.21
200.	8.064	42.740	-0.811	250.	8.295	44.412	- .3975
300.	8.526	46.085	.016	400.	9.241	48.633	.903
500.	10.036	50.780	1.867	600.	10.808	52.679	2.909
700.	11.538	54.400	4.027	800.	12.225	55.956	5.215
1000.	13.467	58.551	7.787	1200.	14.550	61.404	10.592
1400.	15.460	63.718	13.596	1600.	16.205	65.833	16.765
1800.	16.762	67.776	20.086	2000.	17.220	69.566	23.405
2300.	17.825	72.015	28.725	2600.	18.370	74.234	34.154
3000.	19.000	76.908	41.631	3300.	19.341	78.734	47.383
3600.	19.672	80.432	53.235	4000.	20.100	82.527	61.190
	28.0134	0.0					
0	6.956	38.170	-1.379	50.	6.956	38.170	-1.379
100.	6.956	38.170	-1.379	150.	6.956	40.586	-1.031
200.	6.957	42.992	-0.683	250.	6.959	44.402	-0.335
300.	6.961	45.813	0.013	400.	6.990	47.818	0.710
500.	7.069	49.385	1.413	600.	7.196	50.655	2.125
700.	7.350	51.806	2.853	800.	7.512	52.798	3.596
1000.	7.815	54.507	5.129	1200.	8.051	55.955	6.716
1400.	8.252	57.212	8.350	1600.	8.398	58.324	10.015
1800.	8.512	59.320	11.707	2000.	8.601	60.222	13.418
2300.	8.703	61.431	16.015	2600.	8.703	62.505	18.636
3000.	8.855	63.765	22.165	3300.	8.855	64.611	24.829
3600.	8.939	65.367	27.505	4000.	8.983	66.331	31.089
CON	44.0099	-94.054					
0	6.981	42.758	-1.543	50.	6.981	42.758	-1.543
100.	6.981	42.758	-1.543	150.	7.407	45.263	-1.179
200.	7.734	47.769	-0.816	250.	8.315	49.448	-0.400
300.	8.896	51.127	0.016	400.	9.877	53.830	0.958
500.	10.666	55.122	1.987	600.	11.310	58.126	3.087
700.	11.846	59.910	4.245	800.	12.293	61.522	5.453
1000.	12.980	64.344	7.984	1200.	13.456	66.756	10.632
1400.	13.815	68.859	13.362	1600.	14.674	70.722	16.152
1800.	14.269	72.391	18.987	2000.	14.824	73.903	21.857
2300.	14.600	75.931	25.212	2600.	14.734	77.730	30.613
3000.	14.873	79.846	33.532	3300.	14.976	81.72	41.810
3600.	15.030	82.574	43.508	4000.	15.119	84.162	51.538
H	1.008	52.102					
	4.968	19.88	-1.451	50.	4.968	19.382	-1.233

Cards 13  
(Cont'd)

Table 3-14 (Continued)

100.	4.968	21.965	-0.984	150.	4.968	23.979	-0.230
200.	4.968	25.408	-0.488	250.	4.968	26.517	-0.100
300.	4.968	27.423	0.009	400.	4.968	28.852	0.100
500.	4.968	29.961	1.003	600.	4.968	30.867	1.000
700.	4.968	31.032	1.990	800.	4.968	32.290	1.000
1000.	4.968	33.404	3.487	1200.	4.968	34.310	4.000
1400.	4.968	35.075	5.474	1600.	4.968	35.739	6.400
1800.	4.968	36.325	7.461	2000.	4.968	36.844	8.400
2300.	4.968	37.538	9.946	2600.	4.968	38.152	11.400
3000.	4.968	38.852	13.423	3200.	4.968	39.394	14.923
3800.	4.968	39.926	16.423	4000.	4.968	40.636	18.610
NO	30.008	21.58					
100.	0.0	0.0	-2.197	50.0	3.8605	21.143	-1.824
200.	7.721	42.286	-1.451	150.	7.496	44.882	-1.078
300.	7.271	47.477	-0.705	250.	7.202	48.934	-0.346
400.	7.132	50.392	.013	400.	7.157	52.444	.727
500.	7.287	54.053	1.448	600.	7.466	55.397	2.185
700.	7.655	56.562	2.942	800.	7.632	57.596	3.710
1000.	8.125	59.377	5.313	1200.	8.336	60.878	6.000
1400.	8.491	62.175	8.644	1600.	8.605	63.317	10.300
1800.	8.692	64.335	12.084	2000.	8.759	65.255	13.820
2300.	8.837	66.464	16.489	2600.	8.895	67.071	19.100
3000.	8.955	68.849	20.700	3200.	8.991	69.704	24.300
3800.	9.022	70.468	28.090	4000.	9.058	71.440	31.310
NO	17.008	9.33					
100.	0.0	0.0	-2.107	50.	3.7635	17.746	-1.770
200.	7.507	32.802	-1.451	150.	7.408	36.435	-1.070
300.	7.309	41.041	-0.707	250.	7.2215	42.001	-0.307
400.	7.134	43.552	.013	400.	7.077	46.005	.704
500.	7.049	47.552	1.430	600.	7.052	48.867	2.100
700.	7.037	49.956	2.841	800.	7.148	50.406	3.450
1000.	7.327	52.520	5.0	1200.	7.548	53.875	6.007
1400.	7.764	55.055	8.018	1600.	7.963	56.105	9.001
1800.	8.136	57.053	11.207	2000.	8.285	57.919	12.000
2300.	8.470	59.049	15.356	2600.	8.621	60.137	17.000
3000.	8.778	61.362	21.404	3200.	8.873	62.223	24.000
3800.	8.955	62.999	26.726	4000.	9.046	63.947	30.007
NO	16.0	59.559					
100.	0.0	0.0	-1.608	50.	2.833	16.235	-1.300
200.	5.066	32.466	-1.060	150.	5.600	34.405	-0.751
300.	5.434	36.340	-0.523	250.	5.335	37.420	-0.207
400.	5.235	38.501	.010	400.	5.130	39.991	.500
500.	5.051	41.131	1.038	600.	5.049	42.054	1.500
700.	5.029	42.851	2.048	800.	5.015	43.321	2.500
1000.	4.999	44.619	3.552	1200.	4.990	45.387	4.000
1400.	4.954	46.298	5.548	1600.	4.981	46.963	6.000
1800.	4.970	47.550	7.540	2000.	4.973	48.074	8.000
2300.	4.950	48.770	10.029	2600.	4.966	49.001	11.000
3000.	5.004	50.096	13.522	3200.	5.005	50.373	15.000
3800.	5.050	51.012	16.537	4000.	5.021	51.546	19.000
NO	32.0	0.0					
100.	0.0	0.0	-2.075	50.	3.479	20.701	-1.720
200.	6.956	41.402	-1.361	150.	6.9595	43.606	-1.000
300.	6.961	46.225	-0.685	250.	6.992	47.641	-0.300
400.	7.023	49.054	.013	400.	7.196	51.097	.700
500.	7.431	52.727	1.414	600.	7.670	54.103	2.210
700.	7.983	55.102	2.807	800.	8.063	56.557	3.700
1000.	8.336	57.197	4.107	1200.	8.427	59.725	7.110

Cards 13  
(Cont'd)

Table 3-14 (Continued)

1400.	8.674	61.061	8.834	1000.	8.800	62.227	10.484								
1800.	8.916	63.270	12.354	2000.	9.029	64.216	14.144								
2300.	9.194	65.489	16.882	2500.	9.354	66.626	19.604								
3000.	9.551	67.978	23.448	3300.	9.682	68.898	26.331								
3600.	9.799	69.742	29.254	4000.	9.932	70.782	33.201								
CH3	15.03506	34.820													
.	0.0	0.0	-2.487	50.	3.991	18.559	-2.0895								
100.	7.982	37.178	-1.692	150.	8.25	40.012	-1.2815								
200.	8.518	42.848	-.871	250.	8.89	44.642	-.427								
300.	9.262	46.438	.017	400.	10.048	49.21	.633								
500.	10.815	51.536	2.026	600.	11.541	53.572	3.144								
700.	12.231	55.404	4.333	800.	12.888	57.08	5.689								
1000.	14.09	60.088	8.29	1200.	15.109	62.75	11.213								
1400.	15.939	65.144	14.321	1600.	16.802	67.317	17.578								
1800.	17.129	69.304	20.953	2000.	17.548	71.131	24.422								
2300.	18.028	73.618	29.782	2500.	18.38	75.551	32.222								
3000.	18.716	78.006	42.649	3300.	18.901	80.299	42.193								
3600.	19.048	81.95	53.986	4000.	19.194	83.965	51.635								
CH20	30.027	-27.700													
.0	0.0	0.0	-2.395	50.	3.9745	21.7395	-1.9975								
100.	7.949	43.479	-1.60	150.	7.978	40.2375	-1.202								
200.	8.007	48.996	-.804	250.	8.341	50.6545	-.394								
300.	8.475	52.313	.016	400.	9.385	54.869	.906								
500.	10.46	57.077	1.898	600.	11.524	59.079	2.998								
700.	12.505	60.931	4.20	800.	13.38	62.659	5.495								
1000.	14.817	65.806	8.322	1200.	15.893	68.608	11.398								
1400.	16.893	71.121	14.68	1600.	17.291	73.391	18.062								
1800.	17.746	75.455	21.567	2000.	18.095	77.343	25.153								
2300.	18.483	79.90	30.643	2500.	18.76	82.184	33.232								
3000.	19.019	84.888	43.771	3300.	19.159	86.707	43.518								
3600.	19.288	88.372	55.283	4000.	19.379	90.415	53.014								
CH0	29.014	-2.900													
.0	0.0	0.0	-2.387	50.	3.9745	22.465	-1.9975								
100.	7.949	44.93	-1.593	150.	7.974	47.6855	-1.1745								
200.	7.999	50.447	-.796	250.	8.135	52.0905	-.3905								
300.	8.271	53.734	.015	400.	8.703	56.171	.893								
500.	9.184	58.164	1.758	600.	9.66	59.861	2.70								
700.	10.108	61.404	3.689	800.	10.518	62.781	4.72								
1000.	11.21	65.206	6.896	1200.	11.758	67.301	9.19								
1400.	12.172	69.146	11.591	1600.	12.489	70.705	14.019								
1800.	12.732	72.279	16.582	2000.	12.921	73.63	19.146								
2300.	13.133	75.452	23.088	2500.	13.286	77.071	27.022								
3000.	13.43	78.983	32.367	3300.	13.508	80.267	36.405								
3600.	13.669	81.445	40.47	4000.	13.631	82.678	45.911								
M1	1.0	1.0	1.0	3.0	1.0	1.0	2.0	1.0	1.0	1.0	1.0	1.0	1.0	1.0	1.0
M2	1.0	1.0	1.0	10.0	1.0	1.0	3.0	1.0	1.0	2.0	1.0	1.0	1.0	1.0	1.0
M3	1.0	1.0	1.5	1.0	10.0	1.0	1.0	3.0	1.0	1.0	1.0	20.0	1.0	1.0	1.0
H	+OH	+M1	=H2O	+M1						22	6.10-26	2.0	0.0		
O	+H	+M1	=OH	+M1						21	2.00-32	0.0	0.0		
O	+O	+M1	=O2	+M1						24	3.80-30	1.0	-340.0		
H	+H	+M2	=H2	+M2						22	2.80-30	1.0	0.0		
CO	+O	+M3	=CO2	+M3						23	2.00-33	0.0	-4000.0		
OH	+H		=H2	+O						14	1.40-14-1.0		-7000.0		
OH	+H		=H	+O2						11	4.00-11	0.0	0.0		
OH	+H2		=H2O	+H						14	1.00-17-2.0		-2900.0		

Table 3-14 (Continued)

Cards 15  
(Cont'd)

CH1	+C0	=C02	+H	14	1.10-19-2.0	1600.0
CH2	+OH	=H20	+U	13	1.00-11 0.0	-1100.0
CH3	+OH	=CH3	+H20	13	4.7 -11	-5000.0
CH4	+H	=CH3	+H2	13	2.4 -11	-5000.0
CH5	+O	=CH3	+OH	13	3.5 -11	-9100.0
CH6	+O	=CH2O	+H	11	1.1 -10	
CH7	+OH	=CH0	+H20	12	9.0 -13	-5
CH8	+H	=CH0	+H2	13	7.2 -11	-3800.0
CH9	+O	=CH0	+OH	11	1.6 -13	
CH10	+M1	=C0	+H2 +M1	53	3.5 -08	-35000.0
CH11	+OH	=C0	+H20	11	2.1 -10	
CH12	+H	=C0	+H2	13	8.3 -11	-10000.0
CH13	+O	=C0	+OH	11	2.1 -10	
CH14	+O2	=C0	+H +M2	73	8.3 -11	-17000.0
CH15	+M1	=C0	+H +M1	53	1.2 -10	-17000.0

Cards 16

.7478-01	.2078+00	.6382-03	.4019+00	.8570-03	.1257-02	.2031+01
.1030-05	.0000	.0000	.0000	.0000	.0000	
.7410-01	.1899+00	.6236-02	.4589+00	.6444-02	.1184-02	.2762+00
.1131-03	.0000	.0000	.0000	.0000	.0000	
.7707-01	.1247+00	.6214-01	.4704+00	.1665-01	.6084-03	.2661+00
.1167-02	.0000	.0000	.0000	.0000	.0000	
.7700	.2263-01	.1669+00	.4651+00	.6006-01	.3501-03	.2573+01
.1411-02	.1217-03	.2801-05	.7020-05	.0000	.0000	
.0700	.3246-00	.1574+00	.4103+00	.0173+03	.2852-04	.2633+00
.1149-01	.2296-02	.1490-03	.1133-01	.1766-05	.1739-04	
.0000	.0000	.1251-03	.1247+00	.3416+00	.4509-05	.3105+00
.1000-01	.1010-02	.2337-02	.1191-01	.1034-02	.1684-02	
.0000	.0000	.0000-01	.0000-01	.0004+00	.0000	.3240+00
.1100-01	.1270-01	.6107-02	.2900-01	.2019-01	.1017-01	
.0000	.0000	.5879-01	.3497-01	.3649+00	.0000	.3285+00
.1000-01	.0610-02	.1424-01	.3916-01	.6775-02	.3373-01	
.0000	.0000	.4197-01	.2187-01	.3756+00	.0000	.3305+00
.1000-01	.6692-02	.1814-01	.4120-01	.6029-02	.5678-01	
.0000	.0000	.3268-01	.1640-01	.3663+00	.0000	.3317+00
.1000+00	.0015-02	.1994-01	.4000-01	.7905-02	.7733-01	
.0000	.0000	.2739-01	.1315-01	.3612+00	.0000	.3325+00
.1046+00	.4280-02	.2068-01	.3914-01	.7926-02	.8879-01	
.0000	.0000	.2528-01	.1204-01	.3586+00	.0000	.3329+00
.1000+00	.2910-02	.2104-01	.3815-01	.7717-02	.5473-01	
.0000	.0000	.2462-01	.1171-01	.3585+00	.0000	.3332+00
.1007+00	.5786-02	.2095-01	.3766-01	.7592-02	.5616-01	
.0000	.0000	.2649-01	.1172-01	.3628+00	.0000	.3332+00
.1007+00	.4093-02	.2091-01	.3807-01	.7507-02	.6882-01	
.0000	.0000	.2528-01	.1172-01	.3628+00	.0000	.3336+00

Table 3-14 (Concluded)

	.1500+00	.4783-02	.1921-01	.3885-01	.7504-02	.7834-01	
	.0000	.0000	.3678-01	.1890-01	.3770+00	.0000	.3326+00
	.1624+00	.5793-02	.1762-01	.3870-01	.7373-02	.6264-01	
	.0000	.0000	.4717-01	.2637-01	.3806+00	.0000	.3317+00
	.7755-01	.7305-02	.1492-01	.3742-01	.6656-02	.4378-01	
Cards 16 (Cont'd)	.0000	.0000	.6587-01	.4215-01	.3967+00	.0000	.3297+00
	.0751-01	.9816-02	.1039-01	.3252-01	.4976-02	.2009-01	
	.0000	.0000	.1097+00	.1161+00	.3663+00	.1963-05	.3179+00
	.5632-01	.9656-02	.2630-02	.1360-01	.1227-02	.2347-02	
	.0000	.7495-07	.1408+00	.2172+00	.3012+00	.8295-05	.3013+00
.3301-01	.4530-02	.1710-03	.1703-02	.3360-04	.2128-04		
.0000	.7495-07	.1408+00	.2172+00	.3012+00	.8295-05	.3013+00	
.3301-01	.4530-02	.1710-03	.1703-02	.3360-04	.2128-04		
Card 17	34.014	3236.1					
		.8416667E-02	.1027366E+010.			.1055177E+04	.1872436E+02
	.1956083E-02	.8416667E-02	.1029127E+01	.7462402E+00		.1059010E+04	.1867189E+02
	.5912167E-02	.8416667E-02	.1023770E+01	.1501056E+01		.1151958E+04	.1869575E+02
	.5860250E-02	.8416667E-02	.1021379E+01	.2246499E+01		.1485161E+04	.1855997E+02
	.7029333E-02	.8416667E-02	.1020366E+01	.2976366E+01		.2316396E+04	.1851260E+02
	.9780417E-02	.8416667E-02	.1040766E+01	.3730404E+01		.2895027E+04	.1849530E+02
	.1173675E-01	.8416667E-02	.1053406E+01	.4493167E+01		.3109170E+04	.1839137E+02
	.1309758E-01	.8416667E-02	.1066300E+01	.5248717E+01		.3113447E+04	.1815911E+02
	.149007E-01	.8416667E-02	.1075547E+01	.6004541E+01		.3074688E+04	.1799163E+02
	.1730476E-01	.8416667E-02	.1086766E+01	.6757067E+01		.3027286E+04	.1775462E+02
	.1976603E-01	.8416667E-02	.1100176E+01	.7509020E+01		.2998401E+04	.1746671E+02
	.2231022E-01	.8416667E-02	.1115618E+01	.8264529E+01		.2975594E+04	.1714796E+02
	.2497502E-01	.8416667E-02	.1132729E+01	.9020210E+01		.2969294E+04	.1680275E+02
	.2776203E-01	.8416667E-02	.1151470E+01	.9775843E+01		.2975668E+04	.1657135E+02
	.3067317E-01	.8416667E-02	.1171205E+01	.1053251E+02		.2991671E+04	.1590245E+02
	.3371535E-01	.8416667E-02	.1202937E+01	.1128923E+02		.3014766E+04	.1537231E+02
	.3698744E-01	.8416667E-02	.1247830E+01	.1204406E+02		.3036111E+04	.1474476E+02
	.4048942E-01	.8416667E-02	.1274132E+01	.1280798E+02		.3050450E+04	.1411065E+02
	.4422150E-01	.8416667E-02	.1306149E+01	.1355561E+02		.2868930E+04	.1352472E+02
	.4818381E-01	.8416667E-02	.1333497E+01	.1429664E+02		.2536821E+04	.1261520E+02
	.5236621E-01	.8416667E-02	1.3345	15.0		2526.1	12.5928
Card 20	0.0	0.0	0.0	.6		90.0	
Card 21	0.0	0.015	0.0	0.00001	4.0	.375	

Table 3-15  
 EXAMPLE PROBLEM 5 PERTINENT SOLUTION

SUPERSONIC FLOW ANALYSIS USING THE LOCKHEED-HUNTSVILLE MULTIPLE SHOCK COMPUTER PROGRAM

GAS-PARTICLE FLOW SOLUTION

CASE NO. 21

PAGE 1

CASE 21 - 500LNF 6/1 CONE, O/F=2.2, FINITE RATE, INVISCID, VAR O/F

RUN CONTROL PARAMETERS							
ICON(1)	ICON(2)	ICON(3)	ICON(4)	ICON(5)	ICON(6)	ICON(7)	ICON(8)
3	2	21	2	1	0	1	3
ICON(9)	ICON(10)	ICON(11)	ICON(12)	ICON(13)	ICON(14)	ICON(15)	ICON(16)
0	50	21	1	0	0	0	3010

FLOW CALCULATIONS ARE IN ENGLISH UNITS WITH THE R,X COORDINATES IN FEET

THE FLOW FIELD DATA WILL BE WRITTEN ON TAPE

		UPPER BOUNDARY					
TYPE	ITRANS	A	B	C	D	E	MAX
2	1	.00000	.00000	.00000	.26795+00	.36761+01	.20517+00
3	0	.19400+02	.14000+01	.00000	.00000	.00000	.83333+01
		LOWER BOUNDARY					
TYPE	ITRANS	A	B	C	D	E	MAX
2	0	.00000	.00000	.00000	.00000	.00000	.83333+01

LOCKHEED-HUNTSVILLE RESEARCH & ENGINEERING CENTER

3-297

Table 3-15 (Continued)

SPECIFIC THERMODYNAMIC AND REACTION DATA

NT, NS, NR, NM, ICTAPE, KGUP, IDIDO= 24 16 23 3 0 2 1

PRANDTL NUMBER = .70000000+00  
 BASE VISCOSITY = .1865119E-05  
 EXPONENT = .60000000+00

2-298

	REACTIONS BEING CONSIDERED						KR=A*EXP(B/RT+H)/T**N	A	N	B	H	R-TYPE	K-TYPE
1	H	+ OH	+ M1	= H2O	+ H1		2.214+22	2.0	.0	.0	2	2	
2	O	+ H	+ M1	= OH	+ M1		7.260+15	.0	.0	.0	2	1	
3	O	+ O	+ M1	= O2	+ M1		1.379+18	1.0	-390.0	.0	2	4	
4	H	+ H	+ M2	= H2	+ M2		1.016+18	1.0	.0	.0	2	2	
5	CO	+ O	+ M3	= CO2	+ M3		7.260+14	.0	-4000.0	.0	2	3	
6	OH	+ H		= H2	+ O		8.436+09	-1.0	-7000.0	.0	1	4	
7	OH	+ O		= H	+ O2		2.410+13	.0	.0	.0	1	1	
8	OH	+ H2		= H2O	+ H		6.025+06	-2.0	-2900.0	.0	1	4	
9	OH	+ CO		= CO2	+ H		6.627+04	-2.0	1600.0	.0	1	4	
10	OH	+ OH		= H2O	+ O		6.025+12	.0	-1100.0	.0	1	3	
11	CH4	+ OH		= CH3	+ H2O		2.839+13	.0	-5000.0	.0	1	3	
12	CH4	+ H		= CH3	+ H2		1.444+13	.0	-5000.0	.0	1	3	
13	CH4	+ O		= CH3	+ OH		2.109+13	.0	-9100.0	.0	1	3	
14	CH3	+ O		= CH2O	+ H		6.627+13	.0	.0	.0	1	1	
15	CH2O	+ OH		= CHO	+ H2O		5.422+11	-.5	.0	.0	1	2	
16	CH2O	+ H		= CHO	+ H2		1.325+13	.0	-3800.0	.0	1	3	
17	CH2O	+ O		= CO	+ OH		9.648+10	.0	.0	.0	1	1	
18	CH2O	+ M1		= CO	+ H2	+ M1	2.109+16	.0	-35000.0	.0	5	3	
19	CHO	+ OH		= CO	+ H2O		1.265+14	.0	.0	.0	1	1	
20	CHO	+ H		= CO	+ H2		5.001+13	.0	-10000.0	.0	1	3	
21	CHO	+ O		= CO	+ OH		1.265+14	.0	.0	.0	1	1	
22	CHO	+ O2		= CO	+ H		5.001+13	.0	-1600.0	.0	7	3	
23	CHO	+ M1		= CO	+ H	+ M1	7.230+13	.0	-15000.0	.0	5	3	

CATALYTIC SPECIES BEING CONSIDERED

M1	= 1.00 C	1.00 CH4	1.00 CO	1.00 H2	3.00 H2O	1.00 NH3	1.00 N2	
	2.00 CO2	1.00 H	1.00 NO	1.00 OH	1.00 O	1.00 O2	1.00 CH3	
	1.00 CH2O	1.00 CHO						
M2	= 1.00 C	1.00 CH4	1.00 CO	1.00 H2	10.00 H2O	1.00 NH3	1.00 N2	
	3.00 CO2	1.00 H	1.00 NO	2.00 OH	1.00 O	1.00 O2	1.00 CH3	
	1.00 CH2O	1.00 CHO						
M3	= 1.00 C	1.00 CH4	1.50 CO	1.00 H2	10.00 H2O	1.00 NH3	1.00 N2	
	3.00 CO2	1.00 H	1.00 NO	1.00 OH	1.00 O	20.00 O2	1.00 CH3	
	1.00 CH2O	1.00 CHO						



Table 3-15 (Continued)

SPECIE MOLE FRACTIONS ON THE START LINE ARE READ FROM CARDS

POINT	C	CH4	CO	H2	H2O	NH3	N2	CO2	H	NO
1	.74700-01	.20780+00	.63820-03	.43150+00	.85700-03	.12570-02	.28310+00	.56360-05	.00000	.00000
	OH	O	O2	CH3	CH2O	CHO				
	.00000	.00000	.00000	.00000	.00000	.00000				
2	.79100-01	.18990+00	.63360-02	.43860+00	.64440-02	.11840-02	.27820+00	.18310-03	.00000	.00000
	OH	O	O2	CH3	CH2O	CHO				
	.00000	.00000	.00000	.00000	.00000	.00000				
3	.57070-01	.12470+00	.62440-01	.47040+00	.16650-01	.88840-03	.26610+00	.16870-02	.00000	.00000
	OH	O	O2	CH3	CH2O	CHO				
	.00000	.00000	.00000	.00000	.00000	.00000				
3-299										
4	.00000	.22630-01	.16690+00	.48510+00	.60060-01	.35010-03	.25730+00	.74110-02	.12170-03	.28450-06
	OH	O	O2	CH3	CH2O	CHO				
	.73260-05	.00000	.00000	.00000	.00000	.00000				
5	.00000	.32460+06	.15740+00	.31630+00	.21750+00	.28520-04	.28330+00	.21240-01	.29460-02	.12450-03
	OH	O	O2	CH3	CH2O	CHO				
	.11510-02	.27660+04	.17390-04	.00000	.00000	.00000				
A	.00000	.00000	.12350+00	.15270+00	.34160+00	.45090-05	.31050+00	.44860-01	.10100-01	.23370-02
	OH	O	O2	CH3	CH2O	CHO				
	.11410-01	.10340-02	.18840-02	.00000	.00000	.00000				
7	.00000	.07000	.86030-01	.65810-01	.38640+00	.00000	.32400+00	.71680-01	.12700-01	.81070-02
	OH	O	O2	CH3	CH2O	CHO				
	.29160-01	.39190-02	.12178-01	.00000	.00000	.00000				
8	.00000	.00000	.58790-01	.34920-01	.38490+00	.00000	.32850+00	.89300-01	.96100-02	.14240-01
	OH	O	O2	CH3	CH2O	CHO				
	.39160-01	.67750-02	.33730-01	.00000	.00000	.00000				

NOTE: Some points have been omitted for demonstration purposes.

Table 3-15 (Continued)

20	OH	O	O2	CH3	CH2O	CHO				
	.17030-02	.33800-04	.21280-04	.00000	.00000	.00900				
21	C	CH4	CO	H2	H2O	NH3	N2	CO2	H	NO
	.00000	.74950-07	.14080+00	.21720+00	.30120+00	.82950-05	.30130+00	.33010-01	.45300-02	.17100-03
21	OH	O	O2	CH3	CH2O	CHO				
	.17030-02	.33800-04	.21280-04	.00000	.00000	.00000				

CHAMBER PRESSURE (ATM) = .34014+02 CHAMBER TEMPERATURE (DEG.K) = .32361+04

THERE ARE 0 PARTICLE SPECIES PRESENT IN THE GAS-PARTICLE MIXTURE

RUN CUTOFF INFORMATION

UPPER BOUNDARY LOWER BOUNDARY  
 R = .25000+01 X = .00000 THETA = .00000 R = .00000 X = .60000+00 THETA = .90000+02

THE MESH CONSTRUCTION WILL BE CONTROLLED BY THE FOLLOWING VARIABLES  
 DL INTERIOR = .150-01 DX AXIS = .150-01 DL LIM = .000 DL DELETE = .100-04 DEG P.M. = .400+01 F = .375+00

Table 3-15 (Continued)

SUPERSONIC FLOW ANALYSIS USING THE LOCKHEED-HUNTSVILLE MULTIPLE SHOCK COMPUTER PROGRAM  
 GAS-PARTICLE FLOW SOLUTION  
 CASE NO. 21

PAGE 2

CASE 21 - 500LBF 6/1 CONE, O/F=2.2, FINITE RATE, INVISCID, VAR O/F

LINE POINT	DESCRIP - REGIME	R MACH ANGLE TO*	X PRESSURE PO*	M DENSITY S*	THETA TEMPERATURE	ENTROPY GAS CONST.	VELOCITY LOCAL GAMMA	H-TOTAL SHOCK ANGLE	ITR				
1	INPUT = CONTIN	.00000	.84167-02	.10274+01	.00000	.00000	.31052+04	.13224+08	0				
		.76745+02	.27517+03	.54912-02	.18993+04	.37993+04	.12660+01						
		.21660+04	.51429+03	.00000									
CHEMICAL SPECIE MOLE FRACTIONS													
C	7.4785-02	CH4	2.0781-01	CO	6.3824-04	H2	4.3153-01	H2O	8.5705-04	NH3	1.2571-03	N2	2.8312-01
CO2	5.6364-06	H	0.0000	NO	0.0000	OH	0.0000	0	0.0000	O2	0.0000	CH3	0.0000
CH2O	0.0000	CHO	0.0000										
3-301	2	INPUT = CONTIN	.19561-02	.84167-02	.10291+01	.74627+04	.00000	.31983+04	.12984+08	0			
			.76336+02	.27490+03	.53672-02	.19242+04	.38260+04	.12712+01					
			.22006+04	.51479+03	.00000								
CHEMICAL SPECIF MOLE FRACTIONS													
C	7.9104-02	CH4	1.8991-01	CO	6.3363-03	H2	4.3862-01	H2O	6.4443-03	NH3	1.1841-03	N2	2.7821-01
CO2	1.0311-04	H	0.0000	NO	0.0000	OH	0.0000	0	0.0000	O2	0.0000	CH3	0.0000
CH2O	0.0000	CHO	0.0000										
1	3	INPUT = CONTIN	.39122-02	.84167-02	.10238+01	.15011+01	.00000	.32426+04	.11265+08	0			
			.77629+02	.27475+03	.50759-02	.20735+04	.37591+04	.12870+01					
			.23854+04	.51502+03	.00000								
CHEMICAL SPECIE MOLE FRACTIONS													
C	5.7074-02	CH4	1.2971-01	CO	6.2444-02	H2	4.7043-01	H2O	1.6651-02	NH3	8.8846-04	N2	2.6612-01
CO2	1.6871-03	H	0.0000	NO	0.0000	OH	0.0000	0	0.0000	O2	0.0000	CH3	0.0000
CH2O	0.0000	CHO	0.0000										
1	4	INPUT = CONTIN	.58682-02	.84167-02	.10214+01	.22464+01	.00000	.35142+04	.69241+07	0			
			.78256+02	.27276+03	.93259-02	.26733+04	.33964+04	.13038+01					
			.30969+04	.51283+03	.00000								
CHEMICAL SPECIE MOLE FRACTIONS													
C	0.0000	CH4	2.2633-02	CO	1.6692-01	H2	4.8516-01	H2O	6.0067-02	NH3	3.5014-04	N2	2.5733-01
CO2	7.4119-03	H	1.2171-04	NO	2.8453-07	OH	7.0266-06	0	0.0000	O2	0.0000	CH3	0.0000
CH2O	0.0000	CHO	0.0000										

NOTES: (1) Typical printout for the startline data surface.  
 (2) Some points have been omitted for demonstration purposes.

SUPERSONIC FLOW ANALYSIS USING THE LOCKHEED-HUNTSVILLE MULTIPLE SHOCK COMPUTER PROGRAM

GAS-PARTICLE FLOW SOLUTION

CASE NO. 21

PAGE 95

CASE 21 - 500LBF 6/1 CONE, O/F=2.2, FINITE RATE, INVISCID, VAR O/F

LINE POINT	DSCRIP - REGIME	R MACH	X ANGLE TO*	P PRESSURE PO*	M DENSITY S*	THETA TEMPERATURE	ENTROPY GAS CONST.	VELOCITY LOCAL GAMMA	H-TOTAL SHOCK ANGLE	ITR
60	1 WALL - CONTIN	.00000		.62272+01	.20063+01	.00000	.91272-05	.52447+04	.13194+08	3
		.29896+02		.65120+02	.17854+02	.13825+04	.37993+04	.13011+01		
		.22201+04		.35364+03	.00000					

CHEMICAL SPECIE MOLE FRACTIONS

C	7.4785-02	CH4	2.0781-01	CO	6.3824-04	H2	4.3153-01	H2O	8.5705-04	NH3	1.2571-03	N2	2.8312-01
CO2	5.6364-06	H	3.4528-19	NO	0.0000	OH	1.7397-25	O	3.9207-35	O2	0.0000	CH3	3.0251-18
CH2O	5.1725-10	CHO	1.1351-18										

60	21 WALL - CONTIN	.51639-01		.55452-01	.19568+01	.15000+02	.77017+02	.67522+04	.36075+07	3
		.36733+02		.70385+02	.10656-02	.37807+04	.25158+04	.12518+01		
		.56034+04		.35518+03	.00000					

CHEMICAL SPECIE MOLE FRACTIONS

C	0.0000	CH4	4.9604-08	CO	1.4019-01	H2	2.1814-01	H2O	3.0192-01	NH3	8.3046-06	N2	3.0165-01
CO2	3.3406-02	H	3.4555-03	NO	1.7120-04	OH	6.3044-04	O	6.4868-06	O2	4.3406-06	CH3	1.9276-08
CH2O	9.5135-08	CHO	1.4114-05										

PRESSURE INTEGRATION RESULTS

FORCEX	FORCEY	TORQZ	DELFX	DELFY	ISP
.47885+03	.00000	.00000	.14807+01	.00000	.29227+03
61	1 WALL - CONTIN	.00000	.64003+01	.20242+01	.00000
		.29606+02	.63188+02	.17445-02	.13728+04
		.22220+04	.34887+03	.00000	

CHEMICAL SPECIE MOLE FRACTIONS

C	7.4785-02	CH4	2.0781-01	CO	6.3824-04	H2	4.3153-01	H2O	8.5705-04	NH3	1.2571-03	N2	2.8312-01
CO2	5.6364-06	H	3.3760-19	NO	0.0000	OH	1.5902-25	O	2.5212-35	O2	0.0000	CH3	2.9582-18
CH2O	5.1736-10	CHO	1.2096-18										

61	21 WALL - CONTIN	.52895-01		.57151-01	.19735+01	.15000+02	.78910+02	.67916+04	.36068+07	3
		.30445+02		.68429+02	.10418-02	.37597+04	.25158+04	.12521+01		
		.56055+04		.35064+03	.00000					

CHEMICAL SPECIE MOLE FRACTIONS

C	0.0000	CH4	4.9635-08	CO	1.4015-01	H2	2.1819-01	H2O	3.0190-01	NH3	8.3047-06	N2	3.0165-01
CO2	3.3645-02	H	3.4353-03	NO	1.7120-04	OH	6.1685-04	O	6.3040-06	O2	4.2352-06	CH3	1.9187-08
CH2O	9.2748-08	CHO	1.4215-05										

PRESSURE INTEGRATION RESULTS

FORCEX	FORCEY	TORQZ	DELFX	DELFY	ISP
.48033+03	.00000	.00000	.14831+01	.00000	.29304+03

NOTES: (1) Typical printout for a data surface inside the nozzle.  
 (2) Some points have been omitted for demonstration purposes.

LOCKHEED - HUNTSVILLE RESEARCH & ENGINEERING CENTER  
 3-302

Table 3-15 (Continued)

SUPERSONIC FLOW ANALYSIS USING THE LOCKHEED-HUNTSVILLE MULTIPLE SHOCK COMPUTER PROGRAM

GAS-PARTICLE FLOW SOLUTION

CASE NO. 21

PAGE 89

CASE 21 - 500LAF 6/1 CONE, O/F=2.2, FINITE RATE, INVISCID, VAR O/F

LINE POINT	DESCRIP - REGIME	R MACH	X ANGLE TO*	Y PRESSURE PO*	Z DENSITY S*	THETA TEMPERATURE	ENTROPY GAS CONST.	VELOCITY LOCAL GAMMA	H-TOTAL SHOCK ANGLE	ITR			
114	25 PRN-MR = CONTIN	.91755-01		.20517+00	.35807+01	.29767+02	.12437+03	.93012+04	.36189+07	5			
		.16222+02		.39106+01	.10778-03	.20740+04	.25145+04	.12938+01					
		.66397+04		.63189+02	.00000								
CHEMICAL SPECIE MOLE FRACTIONS													
C	0.0000 CH4	5.0639-08	CO	1.3896-01	H2	2.1947-01	H2O	3.0133-01	NH3	8.3088-06	N2	3.0180-01	
CO2	3.5089-02	H	2.9945-03	NO	1.7129-04	OH	1.1603-04	O	1.3375-06	O2	1.6412-06	CH3	1.7015-08
CH2O	2.2823-08	CHO	4.9038-05										
3-303	114	26 PRN-MR = CONTIN	.91755-01	.20517+00	.37735+01	.33459+02	.12437+03	.94722+04	.36189+07	5			
		.15372+02		.27979+01	.83120-04	.19277+04	.25145+04	.12999+01					
		.66397+04		.50267+02	.00000								
CHEMICAL SPECIE MOLE FRACTIONS													
C	0.0000 CH4	5.0639-08	CO	1.3896-01	H2	2.1947-01	H2O	3.0133-01	NH3	8.3088-06	N2	3.0180-01	
CO2	3.5089-02	H	2.9945-03	NO	1.7129-04	OH	1.1603-04	O	1.3375-06	O2	1.6412-06	CH3	1.7015-08
CH2O	2.2823-08	CHO	4.9038-05										
114	27 PRN-MR = CONTIN	.91755-01		.20517+00	.39812+01	.37150+02	.12437+03	.96366+04	.36189+07	5			
		.14553+02		.19633+01	.63034-04	.17837+04	.25145+04	.13063+01					
		.66307+04		.39331+02	.00000								
CHEMICAL SPECIE MOLE FRACTIONS													
C	0.0000 CH4	5.0639-08	CO	1.3896-01	H2	2.1947-01	H2O	3.0133-01	NH3	8.3088-06	N2	3.0180-01	
CO2	3.5089-02	H	2.9945-03	NO	1.7129-04	OH	1.1603-04	O	1.3375-06	O2	1.6412-06	CH3	1.7015-08
CH2O	2.2823-08	CHO	4.9038-05										
114	28 PRN-MR = CONTIN	.91755-01		.20517+00	.42109+01	.40842+02	.12437+03	.97943+04	.36189+07	5			
		.13743+02		.13481+01	.47135-04	.16380+04	.25145+04	.13125+01					
		.66307+04		.30288+02	.00000								
CHEMICAL SPECIE MOLE FRACTIONS													
C	0.0000 CH4	5.0639-08	CO	1.3896-01	H2	2.1947-01	H2O	3.0133-01	NH3	8.3088-06	N2	3.0180-01	
CO2	3.5089-02	H	2.9945-03	NO	1.7129-04	OH	1.1603-04	O	1.3375-06	O2	1.6412-06	CH3	1.7015-08
CH2O	2.2823-08	CHO	4.9038-05										

NOTES: (1) Typical printout for a data surface containing a Prandtl-Meyer Expansion.  
 (2) Some points have been omitted for demonstration purposes.

Table 3-15 (Concluded)

SUPERSONIC FLOW ANALYSIS USING THE LOCKHEED-HUNTSVILLE MULTIPLE SHOCK COMPUTER PROGRAM

GAS-PARTICLE FLOW SOLUTION

CASE NO. 21

PAGE 115

CASE 21 - 50DLRF 6/1 CONE, O/F=2.2, FINITE RATE, INVISCID, VAR O/F

LINE	POINT	DESCRIP - REGIME	R MACH ANGLE TO*	X PRESSURE PO*	M DENSITY S*	THETA TEMPERATURE	ENTROPY GAS CONST.	VELOCITY LOCAL GAMMA	H-TOTAL SHOCK ANGLE	ITR
129	1	WALL - CONTIN	.0000 .19590+02 .23518+04	.22341+00 .12303+02 .14467+03	.29826+01 .50779-03 .00000	.00000 .91833+03	.91677-05 .37993+04	.64753+04 .13507+01	.13187+08	2

CHEMICAL SPECIE MOLE FRACTIONS

C	7.4785-02	CH4	2.0781-01	CO	6.3824-04	H2	4.3153-01	H2O	8.5705-04	NH3	1.2571-03	N2	2.8312-01
CO2	5.6364-06	H	1.2664-21	NO	0.0000	OH	5.3647-29	O	0.0000	O2	0.0000	CH3	1.4675-17
CH2O	5.1793-10	CHO	4.3574-18										

3-304

129	34	FREEBD - CONTIN	.95832-01 .99084+01 .66307+04	.20754+00 .13477+00 .58590+01	.58115+01 .80696-05 .00000	.60194+02 .95627+03	.13845+03 .25140+04	.10475+05 .13514+01	.36062+07	2
-----	----	-----------------	-------------------------------------	-------------------------------------	----------------------------------	------------------------	------------------------	------------------------	-----------	---

CHEMICAL SPECIE MOLE FRACTIONS

C	0.0000	CH4	5.0650-08	CO	1.3879-01	H2	2.1951-01	H2O	3.0140-01	NH3	6.3105-06	N2	3.0186-01
CO2	3.5076-02	H	2.7946-03	NO	1.7132-04	OH	1.1569-04	O	1.3377-06	O2	1.6416-06	CH3	1.7018-08
CH2O	2.2825-08	CHO	2.4958-04										

POINT NO. 32 ON LINE 129 HAS BEEN DELETED

130	1	WALL - CONTIN	.00000 .19571+02 .23522+04	.22400+00 .12248+02 .14428+03	.29853+01 .50609-03 .00000	.00000 .91725+03	.91677-05 .37993+04	.64778+04 .13511+01	.13186+08	2
-----	---	---------------	----------------------------------	-------------------------------------	----------------------------------	---------------------	------------------------	------------------------	-----------	---

CHEMICAL SPECIE MOLE FRACTIONS

C	7.4785-02	CH4	2.0781-01	CO	6.3824-04	H2	4.3153-01	H2O	8.5705-04	NH3	1.2571-03	N2	2.8312-01
CO2	5.6364-06	H	1.2417-21	NO	0.0000	OH	5.2150-29	O	0.0000	O2	0.0000	CH3	1.4575-19
CH2O	5.1793-10	CHO	4.3584-18										

130	33	FREEBD - CONTIN	.96187-01 .99094+01 .66308+04	.20776+00 .13472+00 .58578+01	.58109+01 .80679-05 .00000	.60318+02 .95650+03	.14056+03 .25139+04	.10475+05 .13514+01	.36064+07	2
-----	----	-----------------	-------------------------------------	-------------------------------------	----------------------------------	------------------------	------------------------	------------------------	-----------	---

CHEMICAL SPECIE MOLE FRACTIONS

C	0.0000	CH4	5.0652-08	CO	1.3876-01	H2	2.1957-01	H2O	3.0140-01	NH3	6.3107-06	N2	3.0187-01
CO2	3.5097-02	H	2.7646-03	NO	1.7132-04	OH	1.1562-04	O	1.3376-06	O2	1.6416-06	CH3	1.7018-08
CH2O	2.2825-08	CHO	2.7967-04										

- NOTES: (1) Typical printout for a data surface in the exhaust plume.  
(2) Some points have been omitted for demonstration purposes.

### Example Problem 6

This problem analyzes a two phase finite rate chemistry flow field with the following stipulations:

1. Free molecular calculations are not to be considered.
2. Species mole fractions on the start line are to be read from cards, and
3. The start line is to be input on cards.

Table 3-16 presents first a flow chart and then a listing of the input data for the specified problem. Table 3-17 presents a listing of the pertinent solution.

Table 3-16

REQUIRED INPUT FORMAT FOR EXAMPLE PROBLEM 6

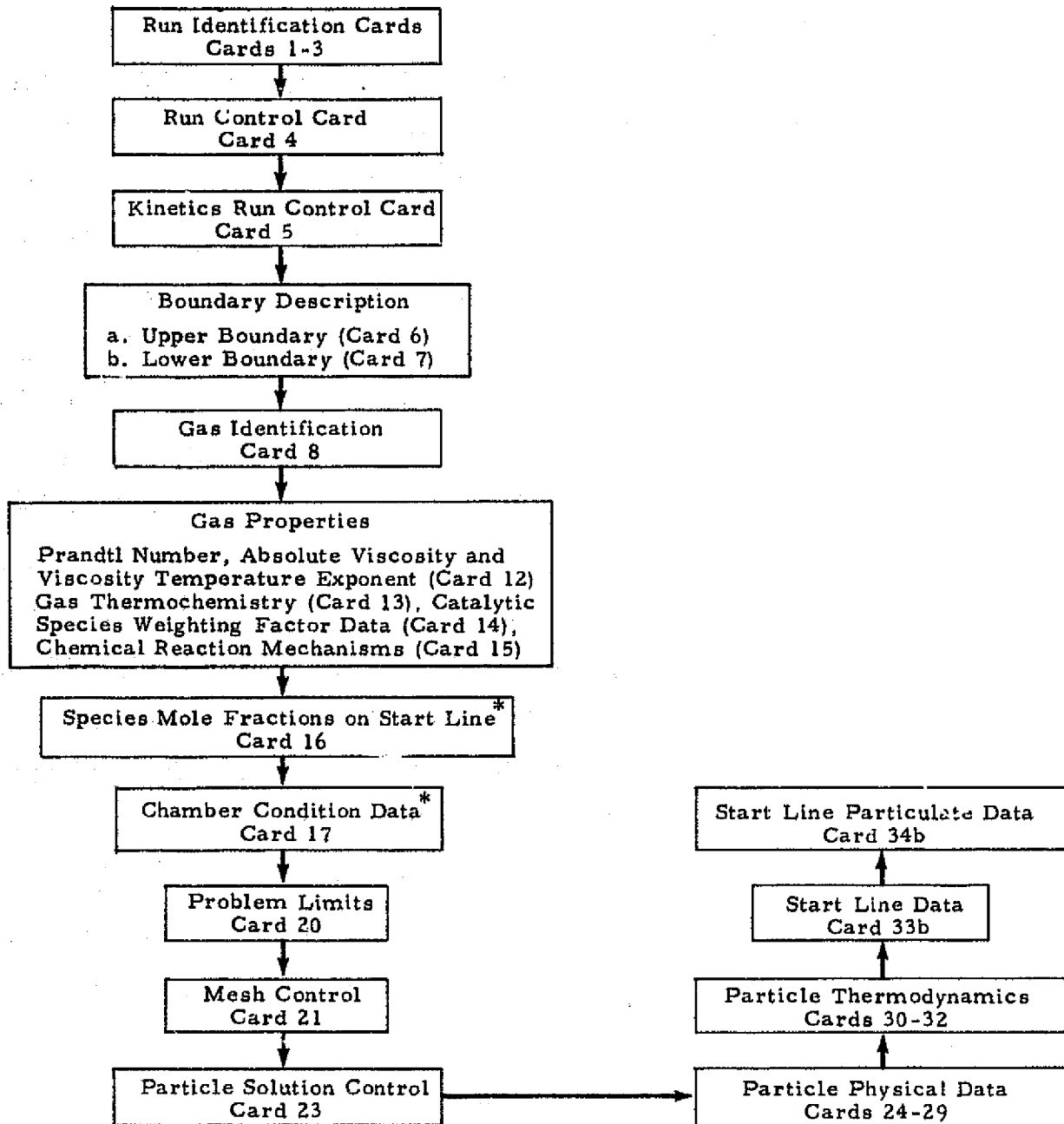

\*If species mole fractions are input on tape (ICTAPE=1) cards 16 and 17 are not required.



Table 3-16 (Continued)

1 PARTICLE (10 MICRON) -- 5000 NOZZLE (NOZT=2); NON-EQUILIBRIUM CHEMISTRY

Card	1	2	20	15	1	0	1	2	1	50	1	11	0	0011010
Card 1-3	1	0	-1.0	20.573784	0.0	-1.0	-6.80375	1.88818024						
Card 4	2	0	0.0	0.0	0.0	.45783585	1.88151307	2.3294203						
Card 5	2	0	0.0	-0.0428782	0.17935006	4.4407486	1.8040599	2.5876164						
	2	0	0.0	-0.00180724	-0.00214308	4.9818083	1.7885723	2.9172414						
	2	0	0.0	0.002544165	-0.2412752	5.88640070	1.6882159	3.5108742						
	2	0	0.0	0.00578032	-0.447274	5.5677881	1.6834728	4.4398324						
	2	0	0.0	0.00617344	-0.2509048	5.7063661	1.6709055	5.0023622						
	2	0	0.0	0.00481254	-0.2274037	5.5693793	1.7082955	6.3789701						
Card 6	2	0	0.0	0.00418498	-0.2144053	5.5462710	1.7247924	7.0572995						
	2	0	0.0	0.00329460	-0.1931032	5.5131318	1.7697172	8.2488444						
	2	0	0.0	0.00281754	-0.1800420	5.51942506	1.8056917	10.000966						
	2	0	0.0	0.00225095	-0.1624483	5.50104522	1.8696222	11.215522						
	2	0	0.0	0.00205779	-0.1555923	5.49318104	1.8996715	11.999881						
Card 7	2	1	0.0	0.0	-0.0801333	4.0097689	2.2751083	12.687039						
Card 8	2	0	579.0	1.4	1.25	0.0	0.0	1000.0						
Card 12	SHUTTLE 700 PC. MKS. 1 1													
	CO	.70	.000893	.60										
		28.011	-25.417											
		0.0	6.956	39.613	-2.072	100.0	6.956	39.613	-1.379					
	400.0	6.957	44.435	-0.663	400.0	7.013	49.488	0.711						
	800.0	7.276	52.152	2.137	800.0	7.624	54.293	3.627						
	1200.0	7.931	56.028	5.183	1200.0	8.168	57.496	6.794						
	1600.0	8.346	58.769	8.466	1600.0	8.480	59.393	10.130						
	2000.0	8.664	61.807	13.561	2000.0	8.728	62.635	15.201						
	2400.0	8.781	63.397	17.082	2400.0	8.825	63.102	18.813						
	2700.0	8.844	64.435	19.696	2700.0	8.863	64.757	20.882						
	2900.0	8.879	65.069	21.469	2900.0	8.895	65.370	22.357						
	3100.0	8.910	65.662	23.248	3200.0	8.924	65.945	24.139						
	CO2	44.00395	-94.054											
	400.0	6.956	42.758	-2.238	100.0	6.981	42.758	-1.543						
	800.0	7.734	47.769	-0.816	400.0	9.477	53.830	0.938						
	1200.0	11.310	50.126	3.087	800.0	12.293	61.522	5.453						
Card 13	1600.0	12.980	64.344	7.984	1200.0	13.466	66.756	10.632						
	2000.0	13.815	68.859	13.362	1600.0	14.074	70.722	16.152						
	2400.0	14.424	73.903	21.857	2000.0	14.547	75.284	24.755						
	2700.0	14.848	76.554	27.674	2400.0	14.734	77.736	30.613						
	2900.0	14.771	78.286	32.082	2800.0	14.807	78.824	33.567						
	3100.0	14.841	79.344	35.049	3000.0	14.873	79.846	36.535						
		14.702	80.336	38.024	3200.0	14.930	80.810	39.515						
	H	1.00797	52.100											
	400.0	4.968	21.965	-1.481	100.0	4.968	21.965	-0.984						
	800.0	4.968	25.408	-0.488	400.0	4.968	28.852	0.506						
	1200.0	4.968	30.867	1.800	800.0	4.968	32.296	2.493						
	1600.0	4.968	33.404	3.487	1200.0	4.968	34.310	4.481						
	2000.0	4.968	35.076	5.474	1600.0	4.968	35.739	6.468						
	2400.0	4.968	36.846	8.455	2000.0	4.968	37.322	9.449						
	2700.0	4.968	37.754	10.442	2400.0	4.968	38.152	11.436						
	2900.0	4.968	38.339	11.933	2800.0	4.968	38.520	12.430						
	3100.0	4.968	38.694	12.926	3000.0	4.968	38.862	13.423						
		4.968	39.025	13.920	3200.0	4.968	39.183	14.417						
	H	0.018	0.0											
		5.393	24.367	-2.024	100.0	5.393	24.367	-1.265						

3-387

REPRODUCIBILITY OF THE ORIGINAL PAGE IS POOR

Table 3-16 (Continued)

	200.0	6.514	28.520	-0.602	400.0	6.975	33.247	0.707
	500.0	7.209	36.082	2.106	800.0	7.087	38.107	3.514
	1000.0	7.219	39.702	4.944	1200.0	7.390	41.033	6.404
	1400.0	7.800	42.187	7.902	1600.0	7.823	43.217	9.446
	2000.0	8.195	45.004	12.651	2200.0	8.353	45.793	14.307
	2400.0	8.506	46.527	15.993	2600.0	8.639	47.213	17.708
	2700.0	8.700	47.540	18.575	2800.0	8.757	47.857	19.448
	2900.0	8.810	48.165	20.325	3000.0	8.859	48.465	21.210
	3100.0	8.911	48.755	22.095	3200.0	8.952	49.040	22.992
H20	18.016		-57.7979					
	.0	7.461	36.396	-2.367	100.0	7.961	36.396	-1.581
	200.0	7.959	41.910	-0.764	400.0	8.185	47.484	0.825
	500.0	8.676	50.891	2.509	800.0	9.246	53.464	4.300
	1000.0	9.851	55.592	6.207	1200.0	10.444	57.441	8.240
	1400.0	10.967	59.092	10.304	1600.0	11.462	60.591	12.630
	2000.0	12.214	63.234	17.373	2200.0	12.505	64.412	19.846
	2400.0	12.753	65.511	22.372	2600.0	12.965	66.541	24.945
	2700.0	13.059	67.034	26.246	2800.0	13.146	67.508	27.556
	2900.0	13.228	67.971	28.875	3000.0	13.304	68.421	30.201
	3100.0	13.374	68.858	31.535	3200.0	13.441	69.284	32.876
0	16.000		59.559					
	.0	5.666	22.465	-1.608	100.0	5.666	32.466	-1.080
	200.0	5.434	36.340	-0.523	400.0	5.135	39.991	0.525
	500.0	5.049	42.054	1.544	800.0	5.015	43.501	2.550
	1000.0	4.999	44.619	3.552	1200.0	4.990	45.529	4.551
	1400.0	4.984	46.295	5.548	1600.0	4.981	46.963	6.544
	2000.0	4.971	48.074	8.536	2200.0	4.979	48.544	9.532
	2400.0	4.981	48.982	10.527	2600.0	4.986	49.381	11.524
	2700.0	4.990	49.569	12.023	2800.0	4.994	49.751	12.522
Cards 13	2900.0	4.999	49.920	13.022	3000.0	5.004	50.096	13.522
(Cont'd)	3100.0	5.010	50.260	14.023	3200.0	5.017	50.419	14.524
OH	17.0074		9.432					
	.0	7.798	35.720	-2.192	100.0	7.798	35.720	-1.467
	200.0	7.356	40.985	-0.711	400.0	7.087	45.974	0.725
	500.0	7.057	48.837	2.137	800.0	7.150	50.877	3.556
	1000.0	7.332	52.491	5.003	1200.0	7.549	53.847	6.491
	1400.0	7.766	55.027	8.023	1600.0	7.963	56.077	9.596
	2000.0	8.266	57.891	12.849	2200.0	8.415	58.666	14.520
	2400.0	8.526	59.424	16.214	2600.0	8.622	60.110	17.929
	2700.0	8.665	60.436	18.794	2800.0	8.706	60.752	19.662
	2900.0	8.744	61.058	20.535	3000.0	8.780	61.355	21.411
	3100.0	8.814	61.644	22.291	3200.0	8.846	61.924	23.174
02	32.000		0.0					
	.0	6.958	41.395	-2.075	100.0	6.958	41.395	-1.381
	200.0	6.961	46.218	-0.665	400.0	7.196	51.091	0.724
	500.0	7.670	54.098	2.210	800.0	8.063	56.361	3.786
	1000.0	8.336	58.192	5.427	1200.0	8.527	59.729	7.114
	1400.0	8.674	61.055	8.835	1600.0	8.800	62.222	10.583
	2000.0	9.029	64.210	14.149	2200.0	9.139	65.076	15.966
	2400.0	9.293	65.876	17.504	2600.0	9.354	66.620	19.664
	2700.0	9.405	66.974	20.602	2800.0	9.455	67.317	21.545
	2900.0	9.503	67.650	22.493	3000.0	9.551	67.973	23.440
	3100.0	9.596	68.287	24.403	3200.0	9.640	68.592	25.365
CL	35.457		28.922					
	.0	4.969	33.955	-1.499	100.0	4.969	33.955	-1.002
	200.0	5.035	37.412	-0.503	400.0	5.370	41.013	0.540
	500.0	5.445	43.212	1.625	800.0	5.389	44.772	2.710
	1000.0	5.514	45.967	3.760	1200.0	5.249	46.930	4.830

Table 3-16 (Continued)

1000.0	5.197	47.795	1.000	1000.0	5.155	48.425	0.915
2000.0	5.101	49.570	0.900	2000.0	5.081	49.055	0.904
3000.0	5.066	50.497	10.999	3000.0	5.053	50.002	12.011
2700.0	5.048	51.092	12.516	2800.0	5.043	51.076	13.020
2500.0	5.038	51.453	13.524	3000.0	5.034	51.623	14.022
3100.0	5.031	51.788	14.531	3200.0	5.027	51.948	15.024
CL2	70.906	0.0					
.0	7.001	45.150	-2.194	100.0	7.001	45.150	-1.498
200.0	7.576	50.156	-0.772	400.0	6.437	55.724	0.845
600.0	8.741	59.212	2.557	800.0	6.078	61.747	4.331
1000.0	8.956	63.737	6.115	1200.0	5.010	65.575	7.912
1400.0	9.051	66.767	9.719	1600.0	5.086	67.978	11.537
2000.0	9.149	70.013	15.179	2000.0	5.184	70.500	17.012
2400.0	9.223	71.687	18.552	2400.0	5.265	72.427	20.701
2700.0	9.293	72.777	21.029	2600.0	5.319	73.116	22.560
2900.0	9.346	73.443	23.493	3000.0	5.374	73.760	24.429
3100.0	9.403	74.068	25.958	3200.0	5.432	74.367	26.310
HCL	36.465	-22.063					
.0	6.959	37.041	-2.065	100.0	6.959	37.041	-1.375
200.0	6.961	41.865	-0.683	400.0	6.973	46.693	0.710
600.0	7.069	49.534	2.112	800.0	7.280	51.595	3.546
1000.0	7.559	53.250	5.030	1200.0	7.519	54.652	6.369
1400.0	8.043	55.875	8.155	1600.0	8.229	58.961	9.783
2000.0	8.509	58.830	13.139	2000.0	8.614	59.646	14.547
2400.0	8.703	60.399	16.579	2600.0	8.778	61.099	18.327
2700.0	8.812	61.431	19.207	2800.0	8.844	61.752	20.090
2900.0	8.876	62.063	20.976	3000.0	8.902	62.364	21.884
3100.0	8.928	62.656	22.756	3200.0	8.953	62.940	23.650
N2	28.0134	0.0					
.0	6.956	38.170	-2.072	100.0	6.956	38.170	-1.379
200.0	6.957	42.992	-0.683	400.0	6.990	47.618	0.710
600.0	7.196	50.685	2.125	800.0	7.512	52.795	3.546
1000.0	7.815	54.507	5.129	1200.0	8.061	55.955	6.718
1400.0	8.232	57.212	8.350	1600.0	8.398	58.324	10.015
2000.0	8.601	60.222	13.410	2000.0	8.672	61.045	15.146
2400.0	8.731	61.502	16.886	2600.0	8.779	62.503	18.638
2700.0	8.800	62.832	19.517	2800.0	8.820	63.155	20.398
2900.0	8.838	63.465	21.230	3000.0	8.855	63.765	22.165
3100.0	8.871	64.055	23.001	3200.0	8.886	64.337	23.939

Cards 13  
(Cont'd)

Cards 14	M1	1.0	2.0	1.0	1.0	3.0	1.0	1.0	1.0	1.0	1.0	1.0
	M2	1.0	3.0	20.0	1.0	10.0	1.0	1.0	1.0	1.0	1.0	1.0
	M3	1.0	3.0	1.0	1.0	10.0	1.0	1.0	20.0	1.0	1.0	1.0

Cards 15	H	+UH	+M1	=H20	+M1				22	6.10-26	2.0	0.0
	U	+H	+M1	=UH	+M1				21	2.00-32	0.0	0.0
	O	+U	+M1	=O2	+M1				24	3.00-30	1.0	-340.0
	H	+H	+M2	=H2	+M2				22	2.00-30	1.0	0.0
	CO	+O	+M3	=CO2	+M3				23	2.00-33	0.0	-4000.0
	H	+CL	+M1	=HCL	+M1				22	1.10-31	1.0	0.0
	OH	+H		=H2	+O				14	1.40-14-1.0		-7000.0
	OH	+O		=H	+O2				11	4.00-11	0.0	0.0
	OH	+H2		=H20	+H				14	1.00-17-2.0		-2900.0
	OH	+CO		=CO2	+H				14	1.10-19-2.0		1600.0
	OH	+OH		=H20	+O				13	1.00-11	0.0	-1100.0
	OH	+HCL		=H20	+CL				13	1.00-14-1.0		-1000.0
	O	+HCL		=OH	+CL				13	2.00-12	0.0	-4500.0

Table 3-16 (Concluded)

Card	CL	+CL2 +M2	=HCL +H	+CL +H		13 2.00-10 0.0	-2400.0	
Cards 15 (Cont'd)						13 5.00-11 0.0	-5260.0	
Card 16		.25335	.01855	.02760	.28554	.15900	.00033	.00570
Card 17		.30057	.00975	.00001	.14952	.09014		
Card 20								
Card 21								
Card 23								
Card 24								
Card 25								
Card 26								
Card 27								
Card 28								
Card 29								
Card 30								
Card 31								
Card 32								
Cards 33b								
Cards 34b								

3-310

Table 3-17

EXAMPLE PROBLEM 6 PERTINENT SOLUTION

TWO PHASE CHECK CASE USING NON-EQUILIBRIUM PROGRAM

DATE 100475

PAGE 1

SUPERSONIC FLOW ANALYSIS USING THE LOCKHEED-HUNTSVILLE MULTIPLE SHOCK COMPUTER PROGRAM

GAS-PARTICLE FLOW SOLUTION

CASE NO. 1

PAGE 1

1 PARTICLE(10MICRON)--SRM NOZZLE(RC/RT=2), NON-EQUILIBRIUM CHEMISTRY

RUN CONTROL PARAMETERS

ICON(1)	ICON(2)	ICON(3)	ICON(4)	ICON(5)	ICON(6)	ICON(7)	ICON(8)
3	2	20	15	1	0	1	2
ICON(9)	ICON(10)	ICON(11)	ICON(12)	ICON(13)	ICON(14)	ICON(15)	ICON(16)
0	SE	1	1	0	0	0	TOTO

FLOW CALCULATIONS ARE IN ENGLISH UNITS WITH THE R-X COORDINATES IN FEET

THE FLOW FIELD DATA WILL NOT BE WRITTEN ON TAPE

UPPER BOUNDARY

TYPE	ITRANS	A	B	C	D	E	MAX
1	0	.10000+01	.20574+02	.00000	.10000+01	.00000	.18882+01
2	0	.00000	.00000	.00000	.45784+00	.18151+01	.23294+01
2	0	.00000	.42678+02	.17936+01	.44907+00	.18041+01	.25876+01
2	0	.00000	.18072+02	.21431+02	.49816+00	.17556+01	.29192+01
2	0	.00000	.54416+03	.24129+01	.56640+00	.16852+01	.35108+01
2	0	.00000	.57633+03	.24493+01	.56779+00	.16835+01	.44396+01
2	0	.00000	.61760+03	.25090+01	.57064+00	.16790+01	.55024+01
2	0	.00000	.48125+03	.22720+01	.55694+00	.17053+01	.63770+01
2	0	.00000	.41850+03	.21441+01	.54827+00	.17248+01	.76373+01
2	0	.00000	.32946+03	.19310+01	.53131+00	.17697+01	.86488+01
2	0	.00000	.20175+03	.18004+01	.51943+00	.18057+01	.10081+02
2	0	.00000	.22569+03	.16245+01	.50105+00	.18496+01	.11216+02
2	0	.00000	.25578+03	.15559+01	.49318+00	.18997+01	.12000+02
2	1	.00000	.00000	.80133+02	.40098+00	.22751+01	.12667+02
3	0	.57900+03	.14800+01	.12500+01	.00000	.00000	.10000+04

LOWER BOUNDARY

TYPE	ITRANS	A	B	C	D	E	MAX
2	0	.00000	.00000	.00000	.00000	.00000	.10000+04

LOCKHEED - HUNTSVILLE RESEARCH & ENGINEERING CENTER

3-311

Table 3-17 (Continued)

REPRODUCIBILITY OF THE ORIGINAL PAGE IS POOR

TWO PHASE CHECK CASE USING NON-EQUILIBRIUM PROGRAM

DATE 100475

PAGE 2

SPECIE THERMODYNAMIC AND REACTION DATA

NT,NS,NR,NM,ICTAPE,KGUP,ITDIO= 20 12 15 3 0 0 0

PRANDTL NUMBER = .7000000E+00  
 BASE VISCOSITY = .18651198-05  
 EXPONENT = .6000000E+00

REACTIONS BEING CONSIDERED						KR=A*EXP(B/RT00H)/T00N	A	N	B	H	R-TYPE	K-TYPE
1	H	+ OH	+ H1	= H2O	+ H1	2.214+22	2.0	.0	.0	2	2	
2	O	+ H	+ H1	= OH	+ H1	7.260+15	.0	.0	.0	2	1	
3	O	+ O	+ H1	= O2	+ H1	1.379+18	1.0	-340.0	.0	2	4	
4	H	+ H	+ H2	= H2	+ H2	1.016+18	1.0	.0	.0	2	2	
5	CO	+ O	+ H3	= CO2	+ H3	7.260+14	.0	-4000.0	.0	2	3	
6	H	+ CL	+ H1	= HCL	+ H1	3.993+16	1.0	.0	.0	2	2	
7	OH	+ H		= H2	+ O	8.435+09	-1.0	-7000.0	.0	1	4	
8	OH	+ O		= H	+ O2	2.410+13	.0	.0	.0	1	1	
9	OH	+ H2		= H2O	+ H	6.025+06	-2.0	-2900.0	.0	1	4	
10	OH	+ CO		= CO2	+ H	6.627+04	-2.0	1600.0	.0	1	4	
11	OH	+ OH		= H2O	+ O	6.025+12	.0	-1100.0	.0	1	3	
12	OH	+ HCL		= H2O	+ CL	6.025+09	-1.0	-1000.0	.0	1	4	
13	O	+ HCL		= OH	+ CL	1.295+12	.0	-4500.0	.0	1	3	
14	H	+ CL2		= HCL	+ CL	1.205+14	.0	-2400.0	.0	1	3	
15	CL	+ H2		= HCL	+ H	4.820+13	.0	-5260.0	.0	1	3	

3-312

CATALYTIC SPECIES BEING CONSIDERED

M1	= 1.00 CO	, 2.00 CO2	, 1.00 H	, 1.00 H2	, 3.00 H2O	, 1.00 O	, 1.00 OH	
	1.00 O2	, 1.00 CL	, 1.00 CL2	, 1.00 HCL	, 1.00 N2			
M2	= 1.00 CO	, 3.00 CO2	, 20.00 H	, 1.00 H2	, 10.00 H2O	, 1.00 O	, 1.00 OH	
	1.00 O2	, 1.00 CL	, 1.00 CL2	, 1.00 HCL	, 1.00 N2			
M3	= 1.50 CO	, 3.00 CO2	, 1.00 H	, 1.00 H2	, 10.00 H2O	, 1.00 O	, 1.00 OH	
	20.00 O2	, 1.00 CL	, 1.00 CL2	, 1.00 HCL	, 1.00 N2			

SPECIE MOLE FRACTIONS ON THE START LINE ARE READ FROM CARDS

POINT	CO	CO2	H	H2	H2O	O	OH	O2	CL	CL2
1	.25335+00	.18930-01	.27400-01	.28554+00	.15706+00	.32000-03	.57009-02	.70000-04	.97500-02	.10000-04
1	HCL	N2								
	.14952+00	.90140-01								

CHAMBER PRESSURE (ATM) = .37697+02 CHAMBER TEMPERATURE (DEG-K) = .33910+04

THERE ARE 1 PARTICLE SPECIES PRESENT IN THE GAS-PARTICLE MIXTURE

RUN CUTOFF INFORMATION

UPPER BOUNDARY LOWER BOUNDARY  
 R# .10000+03 X# .37697+02 THETA# .0000 R# .00000 X# .50000+02 THETA# .90000+02

LOCKHEED - HUNTSVILLE RESEARCH & ENGINEERING CENTER

Table 3-17 (Continued)

TWO PHASE CHECK CASE USING NON-EQUILIBRIUM PROGRAM

DATE 100475

PAGE 3

PARTICLE PHYSICAL DATA				
SPECIE	RADIUS	MASS DENSITY	EMISSIVITY	ACCH. COEFF.
1	.10000+02	.25000+03	.00000	.00000

THE PARTICLES CONSTITUTE 40.28 PERCENT BY WEIGHT FLOW OF THE GAS-PARTICLE MIXTURE

THE INDIVIDUAL PERCENTAGES ARE 1.00

THE PARTICLE TEMPERATURE-ENTHALPY TABLE WILL BE READ IN WITH ENGLISH UNITS

Table 3-17 (Continued)

TWO PHASE CHECK CASE USING NON-EQUILIBRIUM PROGRAM	DATE 800475	PAGE 4
SUPERSONIC FLOW ANALYSIS USING THE LOCKNEED-MUNTSVILLE MULTIPLE SHOCK COMPUTER PROGRAM		
GAS-PARTICLE FLOW SOLUTION		
CASE NO. 1		PAGE 2
1 PARTICLE (10MICRON)--SRM NOZZLE (RC/RT=2), NON-EQUILIBRIUM CHEMISTRY		
PARTICLE TEMPERATURE-ENTHALPY TABLE		
PHASE CHANGE DATA *** TMELT= .417008+04 HSOLID= .278514+08 HLIQUID= .903481+08		
CPHELT= .84971+04 CPSOLID= .66976+04		

3-314



Table 3-17 (Continued)

TWO PHASE CHECK CASE USING NON-EQUILIBRIUM PROGRAM

DATE 100475

PAGE 5

SUPERSONIC FLOW ANALYSIS USING THE LOCKHEED-HUNTSVILLE MULTIPLE SHOCK COMPUTER PROGRAM

GAS PARTICLE FLOW SOLUTION

CASE NO. 1

PAGE 3

1 PARTICLE (10MICRON)--SRH NOZZLE (RC/RT=2), NON-EQUILIBRIUM CHEMISTRY

PARTICLE DRAG TABLE

I	RE	DRAG COEF
1	.0000	.1000+01
2	.1250+01	.1000+01
3	.1255+01	.1000+01
4	.1260+01	.1001+01
5	.1265+01	.1002+01
6	.1582+01	.1063+01
7	.1995+01	.1141+01
8	.2510+01	.1224+01
9	.3160+01	.1315+01
10	.3980+01	.1412+01
11	.5010+01	.1517+01
12	.6310+01	.1625+01
13	.7950+01	.1745+01
14	.1000+02	.1874+01
15	.1260+02	.2026+01
16	.1582+02	.2186+01
17	.1995+02	.2364+01
18	.2510+02	.2555+01
19	.3160+02	.2769+01
20	.3980+02	.3009+01
21	.5010+02	.3292+01
22	.6310+02	.3520+01
23	.7950+02	.3825+01
24	.1000+03	.4155+01
25	.3160+03	.7980+01
26	.1000+04	.2000+02
27	.1000+04	.2000+02
28	.1000+04	.2000+04

Table 3-17 (Continued)

TWO PHASE CHECK CASE USING NON-EQUILIBRIUM PROGRAM

DATE 100475

PAGE 6

SUPERSONIC FLOW ANALYSIS USING THE LOCKHEED-HUNTSVILLE MULTIPLE SHOCK COMPUTER PROGRAM

GAS-PARTICLE FLOW SOLUTION

CASE NO. 1

PAGE 4

1 PARTICLE (10 MICRON) -- SRM NOZZLE (RC/RT=2), NON-EQUILIBRIUM CHEMISTRY

THE MESH CONSTRUCTION WILL BE CONTROLLED BY THE FOLLOWING VARIABLES

DL INTERIOR = .200+31 DX AXIS = .200+00 DL LIM = .305+00 DL DELETE = .200-02 DEG P.W. = .400+01 F = .375+00

Table 3-17 (Continued)

TWO PHASE CHECK CASE USING NON-EQUILIBRIUM PROGRAM

DATE 100975

PAGE 7

SUPERSONIC FLOW ANALYSIS USING THE LOCKHEED-HUNTSVILLE MULTIPLE SHOCK COMPUTER PROGRAM

GAS-PARTICLE FLOW SOLUTION  
CASE NO. 1

PAGE 5

1 PARTICLE (10MICRON)--SRM NOZZLE (RC/RT=2), NON-EQUILIBRIUM CHEMISTRY

LINE POINT	DSCRIP - REGIME	R MACH ANGLE	X PRESSURE	M DENSITY	THETA TEMPERATURE	ENTROPY GAS CONST.	VELOCITY LOCAL GAMMA	H-TOTAL SHOCK ANGLE	ITR				
PARTICLE DATA		Y	THETA	D H	ENTHALPY	DENSITY	TEMPERATURE						
SPECIE POINT	DESCRIPTION												
1	1 INPUT CONTIN	.00000	.47463+00	.11001+01	.22446+00	.00000	.45975+04	.20983+08	0				
		.65369+02	.23736+03	.24693+02	.55195+04	.25078+04	.12618+01						
PARTICLE DATA		.351177+04	.98000	.25980+00	.52657+08	.10284+02	.56186+04						
CHEMICAL SPECIE MOLE FRACTIONS													
CO	2.5335-01	CO2	1.8937-02	H	2.7600-02	H2	2.8554-01	H2O	1.5906-01	0	3.3000-04	OH	5.7000-03
O2	7.0000-05	CL	9.7597-03	CL2	1.0000-05	HCL	1.4952-01	N2	9.0140-02				
1	2 INPUT CONTIN	.12067+00	.47463+00	.11001+01	.31613+00	.00000	.45975+04	.20983+08	0				
		.65369+02	.23736+03	.24693+02	.55195+04	.25078+04	.12618+01						
PARTICLE DATA		.351177+04	-.16577+00	.25980+00	.52657+08	.10284+02	.56186+04						
CHEMICAL SPECIE MOLE FRACTIONS													
CO	2.5335-01	CO2	1.8937-02	H	2.7600-02	H2	2.8554-01	H2O	1.5906-01	0	3.3000-04	OH	5.7000-03
O2	7.0000-05	CL	9.7597-03	CL2	1.0000-05	HCL	1.4952-01	N2	9.0140-02				
1	3 INPUT CONTIN	.24135+00	.47463+00	.11001+01	.63225+00	.00000	.45975+04	.20983+08	0				
		.65369+02	.23736+03	.24693+02	.55195+04	.25078+04	.12618+01						
PARTICLE DATA		.351177+04	-.33155+00	.25980+00	.52657+08	.10284+02	.56186+04						
CHEMICAL SPECIE MOLE FRACTIONS													
CO	2.5335-01	CO2	1.8937-02	H	2.7600-02	H2	2.8554-01	H2O	1.5906-01	0	3.3000-04	OH	5.7000-03
O2	7.0000-05	CL	9.7597-03	CL2	1.0000-05	HCL	1.4952-01	N2	9.0140-02				
1	4 INPUT CONTIN	.36202+00	.47463+00	.11001+01	.94838+00	.00000	.45975+04	.20983+08	0				
		.65369+02	.23736+03	.24693+02	.55195+04	.25078+04	.12618+01						
PARTICLE DATA		.351177+04	-.49732+00	.25980+00	.52657+08	.10284+02	.56186+04						
CHEMICAL SPECIE MOLE FRACTIONS													
CO	2.5335-01	CO2	1.8937-02	H	2.7600-02	H2	2.8554-01	H2O	1.5906-01	0	3.3000-04	OH	5.7000-03
O2	7.0000-05	CL	9.7597-03	CL2	1.0000-05	HCL	1.4952-01	N2	9.0140-02				

NOTES: (1) Typical printout for the startline data surface.  
(2) Some points have been omitted for demonstration purposes.

LOCKHEED-HUNTSVILLE RESEARCH & ENGINEERING CENTER

3-317

Table 3-17 (Continued)

TWO PHASE CHECK CASE USING NON-EQUILIBRIUM PROGRAM

DATE 100475

PAGE 21

SUPERSONIC FLOW ANALYSIS USING THE LOCKHEED-HUNTSVILLE MULTIPLE SHOCK COMPUTER PROGRAM

GAS-PARTICLE FLOW SOLUTION  
CASE NO. 1

PAGE 17

1 PARTICLE (10MICRONI)--SRM NOZZLE (RC/RT=2), NON-EQUILIBRIUM CHEMISTRY

LINE POINT	DSCRIP - REGIME	R	X	M	THETA	ENTROPY	VELOCITY	H-TOTAL	I <sub>TR</sub>			
		MACH ANGLE	PRESSURE	DENSITY	TEMPERATURE	GAS CONST.	LOCAL GAMMA	SHOCK ANGLE				
PARTICLE DATA												
SPECIE POINT	DESCRIPTION	V	THETA	D	H	ENTHALPY	DENSITY	TEMPERATURE				
12	1 WALL - CONTIN	.00000	.75856+00	.10972+01	.00000	.35507+02	.45804+04	.20483+08	4			
		.65703+02	.23215+03	.24191+02	.55191+04	.25039+04	.12613+01					
	PARTICLE DATA											
	1 1	.377147+04	.30600	.19381+00	.52442+08	.96507-03	.55934+04					
	CHEMICAL SPECIE MOLE FRACTIONS											
CO	2.5347-01 CO2	1.9240-02	H	2.5783-02	H2	2.8655-01	H2O	1.5974-01	0	2.7828-04	OH	5.0653-03
O2	6.2410-05	CL	9.2317-03	CL2	1.1623-05	HCL	1.5029-01	N2	9.0283-02			
3-318	12 2 INTER - CONTIN	.12214+00	.75626+00	.10971+01	.28146+00	.35481+02	.45804+04	.20483+08	5			
		.65710+02	.23217+03	.24193+02	.55192+04	.25039+04	.12613+01					
	PARTICLE DATA											
	1 2	.377122+04	.30092+01	.19382+00	.52443+08	.96504-03	.55934+04					
	CHEMICAL SPECIE MOLE FRACTIONS											
CO	2.5347-01 CO2	1.9240-02	H	2.5786-02	H2	2.8655-01	H2O	1.5974-01	0	2.7836-04	OH	5.0661-03
O2	6.2428-05	CL	9.2328-03	CL2	1.1625-05	HCL	1.5029-01	N2	9.0283-02			
	12 3 INTER - CONTIN	.24427+00	.75536+00	.10970+01	.56349+00	.35423+02	.45801+04	.20484+08	5			
		.65720+02	.23221+03	.24196+02	.55193+04	.25039+04	.12613+01					
	PARTICLE DATA											
	1 3	.377057+04	.30391-01	.19390+00	.52443+08	.96511-03	.55935+04					
	CHEMICAL SPECIE MOLE FRACTIONS											
CO	2.5347-01 CO2	1.9241-02	H	2.5789-02	H2	2.8655-01	H2O	1.5974-01	0	2.7854-04	OH	5.0670-03
O2	6.2447-05	CL	9.2338-03	CL2	1.1627-05	HCL	1.5028-01	N2	9.0282-02			
	12 4 INTER - CONTIN	.36639+00	.75386+00	.10969+01	.84617+00	.35322+02	.45796+04	.20486+08	5			
		.65738+02	.23227+03	.24202+02	.55195+04	.25039+04	.12613+01					
	PARTICLE DATA											
	1 4	.376949+04	.31734-01	.19403+00	.52445+08	.96531-03	.55936+04					
	CHEMICAL SPECIE MOLE FRACTIONS											
CO	2.5347-01 CO2	1.9239-02	H	2.5795-02	H2	2.8654-01	H2O	1.5973-01	0	2.7859-04	OH	5.0687-03
O2	6.2460-05	CL	9.2357-03	CL2	1.1630-05	HCL	1.5028-01	N2	9.0282-02			

NOTES: (1) Typical printout for a data surface inside the nozzle.  
(2) Some points have been omitted for demonstration purposes.

LOCKHEED-HUNTSVILLE RESEARCH & ENGINEERING CENTER

Table 3-17 (Continued)

PHASE CHECK CASE USING NON-EQUILIBRIUM PROGRAM

DATE 100475

PAGE 25

SUPERSONIC FLOW ANALYSIS USING THE LOCKHEED-HUNTSVILLE MULTIPLE SHOCK COMPUTER PROGRAM

GAS-PARTICLE FLOW SOLUTION

CASE NO. 1

PAGE 21

1 PARTICLE (IONICRON) -- SRM NOZZLE (RC/RT=2), NON-EQUILIBRIUM CHEMISTRY

LINE POINT	DSCHP = REGIME	R	X	M	THETA	ENTROPY	VELOCITY	M-TOTAL	STR
		MACH ANGLE	PRESSURE	DENSITY	TEMPERATURE	GAS CONST.	LOCAL GAMMA	SHOCK ANGLE	
PARTICLE DATA									
14	16 INTER = CONTIN	.56191+01	.12693+02	.27997+01	.10488+02	.00000	.91296+04	.21706+08	4
		.20927+02	.14112+02	.24475-03	.33782+04	.24579+04	.12793+01		
PARTICLE DATA									
NO PARTICLES ARE PRESENT AT THIS POINT									
CHEMICAL SPECIE MOLE FRACTIONS									
0	2.4864-01 CO2	2.9186-02 H	2.8396-03 H2	3.0614-01 H2O	1.5858-01 O	8.1234-07 OH	1.1580-04		
2	1.8785-07 CL	1.1474-03 CL2	1.1289-07 HCL	1.6137-01 N2	9.1976-02				
-----									
3-319	17 INTER = CONTIN	.58380+01	.12652+02	.27815+01	.10873+02	.00000	.90945+04	.21686+08	4
		.21070+02	.14580+02	.25115+03	.34011+04	.24578+04	.12788+01		
PARTICLE DATA									
NO PARTICLES ARE PRESENT AT THIS POINT									
CHEMICAL SPECIE MOLE FRACTIONS									
0	2.4800-01 CO2	2.9025-02 H	2.8188-03 H2	3.0596-01 H2O	1.5875-01 O	8.2101-07 OH	1.1629-04		
2	1.8973-07 CL	1.1375-03 CL2	1.2263-07 HCL	1.6139-01 N2	9.1978-02				
-----									
14	18 WALL = CONTIN	.60685+01	.12667+02	.27670+01	.11198+02	.00000	.90661+04	.21595+08	4
		.21186+02	.14980+02	.25690-03	.34164+04	.24578+04	.12785+01		
PARTICLE DATA									
NO PARTICLES ARE PRESENT AT THIS POINT									
CHEMICAL SPECIE MOLE FRACTIONS									
0	2.4840-01 CO2	2.8927-02 H	2.7838-03 H2	3.0591-01 H2O	1.5885-01 O	8.1384-07 OH	1.1898-04		
2	1.8793-07 CL	1.1224-03 CL2	1.2940-07 HCL	1.6141-01 N2	9.1979-02				
-----									
14	19 PRN=HR = CONTIN	.60685+01	.12667+02	.28952+01	.14518+02	.00000	.92668+04	.21595+08	4
		.20210+02	.11877+02	.21397+03	.32520+04	.24578+04	.12817+01		
PARTICLE DATA									
NO PARTICLES ARE PRESENT AT THIS POINT									
CHEMICAL SPECIE MOLE FRACTIONS									
0	2.4070-01 CO2	2.8927-02 H	2.7838-03 H2	3.0591-01 H2O	1.5885-01 O	8.1384-07 OH	1.1898-04		
2	1.8793-07 CL	1.1224-03 CL2	1.2940-07 HCL	1.6141-01 N2	9.1979-02				

NOTES: (1) Typical printout for a data surface containing a Prandtl-Meyer Expansion.  
 (2) Some points have been omitted for demonstration purposes.

LOCKHEED-HUNTSVILLE RESEARCH & ENGINEERING CENTER

Table 3-17 (Concluded)

TWO PHASE CHECK CASE USING NON-EQUILIBRIUM PROGRAM											DATE 100975	PAGE 42
SUPERSONIC FLOW ANALYSIS USING THE LOCKHEED-HUNTSVILLE MULTIPLE SHOCK COMPUTER PROGRAM												
GAS-PARTICLE FLOW SOLUTION												
CASE NO. 1											PAGE 38	
1 PARTICLE(10MICRON)--SRM NOZZLE(RC/RT=2), NON-EQUILIBRIUM CHEMISTRY												
LINE POINT	OSCHIP - REGIME	R	X	M	THETA	ENTROPY	VELOCITY	M-TOTAL	ITR			
		MACH ANGLE	PRESSURE	DENSITY	TEMPERATURE	GAS CONST.	LOCAL GAMMA	SHOCK ANGLE				
PARTICLE DATA												
SPECIE POINT	DESCRIPTION	V	THETA	D	H	ENTHALPY	DENSITY	TEMPERATURE				
17	1 WALL - CONTIN	.00000	.13734+02	.25946+01	.00000	.11737+03	.85038+04	.17024+08	3			
		.22670+02	.66679+01	.11434-03	.34107+04	.24622+04	.12791+01					
		.774589+04	.00000	.23124+00	.39259+08	.62302-04	.91700+04					
CHEMICAL SPECIE MOLE FRACTIONS												
0	2.4797-01 CO2	2.9378-02 H	5.2823-03 H2	3.0515-01 H2O	1.5793-01 O	2.8732-06 OH	2.1999-04					
2	6.541-07 CL	2.1216-03 CL2	1.1801-07 HCL	1.6012-01 N2	9.1819-02							
17	20 FREEBD - CONTIN	.62558+01	.13077+02	.33207+01	.24502+02	.61533+00	.98356+04	.21588+08	6			
		.17526+02	.55336+01	.11739-03	.27619+04	.24578+04	.12924+01					
PARTICLE DATA												
NO PARTICLES ARE PRESENT AT THIS POINT												
CHEMICAL SPECIE MOLE FRACTIONS												
0	2.4879-01 CO2	2.9037-02 H	2.7775-03 H2	3.0602-01 H2O	1.5881-01 O	3.5230-07 OH	4.5175-05					
2	1.5190-07 CL	1.1952-03 CL2	7.0311-09 HCL	1.6134-01 N2	9.1980-02							
19	1 WALL - CONTIN	.00000	.13770+02	.25947+01	.00000	.12106+03	.85039+04	.17022+08	3			
		.22668+02	.66557+01	.11414-03	.34105+04	.24622+04	.12791+01					
		.774920+04	.00000	.23029+00	.39237+08	.62024-04	.91700+04					
CHEMICAL SPECIE MOLE FRACTIONS												
0	2.4796-01 CO2	2.9391-02 H	5.2800-03 H2	3.0517-01 H2O	1.5792-01 O	2.8694-06 OH	2.1980-04					
2	6.5400-07 CL	2.1205-03 CL2	1.1870-07 HCL	1.6012-01 N2	9.1819-02							
18	20 FREEBD - CONTIN	.62705+01	.13110+02	.33214+01	.24445+02	.92792+00	.98364+04	.21588+08	6			
		.17522+02	.55270+01	.11720+03	.27612+04	.24578+04	.12924+01					
PARTICLE DATA												
NO PARTICLES ARE PRESENT AT THIS POINT												
CHEMICAL SPECIE MOLE FRACTIONS												
0	2.4878-01 CO2	2.9049-02 H	2.7769-03 H2	3.0603-01 H2O	1.5880-01 O	3.5164-07 OH	4.5097-05					
2	1.4873-07 CL	1.1950-03 CL2	6.9473-09 HCL	1.6134-01 N2	9.1980-02							

NOTES: (1) Typical printout for a data surface in the exhaust plume.  
 (2) Some points have been omitted for demonstration purposes.

LOCKHEED-HUNTSVILLE RESEARCH & ENGINEERING CENTER

3-320

### Example Problem 7

Example problem 7 is the same as example problem 6 except that the start line is calculated internal to the program. Table 3-18 presents a flow chart of the input data for the specified problem. Note that Card 35 replaces Cards 33b and 34b of example problem 6. A listing of the pertinent solution is omitted as it is basically the same as for example problem 6.

Table 3-18  
 REQUIRED INPUT FORMAT FOR EXAMPLE PROBLEM 7

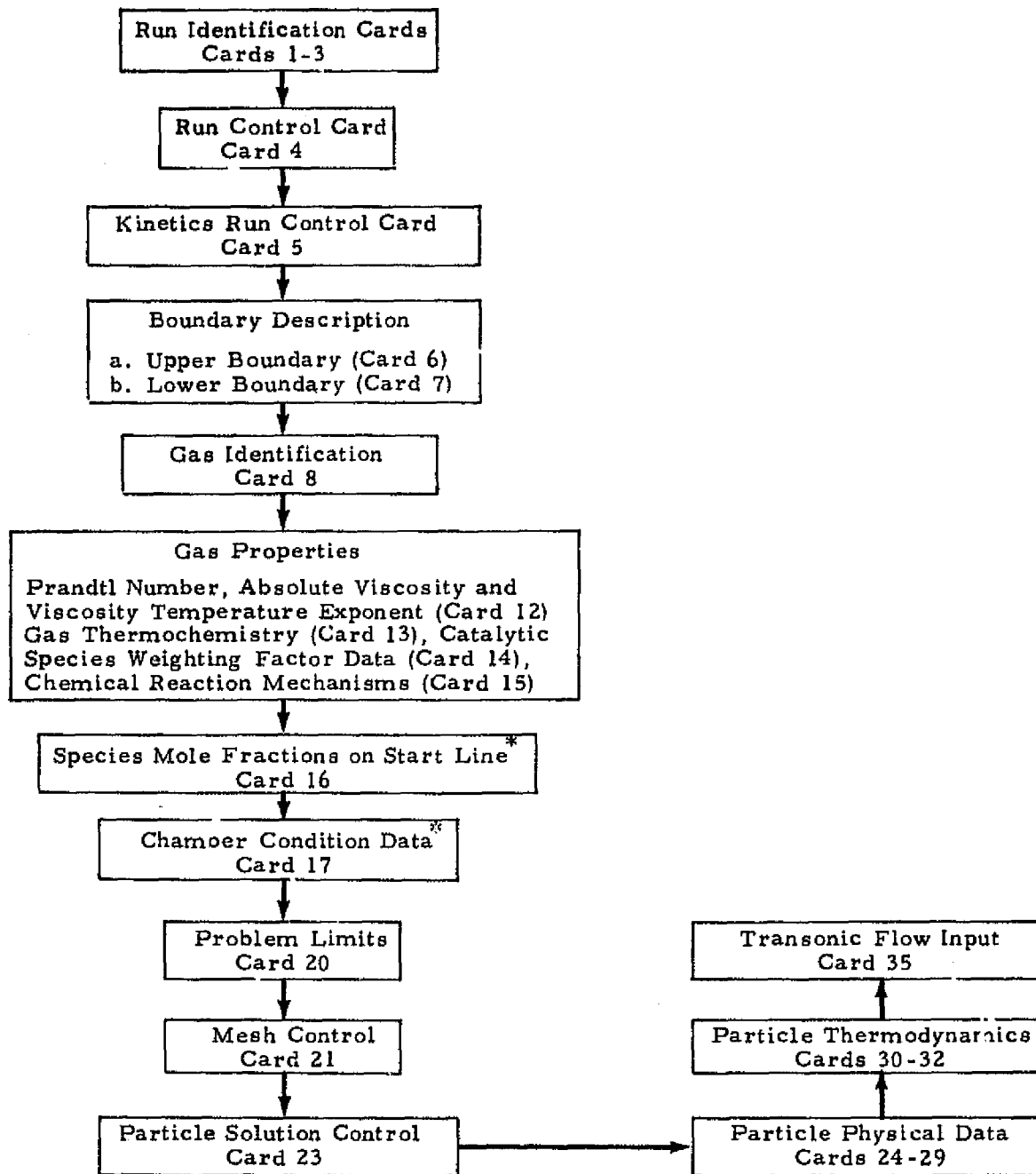

\*If species mole fractions are input on tape (ICTAPE=1) cards 16 and 17 are not required.



### Example Problem 8

This problem analyzes a two-phase ideal gas flow field with the following stipulations:

1. Free molecular flow calculations are not to be considered.
2. The gas properties are to be read from cards, and
3. The start line is to be calculated internal to the program.

Table 3-19 presents first a flow chart and then a listing of the required input data for the specified problem. Table 3-20 presents a listing of the pertinent solution.

2-5

Table 3-19  
REQUIRED INPUT FORMAT FOR EXAMPLE PROBLEM 8

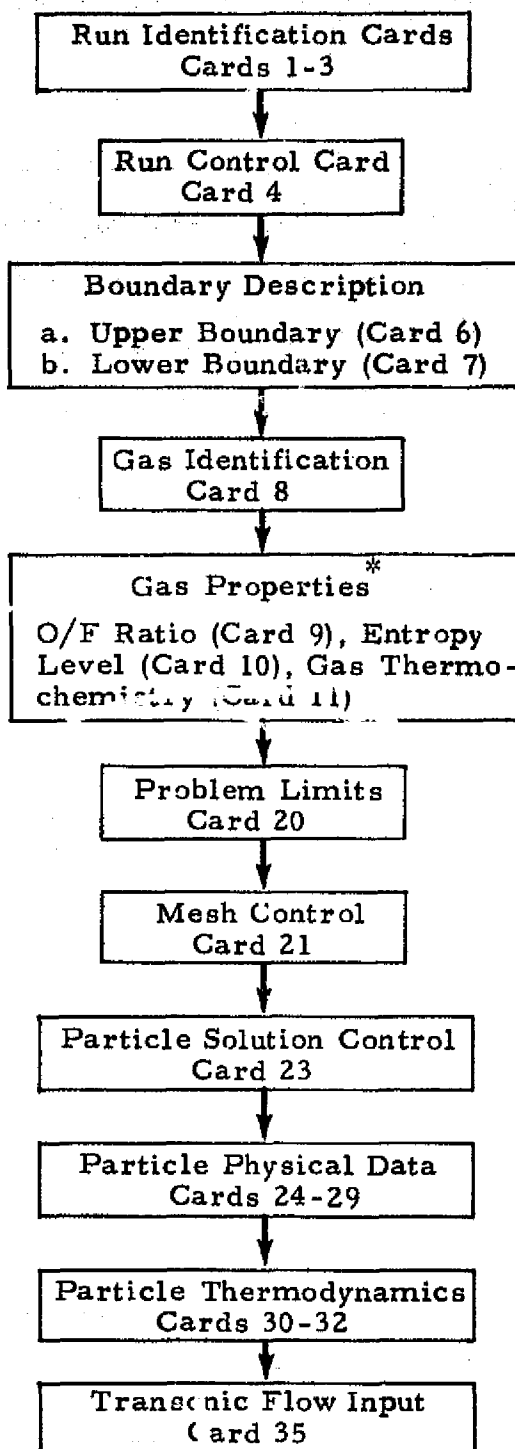

\*If gas properties are input on tape (ICON(1)=2) Cards 9, 10 and 11 are not required.

Table 3-19 (Concluded)

TWO PHASE IDEAL GAS CHECK CASE										
Cards 1-3	1	0	2540051	1	0	1	2	1	15 52 11	02505
Card 4			1.278071402.4517025 16.366						0	1.3261493 2.466111 17.
			1.401649582.4899160818.						0	1.476722832.5150353 19.
			1.551346332.5414608320.						0	1.6254973 2.5691848 21.
			1.699153 2.5981983322.						0	1.7722913 2.6284933323.
			1.844889582.66006 24.						U	1.8881803 2.6796065 24.6
			1.904525 2.6855416724.6						0	2.0116 2.7345666724.6
			2.118666672.7835833324.6						0	2.225733332.8326083324.6
			2.332808332.861625 24.6						0	2.449708332.935 24.4824
			2.590833332.9989583324.2765						0	2.749408333.07005 24.0146
			2.922458333.1466 23.7123						0	3.108308333.2275833323.3785
Card 5			3.305833333.3122416723.0204						0	3.514091673.399925 22.6438
			3.732425 3.4901333322.2526						0	3.960241663.582425 21.8503
			4.19715 3.6764583321.4390						0	4.44285 3.7718833321.0217
			4.696775 3.8683916720.5999						0	4.9587 3.9657416720.1754
			5.228366674.0636916719.7495						0	5.5056 4.1620666719.3
			5.790041674.2606166718.8967						0	6.081658334.3592333318.4715
			6.380191674.4577333318.0482						0	6.6854 4.55595 17.6279
			6.997325 4.6538166717.2099						0	7.315733334.7511833316.7952
			7.640516674.8479416716.3840						0	7.971566674.944 15.9766
			8.308783335.0392583315.5732						0	9.001341675.2270916714.7792
			9.356533335.3195 14.3885						0	9.717558335.410825 14.0030
			10.084183335.5009666713.6222						0	10.45669175.58995 13.2456
			10.834975 5.6776916712.8733						0	11.21874175.7641083312.5063
			11.608175 5.8492 12.1434						0	12.0031 5.9326833311.7854
			12.40336676.0151166711.4326						1	12.67025836.068552 11.2024
			10.							1000. 2.26791667
Card 7	3	0								1000.
Card 8	2	0								1000.
Card 9			SHUTTLE 700 PC			MKS	1	1		
Card 10			.0							
Card 11			.0		1					
Card 20			.0	20.245	1.25	3411.	47.632	.4810	.000934	.67
Card 21			100.	-100.	0.0	0.0	50.	90.		
Card 23			2.0	.2	.2	.002.	4.	.75		
Card 24			.40123							
Card 25			1.0							
Card 26			6.0							
Card 27			250.							
Card 28										
Card 29										
Card 30			AL203 EQ. OF STATE			1ENG				
Card 31			1							
Card 32			4170.0	1112.8	1612.1	0.3395	0.2676			
Card 35			\$DATA THID=30. THFD=7. THJD=10. THIW=16.366. RRT=2. CAPN=.67. ZAX=.672							
			\$END							

Table 3-20  
EXAMPLE PROBLEM 8 PERTINENT SOLUTION

SUPERSONIC FLOW ANALYSIS USING THE LOCKHEED-HUNTSVILLE MULTIPLE SHOCK COMPUTER PROGRAM  
GAS-PARTICLE FLOW SOLUTION  
CASE NO. 52

100 PHASE IDEAL GAS CHECK CASE

RUN CONTROL PARAMETERS							
ICON(1)	ICON(2)	ICON(3)	ICON(4)	ICON(5)	ICON(6)	ICON(7)	ICON(8)
1	0	25	9051	1	0	1	2
ICON(9)	ICON(10)	ICON(11)	ICON(12)	ICON(13)	ICON(14)	ICON(15)	ICON(16)
0	15	52	1	0	0	0	3505

FLOW CALCULATIONS ARE IN ENGLISH UNITS WITH THE R,X COORDINATES IN FEET

THE FLOW FIELD DATA WILL NOT BE WRITTEN ON TAPE

UPPER BOUNDARY POINTS

TYPE	ITRANS	X	R	THETA
2	0	.12701+01	.24517+01	.28564+00
2	0	.13761+01	.24661+01	.29671+00
2	0	.14816+01	.24899+01	.31416+00
2	0	.14767+01	.25150+01	.33161+00
2	0	.15513+01	.25415+01	.34937+00
2	0	.16255+01	.25692+01	.36652+00
2	0	.16992+01	.25982+01	.38397+00
2	0	.17723+01	.26285+01	.40143+00
2	0	.18449+01	.26601+01	.41888+00
2	0	.18882+01	.26796+01	.42935+00
2	0	.19045+01	.26855+01	.42935+00
2	0	.23116+01	.27346+01	.42935+00
2	0	.23187+01	.27436+01	.42935+00
2	0	.22257+01	.28326+01	.42935+00
2	0	.23326+01	.28616+01	.42935+00
2	0	.24497+01	.29351+01	.42735+00
2	0	.25920+01	.29992+01	.42376+00
2	0	.27494+01	.30701+01	.41913+00
2	0	.29225+01	.31466+01	.41386+00
2	0	.31003+01	.32276+01	.40803+00
2	0	.33050+01	.33122+01	.40170+00
2	0	.35141+01	.33999+01	.39521+00
2	0	.37329+01	.34901+01	.38836+00
2	0	.39602+01	.35824+01	.38136+00
2	0	.41971+01	.36765+01	.37418+00
2	0	.44428+01	.37719+01	.36690+00
2	0	.46960+01	.38689+01	.35954+00
2	0	.49587+01	.39657+01	.35213+00
2	0	.52204+01	.40637+01	.34469+00

LOCKHEED-HUNTSVILLE RESEARCH & ENGINEERING CENTER

3-326

Table 3-20 (Continued)

SUPERSONIC FLOW ANALYSIS USING THE LOCKHEED-HUNTSVILLE MULTIPLE SHOCK COMPUTER PROGRAM  
 GAS-PARTICLE FLOW SOLUTION  
 CASE NO. 52

700 PHASE IDEAL GAS CHECK CASE

UPPER BOUNDARY POINTS

TYPE	ITRANS	X	H	THETA
2	0	.55056+01	.41621+01	.33685+00
2	0	.57902+01	.42656+01	.32981+00
2	0	.60817+01	.43592+01	.32239+00
2	0	.63822+01	.44577+01	.31582+00
2	0	.66854+01	.45559+01	.30766+00
2	0	.69973+01	.46538+01	.30037+00
2	0	.73157+01	.47512+01	.29313+00
2	0	.76425+01	.48479+01	.28595+00
2	0	.79716+01	.49440+01	.27804+00
2	0	.83088+01	.50393+01	.27183+00
2	0	.86513+01	.51227+01	.26595+00
2	0	.90065+01	.52195+01	.25113+00
2	0	.93768+01	.53108+01	.24445+00
2	0	.97604+01	.54080+01	.23775+00
2	0	1.01457+02	.55000+01	.23118+00
2	0	1.05357+02	.55777+01	.22488+00
2	0	1.11219+02	.57641+01	.21828+00
2	0	1.18038+02	.58492+01	.21194+00
2	0	1.2803+02	.59329+01	.20569+00
2	0	1.2403+02	.60151+01	.19954+00
2	1	.12670+02	.60686+01	.19552+00
3	0	.00000+02	.00000	.00000

LOWER BOUNDARY

TYPE	ITRANS	A	B	C	D	E	MAX
2	0	.00000	.00000	.00000	.00000	.00000	.10000+04

THERE ARE 1 PARTICLE SPECIES PRESENT IN THE GAS-PARTICLE MIXTURE

THE FOLLOWING GAS PROPERTIES IN ENGLISH UNITS ARE FOR SHUTTLE 700 PC

IDEAL GAS PROPERTIES

V	R	GAMMA	TO	PO	PR	VIS	EXP
.00000	.24554+04	.12500+01	.61398+04	.70000+03	.48100+00	.19588+05	.67000+00

LOCKHEED-HUNTSVILLE RESEARCH & ENGINEERING CENTER

3-327

Table 3-20 (Continued)

SUPERSONIC FLOW ANALYSIS USING THE LOCKHEED-HUNTSVILLE MULTIPLE SHOCK COMPUTER PROGRAM											
GAS-PARTICLE FLOW SOLUTION											
CASE NO. 52											
PAGE 3											
TWO PHASE IDEAL GAS CHECK CASE											
RUN CUTOFF INFORMATION											
UPPER BOUNDARY					LOWER BOUNDARY						
R#	.10000+33	X#	-.10000+03	THETA#	.00000	R#	.00000	X#	.50000+02	THETA#	.90000+02
PARTICLE PHYSICAL DATA											
SPECIFIC HEAT	RADIUS	MASS DENSITY	EMISSIVITY	ACEN. COEFF.							
1	.00000+01	.25000+03	.00000	.00000							
THE PARTICLES CONSTITUTE 42.12 PERCENT BY WEIGHT FLOW OF THE GAS-PARTICLE MIXTURE											
THE INDIVIDUAL PERCENTAGES ARE 1.00											
THE PARTICLE TEMPERATURE-ENTHALPY TABLE WILL BE READ IN WITH ENGLISH UNITS											
PARTICLE TEMPERATURE-ENTHALPY TABLE											
PHASE CHANGE DATA ***											
TMELT#	.41700+04	MSOLID#	.27851+00	HLIQUID#	.40348+08						
CPMELT#	.84971+04	CPSOLID#	.66976+04								

LOCKHEED - HUNTSVILLE RESEARCH & ENGINEERING CENTER

3-328

Table 3-20 (Continued)

SUPERSONIC FLOW ANALYSIS USING THE LOCKHEED-HUNTSVILLE MULTIPLE SHOCK COMPUTER PROGRAM  
 GAS-PARTICLE FLOW SOLUTION  
 CASE NO. 52

PAGE 9

THIRD PHASE IDEAL GAS CHECK CASE

PARTICLE DRAG TABLE

I	RE	DRAG COEF
1	.00000	.10000+01
2	.12500+01	.10000+01
3	.12500+01	.10000+01
4	.12600+01	.10010+01
5	.12650+01	.10020+01
6	.15820+01	.10630+01
7	.19950+01	.11410+01
8	.25100+01	.12240+01
9	.31600+01	.13150+01
10	.39800+01	.14120+01
11	.50100+01	.15170+01
12	.63100+01	.16250+01
13	.79500+01	.17450+01
14	.10000+02	.18740+01
15	.12600+02	.20260+01
16	.15820+02	.21860+01
17	.19950+02	.23040+01
18	.25100+02	.25550+01
19	.31600+02	.27000+01
20	.39800+02	.30000+01
21	.50100+02	.32520+01
22	.63100+02	.32520+01
23	.79500+02	.38250+01
24	.10000+03	.41550+01
25	.12600+03	.47000+01
26	.15820+03	.50000+02
27	.19950+03	.50000+02
28	.25100+03	.50000+02

Table 3-20 (Continued)

SUPERSONIC FLOW ANALYSIS USING THE LOCKHEED-HUNTSVILLE MULTIPLE SHOCK COMPUTER PROGRAM  
GAS-PARTICLE-FLOW SOLUTION  
CASE NO. 52

TWO PHASE IDEAL GAS CHECK CASE

GASEOUS STARTING LINE INFO							
R	X	H	THETA	S	MACH ANGLE	SHOCK ANGLE	H-TOTAL
.0000	.10240+01	.10878+01	.00000	.49594+03	.66822+02	.00000	.74705+08
.98268+01	.15236+01	.10881+01	.34952+00	.49623+03	.66740+02	.00000	.74785+08
.19614+00	.15225+01	.10892+01	.70118+00	.49710+03	.66654+02	.00000	.74704+08
.29420+00	.15205+01	.10909+01	.10571+01	.49857+03	.66495+02	.00000	.74762+08
.39217+00	.15177+01	.10933+01	.14196+01	.50063+03	.66155+02	.00000	.74699+08
.49234+00	.15142+01	.10965+01	.17909+01	.50332+03	.65785+02	.00000	.74696+08
.56841+00	.15099+01	.11004+01	.21735+01	.50665+03	.65335+02	.00000	.74692+08
.68648+00	.15048+01	.11050+01	.25699+01	.51064+03	.64810+02	.00000	.74687+08
.76454+00	.14989+01	.11105+01	.29830+01	.51535+03	.64222+02	.00000	.74661+08
.88281+00	.14922+01	.11166+01	.34156+01	.52080+03	.63559+02	.00000	.74674+08
.98268+00	.14847+01	.11241+01	.38710+01	.52705+03	.62828+02	.00000	.74666+08
.10787+00	.14764+01	.11322+01	.43527+01	.53417+03	.62033+02	.00000	.74657+08
.11768+01	.14674+01	.11414+01	.48643+01	.54223+03	.61174+02	.00000	.74647+08
.12749+01	.14575+01	.11518+01	.54099+01	.55131+03	.60255+02	.00000	.74636+08
.13732+01	.14469+01	.11633+01	.59938+01	.56154+03	.59275+02	.00000	.74623+08
.14712+01	.14355+01	.11762+01	.66204+01	.57304+03	.58235+02	.00000	.74609+08
.15691+01	.14233+01	.11905+01	.72948+01	.58596+03	.57136+02	.00000	.74593+08
.16672+01	.14103+01	.12065+01	.80218+01	.59950+03	.55977+02	.00000	.74574+08
.17652+01	.13965+01	.12244+01	.88069+01	.61688+03	.54757+02	.00000	.74556+08
.18633+01	.13820+01	.12444+01	.96554+01	.63536+03	.53476+02	.00000	.74533+08
.19614+01	.13666+01	.12667+01	.10573+02	.65629+03	.52132+02	.00000	.74508+08
.20594+01	.13505+01	.12918+01	.11564+02	.68007+03	.50723+02	.00000	.74480+08
.22441+01	.13252+01	.13347+01	.13173+02	.72141+03	.48522+02	.00000	.74431+08
.22556+01	.13159+01	.13520+01	.13795+02	.73026+03	.47702+02	.00000	.74411+08
.23536+01	.12974+01	.13802+01	.15033+02	.77403+03	.46386+02	.00000	.74369+08
.24517+01	.12781+01	.14294+01	.16360+02	.81545+03	.44396+02	.00000	.74322+08

PARTICLE START LINE PROPERTIES

POINT	SPECIE	U	V	THETA	ENTHALPY	DENSITY
1	1	.39807+04	.00000	.00000	.50838+08	.15869+02
2	1	.39810+04	.14438+02	.20776+00	.50836+08	.15057+02
3	1	.39844+04	.28980+02	.41677+00	.50832+08	.15017+02
4	1	.39890+04	.43751+02	.62640+00	.50823+08	.14959+02
5	1	.39955+04	.58780+02	.84422+00	.50811+08	.14879+02
6	1	.40040+04	.74514+02	.10662+01	.50793+08	.14784+02
7	1	.40145+04	.90857+02	.12965+01	.50768+08	.14680+02
8	1	.40271+04	.10813+03	.15581+01	.50736+08	.14572+02
9	1	.40419+04	.12662+03	.17943+01	.50693+08	.14467+02
10	1	.40590+04	.14664+03	.20690+01	.50640+08	.14370+02
11	1	.40785+04	.16856+03	.23867+01	.50573+08	.14267+02
12	1	.41005+04	.19280+03	.26920+01	.50492+08	.14221+02



Table 3-20 (Continued)

SUPERSONIC FLOW ANALYSIS USING THE LOCKHEED-HUNTSVILLE MULTIPLE SHOCK COMPUTER PROGRAM							
GAS-PARTICLE FLOW SOLUTION							
CASE NO. 52							
TWO PHASE IDEAL GAS CHECK CASE							
POINT	SPECIE	U	V	THETA	ENTHALPY	DENSITY	
13	1	.41250+04	.21981+03	.30502+01	.50395+08	.14175-02	
14	1	.41522+04	.25004+03	.34461+01	.50201+08	.14159-02	
15	1	.41821+04	.28393+03	.38840+01	.50150+08	.14140-02	
16	1	.42147+04	.32186+03	.43670+01	.50002+08	.14142-02	
17	1	.42500+04	.36403+03	.48957+01	.49837+08	.14145-02	
18	1	.42877+04	.41039+03	.54670+01	.49659+08	.14133-02	
19	1	.43283+04	.46045+03	.60723+01	.49472+08	.14090-02	
20	1	.43710+04	.51307+03	.66948+01	.49283+08	.13989-02	
21	1	.44156+04	.56613+03	.73061+01	.49102+08	.13802-02	
22	1	.44610+04	.61609+03	.78618+01	.48942+08	.13495-02	
23	1	.45314+04	.67178+03	.84327+01	.48795+08	.12736-02	

THE MESH CONSTRUCTION WILL BE CONTROLLED BY THE FOLLOWING VARIABLES

DL INTERIOR = .200+01-DX AXIS = .200+02-DL-LIN = .200+03-DL-DELETE = .200+02-DEG-P.M. = .400+01-F = .750+00

Table 3-20 (Continued)

SUPERSONIC FLOW ANALYSIS USING THE LOCKHEED-HUNTSVILLE MULTIPLE SHOCK COMPUTER PROGRAM  
 GAS-PARTICLE-FLOW SOLUTION  
 CASE NO. 52

THU PHASE IDEAL GAS CHECK CASE

LINE POINT	DESCRIP - REGIME	R RACH ANGLE	X PRESSURE	M DENSITY	THETA TEMPERATURE	ENTROPY GAS CONST.	VELOCITY LOCAL GAMMA	H-TOTAL SHOCK ANGLE	ITR
1	25 INPUT - CONTIN	.23524+01 .46586+02	.12974+01 .16230+03	.13082+01 .19498+02	.15033+02 .48818+04	.72403+03 .24554+04	.53733+04 .12500+01	.74369+00	0

PARTICLE DATA  
 NO PARTICLES ARE PRESENT AT THIS POINT

1	26 INPUT - CONTIN	.24517+01 .44396+02	.12781+01 .15009+03	.14294+01 .18254+02	.16368+02 .48223+04	.81546+03 .24554+04	.54905+04 .12500+01	.74122+00	0
---	-------------------	------------------------	------------------------	------------------------	------------------------	------------------------	------------------------	-----------	---

PARTICLE DATA  
 NO PARTICLES ARE PRESENT AT THIS POINT

GAS MASS FLOW RATE = .73752+04      PARTICLE MASS FLOW RATE = .29617+04      MIXTURE MASS FLOW RATE = .10337+05

PARTICLE PERCENT LOADINGS

RADIUS      LOADING  
 .60000+01      .12000+03

PARTICLE PERCENT LOADING RELATIVE TO THE GAS = .40156+02      PARTICLE PERCENT LOADING RELATIVE TO THE MIXTURE = .20652+02

MOMENTUM INTEGRATION RESULTS

FORCEX	FORCEY	TORQZ	ISP
.20786+07	.00000	.00000	.20111+03
DELFXG	DELFYG	TORQZG	DELFXP
.49147+05	.00000	.00000	.39146+06
DELFTG	DELFTY	TORQZP	DELFTX
.00000	.00000	.00000	.00000

- NOTES: (1) Typical printout for the startline data surface.  
 (2) Some points have been omitted for demonstration purposes.

Table 3-20 (Continued)

SUPERSONIC FLOW ANALYSIS USING THE LOCKHEED-HUNTSVILLE MULTIPLE SHOCK COMPUTER PROGRAM  
 GAS-PARTICLE FLOW SOLUTION  
 CASE NO. 52

TWO PHASE IDEAL GAS CHECK CASE

LINE POINT	USCRIP - REGIME	R RACH ANGLE	X PRESSURE	M DENSITY	THETA TEMPERATURE	ENTROPY GAS CONST.	VELOCITY LOCAL GAMMA	H-TOTAL SHOCK ANGLE	ITR	
PARTICLE DATA										
2	26 INTER - CONTIN	+2358+01	+13164+01	+14668+01	+15374+02	+77483+03	+54128+04	+74369+08	3	
		+45552+02	+18944+03	+19223+02	+48645+04	+24554+04	+12500+01			
PARTICLE DATA NO PARTICLES ARE PRESENT AT THIS POINT										
2	26 WALL - CONTIN	+24549+01	+12495+01	+14344+01	+16539+02	+81545+03	+55143+04	+74322+08	3	
		+4221+02	+14903+03	+18150+02	+48154+04	+24554+04	+12500+01			
PARTICLE DATA NO PARTICLES ARE PRESENT AT THIS POINT										
3-333										
PRESSURE INTEGRATION RESULTS										
		FORCEX	FORCEY	TORQZ	DELFX	DELFY	ISP			
		+22797+07	+33500	+65300	+10653+04	+09000	+26121+03			
PERCENT CHANGE IN MASS, MOMENTUM AND ENERGY NUMERICAL INTEGRATION FOR LINE 2 RELATIVE TO THE START LINE										
		PERCENT CHANGE IN MASS FLOW, GAS =		-0.19320-01	PARTICLE =		-0.56777-01	MIXTURE =		-0.39052-01
		PERCENT CHANGE IN MOMENTUM, GAS =		+0.2371+04	PARTICLE =		+12728+00	MIXTURE =		+52106+00
		PERCENT CHANGE IN ENERGY, GAS =		-0.34322-01	PARTICLE =		+0.1157+00	MIXTURE =		-0.26113-01
3	1 WALL - CONTIN	+00000	+15889+01	+10987+01	+00000	+59956+03	+44254+04	+74608+08	5	
		+05524+02	+20906+03	+29851+02	+52860+04	+24554+04	+12500+01			
PARTICLE DATA										
		+412572+04	+00000	+99237-01	+50696+08	+14828-02	+53078+04			
3	26 WALL - CONTIN	+24623+01	+13135+01	+14461+01	+16833+02	+81545+03	+55501+04	+74322+08	3	
		+43751+02	+14654+03	+17938-02	+47993+04	+24554+04	+12500+01			
PARTICLE DATA NO PARTICLES ARE PRESENT AT THIS POINT										
4	1 WALL - CONTIN	+00000	+16232+01	+11055+01	+00000	+51664+03	+47490+04	+74677+08	5	
		+04762+02	+26593+03	+29557-02	+52767+04	+24554+04	+12500+01			
PARTICLE DATA										
		+424874+04	+00000	+9418-01	+50623+08	+14702-02	+53783+04			

NOTES: (1) Typical printout for a data surface inside the nozzle.  
 (2) Some points have been omitted for demonstration purposes.

LOCKHEED - HUNTSVILLE RESEARCH & ENGINEERING CENTER

Table 3-20 (Continued)

SUPERSONIC FLOW ANALYSIS USING THE LOCKHEED-HUNTSVILLE MULTIPLE SHOCK COMPUTER PROGRAM  
 GAS-PARTICLE FLOW SOLUTION  
 CASE NO. 52

TWO PHASE IDEAL GAS CHECK CASE

LINE POINT	DESCRIP - REGIME	MACH ANGLE	X PRESSURE	M DENSITY	THETA TEMPERATURE	ENTROPY GAS CONST.	VELOCITY LOCAL GAMMA	H-TOTAL SHOCK ANGLE	ITR
PARTICLE DATA									
SPECIE POINT	DESCRIPTION	V	THETA	D N	ENTHALPY	DENSITY	TEMPERATURE		
73	11 FNN-NN CONTIN	.62886+01 .14693+02	.12670+02 .21198+01	.39426+01 .60438+04	.42170+02 .20570+04	.81545+03 .24554+04	.99063+04 .12500+01	.74322+08	3
PARTICLE DATA									
NO PARTICLES ARE PRESENT AT THIS POINT									
73	12 FNN-NN CONTIN	.62486+01 .13927+02	.12673+02 .14932+01	.41544+01 .45590+04	.46037+02 .19170+04	.81545+03 .24554+04	.10074+05 .12500+01	.74322+08	3
PARTICLE DATA									
NO PARTICLES ARE PRESENT AT THIS POINT									
73	13 FNN-NN CONTIN	.62886+01 .13189+02	.12670+02 .10263+01	.43824+01 .33880+04	.49911+02 .17799+04	.81545+03 .24554+04	.10244+05 .12500+01	.74322+08	3
PARTICLE DATA									
NO PARTICLES ARE PRESENT AT THIS POINT									
73	14 FNN-NN CONTIN	.62886+01 .12479+02	.12673+02 .69613+00	.46279+01 .24790+04	.53782+02 .16463+04	.81545+03 .24554+04	.10403+05 .12500+01	.74322+08	3
PARTICLE DATA									
NO PARTICLES ARE PRESENT AT THIS POINT									
73	15 FNN-NN CONTIN	.62886+01 .11795+02	.12670+02 .46179+00	.48923+01 .17858+04	.57648+02 .15166+04	.81545+03 .24554+04	.10554+05 .12500+01	.74322+08	3
PARTICLE DATA									
NO PARTICLES ARE PRESENT AT THIS POINT									
73	16 FNN-NN CONTIN	.62886+01 .11131+02	.12670+02 .24938+00	.61850+01 .12615+04	.61524+02 .13904+04	.81545+03 .24554+04	.10701+05 .12500+01	.74322+08	3
PARTICLE DATA									
NO PARTICLES ARE PRESENT AT THIS POINT									
73	17 FNN-NN CONTIN	.62886+01 .10480+02	.12670+02 .16927+00	.64935+01 .87409+05	.65385+02 .12685+04	.81545+03 .24554+04	.10840+05 .12500+01	.74322+08	3
PARTICLE DATA									
NO PARTICLES ARE PRESENT AT THIS POINT									

LOCKHEED-HUNTSVILLE RESEARCH & ENGINEERING CENTER  
 3-334

NOTES: (1) Typical printout for a data surface containing a Prandtl-Meyer Expansion.  
 (2) Some points have been omitted for demonstration purposes.

Table 3-20 (Concluded)

## SUPERSONIC FLOW ANALYSIS USING THE LOCKHEED-HUNTSVILLE MULTIPLE SHOCK COMPUTER PROGRAM

GAS-PARTICLE FLOW SOLUTION

CASE NO. 52

PAGE 78

TWO PHASE IDEAL GAS CHECK CASE

LINE POINT	USCRIP - REGIME	R MACH ANGLE	X PRESSURE	M DENSITY	THETA TEMPERATURE	ENTROPY GAS CONST.	VELOCITY LOCAL GAMMA	H-TOTAL SHOCK ANGLE	ITR
PARTICLE DATA	SPECIFIC HEAT DESCRIPTION	V	THETA	D	K	ENTHALPY	DENSITY	TEMPERATURE	
111	44 FREEBD - CONTIN	.73951+01 .92569+01	.13099+02 .67445+01	.62166+01 .39226-05	.71054+02 .10383+04	.81545+03 .24554+04	.11097+05 .12500+01	.74322+08	2
PARTICLE DATA NO PARTICLES ARE PRESENT AT THIS POINT									
112	1 WALL - CONTIN	.00000 .24311+02	.15192+02 .83717+01	.24300+01 .13758-03	.00000 .35687+04	.42065+04 .24554+04	.80420+04 .12500+01	.76149+08	4
PARTICLE DATA 1 1 .784351+04 .00000 .59981+01 .25652+08 .64440+04 .36301+04									
DUE TO GAS-PARTICLE STREAMLINE CROSSING THE POINT 29 HAS BEEN REPLACED									
112	44 FREEBD - CONTIN	.76422+01 .92569+01	.13153+02 .67445+01	.62166+01 .39226-05	.70645+02 .10383+04	.81545+03 .24554+04	.11097+05 .12500+01	.74322+08	2
PARTICLE DATA NO PARTICLES ARE PRESENT AT THIS POINT									
113	1 WALL - CONTIN	.00000 .24311+02	.15387+02 .83790+01	.24269+01 .13752-03	.00000 .35734+04	.42207+04 .24554+04	.80371+04 .12500+01	.76167+08	4
PARTICLE DATA 1 1 .785227+04 .00000 .55810+01 .25542+08 .63380+04 .36136+04									
113	44 FREEBD - CONTIN	.76450+01 .92569+01	.13200+02 .67445+01	.62166+01 .39226-05	.70649+02 .10383+04	.81545+03 .24554+04	.11097+05 .12500+01	.74322+08	2
PARTICLE DATA NO PARTICLES ARE PRESENT AT THIS POINT									
114	1 WALL - CONTIN	.00000 .24309+02	.15581+02 .83724+01	.24230+01 .13750-03	.00000 .35763+04	.42335+04 .24554+04	.80317+04 .12500+01	.76184+08	4
PARTICLE DATA 1 1 .786090+04 .00000 .51694+01 .25441+08 .62401+04 .37986+04									
DUE TO GAS-PARTICLE STREAMLINE CROSSING THE POINT 28 HAS BEEN REPLACED									
114	44 FREEBD - CONTIN	.78356+01 .92569+01	.13253+02 .67445+01	.62166+01 .39226-05	.70451+02 .10383+04	.81545+03 .24554+04	.11097+05 .12500+01	.74322+08	2
PARTICLE DATA NO PARTICLES ARE PRESENT AT THIS POINT									

LOCKHEED - HUNTSVILLE RESEARCH &amp; ENGINEERING CENTER

NOTES: (1) Typical printout for a data surface in the exhaust plume.  
 (2) Some points have been omitted for demonstration purposes.

### Example Problem 9

Example problem 9 is the same as example problem 8 except that a single phase ideal gas flow field will be analyzed.

Table 3-21 presents first a flow chart and then a listing of the input data for the specified problem. Table 3-22 presents a listing of the pertinent solution.

Table 3-21  
REQUIRED INPUT FORMAT FOR EXAMPLE PROBLEM 9

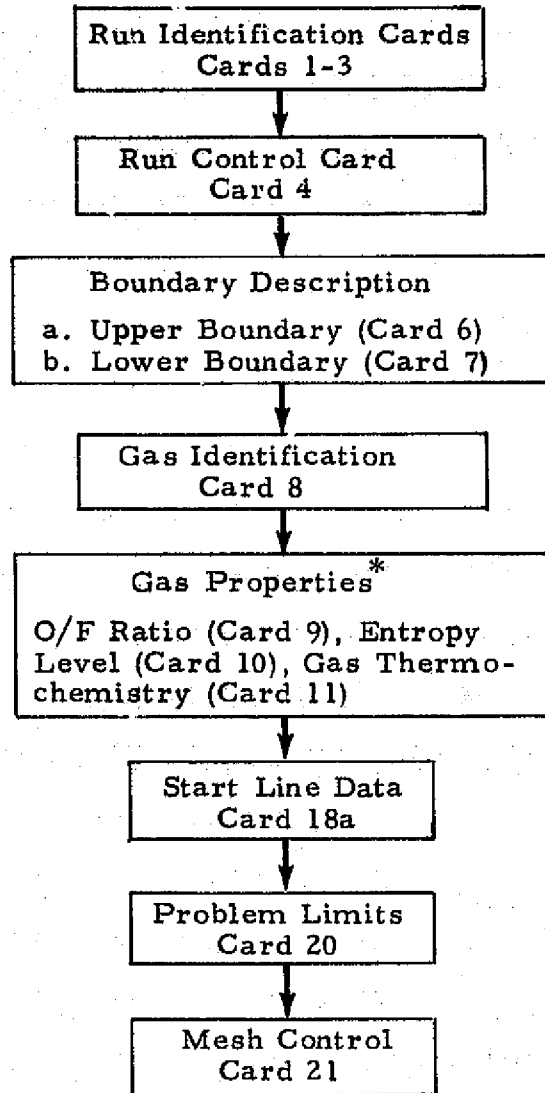

\*If gas properties are input on tape (ICON(1)=2) Cards 9, 10 and 11 are not required.

Table 3-21 (Concluded)

		GASEOUS CHECK CASE									
Cards 1-3											
Card 4		1	121	3	1	1	2	15	1	11	200
Cards 6	1		-1.	.50002	0.0		-1.0		-1.0607	.18659	
	2	1					.27357		.32757	2.4580	
	3		1400.							1000.	
Card 7	2									1000.	
Card 8		IDEAL GAS				ENG		1	1		
Card 9		.0									
Card 10		.0		1							
Card 11		.0	27.23473	1.1443	6049.8	40.827436					
Card 18a		.0	0.0	1.01							
Card 20		100.	-100.	0.0	0.0	4.0	90.				
Card 21		.2	.1	1.	.005	5.	.85				

LOCKHEED - HUNTSVILLE RESEARCH & ENGINEERING CENTER

3-338



Table 3-22

EXAMPLE PROBLEM 9 PERTINENT SOLUTION

SUPERSONIC FLOW ANALYSIS USING THE LOCKHEED-HUNTSVILLE MULTIPLE SHOCK COMPUTER PROGRAM

CASE NO. 1

PAGE 1

GASEOUS CHECK CASE

RUN CONTROL PARAMETERS

ICON(1)	ICON(2)	ICON(3)	ICON(4)	ICON(5)	ICON(6)	ICON(7)	ICON(8)
1	0	21	3	1	0	1	2
ICON(9)	ICON(10)	ICON(11)	ICON(12)	ICON(13)	ICON(14)	ICON(15)	ICON(16)
0	15	1	1	0	0	0	2000

FLOW CALCULATIONS ARE IN ENGLISH UNITS WITH THE R,X COORDINATES IN FEET

THE FLOW FIELD DATA WILL NOT WRITTEN ON TAPE

UPPER BOUNDARY

TYPE	ITRANS	A	B	C	D	E	MAX
1	0	-.10000+01	.50002+00	.00000	-.10000+01	-.10407+01	.18659+00
2	1	.00000	.00000	.00000	.27357+00	.32757+00	.24580+01
3	0	.14000+04	.00000	.00000	.00000	.00000	.10000+04

LOWER BOUNDARY

TYPE	ITRANS	A	B	C	D	E	MAX
2	0	.00000	.00000	.00000	.00000	.00000	.10000+04

THERE ARE 0 PARTICLE SPECIES PRESENT IN THE GAS-PARTICLE MIXTURE

THE FOLLOWING GAS PROPERTIES IN ENGLISH UNITS ARE FOR IDEAL GAS

IDEAL GAS PROPERTIES

V	R	GAMMA	TO	PO
.00000	.18252+04	.11443+01	.60498+04	.60000+03

STARTING LINE INFO

R	X	M	THETA	S	MACH ANGLE	SHOCK ANGLE	OFF
.00000	.00000	.10100+01	.00000	.00000	.81931+02	.00000	.00000
.17477-01	.00000	.10100+01	.00000	.00000	.81931+02	.00000	.00000
.35358-01	.00000	.10100+01	.00000	.00000	.81931+02	.00000	.00000
.53037-01	.00000	.10100+01	.00000	.00000	.81931+02	.00000	.00000
.70716-01	.00000	.10100+01	.00000	.00000	.81931+02	.00000	.00000
.88395-01	.00000	.10100+01	.00000	.00000	.81931+02	.00000	.00000
.10607+00	.00000	.10100+01	.00000	.00000	.81931+02	.00000	.00000
.12375+00	.00000	.10100+01	.00000	.00000	.81931+02	.00000	.00000

LOCKHEED - HUNTSVILLE RESEARCH & ENGINEERING CENTER

3-339

Table 3-22 (Continued)

SUPERSONIC FLOW ANALYSIS USING THE LOCKHEED-HUNTSVILLE MULTIPLE SHOCK COMPUTER PROGRAM							
CASE NO. 1				PAGE 2			
GASEOUS CHECK CASE							
STARTING LINE INFO							
R	X	M	THETA	S	MACH ANGLE	SHOCK ANGLE	O/F
.14143+00	.00000	.10100+01	.00000	.00000	.81931+02	.00000	.00000
.15911+00	.00000	.10100+01	.00000	.00000	.81931+02	.00000	.00000
.17679+00	.00000	.10100+01	.00000	.00000	.81931+02	.00000	.00000
.19447+00	.00000	.10100+01	.00000	.00000	.81931+02	.00000	.00000
.21215+00	.00000	.10100+01	.00000	.00000	.81931+02	.00000	.00000
.22983+00	.00000	.10100+01	.00000	.00000	.81931+02	.00000	.00000
.24751+00	.00000	.10100+01	.00000	.00000	.81931+02	.00000	.00000
.26518+00	.00000	.10100+01	.00000	.00000	.81931+02	.00000	.00000
.28286+00	.00000	.10100+01	.00000	.00000	.81931+02	.00000	.00000
.30054+00	.00000	.10100+01	.00000	.00000	.81931+02	.00000	.00000
.31822+00	.00000	.10100+01	.00000	.00000	.81931+02	.00000	.00000
.33590+00	.00000	.10100+01	.00000	.00000	.81931+02	.00000	.00000
.35358+00	.00000	.10100+01	.00000	.00000	.81931+02	.00000	.00000
RUN CUTOFF INFORMATION							
UPPER BOUNDARY				LOWER BOUNDARY			
HA	.10000+03	X=	.10000+03	THETA=	.00000	R=	.00000
		X=	.40000+01	THETA=	.90000+02		
THE MESH CONSTRUCTION WILL BE CONTROLLED BY THE FOLLOWING VARIABLES							
DL INTERIOR=	.200+00	DL AXIS=	.100+00	DL LIM=	.100+01	DL DELETE=	.500+02
		DEG P.W.=	.500+01	CG	.050+00		

Table 3-22 (Continued)

## SUPERSONIC FLOW ANALYSIS USING THE LOCKNEED-HUNTSVILLE MULTIPLE SHOCK COMPUTER PROGRAM

CASE NO. 1

PAGE 6

## GASEOUS CHECK CASE

LINE	POINT	DESCRIP	REGIME	R MACH	X ANGLE	Y PRESSURE	M DENSITY	THETA TEMPERATURE	ENTROPY GAS CONST.	VELOCITY LOCAL GAMMA	OFF SHOCK	ITN ANGLE
1	14	INPUT	CONTIN	.22983+00 .81931+02	.00000 .34164+03	.10100+01 .47833-02	.00000 .56351+04	.00000 .18252+04	.00000 .11443+01	.34649+04 .00000	.00000	0
1	15	INPUT	CONTIN	.24751+00 .81931+02	.00000 .34164+03	.10100+01 .47833-02	.00000 .56351+04	.00000 .18252+04	.00000 .11443+01	.34649+04 .00000	.00000	0
1	16	INPUT	CONTIN	.26518+00 .81931+02	.00000 .34164+03	.10100+01 .47833-02	.00000 .56351+04	.00000 .18252+04	.00000 .11443+01	.34649+04 .00000	.00000	0
1	17	INPUT	CONTIN	.28286+00 .81931+02	.00000 .34164+03	.10100+01 .47833-02	.00000 .56351+04	.00000 .18252+04	.00000 .11443+01	.34649+04 .00000	.00000	0
1	18	INPUT	CONTIN	.30054+00 .81931+02	.00000 .34164+03	.10100+01 .47833-02	.00000 .56351+04	.00000 .18252+04	.00000 .11443+01	.34649+04 .00000	.00000	0
1	19	INPUT	CONTIN	.31822+00 .81931+02	.00000 .34164+03	.10100+01 .47833-02	.00000 .56351+04	.00000 .18252+04	.00000 .11443+01	.34649+04 .00000	.00000	0
1	20	INPUT	CONTIN	.33590+00 .81931+02	.00000 .34164+03	.10100+01 .47833-02	.00000 .56351+04	.00000 .18252+04	.00000 .11443+01	.34649+04 .00000	.00000	0
1	21	INPUT	CONTIN	.35358+00 .81931+02	.00000 .34164+03	.10100+01 .47833-02	.00000 .56351+04	.00000 .18252+04	.00000 .11443+01	.34649+04 .00000	.00000	0
THE MASS FLOW RATE IS				.209434+03								

## MOMENTUM INTEGRATION RESULTS

FORCEX	FORCEY	TORQZ	ISP
-.41877+05	.00000	.00000	.19995+03

- NOTES: (1) Typical printout for the start line data surface.  
 (2) Some points have been omitted for demonstration purposes.

Table 3-22 (Continued)

SUPERSONIC FLOW ANALYSIS USING THE LOCKHEED-HUNTSVILLE MULTIPLE SHOCK COMPUTER PROGRAM

CASE NO. 1

PAGE 23

GASEOUS CHECK CASE

LINE	POINT	DESCRIP - REGIME	R MACH ANGLE	X PRESSURE	M DENSITY	THEYA TEMPERATURE	ENTROPY GAS CONST.	VELOCITY LOCAL GAMMA	OFF SHOCK ANGLE	TK
76	1	WALL - CONTIN	.00000 .24955+02	.98905+00 .36990+02	.24156+01 .68547-03	.00000 .42579+04	.00000 .18252+04	.72031+04 .11443+01	.00000	3
76	21	WALL - CONTIN	.57707+00 .26656+02	.91200+00 .52849+02	.22290+01 .93628-03	.15300+02 .44534+04	.00000 .18252+04	.67980+04 .11443+01	.00000	1
77	1	WALL - CONTIN	.00000 .23928+02	.10512+01 .33552+02	.24655+01 .62945-03	.00000 .42054+04	.00000 .18252+04	.73070+04 .11443+01	.00000	3
77	21	WALL - CONTIN	.59442+00 .26068+02	.97543+00 .48396+02	.22757+01 .86695-03	.15300+02 .44042+04	.00000 .18252+04	.69019+04 .11443+01	.00000	1
78	1	WALL - CONTIN	.00000 .23526+02	.11168+01 .31031+02	.25052+01 .58792-03	.00000 .41642+04	.00000 .18252+04	.73882+04 .11443+01	.00000	3
78	21	WALL - CONTIN	.61268+00 .25496+02	.10422+01 .44213+02	.23231+01 .80110-03	.15300+02 .43543+04	.00000 .18252+04	.70058+04 .11443+01	.00000	1
79	1	WALL - CONTIN	.00000 .23777+02	.11849+01 .29517+02	.25305+01 .56277-03	.00000 .41380+04	.00000 .18252+04	.74393+04 .11443+01	.00000	3
79	21	WALL - CONTIN	.63154+00 .24952+02	.11111+01 .40370+02	.23705+01 .71990-03	.15300+02 .43044+04	.00000 .18252+04	.71076+04 .11443+01	.00000	1
80	1	WALL - CONTIN	.00000 .23202+02	.12544+01 .29068+02	.25383+01 .55528-03	.00000 .41300+04	.00000 .18252+04	.74548+04 .11443+01	.00000	2
80	21	WALL - CONTIN	.65060+00 .24445+02	.11808+01 .36923+02	.24165+01 .68439-03	.15300+02 .42565+04	.00000 .18252+04	.72051+04 .11443+01	.00000	1
81	1	WALL - CONTIN	.00000 .23282+02	.13240+01 .29547+02	.25300+01 .56328-03	.00000 .41385+04	.00000 .18252+04	.74382+04 .11443+01	.00000	2
81	21	WALL - CONTIN	.66942+00 .23982+02	.12496+01 .33895+02	.24903+01 .63508-03	.15300+02 .42108+04	.00000 .18252+04	.72963+04 .11443+01	.00000	3
82	1	WALL - CONTIN	.00000 .23417+02	.13927+01 .30365+02	.25162+01 .57689-03	.00000 .41528+04	.00000 .18252+04	.74104+04 .11443+01	.00000	2

NOTES: (1) Typical printout for a data surface inside the nozzle.  
(2) Some points have been omitted for demonstration purposes.

LOCKHEED - HUNTSVILLE RESEARCH & ENGINEERING CENTER

3-342

Table 3-22 (Continued)

SUPERSONIC FLOW ANALYSIS USING THE LOCKHEED-HUNTSVILLE MULTIPLE SHOCK COMPUTER PROGRAM

CASE NO. 1

PAGE 30

GASEOUS CHECK CASE

LINE POINT	DESCRIP	REGIME	R MACH	X ANGLE	H PRESSURE	H DENSITY	THETA TEMPERATURE	ENTROPY GAS CONST.	VELOCITY LOCAL GAMMA	O/F SHOCK ANGLE	ITW
97	14	INTER	.63350+00	.25093+01	.29873+01	.29873+01	.98245+01	.00000	.82822+04	.00000	4
			.19557+02	.11649+02	.24973+03		.36802+04	.18757+04	.11443+01		
97	15	INTER	.68430+00	.25002+01	.29967+01	.29967+01	.10463+02	.00000	.82980+04	.00000	4
			.19493+02	.11424+02	.24551+03		.36711+04	.18252+04	.11443+01		
97	16	INTER	.73551+00	.24905+01	.30045+01	.30045+01	.11160+02	.00000	.83111+04	.00000	4
			.19441+02	.11249+02	.24205+03		.36636+04	.18757+04	.11443+01		
97	17	INTER	.78696+00	.24800+01	.30104+01	.30104+01	.11920+02	.00000	.83209+04	.00000	4
			.19401+02	.11104+02	.23949+03		.36580+04	.18252+04	.11443+01		
97	18	INTER	.83849+00	.24687+01	.30145+01	.30145+01	.12729+02	.00000	.83277+04	.00000	4
			.19374+02	.11009+02	.23770+03		.36541+04	.18757+04	.11443+01		
97	19	INTER	.88997+00	.24567+01	.30172+01	.30172+01	.13572+02	.00000	.83322+04	.00000	4
			.19356+02	.10948+02	.23654+03		.36515+04	.18252+04	.11443+01		
97	20	INTER	.94131+00	.24439+01	.30187+01	.30187+01	.14433+02	.00000	.83347+04	.00000	4
			.19346+02	.10914+02	.23590+03		.36500+04	.18257+04	.11443+01		
97	21	WALL	.10000+01	.24580+01	.30237+01	.30237+01	.15300+02	.00000	.83514+04	.00000	4
			.19280+02	.10688+02	.23162+03		.36404+04	.18252+04	.11443+01		
97	22	PRN-MR	.10000+01	.24580+01	.30741+01	.30741+01	.16769+02	.00000	.84260+04	.00000	4
			.18984+02	.97213+01	.21321+03		.35972+04	.18252+04	.11443+01		

NOTES: (1) Typical printout for a data surface containing a Prandtl-Meyer expansion.  
 (2) Some points have been omitted for demonstration purposes.

LOCKHEED - HUNTSVILLE RESEARCH & ENGINEERING CENTER

3-343

Table 3-22 (Concluded)

SUPERSONIC FLOW ANALYSIS USING THE LOCKHEED-HUNTSVILLE MULTIPLE SHOCK COMPUTER PROGRAM

CASE NO. 1

PAGE 35

GASEOUS CHECK CASE

LINE	POINT	DESCRIP - REGIME	R MACH ANGLE	X PRESSURE	M DENSITY	THETA TEMPERATURE	ENTROPY GAS CONST.	VELOCITY LOCAL GAMMA	O/F SHOCK ANGLE	ITR
103	1	WALL - CONTIN	.00000 .19417+02	.27461+01 .11157+02	.30081+01 .24048-03	.00000 .36602+04	.00000 .18252+04	.83171+04 .11443+01	.00000	2
103	22	FREED - CONTIN	.10405+01 .18984+02	.26000+01 .97222+01	.30740+01 .21323-03	.15238+02 .35972+04	.00000 .18252+04	.84259+04 .11443+01	.00000	2
104	1	WALL - CONTIN	.00000 .19319+02	.27883+01 .10821+02	.30227+01 .23416-03	.00000 .36461+04	.00000 .18252+04	.83415+04 .11443+01	.00000	2
104	22	FREED - CONTIN	.10513+01 .18984+02	.26404+01 .97222+01	.30740+01 .21323-03	.14820+02 .35972+04	.00000 .18252+04	.84259+04 .11443+01	.00000	3
105	1	WALL - CONTIN	.00000 .19221+02	.28313+01 .10494+02	.30375+01 .22795-03	.00000 .36320+04	.00000 .18252+04	.83659+04 .11443+01	.00000	2
105	22	FREED - CONTIN	.10421+01 .18984+02	.26418+01 .97222+01	.30740+01 .21323-03	.14404+02 .35972+04	.00000 .18252+04	.84259+04 .11443+01	.00000	3
106	1	WALL - CONTIN	.00000 .19124+02	.28751+01 .10174+02	.30523+01 .22187-03	.00000 .36179+04	.00000 .18252+04	.83909+04 .11443+01	.00000	2
106	22	FREED - CONTIN	.10728+01 .18984+02	.27241+01 .97222+01	.30740+01 .21323-03	.13993+02 .35972+04	.00000 .18252+04	.84259+04 .11443+01	.00000	3
107	1	WALL - CONTIN	.00000 .18987+02	.29390+01 .97301+01	.30736+01 .21338-03	.00000 .35974+04	.00000 .18252+04	.84253+04 .11443+01	.00000	2
107	22	FREED - CONTIN	.10879+01 .18984+02	.27867+01 .97222+01	.30740+01 .21323-03	.13412+02 .35972+04	.00000 .18252+04	.84259+04 .11443+01	.00000	2
108	1	WALL - CONTIN	.00000 .18449+02	.30045+01 .93015+01	.30952+01 .20514-03	.00000 .35772+04	.00000 .18252+04	.84602+04 .11443+01	.00000	2
108	22	FREED - CONTIN	.11029+01 .18984+02	.28503+01 .97222+01	.30740+01 .21323-03	.12837+02 .35972+04	.00000 .18252+04	.84259+04 .11443+01	.00000	2
109	1	WALL - CONTIN	.00000 .18713+02	.30717+01 .88881+01	.31169+01 .19715-03	.00000 .35568+04	.00000 .18252+04	.84952+04 .11443+01	.00000	2

NOTES: (1) Typical printout for a data surface in the exhaust plume.  
 (2) Some points have been omitted for demonstration purposes.

LOCKHEED - HUNTSVILLE RESEARCH & ENGINEERING CENTER

3-344

## Section 4 CONCLUSIONS

A versatile computer program has been described in the preceding sections. The code has numerous options which have necessitated a somewhat generalized set of input data. These options include:

- Gas-Particle Flows
- Chemistry
  - Equilibrium
  - Kinetics
  - Chemically Frozen
  - Constant Thermodynamics
- Single-Phase Solution
  - Non-Isoenergetic Flow
- Non-Continuum Flow
- Performance Calculations
- Shock Waves

In its present form, the code has the capability of producing data for the following applications:

- Gas/Gas-Particle Impingement (Heat Transfer Loads)
- Rocket Nozzle Performance (Thrust,  $I_{sp}$ )
- IR Signatures (Radiating Species)
- RF Attenuation (Electron Densities)
- Plume Radiation (Radiative Heat Transfer Gas/Particles)
- Vehicle Base Pressure
- Base Heating (Convection-Recirculation)

A primary consequence of this work is the extension of gas-particle solutions to treat chemical kinetics for nozzle-exhaust plume flow fields. Since the code has the option of treating single-phase flow, chemical kinetics can also be included in liquid propellant motor analyses as well as solid propellant calculations. The method by which the kinetic equations are modeled also permits thermal nonequilibrium to be treated.

The RAMP code is an advance in the state of the art in the area of two-phase flowfield numerical solutions. Future development of the code may be done in the area of imbedded subsonic regions (Mach disks) and subsonic-supersonic mixing.



Section 5  
REFERENCES

1. Svehla, Roger A., and Bonnie J. McBride, "FORTRAN IV Computer Program for Calculation of Thermodynamic and Transport Properties of Complex Chemical Systems," NASA TN D-7056, January 1973.
2. Gordon, Sanford, and Bonnie J. McBride, "Computer Program for Calculation of Complex Chemical Equilibrium Compositions, Rocket Performance, Incident and Reflected Shocks, and Chapman-Jouget Detonations," NASA SP-273, Lewis Research Center, Cleveland, Ohio, 1968.
3. Ruo, S. R., "Development of a Multiple Shock Computer Program Using a Streamline-Normal Technique," LMSC-HREC A791047, Lockheed Missiles & Space Company, Huntsville, Ala., January 1968.
4. Prozan, R. J., "Development of a Method of Characteristics Solution for Supersonic Flow of an Ideal Frozen or Equilibrium Reacting Gas Mixture," LMSC-HREC A782535, Lockheed Missiles & Space Company, Huntsville, Ala., April 1966.
5. Penny, Morris M., S. D. Smith, L. R. Baker and R. J. Prozan, "Two Phase Flow Development - Final Report," LMSC-HREC TR D390040, Lockheed Missiles & Space Company, Huntsville, Ala., January 1974.
6. Smith, S. D., and A. W. Ratliff, "Rocket Exhaust Plume Computer Program Improvement - Vol IV," LMSC-HREC D162220-IV-A, Lockheed Missiles & Space Company, Huntsville, Ala., January 1972.
7. Kliegel, J. R., and G. R. Nickerson, "Axisymmetric Two-Phase Perfect Gas Performance Program - Vol. I," NASA CR 92060, April 1967.
8. Prozan, R. J., "Solution of Non-Isoenergetic Supersonic Flows by Method of Characteristics - Vol. III," LMSC-HREC D162220-III, Lockheed Missiles & Space Company, Huntsville, Ala., July 1971.
9. Penny, M. M., and C. J. Wojciechowski "User's Manual and Description of a Computer Program for Calculating Heating Rates, Forces and Moments Acting on Bodies Immersed in Rocket Exhaust Plumes," LMSC-HREC D162867-II, Lockheed Missiles & Space Company, Huntsville, Ala., March 1971.
10. JANAF Thermochemical Tables, Second Edition, U. S. Dept. of Commerce, National Bureau of Standards, NSRDS-NBS 37, Washington, D. C., June 1971.

11. Crowe, C. J., "Drag Coefficient of Particles in a Rocket Nozzle," AIAA J., Vol. 5, No. 5, May 1967.
12. Radke, H. H., L. J. Delany and Lt. Palmer Smith, "Exhaust Particle Size Data from Small and Large Solid Rocket Motors," TDE-1001 (52951-18)-3 Air Force Rocket Propulsion Laboratory, Edwards, Calif., July 1967.
13. Laderman, A. J. et al., "Study of Thermal Radiation, Particle Impingement Heating and Flowfield Analysis of Solid Propellant Rocket Exhausts," WO 2386, Philco-Ford, Aeronutronic Division, Newport Beach, Calif., April 1967.

Appendix A  
USER'S INPUT GUIDE FOR THE RAMP  
RADIAL LOOKUP PROGRAM

## Appendix A

### CARD 1 - Run control card

Format: 16I5

<u>Column</u>	<u>Parameter</u>	<u>Value</u>	<u>Description</u>
5	IORDR	0	Will not call data ordering routines but will execute lookup routines. Ordered flowfield tape must be input.
		1	Will order flowfield data and generate Radiance tape.
		2	Will order flowfield data but will not generate Radiance tape.
10	IWRITE	0	No intermediate printout in property lookup routines.
		1	Use a one only if problems are encountered with program and intermediate printout is necessary to determine problem.
14-15	ISP	0	Species and species concentrations will come from flowfield tapes or finite-rate chemistry case.
		N	Number of species and species concentrations to be read from cards (Assumes species and species concentrations constant throughout plume.) (25 max).
20	IDUM1	0	If two entropy tables are present on the RAMP tape both tables will be used to determine local flow properties and species concentrations.
		1	Only first entropy table will be used to determine flow properties.
			Ignore for finite rate chemistry case.

A-1

CARD 1 (Continued)

<u>Column</u>	<u>Parameter</u>	<u>Value</u>	<u>Description</u>
23-25	IXCUT	N	Number of axial cuts to be written on flowfield tape. The values of the cuts will be read from Card 10 (100 max)
26-30	KASE	N	Case number to be written on Radiance tape.
35	INUNIT	0	Output pressure and temperature in English units. Temperature, °R; pressure, lb/ft <sup>2</sup>
		1	Output pressure and temperature in metric units. Temperature, °K; pressure, atm.
40	LSOLID	0	Do not perform 2-phase flow energy calculations for heating analysis.
		1	Perform 2-phase flow energy calculations.
45	LSOLGS	0	MOC input tape on Unit 8.
		1	RAMP input tape on Unit 8.
50	INRS	0	No radiation data on input tape.
		N	Number of radiating species on input tape.
54-55	NS	0	Equilibrium or frozen chemistry.
		N	Number of species on input tape for finite rate chemistry case (RAMP only) (25 max).
60	IPSTR	0	Pitot pressure data not on input tape.
		1	Pitot pressure data on input tape.
65	KUNIT	1	English units used internally.
		2	MKS units used internally (Required only if NS>0).

CARD 2

Reference Card for Property Lookup. These data are used to non-dimensionalize the axial and radial coordinates which are to be looked up in the ordered flow field.

Format: 3E10,6

<u>Column</u>	<u>Parameter</u>	<u>Description</u>
1-10	XREFF	Axial coordinate to which each input axial station is referenced (ft or m).
11-20	ST	Reference length by which all input axial stations and radial coordinates are multiplied (ft or m).
21-30	RREFF	Radial coordinate to which each radial coordinate is referenced (ft or m).

NOTE: RREFF, XREFF and ST are used as follows (in main routine only):

$$X = X*ST-XREFF$$

$$R = R*ST-RREFF$$

CARD 3

This card contains the necessary information to limit the calculations to those areas of interest. Units are consistent with the ordered flow field.

Format: 8E10,6

<u>Column</u>	<u>Parameter</u>	<u>Description</u>
1-10	CUTDAT(1)	Radial coordinate defining upper cut off (ft or m).
11-20	CUTDAT(2)	Axial coordinate defining upper cut off (ft or m).
21-30	CUTDAT(3)	Angle cutoff line makes with horizontal (deg).

CARD 3 (Continued)

<u>Column</u>	<u>Parameter</u>	<u>Description</u>
31-40	CUTDAT(4)	Radial coordinate defining downstream cut off (ft or m).
41-50	CUTDAT(5)	Axial coordinate defining downstream cut off (ft or m).
51-60	CUTDAT(6)	Angle cut off line makes with horizontal (deg).

CARD 4

This card inputs radiation data only when INRS (Card 1) is greater than zero.

Format: 5(A6, 6X)

<u>Column</u>	<u>Parameter</u>	<u>Description</u>
1-6	AIDR(1)	Name of first initial radiating species.
13-18	AIDR(2)	Name of second initial radiating species.
.	.	.
.	.	.
.	.	.
	AIDR(K)	Name of last initial radiating species, where K=INRS.

CARD 5

This card inputs radiation data only when INRS (Card 1) is greater than zero.

Format: 5(A6, 6X)

<u>Column</u>	<u>Parameter</u>	<u>Description</u>
1-6	AIDRT(1)	Name of species that AIDR(1) transforms to during radiation process.
13-18	AIDRT(2)	Name of species that AIDR(2) transforms to during radiation process.
.	.	.
.	.	.
.	AIDRT(K)	Name of species that AIDR(K) transforms to during radiation process.

CARD 6

Control card for the ordering section. Cards 6 and 7 are used only when IORDR (Card 1) is greater than zero.

Format: 16I5

<u>Column</u>	<u>Parameter</u>	<u>Value</u>	<u>Description</u>
5	ISTART		Ordering the flowfield data will begin with this characteristic line number.
10	ISIGN	-1	If the flow field was generated with a reflected shock from the nozzle axis, otherwise leave blank.
15	NUMBER		Number of flowfield data points desired per data record (max. of 300).
20	IDEL	>0	If any points are to be deleted from the flow field.



CARD 6 (Continued)

<u>Column</u>	<u>Parameter</u>	<u>Value</u>	<u>Description</u>
25	IPRINT	>0	If intermediate data are to be printed as the flow field is ordered by distance from the engine exit plane.
30	ITERM		Characteristic line number, where ordering of flowfield data is to be terminated. (This line is not used by program).
35	ISEND	1	If plume boundary is to be curve-fitted for use in the interpolation scheme.
		2	If only the cutoff limits read as input data are to be used to see if a point is within a prescribed boundary.
40	ISKIP		If ISEND = 1 every ISKIP line will be examined for a free boundary point.

CARD 7

<u>Column</u>	<u>Parameter</u>	<u>Description</u>
1-10	RREF*	Radial coordinate to which each flowfield data point will be referenced (ft or m).
11-20	XREF*	Axial coordinate to which each flowfield data point will be referenced (ft or m).
21-30	DELETE	One of two points with a distance between them less than DELETE will be deleted from the flowfield data. Will not delete shock point.
31-40	DIAM	Reference factor, units consistent with plume dimensions. Can be used to scale, etc., the local plume coordinates.

\*The coordinates XREF and RREF are used to accomplish any desired coordinate system translation.

NOTE: RREF, XREF and DIAM are used as follows:

$$R = (R - RREF) / DIAM$$

$$X = (X - XREF) / DIAM$$

#### CARD 8

This card inputs particulate heat transfer data and is used only if LSOLID (Card 1) is greater than zero and when IORDR is greater than zero.

Format: 6E10.6

<u>Column</u>	<u>Parameter</u>	<u>Description</u>
1-10	ACOMCF	Accommodation coefficient.
11-20	TWALL	Wall temperature ( $^{\circ}$ R or $^{\circ}$ K).
21-30	CPS	Particulate phase heat capacity.

#### CARD 9

Species concentration cards (Input only if ISP > 0 and NS = 0) these cards contain the species names and mole fractions if the species concentrations are constant throughout the plume. There are four species per card up to a maximum of 25 species. Overrides species on flowfield tape.

Format: 4(A6, 4X, E10.6)

<u>Column</u>	<u>Parameter</u>	<u>Description</u>
1-6	SONAME(I, 1)	Species name - left adjusted, consistent with RAMP species names.
11-20	AMO(I)	Mole fraction of species.

NOTE: Repeat SONAME and AMO, 4 pairs to a card until all ISP species are read in.

CARD 10

This card(s) reads in the axial stations and the radial increment to be used in constructing the radiance tape. There are 2 stations per card up to 100 stations.

Format: 6E10.6

<u>Column</u>	<u>Parameter</u>	<u>Description</u>
1-10	X(1)	First axial station at which radial distribution of flowfield properties are desired (ft or m).
11-20	DR(1)	Radial increment between data points along radial for station 1 (ft or m)
21-30	RMAX(1)	Maximum value of radial distance desired for station 1. If zero, program determines maximum (ft or m).
31-40	X(2)	Second axial station at which radial distribution of flowfield properties are desired.
41-50	DR(2)	Radial increment between data points along radial for station 2.
51-60	RMAX(2)	Maximum value of radial distance desired for station 2. If zero, program determines maximum.

Repeat until IXCUT (Card 1) number of stations have been input.

Table A-1  
**MAGNETIC TAPE ASSIGNMENTS FOR THE  
 RAMP RADIAL LOOKUP PROGRAM**

Where Required	Tape Units U-1108	Tape Unit Function
<u>Section 1</u>  <u>SORTCT</u>  Subroutine SORTCT is the controlling routine for this section which arranges the RAMP output in the form used by the data acquisition routines. This section is used once per flowfield calculation.	10  8  2  3  4	Flowfield tape generated by RAMP program-input.  Flowfield data ordered for use in property lookup-output.  Flowfield limits data-output.  Scratch tape.  Scratch tape for species concentrations & radiation data.
<u>Section 2</u>  <u>GENERATE RADIANCE TAPE</u>  This section performs the local property lookup and generates the radiance tape.	4  8  2	Radiance tape-output  Ordered flowfield data generated by Section 1-input.  Flowfield limits data generated by Section 1-input.

Appendix B  
ON THE ACCURACY OF PREDICTED EXHAUST PLUME  
FLOWFIELD VARIABLES

Appendix B

ON THE ACCURACY OF PREDICTED EXHAUST PLUME FLOWFIELD VARIABLES\*

by

A.W. Ratliff\*\*  
J.W. Benefield†

Lockheed Missiles & Space Company  
Huntsville, Alabama

ABSTRACT

Various assumptions are used by many organizations to compute rocket motor plumes. In applying plume data, the question of accuracy invariably arises. Some guidelines are therefore needed to estimate the accuracy of the plume data based upon the assumptions that are employed. This paper is intended to serve as a guide for estimating plume accuracy and to alert the plume analyst to the magnitude of error which might be expected if certain assumptions are used. Much of the information contained in this paper, however, is based upon somewhat subjective data and/or certain cases from which some experience has been gained. The data presented should, therefore, be used judiciously, the problem at hand should be carefully considered, and the fact that the error bands have been somewhat grossly estimated should be kept in mind.

---

\*This work was supported by NASA-Marshall Space Flight Center, Contract NAS8-20082. The test data and theoretical analyses cited in this report were sponsored by the Aero-Astrodynamic Laboratory of Marshall Space Flight Center as a continuing effort in rocket plume technology in support of NASA programs.

\*\*Aerodynamics Engineer, Senior; Aeromechanics Department

†Supervisor, Fluid Mechanics Section; Aeromechanics Department

## INTRODUCTION

During the past several years sophisticated techniques for computing rocket motor exhaust plumes have been developed. The prediction methods can take into account such influencing parameters as combustion chamber losses, flow striations, reaction kinetics and non-continuum effects. When a plume flow field is to be computed, the degree of analytical sophistication that will be used should be based on an assessment of such factors as: (1) ultimate purpose of the data; (2) time available to accomplish the calculations; and (3) degree of accuracy required. In most cases, all effects that can be calculated should be included in the calculations. To include all effects may, of course, be time-consuming; this is not always practical if schedules are to be met. Plume data are therefore sometimes generated which circumvent the various effects that are felt to be small. Since much plume data are generated by using various assumptions, some guidelines are needed to estimate the accuracy of the resulting plumes based upon the assumptions that are employed.

Although an absolute accuracy cannot at this time be assigned to the final numbers generated for any given plume calculation, at least a reasonable estimate can be made of the anticipated accuracy, depending upon the various assumptions. Some of the assumptions influence specific regions of the flow field, and the accuracy of the calculations varies with position in the plume.

This document is intended to serve as a guide for estimating the accuracy of axisymmetric plume flowfield calculations. Much of the information, however, is based upon somewhat subjective data and/or certain cases (perhaps even unique cases) from which some experience has been gained. Also, only steady state rocket motor operation is considered. Ignition and shutdown transient influences are omitted.

## DISCUSSION

The effects which are considered important in plume calculations are categorized and discussed in this section. Tables I and II summarize the important flowfield parameters and the estimated percentage of error that may be introduced by each item. The error that is discussed is the error which could exist if an accurate evaluation of the influence of the item is not included in the plume flowfield analysis. The error bands in Table I are considered to correspond to worst-on-worst or three-sigma cases for a 95 percent confidence interval. The error bands are rather large since they reflect the maximum values which have been observed. Most rocket motors will not encounter these effects to the extent shown in Table I. A set of data corresponding to an estimated one-sigma deviation for a 95 percent confidence interval is presented in Table II. The items which contribute to the accuracy bands shown in Tables I and II are discussed in the following paragraphs.

Motor Operating Conditions: Motor operating conditions refers to the fact that rocket motors are generally specified to operate at a nominal set of conditions (chamber pressure, mass flow rate, and oxidizer-to-fuel ratio ( $O/F$ )). Variations from nominal conditions frequently occur during actual operation. A band of  $\pm 10$  percent was arbitrarily assigned for chamber conditions (pressure,  $O/F$  ratio, mass flow). Influences of this  $\pm 10$  percent band on other motor and plume environmental conditions are shown in Table I and Table II.

Combustion Chamber Momentum Loss and Efficiency: Combustion chamber momentum loss and efficiency is included because combustion in a rocket motor does not take place at zero velocity as implied by an equilibrium, infinite area ratio calculation. The situation actually is analogous to heat addition in a finite area duct which results in a decrement in total pressure. The maximum momentum loss that can occur is a function of the propellant system and motor geometry and it can be as high as 20 percent of the actual pressure immediately downstream of the injector face. Most motors, however, fall in the range of 2 to 15 percent momentum loss (Ref. 1).

Coupled with the momentum loss is combustion efficiency; i.e., incomplete mixing and/or reaction of the incoming propellants. This anomaly first appeared when experimental performance data were compared with computed data. Even when all known performance losses were included in the analytical prediction, some discrepancy still existed. This discrepancy has been termed combustion efficiency and several theories have been proffered as possible explanations. The JANNAF Performance Standardization Committee has recommended an arbitrary reduction in the initial propellant energy to account for this loss (Ref. 2). Recently, however, this committee has been working on a droplet vaporization model which will be recommended as the explanation for combustion efficiency. Whatever its source, combustion efficiency must be properly estimated to increase the accuracy of the exhaust plume calculation. The most striking result of combustion efficiency is a temperature prediction considerably below that predicted by the usual adiabatic flame calculation. In this paper, the momentum loss and combustion efficiency problems are combined and assigned a maximum error, which corresponds to the deviations that have been observed between motor performance test data and theoretical results for no-momentum loss and for complete equilibrium chemistry combustion at a nominal motor operating value of  $O/F$ .

Flow Striations ( $O/F$  Ratio Gradient): The flow striation problem is a result of non-uniform distribution of propellant mixture ratio within the combustion chamber. Flow striations may be deliberately induced in the nozzle flow, as in the case of film cooling, or it may result from incomplete mixing and/or combustion in the combustion chamber. The effects that are introduced are variations of the thermochemical data due to combustion at a local  $O/F$  ratio which is different from the nominal  $O/F$  value (Ref. 3). Tables I and II show error bands relative to the nominal  $O/F$  value.

The flow striation effect may be closely related to the combustion efficiency problem; however, these effects are considered independently in this paper.



Reaction Kinetics: Reaction kinetics, as used here, involves the problem of appropriately defining the location in the flow field where the chemical reactions deviate from equilibrium enough that the flow can be considered chemically frozen. From this point on, the species concentrations are constant and the thermodynamic properties vary only with temperature. The problem thus is one of correctly assessing a representative freeze point. The error bands shown in the charts relate the error magnitudes resulting from comparison of results for a finite rate chemistry analysis (Ref. 4) and results obtained by an assumed freeze point based on an equilibrium/frozen chemistry analysis. The errors presented are the range of values which can be expected in the highly expanded plume. The errors in the field nearer the freeze point are not nearly as large. The major source of the errors is related to differences in the values of the thermodynamic properties used to calculate the flow field.

Non-Continuum Effects: The error caused by non-continuum effects is due to the lack of rigorous flow models which can consider the gradual deviation in thermodynamic properties which result as the rate of intermolecular collisions is reduced below a value corresponding to thermodynamic equilibrium. The error bands which are listed in Tables I and II for this item refer to variations which occur between a rigorous non-continuum solution (Refs. 5 and 6) and a sudden-freeze solution which uses continuum flow equations until a "free-molecular" condition is reached (Ref. 7). When this freeze point is reached, the flow calculation is handled as a free molecular calculation. In the transition flow region (Knudsen number greater than 0.1) the error increases until the sudden freeze condition is reached. The maximum error occurs near the freeze point and is the error shown in Tables I and II. Beyond the freeze point, the rigorous solution and the sudden freeze solution tend to converge toward common values (Knudsen number greater than 1.0). The sudden freeze solution yields results which show significant deviation in static temperature. Density and velocity calculations, however, are not greatly affected.

The error bands shown in Tables I and II are based upon the differences found between cases analyzed with: (1) a sudden freeze analysis; and (2) with a rigorous theoretical solution. An additional large error, not shown in the charts, would appear if the rigorous analysis were compared with an all continuum analysis. This would result from the fact that the temperature in a continuum analysis approaches a zero limit while the rigorous solution indicates that the temperature approaches a low but finite value.

Computational Accuracy: This item is an arbitrary estimate of the maximum error conceivable for the numerical computational procedures used.

Viscous Effects (Boundary Layer): The viscous (boundary layer) effects of the nozzle flow have been shown to be of minor consequence on the inviscid flow in the nozzle. (That is, if the boundary layer is considered in terms of displacement thickness to alter the nozzle contour, the effect on the nozzle flow is generally negligible.) The effect considered here is that the boundary layer will influence the plume flow field to some degree and will cause the maximum expansion angle at the nozzle lip to be significantly different. Basically, the boundary layer will tend to: (1) permit the flow to expand well beyond the limiting inviscid expansion angle at the nozzle lip; and (2) alter the temperature, pressure and density in the portion of the theoretically inviscid plume which is influenced by the boundary layer.

The boundary layer affects the entire plume to some extent but the most pronounced effect is in the outer 40 percent of the mass flow within the plume (Refs. 8 and 9).

Condensation: For a rocket motor, the influence of gases condensing in low temperature flow fields has been numerically evaluated only to a limited extent. The condensation will usually occur at low temperatures, at low pressures, and at velocities near the limiting velocity of the gas (Ref. 10). The influences will occur in the highly expanded regions of a flow field corresponding to temperatures below the condensation temperature of the gas. (The flow upstream of the condensation point is not influenced.) Normally the condensation will occur at points in the flow field where the temperature is some 10 to 50°K below the equilibrium condensation point. After initial condensation takes place, the temperature/pressure relations of the flowing system will tend initially to be parallel to and then to converge toward the temperature/pressure variation of a static system in equilibrium. Condensation will cause local static pressures to be different than they would otherwise be by factors of 0 to -100 (condensation causes lower static pressures). Static temperatures will be influenced (with respect to the no-condensation case) by factors of zero to +5 (condensation increases static temperatures). The influence of condensation on some of the other parameters has not currently been defined to a sufficient degree but consequential effects can be expected.

Start Line: The influence of the starting flow conditions has been observed to have significant effects for regions close to the start line (Refs. 9, 11, 12, 13, 14) but these effects tend to weaken farther downstream (2 to 4 start line diameters downstream of the nozzle exit). Near the start line some parameters may be locally in error by almost a factor of 10 (between an estimated and an accurate start line). Downstream the errors will tend to be smaller (on the centerline, less than 25 percent; in the expansion region, as much as 50 to 100 percent). Plume calculations that are begun at the nozzle throat tend to be relatively free from start line effects. Plume calculations initiated at the nozzle exit tend to permit errors in local properties that correspond to a position error in the flow field of plus or minus one startline diameter.

Shock Waves: If shock waves in the nozzle and flow field are not considered, and a plume is computed as an isentropic flow, the errors in the plume flow field are similar in magnitude to those associated with start line effects (Item 9), (Refs. 8 and 9) except that in the immediate vicinity of the shock wave, variations in flow properties can be extremely different from the "no-shock" case. The greatest influence tends to occur along the centerline of the plume where the shock wave is strongest. In the highly expanded portion of a high-altitude (near vacuum) plume calculation the influence of the shock waves diminishes as the shock waves become weaker and weaker. Tables I and II present the maximum error band values anticipated along the centerline of a plume.

Error Band Application: Tables I and II list plume flowfield parameters and the estimated maximum percentage error imposed upon them by the various items (1 through 10) listed in the preceding discussion. Their application is restricted to locations in the plume specified in Table III and in the preceding discussion of each item. Application of the error bands should be

made considering that each error contribution may only partially exist for a particular plume, and the rms values of the sum should normally be used. In the application of error bands to design data, often a simple means of expressing the error band is needed. As a result, a nominal accuracy (or error band) representation has been devised for use on a general basis. This nominal accuracy should be based upon and reflect, for any particular plume, an rms summation of various error contributions cited in this paper. The rms errors should be resolved into a maximum percent error of combined spatial position and flow parameter value. The spatial accuracy band is arbitrarily assigned as being equal in percentage magnitude to the quantitative accuracy band. Results of numerous plume calculations and experimental calculations indicate that the flowfield structure (shock wave locations, etc.) can be in error as a result of the various factors. Some of the effects which produce flowfield parameter quantitative errors, also produce flowfield structure positional errors. Conversely, a highly accurate plume calculation will necessarily reflect accurate flowfield positional accuracies. Consequently, combining the spatial and quantitative accuracy bands is logical. For example, a plume nominal accuracy band might, by the inspection process, be assessed at +20 percent, which means that the calculated location of a particular flow feature (a shock wave for instance) may be in error by +20 percent in both the axial and radial position; also, the magnitude of the flowfield parameters may additionally be in error by +20 percent.

In summary, the process of defining a nominal plume accuracy should be accomplished by:

1. Assessing the applicability of the various items which contribute errors to the computed plume flow field at various plume locations
2. Determining the rms error band for each flowfield parameter for numerous points in the plume
3. Obtaining a "nominal plume accuracy band" rms value by averaging the rms error bands of the various points in the flow field.

#### CONCLUSIONS

Factors that affect the accuracy of plume calculations have been categorized, and anticipated ranges of errors associated with each plume parameter have been estimated. This information is provided for reference and is intended to serve as a guide in estimating the overall accuracy of any given plume analysis based upon the assumptions employed for the plume calculation. Absolute values of accuracy are almost impossible to assign to plume calculations. Therefore, the data presented should be used judiciously, and the problem at hand carefully considered, including the fact that the error bands have been somewhat grossly estimated.

#### SYMBOLS AND NOTATION

Force	force
M	Mach number
$\dot{m}$	mass flow rate
O/F	oxidizer/fuel ratio

P	static pressure
$P_T$	total pressure
$P_{T_2}$	pitot total pressure
T	static temperature
$T_T$	total temperature
V	velocity
$\sigma_i$	i <sup>th</sup> species
$\gamma$	isentropic exponent
$\rho$	density

#### REFERENCES

- 1. Prozan, R.J., "Striated Combustion Solution," LMSC-HREC A791356, Lockheed Missiles & Space Company, Huntsville, Ala., May 1968.
- 2. "ICRFG Liquid Propellant Thrust Chamber Performance Evaluation Manual," CPIA No. 178 Performance Standardization Working Group, September 1968.
- 3. Ratliff, A.W., "The Effect of Nozzle Flow Striations on Engine Performance," LMSC-HREC A784646-A, Lockheed Missiles & Space Company, Huntsville, Ala., August 1967.
- 4. Komianos, S.A., G.D. Bleich and H.S. Pergament, "AeroChem Non-Equilibrium Streamline Program," AeroChem TN 103, AeroChem Research Laboratories, Inc., May 1967.
- 5. Hamel, B.B., and D.R. Willis, "Kinetic Theory of Source Flow Expansion with Application to the Free Jet," Phys. Fluids, Vol. 9, 1966, p. 829.
- 6. Robertson, S.J., "Method of Characteristics Solution of Rarefied Monatomic Gaseous Jet Flow into a Vacuum," LMSC-HREC D148961, Lockheed Missiles & Space Company, Huntsville, Ala., August 1969.
- 7. Ratliff, A.W., et al., "Analysis of Heating Rates and Forces on Bodies Subject to Rocket Exhaust Plume Impingement," LMSC-HREC A791230, Lockheed Missiles & Space Company, Huntsville, Ala., March 1968.
- 8. Smith, S.D., and A.W. Ratliff, "A Study of the Effect of a Boundary Layer Along a Nozzle Wall on the Plume Flowfield," LMSC-HREC D149477, Lockheed Missiles & Space Company, Huntsville, Ala., January 1970.
- 9. Ratliff, A.W., and J.T. Stephens, "A Detailed Plume Flowfield Definition of the R-1E Motor for the Saturn S-IVB Auxiliary Propulsion System," LMSC-HREC D148776-A, Lockheed Missiles & Space Company, Huntsville, Ala., August 1969.
- 10. Haukohl, J., and L.W. Spradley, "Multi-Specie Condensation in Expanding Flows," LMSC-HREC D162239, Lockheed Missiles & Space Company, Huntsville, Ala., June 1970.

11. Ratliff, A.W., "An Investigation of Method-of-Characteristics Starting Line Effects for Rocket Nozzles," LMSC-HREC A782289, Lockheed Missiles & Space Company, Huntsville, Ala., February 1966.
12. Baker, L.R., "Preliminary Data for Plume Definition of the R-1E Engine for the Saturn S-IVB/Auxiliary Propulsion System," LMSC-HREC A791426, Lockheed Missiles & Space Company, Huntsville, Ala., May 1968.
13. Jackson, J.E., "Preliminary Data for Plume Definition of the R-4D Engine for the Command Service Module Reaction Control System, LMSC-HREC A791774, Lockheed Missiles & Space Company, Huntsville, Ala., September 1968.
14. Ratliff, A.W., B.J. Audeh and D.D. Thornhill, "Analysis of Exhaust Plumes from Skylab-Configuration R-4D Attitude Control Motors, LMSC-HREC D162171, Lockheed Missiles & Space Company, Huntsville, Ala., March 1970.

TABLE I. ESTIMATED RANGE OF PERCENTAGE OF ERROR FOR VARIOUS PARAMETERS IN PLUME FLOW FIELD FOR A 3-SIGMA DEVIATION AT 95% CONFIDENCE INTERVAL

Item	1	2	3	4	5	6	7	8	9	10
Item Introducing Error Band in Plume Flow-field Parameters	Engine Operating Condition ( $P_c, O/F, m$ ), $\pm 10\%$ Variation	Chamber Combustion Efficiency and Momentum Loss not Included in Plume Analysis	Fuel Striations (Oxidizer/Fuel Gradients) not Included in Plume Analysis	Reaction Kinetics (Finite Rate Effects) not Included in Plume Analysis	Non-Continuum Flow Effects not Included in Plume Analysis	Computational Accuracy	Viscous Effects (Boundary Layer) Not Included in Plume Analysis	Flow Condensation Not Included in Plume Analysis	Approximate Start Line Used in the Analysis	Shock Waves Not Included in the Analysis
Affected Parameter										
$P_{T_2}$	$\pm 10$	+ 0 - 20	$\pm 10$	0	*	$\pm 5$	**	$\Delta$	0	$\pm 25$
$T_T$	$\pm 3$	+ 0 - 20	+ 0 - 50	+ 25	*	$\pm 5$	**	$\Delta$	0	$\pm 25$
P	$\pm 10$	+ 0 - 20	$\pm 5$	$\pm 100$	$\pm 10$	$\pm 5$	**	+1000 - 0	$\pm 100$	$\pm 100$
T	$\pm 3$	+ 0 - 20	+ 0 - 50	$\pm 100$	+ 100 - 0	$\pm 5$	**	+ 0 - 100	$\pm 100$	$\pm 100$
$\rho$	$\pm 10$	+ 0 - 20	+ 100 - 0	$\pm 100$	$\pm 5$	$\pm 5$	**	$\pm 50$	$\pm 100$	$\pm 100$
V	$\pm 5$	+ 0 - 10	+ 40 - 0	$\pm 5$	$\pm 3$	$\pm 5$	**	$\pm 5$	$\pm 10$	$\pm 10$
$\gamma$	$\pm 3$	$\pm 3$	$\pm 50$	$\pm 25$	$\pm 40$	$\pm 5$	**	$\Delta$	$\pm 0$	$\pm 10$
$c_i$	$\pm 1$	$\pm 25$	$\pm 100$	$\pm 100$	$\pm 1$	$\pm 5$	**	$\Delta$	$\pm 0$	$\pm 5$
F (impingement force) & $P_{T_2}$	$\pm 10$	+ 0 - 20	$\pm 10$	$\pm 5$	$\pm 20$	$\pm 10$	**	$\pm 20$	$\pm 10$	$\pm 10$
M	$\pm 2$	$\pm 5$	+ 5 - 10	$\pm 15$	- 0 + 50	$\pm 5$	**	$\pm 20$	$\pm 10$	$\pm 15$

\* Not meaningful

\*\* Affects mainly the outer 40% of the mass flow (see Discussion)

$\Delta$  Not defined

TABLE II. ESTIMATED RANGE OF PERCENTAGE OF ERROR FOR VARIOUS PARAMETERS IN CALCULATED PLUME FLOW FIELDS FOR 1-SIGMA DEVIATIONS AT 95% CONFIDENCE INTERVALS

Item	1	2	3	4	5	6	7	8	9	10
Item Introducing Error Band in Plume Flowfield Parameters	Engine Operating Condition (P, O/F, m), ±10% Variation	Chamber Combustion Efficiency and Momentum Loss Not Included in Plume Analysis	Fuel Striations (Oxidizer/Fuel Gradients) Not Included in Plume Analysis	Reaction Kinetics (Finite Rate Effects) Not Included in Plume Analysis	Non-Continuum Flow Effects Not Included in Plume Analysis	Computational Accuracy	Viscous Effects (Boundary Layer) Not Included in Plume Analysis	Flow Condensation Not Included in Plume Analysis	Approximate Start Line Used in the Analysis	Shock Waves Not Included in the Analysis
Affected Parameter										
$P_T$	+ 2	+ 0 - 3	+ 2	0	*	+ 2	**	Δ	0	+ 25
$T_T$	+ 1	+ 0 - 3	+ 0 - 10	- 25	*	+ 2	**	Δ	0	+ 25
$P$	+ 2	+ 0 - 3	+ 2	+ 15	+ 10	+ 2	**	+ 50 - 0	+ 25	+ 100
$T$	+ 1	+ 0 - 3	+ 5 - 10	+ 15	+ 100 - 0	+ 2	**	+ 0 - 20	+ 25	+ 100
$\rho$	+ 2	+ 0 - 3	- 20 - 5	+ 15	+ 5	+ 2	**	+ 10	+ 25	+ 100
$V$	+ 1	+ 0 - 2	+ 5 - 10	+ 2	+ 3	+ 2	**	+ 2	+ 2	+ 10
$\gamma$	+ 1	+ 1	+ 5	+ 5	+ 40	+ 2	**	Δ	0	+ 10
$\alpha_i$	+0.5	+ 4	+ 10	+ 15	+ 1	+ 2	**	Δ	0	+ 5
$F$ (impingement force) & $P_{T2}$	+ 2	+ 0 - 3	+ 2	+ 2	+ 20	+ 4	**	+ 5	+ 2	+ 10
	+ 2	+ 2	+ 2 - 5	+ 10	- 0 + 50	+ 2	**	+ 10	+ 10	+ 50

\* Not meaningful  
 \*\*Affects mainly the outer 40% of the mass flow (see Discussion)  
 Δ Not defined

TABLE III. REGIONS OF THE PLUME WHERE ERROR BANDS APPLY

Item	Region of Plume Where Error Bands Apply if the Item is Not Included in the Analysis
1. Engine Operating Conditions	Entire Flow Field
2. Chamber Combustion Efficiency and Momentum Loss	Entire Flow Field
3. Flow Striations	Entire Flow Field
4. Reaction Kinetics	Small errors near nozzle exit, progressively larger errors in the far plume.
5. Non-Continuum Effects	Error applies in the transition flow regime. The error is zero at the onset of transition flow, maximum at the sudden freeze point, and decreases as free molecular flow occurs.
6. Calculational Accuracy	Entire Flow Field
7. Viscous Effects	Error increases in the region of the plume outside of approximately the 60% mass flow streamline (where minor errors exist). Major errors occur outside the inviscid plume region.
8. Condensation	Error is zero upstream of the point in the flow field where the equilibrium condensation temperature exists. Downstream, the error can grow with increasing distances from the equilibrium point.
9. Start Line	Error is maximum near the startline, decreases to smaller values 2 to 5 startline diameters (nozzle throat or exit) downstream.
10. Shock Waves	Error is maximum near the centerline and in the regions where the shock should be; decreases away from the centerline.



Appendix C  
EMPIRICAL INPUT DATA AND INPUT DATA SUGGESTIONS

## Appendix C

The results obtained from the Reacting and Multiphase Computer Program (RAMP) are very sensitive to data which are input. For two-phase cases the mean particle size, distribution of sizes, specific heats, mass density, particle melting temperature, chemistry assumptions and boundary equations are the primary input variables which determine the results. Each of these variables will be discussed in some detail and suggestions will be made as to what values can be used for aluminized propellants. It should be noted, however, that the data presented is not necessarily the best available.

### Mean Particle Size

Several different methods have been employed for obtaining mean particle size. Included are techniques which correlate mean size to throat diameter (Ref. C-1), mean motor  $L^*$  (Ref. C-2) (chamber volume/throat area), chamber pressure, residence time, particle loading, maximum stable droplet size as well as combinations of each of these parameters. As a simple estimate of mean particle size the correlation of Delaney (Ref. C-1) based on throat diameter can be used:

$$D_m = 4 D_t^3 \quad (C.1)$$

where  $D_m$  is the mean particle diameter in microns and  $D_t$  is the throat diameter in inches.

### Particle Size Distribution

For nozzle calculations in which no particle impingement on the wall is anticipated, one particle size at the mean size can be used. However, for plume calculations a knowledge of the particle size distribution is necessary.

Delaney in Ref. C-1 showed that the distribution of particles for smaller motors ( $D_t \leq 3.5$  in.) followed a log normal distribution (Fig. C-1). For the large motors ( $D_t > 3.5$  in.) the data indicate that the size distribution follows a normal distribution (Fig. C-2). To use these distributions; move the curves up or down to the mean size at the 50% coordinate, then divide the curve into 5 or 6 sections and determine the mean size that goes with each of these sections. Table C-1 gives an example of the size distribution (for 6 discrete sizes) which was determined from the curve in Fig. C-1.

#### Particle Specific Heats, Enthalpies and Melting Temperature

The values for particle specific heats, enthalpies and melting temperature which the authors use are shown in Table C-2. The specific heats shown are used for the ideal approximation of particle enthalpy verses temperature (i.e., the specific heat for liquid and solid phases of the aluminum oxide are constant). The user may find the tables of temperature verses enthalpy in the JANAF Thermochemical Tables (Ref. C-3).

#### Particle Mass Density

The mass density for aluminum oxide is different for the solid and liquid phases. Reference C-4 shows the mass density of liquid aluminum oxide ( $Al_2O_3$ ) to be 188 lbm/ft<sup>3</sup>. The mass density of solid  $Al_2O_3$  is 250 lbm/ft<sup>3</sup>. For cases where the particle temperatures will be higher than the melting temperature for most of the flow field, the liquid mass density should be used. In cases where the particle temperature will be below the melting temperature (i.e., plumes) the solid mass density should be used.

#### Chemistry Assumptions

There are numerous chemistry assumptions which can be employed by the RAMP code. The various assumptions are: (1) ideal gas (constant specific heat ratio and molecular weight); (2) equilibrium; (3) frozen (constant molecular weight, varying specific heat ratio); (4) equilibrium/frozen (equilibrium with the molecular weight constant below a specified pressure) or (5) finite-rate chemistry.

C-3

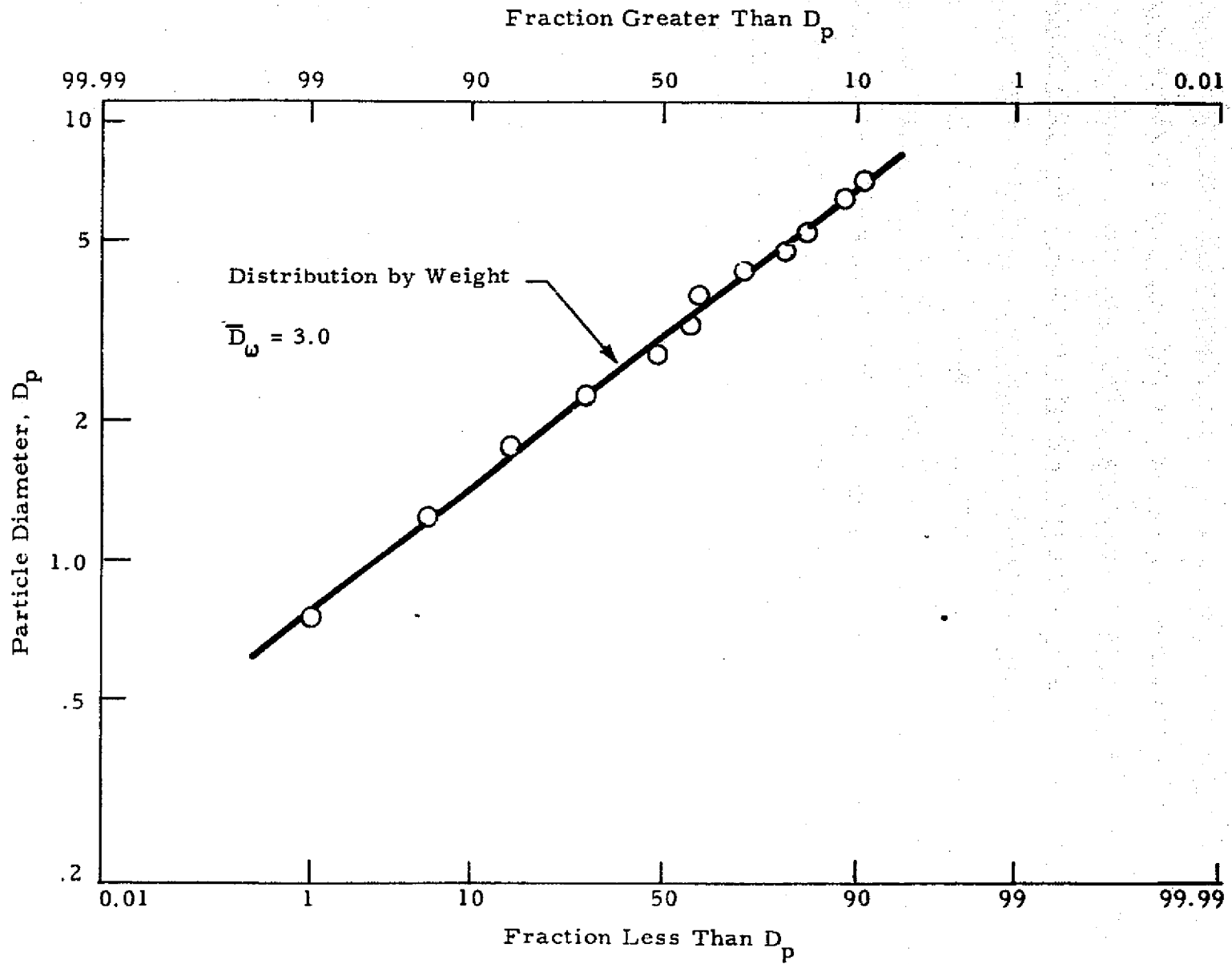

Fig. C-1 - Log Normal Particle Size Distribution from HI 5 PC Motor (Ref. C-1)

C-4

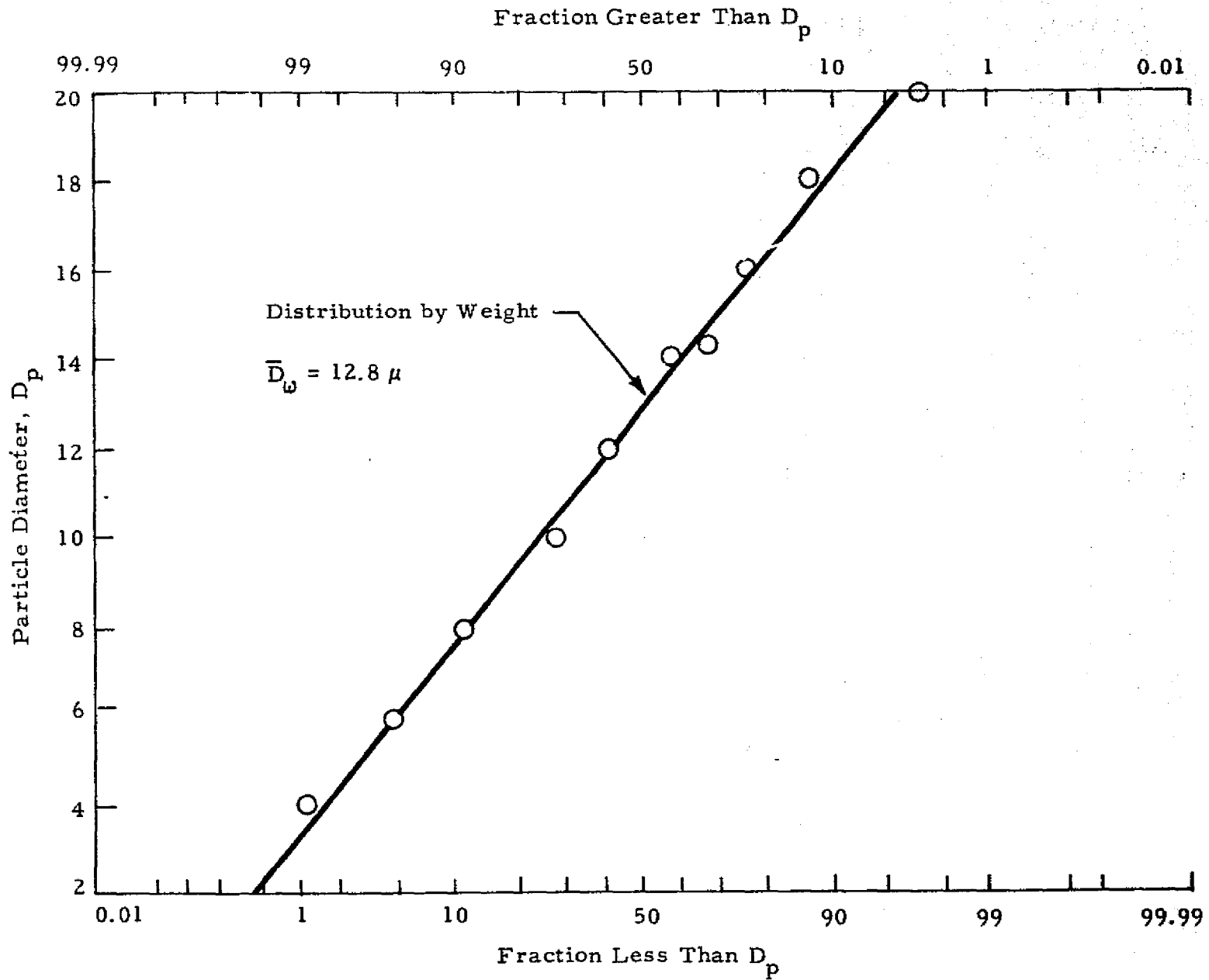

Fig. C-2 - Normal Particle Size Distribution from AGC 260-2 Motor (Ref. C-1)

Table C-1  
LOG NORMAL PARTICLE SIZE DISTRIBUTION  
FOR HI 5 PC MOTOR

Particle Diameter	Percent Total Particle Mass Flow
1.2	10
1.9	20
2.65	20
3.5	20
5.0	20
8.0	10

Table C-2  
 $Al_2O_3$  THERMODYNAMIC DATA

Liquid $Al_2O_3$ Specific Heat ( $C_{p_l}$ )	-	.34 Btu/lbm <sup>o</sup> R
Solid $Al_2O_3$ Specific Heat ( $C_{p_s}$ )	-	.32 Btu/lbm <sup>o</sup> R
Enthalpy of Solid Phase of $Al_2O_3$ at Melting Temperature	-	1358.9 Btu/lbm
Enthalpy of Liquid Phase of $Al_2O_3$ at Melting Temperature	-	1858.7 Btu/lbm
Melting Temperature	-	4188 <sup>o</sup> R

The type of chemistry assumption is very case dependent and also depends on the use of the flow field. Table C-3 presents various cases and applications, along with suggestions as to the type of chemistry assumptions to be used.

Finite rate cases can generally be started at the nozzle throat assuming the species distribution is in chemical equilibrium since this is valid for most propellant systems. Tables C-4 through C-6 present some reaction mechanisms which may be used for applicable propellant systems. These reaction mechanisms were obtained from data presented in Ref. C-5.

### Boundary Equations

The boundary equations which are input to the code should be smooth and not contain discontinuities in either the slopes or coordinates where no discontinuities are physically present. Fictitious discontinuities can result in undesirable mass flow errors showing up during a solution. In Fig. C-3 a description of the boundary equations for the nozzle throat and free boundary are presented.

More complex nozzle contours may be input with discrete points which define the wall as a function of radial position and flow angle versus axial position.

Table C-3  
**SUGGESTED CHEMISTRY ASSUMPTIONS  
 FOR VARIOUS APPLICATIONS**

Application	Ideal Gas	Equilibrium	Equilibrium/Frozen	Finite Rate
Nozzle Performance		x		
Plume Radiation				x
Plume Impingement			x	
Base Pressure (Initial Plume Expansion)	*			
Electron Density				x
Contamination				x

\* Use specific heat ratio which exists at lip.



Table C-4

## REACTION MECHANISM FOR SPACE SHUTTLE SRM PROPELLANT

H	+OH	+M1	=H2O	+M1	22	6.10-26	2.0	0.0
O	+H	+M1	=OH	+M1	21	2.00-32	0.0	0.0
O	+O	+M1	=O2	+M1	24	3.60-30	1.0	-340.0
H	+H	+M2	=H2	+M2	22	2.80-30	1.0	0.0
OH	+H		=H2	+O	14	1.40-14	-1.0	-7000.0
OH	+O		=H	+O2	11	4.00-11	0.0	0.0
OH	+H2		=H2O	+H	14	1.00-17	-2.0	-2900.0
OH	+OH		=H2O	+O	13	1.00-11	0.0	-1100.0
CO	+O	+M3	=CO2	+M3	23	2.00-33	0.0	-4000.0
OH	+CO		=CO2	+H	14	1.10-19	-2.0	1600.0
Cl	+Cl	+M1	=Cl2	+M1	24	4.30-31	1.0	1250.0
H	+Cl	+M4	=HCl	+M4	22	3.00-30	1.0	0.0
OH	+HCl		=H2O	+Cl	14	1.00-14	-1.0	-1000.0
O	+HCl		=OH	+Cl	13	2.00-12	0.0	-4500.0
H	+Cl2		=HCl	+Cl	13	2.00-10	0.0	-2400.0
Cl	+H2		=HCl	+H	13	8.00-11	0.0	-5260.0

Catalytic Species

$$M_1 = 3 \text{ H}_2\text{O}, 2 \text{ CO}_2; \text{ All others: } 1.0$$

$$M_2 = 20 \text{ H}, 10 \text{ H}_2\text{O}, 3 \text{ CO}_2, 2.5 \text{ H}_2; \text{ All others: } 1.0$$

$$M_3 = 20 \text{ O}_2, 10 \text{ H}_2\text{O}, 3 \text{ CO}_2, 1.5 \text{ CO}; \text{ All others: } 1.0$$

$$M_4 = 10 \text{ H}_2\text{O}, 5 \text{ HCl}, 5 \text{ Cl}, 5 \text{ H}, 3 \text{ Cl}_2, 3 \text{ CO}_2; \text{ All others: } 1.0$$

Table C-5  
 REACTION MECHANISM FOR H<sub>2</sub>-O<sub>2</sub> PROPELLANT SYSTEM

H	+CH	+M1	=H2O	+M1	22	6.10-26	2.0	0.0
O	+H	+M1	=OH	+M1	21	2.00-32	0.0	0.0
O	+O	+M1	=O2	+M1	24	3.80-30	1.0	-340.0
I	+H	+M2	=H2	+M2	22	2.80-30	1.0	0.0
CH	+H		=H2	+O	14	1.40-14-1.0		-7000.0
OH	+O		=H	+O2	11	4.00-11	0.0	0.0
OH	+H2		=H2O	+H	14	1.00-17-2.0		-2900.0
OH	+OH		=H2O	+O	13	1.00-11	0.0	-1100.0

Catalytic Species

M<sub>1</sub> = 3 H<sub>2</sub>O; All others: 1.0

M<sub>2</sub> = 20 H, 10 H<sub>2</sub>O, 2.5 H<sub>2</sub>; All others: 1.0

Table C-6  
REACTION MECHANISM FOR LOX-RP1 PROPELLANT SYSTEM

H	+OH	+M1	=H2O	+M1	22	6.10-26	2.0	0.0
C	+H	+M1	=OH	+M1	21	2.00-32	0.0	0.0
C	+C	+M1	=O2	+M1	24	3.80-30	1.0	-340.0
H	+H	+M2	=H2	+M2	22	2.80-30	1.0	0.0
OH	+H		=H2	+O	14	1.40-14-1.0		-7000.0
OH	+O		=H	+O2	11	4.00-11	0.0	0.0
OH	+H2		=H2O	+H	14	1.00-17-2.0		-2900.0
OH	+OH		=H2O	+O	13	1.00-11	0.0	-1100.0
CO	+O	+M3	=CO2	+M3	23	2.00-33	0.0	-4000.0
OH	+CO		=CO2	+H	14	1.10-19-2.0		1600.0

Catalytic Species

$M_1 = 3 \text{ H}_2\text{O}, 2 \text{ CO}_2; \text{ All others: } 1.0$

$M_2 = 20 \text{ H}, 10 \text{ H}_2\text{O}, 3 \text{ CO}_2, 2.5 \text{ H}_2; \text{ All others: } 1.0$

$M_3 = 20 \text{ O}_2, 10 \text{ H}_2\text{O}, 3 \text{ CO}_2, 1.5 \text{ CO}; \text{ All others: } 1.0$

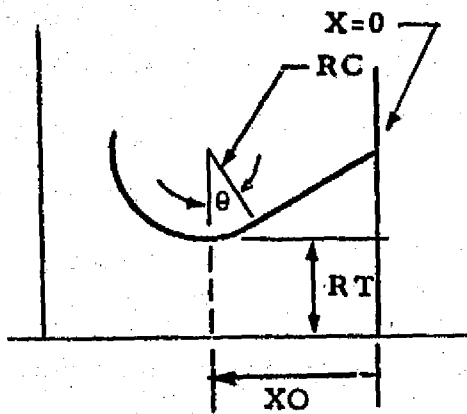

$RC$  = radius of curvature of the circular arc of the throat  
 $RT$  = throat radius  
 $XO$  = axial distance from the origin of the coordinate system to the throat  
 $\theta$  = throat divergence angle corresponding to the maximum value for which the throat conic equation applies

The conic equation for this case would have the following form:

$A = -1$  for an upper equation,  $+1$  for a lower equation ( $-1$  for this case)  
 $B = RC^2 - XO^2$   
 $C = 2XO$   
 $D = -1$   
 $E = -(RC + RT)$   
 $X_{max} = RC \sin\theta + XO$

An example of a free boundary is shown in the sketch below.

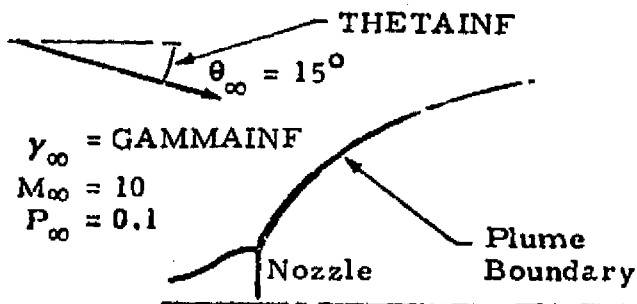

The freestream approach flow is inclined at 15 deg to the plume with a gamma ( $\gamma$ ) of 1.4, a Mach number of 10, and a static pressure of 0.1 psfa.

$P_{INF} = 0.1$  (psfa)  
 $E = 0$  (No pressure variation with axial distance)  
 $\text{GAMMA}_{INF} = 1.4$   
 $M_{INF} = 10$   
 $\text{THETA}_{INF} = -15^\circ$

Fig. C-3 - Sample of Boundary Equations

## REFERENCES

- C-1. Delaney, L. J., "Particle Characteristics in Two-Phase Plumes," Rocket Plume Phenomena Specialists Meeting, Aerospace Corp., San Bernadino, Calif., July 1968.
- C-2. Coats, D. E. et al, "A Computer Program for the Prediction of Solid Propellant Rocket Motor Performance," Vol. I, AFRPL-TR-75-36, July 1975.
- C-3. JANAF Thermochemical Tables, Second Edition, H. S. Dept. of Commerce, National Bureau of Standards, NSRDS-NBS37, Washington, D. C., June 1971.
- C-4. Rasmussen, J. J., and R. P. Nelson, "Surface Tension of Molten  $Al_2O_3$ ," Vol. 54, No. 8, J. American Ceramic Soc.
- C-5. Ring, L. R., "Analysis and Correlation of the Gasdynamic and Radiative Exhaust Plume Properties Obtained in the Emitted Radiation from Special Engines Test Program," LMSC-HREC L511027, Lockheed Missiles & Space Company, Huntsville, Ala., December 1975