

Just For Your ...
TRS-80® COLOR
TDP System 100
Dragon-32

COCO DOES YOUR INCOME TAX

Volume 2 Number 8

February, 1983

\$2.95

£1.95 (U.K.)

the RAINBOW

The Month's **A-Itemized Deduction** for Users

Scroll Listing Slowly
With Your Joystick

Catalog Your Tapes

Automatic Program
Dating

Two Beginners Columns !

Over 30 Product
Reviews

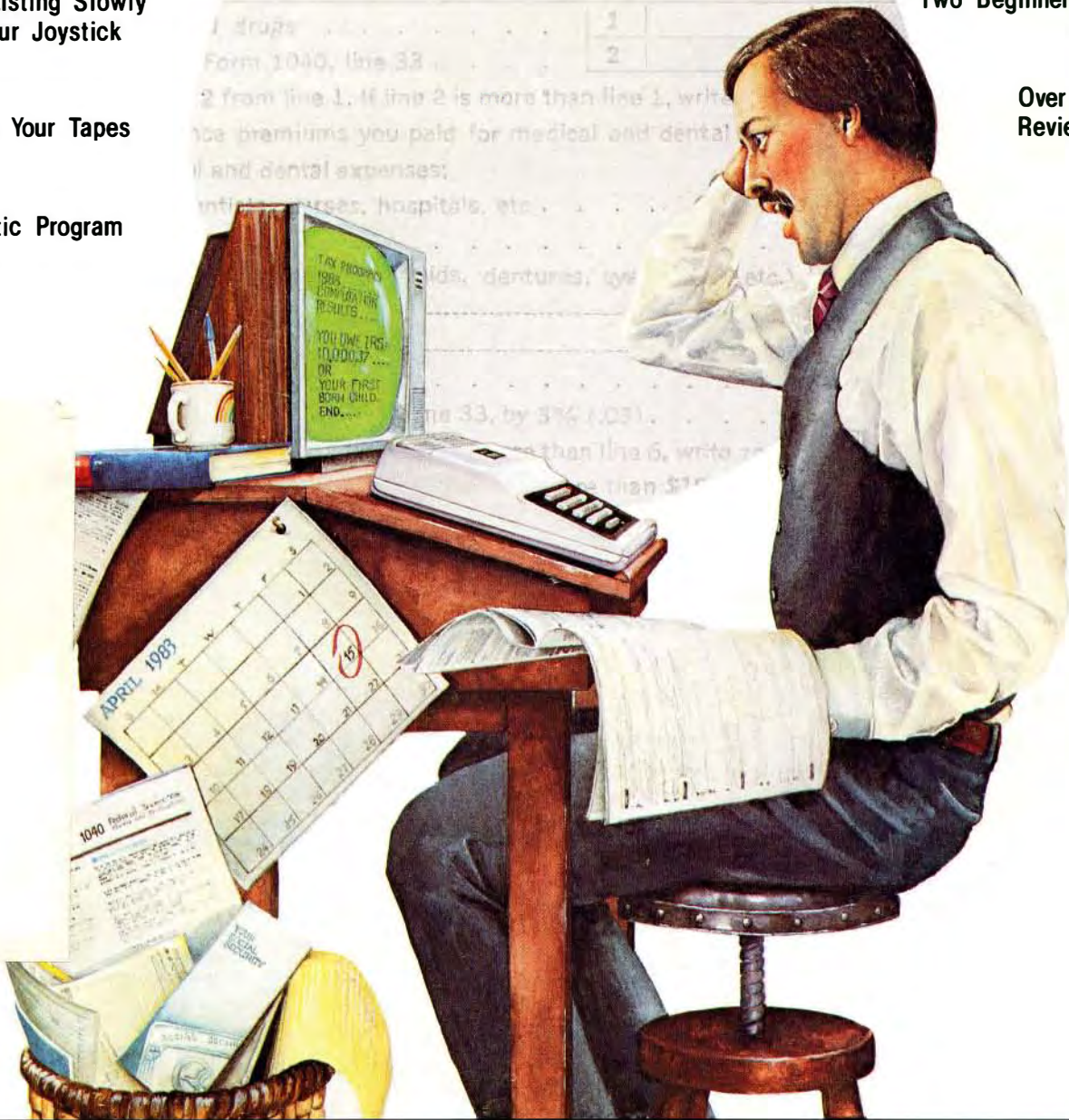

Forwarding Postage Guaranteed
Address Correction Requested

The RAINBOW
9529 U.S. Highway 42
P.O. Box 209
Prospect, KY 40059

Bulk Rate
U.S. Postage
PAID
Prospect, KY
Permit No. 18



Nanos Systems Corp. REFERENCE CARDS

For Models I, II, III, Color, Pocket
and Apple II & II Plus



"Serbo Images"



* TRS-80 is a Registered Trademark of Tandy Corp.
Computer picture reprinted permission Tandy Corp. APPLE is a registered trademark of Apple Computing, Inc.

Each card is a complete summary of the reference manuals and the microcomputer. Cards are two or more colors, printed on 80 pound Beckett Antique cover stock or a comparable stock, stretch-wrapped in plastic for shipping. They are accordion-foldup cards, in the same style as the traditional IBM reference cards used on the major computers for years. Fold-up size is eight and one-half by three and three-quarter inches, so they will fit easily into the shirt pocket. These cards provide a complete summary of the manuals plus many extras at your fingertips.

MODEL I	MODEL II	MODEL III	COLOR	APPLE II & II PLUS
BASIC: Buff & Blue 5 Panels, 10 Pages (For the Classroom) Memory Map. Easy Graphics. Basic Statements. Basic Functions. Basic Facts. Special Characters. Basic Commands. Edit Subcommands. PRINT USING Examples. Message & Codes. Reserved Words. Special Keys. Ascii Character Chart, with Space Compression Codes. Control Codes. Basic Internal Codes. Hex/Dec Conversion Chart. Screen Line Layout. BASIC & ASSEMBLER: Buff 8 Panels, 16 Pages (For the Pro) Complete Z80 Instructions. Assembler Instructions, Commands, Operators. Editor/Assembler Commands, and Edit Subcommands. Flags, Conditions, & Chart. Internal Routines. Assembler Error Msgs. Plus Most Items in the Basic Card	BASIC & ASSEMBLER: Green 10 Panels, 20 Pages (For the Business) Small Memory Map. Screen Layout. Easy Graphics. Complete Z80 Instructions. Series-1 Assembler Instr. Commands, Operators, and Edit Subcommands. Assembler Error Msgs. Power-up Error Msgs. Flags, Conditions, & Chart. Wild Cards, DOS Messages. SVC Procedure Panel. Host Logon Panel. Version 2.0 Lib Command Formats and System Utility Formats. Basic Functions & Statements. DOS File Naming Convention. Basic Commands & Edit Subcommands. Special Keys. Basic Internal Codes and Reserved Words. Basic Msgs. & Codes. PRINT USING Examples. Special Characters. "DO" Utilities & BASIC Command. Ascii Character Chart with SVC Names and Numbers. Control Codes.	BASIC: Blue & Buff 6 Panels, 12 Pages (For the Classroom) Special Characters. Kana Characters. Euro-Characters. Memory Map. Special Keyboard Functions. Ascii Char. Chart w/Space Compression Codes. Control Codes. Cassette Loading Err Msgs. Basic Commands, Edit Subcommands, Special Chars., Basic Statements, Facts, Functions, Derived Functions, Special Operations (POKES). PRINT USING Examples. Basic Msgs. & Codes. Basic Internal Codes. Reserved Words. Screen Line Layout. BASIC & ASSEMBLER: Blue 10 Panels, 20 Pages (For the Pro) Complete Z80 Instructions. Assembler Instructions, Commands, Operators. Series 1 Editor/Assembler Commands & Edit Subcommands. Flags, Conditions, & Chart. Hex/Dec Conversion Chart. Assembler Error Msgs. Internal CALL Routines. Break Processing Procedure. Plus all items in the Basic card.	BASIC & EXTENDED: Grey + 9 Colors. 8 Panels 16 pages (For the Artist) All Color Graphics. System Commands. PRINT USING Examples. Special Characters. Special Keys. Cassette Loading Err Msgs. Basic Functions & Statements. Playing Music, Making a Circle, and Drawing Panels. Derived Functions. Messages & Codes. Musical Notes, by Octave, in Color, Including Rests and Time. Memory Map. Reserved Words. Internal Codes. A Page of Tips. Ascii Char. Codes Chart. Including Inverse Graphics and Color Graphics. Color Group Chart. Pmode Information Summary. Screen Line Layout. Extended Graphics Pmode Illustrations.	BASIC: Red & Pink 7 Panels, 14 Pages (For the Classroom) 48K Memory Map APPLESOFT and INTEGER BASIC. Basic Statements. Basic Functions. Derived Functions. Special Characters & Operators. System & Utility Commands. Pokes, Peeks, Calls. Monitor Commands. Key & Control Functions. APPLESOFT Internal Codes. APPLESOFT Reserved Words. Integer Basic Addressing. DOS 3.3 Command Summary. Color Selection Chart. Error Msgs. & Handling. Reading Machine Language. Hex/Dec Conversion Chart. ASCII, Print, Video, 6502, Integer and APPLESOFT Code Reference Chart, 0-255. Basic & 6502: Red 8 Panels, 16 Pages (For the Pro) All features of the Basic Card, Plus 6502 Timing. 6502 Language Simplified. Flags & Conditions with Reference Chart.

POCKET

BASIC: Purple
5 Panels, 10 Pages
 Operating Characteristics
 Memory Types and Limitations.
 Modes of Operation.
 PRO Mode.
 RUN Mode.
 RESERVE Mode.
 DEF Mode.
 Fixed Variable Facts and
 References.
 System Function Keys.
 Math and Logic Function Keys.
 Normal Character Keys.
 Special Characters and
 Function Keys.
 Basic Commands.
 Cassette Interface Commands.
 Reserved Words.
 Math and Numeric Functions.
 Derived Functions.
 Basic Statements.
 Error Messages and Codes.
 USING Statement Examples
 and more. . . .

A pocket card for your
pocket computer.

Please send me:

()	Card	Price	
()	Copies of MODEL I BASIC & ASSEMBLER	\$4.95	Wholesale prices available in quantities over 24.
()	Copies of MODEL I BASIC-ONLY	2.95	
()	Copies of MODEL II BASIC & ASSEMBLER	5.95	
()	Copies of MODEL II SVC	2.95	
()	Copies of MODEL II COMMANDS & UTILITIES	3.95	
()	Copies of MODEL III BASIC & ASSEMBLER	5.95	
()	Copies of MODEL III BASIC-ONLY	3.95	
()	Copies of COLOR BASIC AND EXTENDED	4.95	
()	Copies of POCKET BASIC	2.95	
()	Copies of APPLE II & II PLUS BASIC	3.95	
()	Copies of APPLE II & II PLUS BASIC & 6502	4.95	
()	Copies of Z80	4.95	
()	Copies of ZX80/81 & TIMEX-SINCLAIR 1000	5.95	

Send Check or Money Order to:
NANOS SYSTEMS CORP.
BOX 24344
SPEEDWAY, IN 46224
(317) 244-4078

NAME: _____
 ADDRESS: _____
 CITY: _____ STATE: _____ ZIP: _____

Indiana Residents Please Add 5 Percent Sales Tax

From Computer Plus to YOU...

PLUS after PLUS after PLUS



Model 16 128K
1 Drive \$4199
2 Drive \$4799



Color Computer 16K \$235
w/16K Ext. Basic \$305
w/32K Ext. Basic \$420



Model III 16K \$799
Model III 48K
2 Disk & RS232 c \$1899



Okidata 80 \$320
Okidata 82A \$399
Okidata 92 \$510



Color Computer Disk Drive
Drive 0 \$470 Drive 1 \$315



Smith Corona TPI
Daisy Wheel \$575

BUY DIRECT Here are just a few of our fine offers...
call TOLL FREE for full information.

COMPUTERS

Model II 64K	\$2675
Model III 4K LEV I	599
MODEL III 16K	799
MODEL III 48K	864
Model III 48K	
2 Disk & RS232 c	1899
Color Computer 16K	235
Color Computer 16K w/extended basic	305
‡Color Computer 32K-64K w/extended basic	420
Pocket Computer 2	230
Model 16 1DR 128K	4199
Model 16 2DR 128K	4799
DT-1 Data Terminal	599
PT-210 Portable Terminal	779

MODEMS

Lynx Direct Connect MII/MIII	235
Hayes Smart Modem II	235
Hayes Smart Modem 1200	599
R.S. Acoustic Coupler AC-3	134

R.S. Modem I D.C.	130
R.S. Modem II D.C.	210
Signalman Modem	89

PRINTERS

Daisy Wheel II	1715
DWP-410	1335
Smith Corona TPI Daisy Wheel	575
Epson MX80	499
Epson MX80 FT	549
Epson MX100	735
CGP-115	199
DMP-100	315
DMP-200	599
DMP-400	1029
DMP-500	1569
Okidata 80	320
Okidata 82A	399
Okidata 83A	655
Okidata 84 Parallel	999
Okidata 92	510
Okidata 93	859
P. C. Plotter Printer	199

DISK DRIVES

R.S. Model III 1ST-Drive	650
Tandon 40 Track MI	289
Color Computer Drive 1	315
Color Computer Drive 0	470
Primary Hard Disk MII	3899
Primary Hard Disk MIII	1999

ETC.

CCR-81 recorder	52
C. C Joysticks	22
16K RAM N.E.C. 200 N.S. chips	25
64K Ram Chips	75
Color Computer Flex D.O.S.	99

Brand Name Software •

Send for listing.
R.S. Software 10% off list

‡Color Computer 64K requires
Disk 0 and D.O.S.

We have the lowest possible
Fully Warranted Prices AND
a full complement of Radio Shack
Software.

Prices subject to change without notice.
Not responsible for typographical errors.
TRS-80 is a registered trademark of Tandy Corp.



**TOLL FREE
1-800-343-8124**

computer plus

P.O. Box 926
480 King Street
Littleton, MA 01460
617-486-3193

Write for your
free catalog

Under the Rainbow

Feature Articles



10

Form 1040A	Department of the U.S. Individual Income Tax
Use IRS label. Other- wise, please print or type.	Your first name and initial (if joint)
	Present home address (Number and street)
	City, town or post office, State and ZIP
Presidential Election Campaign	Do you want If joint return

18



64

COVER watercolor by Fred Crawford.

- Spectaculator Statistics/Judd Posner**10
Use Spectaculator to do analysis of variance.
- Stay Alive At Outpost Five/Dr. Laurence Preble**34
And watch out for the marauding aliens.
- Render Unto IRS/Dr. Lane P. Lester**18
Our feature program allows you to prepare your income tax on CoCo.
- Hang 'Em Up/Douglas C. L'Hommedieu**40
We've received a bunch of "Hangman" games and this one is the best!
- Work On Your Grammar/R. Bartley Betts**48
This program will help you, or your child, learn the parts of speech.
- How 'Bout A Date?/Jorge Mir**58
To keep your files straight, that is.
- And Now...Haunted House Adventure/Geoff Wells**64
Final part of the create-an-Adventure series.
- Flow Gently, Sweet Listing/Kenneth G. Deahl**74
Control the speed your listings scroll on the screen.
- A Catalog For Your Tape/Steve Sullivan**96
List the contents of tapes to screen or printer.
- Cheat At Adventure/Dr. Michael J. Keyes**99
Look at all the secrets hidden in ML Adventure games.
- Solving Parts Of The Problem/Robert L. Crooks**102
This program will deal with fractions.
- CoCo Knows All The Callsigns/Burton B. Witham Jr.**110
A utility for Ham operators.
- Non-Standard Interfaces/Dan Downard**118
A close look at the RS-232 port.
- CoCo As An Educational Bargain/Dr. Paul Kimmelman & David Macali**124
Your favorite computer offers your favorite school more byte for the buck.
- Vroom—Now That's A Decision!/Stan Peppenhorst**132
Victor Vroom's decision-making process is applied to CoCo.
- Five Year's Worth Of Income Tax/J. D. Ray**148
Evaluate your return—and in high resolution, too.
- Inside TDP/Bob Rosen**154
Is this insight to CoCo's future?
- Control Your Home/Alexander B. Trevor**160
Using the Plug 'N Power Controller.
- Once Again With Adventure/Jim Reed**200
A reprise on our Adventure Contest, with some hints to help you win the next one!
- Marquee de Fin/Morton Goldberg**204
What a way to end things up!
- Change Those PRINTs To PRINT #-2s/Ted Blatt**207
A ML utility to make life easier.

Departments

Letters To Rainbow/Our Readers	6
PRINT #-2,/Lawrence C. Falk.....	8
Editor's Notes	
Education Notes/Steve Blyn.....	14
Using Random numbers to select test questions.	
GameMaster's Apprentice/Bob Albrecht	26
Details on how to create game characters.	
Basic Training/Joseph Kolar	56
Getting those tape files organized.	
Bits And Bytes Of Basic/Dick White	88
An in-depth look at variables and their use.	
The Pipeline/Staff	130
Back Issue Information	146
Turn Of The Screw/Tony DiStefano	156
A finger-saving rapid-fire circuit.	
The Dragon's Byte/Bill Nolan	179
Getting down to cases on the construction of a character record file.	
Corrections.....	180
Using Graphics/Don Inman	186
Screen graph plotting techniques.	
Submission Guidelines	192
Assembly Corner/Dennis Lewandowski	194
A look at Editor/Assemblers.	
Advertiser Index	210

Charlie's Machine is not included in this month's issue, due to the burden of work on Mr. Roslund. A machine language utility column will return shortly.

Product Reviews

Addition Concepts.....	77	Light Pen Fun-Pak	32
Alphabet Soup	192	Master Disk System	77
Assembly Language Graphics	94	Maze Race	168
Battle of Gettysburg	54	Millborn	159
Bird Attack	178	Poltergeist	82
Blackjack	184	QTax:82.....	180
C.C. Mailer.....	158	ROML.....	197
C.C. Calc/Stuart Hawkinson.....	62	TP-1 Printer	86
CCEAD/Gary E. Epple	170	Spectrum Light Pen.....	32
Checking Account	169	Star-DOS	60
Dice	198	Stripper	182
Five Exciting Games	86	Text Pro II/Ed Lowe	176
Flight	182	Virtual Memory Loader	198
Foxygraf	84	Warrior & The Wizard	180
Joystick LED Kit.....	36	Wet T-Shirt Contest	92
Las Vegas Weekend.....	100		

NEXT MONTH: Now that you have spent all your money paying your income tax, it is time to save. We'll offer a super utility bill program that will help.

Also, something a little bit different. The theme for next month is still a secret—but it will be out of the ordinary for sure!

PLUS . . . More programs, more tutorials, more information and reviews on CoCo than you can find anywhere! Don't miss the March issue!

The Rainbow

Lawrence C. Falk
Editor

James E. Reed
Managing Editor

Courtney Noe
Associate Editor

Sally Nichols
Art Director

Anne Yeiser
Production Coordinator

Bob Albrecht
Steve Blyn
Don Inman
Joseph Kolar
Dennis Lewandowski
Bill Nolan
Charles Roslund
Dick White
Contributing Editors

Patricia H. Hirsch
General Manager

Ivanka Kleier
Customer Service Manager

Monica Wheat
Research Assistant

Wendy Falk
Transportation

The Rainbow is published every month of the year by FALSOFT, INC., 9529 U.S. Highway 92, P.O. Box 209, Prospect, KY, 40059. Phone (502) 228-4492. The RAINBOW and the Rainbow logotypes are ® Trademarks of FALSOFT, Inc.

Entire contents © by FALSOFT, Inc., 1983. The RAINBOW is intended for the private use and pleasure of its subscribers and purchasers and reproduction by any means is prohibited. Use of information herein is for the single end use of purchasers and any other other use is expressly prohibited. All programs herein are distributed in an "as is" basis, without warranty of any kind whatsoever.

TRS-80, Color Basic, Extended Color Basic, Scripsit and Program Pak are ® trademarks of the Tandy Corp. CompuServe is a ® Trademark of CompuServe Inc.

Subscriptions to the RAINBOW are \$22 per year in the United States. Canadian and Mexican rates are U.S. \$29. Surface mail to other countries is U.S. \$39, air mail U.S. \$57. All subscriptions begin with the next available issue.

Limited back issues are available. Please see notice for issues which are in print and costs. Payment accepted by VISA, MasterCard, American Express, Cash, Check or Money Order in United States currency only.

RAINBOW

HEY, JARROD—LOOKIT THIS

Editor:

In response to Jarrod Hollinghead's letter in the January, 1983, issue: Yes, I had 214,600 on *Donkey Munkey* when a phone call forced me to let all eight of my extra men perish while I talked on the phone. Since then, I have had neither the time nor the patience to try to beat this score.

Jim Herries
Florissant, MO

WHY NOT DONKEY TRON?

Editor:

I just bought *Donkey King* by Tom Mix Software. I do believe it is better and harder than the arcade one. If they can come out with *Donkey King*, why not *Tron*? Please let me know when a software company offers a good version of *Tron*.

Allen Barker
Wellford, SC

INFORMATION, PLEASE

Editor:

I have a problem that might be answerable by some of the *Forth* and CoCo people out there. During the summer, I purchased a *Forth* package for my computer from a company called K & H Software Systems. Everything seems to work fine except the tape *SAVE* and *LOAD* commands. It's very possible that I'm doing something wrong, but the company seems to have gone out of business (there is no response when I write them and I haven't seen any ads from their company since I bought the package).

I would appreciate hearing from anyone who has the same *Forth* package with their *LOAD* and *SAVE* commands working properly. Thanks again for your help and for a fine publication.

Glen Eric Montgomery
Mountain View, CA

Editor:

I am writing about the article by Francis Sherwood in the 10/82 issue: "How Much Will it Cost to Buy on Time?"

I have found that the first part of the program works perfectly. However, Program Two terminates with a balance due. There would seem to be a problem with the logic of the formula, or am I having a unique problem with it? I find this result whether "additional payments" are used or not.

So far, I have been unsuccessful in finding

a fix. Perhaps you have heard from other readers with a fix?

Hilton Wasserman
Little Neck, NY

Editor:

I have access to a Centronics 101 and a 306. They both use the same interface board, using current loops for Data and Demand.

I am interested in learning if anyone has been able to get one to run with the CoCo. Enjoy your magazine tremendously.

Paul E. Sanders
Apalachia, NY

Editor:

I bought my Color Computer about a year and a half ago, and through reading your magazine and others I have gathered several machine language programs that are *POKEd* into high memory, such as LF and CR for the printer, a program called LAZKEY (ML) from *Chromasette* magazine and others.

My question is how could I merge these programs and *CSAVE* or *CSAVEM* as an initialization tape for my machine?

Also, is there a general rule to follow which will tell me how much change a program must undergo in order to not cause a violation of copyright? For example, converting Basic programs for the CoCo, enhancing graphics, adding sound, etc. I think this may scare a lot of people away from submitting material for publication. A good example is the *Falk Word Processor*, then *Falk/Millican Word Processor*, then *Falk/Millican/Becker Word Processor*, then ??? Assuming *Falk Word Processor* is copyrighted, where would your original program lose its identity in the modifications?

Thank you for a fine magazine for the Color Computer. Many thanks from beginning programmers like myself.

Jerry Gatcomb
Chicopee, MA

INSPIRATION, PLEASE

Editor:

Can you tell me who to ask or how to get my 32K TRS-80 CoCo to output the play or sound command with an audio signal to the cassette output? I am working with a musician and we are multitracking computer music. The sound quality of the earphone jack from the TV is very poor.

John Schmidt
Arcada, CA

Editor:

I have a ML tape copy for Compuserve, and since I purchased it, I have graduated to

32K and one disk drive. Can anybody send me (or publish) a short program to enable me to transfer it to high memory so that I can use it with my disk system? My address is 357 June St.

Ed Donovan
Worcester, MA

GAFF ZAPPER

Editor:

We thank you for the thorough review of *The Graph Zapper* in the December, 1982, issue of *the Rainbow*.

The review was accurate in all respects except one. The 32K disk version saves data and graphs to disk only, not to tape as the review implied. However, the tape version will work with 16K or 32K and make use of all the available memory.

Thomas J. Ernst
Southern Software Systems
Merritt Island, FL

THANKS, ROGER

Editor:

My thanks to Mr. Roger Schrag for his article "Patch EDTASM+ to Disk" (*Rainbow*, December 1982). This article met my requirements exactly. I have especially missed ZBUG since changing to Microworks' Macro-80C.

Of special interest in this article is the author's use of the Disk Basic I/O routines. I believe that information concerning the routine addresses and entry/exit conditions for using the Basic OPEN, CLOSE and I/O routines for both tape and disk would be of interest to neophyte M/L programmers. An article on this subject would be appreciated.

Barry Walker
Willowdale, Ontario Canada

WELL, THANK YOU, BARRY

Editor:

Regarding my article, "Patching EDTASM+ to Disk" in the December issue of *the Rainbow*, a note to users of the patch: If you press reset while using EDTASM+, interrupts will be disabled and the disk drive will no longer shut off properly.

To fix this, go into ZBUG and store a \$35 at location \$FF03. If you have any other problem or questions, drop me a line at 2054 Manning Avenue (zip 90025).

Roger Schrag
Los Angeles, CA

ANY COCO PALS OUT THERE?

Editor:

I am 10 years old and have a Color Computer. I have all the Adventures that Radio Shack supplies for it, and I would like to talk to (by mail) some other kids who have these Adventures. We can exchange ideas on how to solve them.

Nathan Miller
3309 SW Malcolm Ct.
Portland, OR 97225

BOUQUETS AND BRICKBATS

Editor:

I think it is about time someone put in a good word for Radio Shack dealers.

I recently purchased a new DMP-100 printer for my Color Computer. It wouldn't work! The store manager (Brookwood Mall in Birmingham) personally took charge and very definitely went "above and beyond the call of duty" to help me solve my problem, doing several things he didn't have to.

I am using my new printer to type this letter, so you can see they solved my problem. Needless to say, I am more sold than ever on both Radio Shack and the Color Computer!

Dennis J. Duke
Bessemer, AL

Editor:

I recently purchased a *Spectrum Stick* from Spectrum Projects, based on your recent review and *the Rainbow* certification seal. Well to say I am disappointed with it is an understatement. It performs worse than the original Radio Shack joysticks.

I wrote Spectrum and informed them of my disappointment, but to date they have not replied. I had originally felt that I may have received a defective stick, but from the (Spectrum Projects') silence I feel that I have been taken. I'm also disappointed that you recommended their products. It's a shame that a company like Spectrum gets away with taking people.

I'll also be interested in seeing if you publish only GOOD letters about advertisers.

John Heinz
Katy, TX

Editor:

You have a superlative magazine. I truly enjoy every article but I would like to see more utilities. Things that are useful and make my hobby just a little easier.

I use *Telewriter* and have red, blue, and green characters. I have tried it on five different color TVs and three different Color Computers, all with the same results. I would be delighted to know how to solve this problem.

If any readers use the version of *Telewriter* that (due to a bug) does not print the header on the second page may try using an (up arrow) immediately following the header and before the text. This works for me and gives me the header on the second page without fail. It wastes a sheet of paper, but saves a lot of headaches and reprinting entire manuscripts.

Herbert B. Ridge
Colorado Springs, CO

Editor:

I recently purchased a *Tiny Compiler* from Aardvark-80, and was very disappointed. While it lived up to its claims of speeding up my program, it is still unusable except under very special circumstances. Neither Aardvark's advertisement nor *Rainbow's* review prepared me for the incredibly inefficient code this program produced.

I wrote a machine language subroutine that required 500 bytes of memory. Then I rewrote it, using the *Tiny Compiler*. It took over 2,000 bytes! I've heard of inefficient compilers, but this is ridiculous!

Kenneth Van Camp
Sparta, NJ

Editor:

Concerning the review in December of *Micro-Script* (page 156), it would be a good experience for anyone to purchase it for no other reason than to rewrite the complete program—really it had to be the poorest "professional" job of a program I've seen yet.

I spent a few hours refining it to a good Basic program which should have been done before it was sold. By that, I mean it should have INKEY\$'s instead of ENTER for every mode change and a simple "SOUND 50,5" in line 1642 which alerts you that you've reached the end of the line without having to look up every few seconds as was mentioned in the review. But, it was a learning experience to rewrite the program.

Keep up the good work. As I've said before, *our* magazine is growing and keeps getting better.

William M. Carroll
Weirton, WV

ARE YOU READING THIS, AL?

Editor:

I am a teacher in junior high and good software is very hard to get. I know that your education column is good, but little is ever seen for older kids. Do you think you could help me out here?

Also, a good friend of mine moved out of the area quickly this last summer. I have not been able to get his new address. I know you're reading this, Al. Will you contact me, please!

I would like to start a Color Computer club in my area. Whether you use the CoCo, the 80C, or the Color Computer I would be interested in getting together with you to share ideas.

Paul N. Lue
Durand, MI

POKE SALLIT

Editor:

I really enjoy *the Rainbow*. It has many good and exciting programs for the CoCo. It has many good hints and secrets. But, in your December 1982 issue, you hinted how to double the basic speed with POKE G5495,0. There was one problem. What we didn't know was that if you POKE and use sound with it, it can cause considerable damage to your computer. It cost us about

\$50 to repair and a new keyboard. All you have to do is POKE 65494,0 before every sound statement to POKE it back to normal speed and POKE after the sound statement. Also, you should hit RESET or POKE to normal speed before you save a program.

Here is an example of "upPOKING:"

```
5—POKE 65495,0
10—X=RND(8)
20—CLS(X)
30—POKE 65494,0: SOUND 1,1: POKE
65495,0
40—GOTO 5
```

With this program it runs fast but does not hurt your computer at all.

Brian Hansen
Potomac, MD

Editor's Note: I don't know who told you it hurt the CoCo, but that person is wrong. Nothing you enter from the keyboard can hurt your machine, including POKES. You can, of course, get some unpredictable results—but you cannot hurt the hardware.

CLUBS, CLUBS, CLUBS

Editor:

I have two things to ask you about users' clubs. First, may we have your permission to reprint certain articles in our newsletters? Of course, anything that is reprinted will receive full credit as having been published in a specific issue of *the Rainbow*. Your comments on this matter would be most appreciated.

Secondly, would you be interested in publishing a list of all the users' clubs and contact people. This might be done on an annual or maybe even a semi-annual basis. The purpose of this would be twofold. It could provide information for new owners as to where the clubs are. It could also be a method by which clubs could contact each other to exchange newsletters (if they publish them), ideas, and even gossip. I have contacted several clubs and found that the response was always good.

Here's our formal club details:

K—W Color Computer Club
c/o Peter Karwowski
23 Hudson Cr.
Kitchener, Ontario N2B 2V7
(519) 579-2953 (after 7:00 p.m.)

The Rainbow is, by far, the BEST magazine for the CoCo around. I'm especially looking forward to the hardware column. Keep up the fantastic work.

Peter Karwowski
Kitchener, Ontario

Editor's Note: We have always given clubs permission to reprint material from *the Rainbow* provided they include notice of copyright. As many of you know, it has been our policy from the beginning to support clubs. We also hope you will note that the RAINBOW CHECK program is available to any and all clubs (as well as other publications) with the same minimal requirement.

PRINT #-2,

Editor:

I would like to clarify a point for your readers. The clubs referred to in both my letter to *the Rainbow* (September 1982) and Andy Nulman's the following month are one in the same. We are not the Rhode Island Tandy Users Group, but we do work with that club. We regret our errors and hope you will print this update.

New England COCONUTS now claims over 50 members from Rhode Island and Massachusetts. Those interested in the club can contact me by writing:

100 Kerri Lyn Road
Warwick, RI 02886
or call (401) 739-8743.

Robert J. Sullivan
New England COCONUTS

Editor:

We wish to announce the formation of the New England Color Computer User's Group (NECCUG). For more information about NECCUG, we may be reached at the following addresses. Please send a S.A.S.E. to either Chris Sweet at P.O. Box 255 or Tom Heim on Ayer Road. Both are in Harvard, MA and our Zip code is 01451. If it is more convenient, our phone numbers are (617) 456-8291 or (617) 772-4316.

Christopher E. Sweet
Thomas A Heim
Harvard, MA

Editor:

Recently you had an article on copyright material and the problems of software theft. I was a skeptic that it even existed, but have now seen it with my own two eyes. You failed to cover the problem of what to do after you found somebody doing it.

I am planning a different club, for honest users of the great Color Computer:

Color Computer Club of Central
Oklahoma
c/o Doug Moller
1402 Allen
Yukon, OK 73099
(405) 354-3342

In all of this rush, I haven't mentioned the great job you are doing. You deserve mountains of credit for your work. This is being typed on your word processor. It is so simple that I will probably modify it instead of buying a new one.

Doug Moller
Yukon, OK

Editor:

There is a Color Computer Users Group now forming in the Morgantown, WV, area. Owners of CoCos and TDP-100s can receive more information by writing to me at:

P.O. Box 295
Granville, WV 26534
or calling (304) 599-4493.

Donald G. Barber, Jr.
Granville, WV

Editor:

I am pleased to announce the formation of the TRS-80 Users Group of Charlotte.

We are three months old with an active membership. Any Color Computer user interested in learning more about CoCo and sharing experiences should call (704) 365-3653 or write to 6613 Summerlin Pl., Charlotte, NC 28211.

John Becker
Charlotte, NC

First and foremost, I want to thank all of you who have written in to us at *the Rainbow* to say so many good things about our magazine. And, too, I would like to thank you for what has obviously been a great deal of pass-along information to friends, relatives and acquaintances about us.

Our subscriptions and other sales have increased tremendously in the past couple of months with no letup in sight. And, of even greater interest, so have our renewals. They are running better than 90 percent. That seems to be telling us that, generally, you like what you are seeing. We're gratified. We are not only what we believe you consider the premier magazine for CoCo users, we are also by far the largest in terms of circulation. We intend to continue to work to improve the quality each month—and as we do, past history shows the size will take care of itself.

I mentioned last month that I saw the CoCo as something more than just a "personal computer"—more like a community of people all interested in a common goal. And, while I can only applaud that general affection for this machine, it does also cause me a bit of concern.

The concern is simply that as more people see CoCo as a "popular" personal computer, more and more will be getting into the act. In many areas this will only be good—competition only breeds better quality. But, it also opens the door for a bunch of quick-buck artists, too. CoCo is now a "hot" commercial machine. That means you will be seeing more software, more hardware, more publications and the like "devoted" to CoCo in the future.

Basically that is, as I said, good. But I still maintain CoCo is a special personal computer. I hope that the many people who will be entering the CoCo world (and whom we welcome) will recognize it as such.

I do wish to call your attention to the **Rainbow Seal of Certification** once again. This Seal is our way of trying to help keep you from being ripped off. It does *not* certify the suitability of a product, but it does certify the *existence* of one.

You should know, too, that the Seal is not an advertising device. It is available to anyone who has a commercial product available for CoCo, whether they advertise in *the Rainbow* or not. It is purely a protection device and once the Seal is awarded, a firm may use it on any advertising it employs—in publications, in flyers, instructions, pamphlets or whatever. We *do* encourage you to let us know of instances when you may suspect a violation of the Seal. We will not only investigate, but will inform you when we do find violations.

As a general rule, you should know that certification for the Seal is awarded after we check a product. But, we do not "test" it and we do not review it at that time. We just insure that it is what it purports to be. Because of that, we are instituting an "added"

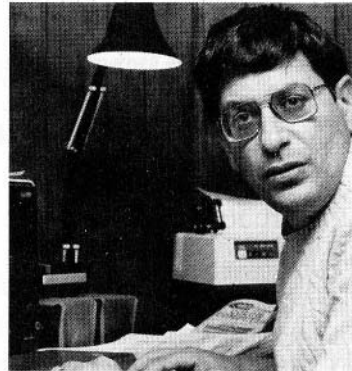

qualification for publications, a major part of which is their ability to deliver their product on a regular basis.

You will not see a Seal awarded to any publication or tape service as soon as it appears on the market. We will insist upon receiving at least three issues of such a publication in a timely manner before we can award a Seal. We do this because we consider delivery of the publication *on time* an essential part of the quality of the product. We think you do, too.

Wayne Green wrote me the other day to say that he did not mind my mentioning him and allowed how "attacks" on him might be good for *the Rainbow's* circulation. I never thought about that. I do feel that Wayne Green Publications has given the CoCo short shrift for two years now and that many of his "predictions" have been far off base and detrimental to CoCo's growth.

I say this by way of introduction to another "attack" on another magazine, *Time*. We can all applaud their selection of the Computer as the "Machine of the Year."

But did you see any mention of CoCo in *Time*? I didn't. They grouped the TRS-80 Model III in with the less expensive computers. Foo.

That only says to me that *Time* was sloppy in its research and reporting—especially on its most important story of the year. There is no excuse for that and I cannot understand it. And you should know this conspicuous omission of

(Continued On Page 167)

anteco

SOFTWARE

DEALERS ... QUALITY SOFTWARE FOR THE COLOR COMPUTER AND
TDP-100 AVAILABLE FOR IMMEDIATE SHIPMENT. ALL ORDERS
SHIPPED FREIGHT PREPAID.



DEALERS
PLACE YOUR ORDERS NOW BY
CALLING TOLL FREE (800)433-7631
TEXAS COLLECT (817)281-8403

anteco
division of
Antenna Electronics Company

P. O. Box 14728
Fort Worth, TX 76117

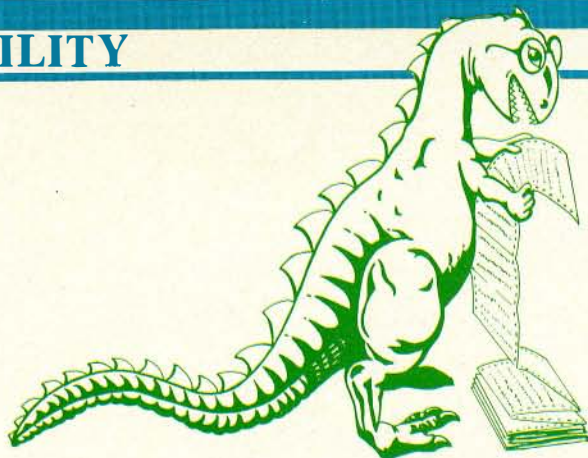

Spectaculator Gives Spectacular Statistics

By Judd C. Posner

One thing has puzzled me as I use *Spectaculator* more and more. Where did they get that name? I mean, just look at the names the Shack has given its software for the 80C. What do they call their tennis game? Tennis, of course. And if you can't guess what's on the Personal Finance Rom Pak you probably don't need it. Dino Wars is not, as you might have guessed, about giant frogs. As my final example, I offer a Rom Pak called Skiing - enough said. No one ever can accuse the good people at Tandy of inflating the price of their software due to large outlays for Madison Ave. pizzazz. Then where in the world did they get a name like *Spectaculator*? The name conjures up to me a Texas oil wildcatter in string tie and snakeskin boots. But that's not the straight-ahead message they are trying to send. The only thing that makes any sense to me is that the name was left over from a game Pak, which never worked out, about a large reptile with glasses.

In any case, whatever the name means, it is a very useful little gadget. A use of *Spectaculator* to do statistics is presented in the back of the manual which is supplied with the Rom Pak. As you would imagine, the application of statistics, in turn, is largely confined to scientific research, but that need not be the only use to which it is put. For example, I recently used a scheme such as will be outlined here to adapt my wife's favorite cookie recipe to the microwave. Basically what we will be using is called an ANOVA (ANalysis Of VAriance) by statisticians. (Statisticians are not very imaginative about names, either.) It allows one, either to analyze data already collected for the important factors influencing the observed outcomes, or more powerfully, to design a meaningful set of experiments to find out which variables are important and how each affects the final result. ANOVAs come in various shapes and levels of complexity. The one we will be looking at is a simple one. I could show anybody how to do one, mechanically, in about 10 minutes. The difficult part is to understand why you are performing the various steps outlined, and what the results mean and how to use them. This particular ANOVA is called a two-level factorial with center points. That means that we are going to examine each factor at two levels (a high and a low level), and at the midpoints.

As for why one would choose this method in preference to any other, let's use the cookie problem as an illustration. Suppose you had to decide what power setting, length of time and water content gave the best cookies when adapting a recipe from a regular oven to the microwave. Most people would simply try various combinations and hope for the best. Those of a more logical bent would try holding two variables (for the sake of argument, let's assume they are water content and time) constant and varying the third. This is a shade better than the blunderbuss approach of the first

group but, I think I can convince you, it is not likely to get you to the optimum result either. In the first place, unless you are a very good guesser, the particular combination of water content of the batter and baking time you choose may not be the best ones. In fact, if you are a bad guesser, they may never yield edible cookies at any power setting you use. It is not hard to see that there is essentially an infinite number of potential combinations of water content and time from which one could start and no way to decide which is the best. Furthermore, if there were interactions between any of the factors, such as, for example, temperature and time, you would never discover that fact using the "hold everything constant and vary one factor" approach.

An example of an interaction in the field of the culinary arts is the following: Suppose it takes two hours to cook a roast at 350 degrees, would you expect that it would take 4 hours at 175 degrees? I would think not! In fact it may take all day at 175. There is, therefore, a strong interaction between temperature and time in this example. Three-way interactions are also possible, although they are quite rare. One example which comes to mind will almost certainly get me in trouble with women's groups, but I cite it only as hearsay and in no way endorse its sentiments. I once asked a friend from New York whom he thought was the world's worst driver, and he answered, "A lady doctor from New Jersey." To this day I cannot find a better example of a three-way interaction.

Suppose you have chosen the three factors you think are the ones to be looked at to solve your particular problem and the particular ranges for each. The next steps are to decide how many experiments to perform, how to do them, and what to do with the results to be able to interpret them. Since we have three factors, each with a high and low value as we mentioned previously, you will have to do a minimum of two "cubed" or eight experiments to cover all possible combinations of the factors, and add a few experiments to cover the midpoints; the midpoint experiment consists of running a trial at (high+low)/2 for each factor - hence, the name, midpoint. The question of how many replicates, or how many times to repeat the same experiment is not easy to answer. It depends on the magnitude of the effects and the error associated with each measurement. Without going

Template							
1	-1	-1	1	-1	1	1	-1
1	1	-1	-1	-1	-1	1	1
1	-1	1	-1	-1	1	-1	1
1	1	1	1	-1	-1	-1	-1
1	-1	-1	1	1	-1	-1	1
1	1	-1	-1	1	1	-1	-1
1	-1	1	-1	1	-1	1	-1
1	1	1	1	1	1	1	1

FIGURE 1

Table Of Column And Row Formulas

Col#	CF	Row#	RF
4	$(C2+C3)/2$	11	SUMR2
5	$(C2-C3)*(C2-C3)/2$	12	R11/4
8	$SQR((C7+C6)/11)$	13	R12/2
9	$1.1*C8$	18	SUMR14/4
10	$1.23*C8$	19	$(R18-R14)*(R18-R14)$
21	$C4*C11$	20	$(R18-R15)*(R18-R15)$
22	$C4*C12$	21	$(R18-R16)*(R18-R16)$
23	$C4*C13$	22	$(R18-R17)*(R18-R17)$
24	$C4*C14$	23	SUMR19
25	$C4*C15$	25	R24-R18
26	$C4*C16$		
27	$C4*C17$		
28	$C4*C18$		

Table 1

into the problem in great detail, it turns out that for most purposes, it is only necessary to do each experiment twice, and replicate each midpoint four times. All of the discussion to follow will assume that this number of experiments has been chosen. So as not to introduce a bias in the experiments resulting from the order in which they are done, they should be randomized. Each of the eight different combinations of factors (i.e. low, high, high, low, low, low, etc.) is assigned a number, called a trial number. The assignment of trial numbers to the condition of the factors is encoded in

columns 2, 3 and 5 of Figure 1, the template. This template should be copied exactly as it stands for each ANOVA. These factors encoded as -1 correspond to the low level for that factor; those encoded as =1 correspond to the high value. Thus trial #1 would have low, low, low for factors 1, 2, and 3 respectively. Trial #2 would correspond to high, low, low for those factors, etc. The trial numbers are usually randomized by using tables of random numbers. That would be a waste of the valuable talents of your computer, which has a built-in random number generator.

Marymae INDUSTRIES, INC.

In Texas, Orders,
Questions & Answers
1-713-392-0747

22511 Katy Freeway
Katy (Houston), Texas 77450

To Order
1-800-231-3680
800-231-3681

SAVE BIG DOLLARS ON ALL TRS-80® HARDWARE & SOFTWARE

TRS-80® by Radio Shack. Brand new in cartons delivered. Save state sales tax. Texas residents, add only 5% sales tax. Open Mon-Sat. 9-6. We pay freight and insurance. Come by and see us. Call us for a reference in or near your city. Ref: Farmers State Bank, Brookshire, Texas.

WE OFFER ON REQUEST

Federal Express (overnight delivery)

Houston Intercontinental Airport
Delivery, Same Day Service

U.P.S. BLUE—Every Day

References from people who have
bought computers from us probably
in your city. We have thousands
of satisfied customers. WE WILL
NOT BE UNDERSOLD!

ED McMANUS

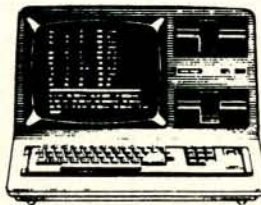

In stock TRS-80 Model
II and III

No Tax on Out of Texas Shipments!

Save
10% 15%
OR MORE

Reserve your Model 16 Today!

TELEX: 77-4132 (FLEXS HOU)

WE ALWAYS OFFER

NO extra charge for Master Card or Visa

We use Direct Freight lines. No long waits

We always pay the freight and insurance

Toll free order number

Our capability to go to the giant TRS-80®
Computer warehouse 5 hours away, in
Ft. Worth, Texas, to keep you in stock.

® TRS-80 is a Registered Trademark of Tandy Corp.

JOE McMANUS



Trial #	X1	X2	AV X	VAR	23,2	11,5S	Pool	Min	Min'C
1	9	11	10.00	2.00	81	130	4.38	4.82	5.39
2	36	30	33.00	18.00					
3	14	20	17.00	18.00					
4	38	48	43.00	50.00					
5	99	91	95.00	32.00					
6	125	129	127.00	8.00					
7	155	155	155.00	0.00					
8	177	179	178.00	2.00					

130.00

63
67
72
60
65.50 CENTER PT AVG
6.25
2.25
42.25
30.25 2
81.00 SUM (X(AV)-X(I))
82.25 13,21
16.75 CURVATURE

FIGURE 2

A quick and elegant way of generating two random sets of all the numbers between one and eight, inclusive (eight runs replicated once), was suggested by my neighbor, Dick White. It goes as follows:

```
10 FOR J=1 TO 2
20 R=RND(8):R$=STR$(R):I=INSTR(1,A$,R$):IF I=0
THEN A$=A$+R$
30 IF LEN(A$) 16 THEN 20
40 PRINT A$:A$="":NEXT
```

A typical example of the result of running the above is:

4 3 8 2 1 6 5 7
7 1 3 4 5 2 8 6

The midpoints are coded as nines and need to be spread evenly throughout the trials. Since we have $16 + 4 = 20$ entries, the nines should be placed every $20/4=5$ numbers. Therefore the final order of trials would be:

9 4 3 8 2 9 1 6 5 7 9 7 1 3 4 9 5 2 8 5.

The order, of course, would be different every time except for the position of the nines.

Having coded and randomized the trials, it is now a simple matter to enter the observed results on the *Spectaculator* worksheet. The worksheet itself is set up using the column and row formulas found in Table 1. It must be stressed that this set of calculations assumes that the ANOVA is run exactly as shown, i.e. four center points, and eight trials duplicated once. The statistics are set up to demonstrate significance at the 95% confidence level for only this combination. A treatment of how to do an ANOVA using less or more experiments, or at a different statistical confidence level, is beyond the scope of this article and the reader is advised to consult any standard text on experimental design. The principals are the same, but the worksheet and the formulas will be different.

Figure 2 shows the areas where the results are entered. What are entered here, once more, are the observed results from running the experiments under the conditions of the ANOVA. They may be expressed in any consistent units, i.e. %, color, yield, or even goodness of taste, if an objective judgment can be made. The results from the center points are entered in column 2, rows 15 through 18. The other results are entered in the appropriate row in columns 2 and 3 corresponding to the trial number in column 1. In the example presented, for example, results of 9 and 11 were obtained when the conditions were low, low, and they were obtained in the seventh and thirteenth experiments; results of 125 and 179 were obtained in the eighth and nineteenth runs under conditions of high, low, high and high, high, high respectively. There are a total of 20 entries to be made at this point. Then enter the CA command and

Color
Computer
Flex*
OS-9†
Users
Move
up to
C
Language

DO YOU WANT faster running programs (over 100 times faster than BASIC)? A high level language that is also a low level language? A compiler that runs in less than 32K? Assembly language output? Position independent code? Extensive library functions in source assembly code? Periodic newsletters with new library functions? An aid in learning assembly language? Liberal version updates?

C IS DESTINED to become the language of the eighties: A compact, highly versatile, easy to use language, excellent to use to build games, applications, utilities, operating systems, etc.

DUGGER'S GROWING SYSTEMS with over 21 years of experience in computing was first on the market with a 6809 C compiler. The compiler has been extensively tested, revised, and proven.

DUGGER'S GROWING SYSTEMS C is a growing subset of the standard C. Version 1 contains all the necessary C commands (while, if, if else, int, char, etc.). Version 2 contains additional features (float, long, for, goto, etc.).

AN EXTENSIVE LIBRARY in assembly language source is provided (char, I/O, formatted print, file handling, string manipulating, etc.) TRS DOS version also has additional functions which use the BASIC ROM functions (CLS, POLCAT, floating point, draw, etc.).

ORDER NOW
(new low prices)

TRS DOS C Version 1.2 (disk version) \$49.95
Computerware disk assembler 49.95
Computerware Scribe (Editor-text formatter) 49.95
Order all three and save \$10 139.95
C Programming Language by
Kernighan & Ritchie (a must) 17.95
OS-9 C Version 1.2 95.00
Flex O9* C Version 2.3 120.00
C.O.D. & Foreign handling add 15%

MasterCard and Visa accepted.

DUGGER'S GROWING SYSTEMS

Post Office Box 305
Solana Beach, California 92075
(619) 755-4373

*OS-9 is a trademark of Microware, Inc.
†FLEX is a trademark of Technical Systems Consultants, Inc.

	MEAN	F1	F2	F1F2	F3	F1F3	F2F3	F1F2F3
	10.00	-10.00	-10.00	10.00	-10.00	10.00	10.00	-10.00
	33.00	33.00	-33.00	-33.00	-33.00	-33.00	33.00	33.00
	17.00	-17.00	17.00	-17.00	-17.00	17.00	-17.00	17.00
	43.00	43.00	43.00	43.00	-43.00	-43.00	-43.00	-43.00
	95.00	-95.00	-95.00	95.00	95.00	-95.00	-95.00	95.00
	127.00	127.00	-127.00	-127.00	127.00	127.00	-127.00	-127.00
	155.00	-155.00	155.00	-155.00	155.00	-155.00	155.00	-155.00
	178.00	178.00	178.00	178.00	178.00	178.00	178.00	178.00
Difference	658.00	104.00	128.00	-6.00	452.00	6.00	94.00	-12.00
Effect	164.50	26.00	32.00	-1.50	113.00	1.50	23.50	-3.00
	82.25							

FIGURE 3

wait. *Spectaculator* has a lot of calculations to make so it takes a while. Three values obtained in this calculation now have to be transferred to open positions in the worksheet. The places into which the numbers are to be transferred are at row 2, columns 6 and 7 and row 24, column 2. These locations are denoted on the worksheet by a set of two numbers which refer to the row and column respectively from which the value is to be transferred. A second calculation is now done, and the mathematics is complete. All that remains is the interpretation. To determine which factors and interactions were statistically significant, you need only compare the number in the row labelled "Effect" in Figure 3 under each of the factors and combinations of factors (F1, F2, F1F2, F3, F1F3, F2F3, and F1F2F3) with the value found in the column marked "Min" (Column 9). Any value greater than Min is significant. The higher the absolute value of the effect, the greater is its effect on the observed result. A negative value for a single factor (main effect) means that increasing that factor leads to a decrease in the observed result. A negative interaction means that increasing the second factor will increase the low level of the first factor more than it will the high level. A positive number means the reverse. In the example presented, factors F1, F2, F3 and interaction F2F3 were found to have significant effects; all others did not. Factor 3 had the greatest effect. The curvature, found in row 25, column 2 is significant when compared with the value of "Min C" in column 10. A significant curvature means that the progression from low to high values is not linear. If there were no significant curvature, we could, in fact, write an equation for the observed behavior in terms of the factors studied. In this case we will have to be content with finding the significant main effects and interaction which govern the outcome.

One word of caution. In using your results, remember what was said about the assumptions on which the ANOVA model was based. It is statistically undeniable, for example, that everyone who inhales air dies. Before you jump to the conclusion that air is toxic remember what was said about being sure you included all the important factors bearing on the outcome.

Lastly, a word about formatting the *Spectaculator* spreadsheet. When starting out, everything should be blank except for the captions for the rows and columns and the template. Those of you with sharp eyes may have wondered why certain parts of the sheet are blank when there should be all rights be figures in them. An example is row 11 of columns 1 through 4. The secret lies in the judicious use of

the ET (enter text) command. Since I have no further mathematical use for the trial numbers, they are entered as text rather than numbers, analogous to converting them to strings in Basic. The figures in columns 2-4, however, need to be used mathematically so they must be entered using the EN command. The secret to why there are no unneeded figures in row 11 is that *Spectaculator* will not write over text with numbers. I think it looks neater (probably as a result of too much early toilet training) not to have all those extraneous figures around, so I enter blank text characters where I don't want numbers. It really takes very little effort, since they can be entered up to 28 at a time, although it does take a little planning.



OWL-WARE

→ BOOKS & PROGRAMS ←

ASSEMBLY LANGUAGE GRAPHICS

for the TRS-80 Color Computer
by DON & KURT INMAN

280 pages \$14.95 + \$1.25 postage & handling

→ SOFTWARE ←

New!!! CRYSTAL REVENGE \$16.95

HI-RES Space War game. The first fully controlled color in PMODE 4! You must defend the CRYSTAL HOME world from the robot attackers. Planet and multicolor attackers remain the same color every game.

STARFIRE \$21.95

Great machine language version of Defenders. Highly rated in the Rainbow. Fast action!

16K EXTENDED BASIC CASSETTES

\$1.25 Per Order
Postage & Handling



All Orders Receive
10% Voucher On Order

OWL-WARE

P.O. Box 116A
Mertztown, PA.
19539

PA. Res. include 6% Tax

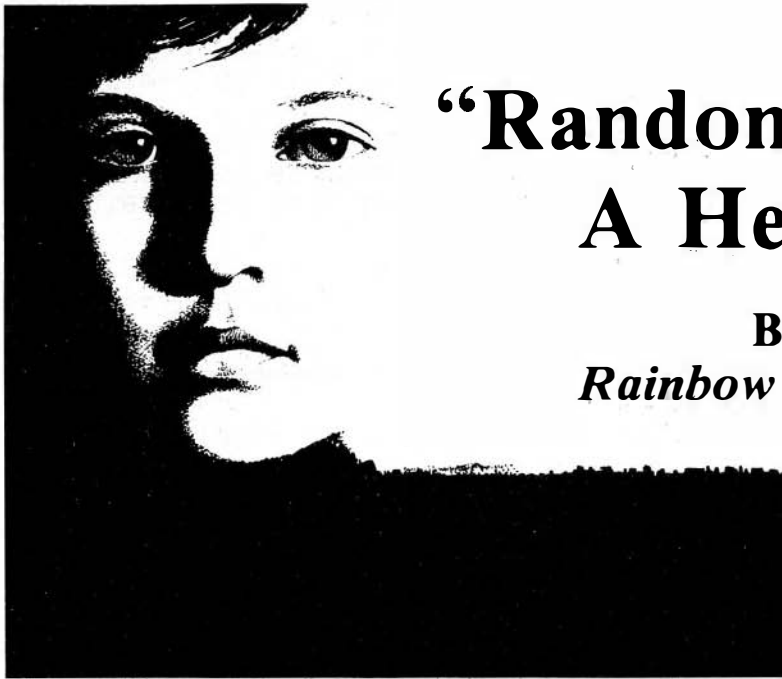

“Random” Often Needs A Helping Hand

By Steve Blyn
Rainbow Contributing Editor

Random numbers are the building blocks of many programs and games. Without the element of random occurrences, we could all too easily predict outcomes. Random keeps us all guessing.

Educational as well as recreational programs often need random numbers selected to make the program challenging. Random numbers can easily be picked out by any of the CoCos using the RND(num) function. We can easily have the computer select a random number between one and 10 by keying in `X=RND(10)`.

If we do 10 occurrences of `X=RND(10)`, then we will have 10 random numbers between one and 10. This is quite sufficient for many recreational games. It is, however, not always correct for many educational game purposes.

Let us suppose that we wish to construct a test for 10 opposites of 10 presidents, state capitals, homonyms, or any other educational topic. The program will present the subject with 10 examples. Do we really care if the questions repeat within the series of 10?

The answer is — of course we do. If any of the questions are repeated, then some will necessarily be left out. We will not get a true test of the 10 items unless each one is used once.

Let's check this out with a short program

```
5 CLS
10 FOR T=1 TO 10
20 X=RND(10)
30 PRINT X
40 NEXT T
```

When you run this program, you will notice that in an overwhelming majority of runs, some of the numbers will be repeated and some omitted within any group of 10.

Although it isn't exactly what we need, we certainly don't want to throw out our `X=RND(10)`. We still need the randomness to insure that the order of questions is different

each time. If the questions do not occur randomly, then the subjects may memorize the questions and answers. What we really need is a way to have the questions appear randomly and also not to repeat or leave out any items during each round.

Here is another short program that will resolve both of our requirements.

```
5 CLS
10 DIM N(10)
15 L=10
20 FOR X=1 TO 10: N(X)=X:NEXT X
30 R=RND(L):T=N(R)
40 N(R)=N(L):L=L-1
50 PRINT "L=";L;"R=";R;"T=";T
60 GOTO 30
```

Lines 10, 15, and 20 dimension and set an array of 10 elements.

Line 30 chooses a random element from the array.

Line 40 is our key line. It removes the element chosen by replacing it with the last element in the array. The array is then decreased by one element. The element chosen cannot be picked again because it is no longer in the array.

Line 50 will print out our results. The "T" becomes our random non-repeating number.

Line 55 will end the program after all of the numbers are picked.

Line 60 goes back to pick the next random number if all have not been used yet.

Here is a printout of a typical run of this program.

```
L=9 R=4 T=4
L=8 R=5 T=5
L=7 R=4 T=10
L=6 R=2 T=2
L=5 R=5 T=9
L=4 R=5 T=6
```

LEARN A SECOND LANGUAGE ON YOUR COLOR COMPUTER • NEW • EXCITING • EASY

Creative Courseware using the latest technology and Professional Programming



- Fulfill your educational objectives
- Improve your job potential
- Have fun learning a new language
- Young and old can learn
- Expand your children's horizons.
- Affordable, only pennies per hour.

- **SEE** — High quality visuals, not dotted graphics
- **HEAR** — High quality audio as spoken by natives
- **UNDERSTAND** — Through programmed instruction
- **RESPOND** — Branching, and looping insure learning.

Our Lessons Teach You to HEAR and THINK in a Second Language

These lessons are for you if you:

- Think you can't learn
- Have had previous difficulties
- Want to start out right
- Want language success

Lessons Now Available in Spanish, English and French

- Color Computer with 16K RAM and tape recorder required
- SLU-1: People, Persons & Family
- SLU-2: Stand, Walk & Run
- SLU-3: Smile, Eat & Talk
- SLU-4: House
- SLU-5: Open & Closed
- SLU-6: Furniture & Appliances
- SLU-7: Meals
- Vocabulary #1, 2 & 3: 200 words each

Other Lessons and Languages Available Soon

Special Values

Special Value #1

SLU 1-3, VOCAB 1, and Lesson Control A **\$129.75** Value for only **\$99.95**.
SV-1 (specify language desired).....\$99.95

Special Value #2

SLU 1-7, VOCAB 1-3, and Lesson Control A **\$249.45** Value for only **\$199.95**.
SV-2 (specify language desired)...\$199.95

Demonstration Lesson (for the doubter)
DEMO-1 \$9.95

Individual Lessons:

(specify language desired)
Second Language Usage (SLU) \$19.95
Vocabulary (SL) \$19.95

Lesson Control: (only one copy needed for all lessons and languages)
LC-CC \$49.50

HOW TO HEAR AND THINK IN A SECOND LANGUAGE

Skilled linguistics have developed our series of second language programs. The lessons utilize the power of programmed instruction wherein you are advanced to new material only after satisfactory learning has occurred at the current level. Our techniques teach you how to think in a language without initially using any printed text material. No mental translation to your native language is required. You learn as a child does, hearing and speaking before reading. The computer both tutors and keeps track of progress as it moves you forward (or backward when review is necessary). AUDIO plus VISUALS plus INTERACTIVE RESPONSE establish the learning process, and literally THOUSANDS of visuals help seal-in the sound patterns of your new language.

All of our lessons are interactive and user friendly; yet, you are unaware of the complex course structure involved. For example: Lesson SLU-1 uses the theme of PEOPLE, PERSONS & FAMILY to teach the use of nouns to name things, to classify them into categories, and to identify members of a group. Sentence structure is developed using the verb 'be' and its relationship to nouns and adverbs, including plural forms and inversions. Noun structure using definite and indefinite articles, and regular and irregular plural forms is also presented. The other lessons are similarly designed. In addition, each VOCABULARY LESSON presents approximately 200 visuals and 200 words that are integrated into the learning process.

While the foregoing might seem complex, and it is, IT IS ALSO THE REASON OUR COURSEWARE CAN TEACH LANGUAGES. If you have tried 'game' or 'tape' language programs you know that they are ineffective. Our programs can teach you a language because we have successfully combined expert authoring of programmed courseware with **audio & visuals & response & branching** into a powerful tutorial package.

DEALER INQUIRIES ACCEPTED

We have a broad range of Audio Visual Computer Aided Instruction under development. Some users of our courseware might include Day Care Centers, Schools (public and private), institutions in various categories, individuals and language tutors.

ABSOLUTELY NO RISK

You may examine your order for 15 days. If you decide not to take advantage of the lesson(s) simply return in good condition for a full refund or cancellation of credit card charges.

*WE PAY UPS IN USA

(street address required for UPS)
*Add \$2.00 if US Mail desired.

*Add 15% for foreign, APO & FPO (Remit in US Funds)

*Virginia Orders add 4% sales tax

*Mail credit card orders please include all card information

WE ACCEPT

- VISA and MASTER CARD
- Money Orders
- Certified Checks

- Other Checks (must clear before shipment)

FREE ORDER LINE
1-800-368-6300

FOR VIRGINIA ORDERS AND OTHER CALLS:
1-804-463-6300

BASIC PROGRAMS, INC.
236 Mustang Trail, #102
Virginia Beach, VA 23452

L=3 R=1 T=1
 L=2 R=1 T=8
 L=1 R=2 T=7
 L=0 R=1 T=3

Look down the "R" column. If we merely used R=RND(L), notice all of the repeats that we would have had. Now look down the "T" column. These are our random, non-repeating numbers.

Let's follow some of the action. On the first trial, the number 4 was picked, and 4 quite naturally occupied the number 4 slot. Line 40 now removes 4 from the number 4 slot and replaces it with 10. Also line 40 now removes the number 10 slot leaving nine slots, with 10 occupying the number 4 slot. On the third trial, the number 4 was picked again, but this time it contained a 10. In this manner, all of the numbers get picked and none can repeat.

This is but one method of accomplishing this task. There are several others that we are familiar with, but this was Computer Island's favorite. We, of course, would enjoy hearing from you with your favorite method.

The program that follows uses this method to test for 10 homonyms. The logic is similar to the program we just reviewed. Please feel free to alter the data to your purposes and use the program in any way that it may be helpful to your children.

The program, as is, will run on Extended Basic. To run on a non-extended computer, delete line 40.

(Mr. Blyn, who teaches both exceptional and gifted children, holds two Master's degrees in the field of education and has won an award for the design of a computer program to aid handicapped children. He and his wife, Cheryl, own Computer Island.)

The listing:

```

40 H=RND(-TIMER) 'THIS LINE IS
FOR EXTENDED BASIC USERS ONLY
50 CR=0 'CORRECT EXAMPLES
60 L=10 '# OF EXAMPLES
70 DIM A$(L),B$(L)
80 FOR W= 1 TO L
90 READ A$(W),B$(W): NEXT
100 R= RND(L)
110 IF L=0 THEN 300 'NO MORE EXA
MPLES
120 A#=A$(R):B#=B$(R)
130 A$(R)=A$(L):B$(R)=B$(L)
140 L=L-1 'REMOVES THE PREVIOUS
EXAMPLE
150 CLS RND(8):PRINT@12,"homonym
5";
160 PRINT@96,"A HOMONYM FOR "A$
;" IS";
170 FOR T=200 TO 250 STEP10: SOU
ND T,2:NEXT T
180 INPUT C$
190 IF C#=B$ GOSUB 220
200 IF C$<>B$ THEN GOSUB 260
210 RESTORE: GOTO 100
220 PRINT@237,"CORRECT";:CR=CR+1
230 SOUND200,8
240 PRINT@386,"PRESS <ENTER> TO
CONTINUE";:INPUT E$
250 CLS:RETURN
260 PRINT@224,"SORRY, THE ANSWER
IS ";B$
270 SOUND 50,5
280 PRINT@386,"PRESS <ENTER> TO
CONTINUE";:INPUT E$
290 RETURN
300 CLS0:FOR T=80TO10STEP-5:SOUN
DT,1:NEXTT
310 PRINT@70," THIS ROUND IS OVE
R ";
320 PRINT@198," YOU HAD ";CR;" C
ORRECT";
330 PRINT@358," PLAY AGAIN (Y/N)
";:INPUT F$
340 IF F$="Y" THEN RUN ELSE IF F
$="N" THEN 350 ELSE 330
350 CLS:PRINT"BYE FOR NOW"
360 DATA HORSE,HOARSE
370 DATA SAIL,SALE
380 DATA HERE,HEAR
390 DATA KNIGHT,NIGHT
400 DATA RIGHT,WRITE
410 DATA SEE,SEA
420 DATA NEW,KNEW
430 DATA NOSE,KNOWS
440 DATA THROUGH,THREW
450 DATA BLUE,BLEW

```

THE DATAMAN	SUGAR SOFTWARE
Datamail 14.95	Auto Run 14.95
Cococopy 12.95	Tims 24.95
First Sampler 9.95	Silly Syntax 19.95
Pretty Printer 12.95	Galactic Hangman new
P.U.F.F. 24.95	

COMPUTER ISLAND	RAINBOW CONNECTION
Circus 9.95	Scepter of Kzingle 16.95
School Maze 11.95	Conquest of Kzingle 21.95
	Stellar Challenge 14.95

HOME RUN COMPUTER PRODUCTS	WEST BAY COMPANY
Run Calc 12.95	Inventory One 19.95
	Spanish One 8.95

BOOKS FROM
 * SYBEX * BYTE * OSBORNE *

**AUTHORS SEND US YOUR PROGRAMS FOR EVALUATION
 WE PAY 50%**

**THE
 DATAMAN**

**All Prices
 Quoted in
 Canadian
 Dollars**

**P.O. BOX 431, STA B, HAMILTON,
 ONTARIO CANADA L8L 7W2
 TELEPHONE 1-(416)-529-1319**

COLORSOFT™ BUSINESS SOFTWARE

AT LAST! BUSINESS SOFTWARE DESIGNED FOR THE COLOR COMPUTER

- ★ MAKE YOUR COLOR COMPUTER A WORKING BUSINESS PARTNER ★
- ★ ALL PROGRAMS ARE MENU DRIVEN AND USER FRIENDLY ★
- ★ PROFESSIONALLY WRITTEN AND FULLY TESTED ★
- ★ AFTER-THE-SALE SUPPORT ★

SMALL BUSINESS ACCOUNTING PACKAGE...Ideally suited for any small business with up to \$1,000,000 in annual sales and 400 accounts receivable and 400 accounts payable. This package provides detailed record keeping on accounts receivable and payable, sales, purchase orders, and allows input and maintenance of payroll related data. Prepares balance sheet and income statement, aging reports, and displays a check register, a listing of sales by date, and a listing of individual purchase orders. Included are printer output options. The step-by-step user's manual and the user friendly, menu driven format makes this program package fast, efficient, and easy to use.
REQUIRES SINGLE DISK DRIVE (User's manual without program \$20).....**\$149.95**

DEPRECIATION...Determines depreciation values for assets based upon the new accelerated cost recovery system (ACRS) and the alternate ACRS methods in addition to the conventional methods. Adjusts for placing assets in service during the year. Screen or printer output.....**\$22.95**

LOAN ANALYSIS...Evaluate cost of borrowing for capital investments or business expansion. Prints amortization schedules and allows user to determine loan status at any point in the term of a loan. Other options allow user to determine either principle, interest, payment, or term based upon input of any three. An auto loan option includes trade-in allowance and taxes. Screen or printer output.....**\$20.95**

ANNUITY...Determine future value of investments, present value of a future amount, compound interest, and amount of an individual retirement account (IRA). Screen or printer output.....**\$18.95**

EXPENSE ACCOUNT DIARY...Keeps a record of travel expenses for up to 25 trips per year. Performs file searches based upon cross-referencing of date of trip, city visited, hotel, or purpose of trip. Screen or printer output. An excellent program for the traveling businessman.....**\$15.95.**

STOCK ANALYZER...Reviewed in July 1982 RAINBOW. New version provides printer output and is disk compatible. Maintains a stock portfolio data base of multiple stocks. Can be used to track performance of sales personnel or similar applications. Features graphing of data to screen or printer along with analyses that includes projection of data trends.....**\$21.95.**

INCLUDE \$2.25 HANDLING PER ORDER
ALL PROGRAMS REQUIRE 16K EXT. BASIC
CUSTOM PROGRAMMING SERVICES AVAILABLE
WRITE FOR FREE CATALOG

**COLOR
SOFTWARE
SERVICES**

BUSINESS SOFTWARE DIV.
P.O. BOX 1708, DEPT. R
GREENVILLE, TEXAS 75401



DEALER INQUIRES INVITED

TELEPHONE ORDERS
(214) 454-3674
9-4 Monday-Saturday

VISA/MASTERCARD



Render Unto Seizure

By Lane P. Lester, Ph.D.

The arrival of a new year with its promise of new challenges and opportunities also heralds the approach of April 15, the deadline for each taxpayer's opportunity to "render unto Caesar the things that are Caesar's" and not one penny more! If you are using the Internal Revenue Service as a non-interest-bearing savings account and look forward each year to a big refund check, you'll want to use INCOMTAX to help that check be as large as legally possible. On the other hand, if you prefer to place your savings in an account with a better return, you'll find the program useful for quarterly evaluations of your tax liability to insure that your withholding (or payment, if self-employed) is kept at a minimum.

At the end of each quarter, receipts, checks, etc. are grouped by category. Although the program includes the addition of new items to existing totals, I have found it easiest to use a calculator for totaling stacks of records. After all records are entered, the "Tax Computation" option provides an *estimate* of one's tax liability to date, based on the assumption of continued earnings at the same rate for the rest of the year. After each new quarter it is only necessary to enter new records to the totals that have been saved previously. At year's end you will have to consult the appropriate tax table for the *exact* amount due you or the IRS.

Tax calculation and line descriptions are provided for Form 1040 and its Schedules A and C. Additional forms can be added by simple changes in the "Calculate Tax," "Form Selection," and "Line Descriptions" sections of the program. The tax table used to calculate the tax liability is taken from Form 1040-ES, "1982 Declaration of Estimated Tax for Individuals." I used Schedule Y for married taxpayers filing joint returns. If your situation differs, I believe you'll find it easy to make the appropriate changes in Lines 390-500.

Both tape and disk storage are provided, and output may be by screen (32-column) or printer (80-column). Two sets of line descriptions are provided for this purpose. Epson MX-80 printer codes are used and may need to be changed for other makes. The following commentary on program logic may be useful for either customizing the program or introducing you to some technique you might find useful.

Line 30: ENTRIES is the total number of lines of all forms and would need to be changed if you add or subtract forms.

Lines 40-50: These are the formats for various PRINTUSINGS.

Lines 60-70: These reflect my personal preference for only one PRINT per line. Notice the more efficient use of two commas as opposed to another PRINT or CHR\$(13).

Lines 90-140: By using the variables DEV and TR\$ a brief routine serves the functions of input and output to tape or disk.

Lines 740-880: Both the "Enter Data" and "Review Data" options use the "Form Selection" routine. This has been generalized to allow adding other forms with ease. SKIP is a factor that allows all lines of all forms to be part of a single sequential array L, and still allow the display of the line numbers for each form. PAGES, FIRST, and LAST are variables used for the screen display of each form, indicating

how many screen "pages" are required and what statements go on each "page." This provides a logical display of related items rather than just a screenful each time.

Lines 150-180: The program is designed to be as helpful as possible to the user. Display of form name, line number, line description, total before entry and new total guard against erroneous entries.

Lines 190-630: All form lines that are calculated from other lines are taken care of by the program. This is accomplished before and after the "Tax Computation" routine. The four columns of the program tax table correspond to columns 2-5 of the IRS schedules. Because the IRS considers income in multiples of \$100, this factor in Line 510 simplifies the Tax Table. A screen summary of tax liability is provided at the end of this option.

Lines 640-700: As mentioned earlier, both screen and printer review of the data are available. Rather than minimize programming in accomplishing both functions by just changing the device number, I chose to provide the most useful displays of the two very different formats.

The listing:

```

10  ? ? INCOMeTAX ?
20  GOTO 1490 ? (PCLEAR1)
30  CLEAR 1000: CLS: ENTRIES=140:
    DIM L(ENTRIES),D1$(ENTRIES),D2$(
    ENTRIES),FIRST(7),LAST(7): GOSU
    B 900
40  F1$="$$$#,###.##": F2$="$$$#,
    ###.##+": F3$="##.%" + STRING$(1
    6," ") + "%$$$#,###.##"
50  F4$=STRING$(10," ") + "##. %"
    + STRING$(32," ") + "% $$$#,##
    #.##"
60  CLS: PRINT"PRESS NUMBER OF DE
    SIREDFUNCTION1. INPUT RECORDED
    DATA", "2. ENTER DATA", "3. CALCU
    LATE TAX"
70  PRINT"4. REVIEW DATA", "5. RE
    CORD DATA", "6. END"
80  K=VAL(INKEY$): IF K<1 OR K>6
    THEN 80 ELSE CLS: ON K GOSUB 90,
    160,200,650,90,1480: GOTO 60
90  ?Recorded Data Routine
100 PRINT"PRESS 1 FOR DISK, 2 FO
    R TAPE"
110 DEV=VAL(INKEY$): IF DEV<1 OR
    DEV>2 THEN 110 ELSE IF DEV=2 TH
    EN DEV=-1
120 IF K=1 THEN TR$="I" ELSE TR$
    ="O"
130 OPEN TR$,DEV,"TAXRECRD": IF
    K=5 THEN FOR I=1 TO ENTRIES PRI
    
```

260	05D9
690	0DDE
1040	16D2
1220	1D5A
END	2640

Get These Action Games for Your TRS-80® Color Computer!

Save Big On Radio Shack's Exciting Super Bustout!

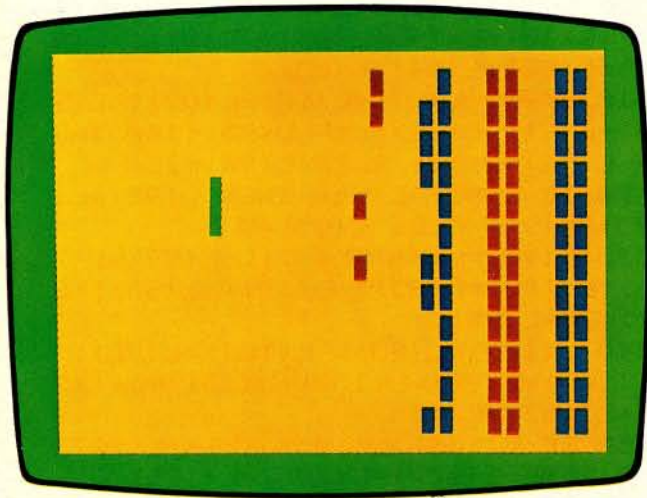

50% Off! **14⁹⁷**
Reg. 29.95

Get ready for some knock-down fun! Use your paddle to break through not one, but three brick walls. The more bricks you knock out, the more points you get. It's doubly hard when you play with "gravity". You'll have to strike the ball hard, or it won't even reach the walls above you. It's lots of fun, and there are several ways to play—alone or with up to three competitors, on the same or separate courts, and with the wall running vertically or horizontally. Hurry—sale ends 2/21/83. Cat. No. 26-3056, \$14.97.

Add To Your Fun with These Exciting Programs!

Hunt for Gold with New Monster Maze!

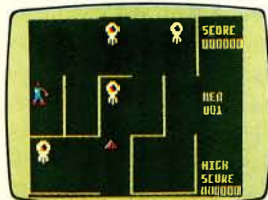

29⁹⁵

Thread your way perilously through the evil dungeon in search of gold. Watch out—laser-firing monsters could be around the next corner! Stay alert to protect yourself with your laser gun. To add to the excitement, the monsters sometimes shoot through the walls! 26-3081, \$29.95.

Fall Under the Spell of Castle Guard!



29⁹⁵

Defend your castle from the giant fireball cast by your enemy. Manuevering Merlin's magical pike, you swat the speeding fireball back at your opponent's castle. With each hit, the castle sinks more deeply into the ground, until only the victor's castle is left standing. For one or two players. 26-3079, \$29.95.

Be a Deadeye with Shooting Gallery!



29⁹⁵

The carnival beckons—flashing lights, happy music, and the shooting gallery! Hit the moving targets—owls, ducks, rabbits, faces, rectangles, and diamonds—each worth different points. Watch out! You'll be penalized if you hit a frowning face. You get 10 turns, with fewer bullets each time. 26-3088, \$29.95.

Increase Your Skill with Bridge Tutor!



34⁹⁵

A grand slam for beginning bridge players. One hundred different hands—each completely analyzed. You sit South and bid the hand you see. Computer grades bidding and gives advice. During play, computer will handle East and West—but still offers advice on your play from hand or dummy. 26-3158, \$34.95.

Radio Shack®

The biggest name in little computers®

A DIVISION OF TANDY CORPORATION

Retail prices may vary at individual stores and dealers.

Send me your free TRS-80 Computer Catalog.

Mail To: Radio Shack, Dept. 83-A-641

300 One Tandy Center, Fort Worth, Texas 76102

NAME _____
ADDRESS _____
CITY _____ STATE _____ ZIP _____
PHONE _____

```

NT#DEV,STR$(L(I)): NEXT: CLOSE:
SOUND 200,2: RETURN
140 FOR I=1 TO ENTRIES: INPUT#DEV, L$: L(I)=VAL(L$): NEXT: CLOSE
: SOUND 200,2: RETURN
150 'Enter Data
160 GOSUB 750: PRINT SKED$
170 PRINT@32,"WHICH LINE NUMBER,
'0' TO STOP";: INPUT L: IF L=0
THEN RETURN ELSE I=L+SKIP: PRINT
@32,D2$(I): PRINTUSING F1$;L(I)
180 INPUT"AMOUNT";AMOUNT: L(I)=L
(I)+AMOUNT: PRINTUSING F1$;L(I):
GOSUB 720: PRINT@64,STRING$(97,
" "): GOTO 170
190 'Calculate Tax
200 INPUT"WHICH QUARTER IS BEING
EVALUATED";QUAR
210 'Business Income
220 L(110)=L(108)-L(109): L(112)
=L(110)+L(111): L(139)=0: FOR I=
113 TO 138: L(139)=L(139)+L(I):
NEXT: L(140)=L(112)-L(139)
230 'Total Income
240 L(11)=L(140): L(21)=0: FOR I
=7 TO 20: L(21)=L(21)+L(I): NEXT
250 'Income Adjustments
260 L(30)=0: FOR I=22 TO 29: L(3
0)=L(30)+L(I): NEXT: L(31)=L(21)

```

```

-L(30)
270 'Itemized Deductions
280 L(69)=.01*L(31): IF L(69)>L(
68) THEN L(70)=0 ELSE L(70)=L(68
)-L(69)
290 L(73)=L(70)+L(71)+L(72): L(7
4)=0.03*L(31): IFL(74)>L(73) THE
N L(75)=0 ELSE L(75)=L(73)-L(74)
300 L(76)=L(67)+L(75): L(82)=L(7
7)+L(78)+L(79)+L(80)+L(81): L(8
6)=L(83)+L(84)+L(85)
310 L(90)=L(87)+L(88)+L(89): L(9
3)=L(91)-L(92): IF L(93)<100 THE
N L(94)=L(93) ELSE L(94)=100
320 IF L(93)>L(94) THEN L(95)=L(
93)-L(94) ELSE L(95)=0
330 L(98)=L(96)+L(97): L(99)=L(7
6):L(100)=L(82): L(101)=L(86): L
(102)=L(90)
340 L(103)=L(95): L(104)=L(98):
L(105)=L(99)+L(100)+L(101)+L(102
)+L(103)+L(104)
350 IF L(106)>L(105) THEN L(107)
=0 ELSE L(107)=L(105)-L(106)
360 'Tax Computation
370 L(32)=L(31)-L(107): L(33)=L(
6)*1000*QUAR/4: L(34)=L(32)-L(33
)
380 'Tax Table Y (Joint)
390 DATA 34, 0, 0, 0
400 DATA 55, 0, 12, 34
410 DATA 76, 252, 14, 55
420 DATA 119, 546, 16, 76
430 DATA 160, 1234, 19, 119
440 DATA 202, 2013, 22, 160
450 DATA 246, 2937, 25, 202
460 DATA 299, 4037, 29, 246
470 DATA 352, 5574, 33, 299
480 DATA 458, 7323, 39, 352
490 DATA 600, 11457, 44, 458
500 DATA 856, 17705, 49, 600
510 L=L(34)*4/QUAR/100: RESTORE
520 READ W,X,Y,Z: IF L<=W THEN T
=X+Y*(L-Z) ELSE 520
530 L(35)=T*QUAR/4: PRINT"TX FR
OM TAX TABLE": PRINTUSING F1$; L
(35): INPUT"ENTER ADDITIONAL TAX
ES";L(36): L(37)=L(35)+L(36)
540 'Tax Credits
550 L(46)=0: FOR I=38 TO 45: L(4
6)=L(46)+L(I): NEXT: L(47)=L(37)
-L(46)
560 'Other Taxes
570 L(54)=0: IF L(11)=>32400 THE
N L(48)=3029.40 ELSE L(48)=.0935
*L(11)
580 FOR I=47 TO 53: L(54)=L(54)+
L(I): NEXT
590 'Tax Payments
600 L(62)=0: FOR I=55 TO 61: L(6

```

Computer Peripheral Resources

5 1/4" Disk Drive Power Supplies



- Guaranteed in writing for 120 days
- Cases accommodate all standard 5 1/4" drives
- Over current and over voltage protection
- Dealer inquiries invited
- Call or write for quantity discounts

Dual Power Supplies

- Horizontal - 12x12x3 1/2\$74.95
 - Vertical - 7x12x6\$74.95
 - Open Frame - 7x2x3 w/o-case\$59.95
 - Single Horiz. P/S - 6x12x3 1/2\$44.95
 - Custom 4' 2-Drive Cable\$21.00
 - 4-Drive Cable\$32.00
 - Dual Case, Horiz. or Vert. (w/o P/S)\$24.95
 - Single Case, Horiz. (w/o P/S)\$18.95
 - Shugart 5 1/4 Disk Drive\$197.50
- SA 405 - 6ms T-T, SS, SD or DD

Terms: Personal checks allow 14 days, COD, MO, Certified Checks . . .
Credit Cards and 3% Shipping and Handling: \$3.00 West and \$5.50 East
states. All shipping UPS surface, other means extra.

Send to:
C.P.R. or call . . .
P.O. Box 634, (206) 679-4797
Oak Harbor, WA 98277

```

2)=L(62)+L(1): NEXT
610 'Refund or Balance Due
620 X=L(62)-L(54): IF X<0 THEN L
(63)=0: L(64)=0: L(65)=0: L(66)=
X*-1 ELSE L(63)=X: L(64)=L(63)-L
(65): L(66)=0
630 FOR I=63 TO 66: PRINTUSING F
3$: I; D2$(I); L(I);: NEXT: GOSU
B 720: RETURN
640 'Review Data
650 GOSUB 750: PRINT SKED$: PRIN
T"PRESS 1 TO DISPLAY REVIEW", "PR
ESS 2 TO PRINT REVIEW"
660 K=VAL(INKEY$): IF K<1 OR K>2
THEN 660 ELSE IF K=1 THEN 690
670 PRINT#-2, CHR$(18)CHR$(13)CH
R$(14)TAB(8)SKED$;CHR$(13): FOR
I=FIRST(1) TO LAST(PAGES)
680 PRINT#-2, USING F4$;I;D1$(I+
SKIP);L(I+SKIP): NEXT: PRINT#-2,
TAB(14)"* = COMPUTER ENTRY"CHR$(
12);: RETURN
690 FOR N=1 TO PAGES: CLS: FOR I
=FIRST(N) TO LAST(N): PRINTUSING
F3$;I;D2$(I+SKIP);L(I+SKIP);: N
EXT I
700 GOSUB 720: PRINT: NEXT N: RE
TURN
710 'Pause
720 PRINT@485, "PRESS 1 TO CONTIN
UE";
730 IF INKEY$<>"1" THEN 730 ELSE
PRINT@485, STRING$(19, " ");: RET
URN
740 'Form Selection
750 PRINT"PRESS NUMBER OF DESIRE
D FORM 1. FORM 1040",, "2. SCH
EDULE A",, "3. SCHEDULE C"
760 K=VAL(INKEY$): IF K<1 OR K>3
THEN 760 ELSE CLS: ON K GOSUB 7
80, 820, 860: RETURN
770 'Form 1040
780 SKED$="FORM 1040": SKIP=0: P
AGES=6
790 FIRST(1)=7: FIRST(2)=21: FIR
ST(3)=31: FIRST(4)=37: FIRST(5)=
47: FIRST(6)=54
800 LAST(1)=21: LAST(2)=31: LAST
(3)=37: LAST(4)=47: LAST(5)=54:
LAST(6)=66: RETURN
810 'Schedule A
820 SKED$="SCHEDULE A": SKIP=66:
PAGES=4
830 FIRST(1)=1: FIRST(2)=11: FIR
ST(3)=21: FIRST(4)=33
840 LAST(1)=10: LAST(2)=20: LAST
(3)=32: LAST(4)=41: RETURN
850 'Schedule C
860 SKED$="SCHEDULE C": SKIP=107
: PAGES=3

```

```

870 FIRST(1)=1: FIRST(2)=5: FIRS
T(3)=20
880 LAST(1)=5: LAST(2)=19: LAST(
3)=33: RETURN
890 'Line Descriptions
900 FOR I=1 TO 12: READ W,X,Y,Z:
NEXT '(Skip Tax Table)
910 FOR I=7 TO ENTRIES: READ D1$
(I): NEXT: FOR I=6 TO ENTRIES: R
EAD D2$(I): NEXT: RETURN
920 'Form 1040
930 DATA "Wages, salaries, tips,
etc.", Interest and dividends, Re
funds of state and local taxes, A
limony received
940 DATA Business income*, Capita
l gain, 40% capital gain not on l
ine 12, Supplemental gains, Fully
taxable pensions & ann.
950 DATA Part. taxable pensions
& ann., "Rents, royalties, etc.",
Farm income, Unemployment compens
ation, Other income*
960 DATA Total income*, Moving ex
pense, Employee business expenses
, Payments to IRA, Payments to Keo
gh, Interest penalty, Alimony paid
970 DATA Disability income, Other

```

NEW from
CoCoHut

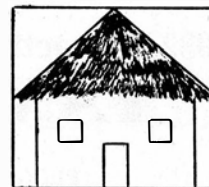

THE ULTIMATE STRATEGY GAME

ZARCONIAN MARBLE

1 or 2 players

Match wits with the computer

16K Ext. Basic required

Cassette 19.95

Disk 24.95

Send check or money order to:

COCO HUT

P. O. BOX 24451

HOUSTON, TX. 77015



adjustments, Total adjustments*, Adjusted gross income*, Adj. gr. inc. - deductions*
 980 DATA Exemptions X \$1000, Taxable income*, Tax from Schedule Y*, Additional taxes, Total (lines 35 & 36)*
 990 DATA Contributions to candidates, Credit for the elderly, Child care expenses, Investment credit, Foreign tax credit
 1000 DATA Work incentive credit, Jobs credit, Residential energy credit, Total credits*, Balance (line 37 - line 46)*
 1010 DATA Self-employment tax*, Minimum tax, Tax from invest. credit recomb., Social security on tips, Tax on IRA
 1020 DATA Adv. earned income credit, Total tax*, Income tax withheld, Estimated tax payments, Earned income credit
 1030 DATA Amount paid with Form 4868, Excess Social Security tax, Credit for fuels tax, Reg. invest. co. credit, Total tax payments*
 1040 DATA Tax overpaid*, Overpayment to be refunded*, Overpayment

to credit next year, Balance due IRS*
 1050 'Schedule A
 1060 DATA Half of insurance premiums, Medicine and drugs, "1% of Form 1040, Line 31*", Line 2 - Line 3*, Balance of insurance premiums
 1070 DATA Other medical & dental expenses, Total (Lines 4-6)*, "3% of Form 1040, Line 31*", Line 7 - Line 8*
 1080 DATA Total medical & dental expenses, State & local income taxes, Real estate tax, Sales tax, Personal property tax, Other taxes
 1090 DATA Total taxes*, Home mortgage interest, Credit and charge card interest, Other interest, Total interest expense*
 1100 DATA Cash contributions, Contributions other than cash, Carry over from prior years, Total contributions*, Casualty or theft losses
 1110 DATA Insurance or other reimbursement, Line 25 - Line 26*, Smaller of \$100 or Line 27*, Total casualty or theft losses*
 1120 DATA Tax return expenses, Other deductions, Total miscellaneous deductions*, Total medical & dental expenses*, Total taxes*
 1130 DATA Total interest expense*, Total contributions*, Total casualty or theft losses*, Total miscellaneous*, Total Lines 33-38*
 1140 DATA Zero bracket amount, Total deductions*
 1150 'Schedule C
 1160 DATA Gross receipts or sales, Cost of operations, Gross profit*, Windfall tax credit, Total income*, Advertising, Amortization
 1170 DATA Bad debts, Bank service charges, Car and truck expenses, Commissions, Depletion, Depreciation, Dues and publications
 1180 DATA Employee benefit programs, Freight, Insurance, Interest on business debts, Laundry & cleaning, Legal & professional expenses
 1190 DATA Office supplies & postage, Pension and profit-sharing plans, Rent on business property, Repairs, Supplies, Taxes
 1200 DATA Travel and entertainment, Utilities and telephone, Wages, Windfall Profit Tax withheld, Ot

1982 Interactive "What If" **TAX Analysis**

PROGRAM - 1040 - SCHED. A
 for the TRS-80 Color Computer™ (16K)

OPTIMIZE TAX RETURNS

Makes It Easy & Simple To:

- MODIFY Tax Data & Receive IMMEDIATE RECALCULATION of Return.
- SAVE/Restore Tax Data
- Menu Driven/Tree Structured S/W



ONLY \$19.99

Add \$1.00 postage
 Plus \$1.50 if C.O.D.
 In VA, add 4% sales tax



SYSTEMS 7602 SEOANE COURT
 FALLS CHURCH, VA 22042

Four smart ways to make your Atari 400/800, TRS-80 COLOR, VIC-20 and Commodore 64 much more intelligent.

1

The Color Accountant pays for itself. This *complete* personal financial package is designed to make your money easier to manage. Included are:

1. Checkbook Maintenance
2. Chart of Accounts
3. Check Search
4. Income/Expense Statement
5. Net Worth Statement
6. Color Graph Design Package
7. Home Budget Analysis
8. Color Payments Calendar
9. Mailing List
10. Decision Maker

This unique menu-driven package requires less than one hour data input per month. The Color Accountant has over 60 pages of documentation including examples and step-by-step instructions. TRS-80 COLOR requires Ext. Basic and 16K for cassette, 32K for diskette; Atari 400/800 requires 24K for cassette, 32K for diskette; VIC-20 requires 16K Expander. Now available for Commodore 64.

**\$74.95 cassette;
\$79.95 diskette**

2

The Tax Handler makes April 15th just another day.

This is the perfect complement to our Color Accountant. The Tax Handler will help prepare your tax returns and probably save you money. Included are:

1. *Form 1040 (Long Form)*—filing status, exemptions, income, income adjustments, computation of tax, tax credits and payments or balance/refund due.
2. *Schedule A (Itemized Deductions)*—medical and dental deductions, taxes, interest expenses, contributions, casualty/theft losses, miscellaneous deductions and summary.
3. *Schedule G (Income Averaging)*—base period income and adjustments, computation of averageable income and computation of tax.

Additional schedules or alterations to the tax codes will be available separately in our monthly magnetic magazines. Atari 400/800 requires 24K for cassette, 32K for diskette. VIC-20 requires 16K Expander. Now available for Commodore 64.

**\$34.95 cassette;
\$39.95 diskette**

3

You'll love your computer with The Magnetic Magazine.

Our magnetic magazines will entertain, inform, educate, challenge and delight you. Each issue contains 4 to 7 ready-to-use quality programs, all fully listable. Every issue includes a newsletter containing instructions, tips on programming techniques and a line-by-line examination of the feature program. And starting with issue number 8, the first in a series of tutorials on machine language programming, Database I with a new application every following issue and a new utility in our Utility-of-The-Month section. And word processing is coming soon!

A full year's subscription consists of 10 issues—over 50 programs a year at a mere fraction of their cost. Available for TRS-80 COLOR Ext. Basic, Atari 400/800; all require 16K. Back issues available.

**One year subscription:
\$50.00 cassette;
\$75.00 diskette
Half year subscription:
\$30.00 cassette;
\$45.00 diskette
Sample issue:
\$10.00 cassette;
\$15.00 diskette
VIX VIDEO issue 1 available
for VIC-20; \$12.95 cassette**

4

The Learning Center teaches and enlightens children.

Our exceptional educational programs are classroom designed and tested. These unique packages have been invented to introduce 3 to 9 year olds to the ease of computer learning. Through the use of basic concepts such as colors, shapes, numbers and letters, children understand counting, math and language skills. Each program is designed to develop a specific skill, rewarding each correct answer with music and a happy face. Most are compatible with our new Edumate Light Pen \$34.95.

Available for Atari 400/800, VIC-20 and Commodore 64; all require 8K for cassette, 16K for diskette. Also available for Timex/Sinclair 1000 and TI-99.

Please ask about programs available and their prices for Pre-School, Kindergarten and Grades 1 & 2. Prices range from \$8.95 for a single cassette to \$79.95 for a complete set on diskette.

Order now! See your local dealer or order direct. New catalog \$2.00. Visa and MasterCard accepted—please add \$2.00 for postage and handling.

Call toll free!

1-800-334-SOFT

DEALER INQUIRIES INVITED

programmer's institute

a division of **FUTURE HOUSE** — dept. r
p.o. box 3470, chapel hill, north carolina 27514, 919-967-0861

her expenses, Total deductions*
 1210 DATA Net profit*
 1220 'Form 1040'
 1230 DATA "DEPENDENTS", "SALARIES
 , ETC.", "INTEREST & DIV.", "REF. S &
 L TAXES, ALIMONY RECEIVED
 1240 DATA BUSINESS INCOME, CAPITAL
 GAIN, 40% CAPITAL GAIN, SUPPL. G
 AINS, F. T. PENS. & AN.
 1250 DATA P. T. PENS. & AN., "REN
 TS, ROY., ETC.", "FARM INCOME, UNEM
 PLOY. COMP., OTHER INCOME, TOTAL I
 NCOME
 1260 DATA MOVING EXPENSE, EMPLOYE
 E BUS. EXP., IRA PAYMENTS, KEOGH P
 AYMENTS, INTEREST PENALTY, ALIMONY
 PAID
 1270 DATA DISABILITY INCOME, OTHE
 R ADJUSTMENTS, TOTAL ADJUSTMENTS,
 ADJ. GROSS INCOME, AGI - DEDUCTIO
 NS
 1280 DATA EXEMPT. X \$1000, TAXABL
 E INCOME, TAX FROM SKED Y, ADDITIO
 NAL TAXES, TOTAL (35 & 36), CONTR.
 TO CAND.
 1290 DATA CREDIT FOR ELDERLY, CHI
 LD CARE EXP., INVESTMENT CREDIT, F
 OREIGN TAX CREDIT, WORK INC. CRED
 IT, JOBS CREDIT
 1300 DATA RES. ENERGY CREDIT, TOT
 AL CREDITS, BALANCE (37-46), SELF-

EMPLOY. TAX, MINIMUM TAX
 1310 DATA INV. CR. REC. TAX, SOC.
 SEC. ON TIPS, TAX ON IRA, ADV. IN
 C. CREDIT, TOTAL TAX, INC. TAX WIT
 HHELD
 1320 DATA EST. TAX PAYMENTS, EARN
 ED INC. CREDIT, AMOUNT FORM 4868,
 EXC. SOC. SEC. TAX, CREDIT FUELS
 TAX
 1330 DATA INV. CO. CREDIT, TOTAL
 TAX PAYMENTS, TAX OVERPAID, AMOUNT
 TO REFUND, AMOUNT TO CREDIT, BALA
 NCE DUE IRS
 1340 'Schedule A
 1350 DATA 1/2 INS. PREMIUMS, MEDI
 CINE AND DRUGS, "1% OF F.1040, L.
 31", LINE 2 - LINE 3, BAL. OF INS.
 PREM.
 1360 DATA OTHER M&D EXPENSES, TOT
 AL (LINES 4-6), "3% OF F.1040, L.
 31", LINE 7 - LINE 8
 1370 DATA TOTAL M&D EXPENSES, ST.
 & LOC. INC. TAX, REAL ESTATE TAX, S
 ALES TAX, PERSONAL PROP. TAX, OTHE
 R TAXES
 1380 DATA TOTAL TAXES, MORTGAGE I
 NTEREST, CR. CARD INTEREST, OTHER
 INTEREST, TOTAL INTEREST
 1390 DATA CASH CONTRIBUTIONS, OTH
 ER CONTRIBUT., CARRYOVER, TOTAL CO
 NTRIBUTIONS, CASUALTY LOSSES
 1400 DATA CASUALTY REIMB., LINE 2
 5 - LINE 26, SMALLER-\$100/L.27, TO
 TAL CASUALTY
 1410 DATA TAX RET. PREP. FEE, OTH
 ER DEDUCTIONS, TOTAL MISC. DED., T
 OTAL M&D EXPENSE, TOTAL TAXES
 1420 DATA TOTAL INT. EXPENSE, TOT
 AL CONTRIBUT., TOTAL CASUALTY, TOT
 AL MISC. DED., TOTAL LINES 33-38,
 ZERO BR. AMOUNT, TOTAL DEDUCTIONS
 1430 'Schedule C
 1440 DATA GROSS RECEIPTS, COST/OP
 ERATIONS, GROSS PROFIT, WIND. PROF.
 CREDIT, TOTAL INCOME, ADVERTISING,
 AMORTIZATION, BAD DEBTS
 1450 DATA BANK SERVICE CHG., CAR
 EXPENSES, COMMISSIONS, DEPLETION, D
 EPRECIATION, DUES & PUBL., EMPLOYE
 E BENEFITS, FREIGHT, INSURANCE
 1460 DATA BUSINESS INTEREST, LAUN
 DRY, LEGAL & PROF. EXP., OFFICE SUP
 PLIES, PENSION PLANS, RENT, REPAIRS
 , SUPPLIES, TAXES, TRAVEL, UTILITIE
 S
 1470 DATA WAGES, WINDFALL TAX, OTH
 ER EXPENSES, TOTAL DEDUCTIONS, NET
 PROFIT
 1480 CLS: END
 1490 PCLEAR 1: GOTO 30



THE COMPOSER

SPEECH SYSTEMS, A MANUFACTURER OF SPEECH, MUSIC, AND SOUND EFFECT SYNTHESIZERS FOR THE SS-50 BUS, INTRODUCES THE COMPOSER FOR THE COLOR COMPUTER. THE COMPOSER IS A 4 VOICE MUSIC COMPILER WHICH ALLOWS ONE TO EASILY DEVELOP MUSIC. EACH VOICE USES ITS OWN WAVESHAPES TABLE. BOTH A BASIC AND A MACHINE LANGUAGE PROGRAM ARE INCLUDED, NO ADDITIONAL HARDWARE IS NECESSARY. THE COMPOSER ALLOWS THE ORIGINAL MUSICAL SCORE TO BE SAVED. IN ADDITION, THE COMPILED MUSIC MAY BE SAVED AND BEST OF ALL IT MAY BE PLAYED WITHOUT ANY OTHER SOFTWARE. EXAMPLES OF HOW THE COLOR COMPUTER CAN BE USED TO REPRODUCE SOUND EFFECTS ARE ALSO INCLUDED. YOU HAVE TO HEAR THE DIFFERENCE TO REALLY COMPARE, BUT JUST LOOK AT SOME OF THESE FEATURES:

	THE COMPOSER	RADIO SHACK MUSIC
PRICE.....	\$24.95	\$29.95
VOICES.....	4	2
OCTAVE RANGE.....	7	4
WAVESHAPES.....	4	4
MANUAL.....	25 full Pages	16 mini-Pages
MUSIC INCLUDED.....	YES	NO
TEMPO (SPEED).....	30+	4
DOTTED NOTE.....	YES	YES
DOUBLE DOTTED.....	YES	NO
TRIPLETT.....	YES	NO
QUARTER NOTE TRIPLETT.....	YES	NO
EIGHTH NOTE TRIPLETT.....	YES	NO
THIRTY SECOND NOTE.....	YES	NO
SOUND EFFECTS.....	YES	NO

Requires 16K Extended BASIC
 CASSETTE VERSION.....\$41.95
 DISK VERSION.....\$29.95

CALL OR WRITE TO ORDER.
 WE ACCEPT CASH, CHECK, COD, VISA, AND MASTERCARD.
 ILLINOIS RESIDENTS PLEASE INCLUDE 5% SALES TAX.
 INCLUDE \$1.50 FOR SHIPPING AND HANDLING.



DEALER INQUIRES INVITED.



38 W 255 DEERPATH ROAD
BATAVIA, IL 60510

(312) 879-6880

TOM MIX SOFTWARE

• FOR THE COLOR COMPUTER • 3424 College N.E., Grand Rapids, MI 49505 (616) 364-4791



DONKEY KING

©1982

32K Machine Language

\$24.95 tape

\$27.95 disc

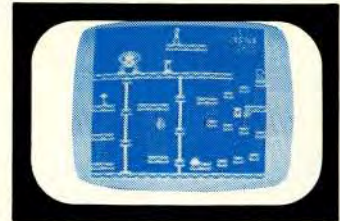

ARCADE ACTION — How high can you climb? Four full graphic screens. Exciting sound - Realistic graphics. Never before has the color computer seen a game like this. Early reviews say: Just like the arcade - Simply outstanding!

PROTECTORS

Exciting fast paced arcade game that looks and plays like the popular arcade game "DEFENDER".

Wave after wave of enemy fighters drop bombs on your city. Destroy them before they destroy your city. Soon the mother ships appear firing laser blasts at you. Watch for the heat seeking mines.

Your defense includes your laser cannon plus four smart bombs on each of your four ships. A new ship with each 5,000 points.

High resolution graphics with four colors make this new 32K arcade game the one for others to follow.

MACHINE LANGUAGE \$24.95 TAPE \$27.95 DISK



KATERPILLAR ATTACK

Outstanding graphics and sound will end all of those trips to the arcade. So much like the arcade you have to see it to believe it.

16K MACHINE LANGUAGE \$24.95
DISK \$27.95



COLOR GOLF

Now sit at your computer and play nine or eighteen holes. Outstanding graphics in the fairway or on the green. Helps your game.

32K EXTENDED BASIC \$16.95

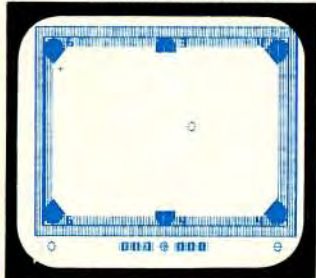

SOLO POOL

Now play pool with your color computer. Two players. Plays like machine language. Super color. High resolution graphics.

16K Extended Basic \$17.95

MAZE RACE

Maze race is a one or two player game. Play either against the built in timer or against your favorite opponent.

16K MACHINE CODE \$14.95

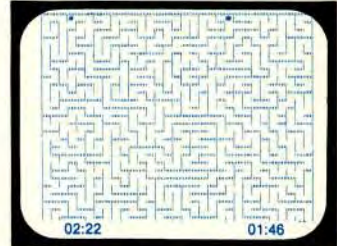

BIRD ATTACK

A fast paced machine language arcade game. Shoot the birdmen before they descend upon you. Watch out for their bombs!

16K Extended Basic \$21.95



OTHER GREAT GAMES

ALL PROGRAMS REQUIRE 16K
ML = MACHINE LANGUAGE B = BASIC

MOON LANDER—Fantastic Graphics. Land on the Moon if you can. 2 Programs. B \$15.95

DANCING DEVIL—Watch him dance to music or program him yourself. ML \$14.95

WAR KINGS—Battle to save your castle and king. High resolution graphics with outstanding sound make this one a real winner. 16K MACHINE LANGUAGE \$19.95

ADVENTURES

TREK-16—Travel thru space with Spock and Capt. Kirk. Adventure. Tough! B 19.95

SHIPWRECK—Escape from a desert isle if you can. Great Adventure! B \$14.95

UTILITIES

COLOR MONITOR—Written in position independent code. (May be located in any free memory). Very compact. Only occupies 1174 bytes of memory. Full Featured. Includes Break-Pointing of machine language programs, register display and modify, memory display and modify, and block memory move commands. Displays memory in hex and ascii format on one line 8 bytes long.

MACHINE LANGUAGE \$24.95

TAPE DUPE—Brand new machine language program that copies any tape effortlessly. Completely automatic. ML \$16.95

DISK TO TAPE—Dump the contents of any disk to tape automatically. ML \$19.95

TAPE TO DISK—Load the contents of any tape to disk automatically. ML \$19.95

MAIL LIST—Maintain a complete mailing list with phone numbers etc. B \$19.95

THE FIXER—Having trouble moving those 600 Hex programs to disk? The fixer will help. Completely automatic. ML \$18.95

TAPE CAT—All new machine language program lists contents of tapes to printer. Make a catalog of your tapes. ML \$17.95

PROGRAM PRINTER UTILITY—This program will list basic programs to your printer in two column format. Saves paper and makes your listing look professional. Disk based. B \$19.95

SPECIAL PACKAGE

10 PLUS PROGRAMS FOR \$20.00

All Basic Programs less than \$2.00 each. A real bargain for the beginner. Requires Extended Basic.



• ADD \$1.00 POSTAGE & HANDLING • TOP ROYALTIES PAID •

MICHIGAN RESIDENTS ADD 4% SALES TAX • LOOKING FOR NEW SOFTWARE



Creating Characters For Fun And Adventure

By Bob Albrecht and George Firedrake
Rainbow Contributing Editors

FANTASY ROLE PLAYING GAMES

Millions of young people, and many not-so-young, are playing fantasy role playing games: *Dungeons & Dragons*, *RuneQuest*, *Tunnels & Trolls*, *Worlds of Wonder* and many others.

A role playing game is a game in which one or more players create and control characters (adventurers) who live their imaginary lives in a specially made game world. The game world is created, managed, and operated by a game master, also called a referee, adventure master, or dungeon master.

Most people who play role playing games use a formal system of rules. Some of the best known fantasy game rule systems are listed below.

Dungeons & Dragons (D&D). From TSR Hobbies, P.O.Box 756 Lake Geneva, WI 53147.

RuneQuest (RQ). From Chaosium, P.O. Box 6302, Albany, CA 94706.

Tunnels & Trolls (T&T). From Flying Buffalo, P.O. Box 1457, Scottsdale, AZ 85252

Worlds of Wonder (WOW). From Chaosium, P.O.Box 6302, Albany, CA 94706

Beginners Beware! Most rulebooks are very difficult to understand. Some are almost incomprehensible. If you are a beginner, first try *Tunnels & Trolls* or *Worlds of Wonder*.

Remember, our abbreviations: **D&D, RQ, T&T, and WOW.**



CREATE A CHARACTER

If you want to play, instead of just watch, you must create a character, an adventurer whom you guide in the GameMaster's world. In "GameMaster's Apprentice," we will show you how to create characters for *RuneQuest*, *Worlds of Wonder*, and *Adventurer's Handbook: A Beginner's Guide to Role Playing Games*.*

Your character begins with seven basic *characteristics*: Strength (STR), Constitution (CON), Size (SIZ), Intelligence (INT), Power (POW), Dexterity (DEX), and Charisma (CHA). These characteristics are similar to the characteristics in other game systems, such as *Dungeons & Dragons* or *Tunnels & Trolls*. The following table shows approximate equivalents.

Adventurer's Handbook, RuneQuest, or Worlds of Wonder
Strength (STR)
Constitution (CON)
Size (SIZ)
Intelligence (INT)
Power (POW)
Dexterity (DEX)
Charisma (CHA)

Dungeons & Dragons
Strength (STR)
Constitution (CON)
Dexterity (DEX)
Intelligence (INT)
Wisdom (WIS)
Dexterity (DEX)
Charisma (CHA)

Tunnels & Trolls
Strength (STR)
Constitution (CON)
Dexterity (DEX)
Intelligence (IQ)
Luck (LK)
Dexterity (DEX)
Charisma (CHR)

Yes, you can modify our programs for D&D or T&T. In fact, we will ask you to do so.

You create a character by rolling three six-sided dice for *each* characteristic. If you have been reading "GameMaster's Apprentice," you know we use the abbreviation "3D6" to mean "three-sided dice."



Oh, you don't have 3D6. Never mind...use your friendly CoCo to roll up a character and display the numbers on the screen. Our program follows. We think it will work for the CoCo, and also for the TRS-80 Models I and III

Listing 1

```
100 REM ** CREATE A CHARACTER
199 :
300 REM ** CLEAR THE SCREEN
310 CLS
399 :
500 REM ** ROLL & PRINT CHARACTE
RISTICS
510 GOSUB 910: PRINT "STR", DICE
520 GOSUB 910: PRINT "CON", DICE
530 GOSUB 910: PRINT "SIZ", DICE
540 GOSUB 910: PRINT "INT", DICE
550 GOSUB 910: PRINT "POW", DICE
560 GOSUB 910: PRINT "DEX", DICE
570 GOSUB 910: PRINT "CHA", DICE
599 :
700 REM ** TELL HOW TO DO AGAIN
710 PRINT
720 PRINT "TO DO AGAIN, PRESS AN
```

**Adventurer's Handbook* is a book in progress by Bob Albrecht and Greg Stafford, to be published in 1983 by Reston Publishing Company.

```

Y KEY"
730 IF INKEY$ = "" THEN 730 ELSE
310
799 :
900 REM ** DICE SUBROUTINE
910 D1 = RND(6)
920 D2 = RND(6)
930 D3 = RND(6)
940 DICE = D1 + D2 + D3
950 RETURN

```

3D6

Dice? See the
DICE SUBROUTINE



As usual, we wrote our program in *blocks*. Each block begins with a REM statement. You don't have to type the REM statements into your CoCo—they are there to help you understand our program.

Last time, we showed you two *RUNs*, which began the lives of Barostan and Joleen. Here they are again.

STR	17	Barostan is big and strong,
CON	17	but not too bright. He is good
SIZ	13	to have on your side in a fight,
INT	8	if someone will tell him who to
POW	7	hit. He acts first, then thinks
DEX	15	later, if at all.
CHA	6	

STR	13	Joleen is a clown, mime, acrobat,
CON	11	dancer, or whatever else might
SIZ	7	entertain an audience. She wants
INT	13	to travel with a troupe of
POW	8	wandering entertainers, and perform
DEX	17	at fairs and festivals. She will
CHA	13	charm you.

Use our program to create a character, *your* character. Look at the characteristics. Who is your character (she or he)? Describe your character. A party game?

Yes, a game. Two or three or more people get together and use the CoCo to create characters. Each person writes down the characteristics of his or her character (oh, you have a printer?... Wonderful!).

Describe the character and give her or him a name, a history, a personality. How old is she or he? After everyone has a character, let them all interact. Play the roles!

Hmmm...imagine a conversation between Barostan and Joleen. Or, you create two or more characters, then imagine them in a conversation. You, of course, play all the roles. To

keep track of your characters, start a *character sheet* for each one. Here are the top parts of character sheets for Barostan and Joleen

CHARACT R NAME	Barostan	AGE	16	SEX	M	RACE	Human		
BACKGROUND	Villager, Beginning Adventurer								
STR	17	Damage	HIT PTS. 0 1 2 3 4 5 6 7 8 9 10						
CON	17	11 12 13 14 15 16 17 18 19 20 21 22 23 24 25							
SIZ	13								
INT	8	Idea	Armour						
POW	7	Luck	POW PTS. 0 1 2 3 4 5 6 7 8 9 10						
DEX	5	Dodge							
CHA	6	Persuade	11 12 13 14 15 16 17 18 19 20 21 22 23 24 25						

CHARACTER NAME	Joleen	AGE	16	SEX	F	RACE	Human		
BACKGROUND	Villager, Beginning Adventurer								
STR	13	Damage	HIT PTS. 0 1 2 3 4 5 6 7 8 9 10						
CON	11	11 12 13 14 15 16 17 18 19 20 21 22 23 24 25							
SIZ	7								
INT	13	Idea	Armour						
POW	8	Luck	POW PTS. 0 1 2 3 4 5 6 7 8 9 10						
DEX	17	Dodge							
CHA	13	Persuade	11 12 13 14 15 16 17 18 19 20 21 22 23 24 25						

Next time, we will tell you more about the character sheet. If you want a head start, get the *Worlds of Wonder* boxed set from Chaosium, P.O. Box 6302, Albany, CA 94025. \$16.00 plus \$2.00 postage and handling. California residents add 6% or 6½% sales tax. In the meantime, here is a part of a blank character sheet you can copy and use to record information about *your* characters.



ColorZAP™

Use Color Power.

ColorZAP uses the power of the Color Computer to provide both rapid scanning and full screen modification capabilities:

- Recover killed and clobbered files.
- Find unreadable disk sectors.
- Modify nibbles in hexadecimal.
- Copy sectors to same or different drive.
- Use color power to scan disk data.

Here's what the reviewers said...

About the program: "ColorZAP is a powerful program that allows you to see what is on the disk, modify it and, if possible, recreate it. Menu-driven, ColorZAP is extremely easy to use and well-documented...A good offering." — The RAINBOW, September 1982

About the manual: "A 24-page manual is included that describes program operation in detail. It also provides valuable information on the important disk system parameters." — MICRO, December 1982

For the TRS-80 Color Computer. Available on disk with an accompanying manual from **Software Options**, 19 Rector Street, New York, N.Y. 10006. 212-785-8285. **Toll-free order line: 800-221-1624.** Price: \$49.95 (plus \$2.00 per order shipping and handling). New York State residents add sales tax. Visa/Mastercard accepted.



**SOFTWARE
OPTIONS INC.™**



CHARACTER NAME _____	AGE _____	SEX _____	RACE _____
BACKGROUND _____			
STR _____	Damage _____	HIT PTS.	0 1 2 3 4 5 6 7 8 9 10
CON _____			11 12 13 14 15 16 17 18 19 20 21 22 23 24 25
SIZ _____			
INT _____	Idea _____	Armour _____	
POW _____	Luck _____		
DEX _____	Dodge _____	POW PTS.	0 1 2 3 4 5 6 7 8 9 10
CHA _____	Persuade _____		11 12 13 14 15 16 17 18 19 20 21 22 23 24 25

Information about a character can change, so *use a pencil* when you write on a character sheet.

COLOR COMPUTER SOFTWARE

Adventure games

- **THE ALCHEMIST'S LABORATORY - \$14.95**

mix the ingredients that will turn lead into gold.

- **LOKAR'S MAGIC STAFF - \$14.95**

can you unlock the deadly secrets of **LOKAR'S** magic staff?

- **MEGAMAZE - \$14.95**

a wild, five dimensional space maze adventure.

- **SQUEEZE - \$14.95**

arcade style game where aliens close in from both sides at once.

- **GRAPHIC SCREEN EDITOR - \$16.95**

create pictures on the screen using joysticks or arrow keys - save on tape, erase, paint, and many other features.

- **COLOR SHOW DISPLAYS - \$8.95**

five graphics programs that create endless changing patterns.

all programs 16-K extended basic cassette only.

Send for free catalogue. We accept checks, money orders, Visa and Mastercharge. (no C.O.D.'s) Please add \$1.00 for shipping. Send to:

REAL SOFTWARE CO.

P.O. BOX 401 • HOPEDALE, MA 01747

(617) 393-6281

CIS orders EMAIL to 71505,430

Mass. residents add 5% sales tax

Dealer inquiries welcomed

VARIATIONS

Our program rolls a number from 3 to 18 for each and every characteristic. Alas, a character with SIZ 15, STR3, and DEX 5 will never make it in the GameMaster's world.

So, *Your Turn*. Replace the DICE SUBROUTINE with any of the following, allowed by a compassionate GameMaster. Each of these is a *simulation* (imitation) of what might happen when rolling dice in an actual game.

►900 REM ** DICE SUBROUTINE

Roll 3D6. If DICE is less than 5, assign 6 as the value. Your character may not like a characteristic of 6, but will have to live with it.

►900 REM ** DICE SUBROUTINE

This GameMaster is even more generous. If DICE is less than 6, add 3. Hmm...this time, a roll of 5 is better than a roll of 6!

►900 REM ** DICE SUBROUTINE

We hear rumors that D&D Dungeon Masters Allow players to roll 4D6 and take the best 3D6. That is, if you roll

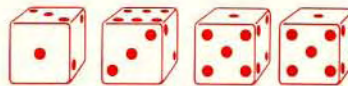

you can discard



and take





NEW for your COLOR COMPUTER

Release the potential of your Color Computer . . .

Use up to 5 compatible Color Computer cartridges at the same time with the BT-1000 Expansion Interface Unit.

- **The BT-1000 is limitless combinations.** Plug in your disk controller, memory boards, Real Time Clock/Calendar, printer interface, experimental boards—all at one time.
- **The BT-1000 is adaptable.** Up to five functional peripheral cartridges, in your choice of combinations, will run with any configuration, any size memory of the Color Computer.
- **The BT-1000 is flexible.** Four 24-pin sockets hold up to 8K static RAM or EPROM (can be supplied with an extra 8K RAM).
- **The BT-1000 is safe.** It will not overload, overheat or damage your Color Computer in any way.
 1. Has own built-in power supply.
 2. Effectively isolated by a buffered cable.

That's not all Basic Technology has to offer . . .

Record date and time on all programs, files, letters, with the accurate, programmable BT-1020 Real Time Clock/Calendar.

- Plugs into your BT-1000 or directly into the Color Computer expansion slot.
- Adds day, date, month, year, hours, minutes, seconds (12/24 hr.)
- Includes internal NiCad battery, crystal controlled to 0.001% accuracy (charges when your computer is on)
- Has 50 bytes of battery backed general purpose memory

All Basic Technology components are first-line quality.

- gold board-edge connectors
- glass epoxy PC boards
- 180-day full parts and labor warranty on all components



Your **Basic Technology** components arrive assembled, tested, ready to plug in and turn on. A comprehensive User/Service Manual is included with complete schematics, PC component layouts, parts lists and hints on mapping your peripheral add-ons anywhere in the CPU addressable memory. Write for free brochure.

BT-1000 incl. cable \$270 BT-1020 Clock/Calendar \$109
BT-1000 w/8K RAM \$300

Add \$5.00 shipping & handling for BT-1000, \$2.50 for BT-1020. Michigan residents add 4% sales tax. Shipping & handling for residents of Canada, Hawaii, Alaska is \$10.00. Overseas orders add 15%. Check, money order, VISA, MC (give account no., expiration date, phone no.). Personal checks allow 2-3 weeks to clear. COD charge \$2.00 (requires certified check or money order).

"Watch for more peripherals from Basic Technology."

basic
TECHNOLOGY

Dept. Q P.O. Box 511 Ortonville, MI 48462

(313) 627-6146

for a total of 13. Do it! Write the DICE SUBROUTINE to roll 4D6 and set DICE equal to the sum of the highest three dice.

THERE IS ALWAYS ANOTHER WAY

Here is another program to roll a character. This time, we read the characteristic abbreviations from *DATA* statements (lines 560 and 570).

Listing 2

```

100 REM ** CREATE A CHARACTER
199 :
300 REM ** CLEAR THE SCREEN
310 CLS
320 RESTORE
399 :
500 REM ** ROLL & PRINT CHARACTE
RISTICS
510 FOR K=1 TO 7
520 : READ CHAR$
530 : GOSUB 910
540 : PRINT CHAR$, DICE
550 NEXT K
560 DATA STR, CON, SIZ, INT
570 DATA POW, DEX, CHA
599 :
700 REM ** TELL HOW TO DO AGAIN
710 PRINT
720 PRINT "TO DO AGAIN, PRESS AN

```

Y KEY"

```

730 IF INKEY$ = "" THEN 730 ELSE
310
799 :
900 REM ** DICE SUBROUTINE
910 D1 = RND(6)
920 D2 = RND(6)
930 D3 = RND(6)
940 DICE = D1 + D2 + D3
950 RETURN

```

And yet another way. Change only Block 500, as follows

Listing 3

```

500 REM ** ROLL & PRINT CHARACTE
RISTICS
510 READ CHAR$
520 IF CHAR$ = "ZZZ" THEN 710
530 GOSUB 910
540 : PRINT CHAR$, DICE
550 GOTO 510
560 DATA STR, CON, SIZ, INT
570 DATA POW, DEX, CHA, ZZZ

```

Your Turn. Modify any or all of our programs to roll a D&D or T&T character. Which program is easiest to modify?

ANNALEE ROLLS 3D6

Last time we asked you to modify Annalee's program to count the number of ways each 2D6 outcome can occur. We asked you to modify her program so the CoCo computes and shows the number of ways each 3D6 outcome can occur. We did it like this.

Listing 4

```

100 REM ** ANNALEE SHOWS THE WAY
110 DIM C(18)
119 :
300 REM ** SET COUNTS TO ZERO
310 FOR K=3 TO 18
320 : C(K) = 0
330 NEXT K
399 :
400 REM ** COUNT OUTCOMES
410 FOR D1=1 TO 6
420 : FOR D2=1 TO 6
430 : FOR D3=1 TO 6
440 : SUM = D1 + D2 + D3
450 : C(SUM) = C(SUM) + 1
460 : NEXT D3
470 : NEXT D2
480 NEXT D1
499 :
600 REM ** TELL WHAT HAPPENED
610 CLS
620 PRINT "OUTCOME" TAB(8) "WAYS
";
630 PRINT TAB(16) "OUTCOME" TAB(
24) "WAYS"
640 FOR K= 3 TO 18 STEP 2
650 : PRINT K TAB(8) C(K);

```



Text Pro II
"The Professional's Word Processor"



**CER
COMP**

TEXT PROCESSOR FEATURES	TEXT EDITOR FEATURES
<ul style="list-style-type: none"> • Character Fill • Programmable Footer • Right Justify Line • Multiple Footnotes • Three Indent Modes • Three Programmable Headers • Ten Programmable Tab Stops • Margin Justification Left and Right • Decimal Align, Center, Left and Right Justify On Tab Column • Display and Input From Keyboard • Change Formatting During Processing 	<ul style="list-style-type: none"> • Single Keystroke Edit Command • Append Files From Tape Or Disk • Fully Integrated Disk File Handler • Edit Or Process Files Larger Than Memory • (No Conversion Required) Fully ASC II Compatible • Full Featured Line Oriented Screen Editor • Search And Replace Any Character Pattern • Copy, Move or Delete Lines Or Blocks of Text • Edit Basic, Text, Or Assembler Files

TEXT PRO II Features Over 70 Commands In All!
Key In Format Command Or Text At Runtime!
Compatible With All Major Printers On The Market!
Multiple Copy or Repeat All Of Or A Portion Of The Text!

16K Or 32K Systems

DISK.....\$79.95

64K Version Now Available-FLEX Not Required

CER-COMP

5566 Ricochet Avenue
Las Vegas, Nevada 89110

All Orders Shipped From Stock
Add \$2.50 Postage



RAINBOW
SOFTWARE

660 : PRINT TAB(16) K+1 TAB(24)
 C(K+1)
 670 NEXT K
 699 :
 999 END

RUN the program to find the number of ways to get 3, or 4, or 5, or any possible outcome up to 18, when you roll 3D6.

This type of information can perhaps be shown more clearly in graphical form. Here is a bar graph showing the number of ways each number can be obtained.

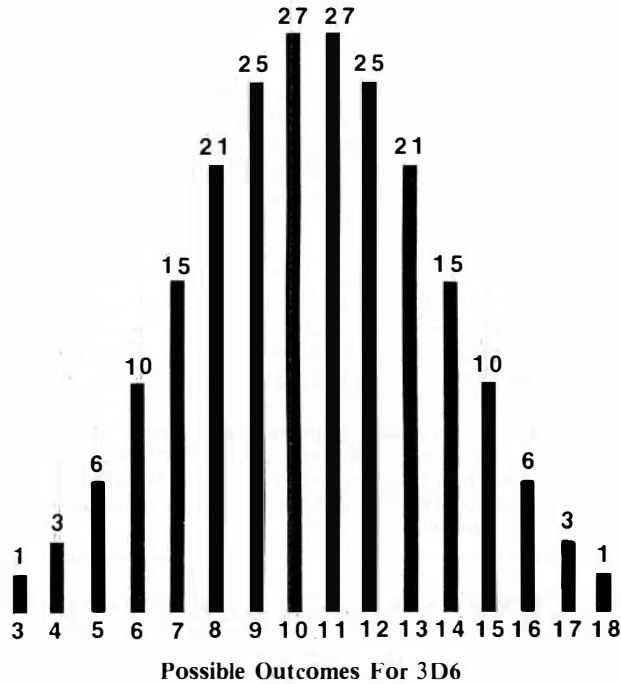

Some of you may see a resemblance to the "bell shaped curve" of statistics.

GAME CONVENTIONS

One of the best ways to savor the flavor of fantasy role playing games is to go to a game convention-- watch or jump in and play. Here are some upcoming Game Conventions.

Jan.22-23

Winter Campaign II. Get info from Winter Campaign, P.O. Box 14630, University Station, Minneapolis, MN 55414.

Feb.11-13

Warcon IX. Info from Texas A&M University, MSC Recreation, P.O.Box J-1, College Station, TX 77844.

Feb. 18-21

Dundracon. Info from Dundracon, Inc., 386 Alcatraz, Oakland, CA 94618.

Feb. 26-27

Game Faire. Info from Channon Ahern, Book and Game Company, West 621 MAllon, Spokane, WA 99201.

Mar. 18-20

Mar. 26-27

NOVA 8. Info from The Order of Leibowitz, Oakland University, Rochester, MI 48063.

**Mar. 31,
Apr. 1-3**

Science Fiction Weekend. Info from Fantasy Publishing, Inc., 1855 W. Main St., Alhambra, CA 91801.

Jul. 14-17

Origins '83. Info from Metro Detroit Gamers, 2616 Kenwyck, Troy, MI 48098. This one is BIG.

COMING ATTRACTIONS

Surely, but slowly, we will explore the following things:

- ★ The elusive RND
- ★ GameMaster's Dice
- ★ Looking up stuff in files. First, files of information in DATA statements and arrays. Next, cassette files. Eventually, disk files.
- ★ Whatever else comes to mind, or is suggested by you.

What do *you* want? If it fits into the general idea of "GameMaster's Apprentice," we might do it. Send your suggestions, complaints, kudos, requests, whatever...to George & Bob, P.O.Box 310, Menlo Park, CA 94025. ☺

"MONEY"

25¢ 

10¢ 

1¢ 

74 ¢

LEVEL 3

Cassette \$19.95

A PROGRAM TO TEACH CHILDREN TO COUNT COINS

TRS-80 Color Computer
Requires 16K Extended Basic
 Ohio Residents Add 5½% Sales Tax *Trademark of Tandy

APPEALING GRAPHICS, FUN REWARDS AND SOUND
Used Successfully in Classrooms and in Homes

ALSO AVAILABLE—CASSETTES

Clock	\$24.95	Mathfact	\$16.95
Add-Carry	\$19.95	ABC's	\$ 9.95
Subtract/Borrow	\$19.95	Spelling	\$16.95
Question	\$19.95	Hangword	\$14.95

WRITE FOR FREE DESCRIPTIVE BROCHURE
DEALER INQUIRIES WELCOME
B5 SOFTWARE



1024 Bainbridge Pl. Columbus, OH 43228
 (614) 276-2752

Light Pen, Fun-Pak A Good Combination

In reviewing a light pen from Moses Engineering several months ago, *the Rainbow* commented that the hardware had potential but the software available left a lot to be desired.

Now, happily, comes some good software from Computer Island, along with a new light pen from Spectrum Projects which seems to be a little more sensitive than the earlier model from Moses.

Lightpen Fun-Pak from Computer Island contains some introductory programs for this interesting device with the promise of more on the way. In truth, a light pen *can* be like, to quote the instructions, "a magic wand for your computer." *Lightpen Fun-Pak* shows some of the possibilities.

The instructions begin with a brief introduction and a four-line introductory program. This illustrates how the light pen does, indeed, read light levels. Armed with this demonstration, you are ready to load in the three programs contained on the cassette tape.

Pen-Etch allows you to move a low-res cursor around the screen, using a trail of color, simply by pointing the light pen at a coded place on the screen. This works fine and is, happily, a nice application of this device. One can see all sorts of applications already.

Then there is *Space Pen*, a shoot-'em-up with aliens. This time, though, you either cover or uncover the end of the light pen to fire off a shot. Again, one sees the possibilities.

The program which captured my imagination the most was *Gaspump*, which was an original game idea and combined light pen technology. A white dot appears at

random locations in the screen and you have to point the light pen at the dot before it moves away in order to "catch" it. When you do, your car fills with gas and you are able to drive it a little closer to home. Then, you have to catch the white dot again to move further. This is played against a timer.

To be honest, none of the three programs are super-great in and of themselves. But, as an introduction to the light pen they do a good job. The instructions are written as are most all from Computer Island, clearly and easy to understand. They do open a whole range of possibilities for programming.

The pen itself is a simple photo cell housed in a black plastic case. It connects to the joystick port and the readings from the cell are then translated to the computer. The program calls for certain readings, and this is how a light pen works.

This one worked with no difficulty. It is considerably smaller than the one offered by Moses Engineering, and thus quite a bit easier to handle. It also has the advantage of plugging right into the joystick pot while the Moses version required you to do some soldering (although not a great deal of it) on the joystick itself.

These items, the hardware and the software, are available separately or as a package. We think they make as fine introduction to light pen technology and, while not fancy, *do* begin to open up the door to a whole new range of options available for CoCo. In short, we see the beginnings of a new area of sophistication for CoCo in this combination.

(Lightpen Fun-Pak, Computer Island, Dept. R, 227 Hampton Green, Staten Island, NY 10312, \$14.95; Light Pen, Spectrum Projects, 93-15 86th Drive, Woodhaven, NY 11421, \$19.95 plus \$2 s/h; Both software and hardware combination, 39.95)

YOUR COLOR COMPUTER JUST EARNED A MATH DEGREE!

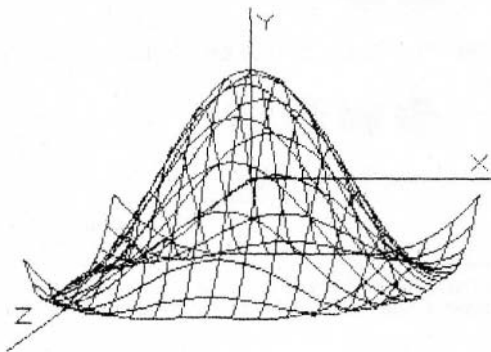

MATHMENU

Developed by an engineer, *Mathmenu* is a powerful menu-driven system to turn your Color Computer into an intelligent, flexible tool for mathematics and engineering. *Mathmenu* takes the tedium out of math, leaving your full brain power to attack the "meat" of your problems. By rapidly manipulating matrices and vectors, performing integration and differentiation, solving quadratic equations, plotting user defined functions and much more, *Mathmenu* can help simplify the most complex problems. Whether you are a student or a professional, if you use math, you need *Mathmenu*.

FEATURING:

- 3D SURFACE PLOTTING — Plots a user defined equation on an X,Y,Z coordinate system in the High-Res graphics mode. Planes, surfaces of revolution, statistical surfaces, etc. can be easily plotted. Surfaces may be saved to disk or tape. We believe this is the only program of its kind commercially available for the Color Computer.

PLUS:

- Complete MATRIX Operations (up to 8 x 8)
- Complete VECTOR Operations
- Numerical Differentiation
- Numerical Integration
- Least Squares Curve Fitting
- Binomial Expansion
- Prime Number Expansion
- Main Menu with Single-key Selection and Return (Disk Only)
- 2D Function Plotting
- Rectangular to Polar Conversions
- Base Conversions
- Large Number Addition and Multiplication
- Reverse Polish Logic Calculator with Hexadecimal
- Quadratic Equation Roots

Complete documentation of all functions is included.

For 32K Disk \$49.95
 For 16K Cassette \$44.95
 Documentation only \$2.00 (refundable with purchase)

Or write for free brochure.



Inter  Action

113 Ward Street • Dept. R • New Haven, CT 06519 • (203) 562-5748

Searching for Service? It's Here.

TRS-80
HARDWARE & SOFTWARE

13% OFF

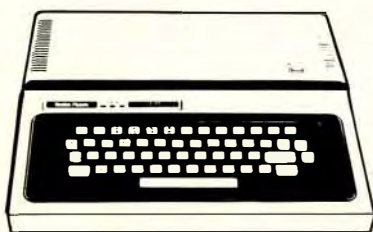

13% OFF
LIST PRICE

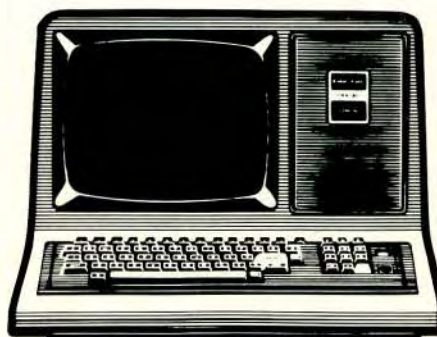

13% OFF
LIST PRICE

FEATURING THESE ITEMS:

VERBATIM DISKS.....	\$27.95
ELEPHANT DISKS.....	\$26.95
WICO COMMAND CONTROL JOYSTICK.....	\$29.95
WICO COMMAND CONTROL ADAPTER.....	\$19.95

ALSO SOFTWARE BY:

SPECTRAL ASSOCIATES • MARK DATA
PRICKLY PEAR • TOM MIX • ANTECO

TOLL FREE
1-800-251-5008

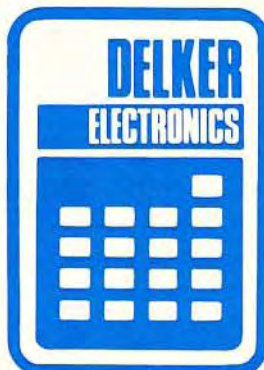

P. O. BOX 897
GILSVILLE FAMILY CENTER
SMYRNA, TENNESSEE 37167
615-459-2636
NASHVILLE, TENNESSEE 254-0088

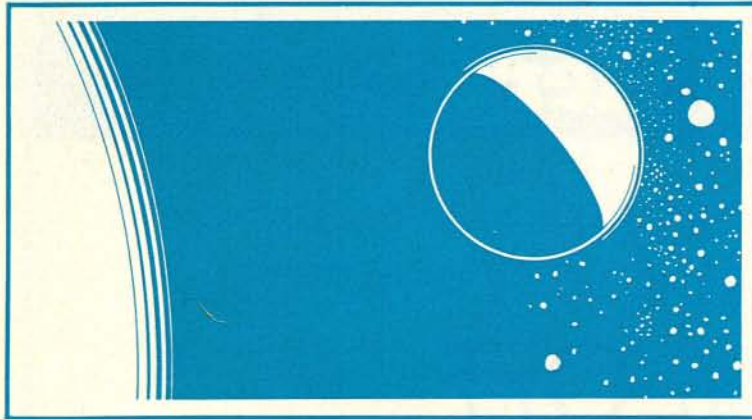

Stayin' Alive At Outpost Five

By Dr. Laurence D. Preble

What do you do on a frosty winter's evening? Well, assuming the wife isn't nearby for some quiet time by the fireside, I like to write programs. Is that so strange?

A 1981 winter's-eve programming effort consisted of my first attempt at learning Extended Color Basic. With all those neat graphics to try out, I couldn't help myself; a game program was inevitable.

Imagine yourself the field commander of five Federation outposts. The outposts rest in synchronous orbit above planet four in the Omega system. Fifteen marauding aliens in saucer ships bombard your outposts kamikaze style.

From your remote station, you control the fire power of the outposts. Your battle computer gives you the simulated view of the attack. You use your joystick to position the cross hairs over the attacking saucer. The button is pressed. Blam! You missed. The alien has deviously engaged a semi-random flight path. BOOM! The outpost on your screen is annihilated in a ball of expanding energy. This is not going to be easy! The view screen switches. Only four outposts left. Another alien plots a zig-zag course. You fire. Missed! This time you use the smart bomb! Your hand flashes to the keyboard of your terminal. You're not sure which key was pressed but it doesn't matter. Your only smart bomb for this outpost has done its job. The saucer disappears in clouds of expanding vapor.

Don't rest yet. Another wave is coming!

The listing:

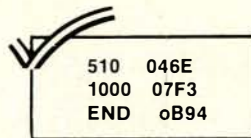

```

10 POKE 65495,1
20 CLS 0:PCLEAR 4:PMODE 1,1:PCLS
 3
30 PRINT @64,"WHAT IS YOUR SKILL
  LEVEL (1-10)";:INPUT SL:CLS 0
40 PRINT @70,"YOU HAVE 5 OUTPOST
  S";
50 PRINT @135,"DESTROY INVADERS"
 ;
60 PRINT @164,"TO SAVE THE FEDER
  ATION";
70 TR=15-SL
80 AS=5
    
```

```

90 DIM S(20,10)
100 SP=5: SX=127: IX=5: IY=5: IZ=1: S
  Z=5
110 GOSUB 650
120 SCREEN 1,0
130 PCOPY 3 TO 1:PCOPY 4 TO 2
140 GOSUB 560
150 X=JOYSTK(0)*3+33
160 Y=JOYSTK(1)*2+33
170 GOSUB 250:H=0:REM NOT HIT
180 IF INKEY$<>" "AND SB>0 THEN
  S=1:GOSUB 860:SB=SB-1
190 F=PEEK(65280)
200 IF F/2=INT(F/2) THEN GOSUB 3
  10
210 IF H=1 THEN SOUND 100,1:X=SX
 :Y=SY:GOSUB 840:SY=10: SX=RND(255
 )+1: IX=(RND(20)+5):PCOPY 3 TO 1:
  PCOPY 4 TO 2:FORX=1TO900:NEXTX:H
  S=HS+1:GOSUB 1260:FOR X=1TO2000:
  NEXTX:SCREEN 1,0
220 RN=RND(2):IF RN=2 THEN IX=IX
 *-1
230 PCOPY 3 TO 1:PCOPY 4 TO 2
240 GOTO 140
250 REM DRAW CROSS HAIRS
260 C$="C4"
270 R$=C$+"BM"+STR$(X)+", "+STR$(
  Y)
280 DRAW R$
290 DRAW "N;U9NR9ND9NL9"
300 RETURN
310 REM FIRE ROUTINE
320 LC=4
330 COLOR LC,3
340 LINE(120,95)-(X,Y),PSET
350 LINE(134,95)-(X,Y),PSET
360 C$="C1":GOSUB 270
370 LC=1:COLOR LC,3
380 PLAY"V31;T25505C04BAG"
390 GOSUB 520:REM CHECK HIT
    
```

```

400 RETURN
410 REM DRAW A SAUCER
420 SZ=SZ+IZ:IF SZ>20 OR SZ<5 THEN IZ=IZ*-1
430 CIRCLE (SX,SY),SZ,4,.3
440 PAINT (SX,SY),4,4
450 RETURN
460 REM CHECK FOR SMARTBOMB HIT
470 FOR J=SX-9 TO SX+9
480 IF PPOINT(J,SY)=LC THEN H=1: RETURN
490 NEXT J
500 H=0
510 RETURN
520 REM CHECK FOR HIT
530 H=0
540 IF ABS(X-SX)<TR AND ABS(Y-SY)<TR THEN H=1
550 RETURN
560 REM MOVE ARRAY
570 IF ABS(SX-127)<20 AND ABS(SY-95)<20 THEN GOSUB 970:SY=30: SX=RND(205)+25
580 SX=SX+IX:SY=SY+IY
590 IF SY<30 THEN IY=RND(15)+5 ELSE IF SY>180 THEN IY=(RND(15)+5)*-1
600 IF SX<25 THEN IX=RND(20)+5: SX=25
610 IF SX>240 THEN IX=(RND(20)+5)*-1: SX=240
620 IF SY<25 THEN SY=25
630 GOSUB 410
640 RETURN
650 REM STARS
660 PMODE 1,3
670 PCLS 3
680 SB=1:REM ONE SMARTBOMB PER OUTPOST
690 FOR X=1 TO 255 STEP 3
700 PSET (RND(255)+1,RND(191)+1,2)
710 NEXT X
720 CIRCLE (127,95),9,2
730 PAINT (127,95),1,2
740 CIRCLE (127,192),100,2,.5
750 PAINT (127,162),2,2
760 FOR X=1 TO 5
770 J=RND(255):K=RND(50):Y=RND(20)
780 CIRCLE (J,K),Y,2
790 PAINT (J,K),2,2
800 NEXT X
810 PMODE 1,1
820 SCREEN 1,0
830 RETURN
840 REM FIRE2 ROUTINE
850 S=2
860 SCREEN 1,1
870 SOUND 1,5:SCREEN 1,0

```

```

880 C=1
890 FOR E=1 TO S
900 FOR R=1 TO 100 STEP 7
910 CIRCLE(X,Y),R,C
920 NEXT R
930 C=3
940 NEXT E
950 GOSUB 460:REM CHECK HIT
960 RETURN
970 REM STATION BLOWS UP
980 AS=AS-1
990 PLAY"T255;04CCCCCCCCCCCCCCCCCCCC"
1000 CLS 0
1010 C=4
1020 X=127:Y=95
1030 FOR K=1 TO 2
1040 ST=1.5
1050 J=1
1060 J=J+ST:ST=ST+.05
1070 CIRCLE (X,Y),J,C
1080 IF J<53 THEN 1060
1090 C=3
1100 NEXT K
1110 FOR K=1 TO 500:NEXT K
1120 SCREEN 0,1:CLS 4:GOSUB 1150

```

New! For Your Color Computer FROG-TREK

(the arcade game)

You may be able to guide your frog through 6 lanes of rush hour traffic, but that isn't enough! You must also cross the river by jumping on logs and turtles to get Froggie safely to his home on the other side. But watch out for the snake! And don't jump on the industrial waste.

A great M/L game at a great price \$14.95. Uses hi-resolution graphics and requires 16K. Arrows on keyboard move frog- no joy-sticks required.

Send check or money order for \$16.50 (includes shipping) to:

OELRICH PUBLICATIONS
4040 N. Nashville
Chicago, IL 60634



```

:GOSUB 1280:GOSUB 650
1130 SCREEN 1,0
1140 RETURN
1150 RM=RND(5)
1160 ON RM GOTO 1170,1190,1210,1
230,1240
1170 PRINT @ 229,"TOO BAD SPACE
CADET!";
1180 RETURN
1190 PRINT @ 236,"GOTCHA!";
1200 RETURN
1210 PRINT @ 233,"BITE THE DUST!
";
1220 RETURN
1230 PRINT @ 235,"YOU BLEW IT!";
1240 PRINT @ 229,"GONE BUT NOT F
ORGOTTEN!";
1250 RETURN
1260 REM PRINT SCORE
1270 CLS 3
1280 PRINT @ 360,HS;"ALIENS DEST
ROYED";
1290 PRINT @ 391,AS;" OUPOSTS RE
MAINING";
1300 PRINT @420,SB;"SMART BOMBS
IN ARSENAL";
1310 K$=INKEY$:K$=""
1320 IF AS=0 THEN PRINT @453,"AL
IENS HAVE DESTROYED YOU";:GOSUB
1350
1330 IF HS=15 THEN PRINT @449,"Y
OU HAVE SAVED THE FEDERATION";:
GOSUB 1350
1340 RETURN
1350 SCREEN 0,1:FOR X=1 TO 1000:
NEXT X
1360 SCREEN 0,0:FOR X=1 TO 2000:
NEXT X
1370 CLS 3
1380 PRINT @ 230,"ANOTHER MISSIO
N (Y/N) ";:INPUT C$
1390 IF LEFT$(C$,1)<>"Y" THEN PO
KE 65494,0:CLS:END
1400 HS=0:AS=5:SB=1
1410 PRINT @64,"CHANGE SKILL LEV
EL (1-10)";:INPUT SL:TR=15-SL
1420 RETURN

```

Hardware Review...

Let Your LED'L Light Shine

CoCo owners I've talked to agree; it would be handy to have an on/off indicator on our machine. Even though one reader tells us he's had his CoCo on continuously, ever since he bought it, with no apparent effect, many of us shudder when we discover we've left our CoCo on all night long. Could this be the fatal oversight that leads to our SAM chip's demise, or who knows what other dreaded, expensive eventuality? Certainly, an on/off light would help us avoid the unknown consequences of forgetting to turn off our machine.

If you're a "hardware hacker," then adding an LED somewhere on the chassis is no big deal. You just buy a couple of whatzits at your local Shack and wire them into the circuitry. Of course, it took you eight years to learn enough to know where to wire it in, you had to find the right parts, and in the process, you probably voided the warranty by opening up CoCo's "innards." Well, now the rest of us can catch up with you electronics wizards and talk about how we modified our unit, too. All Color Software (ACS) has a little package that explains how to add an on/off indicator without voiding the warranty and, best of all, everything you need is contained in the package—all for five bucks.

It looked so easy when I took a look at the package that I concluded even I could manage this bit of home handiwork. Yes, me, the guy who once rented a steering wheel puller in order to change a burned-out dashboard light in my car. Almost without fail, when I begin a project, of any kind, I find that I don't have the right sized screwdriver or even the right screw. If I buy a kit, there usually seems to be a piece missing. This time was to be the exception.

Now, that's not to say that I managed to add my on/off indicators without help, or in a single session. No, I have my own ways of making things hard. My first mistake was getting Dr. Doom to help me; a small hobbyist's vice would have been more useful, and it wouldn't have sneered at me as I fumbled around dropping everything there was to be dropped.

ACS provides two LED's of the correct type and the kind of instructions I've longed for all my life. They assume you know nothing and give you a step-by-step run-through of installing the red-colored LED's onto each joystick—thus avoiding any need to open up your CoCo. Rather than simply saying "remove the bottom cover of your joysticks," ACS tells us: "On the bottom of your R.S. joystick are four (4) screws, two (2) are slightly larger than the others. These two screws hold the top cover of the joystick in place. Remove these 2 screws." The next instruction tells how to grip the box and pull it open. An illustration accompanies each instruction.

Dr. Doom insists on drilling the single hole required in each joystick housing and also decides that, while ACS recommends using a 1/4-inch drill bit, we will use a 7/32-inch bit. I marvel that I can actually find one in my tool kit. He explains, condescendingly, that this will give a tighter fit. Then, he proceeds to start drilling the hole in the joystick housing—using his knee as his workbench. With the kid gloves approach I use with Doom, especially when he holds an instrument of violence in his hand, I suggest to him that if he doesn't watch out, he's going to bust through the plastic housing and drill a hole in his knee. For once, he accepts my advice as being sound, and together, we sort of hold

ATTENTION PROGRAMMERS

Do you wish you could run 200K programs on a 4K Color Computer — without discs? That's right — 200K; or even more! Imagine being able to write programs of unlimited length and making them run on a CoCo of any size memory. With the Memory Loader (formerly the Virtual Memory Loader) from Little Bits you can use any standard cassette player to store your program "overlays." When you run your program, the overlays will automatically load & unload from cassette. Some minor changes must be made to your program, but no hardware modification is necessary. And although Extended BASIC is required of the programmer, the users of your programs don't need it unless your original programs required it. And users don't need a Memory Loader of their own. Your programs will pause during execution while new overlays load in, but otherwise there is no change in run time. Optionally use endless-loop tapes to jump to the end or return to the beginning without pressing a button. During execution, the Memory Loader takes up less than 30 bytes of memory. Ideal for Adventures, as well as serious software. Works for either BASIC or Assembly. Dealer inquiries invited.

MEMORY LOADER \$12.95
Add \$1.50 shipping and handling per order. NJ residents add 5% sales tax.



little bits computing services P. O. Box 396
Hibernia, NJ 07842

Color Computer is a trademark of the Tandy Corp.

Meet the Computerware® Clan!



(we're a fun group to know)

Computerware® can offer you:

One-Stop Shopping



In addition to Computerware software, we carry the major manufacturers' products such as printers, modems, memory and software from such companies as Mark Data, Tom Mix, Micro Works, Botek, Frank Hogg Laboratories, TDP, C. Itoh, Aardvark and Dugger Growing Systems.

Software for OS9!

- OS9 Random BASIC
- OS9 Macro Assembler
- OS9 Editor
- OS9 Text Processor

Also available on FLEX and RS DOS

Products for the Color Computer



- from home management software
- to programming tools



- to fun and challenging video games

An Attractive Authorship Program



for independent programmers who would like to turn software into cash!

Dealer Inquiries Invited

Call or write to:



Computerware®
P.O. Box 668
Encinitas, CA 92024
(619) 436-3512





PETROCCI FREELANCE ASSOCIATES

651 N. Houghton Road
Tucson, AZ 85748
(602) 296-1041

The author of **ASTROLOGY** and **ANCIENT WISDOM TRILOGY** (Copyright Prickly Pear Software) now offers quality programs for the 80-C.

Inspector CLUEseau

Sherlock Holmes / Agatha Christie fans—It's finally here— A murder mystery game for the 80-C! Mr. Goodbody has been killed in his mansion and you must solve the mystery. WHO committed the murder, WHERE did it occur and HOW was it done! Question suspects, find the secret passage, and break the code to get clues. Hi-Res graphics enhances this excellent game. The computer records the clues you obtain on a clue inventory screen and also provides suspect descriptions at the touch of a finger. A fast, fun game that will sharpen your deductive skills. Every game is different!

32K Extended \$19.95

Stress Evaluator

Assess your present level of stress and how it affects your potential for illness. Evaluate the amount of life change you can effectively handle in the future. The Stress Evaluator is a valuable tool for recognizing, measuring and managing stress. The program also provides a Coping Ability Test which shows your ability to handle stress in general. Provides goal setting exercises and meditation graphic screens to help achieve stress-alleviating goals. All results output to printer.

16K Extended \$24.95

Weather Watch

If you **really** care about the weather, this program is for you. Three programs provide you with National Weather Service approved statistics in a monthly report format. Input of daily high and low temp. and rainfall outputs a report of monthly average temps. and range; high and low averages; high and low temp., for month; total rainfall; days rain > .1 in.; heating and cooling degree days; days high > 90; days low < 32; days low temp. < 32 and > 0; days low < 0; day of highest range. Also retrieves a single day from data file for review. All data outputs to printer. Well documented.

16K Extended \$24.95

Include \$1.50 for handling for each program.
Az. Residents add 4% Sales Tax.

Quantity Discounts to Dealers.

**PROGRAM DEVELOPMENT: Computer Software
Documentation / Graphics / Consultation**



everything in mid-air and drill our way through; it's even cleanly done.

There are four solder connections to make. We make the first in record time, only to discover that we forgot to put the LED in its newly drilled hole first. So, we unsolder and redo it. We share a great feeling of accomplishment when we reattach the cover and turn on CoCo and see our little light shine. For added wonder, when we depress the fire button it goes out momentarily. Looking good. We exchange a "high five" and immediately attack the other joystick.

In his "I'm-the-scientist-you're-the-dummy" bit he lays on me whenever we work together, Dr. Doom tells me that an LED is "much like a photocell in reverse, in that electricity impinging on the semiconductor materials causes light to be emitted from their junction." As we solder the second LED in place, he advises me, with a smirk, that I won't have to change any tiny little light bulbs because "LED's, for all practical purposes, don't burn out unless excessive voltage is applied to the device." I pretend I knew it all along.

All done, we turn on CoCo to see two brightly lit LED's, one on each joystick. At least, that's what we expect to see. Instead, we see one lit and one not lit. "I knew it. I knew it," I mutter mostly to myself. We decide that we have managed to burn out one of the LED's by getting the solder too close and not using pliers to absorb the heat. After resoldering the joint a few times, we pack it in for the night.

The next day I go out and buy "one of these things, please" at my nearest Radio Shack. After being led to the LED's, I also see some yellow ones, so I get them, too. Meanwhile, Dr. Doom is elsewhere in the city, also buying LED's. I get back first though, and following my ACS instructions, remove the joystick's back cover all by myself. I decide it will be cute to have one red LED and one yellow LED -- that way I can tell the left joystick from the right one. Step-by-step, I follow the instructions to the letter. The yellow one won't light. I read the package. Yes, the yellow one has different specs than the red one. I have screwed up again. For lack of anything else to do, I reattach the LED we burned out the previous evening. This time it works. I am really not very surprised. I don't know why it didn't work before, but now it works. I am not one to question why—at least until the cover is safely reattached and the LED's are both still working.

Why didn't it work? Well, I am told that LED's have polarity and that even though there are only two wires to hook up, Dr. Doom and I managed to hook it up backwards. I grab the instructions. Nowhere in the instructions does it say "Don't hook it up backwards!" ACS, that's my only criticism. Your illustrations are well done. The parts are all provided. The instructions are clearly written. You just need a line that says "If you make the connection and it doesn't work, reverse the wires and reconnect."

I smile every time I go by my CoCo and see my two LED's brightly glowing. I even switch it on now and then just to see the results of my handiwork. I'm thinking about writing an electronics book. Life is more meaningful now, thanks to ACS.

(ACS, All Color Software, P.O.Box 15235, Plantation, FL 33318, \$5.00)

—Jim Reed

What ROM Have You?

All CoCo's come up with a message which says you are operating with version 1.0 of the operating system. How can you tell whether you have a version 1.0 or 1.1 of the Basic ROM chip?

The answer is a simple one: Just type in EXEC 41175 and the version of your ROM will appear on the screen.



Our Best Seller List For The TRS-80 Color Computer



101 Color Computer Programming Tips & Tricks



By Ron Clark from ARCsoft
Handy collection of practical, easy-to-follow techniques and shortcuts for your color computer. Each of 101 tips features a complete, pre-tested, ready to run program. Includes graphics, sound, games, text on text, number crunching.

Softcover, \$7.95

55 More Color Computer Programs For the Home, School & Office



By Ron Clark from ARCsoft
An all-new and different collection of tested, ready to run software, usable by the beginner or advanced user. Science and history for students and teachers; marketing, investment and invoicing for the businessperson; poetry, games and art for the family; music for everyone.

Softcover, \$9.95

Companion volume also available:

55 Color Computer Programs for Home, School & Office

By Ron Clark from ARCsoft
Softcover, \$9.95

The Color Computer Songbook



By Ron Clark from ARCsoft
Ready for a sing-along? Forget the piano or guitar—just gather 'round your color computer, and vocalize! These 40 song programs are sure to please, including: "Oh! Susanna", "Amazing Grace", "Greensleeves", "Down By the Riverside"; Christmas carols; Bach, Beethoven, and Brahms. Plus hints for composing your own.

Softcover, \$7.95

Color Computer News 1981 Back Issues



This is the complete collection of articles appearing in the first 4 issues of Color Computer News (May to December of '81). 37 different topics are covered, plus continuing features like "REmarks", Kid's Page, and New Products.

Softcover, \$9.95

TRS-80 Programs and Applications for the Color Computer



By Alfred Baker from Reston
Handy guide to your Color Computer: how to play games, balance your checkbook, use your computer as a teacher, etc. With chapters on color and sound, art and music. Helpful for beginning or experienced computer users.

Softcover, \$14.95

TRS-80 Color Basic



By Bob Albrecht from John Wiley & Sons
Step-by-step guide to the unique color, sound and graphic capabilities of your new Color Computer. No previous experience is required. Teach yourself BASIC—there's a whole chapter on typical programming problems and solutions.

Softcover, \$9.95

TRS-80 Color Computer Graphics



By Don Inman with Dymax from Reston
Learn the fascinating graphics capabilities of Extended Color BASIC—how to create graphics to enhance your programs *and* how to write your *own* graphics programs. Includes: coloring; lines and circles; using joysticks; switching from graphics to text mode; sound. With sample programs and 5 appendices.

Softcover, \$14.95

6809 Micro-computer Programming and Interfacing with Experiments



Ed. by Staugaard from Howard W. Sams
This book offers a complete description of how to program and interface the 6809 microprocessor. Topics include: chip structure and basic 6809 concepts; addressing modes; registers and data movement instructions; arithmetic, logic and test instructions; branching; input and output signals; interfacing and applications. Review questions and answers for each chapter, plus 4 appendices.

Softcover, \$14.95

6809 Assembly Language Programming



By Lance Leventhal from McGraw Hill
This comprehensive book covers 6809 assembly language programming in detail. The entire instruction set is presented and fully explained. The book contains many fully debugged, practical programming examples with solutions in both object code and source code. Discussion of assembler conventions, I/O devices, and interfacing methods is also included. If you've never before programmed in assembly language, this book will teach you how. If you're an experienced programmer, you'll find this book an invaluable reference to the 6809 instruction set and programming techniques.

Softcover, \$16.95

For Information Call: (202) 363-9797 **To Order Call Toll-Free: 800-424-2738**

the PROGRAM STORE 4200 Wisconsin Ave., N.W., Dept. 24-02-3 Box 9582 Washington, D.C. • 20016

©1983 The Program Store, Inc. Visit our other stores: Seven Corners Center, Falls Church, VA • W. Bell Plaza, 6600 Security Blvd., Baltimore, MD • 629 Bethel Rd., Columbus OH • White Flint Mall, Rockville, MD • Coming Soon to Boston.

MAIL ORDERS: Send check or money order for total purchase price, plus \$2.00 postage & handling. D.C., MD. & VA.: add sales tax. Charge Cards: include all embossed information.

THE PROGRAM STORE • Dept. 24-02-3 • Box 9582 • 4200 Wisconsin Avenue, NW • Washington, D.C. 20016

Item _____	Tape/Disk/Book _____	Price _____	Postage _____	\$2.00 _____	Name _____
Total _____					Address _____
<input type="checkbox"/> CHECK <input type="checkbox"/> VISA					City _____ State _____ Zip _____
<input type="checkbox"/> MASTERCARD					Card# _____ Exp _____
Computer _____					

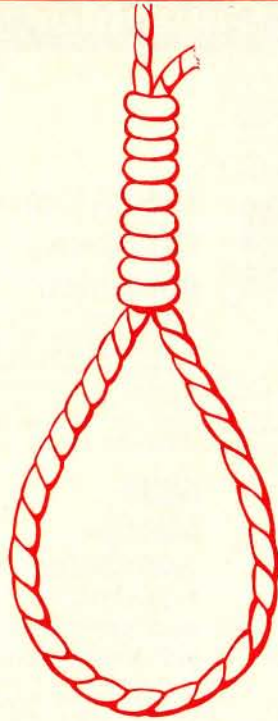

Hang Around, You'll Enjoy This

By Douglas C. L'Hommedieu

480	05E3
930	09FC
1380	0E08
1600	10A4
1970	1419
END	17A4

The Listing:

```

10  '
20  '          HANGMAN
30  '
40  ' DOUG L'HOMMEDIU      5/82
50  '
60  DIM WRD$(10),GWRD$(10),BAD$(9
)
70  WRITE=0
80  CLS
90  PRINT @ 11,"HANGMAN": PRINT
100 PRINT "1 - ONE PLAYER(COMPUT
ER PICKS          THE WORDS)"
110 PRINT "2 - TWO PLAYERS(TAKE
TURNS)"
120 PRINT @ 160, "TYPE 1 OR 2"
130 P$=INKEY$: CPICK=RND(122): I
F P$="" GOTO 130
140 PLRS=VAL(P$)
150 IF PLRS <>1 AND PLRS <> 2 GO
TO 120
160 IF PLRS = 2 GOTO 230
170 PRINT "COMPUTER WILL RANDOML
Y PICK A"
180 PRINT "WORD HAVING FROM 2 TO
 10 LTRS."
190 PRINT "YOU MUST GUESS THE WO
RD."
200 PRINT "YOU CAN HAVE NINE WRO
NG GUESSES"
210 PRINT "BEFORE YOU ARE HUNG!!
!"

```

Though capital punishment might seem a severe penalty for failure to ascertain a certain quantity of deliberately withheld information, millions of otherwise normal folks seem to be dying to put their lives on the line in just such a quest. In fact, striving to satisfy such sadistic demands has long been a favorite pasttime.

Now, CoCo has joined the ranks of those diabolical inquisitors with numerous variations of this heartless scheme we all know affectionately as "Hangman."

In this particular version, *Hangman* has the capability of accepting ten-letter words and allowing nine wrong guesses before being hanged. It contains the following options: One or two people can play; duplicate letters can be displayed when guessed; the program can display the wrong guesses.

With the first option, two friends can take turns guessing each other's words, or the computer will randomly generate words from its 122-word vocabulary. With the second, you can either be forced to guess each letter, or the computer will identify duplicates. For example, one way the computer would identify only one "m" in swimmer, and in the other, both would be identified. With the third option, you can have your wrong guesses displayed, or the computer will keep them a secret.

The program's vocabulary can easily be changed by modifying the words in lines 1990-2060. If you decrease or increase the number of words, lines 130 and 530 will need to be changed correspondingly.

No *ENTERs* are needed except to terminate a word being input. All other responses are one letter responses satisfied by *INKEYS*.

In a *Y/N/C* decision, *Y* is for yes, *N* is for no, and *C* is for change. Change takes you back to the beginning of the program, and all options will again be available.

Now, type this one in and *RUN*. Having fun? Well, I'll be hanged.



SOFT CITY

- Your finest single source for TRS-80®COLOR COMPUTER / TDP SYSTEM 100 compatible software.
- We offer one of the largest and most comprehensive selections of software available anywhere. These major programs have been developed by some of the leading software houses, and are sold at fully competitive prices. Save yourself time and trouble!
- Our latest catalog offers word processing, terminal packages, educational software, and a full selection of utilities for both disk and tape. Many superb games - adventure, arcade, and board style are also available, demonstrating the powerful Hi-Resolution capabilities of the Color Computer. We also carry a number of peripherals and supplies for your system.
- Our catalog is yours free for the asking!

■ We are dealers for:

- | | |
|--|--|
| <input type="checkbox"/> COGNITEC | <input type="checkbox"/> COMPULINK |
| <input type="checkbox"/> COMPUTERWARE | <input type="checkbox"/> CORNSOFT |
| <input type="checkbox"/> EIGEN SYSTEMS | <input type="checkbox"/> FRANK HOGG LABORATORY |
| <input type="checkbox"/> MARK DATA PRODUCTS | <input type="checkbox"/> PRICKLY PEAR SOFTWARE |
| <input type="checkbox"/> SKYLINE SOFTWARE | <input type="checkbox"/> SOFTCORE SOFTWARE |
| <input type="checkbox"/> SPECTRAL ASSOCIATES | <input type="checkbox"/> SPEECH SYSTEMS |
| <input type="checkbox"/> SUGAR SOFTWARE | <input type="checkbox"/> TDP ELECTRONICS |
| <input type="checkbox"/> TOM MIX | <input type="checkbox"/> U.S.ROBOTICS |
| <input type="checkbox"/> VERBATIM | <input type="checkbox"/> YORK |
| <input type="checkbox"/> ETC., ETC.... | |

ORDERING INFORMATION

**ALL ITEMS SHIPPED FROM STOCK
MASTERCHARGE AND VISA WELCOME**

10% discount on orders over \$50.00!

Phone orders may be placed at:
(312) 260-0929 (Our voice line),
or, if you have a modem, you may order through our
METROWEST BBS at:
(312) 260-0640

Mail orders and requests for catalogs should be sent to:

SOFT CITY
442 Sunnyside
Wheaton, Il 60187



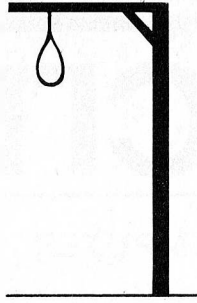

```

220 GOTO 320
230 CLS: PRINT @11,"HANGMAN":PRI
NT
240 PRINT "PLAYER #1 INPUTS A WO
RD - A"
250 PRINT "LETTER AT A TIME(2 TO
10 LTRS)"
260 PRINT "AFTER THE LAST LETTER
SIMPLY"
270 PRINT "PRESS <ENTER>.:PRINT
280 PRINT"PLAYER #2 TAKES OVER A
T THAT"
290 PRINT"TIME TO GUESS THE WORD
. PLAYER"
300 PRINT"#2 CAN HAVE NINE WRONG
GUESSES"
310 PRINT"BEFORE HE IS HUNG !!!"
320 PRINT"-----
-----"

```

```

330 PRINT "1 - EASIER(DUP. LETTE
RS APPEAR)"
340 PRINT "2 - HARDER(MUST GUESS
EVERY LTR)"
350 PRINT @ 448, "TYPE 1 OR 2"
360 E$=INKEY$: IF E$="" GOTO360
370 EASY=VAL(E$)
380 IF EASY <>1 AND EASY <> 2 TH
EN 350
390 PRINT @ 352, "*****
*****"
400 PRINT @ 384, "1 - HELP REMEM
BERING WRONG LTRS"
410 PRINT @ 416, "2 - NO HELP RE
MEMBERING"
420 PRINT @ 448, "TYPE 1 OR 2"
430 H$=INKEY$: IF H$="" GOTO430
440 HELP=VAL(H$)
450 IF HELP <> 1 AND HELP <> 2 G
OTO 420
460 CLS
470 FOR I=1 TO 10: WRD$(I)=" ":
GWRD$(I)=CHR$(128): NEXT I
480 IF PLRS=2 GOTO 640
490 REM ***COMPUTER PICKS WORD**
*
500 PRINT @ 172, "COMPUTER"
510 PRINT @ 203, "IS PICKING"
520 PRINT @ 236, "THE WORD"

```

ENTER THE FASCINATING WORLD OF GAME WRITER™

A SIMPLE TO USE PROGRAM FOR YOUR COLOR COMPUTER

- For writing super-action video games with motion and sound
- For creating high resolution animated graphics scenes
- For experimenting with color, shapes, motion and sound
- For amateur or professional cartooning or commercial game authoring
- For the absolute beginner and for the expert programmer



GAME WRITER is a programming language with all the features you need to write great VIDEO GAMES. It includes a built-in screen oriented text editor, high resolution color graphics support, any number of player-shapes (SPRITES), a shape pattern editor, full TURTLE GRAPHICS, sound effects, support for joy sticks and much, much more. Each player-shape can be given a program to run which tells it what to do. All the player programs run simultaneously to create fantastic game effects. GAME WRITER IS GUARANTEED EASY TO USE. Even if you have never written a program of any kind you will amaze your family, your friends and yourself with the fantastic things you can do with it. The package includes a GAME WRITER rom pak, a complete easy to read manual and a set of sample programs ready to run. GAME WRITER is a great programming language for a child or an adult. GAME WRITER requires a minimum of 16K. Extended BASIC is not required.

PRICE \$129

Orders must be prepaid via check, money order or major bank card. Phone orders accepted for bank cards only—COD orders not accepted. Quantity discounts available. Orders outside U.S. add \$5 shipping. WA state residents add 6.3% sales tax. Add 2 weeks for delivery if paid by personal check.

WASHINGTON COMPUTER SERVICES

3028 SILVERN LANE
BELLINGHAM, WA 98226
1 (206) 734-8248



```

530 CPICK = RND(122)
540 FOR I=1 TO CPICK
550 READ CWORD$
560 NEXT I
570 RESTORE
580 KNT=LEN(CWORD$)
590 FOR I = 1 TO KNT
600 WRD$(I) = MID$(CWORD$,I,1)
610 NEXT I
620 GOTO 850
630 REM ***PLAYER #1 PICKS WORD*
**
640 PRINT @ 6, "INPUT THE WORD,
ONE          LETTER AT A TIM
E"
650 PRINT "    TYPE <ENTER> WHEN
DONE": PRINT
660 FOR I=1TO 10
670 PRINT "LETTER #";I;"- ";
680 WRD$(I)=INKEY$:IF WRD$(I)=""
THEN GOTO 680
690 IF I=1 AND WRD$(I)=CHR$(13)
GOTO740
700 IF I=2 AND WRD$(I)=CHR$(13)
GOTO740
710 FOR K=65 TO 90
720 IF WRD$(I)=CHR$(K) OR WRD$(I
)=CHR$(13) GOTO 750
730 NEXT K
740 PRINT "LETTERS ONLY": GOTO 6
70
750 PRINT WRD$(I)
760 IF WRD$(I)=CHR$(13) GOTO 780
770 NEXT I
780 KNT=I-1
790 PRINT:PRINT"THE WORD IS  - "
;
800 FOR I=1 TO KNT:PRINT WRD$
____
Z____ 810 PRINT: PRINT"
- RIGHT ? (Y/N)"
820 YN$=INKEY$: IF YN$="" GOTO82
0
830 IF YN$="N" GOTO 460.
840 IF YN$<>"Y" GOTO 800
850 CLS
860 FOR I=1 TO 9: BAD$(I)=CHR$(1
28): NEXT I
870 PRINT @ 7, "HANGMAN"
880 FOR I=35 TO 387 STEP 32
890 PRINT @ I, STRING$(16,CHR$(1
28))
900 NEXT I
910 PRINT@ 449,CHR$(128);" ";
920 FOR I=2 TO KNT:PRINT CHR$(12
8);" ";:NEXT I
930 PRINT:MISS=0
940 REM ***MAIN LOOP***
950 IF HELP=2 GOTO1040 'NO HEL
P REMEMBERING'
960 INDX=0

```

```

970 BAD$(MISS)=GS$
980 PRINT @ 214, "--WRONG--"
990 FOR I=0TO128 STEP 64
1000 FOR K=278TO284 STEP 3
1010 INDX=INDX+1
1020 PRINT @ (K+I), BAD$(INDX)
1030 NEXT K: NEXT I
1040 PRINT @ 480, "GUESS LETTER--"
;
1050 GS$=INKEY$:IF GS$="" GOTO 1
050
1060 FOR N=1 TO KNT
1070 IF WRD$(N)<>GS$ GOTO 1180
1080 FOR IS=1TO3
1090 FOR IK=227TO245 STEP 9: SOU
ND IK,1: NEXT IK
1100 NEXT IS
1110 IF GWRD$(N)<>CHR$(128) GOTO
1180
1120 GWRD$(N)=WRD$(N)
1130 FOR K=1 TO KNT
1140 PRINT @ (449+((K-1)*3)),USIN
G"%%";GWRD$(K)
1150 NEXT K
1160 WRITE=1
1170 IF EASY=2 GOTO 1200 'NOT T
HE EASY WAY'
1180 NEXT N
1190 REM ***END MAIN LOOP ***
1200 IF WRITE=0 THEN GOTO1320

```

Chattanooga Choo Choo Software

*Your One Stop Station
For Computer Programs*

Track 29

"Special!"
6% off
TN. orders



Valentine
Special!

Luigi Saves Sweetheart
Intellectronics
Dunkey Monkey (32K) \$19.95

Anteco Software
Intergalactic Force
\$24.95

NEW!

Mark Data Products
Astro Blast, Cave Hunter
and Haywire \$24.95

NEW!

Tom Mix Software
Protectors (32K) \$24.95
Katerpillar Attack \$24.95

**Video
Game Lovers
1983 Calendar
\$4.95**

Spectral Associates
Trilogy (3 games on 1 tape)
Ghost Gobbler, Cosmic Invaders and
Space War \$54.95

NEW!

Planet Invasion, Defense and
Galax Attax \$20.95

Prickley-Pear Software 15% off
Viking Football \$19.95 \$16.95
Preread 1.2 and 3 \$24.95 \$21.20

*Also available on disk (32K) at extra charge
All programs 16K on cassette unless otherwise stated.
Send for free complete catalog and descriptions!
We pay postage within the U.S. and Canada
TN. residents add 6.25% sales tax
C.O.D. orders add \$1.00
Call Anytime!



(615) 875-8656
P.O. Box 15892
Chattanooga, Tn 37415

```

1210 WRITE=0
1220 FOR I=1 TO KNT
1230 IF GWRD$(I)=CHR$(128) GOTO
1040
1240 NEXT I
1250 PLAY"04L8CEGL405C04L8GL405C
"
1260 PRINT @416,"YOU WIN. PLAY A
GAIN? (Y/N/C)"
1270 YN$=INKEY$: IF YN$="" GOTO1
270
1280 IF YN$="Y" GOTO 460
1290 IF YN$="C" GOTO80
1300 IF YN$<>"N" GOTO 1270
1310 END
1320 MISS=MISS+1
1330 FOR I=50TO2 STEP -8: SOUND
I,1:NEXT I
1340 ON MISS GOTO 1360,1390,1520
,1570,1610,1670,1710,1750,1810
1350 PRINT "ERROR":END
1360 REM **BASE**
1370 PRINT @ 388,CHR$(223);STRIN
G$(5,CHR$(220));CHR$(223);STRING
$(8,CHR$(128))
1380 GOTO 940
1390 REM **UPRIGHT**
1400 PRINT @ 359,CHR$(175); STRI
NG$(11,CHR$(128))
1410 PRINT @ 327,CHR$(175);STRIN

```

```

G$(11,CHR$(128))
1420 PRINT @ 295,CHR$(175); STRI
NG$(11,CHR$(128))
1430 PRINT @ 263,CHR$(175); STRI
NG$(11,CHR$(128))
1440 PRINT @ 231,CHR$(175); STRI
NG$(11,CHR$(128))
1450 PRINT @ 199,CHR$(175); STRI
NG$(11,CHR$(128))
1460 PRINT @ 167,CHR$(175); STRI
NG$(11,CHR$(128))
1470 PRINT @ 135,CHR$(175);STRIN
G$(11,CHR$(128))
1480 PRINT @ 103,CHR$(175); STRI
NG$(11,CHR$(128))
1490 PRINT @ 71,CHR$(175);STRING
$(11,CHR$(128))
1500 PRINT @ 39,CHR$(175);STRING
$(11,CHR$(128))
1510 GOTO 940
1520 REM **TOP/NOOSE**
1530 PRINT @ 40,STRING$(6,CHR$(1
72))
1540 PRINT @ 46,CHR$(175);STRING
$(4,CHR$(128))
1550 PRINT @ 78,CHR$(175);STRING
$(4,CHR$(128))
1560 GOTO 940
1570 REM ** HEAD **
1580 PRINT@ 109,CHR$(150);CHR$(1
56);CHR$(153);STRING$(3,CHR$(128
))
1590 PRINT @ 141,CHR$(153);CHR$(
147);CHR$(150);STRING$(3,CHR$(12
8))
1600 GOTO 940
1610 REM **BODY**
1620 PRINT @ 174,CHR$(191);STRIN
G$(4,CHR$(128))
1630 PRINT @ 206,CHR$(191);STRIN
G$(4,CHR$(128))
1640 PRINT @ 238,CHR$(191);STRIN
G$(4,CHR$(128))
1650 PRINT @ 270,CHR$(175);STRIN
G$(4,CHR$(128))
1660 GOTO 940
1670 REM **LEFT LEG**
1680 PRINT @ 301,CHR$(166);STRIN
G$(5,CHR$(128))
1690 PRINT @ 332,CHR$(150);STRIN
G$(6,CHR$(128))
1700 GOTO 940
1710 REM **RIGHT LEG**
1720 PRINT @ 303,CHR$(169);STRIN
G$(3,CHR$(128))
1730 PRINT @ 336,CHR$(153);STRIN
G$(2,CHR$(128))
1740 GOTO 940
1750 REM **LEFT ARM**
1760 PRINT @ 204,CHR$(150)

```

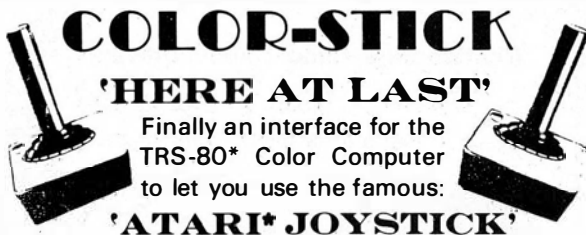

COLOR-STICK 'HERE AT LAST'

Finally an interface for the TRS-80* Color Computer to let you use the famous:

'ATARI* JOYSTICK'

Just plug your Atari or Atari like (the Color-Stick enables the use of most joysticks made for the Atari) joystick into the Color-Stick interface and then plug the Color-Stick into an empty joystick port.

The Color-Stick can improve scores 50% and more while making some games more exciting and fun to play.

Color-Stick interface \$19.95 each OR

Two for \$34.95. (less joysticks)

Atari Joysticks \$9.95 each.

Better Software Company

P.O. Box 2770
Greenville, South Carolina 29602
(803) 295-3648

Add \$2.00 per order shipping and handling. Bank cards welcomed (please include expiration date). Orders paid by cashiers check, money orders, bank cards and C.O.D. are shipped within 48 hours. Personal checks please allow 1-2 weeks. C.O.D. orders add \$1.50 extra. S.C. residents add 4% sales tax. *TRS-80 is a registered trademark of Tandy Corp. Atari is a registered trademark of Atari, Inc.

FLEXPLUS DOS

A powerful, easy-to-use disk operating system!

BEST PRICE ANYWHERE

FLEXPLUS	\$69.95
SUPERCHARGER.....	40.00
EDITOR/ASSEMBLER.....	40.00

**Total FLEXPLUS Package
ONLY \$149.95**

FLEXPLUS is a powerful, easy-to-use disk operating system. Spectral Associates has adapted TSC's FLEX to the best DOS completely compatible with Radio Shack software for use on the Color Computer. Eliminate the need for Radio Shack's TRS DOS - use **FLEXPLUS** with Editor/Assembler and have the options of a full range of utilities. **FLEXPLUS** works on the 32K Radio Shack disk system with 64K memory chips with a High Resolution multi-screen format that supports a 24 line by 51 character display! Also included are special enhancements to Radio Shack's Disk system when you are running FLEX with single or double sided, single or double density, 35, 40 and 80 track drives.

SUPERCHARGER

Allows machine language access to all 64K RAM in a Series E PC board. No hardware mods.

\$39.95

ULTRA 80CC (Editor / Assembler)

Features:

- TRS CC DOS compatible
- Library Files
- Macros
- Conditional Assembly

Most powerful disk-based editor/assembler for the Color Computer available (requiring 32K) and a "must" for anyone considering the development of machine language programs. Complete with 68-page documentation.

FANTASTIC PRICE
\$49.95

ORACLE (Graphic Monitor)

Tired of writing machine language programs with no way to debug them easily? Your problems are solved, the ORACLE is here.

ONLY **\$29.95**

Advantages of FLEXPLUS DOS

- Best price anywhere
- Wealth of existing software
- Easy start-up - just type "RUN FLEX + "
- Print Spooling - print while editing, assembling, etc.
- Allows you to save RS compatible binary disk files from **FLEX-PLUS**
- NO HARDWARE MODIFICATIONS NEEDED
- Warranty will not be voided - no need to open computer
- All FLEX compatible software will run including INTERRUPT DRIVEN SOFTWARE
- Requires Supercharger board
- \$149.95 for **FLEXPLUS**, Editor/Assembler and Supercharger

GREAT BASIC GAMES

ALCATRAZ II	ESCAPE FROM PRISON CITY
C-TREK	SUB HUNT
GAME PACS	LASER COMMAND
GAMBLIN GAMES	SPACE TRADERS
PIRATES AHOY	BATTLE FLEET
DESERT GOLF	LOTHAR'S LABYRINTH

KEYS OF THE WIZARD

Best new adventure game! Over 200 rooms filled with creatures, tricks, treasures and magic spells. Cassette save feature built-in.

\$19.95

MAGIC BOX

Special utility design to load MOD I/III Level II 500 baud BASIC programs into color computer.

SUPER PRICE **\$24.95**

For orders only, call toll-free

1-800-426-1830

Except WA, AK, HI

Business Office and Information

Call 206-565-8483

Office open 8:30-4:30 P.S.T.

We accept VISA, MASTERCARD, AMERICAN EXPRESS.

Add 3% for shipping. NO C.O.D.

All prices U.S. FUNDS.

SPECIAL LOW PRICE

FLEXPLUS with SUPERCHARGER \$89.95

with EDITOR/ASSEMBLER \$149.95

Quality Hardware

and Software Support

TRS-80 COLOR COMPUTER

TDP SYSTEM 100

DRAGON 32

ARCADE GAMES • ADVENTURE GAMES
BASIC GAMES • UTILITIES • BOOKS
HARDWARE • MODEMS

Call or write for a complete catalog.

SPECTRAL ASSOCIATES

143 Harvard Avenue Tacoma, WA 98466

```

1770 PRINT @ 205, CHR$(188)
1780 PRINT @ 206, CHR$(191)
1790 PRINT @ 207, STRING$(4, CHR$(
128))
1800 GOTO 940
1810 REM **RIGHT ARM - HUNG!**
1820 PRINT @ 207, CHR$(188); STRIN
G$(3, CHR$(128))
1830 PRINT @ 208, CHR$(153); STRIN
G$(2, CHR$(128))
1840 IF HELP=2 GOTO 1870
1850 PRINT @ 212, "-ALL WRONG-"
1860 PRINT @ 412, GS$
1870 PRINT @ 416, "YOU'RE HUNG!";
1880 FOR K=1 TO KNT
1890 PRINT @ (449+((K-1)*3)), US
ING "%"; WRD$(K)
1900 NEXT K
1910 PLAY"O1L2GFEDC"
1920 PRINT @ 428, " PLAY AGAIN?
(Y/N/C)"
1930 YN$=INKEY$: IF YN$="" GOTO
1930
1940 IF YN$="Y" GOTO 460
1950 IF YN$ = "C" GOTO 80
1960 IF YN$ <> "N" GOTO 1930
1970 END
1980 REM *** 100 WORD LIST ***
1990 DATA NOTEBOOK, NEWSPAPER, HOR

```

```

SE, POOL, SWIMMING, COMPUTER, CRAFTS
MAN, BOOK, FLOWER, PIANO, SONG
2000 DATA PICTURE, GLASS, STOVE, MI
CROWAVE, OVEN, TYPEWRITER, CASSETTE
, ELEPHANT, POTS, KITCHEN, VASE
2010 DATA CHURCH, SUIT, TENNIS, FOO
TBALL, BASEBALL, TELEVISION, TELEPH
ONE, BIBLE, CHRISTIAN, TENT, GIRAFFE
, TOWEL, PAINT, WATCH, SOAP, REINDEER
2020 DATA ELECTRICITY, CHECK, HOLI
DAY, SHUTTLE, CHAIR, COOKIE, PANCAKE
, WAFFLE, SODA, LIGHT, LION, DOLLAR, G
AME, PILLOW, NUMBER, NAME, SCHOOL
2030 DATA CANDLE, TABLE, SHAMPOO, D
OG, CAT, COW, FARMER, COOK, BARN, DOUG
HNUT, BICYCLE, UNIVERSITY, JUNIOR, D
OCTOR, DENTIST, SPACE, RAIN
2040 DATA SUNSHINE, DANCE, RAINBOW
, FLOUR, DRESSES, CLASSROOM, LOCKER,
ROCKER, CLOCK, CAMERA, ZEBRA, ZOO, BE
AR, TIGER, MOUSE, FISH, AQUARIUM, MAN
2050 DATA FISHERMAN, BEACH, PARK, S
HELL, LOCK, ROCK, OVERHEAD, HEAD, MAC
HINE, BUSH, RESTAURANT, MONKEY, TRUC
K, STREET, CLOUD, STORE, SHIP
2060 DATA SAILBOAT, COUCH, BUILDIN
G, COACH, TERMINAL, BOY, GIRL, FRIEND
, ENEMY, HAND, FOOT, LEG, ARM, FINGER,
SHOE

```

SOUTHERN SOFTWARE SYSTEMS

SERIOUS SOFTWARE FOR THE COLOR COMPUTER
Presenting... THE GRAPH ZAPPER and THE BAR ZAPPER
 Line Graphs and Bar Graphs for the Color Computer

- **THE GRAPH ZAPPER** plots line graphs of data and equations - multiple lines with different symbols - mix equations and data on the same graph - plots lines or points - *"The Graph Zapper is one of the most completely documented pieces of software we have seen . . . The Graph Zapper is an outstanding utility and can be a major tool in statistical, business and other uses where graphic representation of numbers is desirable."* The Rainbow, Dec. 1982.
- **THE BAR ZAPPER** creates bar graphs with multiple bars - plenty of options - shaded or light bars - positive and negative bars - a great companion to **THE GRAPH ZAPPER** - same high quality documentation.
- Endless applications - electric consumption, stock prices, math class equations, children's height and weight, data analysis, trend indication, experimental results, statistical analysis.

Both ZAPPERS Have All These Features:

- High resolution graphs with on screen numbers & labels, with or without grids.
- Sophisticated data editor makes changing data simple.
- Disk version has added features including storing completed graphs on disk and menu driven file loading.
- Detailed user's guides for all features.
- 14 day money back guarantee.
- Requires Ext. Color Basic and delivered on cassette.
- User friendly, easy to understand.
- Thorough error prevention.
- Save data for later graphing or editing.
- Low cost upgrade from tape to disk.
- Hard copies possible with common screen print programs - not supplied.
- Low resolution graphs can't compare.

\$15.95

for 16K tape versions

\$19.95

for 32K disk versions

add \$1.00 for shipping . . . send check or money order

\$29.95 for both tape versions + \$2.00 shipping

\$37.95 for both disk versions + \$2.00 shipping

Florida residents add 5% sales tax

SOUTHERN SOFTWARE SYSTEMS

485 South Tropical Trail, Suite 109 • Merritt Island, Florida 32952 • (305) 452-2217

JARB INC SOFTWARE HARDWARE

COMPUTER PRODUCTS

AUX-KEY

(Auxiliary External Key Board Unit)

This full size, industrial grade key board unit is P.C. Board mounted for trouble free operation and years of use. Mounted in an attractive aluminum case with a 12 key numeric pad, Aux-Key comes with a long cable for remote location placement of your 80C. Requires no soldering to your computer, and only about 15 minutes for installation. Does not affect normal operation of your original key board.

Add \$4.00 Shipping \$134.95

PEN-E-ARCADE

(Light Pen & Arcade System)

This unique system will allow the light pen (included) to be used with supplied software for many tasks normally requiring key board input. In education, choose answers by just touching pen to correct screen location. Can be easily interfaced to your own programs. All instructions supplied. Also includes the JARB arcade target gun and target software. Shoot targets from across the room. No other unit like this is presently available from anywhere else for the 80C or TDP-100 computers.

Add \$4.00 Shipping \$74.95

COMREX CR-6500

(13" Color Monitor)

High resolution display monitor produces an incredibly sharp image. Includes built-in speaker with audio circuit. Compatible with virtually any microcomputer.

..... \$344.95

COMREX CR-1

Compact desk-top daisy wheel printer, especially designed for word processing. Assures high reliability, and produces quiet, high quality printing. Complete with RS-232 interface.

..... \$810.00

U.S FUNDS ONLY
C.O.D. ORDERS ACCEPTED
Sorry, no C.O.D. on printers and monitors.
NO CREDIT CARD ORDERS

* VIDEO INTERFACE KIT

Allows the composite video signal to be interfaced directly to a B/W or color monitor. TV and monitor can be used simultaneously. Complete with comprehensive instructions and all parts, including an external sound output. NOTE: May not work with monitors requiring high input drive - call or write for recommended monitors.

..... \$19.95



DUAL JOYSTICK UNIT (D.J.)

Single unit assembly enhances playability of multi-joystick/player games; convenient press-to-fire buttons

Add \$4.00 shipping \$35.95

EPSON PRINTERS

MX80FT/Graftrax+ \$524.95

MX100FT/Graftrax+ \$699.95

Serial Interface w/4K Buffer

Ideal for 80C use \$109.95

80C TO Epson Cable \$19.95

See shipping Info

NEW PRICES ON DATA CASSETTES

C-05 **C-10**

\$.65 QTY 1-10..... \$.70

\$.60 QTY 11-20..... \$.65

Soft Poly Cases Ea. \$.20

Hard Shelled Cases Ea. \$.22

Cassette Labels (12) Sh. \$.36

Cassette Labels Tractor (1000) \$30.00

Call or write for quantity prices on all cassette products. Special lengths available, eg., C-02, etc.

NANOS COLOR BASIC AND EXTENDED SYSTEM REFERENCE CARD

"The New Industry Standard"
\$4.95

(We pay postage on this one)

All types of Nanos cards available

MEMORY UPGRADE KITS

* 4K/16K MEMORY CHIP SET

Eight 200 NS 4116 Factory Prime Chips, 16K Ram Button, and Upgrade Instructions. No Soldering.

..... \$16.95

* 16K/32K MEMORY UPGRADE KIT

Eight 200 NS 4116 Factory Prime Chips with Piggy Backed Sockets, Sam Socket, Bus Wire, and 32K Ram Button. Comprehensive Instructions. Recommended for "D" or earlier, but may be used on "E". Only 9 simple solder connections to kit. None to computer.

..... \$25.95

* 64K RAM CHIPS

Eight 200 NS Factory Prime 64K RAM Chips. Allows you to upgrade "E" board easily. No soldering needed.

..... \$69.95

**Installation of these items will void the Radio Shack warranty. Radio Shack is a trademark of the Tandy Corp.*

WABASH DISKETTES

\$25.00 per box of 10

DISK DOUBLER

\$12.95

CoCo Chips

Sam, Pia, CPU, Ext. Basic, and 1.1 Standard Available

*We carry products
from many manufacturers.
If you don't see it, ask.*

JARB INC SOFTWARE HARDWARE

1636 D Avenue, Suite C
National City, CA 92050
(619) 474-6213

SHIPPING AND HANDLING: Printers and monitors add 3%. Unless otherwise specified, all other orders \$2.00 per order. California Residents add 6% sales tax.



Here, *The Word* Is 'Grammatical'

By R. Bartly Betts

The Word is an educational program dealing with parts of speech. As set up, it reviews nouns, verbs, pronouns, adverbs, adjectives, prepositions, articles and conjunctions. Each sentence contains a word that matches one of these parts of speech.

The heart of the program prints sentences on the screen in which a word is flashed and then highlighted. The parts of speech are presented in a menu, from which the student chooses the correct answer. If he answers correctly, the word "Right" is flashed in a blue box with accompanying sound. If he is incorrect, the word "Wrong" is flashed in an orange box, with sound, and he is shown the correct answer.

Unlimited Questions:

The program listing contains 20 sentences, but could have as few or as many as desired by adding to or substituting the data appearing at lines 490 to 590. Line 590 must be retained as is to end the program. After the student answers ten questions he is given his score percentage and asked to press *ENTER* to continue. He is then given the next ten questions. This will continue until all of the sentences have been used. The program then asks if the student would like to review the questions or quit.

The format for adding new data lines or changing existing ones is quite simple. The first part of the data line contains all of the sentence up to the target word, followed by a comma. After the comma, and without a space, the remaining portion of the sentence is added and ended with the proper punctuation. A second comma is then inserted followed by the answer (e.g. noun, verb, adjective, etc.). See program line 490 for an example.

Line 335 contains the parts of speech featured in this program. These could easily be changed if different review questions are desired. To change the number of student choices (e.g. to only feature adverbs and adjectives), there are several program changes that are necessary.

The first change will be in line 35. The loop to read the parts of speech into *WD\$* would have to be changed from 8 to 2. Line 335 should read - 335 DATA 1. ADVERB,2. ADJECTIVE. In line 330 the 8 should be changed to a 2.

Line 375 should read "ADVERB" instead of "NOUN" and line 380 should read "ADJECTIVE" instead of "VERB." Lines 380 through 410 should be deleted. In line 370, "8" should be changed to "2" and finally, in line 620, the "43" must be changed to "41."

These same lines would also be the major keys to changing the program over entirely and using it for a quiz in some other subject.

Color And Sound:

The program is quite flashy and has a lot of sound. A short machine language program is loaded in at the beginning, lines 5 through 15, and it is used to flash the title graphics through 42 changes. The program was so fast that I had to insert a sound routine into the loop to slow it down to something less than one swift blur. The routine is called in line 195. By inserting the data lines and the machine language driver (lines 5 through 15), this routine could be used in other programs for the same effect.

As written, the program operates in 32K. To run it in 16K you will need to change 32384 in line 5 to 16200. Change 32384 to 16200 in line 15 as well as both occurrences of 32418 to 16234.

Unusual Technique:

For you programmers, there is at least one routine that is different. At least, I have not seen it mentioned or used elsewhere. Memory location 135 and 137 in the Color Computer contain the current print location in screen memory. Thus, with a command like *PRINT PEEK(136)*256+PEEK(137)*, you can get the computer to tell you its memory location at any point in a print to screen routine. Further, a *PRINT PEEK(136)*256+PEEK(137)-1024* will give you the screen (*PRINT@*) location where a print is taking place. To illustrate better, type in and *RUN* the following short program: (You can leave out the *REM* comments.)

```

10 CLS: DIM SAV(20): ' YOU CAN
RECORD THE LOCATION OF UP TO 20
COMMAS
20 POKE 137,32: 'SET THE CURSOR
TO THE SECOND SCREEN LINE
30 A=PEEK(136): ' STORE THE
CURRENT SCREEN LOCATION
40 B=PEEK(137): 'DITTO
50 PRINT@0,D; :PRINT@8, "Comma
used at:"SAV(LOOK); ' PRINT THE
SCREEN LOCATION IN THE LEFT HAND
CORNER AND THE LOCATION OF THE
LAST COMMA USED
60 C=A*256+B: ' CALCULATE THE
SCREEN MEMORY LOCATION
70 D=C-1024: ' CALCULATE THE
SCREEN LOCATION
80 IN$=INKEY$: ' SET UP LOOP TO
GET KEY INPUT
90 IFIN$="" THEN 80: ' IF NO KEY
BOARD INPUT LOOP AGAIN
100 IF IN$="," THEN LOOK=LOOK+1:
SAV(LOOK)=D: ' IF COMMA IS USED
    
```

```

THEN RECORD LOCATION IN THE SAV
(LOOK) ARRAY
110 IF IN$="." THEN 200: ' IF
PERIOD IS USED THEN END INPUT
AND JUMP TO LINE 200
120 PRINT@,IN$: ' PRINT
KEYBOARD INPUT TO SCREEN
130 GOTO 30: ' DO IT ALL AGAIN
UNTIL TYPIST GETS TIRED
200 PRINT@255, " Commas were us
ed at locations:": FOR T=1 TO LO
OK: PRINT SAV(T)":":NEXT: 'PRINT
OUT ALL LOCATIONS WHERE COMMAS
WERE USED
210 PRINT:INPUT" LOCATION TO CHA
NGE";L: ' SELECT ONE OF COMMA
LOCATIONS GIVEN IN LINE ABOVE
220 LINE INPUT" PUNCTUATION TO I
NSERT: ";C$: ' TYPE PUNCTUATION
YOU WANT TO SUBSTITUTE FOR COMMA
230 POKE L+1024,ASC(C$)+64: '
POKE NEW PUNCTUATION TO SCREEN
LOCATION CONTAINING COMMA
240 GOTO 200: ' KEEP IT UP AS
LONG AS YOU LIKE

```

Now, begin typing and use a lot of commas. You should only type in two or three lines. If all is well, you should get a printout at the top left corner of the screen telling you the location of each character you type on the screen and the location of each comma (shades of a word processor). When you want to end, type a period. The program then allows you to change the commas to any other punctuation.

This is the basic procedure I used to find the location of the target word so that I could flash it on the screen. I simply stored the screen memory location being used when the target word was printed, in variables P and PI (see line 275). I also used the technique to find the proper place to put the rolling cursor before the prompt statement (see line 345).

The *PLAY* command in the cursor routine is used to slow it down so that it rolls and doesn't just blur. The volume is set to 0 in line 350 so there is no distracting noise while the student is contemplating the answer. It also takes less memory and is easier to issue a *PLAY* command than to use a *FOR-NEXT* loop to create a delay.

Program Flow:

For those who want to follow the program flow, here is a description of the steps:

-LINES 5 through 25 protect memory, clear for string space, load the machine language program and clear the screen.

-LINES 30 through 40 prepare the screen for the title and load V\$, W\$, H\$, I\$, J\$, G\$, and T\$ with the values needed to print the graphics and produce the sound for the title.

-LINES 45 through 210 print the title, print a border around it, call the machine language program to flash the title, make all the appropriate sounds and set up the program to ask for the users name.

-LINE 255 is used to wipe out the old sentence from the screen in preparation to printing the new.

-LINE 230 nulls the strings used in the program answer selection so there will be no confusion.

-LINES 245 through 360 print the display to the screen,

flash the target word, present the menu, ask for an answer and flash the prompt cursor in an INKEY\$ loop to await the reply.

-LINES 365 through 420 accept the answer, compare it with the correct reply and jump to the appropriate line...425 for "Right" and 435 for "Wrong."

-LINES 455 through 475 provide the score and are jumped to from line 240 when ten questions have been answered.

-LINES 490 through 590 are the data lines containing the sentences of the quiz.

-LINES 595 through 625 provide the end of the program routine and allow the student to quit or start over again.

-A\$, B\$, and C\$ contain the first part of the sentences used, the second part (including the target word), and the correct answer, respectively.

✓	150 0498
	300 0863
	485 0E2E
	END 141B

The Listing:

```

5 CLEAR 50,32384: CLEAR500
10 DATA 8E,4,0,C6,80,A6,84,81,60
,26,2,E7,84,A6,80,8C,6,0,26,F1,8
E,4,0,A6,84,8B,10,A7,80,8C,6,0,2
6,F5,39
15 FOR X=32384 TO 32418: READ PP$
: B=VAL("&H"+PP$): POKEX,B: NEXT: DE
FUSR0=32384
25 CLS

```

PARENTS & TEACHERS

of children ages 3 to 8

Software written by School Director to utilize computer as an aid in teaching Early Childhood Concepts. Puts fun & excitement into learning.

Requires 16K ext. basic & Joysticks.

COMPUTER LITERACY \$14.95
Introduces computer age terms & concepts to parents & teachers. Audio/visual.

CREATE \$9.95
Use of colors & sounds fascinates all ages. Uses Joysticks to DRAW.

HAND/EYE COORDINATION \$14.95
Guide spaceship thru maze. 13 learning levels. Challenge to all ages.

RECOGNITION \$14.95
Child learns to recognize "like" figures. 2 separate games. Many learning levels.

.....
Following Programs USE VOICE RECORDED EXPLANATIONS & GAMES IN FUN & EXCITING WAY:

PERCEPTION \$14.95
Teaches antonyms, i.e. left/right, first/last, etc.

NUMBER CONCEPTS \$14.95
Teaches meaning of numbers.

ADDITION CONCEPTS \$14.95
Teaches basic arithmetic skills.

20% discount for 3 or more programs; \$75 for all 7 programs.
Send Certified Check or money order for immediate delivery; otherwise 2 weeks.

PROGRAMS BY MR. BOB
P.O. BOX 94
MONTROSE, CA 91020



```

30 PRINT@32
35 FOR T=1 TO 8:READ WD$(T):NEXT
40 V$=CHR$(175):W$=" ":H$="AG":I
$="GA":J$="FE":G$="EF":DIMX(200)
:T$=H$+I$+J$:PLAY"V25;05;T150;L2
55"
45 PLAY T$
50 PRINT TAB(5)STRING$(6,175)W$V
$V$W$W$W$V$V$W$STRING$(5,175)
55 PLAY T$
60 PRINT TAB(7)V$+V$+W$+W$+W$+V$
+V$+W$+W$+W$+V$+V$+W$+V$+V$
65 PLAY T$
70 PRINTTAB(7)V$+V$+W$+W$+W$+V$+
V$+V$+V$+V$+V$+V$+W$+V$+V$+V$+V$
75 PLAY T$
80 PRINT TAB(7)V$+V$+W$+W$+W$+V$
+V$+W$+W$+W$+V$+V$+W$+V$+V$
85 PLAY T$
90 PRINTTAB(7)V$+V$+W$+W$+W$+V$+
V$+W$+W$+W$+V$+V$+W$+V$+V$+V$+
+V$
95 PLAY H$+J$+I$
100 PRINT
105 PLAY H$+J$+I$
110 PRINT TAB(2)V$+V$+W$+W$+W$+V
$+V$+W$+V$+V$+V$+V$+V$+W$+V$+
V$+V$+V$+V$+V$+W$+V$+V$+V$+V$
115 PRINT TAB(2)V$+V$+W$+W$+W$+V

```

```

$+V$+W$+V$+V$+W$+W$+V$+V$+W$+V$+
V$+W$+W$+V$+V$+W$+V$+V$+W$+W$+V$
+V$
120 PLAY T$
125 PRINT TAB(2)V$+V$+W$+W$+W$+V
$+V$+W$+V$+V$+W$+W$+V$+V$+W$+V$+
V$+W$+W$+V$+V$+W$+V$+V$+W$+W$+V$
+V$
130 PLAY T$
135 PRINT TAB(2)V$+V$+W$+V$+W$+V
$+V$+W$+V$+V$+W$+W$+V$+V$+W$+V$+
V$+V$+V$+V$+V$+W$+V$+V$+W$+W$+V$
+V$
140 PLAY T$
145 PRINT TAB(2)V$+V$+V$+V$+V$+V
$+V$+W$+V$+V$+V$+V$+V$+W$+V$+
V$+W$+W$+V$+V$+W$+V$+V$+V$+V$
150 PLAY H$+J$+I$
155 FOR T=1024 TO 1055:POKE T,14
7:NEXT
160 PLAY T$
165 FOR T=1055 TO 1535 STEP 32:P
OKE T,154:NEXT
170 PLAY T$
175 FOR T=1024 TO 1505 STEP 32:P
OKE T,149:NEXT
180 PLAY T$
185 FOR T=1505 TO 1534:POKE T,15
6:NEXT:PLAY T$

```

PARALLEL PRINTER INTERFACE

FOR THE RADIO SHACK COLOR COMPUTER

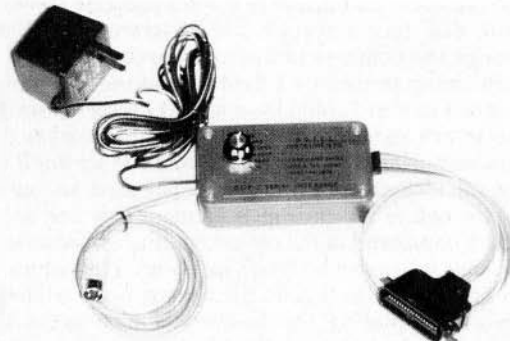

- * RUN ANY STANDARD PARALLEL PRINTER FROM THE COLOR COMPUTER SERIAL I/O PORT
- * WORKS WITH : EPSON MX 70/80/100, NEC PC8023, CENTRONICS, C-ihoh, OKIDATA, SMITH CORONA DAISY WHEEL, RADIO SHACK, OR ANY OTHER PRINTER WITH A STANDARD PARALLEL INPUT.
- * SWITCH SELECTABLE BAUD RATES FROM 300 to 9600
The Color Computer is capable of 9600 Baud -- Poke 150,1.
Running at 9600 Baud greatly increases the printing speed of some printers.
- * COMPLETE - ALL CABLES AND CONNECTORS INCLUDED
- * PRICE : \$69 plus \$3 for shipping and handling. Michigan residents add 4% sales tax.

BOTEK INSTRUMENTS

4949 HAMPSHIRE
UTICA, MICHIGAN 48087
313-739-2910

Dealer inquiries invited

```

190 PLAY"V0"
195 POKE 65494,0:FOR T=1 TO 31:A
=USR(0):PLAY "V"+H$:NEXTT
200 FOR T=1 TO 400:NEXT:PLAY"GGG
GFFFFFFEEEEEDDDDDCCCCCBBBBBAAAAA
"
205 T1=1024:T2=1504
210 FOR T=0 TO 511 STEP 32:PRINT
@T,"":PLAYI$+H$+J$:NEXT
215 POKE 65494,0
220 CT=0:CO=1
225 FOR T=64 TO 192 STEP 32:PRIN
T@T:PLAY"V20;05;A":NEXT:PRINT@0,
;
230 D$=STRING$(32,131):K$="":CH$
="":CH=0:P$="V20;L255;03;AAAA":Q
$="BBBB":C1$=CHR$(175)
235 IF CO=1 THEN PRINTTAB(10)"TH
E WORD:":PRINTD$;:PRINT:PRINT "
YOUR NAME ";;INPUT NM$:CLS:CO=0
240 IF W+R=10 THEN GOTO 450
245 PRINT " NAME THE PART OF
SPEACH:":PRINT D$;
250 CT=CT+1:CT$=STR$(CT)+".":PRI
NT CT$ " ";
255 READ A$,B$,C$:A$=A$+" "
260 IF A$="END " THEN GOTO 595
265 A=INSTR(B$," ")-1:IF A<5 AND
A>0 THEN 270 ELSE IF A=<1 THEN
A=INSTR(B$,".")-1 ELSE IF A=<1 T
HEN A=INSTR(B$,"!")-1 ELSE IF A=
<1 THEN A=INSTR(B$,"?")-1
270 L$=LEFT$(B$,A)
275 PRINT A$;:P=PEEK(136):P1=PEE
K(137):PRINT B$
280 PRINT@485,"RIGHT="R" WRONG=
"W;
285 FOR T=1 TO A
290 X(T)=PEEK(P1+1023+T)
295 NEXT T
300 POKE 65495,0
305 FOR F=1 TO 2
310 FOR T=1 TO A:POKE P1+1023+T,
X(T)-64:NEXT:PLAY Q$
315 FOR T=1 TO A:POKE P1+1023+T,
X(T):NEXT:PLAY P$
320 FOR T=1 TO A:POKE P1+1023+T,
X(T)-64:NEXT:NEXT F
325 POKE 65494,0
330 PRINT@218:FOR T=1 TO 8 STEP
2:PRINT TAB(1)WD$(T);TAB(17)WD$(
T+1):NEXT
335 DATA 1. NOUN,2. VERB,3. PRON
OUN,4. PREPOSITION,5. ADJECTIVE,
6. ADVERB,7. CONJUNCTION,8. ARTI
CLE
340 PRINT:PRINT@384,D$;
345 PRINT " ";;Q=PEEK(137):Q1=P
EEK(136): PRINT "PRESS NUMBER OF
YOUR CHOICE"

```

```

350 PRINT D$;:BL$="V0;L1;A"
355 Y=(1024+Q)+254
360 K$=INKEY$:POKEY,128:PLAY BL$
: POKEY,202:PLAY BL$:POKEY Y,197:
PLAY BL$:POKEY,128:IF K$="" THEN
360
365 CH=VAL(K$)
370 IF CH<1 OR CH>8 THEN 360
375 IF CH=1 THEN CH$="NOUN"
380 IF CH=2 THEN CH$="VERB"
385 IF CH=3 THEN CH$="PRONOUN"
390 IF CH=4 THEN CH$="PREPOSITIO
N"
395 IF CH=5 THEN CH$="ADJECTIVE"
400 IF CH=6 THEN CH$="ADVERB"
405 IF CH=7 THEN CH$="CONJUNCTIO
N"
410 IF CH=8 THEN CH$="ARTICLE"
415 IF CH$=C$ THEN 425
420 IF CH$<>C$ THEN 435
425 PRINT@357,STRING$(21,175);:P
LAY"V20L5005"+ I$:R$="RIGHT":R1$
="right":FOR T=1 TO 8:PRINT@365,
R$;:PRINT@365,S$;:PRINT@365,R1$;
:PLAYG$:NEXT:FOR T=1 TO 200:NEXT
430 R=R+1:GOTO 225
435 PRINT@357,STRING$(21,255);:S
OUND 10,2:W$="WRONG":W1$="wrong"
:FOR T=1 TO 8:PRINT@365,W$;:PRIN

```



PRICKLY-PEAR SOFTWARE

QUALITY PROGRAMS FOR YOUR 80C

PROGRAMS REQUIRE 16K EXTENDED BASIC FOR TAPE, AND 32K DISK UNLESS OTHERWISE NOTED.

Flight

If you'd like to fly a plane then this is what you've been waiting for. A really good graphics oriented flight simulator in high resolution. Four difficulty levels let you go from student level to a difficult instrument-only landing. In front of you on the screen are your instruments, and above them are two representations of your plane in relation to the flight path (top and side views). At the higher levels all you have to go by are the instruments. Can you put it down on the runway to hear the synthesized voice from the tower say "perfect landing"? It's tough! You use your joystick just like the control stick on a plane, and the action is realistic indeed. This program was written by a professional flyer — a pilot for a major United States air carrier, and the high standards of professionalism really show. Just CLOADM and take to the skies!! Requires 32K extended. **TAPE** is \$19.95 — **DISK** is \$24.95



Your Personal check is welcome - no delay. Include \$1.50 shipping for each program ordered. (Shipping free on \$50.00 or larger orders). Az. residents add 4% sales tax. Orders shipped within two days.

Stocked by Quality Dealers, or send order to:

PRICKLY-PEAR SOFTWARE

9822 E. Stella Road
Tucson, Arizona 85730
(602) 886-1505

```

T@365,S$::PRINT@365,W1$::SOUND 1
,1:NEXT:FOR T=1 TO 200:NEXT
440 CLS@:LK$=LEFT$(C$,1):IF LK$=
"A" OR LK$="E" OR LK$="I" OR LK$
="O" OR LK$="U" THEN AN$="AN " E
LSE AN$="A "
442 PRINT@128," "A$;B$:PRINTD$::
PRINT TAB(2)NM$:"":PRINT("";L$")
IS "AN$;C$:PRINT:PRINTD$::PRINT
TAB(2)"PRESS <ENTER> TO CONTINU
E ";;INPUT Z$
445 W=W+1:CLS:GOTO 225
450 CLS:PRINTTAB(7)NM$"'S ";"SCO
RE:";PRINTD$;
455 PRINT" THAT IS" R"RIGHT OUT
OF" R+W" QUESTIONS"
460 PRINT
465 PRINT" YOUR PERCENTAGE IS"R/
(R+W)*100"%
470 PRINT D$
475 PRINT" PRESS <ENTER> TO CONT
INUE ";;LINEINPUTZ$
480 W1=W1+W:R1=R1+R:W=0:R=0
485 GOTO 225
490 DATA TO,COIN A PHRASE YOU NE
ED SOME CENTS.,VERB
495 DATA ROSCO RESCUED THE,RAVIS
HING REDHEAD.,ADJECTIVE
500 DATA THE RAIN IN,SPAIN FALLS
MAINLY ON THE SPANISH.,

```

```

NOUN
505 DATA PINTOS ARE,SPOTTY
PERFORMERS.,ADJECTIVE
510 DATA YOU CAN FINISH THIS QU
IZ,OR FLUNK THE COURSE!,CONJ
UNCTION
515 DATA RED RYDER HAS ,HORSE SC
ENTS.,ADJECTIVE
520 DATA HE SAID THE MINE WAS,MI
NE.,PRONOUN
525 DATA HERBIE WENT BANANAS AND
WOW WHAT,A FRUITCAKE!,ARTIC
LE
530 DATA,HOPE SPRINGS ETERNAL IN
THE WORLD.,NOUN
535 DATA COME TO ME WITH,ZEAL !,
ADVERB
540 DATA THE SPINX SWORE THE SPH
ERE WAS SWAYING,SWEETLY.,AD
VERB
545 DATA STANLEY WASHED AND,DRIE
D THE DISHES.,VERB
550 DATA "HE HITS, HE RUNS," ,HE
SLIDES HE RIPS HIS PANTS!,PRO
NOUN
555 DATA ,SICK BEARS GET HIVES.,
ADJECTIVE
560 DATA CREEPY CRAWLING CRITTER
S CATCH,UNDER GARTERS.,PR
EPOSITION
565 DATA I,BELIEVE YOU DON'T ALW
AYS CARE FOR GRAMMER.,VERB
570 DATA TERINA TOOTH-FAIRY FLEW
FOR FREEDOM ON A
,POWDER-PUFF.,NOUN
575 DATA RED RYDER BRINGS HORSE
SCENTS,WITH HIM.,PREPOS
ITION
580 DATA THE MISSING MISSLE WASN
'T ,MISSING ME!,VERB
585 DATA I THOUGHT THE THOUGHT H
E THOUGHT WAS A THOUGHT,OF
ME.,PREPOSITION
590 DATA END,END,END
595 CLS:PRINT@192,D$::PRINT " TH
AT'S ALL THE QUESTIONS
600 PRINT" TOTAL RIGHT="R+R1;" T
OTAL WRONG="W+W1
605 PRINT" TYPE 'R' TO REVIEW QU
ESTIONS AGAIN OR PRESS 'ENTER
' TO END"
610 PRINT D$
615 IN$=INKEY$:IF IN$="" THEN 61
5
620 RESTORE:FOR T=1 TO 43:READ X
X$:NEXT
625 CT=0:CLS:IF IN$="R" THEN PLA
Y T$+P$+Q$:R1=0:W1=0:GOTO 240
630 CLS:PRINT@234,"THE END";:SOU
ND 50,2:SOUND 1,5:END

```

BATTLE of GETTYSBURG
A Strategy Game
for mature Players

**STOP REBEL INVADERS
OR DIE!**

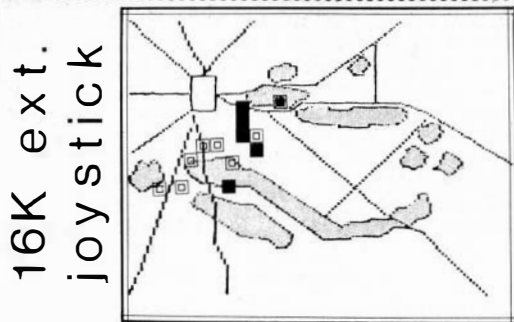

16K ext.
joystick

\$20.95
cassette

SOFTWRIDE
P. O. Box 3504
Austin, Texas: 78764
(512)-444-6135

GIVE YOUR CHILD AN UNFAIR ADVANTAGE

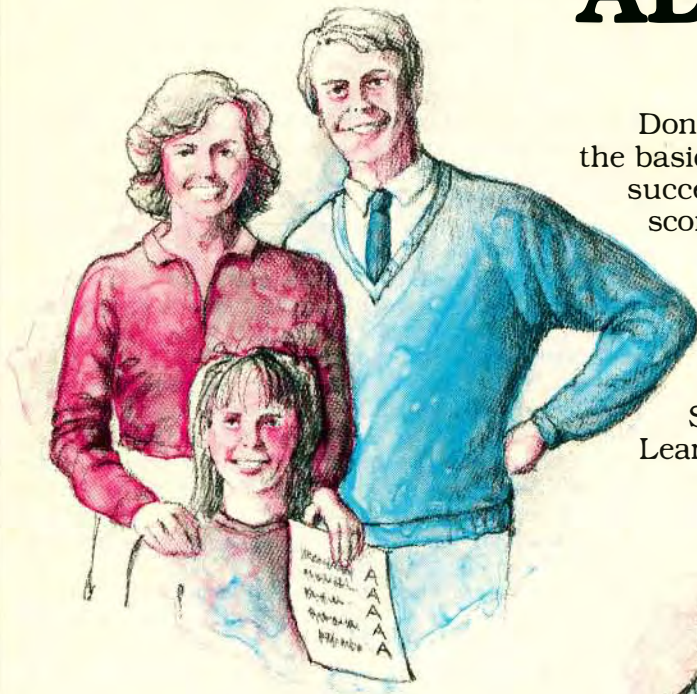

Don't just depend on others to provide the basic education your child needs to succeed in tomorrow's world. While test scores of others may go down, your child's scores can improve dramatically when you provide him or her with individualized **MICRO SCHOOL PROGRAMS**, in Reading, Math, English Usage, Spelling, and Games that Teach. Learning at home can be fun.

He or she can master basic skills, using a MICRO SCHOOL PROGRAM, in just minutes each day if you have an APPLE, ATARI, TRS-80, TRS-80 COLOR or TDP personal computer at home.



ASK FOR MICRO SCHOOL PROGRAMS BY NAME at your local computer store.

BERTAMAX INC.
101 Nickerson #202
Seattle, WA 98109
(206) 282-6249
© 1982, Bertamax, Inc.



PERSONALIZED INSTRUCTION ON PERSONAL COMPUTERS

Battle of Gettysburg A Good, Tactical Challenge

As the Union commander at the *Battle of Gettysburg*, the first and most critical decision you must make is which Southern general to pit your forces against. General Pickett is reported to be a man of direct action who sends his men straight toward the objective, although low morale or exhaustion seem to have made his troops prone to break in combat. General Lee is a more mobile commander. He gives you less time to react, and his troops are made of sterner stuff. Jackson is their best. His well-tuned chain of command allows the rebels to sweep across the battlefield, giving you little time to react, and treating your veteran troops as if they were still green farm boys. Make your choice with care, as once the battle is engaged, time for slow pondering of alternatives is past.

As a wargamer with over 20 years of gaming experience, I have commanded or been part of a team commanding paper, plastic, or metal armies from Baltimore to West Point, the problem being that sometimes you must travel that far just to find an opponent. When the CoCo came into my life last June, it seemed that the perfect opponent had arrived. On call 24 hours a day, it never has to be home by midnight, or get up the next day to support the wife and kids. The only trouble was that in June of '82 all it could do

was shoot down spaceships. A test of hand/eye coordination, not tactical skill.

Battle of Gettysburg is a re-creation of that battle, played with simple high-res graphics on a screen-displayed map of the battlefield. The game is in "real-time"—in that once you begin play, the computer moves when it wants to, and you move when you can. Starting with two brigades against six, you must slow the rebel advance until Union reinforcements allow you to turn the tide. If you fail to slow them, or lose too great a portion of your holding force in the attempt, they will sweep you off the field, destroying your army piecemeal.

A neat 12-page instruction book (cover, 11 pages of text, and one page of maps) is supplemented by an instruction program on side two of the tape. A print subroutine allows you to print a hard-copy of the taped instructions for reference during play.

While there are no loading instructions given in either the book or tape, the program loaded easily with my Radio Shack CTR-80A recorder. It proved difficult to load with my non-Radio Shack backup recorder. As the backup cost less than half of the price of the CTR-80A, this may be more proof that you get what you pay for than a problem with the program.

Speaking of backups, making a backup may prove a difficult project with *Battle of Gettysburg*. Parts of the program are protected, primarily by use of *DATA* statements and ASCII format storage for the map and instruction sections. The body of the program is copyable, to allow saving of modified versions. The author, James Woodruff, offers a number of simple changes to modify play. One changes the odds a bit in your favor, another provides for a stiffer opposition (I felt as if half my troops had been re-armed with puffballs) and another tells how to give yourself more time to move or speed up the game. Both the latter are highly recommended.



Playing time against Pickett, the easiest opponent, is about one hour. Lee is more difficult, lasting 90 to 120 minutes. Jackson can run either shorter or longer; the shorter games being the ones you lose. There is no game-save option, but the games are short enough for this not to be a problem.

Using 16K and Extended Basic with a joystick control, this game provides the best "feel" of any tactical game I've played so far on the Color Computer. Others have the same excitement of challenge, but the real-time aspect in *Battle of Gettysburg* provides the pressure that changes a cool, deliberative exercise into an intense, heart-pumping experience. My only complaint is the limited use of sound, with only a short, rising, irregular beep indicating combat, and final victory (or defeat) being indicated by The Battle Hymn of the Republic, or Dixie.

I'll close with some tactical hints. Remember, the Confederate forces "home in" on your Command Post (CP). Use your CP to force them to attack your strongest defense. First, move your two brigades to block the Rebels, then move the CP to the town itself. This takes several moves, even on the road. Keep checking your blocking forces. Try not to engage more than one or two enemy units at a time, as you lose control during combat. If your line is still holding when the last block of Union troops enters on Baltimore Pike, you are well on your way to victory!

(SOFTWARE, P.O. Box 3304, Austin, TX 78764,
\$20.95)

—Nevin J. Templin





**PREMIUM SOFTWARE
FOR THE COLOR COMPUTER**

SISI (16K EXT. BASIC) \$9.95 Sisi the fortune telling computer uses data that you input to determine a character reading for you.
COLORHYTHM (16K EXT. BASIC) \$9.95 Plots your biorhythm in hi-res graphics for 15 days.
PRESCHOOL PAK (16K EXT. BASIC) \$8.95 Two preschooler learning drills. Contains ALPHABET & COUNTER. Makes use of hi-res graphics and sound. The kids think it's a game!
MONEY MINDER II (16K) \$14.95 A cassette based personal finance program. Up to 56 user definable budget categories. Printout capability. Menu driven—easy to use.
DISK MONEY MINDER (32K plus disk) \$19.95 Similar to MONEY MINDER II but for use with disk. Easier and faster to use.

HARMONYCS

P.O. BOX 1573
SALT LAKE CITY, UTAH 84110





Auto Run is a utility program for the TRS-80* Extended Basic Color Computer. It is used to add convenience and professionalism to your software.

Auto Run will help you create your title screen with the graphics editor. The graphics editor allows you to choose a background color and border style. Using the arrow keys and several other commands you can draw pictures, block letters and also include text.

Auto Run will generate a machine language loader program to precede your program on the tape. Then, to start up your program, simply type CLOADM to load in the Auto Run loader program, which will then automatically start itself up, display your title screen, load your program and then RUN or EXEC it.

Also you may record a vocal or musical introduction preceding your program. The Auto Run loader will control the audio on/off.

Basic programs can be set to load anywhere in memory above \$600 (the PCLEAR 0 page).

Software authors: The Auto Run prefix may be appended to your software products.

Auto Run is \$14.95 and includes complete documentation and an assembly source listing.

Requires 16K Extended Basic.

Galactic Hangman

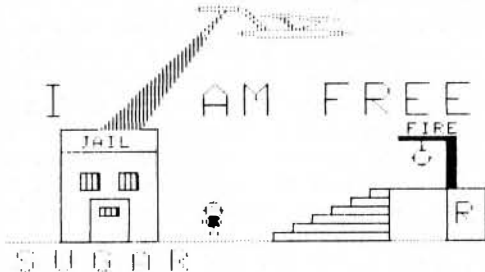

A great new twist to the popular, educational word guessing game for the Color Computer. Large (700 words) and sophisticated vocabulary. Or enter your own words, your child's spelling list, foreign language vocabulary, etc.

Outstanding high resolution graphics, animation and sound effects.

For \$14.95 you get both the 16K and 32K versions of Galactic Hangman.



Tape Information Management System

A user-oriented, easy to use personal database management system for the TRS-80* Color Computer with these outstanding features:

- *keeps files of programs, names, addresses, birthdays, recipes, class or club rosters, anything
- *variable record and field lengths
- *phrase substitution editor
- *up to 8 user-definable fields
- *ML sort (up to 3 fields), search and delete functions
- *2 search modes — range and item
- *user-definable printer format, for any printer
- *up to 230 characters per record

For \$24.95 you get the database management system, our full documentation which includes a reference guide and a programmer's guide, and our 1981 Bibliography of articles relating to the Color Computer. Requires 16K Extended Basic. 32K recommended.

1982 TMS Bibliography — \$9.95



A sensational and educational version of a popular party game for the TRS-80* Color Computer . . .

For 1 to 10 players. Load a story into the computer. The players are asked to supply a noun, verb, part of body, celebrity, etc. which the program uses to complete the story. The story, which is displayed when all words are entered, will be hilarious. Silly Syntax requires 16K Extended Basic (32K for disk version). For \$19.95, you get a user guide and a tape containing the Silly Syntax game and 2 stories. You can create your own stories or order story tapes from the selection below.

Silly Syntax stories — Ten stories per tape.

- | | |
|----------------------|---------------------------|
| SS-001 - Fairy Tales | SS-004 - Current Events |
| SS-002 - Sing Along | SS-006 - Adventure/Sci-Fi |
| SS-003 - X-Rated | SS-007 - Potpourri |

Each story tape is \$9.95. 10% off for 3 or more story tapes. Disk is \$24.95 for Silly Syntax and 2 stories or \$49.95 for Silly Syntax and all 62 stories.



*TRS-80 is a trademark of Tandy Corp.

SUGAR SOFTWARE
2153 Leah Lane
Reynoldsburg, Ohio 43068
(614) 861-0565

CIS orders EMAIL to 70405, 1374

Add \$1.00 per tape or disk for postage and handling. Ohioans add 5.5% sales tax. COD orders are welcome. Dealer inquiries invited.

next program and destroy it.

Now, pay close attention! Remove the dummy plug and press the reset button in back of the computer. You will get a black screen with an "OK." Your program will be safe, but press *RUN* to double check. Rewind to the start of the tape, reset the counter to 000 and fast-forward to the location where your erased program began. You're in business. Now, you can *CSAVE* the revised program in the routine, but run it a few times and you will get the feel of it. If you have the dummy plug, tie a baggie tie-wire or ribbon tightly around the groove. (The plug is easy to misplace or overlook.) You will want to copy this routine into your reference notebook and refer to it until that happy day when you commit the routine to memory.

Get a $\frac{3}{8}$ " X $\frac{3}{8}$ " piece of gummed label. Stand a plastic cassette tape box on end, so that the bottom is to the left and the left side is up. Press the gummed square on the top corner nearest to the hinge. Make sure it is centered so that it doesn't overlap the ends of the box. If it does, it will get dog-eared from use. Take your felt-tipped pen and letter the square, "A." The next box will be "B," and so on. If you have the recommended rotary cassette caddy, and slip the box in a slot, the identifying "A" will stick out prominently on top. You will know you followed instructions correctly.

Do you have the Radio Shack title cards? If you'd rather create your own, send a S.A.S.E. and I will send you a free print-out on how to go about it. Back to the Radio Shack cards: extend the blue line down through the long, oblong square, dividing it into two equal segments.

Make it a point to organize your programs into categories. For instance: fun games, music, tutorials, utility, color graphics, kid stuff, you name it! Make up a demonstration tape to show off your favorite programs. Use one side of a tape for programs that fit into one category.

When you have determined your personal requirements, and picked a name to identify the type of program on the first side of a tape, neatly print, vertically, the category of the contents in the top half of the oblong space. When you figure out what kind of material your second side will contain, print it on the lower oblong. Now, when you store the cassettes, the top will show the "A" and the face will show the category.

Discard any title pages that may come with cassette tapes. If you use only one kind of title card, you get a satisfyingly professional look.

There is no rule saying that you have to fill a 60 minute tape with programs. After you run to about 200 or 250 counter units into a tape, it becomes time-consuming to rewind and locate the higher numbered programs. Start a new tape!

What have we wrought? Each program has a home with an address. "A" means the program is on side one of tape "A." "C2" means the program is on side two of tape "C." (More on this is the next article.)

Following is an example of how to list four programs on side one of tape "A:"

START	NAME	END
3	CAMELOT	17
24	PLUNK	31
38	RED-BOX	40
46	CANYON	62

You would enter the above information in black or blue ink in the top four lines. Note that we left ample space between programs.

Occasionally, you will need special instructions for some programs. For example: *PCLEAR 1*, or you may require joysticks to operate a program. Insert a coded symbol that

FREE SHIPPING UPS GROUND

Buy a disk drive for
your COCO that's
better and saves
you money!!

TANDON DISK DRIVES

Bare/ with case and power supply

TM100-1 Single Sided \$199./\$249.

TM100-2 Double Sided \$299./\$349.

2 DRIVE CABLE \$24.95

PRINTERS

EPSON MX80 \$499.

EPSON MX80/FT \$559.

OKIDATA 82 \$459. w/500 d'pr.

STAR GEMINI-10 \$379.

PROWRITER \$519.

16K CHIP SET \$14.95

HAYS STACK SMART MODEM \$239.

KRAFT JOY STICK \$49.95

WICO COCO TRACKBALL \$69.95

VERBATIM

SS/DD DISKETTES \$25.95

COMPUKIT

1-800-231-6671

1-713-480-6000

P.O. BOX 306 Kemah, Texas 77565

or visit our show room at 16206D

Hickory Knoll Houston, Texas

has meaning to you between the starting number and the name. Make up your own code!

Congratulations! Doesn't it make you feel good to have your tapes under control? Next time, we will establish a "tape register." For now, organize your tapes, and use that notebook you were asked to purchase. And, as I've said before, don't forget to have fun!



PROGRAMMING UTILITY



The Latest Program? Here's A Dating System

By Jorge Mir

If you are like me, you're probably never satisfied with a program. There is always that little change required to satisfy our fancy, to add that subroutine that is missing, to improve the print statements so it looks better, etc., etc.,

Ever since I added the disk system, I hardly ever erase an old program until I just need additional room in the disk. As a result, I end up with copies of the same program at various stages of development and usually have a hard time determining which of the copies represent the latest revision.

The program listed below solved my problem rather simply, since it forces me to indicate the latest date of the revision. This way, I can list the various versions of the program and immediately select the latest one.

Here is how the program works:

When you first load and *RUN* the program, it recognizes that it is the initial run, so it bypasses the "dating" subroutine. Before it starts *EXECuting* the regular program, it records the Basic pointers that indicate the end

of the Basic program (records them at locations &H200 and &H201).

If you make any changes in the program and try to run it again, it compares the new Basic pointers to those recorded initially and recognizes a change has been made which then causes the program to ask you for a new date.

Once you *ENTER* the new date, it is actually imbedded in the program itself so that next time you list the program you can see the new date appearing as part of the program.

Whenever I am going to start a new program, I simply load the program listed below, change the program name appearing at the beginning of the program and start typing the new program at step 10 through 9999.

One word of caution: If you make changes in the program, but the length of the program does not change, it will not recognize that changes have been made and the dating subroutine will be bypassed. For an example, if you add a new line with 10 characters and delete an old line also with 10 characters, the length of the program will not change and the dating subroutine will be bypassed.

Those of you who have the same problem I had in recognizing latest versions of programs might find this program useful.

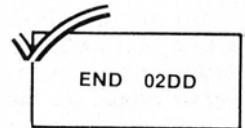

The Listing:

```

5 GOSUB 10000
6 * *****
7 * STEPS 10 THROUGH 9999 ARE
8 * RESERVED FOR YOUR PROGRAM
9 * *****
9999 END
10000 A=PEEK(27)*256+PEEK(28)
10010 B=PEEK(&H200)*256+PEEK(&H201)
10020 IF A=B THEN RETURN
10030 POKE&H200,PEEK(27):POKE&H201,PEEK(28)
10035 IF B&&H600 THEN RETURN
10040 X=VARPTR(DATE$)
10050 CLS:PRINT@168,"LATEST REVISION:"
10060 PRINT TAB(11) DATE$
10070 PRINT@481,"(PRESS <ENTER> FOR NO CHANGE)";
10080 PRINT@264,"ENTER NEW DATE:"
"
10090 PRINT TAB(11)"";:LINE INPUT D$:IF D$="" THEN RETURN
10100 IF LEN(D$)<8 THEN D$=D$+"":GOTO10100
10110 IF LEN(D$)=8 THEN 10140
10120 PRINT:PRINT TAB(11)"TRY AGAIN!"
10130 SOUND200,1:FOR D=1TO500:NEXTD:SOUND200,1:GOTO10050
10140 Y=PEEK(X+2)*256+PEEK(X+3)
10150 FOR X=1TO8:POKE Y,ASC(MID$(D$,X,1)):Y=Y+1:NEXT
10160 RETURN

```



CUBE SOLVER A GRAPHIC SPECTACULAR



MORE THAN FOUR
COLORS IN HIGH
RESOLUTION GRAPHICS
MACHINE LANGUAGE

Humiliate the frustrating little puzzle.

This Program will:

- Let you solve a cube on the screen.
- Solve the cube for you or mix it up.
- Let you mix it up and solve it for you.
- Print all solutions to screen, tape or printer.
- Play a little music to get you started.
- Save your challenges on tape.
- 16K Extended \$19.95 Postage Paid



Moreton Bay



Software

**MORETON BAY
SOFTWARE**
316 Castillo Street
Santa Barbara, CA 93101
(805) 962-3127
CA Residents Add 6% Sales Tax

ADVENTURES

16K CIRCUS ADVENTURE \$9.95
A child's adventure game with many songs, graphics, and surprises. Meet all of your circus favorites while searching for the popcorn man. Great family fun for all ages.

16K SCHOOLMAZE ADVENTURE \$11.95
While in search of a lost computer tape, you travel in a school and draw pictures, compose songs, play basketball, and use the keyboard to travel in the hallways.

GAMES

COCO-JOT by Steve Greenberg
16K \$11.95
A new version of the famous Jotto word game. A guessing game using your powers of reasoning and deduction. 1 or 2 player game. Different levels of play. Ages 8 to adult. User modifiable.

"FROG-MAN" by Carsten Lawrenz
16K Ext. Basic \$11.95
Lively, action packed, joystick controlled game. 7 levels of difficulty and timer. Best score displayed. Get your frogs safely home through several interesting obstacles.



DEALERS INQUIRIES INVITED

Authors: We are seeking quality children's software for leisure or learning. Write for details. Top royalties.



EDUCATIONAL

FOREIGN LANGUAGE GAMES 16K Ext. or 16K \$9.95
FRENCH BASEBALL — Score base hits or home runs for correct answers. You're out if wrong. Correct answers supplied. Fun way to learn and practice vocabulary. 2 levels.
SPANISH BASEBALL — Same game using Spanish vocabulary words.
ITALIAN BASEBALL — Same game using Italian vocabulary words.
User Modifiable.

PLEASE SPECIFY LANGUAGE AND VERSION

HEBREW ALPHABET 16K Ext. Basic \$9.95
Learn to recognize the letters of the Hebrew alphabet. Each letter graphically displayed. Help command, vocabulary words included.

NEW HEBREW BULLETIN BOARD 16K EXT. \$15.95
A utility which will enable YOU to create Hebrew or Hebrew/English words, flash cards, sentences, etc. Easy to learn—Full documentation. It can also use any screen dump.

Computer Island Presents
THE BEST IN SOFTWARE FOR KIDS!

*** **NEW** ***

SOFTWARE FOR SPECTRUM'S LIGHTPEN

FUN-PAK: THIS 3 PROGRAM GAME SET WILL ENTERTAIN YOU WITH A 'GREAT' NEW DIMENSION FOR YOUR COMPUTER.
FUN-PAK TAPE 16-K Ext. \$14.95
LIGHTPEN AND TAPE \$34.95

COMPUTER ISLAND
DEPT. R
227 Hampton Green
Staten Island, N.Y. 10312

(212) 948-2748



BOOK

A BYTE OF COLOR BASIC
by Steve Blyn

A work-text containing — instruction, examples, illustrations, programs, and many practice exercises. 3 Units — Basic, Graphics, and Sound. 24 chapters to teach you what you need to know to begin reading, understanding, and writing your own programs. Answer Key included with each book. Great book for beginners. **\$4.95 NEW LOW PRICE plus 50¢ postage**

SCHOOL DISCOUNTS

MUSIC

NAME THAT SONG GAMES
16K Extended \$9.95 each
1. 72 children's popular songs. 2 levels of difficulty. Timer. Many hours of fun.
2. 72 all time pop, country, and movie melodies from the last three decades.
3. 60 Broadway Show tunes to test you on past musicals. Fun for all trivia buffs.



Free program on tape with orders of \$17.00 or more.

N.Y. Residents, please add proper tax
ALL TAPE orders postpaid

PRESCHOOL

PRESCHOOL PACK 1 by Joseph Kolar
16K Ext. \$11.95
Clown and Fish-Num: Two programs to help your child recognize and count the words and numbers 1 - 10. Hi-res graphics and lively songs help to attract and keep attention.

PRESCHOOL PACK 2 by Joseph Kolar
16K Ext. \$11.95
Count Kids and Add Penny: Two programs to help your child count and add up to 10. Beautiful hi-res graphics.

PRESCHOOL PACK 3 by Joseph Kolar
16K Ext. \$11.95
Alpha-Byte: Programs designed to teach recognition and identification of the alphabet. Attractive hi-res graphics.

MUSIC MARVEL 16K Ext. Basic \$9.95
Play 2 familiar children's songs. Large graphic displays. No reading or musical ability needed. Great for pre-schoolers. 16K version also available. Please specify.

DOLLARS AND SENSE 16K Ext. \$11.95
Learn to make purchases. Graphic displays of items kids love. Player buys using dollars and coins to practice using money correctly. Solutions given.

McCOCO'S MENU 16K Ext. \$11.95
America's favorite pastime — going out to eat! Learn to buy and add up your purchases from a typical fast food restaurant menu. Gain skill in using money. Different prices each time.

ADDITION AND SUBTRACTION 16K \$11.95
Menu driven, 2 level program provides practice in adding or subtracting 2 digit numbers. Vertical format for proper entry of digits in the answers. Report card scoring.

READING 2-PAK 4K \$9.95
POETRY and SILLY SENTENCES: Any child can create his own original reading material about familiar people and things through user input.

READING GAMES 2 Pack 4K \$9.95
Silly Stories and Wizard: These games provide practice in reading simple stories and phrases. User input make these games personal and fun and keep your child interested in reading the results.



A Powerful DOS For Basic Inflexibility

By Dr. Laurence D. Preble

They didn't finish! They could have. There was enough room. But they just didn't finish the job. (No, not you, Mr. Stark.) I am talking about Radio Shack's Disk Operating System (DOS) for the Color Computer.

I don't mean to be overly critical. Radio Shack gave us a fine computer, after all. In the beginning, maybe the folks at Radio Shack just didn't realize that people would want to use their nifty new Color Computer for things other than *Raster Blasters* and the like. You and I know better. Sure! Games are fun. But our little CoCo is capable of much more: word processing, spelling-checker programs, spreadsheet business analysis, telecommunications. All of these and more are possible.

Radio Shack's Disk Basic does allow you to load and save files, initialize a disk, read or write individual sectors, manipulate random access files and do many of the things a good DOS should do. But here's the rub: while Radio Shack's Disk Basic allows you to perform many of the functions of a real DOS, the major drawback is that it only works from Basic. Machine language programs must all be called from Basic. There is no simple way for powerful business programs to use the DOS unless they are at least partly written in Basic; so you are limited in power and speed.

A good DOS should provide a friendly *environment* for the user. The DOS environment should provide numerous means of manipulating disk files and should provide a

simple means of invoking machine language programs. In addition, there should be available detailed instructions for incorporating the various DOS capabilities into your own machine language programs.

In previous months, you have seen my articles on FLEX (TM of Technical Systems Consultants). If you missed any particular issue, I understand that *the Rainbow* is happy to sell you back issues while they last. FLEX is a complete and powerful DOS; however, your computer must be modified to accept 64K of RAM before you can use FLEX. Also, programs that run under Radio Shack DOS will not run under the FLEX DOS without modification.

STAR-DOS To The Rescue

Peter A. Stark, who has previously offered useful additions to CoCo's repertoire such as SPELL 'N FIX (TM), is now offering STAR-DOS (TM).

When I received STAR-DOS for review, I was pleasantly surprised to find that it easily meets my aforementioned definition of a good DOS. STAR-DOS is complete and user friendly. Machine language programs can be called into action by simply typing the file name of the program. For example, STAR-DOS comes with a machine language utility called BUILD/BIN. This utility allows you to type in and save text to disk. Suppose we want to make a text file called NOTES/TXT. We would invoke BUILD/BIN by typing: BUILD NOTES. Note that default file extensions need not be entered. Now start typing your notes. When finished type a '#' as the first character on a line. NOTES/TXT is saved to disk leaving you back in the STAR-DOS operating system.

STAR-DOS comes with a number of DISK RESIDENT commands like BUILD. There is a LIST command to allow you to list the text files you have built. There is a DIR command to get you a directory printout of the files on a particular drive. You can also make your own commands. Any machine language program can be considered a "command."

STAR-DOS also has a few memory resident commands. Memory resident commands are invoked the same way as disk resident commands except that there is no need to wait for a memory resident command to load in.

One of the more interesting memory resident commands is PNS which stands for Printer Non-Standard. This command allows you to use a printer which has no status line (handshaking) and which needs its own line feeds after each carriage return. Baud rates can also be altered.

Unlike FLEX, STAR-DOS is completely compatible with programs written for the Radio Shack DOS. The file structure is the same. Nonetheless, I have a strong suspicion that Mr. Stark was influenced by the design of the FLEX DOS. The two operating systems are very similar in many respects. In fact, Mr. Stark provides some helpful instructions for converting existing FLEX programs to run under STAR-DOS.

Getting into STAR-DOS itself is easy; but first make a backup copy of the supplied disk. I wouldn't want to witness your reaction if your disk drives suddenly decide to chew up your only copy of the software. Next, type RUN "STAR-DOS." STAR-DOS signs on and asks you for today's date. STAR-DOS is ready for your commands. When you want to get back to Basic, just type BAS. ZIP! You're back. Nice.

(STAR-KITS, P.O. Box 209, Mt. Kisco, NY 10549, \$49.95)

Now! THE MOST COMPLETE LIST OF
EDUCATIONAL COLOR COMPUTER™
PROGRAMS IN THE UNITED STATES

Only **\$6⁰⁰** per cassette

A partial list —

- Add
- Algebra
- Alphabet
- Planetary Positions
- Flash cards for German, French, Spanish, States and Capitals
- Biology
- Weather Forecaster
- Physics

Programs for — TRS 80 Color Computer,
VIC 20, Atari 400, Timex-Sinclair

Many more! From Kindergarten through graduate courses. All cassettes \$6⁰⁰ each. Write for free list.

MOSES ENGINEERING COMPANY

P. O. Box 11038 • Ardmore Hwy. Station
Huntsville, Alabama 35805
(205) 837-3356

MONKEY KONG!

By Ken
Kalish

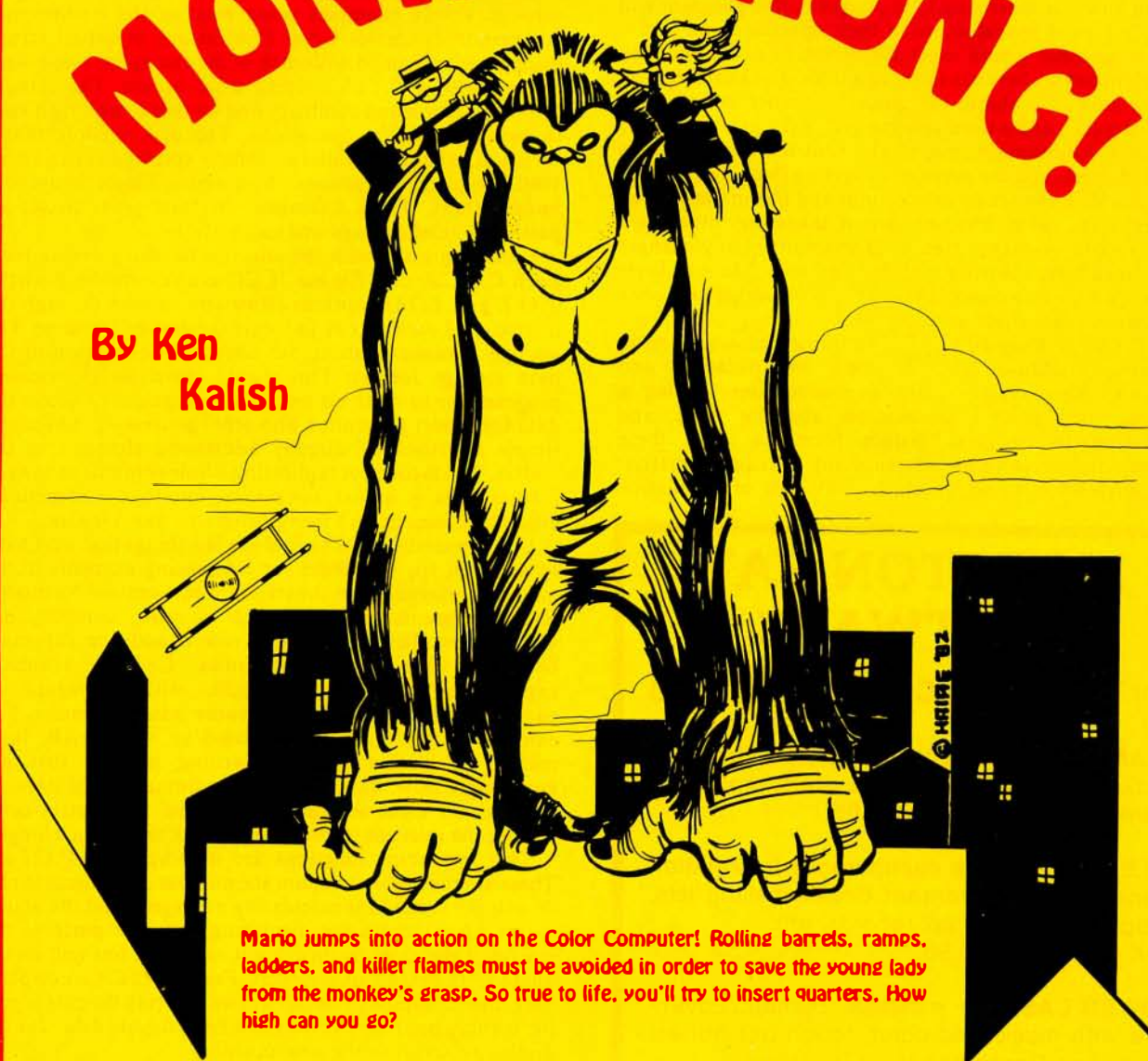

Mario jumps into action on the Color Computer! Rolling barrels, ramps, ladders, and killer flames must be avoided in order to save the young lady from the monkey's grasp. So true to life, you'll try to insert quarters. How high can you go?



MONKEY KONG Color Computer 16K cassette \$24.95
Please add \$2.00 for shipping and handling



**Med Systems Software • P.O. Box 3558 • Chapel Hill, NC 27514
TO ORDER, CALL: 1-800-334-5470**

C.C.Calc: Impressive 'Spread Sheet' For CoCo

C.C.Calc is an electronic spread sheet program designed especially for the Color Computer. It incorporates many of the features found in the popular spread sheet programs like VisiCalc and SuperCalc running on some of the more expensive micros. C.C.Calc does a good job of providing the basics in an inexpensive package. If you have never used a spread sheet or matrixing-type program, this program will provide a good introduction to their operation and use.

An electronic spread sheet allows you to easily establish the relationships between items in a table. For example, you might have a column of prices, another of margins (percentages), and a third column giving the profit in dollar amounts. Additionally, you might want totals for columns one and three, and the average margin on these figures. The program does the actual calculations and fills in the derived values in the table. Furthermore, it takes very little extra work to add or change figures. The results of any changes are immediately incorporated into the table. These features make it possible to engage in 'what if' problem solving, once the spread sheet is set up.

C.C.Calc is designed to perform the common arithmetic operations—addition, subtraction, multiplication and division. Also available are exponentiation (raising a number to a power), summation, absolute value, and truncation to integers. Within formulas using these operations, you can also reference any cells in the matrix. This allows you to set up almost any type of calculation

ordinarily done with a calculator, pencil and a pad of paper.

In C.C.Calc's 26 by 26 matrix, each cell is referenced by a column and row designation (using the letters A-Z). A cursor can be moved from cell to cell by using the arrow keys or by specifying a two-letter column-row address. Each cell in the matrix can have three items associated with it: values, formulas, and labels. This feature is unique to C.C.Calc. Other spread sheet programs allow only values and formulas to be associated with a particular cell. Labels must be put in separate cells. C.C.Calc makes it possible to hide intermediate calculations 'under' labels. This effectively provides more usable space.

The instructions furnished with C.C.Calc lead you through simple examples using most of the features and commands available. Good illustrations of actual screen displays are provided with each of the examples. These were created with C.C.Calc's screen print option. The manual also has a command summary and an index, making it easy to look up specific operations. The disk version, that I reviewed, is supplied with two sample spread sheets, a Form 1040A medical deductions sheet and a simple household budget sheet. These examples illustrate ways to set up particular relationships and calculations.

I was impressed with the effective handling of disk files. Each C.C.Calc data file has /CCC as an extension. Both the SAVE and LOAD options allow you to scan through the directory of such entries to locate the desired filename. The manual contains a short but adequate description of the data storage format. This would allow an experienced programmer to write his own Basic programs to access the data for report generation and other processing. I liked the simple approach of directly addressing elements in the matrix. The facility for replicating whole columns or rows of relationships is a real worksaver, one that is sometimes difficult to accomplish using programs like VisiCalc.

Unfortunately, there were also a few things that were hard to get used to. The order for referencing elements in the matrix is reversed from the standard convention! Normally, matrix elements are referenced by (row, column), but C.C.Calc uses first column, then row. In addition, care must be taken when entering formulas. C.C.Calc evaluates expressions from left to right, without regard to parentheses. This can lead to some unusual results. For example $+2*(AA+AB)$ is evaluated as $+2*AA+AB$. Both matrix calculation and the writing of disk files are annoyingly slow, due mainly to the limitations of Basic. It takes about eight seconds to scan the 676 matrix cells; writing the relevant information to disk takes much longer.

Two important functions are missing from C.C.Calc. These are the ability to count the number of elements in row or column (useful for calculating averages), and the ability to set up windows for displaying different parts of the matrix. This latter feature might not work too well on the limited size of the CoCo display. Further, C.C.Calc displays only three columns by thirteen rows. Moving the cursor past the display boundary results in a few seconds delay for the display to scroll to the new position.

My overall impression of C.C.Calc is very favorable. This inexpensive program, designed to operate in 32K, provides most of the essential features of a spread sheet program at a modest cost. The carefully designed display format and simplified keyboard response is just right for the casual user. C.C.Calc is not designed for extensive business use, but it certainly will fill the bill as a friendly introduction to the use of electronic spread sheets.

(Transformation Technologies, 194 Lockwood Lane, Bloomingdale, IL 60108, \$25.00 disk or tape)

—Stuart Hawkinson

MORETON BAY SOFTWARE

For TRS 80 Color Computer & TDP 100

PLANETARIUM - a five program astronomy package. See constellations, stars, moon and planets 16K extended \$16.95.

FILE CABINET - a multipurpose information management program set. Create mailing lists, recipes, inventory tax records, etc. 16K extended \$25.95.

TOWER CASTLE - a classic thematic adventure with music and color, tough but honest (Reviewed December 1982 Rainbow) 32K extended \$17.95



Moreton Bay



Software
TRS 80 • Tandy Corp.

MORETON BAY SOFTWARE

316 Castillo Street
Santa Barbara, CA 93101
(805) 962-3127

CA Residents Add 6% Sales Tax

A WORD FROM THE SPONSOR

Hi again. This is Month Two in my series of short chats about various Color Computer subjects in these Star-Kits ads. Hope you will find them interesting and useful.

Judging from several phone calls I've received, there seems to be some confusion as to what a DOS (Disk Operating System) can do for you. One recent caller summarized it best when he said, *I'd like to buy your STAR-DOS. Can you tell me how it will help me write better Basic programs?* My answer must have shocked him, because I told him not to buy any DOS. In fact, I myself have talked about a dozen potential STAR-DOS purchasers out of buying it. I don't know whether other DOS vendors have done the same, but I'm convinced that there are many readers among you who have bought a DOS (hopefully not ours) and have absolutely no use for it whatsoever. Let me explain.

To use a disk you need the hardware (a disk drive and controller) and the software (a disk operating system or DOS). In most computers, the controller can do little by itself except load the DOS from the disk into memory. Hence, without the DOS, the disk system is useless. But the Color Computer is unique — its controller has an 8K ROM (Read Only Memory) which acts as an extension to Basic and lets Basic access the disk directly without needing a separate DOS.

Thus, in other computers, you either need a separate DOS on disk to load Basic in the first place, or at least to tell Basic how to access the disk. In the Color Computer, Basic knows how to use the disk as soon as you plug in the controller. Hence, if you only run Basic programs, you have absolutely no need for a separate DOS. (In fact, a DOS just gets in the way of Basic!) So what does a DOS do, you ask?

A disk operating system lets you run machine language programs which use the disk. These can be purchased programs, or programs you write yourself.

But here's another catch. On most other computers, since you must have a DOS to use the disk, everyone writing disk programs simply uses the DOS for the disk functions, since they just assume that everybody has one. But Color Computer disk operating systems are very new. Hence many software suppliers, figuring you don't have a DOS, have gone to great pains to include enough functions in their programs so that you don't need a DOS to run them. (For example, our own SPELL 'N FIX has its own disk routines and does not need any additional DOS.)

So when should you buy a DOS? There are really only two cases: (1) You intend to write your own programs to use the disk, and need some simple way of interfacing to the disk, or (2) there is some specific program you want to run which requires a DOS. For example, if you want to run our DBLS or Disk Sort-Merge (oops . . . we won't announce that 'till next month), then you will need STAR-DOS.

So, if one of these two cases applies to you, by all means buy one. But don't get one unless you have a real need. And that applies to our STAR-DOS as well as others.

By the way . . . did you hear the one about the program to translate English to Russian? To test it, they translated *The spirit is willing but the flesh is weak. The Russian translation came out something like *The vodka is amenable, but the meat tastes bad.**

See you next month.

Pete Stack

SPELL'N FIX

Regardless of whose text processor you use, let SPELL 'N FIX find and fix your spelling and typing mistakes. It reads text faster than you can, and spots and corrects errors even experienced proofreaders miss. It is compatible with all Color Computer text processors, including Telewriter and Radio Shack's Scripsit! (See the review in 80 Micro, November 1982.) \$69.29 in the Radio Shack disk or cassette versions; \$89.29 in the Flex version. (20,000 word dictionary is standard; optional 75,000 word Super Dictionary costs \$50 additional.)

HUMBUG — THE SUPER MONITOR

A complete monitor and debugging system which lets you input programs and data into memory, list memory contents, insert multiple breakpoints, single-step, test, checksum, and compare memory contents, find data in memory, start and stop programs, upload and download, save to tape, connect the Color Computer to a terminal, printer, or remote computer, and more. HUMBUG on disk or cassette costs just \$39.95.

STAR-DOS

A Disk Operating System specially designed for the Color Computer, STAR-DOS is fully compatible with your present Color Computer disk format — it reads disks written by Extended Disk Basic and vice versa. But with STAR-DOS you can use machine and assembly language programs to do things Basic can't. Just \$49.95.

ALL IN ONE — Editor Etc.

Three programs in one — a full function Editor for text or program files; a Text Processor for formatting and printing text files with centering, justification, and paging, and a Mailing List and Mailing Label program which can even generate individually addressed letters for each person (or selected persons) on your mailing list. All this for just \$50. Requires STAR-DOS and 32K.

DBLS for Data Bases

DBLS stands for Data Base Lookup System. A super-fast system for searching for a selected record in a sequential disk file. Supplied with SPELL 'N FIX's 20,000 word dictionary as a sample data file — lets you look up the spelling of any word in under FOUR seconds. Priced at \$29.95. Requires STAR-DOS.

CHECK 'N TAX

Home accounting package combines checkbook maintenance and income tax data collection. Written in Basic for either RS Disk or Flex, \$50.

REMOTERM

REMOTERM — allows full operation of the Color Computer from an external terminal. \$19.95.

NEWTALK

NEWTALK — a memory examine utility for machine language programmers which reads out memory contents through the TV set speaker. \$20.

SHRINK

SHRINK — our version of Eliza, in machine language and extremely fast. \$15.

OXXO

OXXO — our version of Othello, also machine language and fast. \$15.

We accept cash, check, COD, Visa, or Master Card. NY State residents please add appropriate sales tax.

STAR-KITS

P.O. BOX 209-R
MT. KISCO, N.Y. 10549
(914) 241-0287

AHHA! Another Haunted House Adventure!

By Geoff Wells

In this third and final installment of the general all purpose adventure driver (GAPAD) program, we present the changes and additions necessary to run yet another haunted house adventure. This is the complete program for *AHHA*, so those of you who have already typed in *GAPAD* need only make a few changes and add some of the data.

The mysterious old miser has been dead for many years, but the fortune, said to be hidden somewhere in his old mansion, has yet to be found. Many people have entered the mansion to search for the treasure, but none has ever returned. There are stories of the old man's ghost being too mean to leave the money behind, and strange cries of anguish have been heard from those who have tried to steal it.



180	03D6
320	0864
800	0D57
2000	1422
4002	1A43
END	25EC

The Listing:

```

0 'AHHA**ANOTHER HAUNTED HOUSE A
DVENTURE
1 'GEOFF WELLS
2 '21-12 EAST AVE N.
3 'HAMILTON-ONTARIO
4 'CANADA-L8L 5H2
5 '(416) 529-1319
6 'SPRING 1982
7 CLEAR1000
10 DIMMC$(3,6),IN$(4),FW$(40),SW
$(39),FC$(40),SC$(39),OL(14,1),O
D$(14),OK$(14)
20 FORNF=1TO4:IN$(NF)="*":NEXTNF
30 FORNF=1TO60:READDUMMY$:NEXTNF
40 FORNF=1TO40:READFW$(NF),FC$(N
F):NEXTNF
50 FORNF=1TO39:READSW$(NF),SC$(N
F):NEXTNF
60 FORX=1TO3:FORY=1TO6:READMC$(X
,Y):NEXTY,X
70 FORNF=1TO14:READOL(NF,0),OL(N
F,1),OD$(NF),OK$(NF):NEXTNF
90 X=1:Y=6
100 GOSUB4000:D$=MID$(MC$(X,Y),1
,6):L1=VAL(MID$(MC$(X,Y),7,2)):L
2=VAL(MID$(MC$(X,Y),9,2)):L3=VAL
(MID$(MC$(X,Y),11,2)):L4=VAL(MID
$(MC$(X,Y),13,2))
110 RESTORE:L$=""
120 FORNF=1TO4:READDUMMY$:IFL1=N
F THENL$=DUMMY$:NEXTNF ELSENEXTN
F
130 FORNF=1TO15:READDUMMY$:IFL2=N
F THENL$=L$+DUMMY$:NEXTNF ELSEN
EXTNF
140 FORNF=1TO18:READDUMMY$:IFL3=N
F THENL$=L$+DUMMY$:NEXTNF ELSEN
EXTNF
150 FORNF=1TO23:READDUMMY$:IFL4=N
F THENL$=L$+DUMMY$:NEXTNF ELSEN
EXTNF
160 OB$="":FORNF=1TO14:IFOL(NF,0
)=X ANDOL(NF,1)=Y THENOB$=OB$+"-
"+OD$(NF):NEXTNF ELSENEXTNF:IFOB
$="" THENOB$=" NOTHING SPECIAL"
170 CLS:P$="YOU ARE "+L$:GOSUB500
0
180 P$="I SEE"+OB$:GOSUB5000
190 PRINT"POSSIBLE DIRECTIONS "
191 IFMID$(D$,1,1)="N"THENPRINT"
NORTH ";
192 IFMID$(D$,2,1)="S"THENPRINT"
SOUTH ";

```

```

193 IFMID$(D$,3,1)="E"THENPRINT"
EAST ";
194 IFMID$(D$,4,1)="W"THENPRINT"
WEST ";
195 IFMID$(D$,5,1)="U"THENPRINT"
UP ";
196 IFMID$(D$,6,1)="D"THENPRINT"
DOWN ";
197 PRINT:PRINTSTRING$(32,"*");
200 G=RND(10):IFX=1ANDY=4ORX=2AN
DY=1THENG=G+4
201 IFG>9THENPRINT"THE MISERS GH
OST IS HERE"
202 INPUT"WHAT NOW BOSS";C$
210 IFC$="N"THEN601ELSEIFC$="S"
HEN602ELSEIFC$="E"THEN603ELSEIFC
$="W"THEN604ELSEIFC$="U"THEN605E
LSEIFC$="D"THEN606ELSEIFC$="LOOK
"THEN160ELSEIFC$="HELP"THEN650EL
SEIFC$="SAVE"THEN700ELSEIFC$="LO
AD"THEN800ELSEIFLEFT$(C$,2)="GO"
THENC$="*GO"
211 IFLEFT$(C$,3)="INV"THEN611EL
SEIFC$="SCORE"THEN3600
212 IFG>9THENPRINT"THE GHOST CLA
IMS ANOTHER VICTIM":END
220 S=0:SP=0:FORN=1TOLEN(C$):IF
MID$(C$,NF,1)=" "THENS=NF:SP=SP+
1:NEXTNF ELSENEXTNF
230 IFS=0THENPRINT"

```

POWER LINE PROBLEMS?



SPIKE-SPIKER® ...THE SOLUTION!

Protects, organizes, controls computers & sensitive, high tech electronic equipment. Helps prevent software "glitches", unexplained memory loss, and equipment damage. Absorbs damaging voltage spikes & surges, reduce costly equipment downtime. Filter models attenuate conducted RF interference. 120V, 15 Amps. Other models available. Ask for free literature for detailed specs. Call your order in today!



DELUXE POWER CONSOLE

\$79.95

Transient absorber, dual 5-stage filter. 8 individually switched sockets, fused, main switch, and lite.

QUAD-II \$59.95

Transient absorber. Dual 3-stage filter. 4 sockets, lite.

QUAD-I \$49.95

Transient absorber, 4 sockets, lite.

MINI-II \$44.95

Transient absorber, 3-stage filter, 2 sockets, lite.

MINI-I \$34.95

Transient absorber, 2 sockets, lite.



Use your credit card or send check & we pay the shipping.

215-837-0700

Out of state, order toll free

800-523-9685 • TWX 510-651-2101



6584 Ruch Rd., Dept. RB
Bethlehem, PA 18017

PA Res. add 6% sales tax * for COD add \$3.00 + shipping * dealers invited

```

WHAT?---":GOTO200
240 IFSP>1THENPRINT"ONLY TWO WOR
DS PLEASE":GOTO200
250 LC$=LEFT$(C$,S-1):RC$=RIGHT$(
C$,LEN(C$)-S):IFRC$="UP"THENRC$
="*UP"
260 FC$(0)="*":FORNF=1TO40:IFLEF
T$(LC$,3)=FW$(NF)THENFC$(0)=FC$(
NF):NEXTNF ELSENEXTNF
270 IFFC$(0)="*"THENPRINT"I DON'
T RECOGNIZE THE VERB":GOTO200
280 SC$(0)="*":FORNF=1TO39:IFLEF
T$(RC$,3)=SW$(NF)THENSC$(0)=SC$(
NF):NEXTNF ELSENEXTNF
300 IFSC$(0)="*"THENP$="I DON'T
KNOW WHAT A "+RC$+" IS":GOSUB500
:GOTO200
310 M=0:FORNF=1TOLEN(SC$(0)):IFM
ID$(SC$(0),NF,1)=FC$(0)THENM=99:
NEXTNF ELSENEXTNF
320 IFM=0THENP$="I DON'T KNOW HO
W TO "+LC$+" A "+RC$:GOSUB500:GO
TO200
330 ONASC(FC$(0))-64GOSUB1000,11
00,1200,1300,1400,1500,1600,1700
,1800,1900,2000,2100,2200,2300,2
400,2500,2600,2700,2800,2900,300
0,3100,3200,3300,3400,3500
340 IFR=1THENR=0:GOTO100ELSE200

```

```

500 IFLEN(P$)>32THENP1$=LEFT$(P$
,32):P2$=RIGHT$(P$,LEN(P$)-32)EL
SEIFLEN(P$)=32THENPRINTP$::RETUR
NELSEPRINTP$:RETURN
510 IFLEFT$(P2$,1)=" "THENP2$=RI
GHT$(P2$,LEN(P2$)-1):PRINTP1$::P
$=P2$:GOTO500
520 IFRIGHT$(P1$,1)=" "ANDLEN(P1
$)=32THENPRINTP1$::P$=P2$:GOTO50
0ELSEIFRIGHT$(P1$,1)=" "THENPRIN
TP1$:P$=P2$:GOTO500
530 P2$=RIGHT$(P1$,1)+P2$:P1$=LE
FT$(P1$,LEN(P1$)-1):GOTO520
601 IFMID$(D$,1,1)="N"THENY=Y-1:
GOTO100ELSE607
602 IFMID$(D$,2,1)="S"THENY=Y+1:
GOTO100ELSE607
603 IFMID$(D$,3,1)="E"THENX=X+1:
GOTO100ELSE607
604 IFMID$(D$,4,1)="W"THENX=X-1:
GOTO100ELSE607
605 IFMID$(D$,5,1)="U"THENY=Y-3:
GOTO100ELSE607
606 IFMID$(D$,6,1)="D"THENY=Y+3:
GOTO100
607 PRINT"YOU CAN'T GO THAT WAY"
:GOTO200
611 IN$(0)="":FORNF=1TO4:IFIN$(N
F)<>"*"THENFORI=1TO14:IFIN$(NF)=
OK$(I)THENIN$(0)=IN$(0)+"-"+OD$(
I):NEXTI:NEXTNF ELSENEXTI:NEXTNF
ELSENEXTNF
612 IFIN$(0)=" "THENIN$(0)="YOU A
RE NOT CARRYING ANYTHING"ELSEIN$(
0)="YOU ARE CARRYING"+IN$(0)
613 P$=IN$(0):GOSUB500
614 GOTO200
650 IFX=2ANDY=1THENP$="WHAT WAS
WRITTEN IN THE BEGINNING MAY BE
OF SOME HELP HERE" ELSEP$="I CAN
BE OF NO ASSISTANCE HERE"
651 GOSUB500:GOTO200
700 CLS:INPUT"READY TAPE<PLAY &
RECORD>ENTER";E$
710 OPEN"O",-1,"GAPADFIL":PRINT#
-1,X,Y,SC,F:FORNF=1TO4:PRINT#-1,
IN$(NF):NEXTNF:FORZ=1TO3:FORW=1T
O6:PRINT#-1,MC$(Z,W):NEXTW,Z:FOR
NF=1TO14:PRINT#-1,OL(NF,0),OL(NF
,1):NEXTNF:CLOSE:GOTO100
800 CLS:INPUT"READY TAPE<PLAY>EN
TER";E$
810 OPEN"I",-1,"GAPADFIL":INPUT#
-1,X,Y,SC,Y:FORNF=1TO4:INPUT#-1,
IN$(NF):NEXTNF:FORZ=1TO3:FORW=1T
O6:INPUT#-1,MC$(Z,W):NEXTW,Z:FOR
NF=1TO14:INPUT#-1,OL(NF,0),OL(NF
,1):NEXTNF:CLOSE:GOTO100
1000 IN$(0)="":FORNF=1TO4:IFIN$(
NF)=RC$ THENIN$(0)="YOU ALREADY

```

THE SOFTWARE SHOP

(617) 339-3734

We Specialize In Color Computer Programs
Call or Write For Our Catalog

ARCADE STYLE	UTILITIES	EDUCATIONAL
Pac Attac Galax Attax Storm	Tape to Disk Disassembler Assemblers	Spelling Math Geography
ADVENTURE	PERSONAL	BUSINESS
Madness & Minatour Keys of the Wizard El Diablaro	Budget Household Expense Stock Analysis	Word Processing Inventory Gen. Ledgers

Over 100 Different Programs in Stock!

THE SOFTWARE SHOP

200 Chauncy Street
Mansfield, MA 02048

Visa and M.C. Accepted

AARDVARK

TRS-80 COLOR

OSI

VIC-64

VIC-20

SINCLAIR

TIMEX



QUEST — A NEW IDEA IN ADVENTURE GAMES! Different from all the others. Quest is played on a computer generated map of Alesia. Your job is to gather men and supplies by combat, bargaining, exploration of ruins and temples and outright banditry. When your force is strong enough, you attack the Citadel of Moorlock in a life or death battle to the finish. Playable in 2 to 5 hours, this one is different every time. 16k TRS-80, TRS-80 Color, and Sinclair. 13K VIC-20. \$14.95 each.



CATERPILLAR
O.K., the Caterpillar does look a lot like a Centipede. We have spiders, falling fleas, monsters traipsing across the screen, poison mushrooms, and a lot of other familiar stuff. COLOR 80 requires 16k and Joysticks. This is Edson's best game to date. \$19.95 for TRS 80 COLOR.

**PROGRAMMERS!
SEE YOUR PROGRAM IN THIS SPACE!!**
Aardvark traditionally pays the highest commissions in the industry and gives programs the widest possible coverage. Quality is the keyword. If your program is good and you want it presented by the best, send it to Aardvark.



ADVENTURES!!!
These Adventures are written in BASIC, are full featured, fast action, full plotted adventures that take 30-50 hours to play. (Adventures are interactive fantasies. It's like reading a book except that you are the main character as you give the computer commands like "Look in the Coffin" and "Light the torch.")
Adventures require 16k on TRS80, TRS80 color, and Sinclair. They require 8k on OSI and 13k on Vic-20. Derelict takes 12k on OSI. \$14.95 each.

ESCAPE FROM MARS
(by Rodger Olsen)

This ADVENTURE takes place on the RED PLANET. You'll have to explore a Martian city and deal with possibly hostile aliens to survive this one. A good first adventure.

PYRAMID (by Rodger Olsen)

This is our most challenging ADVENTURE. It is a treasure hunt in a pyramid full of problems. Exciting and tough!

HAUNTED HOUSE (by Bob Anderson)
It's a real adventure—with ghosts and ghouls and goblins and treasures and problems — but it is for kids. Designed for the 8 to 12 year old population and those who haven't tried Adventure before and want to start out real easy.

DERELICT

(by Rodger Olsen & Bob Anderson)
New winner in the toughest adventure from Aardvark sweepstakes. This one takes place on an alien ship that has been deserted for a thousand years — and is still dangerous!

Please specify system on all orders

ALSO FROM AARDVARK — This is only a partial list of what we carry. We have a lot of other games (particularly for the TRS-80 Color and OSI), business programs, blank tapes and disks and hardware. Send \$1.00 for our complete catalog.

AARDVARK - 80

2352 S. Commerce, Walled Lake, MI 48088

(313) 669-3110

Phone Orders Accepted 8:00 a.m. to 4:00 p.m. EST. Mon.-Fri.



TUBE FRENZY
(by Dave Edson)

This is an almost indescribably fast action arcade game. It has fast action, an all new concept in play, simple rules, and 63 levels of difficulty. All machine code, requires Joysticks. Another great game by Dave Edson. TRS 80 COLOR ONLY. 16k and Joysticks required. \$19.95.



CATCH 'EM
(by Dave Edson)

One of our simplest, fastest, funnest, all machine code arcade games. Raindrops and an incredible variety of other things come falling down on your head. Use the Joysticks to Catch'em. It's a BALL! — and a flying saucer! — and a Flying Y! — and so on. TRS 80 COLOR. \$19.95.

**BASIC THAT ZOOMS!!
AT LAST AN AFFORDABLE COMPILER!**

The compiler allows you to write your programs in easy BASIC and then automatically generates a machine code equivalent that runs 50 to 150 times faster.

It does have some limitations. It takes at least 8k of RAM to run the compiler and it does only support a subset of BASIC—about 20 commands including FOR, NEXT, END, GOSUB, GOTO, IF, THEN, RETURN, END, PRINT, STOP, USR (X), PEEK, POKE, *, /, +, -, >, <, =, VARIABLE NAMES A-Z, SUBSCRIPTED VARIABLES, and INTEGER NUMBERS FORM 0-64K.

TINY COMPILER is written in BASIC. It generates native, relocatable 6502 or 6809 code. It comes with a 20-page manual and can be modified or augmented by the user. \$24.95 on tape or disk for OSI, TRS-80 Color, or VIC.

```

HAVE THE "+RC$:NEXTNF ELSENEXTNF
1001 IFIN$(0)<>"THEN1050
1005 IFRC$="BOOK"THENP$="IT CRUM
BLES TO DUST AS YOU TOUCH IT":GO
SUB500:OL(3,0)=-1:OL(3,1)=-1:B=-
1:RETURN
1010 FORNF=1TO4:IFIN$(NF)="*"THE
NIN$(0)=STR$(NF):NEXTNF ELSENEXT
NF
1020 IFIN$(0)=""THENIN$(0)="YOU
CAN'T CARRY ANY MORE":GOTO1050
1030 FORNF=1TO14:IFRC$=OK$(NF)AN
DOL(NF,0)=X ANDOL(NF,1)=Y THENIN
$(VAL(IN$(0)))=OK$(NF):OL(NF,0)=
-1:OL(NF,1)=-1:IN$(0)="" :NEXTNF
ELSENEXTNF
1035 IFRC$="CHEST"THENMC$(2,1)="
*****01111223"
1040 IFIN$(0)=""THENR=1ELSEIN$(0
)="I DON'T SEE A "+RC$
1050 PRINTIN$(0):RETURN
1100 IN$(0)="" :FORNF=1TO4:IFIN$(
NF)=RC$ THENIN$(0)="*" :IN$(NF)="
*" :FORCK=1TO14:IFOK$(CK)=RC$ THE
NOL(CK,0)=X:OL(CK,1)=Y:NEXTCK EL
SENEXTCK:NEXTNF ELSENEXTNF
1110 IFIN$(0)=""THENPRINT"YOU AR
E NOT CARRING THAT":RETURNELSE=
1:RETURN
1200 IFX=2ANDY=2ANDRC$="WALL"THE
NCLS:PRINT@40,"THIS ADVENTURE":P
RINT@106,"WRITTEN BY":PRINT@169,

```

```

"GEOFF WELLS":PRINT@229,"21-12 E
AST AVE NORTH":PRINT@295,"HAMILT
ON ONTARIO":PRINT@360,"CANADA L8
L 5H2":PRINT@424,"(416) 529-1319
":PRINT:RETURN
1201 IFX=3ANDY=2ANDRC$="BUTTON"
HENPRINT"IT SAYS **WARNING** DO
NOT TOUCHTHIS BUTTON!!!":RETURN
1210 PRINT"I DON'T HAVE MY GLASS
ES ON":RETURN
1300 PRINT"USE N S E W U D FOR D
IRECTIONS":RETURN
1400 GOTO3700:'OPEN
1500 GOTO3700:'CLOSE
1600 GOTO3700:'HIT ATTACK KILL
1700 GOTO3700:'LOCK
1800 GOTO3700:'UNLOCK
1900 IFRC$="DRESSER"THEN1910ELSE
IFRC$="BAG"THEN1920ELSEIFRC$="CH
AIR"THEN1930ELSEIFRC$="BUTTON"TH
EN1940ELSE3700
1910 IFX=1ANDY=2THEN1911ELSEPRIN
T"I DON'T SEE A DRESSER":RETURN
1911 MID$(MC$(1,2),1,1)="N":MID$
(MC$(1,2),13,2)="03":R=1:RETURN
1920 IFX=1ANDY=1THEN1921ELSEPRIN
T"I DON'T SEE ANY BAGS HERE":RET
URN
1921 MID$(MC$(1,1),3,1)="E":MID$
(MC$(1,1),11,4)="1822":R=1:RETUR
N
1930 IFX=3ANDY=6THEN1931ELSEPRIN
T"I'D BE GLAD TO IF IT WAS HERE"
:RETURN
1931 MID$(MC$(3,6),11,2)="17":OL
(14,0)=3:OL(14,1)=6:R=1:RETURN
1940 IFX=3ANDY=2THENNEWELSEPRINT
"WHAT BUTTON":RETURN
2000 GOTO3700:'CLIMB
2100 GOTO3700:'PLAY
2200 IFX=2ANDY=1ANDRC$="AHHA"THE
N2201ELSEP$="OK '+RC$+' ' ---NOT
HING HAPPENED":GOSUB500:RETURN:'
SAY
2201 R=1:MC$(2,1)="***W**0111121
5":RETURN
2300 IFX=1ANDY=5THEN2301ELSEPRIN
T"I CAN'T SEE IT FROM HERE":RETU
RN
2301 IFB=0THENP$="IT SAYS--'KNOW
LEDGE OF ESCAPE IS A WEIGHTY SEC
RET' ":GOSUB500:RETURNELSEP$="ALL
I SEE IS A PILE OF DUST":GOSUB5
00:RETURN
2400 GOTO3700:'RUB
2500 IFX=2ANDY=5THENMID$(MC$(2,5
),1,1)="N":R=1ELSEPRINT"YOURS OR
MINE":RETURN
2501 IFF=0THENMID$(MC$(2,5),13,2
)="10":RETURNELSEIFF=-1THENMID$(

```

H I B

presents

SOFTWARE FOR THE COLOR COMPUTER TALK PROCESSOR 'I CAN TALK!'

Quick and easy to use. Has over 2 dozen common words. Make up hundreds of statements in 3 voices. Uses digitally recorded human speech for a more natural sound.
16K Ext. Basic \$ 14.95

SUB-MISSION

HI-RES Color Action Game. Dive into the 'Hole' and retrieve the black boxes, but avoid mines and falling depth charges. Elapsed time line, on screen scoring, good sounds, 3 levels and bonus points. Joysticks required.
16K Ext. Basic \$ 12.95

BONUS: Order submission and get
Missile Attack Underground game Free.

For immediate shipment send certified check or money order. NO C.O.D. Personal check orders shipped in 2 weeks. Send to HIB, 3505 Hutch Place, Chevy Chase, Maryland 20815. Add \$1.00 for shipping. Maryland residents add 5%.



```

MC$(2,5),13,2)="11":RETURN
2600 GOTO3700:'TOUCH
2700 GOTO3700:'ASK
2800 GOTO3700:'JUMP
2900 GOTO3700:'SWIM
3000 GOTO3700:'KICK
3100 GOTO3700:'SMASH
3200 IFX=1ANDY=2THEN3201ELSEPRINT
T"WHAT MIRROR?":RETURN
3201 M=0:FORN=1TO4:IFIN$(NF)="T
OWEL"THENM=99:NEXTNF ELSENEXTNF:
IFM=0THENPRINT"WITH WHAT?":RETUR
N
3202 MID$(MC$(1,2),2,1)="S":MID$(
MC$(1,2),11,2)="03":R=1:RETURN
3300 IFX=1ANDY=4THEN3301ELSEIFX=
3ANDY=4THEN3304ELSEPRINT"ON WHAT
":RETURN
3301 IN$(0)="" :FORNF=1TO4:IFIN$(
NF)="PRYBAR"THENIN$(0)="*":NEXTN
F ELSENEXTNF
3302 IFIN$(0)="" THENPRINT"YOU DO
N'T HAVE ONE":RETURN
3303 P$="YOU HAVE DISCOVERED THE
ROTTING CORPSE OF THE OLD MISER
. THE SHOCK HAS SCARED YOU TO DE
ATH!!":GOSUB500:END
3304 IN$(0)="" :FORNF=1TO4:IFIN$(
NF)="FUSE"THENIN$(0)="*":IN$(NF)
="*":NEXTNF ELSENEXTNF
3305 F=-1:MID$(MC$(2,5),13,2)="1
1":PRINT"OK":RETURN
3400 IN$(0)="" :FORNF=1TO4:IFIN$(
NF)="CHEESE"THENIN$(0)="*":NEXTN
F ELSENEXTNF

```

```

3401 IFIN$(0)="" THENPRINT"YOU DO
N'T HAVE ANY CHEESE":RETURN
3402 PRINT"IT WAS POISONED":END
3500 GOTO3700:'DRINK
3600 IFX=1ANDY=6ANDSC=100THENPRI
NT"CONGRATULATIONS-YOU HAVE WON"
:ENDELSEPRINT"YOUR PRESENT SCORE
IS";SC:GOTO200
3700 PRINT"I AM NOT PROGRAMED FO
R THAT":RETURN
4000 IFX=1ANDY=3THEN4001ELSEIFX=
2ANDY=4ANDF=0THEN4002ELSERETURN
4001 M=0:FORN=1TO4:IFIN$(NF)="C
HEST"THENM=99:NEXTNF ELSENEXTNF:
IFM=0THENRETURNELSEY=6:SC=100:PR
INT"THE FLOOR GIVES WAY-YOU ARE"
:FORN=1TO14:PRINT"FALLING!!!!":
NEXTNF:RETURN
4002 PRINT"YOU HAVE FALLEN AND B
ROKEN YOUR NECK":END
10000 DATA IN A ,ON THE ,AT THE
,IN THE
10010 DATA LARGE CLOSET. THERE I
S A COBWEB IN THE CORNER ,SMALL
BEDROOM. THERE IS A ,SMALL ,BRIG
HT & SUNNY CONSERVATORY ,FRONT P
ORCH OF A ,BOTTOM ,PANELED HALLW
AY ,LARGE DAMP BASEMENT. ,UPPER
LANDING ,LONG ,DUSTY ,SMALL STUF
FY CLOSET ,MASTER BEDROOM.
10011 DATA LARGE AIRY KITCHEN ,L
ARGE LIVING ROOM. THERE IS A POR
TRAIT HANGING ON THE WALL AND
10020 DATA WITH A ,VERY DUSTY MI
RROR ON ONE WALL ,LARGE DARK OPE

```

ACS

All Color Software

Post Office Box 15235
Plantation, Florida
33318

New! from ACS . . .

**Give your CoCo an
On/Off light for \$5.00!!**
Will NOT Void Warranty!



Now for only \$5 you can have an on/off light for your CoCo, without voiding your warranty!! If you own a joystick, can drill ONE hole, and make TWO connections, then you are ready for this simple Do-It-Yourself Kit!! This simple kit comes with the parts to modify 2 joysticks, and clearly written instructions on the procedure, which takes only 10 minutes on the average.

Note: This modification Does NOT impede joystick performance. This kit works with any joystick, and is equally easy to install in each.

ORDER NOW!!

NO Extra Shipping Charges!!

Florida residents add 5% sales tax.

Note: Custom joysticks still available.

NING WHERE THE MIRROR USED TO BE
 ,SECRET ROOM.,STUFFY ,SINISTER
 ,OF A ,FOOTPRINTS IN THE DUST LE
 AD TO ,THERE IS A WINE RACK ON T
 HE FAR WALL AND ,OF THE RICKERTY
 ,NARROW CORRIDOR. ,DINGY
 10021 DATA A HUGE FOUR-POSTER BE
 D ,BATHROOM. ,NARROW DINING ROOM
 . ,A CHAIR ,AN OVERTURNED CHAIR
 ,AND A PASSAGE TO THE EAST
 10030 DATA HUGE SPIDER SITTING I
 N THE CENTRE.,AND AN UGLY DRESSE
 R OPPOSITE.,AND A DRESSER BESIDE
 AN OPEN CLOSET.,THE FLOOR CREAK
 S LOUDLY AS YOU WALK ACROSS IT.,
 FLAGSTONE FLOOR.,LIBRARY.,OLD MA
 NSION.,WINDING STAIRCASE.,THE NO
 RTH.
 10031 DATA A DARK HOLE IN THE NO
 RTH WALL.,A LIGHTED PASSAGE RUNN
 ING NORTH.,A PILE OF BONES NEAR
 THE ENTRANCE.,OLD STAIRS.,YOU FE
 EL CLOSE TO SOMETHING IMPORTANT.
 ,ATTIC FULL OF OLD BOXES.,SINGLE
 SHELF AT EYE LEVEL.,DOMINATES T
 HE ROOM.
 10032 DATA THERE ARE RED STAINS
 IN THE TUB.,TABLE IN THE CORNER
 AND A FUSE BOX ON THE WALL.,THER

E ARE SIX CHAIRS AT THE TABLE. S
 KELETONS ARE SEATED AT FIVE OF T
 HEM.,IN FRONT OF THE FIREPLACE.,
 HIDDEN IN THE REAR.

10033 DATA ATTIC FULL OF OLD BOX
 ES. THE EXIT HAS SUDDENLY CLOSED
 . YOU ARE TRAPPED. WHAT DO YOU S
 AY ABOUT THAT.

20000 DATA GET,A,TAK,A,DRO,B,PUT
 ,B,LOO,C,EXA,C,RUN,D,WAL,D,*GO,D
 ,OPE,E,CLO,F,HIT,G,ATT,G,KIL,G,L
 OC,H,UNL,I,MOV,J,LIF,J,TIL,J,TWI
 ,J,PUS,J,PUL,J,SHO,J,CLI,K,PLA,L
 ,SAY,M,REA,N,RUB,O,TUR,P,TOU,Q,A
 SK,R,JUM,S,SWI,T,KIC,U,SMA,V,WIP
 ,W,TRY,X,USE,X,EAT,Y,DRI,Z

30000 DATA CLO,C,COB,CQ,SPI,CGQ,
 MIR,CJQW,DRE,CJQ,FLO,CQ,PED,CJQV
 ,BOO,ACEJNQ,MON,CQ,AHH,M,WAL,CNQ
 ,STA,CK,BON,CJQSU,WIN,CQVZ,RAC,C
 JKQV,CHA,CQV,FLA,CJU,BAG,CEJQ,HE
 A,CJPQ,PRY,ABCJQUWX,CHE,ABCFJQV
 ,CHA,CJQV,POR,CJQV,KEY,ABCJQUX,S
 KE,CGJQUV,TAB,CJOQUVW

30001 DATA BUT,CJOQ,SHE,CQV,BED,
 CJQUV,CHE,ABCFHIJQUVY,FUS,ABCJN
 QX,TOW,ABCQ,KNI,ABCJQ,NOR,D,SOU,
 D,EAS,D,WES,D,*UP,D,DOW,D

40000 DATA *S****01010101,**E***
 01020202,N*****01030404,*****01
 040105,N*E****01030506,**E****0205
 0607

40001 DATA ***W**01111215,*SEW**
 01101114,N*E**D02091013,*S****01
 080912,*SEW**01070809,N***U*0306
 0708

40002 DATA *S****01120116,NS*W**
 04131317,N**W**01031418,*S****01
 140119,NS*W**01101520,N*****0115
 1621

50000 DATA 1,1,A BLACK GARMENT B
 AG HANGING IN THE BACK,BAG,1,4,A
 LOOSE FLAGSTONE IN THE CORNER,F
 LAGSTONE,1,5,A PEDESTAL WITH A T
 ATTERED BOOK LYING OPEN ON IT,BO
 OK

50001 DATA 2,1,A HEAVY SEA CHEST
 STUFFED FULL OF MONEY,CHEST,2,2
 ,SOMETHING SCRALLED ON THE NORTH
 WALL,WALL,2,4,A RUSTY PRYBAR,PR
 YBAR,2,5,A MANGY MOOSE HEAD ON T
 HE NORTH WALL,HEAD,2,6,A FABULOU
 S CRYSTAL CHANDELIER,CHANDELIER

50002 DATA 3,1,A SHINY NEW FUSE,
 FUSE,3,2,A BIG RED BUTTON BESIDE
 THE BED,BUTTON,3,3,A TATTERED S
 CRAP OF TOWEL,TOWEL,3,4,A BLOODS
 TAINED KNIFE,KNIFE,3,5,A LARGE W
 EDGE OF CHEDDAR CHEESE,CHEESE,-1
 ,-1,A SMALL BRASS KEY,KEY

COCO-ACCOUNTANT

USE THE POWER OF YOUR 32K COCO TO MAKE INCOME TAX A
 BREEZE! KEEP TRACK OF HOUSEHOLD EXPENSES USING DATA
 FROM UP TO 450 CANCELED CHECKS. LOOK AT THESE
 FEATURES:

- * LIST EXPENSES BY MONTH
- * LIST EXPENSES BY ACCOUNT (YEAR OR MONTH)
- * LIST EXPENSES BY PAYEE (YEAR OR MONTH)
- * YEAR-TO-DATE SUMMARY BY ACCOUNT
- * FLAGS & TOTALS DEDUCTIBLE EXPENSES
- * COMPUTES SALES TAX YOU PAID ON PURCHASES
- * UP TO 24 USER-DEFINABLE ACCOUNTS
- * SORTS CHECKS BY DATE
- * SAVE DATA ON TAPE (EASY DISK MOD.)
- * LISTS TO SCREEN AND PRINTER

PAYS FOR ITSELF AT TAX TIME! REQUIRES 32K. \$15.95

KOKOMATH!

KIDS BORED WITH EDUCATIONAL PROGRAMS? LET KOKO THE
 MATH CLOWN MAKE ARITHMETIC A JOY! GET 10 PROBLEMS
 RIGHT AND GIVE HIM A BATH! ADD, SUB., MULT.,
 DIVIDE. THREE DIFFICULTY LEVELS. 16K EXT. \$8.95.
 KOKO WITH COMPUTER TIC-TAC-TOE \$11.95.

FEDERAL HILL SOFTWARE
 825 WILLIAM ST.
 BALTIMORE, MD. 21230

Turn your color computer on to the power of FLEX

NOW FROM THE WORLDS LARGEST SUPPLIER OF SOFTWARE FOR FLEX
COMES FHL COLOR FLEX. JUST LOOK AT THESE FEATURES:

**IF YOU'RE TIRED OF
NO DISK SOFTWARE,
THEN FHL Color FLEX
IS THE ANSWER!**

FLEX is the world's most popular operating system for the 6809 and with over 100 programs, we are the largest supplier of software for FLEX. These programs are NOT games but serious programs for your Color Computer. They range from word processors thru business applications to software development tools. Many Fortune 500 companies use our software. FHL Color FLEX turns your Color computer into a powerful system more capable than systems costing several times as much.

Get on our mailing list, call or send for our complete catalog of over 100 products for FLEX. We're doing exciting things with your color computer!

FLEX NOW ONLY \$99

- HI-RES screen formats
- 16 x 32 and 24 x 51, upper and lower case characters
- 24 x 64 and 32 x 64 upper case
- Full ASCII keyboards
- Easy start-up—just type RUN "FLEX"
- Online assistance just type HELP
- Optionally use a standard terminal and printer
- Advance disk I/O and terminal capabilities
- NO additional hardware required
- We have supported FLEX with more software than anyone else in the world for more than 2 years!

SPECIAL

1. DBASIC, RS Disk Basic under FLEX with a utility to copy RS to FLEX disk \$30.
2. ED/ASM line and screen editor and macro assembler, both more powerful than TSC's, and at the same cost, only \$100.
3. UTILITIES, a set of 12 utilities especially designed for FHL Color FLEX \$50.
4. STYLOGRAPH full word processor. Special for FHL Color FLEX only. \$195.00



THE REGENCY TOWER
770 JAMES ST. SYRACUSE, NY 13203
TELEX 646740 • (315) 474-7856

FHL FRANK
HOGG
LABORATORY

*FLEX is a trademark of Technical Systems Consultants Inc.

NOW...FROM THE WORLDS LARGEST SUPPLIER OF SOFTWARE... COMES THE WORLDS LARGEST SOFTWARE CATALOG

Yours For Only \$3
Or FREE In Jan. 83
Color Computer News
Magazine

SEE THE LATEST REVIEWS OF OUR SOFTWARE

November '82 **MICRO**
"FLEX and the TRS-80 Color Computer"
by Ronald Anderson, Page 23.

November '82 **80 MICRO**
"Color Forth"
by Jake Commander, Page 45.

November '82 **68 MICRO JOURNAL**
"CC FORTH"
by James Perotti, Page 19.

October '82 **RAINBOW**
A comparison of FHL Color Flex to 68 Micro
Journal's (Data-Comp) FLEX, Page 64.

February '83 **80 MICRO**
Read the review of our DBASIC for
FHL Color FLEX!

March '83 **80 MICRO**
FHL Color FLEX will be the
feature review!!!

SEE OUR ADS IN

Color Computer News

(5 pages)
REMarkable Software
P.O. Box 1192
Muskegon, MI 49443
US \$21.00 per year

The Rainbow

(5 pages)
5803 Timberridge Dr.
P.O. Box 209
Prospect, KY 40059
US \$16.00 per year
US \$22.00 Canada/Mexico
US \$31.00 Foreign - surface mail
US \$49.00 Foreign - airmail

System 68

(2 pages)
P.O. 310
Conyers, GA 30207
US \$24.00 per year

80 Micro

(1 page)
80 Pine Street
Peterborough, NH 03458
US \$25.00 per year
US \$27.97 Canada/Mexico
US \$44.97 Foreign

68 Micro Journal

(1 page)
5900 Cassandra Smith
P.O. Box 849
Hixson, TN 37343
US \$24.50 per year
US \$42.50 per 2 years
US \$64.50 per 3 years

FHI **FRANK
HOGG
LABORATORY**

THE REGENCY TOWER • SUITE 215 • 770 JAMES ST. • SYRACUSE, NY 13203
PHONE (315)474-7856 • TELEX 646740

STYLOGRAPH™

6809 WORD PROCESSING SYSTEM

AVAILABLE FOR FLEX™, UniFLEX™, and OS-9™

The STYLOGRAPH text processing system is a very easy to use but powerful method of creating and printing text. It allows the operator to type text on the CoCo, modifying and correcting it as it's typed, and then print it out. The STYLOGRAPH SYSTEM is cursor-oriented with dynamic screen formatting. Cursor based editing means that any portion of the text may be worked on by moving the cursor to that point. Dynamic screen formatting means that the text is formatted on the screen in the same way it will appear on the printed copy. The display is continuously updated to show how the text will appear. This is a very important feature and is normally available only on very expensive commercial word processing systems. It significantly reduces the time required to produce a finished copy.

FULL FEATURED TEXT EDITING

A full array of commands help in the creation and modification of text. The text displayed on the screen may be moved up, down, left or right. The cursor can be moved to any page or to any specified series of letters or words. The cursor itself can be moved left, right, up, down, to any tab position, or to the extreme left or right. Any block of text can be moved, copied or deleted. The operator may also do a **global replace** so that all occurrences of a given string will be replaced with or without a "prompt" asking if the item should be replaced.

OPERATOR CONVENIENCE

Files longer than memory can be edited. The operator can move forward through a long text file by selectively dumping text to the disk or filling from the disk.

The supervisor mode is **menu driven** and self prompting so that the operator does not have to remember the syntax of commands. This makes it easier for new operators to use the system.

An "assist" or "help" **function** makes it easy to learn the system since it is normally not necessary to consult the manual to learn the commands. This function is menu driven and lists all of the keyboard functions and the formatting commands.

At the beginning of the text the operator normally types in a few simple commands indicating the line length, left margin, and so forth, and then enters the header and footer as they should appear. After that the operator need not worry about formatting since it is taken care of automatically. Words that extend beyond the end of the line are automatically removed and placed on the next line. **Headers** and **footers** are automatically inserted so that the operator always knows what portion of the page is being worked on. **Ghost hyphens** can be entered so that if the word falls at the end of a line, and a ghost hyphen has been inserted, the hyphen will automatically be added.

FLEXIBLE DISPLAY

Lines longer than the screen width are allowed. STYLOGRAPH can scroll right and left on the screen so that tables can be constructed and appear on the screen exactly as they will appear on the print out.

A command allows viewing of the formatting commands on the screen. Another command allows the operator to see which characters will be modified at print out by underlining, superscripting or boldface. A page status command shows the current format values and other useful information.

COMPLETE FORMATING CONTROL

The text of individual lines may be centered, left justified, right justified, or left and right justified. **Tabs** can be set or cleared at any point. Spacing of the lines on the page is under complete operator control with end of page, spacing and vertical tab commands.

While entering text, it may be specified that the characters have some kind of modification when they are printed, such as underlining, superscript, boldface, overline, or subscript. These character modifications are done with "control" key strokes. For example, to start underlining characters, simply hold down the "CTRL" key, hit the "U" key and continue entering text. To stop underlining, hit the "DEL" or "RUB" key.

POWERFUL PRINTING OPTIONS

Underlining is supported on TTY type printers. For those people who have specialty printers there are a variety of additional capabilities including:

1.5 line spacing
BOLDFACE
superscript
subscript,
underline, overline,
or any combination

Right and left justification of text is accomplished by incremental printing on TTY type printers. True proportional spacing is supported on the specialty printers.

Control codes may be embedded in the text for special applications. For example, some printers require special control sequences for double width, graphics or boldface. These sequences may be embedded in the text for those users that have these printers. In conjunction with this, it is possible to cause the printer to stop in the middle of a print out for changing printwheels. A backspace feature allows overstriking.

OPERATING SYSTEM COMPATIBILITY

STYLOGRAPH is compatible with the FLEX, UniFlex, and OS-9 disk operating systems. Text files prepared using STYLOGRAPH are directly usable by other software such as BASIC and the assembler. (This significantly aids software development since cursor-based editing allows full viewing of the text being worked on, thereby reducing errors and decreasing programming time). File size is limited only by the capacity of the disk system. Files may be loaded into the text at any point making it possible to rapidly create "boiler plate" documents using portions of text that have been previously saved to a text file. Any portion of a text may be saved to a text file for use at a later point. The printer output may be directed to a disk file for later print spooling. Most operating system commands are directly accessible without leaving STYLOGRAPH.

FULLY ADAPTABLE TO MOST PRINTERS

STYLOGRAPH is easily configured by the user for most terminals so there is no need to send for updates as equipment changes are made. Source code of the terminal interface is supplied so that users with unusual equipment configurations may adapt it to their systems. The source code for all of the "prompts" is also supplied so that foreign language versions may be easily constructed.

Printers currently included as standard are: Diablo, Qume, Starwriter, NEC 5515/25, NEC 5510/20; CENTRONICS 737/739; TTY type printer with backspace function; TTY type printer without backspace function.

COMPLETE INSTRUCTIONS

A special tutorial section is included in the manual so that people with little or no computer experience can easily learn to use STYLOGRAPH in a few hours. A text file is included which demonstrates most of the features of STYLOGRAPH and allows the operator to practice most of the functions. The logical arrangement of the commands and the immediate display of the results greatly simplifies the learning process. In addition there is an "assistance" command which helps the new operator learn the commands.

STYLOGRAPH MAIL MERGE

A major option of STYLOGRAPH is the related MAIL MERGE program. This program adds "form letter" capability to STYLOGRAPH. Variables such as names addresses, dates, may be taken from a disk file or the keyboard at print out time and inserted into the text. Successive letters may be printed out without operator intervention.

The second important capability of the MAIL MERGE program allows many STYLOGRAPH text files to be appended at print out time. This allows files to be edited in smaller, more convenient blocks and then appended at print out time so that the page numbers will remain consecutive and the headers and footers will automatically be retained through all of the print out.

STYLOGRAPH SPELLING CHECKER

Another major option of STYLOGRAPH is the related SPELLING CHECKER program. This program reads through a text file and compares the words in the file with a dictionary. Words that are not found in the dictionary may be marked in the text for later editing, corrected on the spot, skipped, or added to the dictionary. Words may be added to or deleted from the dictionary to create unique vocabularies for particular applications.

STYLOGRAPH for the Color Computer FLEX 195.00
STYLOGRAPH MAIL MERGE 125.00
STYLOGRAPH SPELLING CHECK 145.00
STANDARD FLEX Version 295.00



THE REGENCY TOWER • 770 JAMES ST. • SYRACUSE, NY 13203 • TELEX 646740 • (315) 474-7856

Joyfully Humanize CoCo With Joylist

by Kenneth G. Deahl

Almost from the beginning, about a year ago, I have been trying to find some way to slow down the speed of *LISTING* of a program. When I finally tackled Assembly Language, progress occurred, but it wasn't easy, let me tell you!

In this article, you will enjoy the fruits of my labor, and be spared the many agonies suffered during my quest.

OK, the first attempt went like this:

LISTING #1

```

10 FOR X=1000 TO 1012
20 READ A:POKE X,A
30 NEXT X
40 POKE 360,3:POKE 361,232
50 DATA 52,16,142,0,1
60 DATA 189,167,211,53
70 DATA 16,126,130,115
80 NEW
    
```

Handwritten notes:
 M42
 M034 comes up
 will CB 4A
 795K-952A
 with DTR: 8273!
 \$0169 SE8
 \$0167 = \$7E \$0168 = \$03 \$0169 = \$E8

Type in (or load) this program, and *RUN* it. There will be no noticeable effect until you change the value in Memory Location 1003(decimal).

POKE 1003, 0 gives normal speed listings, and
POKE 1003, 225 gives the slowest...

As you *POKE* values higher than 32 into 1003, you'll notice that the keyboard seems sluggish. This is because the program allows the user to determine the amount of delay between the printing of each and every character to the screen; the bigger the value, the longer the delay. The keyboard scan routine in ROM still works normally; you won't see the character 'till after the delay, and, until you do see it, the keyboard is 'dead.'

Line 80 erases the Basic program from memory, but the routine will stay in effect until you power down the computer. The portion of memory used by the routine is unaffected by Basic's normal activities, including any of Extended Color Basic's graphic page allocations.

For those interested in Assembly Language, I've included an assembled source listing, below.

Note: These memory locations *must* contain the following, first:

NOTICE

Due to unfortunate circumstances, **Desert Software** will not be able to handle Daury Educational Software. We regret any inconvenience we may have caused any of our customers and want to assure all of you that we will, in the future, be bringing you the best software in terms of quality at prices you can afford.

DESERT SOFTWARE
 P. O. Box 502
 Cortaro, CA 85230

```

$0167 = $7E    $0168 = $03    $0169 = $E8
03E8 34 10 PSHS X save register
03EA 8E 0001 LDX #1 low limit for loop
03ED BD A7D3 JSR $A7D3 delay routine. in ROM
03F0 35 10 PULS X restore register
03F2 7E 8273 JMP $8273 detour completed
END
    
```

The comment column gives a fair picture of what happens, but is brief, by necessity. What we are doing is inserting a programmable delay in the routine that outputs each character to the screen (or printer and cassette, for that matter). This routine, referred to as *console out*, has a RAM 'hook' in it. In other words, before any character is outputted, *console out* checks with a memory location in RAM for any last-minute instructions. This particular hook is set to the code to jump to location \$8273, which is in Extended Color Basic. There it finds more code instructions that involve resetting some of the Video Display Generator registers, checking for 'DLOAD,' and otherwise keeping you in the alphanumeric mode, if the output 'switch' (not an actual physical one, though) indicates Screen.

Well, being in RAM, this little hook can be changed, and we have done so, by *POKEing* a different address into it. Instead of 7E 8273 (JMP \$8273), we have diverted it to \$03E8 (1000 decimal). There is where our little nugget is stored...First off, we *PSHS X*, or take the contents of the 15-bit X register, and hide it safely away, up on the stack, so we can reuse the register for our own purposes. Next we *LDX #1*, meaning we tell the register to take on the immediate value of "1," which will be our lowest limit for the delay loop.

OK, now we *JSR \$A7D3*, or Jump-to-SubRoutine, located at address \$A7D3, which is in ROM. By the way, part of the structure of the instruction *JSR* automatically saves the place you jumped from, so it knows where to return, later; sort of like *GOSUB/RETURN*, right?

At \$A7D3 is a nifty little routine—quite popular, well-liked, often sought and utilized by many other routines. It takes whatever value that is then in X register and decrements that value to zero, one unit at a time, checking for zero each time through the loop. When, finally, the X register is flat-out empty, the loop terminates, and an RTS (Return to SubRoutine that called this one) transfers control back to where you were.

We can now *PULS X*, or Pull from the Stack (our hiding place) the original contents of the X register, and put them back into it. Then we *JMP \$8273*, as our last instruction, since our detour is finished. The computer goes on its way until the *next* character is to be output, the console out RAM hook is checked, and off we go!

Now, about that lowest limit of one: if the X register had contained a zero when we entered the delay loop at \$A7D3, the first decrement would make the value in X register a negative number, which is *below* zero. A situation, similar to "wordwrap" or "wraparound", in word processors, then occurs. The "-1" gets changed to \$FFFE, or one less than the highest hex number our eight-bit computer can manage. We "wrapped-around" from the bottom to the top, so to speak. Well, now with X register holding \$FFFE, we will have to wait till the loop decrements 65534 times to get to zero before we can get out of it. So, by pre-setting the lower limit to one, we won't get any surprises. As far as the *upper* limit is concerned, that is what the *POKE 1003* (any value) is for. 1003 contains the Most Significant Byte, and 1004 has the Least Significant Byte of the value you place into X register

before *JMPing* to the delay loop.

Well, fine and dandy and all that, but in order to change the speed of *LISTing*, you have to *POKE* a new value in 1003 each time. Not quite what I wanted, yet not too shabby, either... My second attempt allows you to insert the delay two times, in each line during a *LISTing*. The characters for each complete line are output at normal speed, but there is a pause *before* every line number, and again *after* every line number is printed. The line itself whips right along, as usual.

In Listing 2, note that two different RAM hooks are used, both checked by the *LIST* command, at different stages of the execution. Also, the same delay routine is called twice, with your chosen value both times. Using both of the RAM hooks this way tends to give more control over the overall smoothness of scrolling.

LISTING #2

```

210 FOR X=1000 TO 1010
220 READ A:POKE X,A:NEXT X
230 POKE 383,126:POKE 384,3:POKE
    385,232
240 POKE 422,126:POKE 423,3:POKE
    424,232
250 DATA 52,16,142,0,1,189
260 DATA 167,211,53,16,57
    
```

The Assembly Source Listing would be the same as for Listing #1, except in the last instruction. Instead of *JMP* \$8273 (in decimal, the last three Data bytes in line 70 are 126,130, and 115), Listing #2 replaces this with *RTS* (decimal 57, the last Data byte, here, in line 260). Please note

your control is still the same: *POKE 1003,0*=normal speed of listing, and *POKE 1003,255*=the slowest speed. As before, the Basic program can be erased (after *RUNing*); the routine stays in memory. However, the keyboard scan routine is not affected this time, so that's an additional improvement.

Well, I *still* wasn't happy; so back to the EDTASM+ cartridge...

The third and Final listing is IT! All my wishes fulfilled; the Dream now a Reality; the end of the Rainbow! (Sorry, Lonnie...unintentional pun.) The 'Fruits of my Labor' had arrived, overflowing a huge cornucopia! *Joylist* at last...Read on, my friends.

Listing #3

```

300 '***** JOYLIST *****
301 '** K.DEAHL - 9/06/82 **
302 '*****
303 FOR X=1000 TO 1015
304 READ A:POKE X,A:NEXT X
305 POKE 360,3:POKE 361,232
306 DATA 52,86,189,169,222
307 DATA 190,1,91,48,1,189
308 DATA 167,211,53,86,57
309 END:'or NEW, if you like
    
```

Type this in, plug in your Right Joystick, and *RUN* the program. Then pull the Joystick back, type *LIST* and *ENTER*; do it again, perhaps with a longer program of your own, and slide that joystick up and back while you '*Joy-List.*' Is that neat, or what?



★ Dealer inquiries welcome
★ All games require 16 K
★ Quality colour computer software



ARCADE GAMES

Prism Software

CHOPPER RESCUE "By Prism Software" This game puts you at the controls of a rescue helicopter. Your mission: rescue as many victims as possible from a burning city before it is reduced to ashes. (Extended BASIC) **\$13.95**

LAS VEGAS "By Prism Software" This game adds a new twist to the old game of Blackjack. Can you beat the computer and break the bank. A variety of colours and realistic sound effects makes this the best high resolution game of its kind. (Extended BASIC) **\$11.95**

RAIDERS "By Prism Software" In this adventure you must deal with voodoo curses, alligators, ancient traps and hostile natives. This adventure begins in the confusion of a large city and ends (maybe too soon if you're not careful) in a dangerous, dense jungle in South America. (Extended BASIC) **\$16.95**

THE ALIEN "By Prism Software" You are the sole survivor on a huge starship, but you are not alone. A savage ALIEN is stalking you. Can you find a way to destroy it and escape the derelict starship? With numerous sounds. (Extended BASIC) **\$13.95**

★ By Spectral Associates ★

GHOST GOBBLER	\$26.95
ALCATRAZ II	\$11.95
GALAX ATTAX	\$26.95
SPACE WAR	\$26.95
KEYS OF THE WIZARD	\$23.95
COLOUR ZAP	\$11.95

★ By Mark Data Products ★

BLACK SANCTUM	\$28.95
CAVE HUNTER	\$28.95
BERSERK	\$30.95
ASTRO-BLAST	\$30.95
CALIXTO ISLAND	\$28.95

★ By Computerware ★

COLOUR PAC ATTACK	\$30.95
DOODLEBUG	\$30.95
RAIL RUNNER	\$30.95
STARSHIP CHAMELEON	\$30.95

Prism Software

779 Queen St.,
Box 1360, Kincardine,
Ontario, Canada, N0G 2G0
Tel:(519)396-8224



Add 5% for shipping
No C.O.D.
VISA or Mastercard accepted
Ontario residents add 7% sales tax.



Here's the Assembled Source Listing. Note: These memory locations *must* contain the following, first:

```

$0167 = $7E      $0168 = $03      $0169 = $E8
03E8 34 56      START  PSHS  U,X,B,A save registers
03EA BD A9DE      JSR    $A9DE  get joystick
                                readings
03ED BE 015B      LDX    $015B  hi limit=
                                R.Vert:L.Horiz
03F0 30 01      LEAX  1,X    ensure lo
                                limit > 0
03F2 BD A7D3      DELAY  JSR    $A7D3  routine in ROM
03F5 35 56      PULS  A,B,X,U restore
                                registers
03F7 39          RTS      detour
                                complete.
                                END

```

All right, let's go over this new one. First, we saved the affected registers (PSHS U,X,B,A). Then we called the routine to read in the four Joystick values into RAM, from \$015A through \$015D (JSR \$A9DE). These four bytes represent the right horizontal, right vertical, left horizontal, and left vertical positions of each Joystick. When the right Joystick is all the way forward, \$015B will contain a zero, and when you pull it all the way back, the value becomes 63. In Binary notation, 63 Decimal is equal to 0011 1111, or, only the six least significant bits are set, of the eight bits our computer normally handles. The routine at \$A9DE is involved in a sort of six-bit A/D (Analog-to-Digital) conversion, taking in the smooth variations from 0 VDC to +5 VDC, reflecting the Joysticks' relative position(s), and chopping them up into 64 little pieces. (Yes, I said '64,' counting from and including zero you get 64.)

We want to use the right-vertical Joystick, so we put the

values at \$015B and \$015C into the X register (LDX \$015B). Remember, X is a 16-bit register; two eight-bit consecutive bytes. However, this means X will have the right-vertical as its MSB, and the left-horizontal as its LSB. There would be no problem until the left Joystick was all the way over to the left, *and* the right Joystick was all the way forward. Then, \$015B and \$015C would both contain zeros, and when you go to the delay routine with 0000 to start with, you'll have a long wait, as we saw before! We can prevent this by adding "one" to the X register, after loading it with whatever's in \$015B and \$015C.

(LEAX 1,X) does this for us very nicely. It Loads the Effective Address into X, the value that was in X, plus one. (My compliments to the designer(s) of the 6809 CPU for this one...) OK, now we zoom up to the delay routine (JSR \$A7D3), come back and put everything back into place (PULS A,B,X,U), then get back on the main road. Again, all of this goes on before each and every character gets displayed, (or sent to the printer and cassette ports), but you can vary the delay, *while it's happening!*

It's ironic; humans admire computers for the speed they have, among other things, yet here we are, saying "Whoa." Which reminds me; the original idea for *Joylist* came from an article in *Microcomputing*, OCT-1980, called "Whoa, Apple," by Terry Edward Phillips. I have lusted after the concept he presented for quite some time, now. And speaking of speed, do you realize the TRS 80 Color Computer outputs characters to the screen at a blinding 1800 per second? Unreal! (I actually clocked it.) With *Joylist*, and your right Joystick up, we're down to a more civilized 360/sec, and, with the 'Stick' back, a mere five characters appear each second. Joy!

TRS-80® COLOR COMPUTER® SWIVEL ORGANIZER

A REAL VALUE!

ATTRACTIVE AND SOLIDLY BUILT THIS ALL-IN-ONE ORGANIZER IS THE PERFECT WAY TO LEND A PROFESSIONAL INTEGRATED LOOK TO YOUR CC

CHECK THESE FEATURES!

- Water/stain resistant woodgrain laminate over 1/2" plywood
- Metal ball bearing swivel base permits sharing of the computer while still seated. Great for game playing and multi-use work stations
- Allows TV monitor mounting directly over computer to conserve space
- Storage area in rear with clamps for dressing cables neatly
- Comes fully assembled

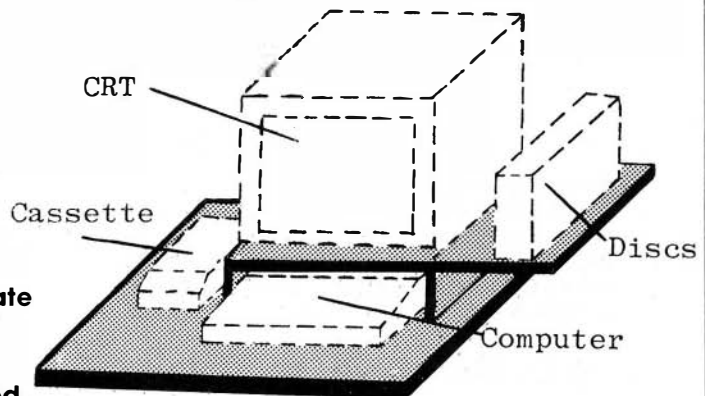

\$34⁹⁵
PLUS SHIPPING

Send Check Or Money Order To:

SHAUNTRONICS P.O. BOX 131
FAIRVIEW, N.J. 07022

N.J. RESIDENTS ADD 5% TAX

TRS-80 & COLOR COMPUTER TRADEMARKS OF TANDY CORP.

Addition Concepts Has Some Minuses As Well As Pluses

Unlike the steady progress of sophisticated arcade games for home computers, much of the educational software is still in its infancy.

Addition Concepts is an educational program to teach younger children simple addition facts for the numbers zero to nine. The program is menu driven to pick three items: number of correct answers before progressing to the next level, which of four sets of numbers to use, and whether or not verbal instructions are wanted.

At the three lowest levels, Mr. Bob, the author, explains the addition of numbers zero to three by counting boxes shown below the numbers. After each explanation, the student is drilled on the facts just taught until the predetermined number of correct answers is reached. The correct answer is chosen from three choices by "flying a space ship" to it, using the right joystick.

After the number three, Mr. Bob explains that the rest of the numbers through nine are treated the same and no further instructions are given. If further repetitions of the lowest numbers are needed, the tape has to be returned to the appropriate counter number before running that segment.

Technically, the program is well done, with liberal use of graphics and sound, and, one unique feature, the actual verbal instructions on tape to the student from Mr. Bob himself.

The graphics use higher resolution to create large, easy to read numbers on the screen. Correct answers are rewarded with a short graphics display and sound.

The printed instructions included with the program are on only one side of a sheet of paper and are not adequate. Nothing is said about which age group is targeted by this program, and only incidentally mentions the need for adult supervision. Half the sheet is spent explaining how to keep track of the verbal instructions on the tape, and the other half includes somewhat confusing instructions on how to use the program.

With the aid of my three children, ages six, nine, and 11, the program was "user tested," and some glaring problems cropped up.

The first noticed, and a very annoying thing, was the audio level difference between Mr. Bob's spoken word and the computer generated sound. The TV audio had to be turned up quite loud to hear the spoken word, but when the program started, the audio was too loud, necessitating a frequent raising and lowering of the volume control. However, you do have the option of eliminating the audio feature altogether.

Another problem was with the use of the joystick. All three kids had some trouble getting the rocket to the correct answer (even though the two older ones are arcade game players). The problem might be lessened if the student could first position the rocket over the correct answer and then push the "fire" button. But, unfortunately, the fire button is used to interrupt the program at any time to start over. This also caused problems because all three kids tended to push the "fire" button now and then by accident, stopping the program in the middle of a sequence.

At the start of each drill, the rocket has to be moved "blindly" to the upper left-hand portion of the screen while the correct answer graphics is being displayed. The kids were usually too busy watching the graphics to remember to do

this, and were reminded with a somewhat annoying barrage of sound and a message telling them to do it. The answer rocket is small and flickering, making it difficult to see and work with.

Lastly, the two older kids found the program boring, not surprising since they are long past addition facts. The youngest, who is halfway through first grade, knew the addition facts but still enjoyed doing the practice drills.

Having had the experience of helping three kids in school to learn their addition facts, I feel Mr. Bob's approach is valid and useful. The major flaw with the program is his failure to adequately user test it with his intended audience (whichever that might be). Correcting the "mechanical" problems would make this a much better program.

(Programs by Mr. Bob, P.O. Box 94, Montrose, CA 91020, \$14.95)

—Chuck Pilipauskas

Software Review...

Master Disk System A Good Librarian

The addition of a disk drive to a system is usually done to increase the efficiency of that system. However, with the advent of disk drives comes the problem of maintaining some sort of order to data stored on them. In other words, what program is on which disk and where did I last put it. The *Master Disk System* from Circle City Software is designed as an answer to which program is on what disk.

COLOR-FORTH
Including **SEMIGRAPHIC-8 EDITOR**
+ UTILITIES

- Disk and Tape utilities
- Boot from disk or tape
- Graphics and Sound commands
- Printer commands
- Auto-repeat and Control keys
- Fast task multiplexing
- Unique TRACE function in kernal
- Clean INTERRUPT handling in HIGH-LEVEL FORTH
- CPU CARRY FLAG accessible
- Game of LIFE demo
- ULTRA FAST:written in assembler
- Directions included for installing optional ROM in disk controller or cartridge
- Free Basic game "RATMAZE"



\$58.95

FORTH

HOYT STEARNS ELECTRONICS

4131 E. CANNON DR. PHOENIX, ARIZONA 85028

602-996-1717

Unfortunately, there is nothing besides a little personal organization which will help you keep track of where you put the disk.

I presently have 25 disks in use, and found it took only about 20 minutes to get them all cataloged with *Master Disk System*. The program comes with six sheets of documentation and the standard disclaimer. The instructions are straightforward and easy to understand.

The entire process does require some playing to become familiar with it. The programs will run on a 16K disk system, but the sort function will be unavailable. It requires a 32K machine to perform a sort, a minor item since it is easy to locate files without the sort function.

The *Master Disk System* is a collection of two main programs and two utilities. The two main programs will catalog the contents of 100 separate disks onto one master disk for easy reference. The contents of the individual disk directories are placed in the data base on the master disk. The disk directory just read will then contain an entry in it indicating on which master disk its directory is cataloged. Besides obtaining the directory, the disk file allocation table is also copied into the master data base. More about that later. For those who have more than 100 disks, the system will support up to 255 master disks, with each master containing 100 entities. Now that's a lot of disks.

The first of the main programs prepares a master disk for use and is called "Diskinit." The second program is the work horse of the system and provides all the necessary services. The "Master" program is menu driven and does a very good job of leading you through all the required steps. The master program contains nine options which provide all the

functions necessary to maintain the master data base.

The data base can be displayed on a singular disk basis. If you want to know what is on disk "two," it will display the contents of just disk two. If you would like to search the entire data base looking for a match on a group of characters it will do that also. A little experimentation with this powerful list function will bring out its hidden value. I use the extended part of the file name to indicate the class of file being stored. Assembly source files are cataloged with a "/txt" extended file name. The assembled version of the same file is cataloged with a "/Bin" extended file name. Entering just the first eight characters of the file name allows me to find all occurrences of the file plus any back-up copies. All this with one list operation. A very nice feature. The displayed data will show the entire file name in which the match was found plus the disk name and ID on which it resides.

The list option offers selected lists of just Basic programs, data files or binary files. Answer "yes" to all three of the prompts and you will get a list of the entire data base. There is just one catch: the selected list function would not display or list any of the files created by Radio Shack's *Spectaculator* or *Scipsit*. A minor problem since the directory search does handle them properly.

If your system has a printer, and the printer is turned on, the option of printing the data rather than displaying it is offered. If the printer remains off, all data is automatically displayed on the screen.

The utilities consist of a sort program and a recovery program which will replace the allocation table of a disk which has crashed. The documentation claims that if either the disk directory or the file allocation table are scoured, the "restore" program will replace them, thus making at least a partial recovery of the data on the disk possible, if not all of it.

I purposely destroyed the directory on a copy of one of my library disks, which was cataloged in the master data base. Running the recovery program restored the disk completely. I tried selectively destroying sectors in the directory. Each time, the destroyed sectors were restored.

I believe that the entire directory track is stored in the master data base, although I did not go into the program to verify it. This means that, as programs are added, changed or deleted, it becomes important to ensure that the master data base is also properly updated. Otherwise, only partial recovery of the disk will occur with the running of the recovery program.

The sort function provides for a displayed or printed list of all the files in the data base, sorted by file name, alphabetically. The display to the screen is held once the screen is full, and scrolled only upon command from the keyboard. Sorted listings to the printer are printed in groups. Each group corresponds to a used letter of the alphabet as the first letter in a file name.

I like *Master Disk System* and the manner in which it was written. It is menu driven, and walks the user through all the necessary steps. Error checking is performed where possible to avoid inadvertent destruction of needed data. The programs are well done, and reflect the thought that must have gone into them. Any disk library of five or more disks is a candidate for this product. The ability to be able to restore a disk if the directory or allocation tables are zapped, is in itself worth the purchase cost, if only needed once. I consider these programs a worthy addition to any library.

(Circle City Software, P.O. Box 30166, Indianapolis, IN 46220, \$29.95)

—Frank J. Esser

AT LAST . . .

Utilities For Extended Basic!

#UK2 COLOR KRUNCHER — \$9.95

- Reduces Memory Requirements Of Any Extended Basic Program
- Speeds Program Execution Time
- Type In A Program From A Magazine, As Is, Debug It, Then Let Kruncher Make It Shorter And Faster
- Includes LN.XREF—Get A Sorted Listing Of All Referenced Line #'s — Can Be Used Separately — Optional Printer Output

#UV4 VARIABLE CROSS REFERENCE — \$6.95

- Locates All Variables In Your Extended Basic Program



- Automatic Sort—Optional Printer Output

#UF2 LLIST FORMATTER — \$6.95

- User-selectable Margins, Page Lengths, Top-of-forms and More
- Optional Space Between Lines—Highlights Line Numbers
- For Most Recent Tandy Printers (can be user modified)

#UT2 TEXT COUNT — \$5.95

- Counts Lines, Sentences, Words, Total Characters Of Any ASCII-Saved Extended Basic Text File

ALL PROGRAMS WORK ON EXT. BASIC TAPE OR DISK!!!

Buy Two Or More On The Same Order And Take 10% Off

Send Check Or Money Order To: (Pa. Residents Add 6%)

(Postage paid in U.S. and Canada)

MICROLOGIC

Box 193, 1st Avenue
East Brady, PA 16028

THE COLORQUEST EXPERIENCE

For the TRS-80C and the TDP System 100 Color Computers

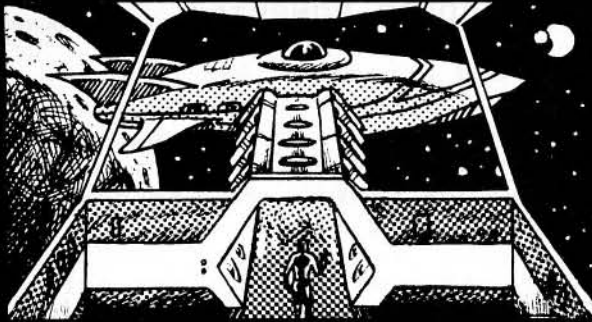

Written by Kevin Herrboldt & Tim Nelson

BEYOND THE CIMEEON MOON A real-time science fiction adventure game of mind-blowing magnitude — staged in deep space on a malign, sentient spacecraft. *Written in fast machine code with 3-dimensional high-res graphics and sound.* Choose from a myriad of fates. Survive the laser barrage set up by a guantlet of robots bent towards your destruction.



Written by Kevin Herrboldt & Tim Nelson

ADVENTURE TRILOGY A Trilogy of quests featuring 3-D high-res graphics in machine code. First comes ritual combat on the **WORLD UNDER THE CIMEEON MOON**, to test your worthiness as a warrior. Once proven, you will be teleported to **DAZMAR'S UNDERWORLD OF DOOM** to search for the Eye of Dazmar. The **FORSAKEN GULCH** is the final arena, where a wicked idol awaits restoration.



THE NIBBLER & MS. NIBBLER A fast maze chase game featuring the nibbler man and three bumbling predators. *Written in machine code and joystick compatible*, this fun packed game is enjoyed by all. **MS. NIBBLER** is similar to **THE NIBBLER** described above but features a different maze and **MS. NIBBLER** for the ladies.

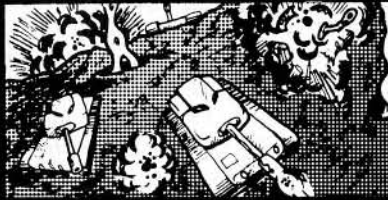

COMBAT GAMEPACK 3 action packed games featuring lifelike graphics and sound. *EXTENDED BASIC required* 2-1-0 **TANK COMBAT** pits two players against each other in 5 different terrains. **STELLAR BATTLE** lets you pilot a flexwing fighter through deep space fighting dorian squadrons. **GALACTIC BLOCKADE** is a favorite two-player arcade game of speed and skill.



VEGAS GAMEPACK The thrills of a Las Vegas casino at home! *Extended BASIC required.* **CASINO CRAPS, 21, ONE ARMED BANDIT, UP AND DOWN THE RIVER, & KENO.** A bank tracks players winnings from game to game.

ORDERING

ALL GAMES ARE \$24.95 for 16K Cassette; \$29.95 for 32K Disk. Include \$3.00 for shipping in the U.S. & Canada, \$6.00 for Foreign orders. C.O.D. add \$2.00
AVAILABLE AT DEALERS EVERYWHERE. IF NOT, ASK WHY!

NELSON™
SOFTWARE
SYSTEMS



9072 Lyndale Avenue So. 612/881-2777

A Division of Softlaw Corporation

Minneapolis, Minnesota 55420 U. S. A.

For Orders Only—Call Toll Free: (800) 328-2737

Super "Color" Writer II

A "ROLLS ROYCE" FOR YOUR COLOR COMPUTER



If you are contemplating buying a word processor for your TRS-80C Color Computer or TDP System 100 Personal Computer, look no further!! The Super "Color" Writer is the most powerful and most versatile word processor available. This *user-friendly* program gives you many times the power and speed, and MORE MEMORY than any other word processor for your computer. The Super "Color" Writer does it all!

No other program lets you fully use every capability built into your printer, **AND WITH EASE!** *Emphasis, italics, double strike, normal mode, compressed, elongated-compressed mode, and ELONGATED EMPHASIZED ITALICS* are at your fingertips, all within JUSTIFIED text. Underlining is a breeze! All the parameters for proper page formatting (margins, page length, etc.) are fully alterable. Yet, without changing a single thing you can print text perfectly the first time.

Don't think for a minute that the Super "Color" Writer II won't work with your letter quality printer. There's no reason you can't give H₂O its proper name or have footnotes. As for bold print, undefining, proportional spacing, **super bold** or any other printer-controlled function - if your printer has it, the Super "Color" Writer II can do it! You can also freely exchange thimbles or daisy wheels to change to italics, or to a totally different typeface with the pause print feature.

And the Super "Color" Writer II has the exclusive WINDOW to make your formatting pleasant and perfect. Enter the window to view your whole text as it will be sent to the printer, **whatever your margins, from 1 to 200 or more!** No longer will you be tied to seeing only 32, 51, 64 or whatever number of characters on a line. You can see that your text is centered, headers and footers are always properly placed, and your columns are correct.

With the Super "Color" Writer II screen editing is a snap; the commands are powerful and hard to forget. You can edit all your BASIC PROGRAMS TOO! With all these features, you must surely agree that this is the "ROLLS ROYCE" of word processors. To learn more, refer to the Nelson Software Systems ad in this magazine. And don't forget that the Super "Color" Writer II is only one important part of the Super "Color" Library, which includes the Super "Color" Terminal, the Super "Color" Mailer, the Super "Color" Disk-ZAP and the soon to be released Super "Color" Calc and Super "Color" Database. No other company gives you such outstanding products and support. You can buy theirs now and ours later, OR you can save your money and get the best from the very start!

This document was prepared using a TRS-80(TM) Color Computer, the Super "Color" Writer II, an Epson MX-80 Graftrax Plus (TM), and an NEC Spinwriter 3510 (TM) to illustrate the great flexibility in formatting allowed by the Super "Color" Writer II.

Spinwriter is a trademark of NEC Information Systems, Inc. MX-80 Graftrax Plus is a trademark of Epson America, Inc. TRS-80 and TDP System 100 Personal Computer are trademarks of the Tandy Corporation.

THE ULTIMATE IN COLORCOMPUTING

For the TRS-80 Color Computer and TDP System 100 Personal Computer

Super "Color" Writer II

By Tim Nelson



The Rolls Royce of Word Processors

The Super "Color" Writer is a FAST, machine code, full featured, character (screen) oriented word processing system for the TRS-80™ Color Computer and ANY printer. The video display is styled after a professional phosphor (green characters on black background) display for hours of use without eye fatigue (optional orange on black). The unique print WINDOW frees you from 32, 51 or 64 character lines FOREVER! This window can be moved anywhere in the text file, up, down, left or right to display the text as it will be printed without wasting paper. You can create or edit Super "Color" Terminal files, ASCII files, BASIC programs or Editor/Assembler source listings. It's simple enough for beginners with 4K and . . . for the professional writer with a 32K disk system and a lot to say, there's plenty of room to say it!

COMPARISON CHART	SUPER COLOR WRITER			THE COMPETITION		
System Size	4K	16K	32K	4K	16K	32K
TAPE: Text space	N/A	7K	23K	N/A	2K	18K
ROMPAK: Text space	2.5K	16K	31K	N/A	N/A	N/A
DISK: Text space	N/A	5.5K	21.5K	N/A	0.5K	16.5K
Right Justify		YES			NO	
Video Window		YES			NO	
Edit any ASCII File		YES			NO	
Programmable Function		YES			NO	

The figures speak for themselves and with professional features like PROGRAMMABLE function string commands to perform up to 28 commands automatically. PROGRAMMABLE text file chaining, PROGRAMMABLE column insert & delete, and right hand JUSTIFICATION with punctuation precedence, the choice is clear but there's still more! In their September '82 issue, "80 MICRO" says, "The Color Computer has finally come of age. Nothing illustrates that coming of age better than this offering (SUPER "COLOR" WRITER) by Nelson Software". The Super "Color" Writer takes full advantage of the new breed of "smart printers" with Control codes 1-31, 20 Programmable control codes 0-255 for special needs. Works perfectly with all Epson, Radio Shack, Okidata, NEC, IDS, Centronics, Citech, Smith Corona, Diablo Etc., Matrix, or Letter Quality Printers.

CHECK THESE FEATURES!!

User friendly • Easy commands • 32K Compatible • Window • Key beep • HELP table • 128 character ASCII & graphics • Mem left and Mem used • Full cursor control • Quick paging • Scrolling • Word wrap around • Tabs • Repeat all functions • Repeat last command • Insert character & line • Delete character, delete to end of line, line to cursor, line & block • Block move, copy & delete • Global Search, Exchange & Delete • Merge or Append files • Imbed Control Codes in text • Underline • Superscripts • Subscripts • Headers, Footers & 2 Auxiliary footnotes on odd, even or all pages. definable position • Flush right • Non-breakable space • 4 centering modes: 5, 8.3, 10 & 16.7 (CPI) • Full page & print formatting in text • Single sheet pause • Set Page length • Line length, Line spacing, Margins, Page numbers • Title pages • Printer baud: 110, 300, 600, 1200, 2400 • Linefeeds after CR • Soft & hard formfeed • Works with 8 bit printer fix • and more!

Super "Color" Writer II Disk

The Disk version of the Super "Color" Writer works with the TRS-80C Disk System and has all the features listed above plus many more! Use with up to four Disk Drives. Includes an extended HELP table you can access at any time. Call a directory, print FREE space, Kill disk files and SAVE and LOAD text files you've created all from the Super "Color" Writer. Print, merge or append any Super "Color" Terminal file, ASCII file, BASIC program or Editor/Assembler source listing stored on the Disk or tape. The Super "Color" Writer Disk version has additional formatting and print features for more control over your printer and PROGRAMMABLE chaining of disk files for "hands off" operation. Print an entire BOOK without ever touching a thing! Includes comprehensive 90 plus page Tutorial manual.

TAPE \$49.95 ROMPAK \$74.95 DISK \$99.95
Tutorial only \$15.00 (Refundable with purchase)

ORDERING INCLUDE \$3.00 for shipping in the U.S. & Canada,
\$6.00 for Foreign orders. C.O.D. add \$2.00.

**NELSON™
SOFTWARE
SYSTEMS**



9072 Lyndale Avenue So. 612/881-2777



A Division of Softlaw Corporation

Minneapolis, Minnesota 55420 U. S. A.

Super "Color" Terminal

By Dan Nelson



The Ultimate in Smart Terminals

The Super "Color" Terminal turns the Color Computer into a Super-smart terminal with all the features of VIDEOTEX™ plus much more. COMMUNICATE with Dow Jones & Compuserve and with computers like the TRS-80™ MODEL I, II, III, APPLE etc., via modem or RS-232 direct! Save the data to tape or print it! Reduces ON-LINE cost to a minimum!

FEATURES

10 buffer size settings from 2-30K • Buffer full indicator • Prints buffer contents • Full 128 ASCII keyboard • Compatible with Super "Color" Writer files • UPLOAD & DOWNLOAD ASCII files, Machine Language & Basic programs • Set RS-232 parameters • Duplex: Half/Full • Baud Rate: 110, 300, 600, 1200, 2400, 4800 • Word Lengths 5, 6, 7 or 8 • Parity: Odd, Even or None • Stop Bits: 1-9 • Local linefeeds to screen • Tape save & load for ASCII files, Machine code & Basic programs • Unique clone feature for copying any tape.

Super "Color" Terminal Disk

The disk version of the Super "Color" Terminal works with the TRS-80C Disk system and has all the features listed above plus many more! Use with up to four Disk Drives • Call a directory, print FREE space, kill disk files, save and load text files or BASIC programs • Echo ability in full duplex • Lower case masking • 10 Keystroke Multiplier (MACRO) buffers that can be saved on disk to perform repetitive log-on tasks and send short messages (up to 250 characters each) • Programmable prompt or delay for send next line • Selectable character trapping • Set printer Baud rate to 110, 300, 600, 1200, & 2400 • Operators Manual.

TAPE \$39.95 ROMPAK \$49.95 DISK \$69.95
Operators manual only \$10.00 (Refundable with purchase)

NEW!! Super "Color" Mailer Correspondence-Mailmerge

The Super "Color" Mailer is a powerful multi-purpose file merging program that uses files created by the Super "Color" Writer II. One of Super "Color" Mailer's most popular uses is producing customized form letters — at a fraction of the time and expense of individually typed letters. With Super "Color" Mailer you can combine a Super "Color" Writer II file containing a form letter with a file containing a list of names and addresses. You can even insert special words and phrases — unique to each addressee — into the body of the letter. Other Super "Color" Mailer uses include creating invoices, printing mailing labels, addressing envelopes, and producing "boiler plate" legal documents out of many different paragraphs. Features include: the ability to selectively print mailing lists by any of up to 10 user definable fields • automatically prints current date • address • salutation • closing • P.S. etc. • prints any ASCII file • justification.

TAPE \$39.95 DISK \$59.95

NEW!! Super "Color" Disk-ZAP The Ultimate in Disk Repair Utilities

A must for ALL Color Computer Disk system owners. A high-speed machine code Disk Utility that can copy sectors and tracks • repair directory tracks and smashed disks, etc. Super "Color" Disk-ZAP has a special screen display that displays sector, track and memory contents in HEXADECIMAL and ASCII at the same time with double cursors that can be moved in any direction. With Super "Color" Disk-ZAP you are able to verify or modify disk sectors at will. You can even type right onto the Disk! You can send sector contents to the printer or any other RS-232 device in either ASCII or HEXADECIMAL listing. Search the entire Diskette for any ASCII or HEXADECIMAL string. Comes complete with comprehensive manual.

DISK ONLY \$69.95

COMING SOON!! Super "Color" Calc Electronic Spread Sheet

The finest electronic spread sheet and financial modeling, program available for the Color Computer — A sophisticated yet easy to use, calculating and planning tool. Project figures into the future to answer the "What if?" questions you face. Create files compatible with the Super "Color" Writer II. Combine spread sheet tables with your documents to create ledgers, projections, statistical & financial reports & budgets.

AVAILABLE AT DEALERS EVERYWHERE. IF NOT, ASK WHY!!

TRS-80 is a registered trademark of the Tandy Corp.

For Orders Only—Call Toll Free: (800) 328-2737

RAINBOWfest To Be In Chicago April 22-24

The very first national show and exhibition for CoCo will be held in Chicago April 22-24, sponsored by *the Rainbow*.

RAINBOWfest will be at the Hyatt-Regency Woodfield, west of the downtown area. The *RAINBOWfest* site is adjacent to Woodfield Mall—the world's largest shopping center.

According to preliminary plans, a large number of software and hardware firms will be on hand to exhibit their products. The meeting will also feature a great deal of fun and conversation about CoCo.

We urge you to make plans to attend. A special hotel rate can be secured by mentioning *the Rainbow*.

Admission will be \$7.50 for all three days through an advance sale, or \$5 per day for a single day. Tickets at the door will be \$11 for the entire session or \$7.50 for a single day.

Other events are planned and will be announced shortly.

RAINBOWfest

Chicago April 22-24

Software Review...

Poltergeist Is Good, Spirited Fun

Poltergeist is a new program cartridge from Radio Shack based on the movie of the same name. At \$34.95 it was not a purchase I made impulsively, but it has proved to be a sound investment in challenging, quality entertainment.

The object of *Poltergeist* is to rescue the little girl, Carol Anne, from the clutches of an evil and elusive spirit. The play progresses through three screens, each of which by itself would be considered a fun game. Combined, they require substantial skill and concentration in order to achieve the objective.

Screen one has you dashing up and down the streets of Westhaven gathering objects you will need to defeat the poltergeist. Your progress is impeded by heavy traffic and you must maneuver from house to house while avoiding being hit by a car. Not a simple task!

Screen two places you at the bottom of a staircase. You must get to the top without bumping any of the objects which the poltergeist has placed in motion upon every step. Watch out! If you move too cautiously the ghost himself will appear and attack you. Failure at Screen two puts you back at the beginning of the game.

Screen three is a shooting gallery with a frightening twist. Out of the blackness at the center of a violent force field, a tiny dot of light emerges, growing into the hideous face of the poltergeist. You must successfully destroy eight of these to rescue Carol Anne. But, horrors! Sometimes the dot of light is the young girl herself, mockingly revealed by the evil spirit. You will have only a split second to make the decision to shoot or hold your fire. Fail here, and you begin all over again in Westhaven.

Sept., '81 RAINBOW
"This program is absolutely excellent!"

TEXT EDITOR

By John Waclo



WORD PROCESSOR FOR THE COLOR COMPUTER

The bottom-line in Word Processors is printed output flexibility and TEXT EDITOR has it. TEXT EDITOR has **Variable Text**, **Multi-Copy**, and right-side **Justification!** Features that are hard to find in other widely advertised Word Processors. With **Variable Text**, you can repetitively generate the same text with predetermined changes in each output. Merge form letters with mailing lists using **Variable Text**. TEXT EDITOR's **Multi-Copy** command automatically does your letters and file copies. 50 copies of your address on mailing labels is a snap with **Multi-Copy**. Give your text that "professional" look with even right-side margins. It's easy, just select **Justification** on the Output Menu.

16K - Special screen display, Save text, Add to text, Find locations of any word. Edit, Insert, Delete, Replace any line of text. Plus Auto Line-Centering! Output to any printer with full control over Left Margin, Right Margin, Line Spacing, Paging, Length of Form, Number of Copies, and right-side Justification. Re-format entered text; Menu driven. Draft of text; full or partial. FREE upgrade to 32K software...and more.

32K - ALL of the above PLUS... More text storage, Auto-Key Repeat, Global word or phrase exchange, and Automatic Letter Headings. Move, Duplicate or Delete blocks of text. User changeable Printer Format menu and text imbedded printer control codes. Plus, Exclusive Variable Text feature...and more.

\$49.95 Tape -- \$59.95 Disk ‡ Includes Manual ‡ Extended Basic required

ELITE Software

Box 11224

Pittsburgh, PA 15238

(412) 795-8492

YOUR COLOR COMPUTER JUST GOT WHEELS!

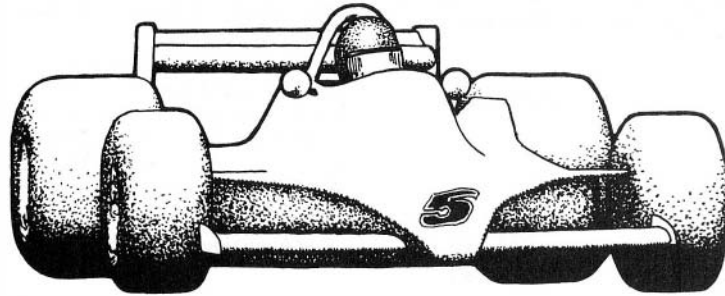

REVOLUTION!

You accelerate hard down a long straightaway, braking heavily at the end for a hard corner. You slice smoothly through the esses, and then boldly keep the power on for a fast sweeper. The Ferrari drifts dangerously near the edge, but you make a tiny correction in the steering, and you are through.

The finish line flashes by, and suddenly you are in the pits. The car falls silent. You see your lap times being held up. Your final lap was a new lap record! At last, you permit yourself a small smile.

You have mastered this powerful car on a difficult track, driving with the assurance and precision that comes only from long hours of practice.

You are driving an *authentic* race car. You are playing *Revolution!*

FANTASTIC ACTION

Revolution uses high resolution, machine language graphics for action that is smooth and fast. The emphasis is on authenticity in the control and motion of your car. As in driving a real race car, accuracy and precision in your driving are what counts. Frills and non-essentials have been left out.

PURE COMPETITION

Like a real race driver in practice and qualifying sessions, you compete against the clock and against the existing lap record for that track. *Revolution* records the lap records and the name of the person who set the record, so you always know who reigns supreme on your favorite track!

DESIGNED WITH YOU IN MIND

Revolution is menu-driven, and self explanatory. Information screens tell you what you need to know. When you're ready to play, a menu of the names of all your tracks is displayed, along with the lap record for each track and the name of the person who set that lap record. You select a track with a single keystroke, and *Revolution* takes you there.

A NEW CONCEPT

Revolution is a unique game, because it allows you to create the most important part of any race game: the track itself.

The first time you run *Revolution*, you will be able to choose from several tracks and cars which are included with the game.

But, with *Revolution*, this is only the beginning! You can create as many tracks as you like. You can make each new track as difficult or as easy as you wish. You can make easy ones to begin with, and tougher ones as you become more skilled. You may find creating tracks to be almost as much fun as driving on them!

You can save your favorite tracks to run on again whenever you wish. *Revolution* will automatically add these new tracks to the menu. And you can exchange your favorite tracks with other *Revolution* owners.

Be careful, though, about letting your friends play this game. They may not want to let you have your computer back!

THE EARLY REVOLUTION

A prototype version of *Revolution* was published in the September, 1982 issue of *Rainbow* magazine, under the name *The Track*. The response to *The Track* has been terrific.

Revolution has all the features that have made *The Track* a favorite, and *Revolution's* fast, high-resolution machine language graphics are dramatically improved over the prototype's.

REVOLUTION NOW!

The original *Revolution* for the TRS-80™ Color Computer requires 32K and one disk drive. A new cassette version has action just like the disk version, and similar track-saving features excluding a menu of available tracks. The cassette version will run on a 16K Color Computer or TDP-100. You can upgrade to the disk version later, too, for a nominal fee.

REVOLUTION

For 32K Disk \$24.95

For 16K Cassette . . . \$21.95

Requires Joysticks
& Extended BASIC

Connecticut residents add 7½% sales tax.
TRS-80 is a trademark of Tandy Corporation.



Inter  Action

113 Ward Street • Dept. R • New Haven, CT 06519 • (203) 562-5748

Whether you just got your CoCo for Christmas or you've been in it since the beginning, PCLEAR 80 has the software you need.

We still carry the finest games...

TOM MIX

DONKEY KING (32K) *New*	\$24.95
PROTECTORS (32K)	\$24.95
KATERPILLAR	\$24.95
SOLO POOL *New* (E.B.)	\$17.95

SPECTRAL SPECIALS

GALAX ATTAX	\$19.95
PLANET INVASION	\$19.95
GHOST GOBLER	\$19.95
WIZARD'S KEYS (Adv)	\$18.95

OTHER GREAT GAMES

DUNKEY MUNKEY (32K) (Intell)	\$22.95
STARFIRE (Intellectronics)	\$19.95
ASTROBLAST (Mark Data)	\$24.95
HAYWIRE (Mark Data)	\$24.95

AND MANY OTHERS...

....BUT WE'RE SERIOUS, TOO!

BUSINESS & UTILITIES

TELEWRITER-64 (Cognitec)	cass. \$49.95	disk \$59.95
T.I.M.S. (Sugar Software)	\$24.95	
Write for info on disk version!		
WORKSAVER (Platinum Software)	\$30.00	
MASTER CONTROL (S.S.M.)	** \$21.95	**
TAPE DUPE (Tom Mix)	\$16.95	
DISKUTIL (A.M. Hearn)	\$49.95	

CALL OR WRITE FOR LATEST CATALOG TODAY!



PCLEAR 80 SOFTWARE



**494 Cline Avenue
Mansfield, OH 44907
(419) 756-4873**

Note: We also carry the RAINBOW



Add \$2 shipping on orders less than \$50. Please add \$2 for COD. Ohio residents add 5% state sales tax

The game allows you three chances at rescuing Carol Anne. Even if you do not succeed you can compete for fun with yourself or another on total score. The scoring mechanism is based on a sophisticated formula involving time spent, number of chances used and screen level achieved.

Poltergeist requires 16K, though not Extended Basic. You will need one joystick, but you had better have two on hand. You just might wear out the first one trying to win.

"Poltergeist" is a trademark of Metro-Goldwyn-Mayer Film Company and SLM Entertainment Limited. The *Poltergeist* program is copyrighted by these companies and Tandy Corporation.

(Available at Radio Shack stores for \$34.95)

—Robert Kelly

Software Review...

Foxygraf Does 'What Tandy Didn't Tell You'

If you've suspected that there might be more to CoCo's graphics than Tandy has told you about, then *Foxygraf* is for you. Requiring a minimum 16K Color Basic system, *Foxygraf* is a graphics development package for the assembly language programmer. *Foxygraf* gives you easy access to all the possible graphic modes, including those unavailable through Extended Basic, and allows you to set up graphic pages anywhere in RAM. There are routines for saving machine language programs, drawing lines and drawing circles or ellipses that are especially helpful for those without Extended Basic. The arrow keys are used for drawing and setting the limits for lines and ellipses. Screen graphics can be saved to tape in different graphic modes, and when loaded back in, the graphic mode will automatically be set, ready for viewing.

Foxygraf is a very friendly program. A list of all commands with definitions and a full page of data about the current graphic page are always just a keystroke away as you create your picture. Any mistake in keying in commands or data simply returns you to the command routine with no hassles or complications. *Foxygraf* is relocatable, and can move itself to any position in memory that you find convenient, leaving the rest of RAM available for graphics.

The manual is easy to read, starting with a simple background on graphics, and going to a more complex discussion of how the various graphic modes are set up. It takes you through your first session, step-by-step, explaining the different commands. Details on each of the graphic modes is sketchy, (you are encouraged to explore on your own) but you are given enough information to find out whatever you want to know.

If you are a hard-core assembly language programmer, the manual tells you how *Foxygraf* works, gives technical data, information on how to customize the program, and lists addresses of useful subroutines.

This program has been carefully designed to be a tool to explore all the graphic modes and abilities of your machine. If you are interested in assembly programming, trying out unusual graphic modes, or exploring the possibilities of your machine, then you will like *Foxygraf*. BUT, if you are dead set against assembly, hex, or binary notation, or if you are only interested in drawing on the screen, then there are drawing and painting programs available that are easier to use.

(Computerware, P.O. Box 668, Encinitas, CA 92024, tape \$29.95, disk \$34.95)

—James Ventling

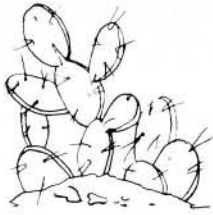

PRICKLY-PEAR SOFTWARE

QUALITY PROGRAMS FOR YOUR COCO & TDP-100

PROGRAMS REQUIRE 16K EXTENDED BASIC FOR TAPE, AND 32K DISK UNLESS OTHERWISE NOTED.

Gangbusters

If you ever wanted to try a life of crime, this is your chance. You will start out as a Punk, but by using brains, and a little muscle, you can rise to become a Hood, Runner, Bookie, Torpedo, Fence, Kingpin, or win by becoming Syndicate Boss. Indulge yourself. Bribe a judge, or the District Attorney. Pay off the Cops. Take out a contract on another player, but watch out, they may be after you. Buy trucking companies, bootleg operations, houses of ill fame, but remember, if you get caught, you may do some hard time. Do you have what it takes to take over? This game will keep you close to your rod, get you thinking about bulletproof glass in your car, and definitely bring out the worst in you, but you'll love every minute of it. For 2 to 6 players, takes about 2 hours to play. Every game is excitingly different. **\$19.95 tape — \$24.95 disk**

Viking!

A simulation for 1 to 4 persons. Each begins as a landowner, and by farming their land, buying and selling land, expanding their fishing fleet, building on to their manufactory, increasing their population, equipping and training more soldiers, and regulating their taxes, each player tries to increase their economic power and rank until one becomes ruler over all. But beware plagues, rats, raiders, revolts, bad weather, and other misfortunes which may lie along the road to success. As you progress, see the map of your holdings increase. Playable in 1 to 2 hours, and different every time, you may have an addiction problem. **\$19.95 tape — \$24.95 disk**

Phonics I

This classroom-tested program is the newest in our Phonics series. Written by the same elementary school teacher, it takes up where PREREAD I, II, & III leave off. Actually two programs (on separate tapes), the TUTORIAL teaches all 22 of the consonant blends using on-screen graphics and voice (controlled by the computer and played through the TV speaker). The TEST program asks for the letters in these blends (again using voice through the speaker), and checks the keyboard input for the correct answer. Again, on screen graphics are used as an aid to learning, and immediate feedback to the learner is given.

Phonics II

Similar to **Phonics I** in concept and execution, but **Phonics II** teaches consonant digraphs. Again there are two programs (on different tapes) for the TUTORIAL and TEST modes.

Both **Phonics I** and **Phonics II** are well documented, and are sold separately on **TAPES** for **\$24.95** each. They are also available as a package — only on **DISK** for **\$44.95**.



ALL Programs in this ad, including disk versions, carry the Rainbow certification seal!

SEND A STAMPED, SELF-ADDRESSED LONG ENVELOPE FOR COMPLETE CATALOGUE

Your Personal check is welcome - no delay. Include \$1.50 shipping for each program ordered. (Shipping free on \$50.00 or larger orders). Az. residents add 6% sales tax. Orders shipped within two days.

NEW THIS MONTH

The Fantasy Master's Secretary

This program will be greatly appreciated by the many people trying to run a fantasy game! It's not easy to keep track of hit points, charges in magic items, monsters, game time, armor values, and a lot more, all while trying to conduct a mellee and listen to 8 people talking at once. If you ever thought you needed a secretary, this is it! It keeps track of all the above and more, and even has a help file in case you forget how to use it. It also figures the experience points of monsters while keeping an electronic eye on value and weight of treasure found. You'll truly wonder how you got along without it!!! If you quit before the campaign is completed, you can save the whole thing to tape (or disk) and take up right where you left off next time you play. At the beginning it will ask you whether or not the players can see the screen, and set its displays up accordingly. Remember, this isn't a game — it's an aid to use with a fantasy game. **\$19.95 tape — \$24.95 disk.**

Eight-bit Bartender:

This will light up your next party! Over 100 great drink recipes are stored by the bartender and called up at your command. Ask for them by drink name, main liquor used, or class of drink (highball, cocktail, etc.). These were gathered from the favorites and house specialties at famous pubs and taverns across the US. It outputs to the screen, printer, or both! At your next party let the guests browse through the Bartender. Needs 32K. **TAPE \$19.95 — DISK \$24.95**

Astrology

Truly a classic, this program will accurately cast your complete horoscope. You just enter the date, time, and place of birth. The sun sign, rising sign, mid heaven (MC), lunar nodes, and planetary influences including houses and aspects between the planets will all be calculated, and a full chart drawn. You can also do progressed charts and transits. It will even tell you the day of the week you were born. The accompanying book will help you interpret this chart of your horoscope. The extent of the documentation is tremendous, even by our exceptionally high standards, and no previous knowledge of the subject is required. You can share in this wisdom which has been used for thousands of years in many cultures. This program was written by a professional Astrologer. Please specify 16K or 32K system. **\$34.95 tape — \$39.95 disk**

Stocked by Quality Dealers, or

Send Order To: **PRICKLY-PEAR SOFTWARE**

9822 E. Stella Road
Tucson, Arizona 85730
(602) 886-1505

Five 'Nice' Games... But *Cosmic Trash Collector*?

When a cassette comes labeled "Five Exciting Games," you can't help but, well, get excited about the prospects for an evening of fun on the homefront. After loading and playing them, however, I wondered whether something like "Five Nice Games" would have served as well.

What you have is a nice-ish assortment of games, ranging from *Cosmic Trash Collector*, *Space Fight*, and *Intercept*—all space games—to *Trap 'Em*, a line game, and *Line Dance*, a random graphics program.

I found *Space Fight* to be the most interesting, primarily because of the sound effects that opened ("Reveille") and closed ("Taps") the game. It's an adventure game, which can be played by one or two players, in which you try to knock the other ship out of existence, using a set of five commands and directional signals.

Trap 'Em consists of two moving lines (yours and a friend's or the computer's) and the object is to make your line last longer. I found that the computer has an advantage over you; it can run into walls, you can't.

In *Cosmic Trash Collector* (I knew you were waiting for this one), you control a "space trash ship" and your mission is to rid the universe of space baggies. You may move your ship up and down, using various keys of the keyboard, but if you're not careful, you'll be shot down by an evil laser ship. In *Intercept*, you attempt to escape a guided missile, which I found to be fairly easy (in fact, I had to maneuver to get a hit a couple of times).

Actually I believe this set of games would be great fare for

the family with young children that wants to familiarize them with the computer through game-playing. My young son had a difficult time tearing himself away from the games, saying something to the effect that "these are for me!"

(Intercept Enterprises, P.O. Box 4016, Cherry Hill, NJ 08034, \$15.95 on tape, 16K E.C.B.)

—Charles Springer

TP-1 'Daisy Wheel' Printer Good Home Word Processor

The Smith-Corona TP-1 printer is probably the most affordable daisy wheel printer available, and any review of it must take into account the price. I will come back to the price in a moment.

A daisy wheel printer (or typewriter) uses a round wheel with the letters on the end of little arms that look something like petals. In use, the machine rotates the wheel until the correct letter is in position, and then hits the back of the arm with a hammer. (It's a small hammer.) The letter is on the front of the arm, and it hits the ribbon and makes the impression on the paper.

Compared to the dot-matrix printers, daisy wheel printers are slow, noisy, and more expensive, but the image produced on the paper is as good as that made by top quality typewriters. In fact, there is no way to tell by looking whether a document was typed by hand on a typewriter or by a computer using a daisy wheel printer. Thus, for all their disadvantages, if you want letters or reports to look typed,



P.O. Box 382
West Point, PA 19486

MISSION:EMPIRE!

NOW FOR 16K
Does NOT require Extended BASIC

Some of the cute is gone, but none of the excitement and playability which made "The RAINBOW" say about the 32K version that

"We recommend MISSION:EMPIRE!"



MISSION:EMPIRE!

for disk or cassette \$19.95

A strategic wargame/strategy game. Starting with one planet, incomplete intelligence and limited resources, you must conquer the rest of your galaxy. The game takes 2-5 hours and is DIFFERENT EVERY TIME! All versions offer the option of saving a game in progress.

Specify 32K disk, 32K cassette or 16K version - the 32K versions require Extended BASIC, the 16K version does not. The disk version is normally shipped on a cassette with instructions for transferring to disk. If you want the program shipped on a disk add \$3.00.

Send check, money order or Mastercard/Visa number (including expiration date and SIGN order). Price includes shipping. PA residents include 6% sales tax.

*All programs require Color Computer™ (Tandy Corp.) or TDP System 100 Computer™ (RCA Corp.).

you need a daisy wheel printer.

Smith-Corona has been making a typewriter that uses daisy wheels for some time, and last summer they introduced their computer printer. It uses many of the same parts as the typewriter, and is thus not really a new product, as many of the parts have been tested and proved in use on the typewriter. Another nice thing is that both the ribbons and daisy wheels are the same as used by the typewriter, and are stocked by most office supply stores, often at discounted prices. At full price, the daisy wheels are only \$5.00, which makes them only about one-sixth the cost of daisy wheels for other machines. The ribbons are also relatively inexpensive, and come in several colors and qualities.

The printer itself shows its typewriter ancestry. When you buy it, you specify either Pica (10 characters per inch) or Elite (12 characters per inch), just as you would do with a typewriter. Also, the paper carriage will be very familiar to typists, and you load single sheets of typing paper just as you would on any office typewriter.

As you would expect from this, the ability to handle single sheets is excellent, but there is no tractor, and thus the manufacturer does not recommend fan-fold or roll paper for use in the printer.

This is a printer for word processing, period. It was conceived and built to convert a computer into a really neat typewriter, and if you have the need for a true letter quality printer, this is not a bad choice. You can do listings on it, but it doesn't have all the characters you need, such as greater-than and less-than, which may be a problem. Also, if the program is long, it will run off the bottom of the single sheet, and you will have to read the platen. (I know people who are successfully using fan-fold paper in the TP-1, but Smith-Corona won't guarantee it will work. It has a tendency to get crooked after a while.)

Now, back to price. This printer has a suggested retail price of \$895. This is already the lowest price for a daisy wheel printer, and I have seen it discounted to below \$600 right here in *the Rainbow*. People will tell you there are lots better daisy wheels, but you'll find them selling for near \$2,000. This printer is fairly slow—only 12 characters per second—and lacks the tractor and other bells as mentioned above, but it is inexpensive and very reliable. Sure, if you are running an office you need a bigger one, but this was designed with the personal, private computer owner in mind. If that's you, take a good look at this printer.

By the way, when you order you must choose between a serial and parallel interface. The CoCo and TDP-100 have a serial interface standard, so unless you want to get an adaptor, stick with the serial. Also, keep in mind that you will need a cable, and a standard Radio Shack serial cable won't work because the jack on the printer is different. If the dealer where you buy the printer can't supply you with a cable for the CoCo, you can get one from Petrocci Freelance Associates. (See their ad in this magazine for the address.)

To summarize, the TP-1 has its drawbacks, but if all you want is a typewriter quality printer for home use, this may be it.

—Bill Nolan

Hint . . .

Painting Must Be Accurate

When you issue a PAINT command, be sure that you set the point at which the PAINTing is to begin within the area that is to be PAINTed. If you set the position on a line which encloses the area, the PAINT will not work.

Also, when using PAINT, be sure that your area is fully enclosed, or the PAINT will leak out and cover the entire screen.

HOMEBASE™ THE COMPLETE TRS-80* COLOR COMPUTER DATABASE

HOMEBASE™ PROVIDES WORD PROCESSING, DATABASE MANAGEMENT, AND SPREAD SHEET CALCULATIONS, IN ONE EASY TO USE PACKAGE. SOME OF THE MANY USEFUL APPLICATIONS OF HOMEBASE™ INCLUDE:

• Check book management • Ledgers • Grocery lists • Shopping lists • Article indexing • Recipes • Disk directories • Notes • Memos • Letters • Phone lists • Customer lists • Business contact lists • Appointments • Mailing lists • Home inventory • Car maintenance scheduling • Income tax preparation • Address lists • Charts • Newsletters • Athletic team records • Form letters •

WORD PROCESSING FEATURES INCLUDE:

- DEFINE 250 screens of text you can search, sort, display, and print using names you assign or using any word or phrase.
- EDIT text by duplicating, moving, clearing, searching and replacing, deleting, or reordering entire records of text or any word or phrase.
- FORMAT labels, memos, letters, and other documents for printing with embedded printer controls for paging, skipping lines, and changing character fonts. Program controls provide setting; right and left margins, lines per page, page width, horizontal tabs, and line spacing.

DATA MANAGEMENT FEATURES INCLUDE:

- DEFINE 50 data fields, including a comment field, in a single record. Dates, time of day, phone numbers and dollar amounts are automatically formatted. You may also define 24 scratchpad data fields.
- REORGANIZE records by moving data fields within records or by moving records within the file. You may sort records using names you assign or data.
- MANAGE files by searching, deleting, clearing, duplicating, and displaying any data field or record. Add, subtract, multiply, divide, or summarize any data field. Use any command on any selected group of data fields and/or records.
- PRINT files using automatic formatting with options to print report titles, a report date, page numbers, record names, and data field names. Print all or selected data fields or records. Use standard or compressed print. Use a special print option to print the comment field as a mailing label.

UTILITIES FOR WORD PROCESSING AND DATA MANAGEMENT INCLUDE:

• Generating new files from old files • Merging files • Duplicating files • Moving data between files • Summarizing files • Moving files from diskette to diskette using one drive • Saving files to cassette and reloading from cassette • File synchronizing • Print disk directory •

HOMEBASE™ IS EASY TO USE:

- NO PROGRAMMING REQUIRED. All options are displayed in menus. HOMEBASE™ automatically requests all required data and edits every entry.
- All commands are single key stroke.
- FULL screen editing for text entry.
- Complete cursor control for entering names, titles, notes, and comments.
- 100 pages of instructions with complete descriptions of each command, and examples.
- Requires 32K of memory, disk basic and only one disk drive. NO equipment modifications required.
- All programs reside entirely in memory.
- Fast response to all commands including search and sort.

ORDER TOLL FREE

Credit card holders call toll free: 800-334-0854 extension 887
In North Carolina Call 800-672-0101 extension 887

or send a check or money order for \$75.00 plus \$5.00
for handling charges to:

HOMEBASE™ COMPUTER SYSTEMS
P.O. Box 3448

Durham, N. C. 27702

N.C. residents add 4% for sales tax. Allow 1 to 3 weeks for delivery.

HOMEBASE™ is a trademark of HOMEBASE™ COMPUTER SYSTEMS,
a subsidiary of Small Business Systems, Durham, N.C. (919) 544-5408.

*TRS-80 is a trademark of Tandy Radio Shack Inc.

Well-Defined Variables Produce Clarity, Conservation

By Richard A. White

In a high level language like Basic, variables are provided to organize and reference the data being used in the program. A variable is simply a name given to a particular piece of data. Data should be thought of as being assigned to a variable, and not as the variable equaling the data even though the equal sign is used to make the assignment. Early Basics emphasized the assignment idea by requiring the use of *LET*. One had to write *LET X = 10* or *LET Y\$ = "Hello."* Color Basic does not allow the use of *LET* though it is an optional statement in Extended Color Basic. You may see *LET* used in older Basic programming books.

In Color Basic you may use any one or two letter combinations, except reserved words, for a variable. What is a reserved word? It is one that is also a Basic statement or function command. *ON*, *TO*, *GO*, and *FN* are examples. When the computer encounters an *ON*, it starts looking for a variable representing a number to use in a following *GOSUB* or *GOTO* action. If your statement had been *ON=20*, no variable comes next, the computer gets confused and registers a complaint as a SN ERROR. You may also use a letter then a number like *X1* for a variable name.

Extended Color Basic allows you to use whole words as variables, but only the first two letters are recognized. The objective is to allow writing clearer programs, but there are drawbacks that keep people from using the capability. First, there is the added memory used, one byte for each added letter each time the variable is used. Secondly, the number of reserved words (Basic commands, remember?) become much more numerous. Lastly, is the trouble in devising meaningful words which always are different from any other in the first two letters. If I had two *FOR-TO-NEXT* loops, one within the other, I might like to name the variable *COUNTTWO*. Since the first two letters are the same the computer cannot tell the difference and the loops won't work the way you expect. So, we will try *ONECOUNT* and *TWOCOUNT* instead. The first two letters are different, but *ONECOUNT* contains *ON*, a reserved word and SN ERROR results. Another loser is *TWO-COUNT*. The computer sees it as the subtraction *TW - CO* without a variable to assign the result or an equal sign. The result is SN ERROR.

There are two basic types of variables used by Color Basic, real and string. Real variables represent numbers, and are used directly in equations making calculations resulting in some number. Some Basic dialects let you define whether a variable will be an integer, a single-precision, floating

decimal number or a double-precision decimal number. The higher the precision, the more memory that is necessary to store the number. CoCo will accept positive or negative numbers up to 10 to the 37th power and will display nine significant digits. This is fine for nearly all programming you are likely to do. I miss the ability to define integer variables, and the benefit from the memory saving that result. Simple counting and other integer number operations are encountered all the time. Where a wealth of integer data is to be used, it can be put into strings and recovered using methods discussed elsewhere.

A string variable references a string of characters. The string may contain any character and may be up to over 240

**Data should be thought of as
being assigned to a variable, and
not as a variable equaling the
data . . .**

characters long. Here, I admit to being fuzzy since there appear to be differences between the 1.0 and 1.1 Basic ROMS with regard to buffer sizes, and perhaps string lengths as well. If you keep your strings to 240 characters or less you will have no trouble. Of course, the *z"\$* following the variable defines it as a string. In the assignment statement for a string variable, characters must be between quotes or defined using *CHR\$(XX)* or *STR\$(Y)*. Here *XX* is the ASCII number for the character. *Y* is a real variable that is converted to a string having a leading space. Examples are *A\$="THIS IS AN example"* *B\$=CHR\$(191)*, which is a solid red block, and *N\$=STR\$(20)*.

Strings can be added to each other in a process called concatenation. *C\$=A\$+"FOR THE ARTICLE ON VARIABLES."* Now *C\$* represents "THIS IS AN example FOR THE ARTICLE ON VARIABLES." If we

Color Computer Expansion Interface

NOW SHIPPING!



COMPARE THESE FEATURES!

- **RS DISK COMPATIBLE** — NO modification required
- **64K Memory access circuit** (for 32K Rev-E computer) — NO modification needed
- **Parallel PIA port** — Drives printer or I/O — leaves RS-232 available for modem, etc.
- **Expansion port** — selects up to 7 more peripheral cards
- **Aluminum chassis** — saves space — computer slides under — TV on top — Room for Expander Card and up to 4 peripheral cards.
- **Additional I/O cards . . . available January 1983**
 - CX-2010A Quad Parallel I/O Port (2 M6821 PIAs) \$99.95
 - CX-2016A Speech Synthesizer (Votrax phoneme system) \$129.95

. . . more peripheral cards on the way!

CX-2001A EXPANDER CARD (REQUIRES CX-2401A)	\$139.95
CX-2401A EXTENSION RIBBON CABLE	\$29.95
CX-3001A ALUMINUM CHASSIS (IDEAL FOR STAND ALONE USE)	\$49.95
CX-P1—INTRODUCTORY OFFER — PACKAGE PRICE	\$199.95

PA RESIDENTS ADD 6% SALES TAX

INCLUDE \$3.50 FOR SHIPPING & HANDLING WITHIN THE CONTINENTAL U.S. ADD \$1.50 FOR C.O.D. CHARGES.



General Automation
9600 Roosevelt Blvd., Suite 100-LL
Philadelphia, PA 19115
(215) 934-3758

concatenate C\$ with B\$ like this D\$=C\$+B\$ we would get the same string as before but with a red block after the period. Enter this program and run it.

```
10 A$="CHARACTERS"
20 FOR X=1 TO 10: A$=A$+CHR$(8): NEXT
30 PRINT A$
```

OK, you ran it and nothing printed. We know there are characters in A\$, but they don't print. The trick is that CHR\$(8) is the backspace or left arrow character. As soon as "CHARACTERS" was printed, 10 back spaces were printed which erased "CHARACTERS." This may not be good for much, but it does give food for thought. There is a "watch-out" here in that you can add non-printing characters to strings that give unexpected results. Also note the A\$=A\$+CHR\$(8). A\$ appears on both sides of the equation. We can also write A=A+10. This comes back to the assignment idea. The right side is evaluated and the result is assigned to the variable on the left. The computer finishes its work on the right portion using whatever A or A\$ represent initially before it redefines them.

Both real and string variables can be viewed as either global or local. Actually Basic variables are always global since they can be used anywhere in a Basic program. In some languages, variables can be defined so they have only a value in a particular subroutine and are in fact local. Further, in these languages, the same variable name will mean one thing in the main program and another in a subroutine. We cannot define our variables like this, but we can view how we use them as local or global. In a file program, the variables that refer to the data records are global in that they are

defined in the input section, changed in the editor, saved in another section to tape or disk, used in search and sort sections and in various subroutines. A variable used in a FOR-TO-NEXT loop in a subroutine means nothing in the program once you exit that subroutine, and may be reused elsewhere.

There is a savings of memory if certain variable names are prechosen and used only for local purposes. They can be redefined and used again and again in other parts of the program. This serves to help clarify the program if it is known that J and K are always used locally, generally serve counting purposes and never have meaning once the using routine is left. This will work well with some careful discipline and I think is much better than trying to find an unused variable each time a loop is needed. You should also define string variables and other real variables for local temporary data holding purposes. Just make sure all local variables are defined when they are first used in the routine and do not contain data needed elsewhere when the routine is exited.

Have you noticed the computer stop for a few minutes in the middle of a program and then continue on its way? When this happens, it's cleaning "garbage" out of the string storage area. To understand what garbage is, we need to understand how the computer stores string data, and finds it, when your program wants it. If you or the program does a CLEAR 2000, 2000 bytes of memory are reserved for string storage. When you first turn the computer on, 200 bytes are reserved so you have some space to get a program started. Each time a string is defined, the computer writes the string into the CLEARed memory area starting at the top. The second string defined is written just below the first one in memory, and so on. When you redefine a string, the new data is written just below the last string defined and the old string up in the memory is forgotten. But the old string is still there taking up space.

Eventually, the CLEARed string space gets full and the computer must stop and do some housekeeping. It starts at the top of string memory and checks if the string there is shown in the variable table. Ah, a variable table! The variable table keeps track of all variables that have been used in the program. For strings, it keeps the length of each string and where it starts in the string space. When the computer finds a string of bytes in the string space that is not listed as a string in the variable table, it moves the next lower listed string up into that area and changes its address in the variable table. Think of it as a bunch of shelves with stuff in boxes and you with a list of what is in each box on each shelf. But, you have emptied some of the boxes and now come with a new full one to put on the shelves only to find the shelves full. You have to stop and pull off the empty boxes to make room and change your list of what is on what shelf. Housekeeping is much the same in the computer and in the house.

While you may not need to consult the variable table very frequently, Extended Color Basic gives you a way to do so with the VARPTR function. VARPTR gives you a way to know where the data in the variable table for a variable can be found in memory. This is most useful in sorting routines where string lengths and addresses can be swapped length and address in the variable table without disturbing the listings in the string space. Considerable program speed can be obtained. To use VARPTR, some things must be known about the variable table.

A Basic program starts just after the last graphics page reserved with PCLEAR and is written from lower to higher memory. If you have Color Basic only, the program starts at 1536, just after the text screen memory. At the end of the program there are three null bytes (zeros in memory) and

Tired of simplistic Printouts? Want to use your printer's full capacity?

AT LAST AT LAST

- * Useful programs for the RS Color Computer
- * Home & Small Business
- * Customized for your printer
- * Easy to use

BUDGET - income & expenditure by month & category. Great for taxes	\$17.95*#
REMINDER LIST - the most complete list you will ever have	17.95 #
APPOINTMENT BOOK - Print an appointment calendar with any number of memos	17.95*
CALORIE COUNTER - automatically helps you diet	17.95
WEIGHT GRAPH - graph your daily weight	14.95
ADDRESS LISTER - makes labels, printouts & alphabetized lists	17.95 #
CAR REPAIRS AND MAINTENANCE LOG - graph when maintenance is needed & keep track of repairs	17.95*#
SALES RECORD - List item, date ordered, delivered, client, prices	14.95
PHONE BOOK - Alphabetical list to keep with you	14.95

Programs supplied on disk - add \$4.00 shipping, handling & disk/cassette charge. DISCOUNT: \$3.00 off second program \$4.00 off all others ordered at same time. \$110.00 for complete package postpaid. Specify: 16-32K, Cassette or RS disk. Type of printer - if possible and send xerox printer manual specifying control codes.

FREE FREE FREE

Grocery list program (14.95 value) with SASE
Supplied on disk/cassette with order

Catalogue Available

CALL or WRITE
BRUCK ASSOCIATES
6609 Westmoreland Ave.
Takoma Park, MD 20912
(301) 270-5822



* Requires printer with compressed character capability
32 K recommended

then the variable table starts. Real variables come first, each with two bytes of the variable name (in ASCII) from Basic and then five bytes which carry the value of the variable. Next come the string variables. The first byte of a string variable is the ASCII value of the first variable letter, and the second byte is the ASCII value of the second letter plus 128. This is the way the ocmputer knows that it has a string listing. The next byte is the length of the string followed by a null byte. Then comes the two-byte address of the string in string space and the fifth byte is another null.

VARPTR gives you the address of the length byte of a string variable. To recover the actual address of the variable in string space, the following code could be used.

```
100 V=0 : AD=0
110 V = VARPTR(A$) : AD = PEEK(V+2)*256 + PEEK(V+3)
```

The first byte of the address is the most significant byte and is multiplied by 256. Note that V, the address of the length byte, and AD, the address of the string, are defined (set equal to zero) before the operation. If this is not done, and V and AD had not been used before, Basic adds them to the real variable table when they are first used moving the string variable portion of the table up. The address of A\$ in the variable table (not in string space) changes and the wrong address AD for A\$ in string space is found.

As we noted before, you may only want to swap string addresses in the variable table. You could use the following code.

```
100 A=0 : B=0 : X=0 : AA=0 : BB=0
110 A=VARPTR(A$) : B=VARPTR(B$)
120 FOR X=0 TO 4 : AA=PEEK(A+X) : BB=PEEK(B+X)
130 POKE B+X,AA : POKE A+X,BB : NEXT
```

Again, all variables used were entered into the variable table before we started by setting them equal to zero.

After the regular variables come the array, or subscripted, variables in the table. The entry for the A\$(10) would look like this.

-7	ARRAY	55
-6	NAME	128
-5	DISPLACEMENT	VX
-4	TO NEXT ARRAY	YZ
-3	# OF DIMENSIONS	1
-2	NUMBER OF	00
-1	ENTRIES	11

VARPTR(A\$(0)) > A\$(0)LENGTH

0
A\$(0)
ADDRESS
0

VARPTR(A\$(1)) > A\$(1) LENGTH

0
A\$(1)
ADDRESS
0

VARPTR(A\$(10)) > A\$(10) LENGTH

0
A\$(10)
ADDRESS
0

The array for A(N) is similar except the value for each member of the array is in each five-byte block. When a subscripted variable is first used, an eleven-entry block is established in the variable table for that variable. Note that A\$(0) is a member of the array. If you need more entries, you must dimension the variable: e.g. DIM A\$(100) or DIM A\$(X). You can also have multi-dimensional arrays in Extended Basic. A\$ could be dimensioned DIM A\$(50,10). Note that such arrays use memoryspace. A\$(50,10) requires 7 + 50*5*10 or 2507 bytes of memory for the variable table alone. Finally, if you know you are only going to use a few members of an array, say four or five, then dimension the array to keep memory table use for only what you really need.

PEACOCK ENTERPRISES
HELP US CELEBRATE

FEBRUARY IS PE COCK'S ANNIVERSARY SALE
MAILIST 5.0 (D) + 1 BOX OF 5 1/4" ELEPHANT MEMORY SYSTEM DISKS \$35.00
MAILIST 5.0 (D) \$19.95; MAILIST 4.0 (T) \$15.95; ELEPHANT MEMORY DISKS \$23.00
ORDER YOUR PROWRITER LINEPRINTER NOW FOR ONLY \$445 (par) \$555 (ser)
ANCHOR SIGNALMAN MKI MODEM \$79.95
SHOW YOUR COLORS! PEACOCK T SHIRTS! \$12.95 (specify color and size)
T SHIRT FREE WITH PROWRITER ORDER!
THESE PRICES ARE EFFECTIVE THRU 28 FEBRUARY 1983
WATCH FOR OUR NEW ADDRESS IN THE MARCH ISSUE!!
DURING OUR MOVE WE WILL CONTINUE TO FILL ORDERS WITH MINIMUM DELAY

NYers add 6% tax: CODs accepted (shipping added) for software only
Send SASE for FREE CATALOG
PE COCK ENT. PHE SANT RUN BOX 494 RD#3 CANASTOTA, NY. 13032 315-697-7147

Wet T-Shirt Contest Teases the Imagination



MISADVENTURE GAMES ARE SLIGHTLY RIBALD AND RISQUE
PLAYED IN THE ADVENTURE-FORMAT

MISADVENTURE NO 1 MADAM ROSA'S MASSAGE PARLOR
IN THIS PARTICULAR MISADVENTURE THE PLAYER HAS TO MAKE HIS WAY FROM THE SLEAZY DESERTED WHARFS, GAIN ADMITTANCE TO THE ANCIENT SPEAKEASY, AND ATTEMPT TO DISCOVER THE HIDDEN PHOTOGRAPHS OF THE POLITICIAN'S BEAUTIFUL DAUGHTER! BRAVE THE DEADLY ALLEYS, HALLWAYS AND TRAPS, AVOID THE BOUNCER AND OTHER CHARACTERS OF QUESTIONABLE REPUTATION, PLAY IN THE RIGGED CARD GAME IF YOU DARE! DISCOVER WHY THE OLD MAN DIED WITH A SMILE ON HIS FACE! FIND OUT WHY THE WIND PREFERS CHEAP BOOZE! ABOVE ALL, TRY TO ESCAPE WITHOUT NEEDING ANY INJECTIONS OF PENICILLIN!!!

MISADVENTURE NO 2 WET T-SHIRT CONTEST
IN THIS PARTICULAR NAUGHTY MISADVENTURE THE PLAYER AWAKENS ONE MORNING TO A LOUD POUNDING ON THE DOOR! THUGS ENTER AND DEMAND THAT YOU PAY THE BOSS THE MONEY OWED TO HIM TONIGHT!!!
YOU MUST SURVIVE THE MANY INTERESTING SITUATIONS FOUND IN THE OVER 100 LOCATIONS! THE SCIENTIST MAY HAVE A WAY TO SOLVE YOUR PROBLEM - IF YOU SOLVE HIS PROBLEM! PERHAPS THE PRIZE MONEY FOR THE WET T-SHIRT CONTEST WILL BE ENOUGH.
ALTHOUGH VERY CHALLENGING, THIS IS A FUN GAME. SO BE PREPARED TO ENJOY YOURSELF!!!

MISADVENTURE NO 3 SEWER OF MOSCOW
IN THIS PARTICULAR MISADVENTURE THE PLAYER'S MISSION REGARDLESS OF WHETHER HE ACCEPTS IT OR NOT, IS TO ELIMINATE THE IMMEDIATE POSSIBILITY OF WW III! BEWARE OF THE TREACHEROUS SEWER! WATCH OUT FOR THE SWIFT SUBWAY VEHICLES! AVOID THE LOYAL COMMUNISTS! THERE ARE OVER 70 LOCATIONS, SO BE VERY CAREFUL NOT TO GET LOST OR KILLED IN THIS MISADVENTURE.
THE BEAUTIFUL SPY YOU FIND TIED SPREAD-EAGLED TO A BED HOLDS THE KEY TO THIS MISADVENTURE, BUT BE VERY CAREFUL WHAT YOU DO TO HER.
THIS IS THE HARDEST MISADVENTURE YET!

MISADVENTURE NO 4 CASINO OF PLEASURE
CASINO OF PLEASURE MISADVENTURE IS AN EXCELLENT PROGRAM FOR THE SERIOUS ADVENTURER WHO ALSO ENJOYS TO GAMBLE!
YOUR FIRST PROBLEM WILL BE FINDING THE HIDDEN CASINO! THIS IS ACCOMPLISHED BY USING TRADITIONAL ADVENTURE-TYPE METHODS.
IF (AND WHEN) YOU MAKE IT TO THE CASINO WITH THE MONEY YOU MUST INCREASE IT SO THAT YOU HAVE ENOUGH MONEY NEEDED TO PAY-OFF THE GANGSTERS WHO AWAIT YOU AT THE CASINO EXITS! BEWARE OF PIT BOSS! DON'T HAVE TOO MANY FREE DRINKS BROUGHT TO YOU BY SEXY YOUNG HOSTESS! ABOVE ALL ENJOY THE MANY GAMBLING DEVICES.

MISADVENTURE TAPE \$15.00 EACH
(16K NON-EXTENDED)



ARCADE STYLE GAME (16K COLOR-JOYSTICK-ML) Tape \$ 19.95

Ohio Res. Include 6% Tax
Immediate shipment! Visa, MasterCard, Money Orders, or phone order.

CHROMATIC SOFTWARE CO.

50 Fillmore Street Dept. 104
Dayton, OH 45410 (513) 252-9306

I must admit that certain sorts of visions bounced around in my easily-activated imagination when I received my review copy of *Wet T-Shirt Contest* from *the Rainbow*. I gave thanks for the thoughtfulness of the editors, marveling at their understanding of my "basic" instincts.

I had no way of knowing then that my mind's-eye would be stretched to the limits for the next four evenings, especially after viewing the slightly ribald (or perhaps, tacky) graphic on the cover of the accompanying instructions.

I was to need a lively imagination over the four days it was to take me to get through the review because *Wet T-Shirt Contest* turned out to be a very difficult adventure game. I knew I was in for a challenge when it took two hours just to get to the first page.

After two days of watching her husband swearing never again to take on an adventure game, my English-teacher wife and crossword fanatic joined me at the keyboard, combining her common-sense approach with my voyeur's instincts. She was to open all kinds of doors for me within a few hours, offering hope where there had been despair.

The *Wet T-Shirt Contest* is a slightly ribald and risqué game, but never really dirty. And, until these adventure games take on the graphic displays that I had originally expected, parents should have no fears about playing the game with young children in the same room (my 7-year-old son, Stevie, had been sent to bed early the first night), but I certainly wouldn't let them play it.

In this adventure, you play a slightly sleazy character who awakens one morning to a loud pounding on the door of his hotel room. Some nasty gangsters rough you up a bit, demanding that you pay the *Boss* the money owed to him tonight or there will be no tomorrow!

You stumble out of your room into a seemingly endless maze of corridors beset with muggers and "piles of smelly trash" as you wander aimlessly about trying to figure out how to raise the needed money. Along the way you visit a video arcade but, until you get some dough, you can't even afford to play Pac Man.

If you wander into the IRS office, you can be penalized for not filing a return.

You can try to get a loan from the bank, but the teller is likely to laugh in your face.

Eventually, if you are persistent, you will wind up in the lobby of the K & K Corporation with its 21-floor elevator. Be careful about which button you push, though; you could be electrocuted or, even worse, be confronted by 10 vicious Doberman Pinchers. You'll run into a suspicious-looking scientist on two or three of the floors and you'll find he's a gas.

He's also into transfiguration experiments and guess who becomes an unwilling volunteer?

Suffice it to say that after you leave the laboratory, you are a changed person. From there you head for the Voom-Voom Room where a wet T-shirt contest is being conducted, with the outcome determining your future!

As a newcomer to the world of CoCo and computers in general, I'll have to admit that I found my foray into the *Wet T-Shirt Contest* to be pretty exasperating. Yet, I must admire the genius of the authors, Bob Krotts and James

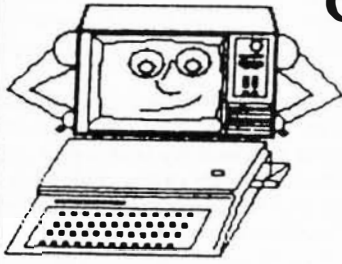

INTERNATIONAL COLOR COMPUTER CLUB

Main Office
2101 E. Main St., Henderson, Texas 75652
Canadian Branch
96 Carleton Dr. Saskatoon, Saskatchewan S7H-3N6

WORLD'S LARGEST COLOR COMPUTER CLUB

HERE ARE SOME GOOD REASONS FOR JOINING

- 1). **FREE PROGRAMS.** Good programs written by our members are contained in the library, in the newsletter, and on the new member tape.
- 2). **NEWSLETTER.** A "magazine" sized newsletter (last issue 56 pages), with programs, tips data, reviews, articles and much more.
- 3). **NEWSLETTER Tape** A tape of all the programs appearing in the newsletter is available from the library for \$2.00 (to members)
- 4). **CLUB LIBRARY.** The club maintains a library of programs, books and Radio Shack ROM-packs. The programs are member written and are yours to keep, there is a small fee to cover postage and tape (\$2.). The books and ROMpacks may be checked out for 3 weeks at a time. (extencions possible)
- 5). **DISCOUNTS.** get large discounts on many software and hardware items for CoCo from some of the MAJOR companies. Also discounts on subscriptions to the RAINBOW, CCN and Chromasette magazines.
- 6). **ADVERTISE FREE** Members may place ads of up to ¼ page per issue in the newsletter FREE. (The ad must be computer related)
- 7). **BORROW PARTS.** Don't wait weeks for the parts to come in from Radio Shack! Just check them out of the Clubs Parts library and return when yours arrive.
- 8). **SURPRISE.** You receive a "New member" package containing many useful items.
- 9). **GET HELP.** This is the worlds largest Color Computer Club. With members in almost every field of expertise. So if you have a problem with the Color Computer, we can almost always get you the answer. Put your problem on the Clubs Bulletin Board, write, or call.
- 10). **FIND FRIENDS** As a new member, you will receive a list of the members in your area whom you may contact for CoCo talk.

HOW TO BECOME A MEMBER:

Write to the club for an application, there are no conditions for membership other than agreeing to obey the rules, being interested and paying the dues. The membership dues are \$30.00 per year and we believe you get more than your moneys worth. You can save more than the \$30.00 in discounts the club offers you. Example: Subscription to the RAINBOW, 25% off of regular subscription rates. Some members have told me that the new member tape alone is worth the \$ 30. it contains 10, very good programs. Some of the programs contained in the library are, Accounts Receivable, General ledger, Inventory, Sales file and ticket program with automatic Inventory update (for 32 K with 2 disc.)

Nunke, and the obviously careful work that they have taken to make this a challenging game even for the oldtimers.

I found an ever-present beep-beep-beep-beep audio prompt to be pretty annoying, however, turning the volume down early in the game.

Actually, when you consider the simple commands that are really necessary, the game is not as difficult as some—like me—tend to make it. At any rate, as I discovered, the authors have a hint sheet available, which you can obtain for another dollar and a self-addressed, stamped envelope.

(The Softcore Software Company, 9 Southmoor Circle, Kettering, OH 45429, cassette \$15.00)

—Charles Springer

Book Review...

New AL Graphics Book Should Be Valuable Resource

Many of you have been looking for a book detailing assembly language programming dedicated to CoCo. Well, the wait is over! Don and Kurt Inman have teamed up to present us with just such a book.

The book, *Assembly Language Graphics*, is published by the Reston Publishing Co., Inc., and is available from Dymax, Owl-Ware, and computer stores all over the country.

Don and Kurt use a different approach to present assembly language techniques. Instead of the mathematical

approach, as used in most other assembly language texts, they use sound and graphics. In this book, as in Don's previous book, *TRS-80 Color Computer Graphics*, a test is available at the end of each chapter. The answers for the odd-numbered questions are given. You are left to ponder the answers to the even-numbered questions. In his earlier book, Don gave an address one could write to for answers not given in the book. This time he did not give an address (ouch!).

I think we can all agree that for most purposes, Microsoft Extended Basic is a very powerful tool. But if you are interested in graphics displays, assembly language is a must to obtain the speed required for hi-res games. This book will give you the information you need to transform that "great idea" you have into the ultimate computer game.

Included in the book is a utility program that you may use to create graphic figures. After the figure is created, a table of data values that show the data necessary to create your figure, and the memory locations to place the data to display the figure, is created. As well as being useful, you can have some fun with this program. However, this book goes beyond teaching you how to design graphic figures for games. It also instructs you how to integrate a sound routine into your program, how to design a joystick program and how to enhance your animation using the paging technique.

Also included in the book is a text editor program. While this is not a full-blown word processor, it can be the basis for a tool that you can modify using your newfound programming skills.

The book provides a character set for graphics in assembly language, and also tells how to locate them on a graphics screen using assembly language. Also provided are instructions on how to access this character set from your Basic programs.

Since Don and Kurt used the CBUG monitor and the SDS80C editor assembler debugger to develop the routines in this book, it might be less confusing to the beginning programmer if he used these same utilities. The book goes into some detail describing the expected output from these programs. These programs are produced by The Micro Works of Del Mar, California. Also mentioned in the book is an EPROM programmer available from Spectral Associates of Tacoma, WA. I must say that I am intrigued by the idea of producing my own EPROMS.

Lastly, the book has a full array of useful information in its several appendixes, such as saving and loading programs using tapes, ASCII and screen codes, graphic mode description, screen offsets, and tables to determine forward and backward branches, and the 6809 instruction set.

In conclusion, if you desire to learn assembly language programming, this book can be a valuable addition to your library. Not only is it very informative, but it is a book that reads well when compared to some of the other assembly language texts. I can definitely recommend that you purchase a copy.

(*Assembly Language Graphics*, Reston Publishing Company, \$14.95)

—Stan Saunders

The
Home
Buyer's
Analyzer

**THE HOME PURCHASER'S
"WHAT IF" TOOL
FOR THE
COLOR COMPUTER**

- Program Projects upto 40 Years, and Computes:
 - * Mortgage Balance * Mortgage Payment
 - * Effective Payments after Taxes and Appreciation
- Displays Year of Purchase & Year of Sale Figures
- Automatically Adjusted Federal Tax Schedules in Program
- Considers Balloon (*Variable Rate*) Mortgages
- Detailed Documentation Booklet Provided ● Graph Results
- Stores Input for Future Runs ● Printer/Monitor Output

- Requires Extended Basic ● Cassette - 32K Required
- Printer Optional ● Disk - 16K Required

PRICE \$34.95 CASSETTE or \$39.95 DISK

Send Check or Money Order (N.J. Residents Add 5% Sales Tax) to:

SILVER SPRING SOFTWARE
18 Silver Spring Road, West Orange, N.J. 07052
(Dealer Inquiries Invited)

Light Bulbs Anyone?

Do you know how many computer programmers it takes to change a light bulb?

None. That's a hardware problem!

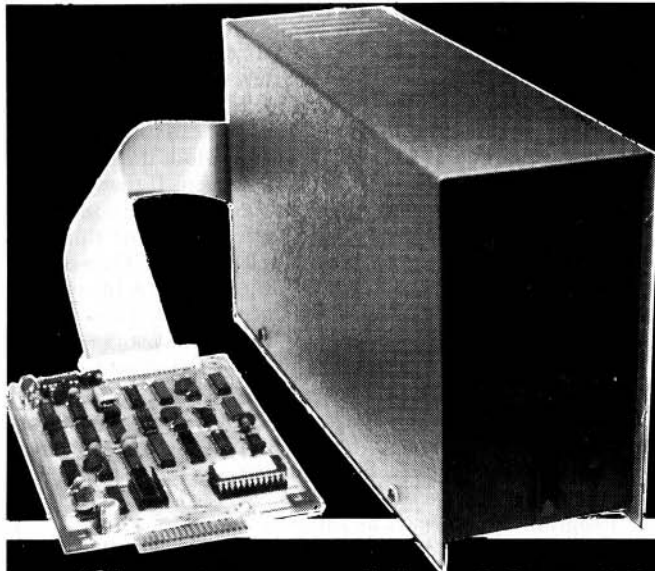

"THE ALTERNATIVE" COLOR COMPUTER DISK SYSTEMS

NOW ONLY 449⁹⁵ 40 TRACK DRIVE **200 K BYTES**
USER STORAGE

NOW ONLY 549⁹⁵ 80 TRACK DRIVE **400 K BYTES**
USER STORAGE

ROM SOFTWARE

A Full Featured
Basic Compatible DOS

INCLUDES: TC-99 Disk Controller w/ CCMD 9 DOS
ROM • 40 Or 80 Track Disk Drive • Power Supply •
Case • 2 Drive Cable • 9 Disk Utility Programs
• CCEDT9 Disk Text Editor • Disk Text Processor I

Manufactured Under License From Tall Grass Technologies

Editor / Assembler CO-RES9

CO-RES9 is a Co-resident Editor/Assembler that will allow you to create, edit and assemble machine language programs for the color computer. It will quickly and efficiently convert assembly language programs into machine code files. It will output machine object code to either cassette tape in a 'CLOADM' compatible format or directly to memory for direct execution.

NOW ONLY

CO-RES9 editor/assembler tape
w/manual ~~\$39.95~~ **\$29.95**
R.S. DISK EDITOR & ASSEMBLER Disk
w/manual ~~\$79.95~~ **\$49.95**
64K Version Now Available—FLEX Not Required

System Monitor TRSMON

TRSMON is a 2K machine language monitor program for use in any color computer system. A Monitor is a program which allows the user to directly manipulate the computer. Small programs may be hand assembled and entered into ram and executed. Program execution can be stopped at any point by using breakpoints to see if it is functioning properly or check its status. TRSMON provides all of the standard functions found in most system monitor programs as well as a printer/terminal driver package. Printer and Terminal modes can be used at rates varying from 300 to 9600 baud and can be changed at any time.

TRSMON on tape w/ manual **\$19.95**

DATA PACK TERMINAL PACKAGE

- Full Text Buffering
- Terminal Baud Rates 300 To 9600 Baud
- Automatic Word Wrap Eliminates Split Words
- Full/Half Duplex
- Automatic File Capture
- Programmable Word Length, Parity & Stop Bits
- Automatic Buffer Size At Memory Limit
- Save & Load Text Buffer To Tape Or Disk
- Send Files Directly From Buffer Or Disk
- Full Disk Support For Disk Version
- Printer Baud Rates 110-4800
- Send Control Codes From Keyboard
- ASCII Compatible File Format

- Display On Screen Or Output Contents Of Buffer To Printer

We also have a disk version available called "DISKPACK." It includes all the commands mentioned plus commands for disk control. They include: Disk Load, Disk Save, Directory, Send Disk File and Kill Disk File. As usual all files are Basic Compatible ASCII formatted files which are also compatible with our Text Editor and Word Processor programs.

Datapack on tape w/ manual **\$24.95**
Diskpack for R.S. disk w/ manual **\$49.95**
Diskpack for CCMD 9 w/ manual **\$39.95**

**CER
COMP**

5566 Ricochet Avenue
Las Vegas, Nevada 89110



(702) 452-0632

All Orders Shipped
From Stock
Add \$2.50
Postage

Skip All That Skipping With *Tape Catalog*

by Steve Sullivan

Are you one of those people who insists on putting more than one program on a tape? If this is the case, aren't you tired of *SKIPPING* over hundreds of programs just to find where a certain one is? If so, your wildest dreams have come true. This program, which in a spasm of originality I have entitled "TAPE CATALOG," will list out the contents of a tape either to a printer or the screen. Sound too good to be true? Read on.

When I first purchased the Radio Shack Editor/Assembler (in my opinion, an excellent piece of software), it was my first real attempt at working with machine language. After some piddling around, I decided that a catalog program for the cassette system was something that I sorely needed. I dug into the *Getting Started* manual and came up with the addresses of the ROM routines for cassette operation. After some experimentation, I got the hang of how the system worked. The program I came up with is very straightforward. Either type in the Basic driver or the assembled version; save it,

then run it. If you are using the assembled version, make sure you change the RTS in line 710 to an SWI. If the output is not appropriate, check the program you saved for errors. When the program is running and the tape is going, the computer should print the name of each file at the top-center of the screen, and at the end of a list of all of the programs encountered so far at the left of the screen. If the location 16127 (3EFF for you hex buffs) contains 225, the computer will print the name out to the printer also. One thing to remember: this program will NOT tell you any I/O errors. If one occurs, the computer simply skips over it. A file will be printed out as long as its name is encountered. Thus, if you have a printer, you can put a tape in, run the program, and go do whatever you want until the tape is finished. When you want to stop you can either press reset or 'BREAK.' If you press 'BREAK,' hold it down. If you are between files or at the end of the tape nothing will happen, and you will have to press reset. If you are in the middle of a file, it will break within one or two seconds.

Program operation is as follows:

At the start, the screen is cleared, and locations 7E and 7F are loaded with IDA, the place in memory where I want the block of text from the cassette to be placed. The cassette is then started and a block is read in (a block is a string of data up to 255 bytes long). If there is an error in the cassette input, the Z flag in the CC register is set; thus the BNE command in 110. If the block is OK, the computer checks to see if the 'BREAK' key is being pressed. If it is, control is sent back to Basic. If it isn't, the block type is checked. If the block is an End Of File, the name in the top-center of the screen is erased and another block is read in. If the block is a header, the name is printed in the top-center of the screen and at the bottom of the list. Location 3EFF (16127 for you decimal buffs) is checked for the value of 255. If the value is 255, a printout of the name is also executed. The program then goes back to get another block. The comment lines in the assembled program should be sufficient for explaining every detail.

This program has saved me, literally, hours by eliminating the need to either continue searching every time a program is needed, or to take a week and write down all of the titles of the programs. I hope it will be as useful for you.



Genesis Software

presents

Color Computer Programs

★ Bigfoot

Hunt Bigfoot in a hidden maze of caverns and twisting tunnels that are displayed in hi-res graphics as you move. Seek out the lair of Bigfoot while avoiding perils along the way. Features multiple levels and many options of play. Each hunt takes place in a new, randomly generated maze. Challenging and fun. Requires 32K extended basic.

Tape cassette (postage paid).....\$21.95

★ The Enchanted Forest

The BIG adventure in hi-res graphics is here! Move through more than 50 scenes on a quest to rescue the captive princess. Decisions are made according to visual clues, not text. This is a sophisticated computer adventure - a real challenge. Requires 32K extended basic.

Tape cassette (postage paid).....\$21.95

★ The Game Show

A four-game pack in which two teams compete against the clock to name items in a category. Color graphics and sound. Requires 16K extended basic and joysticks.

Tape cassette (postage paid).....\$19.95

GENESIS SOFTWARE

P.O. BOX 936, MANCHESTER, MO. 63011

Personal checks are welcome - no delay.
Missouri residents add 5.625 percent sales tax.



```

10 CLS:PRINT@202,"TAPE CATALOG"
20 PRINT@271,"BY"
30 PRINT@329,"STEVE SULLIVAN"
40 FORX=0T0154:READA:POKEX+16128
,A:NEXT
50 CLS:PRINT@225,"DO YOU WANT A
PRINTOUT? (Y/N)":A$=INKEY$
60 A$=INKEY$: IFA$="Y"THENPOKE161
27,255ELSE IFA$="N"THENPOKE16127,
0:GOTO100ELSE60
70 PRINT@192:LINEINPUT" WHAT'S T
HE TITLE OF YOUR TAPE? >> ";A$
80 PRINT#-2,CHR$(31):REM CHR$(31
) is the control code for large
characters on the LP. VII
90 PRINT#-2,A$:PRINT#-2
100 CLS:PRINT@231,"PRESS <&> TO

```



DSL COMPUTER PRODUCTS

P.O. BOX 1113 — DEARBORN, MI 48121 — (313) 582-8930

ALWAYS LOOKING FOR GREAT COLOR COMPUTER SOFTWARE
ADD \$1 SHIPPING AND HANDLING — MICHIGAN RESIDENTS ADD 4%



NEW

CALIGRAPHER

Add a special touch to your letters. Two print fonts available, Old English and Chancery. Designed exclusively for Line Printer VII. Disk only 32K.

\$14.95 each or \$18.95 both

SPELLER

Homework has never been more fun! Spelling/Identification/Word Drill For Pre-School and up. Voice tape program created by user. Self-explanatory instructions included.

\$16.95 Basic

FEBRUARY SPECIAL



One or two player or robot bug against turtle. 32K Ext. \$9.95

THE GENERAL™

This double-entry General Ledger program accomodates 100 accounts and over 500 transactions on the 32K NON-Extended Basic TAPE BASED CoCo. It optionally outputs — to Printer OR to Screen — the following reports:

- 1) Transaction List;
- 2) Chart of Accounts;
- 3) Ledger Account Activity Listing;
- 4) Balance Sheet.

All this, for ONLY \$39.95

Word CC7 (Tape)	\$19.95
Word CC7 (Disk)	\$24.95
Dancing Devil (Tom Mix)	\$14.95
Lunar Lander (Tom Mix)	\$15.95
War Kings (Tom Mix)	\$19.95
Color DFT (Bob Withers)	\$19.95

COLOR COMPUTER CLUB SERVICES

If you are an officer in a club primarily for the Color Computer, contact us about our newest addition — CCCS!

GEO-STUDIES

THIS PACK CONTAINS



USA

CANADA



EUROPE



AUSTRALIA

Learn geography the fun way!
USA-Canada-Europe-Australia\$9.95 each

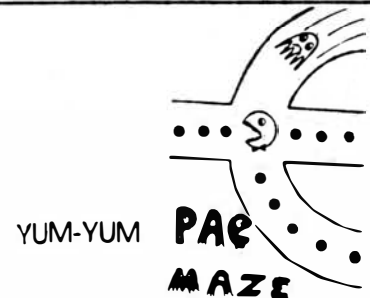
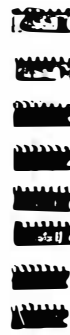

YUM-YUM

PAE
MAZE

Machine language arcade fun! \$16.95

Stop Straining The Connectors

RS-232 SWITCHER



Up to three items connect to your 232 port. Flip switch for different items and leave the plugs alone. \$39.95

TWO PLUG MODEL \$29.95

ADD POWER TO YOUR COLOR COMPUTER

RAM SLAM



— Solderless Kits —

4-16K	\$25.00
16-32K	\$49.95
4-32K	\$74.95

15 Minute Installation
One Year Warranty

"The Easy Way To More K"



Stranded and alone with Adventure and treasure!

\$14.95



Ultimate tape backup program. Get the cat! \$19.95

```

BEGIN": A$=INKEY$
110 A$=INKEY$: IFA$<>"&"THEN110
120 CLS:DEFUSR0=16128
130 A=USR0(0)
140 END
150 DATA 189,169,40,142,1,218,15
9,126,173,159,160,4,173,159,160,
6,38,250,173,159,160,0,129,3,16,
39,0,121,150,124,129,255,39,99,1
29,0,38,230,134,52,183,255,33,15
,111,142,1,218,198,8,166,128,173
,159,160,2,90,38,247
160 DATA 134,13,173,159,160,2,14
2,1,218,16,142,4,13,198,8,166,12
8,189,63,118,167,160,90,38,246,1
82,62,255,129,255,38,173,134,254
,151,111,142,1,218,198,8,166,128
,173,159,160,2,90,38,247,134,13,
173,159,160,2,126,63,8,129,96,34
,5,129,64,37,4,57,128
170 DATA 96,57,139,64,57,134,96,
198,8,16,142,4,13,167,160,90,38,
251,126,63,8,134,52,183,255,33,5
7

```

```

3F20 B7 FF21 00210 STA %65313 the cassette off
3F20 B8 6F 00220 CLR %6F Set device number to 0
3F2D 8E 01DA 00230 LDX %1DA Load X with buffer address
3F30 C6 00 00240 LDR %1A Load B with No. of characters
3F32 86 00 00250 LOPS LOPS Load A with current character
3F34 AD 9F A002 00260 JSR [CHR] Output to screen
3F36 5A 00 00270 DECB Decrement counter
3F39 26 F7 00280 BNE LOPS Branch if not finished
3F3B 86 00 00290 LDR %B13 Load A with carriage return
3F3D AD 9F A002 00300 JSR [CHR] Output to screen
3F41 9E 01DA 00310 LDX %1DA Load X with buffer beginning
3F44 10BE 040D 00320 LDY %B1037 Load Y with screen position
3F48 C6 00 00330 LDB %B8 Load B with No. of characters
3F4C 8D 3F76 00340 LDR %1A Load A with current character
3F4F A7 A0 00350 JSR [CHR] Find appropriate poke value
3F51 5A 00 00360 STA %Y+ Store A in current position
3F52 26 F6 00370 BNE LOPS Decrement counter
3F54 86 00 00380 LDR %SEFF Branch if not finished
3F57 81 FF 00400 CMPR %6255 Load A with Printout flag
3F59 26 AD 00410 BNE START Is a Printout in order?
3F5B 86 FE 00420 LDR %6FE If not, read next block
3F5D 97 6F 00430 STA %6F device to #2
3F5F 8E 01DA 00440 LDX %1DA Load X with buffer beginning
3F62 C6 00 00450 LDB %B8 Load B with No. of characters
3F64 A6 80 00460 LDR %1A Load A with current character
3F66 AD 9F A002 00470 JSR [CHR] Print it
3F6A 5A 00 00480 DECB Decrement counter
3F6B 26 F7 00490 BNE LOPS Branch if not finished
3F6D 86 00 00500 LDR %B13 Load A with carriage return
3F6F AD 9F A002 00510 JSR [CHR] Print it
3F73 7E 3F08 00520 JMP START Go read another block
3F76 81 60 00530 CMPR %696 Is the character lowercase?
3F79 22 05 00540 BHI SUB If so, branch to SUB
3F7A 81 40 00550 CMPR %64 Is it less than A?
3F7C 25 04 00560 BLO ADD64 If so, add 64
3F7E 39 00 00570 RTS If not, return
3F7F 80 60 00580 SUB %696 Subtract 96 from A
3F81 39 00 00590 RTS Return
3F82 88 40 00600 ADD64 %64 Add 64 to A
3F84 39 00 00610 RTS Return
3F85 86 60 00620 END LDR %696 Load A with No. of characters
3F87 C6 80 00630 LDB %B40 Load Y with screen position
3F89 10BE 040D 00640 JSR [ENDL] Clear current location
3F8D A7 A0 00650 ENDLOP DECB Decrement counter
3F8F 5A 00 00660 BNE ENDLOP Branch if not finished
3F90 26 FB 00670 JMP START Get another file
3F92 7E 3F08 00680 RTS %652 Turn the motor off
3F93 86 34 00690 STA %FF21 Return to BASIC
3F9A 39 00 00710 RTS
0000 00720 END

```

00000 TOTAL ERRORS

```

ADD64 3F82
BLKIN A006
CHR A002
CHARFIG 3F76
CST A004
END 3F85
ENDLOP 3F8D
LOPP 3F6A
LOPP 3F64
LOPS 3F32
POL A000
PRINIT 3F54
RTS 3F95
START 3F08
SUB 3F7F
WRTOP 3F41

```

```

3F00 0002 00010 CHR EQU %3F00
3F03 8E 00020 EQU %A002
3F06 9F 00030 EQU %A004
3F08 AD 9F A004 00040 EQU %A006
3F0B 8E 00040 EQU %A006
3F0E 9F 00050 EQU %A000
3F10 26 FA 00060 JSR %A020 Clear screen
3F12 AD 9F A000 00070 LDX %1DA Set cassette buffer
3F16 81 03 00080 STX %7E In reserved RAM
3F18 1027 0079 00090 JSR [EC61] Start cassette
3F1C 96 7C 00100 LDR %B1037 Read a block
3F1E 81 FF 00110 BNE LOOP If it's bad, read another
3F20 27 63 00120 JSR [CPOL] Check keyboard
3F22 81 00 00130 CMPR %63 Is 'BREAK' being pressed?
3F24 26 E6 00140 LDB %B04 If so, branch to exit routine
3F26 86 34 00150 LDR %67C Load A with block type
0000 00160 BNE %SEFF Is it end of file?
0000 00170 END BEQ If so, branch to cleanup
0000 00180 CMPR %8 Is it a header?
0000 00190 BNE LOOP If not, get another block
0000 00200 LDR %652 If so, turn

```

CZAP

A disk inspect/modify routine. Learn how disks work, fix problems on your disks. \$9.95

NEATDIR

Places the file names in your disk directories in alphabetical order. Keep your disks in order. \$6.95

TREK80C

The classic game. Real time, moving Klingons and action graphics. \$14.95

COPYTAPE

Copy, merge, and backup your tape based software Works even with popular pre-loader tapes. \$9.95

BACKUP

Speed up disk backups, recover crashed disks. Bypass I/O errors and fix your disks. \$9.95

CATALOG

An automatic disk file cataloging system. File the directories of your disks. \$9.95

OFFLOAD

Create tape backups of your disks. A disk to tape, tape to disk copy system. \$9.95

WWIII

Save the world from nuclear destruction. Try to win the all out war with the USSR. \$9.95

Write for free catalog of these and other products. Dealer inquiries invited.





Help for *AD-DICTS* Just for the ASCIIng

By Michael J. Keyes

For those of you who are frustrated with the latest Adventure game, or who would rather have the computer do the hard work, I have devised a program which looks into the bowels of (almost) any machine language program and prints out all of the letters, words and figures contained within. In order to use this program a printer and 32K of memory are necessary, although the PRINT #-2 statements can be altered to allow the output to go to the screen.

To use *AD-DICT*, *CLOAD* and *RUN* the program. The screen will ask for the name of the adventure. After you have typed in the program name, you will be asked to place the machine language tape into your tape recorder, press play, and *ENTER*. That's all you have to do; the computer will do the rest. The first items printed out will be the start, end, and entry addresses (they have to be figured anyway, so why not give them to you) and then your printer will begin to print out the "dictionary" consisting of garbage, messages, and command words.

The program works by offsetting the machine language by 10000 in line 20, and then finding the start, end, and entry addresses in lines 50-110. Lines 170-210 search the appropriate locations for ASCII characters and send them to the printer. All ASCII characters are included because it gives greater separation of key words.

The Listing:

END 0365

```

2 X=RND(-TIMER)
9 CLS:PRINT" ENTER ADVENTURE NAM
E":INPUTNM$:IF LEN(NM$)>8 THEN N
M$=LEFT$(NM$,8)
10 CLS:INPUT"PLACE TAPE, PRESS P
LAY, &<ENTER>";X$
17 CLS:PRINT"LOADING----"
20 CLOADM"",10000
50 FORX=474T0481
60 Y=PEEK(X):IF Y=32 THEN Y=143
70 POKE X+559,Y
80 NEXT X
90 A=PEEK(487)*256+PEEK(488)
100 B=PEEK(126)*256+PEEK(127)-1
110 C=PEEK(157)*256+PEEK(158)
115 CLS:PRINT"PRINTING ADDRESSES
FOR ";NM$:PRINT#-2,,"ADDRESSES
FOR "NM$:PRINT#-2:PRINT#-2
120 PRINT#-2,," DECIMAL",
" HEX"
130 PRINT#-2,," -----",
" ---"
140 PRINT#-2,,"START: "A," "H
EX$(A)
150 PRINT#-2,," END: "B-10000,
" "HEX$(B-10000)

```

```

160 PRINT#-2,,"ENTRY: "C-10000,
" "HEX$(C-10000)
163 FORP=1 TO 4:PRINT#-2:NEXTP:P
RINT#-2,,"DICTIONARY":PRINT#-2:
PRINT#-2
165 CLS:PRINT"SEARCHING RAM---":
PRINT@416,"FROM "A+10000"TO "B
170 FORI=A+10000 TO B
180 AA=PEEK(I)
185 PRINT@240,CHR$(RND(128)+127)
190 IF AA=32 THEN PRINT#-2, CHR$
(AA);
200 IF AA>32 AND AA<122 THEN PR
INT#-2, CHR$(AA);:PRINT@480,"ADD
RESS="I;:SOUND100,1
210 NEXTI
220 CLS:PRINT"DICTIONARY COMPLET
E"
225 END

```



Hint...

Get The Most Memory

You can get the most memory available on your CoCo by entering the command POKE 25,6:NEW. This, in effect, is a PCLEAR0 on your system.

This command will *not* work with a disk installed. It will, instead, clobber the disk operating system. If that happens, simply RESET CoCo.

Aurora Software

FAMILY GAMES

For 16K COLOR COMPUTER

**** STOCKBROKER ****

Up to 6 players can play the
stockmarket --hours of fun!

***** COLORMIND *****

Up to 4 players challenge for
hidden colors -- hours of fun!

1. Game \$20.00
2. Games \$35.00

AURORA SOFTWARE

49 Brookland Ave.
AURORA ONTARIO
CANADA L4G 2H6



Las Vegas Weekend Offers Excitement and Relaxation

For most of us a trip to Las Vegas is a rare experience, something we dream about while socking away a few dollars. We know full well that when and if we ever get to that fabulous city, we'll blow every hard-earned penny. Still, the dream persists that we just could be among the few for whom the slot machine runneth over.

Those dreams can be at least a lot more graphic now, thanks to the addition of *The Las Vegas Weekend* to the stable of fantasy-fulfillment games. "Head out to the desert and plan nine holes of championship golf," say the instructions. "After your shower, head into the casino for some exciting draw-poker action."

A fascinating concept, I think, as I load golf into my CoCo after a hard day at the office. A vivid title page, accompanied by the tune of "Auld Lange Syne," fills the screen, followed by a set of complete instructions and, as the game progresses, nine brilliantly-designed and colorful fairways. Each of them is unique, peppered with sandtraps, streams and waterholes, and ranging in difficulty from easy to very difficult.

At each hole, you must first select your club, then indicate how hard you want to hit the ball before you get around to the action—something that takes a little getting used to at first. It probably would take the average person about five holes, in fact, to get the feel of the course, not to mention the delicacy of maneuvering the joystick. Don't be too surprised if you average anywhere from 10 to 15 strokes on your first run.

After that the fairways are fairly manageable. It's the

greens you have to worry about: the holes are so small that you have to excel on the fairway to come in with a respectable score on that hole. After playing the game several times, I would recommend that the hole be enlarged a bit. (I seem to remember thinking something like that on an actual golf course, however.)

The tape recorder remains in the "play" position throughout the game, loading a new hole into the computer after you finished one. But the wait is made easier by the display of comparative scores on the screen in the meantime.

The pace of the game, unlike that of others with the constant beeping and flashing and the hurry-up activity, was really to my liking, actually relaxing, giving me a chance to slow down, catch my breath and enjoy the challenge that golf makes possible. Having played the Odyssey version of golf with its funny little men, I found that *The Las Vegas Weekend* had more of me involved in the game than another cartoon character.

One person can finish a nine-hole round in 30 minutes. Up to eight can play, however, so plan on a block of time if you're planning on inviting others to join you.

I also found Poker—the second part of the two-game package—to be an engaging game, resembling the poker machines in Las Vegas. You are playing against the computer and what you are trying to do, of course, is to win some money. A pair of Aces is the lowest winning hand, paying one point for every one point you bet.

(The game is a little contagious, so don't expect to control the keyboard for long if you have company.)

When you have bet as much as you like, you hit the space bar to see your cards. If you don't like what you see, you throw away any and all cards and you can be dealt replacements. That's right, you can ask for five new cards, instead of your regular limit of three in "everyday" poker.

When you win, there's a lot of noise and the screen flashes for several seconds.

I was a little disappointed that I couldn't increase my bet after seeing the first five cards, but found the game very engaging. I was ready for it after nine holes of golf.

As a package, I found *The Las Vegas Weekend* a total success with all members of the family, from a young child to my soon-to-be-retired father-in-law. The graphics and sound effects on both games are of high quality, the cassettes load easily, and they left me wanting to come back for more.

(Prickly-Pear Software, 9822 E. Stella Road, Tucson, Arizona 85701, \$24.95 on tape, or \$29.95 for disk)

—Charles Springer

CANADIANS! GET YOUR SOFTWARE HERE IN CANADA

No Hassle, No Duty and
No Converting the Dollar

Soft Sector Marketing

GALAX ATTAX	\$26.95
SPACE WAR	\$26.95
COLOR SPACE INVADERS	\$26.95
METEOROIDS	\$26.95
KEYS OF THE WIZARD	\$24.95
WAR KINGS	\$24.95
MOON LANDER	\$20.95

All Prices In Canadian Dollars

We also have Computerware and
Mark Data Products

Order Now or write for our
complete software list.
TABBY ENTERPRISES

Box 1353 R.R. 1
Yarmouth, Nova Scotia
B5A 4A5
(902) 649-2965

RAINBOWfest To Be In Chicago April 22-24

The very first national show and exhibition for CoCo will be held in Chicago April 22-24, sponsored by *the Rainbow*.

RAINBOWfest will be at the Hyatt-Regency Woodfield, west of the downtown area. The *RAINBOWfest* site is adjacent to Woodfield Mall—the world's largest shopping center.

According to preliminary plans, a large number of software and hardware firms will be on hand to exhibit their products. The meeting will also feature a great deal of fun and conversation about CoCo.

We urge you to make plans to attend. A special hotel rate can be secured by mentioning *the Rainbow*.

Admission will be \$7.50 for all three days through an advance sale, or \$5 per day for a single day. Tickets at the door will be \$11 for the entire session or \$7.50 for a single day.

Other events are planned and will be announced shortly.

Quality Software Is The Number One Priority At K & K Computorware



LASER TANK - Pit yourself in a game of strategy and excitement against the computer. You must defend your flag from attacking tanks and destroy them before they destroy your flag or you!!! High resolution graphics and four levels of difficulty. Only \$14⁹⁵

GAZON - A machine language game that is surpassed by none on the market. The deadly Gazonians are trying to steal your supplies and you must stop them by shooting or ramming them. Action increases as fleets of Gazonians are destroyed. Only \$15⁹⁵

SHOOT TO SPELL AND FLASH MATH - An educational package that helps kids learn to spell and educate them on elementary math. An absolute must for adults with school aged children. Joysticks required. Only \$12⁹⁵

SPACE HARVEST - Pilot your spacecraft above the Planetoid Voltar stealing spacefruit and trying to avoid alien guards and the ground. Fast action machine language programs with high resolution graphics. Only \$14⁹⁵

HORSE RACE - Can you pick the next Secretariat among our thoroughbreds? High speed, life like action for people of all ages. High resolution graphics. Only \$12⁹⁵

SERIAL TO PARELLEL CONVERTER - Have a printer with a parellel port? Tired of waiting for a line list? With this little hardware device you can make your color computer run at any baud rate between 300 and 9600. Let K & K help your printer to go much faster!!! Only \$69⁹⁵



BLACKJACK - A casino game that puts two players against the beady-eyed dealer of the house. This dealer deals the cards as good or even better than Intellivision. If you have any gambling blood at all this game is a must! Same rules as any Las Vegas casino. High resolution graphics. Only \$12⁹⁵

ALL GAME PROGRAMS - require 16K extended (prices are set for cassette, add \$4⁰⁰ for disk, except business)

PROGRAMMERS!!! - K & K pays the highest royalties for your programs. If your program is good, send it to K & K and receive the best possible coverage!

TRS-80 COLOR COMPUTER USERS - New programs are added each week. Send \$1⁰⁰ for our complete catalog.

K & K COMPUTORWARE

37326 Gregory Drive • Sterling Heights, Michigan 48077
Telephone: (313) 264-7345



POLARIS - You are under the ocean in a submarine, attacking planes and enemy destroyers dropping depth charges attempting to destroy your sub. Can you destroy them before they destroy you? This is an extremely fast action machine language program with high resolution graphics. Only \$14⁹⁵.



SUPER ZAP - Enemy spaceships are attacking from all sides and your mission, should you choose to accept it is to defend your starbase from the deadly Armada of Pyrus. This will be a dangerous mission since the Pyrus Armada has never been defeated by any humanoid. Action increases as the game progresses. Only \$14⁹⁵

HOME HELPERS - Have problems balancing your checkbook, remembering important dates or phone numbers, and your mailing lists. Let K & K and your color computer help you. Only \$14⁹⁵

BOWLING SCORED FOR DOLLARS - Do your leagues bowling averages. This program will keep individual scores, team totals, individual averages, team standings, and print all this information to your line printer. Minimum 16K disk required (on cassette too!). Only \$14⁹⁵

INVENTORY CONTROL - This program contains all the necessary features required for all types of inventories, such as sorting of inventory by stock number. This program will list stock number, description, amount in stock, cost, wholesale, profits. Minimum 16K disk required. Only \$39⁹⁵

PROPERTY INVENTORY - This program lists inventory by department, date purchased, and property numbers. Minimum 16K disk required. Only \$29⁹⁵

ACCOUNTS PAYABLE AND RECEIVABLE - These two programs will control the incoming and outgoing money flows for all your business accounts. Only \$59⁹⁵



A Common Denominator For Math Study And Ease

By Robert L. Crooks

Fraction was written after spending several hours on several different days checking my daughter's math homework. She had just started fractions in school, and even though I'm at home with numbers, it was still a large time sink. While in the process of devising a routine for simple checking of simple fractions, it was but a short step (in concept anyway) to the attached routine.

This routine will check problems for you which you input. Problem types that can be checked are reduction of a fraction to lowest terms, finding a common denominator, adding, subtracting, multiplying and dividing fractions. You specify the number of fractions in the problem ($1/2 + 1/3 + 1/6$ has three, for example) and format (mixed, common, improper, etc.). All decisions which are required on your part are menu-driven, so it's pretty difficult to make a mistake. The routine will then give the correct answer. If the answer is greater than one, the program gives the answer both as a mixed fraction and as an improper fraction.

The routine also will make up fractions so that the kids can practice during the long tedious summer. Any of the types of problems that can be checked (see above) can also be generated by the program for test purposes. The routine then prints the "guessed" answer and also the correct answer. The routine keeps track of right answers, and after 10 problems it gives you your score.

A drawback or two exists in the program which can be readily overcome, except that I got tired of fiddling with it. Drawback number one is that all user input must be in fraction form. In other words, if you want to input the number "21," it will have to be entered as "21/1." The screen instructions specify this but you should be forewarned.

The other drawback is that the only way to exit the current format of problem is to "break." If you are zipping along doing addition problems and you want to change to multiplying, you have to "break" then *RUN* and start over. Again, the screen instructions are clear, but I just thought I would warn you.

The major portions of the program are as follows:

For checking problems

- 240-300 Specify type of problem (variable M)
- 380-390 Specify like or unlike (variable C)
- 530-640 Specify format of problem (variable A)
- 650-760 and
- 800-880 Read in fractions to check
- 770 Branch to subroutine that actually performs the math
- 790 Send program to output routine.
- 2210-2420 Main output routine. Checks for mixed fraction, reduces to lowest terms, displays the answer. NU and CD are the answer numerator and denominator, and they may have been formed by any of the six math subroutines.

For making up problems:

- 240-390 Same as above
- 410-520 Generate denominators (BN) and numerators (AN). Size of fractions is checked.
- 770-2420 Same as above
- 2700-2890 Counter to keep track of problems and number of correct answers.

Any further itemizing of the program will just get wordy. I made liberal use of *REMs* so the program listing should be fairly easy to follow. Feel free to make any modification. If there are any questions, you may write or call. The listing is fairly long, but it's worth it. It will run in the 16K machine, and for people who don't like to type I'll make a tape copy of my backup for \$8.

180	0240
750	0880
1150	0C1D
1700	10CE
2420	1887
END	1D1A

The Listing:

```

100 REM FRACTIONS PROGRAM-ALLOWS
    USER TO SELECT
110 REM WHETHER THE COMPUTER WIL
    L MAKE UP PROBLEMS
120 REM OR MERELY CHECK PROBLEMS
    . VARIABLES USED ARE N(#OF FRACT
    IONS PER PROBLEM), NU(NUMERATOR
    OF INTERMEDIATE OR FINAL FRACTIO
    N),
130 REM CD(DENOMINATOR OR COMMON
    DENOMINATOR),W(WHOLE NUMBER PAR
    T OF FRACTION),AN(NUMERATOR INPU
    T),BN(DENOMINATOR INPUT)
140 REM COUNTERS USED ARE:
150 REM ZZ(ARRAY FOR AN AND BN)X
    T(AVOID REPEAT OF INSTRUCTIONS)K
    ,L(LOCAL LOOP COUNTERS)TA,TB,AA(
    INTERMEDIATE VALUES FOR NU AND C
    D)
160 REM R$, DUMMY VARIABLES
170 REM B(MAKE UP OR CHECK)
180 REM C(LIKE OR UNLIKE)
190 REM M PROBLEM MODE (ADD,SUB,M
    UL,DIV,COM DENOM,REDUCE)
200 IF XT>0 THEN 400
    
```

"WANNA FIND OUT WHAT FUN REALLY IS?"

THE KIND OF EXCITEMENT YOU GET OUT OF YOUR SYSTEM DEPENDS ON
WHAT GAMES YOU PUT INTO IT.

If You Want to Find Out What it's Like to Use your Computer to its Fullest...Then These are the Games
You'll Need! FOR YOUR TRS-80 COLOR COMPUTER

Dunkey Monkey

32K EXTENDED BASIC NOT REQUIRED

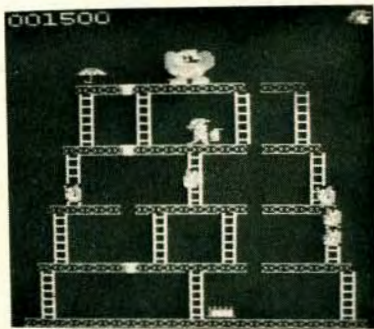

ON THIS SCREEN:
Pop the Rivets and Fight Fires

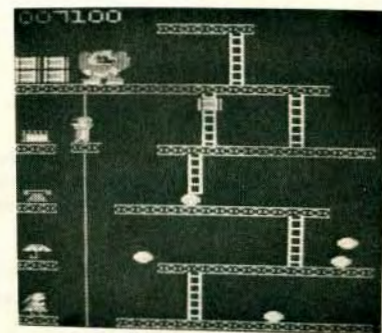

ON THIS SCREEN:
Jump Barrels and Ride the Elevator

We're sure you already know the rules to this game! As game progresses so does the difficulty level.

Cassette \$24.95
Diskette \$29.95

ULTRA-FAST MACHINE LANGUAGE ■ HIGH RESOLUTION GRAPHICS ■ SPECTACULAR SOUND EFFECTS

STARFIRE

16K EXTENDED BASIC NOT REQUIRED



Plays like popular arcade game Defender™ including:

- Hyperspace
- Smart Bombs
- Radar Scanner

Cassette \$21.95
Diskette \$26.95



SCREEN - 64

64 Characters X 32 Lines
Upper & Lower Case

16K EXTENDED BASIC NOT REQUIRED

1. Load in SCREEN-64
2. Type EXEC
3. You're Back in BASIC with a 64 x 32 Screen plus....

FEATURES:

- Slow/Fast Scroll Selectable
- Window Capabilities
- Text & Graphic on same screen
- Superscript/Subscript
- Reverse Screen/Reverse Video
- No Hardware Modification Needed

Cassette \$19.95
Diskette \$24.95

Intellectronics Ltd

22 Churchill Lane
Smithtown, N.Y. 11787
(516) 543-6642

DEALER INQUIRIES INVITED

We pay all shipping. All orders shipped in 24 hours. N.Y. residents please add sales tax. Canadian orders please send M.O. in U.S. funds only.

AT LAST

Real Arcade Joysticks For Co-Co

Just plug in our adaptor (below) and use your ATARI® joysticks or for REAL ARCADE action....get one of ours!

➔ Made by WICO® ➔

COMMAND CONTROL adaptor 19⁹⁵



Radio Shack® TRS80® Color Computer

COMMAND CONTROL joysticks

- Injection-molded modular construction and 6 leaf-type molded switches — identical to the best commercial arcade models.
- Two fire button locations, activated by a base-mounted slide switch.
- Extra-long 5' cord.



Joystick 15-9714 29⁹⁵

- Extra-long arcade-style bat handle grip that moves smoothly and easily into all 8 standard positions.
- Low-profile, heavy-duty plastic base.



Famous Red Ball™ Joystick 15-9730 34⁹⁵

- Arcade-type red ball handle that moves smoothly and easily into all 8 standard positions.
- Low-profile, heavy-duty plastic base.

COMMAND CONTROL trackballs* 65⁹⁵



- Features injection-molded modular construction.
- Phenolic ball provides unique 360 degree movement to an infinite number of positions; can also be used to vary the speed of on-screen objects.

- Quick-action fire button next to the ball, for smooth, two-handed control.

*AC power supply included.

COMMAND CONTROL extension cords

12' length—15-1756 8⁹⁵

6' length—15-1755 5⁹⁵

All backed by a full one-year limited manufacturer's warranty.

* * * * SOFTWARE * * * *

from SHELL

DEATH STAR "An Adventure" 32K/ECB 19⁹⁵

A text adventure that's different
SUB-HUNT Arcade type 16K/ECB (Low Res.) 9⁹⁵

from ACESOFT

GAMER 4-PAC 16K/ECB 19⁹⁵

DISK BUSINESS PACKAGE 16K/ECB 14⁹⁵
Master File, Minicalc, Supergraph

from TOM MIX

DONKEY KING 4 full screens, Just like 24⁹⁵
the ARCADE - Super!!

\$ FREE 16K Adv. game with \$50 order **\$**
Orders under \$50-add 1.50 shp/hnd

Write for other software available.

----- VISA/MC, CK, MO -----
9 to 5 EST (305) 894-1887

S & S ARCADE SUPPLIES

8301 Sarnow Dr. Orlando, Fl 32807

Ph (305) 275-8490 Evenings

-Fla res. add 5% sales tax-

```

210 CLS:PRINT@72,"F R A C T I O
N"
220 PRINT@200,"BY CROOKS, 2/82"
230 FOR P=1TO2000:NEXT
240 CLS:PRINT:PRINT"WHAT KIND OF
PROBLEMS?"
250 PRINT"1-ADDITION"
260 PRINT"2-SUBTRACTION"
270 PRINT"3-MULTIPLICATION"
280 PRINT"4-DIVISION"
290 PRINT"5-FIND COMMON DENOMINA
TOR"
300 PRINT"6-REDUCTION TO LOWEST
TERMS":PRINT:PRINT
310 INPUT "WHICH ONE";M
320 CLS:PRINT"AM I GOING TO MAKE
UP PROBLEMS"
330 PRINT"OR CHECK YOURS. TYPE <
1> FOR ME"
340 PRINT"TO MAKE UP PROBLEMS OR
<2> FOR"
350 PRINT"ME TO CHECK YOURS"
360 INPUTB
370 IF M=6 GOTO 400
380 PRINT:PRINT"WILL THESE BE LI
KE OR UNLIKE?"
390 INPUT "1=LIKE 2=UNLIKE";C
400 XX=0:ON B GOTO 410,530
410 BN(1)=RND(8):AN(1)=RND(6):RE
M MAKE UP MODULE
420 BN(2)=RND(10):AN(2)=RND(9)
430 N=2
440 IF C=1 THEN 500
450 IF AN(2)/BN(2)>AN(1)/BN(1) T
HEN BN(2)=BN(2)*2:GOTO 450
460 IF M=6 THEN AN(1)=AN(1)*RND(
6)*2
470 IF M=6 THEN BN(1)=BN(1)*RND(
4)
480 REM 3 PREVIOUS STATEMENTS GU
ARANTEES SIZE OF FRACTIONS
490 GOTO 760
500 IF AN(1)<AN(2) THEN AN(1)=AN
(1)*2:GOTO 500
510 BN(2)=BN(1)
520 GOTO 760
530 REM READ IN FRACTIONS
540 CLS:IF XT<>0 THEN 620:REM SK
IP INSTRUCTIONS
550 PRINT"WHICH FORM ARE YOUR PO
RBLEMS?"
560 PRINT"1-COMMON FRACTIONS (LI
KE 1/2)"
570 PRINT"2-IMPROPER (LIKE 9/4)"
580 PRINT"3-MIXED (LIKE 3 4/7)"
590 PRINT"ALL OF YOUR FRACTIONS
HAVE TO"
600 PRINT"BE THE SAME FORM."
610 INPUT "WHICH FORM";A
620 CLS:PRINT"HOW MANY FRACTIONS

```



```

IN"
630 INPUT"THIS PROBLEM";N
640 IF N>4 OR N<1 THEN 860
650 ZZ=1:REM READ IN NUM AND DEN
OM IN ARRAY
660 IF A=3 THEN 800
670 IF ZZ=1 THEN 730
680 INPUT"GIVE ME THE NEXT NUMER
ATOR";AN(ZZ)
690 INPUT"GIVE ME NEXT DENOMINAT
OR";BN(ZZ)
700 IF ZZ=N THEN 760
710 ZZ=ZZ+1
720 GOTO 660
730 INPUT "GIVE ME THE FIRST NUM
ERATOR";AN(ZZ)
740 INPUT"GIVE ME FIRST DENOMINA
TOR";BN(ZZ)
750 GOTO 700
760 REM END OF ARRAY FORMING
770 ON M GOSUB 1160,1320,1440,15
70,1710,2130:REM M=MODE
780 XT=XT+1
790 GOTO 2210:REM PRINT ANSWER
800 REM READ MIXED FRACTIONS
810 IF ZZ<>1 THEN 840
820 INPUT"GIVE ME THE FIRST WHOL
E NUMBER";W(ZZ)
830 GOTO 670
840 INPUT "GIVE ME NEXT WHOLE NU
MBER";W(ZZ)
850 GOTO 670
860 CLS:PRINT"INPUT ERROR. YOU E
ITHER PUT"
870 PRINT"A WRONG NUMBER OR A NU
MBER"
880 PRINT"GREATER THAN 4. SORRY.
":GOTO 620
890 REM GET COMMON DENOM FOR ADD
OR SUBTR
900 IF N<>2 THEN 990
910 IF BN(1)<>BN(2) THEN 940
920 IF C=1 THEN DN=BN(1)
930 RETURN
940 DN=BN(1)*BN(2)
950 AN(1)=BN(2)*AN(1)
960 AN(2)=BN(1)*AN(2)
970 BN(1)=DN:BN(2)=DN
980 GOTO 930
990 IF N>3 THEN 1070
1000 IF BN(1)=BN(2) AND BN(2)=BN
(3) THEN 930
1010 DN=BN(1)*BN(2)*BN(3)
1020 FOR L=1 TO N
1030 AN(L)=DN*AN(L)/BN(L)
1040 NEXT L
1050 BN(1)=DN:BN(2)=DN:BN(3)=DN
1060 GOTO 930
1070 IF BN(1)=BN(2) AND BN(2)=BN
(3) AND BN(3)=BN(4) THEN 930

```

```

1080 DN=BN(1)*BN(2)*BN(3)*BN(4)
1090 FOR L=1 TO N
1100 AN(L)=DN*AN(L)/BN(L)
1110 NEXT L
1120 FOR L =1 TO N
1130 BN(L)=DN
1140 NEXT L
1150 GOTO 930
1160 REM SUBROUTINE TO ADD
1170 NU=0:CD=0
1180 IF B<>1 THEN 1230
1190 CLS:PRINT:PRINT"HOW MUCH IS
";AN(1);"/";BN(1);"+";AN(2);"/"
;BN(2)
1200 PRINT:PRINT:PRINT"YOUR ANSW
ER?"
1210 INPUT "NUMERATOR=";NN
1220 INPUT"DENOMINATOR =";NP
1230 GOSUB 890
1240 FOR K=1 TO N
1250 IF A=3 THEN GOSUB 1300
1260 NU=NU+AN(K)
1270 NEXT K
1280 CD=DN
1290 RETURN
1300 AN(K)=W(K)*BN(K)+AN(K)
1310 RETURN
1320 REM SUBROUTINE TO SUBTRACT
1330 IF B<>1 THEN 1380

```

MICRO-DOC

- Just what the Doctor ordered for: EQUIPMENT CONTROL
DATA FILE CONTROL
PROGRAM CONTROL 
- An easy-to-follow documentation system which will help both beginners and experienced professionals organize their micro-computer installations
- Includes manual and complete set of documentation forms

Send only \$12.95 to:
MICRO-DOC
97 Montowese Trail
Wallingford, CT 06492

Send check or money order only
No CT residents add 7½%
COD sales tax

```

1340 CLS:PRINT:PRINT"HOW MUCH IS
";AN(1);"/";BN(1);"-";AN(2);"/"
;BN(2)
1350 PRINT:PRINT"WHAT IS YOUR AN
SWER?"
1360 INPUT "NUMERATOR=";NN
1370 INPUT "DENOMINATOR=";NP
1380 GOSUB 890
1390 IF A=3 THEN K=1:GOSUB 1300
1400 NU=AN(1):CD=BN(1)
1410 IF A=3 THEN GOSUB 1300
1420 NU=NU-AN(2)
1430 RETURN
1440 REM SUBROUTINE TO MULTIPLY
1450 IF A=3 THEN K=1:GOSUB 1300
1460 NU=AN(1):CD=BN(1)
1470 IF B<>1 THEN 1520
1480 CLS:PRINT:PRINT"HOW MUCH IS
";AN(1);"/";BN(1);"X";AN(2);"/"
;BN(2)
1490 PRINT:PRINT"YOUR ANSWER, PL
EASE"
1500 INPUT"NUMERATOR=";NN
1510 INPUT "DENOMINATOR=";NP
1520 FOR K=2 TO N
1530 IF A=3 THEN GOSUB 1300
1540 NU=NU*AN(K):CD=CD*BN(K)
1550 NEXT K
1560 RETURN

```

```

1570 REM SUBROUTINE TO DIVIDE
1580 IF A=3 THEN K=1:GOSUB 1300
1590 K=K+1:IFK>N THEN 1620
1600 GOSUB 1300
1610 GOTO 1590
1620 IF B<>1 THEN 1680
1630 CLS:PRINT:PRINT"HOW MUCH IS
";AN(1);"/";BN(1);" DIVIDED"
1640 PRINT TAB(9);"BY ";AN(2);"/"
;BN(2)
1650 PRINT:PRINT:PRINT"YOUR ANSW
ER?"
1660 INPUT "NUMERATOR=";NN
1670 INPUT "DENOMINATOR=";NP
1680 NU=AN(1)*BN(2)
1690 CD=BN(1)*AN(2)
1700 RETURN
1710 REM FIND A COMMON DENOM
1720 CLS
1730 IF B=1 THEN 1910
1740 CLS:PRINT:PRINT"GIVE ME YOU
R DENOMINATORS"
1750 IF Z<>0 THEN 1800
1760 PRINT"PLEASE GIVE THEM TO M
E IN"
1770 PRINT"ASCENDING ORDER. THAT
MEANS"
1780 PRINT"LOWEST FIRST AND HIGH
EST LAST."
1790 PRINT"LIST ONLY DENOMINATOR
S..."
1800 INPUT"ARE YOU READY";R$
1810 IF LEFT$(R$,1)="N" THEN 180
0
1820 FOR K=1TON
1830 PRINT"DENOMINATOR-";K;"=":I
NPUT;BN(K)
1840 NEXT K
1850 IF BN(N)<BN(N-1) THEN PRINT
"NOT ASCENDING ORDER! REDO.":GOT
O 1830
1860 CLS:X=1
1870 ON N GOSUB 1970,1970,2030,2
080
1880 IF XX=1 THEN PRINT"I CAN'T
FOR THOSE NUMBERS"
1890 CD=BN(N)*X
1900 RETURN
1910 PRINT"WHAT IS THE COMMON"
1920 PRINT"DENOMINATOR FOR 1/";B
N(1);" AND 1/";BN(2)
1930 PRINT:PRINT
1940 INPUT "YOUR ANSWER=";NP
1950 X=1
1960 GOTO 1870
1970 IF (X*BN(2)/BN(1))=INT(X*BN(
2)/BN(1)) THEN 2020
1980 X=X+1
1990 IF X>BN(1)*BN(2) THEN 2010
2000 GOTO 1970

```

TAKE THE GUESSWORK OUT OF STOCK & FUND INVESTING

FUNDGRAF is a new computer program which not only graphs and analyzes funds or stocks, but also makes decisions on when to buy and sell. Use your TRS-80 Color Computer (TM Tandy Corp.) as a valuable investment tool.

- GRAPHS the progress of your funds or stocks
- SUPERIMPOSES for comparison:
 - a line of constant percent growth
 - a graph of any other fund
- CALCULATES over any given time span:
 - percent price change
 - the moving average
- INDICATES BUY and SELL signals

Tape version compares stocks or funds in groups of seven for up to 70 weeks.
---\$49.95--

Disk version compares any 36 funds on one disk for up to 200 weeks.
---\$69.95--

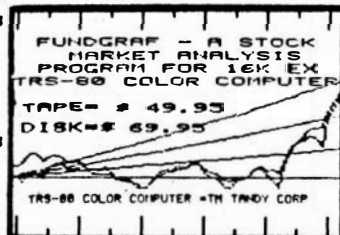

-Sample data and detailed instructions furnished.
-Both versions require 16 K Extended Basic.
-For more information send S.A.S.E.
-For your FUNDGRAF program send the price indicated above plus \$2.00 handling to:

**PARSONS SOFTWARE
118 WOODSHIRE DRIVE
PARKERSBURG, WV 26101**

COLOR COMPUTER NEW!

MACRO-80C

The Micro Works is pleased to announce the release of its **disk-based editor, macro assembler and monitor**, written for Color Computer by Andy Phelps. THIS IS IT — The ultimate programming tool!

The powerful 2-pass macro assembler features conditional assembly, local labels, include files and cross referenced symbol tables. MACRO-80C supports the complete Motorola 6809 instruction set in standard source format. There are no changes, constraints or shortcuts in the source language definition. Incorporating all of the features of our Rompack-based assembler (SDS80C), MACRO-80C contains many more useful instructions and pseudo-ops which aid the programmer and add power and flexibility.

The screen-oriented text editor is designed for efficient and easy editing of assembly language programs. The "Help Key" feature makes it simple and fun to learn to use the editor. As the editor requires no line numbers, you can use the arrow keys to position the cursor anywhere in the file. MACRO-80C allows global changes and moving/copying blocks of text. You can edit lines of assembly source which are longer than 32 characters.

DCBUG is a machine language monitor which allows examining and altering of memory, setting break points, etc.

The editor, assembler and monitor — as well as sample programs — come on one Radio Shack compatible disk. Extensive documentation included. **MACRO-80C Price: \$99.95**

YOU NEED COLOR FORTH!!

Why?

- Forth is faster to program in than Basic
- Forth is easier to learn than Assembly Language
- Forth executes in less time than Basic

Forth is a highly interactive language like Basic, with structure like Pascal and execution speed close to that of Assembly Language. The Micro Works Color Forth is a Rompack containing everything you need to run Forth on your Color Computer.

Color Forth consists of the standard FORTH Interest Group (FIG) implementation of the language plus most of FORTH-79. It has a super screen editor with split screen display. Mass storage is on cassette. Color Forth also contains a decompiler and other aids for learning the inner workings of this fascinating language. It will run on 4K, 16K, and 32K computers. Color Forth contains 10K of ROM, leaving *your* RAM for *your* programs! There are simple words to effectively use the Hi-Res Color Computer graphics, joysticks, and sound. The 112-page manual includes a glossary of the system-specific words, a full standard FIG glossary and complete source listing. **COLOR FORTH ... THE BEST! From the leader in Forth, Talbot Microsystems. Price: \$109.95**

SOFTWARE DEVELOPMENT SYSTEM

The Micro Works Software Development System (SDS80C) is a complete 6809 editor, assembler and monitor package contained in one Color Computer program pack! Vastly superior to RAM-based assemblers/editors, the SDS80C is non-volatile, meaning that if your application program bombs, it can't destroy your editor/assembler. Plus it leaves almost all of 16K or 32K RAM free for *your* program. Since all three programs, editor, assembler and monitor are co-resident, we eliminate tedious program loading when going back and forth from editing to assembly and debugging!

The powerful screen-oriented Editor features finds, changes, moves, copies and much more. All keys have convenient auto repeat (typamatic), and since no line numbers are required, the full width of the screen may be used to generate well commented code.

The Assembler features **all** of the following: complete 6809 instruction set; conditional assembly; local labels; assembly to cassette tape or to memory; listing to screen or printer; and mnemonic error codes instead of numbers.

The versatile monitor is tailored for debugging programs generated by the Assembler and Editor. It features examine/change of memory or registers, cassette load and save, breakpoints and more. **SDS80C Price: \$89.95**

MICROTEXT: COMMUNICATIONS VIA YOUR MODEM!

Now you **can** use your printer with your modem! Your computer can be an intelligent printing terminal. Talk to timeshare services or to other personal computers; print simultaneously through a second printer port; and re-display text stored in memory. Dump to a cassette tape, or printer, or both. Microtext can be used with any printer or no printer at all. It features user-configurable duplex/parity for special applications, and can send any ASCII character. You'll find many uses for this general purpose module! Microtext is available in ROMPACK, ready-to-use, for **\$59.95**.

PARALLEL PRINTER INTERFACE — Serial to parallel converter allows use of all standard parallel printers. P180C plugs into the serial output port, leaving your Rompack slot free. You supply the printer cable. **P180C Price: \$69.95**

GAMES

Star Blaster — Blast your way through an asteroid field in this action-packed Hi-Res graphics game. Available in ROMPACK; requires 16K. **Price: \$39.95**

Pac Attack — Try your hand at this challenging game by Computerware, with fantastic graphics, sound and action! Cassette requires 16K. **Price: \$24.95**

Berserk — Have fun zapping robots with this Hi-Res game by Mark Data Products. Cassette requires 16K. **Price: \$24.95**

Adventure — *Black Sanctum* and *Calixto Island* by Mark Data Products. Each cassette requires 16K. **Price: \$19.95** each.

Cave Hunter — Experience vivid colors, bizarre sounds and eerie creatures in hot pursuit as you wind your way through a cave maze in search of gold treasures. This exciting Hi-Res game by Mark Data Products requires 16K for cassette version. **Price: \$24.95**

Also Available: Machine Language Monitor ★ 2-Pass Disassembler ★ Memory Upgrade Kits ★ We Stock 64K Chips
★ Parts and Services ★ Books ★ Call or write for information

THE
**MICRO
WORKS**



GOOD STUFF!

P.O. BOX 1110, DEL MAR, CA 92014 [619] 942-2400

MasterCharge/Visa Accepted
California residents add 6% tax.

```

2010 PRINT"ICAN'T FOR ";BN(1);"A
ND";BN(2):XX=1
2020 RETURN
2030 IF (X*BN(3)/BN(1))=INT(X*BN
(3)/BN(1)) AND (X*BN(3)/BN(2))=I
NT(X*BN(3)/BN(2)) THEN 2070
2040 X=X+1
2050 IF X>BN(3)*BN(2)*BN(1) THEN
  XX=1:GOTO 2070
2060 GOTO 2030
2070 RETURN
2080 IF (X*BN(4)/BN(1))=INT(X*BN(
4)/BN(1)) AND (X*BN(4)/BN(2))=IN
T(X*BN(4)/BN(2)) AND (X*BN(4)/BN
(3))=INT(X*BN(4)/BN(3)) THEN 212
0
2090 X=X+1
2100 IF X>BN(4)*BN(3)*BN(2)*BN(1
) THEN XX=1:GOTO 2120
2110 GOTO 2080
2120 RETURN
2130 CLS:PRINT:PRINT"REDUCE TO L
OWEST TERMS":PRINT:PRINT
2140 PRINTAN(1);"/";BN(1)
2150 PRINT:PRINT"YOUR ANSWER, PL
EASE?"
2160 INPUT "NUMERATOR=";NN
2170 INPUT "DENOMINATOR=";NP
2180 XT=1
2190 NU=AN(1):CD=BN(1)
2200 RETURN
2210 REM PART OF PROBLEM MODULE6
0001 REM AND OUTPUT ROUTINE
2220 REM THIS PORTION REDUCES TH
E COMPUTER'S ANSWER TO LOWEST TE
RMS
2230 IF XX=1 THEN GOTO 2460
2240 IF M=5 THEN 2550
2250 IF NU<=CD THEN AA=NU ELSE A
A=CD
2260 FOR K=2 TO AA
2270 IF NU/K=INT(NU/K) THEN 2640
2280 NEXT K
2290 REM CHECK FOR MIXED NUMBER
2300 IF NU=<CD THEN 2340
2310 TA=INT(NU/CD):REM TA IS WHO

```

```

LE NR PART OF FRACTION
2320 TB=NU-TA*CD:REM NEW NUMERAT
OR
2330 ZA=1:REM ZA IDENTIFIES A WH
OLE NUMBER PRESENT
2340 IF B=1 THEN 2530
2350 IF ZA=0 THEN 2400
2360 IF TB=0 THEN 2670
2370 IF B=2 THEN CLS ELSE GOTO 2
400
2380 PRINT:PRINT:PRINT"THE FINAL
ANSWER SHOULD"
2390 PRINT"BE ";TA;TB;"/";CD;" O
R IN OTHER FORM"
2400 IF NU=0 THEN 2690
2410 PRINT:PRINT:IF CD=1 THEN PR
INT:PRINT"THE ANSWER IS ";NU:GOT
O 2430
2420 PRINT:PRINT:PRINT"THE ANSWE
R IS ";NU;"/";CD
2430 REM PROBLEM COUNTING ROUTIN
ES
2440 GOSUB 2700
2450 ZA=0
2460 FOR LL=1TO2000:NEXT
2470 GOSUB 2800:REM ENDING ROUTI
NE
2480 PRINT:PRINT:PRINT"PRESS <BR
EAK> TO STOP"
2490 PRINT"OR CHANGE PROBLEM TYP
E"
2500 FORML=1TO1000:NEXT:GOTO 400
2510 IF LEFT$(R$,1)="Y" THEN XT=
XT+1:GOTO 400
2520 PRINT:PRINT:PRINT"THE END":
END
2530 CLS:PRINT:PRINT"YOUR ANSWER
IS ";NN;"/";NP
2540 GOTO 2350
2550 CLS:PRINT:PRINT
2560 PRINT:PRINT"YOU SPECIFIED "
;N;" DENOMINATORS"
2570 PRINT"THEY WERE:"
2580 FOR K=1TON
2590 PRINT"D-";K;"=";BN(K)
2600 NEXT K
2610 PRINT"THEIR COMMON DENOMINA
TOR IS";CD
2620 PRINT:PRINT"YOUR ANSWER WAS
";NP
2630 GOTO 2430
2640 IF CD/K=INT(CD/K) THEN 2660
2650 GOTO 2280
2660 NU=NU/K:CD=CD/K:GOTO 2260
2670 PRINT:PRINT:PRINT"THE ANSWE
R IS ";TA
2680 GOTO 2430
2690 PRINT:PRINT:PRINT"THE ANSWE
R IS ZERO":GOTO 2440
2700 REM CORRECT ANSWER COUNTER

```



Introductory Offer

DUNGEON MASTER

\$14.....POST PAID

- Roll all dice combinations
- Roll characters at a touch
- Draw maps (high and low res.)
- Save 12 maps/characters in memory or on cassette
- Generate names

10K Extended Basic and Joystick required
Cassette.....check or money order \$14.00
DRAGONFLY SOFTWARE 12203 DAWN COLLETSVILLE, MD 20904

```

2710 IF B<>1 THEN 2790
2720 K1=K1+1:REM NUMBER OF PROBL
EMS IN THIS SET
2730 IF ZAK>0 THEN 2770
2740 IF M=5 THEN GOTO 2880
2750 IF NU=0 THEN IF NN=0 THEN K
2=K2+1:GOTO 2790
2760 IF NU=NN AND CD=NP THEN K2
=K2+1:GOTO 2790
2770 IF TB=0 THEN IF TA=NN THEN
K2=K2+1:GOTO 2790
2780 IF NU=NN AND CD=NP THEN K2
=K2+1:GOTO 2790
2790 RETURN
2800 IF K1<>10 THEN 2870
2810 FOR TY=1TO1000:NEXT TY:CLS:
PRINT:PRINT"THAT CONCLUDES TEN P
ROBLEMS.":PRINT:PRINT"YOU GOT ";
K2;" OF THEM RIGHT!"
2820 FOR L1=1 TO K2
2830 SOUND 100+RND(100),4
2840 NEXT
2850 K1=0:K2=0
2860 PRINT:PRINT:INPUT "PRESS <E
NTER> TO CONTINUE";PO
2870 RETURN
2880 IF NP=CD THEN K2=K2+1
2890 GOTO 2800

```



TRANSTEK



- C.C.Calc** **\$25**
Our own Electronic Spreadsheet for the Color Computer is a sophisticated but easy to use calculating and planning program. C.C.Calc takes the drudgery out of budgeting, taxes, and other financial or planning activities. Wide reports can be printed in sections. 32K Cas. or Disk.
- C.C.File** **\$7**
A nifty little data base package with lots of uses. A "Best Buy" at just \$7 for both Cassette and Disk.
- C.C.Writer** **\$30**
A quick to learn and easy to use word processor. Right justification, Global commands, etc. Works with any printer including daisy wheels. 16-32K Cas, 32K Disk.
- C.C.Mailer** **\$20**
Mailing list data base for CoCo and any printer. From 90 to over 1000 records depending on your system. The C.C.Merger option merges Name and Address with C.C.Writer letters. Creates salutations too. Up to 4 line Address. Disk or Cassette. With C.C.Merger-\$35
- Mailer/Merger/Writer Pkg.** **\$50**

TransTek
194 Lockwood
Bloomington, IL 60108

★ ★ ★ ★ SELECTED SOFTWARE ★ ★ ★ ★

FOR THE COLOR COMPUTER

All programs are in 16K machine language unless noted. Extended basic not required.

MARK DATA PRODUCTS

- ** **SPACE RAIDERS** New Invader-type game. Super Hi-Res Graphics and Sound. You'll love it. **\$24.95**
- * **ASTRO BLAST** Excellent space shooting game. Super Hi-Res Graphics and Sound. **\$24.95**
- * **COLOR HAYWIRE** Classic arcade game, rated A+ by Color Computer magazines. **\$24.95**

SPECTRAL ASSOCIATES

- * **GALAX ATTAX** Protect your base by shooting alien fighter in formation. Excellent Graphics and Sound. **\$21.95**
- ** **SPACE RACE** Maneuver yourself in space but alien ships appear and must be destroyed. Hi-Res Graphics and Sound. **\$21.95**
- * **PLANET INVASION** Excellent Defender-type game. Highest-Res Graphics and Sound. **\$21.95**
- * **DEFENSE** Defend your spaceships from enemy laser beams. **\$21.95**
- * **SPACE WAR** You must break through the enemy fighters and the defenses of Death Star. Super fast. **\$21.95**
- ** **SPACE INVADERS** Fast action Invader game. Excellent Graphics and Sound. **\$21.95**
- * **GHOST GOBBLER** Highly rated Pac Man-type game. 16 skill levels and lots of action. **\$19.95**
- KEYS OF THE WIZARD** Super adventure game! Great sound! You never play the same twice. **\$19.95**
- MADNESS AND THE MINOTAUR** Challenging adventure game, different everytime. **\$19.95**

TOM MIX SOFTWARE

- * **DONKEY KING** (32K) Just Outstanding! **\$24.95**
- * **KATERPILLAR** Excellent Centipede-type game. Highly rated by Color Computer magazines! **\$24.95**
- * **WAR KINGS** Battle to save your castle and king. Hi-Res Graphics with Outstanding Sound. **\$19.95**
- * **PROTECTORS** (32K) Excellent Graphics and Sound. **\$24.95**

MED SYSTEMS

- INVADER'S REVENGE** You are the last survived space invader. You must revenge! **\$19.95**
- PHANTOM SLAYER** Enter the deadly catacombs and destroy the phantoms. 3-D Graphics. **\$19.95**

INTELLECTRONICS

- * **DUNKEY MUNKEY** (32K) Absolutely excellent Donkey Kong-type game. You'll love it! **\$21.95**
- STAR FIRE** One of the best Defender-type game. Hi-Res Graphics and Sound. **\$19.95**

INTRACOLOR

- ** **COLORPEDE** Just like the arcade. **\$29.95**

THE PROGRAMMER'S GUILD

- ** **PACDROIDS** The most challenging Pac Man-type. Super Hi-Res Graphics and Sound. **\$19.95**

UPGRADE YOUR COLOR COMPUTER!

Complete solderless kits with easy-to-follow instructions.

4K-16K	\$15.95
16K-32K	\$29.95

*Requires Joystick **Joystick Optional

Write for complete listings
Buy 2 items and get 10% off
We pay postage on all orders
Send check or money order to:

SELECTED SOFTWARE
P.O. Box 32228, Fridley, MN 55421
(MN Residents add 6% sales tax.)



Who Knows All Those Callsigns? CoCo Knows!

By Burton B. Witham, Jr.

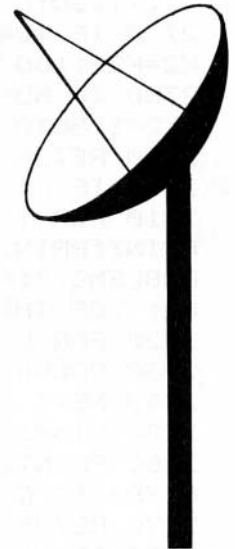

Where in the deuce is "UO5?" How often I have reached for the call book, thumbed through the pages and read all that fine print to locate a callsign! *Nobody* could remember them all. But CoCo can! Ergo, I wrote a program to do it for me.

PREFIX is an international amateur radio call prefix locator. The operation and coding of the program is pretty straightforward -- input arguments of either a call prefix (to locate the country), or a country (to locate the proper prefix), is permitted; and the read-out provides the answer.

The number of data elements (lines 240 and up) will depend on the memory available, and can be adjusted as needed. As written the program requires about 12K.

The Listing:

```

10  * *****
12  *  HAM RADIO
14  *  PREFIX
16  *  LOCATOR-
18  *  BY:W4CNZ
20  *  B.B.WITHAM
22  *  3501
24  *  SEA GULL RD
26  *  VIRGINIA
28  *  BEACH, VA
30  *  23452
32  *  804-3402628
34  *  ALL RIGHTS
36  *  RESERVED
38  * *****
40  CLEAR700: DIM N$(350), Q$(350),
    B$(350)
45  *  PGM SELECT
50  CLS: PRINTSTRING$(32, 255): PRIN
    T"      CALL PREFIX LOCATOR": PRI
    
```

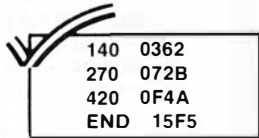

```

NTSTRING$(32, 255): SOUND180, 1
60  C$="": F$="": PRINT@130, "CALLSI
    GN PREFIX OR COUNTRY      (P OR
    C)?":: FORTM=1 T0999: NEXT: PRINT@1
    30, "CALLSIGN PREFIX OR
        (p OR )?":: FORTM=1 T0500: NE
    XT: PRINT@130, "CALLSIGN      OR
    COUNTRY      ( OR c)?":: FORTM=
    1 T0500: NEXT
70  A$=INKEY$: IFA$="" THEN60
80  IFA$="P" THENPRINT@193, "INPUT
    PREFIX:-": INPUTC$: GOTO110
90  IFA$="C" THENPRINT@193, "INPUT
    COUNTRY:-": INPUTF$: GOTO110
100 IFA$<>"P" OR A$<>"C" THENSOU
    ND10, 5: GOTO60
105 *  READ DATA
110 POKE65495, 0: FORN=1 T0295: REA
    DN$, Q$, B$
120 IFC$=N$ OR F$=Q$ THEN160
130 IFN$="END" AND Q$="END" ANDB
    $="END" THEN150
140 NEXTN
150 CLS: RESTORE: SOUND5, 5: PRINT@1
    36, "  NOT FOUND!": PRINTSTRING$(3
    2, 128): GOTO170
155 *  READ OUT
160 CLS: PRINT@1, "FILE #:"; N: PRIN
    T@165, N$; "--"; Q$"--": PRINT@198, "
    BRG.-"; B$: FORTM=1 T03: SOUND180, 1:
    SOUND200, 1
170 POKE65494, 0: PRINT@262, "ANOTH
    ER ENTRY (Y/N) ?";
    
```

RAINBOWfest

April 22-24, 1983

CoCo's Very First Show!

CoCo has grown up and it's time for CoCo's very first show. Sponsored by *the Rainbow*, the premier magazine for the TRS-80 Color, TDP System-100 and Dragon-32 computers, RAINBOWfest will be *the* place to be this Spring.

Exhibits will abound. Information will flow. New products will be shown and introduced. Many of the "names" in the CoCo world will be in attendance. It all boils down to three days of fun, excitement and learning for everyone lucky enough to own a CoCo (or those who just wish they did)!

The place is the Regency-Hyatt Woodfield, located on the western outskirts of Greater Chicagoland, within easy access to highways and O'Hare International Airport.

The dates are April 22-24.

The times are 7-10 p.m. Friday; 9 a.m.—8 p.m. Saturday; and 10 a.m.—5 p.m. Sunday at the Grand Ballroom.

The cost is only \$7.50 for a three-day ticket in advance or \$11 for a three-day ticket at the door. One-day tickets are \$5. in advance or \$7.50 at the door.

A Saturday "let's make friends" breakfast is also planned. Cost of \$10 includes breakfast and a speaker—someone well known in the world of Color Computers.

Rooms are available at the Regency-Hyatt Woodfield for a special RAINBOWfest rate of \$43 per night, single or double occupancy.

Admission tickets, breakfast tickets and reservation cards for the hotel can be secured directly from *the Rainbow*. Mail the form below to *the Rainbow*, P.O. Box 209, Prospect, KY 40059. Advance sale tickets will be sent by return mail up until April 15. After that, they will be available at the door.

Oh yes...for the "others" who (perish the thought) don't get into CoCo like you do, Woodfield Shopping Center directly adjacent to RAINBOWfest is the world's largest enclosed shopping mall. And, you are only a short drive from downtown Chicago's museums, theatres, aquarium and shops.

RAINBOWfest has it all! Don't miss CoCo's very first show!



YES, I'm coming to CoCo's very first show! Please send me:

_____ three-day tickets at \$_____ total _____
 _____ one-day tickets at \$_____ total _____
 _____ breakfast tickets at \$10 total _____
 handling charge \$1.00

TOTAL ENCLOSED (U.S. FUNDS ONLY, PLEASE)\$_____

- Also send me a reservation card for the Hyatt-Regency Woodfield.

NAME _____

STREET & NUMBER _____

CITY & STATE _____

TELEPHONE _____ ZIP CODE _____

COMPANY _____

Advance Sale ends Thursday, April 21.

Make checks payable to:
the Rainbow

MAIL TO:
 RAINBOWfest
 P.O. Box 209
 Prospect, KY 40059

, OMAN, 050, A5, BHUTAN, 20, A6, UNITED ARAB EMIRATES, 50, A7, QATAR, 50, A9, SAUDI ARABIA, 50, B, CHINA, 344, BV, TAIWAN, 344

250 DATA CE, CHILE, 175, CM, CUBA, 203, CO, CUBA, 203, CN, MORROCO, 80, CP, BOLIVIA, 170, CR9, MACAO, 344, CT, PORTUGAL, 64, CT2, AZORES, 70, CT3, MADIERA, 72260 DATA CX, URUGUAY, 163, C6, BAHAMAS, 190, DA, W. GERMANY, 47, DL, W. GERMANY, 47, DU, PHILLIPINES, 339, EA, SPAIN, 62, EI, IRELAND, 41, EL, LIBERIA, 115, EP, IRAN, 95, ET, ETHIOPIA, 80270 DATA F, FRANCE, 51, FC, CORSICA, 56, FG, GUADALOUPE, 135, FM, MARTINIQUE, 135, FO, CLIPPERTON, 235, FP, ST. PIERRE-MIQ., 45, FS, ST. MARTIN, 135, G, ENGLAND, 40, GO, ISLE OF MAN, 40280 DATA GI, N. IRELAND, 38, GJ, JERSEY, 40, GM, SCOTLAND, 35, GU, GUERNSEY, 40, GW, WALES, 40, HA, HUNGARY, 38, HB, SWITZERLAND, 51, HB0, LICHTENSTIEIN, 40, HC, ECUADOR, 184, HC8, GALAPAGOS, 200, HG, HUNGARY, 38, HH, HAITI, 175290 DATA HI, DOMREP, 175, HK, COLUMBIA, 176, HL, KOREA, 335, HM, KOREA, 335, HP, PANAMA, 195, HR, HONDURAS, 205300 DATA HS, THAILAND, 0, HV, VATICAN, 55, HZ, SAUDI ARABIA, 96, H4, SOLOMON IS., 283, I, ITALY, 55, IS, SARDINIA, 57, IT, SICILY, 55, JA, JAPAN, 331, JT, MONGOLIA, 5, JW, SVALBARD, 12, JY, JORDAN, 95, J2, DJIBOUTI, 60310 DATA J3, GRENADA, 140, J6, ST LUCIA, 140, J73, DOMINICA, 140, J8, ST. VINCENTS, 140, K, USA, XX320 DATA KA, US IN JAPAN, 331, KB6, HOWLAND/BAKER, 280, KH1, HOWLAND/BAKER, 280, KC4, ANTARCTICA, 180, KC4, NAVASSA, 170, KP1, NAVASSA, 170, KC6, CAROLINE IS., 315330 DATA KG4, GTMO, 200, KG6, MARIANAS, 325, KH6, HAWAII, 283, KH7, KURE, 275, KJ6, JOHNSTON, 284, KL7, ALASKA, 323, KM6, MIDWAY, 275, KP4, PUERTO RICO, 140340 DATA KP6, JARVIS/PAL., 238, KH5



, JARVIS/PAL., 238, KS6, AM. SAMOA, 241, KH8, AM. SAMOA, 241, KV4, VIRGIN IS., 160, KP2, VIRGIN IS., 160, KW6, WAKE, 280, KH9, WAKE, 280, KX6, MARSHALLS, 278, LA, NORWAY, 36, LJ, NORWAY, 36, LU, ARGENTINA, 165350 DATA LX, LUXEMBURG, 40, LZ, BULGARIA, 42, M1, SAN MARINO, 55, N, USA, XX, OA, PERU, 181360 DATA OD, LEBANON, 93, OE, AUSTRIA, 40, OH, FINLAND, 33, OK, CZECH, 46, OL, CZECH, 46, ON, BELGIUM, 40, OX, GREENLAND, 30, OY, FAROES, 36, OZ, DENMARK, 38, PA, NETHERLANDS, 46, PZ, SURINAM, 140, P2, NEW GUINEA, 281370 DATA SJ, SWEDEN, 38, SM, SWEDEN, 38, SP, POLAND, 40, ST, SUDAN, 81, SU, EGYPT, 56380 DATA SV, GREECE, 52, S2, BANGLADESH, 40, S79, SEYCHELLES, 63, S8, TRANSKEI, XX, S9, SAO TOME/PRIN., 135, TA, TURKEY, 40, TC, TURKEY, 40, TF, ICELAND, 35, TG, GUATEMALA, 213390 DATA TI, COSTA RICA, 197, TJ, CAMEROON, 95, TL, C. AFR. REP., 90, TN, CONGO, 92, TR, GABON, 92, TT, CHAD, 88, TU, IVORY COAST, 95, TY, BENIN, XX400 DATA TZ, MALI, 90, T2, TAVALU, IX, T3, KIRIBATI, XX, UA, USSR, 36, UB5, UKRAINE, 38, UC2, WH. RUSSIA, 36, UD6, AZERBAIDZHAN, 38, UF6, GEORGIA, 38, UG6, ARMENIA, 38, UH8, TURKMEN, 36410 DATA UI8, UZBEK, 36, UJ8, TADZHIK, 35, UL7, KAZAKH, 35, UM8, KIRGHIZ, 35, UNI, KARELO/FIN., 34, UO5, MOLDAVIA, 35, UP2, LITHUANIA, 36420 DATA UQ2, LATVIA, 35, UR2, ESTONIA, 35, VE, CANADA, XX, VK, AUSTRALIA, 260, VO1, NEWFOUNDLAND, 35, V02, LABRADOR, 15, VP1, BELIZ, 213, VP2, LEEWARD WINDWARD IS., 135, VP9, BERMUDA, 100, VS6, HONGKONG, 344, VU, INDIA, 33, VY1, YUKON, 324430 DATA W, USA, XX, XE, MEXICO, 235, XF, MEXICO, 235, XT, VOLTA, 92, XU, CAMBODIA, 05, XV, VIETNAM, 00440 DATA XW, LAOS, 00, XZ, BURMA, 08, YA, AFGHANISTAN, 30, YB, INDONESIA, 355, YC, INDONESIA, 355, YD, INDONESIA, 355, YI, IRAQ, 45, YK, SYRIA, 48, YN, NICARAGUA, 200, YO, RUMANIA, 45450 DATA YS, ELSALVADOR, 220, YU, YUGOSLAVIA, 80, YV, VENEZUELA, 160, ZA, ALBANIA, 82, ZB2, GIBRALTER, 68, ZC, B.R. CYPRUS, 50460 DATA ZD7, ST. HELENA, 116, ZD8, ASCENSION, 116, ZD9, TR. D. CUNHA, 135, ZE, ZIMBABWE, 110, ZF, CAYMAN IS., 190, ZK1, COOK IS., 253, ZK2, NIUE IS., 253

CO-EXISTENCE

Tired of watching? Two to six players manage their countries in a poor world. (map provided with markers)

\$24.75

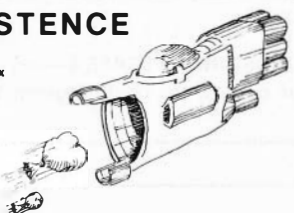
Also Five Exciting Games for \$15.95

P. O. Box 4016
Cherry Hill, NJ 08034

***NEW** ADVANCED
 ***NEW** ADVANCED
 ***NEW** ADVANCED

STAR*TRENCH

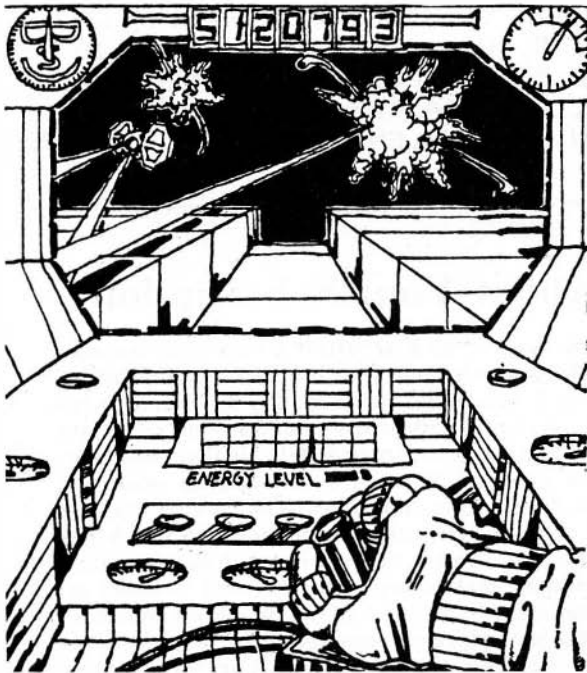

Even if you've tried our short sample version of this game, you will have to own this advanced, highly graphic version of STAR*TRENCH WARFARE. This High-Res Color Game has the most elaborate graphics of any Color Computer Game created to date. We thought it would take 32K to give you the detail of this dazzling simulation, but we've actually crammed it into 16K and added the most remarkable speed and flicker free animation found in ANY Extended Basic program. (You will not believe this program is really in Basic, plus you can always list our program to learn the programming techniques that make our software stand out from ALL the other basic programs available.)

ADVANCED STAR*TRENCH WARFARE includes a moving trench, cockpit perspective, on screen rapid scoring, energy and ship gauges, automatic high score tally, joystick control, and a recharge and crash sequence you'll have to see to believe. Pop on a pair of 3D glasses and WOW!!!, your Color Computer will jump to life with an even greater sense of depth with 3D-like color graphics. (3D glasses are not included, and are not required for you to enjoy this fine game.) You'll surely want this remarkable game as part of your software collection. Buy it and you'll see that color software doesn't have to be Machine Language to be the best!!!!

WARFARE

ADVANCED STAR*TRENCH WARFARE AVAILABLE AS
 *****16K EXTENDED BASIC GAME ON CASSETTE \$18.95*****
 =====ALSO TRY=====

WORDCLONE

Color WordClone makes word processing simple. This program can be used with tape or disk and provides you with real *UPPER* and *LOWER CASE* letters with descenders. PLUS . . . 50 letters by 23 lines on the screen at one time! Why pay more when this is all you need? *JUST \$18.95* supplied on tape (minimum system 16K Extended Basic). USER MODIFIABLE!!!

\$18.95



16K Extended Color Basic Tape Programs

CREATAVADER — Create your own targets or choose from a menu of predesignated four-color targets.

GATOR ZONE — Battle against alien "preppy gators" before they eat your shirt! An IMB original.

KOSMIC KAMIKAZE — Our best-selling high-res, deep space arcade game which the *RAINBOW* called "...the best spaceship graphics we have seen in a non-machine language program."

MANY MORE TITLES available, including *STAR SIEGE PLUS*, *GALLOPING GAMBLERS*, *SELECT-A-GAME*, *STARBASE ATTACK*, *METEOR STORM*, plus new releases coming.

\$18.95
EACH



illustrated memory banks
P.O. BOX 289
 WILLIAMSTOWN, MA. 01267-0289

VISA AND MASTERCARD ACCEPTED
 CALL (413) 663-9648 3-7 P.M. EST

SPECIAL OFFER: Mention this magazine ad and select a FREE program for every two programs you order !!



470 DATA ZL, NEW ZEALAND, 251, ZP, P
 ARAGUAY, 161, ZS, S. AFR., 116, ZR3, NA
 MBIBIA, 110, 3A, MONACO, 55, UA9, ASIA
 N USSR, 10, UA0, ASIAN USSR, 10
 480 DATA 3B8, MAURITIUS, 90, 3C, EQU
 ATORIAL AFR., 89, 3D2, FIJI IS., 260
 , 3D6, SWAZILAND, 110, 3V, TUNIS, 75, 4
 K1, USSR ANTARCTIC, 180, 4S, SRI LAN
 KA, 10
 490 DATA 5R, MADAGASCAR, 90, 5T, MAU
 RITANIA, 88, 5U, NIGER, 80, 5V, TOGO, 9
 2, 5W, W. SAMOA, 260, 5X, UGANDA, 80, 5Z
 , KENYA, 78, 60, SOMALI, 70, 6W, SENEGA
 L, 94, 6Y, JAMAICA, 190, 70, S. YEMEN, 5
 0, 7P, LESOTHO, 90
 500 DATA 7X, ALGERIA, 65, 7Z, SAUDI
 ARABIA, 45, 8P, BARBADOS, 135, 8Q, MAL
 DIVE, 45, 8R, GUYANA, 137, 9G, GHANA, 9
 3, 9H, MALTA, 61
 510 DATA 9I, ZAMBIA, 100, 9J, ZAMBIA
 , 100, 9K, KUWAIT, 40, 9L, SIERRA LEON
 E, 100, 9M2, W. MALAYSIA, 0, 9M8, SARAW
 AK, 355, 9N, NEPAL, 20, 9Q, ZAIRE, 100,
 9U, BURUNDI, 100, 9V, SINGAPORE, 0, 9Y
 , TRINIDAD-TOBAGO, 150
 520 DATA VP2A, ANTIGUA/BARBUDA, 14
 8, VP2K, ST. KITTS, 148, VP2M, MONTSER
 RAT, 145, VP2V, BR. VIRGIN IS., 140, 3
 Y, NORWEGIAN ANTARCTICA, 180, IC, CA
 PRI/ISCHIA, 56, JR6, OKINAWA, 330, 8J
 , JAP. ANTARCTICA, 180, CE9AA, CHILEA
 N ANTARCTIC, 180
 530 DATA CE0A, EASTER IS., 195, D2,
 ANGOLA, 100, D4, CAPE VERDE, 102, EAB

, CANARY, 85, FY, FR. GUIANA, 140, H4,
 SOLOMON IS., 275, IA, TUSCA, 70, IC, C
 APRI, 70, JR6, OKINAWA, 320, VK9, CHRI
 STMAS IS., 255
 540 DATA VP5, TURKS, 135, VP8, FALKL
 AND, 175, 4U, UN-NEW YORK, 10, 5A, LIB
 YA, 45, 5B, CYPRUS, 40, 5H3, TANZANIA,
 85, 5L, LIBERIA, 100, 5N, NIGERIA, 90,
 3X, GUINEA, 100, END, END, END



About Your Subscription

Your copy of *the RAINBOW* is sent third class mail and, for subscribers in the United States, the date of mailing is printed on the label. If you do not receive your copy by the 25th of any month, send us a card and we will mail another immediately via first class mail.

You must notify us of a new address when you move. Notification should reach us no later than the 15th of the month prior to the month in which you change your address. Sorry, we cannot be responsible for sending another copy when you fail to notify us.

Your mailing label also shows an "account number" and the subscription expiration date. Please indicate this account number when renewing or corresponding with us. It will help us help you better and faster.

For Canadian and other non-U.S. subscribers, there may be a mailing address shown that is different from our editorial office address. Do not send any correspondence to that mailing address. Send it to our editorial offices at P.O. Box 209, Prospect, KY 40059. This applies to everyone *except* those whose subscriptions are through our distributor in Australia.

<p>P.O. Box 513 LASALLE QUE. H8P 3J4 CANADA</p>	<p>! CANADIANS ! F & T SOFTWARE</p>	<p>Inquiries and Orders Call (516) 365-5392 Between 1-7 p.m. (E.S.T.)</p>																														
<p>We are Canada's largest importer of software for the Color Computer!</p> <ul style="list-style-type: none"> ★ Avoid the hassles and surcharges of importing directly from the U.S. ★ Avoid Customs Problems. ★ Save Time and Money. <p>Choose from our vast selection of quality software and pay in CDN FUNDS.</p> <p>ORDERS: Write or call us ★ Personal cheques O.K. ★ COD's Under \$100 add \$1.50 (Postal Rate) ★ Quebec Residents Only Add 9% Sales Tax</p> <p>CATALOGS: Send \$1 (refundable on first order), we'll send you our present catalog and we will insert you in our mailing list for free future updates.</p>	<p>This Month F&T Features SPECTRAL ASSOCIATES</p> <p>NEW! KEYS OF THE WIZARD Super new text Adventure game, three skill levels and a cassette save feature. An Extremely challenging and gripping game! Clues provided on request. 16K Cassette CDN \$26.00</p> <p>NEW! GALAX ATTAX Fast, challenging action game with rows of alien attackers swooping down on your ship! Bonus ships. Highest resolution. Machine Language. 16K Cassette CDN \$28.00</p> <p>SPACE WAR Command only remaining combat viper and break through enemy fighters and the Death Star! Highest resolution. Machine Language. We consider it a classic! 16K Cassette CDN \$29.50</p>	<p>UTILITIES</p> <table border="0"> <tr><td>Compuvoice</td><td>CDN \$55.00</td></tr> <tr><td>Soundsource & Cable</td><td>CDN \$33.00</td></tr> <tr><td>Bugout Monitor</td><td>CDN \$28.00</td></tr> <tr><td>Magic Box</td><td>CDN \$33.00</td></tr> </table> <p>GAMES</p> <p>NEW</p> <table border="0"> <tr><td>Planet Invasion</td><td>CDN \$28.00</td></tr> <tr><td>Defense</td><td>CDN \$28.00</td></tr> <tr><td>CCThello</td><td>CDN \$21.00</td></tr> </table> <p>ALSO</p> <table border="0"> <tr><td>Laser Command</td><td>CDN \$17.50</td></tr> <tr><td>Cosmic Super Bowl</td><td>CDN \$22.00</td></tr> <tr><td>Minotar</td><td>CDN \$27.50</td></tr> <tr><td>Ghost Gobbler</td><td>CDN \$29.50</td></tr> <tr><td>Graphic Animator</td><td>CDN \$17.00</td></tr> </table> <p>BOOKS</p> <table border="0"> <tr><td>Spectral—The Facts</td><td>CDN \$22.00</td></tr> <tr><td>McGraw-Hill—6809 Assembly Language Programming</td><td>CDN \$24.00</td></tr> <tr><td>ArcSoft—101 Program Tips & Tricks for the Color Computer</td><td>CDN \$14.00</td></tr> </table>	Compuvoice	CDN \$55.00	Soundsource & Cable	CDN \$33.00	Bugout Monitor	CDN \$28.00	Magic Box	CDN \$33.00	Planet Invasion	CDN \$28.00	Defense	CDN \$28.00	CCThello	CDN \$21.00	Laser Command	CDN \$17.50	Cosmic Super Bowl	CDN \$22.00	Minotar	CDN \$27.50	Ghost Gobbler	CDN \$29.50	Graphic Animator	CDN \$17.00	Spectral—The Facts	CDN \$22.00	McGraw-Hill—6809 Assembly Language Programming	CDN \$24.00	ArcSoft—101 Program Tips & Tricks for the Color Computer	CDN \$14.00
Compuvoice	CDN \$55.00																															
Soundsource & Cable	CDN \$33.00																															
Bugout Monitor	CDN \$28.00																															
Magic Box	CDN \$33.00																															
Planet Invasion	CDN \$28.00																															
Defense	CDN \$28.00																															
CCThello	CDN \$21.00																															
Laser Command	CDN \$17.50																															
Cosmic Super Bowl	CDN \$22.00																															
Minotar	CDN \$27.50																															
Ghost Gobbler	CDN \$29.50																															
Graphic Animator	CDN \$17.00																															
Spectral—The Facts	CDN \$22.00																															
McGraw-Hill—6809 Assembly Language Programming	CDN \$24.00																															
ArcSoft—101 Program Tips & Tricks for the Color Computer	CDN \$14.00																															
<p>FREE SHIPPING & HANDLING — NO HIDDEN CHARGES — CANADIAN \$\$</p>																																

TAKE A CLOSER LOOK THERE'S SOMETHING For EVERYONE

SOFTWARE

CCM#3

by Charles Santee, Ed.D.

This program allows total communication for special persons and does this with only one joystick. Easy to use, and also recommended for young children; can help teach spelling and sentence structure. Excellent documentation.

32K EXT **\$32.95**

BIGNUM

If you dislike seeing numbers like 1.23045 E 23, and wish you could have **all** the accurate digits instead, then BIGNUM is for you. Add, subtract, multiply, divide and raise BIG numbers to BIG powers and get totally accurate results. Even if you are satisfied with an approximation, without this program the Color Computer would return an "OV ERROR" with this problem: 34↑45. BIGNUM returns the entire 68 digit result! Accurate to 1,024 digits in 16K & about 3,068 digits with 32 RAM.

16K **\$9.95**

SKY-DEFENSE

Can you survive the first wave of attack? Or the next? Or the next? Only your joystick will ever know! Features horizontal flight in highres graphics, and fast-paced action. Machine language; joystick required. 16K **\$18.95**

THE WALL

Here is a 9 color joystick game that isn't another "Breakout" but a new idea. You are a brick shooting Bricks at the WALL to get the brick on the other side! (strange plot) This one's unique. Time limit on play. Joystick required.

16K **\$6.95**

HARDWARE

AUX-KEY

by JARB

(Auxiliary External Keyboard Unit)

This full size, industrial grade keyboard unit is P.C. board mounted for trouble free operation and years of use. Mounted in an attractive aluminum case with a 19-key numeric pad, AUX-KEY comes with long cable for remote placement of your 80C. No soldering required for installation. Will not affect normal operation of the original keyboard. **\$134.95**

16K-32K UPGRADE KIT

Kit includes 8 200 ns #4116 Factory Prime Chips, piggybacked sockets, SAM socket, and "32K" button to replace the 16K on your computer's case. Easy to remove. No soldering to computer. **\$25.95**

64K RAM CHIPS

200 ns #4164 chip set will upgrade your "E" board easily. Factory Prime Chips. (Compare the price elsewhere!) . **\$69.95**

Nanos Reference Cards

Model I BASIC & ASSEMBLER	\$4.96
Model I BASIC ONLY	2.95
Model II BASIC & ASSEMBLER	5.95
Model II SVC	2.95
Model II Commands & Utilities.	3.95
Model III BASIC & ASSEMBLER	5.95
Model III BASIC ONLY	3.95
Color Computer & TDP-100	
Color BASIC & EXTENDED	4.95
POCKET BASIC	2.95
APPLE II & II+ BASIC	3.95
APPLE II & II+ BASIC & 6502	4.95
Z-80	4.95

Add \$1.50 per software order and \$2.00 per hardware order for postage and handling.

California residents add 6% Sales Tax.

QUASAR ANIMATIONS

1520 Pacific Beach Drive, San Diego, California 92109
(619) 274-2202

Consumer Electronics Show Has It All . . . And Then Some

By Lawrence C. Falk
Rainbow Editor

There was, indeed, something for everyone at the Consumer Electronics Show last month in Las Vegas. We almost said that there was a little something for everyone—but that would have been untrue. There was a *lot* of something for everyone.

CES is the biggest single electronics show in the world. Just about everyone who manufactures any hardware-type product was in attendance, either at a booth or just “working the show” to see what there was to see. CoCo

Zaxxon game, according to Dennis Wallin. It looks like a good version. Datasoft has spent a great deal of time writing programs for Radio Shack in the last year but will bring Zaxxon (and, we hear, some other products) to market under its own name.

Anteco was in attendance as well. Business appeared brisk at their booth and marketing director Dick Hatcher says plans to put all their software on ROM Pack are moving ahead. Expect them to be available at dealers soon.

A new printer, a Star, is about ready to make some real waves. It is manufactured by a firm which makes parts for Epson, and should be priced lower than the Epson—and with more features, according to people at their booth.

A couple of firms were showing joysticks and other products designed for CoCo. You can expect to be seeing and reading about them in the coming months as they move to market.



WINTER CES MAIN FLOOR is a maze of signs, displays and exhibits. There were many new computers and a large number of games — both video and computer — introduced.

devotees were present as well and, although the booths were few (they are *very* expensive) quite a number of people were in attendance.

And, as usual in a show of this type, rumors abounded. But, to a large degree they were overshadowed by the sheer volume of what was on display.

Frankly, if it was electronic, it was at CES. There were computers of all kinds, shapes and descriptions (including CoCo, of course, although Tandy does not display at the show, most likely because they have their own company and dealer outlets). There were also hi fi systems, TV sets, telephones, burglar alarms, earth stations, printers and software houses. The game machines were in full force, too.

Some interesting things were happening that will have an effect on CoCo. One of them was the rumor of a new series of printers from Epson America that will have a serial interface built in. The CoCo influence? Perhaps. Look for this new line to be announced soon.

Data Soft was showing some new software, including a



JOHN AND LINDA Nielson of Moreton Bay Labs survey the CES floor.

The Sampo firm, which is planning on manufacturing a CoCo “workalike,” was in attendance, but with no computer to show. We understand that it is in the final development

stage—with a little more modification on the memory map system still to be done. The other CoCo “workalike,” the Dragon-32, was represented at the show but not displayed. Two people from the English firm were at CES and we heard that there are plans to manufacture a U.S. version of this computer.

Radio Shack people were out in force, with the marketing division led by vice president Jon Shirley. A host of other people, including the top CoCo people, were also on hand.

So was the other part of the Tandy Tandem, the TDP contingent. Jerry Congdon led the forces.

Others represented at the show were Moreton Bay Labs, Elite Software, Electronic World and a number of others.

New Computers

But the biggest news on the CES front was the number of electronic games and new personal computers. Atari had a mammoth display and unveiled a new computer; Mattel got into the computer business and several other firms were showing computers either for the first time or new models of present versions. All the “big names” were showing a host of games.

Examination of the “new” computers, frankly, left quite a bit to be desired vis-a-vis CoCo. Most of the new entries are designed toward the “low end” of the market, and our concern is that many people will buy these computers based solely on price and will then become frustrated with their inability to add memory, other hardware or the like. We also found some “sneaky” things, such as the cost of tape recorders (because of special cables and the like) being all out of proportion to the computers.

We are convinced that CoCo remains a top notch buy for anyone interested in personal computing. Friends who ask for your insight would be well advised to check the cost of an *entire system* and not be wooed too heavily by the initial cost of a particular computer itself.

Another important factor must be how versatile a system might be. For instance, the new Atari computer uses an interesting daisy-chain system to hook up printer, recorder and other devices. It appears that, if the owner does not like

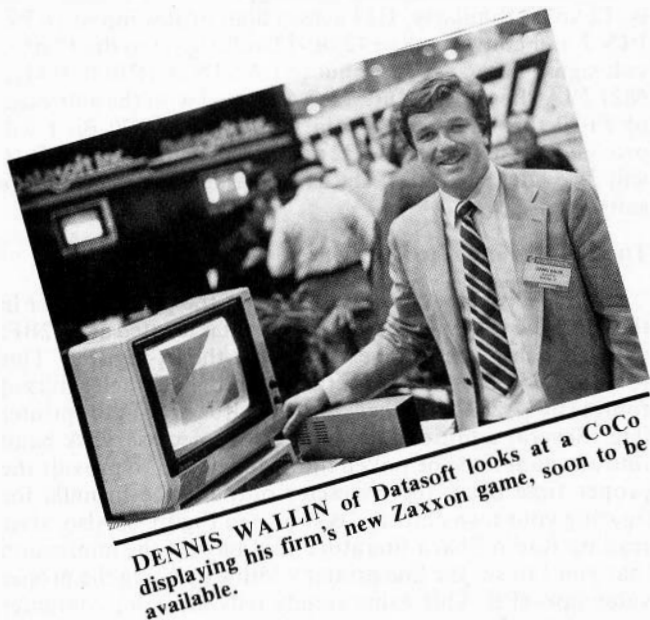

DENNIS WALLIN of Datasoft looks at a CoCo displaying his firm's new Zaxxon game, soon to be available.

displays on some other computers. The key is how easy is it

to program all those gee-whiz things. For most of the new personal computers, it appears you need to go into machine language for many of the things you can do quite well in Basic with CoCo.

The Game Scene

Everyone seemed to have a game or two. And, frankly, we saw more Atari game machines than any other single piece of hardware at CES. All the game cartridge makers were plugging Atari versions heavily and using Atari game machines to display them.

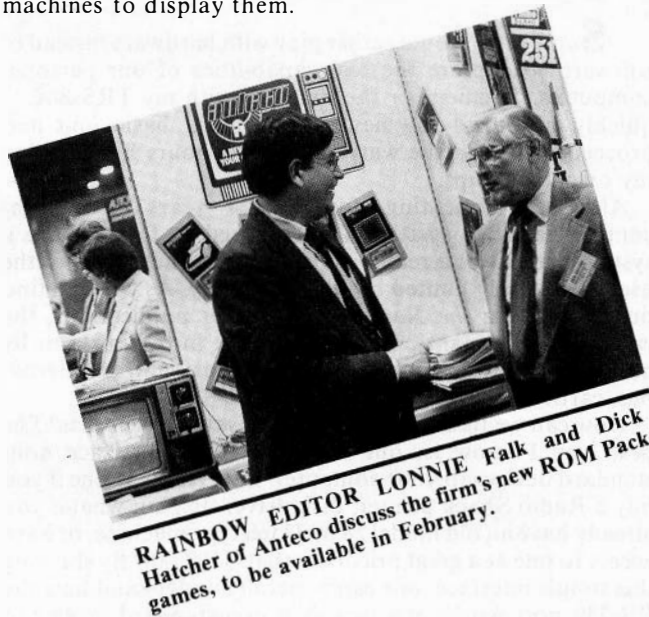

RAINBOW EDITOR LONNIE Falk and Dick Hatcher of Anteco discuss the firm's new ROM Pack games, to be available in February.

Many were quite good. But, frankly, we saw none that were better than the top of the line CoCo products. Data Soft's Zaxxon was top notch, Anteco's Intergalactic Force attracted a crowd.

Much of the talk was of the fall-off in game sales for the game machines. This happening came about when Atari reported less-than-expected sales of cartridges just before Christmas—a news item which sent the stock market into a brief tailspin.

Talk at CES focused on this, and much of what we picked up centered around the difference between game machines and personal computers.

Much of this thinking goes like this: If you have a game machine and people get tired of games, then you have problems. Game machines are, after all, game machines. The hardware is configured to games.

But personal computers like CoCo are much more than game machines. They have the ability to provide educational help, to perform many home and small business functions, play music, entertain and allow you to write programs to meet your own very specific needs. Thought is that the game machines will eclipse somewhat in the coming years as computers surge.

And, so, what sort of computer. As one observer of the market said: “It is important to consider the orientation of the computer.

“Take your Color Computer, for example. It was designed by Radio Shack, which makes *computers*. Then, look at the Atari or Mattel. It was designed by people who are into *games*.

“The subtle difference really isn't very subtle at all and will, sooner rather than later, be recognized by the consumer.”



The Rewards Of Non-Standard Interfacing

By Dan Downard

Some of us would rather play with hardware instead of software to explore the real capabilities of our personal computers. I remember the first day with my TRS-80C. I quickly un-boxed my new 4K standard basic unit and proceeded to void the warranty in two hours by installing my own 15K chips.

After experimenting for several years with non-commercial 6800 systems I am pleased to finally have a system that offers a realm of software and hardware to the user, really only limited by your ingenuity. As you will find out by reading *the Rainbow* and other publications, the capability of expansion is already built in to your unit by means of an RS-232 interface, joystick ports and an external bus/cartridge slot.

How can we find out how to use these external ports? The best way I know is, out of necessity, to interface non-standard devices to your computer. Everything is fine if you buy a Radio Shack printer, disk drive, etc., but what if you already have an old model 28 or 33 teletype machine, or have access to one at a great price (less than \$100.00)? By showing this simple interface, one can hopefully understand how the RS-232 port works and modify a non-standard printer to function. At the same time, for assembly language programming or many applications a printer is almost a necessity.

The RS-232 Interface-Hardware

A simplified version of the internal logic in the color computer is shown in Figure 1. According to Radio Shack the functions of P2 (Serial I/O) on the rear of the computer are as follows:

- PIN 1. CD
- PIN 2. RS232IN
- PIN 3. GROUND
- PIN 4. RS232OUT

- Input Status Line
- Serial Data Input
- Zero Voltage Reference
- Serial Data Out

Unfortunately, these PIN designations are only for Serial I/O and can be redefined as follows for printer operation:

- PIN 1.
- PIN 2. HANDSHAKE
- PIN 3. GROUND
- PIN 4. RS232OUT

- Not Used
- Printer Handshake
- Zero Voltage Reference
- Serial Data To Printer

Since we are mainly concerned with printer interfacing in this article, we will discuss how this particular logic works. RS-232 defines a "high" (Logic 1) as a voltage from +3 to +12

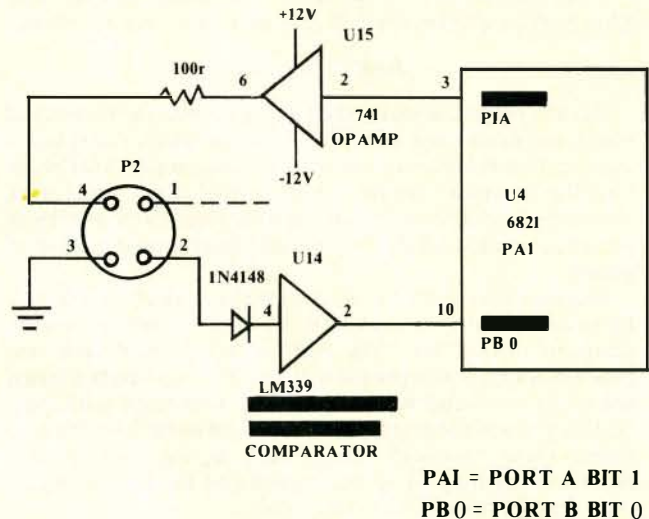

FIGURE 1

volts D.C. Similarly, a "low" (Logic 0) is defined as a voltage from -3 to -12 volts D.C. These levels hold true for both inputs and outputs. As you can see the signal from U4-PIN 3 (PA1) is amplified through U15 such that when U4-PIN 3 is high (+5 volts), P2-PIN 4 is +12 volts.

On the other hand, if U4-PIN 3 is low (0 volts), P2-PIN 4 is -12 volts. Similarly, U14 senses high or low inputs to P2-PIN 2 and converts the +12 or -12 volt signal to the +5 or -5 volt signal necessary for input to U4-PIN 10 (PBO). U4 is a 6821 PIA (Peripheral Interface Adapter) with the addresses of FF20 through FF23. Data written to \$FF20-Bit 1 will provide output to the RS-232 port. Data read at \$FF22-Bit 0 will provide a printer status signal to the appropriate software.

The RS-232 Interface-Software

Listing 1 is a commented version of the printer driver in the color basic ROM. As you can see, it is located at \$A2BF, with the character to be output in the A-register. This routine is called as a subroutine from the character output routine at \$A282 after checking the status of \$6F, the printer flag. Several additional comments are necessary. A baud rate constant must be poked into address \$95 to provide the proper time delay for character output. The formula for figuring your own constant is shown in Figure 2. Also, after reading Radio Shack literature you may get the impression that you can set the line printer width by poking the proper value into \$9B. This value simply tells the color computer that a CR/LF is being output by the printer and a delay is necessary. The computer does not output a CR. Also, as mentioned in several previous articles, the software only outputs a CR at the end of a line. The printer must generate the LF. The character output routine at \$A282 first jumps to

$$\text{BAUD CONSTANT} = \left(\frac{55930}{\text{BAUD RATE}} \right) - 5$$

EXAMPLE: 110 BAUD T-DECIMAL H-HEX

$$\left(\frac{55930}{110} \right) - 5 = 503\text{T} = 01\text{F7H}$$

01H = 1T

F7H = 247T

POKE 149,1: POKE 150,247

FIGURE 2

a RAM hook at \$0167 which is initialized as an RTS. Any user routine may be inserted by replacing the RTS with a JSR to his particular character output routine.

Universal Teletype Interface-Hardware

Figure 3 shows a simple interface that I use to convert the +12 volt or -12 volt RS-232 signal to a 20 milliamp current loop required by most teletype machines. Some teletype machines already have the RS-232 interface built in, but trying to find the wiring diagram is sometimes impossible. In

addition, I prefer the optical isolation provided by this circuit as safety from any stray voltages appearing in the computer. Be sure to wire this interface directly to the SMD (Selector Magnet Driver) card in the rear of the machine, as various other devices may be ahead of this circuit, preventing proper operation. The SMD cards are found on model 33 and 35 machines. For interface to model 15 or 28, machine wire the interface directly to the magnets on the right side of the machine. Make sure the magnets are wired in parallel for 20 milliamp operation.

Model 33/35 Teletype Interface-Software

Model 33/35 teletype machines are ASCII encoded, that is, they accept the output language of the color computer. Unfortunately, they are not as sophisticated as some of your more modern printers, and are not usually equipped with auto line feed - nor can they print lower case characters. They usually are set up for 110 baud operation, and provide very cheap, reliable hard copy.

Software to drive a teletype machine must satisfy the following criteria:

1. The baud rate must be set.
2. A LF must be output after a CR.
3. A CR/LF must be output after 72 characters.
4. The RAM hook at \$0167 must point to the new routine.

Listing 2 shows a software driver that is loaded into the computer at powerup and remains until you turn it off. The program is written for a 32K machine and may be relocated as noted for other systems. Be sure to note the jumper shown in Figure 3 between P2-PIN 2 and one of the joystick ports-

ECM! ELECTRICITY CONSUMPTION MONITER...



16 OR 32K EXTENDED BASIC REQUIRED

DID YOUR CoCo HELP SAVE YOUR MONEY TODAY? IT COULD HAVE WITH WITH "ECM", AN EASY AND ENTERTAINING TO USE HOUSEHOLD ELECTRICITY CONSUMPTION MONITER FOR TRS-80C*. THE SIXTEEN PAGE MANUAL EXPLAINS EACH STEP IN FULL DETAIL WITH PLENTY OF EXAMPLES. ECM CAN SHOW YOUR DAILY USAGE IN DOLLARS OR KILOWATT HOURS FOR THE LAST THIRTY DAYS WITH AVERAGE, HIGH AND LOW DAYS. IT CAN GRAPH THE LAST SIXTY DAYS IN KWH WITH AVERAGE INDICATOR, PREDICT YOUR NEXT BILL ANYTIME DURING THE MONTH WITH SURPRISING ACCURACY AND MORE! HELPING YOU MANAGE YOUR ELECTRICAL CONSUMPTION IS A JOB YOUR HOME COMPUTER SHOULD BE DOING! THE INTRODUCTORY PRICE OF \$8.95 INCLUDES A PROFESSIONAL MANUAL, CASSETTE TAPE, AND 'NEAT' PROGRAM LISTING, PRINTER IS NOT REQUIRED. SPECIAL PRICE EFFECTIVE THRU MARCH 1, 1983 ONLY, A SAVINGS OF 1.50 OFF THE REGULAR PRICE! FULL REFUND IF NOT COMPLETELY SATISFIED!

Send me "ECM"! (\$9.70 = 8.95 + 75¢ S&H)

Information! (Tell me more about ECM)

MAIL TO: CoCoDATA Enterprises
1215 Emerald Drive
Orlando, Fla. 32808

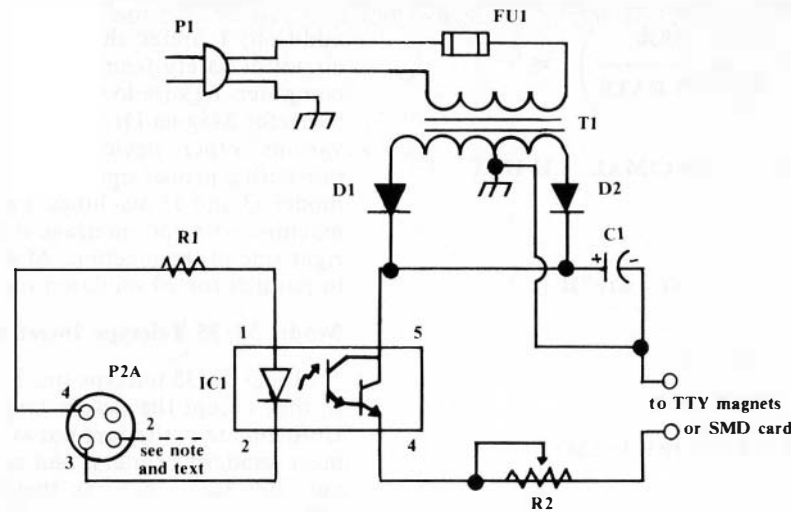

P1 HUBBELL 5664 PLUG-120 VOLT

P2A SERIAL I/O PLUG-RADIO SHACK

IC1 4N33 OPTICAL ISOLATOR WITH SOCKET

T1 120V PRIMARY—24VCT SECONDARY TRANSFORMER

D1,D2 1N4001 DIODE-50 PRV-1AMP

C1 1000uf CAPACITOR-25WVDC -SPRAGUE TVA1211

R1 220 RESISTOR-½WATT-

OHMITE RC20

R2 1000 RESISTOR-12WATT-ADJUSTABLE OHMITE 1023

FU1 FUSE -BUSS AGC-1 WITH BUSS HKP HOLDER

MISC CABINET, TERMINAL STRIP, HARDWARE, POWER CORD, WIRE, ETC.

NOTE CONNECT P2/P2A PIN2 (HANDSHAKE) TO +5 VOLTS D.C. OR JOYSTICK-PIN 5.

FIGURE 3

PIN 5. This disables the handshake, since we are sending data at the same speed that the teletype machine is printing.

Be careful while using this driver with machine language routines. Two things have happened. One program put the user stack pointer at the same location as my printer driver, requiring relocation. Another program called the subroutine at \$A2BF for printer output, instead of at \$A282. The RAM hook was no longer effective. For the second problem, you will have to change the RTS instruction at the end of the driver routine to a JMP \$A2BF, and change all program JSR \$A2BF's to JSR \$ (driver address).

Model 15/28 Teletype Interface-Software

Model 15 and 28 machines are baudot machines. Baudot is a five level code that preceded ASCII. By slowing down the baud rate of the computer and sending highs (Logic 1) for the last three of eight bits, we can simulate baudot code by a conversion process in software.

Listing 3 is a commented machine language baudot driver for the TRS-80C. Note that baudot cannot print all of the

ASCII character set. The following symbols are among those excluded:

* + < = > @

The driver routine inserts a space whenever these characters are encountered. As you can see, they are commonly-used math symbols in Basic programs. Well, you can't have everything. Also, the most common speed for baudot machines is 100 words per minute, or 75 baud, considerably slower than the ASCII machines. Load in the program with C-BUG or EDTASM+, etc. Listing 3 shows the program located at \$3F00, or near the top of 16K memory. For 32K, change the ORG statement to \$7F00, and for 4K, change it to \$0F00. This assumes you are using an assembler. If you are not, extended addresses will have to be changed. When the program is in memory, run the short Basic program in Listing 4. This program will initialize the baud rate and set the Basic RAM hook to point to the new routine. Anytime a PRINT #-2 statement is encountered, Basic will now output to your printer.

Summary

Teletype machines provide a cheap method of hard copy for occasional users, and really give you an insight into the operation of the computer. In the future, I hope to explain the operation of the ROM port by interfacing a parallel printer by means of an external PIA. There are so many things you can do if you have a good understanding of both the hardware and software aspects of microcomputers. I might suggest, for an in-depth discussion of this subject, that you purchase "6809 Microcomputer Programming and Interfacing" by Andrew Staugaard, Jr.(SAMS #21798). This book not only explains assembly language programming, but how to use the 6809 with peripheral devices, such as a PIA.

Good luck—and let's be careful out there.

Cartridge to Tape Back-up

RELOCATOR makes automatic tape copies of the Color Computer cartridges. Allow changes to be made to the program such as (Print-out *Videotex, change band rate in *Scripsit, etc.) Requires either 64K mod. or 4 to 8K of cartridge memory expansion in the address range of &COOO to &DFFF (64K requires some program changes.)

Requires 16K min
Cassette \$29.00
plus \$1.00 shipping

*Trademark of Tandy Corp.

Transition Technology
1458 W. Birchwood Ave.
Chicago, IL 60626

"TRS-80 COLOR COMPUTER PRODUCTS" "THE 1248-EP EPROM PROGRAMMER"

The 1248-EP EPROM PROGRAMMER is a full function unit that is compatible with virtually all popular 1K, 2K, 4K & 8K -by-8, 24 pin, 5 volt EPROMS. Compatible devices are 2508's, 2758 -0/1's, 2516's, 2716's, 2532's, 68732-0/1's, 68764's, and 68766's. Components 2732, 2732A, 2564, and 2764 are compatible via adapters (not supplied). The programmer is totally menu driven by resident position independent firmware in EPROM, which makes it suitable for experienced computer operators and novices alike.

Select the device type to be programmed from the device menu. Next, select the function to be performed from the function menu. On your command the 1248-EP will verify EPROM erasure, compare EPROM contents to specified contents of RAM or ROM, program blocks or individual bytes of EPROM memory or copy an EPROM's contents to user specified RAM.

The 1248-EP plugs into the cartridge slot of the Color Computer and is invoked by the user with the "EXEC & HCOO0" BASIC command. The 1248-EP contains its own on-board programming power supply, and has a quality "Zero Insertion Force" socket.

The combination of the TRS-80 Color Computer, an editor/assembler/monitor such as the Micro Works SOS80C** and the 1248-EP EPROM programmer, makes a high performance, cost effective software development station for MC-6800/6809 microprocessor based systems. Use the system to store your own games or utility programs in EPROM's for execution from the cartridge slot using the CK4 PROM/RAM card described below.

The cost of the 1248-EP EPROM PROGRAMMER, instructions and adapter diagrams is just \$99.95.

"THE CK4 PROM/RAM CARD"

The CK4 works with 2K, 4K or 8K-by-8 ROM's or EPROM's of the 5 volt only variety in 24 pin packages. In addition, the CK4 may be used with 4 static RAM's such as 6116's to expand the computers memory work space by 8192 bytes. Each of the four on-board sockets can be decoded to any 2K block of the memory map from \$C000 through \$F800 of the Color Computer. In addition, each socket can be configured to respond to address blocks from 2K to 8K bytes in length, thus accommodating 2K, 4K or 8K-by-8 ROM's, EPROM's or RAM's. ROM and RAM can be mixed on the card as well. RAM, on the card, can be written to and then "write protected" via dip switches on the CK4 to emulate ROM.

The instructions include information on how to set up the socket decoding circuitry and how to provide battery backup for programs stored in CMOS static RAM on the CK4 with the computer off or the cartridge removed.

The popular CK4 PROM/RAM card is now available in three versions.

1) The full featured CK4 remains the standard of cartridge board flexibility with the added capability of providing battery backup for CMOS static RAM's such as 6116's. Cost of the CK4 is still just \$29.95.

2) The CK4-1 is a ROM only version of the CK4 card for use with CoCo's with later than "E series" circuit boards. These later versions of CoCo are not able to write to cartridge based RAM without modification. Cost is \$27.95 for the CK4-1.

3) The CK4-2 is the unpopulated CK4 series circuit board only. Buy this version of the CK4 and configure them to meet your specific requirements at a price designed to stretch your dollars value. Cost is \$15.95 each.

"MORSE ENCODER/DECODER KIT"

The MEDK80 Morse En/Decoder Kit consists of a machine code software driver on tape, a schematic diagram of the interface circuitry, component parts, a printed circuit board (PCB), packaging suggestions and complete instructions for building a Morse code transmission and reception system that is compatible with 4K RAM and up models of the TRS-80 Color Computer.

The transmitter/receiver interface circuitry is totally optically isolated and is, therefore, compatible with all receivers and transmitters. Transmitter and receiver both connect to the interface unit and to the Color Computer via the RS-232 port.

The MEDK80 Morse En/Decoder kit operates at speeds up to 70 words per minute and automatically adapts to speed variations of the sender. When transmitting, words are transmitted only when fully formed, i.e., followed by a space, and the transmit text buffer gives visual notification to the operator of what word/character is currently being sent. In addition, the text buffer is 512 characters deep, which is sufficiently large to keep up with the best of "rag-chewers".

Potential purchasers of this product should have previous kit building experience. However, this is not a kit of great complexity, and is well within the abilities of those actively involved in amateur radio or electronic hobbies to construct. To reduce the chance of wiring errors, component placement is indicated on the PCB and detailed assembly instructions are included.

The cost of the MEDK80 software, parts, and instructions is \$39.95.

"COCO" GETS A BREADBOARD

The COCO BREADBOARD is a circuit board that plugs directly into the cartridge slot of the Color Computer and provides the user with 16 square inches of predrilled breadboarding area for circuit development, interfacing experiments, motherboard implementation, or whatever your imagination conjures up. The plated thru holes in the breadboard are wirewrap pin compatible and on 0.10 inch centers.

The COCO BREAD BOARD brings all of the data, address, and control signals available at the cartridge slot outside of the body of the computer and the signal lines are appropriately labeled to facilitate error free wiring of breadboards. A ground plane is provided on the top side of the board and solder pads are provided on the bottom of the board, thus facilitating circuit grounding and point-to-point wiring. In short, the COCO BREADBOARD was designed with the experimenter in mind.

The COCO BREADBOARD is attractively priced to justify its use for even the lowest budget projects. It is an ideal vehicle for learning interfacing techniques. Buy extras to have on hand for those rainy weekends.

The COCO BREADBOARD costs just \$19.95. Price for two (2) or more is \$16.95 each.

FACTORY FRESH COMPONENTS:

ITEM	DESCRIPTION	PRICE
2716 EPROM	2K by 8 Bit, 350 ns	\$4.50 ea.
2532 EPROM	4K by 8 bit, 350 ns	\$6.50 ea.
6821P	P.I.A.	\$3.50 ea.
74LS156	Open collector decoder	\$1.70 ea.
Socket	ZIF, 24 pin, Aries	\$7.95 ea.

Minimum component order: \$25.00

ORDERING INFORMATION:

Add \$3.00 to all orders to cover shipping and handling. Allow two weeks for personal checks. Canadian residents add 5% to cover special handling. Arizona residents add 4% sales tax. Sorry! No charges accepted. All items shipped UPS.

Make checks payable to:

**COMPUTER ACCESSORIES OF ARIZONA
5801 E. VOLTAIRE DRIVE
SCOTTSDALE, ARIZONA 85254
(602) 996-7569**

*: TRS-80 is a trademark of TANDY CORP.
** SOS80C is a trademark of the MICRO WORKS.
Prices subject to change without notice.

Listing 1

```

A2B F PSHS X,B,A,CC SAVE REGISTERS
A2C 1 ORCC #550 DISABLE INTERRUPTS
A2C 3 BSR A2FB SEND START BITS
A2C 5 CLR B " " "
A2C 6 BSR A2FD B-BIT COUNTER
A2C 8 LDB #508 SAVE BIT COUNTER
A2CA PSHS B B=0
A2CC CLR B A-BITO INTO CARRY
A2CD LSR A CARRY INTO B-BITO
A2CE ROL B B-BITO TO BITI
A2CF ASL B SEND BIT IN B-BITI
A2D 0 BSR A2FD RESTORE BIT COUNTER
A2D 2 PULS B SUBTRACT 1 FROM COUNTER
A2D 4 DEC D IF NOT ZERO SEND ANOTHER
A2D 5 BNE A2CA SEND STOP BITS
A2D 7 BSR A2FB RESTORE SOME REGISTERS
A2D 9 PULS CC,A CARRIAGE RETURN?
A2DB CMPA #30D GO TO WIDTH ROUTINE
A2DD BEQ A2E7 INCREMENT WIDTH COUNTER
A2DF INC $9C COUNTER TO B REG
A2E 1 LDB $9C EQUAL TO WIDTH?
A2E 3 CMPB $9B IF LOWER BRANCH
A2E 5 BLO A2ED IF EQUAL THEN DELAY
A2E 9 BSR A305 DELAY AGAIN
A2EB BSR A305 CHECK HANDSHAKE
A2ED LDB FF22 BIT 0 INTO CARRY
A2FO LSR B LOOP IF NO SIGNAL
A2F 1 BLO A2ED RESTORE REGS & RETURN
A2F 3 PULS P,X,PC

A2FB LDB #52 SET BITI IN B REG
A2FD STB #F20 SEND IT
A30 0 BSR A302 BRANCH TO DELAY
A30 2 LDX $95 LOAD BAUD RATE
A30 4 CMPX DUMMY INSTRUCTION
A30 5 LDX $97 LOAD LINE DELAY
A30 7 JMP A7D3 GOTO DELAY

A7D 3 LEAX -1,X DECREMENT X REG
A7D 5 BNE A7D3 AGAIN IF NOT ZERO
A7D 7 RTS RETURN

$9 5 BAUD RATE CONSTANT
$9 7 LINE DELAY CONSTANT
$9 8 PRINTER WIDTH CONSTANT
    
```

Listing 2

```

100 *PRINTER DRIVER-DAN DOWNARD
110 *REV 1 12/82 FOR 32K TRS-80C
120 CLEAR25,32718
130 *FOR 4K CHANGE 32718 TO 4046
140 *FOR 16K CHANGE 32718 TO 16334
150 DATA2,20,246,0,111,193,254
160 DATA3,20,246,0,156,92,241
170 DATA4,155,39,14,129,13,38
180 DATA7,190,160,2,173,3,134
190 DATA10,53,20,57,52,2,134
    
```

```

200 DATA13,190,160,2,173,3,134
210 DATA10,173,3,53,2,32,236
220 FOR D=32719 TO 32767
230 *4K-FOR D=4047 TO 4095
240 *16K-FOR D=15335 TO 16383
250 READ E:POKE D,E:NEXT D
260 POKE1021,PEEK(359)
270 POKE1022,PEEK(360)
280 POKE1023,PEEK(361)
290 POKE359,126:POKE360,127:POKE361,207
300 POKE149,2:POKE150,0
310 POKE155,72
320 POKE151,64:POKE152,0
330 END
    
```

Listing 3

```

00100 *BAUDOT-TTY DRIVER
00110 OUT EQU $A2BF
00120 ORG $3F00
00150 TABLE FCB $E4 @ (SPACE)
00160 FCB $E3 A
00170 FCB $F9 B
00180 FCB $E2 C
00190 FCB $E9 D
00200 FCB $E1 E
00210 FCB $ED F
00220 FCB $FA G
00230 FCB $FA H
00240 FCB $E6 I
00250 FCB $EB J
00260 FCB $EF K
00270 FCB $F2 L
00280 FCB $FC M
00290 FCB $EC N
00300 FCB $F8 O
00310 FCB $F6 P
00320 FCB $F7 Q
00330 FCB $EA R
00340 FCB $E5 S
00350 FCB $F0 T
00360 FCB $E7 U
00370 FCB $FE V
00380 FCB $F3 W
00390 FCB $FD X
00400 FCB $F5 Y
00410 FCB $F1 Z
00420 FCB $E4 [(SPACE)
00430 FCB $E4 / (SPACE)
00440 FCB $E4 ] (SPACE)
00450 FCB $E4 + (SPACE)
00460 FCB $E4 - (SPACE)
00470 FCB $E4 SPACE
00480 FCB $ED 1
00490 FCB $F1 "
00500 FCB $FA #
00510 FCB $E9 $
00520 FCB $E4 Z (SPACE)
00530 FCB $FA &
    
```

GET YOUR BUGS OFF YOUR HANDS.

Bugs in your programs can really get under your skin. Especially when they've been bugging you for longer than you'd like to think.

So get your bugs off your hands. And onto somebody else's.

Pack them off to DeBug. (On cassette, thank you.) With a description of where you were going. And where you got stuck. If it's an interesting enough program, we'll send it to people who like to stomp on other people's bugs.

If somebody can get all the bugs out of your 16K Extended Basic CoCo program, we'll try to sell it. And everyone shares the profits.

Send \$5 per entry. Or \$9 for a sample cassette of 20 or so very buggy programs. Or \$12 for both.

DEBUG 114 West Central St.
Natick, MA 01760



3F27	EB	00540	FCB	\$EB	*
3F28	EF	00550	FCB	\$EF	(
3F29	F2	00560	FCB	\$F2)
3F2A	E4	00570	FCB	\$E4	*(SPACE)
3F2B	E4	00580	FCB	\$E4	+(SPACE)
3F2C	EC	00590	FCB	\$EC	*
3F2D	E3	00600	FCB	\$E3	-
3F2E	FC	00610	FCB	\$FC	.
3F2F	FD	00620	FCB	\$FD	/
3F30	F6	00630	FCB	\$F6	0
3F31	F7	00640	FCB	\$F7	1
3F32	F3	00650	FCB	\$F3	2
3F33	E1	00660	FCB	\$E1	3
3F34	EA	00670	FCB	\$EA	4
3F35	FO	00680	FCB	\$FO	5
3F36	F5	00690	FCB	\$F5	6
3F37	E7	00700	FCB	\$E7	7
3F38	E6	00710	FCB	\$E6	8
3F39	F8	00720	FCB	\$F8	9
3F3A	EE	00730	FCB	\$EE	+
3F3B	FE	00740	FCB	\$FE	+
3F3C	E4	00750	FCB	\$E4	*(SPACE)
3F3D	E4	00760	FCB	\$E4	*(SPACE)
3F3E	E4	00770	FCB	\$E4	*(SPACE)
3F3F	F9	00780	FCB	\$F9	?
3F40	34	00790	TEST	PSHS	B,X,Y SAVE REGISTERS
3F42	D6	00800		LDB	LOAD OUTPUT FLAG
3F44	C1	00810		CMPB	#-2 CHECK FOR PRINTER
3F46	26	00820		BNE	EXIT RETURN IF NOT
3F48	81	00830	OUTY	CMPA	#55E GRAPHICS CHAR?
3F4A	22	00840		BHI	SPI SEND SPACE IF FOUND
3F4C	108E	00850	3F00	LDY	#TABLE Y REG-START OF TABLE
3F50	81	00860	CRLF	CMPA	#30D IS CHAR A CR?
3F52	26	00870		BNE	SP
3F54	86	00880		LDA	#5E8 SEND CR
3F56	8D	00890		JSR	OUT
3F59	86	00900		LDA	#5E2 SEND LF
3F5B	20	00910		BRA	EXIT
3F5D	81	00920	SP	CMPA	#520 IS CHAR A SPACE?
3F5F	26	00930		BNE	CNTRL
3F61	86	00940	SPI	LDA	#5E4 SEND SPACE
3F63	20	00950		BRA	EXIT
3F65	81	00960	CNTRL	CMPA	#51F CONTROL CODE?
3F67	23	00970		BLS	SPI IF YES SEND SPACE
3F69	34	00980	SH	ANDA	#53F CONVERT TO 6-BIT
3F6B	1F	00990		IFR	A,B SAVE CHAR IN B
3F6D	84	01000		ANDA	#520 MASK BIT 6
3F6F	81	01010	LAST	CMPA	#5FF COMPARE TO LAST CHAR
3F71	27	01020		BEQ	SEND IF SAME SHIFT SEND
3F73	23	01030		BLS	LTRS
3F75	86	01040	FIGS	LDA	#520 STORE FIGS FLAG
3F77	D7	01050	3F70	STA	LAST+1
3F7A	86	01060		LDA	#5FB SEND FIGS SHIFT
3F7C	8D	01070		JSR	OUT
3F7F	20	01080		BRA	SEND
3F81	7F	01090	LTRS	CLR	LAST+1 STORE LTRS FLAG
3F84	86	01100		LDA	#5FF SEND LTRS SHIFT
3F86	8D	01110		JSR	OUT
3F89	A5	01120	SEND	LDA	B,Y LOAD CHAR FROM TABLE
3F8B	35	01130	EXIT	PULS	B,X,Y SEND IT
3F8D	39	01135		RTS	
		01140		END	
	0000	01140			
00000	TOTAL ERRORS				

Listing 4

```

100 INITIALIZE BAUDOT DRIVER
110 DAN DOWNWARD 12/82
120 FOR 16K TRS-80C WITH
130 ROUTINE LOCATED AT $3F00
140 CLEAR25,16127
150 POKE1021,PEEK(359)
160 POKE1022,PEEK(360)
170 POKE1023,PEEK(361)
180 POKE359,126:POKE360,63:POKE361,64
190 POKE149,2:POKE150,247
200 POKE151,64:POKE152,0
210 END

```



Hint . . .

Painting Must Be Accurate

When you issue a PAINT command, be sure that you set the point at which the PAINTing is to begin within the area that is to be PAINTed. If you set the position on a line which encloses the area, the PAINT will not work.

Also, when using PAINT, be sure that your area is fully enclosed, or the PAINT will "leak" out and cover the entire screen.

MASTER DIRECTORY

Put order in your life! Have your diskettes multiplied and now are out of control? MASTER DIRECTORY will sort out your problems and locate all of your programs. Only takes seconds to add all of the files on one diskette to the master directory.

- ‡ Master listing by diskette number with description.
- ‡ Master listing of all your programs in either diskette sequence or program sequence.
- ‡ Basic for easy customizing: fast mach lang sort
- ‡ Requires 32k with printer
- ‡ Only \$20

Other COCOPRO products: (All machine language)

FULL SCREEN EDITOR ----- \$15
Adds arrow-key control for editing of basic programs.

REVERSI ----- \$9
"Othello"

EXPANDED DIRECTORY ----- \$15
Saves 120 files on one diskette.

COLOR DIRECTORY ----- \$12
Fantastic DIR!

COCOSLOTS ----- \$9
Las Vegas at home.

CASSETTE DIRECTORY

List program name, length of basic program or start, end and transfer addresses for mach lang program. FREE with all orders if requested or send \$2.50 for program on cassette.

>> FREE CATALOG <<
Send SASE

Send check or money-order to:

COCOPRO
P.O. BOX 37022
ST LOUIS, MO 63141



Postage paid on all pre-paid orders in continental U.S.
MO residents include 5.625% sales tax.

The Color Computer And Our Schools

by
Dr. Paul Kimmelman,
Assistant Superintendent
and
David Macali,
Coordinator of Instructional Services
Norton City (Ohio) Schools

Educational Network

We are currently working on a Color Computer educational network. Radio Shack has agreed to include our efforts in a future *Microcomputer News*. When a significant list has been assembled, *the Rainbow* will publish information on how to obtain a copy.

If you are currently using the Color Computer in your schools or for an educational purpose, please send the following information to:

Dr. Paul Kimmelman
Norton City Schools
Norton, Ohio 44203

- A. Computer Coordinator's Name
- B. School District
- C. Address

- D. Educational use of Color Computer
- E. Software being used and evaluations

Radio Shack Logo

With all due respect to the many software distributors, it must now be said that to obtain maximum and proper utilization of computers for educational purposes, Logo is number one. While the technical Logo "purists" have registered some criticisms of the Radio Shack Logo version, it can easily be said that Radio Shack Logo with the Color Computer in elementary schools is the most significant step Radio Shack has made toward computer literacy with the Color Computer for younger children.

We are not about to condemn some of the outstanding software available, especially *Moptown* and *Bumble Games* from Follett, and some of the programs from Tom Mix, but *Logo* is the one elementary program that makes the student run the computer and not vice versa. In the near future we hope to provide the readers with a recommended Color Computer *Logo* Learning Lab and curriculum. In the meantime, the wait for the Radio Shack *Logo* ROM pack will be well worthwhile.

Questions

We have received many calls and questions concerning "Why a Radio Shack Color Computer instead of an Apple or some other brand?" Again, we don't intend to make any value judgments about other brands of computers because we are exclusively Radio Shack.

When you consider the initial cost of the Color Computer in comparison to the Apple it is apparent that, at least for elementary school use, you can get more hardware for your money. Further, with Follett condensing 48K Apple disk programs into 16K Color Computer cassettes, software costs will be reduced as well.

All of you are also well aware of the many fine third party software distributors that advertise in *the Rainbow*. Clearly, there is no shortage of software for the Color Computer.

It would be our opinion that when weighing the value of the Color Computer service, dollar-for-dollar, schools can't go wrong if it is properly utilized.

Future Articles

We are looking for your questions and ideas for future articles. The educational implementation of the Color Computer has many facets. Soon to come: a great joystick, furniture, books, curriculum, modems, and "problems."



What's A CoCo?

CoCo is the affectionate nickname which *the Rainbow*, many users and, even Radio Shack, has adopted for the TRS-80 Color Computer.

As used in *the Rainbow*, CoCo also means the TDP System-100 and, generally, the Dragon-32 computers as well. Since the TRS-80 Color and TDP System-100 are the same computer, with the exception of the case design, all programs in *the Rainbow* will run equally well on both. The Dragon-32 is slightly different in memory mapping, but the vast majority of our Basic programs will run with no modification.

For this reason, we use the term CoCo to describe all three computers. Others may use 80C, 80CC or TRS-80 Color but, *unless specifically noted*, these terms all refer to all three computers as well.



START

COMPUTER PROGRAMS
TRS-80 MODEL 1/3 16K LEVEL II
TRS-80 16K COLOR

\$3 FROG RACE \$3
DEMO PROGRAM FROG RACE COMES ON CASSETTE WITH A
REFUND COUPON TO USE ON YOUR NEXT ORDER.
FROG RACE CASSETTE \$3. WITH CATALOG

DUO-PAKS ARE \$10 EACH.

PAK NO.	PROGRAM SIDE 1 /	PROGRAM SIDE 2
DUO-PAK-1	GONE FISHING /	CONCENTRATION
DUO-PAK-2	CRAPS /	SLOT-MACHINE
DUO-PAK-3	STARSHIP /	SHERLOCK HOLMES
DUO-PAK-4	TANK ATTACK /	ASSOCIATION
DUO-PAK-5	NUMBER GUESS /	DICE ROLL
DUO-PAK-6	IN-BETWEEN /	SHELL GAME
DUO-PAK-7	SAFARI /	STARSHIP-2
DUO-PAK-8	MORTAR BATTLE /	PUZZLE
DUO-PAK-9	TEASERS /	MOUSE
DUO-PAK-10	PT BOAT /	TURTLE RACE
DUO-PAK-11	CHEK-CHEK /	STARSHIP-3
DUO-PAK-12	THINK /	LUCK & LOGIC
DUO-PAK-13	TREASURE ISLAND /	RESCUE
DUO-PAK-500	DC-OHMS LAW /	FLC-FRC
DUO-PAK-501	IC-TIMER-1 /	IC-TIMER 2

SYSTEM PROGRAMS \$10 EACH

SUI CASSETTE COPY / CASSETTE COPY

ORDERS WILL BE SENT BY FIRST CLASS MAIL PPD.
SORRY NO COD'S
BE SURE TO SPECIFY WHICH COMPUTER YOU HAVE.
B. ERICKSON P.O. BOX 11099
CHICAGO, IL. 60611

BASIC AID

AT LAST! Help for the BASIC programmer. **BASIC AID** is an indispensable addition to the Color Computer. It will save you valuable time and effort. If you write or modify BASIC programs, you need **BASIC AID**.

You get **43** Common BASIC commands available as single Control Key inputs. Greatly speeds up program entry.

A powerful feature is the ability to **redefine** any or all of the keys to your own specifications **PLUS** you get invaluable features such as a **MERGE** command, **Move Line** command and **Automatic Line Numbering**.

MERGE— Insert programs stored on cassette into your Basic program. You can even assign new line numbers to the program you read in. Great for creating your own tape library.

MOVE— Lets you move and renumber any part of your Basic program. GOTOs and GOSUBs are automatically changed.

Redefine any or all keys! Put in **your** most frequently used commands. Then save them to tape for use another time.



"An excellent program and fine utility." — **RAINBOW** review, August, 1982, Page 27

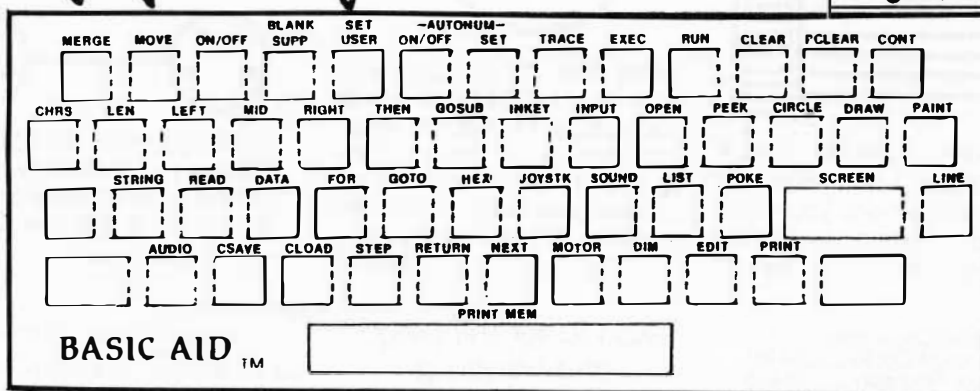

All of this in a convenient **ROM** cartridge which is available instantly on power-up. And, it uses almost none of your valuable memory! Comes with a convenient, easy to remove, **plastic** keyboard overlay.



BASIC AID CARTRIDGE

\$34.95

Add \$2 Shipping and Handling

SPECTRUM PROJECTS

93-15 86th DRIVE (212) 441-2807 (VOICE)
WOODHAVEN, N.Y. 11421 (212) 441-3755 (DATA)

CHECK OUT OUR COLOR BBS' AT (212) 441-3755 & 441-3766



COLOR CABLES +

from SPECTRUM PROJECTS



The must CoCo book for 1983. Contains a myriad of peeks and pokes, ROM and RAM upgrades, machine language backups, printer potpourri and more! Make your computer do things it never did before.
.....\$14.95

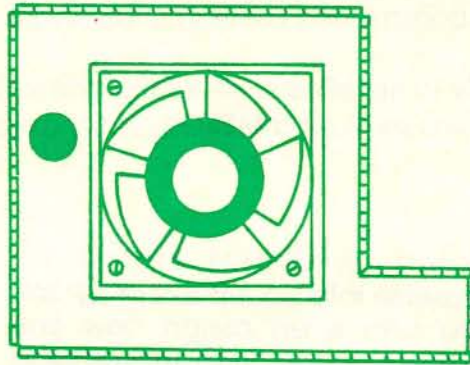

COCO COOLER—Internal cooling system. Prevent heat buildup inside your Color Computer. "CoCo Cooler keeps things cool."—Rainbow Review, Dec., 1982, Page 39.....\$19.95

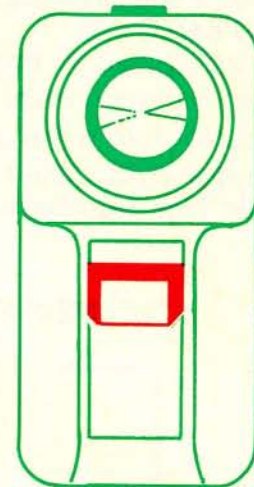

THE SPECTRUM PADDLE—Enjoy quicker response and higher game scores. Great for games with side-to-side action like Astro Blast, Space Invaders, Shooting Gallery and Clowns and Balloons. Includes "softtouch" fire button. "You have better control of the right to left movement than with any joystick we have seen so far"—Rainbow Review, Jan., 1983, Page 134.....\$19.95

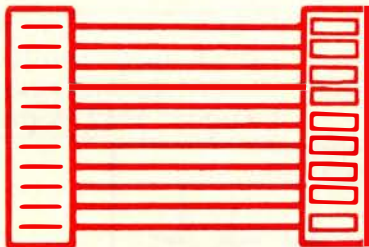

DISK INTERFACE/ROM PACK EXTENDER — 3 FEET. Move your disks and ROM packs where you want them. Gold plated contacts eliminate corrosion. \$29.95

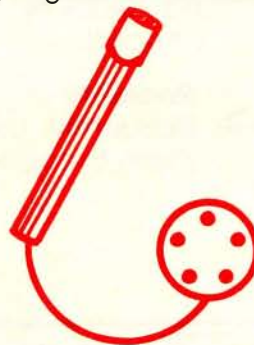

LIGHT PEN—Plugs right in to your joystick port and reads the colors off your screen. Includes four demo programs and is completely compatible with Computer Island's Fun-Pak software.
.....\$19.95

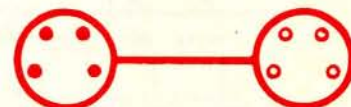

FOUR-PIN MALE TO FOUR PIN FEMALE—15 FEET. Move your printer or modem to another location—easier use...\$14.95

MORE CABLES . . .

- Coaxial RF Adapter Cable and 8 Ft. RG59/u Coaxial Cable ____ \$9.95*
- Cassette Recorder Extension ____ \$14.95
- SAM Saver (LED On/Off Indicator) \$14.95
- Joystick Cable Extension ____ \$14.95
- Disk Drive Extender ____ \$14.95
- Serial Cable (specify printer) ____ \$17.95
- Joystick "Y" Adapter ____ \$19.95
- Two Drive Cable ____ \$29.95
- Parallel Printer Cable ____ \$34.95
- Four Drive Cable ____ \$39.95
- Customized Cables ____ CALL

*Replaces gray audio cable to help reduce TV interference. Direct 75 ohm hookup.

Add \$2 for Shipping and Handling



SPECTRUM PROJECTS

NEW ITEMS . . .

- Color Computer Editor, Assembler and Debugger ____ \$6.95
- The Stripper (delete REMS, pack lines and remove spaces) ____ \$7.95
- Deluxe Tape Storage Holders
- 48 Cassettes (3 Drawers) ____ \$22.95
- 96 Cassettes (6 Drawers) ____ \$39.95
- Printer Stand ____ \$39.95
- Printer Stand w/shelf (LP VII, LP VIII, MX-80, Okidata) ____ \$49.95
- CoCo Numeric Keypad ____ \$99.95 (Plugs into joystick port)

93-16 88th DRIVE (212) 441-2807 (VOICE)
WOODHAVEN, N.Y. 11421 (212) 441-3756 (DATA)

Check Out Our Color BBS' At (212) 441-3755 & (212) 441-3766 24 Hours Every Day

DEALER/CLUB INQUIRIES WELCOME

New York State Residents add appropriate taxes



Tired of plugging and unplugging devices from the RS232 port of your Color Computer? Make your life easier. Buy our RS232 expansion cable and connect two devices at the same time. Just right for printers, modems, etc. Anything that plugs into the Color Computer will plug into this high quality cable.

RS232 Cable \$20.00

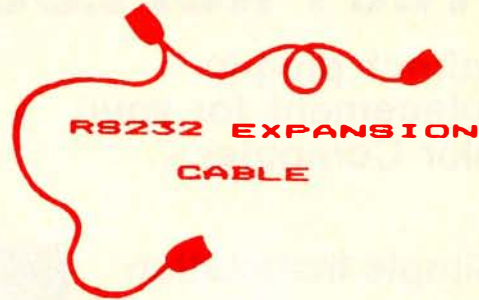

COLORCOM/E BONUS! Order COLORCOM/E and get the RS232 cable for only \$15.00. Save \$5.00

32K RAM Button	\$2.99
Nanos System Reference Card	\$3.99
16K Chips	\$16.00/set
64K Chips	\$64.00/set
Basic ROM 1.1	\$36.00
6821 (PIA) Chip	\$9.95
6847 (VDG) Chip	\$17.95
6883 (SAM) Chip with heat sink	\$29.95
6809E	\$29.95
CoCo First Aid Kit (Be Prepared) (2 6821's, 6809E, & 6883)	\$69.95

Color Computer Tech Manual	\$7.95
Epson Printer Interface (Serial I/O Port)	\$49.95
The Extension Interface	\$59.95
Extended Basic ROM Kit	\$88.00
64K "E"/"F"/TDP Board Upgrade	\$99.95*
64K "D" Board Upgrade w/1.1 ROM	\$149.95*
RS Disk Interface (with manual)	\$179.95
Epson MX-80 w/CoCo Interface	\$499.95

*Add \$6 for return UPS shipping

STINGER IS HERE! The ultimate maze game.
Cassette \$24.95 Disk \$29.95 ROM Pak \$34.95



COLORCOM / E

SMART TERMINAL PACKAGE

WE DIDN'T WAIT for the competition to catch up with us! We've added even **MORE** features to COLORCOM/E, our superb Smart Terminal program for the Color Computer. Compare before you buy. **NOBODY** offers you more!

- ★ Complete Upload and Download Support
- ★ Online Cassette/Disk Reads and Writes
- ★ 110, 300, 600, or 1200 Baud
- ★ Full or Half Duplex
- ★ Preenter Data Before Calling (Saves \$\$'s)
- ★ Offline and Online Scrolling
- ★ Automatic Capture of Files
- ★ Send All 127 ASCII Characters From Keyboard
- ★ Word Mode Eliminates split Words
- ★ 7 or 8 Data Bits (Including Graphics Support)
- ★ Efficient Data Storage S-t-r-e-t-c-h-e-s Memory
- ★ ROM Pack or Disk

COLORCOM/E \$49.95

AND, our efficient storage and easy editing of received data makes printing to your printer offline a snap. Select any portion of the received data for printing. No need to print everything.



Add \$2 for Shipping and Handling

TOM MIX SOFTWARE

*Donkey King	\$24.95
Katerpillar Attack	\$24.95
*Protectors	\$24.95



INTELLECTRONICS

*Dunkey Munkey	\$14.95
----------------	---------

INTRACOLOR

Colorpede	\$29.95
-----------	---------

* Requires 32K

SPECTRUM PROJECTS

93-15 86th DRIVE (212) 441-2807 (VOICE)
WOODHAVEN, N.Y. 11421 (212) 441-3755 (DATA)

MARK DATA PRODUCTS

Astro Blast	\$24.95
Cave Hunter	\$24.95
Color Haywire	\$24.95
Space Raider's	\$24.95

ILLUSTRATED MEMORY BANKS

Star-Trench Warfare	\$18.95
---------------------	---------

LARRY BANKS SOFTWARE

64K Disk Utility Package	\$21.95
--------------------------	---------

Check Out Our Color BBS' At (212) 441-3755 & (212) 441-3766..... 24 Hours Every Day

DEALER/CLUB INQUIRIES WELCOME
New York State Residents add appropriate taxes

The PROFESSIONAL Keyboard

A direct plug-in replacement for your Color Computer.

- Simple Installation
- Standard Layout
- Electric Quality

\$ 89.95

Made by MACROTRON
Call for TDP and
F Color models.



SPECTRUM SWITCHER

by TJN SYSTEMS



\$ 99.95

Have your Disk and Cartridge too!
Transforms a Color Computer into a dual slot
system. Comes with extender cable.

SPECTRUM PROJECTS

93-15 86th DRIVE WOODHAVEN, NY 11421
212-441-2807

all orders plus \$2 S/H, N.Y. residents add sales tax

THE DOUBLE STICK INTERFACE*



Now you can
hookup two Atari* type
joysticks to your Color Computer
or TDP System-100 for only **\$19.95**

\$39.95 - The Interface with two Atari* joysticks

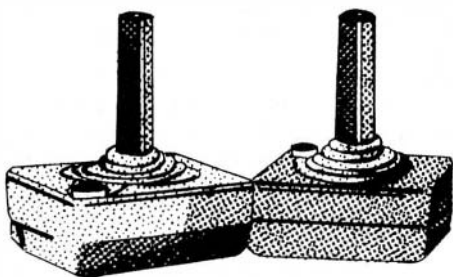

* Interface made by WICO. Atari is
a registered trademark of Atari, Inc.

YES! PLEASE SEND:
 INTERFACES... \$19.95
 STICK/INTERFACE SETS... \$39.95
 all orders plus \$2 shipping

NAME _____
 ADDRESS _____
 CITY, STATE, ZIP _____

N.Y. residents add sales tax

SPECTRUM PROJECTS

93-15 86th DRIVE
 WOODHAVEN, NY 11421
 212-441-2807

PIPELINE

WHAT IT WAS WAS football. CoCo came to the rescue recently in determining one of those "Who's Number One" controversies in New Jersey. It seems the teams from Butler and Pompton Lakes had played each other for the last 50 years, but did not meet this year—the season that, as luck would have it, both went undefeated. So, editor Harold Ball of *Suburban Trends* set up a playoff—using his CoCo and the *FOOTBALL* game marketed by Prickly-Pear Software. Ball reports the Butler youngsters are better at football than *FOOTBALL*—they lost the "game" 31-0.

By the way, Ball also reports that even though the newspaper has a couple of mini-computers, it is CoCo that he and publisher Edward C. Slingland use to work out newspaper budgets, budgeting and a number of projections.

SPEAKING OF MINIS, the word in the computer industry is that they may be on the way out. We hear that as power grows for micros (there *is* such as thing as a 512K chip that *can* be plugged into CoCo) the minis may become the dinosaurs of the computer business. Not as powerful as a mainframe, but *proportionately* just as expensive, micros may be the computer of choice to replace all those minis as time passes. The way we hear it, the super fast, super big mainframes will always be with us, but the micros may well take over for the minis in a few years.

INSTEAD OF SENDING YOUR kids to camp for roughing it, how about a camp for computers? Now in its sixth year, the national computer camps announce they will have three locations for the summer of '83—in Simsbury, CT; Atlanta, GA; and St. Louis, MO. You can get information about the National Computer Camps by writing Dr. Michael Zabinski, P.O. Box 585, West Orange, CT 06477.

RADIO SHACK'S EDUCATIONAL division has set March 15 as the deadline for submission of instructional software packages in the second edition of the Educational Software Sourcebook. The Sourcebook is available through Radio Shack stores and computer Centers. The first

edition was very popular and the new one will feature publisher profiles, expanded classification of instructional software, software user site references and supplemental information on the instructional use of microcomputers. Information on how to be listed can be obtained by writing Educational Software Sourcebook, Radio Shack Education Division, 1400 One Tandy Center, Ft. Worth, TX 76102. Or, you can call (817) 390-3523.

ANOTHER BULLETIN BOARD for CoCo users has come on line, this one in Wheaton, IL. It operates 24 hours a day and can be reached through (312) 260-0640. Terry Haas of Soft City is the SYSOP for the new system.

IF YOU SAW THE ADS for Spectral Associates' arcade game contest, you might be interested in who the big winners are. Brett Norman of Oklahoma won first prize, and \$2000, for his program *Whirlbird*. Second place (and \$500) went to Tommy Keeton of Texas for *Storm Arrows* while third place (and \$200) was won by John Nakoski of New York for *Space Sentry*. Mr. Norman also wins Spectral's *Prism Award* and his game will be published by Spectral.

IT IS A MOVING experience for Micro Technical Products, whose new address is 123 N. Serrine, Suite 106-A, Mesa, AZ 85201. New phone number is (502) 834-0283.

OUR BOB ALBRECHT HAS been a busy fellow. He is in the process of writing a series of booklets on LOGO with Ramon Zamora for Radio Shack and a documentary film on which he worked with David Shepardson has won the Gold Award at the International Film and TV Festival in New York. The film is titled "Don't Bother Me, I'm Learning."

IF YOU ENJOYED OUR racing game of a couple issues ago, you will be interested to know that it has been expanded quite a bit and is being marketed as *Revolution* by

Inter+Action of 113 Ward Street, New Haven, CT 06519. It is based on *The Track* by the same author, Al Hine, but has a great number of enhancements for 32K, one disk drive and joysticks. A slightly abridged version is available for 16K cassette.

RADIO SHACK IS OUT with a whole passel of new programs for CoCo. Some of them are quite unique. *Gin Champion* lets you play 16 different variations of gin at difficulty levels of from one to ten. *Crosswords* lets from one to four plays make up crossword puzzles. Another new program is called *Personafile*, a disk version of their *Color File* on Rom Pak.

There are also a host of new arcade-style games—*Castle Guard*, *Monster Maze*, *Robot Battle*, and *Shooting Gallery*. In addition, two new Adventures grace the RS line now, *Madness and the Minotaur* and *Sands of Egypt*. The latter is billed as an "antimated graphics game" and is available on disk.

WE KEEP HEARING REPORTS, all unconfirmed, of a new Color Computer. A "bigger" version. This one may make its debut soon and would have some goodies like built-in disk drives—yet sell for a very good price. Don't rush out and sell your CoCo, through, because it is our understanding that any new machine would be software compatible with CoCo itself. We cannot confirm these reports, but where there is smoke may mean that there will be some fire.

Even more interesting is another rumor, again just speculation, that there may be a "little" Color Computer someday, too. If such be the case, it, too, would—we hear—be software compatible with CoCo.

If all those *did* happen, would that mean that someday we would be telling our kids stories about Tandy and the Three CoCos? Humm.

IS THERE NO END to the games that will be adapted to CoCo? Now comes *Dominoes*, an age-old classic. It is available from JPR Software, Box 4155, Winter Park, FL 32793.

A NEW SMALL BUSINESS inventory package is now available from the West Bay Company, Rt. 1, Box 656, White Stone, VA 22578. It has 12 fields and will keep an inventory of 40 items in 16K or 148 in 32K.

Spectrum Projects
Your TDP-100 Dealer
Trims Down Prices!

**64K TDP-100
with Ext/Basic**
\$499.95

**Line Printer I
(DMP-100)**
\$299.95

**Color Graphic
Printer**
\$199.95

**DC Modem I
Communications**
\$129.95

**Color Cassette
Recorder**
\$49.95

**16K TDP-100
with Ext/Basic**
\$399.95

CALL 212-441-2807
all orders plus \$2.00 S/H
N.Y. residents add sales tax

SPECTRUM PROJECTS
93-15 86th DRIVE
WOODHAVEN, NY 11421

Make Authoritative Decisions With This Situational Model

By Stan Peppenhorst

As a person with management responsibility, you are constantly being called upon to make decisions. Sometimes the proper decision presents itself so plainly that all you must do is announce it; yet, more often, it seems, there are decisions which must be forged from a complexity of factors requiring considerable balance and insight. It is this latter difficulty the following model addresses.

Victor Vroom and P. W. Yetton established in 1973 a

situational model of leadership involving decision-making and leadership style. Texts on management and organizational behavior often discuss this process. This program contains the eight questions of the model and five possible management styles (two autocratic, two consultative, and one joint decision making).

Each question must be answered by a "yes" or a "no" (Y or N), and after the situation has been described, the method or procedure which can be used is listed. If more than one is listed, then the choice should be made on other considerations such as time, pressure, development of subordinates, and the leader's preference. When time is scarce, for example, the decision style should be closest to 1; if time is plentiful, closest to 5. Those closest to 5 also provide the greatest potential for developing subordinates.

Lines 200-270 contain the questions, and lines 300-340 contain the decision-making styles. Reading time can be increased by enlarging the 5000 in line 130 and the 7500 in the timer loops of lines 410-430, 510, 520-620, 710-1010.

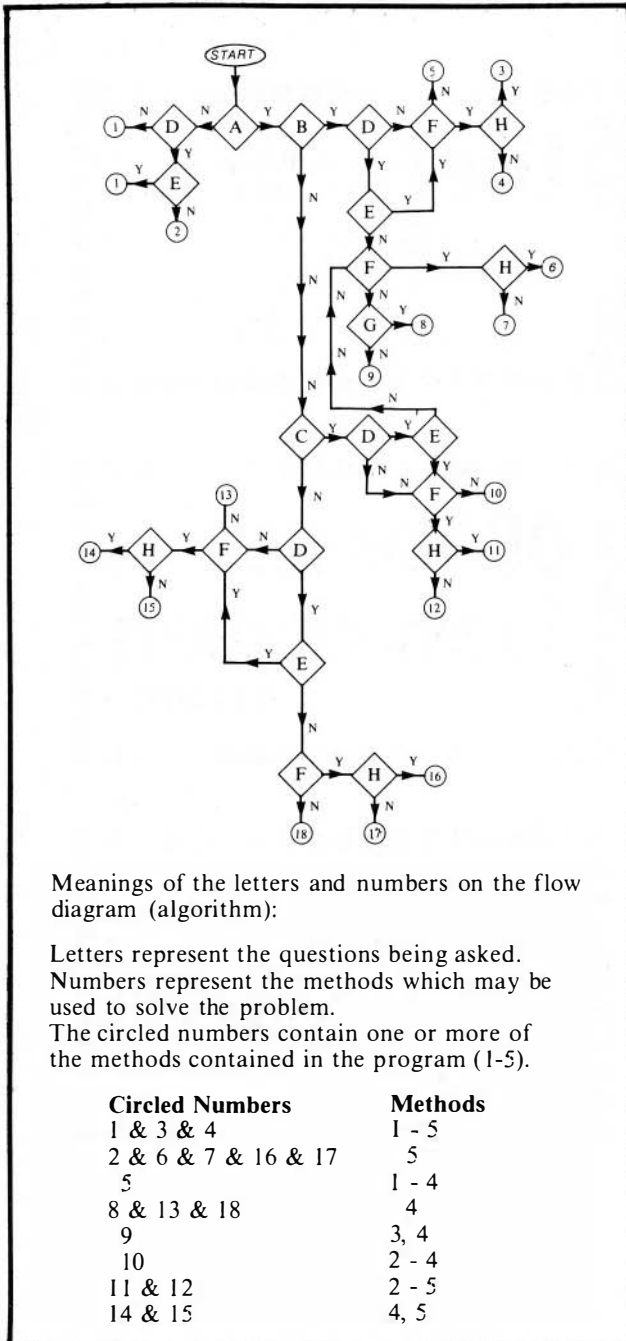

The listing:

```

350 070D
END 0D5D
    
```

```

30  *BY STAN PEPPENHORST
40  *MEMPHIS, TENNESSEE
60  CLS
100 PRINT:PRINT"      VROOM'S DECI
    SION PROCESS"
110 PRINT:PRINT:PRINT"THIS PROGR
    AM AIDS THE MANAGER IN MAKING MA
    JOR DECISIONS.      SUBORDINAT
    ES MAY OR MAY NOT BE  INVOLVED.
    "
120 PRINT:PRINT:PRINT:PRINT"ANSW
    ER THE FOLLOWING QUESTIONS WITH
    YES OR NO BY USING      *Y*
    OR *N*."
130 FOR T=1 TO 5000:NEXT T
140  *
200 A$="IS THERE A QUALITY REQUI
    REMENT SUCH THAT ONE SOLUTION I
    S      LIKELY TO BE MORE RATION
    AL      THAN ANOTHER?"
210 B$="DO I HAVE SUFFICIENT INF
    ORMATION TO MAKE A HIGH QUALITY
    DECISION?"
220 C$="IS THE PROBLEM STRUCTURE
    D?"
230 D$="IS THE ACCEPTANCE OF THE
    DECISION BY SUBORDINATES
    CRITICAL TO EFFECTIVE
    IMPLEMENTATION?"
240 E$="IF I WERE TO MAKE THE DE
    CISION BY MYSELF, IS IT REASONA
    BLY      CERTAIN THAT IT WOULD BE
    ACCEPTED BY MY SUBORDINA
    TES?"
250 F$="DO SUBORDINATES SHARE TH
    E ORGAN-IZATIONAL GOALS TO BE AT
    TAINED IN SOLVING THIS PROBLEM?"
    "
260 G$="IS CONFLICT AMONG SUBORD
    
```

LOSING BATTLES WITH A GLOOMSTICK?

PUT THE JOY BACK IN
COLOR COMPUTING
WITH A NEW.....

SPECTRUM STICK

Features include:

- Power on/off LED indicator
- Ball joint components for a true feel of control
- Extra long cables
- Sturdy construction
- Hair trigger response

"Both the joystick and pushbutton should have a considerably longer life than the Radio Shack unit since they are made of higher quality components"—
Creative Computing, Feb., 1983, Issue.

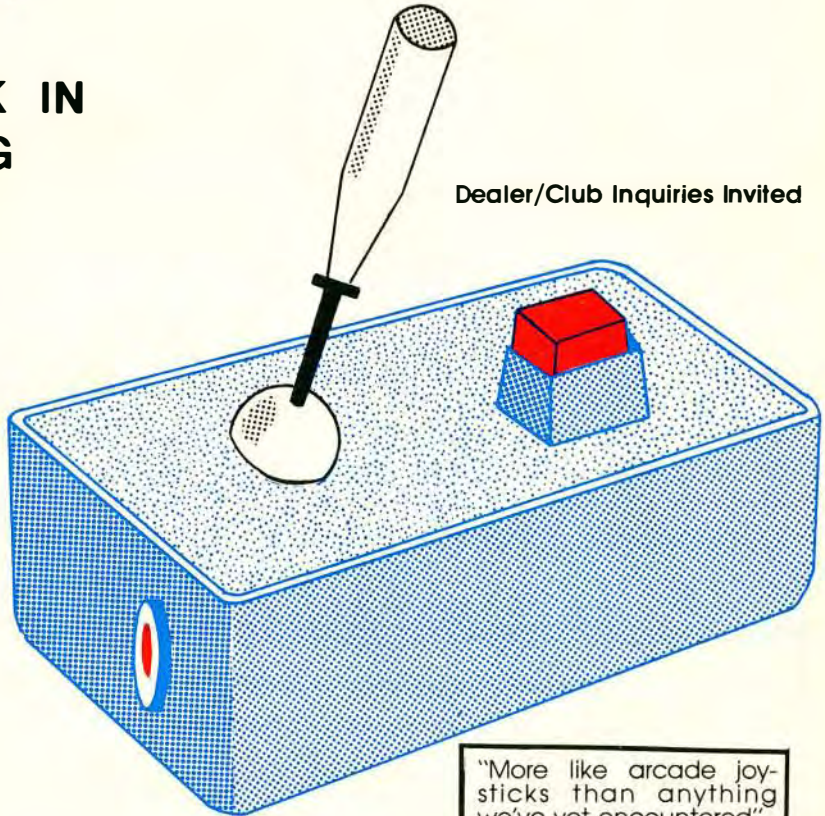

Dealer/Club Inquiries Invited

"More like arcade joysticks than anything we've yet encountered"
Rainbow review October 1982, Page 112

please send() SPECTRUM STICK(s) at
\$39.95 each plus \$2.00 shipping to

name _____

address _____

city,state,zip _____

N.Y. Residents Add Appropriate Taxes

SPECTRUM PROJECTS

93-15 86th DRIVE

WOODHAVEN, N.Y. 11421



```

INATES LIKELY IN PREFERRED SOLUTIONS? (THIS QUESTION IS IRRELEVANT TO INDIVIDUAL PROBLEMS.)"
270 H$="DO SUBORDINATES HAVE SUFFICIENT INFORMATION TO MAKE A HIGH QUALITY DECISION?"
280 '
300 J$="1. SOLVE THE PROBLEM OR MAKE THE DECISION USING THE INFORMATION AVAILABLE AT THE TIME."
310 K$="2. OBTAIN NECESSARY INFORMATION FROM SUBORDINATES THEN DECIDE ON THE SOLUTION TO THE PROBLEM."
320 L$="3. SHARE THE PROBLEM INDIVIDUALLY WITH SUBORDINATE S. OBTAIN IDEAS AND SUGGESTIONS AND MAKE THE DECISION ."
330 M$="4. SHARE THE PROBLEM WITH SUBORDINATES AS A GROUP. OBTAIN IDEAS AND SUGGESTIONS AND MAKE THE DECISION."
340 N$="5. SHARE THE PROBLEM WITH SUBORDINATES AS A GROUP. GENERATE AND EVALUATE ALTERNATIVES AND TOGETHER TRY TO REACH A AGREEMENT ON A SOLUTION."
350 '

```

```

400 PRINT:PRINT:PRINT A$:INPUT A1$:IF A1$="Y" THEN 500
410 PRINT:PRINT D$:INPUT D1$:PRINT:IF D1$="Y" THEN PRINT E$ ELSE
430:INPUT E1$:PRINT:IF E1$="Y" THEN PRINT J$:PRINT:PRINT K$:FOR T=1 TO 7500:NEXT T:CLS:PRINT L$:PRINT:PRINT M$:PRINT:PRINT N$:FOR T=1 TO 7500:NEXT T:GOTO 10
420 INPUT E1$:PRINT:PRINT:PRINT:PRINT:IF E1$="N" THEN PRINT N$:FOR T=1 TO 7500:NEXT T:GOTO 10
430 PRINT:PRINT J$:PRINT:PRINT K$:FOR T= 1 TO 7500:NEXT T:PRINT L$:PRINT:PRINT M$:PRINT:PRINT N$:FOR T=1 TO 7500:NEXT T:GOTO 10
500 PRINT:PRINT B$
510 INPUT B1$:PRINT:IF B1$="Y" THEN PRINT D$:INPUT D1$:PRINT:IF D1$="N" THEN PRINT F$:INPUT F1$:PRINT:PRINT:IF F1$="N" THEN PRINT J$:PRINT:PRINT K$:FOR T=1 TO 7500:NEXT T:PRINT L$:PRINT:PRINT M$:FOR T=1 TO 7500:NEXT T:GOTO 10
515 IF B1$="N" THEN 800
520 IF F1$="Y" THEN PRINT H$:INPUT H1$:PRINT:PRINT:PRINT J$:PRINT:PRINT K$:PRINT:FOR T=1 TO 7500

```

COMPUKIDS MAGAZINE

The Computer Magazine for Beginners

Educational articles that are easy to understand
 Game programs
 Computer book reviews
 Program problems

CompuKids Club

1 year magazine subscription
 Contests with GREAT prizes
 Free computer advice
 Program exchange
 Educational programs
 ... and lots more ...

- One year subscription *plus* one year membership in CompuKids Club — \$24.00 (Canada — \$31.00)
- One year subscription only — \$16.00 (Canada — \$20.00)
- Six month trial subscription — \$9.00 (Canada — \$11.00)
- Payment enclosed (check or money order)
- Please bill me later (a \$1.00 billing fee will be added)

(Special School and Group Rates Available)

Name _____ Age _____ Signature if billing _____

Address _____ City _____ State _____

Zip Code _____ Phone _____

Mail Check or Money Order to:

CompuKids Magazine RB
 P.O. Box 874
 Sedalia, MO 65301

Or Phone TOLL FREE:
 1-800-822-KIDS

```

: NEXT T: CLS: PRINT L$: PRINT: PRINT
M$: PRINT: PRINT N$: FOR T=1 TO 75
00: NEXT T: GOTO 10
600 IF D1$="Y" THEN PRINT E$: INP
UT E1$: PRINT: IF E1$="Y" THEN PRI
NT F$: PRINT: INPUT F1$: PRINT: PRIN
T: IF F1$="N" THEN PRINT J$: PRINT
: PRINT K$: FOR T=1 TO 7500: NEXT T
: PRINT L$: PRINT: PRINT M$: FOR T=1
TO 7500: NEXT T: GOTO 10
610 IF F1$="Y" THEN PRINT H$: INP
UT H1$: PRINT: PRINT: IF H1$="Y" TH
EN PRINT J$: PRINT: PRINT K$: PRINT
: FOR T=1 TO 7500: NEXT T: CLS: PRIN
T L$: PRINT: PRINT M$: PRINT N$: FOR
T=1 TO 7500: NEXT T: GOTO 10
620 IF H1$="N" THEN PRINT J$: PRI
NT: PRINT K$: PRINT: FOR T=1 TO 750
0: NEXT T: CLS: PRINT L$: PRINT: PRIN
T M$: PRINT: PRINT N$: FOR T=1 TO 7
500: NEXT T: GOTO 10
700 PRINT F$: INPUT F1$: PRINT: IF
F1$="Y" THEN PRINT H$: INPUT H1$:
PRINT: PRINT: PRINT N$: FOR T=1 TO
7500: NEXT T: GOTO 10
710 PRINT G$: INPUT G1$: PRINT: IF
G1$="Y" THEN PRINT M$: FOR T=1 TO
7500: NEXT T: GOTO 10
720 PRINT L$: PRINT: PRINT M$: FOR
T=1 TO 7500: NEXT T: GOTO 10
800 PRINT C$: INPUT C1$: PRINT: IF
C1$="Y" THEN PRINT D$ ELSE 900: I
NPUT D1$: PRINT: IF D1$="Y" THEN P
RINT E$: INPUT E1$: PRINT: IF E1$="
N" THEN 700
810 PRINT F$: INPUT F1$: PRINT: IF
F1$="N" THEN PRINT K$: PRINT: PRIN
T L$: PRINT: PRINT M$: FOR T=1 TO 7
500: NEXT T: GOTO 10
820 PRINT H$: INPUT H1$: PRINT: PRI
NT K$: PRINT: PRINT L$: PRINT: FOR T
=1 TO 7500: NEXT T: PRINT M$: PRINT
: PRINT N$: FOR T=1 TO 7500: NEXT T
: GOTO 10
900 PRINT D$: INPUT D1$: PRINT: IF
D1$="Y" THEN PRINT E$: INPUT E1$:
PRINT: IF E1$="N" THEN PRINT F$: I
NPUT F1$: PRINT: IF F1$="N" THEN P
RINT M$: FOR T=1 TO 7500: NEXT T: G
OTO 10
910 IF F1$="Y" THEN PRINT H$: INP
UT H1$: PRINT: PRINT N$: FOR T=1 TO
7500: NEXT T: GOTO 10
1000 PRINT F$: INPUT F1$: PRINT: IF
F1$="Y" THEN PRINT H$: INPUT H1$
: PRINT M$: PRINT: PRINT N$: FOR T=1
TO 7500: NEXT T: GOTO 10
1010 PRINT M$: FOR T=1 TO 7500: NE
XT T: GOTO 10
1100 END

```



Double Density Software

COLOR TERM +PLUS+ Look at these features: Operates at 110-19200 BAUD: Half or Full Duplex; 1 or 2 stop bits; odd, even, or no parity; send and receive BASIC & Machine Language programs; word wrap; Edit Buffer; Code & Decode buffer using a user defined key word; save and load buffer to tape. +PLUS+ much more!

16k or 32k Reg. or Ext. BASIC. PRICE \$29.95 (tape)*

TAPENAME Tapename searches tape and stores the name of any program or file. You can print the information to the screen, printer or tape. Also checks for load errors. 4k, 16k, or 32k Reg. or Ext. BASIC. PRICE \$7.95 (tape)*

COLOR DISK SAVER Saves a disk to tape. Reloads disk from saved tape. Also has tape verify command! 32k Ext. BASIC Req. PRICE \$12.95 (tape)**

COLOR IAGO Based on popular Othello game. Match wits with your computer! Uses high res color graphics. 5 levels of difficulty. Joysticks required. 16k or 32k Ext. BASIC. PRICE \$15.95 (tape)

CLONE ATTACK Blast those nasties as they appear! 3 skill levels and 9 levels of difficulty. Uses high res color graphics. Joysticks required. 16k or 32k Ext. BASIC only. PRICE \$15.95 (tape) (Disk 32k only) [Special 32k version \$2.00 extra]

MOON BASE INVASION Nuclear bombs are nearing your cities! Can you stop them before they reach you? 16k or 32k Ext. BASIC Req. High res graphics. PRICE \$12.95 (tape)

—NEW PROGRAMS—

COLOR BIORHYTHM Are you up or down today, tomorrow, or years from now? Find out with COLOR BIORHYTHM. Uses high res graphics. Send the chart to printer. 16k or 32k Ext. BASIC Req. PRICE \$14.95 (tape)

DD CLOCK Don't forget what time it is when you are programming. The time is displayed in the upper right corner of your screen. Shows hours, minutes and seconds. Beeps every hour. 4k, 16k, or 32k. PRICE \$9.95 (tape)* Ext. BASIC not required.

Use your MODEM for something other than a dust catcher—play games!

MODEM CHESS Use your Modem and your Color Computer to play chess *over the phone!* Has high res color graphics board and pieces. Make your move, select a message to send, press a button—seconds later your opponent's board is updated automatically. Has audio alerts, let's you know when a move is being made. 16k or 32k Ext. BASIC Req. PRICE \$39.95 (tape)

MODEM CHECKERS Play checkers *over the phone!* Program allows up to 4 jumps to be made at a time, crown pieces, etc. 16k or 32k Ext. BASIC Req. PRICE \$39.95 (tape)**

MODEM IAGO Play our version of Othello *over the phone!* Make your move, press a key, your opponent's board is updated seconds later! Has a takeback key if you decide you don't like the move you made. 16k or 32k Ext. BASIC Req. PRICE \$39.95 (tape)**

Most programs are Disk compatible. Specify Disk when ordering and add \$5.00 per program. Save money and ask that all ordered programs be loaded on one disk. You pay only for the one disk! Please add \$2.00 shipping and handling on all orders. Texas residents add 5% sales tax. Allow two weeks for personal checks. Your order will usually be shipped within two to three days. We will notify you of any problems within one week. **Send orders to: DOUBLE DENSITY SOFTWARE, 920 Baldwin Street, Denton, Texas 76201. Phone 817/566-2004.**

We are looking for quality software. If you have a program you think is a winner, send it to us. If it meets our standards, you will be paid TOP royalties.

*Machine Language.

**Machine Language Subroutines.

Many Happy Returns! —A Taxpayer's Utility

By Michael J. Himowitz

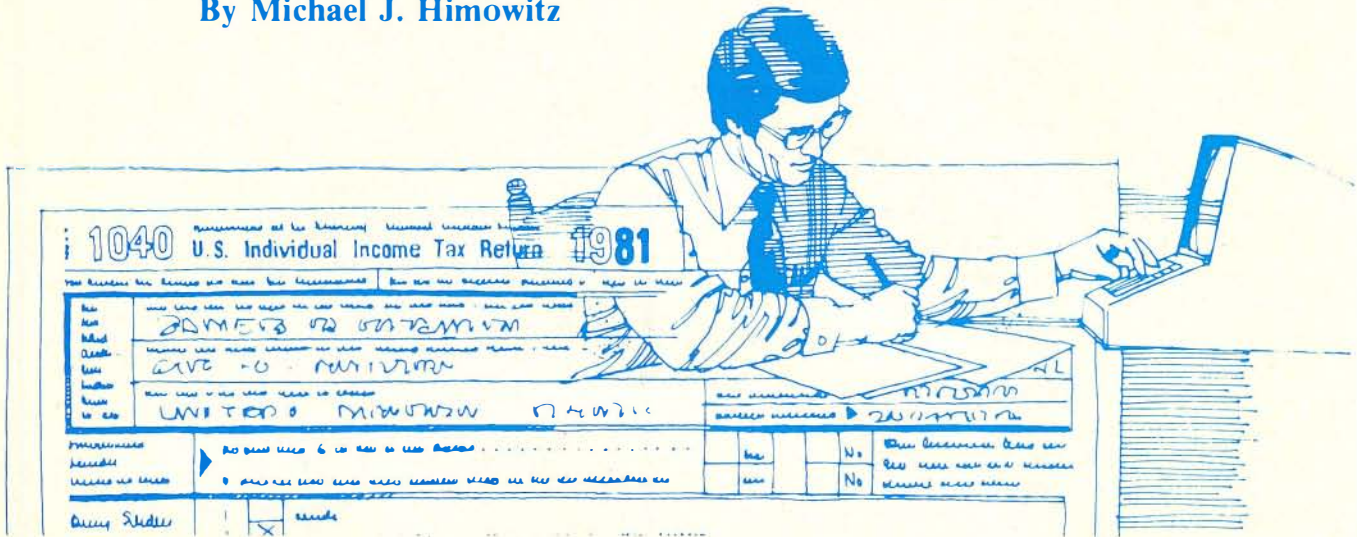

One of the things I hate most at income tax time is sorting through the year's checks, trying to figure out how much I spent on what.

So, when I got my Color Computer I decided to write a program that would do that for me, as well as give me a tool to see where the family budget was going. The result was Color Accountant.

Basically, all you have to do is enter the data from your canceled checks (up to 200 checks in the 16K version, 450 checks for 32K machines). If you update every month, it should take you no more than 10 minutes at each session. If you wait until the end of the year, it may take about 90 minutes. The program will give you screen or printer displays of all your expenditures by account, by payee or by month, and total them all for you. It will also give you a yearly summary by account and sort your checks by date.

You can store your data on tape and update it whenever you wish, and if you discover an error in one of your entries, the program will give you a chance to correct it.

The listing here will work in a 16K machine and handle 200 checks. Because it involves large amounts of string storage, you must type `POKE 25,6:NEW` and hit the `ENTER` key before loading it. This clears out the graphics memory pages for storage of your data. Before running the program, all remark lines should be deleted.

If you still get an OM error, you may want to get rid of some of the less useful routines, such as the listing of accounts beginning at line 20000, or the listing of all checks beginning at line 18000.

If you have a 32K machine, the program will easily handle 450 checks if you make the following changes. A simple `PCLEAR 1` before loading should clear enough space for it to run.

```
10 CLEAR 16000
```

```
20 DIM C$(450)
105 FOR X=A TO 450
117 IF X 499 THEN PRINT "THIS IS THE LAST CHECK!"
```

The accounts I have set up reflect my family budget. To set up your own, you can change the account listings in lines 920 through 970, 1000 through 1090, and 1170 through 1260. I have 10 accounts, but you can set up as many as 12 without overflowing the screen display. If you don't care about the screen and just want printouts, set up as many accounts as you want.

If you don't want to type in the program, send \$7.00 to Mike Himowitz, 825 William St., Baltimore, MD 21230, and I'll send you a copy.

Here's how to use the program, which is menu-driven:

1. **ENTER CHECKS FROM KEYBOARD.** Just give the machine what it asks for. The date should be only month and day, i.e. 5/28 (the program is designed to keep records for a single year). The check number should be no greater than four digits. The payee should be no larger than eight letters. If you type in more than eight, the program will only remember the first eight.

For the amount of the check, the limit is \$9,999. An even dollar amount, such as \$24, does not require a decimal point and two zeros, although the machine will accept this. When you've entered the amount, the computer will ask you whether it's correct. Type "Y" or "N." If you type "Y" you'll get a prompt for the next check. If you type "N" you'll get a prompt for a corrected entry. To correct an entry, you must enter all the data for that check again.

When you're through entering checks, just hit the `ENTER` key when asked for the date. You will return to the main

JUST GOOD SOFTWARE

DISK DOUBLE ENTRY - If you have spent hours trying to balance your Debits and Credits, this program is for you! Designed for small business, club, and personal use. Enter transactions in a journal type format. Program will maintain current account balances, produce Trial Balance, Income, and Balance Sheet reports and complete Account Ledgers. Will handle up to 300 accounts including report headings and totals. Up to 1400 average transactions on a diskette. Summary reports and four levels of subtotals available. **REQUIRES 32K** and a user understanding of standard double entry accounting concepts. - \$44.95 in BASIC with Machine Language subroutines.

DISK DATA HANDLER - Will allow you to design disk data files for your specific applications. Provides a powerful facility for on-screen input and update, fast selection and sorting, user defined output of reports to screen or printer, and output to disk files which may be read by your BASIC programs for any computational or special formatting requirements. You define a basic record of up to 14 fields and 246 characters. Sort or select records based on any field or combination of fields in this record. Maximum number of records you may work with at one time will depend on record size (500 - 23 char records, 50 - 246 char records). An optional Extended record linked to the basic record may also be defined. The size of the Extended record is not a factor in determining maximum number of records. Disk Data Handler is the type of tool which will provide the growth capability needed for your increasingly sophisticated applications. **REQUIRES 32K**. - \$44.95 in BASIC with Machine Language subroutines.

NOW - Also available in a **64K** version. More than three times the number of records shown above **plus** enhanced performance and report formatting capabilities. Uses standard ROM's - No special operating system required! **DISK DATA HANDLER - 64K - \$54.95**

DATE-O-BASE CALENDAR - Puts you in charge of your schedule! Graphically displays any monthly calendar between 1700 and 2099. You put in up to twelve 28 character memos per day - calendar shows where the memos are - call up of day shows details. Use for appointments and a log of past activity. Study the chronology of the American Revolution or note the day your mortgage will be paid off. Search capability allows you to list or print all memos between two specified dates or only ones meeting key word criteria. Date computation shows elapsed time between two dates in days, weeks, months, and years. **REQUIRES 32K** in BASIC.

TAPE DATE-O-BASE CALENDAR - \$16.95
(max. 400 memos/tape file)

DISK DATE-O-BASE CALENDAR - \$19.95
(over 4,000 memos/disk - max. 300 memos/month)

MATH TUTOR - Five programs that go from math fact (+, -, X, /) drill to full addition, subtraction, multiplication, and division at four levels of difficulty. Provides a step by step approach with error correction and rewards for good performance. - \$13.95 in BASIC.

SPELLING TEACHER - Up to 200 of their spelling words stored on tape or disk are presented in four lively study modes including a scrambled word game. - \$12.95 in BASIC.

ALPHA-DRAW - A subroutine designed to let you easily add characters to your graphic displays. You define X and Y coordinates and a string variable of one or more characters and Alpha-Draw will do the rest. Includes all keyboard characters. Comes with instructions for a true line numbered merge of tape files. Works great with the Screen Print program! - \$8.95 in BASIC.

GRAPHIC SCREEN PRINT PROGRAM - Works in ALL PMODES and lets you shift screen image anywhere on the printed page. Relocatable code lets you use all of your 16K or 32K machine. Available for both Color Basic 1.0 and 1.1. Use EXEC 41175 to see which you have and SPECIFY with order. In Machine Language.

\$7.95 - For TRS-80® LP-VII/VIII & DMP 100/200/400

\$9.95 - For Epson GRAFTRAX®, PROWRITER®, NEC® PC 8023A-C (specify printer type)
Microline® 82A/83A (with OKIGRAPH® I), Microline 84
IDS-440/445, Paper Tiger® 460/560, Prism® 80/132 (with dot plotting)

(Trademarks of Tandy Corp., Epson America, Inc., C-Itoh, NEC America, Okidata Corp., Integral Data Systems, Inc.)

ALL PROGRAMS require Extended Color Basic and are delivered on cassette. All, except Tape Date-O-Base Calendar, are DISK System compatible.

*We want your
SUGGESTIONS!*

Custom Software Engineering, Inc.

807 Minutemen Causeway (D-2), Cocoa Beach, Florida 32931
(305) 783-1083



For VISA and Master Card orders:
Include type, account number, expiration
date, signature and phone number.
Sorry! No COD's.

Add \$1.00 per order for shipping. Florida
residents add 5% sales tax. Return within
two weeks if not completely satisfied.



RAINBOW
REVIEW DATES
JAN '83

OCT '82

JUNE '82

SEP
'82

SEP
'82

AUG
'82

MAY '82

menu.

2. ENTER CHECKS FROM TAPE. If you have already stored checks on tape and want to load them into the machine (you must do this before entering new checks from the keyboard), just follow the directions. Type "Y" or "N" when it asks you "ARE YOU SURE?" If you type "Y" the machine will tell you to prepare the recorder to play. Once you've done that, hit the *ENTER* key, and the checks will be loaded in. If you type "N" it will send you back to the main menu. When the checks are loaded, you will return to the menu. At this point, if you want to enter more checks, the machine will add them to the file you've already entered.

3. SAVE DATA ON TAPE. When you're through entering checks from the keyboard, use this function, setting the cassette recorder to record on clean tape (never record over old data).

4. LIST CHECKS BY MONTH. The machine will ask if you're sure you want this, and if you do, type "Y." Then type the month and press *ENTER*. The listing will pop up, allowing you to page through the entries if they take up more than one screen.

5. LIST CHECKS BY ACCOUNT. Tell the machine whether you want year, month or return to main menu by typing the letters indicated (Y/M/R). Then type in the account code, such as FD for food and hit *ENTER*. The machine will do the work.

6. LIST CHECKS BY PAYEE. Follow the same procedure as for ACCOUNT, except you should enter the name of the payee you are looking for, such as SMITH. Make sure the entry is identical to the payee entries you have made. (The computer thinks that SMITH and SMYTH are two different words.)

7. YEAR SUMMARY. The machine does all the work here.

8. SORT BY DATE. This will sort the checks in date order, telling you how many passes through the data the machine has made. When it's through, you'll go back to the main menu. This can take a while. Your best bet will be to enter a month's checks, go to the sort routine, and then do the next month. If you enter a whole year's checks at once and want the machine to sort them, you'll have enough time to read a few chapters in a novel or eat dinner before it's through.

A. CORRECT ERROR. While using the other functions, you may spot an error you didn't catch when you entered the checks. Merely type in the number of the check you botched, and it will prompt you for the correct information. Enter all the data for the check, but set it right this time.

B. LIST ALL CHECKS: This will list all the checks in the order the machine has them (sorted if you've used the SORT feature, unsorted if not).

C. LIST ACCOUNTS: This shows you a reminder list of all the accounts the program uses and the two-letter codes to use when entering checks.

I hope the use of this program will help make preparation of your IRS forms less taxing this year.

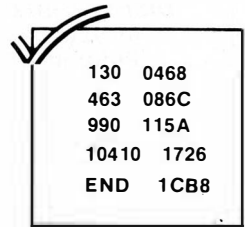

130	0468
463	086C
990	115A
10410	1726
END	1CB8

The Listing:

```
1 ' COLOR ACCOUNTANT
2 ' (C) BY MIKE HIMOWITZ
3 ' 825 WILLIAM ST.
4 ' BALTIMORE, MD. 21230
5 ' FOR PERSONAL USE OF RAINBOW
  READERS ONLY. ALL OTHER COPYWRI
  T E RESTRICTIONS APPLY
6 ' DELETE LINES 1-6 AND OTHER RE
  MARKS BEFORE RUNNING. POKE 25,6:
  HEW BEFORE LOADING
10 CLEAR 6000
20 DIM C$(200)
25 A=1
30 R=0:T=0:CLS:PRINT"COLOR ACCOU
  NTANT":PRINT:PRINT"1. ENTER CHEC
  KS FROM KEYBOARD":PRINT"2. ENTER
  CHECKS FROM TAPE":PRINT"3. SAVE
  DATA ON TAPE"
40 PRINT"4. LIST CHECKS BY MONTH
  ":PRINT"5. LIST CHECKS BY ACCOUN
  T":PRINT"6. LIST CHECKS BY PAYEE
  "
42 PRINT"7. YEAR SUMMARY":PRINT"
  8. SORT BY DATE"
45 PRINT"A. CORRECT ERROR":PRINT
  "B. LIST ALL CHECKS":PRINT"C. LI
  ST ACCOUNTS"
60 CH$=INKEY$:IF CH$="" THEN 60
62 IF CH$="B" THEN 18000
63 IF CH$="A" THEN 14000
64 IF CH$="C" THEN 20000
65 ON VAL(CH$) GOTO 100, 200, 30
  0, 400, 500, 700, 900, 12000
70 GOTO 30
100 GOTO 105
105 FOR X=A TO 200
110 CLS
115 PRINT "ENTRY NO. "X
116 PRINT"HIT <ENTER> TO RETURN
  TO MENU"
117 IF X>199 THEN PRINT "THIS IS
  THE LAST CHECK"
120 PRINT:INPUT "DATE (M/D ONLY)
  ";D$:IF D$="" THEN 160
123 IF LEN(D$)>5 THEN PRINT"MONT
  H AND DAY ONLY":GOTO 115
125 INPUT "CHECK NO. ";CN$:INPUT
  "PAYEE";P$:INPUT "ACCOUNT ";AC
```

EPROM PROGRAMER 2K-4K-8K-16K-?

Plugs into car. Slot of the 80C (16K).
Program (ML) Contains: Erased? - Program-
Verify - Move Rom or Mem - Exam/Change Mem.
Comes with 3 P.M.'s (Please Specify):
25/2716 - 2532 - 2732 - 2732A - 2564 - 2764 - 27128
Eprom Eraser - Has a 44 Chip Capacity.
Eprom Programmer - \$84.95 PD
Eprom Eraser - \$ 84.95 PD

INTRONICS P.O. BOX 13723
913-422-2094 EDWARDSVILLE, KS. 66113

Quality Hardware and Software
Support for the TRS 80
Color Computer

International Softwares
TOP STIX im

THE TRS-80 COLOUR COMPUTER
JOYSTICK INTERFACE
PAT: PENDING

TOP STIX IS A NEW PRODUCT ON THE MARKET PLACE
THIS INTERFACE WILL ALLOW YOU TO USE THE MOST
FAMOUS OF JOYSTICKS NAMELY THE ATARI JOYSTICK
BUT YOU CAN ALSO USE DATASOFT'S LE-STICK NOW
THAT HAS TO BE VALUE, SO ORDER YOURS NOW,

TOP STIX PRICE IS A LOW \$29.95



BATTLEFLEET
\$18.95

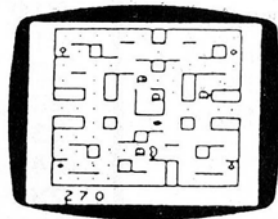

GHOST GOBLER
\$27.75

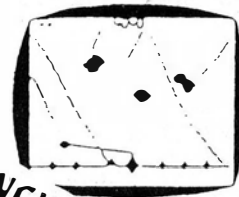

NEW
DEFENSE
\$27.75

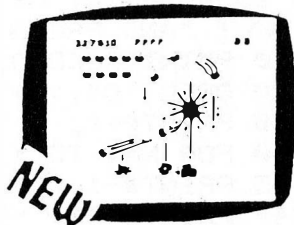

NEW
GALAX ATTAX
\$27.75

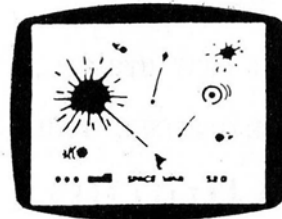

SPACE WAR
\$27.75

- LOTHAR'S LABYRINTH \$10.75
- PLANET INVASION **NEW** \$27.75
- COLOR COSMIC INVADERS \$27.75
- KEYS OF THE WIZARD \$25.75
- MADNESS AND THE MINOTAUR \$25.75

CALL OR WRITE FOR ARE FREE
CATALOGUE.

AND LOTS AND LOTS MORE.

TO ORDER SEND CHEQUE OR MONEY ORDER TO ADDRESS BELLOW. WE ALSO TAKE VISA, NO C.O.D.S PLEASE
WITH CHEQUE PLEASE ALLOW 8 BANKING DAYS FOR CHEQUE TO CLEAR. PLEASE ALLOW 2 TO 3 WEEKS FOR
DELIVERY, THANKYOU FOR YOUR ORDER.



INTERNATIONAL SOFTWARE INC.

(604) 474 2271

771, Hockley Ave., Victoria. B.C. V9B 2V5



HAPPY NEW YEAR

Whether you just got your CoCo for Christmas or you've been in it since the beginning, PCLEAR 80 has the software you need.

We still carry the finest games...

Tom Mix

DONKEY KING (32K)	*New*	\$24.95
PROTECTORS (32K)		\$24.95
KATERPILLAR		\$24.95
SOLO POOL *New* (E.B.)		\$17.95

SPECTRAL SPECIALS

GALAX ATTAX		\$19.95
PLANET INVASION		\$19.95
GHOST GOBBLER		\$19.95
WIZARD'S KEYS (Adv)		\$18.95

OTHER GREAT GAMES

DUNKEY MUNKEY (32K) (Intell)		\$22.95
STARFIRE (Intellectronics)		\$19.95
ASTROBLAST (Mark Data)		\$24.95
HAYWIRE (Mark Data)		\$24.95

AND MANY OTHERS...

....BUT WE'RE SERIOUS, TOO!

BUSINESS & UTILITIES

TELEWRITER-64 (Cognitec)	cass.	\$49.95
	disk	\$59.95
T.I.M.S. (Sugar Software)		\$24.95
Write for info on disk version!		
WORKSAVER (Platinum Software)		\$30.00
MASTER CONTROL (S.S.M.)	**	\$21.95 **
TAPE DUPE (Tom Mix)		\$16.95
DISKUTIL (A.M. Hearn)		\$49.95

CALL OR WRITE FOR LATEST CATALOG TODAY!



PCLEAR 80 SOFTWARE

**494 Cline Avenue
Mansfield, OH 44907
(419) 756-4873**

Note: We also carry the RAINBOW



Add \$2 shipping on orders less than \$50. Please add \$2 for COD. Ohio residents add 5% state sales tax.

```

$:INPUT "AMOUNT $";AM$
127 P$=LEFT$(P$,8)
130 PRINT:PRINT"IS THIS CORRECT?
(Y/N)"
135 Y$=INKEY$:IF Y$="" THEN 135
140 IF Y$="Y" THEN 150
143 CLS
145 PRINT"CORRECTED":GOTO 115
150 C$(X)=D$+STRING$(5-LEN(D$),"
")+STRING$(5-LEN(CN$),"")+CN$+
" "+P$+STRING$(8-LEN(P$),"")+
"+AC$+" "+AM$
153 IF CH$="A" THEN 30
155 NEXT X
160 X=X-1:A=X+1
165 GOTO 30
200 CLS:PRINT"INPUT FROM TAPE":G
OSUB 10000:PRINT"PREPARE RECORDE
R":INPUT "AND PRESS <ENTER>";PE
210 OPEN "I", #-1, "CHECKS 82"
215 INPUT#-1, X
220 FOR K=1 TO X
230 INPUT #-1, C$(K)
235 PRINT@480,"ENTRY NO. "K;
240 NEXT K
250 CLOSE #-1
255 A=X+1
260 GOTO 30
300 CLS:PRINT"SAVE ON TAPE":GOSU
B 10000:PRINT"PREPARE RECORDER":
INPUT "AND PRESS <ENTER>";PE
310 PRINT"RECORDING" X "ENTRIES"
320 OPEN "O", #-1, "CHECKS 82"
330 PRINT#-1, X
340 FOR K=1 TO X
345 PRINT#-1, C$(K)
347 PRINT@480, "ENTRY NO. "K;
350 NEXT K
360 CLOSE#-1:GOTO 30
400 CLS:PRINT"LIST CHECKS BY MON
TH":GOSUB 10000
405 T=0
410 INPUT "MONTH (1-12)";M
415 IF M<1 OR M>12 THEN 410
420 PRINT"SCREEN OR PRINTER?"
422 PRINT"(S) OR (P)"
425 CH$=INKEY$:IF CH$="" THEN 42
5
430 IF CH$="S" THEN 435 ELSE IF
CH$="P" THEN 465 ELSE 425
435 CLS:FOR K=1 TO X
440 IF VAL(LEFT$(C$(K),2))=M THE
N GOSUB 10200
445 IF R>10 THEN GOSUB 10300
450 NEXT K
455 PRINT@336,"TOTAL";:PRINT @34
2,USING"#####.##"; T
460 PRINT"PRINT THIS? (Y/N)":GOS
UB 10400
463 T=0
    
```

NEW for the Color Computer TRS-80 'COCOCASSETTE' SUBSCRIPTION SOFTWARE

*TRS-80 IS A TRADEMARK OF TANDY COMPANY



ENJOY A MONTHLY COLLECTION OF 8-10 PROGRAMS!
Including games, education, home finance and more;
on cassette for as low as \$5.00 a month! Add some ac-
tion and imagination to your Color Computer. . . Best of
all, we do the work!

LOOK AT SOME OF THE LETTERS WE RECEIVED FROM OUR SUBSCRIBERS.

"I just thought I'd let you know that your cassettes arrive in good order, load just fine, and I really enjoy your programs!"
MARION, OHIO

"I was extremely impressed by the first tape I received from you. The added extras are just super."
WILLOW GROVE, PENNSYLVANIA

"Seldom do I ever write a fan letter. Usually if something is good, nothing is ever said. I just renew the subscription or buy the product instead. T&D is an exception. I subscribe to several cassette computer magazines. Yours is certainly the most creative. The covers are original and clever. The material covered is excellent!"
PINE BLUFF, ARKANSAS

"I only entered a six-month trial but am already willing to extend my subscription!"
COLTEWAH, TENNESSEE

PRICES	
1 YR (12 ISSUES) . .	\$55.00
6 MO (6 ISSUES) . .	\$30.00
SINGLE COPIES . .	\$ 6.00

—MICHIGAN RESIDENTS: ADD 4% TO ORDER
—OVERSEAS: ADD \$10.00 TO SUBSCRIPTION AND \$1.00 TO SINGLE COPIES

616 396-7577

PROGRAMS ARE FOR
EXTENDED BASIC
MODEL ONLY. ISSUES
ARE SENT FIRST CLASS.



SUBSCRIPTION SOFTWARE



IMMEDIATE SHIPMENT!
PERSONAL CHECKS WELCOMED!
SEND CHECK OR MONEY ORDER TO:



T & D SOFTWARE P.O. BOX 256-C • HOLLAND, MICH 49423

```

465 PRINT#-2:PRINT#-2, "*****
** ALL CHECKS IN MONTH "M" *****
*****":PRINT#-2
470 CLS:PRINT"PRINTING MONTH "M:
FOR K=1 TO X
475 IF VAL(LEFT$(C$(K),2))=M THE
N GOSUB 10600
480 NEXT K
485 PRINT#-2:PRINT#-2, STRING$(2
2," ");:PRINT#-2, USING "#####.#
#";T
490 PRINT#-2:PRINT#-2:GOSUB 1070
0:GOTO 30
500 CLS:PRINT"LIST CHECKS BY ACC
OUNT":PRINT"YEAR, MONTH OR RETUR
N (Y/M/R)"
505 CH$=INKEY$:IF CH$="" THEN 50
5
510 IF CH$="Y" THEN 515 ELSE IF
CH$="M" THEN 570 ELSE 30
515 PRINT"ENTIRE YEAR":INPUT "WH
ICH ACCOUNT?";CA$
520 CLS:FOR K=1 TO X
525 IF MID$(C$(K),21,2)=CA$ THEN
GOSUB 10200
530 IF R>10 THEN GOSUB 10300
535 NEXT K
540 PRINT@336,"TOTAL";:PRINT@342
, USING "#####.#";T
545 PRINT"PRINT THIS? (Y/N)":GOS
UB 10400
548 T=0
550 PRINT#-2:PRINT#-2, "ALL CHEC
KS TO ACCOUNT "CA$:PRINT#-2
555 FOR K=1 TO X
560 IF MID$(C$(K),21,2)=CA$ THEN
GOSUB 10600
563 NEXT K
565 PRINT#-2:PRINT#-2, STRING$(2
2," ");:PRINT#-2, USING "#####.#
#";T:PRINT#-2:GOTO 30
570 INPUT "WHICH MONTH (1-12)";M
:IF M<1 OR M>12 THEN 570
575 INPUT "WHICH ACCOUNT ";CA$
580 CLS:FOR K=1 TO X
585 IF VAL(LEFT$(C$(K),2))=M AND
MID$(C$(K),21,2)=CA$ THEN GOSUB

```

```

10200
590 IF R>10 THEN GOSUB 10300
595 NEXT K
600 GOSUB 10800:PRINT"PRINT THIS
? (Y/N)":GOSUB 10400
605 PRINT#-2:PRINT#-2, "CHECKS T
O ACCOUNT "CA$ " IN MONTH "M:PRI
NT#-2
610 FOR K=1 TO X
615 IF VAL(LEFT$(C$(K),2))=M AND
MID$(C$(K),21,2)=CA$ THEN GOSUB
10600
620 NEXT
630 GOTO 11000
700 CLS:PRINT"LIST BY PAYEE":PRI
NT"MONTH, YEAR, OR RETURN (M/Y/R
)"
705 CH$=INKEY$:IF CH$="" THEN 70
5
710 IF CH$="M" THEN 720 ELSE IF
CH$="Y" THEN 800 ELSE 30
720 INPUT "WHICH MONTH (1-12)";M
:IF M<1 OR M>12 THEN 720
725 INPUT "WHICH PAYEE";CA$
730 CLS:FOR K=1 TO X
735 IF VAL(LEFT$(C$(K),2))=M AND
MID$(C$(K),12,LEN(CA$))=CA$ TH
EN GOSUB 10200
740 IF R>10 THEN GOSUB 10300
750 NEXT K
755 GOSUB 10800:PRINT"PRINT THIS
? (Y/N)":GOSUB 10400
758 T=0
760 PRINT#-2:PRINT#-2, "CHECKS P
AID TO "CA$ " IN MONTH "M:PRINT#
-2
765 FOR K=1 TO X
770 IF VAL(LEFT$(C$(K),2))=M AND
MID$(C$(K),12,LEN(CA$))=CA$ THE
N GOSUB 10600
775 NEXT K
780 GOSUB 11000
800 INPUT "PAYEE";CA$:CLS:FOR K=
1 TO X
805 IF MID$(C$(K),12,LEN(CA$))=C
A$ THEN GOSUB 10200
810 IF R>10 THEN GOSUB 10300
815 NEXT K
830 GOSUB 10800:PRINT"PRINT THIS
? (Y/N)":GOSUB 10400
833 T=0
835 PRINT#-2:PRINT#-2, "ALL CHEC
KS PAID TO "CA$:PRINT#-2
840 FOR K=1 TO X
845 IF MID$(C$(K),12,LEN(CA$))=C
A$ THEN GOSUB 10600
850 NEXT K
855 GOSUB 11000
900 CLS:PRINT"YEAR TO DATE SUMMA
RY"

```

\$ STOCK OPTION STRATEGIES \$

THIS PROGRAM ALLOWS YOU TO DEVISE YOUR OWN STOCK OPTION STRATEGIES. COVERED OPTIONS, STRADDLES, CALLS AND PUTS. % GAINS AND LOSSES VS. FUTURE STOCK PRICES GRAPHED IN COLOR. EASY TO USE, NO DATA BASE REQUIRED, JUST ENTER FROM KEYBOARD. MENU DRIVEN. 16K

CASSETTE \$14.95
SEND CHECK OR
MONEY ORDER TO:



GREENTREE SOFTWARE
P.O. BOX 97
GREENWOOD, IN. 46142

NEW!

● **ROML — ROM PAK Loader**

- Save your ROM PAKS (or ANY machine language program) on disk then load and execute with ROML.
- You no longer need to remove your disk controller to execute your ROM PAK software!
- Also allows you to load from disk or tape and execute all machine language programs which are incompatible with the disk system!
- Includes a utility to copy non-protected tapes to disk.
- Note—ROM PAK execution requires good 64K RAM system.
- Copy of article included describing how to access 64K RAM.

Tape: \$25.00 Disk: \$29.00

NEW!

● **PLUS32**

- Unleash the hidden 32K RAM in your 64K system.
- Runs ROM BASIC from RAM where you can modify it!
- Will not crash system if upper 32K is defective or not available.
- Note—Requires good 64K RAM system.

Tape: \$15.00 Disk: \$19.00

NEW!

● **ROMKIL — BASIC ROM disable routine**

- Your choice:
 - Disables DISK BASIC ROM—returning your system to EXTENDED BASIC, or
 - Disables EXTENDED BASIC ROM—returning your system COLOR BASIC.
- Frees up extra RAM.
- System stays in the level of BASIC you select even if you press the Reset switch.
- Turning power off and on returns system to original configuration.
- Allows disk-incompatible machine language programs to be loaded and executed from tape without removing the disk controller.

Tape: \$15.00 Disk: \$19.00

NEW!

● **BANNER**

- Make your TV a moving Marquee with Color BANNER!
- Enter any message and have it move across the screen in GIANT letters in the colors of your choice.
- Control speed, delay and pause from within your message!
- Great for parties and exhibitions!

Tape: \$19.00 Disk: \$23.00

FUN!

● **PAC ATTACK — from Computerware**

- The most popular game for the Color Computer!
- Fast action and brilliant colors!
- All the fun of the Arcade without the quarters!

Tape: \$24.95



BEST!

● **Nelson's SUPER "COLOR" WRITER II**

- By far the BEST word processor available for the Color Computer!
- More Features than any other.
- Supports ANY line printer!
- Excellent quality documentation!

ROM PAK: \$74.95 Disk: \$99.95



WOW!

● **LCA-47 — Lower Case Adapter**

- Provides real lowercase letters with true descenders!
- Compatible with ALL Color Computer Software!
- Provides bright characters on a dark background!
- Superb User's Manual included.
- Easy 5 minute installation!
- Uses NO system memory!
- 1 year warranty.
- Hundreds of owners, all happy!

Assembled and Tested: \$75.00



SAVE!

● **SPECIAL — Save \$25.00 when you purchase Super "Color" Writer II and an LCA-47 at the same time! Order NOW!**

GOOD!

● **PP-16 — EPROM Programmer**

- Programs single supply 2516, 2716, and 2758 EPROMs.
- Program—entire or partial. Auto verify after programming.
- Transfer contents to RAM for modifying or duplicating.
- Select Documentation for:

6502
6800
6809
8080/8085/Z80

Interface to:
6820 PIA or 6522 VIA
6820 PIA
6820 PIA
8255 PPI

- Comprehensive documentation booklet contains schematic, instructions for construction, check-out and use, and a well commented assembly listing for the specified MPU.
- Note—User must supply the specified parallel interface.
- Specify MPU and computer system when ordering.

Complete Kit (includes ZIF socket): \$45.00
PC board only (with documentation): \$25.00

```

==          ==          ==          ==
==          ==          ==          ==
==          ==          ==          ==
==          ==          ==          ==
==          ==          ==          ==
==          ==          ==          ==
==          ==          ==          ==
==          ==          ==          ==
==          ==          ==          ==
==          ==          ==          ==
==          ==          ==          ==

```

Micro Technical Products, Inc.

123 N. Surrine-Suite 106-A
Mesa, AZ 85201
Phone: (602) 834-0283



Add 5% for shipping. Overseas add 10%. Arizona residents add 5% tax. MasterCard & Visa welcome.

```

904 FD=0:MD=0:CC=0:CR=0:UT=0:PH=
0:MG=0:IS=0:MI=0:CS=0
905 FOR K=1 TO X:AM=VAL(MID$(C$(
K),23,8))
910 Z$=MID$(C$(K),21,2)
920 IF Z$="FD" THEN FD=FD+AM
925 IF Z$="MD" THEN MD=MD+AM
930 IF Z$="CC" THEN CC=CC+AM
935 IF Z$="CR" THEN CR=CR+AM
940 IF Z$="CS" THEN CS=CS+AM
945 IF Z$="UT" THEN UT=UT+AM
950 IF Z$="PH" THEN PH=PH+AM
960 IF Z$="IS" THEN IS=IS+AM
965 IF Z$="MG" THEN MG=MG+AM
970 IF Z$="MI" THEN MI=MI+AM
990 NEXT K
1000 PRINT"FOOD          ";;PRINTUSI
NG"##,###.##";FD
1010 PRINT"MEDICAL      ";;PRINTUSI
NG"##,###.##";MD
1020 PRINT"CHILD CARE";:PRINTUSI
NG"##,###.##";CC
1030 PRINT"CREDIT CD. ";:PRINTUSI
NG"##,###.##";CR
1040 PRINT"UTILITIES   ";;PRINTUSI
NG"##,###.##";UT
1050 PRINT"PHONE       ";;PRINTUSI
NG"##,###.##";PH
1060 PRINT"MORTGAGE    ";;PRINTUSI

```

```

NG"##,###.##";MG
1070 PRINT"INSURANCE ";:PRINTUSI
NG"##,###.##";IS
1080 PRINT"CASH          ";;PRINTUSI
NG"##,###.##";CS
1090 PRINT"MISC.        ";;PRINTUSI
NG"##,###.##";MI
1100 PRINT"TOTAL        ";;PRINT US
ING"##,###.##";FD+MD+CC+CR+UT+PH
+MG+IS+CS+MI
1110 PRINT"PRINT THIS? (Y/N)"
1120 CH$=INKEY$: IF CH$="" THEN 1
120
1130 IF CH$="Y" THEN 1140 ELSE 3
0
1140 INPUT "TODAY'S DATE (M/D/Y)
";TD$
1150 PRINT#-2:PRINT#-2, "*****
*** YEAR SUMMARY AS OF "TD$" ***
*****":PRINT#-2
1160 W$="##,###.##"
1170 PRINT#-2, "FOOD          ";;PRI
NT#-2, USING W$; FD
1180 PRINT#-2, "MEDICAL      ";;PRI
NT#-2, USING W$; MD
1190 PRINT#-2, "CHILD CARE";:PRI
NT#-2, USING W$; CC
1200 PRINT#-2, "CREDIT CD. ";:PRI
NT#-2, USING W$; CR

```

Design a training program to bring you to your top speed— with RUNCALC

Written by Bill Brown, a former coach and 2:47 marathoner, RUNCALC is an invaluable aid to distance runners of all ages and ability levels.

RUNCALC can help you:

- Evaluate your training quality
- Compare performances of different lengths
- Find pace per mile, per quarter-mile, per meter, etc.
- Find speed in miles/hr., meters/sec., ft/sec.
- Do metric conversions
- Generate split times for goal distances and times
- Set meaningful goal times for interval training
- Calculate calorie usage for a given run.

RUNCALC was designed for the Tandy Radio Shack TRS-80 Color Computer. It is an easy to use menu-driven program requiring 16K Ext. Color Basic and is supplied on cassette with guide for only \$12.95 including postage. Indiana residents include 4% sales tax.

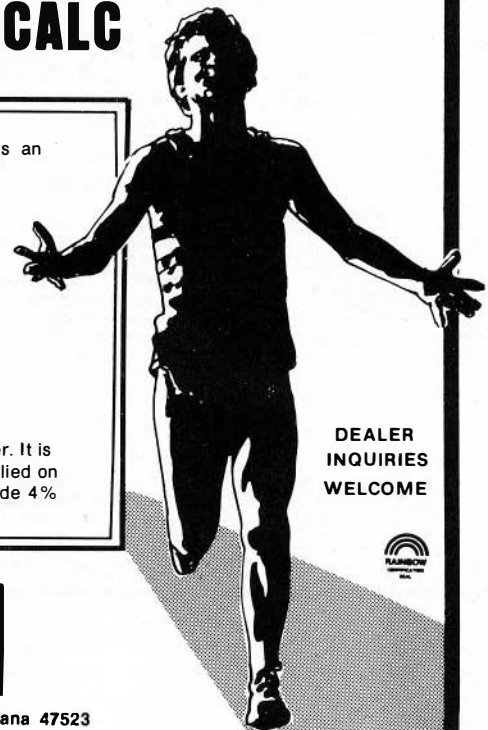

DEALER
INQUIRIES
WELCOME



SEND CHECK OR MONEY ORDER TO:

HOME RUN
COMPUTER PRODUCTS

Box 511 Dale, Indiana 47523

```

1210 PRINT#-2, "UTILITIES ";:PRI
NT#-2, USING W$; UT
1213 PRINT#-2, "PHONE ";:PRI
NT#-2, USING W$; PH
1220 PRINT#-2, "MORTGAGE ";:PRI
NT#-2, USING W$; MG
1230 PRINT#-2, "INSURANCE ";:PRI
NT#-2, USING W$; IS
1250 PRINT#-2, "CASH ";:PRI
NT#-2, USING W$; CS
1260 PRINT#-2, "MISC. ";:PRI
NT#-2, USING W$; MI
1265 PRINT#-2:PRINT#-2, "TOTAL
";:PRINT#-2, USING W$; FD+MD+
CC+CR+UT+PH+MG+IS+CS+MI
1270 PRINT#-2:PRINT#-2:GOTO 30
10000 PRINT"ARE YOU SURE? (Y/N)"
10010 SR$=INKEY$: IF SR$="" THEN
10010
10020 IF SR$="Y" THEN RETURN
10030 GOTO 30
10200 AM=VAL(MID$(C$(K),23,8))
10201 PRINT LEFT$(C$(K),23);:PRI
NT USING "####.##"; AM
10210 T=T+AM
10220 R=R+1
10230 RETURN
10300 ' PAGING SUBROUTINE
10301 PRINT"CONTINUE (C) OR MENU
(M)"
10304 CJ$=INKEY$: IF CJ$="" THEN
10304
10305 IF CJ$="C" THEN 10310 ELSE
IF CJ$="M" THEN 30 ELSE 10304
10310 R=0
10315 CLS
10320 RETURN
10400 CH$=INKEY$: IF CH$="" THEN
10400
10410 IF CH$="Y" THEN RETURN ELS
E 30
10600 ' PRINTER ROUTINE
10605 AM=VAL(MID$(C$(K),23,8))
10611 PRINT#-2, LEFT$(C$(K),23);
:PRINT#-2, USING "####.##"; AM
10620 T=T+AM
10630 RETURN
10700 PRINT#-2, STRING$(44,"*");
PRINT#-2:PRINT#-2:RETURN
10800 PRINT@336,"TOTAL";:PRINT@3
43, USING"####.##";T:T=0:RETURN
11000 PRINT#-2:PRINT#-2, STRING$
(23," ");:PRINT#-2, USING "####.
##";T:PRINT#-2:T=0:GOTO 30
12000 POKE 65495,0:SP=1:CLS:PRIN
T"SORTING BY DATE"
12010 T=0
12020 FOR L=1 TO X-1
12030 F$=LEFT$(C$(L),2):NX$=LEFT
$(C$(L+1),2):M1$=MID$(C$(L),INST

```

```

R(C$(L),"/")+1,2):M2$=MID$(C$(L+
1),INSTR(C$(L+1),"/")+1,2)
12040 IF 31*(VAL(F$)-1)+VAL(M1$)
<=31*(VAL(NX$)-1)+VAL(M2$) THEN
12070
12050 E$=C$(L):C$(L)=C$(L+1):C$(
L+1)=E$
12060 T=1
12070 NEXT L
12080 PRINT@128, "PASS NO. "SP;:
SP=SP+1
12090 IF T=1 THEN 12010
12100 POKE 65494,0
12110 PRINT:PRINT"SEARCH COMPLET
ED":INPUT "HIT ENTER FOR MAIN ME
NU";PE:GOTO 30
14000 CLS:PRINT"CORRECT AN ENTRY
":INPUT "WHAT CHECK NO.";NC
14005 PRINT"CURRENT DATA"
14010 FOR K=1 TO X
14020 IF VAL(MID$(C$(K),6,7))=NC
THEN 14027
14025 NEXT K
14027 GOSUB 10200
14030 PRINT"CORRECTED ENTRY NO.
"K
14035 INPUT"DATE ";DT$:INPUT "CH
ECK NO.";CN$:INPUT "PAYEE";P$:IN
PUT "ACCOUNT";AC$:INPUT "AMOUNT
";AM$

```



PRICKLY-PEAR SOFTWARE

QUALITY PROGRAMS FOR YOUR 80C

PROGRAMS REQUIRE 16K EXTENDED BASIC FOR
TAPE, AND 32K DISK UNLESS OTHERWISE NOTED.

Dear Software Dealer,

You are participants in the fastest growing phenomom in recent retailing history. The software customer, once content to order by mail, is seeking out local sources to supply software needs. If you aren't stocking our software, you are doing that customer a great dis-service.

You aren't doing yourself any good either! We have as wide a variety and as high a quality as anyone in the industry. Our software is in demand, and your customers expect to find it in your store. Just as important to you, we have the strongest dealer support program in the software field, bar none, and our programs are available for the TRS-80 Color Computer, the VIC-20, and the Commodore 64.

Do yourself a favor. Call or write us, and find out for yourself that there are a few professional software publishers!

PRICKLY-PEAR SOFTWARE

9822 E. Stella Road
Tucson, Arizona 85730
(602) 886-1505

COLOR COMPUTER SOFTWARE

★ UNIVERSAL PROGRAM 1 (UP-1) ★

Known as the Program Stacker, UP-1 allows several programs to be loaded until the memory is filled. Quickly jump from one program to another or compose new programs while retaining the old ones. Programs are included for patching damaged programs. Allows data or machine language programs to be stored and retrieved from a cassette. Programs are included for writing values or characters to memory and displaying memory contents. Blocks of memory can be relocated. UP-1 can be used as a Word Processor by allowing text to be stored in memory and printed on the screen or an external printer. UP-1 Cassette \$14.95

★ DISSASSEMBLER-ASSEMBLER ★

Using English mnemonics and Decimal Locations, DISASM is an easy way to learn to assemble machine language programs or subroutines. Subroutines can be used with Basic programs and can be called by either `USR` or `EXEC` commands. For CC compatibility, all locations are given in decimal values, eliminating the confusion associated with using HEX. All commands are menu oriented and the user provides the particulars for the commands without having to remember command formats. The Disassembler can be used to analyze machine language programs as well as the Basic and Extended Basic CC ROMs. Example programs are included. Cassette \$19.95

★ DYNAMIC WORD PROCESSOR (DYWORD) ★

DYWORD is designed to handle all the word processing requirements of the Color Computer. It allows the creation of separate files for recipes, term papers, addresses, invoices, etc. Printer controls and graphic characters can be easily entered with the text. A full screen editor is included with up/down and left/right cursor position controls. The whole screen is changed as characters are added or deleted to five a realtime display. New characters can be written over old ones and, at any time, printer or graphic control values can be entered. DYWORD's files consist of Basic remark statements and can be loaded, saved or modified like any other Basic program. Fast machine language subroutines allow a printer to print text at its fastest speed and control the realtime screen display. DYWORD also allows numbers to be processed. For example, the costs of items can be entered in text in DYWORD and the program will convert these characters to numbers. Special characters such as `CHR$`, `PRINT#`, `2`, or `A$(N)` are not required. The Basic Control Program allows flexibility in processing text between any two statement numbers and in any order. Thus, it is easy to write the same letter addressed to different people. If you need a truly flexible word processor at a reasonable price then DYWORD is for you. Cassette \$24.95.

EXTENDED BASIC IS NOT REQUIRED FOR PROGRAMS

★ Put Your Programs On A PROM Pack ★

Send us a PROM PACK and your Basic or ML programs in a cassette and we will put your program in the pack. We add a sprocket and switch to select the original or your program. Total cost is \$39.95 for 4K or \$49.95 for 8K. We furnish and program the chips so the pack is ready for operation with your programs when we return it to you. Additional programmed chips are \$20 for 4K and \$30 for 8K. We will reprogram the chips for \$10. These programs are immediately available on power-up and are not lost with power failures or programming mistakes. Impress your friends with your permanent programs.

Checks, VISA, MC Cards

Add \$1 shipping

DYNAMIC ELECTRONICS

P.O. Box 896

Hartselle, AL 35640

(205) 773-2758

```
14040 C$(K)=DT$+STRING$(5-LEN(DT$), " ") + STRING$(5-LEN(CN$), " ") +
CN$+" "+P$+STRING$(8-LEN(P$), " ")
)+ " "+AC$+" "+AM$
14045 PRINT"CORRECTED":GOSUB 102
00
14050 PRINT"IS THIS CORRECT? (Y/
N)"
14060 CM$=INKEY$:IF CM$="" THEN
14060
14070 IF CM$="Y" THEN 30 ELSE 14
030
18000 CLS:FOR K=1 TO X
18010 GOSUB 10200
18020 IF R>12 THEN GOSUB 10300
18030 NEXT K
18040 INPUT "HIT ENTER FOR MENU"
; PE:GOTO 30
20000 CLS:PRINT"ACCOUNTS":PRINT
20010 PRINT"FD=FOOD":PRINT"MD=ME
DICAL":PRINT"CC=CHILD CARE":PRIN
T"CR=CREDIT CARDS":PRINT"CS=CASH
":PRINT"UT=UTILITIES":PRINT"PH=P
HONE":PRINT"IS=INSURANCE":PRINT"
MG=MORTGAGE":PRINT"MI=MISCELLANE
OUS"
20020 INPUT "HIT <ENTER> FOR MEN
U";PE:GOTO 30
```

Back Issue Availability

Back copies of many issues of *the RAINBOW* are still available.

All back issues sell for the single issue cover price—which is \$2 for copies of numbers 1-8 (through February, 1982), \$2.50 for numbers 9-14 (through August, 1982) and \$2.95 for numbers greater than 14. In addition, there is a \$3.50 charge *per order* for postage and handling if sent by United Parcel Service and \$6 for orders sent U.S. Mail. UPS *will not* deliver to a post office box or to another country. This charge applies whether you want one back issue or all of them.

Most back issues are available on white paper in a reprint form. All back issues now available (Issues out of print include August, September, October and December, 1982) would be \$31.45, plus shipping and handling—a total of \$34.95 UPS or \$37.45 U.S. Mail. VISA and MasterCard accepted. Kentucky residents please add 5 percent state sales tax.

Due to heavy demand, we suggest you order back issues you want now while supplies last.

In addition, copies of the cover *only* of the July, 1982, Anniversary Issue are available separately for \$1 each, plus 50 cents shipping and handling. These are suitable for framing.



ENDICOTT SOFTWARE

JOYSTICKS

DEALER INQUIRIES INVITED



AFFORDABLE

**ONLY
\$19.95**

**TWO FOR
\$37.95**



ACCURATE

**SMOOTH
RESPONSE**

**BUILT TO
LAST**

Tired of broken joysticks? We offer an **affordable** joystick based on proven components. Each unit is hand assembled and checked to ensure **reliability**. The handles and internal mechanism have proven to be extremely **rugged** and **reliable** under extensive use with arcade-type games. The pots function smoothly to provide excellent cursor/character control. Get your joystick programs working the way they **should!** Our joysticks are backed by a 90 day warranty on material and labor (physical abuse excluded).

EXCELLENT PROGRAMS FROM LEADING SOFTWARE HOUSES

PRICKLY-PEAR SOFTWARE 15% OFF

* VIKING Go from peasant to King!	\$19.95	\$16.95	
* GANGBUSTERS Lead a life of crime and win!	\$19.95	\$16.95	
* FANTASY GAMER'S PACKAGE Generates dungeons, characters, and monsters and includes sample module.	\$19.95	\$16.95	
PANDORA'S BOX Includes: "pac" game, "defender-type" game, Divebomb, Blockade, slot machine, and Squares (similar to cube).	\$24.95	\$21.20	
* PREREAD I, II, & III Prepare your preschooler to learn to read	\$24.95	\$21.20	

MARK DATA PRODUCTS:

HAYWIRE Will drive you BERZERK!	\$24.95	\$24.95	
BLACK SANCTUM Challenging adventure!	\$19.95	\$19.95	
ASTRO BLAST New! Fight waves of alien attackers	\$24.95	\$24.95	

COLORSOFT:

* MATH DERBY Fun while learning!	\$11.95	\$11.95	
* STOCK ANALYZER New version disk compatible & added printer output.	\$21.95	\$21.95	

COMPUTERWARE 15% OFF

DOODLE BUG New! Like Ladybug.	\$24.95	\$21.20	
RAIL RUNNER New! Like Frogger.	\$19.95	\$16.95	
PAC ATTACK Bigger maze than the original.	\$24.95	\$21.20	
STORM A real Tempest!	\$24.95	\$21.20	
COLOR INVADERS Like the original.	\$19.95	\$16.95	

TOM MIX SOFTWARE:

KATERPILLAR ATTACK Fast Action!	\$24.95	\$24.95	
SNAK PAK Great arcade action!	\$24.95	\$24.95	
* SHIP WRECK Great adventure!	\$14.95	\$14.95	
WAR KINGS Two player action.	\$19.95	\$19.95	
* MOON LANDER 2 games in 1	\$15.95	\$15.95	
* CASINO 3 Game Pack	\$12.95	\$12.95	
TAPE DUPE Copies any ML tape.	\$16.95	\$16.95	

*Requires 16K Ext. Basic minimum - others 16K Std. Basic minimum.

KONG IS HERE!

Call or write for free catalog.
WE PAY postage on all software orders. Add \$2.00 for shipping joysticks (unless purchased with software - then we'll pay).
 Please add \$1.50 for C.O.D. orders.
 Allow 2 weeks for personal checks to clear.

ENDICOTT SOFTWARE
 P.O. Box 12543, Huntsville, AL 35802

(205) 881-0506

PHONE OPEN 7 DAYS A WEEK!



★ ★ 32Korner ★ ★

TOM MIX'S DONKEY KING 4 Screens - Full action!	\$24.95	\$24.95	
PROTECTORS Brand new Defender type So good it had to go to 32K	\$24.95	\$24.95	
PRICKLY-PEAR'S 32K FANTASY GAMER'S PACKAGE Like 16K version, but much more!	\$24.95	\$21.20	

*Requires 32K Ext. Basic Minimum - others 32K Std. Basic minimum

Five Year Evaluaton Of That Ubiquitous Bugaboo

By J.D. Ray

I am aware that Income Tax is not everyone's favorite subject, however, it does contain certain information that can be utilized for interesting financial decisions for the average household. This program evaluates five years of income tax information (1978-1982). It can be altered to evaluate other periods of time. You have ten different items on your individual tax form to compare. The most exciting feature of this program is the high resolution graphic display of the information. Your individual tax information is stored in the Data Statements.

The program summary is as follows:

10 - 120 Credits and Title
130 - 240 Data Statements
250 - 420 Menu Selections
430 - 600 Information Summary & Display
610 - 915 Graph plot with alphanumerics
920 - 970 Line plot

I chose *DATA*/Statements in lines 145-280 to store information due to the fact that this information does not change once entered. The other methods for entering and storing data information, such as setting up a tape file or using *INPUT* lines to enter information each time the program is run, did not seem worth the effort in this particular program.

The high resolution graph with alphanumerics is very interesting and has many applications. This particular graph is actually two different measuring grids, depending on the information being displayed. It works in the \$0-\$50,000 range and also in the \$0-\$5,000 range. This is accomplished by a variation in the line plot formula in line 610 and 970.

To Use

To change the menu listing, adjust line 280 and the corresponding *REM* lines in 145-240. The figures in the data lines are for demonstration purposes only. When adding in your personal information in the data lines, be sure to use commas only to separate the yearly figures. You need to use five figures in each data line or use zero. If you use the program for less than five figures, you need to change the formula in line 550 to: $T=T/\text{number of years you are comparing}$.

All figures you use should not exceed \$50,000. To change the program for \$0-\$100,000 range, you would need to change formulas in line 610 and 970 and change alphanumerics in lines 720-915. To exit entire program, hit any other key. Use *CSAVE "TAX*HIST"* for tape storage.

This program, with a little imagination, could be used to summarize and visualize household budgets, business sales, income, utility costs, and much more. For those with more money than time to key in programs, this is available for \$4.95 plus 50¢ handling. Send to J.D. Ray, 5065 France

Avenue, North Charleston, SC 29406.

The listing:

The Listing:

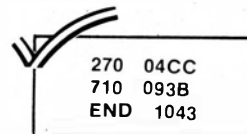

```

10 '***INCOME TAX HISTORY***
20 'BY J. D. RAY
30 ' 5065 FRANCE AVENUE
40 ' N. CHARLESTON, S.C. 29406
50 ' 1-803-554-0637
60 CLS6:PRINT@100,STRING$(24,"*")
);
70 PRINT@132,"** INCOME TAX HIST
ORY **";
80 PRINT@164,"**
**";
90 PRINT@196,"** BY J. D. RAY
**";
100 PRINT@228,"** COPYRIGHT (C)
1982 **";
110 PRINT@260,STRING$(24,"*");
120 FORX=1TO1000:NEXTX
130 DIM A(10),B(10),C(10),D(10),
E(10)
140 DIM Z$(10)
145 'WAGES, PROFIT INCOME (LIST
FROM 1978-1982)
150 DATA 8250.00, 8800.00, 9650.
00, 12570.00, 14865.00
155 'INTEREST INCOME
160 DATA 300.00, 600.00, 750.00
,1200.00, 800.00
165 'ADJUSTED GROSS INCOME
170 DATA 9000.00, 12320.00, 1435
0.00, 18900.00, 26900.00
175 'TOTAL ITEMIZED DEDUCTIONS
180 DATA 3600.00, 4100.00, 3900.
00, 4120.00, 3175.00
185 'INCOME TAX PAID
190 DATA 240.00, 340.00, 420.00,
600.00, 1200.00
195 'BUSINESS PROFIT
200 DATA 9785.13, 10900.00, 1403
9.00, 15756.00, 18350.00
205 'BUSINESS EXPENSES

```

MACROTRON® Presents The

PROFESSIONAL KEYBOARD

For the TRS-80® Color Computer



\$89.95

FEATURES

Professional Quality, Full Travel
Simple Plug-In Installation
Four User Defined Function Keys
Complete Documentation Included



Present version not compatible with Revision F Color and TDP-100 Computers

Available From

MICRONIX SYSTEMS
#7 Gibraltar Square
Saint Charles, Missouri 63301
(314) 441-0341

All Orders Shipped From Stock
COD Orders add \$3.50 shipping Check, Money Order add \$2

Dealer Inquiries Invited

```

210 DATA 2000.00, 2575.00, 3125
.00, 3600.00, 4120.00
215 'SELF-EMPLOYMENT INCOME
220 DATA 10985.13, 13000.00, 141
00.00, 13750.00, 15150.00
225 'SELF-EMPLOYMENT TAX
230 DATA 889.80, 1189.00, 1231.
00, 1201.00, 1498.00
235 'STATE TAX
240 DATA 110.24, 175.00, 320.00
, 400.00, 320.00
250 FORX=1T010
260 READ A(X),B(X),C(X),D(X),E(X
)
270 NEXT X
280 DATA WAGES, INTEREST INC.,A.
G.I.,TOTAL ITEMIZED DED.,INCOME
TAX,BUSINESS INC.,BUSINESS DED.,
S.E. INCOME, S.E. TAX, STATE TAX
290 FORX=1T010
300 READ Z$(X)
310 NEXT X
320 CLS
330 PRINT@69,"WOULD YOU LIKE TO
SEE"
340 L=130
350 FORX=1T010
360 PRINT@L,X;Z$(X)
370 L=L+32
380 NEXT X
390 PRINT@460,"(1-10)"
400 INPUT X
410 IFX<0ORX>10THEN400
420 ON X GOSUB430
430 CLS:PRINT@6,"INCOME TAX SUMM
ARY"
440 PRINT@47-INT(LEN(Z$(X))/2),Z
$(X)
450 A$="###.###.###"
460 PRINT@100,"1978: ";:PRINTU
SINGA$;A(X)
470 PRINT@132,"1979: ";:PRINTU
SINGA$;B(X)
480 PRINT@164,"1980: ";:PRINTU
SINGA$;C(X)
490 PRINT@196,"1981: ";:PRINTU
SINGA$;D(X)

```

```

500 PRINT@228,"1982: ";:PRINTU
SINGA$;E(X)
510 GOSUB 520
520 T=A(X)+B(X)+C(X)+D(X)+E(X)
530 A$="###.###.###"
540 PRINT@289,"TOTAL: ";:PRINT
USINGA$;T
550 T=T/5
560 PRINT@353,"AVERAGE: ";:PRINT
USINGA$;T
570 PRINT@448,"DO YOU WANT TO SE
E GRAPH? (Y/N)"
580 R$=INKEY$:IF R$="" THEN 580
590 IFR$="Y"THEN610
600 IFR$="N"THEN320
610 A=INT(A(X)/1000)*3:B=INT(B(X
)/1000)*3:C=INT(C(X)/1000)*3:D=I
NT(D(X)/1000)*3:E=INT(E(X)/1000)
*3:G=D
614 IF A>150 THEN A=150
615 IF B>150 THEN B=150
616 IF C>150 THEN C=150
617 IF D>150 THEN D=150
618 IF E>150 THEN E=150
630 IF A<9THEN GOSUB 970
640 CLS:PMODE3,1:COLOR3,2:PCLS:S
CREEN1,0
650 FORY=25TO175STEP15
660 LINE(50,Y)-(250,Y),PSET
670 NEXT Y
680 COLOR 1,2
690 FORX=50TO275 STEP50
700 LINE(X,25)-(X,175),PSET
710 NEXT X
720 DRAW"S3;C3BM25,21L3R5L3U20L3
R6" 'I
725 DRAW"C3BM37,21U20F20U20" 'N
730 DRAW"C3BM65,21R12L12U20R12"
'C
735 DRAW"C3BM90,21U20R18D20L18"
'O
740 DRAW"C3BM115,21U20RF8E8D20"
'M
745 DRAW"C3BM140,21R10L10U11R10L
10U10R10" 'E
750 DRAW"C3BM180,21U20L6R12" 'T
755 DRAW"C3BM196,21U20R12D10L12R
12D11" 'A
760 DRAW"C3BM215,21U4E12U4BL12D4
F12D4"
765 DRAW"S3;C3BM40,190U10" '1
770 DRAW"C3BM48,190U10L5D5R5" '9
775 DRAW"C3BM57,190U5E6L8" '7
780 DRAW"C3BM65,190U10R5D5L5R5D6
L5" '8
785 DRAW"C3BM90,190U10" '1
790 DRAW"C3BM98,190U10L5D5R5" '9
795 DRAW"C3BM107,190U5E6L8" '7
800 DRAW"C3BM120,190U10L5D5R5" '
9

```

64K for \$99!

We will convert any Radio Shack Color Computer to a full 64K for only \$99.00 plus shipping. (Compare this with RS price of \$149 + \$30 labor for 32K upgrade.) No matter what board you have — No matter what ROM you have — Typically 24 hour turn around — Includes hardware modification to access the entire 64K, with special software and instructions on use of the upper 32K. Pack your computer well. Include cashiers check, money order, or personal check (allow 2 weeks for personal checks) for \$104.00 (\$99.00 + \$5.00 shipping) to PYRAMID. You may pay also by Mastercharge or return COD. We will treat your computer tenderly and rush it back to you.
 PYRAMID — 527 Hill St. — Santa Monica, CA — 90405 — (213) 399-2222

The Platinum Work saver[®]

...Programming Made Easy

FULL SCREEN EDITING OF BASIC PROGRAMS

With the PLATINUM WORKSAVER'S editor, there's no more counting the numbers of characters to delete or change, or wondering if you deleted too many or too few. You see the whole line as it's edited. Changes, deletes and inserts are automatic and the cursor can be moved anywhere on the screen.

FULL SCREEN EDITING OF NUMERIC AND STRING ARRAYS

But that's only the beginning! The editor (Written in machine language) also comes with a short, two line BASIC subroutine that will allow you to use the full screen editor on your numeric and string arrays. This is the springboard you need for developing your own VisiCalc™ or word processor.

SINGLE KEY ENTRIES OF BASIC WORDS

So, the PLATINUM WORKSAVER makes it easier to write useful programs and edit them, but that's not all! Entering programs is a breeze with single entry of over 80 basic words, on a beautifully designed KEYBOARD OVERLAY, color-keyed to function. No need to memorize or consult a conversion chart to find a word.

PROGRAM CHAINING AND DYNAMIC DEBUGGING

Now you can write, enter and change programs easily, but what about debugging? This is the frustrating, time consuming aspect of programming and frankly, the Color Computer doesn't help you much... you have to start the program over each time you make a change. But not with the PLATINUM WORKSAVER!! With it you can change, delete, add and rearrange or join lines. The special reserved key is excellent for copying or moving parts of lines to other lines... plus, you can even LOAD A WHOLE NEW PROGRAM without disturbing the data you've created.

NUMERIC KEYPAD

We've solved another Color Computer weakness. Press a control key and letters J, K, L, U, I, O, P become number keys 1-7. Numbers 8-0 remain in their normal positions. The keypad numbers are clearly labeled on the overlay.

- Over 100 programmable keys
- Loads to Disk
- 16 K min. required
- Includes cassette merge

A COLOR COMPUTER* MACHINE LANGUAGE ENHANCEMENT PACKAGE THAT PROVIDES:

- Dynamic full screen editing of BASIC programs.
- Dynamic full screen editing of numeric and string arrays. The advanced user will be able to write VisiCalc™, word processor etc.!
- Single key entries for 80 commands and functions.
- Functionally laid out plastic keyboard overlay.
- Numeric Keypad conversion.
- Automatic line numbering.
- Best value per dollar than any other enhancement package available.



With the Platinum Work saver[®], programming time and hassle can be cut by 50%. You'll spend less time typing, more time being creative with your Platinum Enhanced 16K Color Computer!

LOOK WHAT JUST \$30 CAN DO FOR YOUR 16K COLOR COMPUTER:

Platinum Enhanced 16K Color Computer	vs.	Regular 16K Extended Color Computer
<ul style="list-style-type: none"> • Relocate, join, duplicate individual and unique sets of lines at the push of a button • Create the following using only 31 keystrokes: CLS:AS-Strings\$ (15"") + MID\$(CLS, 6, 2). To change the - symbol to = requires only 3 keystrokes!!!! • Retain the sequence of commands in temporary memory with special reserved key • One keypush and the right side of the keyboard converts to a numeric Keypad • Correct bugs while your program is running, without losing data. • Edit programs, data and strings using the full screen editor. 		<ul style="list-style-type: none"> • Retype entirely any lines to be moved or joined • Type that line using 47 keystrokes. To change the symbol, Backspace and retype using 33 more strokes! • Retype lost lines! • Stretch those fingers! • Oops! Lost data! Retype, Reload and Save data while swearing a lot. • NO CAN DO!

THE PLATINUM WORKSAVER INCLUDES:

- Enhancement program, including a sample array Editor, on a high-quality Agfa Cassette
- Fully labeled acetate keyboard overlay, NOT a cheap stick-on
- Complete instructions
- Loads in seconds, takes less than 2K

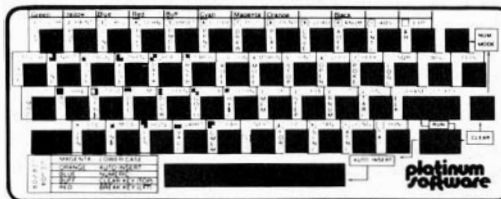

The PLATINUM WORKSAVER costs \$30.00 plus \$3.00 S&H (NY residents add tax). To order write:

PLATINUM SOFTWARE
P.O. Box 833
Plattsburgh, N.Y. 12901
Phone orders: (518) 643-2650

VISA, MASTERCARD ACCEPTED. PERSONAL CHECKS TAKE 2-3 WEEKS TO PROCESS.



You're Serious About Your Color Computer.* SO ARE WE.

*Color Computer & TRS-80 are registered trademarks of Tandy Corp.

```

805 DRAW"C3BM140,190U10" '1
810 DRAW"C3BM148,190U10L5D5R5" '
9
815 DRAW"C3BM154,190U10R6D5L6R6D
6L6" '8
820 DRAW"C3BM165,190U10R6D10L6"
'0
825 DRAW"C3BM190,190U10" '1
830 DRAW"C3BM198,190U10L5D5R5" '
9
835 DRAW"C3BM205,190U10R6D5L6R6D
6L6" '8
840 DRAW"C3BM214,190U10" '1
845 DRAW"C3BM228,190U10" '1
850 DRAW"C3BM236,190U10L5D5R5" '
9
855 DRAW"C3BM242,190U10R6D5L6R6D
6L6" '8
860 DRAW"C3BM254,190L5U4R5U6L5"
'2
865 DRAW"S2;C3BM5,175U2E8U2BL8D2
F8D2":DRAW"C3BM20,175U10":DRAW"C
3BM25,175U10R7D10L7":DRAW"C3BM33
,175U10R7D10L7":IFG>9THENDRAW"C3
BM40,175U10R8D10L8" 'X 1000
870 DRAW"S3;C3BM25,160R10U5L10U5
R10" '5
875 DRAW"C3BM25,145U10R10D10L10"
'0
880 DRAW"C3BM20,145U10G3" '1
885 DRAW"C3BM25,130R10U5L10U6R10
":DRAW"C3BM20,130U10G3" '15

```

```

890 DRAW"C3BM25,115U10R10D10L10"
:DRAW"C3BM20,115L7U4R7U6L7" '20
895 DRAW"C3BM25,100R10U5L10U6R10
":DRAW"C3BM20,100L7U4R7U6L7" '25
900 DRAW"C3BM25,85U10R10D10L10":
DRAW"C3BM14,85R8U6L4R4U5L8" '30
905 DRAW"C3BM25,70R10U5L10U6R10"
:DRAW"C3BM14,70R8U6L4R4U5L8" '3
5
910 DRAW"C3BM25,55U10R10D10L10":
DRAW"C3BM18,55U10G6R8" '40
915 DRAW"C3BM25,40R10U5L10U6R10"
:DRAW"C3BM18,40U10G6R8" '45
920 COLOR4,2
930 LINE (50,175-A)-(100,175-B),
PSET:LINE -(150,175-C),PSET:LINE
-(200,175-D),PSET:LINE-(250,175-
E),PSET
940 R$=INKEY$:IFR$=""THEN940
950 IFR$="Y"THEN320
960 END
970 A=INT(A(X)/100)*3:B=INT(B(X)
/100)*3:C=INT(C(X)/100)*3:D=INT(
D(X)/100)*3:E=INT(E(X)/100)*3:RE
TURN

```



The Warrior And The Wizard Adventure With Good Graphics

I don't know why I buy adventures. I don't like being killed. I don't like to have to retype all those instructions when I start over. I don't like illogical sequences or random luck playing an essential part of the adventure. I don't like adventures, since I have yet to successfully solve a single one. Yet, like bees to honey or dressing to salad, I am a pushover for a new/different adventure.

"*The Warrior and the Wizard*, a 32K disk drive graphics-assisted adventure." Hmmm. Sounds interesting. Let's give it a try. A "DIR" shows the disk contains 18 pictures and a Basic program. Let's *RUN* it. The introduction allows you to choose from five characters. You then select your choice of weapon or spell and type of armor. These *do* have an effect on the play of the game, according to the documentation. You are then shown your character in full "Pmode 4" color. Cute, beautiful, ugly, intriguing; the pictures are very well done.

The play is fast enough. Very little delay between input and response. In this game, it is almost worth dying just to see the pictures. An umberhulk, a dragon, a cobra, all in high resolution Pmode 4 color, greeting you

Thus begins an enjoyable adventure. Did I say that? The program is a good one and the graphics are excellent. However, the documentation leaves a little to be desired.

The Warrior and the Wizard fills a need and breaks new ground through the clever use of graphics. It is worth the price.

I have yet to "solve" my first adventure, but with games such as *The Warrior and the Wizard*, I'll keep on trying.

(JARB Inc., 1636 D Avenue, Suite C, National City, CA 92050, \$19.95, disk)

—Bernard Roskoski

Y-PAK Dual Slot Expander for Radio Shack's Color Computer

Have your Disk and Cartridge too!
Select between 2 Cartridge slots with one
switch and control the Auto Start with
the other switch.

\$70.00 Complete

USER-PAK for Color Computer

Your own RAM/EPROM Cartridge
Cartridge holds two 2732s, or any combination
of four 2716s/6116s.

\$30.00 less RAM/EPROM
\$90.00 with 8K RAM

EPROMs burned from your CC cassette.
Write for details.

B. Erickson

P.O. Box 11099 Dept. RB
Chicago, IL 60611

NOW THERE ARE TWO TOOLKITS FOR THE COLOR COMPUTER

The software development tools that let you put even more **power** into the already powerful Color Computer. They're full of tools, aids, bells and whistles useful to the BASIC or MACHINE LANGUAGE programmer, in friendly, easy-to-use software packages.

BOTH TOOLKITS CONTAIN . . .

- **Light characters on dark background with Current Line Highlighting;** or normal characters
- **Full Screen Editor with Arrow Key controlled cursor; open up space/delete and close up space**
- Enabling selective **Line Renumber/copy/move/merge;** or normal Extended Basic line editor
- **Protect** the current BASIC program from being wiped out with a CLOAD, NEW etc.; or from being LISTed
- **Restore** a protected BASIC program/**Append** any number of BASIC programs together easily
- **Tone** on keypress or normal silent keys (Tone modifiable by use of Sound n,n Command)
- **Global Search** of command or text strings in BASIC programs with **wildcard** character and **next "."**
- **9 Screen Print Delays** with keyboard override (for slow, readable LISTings and DISK DIRectories)
- **Variable Name List/String-Byte memory usage/Range of FREE MEM/Top of memory address display**
- Fast Machine Code to BASIC DATA **converter** for storing machine code visibly in BASIC
- (C)SAVEM address/**Backup Tool** (Last file name, start, end and execute address)
- **Recovery of Lost BASIC** programs after NEW, BACKUP, DSKINI, etc.
- **Break Key Disable/Enable** (Pause keys still available)
- **Modified TRON** display (.LN replaces LN)

THE FULL TOOLKIT ALSO CONTAINS . . .

- Merge BASIC** with Machine Code routines so machine code is "invisible" and (C)SAVE/(C)LOADable
- 9BASIC RUN delays** with keyboard override; **Single Step(s)** mode with current line number display
- Memory Examine/Modify** with HEX/ASCII/DEC/Double Decimal output and HEX/ASCII input
- Memory **Block Move** for relocating machine code programs, DATA blocks, etc.; or the Kit itself
- Ten User Defined Function Keys** accessible with @/number (BASIC Macros/Block storage)
- Automatic linefeed** for printers that don't/double space LISTings; or normal PRINT
- Delete all spaces** (not in PRINT strings, DATA or REMARK lines)
- ASCII/HEX memory **Dumps** to screen or printer
- Delete all REMarks** (either REM or ' type)
- Parallel **ECHO** of screen output to printer

THESE FEATURES ARE FOUND ON BOTH VERSIONS . . .

- **Transparent** to the user, Install it and forget it until you need it
- BASIC runs up to one-third faster through the Toolkit (5-10% typical)
- **HELP** command lists all Kit commands and current Kit address
- Same program works with tape or disk and in 16 or 32K
- Entire system totally **removable** at any time
- **Compatible** with other utility programs
- Green/Orange text screen capability
- Easily **modifiable** command syntax

The Kits are relocatable programs that load any time without bothering your BASIC program or variables or top of memory address. All tools may be turned on or off at will, including the Kit itself.

The tools are available with simple three or four letter commands entered in the direct mode, with the entire instruction set viewable through the HELP command.

The Colorkit is 5K bytes for \$29.95
Available on disk with handy BASIC Kit loader for additional \$5



The Microkit is 2.5K bytes for \$27.95
Manual available separately for \$5

THE GOOD LIFE

\$16.95

- The Classic Game of Life With:
- 64x64 color symmetrical display
- **3 Selectable birth and old age colors**
- **15 modifiable pre-programmed patterns**
- **Save/Load life screens to tape/disk**
- **Speeds from 8 gen/sec to 1 a second**
- **Joystick or arrow key input**
- **Written in user-modifiable BASIC**
- **With machine code LIFE processor**
- **Help screen command list**
- **Tape/Disk compatible**
- **Selectable color sets**
- **Y&X axis wraparound**



THE DISK COMMANDER

\$19.95

- Disk File Utility with:
- **One key view/copy/load(m) of files**
- **Two key kill/rename of files**
- **Sort directory on name/extension**
- **Pack directory so new files put at end**
- **Directory keyword search of filename**
- **Print DIR with machine code address**
- **Recover killed files**

DEER HUNT

\$15.95

- **Arcade shoot-em-up skill game**
- **Aim only for the deer**
- **Avoid hitting people, cars, train**
- **Will not cause tension headache**
- **BASIC/machine code hybrid**
- **Tape/Disk compatible**

ARIZIN
P. O. Box 8825
Scottsdale, AZ 85252



The New TDP-100— A Glimpse At CoCo's Future?

By Bob Rosen

What is a TDP? TDP stands for Tandy Distributor Products. It is a new distribution channel for marketing Radio Shack merchandise. At the moment, antennas and computers are its main products. It involves some 60 independent distributors of RCA products supplying 2000

Across The Rubicon

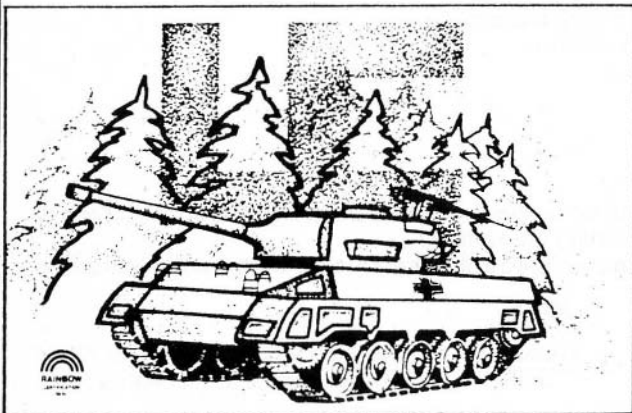

Call it the Huertgen Forest, dubbed the "death trap" by G. I.'s, where the Germans bore-sighted every hill and valley, and tree-bursting shells made diving for cover more deadly than standing tall. Too large to outflank, the Huertgen blocked the approaches to Cologne and the Ruhr; it had to be taken. But Hitler had sworn that no invader would ever step foot on German soil, and too many pledges had already been broken. And there was another reason, known only to Hitler and a handful of trusted staff: Delaying the Americans in the Huertgen would provide time to assemble and unleash his attack in the Ardennes.

Each game turn represents about three days of the actual battle, and twenty turns roughly the three months it really took the American forces. Capture the objectives in twenty turns and DRAW, reduce the turns and do what the Americans were unable to do: prevent the bloodiest American battle since the Civil War — The Battle of the Bulge.

ARK ROYAL GAMES

P. O. Box 14806
Jacksonville, FL 32238

\$16.95

16K Ext

Cassette

Allow 14 Days For Checks Florida Residents Add 5% Tax

retailers. The TDP-100 is their version of the Color Computer.

All Color Computer software and peripherals will work with the TDP-100. But there are differences from the current 26-3002 and 26-3004 Color Computer models. The most obvious is the outside case. Instead of gray (some call it "battleship gray"), it is white. The ventilation holes are now across the top instead of the sides. With all the heating problems of the infamous SAM chip, this is a welcomed improvement. The keys are beveled and have a tighter feel. There are no more RAM ID buttons, but rather an attractive blue TDP label. There is a lip beneath the keyboard for resting your palms while typing. Finally, on the back of the computer, the letters are raised in the plastic instead of being pressed on.

Now that you know about the outside differences, we'll explore the insides of the TDP-100. To start with, it has a completely redesigned board. And contrary to popular belief of "D" and "E" board owners, it is not marked "F" but either "NC" or "ET." This new board has been designed to upgrade from 16K to 64K rather easily. No more cutting traces or jumping wires are required. All you need to do is remove the RF shield, which is smaller now and covers only the memory chips and the 6883. There are seven tabs on the bottom of the shield that need to be bent downward to remove the shield. Three jumpers exist that need to be moved from the 16K position to the 64K. A fourth jumper is required to go on two bare staking pins. Finally, eight capacitors are to be cut out of the board and *voila!* You have 64K. With the price of 64K chips dropping, it would be a wise investment, since many high quality arcade type games like Donkey King and Protectors require 32K of RAM. Also, the FLEX DOS requires 64K, and many programs are being rewritten to take advantage of the added memory.

Looking closer inside the TDP-100, one finds a new cassette relay. Instead of a reed relay, there is now a 12-volt DC relay. The clicking is more pronounced when the computer or tape recorder is turned on. The keyboard PIA is now a 6822 which generates less hash during keyboard interrupts. The cartridge door is now part of the main board instead of the top case, and the power supply is off the board, making for easier servicing. You will need a new technical manual as the part numbers of the chips have been changed. The PIAs are no longer U4 and U8 but U17 and U18. The Basic and Extended Basic chips are now towards the middle of the board, and there are other minor changes.

Is this new TDP-100 an improvement over the stock Radio Shack Color Computer? I think so, judging from the above observations. Also, all TDP-100 computers come with two joysticks and a Super Bust-out ROMPACK. There are 52 nationwide service centers that will repair the TDP-100, and a toll-free number to tell you of the closest one to you. With its easy 64K expansion and attractive white case, many present Color Computer owners will be upgrading to it. They will, I feel, be as impressed as I am with it. ☺

Hint . . .

Print Out Disk Directory

If you have a long disk directory and want to see all of it, or if you simply wish to have a hard-copy printout of your directory, one simple command will allow you to do this easily.

Just POKE 111,254:DIR and the entire disk directory will appear on your printer, even if it is too long to be fully displayed on the screen.

GRAND OPENING SALE

COLOR BONANZA

50 PROGRAMS - 6 CASSETTES IN A HANDSOME LIBRARY CASE
 • SOME 4K • SOME 16K • SOME 32K •

Truly a bonanza for the Color Computer owner. More than twenty games - Football, Bomber, Lunar Lander, Hurdler (this one alone sells for \$14.95), Lost Atom and many more.

Educational programs like Hangman, Multiply, Divide and Ohms law, just to name a few. A Disassembler, even a Checkbook program to help you manage your budget.

The Color Bonanza has something for everybody. Sure to provide you with hours of family fun.

The six cassettes are easily stored in the handsome vinyl library case provided.

Don't miss the opportunity to get your Color Bonanza at this low, low price. Send your order today! Add \$2.50 shipping charge.

DON'T MISS THIS
 SUPER BUY!
\$34⁹⁵
 Reg. \$49.95

ORDER EARLY . . . QUANTITIES LIMITED AT THIS SPECIAL PRICE!

TELEWRITER™

Telewriter is a powerful word processor designed for the Color Computer. It can handle almost any serious writing job. Extremely easy to use. It has all the advanced features you need to create, edit, store, format and print any kind of text. The only one with all these features: 51 column x 24 line screen display, Full-screen editor, Real lower case characters, Powerful text formatter. Works with any printer. Special MX-80 driver, runs in 16K or 32K, Disk & cassette I/O. Requires no hardware modifications.

Tape **\$49.95**
 Disk **\$59.95**

MAGIC BOX

By Spectral Associates

Magic Box is a special purpose utility designed to load TRS-80 Model I and III 50 Baud Basic programs into the Color Computer. Makes available a wide selection of software. Magic Box DOES NOT convert Machine language programs. Requires 16K Extended BASIC.

Reg. \$24.95 **\$21.95**

MASTER CONTROL

By A. Schwartz
 Copyright Soft Sector Marketing

Master Control is a Machine language program designed to save typing time and errors. Look at all these features:

- 50 preprogrammed command keys, standard and extended BASIC commands.
- Keyboard overlay for easy program use.
- Programmable custom key.
- Easy one stroke entry of entire commands.
- Automatic line numbering, starting point and increment alterable.

- Direct control of motor, trace and audio.
- Direct run button.

Load Master Control into your machine then either type in a BASIC program or load one in from tape to edit. Cuts programming time by 50% or more.

Reg. \$24.95 **\$21.95**



DONKEY KING

By Tom Mix Software

Exciting sound - Realistic graphics. Never before have you seen a game like this for your color computer. Four graphic screens just like the actual arcade game.

Do you have the skill to rescue the girl from the clutches of an ape gone ape? Watch out for the rolling barrels, the flame and other perils. How high can you climb?

Cassette **\$24.95**
 Disk **\$27.95**

KEYS of the WIZARD

By Spectral Associates

Keys of the Wizard is a fast-action, Machine language adventure game filled with tricks, traps, treasures and creatures all of which are randomized at the beginning of each adventure so that no adventure will ever be exactly the same. Three different skill levels to choose from. Cassette only.

Reg. \$19.95 **\$16.95**

ARCADE GAMES

Special . . . Take 15% discount from prices shown.

- All Require 16K -

MONKEY KONG by Med Systems
 Mario jumps into action on the color computer! Rolling barrels, ramps, ladders and killer flames must be avoided to save the lady from the monkey's grasp.
 Cassette only **\$24.95**

KATERPILLAR ATTACK by Tom Mix Software
 Katerpillar is a fast-paced arcade game. Machine language. Requires joysticks.
 Cassette only **\$24.95**

GHOST GOBBLER by Spectral Associates
 This is an excellent version of the popular arcade game of PAC-MAN. You control maze with the right joystick. Requires Extended BASIC.
 Cassette only **\$21.95**

WAR KINGS by Tom Mix Software
 Shield your castle from cannonball attacks and deflect them towards your opponent's castle. Machine language, Ext. BASIC. Requires joysticks.
 Cassette only **\$19.95**

PHANTOM SLAYER by Med Systems
 They are the mutant phantoms. You are the Phantom Slayer. Enter the deadly catacombs and destroy the phantoms.
 Cassette only **\$19.95**

CAVE HUNTER by Mark Data Products
 Fast-paced action for the Color Computer. Super Hi-Res graphics, dynamite sound effects. This game will astonish you with its detail and quality.
 Cassette only **\$24.95**

SUB HUNT by Spectral Associates
 Seek and destroy alien subs! Requires Ext. BASIC.
 Cassette only **\$14.95**

HAYWIRE by Mark Data
 Have fun zapping robots with fast paced action combined with dynamite sound effects and super Hi-Res graphics. For one or two players.
 Cassette only **\$24.95**

GALAX ATTAX by Spectral Associates
 Under a constant barrage of enemy fire you protect your ground base by shooting alien fighters. Use the right joystick to control the motion of your ship and right fire button to fire.
 Cassette only **\$21.95**

BATTLEFLEET by Spectral Associates
 This grown-up version of Battleship is the toughest thinking game available. There is no luck involved as you seek out the computers hidden fleet.
 Cassette only **\$14.95**

CoCo Warehouse

500 N. Dobson • Westland, MI 48185
 Phone (313) 722-7957



HOW TO ORDER BY MAIL: For prompt and courteous shipment, SEND MONEY ORDER, CERTIFIED CHECK, CASHIERS CHECK, MASTERCARD/VISA (include card number, inter-bank No., expiration date and signature). PERSONAL AND BUSINESS CHECKS MUST CLEAR OUR BANK BEFORE PROCESSING. Shipping and packaging charge of \$2.50 minimum must be added to all orders in continental US (Canadian orders \$5.00 minimum). Michigan residents include 4% sales tax. 10% deposit required on C.O.D. orders

COLORSOFT™

ESCAPE

*A 3-D GRAPHICS ADVENTURE WITH SOUND
(Machine Language for Fast Action)*

This is NOT the usual "find the treasure" adventure. In **ESCAPE**, you are trapped on the top floor of a skyscraper and the only way out is by using a very unusual elevator. You must give the elevator the correct code or else the ride down is a real killer. The maze-like halls seem to come to life due to the fantastic 3-D graphics. Search the halls for rooms which contain clues to the correct code. Clues must be deciphered to learn the elevator's secret code. Game times depends on the skill of the player, but it is typically 8-10 hours. **ESCAPE** is suitable for group play. A mentally stimulating experience.

16K BASIC

\$18.95

RECIPE FILE

*A CASSETTE BASED STORAGE AND
RETRIEVAL SYSTEM*

This program permits storage of your favorite recipes for retrieval by your computer. Once a recipe has been recalled, then the computer can adjust the ingredient measure for serving the desired number of persons. Each recipe can contain special comments on preparation as well as the full instructions for using the recipe. Included is a line oriented text editor for creating and editing the variable length files. Completely menu driven and very user friendly. Easily modified by the user for use in keeping track of record, coin or stamp collections or whatever your interest. Screen or printer output.

16K Ext. BASIC

\$21.95

SPECIAL: *A collection of 30 recipies covering main meals to snacks. Only \$3.95 with program.*

SQUIRE

SQUIRE is a challenging game of asset management. The player must manage a country estate and contend with crop failure, investment losses, taxes and other such headaches. The object of the game is to increase the estate's value while providing for the peasant workers. The starting assets are computer selected so that each game offers different challenges. Great experience for the kids or aspiring executives.

16K Ext. BASIC

\$14.95

HOUSEHOLD EXPENSE MANAGER

This menu driven program package is designed for creating and maintaining a data file on cassette of 30 household expense categories for a 12-month period. It also keeps cumulative totals and a separate total of tax deductible expenses. A comparative analysis program provides a graphic presentation of relative expenses between any two months during the year. The user can change categories by modifying program code. Screen or printer output.

16K Ext. BASIC

\$19.95

FLIPPER

A fun and challenging version of the Othello™ type board games. This version includes options for play solely by the computer, one player against the computer, or two players against each other. The computer can play on four skill levels. Very colorful with plenty of sound. Fun for kids and challenging for adults. Great for parties.

16K Ext. BASIC

\$16.95

**COLOR
SOFTWARE
SERVICES**

P.O. BOX 1708, DEPT. R
GREENVILLE, TEXAS 75401

INCLUDE \$2.25 HANDLING PER ORDER
WRITE FOR FREE CATALOG

DEALER INQUIRES INVITED



TELEPHONE ORDERS
(214) 454-3674
9-4 Monday-Saturday

VISA/MASTERCARD

There is only one more wire to add. This is the point marked "out" on the schematic. One end of the wire comes from the free end of the button you mounted. The other end of this wire goes to the already existing button. There are two wires on the existing button. The one you want is the one that comes from the connector side, not the side that goes to the joystick pot—that's ground. Solder your wire to the same spot, but make sure that the original wire does not come loose when you do. This completes the wiring.

Carefully insert the chip into its socket. Make sure that pin #1 is in the right place. You are now ready to try out the circuit. With the board not touching anything (off to one side) plug in the joystick and turn on the computer. Type in this program and run it...

```
10 CLS
20 PRINT@0, PEEK ($5280) : GOTO 20
```

A number should appear on the screen. Press the regular fire button. The number should change. It doesn't matter what the number is, just that it changes. Now press the rapid fire button. The value you see on your screen should change rapidly. Turn the pot on the joystick from one end to the other slowly. This is your speed control. You should adjust it according to your needs. The number should change from slow to fast. If it does, then all is well and it's time to close up the joystick. If it doesn't, then check your work carefully and correct the errors. The most common is the pinout of the transistor. Make sure that the base and collector are in their right places. Before you close up the joystick, put a little dab of rubber cement or silicon glue to hold down the board to the inside of the joystick. Anywhere that fits will do. Make sure that it doesn't touch anything. Close it all up and have fun.



Q SOFT
PRESENTS

• JUMPS •

Q-SOFT's challenging version of a very old European
solitaire game by the name of HI-Q. An ADDICTIVE board
game in HI-RES graphics. A game for ages 3-99. Also
available in 4K
Cassette: 16K E.C.B. \$10.95
Cassette: 4K C.B. \$ 8.95

• TIC-TAC-TOE •

If you thought Tic-Tac-Toe is an easy game, try
matching your wits against this version. Play it with or without
joysticks. A special "SMALL FRY" level of difficulty is
provided for those "SMALL PROGRAMMERS" in your house.
Cassette: 16K C.B. \$10.95

• CONVERSIONS •

A 6-way menu driven conversion program that will
convert DECIMAL to BINARY and vice versa. HEXADECIMAL
to DECIMAL and vice versa, and BINARY to HEXADECIMAL
and vice versa. A MUST!
Cassette: 16K E.C.B. \$10.95

• ONE CHECK •

NEW!! 48 "CHECKERS" are placed on the two
outside rows of a standard checker board. The idea is to
remove as many "checkers" as possible, jumping diagonally
as in regular checkers. It's a real challenge to remove more
than 35. Play with or without joysticks.
Cassette: HI-RES GRAPHICS 16K E.C.B. \$10.95

Q-SOFT
1006 ROBINHOOD DRIVE • PAINESVILLE, OHIO 44077
C.O.D. orders add \$3.00 call 216-352-2675

That's about it for this month. I hope my "Finger Saving Rapid Fire Circuit" can save a few fingers.



Software Review...

C.C. Mailer Is Easy And (Small) User Friendly

The *C.C. Mailer* is written in Extended Color Basic and will operate with 16K or 32K in the cassette version. The disk version requires 32K and one drive, however two drives will provide greater flexibility.

C.C. Mailer is totally menu driven and very user friendly. It is especially suited to personal and hobby use which will not require massive mail lists. The tutorial is clearly written and will allow the beginner to operate the system easily in minutes.

The program has a graphic title screen which displays during the loading of the basic program. After *RUNning* the program, the first prompt appears asking if this is a new file. If YES, the program jumps to the main menu. If NO, the program will load your file from storage. The completion of the load will then prompt for a new file revision date. It will also show the number of records on file and the last revision date.

The main menu is very straight-forward. Choosing to UPDATE the file will take you to another menu which lets you select: ADD to the file, DELETE a record, CHANGE an existing record, or RETURN to the main menu.

The program sets up eight strings for each record so that the ADD record display is semi-formatted to ease entry and correction. There are no edit functions in the program, corrections are made by *reENTERing* the specific string. The mechanics for this are very simple and well thought out.

The CHANGE-an-existing-record option provides a last name or a code search to locate the specific record. The record is then displayed the same as the ADD screen.

The PRINT-a-file option on the main menu will print a fully formatted record, plus the record code and the telephone number, if available. The print routine sends a top of page signal to the printer after the completion of each separate code listing. The print routine will not search for last names, which is inconvenient if you only want to print a few records or labels. The PRINT-labels function essentially uses the same routine, except the printing of the sort code is optional on the label. The program also provides a test label print to allow for manual printer alignment.

The SORT-the-file command will arrange the records in alphabetical order by last name. The author describes this as a ripple sort from back to front. This routine is quite satisfactory for smaller files, however, the time to sort the file using Basic tends to extend exponentially as the file size increases.

EXTRACT-from-file seems to have a correctable flaw in the program. The default name for the file is "CCMAILEX," or you can enter a name. The problem arises when you try to load the file back into the program. The program loads "MAILFILE."

A final word about the Sort Code used in the cassette program. The author has dedicated one string for the sort routine. It is set at a length of ten characters. If you pre-plan your codes, it can provide almost infinite sort arguments.

**(Transformation Technologies, 194 Lockwood,
Bloomingdale, IL 60108, \$20.00 tape or disk)**

—Ed Sehlhorst

Millborn: Fun Racing CoCo To The Finish Line

Pretend that you are driving your car in a long distance road race. Your goal is to travel 700 miles before your opponent (the Color Computer) does. Of course, in this race you are subject to certain rules of the road. Namely: you must obey traffic signals and observe speed limits. If you have a flat tire or accident, repairs must be made before you can continue. If you run out of gas, you must wait for gasoline. The fun part is that this is an attack game, which means that in addition to trying to reach the 700 mile goal first, you try to prevent CoCo from traveling that distance. This is done by creating chaos for the computer, such as causing CoCo's car to have a flat tire, run out of gas, have a fender bender, etc. Of course, CoCo can cause the same kind of problems for you also.

Millborn is a non-graphic game, similar to the French card game *Mille Bornes*. To begin each hand, CoCo shuffles the cards. It then deals six cards to you and itself. The remaining 89 cards are placed in the "draw" pile. There are 19 different types of cards in this game. Any given card will fall into one of four different categories. The categories are MILES CARDS (used to accumulate mileage), HAZARD CARDS (used to overcome a hazard), REMEDY CARDS (used to overcome a hazard), and SAFETIES (used to prevent hazards).

Each player's turn consists of drawing a card from the pile and either playing or discarding a card from his hand. The object, of course, is to be the first to reach the 700 mile goal by playing MILES CARDS. If you want to play dirty (and

believe me, CoCo does) you can play a HAZARD CARD on your opponent. A hazard can only be overcome by playing a REMEDY CARD or a SAFETY.

At the end of each hand points are awarded, based on your total mileage, plus bonus points you can accumulate. A game is won by scoring 10,000 points first. This usually takes about five or six hands.

Apparently CoCo is a real hustler. The first time I played the game I nearly had a shut-out, and thought the game was going to get boring real fast. After that first game, though, CoCo has taught me a lesson or two.

The display format is similar to a non-graphic adventure game. Your hand is displayed on the screen along with your and CoCo's current status. If you like to cheat you have the option of looking at CoCo's hand. This writer would never normally cheat on his CoCo, but being a responsible reviewer I did just once to make sure the game was all the designers said it was. Another feature the game has is the ability to see what the computer is thinking during its turn to play.

The only two things I don't like about the game are when you are trying to cheat and look at CoCo's hand, the information scrolls off the screen too fast (this can be stopped, though, by pressing the "shift" and "@" keys and play is resumed by pushing any key), and, it would be nice if there was a provision made to save a game in progress.

A *PCLEAR1* allows you to load *Millborn* into 16K.

All in all, this is an easy to play game, requiring some strategy and a lot of luck. The four pages of documentation are good and can have you playing the game within 30 minutes.

(Ilume Design, Dept.R., 4653 Jeanne Mance St.,
Montreal, Quebec, Canada H2V 4J5, \$14.95)

—Michael Hunt

ALL YOU'VE WANTED IN A COMPUTER! AND MORE...

TDP SYSTEM 100

A COMPLETE SYSTEM READY TO PLUG INTO YOUR COLOR T.V. SET

Features:

- 16K Memory
- Expandable to 32K at any TDP Service Center Nationwide; and to 32/64K through Southco, the Georgia Distributor
- Designer Cosmetics in White and Black High Impact Case
- Raised Keyboard with Gold Contacts to Withstand Constant Use
- Standard Basic Built-in (Microsoft)
- RS232 Interface Device Built-in (Permits hook up with printer or telephone modem without purchase of the RS232, a \$200.00 extra charge on most computers.)
- RF Interface for Direct Hook Up to any TV Built-in
- Vast Source of High Resolution Arcade Color Games
- Inexpensive Telewriter Word Processing Applications Available
- Programming Manual (s) Included at No Charge
- Bust Out Game Pak Included at No Charge
- Joy Sticks Included at No Charge

MODEL 10-1000



suggested retail
ONLY \$379

SOUTHCO
SALES CORPORATION

Dealer Enquiries for Complete Information Call or Write:
Tommy Thompson or Roy Green (404) 355-2960
1500 Marietta Blvd. N.W. Atlanta, Georgia 30318

Let CoCo Control Your Home Power Units

(Part I Of A Series)

By A.B. Trevor

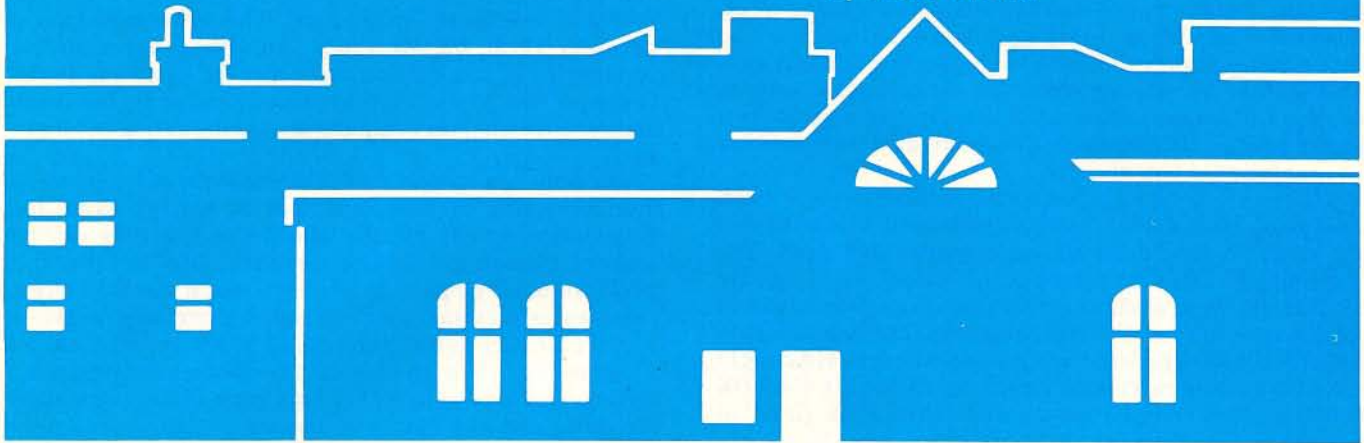

Have you ever wanted to have your house lights turned on and off in a different pattern each day when you were out of town? Would you like to have various appliances and lights shut off after you go to bed each weeknight (but not weekends)? How about watering your lawn before you wake up every *other* morning? This may sound like another impractical "home of the future" story, but all these tasks are performed for me without special house wiring by my 80C, a few Plug 'n Power components, and the software that will be presented in this series of articles.

PLUG 'N POWER (X10) SYSTEM

Let's examine the Plug 'n Power Controller and what it can do. This peripheral can extend the power and usefulness of your computer beyond the physical boundaries of your computer room, yet it is one of the least expensive and least exploited 80C devices. The controller is packaged in a small box that plugs into the cassette port. Your cassette cable plugs into a jack on the rear of the controller, and a switch permits selection of "CTRL" or "CASS" so you can leave the device plugged in at all times. The hardware itself is extremely simple; it consists logically of two main components: 1) an 120kHz oscillator that can be gated onto your home's electric power wiring under computer control, and 2) a power line frequency detector that can be read by the computer. Under software control, coded signals are sent out over your house wiring to various wall switches, appliance modules, lamp dimmers and electrical outlets. These remote devices constantly look for their own "house code" and "device code" on the power line. If a device detects its own code, then it will respond to an "ON," "OFF," "DIM" or "BRIGHTEN" command.

Compatible remote modules are available from a number of sources, including Radio Shack, Heathkit, Sears, and others. Actually, they are all manufactured by BSR (LTD) as components of their "X10" system. X10 uses a fairly sophisticated digital encoding scheme (more on that in a later article), but suffers from a basic limitation: there is no

return communications from the remote devices, so there is no way for the controller (or your CoCo) to assure that the commanded function actually occurred. In actual practice this is seldom a real problem unless you operate other carrier current devices (such as FM intercoms) that interfere with the X10 signals. Interference can also originate in another house on the same power transformer. When the BSR X10 system was first released it was somewhat sensitive to voltage spikes on the power line, and the failure rate of the remote units was quite high. I had two units fail, (one from Sears, and one from Radio Shack), but in both cases the store exchanged the failed parts on the spot. Since then, I have operated 11 remote modules for over two years without a failure. However, I know of one household that nearly gave up on the X10 system because one inhabitant couldn't seem to remember not to plug vacuum cleaners, toasters, and hair dryers into the 300 watt X10 lamp modules.

CONTROL SOFTWARE

Perhaps the biggest reason for the Plug 'n Power's lack of widespread popularity (at least among 80C owners) is the lack of good control software. With each controller, Radio Shack packs two cassettes containing programs for various Mod I/III configurations, and one program for the 4K 80C. The instruction manual includes Basic control programs for three flavors of Mod III, but alas, none for the 80C! At the end of this article is a small Basic program that corrects that situation. The machine language program that is supplied by Radio Shack with the controller has several problems: 1) there is no way to save your schedules — they must be typed in every time you wish to use them; 2) the clock loses time on each event; 3) it won't work on a disk system unless you disable the IRQ (see *the Rainbow*, September, 1982, page 92), and 4) it crashes occasionally.

PROGRAM DESCRIPTION

The Basic program that follows includes a relocatable

RAINBOW CONNECTION SOFTWARE presents...



5 soundational, colorful, graphic games for your Color Computer including: Brickout, B-17 Bomber, Blackjack, Jackpot and Computation - all for the price you might expect to pay for just one of these games!!! Plus added bonus - Compumind! guess the computer's secret code from clues provided - a game of logic for the whole family. At this price can your library afford to be without them?

All machines - Ext. Basic NOT Required
\$19.95 Cassette - \$24.95 Disk

RAINBOW CONNECTION SOFTWARE presents...

STAR WARRIOR CHALLENGE

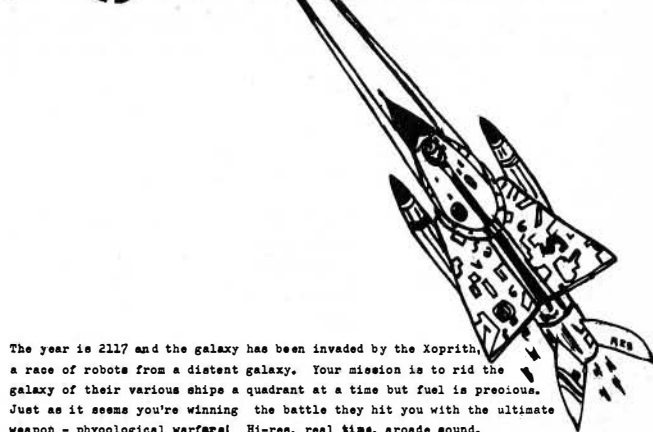

The year is 2117 and the galaxy has been invaded by the Xoprith, a race of robots from a distant galaxy. Your mission is to rid the galaxy of their various ships a quadrant at a time but fuel is precious. Just as it seems you're winning the battle they hit you with the ultimate weapon - phyological warfar! Hi-ree, real time, arcade sound.

16K Ext. Basic & Joystick
\$14.95 Cass

RAINBOW CONNECTION SOFTWARE presents...

CONQUEST OF KZIROLA



You've traversed the dungeons of Kzirola and reclaimed the almighty Scepter. Now you must use its invincible powers and all your weapons to slay a myriad of monsters and fireballs in your attempt to destroy the evil wizard. If you like the challenge and mystique but not the boredom of text only adventure games then this real time, hi-res sequel to the ever popular Scepter of Kzirola is for you!

CONQUEST OF KZIROLA for the Color Computer

16K Ext Basic Cass - \$21.95
32K Diskette - \$26.95

SCEPTER OF KZIROLA



RAINBOW CONNECTION SOFTWARE presents...



At last...a real-time graphics adventure game with arcade sound for your Color Computer! If you are bored with silent screens of text but enjoy the challenge and complexity of adventure games then SCEPTER OF KZIROLA is for you.

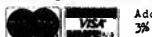

Add 3%

16K Ext. Basic Req.
\$16.95 cass - \$21.95 disk

Include \$2.00 shipping.
Minn. residents add 5% tax.
Dealer inquiries invited.



RAINBOW CONNECTION SOFTWARE
3514 6th Place N.W.
Rochester, MN 55901

Not affiliated with THE RAINBOW.

machine language subroutine that generates legal X10 signals. You can easily modify this program to implement control sequences appropriate to your situation. Nearly any Basic facility may be used, such as Timer, RND, graphics, etc. Of course, you cannot perform cassette I/O, and you should avoid other functions that use the A/D converter — specifically, JOYSTK, PLAY, and SOUND. As it is, the program prompts for house code (A through P), unit code (1 — 16), and command (ON, OFF, DIMn, BRn, ALL, and CLR), then sends the appropriate control sequence. The "ALL" command turns on all lights to full brightness, while CLR turns them all off. Neither command affects appliance modules. The DIM and BR commands must be suffixed by a digit from 1 to 9; they also have no effect on appliance modules.

You will note that a machine language subroutine (USR0) is necessary in order to generate the precisely timed X10 signals. USR0 requires an integer argument whose 16 bits are encoded as follows:

Bits	Contents
15	0 always
14	address/command flag
11-8	repetition count
7-4	house code unit code

An address packet argument is calculated in line 250 and passed to USR0 in Line 260; a command packet argument is

calculated in Line 350. Table BTAB is used to map house codes A — P and unit codes 1 — 15 into the actual values used in the X10 protocol. Line 110 contains the hex values loaded into BTAB. The repetition count is set to three for all commands except DIM and BR, which use twice the given digit plus one.

Before using the X10 Basic program, you must be sure that the controller switch is in the "CTRL" position; it won't be if you just loaded the program from tape! If you forget, USR0 will hang until you throw the switch.

DEVICE AVAILABILITY

Radio Shack's Christmas Computer Center catalog lists the Plug 'n Power controller at only \$19.95 — half the former price. Of course, such a large price cut probably means that they are soon going to discontinue this item; so if you have any interest in putting your 80C to work around the house, you probably should pick up one soon. Remote modules cost from \$15 to \$22, depending on supplier and model. Lamp dimmers and appliance modules just plug into an existing outlet; wall switches and outlets are also available that can be installed in your walls. Other available X10 components include manual control units (\$25 — \$45), a telephone remote controller, a timer control, and a sprinkler control valve (from Heathkit, \$60). Of course, the timer controller has nowhere near the programming flexibility of your 80C, and is limited to eight devices (your 80C can control 256). But, it might be useful on those presumably frequent occasions when you want to use your 80C for something else.

In the next article I shall discuss how to use the Plug 'n Power controller as an accurate, real time clock, the format

™ TRS80 color

From the January 1981 issue of the CSRA Computer Club newsletter:

There was some amusement at the November meeting when the Radio Shack representatives stated that the software in the ROM cartridges could not be copied. This month's 68 Micro Journal reported they had disassembled the programs on ROM by covering some of the connector pins with tape. They promise details next month. Never tell a hobbyist something can't be done! This magazine seems to be the only source so far of technical information on the TRS-80 color computer™. Devoted to SS-50 6800 and 6809 machines up to now. 68 Micro Journal plans to include the TRS-80 6809 unit in future issues.

NOTE: This and other interesting and needed articles for the Radio Shack TRS-80 color computer™ are being included monthly in 68 Micro Journal — The Largest specialty computer magazine in the world!

68 MICRO JOURNAL

5900 Cassandra Smith Road
Hixson, Tennessee 37343
615 842-4600

Subscription Rates

USA: 1-year \$24.50; 2-year \$42.50; 3-year \$64.50
CANADA and MEXICO: Add \$5.50 per year to USA Price
Foreign Surface: Add \$12.00 per year to USA Price
Foreign AIRMAIL: Add \$36.00 per year to USA Price

** Sample issue - \$3.50



68 Micro Journal™ was established with one objective in mind; to provide a Magazine FOR 68xx Users BY 68xx Users. Because of a strict advertiser policy, 68 Micro Journal™ has gained a strong following WORLDWIDE because the reader KNOWS what he is getting when purchasing from a 68 Micro Journal™ Advertiser. It has gained a strong User following because most of the material published is contributed BY USERS, and, therefore, is relevant to the Users needs.

Currently, and even before the Color Computer™ hit the stores, 68 Micro Journal™ was devoting more space to the TRS-80C Color Computer™ and information concerning the Motorola 6809 (which is the CPU in the Color Computer™) than ANY OTHER Computer Magazine. Examples include:

REVIEWS of the three major Disk Control Systems for the Color Computer™, most of the Monitors, Assemblers, and Disassemblers, Word Processors and Editors, "Terminal" Programs (for use with Modems, Communications with other Computers, etc.), and of course, Games.

HINTS for Expanding Memory, Power Supply Cooling, repairing sticky keyboards, disabling the ROM PAK "Take Over", hooking up to Printers, etc.

DISCUSSIONS of the 6883 Synchronous Address Multiplexer, using the Color Computer™ with 64K and 96K memory (which it is ALREADY capable of handling), thoughts on Programming, etc.

I suggest that you subscribe to 68 Micro Journal™, SOON, as many back issues are sold-out.

We still, and will continue to, lead in the type information you need to FULLY UTILIZE the POWER of the 6809 in the Radio Shack TRS-80 Color Computer™.

Bob Nay
Bob Nay
Color Computer Editor

of X10 signals, and I'll provide assembly language listings of the clock and X10 routines. In the third article in this series I will present a full-fledged control program that displays schedules with color bar graphs, has accurate timing, allows saving and restoring of schedules to disk or tape, and is 85% Basic for your ease of modification.

This month's X10 program can be downloaded from the ACCESS data base on CompuServe. Type "R ACCESS" from the PROgrammer's area, then "DOW BSR.CC(70000,130)". (Procedures for non-VIDTEX(tx) terminal software vary.)

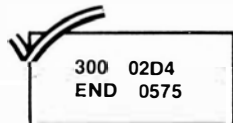

The listing:

```

10 *****
20 BASIC HOME CONTROL
30 FOR PLUG'N POWER SYSTEMS
40
50 (C) A.B. Trevor 1982
60
70 *****
80
90 CLEAR 100,&H2FFF
100 DIM BTAB(16),CMD$(6)
110 DATA 6,E,2,A,1,9,5,D,7,F,3,B
,0,8,4,C
120 DATA CLR,ALL,ON,OFF,DIM,BR
130 DEFUSR0=&H3000
140 FOR I=1 TO 16:READ A$: BTAB(
I)=VAL("&H"+A$): NEXT I
150 FOR I=1 TO 6: READ CMD$(I):
NEXT I
160 FOR I=&H3000 TO &H3076
170 READ A:POKE I,A: NEXT I
180
190 INPUT"HOUSE CODE";H$
200 IF H$="" THEN 220
210 HC=ASC(H$)-ASC("A")+1
220 IF HC<1 OR HC>16 THEN SOUND
99,5: GOTO 190
230 INPUT"UNIT ";UN
240 IF UN<1 OR UN>16 THEN SOUND
99,5: GOTO 230
250 ARG=3*256+BTAB(HC)*16+BTAB(U
N)
260 X=USR0(ARG)
270 INPUT"COMMAND ";A$
280 FOR CD=0 TO 5
290 IF LEFT$(A$,2)=LEFT$(CMD$(CD
+1),2) THEN 340
300 NEXT CD
310 PRINT"? LEGAL COMMANDS ARE:"
320 FOR I=1 TO 6: PRINT CMD$(I);
" ";:NEXT I
330 PRINT:GOTO 270
340 IF CD>3 THEN RP=2*VAL(RIGHT$(
A$,1))+1 ELSE RP=3
350 ARG=RP*256+BTAB(HC)*16+CD+&H
4000

```

```

360 X=USR0(ARG)
370 PRINT"--->DONE<---":PRINT
380 GOTO190
390 DATA 189,179,237,237,141,0,1
13,132,63,167
400 DATA 141,0,106,141,57,141,55
,141,53,141
410 DATA 46,166,141,0,96,142,0,8
,141,19
420 DATA 166,141,0,86,73,142,0,1
,141,9
430 DATA 106,141,0,75,38,223,57,
0,252,73
440 DATA 37,6,141,13,141,16,32,4
,141,12
450 DATA 141,5,48,31,38,239,57,4
9,140,233
460 DATA 32,3,49,140,229,52,18,1
82,255,32
470 DATA 133,1,39,249,134,52,74,
38,253,198
480 DATA 3,166,164,183,255,32,13
4,178,74,38
490 DATA 253,127,255,32,28,0,90,
39,8,134
500 DATA 248,18,74,38,252,32,230
,53,146
510 END

```



SUPERIOR ORACLE SOFTWARE
PRESENTS

THE C C QUBE

A MAGIC CUBE SIMULATION FOR THE COLOR COMPUTER

FEATURING:

- Easy to use commands
- Fast - uses machine language routines
- Random mixes
- Undo moves or random mixes
- See all 6 faces
- Save QUBE to tape - for later reload
- Only \$14.95

Send Check or M.O. to:

SUPERIOR ORACLE SOFTWARE
PO Box 4505
Greenwich, Conn. 06830

Conn. residents add 7 1/4% sales tax
Shipping and handling included
Personal checks require
2 weeks to clear
No C.O.D.s
Requires 16K Extended Basic

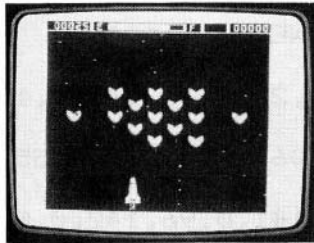

ASTRO BLAST

Your routine space patrol in an outer galaxy sector becomes a life and death struggle with alien invasion forces advancing towards Earth. Wave after wave of attack squadrons challenge you in this super hi-res machine language shoot-em-up game. One or two players. 16K. Tape version..... **\$24.95**

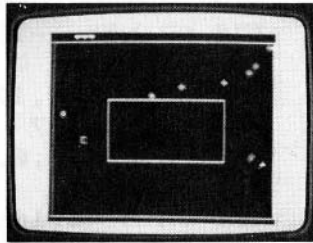

SPACE RACE

Maneuver your ship around the four cornered "race track" in space while destroying hordes of alien ships. As you fly around the "race track" bouncing off the walls, watch out for mines laid by the swarmers. Great color and sound and a new approach. 16K. Tape..... **\$21.95**

Four great reasons why you should buy from Computer Shack (1) We have a toll free line. it costs you nothing to call us. (2) We ship all orders out within 24 hours (3) Most of our salespeople have color computers and they will be more than happy to help you pick out games, books, etc. (4) If you buy more than one program we will give you a discount. If you buy 2 programs you can take 10% off both programs. If you buy 3 programs you can take 15% off. and if you buy 4 or more programs you can take 20% off the price of all four. We are still in need of some additional people to add to our top ten panel. If you are interested send us a listing of your 10 favorite games. We carry many programs that are not in our ad's, please call if there is a special program you want.

MONKEY KONG

Once again, Mario jumps into action. Avoiding rolling barrels, ramps, ladders, and killer flames while trying to save the beautiful girl from the clutches of the giant ape. Written by Ken Kalish its so much like the arcade version, you might try to insert a quarter. 16K. Tape..... **\$19.95**

SPACE RAIDERS

A Classic Hi-Res graphics game. As the alien raiders descend, you must eliminate them while avoiding your own destruction. This two player, action arcade game uses either keyboard or joystick control. Written by Mark Data. 16K. Tape..... **\$24.95**

SPACE TRADER

Establish vast interstellar shipping lanes and purchase stock in the companies that control those trade routes. This is a multi-play board game with graphics. This is a game for the thinkers, it takes more than a quick hand to win this one. 16K. Tape..... **\$21.95**

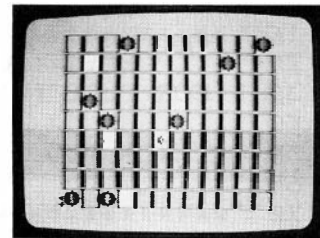

PLANET INVASION

A great new Defender action game, its success insured by its spellbinding graphics and marvelous sound, but most of all by its controlability. Using both the keyboard and the joystick, you maneuver your way through this revolutionary new game. 16K. Tape..... **\$21.95**



VENTURER

Fantastic arcade game comes to life on your Color Computer screen. Upon entering each room you'll find new treasures and new challenges. Using your joystick, get the treasure while fending off the attacking creatures. This great new adaptation be Aardvark will put excitement back into your Color Computer. 16K. Tape..... **\$19.95**

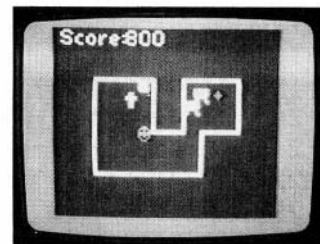

GOLF

Aardvark has brought this age old game to your Color Computer. With sandtraps, trees, water holes, and a great sound track, you just might mistake it for the real thing. Choose your club and select a swing, if you make it to the green, you can even putt. 16K extended color basic. Tape..... **\$9.95**

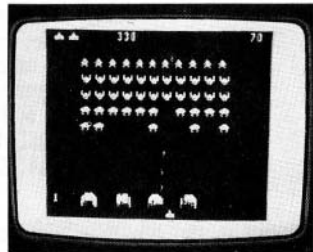
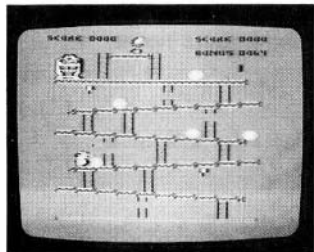
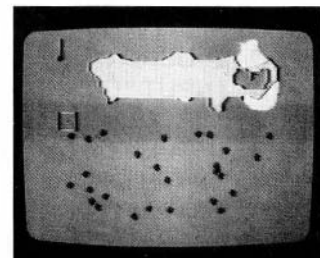

COMPUTER SHACK
1691 Eason • Pontiac, Michigan 48054
Info: (313) 873-8700 • Orders: CALL TOLL FREE (800) 392-8881
Master Charge and VISA OK. Please add \$3.00 for shipping in the U.S.A. - \$5.00 for Canada or Mexico - Proper postage outside of U.S. - Canada - Mexico.
Dealers: We are distributors for all items in this ad. Write for our catalog and price list.

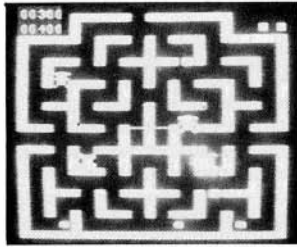

CAVE HUNTER

With skill and technique, you must guide your hunter robot through the maze of caverns in search of treasure. But watch out, the cave is possessed with spooky creatures that'll feast upon your robot. You can destroy them by super charging your robot with energy or just try to out run them. Written by Mark Data. Uses Joysticks, 16K. Tape \$24.95

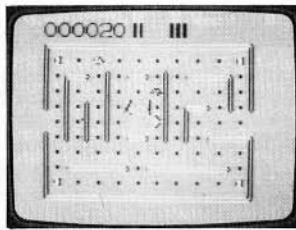

PACDROIDS

With its space theme, the Super Saucer lays destructomines and the Super Bomb that disintegrates everything in your path, right up to the wall. The maze changes every 10,000 points as the difficulty escalates. 1-4 players. 16K extended basic. Tape \$19.95

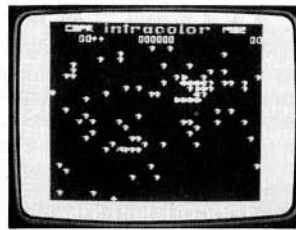

COLORPEDE

Colorpede has a variety of bugs ranging from a tiny beetle to the gigantic colorpede. Colorpede has better graphics than Katterpillar but the sound is not as good. Colorpede also has a more varied and complicated play routine. 16K. Tape \$29.95

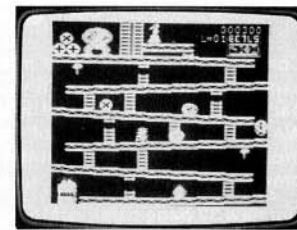

DONKEY KING

Using the four stages from the original arcade game, with your joystick in hand try to jump the barrels, collect the pins, manuever your way past the falling jacks, and figure out the crazy conveyor belts. Written by Tom Mix, this ones sure to become a classic! 32K. Tape ... \$24.95 Disk ... \$27.95

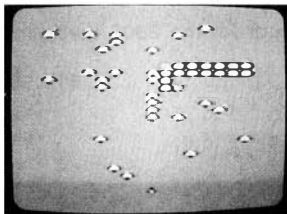

Katterpillar Attack

Modeled after the popular arcade game, Centipede. This is a well written game. It has slightly larger graphics and better sound than Colopede. It is also simpler to play than Colorpede. 16K. Tape ... \$24.95 Disk ... \$27.95

PHANTOM SLAYER

You must chase the phantoms and kill them with your assortment of weapons. This is a graphics type maze/adventure game with full screen three dimensional graphics. You are armed with a laser pistol, and proximity detector. 16K. Tape \$19.95

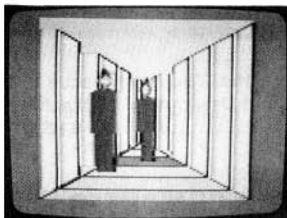

KEYS OF THE WIZARD

A fast action, machine language adventure game filled with tricks, traps, treasures and creatures all of which are randomized at the beginning of each adventure so that no adventure will ever be exactly the same. There are three different skill levels. 16K. Tape \$21.95

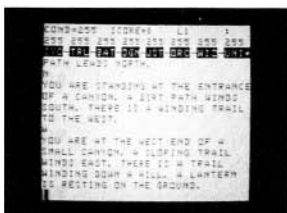

GHOST GOBBLER

Ghost Gobbler is an excellent version of Pac-Man™. You must gobble all the food dots while avoiding the ghosts. There are four energizer dots which will make the ghosts turn blue and become scared. This is the best copy of the arcade game. 16K. Tape \$21.95

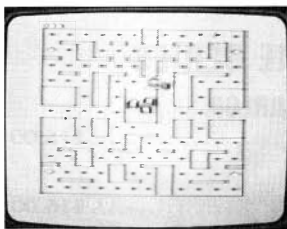

Now you can deduct up to 20% on the price of games: buy any 2 games deduct 10%, buy any 3 games deduct 15%, buy any 4 games deduct 20% from games prices.

TOP TEN

- 1.) **COLORPEDE** by Intracolor
- 2.) **PLANET INVASION** by Spectral Assoc.
- 3.) **DONKEY KING** by Tom Mix
- 4.) **ASTRO BLAST** by Mark Data
- 5.) **PACDROIDS** by Programmers Guild
- 6.) **SPACE RACE** by Spectral Assoc.
- 7.) **VENTURER** by Aardvark
- 8.) **HAYWIRE** by Mark Data
- 9.) **GHOST GOBBLER** by Spectral Assoc.
- 10.) **SPACE RAIDERS** by Mark Data

INVADERS REVENGE

You, as the last remaining space Invader, must battle the human ships that prowl the space lanes, and avoid the laser station that seeks to destroy you. A great game from Med. Systems. Reverses the roll in space invaders you attack the laser bases. 16K. Tape \$19.95



HAYWIRE

This is Mark Data's version of "Beserk". Super Colors and dynamite sound effects in this fast paced arcade game for one or two players. The exciting combination of angry robots on the Indestructible Menace will provide hours of action filled fun. Tape \$24.95

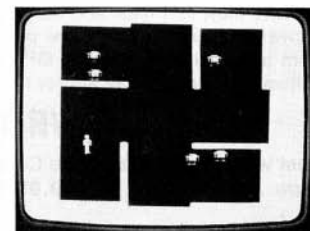

COMPUTER SHACK

1691 Eason • Pontiac, Michigan 48054

Info: (313) 873-8700 • Orders: CALL TOLL FREE (800) 392-8861

Master Charge and VISA OK. Please add \$3.00 for shipping in the U.S.A. - \$5.00 for Canada or Mexico - Proper postage outside of U.S. - Canada - Mexico. Dealers: We are distributors for all items in this ad. Write for our catalog and price list.

- COMPUTER SHACK -

Computer Shack has been in the publishing business for 2 years publishing software for the TRS-80 Model I and III. We are now expanding into the COCO. If you would like a major publisher to handle your software send us a copy for evaluation. We have full color packaging, and established dealer network, foreign distributors, and have booths at major computer shows throughout the country, etc. We can sell more copies of your programs than any other distributor. If you are a machine language programmer we have some programs that run on the model I and III that we would like to convert to the COCO. If you are interested in this send us a sample of your programming along with your name and address.

Our new 32 page catalog (Model I, III and COCO) is hot off the press. It contains software, hardware, and misc. If you live in the U.S. write now for your free copy. Due to the high cost of mailing, if you live outside the U.S. please send \$1.00 for your catalog and we will refund this on your first order.

Note our policy of giving a discount for larger orders. We make more money on a big order and we pass the savings along to you. You can save 20% on all your software by buying 4 programs.

PRINTERS & PRINT BUFFERS

The COCO has a serial print port and to use a printer you must either buy a serial printer (they cost more) or buy a converter. Computer Shack now has a converter that also stores the data in its memory until the printer is ready for it. This is an outstanding feature as most printers are fairly slow.

16K Ser to Par	\$239.00
16K Ser to Ser	\$259.00
X-TRA 16k memory	\$30.00
C. Itoh Prowriter Parallel	\$467.00
C. Itoh Prowriter Serial	\$579.00
Epson MX 80 Ft Parallel	\$529.00
Epson MX 80 FT Serial	\$629.00

COLOR TAPE COPY \$15.95

By Bob Withers

There have been few copy programs on the market for the Color Computer but none can compare with Color Tape Copy. This program is designed so that you don't lose any of your valuable programs or data bases.

It will make a backup of any Color Computer Tape: Machine language, data, or basic program.

First load color tape copy into your CC. Then it prompts you to put your original copy into the recorder. After it loads the program into memory it tells you to put a blank tape into the recorder and press the record button. It then writes the program to a new tape.

You'll never have to worry about your little kids destroying your \$20.00 tapes. 16K

COLOR DIRECT FILE TRANSFER

Tape Version \$19.95

By Bob Withers

Now a program for the Color Computer that allows you to download basic programs from Bullet-80 systems. It will also send and receive programs from other Color Computers, Model I's and Model III's. Direct File Transfer (DFT) is a modem program which will handle the direct uploading and downloading of machine language, work processors files, text files, and basic programs directly to tape with no conversion necessary. It is the program you must have to download from any Bullet 80 system. DFT also has a chat mode, and has software controlled half and/or full duplex. For modem use only.

TELEWRITER - 64

Best word processor for the Color Computer.

Tape..... \$49.95 Disk..... \$59.95

HAYES SMART MODEM

The very finest modem you can buy for the Color Computer or any other computer. Features include auto dial, auto answer, built in speaker LED signals auto redial, etc.

300 Baud..... \$239.00 1200 Baud..... \$569.00

BUGOUT

A compact but very powerful monitor for the 6809 microprocessor.

Only..... \$19.95

MADNESS AND THE MINOTAUR

A classic adventure game utilizing two word commands.

Price..... \$19.95

DRAGONQUEST

A new text adventure by Charles Forsythe. You must rescue the princess from the Smaaeogor Monarch of Dragonfolk. All Machine language. Fast, Exciting and only

\$15.95

BOOKS FOR THE COLOR COMPUTER

Programs and Applications for the COCO

Alfred Baker..... \$14.95

TRS-80 Color Basic

Bob Albrecht..... \$9.95

Color Computer Graphics

Ron Clark..... \$9.95

Color Computer Song Book

Ron Clark..... \$7.95

TRS-80 Color Programs

Rugg & Feldman..... \$19.95

MISADVENTURE SERIES

MADAM ROSA'S MASSAGE PARLOR

Tape..... \$15.00

WET T-SHIRT CONTEST

Tape..... \$15.00

COMPUTER SHACK

1691 Eason • Pontiac, Michigan 48054

Info: (313) 873-8700 • Orders: CALL TOLL FREE (800) 392-8881

Master Charge and VISA OK. Please add \$3.00 for shipping in the U.S.A. - \$5.00 for Canada or Mexico - Proper postage outside of U.S. - Canada - Mexico.

Dealers: We are distributors for all items in this ad. Write for our catalog and price list.

CoCo was certainly *not* because they had no information. Several months ago we queried both their Chicago bureau and their headquarters "Computers" department about a possible story on CoCo. In short, they had some information, knew where to get more, and have in their files an open invitation of help from us in preparing an article on what we termed the "CoCo Story."

Many of you may know that my journalism background included a decade with United Press International. During that time I was lucky enough to cover several of the "big" stories of the '60s—the civil rights struggle, the Apollo lunar landings and some of the politics of the decade. I usually found my perceived versions of what happened were different from that of *Time's* reporters.

I don't see how you can write a story about personal computers without writing about CoCo. I really don't. And the grouping of Model III with the Atari, VIC-20 and other computers of that ilk seems to me to be evidence of a lack of understanding about the computer market in general.

Things are really shaping up for RAINBOWfest in Chicago April 22-24. There is an advertisement inside this issue from which you can order advance admission tickets. A three-day pass is a bargain at the advance price of \$7.50 and I hope many of you will attend.

We're billing it as "CoCo's Very First Show." You might want to make plans now to attend—and see if you can get a group together. We've already heard from a couple of groups investigating the possibility of chartering buses for it. Note, too, that there is a special hotel rate for RAINBOWfest.

I write this in the middle of a move to a new location. *The Rainbow*, in what I would call the best tradition of the personal computer business, started out in an extra bedroom of our home and expanded to the entire basement—which we renovated into an office.

We have completely outgrown the basement office (some 1200 square feet) and are now in the process of moving into commercial space (with about 2100 square feet). As I write this, the "business side" of *the Rainbow* has already moved—so our customer services operation is already set up in the new location. The editorial part of the operation will be moved by the time you read this—as soon as we put this month's issue to bed. In short, you should experience no interruption in delivery of your magazines, no delays in getting subscriptions started or renewed, no waits for back issue orders and no problems in handling of *Rainbow On Tape*, RAINBOWfest ticket orders and so on.

Ever-efficient Pat Hirsch planned this move and it has worked like a charm.

The new location offers several advantages to us: It gives us space to continue to expand, it is right next door to the Prospect Post Office and it means we will be able to have a Pepsi-Cola machine on the premises. That's a "perk" of working for *the Rainbow*, all the free Pepsi you can drink!

While a certain part of our former offices will continue to be devoted to CoCo, it does mean our street address changes. From now on it is 9529 Highway 42, Prospect, KY 40059. Using the Timber Ridge Drive address will only delay things for you, but, frankly, the fastest way to communicate with us is to continue to use the same post office box (P.O. Box 209) for all your correspondence.

There are some disadvantages, too. The greatest is that my commute to work has become much greater. Is there no end to what I will do for the betterment of *the Rainbow*? The commute now changes from two flights of steps to .8 mile. And there is no pizza store of any kind in the new location!

Our phone number, (502) 228-4492, remains the same.

In closing for this month, I do also want to thank all of you who have volunteered to become members of our outside reviewing staff. The response to our invitation has been overwhelming and there are a lot of "new names" on reviews this month. If you have not heard from us, you will in the near future.

Generally, our new outside reviewers worked very hard to meet deadlines and provide a comprehensive look at products available for CoCo. Their net contribution will

GOLD LABEL™ BLANK CASSETTES

- ★ PREMIUM 5 SCREW SHELL
- ★ COMPUTER DATA QUALITY ★ LOW NOISE
- ★ MADE IN USA ★ GUARANTEED

1 DOZEN C-10 LENGTH \$8.50 + \$2.50 shpg.
2 DOZEN C-10 LENGTH \$16.00 + \$3.50 shpg.

1 DOZEN C-30 LENGTH \$12.50 + \$2.50 shpg.
2 DOZEN C-30 LENGTH \$23.50 + \$3.50 shpg.

Individual storage boxes (sold only with cassettes) \$2.40 per dozen.
CASSETTE CADDY: \$3.95 + \$2.00 shpg.
2 for \$7.00 + \$3.00 shpg.

Free shipping on one caddy with each dozen cassettes.

Foreign orders include shipping at 16 oz. per dozen tapes/9 oz. per caddy/13 oz. per dozen boxes. Shipped in U.S. by UPS.

CASSETTE CADDY

TIRED OF MISPLACED TAPES AND A CLUTTERED WORK AREA? TRY OUR HINGED TOP SMOKED PLASTIC CADDY THAT HOLDS 12 TAPES IN ONE HANDY LOCATION. EDGE LABELS INCLUDED TO IDENTIFY TAPES.

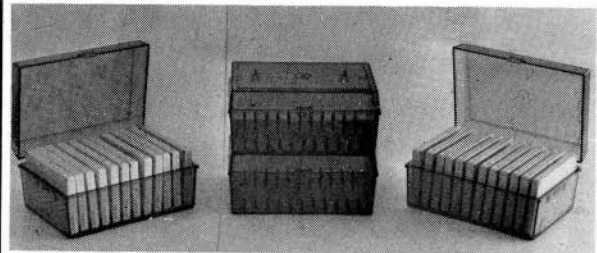

Visa and Mastercard accepted (include expiration date) Orders paid by cashier's check, money order or bankcard are shipped within 48 hours. Personal check takes 1-2 wks. No COD. Some foreign sales are restricted. Texas residents add 5% tax.

COLOR SOFTWARE SERVICES
P.O. BOX 1708, DEPT. R
GREENVILLE, TEXAS 75401

Telephone Orders: (214) 454-3674 9-4 Monday-Saturday

★ DEALER INQUIRIES INVITED ★ QUANTITY DISCOUNTS AVAILABLE

COLORPENS



An exciting new game from the company that is setting the standards. Colorful, high scoring, fast action play with arcade quality sound effects. High resolution, multicolored characters on a black background. Smooth accurate joystick control. Demonstration mode. Pause feature. 1 or 2 players. 100% machine language. Requires 16K color computer with joysticks.

Cassette—\$29.95 Disc—\$34.95
Add \$1.50 for shipping; \$3 outside U.S.; 4% tax in Mich. VISA, MasterCard or Money order. Please allow 2 weeks for checks.



DEALER INQUIRIES INVITED.

14852944 268093 2 UP 16243

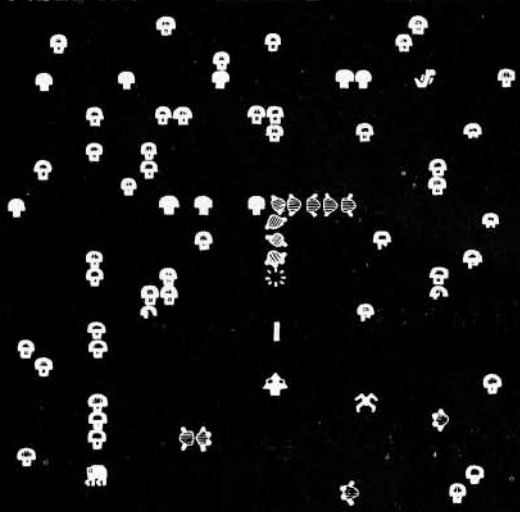

intracolor
COMMUNICATIONS
SETTING THE STANDARDS

P.O. Box 1035, East Lansing, MI 48823
(517) 351-8537

TRS 80 Color Computer is TM of Tandy Corp.

only benefit you more and, we hope, make *the Rainbow* more valuable to you.

To return to the theme of the beginning of this column, the great response to our request for outside reviewers and the diligent way in which those initially selected responded to products sent them seems to reinforce my feeling of "CoCo Community."

Yes, I do think the people at Radio Shack may have soldered in a little heart somewhere in the CoCo's innards.

—Lonnie Falk

Software Review...

A Maze(ing) Race: I Once Was Lost, But Now...

Racing against the clock, at first your movements are uncertain. But then your alert mind perceives a way through what had seemed an impenetrable maze, and you're off and running, nimbly manipulating your joystick.

"Whaddaya mean, a dead end?! But that means I gotta go all the way back to where I came from and...(scream)."

That turns out to be the scenario rather often with *Maze Race*, a new 16K game in machine language from Tom Mix Software. Either you find yourself swearing you saw an opening which isn't there when you show up, or else you see one you needed fifteen seconds ago.

Playable by one or two people, this game generates one-of-a-kind, blue-on-cyan mazes that have over 50 possible vertical and horizontal corridors, not counting dozens and dozens of obstacles, twists and turns. In fact, with so many 1/4" passageways on the screen, you can get downright blurry-eyed if you spend too much time in front of the TV. You'll get an occasional, relatively easy game, but the next one's just as likely to leave you utterly lost and frustrated.

If you finally make it through a tough one, you can request the same maze as many times as you wish in order to better your time. The screen will show both your actual time and the best time in real minutes and seconds. And, if you really get hung up, don't worry about it too much—the timer can go as high as 99 hours, 99 minutes and 99 seconds. The game's creator must have been trying to teach patience and persistence, because I couldn't find any way to get out of a totally frustrating game once it had started without resetting—and thereby having to reload the tape to continue.

Want to race with a friend? You'll get some rather amusing and frantic action this way, which I thought was the most fun.

The tiny blue and red stick-figures move in rapid 1/4" up-or-down steps in response to your joystick(s). Since the Radio Shack joysticks I have are not the world's most precise, it took some practice before I could negotiate the turns at a fast speed—but it is possible.

If you're looking for fancy title pages or lots of bells and whistles, forget it. All of the considerable effort here went into the mazes. I wish I knew how you write a program that generates mazes this complex with only one possible way through. They make the ones on the place mats at Pizza Hut look like real kindergarten stuff.

Incidentally, an optional screen-dump would be a good addition to this program—you could take along a half-dozen printouts as excellent diversions for the kids (of all ages) on trips, in waiting rooms, etc.

The two copies on my tape loaded well, although I did run

into an I/O error just before the first copy started to load. If you happen to run into the same thing—maybe caused by a bad batch of tapes—all you have to do is type another *CLOADM*.

If you like to do mazes, you'll probably like this game. Our sharp, next-door eight-year-old thinks it's super, so the younger set in particular should enjoy it. Besides, it probably can help them learn to recognize patterns and develop quick eye-hand coordination. That's why you play computer games too, right?

WARNING: The game does leave you with a troublesome ethical question—is it ever right to work a maze backwards?

(Tom Mix Software, 3424 College, N.E., Grand Rapids, MI 49505. Cassette, \$14.95)

—Warren S. Napier

Software Review...

Checking Account 'Credit Where Credit's Due'

Bankers beware!

How many of you have argued with a bank manager or teller regarding the proper balance in your checking account? Did you win or lose? Did the manager start laughing and call all of his assistants over to see your patented shorthand method of reconciliation of your statement? From now on, this embarrassing judgment day will be a snap if you use *Checking Account* by F & G Enterprises.

Checking Account is written in Extended Basic and furnished on cassette. The program uses a novel loading system. First you load a short Basic program using the *CLOAD* command. After loading, you enter *RUN* and the program sets the data pointers such that the main program starts at \$H600 and automatically loads the main program. For those of us who forget the *PCLEAR* to conserve memory this makes it easy.

A small 11-page instruction manual is included with various examples of program operation. I would say the documentation is above average.

Program features are:

- *Up to \$10,000 debit amounts and increment totals
- *Up to \$100,000 deposit or interest amounts
- *130 monthly transactions with instructions on using the program with more memory
- *Warnings for transaction or memory limits
- *Incremental totals by line

Main Menu:

- 1 -input/add
entry of month, year, date, check number,
payable to and amount
- 11 month/year
modify month and year
- 2 -insert
add transaction at selected location
- 3 -modify
change data entries
- 33 category
review/modify data entries
- 4 -delete
- 5 -list
- 6 -create bank statement
- 7 -create new active account
- 8 -load
- 9 -save

I am no accountant, but, come to think of it, that is what this program is all about. The program uses a system of checkbook accounting labeled bank transactions and account transactions. Bank transactions are the type of things you see on your monthly statement such as cleared checks. Account transactions are your personal records of your balance. What it boils down to is that even though the bank may show a balance of \$652.00, if your account transaction balance shows \$152.00, you cannot buy that disk drive. You'll have to settle for a new modem.

The program is professionally written and all screen output is in an organized format that is very easy to understand. Prompting is adequate and the documentation will explain any problems. I think some means should have been included for hard copy of the bank statements. Due to the format of the screen, a "screen dump" program would rectify the situation. I found the program very easy to use with one exception. When I made a mistake, there was no easy way of correcting it without stepping through the full sequence of entries for a transaction and then deleting the transaction.

In conclusion, I am pleased with *Checking Account* and have dreams of the elimination of drawers of canceled checks and bank statements in the future, all replaced by a cassette. At the same time, I think a program of this nature is more suited to disk operation and the authors should work on an advanced version. Maybe add a column with an "account" heading for flagging information for tax purposes. The program does an excellent job for a cassette-based system. I would recommend it for anyone who wants to experiment with computerized checking.

(F & G Enterprises, 3922 Millcreek Drive, Annadale, VA 22003, \$18.95 on tape.)

—Dan Downard

NEW SOFTWARE for TRS 80 Model III and the Color Computer

■ Church Contribution System

designed to simplify and facilitate the tedious chore of recording envelopes. Provides a variety of reports. Maintains its own data-files.

Only \$150

■ Data Base Manager

designed to help organize all your data and provide you with meaningful reports. Add or delete any information. New files can be created and old information transferred.

Only \$150

■ Single Entry Ledger

designed as an uncomplicated control of finances for home or small business. Add, delete, edit at any time. Compatible with DBM.

Only \$95

Write or phone for complete software price list.



2457 Wehrle Drive
Amherst, NY 14221
716/631-3011

CCEAD Packs Power For Low Price

One piece of the standard software equipment imbedded in the CoCo's ROM is a Basic interpreter which translates Basic statements into sequences of 6809 machine instructions. While Basic is suitable for many applications, it seems that there are just as many situations where it proves to be unsatisfactory. This may be due to the relatively inefficient use of memory space by Basic, the speed, or lack thereof, with which Basic routines execute, or the need for an operation or function which Basic cannot provide. The most obvious alternative is to code directly in machine language or in assembly language where each line of code corresponds to a single 6809 instruction. This is where *CCEAD* comes in.

CCEAD, an acronym for Color Computer Editor Assembler Debugger, provides three essential tools for the development of machine language routines in one neat package. The Editor allows for entry and modification of assembly language source code, the Assembler takes the source code and produces 6809 machine code and the Debugger is a tool for checking out machine language routines.

When my copy of *CCEAD* arrived, I was pleasantly surprised by the quality of the documentation and the product itself. The cassette on which the program was delivered contained two versions of *CCEAD*'s Basic source code, one fully documented and formatted for readability

and the other, stripped of comments and superfluous blanks. The stripped version, which is the one normally used, occupies about 7600 bytes of memory as opposed to the verbose version which requires approximately 12300. This program requires 16K Extended Basic to run.

Prior to *CLOADing CCEAD*, the user is instructed to use the *PCLEAR* command to allocate one or more graphics pages for use as buffer space by the Assembler. It is here that the generated machine object code will eventually be placed. The space not used by *CCEAD* and not reserved via the *PCLEAR* command is used as text storage for the assembly source code, so it pays to *PCLEAR* as few graphics pages as possible.

Upon running *CCEAD*, I was immediately greeted with the master menu, which presents five options. In addition to the options selecting the Editor, Assembler and Debugger, a tape read and a tape write option are provided to facilitate tape filing of assembly source programs. The option to be selected is specified by entering the option number. Since the two tape options are self explanatory, I will discuss only the three main utilities.

The Editor—*CCEAD* provides the user with a fancy little full screen editor which naturally does all of the things one would expect an editor to do. By using the *ENTER*, *shift*, and arrow keys, the user can insert and delete lines, move the cursor left or right within a source line, and scroll the screen up or down by either one line or screenful of lines. Once all of the source code has been entered or changes have been made, a *shift/clear* exits the Editor and brings the user back to the main menu where the source can be saved to tape, if desired.

The Assembler—Once the source code is in memory as a result of tape read of the Editor, *CCEAD*'s Assembler may be invoked. Selection of the Assembler option on the main menu causes *CCEAD* to prompt for two items: the listing device (screen or printer), and the memory address at which the first byte of generated object code is to be placed. After the necessary information is provided, CoCo begins to churn away, generating object code and the assembly listing. On the average, *CCEAD* takes about five seconds to process each source assembly statement, due primarily to its being implemented in Basic. Upon completion of the assembly, *CCEAD* returns to the master menu.

Input to the *CCEAD* assembler is very similar in syntax, instruction and directive mnemonics, and format to the three other 6809 assemblers with which I am familiar. Of course, all of the instructions and addressing modes inherent to the 6809 are supported. In addition to processing standard assembly statements, *CCEAD* supports five different assembler directives which tell the assembler to change the current location counter for the generated code (*ORG*), reserve blocks of memory (*RMB*), initialize bytes or words of memory (*FCB*, *FDB*) and equate values to symbol names (*EQU*). *CCEAD* contains all of the functions essential to any good assembler.

The assembly listing produced by *CCEAD* is also similar in content and format to other common 6809 assemblers. It displays three major pieces of information for each assembly statement: the memory address of the generated code or data, the generated code or data itself and finally the assembler source statement. The only thing that is missing and could be useful is a symbol table listing.

The *CCEAD* assembler detects six different errors during the assembly process. These are Invalid Syntax, Illegal Instruction, Illegal Indexed Instruction, Illegal Index Value, Relative Branch Out Of Range, and Undefined Symbol. Any error messages appear on the assembly listing

**the
Naked Gamer**

If you think strip poker sounds like fun, read on. Actually, the name of this program package is not completely accurate. Only one player will end up completely undressed. These games are for the adventurous couple!!

The two games are good by themselves, but in the right company they can be terrific. The first is called **Strip Tails**, and is an arcade game played by two players simultaneously. You will need quick hands on the joystick and a quick grasp of the tactics to win, and if you lose, you could really lose your shirt. The other game is called **Sex**, and is something like Mastermind™. Both the player and the computer choose a three letter word, and the player has to guess the computer's word before the computer can guess the player's.

At the end of each round of either game, the computer will instruct one of the players, by name, to remove a specific item of their clothing. Don't worry, there isn't anything obscene in these programs. (Remember, you are choosing a THREE letter word.) On the other hand, the RESULTS from playing could be interesting indeed, and the games are really good even if you elect to keep your clothes on. Available on **TAPE** for \$21.95, or on **DISK** for \$26.95. You will like these!!!

WE HAVE MORE — WRITE FOR LIST

Az. residents add 6% tax. Please add \$2.00 shipping and handling per program, and specify your choice of 1st class or UPS.

Boudoir Software
Intelligent Adult Software

P. O. Box 17421 • Tucson, AZ 85731
Dealer & Author Inquiries Invited



Color Computer Power!

DATAFILE

\$24.95

A unique, multi-purpose data storage system. DATAFILE is a sophisticated, non-formatted database with user define categories. It performs string searches, deletes, sorts (with ML Subroutines) and prints in various formats. DATAFILE also works with files (Disk) larger than available RAM! Ideal for address lists, cataloging, etc. A surprise FREE file is included with each order. Complete documentation.

DATAFILE 64k

\$29.95

All the features of the above with much more memory space. Ideal for small business applications. DATAFILE is the most versatile Color Computer program of its kind.

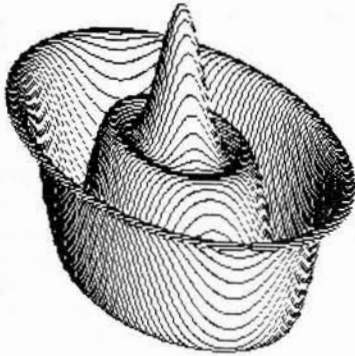

SCREEN PRINT

\$14.95

For use with Epson MX-80/100 printers. Three print formats, all versions of Basic, PMODES 0,2,3&4. Normal or negative image. Written in ML, can be customized by POKES. Many other features! Complete Documentation

TTD \$14.95 **DTT** \$14.95

Transfer your programs to disk or tape effortlessly.

DISKPRO

\$29.95

No more crashed disks! This program can be your lifesaver. DISKPRO creates back-ups of your disk directory and allocation tables. A valuable tool to protect your software. Comes on disk with documentation.

Beethoven's Fifth William Tell Overture

\$14.95

\$14.95

You really won't believe the incredible music coming from your Color Computer! "It is without a doubt the best example of computer music I've ever heard." (Color Computer News magazine) Now you can enjoy these high quality machine language programs at an affordable price. Specify Beethoven or William Tell when ordering. 16K & 32K versions on the same tape.

SPIDER ATTACK

\$14.95

Shoot-em up action! Now you can stop nasty invading spiders with your joystick controlled laser gun. Written in Extended Basic with machine language subroutines for fast action. Watch out you don't get eaten!

MILLBORN

\$14.95

Like to play cards? From France, we bring you this popular card game for CoCo. The object of the game is to drive 700 miles, while avoiding accidents, tire blow-outs, detours, etc. Lots of fun!

COLORSHOW

\$14.95

Music, Color and your CoCo! Just load in COLORSHOW, connect the 80C to your stereo (or simply put a musical tape in your recorder) and watch the fun. Having a party? Turn off the room lights, turn up the music and put on COLORSHOW. Works great with Rock 'n Roll!

STARS

\$19.95

Educational and entertaining, STARS will create a dome of the night sky on your TV. Constellations, stars, and other naked eye objects are drawn using Extended Resolution graphics. Special horizon views show the planets after sunset. Detailed documentation.

Add \$1.00 postage for each software. Programs available on disk for \$5.00 extra. We pay highest royalties to software authors.

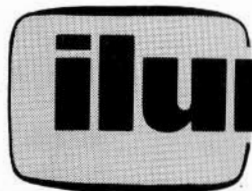

ilume design

Dept. R, 4653 Jeanne Mance St.,
Montreal, Quebec, Canada H2V 4J5

immediately after the offending statement and simply consist of the message "ERR nn" where "nn" identifies one of the six errors. The user is warned in the documentation that "gross" source format errors may cause a Basic error in CCEAD which results in the assembly source code becoming irretrievably lost. The moral of the story is that source code should be saved to tape prior to the first assembly.

While the CCEAD assembler is very good for its size, the more experienced programmer may wish to add features such as symbol table listing, enhanced error messages, expression evaluation for arguments and maybe even conditional assembly and macros. Making these enhancements to CCEAD appears to be a relatively straightforward proposition, thanks to the commented source listing and the in-depth program design information in the CCEAD documentation. However, any large scale modification probably requires a 32K CoCo.

The Debugger—After getting an error-free assembly, the user is most likely to specify the Debugger option on the main menu to try out the new routine. The Debugger, the skimpiest of the CCEAD utilities, is primarily a memory patching tool with which the user may PEEK and POKE at his code and data.

The only program execution control command in the Debugger is the "G" command with which the user causes execution to begin at a given address. To set a breakpoint, one must patch a subroutine return (RTS) into the appropriate place in the code. This is because CCEAD uses the Basic "USR" function to implement the "G" command. Another unfortunate side effect of the USR implementation is that several of the 6809's registers must be saved by the code under test and must be restored prior to the execution

of the breakpoint "RTS." Should this convention not be followed, the 6809 branches off into the wilderness, never to return.

Another very useful function not included in the Debugger is the ability to examine and change register contents at a breakpoint. I found that the quickest way to initialize register contents is to patch Load Immediate instructions into the code under test. To examine register contents at breakpoints, patching in Push to Stack instructions just before the "RTS" seemed to work fairly well.

In light of the delicate nature of the interface between CCEAD and the code being tested, it pays to remember Murphy's law that says something to the effect that "anything that can go wrong, will, usually at the least opportune moment." I found the safest and most time efficient debug practice was to use CSAVEM to copy object code to tape prior to testing so that reassembly of long routines was minimized.

Conclusions—All in all, CCEAD is a high quality program and excellent value. The documentation is clear and thorough and the Editor, Assembler and Debugger work as advertised, although the Debugger did take a little ingenuity to use effectively. When used in conjunction with a 6809 programming book, CCEAD is an ideal tool for learning the basics of assembly language programming. With a 32K machine and a few enhancements, it is well suited for development of large machine language routines. For the price, CCEAD is a tool that no assembly language programmer can afford to be without.

(Spectrum Projects, 93-15 86th Drive, Woodhaven, NY 11421, \$6.95.)

—Gary E. Epple

The Original FLEX for Color Computers

- * Upgrade to 64K
- * RS to FLEX, FLEX to RS file transfer ability
- * Create your own character set
- * Automatic recognition of single or double density and single or doubled sided
- * All features available for either single or multiple drive systems
- * Settable Disk Drive Seek Rates
- * Faster High Resolution Video Display with 5 different formats
- * Save RS Basic from RAM to Disk
- * Move RS Basic to RAM
- * Load and save function on FLEX disk
- * 13 Support Commands 8 with Source Text

Languages Available

Pascal, Fortran, RS Basic, RS Assembler, TSC Basic, TSC Assembler, Relocating Assembler, Macro Assembler, Mumps

If you are tired of playing games on your TRS-80C™ Color Computer, or find that you are handicapped by the limitations of the RS BASIC in trying to write a Program that will allow you to actually USE the Color Computer as a COMPUTER, YOU ARE READY TO MOVE UP TO THE FLEX9™ Operating System. If you want to have REAL PROGRAMMING POWER, using an Extremely Powerful Business BASIC, PASCALS, C Compilers, a full-blown Macro Assembler with a Library capability so you are not continuously "reinventing the wheel". YOU ARE READY TO MOVE UP TO THE FLEX9™ Operating System. If you would like to see if YOU REALLY COULD USE A COMPUTER IN YOUR BUSINESS, or begin to make your Computer start PAYING IT'S OWN WAY by doing some Computer Work for the millions of small businesses around you, such as Wordprocessing, Payroll, Accounting, Inventory, etc., then YOU ARE READY TO MOVE UP TO THE FLEX9™ Operating System. How?? DATA-COMP has the way!

DATA-COMP's FLEX9™ Conversion for the TRS-80C™ Color Computer was designed for the SERIOUS COMPUTER USER; with features like greatly increased Display Screens, WITH Lower Case Letters, so you can put a FULL Menu on ONE Screen, or see SEVERAL Paragraphs at the same time; with features like providing a FULL Keyboard so you have FULL Control of your Computer AND it's Programs NATURALLY, without needing a chart to see what Key Combination will give you what function; with USER ORIENTED functions to make using the Operating System natural, like having the Computer AUTOMATICALLY determine what type of Disk is being used in what type of Disk Drive and working accordingly, rather than you have to specify each and every thing for it, or like having the Computer work with the Printer you have been using all along without you having to tell the new Operating System what is there; etc., etc., etc.

DATA-COMP has everything you need to make your TRS-80C™ Color Computer WORK for YOU; from Parts and Pieces to Full, Ready To Use SYSTEMS, DATA-COMP designs, sells, services, and SUPPORTS Computer SYSTEMS, not just Software. CALL DATA-COMP TODAY to make your Computer WORK FOR YOU!

System Requirements

FLEX9 Special General Version x/Editor & Assembler (which normally sell for \$50.00 ea.)	\$150.00
F-MATE(RS) FLEX9 Conversion Rout. for the RS Disk Controller when purchased with Special General FLEX9 Sys	\$69.95
when purchased without the General FLEX9 Sys	\$79.95
Set of Eight 64K RAM Chips w/Mod. Instructions	\$99.95
Color Computer with 64K RAM and EXT. BASIC	\$549.95
Color Computer with 16K RAM	\$375.95
Color Computer with 16K RAM and EXT. BASIC	\$465.95

Now Available

Enhanced F-MATE Version 2.1

SPECIAL SYSTEM PACKAGES

64K Radio Shack COLOR COMPUTER, Radio Shack COLOR DISK CONTROLLER, a Disk Drive System, Special General Version of FLEX9™, F-MATE(RS)™ and a Box of 10 Double Density Diskettes; a COMPLETE, ready to run SYSTEM on your Color TV Set. \$1249.95

DISK DRIVE PACKAGES, etc.

These Packages include the Radio Shack Disk Controller, Disk Drives with Power Supply and Cabinet, and Disk Drive Cable.	
PAK #1 — 1 Single Sided, Double Density Sys.	\$499.95
PAK #2 — 2 Single Sided, Double Density Sys.	\$769.95
PAK #3 — 1 Double Sided, Double Density Sys.	\$599.95
PAK #4 — 2 Double Sided, Double Density Sys.	\$949.95

PARTS AND PIECES

Radio Shack Disk Controller	\$179.95
1 ea. Single Sided, Double Density Disk Drive	\$249.95
1 ea. Double Sided, Double Density Disk Drive	\$349.95
Single Drive Cabinet with Power Supply	\$89.95
Double Drive Cabinet with Power Supply	\$109.95
Single Drive Disk Cable for RS Controller	\$24.95
Double Drive Disk Cable for RS Controller	\$34.95
Micro Tech. Prods., Inc. LOWER CASE ROM Adapter	\$74.95
Radio Shack BASIC Version 1.1 ROM	\$34.95

DATA-COMP

P.O. Box 794 HIXSON, TN 37343

1-615-842-4601



ONLY THE BEST SOFTWARE ON TAPE AT THE BEST PRICE

(under 75 cents a program...)

Radio Shack
Color Computer
TDP
System 100



Get 12 tapes a year containing over 75 colorful programs — and give your typing fingers a vacation.

A subscription to **CHROMASETTE Magazine** consists of 6 to 8 ready-to-load programs on tape delivered by First Class Mail every month. Programs like Blockade, Drawer, Mansion Adventure, CK Monitor, Append, Germ, and Cataloger.

Give yourself an extended holiday — Get a subscription to **CHROMASETTE Magazine**. Or just take a break and try a back issue (your fingers may never work again) . . .

The Bottom Line:

1 year (12 issues)	\$45.00	Calif. residents add 6% to single copies.
6 months (6 issues)	\$25.00	North America — First Class postage included
Single Copies	\$ 5.00	Overseas — add \$10 to subscriptions and \$1 to single copies. Sent AO rate.

The Fine Print:

All issues from July 1981 available — ask for list.

Programs are for the **Extended BASIC** models and occasionally for disks.

Chromasette MAGAZINE

P.O. Box 1087 Santa Barbara, CA 93102 (805) 963-1066
MasterCard/Visa



The Programmer's Guild Presents . . .

PAC — DROIDS™

BY
Charles Forsythe

THE ULTIMATE IN PAC-ACTION

ONLY \$19⁹⁵

UP TO FOUR PLAYERS!!

*Unlike Any Other "PAC" Game You've Ever Seen!!
Hot Machine Language Multi-Color
High-Res Graphics For All 16K
TRS-80 Color Computers*

**MORE SOUND — MORE ACTION
MORE FEATURES THAN ANY
"PAC" GAME IN EXISTENCE!!**

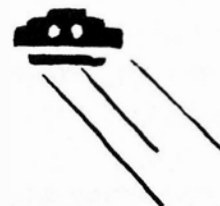

Try PAC-DROIDS™ for the Outer Limit in pure,
explosive arcade action!!

SEND \$19.95 CHECK/MONEY ORDER or VISA/MC NUMBER
TO

**THE PROGRAMMER'S GUILD
P.O. BOX 66
PETERBOROUGH, NH 03458
—or Call (603) 924-6065 for COD—**

*AND GET "FREE" SHIPPING ANYWHERE ON THE PLANET
EARTH OR HER COLONIES*



NOW!
For Color Computer
16K Extended BASIC

Dragonquest!

In a desperate race against the sun you search for SMAEGOR Monarch of Dragonfolk, who has kidnapped the Princess of the Realm and holds her in a distant and unknown place. In a quest for Honor and glory, you must search the land, seeking out the tools needed for the ultimate confrontation. On The River Delta, in the abandoned Temple of Baathteski, Goddess of the Blade, everywhere, clues abound. But WHERE is the Princess?

Now, as never before, the genius of CHARLES FORSYTHE shines in this new machine language ADVENTURE. DRAGONQUEST! Can YOU save M'lady from the iron clutches of SMAEGOR?

TAPE \$15.95

Dealer Inquiries Invited

DISK \$21.95

THE PROGRAMMER'S GUILD
BOX 66, PETERBOROUGH, N.H. 03458
(603) 924-6065 AFTER 6 PM EST

MASTERCARD AND VISA ACCEPTED



Text Pro II: Powerful Tool With Weak Documentation

Ever have one of those days when nothing seemed to go right? When even the cat ran away from home? I did one day this past December. It started when I carefully ripped open the envelope containing a copy of Cer-Comp's *TEXT PRO II*, "the Professional's Word Processor." Page one of their 32 pages of documentation should have warned me. In the words of the author:

"...It should be noted by the user that this is a complex program and cannot be fully understood with a single reading. It will require the user many hours of study, usage, and experimentation to fully understand the power of this invaluable tool."

Really now! I thought we were past that stage in software development for the Color Computer. Sixteen pieces of flimsy copier paper dot-matrix printed on both sides with a staple in the upper lefthand corner. That's not so bad, but start reading and you're off to Confusion Land, compounded by syntactical, spelling and structural language problems everywhere. That's why this program can't be understood in a single reading - you've first gotta figure out what they're talking about.!

It took this reviewer some good old-fashioned head scratching and sleuthing—not to mention patience—to break through the haze. I think I've got it about 90% decoded. And that, my friends, is the major hurdle in discovering this otherwise excellent word processor utility.

The Color Computer is no longer the new hungry kid on the block whose owners are begging and scratching for just anything, but anything, to show its versatility and power. Remember what seems like just a few short months ago when so many of us were really worried about software support? Well, from what I see on these pages and in other magazines lately, we've moved up from the other side of the tracks. We don't have to put up with hastily thrown together packages. Vendors who expect us to shell out our pesos now had better be concerned about competitive packaging—and across the board professionalism. Cer-Comp's *TEXT PRO II* is one such package which suffers from its wrappings. Sorta like handing your sweetheart a diamond ring in a peanut bag!

An hour after unwrapping *TEXT PRO II*, I was still

completely confused, more than a little lost, and to say the least, some mad. The documentation is poorly written. They've got a gem of a machine language program here, yet, it is accompanied by such amateurish documentation! It doesn't take an English major to proof copy before it's released.

Anyway, after trying to make some sense of the manual for over an hour, I decided to go for broke, boot up the program and see what light might be shed there. Half an hour later I was still getting "NE ERROR" and other garbage. The manual said that all I had to do was *LOADM "TXTPROII" ENTER* for R.S.Disk (which I have) or, if using Tallgrass Technologies TG-99 disk controller with *CCMD+9*, just enter the drive number followed by the file name. Didn't work. I was beginning to think I had a dud or had suddenly reached that period in life when the brain just stops functioning.

But wait a minute. Let's think this thing out systematically. Let's call up the directory and see what's on this quality disk (the one with the elephant logo). *DIR* yielded:

```
RSTXP11 BIN 2 B 3
RSTXP12 BIN 2 B 3
RSTXP13 BIN 2 B 3
TXPDEMO DAT 1 A 2
```

So the filename isn't *TXTPROII* after all! Let's try again. (*PCLEAR1* as a delaying tactic. Check the drive with another disk to be sure the goblins didn't zap it overnight.) Make a long distance call to Las Vegas? No way. OK, the *DIR* said *RSTXP11*, and since R.S.Disk demands the extension, gotta throw the *BIN* in, too.

Voila! Up pops the company screen logo, a *READY* prompt, and a blinking black cursor. No congrats for breaking the code, no nothing. Not even a screen clear. So, now what? I'll tell you what: put this thing aside for a while and refuel the system with some tuna casserole because you're suffering from a case of the "befuddleds and bedazzleds" already!

Turn the Lights Back On, Billy!

A fresh cuppa coffee, a new plan of attack in mind, and a full stack of paper in the LP-VII, and you're ready to tackle it again the following morning. Never say die, so you bring the program up, hesitantly enter some text and again ask that now familiar question, "now what?" You've got some text entered but you just can't seem to get started with the editor and processor commands. Then, with a stroke of genius (that's the way you're feeling this morning) you recall the *DEMO* on the disk. Calling it up for processing by guessing at the procedure yields a commercial for *TEXT PRO*, the cassette version. That's nice. Now what? Wait! Try listing the *DEMO* to see how they used the commands. Eureka! The key! "A demonstration file to show how a text processing file might appear." Now what the heck is that doing buried on the disk? Should be in the darn manual!

Life Gets Easier by the Numbers

It soon becomes apparent, despite the author's "efforts" and my increasing negative impressions, that *TEXT PRO II* is really not so complex a program. Even though it helps to understand the manual, if you've spent a quarter century in the military, you can get around it. The real complexity lies in plotting your route around, through, and over the manual's poor organization, disjointed syntax and generally sloppy wordsmanship.

ASTRO LANDER

The new *IMMASTERABLE* lunar lander game. Try to capture planets by landing ships on three different planetary regions, while simultaneously firing at enemy bases with your lasers before their missiles kill you. Five skill levels, superb graphics and sound. 16K Extended Basic and joysticks are required.

Send \$16.95
(plus \$2.00 shipping)

ColorSoft Software Co.
11764 Raintree Ct.
Utica, MI 48087

NOVA-PINBALL

AN EXCITING NEW PINBALL SIMULATION FOR THE COLOR COMPUTER! WITH ALL THE ACTION THAT'S MADE IT AN ALL TIME FAVORITE! \$20



NOVA

**HIRES
COLOR**

FEATURES.

- Arcade Action Graphics and Sound
- 4 Players
- Live Action Flippers
- Action Bumpers and Thumpers
- Double and Triple Bonus Scores
- Extra Bonus Ball
- Ball Kicker

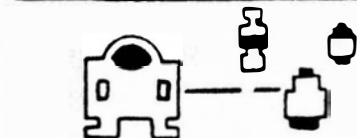

CYBORG WARS

LIKE THE ARCADE!
ROBOTS ARE INVADING EARTH IN WAVE AFTER ADVANCING WAVE!

Your mission is to destroy all robots and save the surviving humans. Watch for the missile firing BRAINS and the fatal touch of the HULKS! \$18

ALL PROGRAMS
MACHINE
LANGUAGE
REQUIRE
16k

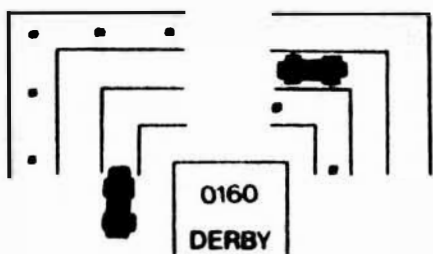
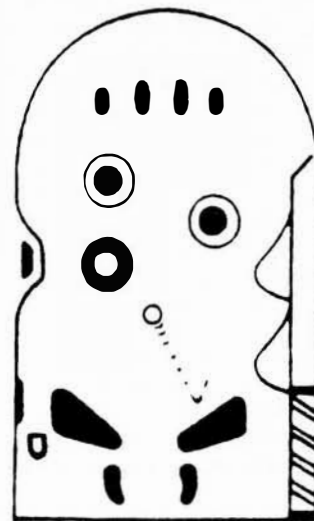

DERBY

Race around the track with a computer controlled car in pursuit. Like the arcade, DODGE-EM! \$14

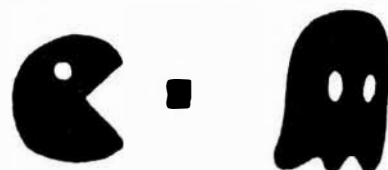

PAC-MAC BUG-ZAP

Great PAC-MAN action!

Shoot bugs in formation, before they swoop down to attack you! \$9

BUMBLEBEE SOFTWARE

Color Computer Machine Language Programs
P.O. Box 25427
Chicago, IL 60625

ARCADE ACTION!

**HOPPY
NEW!**



GUIDE HOPPY SAFELY HOME TO HIS DOCK. TRAVEL ACROSS A HIGHWAY AND HOP ON LOGS & TURTLES TO GET THERE! LIKE THE ARCADE! \$18

DEALER, AUTHOR INQUIRIES INVITED

Consider: what you finally find yourself with is an excellent word processor that'll do almost everything but pour the coffee for you. Full justification, special effects justification, an elaborate system of tab functions, an array of text editor and processor commands that's completely out of this world, breezy editing, short keystrokes (most commands are no more than four strokes), compatibility with two major disk operating systems and tape, as well as the capability to control any printer you can hook up to the CC, all transparently - and with a typewriter approach to upper and lower case. (Just set lower case and use shift+letter for upper case. Commands can even be typed in lower case!) All that and more! Autonumbering (you set the increments), expanded print, centering...The combinations go on and on. The real joy is that (once you've broken the command code) these functions come out with only a few simple keystrokes!

But there's that implied limitation: it's just not for the casual or occasional user. I mean, it is NOT a suitable gift for the wife whom you're trying to get to finish those short stories because it'll most assuredly prolong her "computer illiteracy" and delay any literary acclaim. It just ain't the epitome of user friendly to the novice. But, if you're past that stage, go for it. You'll find that you have to turn off more good features than the average program comes with.

The Cer-Comp ad lists the majority of its features and capabilities. Those that are advertised work with ease. There are a couple of things I personally haven't figured out yet.

* I definitely haven't gotten a handle on the elaborate tab variations yet. (There're six of them with their own variations, including tab centering on the decimal!)

* I get a bit queazy about having to print out a whole buffer file just to see how a few doubtful lines come out, but I haven't found a way around that yet.

* On startup, memory size is returned as 21830 for my 32K Extended system (without PCLEAR). That implies that only 93 bytes are taken out of user RAM (by the logo, prompt and cursor) with the program occupying DOS'turf. I don't know for sure because that kind of information is not included in the manual.

Since the program is written in machine language, it is extremely fast at doing its thing. For example, there is no noticeable increase in time between data transfer to the LP-VII's small buffer and print, even though there is a lot of command and control interpretation going on. Practically the only thing you'll ever see on the screen, besides your own input and the READY prompt, is an occasional INPUT ERROR prompted by a syntax error on your part.

Still worried about buying programs that're all locked up? Don't be. The third intelligible thing the Cer-Comp people tell you (even encourage you to do) is how to make a copy of

your original with the BACKUP command (or the appropriate CCMD+9 procedure).

Your Choice

If you're the adventurous type who likes to look for that super bargain or gem now and then, then this one is for you. You'll have to disregard the current wrappings to get to the goodies, but they are there in spades.

On the other hand, if you're the type who likes to LOAD a program and have it lead you by the hand to the finished product, this one probably isn't for you. It'll take operator/user practice to get the full benefit from TEXT PRO II.

Who knows? Maybe the author will come out soon with a better organized and more professional manual/documentation. *Hint!*

(Cer-Comp, 5566 Ricochet Avenue, Las Vegas, NV 89110, \$49.95)

-Ed Lowe

Software Review...

May A 'Mad' Bird Attack Your Blahs

If I had stumbled across *Bird Attack* and not known its origin, I would have bet my left joystick that *Mad magazine* had become a software house.

Bird Attack is a parody of the space war type of arcade game in which the enemy fleet swoops down in random attacks and fires missiles at your roving weapon at the bottom of the screen.

To play, do a CLOADM and EXEC. The instructions are simple and complete.

After you EXECute the program, you are presented with a title page and asked to ENTER your name. Once you've identified yourself to the program, for comparative scoring purposes, you are asked to choose a difficulty level, from one to five.

You get three "men" to start, and an extra one for each 10,000 points.

The four-color, high resolution graphics are very good and the sound effects match the theme of the game. Joystick response is good, but I would prefer a more direct response from the fire button.

As play begins, you are standing on a flat barren plane at the bottom of the screen, while above is assembled a large flock of rather rude birds with an aggressive tendency to behave like miscreant bombardiers. As they seem to have taken you for a no-good nest robber, they are in no mood to compromise just because you (foolishly) brought your shotgun instead of an umbrella. *Mad magazine* aside, this is beginning to look like a production of *The Birds*, had Alfred Hitchcock turned the script over to Mel Brooks.

Bird Attack can stand on its own merits as a shoot-em-up style of game, and its humorous theme is sure to evoke a series of one-liners when you introduce it to your friends. The game operates in 16K and uses machine language to enhance action.

(Tom Mix Software, 3424 College N.E., Grand Rapids, MI 49505, 16K Extended Basic, \$21.95)

-Rich Krankoski

SUPER GAME VALUE

TWO GAME CASSETTE FOR ONLY \$6.95



***** COAL MINE ADVENTURE *****

EXPLORE AN ABANDONED COAL MINE WITH 24 ROOMS OF TREASURE AND DANGER. THE LONGER YOU SURVIVE THE HIGHER YOUR SCORE. A GREAT BEGINNER'S ADVENTURE. 16K EXTENDED BASIC REQ.

***** BLOCK-MAN *****

COLOR BASIC VERSION OF PAC-MAN LIKE ARCADE GAME. COLOR GRAPHICS AND SOUND. FUN FOR ALL AGES. JOYSTICK REQUIRED.

Free U.S. Postage	STARSHIP SOFTWARE
Can. \$1.00 No COD	P.O. BOX 776
No Charge Cards	ALLENTOWN, PA. 18105



Continuing Your Character Record File

By Bill Nolan
Rainbow Contributing Editor

This month in the Dragon's Byte, I will be working on the character record program again. If you read last month's column you know we were going through the process of developing a program, starting at the very beginning. If you haven't read last month's column, you will want to do so before getting into this one.

What we have to do now is break our program up into segments and decide exactly how we want the segments arranged. Let's start by having a menu on the screen, and let's put that menu beginning at line 100. A menu is nothing more than a list of choices, so let's make our list now. Following each item on the list I will put a number in parentheses. This will be the beginning line number of that section.

1. Load or save our information. (1000)
2. Print our information on paper. (2000)
3. Start a new character. (3000)
4. Update basic information. (4000)
5. Non-Magical Possessions. (5000)
6. Magical Possessions. (5000)
7. Spell Book for Mages. (7000)
8. Thief abilities if applicable. (8000)
9. Saving throws. (9000)
0. Weapon proficiency, armor class and combat adjustments. (10000)

I think that about covers the basic choices, and we will start another block at line 11000 to use for any subroutines which will be called by more than one of the above sections. Now let's consider what we will do in each section.

Numbers 1 and 2 will be the last ones to be done, as we will need to have all of our information formatted before we can save or print it. In number 3, we will clear all old information and provide for the input of character name, class alignment, race, age, height, weight, sex, hit points, and basic ability scores such as strength, wisdom, dexterity, etc. All of this information could be stored in a single array having one dimension. We will store all the information as strings, and use the VAL function to convert them to numbers if needed. Let's name this array BS (the B stands for Basic information).

Number 4 in our list will deal with making changes in the information already entered into the array BS. Number 5

will be simply a list of non-magical possessions. We can store that list in another array having one dimension. Let's call it NPS (for Non-magical Possessions). Number 6 will be the same except for being a list of Magical Possessions. Let's call that array MPS.

Number 7 will be a list of spells, and these can be easily divided into levels. Since there are nine levels of spell power in most fantasy games, let's store these in a two-dimensional array called SB\$ (the SB is for Spell Book). Number 8 will be the thieving ability scores. Since we will already know the class, level, race, and dexterity score we can let the computer figure out the thieving abilities. In my column last May I wrote a program to do just that, so I will just adapt it as a subroutine here.

Number 9 will be a short list of saving throw numbers, and we can store them in an array called ST. Number 0 is also a list, but some of the items on it are strings, so let's call it CIS (for Combat Information). Through the entire program I will use the variable name K\$ with the INKEY\$ function, the variable K for temporary use with the VAL function, and all variables starting with X, Y, or Z for temporary storage.

If any of our sub-programs need DATA (I know the thief skills part will) we will group all of our DATA lines together starting at line 12000. This is a matter of individual preference, as DATA statements can be anywhere in the program. I usually put them at the end, but many people put them all at the beginning or put them in various places next to the section of the program where they are used. Suit yourself. Just remember what Rudyard Kipling said:

"There are nine and fifty ways
To construct the tribal lays,
and every single one of them is right."

You will remember that we are going to put some subroutines at line 11000. A couple that come to mind right away are two I use all the time. One draws a border around the screen, and one PRINTs "HIT ANY KEY TO GO ON" across the bottom of the screen and then waits for a key to be pressed before going on.

A couple of times in the past I have included a border routine in one of my programs for this column. These were always in Basic, and you could watch it draw around the

screen. For this program I will give you one I wrote that is machine language and appears instantly. It is only 36 bytes long, and we will include it in the Basic program as a few *DATA* statements and then *POKE* it into memory when the program runs.

Next month, the complete program will be in this column, along with complete instructions for using it. It will run on a 16K Extended Basic Color Computer or TDP-100. I will include any changes that will have to be made to use it with a disk drive, and it will very likely need 32K if used with a disk system.

Let me tell you quickly how I go about writing a program like this. After doing the preliminary thinking such as we have done above, I write the menu section and the most necessary subroutines. I then put a *RETURN* at the proper line number for each of the sections. At this point the program will run, although it won't do anything except print the menu on the screen. However, as I finish each section I can *RUN* the program and test that section. That way, when I finish the last section, the program is already debugged, and I find it easier to debug one small section at a time, rather than a whole big program all at once.

Well, I guess that does it for this month. You all have a very nice Valentine's Day, and I'll get back to work on the program. If you have any questions or last minute suggestions concerning the character record keeper, let me know right away. You can contact me by writing:

Bill Nolan
c/o Prickly-Pear Software
9822 E. Stella Rd.
Tucson, AZ 85730
(602) 886-1505

(Mr. Nolan, an experienced Dungeonmaster in a popular fantasy role playing game on a weekly basis, is the president of Prickly-Pear Software.)



IT'S HERE!!

DYNABYTE SOFTWARE™

TSASA, INC. PRESENTS

COLOR COMPUTER

BUSINESS & HOME SOFTWARE

That'll KNOCK Your Mainframe

OUT!

50 CASSETTES \$8.95-\$29.95

INCLUDING...

The Accountant	\$29.95	Checkbook Booky	\$12.95
Business Inventory	\$18.95	At Home Inventory	\$12.95
The Billing Solver	\$19.95	Dear Diary	\$12.95
The Client Tickler	\$19.95	The Tape Geni	\$9.95
Cash Flow Model	\$13.95	The Phone Directory	\$9.95
The Bidder	\$14.95	The Mailman	\$13.95
Linear Regress	\$16.95	Home Budget	\$12.95

(16K Rec.)

FREE CATALOG

DYNABYTE 2 Chipley Run, West Berlin, N.J. 08091
TELEPHONE: 609-346-3063

Add \$1.50 Postage and Handling and \$1.50 C. O. D.

NAME _____

ADDRESS _____

Software Review...

QTAX-82 Relieves Tax Tedium

For those who have been searching for a way to convince your spouse that your 80C is more than a sophisticated arcade game, *QTAX-82* is here. After all, what could be more serious and down to business than preparing your income tax?

Nature has a way of balancing itself. *QTAX-82* and my 1040 federal income tax form arrived in the mailbox the same day.

QTAX-82, referred to as *Tax Analysis* in some advertising, is a menu driven program which, through a series of interconnected, displayed menus, asks you to input your status, (filing status, exemptions, over 65, etc.) and financial data (income, adjustments, deductions, etc.) resulting in a completed 1040 return.

The menu screens are divided into groups matching the sections of the 1040 forms. As data is entered, subtotals for each section are displayed, and interact with each other to simplify the tax computations necessary to complete the 1040 and 1040 schedule A.

For instance, after adjusted gross income has been calculated, this amount is carried over and automatically enters the one percent of A.G.I. when calculating deductible medical and dental expenses. *QTAX* calculates the 1040 federal form and the 1040 schedule A itemized deductions form. Where appropriate, you are referred to other forms not included with *QTAX*. *You must then enter the bottom line from these forms for the program to calculate your taxes.*

Tax programs of this type are most useful prior to the end of a tax year. By using QTAX you could easily see the net effect of a tax pre-payment on your net taxes prior to doing so. After the end of the year, it is often too late to take advantage of tax breaks.

QTAX will quickly determine if it is most advantageous to take the standard deductions or to itemize them.

Unfortunately, *QTAX* does not have a print option which would allow the review of your data away from your 80C. A "hard copy" is a handy thing to have at a tax audit. *QTAX* does allow you to save the data on tape and recall it later for review or change.

QTAX is not a CPA, nor does it offer advice; it just rapidly calculates your 1040 from entered data. As the instruction manual stresses, the results are only as good as the entered data. "Garbage in-garbage out." It operates in 16K.

(Q Systems, 7602 Seoane Court, Falls Church, VA 22042, \$19.99)

—Bruce Rothermel

Corrections

Paul S. Hoffman offers a minor correction for one of the listings in his in-depth hardware review, "The Expressive, Expeditious, Exhilarating X-Pad!," which ran in our last issue.

On Listing 5, which appears on page 90 of the January, 1983, *Rainbow*, changing the "FG" variable in lines 1100, 1120, 1140 to "FA" will make the program run smoother, says Paul. "FG" was used earlier, back in Listing 2.

Telewriter-64™

the Color Computer Word Processor

- **3 display formats: 51/64/85 columns × 24 lines**
- **True lower case characters**
- **User-friendly full-screen editor**
- **Right justification**
- **Easy hyphenation**
- **Drives any printer**
- **Embedded format and control codes**
- **Runs in 16K, 32K, or 64K**
- **Menu-driven disk and cassette I/O**
- **No hardware modifications required**

THE ORIGINAL

Simply stated, Telewriter is the most powerful word processor you can buy for the TRS-80 Color Computer. The original Telewriter has received rave reviews in every major Color Computer and TRS-80 magazine, as well as enthusiastic praise from thousands of satisfied owners. And rightly so.

The standard Color Computer display of 32 characters by 16 lines without lower case is simply inadequate for serious word processing. The checkerboard letters and tiny lines give you no feel for how your writing looks or reads. Telewriter gives the Color Computer a 51 column by 24 line screen display with *true lower case characters*. So a Telewriter screen looks like a printed page, with a good chunk of text on screen at one time. In fact, more on screen text than you'd get with Apple II, Atari, TI, Vic or TRS-80 Model III.

On top of that, the sophisticated Telewriter full-screen editor is so simple to use, it makes writing fun. With single-letter mnemonic commands, and menu-driven I/O and formatting, Telewriter surpasses all others for user friendliness and pure power.

Telewriter's chain printing feature means that the size of your text is never limited by the amount of memory you have, and Telewriter's advanced cassette handler gives you a powerful word processor without the major additional cost of a disk.

...one of the best programs for the Color Computer I have seen...

— Color Computer News, Jan. 1982

TELEWRITER-64

But now we've added more power to Telewriter. Not just bells and whistles, but major features that give you total control over your writing. We call this new supercharged version Telewriter-64. For two reasons.

64K COMPATIBLE

Telewriter-64 runs fully in any Color Computer — 16K, 32K, or 64K, with or without Extended Basic, with disk or cassette or both. It automatically configures itself to take optimum advantage of all available memory. That means that when you upgrade your memory, the Telewriter-64 text buffer grows accordingly. In a 64K cassette based system, for example, you get about 40K of memory to store text. So you don't need disk or FLEX to put all your 64K to work immediately.

64 COLUMNS (AND 85!)

Besides the original 51 column screen, Telewriter-64 now gives you 2 additional high-density displays: 64 × 24 and 85 × 24!! Both high density modes provide all the standard Telewriter editing capabilities, and you can switch instantly to any of the 3 formats with a single control key command.

The 51 × 24 display is clear and crisp on the screen. The two high density modes are more crowded and less easily readable, but they are perfect for showing you the exact layout of your printed page, *all on the screen at one time*. Compare this with cumbersome "windows" that show you only fragments at a time and don't even allow editing.

RIGHT JUSTIFICATION & HYPHENATION

One outstanding advantage of the full-width screen display is that you can now set the screen width to match the width of your printed page, so that "what you see is what you get." This makes exact alignment of columns possible and it makes hyphenation simple.

Since short lines are the reason for the large spaces often found in standard right justified text, and since hyphenation is the most effective way to eliminate short lines, Telewriter-64 can now promise you some of the best looking right justification you can get on the Color Computer.

FEATURES & SPECIFICATIONS:

Printing and formatting: Drives any printer (LPVII/VIII, DMP-100/200, Epson, Okidata, Centronics, NEC, C. Itoh, Smith-Corona, Terminus, etc).

Embedded control codes give full dynamic access to intelligent printer features like: underlining, subscript, superscript, variable font and type size, dot-graphics, etc.

Dynamic (embedded) format controls for: top, bottom, and left margins; line length, lines per page, line spacing, new page, change page numbering, conditional new page, enable/disable justification.

Menu-driven control of these parameters, as well as: pause at page bottom, page numbering, baud rate (so you can run your printer at top speed), and Epson font. "Typewriter" feature sends typed lines directly to your printer, and Direct mode sends control codes right from the keyboard. Special Epson driver simplifies use with MX-80.

Supports single and multi-line headers and automatic centering. Print or save all or any section of the text buffer. Chain print any number of files from cassette or disk.

File and I/O Features: ASCII format files — create and edit BASIC, Assembly, Pascal, and C programs, Smart Terminal files (for uploading or downloading), even text files from other word processors. Compatible with spelling checkers (like Spell 'n Fix).

Cassette verify command for sure saves. Cassette auto-retry means you type a load command only once no matter where you are in the tape.

Read in, save, partial save, and append files with disk and/or cassette. For disk: print directory with free space to screen or printer, kill and rename files, set default drive. Easily customized to the number of drives in the system.

Editing features: Fast, full-screen editor with wordwrap, block copy, block delete, line delete, global search and replace (or delete), wild card search, fast auto-repeat cursor, fast scrolling, cursor up, down, right, left, begin line, end line, top of text, bottom of text; page forward, page backward, align text, tabs, choice of buff or green background, complete error protection, line counter, word counter, space left, current file name, default drive in effect, set line length on screen.

Insert or delete text anywhere on the screen without changing "modes." This fast "free-form" editor provides maximum ease of use. Everything you do appears immediately on the screen in front of you. Commands require only a single key or a single key plus CLEAR.

*...truly a state of the art word processor...
outstanding in every respect.*

— The RAINBOW, Jan. 1982

PROFESSIONAL WORD PROCESSING

You can no longer afford to be without the power and efficiency word processing brings to everything you write. The TRS-80 Color Computer is the lowest priced micro with the capability for serious word processing. And only Telewriter-64 fully unleashes that capability.

Telewriter-64 costs \$49.95 on cassette, \$59.95 on disk, and comes complete with over 70 pages of well-written documentation. (The step-by-step tutorial will have your writing with Telewriter-64 in a matter of minutes.) To order, send check or money order to:

Cognitec
704 Nob Street
Del Mar, CA 92014

Or check your local software store. If you have questions, or would like to order by Visa or Mastercard, call us at (619) 755-1258 (weekdays, 8AM-4PM PST). Dealer inquiries invited.

(Add \$2 for shipping. Californians add 6% state tax. Allow 2 weeks for personal checks. Send self-addressed stamped envelope for Telewriter reviews from CCN, RAINBOW, 80-Micro, 80-U.S. Telewriter owners: send SASE or call for information on upgrading to Telewriter-64. Telewriter-compatible spelling checker (Spell 'n Fix) and Smart Terminal program (Colorcom/E) also available. Call or write for more information.)

Apple II is a trademark of Apple Computer, Inc.; Atari is a trademark of Atari, Inc.; TRS-80 is a trademark of Tandy Corp; MX-80 is a trademark of Epson America, Inc.

Flight Is Excellent Aircraft Simulator

Imagine yourself alone at the controls of a Cessna 150 coming in for your first "solo" landing. The tower gives you clearance for "runway three-two" and you acknowledge. Well, if your family hears all of this while you're sitting in front of your computer they will probably send you straight to the funny farm. But just think of all the time you will have to play games, especially if they let you take your CoCo with you.

Flight by Dave Hooper and Mark Barnes is an excellent aircraft simulator program by Prickly Pear Software. It's more of a game than a real time flight simulator, but it features excellent graphics and time response. The program is written for 32K Extended Color Basic and is supplied on cassette or disk. One joystick is required. The cassette version uses the "auto-loader" program by Sugar Software and gives you something to look at while loading a total of three separate programs with one *CLOADM* command. The documentation is quite skimpy, almost to the point of being inadequate, but program prompts and operation do not really need explanation. I would like to have seen an explanation of the method of score calculation and operation.

The game has eight different skill levels and asks immediately if you want high or normal speed operation. Caution is given in the manual regarding the fact that some TRS-80C's will not operate in the high-speed mode. My

32/64K Extended Basic machine worked fine at high speed without any modification.

The user is then asked which skill level he prefers:

- A—student pilot
visual landing—no cross wind
- B—private pilot
visual landing—cross wind
- C—commercial pilot
instrument landing—no cross wind
- D—airline transport pilot
instrument landing—cross wind

Each level is capable of operation in the normal or high-speed mode. All pilots (up to five) must use the same level. Each pilot is required to log-in his name and asked to fasten his seat belt. After a short delay, one of the finer graphic screen presentations I have seen appears on the CoCo. The screen is divided into thirds. The top display is called the "azimuth" and shows the glide path, runway and your plane from overhead. The middle display is called the "glide path" view, as it shows an elevation from the ground. The bottom display consists of three real time instruments, two hairlines indicating azimuth, and artificial horizon and an altimeter. These instruments are very responsive to joystick control and very realistic.

If you hit the ground before the runway you will certainly know you have crashed. If you are too high to land, the tower will inform you to "go around" and try again. If you make a successful landing, a voice synthesization of "perfect landing" will congratulate you. As a side comment, this game takes advantage of the Radio Shack joysticks. Since the response is so quick the game becomes more of a challenge. Spring loaded joysticks would make it much easier.

In conclusion, I feel *Flight* would be an excellent addition to your tape library for several reasons. The graphics alone are excellent. The real time response of the joysticks makes the game realistic. Several different skill levels offer everyone a challenge from kids to adults.

(Prickly-Pear Software, 9822 E. Stella Road, Tucson, AZ 85730, \$19.95 tape, \$24.95 disk)

—Dan Downard

TRS-80 COLOR BASIC

by BOB ALBRECHT

Beginners

This entertaining self-instructional book is packed with games, experiments, scores of intriguing challenges, and activities related to fantasy role-playing games. The ideal introductory aid for kids, parents and teachers using the Color Computer.

John Wiley & Sons
605 Third Ave., New York, NY 10158

\$9.95

TRS-80 COLOR COMPUTER GRAPHICS

by DON INMAN

Intermediate

Explore the creative and imaginative blending of computers and color. This exciting book will enable you to explore all the graphics capabilities of Extended Color BASIC.

Reston Publishing Company
11480 Sunset Hills Rd., Reston, VA 22090

\$14.95

ASSEMBLY LANGUAGE GRAPHICS FOR THE TRS-80 COLOR COMPUTER

by DON INMAN and KURT INMAN

Advanced

This book is specific to the TRS-80 Color Computer with applications using sound and graphics to illustrate how an assembler can be used to perform feats that would be quite difficult, if not impossible in the BASIC language.

Reston Publishing Company

\$14.95

DYMAX, P.O. 310, MENLO PARK, CA 94025

Dymax orders must be prepaid via check, money order, Visa or Mastercard. Sorry, no Purchase Orders or COD orders. Please add \$2.00 shipping and handling. California residents add 6% sales tax.



The Stripper Gives You The Bare Essentials

Sorry guys, this is not an X-rated graphics demonstration, but a handy utility that has been designed to reduce the size of your Basic programs. This can really be helpful if you have ever been hit with the dreaded "OM ERROR."

The Stripper is a machine language program supplied on cassette, and includes two sheets (double-sided text) of excellent instructions. It is menu driven, and the following commands are available: 1) delete remarks, 2) pack lines, 3) remove blanks, and 4) exit. The program can be loaded into any protected area of memory and the instructions give examples of loading for disk and non-disk users.

To use *The Stripper* you should have a good Basic program loaded into your computer and have a copy on tape of this unstripped version. Next, *CLOAD* and *EXECUTE The Stripper*. Another nice feature you'll notice as you're presented with the menu is a window showing the amount of memory space the loaded Basic program is using. This lets

Note:
These are the
programs that
have received such
National Acclaim!!

ExIBMer (NOW RETIRED)
For the FIRST TIME — Makes available to the PUBLIC
His personal collection of superior programs for the

TRS-80 COLOR

SEE HOW THE PROFESSIONALS DO IT!!
ALL PROGRAMS ARE OVER 14K LONG!!

TALKING GRAPHIC DEMONSTRATION

Like no other Computer Program that ever existed! Your CoCo will talk to you with a beautiful musical background and tell all about himself while displaying dozens of action packed hi-resolution graphic demonstrations. Programs RUN non-stop for 12 FANTASTIC minutes from 1 CLOAD.

"This demonstration is MANDATORY. You and your CoCo deserve this program."

Quote The Rainbow.

\$24.95T★



THE DISK DOCTOR

— Cure that sick feeling and utter frustration caused by CRASHED I/O ERROR and UNREADABLE disks. Will SALVAGE M/L, BASIC, DATA, ASCII, even MPP Pictures. Menu driven for easy use. 100% visible operation lets you see what you are doing.

Automatic SALVAGE to NEW disk. All in OPEN BASIC!

\$49.95D★



MPP-TUTORIAL

— Programming tool of the professionals — "lets you EASILY create superior graphics without using the tedious DRAW, PAINT, LINE, PSET, CIRCLE, etc. commands. I have seen the results, and they are INCREDIBLE — If you want to see and use the full graphic potential of your CoCo, this program is — REQUIRED!" Quote Chromasette.

\$34.95T or D★



EL CASINO

— Three STARTLING action packed hi-res graphic games that have received RAVE reviews. All programmed with MPP. Each game is over 14K long.

All three games below.....

\$49.95T or D★



DICE GAME

— The ONLY crap game that allows 4 players to make 12 Field Bets before every roll.....

\$24.95T or D★



BLACK JACK

— Gives you the FAMOUS CARD COUNTER sold for hundreds of dollars elsewhere.....

\$24.95T or D★



SLOT MACHINE

— Looks like a \$30,000 Casino machine. Sounds like one, too. Adjustable pay-off.....

\$24.95T or D★



★ T = 16K-EXTENDED

★ D = 32K-DOS

★ POSTAGE PAID

SUPERIOR GRAPHIC SOFTWARE

406 LITTLE MOUNTAIN ROAD — WAYNESVILLE, N. C. — 28786

you see how much memory you are recovering as the various options are *EXECuted*. Removing remarks and spaces should be done next; this is pretty straightforward and may not result in a significant savings of memory. It's the pack lines option that really gives the most dramatic results in memory savings and program structure. This is done by making multiple statement lines from individual statements in the Basic program. Of course, line renumbering and proper syntax is taken care of in the now-stripped program. The next step is to *EXECute* the exit command; this will get you back to the Basic operating system and allow you to *CSAVE* the stripped program.

How much memory can you save? Well, to find out, I ran eight randomly selected Basic programs through *The Stripper*. Some of these were purchased and some were my own creations. They varied in length from approximately 2K to 10K of memory storage. The savings for these programs varied from 4% to 34% reduction in memory requirements, with about a 25% average. Also, since these are now shortened, there may be a slight speed advantage when running.

I find another advantage of this utility is that it helps me write more understandable Basic programs. Now I can load up my program with remarks and spaces, *CSAVE* it, strip it for the working version, and go back to the original six months from now and easily figure out what I was doing.

Give it a try, you will like it!

(Spectrum Projects, 93-15 86th Drive, Woodhaven, NY 11421, \$7.95 = \$2.00 s/h)

—Ronald Hansen

Software Review...

Reviewer Stands Pat: *Blackjack, A Hit*

You'd better be ready for some serious gambling when you take on the shifty-eyed dealer in *Blackjack* because his never-changing expression tells you he's out to take you for all he can get.

A heavy silence hangs over the table as the tight-lipped dealer ceremoniously shuffles the cards, deals them to you and waits for you to make a mistake. There are no "tah-tah-tahs!" when you win, nor does the screen ever flash, because the "house" apparently takes losing very seriously.

Designed for two players, as well as the character mentioned earlier, *Blackjack* is a nicely-conceived game, playing-wise and graphically, but requires a lot of concentration because there are no sound effects.

Joysticks are needed and it may take a couple of dry runs to get used to their movements (while the dealer, meanwhile,

takes advantage of your fumbling around).

After the dealer has given each player two cards, the player whose turn it is sees his money flashed to the right of the screen, opposite his cards. Then, there's a sequence of numbers—10, 20, 30, etc. on up to 100—which represents the amount of money you want to bet on that hand. To stop the sequence and place your bet, you push the joystick forward. But first, you will probably want to press your fire button to see what's in your hand (at this time, the other player is expected to turn his head as a courtesy). If you like your hand, pulling the joystick to the left lets you stand pat. Want a hit? Pull it to the right.

More advanced *Blackjack* players may find the initial action a little too slow. No problem: there's a *POKE* command that allows you to speed up the action. However, if you're among those who need a lot of time to make up your mind, there's still no rush to place your bet after you've seen your hand. Until you pull your joystick to the right or left, you are not committed. While you're making up your mind, the word "Hit?" is displayed at the upper righthand part of the screen. Except for the dealer's ever-shifting eyes, that's the only message displayed—in the version I played. A peek at the listing, however, showed that the dealer was supposed to say "Player A (or B) wins, you lose!" I guess, in my case, he wasn't as interested in rubbing it in, as he was in taking my money.

The game proved to be very challenging, especially when another person besides you and the dealer are involved. The dealer, actually, proves to be an honorable type, allowing us to win on quite a few occasions. Still, there were those eyes, and I couldn't help wondering how much better the game would be with a few "tah-tah-tah-tahs!"

(K & K Computerware, 37326 Gregory Drive, Sterling Heights, MI 48077, 16K Ext. Basic., \$12.95 tape.)

—Charles Springer

RAINBOWfest

Chicago April 22-24

The very first national show and exhibition for CoCo will be held in Chicago April 22-24, sponsored by *the Rainbow*.

RAINBOWfest will be at the Hyatt-Regency Woodfield, west of the downtown area. The *RAINBOWfest* site is adjacent to Woodfield Mall—the world's largest shopping center.

According to preliminary plans, a large number of software and hardware firms will be on hand to exhibit their products. The meeting will also feature a great deal of fun and conversation about CoCo.

We urge you to make plans to attend. A special hotel rate can be secured by mentioning *the Rainbow*.

Admission will be \$7.50 for all three days through an advance sale, or \$5 per day for a single day. Tickets at the door will be \$11 for the entire session or \$7.50 for a single day.

Other events are planned and will be announced shortly.

GAMES FOR THINKERS

MINEFIELD (4K) - Follow the clues of your mine detector to find your way safely through the minefield. 10 levels of play. Tough!
G11 - \$4.95

WALL STREET (16K) - Buy and sell stocks to make your fortune! 1-4 players. Stock & market, history charts. Many extras! Good family fun!
G12 - \$9.85

We pay shipping. Wa. residents add 6.4% sales tax. No C.O.D. Personal check orders ship in 2 weeks.



Valhalla Enterprises

P.O. Box 243
Summer, Wa. 98390

JARB IN C SOFTWARE HARDWARE

COMPUTER PRODUCTS

ADVENTURES

MANSION OF DOOM

by PAL Creations

Rescue the Princess Marlena from the mysterious Count Von Steinoff and reunite her with the townspeople of her village in Transylvania. The Count's mansion has 76 distinct locations for you to explore in your rescue attempt.

32K EXT..... \$14.95

S.S. POSEIDON

by Bill & Debbie Cook

You are aboard the S.S. Poseidon when it is capsized by a tidal wave. It is floating bottom-up on the surface and taking on water. Will you survive to tell your tale?

16K EXT..... \$14.95

THE FINAL COUNTDOWN

by Bill & Debbie Cook

You are outside a missile base which has just been evacuated because a beserk General has started the countdown on a nuclear missile - target: MOSCOW. Your mission, if you accept it, is to stop the missile launch and prevent WWII.

16K EXT..... \$14.95

STALAG & ENO

by PAL Creations

1) You are an allied POW in a German prison camp in 1944 and were forgotten in the hot box when the camp was evacuated due to unexpected bombing raids. How will you get out ALIVE?

2) Your eccentric old aunt just died and left you a fortune in cash. To prove you deserve it, you must decipher the clues and find your fortune, which she hid in her living room.

32K EXT..... Both for \$14.95

BIG NUM

by Quasar Animation

..... \$6.95

THE WALL

by Quasar Animation

..... \$9.95

MYSTERY MAZE

by Faith Robinson Enterprises

..... \$14.95

DOODLE BUG

by Computerware

..... \$24.95

COLORPEDE

by Intracolor

..... \$29.95

THE WARRIOR & THE WIZARD

by Jimmy Jones

Choose your character, weapons and armor to battle warlords, pygmies and other foes as well as hidden monsters, snakes, booby traps and numerous other dangers in this disk based graphics assisted adventure. Beware of the EVIL WIZARD!

32K EXT..... Plus one disk \$19.95

CCM#3

by Charles Santee, Ed.D.

Using only one joystick, CCM#3 allows total communication for special persons. Contains many features and is easy to use. Excellent for young children. Also helps teach spelling and sentence structure. Complete documentation.

32K EXT..... \$32.95



SKY DEFENSE

By Quasar Animations

Fight off the attacking waves of enemy craft in fast realtime combat. Machine language.

16K..... \$18.95

BLACK SANCTUM

by Mark Data

..... \$19.95

CALIXTO ISLAND

by Mark Data

..... \$19.95

EL DIABLERO

by Computerware

..... \$19.95

JARB IN C SOFTWARE HARDWARE

COMPUTER PRODUCTS

1636 D Avenue, Suite C
National City, CA 92050
(619) 474-6213

Dealer/Author Inquiries Invited

All programs warranted 60 days from date of purchase to original purchaser. Unless otherwise specified, shipping and handling \$2.00 per order. California Residents add 6% sales tax.



JUNGLE TREK

Lost in a jungle with wild animals lurking; your only survival is to find a safe compound before you are lunch for lions; high resolution; multi-color.

16K EXT..... \$14.95



LAZER STAR & HELO BATTLE

1) 2 players avoid destruction by blasts of mysterious lazerstar while battling each other for possession of Lazerstar

16K EXT

2) 1 player/2 joystick combat game to blow up 5 blockhouses while watching fuel, ammo, and avoiding anti-aircraft fire

16K EXT..... Both for \$14.95



JARB CODE

Encode/decode important messages or other information in a virtually unbreakable format.

16K Standard/Extended..... \$15.95



BIORHYTHM/ PSYCHIC APT.

1) Prints biorhythm charts of nearly unlimited length; attractively formatted for use on Line Printer VII.

16K

2) Your psychic ability is determined through questions evaluating your psychic experiences

16K Ext..... Both for \$15.95

SCORE-EZ

From 1 to 6 people can play this excellent adaptation of a popular board game. The computer keeps score for all players, and rolls dice. You can roll again just like the original game. Properly position the results of each turn for maximum score. The only thing you will need besides your computer is players. Color graphics and sound will entertain you for hours, and it's EZ to play.

16K EXT..... \$15.95

U.S FUNDS ONLY
C.O.D. ORDERS ACCEPTED
NO CREDIT CARD ORDERS

Techniques For Plotting Screen Graphs

By Don Inman
Rainbow Contributing Editor

This is the fifth part of a series of articles on the graphic capabilities of Extended Color Basic. Portions of this article are taken from the book *TRS-80 Color Computer Graphics*, copyrighted by Reston Publishing Company, Inc.

Mathematicians, engineers, and some normal people are often disturbed by the way that most microcomputers reference horizontal and vertical positions on the video display. As you know, the Color Computer uses the upper left corner of the screen as the zero location for both horizontal and vertical positions. The horizontal positions increase as you move to the right (0 - 255), and the vertical positions increase as you move downward (0 - 191). Technically-oriented people usually refer to the graphic positions in terms of X,Y coordinates. The screen positions used by the Color Computer (and most other microcomputers) can be graphically represented by a two-axes system where each position is represented by one X,Y coordinate pair of numbers.

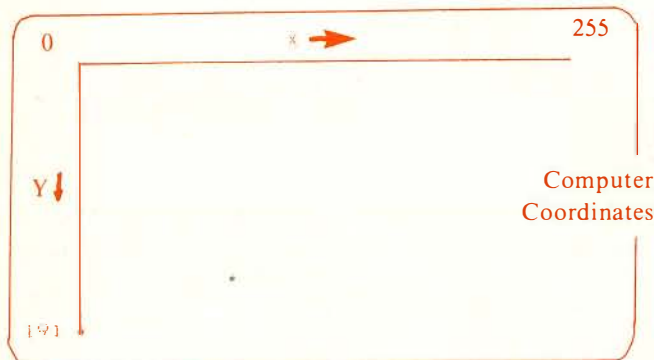

This system bears a close resemblance to the first quadrant of the Cartesian Coordinate System of the mathematical world. The one major exception is that the Y axis of computer graphic screens is reversed (upside down) from the orientation of normal mathematical thought. Positive values for Y are thought of as increasing as you move upward in the first quadrant of the Cartesian system.

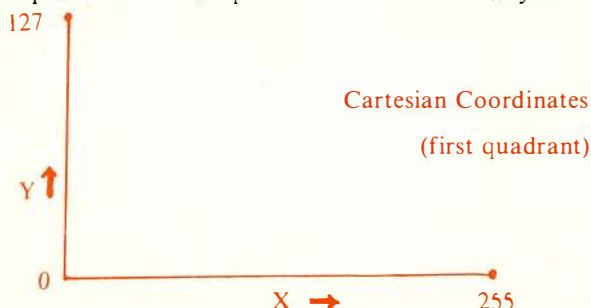

In this article and others that will follow, we will be making use of some equations to improve our graphic skill. For this reason, we will use the system that you became acquainted with in your high school mathematics. We will modify the computer's system to fit the Cartesian system. The following equation can be used to turn the Y axis of the computer system upside down.

$$YG = 191 - Y$$

Computer's Y
Cartesian Y

DOUBLE DUTY

You've spent a lot of money on your computer. Let it do double duty and protect your residence when you are away.

DOUBLE DUTY connects quickly to CoCo's ports and allows timed on/off control of one or more devices such as bells, sirens, lights, dialers, even sprinkler systems. Any number or combination of dry contact magnetics switches, foil, electric eyes, motion detector or may be connected. Series or parallel, norm. open or closed contacts. 10 foot cord allows remote location to avoid wire clutter.

Software may be user modified or write your own short simple programs in BASIC. DOUBLE DUTY will work with any COLOR COMPUTER, even 4K!

Full documentation included with tips for designing an effective alarm system layout.

DOUBLE DUTY plus tape, \$39.95 postage included

BLACKJACK ROYALE

More than just a game, but a system to help you win at the casinos. High resolution graphics deal realistic cards (10 of diamonds has 10 diamonds) and pre-set rules duplicate 80% of the world's casinos or enter you own to match where you play.

Full realistic play includes double down, splits, surrender, insurance bet, 1-8 decks used, burnt cards, shuffle frequency and more. A complete card counter option allows entry of any commercial blackjack winning system for evaluation. Each card can be given any count value and the computer keeps track of how many of what cards have been dealt and the total remaining deck point value. Teaches the game and will train you to count cards and win.

Play your cards right and this software will make you money at the casinos, the author did!

Requires 32K EB, no joysticks req'd.
Cassette and very complete documentation and Blackjack tutorial. \$34.95 postage included

JMN

CA RESID. ADD 6 1/2% SALES TAX

BOX 32215, SAN JOSE, CA 95152

CIS 71525,367

YORK 10

BASF-DPS

WORLD STANDARD TAPE

**MONEY BACK
GUARANTEE**

COMPUTER GRADE BLANK CASSETTES

PREMIUM 5-SCREW SHELL WITH LEADER FITS ALL STANDARD RECORDERS
PREFERRED BY SOFTWARE PRODUCERS, SCHOOLS AND BUSINESSES NATIONWIDE



DATA TRAC / C-05, C-10, C-20

CASSETTE STORAGE CADDY

NEW!
ORGANIZE
YOUR TAPES!
\$2.95 EACH



STACKABLE

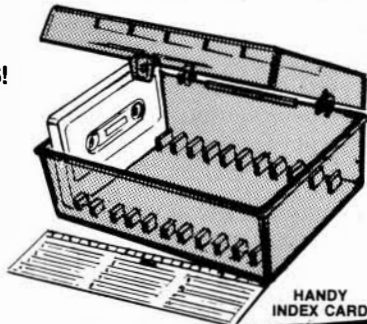

HANDY
INDEX CARD

INTRODUCTORY OFFER!
ORDER 2 DOZ. CASSETTES, ORDER 1 CADDY
GET 1 CADDY FREE!
ORDER 4 DOZ. CASSETTES AND
2 CADDIES — GET 2 FREE

HERE'S WHAT USERS SAY ABOUT YORK 10 CASSETTES:

"It's nice to have a tape you can rely on 100% of the time to perform with such quality. And the fast, courteous service was a pleasant surprise."
Tom Parkinson—Madison, OH

"We monitored the output to the computer with a specially built meter and found absolutely no dropouts throughout the tape . . ."
Stace Papadopoulos—Beaverton, OR

"YOU'VE TRIED THE REST, NOW BUY THE BEST!"

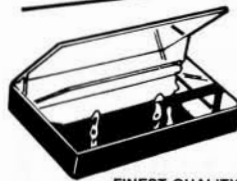

FINEST QUALITY
PHILIPS (NORELCO)
TYPE HARD BOXES

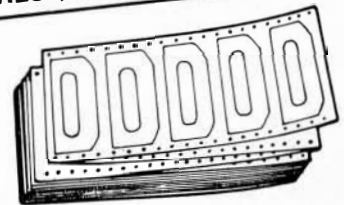

TRACTOR FEED
DIE-CUT BLANK
CASSETTE LABELS



Call: 213/710-1430
FOR IMMEDIATE SHIPMENT
on Credit Card Orders.



ORDER NOW
Mail To . . .

YORK 10 Computerware

24573 Kittridge St., #R1 Canoga Park, CA 91307

ITEM	1 DOZEN	2 DOZEN	TOTAL
C-05	<input type="checkbox"/> 7.50	<input type="checkbox"/> 13.50	
C-10	<input type="checkbox"/> 8.00	<input type="checkbox"/> 14.40	
C-20	<input type="checkbox"/> 10.00	<input type="checkbox"/> 18.00	
Hard Box	<input type="checkbox"/> 2.50	<input type="checkbox"/> 4.00	
Storage Caddy @ \$2.95 ea.:	Quantity: _____		
	FREE: Quantity: _____		
Blank labels	<input type="checkbox"/> 4.00/100	<input type="checkbox"/> 30.00/1000	
SUB TOTAL			
Calif. residents add 6% sales tax			
Shipping/handling 1 doz. \$2; 2 doz. \$3.50; 3 doz. \$4.50; each additional doz. \$.50.			
For Parcel Post instead of UPS ADD \$1			
Outside Continental USA, ADD \$2			
TOTAL			

Each cassette includes two YORK 10 labels only. Boxes are sold separately. Shipments are by U.P.S. unless Parcel Post requested. Boxes, caddies, and blank labels are free of shipping charges when ordered with cassettes. When ordered without cassettes, shipping charges: Boxes—\$1.00/doz., Caddies \$1.00 each. MINIMUM SHIPPING/HANDLING ON ANY ORDER—\$2.00.

Check or M.O. enclosed **Charge to Credit Card:** VISA MASTERCARD

Card No. _____ Exp. _____

Name _____

Address _____

City _____ State/Zip _____

Signature _____

Computer make & model _____ Disk?(y/n) _____

CHECK HERE FOR QUANTITY DISCOUNTS PRICE LIST

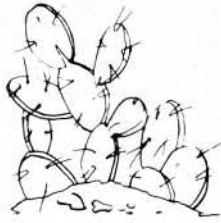

PRICKLY-PEAR SOFTWARE

QUALITY PROGRAMS FOR YOUR 80C

PROGRAMS REQUIRE 16K EXTENDED BASIC FOR TAPE, AND 32K DISK UNLESS OTHERWISE NOTED.

Gangbusters

If you ever wanted to try a life of crime, this is your chance. You will start out as a Punk, but by using brains, and a little muscle, you can rise to become a Hood, Runner, Bookie, Torpedo, Fence, Kingpin, or win by becoming Syndicate Boss. Indulge yourself. Bribe a judge, or the District Attorney. Pay off the Cops. Take out a contract on another player, but watch out, they may be after you. Buy trucking companies, bootleg operations, houses of ill fame, but remember, if you get caught, you may do some hard time. Do you have what it takes to take over? This game will keep you close to your rod, get you thinking about bulletproof glass in your car, and definitely bring out the worst in you, but you'll love every minute of it. For 2 to 6 players, takes about 2 hours to play. Every game is excitingly different. **\$19.95 tape — \$24.95 disk**

Viking!

A simulation for 1 to 4 persons. Each begins as a land-owner, and by farming their land, buying and selling land, expanding their fishing fleet, building on to their manufactory, increasing their population, equipping and training more soldiers, and regulating their taxes, each player tries to increase their economic power and rank until one becomes ruler over all. But beware plagues, rats, raiders, revolts, bad weather, and other misfortunes which may lie along the road to success. As you progress, see the map of your holdings increase. Playable in 1 to 2 hours, and different every time, you may have an addiction problem. **\$19.95 tape — \$24.95 disk**

Fantasy Gamer's Package

Two programs: The first will display your choice of 99 different rooms in Hi-Res graphics at the touch of a key. All standard sizes, plus some with pools, pillars, stairs, odd shapes, etc. Saves lots of game time spent describing room sizes, shapes, and door locations. Includes a super fast dungeon designing system and a completely keyed sample dungeon module — ready to play. The second program in the package generates **COMPLETE** characters including abilities, race, classes, hit points, age, thieving skills, much more, and also generates monsters. This package was developed by an active DM, and has been tested in his campaign. 20 pages of documentation. **\$19.95**

Fantasy Gamer's 32K Package

Similar to our popular Fantasy Gamer's Package, but both the Rooms and the Character & Monster Generator are in memory at the same time. You make your selection from a menu. In addition, you can select the **Dice Bag**, which will roll just about any probability you need. **\$24.95 tape — \$29.95 disk**



ALL Programs in this ad, including disk versions, carry the Rainbow certification seal!

SEND A STAMPED, SELF-ADDRESSED LONG ENVELOPE FOR COMPLETE CATALOGUE

Your Personal check is welcome - no delay. Include \$1.50 shipping for each program ordered. (Shipping free on \$50.00 or larger orders). Az. residents add 4% sales tax. Orders shipped within two days.

NEW THIS MONTH

Eight-bit Bartender:

This will light up your next party! Over 100 great drink recipes are stored by the bartender and called up at your command. Ask for them by drink name, main liquor used, or class of drink (highball, cocktail, etc.). These were gathered from the favorites and house specialties at famous pubs and taverns across the US. It outputs to the screen, printer, or both! At your next party let the guests browse through the Bartender. Needs 32K. **TAPE \$19.95 — DISK \$24.95**

Phonics I

This classroom-tested program is the newest in our Phonics series. Written by the same elementary school teacher, it takes up where PRE-READ I, II, & III leave off. Actually two programs (on separate tapes), the TUTORIAL teaches all 22 of the consonant blends using on-screen graphics and voice (controlled by the computer and played through the TV speaker). The TEST program asks for the letters in these blends (again using voice through the speaker), and checks the keyboard input for the correct answer. Again, on screen graphics are used as an aid to learning, and immediate feedback to the learner is given.

Phonics II

Similar to **Phonics I** in concept and execution, but **Phonics II** teaches consonant digraphs. Again there are two programs (on different tapes) for the TUTORIAL and TEST modes.

Both **Phonics I** and **Phonics II** are well documented, and are sold separately on **TAPES** for **\$24.95** each. They are also available as a package — only on **DISK** for **\$44.95**.

Astrology

Truly a classic, this program will accurately cast your complete horoscope. You just enter the date, time, and place of birth. The sun sign, rising sign, mid heaven (MC), lunar nodes, and planetary influences including houses and aspects between the planets will all be calculated, and a full chart drawn. You can also do progressed charts and transits. It will even tell you the day of the week you were born. The accompanying book will help you interpret this chart of your horoscope. The extent of the documentation is tremendous, even by our exceptionally high standards, and no previous knowledge of the subject is required. You can share in this wisdom which has been used for thousands of years in many cultures. This program was written by a professional Astrologer. Please specify 16K or 32K system. **\$34.95 tape — \$39.95 disk**

Stocked by Quality Dealers, or

Send Order To: **PRICKLY-PEAR SOFTWARE**
9822 E. Stella Road
Tucson, Arizona 85730
(602) 886-1505

Using this data, we obtained the following results

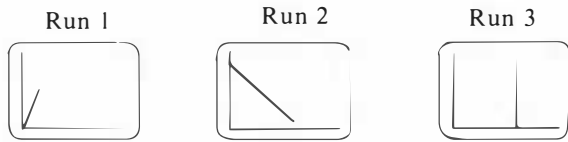

Taking a close look at Run 3, notice that the location of the point 160,160 looks farther from the X axis than it does from the Y axis. To show this more clearly, use the same inputs as in Run 3, but add the following lines to the program.

```
280 X2=0: Y2=160      'DEFINE NEW POINT
290 GOSUB 1010        'DRAW A SECOND LINE
```

When the program is run with the addition of lines 280 and 290, the two lines produced on the screen were measured. The vertical line on my video screen measured 14.7 centimeters and the horizontal line measured 11.8 centimeters.

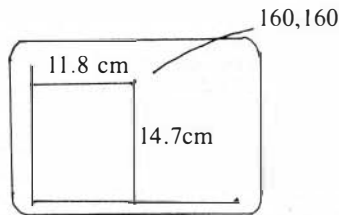

If I should attempt to draw a square with equal X and Y values, the figure would be deformed and would appear as a rectangle with unequal sides. If I want things on the screen to appear as they are mathematically planned, I must correct the deformity produced on my video screen. You should conduct a similar experiment with your video display to find its deformity. My deformity factor can be expressed as a ratio of width to height.

$$D = \frac{11.8}{14.7} \approx 0.8 \text{ for my screen}$$

If I multiply the Y coordinates used for graphics in my program by 0.8, the corrected values should create the desired appearance. This can most easily be done in line 1010 of the *DRAW* subroutine.

```
1010 Y1=181-.8*Y1: YT=Y2: Y2=181-.8*Y2
```

When the program is run with this change, I see:

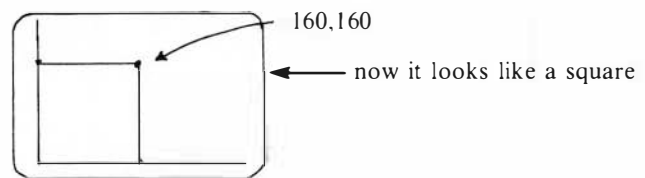

EDUCATIONAL SOFTWARE
For the Color Computer

TOM MIX SOFTWARE

3424 College N.E.
Grand Rapids, MI 49505
(616) 364-4791

CLOCK-With the ever increasing use of digital clocks, more and more young people are unpracticed in the use of the "ANALOG" clocks. You remember those, the ones with the hands. This program will attempt to teach the relationship between the two types of clocks.

REQUIRES 16K EXT. BASIC \$14.95

SPELLING TEST is designed to give a standard oral spelling test using the audio track of the computer's tape recorder to dictate test words and sample sentences. Student responses are typed on the keyboard and checked by the computer. Results are displayed on the screen and (if connected) on a printer.

REQUIRES 16K EXT. BASIC \$19.95

MATH DRILL is a program designed to help children to practice addition, subtraction, multiplication, and division skills on the COLOR COMPUTER. It has several features that make its use particularly attractive.

- Up to 6 students may use the program at the same time.
- Answers for addition, subtraction and multiplication are entered from right to left, just as they are written on paper.
- Commas may be included in the answers.
- Partial products for the multiplication problems may be computed on the screen.
- Division answers that have a remainder are entered as a whole number followed by the letter "R" and the remainder.
- There are ten, user modifiable, skill levels.
- A "SMILEY FACE" is used for motivation and reward. Its size increases relative to the skill level.
- Skill levels automatically adjust to the student's ability.
- A timer measures the time used to answer each problem and the total time used for a series of problems.
- After a problem has been answered incorrectly the correct answer appears under (above in division) the incorrect answer.

REQUIRES 16K EXT. BASIC \$19.95

WORD DRILL is designed to give a multiple choice vocabulary quiz. Words and definitions are entered into the program from the keyboard or from a tape file. The computer displays a randomly chosen definition and eight word choices. The student must enter his response before a built in timer reaches zero.

REQUIRES 16K EXT. BASIC \$19.95

**EDUCATIONAL PACKAGE — SPELLING TEST —
WORD DRILL — MATH DRILL — ESTIMATE —
ALL FOR — \$69.95**



• ADD \$1.00 POSTAGE & HANDLING • TOP ROYALTIES PAID •
MICHIGAN RESIDENTS ADD 4% SALES TAX • LOOKING FOR NEW SOFTWARE

ESTIMATE is a program designed to help children to practice estimating the answers to addition, subtraction, multiplication and division problems on the COLOR COMPUTER. It has many features that make its use particularly attractive:

- Up to 5 students may use the program at the same time.
- There are 5, user modifiable, skill levels.
- The acceptable percent error may be changed as a student's skill improves.
- A timer measures the number of seconds used to answer each problem and the total time used for a series of problems.
- If a problem has been answered incorrectly, the student is told the percent error and asked to try again.
- If a problem is answered incorrectly a second time, the student is told the correct answer and the range of acceptable answers is displayed.
- A report is given at the end of each set of problems that includes the number of problems done, the number of problems answered correctly on the first try and the average percent error.
- The (BREAK) key has been disabled so that a child will not inadvertently stop the program from running.

16K EXT. BASIC \$19.95

TEACHERS' DATABASE is a program designed to allow a teacher to keep a computerized file of information about his/her students. There are many features that make this program particularly attractive.

- Information on as many as 100 students (or more) may be in the computer at one time.
- Each student may have as many as 20 (or more) individual items of data in his/her record.
- The program will run from cassette or disk.
- Cassette and disk files are completely compatible.
- The program is menu driven.
- Records may be easily changed, deleted, combined or added.
- Information about students may be numerical or text.
- Records may be quickly alphabetized.
- Records may be sorted by various criteria.
- Records may be reordered (ranked) based on test scores or other data.
- Data displayed during a sort may be printed on a printer or saved on disk or cassette as a new file.
- A full statistical analysis of data may be done and sent to the printer.
- Student test scores may be weighted.

32K EXT. BASIC TAPE \$39.95 DISC \$42.95

Our experimenting with the screen is over for the time being. However, we should change the program so that it is more general. Let's fix it so that it has the capability to draw any number of straight lines with each line joined to the one that preceded it. The second point of each straight line will become the first point of the line that follows. Program lines that have been added or changed are marked with an asterisk.

PLOTTER PROGRAM #2

```

100 REM INPUT END POINTS
110 CLS
* 120 INPUT "HOW MANY LINES";N
* 130 DIM X(N),Y(N)
* 140 FOR Z=1 TO N
* 150 PRINT Z: INPUT "COORDINATE";X(Z),Y(Z)
* 160 NEXT Z

200 REM DRAW AXES
210 PMODE 4,1
220 PCLS1
230 COLOR 0,1
240 LINE(0,181):(255,181),PSET
250 LINE(0,0)-(0,181),PSET
260 SCREEN 1,0
* 270 FOR Z=1 TO N
* 280 GOSUB 1010
* 290 NEXT Z

900 GOTO 900

* 1000 REM LINE DRAWER
* 1010 Q=Z+1: IF Q=N+1 THEN Q=1
* 1020 Y1=181-.8*Y(Z): Y2=181-.8*Y(Q)
* 1030 LINE(X(Z),Y1)-(X(Q),Y2),PSET
* 1040 RETURN

```

INPUTS
N=4

40,20
220,40
200,140
20,120

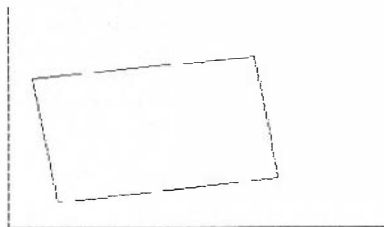

INPUTS
N=3

60,20
220,60
100,140

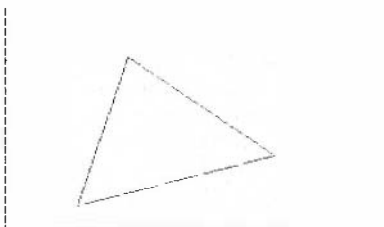

INPUTS
N=5

80,40
180,40
180,120
130,160
80,20

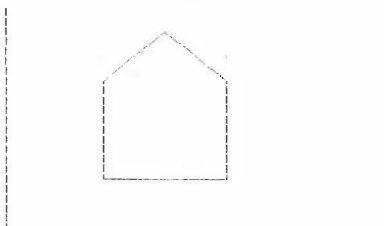

INPUTS
N=6

80,20
180,20
220,100
180,180
80,180
40,100

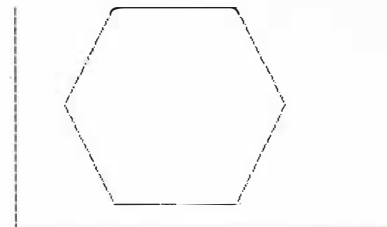

INPUTS
N=5

80,20
140,160
200,20
40,100
240,100

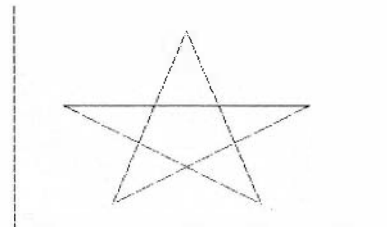

INPUTS
N=9

120,100
120,120
160,120
160,80
100,80
100,140
180,140
180,60
120,60

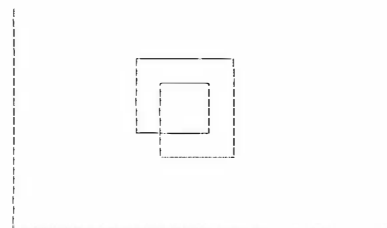

There are many options that you could add to Plotter Program #2. Most apparent are the addition of restrictions to the inputs.

If you are drawing a plane geometric figure, the number of lines (N) must be greater than, or equal to, three. Another major consideration is that the coordinates for the points must lie within the boundaries of the screen. These deficiencies can be remedied with the addition of a few lines in the *INPUT* section of the program.

```

125 IF N < 3 THEN PRINT "I NEED AT LEAST 3 LINES": GOTO 120

```

```

153 IF X(Z) > 255 OR X(Z) < 0 THEN PRINT "INPUT OUT OF BOUNDS — TRY AGAIN": GOTO 150

```

```

156 IF Y(Z) > 181 OR Y(Z) < 0 THEN PRINT "INPUT OUT OF BOUNDS — TRY AGAIN": GOTO 150

```

Another feature that would be useful is to make a new drawing without using the "break" key to re-RUN the program. The INKEY function would work nicely at line 900.

```

900 A$=INKEY$: IF A$="" THEN 900 ELSE 110

```

Watch next month for USING GRAPHICS — PART VI
Rotating Figures



Alphabet Soup: Educationally Nutritious

Alphabet Soup is a CoCo variation of traditional spelling/wordplay games like Boggle and Perquacky. From a graphics "soupbowl," the program ladles out from five to fourteen letters of the alphabet, fewer for more skilled players, more for beginners. The timer starts, allowing up to two hundred seconds for the least skilled players to make as many words as they can from the assigned letters. Each word earns the player the square of the number of its letters, so long words earn higher scores. If a player creates twenty-one words from his bowl of soup, he has cleared the board; trumpets sound, and he receives a new group of letters to work with for the remaining time on the clock. When time has expired, the player is asked to identify words he has misspelled, or words which he cannot define (usually made-up words), and is penalized fifty points per error. Identification of mistakes is left up to the individual player via the honor system or is the responsibility of fellow players. From one to five can play the game, and the program will keep each person's score and remind the players whose turn comes next.

Spelling games of this kind are simple enough that players of many different skill levels can enjoy them, and this program does an attractive job of putting a spelling game on the computer. Clear rules are built into the program, as are warning messages when a player has made certain illegal moves, such as using a letter not part of his soup, or using the same letter twice. Beeps and bleeps abound—including a beeping time clock, tones each time a player presses the keyboard, and snatches of the "alphabet song" and the Campbell's Soup jingle. I personally found the amount of noise distracting and played the game with the sound turned

down, but my teenaged kids, who spend far more time in arcades than I do, had no trouble concentrating on the game. It appeared to me that the sound effects accompanying each touch of the keyboard slowed the response time, as I often typed faster than the program could accept, and words I had typed correctly appeared incorrectly on the screen.

I also found the concept of difficulty level in this program a bit misleading. Level zero players receive fourteen letters to work with and two hundred seconds to find words. The skilled player gets only five letters and ninety seconds. However, I found that when playing level nine I often exhausted the possibilities of five letters quickly, and on the whole, it was much more difficult to find all the combinations available at the lower, supposedly easier, levels. Further, it was just plain more fun to play the game with more letters. I also wished for some sort of "I Quit" function that would allow me to stop playing a round when I had exhausted the words in my "soup;" instead, I had to wait until the clock had ticked off my full allotment of seconds.

The penalty system, a flat fifty points off per error, presents certain advantages to the person who wishes to "take a flier" and gamble with a long word. In fact, any word of more than seven letters will result in a gain in score, regardless of whether the word is spelled correctly.

All in all, my family and I found the game a real delight, and because the game calls on the player to be imaginative in finding words, it is several cuts above some of the "skill and drill" spelling programs I've seen on the market. Although the instruction manual for *Alphabet Soup* makes no substantial educational claims, any youngsters or adults playing the game regularly would, I'm convinced, sharpen their awareness of spelling and vocabulary, especially if it is played with several players. The program is a hearty stock to add to any school or home CoCo program library.

Alphabet Soup requires 16K with Extended Basic. A version for 16K without Extended Basic is also available.

(Creative Technical Consultants, 16-8 Sangre de Cristo,
P.O. Box 652, Cedar Crest, New Mexico 87008. Tape,
\$14.95)

—Stephen Tchudi

Y-PAK Dual Slot Expander for Radio Shack's Color Computer

Have your Disk and Cartridge too!
Select between 2 Cartridge slots with one
switch and control the Auto Start with
the other switch.

\$70.00 Complete

USER-PAK for Color Computer

Your own RAM/EPROM Cartridge

Cartridge holds two 2732s, or any combination
of four 2716s/6116s.

\$30.00 less RAM/EPROM

\$90.00 with 8K RAM

EPROMs burned from your CC cassette.

Write for details.

B. Erickson

P.O. Box 11099 Dept. RB

Chicago, IL. 60611

Submitting Material To the Rainbow

Contributions to *the RAINBOW* are welcome from everyone. We like to run a variety of programs which will be useful/helpful/fun for other CoCo owners.

Program submissions must be on tape or disk and it is best to make several saves, at least one of them in ASCII format. We're sorry, but we do not have time to key in programs. All programs should be supported by some editorial commentary, explaining how the program works. We're much more interested in how your submission works and runs than how you developed it. Programs should be learning experiences.

We do pay for submissions, based on a number of criteria. Those wishing remuneration should *so state* when making submissions.

For the benefit of those who wish more detailed information on making submissions, please send a SASE to: Submissions Editor, *the RAINBOW*, P.O. Box 209, Prospect, KY 40059. We will send you some more comprehensive guidelines.

Please do not submit programs or articles currently submitted to another publication.

80-U.S.

THE TRS-80 USERS JOURNAL

If you own a TRS-80® Model I, Model II, Model III, the Color Computer, or the new Pocket Computer, YOU NEED 80-U.S.!

The 80-U.S. Journal has

programs for your enjoyment and enlightenment. Every issue contains several Basic or machine language program listings. It contains Business articles and program listings. No matter where you are, there is something for YOU in the Journal!

and...

The Journal contains reviews of hardware and software. Our "Evaluation Reports" will help you make the best choice in selecting additions to your system.

Save Over 50%

You can save over 50% off the cover price of *80-U.S. Journal*. For the remarkably low price of *only* \$16.00, a savings of \$20.00 (cover price), you will receive a wealth of useful information every month. As a special **BONUS**, if you enclose payment with your order, you will receive an extra issue for each year of your subscription order. *Order three years of 80-U.S. and receive three extra issues! At no cost to you!*

Is your
TRS-80
Lonely?

Write today for
our

"No Risk Offer"

SEND TO:

80-U.S. Journal
3838 South Warner Street
Tacoma, Washington 98409
Phone (206) 475-2219

Name _____

Address _____

City _____ State _____ Zip _____

Visa/MC _____

Exp. Date _____

1 yr. \$16 2 yrs. \$31 3 yrs. \$45

Please allow 6 to 8 weeks for your first issue.

TRS-80 is a Registered Trademark of the Tandy Corp.

Hold The 'Vaders' First, Editor/Assemblers

By Dennis S. Lewandowski
Rainbow Contributing Editor

It looks as if those nasty vaders will have to hold on for another month! (Sorry.) Toward the latter part of November, I received quite a few letters and phone calls, from people who were typing in the programs. They seem to share a common problem; they were entering them into Basic, or using a monitor program which was totally unsuitable for the task. So for this month we are going back to square one, and introducing the Editor/Assembler. We are going to look at the two most popular Editor/Assembler packages on the market today. The Micro-Works SDS80C, and the Radio Shack EDTASM+. There are differences between the two, and it is the differences which are causing all the confusion. A small note to all the "experts," while this may seem unimportant to you, please try to remember the first time you tried to enter a program in your assembler. There are quite a few people going through that phase now, so let's share with them what we learned the hard way.

What is an Editor/Assembler? It's a program for your Color Computer, which can consist of as many as three parts. The Editor is a text handling program, it will allow you to enter mnemonic (new-mon-ik) instructions into a text buffer, much like entering a program while in the command mode of Basic. First let's insert the ROM pack into the cartridge slot of the computer. *Always* power down your unit, before inserting or removing a ROM pack. If not you will KILL your computer.

To enter the instructions, you must get into the correct mode. In the SDS80C package enter the letter "L" for line insert. With EDTASM+ enter the letter "I" for inset. The SDS80C will tell you which mode it is in using the first line of the screen, while the EDTASM+ will put a line number (usually 00100) on the screen. Here comes the hard part, the main difference between these two packages is that SDS80C is a "line editor," and the EDTASM+ is a "line number based editor." As long as the guidelines of each are followed, either one is an excellent choice. To enter a line in the SDS80C, or the EDTASM+, imagine that you are entering data into a FOUR column pad. The first column contains the label, since there are no *GOTO*, or *GOSUB* statements in assembly language, the label marks a point in the text for reference. The second column of this pad contains the mnemonic, or operational code, for that line. The mnemonic is the action the CPU must take when it runs the program. (Just to keep the record complete, a mnemonic is also referred to as an OP-CODE, and INSTRUCTION.) The third column of the pad contains the data field. This field can contain a variety of things, a register, number, address, or even nothing. The fourth column is left for comments; many programmers will enter hundreds of programs without ever using this column. Others won't allow even one uncommented line. A difference between the

two packages is that the SDS80C will only allow 32 characters per line for *all four* columns, the EDTASM+ will allow up to 128. The screen will break up the line, but the EDTASM+ will always look at it as one line.

To insert text, type in the word START with the SDS80C, and press the space bar to move to the next column. Using EDTASM+ press the right arrow key. The cursor should jump about three spaces in either package. Type in LDX—this is the mnemonic for loading the X register, the action of this line. Again press the space bar for SDS80C, or right arrow for EDTASM+. Now type #0400. This is the data of this line. Get to the fourth column by pressing the space bar or arrow, and type LOAD X. Now all four columns contain some text, so press *ENTER*. In SDS80C, the cursor will move to the next line. In EDTASM+ another line number will be displayed. Pressing the Break key will return you to the command mode with either package, so do that now.

When we started, I said Editor/Assembler; now, what's an Assembler? Again, it's a program for the computer, however, this one takes the text we just typed in, and converts it into a machine language program. Let's try it and see. For the SDS80C press the "@" key, then LS and *ENTER*. You will have to press the space bar rather quickly after pressing *ENTER* or the listing will scroll by before you can see it. With EDTASM+ just type in A/WE/NO and press *ENTER*. Don't worry about the error right now. What have we here, more columns? Yes, both packages have produced a "source" code of the line we entered. Here is what my screen displays:

```
0001 0600 8E0400
START LDX #0400 LOAD X      (SDS80C)
```

```
0000 8E 0400 00100 START
LDX #0400 LOAD X      (EDTASM+)
```

Starting with the SDS80C output, the first column contains the line number, this line number is just for our reference. The second column contains the address in RAM memory that this would occupy if it were a valid program. The third column contains the actual CPU code and data of the text we entered. The second line on the screen is the text we entered still in column form. The EDTASM+ did basically the same thing, yet slightly different. The first column here contains the address of RAM memory. The second contains the CPU code. The third contains the data. This is followed by the line number and text we entered. This slight difference has caused many computer owners to throw up their hands, and ignore assembly language due to the inconsistencies of listings in magazines. *Most* listings are *source* code. Source code is the text, or text and code listing sent to the printer from the assembler. When you type in an

Two more "good'uns" and only from ZETA SOFTWARE

MUSICAL LIGHTS (16K either BASIC).....\$14.95

A real-time sound "imager" written in Machine Language. Use your cassette recorder to play audio/music tapes or pick up voice input to produce sound displays in any of the 80C's nine 8-color modes---graphics, semigraphics, and alphanumeric. Lineprintable results in either resolution mode. (LORES version, 4K either BASIC, is only \$7.95) Features include PAUSE, STEP-CAPTURE, COLOR and CHARACTER CONTROL, and MODE SELECTION. Booklet gives you a BASIC program to merge MUSICAL LIGHTS 16K and a HIRES print routine.

GRAPH16/32-Cassette and 32-Disk still available. Write or call for free catalog of ZETA products. Also ZX80/81 & TS1000

ZETA SOFTWARE
P.O. BOX 3522
GREENVILLE SC 29608

ASTRONOMY 1.....\$24.95

32K-Cassette Extended BASIC by David Eagle. His five most useful programs in BASIC for the SWTP, now available for the 80C in one program: LUNAR, PLANETARY, SOLAR, STAR, and COMET. All sections calculate positions in Azimuth/Elevation and Right Ascension/Declination for your convenience. Results are lineprintable before you go out to set up your telescope OR you can take your 80C and red-filter TV with you and have fast, cosmic positions at your fingertips. Most sections also give you distance.

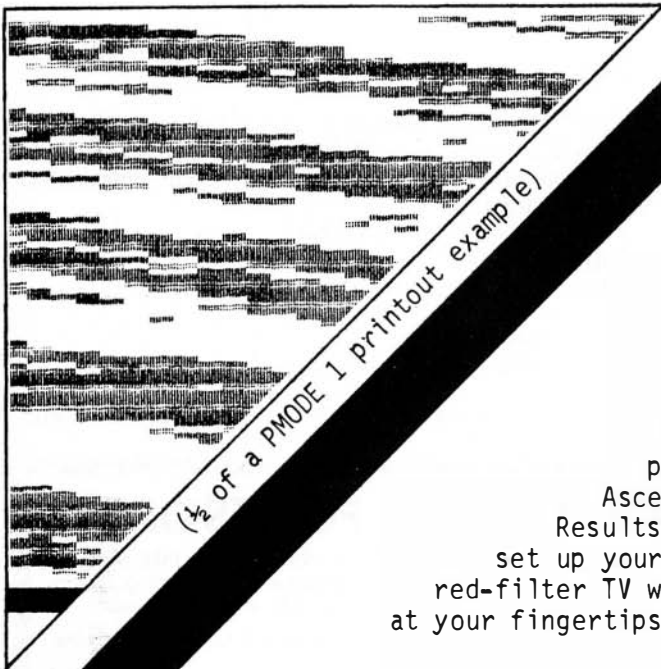

Clip or copy Order Blank and mail with payment.



Do you produce or publish 80C programs? Write or call for information package on CUSTOM printed keyboard overlays.

ZETA SOFTWARE (803)246-1741 1-9pm EST

Please send: MUSICAL LIGHTS 16K @ \$14.95
 MUSICAL LIGHTS 4K @ 7.95
 ASTRONOMY 1 32K @ 24.95

To: _____

_____ ZIP _____

Enclosed is _____ + \$2.50 S&H = \$ _____
 US funds only. No CODs or charge cards.

assembly language program you will ignore the RAM addresses and CPU codes, just entering the text. The text always starts with the label column. Save the source code using the W command, for write, in both SDS80C and EDTASM+. Both will allow you to assemble a program in memory, and execute it. Wait! Always save your source code first. If there is a bug in the program five will get you ten that it will clobber your text, or hang up the computer.

Both SDS80C and EDTASM+ have monitor programs built in. SDS80C has ABUG, while EDTASM+ has ZBUG. What's with all the bugs? Well, working with assembly language, you will encounter a problem or two. Once the source code is assembled, there are no syntax errors, just hang-ups, and garbage. Careful use of a monitor program may be able to pinpoint a problem. Both manuals cover the use of the monitor rather well. So we shall move along to the reason I brought them up. If you see a listing like this:

```
A000 A1 C1 A2 82 A7 7C A7 0B
A008 A7 F4 A9 DE A7 D8 10 CE (SDS80C)
```

or this:

```
A000/ 0A1C1
A002/ 0A282
A004/ 0A77C
A006/ 0A70B (EDTASM+)
```

you are looking at the output of a monitor program. If you encounter a listing like this, simply type in the second column at the memory location contained in the first column. This output is known as machine code or object code. It is the actual program as the CPU sees it. True, it's not as nice as assembly source, since no comments can be placed, but if typed in accurately, the program should work.

Now, about differences, true source code is typically portable—meaning it should work in any Editor/Assembler. However, certain functions will vary from one to the next. Using the pseudo-op NAM NAME into SDS80C, will cause the object code to be written to tape with that filename. (A pseudo-op is an operation code for the assembler rather than the CPU.) Yet enter NAM into EDTASM+, and you will get an error. Using EDTASM+ you would enter A NAME while in the command mode to write the object code to tape using the filename NAME.

Another pseudo-op which differs is FCB or FDB. Using SDS80C you can enter:

```
FCB $80,$81,$82
```

while EDTASM+ will only accept it:

```
FCB $80
FCB $81
FCB $82
```

When entering strings, or text, you wish outputted:

```
SDS80C
FCC UPTO 21 CHARACTERS PER LINE
EDTASM+
FCC /UPTO 121 CHARACTERS BETWEEN
SLASHES/
```

How about where the program will start and execute:

```
SDS80C
ORG $600 (optional)
EDTASM+
ORG $600 (mandatory)
```

If the ORG, for "originate," statement is left out of the SDS80C package it will assume \$600. EDTASM+ will assume \$0000, which when loaded will clobber the pointers maintained by ROM in low memory, causing the computer to hang up.

```
SDS80C
END (as last line of text)
EDTASM+
END START (mandatory)
```

SDS80C will assume \$600 as the start of the program, unless it is ORGed elsewhere, or END START is used. EDTASM+ will assume \$0000 as the start of the program, unless END START is used.

```
SDS80C
ORG $600
ORG $E00 (multiple ORG used)
EDTASM+
ORG $600
ORG $E00 (multiple ORG used)
```

SDS80C will fill the memory between \$600 and \$E00 with

ARE YOUR WALKING FINGERS GETTING FOOTSORE ?

Tired of typing in those long, but wonderful, programs from each issue of **the RAINBOW**? Now, you can get **RAINBOW ON TAPE** and give those tired fingers a rest. With **RAINBOW ON TAPE**, you'll be able to spend your time enjoying programs instead of just typing...typing...typing them! All you need to do ever again is pop a **RAINBOW ON TAPE** cassette into your recorder, CLOAD and RUN any one you want.

RAINBOW ON TAPE is available as a single issue for \$6.50 or on a yearly subscription basis for only \$60. It is the perfect complement for **the RAINBOW** itself.

VISA, MasterCard and American Express accepted. All subscriptions begin with the current issue and back issues are available beginning with April, 1982. Subscriptions are sent first class mail to coincide with the arrival of your current issue of **the RAINBOW**.

The RAINBOW
9529 U.S. Highway 42
P. O. Box 209
Prospect, KY 40059

YES! Sign me up for **RAINBOW ON TAPE**. I want:

___ A Full Year for \$60 ___ A month for \$6.50 (Specify Month _____)

Name _____

Firm Name _____

Address _____

City _____ State _____ Zip _____

Payment Enclosed Charge my VISA account Charge my MasterCard account Charge my American Express account

Account # _____ Signature _____ Card Expires _____ Interbank # _____

\$3F (code for SWI) rather than update the loading address of the code. EDTASM+ will update the loading address of the code, and not overwrite the memory in between. This is a very handy feature, and certain programs written using it cannot be duplicated in any other method.

Well, I'm sure I have overlooked a multitude of other differences but that's it for this month. If you have another brand Editor/Assembler you will have to figure out its compatibility with listings in magazines. The best method is trying out a strange op-code and seeing what happens. If it doesn't work you can always delete that line of text. There seems to be as many Editor/Assembler packages out today as there were STAR TREK games in the early days of the Model I. Yet not one has a good step-by-step tutorial similar to the Basic manuals provided with the 80C. I know how easy it is for a programmer to assume the end-user is well versed in the operation of the software he has just written. That's the reason I write these articles—to share my experiences with you, so you won't lock a fun and useful computer in the closet with the video game.

(Mr. Lewandowski, an experienced assembly language programmer and teacher, is president of DSL Computer Products.)



Software Review...

Reviewer Praises ROML As 'User-Friendly Magic'

My cassette recorder has become rather dusty since I got my disk drive. With it I can load and save programs at mach 5 speed compared to tape. But what if I get the urge to load one of my machine language games that clobbers the disk system? No problem, I just shut off my CoCo, remove the disk controller, turn CoCo back on, and wait a minute or so for the program to load. Naturally, I have to reverse the process when I want to use my disk again. By now you might be saying to yourself, "there has to be a better way." Well, as you might have guessed by now, there is. Enter ROML. With this package you can load and save these programs from disk as if they were designed with the disk system in mind. Also, if you have 64K, you can load and save ROM Packs from disk as well. If you're still with me, let's find out how ROML really works. After all it does sound a little hard to believe.

When you load ROML it auto-executes and asks you for the name of the program to be loaded. You then type in the name and hit ENTER. It then asks you if the program is to be loaded from tape or disk. Wait a minute! If the program is going to clobber the disk system, how can I load it from disk? What a dumb question. Obviously I don't have any of these programs on disk, so I told ROML to load from tape. After the program is loaded, you are informed that your disk ROM has been disabled. What next? At this point I'm really beginning to wonder about ROML. The screen now has the start, end, and execute addresses of the program I just loaded, and I'm being told to "hit any key to start program." I'll try almost anything once, so I hit ENTER. Much to my amazement, the program is working just like it did before I got my disk.

Now I'm impressed. But what about my disk ROM, and what about loading from disk? A quick glance at the documentation answers these questions with ease. First, I hit the reset button and disk Basic signed on as usual. Then, I loaded the "TAP2DSK" program which is supplied along with ROML. There is no mention of how to use

"TAP2DSK" in the documentation, but the program is asking me for a name as did ROML. After entering the name, the program is loaded, and you are prompted to insert a disk into your drive and hit ENTER. After the program is saved to disk, you can exit "TAP2DSK" or load another program and repeat the process. Now comes the best part of all. Load ROML and tell it to load your program from disk. As you might have already guessed, the program works after being loaded from disk just like it did without the disk. A pretty swift piece of work if I do say so.

One of the additional features of this amazing package is for those of you with 64K. With it you can save and load your ROM Packs from disk just like you would any other program. I was unable to verify this feature, but I have no doubt that it works. Although this package will benefit disk users the most, those of you with 64K and no disk can still use ROML to save and load your ROM Packs from tape.

Loading and running ROML could not be easier. The program always lets you know what it is doing and what it is that you should be doing. The programs are so user-friendly that you can read the documentation once and then forget it exists. The documentation includes a section describing how to save your ROM Packs to tape, a section on testing your 64K, and a section describing how to move the Basic ROMs to RAM and run Basic from there if you have 64K.

If you're like me and can't stand waiting for those tapes to load, then this package is for you. It is well written, easily understood, and it works like magic. I think it is done with mirrors.

(Micro Technical Products, Inc., 814 W. Keating Ave., Mesa, AZ 85202, \$29.00 disk, \$25.00 tape.)

—Gerry Schechter

COLOR COMPUTER WEEKLY

NEW!

CAN YOU AFFORD \$1 A WEEK?

The CCW Newsletter will give you this if you can:

- An issue loaded with program listings of all sorts (for just a buck a week—unbelievable!)
- Latest news and information — if it happens on Monday you'll know about it by Friday (for a mere 100 cents a week!)
- Mailed out to you first class every week! (At last a reason to live from week to week!)
- Free software/hardware manufacturer's directory (This alone is worth the price of the subscription, and we even send regular updates to subscribers.)!

All it takes is ten thin dimes a week to bring meaning to your life. Cumulatively we'll take payment in the following ways:

- Charge my Visa or MasterCard at once for the full amount (\$52/year)
- Charge my Visa or MasterCard quarterly at the rate of \$13 every three months
- Here's my check for \$14 for the first quarter, bill me in three months for the next quarter (we have to charge you extra to send out those bills)
- Here's my check for \$52 for the full year hurry and send me my first issue

Name _____
 Address _____
 City _____ State _____ Zip _____
 Visa MC Exp. Date _____ # _____
 Tiny Signature _____

Send to: CCW • P.O. Box 1355 • Boston, MA 02205

This Program Will Supersaturate Your Memory

Do you need more memory, but don't have the money to expand to 32K or 64K? Or, if you're like me and just don't want to be without your CoCo, even for the time it takes for a simple conversion, then this program may be just what you need. Yes, that's right, with *Virtual Memory Loader*, you can produce programs that are two, three or more times larger than the memory of your Color Computer. And by using just your standard recorder, too.

How can that be? *Virtual Memory Loader*, which is really two programs, uses an "overlay" system, and with the insertion of a couple of lines to call a new overlay over the old one, in almost all cases, the variable values are retained from one overlay to the next.

For test purposes, I made a first overlay containing the assigned variables, and then used a second overlay to draw and write simple statements. For example, circle (a,b),c would be in the second overlay, without any values assigned in that particular overlay.

I then broke and listed my program: lo and behold, all lines from my first overlay were gone from my listing. But don't *break* if you want to retain your variables in memory. Typing *CONT* does not let it work without the variables from the previous overlay. Simple assigned string variables are not carried over, either.

To use *Virtual Memory Loader*, first *CLOAD* Loader-1, which is the basic part of operation. List it, and you will see that it contains only three lines. Don't change or overwrite them. The spacing in Line 1 is critical to the operating procedure. All you need to do now is write your program in

the normal manner. When you get near the end of your memory, add the following line: *Z\$*="the name of the overlay up to 8 characters":*GOTO2*. *CSAVE* it with Loader-2. Now, if you don't have Loader-2 in memory add it in and then *EXEC 1728*. You should now see the copyright statement and *PCLEAR*. Although the cursor is not seen, *INPUT* the amount that you *PCLEARed* in your program. Striking *ENTER* is not necessary. Striking *ENTER* without inputting a value defaults to 4. Using any value other than that used in your program will result in an error message.

Next you will see *RAM*. *INPUT* either 16 or 32. If you have 64K enter 32 since the upper 32K is inaccessible under normal operation. Now you will see *END* followed by a number. Copy this number and make sure that none of the overlays are higher, it can lead to problems. Here is your last prompt: *NAME* .Enter the name you gave to *Z\$*. Now check your recorder to save the program when you push *ENTER*. *ENTER* must be pushed this time. This gives you a machine language save of your overlay. If your recorder wasn't ready don't worry you can still save the program.

Virtual Memory Loader comes with four pages of instructions, including hints, tips, suggestions and details of what must be included in each overlay.

The only part that really gave me any trouble was that I missed making a normal *CSAVE* of the first portion of my test program. The use of Loader-2 saves in machine language. If your program has been put together properly, only one *CLOAD* is necessary, no matter how many overlays you may call up.

What I really like about *Virtual Memory Loader* is that it is fairly simple to use. It will let the programmer produce programs larger than his computer's memory. And best of all, it is not needed to use a program that was made with it.

Virtual Memory Loader needs at least 16K and Extended Basic. I'll be watching the pages of this magazine for ads of programs 48K or larger for my computer, so get busy all you programmers out there!

(Little Bits Computing Services. P.O.Box 396, Hibernia, N.J. 07842, \$12.95)

—Willis Bish

DESERT SOFTWARE					
PRICKLY-PEAR SOFTWARE 15% OFF ALL LIST					
Viking*	19.95	16.95	Astrology*	34.95	29.95
Gangbuster	19.95	16.95	Great Word Game*	19.95	16.95
Football	19.95	16.95	Household Helper	19.95	16.95
I Ching	19.95	16.95	Math Pack 1	19.95	16.95
Numerology	19.95	16.95	Pre-Read	24.95	21.94
Tarot	19.95	16.95	Song Book (w/tapes)	29.95	25.95
Trilogy (I Ching, Numerology, Tarot)	39.95	33.95	Fantasy Games Pk	19.95	16.95
Phonics I	24.95	22.45	Fantasy Games Pk 32K	24.95	21.95
8-Bit Bartender	19.95	16.95	Phonics II	24.95	22.45
			Las Vegas Weekend	24.95	22.95
Sugar Software					
Silly Syntax	19.95				
Additional S.S. Tapes	9.95				
Fairy Tales					
Sing Along					
X-Rated					
Current Events					
Adventure					
Potpourri					
Auto Run	14.95				
TIMS (32K)	24.95				
Aardvark Products					
Haunted House	9.95				
Killer Bot	13.95				
Labyrinth	14.95				
Starship Herc.	14.95				
Time Trek	14.95				
Escape from Mars	14.95				
Pyramid	14.95				
Quest	14.95				
Trek Adventure	14.95				
Circle World	14.95				
Nuclear Sub	14.95				
Venture	19.95				
Tiny Compiler	24.95				
Tube Frenzy	19.95				
Derelict	14.95				
Caterpillar	19.95				
Space Battler	12.95				
Golf	9.95				
Catchem	19.95				
Special Introductory Price!					
Dairy Educational Software (For Pre-school)					
Shapes			9.95		
Letters			9.95		
Numbers			9.95		
Big, Bigger, Biggest			9.95		
All Four			@ 34.95		
Eigen Systems					
Basic Aid (cart.)			34.95		
Stripper			7.95		
ccead			6.95		
B5 Company					
Clock			24.95		
Money			19.95		
Math Fact			16.95		
ABC's			9.95		
SPECIAL!!					
64K RAMS Set of 8			54.95		
Terms: Cash, money order, your personal checks welcome. No waiting to clear. Shipping - \$1.50 per order except where noted. Arizona resident add 4% sales tax. We reserve the right to change prices without notice. All programs 16K Ext. except where noted. *VIC-20 compatible. State computer when ordering.					
Desert Software					
P.O. Box 502, Cortaro, AZ 85230 • (602) 744-1252					

Dice Is Simple, Straightforward

Board games are easier to play, thanks to *Dice* by Q-Soft. Do you like to play board games? If you are like me, you do, but when you dig the game out of the cluttered closet, you examine it only to find that the dice are missing. So, what is a person to do? I'll tell you how to solve this problem. There is now a high resolution, random dice thrower program, by Q-Soft that is excellent as far as graphics, sound and overall appearance is concerned. The program is not well documented, but it's pretty much self-explanatory on how it works. You just load and play. Hitting the space bar, or any key for that matter, will trigger a roll of the dice. That's it. Straightforward, no-nonsense.

Dice could be useful in helping young children learn to count, but primarily its usefulness is as an adjunct to other activities.

Dice is in 16K ECB. If you would ask me if you should buy it, I'd say yes you should.

(Q-Soft, 1006 Robinhood Drive, Painesville, Ohio 44077, \$5.95 for cassette)

—Mike Erdy

THE COLOR COMPUTER SPECIALISTS

COLORFORTH



MOVE UP FROM BASIC! Forth is a new, high level language available now for the color computer. **COLORFORTH**, a version of fig FORTH, has an execution time as much as 10 to 20 times faster than Basic, and can be programmed faster than basic. **COLORFORTH** is highly modular which make testing and debugging much simpler. **COLORFORTH** has been specially customized for the color computer and requires only 16K. It does not require extended Basic. When you purchase **COLORFORTH**, you receive both cassette and RS/DISK versions, the standard fig EDITOR and an extensive instruction manual. Both versions and manual, all for only \$49.95

ARMADILLO BUG MACHINE LANGUAGE MONITOR

"Armadillo Bug" is an excellent system for beginners to learn to write and debug machine language programs. This package includes: memory examine and change; move; punch and load; fill commands; and more! Does not require extended Basic. Runs in 16K. Comes complete with printed manual.

Just \$14.95

BIORHYTHMS

A neat little program you can use to chart the future (or past). Hi-res graphics without extended Basic being required. Runs in 16K. You will be impressed! With instructions, only \$10.95

OTHER ITEMS OF INTEREST

"Starting Forth", a book by Leo Brodie. The best introductory Forth text available. 384 pages. Soft cover \$16.00

"Computers Piss Me Off". Wear the official programmers badge. Large 2-1/4 inch yellow button says It all! \$1.50

"I ♥ My Color Computer". White button with black lettering and red heart. 2-1/4 inches. Only . . . \$1.50

DEALER AND AUTHOR INQUIRIES INVITED

All items are post paid in U.S. Texas Residents add 5 percent

Armadillo Int'l Software

P. O. BOX 7661
AUSTIN, TEXAS 78712



PHONE (512) 459-7325

Adventure Round-Up

By Jim Reed
Rainbow Managing Editor

"You are standing on a busy eight-lane highway during rush hour."

"What do you want to do?"

Is "pray" a CoCo command?

You find yourself in the dangdest places in computer Adventure games. Sometimes any action seems to be the wrong one. At other times, it's crazy not to take action. As I recall, in *Escape from Sparta*, one of the *Rainbow* Adventure Contest winners, my first try began immediately with a robot shooting at me. I hit "N" for North about eight times before stopping to catch my breath in that Spartan atmosphere.

After playing each and every game in the *Rainbow* Adventure Contest several times, and the better ones many times, I feel like an old warrior. Yessir, I have a lot of war stories. My campaign medals are numerous, too. Purple hearts galore, and if there were a special medal for dying in action, I'd have hundreds. Trouble is, there was usually not enough left of me to pin a medal on in these armchair-keyboard battles.

We, here at the *Rainbow*, were so impressed with the variety of styles and types of Adventures in our contest, mostly non-graphic, that we've decided to publish a compendium of the best in book form. We're already

working on it, in fact. Books take a while, though, so, in the meantime, let's reflect on some of what we've learned, and share these behind-the-scenes conclusions, not only with our entrants, but with everyone who is "into" Adventure games.

Our judges were recruited from varied backgrounds. Some judged only a game or two, while the "core group," who took a crack at most everything, consisted of a pharmacist who has a definite violent streak, a psychiatric researcher who loves kitty cats, an interior designer who loves giant dogs, an aging Frisbee freak, a nationally-active "No Nukes" demonstrator with jail time to prove it, and yours truly, just a normal all-American guy with no hangups at all, except a tendency to seek out weird people.

That our oddlot assortment of judges spoke with such unanimity in their collective conclusions gives, I believe, a measure of validity to the observations which follow, and which should be helpful to those who are going to enter our *Rainbow* simulation contest.

First observation: those entries with extensive, well-written documentation scored highly. Our two top winners, *Sir Randolf of the Moors* and *Dungeon Adventure*, both had several pages each of instructions, hints and other helpful information. We were most taken with those entries which had on-screen instructions, but which were also backed up with narrative introductory material and notes to improve scores. A number of games were very good, once we learned what to do by trial and error, but gave us no small amount of frustration in just getting started because of lack of documentation. Yes, programming takes hours and hours of days and weeks over months and months, and the software is the centerpiece of your creative work, but please give due thought to the total package.

STOP- THE MERZOID INVASION

BEFORE THEY PLUNDER AND DESTROY the HOMEWORLD COLONIES. ONLY THE STAR-BATTLESHIP "OMEGA" STANDS A CHANCE

GAME FEATURES: MOVING ENEMY SHIPS, COMPUTER GALAXY MAP, SYSTEMS DAMAGE, COMMUNICATION WITH ENGINEERING, ENEMY FLAGSHIP ON 32K VERSION

REAL-TIME ACTION (WITH SHORT PAUSES TO LET YOU GIVE COMMANDS). USE LASERS AND SPACE-TORPEDOS TO DESTROY THE ENEMY...!

16K NON-DISK VERSION SIMILAR TO 32K NOVICE LEVEL. BOTH VERSIONS ON SAME TAPE OR SPECIFY DISK.

16K OR 32K

MASTER

DISK SYSTEM

THE EDUCATED DISK FILE AN INCREASING NUMBER OF DISKS WITH MANY PROGRAMS OR FILES LEAVES YOU GUESSING "WHERE DID I PUT THAT FILE?!"

5 SEARCH METHODS! LIST EMPTY DISKS. LIST ALL FILES ON A CERTAIN DISK. LIST ALL FILES ON ALL DISKS. LIST DISK NAMES AND NOS. FIND A TARGET FILE NAME ON ALL DISKS.

RECOVER DIRECTORY CRASHES OF ALL DISKS FILED UNDER A MASTER... 32K SORT INCLUDED- SELECT SCREEN OR PRINTER WE USE THIS PROGRAM OURSELVES, IT WILL EASILY BE YOUR MOST IMPORTANT PROGRAM! FILE 100 DISKS PER MASTER - 25,000 PER SYSTEM

MASTER DISK SYSTEM \$29.95

STAR PILOT

\$19.95



SAVE

THE PRINCESS FROM THE

EVIL TROLL...

SURELY, IN ALL THE KINGDOM THERE IS ONE BRAVE FIGHTER SMART ENOUGH TO CONQUER THE SECRETS OF THE MAZE... A GRAPHICS GAME? **BOTH!** A WORD ADVENTURE? **BOTH!** TO ESCAPE THE MAZE IS THE TRICKY PART; CAN ONLY BE DONE WITH CERTAIN MAGIC ITEMS.

THE GREAT DUNGEON MAZE

SORRY-32K SYSTEMS ONLY - DISK OR TAPE **\$27.95**



PROGRAMMER'S GRAB BAG

JUST OVER ONE DOLLAR EACH - IN PACKAGE DEAL

ASSORTMENT OF PROGRAMS MOSTLY UTILITIES FOR DISK, TAPE, PRINTER, ETC. INCLUDING RIGHT-TO-USE SUBS, DISK REBUILD AND MANY MORE!

OTHER VENDORS SELLING INDIVIDUAL PROGRAMS AT MORE THAN COST OF THIS WHOLE PACKAGE! **\$29.95**

SOME ARE WINNERS - SOME AREN'T. DISK CATALOG ON TAPE + 2 BONUS PROGRAMS \$ 3.99

Circle City Software

P.O. Box 30166 • INDIANAPOLIS, IN 46220
SOFTWARE FOR COLOR COMPUTER AND TDP SYSTEM 100

COMPUSERVE
EMAIL NUMBER
E11645,5147

FIRST ANNIVERSARY SPECIAL

That's right people, we have been in business for one year. Hence we are having a first Anniversary special. Snake Mountain Software is proud to announce a new line of products. We are going into the cartridge business. Our cartridges are very similar to Radio Shack's cartridges. Prices good through Jan. 31, 1983.

PROGRAMS

An enhanced version of the Solution on a cartridge. \$29.95

HARDWARE

A cartridge case and PC board with a socket. Accepts either a 2716 or 2732.

CUSTOM CARTRIDGES

You send in a program, we send you back a cartridge with a program in it. We can do either Basic or ML programs. Prices start at \$19.95. Send for complete details.

GRAPH LABEL

Have you ever wanted to place characters on a graphic screen but couldn't find an easy way to do it. Well then **GRAPH LABEL** is for you. This program will enable you to place characters anywhere on a graphic screen. It will place any of 96 ASCII characters on the screen or you may create your own characters. It features a cursor that may be moved anywhere around the screen with out rubbing out what it goes over. Superscripts and subscripts may be used since the cursor may be moved vertically and horizontally in steps as small as one pixel. Lowercase characters have descenders. **GRAPH LABEL** is written in Basic and is therefore easy to modify. It may be used by itself or as a subroutine. **\$8.95**



PILOT is a language which enables people with little knowledge to write educational programs. The language uses simple one or two letter commands for program functions.

SUPER PILOT

An enhanced version of Pilot for use with Extended Basic. Includes features for math, graphics, and sound. Has a feature that makes it easy to create flash card type drill programs. Programs are pseudo compiled for faster execution. Comes with a 24 page tutorial manual and demo programs. Sample program included on tape to get you started. **\$12.95**

SCRIPTFIX

An ML program that enables Color Scriptit to have true upper and lower case characters—none of the reversed upper case characters. Features solid green background and all normal Scriptit functions. No decrease in typing speed. Please specify your machine type when ordering. **\$9.95**

DISCOUNT — order 10 or more programs (you may mix types) and you will receive a 30% discount on the order. Dealer discounts are also available.

SNAKE MOUNTAIN SOFTWARE
P.O. BOX 5722
RALEIGH, NC 27650

919-828-6669

Congratulations

you made the right choice when you purchased a Color Computer. It is a very powerful machine. However the standard display format does not do the machine justice. The machine is capable of much more than 16 lines of 32 all capital characters. Now you can give your Color Computer the display it deserves. **THE SOLUTION** gives the Color Computer a much better display than it normally has, and really makes the machine shine. Its features include:

- provides a screen of **42 characters** by 21 lines displayed
- linked directly to basic — program is transparent to the user
- prints all 96 ASCII characters, lowercase characters have descenders, has a slashed **zero** to avoid confusion when programming
- prints characters on any two-color graphic screen
- graphics and text may be intermixed on the same screen
- special mode with 4 lines of text at the bottom of the screen (just like some other famous color machines) — great for working with graphics
- large character mode for small children or the visually impaired
- character set may be reversed
- written in machine language, program is relocatable
- fast — prints at over 600 characters per second
- works with both cassette and disk
- includes a 20 page manual with demo programs (a lunar lander program is included)

SOLUTION \$14.95

EXTENDER

Still want more than 42 characters per line from your computer. Then the **EXTENDER** is for you. This program when used with **THE SOLUTION** will give a display of 51 characters per line by 21 lines displayed. Please include your program serial number when ordering. **\$7.95**

SCREEN PRINT PACKAGE

A package of 2 programs for use with the LPVII, LPVIII, DMP100, DMP200, DMP400, DMP500. The programs will print an image of what is on a graphic screen to the printer. Both programs work with all the standard PMODEs. The programs are written in machine language and may be moved anywhere in memory. The two programs are:

1) **SCREEN PRINT** — will produce a regular size print. The image may be located anywhere on a page.

2) **DOUBLE SIZE SCREEN PRINT** — this program will produce a full size image that will fill up a sheet of paper. The finished product is 8 by 6.5 inches in size. Your computer graphics look really good when they are printed out with this program. **\$4.95**

All programs for 16K, 32K Extended Basic machines unless otherwise noted. All programs on cassette. Add \$4.00 per order for disk.

SHIPPING — add \$2.00 for orders less than \$20.00. Shipping is free on orders of more than \$20.00.

Canadians — please send money orders only.

Phone C.O.D. orders accepted.

All orders shipped within 5 working days.

DONKEY KING

(C) 1982



32K Machine Language

\$24.95 TAPE

\$27.95 DISK

ARCADE ACTION

This game contains all 4 screens like the popular arcade game. The actual screen photos shown are only 2 of the four contained in this program.

Actual T.V. Screen Photos.

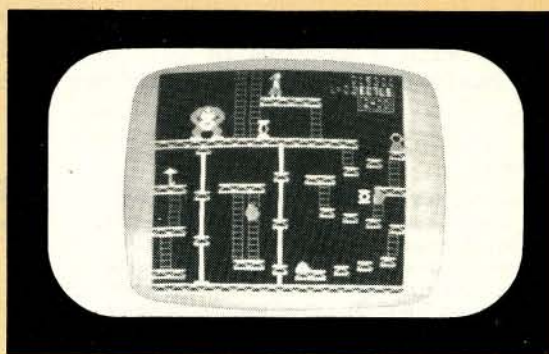

How high can you climb?
Plays like the popular arcade game!

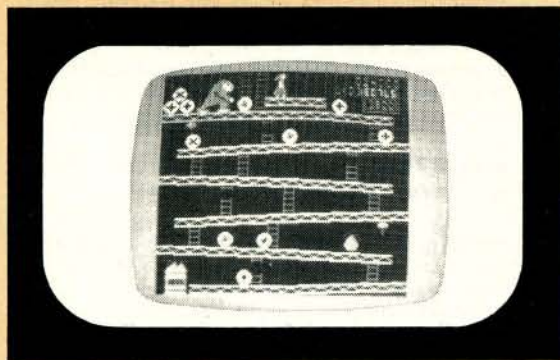

Four full graphic screens. Exciting sound and realistic graphics. Never before has the color computer seen a game like this. Early reviews say simply outstanding.

"This is the best Color Computer program I have ever seen!"
—Bob Rosen, NYC

TOM MIX SOFTWARE

For The Color Computer and The TDP-100

"This is a really slick, neat and outstanding game."
—John Brissie, Greenville, SC

3424 College, N.E., Grand Rapids, MI 49505 • (616) 364-4791



Add \$1.00 Postage & Handling • Top Royalties Paid
Michigan Residents Add 4% Sales Tax • Looking For New Software



Along this same line, a couple of notes about the cassette tape itself. Quite frankly, we were surprised by the number of entries sent in on practically worn-out cassettes. Some were on old music tapes, some on recycled answering-device tapes. When good, brand-new tapes are available for 59 cents, why risk submitting your best effort on anything but a new tape? Some of these entries were also-rans because they simply would not load, no matter what we tried. A potential winner may have been among them.

Just as surprising was the fact that a large minority made only one save of their entry, when a backup save could have fit on the same side or the opposite side of the tape.

The judges were very charitable and very conscientious in trying to review all games, but "no-load" was "no-win" for all involved. (Speaking of no-load, take some penalty points off the score of this month's *Rainbow On Tape*. *Sir Randolph of the Moors* was a casualty and was not on some of the copies of our tape version of the magazine. We're sorry. It will be on all copies of our February edition for sure.)

The judges were in agreement that there needs to be some standardization of verbs and nouns used in Adventure games. At the very least, the author should list the verbs the program recognizes in the accompanying documentation. Most of our winners did this. We don't think it adds anything to the game to guess whether to "push," "pull," "throw," "turn," "flip," or "hit" a switch once we've found one. The fun part is in flipping a switch with no apparent effect, only to find later on that we've killed the lights in another area and have to go back and turn them on again, or something akin to that.

Taking inventory was sometimes a chore because we didn't know what command to use. A particularly clever entrant wrote his program so that hitting the CLEAR button would show you where you were, at any time.

Abbreviations are great and save time—if you provide a key to them on a hard copy of the documentation. Most entrants used N, S, W, E, U and D for the compass directions and "Up" and "Down." Rather than say "Go North," you just hit "N" and the ENTER key. We also appreciated the thoughtfulness of those entrants who explained that you could just key in the first three letters of most words to enter a command, EXA for EXAMINE, for instance. The more time spent on action than on repetitive activities, the better.

Perhaps the most important observation of all: Test-play, or if you prefer, play-test your Adventure game with other people who can begin "cold," rather than armed with your insights and perspectives. You may have a screen line that says, "There is a bag of money sitting on the ground," fully expecting the Adventurer to EXAMINE MONEY.

But, instead, he or she decides to EXAMINE GROUND. Well, like as not, CoCo will reply with something like "THERE IS NO GROUND." That can cause Adventurers to pull their hair out.

Better to plan for such unexpected commands as many of our winning group did, by using a catchall line that says IF none of the desired commands are entered THEN PRINT something like "Don't Be Silly!" Such an IF/THEN command will avoid some rather preposterous situations.

Play-test and test-play. You'll learn a lot about your program's idiosyncrasies, or even eccentricities, and then you can alert Adventurers with a few words of explanation in the documentation if you wish to preserve a peculiarity, or modify the program to eliminate the situation.

The more you use other people to play-test your creation, the more you'll learn about it. This is good advice even for commercial producers, who sometimes rush to production before the bugs are fully exterminated.

High praise went to those who challenged the Adventurer with a task to complete rather than just having to plod along trying to stay alive. A sense of purpose, an objective, stimulates the imagination and makes the Adventure more fun. Traps, tricks and other obstacles are great—if they make sense and there is some logical method of avoiding them in the next life, which is as cheap as RUN. Our winners had some novel traps.

To hold an Adventurer's attention, a program must maintain a large degree of logic. If the only way to get past a wall is to say "Wall Away," a lifetime of logic may never solve the problem and the Adventurer may have to BREAK into the listing or simply toss your program on the back shelf.

This may seem like a superfluous observation to many readers, but we found a high degree of illogical sequences. After being totally stumped in an otherwise very enjoyable game, we found that the only way to get to a certain spot was to first get some dirt and then throw it on the spot. Hudathunkit!

If the Adventurer gets the notion that no logical story line is unfolding, he probably will quickly lose interest. He'll feel like he has no control, so why bother.

As a group, the judges don't care a bit for mazes even though they learned many of the tricks for getting through them. Mostly, finding ourselves in a maze, we heaved a sigh and then heaved the program too, promising to get back to it.

Yes, I suppose I'm a nitpicky cuss. And, yes, it is easy to play the position of Monday morning quarterback. Really, all of us enjoyed the homemade Adventures and we felt that many could have been commercially packaged and that others, with a few repairs, could have been brought up to market grade. *Polynesian Adventure*, for instance, is a colorful, musical delight. It alone will make our upcoming Adventure book worth the cover price. Collectively, our winners' Adventures run the gamut and we're all anxious to

COLORTERM I.I

NOW! DISK COMPATIBLE VERSION AND
NEW FEATURES INCLUDED —
NO PRICE INCREASE

The Color Computer* as an intelligent terminal
with 51 or 64 columns by 21 lines
plus true lowercase! All done in software.

Any data format — 16K or 32K — 300 or 110 Baud
Print and save host data to cassette

Encode data for secure storage 

User programmable keys

Much more!

● reverse video	● macro buffers for often-used output
● partial screen clear	● patch the 51 or 64 column display
● 4-way cursor control	to your own basic and assembly
● automatic repeat when	programs
key is held down	● preserve a "window" of any size.
● enter data offline for	new material scrolls through
later uploading to host	remainder of screen

"...Very impressed..." — The Rainbow

"...Very pleased...high marks..." — Color Computer News

"...Easy to use...text densities are high enough to allow
doing some serious work." — 80 Micro

Cassette and disk versions included with all orders.
add \$5.00 if you want programs on a disk

\$34.95 (U.S.) \$40.95 (Canadian)
M.O., VISA, M/C (include expiry)

MARTIN CONSULTING, 94 Macalester Bay
Winnipeg, Man. R3T 2X5 CANADA
*T.M. of Tandy Corp.

compu•sette®

TAPES & DISKS

100% ERROR-FREE
FULLY GUARANTEED



Compu•sette, a product of MICRO-80 INC

The Micro-Trac™ Generation

Used by Software Firms & Computer Hobbyists
Choice of School Districts Nationwide

CASSETTES	MINI	STANDARD
	12-PAK	24-PAK
C-05.....	\$.79	\$.59
C-10.....	\$.89	\$.69
C-20.....	\$.99	\$.89
C-30.....	\$1.29	\$1.09
Custom Cases.....	\$.25	\$.21

Cases recommended to protect sensitive cassettes

5 1/4" DISKETTES	MINI	STANDARD
	5-PAK	10-PAK*
Soft Sector Single Sided S/D Density.....	\$14.95	\$26.95

*10 PAK w/custom library case, add \$3.00

— UPS SHIPPING —

(No. P.O. Boxes please)

\$3.00 per pack

— Canadian shipping multiply by 2 —

No. 1 Magnetic Media in the USA!

— Write for volume prices —

TOLL-FREE
(orders only)

1-800-528-6050

ext. 3005

In Arizona State

1-800-352-0458

ext. 3005

MICRO-80™ INC.

E. 2665 Busby Road
Oak Harbor, WA 98277
1 (206) 675-6143



publish their creative work so that others can learn how to program in winning style.

Now, more constructive criticism, as we self-styled critics like to say. Why, in some Adventures, do I have to die every time I commit even the tiniest infraction? One of the many enchanting things about the *Polynesian Adventure* is that you may get your nose stung or your fingers burned, but it is hard to get killed. With some entries, though, death came swiftly and without warning—and we had to start all over again.

I know that the ever-present danger of killing yourself does add tension to the game, but we found that suffering a wound was, for us, a more pleasant way to be penalized. Several wounds and *then* you die. Can't argue with that.

Lastly, the grand finale. Sad to say, most Adventure games we reviewed seemed to be anticlimactic at the very moment we had finally won. All we usually got was "You have saved the princess" printed on the green text screen. How much more we enjoyed those games that gave us a song and dance routine when we finally successfully completed the Adventure.

When you've survived a RUN through the Valley of Death you want and expect and, darn it, *deserve* flashing screen colors, music and all sorts of rewarding hoopla!

The *Rainbow Adventure Contest!* Want to play again? Well, let's do, next Fall. In the meantime, let's give a special round of congratulations to our winners, who were named in the January Adventure issue, and special thanks to *all* who entered. Also, we want to mention again the generosity of our advertisers who supported the contest by offering valuable prizes:

Gregory Clark, of Syracuse, N.Y., our winner in the non-graphics division, received a \$125 gift certificate from the people at **Computer Plus**. Gregory Ricketts of Columbus, Ohio, won a \$150 gift certificate from **JARB Software**. Valuable merchandise credits and selected prizes for our other Lucky 13 winners were provided by:

Spectrum Projects **Prickly-Pear Software**
Superior Graphic Software **Computer Island**
Custom Software Engineering **Nanos Systems Corp.**
Spectral Associates **Illustrated Memory Banks**
Transformation Technologies

What next? A simulation contest! Be looking for an announcement of the competition rules in *the Rainbow*.



Graphics

4K



Marquee de Fin

Ever get to the end of a tough adventure game, with your heart pounding with pride from finally winning, and your ears flapping violently under your hat, only to receive nothing more for your valiant effort than a green screen with the tiny words "Want to play again? Y/N"?

Well, from Morton Goldberg of Newtown, MA, here's some medicine for that malady, a way to go out in style when the "end" comes. If you're a beginner, remember that the program lines beginning with REM are just comment lines, or REMarks, about what that section of the program does; you need not type these lines in for the program to work. The REM statements will help you if you want to modify the program to your own needs. Or, just use *Marquee* as is and tack it on the end of one of your programs.

Here's a listing that's really "the end":

```

196 022D
296 0321
496 04FC
END 0744

```

```

21 CLS(8)
26 FOR H=0 TO 63
31 SET(H,0,3)
36 NEXT H
41 FOR V=0 TO 31
46 SET(63,V,3)
51 NEXT V
56 FOR H=63 TO 0 STEP-1
61 SET(H,31,3)
66 NEXT H
71 FOR V=31 TO 0 STEP-1
76 SET(0,V,3)
81 NEXT V
86 FOR H=3 TO 60
91 SET(H,2,1)
96 NEXT H
101 FOR V=3 TO 29
106 SET(60,V,1)
111 NEXT V
116 FOR H=60 TO 3 STEP-1
121 SET(H,29,1)
126 NEXT H
131 FOR V=29 TO 3 STEP-1
136 SET(3,V,1)
141 NEXT V
146 FOR H=7 TO 56 STEP 2

```

```

151 RESET(H,6)
156 NEXT H
161 FOR V=8 TO 24 STEP 2
166 RESET(57,V)
171 NEXT V
176 FOR H=56 TO 6 STEP-2
181 RESET(H,26)
186 NEXT H
191 FOR V=24 TO 7 STEP-2
196 RESET(6,V)
201 NEXT V
206 REM ("T")
211 FOR H=9 TO 13
216 RESET (H,12)
221 NEXT H
226 FOR V=13 TO 18
231 RESET (11,V)
236 NEXT V
241 REM ("H")
246 FOR H=17 TO 20
251 RESET (H,15)
256 NEXT H
261 FOR V=12 TO 18
266 RESET (16,V)
271 NEXT V
276 FOR V=12 TO 18
281 RESET (21,V)
286 NEXT V
291 REM ("E")
296 FOR H=25 TO 27
301 RESET (H,12)
306 NEXT H

```

TRS-80* COLOR COMPUTER*

- 16K Extended Basic, Menu-Driven, Well-Documented, Easily-Modified.
- For either cassette or diskette systems (Be sure to specify).
- Place an order of at least \$40 and get one extra of your choice free.
- Orders shipped on cassette - Add \$5 for shipment on diskette.

-FURST-



Data Element Dictionary driven File Update and Retrieval SysTem. Create and maintain files according to your specifications. Ideas for applications included. \$25

-MAILING LABELS-



Generate and maintain mailing label records. Selectively print desired quantities. Can keep several label files if desired. Designed for Printer VII, easily modified. \$20

-REPORT WRITER-



Used in conjunction with FURST to selectively format reports on your printer. Includes headings and total capabilities. \$15

-EXERCISE PLANNER-



Build and maintain complete exercise schedule for regular and/or weight programs. Display guides you through daily-calculated routines. Print complete schedule if desired. \$15

-DISK DIRECTORY PRINT-



For diskette users only. Get hard copy of disk directories on your printer for easy use and reference. Only \$5

Send check or money order to:



LAND SYSTEMS

P.O. Box 232
Bellbrook, Ohio 45305



*TRS-80 and COLOR COMPUTER are Trademarks of Tandy Corp.

311 FOR H=25 TO 27
 316 RESET (H, 15)
 321 NEXT H
 326 FOR H=25 TO 27
 331 RESET (H, 18)
 336 NEXT H
 341 FOR V=12 TO 18
 346 RESET (24, V)
 351 NEXT V
 356 REM ("E")
 361 FOR H=34 TO 37
 366 RESET (H, 12)
 371 NEXT H
 376 FOR H=34 TO 37
 381 RESET (H, 15)
 386 NEXT H
 391 FOR H=34 TO 37
 396 RESET (H, 18)
 401 NEXT H
 406 FOR V=12 TO 18
 411 RESET (34, V)
 416 NEXT V
 421 REM ("N")
 426 FOR V=12 TO 18
 431 RESET (40, V)
 436 NEXT V
 441 FOR V=12 TO 18

446 RESET (46, V)
 451 NEXT V
 456 H=41
 461 RESET (H, 12)
 466 H=41
 471 RESET (H, 13)
 476 H=42
 481 RESET (H, 14)
 486 H=43
 491 RESET (H, 15)
 496 H=44
 501 RESET (H, 16)
 506 H=45
 511 RESET (H, 17)
 516 H=45
 521 RESET (H, 18)
 526 REM ("D")
 531 FOR H=49 TO 54
 536 RESET (H, 12)
 541 NEXT H
 546 FOR H=49 TO 54
 551 RESET (H, 18)
 556 NEXT H
 561 FOR V=13 TO 17
 566 RESET (50, V)
 571 NEXT V
 576 FOR V=13 TO 17

NEW!

From **GREAT X·P·T**
 for TRS 80 Color Computer

MISSILE BARRAGE

Color Sound
 High Res. Graphics
 Req. 16k Ext Basic
 \$10.95ea.

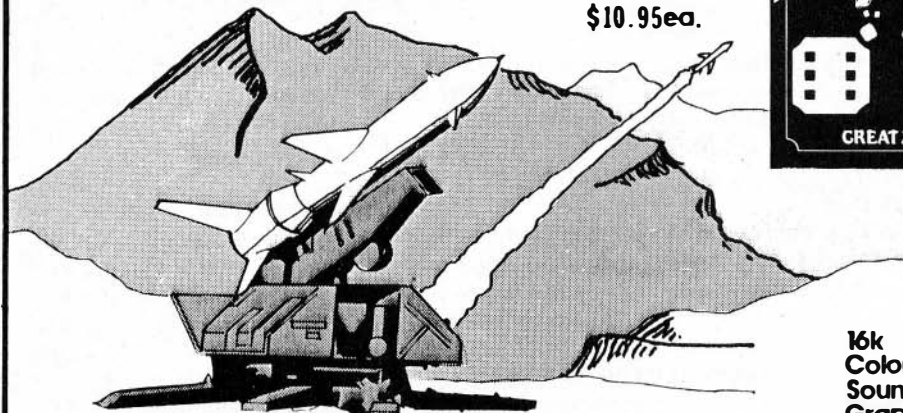

GREAT X·P·T

P.O. Box 9212
 Livonia, Mi. 48150

Mich. Res. add 4% Sales Tax
 C.O.D. add \$1.00

16k
 Color
 Sound
 Graphics
 \$10.95ea.



FOR THE
 GAMBLER
 16k Ext Basic
 High Res. Graphics
 Play Alone
 or Against
 Your Friends
 \$10.95 ea.



FREE CATALOG AVAILABLE

TRS 80 IS A T.M. OF THE TANDY CORP.

HOLIDAY SALE ... ALL THREE FOR \$ 25.95

```

581 RESET (54,V)
586 NEXT V
591 REM (ANIMATION)
596 FOR H=5 TO 56 STEP 2
601 SET (2+H,6,8)
606 NEXT H
611 FOR H=5 TO 56 STEP 2
616 RESET (2+H,6)
621 NEXT H
626 FOR V=6 TO 25 STEP 2
631 SET (57,2+V,8)
636 NEXT V
641 FOR V=6 TO 23 STEP 2
646 RESET (57,2+V)
651 NEXT V
656 FOR H=56 TO 6 STEP-2
661 SET (2+H,26,8)
666 NEXT H
671 FOR H=54 TO 5 STEP-2
676 RESET (2+H,26)
681 NEXT H
686 FOR V=24 TO 6 STEP-2
691 SET (6,2+V,8)
696 NEXT V
701 FOR V=24 TO 6 STEP-2
706 RESET (6,2+V)
711 NEXT V
716 GOTO 596
721 END

```



Print Those Print Statements With This ML Feature

16K
ECB

By Ted Blatt



Here's a machine language program that changes regular *PRINT* statements into Print #-2's for your printer. And it will make the changes without affecting *INPUT* statements.

The program begins by getting the start pointer of the Basic program. From there forward, it searches for a *PRINT* statement. Once it finds a *PRINT* statement it gets the end pointer. From the end of the Basic program, it works backwards, taking bytes and moving them up four addresses. It stops when it reaches the *PRINT* statement it found previously. Backwards from the *PRINT* statement it looks for a zero indicating the beginning of a line. Then from the beginning of the line it takes the line pointers and increments their values and addresses by four. From the *PRINT* statement it adds a #-2 and either a comma or a space depending on whether there are any characters ahead on that line. From there, it increments the start and end pointers by four. The program returns to searching for a *PRINT* statement until it reaches the end pointer and ends, returning to Basic.

The Listing:

```

50 CLEAR350,15999
60 FORX=16000TO16308
70 READA:POKEX,A
80 NEXTX
90 LINEINPUT"READY CASSETTE / PR
ESS PLAY AND RECORD / ENTER WHEN
READY";B$
100 CSAVEM"PRNTCHG",16000,16308,
16000
110 DATA 220,25,253,62,135,32,8,

```

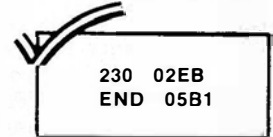

Find The COLOR COMPUTER INFORMATION YOU NEED

INDEX TO ARTICLES, PROGRAMS, LETTERS
HARDWARE AND SOFTWARE REVIEWS
IN MAGAZINES

COLOR COMPUTER INDEX 

CATALOG LISTING

VENDORS, HARDWARE, SOFTWARE
SUPPLIES, PUBLICATIONS

COLOR COMPUTER CATALOG 

American Library and Information Services
Dept. R, 3705 Mary Ellen NE, Albuquerque, NM 87111

Gentlemen:

- Yes! Send me **COLOR COMPUTER INDEX 1980-1981** at \$5 (Canada and Mexico \$6)
- Yes! Sign me up for **COLOR COMPUTER INDEX 1982** (4 issues) for \$16 (Canada and Mexico \$20)
- Yes! Sign me up for **COLOR COMPUTER CATALOG 1982** (two issues) for \$20 (Canada and Mexico \$24)

Name _____
Address _____
City _____ State _____ Zip _____

from
MICRO-80™ INC.



THE ULTIMATE WORD PROCESSOR

MICRO-SCRIPT™

A professional word processor at an affordable price! Features enhancements found in programs three times its cost.

Speed typists will appreciate its tracking capability. Novices will enjoy quick familiarity. Regardless of your application, the versatility of MICRO-SCRIPT™ makes it the logical choice for saving time and money for both home and office environments.

Bells and whistles? You bet! MICRO-SCRIPT™ is line-oriented, offers expanded cursor control, user-defined printer and video options; provides character, word and line insertion, correction, mobility, replace and deletion; global search and replace; headers and footers, auto pagination, true justification line and title centering, name and address merging for multiple letters; prints up to four selectable character sizes on command and much more!

MICRO-SCRIPT™ has unlimited applications. It's a serious masterpiece which fills the void in any program library. It is compatible with all major printers on the market today.

Specify
Tape or Disk
Version

TOLL-FREE

(orders only)

1-800-528-6050

extension 3005

In Arizona

1-800-352-0458

extension 3005



Co-Co
Limited
Offer
\$26.95



MICRO-80™ INC.

2665 Busby Rural Road
Oak Harbor, WA 98277

— Distributors Wanted —

18, 18, 18
120 DATA 18, 18, 18, 18, 18, 252, 62, 1
35, 195, 0
130 DATA 1, 253, 62, 135, 166, 159, 62
, 135, 129, 135
140 DATA 39, 12, 220, 31, 16, 179, 62,
135, 16, 39
150 DATA 1, 10, 32, 227, 220, 31, 253,
62, 137, 252
160 DATA 62, 137, 131, 0, 1, 253, 62, 1
37, 252, 62
170 DATA 137, 195, 0, 4, 253, 62, 139,
166, 159, 62
180 DATA 137, 167, 159, 62, 139, 252,
62, 137, 131, 0
190 DATA 1, 16, 179, 62, 135, 39, 2, 32
, 216, 252
200 DATA 62, 135, 253, 62, 141, 252, 6
2, 141, 131, 0
210 DATA 1, 253, 62, 141, 166, 159, 62
, 141, 129, 0
220 DATA 39, 2, 32, 237, 252, 62, 141,
131, 0, 3
230 DATA 253, 62, 141, 166, 159, 62, 1
41, 129, 0, 38
240 DATA 11, 252, 62, 141, 195, 0, 1, 2
53, 62, 141
250 DATA 32, 9, 252, 62, 141, 195, 0, 4
, 253, 62
260 DATA 141, 236, 159, 62, 141, 195,
0, 4, 237, 159
270 DATA 62, 141, 253, 62, 141, 16, 14
7, 31, 36, 2
280 DATA 32, 235, 252, 62, 135, 195, 0
, 1, 253, 62
290 DATA 135, 134, 35, 167, 159, 62, 1
35, 252, 62, 135
300 DATA 195, 0, 1, 253, 62, 135, 134,
172, 167, 159
310 DATA 62, 135, 252, 62, 135, 195, 0
, 1, 253, 62
320 DATA 135, 134, 50, 167, 159, 62, 1
35, 252, 62, 135
330 DATA 195, 0, 1, 253, 62, 135, 252,
62, 135, 253
340 DATA 62, 137, 134, 0, 183, 62, 139
, 252, 62, 137
350 DATA 195, 0, 1, 253, 62, 137, 166,
159, 62, 137
360 DATA 129, 58, 39, 13, 129, 0, 39, 9
, 129, 32
370 DATA 39, 231, 124, 62, 139, 32, 22
6, 182, 62, 139
380 DATA 129, 0, 38, 4, 134, 32, 32, 2,
134, 44
390 DATA 167, 159, 62, 135, 220, 31, 1
95, 0, 4, 221
400 DATA 31, 220, 27, 195, 0, 4, 221, 2
7, 220, 29
410 DATA 195, 0, 4, 221, 29, 126, 62, 1
43, 57

THESE FINE STORES CARRY THE RAINBOW

The retail stores listed below carry the **RAINBOW** on a regular basis and may have other products of interest to Color Computer users. We suggest you patronize those in your area.

Abacus Computers
S. Holland, Mich.
Accolade Distributors
San Diego, Calif.
Acme Book Co.
Baton Rouge, La.
A Computer Store
Indianapolis, Ind.
Act One Video
Marietta, Ga.
Adventure International Store
Longwood, Fla.
All-Pro Souvenirs
Pittsburgh, Pa.
All Systems Go
Orlando, Fla.
Tempe, Ariz.
Alonzo Book & Periodical
Alexandria, Va.
Amateur Radio Equipment Co.
Wichita, Kan.
Anderson Electronics
Benton, Ky.
Appalachian Computing
Kingwood, W. Va.
Applefree Computers
Dekalb, Ill.
Atlantic News
Halifax, N.S.
Audio Concepts Unlimited
Denton, Tex.
Aurora Newslard
Aurora, Cal.
Bauer Electronics
Lawrenceburg, Ind.
B. Dalton Booksellers
West Jackson St. - Chicago, Ill.
N. Wabash St. - Chicago, Ill.
Milwaukee, Wisc.
Peoria, Ill.
Bagley Drugs
Crestwood, Ky.
B.I.E.S. Systems
Oak Park, Ill.
Bill's TV Radio Shack
Newton, Ill.
Bob's In Newtown
Chicago, Ill.
Bob's News Emporium
Chicago, Ill.
Bob's Rogers Park
Chicago, Ill.
Book Market
East Cedar - Chicago, Ill.
North Cicero - Chicago, Ill.
West Diversey - Chicago, Ill.
Peoria, Ill.
Champaign, Ill.
Danville, Ill.
Book Nook
Lisle, Ill.
Book Tree
Milwaukee, Wisc.
Booked Solid
Milwaukee, Wisc.
Booked Solid II
Milwaukee, Wisc.
Bookland, Inc.
Indianapolis, Ind.
Buffalo Teknologies
Amherst, N.Y.
Byte By Byte
Utica, Mich.
Campus Computer Corp.
Nashville, Tenn.
C&J Electronics Computer Center
Richard, Wash.
C/C Computer Systems
Owosso, Mich.
Capitol Microcomputers
Austin, Tex.
Caribbean Engineering Corp.
Stuart, Fla.
Caves Books Co.
Hong Kong
Chattanooga Choo-Choo
Chattanooga, Tenn.
Chester Electronic Supply
Kenosha, Wisc.
Chicago-Main News
Evanston, Ill.

Chips, Inc.
Atlanta, Ga.
CMD Micro
Edmonton, Alta.
Coast Electronics
Morro Bay, Calif.
Color Computing
Southgate, Calif.
Color Products Unalike
Vancouver, B.C.
Community News Center
Ann Arbor, Mich.
CompuLit
Burnaby, B.C.
Computer Center
Albuquerque, N.M.
The Computer Center
New York, N. Y.
The Computer Center of York
York, Pa.
The Computer Connection
Boulder, Col.
Computer Corner
Lapeer, Mich.
Computer Shack
Pontiac, Mich.
The Computer Store
Louisville, Ky.
The Computer Store
Phoenix, Ariz.
The Computer Store
San Diego, Calif.
The Computer Store
Tulsa, Okla.
The Computer Store
Casper, Wyo.
Computer Emporium
Louisville, Ky.
Computer Resource
Williamsville, N.Y.
CompServ of Danbury
Danbury, Conn.
Computer Concerns
Havlock, N.C.
Computer Services
Lawrenceburg, Ind.
Computer SOS
Shreveport, La.
Computer Town
Cord Springs, Fla.
Computerware Store
Encinitas, Calif.
Cosmos Computers
Bettendorf, Iowa
Croucher Electronics
Conroe, Texas
Cudahy News & Hobby
Cudahy, Wisc.
Dallas Computer Center
Dallas, Tex.
Data Born
Renton, Wash.
Data Byte Computer Center
Beaufort, S.C.
Data Concepts
Scottsdale, Ariz.
Data Domain
Schramberg, Ill.
Data Link
Dayton, Ohio
Dave's Elect. Radio Shack
Pennsville, N.J.
D. Data
Stillwater, Okla.
Deiker Electronics
Smyrna, Tenn.
Disney's Electronics
San Diego, Calif.
Dimensional Software
San Diego, Calif.
DSL Computer Products
Daerborn, Mich.
E. B. Garcia & Associates
Chicago, Ill.
The Eight Bit Corner
Muskegon, Mich.
Electrobrain
Alwater, Calif.
Electronic World
Fairbanks, Alaska

Elx Mart
Jasper, Ind.
F.M. Electronics
Jay, Maine
Final Edition
University City, Mo.
Galls Book World
Hamilton, Ont.
Game Preserve
Indianapolis, Ind.
Gopher Hole
Brooklyn Center, Minn.
The Green Dragon
N. Charleston, S.C.
Guild Books and Periodicals
Chicago, Ill.
Guild News Agency
Atlanta, Ga.
Gus-Stan Enterprises
Pikeville, Ky.
H&H Co.
Whitehorse, Yukon
H&H Electronics
Woodward, Okla.
Hands On Computer
Atlanta, Ga.
Hawley-Cook Booksellers
Louisville, Ky.
Hathaway's Magazines
Colorado Springs, Col.
Hobby Shop
Hopkinsville, Ky.
Home Computer Store
Westville, Ohio
Home Brew Computers
Casper, Wyo.
Hurley Electronics
Santa Anna, Calif.
HW Electronics
Northridge, Calif.
Indiana News
Indianapolis, Ind.
Interstate Distributors
Billings, Mont.
John's News Stand
Medford, Ore.
K&S News Stand
Winston-Salem, N.C.
Kona Recreation
Kailua-Kona, Hawaii
Kelly Software Distributors
Edmondston, Alta.
Kroch's & Brentano's
South Wabash - Chicago, Ill.
West Jackson, Chicago, Ill.
835 N. Michigan - Chicago, Ill.
516 N. Michigan - Chicago, Ill.
Oak Park, Ill.
Oak Brook, Ill.
Skokie, Ill.
Aurora, Ill.
L&R Electronics
Grant's Pass, Ore.
Lea's Book & Wine Shop
Toledo, Ohio
Level IV Products
Livonia, Mich.
Levity Distributors
Hollywood, Calif.
Libra Books
Eugene, Ore.
Little Professor Book Center
Philadelphia, Ohio
Canton, Ohio
Lloyd's Radio
Wichita, Kan.
Madison Books
Madison, Ala.
M&W Electronics
Harrodsburg, Ky.
Magnum Computer Products
Boise, Idaho
Marlin
Cincinnati, Ohio
Merit Micro Software
Oklahoma City, Okla.
Micro Byte
Miami, Fla.
Microcomputer Software Center
Manchester, N.H.
Lawrenceville, N.J.

Microconnection Software
Woburn, Wash.
Microwest Distributors
N. Vancouver, B.C.
Micro World II
Clinton, N.J.
Mike's Electronics Distributor
Ft. Lauderdale, Fla.
Milling's Electronics
Walpole, Ind.
Steven Moreno
Stockton, Calif.
Multi-Mag
London, Ont.
The News Rack
Miami, Fla.
Ninis Corner, Inc.
Cambridge, Mass.
NORMAR
Wilmington, Del.
OPAMP Technical Books
Los Angeles, Calif.
Out Of Town News
Cambridge, Mass.
Parkwest Books
Chicago, Ill.
Parkway Drugs
Chicago
PCEAR80
Mansfield, Ohio
Perry's News Shop
Avondale, Pa.
Personal Computer Place
Mesa, Ariz.
Personal Software
Malvern, Pa.
Pitt Computer & Software
Pleasant Hills, Pa.
Poling Place
Pinellas Park, Fla.
South Pasadena, Fla.
Portsmouth Computers
Portsmouth, N.H.
Printers, Inc.
Palo Alto, Calif.
Prism Software
Kincardine, Ont.
Pro Am Electronics
Pacific Beach, Calif.
The Program Store
Baltimore, Md.
Falls Church, Va.
Columbus, Ohio
Washington, D.C.
Programs Plus
Tukwila, Wash.
Programs Unlimited
Mayfield Heights, Ohio
Prospect News & Magazines
Milwaukee, Wisc.
Radio Shack
El Cajon, Calif.
Radio Shack
Freehold, N.J.
Radio Shack
Paducah, Ky.
Radio Shack
Peterborough, N.H.
Radio Shack
San Diego, Calif.
Rainbow Software Services
Calgary, Alta.
R&V Sound
Fortuna, Calif.
Recycle Computers
Houston, Tex.
Read-More News
Minneapolis, Minn.
RFI Electronics
Ft. Worth, Tex.
Road Runner Computer Products
Glendale, Ariz.
John Rollins
Kalamazoo, Mich.
Sail of the Earth
Albuquerque, N.M.
Sandmeyer's Bookstore
Chicago, Ill.
Harry Schwartz Bookshop
Milwaukee, Wisc.

Sewing Center
Orlando, Fla.
Soenen & Wilmoth Books
Clearwater, Fla.
Soft Sector Marketing
Garden City, Mich.
Software Access
Irving, Tex.
Software 'n' Suds
E. Windsor, N.J.
Soft Shop
Yuma, Ariz.
Software Centre
Torrance, Calif.
Software City
Fairview, N.J.
Midland Park, N.J.
Montvale, N.J.
River Edge, N.J.
Summit, N.J.
Teaneck, N.J.
Software Concepts
Dallas, Tex.
Software Connection
Ft. Lauderdale, Fla.
Software, Etc.
Houston, Tex.
Software 1st
Santa Rosa, Calif.
Software Plus
Citrus Heights, Calif.
Software Shop
Mansfield, Mass.
Software Station
Rockaway, N.J.
Software Store
Tampa, Fla.
The Software Store
Rockville, Md.
Software Unlimited
Tucson, Ariz.
Software Unlimited
Orlando, Fla.
Sound Trader & Computer Center
Tampa, Fla.
Sound Video Ltd.
Niles, Ill.
Spectrum Projects
Woodhaven, N.Y.
Srepro Electronics
Dayton, Ohio
Sterling Book Center
Sterling Heights, Mich.
Stevens Radio Shack
Phoenixville, Pa.
Strawflower Electronics
Half Moon Bay, Calif.
Tobacco Corner Newsroom
Memphis, Tenn.
T. M. Computers
Kingston, Ont.
Trade 'N Books
Montgomery, Ala.
Tri-Count Electronic Radio Shack
Fenton, Mich.
Tri-Tek Computers
Phoenix, Ariz.
Unicom Electronics
Johnson City, N.Y.
University of Chicago Bookstore
Chicago, Ill.
University of Illinois Bookstore
Chicago, Ill.
University of Wisconsin Bookstore
Milwaukee, Wisc.
Videomat, Inc.
Chicago, Ill.
Village Green
Rochester, N.Y.
Village Computer & Software
Cedar Knolls, N.J.
Wayne Software
Wayne, N.J.
Willy's Electronics
National City, Calif.

RAINBOWfest

Regency-Hyatt Woodfield Chicago April 22-24

ADVERTISER'S INDEX

We encourage you to patronize our advertisers—all of whom support the TRS-80 Color and TDP System-100 computers. We will appreciate your mentioning the RAINBOW when you contact these firms.

Aardvark 80	67	Dymax	182	Peacock Enterprises	91
All Color Software	69	Dynamic Electronics	146	Petrocci Freelance Associates	38
A. M. Hearn Software	98	80-U.S. Journal	193	Platinum Software	151
American Library & Info Services	207	Elite Software	82	Prickly-Pear Software	51, 85, 145, 189
Anteco	9	Endicott Software	147	Prism Software	75
Arizin	153	Erickson, B.	124, 152, 192	Programs By Mr. Bob	49
Ark Royal Games	154	Federal Hill Software	70	The Program Store	39
Armadillo International	199	General Automation	89	The Programmer's Guild	174, 175
Aurora Software	99	Genesis Software	96	The Programmer's Institute	23
Basic Programs	15	Great X•P•T	206	Pyramid Distributors	150
Basic Technology	29	Greentree Software	142	Q-Soft	158
Bertamax	53	Harmonycs	54	Q Systems	22
Better Software	44	HIB Software	68	Quasar Animations	115
B5 Software	31	Home Base Systems	87	Radio Shack	19
Botek Instruments	50	Home Run Software	144	Rainbow Connection Software	161
Boudoir Software	170	F & T Software	114	RAINBOWfest	111
Bruck Associates	90	Frank Hogg Laboratory	71, 72, 73	Rainbow On Tape	196
Bumblebee Software	177	Illustrated Memory Banks	113	Real Software	28
Cer-Comp	30, 95	Ilume Design	171	S & S Arcade	104
Chattanooga Choo-Choo Software	43	Intellectronics	103	Selected Software	109
Chromasette	173	Inter+Action	32, 83	Shauntronics	76
Chromatic Software	92	Intercept Enterprises	112	Silver Spring Software	94
Circle City Software	200	International Software	139	Snake Mountain Software	201
CoCo Data Enterprises	119	Intracolor	168	Soft City	41
CoCo Hut	21	Intronics	138	Software Options	27
CoCo Pro	123	International Color Computer Club	93	Software Shop	66
CoCo Warehouse	155	JARB Software	47, 185	Softwide	52
Cognitec	181	JMN	186	Southco Sales	159
Color Computer Weekly	197	JPC	188	Southern Software Systems	46
Color Software Services	17, 157, 167	Kalglo Electronics	65	Spectral Associates	45, BC
Color Soft Software	176	K&K Computerware	101	Spectrum Projects	125, 126, 127, 128, 129, 131, 133
Comp-U-Kids	134	Land Systems	205	Speech Systems	24
Compukit	57	Little Bits Computing Services	36	Star-Kits	63
Computer Accessories of Arizona	121	Mark Data Products	IBC	Starship Software	178
Computer Island	59	Martin Consulting	203	Hoyt Stearns Electronics	77
Computer Peripheral Resources	20	Marymac Industries	11	Strictly Color	86
Computer Plus	3	Med Systems Software	61	Sugar Software	55
Computer Shack	164, 165, 166	Micro-Doc	105	Superior Graphic Software	183
Computerware	37	Micro-80	204, 208	Superior Oracle Software	163
Custom Software Engineering	137	Micrologic	78	Tabby Enterprises	100
Data-Comp	162, 172	Micronics	149	TASADA	180
Dataman	16	Micro Technical Products	143	T&D Software	141
Debug	122	The Micro Works	107	Transformation Technologies	109
Delker Electronics	33	Tom Mix Software	25, 190, 202	Transition Technology	120
Desert Software	74, 198	Moreton Bay Laboratory	58, 62	Universal Data Research Inc.	169
Double Density Software	135	Moses Engineering	60	Valhalla Enterprises	184
Dragonfly Software	108	Nanos Systems Corp.	IFC	Washington Computer Services	42
DSL Computer Products	97	Nelson Software Systems	79, 80, 81	York-10	187
Dugger's Growing Systems	12	Oelrich Publications	35	Zeta Software	195
		Owl-Ware	13		
		Parsons Software	106		
		PCLEAR 80	84, 140		

FAST EFFICIENT MACHINE LANGUAGE

COLOR COMPUTER

Action Games

ARCADE GAMES SEND FOR OUR LATEST FLYER. GET ON OUR MAILING LIST.

NEW!



Space Raiders

Not just another invaders type game. We think this one is the best—great action, great sound, you'll love it!!

CASSETTE (16K) . . . \$24.95
DISK (32K) . . . \$29.95

ASTRO BLAST

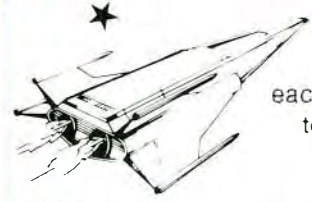

A new super hi-res space game. Wave after wave of alien attackers. each one a different and unique challenge to your skills.

CASSETTE (16K) . . . \$24.95
DISC (32K) . . . \$29.95

CAVE HUNTER

Outsmart the creatures that pursue you as you hunt for treasure in a maze of cave passages. Lots of colors and sounds!

CASSETTE (16K) . . . \$24.95
DISC (32K) . . . \$29.95

COLOR HAYWIRE

They're calling this one a "classic". You'll have hours of fast-paced fun zapping robots. Super hi-res action!

CASSETTE (16K) . . . \$24.95
DISC (32K) . . . \$29.95

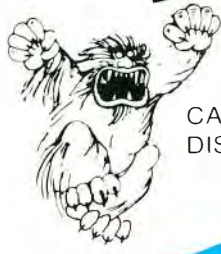

ADVENTURE GAMES

Finally... software worthy of the Color Computer. KC Westery, RI
The ads and reviews were right! Great stuff! RS Los Angeles, CA

BUY DIRECT OR FROM YOUR FAVORITE DEALER

Calixto Island



A challenging puzzle with an occasional twist of humor. There's a treasure waiting to be discovered!

CASSETTE (16K) . . . \$19.95

The Black Sanctum

For the player who enjoys suspense. . . You'll encounter the forces of black magic in this spooky adventure.

CASSETTE (16K) . . . \$19.95



MARK DATA PRODUCTS

24001 ALICIA PARKWAY—SUITE 226, MISSION VIEJO, CA 92691 • (714) 768-1551

We pay shipping on all orders in the continental U.S. and Canada. Overseas add \$3.00. California residents please add 6% sales tax. We are always looking for quality machine language programs. Contact us for details.
MASTER CHARGE OR VISA ACCEPTED

SPECTRAL ASSOCIATES

16K Arcade Quality Games
For TRS-80 Color Computer

Only
\$21.95



SPECTRAL ASSOCIATES, 141 HARVARD AVE., TACOMA, WA. 98466

BEST SELECTION ANYWHERE

GREAT UTILITIES

FLEX+ DOS

BEST EDITOR/ASSEMBLER

SUPER MACHINE LANGUAGE GAMES

FANTASTIC BASIC GAMES

BOOKS

TOLL FREE FOR ORDERS ONLY: **1-800-426-1830** 8:30-4:30 P.S.T.

Except WA, AK, HI

BUSINESS OFFICE: 206-565-8483

We accept VISA, MASTERCARD, AMERICAN EXPRESS.

Add 3% for shipping. NO C.O.D. All prices U.S. FUNDS.

To find out about our other products, write or call for catalog.

Place
Stamp
Here

the RAINBOW

P. O. Box 209
Prospect, KY 40059

Get Your Very Own Pot O' Gold!

Here's your chance to have a Pot O' Gold full of programs, articles and information about CoCo every month! A subscription to **the Rainbow** is only \$22 a year, and you won't miss a single chock-full issue!

The Rainbow is the premier magazine for the TRS-80 Color, TDP-100 and Dragon-32 personal computers. The reason? More of everything you and your CoCo want and need than you can find anywhere! Do yourself and your CoCo a favor and subscribe to **the Rainbow** today!

We accept VISA, MasterCard or American Express. Non-U.S. rates slightly higher. U.S. currency only, please.



the RAINBOW
5803 Timber Ridge Drive
P.O. Box 209
Prospect, KY 40059



(502) 228-4492

YES! Sign me up for a year (12 issues) of **the RAINBOW**.

Name _____

Address _____

City _____ State _____ Zip _____

Payment Enclosed

Charge VISA MasterCard American Express

My Account # _____ Interbank # (MC only) _____

Signature _____ Card Expiration Date _____

Subscriptions to **the RAINBOW** are \$22 a year in the United States. Canadian and Mexican rate U.S. \$29. Surface rate to other countries U.S. \$39; air rate U.S. \$57. All subscriptions begin with the current issue. Please allow up to 5-6 weeks for first copy.

