



Product characteristics



Eco-friendly Material

Adopted full-water foaming system and water-based paint, all the products meet the EU SGS-SVHC standards, VOC content lower than the EU and American standards.



Insect and Mildew Resistance

Low water absorption. Could not get moldy even put in water for long time; Also can effectively prevent the damage of termites and insects to products.



Customizable

Customizing customers' personalized products according to the requirements.



Dimensional Stability

Small thermal expansion and cold contraction, excellent dimensional stability



Durability

Subsequently formed polyurethane and the previously formed waterborne film can be perfectly adhered together without peeling off and discoloration, same life as building.



Profiling Performance

Superb mold technology enables the product surface possessing realistic wood-grained texture.

The Beauty of Urethane

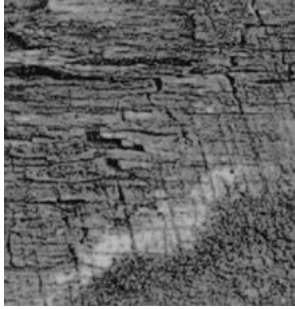

MOISTURE RESISTANT

Urethane millwork's closed cell structure prevents water penetration and absorption.



SPLINTER RESISTANT

Urethane millwork does not splinter like wood. If surface blemishes occur during installation, they can be easily repaired with ordinary plastic wood filler.

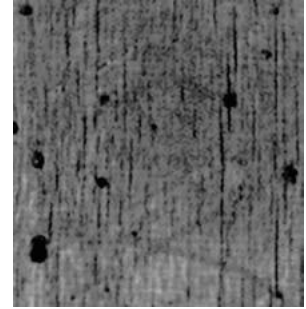

INSECT RESISTANT

Urethane millwork provides a practical alternative if you want the look of real wood detailing for your projects, but live in an area that is prone to insect infestation. Urethane Millwork/Wood Considerations.

Urethane Millwork/Wood Considerations

CONSIDERATION	URETHANE MILLWORK	WOOD
Quality/composition	consistent quality; no waste; consistent finish	quality varies; knots and gouges result in waste; blotching, disappearing grain and discoloration can occur
Versatility	all products suitable for interior or exterior application	different grade of material and finish required for outdoor application
Durability	resists warping or splitting; resists weather damage and insect infestation	can warp; susceptible to splitting; susceptible to rotting and insect damage
Labor Savings	requires no sanding, priming or sealing; mouldings easy to install	requires sanding, priming and sealing; intricate mouldings require multiple application process incurring high labor costs
Value	reasonable, stable price; long lasting good looks with low maintenance; increases home/building resale value	market price fluctuates; requires periodic maintenance; may need replacement/refinishing as damage occurs

Contents

5

Window & Door Trim

Crossheads & Pediments

Pilasters

Keystones

Window & Door Trim

21

Shutters

Wood-Grained Shutters

Louvered Shutters

34

Mouldings

Smooth Flat Trim

Wood-Grained Flat Trim

Mouldings

51

Louvers & Gable Vents

Decorative Louvers

Functional Louvers

59

Decorative Millwork

Smooth Brackets

Wood-Grained Brackets

72

Faux Wood Beams

Faux Wood Beams

Rafter Tails

Wood-Grained Panels

Gable Pediments

84

Ceiling Medallions

Ceiling Medallions

86

Balustrades & Columns

Balusters

Railing

Newel Posts

Columns

A close-up photograph of several pieces of white decorative trim, likely for windows or doors. The trim features a classic fluted or beaded design. The pieces are arranged in a way that shows their profile and how they would fit together. The lighting is soft, highlighting the texture and curves of the material.

Window & Door Trim

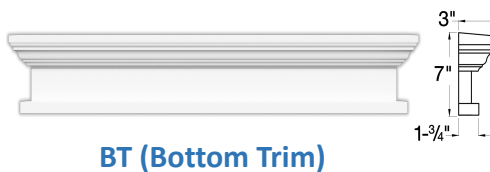
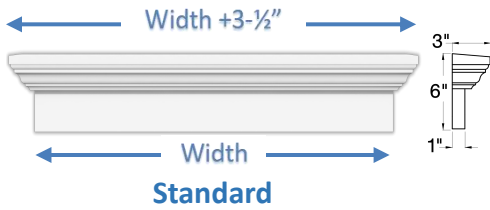

Choose a style above and add either D, K, T or BT* to the end of the Part#.

*Bottom Trim adds 1" to overall height.

WH24X7BT

6" Classic Crosshead			
Part#	Width	Part#	Width
WH24X6	24"	WH60X6	60"
WH28X6	28"	WH64X6	64"
WH30X6	30"	WH66X6	66"
WH31X6	31"	WH67X6	67"
WH32X6	32"	WH68X6	68"
WH33X6	33"	WH72X6	72"
WH34X6	34"	WH73X6	73"
WH35X6	35"	WH74X6	74"
WH36X6	36"	WH76X6	76"
WH37X6	37"	WH78X6	78"
WH38X6	38"	WH79X6	79"
WH40X6	40"	WH80.5X6	80-1/2"
WH41X6	41"	WH80X6	80"
WH43X6	43"	WH84X6	84"
WH44X6	44"	WH86X6	86"
WH46X6	46"	WH87X6	87"
WH47X6	47"	WH96X6	96"
WH48X6	48"	WH100X6	100"
WH50X6	50"	WH103X6	103"
WH51X6	51"	WH104X6	104"
WH52X6	52"	WH108X6	108"
WH54X6	54"	WH110X6	110"
WH56X6	56"	WH144X6	144"

Crossheads

9" Classic Crosshead			
Part#	Width	Part#	Width
WH20X9	20"	WH70X9	70"
WH24X9	24"	WH72X9	72"
WH25X9	25"	WH73X9	73"
WH26X9	26"	WH74X9	74"
WH27X9	27"	WH75X9	75"
WH28X9	28"	WH76X9	76"
WH29X9	29"	WH77X9	77"
WH30X9	30"	WH78X9	78"
WH32X9	32"	WH80X9	80"
WH33X9	33"	WH81X9	81"
WH34X9	34"	WH82X9	82"
WH35X9	35"	WH84X9	84"
WH36X9	36"	WH85X9	85"
WH37X9	37"	WH86X9	86"
WH38X9	38"	WH88X9	88"
WH40X9	40"	WH90X9	90"
WH41X9	41"	WH93X9	93"
WH42X9	42"	WH96X9	96"
WH43X9	43"	WH99X9	99"
WH44X9	44"	WH100X9	100"
WH45X9	45"	WH101X9	101"
WH46X9	46"	WH103X9	103"
WH48X9	48"	WH104X9	104"
WH49X9	49"	WH108X9	108"
WH50X9	50"	WH110X9	110"
WH54X9	54"	WH112X9	112"
WH56X9	56"	WH113X9	113"
WH58X9	58"	WH120X9	120"
WH60X9	60"	WH124X9	124"
WH62X9	62"	WH144X9	144"
WH64X9	64"	WH192X9	192"
WH65X9	65"	WH196X9	196"
WH66X9	66"	WH197X9	197"
WH67X9	67"	WH200X9	200"
WH68X9	68"	WH204X9	204"
WH69X9	69"	WH207X9	207"

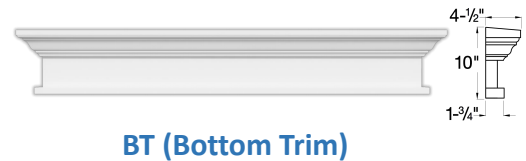
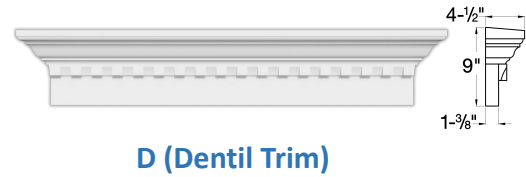
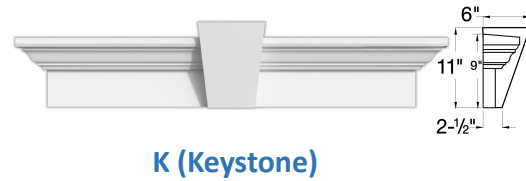
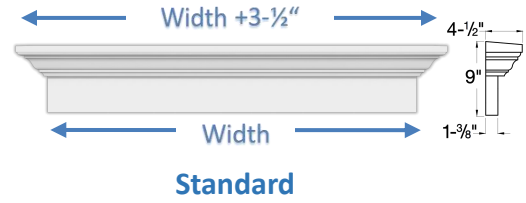

Choose a style above and add either D, K, T or BT* to the end of the Part#.

*Bottom Trim adds 1" to overall height.

WH20X10BT

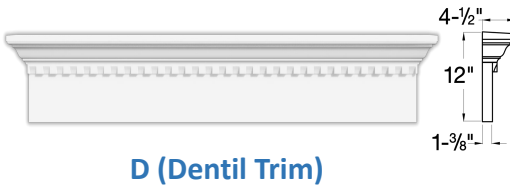
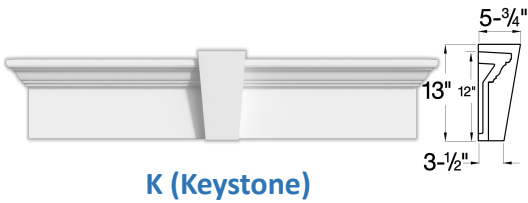
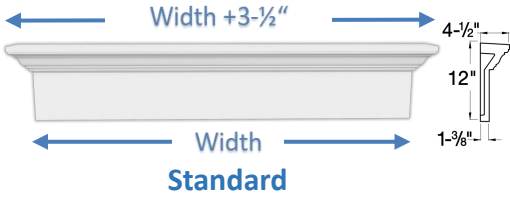

12" Classic Crosshead

Part#	Width
WH36X12	36"
WH40X12	40"
WH44X12	44"
WH48X12	48"
WH54X12	54"
WH56X12	56"
WH64X12	64"
WH72X12	72"
WH96X12	96"
WH102X12	102"
WH104X12	104"
WH144X12	144"
WH200X12	200"
WH203X12	203"
WH213X12	213"

Choose a style above and add either D, K, T or BT* to the end of the Part#.

*Bottom Trim adds 1" to overall height.

WH36X13BT



Crossheads



Standard

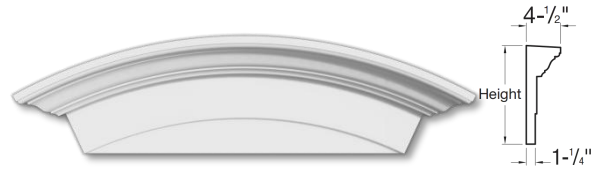

Standard

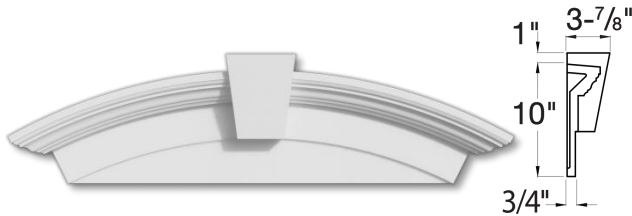

K (Keystone)



K (Keystone)

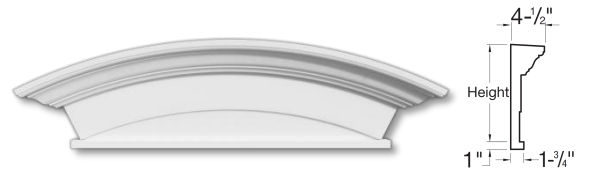

BT (Bottom Trim)

6" Crosshead Arch

Part#	Bottom Width	Overall Width	Height
WH6AR34X10	34"	42- ⁷ / ₈ "	10"



Large Door Crosshead

Part#	Bottom Width	Overall Width	Height
DH58X18	58"	67- ¹ / ₂ "	18- ¹ / ₄ "
DH62X18	62"	71- ¹ / ₂ "	18- ¹ / ₄ "
DH87X18	87"	96- ¹ / ₂ "	18- ¹ / ₄ "
DH90X18	90- ¹ / ₂ "	100"	18- ¹ / ₄ "
DH94X18	94- ¹ / ₂ "	104"	18- ¹ / ₄ "

9" Crosshead Arch

Part#	Bottom Width	Overall Width	Height
WHAR33X14	33"	48- ³ / ₈ "	14"
WHAR36X13	36"	49- ¹ / ₄ "	13"
WHAR43X13	43"	55- ¹ / ₄ "	13"
WHAR54X16	54"	68- ³ / ₈ "	16"
WHAR64X14	64"	75- ¹ / ₂ "	14"
WHAR68X12	68"	77- ¹ / ₄ "	12"
WHAR68X16	68"	77- ¹ / ₄ "	16"
WHAR72X13	72"	82- ¹ / ₂ "	13"
WHAR75X13	75"	84- ³ / ₈ "	13- ³ / ₈ "
WHAR80X15	80"	91- ¹ / ₄ "	15"
WHAR84X16	84"	95- ¹ / ₄ "	16"
WHAR89X13	89"	98- ³ / ₈ "	13"
WHAR97X17	97"	108- ³ / ₄ "	17"
WHAR101X13	101"	110"	13"
WHAR108X19	108"	119- ³ / ₈ "	19"

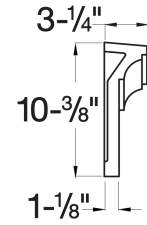

Standard



K (Keystone)

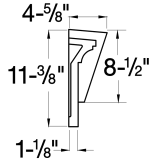

BT (Bottom Trim)

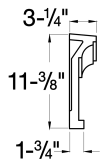

10" Eyebrow Crosshead

Part#	Inside Width	Bottom Width	Overall Width	Height
WHSG28X10	37-1/4"	41-1/2"	28"	10-3/8"
WHSG30X10	39-1/8"	43-3/8"	29-7/8"	10-3/8"
WHSG34X10	44"	48-1/4"	34"	10-3/8"
WHSG36X10	45"	49-1/4"	36"	10-3/8"
WHSG43X10	48"	52-1/4"	43"	10-3/8"
WHSG44X10	49"	53-1/4"	44"	10-3/8"
WHSG64X10	73-1/4"	77-1/2"	64"	10-3/8"
WHSG72X10	81"	72"	85-1/4"	10-3/8"



Pediments



Half-Round Spoked Pediment

Part#	Width	Height	Projection
HSP36X18	36"	18"	1- $\frac{3}{4}$ "
HSP48X24	48"	24"	1- $\frac{3}{4}$ "
HSP72X36	72"	36"	1- $\frac{3}{4}$ "



Segment Sunburst

Part#	Width	Height	Projection
HSWH24X12	24"	12"	1- $\frac{3}{4}$ "
HSWH28X14	28"	14"	1- $\frac{3}{4}$ "
HSWH30X15	30"	15"	1- $\frac{3}{4}$ "
HSWH32X16	32"	16"	1- $\frac{3}{4}$ "
HSWH33X17	33- $\frac{5}{8}$ "	16- $\frac{3}{4}$ "	1- $\frac{3}{4}$ "
HSWH36X18	36"	18"	1- $\frac{3}{4}$ "
HSWH37X19	37- $\frac{5}{8}$ "	19"	1- $\frac{3}{4}$ "
HSWH40X20	40"	20"	1- $\frac{3}{4}$ "
HSWH42X21	42"	21"	1- $\frac{3}{4}$ "
HSWH44X22	44"	22"	1- $\frac{3}{4}$ "
HSWH48X24	48"	24"	1- $\frac{3}{4}$ "
HSWH56X28	56"	28"	1- $\frac{3}{4}$ "
HSWH60X30	60"	30"	1- $\frac{3}{4}$ "
HSWH64X32	64"	32"	1- $\frac{3}{4}$ "
HSWH68X34	68"	34"	1- $\frac{3}{4}$ "
HSWH72X36	72"	36"	1- $\frac{3}{4}$ "
HSWH76X38	76"	38"	1- $\frac{3}{4}$ "
HSWH100X50	100"	50"	1- $\frac{3}{4}$ "



Segment Sunburst

Part#	Width	Height	Projection
HSWH36X9	36"	9"	1- $\frac{3}{4}$ "
HSWH48X13	48"	13"	1- $\frac{3}{4}$ "
HSWH68X14	68"	14"	1- $\frac{3}{4}$ "
HSWH72X14	72"	14"	1- $\frac{3}{4}$ "
HSWH76X15	76"	15"	1- $\frac{3}{4}$ "
HSWH80X15	79- $\frac{1}{2}$ "	15"	1- $\frac{3}{4}$ "



Half-Round Sunburst

Part#	Width	Overall Width	Height	Projection
HSWH36X18-4FK	36"	43"	18"	2-¼"



Elliptical Sunburst

Part#	Width	Height	Projection
ESWDH76X23	76-7/8"	23"	3-½"



Sunburst Pediment

Part#	Width	Overall Width	Height	Projection
SP56	55-¼"	57"	16-¾"	4-½"
SP667	66-¾"	69-¼"	20-¾"	5-½"
SP86	85-¾"	87-¼"	22-½"	4-½"
SP91	90-½"	92-½"	26"	4-½"



Standard



BT (Bottom Trim)

Combination Sunburst Pediment

Part#	Width	Overall Width	Height	Projection
SP54	54"	58-½"	21-¾"	3-¾"
SP75	75"	70-5/8"	23-¾"	3-¾"
SP80	80"	84-5/8"	25-½"	3-¾"
SP85	85"	89-½"	26-¾"	3-¾"

Pediments



Standard



BT (Bottom Trim)



Standard



BT (Bottom Trim)

Combination Segment Pediment

Part#	Bottom Width	Overall Width	Height	Projection
SAP36	36"	41-½"	20"	4-½"
SAP48	48"	53-½"	22-½"	4-½"
SAP65	65"	70-½"	28-¾"	4-½"
SAP84	84"	89-½"	28"	4-½"

Combination Peaked Cap Pediment

Part#	Width	Overall Width	Height	Projection
PCP48	47-½"	52"	19-½"	3-⅝"
PCP50	50"	54-½"	20-¼"	3-⅝"
PCP54	54"	58-¼"	21"	3-⅝"
PCP58	58"	62-¾"	22"	3-⅝"
PCP67	67-½"	72"	24-½"	3-⅝"
PCP75	75"	79-½"	26-¼"	3-⅝"
PCP80	80"	84-½"	27-¾"	3-⅝"
PCP85	85"	89-½"	28-¾"	3-⅝"



Peaked Cap Pediment

Part#	Width	Height	Projection
PCP56	56-½"	13-⅝"	4-½"
PCP667	68-¾"	23-¾"	5-½"



Standard

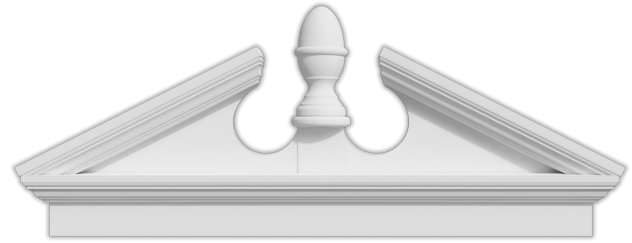

Standard



BT (Bottom Trim)

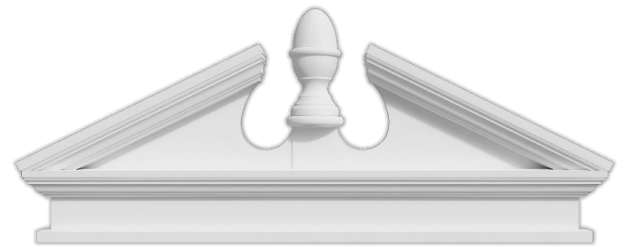

BT (Bottom Trim)

Half-Round Sunburst

Part#	Width	Overall Width	Height	Projection
CCP37	37-5/8"	41-3/4"	20-1/2"	4-1/2"

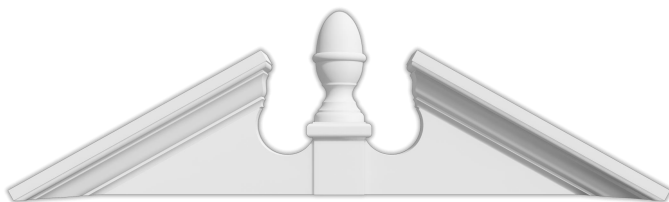

Acorn Pediment

Part#	Width	Height	Projection
AP56	57"	16-5/8"	4-1/2"
AP61	62"	16-3/4"	4-1/2"
AP667	68-7/8"	23-1/4"	5-1/2"
AP86	87-1/4"	24"	4-1/2"
AP91	92-1/8"	24-1/2"	4-1/2"
AP98	99-1/8"	24-1/2"	4-1/2"
AP115	105"-115"*	25-5/8"	4-1/2"

Combination Acorn Pediment

Part#	Width	Overall Width	Height	Projection
CP47E**	47"	50-1/8"	13-5/8"	2-1/8"
CP50	50"	54-1/2"	21-1/8"	3-1/8"
CP54	54"	58-1/2"	21-3/8"	3-1/8"
CP58	58"	62-1/2"	21-3/4"	3-1/8"
CP67	67-1/2"	72"	24-1/8"	3"
CP75	75"	79-1/2"	25-1/8"	3-1/8"
CP80	80"	84-7/16"	25-3/8"	3-1/8"
CP85	85"	89-3/8"	28-3/8"	3-1/8"

**No BT

*Adjustable

Pediments



Standard



BT (Bottom Trim)

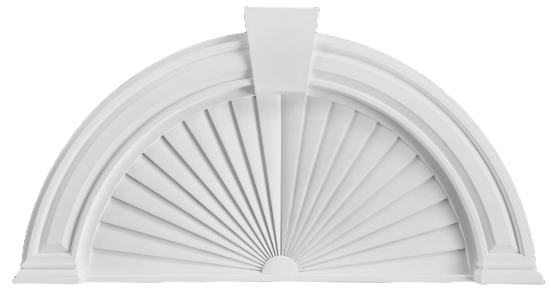

7" Panel Arch

Part#	Width	Overall Width	Height	Projection
AM40X54PSK	40"	54"	29"	20"

Combination Rams Head Pediment

Part#	Width	Overall Width	Height	Projection
RHP54	54"	58"	23-1/2"	3-1/8"
RHP67	67-1/2"	71-1/2"	27"	3-1/8"
RHP75	75"	79"	29-1/8"	3-1/8"
RHP80	80"	84"	35-3/4"	3-1/8"
RHP85	85"	89"	33-3/8"	3-1/8"



10" Decorative Arch

Part#	Width	Overall Width	Height	Projection
AM36X10SK	36"	56"	30-1/8"	4"

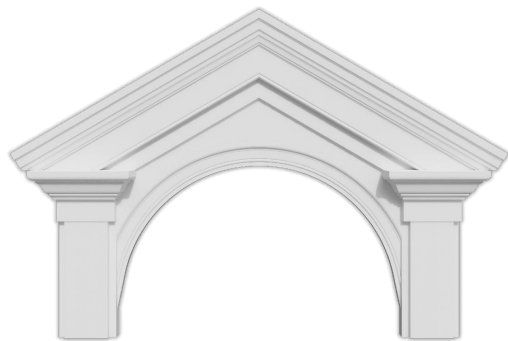

Deluxe Victorian Pediment

Part#	Inside Width	Overall Width	Height	Projection
DVP40	40"	67-1/4"	24-1/2"	20"

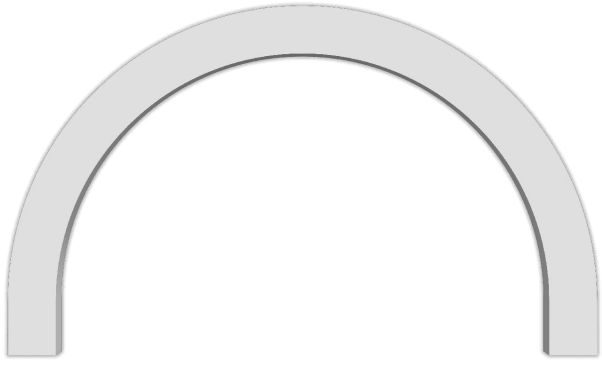

Flat Half-Round Arch Trim

Part#	Flat Width	Inside Width	Inside Height
AF24X4	3-½"	24-⅞"	16-⅞"
AF36X4	3-½"	36"	22"
AF37X4	3-½"	37-⅝"	22-¾"
AF48X4	3-½"	48"	28"
AF72X4	3-½"	72"	40"
AF36X6	5-½"	36"	22"
AF48X6	5-½"	48"	28"



Decorative Half-Round Arch Trim

Part#	Flat Width	Inside Width	Inside Height
AM36X4	3-½"	36"	22"
AM48X4	3-½"	48"	28"
AM36X6	5-½"	36"	21"
AM40X6	5-½"	40"	24"
AM48X6	5-½"	48"	28"
AM60X6	5-½"	60"	34"
AM72X6	5-½"	72"	40"

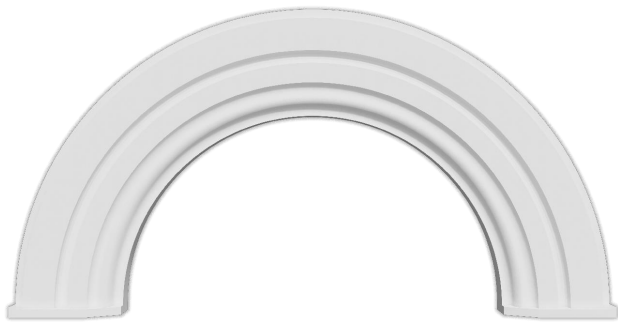

10M Decorative Half-Round Arch Trim

Part#	Flat Width	Inside Width	Inside Height
AMC36X10	10"	18-¾"	36"
AMC64X10	10"	32-¾"	64"

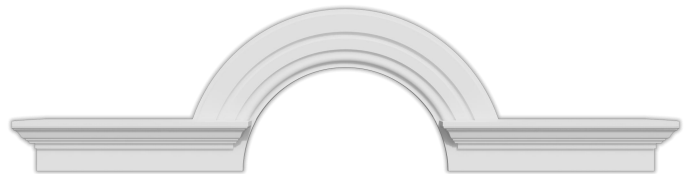

Half-Round Arch Trim with Flankers

Part#	Inside Width	Inside Height	Flanker Width
AM36X10L108	36"	18"	36"

Pilasters

Plain Pilaster

Part#	Width	Height	Projection	Plinth Block Height	Plinth
PL5X90P	5-¼"	90"	1-⅝"	10-⅞"	Molded
PL6X90P	6"	90"	2-½"	13-¼"	Molded
PL7X90P	7"	90"	2-½"	13-¼"	Molded
PL8X90P	8"	90"	2-½"	13-¼"	Molded
PL9X90P	9"	90"	3"	14-½"	Molded
PL5X108P	5-¼"	108"	1-⅝"	10"	Adjustable
PL6X120P	6"	120"	2-½"	13-¼"	Adjustable
PL7X108P	7"	108"	2-½"	13"	Adjustable
PL7X120P	7"	120"	2-½"	13"	Adjustable
PL8X108P	8"	108"	2-⅝"	13"	Adjustable
PL9X108P	9"	108"	3"	14-½"	Adjustable
PL9X120P	9"	120"	3"	14-½"	Adjustable
PL10X120P	10"	120"	3-¼"	14-½"	Adjustable
PL11X90P	11"	90"	3-½"	14-½"	Adjustable
PL11X96P	11"	96"	3-½"	14-½"	Adjustable
PL11X108P	11"	108"	3-½"	14-½"	Adjustable
PL11X120P	11"	120"	3-½"	14-½"	Adjustable

Fluted Pilaster

Part#	Width	Height	Projection	Plinth Block Height	Plinth
PL3X81	3-½"	81"	1-⅝"	10"	Molded
PL4X83	4-½"	82-¾"	1-⅝"	7-¾"	Molded
PL4X86	4-½"	86"	1-⅝"	11"	Molded
PL4X90	4-½"	90"	1-⅝"	10"	Molded
PL5X82	5-¼"	82"	1-¾"	8"	Molded
PL5X90	5-¼"	90"	1-¾"	10-⅞"	Molded
PL6X90	6-¼"	90"	2-½"	13-¼"	Molded
PL7X90	7"	90"	2-½"	13-¼"	Molded
PL9X90	9"	90"	3"	14-½"	Molded
PL11X90	11"	90"	3-½"	14-¼"	Molded
PL3X108	3-½"	108"	1-⅝"	10"	Adjustable
PL4X108	4-½"	108"	1-⅝"	10"	Adjustable
PL5X108	5-¼"	108"	1-⅝"	10"	Adjustable
PL6X108	6-¼"	108"	2-½"	13-¼"	Adjustable
PL6X144	6-¼"	144"	2-½"	13-¼"	Adjustable
PL7X102	7"	102"	2-½"	13-¼"	Adjustable
PL7X108	7"	108"	2-½"	13"	Adjustable
PL7X144	7"	144"	2-½"	13"	Adjustable
PL8X90	8"	90"	2-½"	13"	Adjustable
PL8X108	8"	108"	2-½"	13"	Adjustable
PL8X144	8"	144"	2-½"	13"	Adjustable
PL9X102	9"	102"	3"	14-½"	Adjustable
PL9X108	9"	108"	3"	14-½"	Adjustable
PL9X144	9"	144"	3"	14-½"	Adjustable
PL11X108	11"	108"	3-½"	14-½"	Adjustable
PL11X120	11"	120"	3-½"	14-½"	Adjustable
PL11X144	11"	144"	3-½"	14-½"	Adjustable

Fluted Narrow Pilaster

Part#	Width	Height	Projection	Plinth Block Height	Plinth
PL5X90E	5-¼"	90"	1-¼"	14-¼"	Molded
PL7X90E	7"	90"	1-¼"	14-¼"	Molded
PL9X90E	9"	90"	1-¼"	14-¼"	Molded
PL5X120E	5-¼"	120"	1-¼"	14-¼"	Adjustable

Pilasters are sold as a pair.

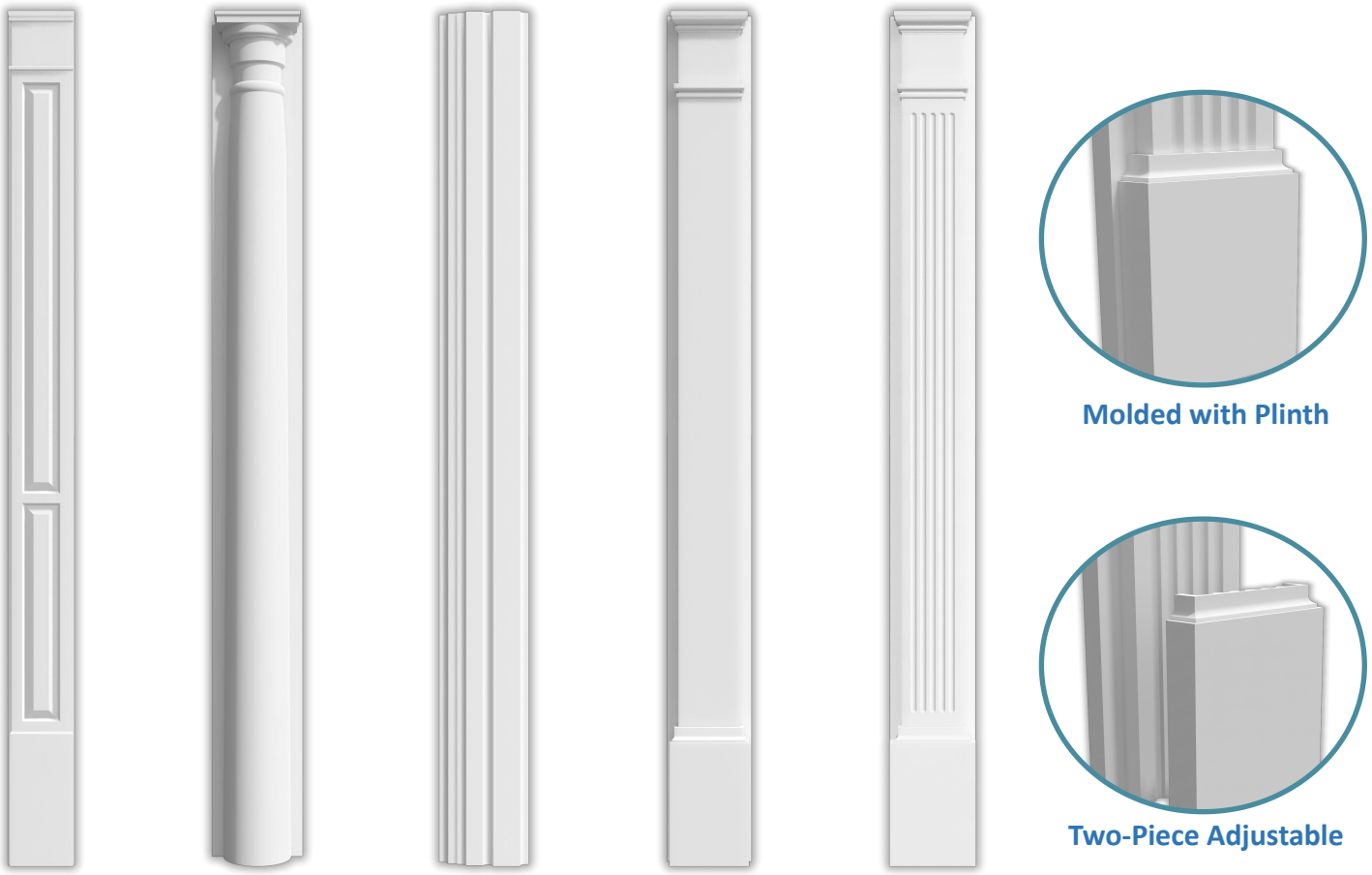

Double Panel

Half-Round Column

Arch Profile

Plain

Fluted

Double Panel Pilaster

Part#	Width	Height	Projection	Plinth Block Height	Plinth
PL5X90DP	5-¼"	90"	1-⅝"	10-⅝"	Molded
PL7X90DP	7"	90"	2-½"	14-¼"	Molded
PL7X104DP	7"	104"	2-½"	14-¼"	Molded
PL9X90DP	9"	90"	3"	14-½"	Molded
PL9X100DP	9"	100"	3"	14-½"	Molded
PL11X90DP	11"	90"	3-½"	14-½"	Molded
PL11X108DP	11"	108"	3-½"	14-½"	Molded
PL7X90DPE*	7"	90"	1-¼"	14-¼"	Molded

Half-Round Pilaster

Part#	Width	Height	Top Projection	Bottom Projection	Plinth
PL10X96HC	10"	80"-93-⅝"	4-⅞"	5-½"	Adjustable

Arch Profile Pilaster

Part#	Width	Height	Projection
PL10X96A	10"	96"	2-⅝"
PL10X192A	10"	192"	2-⅝"

Pilasters are sold as a pair.

Keystones



Part#	Top Width	Bottom Width	Height	Part#	Top Width	Bottom Width	Height	Part#	Top Width	Bottom Width	Height
K6	4-¾"	2-¾"	6-½"	KP4F	4-¾"	3"	4-½"	KP6M	5-¾"	4"	7"
K8	9-¾"	5-¾"	7-¾"	KP6F	6"	4"	7"	KP9M	8"	6"	11"

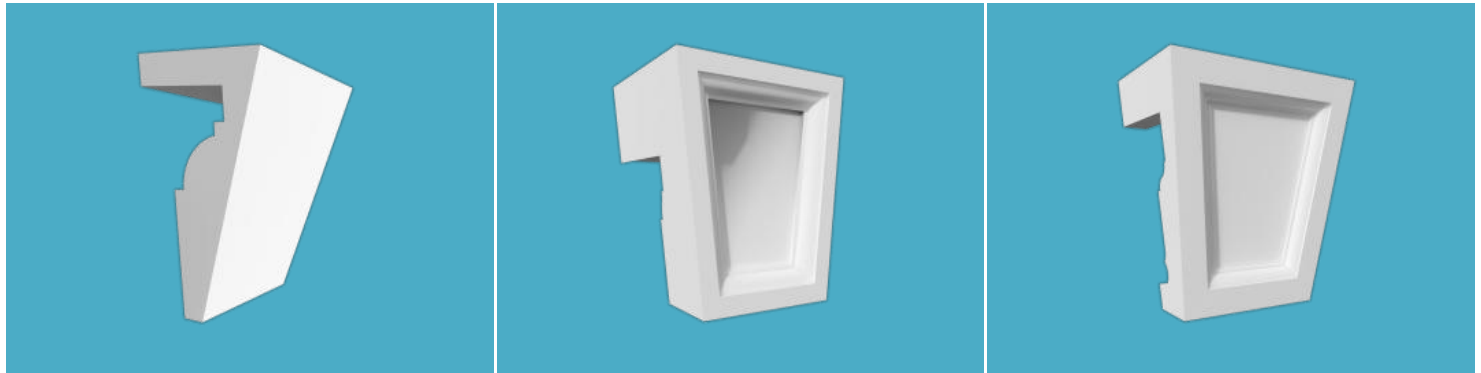

Part#	Top Width	Bottom Width	Height	Part#	Top Width	Bottom Width	Height	Part#	Top Width	Bottom Width	Height
K10S	8"	6"	8-½"	K180	2-¾"	2"	3-⅞"	KP4TM	4-¼"	3"	4-½"
								KP6TM	6"	4"	7"



Part#	Top Width	Bottom Width	Height	Part#	Top Width	Bottom Width	Height	Part#	Top Width	Bottom Width	Height
K4F	4-¾"	3"	4-½"	K6M	5-¾"	4"	7"	K4TM	4-¼"	3"	4-½"
K6F	6"	4"	7"	K9M	8"	6"	11"	K6TM	6"	4"	7"
K8F	7"	5"	8-⅞"	K12M	8-½"	6"	13"	K10TM	8"	5-½"	11-½"

Windows & Door Trim

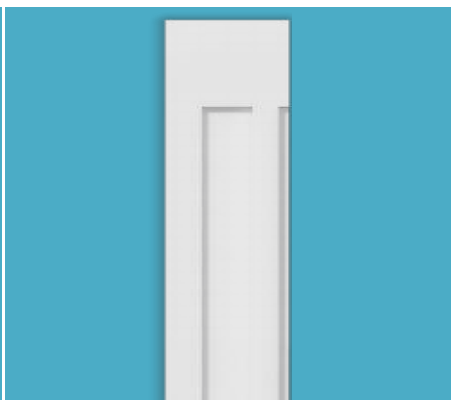

Part#	Inside Width	Trim Width	Project	Part#	Width	Height	Project	Part#	Width	Height	Project
CF24X4	24- $\frac{1}{4}$ "	3- $\frac{1}{2}$ "	1"	DTST7X69	6- $\frac{3}{4}$ "	68- $\frac{5}{8}$ "	1- $\frac{3}{4}$ "	DT44	43- $\frac{3}{4}$ "	33- $\frac{1}{4}$ "	4- $\frac{1}{2}$ "
CF36X4	36- $\frac{3}{8}$ "	3- $\frac{1}{2}$ "	1"								

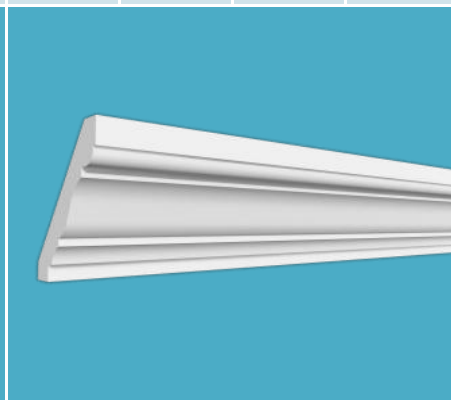
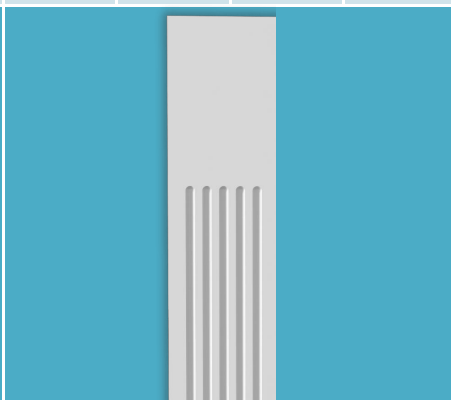

Part#	Inside Width	Inside Height	Trim Width	Project	Part#	Width	Height	Project	Part#	Width	Height	Project
OVB24X36X4F	24- $\frac{3}{8}$ "	36- $\frac{3}{8}$ "	3"	1"	FP12X96	12"	96"	1- $\frac{1}{2}$ "	DTR457-10	6- $\frac{3}{4}$ "	68- $\frac{5}{8}$ "	1- $\frac{1}{2}$ "

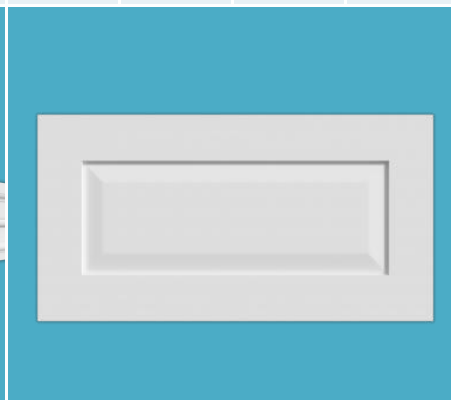
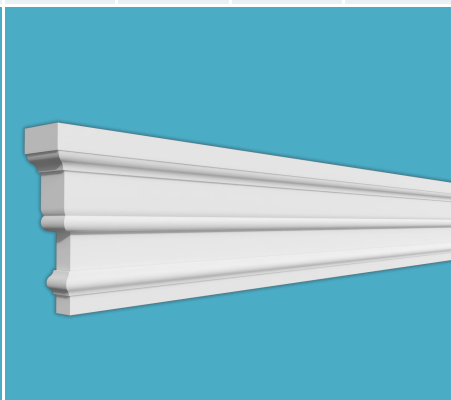

Part#	Inside Width	Inside Height	Trim Width	Project	Part#	Width	Length	Project	Part#	Width	Height	Project
OVB24X36X4M	24- $\frac{3}{8}$ "	36- $\frac{3}{8}$ "	1- $\frac{3}{4}$ "	3- $\frac{1}{2}$ "	DWS221	5- $\frac{1}{2}$ "	94"	1- $\frac{3}{4}$ "	WDP36X18	36"	18"	1- $\frac{1}{8}$ "



Shutters

Wood-Grained Shutters

2-Board Plank Shutters - 3-Batten

Part#	Width	Height	Projection
ST2P3T12X24CRS-G	12"	24"	1-½"
ST2P3T12X36CRS-G	12"	36"	1-½"
ST2P3T12X48CRS-G	12"	48"	1-½"
ST2P3T12X60CRS-G	12"	60"	1-½"
ST2P3T12X72CRS-G	12"	72"	1-½"
ST2P3T12X84CRS-G	12"	84"	1-½"
ST2P3T12X96CRS-G	12"	96"	1-½"
ST2P3T12X108CRS-G	12"	108"	1-½"
ST2P3T12X120CRS-G	12"	120"	1-½"



2-Board & Batten Shutters - 3-Batten

Part#	Width	Height	Projection
ST2P3T12X24CRS	12"	24"	1-½"
ST2P3T12X36CRS	12"	36"	1-½"
ST2P3T12X48CRS	12"	48"	1-½"
ST2P3T12X60CRS	12"	60"	1-½"
ST2P3T12X72CRS	12"	72"	1-½"
ST2P3T12X84CRS	12"	84"	1-½"
ST2P3T12X96CRS	12"	96"	1-½"
ST2P3T12X108CRS	12"	108"	1-½"
ST2P3T12X120CRS	12"	120"	1-½"



2-Board Plank Shutters - 2-Batten

Part#	Width	Height	Projection
ST2P2T12X24CRS	12"	24"	1-½"
ST2P2T12X36CRS	12"	36"	1-½"
ST2P2T12X48CRS	12"	48"	1-½"
ST2P2T12X60CRS	12"	60"	1-½"
ST2P2T12X72CRS	12"	72"	1-½"
ST2P2T12X84CRS	12"	84"	1-½"
ST2P2T12X96CRS	12"	96"	1-½"
ST2P2T12X108CRS	12"	108"	1-½"
ST2P2T12X120CRS	12"	120"	1-½"



Shutters are sold as a pair.



2-Board Plank Shutters - Diamond

Part#	Width	Height	Projection
ST2P2T12X24CRS-D	12"	24"	1-½"
ST2P2T12X36CRS-D	12"	36"	1-½"
ST2P2T12X48CRS-D	12"	48"	1-½"
ST2P2T12X60CRS-D	12"	60"	1-½"
ST2P2T12X72CRS-D	12"	72"	1-½"
ST2P2T12X84CRS-D	12"	84"	1-½"
ST2P2T12X96CRS-D	12"	96"	1-½"
ST2P2T12X108CRS-D	12"	108"	1-½"
ST2P2T12X120CRS-D	12"	120"	1-½"



2-Board & Batten Shutters - End Batten

Part#	Width	Height	Projection
ST2P2ET12X24CRS	12"	24"	1-½"
ST2P2ET12X36CRS	12"	36"	1-½"
ST2P2ET12X48CRS	12"	48"	1-½"
ST2P2ET12X60CRS	12"	60"	1-½"
ST2P2ET12X72CRS	12"	72"	1-½"
ST2P2ET12X84CRS	12"	84"	1-½"
ST2P2ET12X96CRS	12"	96"	1-½"
ST2P2ET12X108CRS	12"	108"	1-½"
ST2P2ET12X120CRS	12"	120"	1-½"



2-Board & Batten Shutters - Quarter Round

Part#	Width	Height	Projection
ST2RP2T12X24CRS	12"	24"	1-½"
ST2RP2T12X36CRS	12"	36"	1-½"
ST2RP2T12X48CRS	12"	48"	1-½"
ST2RP2T12X60CRS	12"	60"	1-½"
ST2RP2T12X72CRS	12"	72"	1-½"
ST2RP2T12X84CRS	12"	84"	1-½"
ST2RP2T12X96CRS	12"	96"	1-½"
ST2RP2T12X108CRS	12"	108"	1-½"
ST2RP2T12X120CRS	12"	120"	1-½"

Shutters are sold as a pair.

Wood-Grained Shutters

2-Board Plank Shutters - 2-Batten

Part#	Width	Height	Projection
ST2P2T12X24CRS-G	12"	24"	1-½"
ST2P2T12X36CRS-G	12"	36"	1-½"
ST2P2T12X48CRS-G	12"	48"	1-½"
ST2P2T12X60CRS-G	12"	60"	1-½"
ST2P2T12X72CRS-G	12"	72"	1-½"
ST2P2T12X84CRS-G	12"	84"	1-½"
ST2P2T12X96CRS-G	12"	96"	1-½"
ST2P2T12X108CRS-G	12"	108"	1-½"
ST2P2T12X120CRS-G	12"	120"	1-½"



2-Board Plank Shutters - Z-Batten

Part#	Width	Height	Projection
ST2PZT12X24CRS-G	12"	24"	1-½"
ST2PZT12X36CRS-G	12"	36"	1-½"
ST2PZT12X48CRS-G	12"	48"	1-½"
ST2PZT12X60CRS-G	12"	60"	1-½"
ST2PZT12X72CRS-G	12"	72"	1-½"
ST2PZT12X84CRS-G	12"	84"	1-½"
ST2PZT12X96CRS-G	12"	96"	1-½"
ST2PZT12X108CRS-G	12"	108"	1-½"
ST2PZT12X120CRS-G	12"	120"	1-½"



2-Board & Batten Shutters - Z-Batten

Part#	Width	Height	Projection
ST2PZT12X24CRS	12"	24"	1-½"
ST2PZT12X36CRS	12"	36"	1-½"
ST2PZT12X48CRS	12"	48"	1-½"
ST2PZT12X60CRS	12"	60"	1-½"
ST2PZT12X72CRS	12"	72"	1-½"
ST2PZT12X84CRS	12"	84"	1-½"
ST2PZT12X96CRS	12"	96"	1-½"
ST2PZT12X108CRS	12"	108"	1-½"
ST2PZT12X120CRS	12"	120"	1-½"



Shutters are sold as a pair.



3-Board Plank Shutters - 3-Batten

Part#	Width	Height	Projection
ST3P3T18X24CRS-G	18"	24"	1-½"
ST3P3T18X36CRS-G	18"	36"	1-½"
ST3P3T18X48CRS-G	18"	48"	1-½"
ST3P3T18X60CRS-G	18"	60"	1-½"
ST3P3T18X72CRS-G	18"	72"	1-½"
ST3P3T18X84CRS-G	18"	84"	1-½"
ST3P3T18X96CRS-G	18"	96"	1-½"
ST3P3T18X108CRS-G	18"	108"	1-½"
ST3P3T18X120CRS-G	18"	120"	1-½"



3-Board & Batten Shutters - 3-Batten

Part#	Width	Height	Projection
ST3P3T14X24CRS	14"	24"	1-½"
ST3P3T14X36CRS	14"	36"	1-½"
ST3P3T14X48CRS	14"	48"	1-½"
ST3P3T14X60CRS	14"	60"	1-½"
ST3P3T14X72CRS	14"	72"	1-½"
ST3P3T14X84CRS	14"	84"	1-½"
ST3P3T14X96CRS	14"	96"	1-½"
ST3P3T14X108CRS	14"	108"	1-½"
ST3P3T14X120CRS	14"	120"	1-½"
ST3P3T18X24CRS	18"	24"	1-½"
ST3P3T18X36CRS	18"	36"	1-½"
ST3P3T18X48CRS	18"	48"	1-½"
ST3P3T18X60CRS	18"	60"	1-½"
ST3P3T18X72CRS	18"	72"	1-½"
ST3P3T18X84CRS	18"	84"	1-½"
ST3P3T18X96CRS	18"	96"	1-½"
ST3P3T18X108CRS	18"	108"	1-½"
ST3P3T18X120CRS	18"	120"	1-½"

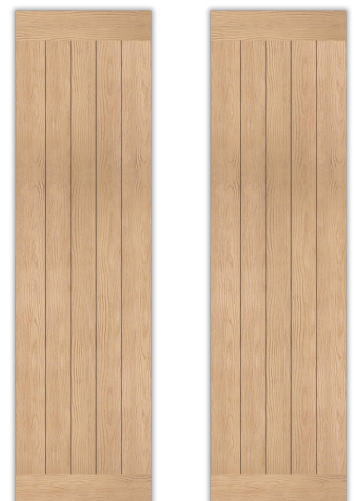

Wood-Grained Panel Shutter with Border

Part#	Width	Height	Projection
ST3PB18X66S	18"	66"	1-½"

Shutters are sold as a pair.

Wood-Grained Shutters

3-Board & Batten Shutters - 2-Batten

Part#	Width	Height	Projection
ST3P2T14X24CRS	14"	24"	1-½"
ST3P2T14X36CRS	14"	36"	1-½"
ST3P2T14X48CRS	14"	48"	1-½"
ST3P2T14X60CRS	14"	60"	1-½"
ST3P2T14X72CRS	14"	72"	1-½"
ST3P2T14X84CRS	14"	84"	1-½"
ST3P2T14X96CRS	14"	96"	1-½"
ST3P2T14X108CRS	14"	108"	1-½"
ST3P2T14X120CRS	14"	120"	1-½"
ST3P2T18X24CRS	18"	24"	1-½"
ST3P2T18X36CRS	18"	36"	1-½"
ST3P2T18X48CRS	18"	48"	1-½"
ST3P2T18X60CRS	18"	60"	1-½"
ST3P2T18X72CRS	18"	72"	1-½"
ST3P2T18X84CRS	18"	84"	1-½"
ST3P2T18X96CRS	18"	96"	1-½"
ST3P2T18X108CRS	18"	108"	1-½"
ST3P2T18X120CRS	18"	120"	1-½"



3-Board Plank Shutters - Diamond

Part#	Width	Height	Projection
ST3P2T18X24CRS-D	18"	24"	1-½"
ST3P2T18X36CRS-D	18"	36"	1-½"
ST3P2T18X48CRS-D	18"	48"	1-½"
ST3P2T18X60CRS-D	18"	60"	1-½"
ST3P2T18X72CRS-D	18"	72"	1-½"
ST3P2T18X84CRS-D	18"	84"	1-½"
ST3P2T18X96CRS-D	18"	96"	1-½"
ST3P2T18X108CRS-D	18"	108"	1-½"
ST3P2T18X120CRS-D	18"	120"	1-½"

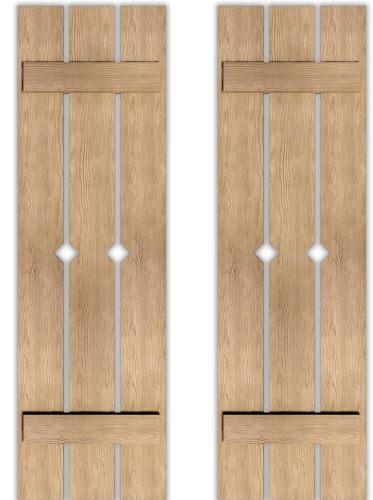

Shutters are sold as a pair.

3-Board & Batten Shutters - End Batten



Part#	Width	Height	Projection
ST3P2ET14X24CRS	14"	24"	1-½"
ST3P2ET14X36CRS	14"	36"	1-½"
ST3P2ET14X48CRS	14"	48"	1-½"
ST3P2ET14X60CRS	14"	60"	1-½"
ST3P2ET14X72CRS	14"	72"	1-½"
ST3P2ET14X84CRS	14"	84"	1-½"
ST3P2ET14X96CRS	14"	96"	1-½"
ST3P2ET14X108CRS	14"	108"	1-½"
ST3P2ET14X120CRS	14"	120"	1-½"
ST3P2ET18X24CRS	18"	24"	1-½"
ST3P2ET18X36CRS	18"	36"	1-½"
ST3P2ET18X48CRS	18"	48"	1-½"
ST3P2ET18X60CRS	18"	60"	1-½"
ST3P2ET18X72CRS	18"	72"	1-½"
ST3P2ET18X84CRS	18"	84"	1-½"
ST3P2ET18X96CRS	18"	96"	1-½"
ST3P2ET18X108CRS	18"	108"	1-½"
ST3P2ET18X120CRS	18"	120"	1-½"

3-Board & Batten Shutters - Quarter Round



Part#	Width	Height	Projection
ST3RP2T14X36CRS	14"	36"	1-½"
ST3RP2T14X48CRS	14"	48"	1-½"
ST3RP2T14X60CRS	14"	60"	1-½"
ST3RP2T14X72CRS	14"	72"	1-½"
ST3RP2T14X84CRS	14"	84"	1-½"
ST3RP2T14X96CRS	14"	96"	1-½"
ST3RP2T14X108CRS	14"	108"	1-½"
ST3RP2T14X120CRS	14"	120"	1-½"
ST3RP2T18X36CRS	18"	36"	1-½"
ST3RP2T18X48CRS	18"	48"	1-½"
ST3RP2T18X60CRS	18"	60"	1-½"
ST3RP2T18X72CRS	18"	72"	1-½"
ST3RP2T18X84CRS	18"	84"	1-½"
ST3RP2T18X96CRS	18"	96"	1-½"
ST3RP2T18X108CRS	18"	108"	1-½"
ST3RP2T18X120CRS	18"	120"	1-½"

Shutters are sold as a pair.

Wood-Grained Shutters

3-Board Plank Shutters - 2-Batten

Part#	Width	Height	Projection
ST3P2T18X24CRS-G	18"	24"	1-½"
ST3P2T18X36CRS-G	18"	36"	1-½"
ST3P2T18X48CRS-G	18"	48"	1-½"
ST3P2T18X60CRS-G	18"	60"	1-½"
ST3P2T18X72CRS-G	18"	72"	1-½"
ST3P2T18X84CRS-G	18"	84"	1-½"
ST3P2T18X96CRS-G	18"	96"	1-½"
ST3P2T18X108CRS-G	18"	108"	1-½"
ST3P2T18X120CRS-G	18"	120"	1-½"



3-Board Plank Shutters - Z-Batten

Part#	Width	Height	Projection
ST3PZT18X24CRS-G	18"	24"	1-½"
ST3PZT18X36CRS-G	18"	36"	1-½"
ST3PZT18X48CRS-G	18"	48"	1-½"
ST3PZT18X60CRS-G	18"	60"	1-½"
ST3PZT18X72CRS-G	18"	72"	1-½"
ST3PZT18X84CRS-G	18"	84"	1-½"
ST3PZT18X96CRS-G	18"	96"	1-½"
ST3PZT18X108CRS-G	18"	108"	1-½"
ST3PZT18X120CRS-G	18"	120"	1-½"



3-Board & Batten Shutters - Z-Batten

Part#	Width	Height	Projection
ST3PZT14X24CRS	14"	24"	1-½"
ST3PZT14X36CRS	14"	36"	1-½"
ST3PZT14X48CRS	14"	48"	1-½"
ST3PZT14X60CRS	14"	60"	1-½"
ST3PZT14X72CRS	14"	72"	1-½"
ST3PZT14X84CRS	14"	84"	1-½"
ST3PZT14X96CRS	14"	96"	1-½"
ST3PZT14X108CRS	14"	108"	1-½"
ST3PZT14X120CRS	14"	120"	1-½"
ST3PZT18X24CRS	18"	24"	1-½"
ST3PZT18X36CRS	18"	36"	1-½"
ST3PZT18X48CRS	18"	48"	1-½"
ST3PZT18X60CRS	18"	60"	1-½"
ST3PZT18X72CRS	18"	72"	1-½"
ST3PZT18X84CRS	18"	84"	1-½"
ST3PZT18X96CRS	18"	96"	1-½"
ST3PZT18X108CRS	18"	108"	1-½"
ST3PZT18X120CRS	18"	120"	1-½"



Shutters are sold as a pair.

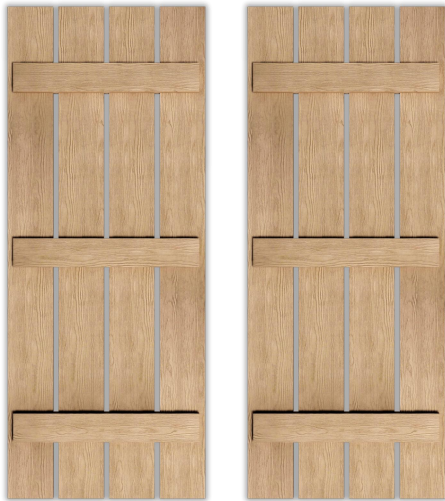

4-Board Plank Shutters - 3-Batten

Part#	Width	Height	Projection
ST4P3T24X24CRS-G	24"	24"	1-½"
ST4P3T24X36CRS-G	24"	36"	1-½"
ST4P3T24X48CRS-G	24"	48"	1-½"
ST4P3T24X60CRS-G	24"	60"	1-½"
ST4P3T24X72CRS-G	24"	72"	1-½"
ST4P3T24X84CRS-G	24"	84"	1-½"
ST4P3T24X96CRS-G	24"	96"	1-½"
ST4P3T24X108CRS-G	24"	108"	1-½"
ST4P3T24X120CRS-G	24"	120"	1-½"



4-Board & Batten Shutters - 3-Batten

Part#	Width	Height	Projection
ST4P3T24X24CRS	24"	24"	1-½"
ST4P3T24X36CRS	24"	36"	1-½"
ST4P3T24X48CRS	24"	48"	1-½"
ST4P3T24X60CRS	24"	60"	1-½"
ST4P3T24X72CRS	24"	72"	1-½"
ST4P3T24X84CRS	24"	84"	1-½"
ST4P3T24X96CRS	24"	96"	1-½"
ST4P3T24X108CRS	24"	108"	1-½"
ST4P3T24X120CRS	24"	120"	1-½"



4-Board & Batten Shutters - 2-Batten

Part#	Width	Height	Projection
ST4P2T24X24CRS	24"	24"	1-½"
ST4P2T24X36CRS	24"	36"	1-½"
ST4P2T24X48CRS	24"	48"	1-½"
ST4P2T24X60CRS	24"	60"	1-½"
ST4P2T24X72CRS	24"	72"	1-½"
ST4P2T24X84CRS	24"	84"	1-½"
ST4P2T24X96CRS	24"	96"	1-½"
ST4P2T24X108CRS	24"	108"	1-½"
ST4P2T24X120CRS	24"	120"	1-½"

Shutters are sold as a pair.

Wood-Grained Shutters

4-Board Plank Shutters - Diamond

Part#	Width	Height	Projection
ST4P2T24X24CRS-D	24"	24"	1-½"
ST4P2T24X36CRS-D	24"	36"	1-½"
ST4P2T24X48CRS-D	24"	48"	1-½"
ST4P2T24X60CRS-D	24"	60"	1-½"
ST4P2T24X72CRS-D	24"	72"	1-½"
ST4P2T24X84CRS-D	24"	84"	1-½"
ST4P2T24X96CRS-D	24"	96"	1-½"
ST4P2T24X108CRS-D	24"	108"	1-½"
ST4P2T24X120CRS-D	24"	120"	1-½"

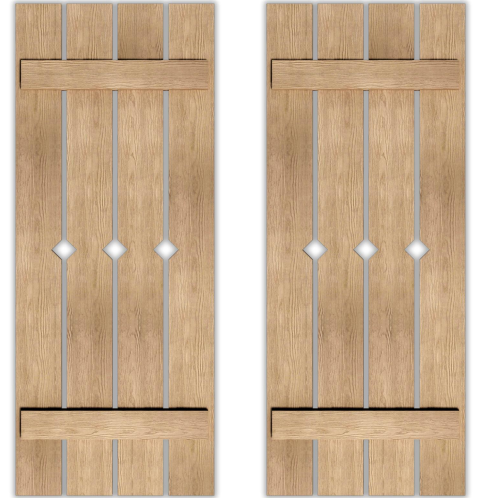

4-Board & Batten Shutters - End Batten

Part#	Width	Height	Projection
ST4P2ET24X24CRS	24"	24"	1-½"
ST4P2ET24X36CRS	24"	36"	1-½"
ST4P2ET24X48CRS	24"	48"	1-½"
ST4P2ET24X60CRS	24"	60"	1-½"
ST4P2ET24X72CRS	24"	72"	1-½"
ST4P2ET24X84CRS	24"	84"	1-½"
ST4P2ET24X96CRS	24"	96"	1-½"
ST4P2ET24X108CRS	24"	108"	1-½"
ST4P2ET24X120CRS	24"	120"	1-½"

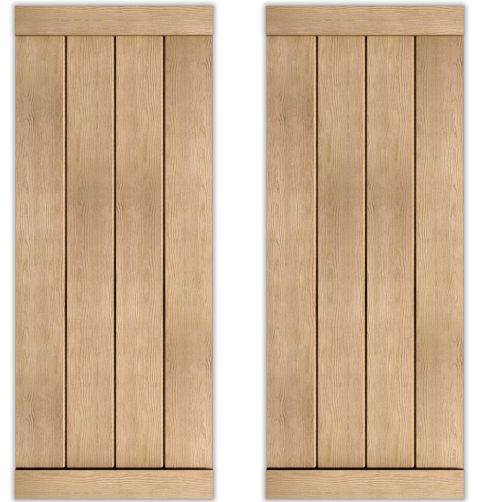

4-Board & Batten Shutters - Quarter Round

Part#	Width	Height	Projection
ST4RP2T24X48CRS	24"	48"	1-½"
ST4RP2T24X60CRS	24"	60"	1-½"
ST4RP2T24X72CRS	24"	72"	1-½"
ST4RP2T24X84CRS	24"	84"	1-½"
ST4RP2T24X96CRS	24"	96"	1-½"
ST4RP2T24X108CRS	24"	108"	1-½"
ST4RP2T24X120CRS	24"	120"	1-½"



Shutters are sold as a pair.

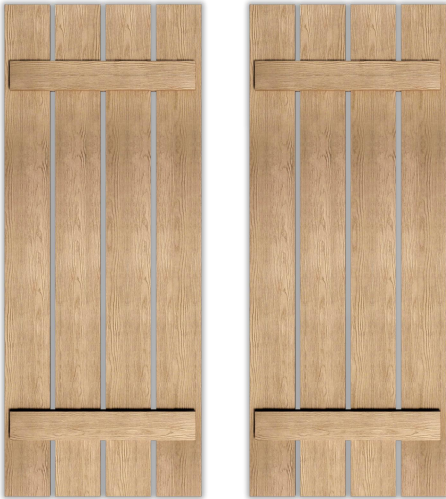

4-Board Plank Shutters - 2-Batten

Part#	Width	Height	Projection
ST4P2T24X24CRS-G	24"	24"	1-½"
ST4P2T24X36CRS-G	24"	36"	1-½"
ST4P2T24X48CRS-G	24"	48"	1-½"
ST4P2T24X60CRS-G	24"	60"	1-½"
ST4P2T24X72CRS-G	24"	72"	1-½"
ST4P2T24X84CRS-G	24"	84"	1-½"
ST4P2T24X96CRS-G	24"	96"	1-½"
ST4P2T24X108CRS-G	24"	108"	1-½"
ST4P2T24X120CRS-G	24"	120"	1-½"

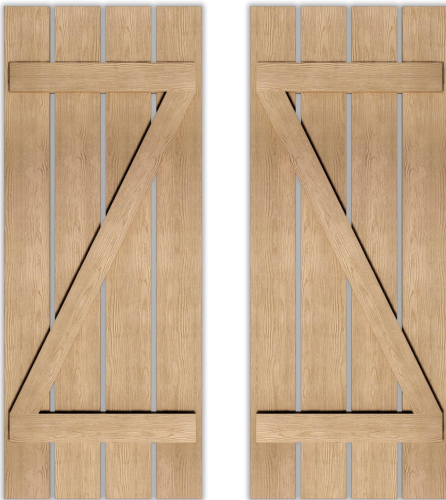

4-Board Plank Shutters - Z-Batten

Part#	Width	Height	Projection
ST4PZT24X24CRS-G	24"	24"	1-½"
ST4PZT24X36CRS-G	24"	36"	1-½"
ST4PZT24X48CRS-G	24"	48"	1-½"
ST4PZT24X60CRS-G	24"	60"	1-½"
ST4PZT24X72CRS-G	24"	72"	1-½"
ST4PZT24X84CRS-G	24"	84"	1-½"
ST4PZT24X96CRS-G	24"	96"	1-½"
ST4PZT24X108CRS-G	24"	108"	1-½"
ST4PZT24X120CRS-G	24"	120"	1-½"

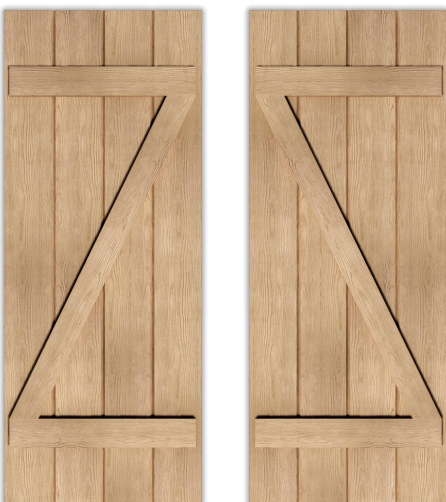

4-Board & Batten Shutters - Z-Batten

Part#	Width	Height	Projection
ST4PZT24X24CRS	24"	24"	1-½"
ST4PZT24X36CRS	24"	36"	1-½"
ST4PZT24X48CRS	24"	48"	1-½"
ST4PZT24X60CRS	24"	60"	1-½"
ST4PZT24X72CRS	24"	72"	1-½"
ST4PZT24X84CRS	24"	84"	1-½"
ST4PZT24X96CRS	24"	96"	1-½"
ST4PZT24X108CRS	24"	108"	1-½"
ST4PZT24X120CRS	24"	120"	1-½"

Shutters are sold as a pair.

Louvered Shutters

With Center Rail

Part#	Width	Height	Projection
LVST12X36CR	12"	36"	1"
LVST12X48CR	12"	48"	1"
LVST16X54CR	16"	54"	1"
LVST16X60CR	16"	60"	1"
LVST16X72CR	16"	72"	1"
LVST18X60CR	18"	60"	1"
LVST18X66CR	18"	66"	1"
LVST18X72CR	18"	72"	1"
LVST24X60CR	24"	60"	1"
LVST24X72CR	24"	72"	1"



Without Center Rail

Part#	Width	Height	Projection
LVST16X54	16"	54"	1"
LVST16X72	16"	72"	1"
LVST18X54	18"	54"	1"
LVST18X60	18"	60"	1"
LVST18X72	18"	72"	1"
LVST24X60	24"	60"	1"
LVST24X72	24"	72"	1"



Double Panel

Part#	Width	Height	Projection
ST16X48DP	16"	48"	1-¼"
ST16X54DP	16"	54"	1-¼"
ST16X60DP	16"	60"	1-¼"
ST16X65DP	16"	65"	1-¼"
ST16X72DP	16"	72"	1-¼"
ST18X53DP	18"	53"	1-¼"
ST18X59DP	18"	59"	1-¼"
ST18X66DP	18"	66"	1-¼"
ST18X72DP	18"	72"	1-¼"

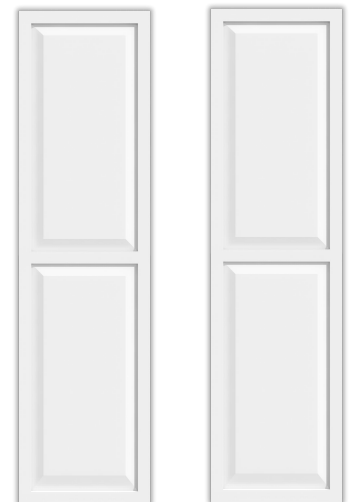

Shutters are sold as a pair.

Wood-Grained Shutters Board Fabrication Panels

Rough Sawn Cedar

Part#	Width	Height	Thickness
STB12X144CRS	12"	144"	$\frac{3}{4}$ "



Rough Sawn Cedar

Part#	Width	Height	Thickness
STB14X144CRS	14"	144"	$\frac{3}{4}$ "

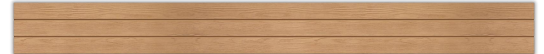

Rough Sawn Cedar

Part#	Width	Height	Thickness
STB18X144CRS	18"	144"	$\frac{3}{4}$ "



Rough Sawn Cedar

Part#	Width	Height	Thickness
STB24X144CRS	24"	144"	$\frac{3}{4}$ "

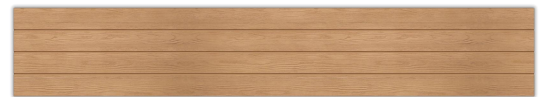

For Shaker-style and Modern Farmhouse Shaker-style Shutters

Part#	Width	Height	Thickness
STFP12X144	12"	144"	1- $\frac{3}{8}$ "



For Shaker-style and Modern Farmhouse Shaker-style Shutters

Part#	Width	Height	Thickness
STFP16X144	16"	144"	1- $\frac{3}{8}$ "

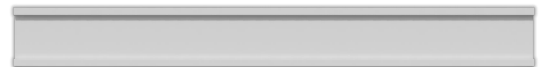

For Shaker-style and Modern Farmhouse Shaker-style Shutters

Part#	Width	Height	Thickness
STFP18X144	18"	144"	1- $\frac{3}{8}$ "

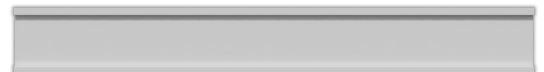

For Shaker-style and Modern Farmhouse Shaker-style Shutters

Part#	Width	Height	Thickness
STFP24X144	24"	144"	1- $\frac{3}{8}$ "

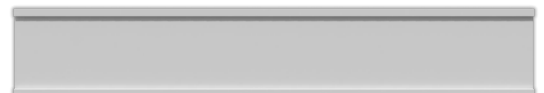

Mouldings



Smooth Flat Trim



Part#	Projection	Height	Length
FT1X3-12	3/4"	2-1/2"	12'
FT40X96	1"	40"	8'
FT100-12	5/8"	4-3/4"	12'
FT101-12	3/4"	1-1/2"	12'
FT102-10	3/4"	2-1/8"	10'
FT103-12	3/4"	2-1/8"	12'
FT109-12	3/4"	6"	12'
FT110-16	3/4"	5-1/2"	16'
FT113-8	3/4"	8"	8'
FT118-8	3/4"	10"	8'
FT119-17	1"	32-1/4"	16'11"
FT122-16	3/4"	3-1/2"	16'
FT125-8	1"	36"	8'
FT131-16	1/2"	3"	16'
FT152-8	1"	3-1/2"	8'
FT152-12	1"	3-1/2"	12'
FT152-16	1"	3-1/2"	16'
FT153-12	1"	4"	12'
FT159-8	1"	5-1/2"	8'
FT159-12	1"	5-1/2"	12'
FT159-16	1"	5-1/2"	16'
FT162-8	1"	7-1/2"	8'
FT162-14	1"	7-1/2"	14'
FT163-16	1-1/2"	7-1/2"	16'
FT170-12	1"	9-1/2"	12'
FT170-16	1"	9-1/2"	16'
FT172-16	1"	11-1/2"	16'
FT175-12	1"	12"	12'
FT178-8	1/2"	14"	8'
FT179-12	1"	16"	12'
FT180-12	1"	24"	12'
FT182-12	1-1/2"	12-1/4"	12'
FT183-12	1-1/2"	5-1/2"	12'
FT185-12	1-1/2"	16-1/2"	12'
FT186-16	3/4"	7-1/4"	16'
FT190-12	2"	4"	12'
FT194-10	1-1/2"	3-1/2"	10'

Wood-Grained Flat Trim



Brickmould

Part#	Projection	Height	Length
MDWM180-8	1-¼"	2"	8'
MDWM180-16	1-¼"	2"	16'
MDWM182-12	1-¼"	3"	12'

Wood-Grained Flat Trim

Part#	Projection	Height	Length
FT1X4-12RS	¾"	3-½"	12'
FT9X4X216S	3-½"	8-½"	18'
FT30X228X1S	1"	30"	19'
FT110-12S	¾"	5-½"	12'
FT111-12S	1-½"	5-½"	12'
FT150-12S	1-½"	3-½"	12'
FT151-12S	¾"	3-½"	12'
FT173-12S	¾"	11-½"	12'
FT187-12S	¾"	7-½"	12'
FT192-12S	1-½"	11-½"	12'
FT197-12S	1-½"	7-½"	12'



Brickmould

Part#	Projection	Height	Length
MDWM180-8S	1-¼"	2"	8'



Moulding Accessories

Part#	Projection	Height	Length
PB2.5X2.5	¾"	2-½"	2-½"
PB3X3	7/8"	3-⅝"	3-⅝"
PB3.5X3.5	¾"	3-½"	3-½"
PB3.875X3.875	1-⅛"	3-⅞"	3-⅞"
PB4X4	1-⅛"	3-⅝"	3-⅝"
PB5X5	1"	5-¼"	5-¼"
PB6X6	1-⅛"	5-⅝"	5-⅝"

Mouldings

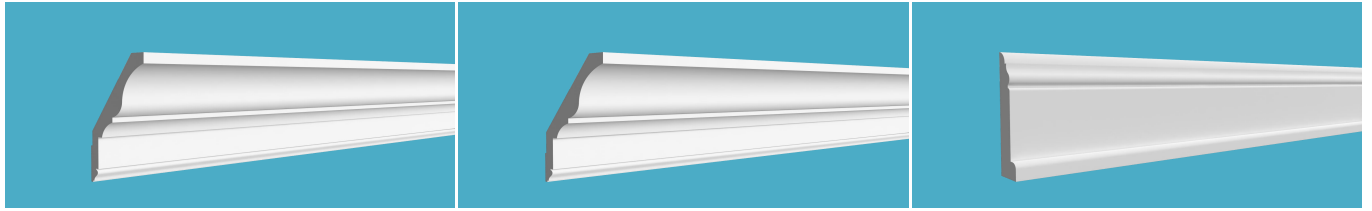

Part#	MD1001-12	Part#	MD1002-12	Part#	MD1019-12
Projection	4- $\frac{1}{8}$ "	Projection	5- $\frac{1}{8}$ "	Projection	1- $\frac{1}{8}$ "
Height	8- $\frac{1}{8}$ "	Height	10- $\frac{1}{8}$ "	Height	5- $\frac{1}{4}$ "
Length	12'	Length	12'	Length	12'

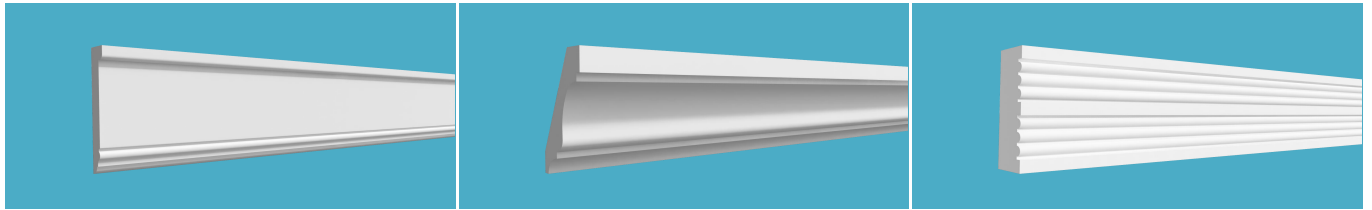

Part#	MD1020-12	Part#	MD1037-12	Part#	MD205-8	MD205-12
Projection	1- $\frac{1}{8}$ "	Projection	3- $\frac{1}{8}$ "	Projection	7/8"	7/8"
Height	7- $\frac{1}{4}$ "	Height	5- $\frac{5}{8}$ "	Height	3"	3"
Length	12'	Length	12'	Length	8'	12'

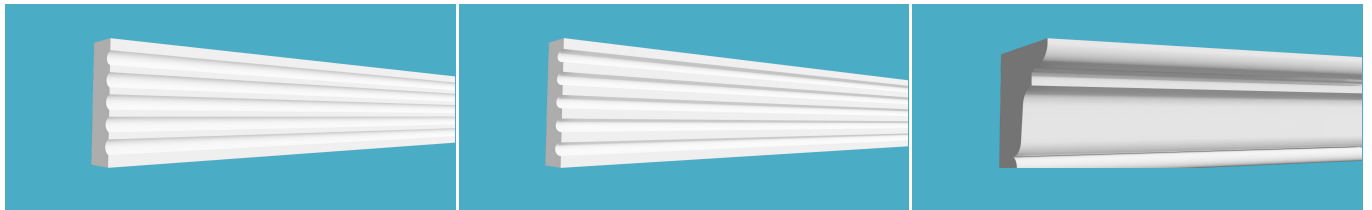

Part#	MD207-16	Part#	MD208-16	Part#	MD214-12
Projection	1"	Projection	1"	Projection	2"
Height	5- $\frac{1}{4}$ "	Height	7- $\frac{1}{4}$ "	Height	2- $\frac{3}{8}$ "
Length	16'	Length	16'	Length	12'



Part#	MD215-12	Part#	MD220-12	MD220-16	Part#	MD221-16
Projection	1- $\frac{3}{4}$ "	Projection	1- $\frac{3}{4}$ "	1- $\frac{3}{4}$ "	Projection	1- $\frac{3}{4}$ "
Height	3- $\frac{1}{2}$ "	Height	5- $\frac{1}{2}$ "	5- $\frac{1}{2}$ "	Height	7"
Length	12'	Length	12'	16'	Length	16'

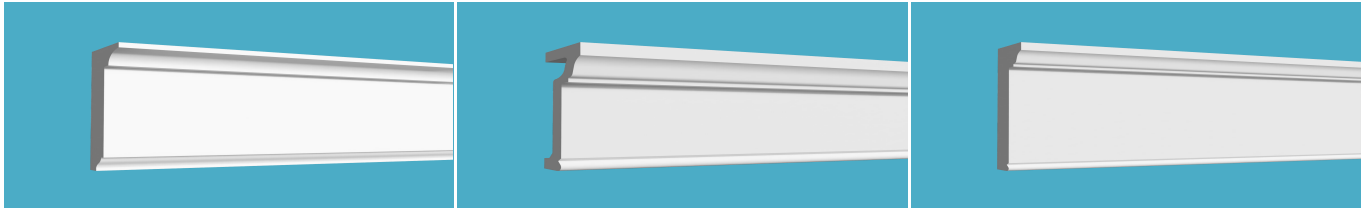

Part#	MD224-12	Part#	MD226-10	MD226-12	MD226-16	Part#	MD227-16
Projection	1-½"	Projection	1-½"	1-½"	1-½"	Projection	1-½"
Height	5-½"	Height	5-½"	5-½"	5-½"	Height	9"
Length	12'	Length	10'	12'	16'	Length	16'

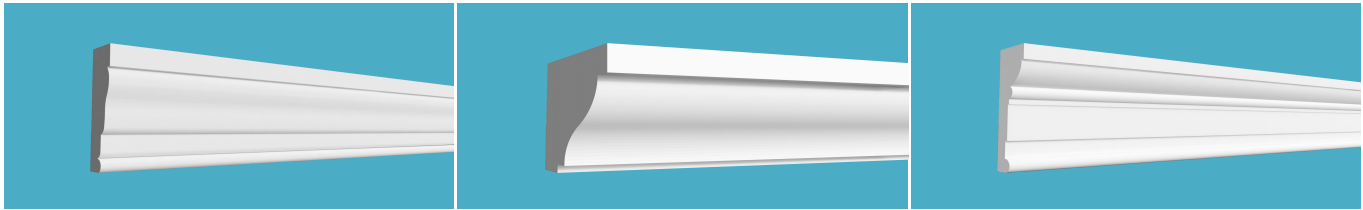

Part#	MD230-12	MD230-16	Part#	MD231-12	Part#	MD234-16
Projection	¾"	¾"	Projection	1"	Projection	1"
Height	3-¼"	3-¼"	Height	1-¾"	Height	3-½"
Length	12'	16'	Length	12'	Length	16'

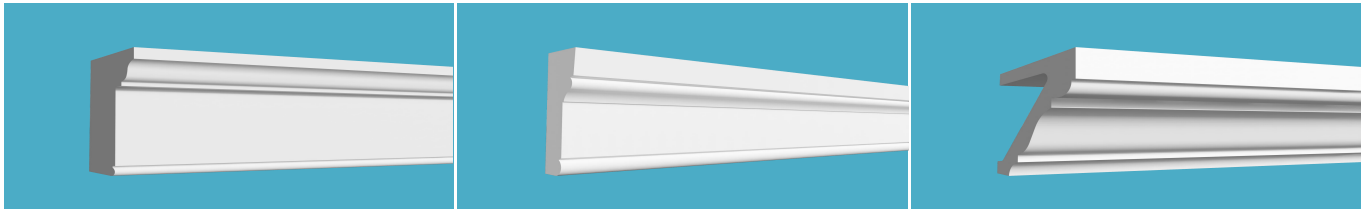

Part#	MD236-16	Part#	MD237-16	Part#	MD240-8
Projection	2"	Projection	1-⅝"	Projection	3-¼"
Height	5-½"	Height	3-½"	Height	4"
Length	16'	Length	16'	Length	8'



Part#	MD246-16	Part#	MD247-16	Part#	MD250-8	MD250-12
Projection	3-⅝"	Projection	1-⅞"	Projection	1-¾"	1-¾"
Height	9-⅞"	Height	8-¾"	Height	4-½"	4-½"
Length	16'	Length	16'	Length	8'	12'

Mouldings

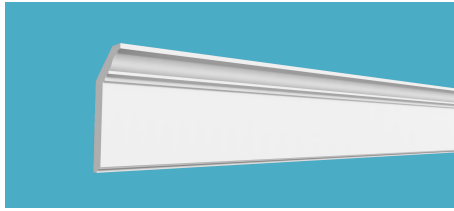

Part#	MD253-16
Projection	2- ³ / ₈ "
Height	7- ⁵ / ₈ "
Length	16'

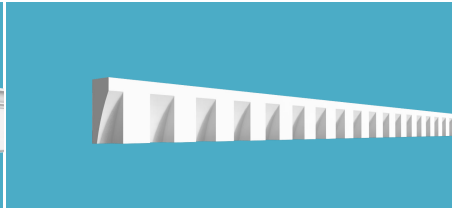

Part#	MD303-5
Projection	5/8"
Height	1- ¹ / ₄ "
Length	5'

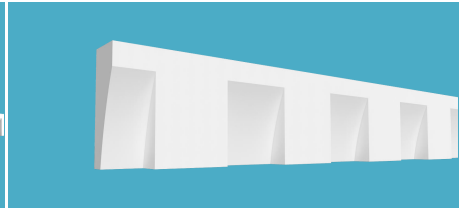

Part#	MD304-8
Projection	5/8"
Height	1- ¹ / ₄ "
Length	8'

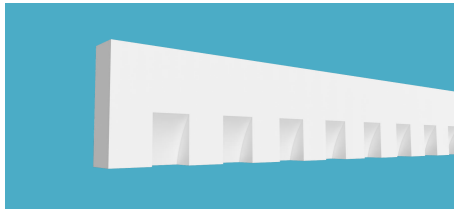

Part#	MD310-8	MD310-12	MD310-16
Projection	1- ¹ / ₄ "	1- ¹ / ₄ "	1- ¹ / ₄ "
Height	4- ¹ / ₂ "	4- ¹ / ₂ "	4- ¹ / ₂ "
Length	8'	12'	16'

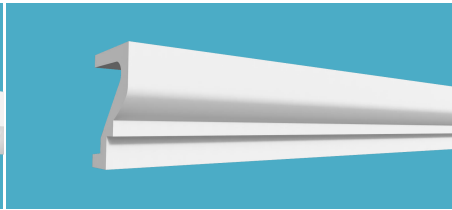

Part#	MD311-16
Projection	5- ³ / ₈ "
Height	7- ³ / ₄ "
Length	16'

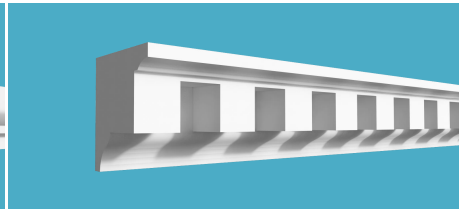

Part#	MD313-8
Projection	2- ¹ / ₄ "
Height	2- ³ / ₈ "
Length	8'

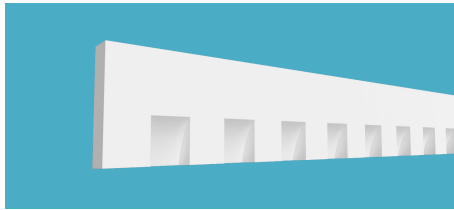

Part#	MD320-8	MD320-12	MD320-16
Projection	1- ⁵ / ₈ "	1- ⁵ / ₈ "	1- ⁵ / ₈ "
Height	5- ³ / ₄ "	5- ³ / ₄ "	5- ³ / ₄ "
Length	8'	12'	16' 1- ¹ / ₂ "

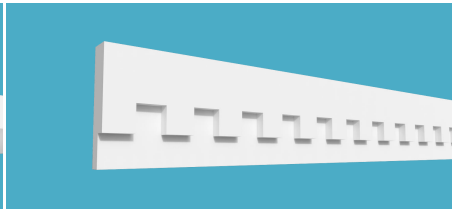

Part#	MD330-12
Projection	1- ⁵ / ₈ "
Height	7"
Length	12'

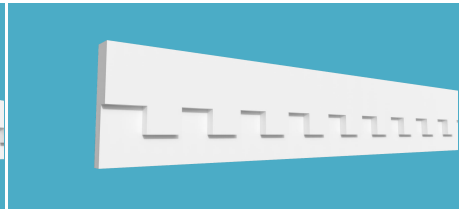

Part#	MD331-16
Projection	1- ³ / ₈ "
Height	9- ¹ / ₂ "
Length	16'

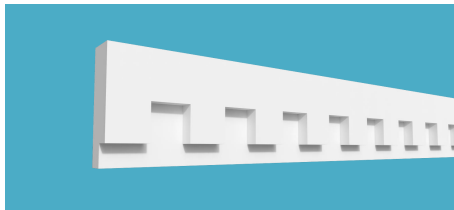

Part#	MD332-8
Projection	1- ⁵ / ₈ "
Height	5"
Length	8'

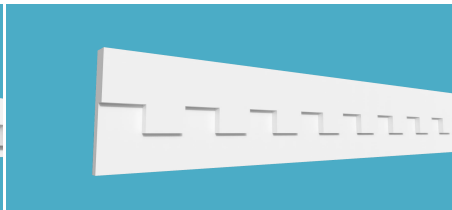

Part#	MD333-12
Projection	1- ³ / ₁₆ "
Height	11- ¹ / ₂ "
Length	12'

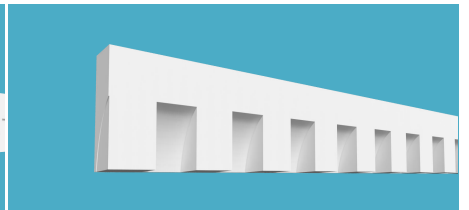

Part#	MD335-12
Projection	3- ³ / ₈ "
Height	6- ¹ / ₈ "
Length	12'



Part#	MD336-16
Projection	3- $\frac{1}{8}$ "
Height	9- $\frac{3}{8}$ "
Length	16'

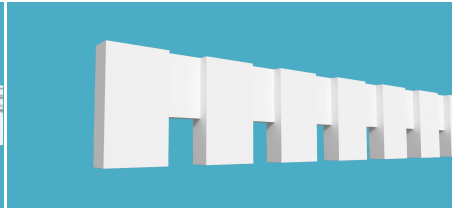

Part#	MD350-8
Projection	7/8"
Height	3- $\frac{1}{2}$ "
Length	8' 3- $\frac{3}{4}$ "

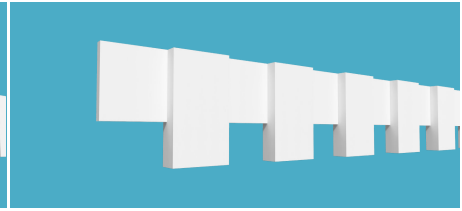

Part#	MD351-8
Projection	1- $\frac{1}{4}$ "
Height	3- $\frac{1}{4}$ "
Length	8' 2"

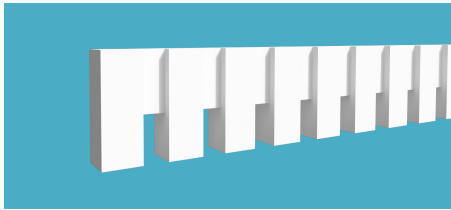

Part#	MD352-8
Projection	2"
Height	3- $\frac{1}{2}$ "
Length	8'

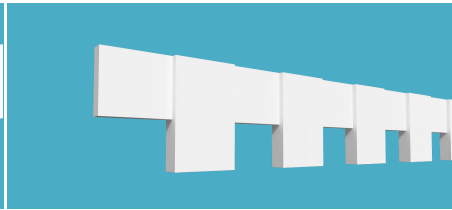

Part#	MD353-8
Projection	1- $\frac{1}{4}$ "
Height	4- $\frac{1}{2}$ "
Length	8' 1/4"

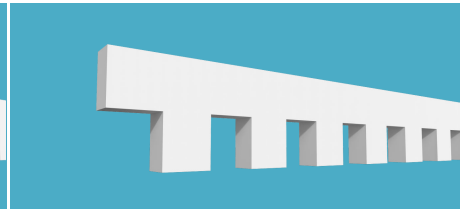

Part#	MD354-12
Projection	1"
Height	3- $\frac{1}{8}$ "
Length	146- $\frac{1}{4}$ "

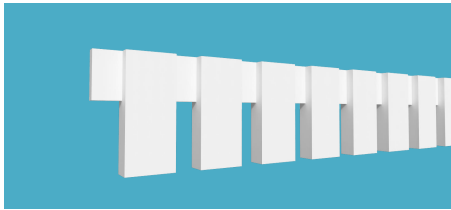

Part#	MD355-8
Projection	5/8"
Height	2- $\frac{1}{2}$ "
Length	96- $\frac{1}{2}$ "

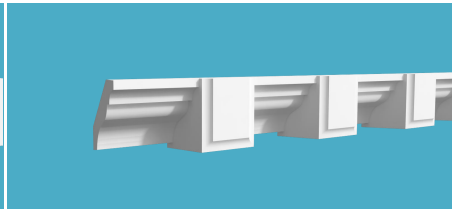

Part#	MD360-8
Projection	3- $\frac{1}{2}$ "
Height	3- $\frac{3}{4}$ "
Length	8'

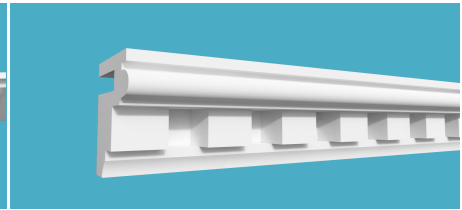

Part#	MD362-16
Projection	5- $\frac{1}{8}$ "
Height	8- $\frac{3}{8}$ "
Length	16'

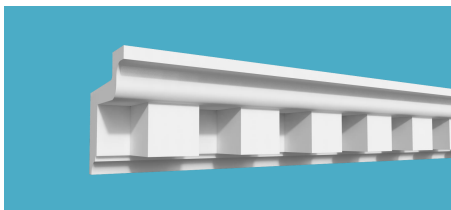

Part#	MD365-16
Projection	5"
Height	5"
Length	16'



Part#	MD370-8
Projection	6- $\frac{1}{2}$ "
Height	7- $\frac{1}{2}$ "
Length	8'

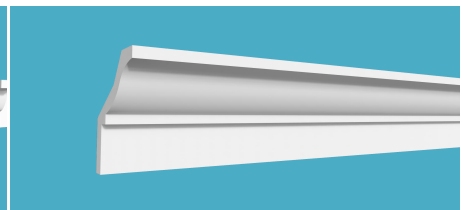

Part#	MD371-16
Projection	6- $\frac{1}{2}$ "
Height	11"
Length	16'

Mouldings

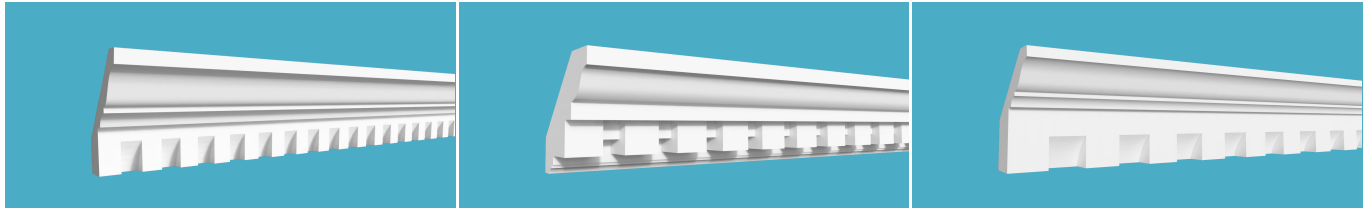

Part#	MD404-12	MD404-16	Part#	MD406-16	Part#	MD410-12
Projection	2-½"	2-½"	Projection	3-¾"	Projection	3-¼"
Height	3-⅞"	3-⅞"	Height	4"	Height	6-⅞"
Length	12'	16'	Length	16'	Length	12'



Part#	MD411-16	Part#	MD412-16	Part#	MD413-12
Projection	4-½"	Projection	5-¾"	Projection	5-¾"
Height	7"	Height	10-⅝"	Height	11-⅞"
Length	16'	Length	16'	Length	12'

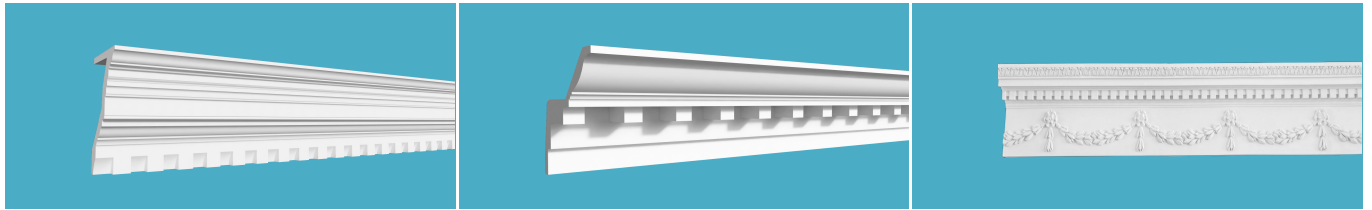

Part#	MD419-12	Part#	MD421-12	Part#	MD425-12
Projection	6-¾"	Projection	10"	Projection	4-⅞"
Height	14-½"	Height	14-½"	Height	9-½"
Length	12'	Length	12'	Length	11' 5"

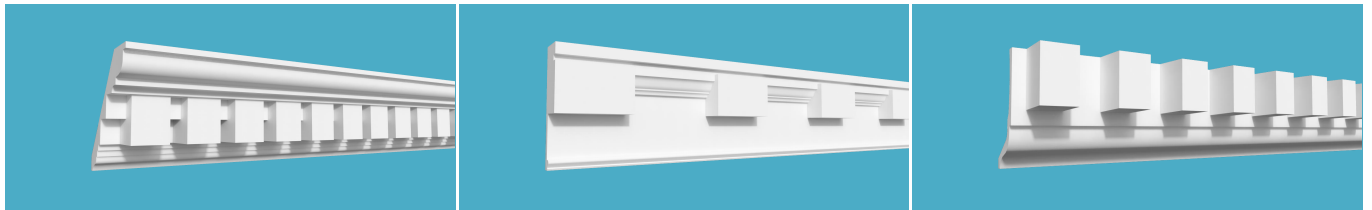

Part#	MD430-12	Part#	MD434-16	Part#	MD435-16
Projection	5-¾"	Projection	3-¾"	Projection	9"
Height	8"	Height	16"	Height	10"
Length	12' 2-¼"	Length	16'	Length	16'

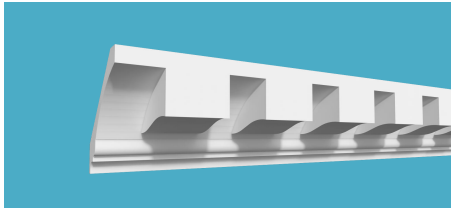

Part#	MD440-12
Projection	6-½"
Height	7-¼"
Length	12'

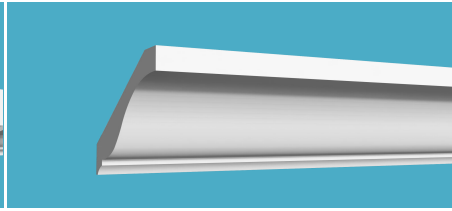

Part#	MD449-16
Projection	7-½"
Height	8-½"
Length	16'

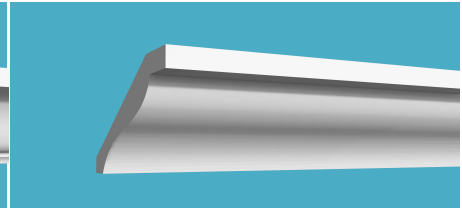

Part#	MD450-16
Projection	11-½"
Height	9-⅝"
Length	16'

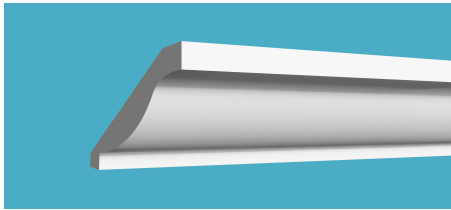

Part#	MD451-16
Projection	3-⅝"
Height	3"
Length	16'

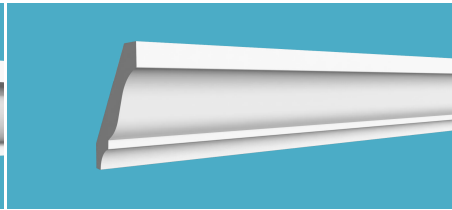

Part#	MD452-12
Projection	2"
Height	3"
Length	12'

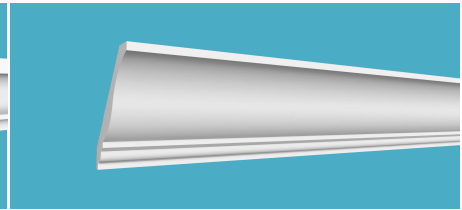

Part#	MD453-16
Projection	4-¾"
Height	6-¾"
Length	16'

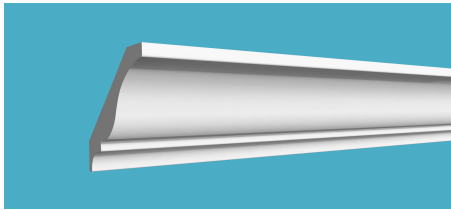

Part#	MD454-12
Projection	3-⅝"
Height	4-⅝"
Length	12'

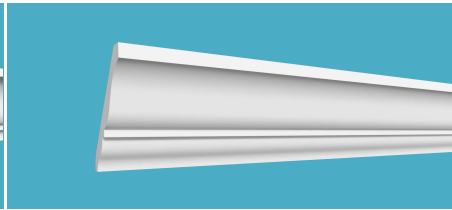

Part#	MD456-16
Projection	2-¾"
Height	4-⅝"
Length	16'

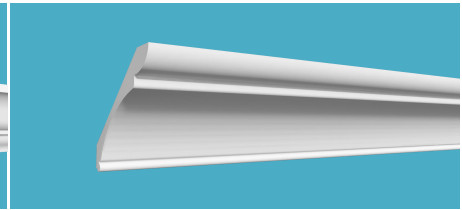

Part#	MD457-12
Projection	6-⅞"
Height	7-⅝"
Length	12'

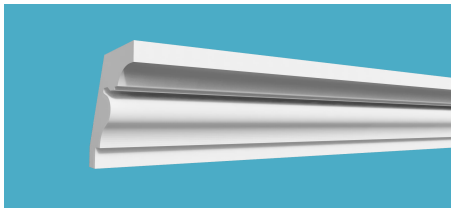

Part#	MD460-12
Projection	4-¾"
Height	5-⅝"
Length	12'



Part#	MD461-8
Projection	9-⅞"
Height	19"
Length	8'

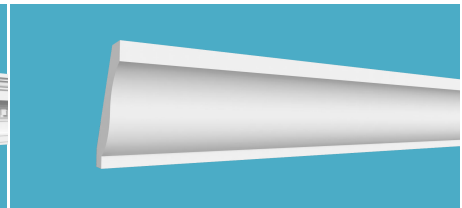

Part#	MD467-16
Projection	2-¾"
Height	4-¾"
Length	12'

Mouldings

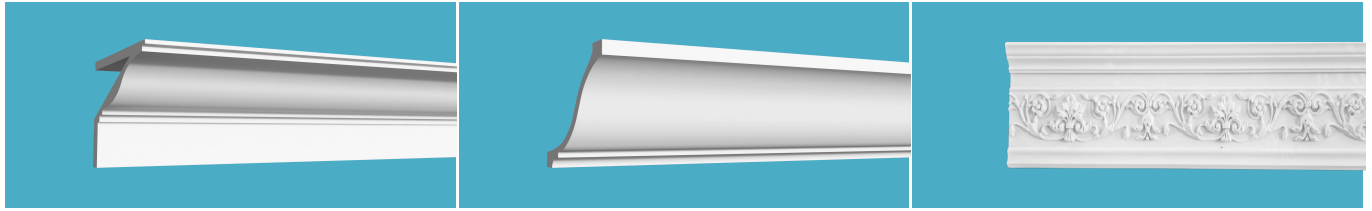

Part#	MD472-12	Part#	MD481-12	Part#	MD490-12
Projection	11- $\frac{1}{4}$ "	Projection	14"	Projection	6"
Height	15- $\frac{1}{2}$ "	Height	17- $\frac{1}{2}$ "	Height	5- $\frac{1}{2}$ "
Length	12'	Length	12'	Length	11' 5"

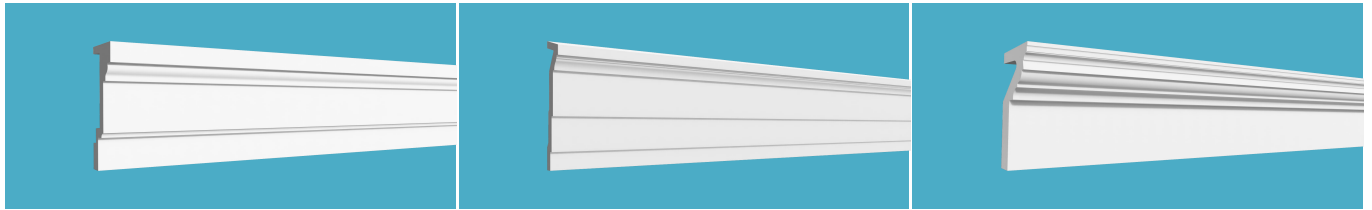

Part#	MD505-8	Part#	MD506-16	Part#	MD508-12
Projection	3- $\frac{3}{8}$ "	Projection	3"	Projection	3- $\frac{5}{8}$ "
Height	13"	Height	16- $\frac{3}{8}$ "	Height	8- $\frac{3}{8}$ "
Length	8'	Length	16'	Length	12'

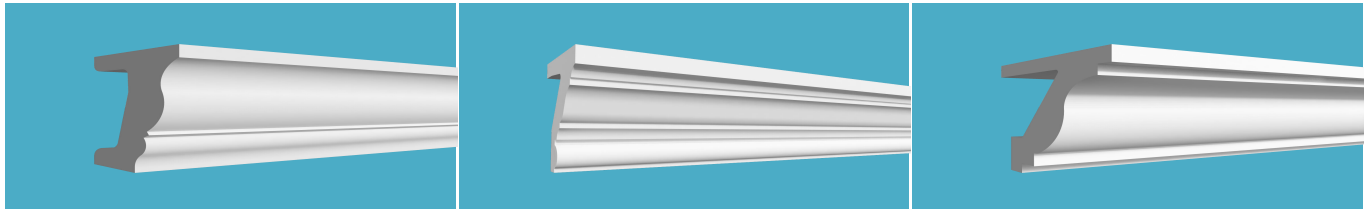

Part#	MD509-16	Part#	MD510-12	Part#	MD511-12
Projection	3- $\frac{1}{4}$ "	Projection	4- $\frac{3}{8}$ "	Projection	5- $\frac{1}{4}$ "
Height	5- $\frac{3}{8}$ "	Height	5- $\frac{1}{2}$ "	Height	6- $\frac{1}{2}$ "
Length	16'	Length	12'	Length	12'

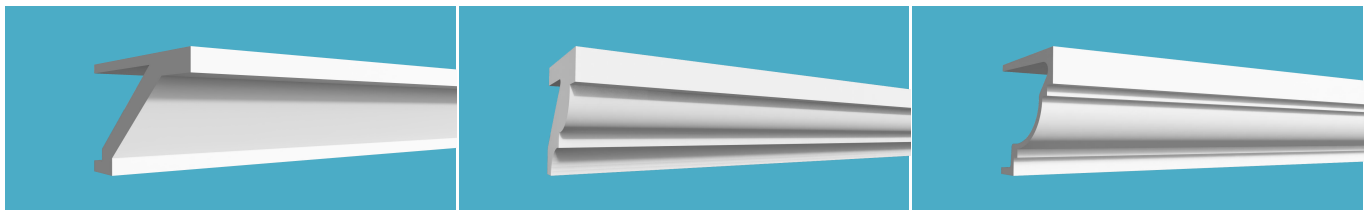

Part#	MD512-16	Part#	MD513-16	Part#	MD520-16
Projection	8- $\frac{1}{2}$ "	Projection	4- $\frac{1}{8}$ "	Projection	6- $\frac{1}{8}$ "
Height	12- $\frac{1}{8}$ "	Height	4- $\frac{3}{8}$ "	Height	8- $\frac{1}{8}$ "
Length	16'	Length	16'	Length	16'

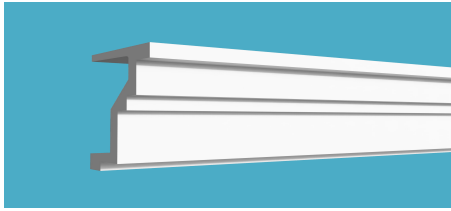

Part#	MD521-8
Projection	5"
Height	13- $\frac{7}{8}$ "
Length	8'

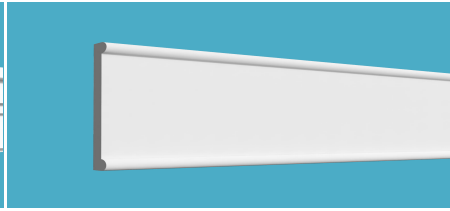

Part#	MD522-16
Projection	1- $\frac{5}{8}$ "
Height	14- $\frac{3}{4}$ "
Length	16'

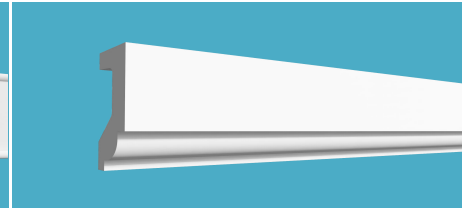

Part#	MD523-16
Projection	2"
Height	5- $\frac{1}{4}$ "
Length	16'

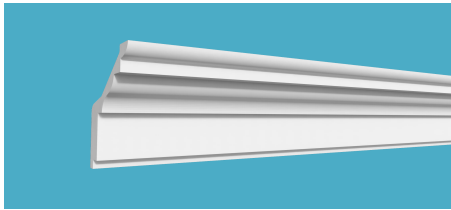

Part#	MD524-16
Projection	8"
Height	12- $\frac{7}{8}$ "
Length	16'

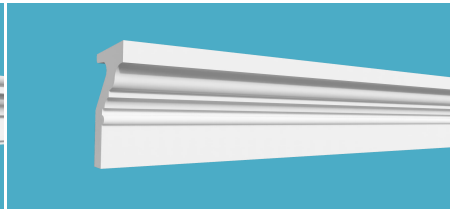

Part#	MD527-16
Projection	3- $\frac{1}{2}$ "
Height	7- $\frac{5}{8}$ "
Length	16'

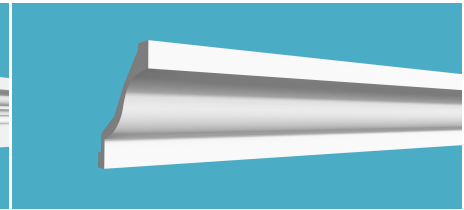

Part#	MD528-12
Projection	9- $\frac{1}{2}$ "
Height	15- $\frac{3}{4}$ "
Length	12'



Part#	MD530-8
Projection	1- $\frac{1}{2}$ "
Height	12- $\frac{5}{8}$ "
Length	8'

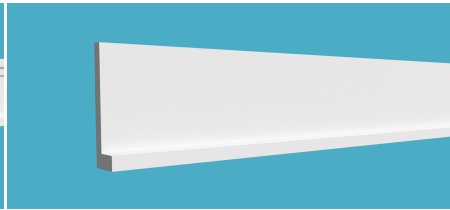

Part#	MD531-8
Projection	1- $\frac{1}{2}$ "
Height	12"
Length	8'



Part#	MD533-12
Projection	5- $\frac{1}{2}$ "
Height	17"
Length	12'

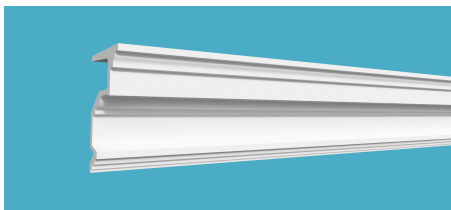

Part#	MD534-12
Projection	8- $\frac{7}{8}$ "
Height	19- $\frac{1}{8}$ "
Length	12'

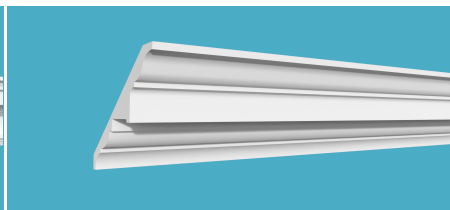

Part#	MD535-16
Projection	9"
Height	9- $\frac{1}{2}$ "
Length	16'

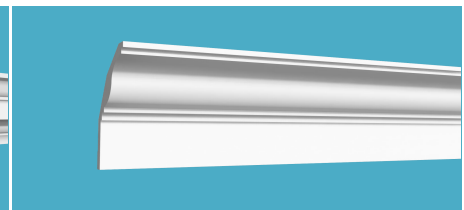

Part#	MD536-12
Projection	8- $\frac{1}{8}$ "
Height	15- $\frac{1}{2}$ "
Length	12'

Mouldings

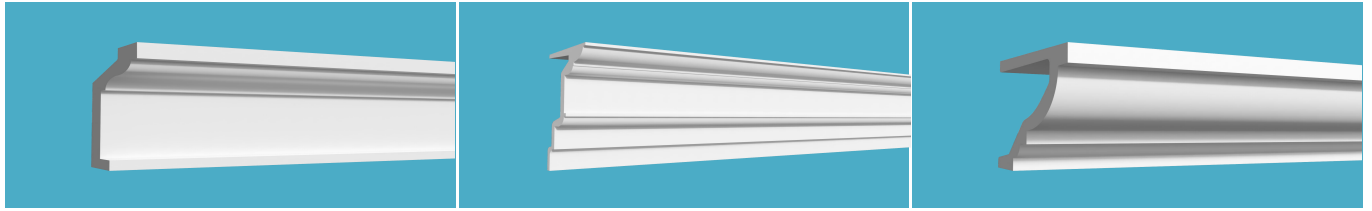

Part#	MD539-16	Part#	MD543-12	Part#	MD545-12
Projection	4-½"	Projection	8-¼"	Projection	10"
Height	12"	Height	19"	Height	9-½"
Length	16'	Length	12'	Length	12'



Part#	MD547-16	Part#	MD548-16	Part#	MD552-12
Projection	5-¾"	Projection	3-⅛"	Projection	2-⅝"
Height	8-⅝"	Height	7-½"	Height	3-½"
Length	16'	Length	16'	Length	12'

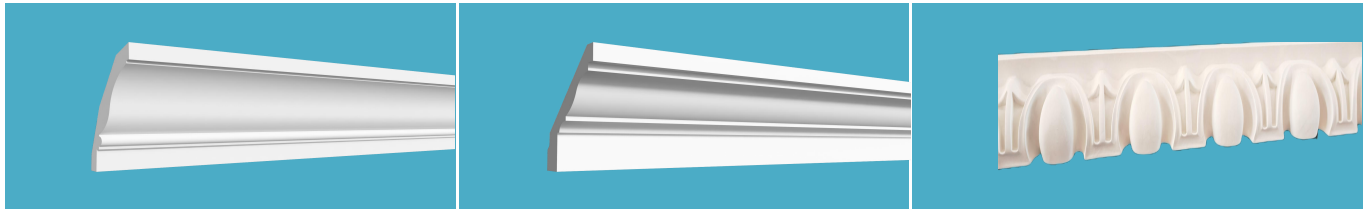

Part#	MD555-12	Part#	MD556-16	Part#	MD562-8
Projection	5-¼"	Projection	10"	Projection	2-⅝"
Height	10-¾"	Height	15"	Height	3"
Length	12'	Length	16'	Length	8'

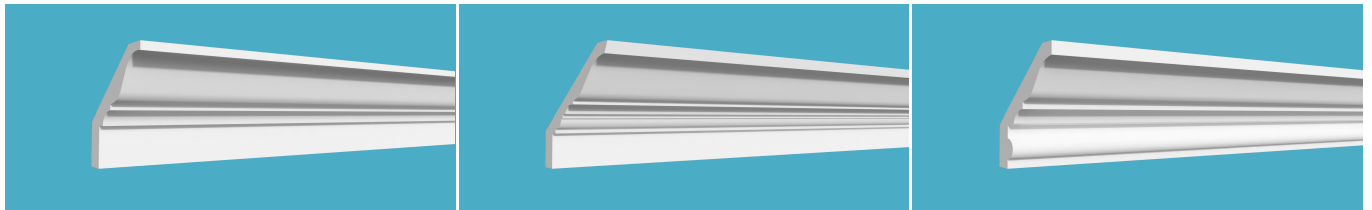

Part#	MD569-12	Part#	MD570-12	Part#	MD572-16
Projection	5-¾"	Projection	5-½"	Projection	3-¼"
Height	7-½"	Height	6-⅞"	Height	4-¼"
Length	12'	Length	12'	Length	16'

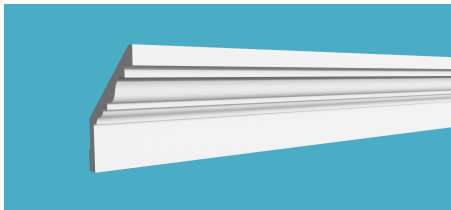

Part#	MD580-12
Projection	7- $\frac{1}{8}$ "
Height	12- $\frac{3}{8}$ "
Length	12'

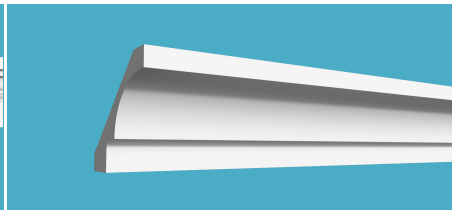

Part#	MD582-12
Projection	7- $\frac{7}{8}$ "
Height	7- $\frac{7}{8}$ "
Length	12'

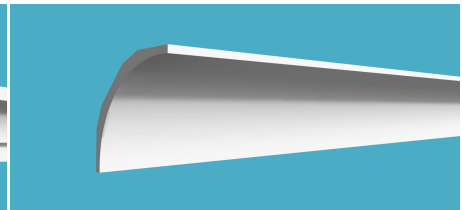

Part#	MD583-16
Projection	8"
Height	8"
Length	16'

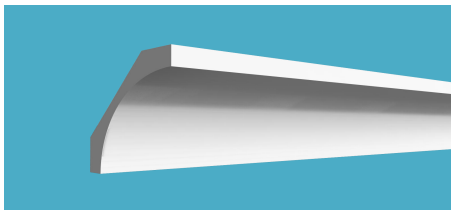

Part#	MD584-16
Projection	4- $\frac{3}{4}$ "
Height	4- $\frac{3}{4}$ "
Length	16'

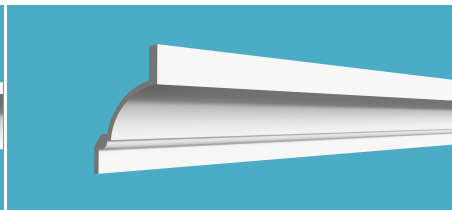

Part#	MD585-12
Projection	1- $\frac{1}{2}$ "
Height	17"
Length	12'

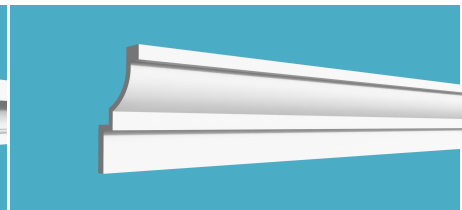

Part#	MD586-16
Projection	7"
Height	16- $\frac{1}{2}$ "
Length	16'



Part#	MD587-16
Projection	2- $\frac{3}{8}$ "
Height	5- $\frac{3}{4}$ "
Length	16'

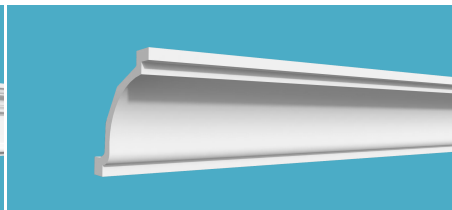

Part#	MD588-16
Projection	9- $\frac{1}{4}$ "
Height	11"
Length	16'

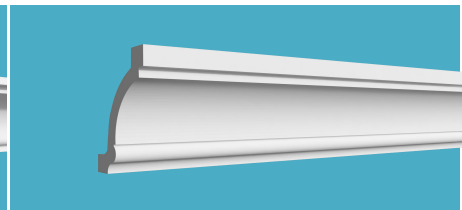

Part#	MD589-16
Projection	4- $\frac{3}{8}$ "
Height	6- $\frac{1}{2}$ "
Length	16'

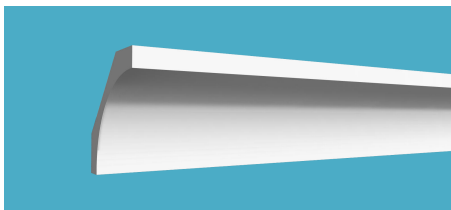

Part#	MD590-16
Projection	6"
Height	6- $\frac{1}{4}$ "
Length	16'

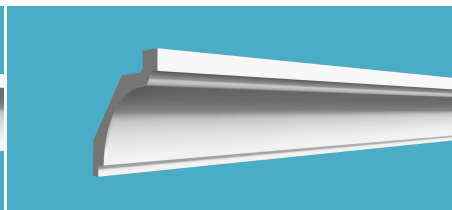

Part#	MD591-16
Projection	10- $\frac{1}{4}$ "
Height	9- $\frac{1}{2}$ "
Length	16'

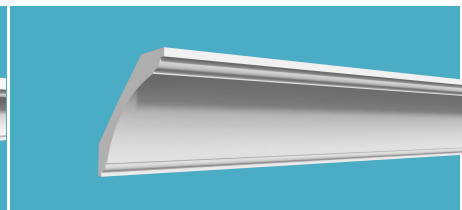

Part#	MD592-16
Projection	3- $\frac{3}{4}$ "
Height	3- $\frac{7}{8}$ "
Length	16'

Mouldings



Part#	MD593-16	Part#	MD600-10	Part#	MD601-12
Projection	2-½"	Projection	¾"	Projection	1-¼"
Height	2-½"	Height	4-¼"	Height	1-½"
Length	16'	Length	10'	Length	12'

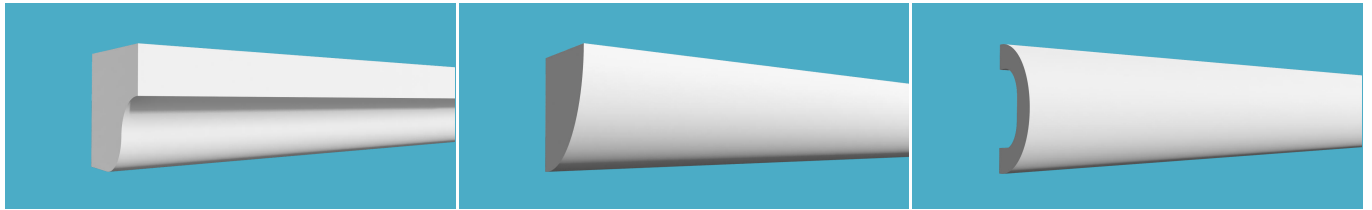

Part#	MD602-8	Part#	MD603-8	Part#	MD605-12
Projection	¾"	Projection	½"	Projection	1-¾"
Height	¾"	Height	½"	Height	3-½"
Length	8'	Length	8'	Length	12'

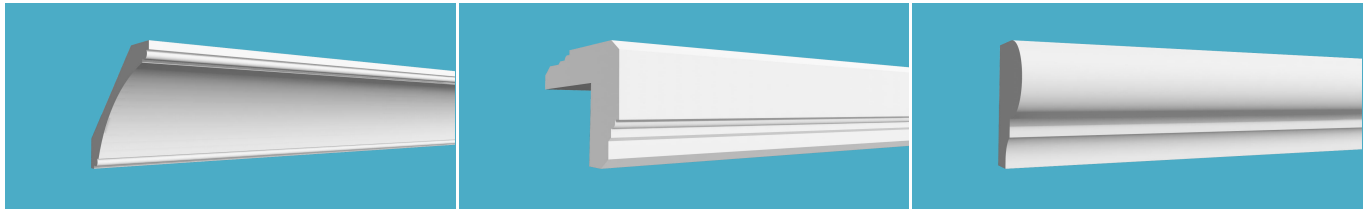

Part#	MD606-12	Part#	MD607-8	Part#	MD610-8
Projection	5-¼"	Projection	2-¼"	Projection	1-½"
Height	5-¼"	Height	2-¼"	Height	2-¾"
Length	12'	Length	8'	Length	8'

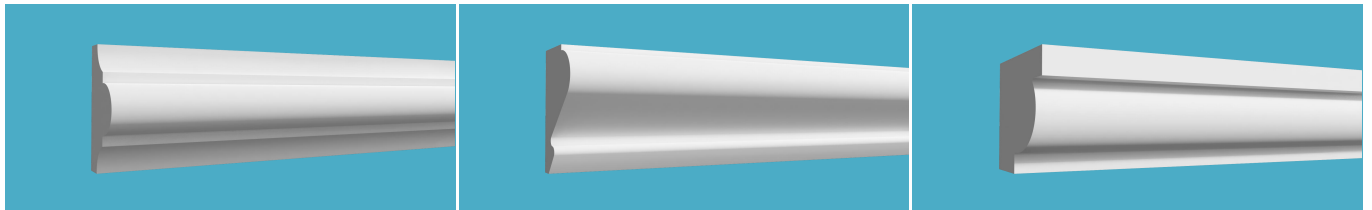

Part#	MD611-12	Part#	MD612-12	Part#	MD613-12	MD613-16
Projection	1-⅝"	Projection	¾"	Projection	2-⅝"	2-⅝"
Height	2-¼"	Height	1-⅝"	Height	2-¾"	2-¾"
Length	12'	Length	12'	Length	12'	16'

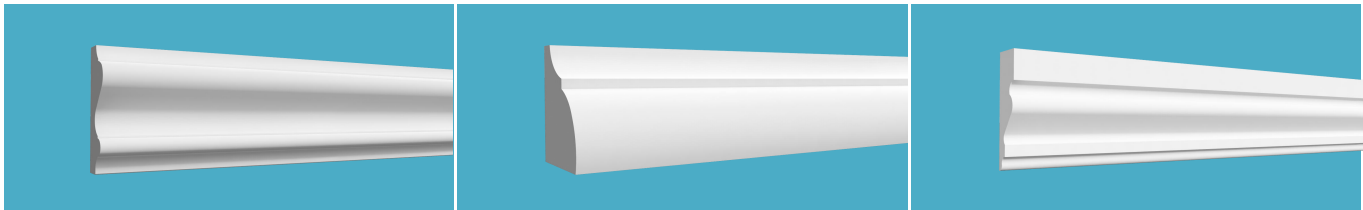

Part#	MD614-16	Part#	MD618-16	Part#	MD621-16
Projection	1- $\frac{5}{8}$ "	Projection	1"	Projection	1/2"
Height	5- $\frac{1}{2}$ "	Height	1- $\frac{1}{2}$ "	Height	2"
Length	16'	Length	16'	Length	16'

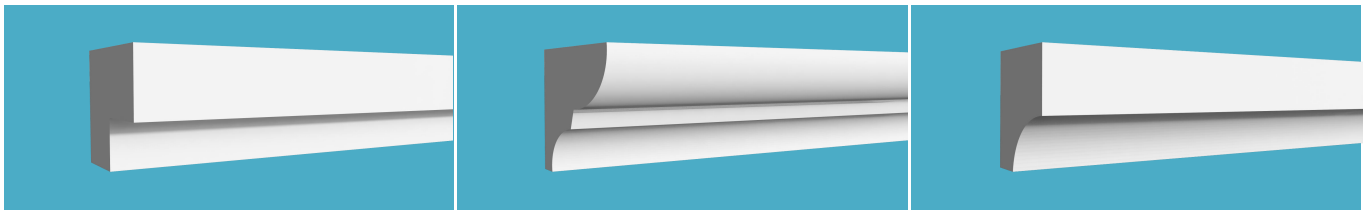

Part#	MD625-16	Part#	MD626-8	Part#	MD627-16
Projection	3"	Projection	1- $\frac{5}{8}$ "	Projection	1- $\frac{5}{8}$ "
Height	4"	Height	1- $\frac{1}{4}$ "	Height	2- $\frac{1}{8}$ "
Length	16'	Length	8'	Length	16'

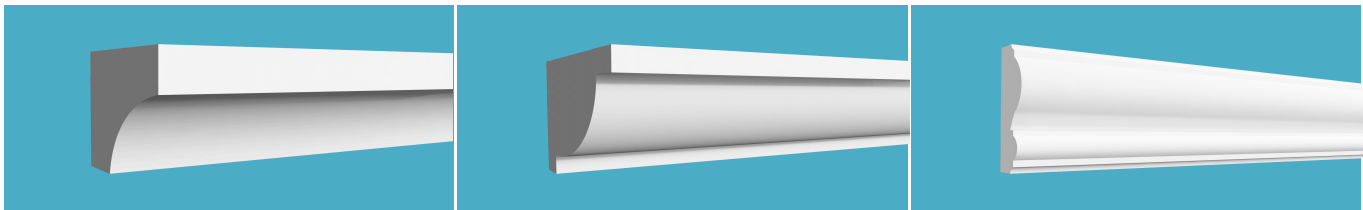

Part#	MD628-8	Part#	MD629-10	Part#	MD631-16
Projection	3/4"	Projection	2- $\frac{1}{4}$ "	Projection	7/8"
Height	3/4"	Height	2- $\frac{1}{4}$ "	Height	3"
Length	8'	Length	10'	Length	16'

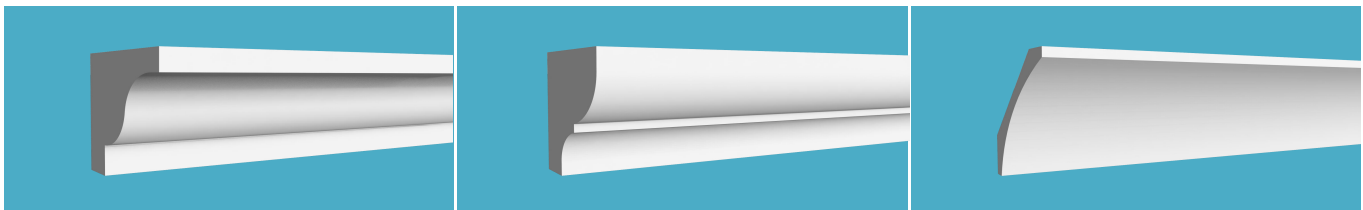

Part#	MD633-8	Part#	MD634-16	Part#	MD635-12
Projection	3/4"	Projection	1- $\frac{3}{8}$ "	Projection	6"
Height	3/4"	Height	1- $\frac{7}{8}$ "	Height	9"
Length	8'	Length	16'	Length	12'

Mouldings

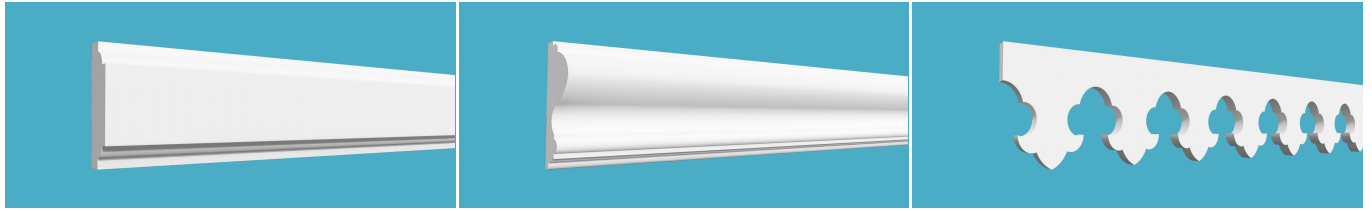

Part#	MD637-16	Part#	MD639-16	Part#	MD640-8
Projection	1/2"	Projection	1-7/8"	Projection	1"
Height	1-1/2"	Height	6-3/4"	Height	5-3/4"
Length	16'	Length	16'	Length	8'

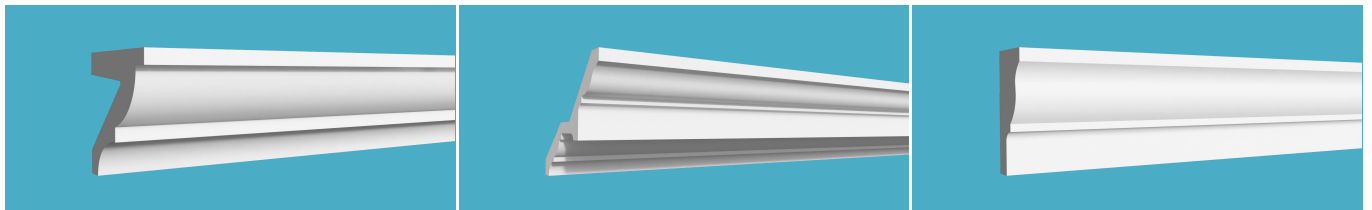

Part#	MD641-16	Part#	MD642-12	Part#	MD644-16
Projection	3-3/8"	Projection	12"	Projection	3"
Height	4-3/8"	Height	11-3/4"	Height	9-3/4"
Length	16'	Length	12'	Length	16'

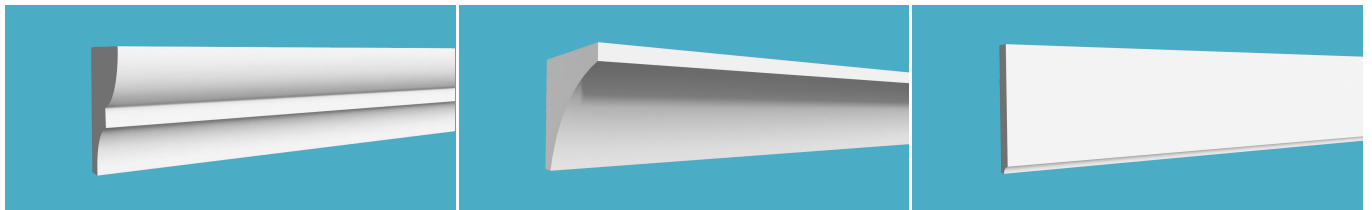

Part#	MD649-16	Part#	MD660-10	Part#	MD705-16
Projection	1-1/2"	Projection	2-3/8"	Projection	3/4"
Height	2-1/8"	Height	2-3/8"	Height	7-1/2"
Length	16'	Length	10'	Length	16'

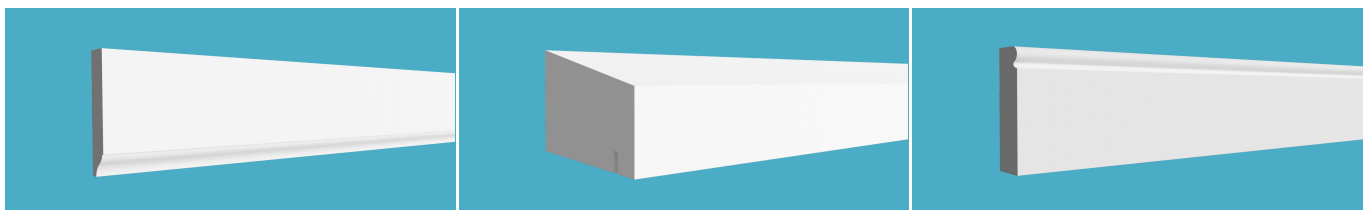

Part#	MD706-16	Part#	MD710-10	Part#	MD715-16
Projection	5/8"	Projection	3-1/2"	Projection	1"
Height	5-1/4"	Height	1-1/2"	Height	4"
Length	16'	Length	10'	Length	16'

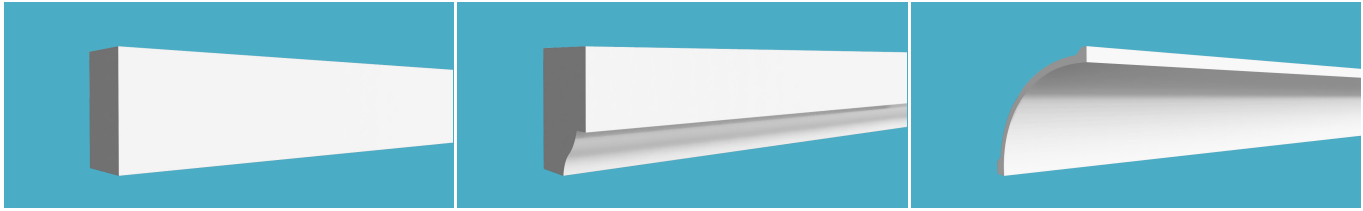

Part#	MD716-12	MD758-12	Part#	MD730-8	Part#	MD734-12
Projection	1"	1- $\frac{3}{4}$ "	Projection	7/8"	Projection	14- $\frac{3}{8}$ "
Height	1"	1"	Height	1"	Height	14- $\frac{3}{8}$ "
Length	12'	12'	Length	8'	Length	12'





Louvers & Gable Vents

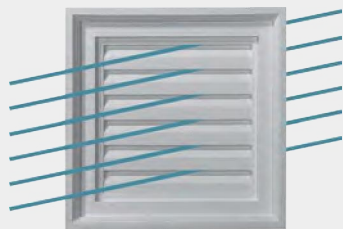

FUNCTIONAL

allows airflow to pass through the vent



DECORATIVE

same look without the airflow



Peaked Top Louvers

Part#	Functional	Width	Height
PLV18X24-8	PLV18X24F-8	18"	24"
PLV18X36-10	PLV18X36F-10	18"	36"
PLV24X30-10	PLV24X30F-10	24"	30"
PLV24X36-10	PLV24X36F-10	24"	36"
PLV24X36-12	PLV24X36F-12	24"	36"



Half Round Louvers

Part#	Functional	Width	Height
HRLV24X12	HRLV24X12F	24"	12"
HRLV28X14	HRLV28X14F	28"	14"
HRLV32X16	HRLV32X16F	32"	16"
HRLV36X18	HRLV36X18F	36"	18"
HRLV40X20	HRLV40X20F	40"	20"
HRLV42X21	HRLV42X21F	42"	21"
HRLV48X24	HRLV48X24F	48"	24"
HRLV60X30	HRLV60X30F	60"	30"
HRLV72X36	HRLV72X36F	72"	36"



Eyebrow Louvers

Part#	Functional	Width	Height
ELV12X24	ELV12X24F	12"	24"
ELV18X30	ELV18X30F	18"	30"
ELV22X32	ELV22X32F	22"	32"

Louvers & Gable Vents



Vertical Louvers

Part#	Functional	Width	Height
LV8X15	LV8X15F	8"	15"
LV8X24	LV8X24F	8"	24"
LV8X30	LV8X30F	8"	30"
LV12X18	LV12X18F	12"	18"
LV12X24	LV12X24F	12"	24"
LV12X30	LV12X30F	12"	30"
LV12X36	LV12X36F	12"	36"
LV12X40	LV12X40F	12"	40"
LV14X27	LV14X27F	14"	27"
LV14X30	LV14X30F	14"	30"
LV14X32	LV14X32F	14"	32"
LV16X24	LV16X24F	16"	24"
LV16X36	LV16X36F	16"	36"
LV18X24	LV18X24F	18"	24"
LV18X30	LV18X30F	18"	30"
LV18X36	LV18X36F	18"	36"
LV18X42	LV18X42F	18"	42"
LV20X28	LV20X28F	20"	28"
LV24X24	LV24X24F	24"	24"
LV24X30	LV24X30F	24"	30"
LV24X36	LV24X36F	24"	36"
LV24X48	LV24X48F	24"	48"
LV30X42	LV30X42F	30"	42"

Triangle Louvers

Part#	Functional	Width	Height
TLV32X16	TLV32X16F	32"	16"
TLV36X18	TLV36X18F	36"	18"
TLV42X21	TLV42X21F	42"	21"
TLV48X12	TLV48X12F	48"	12"
TLV48X16	TLV48X16F	48"	16"
TLV48X18	TLV48X18F	48"	18"
TLV48X22	TLV48X22F	48"	22"
TLV48X24	TLV48X24F	48"	24"
TLV60X18	TLV60X18F	60"	17-½"
TLV60X23	TLV60X23F	60"	22-½"
TLV60X25	TLV60X25F	60"	25"
TLV60X30	TLV60X30F	60"	30"
TLV64X27	TLV64X27F	64"	26-½"
TLV64X32	TLV64X32F	64"	32"
TLV66X22	TLV66X22F	66"	22"
TLV72X36	TLV72X36F	72"	36"
TLV76X19	TLV76X19F	76"	19"
TLV84X18	TLV84X18F	84"	17-½"
TLV84X21	TLV84X21F	84"	21"
TLV88X22	TLV88X22F	88"	22"



Cathedral Top Louvers

Part#	Functional	Width	Height
CLV12X24	CLV12X24F	12"	24"
CLV14X22	CLV14X22F	14"	22"
CLV16X36	CLV16X36F	16"	36"
CLV18X24	CLV18X24F	18"	24"
CLV18X30	CLV18X30F	18"	30"
CLV22X31	CLV22X31F	22"	31-½"
CLV24X48	CLV24X48F	24"	48"
CLV28X43	CLV28X43F	28"	43"
CLV36X48	CLV36X48F	36"	48"



Cathedral Top Louver Trim

Part#	Outside Width	Outside Height	Inside Width	Inside Height
CLV18X30X4F	25-¼"	37-¼"	18-¼"	30-¼"
CLV22X31X4F	29-¼"	38-¼"	22-¼"	31-¼"



Round Louvers

Part#	Functional	Diameter
RLV12	RLV12F	12"
RLV16	RLV16F	16"
RLV18	RLV18F	18"
RLV22	RLV22F	22"
RLV24	RLV24F	24"
RLV28	RLV28F	28"
RLV30	RLV30F	30"
RLV36	RLV36F	36"
RLV42	RLV42F	42"
RLV48	RLV48F	48"



Round Louver Trim

Part#	Outside Diameter	Inside Diameter
RLV18X4F	25-¼"	18-¼"
RLV24X4F	31-¼"	24-¼"
RLV28X4F	35-¼"	28-¼"

Louvers & Gable Vents



Two-Piece Triangle Louver

Part#	Functional	Width	Height
TLVLR60X25	TLVLR60X25F	60"	25"
TLVLR60X30	TLVLR60X30F	60"	30"
TLVLR108X27	TLVLR108X27F	108"	27"
TLVLR115X35	TLVLR115X35F	115"	34-½"
TLVLR120X30	TLVLR120X30F	120"	30"



Round Louver with Decorative Trim & Keystone

Part#	Functional	Overall Width
RLV16MTK	RLV16F-MTK	17-⅝"
RLV18MTK	RLV18F-MTK	19-⅝"
RLV24MTK	RLV24F-MTK	25"
RLV30MTK	RLV30F-MTK	31-⅝"
RLV32MTK	RLV32F-MTK	33-⅝"
RLV40MTK	RLV40F-MTK	41-⅝"



Round Louver with Flat Trim & Flat Keystones

Part#	Functional	Overall Width
RLV24-4FTK	RLV24F-4FTK	32-⅝"
RLV24-6TK	RLV24F-6TK	38"
RLV30-6TK	RLV30F-6TK	44"



Half-Round Louver with Decorative Trim & Keystones

Part#	Functional	Width	Height
HRLV36X18DTK	HRLV36X18FTK	36"	18-½"



Oval Louver

Part#	Functional	Width	Height
OLV18X24	OVB18X24F-T	18"	24"
OLV25X37	OVB25X37F-T	24-½"	37"



Diamond Louver

Part#	Functional	Width	Height
DLV24X24	DLV24X24F	34"	34"

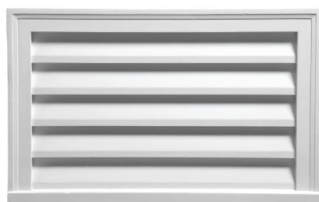

Horizontal Louver

Part#	Functional	Width	Height
LV27X17	LV27X17F	27"	17"
LV32X16	LV32X16F	32"	16"



Vertical Louver

Part#	Functional	Width	Height
LV18X24-T	LV18X24TF	26-½"	33-½"



Half-Round Louver

Part#	Functional	Width	Height
HRLV36X18-4F	HRLV36X18F-4F	43"	25"
HRLV36X18-6F	HRLV36X18F-6F	47"	29"



Vertical Louver

Part#	Functional	Width	Height
LVNT18X24	NSLV18X24F	18"	24"

Louvers & Gable Vents

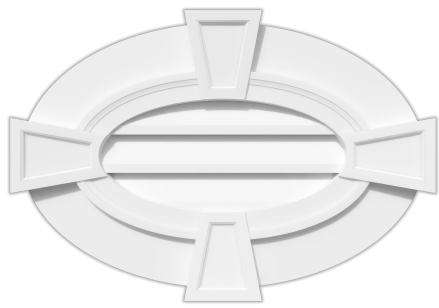

Oval Louvers with Keystone

Part#	Width	Height
OVB29X20FTK	29"	20-5/8"



Oval Louvers with Keystone

Part#	Functional	Width	Height
OVB20X29FTK	OVB20X29F-T	20-5/8"	29"



Octagon Louver

Part#	Functional	Width	Height
OVA18	OVA18F	18"	18"
OVA22	OVA22F	22"	22"
OVA24	OVA24F	24"	24"
OVA28	OVA28F	28"	28"



Round Louvers with Keystone

Part#	Functional	Diameter
RLV24FTK	RLV24F-FTK	24"
RLV30FTK	RLV30F-FTK	30"
RLV32FTK	RLV32F-FTK	31-1/2"
RLV36FTK	RLV36F-FTK	36"



Oval Louver-Vertical

Part#	Functional	Width	Height
OVB28X35-T	OVB28X35F-T	30"	37-1/2"



Oval Louver-Vertical

Part#	Functional	Width	Height
OVB35X28-T	OVB35X28F-T	37-1/2"	30"



Half-Round Louver

Part#	Functional	Width	Height
HRLV29-T	HRLV29-6DTK	41- $\frac{5}{8}$ "	29"



Round Louver with Flat Trim

Part#	Functional	Diameter
RLV32-2F	RLV32F-2F	32"



Vertical Louver

Part#	Trim Width	Width	Height
LV18X30-4F	3- $\frac{1}{2}$ "	25"	37"

Decorative Millwork



Smooth Brackets

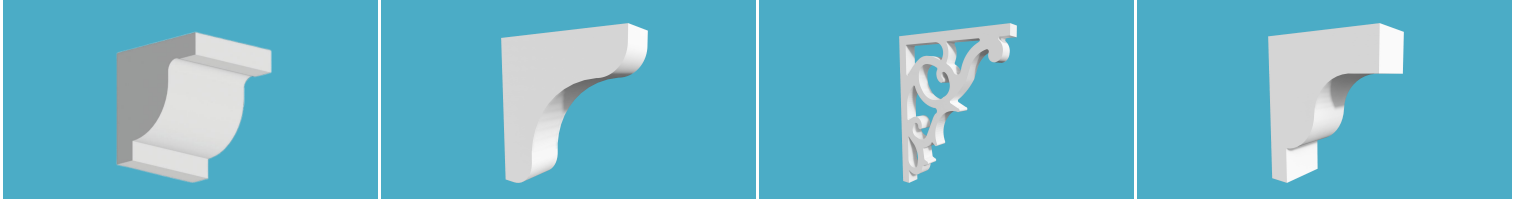

Part#	BCD10X10X9	Part#	BCD10X11	Part#	BCD10X12	Part#	BCD10X12X4
Width	9- $\frac{1}{8}$ "	Width	3"	Width	1"	Width	4"
Height	10"	Height	11- $\frac{1}{4}$ "	Height	12- $\frac{1}{2}$ "	Height	12"
Projection	10"	Projection	10- $\frac{1}{2}$ "	Projection	10- $\frac{1}{8}$ "	Projection	10"

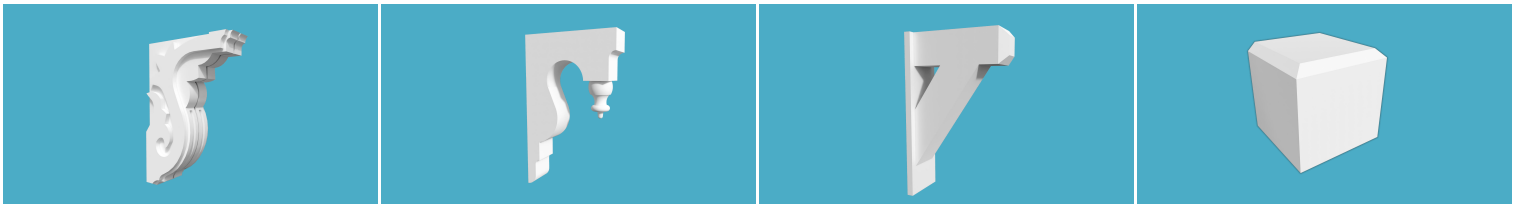

Part#	BCD10X14	Part#	BCD10X16	Part#	BCD10X16X4	Part#	BCD3.5X3.5X3.5
Width	3- $\frac{3}{4}$ "	Width	2- $\frac{3}{4}$ "	Width	4- $\frac{1}{2}$ "	Width	8- $\frac{1}{8}$ "
Height	14- $\frac{1}{2}$ "	Height	16"	Height	16"	Height	8- $\frac{1}{8}$ "
Projection	9- $\frac{3}{4}$ "	Projection	9- $\frac{3}{4}$ "	Projection	9- $\frac{7}{8}$ "	Projection	9"

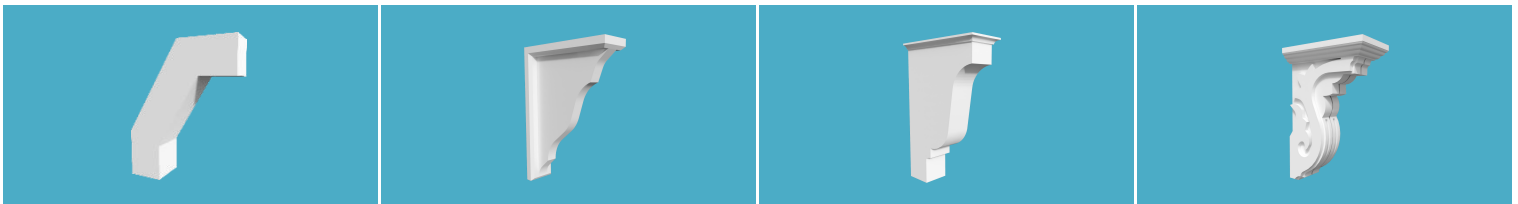

Part#	BCD11X12X3	Part#	BCD11X15	Part#	BCD11X16	Part#	BCD11X16X6
Width	3- $\frac{1}{2}$ "	Width	3"	Width	4- $\frac{3}{8}$ "	Width	6"
Height	12"	Height	15"	Height	16- $\frac{1}{4}$ "	Height	16- $\frac{1}{4}$ "
Projection	11- $\frac{1}{4}$ "	Projection	11"	Projection	10- $\frac{1}{2}$ "	Projection	11"

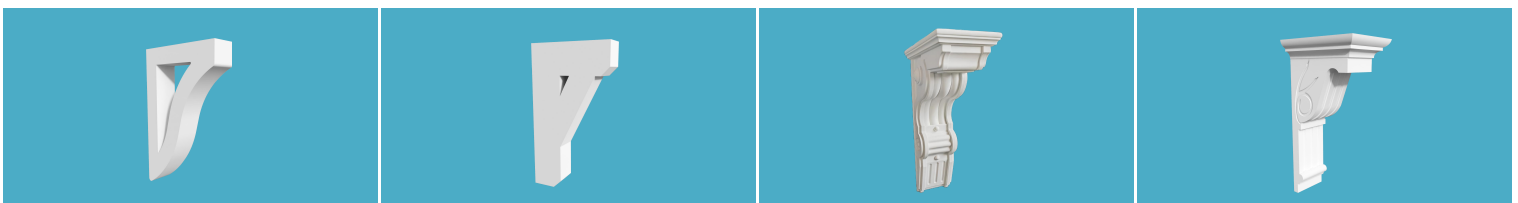

Part#	BCD11X17	Part#	BCD11X20	Part#	BCD11X20X6	Part#	BCD11X20X8
Width	2- $\frac{7}{8}$ "	Width	3- $\frac{1}{8}$ "	Width	6- $\frac{1}{2}$ "	Width	8"
Height	17"	Height	20"	Height	20"	Height	20- $\frac{1}{2}$ "
Projection	11"	Projection	11"	Projection	11"	Projection	11"

Smooth Brackets

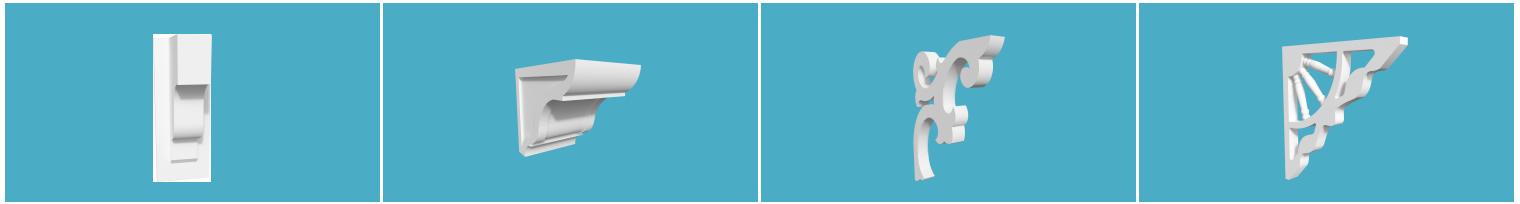

Part#	BCD11X30	Part#	BCD12X10	Part#	BCD12X12	Part#	BCD12X12GP
Width	11- $\frac{1}{4}$ "	Width	7- $\frac{1}{4}$ "	Width	1- $\frac{1}{8}$ "	Width	1"
Height	30"	Height	10- $\frac{1}{8}$ "	Height	11- $\frac{1}{2}$ "	Height	12"
Projection	11- $\frac{1}{4}$ "	Projection	12"	Projection	12- $\frac{1}{4}$ "	Projection	12"

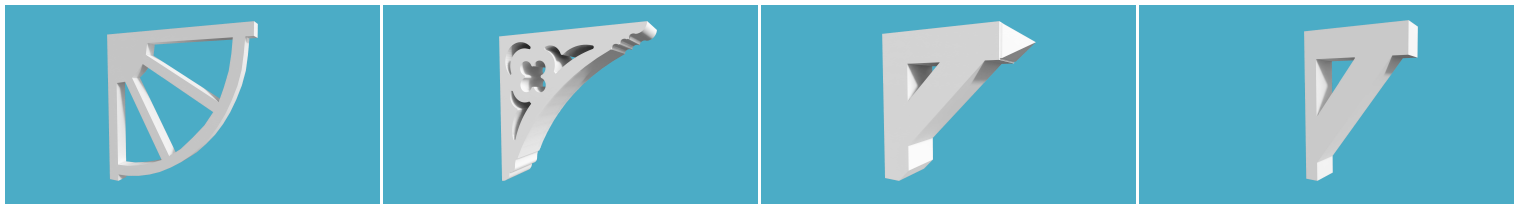

Part#	BCD12X12WW	Part#	BCD12X12X3	Part#	BCD12X12X4	Part#	BCD12X16
Width	1"	Width	3"	Width	3- $\frac{1}{2}$ "	Width	3"
Height	12"	Height	12"	Height	12"	Height	16"
Projection	12"	Projection	12"	Projection	12"	Projection	11- $\frac{1}{2}$ "

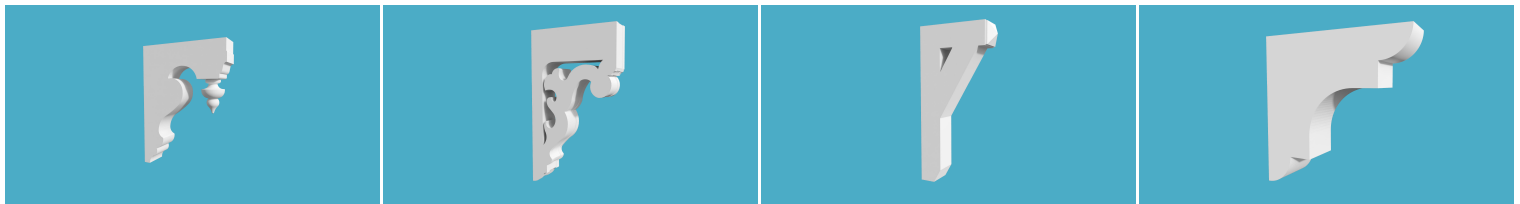

Part#	BCD12X17	Part#	BCD12X21X3	Part#	BCD12X24X3	Part#	BCD13X13X3
Width	3"	Width	3- $\frac{1}{4}$ "	Width	3- $\frac{1}{2}$ "	Width	3- $\frac{1}{2}$ "
Height	16- $\frac{1}{2}$ "	Height	21- $\frac{1}{8}$ "	Height	24"	Height	13"
Projection	12- $\frac{1}{8}$ "	Projection	12- $\frac{1}{4}$ "	Projection	12"	Projection	13"

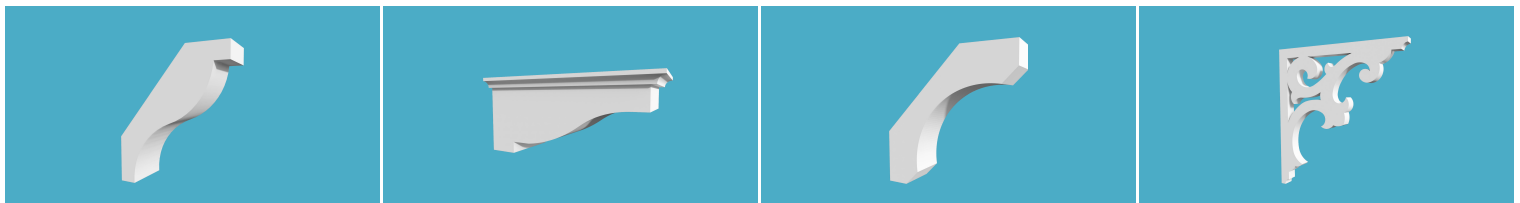

Part#	BCD13X15	Part#	BCD13X6	Part#	BCD14X14	Part#	BCD14X15
Width	5"	Width	5- $\frac{7}{8}$ "	Width	3- $\frac{1}{2}$ "	Width	1"
Height	14- $\frac{3}{4}$ "	Height	5- $\frac{3}{4}$ "	Height	13- $\frac{1}{4}$ "	Height	14- $\frac{3}{4}$ "
Projection	12- $\frac{1}{2}$ "	Projection	13- $\frac{1}{4}$ "	Projection	13- $\frac{1}{4}$ "	Projection	14"

Smooth Brackets

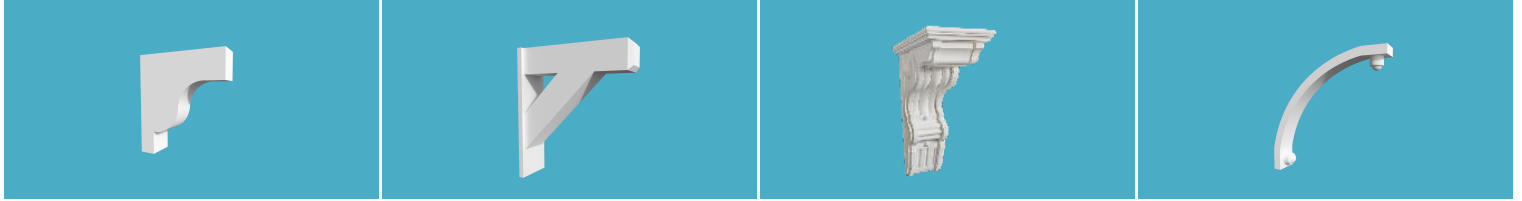

Part#	BCD14X16	Part#	BCD14X16X4	Part#	BCD14X26	Part#	BCD15X15
Width	4"	Width	4-½"	Width	6-½"	Width	2-½"
Height	15-¾"	Height	16"	Height	26"	Height	15"
Projection	14"	Projection	14"	Projection	14-½"	Projection	15"

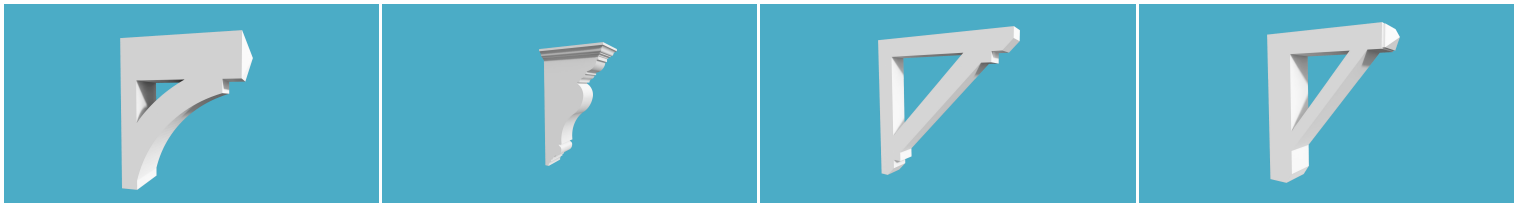

Part#	BCD15X18X6	Part#	BCD15X28	Part#	BCD16X16	Part#	BCD16X18X3
Width	6"	Width	8-¾"	Width	2"	Width	3-½"
Height	18"	Height	27-½"	Height	15-¾"	Height	18"
Projection	15"	Projection	15-¾"	Projection	15-¾"	Projection	16"

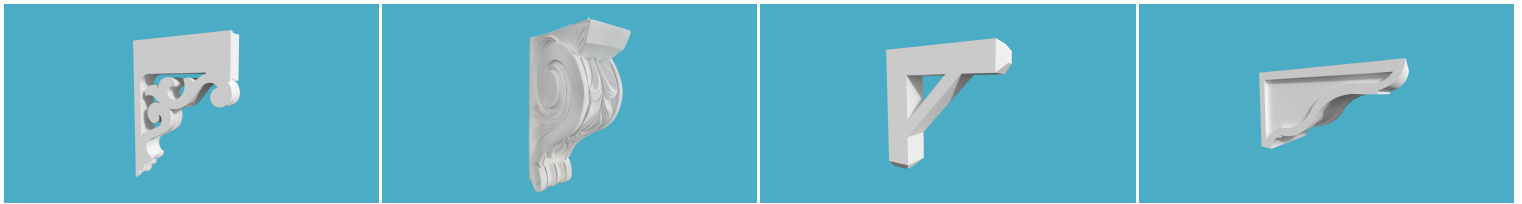

Part#	BCD16X23X3	Part#	BCD16X9	Part#	BCD17X17	Part#	BCD18X10
Width	3-¾"	Width	3-¾"	Width	3-½"	Width	7-¼"
Height	22-¾"	Height	15-¾"	Height	16-½"	Height	10-½"
Projection	16-¾"	Projection	9-¼"	Projection	16-½"	Projection	18"

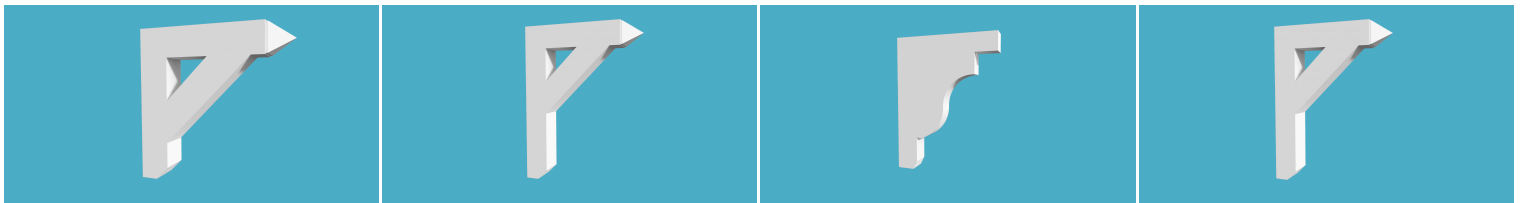

Part#	BCD18X18X4	Part#	BCD18X24	Part#	BCD18X24X3	Part#	BCD18X24X4
Width	3-½"	Width	18"	Width	3"	Width	3-½"
Height	18"	Height	24"	Height	24"	Height	24"
Projection	18"	Projection	1"	Projection	24"	Projection	18"

Smooth Brackets

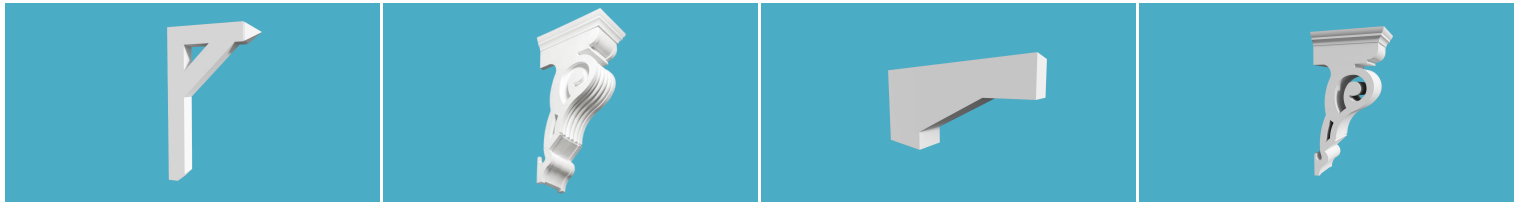

Part#	BCD18X30X4	Part#	BCD18X35	Part#	BCD18X9X3	Part#	BCD19X20
Width	3-½"	Width	11"	Width	3"	Width	1-⅞"
Height	30"	Height	35"	Height	9"	Height	20"
Projection	18"	Projection	17-½"	Projection	18"	Projection	19-½"

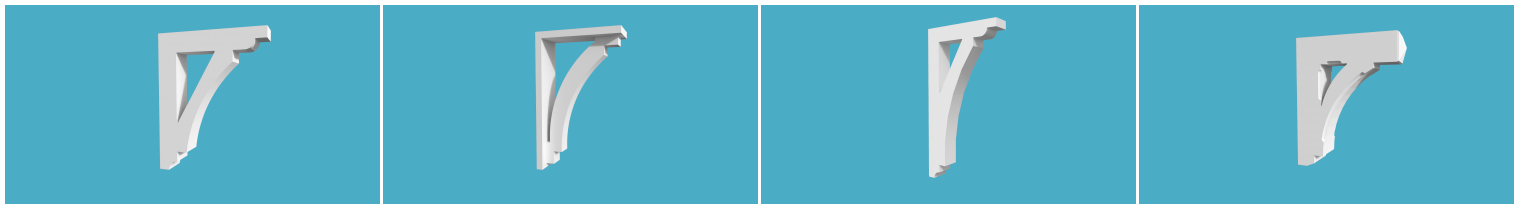

Part#	BCD19X24X4	Part#	BCD19X31	Part#	BCD19X36X4	Part#	BCD20X24X5
Width	4"	Width	7-¼"	Width	4"	Width	5"
Height	24"	Height	31-½"	Height	36"	Height	24"
Projection	18-⅝"	Projection	19-½"	Projection	19"	Projection	20"

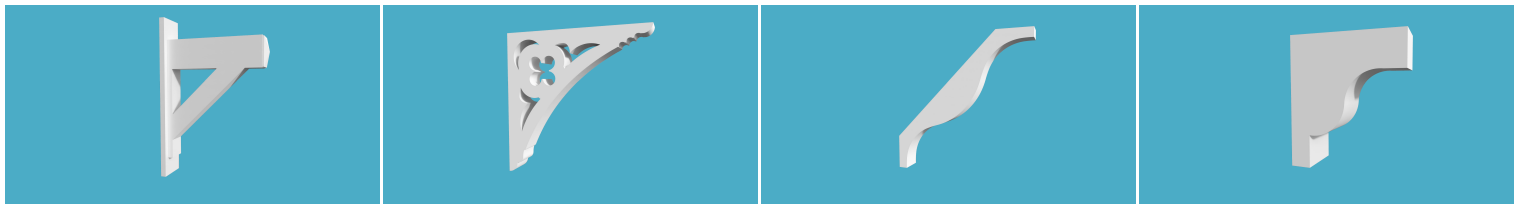

Part#	BCD20X30X6	Part#	BCD22X21	Part#	BCD22X22	Part#	BCD22X26
Width	5-½"	Width	3"	Width	2-¾"	Width	8-½"
Height	30"	Height	21-½"	Height	22"	Height	26"
Projection	20"	Projection	21-¾"	Projection	22"	Projection	22-½"

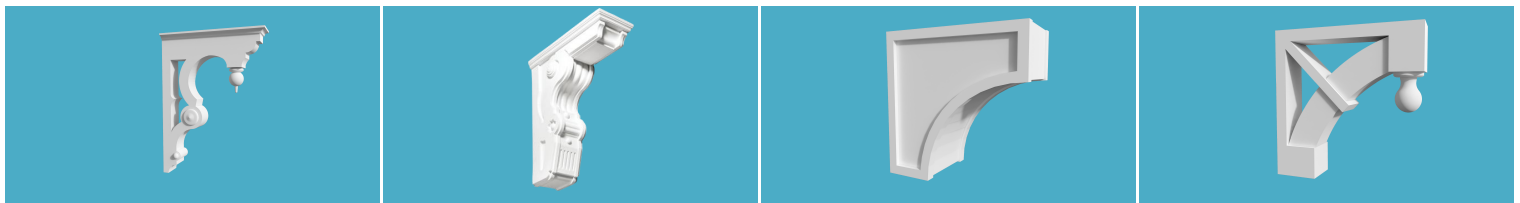

Part#	BCD22X30	Part#	BCD23X26	Part#	BCD24X24X12	Part#	BCD24X24X5
Width	5-½"	Width	8-½"	Width	12"	Width	5"
Height	30"	Height	26"	Height	24"	Height	24"
Projection	22"	Projection	22-½"	Projection	24"	Projection	24"

Smooth Brackets

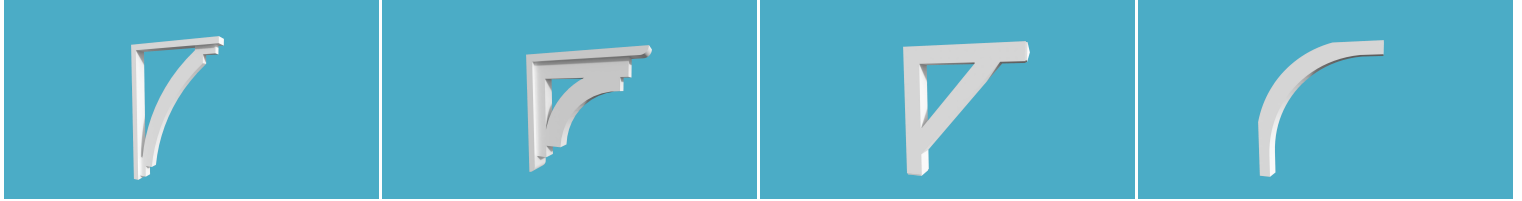

Part#	BCD24X36	Part#	BCD25X25	Part#	BCD25X27	Part#	BCD26X28
Width	3-½"	Width	4"	Width	3-½"	Width	2-½"
Height	36"	Height	25"	Height	27-½"	Height	28"
Projection	24"	Projection	25"	Projection	25"	Projection	26"

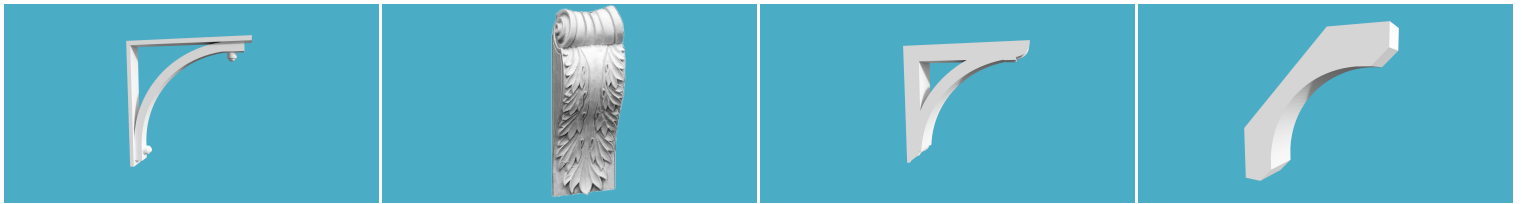

Part#	BCD28X30	Part#	BCD2X10	Part#	BCD30X30	Part#	BCD30X30X8
Width	3-½"	Width	3-½"	Width	6"	Width	6-⅞"
Height	30"	Height	9-½"	Height	30"	Height	30"
Projection	28"	Projection	2"	Projection	30"	Projection	30"

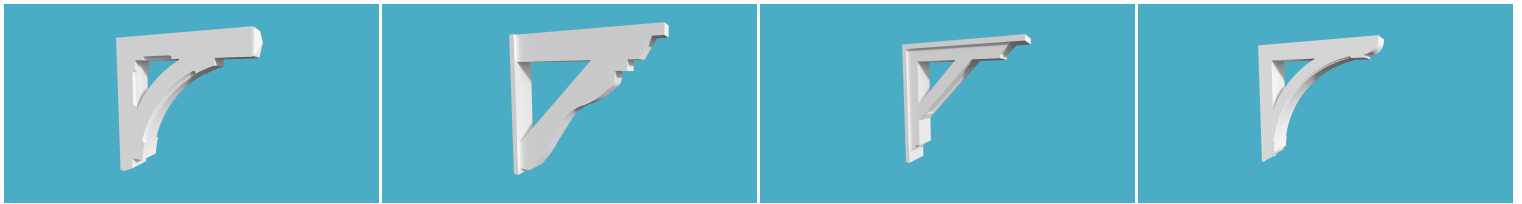

Part#	BCD31X30X5	Part#	BCD32X31X5	Part#	BCD32X32	Part#	BCD36X36
Width	5"	Width	5-¼"	Width	6"	Width	6"
Height	30"	Height	30-⅝"	Height	32"	Height	36-⅞"
Projection	31"	Projection	32-½"	Projection	32"	Projection	36-⅞"

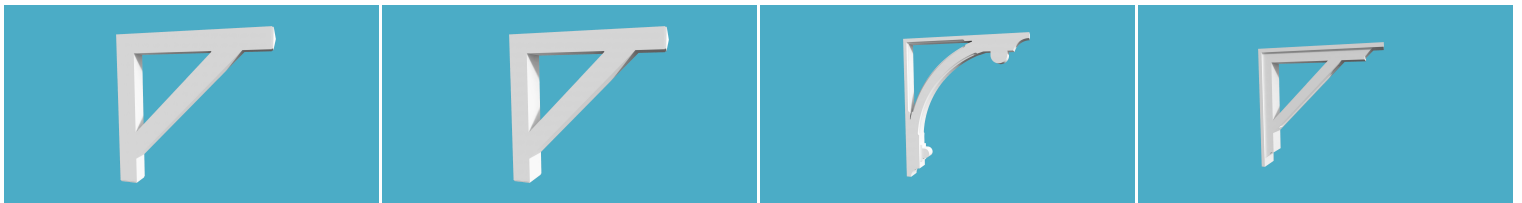

Part#	BCD36X36X4	Part#	BCD36X36X6	Part#	BCD36X42	Part#	BCD40X40
Width	4"	Width	6"	Width	3-½"	Width	6"
Height	36"	Height	36"	Height	42-¼"	Height	40"
Projection	36"	Projection	36"	Projection	36-¼"	Projection	40"

Smooth Brackets

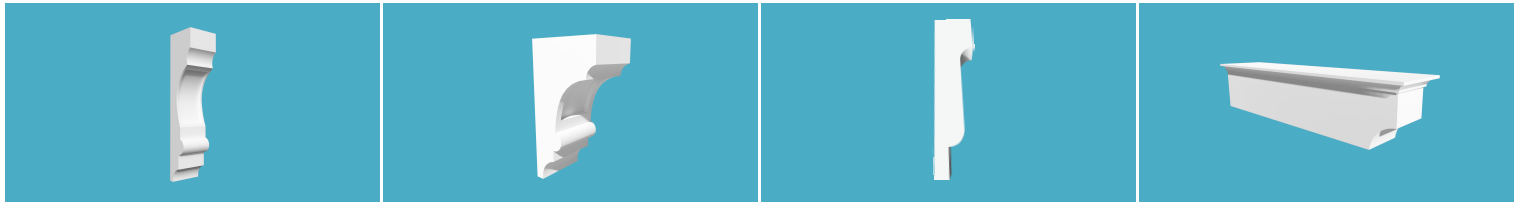

Part#	BCD4X18X4	Part#	BCD5X10	Part#	BCD5X20	Part#	BCD5X4
Width	4"	Width	4"	Width	3"	Width	4- $\frac{3}{4}$ "
Height	18"	Height	10"	Height	20"	Height	4- $\frac{3}{4}$ "
Projection	4"	Projection	5- $\frac{1}{4}$ "	Projection	5"	Projection	20- $\frac{1}{2}$ "

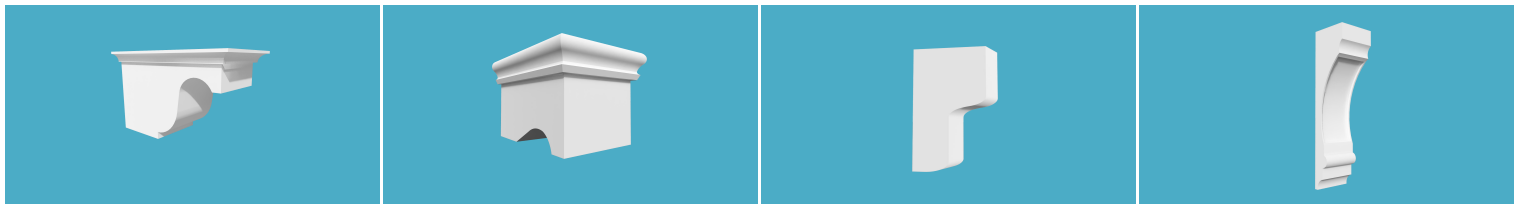

Part#	BCD5X5X9	Part#	BCD5X8X6	Part#	BCD6X24	Part#	BCD6X24X6
Width	4- $\frac{7}{8}$ "	Width	5- $\frac{3}{4}$ "	Width	4"	Width	6"
Height	5- $\frac{3}{8}$ "	Height	5"	Height	24"	Height	24"
Projection	8- $\frac{3}{4}$ "	Projection	7- $\frac{7}{8}$ "	Projection	6"	Projection	6"

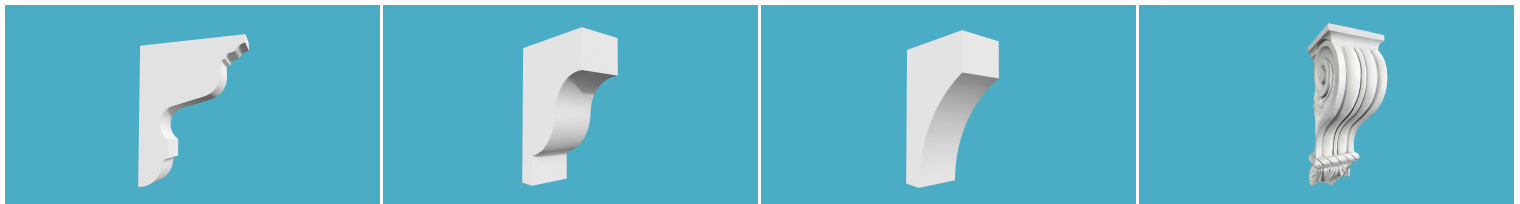

Part#	BCD6X8	Part#	BCD7X11X3	Part#	BCD7X12X4	Part#	BCD7X16
Width	1- $\frac{1}{2}$ "	Width	3- $\frac{1}{2}$ "	Width	4"	Width	5- $\frac{1}{2}$ "
Height	8"	Height	11"	Height	12"	Height	16- $\frac{1}{4}$ "
Projection	6"	Projection	7"	Projection	7- $\frac{1}{4}$ "	Projection	7- $\frac{1}{2}$ "

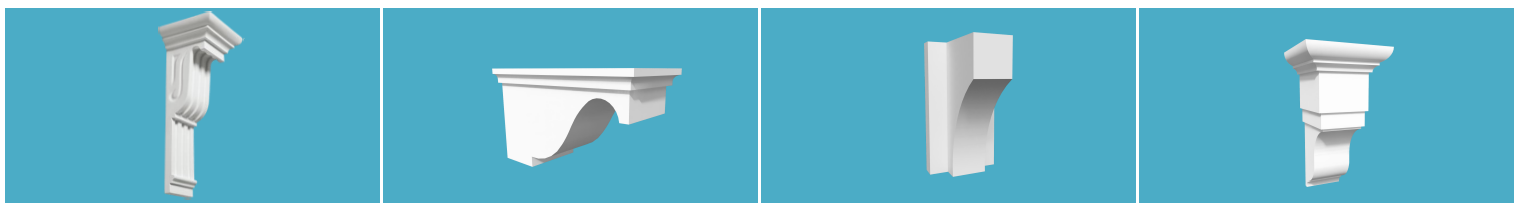

Part#	BCD7X18	Part#	BCD7X6X12	Part#	BCD8X13	Part#	BCD8X15
Width	7- $\frac{3}{4}$ "	Width	5- $\frac{1}{2}$ "	Width	7- $\frac{1}{2}$ "	Width	8- $\frac{1}{4}$ "
Height	18- $\frac{1}{4}$ "	Height	6- $\frac{3}{4}$ "	Height	13"	Height	14- $\frac{7}{8}$ "
Projection	6- $\frac{3}{4}$ "	Projection	11- $\frac{1}{2}$ "	Projection	8"	Projection	7- $\frac{7}{8}$ "

Smooth Brackets

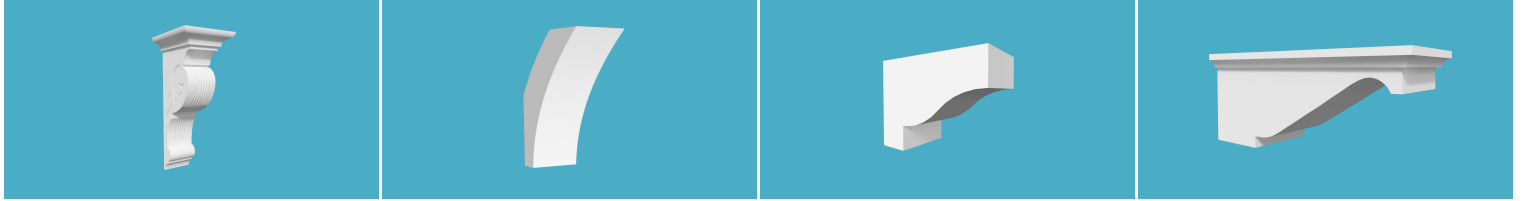

Part#	BCD8X17	Part#	BCD8X29X4	Part#	BCD8X6	Part#	BCD8X7X18
Width	6- $\frac{1}{4}$ "	Width	4"	Width	4"	Width	7"
Height	16- $\frac{3}{8}$ "	Height	29"	Height	6"	Height	7- $\frac{3}{8}$ "
Projection	8- $\frac{1}{4}$ "	Projection	8- $\frac{1}{4}$ "	Projection	8"	Projection	18"

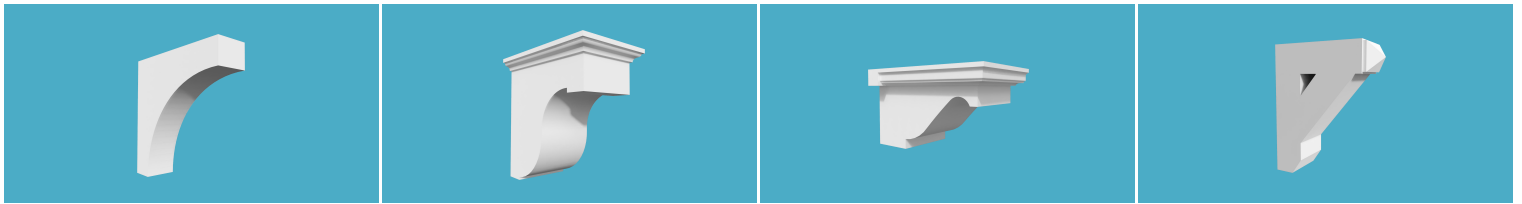

Part#	BCD8X8	Part#	BCD8X8X4	Part#	BCD8X9X14	Part#	BCD9X11
Width	2"	Width	4- $\frac{7}{8}$ "	Width	9"	Width	3- $\frac{1}{2}$ "
Height	8"	Height	8"	Height	8"	Height	11"
Projection	8"	Projection	8"	Projection	14"	Projection	9"

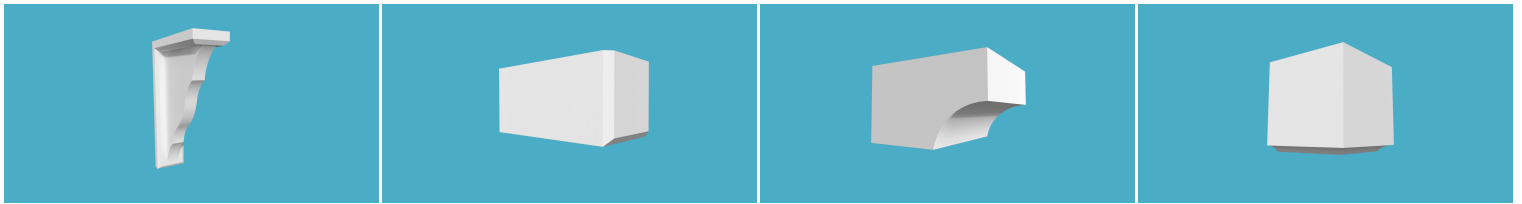

Part#	BCD9X13	Part#	BCD3.5X3.5X7	Part#	BCD3.5X5.5X5.5	Part#	BCD3X3X3
Width	3"	Width	3- $\frac{1}{2}$ "	Width	5- $\frac{1}{2}$ "	Width	3- $\frac{1}{2}$ "
Height	13"	Height	3- $\frac{1}{2}$ "	Height	3- $\frac{1}{2}$ "	Height	3- $\frac{1}{2}$ "
Projection	9"	Projection	7- $\frac{3}{8}$ "	Projection	5- $\frac{1}{2}$ "	Projection	3- $\frac{1}{2}$ "

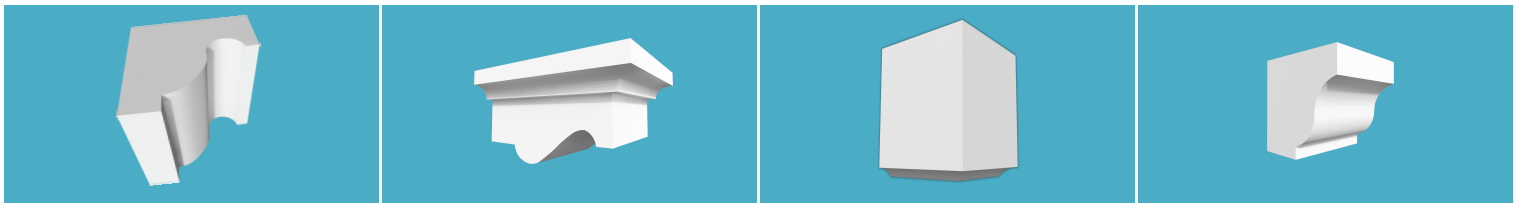

Part#	BCD3X3X4	Part#	BCD3X5X6	Part#	BCD4.5X4X4	Part#	BCD4X4X4
Width	3- $\frac{3}{4}$ "	Width	4- $\frac{1}{2}$ "	Width	3- $\frac{1}{2}$ "	Width	4"
Height	3- $\frac{3}{4}$ "	Height	3- $\frac{3}{8}$ "	Height	3- $\frac{1}{2}$ "	Height	4"
Projection	4- $\frac{1}{2}$ "	Projection	5- $\frac{3}{4}$ "	Projection	4- $\frac{1}{2}$ "	Projection	4"

Smooth Brackets

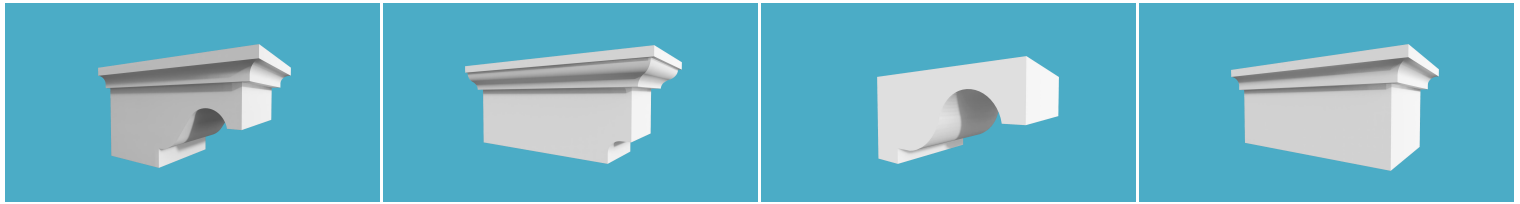

Part#	BCD4X4X7	Part#	BCD4X4X9	Part#	BCD4X5X7	Part#	BCD4X5X8
Width	5"	Width	4- $\frac{3}{4}$ "	Width	5- $\frac{1}{8}$ "	Width	5"
Height	4- $\frac{3}{8}$ "	Height	3- $\frac{7}{8}$ "	Height	4- $\frac{1}{4}$ "	Height	3- $\frac{3}{8}$ "
Projection	7- $\frac{1}{4}$ "	Projection	9"	Projection	7- $\frac{3}{4}$ "	Projection	7- $\frac{3}{4}$ "

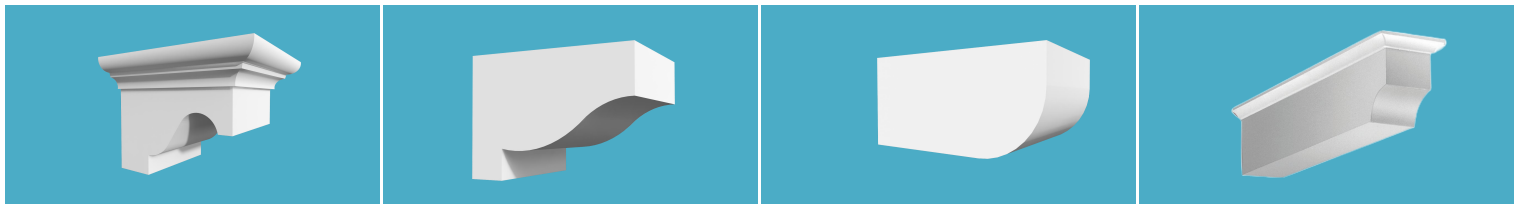

Part#	BCD4X6X6	Part#	BCD4X6X7	Part#	BCD4X6X9	Part#	BCD5X4X20
Width	5- $\frac{3}{4}$ "	Width	6"	Width	6"	Width	4- $\frac{3}{4}$ "
Height	4- $\frac{1}{2}$ "	Height	4"	Height	4- $\frac{1}{4}$ "	Height	4- $\frac{3}{4}$ "
Projection	6- $\frac{1}{4}$ "	Projection	7- $\frac{1}{8}$ "	Projection	8- $\frac{3}{4}$ "	Projection	20- $\frac{1}{2}$ "

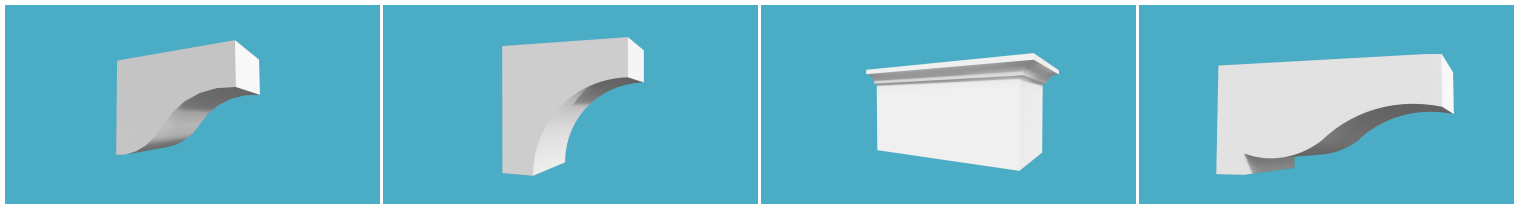

Part#	BCD5X4X7	Part#	BCD5X5X3	Part#	BCD5X6X10	Part#	BCD5X6X11
Width	4- $\frac{3}{8}$ "	Width	3- $\frac{1}{2}$ "	Width	5- $\frac{7}{8}$ "	Width	6"
Height	5- $\frac{3}{8}$ "	Height	5- $\frac{1}{2}$ "	Height	4- $\frac{3}{4}$ "	Height	5- $\frac{1}{4}$ "
Projection	6- $\frac{7}{8}$ "	Projection	5- $\frac{1}{2}$ "	Projection	9- $\frac{1}{2}$ "	Projection	10- $\frac{3}{4}$ "

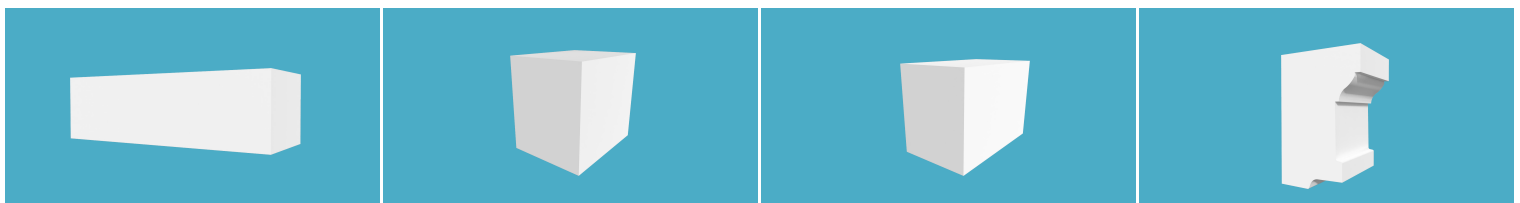

Part#	BCD5X6X18	Part#	BCD5X6X6	Part#	BCD5X6X8	Part#	BCD5X8
Width	6"	Width	6"	Width	6"	Width	4- $\frac{13}{16}$ "
Height	5"	Height	5"	Height	5"	Height	8- $\frac{1}{4}$ "
Projection	17- $\frac{5}{8}$ "	Projection	6"	Projection	8- $\frac{1}{2}$ "	Projection	5- $\frac{7}{16}$ "

Smooth Brackets

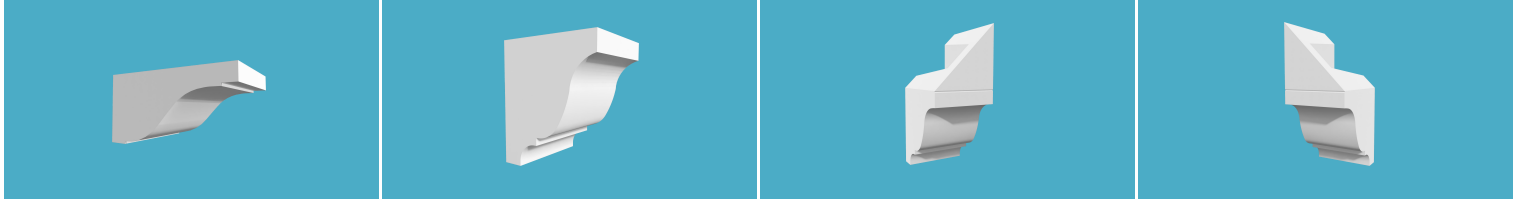

Part#	BCD5X8X10	Part#	BCD6X4X6	Part#	BCD6X4X6L12	Part#	BCD6X4X6R12
Width	7- $\frac{3}{8}$ "	Width	4- $\frac{3}{4}$ "	Width	4- $\frac{3}{4}$ "	Width	4- $\frac{3}{4}$ "
Height	5- $\frac{3}{8}$ "	Height	6- $\frac{1}{8}$ "	Height	10- $\frac{15}{16}$ "	Height	11"
Projection	10"	Projection	5- $\frac{1}{2}$ "	Projection	5- $\frac{1}{2}$ "	Projection	5- $\frac{1}{2}$ "

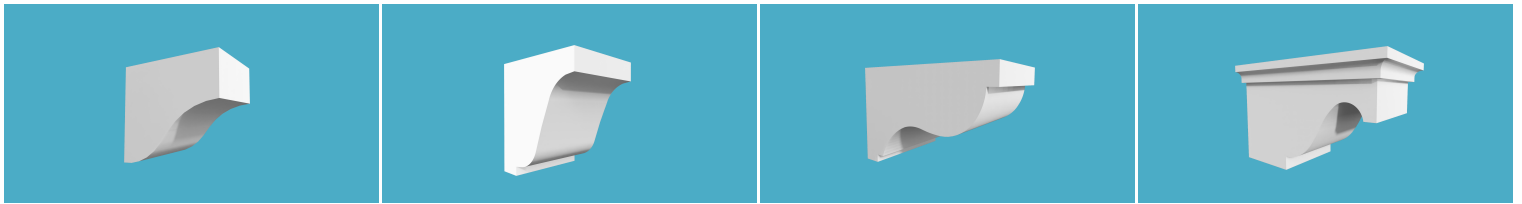

Part#	BCD6X5X7	Part#	BCD6X6X5	Part#	BCD6X6X8	Part#	BCD6X6X9
Width	5"	Width	4- $\frac{3}{4}$ "	Width	5- $\frac{1}{2}$ "	Width	5- $\frac{1}{2}$ "
Height	6- $\frac{5}{16}$ "	Height	6- $\frac{1}{4}$ "	Height	5- $\frac{3}{8}$ "	Height	5- $\frac{3}{4}$ "
Projection	6- $\frac{3}{4}$ "	Projection	5- $\frac{1}{2}$ "	Projection	8"	Projection	9- $\frac{3}{8}$ "

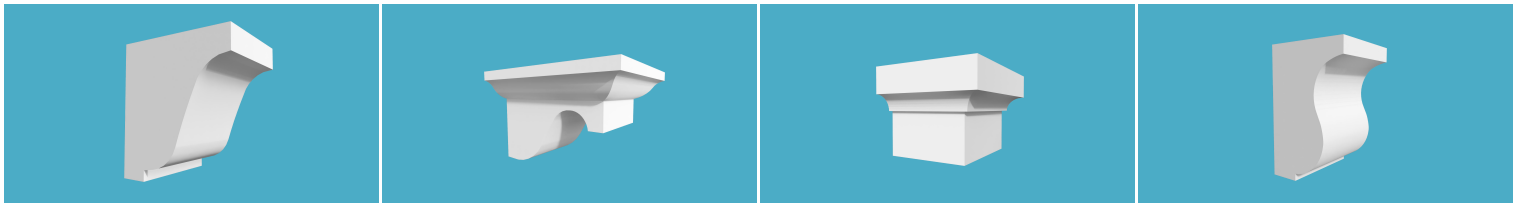

Part#	BCD6X6X9.25	Part#	BCD6X7X9	Part#	BCD6X9X7	Part#	BCD8X6X6
Width	6"	Width	7- $\frac{1}{4}$ "	Width	8- $\frac{3}{4}$ "	Width	5- $\frac{1}{2}$ "
Height	6"	Height	6"	Height	5- $\frac{1}{2}$ "	Height	8- $\frac{1}{8}$ "
Projection	9- $\frac{1}{4}$ "	Projection	9- $\frac{1}{4}$ "	Projection	6- $\frac{1}{2}$ "	Projection	5- $\frac{3}{16}$ "

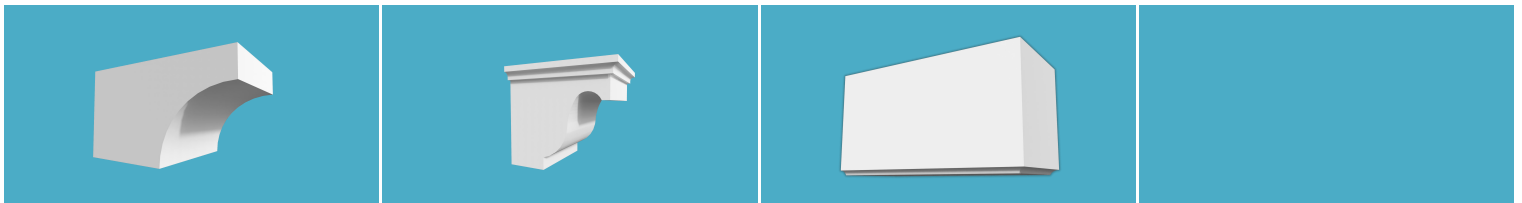

Part#	BCD9X11X16	Part#	BCD9X8X8	Part#	F100		
Width	11- $\frac{1}{4}$ "	Width	8- $\frac{1}{8}$ "	Width	8- $\frac{1}{8}$ "		
Height	9- $\frac{1}{4}$ "	Height	8- $\frac{1}{8}$ "	Height	8- $\frac{1}{8}$ "		
Projection	16"	Projection	9"	Projection	9"		

Wood-Grained Brackets

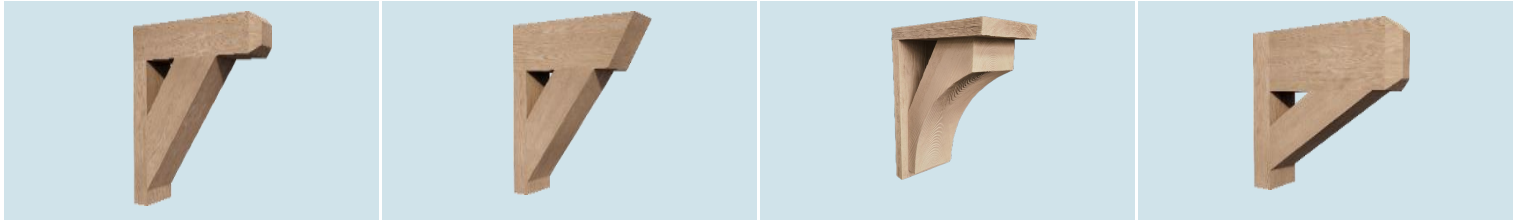

Part#	BCD12X18X3X1S	Part#	BCD12X20X3S	Part#	BCD13X18X8S	Part#	BCD14X16X3.5S
Width	3-½"	Width	3-½"	Width	8"	Width	3-½"
Height	18"	Height	20"	Height	18"	Height	16"
Projection	12"	Projection	12"	Projection	13"	Projection	14"

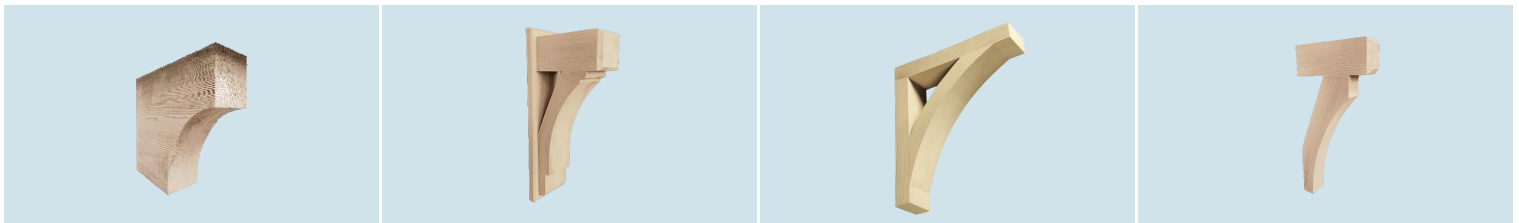

Part#	BCD11X11X5S	Part#	BCD14X30X7.5S	Part#	BCD16X18X4S	Part#	BCD16X32X4S
Width	5"	Width	7-½"	Width	4"	Width	4"
Height	11"	Height	30"	Height	18"	Height	32"
Projection	11"	Projection	13-½"	Projection	16"	Projection	16"

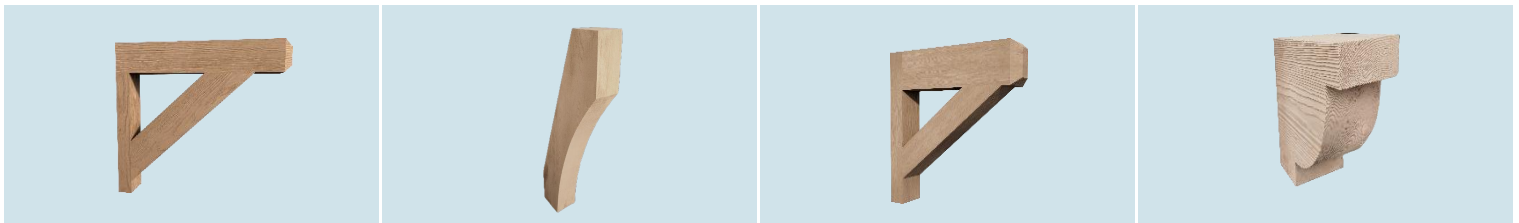



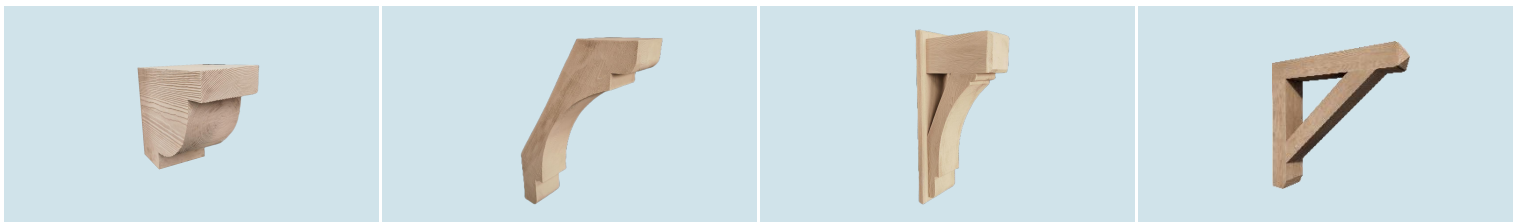

Part#	BCD18X18X3X1S	Part#	BCD12X24X3S	Part#	BCD18X24X3X2S	Part#	BCD11X13X6S
Width	3-½"	Width	3-¾"	Width	3-½"	Width	6"
Height	18"	Height	24"	Height	24"	Height	13"
Projection	18"	Projection	12"	Projection	18"	Projection	11"



Part#	BCD14X12X6S	Part#	BCD22X30X6S	Part#	BCD22X30X8S	Part#	BCD24X18X4S
Width	6"	Width	6"	Width	7-½"	Width	4"
Height	12"	Height	30"	Height	30"	Height	18"
Projection	14"	Projection	21-½"	Projection	21-½"	Projection	24"

Wood-Grained Brackets



							
Part#	BCD16X7X3S	Part#	BCD32X31X5S	Part#	BCDS18X24X6S	Part#	BCD5X5S
Width	3-¼"	Width	5-¼"	Width	5-½"	Width	5-½"
Height	7-¼"	Height	30-½"	Height	24"	Height	5-½"
Projection	16"	Projection	32-½"	Projection	18"	Projection	5-½"





				
Part#	BCDCV21X30X4S	BCDCV21X30X6S	BCDCV18X24X4S	BCDCV18X24X6S
Width	3-¼"	5-¼"	3-¼"	5-¼"
Height	30"	30"	24"	24"
Projection	21"	21"	18"	18"

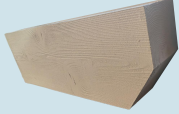

				
Part#	BCD26X24X6S	BCD14X16X6S	BCD22X24X4S	BCD22X24X6S
Width	5-½"	5-½"	3-½"	5-½"
Height	24"	16"	24"	24"
Projection	26"	14"	22"	22"





							
Part#	BCD16X8S	Part#	BCD18X8X6S	Part#	BCD18X9X3S	Part#	BCD24X5X5S
Width	6"	Width	6"	Width	3"	Width	5-½"
Height	8"	Height	8"	Height	9"	Height	5-½"
Projection	16"	Projection	18"	Projection	18"	Projection	24"

Wood-Grained Brackets

							
Part#	BCD24X8X4S	Part#	BCD24X8X6S	Part#	BCD39X10X5.5S	Part#	BCD8X8X6S
Width	4"	Width	6"	Width	5-½"	Width	6"
Height	8"	Height	8"	Height	9-¾"	Height	8"
Projection	24"	Projection	24"	Projection	39-¼"	Projection	8"

							
Part#	BCD5X5X3S	Part#	BCD7X11S	Part#	BCD7X13X7S	Part#	BCD7X15X4S
Width	3-½"	Width	7"	Width	7-½"	Width	4"
Height	5-½"	Height	7-¾"	Height	7-¼"	Height	15"
Projection	5-½"	Projection	11-¾"	Projection	13"	Projection	7"

								
Part#	BCDCV18X8X6S	BCDCV18X12X6S	BCDCV18X6X6S	BCDCV18X8X4S	Part#	BCDOGD15X7S	Part#	BCDOGA15X7S
Width	5-¼"	5-¼"	5-¼"	3-¼"	Width	6"	Width	6"
Height	7-¼"	11-¼"	5-¼"	7-¼"	Height	7-¼"	Height	7-¼"
Projection	18"	18"	18"	18"	Projection	14-½"	Projection	14-½"

							
Part#	BCDOG8X12S	Part#	BCDOG15X7S	Part#	BCDOG20X7S	Part#	BCDOG24X6S
Width	7-¾"	Width	6"	Width	8-½"	Width	5-⅝"
Height	7-¾"	Height	7-¼"	Height	7"	Height	5-⅞"
Projection	11-¾"	Projection	14-½"	Projection	20"	Projection	24"



*Faux
Wood
Beams*

Faux Wood Beams



Beam-Hand Hewn

Part#	Length	Width	Height
BM4X6X96HS	8'	3-½"	5-½"
BM4X6X120HS	10'		
BM4X6X144HS	12'		
BM4X6X168HS	14'		
BM4X6X192HS	16'		
BM4X6X216HS	18'		
BM4X6X234HS	19'6"		
BM6X8X96HS	8'	5-½"	7-½"
BM6X8X120HS	10'		
BM6X8X144HS	12'		
BM6X8X168HS	14'		
BM6X8X192HS	16'		
BM6X8X216HS	18'		
BM6X8X234HS	19'6"		
BM8X10X96HS	8'	7-½"	9-½"
BM8X10X120HS	10'		
BM8X10X144HS	12'		
BM8X10X168HS	14'		
BM8X10X192HS	16'		
BM8X10X216HS	18'		
BM8X10X234HS	19'6"		
BM10X12X96HS	8'	9-½"	11-½"
BM10X12X120HS	10'		
BM10X12X144HS	12'		
BM10X12X168HS	14'		
BM10X12X192HS	16'		
BM10X12X216HS	18'		
BM10X12X234HS	19'6"		

Beam-Mesa

Part#	Length	Width	Height
BM4X6X96WS	8'	3-½"	5-½"
BM4X6X120WS	10'		
BM4X6X144WS	12'		
BM4X6X168WS	14'		
BM4X6X192WS	16'		
BM4X6X216WS	18'		
BM4X6X234WS	19'6"		
BM6X8X96WS	8'	5-½"	7-½"
BM6X8X120WS	10'		
BM6X8X144WS	12'		
BM6X8X168WS	14'		
BM6X8X192WS	16'		
BM6X8X216WS	18'		
BM6X8X234WS	19'6"		
BM8X10X96WS	8'	7-½"	9-½"
BM8X10X120WS	10'		
BM8X10X144WS	12'		
BM8X10X168WS	14'		
BM8X10X192WS	16'		
BM8X10X216WS	18'		
BM8X10X234WS	19'6"		
BM10X12X96WS	8'	9-½"	11-½"
BM10X12X120WS	10'		
BM10X12X144WS	12'		
BM10X12X168WS	14'		
BM10X12X192WS	16'		
BM10X12X216WS	18'		
BM10X12X234WS	19'6"		

Available from 96" to 234"



Beam-Rough Saw

Part#	Length	Width	Height
BM4X6X96CRS	8'	3-½"	5-½"
BM4X6X120CRS	10'		
BM4X6X144CRS	12'		
BM4X6X168CRS	14'		
BM4X6X192CRS	16'		
BM4X6X216CRS	18'		
BM4X6X234CRS	19'6"		
BM6X8X96CRS	8'		
BM6X8X120CRS	10'		
BM6X8X144CRS	12'		
BM6X8X168CRS	14'		
BM6X8X192CRS	16'		
BM6X8X216CRS	18'		
BM6X8X234CRS	19'6"		
BM8X10X96CRS	8'	7-½"	9-½"
BM8X10X120CRS	10'		
BM8X10X144CRS	12'		
BM8X10X168CRS	14'		
BM8X10X192CRS	16'		
BM8X10X216CRS	18'		
BM8X10X234CRS	19'6"		
BM10X12X96CRS	8'		
BM10X12X120CRS	10'		
BM10X12X144CRS	12'		
BM10X12X168CRS	14'		
BM10X12X192CRS	16'		
BM10X12X216CRS	18'		
BM10X12X234CRS	19'6"		

Beam-Tahoe

Part#	Length	Width	Height
BM4X6X96CS	8'	3-½"	5-½"
BM4X6X120CS	10'		
BM4X6X144CS	12'		
BM4X6X168CS	14'		
BM4X6X192CS	16'		
BM4X6X216CS	18'		
BM4X6X234CS	19'6"		
BM6X8X96CS	8'		
BM6X8X120CS	10'		
BM6X8X144CS	12'		
BM6X8X168CS	14'		
BM6X8X192CS	16'		
BM6X8X216CS	18'		
BM6X8X234CS	19'6"		
BM8X10X96CS	8'	7-½"	9-½"
BM8X10X120CS	10'		
BM8X10X144CS	12'		
BM8X10X168CS	14'		
BM8X10X192CS	16'		
BM8X10X216CS	18'		
BM8X10X234CS	19'6"		
BM10X12X96CS	8'		
BM10X12X120CS	10'		
BM10X12X144CS	12'		
BM10X12X168CS	14'		
BM10X12X192CS	16'		
BM10X12X216CS	18'		
BM10X12X234CS	19'6"		

Available from 96" to 234"

Faux Wood & Smooth Beams

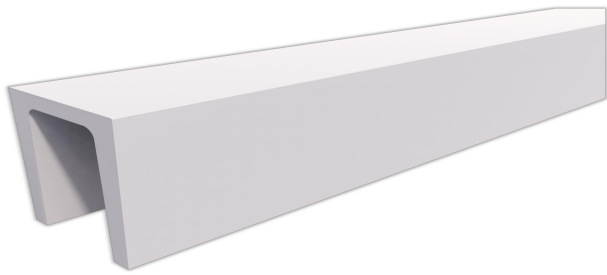

Smooth Beam					
Part#	Length	Width	Height		
BM4X4X96	8'	3-½"	3-½"		
BM4X4X120	10'				
BM4X4X144	12'				
BM4X4X168	14'				
BM4X4X192	16'				
BM4X4X216	18'				
BM4X4X234	19'6"				
BM4X6X96	8'			3-½"	5-½"
BM4X6X120	10'				
BM4X6X144	12'				
BM4X6X168	14'				
BM4X6X192	16'				
BM4X6X216	18'				
BM4X6X234	19'6"				
BM6X8X96	8'	5-½"	7-½"		
BM6X8X120	10'				
BM6X8X144	12'				
BM6X8X168	14'				
BM6X8X192	16'				
BM6X8X216	18'				
BM6X8X234	19'6"				
BM8X10X96	8'	7-½"	9-½"		
BM8X10X120	10'				
BM8X10X144	12'				
BM8X10X168	14'				
BM8X10X192	16'				
BM8X10X216	18'				
BM8X10X234	19'6"				

Available from 96" to 234"



Beam Mantel-Hand Hewn			
Part#	Length	Width	Height
BM6X8X60HS-TC	5'	5-½"	7-½"
BM6X8X66HS-TC	5'6"		
BM6X8X72HS-TC	6'		
BM6X8X78HS-TC	6'6"		
BM6X8X84HS-TC	7'		
BM6X8X90HS-TC	7'6"		
BM8X10X60HS-TC	5'	7-½"	9-½"
BM8X10X66HS-TC	5'6"		
BM8X10X72HS-TC	6'		
BM8X10X78HS-TC	6'6"		
BM8X10X84HS-TC	7'		
BM8X10X90HS-TC	7'6"		



Beam Mantel-Rough Sawn			
Part#	Length	Width	Height
BM6X8X60CRS-TC	5'	5-½"	7-½"
BM6X8X66CRS-TC	5'6"		
BM6X8X72CRS-TC	6'		
BM6X8X78CRS-TC	6'6"		
BM6X8X84CRS-TC	7'		
BM6X8X90CRS-TC	7'6"		
BM8X10X60CRS-TC	5'	7-½"	9-½"
BM8X10X66CRS-TC	5'6"		
BM8X10X72CRS-TC	6'		
BM8X10X78CRS-TC	6'6"		
BM8X10X84CRS-TC	7'		
BM8X10X90CRS-TC	7'6"		

Beam-Milled

Part#	Length	Width	Height
BMWS4.5X4.5X84S-CN	7'	4"	4"
BM4.625X2.5X96S-CN	8'	4- $\frac{1}{8}$ "	2"
BM4.625X2.5X120S-CN	10'	4- $\frac{1}{8}$ "	2"
BMFT0.75X24X188S-CN	15'8"	3- $\frac{1}{8}$ "	1- $\frac{1}{2}$ "
BM3.625X2X140S-CN	11'8"	3- $\frac{1}{2}$ "	2- $\frac{3}{8}$ "
BM10.5X4.5X144S-CN	12'	10"	4"
BM10.5X4.5X96S-CN	8'	10"	4"
BM4.5X2.75X140S-CN	11'8"	4"	2- $\frac{3}{8}$ "
BM5.25X3.625X140S-CN	11'8"	4- $\frac{3}{4}$ "	3- $\frac{1}{8}$ "
BM4.75X3.125X140S-CN	11'8"	4- $\frac{1}{4}$ "	2- $\frac{3}{4}$ "
BM6.75X5.25X140S-CN	11'8"	6- $\frac{1}{4}$ "	4- $\frac{3}{4}$ "
BM8.75X4.875X196S-CN	16'4"	8- $\frac{1}{4}$ "	4- $\frac{1}{4}$ "
BM8.75X7.625X188S-CN	15'8"	8- $\frac{1}{4}$ "	7- $\frac{1}{8}$ "
BM8X6X168CS	14'	7- $\frac{1}{4}$ "	5- $\frac{3}{4}$ "



Smooth Classic Beam

Part#	Width	Overall Width	Overall Height	Length
BM4X5X192	4- $\frac{1}{4}$ "	6- $\frac{7}{8}$ "	5"	16'

Available from 96" to 234"

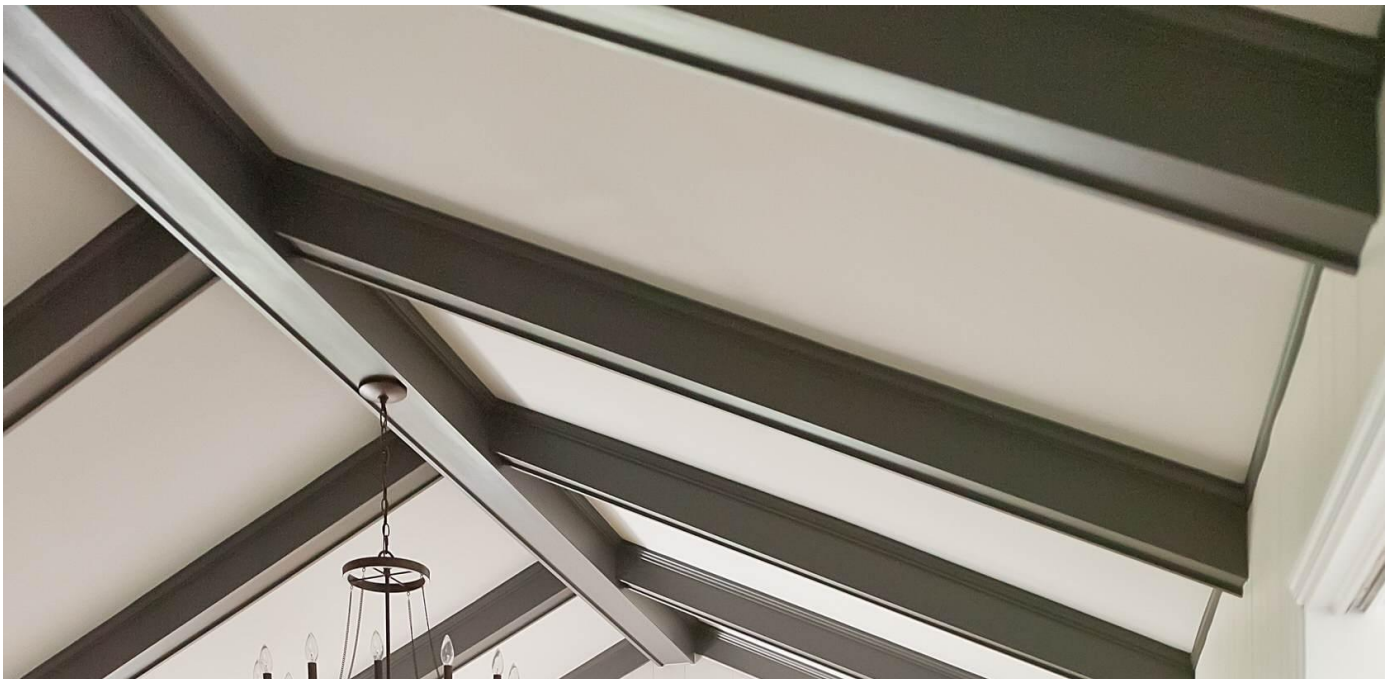

Beam Accessories

Beam Plates-Hammered



Part#	Width	Overall Height
BMP6X10H	5"	10"
BMP8X10H	7"	10"
BMP10X15H	9"	15"
BMP15X20H	14"	20"
BMP36X36H	36"	36"
BMP48X48H	48"	48"

Beam Plates-Smooth



Part#	Width	Overall Height
BMP6X10S	5"	10"
BMP8X10S	7"	10"
BMP10X15S	9"	15"
BMP15X20S	14"	20"
BMP36X36S	36"	36"
BMP48X48S	48"	48"

Beam Straps-Hammered



Part#	Inside Width	Bottom Height
BMSP4X6H	3-3/4"	6"
BMSP6X8H	5-3/4"	8"
BMSP8X10H	7-3/4"	10"
BMSP10X12H	9-3/4"	12"

Beam Straps-Smooth



Part#	Width	Overall Height
BMSP4X6S	3-3/4"	6"
BMSP6X8S	5-3/4"	8"
BMSP8X10S	7-3/4"	10"
BMSP10X12S	9-3/4"	12"

Beam End Cap

Part#	Width	Projection	Length
BC10X15	9-1/8"	3/4"	15-7/8"



Beam Top-Mesa

Part#	Width	Projection	Length
BM6X144T	5-1/2"	3/4"	12'
BM8X144T	7-1/2"	3/4"	12'
BMFT0.75X8X188S-CN	8-1/8"	3/4"	15'8"
BMFT0.75X24X188S-CN	24-7/8"	3/4"	15'8"

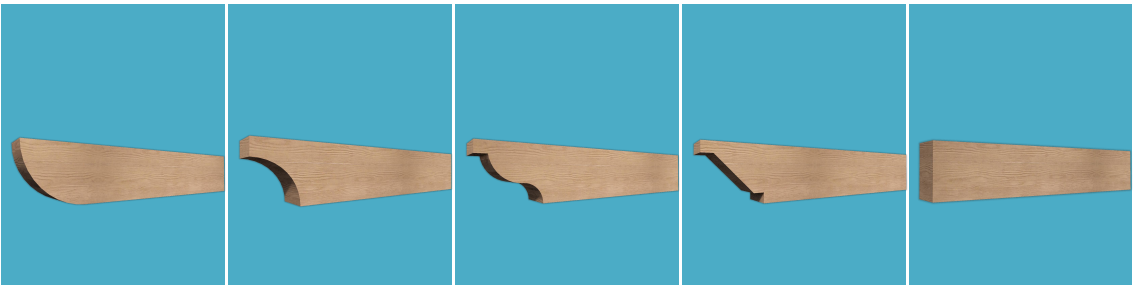

							
Bullnose Profile	Cove Profile	Scroll Profile	Slant Profile	Straight Profile			
Part#					Length	Width	Height
BMBL4X6X12RS	BMCV4X6X12RS	BMSC4X6X12RS	BMSL4X6X12RS	BMST4X6X12RS	12"	3-½"	5-½"
BMBL4X6X18RS	BMCV4X6X18RS	BMSC4X6X18RS	BMSL4X6X18RS	BMST4X6X18RS	18"		
BMBL4X6X24RS	BMCV4X6X24RS	BMSC4X6X24RS	BMSL4X6X24RS	BMST4X6X24RS	24"		
BMBL4X6X30RS	BMCV4X6X30RS	BMSC4X6X30RS	BMSL4X6X30RS	BMST4X6X30RS	30"		
BMBL4X6X36RS	BMCV4X6X36RS	BMSC4X6X36RS	BMSL4X6X36RS	BMST4X6X36RS	36"		
BMBL4X6X42RS	BMCV4X6X42RS	BMSC4X6X42RS	BMSL4X6X42RS	BMST4X6X42RS	42"		
BMBL4X8X18RS	BMCV4X8X18RS	BMSC4X8X18RS	BMSL4X8X18RS	BMST4X8X18RS	18"	3-½"	7-½"
BMBL4X8X24RS	BMCV4X8X24RS	BMSC4X8X24RS	BMSL4X8X24RS	BMST4X8X24RS	24"		
BMBL4X8X30RS	BMCV4X8X30RS	BMSC4X8X30RS	BMSL4X8X30RS	BMST4X8X30RS	30"		
BMBL4X8X36RS	BMCV4X8X36RS	BMSC4X8X36RS	BMSL4X8X36RS	BMST4X8X36RS	36"		
BMBL4X8X42RS	BMCV4X8X42RS	BMSC4X8X42RS	BMSL4X8X42RS	BMST4X8X42RS	42"		

Rafter Tails



Rafter Tails Standard Wood Grain

Part#	Width	Overall Height	Length
BMS6X4X24S	3-¼"	5-¼"	24"
BMS8X4X24S	3-¼"	7-¼"	24"



Rafter Tails Standard Wood Grain

Part#	Width	Overall Height	Length
BMT25X12X6S	6"	12"	25"



Rafter Tails Double-Ended Standard Wood Grain

Part#	Width	Overall Height	Length
BMT4X8X42S	4"	8"	42"

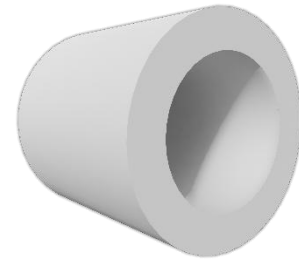

Tile Vents

Part#	Width	Overall Height	Projection
T6X6	6"	6"	6"

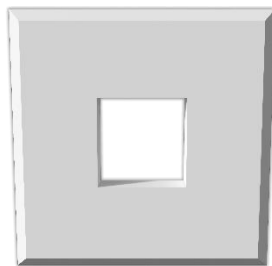

Fixture Mounts

Part#	Width	Inside Width	Overall Height	Bottom Height	Projection
FMS8X8X2	8"	3-¾"	8"	2-¾"	2"
FM8X12X2	8"	2-½"	12"	4"	2"



Pine Tile Panel

Part#	Length	Overall Height	Projection
SDG0.75X18.5X50S-CN	50-¾"	18-¾"	¾"



Pine Panel

Part#	Width	Length	Projection
FT0.5X24X118S-CN	23- ⁵ / ₈ "	11- ¹ / ₈ "	1/2"



Fishscale Panel-Round Scales

Part#	Width	Overall Width	Overall Height	Projection
FSP103X17	99- ¹ / ₄ "	102- ¹ / ₈ "	16- ¹³ / ₁₆ "	3/4"



Joinable Pine Panel

Part#	Width	Length	Projection
FT0.75X6.75X94S-CN	6- ³ / ₄ "	94- ¹ / ₈ "	3/4"



Tile Panel

Part#	Width	Length	Projection
TL1X25X96-CN	25- ¹ / ₄ "	96"	1"



Internal Corner

Part#	Width	Length	Projection
MD2.4X2.4X102S-IC	2- ³ / ₈ "	101- ¹ / ₈ "	2- ³ / ₈ "

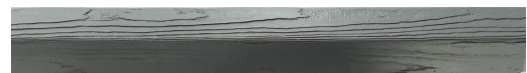

External Corner

Part#	Width	Length	Projection
MD2.4X2.4X102S-OC	2- ³ / ₈ "	101- ¹ / ₈ "	2- ³ / ₈ "

Full-Round Finial & Spires



	Acorn	Pedestal Ball	Post Ball	Decorative Ball
Part#	AF10	B3X4	B3X5	B7X9
Overall Height	11- $\frac{1}{8}$ "	4- $\frac{5}{8}$ "	5- $\frac{1}{4}$ "	8- $\frac{1}{2}$ "
Ball Diameter	4- $\frac{7}{8}$ "	3- $\frac{1}{8}$ "	3- $\frac{1}{4}$ "	6- $\frac{1}{4}$ "
Base Diameter	4- $\frac{1}{2}$ "	3- $\frac{1}{4}$ "	3- $\frac{1}{4}$ "	6- $\frac{1}{2}$ "



Post Ball						
Part#	B5X7	B6X8	B6X9	B8X10	B10X13	B12X16
Overall Height	6- $\frac{3}{4}$ "	7- $\frac{3}{4}$ "	9"	10"	12- $\frac{7}{8}$ "	16"
Diameter	5- $\frac{1}{4}$ "	5- $\frac{7}{8}$ "	7"	8"	10"	12"
Ball Diameter	4- $\frac{3}{8}$ "	5- $\frac{7}{8}$ "	5- $\frac{7}{8}$ "	8- $\frac{1}{4}$ "	8- $\frac{1}{2}$ "	12"

Pineapple		
Part#	PAPE5X11	PAPE6X14
Overall Height	5- $\frac{5}{8}$ "	11"
Diameter	7- $\frac{1}{8}$ "	14"
Ball Diameter	5- $\frac{3}{8}$ "	11"



Spires			
Part#	S4X21	S6X32	S8X56
Overall Height	21- $\frac{1}{4}$ "	32- $\frac{1}{4}$ "	56"
Diameter	7"	6"	8"
Ball Diameter	3- $\frac{1}{2}$ "	4- $\frac{1}{4}$ "	8"

Victorian Gable Pediments

Part#	Overall Width	Overall Height	Projection
GP64X32	62"	32- $\frac{1}{4}$ "	1"
GP70X35	70"	35"	2- $\frac{3}{4}$ "
GP80X33	80- $\frac{1}{4}$ "	32- $\frac{1}{4}$ "	1"
GP88X29	86- $\frac{3}{8}$ "	29- $\frac{3}{8}$ "	1"
GP96X28	96"	28"	1"



Arched Gable Pediments

Part#	Overall Width	Overall Height	Projection
GPA104X26	103- $\frac{1}{2}$ "	25- $\frac{7}{8}$ "	3- $\frac{1}{4}$ "
GPA70X35	70"	35"	3- $\frac{1}{4}$ "
GPA81X34	80- $\frac{1}{2}$ "	33- $\frac{1}{2}$ "	3- $\frac{1}{4}$ "
GPA86X32	85- $\frac{1}{4}$ "	32- $\frac{1}{4}$ "	3- $\frac{1}{4}$ "
GPA87X29	86- $\frac{7}{8}$ "	29"	3- $\frac{1}{4}$ "
GPA95X28	95- $\frac{1}{4}$ "	27- $\frac{3}{4}$ "	3- $\frac{1}{4}$ "



Flat Gable Pediments

Part#	Overall Width	Overall Height	Projection
GPF66X33	66"	36- $\frac{1}{2}$ "	1"

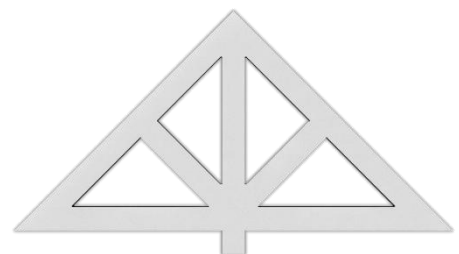

Gable Pediments

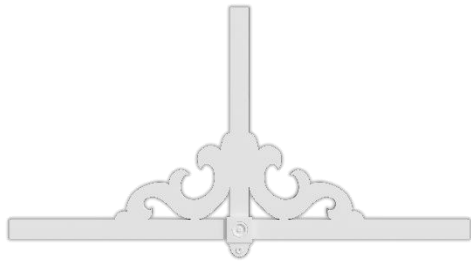

Basic Gable Pediment Kits				
Part#	Width	Overall Width	Thickness	Pitch
GP100	96"	51-5/8"	1-1/4"	Adjustable from 6 / 12 to 12 / 12







Basic Gable Pediment Kits			
Part#	Overall Height	Thickness	Pitch
GPK401	39-1/4"	1-5/8"	Adjustable from 5 / 12 to 14 / 12







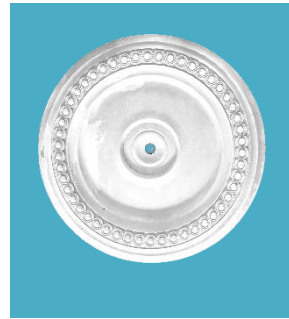

Ceiling Medallions

Ceiling Medallions

	Part#	CM14BL
	Diameter	14"
	Inside Diameter	-
	Projection	1"
	Part#	CM15BM
	Diameter	14-3/8"
	Inside Diameter	1"
	Projection	2-3/4"
	Part#	CM16FL
	Diameter	16"
	Inside Diameter	4-3/8"
	Projection	1-1/8"
	Part#	CM16JE
	Diameter	15-1/2"
	Inside Diameter	3-7/8"
	Projection	1-1/8"
	Part#	CM16TL
	Diameter	16"
	Inside Diameter	4"
	Projection	1-1/2"

	Part#	CM24RE
	Diameter	24-13/16"
	Inside Diameter	-
	Projection	1-5/16"
	Part#	CM24RN
	Diameter	24-3/8"
	Inside Diameter	1"
	Projection	1-1/2"
	Part#	CM31WI
	Diameter	31"
	Inside Diameter	1"
	Projection	2"
	Part#	CM32RO
	Diameter	19-1/4"
	Inside Diameter	2-1/2"
	Projection	30-7/8"
	Part#	CM36NI
	Diameter	35-13/16"
	Inside Diameter	1"
	Projection	2"



*Balustrades
& Columns*

Square Baluster

Part#	Rail Width	Spindle Width	Spindle Height
BL2X20Q	5"	1- $\frac{3}{4}$ "	20"
BL2X24Q	5"	1- $\frac{3}{4}$ "	24"
BL2X28Q	5"	1- $\frac{3}{4}$ "	28"
BL2X32Q	5"	1- $\frac{3}{4}$ "	32"
BL5X28Q	7"	4- $\frac{7}{8}$ "	28"



Logan Baluster

Part#	Rail Width	Spindle Width	Top Block Height	Bottom Block Height	Spindle Height
BL3X24L	5"	3"	3"	3"	24"
BL3X28L	5"	3"	3"	3"	28"



Rosedale Baluster

Part#	Rail Width	Spindle Width	Top Block Height	Bottom Block Height	Spindle Height
BL5X20R	7"	4- $\frac{1}{2}$ "	4"	4"	20"



Stone Euro Baluster

Part#	Rail Width	Spindle Width	Top Block Height	Bottom Block Height	Spindle Height
BL5X28EU	7"	5- $\frac{3}{8}$ "	4- $\frac{1}{8}$ "	3- $\frac{3}{4}$ "	27- $\frac{3}{4}$ "



Balusters



Ashley Baluster					
Part#	Rail Width	Spindle Width	Top Block Height	Bottom Block Height	Spindle Height
BL2.5X15A	5"	2-½"	3"	3"	15"
BL3X20A	5"	2-½"	2-½"	2-½"	20"
BL3X24A	5"	2-½"	4-½"	4-½"	24"
BL3X28A	5"	2-½"	4-½"	4-½"	28"
BL3X32A	5"	2-½"	4-½"	4-½"	32"
BL3X36A	5"	2-½"	6"	6"	36"
BL4X24A	7"	4-½"	4-½"	4-½"	24"
BL5X20A	7"	4-½"	3-½"	3-½"	20"
BL5X24A	7"	4-½"	3-½"	3-½"	24"
BL5X32A	7"	4-½"	4-½"	4-½"	32"



Woodruff Baluster					
Part#	Rail Width	Spindle Width	Top Block Height	Bottom Block Height	Spindle Height
BL3X18W	5"	2-½"	4"	4"	20"
BL3X20W	5"	2-½"	4"	4"	24"
BL3X24W	5"	2-½"	4"	4"	28"
BL3X28W	5"	2-½"	4"	4"	32"
BL3X32W	5"	2-½"	4"	4"	32"
BL3X36W	5"	2-½"	4"	4"	36"
BL5X20W	7"	4-½"	4"	4"	20"
BL5X24W	7"	4-½"	4"	4"	24"
BL5X28W	7"	4-½"	4"	4"	28"
BL5X32W	7"	4-½"	4"	4"	32"



Beaumont Baluster					
Part#	Rail Width	Spindle Width	Top Block Height	Bottom Block Height	Spindle Height
BL4X22B	7"	4"	1- $\frac{1}{8}$ "	1- $\frac{3}{4}$ "	22"
BL5X19B		5- $\frac{1}{4}$ "	1- $\frac{1}{8}$ "	1- $\frac{3}{4}$ "	19- $\frac{1}{8}$ "
BL5X22B		5"	2- $\frac{3}{8}$ "	3- $\frac{3}{4}$ "	22"



Classic Baluster					
Part#	Rail Width	Spindle Width	Top Block Height	Bottom Block Height	Spindle Height
BL3X20C	5"	2- $\frac{1}{2}$ "	3- $\frac{1}{2}$ "	3- $\frac{1}{2}$ "	20"
BL3X24C		2- $\frac{1}{2}$ "	3- $\frac{1}{2}$ "	3- $\frac{1}{2}$ "	24"
BL3X28C		2- $\frac{1}{2}$ "	3- $\frac{1}{2}$ "	3- $\frac{1}{2}$ "	28"
BL3X32C		2- $\frac{1}{2}$ "	3- $\frac{1}{2}$ "	3- $\frac{1}{2}$ "	32"
BL5X20C	7"	5"	5"	5"	20"
BL5X24C		5"	5"	5"	24"
BL5X28C		5"	5"	5"	28"
BL5X30C		5"	5"	5"	30- $\frac{1}{2}$ "
BL5X32C		5"	5"	5"	32"



Woodruff Baluster					
Part#	Rail Width	Spindle Width	Top Block Height	Bottom Block Height	Spindle Height
BL4X27CO	7"	4- $\frac{1}{4}$ "	4"	4"	27"
BL4X31CO		4- $\frac{1}{4}$ "	4"	4"	31"
BL5X28CO		4- $\frac{1}{2}$ "	3- $\frac{3}{8}$ "	3- $\frac{3}{8}$ "	28"

Railing

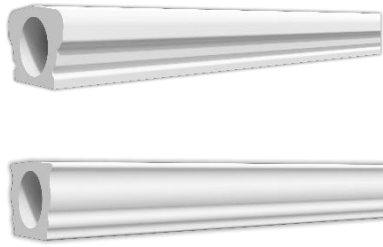

Top Straight Rails		
Part#	Rail Width	Length
TR5X96	5"	96"
TR5X144		144"
TR7X96	7"	96"
TR7X120		120"
TR7X144		144"

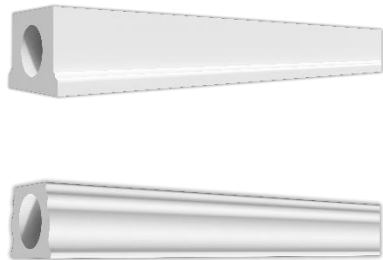

Bottom Straight Rails		
Part#	Rail Width	Length
BR5X96	5"	96"
BR5X144		144"
BR7X96	7"	96"
BR7X120		120"
BR7X144		144"

Balustrade Rail Installation Kits

Installation Kit	Kit Contents	Installation Notes	
BRK5	(2) Angle Brackets & Mounting Hardware	Connects both ends of one 5" top or bottom rail to support structure. Order two kits per section.	
BRK6-7	(2) Angle Brackets & Mounting Hardware	Connects both ends of one 7" top or bottom rail to support structure. Order two kits per section.	



Plain Newel Post			
Part#	Balustrade System	Width	Height
NP6X48	5"	5-½"	48"
NP8X48	7"	7-½"	48"



Decorative Newel Post			
Part#	Balustrade System	Width	Height
NCP8X48	7"	8"	48"





Corner Panel Newel Post			
Part#	Balustrade System	Width	Height
NSP8X48	7"	8"	48"

Newel Posts Installation Kits

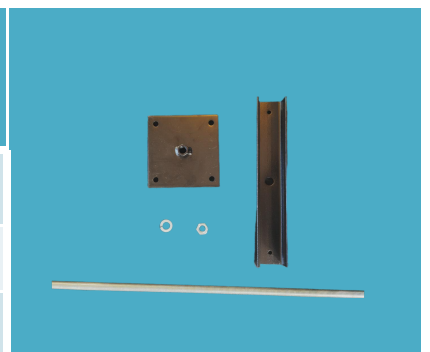

Installation Kit	Installation Notes(Use one kit per post)
PK400	Secures one 6" newel post to the structural substrate.
PK600	Secures one 8" newel post to the structural substrate.

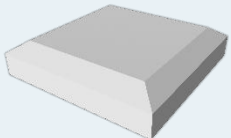
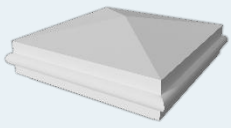
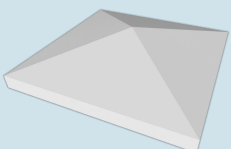
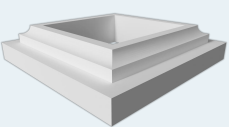

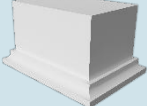

Post Accessories

Post Accessories				
Part#	Overall Width	Height	Coordinate	
NPT7X7	4-½"	1-½"	B5X7 NP6X48	
NPT10X10	6-¼"	2"	NP8X48 NPCP8X48 NPSP8X48	
NPT6X6P	5-⅞"	2-⅞"	NP6X48	
NPT8X8P	8-⅞"	3"	NP8X48	
NPT9X9P	8-⅞"	3"	NPCP8X48 NPSP8X48	
NPT7X7P	6-½"	1-½"	NP6X48	
T6C	5-⅝"	2"	NP6X48	
T8C	7-⅝"	2"	NP8X48	
T8-8C	8-⅞"	2"	NPCP8X48 NPSP8X48	
B3X4	3-½"	4-⅝"		
B5X7	5-¼"	6-¾"	NPT7X7	
RS4X4X6	4"	4"	Rail5"/7"	

Porch Spandrels

Part#	Length	Height	Projection	
PRS48X8	48"	7- $\frac{3}{4}$ "	1"	
PRS96X8	97- $\frac{1}{2}$ "	8- $\frac{1}{4}$ "	5- $\frac{7}{8}$ "	

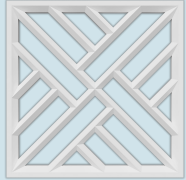
Decorative Panel



Part#	Width	Height	Projection	
DP28X28CH	27- $\frac{3}{4}$ "	27- $\frac{3}{4}$ "	1- $\frac{1}{2}$ "	
DP28X28CH-B*	27- $\frac{3}{4}$ "	27- $\frac{3}{4}$ "	1- $\frac{1}{2}$ "	
DP28X28SQX	28"	28"	1- $\frac{5}{16}$ "	

*Functional

Dentill Shelf

Part#	Width	Height	Projection	
DSB4	25- $\frac{3}{8}$ "	2- $\frac{5}{8}$ "	2- $\frac{5}{8}$ "	
DSW4	25- $\frac{3}{8}$ "	2- $\frac{5}{8}$ "	2- $\frac{5}{8}$ "	

Columns

Colonial Porch Post				
Part#	Width	Overall Height	Bottom Block Height	
PP6X96	5-½"	96"	44-½"	
PP6X108	5-½"	108"	44-½"	
PP6X120	5-½"	120"	44-½"	
PP8X120A	7-½"	120"	42"	

Panel Square Columns

Part#	Width	Base Width	Height	
SPCOL8X96	6"	8"	95- $\frac{5}{8}$ "	
SPCOL11X96	8"	10- $\frac{1}{2}$ "	95- $\frac{5}{8}$ "	
SPCOL11X108	8"	10- $\frac{1}{2}$ "	107- $\frac{5}{8}$ "	

Structural Wood-Grained Column

Part#	Width	Height	
SKPP6X108S	7"	108"	

Lamp Post

Part#	Top Width	Overall Height	Bottom Block Height	
LP6X96	3- $\frac{1}{2}$ "	96"	5- $\frac{1}{2}$ "	

Columns

Column Cap

Part#	Width	Thickness	
CC8	9- $\frac{7}{8}$ "	2- $\frac{5}{8}$ "	
CC10	12- $\frac{1}{8}$ "	3- $\frac{5}{8}$ "	
CC12	14- $\frac{5}{8}$ "	3- $\frac{7}{8}$ "	

Column Base

Part#	Width	Thickness	
CB8	10- $\frac{7}{8}$ "	4- $\frac{1}{4}$ "	
CB10	13- $\frac{1}{2}$ "	5- $\frac{1}{4}$ "	
CB12	16- $\frac{1}{4}$ "	6"	

