

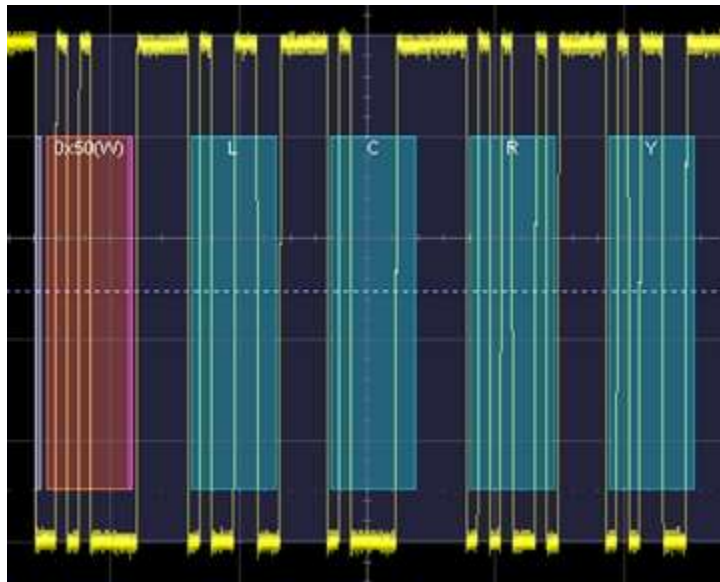

# Serial Data Debug Solutions



Operator's Manual

August, 2011



**LeCroy Corporation**

700 Chestnut Ridge Road

Chestnut Ridge, NY, 10977-6499

Tel: (845) 578-6020, Fax: (845) 578 5985

**Internet:** [www.lecroy.com](http://www.lecroy.com)

© 2011 by LeCroy Corporation. All rights reserved.

Unauthorized duplication of LeCroy documentation materials other than for internal sales and distribution purposes is strictly prohibited. However, clients are encouraged to distribute and duplicate LeCroy documentation for their own internal educational purposes.

LeCroy and other product or brand names are trademarks or requested trademarks of their respective holders. Information in this publication supersedes all earlier versions. Specifications are subject to change without notice.

---

919586 RevA

---

## TABLE OF CONTENTS

<b>Serial Data Debug Solutions Introduction .....</b>	<b>9</b>
Overview .....	9
Structure of This Manual .....	9
Assumptions .....	9
Toolsets and Supported Protocols.....	9
Compatibility.....	10
<b>Accessing and Using Supported Protocol Toolsets .....</b>	<b>12</b>
Accessing and Using Supported Protocol Toolsets Overview .....	12
The D and TD Toolsets .....	12
Technical Explanation of Serial Decode and Trigger .....	12
Accessing The D and TD Supported Protocol Toolsets .....	13
Using The D Supported Protocol Toolsets .....	14
Decode Toolset Features and Controls.....	18
Using The T Supported Protocol Toolsets .....	22
Accessing and Using The PROTObus MAG Supported Protocol Toolset .....	23
Decode Output Operation Detail.....	24
Decode Measurement Parameters via Measure Setup .....	24
The ProtoSync Toolset .....	26
The ProtoSync Toolset Overview.....	26
The CATC Protocol View .....	27
The CATC Bit Tracer View - PCI Express (PCIe) Only .....	30
Oscilloscope and Protocol Analyzer - A Concurrent Analysis Example .....	30
Accessing and Using The Graphing Tools for Supported Protocols.....	32
Physical Layer Eye Diagram .....	32
Debug Examples .....	32
Using the TD Packages: Characterize Embedded Controller Performance .....	32
Isolating and Analyzing Serial Bus Activity.....	37
<b>Serial Pattern Encoding Schemes - 8b/10b .....</b>	<b>45</b>
Serial Pattern Encoding Schemes Overview .....	45
8b/10b .....	45
Using the 8b/10b Option .....	45
Using the 8b/10b Option Overview .....	45
8b/10b Decode Setup Detail.....	45
Using 8b/10b Hi-Speed Serial Triggers on Zi Oscilloscopes .....	47
Encoding Table Reference .....	50
8b/10b Decode Search .....	52
<b>General Purpose Embedded Protocols .....</b>	<b>53</b>
General Purpose Embedded Protocols Overview .....	53

## Serial Data Debug Solutions

---

I <sup>2</sup> C.....	53
SPI .....	53
UART .....	53
RS-232 .....	53
Using the I2Cbus Option .....	53
Using the I <sup>2</sup> Cbus Option Overview.....	53
I <sup>2</sup> C Decode Setup Detail.....	54
Creating an I <sup>2</sup> Cbus Trigger Condition.....	55
I <sup>2</sup> C Trigger Setup Detail.....	56
Using the SPIbus Option .....	58
Using the SPIbus Option Overview .....	58
SPIbus Decode Setup Detail.....	59
Creating a SPIbus Trigger Condition .....	60
SPIbus Trigger Setup Detail.....	61
Using the UART-RS232bus Options .....	63
Using the UART-RS232bus Options Overview .....	63
UART-RS232bus Decode Setup Detail .....	63
Creating a UART-RS232bus Trigger Condition .....	65
UART-RS232bus Trigger Setup Detail .....	66
<b>Automotive and Industrial Protocols .....</b>	<b>68</b>
Automotive and Industrial Protocols Overview .....	68
CAN .....	68
LIN .....	68
FlexRay.....	68
Using the CANbus Option .....	68
Using the CANbus Option Overview .....	68
CANbus Decode Setup Detail.....	69
Creating a CANbus Trigger Condition .....	70
CANbus Trigger Setup Detail.....	70
PROTObus MAG and CANbus TDM Toolset Differences .....	72
Using the LINbus Option.....	73
Using the LINbus Option Overview.....	73
LINbus Decode Right-Hand Dialog.....	73
Creating a LINbus Trigger Condition .....	74
LINbus Trigger Setup Detail .....	75
Using the FlexRaybus Option.....	77
Using the FlexRaybus Option Overview.....	77
FlexRaybus Decode Setup Detail .....	78
Creating a FlexRaybus Trigger Condition.....	79

FlexRaybus Trigger Setup Detail .....	80
FlexRaybus Physical Layer and Eye Diagram Analysis .....	83
FlexRaybus Measurement Parameter Setup .....	85
FlexRaybus Physical Layer Measurement Parameters .....	86
Viewing FlexRaybus Physical Layer Measurements .....	86
<b>Serial Audio Protocol .....</b>	<b>87</b>
Serial Audio Protocol Overview .....	87
I <sup>2</sup> S .....	87
Using the Audiobus Option.....	87
Using the AudioBus Option Overview .....	87
AudioBus Decode Setup Detail .....	87
Creating an AudioBus Trigger Condition .....	91
AudioBus Trigger Setup Detail .....	92
AudioBus Measure/Graph Setup Detail .....	96
<b>Military and Avionic Protocols.....</b>	<b>97</b>
Military and Avionic Protocols Overview .....	97
ARINC 429 .....	97
MIL-STD-1553 .....	97
Using the ARINC 429 Option.....	97
Using the ARINC 429 Option Overview .....	97
ARINC 429 Decode Setup Detail .....	97
ARINC 429 Decode Trace Annotations .....	100
ARINC 429 Decode Table Column Details.....	101
ARINC 429 Decode Search .....	102
Using the MIL-STD-1553 Option.....	102
Using the MIL-STD-1553 Option Overview.....	102
MIL-STD-1553 Decode Setup Detail .....	103
MIL-STD-1553 Decode Trace Annotations.....	104
MIL-STD-1553 Decode Table Column Details .....	105
MIL-STD-1553 Decode Search .....	106
Creating a MIL-STD-1553 Trigger Condition .....	106
MIL-STD-1553 Trigger Setup Detail .....	107
Sub-Types, Setup Format, and Right-Hand Dialogs.....	108
<b>Handset, Cellular, and Mobile Computing Protocols.....</b>	<b>118</b>
Handset, Cellular, and Mobile Computing Protocols Overview .....	118
DigRF 3G .....	118
DigRF 4G .....	118
D-PHY (CSI-2/DSI).....	118
M-PHY .....	118

## Serial Data Debug Solutions

---

Using the DigRF 3G Option .....	118
Using the DigRF 3G Option Overview .....	118
DigRF 3G Decode Setup Detail.....	118
DigRF 3G Decode Trace Annotations.....	120
DigRF 3G Decode Table Column Details .....	121
DigRF 3G Decode Search.....	122
Using the DigRF v4 Option .....	122
Using the DigRF v4 Option Overview.....	122
DigRF v4 Decode Setup Detail .....	123
DigRF v4 Decode Trace Annotations.....	125
DigRF v4 Decode Table Column Details .....	126
DigRF v4 Decode Search .....	127
Customizing WordName and Comment Definitions .....	128
Using the MIPI D-PHY (CSI-2/DSI) Option .....	128
Using the MIPI D-PHY Decode Option Overview .....	128
MIPI D-PHY Decode Setup Detail.....	128
MIPI D-PHY Decode Trace Annotations .....	130
MIPI D-PHY Decode Table Column Details .....	131
MIPI D-PHY Decode Search.....	132
MIPI D-PHY Physical Layer Measurement Parameters.....	133
Using the MIPI M-PHY.....	145
Using the MIPI M-PHY Decode Option Overview .....	145
MIPI M-PHY Decode Setup Detail.....	145
MIPI M-PHY Decode Trace Annotations .....	146
MIPI M-PHY Decode Table Column Details .....	147
MIPI M-PHY Decode Search.....	148
MIPI M-PHY Physical Layer Measurement Parameters.....	148
<b>Storage, Peripherals, and Interconnect Protocols .....</b>	<b>154</b>
Storage, Peripherals, and Interconnect Protocols Overview .....	154
SAS .....	154
Fibre Channel.....	154
SATA.....	154
PCIe .....	155
USB 2.0.....	155
USB 3.0.....	155
Using the SAS Option .....	155
Using the SAS Option Overview.....	155
SAS Decode Setup Detail .....	155
SAS Decode Trace Annotations.....	157

---

SAS Decode Table Column Details .....	157
SAS Decode Search .....	158
Using the FibreChannel Option .....	159
Using the FibreChannel Option Overview .....	159
FibreChannel Decode Setup Detail .....	160
FibreChannel Decode Trace Annotations .....	161
FibreChannel Decode Table Column Details .....	162
FibreChannel Decode Search .....	163
Using the PCIe Option .....	163
Using the PCIebus Option Overview .....	163
PCIExpress Decode Setup Detail .....	164
PCIExpress Decode Trace Annotations .....	167
PCIExpress Decode Table Column Details .....	168
PCIExpress Decode Search .....	170
PCIExpress Decode Examples .....	171
Using the SATA Option .....	175
Using the SATA Option Overview .....	175
SATA Decode Setup Detail .....	176
SATA Decode Trace Annotations .....	177
SATA Decode Table Column Details .....	178
SATA Decode Search .....	178
Creating a SATA Trigger Condition .....	179
SATA Trigger Setup Detail .....	180
Using the USB2 Option .....	183
Using the USB2 Option Overview .....	183
USB2 Decode Setup Detail .....	183
USB2 Decode Trace Annotations .....	184
USB2 Decode Table Column Details .....	185
USB2 Decode Search .....	186
Creating a USB2 Trigger Condition .....	187
USB2 Trigger Setup Detail .....	188
Using the USB3 Option .....	191
Using the USB3 Option Overview .....	191
USB3 Decode Setup Detail .....	191
USB3 Decode Trace Annotations .....	192
USB3 Decode Table Column Details .....	193
USB3 Decode Search .....	194
Troubleshooting Storage, Peripherals, and Interconnects Issues .....	195
Polarity Correction .....	195

# Serial Data Debug Solutions

---

- Reference .....196**
  - Dialog Area.....196
  - Touch Screen Controls.....196
  - Specifications .....199
  - Contact LeCroy for Support .....199
- Index .....201**



---

# Serial Data Debug Solutions Introduction

## Overview

LeCroy's **Serial Data Debug Solutions** (SDDS) provide different **Toolsets** for analysis of the **Supported Protocols**.

### *Structure of This Manual*

The documentation is structured in the following manner.

- **Introduction** - This introduction explains the **Toolsets**.
- **Accessing Toolsets** - Where you'll find the various toolsets on the interface/dialogs when the different software options are enabled.
- **Using Toolsets** - We then take you to the point of using the general parts of a given toolset - just up to the point where protocol specific functions come into play.
- **Documentation for Each Supported Protocol** - These remaining sections of the manual group the various protocols into market-specific collections.

These collections include **Encoding Schemes, General Purpose Embedded Protocols, Automotive and Industrial Protocols, Audio Protocols, Military and Avionic Protocols, Handset and Cellular Protocols, and Storage, Peripherals, and Interconnects**.

### *Assumptions*

A basic understanding of the various serial data standard physical and protocol layer specifications, and knowledge of how these standards are used in embedded controllers is prerequisite. In addition, a basic understanding of oscilloscope operation (specifically the LeCroy oscilloscope with which the serial trigger and decode option is used) is required. Wherever practical or necessary, details on specific oscilloscope features have been included in the material.

#### **PLEASE NOTE THE FOLLOWING:**

- The **Dialog Area** (on page 196) topic covers essential input entry methods using standard LeCroy oscilloscope interface controls and has been included in the **Reference** section at the end of this documentation for convenience.
- LeCroy has a policy of frequently updating software. While screen images in this manual may not exactly match what is seen on your oscilloscope display, be assured that the functionality is nearly identical.
- We are constantly expanding the coverage of serial data standards. Some capabilities covered in this documentation may only be available with the latest version of our firmware at [www.lecroy.com](http://www.lecroy.com).
- Many of the capabilities described require updated versions of the firmware. If you are experiencing trouble with your software option, please try updating your firmware version to 6.4.0.x or higher.

## Toolsets and Supported Protocols

Serial Data Debug Solution Toolsets are integrated into the oscilloscope – no external hardware is used. Serial data signals are input to the oscilloscope through normal passive or active probes, such as LeCroy's ZS Series of high impedance active probes or ZD Series of differential probes, or through the use of cable inputs.

Serial Data Debug Solution Toolsets include the following:

- **Decode (D)** - Both D and TD Toolsets greatly increase your ability to debug and analyze embedded controllers using serial bus communications. Protocols having only the D Toolset only have Serial Decode functionality. The D Toolset provides algorithms that interpret and annotate protocol signals and simplify data viewing and analysis. **Trigger and Decode (TD)** - Protocols having the TD Toolset have both Serial Trigger and Decode capabilities. In addition to the Decode capabilities described above, the TD Toolset also recognizes serial data patterns to trigger the oscilloscope at a pre-determined time; other signals coincident with the desired serial data pattern can also be captured simultaneously.

## Serial Data Debug Solutions

---

- **PROTObus MAG** - The PROTObus MAG Toolset equips certain protocols (I<sup>2</sup>C, SPI, UART, RS-232, CAN, LIN, FlexRay, DigRF 3G, and MIL-STD-1553) with decoders and a variety of data extraction, timing, and other measurement and graphing functionality. It provides insight into the serial bus standards not provided by any other analyzer or oscilloscope. The package includes five timing measurements, three bus utilization measurements, and two tools for extracting the encoded digital data from a serial data message and displaying it as an analog value or waveform representation. These are essential capabilities for engineers who require more insight into serial data protocols under test and how they interact with other circuit elements in embedded designs. This toolset is the basic building block upon which many other LeCroy serial trigger and decoder options can then be added and significantly extending the trigger and decode functionality of these other packages by providing tools for more complete and faster validation and debugging of embedded designs. It provides the deepest level of insight possible.
- **ProtoSync** - The ProtoSync toolset provides full protocol analysis for supported protocols. While using it you can view decoded waveforms while also viewing both **CATC Protocols** and **Bit Tracer Data** concurrently using a **Packet Analysis View**. Once a linkage is established and data is transferred between your oscilloscope and the Protocol Analysis software, the programs work simultaneously; meaning, actions executed either on the oscilloscope or in the Protocol Analysis software updates the other in real time for extremely comprehensive protocol analysis.

There are some toolkits specifically designed for particular protocols. **Physical (P)** and **Graph (G)** toolsets exist and are perfectly suited for **FlexRay** and **I<sup>2</sup>S (Audiobus)** protocols, respectively.

- **Measure (M)** - Measure is a legacy toolset used for the CANbus TDM package. Measurement applications have been improved and made part of the PROTObus MAG toolset. Measurement toolsets provide controls for assigning measurement parameters to your protocol signal sources.

### PLEASE NOTE THE FOLLOWING:

- Currently, the PROTObus MAG toolset handles most measurement instances for supported protocols. However, the CANbus TDM option is handled and covered in a manner differently than PROTObus MAG. The difference are explained in **PROTObus MAG and CANbus TDM Toolset Differences** (on page 72)
- The TDM Toolset can also support some Graphing capabilities as well. In this context, Measure provides various protocol-specific timing or other measurement parameters and Graph provides the ability to extract digital data from a message and display it either as a measurement parameter value or as an analog waveform representation of the digitally encoded data.
- **Physical (P)** - The **Physical (P, or TDP)** toolset supports Physical layer analysis capable of showing an eye diagram with a mask on **FlexRaybus**, **MIPI D-**, and **M-PHY** signals.
- **Graph (G)** - The **Graph (G, or TDM/G)** toolset provides additional tools on protocol signal source measurement parameters rendering graphical representations of the signal (Histo, Trend, and Track), if desired for **I<sup>2</sup>S Audiobus** signals.

### Compatibility

The supported protocols are packaged and indicate specific toolsets as part of the name in the following manner:

#### Supported Protocol Name+bus + a Toolset Suffix

Toolset suffixes are the names (many abbreviations) listed in the previous topic (D, TD, TDM). The following table shows a list of supported protocols and their associated toolsets.

### PLEASE NOTE THE FOLLOWING:

- Contact LeCroy for more information about these Software Options by referring to the **Contact LeCroy for Support (on page 199)** topic for more details.
- Not all supported protocol software options are offered for each oscilloscope product line.

Protocol	D	TD	PROTObus MAG	ProtoSync	P, G, Toolsets*
I <sup>2</sup> C	•	•	•		
SPI	•	•	•		
UART, RS-232	•	•	•		
CAN	•	•	•		
LIN	•	•	•		
FlexRay	•	•	•		P
I <sup>2</sup> S (Audiobus)	•	•			G
ARINC 429	•				
MIL-STD-1553	•	•	•		
DigRF 3G	•		•		
DigRF v4	•		•		
MIPI D-PHY/CSI-2/DSI	•				P
MIPI M-PHY	•				P
SAS	•			•	
FibreChannel	•			•	
PCIe	•	•		•	
SATA	•	•		•	
USB 2.0	•	•		•	
USB 3.0	•			•	

Table 3-1. \*Physical (P) and Graph (G) Toolsets are specialized for both FlexRay and I<sup>2</sup>S Audiobus supported protocols.

# Accessing and Using Supported Protocol Toolsets

## Accessing and Using Supported Protocol Toolsets Overview

LeCroy's various serial data debug solutions utilize advanced trigger circuitry and advanced software algorithms to provide powerful capability for serial data triggering, decoding, and analysis. The various software options are accessed in the user interfaces in different ways. Some options are provided with certain oscilloscope models; others are purchased and installed.

### PLEASE NOTE THE FOLLOWING:

- This section of the manual is meant to provide an initial explanation as to how the different toolsets are accessed and used with some technical explanations at the end of the section. The information is provided in this fashion to illustrate the commonality among toolset usage across supported protocols.
- Since each serial protocol is quite different, serial trigger conditions and other settings for supported protocols are also different. Detailed information as to how a serial trigger conditions is set up for a specific supported protocol is covered in corresponding sections of this manual for each option. Ask your local LeCroy representative for more information about any Serial Data Debug Solution Protocols or Toolkits using the **Contact LeCroy for Support** (on page 199) topic.

## The D and TD Toolsets

### *Technical Explanation of Serial Decode and Trigger*

#### **SERIAL DECODE**

Both the D and TD options contain powerful protocol decoding and annotation software algorithms. This algorithm is used in all LeCroy serial decoders sold with oscilloscopes, and differs slightly for serial data signals that have a clock embedded in data or a clock separate from data.

The software algorithm examines the embedded clock (see **Serial Data Debug Solutions** (on page 9) for synchronous/asynchronous protocol details) for each message based on a default (or user set) vertical level. Once the clock signal is extracted or known, the algorithm examines the corresponding data signal at a predetermined vertical level to determine whether a data bit is high or low. The default vertical level is usually set to 50% and is determined from a measurement of peak amplitude of the signals acquired by the oscilloscope. It can also be set to an (absolute) voltage level, if desired. The algorithm intelligently applies a hysteresis to the rising and falling edge of the serial data signal to minimize the chance of perturbations or ringing on the edge affecting the data bit decoding.

After determining individual data bit values, a different algorithm performs a decoding of the serial data message after separation of the underlying data bits into logical groups (Header/ID, Data Length Codes, Data, CRC, Start Bits, Stop Bits, etc.) specific to the protocol. Once the clock signal is acquired and the decoding is completed for a serial data message with separate clock and data lines, the oscilloscope channel showing the capture clock signal can be turned OFF to reduce screen clutter.

Finally, another algorithm provides the appropriate color coding of the message, and displays the protocol message data on the screen, as desired, overlaid on the source trace. Various compaction schemes are utilized to show the data during a long acquisition (many hundreds or thousands of serial data messages) or a short acquisition (one serial data message acquisition). In the case of the longest acquisition, only the most important information is highlighted. In the case of the shortest acquisition, all information is displayed (Header/ID, Data Length Codes, Data, CRC, Start Bits, Stop Bits, etc.) with additional highlighting of the complete message frame.

**Note:** Although the decoding algorithm is based on a clock extraction software algorithm using a vertical level, the results returned are the same as those from a traditional protocol analyzer using sampling point-based decode. In addition, the clock extraction technique allows partial decoding of messages in the event of physical layer noise, in many cases, whereas a protocol analyzer usually cannot. This is a significant advantage for the LeCroy software algorithm.

If the sampling rate (SR) is insufficient to resolve the signal adequately based on the bit rate (BR) setup or clock frequency, the protocol decoding is turned OFF to protect the operator from incorrect data. The minimum SR:BR ratio required is 4:1. It is suggested that you use a slightly higher SR:BR ratio if possible, and use significantly higher SR:BR ratios if you want to also view perturbations or other anomalies on your serial data analog signal.

### **SERIAL TRIGGER**

TD options for some supported protocols contain advanced serial data triggering. This serial data triggering is implemented directly within the hardware of the oscilloscope acquisition system, and contains advanced algorithms to protocol decode, recognize, and trigger on user-defined serial data patterns. This allows a recognized serial data pattern to be used to trigger the oscilloscope at a pre-determined time, and other signals coincident with the desired serial data pattern can be captured simultaneously.

### **Accessing The D and TD Supported Protocol Toolsets**

These respective toolsets are accessed by locating the **Serial Decode** and **Serial Trigger** dialogs.

**Note:** Users approach the Trigger and Decode software options differently. Some use Decode first, and then Trigger. In fact, LeCroy has a [Link To Trigger](#) feature used to specifically tie Decoded channels to Triggers. Currently, the specific protocol content in this Serial Data Debug Solutions manual covers Decode, and then Trigger tools. Still, the content is clearly titled so no matter what order you access Trigger and Decode software, the functionality you're looking for is never far.

### **DECODERS**

Decoders are all initially accessed by touching **Analysis** → **Serial Decode** from the menu bar.

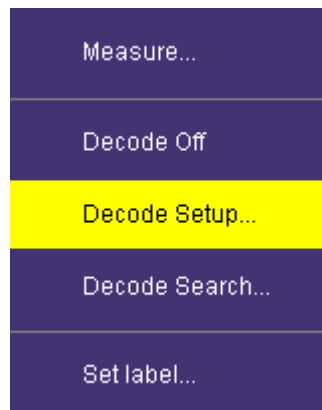

Alternatively, you can also touch a Channel or Memory trace descriptor label showing its corresponding (channel or memory) dialog, and then touch the **Decode** button listed shown on the lower part of the dialog. If a decode table is already displayed, you can shortcut to the decode setup by touching the color-coded protocol name in the upper-left corner of the decode table itself. See **Protocol Results Table** (on page 19) for more information.

## Serial Data Debug Solutions

Some oscilloscope models also allow you to access the Serial Decode dialog the following ways:

- Touch the grid display of a Channel, Memory, or Math trace and a pop-up dialog shows a **Decode Setup...** shortcut if available on your instrument model. Touch this shortcut.
- Press the **Decode** front panel button if available on your instrument model. The Serial Decode dialog is then shown on the screen.

Use any of the aforementioned methods to access the main **Serial Decode...** dialog is shown.

### TRIGGERS

Triggers are accessed by touching **Trigger** → **Trigger Setup...** from the menu bar. Alternatively, you can also touch the **Trigger** trace descriptor label.

**Note:** Some oscilloscope models may also have a **Trigger** front panel button which shows the main Serial Decode dialog when pressed.

Use your preferred method to access the main **Trigger** dialog.

### Using The D Supported Protocol Toolsets

The main **Serial Decode** dialog acts as a summary page for your decode settings.

#### MAIN SERIAL DECODE DIALOG

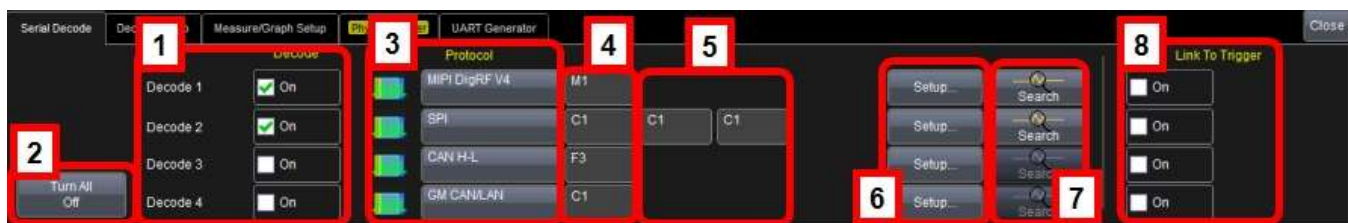

There are four independent decoders. A user can operate up to four at a single time, although limitations may occur with regard to how the numbers of channels are accommodated at one time. Practically speaking, if a user decodes signals with a clock and data line (and perhaps also a chip select or other third line), then two simultaneous decodes is the maximum number using the LeCroy oscilloscope analog channels. The addition of the MS-250 or MS-500 Mixed Signal Oscilloscope options allow usage of digital lines for trigger and decoding, which preserves analog channels for other uses. Contact your local LeCroy sales office for more information about this option.

Numbered labels on this screen-shot correspond with the following explanations.

1. **Decode** - Mark or un-mark this checkbox to quickly enable or disable decoded signals.
2. **Turn All Off** - This button is provided for a convenient way to instantly disable all the decoded signals.
3. **Protocol** - Touch this field and select a desired protocol from the ones you have installed on your instrument.
4. **Source** - Select which signal source to which you wish to apply your selected protocol.
5. **Data and Clock Selection** - These controls are available for certain protocols and provide pop-up channel or source selections for the corresponding decode. Some protocols may require a third selection (for instance, [SPI](#) also requires a Chip or Slave Selection). Asynchronous protocols, such as [UART](#), [RS-232](#), [CAN](#), [LIN](#), [FlexRay](#), and most high-speed serial data signals only require a single source.
6. **Setup** - Use this button to quickly access the corresponding detailed Decode Setup dialog for the particular protocol selected.
7. **Search** - Use this button to quickly create a Zoom of the corresponding decoded signal. The right-hand dialog of this Zoom provides search capabilities for the decode signal.
8. **Link To Trigger** - Mark or un-mark this checkbox to quickly tie the decoded signal to an additional Trigger setup. This provides a faster, easier setup where the trigger is set similar as the decoder.

### THE DECODE SETUP DIALOG

The **Decode Setup** dialog is where the details of a specific protocol decode is entered. It appears as follows (the [UART](#) Decode Setup dialog is shown as an example):



This is a single tab with an indicator on the left side describing to which of the four decoders the setup information pertains.

The left side of this dialog box is described here (the right side is explained in the protocol specific topics). Numbered callouts correspond with the following explanations.

**Note:** DigRF 3 and 4G protocols are the only exceptions where a **View I & Q** button is available in place of **Measure** in the **Action for decoder** section of the main **Decode Setup** dialog.

1. **Decoder # Buttons** - Indicates which of the four decoders to which the current information pertains.
2. **View Decode Checkbox** - Use this checkbox to turn decoding turned ON or OFF for the particular decoder. Decoding ON provides a highlight of each message frame with color-coded highlighting and decoding of the various protocol message portions.

**PLEASE NOTE THE FOLLOWING:**

- If the View Decode checkbox is checked, the Table display is also shown. When the View Decode checkbox is not marked the Table display is not shown.
- When the Table is displayed, it appears similar to that shown previous (the example shown is for [MIL-STD-1553](#)).
- The first column heading (top left most cell of the table) bears the name of the corresponding protocol. The cell's fill color matches the protocol color used on the grid display. Touching this colored, first column heading opens the Decode Setup dialog.
- Touching the number cell (first cell) for each table row automatically sets up a Zoom for the corresponding message position.

## Serial Data Debug Solutions

- Touching anywhere else on the table shows a pop-up with **Off**, **Zoom**, **Setup...**, **Export**, and **Measure...** choices.

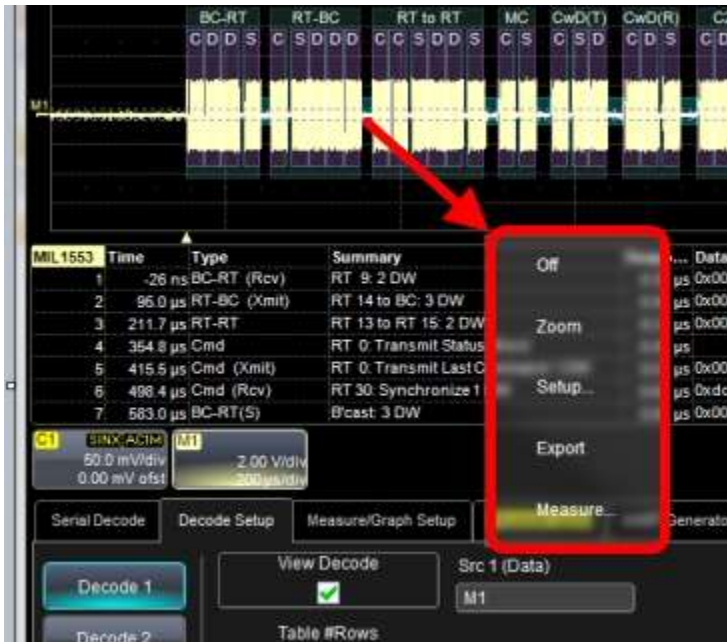

- Decoding of an entire acquisition with very long acquisitions including thousands of messages takes longer than shorter acquisitions.
3. **Source Selection** - Touch these selections to open a pop-up dialog where you can select sources for **Data**, and (for some protocols) controls for **Clock** and other lines - for example **Chip Select** for [SPI](#).

### PLEASE NOTE THE FOLLOWING:

- Source selection is dynamically linked to the Protocol selection, so the appearance and number of sources to choose changes based on your selected Protocol.
  - Source can be a Channel (C1 – C4), a Memory Trace (M1 – M4), a Math Function (F1 – F4), or digital lines (D1 - D36 on MS-250 or MS-500).
  - Use a Channel for a new, real-time acquisition.
  - Use a Memory for recalling saved data from a previous acquisition for further analysis. Refer to your oscilloscope's **Save and Recall Waveforms** topic for more details.
  - Use a Math Function to view decoded data on Sequence mode acquisitions. Sequence Mode is a unique capability where you can utilize oscilloscope memory to capture events widely spaced in time and then view them sequentially. Reference the chapter on Isolating and Analyzing Serial Bus Activity for more information on setting the oscilloscope up in this mode.
4. **Protocol Selection** - Touch this selection to open a pop-up dialog box and choose a protocol decoder. Depending on the decoder selected, the correct inputs (Clock, Data, and a third line, if required) are shown to the left.



5. **Table #Rows** - Touch this option and provide a value (1-20) for the number of table rows for display. One row of data is shown by default. If a value of 1 - 4 rows is provided, the scroll bar to the right of the table is replaced with a pop-up scroll for more convenient use.

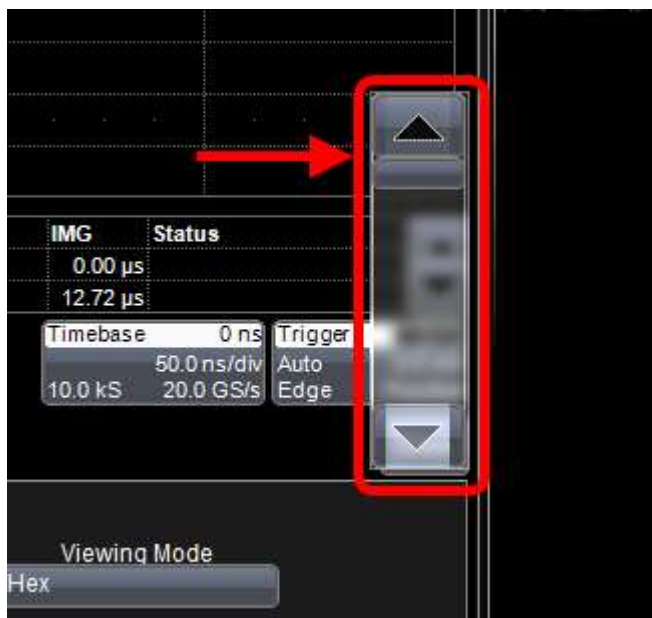

6. **Action for Decoder Toolbar** - Various buttons on this toolbar provide context-sensitive shortcuts for decoding.
- **Search** allows quick creation of a zoom trace and changes the dialog box to the zoom/search dialog box.  
Acquire long records of message data, and use Search to look through the record for a specific message. When the message meeting the search criteria is found, the complete message is then shown with the Zoom Trace. Use the arrow buttons to navigate forward and backward through the messages. Unsuccessful searches are noted with a line of text.
  - **Configure Table** displays a pop-up dialog box specific to a particular protocol. The dialog contains checkboxes for various columns in the table. Check or uncheck the checkboxes to show or hide specific columns on the table.
  - **Export Table** exports the complete protocol table data to a **.CSV** file.
  - The **Output File** name and directory can be selected by the user using the controls to the right. Click the **Browse** button to select a file.

**Note:** If you have the **PROTObus MAG** toolkit option, those screens are easily accessed from the Decode Setup screen by clicking either the **Measure** button or the **Measure/Graph Setup...** tab.

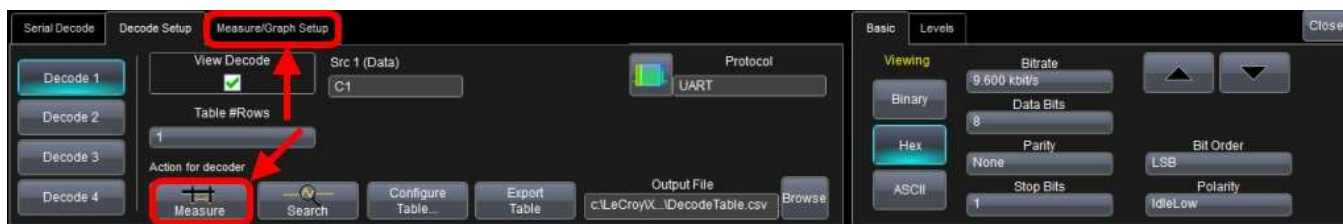

## Serial Data Debug Solutions

### Decode Toolset Features and Controls

#### DECODE TOOLSET FEATURES AND CONTROLS OVERVIEW

Data packets (or messages) on properly decoded signals for a given protocol can be easily viewed using **Serial Decode Trace Annotations** (below), the **Protocol Results Table** (on page 19), and/or by **Searching for Messages** (on page 21) (Types and Subtypes). These concurrent tools provide fast insight and perspective and are very effective when used together.

#### PLEASE NOTE THE FOLLOWING:

- Messages for most protocols are classified into Frames, Errors, Unknown or Grouped Primitives specific to a given protocol. Sub Types then further classify each main message type into more protocol-specific messages.
- Protocol-specific topics may define a few messages while explaining how to access annotations, table results, and search. Please refer to the corresponding protocol specification (maintained by groups external to LeCroy). Links to these groups can be found in corresponding **Overview** content for each market-specific collection.
- LeCroy's market-specific collections of protocol solutions include **Encoding Schemes, General Purpose Embedded Protocols, Automotive and Industrial Protocols, Audio Protocols, Military and Avionic Protocols, Handset and Cellular Protocols, and Storage, Peripherals, and Interconnects.**
- Specifications are subject to change without notice.

#### SERIAL DECODE TRACE ANNOTATIONS

When protocol signals are decoded and shown on the grid display area, highlighted overlays are shown to help label specific data within the signal.



#### Information Shown Based on Annotation Rectangle Width

The information shown on a given annotation is affected by the rectangle width.

Annotations may include name, repetitions, and the contents of the details table display column, provided the rectangle is wide enough. Sizes and information displayed are based on the following:

- If an annotation rectangle is less than 10 pixels wide no annotation is shown.
- Only the short form name is shown for annotation rectangles > 10 but < 100 pixels wide.
- The long form name and repetition count are shown on annotation rectangles > 100 but < 500 pixels wide.
- Details are also shown on rectangles > 500 pixels.

**PROTOCOL RESULTS TABLE**

The protocol results table provides a quick and easy way to understand all of your protocol data as decoded by the oscilloscope, even when messages are too compact to allow annotation on the display. In addition, the table provides a quick and easy method to view decode results and quickly zoom to a specific message. Since the table uses the decoded data (extracted as previously described) as its source, the **View Table** button (from the user interfaces) is always checked and the table is shown by default as signals are decoded.

**Note:** All protocols with Decode (D) capability have a corresponding decode result table. Selecting a row on the table creates a zoom of the specific row/message, regardless of protocol. Refer to **Using The D Supported Protocol Toolsets** (on page 14) for more information about the **View Table** button and other information about the protocol results table.

When displayed, the protocol results table appears under the waveform grid. The following protocol results table is showing **DigRF V4** data (each protocol's table looks different) and provides an example of what the table looks like:

MIPI DigRF V4	Time	LCID	CRI	Word Name	Size	Payload	CRC
1	24 ns RBCLC	6			8	02 00 00 00 00 00 00 01	CRC OK--2558/2558
2	128 ns TICLC	7		DUMMY_FRAME 2	96	00	CRC OK--A6D9/A6D9
3	75.58 µs DCL0	0			32	00 30 FF D0 00 40 FF ED 00 20 00 20 FF D0 00 50 FF A0...	CRC OK--7F36/7F36
4	75.87 µs TICLC	1		DUMMY_FRAME 2	96	00	CRC OK--3DB2/3DB2
5	90.35 µs DCL0	2			32	FF B0 FF B0 FF E0 FF C0 00 10 FF F0 00 10 00 20 FF E...	CRC OK--11B7/11B7

**Note:** If a value of only 1 - 4 rows is provided, oscilloscope models provide different solutions. Some replace the vertical scroll bar to the right of the table with a pop-up scroll for more convenient use. Others turn the vertical scroll bar yellow, indicating that the **Adjust** knob on the oscilloscope front panel can be used to navigate table rows.

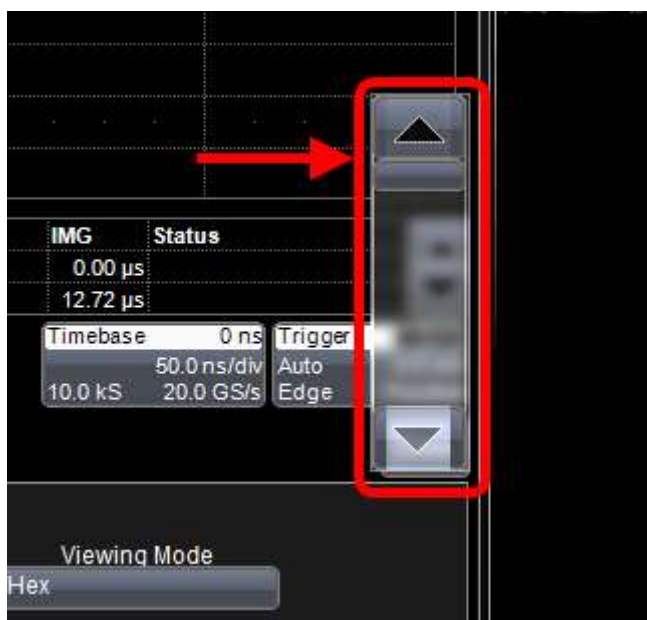

The first column heading (top left most cell of the table) bears the name of the corresponding protocol and the cell's fill color matches the protocol color used on the grid display.

## Serial Data Debug Solutions

Touching this colorized, first column heading opens the **Decode Setup** dialog. Touching any table row creates a zoom trace of the corresponding decoded message.

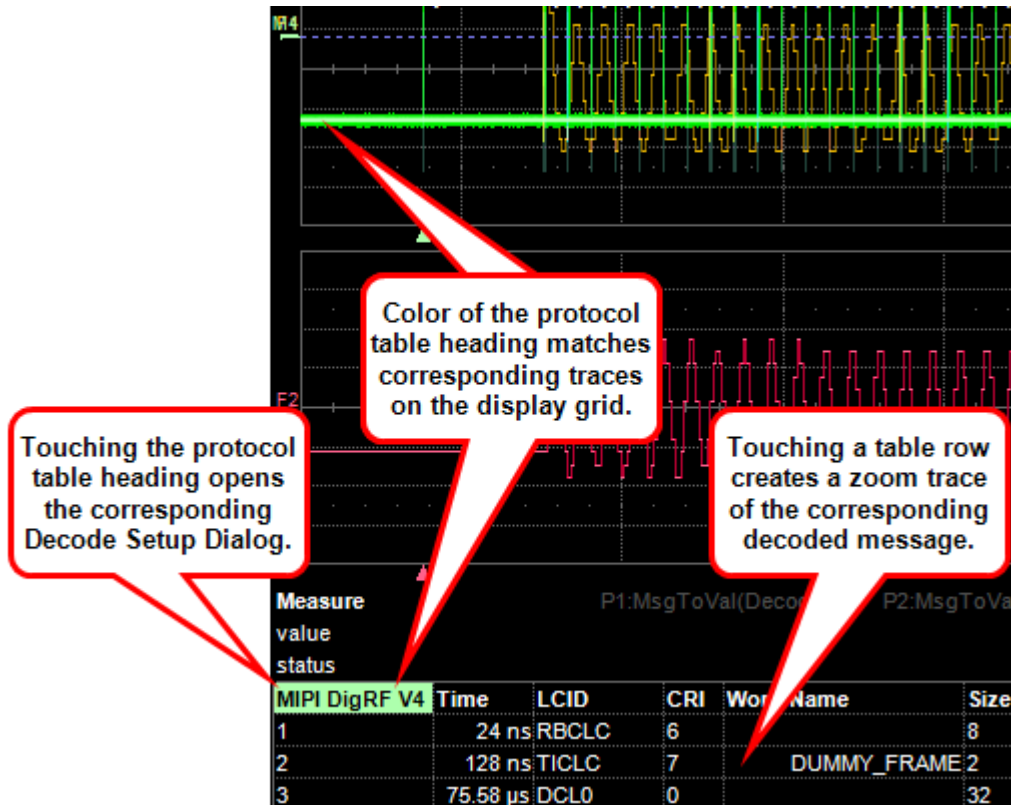

The table is only shown if the View Table checkbox is marked on the **Decode Setup Dialog** and **decoding has occurred on the trace**. Only one protocol table can be viewed at a time. As described in the previous section, the protocol table can be configured or exported. Touching the **Configure Table** button on the **Decode Setup Dialog** shows the View Columns pop-up similar to the following (they vary based on protocol):

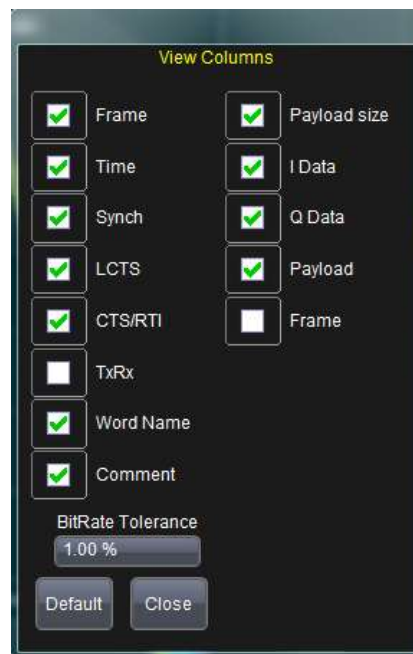

**Note:** See [Using The D Supported Protocol Toolsets](#) (on page 14) for more information.

- **Checkboxes** - Touch items to check the box and include them as table columns for a particular protocol.
- **BitRate Tolerance** - Some protocols have a Bit Rate Tolerance setting. This can be set to any value from 0.01% to 10%. If the bit rate is outside the tolerance range set, then the calculated bit rate appears in red text on the table.

Protocols with a wide variance of bit rates, such as **I<sup>2</sup>C** (which often has clock stretching) do not have this feature.

- **Default** - Press the Default button to reapply standard settings for a particular protocol.

## SEARCHING FOR MESSAGES

There are several ways to search for specific messages. The following are all valid ways to search messages.

- Touch the decoded waveform. A pop-up dialog is shown where you can select **Decode Search** as follows:

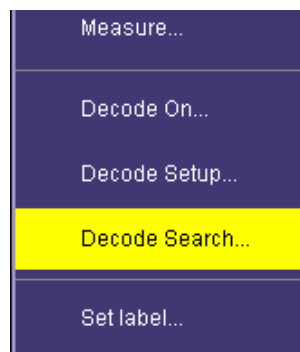

OR

- Touch the **Search** button in the Serial Decode Summary dialog box or the Decode Setup dialog box.



OR

- Go to **Math** → **Zoom Setup...** from the Menu Bar to turn a Zoom ON, define its source, and search directly.

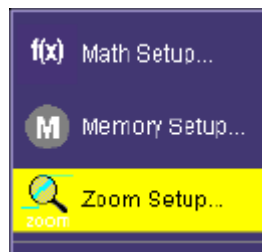

Any of the aforementioned methods show the Zoom dialog box and a corresponding Search dialog box on the right side.



## Serial Data Debug Solutions

### PLEASE NOTE THE FOLLOWING:

- Search capabilities differ by protocol. For instance, SPI has no Address, so there is no capability to Search by Address in [SPI](#), while there is when searching under the [I<sup>2</sup>C protocol.](#)
- Use the Search Options buttons to define the type of Search you want, enter a value in Hexadecimal format, and use the left and right arrows to move your way from one message to the next.
- When using search on a multi-data-lane protocol (PCIe), Z5 - Z8 zoom traces are used. Otherwise, single-data-lane protocols use Z1 - Z4 zoom traces (based on the decoder assignment).

### Using The T Supported Protocol Toolsets

When you acquire a LeCroy Serial Data Debug Solution equipped with a **Serial Trigger**, you access the specific protocol trigger using one of the following methods:

- Touch the Trigger Descriptor Box in the lower right hand corner of the oscilloscope display.



OR

- Touch **Trigger** → **Trigger Setup** from the Menu Bar.
- Some oscilloscope models may also have a **Decode** front panel button which shows the main Serial Decode dialog when pressed.

Now, touch the **Serial** button on the **Type** section of the Trigger dialog.

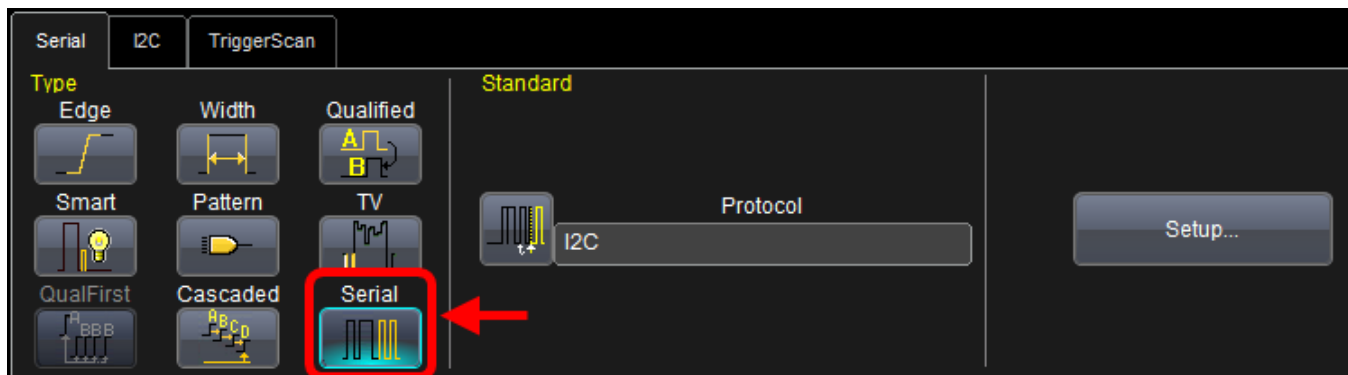

Touch the **Protocol** field on the **Standard** section of the Trigger dialog and select your protocol from the choices shown.

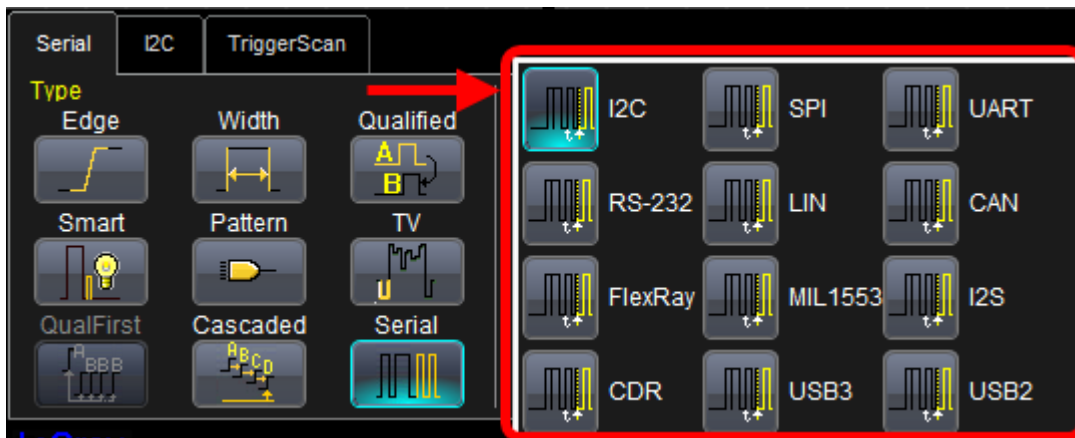

The focus then selects one tab to the right showing the selected **Trigger Condition** dialog reflecting the selected protocol standard just selected.

**PLEASE NOTE THE FOLLOWING:**

- Since each serial protocol is quite different, serial trigger conditions are also different. Detailed information as to how a serial trigger conditions is set up for a specific protocol is covered in corresponding protocol-specific sections of this manual.
- Users approach Trigger and Decode software options differently. Some use Decode first, and then Trigger. In fact, LeCroy has a [Link To Trigger](#) feature used to specifically tie Decoded channels to Triggers. Currently, the protocol content in this Serial Trigger Decode and ProtoSync manual is covered in Decode, and then Trigger order. Still, the topics are clearly covered so no matter what order you access Trigger and Decode software, the functionality you're looking for is never far.

## Accessing and Using The PROTObus MAG Supported Protocol Toolset

Certain protocol packages include the **PROTObus MAG Serial Debug Toolset** which provides capabilities for making automated timing measurements using a set of provided measurement parameters. For instance, the time between an analog signal and a corresponding serial data message can be measured with a user-definable parameter, or an analog data value can be extracted from an embedded digital data signal or stream (digital-to-analog conversion) and displayed. Other protocol-specific measurements may also be included.

The PROTObus MAG toolset is accessed in the following manner:

1. Once you've accessed the **Decode Setup** dialog as explained in **Accessing The D and TD Supported Protocol Toolsets** (on page 13), touch the **Measure** button for the desired Decode.

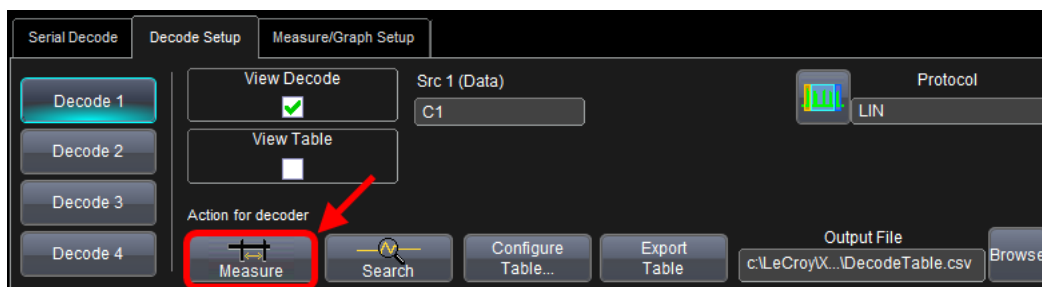

2. The **Select operation to apply on decoder output** pop-up is shown.



## Serial Data Debug Solutions

---

The operations are organized in **Digital to Analog**, **Timing**, and **Other** columns on the pop-up for convenience.

Choose the desired operation for your decode output by clicking the large icons on the pop-up.

**Note:** When accessing these parameters from the **Measure** button, the measurement source defaults to **DecodeX**. Measurements also can be accessed using the standard **Measure → Measure Setup...** and **Measure** dialogs. When accessed using the latter method, DecodeX has to be deliberately set as the source - instead of the standard Signal, Math, Memory, or other trace (C1, F1, M1, etc.).

### ***Decode Output Operation Detail***

The following decode output operation explanations are organized into **Digital to Analog**, **Timing**, and **Other** sections to coincide with the pop-up.

#### ***DIGITAL TO ANALOG DECODE OUTPUT OPERATIONS***

- **View Serial Encoded Data as Analog Waveform** - Automatically sets up a Message to Value parameter and then tracks the assigned measurement. In doing so, a Digital-to-Analog Conversion (DAC) of the embedded digital data is performed and the digital data is displayed as an analog waveform.
- **Message to Value** - Extract and convert a specific portion of the data/payload in the message and display it as an analog value.

#### ***TIMING DECODE OUTPUT OPERATIONS***

- **MsgToAnalog (Message to Analog)** - Computes the time difference from a protocol message to the crossing of a threshold on an analog signal.
- **AnalogToMsg (Analog to Message)** - Computes the time difference from the crossing of a threshold on an analog signal to a protocol message.
- **MsgToMsg (Message to Message)** - Computes the time difference from one protocol message to another protocol message.
- **DeltaMsg (Delta Message)** - Computes the time difference between two messages on a single decoded line.
- **Time@Msg (Time at Message)** - Time from trigger to each protocol message (meeting specified conditions).

#### ***OTHER DECODE OUTPUT OPERATIONS***

- **BusLoad** - Computes the load of user-defined messages on the bus (as a percent).
- **MsgBitrate** - Computes the bitrate of user-specified messages on decoded traces.
- **NumMessages (Number of Messages)** - Computes the number of messages which match a user-specified definition in decoded traces.

### ***Decode Measurement Parameters via Measure Setup***

**TIP:** You can also access these same Decode Measurement parameters from **Measure → Measure Setup...** on the menu bar.

After selecting a given **Px** measurement from the main **Measure** dialog, additional settings can be made to the corresponding dialog as follows:



**Px DIALOG****Source**

Select the **source** for your parameter measurement. The source for a measurement made on a decoded waveform should be the **DecodeX** applied to the channel and not the **Cx** channel itself.

**Measure**

Click in this field to select the desired **measurement** from the pop-up.

Protocol measurements (where applicable) can also be selected as the **source** for **histogram**, **trend**, or **track** functions.

**Actions for Px**

- **Histo** - The Histogram displays a statistical distribution of a measurement parameter. Histogram is helpful to understand the modality of a measurement parameter, and to debug the root cause of excessive variation.

**Note:** After touching **Histo**, **Trend**, or **Track** buttons, a **Math selection** pop-up is shown to select which Math trace in which you want the results to be placed.

- **Trend** - The Trend statistical tool visualizes the evolution of a timing parameter over time in the form of a line graph. The graph's vertical axis is the value of the parameter; its horizontal axis is the order in which values were acquired. Trend is typically used for a multi-shot acquisition. Trend is analogous to a chart recorder.
- **Track** - The Track displays a time-correlated accumulation of values for a single acquisition. Track can be used to plot the digital-to-analog converted (DAC) values of serial data (using the Message to Value parameter) and compare them to a corresponding analog signal, or observe changes in timing. Track is typically used for a single-shot acquisition. A long acquisition with many parameter measurements analyzed with Track could provide information about the modulation of the parameter.

Now, on the main **Measure** dialog, additional settings can be made as follows:

**MEASURE DIALOG****Statistics**

Mark the **On** checkbox to add the statistics of your data to the lower grid display area (same area as displayed data for the View and Load Table checkbox).

## Serial Data Debug Solutions

### Histicons

Mark the **Histicons** checkbox to show or hide this additional statistical information in your lower grid display area. The information is graphically represented a **Histicon** directly beneath measurement values.

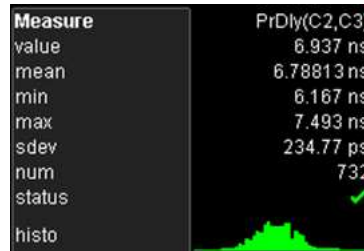

### Show Table

Marking the **Show Table** checkbox displays table data along with measurement values on the lower portion of the grid display.

Measure	PrDly(C2,C3)	AsDly(C2,C3)	Trunc(C2,C3)	Jitter(C2)
value	7.145 ns	-66 ps	1.044 ns	1.000091 $\mu$ s
status	✓	✓	✓	✓

## The ProtoSync Toolset

### The ProtoSync Toolset Overview

Using The Full ProtoSync and PE-B Protocol Analysis and BitTracer Displays

ProtoSync provides advanced protocol analysis tools simultaneous with physical layer waveform displays. The protocol analysis software provided is a viewing, analyzing, and trace printing subset of the software provided with LeCroy's hardware protocol analyzer product families.

Using the ProtoSync Protocol Analysis (available for USB, SATA, SAS, FiberChannel, or PCI Express) or ProtoSync-BT Protocol Analysis and Bit Tracer display option (available for PCI Express only), signal data can be transferred from the oscilloscope to LeCroy's viewing and analysis subset of LeCroy's Protocol Analysis or BitTracer software.

### SENDING DATA TO PROTOSYNC

ProtoSync works together with various LeCroy serial decode options to provide more detailed views of the protocol. ProtoSync and serial decoders supports USB2, USB3, SAS, SATA, FibreChannel, and PCI Express, and if the following are present on the LeCroy oscilloscope, complete views are obtainable:

#### Storage, Peripherals, and Interconnect Protocols Overview (on page 154)

- Serial decode option for USB2, USB3, SAS, SATA, FibreChannel, or PCI Express
- ProtoSync or ProtoSync-BT option
- LeCroy's Protocol Analysis software for USB2/3 (Voyager), PCI Express (PE Tracer), or SAS/SATA/FibreChannel (Sierra)

Then, when the serial datastream is decoded, both **CATC Protocols** (Protocol Analysis software) and **Bit Tracer Data** (PCI Express only) may also be concurrently shown on a separate window or display. Automatic transfer and linkage between the two programs makes this possible. Selection of packets or bytes on either the oscilloscope or ProtoSync display updates the other in real time for extremely simultaneous and comprehensive physical layer and protocol layer debug and analysis.

### PLEASE NOTE THE FOLLOWING:

- The **-BT** suffix for ProtoSync-BT indicates BitTracer view capability and is therefore only used for the PCIEbus decode option.

- Respective protocols in the [Storage, Peripherals, and Interconnects](#) section of this manual show how each protocol has their own **Exporter** right-hand dialog used for sending specific protocol data to ProtoSync.

### The CATC Protocol View

When ProtoSync is used to generate a protocol packet view of physical layer signals (in the screen-shots, using the PCIe protocol), data packets are color-coded and shown as rows on the display. Transactions are even shown as either upstream or downstream (shown here as **R→** and **R←**, respectively for PCIebus) .

**Note:** Viewing results look similar when using other **Storage, Peripherals, and Interconnect Protocols**. See **Storage, Peripherals, and Interconnect Protocols Overview** (on page 154) for more information.

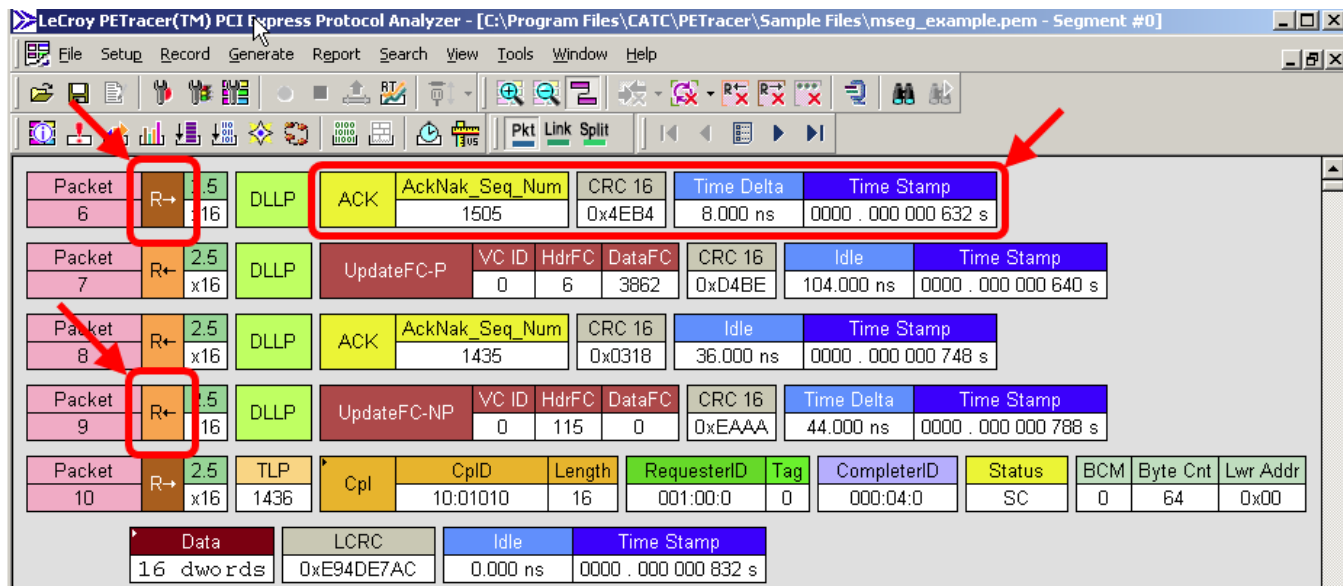

### DECODED TABLE DATA CORRELATES TO CATC PROTOCOL DATA

While the Decode Annotation Table data is labeled and displayed differently than the CATC Protocol display, correlation still exists between the two displays. The following table and screen-shots equates some of the values for the PCIebus option.

**Note:** Please refer to **LeCroy Protocol Analyzer Software** (Voyager, PE Tracer, or Sierra) user manuals at [www.lecroy.com](http://www.lecroy.com) for information regarding more specific usage when using specific supported protocols.

Label in the PCIebus D Decode Annotation Oscilloscope Table Display	Label in PETracer CATC Protocol View
1. <b>Idx</b>	1. <b>Packet #</b> - Actual numbers may vary from PCIebus D decode annotation table in the oscilloscope to PETracer protocol packet view since repetitions are handled differently.
2. <b>Time (μs)</b>	2. <b>Time Stamp</b> - Times are likely to differ (see subsequent note).
3. <b>Up/Dn</b>	3. <b>Upstream (R→) or Downstream ( R← )</b>
4. <b>Name</b>	4. <b>Packet Name</b>
5. <b>Repetitions</b> - LeCroy shows one entry in the table and indicates the number of repetitions.	5. <b>Repetitions</b> - PETracer protocol packet view shows each repetition as a packet header row in the display.
6. <b>Details</b>	6. <b>Details</b> - Vary for each packet header type.
7. <b>Nominal Rate</b>	7. <b>Packet Header Bit Rate</b>

# Serial Data Debug Solutions

## OSCILLOSCOPE TABLE DISPLAY

Callouts for Oscilloscope Table Display:

- 1. Idx
- 2. Time (Microseconds)
- 3. Upstream/Downstream
- 4. Name
- 5. Repetitions
- 6. Details
- 7. Nominal Rate

Idx	Time(us)	Up/Dn	Name	Repetitions	Details	Nominal Rate
223	100.93416	Dn	DLLP	1	Type 90h (UpdateFC-NP VC0): 8 symbols including SDP and END	2500000000
224	100.96621	Dn	Logical Idle	1	24 symbols	2500000000
225	101.03659	Uo	DLLP	1	Type 80h (UpdateFC-P VC0): 8 symbols including SDP and END	2500000000
226	101.06234	Dn	DLLP	1	Type 80h (UpdateFC-P VC0): 8 symbols including SDP and END	2500000000
227	101.06864	Uo	DLLP	1	Type 90h (UpdateFC-NP VC0): 8 symbols including SDP and END	2500000000
228	101.09438	Dn	Logical Idle	1	216 symbols	2500000000
229	101.10069	Uo	Logical Idle	1	894 symbols	2500000000
230	101.95946	Dn	SKIP	1		2500000000
231	101.97547	Dn	Logical Idle	1	1405 symbols	2500000000

## PROTOSYNC PACKET VIEW

Callouts for ProtoSync Packet View:

- 1. Packet #
- 2. Time Stamp
- 3. Upstream/Downstream
- 4. Packet Name
- 5. Repetitions - Each shown as an individual packet header row in ProtoSync PE.
- 6. Details - Vary for each packet header type.
- 7. Packet Header Bit Rate

Packet	R→	G1	TLP	Mem	MWvr(64)	RequesterID	Tag	Address	1st BE	Last BE
0	x1	1			11:00000	000:01:2	3	781F33AB:12340000	1111	1111
Last BE		Data		ECRC	LCRC	Idle	Time Stamp			
000		1023 dwords		0x0D632C96	0x36214D17	0.000 ns	0000 . 000 000 000 s			
Packet	R→	G1	TLP	Mem	MRd(32)	RequesterID	Tag	Address	1st BE	Last BE
1	x1	2			00:00000	000:01:2	4	00010000	1111	1111
ECRC		LCRC		Time Delta	Time Stamp					
0x0A83F0CE		0xA3AD0991		96.000 ns	0000 . 000 016 480 s					

**Note:** Regarding **Time** (oscilloscope) and **Time Stamp** (protocol analyzer), Unless your oscilloscope trigger delay is set to be the exact left edge of the display grid, the Protocol Analyzer **Time Stamp** values do not correlate with the instrument.

The screenshot shows the 'ProtoSync PE' dialog box. At the top, there are tabs for 'PCleDecoder' and 'ProtoSync PE'. A checkbox labeled 'Show Protocol Analysis on every trigger' is checked. To its right is a 'Show Protocol Analysis' button. Below this is a 'View Mode' section with three buttons: 'Protocol', 'BitTracer', and 'ProtocolAndBitTracer'. The 'Protocol' button is highlighted. Below the dialog is an oscilloscope waveform and a table of data. A callout points to the 'Time Stamp' column in the table, and another callout points to the 'Time Stamp' values in the table. A third callout points to the 'Time Stamp' column in the table.

Use this checkbox to export the oscilloscope data to the Protocol Analyzer software on every trigger event. Otherwise, use the Show Protocol Analysis button to manually force the data.

Time Stamp values shown in the Protocol Analyzer.

The Time column on the oscilloscope.

Count	Time Stamp
2	0.000 000 230
Off, Scrambling On	0.000 000 368

Idx	Time(us)	Name	Repetitions	Details
24	-5.85237	SKIP	1	
25	-5.83640	TS1	32	Link: 1, Lane#: 0, N, FTS: 50, Speeds: 2
26	-3.79104	TS2	33	Link: 1, Lane#: 0, N, FTS: 50, Speeds: 2
27	-1.68045	EIOS	1	
28	-1.66485	Electrical Idle or error	1	
29	61.224-3	EIEOS	1	
30	83.236-3	TS1	22	Link: 1, Lane#: 0, N, FTS: 50, Speeds: 2
31	787.436-3	TS2	17	Link: 1, Lane#: 0, N, FTS: 50, Speeds: 2
32	1.33168	Logical Idle	1	68 symbols

If you don't have the Protocol Analysis software installed, this particular dialog instead shows a notification message in place of the controls used to send your oscilloscope data to the Protocol Analyzer.

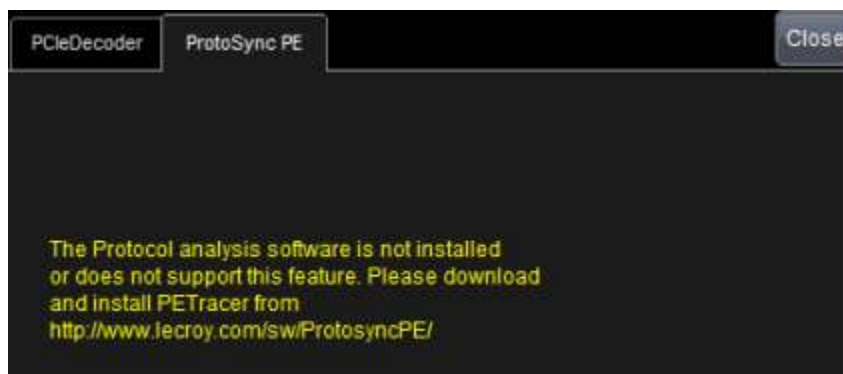

**PLEASE NOTE THE FOLLOWING:**

- In addition to the CATC Protocol View, the Protocol Analyzer also has **Link** and **Split** views for more a more convenient display. The Link View is not to be confused with the **Link Layer** which is part of the PCIebus D decode option and decodes everything up to (but not including) the transaction layer packet information.

## Serial Data Debug Solutions

- Please refer to **LeCroy Protocol Analyzer Software** user manuals at [www.lecroy.com](http://www.lecroy.com) for information regarding more specific usage for other **Storage, Peripherals, and Interconnect Protocols**. See **Storage, Peripherals, and Interconnect Protocols Overview** (on page 154) for more information.

### The CATC Bit Tracer View - PCI Express (PCIe) Only

Based on selections made on ProtoSync Right-Hand Dialogs (located on protocol decode dialogs), ProtoSync PE-B may also be used to display a CATC Bit Tracer view. This view is ideally correlated with the LeCroy 8b/10b Decode. See 8b/10b **Decode Setup Detail** (on page 45) for detailed steps to send 8b/10b Decode data to ProtoSync.

The CATC Bit Tracer view shows the Hexadecimal form of each data bit of your transferred data. Oscilloscope Decode and ProtoSync results look like the following:

The screenshot shows the LeCroy PE Tracer software interface. The main window is titled "LeCroy PE Tracer(TM) PCI Express Protocol Analyzer - [C:\Program Files\LeCroy\PE Tracer\Data74.peraw]". The interface includes a menu bar (File, Setup, Record, Generate, Edit, Markers, Search, View, Tools, Window, Help) and a toolbar. The main display area is divided into "Upstream" and "Downstream" sections, each showing a grid of data bits (lanes) with hexadecimal values. The "Timing" panel on the right shows a table of transitions (X to Y, X to T, Y to T, X to U1, X to U3, X to U2, T to U1) with their corresponding times. The "Errors" panel shows counts for "Invalid 10b Code" and "Disparity Error". The "Symbols" panel shows counts for various symbols like COM, SKP, FTS, IDL, EIE, PAD, STP, SDP, END, and EDB. A "Decoding (spec)" dialog is open at the bottom, displaying "No packets found around current position".

**Note:** Please refer to **LeCroy Protocol Analyzer Software** user manuals at [www.lecroy.com](http://www.lecroy.com) for information regarding more specific usage.

### Oscilloscope and Protocol Analyzer - A Concurrent Analysis Example

This topic demonstrates the concurrent use of the Oscilloscope and Protocol Analyzer programs using PCIebus signals.

**Note:** Please refer to **LeCroy Protocol Analyzer Software** user manuals at [www.lecroy.com](http://www.lecroy.com) for information regarding more specific usage when using other supported protocols, see **Storage, Peripherals, and Interconnect Protocols Overview** (on page 154).

The following screen-shot shows the oscilloscope Table display along with a corresponding CATC Protocol view.

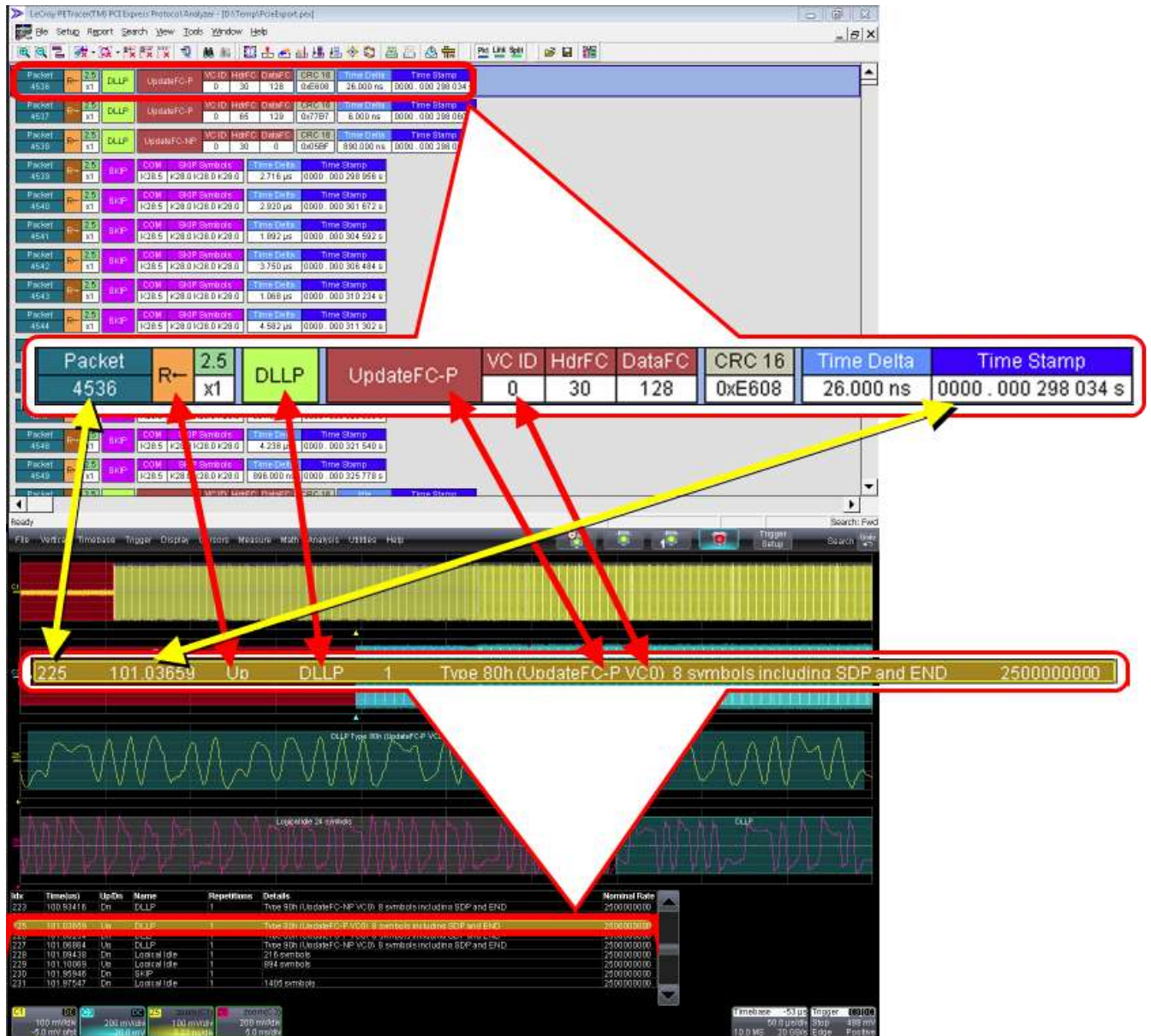

**Note:** Yellow arrows indicate an indirect correlation between the fields (values may not be exactly the same, but the fields correspond to one another), while Red arrows are exact correlations between the Table display row and the ProtoSync PE packet data.

On the oscilloscope display, if a specific table entry is touched in the PCIebus D decode annotation table, the physical layer waveform and decode annotation view is zoomed to just that table entry (a new zoom waveform is shown). If there are multiple channels (lanes), or if both transmit and receive lanes are displayed, and the protocol packet information is not exactly synchronized in time between lanes, then the lane corresponding to the table entry is precisely zoomed and the other channels/lanes are zoomed with the same ratio as the selected table entry.

## Serial Data Debug Solutions

---

If the appropriate selections are made in the ProtoSync right-hand dialog, then simultaneously with the oscilloscope physical layer zoom, the Protocol Analysis viewing software is opened on the same or a second monitor (depending on your setup) and the Protocol Analysis Packet and/or CATC Bit Tracer views locate the packet or bytes corresponding to the selected oscilloscope PCIebus D decode annotation table entry at the top of the Protocol Analysis or Bit Tracer display. Conversely, if a protocol packet or byte is touched in the CATC Protocol Analysis or Bit Tracer display, the PCIebus D decode annotation zoom shows the physical layer waveform corresponding to that packet or byte and simultaneously highlights the table entry. This makes it possible to quickly and easily view both the physical layer waveform, data link layer (PCIe bus D decode annotation), the transaction layer protocol packet (CATC Protocol Analysis View of ProtoSync) or Bit/Byte view (CATC Bit Tracer view of ProtoSync-BT).

### Accessing and Using The Graphing Tools for Supported Protocols

The AudioBus (I2S) TDG package contains capability to extract digital data from a serial data message and graph it as an analog signal - effectively performing a digital-to-analog conversion. [I<sup>2</sup>S](#) (serial digital audio) encodes multiple channel analog sound data as digital values in a streaming serial data message. By converting this digital data back to an analog value and graphing it as an analog audio signal, errors in data conversion, or unexpected glitches, clips or mutes are easily viewed.

Some packages contain capability to extract digital data from a serial data message and graph it as an analog signal - effectively performing a digital-to-analog conversion. This can be helpful to intuitively understand the digitally encoded data that is indecipherable in a serial data message or table display. For instance, [CAN](#) commonly encodes sensor data digitally, and CANbus TDM allows this data to be viewed as an analog plot of the digitally encoded data values for a specific sensor versus time. [I<sup>2</sup>S](#) (serial digital audio) encodes multiple channel analog sound data as digital values in a streaming serial data message. By converting this digital data back to an analog value and graphing it as an analog audio signal, errors in data conversion, or unexpected glitches, clips or mutes are easily viewed.

**AudioBus Decode Setup Detail** (on page 87)

#### PLEASE NOTE THE FOLLOWING:

- The Graph package included in **I<sup>2</sup>S TDG** protocol packages, provide unique functionality separate from the **PROTObus MAG** toolkit.
- Ask your local LeCroy representative for more information about the **Accessing and Using The PROTObus MAG Supported Protocol Toolset** (on page 23) using the **Contact LeCroy for Support** (on page 199) topic.

### Physical Layer Eye Diagram

The FlexRaybus package provides a display of the physical layer serial data signal in an eye diagram for quick and easy determination of physical layer abnormalities at the bit level.

For more information refer to **Using the FlexRaybus Option Overview** (on page 77) and **FlexRaybus Physical Layer Measurement Parameters** (on page 86).

### Debug Examples

#### ***Using the TD Packages: Characterize Embedded Controller Performance***

##### ***USING THE TD PACKAGES: CHARACTERIZING EMBEDDED CONTROLLER PERFORMANCE USING STANDARD OSCILLOSCOPE TOOLS OVERVIEW***

The standard oscilloscope contains a number of built-in tools, such as cursors, measurement parameters, and statistical analyzers. They can be used to characterize performance for serial data signals (just as they are also used to characterize performance on other signals). You may want to use cursors to make single-shot timing measurements and measurement parameters when you need to accumulate statistical data over many different acquisitions. Measurement parameters are also helpful to determine the underlying integrity of the serial data physical signals.



All TD packages provide basic tools to characterize embedded controller performance. The tools can be used on the decoded channels, memories, zooms, functions, etc. just like they are used on any un-decoded channels, memories, zooms, functions, etc. You also can use normal Edge or SMART Triggers on an analog channel input to trigger the oscilloscope when a certain analog signal occurs, and then measure to a particular serial data message using the decoded info as your guide.

In general, some of these standard tools require a fair amount of manual setup. If the goal is to make many hundreds or thousands of measurements, you might want to consider using functionality built into the **PROTObus MAG** toolset.

**Note:** The following examples use [CANbus](#) messages; however, similar needs exist for other serial data signals, and the included oscilloscope tools described in the following sections can be applied in the same way.

Take the following example of an analog signal creating a burst of CAN messages:

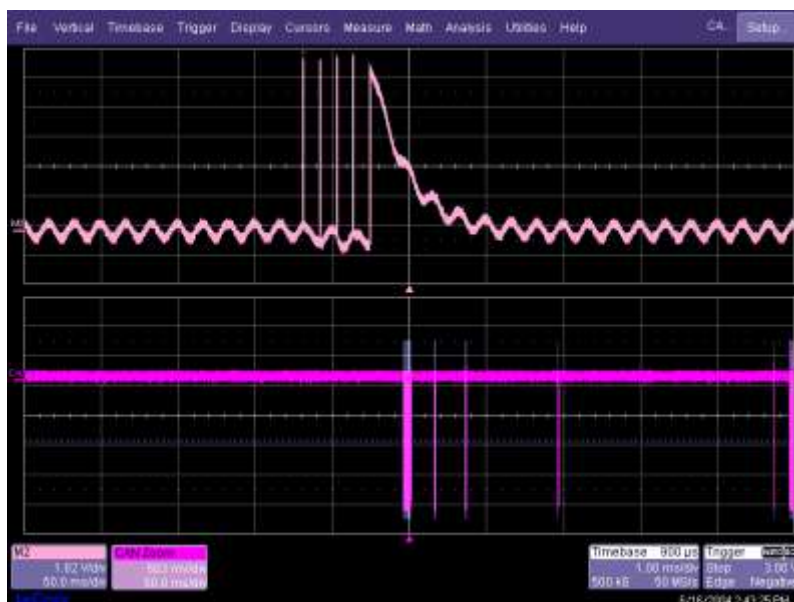

This data was acquired over a 500 ms duration. It is likely you want to understand whether the analog signal input to your electronic control unit (ECU) is creating the desired CAN message output from the ECU. There are a few ways this can be done as the following topics explain.

## Serial Data Debug Solutions

### CHARACTERIZATION USING CURSORS

Use horizontal cursors to mark locations on the waveform where the time measurement should be done, and then read the cursor values to establish the measurement. Adjust the timebase or create zooms of the decoded trace(s) as needed in order to view the signal with enough detail. This is a good method for single-shot / single measurements.



### CHARACTERIZATION USING MEASUREMENT PARAMETERS

Measurement parameters can be used to make basic signal integrity or timing measurements of serial data signals.

Basic parameters, such as Amplitude, Rise, Fall, Overshoot, etc. are ideal for basic signal integrity checks, which is often all that is required for low speed (~1 Mb/s) serial data signals. Timing parameters, such as Delay, Delta Delay, Delta Time @ Level, etc., are ideal for measuring timing from trigger to other signals (such as from an [I<sup>2</sup>C](#) or [SPI](#) Trigger to an analog signal). SDAII is ideal for performing standard-specific physical layer measurements on high speed serial data signals, such as PCI Express. Delta Trig Time is ideal for measuring the time between segments of a Sequence Mode acquisition.

Please see [Isolating and Analyzing Serial Bus Activity](#) topics for more information on Sequence mode.

- **Amplitude** - Noise and overshoot resistant measurement of the amplitude of the signal (measurement of amplitude from Top to Base).



- **Base** - Value of the lowermost state in a bi-modal waveform, such as an [I<sup>2</sup>C](#), [SPI](#), or [CAN](#) Message.



- **Delay** - Time from the trigger to the first transition at the 50% amplitude crossing.



- **Delta Delay** - Time between the 50% crossing of the first transition of two waveforms.



- **Delta Time @ Level** - Time between selectable levels of two waveforms.



**Note:** Delta Time @ Level is not available on WaveSurfer Series oscilloscopes.

- **Delta Trig Time** - The time from last trigger to this trigger (usually used in Sequence mode).



- **Fall (90-10), Fall 80-20, Fall@Level** - Transition time on the falling edge. Three selections are available for the user to determine at which vertical level the measurement is made.



**Note:** Fall@Level is not available on WaveSurfer Series oscilloscopes.

- **Maximum** - Highest value in the input waveform.



- **Mean** - Average of all data values.



- **Minimum** - Lowest value in the input waveform.



- **Overshoot Negative** - Overshoot following a falling edge.



- **Overshoot Positive** - Overshoot following a rising edge.



- **Peak to Peak** - Difference between the Maximum and Minimum data values.



## Serial Data Debug Solutions

- **Rise (10-90), Rise (20-80), Rise@Level** - Transition time on the rising edge. Three selections are available for the user to determine at which vertical level the measurement is made.



**Note:** Rise@Level is not available on WaveSurfer Series oscilloscopes.

- **Top** - Value of the uppermost state in a bi-modal waveform, such as an [I<sup>2</sup>C](#), [SPI](#), or [CAN](#) Message.



### Gating with Measurement Parameters

Gating is available on each standard parameter. This allows you to set a measurement window in which the parameter should be made active. This also allows you to eliminate unwanted portions of the acquisition from your measurement.

Select gating from the Measure dialog by selecting the tab for the appropriate measurement (P1, P2, etc.), and then setting start and stop values for the gate.

Please refer to **Measure Gate** in the online help for more information about Gating.

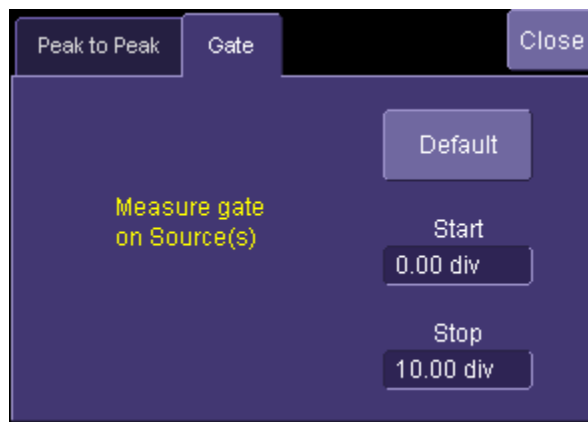

### Statistics and Graphing with Measurement Parameters

Statistics and Histicons are included with nearly every LeCroy oscilloscope (Histicons are not available on WaveSurfer Series oscilloscopes). They allow you to gather numerical and visual information on the distribution of your various measurements.

Turn **on Statistics** and **Histicons** separately by marking their corresponding checkboxes on the **Measure** dialog. Additionally, some LeCroy programs (such as JTA2) add the ability to produce larger **histograms**, **trends**, and **tracks** of your measurement parameters. If you have this capability, access it through the Measurement Parameter setup dialog (the Px tab) on the section of the dialog labeled **Actions for P1**.

### Pass/Fail Analysis with Measurement Parameters

Set up Pass/Fail conditions by touching **Analysis** → **Pass/Fail Setup** on the menu bar.

Refer to your oscilloscope's online help for more pass/fail setup detail.

The powerful Pass/Fail analysis using measurement parameters has a simple setup. For instance, you can define a timing measurement, define the limits for the timing measurement, and then run the oscilloscope in a Normal trigger mode, capturing thousands of measurement events.

What's more is Pass/Fail can then be used to save the Waveform in the event of a Fail, or send an email in the event of a fail.

## Isolating and Analyzing Serial Bus Activity

### ISOLATING AND ANALYZING SERIAL BUS ACTIVITY OVERVIEW

The combination of Serial Data Triggering, Decoding, and normal oscilloscope features is a powerful mixture of tools that can make it very easy to find latent Serial Data hardware or software problems in your circuit. No longer is the oscilloscope a tool just for the hardware engineer. Now, software engineers can also easily visualize the Serial Data signals and relate them to programming code and operation. Decode and Trigger toolsets allow hardware and software Engineers to speak the same language when it comes to system debugging and performance checking.

For more detailed explanations of Decode and Trigger toolsets refer to **Technical Explanation of Serial Decode and Trigger** (on page 12). Some common Serial Data analysis needs and methods are discussed in the following topics.

### CAPTURING LONG PRE-TRIGGER TIMES

LeCroy oscilloscopes are available with optional, very long acquisition memory. When decoding low speed (~1 Mb/s) serial data signals, it is possible to set the sample rate to a minimum value (such as 5 MS/s) and capture and decode seconds of serial data traffic, even with standard 10 Mpt/ch memories. When decoding high speed (Gb/s) serial data signals, higher sample rates are needed, which reduces capture time, but many LeCroy oscilloscopes suitable for these serial data rate signals have optional very long acquisition memories that can be used to achieve long capture times.

If necessary the capture can be 100% pre-trigger, 100% post-trigger, or something in between.

1. First, adjust Pre-Trigger and Post-Trigger time using the **Delay** knob on the oscilloscope's front panel.
2. Now, optimize your Sample Rate or Memory Length by accessing the Horizontal Dialog on your oscilloscope and selecting either **Set Maximum Memory** mode or **Fixed Sample Rate** mode.
  - If you choose to **Set Maximum Memory**, you can decrease the memory usage so you do not sample at too high a sample rate (too high a sample rate slows down the decoding algorithm). Then, adjust your timebase setting to a length sufficient to capture the event.

**Note:** Make sure your timebase setting and memory length combined do not result in too low a sample rate. Otherwise, adequate capture and decode is not performed.

- More commonly, you will probably choose to **fix the sample rate** to a specific value providing the necessary oversampling required to capture your Serial Data messages (at least 4X the bit rate). Also, it affords a high enough sample rate to capture transients you may want to see on Serial Data and analog signals (at least 2X the frequency of any expected transients, preferably 10X).

**Note:** Reference your oscilloscope's online help for more information about the core oscilloscope settings mentioned earlier in this topic.

### REPEATEDLY TRIGGERING AND SAVING THE DATA TO A HARD DRIVE

You may wish to set up your oscilloscope to capture a short or long memory acquisition for a certain trigger condition, and then save data to a hard drive or memory stick whenever the trigger condition is met.

**Note:** While this can be easily done in most LeCroy oscilloscopes, realize there is significant trigger dead time while using this method. Minimize dead time by using the method described in the following Repeated Triggering and Storing all Triggers (Sequence Mode) topic.

Repeatedly trigger and save the data to a hard drive by doing the following:

1. First, set up your desired serial data (or other) trigger condition (see corresponding protocol sections previously covered in this documentation for details).

## Serial Data Debug Solutions

- Now, choose **File** → **Save Waveform** from the menu bar. The **Auto Save** dialog is shown where you can set up the Save Waveform conditions.

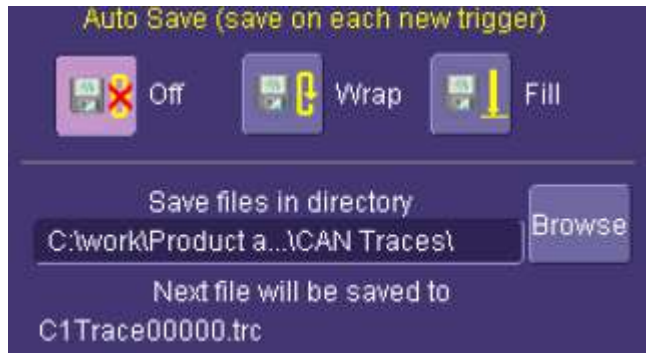

As the previous screen-shot shows, you can disable the Auto Save function by clicking the OFF button. Or, select WRAP where Auto Save occurs until the hard drive is filled, and then discards the oldest data in order to write the newest data. Lastly, select FILL which Auto Saves until the hard drive is filled and then stops.

### PLEASE NOTE THE FOLLOWING:

- Be sure to choose a Binary file format if you wish to recall the traces into a LeCroy oscilloscope for later analysis.
- Even though the LeCroy oscilloscope hard drives are very large, it is a good idea to make sure your trigger condition is set correctly before running your acquisitions.

### **REPEATEDLY TRIGGERING AND STORING ALL TRIGGERS (SEQUENCE MODE)**

LeCroy oscilloscope's have a powerful Sequence Mode function which stores all triggered events by minimizing the dead time between triggers to < 800 nanoseconds. It's ideal for finding repetitive problem causes on your serial data buses or associated signals. (Sequence Mode is not available on WaveSurfer Series oscilloscopes.)

Sequence Mode uses long acquisition memory divided into "segments." As triggered events are acquired, they are stored in acquisition segments for recalling at a later date. The length of each sequence mode acquisition segment and the total number of segments allowed is roughly determined by the total acquisition memory in the oscilloscope. For instance, on a WaveRunner Xi you can acquire 10,000 segments each a maximum of 625 samples long, or 10 segments each a maximum of 1.25 megasamples long, or something in between. Different acquisition memory lengths have different ranges of segments and segment lengths. You can define any number of segments from 2 to the maximum for that memory length (refer to your oscilloscope's specifications for details) and any length of segment (provided there is sufficient acquisition memory). After acquisition of all segments is complete, you can recall them one-by-one and view them in decoded format on the oscilloscope screen.

Acquisition dead time is kept to a minimum because there are no operations performed during the acquisition. All data for each triggered event is written only into high-speed acquisition memory. Until the entire sequence is completed, there is no updating of the oscilloscope display, or other operations causing unnecessary dead time. It's ideal for situations where you cannot take a chance on losing data.

In the following example, we have only acquired Channel 1 in sequence mode. Keep in mind, additional analog or other signals can also be acquired (if desired or necessary) in order to perform a more proper analysis.

- Touch the **Timebase** trace descriptor label to open the Timebase dialog.

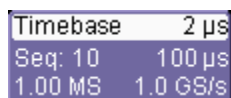

- In the Sampling Mode area, select Sequence Mode.

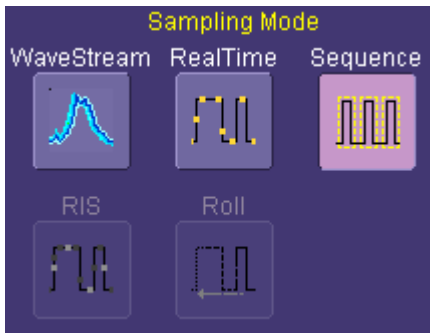

Touch the tab labeled **Sequence** that is now shown next to the Timebase tab.

- On the Sequence tab, select the **Display Mode** and select the **Number of Segments Displayed** at one time.



**Note:** If you have acquired more segments than you can display at one time, use the **Starting at** field to specify a segment at which to begin the display.

### Serial Trigger Setup for Specific Events

At this point, the Serial Trigger is now set up to capture the desired event. The following sections provide event-based setup explanations.

- You can trigger on a specific address or data value and capture long pre-trigger time to determine what precedes the message.

Our example here uses an I<sup>2</sup>C Start trigger. Start the sequence mode acquisition by pressing the front panel SINGLE trigger button. Each time the trigger condition is met, the TRIG'D light on the front panel flashes.

## Serial Data Debug Solutions

When you've acquired the set number of segments, the trigger STOPS and a display similar to the following is shown (this is a 50 segment acquisition in Mosaic display mode).

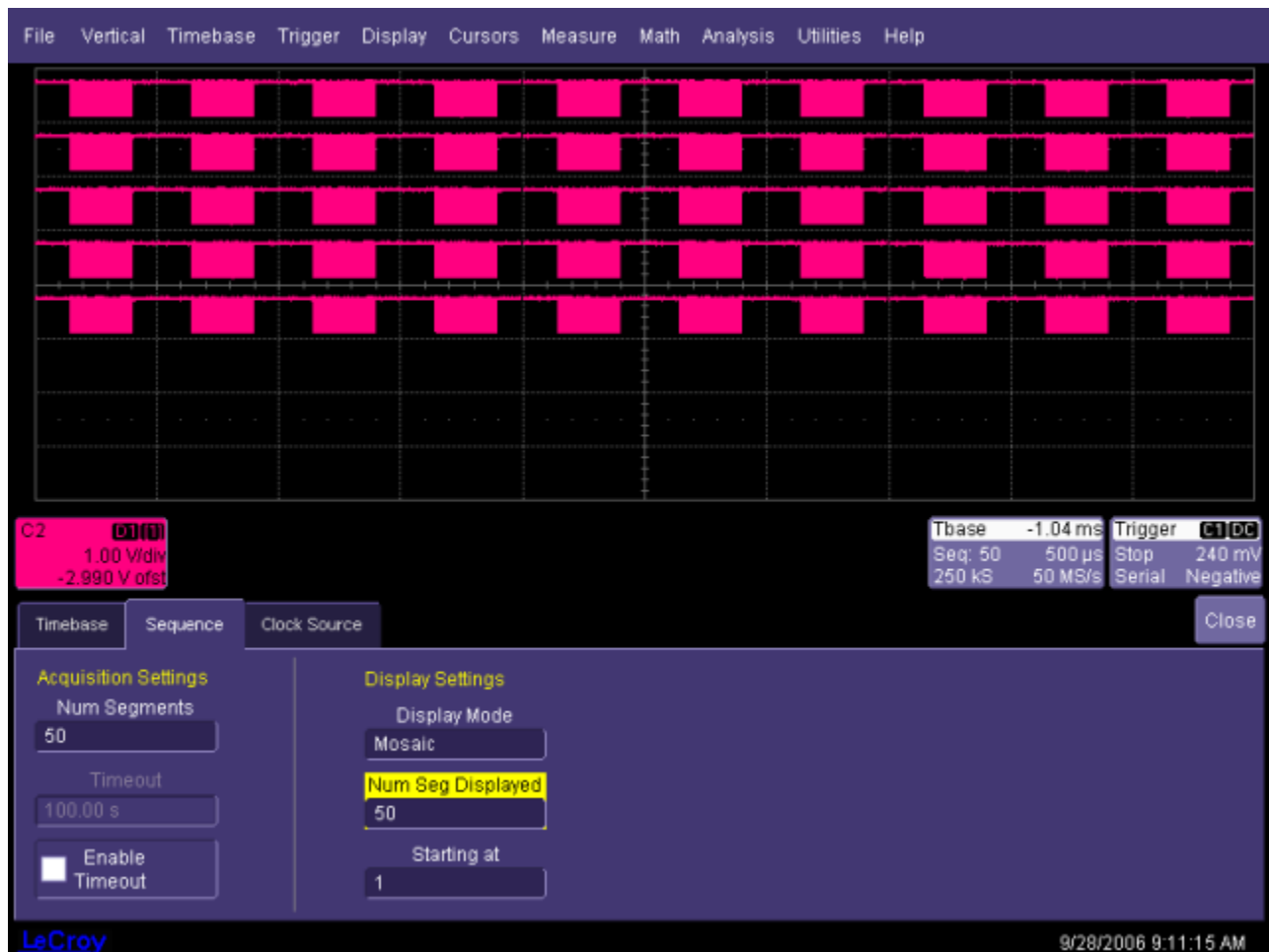

- You can display an individual segment separately from the main channel display by selecting **Math** → **Math Setup...** from the menu bar. Choose a math trace to define as a Segment (in this case, F1 is defined as a Segment of C2). Use the channel that your serial data was acquired on (in this case Channel 2) as a Source.



Display the trace by checking the TRACE ON checkbox. Select the segment for viewing by touching the Select tab and selecting a segment using the pop-up keypad or the front panel Adjust knob.



- You can view decoded data on the individual segment by setting up the Decode to use the Math trace as the source for Data (in this case F4 is the Source).

## Serial Data Debug Solutions

If you wish to change the segment that is decoded, just select a new segment from the Math trace dialog (as shown in the previous step).



**Note:** Conserve display space by turning off the Channel and only select the segment you wish to view as the following screen-shot shows.



- You can view the timestamps for each segment by selecting **Vertical** → **Channels Status** from the menu bar and selecting **Time** on the **Show Status For** section of the dialog as shown.

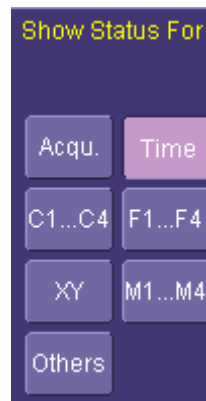

## Serial Data Debug Solutions

A display of timestamp information for each segment in the sequence acquisition is then shown (as follows).

Time			
Seg	Time	since Segment 1	between Segment
1)	16-June-2004 11:53:35		
2)	16-June-2004 11:53:37	1.617166812 s	1.617166812 s
3)	16-June-2004 11:53:37	1.718687863 s	101.521050 ms
4)	16-June-2004 11:53:37	1.919879959 s	201.192096 ms
5)	16-June-2004 11:53:37	2.423745193 s	503.865234 ms
6)	16-June-2004 11:53:38	3.333904655 s	910.159462 ms
7)	16-June-2004 11:53:40	5.247904552 s	1.913999897 s
8)	16-June-2004 11:53:40	5.347525592 s	99.621040 ms
9)	16-June-2004 11:53:42	7.263465499 s	1.915939907 s
10)	16-June-2004 11:53:43	7.566198649 s	302.733150 ms

Select segment  
1  
▼

**Note:** Ten timestamps fit on the display at one time. Choose which segments to display by using the **Select Segment** control. You can also page through the segments one at a time by using the **Adjust** knob on the front panel.

---

## Serial Pattern Encoding Schemes - 8b/10b

### Serial Pattern Encoding Schemes Overview

#### *8b/10b*

**8b/10b** encoding is not a protocol, but a widely used method to encode 8-bit words within a 10-bit symbol, or character. The extra bits are used to ensure the long-term ratio of 1s and 0s transmitted is 1:1, ensuring the serial data encoding is DC free. Serial data standards using 8b/10b encoding also define special symbols or control characters indicating start or end-of-frame, skips, link idles, or other protocol-specific non-data information. Many high-speed serial data standards, such as PCI Express, SATA, SAS, Fibre Channel, etc. use 8b/10b as the underlying encoding method below the protocol layer. Each standard defines their own set of special symbols or control characters.

The remainder of this section provides a brief introduction to the various protocols available as part of LeCroy's Serial Data Debug Solutions for convenience.

### Using the 8b/10b Option

#### *Using the 8b/10b Option Overview*

8b/10b encoding is not a protocol, but a widely used method to encode 8-bit data words within a 10-bit symbol, or character. The extra bits are used to ensure the long-term ratio of **1s** and **0s** transmitted is **1:1**; ensuring the serial data encoding is DC free. Also, any bit transmission longer than five consecutive **1s** or **0s** is prohibited, which limits the requirements for the lowest required bandwidth in the serial data transmission channel. Furthermore, an additional requirement is that the difference in number between **1 bit** and **0 bit** transmissions is **never more than two**. Theoretically, there are 1024 (2 to the 10th power) different 8b/10b encoded bytes possible, far fewer are allowed based on these aforementioned rules.

In order to maintain the DC-free nature of the signal, a running disparity counter is kept for each byte. This count reflects the bias of 1s or 0s from the transmitted byte, and the 8b/10b encoder makes use of the value of this running disparity counter to determine whether to encode the next byte as a +1 or -1 running disparity so as to keep the overall DC bias of the transmitted signal at zero. Thus, there are two valid bit sequences for any byte, depending on the running disparity used. The LeCroy 8b/10b decoder takes all this into account so that the user doesn't have to.

Serial data standards that use 8b/10b encoding also define special symbols or control characters that indicate start or end-of-frame, skips, link idles, or other protocol-specific non-data information. These are commonly referred to as primitives. Many high speed serial data standards, such as PCI Express, SATA, SAS, Fibre Channel, etc. use 8b/10b as the underlying encoding method below the protocol layer. Each standard defines their own set of primitives. Primitives convey more basic information than contained in a full protocol decode, but they can be valuable as well for debugging or quality control purposes.

#### *8b/10b Decode Setup Detail*

For general information about using controls shown on the main Serial Decode dialog, refer to **Accessing The D and TD Supported Protocol Toolsets** (on page 13).

#### *8B/10B DECODE BASIC, FILTER, AND DVPT RIGHT-HAND DIALOGS*

Access the **Serial Decode** dialog by touching **Analysis** → **Serial Decode** on the menu bar.

Touch the corresponding **Setup...** button for your decode. The **Decode Setup...** along with corresponding right-hand dialogs are shown. Select the 8b/10b Decode protocol from the **Protocol** control.

Additional setup details for sending 8b/10b Decode to ProtoSync involve selecting a single source (trace) for the data, and configuring the right-hand dialogs for **Basic** and **Filter**.

## Serial Data Debug Solutions

### The Basic Right-Hand Dialog

The 8b/10b Basic Right-Hand dialog provides detailed fields and setup conditions as follows:

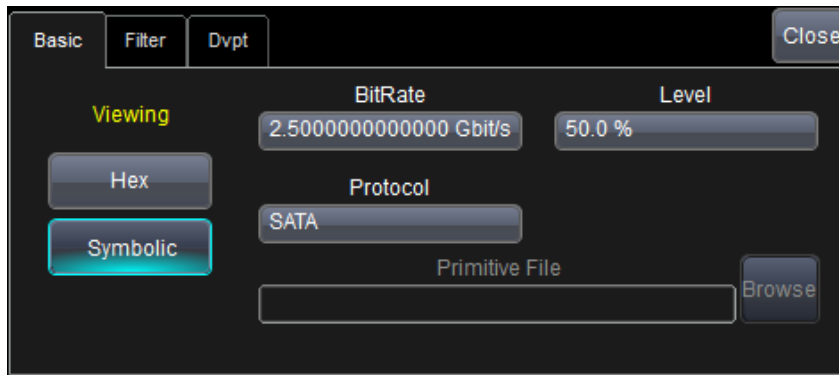

- Use the **Viewing** buttons to Choose from **Hexadecimal** or **Symbolic**. Hexadecimal decode viewing automatically ignores the non-data bits in the 10-bit symbol/character and returns a Hexadecimal value for the 8 data bits only. Symbolic decode viewing provides a protocol-specific view of the 10-bit symbol, using the Protocol selection to the right (and described next).

**Note:** Regardless of your choice here, both are shown on the table display. This selection determines which base is used in trace annotations on the display grid.

- **Protocol** - Make a selection from the standards available in this field. Each standard has a pre-defined translation of the 10-bit symbol into a character name (primitive) - reference the latest version of that particular standard for a detailed translation table.

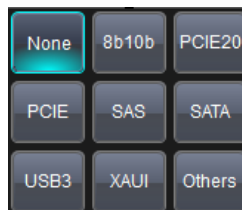

- **Primitive File** - Selecting **Others** from the Protocol field enables this field which can be used to provide your own definition file for primitives and even name default filters.

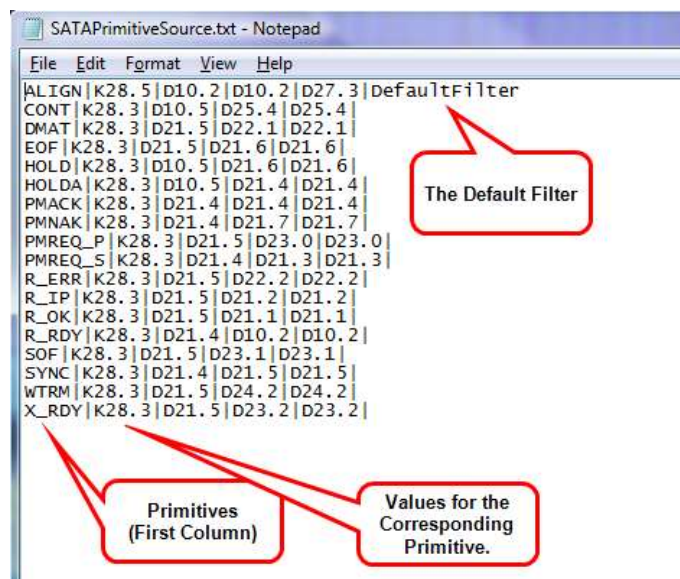

*Example primitive file for SATA.*

### The Filter Right-Hand Dialog

Use this dialog to specify which primitives for the protocol standard (selected from the basic Right-Hand Dialog, previously) are **Decoded** or **Filtered** out of the results.

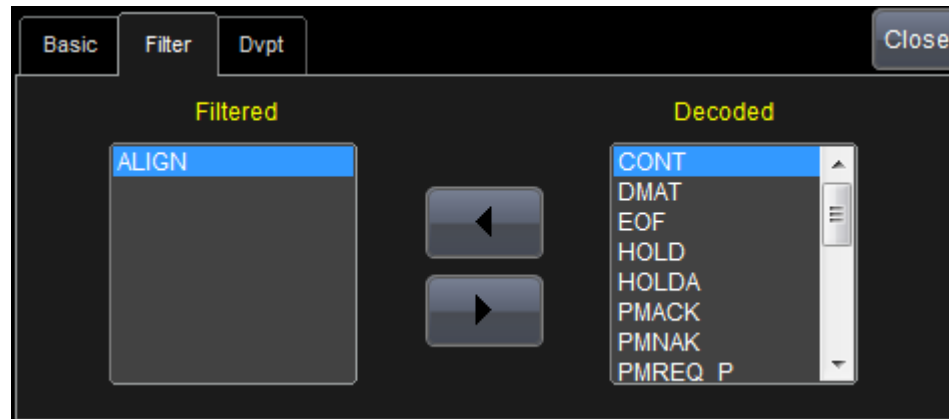

### Using 8b/10b Hi-Speed Serial Triggers on Zi Oscilloscopes

*SOMETIMES REFERRED TO AS SERIAL TRIGGER*

#### [High Speed Serial Trigger Setup](#)

#### [Source Setup](#)

#### [Encoding](#)

#### [Entering Binary, Hexadecimal, and 8b/10b Trigger Patterns](#)



#### WARNING

**Prevent serial trigger module damage and never apply external voltages to the clock and data output connectors.**

SDA 7 Zi and 8 Zi model oscilloscopes include a serial pattern trigger and a Clock and Data Recovery module.

#### PLEASE NOTE THE FOLLOWING:

- SDA 725 Zi and SDA 735 Zi model oscilloscopes include the WavePro Medium Speed Serial Trigger module option (WPZi-MSPT). The CDR range is 100 Mb/s - 1.25 Gb/s.
- SDA 740 Zi and SDA 760 Zi model oscilloscopes include the WavePro High Speed Serial Trigger module option (WPZi-HSPT). The CDR range 100 Mb/s - 2.7 Gb/s, 3.0, 3.125 Gb/s.
- All of the SDA 8 Zi and Zi-A model oscilloscopes include the WaveMaster High Speed Serial Trigger module option (WM8Zi-HSPT). The CDR range 100 Mb/s - 2.7 Gb/s, 3.0, 3.125 Gb/s.

The CDR module is built into the instrument and is accessible through the channel 4 input. The signal on channel 4 is always present at the input to the serial pattern trigger module. The serial trigger also includes two outputs located on the front panel, to the right of the channel 4 input. These two SMA connectors allow access to the recovered clock and data signals from the serial trigger module for signals up to 2.7 Gb/s. The signals at these connectors are nominally zero mean with a peak-to-peak amplitude of 330 mV.

**Note:** The recovered clock and recovered data output signals are not available for 3 and 3.125 Gb/s.

## Serial Data Debug Solutions

### HIGH SPEED SERIAL TRIGGER SETUP

Access the **High Speed Serial** trigger dialog by touching the **Trigger** descriptor label, and then the **Serial Trigger** button.



The **High Speed Serial** trigger dialog is then shown. Notice how the dialog is divided into three sections for **Source Setup**, **Encoding**, and **Trigger Patterns**.



The remainder of this topic explains these sections and their controls.

### SOURCE SETUP

Click the **Compute Bitrate** button to find the bitrate of your signal and lock the CDR on the incoming signal. The Serial Data input must be present on Channel 4 in order to use the Serial Trigger. Verify that the lock is closed and the correct bitrate has been found before proceeding.

**Note:** For SDA 820 Zi or higher bandwidth oscilloscopes, channel 3 is used for serial trigger input when channels 3 and 4 are operating in DBI mode.

The **PLL** section then indicates that the Phased Locked Loop has locked to your bitrate.

### ENCODING

Choose **Binary**, **Hex**, or **Symbolic (8b/10b)** formats for providing your trigger pattern values.

#### PLEASE NOTE THE FOLLOWING:

- Trigger pattern value encoding formats can be changed after providing your entry. Just click on the format and the conversion is done for you. For example, provide a Hex value on which you would like to trigger, click the Binary button, and the Hex value is automatically converted into Binary.
- Conversions may be done from Hex to Binary, Binary to Hex, Symbolic (8b/10b) to Hex or Binary - however, Hex or Binary to Symbolic (8b/10b) is not supported.

### TRIGGER PATTERNS

Now, set the Data Pattern on which to trigger. **Binary** and **Hex** data patterns are entered similarly, while **Symbolic 8b/10b** differs.

#### Entering Binary and Hex Data Patterns

- You can provide 2 data patterns (80 bit) for triggering. If 2 are used, the system triggers on data pattern 1 **OR** 2 (indicated on the **Trigger On** section of the dialog).
- Provide your values by typing directly into the **Data Value** field, or **double-click** the field and use the **corresponding pop-up keypad**.

**Note:** Notice how the virtual keypad shown after double-clicking the Data Value field corresponds with the selected encoding format.

- The Highlight Pattern check box may be used to shade the portion of the waveform on the grid display where your data value occurs.



### Entering Symbolic 8b/10b Data Patterns

When Symbolic Encoding is selected:

- The tab on the **High Speed Serial** trigger dialog changes to **8B10B**
- A **Running Disparity** section is added to the dialog with choices for **Positive**, **Negative**, or **Either**.
- A **Trigger Pattern** section designed for 8b/10b is shown.

**Running Disparity** selections directly affect the Trigger Pattern fields in a corresponding manner. The Positive Running Disparity button activates only the Positive Running Disparity field, the Negative activates only the Negative, and Either activates both. When using Both Running Disparity Trigger Patterns, the system triggers on the Positive **OR** the Negative (as indicated on the **Trigger On** section of the dialog when the values are provided).

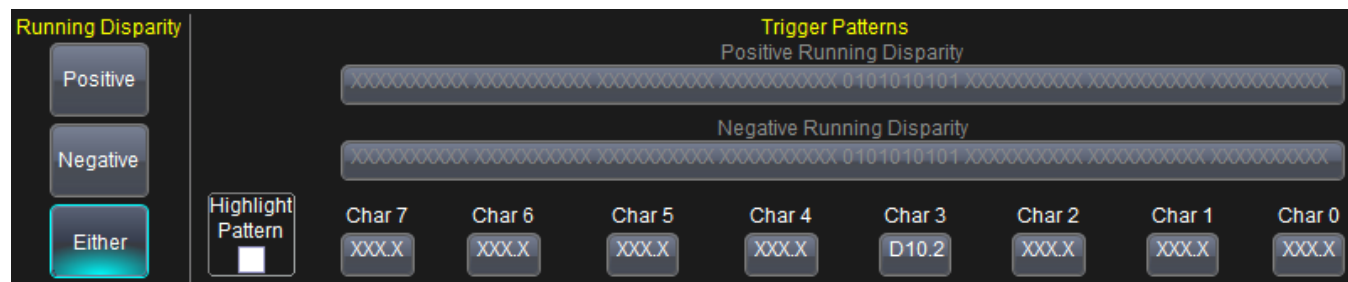

- Provide your 8b/10b Character values in the **Char 7** through **Char 0** fields. Provide values by typing directly into the **Data Value** field, or **double-click** the field and use the **8b/10b pop-up keypad**.

**Note:** For more information on specific 8b/10b characters refer to the **Encoding Table Reference** (on page 50) topic.

- Due to the fact that 8b/10b is a dual-parity protocol, triggering on non-consecutive 8b/10b amounts with "don't care" values in between is not possible. This is because preceding characters affect subsequent parity bits.

**For Example:**

	Char 7	Char 6	Char 5	Char 4	Char 3	Char 2	Char 1	Char 0
<b>Valid Trigger Sequence</b>	XXX.X	XXX.X	K28.5	D10.3	XXX.X	XXX.X	XXX.X	XXX.X
<b>Invalid Trigger Sequence</b>	K28.5	XXX.X	XXX.X	XXX.X	XXX.X	XXX.X	XXX.X	D10.3

- The Highlight Pattern check box may be used to shade the portion of the waveform on the grid display where your data value occurs.

### Helpful Trigger Pattern Tools

- Binary and Hex Data Patterns have a group of buttons to the right of the **High Speed Serial** trigger dialog and can be used to quickly set the pattern to all 0s, all Xs, all 1s, or an inversion of the value provided in the field.
- Saving and Recalling Serial Data Patterns into the Trigger keeps you from having to repeatedly re-enter them. The serial trigger pattern is also stored in the setup file whenever you save the panel file through the **File → Save Setup** dialog. So, the trigger pattern can be recalled simply by recalling the corresponding panel file. However, the panel setup file saves the entire state of the instrument, which may not always be desirable. In such cases, use this Save/Recall control to save the Binary, Hex, or Symbolic pattern alone into CDR (Clock Data Recovery) Pattern.Iss files.

## Serial Data Debug Solutions

### Encoding Table Reference

For convenience, the following standard tables provide data for **5b/6b**, **3b/4b**, and **Control Symbols**.

#### 5B/6B

Input		RD = -1	RD = +1	Input		RD = -1	RD = +1
	EDCBA	abcdei			EDCBA	abcdei	
D.00	00000	100111	011000	D.16	10000	011011	100100
D.01	00001	011101	100010	D.17	10001	100011	
D.02	00010	101101	010010	D.18	10010	010011	
D.03	00011	110001		D.19	10011	110010	
D.04	00100	110101	001010	D.20	10100	001011	
D.05	00101	101001		D.21	10101	101010	
D.06	00110	011001		D.22	10110	111010	
D.07	00111	111000	000111	D.23 †	10111	111010	000101
D.08	01000	111001	000110	D.24	11000	110011	001100
D.09	01001	100101		D.25	11001	100110	
D.10	01010	010101		D.26	11010	010110	
D.11	01011	110100		D.27 †	11011	110110	001001
D.12	01100	001101		D.28	11100	001110	
D.13	01101	101100		D.29 †	11101	101110	010001
D.14	01110	011100		D.30 †	11110	011110	100001
D.15	01111	010111	101000	D.31	11111	101011	010100
				K.28	11100	001111	110000

Table 3-2. † Same code used for K.x.7

#### 3B/4B

Input		RD = -1	RD = +1	Input		RD = -1	RD = +1
	HGF	fghj			HGF	fghj	
D.x.0	000	1011	0100	K.x.0	000	1011	0100
D.x.1	001	1001		K.x.1 ‡	001	0110	1001
D.x.2	010	0101		K.x.2 ‡	001	1010	0101
D.x.3	011	1100	0011	K.x.3	011	1100	0011
D.x.4	100	1101	0010	K.x.4	100	1101	0010
D.x.5	101	1010		K.x.5 ‡	001	0101	1010
D.x.6	110	0110		K.x.6 ‡	001	1001	0110
D.x.P7 †	111	1110	0001				
D.x.A7 †	111	0111	1000	K.x.7 † ‡	111	0111	1000

Table 3-3. † For D.x.7, the Primary (D.x.P7) or Alternate (D.x.A7) encoding must be selected in order to avoid a run of five consecutive 0s or 1s when combined with the preceding 5b/6b code. Sequences of five identical bits are used in comma codes for synchronization issues. D.x.A7 is only used for x=17, x=18, and x=20 when RD=-1 and for x=11, x=13, and x=14 when RD=+1. With x=23, x=27, x=29, and x=30, the same code forms the control codes K.x.7. Any other x.A7 code can't be used as it would result in chances for misaligned comma sequences.

‡ The alternate encoding for the K.x.y codes with disparity 0 allow for K.28.1, K.28.5, and K.28.7 to be "comma" codes that contain a bit sequence that can't be found elsewhere in the data stream.

#### CONTROL SYMBOLS

Input	RD = -1		RD = +1
	HGF EDCBA	abcdei fghj	abcdei fghj
K.28.0	000 11100	001111 0100	110000 1011
K.28.1 †	001 11100	001111 1001	110000 0110
K.28.2	010 11100	001111 0101	110000 1010
K.28.3	011 11100	001111 0011	110000 1100
K.28.4	100 11100	001111 0010	110000 1101
K.28.5 †	101 11100	001111 1010	110000 0101
K.28.6	110 11100	001111 0110	110000 1001
K.28.7 ‡	111 11100	001111 1000	110000 0111
K.23.7	111 10111	111010 1000	000101 0111
K.27.7	111 11011	110110 1000	001001 0111
K.29.7	111 11101	101110 1000	010001 0111
K.30.7	111 11110	011110 1000	100001 0111

Table 3-4. † Within the control symbols, K.28.1, K.28.5, and K.28.7 are "comma symbols." Comma symbols are used for synchronization (finding the alignment of the 8b/10b codes within a bit-stream). If K.28.7 is not used, the unique comma sequences 0011111 or 1100000 cannot be found at any bit position within any combination of normal codes.

‡ If K.28.7 is allowed in the actual coding, a more complex definition of the synchronization pattern than suggested by † needs to be used, as a combination of K.28.7 with several other codes forms a false misaligned comma symbol overlapping the two codes. A sequence of multiple K.28.7 codes is not allowable in any case, as this would result in undetectable misaligned comma symbols.

K.28.7 is the only comma symbol that cannot be the result of a single bit error in the data stream.

#### SOURCE

Peter A. Franaszek, Albert X. Widmer, et al. "Byte oriented DC balanced (0,4) 8B/10B partitioned block transmission code." US Patent 4486739. December 4, 1984.

## Serial Data Debug Solutions

---

### 8b/10b Decode Search

The **8b/10b Search** right-hand dialog appears when the Zoom dialog is shown.

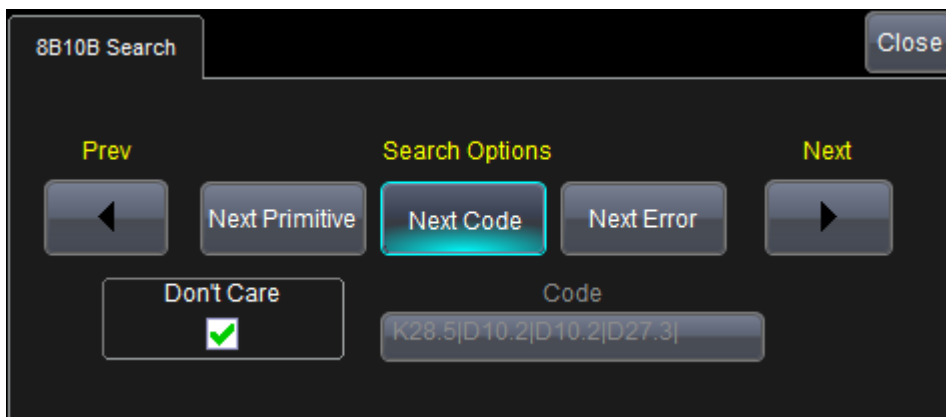

Use the **Prev** and **Next** buttons to advance through **Primitive**, **Code**, or **Error** occurrences.

- With **Next Primitive** selected, you can select a specific message based on the protocol chosen on the **Basic** Right-Hand dialog, see **Decode Setup Detail** (on page 45).
- When **Next Code** is selected, you can mark the **Don't Care** checkbox, or unmark it to enable the **Code** control and provide a specific code value.

## General Purpose Embedded Protocols

### General Purpose Embedded Protocols Overview

#### I<sup>2</sup>C

I<sup>2</sup>C is a standardized protocol created by Philips with a documented technical specification.

NXP (formerly Philips Semiconductors) provide a full description of the standard at [www.standardics.nxp.com](http://www.standardics.nxp.com).

Number of Lines	Data rate	Synchronous or Asynchronous
2	Up to 3.4 Mb/s	Synchronous

#### SPI

SPI was popularized by Motorola but is not standardized, per se - there are a variety of variants with the differences characterized by how data is clocked, whether data is MSB or LSB format, and whether it is multi-slave or single-slave.

While the SPI has no formal standard, information is often included in the technical documentation for the microprocessor supporting the protocol.

Number of Lines	Data rate	Synchronous or Asynchronous
3	Up to ~50 Mb/s	Synchronous

#### UART

UART is a generic backbone for many proprietary serial data protocols (too numerous to mention) each with different physical layers.

UART has no formal standard. The protocol evolved from mechanical rotating teletypewriter devices. Formats were formalized with the advent of the first electronic computers.

Number of Lines	Data rate	Synchronous or Asynchronous
1	Up to 1 Mb/s (typical)	Asynchronous

#### RS-232

RS-232 is a special case of UART, with a more defined protocol and specific physical layer.

The physical layer is defined in the Electronic Industries Association (EIA) EIA-RS-232-C and the Telecommunications Industry Association (TIA) TIA-232-F. Its protocol layer is not specified; however, UART is commonly implemented. Resources can be found at [www.eia.org](http://www.eia.org) and [www.tiaonline.org](http://www.tiaonline.org).

Number of Lines	Data rate	Synchronous or Asynchronous
1	Up to 57.6 kb/s (typical)	Asynchronous

## Using the I2Cbus Option

### Using the I<sup>2</sup>Cbus Option Overview

Both I<sup>2</sup>Cbus D and TD options contain powerful software algorithms to extract serial data information from physical layer waveforms measured on your oscilloscope. The extracted information is overlaid (annotated) on the actual physical layer waveforms, and color-coded to provide fast, intuitive understanding.

The I2Cbus TD option contains a very powerful and flexible trigger, but it is also very easy to set up for basic triggering. The I<sup>2</sup>Cbus TD option contains a conditional I<sup>2</sup>C DATA trigger to select a range of DATA values to trigger on, not just a single DATA value.

## Serial Data Debug Solutions

Oftentimes, I<sup>2</sup>C utilizes DATA bytes to specify sub-addresses for accessing memory locations in EEPROMs. Conditional DATA trigger allows triggering on a range of DATA bytes corresponding with reads or writes to specific sub-address memory blocks in the EEPROM. It can also aid in monitoring DATA outputs from I<sup>2</sup>C-based sensors, such as analog-to-digital converters, and triggering when DATA is outside a safe operating range. In both cases, verifying proper operation becomes a simple task. Other powerful and user-friendly features included in I<sup>2</sup>Cbus TD trigger include:

- Ability to define an ADDR or DATA condition in either **Binary** or **Hexadecimal (Hex)** formats.
- Ability to define an ADDR condition in binary with the DATA condition defined in hexadecimal so as to trigger on a range of ADDR values using Don't Care bits.
- FRAME LENGTH trigger setups.
- EEPROM trigger setups to trigger on up to 96 bits (12 bytes) of DATA at any location within an I<sup>2</sup>C frame or at a user-defined location in a 2048 byte window.
- All permutations of Read, Write, or R/W Don't Care conditional setup for 7 and 10-bit addresses.
- For any I<sup>2</sup>C message trigger, select whether an ACK condition should be ACK, NO ACK, or DON'T CARE. You can choose to trigger on a NO ACK condition by itself, or as part of a more complex ADDR/DATA trigger.

If you are not familiar with or are just learning about I<sup>2</sup>C, start by using the simplest trigger conditions (Start, Stop, ReStart, NoAck) to gain confidence, and then set up simple ADDR only conditions. When you are confident with understanding I<sup>2</sup>C operation, set up an ADDR+DATA condition with a condition of "DATA =". Then, try different setups using other DATA conditions (>, <, INRANGE, etc.). Lastly, experiment with the EEPROM trigger setup, which provides the most flexibility by allowing location of data, with conditions, within specific bytes of a long sequence of DATA bytes.

**Note:** Ask your local LeCroy representative for more information about any Serial Data Debug Solution Protocols or Toolkits using the **Contact LeCroy for Support** (on page 199) topic.

### I<sup>2</sup>C Decode Setup Detail

For general information about using controls shown on the main Serial Decode dialog, refer to **Accessing The D and TD Supported Protocol Toolsets** (on page 13).

#### I<sup>2</sup>C BASIC AND LEVELS RIGHT-HAND DIALOGS

Access the **Serial Decode** dialog by touching **Analysis** → **Serial Decode** on the menu bar.

Touch the corresponding **Setup...** button for your decode. The **Decode Setup...** along with corresponding right-hand dialogs are shown.

#### I<sup>2</sup>C Basic Right-Hand Dialog

The **Basic** right-hand dialog provides detailed controls and setup conditions as follows:

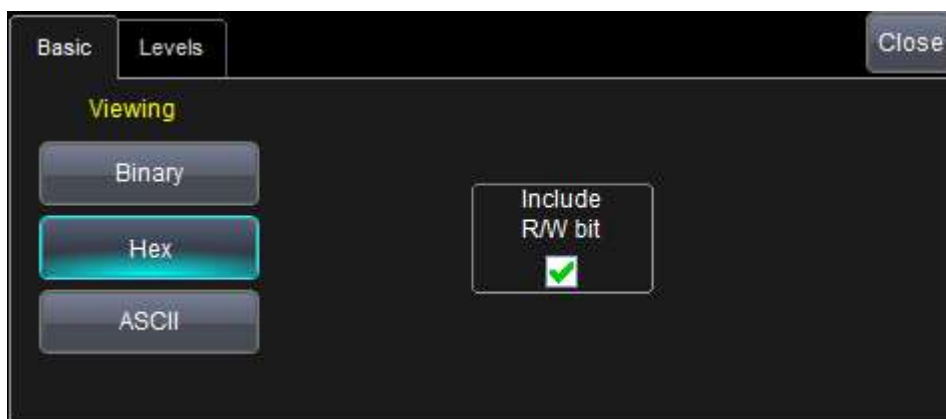

- **Viewing** - Select to view the protocol data in **Binary**, **Hexadecimal**, or **ASCII** modes.

**Note:** If the trigger is set up first, the trigger settings copy into the decode settings.

- **Include R/W Bit** - Some engineers think of the 7-bit address pattern as including the R/W bit (i.e. 8-bits) and others think of the address pattern as not including the R/W bit (i.e. 7-bits). If you decoded I<sup>2</sup>C messages include 7-bit addresses, mark the checkbox if you want to **include the R/W bit** in the decoded Address value.

**Note:** There is an identical checkbox selection in the I<sup>2</sup>C trigger setup dialog. These two setups are dynamically linked, so selections here in decode results in an identical selection in trigger. This ensures that the decode address format matches trigger setup information.

### I<sup>2</sup>C Levels Right-Hand Dialog

The **Levels** right-hand dialog provides detailed controls and setup conditions as follows:

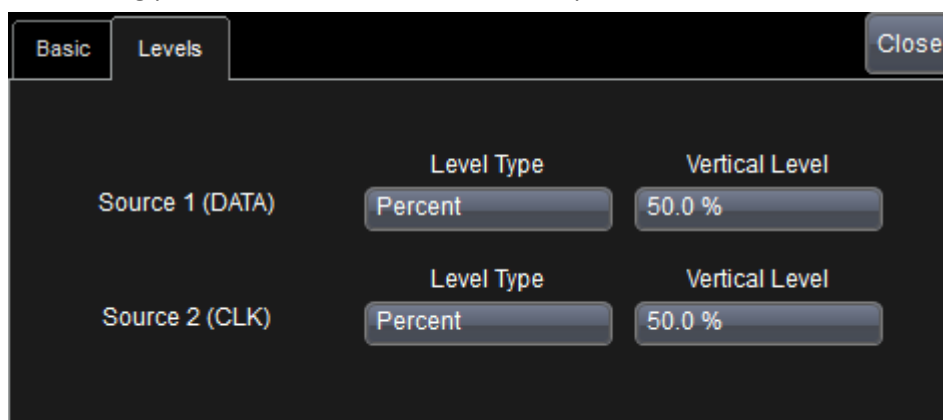

- **Level Type** and **Vertical Level** - The message decoding algorithm setup is performed here. The level is normally set up in %, and defaults to 50%. To adjust the level, touch inside the number area to highlight the box title, and then use the oscilloscope front panel Adjust knob to adjust. Or touch inside the number area twice and select a value using the pop-up numeric keypad.

**PLEASE NOTE THE FOLLOWING:**

- The set Level appears as a dotted horizontal line across the oscilloscope grid.
- If initial decoding indicates that there are a number of error frames, make sure that the level is set to a reasonable value.
- DATA and CLOCK can have different level settings, but they are typically the same level.

### Creating an I<sup>2</sup>Cbus Trigger Condition

The following trigger setup detail topics show the dialog selections for an I<sup>2</sup>Cbus Trigger with detail on some of the setup conditions.

**Note:** Refer to **Using The D Supported Protocol Toolsets** (on page 14) to correctly access the Trigger Condition dialog specific to your desired protocol.



## Serial Data Debug Solutions

Selection of Trigger Type results in dynamic changes to the I<sup>2</sup>Cbus Trigger dialog. Simple I<sup>2</sup>C triggers, such as Start, Stop, ReStart, and NoAck, require no additional setup, while frame-based triggers, such as ADDR, ADDR+DATA, FRAME LENGTH, and EEPROM require addition user-defined setup information.

Select condition values by touching fields (using your finger, or use a mouse pointer). A pop-up is shown where you can choose from **Equal**, **Not Equal**, **Less than**, **Less than or Equal to**, **Greater than**, **Greater than or Equal to**, **In Range**, or **Out Range** condition values.

### I<sup>2</sup>C Trigger Setup Detail

The following topic provides specific control settings for an I<sup>2</sup>Cbus Trigger.



The previously numbered I<sup>2</sup>Cbus trigger sections correspond with the following explanations.

#### 1. SOURCES SETUP

- **DATA and CLOCK** - The pop-up dialog is used to select the appropriate channel or EXT inputs for each. Set these fields up with caution or your trigger may not function correctly.
- **Threshold (Trigger)** - Adjust the vertical level for the trigger. Much like an Edge trigger, a user must specify the level used in order to process the incoming signals and determine whether the desired serial data pattern is meeting the set trigger condition. This value is used for both DATA and CLOCK signals.

#### 2. TRIGGER TYPE

The I<sup>2</sup>C trigger can be configured to trigger on simple conditions; meaning the presence of a **START**, **STOP**, **RESTART** bit, or the absence of an **ACK** bit (**NO ACK**). In addition, more complex trigger conditions can be created using **ADDR**, **ADDR+DATA**, **FRAME LENGTH**, or **EEPROM** setups.

If one of the more complex trigger conditions is selected, then reference the following sections for information on Address and Data Pattern Setup.

#### 3. SETUP FORMAT

Select either **Binary** or **Hexadecimal (Hex)** setup mode. The format propagates through the entire I<sup>2</sup>C trigger setup.

A user can select Binary mode, and set up the address in binary format, then reselect Hex mode and set up the data in hexadecimal format. Toggling back and forth between the modes does not result in lost information (binary is used internally as the core format for all triggering and decoding operations), though use of don't care bits in a binary setup results in the display of an X (for a full nibble don't care) or a \$ (for a partial nibble don't care).

#### 4. ADDRESS SETUP

These following setup choices demonstrate ADDR, ADDR+DATA, FRAME LENGTH, or EEPROM Trigger Selections.

- **Address Length** - I<sup>2</sup>C utilizes either 7 or 10-bit formats for the address, depending on the device. Make the appropriate selection so as to be able to enter the correct address value.



- **Include R/W bit** - If 7-bit address length is selected, another selection will appear for whether the Read/Write bit should be included as part of the address value entered. For instance, some engineers think of the address pattern as including the R/W bit (i.e. 8-bits) and others think of the address pattern as not including the R/W bit (i.e. 7-bits). Check the checkbox if you want to include the R/W bit in your entered Address value. If this is done, then the Direction value will auto select either Read or Write (as appropriate) and gray out as not-selectable by the user.

**Note:** There is an identical checkbox selection in the I<sup>2</sup>C decode setup dialog. These two setups are dynamically linked, so selecting it one way in trigger results in an identical selection in decode. This ensures that the trigger address format matches decoded information on the display.

- **Address Value Setup...** - Enter the Address Value in binary or hex (depending on what was selected in the Setup Mode). The pattern condition for the Address is always **equal**.

Binary addresses allow use of don't care conditions in any bit position (entered as X). Hexadecimal addresses allow use of don't care conditions in any nibble position) also entered as an X. If an address is set up in Binary, then converted to Hex with a Setup Mode change, then any non-nibble length don't care values will be shown as \$.

**Note:** Address values are always MSB format. Therefore, conversion of address values from binary to hex when don't care values are used will be on that basis.

- **Direction** - Enter a Direction (**Read**, **Write**, or **Don't Care**) for the Address value. If you have selected to use 7-bit addresses with the R/W bit included in the address value, then this selection will be grayed out and not selectable.

## 5. DATA PATTERN SETUP

This step is explained using demonstrations based on **ADDR+DATA or EEPROM (Data Setup)** and **FRAME LENGTH (Frame Length)** trigger type selections.

- **Data Setup...** - These setup selections are displayed if the Trigger Selection is **ADDR+DATA** or **EEPROM**.
- **Data Pattern Value** - The pattern value is entered in either **Binary** or **Hexadecimal** mode depending on the previous selection of Setup Mode. There are two selections for pattern value - **Data Value** and **Data Value To**. The second selection is exposed for entry if the Condition is set to INRANGE or OUT(of)RANGE. Otherwise, it is grayed out. Up to 12 bytes of data can be entered as a pattern value.

If less than 12 bytes of data is entered for the pattern value, the data is assumed to begin at the 0 (i.e. first) data byte in the I<sup>2</sup>C message. If this is not desired, then add preceding or trailing don't care (X) nibbles to the pattern value.

### PLEASE NOTE THE FOLLOWING:

- When more than one byte of data is entered as a data pattern value, the data is treated as **Most Significant Byte (MSB) First**. This is especially important to remember when setting up conditional comparisons.
- In Hexadecimal format, data must be entered as full bytes even though the minimum required acceptable entry is a nibble. If less than a full byte is entered, then a don't care X precedes the pattern values entered.
- **Condition** - The DATA condition can be set many different ways. Possible conditions are **Equal**, **Not Equal**, **Less than**, **Less than or Equal to**, **Greater than**, **Greater than or Equal to**, **In Range**, or **Out Range**. Oftentimes, I<sup>2</sup>C utilizes DATA bytes to specify sub-addresses for accessing memory locations in EEPROMs.

## Serial Data Debug Solutions

---

Conditional DATA trigger allows triggering on a range of DATA bytes that correspond to reads or writes to specific sub-address memory blocks in the EEPROM. It can also aid in monitoring DATA outputs from I<sup>2</sup>C-based sensors, such as analog-to-digital converters, and triggering when DATA is outside a safe operating range. In both cases, verifying proper operation becomes a simple task.

- **Length** - The pattern length value defaults to the length, in bytes, of the pattern set in the Data Value selection. If the length is changed to a lesser value, it truncates the beginning of the value. If the length is increased, it would add don't care XX byte values to the beginning of the value.
- **At Position, Position** - These selections are present only when the Trigger Selection is EEPROM or ADDR+DATA. At Position can be either VALUE or DON'T CARE. When At Position = VALUE, you must also enter a data byte number for Position (0 = the first data byte). For EEPROM triggering, use this to specify a specific location of data, such as a sub-address memory block, that the Pattern Value must occupy in order for triggering to occur. For ADDR+DATA triggering, use this to specify a specific location where the data values should be located without using don't care (X) values in the pattern value. In both cases, you can select a Position in up to a 2048 byte data pattern, starting with Byte 0.

**Note:** The first byte is counted as Byte 0, not Byte 1.

- **Frame Length Setup...** - This setup selection is displayed if the Trigger Selection is FRAME LENGTH. It is used to trigger on a specific Address value with a defined length of data bytes.
  - **Bytes Length** - Specify a data length value between 0 and 2047. 1 is the default value.
- If the Data Length Condition (as follows) is selected to be either INRANGE or OUT(of)RANGE, then it is applied toward the minimum data length value, meaning the lower value of the range you wish to include or exclude.

**Note:** All values entered in this field are always in decimal format.

- **Bytes Length Max** - If the Data Length Condition is selected to be either INRANGE or OUT(of)RANGE, then you also need to specify a maximum data length value (i.e. the upper value of the range you wish to include or exclude).
- **Length Condition** - The Data Length Condition can be set to many different values, such as **Equal, Not Equal, Less than, Less than or Equal to, Greater than, Greater than or Equal to, In Range, or Out Range**. Select the correct condition for your needs.

### 6. ACK SETUP

Use this setup to choose whether you want to add an Acknowledge bit condition to your ADDR, ADDR+DATA, FRAME LENGTH, or EEPROM trigger condition. **X** (Don't Care) would be the most common setup, although **ACK** or **NO ACK** might be a useful condition to add for an unusual or hard to find I<sup>2</sup>C problem. An example of this would be triggering on an EEPROM write (selected by an ADDR trigger) where the EEPROM failed to acknowledge a byte written.

## Using the SPIbus Option

### Using the SPIbus Option Overview

Both SPIbus D and TD options contain powerful software algorithms to extract serial data information from physical layer waveforms measured on your oscilloscope. The extracted information is overlaid (annotated) on the actual physical layer waveforms, and color-coded to provide fast, intuitive understanding.

This option includes the **SIOP** and **SSPI** variants of the **SPI** protocol. You may notice these variants labeled on some dialog controls.

The SPIbus TD option contains a data trigger that can be configured for the many variants of SPI, such as SSPI (single master and slave with predetermined format settings) and SIOP. The basic SPI Type is all-inclusive and the SSPI and SIOP types are just pre-selected settings in the basic SPI trigger.

The SPI trigger does not require use of a Chip Select line. In its place is the ability to set a minimum Interframe Time corresponding with a time that (in AUTO mode) is (typically) 4x a single bit time and less than the interframe time between different message packets. By eliminating the Chip Select line presence requirement, an additional oscilloscope channel is preserved for use with other analog signals. This is a significant feature. It also allows a user to trigger on simplified SPI (SSPI, SIOP, etc.) protocols with a single Master and Slave and no Chip Select line.

**Note:** Ask your local LeCroy representative for more information about any Serial Data Debug Solution Protocols or Toolkits using the **Contact LeCroy for Support** (on page 199) topic.

### **SPIbus Decode Setup Detail**

For general information about using controls shown on the main Serial Decode dialog, refer to **Accessing The D and TD Supported Protocol Toolsets** (on page 13).

#### **SPIBUS SPI AND LEVELS RIGHT-HAND DIALOGS**

Access the **Serial Decode** dialog by touching **Analysis** → **Serial Decode** on the menu bar.

Touch the corresponding **Setup...** button for your decode. The **Decode Setup...** along with corresponding right-hand dialogs are shown.

#### **SPIbus SPI Right-Hand Dialog**

The **SPI** right-hand dialog provides detailed controls and setup conditions as follows:

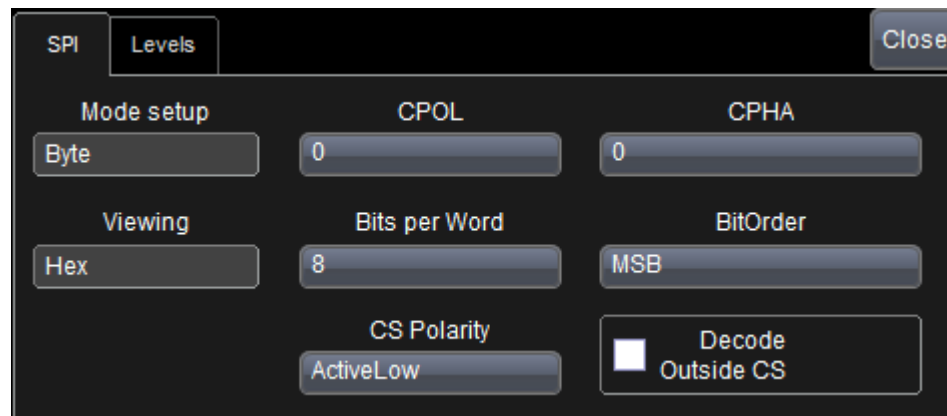

**Note:** A similar dialog is shown when SSPI or SIOP are selected; however, these protocols do not use a Chip Select, so the Chip Select selections are omitted.

- **Mode setup** - Configure your decode setup relative to **Byte** or **Frame** using this control.
- **Viewing** - Select to view the protocol data in **Binary**, **Hexadecimal**, **ASCII**, or **Decimal** modes.

**Note:** If the trigger is set up first, the trigger settings copy into the decode settings.

- **Clock Polarity** and **Phase** - SPI requires that selections be made for the clock polarity and phasing of the data to the clock. SPI microcontrollers and peripherals have settings for CPOL (Clock Polarity) and CPHA (Clock Phase) that are published in the technical datasheets for those products. These values need to be entered in this section.

**Note:** SPI Mode 0 = CPOL 0 and CPHA 0. SPI Mode 1 = CPOL 0 and CPHA 1. SPI Mode 2 = CPOL 1 and CPHA 0. SPI Mode 3 = CPOL 1 and CPHA 1.

## Serial Data Debug Solutions

- **Bits per Word and Bit Order** - Provide a number of bits per word and select either **MSB** or **LSB** bit order format, as appropriate.

**Note:** Identical selections for Clock Polarity, Clock Phase, and Data are located in the SPI trigger setup dialog. If you have a single SPI decoder set up, these settings are linked dynamically and copy over from the trigger setup, and vice versa. If you have multiple SPI decoders setup, these settings are also dynamically linked and copy over to the lowest numbered SPI Decoder from the trigger setup, and vice versa. This ensures that the decode address format matches trigger setup information.

- **CS Polarity and Decode Outside CS** - Set the Chip Select Polarity to either **Active Low** or **Active High**. Also, mark the **Decode Outside CS** checkbox if you want to decode all SPI bytes instead of those active during the Chip Select.

### SPIbus Levels Right-Hand Dialog

The **Levels** right-hand dialog provides detailed controls and setup conditions as follows:

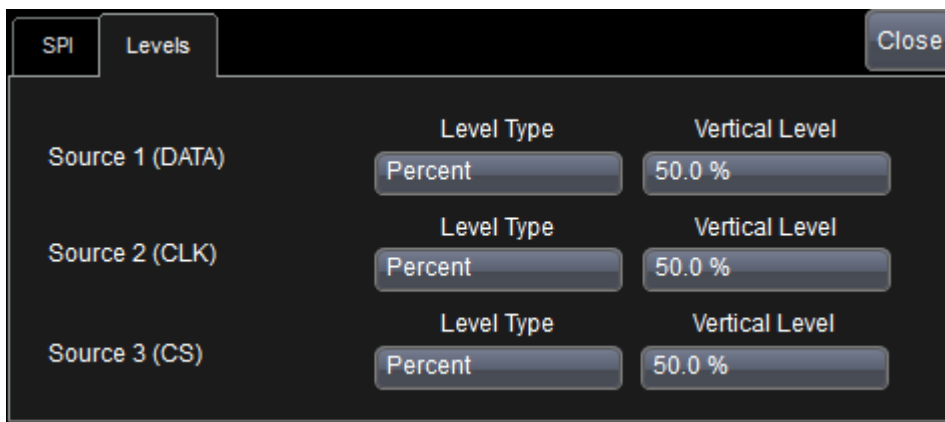

- **Level Type and Level** - The message decoding algorithm setup is performed here. The level is normally set up in %, and defaults to 50%. Adjust the level by touching inside the number area to highlight the box title, and then use the oscilloscope front panel **Adjust** knob to make your change. Alternatively, touch inside the number area twice and select a value using the pop-up numeric keypad.

#### PLEASE NOTE THE FOLLOWING:

- The set Level appears as a dotted horizontal line across the oscilloscope grid.
- If initial decoding indicates that there are a number of error frames, make sure that the level is set to a reasonable value.

### Creating a SPIbus Trigger Condition

The SPIbus Trigger dialog, with detail on some of the setup conditions, is shown in the following topics.

**Note:** Refer to **Using The D Supported Protocol Toolsets** (on page 14) to correctly access the Trigger Condition dialog specific to your desired protocol.



The SPIbus trigger dialog is very flat, meaning there are few dynamic changes to the dialog based on selections within. The one exception is the SPI Type on the far left. When selecting between SPI, SIOP, and SSPI types, the dialog to the right changes to reflect a specific setup type.

Select condition values by touching fields (using your finger, or use a mouse pointer). A pop-up is shown where you can choose from **Equal**, **Not Equal**, **Less than**, **Less than or Equal to**, **Greater than**, **Greater than or Equal to**, **In Range**, or **Out Range** condition values.

### ***SPIbus Trigger Setup Detail***

The following topic provides specific control settings for a SPIbus Trigger.



The previously numbered SPIbus trigger sections correspond with the following explanations.

#### **1. SPI TYPE SELECTION**

- Unlike some other serial data standards (such as I<sup>2</sup>C), SPI is not defined by a single standard; rather, there are several implementations of SPI based on fixed clock polarities, phase, and whether Chip Select is present or absent. The basic **SPI** Type is all-inclusive and the **SSPI** (Simplified SPI) and **SIOP** (Synchronous Serial I/O Port) types are just pre-selected settings in the basic SPI trigger and provided for operator convenience. SSPI and SIOP do not use a Chip Select line, but are single Master and single Slave implementations of SPI. The **DDR** button enables triggering on double data rate SPI signals where data is transmitted on both the rising and falling edge of the clock.

#### **2. SOURCE SETUP**

- **DATA** and **CLK (CLOCK)** - The pop-up dialog is used to select the appropriate channel or EXT inputs for each. Set these fields up with caution or your trigger may not function correctly.
- **CS (Chip Select)** and **Polarity** - These fields are enabled (SPI) or disabled (SSPI, SIOP) based on the SPI Type selected.

If enabled, choose a Channel or EXT, as appropriate, and make a Polarity selection.

- **Threshold (Trigger)** - Adjust the vertical level for the trigger. Much like an Edge trigger, a user must specify the level used in order to process the incoming signals and determine whether the desired serial data pattern is meeting the set trigger condition. This value is used for DATA, CLOCK, and Chip Select signals.

#### **3. SPI FORMAT SETUP**

- **Clock Polarity and Phase** - SPI requires selections made for the clock polarity and phasing of the data to the clock. SPI microcontrollers and peripherals have settings for CPOL (Clock Polarity) and CPHA (Clock Phase) that are published in the technical datasheets for those products. Selections are made based on the SPI Type chosen previously.

**Note:** When the basic SPI Type is chosen, you can make selections by clicking on the button containing the graphic that corresponds with your needs as follows:  
**SPI Mode 0 = CPOL 0 and CPHA 0. SPI Mode 1 = CPOL 0 and CPHA 1. SPI Mode 2 = CPOL 1 and CPHA 0.**  
**SPI Mode 3 = CPOL 1 and CPHA 1.**

- **Bit Order** - Select either MSB or LSB format, as appropriate.

## Serial Data Debug Solutions

### 4. SETUP FORMAT

Select either **Binary** or **Hexadecimal (Hex)** setup mode. The mode selected affects the format of the following **Data Pattern Equals** control.

### 5. DATA PATTERN SETUP

- **Data Value** - The pattern value is entered in either Binary or Hexadecimal mode depending on the previous Setup Mode selection. There are two selections for pattern value - **Data Value** and **Data Value To**. The second selection is exposed for entry if the Condition is set to INRANGE or OUT(of)RANGE. Otherwise, it is grayed out. Up to 12 bytes (96 bits) of data can be entered as a pattern value.
- **Condition** - The DATA condition can be set many different ways. Possible conditions include **Equal, Not Equal, Less than, Less than or Equal to, Greater than, Greater than or Equal to, In Range** or **Out Range**.
- **Data Bit Position** - Specify a specific location in a pattern to trigger on the data value.
- **Data Bit Length** - Specify the number of bits to trigger on, the value may be any number between 1 and 96.

### 6. INTERFRAME SETUP

InterFrame Setup is used to define the position of data in SPI packets. Data is sent in a burst of bits (usually forming words). Bits are separated by a constant time (and form words with a constant number of bits). Since packets can include several words and sometimes a signal is encoded over several words, it's important to establish a bit numbering scheme with a 0 point where counting begins.

Click the appropriate button to select **Auto** or **Manual** mode. The **Manual** mode enables the **InterFrame Time** field where you can provide a specific value. **Auto** mode sets the InterFrame time to four times the length of a bit.

This is valid with or without chip select; the chip select only marks which bits are considered for signal inclusion.

Using InterFrame Setup, you can determine how bits are counted in a packet by establishing when to start counting (which bit is numbered as 0) and when the counter is reset to 0 for the next packet.

#### InterFrame Time Explanation

When using **Manual** mode InterFrame Setup, you can determine when to start counting and when to reset using the **InterFrame Time** control. The time between each bit reading transition on the CLK signal is read. Inside a word, this time is equal to the length of a bit. At the end of a word, the time until the next transition can be bigger than a bit length. This specific time separation length defines how the bits are numbered; when the read InterFrame Time is **greater than the one you provided**, the bit counter is reset to 0 (as shown in the following image).

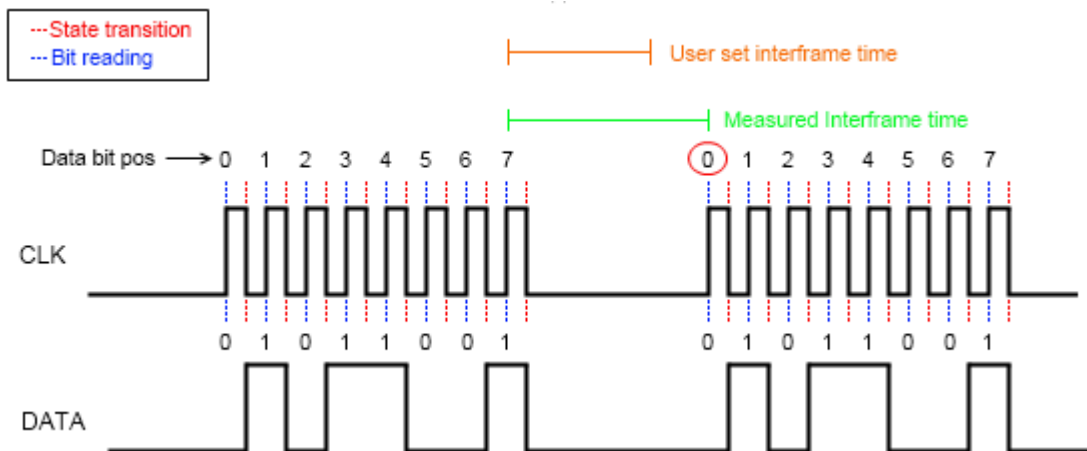

When the read InterFrame Time is **smaller than the one you provided**, subsequent bits are considered part of the same packet and continue to accrue sequentially.

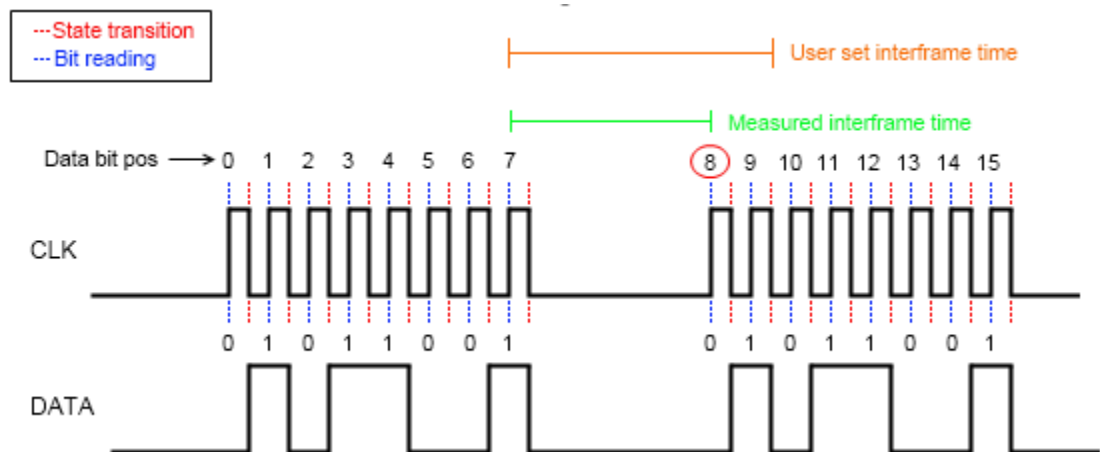

## Using the UART-RS232bus Options

### Using the UART-RS232bus Options Overview

Both UART-RS232bus D and TD options contain powerful software algorithms to extract serial data information from physical layer waveforms measured on your oscilloscope. The extracted information is overlaid (annotated) on the actual physical layer waveforms, and color-coded to provide fast, intuitive understanding.

The UART-RS232bus TD option allows triggering on both DATA conditions and Parity ERRORS. DATA triggering can be set conditionally to select a range of DATA values to trigger on, not just a single DATA value. Other powerful and user-friendly features included in UART-RS232bus TD trigger include:

- Ability to define the UART byte with 9-bit DATA, with the 9<sup>th</sup> DATA bit functioning as an alert bit with a value settable to 0, 1, or X.
- Ability to define as few as 5 bits of DATA in the UART byte.
- Polarity configurable to either IdleLow or IdleHigh.
- Decoding in **Binary**, **Hexadecimal (Hex)**, or **ASCII** formats.
- Triggering on up to 12 bytes of DATA in a data string up to 2048 bytes long.
- Ability to define the frame the UART byte messages into a single long message packet for purposes of triggering.
- Shortcut setup for RS-232 triggering and decoding.

If you are not familiar with or are just learning about UART or RS-232, start by using the simplest trigger conditions (single data byte, any position). Then, experiment with the Interframe Time Setup to “frame” the UART messages into message packets, and trigger on a specific byte value at a known location. Lastly, try triggering on multiple bytes conditionally (INRANGE, or GREATER THAN) in a known location.

**Note:** Ask your local LeCroy representative for more information about any Serial Data Debug Solution Protocols or Toolkits using the **Contact LeCroy for Support** (on page 199) topic.

### UART-RS232bus Decode Setup Detail

For general information about using controls shown on the main Serial Decode dialog, refer to **Accessing The D and TD Supported Protocol Toolsets** (on page 13).

### UART-RS232BUS BASIC AND LEVELS RIGHT-HAND DIALOGS

Access the **Serial Decode** dialog by touching **Analysis** → **Serial Decode** on the menu bar.

## Serial Data Debug Solutions

Touch the corresponding **Setup...** button for your decode. The **Decode Setup...** along with corresponding right-hand dialogs are shown.

### UARTbus Basic Right-Hand Dialog

The **Basic** right-hand dialog provides detailed controls and setup conditions as follows:

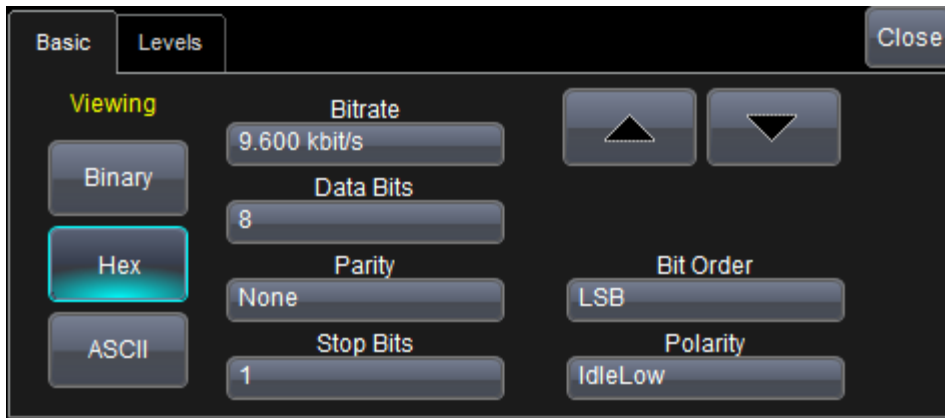

- **Viewing** - Select to view the protocol data in **Binary**, **Hexadecimal (Hex)**, or **ASCII** modes.

**Note:** If the trigger is set up first, the trigger settings copy into the decode settings.

- **Bitrate** - Adjust this bitrate value to match the one on the bus to which you are connected. This bit rate selection is dynamically linked to the decoding bitrate (they are always the same value). Use the arrows to move through standard bitrates (300 b/s, 1.2, 2.4, 4.8, 9.6, 19.2, 28.8, 38.4, 57.6, 76.8, 115.2, 230.4, 460.8, 921.6, kb/s, 1.3824 1.8432, 2.7648 Mb/s) and make a selection. Or, touch the number twice (with a finger, or using a mouse) and open the pop-up keypad to enter the value directly.
- **Data Bits** - Select the number of data bits per byte (not including the START, STOP, or PARITY bits). If you wish to decode on UART with a 9<sup>th</sup> DATA bit used as an **Alert** bit, select Data Bits = 9.
- **Parity** - Choose from **Odd**, **Even**, or **None** on the Parity control.
- **Stop Bits** - Choose **1**, **1.5**, or **2** Stop Bits on the control.
- **Bit Order** - Choose either **Most Significant Bit (MSB)** or **Least Significant Bit (LSB)** bit order on this selection box.

**Note:** For RS-232 decode, the selection defaults to LSB and cannot be changed.

- **Polarity** - Choose Polarity of the UART signal as either **IdleLow** (Data 1 = High) or **IdleHigh** (Data 1 = Low).

**Note:** For RS-232 decode, the selection defaults to IdleLow and cannot be changed.

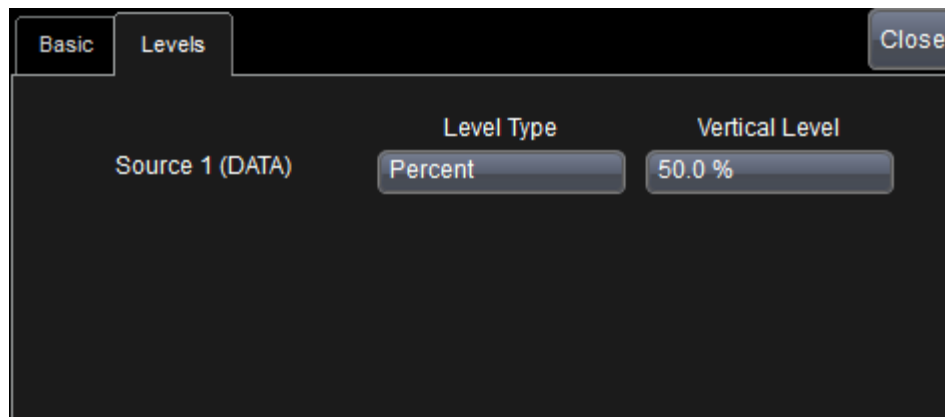

**UARTBUS LEVELS RIGHT-HAND DIALOG**

- **Source 1 (DATA) Level Type and Vertical Level** - The message decoding algorithm setup is performed here. The level is normally set up in %, and defaults to 50%. Adjust the level by touching inside the field and highlight the box title, then use the oscilloscope front panel **Adjust** knob to make the change. Alternatively, touch inside the field twice and select a value using the pop-up numeric keypad.

**Creating a UART-RS232bus Trigger Condition**

The UARTbus Trigger dialog, with detail on some of the setup conditions, is shown in the following topics.

**PLEASE NOTE THE FOLLOWING:**

- The RS-232 Trigger dialog is nearly the same, but contains less flexibility. Therefore, only the UART Trigger dialog is described here.
- Refer to **Using The D Supported Protocol Toolsets** (on page 14) to correctly access the Trigger Condition dialog specific to your desired protocol.



The Source and UARTbus Setup information must be defined. The datasheet for your part should contain the information you need to properly setup the UART Trigger.

Selection of Trigger Type results in dynamic changes to the UART Trigger dialog. Simple Parity ERROR triggering requires no additional setup, while DATA triggers require defining of the Data Pattern, selection of Condition, etc. Also, if you are looking for the exact Position of DATA, then the Interframe Time must be defined.

Select condition values by touching fields (using your finger, or use a mouse pointer). A pop-up is shown where you can choose from **Equal**, **Not Equal**, **Less than**, **Less than or Equal to**, **Greater than**, **Greater than or Equal to**, **In Range**, or **Out Range** condition values.

## Serial Data Debug Solutions

### UART-RS232bus Trigger Setup Detail

The following topic provides specific control settings for a UARTbus Trigger (again, since they're almost identical, but UART contains a bit more detail than RS-232).

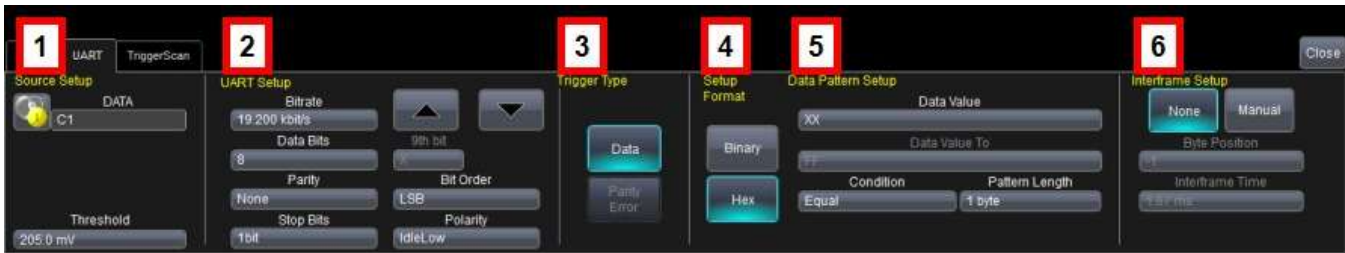

The previously numbered UARTbus trigger sections correspond with the following explanations.

#### 1. SOURCES SETUP

- **DATA** - The pop-up dialog is used to select the appropriate channel or EXT inputs for each. Set these fields up with caution or your trigger may not function correctly.
- **Threshold (Trigger)** - Adjust the vertical level for the trigger. Much like an Edge trigger, you must specify the level used to process the incoming signals and determine whether the desired serial data pattern is meeting the set trigger condition.

#### 2. UART SETUP

- **Bitrate** - Use the Baudrate field to adjust the value and match the bus to which you are connected. This bitrate selection is dynamically linked to the decoding bitrate (they are always the same value). Use the arrows to move through standard bit rates (300 b/s, 1.2, 2.4, 4.8, 9.6, 19.2, 28.8, 38.4, 57.6, 76.8, 115.2, 230.4, 460.8, 921.6, kb/s, 1.3824 1.8432, 2.7648 Mb/s) and make a selection. Or, touch the number twice (with a finger, or using a mouse) and open a pop-up keypad and enter the value directly, anywhere between 30 b/s and 500 Mb/s.
- **Data Bits** - Select the number of data bits per byte (not including the START, STOP, or PARITY bits). Trigger on UART with a 9<sup>th</sup> DATA bit used as an **Alert** bit by entering Data Bits = 9, and then define the 9<sup>th</sup> Alert bit as a 0, 1, or X (don't care) as needed.
- **Parity** - Choose from **Odd**, **Even**, or **None** in the Parity field. Only when Odd or Even values are made in this field is the **Parity Error** Trigger Type enabled.
- **Stop Bits** - Choose **1**, **1.5**, or **2** Stop Bits in this field.
- **Bit Order** - Choose either **Most Significant Bit (MSB)** or **Least Significant Bit (LSB)** bit order in this field.

**Note:** This field defaults to LSB and cannot be changed on an RS-232 trigger.

- **Polarity** - Choose the Polarity of the UART signal as either **IdleLow** (Data 1 = High) or **IdleHigh** (Data 1 = Low).

**Note:** This field defaults to IdleLow and cannot be changed on an RS-232 trigger.

#### 3. TRIGGER TYPE

The Data button is selected by default unless **Odd** or **Even Parity** is selected on the **Parity** field. Then, the **Parity Error** Trigger Type button is enabled for use.

#### 4. SETUP FORMAT

Select either **Binary** or **Hexadecimal (Hex)** setup mode. The mode selected affects the format of the following **Data Value** and **Data Value To** fields.

## 5. DATA PATTERN SETUP

- **Data Value** - Provide an appropriate value based on your Binary or Hexadecimal format selection.
- **Data Value To** - Specify a size in bits for your pattern.
- **Condition** - Possible entries for this field include **Equal**, **Not Equal**, **Less than**, **Less than or Equal to**, **Greater than**, **Greater than or Equal to**, **In Range**, or **Out Range**.
- **Pattern Length** - The pattern length value defaults to the length, in bytes, of the pattern set in the Data Value selection. If the length is changed to a lesser value, it truncates the beginning of the value. If the length is increased, it would add don't care XX byte values to the beginning of the value.

## 6. INTERFRAME SETUP

Click the appropriate button to select **None** or **Manual**. The **Manual** button enables the **Byte Position** and **Interframe Time** fields where you can provide specific values.

# Automotive and Industrial Protocols

## Automotive and Industrial Protocols Overview

### CAN

[CAN](#) is a vehicle bus designed specifically for automotive applications, but it is now found in other applications as well.

The CAN specification is maintained by the International Organization for Standards (ISO). The relevant documents are **ISO11519** and **ISO11898** and can be obtained at [www.iso.org/iso/home.htm](http://www.iso.org/iso/home.htm).

Number of Lines	Data rate	Synchronous or Asynchronous
1 (differential)	Up to 1 Mb/s	Asynchronous

### LIN

[LIN](#) is a low cost master/slave system designed for low cost implementation in vehicles, typically in what is commonly referred to as body electronics.

The LIN specification is published by the LIN Consortium and can be obtained at [www.lin-subbus.de](http://www.lin-subbus.de).

Number of Lines	Data rate	Synchronous or Asynchronous
1	Up to 19.2 kb/s	Asynchronous

### FlexRay

[FlexRay](#) is a time-triggered automotive communications bus designed for higher speeds and fault tolerance.

The FlexRay specification is published by the FlexRay Consortium. Separate specifications exist for the physical layer and data link layer. Both can be obtained at [www.flexray.com](http://www.flexray.com).

Number of Lines	Data rate	Synchronous or Asynchronous
1 (differential)	2.5, 5 or 10 Mb/s	Asynchronous

## Using the CANbus Option

### Using the CANbus Option Overview

#### CANbus TD (Trigger and Decode)

The CANbus TD option contains powerful software algorithms to extract serial data information from physical layer waveforms measured on your oscilloscope. The extracted information is overlaid (annotated) on the actual physical layer waveforms, and color-coded to provide fast, intuitive understanding. This option includes **GM CAN/LAN**, **CAN H-L**, and **GM CAN H-L**. You may notice these items available on some controls.

The CANbus TD option allows triggering on CAN Frames and Errors. Frame triggering can be set to trigger on any frame, one specific Frame ID, a range of Frame IDs, Remote Frames and Errors. Frame triggering and data triggering can be done for a single ID or message or a range of IDs and data by using the conditional trigger capabilities. Other powerful and user-friendly features included in CANbus TD include:

- The ability to trigger and decode CAN at bit rates from 10 kb/s to 1 Mb/s.
- The ability to create powerful, conditional Frame ID and Data triggers.
- Triggering on CAN protocol errors and remote frames.

If you are unfamiliar or are just learning about CAN, start by using the simplest trigger conditions (All Frames or Frame ID). Next, experiment with an ID and Data to trigger on a specific value. Then, try a conditional ID + Data trigger (ID Greater Than or In Range).

**PLEASE NOTE THE FOLLOWING:**

- The CANbus option also provides Measure tools. Measure is a legacy toolset specifically designed for the CANbus TDM package. Measurement applications have been improved and made part of the PROTObus MAG toolset. However, the CANbus TDM option is handled and covered in a manner differently than PROTObus MAG. The difference are explained at the end of this section in **PROTObus MAG and CANbus TDM Toolset Differences** (on page 72).
- Ask your local LeCroy representative for more information about any Serial Data Debug Solution Protocols or Toolkits using the **Contact LeCroy for Support** (on page 199) topic.

**CANbus Decode Setup Detail**

For general information about using controls shown on the main Serial Decode dialog, refer to **Accessing The D and TD Supported Protocol Toolsets** (on page 13).

**CANBUS BASIC RIGHT-HAND DIALOG**

Access the **Serial Decode** dialog by touching **Analysis** → **Serial Decode** on the menu bar.

Touch the corresponding **Setup...** button for your decode. The **Decode Setup...** along with a corresponding right-hand dialog is shown.

**CANbus Basic Right-Hand Dialog**

The **Basic** right-hand dialog provides detailed controls and setup conditions as follows:

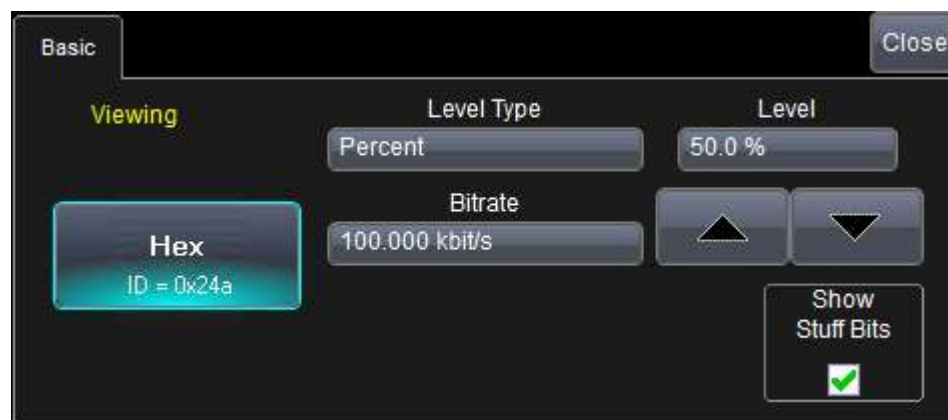

- **Viewing** - The decode format is displayed here as Hexadecimal for CANbus.
- **Bitrate** - Adjust the bit rate value here to match the bit rate on the bus you are connected to. This bit rate selection is dynamically linked to the decoding bit rate (they are always the same value). Use the arrows to move through standard bit rates (10, 25, 33.333, 50, 83.333, 100, 125, 250, 500, and 1000 kb/s) and make a selection. Or, touch the number twice (with a finger, or using a mouse) and open the pop-up keypad to enter the value directly. Any value from 10-1000 kb/s may be entered in this way.
- **Show Stuff Bits** - Mark this checkbox to indicate whether you want stuff bits highlighted on each CAN message frame.
- **Level Type and Level** - The message decoding algorithm setup is performed here. The level is normally set up in %, and defaults to 50%. To adjust the level, touch inside the number area (highlighting the box title), and then use the oscilloscope front panel Adjust knob to adjust. Or touch inside the number area twice and select a value using the pop-up numeric keypad.

The set Level appears as a dotted horizontal line across the oscilloscope grid.

If your initial decoding indicates that there are a number of error frames, make sure that the level is set to a reasonable value.

## Serial Data Debug Solutions

### Creating a CANbus Trigger Condition

The CANbus Trigger dialog, with detail on some of the setup conditions, is shown in the following topics.

**Note:** Refer to **Using The D Supported Protocol Toolsets** (on page 14) to correctly access the Trigger Condition dialog specific to your desired protocol.



### CANbus Trigger Setup Detail

The following topic provides specific control settings for a CANbus Trigger.



The previously numbered CANbus trigger sections correspond with the following explanations.

#### 1. SOURCE SETUP

- **DATA** - The **DATA** field's pop-up dialog is used to select the appropriate channel or EXT input for each. Set this field up with caution or your trigger may not function correctly. Use the **Threshold** field to adjust the vertical level for the trigger. Much like an Edge trigger, a user must specify the level used in order to process the incoming signals and determine whether the desired serial data pattern is meeting the set trigger condition.

#### 2. CAN SETUP

- **Bitrate** - Use the Bitrate field to adjust the value and match the bus to which you are connected. This bitrate selection is dynamically linked to the decoding bitrate (they are always the same value). Use the arrows to move through standard bit rates (10, 25, 33.333, 50, 83.333, 100, 125, 250, 500, and 1000 kb/s) and make a selection. Or, touch the number twice (with a finger, or using a mouse) and open a pop-up keypad and enter the value directly.

#### 3. TRIGGER TYPE

**Trigger Type** - Depending on your Trigger Type selection, certain Frame ID and Data Pattern Setup fields are enabled or disabled as follows:



- **All** - Triggers on all signals. No Frame ID and Data Pattern ID Setup fields are enabled.

- **Remote** - Only Frame ID Setup fields are enabled.
- **Data** - Both Frame ID and Data Pattern ID Setup fields are enabled.
- **Error** - Triggers only when an error signal occurs. No Frame ID and Data Pattern ID Setup fields are enabled.

#### 4. SETUP FORMAT

Select either **Binary** or **Hexadecimal (Hex)** setup mode. The mode selected propagates through the entire CANbus trigger setup.

Try selecting Binary mode, and set up the Frame ID in binary format, then re-select HEX mode and set up the data in hexadecimal format. Toggling back and forth between the modes does not result in loss of information.

#### 5. FRAME ID SETUP

Frame ID Setup is used to trigger on a specific Frame ID value with either 11 or 29 Bits.

When CANbus trigger selections are either Remote or Data, use the Frame ID Setup fields as follows:

- **ID Condition** - The ID condition can be set to many different values. If the ID condition is set to **Equal**, then a data definition can also be set. Any other ID condition precludes setting up a Data condition. The ID condition can be set to **Equal, Not Equal, Less than, Less than or Equal to, Greater than, Greater than or Equal to, In Range, Out Range, or Don't Care**. a range, out of a range, or don't care.
- **ID Bits** - The trigger can be set to trigger on CAN messages with either 11-bits (Standard CAN) or 29-bits (Extended CAN). You can also set the trigger so that it triggers on a message that meets a condition for either the 11-bit or 29-bit ID. For instance, there might be an 11-bit ID value that is present in both an 11-bit and a 29-bit ID, and by choosing ALL, you could trigger when that ID is present on either of those messages.
- **Frame ID** - Specify the desired frame ID for triggering here.
- **To Frame ID** - When using an in range or out of range ID Condition (previous), specify a To Frame ID value for triggering.

#### 6. DATA PATTERN SETUP

Fields on this section of the dialog are only enabled when using the Data trigger type.

- **Data Condition** - The Data Condition can be set to many different values. The Data condition can be set to **Equal, Not Equal, Less than, Less than or Equal to, Greater than, Greater than or Equal to, In Range, or Out Range**.
- **DLC** - The DLC (data length code) can be set to any integer value from 0 to 8. It should match the DLC of the CAN message you want to trigger on. If you set it to a value less than 0, it defaults to 0. If you set it to a value greater than 8, it defaults to 8.
- **Byte Order** - Choose from either Motorola (default) or Intel byte orders.
- **Start Bit and # Data Bits** - The CANbus trigger allows you to trigger on up to 64 contiguous data bits (8 data bytes). This maximum 64-bit string can start at any location in the CAN message data field - it is not limited to the start of a full byte or a nibble.

The Start Bit can be any value from 0 to 63. If you enter a value less than 0, it defaults to 0. If you enter a value more than 63, it defaults to 63. The Start Bit value is always in LSB format (i.e., the bit number as shown on the decoded waveform, with bit 0 being at the far left and bit 63 being at the far right of the data string). Remember that the 1st data byte is bits 0-7, the 2nd data byte is bits 8-15, etc. Also, make sure that your Start Bit value makes sense in relation to the DLC Value. For instance, a Start Bit value of 32 with a DLC Value of 4 is not going to result in a successful trigger.

## Serial Data Debug Solutions

---

The # Bits can be any value from 1 to 64. If you enter a value less than 1, it defaults to 1. If you enter a value more than 64, it defaults to 64.

- **Sign Type** - Choose between signed and unsigned integer format.
- **Data Value** and **Data Value To** - The Data Value is set in Binary or Hexadecimal format. For Hexadecimal, if desired, you can precede the ID value with **0x**, but this is not necessary. Be sure to enter a Data Value that matches the DLC Value.

When using an in range or out of range Data Condition (previous), specify a **Data Value To** value for triggering.

### ***PROTObus MAG and CANbus TDM Toolset Differences***

**PROTObus MAG** and **CANbus TDM** both provide powerful tools for your specific protocol measurement uses. These tools allow you to quickly and easily accumulate statistical information on a wide variety of events while using the graphical display tools to visualize the data on your oscilloscope screen. These sophisticated measurement and graphical display tools are the missing link between standard oscilloscope and protocol analyzer capability. **PROTObus MAG** and **CANbus TDM** tools provide the capability to trigger on defined events, observe actions/reactions, measure timing among MSG or CAN and Analog signals while viewing results directly on the display, all with no complicated data exporting. Data on tens of thousands of events can be automatically and quickly gathered and analyzed in a fraction of the time it takes to manually perform the same testing.

However, there are a few differences between the two products as follows:

#### ***PROTOBUS MAG ADVANTAGES***

- PROTObus MAG provides **Gating** controls over your measurements.
- PROTObus MAG provides **Holdoff (event)** controls over your measurements as they apply to **MSG-MSG**, **MSG-Analog**, and **Analog-MSG**.
- PROTObus MAG provides a **Message to Value measurement parameter** allowing you to apply your own symbolic lookup file.

#### **PLEASE NOTE THE FOLLOWING:**

- The Message to Value parameter only interprets Intel Format (not Motorola as CANbus TDM does).
- PROTObus MAG does not accept .dbc lookup files.

#### ***CANBUS TDM ADVANTAGES***

- CANbus TDM interprets Motorola format when using the **CAN2Value measurement parameter** and applying your own symbolic lookup file.
- CANbus TDM **accepts .dbc lookup files**.
- CANbus TDM provides **FRAME Type support**.

Measurement parameter tools for **PROTObus MAG** and **CANbus TDM** provide similar functionality, but currently have different names for each respective parameter set. **PROTObus MAG** parameters are more generically named as covered in **Accessing and Using The PROTObus MAG Supported Protocol Toolset** (on page 23), while **CANbus TDM** parameters have CAN-specific names as follows:

- **Measure Timing  $\Delta$  Between CAN and Analog Signals and Accumulate Statistics** - Measure the time difference between an analog signal and CAN signal generated in response to it (or vice-versa). View the mean, minimum, and maximum timing values, the number of samples, and the standard deviation of the measurements.
- **Measure Timing  $\Delta$  Between Two CAN Messages and Accumulate Statistics** - Same as previous, but with two CAN signals.
- **Measure Timing  $\Delta$  From the Trigger Point to a CAN Message** - Same as previous, but the trigger point can be anything - a CAN message, an Analog signal, a Pattern of signals, a Dropout condition, etc.



- **Measure Timing, Accumulate Statistics, View Distribution** - Instead of just looking at numerical values, graph/plot the distribution as a histogram to better understand the shape of the distribution, the quantity of extreme events, and determine underlying cause.
- **Graph/Plot CAN Data Values from a Single Acquisition** - Extract CAN Data values in decimal format and compare them to an analog signal in a time-correlated fashion.
- **Graph/Plot CAN Data Values Over Multiple Acquisitions** - Extract CAN Data values in decimal format and graph/plot them over multiple acquisitions.
- **Measure CANbus Load, Graph/Plot** - Understand how bus loading relates to other CAN and Analog signal events.

Some of this information could be gathered using standard oscilloscope tools, but the accumulation of the data would take hours or days. It is more likely the engineer would instead gather a small sample set and skip the statistical evaluation to save time. The result is reduced product quality and corresponding greater risk of shipping products functioning incorrectly in some situations.

CANbus TDM contains additional CAN specific measurement, graphing, and statistical analysis capability. The following topics explain them in a bit more detail.

## Using the LINbus Option

### *Using the LINbus Option Overview*

Both LINbus D and TD options contain powerful software algorithms to extract serial data information from physical layer waveforms measured on your oscilloscope. The extracted information is overlaid (annotated) on the actual physical layer waveforms, and color-coded to provide fast, intuitive understanding.

The LINbus TD option allows triggering on both Sync Breaks (Start of Frame), Frame ID, Frame ID+DATA, and some ERROR condition. Set DATA triggering conditionally and select a range of DATA values (instead of a single DATA value) on which to trigger. Other powerful and user-friendly features of the LINbus TD trigger include:

- Ability to trigger and decode LIN Version 1.3, 2.x, and SAE J2602 formats, even when LINbus traffic contains mixed versions.
- Ability to decode LINbus in either **Binary** or **Hexadecimal (Hex)** formats.
- Triggering on Checksum, Header Parity, and Sync Byte Errors

If you are not unfamiliar with or are just learning about LIN, start by using the simplest trigger conditions (Break, or Frame ID). Then, experiment with an ID+DATA condition with DATA Equal to a specific value. Then, try a conditional ID+DATA trigger (DATA set to Greater Than or In Range).

**Note:** Ask your local LeCroy representative for more information about any Serial Data Debug Solution Protocols or Toolkits using the **Contact LeCroy for Support** (on page 199) topic.

### *LINbus Decode Right-Hand Dialog*

For general information about using controls shown on the main Serial Decode dialog, refer to **Accessing The D and TD Supported Protocol Toolsets** (on page 13).

#### *LINBUS BASIC RIGHT-HAND DIALOG*

Access the **Serial Decode** dialog by touching **Analysis** → **Serial Decode** on the menu bar.

Touch the corresponding **Setup...** button for your decode. The **Decode Setup...** along with a corresponding right-hand dialog is shown.

## Serial Data Debug Solutions

### LINbus Basic Right-Hand Dialog

The **Basic** right-hand dialog provides detailed controls and setup conditions as follows:



- **Viewing** - Select to view the protocol data in either **Binary** or **Hexadecimal (Hex)** formats.

**Note:** If the trigger is set up first, the setup format (Binary or Hex) made from the trigger dialog is displayed here.

- **Level Type** and **Level** - The message decoding algorithm setup is performed here. The level is normally set up in %, and defaults to 50%. Adjust the level by touching inside the field to highlight the box title, then use the oscilloscope front panel **Adjust** knob to make the change. Alternatively, touch inside the number area twice and select a value using the pop-up keypad.

#### PLEASE NOTE THE FOLLOWING:

- The set Level appears as a dotted horizontal line across the oscilloscope grid.
- If your initial decode indicates there are a number of error frames, verify your level is set to a reasonable value.
- **Bitrate** - Adjust this bitrate value to match the one on the bus to which you are connected. This bit rate selection is dynamically linked to the decoding bitrate (they are always the same value). Use the arrows to move through standard bit rates (1.2, 2.4, 4.8, 9.6, 10.417, or 19.2 kb/s) and make a selection. Or, touch the number twice (with a finger, or using a mouse) and open a pop-up keypad and enter the value directly. Any value from 1-20 kb/s may be entered this way.

### Creating a LINbus Trigger Condition

The following trigger setup detail topics show the dialog selections for a LINbus Trigger with detail on some of the setup conditions.

**Note:** Refer to **Using The D Supported Protocol Toolsets** (on page 14) to correctly access the Trigger Condition dialog specific to your desired protocol.



The Source Setup information must be defined. The datasheet for your part should contain the information you need to properly setup the LINbus Trigger.

Previous Trigger Type selections result in dynamic changes to the LINbus Trigger dialog.

Select condition values by touching fields (using your finger, or use a mouse pointer). A pop-up is shown where you can choose from **Equal**, **Not Equal**, **Less than**, **Less than or Equal to**, **Greater than**, **Greater than or Equal to**, **In Range**, or **Out Range** condition values.

### LINbus Trigger Setup Detail

The following topic provides specific control settings for a LINbus Trigger.



The previously numbered LINbus trigger sections correspond with the following explanations.

#### 1. SOURCES SETUP

- **DATA** - The pop-up dialog is used to select the appropriate channel or EXT input for each. Set this field up with caution or your trigger may not function correctly.
- **Threshold (Trigger)** - Adjust the vertical level for the trigger. Much like an Edge trigger, a user must specify the level used in order to process the incoming signals and determine whether the desired serial data pattern is meeting the set trigger condition.

#### 2. LIN SETUP

- **Bitrate** - The LIN trigger can be configured to trigger on LIN busses at several different bitrates including **1.2 kb/s, 2.4 kb/s, 4.8 kb/s, 9.6 kb/s, 10.417 kb/s, and 19.2 kb/s.**

#### 3. TRIGGER TYPE

The LIN trigger can be configured to trigger on simple Start of Frame (Break) conditions, ID only, or complete ID+DATA conditions with DATA conditions other than equals. Some Error Frame triggering is also supported.

Choose a desired Trigger Type and the trigger dialog changes based on the selection made.

For example, the following trigger selections disable or enable fields on the **Setup Format, Frame ID Setup, Data Pattern Setup, and Checksum Error Setup...** (Checksum error only for Error trigger type) sections of the trigger dialog:

- **Break** - When selected, the Setup Format, Frame ID Setup, and Data Pattern Setup fields are disabled.
- **Frame ID** - When selected, Setup Format and Frame ID Setup fields are enabled, and the Data Pattern Setup fields are disabled.
- **ID + Data** - When selected, Setup Format, Frame ID Setup, and the Data Pattern Setup fields are enabled.
- **Error** - When selected, Setup Format fields are enabled and the Frame ID Setup fields are disabled. The Pattern Setup fields (step 6a, as follows) aren't shown (and are therefore disabled). Instead, the Checksum Error Setup fields (step 6b, as follows) are shown and enabled.

## Serial Data Debug Solutions

---

### 4. SETUP FORMAT

With the Frame ID, ID + Data, or Error trigger types chosen, select either the **Binary** or **Hexadecimal (Hex)** setup format. The format propagates through the entire LIN trigger setup.

Toggling back and forth between the formats does not result in lost information (binary is used internally as the core format for all triggering and decoding operations), though use of don't care bits in a binary setup results in the display of an X (for a full nibble don't care) or a \$ (for a partial nibble don't care).

### 5. FRAME ID SETUP

Frame ID Setup is used to trigger on a specific Frame ID value with either 11 or 29 Bits.

When LINbus trigger selections are either Frame ID or ID + Data, use the Frame ID Setup fields as follows:

- **ID Condition** - Select from **Equal**, **Not Equal**, **Less than**, **Less than or Equal to**, **Greater than**, **Greater than or Equal to**, **In Range**, or **Out Range** conditions available.
- **Frame ID** - Provide a value in either **Binary** or **Hexadecimal** mode based on the Setup Format selection made in the previous step.
- **To Frame ID** - If the Frame ID condition (previous) is In Range of or Out of Range, provide a value here to specify the full ID trigger range.

**Note:** If the Frame ID is equal to 3C or 3D, the **# Data Bytes** field in the following Data Pattern Setup step defaults to 8.

### ID + DATA TRIGGER SETUP DETAIL

#### 6a. Data Pattern Setup

When the LINbus trigger selection is **ID + Data**, use the Data Pattern Setup fields as follows:

- **Data Value** - Provide a value in either **Binary** or **Hexadecimal** mode based on the selection made in the previous Setup Format step.
- **Data Value To** - This field is only enabled when the following **Condition** field contains an **In Range of** or **Out of Range** value.

#### PLEASE NOTE THE FOLLOWING:

- Up to 8 bytes of data can be entered as a pattern value.
- If less than 8 bytes of data is entered for the pattern value, the data is assumed to begin at Data Byte 1 in the LIN message. If this is not desired, then add preceding or trailing don't care (X) nibbles to the pattern value.
- In Hexadecimal format, data must be entered as full bytes even though the minimum required acceptable entry is a nibble. If less than a full byte is entered, then a don't care X precedes the pattern values entered.
- **Condition** - Select from **Equal**, **Not Equal**, **Less than**, **Less than or Equal to**, **Greater than**, **Greater than or Equal to**, **In Range**, or **Out Range** conditions available.
- **# Data Bytes** - This field value defaults to the length, in bytes, of the pattern set in the Pattern Value selection. If you were to change the length to be less than this value, it would truncate the beginning of the pattern value. If you were to increase the pattern length, it would add don't care XX byte values to the beginning of the pattern value. The maximum number of data bytes is 8, per the LIN standard.

**ERROR TRIGGER SETUP DETAIL****6b. Checksum Error Setup**

When the LINbus trigger selection is **Error**, use the Checksum Error Setup fields as follows:

- **Error Frame ID** - Provide a value in either **Binary** or **Hexadecimal** mode based on the selection made in the previous Setup Format step.
- Use the **Checksum Error**, **Header Parity**, and **Sync Byte** checkboxes to include or exclude the specific Error Frame Trigger's trigger type.

**Note:** When the Checksum Error checkbox is selected, the **LIN Spec.** and **# Data Bytes** fields are enabled.

- **LIN Spec.** - Select a LINbus specification from the available choices.
- **# Data Bytes** - Provide a value using the pop-up keypad.

**Note:** The value entered in this field is dynamically copied to the Data Pattern Setup entry for # Data Bytes (ID + Data Trigger Type selection).

## Using the FlexRaybus Option

### Using the FlexRaybus Option Overview

Both FlexRaybus D and TD options contain powerful software algorithms to extract serial data information from physical layer waveforms measured on your oscilloscope. The extracted information is overlaid (annotated) on the actual physical layer waveforms, and color-coded to provide fast, intuitive understanding. This is especially helpful for FlexRay, an emerging standard that many engineers are just starting to use.

The FlexRaybus TD option allows triggering on TSS (Start), Frame, Symbol or Errors. Conditionally set frame triggers to select a range of Frame ID values on which to trigger, instead of just a single ID. Other powerful and user-friendly features included in FlexRaybus trigger include:

- Ability to trigger and decode FlexRay protocol version 2.1 at 10 Mb/s, 5 Mb/s or 2.5 Mb/s.
- Ability to create powerful Frame triggers including Cycle Count and Frame Qualifiers.
- Triggering on FSS, BSS, FES, Header CRC and Payload CRC errors as well as CID, CAS/MTS and Wakeup Patter Symbols.

If you are unfamiliar with or are just learning about FlexRay, start by using the simplest trigger conditions (TSS, or Frame ID). Next, experiment with an ID + Count Equal to a specific value. Finally, try a conditional ID + Cycle Count trigger (ID Greater Than or In Range).

#### PLEASE NOTE THE FOLLOWING:

- The FlexRaybus option also provides **Physical Layer** tools. See **FlexRaybus Physical Layer Measurement Parameters** (on page 86) or **Physical Layer Eye Diagram** (on page 32) for more information.

## Serial Data Debug Solutions

- Ask your local LeCroy representative for more information about any Serial Data Debug Solution Protocols or Toolkits using the **Contact LeCroy for Support** (on page 199) topic.

### *FlexRaybus Decode Setup Detail*

For general information about using controls shown on the main Serial Decode dialog, refer to **Accessing The D and TD Supported Protocol Toolsets** (on page 13).

#### *FLEXRAYBUS BASIC AND LEVELS RIGHT-HAND DIALOGS*

Access the **Serial Decode** dialog by touching **Analysis** → **Serial Decode** on the menu bar.

Touch the corresponding **Setup...** button for your decode. The **Decode Setup...** along with corresponding right-hand dialogs are shown.

#### **FlexRaybus Basic Right-Hand Dialog**

The **Basic** right-hand dialog provides detailed controls and setup conditions as follows:



- **Bitrate** - Adjust this bitrate value to match the one on the bus to which you are connected. This bit rate selection is dynamically linked to the decoding bitrate (they are always the same value). Use the arrows to move through standard bitrates (2.5, 5.0 or 10.0 Mb/s) and make a selection. Or, touch the number twice (with a finger, or using a mouse) and open the pop-up keypad to enter the value directly.
- **Channel** - Select the appropriate channel for decoding (based on whether it's coming from Channel A or Channel B of the FlexRay bus). The channel selection drives the CRC computation.

**Note:** Decode still works when the wrong channel is selected. It results in CRC errors being shown on the decode. Fix it by switching the channel selection.

#### **FlexRaybus Levels Right-Hand Dialog**

The **Levels** right-hand dialog provides detailed controls and setup conditions as follows:

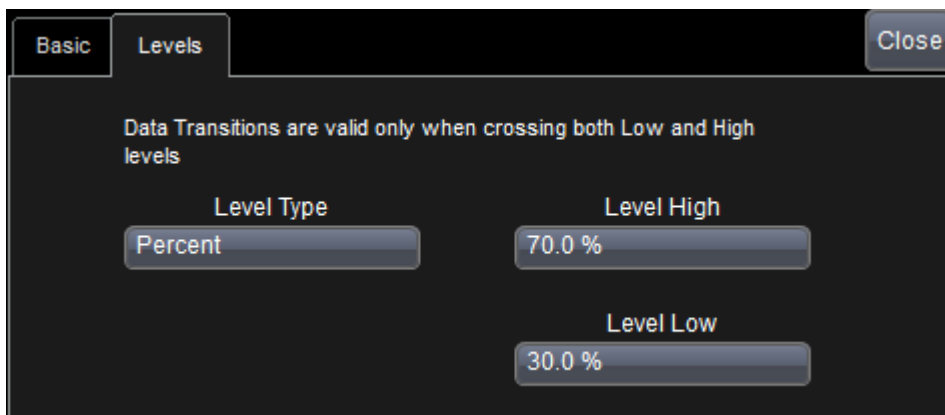

The message decoding algorithm setup is based the control values provided on this dialog. FlexRay is a tri-level signal and requires 2 levels for the oscilloscope to distinguish between 1 and 0. As indicated on the dialog, Data Transitions are valid only when crossing both Low and High levels.

- The **Level Type** is normally set up as Percent, and defaults to 70% and 30% **Level High** and **Low** values, respectively.  
Selecting the **Absolute** Level Type allows entry of voltage levels (on the Level High and Low fields) instead of percentages.
- Change the **Level High** and **Low** values by selecting the field (so it's highlighted) and using the oscilloscope front panel **Adjust** knob to provide a new amount. Alternatively, select the field twice and provide a value using the pop-up keypad.
- Change **Level High** and **Low** values by selecting the field (so it's highlighted) and using the oscilloscope front panel **Adjust** knob to provide a new amount. Alternatively, select the field twice and provide a value using the pop-up keypad.

The Level set is then shown as a dotted horizontal line on the oscilloscope grid.

**Note:** If your initial decoding indicates a number of error frames, ensure your level is set to a reasonable value.

### Creating a FlexRaybus Trigger Condition

The following trigger setup detail topics show the dialog selections for a FlexRaybus Trigger with detail on some of the setup conditions.

**Note:** Refer to the **Accessing The D and TD Supported Protocol Toolsets** (on page 13) topic to correctly access the Trigger Condition dialog specific to your desired protocol.



The Source Setup information must be defined. The datasheet for your part should contain the information you need to properly setup the FlexRay Trigger.

Selection of Trigger Type results in dynamic changes to the FlexRay Trigger dialog.

Select condition values by touching fields (using your finger, or use a mouse pointer). A pop-up is shown where you can choose from **Equal**, **Not Equal**, **Less than**, **Less than or Equal to**, **Greater than**, **Greater than or Equal to**, **In Range**, or **Out Range** condition values.

# Serial Data Debug Solutions

## FlexRaybus Trigger Setup Detail

The following topic provides specific control settings for a FlexRaybus Trigger.



All Trigger Setups use **Source Setup**, **FlexRay Setup**, and **Trigger Type** fields.

Other fields vary based on the Trigger Type Selections as follows:

- **TSS (Start)** and **Frame Triggers** have [Setup Format](#) fields.
- **Frame Trigger** has [Setup Format](#), [Frame ID Setup](#), [Cycle Count](#), and [Frame Qualifier](#) fields.
- **Symbol Trigger** has [Trigger On](#) and [System Parameters](#) fields.
- **Errors Trigger** has [Protocol and CRC Errors](#) fields.

Previously numbered FlexRaybus trigger sections correspond with the following explanations.

### 1. SOURCES SETUP

- **DATA** - The pop-up dialog is used to select the appropriate channel or EXT input for each. Set this field up with caution or your trigger may not function correctly.
- **Threshold (Trigger)High, Low, and Find** - Adjust the vertical level thresholds for the trigger. FlexRay is a tri-level signal and requires 2 voltage threshold settings which enable the oscilloscope to distinguish between 1 and 0.

Like an Edge trigger, the level must be specified to process the incoming signals and determine if the desired serial data pattern meets the set trigger condition.

If desired, use the automated **Find Threshold** button to detect and set appropriate thresholds.

### 2. FLEXRAY SETUP

- **Bitrate** - The FlexRay trigger can be configured to trigger on FlexRay signals at 2.5 Mb/s, 5 Mb/s and 10 Mb/s as defined in the FlexRay specification.

### 3. TRIGGER TYPE

The FlexRay trigger can be configured to trigger on simple **TSS (Start)**, **FlexRay Frame (ID, Cycle Count, Frame Qualifiers)**, **FlexRay Symbols (CID, CAS/MTS and Wakeup Pattern)**, and **Error Frame** triggering is supported for FSS, BSS and FES, Header CRC and Payload CRC errors.

Select the Trigger Type desired. The trigger dialog dynamically changes based on the selection made in the following manner:

- **TSS (Start)** - When selected, the Setup Format fields are shown and enabled. However, the Frame ID Setup, Cycle Count, and Frame Qualifiers fields, while shown, are disabled.



- **Frame** - When selected, the Setup Format, Frame ID Setup, Cycle Count, and Frame Qualifiers fields are shown and enabled.

**Note:** Some Frame ID Setup and Cycle Count fields are enabled based on selected condition values indicated in respective detail sections).

- **Symbol** - When selected, the Setup Format, Frame ID Setup, Cycle Count, and Frame Qualifiers fields aren't shown (and are therefore disabled). Instead, the Trigger On and System Parameters fields (step 4b and 5b, as follows) are shown and enabled.
- **Errors** - When selected, the Setup Format, Frame ID Setup, Cycle Count, and Frame Qualifiers fields aren't shown (and are therefore disabled). Instead, the Protocol Errors, CRC Errors, Select all Errors, and Deselect all Errors fields (step 4c and 5c, as follows) are shown and enabled.

**Note:** When the Payload CRC checkbox on the CRC Errors section is selected, the Payload Channel field is enabled. Select a channel as desired.

### **TSS (START) OR FRAME TRIGGER SETUP DETAIL**

#### **4a. Setup Format - TSS (Start) or Frame Trigger Setup Only**

When the FlexRaybus trigger selection is **TSS (Start)** or **Frame**, select either **Binary** or **Hexadecimal (Hex)** setup mode. The format propagates through the entire FlexRaybus trigger setup.

**Note:** Completely different fields are shown (instead of Setup Format, Frame ID Setup, Cycle Count, and Frame Qualifiers sections) when Symbol and Error FlexRaybus triggers are used.

A user can select Binary mode, and set up the address in binary format, then reselect Hex mode and set up the data in hexadecimal format. Toggling back and forth between the modes does not result in lost information (binary is used internally as the core format for all triggering and decoding operations), though use of don't care bits in a binary setup results in the display of an X (for a full nibble don't care) or a \$ (for a partial nibble don't care).

### **FRAME TRIGGER SETUP DETAIL**

#### **5. Frame ID Setup - Frame Trigger Setup Only**

When **Frame** is selected as the FlexRaybus trigger, use the Frame ID Setup fields as follows:

**Note:** The Frame ID setup fields are shown, but disabled when **TSS (Start)** is selected as the FlexRaybus trigger. Completely different fields are shown in these sections when Symbol and Error FlexRaybus triggers are used.

- **Condition** - Select from **Equal**, **Not Equal**, **Less than**, **Less than or Equal to**, **Greater than**, **Greater than or Equal to**, **In Range**, or **Out Range** conditions available. The default setting is Equal.
- **Value** - Use this field's keypad to enter the desired Frame ID.
- **To** - When the condition is set to **In Range of** or **Out of Range**, select a To value specifying the full ID range for the trigger.

#### **6. Cycle Count - Frame Trigger Setup Only**

Cycle Count combines with Frame ID enabling powerful FlexRay triggering. The Cycle Count is a decimal value between 0 and 63 correlating to the FlexRay Cycle Count numbering system. The default Value is Cycle Count 0 (Value).

When **Frame** is selected as the FlexRaybus trigger, use the Cycle Count fields as follows:

## Serial Data Debug Solutions

**Note:** The Cycle Count fields are shown, but disabled when **TSS (Start)** is selected as the FlexRaybus trigger.

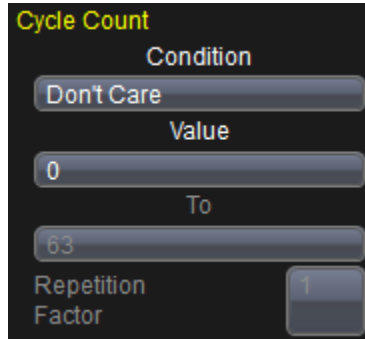

- **Condition** - Select from **Equal**, **Not Equal**, **Less than**, **Less than or Equal to**, **Greater than**, **Greater than or Equal to**, **In Range**, or **Out Range** conditions available. The default setting is Equal.
- **Value** - Use this field's keypad to enter the desired Frame ID.
- **To** - When the condition is set to **In Range of** or **Out of Range**, select a To value specifying the full ID range for the trigger.
- **Repetition Factor** - When the condition is set to **Equal**, this field can be set to a value of 1, 2, 4, 8, 16, 32 or 64 for triggering when Cycle multiplexing is used.

### 7. Frame Qualifiers - Frame Trigger Setup Only

Defined in the FlexRay specification, these fields allow an additional level of complexity in creating a very powerful FlexRay trigger. The default Qualifier setting is Don't Care, each field can be set to One, Zero or Don't Care as independent variables in the trigger setup.

**Note:** The Frame Qualifiers fields are shown, but disabled when **TSS (Start)** is selected as the FlexRaybus trigger.

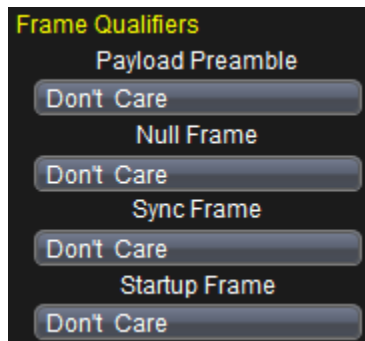

### *SYMBOL TRIGGER SETUP DETAIL*

#### 4b. Trigger On - Symbol Trigger Setup Only

When **Symbol** is selected as the FlexRaybus trigger, use the Trigger On fields as follows:

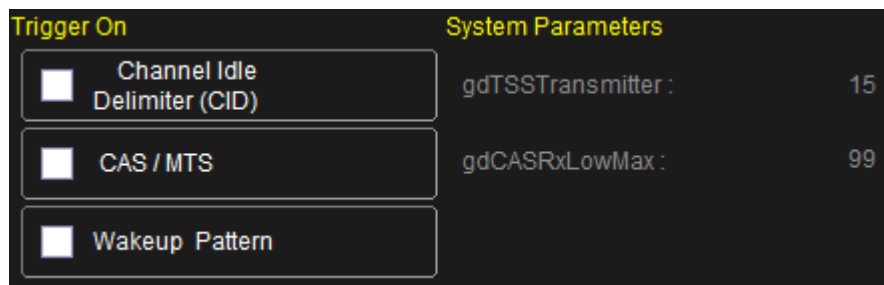

Include or exclude **Channel Idle Delimiter (CID)**, **CAS/MTS**, or **Wakeup Pattern** from your trigger by checking or un-checking as desired. Multiple values may be selected and included in your Symbol trigger.

#### **ERRORS TRIGGER SETUP DETAIL**

#### **4c. Protocol and CRC Errors - Error Trigger Only**

When **Errors** is selected as the FlexRaybus trigger, use the Protocol and CRC Errors fields in the following manner:

The screenshot shows a dark-themed interface for error trigger setup. On the left, under 'Protocol Errors', there are three checkboxes for FSS, BSS, and FES, all of which are currently unchecked. On the right, under 'CRC Errors', there are two checkboxes for Header CRC and Payload CRC, also unchecked. Below the Payload CRC checkbox is a 'Payload Channel' dropdown menu currently set to 'ChannelA'. To the far right, there are two buttons: 'Select all Errors' and 'Deselect all Errors'.

- **Protocol Errors** - Include or exclude **FSS**, **BSS**, or **FES** errors from your trigger by checking or un-checking as desired.
- **CRC Errors** - Include or exclude **Header CRC** or **Payload CRC** errors from your trigger by checking or un-checking as desired.
- **Payload Channel** - If you include Payload CRC errors in your Error trigger, use this field to select the correct channel.
- **Select all Errors** and **Deselect all Errors** - Use these buttons to conveniently select or deselect all **Protocol** and **CRC Errors** with a single click.

#### **FlexRaybus Physical Layer and Eye Diagram Analysis**

LeCroy's FlexRaybus option contains a software algorithm which creates eye diagrams, performs mask testing and measures timing parameters as defined in the FlexRay specification. The algorithm creates eye diagrams by slicing up all the bits transmitted in the FlexRay signal and superimposing each bit on to an eye diagram. The signal is sliced based on measurements taken at the falling edge of the first Bytes Start Sequence (BSS) and the time between consecutive BSS symbols. These measurements allow the algorithm to compute the rate of the embedded clock and slice the FlexRay waveform in to sub-waveforms one bit in length. The clock uses a constant bitrate specified by the user and is resynchronized on every BSS. These sub-waveforms are then scaled to fill 8 horizontal divisions on the oscilloscope and represent 1 Unit Interval (UI) in the eye diagram and superimposed on top of each other.

Mask testing can be performed on the eye diagram with masks defined at TP1 and TP4. The mask is aligned horizontally by computing the time for a single UI and centering it on the display. The mask is centered vertically around 0V.

Along with eye diagrams and mask testing the TDP option adds 4 FlexRay specific measurements to the oscilloscope. These measurements are **Propagation Delay**, **Asymmetric Delay**, **Truncation**, and **Jitter**. They are measured as defined in the FlexRay specification. These measurements characterize timing properties of the propagation of signals along the communication channel.

## Serial Data Debug Solutions

### EYE DIAGRAM AND MASK TEST SETUP DETAIL

The Left Hand side of the FlexRay Physical Layer tab has all the settings for Eye Diagram Mask testing as follows.

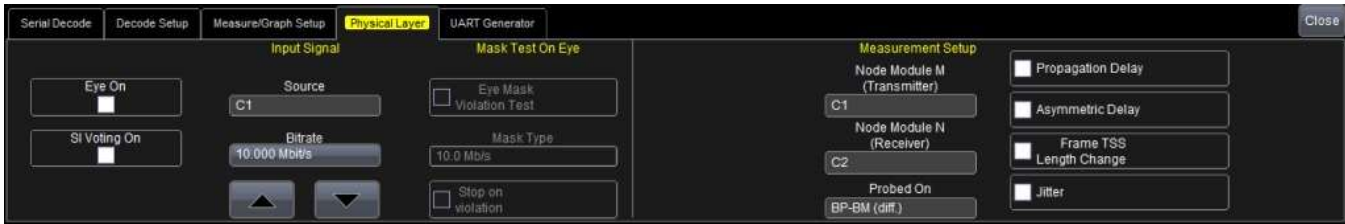

#### Input Signal Setup

- **Eye On/Off** - Mark this checkbox to turn on the eye diagram. When marked, the **Eye Mask Violation Test** and **Mask Type** fields are enabled.
- **SI Voting On** - Mark this checkbox to apply this signal integrity compliance procedure for further analysis in the event of eye diagram test result failures.
- **Source** - The pop-up dialog is used to select the channel, math or memory waveform to use for the eye diagram creation.
- **Bitrate** - The eye diagram can be created from FlexRay waveforms with bitrates of 2.5 Mb/s, 5 Mb/s and 10 Mb/s as defined in the FlexRay specification. The value can be entered by using the arrow keys or touching the field and entering a value.

**Note:** The time required to build long memory waveform eye diagrams is longer than required for short memory waveforms.

#### Mask Test On Eye Setup

- **Eye Mask Violation Test** - When the **Eye On** checkbox is marked, this field is enabled and you can then mark this checkbox to turn on the **Eye Mask Violation Test**. Similarly, when **Eye Mask Violation Test** is marked, the **Stop on violation** field is enabled and may also be used.
- **Mask Type** - Select the desired mask (as defined in the FlexRaybus specification) to use for your testing purposes.
- **Stop on violation** - This function may only be added to your physical layer measurement (by marking the checkbox) when the **Eye On** and **Eye Mask Violation Test** checkboxes are both also marked.

## Mask Test Display

The FlexRay TDP option allows you to verify signal integrity of the communication channel and corresponding protocol data simultaneously as follows. Points where the FlexRay signal intersects the mask are indicated with red failure marks.

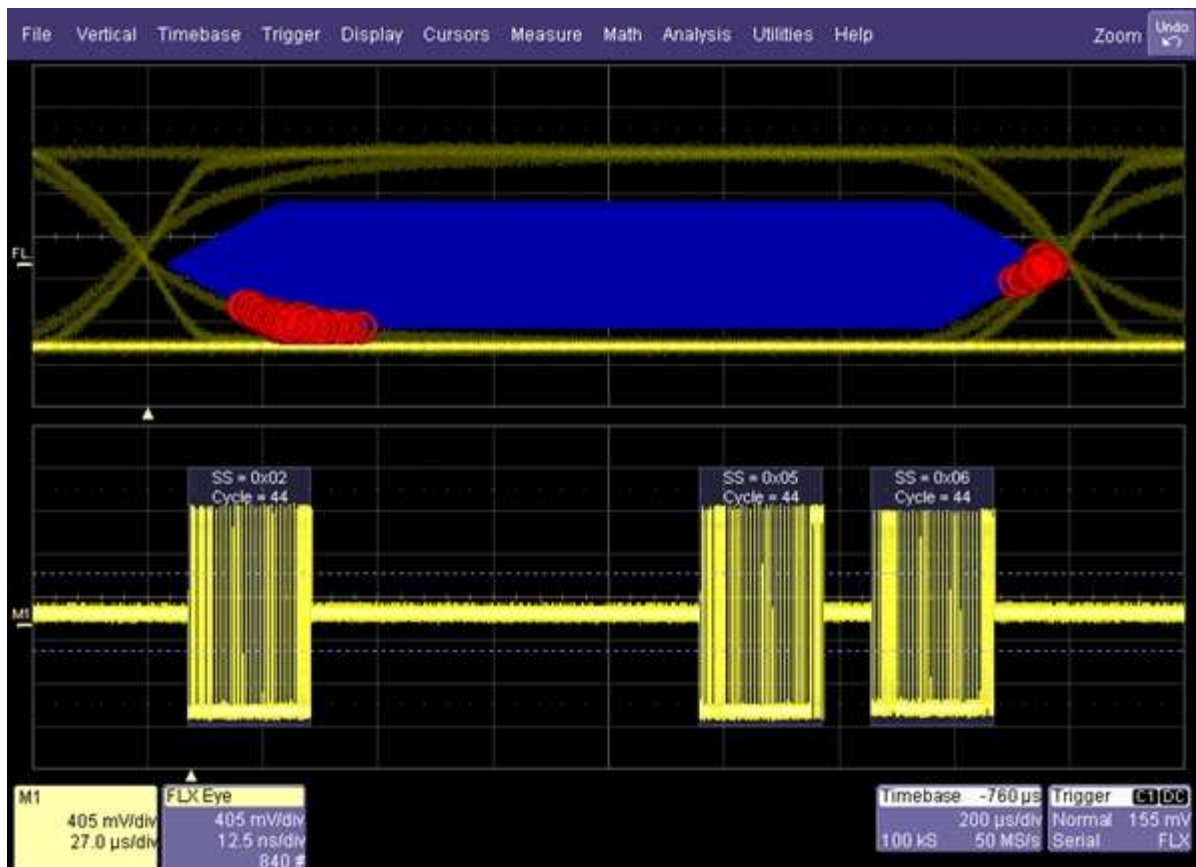

## FlexRaybus Measurement Parameter Setup

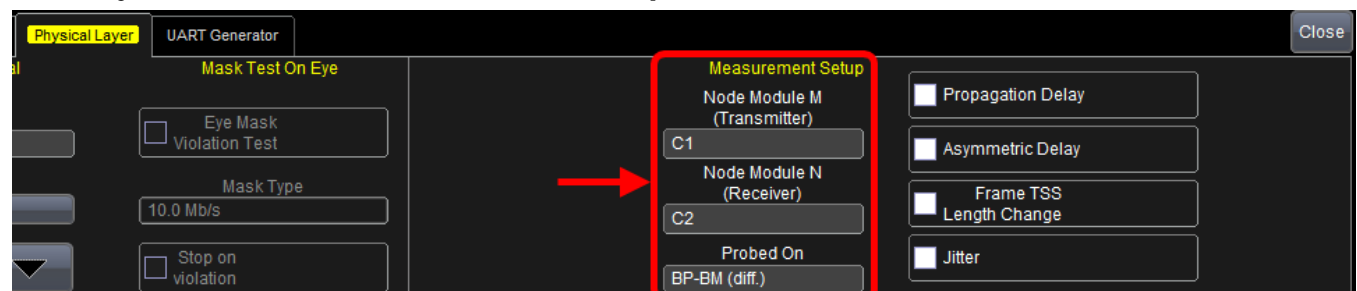

- **Source** - Select the emitting and receiving nodes (Node Module M and N) on the FlexRay channel where Propagation Delay, Asymmetric Delay, and Frame TSS Length Change are being measured.

**Note:** Jitter is measured on a single channel.

- **Measurements** - Select one of the 4 **FlexRaybus Physical Layer Measurement Parameters** (on page 86). Measurement values are shown on the oscilloscope display as boxes are marked.
- **Probing point** - Select the type of line on which you are probing as either **BP-BM (diff.)** if the signal is a differential signal on the communication channel, or **RxD-TxD (dig.)** if the signal is the two level digital signal of the communication controller interface.

## Serial Data Debug Solutions

### ***FlexRaybus Physical Layer Measurement Parameters***

The FlexRaybus option provides four measurement parameters defined in the FlexRay physical layer specification. These measurements characterize timing properties of the signal along the communication channel.

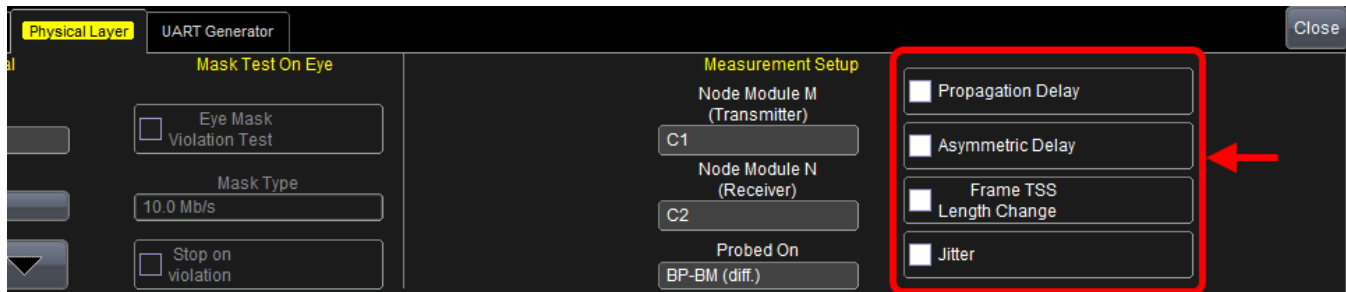

- **Propagation Delay** - This measurement is made on two points along the communication channel from the emitter node module to the receiver node module.  
Propagation Delay characterizes the propagation time of the signal using the first transition of the Bye Start Sequence (BSS).
- **Asymmetric Delay** - This measurement is made on two points along the communication channel from the emitter node module to the receiver node module.  
Asymmetric delay characterizes the difference in delay between rising and falling edges.
- **Frame TSS Length Change** - This measurement is made on two points along the communication channel from the emitter node module to the receiver node module.  
Truncation measures the change in width of the TSS.
- **Jitter** - This measurement is made at one point, usually the receiving node  
Jitter measures the change of length between the last BSS and the FSS. This should usually be 1 $\mu$ s.

### ***Viewing FlexRaybus Physical Layer Measurements***

FlexRaybus physical layer measurements appear in the **Measurement Table** (just like other measurements) directly under the waveform grid.

Refer to **Accessing and Using The PROTObus MAG Supported Protocol Toolset** (on page 23) for more information.

## Serial Audio Protocol

### Serial Audio Protocol Overview

#### I<sup>2</sup>S

I<sup>2</sup>S, LeCroy's AudioBus option, includes I<sup>2</sup>S, LJ, RJ, and TDM protocol variants. It is a synchronous bus based on 3 wires which are used to pass multiple channels of audio data over a single line for use in connecting digital audio devices together.

NXP (formerly Philips Semiconductors) provide a full description of the I2S AudioBus variant in .pdf format at [www.nxp.com](http://www.nxp.com).

Number of Lines	Data rate	Synchronous or Asynchronous
3	Up to 5 Mb/s	Synchronous

### Using the Audiobus Option

#### Using the AudioBus Option Overview

The AudioBus option includes **Inter-IC Sound**, I<sup>2</sup>S, Left Justified (**LJ**), Right Justified (**RJ**), and Time Division Multiplex (**TDM**) variants (not to be confused with the TDM toolkit). You may notice these items available on some controls.

Both AudioBus TD and G options contain powerful software algorithms to extract serial data information from physical layer waveforms measured on your oscilloscope. The extracted information is overlaid (annotated) on the actual physical layer waveforms, and color-coded to provide fast, intuitive understanding.

The AudioBus TD option contains a data trigger that is configurable from the main dialog for the Inter-IC Sound, I<sup>2</sup>S, LJ, RJ, and TDM variants.

The AudioBus Trigger Decode Graph (TDG) package includes a powerful feature allowing an analog format display of the digital channel data. This is extremely beneficial for debugging since it provides an intuitive view of glitches, clipping, and other distortions and irregularities that cannot be quickly understood by looking at raw digital data.

**Note:** Ask your local LeCroy representative for more information about any Serial Data Debug Solution Protocols or Toolkits using the **Contact LeCroy for Support** (on page 199) topic.

#### AudioBus Decode Setup Detail

Decode protocol setup involves making settings on the **Serial Decode**, **Decode Setup**, **Audio**, and **Level** dialogs.

AudioBus uses color-coded overlays or **annotations** on various sections of the protocol decode for an easy-to-understand visual display. This LeCroy exclusive feature is intuitive to experienced audio engineers and especially useful for users new to the I2S, LJ, RJ, or TDM AudioBus standards. The decode information condenses or expands depending on the timebase/zoom ratio setting, simplifying both routine verification and complex troubleshooting. Choose to decode into Hex, Binary, Decimal, or dB formats.

For general **Serial Decode** and **Decode Setup...** dialog information, refer to **Accessing The D and TD Supported Protocol Toolsets** (on page 13).

## Serial Data Debug Solutions

### TRIGGER, DECODE, AND GRAPH

LeCroy offers two methods for converting your digital signals into waveforms - **View Audio** and **Measure/Graph Setup**.... The following screen-shot shows the end result of digital signals converted into waveforms.



### Decode Setup Dialog's View and Play Audio Buttons

View and Play Audio converts the digitally-encoded serial data audio signal into an analog waveform which is displayed or played aloud. This provides an intuitive way to understand circuit problems causing clipping, glitches, and other anomalies in the audio circuit. It also helps show the effects of the audio signal before Digital Signal Processing (DSP).

View Audio can be performed for up to four audio channels for conventional Left/Right audio, or home cinema applications (enabled by time division multiplexed audio buses).

Access the **View** and **Play Audio** buttons from the AudioBus Decode Setup dialog as follows:

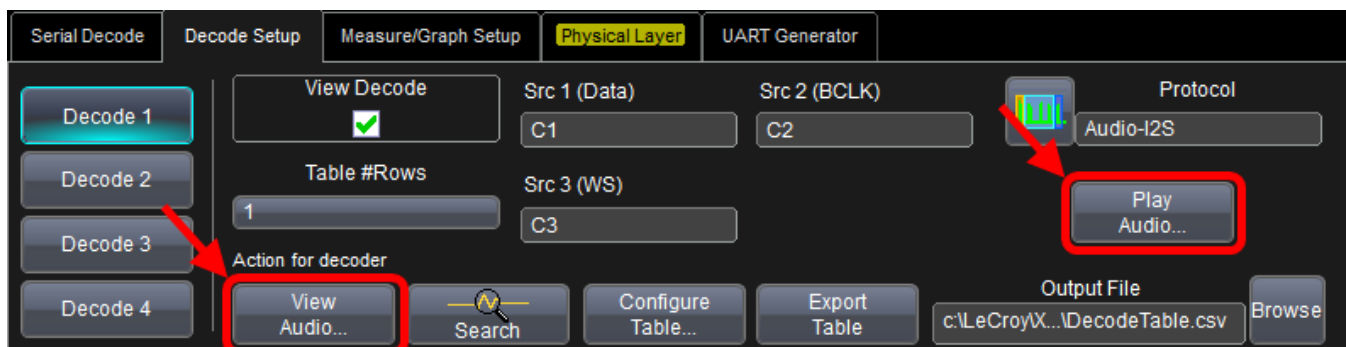



- The **View Audio** button shows the **Audio Track Wizard** (as follows) which sets up Math traces for the audio channel you wish to view on the display grid.



- Click the **Play Audio** button and the decoded audio waveform data plays for the channel selected.

**Note:** Ensure external speakers or headphones are connected to your instrument before using **Play Audio**.

Resuming with Decode, detailed fields and setup conditions for decode are available from **Audio** and **Level** dialogs on the right side of the display. These dialogs are covered in the following topics.

#### **SAVING WAVEFORMS IN THE .WAV FILE FORMAT**

Save your waveforms into the .wav format by touching **File** → **Save Waveform** on the menu bar. Now, on the **Save Waveform** dialog, touch the **Data Format** field and select **Audio** from the pop-up shown.



## Serial Data Debug Solutions

### AUDIO DIALOG

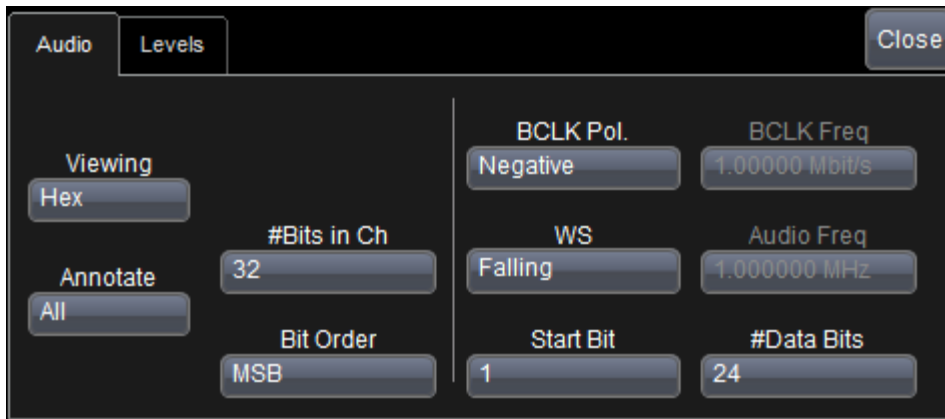

- **Viewing** - Select to view the protocol data in **Binary**, **Hexadecimal (Hex)**, or **ASCII** modes.
- **Annotate** - Select from **All**, **Left**, **Right** (and **Audio 1-8** for TDM) choices.
- **# Bits In Ch** - This field is only enabled when using AudioBus **TDM**, **LJ**, and **RJ** protocol variants. Enter a value using the pop-up numeric keypad for the amount illustrated as follows.



- **Bit Order** - Only selectable when using the **TDM** AudioBus protocol variant. Choose based on the Most and Least Significant Bits (**MSB**, **LSB**) for your Decode.
- **BCLK (Bit Clock) Pol.** - Select a polarity (**0** or **1**) where the first data bit is decoded.
- **BCLK Freq** - This display field shows you the **WS** (Word Select) or **FRS** (Frame Select) as a frequency value for your reference.

- **WS (or FRS, for TDM Protocol Variant)** - The Word Select field is enabled when using the LJ and RJ AudioBus protocol variant. Click the field and select either a **Falling** or **Rising** value.  
The same field is in display mode when using the Audio I2S AudioBus protocol variant.  
Lastly, the field is changed to **FRS** (Frame Select) when using the TDM AudioBus protocol variant. Click the field and select either a **Rising** or **Falling** value.
- **Audio Freq** - This display field shows you the channel data value as a frequency for Left and Right (or 1-8 for TDM AudioBus protocol variant) for your reference.
- **Start Bit** - Only selectable when using the **TDM** AudioBus protocol variant. Enter a value using the pop-up numeric keypad.
- **#Data Bits** - Provide a field value using the pop-up numeric keypad.

#### **LEVEL RIGHT-HAND DIALOG**

The **DATA**, **CLK**, and **WS** signal sources can each have their levels adjusted from this dialog.

**Level Type** and **Vertical Level** - The message decoding algorithm setup is performed here. The level is normally set up in %, and defaults to 50%. Adjust the level by touching inside the number area to highlight the box title, and then use the oscilloscope front panel **Adjust** knob to make your change. Alternatively, touch inside the number area twice and select a value using the pop-up numeric keypad.

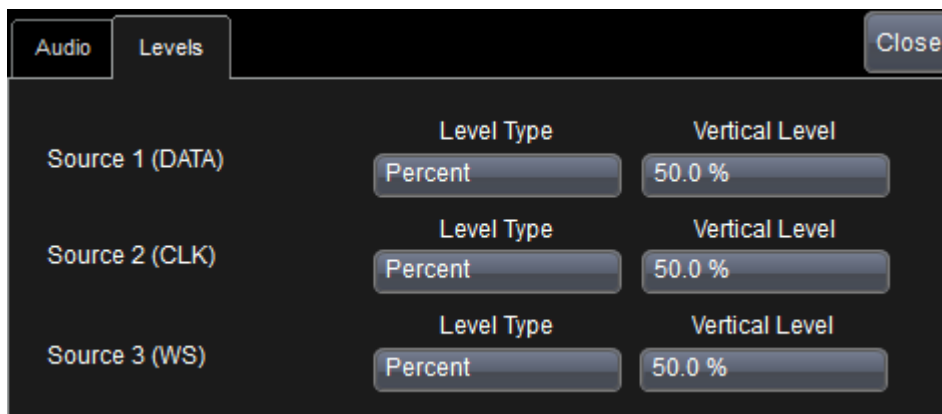

#### **PLEASE NOTE THE FOLLOWING:**

- When Muting a decoded signal or using a Mute Trigger, set your source level types to **Absolute**. Adjust the voltage level so it moves to a position above the muted trace on the display grid.
- The set Level appears as a dotted horizontal line across the oscilloscope grid.
- If initial decoding indicates there are a number of error frames, make sure that the level is set to a reasonable value.

#### **Creating an AudioBus Trigger Condition**

The AudioBus trigger can be configured for **I2S**, **LJ**, or **RJ** variants. Powerful conditional triggering can be applied to either left or right channel data, while unique triggers like [mute](#), [clip](#), and [glitch](#) help isolate rare problems not easily detected by viewing decoded data alone. AudioBus turns the oscilloscope into a protocol analyzer with a customizable table display of protocol information which you can even export into Microsoft Excel format.

## Serial Data Debug Solutions

The AudioBus Trigger dialog, with detail on some of the setup conditions, is shown in the following topics.

**Note:** Refer to **Accessing The D and TD Supported Protocol Toolsets** (on page 13) for information on finding the Trigger Condition dialog specific to your desired protocol.



Select condition values by touching fields (using your finger, or use a mouse pointer). A pop-up is shown where you can choose from **Equal**, **Not Equal**, **Less than**, **Less than or Equal to**, **Greater than**, **Greater than or Equal to**, **In Range**, or **Out Range** condition values.

### AudioBus Trigger Setup Detail

The detail you provide on this dialog is based on the Audio Variant you select. Certain fields may be enabled and/or disabled based on your choices.

### AUDIOBUS TRIGGER DETAIL CONSIDERATIONS

Keep the following in mind when setting up your AudioBus trigger details:

- Values for I2S data is transmitted with the most significant bit (MSB) first.
- MSB is always transmitted 1 clock cycle after framesync transition and the framesync is typically 32-Bits.
- Polarity of word select signifies whether data is transmitted from the left or right channel.
- Word select transitions indicate the start-of-word position and occur at the sample frequency. Notice how the following I<sup>2</sup>S illustration shows the MSB occurring one clock cycle after the frame sync transition

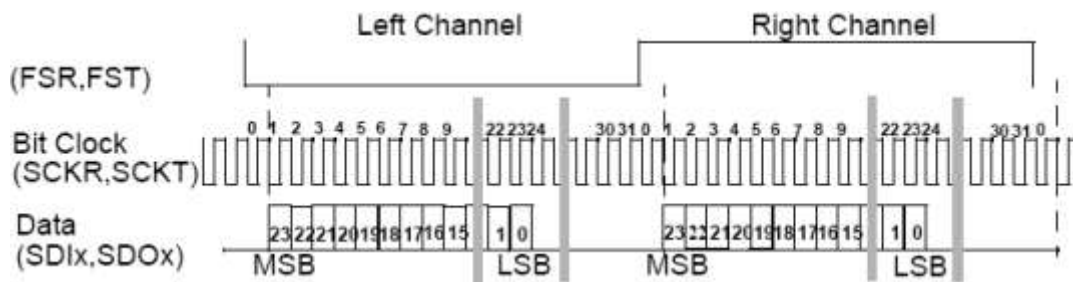

*I<sup>2</sup>S Variant Timing Format*

- LJ is similar to I<sup>2</sup>S with the exception that the MSB occurs at the frame sync transition, rather than one clock cycle after, as follows.

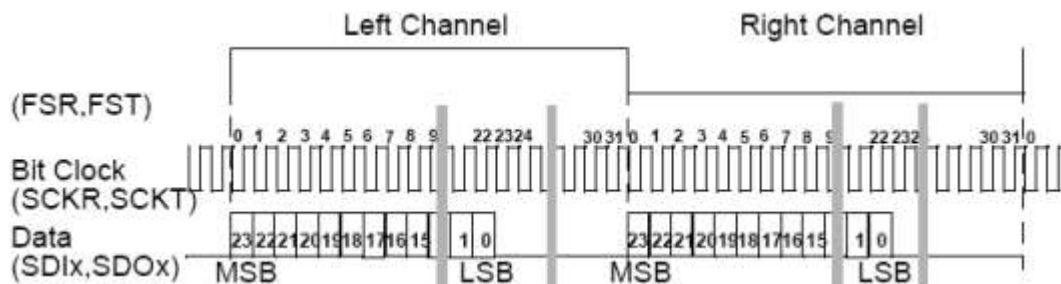

*LJ Variant Timing Format*

- RJ is similar to I<sup>2</sup>S with the exception that the LSB occurs at the end of the frame sync, as follows.

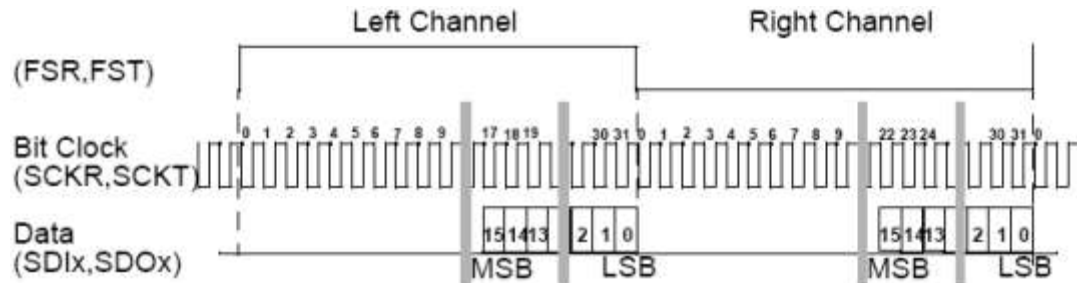

*RJ Variant Timing Format*

### AUDIOBUS TRIGGER DETAIL SELECTIONS

The following topic provides specific control settings for an AudioBus Trigger.



The previously numbered AudioBus trigger sections generally correspond with the following explanations.

#### 1. AUDIOBUS AUDIO VARIANTS

- The different AudioBus variants are closely based on the I<sup>2</sup>S standard. Each variant has a bus consisting of at least 3 lines - **Serial Clock** (Bit Clock), **Left/Right Clock** (Word Select), and **at least one multiplexed data line**.

#### 2. SOURCE SETUP

- **DATA** and **BCLK (BIT CLOCK)** - The pop-up dialog is used to select the appropriate channel or EXT inputs for each. Set these fields up with caution or your trigger may not function correctly.
- **Polarity** and **WS (Word Select)** - These fields are enabled or disabled based on the selected AudioBus variant.
- **Sync on** - This field is enabled when either LJ or RJ variants are selected. Click the field and select either a **Falling** or **Rising** value.
- **Threshold (Trigger)** - Adjust the vertical level for the trigger. Much like an Edge trigger, a user must specify the level used in order to process the incoming signals and determine whether the desired serial data pattern is meeting the set trigger condition. This value is used for **DATA**, **BCLOCK**, and **WS** signals.

#### 3. TYPE

- **Data** - Applies a trigger to data on either left or right channels. When selected, the **Data Condition** field on the Data Pattern Setup section is enabled and may be used.
- **Mute** - Applies a trigger when your data level is below a specified **noise floor** for a specified **number of frames**. When selected, the Setup Format section does not appear and the Data Pattern Setup section is replaced with a Mute Setup section which includes **Noise Floor** and **Duration (# of Frames)** fields.
- **Clip** - Applies a trigger when your data level exceeds a specified **clip level** for a specified **number of frames**.
- **Glitch** - Applies a trigger when the **rise time** between two adjacent audio samples exceed the specified **threshold**.
- **Rising Edge** - Applies a trigger when your data level is **rising** at a specified **threshold**.
- **Falling Edge** - Applies a trigger when your data level is **falling** at a specified **threshold**.

## Serial Data Debug Solutions

### 4. AUDIO CHANNEL

- **Channel** - Choose **Left** or **Right** as desired.
- **Bit Order** - This field is only enabled when an **LJ** or **RJ** variant (step 1, previous) is used. Choose from **MSB** (most-significant bit) or **LSB** (least-significant bit), as desired.
- **# Bits In Channel** - Enter a value using the pop-up numeric keypad for the amount illustrated as follows.
- **Start Bit** - Grayed out field because AudioBus TDM trigger is unavailable.
- **# Data Bits** - Enter a value using the pop-up numeric keypad for the amount illustrated as follows.



### 5. SETUP FORMAT - ONLY AVAILABLE FOR DATA TYPE SETUP

**Note:** This setup sections only appears when the **Data** type is chosen from the **Type** (step 3, previous).

Select either **Binary** or **Hexadecimal (Hex)** setup mode. The mode selected affects the format of the following **Data Pattern Equals** control.

### 5. MUTE, CLIP, GLITCH, RISING, AND FALLING EDGE SETUP

When Mute, Clip, Glitch, or Rising and Falling Edge types are selected, the Setup Format choices change from Binary or Hex to Dec and dB buttons (as shown in the following three screen-shots).

**Note:** These setup sections appear when their corresponding type is chosen from the Type (step 3, previous).

- **Mute Setup...** - Provide values using the pop-up numeric keypad for **Noise Floor** and **Duration (# Frames)** amounts.

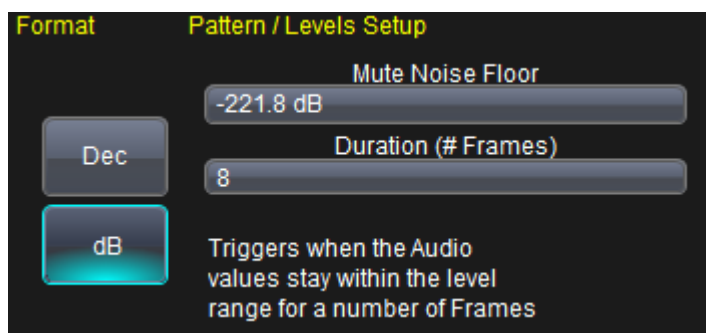

**Mute Noise Floor** is calculated based on the number of bits inside the data channel.

The amount is equal to  $2^{n-1}$ , where **n** = the **number of data bits**.

The **Duration (# Frames)** defines the span of time where the data must be below the set **Noise Floor** in order to meet the trigger criteria.

- **Clip Setup...** - Provide values using the pop-up numeric keypad for **Clip Level** and **Duration (# Frames)** amounts.

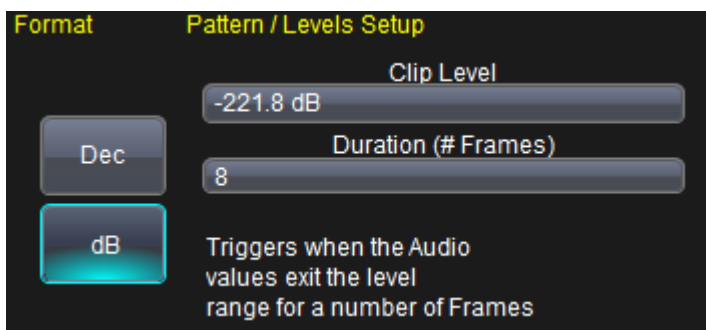

**Clip Level** is calculated based on the number of bits inside the data channel.

The amount is equal to  $2^{n-1}$ , where **n** = the **number of data bits**.

The **Duration (# Frames)** defines the span of time where the data must be above the set **Clip Level** in order to meet the trigger criteria.

- **Glitch/Edge Setup...** - When Glitch, Rising, or Falling Edge Types are chosen (step 3, previous) provide a **Threshold** value using the pop-up numeric keypad.

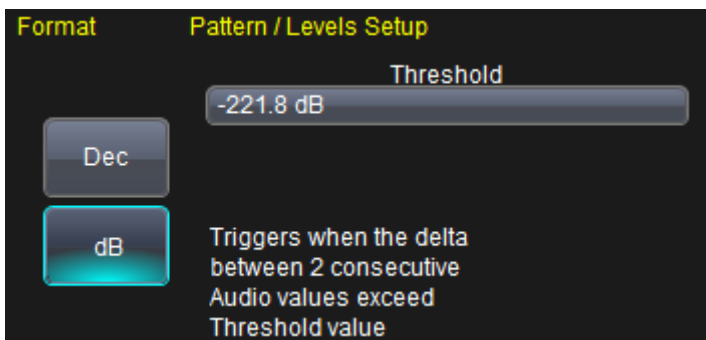

The **Threshold** value is equal to  $2^n$ , where **n** = the **number of data bits**. As indicated on the dialog, it Triggers when the delta between 2 consecutive Audio values exceed the threshold value.

## Serial Data Debug Solutions

**Note:** For **Rising** or **Falling Edge** Types, a **Data Value** display field is shown and is converted based on your last **Setup Format** selection made for a **Data Type** (steps 3 and 5, previous).  
The **Rising** edge type triggers when audio values cross above the Threshold level specified. **Falling** triggers when the values cross below the Threshold level specified.

### 6. DATA PATTERN SETUP - ONLY AVAILABLE FOR DATA TYPE SETUP

**Note:** This setup sections only appears when the **Data** type is chosen from the **Type** (step 3, previous).

- **Data Condition** - Select from **Equal**, **Not Equal**, **Less than**, **Less than or Equal to**, **Greater than**, **Greater than or Equal to**, **In Range**, or **Out Range** conditions available. The default setting is Equal.
- **Data Value** - Use this field's keypad to specify an exact amount.
- **Data Value To** - Use this field's keypad to specify an exact amount.

### AudioBus Measure/Graph Setup Detail

The following topics explain selections on the AudioBus **Measure/Graph Setup...** dialog.



Controls on this dialog are described as follows:

1. **View and Load Table** - Use this checkbox to add or remove settings to your waveform on the signal display grid and show data under the grid in tabular format.
2. **P1 - P4** - Each of the four Decoders can be assigned a **Measurement Parameter** value. Click the button or field to choose from the **Select Measurement** pop-up.
3. There's also a corresponding field where you can specify the **Source**.
4. **Setup Button** - Click the **Setup...** button. The corresponding Decode and the **Measurement Parameter** dialog is shown where you can make additional settings. There are additional dialogs on the right where even more Decode settings can be made.
5. **Histo**, **Trend**, and **Track** Buttons - Each Decode also has a **Histo**, **Trend**, and **Track** button. Click the desired button and choose which Math trace in which you want to display results.
6. **Statistics** - Use the **On** and **Histicons** checkboxes to display data on the signal display grid. Use the **Clear Sweeps** button (when enabled) to clear the data from multiple acquisitions.



## Military and Avionic Protocols

### Military and Avionic Protocols Overview

#### **ARINC 429**

Aircraft Radio Incorporated, or [ARINC 429](#) is an avionic standard often found on commercial and freight aircraft. Connections consist of twisted pairs carrying balanced differential signaling. Single wire pair connections are limited to 20 receivers or less. Self-clocking is allowed from the receiver end, eliminating the need for clock data transmitting.

The standard is maintained by the ARINC Organization. Additional information, including the specification, can be found at [www.arinc.com/](http://www.arinc.com/).

Number of Lines	Data rate	Synchronous or Asynchronous
1	100 Kb/s or 12.5 Kb/s	Asynchronous

#### **MIL-STD-1553**

[MIL-STD-1553](#) is a Department of Defense military standard used for defining mechanical, electrical, and functional serial data bus characteristics. Originally used for fighter aircraft, use of the standard has spread to spacecraft and civil aircraft applications.

The standard is maintained by the Aerospace branch of the Society of Automotive Engineers [www.sae.org/](http://www.sae.org/).

Number of Lines	Data rate	Synchronous or Asynchronous
1	1 Mb/s	Asynchronous

### Using the ARINC 429 Option

#### **Using the ARINC 429 Option Overview**

The ARINC 429 option interprets the Word format of this protocol and can apply a Binary, Hex, or Decimal custom decode.

**Note:** Ask your local LeCroy representative for more information about any Serial Data Debug Solution Protocols or Toolkits using the **Contact LeCroy for Support** (on page 199) topic.

#### **ARINC 429 Decode Setup Detail**

For general information about using controls shown on the main Serial Decode dialog, refer to **Accessing The D and TD Supported Protocol Toolsets** (on page 13).

#### **ARINC 429 BASIC, USER DEFINED, FILTER, AND LEVELS RIGHT-HAND DIALOGS**

Access the **Serial Decode** dialog by touching **Analysis** → **Serial Decode** on the menu bar.

Touch the corresponding **Setup...** button for your decode. The **Decode Setup...** along with corresponding right-hand dialogs are shown.

## Serial Data Debug Solutions

### ARINC 429 Basic Right-Hand Dialog

The **Basic** right-hand dialog provides detailed controls and setup conditions as follows:

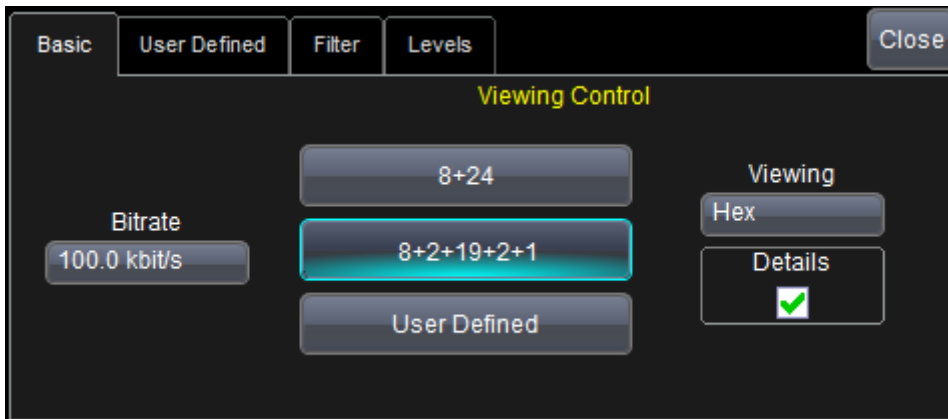

- **Bitrate** - Provide a value using the pop-up numeric keypad. Typically **12.5** or **100** kbps.
- **Viewing Control Buttons** - These three buttons control how the data is decoded on waveforms into **8+24**, **8+2+19+2+1**, and **User Defined** word format divisions.

**Note:** **User Defined** must be selected in order to view a user-defined label file from the Symbolic dialog.

- **Viewing** - Choose the format you wish to view your decoded waveforms from **Binary**, **Hex**, and **Decimal**.
- **Details** - Marking this checkbox provides an extra layer of information in the decode. This is visible when looking at trace annotations on a decoded waveform.

### ARINC 429 User Defined Right-Hand Dialog

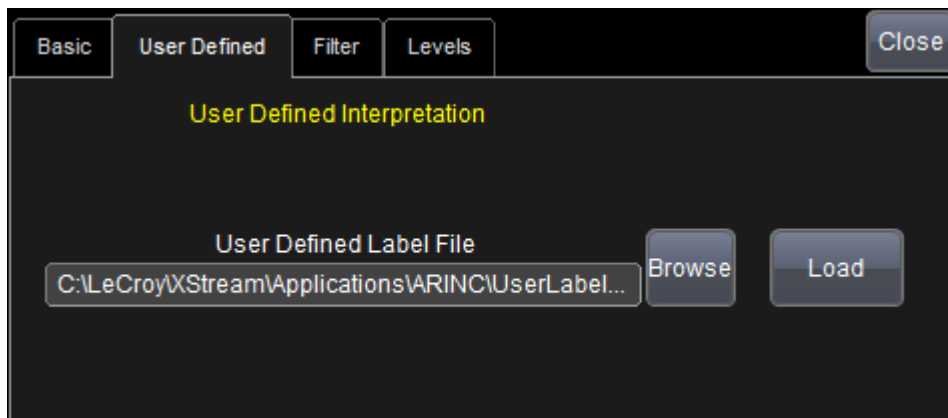

The User Defined right-hand dialog can be used to provide a personalized interpretation of your ARINC 429 decode.

**Note:** The **User Defined** Viewing Control button must be selected on the **Basic** dialog in order to view a User Defined Label File.

- **Browse** - Click this button and navigate to locate your label file.
- **Load** - Once you've found your label file using the Browse button, click this button and apply it to your ARINC 429 decode.
- **Clear** - Use this button to remove your user-defined labels from your ARINC 429 decode.

## User Label Description Files

Effective use of a **User Label Description File (ULDF)** provides several viewing modes. ULDF files are Comma Separated Values (CSV) containing 12 to 14 of the following tokens:

### ULDF Tokens

**Label<sup>1</sup>, EquipmentID<sup>2</sup>, Name<sup>3</sup>, Units<sup>4</sup>, Min<sup>5</sup>, Max<sup>6</sup>, SigBits<sup>7</sup>, PosSense<sup>8</sup>, Resolution<sup>9</sup>, MinTransit<sup>10</sup>, MaxTransit<sup>11</sup>, LabelType1<sup>12</sup>, Offset<sup>13</sup>, DetailsList<sup>14</sup>**

**Note:** You can use any neutral text editor to create/modify your ULDF file, as long as it does not add extraneous characters or remove characters.

### Token Deviations from ARINC 429

2. **Equipment ID** is decimal rather than hexadecimal.
5. (and 6.) **Min and Max** are consolidated on ARINC tables. These tokens often contain information not readily parsed. However, inside the ULDF, the **Min** and **Max** tokens have dedicated columns, and therefore dedicated tokens.

### Token Extensions from ARINC 429

12. **Label Type1** are Binary, BCD, and Discrete.
13. Zero based **Offset** in bits (from bit 0 at the beginning of the message).
14. **DetailsList** contains additional information for BCD and Enumerated Discrete's.
  - For an **Enumerated** type details look like **Enum: On|Off, Enum: Disengaged|Engaged, or Enum: Off|Low|Medium|Full.**
  - For a **BCD** type it would look like **BCD: 3|4** or **BCD: 2|4|4|4.**

### Unused Tokens

10. (and 11.) **Min/Max Transit** times 111 and 222 are not used.
5. (and 6.) **Min/Max** values are parsed but not used at this time.
8. **PosSense** is not used by the interpretation algorithm at this time.

### ARINC 429 Filter Right-Hand Dialog



The **Filter** dialog can be used to exclude or include certain labels (user-defined or otherwise) from your ARINC 429 decode.

- **Filter Mode** - Choose your Message Filter Mode as either **Only Show Selected Labels** or **Show All Labels Except Those Listed**.
- **Only Decode Labels** - This field is only shown if the **Only Show Selected Labels** Filter Mode is selected. Click this field and use the Virtual Keyboard (or your attached, USB keyboard) to provide your labels (separated by semicolons) for exclusion.
- **Remove Labels** - This field is only shown if the **Show All Labels Except Those Listed** Filter Mode is selected. Click this field and use the Virtual Keyboard (or your attached, USB keyboard) to provide your labels (separated by semicolons) for exclusion.

## Serial Data Debug Solutions

**Note:** The **Clear Label Filter** button resets all your labels to empty values so you can start your filter selections over again.

### ARINC 429 LEVEL RIGHT-HAND DIALOG

Adjust levels using **Absolute** or **Percent** Types for your ARINC 429 decode. While **High** and **Low** values can be modified, preset levels are initially set to cross small amplitude signals.

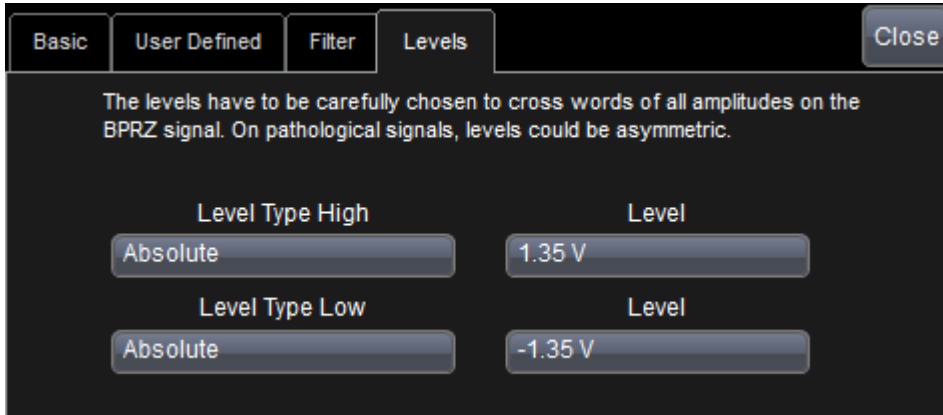

#### PLEASE NOTE THE FOLLOWING:

- Choose voltage or percentage level values carefully. High and Low values you provide are applied across all amplitudes.
- While ARINC 429 messages can contain varied amplitudes, they are still decoded.

Take an example where a transaction contains a 20 V amplitude on the bus controller word and 2 V on the reply words of the remote terminal; a ratio of 2:10.

The gain then has to be adjusted to decode the lowest amplitude words (2 V) with a gain of, say, 1 V/div.

While the high amplitude words (20 V) are overflow, they are still decoded.

### ARINC 429 Decode Trace Annotations

Like all trace annotations, ARINC 429 Decode annotations are rectangular shadings used to highlight messages on decoded waveforms for easy viewing.

**Tip:** Data packets (or messages) on properly decoded protocol signals can be viewed using **Serial Decode Trace Annotations** (on page 18), the **Protocol Results Table** (on page 19), and/or by **Searching for Messages** (on page 21) (Types and Subtypes). Using these tools together provides fast insight to your data. See **Serial Decode Trace Annotations** (on page 18) for more information.

Messages shown as **annotations**, **table columns**, and **search types** for most protocols are classified into **Frames**, **Errors**, **Unknown**, or **Grouped Primitives** specific to the protocol. Sub Types then further classify each main message type into more protocol-specific messages.

Decode annotations unique to ARINC 429 include the following (some annotations are not shown in the screenshot):

## ARINC 429 Decode Annotations

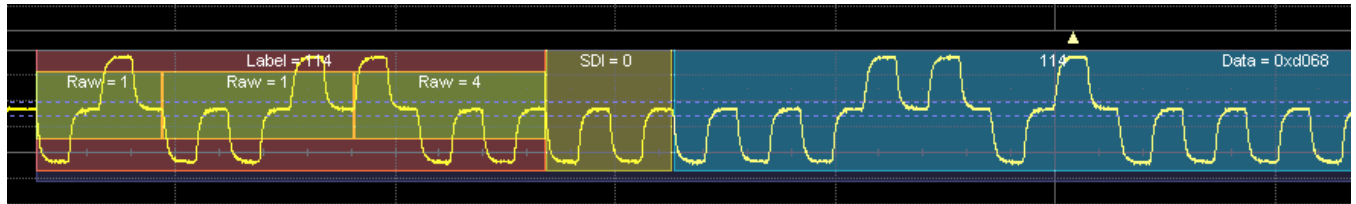

- **Label** - Identifier showing data type and parameter association. Typically shown as octal numbers.
- **SDI** - Source/Destination identifier.
- **Data** - Bits 29 - 11.
- **SSM** - Sign/Status Matrix.
- **Pa** - Parity.
- **Msg** - Displays the symbolic information.
- **Symbols**
- **Bits/Resolution**
- **Pad**
- **Status**

**Note:** Specifications are subject to change without notice.

## ARINC 429 Decode Table Column Details

ARINC 429 table column values available include the following:

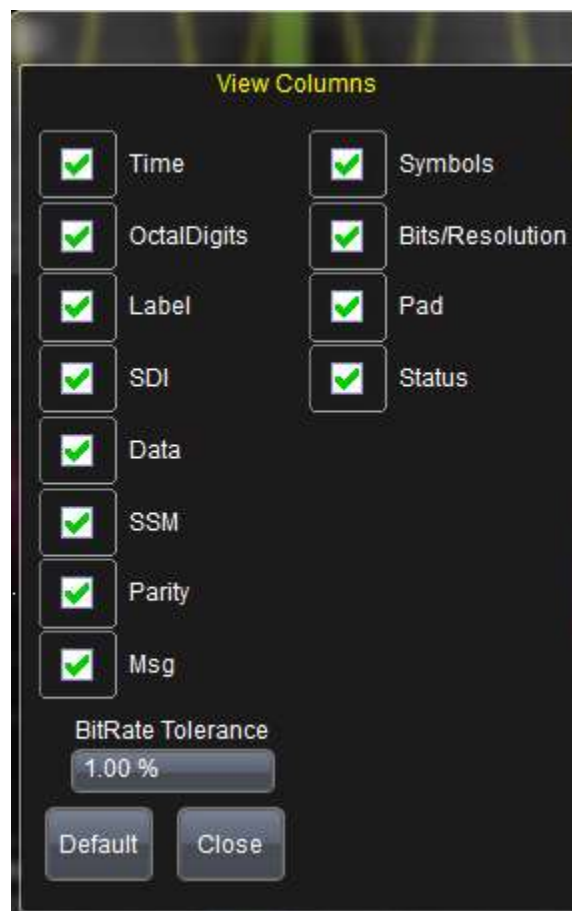

## Serial Data Debug Solutions

Make selections as desired. You can also set a **BitRate Tolerance** percentage or touch the **Default** button to load the preset selections. Touch the **Close** button when finished.

See **Protocol Results Table** (on page 19) for general information about the Table display.

After setting up your ARINC 429 decode and checking the **View Table** checkbox, the table should be shown on the display grid.

**Note:** After touching the **View Table** checkbox, touch the **Close** button at the upper-right portion of the Decode Setup dialog to maximize the display grid area.

### EXPORTING TABLE DATA

You can also Exported your table data as a **.CSV** file. Touch the **Export Table** button on the **Decode Setup...** dialog and follow the procedure explained in **Accessing The D and TD Supported Protocol Toolsets** (on page 13).

### ARINC 429 Decode Search

After clicking the Search button from the Decode dialog, the Zoom dialog is shown along with the **ARINC 429 Search** right-hand dialog.

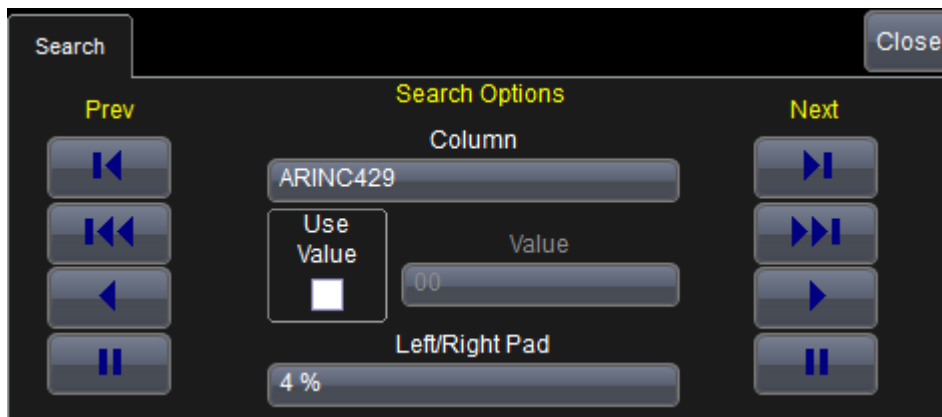

### NAVIGATION FIELDS

On either side of the dialog there are four **Prev** and **Next** buttons for **navigating through each occurrence, jump to the last or first occurrence, play in either direction, and pause.**

### SEARCH OPTIONS CONTROLS

The **Search Options** controls in the center of the dialog allow you to restrict your search based on parameter values for **Column**, **Left/Right Pad**, and **Value**. Value may be included or excluded from the search parameters using the **Use Value** checkbox. Provide a percentage value in the **Left/Right Pad** control if desired.

**Column** control values are available for your searches on **ARINC429**, **Time**, **OctalDigits**, **Label**, **SDI**, **Data**, **SSM**, **Parity**, **Msg**, **Symbols**, **Bits/Resolution**, **Pad**, **Status**, and **Attributes**.

## Using the MIL-STD-1553 Option

### Using the MIL-STD-1553 Option Overview

The MIL-STD-1553 option extracts serial data information for Transfer, Word, Error, and Timing messages in your oscilloscope waveforms.

**Note:** Ask your local LeCroy representative for more information about any Serial Data Debug Solution Protocols or Toolkits using the **Contact LeCroy for Support** (on page 199) topic.

## MIL-STD-1553 Decode Setup Detail

For general information about using controls shown on the main Serial Decode dialog, refer to **Accessing The D and TD Supported Protocol Toolsets** (on page 13).

### MIL-STD-1553 BASIC AND LEVELS RIGHT-HAND DIALOGS

Access the **Serial Decode** dialog by touching **Analysis** → **Serial Decode** on the menu bar.

Touch the corresponding **Setup...** button for your decode. The **Decode Setup...** along with corresponding right-hand dialogs are shown.

### MIL-STD-1553 Basic Right-Hand Dialog

The **Basic** right-hand dialog provides detailed controls and setup conditions as follows:

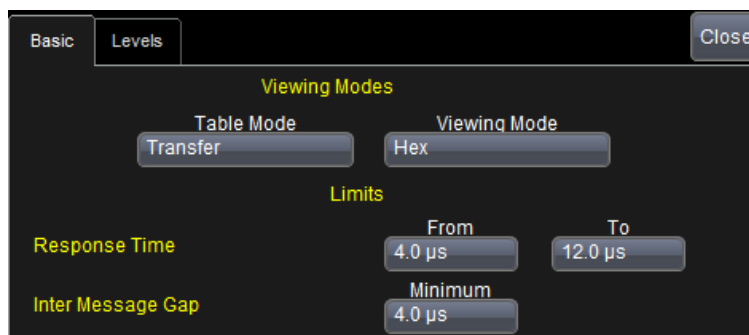

- **Table Mode** - Choosing **Word** or **Transfer** shows/hides different columns from the table display. **Word** displays the **Status** column on your table display; **Transfer** shows **Resp**, **Data**, **IMG**, and **Status** columns on your table display.
- **Viewing Mode** - Select to view the protocol data in **Binary** or **Hexadecimal** mode.
- **Response Time** - Provide **From** and **To** time lengths as desired.
- **Inter Message Gap** - Enter a **Minimum** threshold value for this parameter.

### MIL-STD-1553 Level Right-Hand Dialog

The **Level** right-hand dialog provides detailed controls and setup conditions as follows:

Adjust levels using **Absolute** or **Percent** Types. While **High** and **Low** values can be modified, preset levels are initially set to cross small amplitude signals.

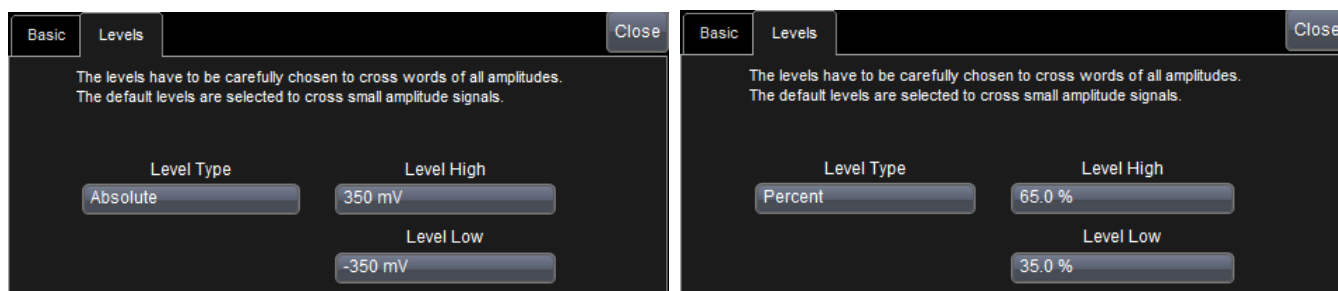

### PLEASE NOTE THE FOLLOWING:

- Choose voltage or percentage level values carefully. High and Low values you provide are applied across all amplitudes.
- While MIL-1553 messages can contain varied amplitudes, they are still decoded.  
Take an example where a transaction contains a 20 V amplitude on the bus controller word and 2 V on the reply words of the remote terminal; a ratio of 2:10.  
The gain then has to be adjusted to decode the lowest amplitude words (2 V) with a gain of, say, 1 V/div.  
While the high amplitude words (20 V) are overflow, they are still decoded.

## Serial Data Debug Solutions

### MIL-STD-1553 Decode Trace Annotations

Like all trace annotations, MIL-STD-1553 Decode annotations are rectangular shadings used to highlight messages on decoded waveforms for easy viewing.

**Tip:** Data packets (or messages) on properly decoded protocol signals can be viewed using **Serial Decode Trace Annotations** (on page 18), the **Protocol Results Table** (on page 19), and/or by **Searching for Messages** (on page 21) (Types and Subtypes). Using these tools together provides fast insight to your data. See **Serial Decode Trace Annotations** (on page 18) for more information.

Messages shown as **annotations**, **table columns**, and **search types** for most protocols are classified into **Frames**, **Errors**, **Unknown**, or **Grouped Primitives** specific to the protocol. Sub Types then further classify each main message type into more protocol-specific messages.

Decode annotations unique to MIL-STD-1553 include the following (some annotations are not shown in the screen-shot):

#### MIL-STD-1553 Decode Annotations

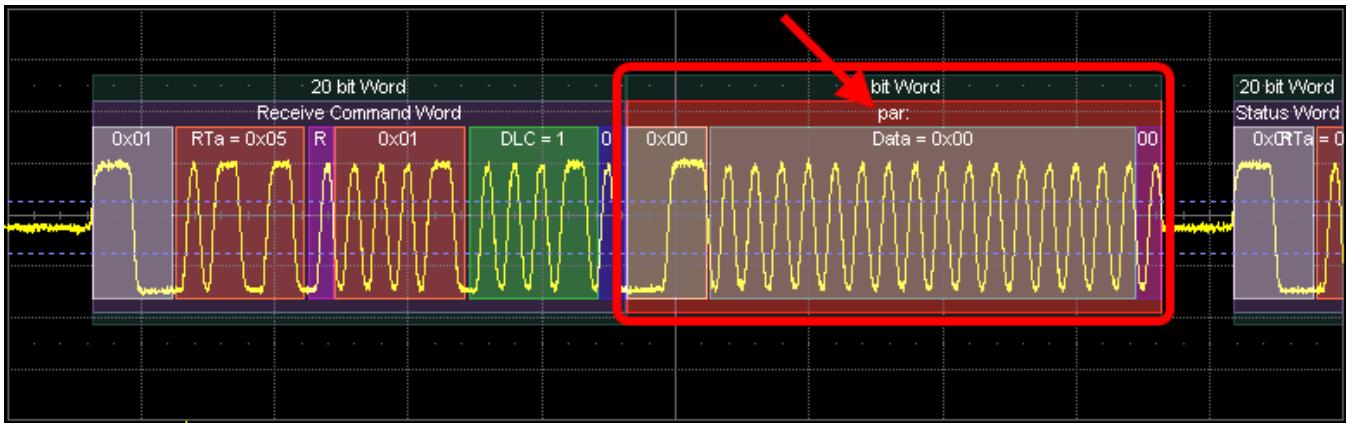

#### WORD AND TRANSFER LEVEL ERROR CODES ON DECODED WAVEFORM ANNOTATIONS

Whether selected or not from the Error Right-Hand Dialog covered in **MIL-STD-1553 Trigger Setup Detail** (), errors produced from the **Word and Transfer Level Errors** checkboxes (Sync, Manchester, Parity, and InvalidSync Errors) are then displayed on waveforms in a 3-Letter form. An example is the **par:** annotation on the following decoded waveform.

- **par** - Parity Word Error
- **ADD** - Add Mismatch Transfer Error
- **RTI** - Response Time Transfer Error
- **WCO** - Word Count Transfer Error
- **IMG** - Inter-Message Gap Transfer Error
- **Msg** - Displays the symbolic information.
- **CTG** - Non-Contiguous Transfer Error

#### PLEASE NOTE THE FOLLOWING:

- Lowercase error codes are for Word errors, while Uppercase error codes are for Transfer errors.
- Specifications are subject to change without notice.



### MIL-STD-1553 Decode Table Column Details

MIL-STD-1553 table column values available include the following:



Make selections as desired. You can also set a **BitRate Tolerance** percentage or touch the **Default** button to load the preset selections. Touch the **Close** button when finished.

See **Protocol Results Table** (on page 19) for general information about the Table display.

After setting up your MIL-STD-1553 decode and checking the **View Table** checkbox, the table should be shown on the display grid.

**Note:** After touching the **View Table** checkbox, touch the **Close** button at the upper-right portion of the Decode Setup dialog to maximize the display grid area.

#### EXPORTING TABLE DATA

You can also Exported your table data as a **.CSV** file. Touch the **Export Table** button on the **Decode Setup...** dialog and follow the procedure explained in **Accessing The D and TD Supported Protocol Toolsets** (on page 13).

## Serial Data Debug Solutions

### MIL-STD-1553 Decode Search

After clicking the Search button from the Decode dialog, the Zoom dialog is shown along with the **MIL 1553 Search** right-hand dialog.



#### NAVIGATION FIELDS

On either side of the dialog there are four **Prev** and **Next** buttons for **navigating through each occurrence, jump to the last or first occurrence, play in either direction, and pause.**

#### SEARCH OPTIONS FIELDS

**Search Options** fields in the center of the dialog allow you to restrict your search based on parameter values for **Column, Left/Right Pad, and Value.** Value may be included or excluded from the search parameters using the **Use Value** checkbox. Provide a percentage value in the **Left/Right Pad** field if desired.

**Column** control values are available for your searches on **MIL1553, Time, Msg, Tran, Type, Summary, Sync, RTAddress, t/r, SubAddress, Count, ModeCode, Parity, ResponseTime, RTAddressAck, MsgErr, Instr, SRQ, Reserved, BcastRec, Busy, SubSystFlg, DynBusAcc, TermFlg, Data, IMG, Status, and Attributes.**

#### Creating a MIL-STD-1553 Trigger Condition

Detail on some of the setup conditions for the MIL-STD-1553 Trigger dialog, along with the right hand dialogs, is shown in the following topics.

**Note:** Refer to the **Using The T Supported Protocol Toolsets** (on page 22) topic to correctly access the Trigger Condition dialog specific to your desired protocol.

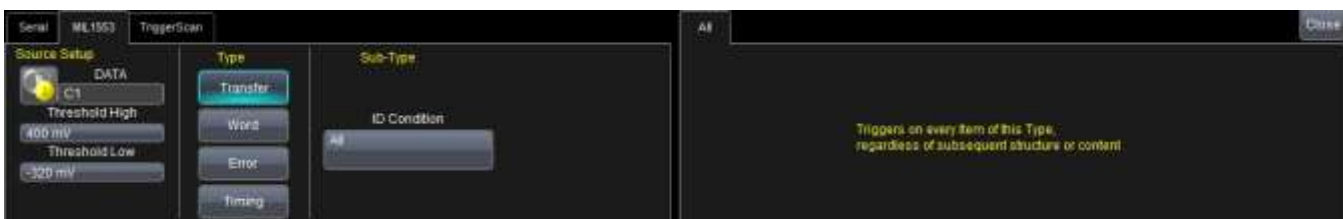

Make settings or provide values by touching controls (using your finger, stylus, or connected mouse). On applicable controls, a pop-up dialog box is shown where precise entry values can be set.

## MIL-STD-1553 Trigger Setup Detail

The following topics show the **main** and **right hand** dialog selections for a MIL-STD-1553 Trigger.

### MIL1553 TRIGGER MAIN DIALOG DETAIL



A few points about different MIL-STD-1553 trigger setup combinations:

- All trigger setups use **Source Setup...** and **Type** fields.
- All Types **except for Error** use **Sub-Type** (label 3, in the screen-shot) fields.
- Only the **Word** Type uses the Setup Format (label 4, in the screen-shot) fields.
- All Types **except for Transfer** have right-hand dialogs (label 5, in the screen-shot).

**Note:** Dialog fields vary based on your selections and are explained in respective sections as follows.

Previously numbered MIL 1553 trigger main dialog sections correspond with the following explanations.

#### 1. SOURCE SETUP

- **DATA** - The pop-up dialog is used to select the appropriate channel or EXT input for each. Set this field up with caution or your trigger may not function correctly.
- **Threshold (Trigger)High and Low** - Adjust the vertical level thresholds for the trigger. MIL 1553 is a tri-level signal and requires 2 voltage threshold settings which enable the oscilloscope to distinguish between 1 and 0.

Like an Edge trigger, the level must be specified to process the incoming signals and determine if the desired serial data pattern meets the set trigger condition.

#### 2. TYPE

Type selections include **Transfer**, **Word**, **Error**, and **Timing**.

**Note:** Additional fields shown on the dialog (including right-hand dialogs) vary and are based on the **Type** selection.

#### 3. SUB-TYPE

All Types (except for **Error**) have **Sub-Types** (label 3, in the screen-shot). **Transfer** and **Word** sub-types present additional sections on the main dialog. **Transfer**, **Word**, and **Timing** sub-types show several right-hand dialogs. These sections and right-hand dialogs are explained in the rest of the MIL-STD-1553 topics of this manual.

## Serial Data Debug Solutions

### Sub-Types, Setup Format, and Right-Hand Dialogs

#### TRANSFER SUB-TYPES, SETUP FORMAT, AND RIGHT-HAND DIALOGS

#### 4. Setup Format

**Note:** When **Transfer** and **Word** Types are selected, the **Setup Format** section is shown in the area on label **4** of the screen-shot in the **MIL-STD-1553 Trigger Setup Detail** (on page 107) topic.

Select from either **Binary** or **Hexadecimal (Hex)** formats for your values entered on sub-type right-hand dialogs.

When the **Transfer** Type is selected on the **Trigger Condition** dialog, the following 11 sub-types are available.

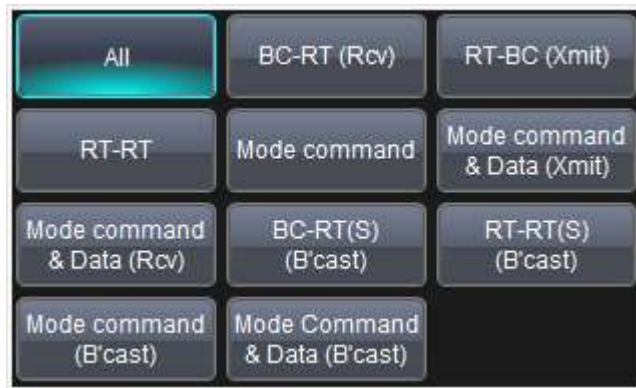

#### 5. Transfer Sub-Type Right-Hand Dialogs

When any sub-types other than **All** is selected, additional right-hand dialogs are shown on the Trigger Condition dialog.

**Note:** Right-hand dialogs are located in the area shown on label **5** of the screen-shot in the **MIL-STD-1553 Trigger Setup Detail** (on page 107) topic.

#### BC-RT (Rcv) Sub-Type and Right-Hand Dialogs

When the **BC-RT (Rcv)** sub-type is selected, the **RxCmd2**, **DW**, and **RxStat2** right-hand dialogs are made available.

- **RxCmd2 Right-Hand Dialog** - Provide values for the **RT** and **Sub Address** fields complete with **Condition**, **Value**, **To** (for range conditions), and **T/R** controls. Word Count/Mode Code fields include **Condition** and **Word Count** (amount) controls.

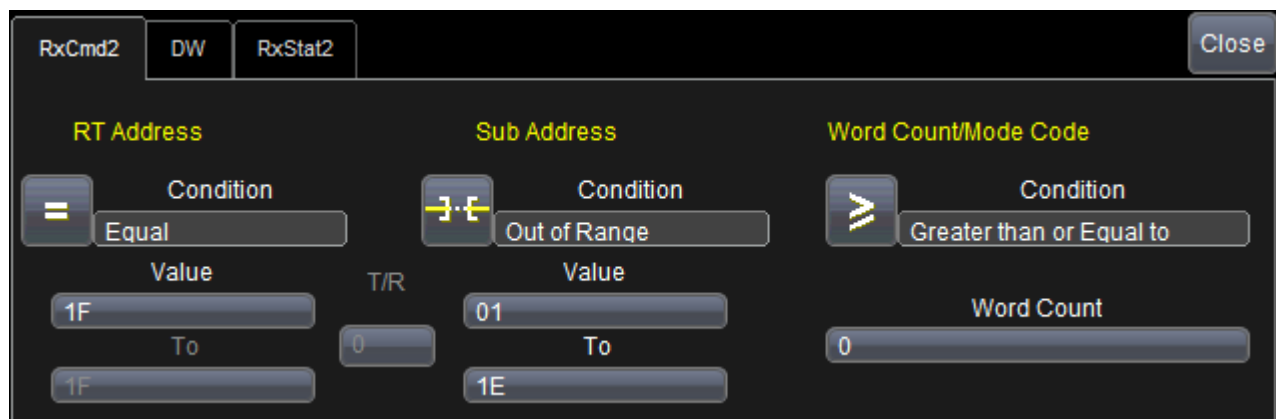

- **DW Right-Hand Dialog** - Provide Data Pattern Setup field values for **Data Condition**, **Start Bit** and **# Data Bits**, **Data Value** and **Data Value To** (for range conditions).

The screenshot shows the 'DW' dialog box with the 'Data Pattern Setup' section. It includes a 'Data Condition' dropdown set to 'Equal', a 'Start Bit' field set to '0', and a '#Data Bits' field set to '8'. Below these are 'Data Value' and 'Data Value To' fields, both set to 'XX' and 'FF' respectively. A 'Close' button is in the top right corner.

- **RxStat2 Right-Hand Dialog** - Provide RT Address field values for **Condition**, **Value** and **To** (for range conditions). Select Status Word Setup values (**0**, **1**, or **X**) for **Error**, **Instr**, **SRQ**, **Bcast Rcvd**, **Busy**, **Sub Syst**, **Dyn Bus**, and **Term Flg**.

The screenshot shows the 'RxStat2' dialog box with the 'Status Word Setup' section. It features an 'RT Address' section with 'Condition' set to 'Equal', 'Value' set to 'XX', and 'To' set to '1F'. To the right, there are seven status word setup fields: 'Error' (X), 'Instr' (X), 'SRQ' (1), 'Bcast Rcvd' (X), 'Busy' (X), 'Sub Syst' (X), 'Dyn Bus' (X), and 'Term Flg' (X). A 'Close' button is in the top right corner.

**RT-BC (Xmit) Sub-Type and Right-Hand Dialogs**

When the **RT-BC (Xmit)** sub-type is selected, the **TxCmd1**, **DW**, and **TxStat1** right-hand dialogs are made available.

**Note:** Different combinations of similar right-hand dialogs are made available for the various Sub-Types. See [BC-RT \(Rcv\) Sub-Type Right-Hand Dialogs](#) for screen-shots. Otherwise, provide field information as directed verbally.

- **TxCmd1 Right-Hand Dialog** - Provide values for the **RT** and **Sub Address** fields complete with **Condition**, **Value**, **To** (for range conditions), and **T/R** controls. Word Count/Mode Code fields include **Condition** and **Word Count** (amount) controls.
- **DW Right-Hand Dialog** - Provide Data Pattern Setup field values for **Data Condition**, **Start Bit** and **# Data Bits**, **Data Value** and **Data Value To** (for range conditions).
- **TxStat1 Right-Hand Dialog** - Provide RT Address field values for **Condition**, **Value** and **To** (for range conditions). Select Status Word Setup values (**0**, **1**, or **X**) for **Error**, **Instr**, **SRQ**, **Bcast Rcvd**, **Busy**, **Sub Syst**, **Dyn Bus**, and **Term Flg**.

## Serial Data Debug Solutions

---

### RT-RT Sub-Type and Right-Hand Dialogs

When the **RT-RT** sub-type is selected, the **TxCmd1**, **RxCmd2**, **DW**, **TxStat1**, and **RxStat2** right-hand dialogs are made available.

**Note:** Different combinations of similar right-hand dialogs are made available for the various Sub-Types. See [BC-RT \(Rcv\) Sub-Type Right-Hand Dialogs](#) for screen-shots. Otherwise, provide field information as directed verbally.

- **TxCmd1 Right-Hand Dialog** - Provide values for the **RT** and **Sub Address** fields complete with **Condition**, **Value**, **To** (for range conditions), and **T/R** controls. Word Count/Mode Code fields include **Condition** and **Word Count** (amount) controls.
- **RxCmd2 Right-Hand Dialog** - Provide values for the **RT** and **Sub Address** fields complete with **Condition**, **Value**, **To** (for range conditions), and **T/R** controls. Word Count/Mode Code fields include **Condition** and **Word Count** (amount) controls.
- **DW Right-Hand Dialog** - Provide Data Pattern Setup field values for **Data Condition**, **Start Bit** and **# Data Bits**, **Data Value** and **Data Value To** (for range conditions).
- **TxStat1 Right-Hand Dialog** - Provide RT Address field values for **Condition**, **Value** and **To** (for range conditions). Select Status Word Setup values (**0**, **1**, or **X**) for **Error**, **Instr**, **SRQ**, **Bcast Rcvd**, **Busy**, **Sub Syst**, **Dyn Bus**, and **Term Flg**.
- **RxStat2 Right-Hand Dialog** - Provide RT Address field values for **Condition**, **Value** and **To** (for range conditions). Select Status Word Setup values (**0**, **1**, or **X**) for **Error**, **Instr**, **SRQ**, **Bcast Rcvd**, **Busy**, **Sub Syst**, **Dyn Bus**, and **Term Flg**.

### Mode command Sub-Type and Right-Hand Dialogs

When the **Mode command** sub-type is selected, the **TxCmd1** and **TxStat1** right-hand dialogs are made available.

**Note:** Different combinations of similar right-hand dialogs are made available for the various Sub-Types. See [BC-RT \(Rcv\) Sub-Type Right-Hand Dialogs](#) for screen-shots. Otherwise, provide field information as directed verbally.

- **TxCmd1 Right-Hand Dialog** - Provide values for the **RT** and **Sub Address** fields complete with **Condition, Value, To** (for range conditions), and **T/R** controls. Word Count/Mode Code fields include **Condition** and **Mode Code** controls. Select from 32 possible **Mode Code** values:

Mode Code Field Values					
Dynamic Bus Control	Synchronize	Transmit Status Word	Initiate Self Test	Transmitter Shutdown	Override Transmitter Shutdown
Inhibit Terminal Flag	Override Inhibit Terminal Flag	Reset Remote Terminal	Reserved	Reserved	Reserved
Reserved	Reserved	Reserved	Reserved	Transmit Vector Word	Synchronize
Transmit Last Command	Transmit BIT Word	Selected Transmitter Shutdown	Override Selected Transmitter Shutdown	Reserved	Reserved
Reserved	Reserved	Reserved	Reserved	Reserved	Reserved
Reserved	Reserved				

- **TxStat1 Right-Hand Dialog** - Provide RT Address field values for **Condition, Value** and **To** (for range conditions). Select Status Word Setup values (**0, 1, or X**) for **Error, Instr, SRQ, Bcast Rcvd, Busy, Sub Syst, Dyn Bus, and Term Flg**.

#### Mode command & Data (Xmit) Sub-Type and Right-Hand Dialogs

When the **Mode command & Data (Xmit)** sub-type is selected, the **TxCmd1, DW,** and **TxStat1** right-hand dialogs are made available.

**Note:** Different combinations of similar right-hand dialogs are made available for the various Sub-Types. See [BC-RT \(Rcv\) Sub-Type Right-Hand Dialogs](#) for screen-shots. Otherwise, provide field information as directed verbally.

## Serial Data Debug Solutions

- **TxCmd1 Right-Hand Dialog** - Provide values for the **RT** and **Sub Address** fields complete with **Condition, Value, To** (for range conditions), and **T/R** controls. Word Count/Mode Code fields include **Condition** and **Mode Code** controls. Select from 32 possible **Mode Code** values:

Mode Code Field Values					
Dynamic Bus Control	Synchronize	Transmit Status Word	Initiate Self Test	Transmitter Shutdown	Override Transmitter Shutdown
Inhibit Terminal Flag	Override Inhibit Terminal Flag	Reset Remote Terminal	Reserved	Reserved	Reserved
Reserved	Reserved	Reserved	Reserved	Transmit Vector Word	Synchronize
Transmit Last Command	Transmit BIT Word	Selected Transmitter Shutdown	Override Selected Transmitter Shutdown	Reserved	Reserved
Reserved	Reserved	Reserved	Reserved	Reserved	Reserved
Reserved	Reserved				

- **DW Right-Hand Dialog** - Provide Data Pattern Setup field values for **Data Condition, Start Bit** and **# Data Bits, Data Value** and **Data Value To** (for range conditions).
- **TxStat1 Right-Hand Dialog** - Provide RT Address field values for **Condition, Value** and **To** (for range conditions). Select Status Word Setup values (**0, 1, or X**) for **Error, Instr, SRQ, Bcast Rcvd, Busy, Sub Syst, Dyn Bus,** and **Term Flg.**

### Mode command & Data (Rcv) Sub-Type and Right-Hand Dialogs

When the **Mode command & Data (Rcv)** sub-type is selected, the **RxCmd2, DW,** and **RxStat2** right-hand dialogs are made available.

**Note:** Different combinations of similar right-hand dialogs are made available for the various Sub-Types. See [BC-RT \(Rcv\) Sub-Type Right-Hand Dialogs](#) for screen-shots. Otherwise, provide field information as directed verbally.



- **RxCmd2 Right-Hand Dialog** - Provide values for the **RT** and **Sub Address** fields complete with **Condition, Value, To** (for range conditions), and **T/R** controls. Word Count/Mode Code fields include **Condition** and **Mode Code** controls. Select from 32 possible **Mode Code** values:

Mode Code Field Values					
Dynamic Bus Control	Synchronize	Transmit Status Word	Initiate Self Test	Transmitter Shutdown	Override Transmitter Shutdown
Inhibit Terminal Flag	Override Inhibit Terminal Flag	Reset Remote Terminal	Reserved	Reserved	Reserved
Reserved	Reserved	Reserved	Reserved	Transmit Vector Word	Synchronize
Transmit Last Command	Transmit BIT Word	Selected Transmitter Shutdown	Override Selected Transmitter Shutdown	Reserved	Reserved
Reserved	Reserved	Reserved	Reserved	Reserved	Reserved
Reserved	Reserved				

- **DW Right-Hand Dialog** - Provide Data Pattern Setup field values for **Data Condition, Start Bit** and **# Data Bits, Data Value** and **Data Value To** (for range conditions).
- **RxStat2 Right-Hand Dialog** - Provide RT Address field values for **Condition, Value** and **To** (for range conditions). Select Status Word Setup values (**0, 1, or X**) for **Error, Instr, SRQ, Bcast Rcvd, Busy, Sub Syst, Dyn Bus,** and **Term Flg.**

#### BC-RT(S) (B'cast) Sub-Type and Right-Hand Dialogs

When the **BC-RT(S) (B'cast)** sub-type is selected, the **RxCmd2** and **DW** right-hand dialogs are made available.

**Note:** Different combinations of similar right-hand dialogs are made available for the various Sub-Types. See [BC-RT \(Rcv\) Sub-Type Right-Hand Dialogs](#) for screen-shots. Otherwise, provide field information as directed verbally.

- **RxCmd2 Right-Hand Dialog** - Provide values for the **RT** and **Sub Address** fields complete with **Condition, Value, To** (for range conditions), and **T/R** controls. Word Count/Mode Code fields include **Condition** and **Word Count** (amount) controls.
- **DW Right-Hand Dialog** - Provide Data Pattern Setup field values for **Data Condition, Start Bit** and **# Data Bits, Data Value** and **Data Value To** (for range conditions).

#### RT-RT(S) (B'cast) Sub-Type and Right-Hand Dialogs

When the **RT-RT(S) (B'cast)** sub-type is selected, the **TxCmd1, RxCmd2, DW,** and **TxStat1** right-hand dialogs are made available.

**Note:** Different combinations of similar right-hand dialogs are made available for the various Sub-Types. See [BC-RT \(Rcv\) Sub-Type Right-Hand Dialogs](#) for screen-shots. Otherwise, provide field information as directed verbally.

## Serial Data Debug Solutions

- **TxCmd1 Right-Hand Dialog** - Provide values for the **RT** and **Sub Address** fields complete with **Condition, Value, To** (for range conditions), and **T/R** controls. Word Count/Mode Code fields include **Condition** and **Word Count** (amount) controls.
- **RxCmd2 Right-Hand Dialog** - Provide values for the **RT** and **Sub Address** fields complete with **Condition, Value, To** (for range conditions), and **T/R** controls. Word Count/Mode Code fields include **Condition** and **Word Count** (amount) controls.
- **DW Right-Hand Dialog** - Provide Data Pattern Setup field values for **Data Condition, Start Bit** and **# Data Bits, Data Value** and **Data Value To** (for range conditions).
- **TxStat1 Right-Hand Dialog** - Provide RT Address field values for **Condition, Value** and **To** (for range conditions). Select Status Word Setup values (**0, 1, or X**) for **Error, Instr, SRQ, Bcast Rcvd, Busy, Sub Syst, Dyn Bus,** and **Term Flg**.

### Mode command (B'cast) Sub-Type and Right-Hand Dialogs

When the **Mode command (B'cast)** sub-type is selected, the **TxCmd1** right-hand dialog is made available.

**Note:** Different combinations of similar right-hand dialogs are made available for the various Sub-Types. See [BC-RT \(Rcv\) Sub-Type Right-Hand Dialogs](#) for screen-shots. Otherwise, provide field information as directed verbally.

- **TxCmd1 Right-Hand Dialog** - Provide values for the **RT** and **Sub Address** fields complete with **Condition, Value, To** (for range conditions), and **T/R** controls. Word Count/Mode Code fields include **Condition** and **Mode Code** controls. Select from 32 possible **Mode Code** values:

Mode Code Field Values					
Dynamic Bus Control	Synchronize	Transmit Status Word	Initiate Self Test	Transmitter Shutdown	Override Transmitter Shutdown
Inhibit Terminal Flag	Override Inhibit Terminal Flag	Reset Remote Terminal	Reserved	Reserved	Reserved
Reserved	Reserved	Reserved	Reserved	Transmit Vector Word	Synchronize
Transmit Last Command	Transmit BIT Word	Selected Transmitter Shutdown	Override Selected Transmitter Shutdown	Reserved	Reserved
Reserved	Reserved	Reserved	Reserved	Reserved	Reserved
Reserved	Reserved				

### Mode command & Data (B'cast) Sub-Type and Right-Hand Dialogs

When the **Mode command & Data (B'cast)** sub-type is selected, the **RxCmd1** and **DW** right-hand dialogs are made available.

**Note:** Different combinations of similar right-hand dialogs are made available for the various Sub-Types. See [BC-RT \(Rcv\) Sub-Type Right-Hand Dialogs](#) for screen-shots. Otherwise, provide field information as directed verbally.

- **RxCmd1 Right-Hand Dialog** - Provide values for the **RT** and **Sub Address** fields complete with **Condition, Value, To** (for range conditions), and **T/R** controls. Word Count/Mode Code fields include **Condition** and **Mode Code** controls. Select from 32 possible **Mode Code** values:

Mode Code Field Values					
Dynamic Bus Control	Synchronize	Transmit Status Word	Initiate Self Test	Transmitter Shutdown	Override Transmitter Shutdown
Inhibit Terminal Flag	Override Inhibit Terminal Flag	Reset Remote Terminal	Reserved	Reserved	Reserved
Reserved	Reserved	Reserved	Reserved	Transmit Vector Word	Synchronize
Transmit Last Command	Transmit BIT Word	Selected Transmitter Shutdown	Override Selected Transmitter Shutdown	Reserved	Reserved
Reserved	Reserved	Reserved	Reserved	Reserved	Reserved
Reserved	Reserved				

- **DW Right-Hand Dialog** - Provide Data Pattern Setup field values for **Data Condition, Start Bit** and **# Data Bits, Data Value** and **Data Value To** (for range conditions).

**WORD SUB-TYPES, SETUP FORMAT, AND RIGHT-HAND DIALOGS**

**4. Setup Format**

**Note:** When **Transfer** and **Word** Types are selected, the **Setup Format** section is shown in the area on label **4** of the screen-shot in the **MIL-STD-1553 Trigger Setup Detail** (on page 107) topic.

Select from either **Binary** or **Hexadecimal (Hex)** formats for your values entered on sub-type right-hand dialogs. When the **Word** Type is selected on the **Trigger Condition** dialog, the **All, Command, Data,** and **Status** sub-types are available.

**5. Word Sub-Type Right-Hand Dialogs**

When any sub-types other than **All** is selected, a correspondingly named right-hand dialog is shown.

**Note:** Right-hand dialogs are located in the area shown on label **5** of the screen-shot in the **MIL-STD-1553 Trigger Setup Detail** (on page 107) topic.

**Command Sub-Type and Right-Hand Dialog**

When the **Command** sub-type is selected, the **Command** right-hand dialog is made available. Provide values for the **RT** and **Sub Address** fields complete with **Condition, Value, To** (for range conditions), and **T/R** controls. Word Count/Mode Code fields include **Condition** and **Word Count** (amount) controls.

**Data Sub-Type and Right-Hand Dialog**

When the **Data** sub-type is selected, the **Data** right-hand dialog is made available. Provide Data Pattern Setup field values for **Data Condition, Start Bit** and **# Data Bits, Data Value** and **Data Value To** (for range conditions).

## Serial Data Debug Solutions

### Status Sub-Type and Right-Hand Dialog

When the **Status** sub-type is selected, the **Status** right-hand dialog is made available. Provide RT Address field values for **Condition**, **Value** and **To** (for range conditions). Select Status Word Setup values (**0**, **1**, or **X**) for **Error**, **Instr**, **SRQ**, **Bcast Rcvd**, **Busy**, **Sub Syst**, **Dyn Bus**, and **Term Flg**.

#### 5. ERROR SUB-TYPE AND RIGHT-HAND DIALOG

When the **Error** sub-type is selected, a correspondingly named **Error** right-hand dialog is shown.

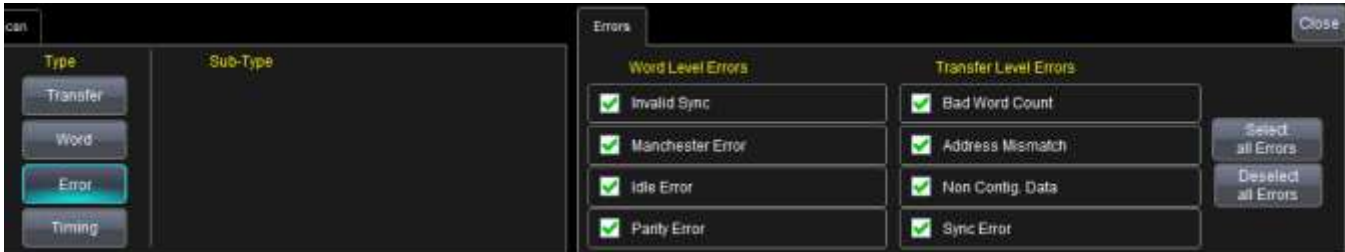

**Note:** Right-hand dialogs are located in the area shown on label 5 of the screen-shot in the **MIL-STD-1553 Trigger Setup Detail** (on page 107) topic.

### Error Sub-Type and Right-Hand Dialog

Mark/unmark checkboxes as desired for **Word** and **Transfer Level Errors**. The **Select all Errors**, and **Deselect all Errors** buttons are available for convenience.

#### 5. TIMING SUB-TYPES AND RIGHT-HAND DIALOGS

When the **Timing** Type is selected, the **Response Time** and **Inter Message Gap** Sub-Types are available on the main dialog.

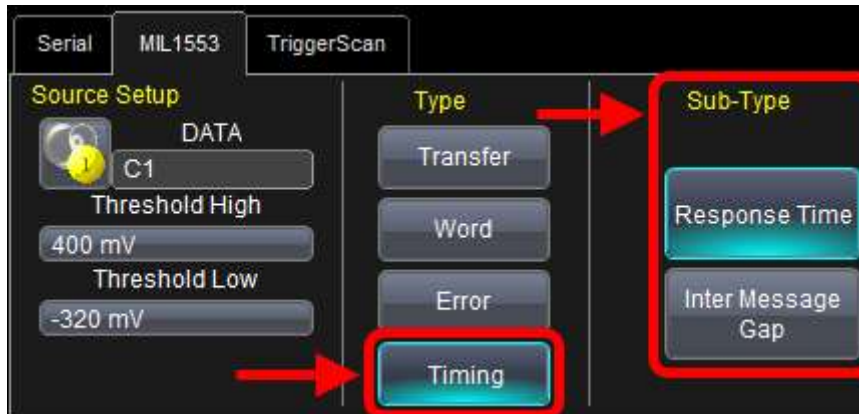

**Response Time** and **Inter Message Gap** Sub-Types show correspondingly named right-hand dialogs as follows:

**Note:** Right-hand dialogs are located in the area shown on label 5 of the screen-shot in the **MIL-STD-1553 Trigger Setup Detail** (on page 107) topic.

## Response Time Right-Hand Dialog

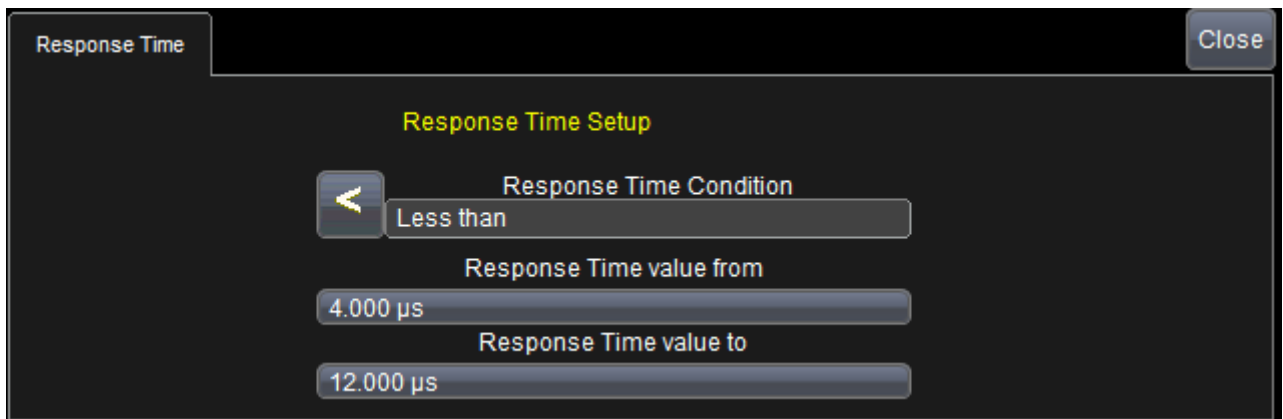

The dialog box is titled "Response Time" and has a "Close" button in the top right corner. The main content area is titled "Response Time Setup" in yellow. It contains a dropdown menu for "Response Time Condition" with "Less than" selected. Below this are two input fields: "Response Time value from" with "4.000 μs" and "Response Time value to" with "12.000 μs".

Provide **Response Time Setup...** values for **Condition**, **Value**, and **To** (for range conditions).

## Inter Message Gap Right-Hand Dialog

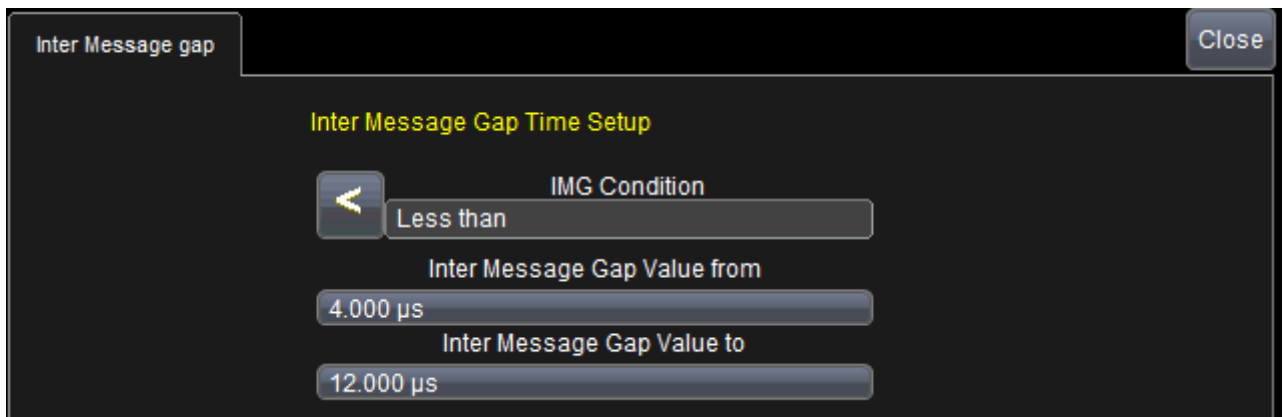

The dialog box is titled "Inter Message gap" and has a "Close" button in the top right corner. The main content area is titled "Inter Message Gap Time Setup" in yellow. It contains a dropdown menu for "IMG Condition" with "Less than" selected. Below this are two input fields: "Inter Message Gap Value from" with "4.000 μs" and "Inter Message Gap Value to" with "12.000 μs".

Provide **Inter Message Gap Time Setup...** values for **Condition**, **Value**, and **To** (for range conditions).

# Handset, Cellular, and Mobile Computing Protocols

## Handset, Cellular, and Mobile Computing Protocols Overview

### *DigRF 3G*

The [DigRF 3G](#) is a Mobile Industry Processing Interface (MIPI) standard for wireless mobile RFIC to BBIC mobile device interfaces.

The standard is maintained by MIPI Alliance. Additional information, including the specification, can be found at [www.mipi.org/](http://www.mipi.org/).

Number of Lines	Data rate	Synchronous or Asynchronous
2	312 Mb/s	Asynchronous

### *DigRF 4G*

The [DigRF 4G](#) is a Mobile Industry Processing Interface (MIPI) standard for wireless mobile RFIC to BBIC mobile device interfaces.

The standard is maintained by MIPI Alliance. Additional information, including the specification, can be found at [www.mipi.org/](http://www.mipi.org/).

Number of Lines	Data rate	Synchronous or Asynchronous
2	312 Mb/s	Asynchronous

### *D-PHY (CSI-2/DSI)*

The [MIPI D-PHY \(CSI-2/DSI\)](#) is another Mobile Industry Processing Interface (MIPI) standard.

The standard is also maintained by MIPI Alliance. Additional information, including the specification, can be found at [www.mipi.org/](http://www.mipi.org/).

Number of Lines	Data rate	Synchronous or Asynchronous
2	Up to 1 Gb/s	Asynchronous

### *M-PHY*

The [MIPI M-PHY](#) is another Mobile Industry Processing Interface (MIPI) standard.

The standard is also maintained by MIPI Alliance. Additional information, including the specification, can be found at [www.mipi.org/](http://www.mipi.org/).

Number of Lines	Data rate	Synchronous or Asynchronous
2	Up to 1 Gb/s	Asynchronous

## Using the DigRF 3G Option

### *Using the DigRF 3G Option Overview*

The DigRF 3G option displays the digital conversion of **I** and **Q** RF signals, and then displays the entire frame structure, including the **Sync field**, **Header**, **Payload Size** coding, and **Payload**.

**Note:** Ask your local LeCroy representative for more information about any Serial Data Debug Solution Protocols or Toolkits using the **Contact LeCroy for Support** (on page 199) topic.

### *DigRF 3G Decode Setup Detail*

For general information about using controls shown on the main Serial Decode dialog, refer to **Accessing The D and TD Supported Protocol Toolsets** (on page 13).

**DIGRF 3G VIEW I & Q BUTTON AND MIPI DIGRF 3G RIGHT-HAND DIALOG**

Access the **Serial Decode** dialog by touching **Analysis** → **Serial Decode** on the menu bar.

Touch the corresponding **Setup...** button for your decode. The **Decode Setup...** along with corresponding right-hand dialogs are shown.

**DigRF 3G View I & Q Button**

The main Decode Setup dialog contains a **View I & Q** Action for decoder button.

When the **View I & Q** button is touched, the **View I & Q Wizard** pop-up is shown.

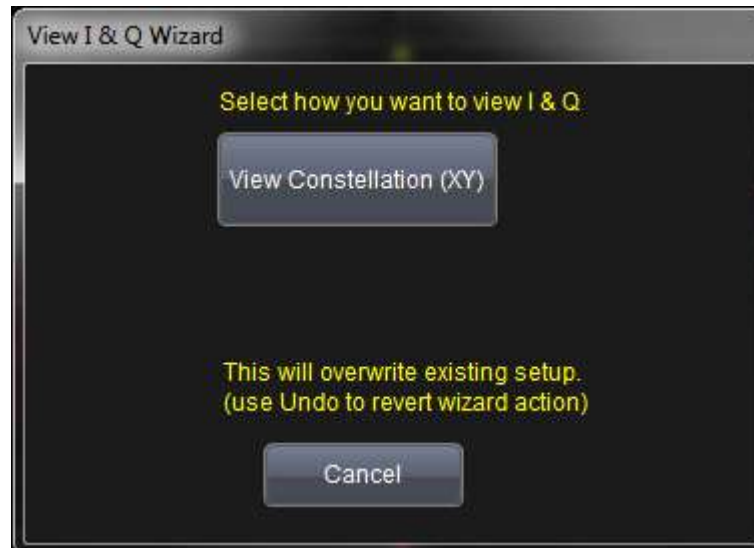

For general information about using controls shown on the main Serial Decode dialog, refer to **Accessing The D and TD Supported Protocol Toolsets** (on page 13).

**MIPI DigRF 3G Right-Hand Dialog**

The **MIPI DigRF 3G** dialog is located on the lower-right part of the screen.

DigRF 3G uses color-coded overlays or **annotations** on various sections of the protocol decode for an easy-to-understand visual display.

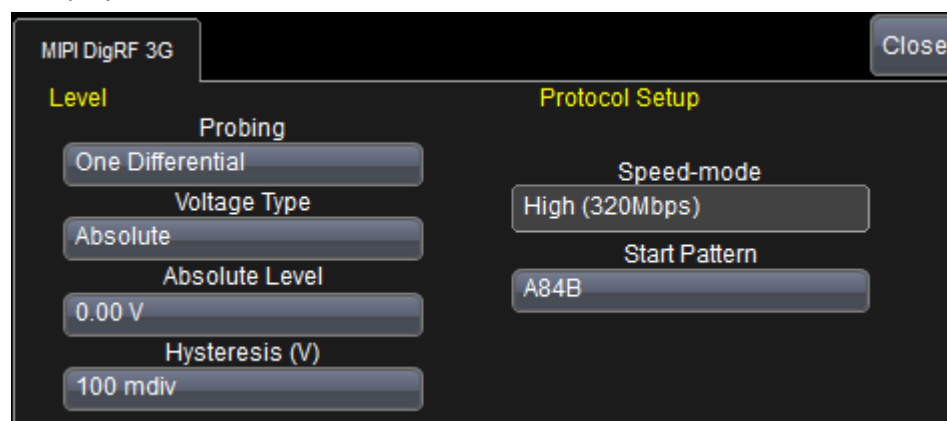
**Level**

- **Probing** - Choose from **One Differential** and **Two Single Ended** values.
- **Voltage Type** - Choose from **Absolute** and **Percent** values.
- **Absolute Level** - Provide a desired amount in volts for your decode. Enter a value using your preferred input control method.

## Serial Data Debug Solutions

- **Hysteresis (V)** - Provide a desired voltage level for the Hysteresis.

### Setup

- **Speed-mode** - Choose from **Low (6.5Mbps)**, **Medium (26Mbps)**, and **High (320Mbps)** values.
- **Start Pattern** - Provide a desired value using the **Hexadecimal Virtual Keypad**, if desired.

### DigRF 3G Decode Trace Annotations

Like all trace annotations, DigRF 3G Decode annotations are rectangular shadings used to highlight messages on decoded waveforms for easy viewing.

**Tip:** Data packets (or messages) on properly decoded protocol signals can be viewed using **Serial Decode Trace Annotations** (on page 18), the **Protocol Results Table** (on page 19), and/or by **Searching for Messages** (on page 21) (Types and Subtypes). Using these tools together provides fast insight to your data. See **Serial Decode Trace Annotations** (on page 18) for more information.

Messages shown as **annotations**, **table columns**, and **search types** for most protocols are classified into **Frames**, **Errors**, **Unknown**, or **Grouped Primitives** specific to the protocol. Sub Types then further classify each main message type into more protocol-specific messages.

Decode annotations unique to DigRF 3G include the following (some annotations are not shown in the screenshot):

### DigRF 3G Decode Annotations

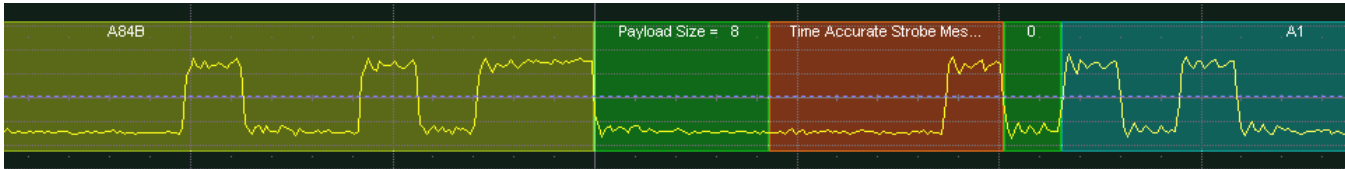

- **Sync**
- **Payload Size**
- **LCTS**
- **CTS/RTI**
- **Word Name**
- **Comment**
- **Payload**
- **I Data**
- **Q Data**

**Note:** Specifications are subject to change without notice.



### DigRF 3G Decode Table Column Details

DigRF 3G table column values available include the following:

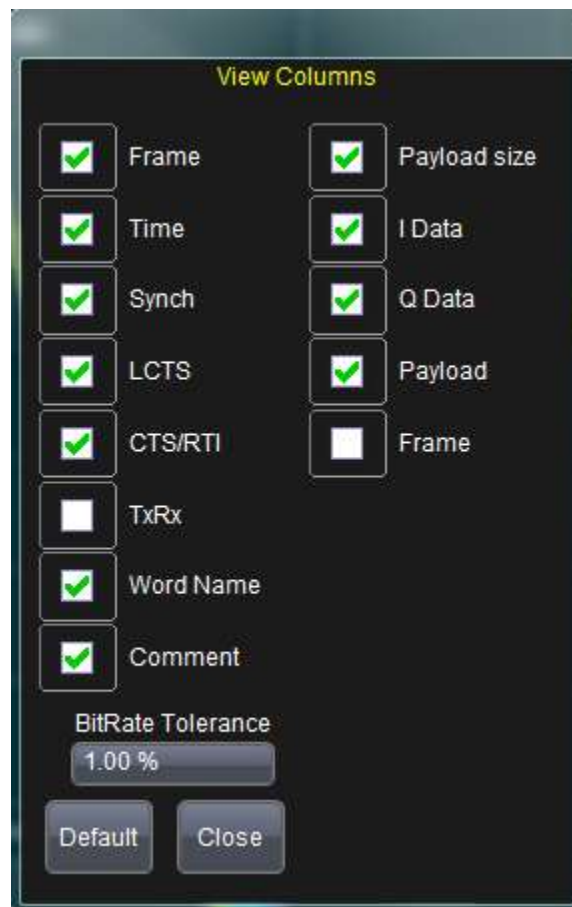

Make selections as desired. You can also set a **BitRate Tolerance** percentage or touch the **Default** button to load the preset selections. Touch the **Close** button when finished.

See **Protocol Results Table** (on page 19) for general information about the Table display.

After setting up your DigRF 3G decode and checking the **View Table** checkbox, the table should be shown just beneath the signal display grid.

**Note:** After touching the **View Table** checkbox, touch the **Close** button at the upper-right portion of the Decode Setup dialog to maximize the display grid area.

#### EXPORTING TABLE DATA

You can also Exported your table data as a **.CSV** file. Touch the **Export Table** button on the **Decode Setup...** dialog and follow the procedure explained in **Using The D Supported Protocol Toolsets** (on page 14).

## Serial Data Debug Solutions

### *DigRF 3G Decode Search*

After clicking the Search button from the Decode dialog, the Zoom dialog is shown along with the **DigRF 3G Search** right-hand dialog.

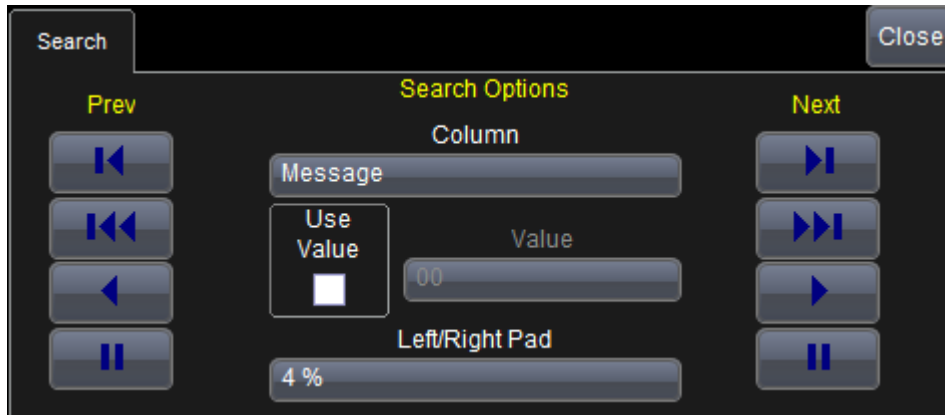

#### **NAVIGATION FIELDS**

On either side of the dialog there are four **Prev** and **Next** buttons for **navigating through each occurrence, jump to the last or first occurrence, play in either direction, and pause.**

#### **SEARCH OPTIONS FIELDS**

**Search Options** fields in the center of the dialog allow you to restrict your search based on parameter values for **Column**, **Left/Right Pad**, and **Value**. Value may be included or excluded from the search parameters using the **Use Value** checkbox. Provide a percentage value in the **Left/Right Pad** field if desired.

The following **Column** field values are available for your searches.

- **Message**
- **Time**
- **Synch**
- **LCTS** - Logical Channel Types
- **CTS/RTI**
- **TxRx** - Transmit or Receive
- **WordName** - A user-defined value when the **DigRFv4\_B10I.xml** file is modified as described in **Customizing WordName and Comment Definitions** (on page 128).
- **Comment** - Another user-defined value when the same **DigRFv4\_B10I.xml** file is modified.
- **Payload size** - Packet Size
- **Payload** - Raw data
- **I Data** - In-Phase payload interpreted data.
- **Q Data** - Quadrature payload interpreted data.
- **Frame** - Start and stop time of the packet (hidden column).
- **Attributes**

## Using the DigRF v4 Option

### *Using the DigRF v4 Option Overview*

The DigRF v4 option displays the digital conversion of **I** and **Q** RF signals, and then displays the entire frame structure, including the **Sync field**, **Header**, **Payload Size** coding, and **Payload**.

**Note:** Ask your local LeCroy representative for more information about any Serial Data Debug Solution Protocols or Toolkits using the **Contact LeCroy for Support** (on page 199) topic.

### ***DigRF v4 Decode Setup Detail***

For general information about using controls shown on the main Serial Decode dialog, refer to **Accessing The D and TD Supported Protocol Toolsets** (on page 13).

#### ***DIGRF v4 VIEW I & Q BUTTON AND MIPI DIGRF v4 RIGHT-HAND DIALOG***

Access the **Serial Decode** dialog by touching **Analysis** → **Serial Decode** on the menu bar.

Touch the corresponding **Setup...** button for your decode. The **Decode Setup...** along with corresponding right-hand dialogs are shown.

#### **DigRF v4 View I & Q Button**

The main Decode Setup dialog contains a **View I & Q** Action for decoder button.

When the **View I & Q** button is touched, the **View I & Q Wizard** pop-up is shown.

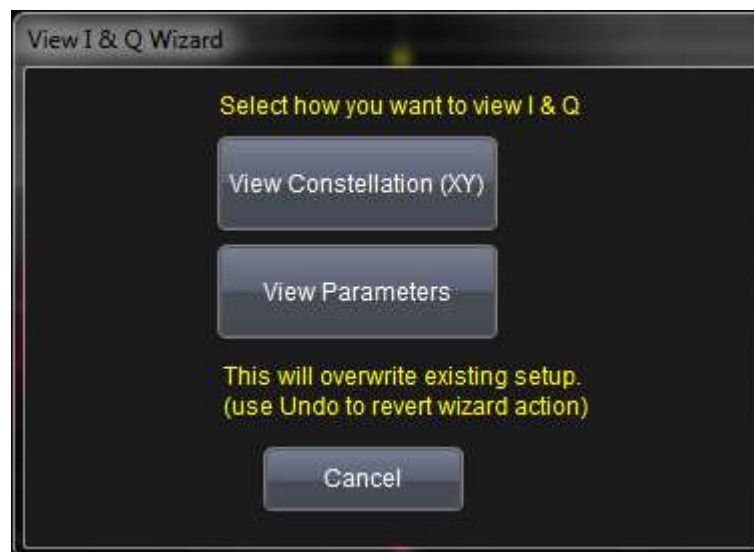

## Serial Data Debug Solutions

You can touch buttons on the **View I & Q Wizard** pop-up to **View Constellation (XY)** or **View Parameters**.

- **View Constellation** creates a Constellation Diagram using the converted I an Q waveforms from your signal.
- **View Parameters** show DigRF v4-specific measurement parameters in tabular form beneath the signal display grid.

The screenshot displays the Serial Decode software interface. At the top, there are menu options: File, Vertical, Timebase, Trigger, Display, Cursors, Measure, Math, Analysis, Utilities, Help. The main display area is divided into several sections:

- Signal Waveforms:** The top section shows multiple waveforms, including a green one labeled 'M4' and a red one labeled 'P2'. A callout box points to the waveforms, stating: "View Constellation creates a Constellation Diagram using the converted I an Q waveforms from your signal."
- Constellation Diagram:** A callout box points to a constellation diagram on the right side of the screen, stating: "View Constellation creates a Constellation Diagram using the converted I an Q waveforms from your signal."
- Measure Status Table:** A table below the waveforms shows measurement parameters:
 

Measure	status	P1 Mag (Vrms)(Decode3)	P2 Mag (Vrms)(Decode3)	P3 IVRms (Decode3)	P4 QVRms (Decode3)	P5 PIQ (Decode3)	P6 IDC (Decode3)	P7 QDC (Decode3)	P8
status	status			59	55	41 dBm	-69 lsb	4 lsb	
- Table of Decoded Data:** A table below the measure status table shows decoded data:
 

Time	LCID	CRI	Word Name	Size	Payload	CRC
24 ns RBCLC	6			8	02 00 00 00 00 00 01	CRC OK-25582558
128 ns TICLC	7		DUMMY_FRAME-2	96 00		CRC OK-46D9A6D9
75.58 µs DCL0	0			32	00 30 FF D0 00 40 FF E0 00 20 00 20 FF D0 00 50 FF A0	CRC OK-7F367F36
75.97 µs TICLC	1		DUMMY_FRAME-2	96 00		CRC OK-30B230B2
90.35 µs DCL0	2			32	FF B0 FF B0 FF E0 FF C0 00 10 FF F0 00 10 20 FF E	CRC OK-11B711B7
- Serial Decode Dialog:** The bottom section shows the Serial Decode dialog with buttons for Decode 1, Decode 2, Decode 3, and Decode 4. The 'View Decode' button is highlighted, and the 'Table #Rows' is set to 5. The 'Action for decoder' is set to 'View I & Q'. The 'Protocol' is set to 'MIPI DigRF V4'. The 'Output File' is 'c:\LeCroy\X...DecodeTable.csv'.
- DigRFV4Decoder Dialog:** A callout box points to the DigRFV4Decoder dialog, stating: "View Parameters show DigRF 4G-specific measurement parameters in tabular form beneath the signal display grid."

For general information about using controls shown on the main Serial Decode dialog, refer to **Accessing The D and TD Supported Protocol Toolsets** (on page 13).

### MIPI DigRF v4 Right-Hand Dialog

The **MIPI DigRF v4** dialog is located on the lower-right part of the screen.

DigRF v4 uses color-coded overlays or **annotations** on various sections of the protocol decode for an easy-to-understand visual display.

The screenshot shows the DigRFV4Decoder dialog with the following settings:

- Probing / Level:**
  - Probing: One Differential
  - Level: 0.00 V
  - Hysteresis: 100 mdiv
- Protocol Setup:**
  - Speed-mode: Medium (1248Mbps)
  - IQ Period: IQ Period
  - Level: 2G(541.66kHz)
  - IQ Format: Standard
  - RF Path: Main

## Probing/Level

- **Probing** - Choose from **One Differential** and **Two Single Ended** values.
- **Level** - Provide a desired voltage level for your decode. Enter a value using your preferred input control method. Additional information on using the touch screen controls can be found in the **Dialog Area** (on page 196).
- **Hysteresis (V)** - Provide a desired voltage level for the Hysteresis.

## Protocol Setup

- **Speed-mode** - Choose from **Low (26Mbps)**, **Medium (1248Mbps)**, and **High (1456Mbps)**.
- **IQ Period** - Choose from **2G(541.66kHz)**, **3G(7.68MHz)**, **LTE(1.4MHz)**, **LTE(3MHz)**, **LTE(5MHz)**, **LTE(10MHz)**, **LTE(15MHz)**, and **LTE(20MHz)**.
- **IQ Format** - Choose from **Standard** and **Custom** values. Custom rescales I & Q by a factor of 16.
- **RF Path** - Choose from **Main** and **Diversity** values. This control extracts I & Q data from an LC packet. LC packets labeled **ID5** are for **Main** selections and **ID6** are for **Diversity** selections.

## DigRF v4 Decode Trace Annotations

Like all trace annotations, DigRF v4 Decode annotations are rectangular shadings used to highlight messages on decoded waveforms for easy viewing.

**Tip:** Data packets (or messages) on properly decoded protocol signals can be viewed using **Serial Decode Trace Annotations** (on page 18), the **Protocol Results Table** (on page 19), and/or by **Searching for Messages** (on page 21) (Types and Subtypes). Using these tools together provides fast insight to your data. See **Serial Decode Trace Annotations** (on page 18) for more information.

Messages shown as **annotations**, **table columns**, and **search types** for most protocols are classified into **Frames**, **Errors**, **Unknown**, or **Grouped Primitives** specific to the protocol. Sub Types then further classify each main message type into more protocol-specific messages.

Decode annotations unique to DigRF v4 include the following (some annotations are not shown in the screenshot):

## DigRF v4 Decode Annotations

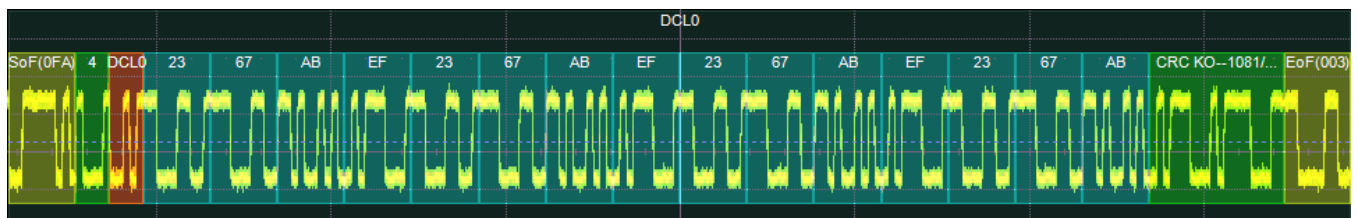

- **N°**
- **Time** - Duration measured from the trigger location.
- **Synch**
- **SoF** - Start of Frame
- **LCID** - Logical Channel Identifier
- **CRI** - Cyclic Running Index
- **TxRx** - Transmit or Receive
- **WordName** - User-defined column. Define/customize this column by modifying the **DigRFv4\_B10I.xml** file as described in **Customizing WordName and Comment Definitions** (on page 128).

## Serial Data Debug Solutions

- **Comment** - Another user-defined column. Define/customize this column by modifying the same **DigRFv4\_B10I.xml** file.
- **Size** - Packet Size
- **I Data** - In-Phase payload interpreted data.
- **Q Data** - Quadrature payload interpreted data.
- **Payload** - Raw data
- **Header Type** - Indicates 8 or 16-Bit length.
- **RTI** - Re-Transmission Indicator
- **CRC** - Coherency Redundancy Check
- **EoF** - End of Frame
- **Frame** - Start and stop time of the packet (hidden column).

**Note:** Specifications are subject to change without notice.

### **DigRF v4 Decode Table Column Details**

DigRF v4 table column values available include the following:



Make selections as desired. You can also set a **BitRate Tolerance** percentage or touch the **Default** button to load the preset selections. Touch the **Close** button when finished.

See **Protocol Results Table** (on page 19) for general information about the Table display.

After setting up your DigRF v4 decode and checking the **View Table** checkbox, the table should be shown just beneath the signal display grid.

**PLEASE NOTE THE FOLLOWING:**

- Table columns generally coincide with respective **DigRF v4 Decode Trace Annotations** (on page 125).
- After touching the **View Table** checkbox, touch the **Close** button at the upper-right portion of the Decode Setup dialog to maximize the display grid area.

**EXPORTING TABLE DATA**

You can also Exported your table data as a **.CSV** file. Touch the **Export Table** button on the **Decode Setup...** dialog and follow the procedure explained in the **Using The D Supported Protocol Toolsets** (on page 14) topic.

**DigRF v4 Decode Search**

After clicking the Search button from the Decode dialog, the Zoom dialog is shown along with the **DigRF v4 Search** right-hand dialog.



**NAVIGATION FIELDS**

On either side of the dialog there are four **Prev** and **Next** buttons for **navigating through each occurrence, jump to the last or first occurrence, play in either direction, and pause.**

**SEARCH OPTIONS FIELDS**

**Search Options** fields in the center of the dialog allow you to restrict your search based on parameter values for **Column**, **Left/Right Pad**, and **Value**. Value may be included or excluded from the search parameters using the **Use Value** checkbox. Provide a percentage value in the **Left/Right Pad** field if desired.

The following **Column** field values are available for your searches.

- **SoF** - Start of Frame
- **LCID** - Logical Channel Identifier
- **CRI** - Cyclic Running Index
- **TxRx** - Transmit or Receive
- **WordName** - A user-defined value when the **DigRFv4\_B10I.xml** file is modified as described in **Customizing WordName and Comment Definitions** (on page 128).
- **Comment** - Another user-defined value when the same **DigRFv4\_B10I.xml** file is modified.
- **Size** - Packet Size
- **Payload** - Raw data
- **I Data** - In-Phase payload interpreted data.
- **Q Data** - Quadrature payload interpreted data.
- **Frame** - Start and stop time of the packet (hidden column).
- **Header Type** - Indicates 8 or 16-Bit length.

## Serial Data Debug Solutions

- RTI - Re-Transmission Indicator
- CRC - Coherency Redundancy Check
- EoF - End of Frame

### Customizing WordName and Comment Definitions

Definitions for both **WordName** and **Comment** appear as table columns, trace descriptor labels, and search parameters for DigRF v4 decoded waveforms.

Use the following steps to create your own customizations to **WordName** and **Comment** values.

1. **Minimize** the oscilloscope application by selecting **File** → **Minimize** on the menu bar.
2. Open **File Explorer** and access the **DigRFv4\_B10I.xml** file on your oscilloscope located in the [D:\Applications\DigRF](#) folder.
3. Open the **DigRFv4\_B10I.xml** file in your preferred text or XML editor. Search for the hexadecimal value (shown in the XML code as a value for the **ID\_VAL** property) for mapping to your custom value. In the case of our example, we'll look for **0x96**.
4. Now, modify the corresponding **TITLE** property to your custom value.

```
30490 </ICLC>
30491 <ICLC ID="TURN_LINE_LVL_LO" TITLE="Turn Line-Level Loopback On" ID_VAL="0x92">
30492 </ICLC>
30493 <ICLC ID="TURN_TEST_MODE_OFF" TITLE="Turn Test Mode Off" ID_VAL="0x93">
30494 </ICLC>
30495 <ICLC ID="PING_REQUEST" TITLE="Ping Request" ID_VAL="0x94">
30496 </ICLC>
30497 <ICLC ID="PING_RESPONSE" TITLE="Ping Response" ID_VAL="0x95">
30498 </ICLC>
30499 <ICLC ID="DUMMY_FRAME" TITLE="Dummy Frame" ID_VAL="0x96">
30500 </ICLC>
30501 <ICLC ID="TURN_DITHBURST_TXDATA_SUB" TITLE="Turn on Dithering of Bursts on TxData Sublin
30502 </ICLC>
30503 <ICLC ID="TURN_DITHBURST_RXDATA_SUB" TITLE="Turn on Dithering of Bursts on RxData Sublin
30504 </ICLC>
30505 </ICLC_ALL>
30506 </IC>
```

5. After saving and closing the **DigRFv4\_B10I.xml** file, Exit the oscilloscope application by selecting **File** → **Exit**. Re-launch the oscilloscope application by double-clicking the **Start DSO** shortcut on the desktop.
6. Notice your customizations appearing on **WordName** and **Comment** values for table columns, trace descriptor labels, and search parameters.

## Using the MIPI D-PHY (CSI-2/DSI) Option

### Using the MIPI D-PHY Decode Option Overview

The MIPI D-PHY decode option defines lowest layers of high-speed, source-synchronous interfaces based on the MIPI Alliance specification.

The D-PHY option has separate decoder selections available for **MIPI D-PHY**, **MIPI CSI-2**, and **MIPI DSI**. The **CSI-2** and **DSI** signals define the application layer of camera and display protocols, respectively (based on the D-PHY physical layer).

**Note:** Ask your local LeCroy representative for more information about any Serial Data Debug Solution Protocols or Toolkits using the **Contact LeCroy for Support** (on page 199) topic.

### MIPI D-PHY Decode Setup Detail

For general information about using controls shown on the main Serial Decode dialog, refer to **Accessing The D and TD Supported Protocol Toolsets** (on page 13).



**MIPI D-PHY SOURCE AND CLOCK CONTROLS, BASIC, AND LEVELS RIGHT-HAND DIALOGS**

Access the **Serial Decode** dialog by touching **Analysis** → **Serial Decode** on the menu bar.

Touch the corresponding **Setup...** button for your decode. The **Decode Setup...** along with corresponding right-hand dialogs are shown.

**Decode Setup**, **Basic**, and **Level** dialogs for **MIPI D-PHY**, **MIPI CSI-2**, and **MIPI DSI** decoders include the following respective controls:

**D-PHY Source and Clock Controls**

Depending on selections made on the **Decode**, **Data Probing**, and **Clock Probing** controls located on the **Basic** dialog, corresponding source controls are enabled/disabled for **Ddiff** (differential clock trace), **Dp** (Data positive), **Dn** (Data negative), **CLKp** (Clock Positive), **CLKn** (Clock Negative).

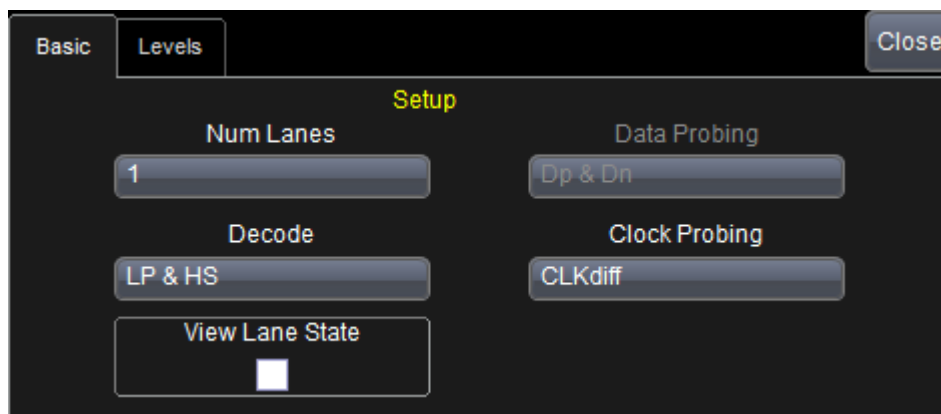
**D-PHY Basic Right-Hand Dialog**

- **Decode** - Choose from **LP & HS**, **HS only**, and **LP only** values. Selections affect remaining fields on the dialog as follows: When **LP & HS** is selected **only Clock Probing** is available. When **HS only** is selected **both Data and Clock Probing** are available. When **LP only** is selected, **neither Data or Clock Probing** are available.
- **Data Probing** - This field is only enabled when **HS only** is selected from the **Decode** field. When the Data Probing field is enabled, choose from **Dp & Dn**, **Dp**, **Dn**, and **Ddiff** values.
- **Clock Probing** - This field is enabled when either **LP & HS** or **HS only** is selected from the **Decode** field. When the Clock Probing field is enabled, choose from **CLKp & CLKn**, **CLKp**, **CLKn**, **CLKdiff**, and **none (CDR)** values.

## Serial Data Debug Solutions

### D-PHY Level Right-Hand Dialog

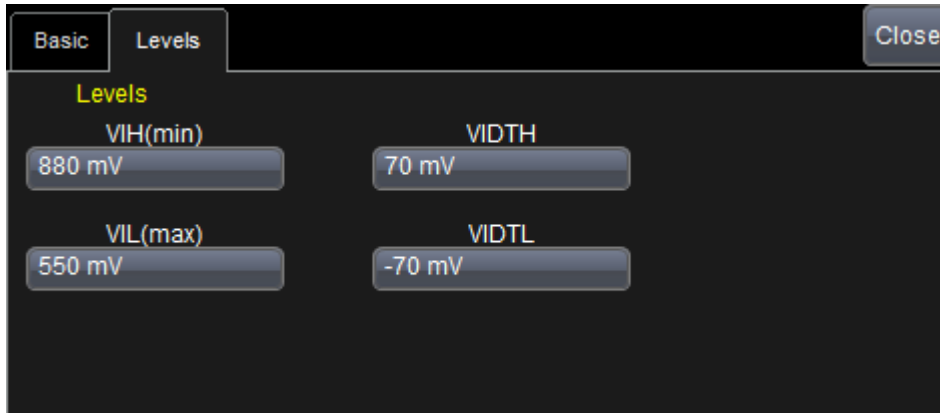

- **VIH(min)** - Provide a minimum voltage amount for your decode. Provide a value using your preferred input control method.
- **VIDTH** - Provide a voltage amount for your decode. Provide a value by clicking once inside the field and using the **slider bar** or clicking again inside the and using the **pop-up keypad**. If the field value is highlighted you can type a value directly from a keyboard, if desired.
- **VIL(max)** - Provide a maximum voltage amount for your decode. Provide a value by clicking once inside the field and using the **slider bar** or clicking again inside the and using the **pop-up keypad**. If the field value is highlighted you can type a value directly from a keyboard, if desired.
- **VIDTL** - Provide a voltage amount for your decode. Provide a value by clicking once inside the field and using the **slider bar** or clicking again inside the and using the **pop-up keypad**. If the field value is highlighted you can type a value directly from a keyboard, if desired.

### MIPI D-PHY Decode Trace Annotations

Like all trace annotations, D-PHY Decode annotations are rectangular shadings used to highlight messages on decoded waveforms for easy viewing.

**Tip:** Data packets (or messages) on properly decoded protocol signals can be viewed using **Serial Decode Trace Annotations** (on page 18), the **Protocol Results Table** (on page 19), and/or by **Searching for Messages** (on page 21) (Types and Subtypes). Using these tools together provides fast insight to your data. See **Serial Decode Trace Annotations** (on page 18) for more information.

Messages shown as **annotations**, **table columns**, and **search types** for most protocols are classified into **Frames**, **Errors**, **Unknown**, or **Grouped Primitives** specific to the protocol. Sub Types then further classify each main message type into more protocol-specific messages.

Decode annotations for D-PHY include the following (some annotations are not shown in the screen-shot):

#### D-PHY Decode Annotations



- **Label** - Identifier showing data type and parameter association. Typically shown as octal numbers.
- **SDI** - Source/Destination identifier.
- **Data** - Bits 29 - 11.
- **SSM** - Sign/Status Matrix.
- **Pa** - Parity.
- **Msg** - Displays the symbolic information.

- Symbols
- Bits/Resolution
- Pad
- Status

**Note:** Specifications are subject to change without notice.

### ***MIPI D-PHY Decode Table Column Details***

D-PHY table column values available include the following:

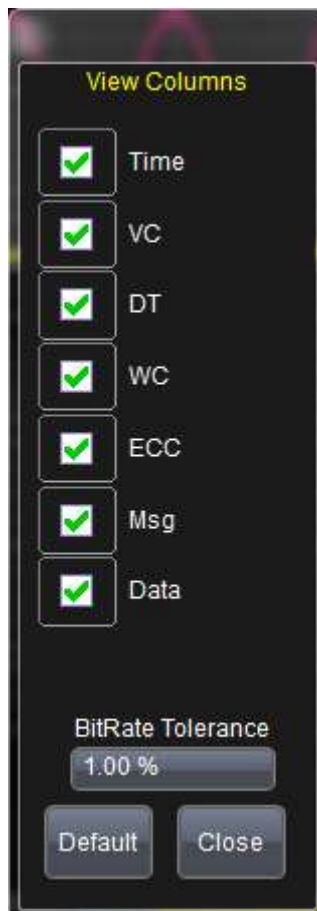

Make selections as desired. You can also set a **BitRate Tolerance** percentage or touch the **Default** button to load the preset selections. Touch the **Close** button when finished.

See **Protocol Results Table** (on page 19) for general information about the Table display.

After setting up your D-PHY decode and checking the **View Table** checkbox, the table should be shown on the display grid.

**Note:** After touching the **View Table** checkbox, touch the **Close** button at the upper-right portion of the Decode Setup dialog to maximize the display grid area.

### ***EXPORTING TABLE DATA***

You can also Exported your table data as a **.CSV** file. Touch the **Export Table** button on the **Decode Setup...** dialog and follow the procedure explained in the **Using The D Supported Protocol Toolsets** (on page 14) topic.

## Serial Data Debug Solutions

### MIPI D-PHY Decode Search

After clicking the Search button from the Decode dialog, the Zoom dialog is shown along with the D-PHY Search right-hand dialog.

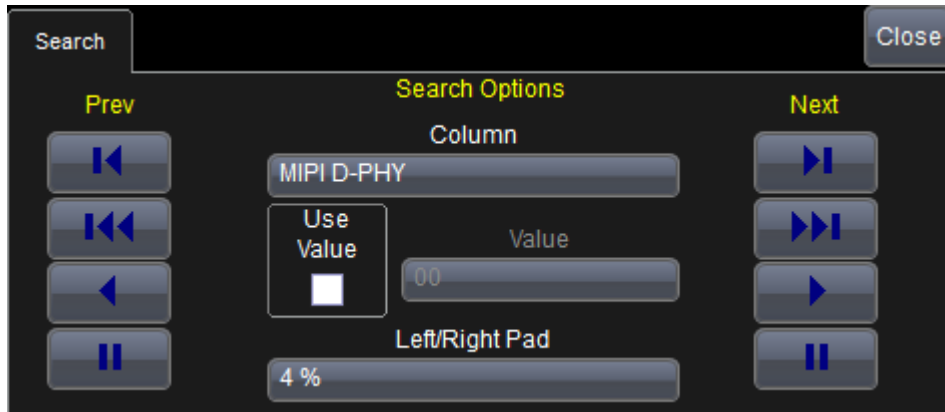

#### NAVIGATION FIELDS

On either side of the dialog there are four **Prev** and **Next** buttons for **navigating through each occurrence, jump to the last or first occurrence, play in either direction, and pause.**

#### SEARCH OPTIONS FIELDS

**Search Options** fields in the center of the dialog allow you to restrict your search based on parameter values for **Column**, **Left/Right Pad**, and **Value**. Value may be included or excluded from the search parameters using the **Use Value** checkbox. Provide a percentage value in the **Left/Right Pad** field if desired.

The following **Column** field values are available for your searches.

- MIPI D-PHY
- Time
- Msg
- TLPX-DATA
- TLP01-DATA
- THS-PREPARE
- THS-ZERO
- THS-SYNC
- THS-TRAIL
- TREET
- TLPX-CLK
- TLP01-CLK
- TCLK-PREPARE
- TCLK-ZERO
- TCLK-HS
- TCLK-TRAIL
- TCLK-REOT
- DI
- VC
- DT
- WC
- WC2
- ECC

- Data
- DataL1
- DataL2
- DataL3
- DataL4
- CS
- CSL1
- CSL2
- CSL3
- CSL4
- HS0
- HS1
- HSBITS
- Bit Rate/Msg
- Status
- Attributes

### ***MIPI D-PHY Physical Layer Measurement Parameters***

#### ***MIPI D-PHY PHYSICAL LAYER MEASUREMENT PARAMETERS***

MIPI D-PHY physical layer measurements are configured on a separate dialog accessed from **Analysis** → **MIPI D-PHY** on the menu bar.

The **MIPI D-PHY** dialog is shown.

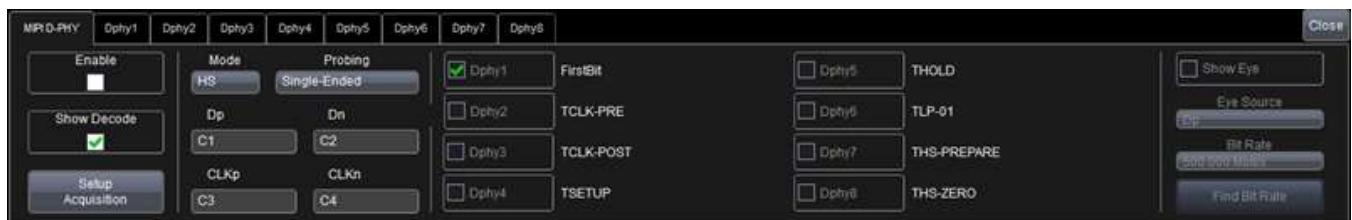

#### ***MIPI D-PHY DIALOG DETAILS***

Use the following sections to work through areas of the main dialog.

##### **Enable, Show Decode, Setup Acquisition**

# Serial Data Debug Solutions

## Enable

Marking the **Enable** checkbox enables the controls on the dialog.

Notice how MIPI D-PHY provides its own, unique **table, statistics** and **set of test parameters** for the measurements.

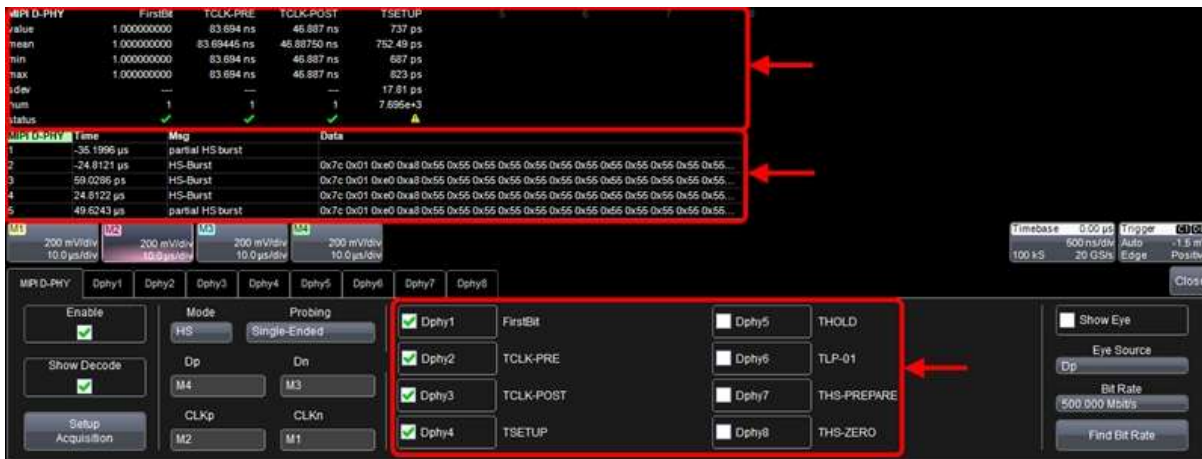

**Tip:** Touch the protocol name on the top left of the **Statistic** or **Table** column headings to show corresponding **Physical** and **Decode Setup** dialogs, respectively.

## Show Decode



**Note:** If you do not have the MIPI D-PHY Serial Decode Option (D PHY-D), you won't see the **Show Decode** checkbox beneath the **Enable** checkbox. Marking this checkbox (when you have the option) shows annotations on your waveforms.

**Setup Acquisition**

The **Setup Acquisition** button automatically makes the following settings. The settings are largely based on your **LP (Low Power)** or **HS (High Speed)** mode selection on the **Mode and Input Selection Area of the MIPI D-PHY Dialog** (below).

**SETUP ACQUISITION FOR LP LOW POWER MODE**

Your channels are set to **200 mV/div, -600 mV** offset, and a **Qualified-Pattern** trigger is applied to the signal for capturing the **ULPS** sequence.

**SETUP ACQUISITION FOR HS HIGH SPEED MODE**

Your channels are set to **200 mV/div, -600 mV** offset, and an **Edge** trigger is applied to the signal.

**MODE AND INPUT SELECTION AREA OF THE MIPI D-PHY DIALOG**



As previously mentioned in the **MIPI D-PHY Dialog Details** (on page 133) topic, the **Mode** selection affects the settings the **Setup Acquisition** button has based on the **LP (Low Power)** or **HS (High Speed)** choices.

The selection also controls which tests are presented on the **Test Parameter Switchboard** and corresponding **Test Dialogs**.

**Dp, Dn, CLKp, and CLKn Controls**

The remaining fields on this section of the **MIPI D-PHY Dialog** include controls for **Dp (Data Positive)**, **Dn (Data Negative)**, **CLKp (Clock Positive)**, and **CLKn (Clock Negative)**.

When these fields are selected, a pop-up is shown where you can select your input source for each of the four required signals.

**TEST PARAMETER SUMMARY AREA**

The Test Parameter Summary area is a section of the MIPI D-PHY dialog showing all the available tests for HS and LP Modes.

**Enabling Tests**

Enable/disable a test by either marking/unmarking its respective checkbox from the summary area...

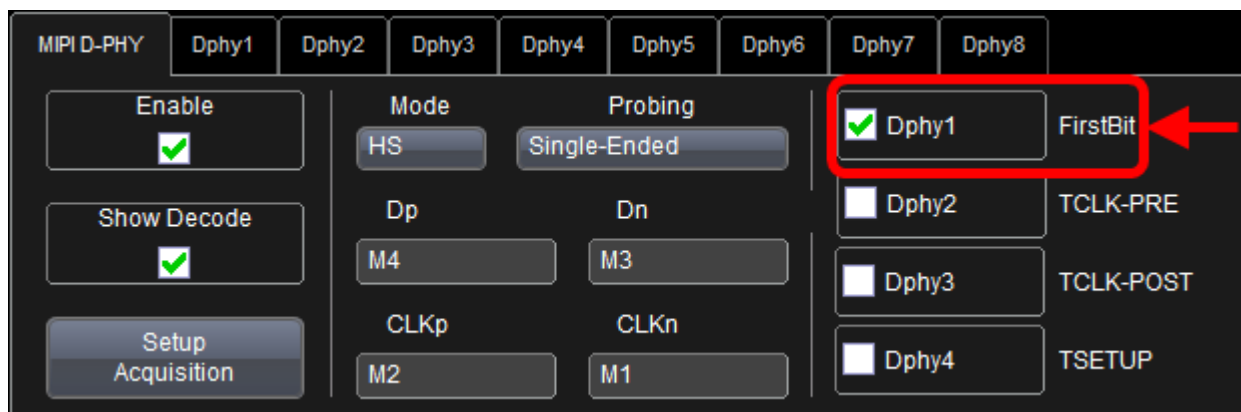

## Serial Data Debug Solutions

OR

Go directly to its corresponding test dialog and enable/disable it from there. Additional controls for **Measure On**, **Burst Index**, and **Actions for Dphy1** buttons are made available from the specific test dialog.

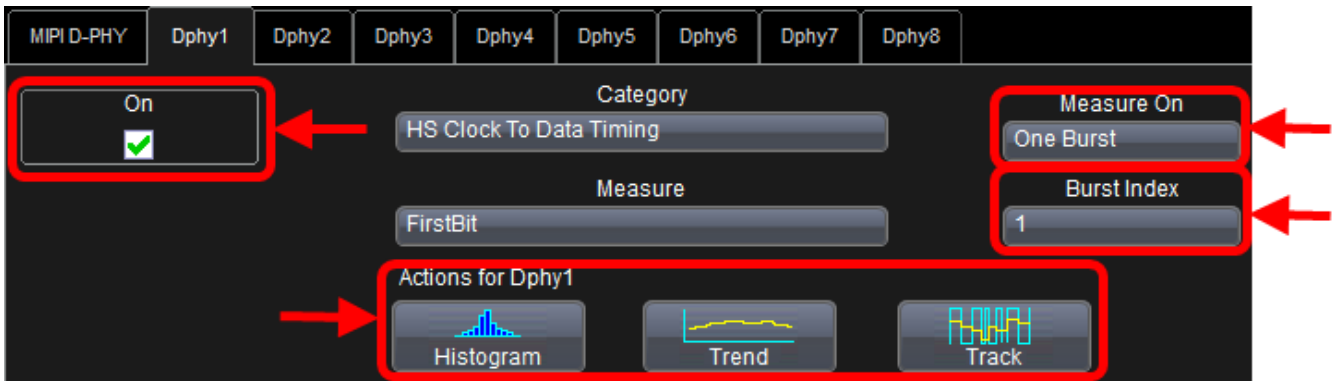

### LP (LOW POWER) TESTS

All **Dphy1 - X** dialogs have controls for **On**, **Category**, **Measure On**, **Measure** and **Actions for Dphy1** buttons. When the **LP Rise & Fall** category is selected, **Dn-VOH**, **Dn-VOL**, and **Find Levels** controls are also shown.

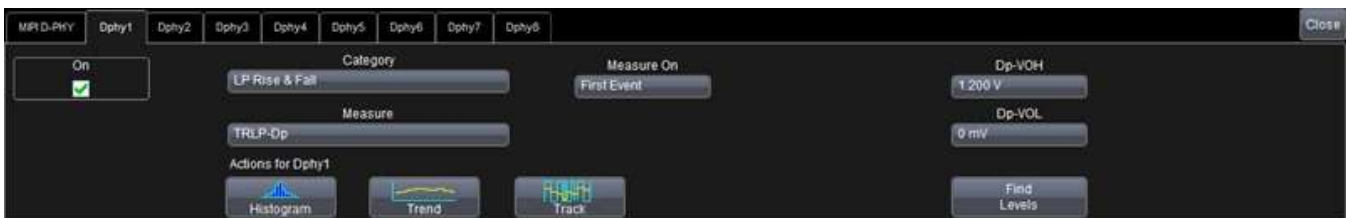

With LP (Low Power) selected as your **Mode** on the **Mode and Input Selection Area of the MIPI D-PHY Dialog** (on page 135), **Categories** and **Measurements** on the Dphy1 - X dialogs vary in the following manner.

**Note:** For HS (High Speed) Tests, refer to the **HS (High Speed) Tests** (on page 139) topic.



## Category and Measure Combinations for LP Dphy1 - X Dialogs

### BRIEF LP LEVELS TEST DESCRIPTIONS

- With **LP Levels** selected in the **Category** field, the following **Measure** values are available:  
**VOH-Dp, VOH-Dn, VOH-CLKp, VOH-CLKn, VOL-Dp, VOL-Dn, VOL-CLKp, and VOL-CLKn.**

Name	Purpose
<b>VOH-Dp</b>	To verify that the Thevenin Output High Level Voltage (VOH) of the DUT's Data & Clock Lanes LP transmitter is within the conformance limits.
<b>VOH-Dn</b>	
<b>VOH-CLKp</b>	
<b>VOH-CLKn</b>	
<b>VOL-Dp</b>	To verify that the Thevenin Output Low Level Voltage (VOL) of the DUT's Data & Clock Lanes LP transmitter is within the conformance limits.
<b>VOL-Dn</b>	
<b>VOL-CLKp</b>	
<b>VOL-CLKn</b>	

### BRIEF LP RISE & FALL TEST DESCRIPTIONS

- With **LP Rise & Fall** selected in the **Category** field, the following **Measure** values are available:  
**TRLP-Dp, TRLP-Dn, TRLP-CLKp, TRLP-CLKn, TFLP-Dp, TFLP-Dn, TFLP-CLKp, and TFLP-CLKn.**

**Note:** As mentioned previously in this section, when this category is selected, **Dn-VOH, Dn-VOL,** and **Find Levels** controls are also shown. **Provide values for the additional fields** or use the **Find Levels** button as desired.

Name	Purpose
<b>TRLP-Dp</b>	To verify that the 15%-85% Rise Time (TRLP) of the DUT's Data & Clock Lanes LP transmitter is within the conformance limits.
<b>TRLP-Dn</b>	
<b>TRLP-CLKp</b>	
<b>TRLP-CLKn</b>	
<b>TFLP-Dp</b>	To verify that the 15%-85% Fall Time (TFLP) of the DUT's Data & Clock Lanes LP transmitter is within the conformance limits.
<b>TFLP-Dn</b>	
<b>TFLP-CLKp</b>	
<b>TFLP-CLKn</b>	

## Serial Data Debug Solutions

### BRIEF LP TIMING TEST DESCRIPTIONS

- With **LP Timing** selected in the **Category** field, the following **Measure** values are available:  
**TLP-PER-Data-500, TLP-PER-Data-930, TLP-PULSE-Data-500, TLP-PULSE-Data-930, FIRST-TLP-PULSE-Data-500, FIRST-TLP-PULSE-Data-930, LAST-TLP-PULSE-Data-500, and LAST-TLP-PULSE-Data-930.**

Name	Purpose
TLP-PER-Data-500	To verify that the period (TLP-PER-TX) of the DUT's Data Lane LP transmitter XOR Clock is within the conformance limits.
TLP-PER-Data-930	
TLP-PULSE-Data-500	To verify that the pulse width (TLP-PULSE-TX) of the DUT's Data Lane LP transmitter XOR Clock is within the conformance limits.
TLP-PULSE-Data-930	
FIRST-TLP-PULSE-Data-500	
FIRST-TLP-PULSE-Data-930	
LAST-TLP-PULSE-Data-500	
LAST-TLP-PULSE-Data-930	

### BRIEF LP SLEW RATE TEST DESCRIPTIONS

- With **LP Slew Rate** selected in the **Category** field, the following **Measure** values are available:  
**SR-MAX-Dp, SR-MAX-Dn, SR-MAX-CLKp, SR-MAX-CLKn, SR-FALL-MIN-Dp, SR-FALL-MIN-Dn, SR-FALL-MIN-CLKp, SR-FALL-MIN-CLKn, SR-RISE-400-700-MIN-Dp, SR-RISE-400-700-MIN-Dn, SR-RISE-400-700-MIN-CLKp, SR-RISE-400-700-MIN-CLKn, SR-RISE-700-930-MIN-Dp, SR-RISE-700-930-MIN-Dn, SR-RISE-700-930-MIN-CLKp, and SSR-RISE-700-930-MIN-CLKn.**

Name	Purpose
SR-MAX-Dp	To verify that the Slew Rate ( $\delta V/\delta t_{SR}$ ) of the DUT's Data & Clock Lanes LP transmitter is within the conformance limits, for specific capacitive loading conditions.
SR-MAX-Dn	
SR-MAX-CLKp	
SR-MAX-CLKn	
SR-FALL-MIN-Dp	
SR-FALL-MIN-Dn	
SR-FALL-MIN-CLKp	
SR-FALL-MIN-CLKn	
SR-RISE-400-700-MIN-Dp	
SR-RISE-400-700-MIN-Dn	
SR-RISE-400-700-MIN-CLKp	
SR-RISE-400-700-MIN-CLKn	
SR-RISE-700-930-MIN-Dp	
SR-RISE-700-930-MIN-Dn	

Name	Purpose
SR-RISE-700-930-MIN-CLKp	
SR-RISE-700-930-MIN-CLKn	

**Official MIPI D-PHY Test Algorithms**

Specific test information is maintained by the MIPI Alliance and can be found at [www.mipi.org](http://www.mipi.org).

**Note:** Registration with the Alliance is required to access the document.

**HS (HIGH SPEED) TESTS**

All **Dphy1 - X** dialogs have controls for **On**, **Category**, **Measure On**, **Measure**, **Burst Index**, and **Actions for Dphy1** buttons. When the **HS Rise & Fall** category is selected, **DATA/CLK-VOD1**, **DATA/CLK-VOD0**, and **Find Levels** controls are also shown.



With HS (High Speed) selected as your **Mode** on the **Mode and Input Selection Area of the MIPI D-PHY Dialog** (on page 135), **Categories** and **Measurements** on the Dphy1 - X dialogs vary in the following manner.

**Note:** For LP (Low Power) Tests, refer to the **LP (Low Power) Tests** (on page 136) topic.

**Category and Measure Combinations for HS Dphy1 - X Dialogs**

**BRIEF HS CLOCK TO DATA TIMING TEST DESCRIPTIONS**

- With **HS Clock To Data Timing** selected in the **Category** field, the following **Measure** values are available: **FirstBit**, **TCLK-PRE**, **TCLK-POST**, **TSETUP**, and **THOLD**.

Name	Purpose
<b>FirstBit</b>	To verify that the DUT HS Clock is properly aligned to the payload data signaling.
<b>TCLK-PRE</b>	To verify that the time that the HS clock is driven prior to an associated Data Lane beginning the transition from LP to HS mode (TCLK-PRE), is greater than the minimum required value.
<b>TCLK-POST</b>	To verify that the DUT Clock Lane HS transmitter continues to transmit clock signaling for the minimum required duration (TCLK-POST) after the last Data Lane switches to LP mode.
<b>TSETUP</b>	To verify the Setup time between the clock and data signaling is within conformance limits.
<b>THOLD</b>	To verify the Hold time between the clock and data signaling is within conformance limits.

**BRIEF HS DATA TIMING TEST DESCRIPTIONS**

- With **HS Data Timing** selected in the **Category** field, the following **Measure** values are available: **TLP-01**, **THS-PREPARE**, **THS-ZERO**, **THS-PREPARE+ZERO**, **THS-SYNC**, **THS-TRAIL**, **TEOT**, **TREOT**, and **THS-EXIT**.

## Serial Data Debug Solutions

Name	Purpose
<b>TLP-01</b>	To verify that the duration (TLPX) of the final Data Lane LP-01 state immediately before HS transmission is greater than the minimum conformant value.
<b>THS-PREPARE</b>	To verify that the duration of the final LP-00 state immediately before HS transmission (THS-PREPARE) is within the conformance limits.
<b>THS-ZERO</b>	To verify the time the DUT Data Lane transmitter drives the HS-0 differential state prior to transmitting the HS Sync sequence.
<b>THS-PREPARE+ZERO</b>	To verify that the combined time of THS-PREPARE plus the time the DUT Data Lane transmitter drives the HS-0 differential state prior to transmitting the HS Sync sequence (THS-ZERO) is greater than the minimum required duration.
<b>THS-SYNC</b>	To verify the time to transmit of the HS Sync sequence before the first bit of data is transmitted.
<b>THS-TRAIL</b>	To verify that the duration the DUT Data Lane TX drives the inverted final differential state following the last payload data bit of a HS-TX burst (THS-TRAIL), is greater than the minimum required value.
<b>TEOT</b>	To verify that the combined duration of the THS-TRAIL plus TREOT intervals (a.k.a. TEOT) of the DUT Data Lane transmitter is less than the maximum allowed value.
<b>TREOT</b>	To verify that the 30%-85% Post-EoT Rise Time (TREOT) of the DUT LP Data Lane transmitter is within the conformance limits.
<b>THS-EXIT</b>	To verify that the duration that the Data Lane transmitter remains in the LP-11 (Stop) state after exiting HS mode (THS-EXIT), is greater than the minimum required value.

## BRIEF HS CLOCK TIMING TEST DESCRIPTIONS

- With **HS Clock Timing** selected in the **Category** field, the following **Measure** values are available:  
**TLP-01**, **TCLK-PREPARE**, **TCLK-ZERO**, **TCLK-PREPARE+ZERO**, **TCLK-TRAIL**, **TREOT**, **TEOT**, **THS-EXIT**, **UInst**, and **HS-Bitrate**.

Name	Purpose
<b>TLP-01</b>	To verify that the duration (TLPX) of the final Clock Lane LP-01 state immediately before HS transmission is greater than the minimum conformant value.
<b>TCLK-PREPARE</b>	To verify that the time that the DUT Clock Lane transmitter drives LP-00 (TCLK-PREPARE) prior to driving TCLK-ZERO when entering HS mode, is within the conformance limits.
<b>TCLK-ZERO</b>	To verify the time that the DUT Clock Lane transmitter drives the extended HS-0 differential state prior to starting clock transmission.
<b>TCLK-PREPARE+ZERO</b>	To verify that the combined time of TCLK-PREPARE plus the time that the DUT Clock Lane transmitter drives the extended HS-0 differential state prior to starting clock transmission (TCLK-ZERO) is greater than the minimum required duration.
<b>TCLK-TRAIL</b>	To verify that the duration that the DUT Clock Lane HS transmitter drives the final HS-0 differential state following the last payload clock bit of a HS transmission burst (TCLK-TRAIL) is greater than the minimum required value.
<b>TREOT</b>	To verify that the 30%-85% Post-EoT Rise Time (TREOT) of the DUT LP Clock Lane transmitter is within the conformance limits.
<b>TEOT</b>	To verify that the interval measured from the start of the DUT Clock Lane HS transmitter's TCLK-TRAIL to the start of the first Clock Lane LP-11 state (TEOT) is less than the maximum allowed limit.
<b>THS-EXIT</b>	To verify that the duration that the Clock Lane transmitter remains in the LP-11 (Stop) state after exiting HS mode (THS-EXIT), is greater than the minimum required value.
<b>UInst</b>	To verify that the Instantaneous Unit Interval values (UIINST) of the DUT HS Clock are within the conformance limits.
<b>HS-Bitrate</b>	To verify the Bitrate of the DUT HS Clock is within conformance limits.

## Serial Data Debug Solutions

### BRIEF HS COMMON MODE TEST DESCRIPTIONS

- With **HS Common Mode** selected in the **Category** field, the following **Measure** values are available:  
**VCMTX-DATA-1**, **VCMTX-DATA-0**, **VCMTX-CLK-1**, **VCMTX-CLK-0**, **dVCMTXLF-DATA**, **dVCMTXHF-DATA**,  
**dVCMTXLF-CLK**, and **dVCMTXHF-CLK**.

Name	Purpose
<b>VCMTX-DATA-1</b>	To verify that the Static Common-Mode Voltages (VCMTX(1), and VCMTX(0)) of the DUT Data & Clock Lanes HS transmitter are within the conformance limits.
<b>VCMTX-DATA-0</b>	
<b>VCMTX-CLK-1</b>	
<b>VCMTX-CLK-0</b>	
<b>dVCMTXLF-DATA</b>	To verify that the AC Common-Mode Signal Level Variations between 50 and 450MHz ( $\Delta$ VCMTX(LF)) of the DUT Data & Clock Lanes HS transmitter are less than the maximum allowable limit.
<b>dVCMTXLF-CLK</b>	
<b>dVCMTXHF-DATA</b>	To verify that the AC Common-Mode Signal Level Variations above 450MHz ( $\Delta$ VCMTX(HF)) of the DUT Data & Clock Lanes HS transmitter are less than the maximum allowable limit.
<b>dVCMTXHF-CLK</b>	

### BRIEF HS LEVELS TEST DESCRIPTIONS

- With **HS Levels** selected in the **Category** field, the following **Measure** values are available:  
**VOD-DATA-1**, **VOD-DATA-0**, **VOD-CLK-1**, **VOD-CLK-0**, **VOHHS-Dp**, **VOHHS-Dn**, **VOHHS-CLKp**, and **VOHHS-CLKn**.

Name	Purpose
<b>VOD-DATA-1</b>	To verify that the Differential Voltages (VOD(0) and VOD(1)) of the DUT Data & Clock Lanes HS transmitter are within the conformance limits.
<b>VOD-DATA-0</b>	
<b>VOD-CLK-1</b>	
<b>VOD-CLK-0</b>	
<b>VOHHS-Dp</b>	To verify that the Single-Ended Output High Voltages (VOHHS(DP) and VOHHS(DN)) of the DUT Data & Clock Lanes HS transmitter are less than the maximum conformance limit.
<b>VOHHS-Dn</b>	
<b>VOHHS-CLKp</b>	
<b>VOHHS-CLKn</b>	

## BRIEF HS RISE &amp; FALL TEST DESCRIPTIONS

- With **HS Rise & Fall** selected in the **Category** field, the following **Measure** values are available: **TR-DATA**, **TF-DATA**, **TR-CLK**, and **TF-CLK**.

**Note:** As mentioned previously in this section, when this category is selected, **DATA/CLK-VOD1**, **DATA/CLK-VOD0**, and **Find Levels** controls are also shown. **Provide values for the additional fields** or use the **Find Levels** button as desired.

Name	Purpose
<b>TR-DATA</b>	To verify that the 20%-80% Rise Time (tR) of the DUT Data & Clock Lanes HS transmitter is within the conformance limits.
<b>TR-CLK</b>	
<b>TF-DATA</b>	To verify that the 80%-20% Fall Time (tF) of the DUT Data & Clock Lanes HS transmitter is within the conformance limits.
<b>TF-CLK</b>	

**Official MIPI D-PHY Test Algorithms**

Specific test information is maintained by the MIPI Alliance and can be found at [www.mipi.org](http://www.mipi.org).

**Note:** Registration with the Alliance is required to access the document.

**EYE DIAGRAM CONTROL AREA**

**Note:** Some of the controls on this dialog are enabled/disabled based on **Mode**, **Probing**, and **Input Selection** control choices.

The **Eye Diagram Control Area** of the MIPI D-PHY dialog contains **Show Eye**, **Eye Source**, **Bit Rate**, and **Find Bit Rate** controls. As controls are used, MIPI M-PHY processes the information and responds in real time.

## Serial Data Debug Solutions

### Show Eye

Marking this checkbox shows the eye diagram trace on the display area and includes a corresponding trace descriptor label.



### Eye Source

With **HS High Speed Mode** (**LP Mode** disables the **Eye Diagram Control Area**) selected and inputs selected as indicated in the **Mode and Input Selection Area** of the **MIPI D-PHY Dialog** (on page 135) topic, use the **Eye Source** field to select the HS signal (**Dp** (Data Positive), **Dn** (Data Negative), **CLKp** (Clock Positive), and **CLKn** (Clock Negative)) for use on your Eye Diagram.

Additional choices for your Eye Diagram include **Ddiff** (Differential Data) and **CLKdiff** (Differential Clock).

### Bit Rate and Find Bit Rate

These fields allow you to either enter a specific **Bit Rate**, or have MIPI D-PHY find your signal's bitrate.



## Using the MIPI M-PHY

### Using the MIPI M-PHY Decode Option Overview

The MIPI M-PHY decode option defines the next-generation lowest physical layers of high-speed, source-synchronous interfaces based on the MIPI Alliance specification.

**Note:** Ask your local LeCroy representative for more information about any Serial Data Debug Solution Protocols or Toolkits using the **Contact LeCroy for Support** (on page 199) topic.

### MIPI M-PHY Decode Setup Detail

For general information about using controls shown on the main Serial Decode dialog, refer to **Accessing The D and TD Supported Protocol Toolsets** (on page 13).

### MIPI M-PHY SOURCE AND CLOCK CONTROLS, BASIC, AND LEVELS RIGHT-HAND DIALOGS

Access the **Serial Decode** dialog by touching **Analysis** → **Serial Decode** on the menu bar.

Touch the corresponding **Setup...** button for your decode. The **Decode Setup...** along with a corresponding right-hand dialog is shown.

**Decode Setup** and **MPHY Decode** dialogs include the following controls:

#### M-PHY Source and Clock Controls

Depending on your probing selection on the right-hand dialog, corresponding source controls are provided for **Ddiff** (differential clock trace), or **Dp** (Data positive) and **Dn** (Data negative).

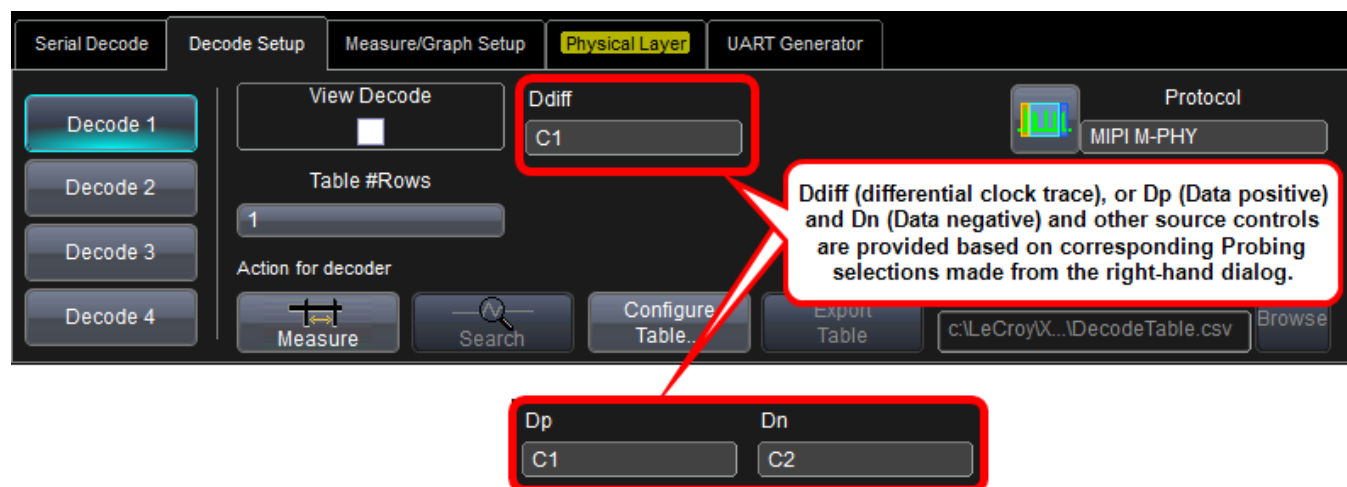

## Serial Data Debug Solutions

### M-PHY Decode Right-Hand Dialog

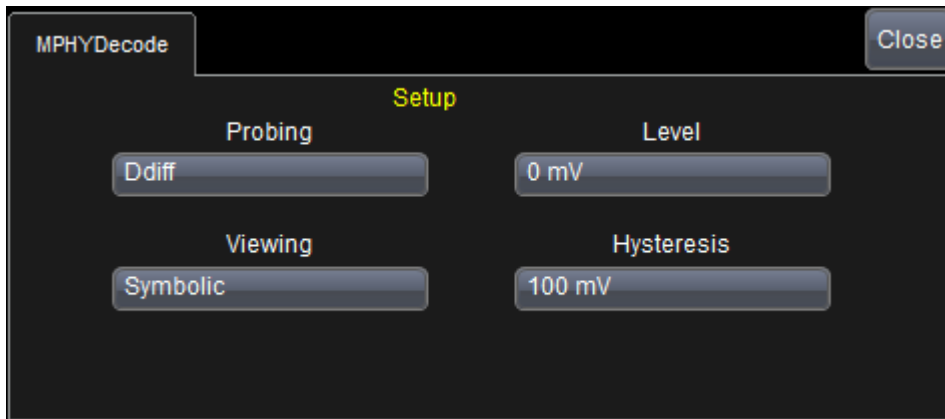

- **Probing** - Selections made from this control manage the corresponding source controls shown for either for **Ddiff** (differential clock trace), or **Dp** (Data positive) and **Dn** (Data negative) on the main Decode dialog.
- **Level** - Provide a desired voltage level for your decode. Enter a value using your preferred input control method. Additional information on using the touch screen controls can be found in the **Dialog Area** (on page 196).
- **Viewing** - Select to view the protocol data in **Binary**, **Hexadecimal**, **Symbolic**, or **Symbolic 10b** modes.
- **Hysteresis** - Provide a desired voltage level for your hysteresis. Enter a value using your preferred input control method. Additional information on using the touch screen controls can be found in the **Dialog Area** (on page 196).

### MIPI M-PHY Decode Trace Annotations

Like all trace annotations, M-PHY Decode annotations are rectangular shadings used to highlight messages on decoded waveforms for easy viewing.

**Tip:** Data packets (or messages) on properly decoded protocol signals can be viewed using **Serial Decode Trace Annotations** (on page 18), the **Protocol Results Table** (on page 19), and/or by **Searching for Messages** (on page 21) (Types and Subtypes). Using these tools together provides fast insight to your data. See **Serial Decode Trace Annotations** (on page 18) for more information.

Messages shown as **annotations**, **table columns**, and **search types** for most protocols are classified into **Frames**, **Errors**, **Unknown**, or **Grouped Primitives** specific to the protocol. Sub Types then further classify each main message type into more protocol-specific messages.

Decode annotations unique to M-PHY include the following (some annotations are not shown in the screenshot):

#### M-PHY Decode Annotations

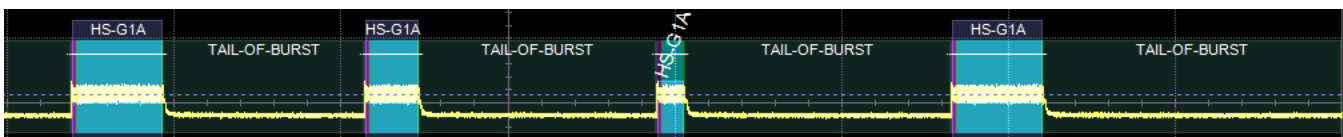

- **Time**
- **Msg** - Displays the symbolic information.
- **PREPARE**
- **SYNC**
- **CONTROLS**
- **LineStyle**

- **Payload**
- **Data** - Bits 29 - 11.
- **TAIL-OF-BURST**
- **Bit Rate/Msg**
- **Status**
- **Attributes**

**Note:** Specifications are subject to change without notice.

### ***MIPI M-PHY Decode Table Column Details***

M-PHY table column values available include the following:

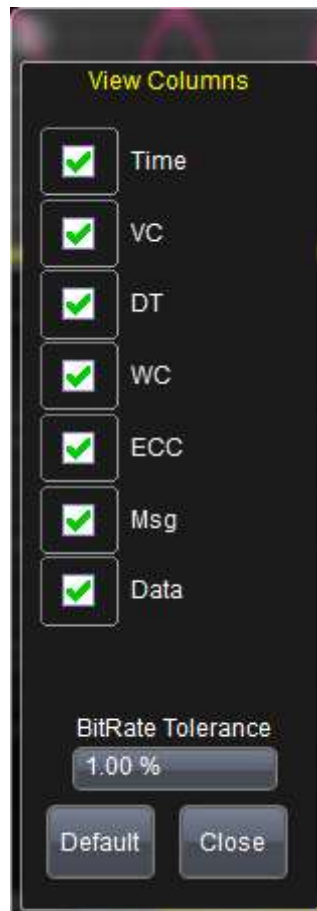

Make selections as desired. You can also set a **BitRate Tolerance** percentage or touch the **Default** button to load the preset selections. Touch the **Close** button when finished.

See **Protocol Results Table** (on page 19) for general information about the Table display.

After setting up your M-PHY decode and checking the **View Table** checkbox, the table should be shown on the display grid.

**Note:** After touching the **View Table** checkbox, touch the **Close** button at the upper-right portion of the Decode Setup dialog to maximize the display grid area.

### ***EXPORTING TABLE DATA***

You can also Exported your table data as a **.CSV** file. Touch the **Export Table** button on the **Decode Setup...** dialog and follow the procedure explained in the **Using The D Supported Protocol Toolsets** (on page 14) topic.

## Serial Data Debug Solutions

### MIPI M-PHY Decode Search

After clicking the Search button from the Decode dialog, the Zoom dialog is shown along with the M-PHY Search right-hand dialog.



#### NAVIGATION FIELDS

On either side of the dialog there are four **Prev** and **Next** buttons for **navigating through each occurrence, jump to the last or first occurrence, play in either direction, and pause.**

#### SEARCH OPTIONS FIELDS

**Search Options** fields in the center of the dialog allow you to restrict your search based on parameter values for **Column**, **Left/Right Pad**, and **Value**. Value may be included or excluded from the search parameters using the **Use Value** checkbox. Provide a percentage value in the **Left/Right Pad** field if desired.

- **PREPARE**
- **SYNC**
- **CONTROLS**
- **LineState**
- **Payload**
- **Data - Bits 29 - 11.**
- **TAIL-OF-BURST**
- **Bit Rate/Msg**
- **Status**
- **Attributes**

### MIPI M-PHY Physical Layer Measurement Parameters

#### MIPI M-PHY PHYSICAL LAYER MEASUREMENT PARAMETERS

MIPI M-PHY physical layer measurements are configured on a separate dialog accessed from **Analysis → MIPI M-PHY** on the menu bar.

#### The MIPI M-PHY Dialog

The **MIPI M-PHY** dialog is shown.

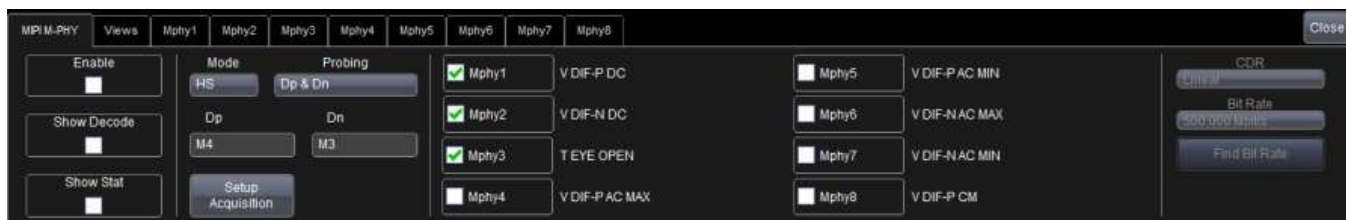

### MIPI M-PHY DIALOG DETAILS

Use the following sections to work through areas of the main dialog.

#### Enable, Show Decode, Setup Acquisition

##### Enable

Marking the **Enable** checkbox enables the controls on the dialog.

Notice how MIPI D-PHY provides its own, unique **table** and **set of test parameters**.

MIPI D-PHY	FirstBit	TCLK-PRE	TCLK-POST	TSETUP
value	1.000000000	83.694 ns	46.887 ns	737 ps
mean	1.000000000	83.69445 ns	46.88750 ns	752.49 ps
min	1.000000000	83.694 ns	46.887 ns	687 ps
max	1.000000000	83.694 ns	46.887 ns	823 ps
stdev	---	---	---	17.81 ps
num	---	---	---	7.695e+3
status	✓	✓	✓	▲

MIPI D-PHY	Time	Msg	Data
1	-35.1996 µs	partial HS burst	
2	-24.8121 µs	HS-Burst	0x7c 0x01 0xe0 0xa8 0x55 0x55 0x55 0x55 0x55 0x55 0x55 0x55 0x55 0x55 0x55 0x55
3	59.0286 ps	HS-Burst	0x7c 0x01 0xe0 0xa8 0x55 0x55 0x55 0x55 0x55 0x55 0x55 0x55 0x55 0x55 0x55 0x55
4	24.8122 µs	HS-Burst	0x7c 0x01 0xe0 0xa8 0x55 0x55 0x55 0x55 0x55 0x55 0x55 0x55 0x55 0x55 0x55 0x55
5	49.6243 µs	partial HS burst	0x7c 0x01 0xe0 0xa8 0x55 0x55 0x55 0x55 0x55 0x55 0x55 0x55 0x55 0x55 0x55 0x55

MIPI D-PHY:  Enable,  Show Decode,

Mode: HS, Single-Ended

Probing: Dp, Dn, M4, M3, CLKp, CLKn, M2, M1

DPHY Channels:

- Dphy1: FirstBit
- Dphy2: TCLK-PRE
- Dphy3: TCLK-POST
- Dphy4: TSETUP
- Dphy5: THOLD
- Dphy6: TLP-01
- Dphy7: THS-PREPARE
- Dphy8: THS-ZERO

Other controls:  Show Eye, Eye Source, Dp, Bit Rate, 500 000 Mbits, Find Bit Rate

**Tip:** Touch the protocol name on the top left of the **Statistic** or **Table** column headings to show corresponding **Physical** and **Decode Setup** dialogs, respectively.

# Serial Data Debug Solutions

## Show Decode

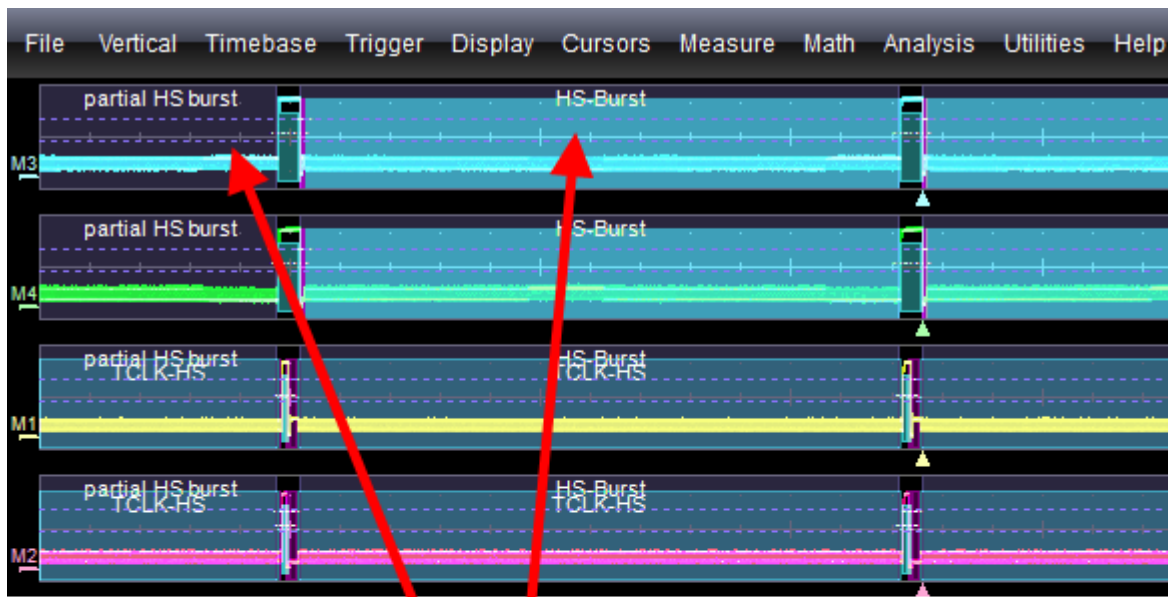

MIPI D-PHY | Dphy1 | Dphy2 | Dphy3 | Dphy4 | Dphy5 | Dphy6 | Dphy7 | Dphy8

<input checked="" type="checkbox"/> Enable	Mode	Probing	<input checked="" type="checkbox"/> Dphy1	FirstBit
	HS	Single-Ended	<input checked="" type="checkbox"/> Dphy2	TCLK-PR
	Dp	Dn	<input checked="" type="checkbox"/> Dphy3	TCLK-PO
	M4	M3	<input checked="" type="checkbox"/> Dphy4	TSETUP
<input checked="" type="checkbox"/> Show Decode	CLKp	CLKn		
Setup Acquisition	M2	M1		

**Note:** If you do not have the MIPI D-PHY Serial Decode Option (D PHY-D), you won't see the **Show Decode** checkbox beneath the **Enable** checkbox. Marking this checkbox (when you have the option) shows annotations on your waveforms.

### Setup Acquisition

The **Setup Acquisition** button automatically makes the following settings. The settings are largely based on your **LP (Low Power)** or **HS (High Speed)** mode selection on the **Mode and Input Selection Area of the MIPI M-PHY Dialog** (on page 151).

#### SETUP ACQUISITION FOR LP LOW POWER MODE

Your channels are set to **200 mV/div**, **-600 mV** offset, and a **Qualified-Pattern** trigger is applied to the signal for capturing the **ULPS** sequence.

**SETUP ACQUISITION FOR HS HIGH SPEED MODE**

Your channels are set to **200 mV/div**, **-600 mV** offset, and an **Edge** trigger is applied to the signal.

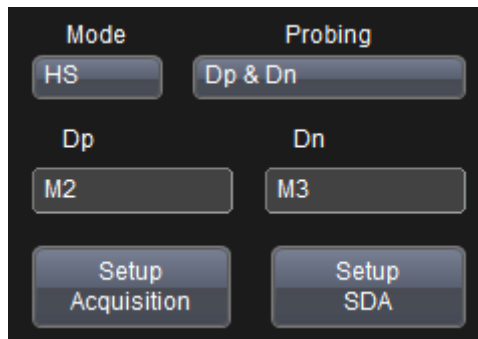
**MODE AND INPUT SELECTION AREA OF THE MIPI M-PHY DIALOG**

As previously mentioned in the **MIPI M-PHY Dialog Details** (on page 149) topic, the **Mode** selection affects the settings the **Setup Acquisition** button has based on the **HS** (High Speed), **PWM**, or **SYS** choices.

The selection also controls which tests are presented on the **Test Parameter Switchboard** and corresponding **Test Dialogs**.

**Dp, Dn, CLKp, and CLKn Controls**

Corresponding source controls are provided on the dialog depending on your selection made for the **Probing** control. Possible controls include **Dp** (Data positive), **Dn** (Data negative), **Ddiff** (differential clock trace), and **CM**. When these controls are selected, a **Select Source** pop-up is shown where you can select your input source for the required signals.

**Setup Acquisition and Setup SDA Buttons**

Depending on your selection on the Mode control of **HS** (High Speed), **PWM**, or **SYS**, the following settings are made after touching the **Setup Acquisition** button.

**SETUP ACQUISITION FOR HS (HIGH SPEED) MODE**

Your channels are set to **200 mV/div**, **-600 mV** offset, and an **Edge** trigger is applied to the signal.

**SETUP ACQUISITION FOR PWM MODE**

Your channels are set to **200 mV/div**, **-600 mV** offset, and a **Qualified-Pattern** trigger is applied to the signal for capturing the **ULPS** sequence.

**SETUP ACQUISITION FOR SYS MODE**

Your channels are set to **200 mV/div**, **-600 mV** offset, and a **Qualified-Pattern** trigger is applied to the signal for capturing the **ULPS** sequence.

Touch the **Setup SDA** button and

**TEST PARAMETER SUMMARY AREA**

The Test Parameter Summary area is a section of the MIPI D-PHY dialog showing all the available tests for HS and LP Modes.

## Serial Data Debug Solutions

### Enabling Tests

Enable/disable a test by either marking/unmarking its respective checkbox from the summary area...

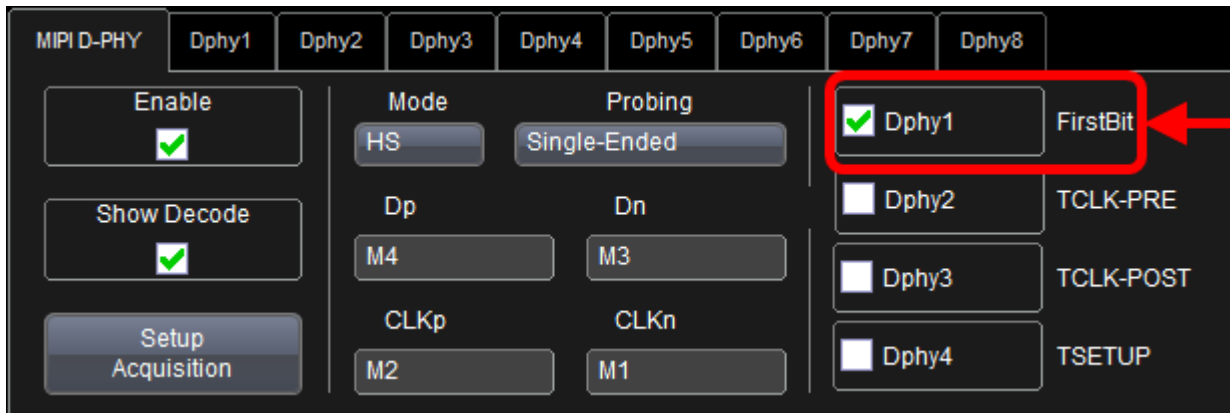

OR

Go directly to its corresponding test dialog and enable/disable it from there.

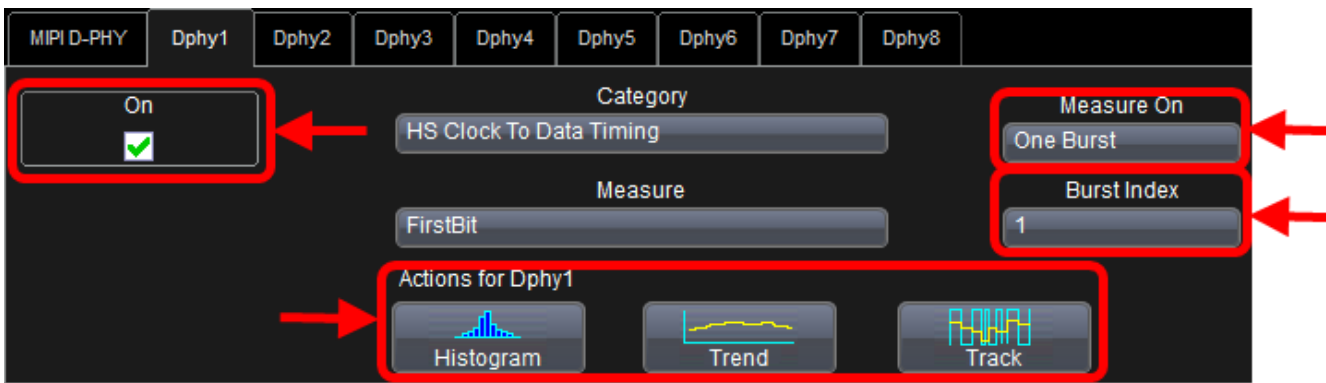

### Official MIPI M-PHY Test Algorithms

Specific test information is maintained by the MIPI Alliance and can be found at [www.mipi.org](http://www.mipi.org).

**Note:** Registration with the Alliance is required to access the document.

### ADDITIONAL CONTROLS

**Note:** Some of the controls on this dialog are enabled/disabled based on **Mode, Probing, and Input Selection** control choices.

The far right of the MIPI M-PHY dialog includes additional controls for **CDR, Bit Rate, Find Bit Rate,** and **SDA Menu....** As controls are used, MIPI M-PHY processes the information and responds in real time.





- Touch the **CDR** control and select from **Linear**, **Filtered**, and **Short-Term** choices.
- The next two controls allow you to either enter a specific **Bit Rate**, or have MIPI M-PHY find your signal's bitrate.
- Finally a convenient **SDA Menu...** button is available for quick access to the main SDA dialog.

**THE VIEWS DIALOG (INCLUDING THE SHOW EYE CONTROL)**

Touch the Views tab and the **Views** dialog is shown.



**Note:** Some of the controls on this dialog are enabled/disabled based on **Mode**, **Probing**, and **Input Selection** control choices.

This dialog includes controls for **Data Diff**, **Eye**, **Mask Mode**, **CDR**, **Common-mode**, **PSD**, **CM Load**, **Fall**, and **Rise**. As controls are used, MIPI M-PHY processes the information and responds in real time.

**The Show Eye Control**

Marking this checkbox shows the eye diagram trace on the display area and includes a corresponding trace descriptor label.

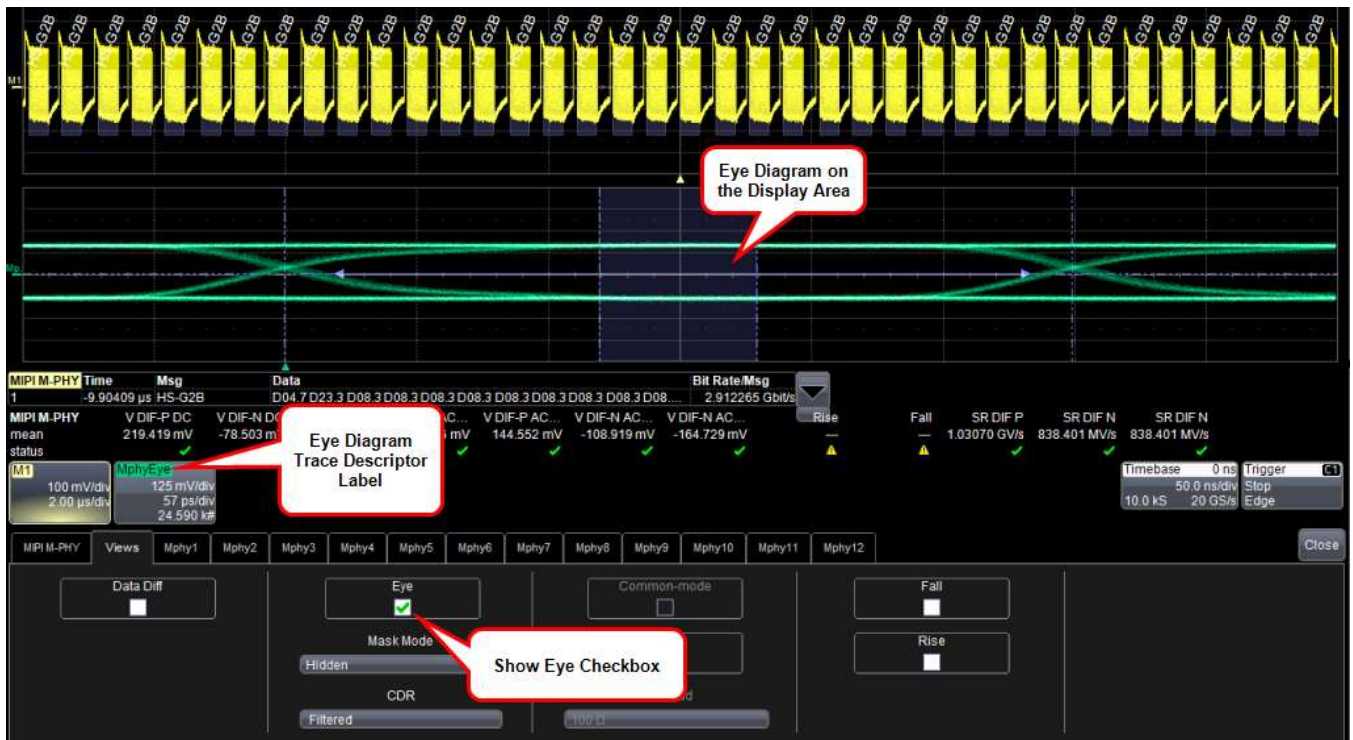

# Storage, Peripherals, and Interconnect Protocols

## Storage, Peripherals, and Interconnect Protocols Overview

### SAS

The [SAS](#) computer bus standard was initially designed to transfer data off and onto hard and tape drives. SAS also has backward compatibility from second-generation SATA drives; meaning SATA 3 Gb/s drives may be connected to SAS backplanes, but not vice versa.

Standards are maintained by **T10 Technical Committee** of the **InterNational Committee for Information Technology Standards (incits)**. Specification information can be found at <http://www.t10.org/>. 1.5, 3 and 6

Number of Lines	Data rate	Synchronous or Asynchronous
2 (differential)	1.5 Gb/s 3 Gb/s 6 Gb/s	Asynchronous

### Fibre Channel

Starting out as a solution to simplify connections and increase transfer distances, [Fibre Channel](#) evolved into a standard designed to connect SCSI disk storage (among other connected devices) and increasing transfer speeds.

Standards vary based on protocols/variants and are maintained by **Joint Technical Committee 1** of the **InterNational Committee for Information Technology Standards (incits)**. Specification information can be found at <http://standards.iso.org/ittf/PubliclyAvailableStandards/index.html>.

Number of Lines	Data rate	Synchronous or Asynchronous
2 (differential)	1.0625 Gb/s 2.125 Gb/s 4.25 Gb/s 8.5 Gb/s 14.025 Gb/s	Asynchronous

### SATA

Typically used to connect host bus adapters to hard drives and optical drives, Serial Advanced Technology Attachment, or [SATA](#) replaced the AT Attachment, or ATA protocol. SATA made great improvements on its predecessors by reducing the number of connecting wires, providing more efficient and faster data transfers, and allowing for hot swap connections.

The standard is maintained by the Serial ATA International Organization. Additional information, including the specification, can be found at [www.sata-io.org/](http://www.sata-io.org/).

Number of Lines	Data rate	Synchronous or Asynchronous
1 (differential)	Up to 6 Gb/s	Synchronous

## PCIe

**PCIe** is a computer expansion card standard designed for mainstream PCs to replace older parallel data PCI, PCI-X, and AGP technology.

**PCI-SIG** (registered trademark) maintains the specification. Download the specification at [www.pcisig.com](http://www.pcisig.com).

Number of Lines	Data rate	Synchronous or Asynchronous
1 - 32 (differential, multi-lane)	Up to 8 GT/s	Asynchronous

## USB 2.0

**USB 2.0** is a version of the universal serial bus specification which is used to connect a host controller (typically a PC) to various devices. The 2.0 version brought a higher maximum bandwidth (480 Mb/s) and features such as the Mini-B Connector, the Battery Charging specification, and the Micro-USB Cables and Connectors specification, to name a few.

USB standards are maintained by the non-profit USB Implementers Forum, Inc. (USB-IF). Additional information, including specifications for specific versions, can be found on their website at [www.usb.org/](http://www.usb.org/).

Number of Lines	Data rates	Synchronous or Asynchronous
1 (differential)	1.5 Mb/s (USB 1.0) 12 Mb/s (USB 1.1) 480 Mb/s (USB 2.0)	Synchronous

**Note:** Currently, USB2 Trigger functionality is available exclusively for the WaveRunner 6 Zi oscilloscope.

## USB 3.0

**USB 3.0** is a subsequent version of the universal serial bus specification using the SuperSpeed bus feature which is a 5.0 Gb/s fourth transfer mode (bringing modifications to the used to connect a host controller (typically a PC) to various devices.

USB standards are maintained by the non-profit USB Implementers Forum, Inc. (USB-IF). Additional information, including specifications for specific versions, can be found on their website at [www.usb.org/](http://www.usb.org/).

Number of Lines	Data rate	Synchronous or Asynchronous
1 - 32 (differential, multi-lane)	Up to 8 GT/s	Synchronous

## Using the SAS Option

### Using the SAS Option Overview

The Serial Advanced Technology Attachment (SATA) is an evolved computer bus interface used to connect host adapters to mass storage devices like hard disk and optical drives.

SATA's evolution has brought reduced cable-bulk and cost (reduced from 80 wires to seven), increased speed, more efficient data transfer, and hot swapping.

**Note:** Ask your local LeCroy representative for more information about any Serial Data Debug Solution Protocols or Toolkits using the **Contact LeCroy for Support** (on page 199) topic.

### SAS Decode Setup Detail

For general information about using controls shown on the main Serial Decode dialog, refer to **Accessing The D and TD Supported Protocol Toolsets** (on page 13).

## Serial Data Debug Solutions

### SAS DECODER AND EXPORTER RIGHT-HAND DIALOGS

Access the **Serial Decode** dialog by touching **Analysis** → **Serial Decode** on the menu bar.

Touch the corresponding **Setup...** button for your decode. The **Decode Setup...** along with corresponding right-hand dialogs are shown.

#### SASDecoder Right-Hand Dialog

The **SASDecoder** right-hand dialog provides detailed controls and setup conditions as follows:

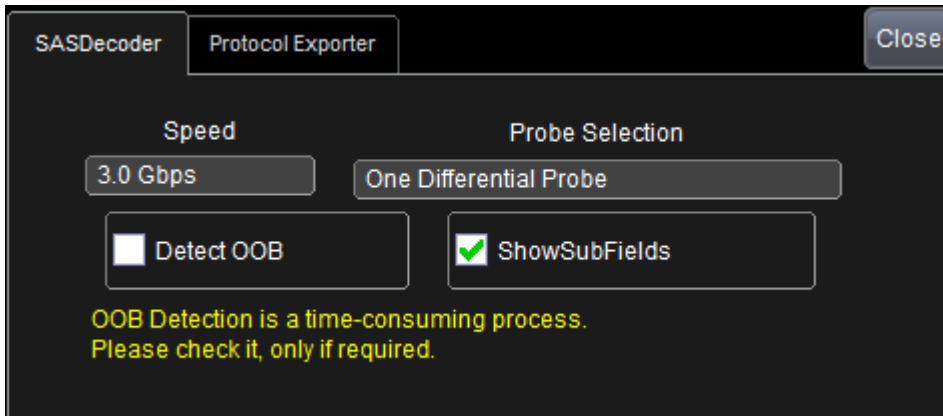

- Select a **Speed** value from **1.5**, **3.0**, **6.0**, and **12.0 Gbps** choices.
- Configure the **Probe Selection** control based on whether you're using **One Differential Probe** or **Two Single Ended Probes**.
- Mark the **Detect OOB** and/or **ShowSubFields** checkboxes as desired.

**Note:** As indicated on the dialog, since OOB detection is time consuming, it's best to only use if truly necessary.

#### SAS Protocol Exporter Right-Hand Dialog

The **SAS Protocol Exporter** right-hand dialog provides detailed controls for synchronizing and sending your data to the **Protocol Analyzer**.

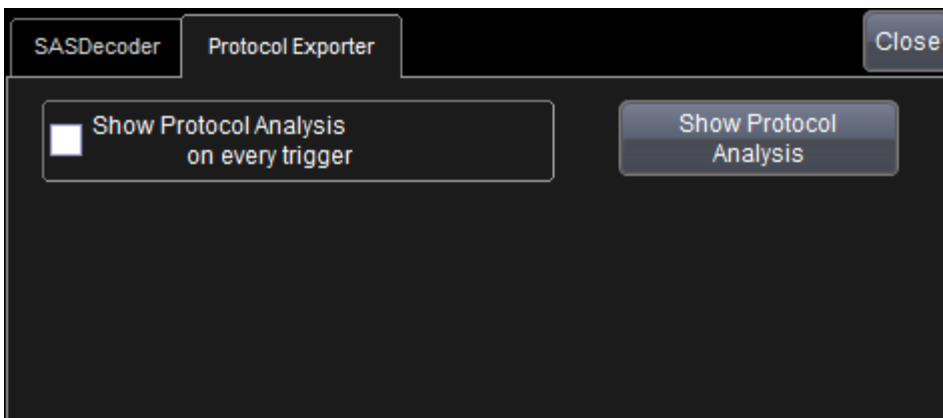

## SAS Decode Trace Annotations

Like all trace annotations, SAS Decode annotations are rectangular shadings used to highlight messages on decoded waveforms for easy viewing.

**Tip:** Data packets (or messages) on properly decoded protocol signals can be viewed using **Serial Decode Trace Annotations** (on page 18), the **Protocol Results Table** (on page 19), and/or by **Searching for Messages** (on page 21) (Types and Subtypes). Using these tools together provides fast insight to your data. See **Serial Decode Trace Annotations** (on page 18) for more information.

Messages shown as **annotations**, **table columns**, and **search types** for most protocols are classified into **Frames**, **Errors**, **Unknown**, or **Grouped Primitives** specific to the protocol. Sub Types then further classify each main message type into more protocol-specific messages.

Decode annotations unique to SAS include the following (some annotations are not shown in the screen-shot):

### SAS Decode Annotations

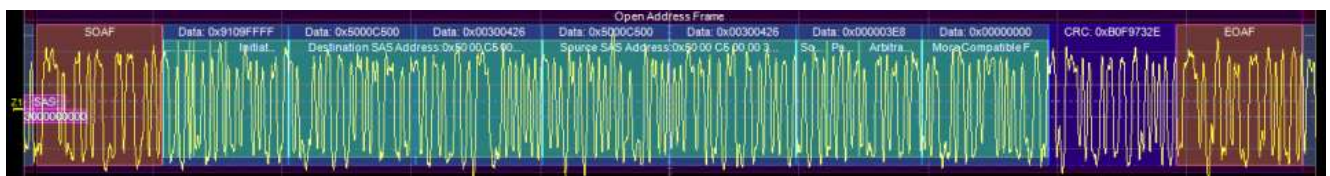

- Time( $\mu$ s)
- Type
- Details
- TypeCode
- PEMask
- RDisparity
- Speed

**Note:** Specifications are subject to change without notice.

### SAS Decode Table Column Details

SAS table column values available include the following:

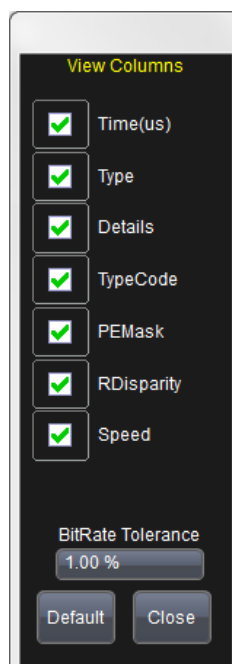

## Serial Data Debug Solutions

Make selections as desired. You can also set a **BitRate Tolerance** percentage or touch the **Default** button to load the preset selections. Touch the **Close** button when finished.

See **Protocol Results Table** (on page 19) for general information about the Table display.

After setting up your FibreChannel decode and checking the **View Table** checkbox, the table should be shown on the display grid.

**Note:** After touching the **View Table** checkbox, touch the **Close** button at the upper-right portion of the Decode Setup dialog to maximize the display grid area.

### EXPORTING TABLE DATA

You can also Exported your table data as a **.CSV** file. Touch the **Export Table** button on the **Decode Setup...** dialog and follow the procedure explained in **Using The D Supported Protocol Toolsets** (on page 14).

### SAS Decode Search

After clicking the Search button from the Decode dialog, the **SAS Search** right-hand dialog appears when the Zoom dialog is shown.

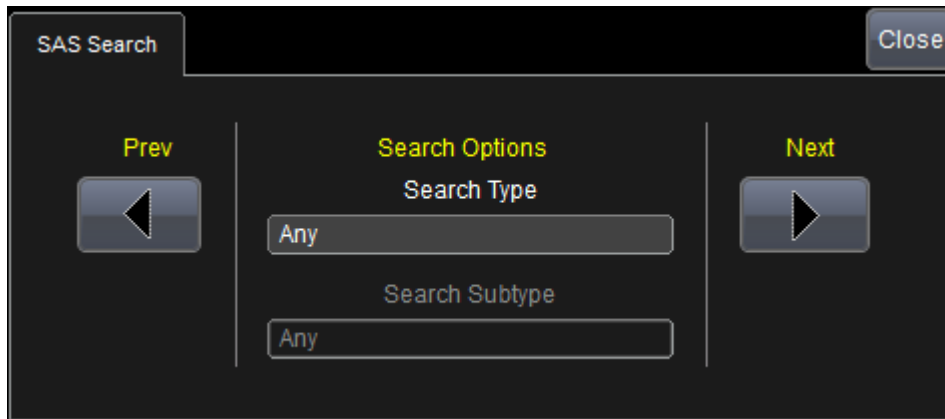

Use the **Prev** and **Next** buttons to advance through occurrences. Use the **Type** and **Subtype** controls to refine your search.

**Note:** The Type control selection determines which Subtypes are made available.

SAS Type selections include **Any**, **SSP Frame**, **STP Frame**, **SMP Frame**, **Addr Frame**, **Grouped Primitives**, **Idle Data**, **Protocol Error**, **OOB**, **Speed Negotiation**, **Electrical Idle**, and **Unknown**. The following **Subtypes** are available for each Type:

- **Any** - No Subtype selection is available.
- **SSP Frame** - With the SSP Frame Type selected, **Any**, **DATAframe**, **XFER\_RDYframe**, **COMMANDframe**, **RESPONSEframe**, **TASKframe**, **Reserved**, **Vendorspecific 0xF0**, **Vendorspecific 0xF1**, **Vendorspecific 0xF2**, **Vendorspecific 0xF3**, **Vendorspecific 0xF4**, **Vendorspecific 0xF5**, **Vendorspecific 0xF6**, **Vendorspecific 0xF7**, **Vendorspecific 0xF8**, **Vendorspecific 0xF9**, **Vendorspecific 0xFA**, **Vendorspecific 0xFB**, **Vendorspecific 0xFC**, **Vendorspecific 0xFD**, **Vendorspecific 0xFE**, and **Vendorspecific 0xFF** Subtypes are available.
- **STP Frame** - With the STP Frame Type selected, **Any**, **REG\_H2D**, **REG\_D2H**, **SDB**, **DMA\_ACTIVATE\_D2H**, **DMA\_SETUP**, **BIST\_ACTIVATE**, **PIO\_SETUP**, **DATA**, **Reserved 0xA6**, **Reserved 0xB8**, **Reserved 0xBF**, **Reserved 0xD9**, **Vendor\_Specific 0xC7**, and **Vendor\_Specific 0xD4** Subtypes are available.
- **SMP Frame** - With the SMP Frame Type selected, **Any**, **SMPREQUEST**, **SMPRESPONSE**, and **Reserved** Subtypes are available.
- **Addr Frame** - With the Addr Frame Type selected, **Any**, **IDENTIFY**, and **OPEN** Subtypes are available.

- **Grouped Primitives** - With the Grouped Primitives Type selected, **Any**, **AIP(NORMAL)**, **AIP(RESERVED0)**, **AIP(RESERVED1)**, **AIP(RESERVED2)**, **AIP(RES WAITING ON PARTIAL)**, **AIP(WAITING ON CONNECTION)**, **AIP(WAITING ON DEVICE)**, **AIP(WAITING ON PARTIAL)**, **BREAK**, **BREAK2**, **BREAK REPLY**, **BROADCAST(CHANGE)**, **BROADCAST(SES)**, **BROADCAST(EXPANDER)**, **BROADCAST(ASYNCHRONOUS EVENT)**, **BROADCAST(RESERVED3)**, **BROADCAST(RESERVED4)**, **BROADCAST(RESERVED CHANGE0)**, **BROADCAST(RESERVED CHANGE1)**, **CLOSE(CLEAR AFFILIATION)**, **CLOSE(NORMAL)**, **CLOSE(RESERVED0)**, **CLOSE(RESERVED1)**, **ERROR**, **HARD RESET**, **OPEN ACCEPT**, **OPEN REJECT BAD DESTINATION**, **OPEN REJECT(CONNECTION RATE NOT SUPPORTED)**, **OPEN REJECT(NO DESTINATION)**, **OPEN REJECT(PATHWAY BLOCKED)**, **OPEN REJECT(PROTOCOL NOT SUPPORTED)**, **OPEN REJECT(ZONE VIOLATION)**, **OPEN REJECT (RESERVED ABANDON2)**, **OPEN REJECT (RESERVED ABANDON3)**, **OPEN REJECT (RESERVED CONTINUE0)**, **OPEN REJECT (RESERVED CONTINUE1)**, **OPEN REJECT (RESERVED INITIALIZE0)**, **OPEN REJECT (RESERVED INITIALIZE1)**, **OPEN REJECT (RESERVED STOP0)**, **OPEN REJECT (RESERVED STOP1)**, **OPEN REJECT (RETRY)**, **OPEN REJECT (STP RESOURCES BUSY)**, **OPEN REJECT (WRONG DESTINATION)**, **TRAIN**, **TRAIN DONE**, **MUX(LOGICAL LINK1)**, **PS REQ PARTIAL**, **PS REQ SLUMBER**, **PS ACK**, **PS NAK**, **ACK**, **CREDIT BLOCKED**, **DONE (ACK NAK TIMEOUT)**, **DONE (CREDIT TIMEOUT)**, **DONE (NORMAL)**, **DONE (RESERVED 0)**, **DONE (RESERVED 1)**, **DONE (RESERVED TIMEOUT 0)**, **DONE (RESERVED TIMEOUT 1)**, **NAK(CRC ERROR)**, **NAK(RESERVED 0)**, **NAK(RESERVED 1)**, **NAK(RESERVED 2)**, **RRDY(NORMAL)**, **RRDY(RESERVED 0)**, **RRDY(RESERVED 1)**, **SATA\_DMAT**, **SATA\_ERROR**, **SATA\_HOLD**, **SATA\_HOLDA**, **SATA\_PMACK**, **SATA\_PMNAK**, **SATA\_PMREQ\_P**, **SATA\_PMREQ\_S**, **SATA\_R\_ERR**, **SATA\_R\_IP**, **SATA\_R\_OK**, **SATA\_R\_RDY**, **SATA\_R\_SYNC**, **SATA\_R\_WTRM**, **SATA\_X\_RDY**, **BREAK GROUP**, **TRAIN GROUP**, **MUX GROUP**, **PS GROUP**, **DONE GROUP**, **NAK GROUP**, **RRDY GROUP**, **AIP GROUP**, **ALIGN GROUP**, **BROADCAST GROUP**, **CLOSE GROUP**, **NOTIFY GROUP**, **OPEN REJECT GROUP**, and **OPEN GROUP** Subtypes are available.
- **Idle Data** - No Subtype selection is available.
- **Protocol Error** - With the Protocol Error Type selected, **Any**, **Extra STP SOF**, **Extra STP EOF**, **Extra SOF**, **Extra EOF**, **Extra SOAF**, **Extra EOAF**, **Missing STP SOF**, **Missing STP EOF**, **Missing SOF**, **Missing EOF**, **Missing SOAF**, **Missing EOAF**, **Mismatched NumberOfFillBytes**, **Deletable Prim Inside Frame**, **Insufficient Frame Data**, **Over FrameLength**, **Under FrameLength**, **Unknown Frame Type**, **Bad Burst Time**, **Bad Idle Time**, **Bad NegationTime**, **SNW Bad Pattern Sequence**, **8b10b Error**, **Payload Size greater than 2048**, **Payload Size 0**, and **CRC Error** Subtypes are available.
- **OOB** - With the OOB Type selected, **Any**, **ComWake**, **ComInitOrComReset**, **ComSas**, and **Unknown OOB** Subtypes are available.
- **Speed Negotiation** - With the Speed Negotiation Type selected, **Any**, **SNWx**, **Final SNW**, and **Train SNW** Subtypes are available.
- **Electrical Idle** - No Subtype selection is available.
- **Unknown** - No Subtype selection is available.

## Using the FibreChannel Option

### *Using the FibreChannel Option Overview*

PCI Express (PCIe) is a serial computer expansion card interface standard developed to replace parallel PCI, PCI-X, and AGP standards. It is now pervasive in computing systems, and its earliest generation (PCIe 1.x) is becoming more common in embedded systems. PCIe utilizes point-to-point connections and typically consists of multiple lanes of both transmit (Tx) and receive (Rx) datastreams, with data being "striped" across multiple datastreams to achieve higher data transmission rates than a single lane could provide.

### **Correcting Poor Signal Quality or Inverted Signals**

It is important to provide a high quality signal when using the Serial Decode package; this is true for PCI Express decode as well as all the other types. If bits cannot be interpreted correctly the decode, of course, is bad. Notice how the relatively good quality of the signal shown in the speed change screen-shots towards the end of

## Serial Data Debug Solutions

**PCIExpress Decode Examples** (on page 171). The capture was made with a high impedance differential probe at the add-in card's driver chip, both for its TX and RX. Do not capture in the middle of the bus (at the PCIe connector) as reflections may seriously degrade the signal. Also, we used the FFE in the LeCroy Eye Doctor II software option package to equalize this signal, to further "open the eye." Signals traversing a significant length of FR4 (printed circuit board material) and coming through a PCIebus D may show significant degradation at 5 GT/s to warrant some equalization, depending on the quality of the probe and where it was connected. At 8 GT/s, equalization is most definitely required, as it is in 8 GT/s PCIe receivers.

An oscilloscope cannot automatically determine if the signal is inverted and compensate like real receivers do. Therefore, the PCIebus Decoder tries to parse the signal supplied – it has no choice because, as in the figures showing speed change, the capture may begin long after link initialization. Therefore it is important to give the decoder a signal with correct polarity. If the decode table shows lots of UNRECOGNIZED and single bytes of IDL (basically junk) then the signal probably needs to be inverted.

If the signal is captured with the wrong polarity, it can easily be corrected later. If the capture is two single-ended waveforms, then just try both subtraction orders; one of them is correct. If the signal is captured using a differential probe, invert it (if necessary) and refer to the **Polarity Correction** (on page 195) topic.

**Note:** Ask your local LeCroy representative for more information about any Serial Data Debug Solution Protocols or Toolkits using the **Contact LeCroy for Support** (on page 199) topic.

### **FibreChannel Decode Setup Detail**

For general information about using controls shown on the main Serial Decode dialog, refer to **Accessing The D and TD Supported Protocol Toolsets** (on page 13).

#### **FIBRECHANNEL DECODER AND EXPORTER RIGHT-HAND DIALOGS**

Access the **Serial Decode** dialog by touching **Analysis** → **Serial Decode** on the menu bar.

Touch the corresponding **Setup...** button for your decode. The **Decode Setup...** along with corresponding right-hand dialogs are shown.

#### **FibreChannel Decoder Right-Hand Dialog**

The **FibreChDecoder** right-hand dialog provides detailed controls and setup conditions as follows:

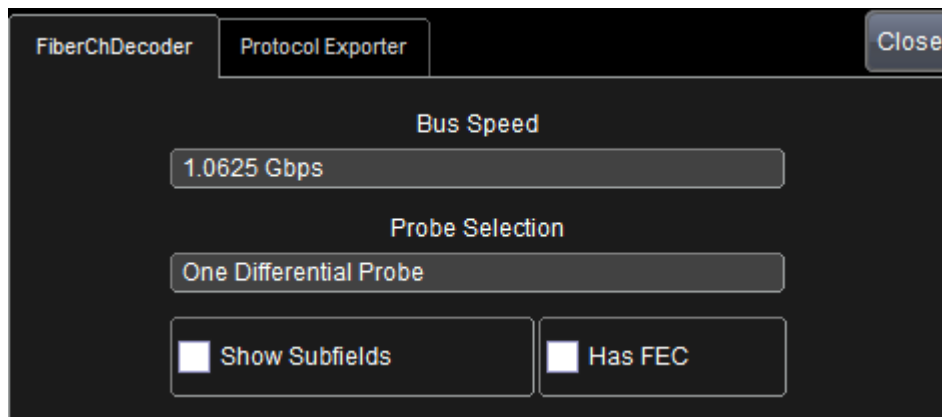

- Select a **Bus Speed** value. Choices include **1.0625**, **2.125**, **4.25**, **8.5**, and **14.025 Gbps**.
- Configure the **Probe Selection** control based on whether you're using **One Differential Probe** or **Two Single Ended Probes**.
- Mark the **Show Subfields** and/or **Has FEC** checkboxes as desired.



### FibreChannel Protocol Exporter Right-Hand Dialog

The FibreChannel **Protocol Exporter** right-hand dialog provides detailed controls for synchronizing and sending your data to the **Protocol Analyzer**.

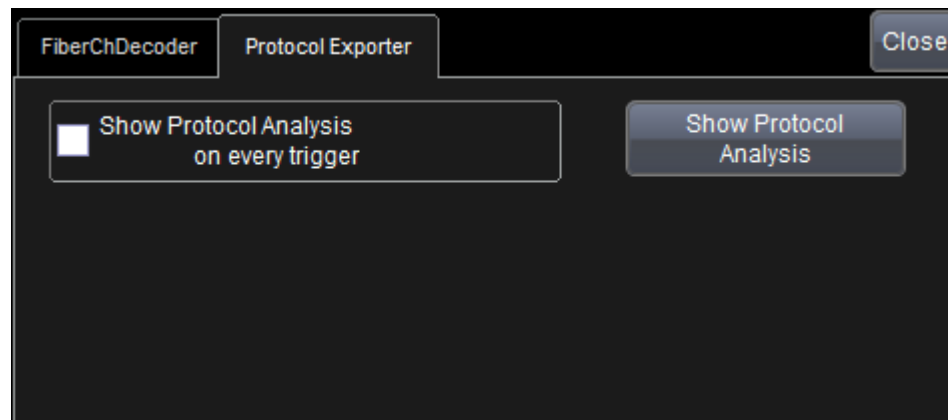

### FibreChannel Decode Trace Annotations

Like all trace annotations, FibreChannel Decode annotations are rectangular shadings used to highlight messages on decoded waveforms for easy viewing.

**Tip:** Data packets (or messages) on properly decoded protocol signals can be viewed using **Serial Decode Trace Annotations** (on page 18), the **Protocol Results Table** (on page 19), and/or by **Searching for Messages** (on page 21) (Types and Subtypes). Using these tools together provides fast insight to your data. See **Serial Decode Trace Annotations** (on page 18) for more information.

Messages shown as **annotations**, **table columns**, and **search types** for most protocols are classified into **Frames**, **Errors**, **Unknown**, or **Grouped Primitives** specific to the protocol. Sub Types then further classify each main message type into more protocol-specific messages.

Decode annotations unique to FibreChannel include the following (some annotations are not shown in the screen-shot):

#### FibreChannel Decode Annotations

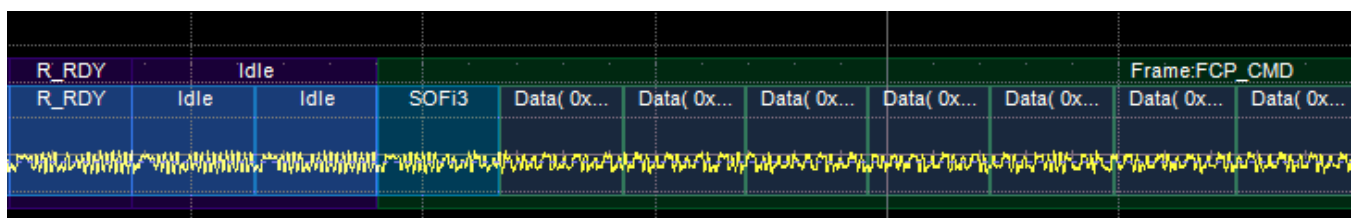

- Time( $\mu$ s)
- Type
- Details

**Note:** Specifications are subject to change without notice.

## Serial Data Debug Solutions

### *FibreChannel Decode Table Column Details*

FibreChannel table column values available include the following:

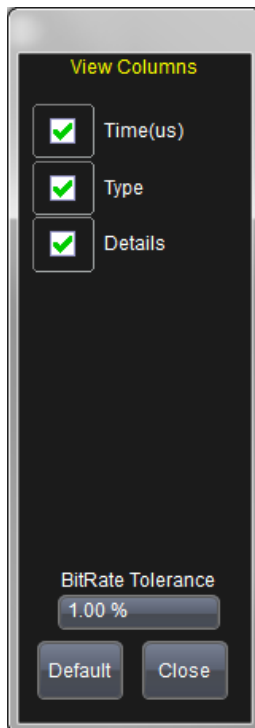

Make selections as desired. You can also set a **BitRate Tolerance** percentage or touch the **Default** button to load the preset selections. Touch the **Close** button when finished.

See **Protocol Results Table** (on page 19) for general information about the Table display.

After setting up your FibreChannel decode and checking the **View Table** checkbox, the table should be shown on the display grid.

**Note:** After touching the **View Table** checkbox, touch the **Close** button at the upper-right portion of the Decode Setup dialog to maximize the display grid area.

#### **EXPORTING TABLE DATA**

You can also Exported your table data as a **.CSV** file. Touch the **Export Table** button on the **Decode Setup...** dialog and follow the procedure explained in **Using The D Supported Protocol Toolsets** (on page 14).

## FibreChannel Decode Search

After clicking the Search button from the Decode dialog, the **FibreChannel Search** right-hand dialog appears when the Zoom dialog is shown.

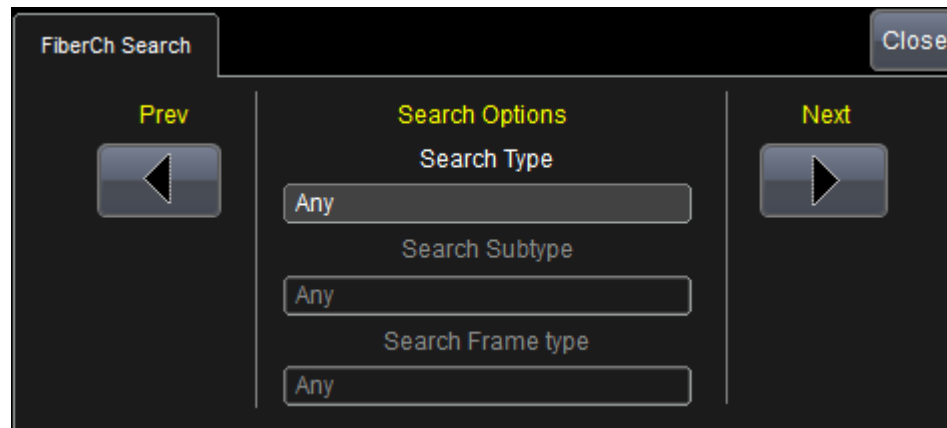

Use the **Prev** and **Next** buttons to advance through occurrences. Use the **Type**, **Subtype**, and **Frame type** controls to refine your search.

**Note:** Selections made on these controls determine which Subtypes (and for Frame, additional Frame types) are available.

FibreChannel Type selections include **Any**, **Frame**, **Grouped Primitives**, **Protocol Error**, and **Unknown**. The following **Subtypes** are available for each Type:

- **Any** - No Subtype selection is available.
- **Frame** - With the Frame Type selected, **ANY**, **FCP**, **Switch Internal Link**, **Generic Link Service**, **FICON**, **AE1553**, **Device\_Data**, **Extended\_Link\_service**, **FC4\_Link\_Data**, **Video\_data**, **Basic\_Link\_service**, **Link\_Control\_Frame**, **Extended\_Routing**, and **UNKNOWN** Subtypes are available.
- **Grouped Primitives** - With the Grouped Primitives Type selected, **Any**, **CLS**, **DHD**, **MRKx**, **R\_RDY**, **VC\_RDY**, **BB\_SCs**, **BB\_SCr**, **NOS**, **OLS**, **LR**, **LRR**, **LPByx**, **LPBfx**, **LPEyx**, **LPEfx**, **LIP\_F7\_F7**, **LIP\_F8\_F7**, **LIP\_F7\_x**, **LIP\_F8\_x**, **LIPyx**, **LIPfx**, **LIPba**, **Idle**, **Idle2**, **Idle3**, **ARBff**, **ARByx**, **ARB\_val**, **SYNx**, **SYNy**, **SYNz**, **OPNyx**, **OPNy**, **OPNyr**, and **OPNfr** Subtypes are available.
- **Protocol Error** - With the Protocol Error Type selected, **Any**, **VC\_RDY Primitive Error**, **Miss EOF**, **Miss SOF**, **Frame Length Error**, **CRC Error**, **Alignment Error**, **Primitive Error**, **Spacing Error**, and **Extra SOF or EOF** Subtypes are available.
- **Unknown** - No Subtype selection is available.

## Using the PCIe Option

### Using the PCIebus Option Overview

PCI Express (PCIe) is a serial computer expansion card interface standard developed to replace parallel PCI, PCI-X, and AGP standards. It is now pervasive in computing systems, and its earliest generation (PCIe 1.x) is becoming more common in embedded systems. PCIe utilizes point-to-point connections and typically consists of multiple lanes of both transmit (Tx) and receive (Rx) datastreams, with data being "striped" across multiple datastreams to achieve higher data transmission rates than a single lane could provide.

## Serial Data Debug Solutions

### Correcting Poor Signal Quality or Inverted Signals

It is important to provide a high quality signal when using the Serial Decode package; this is true for PCI Express decode as well as all the other types. If bits cannot be interpreted correctly the decode, of course, is bad. Notice how the relatively good quality of the signal shown in the speed change screen-shots towards the end of **PCIEbus Decode Examples** (on page 171). The capture was made with a high impedance differential probe at the add-in card's driver chip, both for its TX and RX. Do not capture in the middle of the bus (at the PCIE connector) as reflections may seriously degrade the signal. Also, we used the FFE in the LeCroy Eye Doctor II software option package to equalize this signal, to further "open the eye." Signals traversing a significant length of FR4 (printed circuit board material) and coming through a PCIEbus D may show significant degradation at 5 GT/s to warrant some equalization, depending on the quality of the probe and where it was connected. At 8 GT/s, equalization is most definitely required, as it is in 8 GT/s PCIe receivers.

An oscilloscope cannot automatically determine if the signal is inverted and compensate like real receivers do. Therefore, the PCIEbus Decoder tries to parse the signal supplied – it has no choice because, as in the figures showing speed change, the capture may begin long after link initialization. Therefore it is important to give the decoder a signal with correct polarity. If the decode table shows lots of UNRECOGNIZED and single bytes of IDL (basically junk) then the signal probably needs to be inverted.

If the signal is captured with the wrong polarity, it can easily be corrected later. If the capture is two single-ended waveforms, then just try both subtraction orders; one of them is correct. If the signal is captured using a differential probe, invert it (if necessary) and refer to the **Polarity Correction** (on page 195) topic.

**Note:** Ask your local LeCroy representative for more information about any Serial Data Debug Solution Protocols or Toolkits using the **Contact LeCroy for Support** (on page 199) topic.

### PCIEbus Decode Setup Detail

For general **Serial Decode** and **Decode Setup...** dialog information, refer to the [Serial Decode and Decode Setup](#) topic. PCIEbus D has additional functionality used to send data to ProtoSync.

#### SENDING PCIEBUS D DATA TO PROTO SYNC

Access the **Serial Decode** dialog in the oscilloscope software from **Analysis** → **Serial Decode** on the menu bar.



At this point, using PCIEbus D decode and exporting to ProtoSync becomes a matter of selecting the appropriate PCIEbus D decode protocol from **PCIE-1X1**, **PCIE-1X2**, and **PCIE-4X1** to suit your specific lane needs.

Each of these selections changes the PCIEbus D **Decode Setup...** dialog in the following ways.

## PCIe-1X1 - One Lane Either Upstream or Downstream

When selected, PCIe-1X1 shows **Lane 0**. Now, select a **Source** for **Lane 0's Upstream or Downstream** packets.

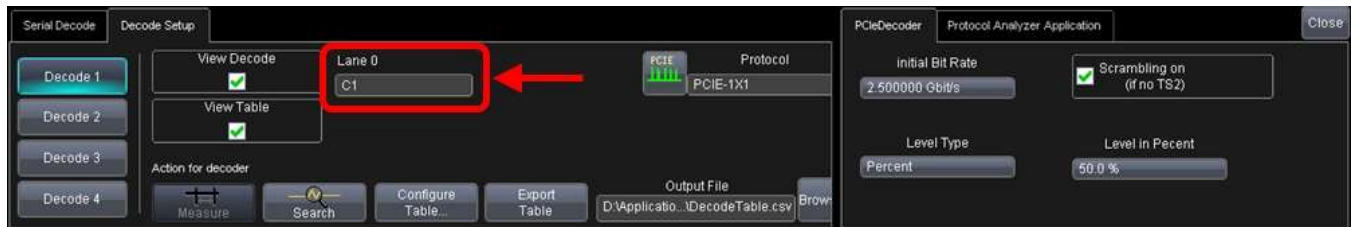

**Tip:** Quickly change PCIebus D protocols using the Protocol field on the Decode Setup dialog.

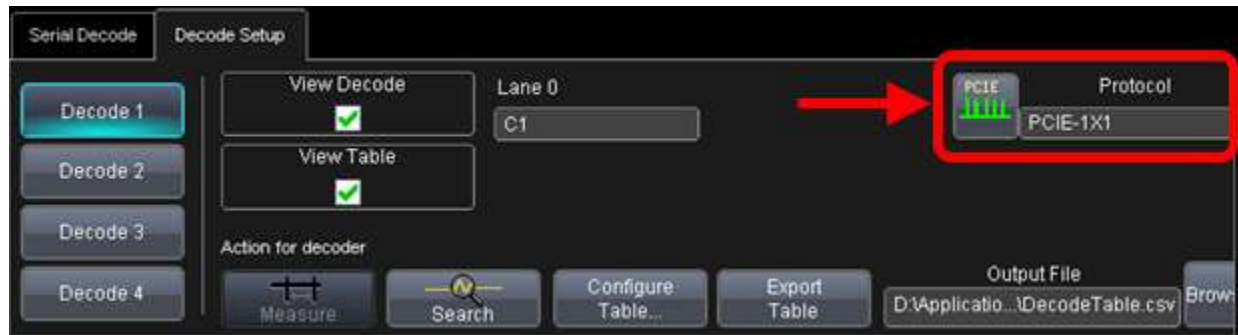

Now, use the right-hand dialog to set **Initial Bit Rate**, **Level Type**, **Level in Percent** (percent or absolute, based on type selection), and **Scrambling on (if no TS2)** checkbox for your PCIebus D lane information as desired.

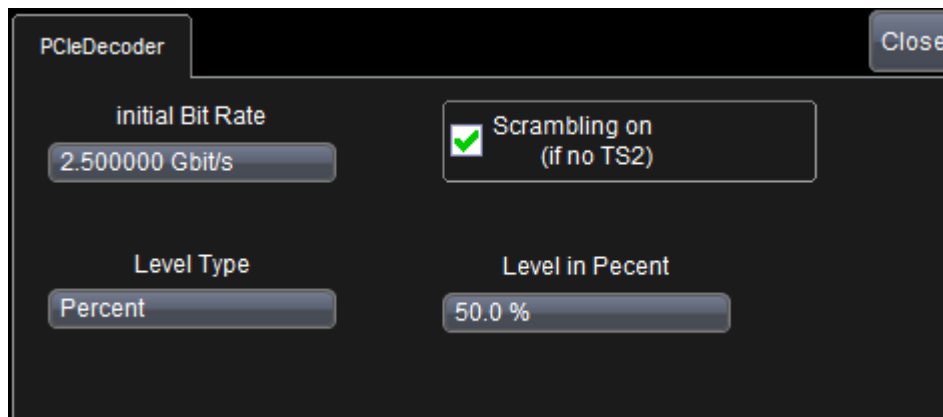

- **Initial Bit Rate** - Adjust the initial bit rate value here to match the initial bit rate on the bus to which you are connected.

LeCroy's PCIebus Decode follows speed changes. It detects the request, and the subsequent Electrical Idle Ordered Set (EIOS) triggers the speed change to the highest agreed upon supported rate. On the Setup dialog for PCI Express decode, the user must enter the Initial Bit Rate, that is, the bit rate at the beginning of the waveform.

Use the arrows to move through standard bit rates (2.5, 5, or 8 GT/s) and make a selection.

**OR**

Touch the field twice (with a finger, or using a mouse) and provide a value using the **slider bar**, **pop-up keypad** button (or keyboard), or the **Default** button.

## Serial Data Debug Solutions

- **Scrambling on (if no TS2)** - Some PCIebus standards use a scrambling algorithm to reduce electromagnetic interference (EMI) caused by repetitive data patterns. The LeCroy software automatically detects if scrambling is being used by reading values in the TS2. If no TS2 exists in the transmission, you can indicate its use by checking this box.
- **Level Type and Level in Percent** - The message decoding algorithm setup is performed here. The level is normally set up in %, and defaults to 50%. You can change the type from percent to. Adjust the level by touching inside the number area to highlight the box title, and then use the oscilloscope front panel Adjust knob to adjust. Or touch inside the number area twice and select a value using the pop-up numeric keypad.

### PLEASE NOTE THE FOLLOWING:

- The set Level appears as a dotted horizontal line across the oscilloscope grid.
- If initial decoding indicates that there are a number of error frames, make sure that the level is set to a reasonable value.

### PCIe-1X2 - Two Lanes, Each Either Upstream or Downstream

When selected, PCIe-1X2 shows **Lane 0 up** and **Lane 0 down**. The first 0 Lane is designated for **Upstream** packets and the second 0 Lane is designated for **Downstream**. With this in mind, select a **Source** for **Lane 0 up** and **Lane 0 down**.



Now, as described previously, use the right-hand dialog to set **Initial Bit Rate**, **Level Type**, **Level in Percent** (percent or absolute, based on type selection), and **Scrambling on (if no TS2)** checkbox for your PCIebus D lane information as desired.

### PCIe-4X1 - Four Lanes All Upstream or All Downstream

When selected, PCIe-4X1 shows **Lane 0 - 3**. Select **Sources** for **Lanes 0-3** all packets sent through these lanes are either **Upstream** or **Downstream**.

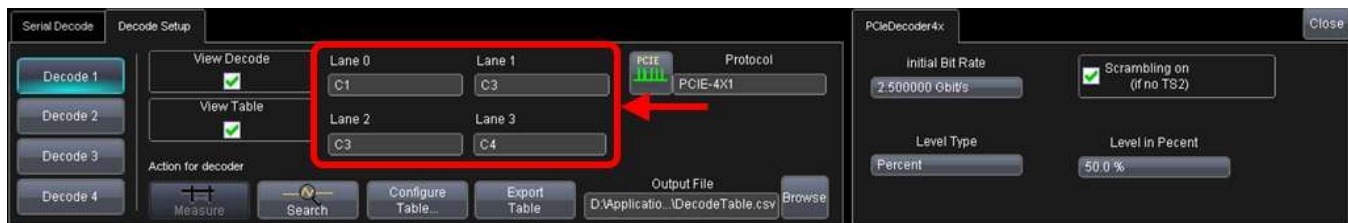

Now, as described previously, use the right-hand dialog to set **Initial Bit Rate**, **Level Type**, **Level in Percent** (percent or absolute, based on type selection), and **Scrambling on (if no TS2)** checkbox for your PCIebus D lane information as desired.

### The ProtoSync Right-Hand Dialog

After setting up your specific Lane configuration, use the ProtoSync right-hand dialog for PCIebus D to either repeatedly send your Lane data to ProtoSync on each oscilloscope trigger or manually exporting the Lane data to ProtoSync.

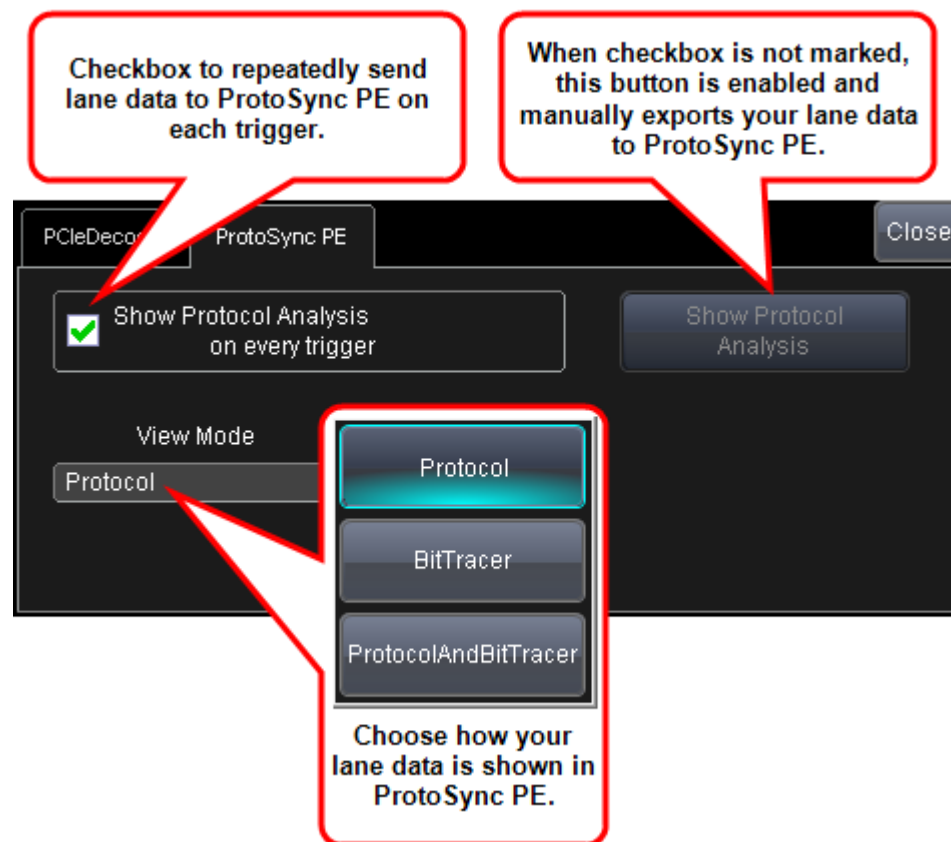

- **Enable Time Sync between Scope and PE Tracer** - Marking this checkbox disables the Export Now button and repeatedly sends data to ProtoSync on each oscilloscope trigger.
- **View** - Choose to send your data to ProtoSync and have it displayed in **Protocol**, **Bit Tracer**, or use **Both** views.
- **Export Now** - When the **Enable Time Sync between Scope and PE Tracer** checkbox is unmarked, this button is enabled and allows you to manually export your data to ProtoSync and displayed in the manner selected from the **View** field.

**Note:** Please refer to the **LeCroy PETracer™ PCI Express Protocol Analyzer Software** user manual at [www.lecroy.com](http://www.lecroy.com) for information regarding more specific usage.

### PCIExpress Decode Trace Annotations

Like all trace annotations, PCIebus Decode annotations are rectangular shadings used to highlight messages on decoded waveforms for easy viewing.

**Tip:** Data packets (or messages) on properly decoded protocol signals can be viewed using **Serial Decode Trace Annotations** (on page 18), the **Protocol Results Table** (on page 19), and/or by **Searching for Messages** (on page 21) (Types and Subtypes). Using these tools together provides fast insight to your data. See **Serial Decode Trace Annotations** (on page 18) for more information.

## Serial Data Debug Solutions

---

Messages shown as **annotations**, **table columns**, and **search types** for most protocols are classified into **Frames**, **Errors**, **Unknown**, or **Grouped Primitives** specific to the protocol. Sub Types then further classify each main message type into more protocol-specific messages.

Decode annotations unique to PCIebus (some have long and short forms) include the following (some annotations are not shown in the screen-shot):

### PCIExpress Decode Annotations

Decode annotations unique to PCIe include the following:

**TS1, TS2, SKIP, DLLP, TLP, EIOS, EIEOS, and FTS.**

The following annotations have long and short forms:

- **EI** - Electrical Idle or Error
- **?** - Unrecognized
- **Comp** - Compliance
- **MComp** - Modified Compliance
- **CompD** - Compliance Delayed
- **MCompD** - Modified Compliance Delayed
- **IDL** - Logical Idle

### PLEASE NOTE THE FOLLOWING:

- Compliance annotations appear at 2.5 and 5GT/s.
- At 8GT/s, both Compliance and Modified Compliance appear simply as blocks of Logical Idle separated by EIEOS, and in Modified Compliance, by SKP Ordered Sets.
- In Compliance, the repeating pattern is one EIEOS followed by 32 Data Blocks of IDL.
- In Modified Compliance, after the EIEOS, there are 256 Data Blocks of IDL, then 255 repetitions of: SKP Ordered Set followed by 256 Data Blocks of IDL. The state can be determined from the Details annotation for the SKP Ordered Set. There is no concept of delayed compliance at 8GT/s, instead each lane has a unique initialization of its LFSR.
- Specifications are subject to change without notice.

### *PCIExpress Decode Table Column Details*

The table shows details about the contents but does not show the value of every byte. If a line on the table is touched, a zoom (typically Z1) appears showing the region of the waveform corresponding to that line of the table. The rectangle on the zoom trace spans almost the entire width of the screen, and so all possible annotation appears in the rectangle on the Zoom trace. The Zoom trace can be zoomed out – or in – after it is automatically positioned, like any normal Zoom trace. The annotation on the Zoom trace updates.

Once you've setup a basic PCI Express decode by:

- Touching **Analysis** → **Serial Decode**.
- Selecting **PCI Express** as the Protocol for one of your Decodes on the main Serial Decode dialog.
- Set your Source 1 DATA as desired for your PCI Express Decode on the Decode Setup dialog.
- Viewing the Table by touching the **View Table** checkbox on the Decode Setup dialog.



The Table should be shown on the display grid as follows:

**Note:** After touching the **View Table** checkbox, touch the **Close** button at the upper-right portion of the Decode Setup dialog to maximize the display grid area.

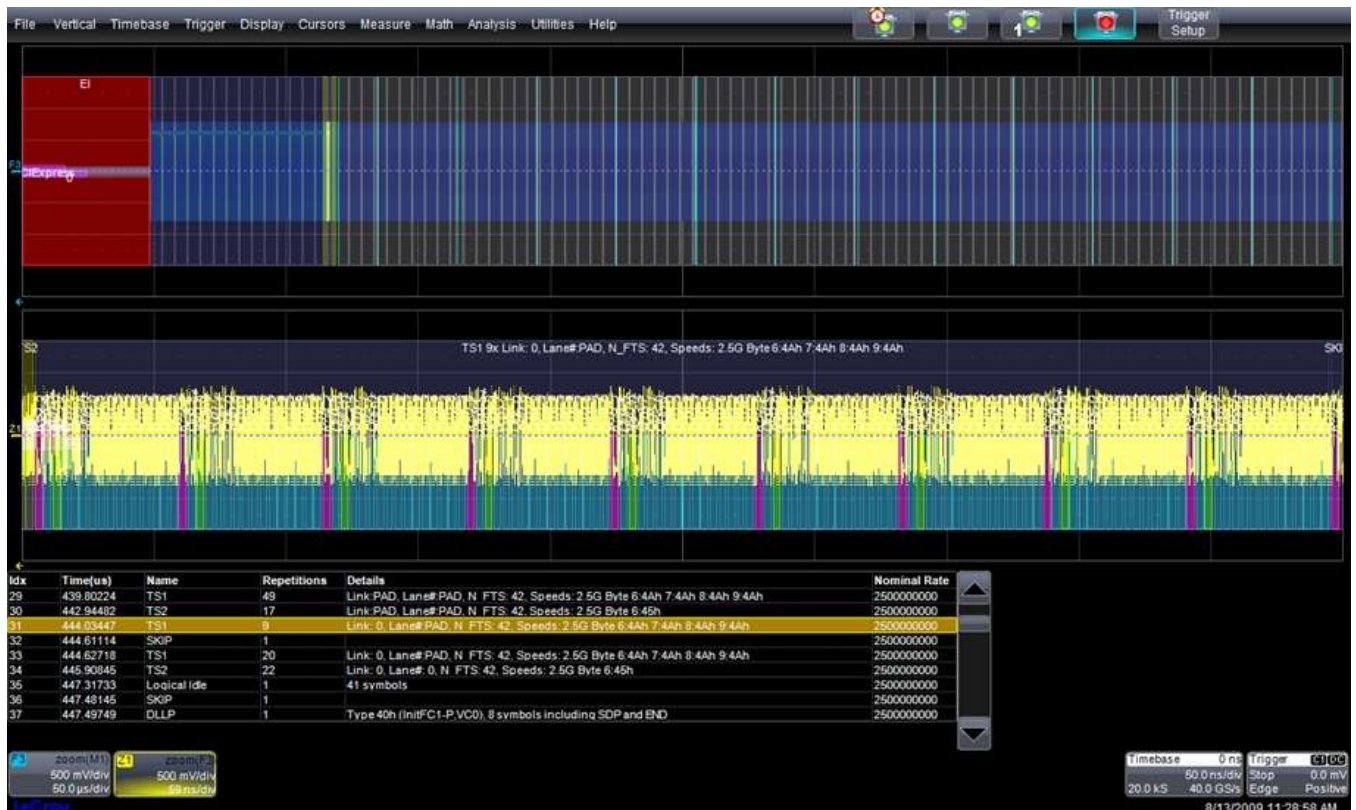

### TABLE COLUMN NAMES AND DETAILS

Table column headings include the following:

- **Idx:** A line number.
- **Time( $\mu$ s):** Start time of the sequence of symbols referred to by this line, in microseconds relative to the trigger position. The trigger position is at Time 0 by definition.
- **Name:** The name of the sequence of symbols. Some names shown here are long, in which case there are shorter forms used to annotate the translucent rectangles overlaying the displayed traces when the rectangles are too narrow to fit the long form. See **PCIebus Decode Trace Annotations** (on page 167) for more information.
- **Repetitions:** Since startup begins with 1024 TS1 all of which are identical, and then possibly dozens more TS1 and TS2 sequences in each state as the Link and Lane# are agreed upon, the table shows one line for all identical, contiguous, TS1 and TS2 sequences. The number of repetitions is shown in this column. The table also encodes a continuous run of IDL as one line, but since Logical Idle is scrambled IDL and not repetitions of the same symbols, the number of symbols in a continuous run of Logical Idle is given in the Details column.
- **Details:** Selected (by us, at design time) information from within the structure being annotated. For TS1 and TS2: Link, Lane#, N\_FTS, Speeds advertised, and if present: Speed Change Request, Autonomous Change, Training Control: Hot Reset, Disable Link, Loopback, Disable scrambling, Compliance receive.

## Serial Data Debug Solutions

The value of the next byte is annotated for TS2, the next 4 bytes for TS1; these bytes may contain equalization setup information for 8GT/s, if that speed is supported. For TLP, the Type (or Type and Fmt) are spelled out using exactly the TLP Type names given in Table 2-3 of the PCI Express Base Specification. For DLLP, the Type is spelled out using exactly the DLLP Type names given in Table 3-1 in the PCI Express Base Specification.

At 8GT/s, details about the three bytes following SKP END are annotated, including LFSR value (and we set our LFSR, so we can decode from the first SKIP OS in a waveform that starts in the middle of a data stream), or **in Loopback, Master** or **in Loopback, Slave** or **in Compliance, Err Cnt =** . Also, if an invalid sync header is found, **UNRECOGNIZED** has Details, which are: **Invalid sync:** and the value of the sync header (either 0 or 3).

- **Nominal Rate:** This is the nominal bit rate the decoder is currently using to separate bits. Is it not a measurement. It shows as **2500000000** or **5000000000** or **8000000000**.

See **Protocol Results Table** (on page 19) for general information about the Table display.

### EXPORTING TABLE DATA

You can also Exported your table data as a **.CSV** file. Touch the **Export Table** button on the **Decode Setup...** dialog and follow the procedure explained in **Using The D Supported Protocol Toolsets** (on page 14).

### PCIEbus Decode Search

The **PCI Express Search** right-hand dialog appears when the Zoom dialog is shown.

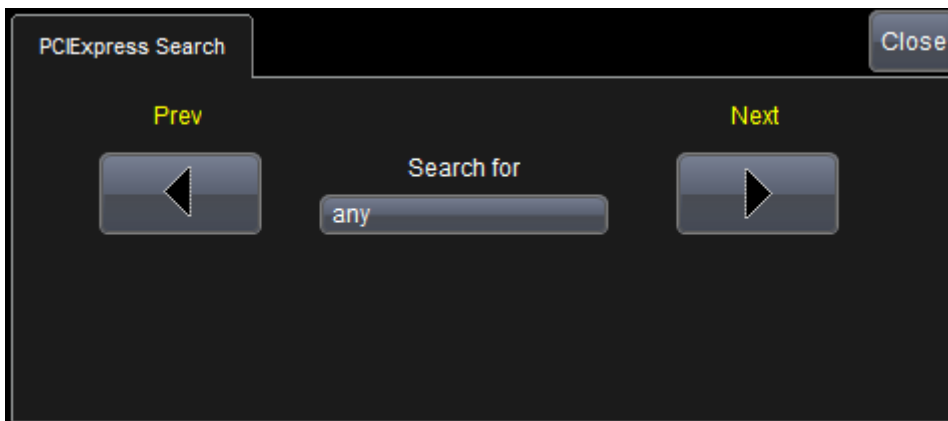

Use the **Prev** and **Next** buttons to advance through occurrences. The **Search for** field allows you to select from any, Compliance, EIEOS, EIOS, Electrical Idle, DLLP, Logical Idle, SKIP (ordered sequence), TLP, TS1, TS2, FTS, and UNRECOGNIZED ( at 2.5 and 5GT/s: something that started with K28.5 but did not parse as any possible valid Ordered Set. At 8GT/s: invalid sync header). The following search parameters are available.

- any
- Compliance
- EIEOS
- EIOS
- Elec Idle or Error
- DLLP
- LogicalIdle
- SKIP
- TLP
- TS1
- TS2
- UNRECOGNIZED

### PCIEbus Decode Examples

Let's show some examples while performing a PCIEbus Decode setup. Start by touching **Analysis** → **Serial Decode** and selecting **PCI Express** as the Protocol for one of your Decodes on the main Serial Decode dialog. Now, touch the corresponding **Setup...** button for the PCI Express decode. The **Decode Setup...** dialog is shown.



The Table should now be shown on the display grid.

### SEQUENCES, TABLE ROWS, AND ANNOTATIONS

Following are some examples of the PCIe and 8b/10b Decode applied to a 2.5 GT/s Gen1 PCIe signal. In the first example that follows, the transmitted signal of a single lane is captured. The captured signal is shown as F3 (F3 is a math trace representing a Zoom of a Memory Trace). This signal is further zoomed and shown as the Z1 trace. The PCIe decode is applied to the F3 signal. Since Z1 is a zoom of F3, it also shows the applied PCIe decode. Furthermore, 8b/10b is additionally applied only on the Z1 trace.



2.5 GT/s Gen1 Startup.

Look to the left and right of the Zoom trace in the following screen-shot. The PCIe table has been turned on by touching the **View Table** checkbox on the Decode Setup dialog. The table is showing all the PCIe decoded values.

# Serial Data Debug Solutions

## Automatic Zoom by Table Row Selection

Continuing from the previous section, select the Idx 31 row on the table and Z1 automatically zooms to the width of the grid display. On the Z1 trace, the very small piece of the rectangle on the left is labeled **TS2**, and it is also showing as the previous line in the table (Idx 30). The very small piece of the rectangle on the right is labeled **SKIP**, and it is also showing as the next line in the table (Idx 32).

**Tip:** After touching the **View Table** checkbox, touch the **Close** button at the upper-right portion of the Decode Setup dialog to maximize the table and display grid areas.

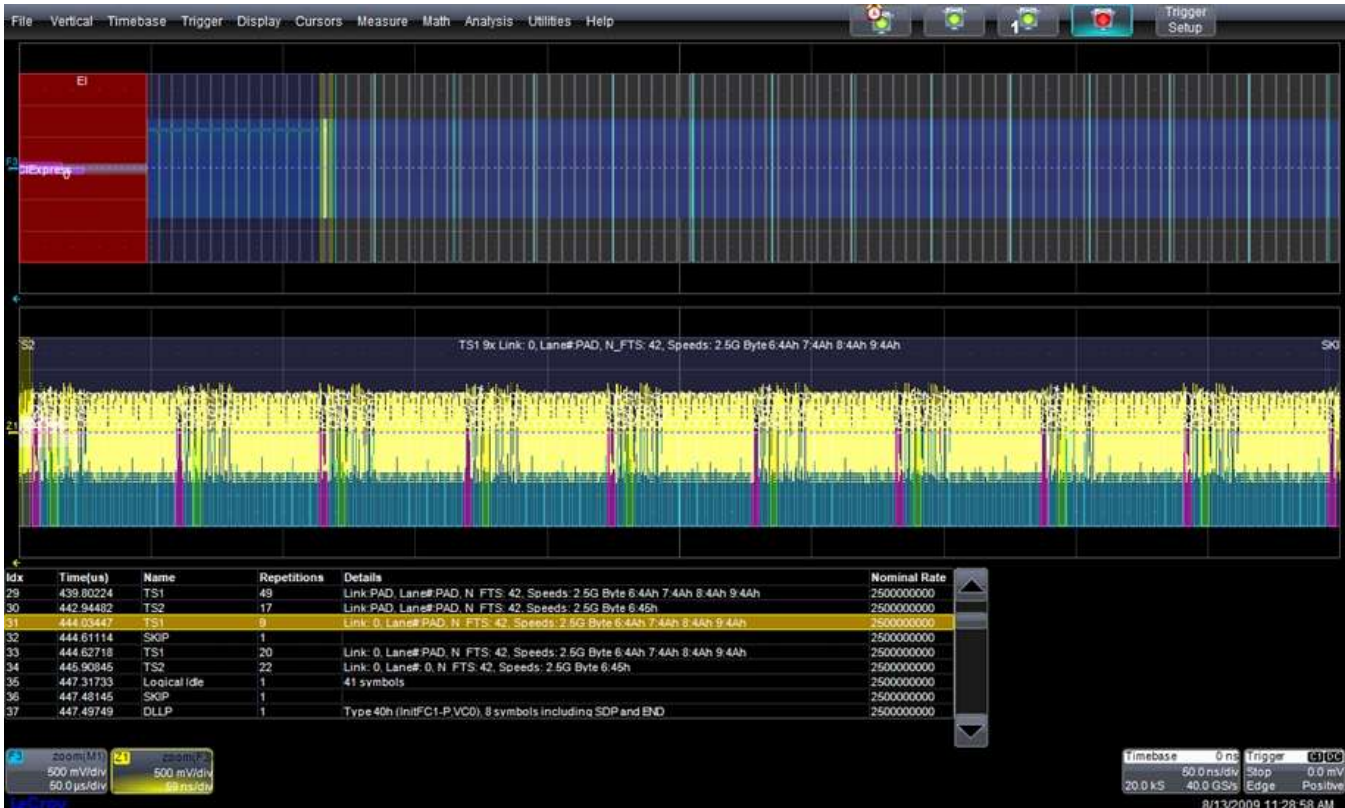

PCI Express Decode on F3, and 8b/10b Decode on Z1 showing nine identical TS1.

The following figure shows row Idx 34 selected and Z1 resized accordingly. The zoom position is adjusted corresponding to a TS1 sequence. An 8b/10b decode is clear on one of the TS1 sequences.



**Zoomed in on Z1, showing the 8b/10b decode of a TS1 sequence.**

The following figure shows partial annotation rectangles on the left and right sides showing name and repetition count values (because the annotations are large enough). However, they do not contain Details. Notice how the middle annotation rectangle contains Name, repetition count, and Details (because the annotation wide enough for all this information).

On the top trace, only the Electrical Idle is annotated with its short form Name, **EI**; all the other rectangles are too narrow to hold any annotation. Even so, we can see the repetitive dim vertical stripes, which are **SKIP** ordered sets; and the bright blue vertical stripes are **DLLPs**. Dull blue (on the left) is **TS1**; Grey (between SKIPS starting about 1/3 of the way from the left) is **Logical Idle**.

## Serial Data Debug Solutions

Yellow is **TS2**, as shown. Notice how trace annotation rectangle colors are consistent among the source trace display, the Zoom trace display, and the table row.



*Zoomed out on Z1.*

### Proper Decode with Speed Change

The following screen-shot shows an annotation on the source trace showing a speed change.



Following a speed change.

Idx	Time(us)	Name	Repetitions	Details	Nominal Rate
24	-5.85237	SKIP	1		2500000000
25	-5.83640	TS1	32	Link: 1, Lane#: 0, N FTS: 50, Speeds: 2.5G, 5G, Speed Change Request Byte 6:4Ah 7:4Ah 8:4Ah 9...	2500000000
26	-3.79104	TS2	33	Link: 1, Lane#: 0, N FTS: 50, Speeds: 2.5G, 5G, Speed Change Request Byte 6:45h	2500000000
27	-1.68045	EIOS	1		2500000000
28	-1.66485	Electrical Idle or error	1		5000000000
29	51.22e-3	EIEOS	1		5000000000
30	83.23e-3	TS1	22	Link: 1, Lane#: 0, N FTS: 50, Speeds: 2.5G, 5G Byte 6:4Ah 7:4Ah 8:4Ah 9:4Ah	5000000000
31	787.43e-3	TS2	17	Link: 1, Lane#: 0, N FTS: 50, Speeds: 2.5G, 5G Byte 6:45h	5000000000
32	1.33168	Logical Idle	1	68 symbols	5000000000

Speed change table detail.

This speed change is captured by setting the trigger level at about 50 mV and using a Smart Trigger - negative width greater than 150 ns. We powered on the computer containing the PCIe device under test and then, within the first couple of seconds, pressed Arm on the oscilloscope. The speed switch happened approximately four seconds after the PC was powered on, and the oscilloscope triggered on the Electrical Idle. This is shown by the trigger time indicator (the triangle under the center of the top trace).

## Using the SATA Option

### Using the SATA Option Overview

The Serial Advanced Technology Attachment (SATA) is an evolved computer bus interface used to connect host adapters to mass storage devices like hard disk and optical drives.

SATA's evolution has brought reduced cable-bulk and cost (reduced from 80 wires to seven), increased speed, more efficient data transfer, and hot swapping.

**Note:** Ask your local LeCroy representative for more information about any Serial Data Debug Solution Protocols or Toolkits using the **Contact LeCroy for Support** (on page 199) topic.

## Serial Data Debug Solutions

### SATA Decode Setup Detail

For general information about using controls shown on the main Serial Decode dialog, refer to **Accessing The D and TD Supported Protocol Toolsets** (on page 13).

#### SATADecoder AND EXPORTER RIGHT-HAND DIALOGS

Access the **Serial Decode** dialog by touching **Analysis** → **Serial Decode** on the menu bar.

Touch the corresponding **Setup...** button for your decode. The **Decode Setup...** along with the **SATADecoder** right-hand dialog is shown.

#### SATADecoder Right-Hand Dialog

The **SATADecoder** right-hand dialog provides detailed controls and setup conditions as follows:

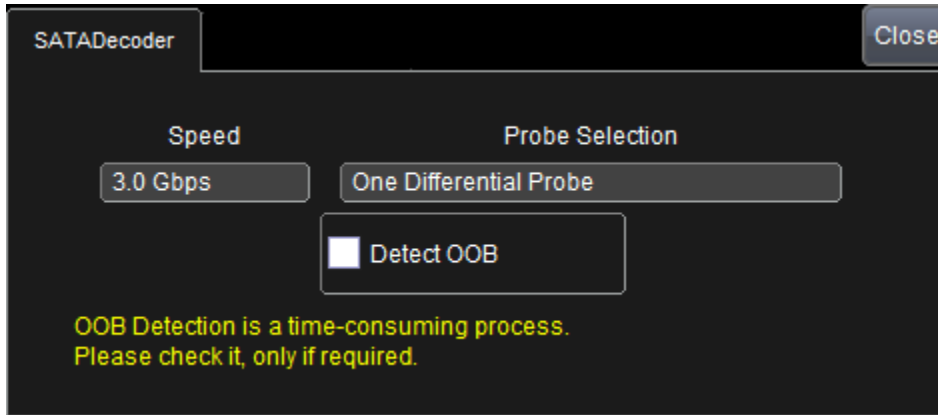

- Select a **Speed** value from **1.5**, **3.0**, and **6.0 Gbps** choices.
- Configure the **Probe Selection** control based on whether you're using **One Differential Probe** or **Two Single Ended Probes**.
- Mark the **Detect OOB** checkbox as desired.

**Note:** As indicated on the dialog, since OOB detection is time consuming, it's best to only use if truly necessary.

#### SATA Protocol Exporter Right-Hand Dialog

The **SATA Protocol Exporter** right-hand dialog provides detailed controls for synchronizing and sending your data to the **Protocol Analyzer**.

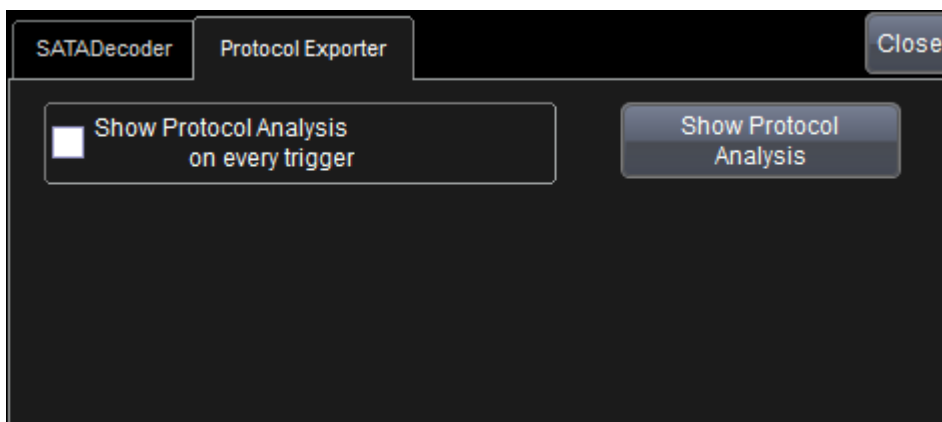



## SATA Decode Trace Annotations

Like all trace annotations, SATA Decode annotations are rectangular shadings used to highlight messages on decoded waveforms for easy viewing.

**Tip:** Data packets (or messages) on properly decoded protocol signals can be viewed using **Serial Decode Trace Annotations** (on page 18), the **Protocol Results Table** (on page 19), and/or by **Searching for Messages** (on page 21) (Types and Subtypes). Using these tools together provides fast insight to your data. See **Serial Decode Trace Annotations** (on page 18) for more information.

Messages shown as **annotations**, **table columns**, and **search types** for most protocols are classified into **Frames**, **Errors**, **Unknown**, or **Grouped Primitives** specific to the protocol. Sub Types then further classify each main message type into more protocol-specific messages.

Decode annotations unique to SATA include the following (some annotations are not shown in the screen-shot):

### SATA Decode Annotations

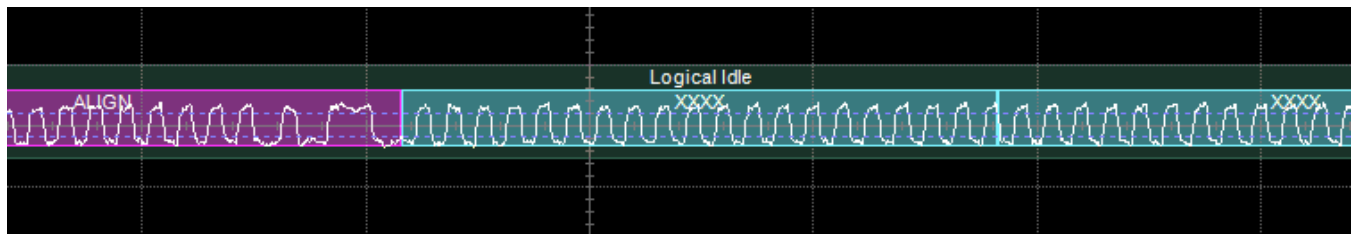

- **Frame** - An indivisible unit of information exchanged between a host and device. A frame consists of SOF, a Frame Information Structure, a CRC calculated over the contents of the FIS, and EOF.
- **X\_RDYs** - Transmission data ready.
- **WTRMS** - Wait for frame termination.
- **Logical Idle** - Period of one or more symbol times when no information (packets or link commands) is being transmitted.
- **OOB** - Out of Band Signaling.
- **Speed Negotiation** - Signal sent to the host to indicate a change in speed.
- **Electrical Idle** - Electrical Idle is a steady state condition where the transmitter Txp and Txn voltages are held constant at the same value.
- **Protocol Error** - Frame error using CRC (Cyclical Redundancy Check).

**Note:** Specifications are subject to change without notice.

## Serial Data Debug Solutions

### **SATA Decode Table Column Details**

SATA table column values available include the following:

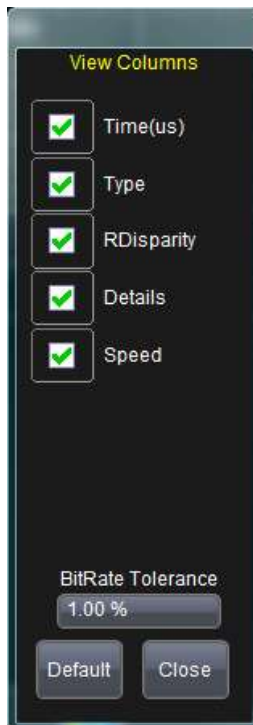

Make selections as desired. You can also set a **BitRate Tolerance** percentage or touch the **Default** button to load the preset selections. Touch the **Close** button when finished.

See **Protocol Results Table** (on page 19) for general information about the Table display.

After setting up your SATA decode and checking the **View Table** checkbox, the table should be shown on the display grid.

**Note:** After touching the **View Table** checkbox, touch the **Close** button at the upper-right portion of the Decode Setup dialog to maximize the display grid area.

### **EXPORTING TABLE DATA**

You can also Exported your table data as a **.CSV** file. Touch the **Export Table** button on the **Decode Setup...** dialog and follow the procedure explained in **Using The D Supported Protocol Toolsets** (on page 14).

### **SATA Decode Search**

After clicking the Search button from the Decode dialog, the Zoom dialog is shown along with the **SATA Search** right-hand dialog.

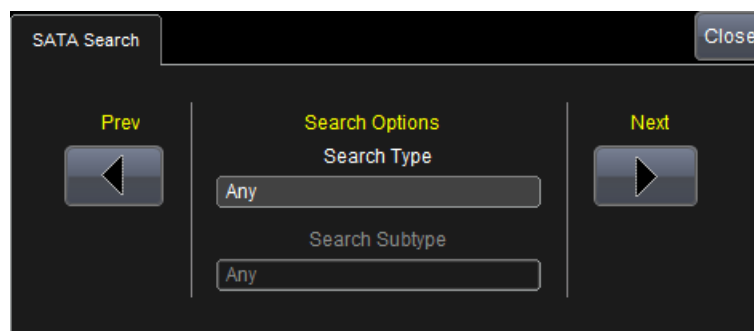

**NAVIGATION FIELDS**

A **Prev** and **Next** button is on either side of the dialog to navigate through each search result/occurrence.

**SEARCH OPTIONS FIELDS - TYPE AND SUBTYPE**

**Search Options** fields in the center of the dialog allow you to restrict your search based on **Type** and **Subtype** selections.

**Note:** Selections made on the Search Type control determines which Subtypes are available.

SATA Type selections include **Any**, **Frame**, **X\_RDYs**, **WTRMs**, **Logical Idle**, **OOB**, **Speed Negotiation**, **Electrical Idle**, **Protocol Error**, and **Unknown**. The following **Subtypes** are available for each Type:

- **Any** - No Subtype selection is available.
- **Frame** - With the Frame Type selected, **ANY**, **REG\_H2D**, **SDB**, **DMA\_ACTIVATE\_D2H**, **DMA\_SETUP**, **BIST\_ACTIVATE**, **PIO\_SETUP**, **DATA**, **RESERVED**, **VENDOR\_SPECIFIC**, and **UNKNOWN** Subtypes are available.
- **X\_RDYs** - No Subtype selection is available.
- **WTRMs** - No Subtype selection is available.
- **Logical Idle** - No Subtype selection is available.
- **OOB** - With the OOB Type selected, **Any**, **Com\_Wake**, **ComInit/ComReset** and **Unknown** Subtypes are available.
- **Speed Negotiation** - No Subtype selection is available.
- **Electrical Idle** - No Subtype selection is available.
- **Protocol Error** - With the Protocol Error Type selected, **Any**, **Missing SOF**, **Missing EOF**, **Extra SOF**, **Payload Size greater than 2048**, **Payload Size 0**, **CRC Error**, **Unknown FIS Type**, **Excessive payload for FIS Type**, **Unexpected R\_IP inside frame**, **Unexpected R\_OK inside frame**, **Unexpected R\_RDY inside frame**, **Unexpected X\_RDY inside frame**, **Missing expected 2 primitive prior CONT**, **Missing expected wtrm after EOF**, **Insufficient bytes in Dword**, **8b10bresult-Data and Symbolic Length Not Matched**, **8b10bresult-Length not matched with Symbolic Length**, and **8b10bresult-Length not matched with Data Length** Subtypes are available.
- **Unknown** - No Subtype selection is available.

**Creating a SATA Trigger Condition**

Detail on some of the setup conditions for the SATA Trigger dialog is shown in the following topics.

**Note:** Refer to the **Using The T Supported Protocol Toolsets** (on page 22) topic to correctly access the Trigger Condition dialog specific to your desired protocol.



Make settings or provide values by touching controls (using your finger, stylus, or connected mouse). On applicable controls, a pop-up dialog box is shown where precise entry values can be set.

# Serial Data Debug Solutions

## SATA Trigger Setup Detail

The following topic provides specific control settings for a SATA Trigger setup.



### PLEASE NOTE THE FOLLOWING:

- Most Trigger Setups have some form of **Source** and **Type** control.
- Only the **Symbol Type** uses **Setup Mode** and **Symbol Detail** controls.
- Remaining dialog controls vary based on the selected **Pattern Type** and are explained in the following sections.

### 1. SETUP

- **Bus Speed** - Select the desired bitrate of the connected SATA source from **1.5 Gbps**, **3 Gbps**, or **Auto**.
- **Host Channel** - Select the input channel that contains the **Host** device (**C1**, **2**, **3**, or **4**). Typically this refers to the SATA transmitter. If the transmitter is unavailable, select **None**.
- **Device Channel** - Select the input channel that connects to the SATA device (**C1**, **2**, **3**, or **4**). This typically refers to the SATA receiver. If a receiver is not available, select **None**.

**Note:** If using two single-ended probes, select the channel that corresponds to the positive terminal.

- **Direction** - Select whether to trigger on the **Host** or **Device**.

### 2. FORMAT

Depending on the pattern type, use this control to select either **hexadecimal** or **binary** formats.

### 3. PATTERN TYPE

Pattern Type selections include **Symbol**, **Primitive**, **FIS Pattern**, **Data Payload**, **Protocol Error**, and **Bus Condition**.

### REMAINING DIALOG CONTROLS BASED ON PATTERN TYPE SELECTION

#### Symbol Pattern Type Selection Controls

With this pattern type selected, triggering is performed on a specified 8B/10B character. Remaining controls on the dialog vary based on a **Symbol Pattern Type** selection in the following manner:

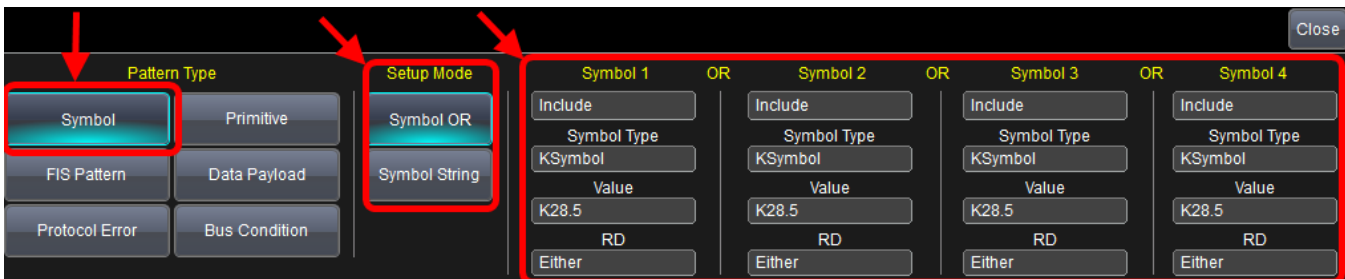

**Setup Mode**

Select **Symbol OR** to trigger on a logical OR combination of characters or **Symbol String** to trigger using a logical AND.

**Note:** When a **Symbol String** is used, the **Include** control for all four Symbols and the **OR** operator between the four Symbols are removed from the dialog.

**Symbol Detail (1 - 4)**

**Note:** The four Symbol controls are shown on the dialog in first to last byte order.

- **Include/Exclude** - With **Symbol OR** selected as the Setup Mode, each symbol can be specifically included or excluded from the trigger pattern.
- **Symbol Type** - Select either **KSymbol (control)** or **DSymbol (data)**.
- **Value** - Select either **K28.3** or **K28.5** if a **KSymbol (control)** Symbol Type is selected. If a **DSymbol (data)** Symbol Type is selected provide either a **two-character hex value** or an **8-bit pattern** depending on the Hex or Bin **Format** selection made previously on the dialog.
- **RD (Running Disparity)** - Select positive **+**, negative **-**, or **Either**.

**Primitive Pattern Type Selection Controls**

Remaining controls on the dialog vary based on a **Primitive Pattern Type** selection in the following manner:



Select the desired primitive from the 19 **SATA Primitive Types** provided on which you would like to trigger.

**FIS Pattern Type Selection Controls**

Remaining controls on the dialog vary based on a **FIS Pattern Type** selection in the following manner:



Select one of the FIS types available on the **FIS Type** control. Available types include: **Any**, **REG\_H2D (Register – Host to Device)**, **REG\_D2H (Register – Device to Host)**, **DMA\_Activate\_D2H (DMA Activate – Device to Host)**, **DMA\_Setup (Bi-directional)**, **DATA (Bi-directional)**, **BIST Activate (bi-directional)**, **PIO\_Setup (Device to Host)**, **Set\_Device\_Bits (Device to Host)**.

## Serial Data Debug Solutions

### PLEASE NOTE THE FOLLOWING:

- Some additional reserved and vendor-specific FIS values are also available for selection.
- Specific FIS values may require additional information. Consult the Serial ATA specification for specific FIS type details at [www.sata-io.org/](http://www.sata-io.org/).

### Data Payload Pattern Type Selection Controls

Remaining controls on the dialog vary based on a **Data Payload Pattern Type** selection in the following manner:



Now, provide values for the controls on the dialog as desired.

- Select an **Operator** from Equal = or Unequal <> values. Selecting Unequal triggers on all data patterns not matching the one specified.

Use the remaining controls to specify your desired data pattern. The byte order follows a **little endian** representation where the least-significant byte is ordered first. Within each byte, the bits must be arranged in a most-significant bit first order (msb).

- Provide a value in the **At Position (in Dword)** control.
- Enter a bit string in the **Data (1 - 128 bytes)** control.

### Protocol Error Pattern Type Selection Controls

Remaining controls on the dialog vary based on a **Protocol Error Pattern Type** selection in the following manner:



Mark the checkbox adjacent to the protocol error type on which you wish to trigger. Protocol error types include: **Symbol Violation**, **Disparity Error**, **Align Error**, **Frame Type Error**, **Frame Length Error**, and **CRC Error**.

### Bus Condition Pattern Type Selection Controls

Remaining controls on the dialog vary based on a **Bus Condition Pattern Type** selection in the following manner:



Mark the checkbox adjacent to the bus condition on which you wish to trigger. Bus conditions include: **Electrical Idle On**, **Electrical Idle Off**, **Electrical Burst**, **COMINIT/COMRESET**, and **COMWAKE**.

**Note:** The Trigger dialog's tab label indicates your **Setup Mode** selection for convenience.

## Using the USB2 Option

### Using the USB2 Option Overview

The USB 2.0 decode option shows the packet level of the USB 2.0, USB 1.1, and USB 1.0 standards, consisting of **Token**, **Data**, and **Status** packets.

#### PLEASE NOTE THE FOLLOWING:

- Currently, USB2 Trigger functionality is available exclusively for the WaveRunner 6 Zi oscilloscope.
- Ask your local LeCroy representative for more information about any Serial Data Debug Solution Protocols or Toolkits using the **Contact LeCroy for Support** (on page 199) topic.

### USB2 Decode Setup Detail

For general information about using controls shown on the main Serial Decode dialog, refer to **Accessing The D and TD Supported Protocol Toolsets** (on page 13).

#### USB2DECODER AND EXPORTER RIGHT-HAND DIALOGS

Access the **Serial Decode** dialog by touching **Analysis** → **Serial Decode** on the menu bar.

Touch the corresponding **Setup...** button for your decode. The **Decode Setup...** along with the **USB2Decoder** right-hand dialog is shown.

#### USB2Decoder Right-Hand Dialog

The **USB2Decoder** right-hand dialog provides detailed controls and setup conditions as follows:

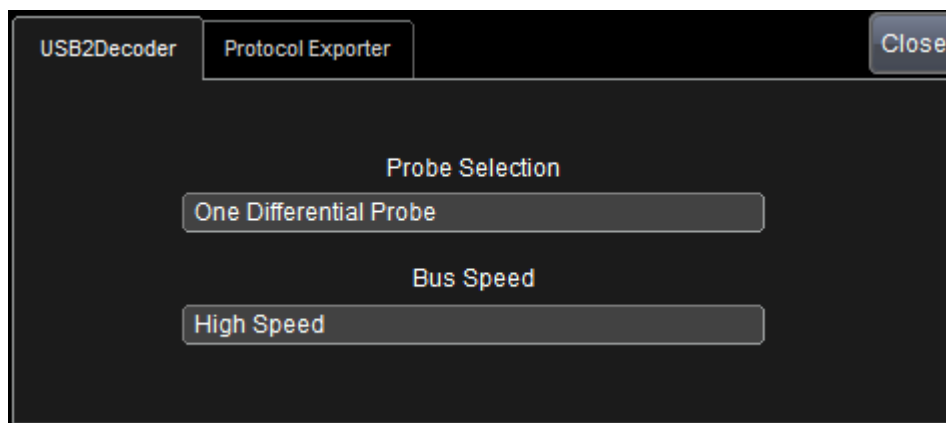

- Configure the **Probe Selection** control based on whether you're using **One Differential Probe**, **Two Single Ended Probes** or **One Single Ended Probe**.

The number of **Source Selectors** on the **Decode Setup** dialog change to accommodate the chosen **Probe Selection** in the following manner:

#### One Differential Probe

With **One Differential Probe** selected, a **single data positive, data negative Source Selector** is shown on the main **Decode Setup...** dialog.



## Serial Data Debug Solutions

### Two Single Ended Probes

With **Two Single Ended Probes** selected, separate **data positive** and **data negative Source Selectors** are shown on the main **Decode Setup...** dialog.



### One Single Ended Probe

With **One Single Ended Probe** selected, a single **data positive OR data negative Source Selector** is shown on the main **Decode Setup...** dialog.



- Select a **Bus Speed** value from **Low**, **Full**, and **High** choices.

### USB2 Protocol Exporter Right-Hand Dialog

The USB2 **Protocol Exporter** right-hand dialog provides detailed controls for synchronizing and sending your data to the **Protocol Analyzer**.

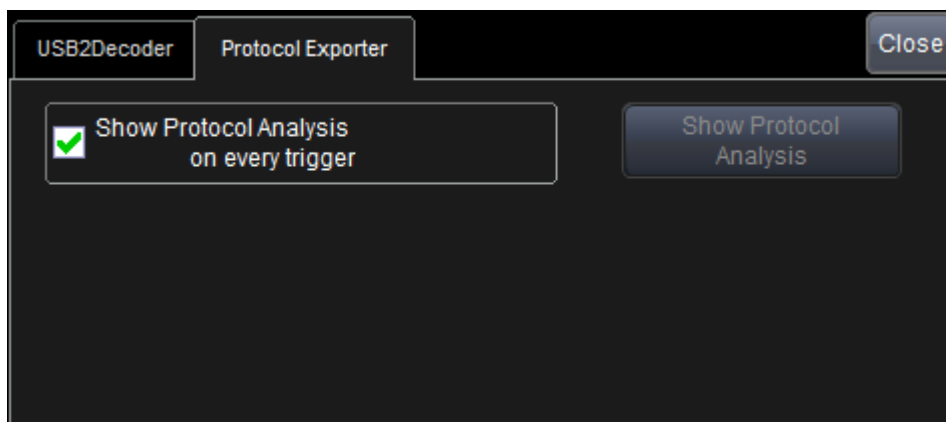

### USB2 Decode Trace Annotations

Like all trace annotations, USB2 Decode annotations are rectangular shadings used to highlight messages on decoded waveforms for easy viewing.

**Tip:** Data packets (or messages) on properly decoded protocol signals can be viewed using **Serial Decode Trace Annotations** (on page 18), the **Protocol Results Table** (on page 19), and/or by **Searching for Messages** (on page 21) (Types and Subtypes). Using these tools together provides fast insight to your data. See **Serial Decode Trace Annotations** (on page 18) for more information.

Messages shown as **annotations**, **table columns**, and **search types** for most protocols are classified into **Frames**, **Errors**, **Unknown**, or **Grouped Primitives** specific to the protocol. Sub Types then further classify each main message type into more protocol-specific messages.



Decode annotations unique to USB2 include the following (some annotations are not shown in the screen-shot):

### USB2 Decode Annotations

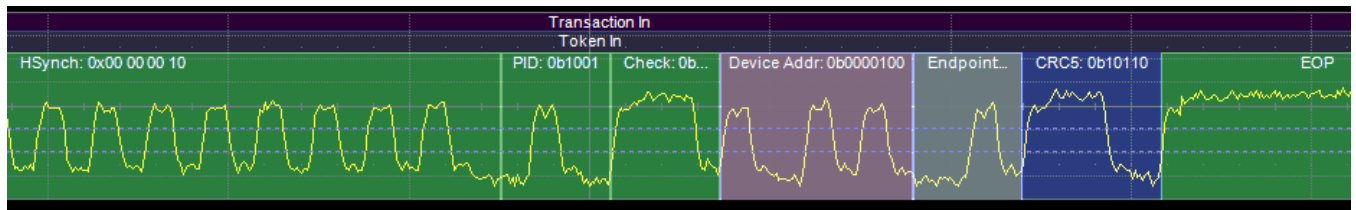

- **Label** - Identifier showing data type and parameter association. Typically shown as octal numbers.
- **SDI** - Source/Destination Identifier
- **Data** - Bits 29 - 11.
- **SSM** - Sign/Status Matrix
- **Pa** - Parity
- **Msg** - Displays the symbolic information.
- **Symbols**
- **Bits/Resolution**
- **Pad**
- **Status**

**Note:** Specifications are subject to change without notice.

### USB2 Decode Table Column Details

USB2 table column values available include the following:

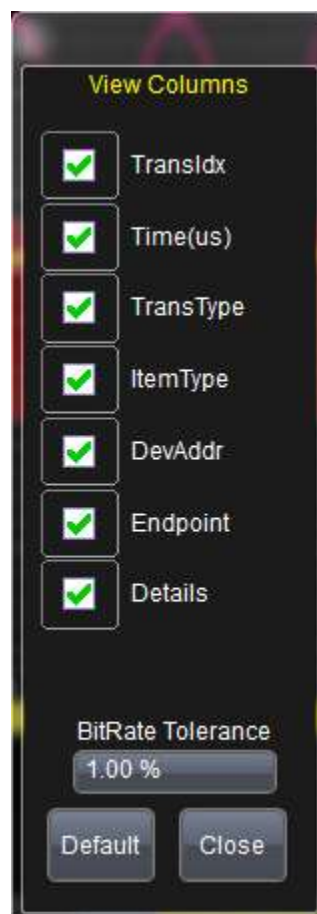

## Serial Data Debug Solutions

Make selections as desired. You can also set a **BitRate Tolerance** percentage or touch the **Default** button to load the preset selections. Touch the **Close** button when finished.

See **Protocol Results Table** (on page 19) for general information about the Table display.

After setting up your USB2 decode and checking the **View Table** checkbox, the table should be shown on the display grid.

**Note:** After touching the **View Table** checkbox, touch the **Close** button at the upper-right portion of the Decode Setup dialog to maximize the display grid area.

### EXPORTING TABLE DATA

You can also Exported your table data as a **.CSV** file. Touch the **Export Table** button on the **Decode Setup...** dialog and follow the procedure explained in **Using The D Supported Protocol Toolsets** (on page 14).

### USB2 Decode Search

After clicking the Search button from the Decode dialog, the Zoom dialog is shown along with the **USB2 Search** right-hand dialog.

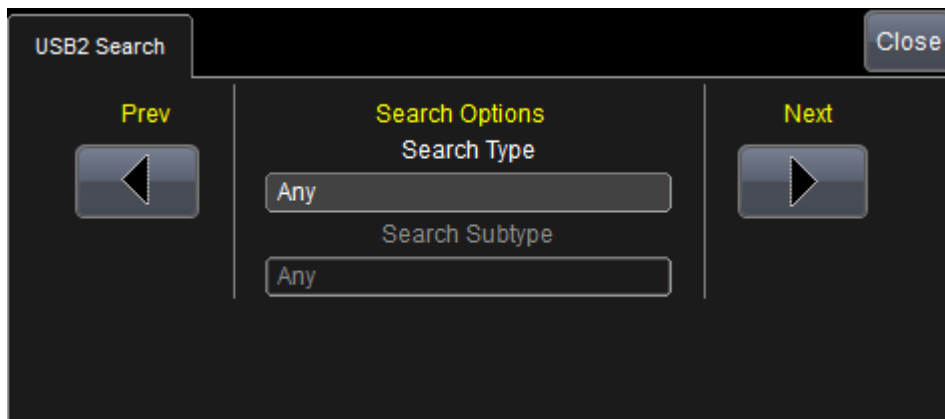

### NAVIGATION FIELDS

A **Prev** and **Next** button is on either side of the dialog to navigate through each search result/occurrence.

### SEARCH OPTIONS FIELDS - TYPE AND SUBTYPE

**Search Options** fields in the center of the dialog allow you to restrict your search based on **Type** and **Subtype** selections. USB2 Type selections include **any**, **Event**, **Packet**, **Transaction**, and **Protocol Error**.

When **Transaction** is selected as your Search Option, the **Enable DevAddr & EP** checkbox is made available for use.

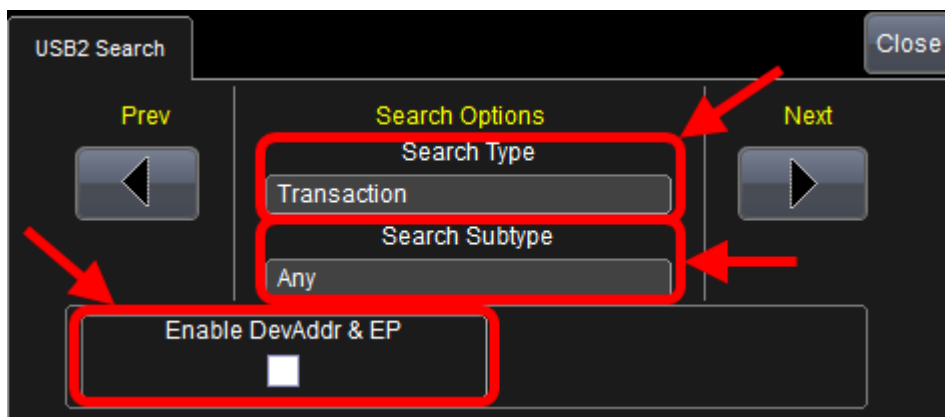

**SEARCH SUBTYPE FIELDS**

**Search Options** fields in the center of the dialog allow you to restrict your search based on **Type** and **Subtype** selections. USB3 Search Type selections include **any**, **Event**, **Packet**, **Transaction**, and **Protocol Error**. The following **Search Subtypes** are available for each Search Type:

- With the **any** Search Type selected, no additional Search Subtypes are available.
- With the **Event** Search Type selected, the **Idle**, **Resume**, **Reset**, **Suspend**, **KeepAlive**, **Chirp\_J**, **Chirp\_K**, **Glitch**, and **Unknown** Search Subtypes are available.
- With the **Packet** Search Type selected, the **Token Out**, **Token In**, **Setup**, **SOF**, **DATA0**, **Data1**, **Data2**, **MData**, **ACK**, **NAK**, **Stall**, **NYet**, **Preamble**, **ERR**, **Split**, **Ping**, and **Unknown Packet** Search Subtypes are available.
- With the **Transaction** Search Type selected, the **Trans In**, **Trans Out**, **Trans Setup**, **Trans Ping**, **Trans SSplit In**, **Trans SSplit Out**, **Trans SSplit Setup**, **Trans CSplit In**, **Trans CSplit Out**, and **Trans CSplit Setup** Search Subtypes are available.
- With the **Protocol Error** Search Type selected, the **CRC5 Error**, **CRC16 Error**, **Bit Stuff Error**, **PID and Check Mismatch Error**, and **Packet Length Error** Search Subtypes are available.

**Creating a USB2 Trigger Condition**

Detail on some of the setup conditions for the USB2 Trigger dialog is shown in the following topics.

**PLEASE NOTE THE FOLLOWING:**

- Currently, USB2 Trigger functionality is available exclusively for the WaveRunner 6 Zi oscilloscope.
- Refer to the **Using The T Supported Protocol Toolsets** (on page 22) topic to correctly access the Trigger Condition dialog specific to your desired protocol.

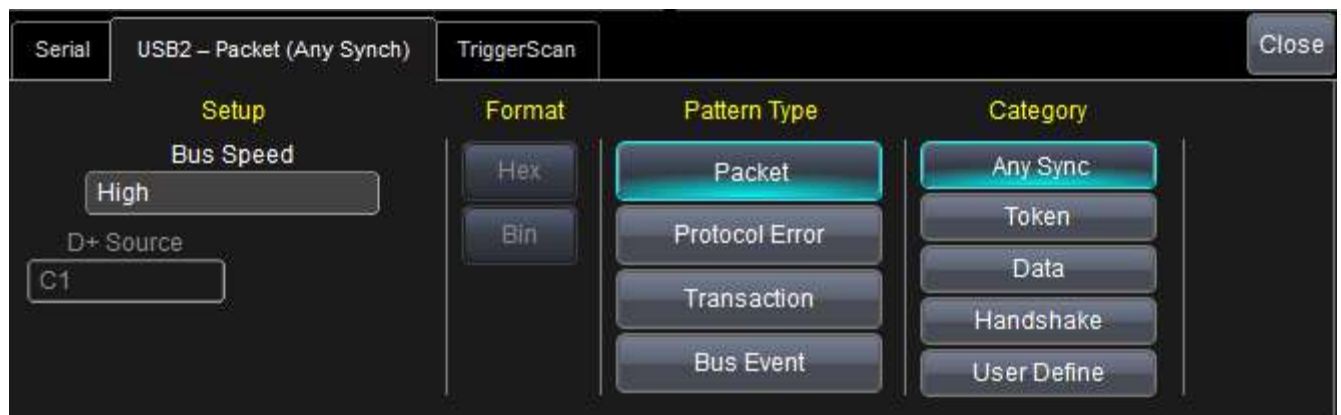

Make settings or provide values by touching controls (using your finger, stylus, or connected mouse). On applicable controls, a pop-up dialog box is shown where precise entry values can be set.

## Serial Data Debug Solutions

### USB2 Trigger Setup Detail

The following topic provides specific control settings for a USB2 Trigger setup.

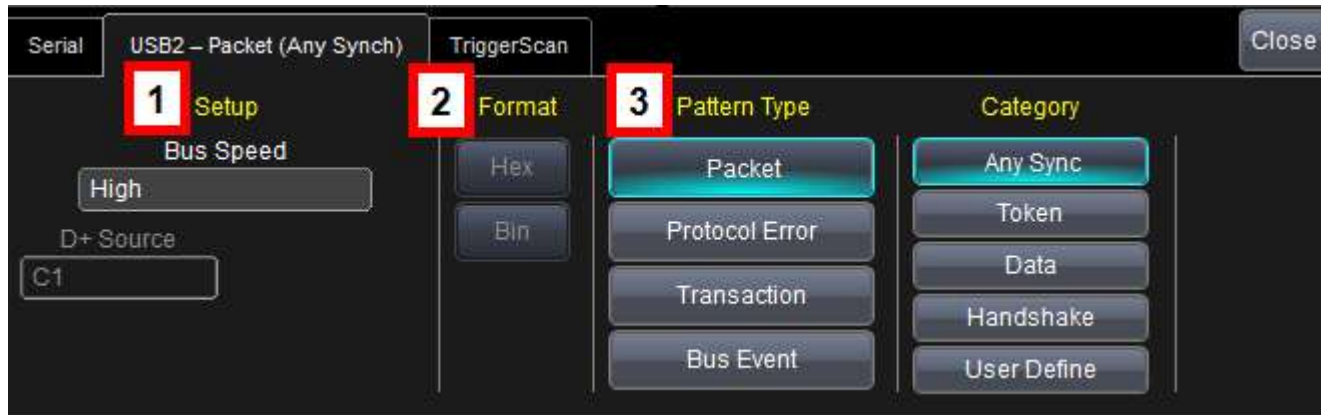

#### PLEASE NOTE THE FOLLOWING:

- Most Trigger Setups have some form of **Source** and **Type** control.
- Remaining dialog controls vary based on the selected **Pattern Type** and are explained in the following sections.

#### 1. SETUP

**Bus Speed** - Select the desired bitrate of the connected USB2 source from **Low**, **Full**, and **High**.

Additional controls on the Setup section vary based on the **Bus Speed** selection as follows:

- **Low** or **Full** - With either Low or Full Bus Speeds selected, **D+ and - Sources** and **D+ and - Level** controls are available.
- **High** - With the High Bus Speed selected, no additional fields are provided on the Setup section.

#### 2. FORMAT

Depending on the pattern type and category selections made, this control allows you to select either **hexadecimal** or **binary** formats.

#### 3. PATTERN TYPE

Pattern Type selections include **Packet**, **Protocol Error**, **Transaction**, and **Bus Event**.

#### REMAINING DIALOG CONTROLS BASED ON PATTERN TYPE SELECTION

##### Packet Pattern Type Selection Controls

With the Packet pattern type selected, Category controls are provided on the dialog for **Any Sync**, **Token**, **Data**, **Handshake**, and **User Define**.

Additional Dialog Controls Based on Packet Category Selections

- With the **Any Sync** category selected, no additional controls are provided on the dialog.
- With the **Token** category selected, up to three Token PID controls may be used together (using OR operator logic) unless Any is selected on the first PID, disabling the other two. Token PID controls (when enabled) can be set to **Any, In, Out, Setup, Ping, Split, SOF**, or **Preamble**.



PLEASE NOTE THE FOLLOWING:

- Token PID values are enabled or disabled based on **Bus Speed** selection.
- When **Any** and **Preamble** Token PID values are chosen, no additional controls are provided for that specific Token PID.
- When **In, Out, Setup,** and **Ping** Token PID values are chosen, additional controls for DevAddress and End Point are provided for that specific Token PID.
- When the **Split** Token PID value is chosen, additional controls for **Hub Address, S, SC, E, Port,** and **ET** are provided for that specific Token PID.
- When the **SOF** Token PID value is chosen, a **Frame Number** control is provided for that specific Token PID.
- With the **Data** category selected, up to three Data Pattern PID controls may be used together (using OR operator logic) unless Any Type is selected on the first PID, disabling the other two. Data Pattern PID controls (when enabled) can be set to **Any Type, Data0, Data1, Data2,** or **MData**.



PLEASE NOTE THE FOLLOWING:

- Data Pattern PID values are enabled or disabled based on **Bus Speed** selection.
- **Compare Type** (select Data Value or Data Length), **Compare Operator** (select equal or unequal), **At position,** and **Data (1-16 Bytes)** (in Hexadecimal or Binary based on selection from step 2 previously shown) controls are provided for each Data Pattern PID.
- With the **Handshake** category selected, Handshake Type control buttons are available for **Any Type, ACK, NAK, STALL, NYET,** and **Error** on the dialog.
- With the **User Define** category selected, a Data (1-16 Bytes) control is provided for entering a specific value in Hexadecimal or Binary (based on selection from step 2 previously shown).

## Serial Data Debug Solutions

### Protocol Error Pattern Type Selection Controls

With the Protocol Error pattern type selected, the following Protocol Error Type checkboxes are provided on the dialog for **PID And Check Error**, **Frame Length Error**, **CRC5 Error**, **Invalid PID Error**, and **CRC16 Error**. Mark the protocol error types as desired.

The screenshot shows the 'USB2 - Protocol Error' dialog. The 'Pattern Type' is 'Protocol Error'. The 'Protocol Error Types' section is highlighted with a red box and contains the following checked items:

- PID And Check Error
- Frame Length Error
- CRC5 Error
- Invalid PID Error
- CRC16 Error

### Transaction Pattern Type Selection Controls

With the Transaction pattern type selected, **Token**, **Data**, and **Handshake** sections of the dialog are shown. Each of these three sections contain a Type control where you can select Any Type, In, Out, Setup, or Ping values.

The screenshot shows the 'USB2 - Transaction' dialog. The 'Pattern Type' is 'Transaction'. The 'Token' section has 'Setup' selected for Type, 'XX' for Dev Address, and 'X' for End Point. The 'Data' section has 'Not Exist' selected for Type. The 'Handshake' section has 'Any Type' selected for Type. A red box highlights the 'Any Type', 'In', 'Out', and 'Setup' buttons in the 'Token' section.

**Note:** Transaction Pattern Type values are enabled or disabled based on **Bus Speed** selection.

Additional **Dev Address** and **End Point** controls are provided for the **Token** section of the dialog.

### Bus Event Pattern Type Selection Controls

With the Bus Event pattern type selected, the following Bus Event checkboxes are provided on the dialog for **Reset**, **Resume**, **Suspend**, **Chirp**, and **Keep Alive**. Mark the bus event types as desired.

The screenshot shows the 'USB2 - Bus Event' dialog. The 'Pattern Type' is 'Bus Event'. The 'Bus Events' section is highlighted with a red box and contains the following checked items:

- Reset
- Suspend
- Keep Alive
- Resume
- Chirp

**Note:** Bus Event checkboxes are enabled or disabled based on **Bus Speed** selection.

## Using the USB3 Option

### Using the USB3 Option Overview

USB 3.0 (also referred to as SuperSpeed USB) is a standard striving for a bus bit rate of 5 Gb/s. The standard is backward compatible and retains use with hubs and other related devices.

So as to accommodate very high bit rate and reduce bus turnaround time limitation, USB 3.0 defines separate dual simplex transmission and reception on differential lines. The additional lines (equipped with the new 3.0 standard) are run parallel to the USB 2.0 lines for forward and backward compatibility.

**Note:** Ask your local LeCroy representative for more information about any Serial Data Debug Solution Protocols or Toolkits using the **Contact LeCroy for Support** (on page 199) topic.

### USB3 Decode Setup Detail

For general information about using controls shown on the main Serial Decode dialog, refer to **Accessing The D and TD Supported Protocol Toolsets** (on page 13).

#### USB3DECODER AND EXPORTER RIGHT-HAND DIALOGS

Access the **Serial Decode** dialog by touching **Analysis** → **Serial Decode** on the menu bar.

Touch the corresponding **Setup...** button for your decode. The **Decode Setup...** along with the **USB3 Decoder** right-hand dialog is shown.

#### USB3 Decoder Right-Hand Dialog

The **USB3Decoder** right-hand dialog provides detailed controls and setup conditions as follows:

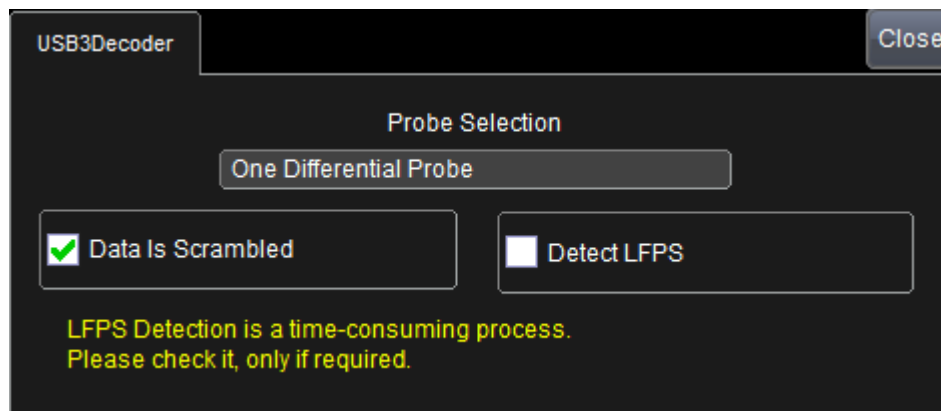

- Configure the **Probe Selection** control based on whether you're using **One Differential Probe** or **Two Single Ended Probes**.
- Use the **Data Is Scrambled** check-box as desired.
- Mark the **Detect LFPS** checkbox as desired.

**Note:** As indicated on the dialog, since LFPS detection is time consuming, it's best to only use if truly necessary.

## Serial Data Debug Solutions

### USB3 Decode Trace Annotations

Like all trace annotations, USB3 Decode annotations are rectangular shadings used to highlight messages on decoded waveforms for easy viewing.

**Tip:** Data packets (or messages) on properly decoded protocol signals can be viewed using **Serial Decode Trace Annotations** (on page 18), the **Protocol Results Table** (on page 19), and/or by **Searching for Messages** (on page 21) (Types and Subtypes). Using these tools together provides fast insight to your data. See **Serial Decode Trace Annotations** (on page 18) for more information.

Messages shown as **annotations**, **table columns**, and **search types** for most protocols are classified into **Frames**, **Errors**, **Unknown**, or **Grouped Primitives** specific to the protocol. Sub Types then further classify each main message type into more protocol-specific messages.

Decode annotations unique to USB3 include the following (some annotations are not shown in the screen-shot):

#### USB3 Decode Annotations

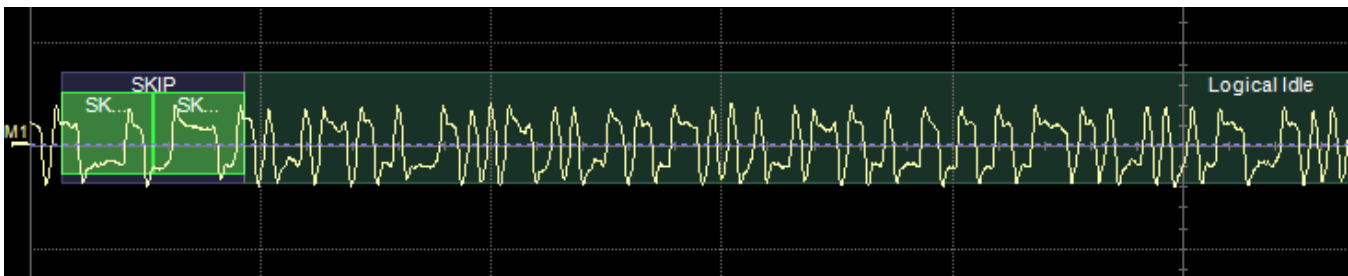

- **LMP** - Link Management Packet
- **TP** - Transition Packet
- **DPH** - Data Packet Header
- **ITP** - Isochronous Timestamp Packet
- **DPP** - Data Packet Payload
- **Link Command** - An eight symbol sequence used for link-level flow control, retries, power management, and device removal.
- **TS1** - Training Sequence 1, a type of ordered set.
- **TS2** - Training Sequence 2, a type of ordered set.
- **TSEQ** - Training Sequence
- **SKIP** - A K code indicating a skip.
- **Idle** - Period of one or more symbol times when no information (packets or link commands) is being transmitted.
- **E.Idle** - Electrical Idle is a steady state condition where the transmitter Txp and Txn voltages are held constant at the same value.
- **LFPS** - Low Frequency Periodic Signaling
- **Protocol Error** - A stored or transmitted result is compared to a CRC calculated from the data to determine if an error has occurred.

**Note:** Specifications are subject to change without notice.



### USB3 Decode Table Column Details

USB3 table column values available include the following:

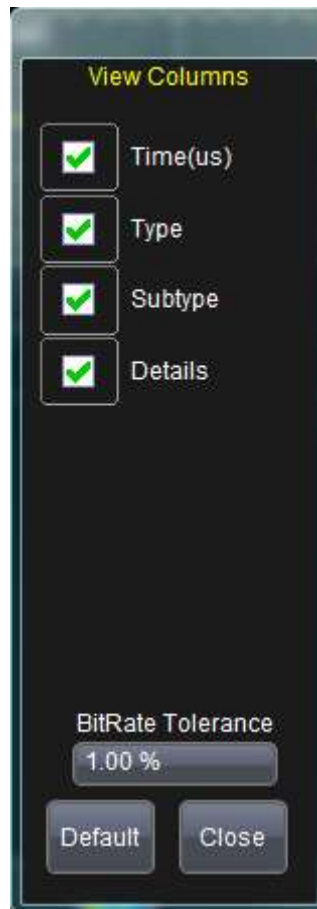

Make selections as desired. You can also set a **BitRate Tolerance** percentage or touch the **Default** button to load the preset selections. Touch the **Close** button when finished.

See **Protocol Results Table** (on page 19) for general information about the Table display.

After setting up your USB3 decode and checking the **View Table** checkbox, the table should be shown on the display grid.

**Note:** After touching the **View Table** checkbox, touch the **Close** button at the upper-right portion of the Decode Setup dialog to maximize the display grid area.

#### EXPORTING TABLE DATA

You can also Exported your table data as a **.CSV** file. Touch the **Export Table** button on the **Decode Setup...** dialog and follow the procedure explained in the **Using The D Supported Protocol Toolsets** (on page 14) topic.

## Serial Data Debug Solutions

### USB3 Decode Search

After clicking the Search button from the Decode dialog, the Zoom dialog is shown along with the **USB3 Search** right-hand dialog.

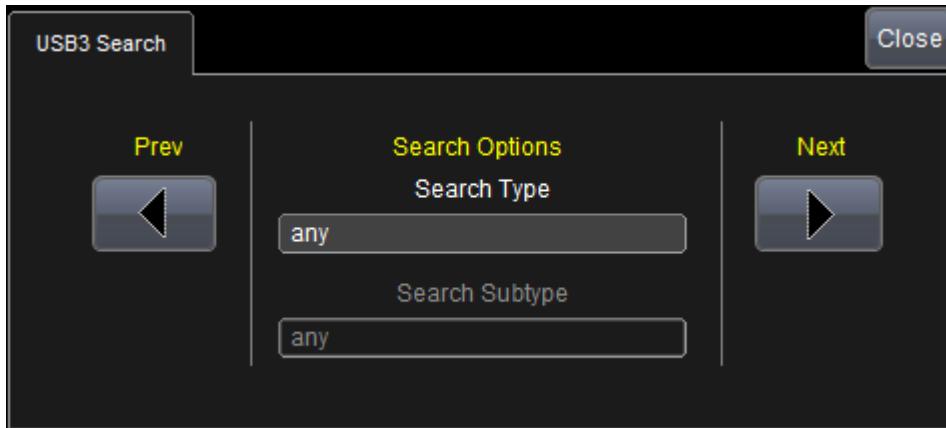

#### NAVIGATION FIELDS

A **Prev** and **Next** button is on either side of the dialog to navigate through each search result/occurrence.

#### SEARCH OPTIONS CONTROLS - TYPE AND SUBTYPE

**Search Options** fields in the center of the dialog allow you to restrict your search based on **Type** and **Subtype** selections. USB3 Search Type selections include **any**, **LMP**, **TP**, **DPH**, **ITP**, **DPP**, **Link Command**, **TS1**, **TS2**, **TSEQ**, **SKIP**, **Idle**, **E. Idle**, **LFPS**, **Protocol Error**, and **Unknown**. The following **Search Subtypes** are available for each Search Type:

- With the **any** Search Type selected, no additional Search Subtypes are available.
- With the **LMP** Search Type selected, the **Set Link Function**, **U2 Inactivity Timeout**, **Port Capability**, **Port Configuration**, **Port Config Response**, and **Unknown** Search Subtypes are available.
- With the **TP** Search Type selected, the **ACK**, **NRDY**, **ERDY**, **Status**, **Stall**, **Device Notification**, **Ping**, **Ping Response**, and **Unknown** Search Subtypes are available.
- With the **DPH** Search Type selected, no additional Search Subtypes are available.
- With the **ITP** Search Type selected, no additional Search Subtypes are available.
- With the **DPP** Search Type selected, no additional Search Subtypes are available.
- With the **Link Command** Search Type selected, the **LGOOD\_0**, **LGOOD\_1**, **LGOOD\_2**, **LGOOD\_3**, **LGOOD\_4**, **LGOOD\_5**, **LGOOD\_6**, **LGOOD\_7**, **LBAD**, **LCRD\_A**, **LCRD\_B**, **LCRD\_C**, **LCRD\_D**, **LRTY**, **LGO\_U1**, **LGO\_U2**, **LGO\_U3**, **LAU**, **LXU**, **LMPA**, **LUP**, **LDN**, and **Unknown** Search Subtypes are available.
- With the **TS1** Search Type selected, no additional Search Subtypes are available.
- With the **TS2** Search Type selected, no additional Search Subtypes are available.
- With the **TSEQ** Search Type selected, no additional Search Subtypes are available.
- With the **SKIP** Search Type selected, no additional Search Subtypes are available.
- With the **Idle** Search Type selected, no additional Search Subtypes are available.
- With the **E. Idle** Search Type selected, no additional Search Subtypes are available.
- With the **LFPS** Search Type selected, the **Polling**, **Ping**, **U1Exit**, **U2Exit**, **U3Exit**, **Reset**, and **Unknown** Search Subtypes are available.
- With the **Protocol Error** Search Type selected, the **CRC5 Error**, **CR16 Error**, **CR32 Error**, and **Mismatch LinkCtrl Words** Search Subtypes are available.
- With the **Unknown** Search Type selected, no additional Search Subtypes are available.

## Troubleshooting Storage, Peripherals, and Interconnects Issues

### Polarity Correction

It is important to provide a high-quality signal when using the Serial Decode package. If bits cannot be interpreted correctly the decode, of course, is bad.

If the signal is captured with the wrong polarity, it can easily be corrected later. If the capture is two single-ended waveforms, then just try both subtraction orders; one of them is correct. If the signal is captured using a differential probe, invert it (if necessary) using the Basic Math **Invert** operator as follows.

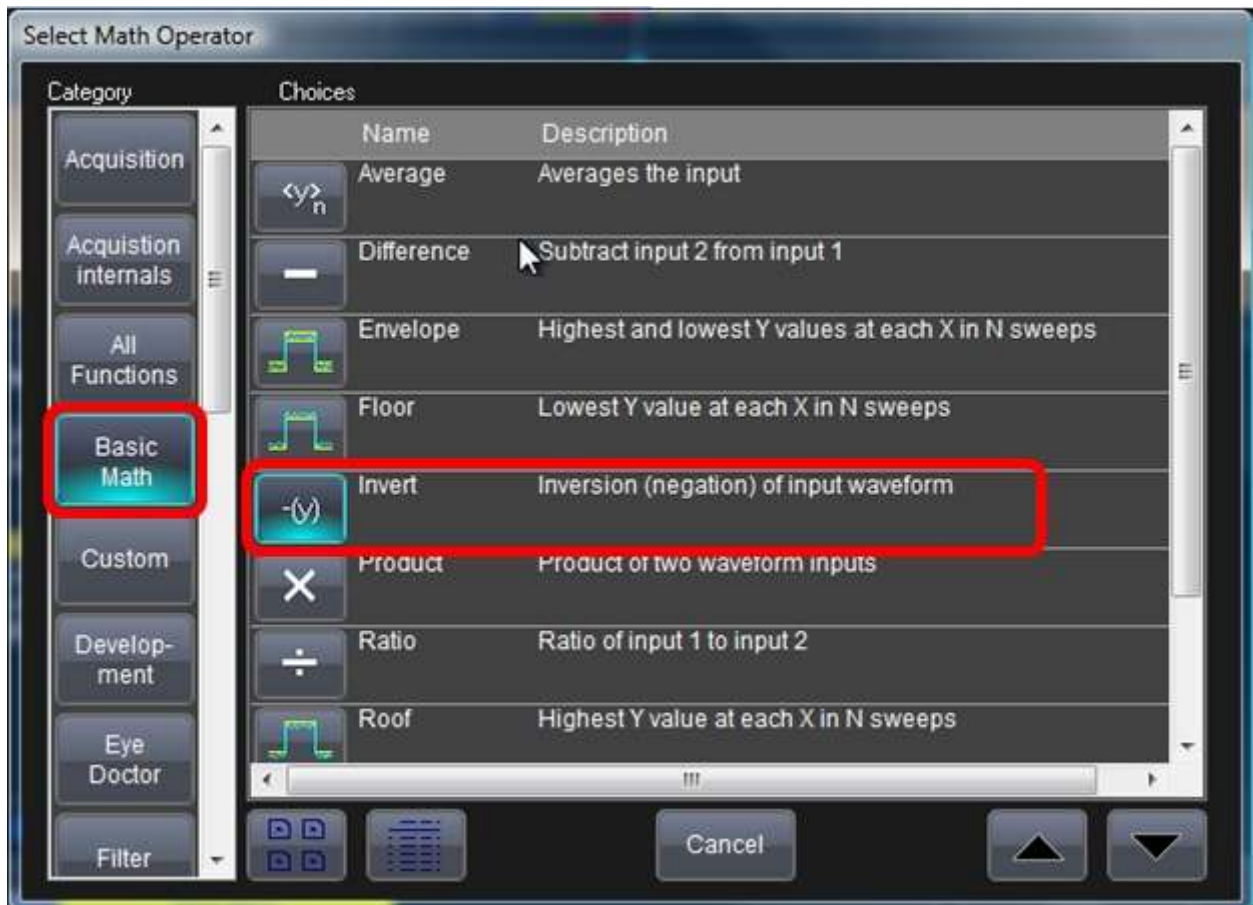

You can also invert your signal directly from the Channel dialog. Just touch the **Invert** checkbox on the right side of the dialog.

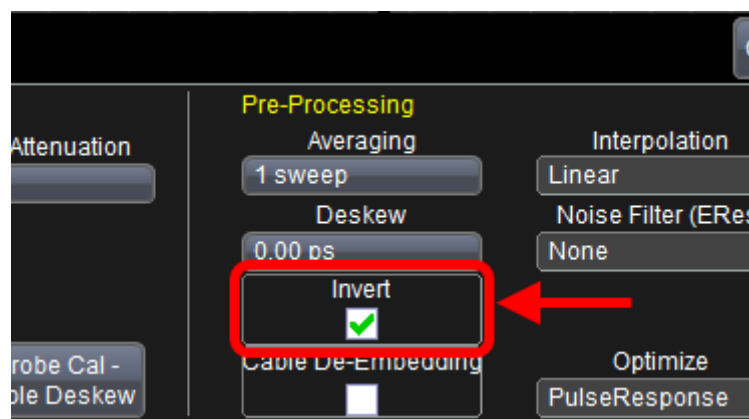

## Reference

### Dialog Area

The lower portion of your oscilloscope screen is where information is shown, selections are made, and data is input. These screens are organized into tabular displays, subtabs, or pop-up dialogs. The dialog area is controlled by **Touch Screen Controls** and **Front Panel Controls**.

#### **Touch Screen Controls**

Various touch screen user interface controls are provided for easily entering data. Their functionality is described in this topic and you'll see them referenced throughout the documentation.

#### **POP-UP SELECTOR CONTROLS**

When Pop-Up selector controls are touched, sometimes a very small box is shown right inside the control - as in the following control for **Coupling** on the C1 dialog.



*Pop-Up Selector Control for smaller values.*

Other times, a larger box is shown after touching a control. This larger Pop-Up has categorical buttons along the left column along with labels (and sometimes descriptions) for the selectable entry values.

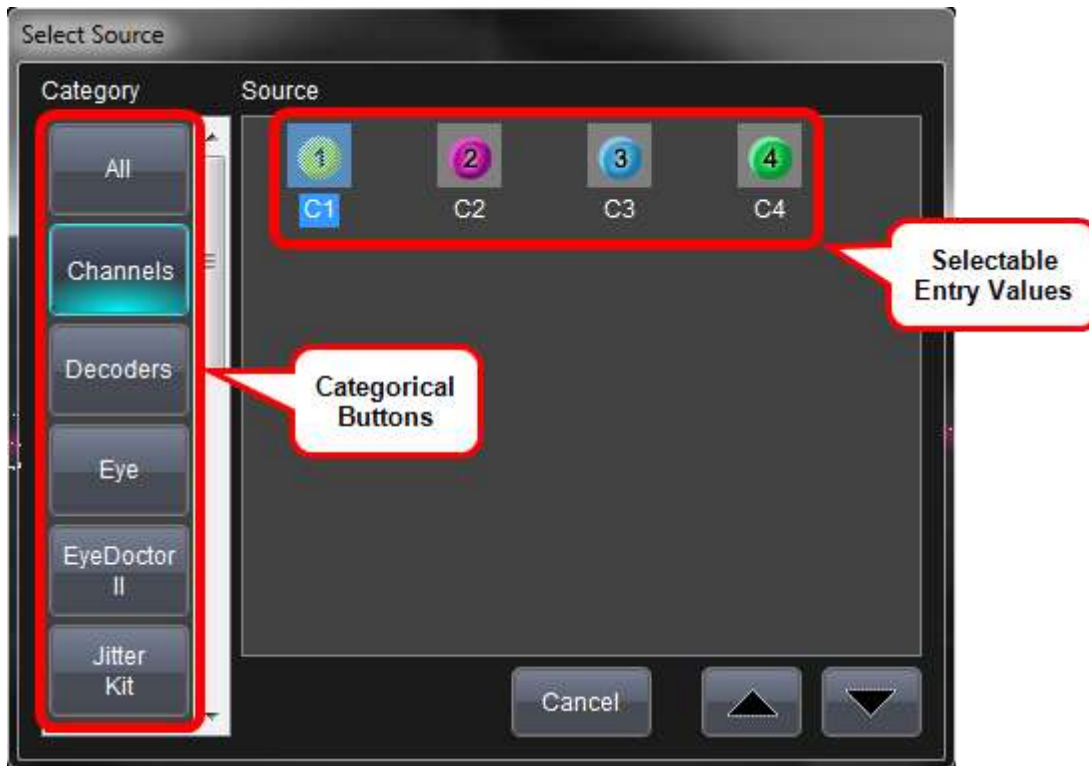

*Pop-Up Selector Control for values with varied types.*

**TEXT ENTRY CONTROLS**

Most controls can be touched once and you can then provide a value using an attached (or double-touch/click to use the Virtual, on-screen) keyboard.

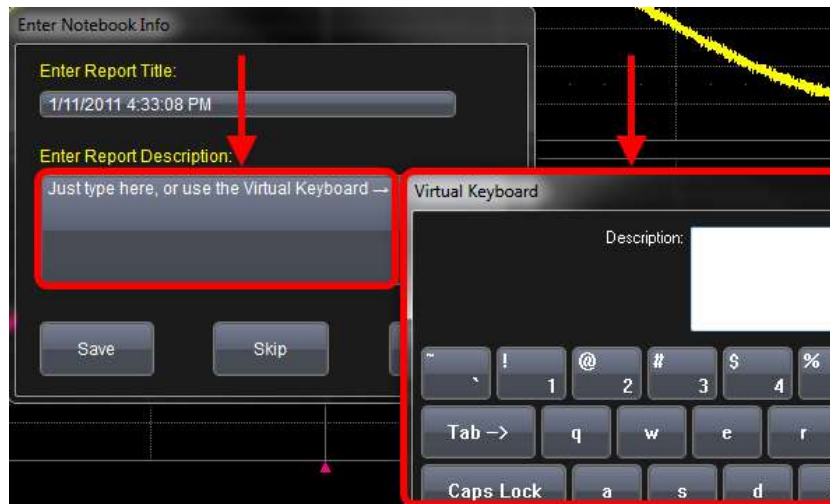

*Text entry field for LabNotebook using the Virtual Keyboard.*

**FOLDER/FILE BROWSING CONTROLS**

These controls allow for navigation to or from folders (on the hard drive or memory device) for retrieving or storing items such as waveforms, LabNotebook entries, to name a few.

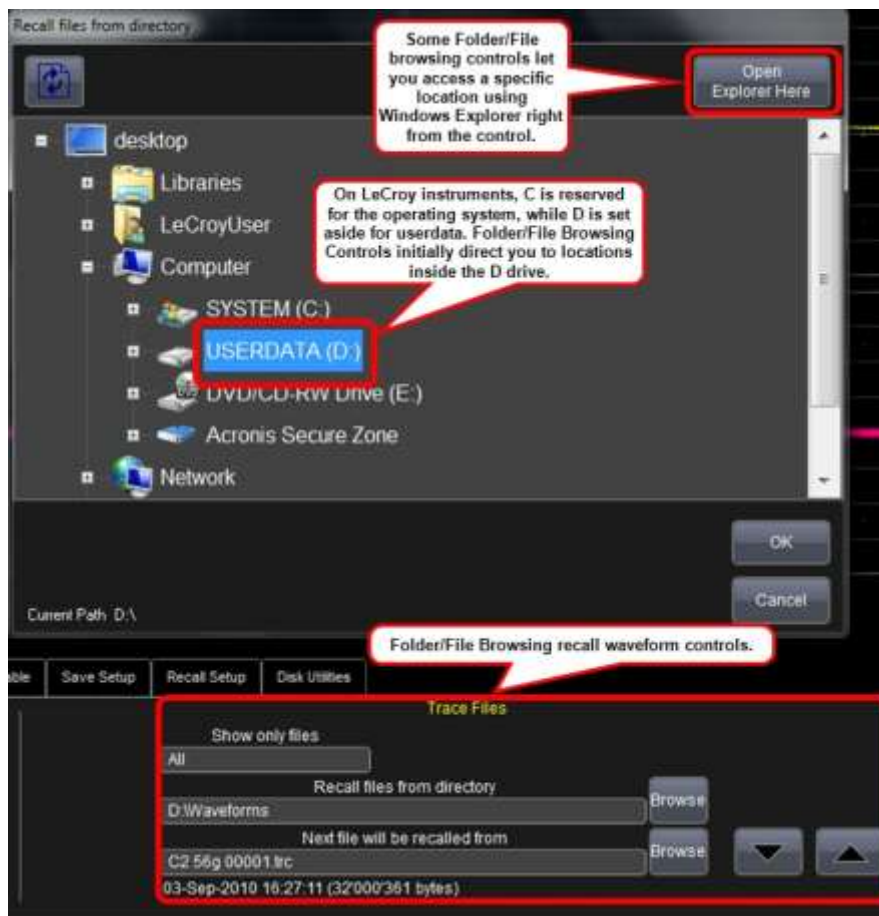

*Folder/File Browsing recall waveform controls.*

## Serial Data Debug Solutions

**Note:** The instrument's hard disk is partitioned into drive C: and drive D:. Drive C: contains the Windows operating system and the instrument application software. Drive D: is intended for data files.

### FLYOUT MENU CONTROLS

Flyout Menus provides a variety of solutions for a particular main area of functionality. It does this by providing a set of buttons subdividing the control into more specific functions on the right-side of the display.

An example of Flyout Menu Controls is seen in the **Setup** front panel button.



*Setup Flyout Menu control.*

### PRECISION DATA ENTRY CONTROLS

Certain fields requiring precise value entry assist you by having precision entry means. When these controls are selected, you can provide values as follows:

#### Keyboard

Touch inside a text entry control and you can manually type the value in using an attached (or double-touch/click to use the Virtual, on-screen) keyboard.

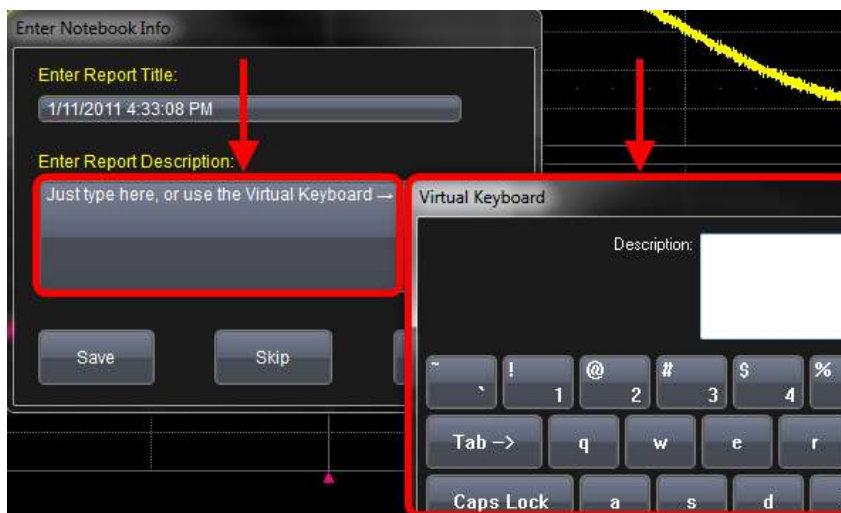

*Text entry field for LabNotebook using the Virtual Keyboard.*

### Slider Bar

Some models provide what is known as a **Slider Bar** along the bottom of the screen **when a keyboard is attached** to the instrument. The Slider Bar allows you to select your entered value by moving a horizontal slider (left to right provides low to high amounts).



*The Slider Bar*

### Pop-Up Keypad

Some models provide a pop-up Keypad when you touch twice in the same control. A keypad button is also provided on the slider bar (on models that have the slider bar) which shows the pop-up keypad when touched.

For many controls, once the Pop-Up Keypad is shown the **Front Panel Controls** can be used to adjust the value in the pop-up. The Pop-Up contains **Up** and **Down** arrow buttons, **Set to Max**, **Default**, and **Min** buttons, and the **Keypad** itself for providing your value.

The slider bar also has a handy default value button for quickly entering the default for the control.



Default and Keypad Buttons on the Slider Bar are only shown on 7, 8, and 9 Zi models (with a keyboard attached).

**UNIQUE WaveRunner 6 Zi and 12-Bit HRO and 12-Bit HRO FEATURE:** The 6 Zi and 12-Bit HRO provides touch-screen interface controls in a different manner. See **The WavePilot Control Area and The SuperKnob Overview** in the online help.

## Specifications

**Note:** Specifications are subject to change without notice.

Please refer to the LeCroy website at [www.lecroy.com](http://www.lecroy.com) for the most current specification information regarding your product.

## Contact LeCroy for Support

Use the following regional contacts to find the appropriate support location nearest you.

Whether you're looking for sales or technical support, our staff can provide assistance with installation, calibration, and product knowledge regarding a full-range of our software applications and accessories.

## Serial Data Debug Solutions

You can also find contact information for our offices on the LeCroy Web sites shown for the following regions:

### Contact Your Local LeCroy Office for Sales and Technical Assistance

#### **United States and Canada - World Wide Corporate Office**

LeCroy Corporation  
700 Chestnut Ridge Road  
Chestnut Ridge, NY, 10977-6499  
**Phone (Sales, Applications, and Service):** 800-553-2769 (options 1, 2, and 3, respectively) or 845-425-2000  
**Fax (Sales, Applications, and Service):** 845-578-5985  
**Email (Sales, Applications, and Service):** [contact.corp@lecroy.com](mailto:contact.corp@lecroy.com)  
**Web Site:** [www.lecroy.com](http://www.lecroy.com)

#### **United States - Protocol Solutions Group**

LeCroy Corporation  
3385 Scott Boulevard  
Santa Clara, CA, 95054  
**Phone (Sales and Service):** 800-909-7211 or 408-727-6600  
**Phone (Support):** 800-909-7112 or 408-653-1260  
**Fax (Sales, Service, and Support):** 408-727-0800  
**Email (Sales and Service):** [contact.corp@lecroy.com](mailto:contact.corp@lecroy.com)  
**Email (Support):** [psgsupport@lecroy.com](mailto:psgsupport@lecroy.com)  
**Web Site:** [www.lecroy.com](http://www.lecroy.com)

#### **European Headquarters**

LeCroy Europe  
4, Rue Moïse Marcinhes  
Case postale 341  
1217 Meyrin 1  
Geneva  
**Phone (Sales, Service, and Support):** + 41 22 719 2228, +41 22 719 23 23, and +41 22 719 22 77 use +44(1276)503 971 for Protocol Analyzers  
**Fax (Sales and Service):** +41 22 719 22 33  
**Email (Sales, Service, and Support):** [contact.sa@lecroy.com](mailto:contact.sa@lecroy.com), [samir.shafik@lecroy.com](mailto:samir.shafik@lecroy.com), and [applications.indirect@lecroy.com](mailto:applications.indirect@lecroy.com)  
**Web Site:** <http://www.lecroy.com/europe>

#### **China**

LeCroy Corporation Beijing Office and Service Center  
Rm. 2001 - Office; Rm. 2002 - Service Center  
Unit A, Horizon Plaza  
No. 6, Zhichun Road, Haidian District  
Beijing 100088,  
China  
**Phone:** ++86 10 8280 0318 / 0319 / 0320  
**Phone Service:** ++86 10 8280 0245  
**Fax (Sales and Support):** +86 10 8280 0316  
**Web Site:** <http://www.lecroy.com.cn>

#### **Korea - Seoul**

LeCroy Korea  
10th fl. Ildong Bldg.  
968-5 Daechi-dong, Gangnam-gu  
Seoul 135-280, Korea  
**Phone (Sales and Support):** ++ 82 2 3452 0400  
**Fax (Sales and Support):** ++ 82 2 3452 0490  
**Web Site:** <http://www.lecroy.co.kr>

#### **Singapore (Oscilloscopes)**

LeCroy Singapore Pte Ltd  
Blk 750C Chai Chee Road #02-08  
Technopark@ Chai Chee  
Singapore 469003  
**Phone (Sales and Support):** ++ 65 64424880  
**Fax (Sales and Support):** ++ 65 64427811

#### **Singapore (Protocol Analyzers)**

Genetron Singapore Pte Ltd  
37 Kallang Pudding Road, #08-08  
Tong Lee Building Block B  
Singapore 349315  
**Phone (Sales and Support):** ++ 65 9760-4682

#### **Taiwan**

LeColn Technology Co Ltd  
Far East Century Park, C3, 9F,  
No. 2, Chien-8th Road,  
Chung-Ho City,  
Taipei Hsien,  
Taiwan, R.O.C.  
**Phone (Sales and Support):** ++ 886 2 8226 1366  
**Fax (Sales and Support):** ++ 886 2 8226 1368  
**Email (Sales):** [sales\\_twn@lecoln.com.tw](mailto:sales_twn@lecoln.com.tw)  
**Web Site:** <http://www.lecoln.com.tw>

#### **Tokyo**

LeCroy Japan  
Hobunsha Funchu Bldg, 3F  
3-11-5, Midori-cho, Fuchu-Shi  
Tokyo, 183-0006  
Japan  
**Phone (Sales and Support):** ++ 81 4 2402 9400  
**Fax (Sales and Support):** ++ 81 4 2402 9586  
**Web Site:** [www.lecroy.com/japan](http://www.lecroy.com/japan)



## Index

- 3**
- 3b/4b, 50
- 5**
5. Error Sub-Type and Right-Hand Dialog, 116
5. Timing Sub-Types and Right-Hand Dialogs, 116
5. Transfer Sub-Type Right-Hand Dialogs, 108
5. Word Sub-Type Right-Hand Dialogs, 115
- 5b/6b, 50
- 8**
- 8b/10b Decode Search, 52
- 8b/10b Decode Setup Detail, 45
- A**
- Accessing and Using Supported Protocol Toolsets Overview, 12
- Accessing and Using The Graphing Tools for Supported Protocols, 32
- Accessing and Using The PROTObus MAG Supported Protocol Toolset, 23
- Accessing The D and TD Supported Protocol Toolsets, 13
- Additional Controls, 152
- ARINC 429 Decode Search, 102
- ARINC 429 Decode Setup Detail, 97
- ARINC 429 Decode Table Column Details, 101
- ARINC 429 Decode Trace Annotations, 100
- Assumptions, 9
- AudioBus Decode Setup Detail, 87
- AudioBus Measure/Graph Setup Detail, 96
- AudioBus Trigger Setup Detail, 92
- Automotive and Industrial Protocols Overview, 68
- B**
- BC-RT (Rcv) Sub-Type and Right-Hand Dialogs, 108
- BC-RT(S) (B'cast) Sub-Type and Right-Hand Dialogs, 113
- Bit Rate, 144, 153
- C**
- CANbus Decode Setup Detail, 69
- CANbus Trigger Setup Detail, 70
- Capturing Long Pre-Trigger Times, 37
- Category and Measure Combinations for HS Dphy1 - 12 Dialogs, 139
- Category and Measure Combinations for LP Dphy1 - 12 Dialogs, 137
- Characterization Using Cursors, 34
- Characterization Using Measurement Parameters, 34
- Characterizing Embedded Controller Performance Using Standard Oscilloscope Tools Overview, 32
- Command Sub-Type and Right-Hand Dialog, 115
- Compatibility, 10
- Control Symbols, 51
- Creating a CANbus Trigger Condition, 70
- Creating a FlexRaybus Trigger Condition, 79
- Creating a LINbus Trigger Condition, 74
- Creating a MIL-STD-1553 Trigger Condition, 106
- Creating a SATA Trigger Condition, 179
- Creating a SPIbus Trigger Condition, 60
- Creating a USB2 Trigger Condition, 187
- Creating an I2Cbus Trigger Condition, 55
- Customizing WordName and Comment Definitions, 128
- D**
- Data Sub-Type and Right-Hand Dialog, 115, 117
- Decode Toolset Features and Controls Overview, 18
- Dialog Area, 196

## Serial Data Debug Solutions

---

DigRF 3G Decode Search, 122

DigRF 3G Decode Setup Detail, 118

DigRF 3G Decode Table Column Details, 121

DigRF 3G Decode Trace Annotations, 120

DigRF v4 Decode Search, 127

DigRF v4 Decode Setup Detail, 123

DigRF v4 Decode Table Column Details, 126

DigRF v4 Decode Trace Annotations, 125

Dp, Dn, CLKp, and CLKn Controls, 135, 151

### E

Enable, 134, 149

Enable, Show Decode, Setup Acquisition, 133, 149

Enabling Tests, 135, 152

Encoding, 48

Encoding Table Reference, 50

Entering Binary and Hex Data Patterns, 48

Entering Symbolic 8b/10b Data Patterns, 49

Error Sub-Type and Right-Hand Dialog, 116

Eye Diagram Control Area, 143

Eye Source, 144

### F

FibreChannel Decode Search, 163

FibreChannel Decode Setup Detail, 160

FibreChannel Decode Table Column Details, 162

FibreChannel Decode Trace Annotations, 161

Find Bit Rate, 144, 153

FlexRaybus Decode Setup Detail, 78

FlexRaybus Physical Layer Measurement Parameters, 86

FlexRaybus Trigger Setup Detail, 80

### G

General Purpose Embedded Protocols Overview, 53

### H

Handset, Cellular, and Mobile Computing Protocols Overview, 118

Helpful Trigger Pattern Tools, 49

High Speed Serial Trigger Setup, 48

HS (High Speed) Tests, 139

### I

I2C Decode Setup Detail, 54

I2C Trigger Setup Detail, 56

Isolating and Analyzing Serial Bus Activity Overview, 37

### L

LINbus Decode Setup Detail, 73

LINbus Trigger Setup Detail, 75

LP (Low Power) Tests, 136

### M

Military and Avionic Protocols Overview, 97

MIL-STD-1553 Decode Search, 106

MIL-STD-1553 Decode Setup Detail, 103

MIL-STD-1553 Decode Table Column Details, 105

MIL-STD-1553 Decode Trace Annotations, 104

MIL-STD-1553 Trigger Setup Detail, 107

MIPI D-PHY Decode Search, 132, 148

MIPI D-PHY Decode Setup Detail, 128

MIPI D-PHY Decode Table Column Details, 131

MIPI D-PHY Dialog Details, 133, 149

MIPI D-PHY Physical Layer Measurement Parameters, 133

MIPI M-PHY Decode Setup Detail, 145

MIPI M-PHY Decode Table Column Details, 147

MIPI M-PHY Decode Trace Annotations, 130, 146

MIPI M-PHY Physical Layer Measurement Parameters, 148

Mode and Input Selection Area of the MIPI M-PHY Dialog, 151

Mode command & Data (B'cast) Sub-Type and Right-Hand Dialogs, 114

Mode command & Data (Rcv) Sub-Type and Right-Hand Dialogs, 112

Mode command & Data (Xmit) Sub-Type and Right-Hand Dialogs, 111

Mode command (B'cast) Sub-Type and Right-Hand Dialogs, 114

Mode command Sub-Type and Right-Hand Dialogs, 110

Mode Section of the MIPI D-PHY Dialog, 135

**N**

Navigation Fields, 179

**O**

Official MIPI D-PHY Test Algorithms, 143, 152

Overview, 9

**P**

PCIEbus Decode Examples, 171

PCIEbus Decode Search, 170

PCIEbus Decode Setup Detail, 164

PCIEbus Decode Table Column Details, 168

PCIEbus Decode Trace Annotations, 167

Physical Layer Eye Diagram, 32

Polarity Correction, 195

PROTObus MAG and CANbus TDM Toolset Differences, 72

Protocol Results Table, 19

**R**

Repeatedly Triggering and Saving the Data to a Hard Drive, 37

Repeatedly Triggering and Storing All Triggers (Sequence Mode), 38

Response Time Right-Hand Dialog, 117

RT-BC (Xmit) Sub-Type and Right-Hand Dialogs, 109

RT-RT Sub-Type and Right-Hand Dialogs, 110

RT-RT(S) (B'cast) Sub-Type and Right-Hand Dialogs, 113

**S**

SAS Decode Search, 158

SAS Decode Setup Detail, 155

SAS Decode Table Column Details, 157

SAS Decode Trace Annotations, 157

SATA Decode Search, 178

SATA Decode Setup Detail, 176

SATA Decode Table Column Details, 178

SATA Decode Trace Annotations, 177

SATA Trigger Setup Detail, 180

Search Options Fields - Type and Subtype, 179, 186, 194

Searching for Messages, 21

Serial Trigger, 47

Serial Audio Protocol Overview, 87

Serial Decode Trace Annotations, 18

Serial Pattern Encoding Schemes Overview, 45

Setup Acquisition, 135, 150

Setup Acquisition and Setup SDA Buttons, 151

Show Decode, 134, 150

Show Eye, 144

Source Setup, 48

SPIbus Decode Setup Detail, 59

SPIbus Trigger Setup Detail, 61

Status Sub-Type and Right-Hand Dialog, 116

Storage, Peripherals, and Interconnect Protocols Overview, 154

Structure of This Manual, 9

**T**

Technical Explanation of Serial Decode and Trigger, 12

technical support, 199

Test Parameter Summary Area, 135, 151

The Bit Tracer View - PCI Express (PCIe) Only, 30

The CATC Protocol View, 27

## Serial Data Debug Solutions

---

The ProtoSync Toolset, 26  
The Show Eye Control, 153  
The Views Dialog, 153  
Toolsets and Supported Protocols, 9  
Transfer Sub-Types, Setup Format, and Right-Hand Dialogs, 108  
Trigger Patterns, 48

### U

UART-RS232bus Decode Setup Detail, 63  
UART-RS232bus Trigger Setup Detail, 66  
USB2 Decode Search, 186  
USB2 Decode Setup Detail, 183  
USB2 Decode Table Column Details, 185  
USB2 Decode Trace Annotations, 184  
USB2 Trigger Setup Detail, 188  
USB3 Decode Search, 194  
USB3 Decode Setup Detail, 191  
USB3 Decode Trace Annotations, 192  
USB3 TD Decode Table Column Details, 193  
USB3Decoder and Exporter Right-Hand Dialogs, 191  
Using 8b/10b Hi-Speed Serial Triggers (Zi Oscilloscopes), 47  
Using the 8b/10b Option Overview, 45  
Using the ARINC 429 Option Overview, 97  
Using the AudioBus Option Overview, 87

Using the CANbus Option Overview, 68  
Using The D Supported Protocol Toolsets, 14  
Using the DigRF 3G Option Overview, 118  
Using the DigRF v4 Option Overview, 122  
Using the FibreChannel Option Overview, 159  
Using the FlexRaybus Option Overview, 77  
Using the I2Cbus Option Overview, 53  
Using the LINbus Option Overview, 73  
Using the MIL-STD-1553 Option Overview, 102  
Using the MIPI D-PHY Decode Option Overview, 128  
Using the MIPI M-PHY Decode Option Overview, 145  
Using the PCIebus Option Overview, 163  
Using the SAS Option Overview, 155  
Using the SATA Option Overview, 175  
Using the SPIbus Option Overview, 58  
Using The T Supported Protocol Toolsets, 22  
Using the TD Packages, 32  
Using the UART-RS232bus Options Overview, 63  
Using the USB2 Option Overview, 183  
Using the USB3 Option Overview, 191

### W

Word Sub-Types, Setup Format, and Right-Hand Dialogs, 115