



Operator's Manual

Optical Modulation Analyzer

Optical Modulation Analyzer

Operator's Manual

August, 2016





700 Chestnut Ridge Road
Chestnut Ridge, NY 10977
(845) 425-2000
teledynelecroy.com

Optical Modulation Analyzer Operator's Manual

© 2016 Teledyne LeCroy, Inc. All rights reserved.

Unauthorized duplication of Teledyne LeCroy documentation materials other than for internal sales and distribution purposes is strictly prohibited. However, clients are encouraged to duplicate and distribute Teledyne LeCroy documentation internally for their own educational purposes.

LabMaster, X-Stream, and Teledyne LeCroy are trademarks of Teledyne LeCroy, Inc. Other product or brand names are trademarks or requested trademarks of their respective holders. Information in this publication supersedes all earlier versions. Specifications are subject to change without notice.

927295-00 Rev A
August, 2016

Contents

About This Manual	iv
Definitions.....	iv
About Teledyne LeCroy	iv
About Coherent Solutions	iv
Introduction	1
Shipped Items.....	2
OMA Accessories	2
Coherent Receiver Features.....	3
LabMaster Real-Time Oscilloscope	4
Compatible Hardware.....	4
OMA System Architecture.....	5
Safety	7
Symbols	7
Oscilloscope Precautions.....	7
Coherent Receiver Precautions.....	8
Operating Environment.....	8
Cooling	9
Cleaning	9
Calibration.....	9
Lifting and Moving.....	9
Power	10
Fuse Replacement.....	10
Grounding	10
System Installation	11
Hardware Configuration	11
Optical Configuration	14
Coherent Receiver LCD Control Interface	20
Navigating the LCD Control Interface	20
Changing Numerical Values.....	20
Changing Numerical Units	20
Changing Step Size	21
Changing the Output Power	21

Preparing for Optimal Measurements	22
Warm Up	22
Deskew Channels	22
Adjust Signal Pre-Processing.....	23
Using the Optical Modulation Analyzer Software.....	24
Starting the OMA Software	24
Acquisition Controls	25
Optical Inputs	26
Electrical Inputs.....	29
Signal Processing.....	32
Graphs.....	39
Measurements.....	45
Using Custom MATLAB Scripts	50
Using X-Stream Browser	51
Applying Math and Measurements to OMA Data	52
Applying Math Functions	52
Applying Measurements	53
Maintenance	54
Troubleshooting	54
Technical Support	55
Returning a Product	56
Warranty.....	57
Certifications	58
Appendix 1: OMA Calibration	61
Coherent Receiver Factory Calibrations	61
Full System Factory Calibrations.....	61
Manual Calibrations	61
Dynamic Calibrations	61
Appendix 2: OMA Algorithms	62
Dispersion Compensation	62
Polarization De-multiplexing	63
Frequency Estimation	64
Phase Estimation	65

Appendix 3: OMA Measurement Definitions.....	66
I and Q Bias Offset.....	66
IQ Offset.....	67
IQ Quadrature Error.....	67
IQ Skew.....	68
IQ RF Imbalance.....	69
Error Vector Magnitude.....	70
Magnitude Error.....	71
PMD.....	71
PDL.....	72
XY Skew.....	72
Q-Factor.....	72
BER Estimate.....	72
Appendix 4: Reference Symbols and Encodings.....	73

About This Manual

This manual covers procedures for setting up and configuring a Teledyne LeCroy Optical Modulation Analyzer (OMA) system. Complete procedures for using the oscilloscope functions of the OMA can be found in the *LabMaster 10 Zi-A Operator's Manual* shipped with the OMA and available for free from:

teledynelecroy.com/support/techlib/

Definitions

The OMA system shown throughout this manual is based on an OMA configuration using X-Stream™ v. 8.1.x.x. Your user interface may look slightly different than that shown here, but the functionality described is the same.

As OMA functionality can be added to existing LabMaster systems, there is potential variation among the components that make up an OMA system. The terms below should be understood to mean the following wherever they appear:

OMA: System combining one LabMaster control module, one coherent receiver, and one or more LabMaster acquisition modules.

Control module: The MCM-Zi-A or another compatible control module (MCM-Zi, 9CZi-A).

Acquisition module: The LabMaster 10-25Zi-A, LabMaster 10-36Zi-A, LabMaster 10-65Zi-A, or one of the compatible acquisition modules listed on page 4.

Coherent receiver: Teledyne LeCroy IQS25, IQS42 or IQS70, or Coherent Solutions IQScope-RT.

OMA Software: The Optical LinQ™ optical modulation analysis software (v. 8.0.x.x or higher)

Firmware: The X-Stream oscilloscope software.

About Teledyne LeCroy

Teledyne LeCroy is a leading manufacturer of advanced test instruments that measure, analyze, and verify complex electronic signals. The Company offers high-performance oscilloscopes and protocol test solutions used by electronic design engineers in a wide range of applications and end markets. Teledyne LeCroy is based in Chestnut Ridge, N.Y. For more information, visit Teledyne LeCroy's website at: teledynelecroy.com

About Coherent Solutions

OMA systems feature a coherent receiver designed by Coherent Solutions Ltd. Coherent Solutions is a leading photonics technology company specializing in R&D equipment in the fields of coherent communication technologies and short laser pulse characterization. Coherent Solutions offers a complete range of test and measurement solutions from signal generation to complex optical modulation format signal characterization. Coherent Solutions is based in Auckland, New Zealand. For more information, visit Coherent Solutions' website at: www.coherent-solutions.com

Introduction

The Optical Modulation Analyzer (OMA) system combines the Teledyne LeCroy-Coherent Solutions coherent receiver with the LabMaster 10 Zi-A real-time oscilloscope. Taking advantage of the LabMaster's high bandwidth and long acquisition memory, the coherent receiver enables high-speed and accurate characterization of complex optical modulations.



Optical Modulation Analyzer hardware

The fully integrated Optical LinQ™ software provides intuitive, touch screen control of the OMA system, measurements designed for optical analysis, and powerful signal visualization capabilities.



Optical Modulation Analyzer Optical LinQ software

Shipped Items

Check that the following items have been included with your shipment. Contact Teledyne LeCroy immediately if any are missing.

System	Item	Quantity
All	MCM Zi-A Master Control Module	1
	Polarization Maintaining Patch Cord	1
	USB Type A to Type B Cable	1
	Operator's Manual	1
25 GBaud	LM 10-25Zi-A Acquisition Module	1
	IQS25 Coherent Receiver	1
36 GBaud	LM 10-36Zi-A Acquisition Module	1
	IQS42 Coherent Receiver	1
56 GBaud	LM 10-65Zi-A Acquisition Module	1 / 2*
	IQS70 Coherent Receiver	1

* Depending on desired number of high-bandwidth polarizations.

OMA Accessories

The following may be purchased separately for an OMA system. Contact your regional sales representative.

Item	PN	Quantity
Receiver Rackmount Kit (for use with standard 19-inch rack)	IQS-RACKMOUNT	1
Standard RF Cables (for < 50 GHz inputs)	IQSCABLES-SBW	4
High-bandwidth RF Cables (for ≥ 50 GHz inputs)	IQSCABLES-HBW	4

Coherent Receiver Features

1. X Pol I RF output
2. X Pol Q RF output
3. LCD control interface screen
4. Control dial for LCD control interface
5. Y Pol I RF output
6. Y Pol Q RF output
7. Laser On/Off
8. Power On/Off
9. Built-in laser output PM FC/PM
10. Reference LO input PM FC/PC
11. Modulated optical signal input FC/PC
12. USB connection to MCM-Zi-A
13. Mains power isolation switch
14. AC power inlet
(~100 - 240 V; 50/60 Hz; 20W max.)

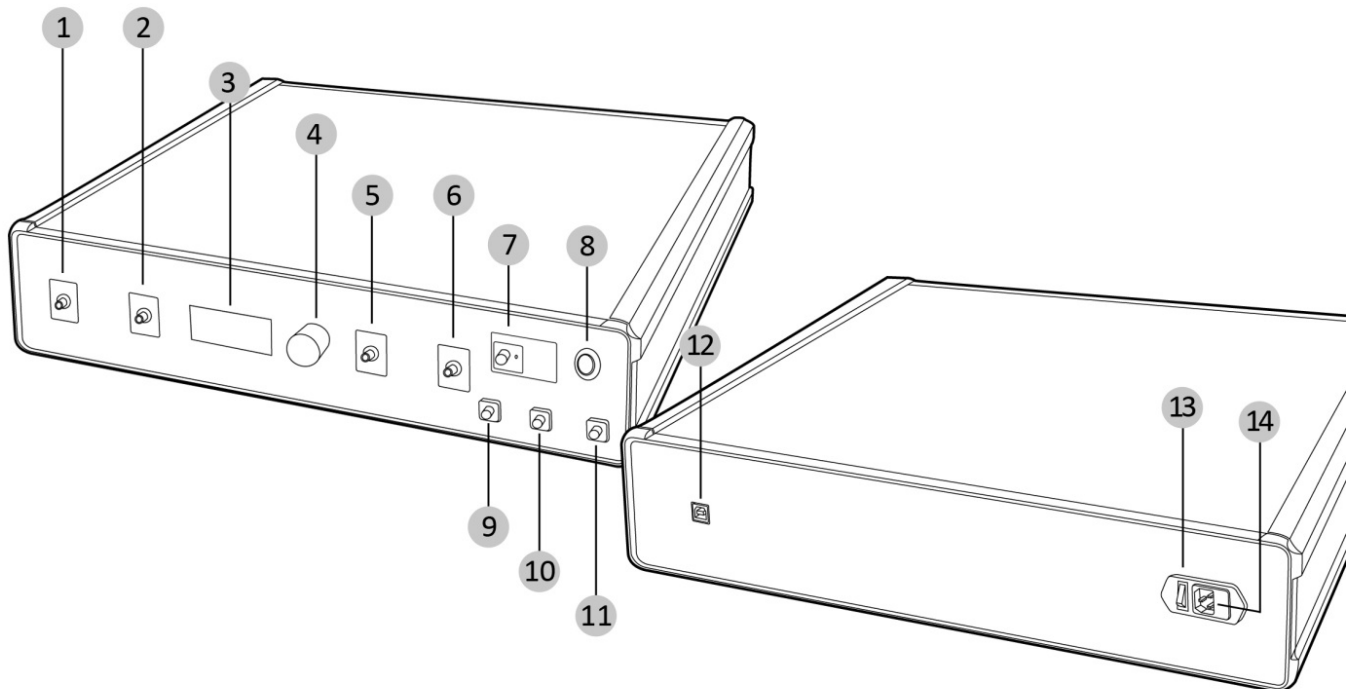

LabMaster Real-Time Oscilloscope

See the *LabMaster 10 Zi-A Operator's Manual* included with your MCM-Zi-A unit for a description of the LabMaster hardware features.

Compatible Hardware

Coherent receiver, oscilloscope modules, and software may be purchased independently and combined to form an OMA system, although system performance may not equal that of a complete Teledyne LeCroy OMA system. The following hardware has been tested to be compatible with each other and the Optical LinQ OMA software.

Coherent Receivers

Coherent Solutions IQScope-RT

Master Control Modules

- LabMaster MCM-Zi/Zi-A
- LabMaster 9CZi-A

Acquisition Modules

- LabMaster 10-20Zi/Zi-A
- LabMaster 10-25Zi/Zi-A
- LabMaster 10-30Zi/Zi-A
- LabMaster 10-36Zi/Zi-A
- LabMaster 10-50Zi/Zi-A
- LabMaster 10-60Zi/Zi-A
- LabMaster 10-65Zi/Zi-A
- LabMaster 10-100Zi-A (36 GHz polarizations only)
- LabMaster 913SZi-A
- LabMaster 916SZi-A
- LabMaster 920SZi-A
- LabMaster 930SZi-A
- LabMaster 945SZi-A

OMA System Architecture

A modulated optical signal is input to the coherent receiver along with a Local Oscillator (LO). The coherent receiver also outputs a laser which can be used as a source for the LO. The output LO can be controlled from the coherent receiver's LCD interface as well as from the OMA software.

The coherent receiver converts the optical input into four electrical signals labeled **XI**, **XQ**, **YI**, and **YQ** which are then input to the LabMaster acquisition module.

The Analogue-to-Digital Converters (ADCs) in the LabMaster perform the front-end sampling and present this data to the OpticalLinQ OMA software for analysis:

- The first step in this process is receiver calibration and correction, which must be performed every time an acquisition session is to be started.
- The next stage in the process is a set of Digital Signal Processing (DSP) algorithms which form the core of the OMA functionality. The DSP operates in three stages: **Dispersion Compensation**, **Polarization De-multiplexing** and **Carrier Recovery**. Details of these operations will be provided later in the document.

The output of the DSP kernel is fed to the various visualizers such as **Constellations**, **Trajectories**, **Eye Diagrams** and **Masks**.

In addition to this, a range of measurements are also provided for complete signal characterization.

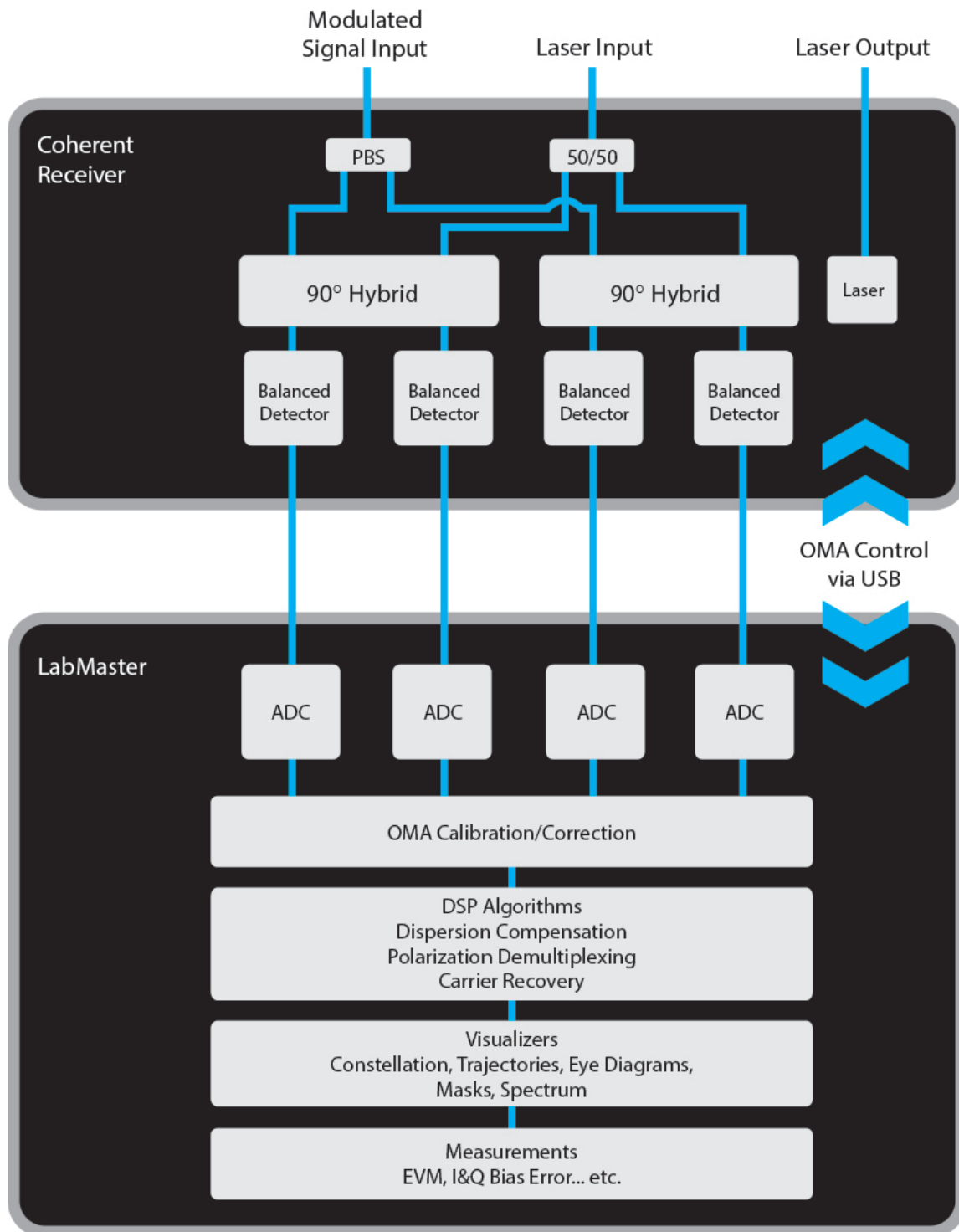

OMA system architecture with an emphasis on signal flow through the various components

Safety

To maintain the OMA in a correct and safe condition, observe generally accepted safety procedures in addition to the precautions specified in this section. **The overall safety of any system incorporating this product is the responsibility of the assembler of the system.**

Symbols

These symbols appear on the instrument or in documentation to alert you to important safety concerns:



CAUTION of potential damage to instrument, or **WARNING** of potential bodily injury. Refer to the accompanying information. Do not proceed until the information is fully understood and conditions are met.



CAUTION, risk of electric shock or burn.



Laser safety **WARNING**.



CAUTION, contains parts/assemblies susceptible to damage by Electrostatic Discharge (ESD).



Measurement ground connection.



Safety (protective) ground connection.



Alternating current.



Standby power (front of instrument).



Power On (rear Power switch); connected to AC mains.



Power Off (rear Power switch); disconnected from AC mains.

Oscilloscope Precautions



Comply with the following instructions to avoid personal injury or damage to your equipment.

Maintain ground. This product is grounded through the power cord grounding conductor. To avoid electric shock, connect only to a grounded mating outlet.

Connect and disconnect properly. Do not connect/disconnect probes, test leads, or cables while they are connected to a live voltage source.

Use indoors only within the specified operating environment. Do not use in wet or explosive atmospheres.

Do not operate with suspected failures. Do not use the product if any part is damaged. Obviously incorrect measurement behaviors (such as failure to calibrate) might indicate impairment due to hazardous live electrical quantities. Cease operation immediately and sequester the instrument from inadvertent use.

Observe all terminal ratings. Do not apply a voltage to any input that exceeds its maximum rating. Refer to the front of the instrument for maximum input ratings.

Use only power cords shipped with the instrument and certified for the country of use.

Keep product surfaces clean and dry.

Do not remove the covers or inside parts. Refer all maintenance to qualified personnel.

Coherent Receiver Precautions

Invisible Laser Radiation



WARNING

Exercise laser safety precautions. The coherent receiver contains a Class 1M laser, λ :1500 to 1650 nm, P_{out} maximum < 50 mW. Do not view the laser output directly with optical instruments such as magnifiers or microscopes.

Electrical Connections



WARNING

Exercise electro-static discharge precautions. The instrument contains static-sensitive components. When making RF connections, always wear a grounding wrist strap.



CAUTION

Always hold on to the cable or component while tightening the hex nut to prevent the center pin from twisting inside the female connector when making RF connections.

Use a torque wrench to control the tightening pressure on all RF connections.

Optical Connections



WARNING

Do not install or terminate fibers while a light source is active. Care must be taken to ensure that any connected light sources and the instrument have been turned off before inspecting the end face(s) of the instrument or any optical patch cords connected to the instrument. Never look directly into a live fiber, and wear eye protection at all times.



CAUTION

Always clean the optical connectors and ensure the facet is free from dirt or impurities when making optical connections.

Check the connector type. Optical connectors used in the coherent receiver are FC/PC type, unless stated otherwise.

Do not connect FC/APC type connectors directly to coherent receivers designed for FC/PC type. Doing so will result in damaging the connector. A convertor patch cord can be used in case FC/APC connectors need to be used.

Operating Environment

Temperature: 5 to 40° C

Humidity: Maximum RH 80 % for temperatures up to 31° C, decreasing linearly to 50% RH at 40° C

Altitude: Up to 3,000 m at or below 30° C

Cooling

The LabMaster relies on forced air cooling with internal fans and vents. Take care to avoid restricting the airflow to any part. In a bench top configuration, leave a minimum 15 cm (6 inch) gap around the sides and rear. The feet provide adequate bottom clearance. Observe spacing indicated in cart mount and rackmount instructions.



Do not block cooling vents. Always keep the area beneath the instrument clear of paper and other items.

Cleaning

Clean only the exterior of the instrument using a soft cloth moistened with water or an alcohol solution. Do not use harsh chemicals or abrasive elements. Under no circumstances submerge the instrument or allow moisture to penetrate it.



Unplug the power cord from the AC inlet before cleaning to avoid electric shock.



Do not attempt to clean internal parts. Refer to qualified service personnel.

See “Clean Optical Fiber” and “Clean Optical Bulkhead Connector” for optical cleaning instructions.

Calibration

The oscilloscope and the coherent receiver are calibrated at the factory prior to being shipped. The recommended calibration interval for both is one year.



Calibration should be performed by qualified personnel only.

Schedule an annual factory calibration as part of your regular maintenance. Extended warranty, calibration, and upgrade plans are available for purchase. Contact your Teledyne LeCroy sales representative or customersupport@teledynelecroy.com to purchase a service plan.

The LabMaster software includes both automatic and user-initiated deskew calibration functions.

Lifting and Moving

Components housed in the OC910 oscilloscope cart may be moved from place to place as a unit. If components must be removed from the cart or other mounting, disconnect all cables from the units and move components separately.



Seek assistance when lifting and moving heavy OMA components.

Power

LabMaster power ratings vary by model. If you are using LabMaster components other than those shipped as part of an OMA system, see the product datasheet at teledynelecroy.com for power ratings.

Component	AC Power Source*	Max. Consumption (all accessories installed)	Standby Consumption
MCM-Zi-A	100 to 240 VAC ($\pm 10\%$) at 50/60 Hz ($\pm 10\%$)	≤ 450 watts (450 VA)	5 W
LM 10-36Zi-A LM 10-25Zi-A	100 to 240 VAC ($\pm 10\%$) at 50/60 Hz ($\pm 10\%$)	≤ 1225 watts (1225 VA)	12 W
LM 10-65Zi-A	100 to 240 VAC ($\pm 10\%$) at 50/60 Hz ($\pm 10\%$)	≤ 1275 watts (1275 VA)	12 W
IQS25, IQS40, IQS70	110 to 240 ($\pm 10\%$) VAC at 50/60 Hz ($\pm 10\%$)	≤ 20 watts (20 VA)	0 W

* The system automatically adapts to line voltage; manual voltage selection is not required.

Fuse Replacement

The coherent receiver is equipped with a user-replaceable AC mains fuse.



Unplug the power cord before inspecting or replacing the fuse to avoid electric shock.

1. Open the black fuse holder (located at the rear of the instrument next to the mains inlet) using a small, flat-bladed screw driver.
2. Remove the old fuse and replace it with a new 5 X 20 mm T rated 1.0 A/250 V fuse.
3. Replace the fuse holder.

Grounding

The MCM-Zi-A Master Control Module is provided with a 10A/250V rated grounded cord set containing a molded three-terminal polarized plug with a standard IEC-60320 (Type C13) connector.

The LM 10-36Zi-A, LM 10-25Zi-A and LM 10-65Zi-A acquisition modules are provided with a 16A/250V or 15A/125V rated grounded cord set containing a molded three-terminal polarized plug and a specific IEC-60320 (Type C19) connector.

The IQS25, IQS42 and IQS70 coherent receivers are provided with a 10A/250V rated grounded cord set containing a molded three-terminal polarized plug and an IEC-60320 (Type C13) connector.

The power cords mate to a compatible AC power inlet on the back of the instruments for line voltage and safety ground connections. The AC inlet ground is connected directly to the frame of the instrument. For adequate protection against electric shock, connect to a mating outlet with a safety ground contact.



To maintain ground, use only the power cord provided with each component. Interrupting the protective conductor inside/outside the oscilloscope or disconnecting the safety ground terminal creates a hazardous situation. Intentional interruption is prohibited.

System Installation

Hardware Configuration

The OMA has been designed to accommodate your preferred system configuration, whether that is a bench-top or rack-mount arrangement. The dimensions and layout of the panel elements ensure user friendly integration.



OMA components are heavy. Do not attempt these installation procedures without assistance.

Standard Bench-Top Configuration

The depth of the coherent receiver case has been designed to provide solid support for the MCM-Zi-A.

Place the coherent receiver on top of the acquisition module, then place the control module on top of the coherent receiver.

Go on to make the power, USB, and other cable connections on the backs of the units before making the RF and optical cable connections on the front.

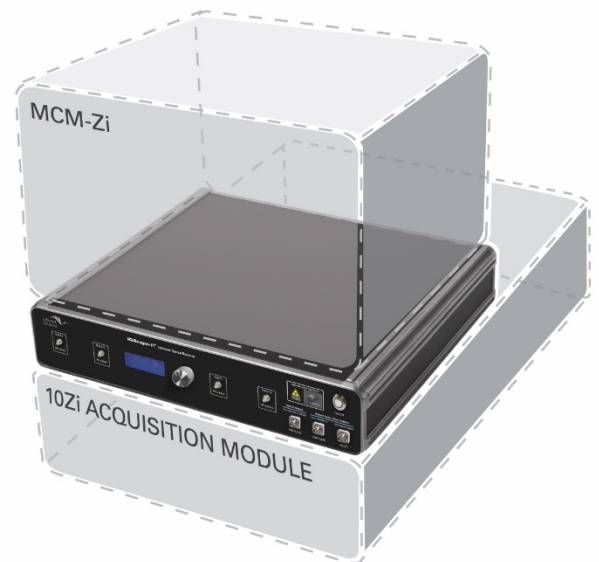

Rackmount Configuration

The OMA may also be mounted in a standard 19-inch rack.



Remove all cables attached to the instruments before attempting to mount the units within the rack.

YOU PROVIDE

- Optional OMA rackmount kit (IQS-RACKMOUNT) and optional LabMaster rackmount kits (MCM-Zi-RACKMOUNT and LM10Zi-ACQMOD-RACKMOUNT).
- Phillips screwdriver.
- At least four (4) fasteners to attach the coherent receiver to the rack. Consult the rack manufacturer's documentation to ensure the correct fasteners are used.



STEPS

1. Fasten the mounting brackets (supplied with the rackmount kit) to the threaded holes located at the front of both sides of the coherent receiver. Ensure all four screws of both brackets are securely fastened.
2. With assistance, position the coherent receiver within the instrument rack.

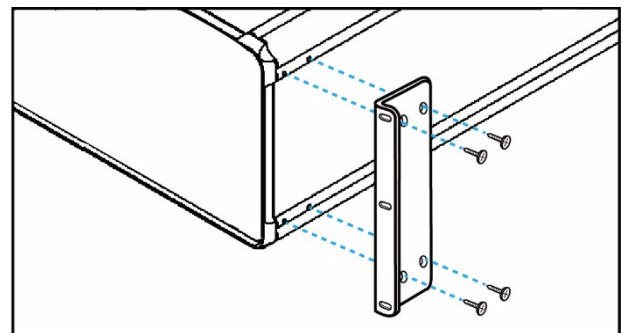

IMPORTANT: Ensure sufficient room to mount the other units around the receiver. This varies depending on the number of acquisition modules.

3. With the coherent receiver held in position, securely attach the mounting brackets to the instrument rack using the fasteners specified by your rack manufacturer.
4. Follow the instructions included with the LM 10 Zi rackmount kit to install the control module and the acquisition module in the rack.
5. Go on to make the power, USB, and other cable connections on the backs of the units before making the RF and optical cable connections on the front.

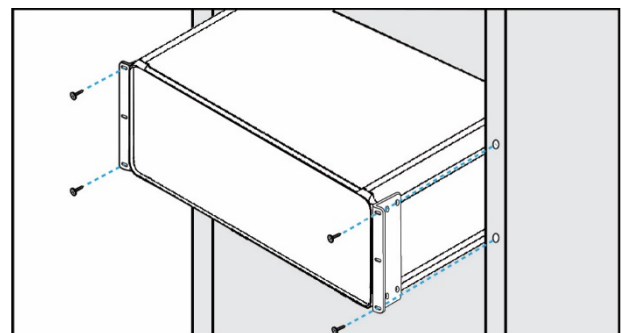

Connect Power

Connect mains power to the OMA components first to provide ground connection. Always use an AC outlet with a good ground connection.



Always wear an anti-static wrist strap before handling electrical components and equipment.



Ensure that all cable connections are made before powering on the instruments.

A red **Mains Power switch**  is located on the back of the control module. Press this switch to connect the system to the AC mains.

Once the AC is connected, press the **Standby Power button**  on the front of the control module to switch into operational mode. Press the button again to switch into “standby” (reduced power) mode.



The Standby Power button does not completely power down the system. The only way to fully power down the system is to use the mains power isolation switch or unplug the power cords. Standby Power will not function if any of the LabMaster cable connections are incorrect.

The coherent receiver's AC mains socket is also located on the back of the instrument. Above this socket is a mains power switch that can only be turned on after AC power is connected. Once turned on, the switch will illuminate indicating that the AC power supply is live and the coherent receiver is ready to be powered on.

Press the **Power On/Off** button on the front of the coherent receiver to power on.

Connect Coherent Receiver to Control Module

The coherent receiver must have a USB connection to the control module in order for the OMA software to read the factory calibration data from the instrument and perform signal processing.

1. Connect the B type connector of the supplied USB cable to the back of the coherent receiver.
2. Connect the A type connector of the USB cable to any available USB port on the control module.

Connect Acquisition Module to Control Module

See the *LabMaster 10 Zi-A Operator's Manual* for instructions on connecting the LabMaster components.

Update Firmware/Install Optical LinQ Software

If you have purchased a complete OMA solution, your system arrives pre-installed with the latest versions of all required software. You do not need to do anything further.

If you are adding OMA capabilities to an existing LabMaster system, you will be emailed an option key to activate the Optical LinQ software. Follow the procedures in the *LabMaster 10 Zi-A Operator's Manual* to update firmware and install the option key. Contact Customer Support to learn if there are any patches to be applied to the coherent receiver. They will guide you through the process.

Optical Configuration

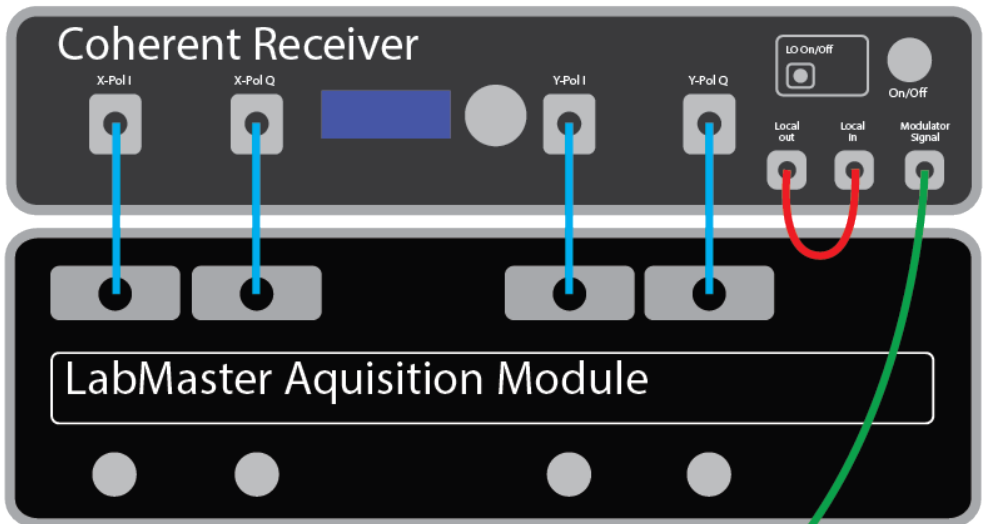

Legend

- RF Cable
- FC/PC PM Optical Fiber Patch cord
- FC/PC Optical Fiber Patch cord

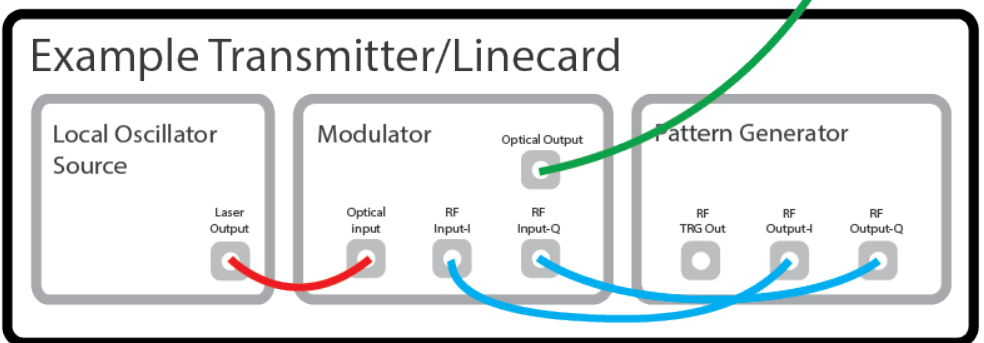

Typical dual-polarization optical configuration

Example Optical Configurations

DUAL-POLARIZATION, BUILT-IN LO

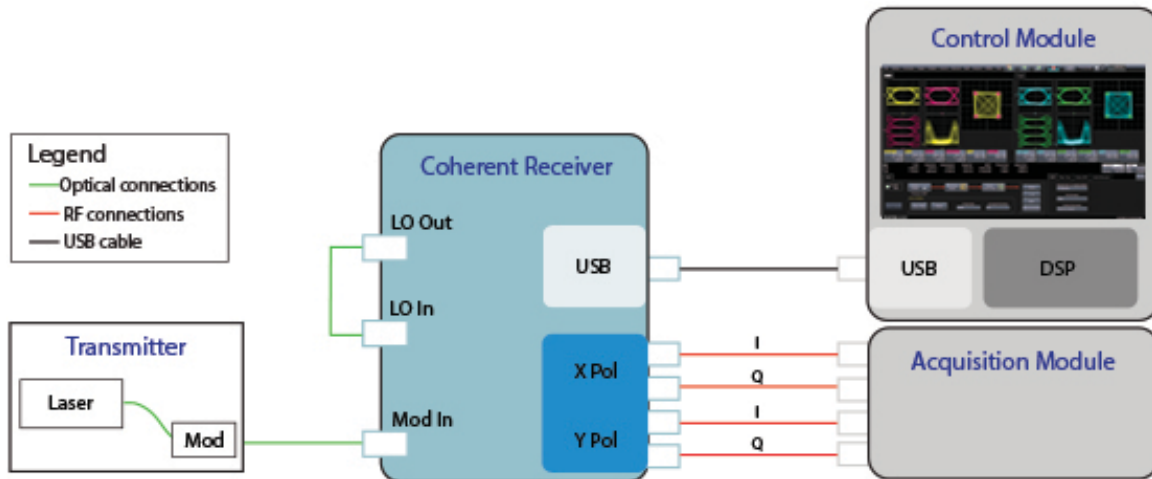

DUAL-POLARIZATION, USER SUPPLIED LO

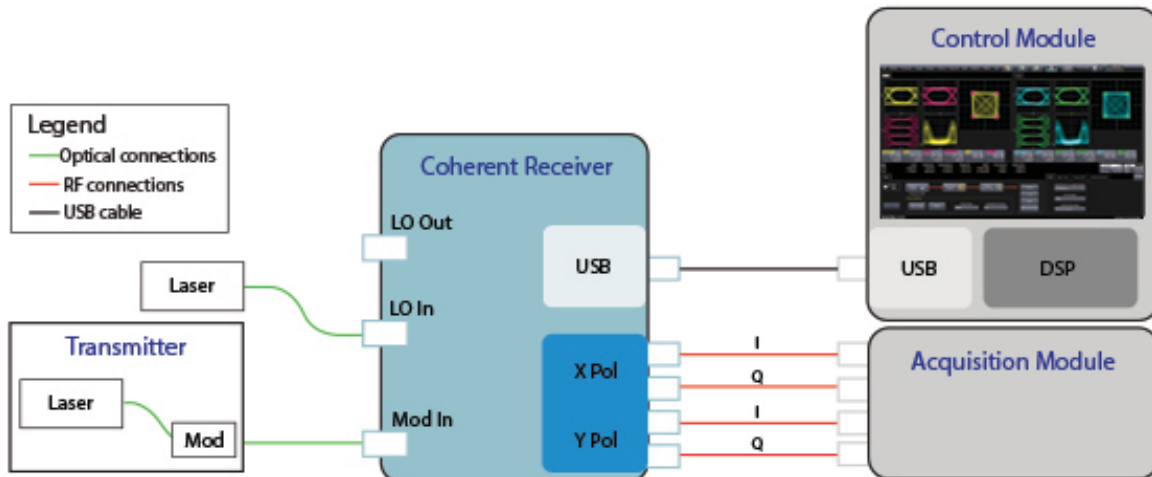

SINGLE-POLARIZATION, BUILT-IN LO

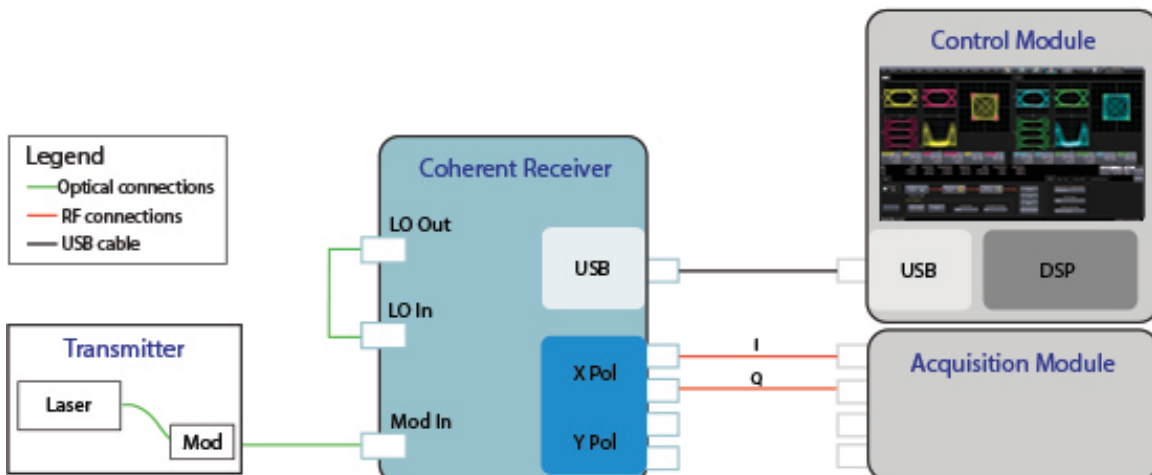

Connect Standard RF Cables



Follow these instructions to connect the standard RF cables (IQSCABLES-SBW) to the acquisition module's 2.92mm interfaces. The supplied RF cables are labeled 'XI', 'XQ', 'YI', and 'YQ'.



Do not bend or deform the cables, as this will damage them. Connect cables as labeled. The cables are calibrated to perform within specification only when connected as labeled.



1. Using the 'XI' RF cable, attach the 1.85mm/2.4mm connector to the *X-Pol I* port on the coherent receiver.



Then, attach the 2.92mm connector to the *CH1* port of the acquisition module.

2. Repeat this using the following cables and inputs:
 - Attach the 'XQ' RF cable from the *X-Pol Q* port on the coherent receiver to the *CH2* port of the LabMaster acquisition module.
 - Attach the 'YI' RF cable from the *Y-Pol I* port on the coherent receiver to the *CH3* port of the LabMaster acquisition module.
 - Attach the 'YQ' RF cable from the *Y-Pol Q* port on the coherent receiver to the *CH4* port of the LabMaster acquisition module.

Your system should look like this:

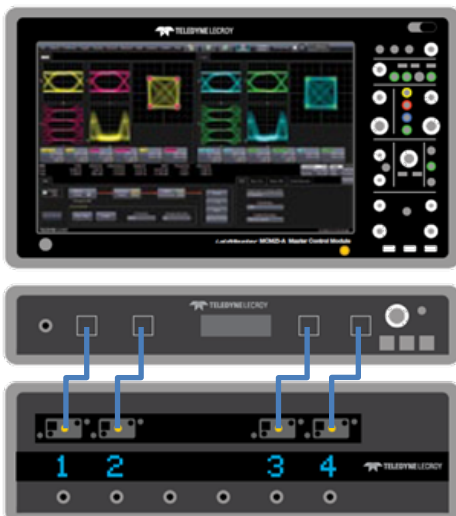

Connect High Bandwidth RF Cables



The following instructions apply when connecting the coherent receiver to DBI-enabled LabMaster acquisition modules. The semi-rigid RF cables are labeled 'XI', 'XQ', 'YI', and 'YQ'.



Do not bend the cables sharply; keep the cables' curvature as large as possible. Connect cables as labeled. The cables are calibrated to perform within specification only when connected as labeled.

1. Using the 'XI' RF cable, connect X-Pol I output of the coherent receiver to a DBI channel of the LabMaster acquisition module (e.g., CH2B).
2. Using the 'XQ' RF cable, connect X-Pol Q output of the Coherent receiver to a DBI channel of the LabMaster acquisition module (e.g., CH3B).

Your system should look similar to this:



For dual-polarization set up with two DBI acquisition modules, continue with the Y-polarization connections:

3. Using the 'YI' RF cable, connect Y-Pol I output of the coherent receiver to a DBI channel of the second LabMaster acquisition module (e.g. CH6B).
4. Using the 'YQ' RF cable, connect Y-Pol Q output of the coherent receiver to a DBI channel of the second LabMaster acquisition module (e.g. CH7B).

Optical Modulation Analyzer

Your system should look similar to this:

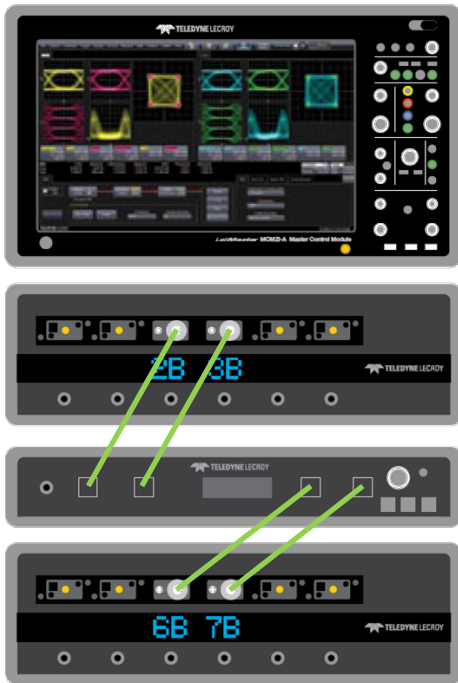

Connect Optical Signals



CAUTION

Teledyne LeCroy coherent receivers utilize good quality connectors in compliance with EIA-455-21A standards. To keep connectors clean and in good condition, inspect them with a fiber-inspection probe before connecting them. Failure to do so will result in permanent damage to the connectors and degradation in measurements.

CLEAN OPTICAL FIBERS

Clean the fiber ends as follows:

1. Gently wipe the fiber end with a lint-free swab moistened with isopropyl alcohol.
2. Use compressed air to dry it completely.
3. Visually inspect the fiber end to ensure its cleanliness.

CLEAN OPTICAL BULKHEAD CONNECTORS

Inspect the instrument bulkhead using a fiber inspection microscope:

- If the bulkhead is clean, proceed to connecting your optical fiber.
- If the bulkhead is dirty, clean it using the appropriate bulkhead cleaning tool for your connector type.

We recommend using IBC™ Brand Cleaners to clean optical bulkhead connectors. Follow the instructions provided with the IBC cleaning product.

CONNECT LOCAL OSCILLATOR

You can use either the Internal Local Oscillator output of the coherent receiver (as shown in the example) or your own narrow-linewidth local oscillator.

IMPORTANT: Linewidth needs to be less than 500 kHz.

Using a PM FC/PC patch cord, connect the local oscillator optical output to the **Local Oscillator** optical input of the coherent receiver.

CONNECT OPTICAL FIBER

Connect the modulated signal you wish to measure into the **Modulated Signal** optical port of the coherent receiver. The fiber type can be either PM or non-PM. The optical connector type is FC/PC.

IMPORTANT: The power level going into the Modulated Signal input must be between 0 dBm and 12 dBm.

1. Carefully align the connector and port to prevent the fiber end from touching the outside of the port or rubbing against other surfaces. If your connector features a key, ensure that it is fully fitted into the port's corresponding notch.
2. Push in the connector so that the fiber-optic cable is firmly in place, ensuring adequate contact.
3. If your connector features a screw sleeve, tighten the connector enough to firmly maintain the fiber in place. Do not over tighten, as this will damage the fiber and the port.



CAUTION

If your fiber-optic cable is not properly aligned and/or connected, you will notice heavy loss and reflection.



Coherent Receiver LCD Control Interface

The LCD Control Interface may be used to manually set and configure the optical characteristics of the coherent receiver's Internal Local Oscillator output.

NOTE: The Internal Local Oscillator is automatically controlled from the OMA software when the coherent receiver is connected to the LabMaster and the system is powered on. To enable software control, press the Laser On/Off button on the front of the coherent receiver.

Navigating the LCD Control Interface

The LCD Control Dial, found next to the LCD display, is used to navigate within the control interface menu system:

- Turn the dial left to move the cursor up or right to move the cursor down.
- Once the cursor is at the desired menu item, select it by pressing in the control dial once.

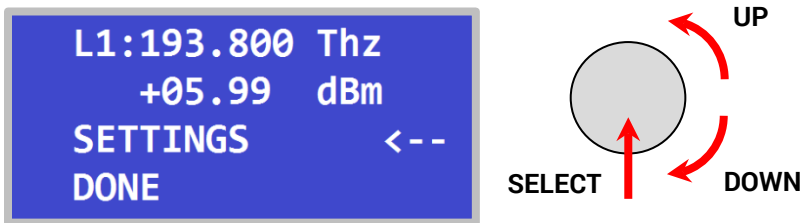

Changing Numerical Values

1. Move the cursor to select the line containing the value.
2. Turn the dial until the digit you wish to change is flashing.
3. Press the dial in once, then turn it until the desired value is shown.
4. Press the dial again to exit the current selection.
5. Turn the dial to the far right side of the menu until <OK> is selected.
6. Press the dial to exit back to the main line selection.

Changing Numerical Units

1. Move the cursor to select the line containing the unit.
2. Turn the dial towards the unit so that it is encased by < > (e.g. <THz>).
3. Press the dial until you see the desired unit.
4. Turn the dial to the far right side of the menu until <OK> is selected.
5. Press the dial to exit back to the main line selection.

Changing Step Size

Follow this procedure to change the step size (the increment increase) of the laser frequency or wavelength.

1. Turn the dial to select the 'SETTINGS' menu, then press.
2. Turn the dial to select the 'STEP SIZE' menu, then press.
3. Continue pressing the dial until you see the desired step increment. The value can be toggled from 0.1GHz to 25GHz.



```
STEP SIZE
L1: 00.1 GHz<--
DONE
```

4. Turn the dial until 'DONE' is selected, then press.

Changing the Output Power

The second line on the menu for the output laser is the power output. This has units of either dBm or mW. The values can be adjusted in steps of 0.01 dBm or 0.01 mW.

Preparing for Optimal Measurements

The following procedures will prepare the oscilloscope to yield the most accurate measurements. We highly recommend performing each of them before starting an OMA test session.

Warm Up

Power on all components and allow them to warm for at least 20 min. before starting a test session.

Deskew Channels

The LabMaster oscilloscope has several self-calibration functions to correct for skew between channels. ChannelSync Calibration should be performed when the LabMaster is set up for the first time and thereafter whenever a new acquisition module is installed.

NOTE: You will need a high-bandwidth RF cable to connect from the Fast Edge output of the MCM-Zi-A to each of the input channels on the acquisition module.

1. From the menu bar, choose **Vertical > Channel 1 Setup** and click the **ChannelSync Cal** button.
2. On the ChannelSync Calibration Wizard, choose the input configuration in use: Input A (four standard inputs) or Input B (two DBI inputs).
3. Set **V/Div** to 50 mV and touch **Next**.

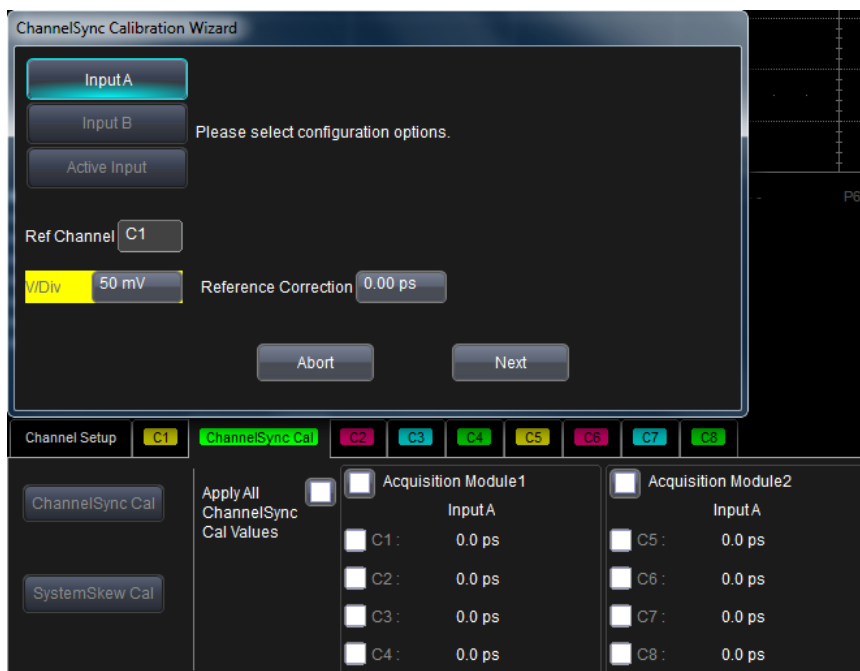

4. Follow the prompts to connect the cable from the fast edge output to each channel in turn.
5. When the calibration is finished, select and apply all the calibration values on the ChannelSync Cal dialog.

Adjust Signal Pre-Processing

These Pre-processing settings on the Channel setup dialog affect pre-acquisition processes that will affect the waveform, such as noise filtering and interpolation.

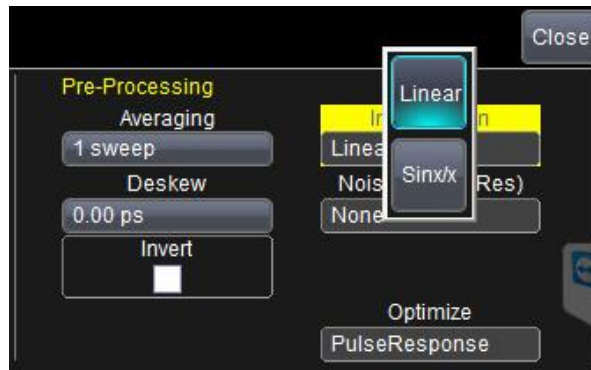

Channel Pre-processing settings

Interpolation

The LabMaster takes discrete signal samples which are then joined to show a continuous waveform trace. The oscilloscope offers various interpolation profiles to suit different signal characteristics. Interpolation can be set for each channel individually.

Linear, which inserts a straight line between sample points, is best used to reconstruct straight-edged signals such as square waves.

Sinx/x is suitable for reconstructing curved or irregular waves, especially when the sampling rate is 3 to 5 times the system bandwidth. Use Sinx/x interpolation to achieve the best results for high baud rate signals where the transitions in the data stream are smooth and curved.

TIP: You can also turn off linear interpolation and display only discrete samples. Go to Display > Setup.

Response Optimization Mode

The frequency response and group delay of the oscilloscope contribute to the pulse response characteristics of the instrument. The characteristic response of the oscilloscope can be optimized for your specific application by adjusting the **Optimize** setting on the Channel (Vertical) setup dialog.

Pulse Response compensates group delay by minimizing preshoot. This selection most resembles the response of analog oscilloscopes by controlling the delay to be slightly non-zero at the highest frequencies.

Eye Diagram is a flat group delay compensation resulting in equalized preshoot and overshoot. This selection improves the symmetry of serial eye diagrams.

Flatness is a flat group delay compensation with a brick-wall frequency response. While this provides the fastest rise time, there is also a slight penalty of more preshoot and overshoot compared to Eye Diagram mode. Use Flatness mode to achieve the best results for high baud rate signals where the instrument filters out high frequency components.

Using the Optical Modulation Analyzer Software

Starting the OMA Software

Optical LinQ, Teledyne LeCroy's optical modulation analysis software, is fully integrated into the LabMaster X-Stream firmware application. It can be started by choosing **Analysis->OMA** from the LabMaster touch screen menu bar.

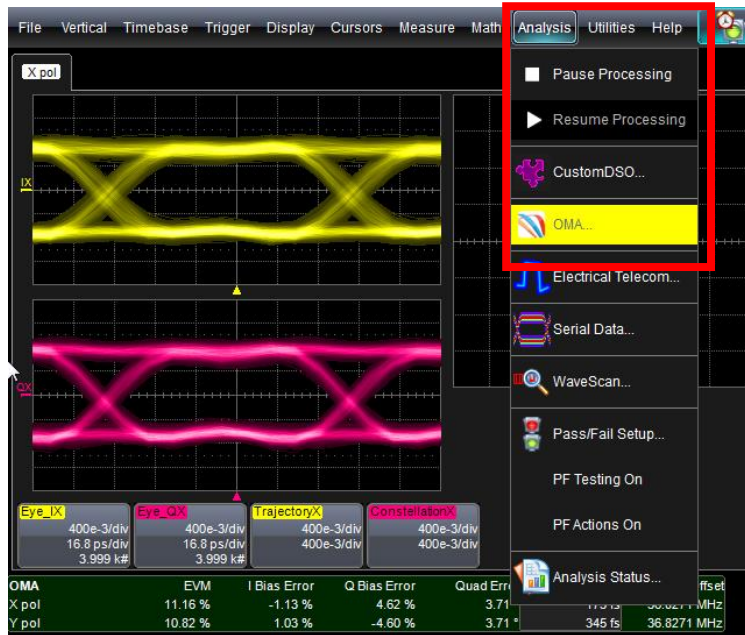

The OMA dialog appears at the bottom of the touch screen for you to begin to configure the inputs.



The OMA dialog is divided into the following control groups:

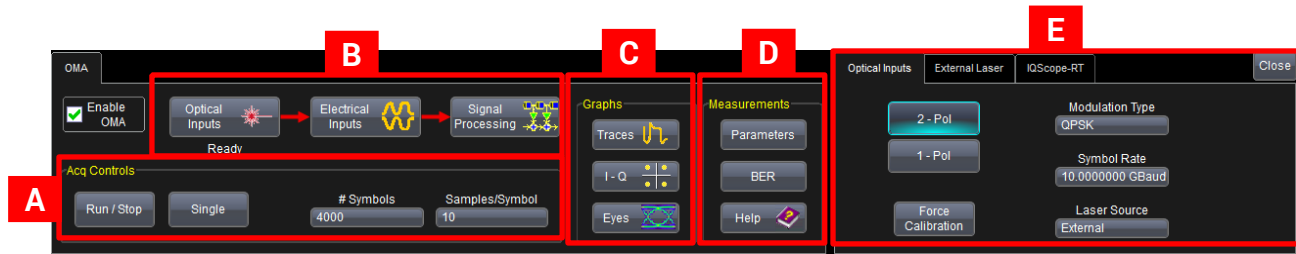

- Acquisition controls allow you to make signal acquisition settings and control the acquisition trigger from within the OMA dialog.
- OMA workflow buttons show the general OMA process and open the configuration subdialogs belonging to each phase.
- Graphs buttons present different ways you can visualize the processed signals. As with the workflow, each button opens a group of subdialogs for configuring the graphs.
- Measurements buttons present different types of OMA measurements that can be applied to the processed signals and open the corresponding configuration subdialogs.
- Configurations dialogs present the optical input, electrical input, signal processing, graphing, and measurement settings.

Acquisition Controls

These parameters control the time domain of the acquisition. The default values are filled in at startup. Longer acquisition implies that OMA will update its output slowly. Typically, 2000-3000 symbols and 10-20 samples per symbol are enough for a reasonable visualization.

Control	Action
Enable OMA	Turns on/off the OMA functionality. NOTE: Turning off the OMA functions will discard all data in the acquisition buffers.
Run/Stop	Starts continuous acquisition, or stops an acquisition in progress.
Single	Makes a single acquisition, then stops.
# of Symbols	Sets number of symbols in one acquisition.
Samples/Symbol	Sets number of samples per symbol

Optical Inputs

Touch the **Optical Inputs** workflow button to access the OMA’s optical configuration dialogs.

Optical Inputs

This subdialog is used to select the optical level parameters of the signal under test.

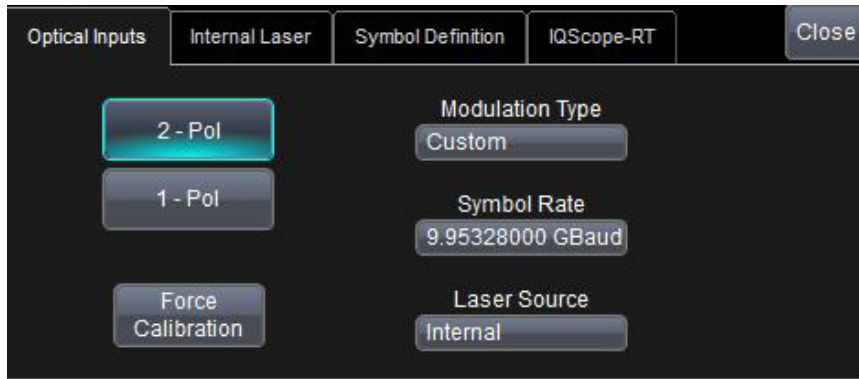

NOTE: The OMA software will perform a calibration every time it detects changes in its settings. However, if there are changes on the transmitter side (such as output power change), then a manual calibration (Force Calibration) may be required for better signal characterization.

Control	Action
2-Pol	Specifies signal is polarization multiplexed.
1-Pol	Specifies signal is not polarization multiplexed.
Force Calibration	Repeats calibration.
Modulation Type	Sets signal’s digital modulation scheme. Select from a wide variety of complex modulation formats, or use a Custom format.
Symbol Rate	Sets signal’s symbol rate in bauds.
Laser Source	Specifies the Local Oscillator source: coherent receiver Internal LO output or External source.

Custom Modulation

Upon selecting Custom Modulation Type, a new Symbol Definition dialog will appear. Use the Symbol Definition dialog to enter symbol definitions (QPSK example shown below).

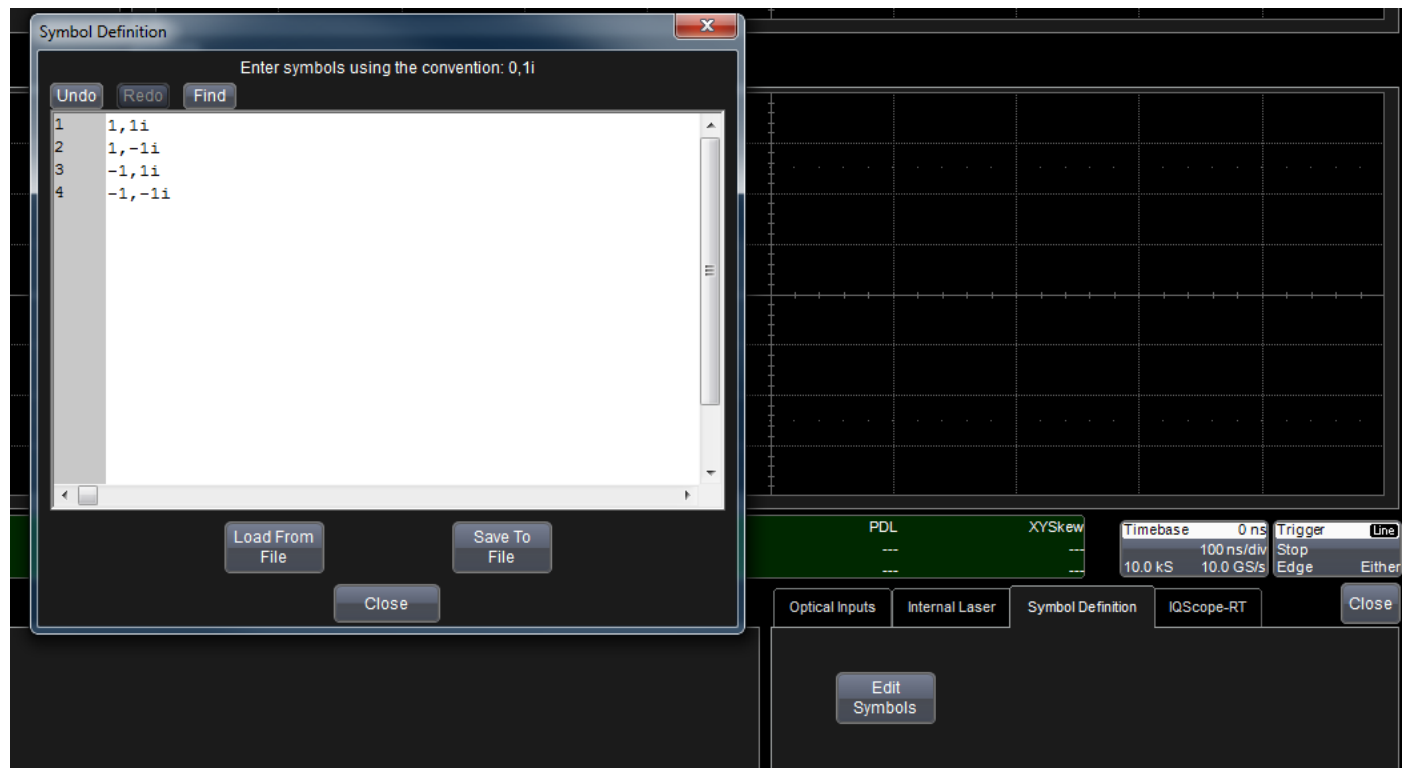

Control	Action
Edit Symbols	Opens the Symbol Editor.
Load From File	Allows you to browse to and load a previously saved symbol file.
Save to File	Saves contents of the Editor window to a new symbol file.
Close	Submits symbol list.

Internal Laser

The Internal Laser dialog can be used to control the internal laser output. This dialog performs the same functions as the coherent receiver LCD Control Interface (p.20); it is added for convenience and remote control applications.

NOTE: The coherent receiver’s internal laser measures its own output power. This figure is displayed below the **Power** control. This measurement can differ slightly from the Power control setting.

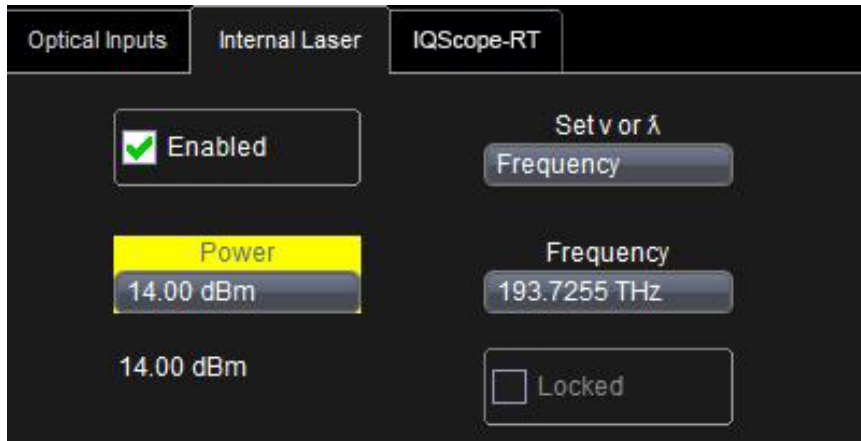

Control	Action
Enabled	Turns the laser on/off.
Power	Sets the output power specified in dBm.
Set v or λ	Changes the units (frequency/wavelength).
Frequency	Sets the output frequency specified in the selected units.
Locked	Indicates whether laser is at the requested frequency.

IQScope-RT

The last dialog in the Optical Inputs group shows version information for the instrument.

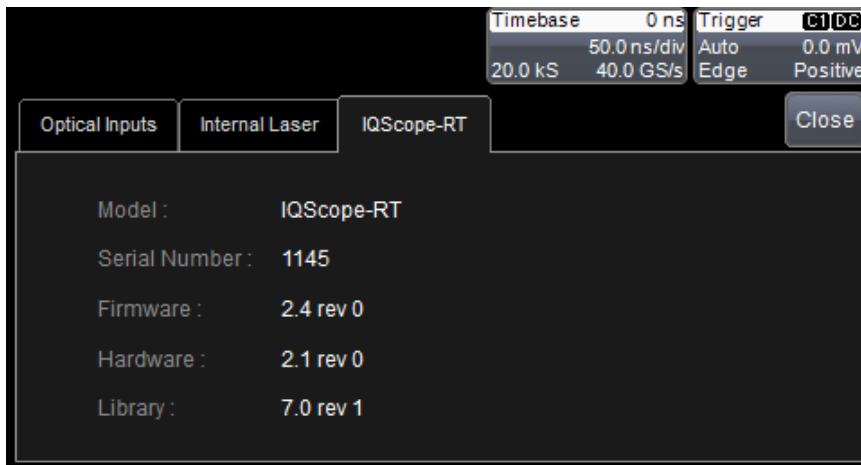

Electrical Inputs

Touch the **Electrical Inputs** workflow button to access the OMA's electrical configuration dialogs.

Electrical Inputs

The Electrical Inputs dialog is used to specify which channels on the acquisition module receive which RF outputs (*X-Pol I*, *X-pol Q*, etc.).

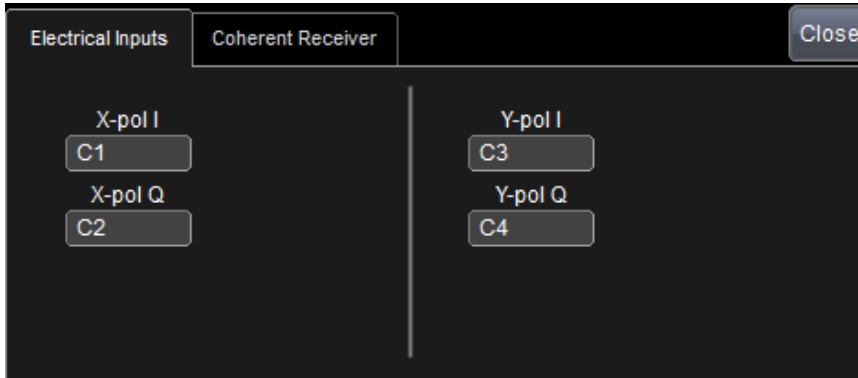

Coherent Receiver

The Coherent Receiver dialog is used to select the calibration script used by the receiver.

If using a Teledyne LeCroy IQSxx or a legacy Coherent Solutions IQScope-RT, select **IQScope**.

The **IQScope Connected** status checkbox will turn green when the software detects an IQScope via USB interface.

If using a third-party coherent receiver, select **Custom**, then touch **Browse** and select your custom calibration script (.CRS) file.

NOTE: The default script is located on the oscilloscope hard drive in D:\Scripts. You may copy the sample script below and use this as the basis for your custom script.

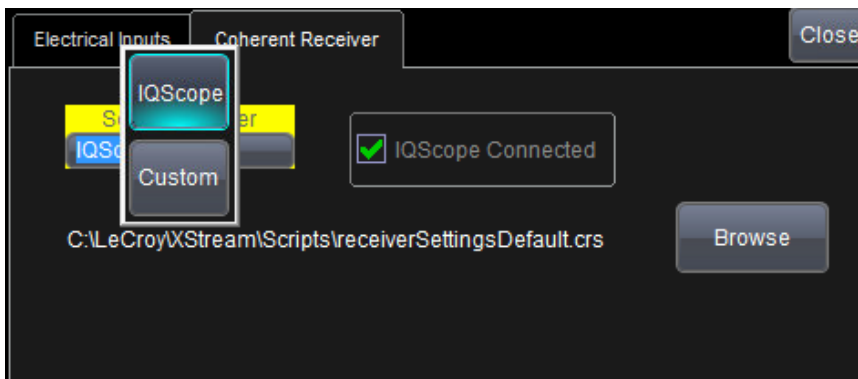

CUSTOM COHERENT RECEIVER CALIBRATION SCRIPT EXAMPLE

```
; Custom Coherent Receiver .crs file
; Coherent Solutions 2014
;
; Notes:
; Each float in the following must be specified in not more than 4 decimal places.
; Units have been selected so that there is no need for directly specifying very
; large or very small numbers.
;
[RX_version]
; File version number used by OMA to identify .crs file
version = 0.1

[identifier]
; Taken as an unsigned number.
serial = 9876
model = 1

[phase]
; Units = radians
; Type = float
; Range = -pi to +pi
; Default = 0
XpolIQPhaseError_rads=0
YpolIQPhaseError_rads=0

[skew]
; Units = picoseconds
; Type = float
; Range = -1 us to +1 us
; Default = 0
XqtoXiSkew_ps=0
YitoXiSkew_ps=0
YqtoXiSkew_ps=0

[frequency]
; Units = Hz
; Type = Float array
; Range = 0 to 1 THz
; Default = 0
FrequencyAxis_Hz= 0, 2068965517.24138, 4137931034.48276, 6206896551.72414,
8275862068.96552, 10344827586.2069, 12413793103.4483, 14482758620.6897,
16551724137.9310, 18620689655.1724, 20689655172.4138, 22758620689.6552,
24827586206.8966, 26896551724.1379, 28965517241.3793, 31034482758.6207,
33103448275.8621, 35172413793.1035, 37241379310.3448, 39310344827.5862,
41379310344.8276, 43448275862.0690, 45517241379.3104, 47586206896.5517,
49655172413.7931, 51724137931.0345, 53793103448.2759, 55862068965.5172,
57931034482.7586, 60000000000.0000
```

Signal Processing

The Signal Processing dialog group is used to select the algorithms and their parameters to be applied at each stage of the optical signal processing. Touch the Signal Processing workflow button to access this group.

See Using Custom MATLAB Scripts on p.50 for details on using custom algorithms.

See Appendix 2: OMA Algorithms on p.62 for details about the default algorithms for polarization de-multiplexing and carrier recovery.

DSP

Use the DSP subdialog to select the algorithms to be applied to the signal.

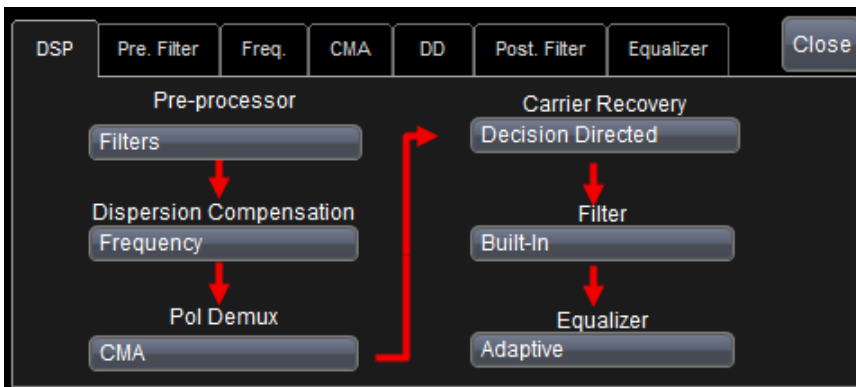

Control	Action
Pre-processor	First stage in the DSP chain. Can be set to built-in Filters , a Custom algorithm, or None .
Dispersion Compensation	Sets dispersion compensation algorithm used: Frequency -based, FIR (Finite Impulse Response), a Custom algorithm, or None .
Pol DeMux	Sets polarization de-multiplexing algorithm used: CMA , MMA , a Custom algorithm, or None .
Carrier Recovery	Sets carrier recovery algorithm used: Decision Directed , Viterbi & Viterbi , a Custom algorithm, or None . See p.36 for a description of the methods.
Filter	Post processor filters. Can be set to Built-In filters or None .
Equalizer	Adaptive algorithm to improve signal quality. Can be set to Adaptive , Custom or None .

Pre-processor Parameters (Pre. Filter)

This is the first stage in the DSP chain. You can use a range of built-in filters to improve signal quality or apply a custom algorithm via MATLAB™. There is also a **None** option that can be used to bypass this processing stage.

The three built-in filters are **Gaussian** (impulse response a Gaussian function), **RC** (Raised Cosine, frequency spectrum resembles a cosine function), and **RRC** (Raised Root Cosine, the square root of the RC filter). The controlling parameters for these filters are described below.

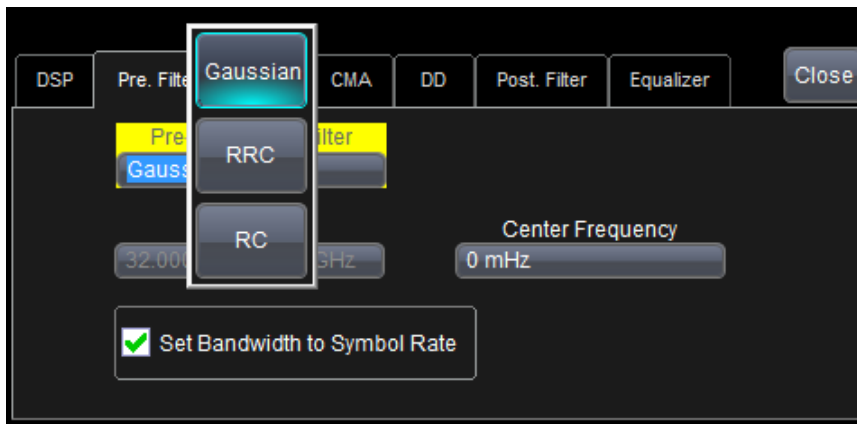

Control	Action
Bandwidth	Sets filter's bandwidth (the difference between upper and lower cutoff frequencies).
Center Frequency	Sets central frequency between upper and lower cutoff.
Rolloff	Controls the steepness of the frequency transfer function. Only available for RRC and RC filter types.
Set Bandwidth to Symbol Rate	Sets filter bandwidth to symbol rate.

Optical Modulation Analyzer

When the **Custom** filter option is selected, the Pre. Custom subdialog is displayed. Click **Edit Code** to open the MATLAB editor and input your algorithm. More information can be found in Using Custom MATLAB Scripts on p.50.

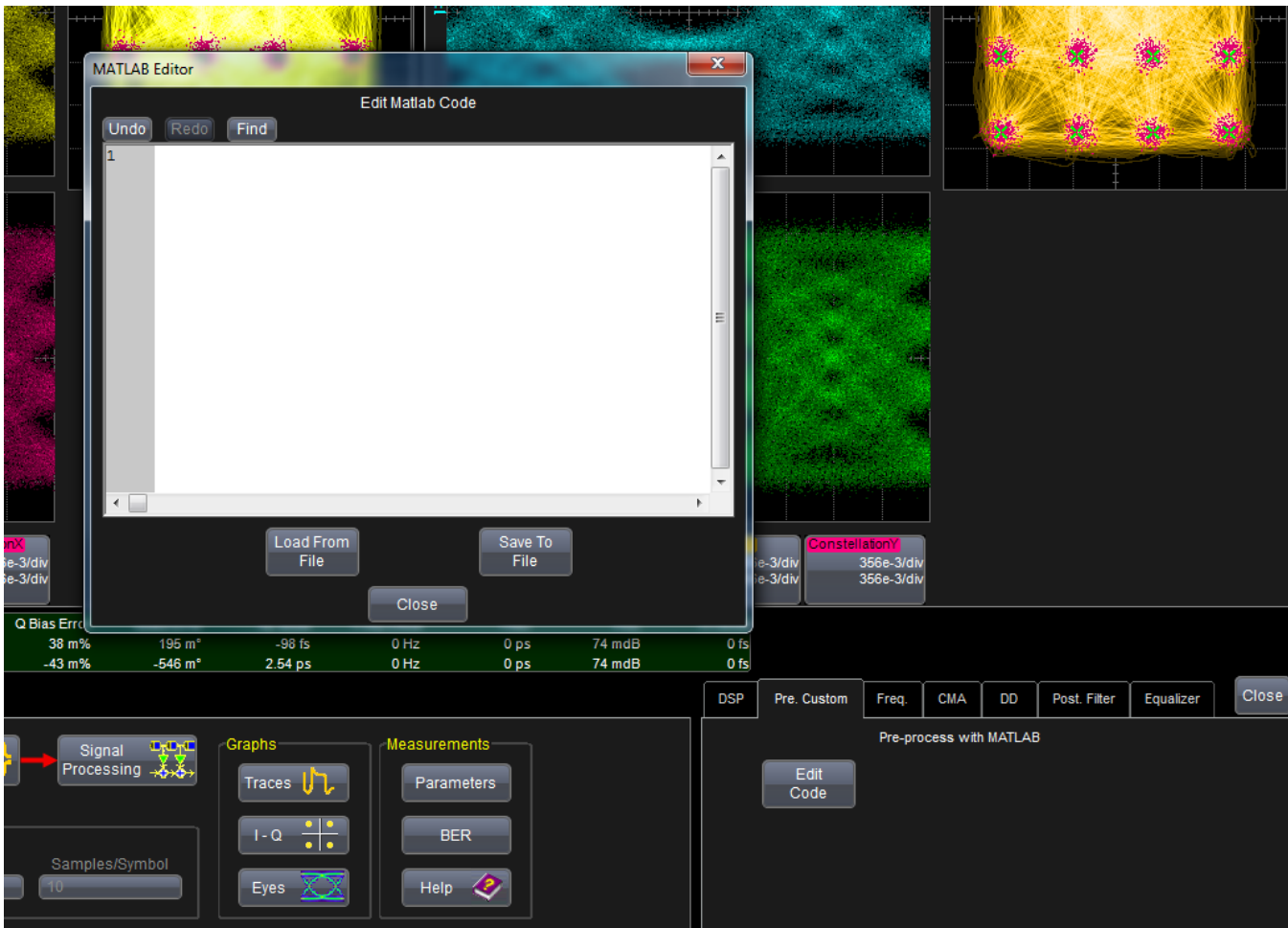

Dispersion Compensation Parameters (Disp. ...)

Use the Disp... subdialog to specify the parameters for the selected dispersion compensation algorithm.

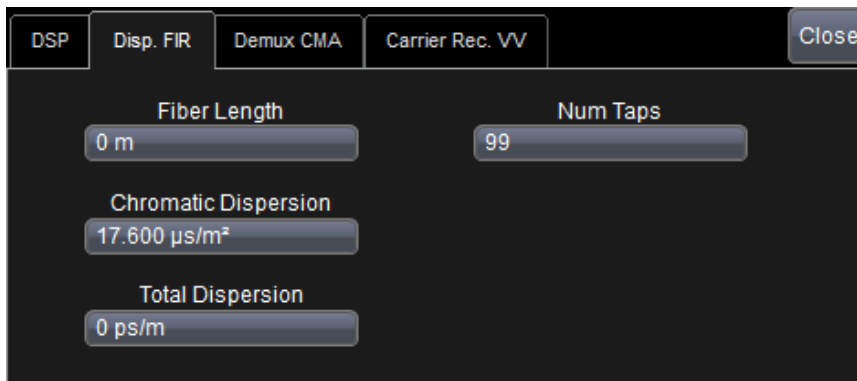

Control	Action
Fiber Length	Sets length of the optic fiber in meters.
Chromatic Dispersion	Sets chromatic dispersion of the fiber in s/m ² .
Total Dispersion	Displays the product of the above two parameters or can be used to directly specify the value.
Num Taps (FIR only)	Sets the number of filter taps.

Polarization De-Multiplexing Parameters (Demux...)

Use the Demux... subdialog to specify the parameters for the selected polarization de-multiplexing algorithm.

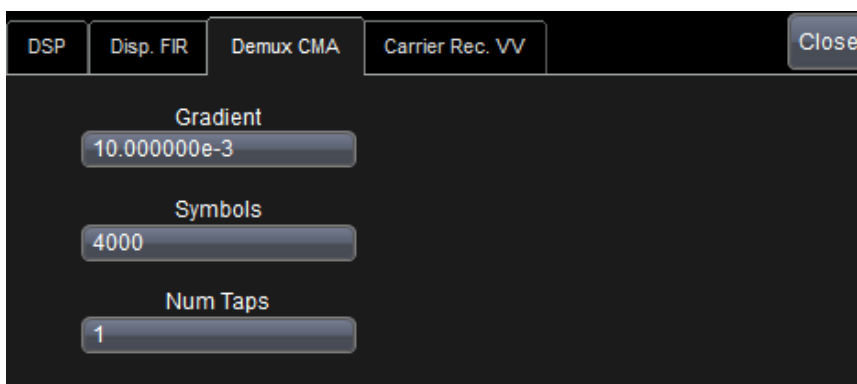

Control	Action
Gradient	Sets speed and accuracy of the adaptation.
Symbols	Sets length of the training set.
Num Taps	Sets number of taps in the equalization filter.

Carrier Recovery Parameters (Carrier Rec. ...)

Use the Carrier Recovery subdialog to specify parameters for the Carrier Recovery algorithm. Two built-in methods are provided for selection on the DSP subdialog.

The first is a modified Viterbi & Viterbi algorithm. Here, we first estimate frequency offset, which is then applied to the signal. The new signal is the raised to M th power where M is the number of possible phases in the signal (e.g., 4 for QPSK). This removes modulation. In the next step, successive k symbols are considered where k is the number of symbols set from the Carrier Rec. VV subdialog. Within each window every symbol's phase is added together and then divided by M . The resulting angle is adjusted in case it lies outside $-\pi/2$ or $\pi/2$. Finally, the estimated phase error is applied to the signal. The modified VV algorithm suits PSK modulation formats where all symbol phases are equidistant.

For high density QAM, the DD algorithm is provided, which uses a feed forward mechanism. Here we consider each symbol and match it with the closest reference symbol. The calculated phase error is stored and is then applied to the next symbol within a window of k symbols where k is the # of symbols set from the Carrier Rec. DD subdialog.

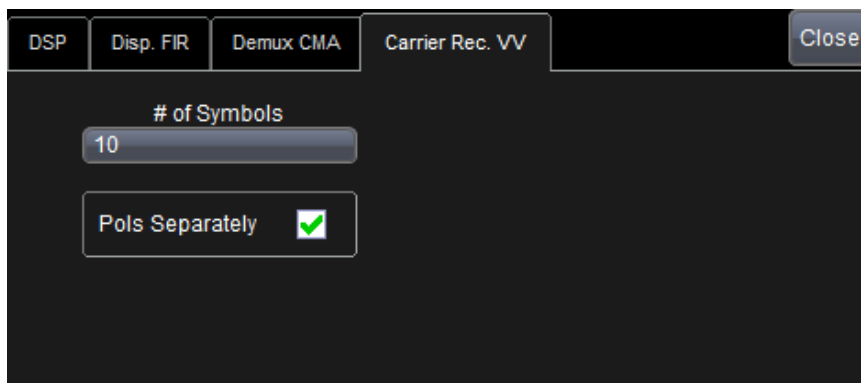

Control	Action
# of Symbols	Sets length of the training set.
Pols Separately	Sets method for frequency/phase estimation. When checked, frequency/phase estimation is performed independently for X and Y Pols. When unchecked, the procedure runs on the X-Pol only and applies the same results for Y-Pol, which reduces processing time.

Post-processor Filter Parameters (Post. Filter)

This is similar to the Pre-processor stage (p.33) where a range of built-in filters can be selected. You can input a custom algorithm via MATLAB or set to None to simply bypass.

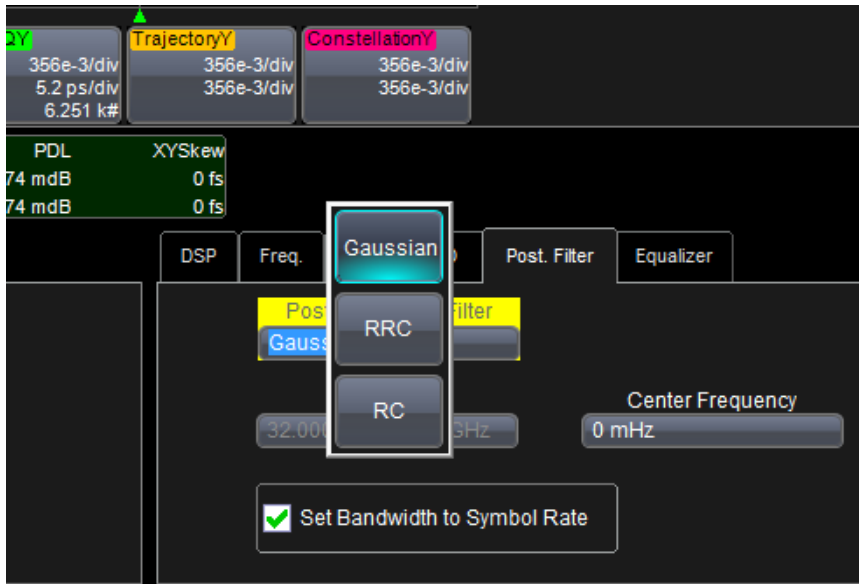

Equalizer Parameters (Equalizer)

The purpose of the equalizer is to correct frequency dependent distortion in the signal. It is an adaptive Finite Impulse Response (FIR). Similar to the other stages you can add a **Custom** algorithm via MATLAB or set it to **None**.

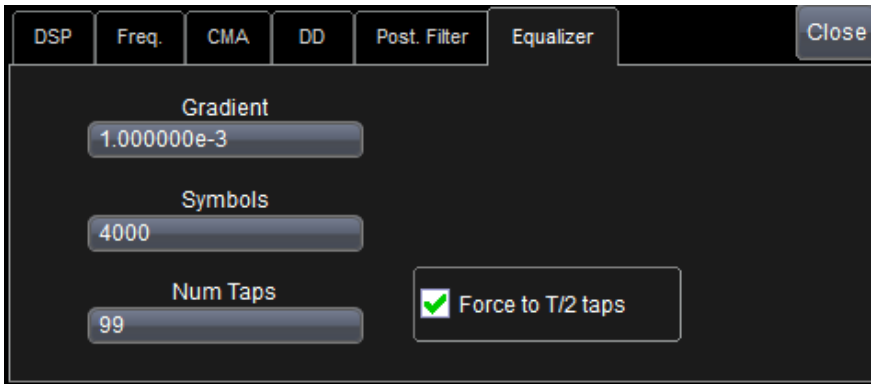

Control	Action
Gradient	This value controls the speed and accuracy of the adaptation. The value ranges from 1e-6 to 1. Smaller numbers will result longer convergence time over the training symbols but better results in presence of noise, and vice versa for higher numbers. The default is a good compromise between the two, as seen over a range of signals.
Symbols	Enter the length of the training set.
Num Taps	Enter the number of taps in the equalizer kernel.
Force to T/2 Taps	If selected, sets the taps per baud to 2. If left unselected, the taps per baud is equal to the number of symbols.

Graphs

The Graphs functions allow you to control the display of several important time and frequency domain visualizations.

The visualizations are divided into three categories for ease of use: **Traces**, **IQ**, and **Eyes**. Touch the button to open the configuration dialogs for that category.

Visualizations from all three categories can be displayed simultaneously, as shown below.

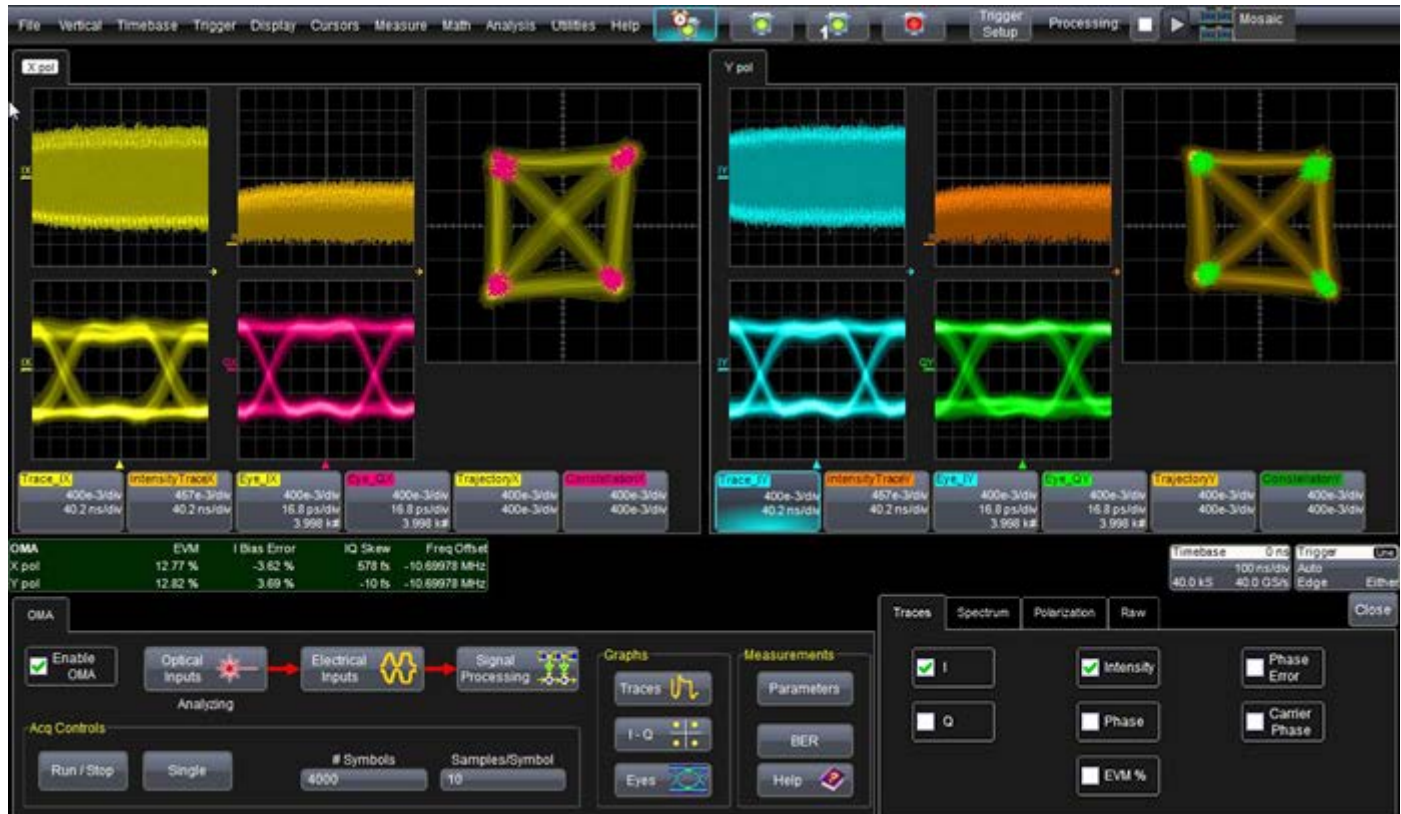

Several visualizations for a QPSK Dual-Pol signal arranged in mosaic mode

Most of the standard LabMaster display features can also be applied to OMA graphs:

- Traces and eye diagrams can be moved to different grids simply by dragging-and-dropping the descriptor box onto the destination grid.

NOTE: The I-Q grid, which shows the constellation and trajectories, is an exception; other plots cannot be moved to this grid.

- Traces can be labeled with custom annotations using the Label feature or LabNotebook™.
- Display Persistence functions can be applied to OMA graphs to further enhance the visualization with color and dimension that illustrate the frequency of samples.

See the *LabMaster 10 Zi-A Operator's Manual* for more information about using persistence and other oscilloscope features on OMA data.

Optical Modulation Analyzer

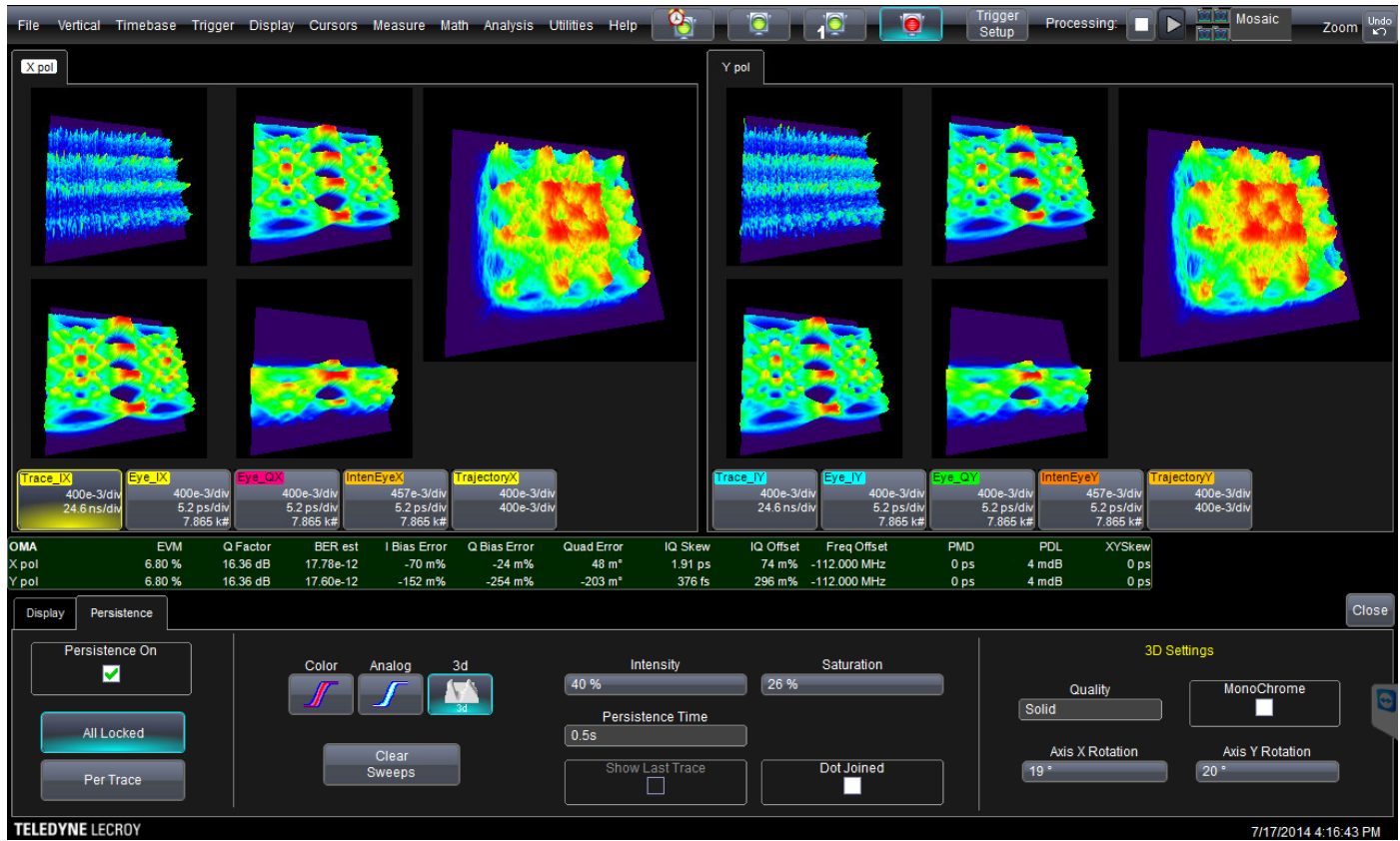

OMA display with 3D color persistence applied to highlight more frequently occurring samples

Traces

This set of visualizations shows time domain behavior of the input signals. The LabMaster Math functions allow further processing of the OMA trace data. See Applying Math Functions on p.52.

TRACE DISPLAY MODE

When in **Single** mode (selected at top-right corner of the menu bar), X and Y pols are each displayed in different tabs, as shown here:



In **Mosaic** mode these tabs are shown side by side:



TRACE SELECTION

Each trace can be turned on or off individually. The Traces dialogs also allow the display of **S1-S3** polarization data as well as **RAW** traces and calibration buffers output from the acquisition unit.

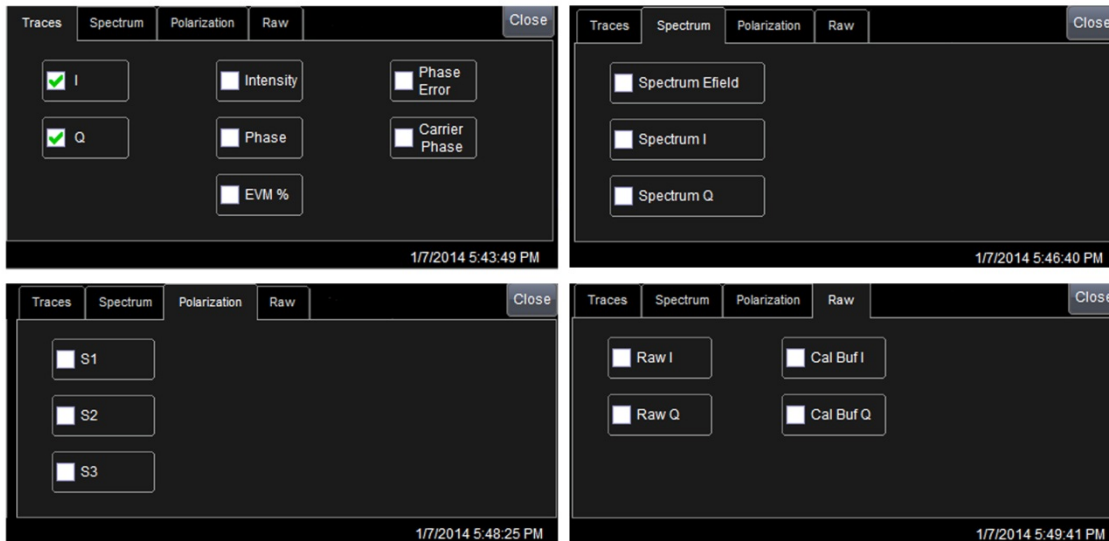

The various trace selection dialogs

Dialog	Trace Selector	Shows
Traces	I, Q	Output electric field after all DSP processing has been applied (i.e., dispersion compensation, polarization de-multiplexing, carrier recovery, and ambiguity resolution).
	Intensity	Magnitude of the electric field.
	Phase	Phase of the electric field. Units are in degrees.
	EVM%	Error vector as a percentage. See p.70 for details on how this value is computed.
	Phase Error	Estimated phase error. Units are in degrees.
	Carrier Phase	Estimated phase of the carrier wave. Units are in degrees.
Spectrum	Spectrum Efield	Power spectrum of the Efield. Units are in dB.
	SpectrumI, SpectrumQ	Power spectrum of the I and Q. Units are in dB.
Polarization	S1, S2, S3	Stokes parameters describing the state of polarization. Values range from 0 to 1.
Raw	RawI, RawQ	Output from the scope's front-end sampling system.
	CalBufI, CalBufQ	Traces used for calibrating the instrument.

I-Q

Touch the **I-Q button** to turn on/off **Trajectory** and **Constellation** diagrams. As with traces, these diagrams can be shown in Mosaic mode or Single mode.

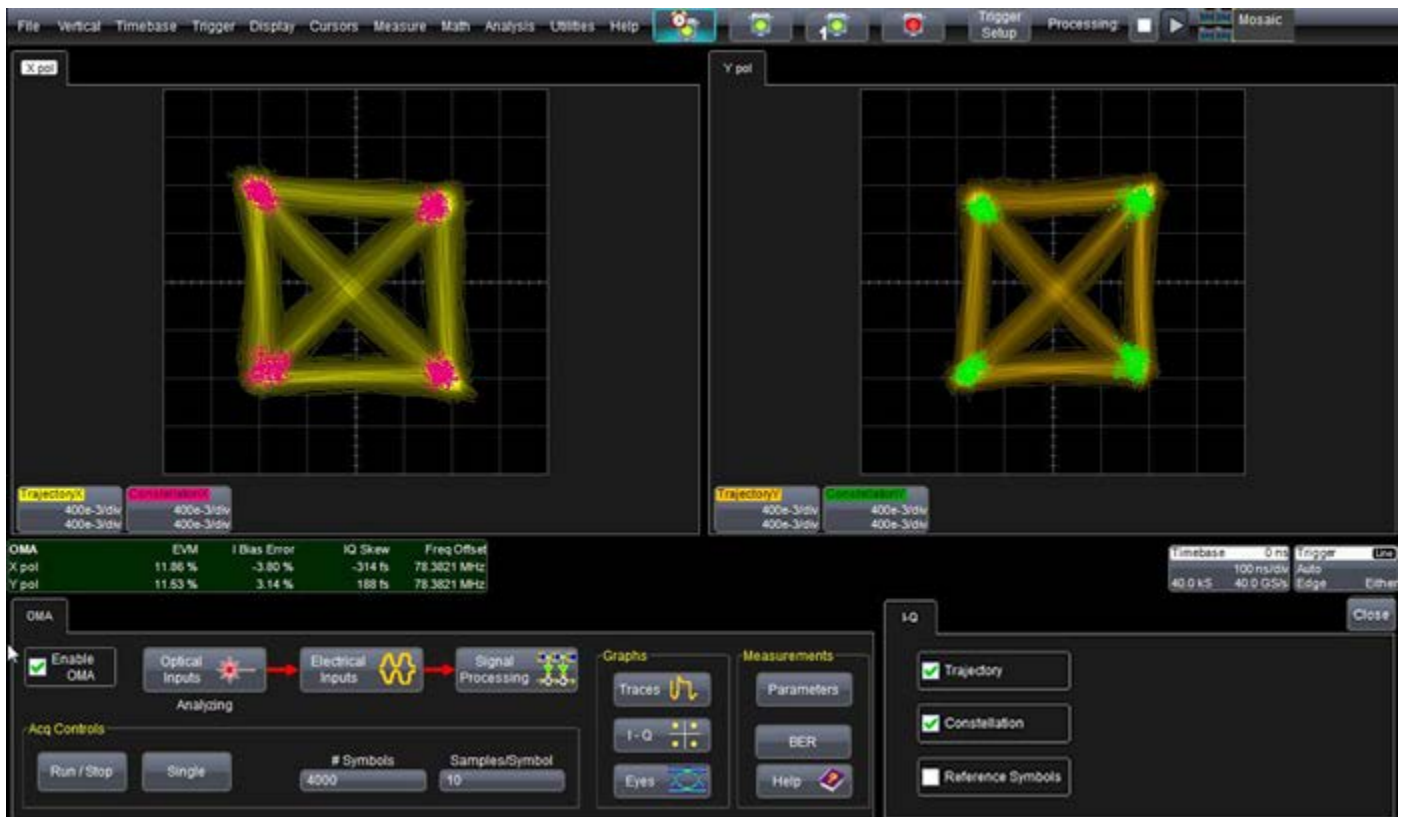

Constellation diagrams for a QPSK dual-Pol signal arranged in mosaic mode

The **Scale Factor** on the I-Q dialog controls how much area will be occupied by the plot inside the window.

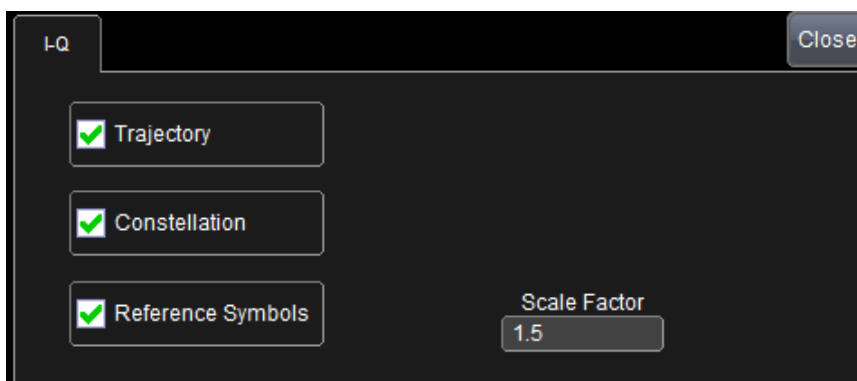

Eyes

Several eye diagrams are supported. Touch the **Eyes** button, then select the eye diagrams to compute from the Eyes subdialog.



I and Q eye diagrams for a QPSK dual-Pol signal arranged in mosaic mode

The **Scale Factor** controls how much area will be occupied by the plot inside the window. This is the same variable as for the I-Q plots and changing it will change their scale, too, and vice versa.

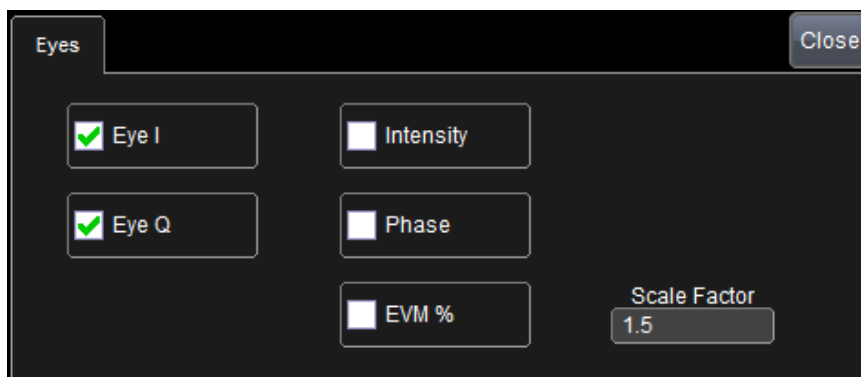

Measurements

Measurements allow you to access key metrics of interest in tabular form. When turned on, OMA measurements appear immediately below the display grid. Each measurement can be enabled/disabled separately. Up-to-12 measurements can be enabled at once.

Touch the **Parameters** button, then select from the Measurements and Meas. PolDemux subdialogs.

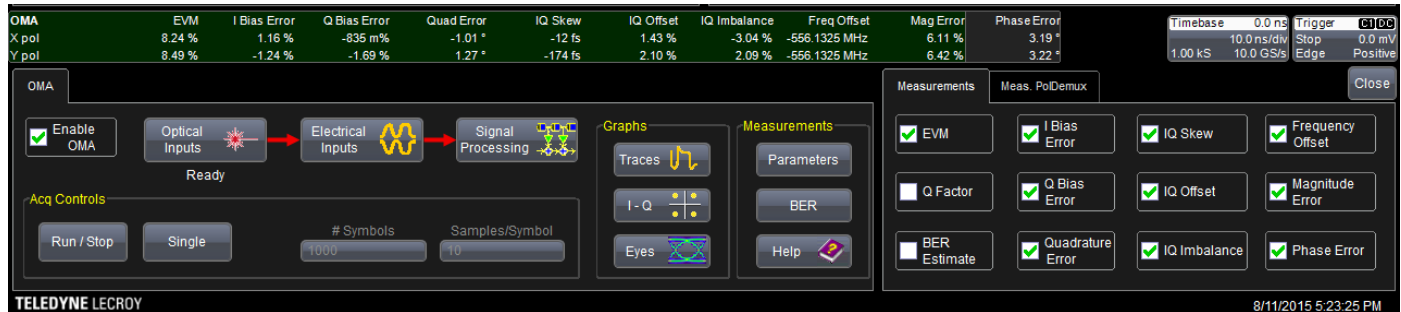

Parameters

These commonly used optical parameters can be measured on OMA traces. See Appendix 3: OMA Measurement Definitions on p.66 for information about how measurements are calculated.

NOTE: The PMD parameter is enabled only when the number of taps is set to greater than 1 in the Pol Demux setting.

Measurement	Shows
EVM	Magnitude of the error vector, which is the difference between the signal vector and the ideal reference vector.
Q Factor	An alternate representation of the signal-to-noise ratio, presented in dB.
BER Estimate	An instantaneous estimation of the bit error rate calculated from the Q Factor. A less time consuming alternative to actual bit counting.
I Bias Error	Center of the I component with reference to the ideal center point, presented as a percentage.
Q Bias Error	Center of the Q component with reference to the ideal center point, presented as a percentage.
IQ Quadrature Error	Phase error of the constellation points with respect to the ideal phase relationship between the constellation points.
IQ Skew	Time difference between the in-phase and quadrature crossing points in the eye diagrams.
IQ Skew C	Time difference between the in-phase and quadrature eyes based on their center. This measurement method provides better results for higher density modulation formats than the IQ Skew measurement above.

Measurement	Shows
IQ Offset	Center of the constellation with reference to the ideal center point, presented as a percentage.
IQ RF Imbalance	Ratio of the In-phase component versus the Quadrature component of the constellation points, presented as a percentage.
Frequency Offset	Frequency difference between the Transmitter laser and the OMA Local Oscillator.
Magnitude Error	The difference in amplitude between the reference symbol and the signal vector.
Phase Error	Phase difference between the signal vector and the ideal reference vector.
PMD	Polarization Mode Dispersion parameter calculated within the Polarization Demultiplexing Algorithm. Requires the selection of a Polarization De-multiplexing algorithm.
XY Skew	The difference between the X polarization and Y polarization symbol centers. Requires the selection of a Polarization De-multiplexing algorithm.
PDL	The Polarization Dependent Loss calculated within the Polarization Demultiplexing Algorithm, presented in dB. Requires the selection of a Polarization De-multiplexing algorithm.

Bit Error Rate (BER)

After the input signals are digitally processed, the OMA can create the bit stream that was optically modulated. This bit-stream can be viewed on the touch screen display grid (as a trace) or saved to a file for further analysis.

The OMA provides maximum flexibility in terms of how symbols can be mapped to bits. Several common symbol-to-bit encodings are built in. You can also define how reference symbols are one-to-one mapped to your own bit encodings. Once symbol-level encoding is done, the next step is to define how data can be found in individual I and Q channels. Several channel mappings are built in to support typical testing scenarios.

The recovered bit stream is then used to calculate bit error rate (BER). A range of Pseudo Random Bit Sequences (PRBS) are provided to support common cases. You can also define custom bit patterns.

Touch the **BER button** to access the BER subdialog group.

BER SETTINGS

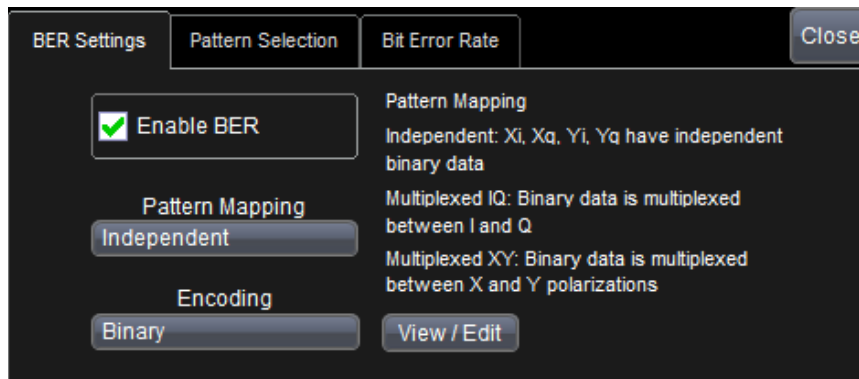

Control	Selection	Action/Description	Streams
Enable BER		Turns on/off BER functionality.	
Pattern Mapping	Independent	Xi, Xq, Yi and Yq are considered independent data streams. Yi and Yq will only be available in Dual Pol mode.	4
	MultiplexedIQ	XiXq and YiYq are considered two independent streams. We take bitsPerSymbol bits from Xi followed by the same number from Xq, back to bitsPerSymbol from Xi and so on. The same selection is applied to YiYq in dual Pol mode.	2
	MultiplexedXY	XiXqYiYq is considered a single stream. bitsPerSymbol bits are taken from each and concatenated in the same order to create the final bit array.	1
Encoding	(various)	See Appendix 4: Reference Symbols and Encodings on p.73. After selecting, touch View/Edit and if necessary modify the symbol-to-bit encoding.	

SYMBOL ENCODING

The OMA comes with a set of built-in encodings for the various modulation formats. Details of these can be found in Appendix 4: Reference Symbols and Encodings on p.73.

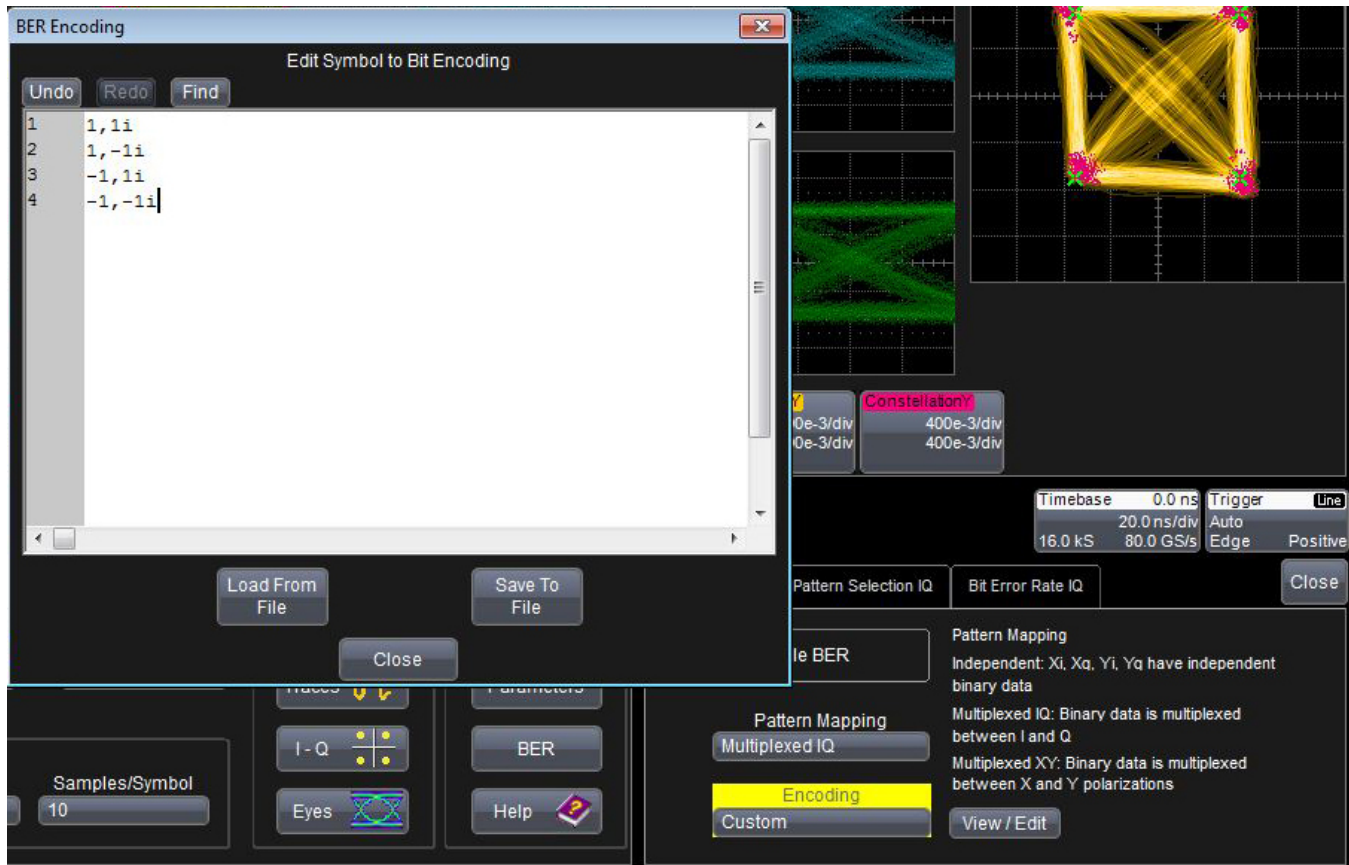

Custom BER encoding defined through Optical LinQ software.

You may input a **Custom** symbol-to-code map. Touch View/Edit and input your symbol codes one per line on the BER Encoding window. The order of these codes must match the custom reference symbols you input on the **Optical Inputs-> Modulation Type** dialog.

PATTERN SELECTION

Use the Pattern Selection subdialog to specify the pattern that comprises the incoming bit stream. A range of polynomials can be selected, as well as **Custom** patterns. Each output stream requires its pattern to be specified.

Xi, Xq, Yi, Yq have independent binary data

Pattern Xi:

Pattern Yi:

Pattern Xq:

Pattern Yq:

BIT ERROR RATE

Once patterns mapping and selection has been performed, the results can be seen on the Bit Error Rate subdialog. The number of rows in this table depends on how many output streams are present. A cumulative bit and error count is displayed which can be cleared using the **Reset** button.

A green checkmark in **Lock** indicates that the pattern was found in the incoming data stream and the BER is below 1 e-3.

	Lock	BER	Error Count	Total Bits
Xi	<input checked="" type="checkbox"/>	0	0	9.000e+3
Xq	<input checked="" type="checkbox"/>	0	0	9.000e+3
Yi	<input checked="" type="checkbox"/>	0	0	9.000e+3
Yq	<input checked="" type="checkbox"/>	0	0	9.000e+3
Xpol	<input checked="" type="checkbox"/>	0	0	18.000e+3
Ypol	<input checked="" type="checkbox"/>	0	0	18.000e+3
Total	<input checked="" type="checkbox"/>	0	0	36.000e+3

Using Custom MATLAB Scripts

The OMA user interface allows you to select custom algorithms specified in MATLAB™ for numerous processing functions.

NOTE: You must have MATLAB installed and running on the LabMaster in order to utilize custom algorithms.

Creating Custom Algorithms

An example template MATLAB.m file is installed on the LabMaster at: D:\Scripts

This file will guide you in setting up the input and output parameters.

Choosing Custom Algorithms

When you make a Custom selection for any of the Signal Processing algorithms, the parameter input subdialogs provide access to the MATLAB Editor window. From there, you can navigate to and load a MATLAB script file, or begin scripting in the editor window.



Custom scripts written in MATLAB™ can be called from within the OMA software

Using X-Stream Browser

The LabMaster is installed with an application called X-Stream Browser™ that can be used to access data that may not be shown on the OMA dialogs: for example, DSP tap values, as shown below. To open X-Stream Browser:

1. Choose **File > Minimize** to show the LabMaster Windows desktop.
2. Double-click the **X-Stream Browser** icon.
3. In the X-Stream Browser window, click the top left icon to connect to the local oscilloscope application.

Navigating to OMA will show the data corresponding to the current state of the OMA software. Some values can be changed from within this application by right clicking and entering new data. The LabMaster automatically shows the updated results.

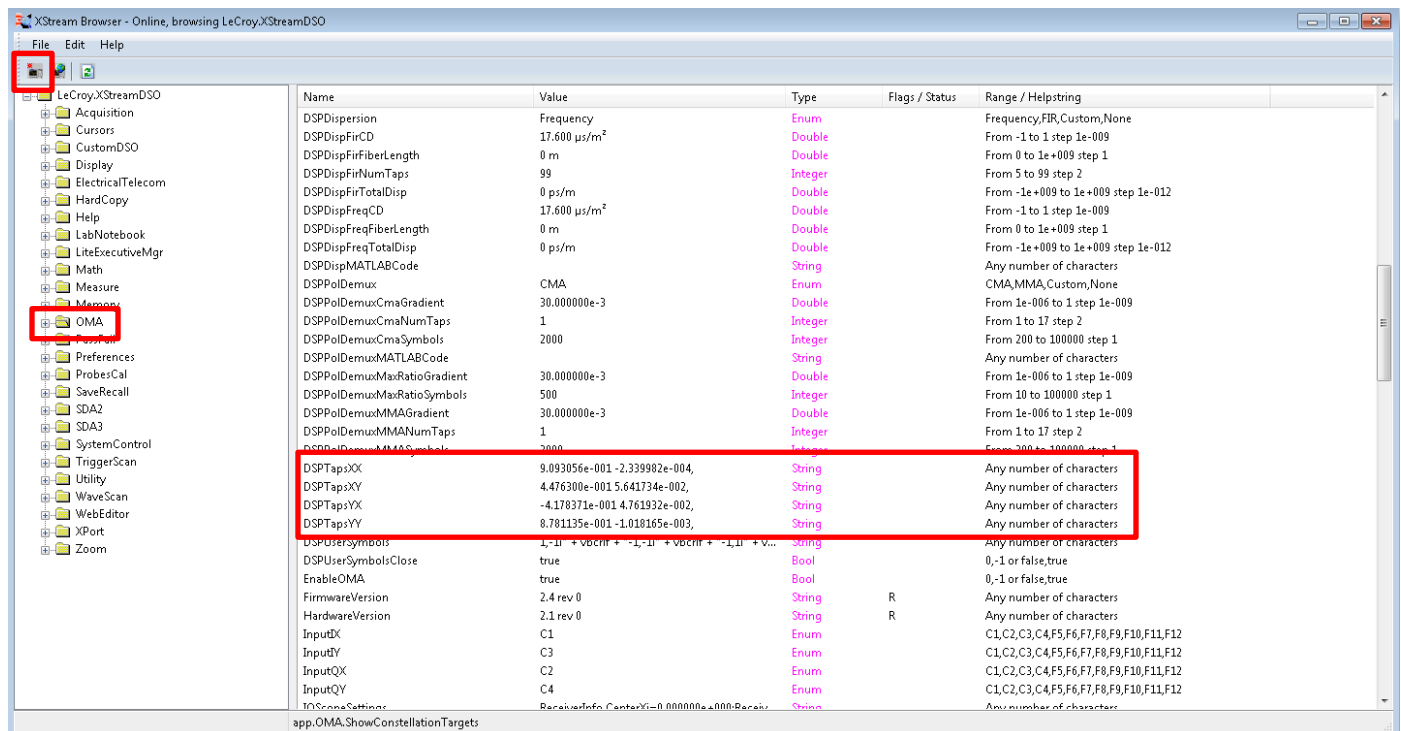

X-Stream Browser window after selecting OMA application shows the state of internal variables

Applying Math and Measurements to OMA Data

The OMA functions are completely integrated with the other LabMaster functions, allowing you to apply extensive analysis features to OMA data.

See the *LabMaster 10 Zi-A Operator's Manual* for instructions on using Math and Measurement features.

Applying Math Functions

The LabMaster Math functions can be operated on any of the OMA's data outputs. There are 12 math function slots available for use (F1 - F12). When a function is configured and turned on, a new Math trace appears on the display showing the result of the operation applied to the OMA data.

Choose **Math > Math Setup** from the menu bar, then open a function tab (Fx). Check **Trace On** to show the Math trace.

When selecting the function **Source**, navigate to the **Main > OMA** submenu and choose from the OMA output traces and data. Back on the Fx dialog, select the math **Operator** as usual.



Applying Measurements

Any of the LabMaster measurements can also be applied to any of the OMA's data outputs. There are 12 parameter slots available to use (P1 – P12). Measurements are added to a tabular display immediately below the waveform grids.

Choose **Measure > Measure Setup** from the menu bar. Be sure to check **Show Table** to display the measurement table, then open one of the parameter (Px) dialogs.

When selecting the parameter **Source**, navigate to the **Main > OMA** submenu and choose from the OMA output traces and data. Back on the Px dialog, select the **Measure(ment)** as usual.



You may optionally show measurement statistics in addition to the acquired values, or plot measurements over time using histograms, tracks, and trends.

Maintenance

Troubleshooting

The OMA can fail to display results if not configured correctly. Warning and error messages are shown in red at bottom of the LabMaster touch screen display. While these messages are self-explanatory, two common errors are discussed below to assist you with troubleshooting.

“OMA module not found!”

Check that the coherent receiver hardware unit is turned on and the USB cable is connected between it and the oscilloscope. The USB connection is mandatory for the device operation because the OMA software requires stored calibration data.

“OMA cal unsuccessful”

OMA calibration can fail due to a number of reasons. If this occurs:

- 1) Check the optical data transmitter is on.
- 2) Check that the wavelength of the laser (internal or external) matches that of the transmitter.
- 3) Check RAW traces in OMA to make sure that signal values are not clipped or too low. Some transmitters do not send stable signals right after they are powered on. Any RX calibration during this phase will fail as the signal may clip when out of range.

Another common failure mode is that calibration succeeds, but output eye and constellation diagrams are collapsed. This can happen for a number of reasons:

- Laser wavelength for the transmitter and receiver do not match.
- Laser (internal and external) power level is too low.
- Transmitter signals are not at the right power.
- Transmitter bias settings need adjusting. Please consult your transmitter’s manual to find out how to perform this operation.
- Modulation type set on the Optical Inputs dialog is different from the actual signal input to the system.
- Symbol rate set on the Optical Inputs dialog is not correct.

Technical Support

Live Support

Registered users can contact their regional Teledyne LeCroy service center at the number listed on our website.

Resources

Teledyne LeCroy publishes a free Technical Library on its website. Manuals, tutorials, application notes, white papers, and videos are available to help you get the most out of your Teledyne LeCroy products.

The Datasheet published on the product page contains the detailed product specifications. Oscilloscope System Recovery Tools and Procedures contains instructions for using the Acronis® True Image® Home recovery application included with the instrument.

You can also submit Technical Support requests via the website at:

teledynelecroy.com/support/techhelp

Service Centers

For a complete list of offices by country, including our sales & distribution partners, visit:

teledynelecroy.com/support/contact

Teledyne LeCroy
700 Chestnut Ridge Road
Chestnut Ridge, NY, 10977, USA
teledynelecroy.com

Sales and Service:

Ph: 800-553-2769 / 845-425-2000
FAX: 845-578-5985
contact.corp@teledynelecroy.com

Support:

Ph: 800-553-2769
customersupport@teledynelecroy.com

Returning a Product

Contact your local Teledyne LeCroy service center for calibration or other service. If the product cannot be serviced on location, the service center will give you a **Return Material Authorization (RMA)** code and instruct you where to ship the product. All products returned to the factory must have an RMA.

Return shipments must be prepaid. Teledyne LeCroy cannot accept COD or Collect shipments. We recommend air-freighting. Insure the item you're returning for at least the replacement cost.

1. Remove all accessories from the device.
2. Pack the product in its case, surrounded by the original packing material (or equivalent). Do not include the manual.
3. Label the case with a tag containing:
 - The RMA
 - Name and address of the owner
 - Product model and serial number
 - Description of failure or requisite service
4. Pack the product case in a cardboard shipping box with adequate padding to avoid damage in transit.
5. Mark the outside of the box with the shipping address given to you by Teledyne LeCroy. Be sure to add the following:
 - ATTN: <RMA code assigned by Teledyne LeCroy>
 - FRAGILE
6. **If returning a product to a different country:**
 - Mark the shipment as a "Return of US manufactured goods for warranty repair/recalibration."
 - If there is a cost for the service, list the cost in the Value column and the original purchase price "For insurance purposes only."
 - Be very specific about the reason for shipment. Duties may have to be paid on the value of the service.

Extended warranty, calibration, and upgrade plans are available for purchase. Contact your Teledyne LeCroy sales representative.

Warranty

THE WARRANTY BELOW REPLACES ALL OTHER WARRANTIES, EXPRESSED OR IMPLIED, INCLUDING BUT NOT LIMITED TO ANY IMPLIED WARRANTY OF MERCHANTABILITY, FITNESS, OR ADEQUACY FOR ANY PARTICULAR PURPOSE OR USE. TELEDYNE LECROY SHALL NOT BE LIABLE FOR ANY SPECIAL, INCIDENTAL, OR CONSEQUENTIAL DAMAGES, WHETHER IN CONTRACT OR OTHERWISE. THE CUSTOMER IS RESPONSIBLE FOR THE TRANSPORTATION AND INSURANCE CHARGES FOR THE RETURN OF PRODUCTS TO THE SERVICE FACILITY. TELEDYNE LECROY WILL RETURN ALL PRODUCTS UNDER WARRANTY WITH TRANSPORT PREPAID.

The product is warranted for normal use and operation, within specifications, for a period of three years from shipment. Teledyne LeCroy will either repair or, at our option, replace any product returned to one of our authorized service centers within this period. However, in order to do this we must first examine the product and find that it is defective due to workmanship or materials and not due to misuse, neglect, accident, or abnormal conditions or operation.

The instrument's firmware has been thoroughly tested and is presumed to be functional. Nevertheless, it is supplied without warranty of any kind covering detailed performance.

Teledyne LeCroy shall not be responsible for any defect, damage, or failure caused by any of the following: a) attempted repairs or installations by personnel other than Teledyne LeCroy representatives or b) improper connection to incompatible equipment, or c) for any damage or malfunction caused by the use of non-Teledyne LeCroy supplies. Furthermore, Teledyne LeCroy shall not be obligated to service a product that has been modified or integrated where the modification or integration increases the task duration or difficulty of servicing the instrument. Spare and replacement parts, and repairs, all have a 90-day warranty.

Products not made by Teledyne LeCroy are covered solely by the warranty of the original equipment manufacturer.

Certifications

Teledyne LeCroy certifies compliance to the following standards as of the time of publication. See the *EC Declaration of Conformity* shipped with your product for the current certifications.

EMC Compliance

EC DECLARATION OF CONFORMITY- EMC

The Optical Modulation Analyzer system meets intent of EC Directive 2014/30/EU for Electromagnetic Compatibility. Compliance was demonstrated to the following specifications listed in the Official Journal of the European Communities:

EN 61326-1:2013, EN 61326-2-1:2013 EMC requirements for electrical equipment for measurement, control, and laboratory use. ¹

Electromagnetic Emissions:

EN 55011:2010, Radiated and Conducted Emissions Group 1, Class A ²³

EN 61000-3-2/A2:2009 Harmonic Current Emissions, Class A

EN 61000-3-3:2008 Voltage Fluctuations and Flickers, Pst = 1

Electromagnetic Immunity:

EN 61000-4-2:2009 Electrostatic Discharge, 4 kV contact, 8 kV air, 4 kV vertical/horizontal coupling planes ⁴

EN 61000-4-3/A2:2010 RF Radiated Electromagnetic Field, 3 V/m, 80-1000 MHz; 3 V/m, 1400 MHz-2 GHz; 1 V/m, 2 GHz - 2.7 GHz

EN 61000-4-4/A1:2010 Electrical Fast Transient/Burst, 1 kV on power supply lines, 0.5 kV on I/O signal data and control lines ⁴

EN 61000-4-5:2006 Power Line Surge, 1 kV AC Mains, L-N, L-PE, N-PE ⁴

EN 61000-4-6:2009 RF Conducted Electromagnetic Field, 3 Vrms, 0.15 MHz - 80 MHz

EN 61000-4-11:2004 Mains Dips and Interruptions, 0%/1 cycle, 70%/25 cycles, 0%/250 cycles ⁴⁵

1. To ensure compliance with all applicable EMC standards, use high-quality shielded interface cables.
2. Emissions which exceed the levels required by this standard may occur when the instrument is connected to a test object.
3. This product is intended for use in nonresidential areas only. Use in residential areas may cause electromagnetic interference.
4. Meets Performance Criteria "B" limits of the respective standard: during the disturbance, product undergoes a temporary degradation or loss of function or performance which is self-recoverable.
5. Performance Criteria "C" applied for 70%/25 cycle voltage dips and 0%/250 cycle voltage interruption test levels per EN61000-4-11.

European Contact:*

Teledyne LeCroy Europe GmbH
Im Breitspiel 11c
D-69126 Heidelberg, Germany
Tel: + 49 6221 82700

AUSTRALIA & NEW ZEALAND DECLARATION OF CONFORMITY– EMC

The Optical Modulation Analyzer system complies with the EMC provision of the Radio Communications Act per the following standards, in accordance with requirements imposed by Australian Communication and Media Authority (ACMA):

AS/NZS CISPR 11:2011 Radiated and Conducted Emissions, Group 1, Class A.

Australia / New Zealand Contacts:*

RS Components Pty Ltd.
Suite 326
The Parade West
Kent Town, South Australia 5067

RS Components Ltd.
Unit 30 & 31 Warehouse World
761 Great South Road
Penrose, Auckland, New Zealand

*Visit teledynelecroy.com/support/contact for the latest contact information.

Safety Compliance**EC DECLARATION OF CONFORMITY– LOW VOLTAGE**

The Optical Modulation Analyzer system meets intent of EC Directive 2006/95/EC for Product Safety. Compliance was demonstrated to the following specifications as listed in the Official Journal of the European Communities:

EN 61010-1:2010 Safety requirements for electrical equipment for measurement, control, and laboratory use – Part 1: General requirements

EN 61010-2:030:2010 Safety requirements for electrical equipment for measurement, control, and laboratory use – Part 2-030: Particular requirements for testing and measuring circuits

The design has been verified to conform to the following limits put forth by these standards:

- Mains Power Supply Circuits: Overvoltage Category II, instrument intended to be supplied from the building wiring at utilization points (socket outlets and similar).
- Measuring Circuit Terminals: No rated measurement category. Terminals not intended to be directly connected to the mains supply.
- Unit: Pollution Degree 2, operating environment where normally only dry, non-conductive pollution occurs. Temporary conductivity caused by condensation should be expected.

U.S. NATIONALLY RECOGNIZED AGENCY CERTIFICATION

The LabMaster LM 10-36Zi-A & LM 10-65Zi-A acquisition modules and MCM-Zi-A control module have been certified by Underwriters Laboratories (UL) to conform to the following safety standard and bear the UL Listing Mark:

UL 61010-1 Third Edition – Safety standard for electrical measuring and test equipment.

This certification does not apply to the IQS25, IQS42, or IQS70 coherent receiver.

Optical Modulation Analyzer

CANADIAN CERTIFICATION

The LabMaster LM 10-36Zi-A, LM 10-65Zi-A acquisition modules and MCM-Zi-A control module have been certified by Underwriters Laboratories (UL) to conform to the following safety standard and bear the cUL Listing Mark:

CAN/CSA-C22.2 No. 61010-1-12. Safety requirements for electrical equipment for measurement, control and laboratory use.

This certification does not apply to the IQS25, IQS42, or IQS70 coherent receiver.

Environmental Compliance

END-OF-LIFE HANDLING



The Optical Modulation Analyzer instruments are marked with this symbol to indicate that they comply with the applicable European Union requirements to Directives 2012/19/EU and 2013/56/EU on Waste Electrical and Electronic Equipment (WEEE) and Batteries.

The instruments are subject to disposal and recycling regulations that vary by country and region. Many countries prohibit the disposal of waste electronic equipment in standard waste receptacles. For more information about proper disposal and recycling of your Teledyne LeCroy product, please visit teledynelecroy.com/recycle.

RESTRICTION OF HAZARDOUS SUBSTANCES (RoHS)

The Optical Modulation Analyzer instruments and their accessories conform to the 2011/65/EU RoHS2 Directive.

FDA Certification

The IQS25, IQS42 and IQS70 coherent receivers comply with 21 CFR 1040.10 and 1040.11 except for deviations pursuant to laser notice no.50, dated June 24, 2007.

ISO Certification

Manufactured under an ISO 9000 Registered Quality Management System.

Appendix 1: OMA Calibration

The OMA system is calibrated at various stages to enable highly accurate signal measurements.

Coherent Receiver Factory Calibrations

- Skew between output channels of the coherent receiver including external cables
- Frequency Response of the coherent receiver
- Temperature dependence of the coherent receiver

Full System Factory Calibrations

- X-pol and Y-pol channel balance of the complete system, including the oscilloscope

Manual Calibrations

- LabMaster ChannelSync (deskew) calibration

Dynamic Calibrations

- LabMaster temperature-dependent calibration (± 5 °C factory calibration temperature)
- OMA software calibrations prior to each signal measurement. These dynamic calibrations include:
 - Voltage scale optimization
 - I & Q channel imbalance correction
 - Offset removal between all channels
 - Channel deskew (fine-tuning in sub-ps scale, to line up sampling points)

Appendix 2: OMA Algorithms

Dispersion Compensation

Dispersion is the process by which the different EM waves in the fiber travel at different speeds. The dispersion can originate from various different sources, such as material dispersion, waveguide dispersion, modal dispersion and polarization mode dispersion.

Chromatic dispersion refers to the effect where different wavelengths travel at different speeds. It results from two different sources, material dispersion and waveguide dispersion, but as chromatic dispersion is usually measured as a single resultant parameter, the two sources are not often mentioned or discussed.

In practice, chromatic dispersion is treated as the main linear dispersion for signals traveling in a single-mode fiber (SMF) and polarization mode dispersion is treated as the main non-linear dispersion. Uncorrected fiber dispersion distorts the optical signal and it needs to be corrected for to obtain the transmitted signal information.

$$H(f) = e^{i \frac{(2\pi f)^2 d^2 \beta / df^2}{2}}$$

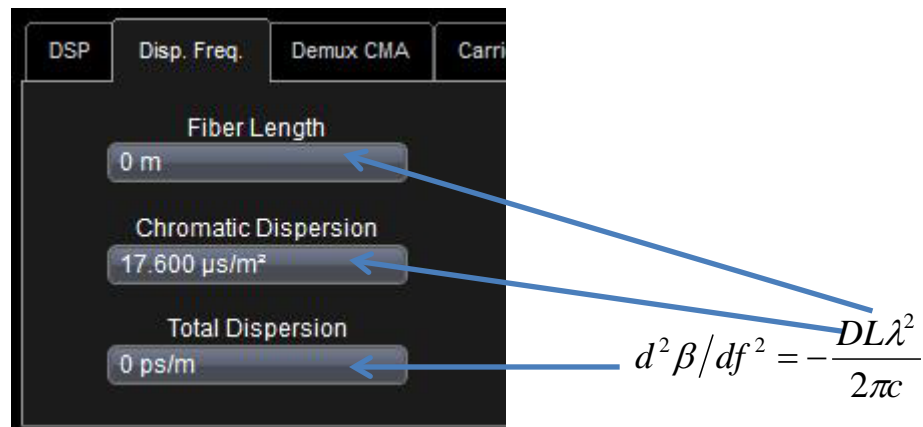

OMA parameters for correcting chromatic dispersion

Chromatic Dispersion (CD) is a linear process, and it can be compensated by applying the opposite dispersion in either the frequency domain (FFT), or the time domain (FIR).

- Frequency domain CD compensation involves the use of FFT and inverse FFT. There is no restriction on the amount of dispersion that can be compensated.
- Time domain CD compensation uses finite impulse response to rearrange the dispersed signal within the tab window. The amount of dispersion which can be compensated for is restricted by the number of tabs used, but this technique is more computationally efficient (no need to FFT). This is the technique often used in ASIC due to its efficiency.

Polarization De-multiplexing

The term polarization refers to the directional plane that the Electromagnetic (EM) wave (carrier wave) oscillates in.

Two EM waves can be made to propagate along the same fiber by combining them with a 90 degree difference in polarization (orthogonal polarization states or modes, A_x and A_y). Each of these orthogonal polarization states can carry data (e.g. QPSK, QAM) that is independent of the other, effectively doubling the amount of information transmitted over the same fiber. A single mode fiber (SMF) can carry two orthogonal optical modes (A_x and A_y) which may rotate as it propagates (while maintaining their orthogonality). As these modes travel through SMF, they rotate and experience different propagation delays through the fiber due to fiber birefringence. These effects cannot easily be predicted since they are dependent on stresses and strains on different parts of the fiber.

NOTE: A specially designed type of fiber known as polarization maintaining (PM) fiber does not allow the polarization to rotate so that the light exits fiber at a known polarization state.

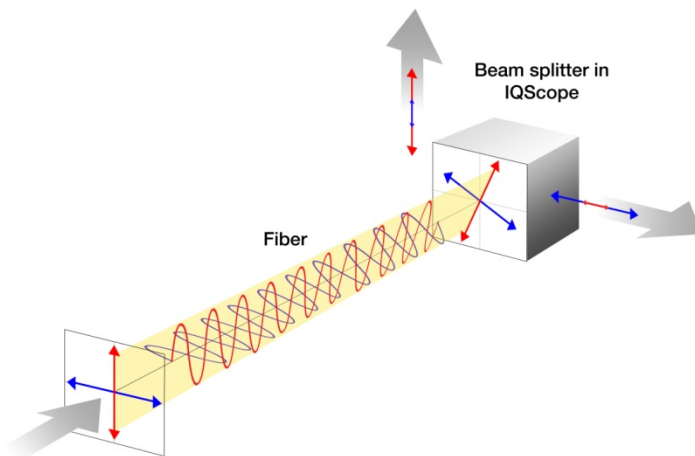

$$E(t) = \vec{A}_X(t)e^{i(kz-2\pi ft)} + \vec{A}_Y(t)e^{i(kz-2\pi ft)}$$

One of the most common Polarization De-multiplexing Algorithm is Constant Modulus Algorithm (CMA). The algorithm takes advantage of the fact that all QPSK symbols have same amplitude (constant modulus) when they are polarization de-multiplexed. It is an iterative algorithm that uses time-domain taps to bring back signal components shifted in time due to PMD, (PMD correction) while re-distributing the mixed X and Y signal components. Here the **Gradient** controls the speed and accuracy of the adaptation and **Symbols** is the length of training set and **Num Taps** refer to the number of taps in the equalization filter.

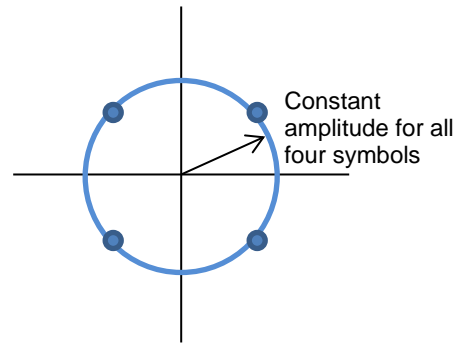
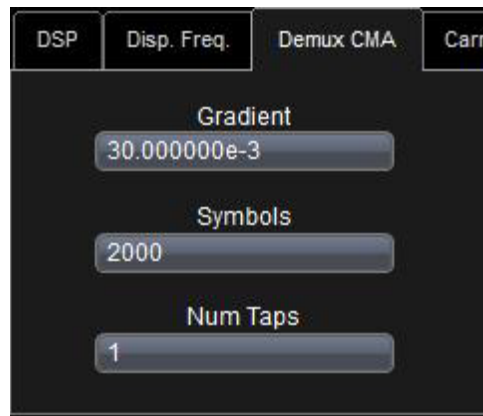

OMA parameters for polarization de-multiplexing

Frequency Estimation

Since the OMA is based on Heterodyne Detection (Laser on Transmitter is not *exactly* the same laser on IQScope-RT), there will be a small frequency offset between the lasers. The frequency offset results in the rotation of the constellation plot. The DSP scans the entire range of frequency offset and finds the value which gives the minimum error. The DSP automatically corrects this frequency offset. The maximum frequency offset that the DSP can handle is 10% of the baud rate.

For more information on the frequency offset compensation technique, please refer to:

Y. Wang, E. Serpedin and P.Ciblat. "Non-Data Aided Feedforward Estimation of PSK-Modulated Carrier Frequency Offset", In IEEE International Conference on Communications 2002, Volume 1, pp.192-196.

Phase Estimation

Lasers are not spectrally pure and they have random phase noise that needs to be corrected. The phase estimate technique commonly used in wireless transmission is called "Viterbi & Viterbi". It finds the average phase error between an ideal symbol on a group of symbols and corrects for it. If the number of symbols is too low, you will get over-correction. For example, if only one symbol is used, its offset from the ideal location on the I-Q plane will be considered to be the average, and the symbol will be shifted to the ideal position when the average phase error is corrected.

The frequency estimate and phase estimate algorithms can be performed on each polarization independently or you can speed up the processing time by assuming that they are identical for each state of polarization for dual polarization signals originating from a single laser source (**Pols Separately** checkbox).

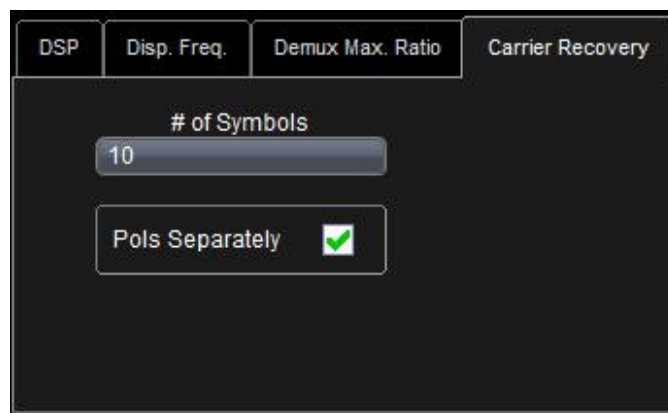

OMA parameters for phase estimation

For more information on phase noise correction, please refer to:

A. Viterbi. "Nonlinear estimation of PSK-modulated carrier phase with application to burst digital transmission", In IEEE transactions on Information Theory, 1983, Volume 29, Issue 4, pp.543-551.

Appendix 3: OMA Measurement Definitions

I and Q Bias Offset

The bias offset is a measure of how far the center of the constellation is with respect to the ideal center point. For QPSK and QAM modulation formats, the ideal center point is [0, 0] (I, Q). It is more convenient to represent the bias errors in percentages since this makes it independent of the average optical power.

Additionally, the bias error can be separated into orthogonal components (I and Q) as shown in Equation 1 to help identify the origin of the bias error. Since the electrical to optical transfer function of optical modulators is typically non-linear, a 5% bias offset as measured in the optical domain may not necessarily correspond to a 5% error in bias voltage.

$$I_{bias_Error\%} = \frac{\Re(\text{centre})}{\Re(\text{reference})} \times 100$$

$$Q_{bias_Error\%} = \frac{\Im(\text{centre})}{\Im(\text{reference})} \times 100$$

Equation 1 - I and Q Bias offset calculations

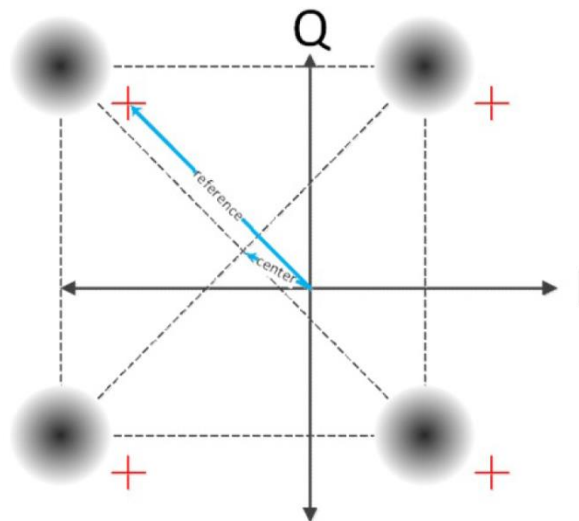

I and Q Bias offset for QPSK

IQ Offset

The IQ Offset is the shift in the center of the constellation points from the ideal location and is represented by the length of the Center vector as shown in the figure above.

IQ Quadrature Error

The quadrature error is a measure of the phase error of the constellation points with respect to the ideal phase relationship between the constellation points. For QPSK and QAM modulation formats, the ideal phase between the constellation points is 90°. The quadrature error is an average measurement taken over all the constellation points (Equation 2).

$$Quad_{Error} = \frac{\angle A - \angle B + \angle C - \angle D}{4}$$

Equation 2 - Quadrature error calculation

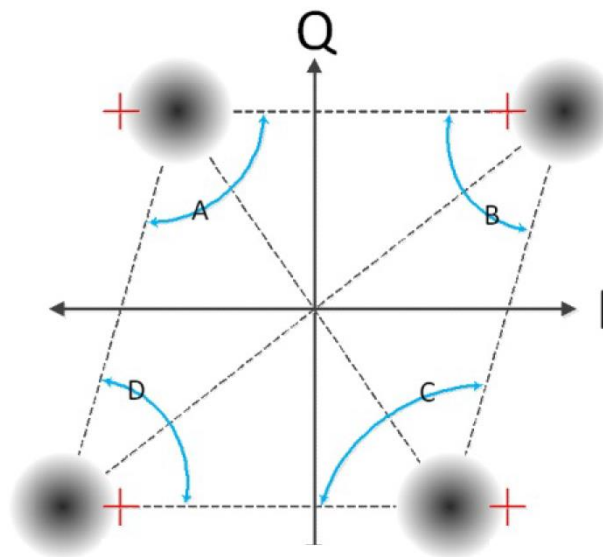

Quadrature error for QPSK

IQ Skew

The IQ skew is a measure of the time difference between the in-phase and quadrature crossing points in the eye diagrams as shown below.

$$Skew_{IQ}(s) = t_I(s) - t_Q(s)$$

Equation 3 - Skew timing calculation

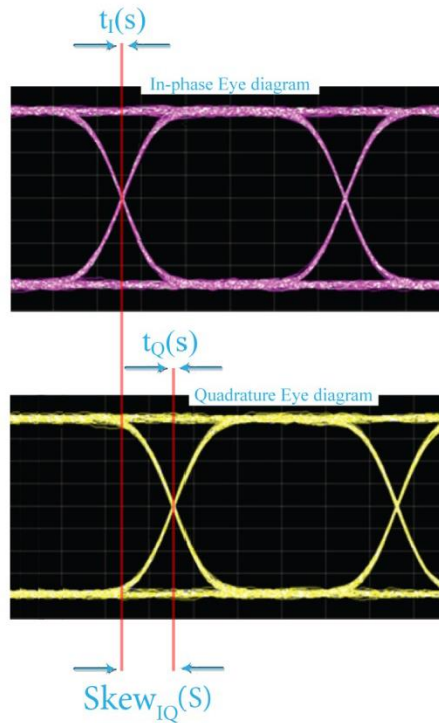

Eye diagrams of QPSK signal skew

IQ RF Imbalance

The IQ RF imbalance is the ratio of the In-phase component versus the Quadrature component of the constellation points. The ratio is represented as a percentage, so 10% IQ RF imbalance would mean that the In-phase component is 10% larger than the Quadrature component.

$$IQ_{\text{Imbalance}} \% = \left(\frac{|B|}{|A|} - 1 \right) \times 100$$

Equation 4 - IQ RF imbalance calculation

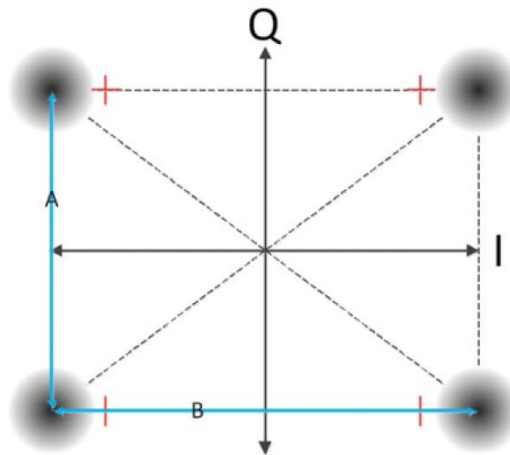

IQ RF imbalance for QPSK

Error Vector Magnitude

The error vector magnitude is the magnitude of the error vector, which is the difference between the signal vector and the ideal reference vector. It is more convenient to represent the EVM as a percentage such that it is unaffected by the average signal power (Equation 5). The numerical value displayed as EVM in the software is the RMS of all the symbols captured during that acquisition.

$$EVM\% = \frac{|signal-reference|}{|reference|} \times 100$$

Equation 5 - Error vector magnitude calculation

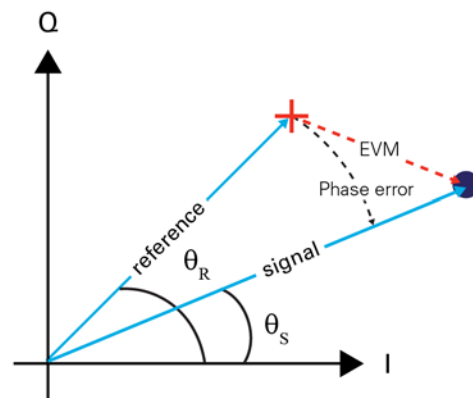

Error vector magnitude, single sample point

Magnitude Error

The magnitude error is the difference in amplitude between the reference symbol and the signal vector, as shown in Equation 6. The numerical value displayed as Magnitude Error in the software is the RMS of all the symbols captured during that acquisition.

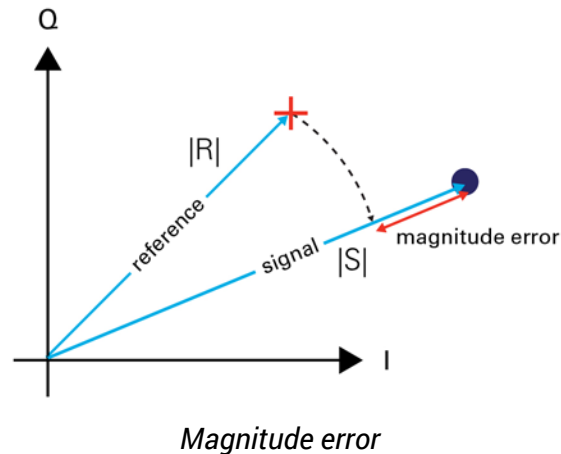

$$\text{Magnitude Error} = |S| - |R|$$

$$\text{Magnitude Error}_{RMS} = \sqrt{\frac{1}{N} (\text{Magnitude Error}_1^2 + \text{Magnitude Error}_2^2 \dots + \text{Magnitude Error}_N^2)}$$

Equation 6 – Magnitude error calculation

PMD

The Polarization Mode Dispersion parameter is calculated within the Polarization Demultiplexing Algorithm. The resolution of this measurement is determined by the number of samples per baud.

$$PMD = \frac{(\text{MaxTapIndex}_X - \text{MaxTapIndex}_{XY})}{\text{SampleRate_Hz}}$$

Equation 7 - Polarization Mode Dispersion calculation

where MaxTapIndex parameter is the index of the highest FIR filter tap used within the CMA/MMA algorithm.

PDL

The Polarization Dependent Loss is calculated within the Polarization Demultiplexing Algorithm and its value is presented in dB. The resolution of this measurement is determined by the number of samples per baud.

$$PDL_{dB} = \left| 20 \log_{10} \left\{ \frac{|\max(Tap_{XX})| + |\max(Tap_{XY})|}{|\max(Tap_{YY})| + |\max(Tap_{YX})|} \right\} \right|$$

Equation 8 - Polarization Dependent Loss calculation

where max(Tap) gives the maximum of the corresponding array of tap values.

XY Skew

The skew between X and Y polarization signals is the difference between the X polarization and Y polarization symbol centers. It is calculated within the Polarization Demultiplexing Algorithm. The resolution of this measurement is determined by the number of samples per baud.

Q-Factor

Q-Factor is an alternate representation of the signal to noise ratio that is commonly used since its relationship with the BER is more intuitive. Q factor is often represented in dB.

$$Q \text{ factor} = \sqrt{\frac{3 \log_2 L}{L^2 - 1} \frac{2}{(EVM\%/100)^2 \log_2 2^{SpB}}}$$

Equation 9- Q-Factor calculation

$$Q \text{ factor}_{dB} = 20 \log_{10}(Q \text{ factor})$$

Equation 10- Q-Factor in dB

BER Estimate

The BER Estimate is calculated from the Q-factor through the relationship given by Equation 11. This provides an instantaneous estimation of the bit error rate to act as an alternative to actual BER counting, which can be time consuming.

$$BER_{est} = \frac{1 - \frac{1}{L}}{\log_2 L} \operatorname{erfc} \left(\frac{Q \text{ factor}}{\sqrt{2}} \right)$$

Equation 11 - BER estimate calculation

where erfc is the complimentary error function, which applies the assumption of Gaussian distribution of constellation points.

Appendix 4: Reference Symbols and Encodings

NOTE: The symbol values shown in the following table are normalized. When specifying custom symbols, you do not need to normalize the values as the OMA will do it automatically.

Modulation = On Off Keying (bitsPerSymbol=1)				
Index	Symbol	Encoding		
		Binary	Gray1	Gray2
0	0.0000	0		
1	1.4142	1		

Modulation = BPSK (bitsPerSymbol=2)				
Index	Symbol	Encoding		
		Binary	Gray1	Gray2
0	1	1		
1	-1	0		

Modulation = QPSK (bitsPerSymbol=2)				
Index	Symbol	Encoding		
		Binary (N/A)	Gray1	Gray2
0	$0.7071 - 0.7071i$		11	
1	$-0.7071 - 0.7071i$		01	
2	$-0.7071 + 0.7071i$		00	
3	$0.7071 + 0.7071i$		10	

Modulation = 8PSK (bitsPerSymbol=3)				
Index	Symbol	Encoding		
		Binary (N/A)	Gray1	Gray2
0	$1 + 0i$		000	
1	$0.7071 + 0.7071i$		001	
2	$0 + 1i$		011	
3	$-0.7071 + 0.7071i$		010	
4	$-1 + 0i$		110	
5	$-0.7071 - 0.7071i$		111	
6	$0 - 1i$		101	
7	$0.7071 - 0.7071i$		100	

Modulation = 8QAM (bitsPerSymbol=3)				
Index	Symbol	Encoding		
		Binary	Gray1	Gray2
0	$0.577 + 0.577i$	110		
1	$-0.577 + 0.577i$	010		
2	$-0.577 - 0.577i$	011		
3	$0.577 - 0.577i$	111		
4	$1.155 + 0i$	101		
5	$-1.155 + 0i$	000		
6	$0 + 1.155i$	100		
7	$0 - 1.155i$	001		

Modulation = 16QAM (bitsPerSymbol=4)				
Index	Symbol	Encoding		
		Binary	Gray1	Gray2
0	$-0.316 - 0.316i$	0101	0101	0111
1	$0.316 - 0.316i$	1001	1101	1111
2	$0.316 + 0.316i$	1010	1111	1101
3	$-0.316 + 0.316i$	0110	0111	0101
4	$-0.9487 - 0.316i$	0001	0001	0011
5	$-0.316 - 0.9487i$	0100	0100	0110
6	$0.316 - 0.9487i$	1000	1100	1110
7	$0.9487 - 0.316i$	1101	1001	1011
8	$0.9487 + 0.316i$	1110	1011	1001
9	$0.316 + 0.9487i$	1011	1110	1100
10	$-0.316 + 0.9487i$	0111	0110	0100
11	$-0.9487 + 0.316i$	0010	0011	0001
12	$-0.9487 - 0.9487i$	0000	0000	0010
13	$0.9487 - 0.9487i$	1100	1000	1010
14	$0.9487 + 0.9487i$	1111	1010	1000
15	$-0.9487 + 0.9487i$	0011	0010	0000

Modulation = 32QAM (bitsPerSymbol=4)				
Index	Symbol	Encoding		
		Binary	Gray1	Gray2
0	-0.2234 - 0.2234i		01110	
1	0.2234 - 0.2234i		10010	
2	0.2234 + 0.2234i		10001	
3	-0.2234 + 0.2234i		01101	
4	-0.6708 - 0.2234i		01010	
5	-0.2234 - 0.6708i		01111	
6	0.2234 - 0.6708i		10011	
7	0.6708 - 0.2234i		10110	
8	0.6708 + 0.2234i		10101	
9	0.2234 + 0.6708i		10000	
10	-0.2234 + 0.6708i		01100	
11	-0.6708 + 0.2234i		01001	
12	-0.6708 - 0.6708i		01011	
13	0.6708 - 0.6708i		10111	
14	0.6708 + 0.6708i		10100	
15	-0.6708 + 0.6708i		01000	
16	-1.118 - 0.2234i		00110	
17	-0.2234 - 1.118i		00010	
18	0.2234 - 1.118i		11110	
19	1.118 - 0.2234i		11010	
20	1.118 + 0.2234i		11001	
21	0.2234 + 1.118i		11101	
22	-0.2234 + 1.118i		00001	
23	-1.118 + 0.2234i		00101	
24	-1.118 - 0.6708i		00111	
25	-0.6708 - 1.118i		00011	
26	0.6708 - 1.118i		11111	
27	1.118 - 0.6708i		11011	
28	1.118 + 0.6708i		11000	
29	0.6708 + 1.118i		11100	
30	-0.6708 + 1.118i		00000	
31	-1.118 + 0.6708i		00100	

Modulation = 64QAM (bitsPerSymbol=5)				
Index	Symbol	Encoding		
		Binary	Gray 1	Gray 2
0	-0.1543 - 0.1543i	011011	010010	
1	0.1543 - 0.1543i	100011	110010	
2	0.1543 + 0.1543i	100100	110110	
3	-0.1543 + 0.1543i	011100	010110	
4	-0.4630 - 0.1543i	010011	011010	
5	-0.1543 - 0.4630i	011010	010011	
6	0.1543 - 0.4630i	100010	110011	
7	0.4630 - 0.1543i	101011	111010	
8	0.4630 + 0.1543i	101100	111110	
9	0.1543 + 0.4630i	100101	110111	
10	-0.1543 + 0.4630i	011101	010111	
11	-0.4630 + 0.1543i	010100	011110	
12	-0.4630 - 0.4630i	010010	011011	
13	0.4630 - 0.4630i	101010	111011	
14	0.4630 + 0.4630i	101101	111111	
15	-0.4630 + 0.4630i	010101	011111	
16	-0.7715 - 0.1543i	001011	001010	
17	-0.1543 - 0.7715i	011001	010001	
18	0.1543 - 0.7715i	100001	110001	
19	0.7715 - 0.1543i	110011	101010	
20	0.7715 + 0.1543i	110100	101110	
21	0.1543 + 0.7715i	100110	110101	
22	-0.1543 + 0.7715i	011110	010101	
23	-0.7715 + 0.1543i	001100	001110	
24	-0.7715 - 0.4630i	001010	001011	
25	-0.4630 - 0.7715i	010001	011001	
26	0.4630 - 0.7715i	101001	111001	
27	0.7715 - 0.4630i	110010	101011	
28	0.7715 + 0.4630i	110101	101111	
29	0.4630 + 0.7715i	101110	111101	
30	-0.4630 + 0.7715i	010110	011101	
31	-0.7715 + 0.4630i	001101	001111	
32	-1.0801 - 0.1543i	000011	000010	

Modulation = 64QAM (bitsPerSymbol=5)				
33	-0.7715 - 0.7715i	001001	001001	
34	-0.1543 - 1.0801i	011000	010000	
35	0.1543 - 1.0801i	100000	110000	
36	0.7715 - 0.7715i	110001	101001	
37	1.0801 - 0.1543i	111011	100010	
38	1.0801 + 0.1543i	111100	100110	
39	0.7715 + 0.7715i	110110	101101	
40	0.1543 + 1.0801i	100111	110100	
41	-0.1543 + 1.0801i	011111	010100	
42	-0.7715 + 0.7715i	001110	001101	
43	-1.0801 + 0.1543i	000100	000110	
44	-1.0801 - 0.4630i	000010	000011	
45	-0.4630 - 1.0801i	010000	011000	
46	0.4630 - 1.0801i	101000	111000	
47	1.0801 - 0.4630i	111010	100011	
48	1.0801 + 0.4630i	111101	100111	
49	0.4630 + 1.0801i	101111	111100	
50	-0.4630 + 1.0801i	010111	011100	
51	-1.0801 + 0.4630i	000101	000111	
52	-1.0801 - 0.7715i	000001	000001	
53	-0.7715 - 1.0801i	001000	001000	
54	0.7715 - 1.0801i	110000	101000	
55	1.0801 - 0.7715i	111001	100001	
56	1.0801 + 0.7715i	111110	100101	
57	0.7715 + 1.0801i	110111	101100	
58	-0.7715 + 1.0801i	001111	001100	
59	-1.0801 + 0.7715i	000110	000101	
60	-1.0801 - 1.0801i	000000	000000	
61	1.0801 - 1.0801i	111000	100000	
62	1.0801 + 1.0801i	111111	100100	
63	-1.0801 + 1.0801i	000111	000100	

927295-00 Rev A
August, 2016



700 Chestnut Ridge Road
Chestnut Ridge, NY 10977
USA
www.teledynelecroy.com