

DATE:	LOCATION:
TYPE:	PROJECT:
CATALOG #:	

**FEATURES**

- Industrial design delivers a small, lightweight fixture for ease of installation
- Electrical architecture delivers industry leading efficiencies (up to 201 LPW) that translate into lowest life cycle cost
- Designed for ambient temperature settings from -30°C up to 55°C
- Offers lumen outputs up to 60,000 to accommodate various ceiling heights, fixture spacings, and application requirements
- Four optical distribution available to meet any design requirement
- Broad offering of integrated sensor options provide energy savings, code compliance, fixture grouping, and wireless connectivity
- Optimized bulk packaging to minimize job site space requirements and ease waste removal
- Uplight options available to illuminate ceiling above fixture

**ECHELÄN**



**SERVICE PROGRAM**

**QS15**

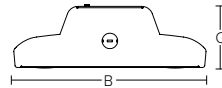

Typical Dimensions and Weights				
Sizes	(A) Length Inches	(B) Width Inches	(C) Height Inches	Weight (lbs)
1	13.75	10.88	3.46	10.0
2	27.30	10.88	3.60	20.0
3	27.30	15.58	3.60	22.0

\*Size dependent on Lumen code. See dimensions page.

**CONTROL TECHNOLOGY**



**SPECIFICATIONS**

**CONSTRUCTION**

- Fixture housing is a combination of steel and aluminum for exceptional durability and heat dissipation
- Fixture design provides easy access to electrical components by removal of bottom channel cover
- Robust white powder coating prevents chipping and/or flaking while providing protection in more demanding environments
- Access plate mounted on back of fixture providing easy access to make wiring connections
- Knockouts on both ends of fixture for electrical connection options

**OPTICS**

- Diffuse optic options, plus wide, narrow, and aisle light distributions to meet any application requirement
- Field changeable lens for maintenance and flexibility

**INSTALLATION**

- Mounting options include Chain/Cable mount, Surface mount, and Pendant mount

**ELECTRICAL**

- Light engine utilizing metal clad boards with high efficacy (up to 201 LPW), long life LEDs protect the fixtures lumen maintenance
- Driver options include 3kV standard surge protection in 120–277V input or 6kV standard surge protection in 347–480V input
- Power Factor >0.9 and THD <20 converts power efficiently and effectively into light
- Driver options for fixed light output or 0-10V dimming down to 10% is available to customize light levels

**CONTROLS**

- Integration of sensors (NX and Other) accomplished through knockout in bottom middle of fixture which eliminates fixture potentially blocking sensor
- High-end trim, occupancy and ambient light detection with dimming available
- NX Lighting Controls provides options for standalone and networked integrated sensor with wired or wireless connectivity for NX system deployments.
- NX Connect is a standalone wireless deployment for room based applications using wireless enabled and battery operated devices.
- DLC 5.1 LLC: Integrated/embedded networked lighting controls, luminaire-level lighting control (LLLC)

**CERTIFICATIONS**

- Emergency battery pack options are California Energy Commission (CEC) Title 20 compliant
- All luminaires are built to UL1598 standard
- Damp location labeling is standard
- UL/cUL Listed
- DLC® (DesignLights Consortium) Qualified. Please refer to the DLC® website for specific product qualifications at [www.designlights.org](http://www.designlights.org)
- Product configurations not including battery packs or controls meet federal procurement law requirements under the Trade Agreements Act (FAR 52.225-11). See [Buy America\(n\) Solutions](#)
- -BAA Option: This product meets federal procurement law requirements under the Buy American Act (FAR 52.225-9). See [Buy America\(n\) Solutions](#)

**WARRANTY**

- 5 year warranty. See [HLI Solutions Standard Warranty](#) for additional information.

**ORDERING GUIDE**

Gray Shading = Service Program Limit of 400 Luminaire **QS15**

Example: ECH1-840-L24-CW-ED-U-ST

CATALOG # \_\_\_\_\_

ECH1						
Model	CRI/CCT	Lumen Output	Optics	Driver	Voltage	Mounting
ECH1 High Performance High Bay	<b>740</b> 4000K 70 CRI	<b>L09</b> 9,000 lm	<b>CW</b> No Lens (120°)	<b>ED</b> 0-10V Dimming	<b>U<sup>6</sup></b> 120-277V	<b>ST</b> Standard
	<b>750</b> 5000K 70 CRI	<b>L12</b> 12,000 lm	<b>DW<sup>9</sup></b> Diffuse Optic Wide (120°)	<b>E</b> Fixed Output	<b>120</b> 120V	<b>SM</b> Surface Mount
	<b>830</b> 3000K 80 CRI	<b>L15</b> 15,000 lm	<b>DN<sup>9</sup></b> Diffuse Optic Narrow (55°)		<b>277</b> 277V	<b>PM</b> Pendant Mount
	<b>835</b> 3500K 80 CRI	<b>L18</b> 18,000 lm	<b>DA<sup>9</sup></b> Diffuse Optic Aisle (30°)		<b>347</b> 347V	
	<b>840</b> 4000K 80 CRI	<b>L24</b> 24,000 lm			<b>480</b> 480V	
	<b>850</b> 5000K 80 CRI	<b>L30</b> 30,000 lm				
	<b>935</b> 3500K 90 CRI	<b>L36</b> 36,000 lm				
	<b>940</b> 4000K 90 CRI	<b>L48</b> 48,000 lm				
		<b>L60</b> 60,000 lm				

Integrated Sensors (Leave Blank If None Needed)	
<b>NX Lighting Controls</b>	
<u>Networked Wireless</u>	
<b>NXW</b>	NX Networked Wireless Radio Module NXRM2 and Bluetooth Programming, without Sensor
<b>NXWHM</b>	NX Networked Wireless Enabled Integral NX SMP2-HMO PIR Occupancy Sensor with Automatic Dimming Photocell and Bluetooth Programming
<u>Networked Wired</u>	
<b>NXE</b>	NX Wired Dual RJ45 SmartPORTS, without Sensor
<b>NXEHM</b>	NX Wired Dual RJ45 SmartPORTS and Integral NX SMP2-HMO PIR Occupancy Sensor with Automatic Dimming Photocell and Bluetooth Programming
<u>Independent Control</u>	
<b>NXCHM</b>	NX Connect NXC-WHS20 Wireless High Bay Occupancy & Photocell Sensor <sup>8, 15</sup>
<b>WSPD360</b>	Integral WSP EMUNV PIR Occupancy Sensor with photocell and 360° Lens
<b>WSPDA</b>	Integral WSP EMUNV PIR Occupancy Sensor with Automatic Dimming Photocell and Aisle Lens
<b>WSPDBT360</b>	Bluetooth® Programmable, WSP DBEMUNV PIR Occupancy Sensor with Automatic Dimming Photocell and 360° Lens
<b>WSPDBTA</b>	Bluetooth® Programmable, WSP DBEMUNV PIR Occupancy Sensor with Automatic Dimming Photocell and Aisle Lens
<b>OS1360</b>	On/Off WASP2 Occupancy/Daylight Sensor, 1-relay, 360 lumens
<b>OS1A</b>	On/Off WASP2 Occupancy/Daylight Sensor, 1-relay, Aisle lens
<u>Other</u>	
<u>Independent Control</u>	
<b>OS</b>	On/Off Sensor 360° high mount sensor <sup>7</sup>
<b>OCS</b>	On/ Off Occupancy/ Daylight Sensor 360° high mount sensor <sup>7</sup>
<b>ODS</b>	Dimming Occupancy Sensor 360° high mount sensor <sup>7</sup>

Options (Leave Blank If None Needed)	
<b>PI</b>	Packaged Individually
<b>ELL20</b>	20W Emergency Battery Pack (CEC Title 20 Compliant) Installed <sup>1, 16</sup>
<b>ELL30</b>	30W Emergency Battery Pack (CEC Title 20 Compliant) installed <sup>17</sup>
<b>DTS</b>	Dimming Bypass Module <sup>2</sup>
<b>BAA</b>	Buy American Act (FAR 52.225-9) Compliant
<u>Cord Options</u>	
<b>F3C006</b>	6', 3 conductor cord
<b>F3C012</b>	12', 3 conductor cord
<b>F4C006</b>	6', 4 conductor cord (for ELL20 option)
<b>F4C012</b>	12', 4 conductor cord (for ELL20 option)
<b>F5C006</b>	6', 5 conductor cord (Line + dimming)
<b>F5C012</b>	12', 5 conductor cord (Line + dimming)
<u>Flexible Metal Conduit Options</u>	
<b>C00388</b>	6', 3 wire flexible metal conduit
<b>C00488</b>	6', 4 wire flexible metal conduit
<b>C00588</b>	6', 5 wire flexible metal conduit
<u>Cord with Plug Options (See NEMA Table Below)</u>	
<b>C6TL15</b>	6' Cord with 15A TL Plug (Only available when specifying discrete voltage codes 120 or 277) <sup>3</sup>
<b>C6TL20</b>	6' Cord with 20A TL Plug (Only available when specifying discrete voltage code 120, 277, 347 or 480) <sup>4</sup>
<b>C6P151</b>	6' Cord with 15A straight blade plug (Only available when specifying discrete voltage code 120, 277 or 347) <sup>5</sup>
<u>Specialty Modular Cord Sets</u>	
<b>LE</b>	ACS-MC Flex + 10ft 2EA 10-LW 277/480 # 16AWG <sup>14</sup>
<b>NE</b>	ACS-MC Flex + 10ft 2EA 12-LW 277/480 # 16AWG <sup>14</sup>
<u>Uplight (nominal lumens) <sup>10, 11, 12, 13</sup></u>	
<b>U1</b>	1000 lumens
<b>U2</b>	2000 lumens
<b>U3</b>	3000 lumens
<b>U4</b>	4000 lumens

Notes:

- ELL20 with 347/480V not available with mounting options SM and PM.
- DTS not available with 347/480V.
- Only available with 120V or 277V
- Only available with 120V, 277V, 347V or 480V
- Only available with 120V, 277V or 347V
- Cords/Plugs and Third Party Sensors not available with the U voltage code option
- Third party sensor are programmable and sensors are typically side mounted.
- NX Connect devices can be customized with the NX Connect app, available on the Apple® App Store. NX Connect sensors are typically bottom mounted.
- DW is polycarbonate, DN and DA are acrylic
- ST mounting option only
- For 347/480V contact factory
- Only available up to 48,000 lumens
- Uplight max ambient temperature = +40°C
- Only available with 277V or 480V
- High mount lens provided. For low, medium, or aisle distribution order appropriate lens accessory and field change
- To determine the lumen output in emergency mode, multiply the battery pack wattage by the fixture lumens per watt (LPW)
- Please consult factory on leadtime for this option

DATE:	LOCATION:
TYPE:	PROJECT:
CATALOG #:	

**ACCESSORY ORDERING GUIDE**

MOUNTING AND ACCESSORIES			
Mounting Options	Description	Configurable Order Logic Code	Accessories
<input type="checkbox"/> <b>Standard Chain/Cable Mount</b>	Available on all fixture configurations (chain not included). Y-Cable w/hook can be ordered as an accessory.	<b>ST</b> = Standard (No chain or mounting hardware included)	n/a
<input type="checkbox"/> <b>Surface Mount (optional)</b>	Available on all fixture configurations. Attaches to structural member in ceiling. (Hardware not included.)	<b>SM</b> = Surface Mount	SKU: 93165274 Description: 1/2" Surface Mounting Kit NOTE: Kit included two (2) brackets.
<input type="checkbox"/> <b>Pendant Mount (optional)</b>	Available on all fixture configurations. Attaches to 3/4" threaded conduit. (conduit not included).	<b>PM</b> = 3/4" Pendant Mount Kit	SKU: 93165273 Description: 3/4" Pendant Mounting Kit
<input type="checkbox"/> <b>Y-Cable w/hook (optional)</b>	Use with Standard Mounting Option only. Order separately. Priced per pair. 5 ft., 10 ft., 15 ft., 20 ft. lengths available	n/a	5' Y Cable/Hook: 93302310 10' Y Cable/Hook: 93302311 15' Y Cable/Hook: 93306699 20' Y Cable/Hook: 93306750
<input type="checkbox"/> <b>V-Clips w/ chains (optional)</b>	Use with Standard Mounting Option only. Order separately. Priced per pair. 3 ft. length chains included.	n/a	93146133G



WIRE GUARDS		
	Description	Ordering SKU
<input type="checkbox"/>	ECH-Size 1 WIRE GUARD WHT-5PK	93306751
<input type="checkbox"/>	ECH-Size 2 WIRE GUARD WHT-5PK	93306752
<input type="checkbox"/>	ECH-Size 3 WIRE GUARD WHT-5PK	93306753

Each pack contains wire guards that cover 5 fixtures of the size indicated

FIELD INSTALLABLE 20W BATTERY KITS*		
	Ordering SKU	ECH Body Size
<input type="checkbox"/>	93313452	Size 1
<input type="checkbox"/>	93313453	Size 2, Size 3

\*Emergency battery pack options are California Energy Commission (CEC) Title 20 compliant

NEMA PLUG TYPE TABLE			
Voltage	TL15 15A Twist Lock	TL20 20A Twist Lock	P151 15A Straight
120V	L5-15P	L5-20P	5-15P
277V	L7-15P	L7-20P	7-15P
347V	N/A	L24-20P	24-15P
480V	N/A	L8-20P	N/A

**FIELD CHANGEABLE NX-WHS20 SENSOR ACCESSORIES**



Ordering Sku	Ordering Cat# Logic	Description
93134999	NX- WHS20_LOW_LENS_KIT_10	Low Lens: 2.5m (8ft) - 10pk
93135001	NX- WHS20_MED_LENS_KIT_10	Med Lens: 6m (20ft) - 10pk
93135003	NX- WHS20_HIGH_LENS_KIT_10	High Lens: 12m (40ft) - 10pk
93134985	NX- WHS20_SNAP_AISLE_MASK_KIT_10	Snap on Aisle Mask

NOTE: See below for NX-WHS20 coverage patterns

**REPLACEMENT PARTS**

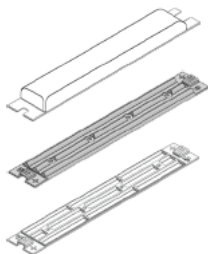

REPLACEMENT LENSES & OPTICS			
Ordering SKU	Ordering Cat# Logic	Fixture Optic Ordering Code	Description
93164585	ECH-WIDE DIFFUSED LENS KIT	DW	Diffuse Optic Wide (120°)
93164587	ECH-DN OPTIC KIT	DN	Diffuse Optic Narrow (55°)ractors in kit
93164588	ECH-DA OPTIC KIT	DA	Diffuse Optic Aisle (30°)

Body Size and number of lenses required:  
 Size 1 = 2 lens = 1 kit  
 Size 2 = 4 lens = 2 kits  
 Size 3 = 8 lens = 4 kits

**DELIVERED LUMENS**

DELIVERED LUMENS AND ELECTRICAL CHARACTERISTICS FOR ECH1								
Ordering Code			Delivered Lumens	120-277V		347/480V		Body
CRI/CCT	Lumen	Optic		Watts	LPW	Watts	LPW	
740 750	L09	DW	9,100	49	186	51	178	Size 1
	L12		12,100	66	183	68	178	
	L15		15,100	85	178	86	176	
	L18		18,200	106	172	104	175	
	L24		24,000	147	163	144	167	
	L30		30,000	168	179	170	176	
	L36		36,400	212	172	209	174	Size 2
	L48		48,000	294	163	289	166	
	L60		60,300	343	176	336	179	
830	L09	DW	8,500	53	160	56	152	Size 1
	L12		11,400	72	158	74	154	
	L15		14,300	94	152	93	154	
	L18		17,200	116	148	114	151	
	L24		22,600	164	138	161	140	
	L30		28,300	186	152	185	153	
	L36		34,300	232	148	229	150	Size 2
	L48		45,200	328	138	322	140	
	L60		56,700	380	149	372	152	
835	L09	DW	8,800	53	166	56	157	Size 1
	L12		11,900	72	165	74	161	
	L15		14,800	94	157	93	159	
	L18		17,800	116	153	114	156	
	L24		23,500	164	143	161	146	
	L30		29,300	186	158	185	158	
	L36		35,600	232	153	229	155	Size 2
	L48		46,900	328	143	322	146	
	L60		58,800	380	155	372	158	
840 850	L09	DW	9,100	53	172	56	163	Size 1
	L12		12,100	72	168	74	164	
	L15		15,100	94	161	93	162	
	L18		18,200	116	157	114	160	
	L24		24,000	164	146	161	149	
	L30		30,000	186	161	185	162	
	L36		36,400	232	157	229	159	Size 2
	L48		48,000	328	146	322	149	
	L60		60,300	380	159	372	162	
935	L09	DW	7,900	53	149	56	141	Size 1
	L12		10,600	72	147	74	143	
	L15		13,200	94	140	93	142	
	L18		15,900	116	137	114	139	
	L24		21,000	164	128	161	130	
	L30		26,200	186	141	185	142	
	L36		31,800	232	137	229	139	Size 2
	L48		41,900	328	128	322	130	
	L60		52,600	380	138	372	141	
940	L09	DW	8,100	53	153	56	145	Size 1
	L12		10,900	72	151	74	147	
	L15		13,500	94	144	93	145	
	L18		16,300	116	141	114	143	
	L24		21,500	164	131	161	134	
	L30		26,900	186	145	185	145	
	L36		32,600	232	141	229	142	Size 2
	L48		43,000	328	131	322	134	
	L60		53,900	380	142	372	145	

**DELIVERED LUMENS (CONTINUED)**

LUMEN OUTPUT MULTIPLIER FOR OPTIC ORDERING CODE		
Optic Ordering Code	Optic Description	Lumen Output Multiplier
CW	No Lens (120°)	108%
DW	Diffuse Optic Wide (120°)	100%
DN	Diffuse Optic Narrow (55°)	101%
DA	Diffuse Optic Aisle (30°)	102%

$$\text{Delivered Lumens (in Table on Previous Page)} \times \text{Lumen Output Multiplier} = \text{Delivered Lumens for fixture with CW, DN, or DA Lens}$$

**PROJECTED LUMEN MAINTENANCE**

Calculation Method	Ambient Temp	25,000 hrs	50,000 hrs	60,000 hrs
TM-21-11	25C/77F	0.96	0.94	0.93
	40C/104F	0.95	0.91	0.90
TM-21-21	25C/77F	0.96	0.94	0.93
	40C/104F	0.95	0.91	0.89

**AMBIENT TEMPERATURE RATINGS**

Lumen Code	L09	L12	L15	L18	L24	L30	L36	L48	L60
Max Ambient	55°C	55°C	55°C	55°C	55°C	55°C	55°C	55°C	55°C
Min Ambient	-30°C	-30°C	-30°C	-30°C	-30°C	-30°C	-30°C	-30°C	-30°C

**NX LIGHTING CONTROLS**

	Control Option Ordering Logic & Description		Control Option Functionality									Control Option Components	
			Networkable	Standalone Grouping	Scheduling	Occupancy	Daylight Harvesting	0-10V Dimming	On/Off Control	Bluetooth App Programming	Sensor Height		
NX Wireless	NXW	NX Networked Wireless Radio Module NXRM2 and Bluetooth Programming, without Sensor	✓	✓	✓	-	-	✓	✓	✓	-	NXRM2-H	
	NXWHM	NX Networked Wireless Enabled Integral NXSMP2-HMO Wireless High Bay Occupancy & Photocell Sensor	✓	✓	✓	✓	✓	✓	✓	✓	Max: 45ft	NXSMP2-HMO	
NX Wired	NXE	NX Wired Dual RJ45 SmartPORTS , without Sensor	✓	✓	✓	-	-	✓	✓	✓**	-	NXFSP	
	NXEHM	NX Wired Dual RJ45 SmartPORTS and Integral NXSMP2-HMO PIR Occupancy Sensor with Automatic Dimming Photocell and Bluetooth Programming	✓	✓	✓	✓	✓	✓	✓	✓	Max: 45ft	NXFSP NXSMP2-HMO	
NX Independent	NXCHM	NX Connect NXC-WHS20 Wireless High Bay Occupancy & Photocell Sensor	-	✓	-	✓	✓	✓	✓	✓*	Low Max: 8ft Med. Max: 20ft High Max: 40ft	NXC-WHS20	
	WSPD360	End Mounted WSPDEMUNV PIR Occupancy Sensor with Automatic Dimming Photocell and 360° Lens	-	-	-	✓	✓	✓	-	-	Max: 45ft	WSPDEMUNV	
	WSPDA	End Mounted WSPDEMUNV PIR Occupancy Sensor with Automatic Dimming Photocell and Aisle Lens	-	-	-	✓	✓	✓	-	-	Max: 45ft	WSPDEMUNV	
	WSPDBT360	End Mounted Bluetooth® Programmable, WSPDBEMUNV Occupancy Sensor with Automatic Dimming Photocell and 360° Lens	-	-	-	✓	✓	✓	✓	✓	Max: 45ft	WSPDBEMUNV	
	WSPDBTA	End Mounted Bluetooth® Programmable, WSPDBEMUNV Occupancy Sensor with Automatic Dimming Photocell and Aisle Lens	-	-	-	✓	✓	✓	✓	✓	Max: 45ft	WSPDBEMUNV	
	OS1360	End Mounted WSPDEMUNV PIR On/Off Occupancy/ Daylight Sensor with 360° Lens	-	-	-	✓	✓	-	On/Off Only No Dim	-	Max: 45ft	WSPDEMUNV	
	OS1A	End Mounted WSPDEMUNV PIR On/Off Occupancy/ Daylight Sensor with Aisle Lens	-	-	-	✓	✓	-	On/Off Only No Dim	-	Max: 45ft	WSPDEMUNV	
Other Independent Control	OS	End Mounted LSXR PIR On/Off Sensor 360° High Mount Sensor	-	-	-	✓	-	-	On/Off Only No Dim	-	Max: 45ft	LSXR6LT	
	OCS	End Mounted LSXR PIR On/Off Occupancy/Daylight Sensor 360° High Mount Sensor	-	-	-	✓	✓	-	On/Off Only No Dim	-	Max: 45ft	LSXR6PLT	
	ODS	End Mounted LSXR PIR Dimming Occupancy Sensor 360° High Mount Sensor	-	-	-	✓	-	✓	-	-	Max: 45ft	LSXR6HLLT	

\* Requires use of NX Connect App available for download from Apple app store  
 \*\* Requires NXBTC (bluetooth programming tool), order separately

**CONTROLS**

**DEFAULT SETTINGS**

NX Wireless & Wired	Occupancy Sensor	Enabled
	Occupancy Sensor Sensitivity	7 Minutes
	Occupancy Sensor Timeout	15 Minutes
	Occupied Dim Level	100%
	Unoccupied Dim Level	0% (OFF)
	Daylight Sensor	Disabled
	Bluetooth	Enabled
	2.4GHz Wireless Mesh	Off
	"Passcode Factory Passcode: HubbN3T!"	Enabled

NX Independent - WSPDBT360/WSPDBTA	Occupancy Sensor	Enabled
	Occupancy Sensor Sensitivity	7 Minutes
	Occupancy Sensor Timeout	8 Minutes
	Occupied Dim Level	100%
	Unoccupied Dim Level	0% (OFF)
Daylight Sensor	Disabled	

NX Independent - NX Connect	Settling/Dwell Time	5 sec
	Hold Time	15 min
	Group Hold Time	15 min
	Grace Time	0 sec
	Strategy	-
	Occupancy Sensitivity	5 (highest)
	Occupancy Indicator	1 (enabled)
	Partial Off/Standby	0%
	Background Level	10%
	Task Level	100%
Daylight Harvesting	1 (enabled)	
Low Ambient Output	250% (of fixtures light output)	
High Ambient Output	OFF	

NX Independent - WSPD360W/SPDA	Occupancy Sensor Timeout	8 Minutes
	Occupied Dim Level	100%
	Unoccupied Dim Level	50%
	Full Off Timeout	Disabled
	Daylight Sensor	Disabled

**PRODUCT IMAGES**

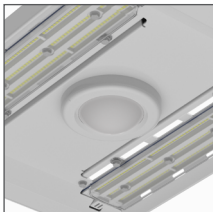

**NXWHM / NXEHM**

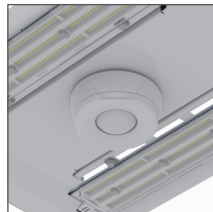

**NXCHM**



**WSPD360 / WSPDA  
WSPDBT360 / WSPDBTA  
OS1350 / OS1A**

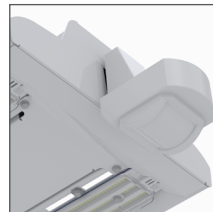

**OS / OCS  
ODS**

**CONTROLS TECHNICAL SUPPORT**

1-800-888-8006 (7:00 am–7:00 pm est)

**APP INFORMATION**

**NX Lighting Controls App**



The NX Lighting Controls App is a free to use mobile application for programming both an NX Lighting Controls System or Standalone Bluetooth Sensors. The mobile app allows you to configure devices, discover and setup wireless enabled luminaires and program your NX system settings.



Android



Apple iOS

**NX Connect App**



The NX Connect mobile App is a free to use mobile application for programming a NX Connect System. The mobile App allows you to discover, configure and share your NX Connect system.



Apple iOS

**CONTROLS (CONTD.)**

**COVERAGE PATTERNS**

**NXWHM (NXSMP2-HMO SENSOR)  
NXEHM (NXSMP2-HMO)**

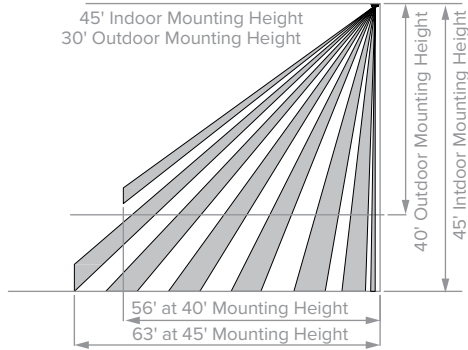

Sensor lens coverage and detection patterns when mounted at 40ft and 45ft with Standard lens

**WSPD360/WSPDA/WSPDBT360/  
WASDBTA/OS1360/OS1A**

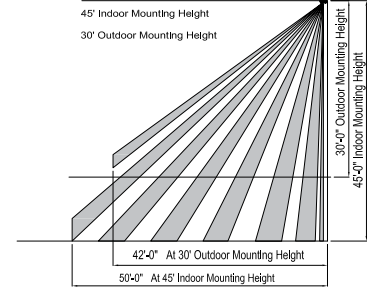
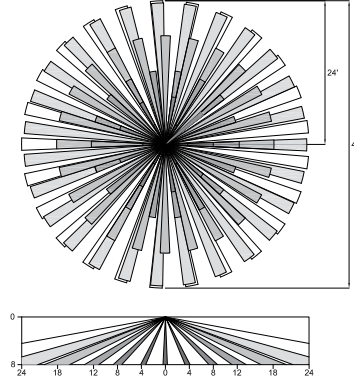

**NXCHM (NXC-WHS20 SENSOR)  
HIGH LENS: 12.2M (40FT)  
27ft Radius/54ft Diameter**

Side View Sensor mounted 33' (10m) from floor

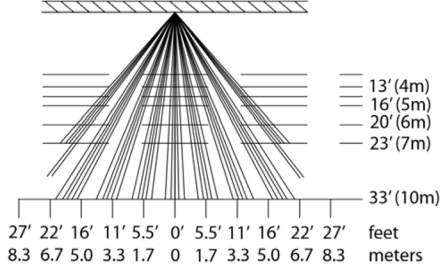

Top View

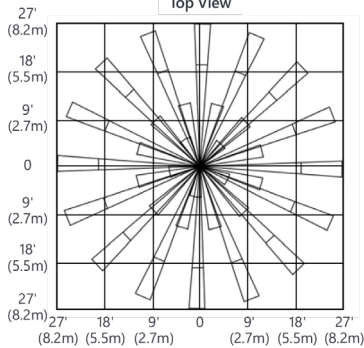

**NXCHM (NXC-WHS20 SENSOR)  
LOW LENS: 2.5M (8FT)  
20ft Radius/40ft Diameter**

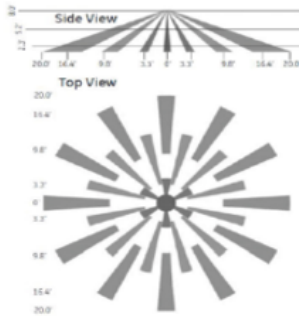

**NXCHM (NXC-WHS20 SENSOR)  
MED LENS: 6M (20FT)  
30ft Radius/60ft Diameter**

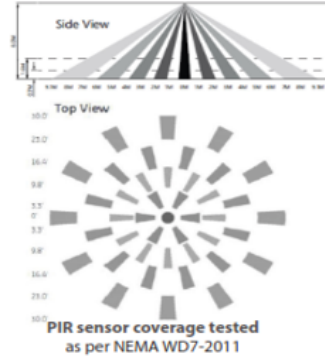



**OTHER LIGHTING CONTROLS**

**OS, OCS, ODS (THIRD PARTY)**

**COVERAGE PATTERNS**

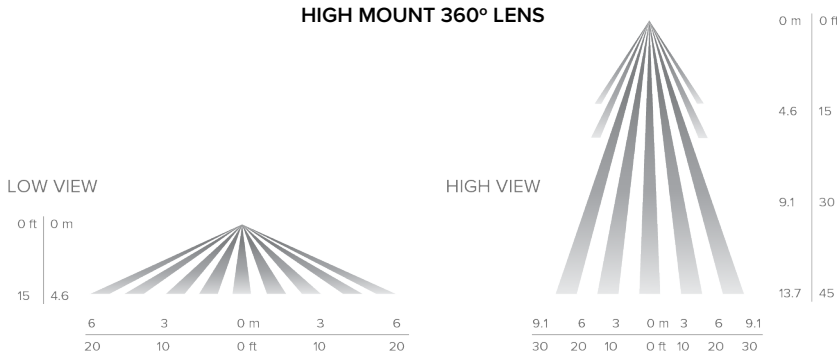

**FUNCTIONALITY AND DEFAULT SETTINGS**

Name	Description	Minimum Value	Maximum Value	Default Values for Cat Logic Choice		
				OS	OCS	ODS
Occupancy Time Delay (1 Pole)	The length of time the sensor will keep the lights controlled by relay 1 on at full bright after it last detects occupancy, assuming Minimum On Time has been met.	30 sec	30 min	10 min	10 min	10 min
Occupancy Time Delay (2 Pole)	The length of time the sensor will keep the lights controlled by relay 2 on after it last detects last occupancy, assuming Minimum On Time has been met.	N/A	30 min	10 min	10 min	10 min
Photocell Set-Point	The target light level (at the sensor) that is to be maintained.	Auto	64fc	N/A	N/A	4fc
Sunlight Discount Factor	Value used to improve the tracking for accuracy of a sensor with a photocell during periods of high daylight. Decreasing the value will lower the controlled level of the lights.	x/1	x/10	N/A	N/A	x/1
Dimming Range Max (High Trim)	The maximum output level of a sensor with dimming.	Off	10 VDC	N/A	10 VDC	10 VDC
Dimming Range Low (Low Trim)	The minimum output level to which the photocell will dim the lights.	Off	10 VDC	N/A	1 VDC	1 VDC
Dual Zone Photocell %	Relative value of photocell set-point that is used to control relay 2.	110%	200%	N/A	N/A	150%
Dim to Off Occupancy Time Delay	After Occupancy Time Delay has expired, this setting specifies the amount of time lights are held at minimum dim before turning off.	0 sec	Never Off	0 sec	0 sec	0 sec

**PACKAGING/SHIPPING INFO**

**JOB PACKAGING IS STANDARD**

Note: Orders less than 14 fixtures are typically sent packaged Individually

**SLEEVE**

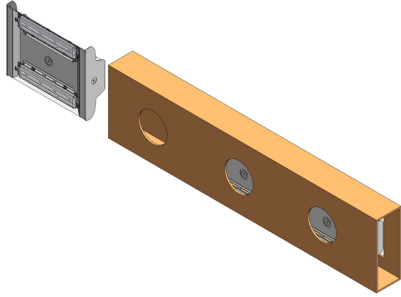

**LAYER**

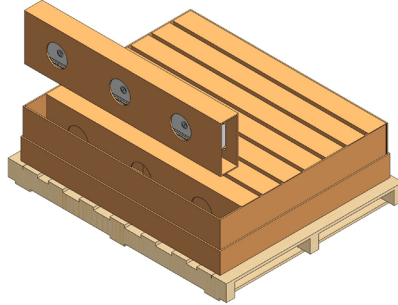

**PALLET**

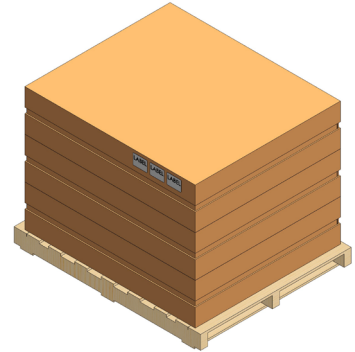

JOB PACK DETAILS			
Size	Fixtures per Sleeve	Sleeves per Layer	Layers per Pallet
1	3	8	3
2	1	8	3
3	1	8	3

JOB PACK PALLET QTYS			
Size	Standard Fixture Qty	Pallet Dimensions	
		L (in) x W(in)	H (in)
1	72	52 x 42	39.0
2	24	52 x 42	39.0
3	24	52 x 42	54.0

JOB PACK PALLET QTYS FOR FIXTURES W/ OPTIONS					
Cord	EL Pack	Bottom Sensor	Fixture Options		
			Bottom Mt Sensor & Cord	Side Mt Sensor	Side Mt Sensor & Cord
63	48	72	63	48	48
21	21	24	21	24	21
21	21	24	21	24	21

**PACKAGED INDIVIDUALLY: OPTION SELECTION PI**

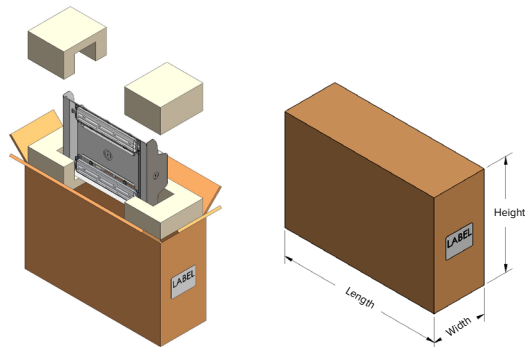

Packaged Individually Box Dimensions			
Size	Length (in)	Width (in)	Height (in)
1	22.3	7.5	15.0
2	36.5	7.5	15.0
3	39.0	9.5	22.0

Packaged Individually Pallet Qty & Dimensions			
Size	Qty	L (in) x W (in)	Height (in)
1	30	52 x 42	49.0
2	20	52 x 42	48.0
3	6	52 x 42	44.5

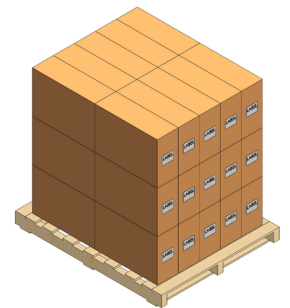

Note: Packaged Individually dimensions do not change if sensor, cord, or EMBB option is added to fixture

**DIMENSIONS**

**ECH SIZE 1**

L09, L12, L15, L18 & L24 LUMEN OUTPUT

Max Weight: 10 lbs

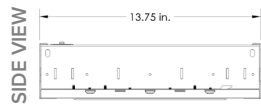
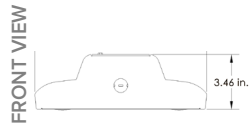
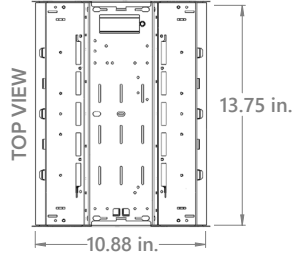

**ECH SIZE 2**

L30, L36 & L48 LUMEN OUTPUT

Max Weight: 20 lbs

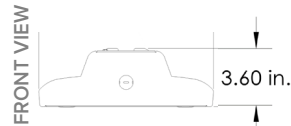
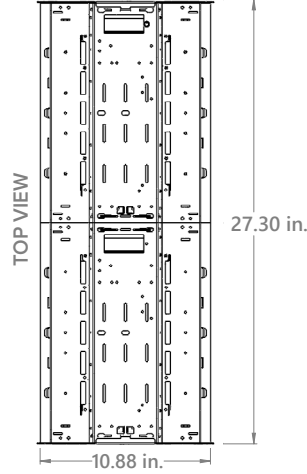

**ECH SIZE 3**

L60 LUMEN OUTPUT

Max Weight: 22 lbs

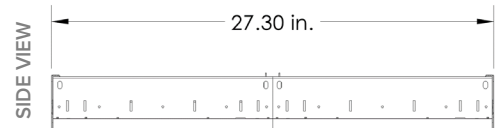
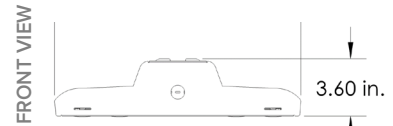
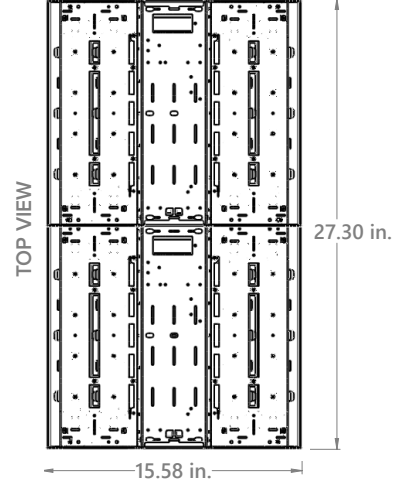

**EMERGENCY BATTERY INFORMATION**

Lumens in Emergency Mode = LPW of Fixture x EM Pack Wattage (20 watts)

**ECH SIZE 1**

L09, L12, L15, L18 & L24 LUMEN OUTPUT  
VOLTAGE: U, 120V, & 277V

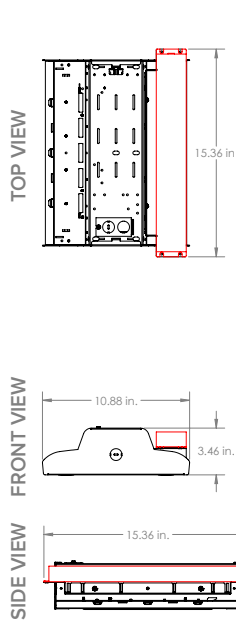

VOLTAGE: 347V & 480V

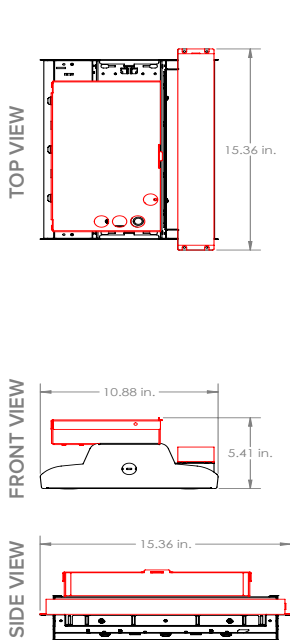

**ECH SIZE 2**

L30, L36 & L48 LUMEN OUTPUT  
VOLTAGE: U, 120V, & 277V

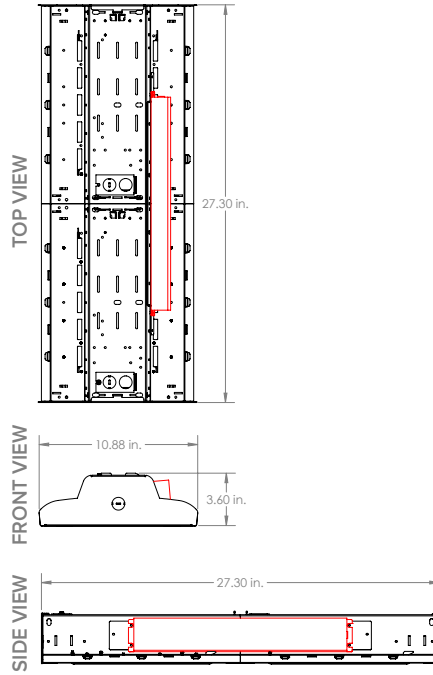

VOLTAGE: 347V & 480V

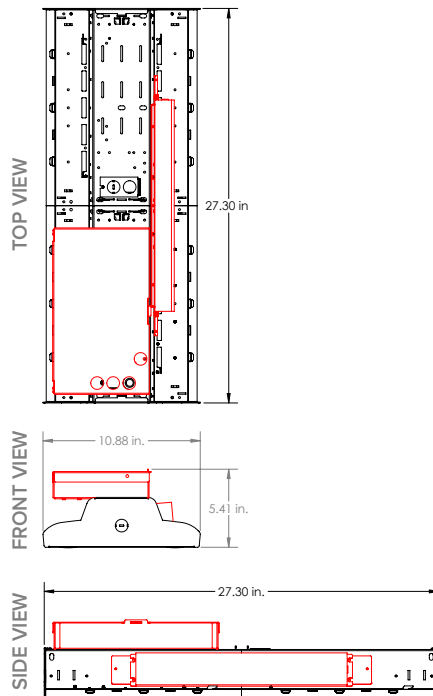

**ECH SIZE 3**

L60 LUMEN OUTPUT  
VOLTAGE: U, 120V, & 277V

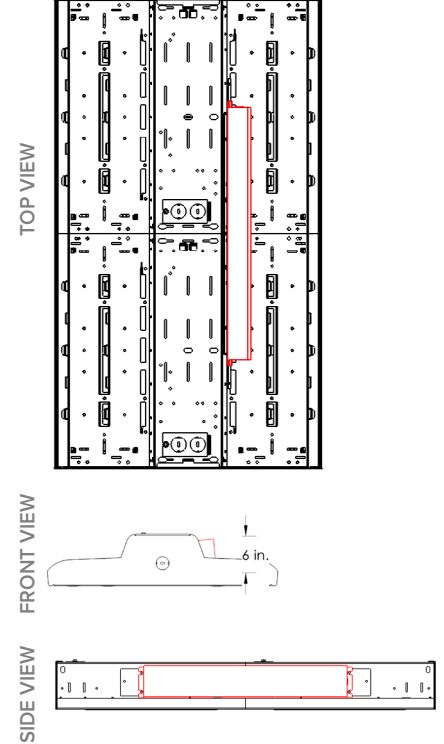

VOLTAGE: 347V & 480V

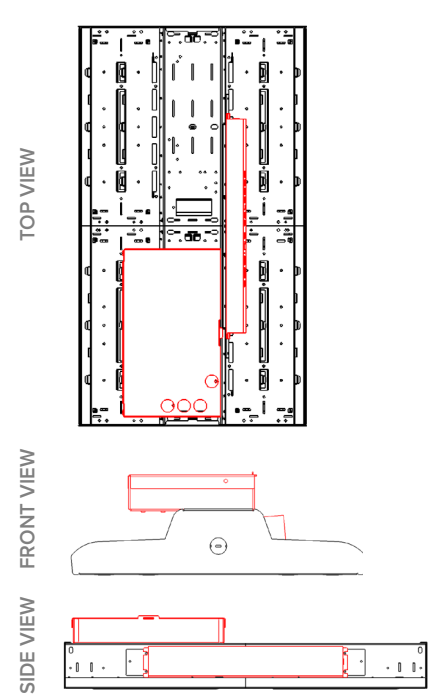

**PHOTOMETRY**

**ECH1-840-L24-DW-EDU-U4**

**LUMINAIRE DATA**

Description	LED Highbay; 24,000 Lumens; Diffuse Optic Wide; Uplight
Delivered Lumens	24,001
Watts	164
Efficacy	146
Spacing Criterion	0°= 1.20 90 = 1.18

**ZONAL LUMEN SUMMARY**

Zone	Lumens	% Luminaire
0-30	7319	30.3
0-40	11697	48.5
0-60	19467	80.9
0-90	23943	99.8
0-180	24001	100

**POLAR GRAPH**

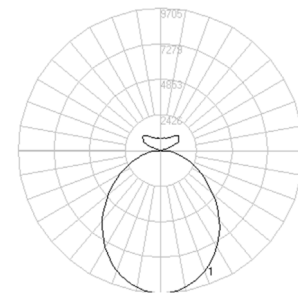

90-270 deg plane

**ECH1-840-L24-DN-EDU**

**LUMINAIRE DATA**

Description	LED Highbay; 24,000 Lumens; Diffuse Optic Narrow
Delivered Lumens	24,240
Watts	164
Efficacy	148
Spacing Criterion	0°= 1.36 90°= .94

**ZONAL LUMEN SUMMARY**

Zone	Lumens	% Luminaire
0-30	11280	46.5
0-40	16767	69.2
0-60	22365	92.3
0-90	24153	99.6
0-180	24240	100

**POLAR GRAPH**

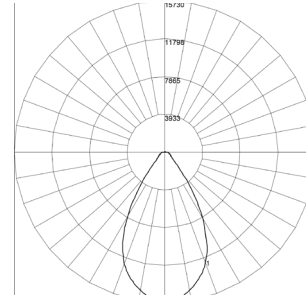

Maximum Candela = 15730 Located At Horizontal Angle = 0, Vertical Angle = 1  
# 1 - Vertical Plane Through Horizontal Angles (90 - 270)

**ECH1-840-L24-DA-EDU**

**LUMINAIRE DATA**

Description	LED Highbay; 24,000 Lumens; Diffuse Optic Aisle
Delivered Lumens	24,480
Watts	164
Efficacy	149
Spacing Criterion	0°= 1.32 90°= .62

**ZONAL LUMEN SUMMARY**

Zone	Lumens	% Luminaire
0-30	12337	50.4
0-40	16790	68.6
0-60	22082	90.2
0-90	24367	99.5
0-180	24480	100

**POLAR GRAPH**

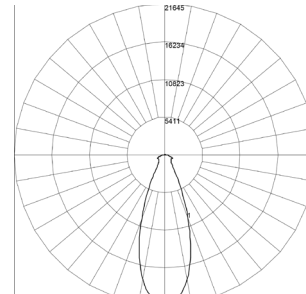

Maximum Candela = 21845 Located At Horizontal Angle = 0, Vertical Angle = 1  
# 1 - Vertical Plane Through Horizontal Angles (90 - 270)