



VERTIV™ KNÜRR®
SPECIAL CATALOG

Networks & Data Centers



Vertiv™

Vertiv designs, builds and services mission critical technologies that enable the vital applications for data centers, communication networks, and commercial and industrial environments. We support today's growing mobile and cloud computing markets with our portfolio of power, thermal, infrastructure management products, software and solutions, all complemented by our global service network. Bringing together global reach and local knowledge, and our decades-long heritage including brands like Chloride®, Liebert® and NetSure™, our team of experts is ready to take on your most complex challenges, creating solutions that keep your systems running—and your business moving. Together, we're building the future of a world where critical technologies always work.

YOUR VISION, OUR PASSION.

VertivCo.com



Table of Contents

Racks



Page	6	Vertiv™ Knürr® MIR2
Page	8	Vertiv Knürr MIR2 - Server Rack
Page	10	Vertiv Knürr MIR2 - Network Rack
Page	18	Vertiv Knürr MIR2 - IP 55 Rack
Page	20	Vertiv Knürr DCM
Page	31	Vertiv Knürr DCM Colocation Rack

Rack Accessories and Components



Page	34	Vertiv Knürr Rack Specific Accessories
Page	50	Vertiv Knürr System Accessories
Page	67	Vertiv Knürr Cable Management
Page	88	Vertiv Knürr Fan Units

Enclosures



Page	97	Vertiv Knürr Smaract®
Page	114	Vertiv Knürr DoubleProRack®
Page	121	Vertiv Knürr ConAct®

Containment



Page	128	Vertiv SmartAisle™ Containment
Page	148	Switch Tubes™

Cooling



Page	157	Vertiv Knürr® DCD
Page	162	Liebert® DCL
Page	170	Liebert® CRV

Power Distribution



Page	182	Vertiv Knürr PowerTrans2®
Page	188	Vertiv MPX™
Page	200	Vertiv MPH2™
Page	212	Vertiv MPE
Page	216	Vertiv Knürr DIS Rack PDU

Security and Monitoring



Page	239	Vertiv Knürr locking systems
Page	244	Vertiv Knürr RMS Compact II®
Page	249	Vertiv™ Knürr® RMS III®
Page	254	Inline Metering Systeme

Table of Contents

Desktop and Server Room IT Management Solutions



Page	262	Vertiv™ Avocent® KVM
Page	263	Vertiv™ Avocent® SwitchView™ KVM
Page	264	Vertiv™ Avocent® Cybex™ KM-Switches
Page	265	Vertiv™ Avocent® Extension Solutions
Page	266	Vertiv™ Avocent® "at-the-rack" access Solutions
Page	267	LCD-Trays

Enterprise IT Infrastructure Solutions for Data Center



Page	269	Remote Management
Page	272	Vertiv™ Avocent® Universal Management Gateway
Page	273	Vertiv™ Avocent® MergePoint Unity™
Page	274	Vertiv™ Avocent® Matrix
Page	275	Vertiv™ Avocent® DSView™
Page	276	Vertiv™ Avocent® Data Center Planner
Page	277	Power Management

Uninterruptible Power Supplies (UPS)



Page	280	Liebert® PSP 500 VA - 650 VA
Page	282	Liebert® PSA 500 VA - 1500 VA
Page	284	Liebert® itON 400 VA - 2000 VA
Page	286	Liebert® PSI 750 VA - 3000 VA
Page	288	Liebert® PSI-XR 1000 VA - 3000 VA
Page	290	Liebert® GXT4™ 700 VA - 3000 VA
Page	292	Liebert® GXT MT+ 1000 VA - 3000 VA Gen. 2
Page	294	Liebert® GXT4™ 5000 VA - 10000 VA
Page	296	Liebert® GXT3 10000 VA T Model
Page	298	Liebert® GXT MT+ 6000 VA - 10000 VA Tower
Page	300	Liebert® APS 5 kVA - 20 kVA

Vertiv

Page	302	Index
------	-----	-------

Vertiv™ Knürr® MIR2

One system with Infinite Possibilities

Vertiv™ Knürr® MIR®, the classic amongst innovative racks, is demonstrated by the long-standing and continuous satisfaction of our customers.

Drawing on Vertiv's extensive experience with a wide range of applications, Miracel has now been adapted for network and server applications. The innovative Vertiv Knürr MIR2 has been designed to meet current requirements in order to ensure that it will continue to meet customers' needs well into the future.

For both network and server applications, the highly versatile Vertiv Knürr MIR2 combines various components and applications in one place.

Being a modular rack system, it can easily be expanded at any time and the cable entry points can be flexibly tailored for specific needs.

With a load rating of 800 kg, Vertiv Knürr MIR2 is a **cleverly designed space-saving rack** that offers ample space for a wide range of equipment and, thanks to the absence of depth members, also present at the sides, it provides maximum flexibility with the greatest possible space for cables and cooling components.

This rack's integrated castors and doors also make it easy to move without needing to be tilted.

Made from aluminum, Vertiv Knürr MIR2 is extremely **light**, minimizing raised floor loading and making it easy to transport and set up. The clever, fully-integrated T-slot system in the aluminum extrusions also allows for the free configuration of accessories and makes it easy to install each and every component.



Vertiv™ Knürr® MIR2

Benefits of an All-in-One Server and Network Rack

Vertiv™ Knürr® MIR2 – Technical Data

- **Material**
 - Extruded aluminum.
 - Corner piece: die-cast aluminum.
 - Casing: galvanized steel sheet.
 - Doors: steel sheet.
- **Installation dimensions in accordance with IEC 60297-1 and IEC 60297-2**
 - Height: 42 HE / 47 HE
(1 HE (or 1U) = 44,45 mm).
 - Width: 482,6 mm (19" version).
- **Available space**
 - 80 mm jumpering space at the front, 215 mm ranges; customizable up on request.
 - Internal hinge: 130° for rack suites: 160° for stand-alone racks.
 - External hinge: 180° for stand-alone racks and rack suites.
- **Installation options**
 - Stationary: on levelling feet.
 - Mobile: with castor mounting and levelling feet.
- **Finish / Colour**
 - Basic rack: polished.
 - Visible surface of casing, powder-coated RAL 7021 dark-grey and RAL 7035 light-grey.
- **Static load rating**
 - 8000 N (stationary version).
 - 4000 N (mobile version).
- **Tests depending on the design**
 - Earthing and earth wire test in accordance with DIN EN 60950.
 - Other standards and certificates upon request.
- **Rack suites**

To create a rack suite with "n" racks, you will need:

 - 1 x rack without side panels and one rack with side panels.
 - 1 x set of rack connectors per connection.





83% Perforation offers optimal airflow



Easy access on all sides enables comfortable service and repair



Raised height from 41/46U up to 42/47U



Load rate raised from 500kg up to 800kg



Light weight aluminium construction, minimizes raised floor loading



Clicksystem, easy mounting accessories



Modular design makes it easy to combine with DCM racks and Smart Aisle Containment



Castors for easy transport



BENEFITS OF AN ALL IN ONE RACK

Vertiv™ Knürr® MIR2 – Server Rack – Features

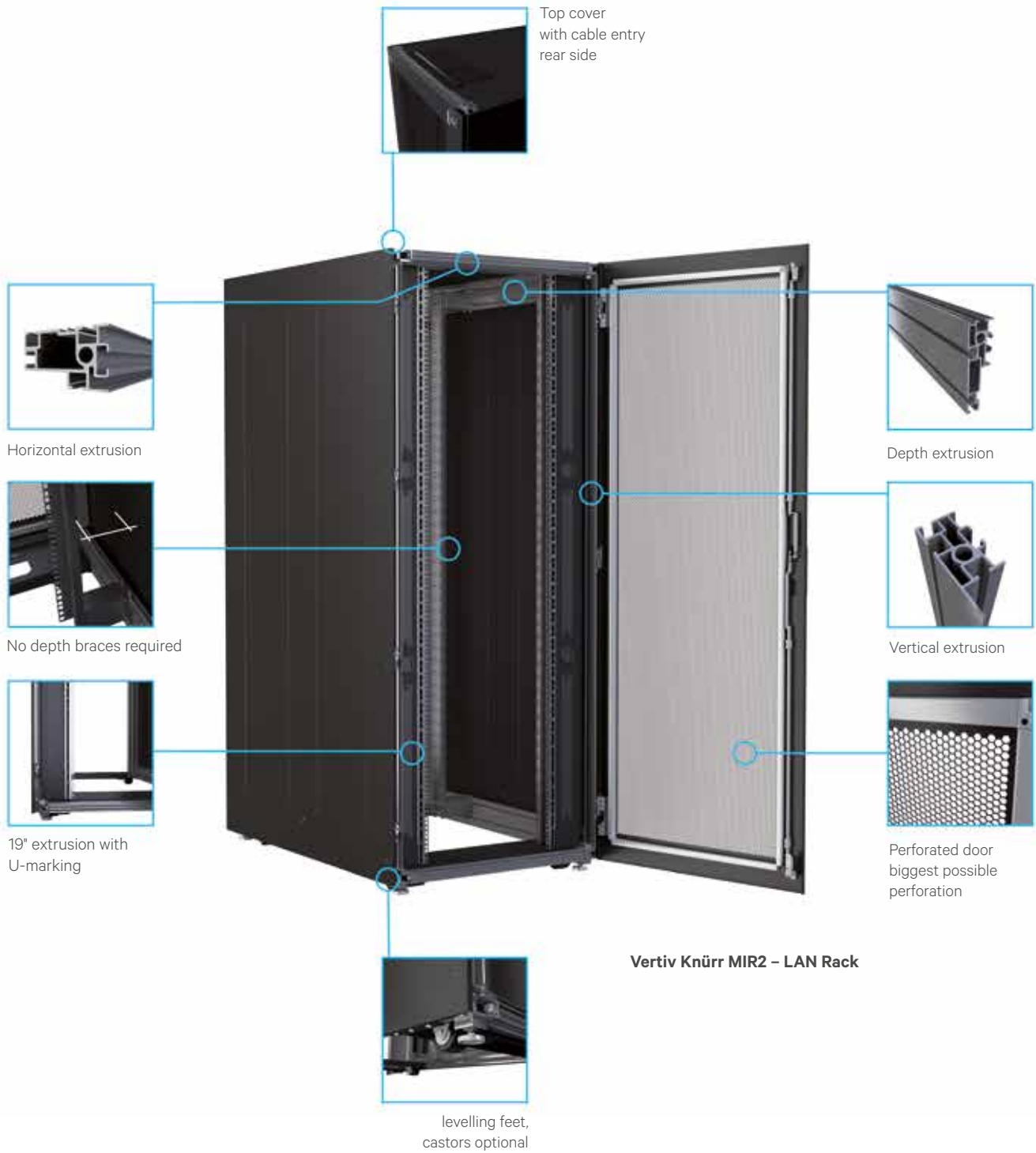



Vertiv Knürr MIR2 Server Rack

Vertiv™ Knürr® MIR2 – Server Rack

- With fixed 19" mounting on the front and rear for IEC 297-3-compliant components.
- Perforated single leaf front and rear doors.
- Special 19" server extrusions for mounting all trade-standard 19" servers.
- Components compliant with IEC 297-3.
- Cable entry via base and top cover.
- Cable entry on the top cover, at the rear, can be completely removed, allowing the top cover to be fitted and removed after cabling.

■ Jumping space

- Front: 80 mm.

■ Load rating

- 8000 N static.

■ Protection rating

- IP 20.

■ Tests

- Earthing compliant with VDE 0100 T 540.
- Earthing compliant with DIN EN 60950.
- IP test EN 60529.

■ Material / Finish

- Basic rack: extruded aluminum.
- Corner piece: die-cast aluminum, polished.
- Covers: galvanized steel sheet, powder-coated texture.
- Doors: steel sheet, powder-coated texture.
- 19" extrusions, 2.0 mm galvanized steel sheet.

■ Colour

- x = .1 visible surfaces and covers, RAL 7035 light-grey.
- x = .8 visible surfaces and covers, RAL 7021 dark-grey.

■ Included in delivery

- 1 x basic rack.
- 4 x 19" steel sheet server extrusions with HE markings.
- 2 x side panels with quick connectors.
- 1 x top cover with cable entry rear (three-piece sliding plates, can also be fully opened).
- 1 x front door, single leaf, with handle and mounting for cylinder lock.
- 1 x rear door, single leaf, with handle and mounting for cylinder lock.
- 1 x complete earthing kit (VDE 0100).
- 4 x levelling feet.

■ Delivered

- Assembled.

■ Note

For drawers, pull-out shelves and slot-in runners, please also order the extrusion adapter 01.1476409.

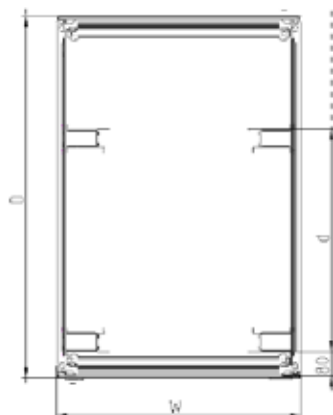
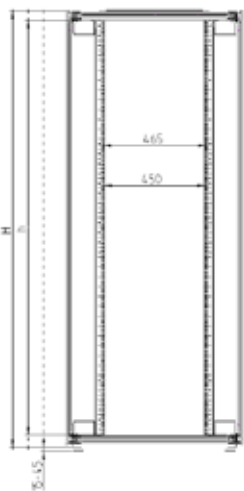

W	H	D	U	h	d	kg	Order No.	Units
600	1969	1000	42	1873	740	84	01.157.007.x-026	1 unit
600	2191	1000	47	2095	740	91	01.157.007.x-036	1 unit
600	1969	1200	42	1873	740	90	01.157.007.x-028	1 unit
600	2191	1200	47	2095	740	98	01.157.007.x-038	1 unit
800	1969	1000	42	1873	740	107	01.157.011.x-026	1 unit
800	2191	1000	47	2095	740	116	01.157.011.x-036	1 unit
800	1969	1200	42	1873	740	111	01.157.011.x-028	1 unit
800	2191	1200	47	2095	740	123	01.157.011.x-038	1 unit

Vertiv™ Knürr® MIR2 – LAN Rack – Features





Vertiv Knürr MIR2 Netzwerk Schrank

Vertiv™ Knürr® MIR2 – Network Rack

- With fixed 19" mounting on the front and rear for IEC 297-3-compliant components.
- Installation of slot-in runners, drawers, pull-out shelves and cable management equipment.
- Cable entry via plinth and top cover.
- Cable entry on the top cover, at the rear; top cover can be attached / removed after equipment installation.
- Heat is discharged via the raised top cover.
- Door opening angle 160° internal hinges.

■ Jumpering space

- Front: 123 mm.

■ Load rating

- 8000 N static .

■ Protection rating

- IP 20.

■ Tests

- Earthing compliant with VDE 0100 T 540.
- IP test EN 60529.

■ Material / Finish

- Basic rack: extruded aluminum.
- Corner piece: die-cast aluminum, polished.
- Casing: galvanized steel sheet, powder-coated texture.
- Doors, steel sheet, powder-coated texture, glass infill front door, single safety-glass panel, 4 mm.
- 19" extrusions, 1.5 mm galvanized steel sheet.

■ Colour

- x = .1 visible surfaces and covers, RAL 7035 light-grey.
- x = .8 visible surfaces and covers, RAL 7021 dark-grey.

■ Included in delivery

- 1 basic rack.
- 4 x 19" perforated steel sheet extrusions with HE markings. Depth 600 2 x 19".
- 2 x side panels with quick connectors.
- 1 x raised top cover with cable entry rear (three-piece sliding plates, can also be fully opened) at the rear.
- 1 x front door, single leaf, single safety-glass panel, with handle and mounting for cylinder lock.
- 1 x rear door, single leaf, steel sheet, with handle and mounting for cylinder lock .
- 1 x plinth with vents at the front and rear, including closed sides and mounting for filter mat.
- 1 x complete earthing kit (VDE 0100).
- 4 x levelling feet.

■ Delivered

- Assembled.

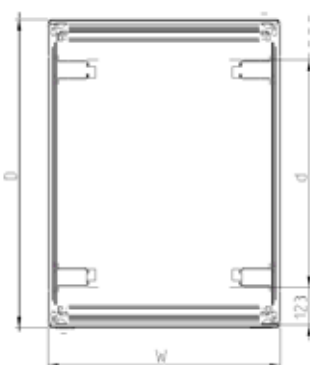
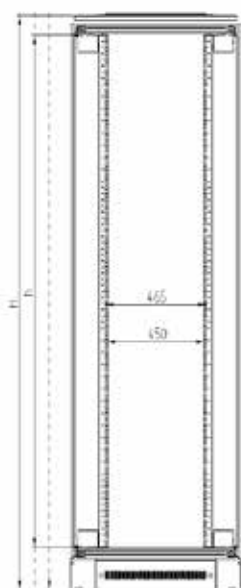

W	H	D	U	h	d	kg	Order No.	Units
800	2120	600	42	1873		88	01.157.005.x-022	1 unit
800	2340	600	47	2095		96	01.157.005.x-032	1 unit
800	2120	800	42	1873	565	115	01.157.005.x-024	1 unit
800	2340	800	47	2095	565	116	01.157.005.x-034	1 unit
800	2120	1000	42	1873	740	126	01.157.005.x-026	1 unit
800	2340	1000	47	2095	740	138	01.157.005.x-036	1 unit

Vertiv™ Knürr® MIR2 Server and Network Rack Configurator

Vertiv Knürr MIR2 – configured by you

Vertiv Knürr MIR2 is one of our configurable rack platforms.

You can easily select the options you need for your individual rack, based on the matrix.



Example product number

Dimensions				Doors		19" Extrusions		Cover parts				Color		
Product	Height	Width	Depth	Front Door	Rear Door	19" Front Vertical Extrusion	19" Rear Vertical Extrusion	Top Cover	Plinth	Side Panel	Packaging	Jumpering Depth	Free	Color
N	B	8	E	A	B	S	S	B	A	B	X	Q	X	8

Option Matrix	Dimensions			Doors		19" Extrusions		Cover parts			Color			
	2	3	4	5	6	7	8	9	10	11	12	13	14	15
	Rack Height	Rack Width	Rack Depth	Front Door	Rear Door	19" Vertical Extrusion Front	19" Vertical Extrusion Rear	Top Cover	Plinth	Side Panel	Packaging	19" vertical extrusion, mounting position front and space between	Free	Color
N= Vertiv™ Knürr® MIR2® Rack	B= 42 U	6= 600 mm	C= 800 mm	A= Glass single door right	A= Glass single door right	A= 19" vertical server extrusion with air partition and 3x1 U cut-outs*	H= 19" vertical extrusion with mounting holes	B= Top Cover, with cut out for fan units, with cable inlet rear	A= Plinth, stationary 100mm, all sides closed	B= Both sides	X= Standard packaging	A= 80/740mm*	X=	1= RAL 7035
	D= 47 U	8= 800 mm	D= 900 mm	B= Sheet steel single door right	B= Sheet steel single door right	B= 19" vertical server extrusion with air partition	S= 19" vertical server extrusion	C= Top cover with cable inlet rear	B= Plinth, stationary 200mm, all sides closed	C= Partitioning wall fixed right		C= 115/740mm*		8= RAL 7021
			E= 1000 mm	C= Perforated single door	C= Perforated single door	C= 19" vertical server extrusion with cable management*	T= 19" Vertical Extrusion with T-Slot	E= Top cover short with lateral cable inlet closed	F= Without plinth. Adjustable feed only	D= Partitioning wall fixed left		D= 123/740mm*		X= blank **
			F= 1100 mm	D= 180° perforated single door right	D= 180° perforated single door right	H= 19" vertical extrusion with mounting holes	X= Without 19" extrusions	G= Top cover short	G= Plinth, stationary 100mm, with vent slots	L= Left		E= 200/740mm*		
			G= 1200 mm	E= Glass double door	E= Glass double door	S= 19" vertical server extrusion		S= Top cover without cut out for fan units, with cable inlet rear, with spacer	H= Plinth, stationary 200mm, with vent slots	R= Right		F= 215/740mm*		
				F= Sheet steel double door	F= Sheet steel double door	T= 19" Vertical Extrusion with T-Slot		X= Without top cover	R= Mobile casters	X= Without side panels		G= 150/740mm*		
				G= Sheet steel perforated double door	G= Sheet steel perforated double door	X= Without 19" extrusions						Q= 80/565mm*		
				H= 180° perforated double door	H= 180° perforated double door							T= 123/565mm*		
				M= 180° sheet steel single door right	M= 180° sheet steel single door right							U= 150/565mm*		
				N= 180° sheet steel double door	N= 180° sheet steel double door							V= 200/565mm*		
				P= 180° glass single door right	P= 180° glass single door right									
				Q= 180° glass double door	Q= 180° glass double door									
				X= Without door	R= rear/front door									
					X= Without door									



P - assemble to order (shipped within 5 working days).
 Caution: In case of larger orders, delivery times may increase.

Remarks:

- * this options might not be possible with each Rack width, depth and 19" mounting position.
- ** use "X" if select no cladding parts.

Vertiv™ Knürr® MIR2 Server and Network Rack Configurator – Technical Overview of selectable options



Overview of all mountable parts

	2	3	4	5	6	7	8	9	10	11	12	13	14	15
Product	Height	Width	Depth	Front Door	Rear Door	19" Vertikal Extrusion front	19" Vertikal Extrusion rear	Top Cover	Plinth	Side Panel	Packaging	Jumpering Space	Free	Color

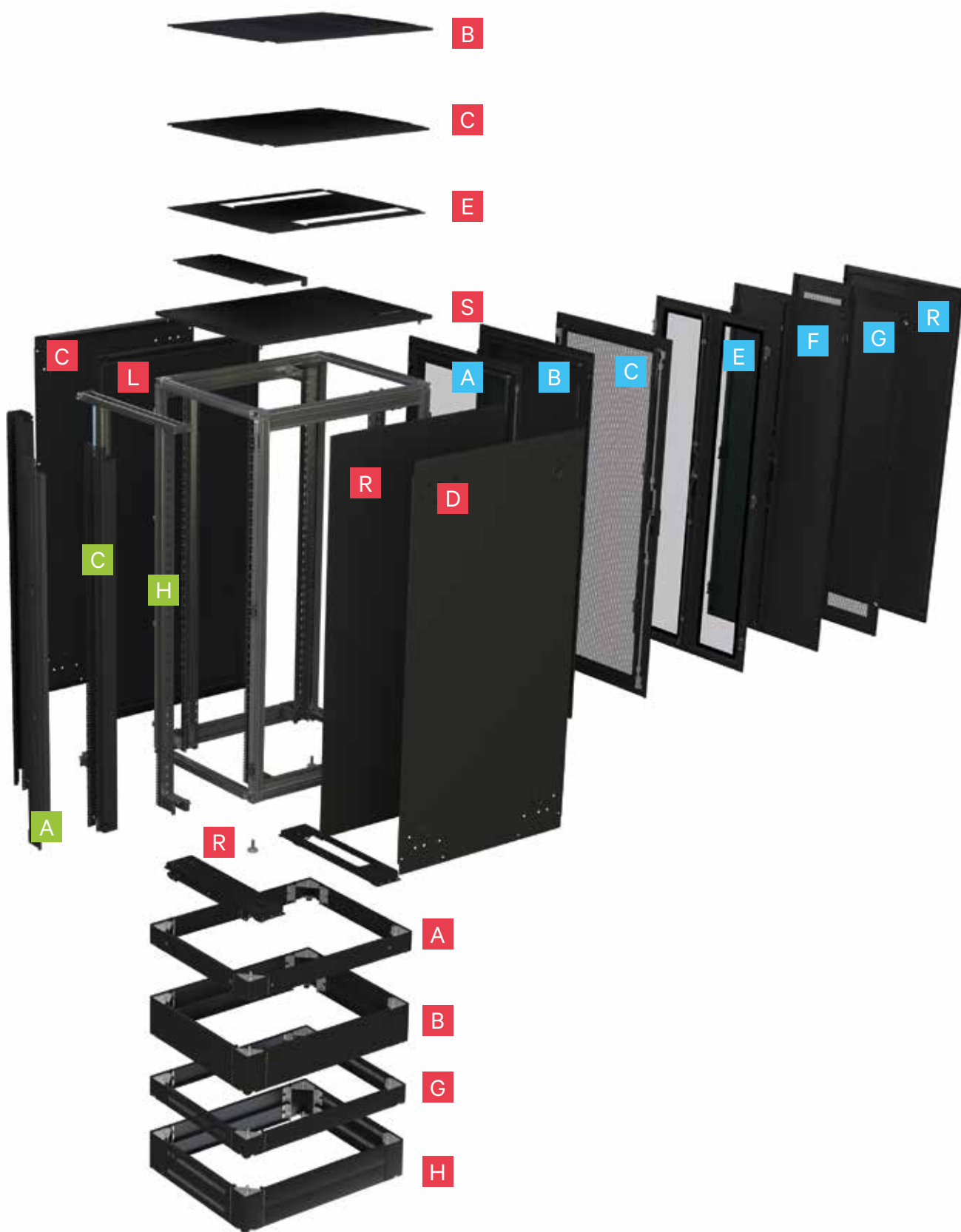

Vertiv™ Knürr® MIR2 Server and Network Rack
Configurator – Technical Overview of selectable dimensions

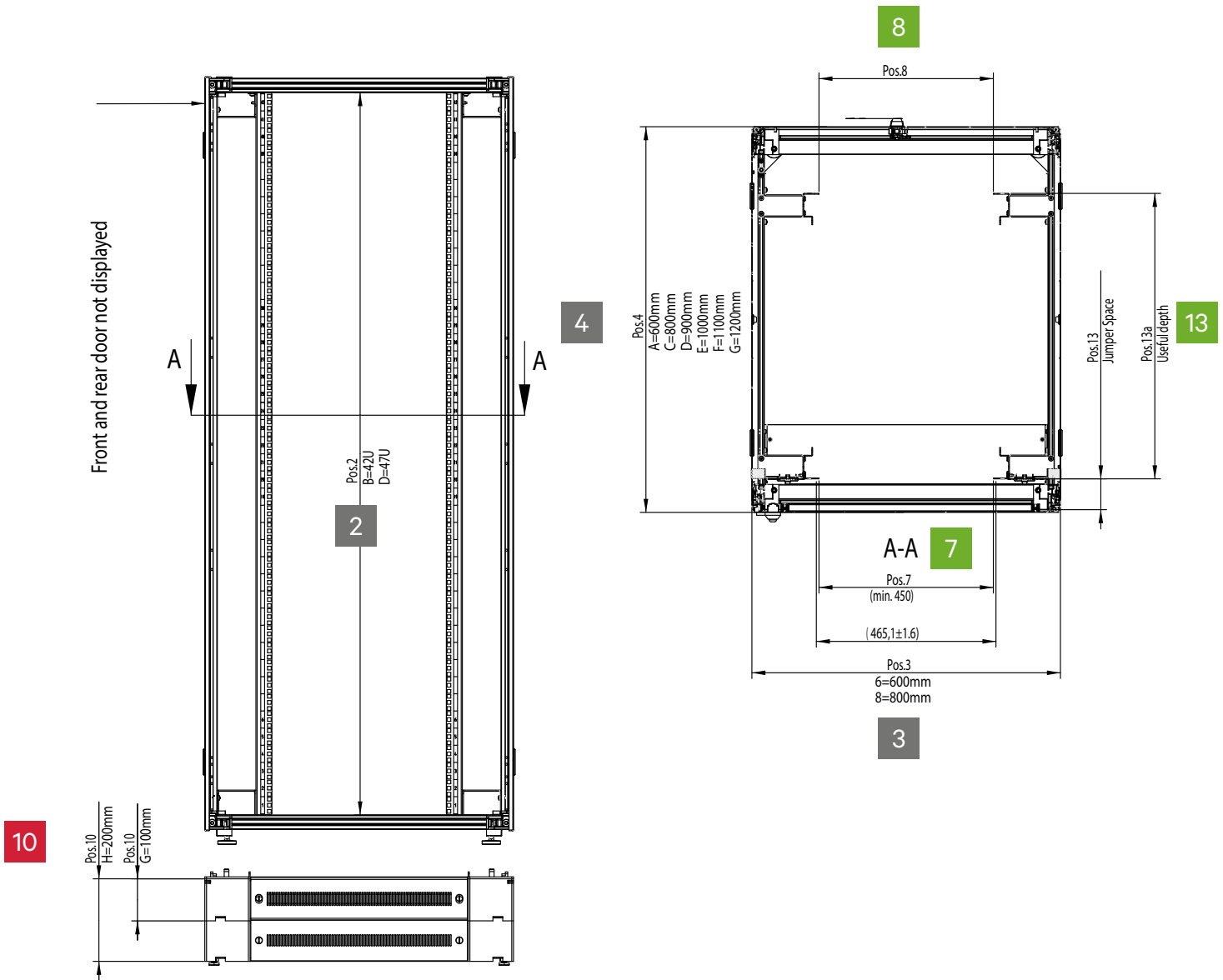

	2	3	4	5	6	7	8	9	10	11	12	13	14	15
Product	Height	Width	Depth	Front Door	Rear Door	19" Vertikal Extrusion front	19" Vertikal Extrusion rear	Top Cover	Plinth	Side Panel	Packaging	Jumpering Space	Free	Color





MIR20336

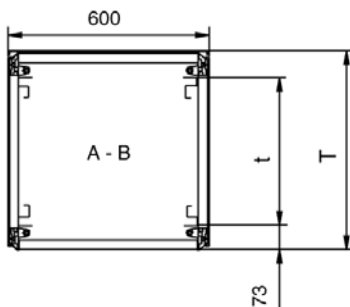
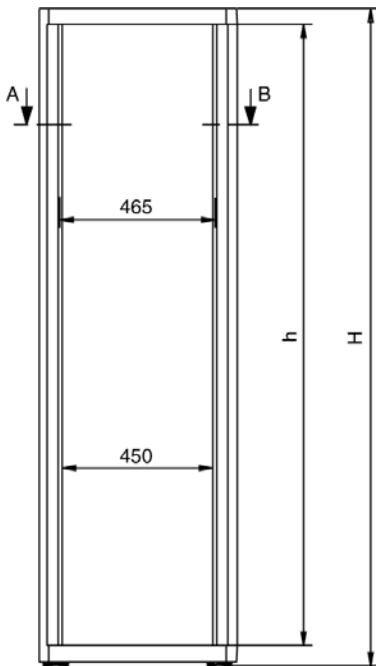

MIR00301

Vertiv™ Knürr® MIR IP 55, on request With single glass door, width 600 mm

- With fixed 19" component on the front and rear.
- For IEC 297-3-compliant components.
- Door opening angle, 180°.
- For installing 19" components on the front and rear.
- For installation equipment with a max. width of 450 mm.
- Installation accessories.

■ Jumping space

- Front 73 mm.

■ Load rating

- 5000 N static.

■ Protection rating

- IP 55.

■ Tests

- Earthing compliant with VDE 0100 T 540.
- Vibration test compliant with MIL-STD 810 E.
- IP test compliant with DIN 40 050 / IEC 529.

■ Material / Finish

- Basic rack, extruded aluminum, polished.
- Corner piece, die-cast aluminum, polished.
- Covers, zinc-passivated sheet steel, powder-coated texture.
- Doors, sheet steel, powder-coated texture, glass infill, front door, single safety-glass panel, 4 mm.
- Multifunctional braces and 19" extrusions, sheet steel, zinc-passivated.

■ Color

- Visible surface of the covers, RAL 7035 light-grey.

■ Scope of delivery

- 1 x basic rack.
- 4 x 19" sheet steel angular extrusions with mounting holes.
- 2 x multifunctional braces for cable clamping and universal mounting options.
- 1 x top cover, closed, IP 55.
- 1 x front door, single, single safety-glass panel, with handle and mounting for cylinder lock, IP55.
- 1 x rear panel with quick connectors, IP 55.
- 2 x side panels with quick connectors, IP 55.
- 1 x floor, closed, IP 55.
- 4 x leveling feet (0 - 25 mm).

■ How supplied

- Mounted.

■ Note on rack suites

To create a rack suite with "n" racks, the following is required:

- (n-1) racks without side panels.
- 1 rack with side panels.

In a rack suite, per connection you will require a set of BN 01.130.935.7 suite connectors.

W	H	D	U	h	d	kg	Order No.	UP
600	1800	600	37	1652	440	75	01.132.271.1	1 unit
600	2000	600	41	1852	440	80	01.132.272.1	1 unit
600	1800	800	37	1652	640	83	01.132.277.1	1 unit
600	2000	800	41	1852	640	90	01.132.278.1	1 unit

Accessories for Vertiv Knürr MIR IP55 Rack on request



MIR00070

Vertiv™ Knürr® MIR top cover Closed, IP55

– Can be optionally used as top cover or bottom cover (combination with stationary plinth is not possible with us as bottom cover).

■ **Protection rating**

– Installation in the Vertiv™ Knürr® MIR® (depending on other rack components), achieves a maximum protection rating of IP 55.

■ **Finish**

– Powder-coated texture, RAL 7035.

■ **Scope of delivery**

– 1 x cover, closed.
– 1 x Mounting kit.

■ **How supplied**

– In sets.

W	D	Order No.	UP
600	600	01.130.690.1	1 unit
600	800	01.130.691.1	1 unit
600	900	01.130.692.1	1 unit
600	1000	01.127.700.1	1 unit
600	1200	01.133.760.1	1 unit
800	600	01.130.691.1	1 unit
800	800	01.130.699.1	1 unit
800	900	01.130.700.1	1 unit
800	1000	01.127.702.1	1 unit
800	1200	01.133.762.1	1 unit

Dimensions in mm:

W = Width h = Installation height U = Standard rack unit
 H = Height d = Insertion depth (1 U = 44.45 mm)
 D = Depth L = Length UP = Packaging unit

Conversion:

1 mm = 0.03937 inch
 1 kg = 2.2046 pounds

Vertiv™ Knürr® DCM Rack System

Market-leading Data Center Technologies for your Company

Integrated solutions.

Integrated benefits.

Integrated energy efficiency.

- **Reliability:**
Proven business-critical technologies that minimize failure sources and guarantee the greatest possible reliability for your IT systems.
- **Everything from one source:**
One central provider for the provision, configuration, installation and support of your products and technologies.
- **Integration:** From the rack through to the entire room – our products and services form one integrated holistic system.
- **Technical support:** Where required, on-site and factory-site support is provided by application specialists. Vertiv has the largest team of customer service specialists in the world.
- **Flexible configuration options:** Our products and technologies deliver flexibility, adaptability and cost-effective solutions.
- **Energy efficiency:** We offer our customers "Green IT" solutions that set standards on the ITC market – a data-center infrastructure that stays abreast current and future requirements and facilitates management and automation of physical infrastructure.

Vertiv™ Knürr® provides comprehensive products and services for all requirements – from compact racks and computer rooms, right through to global data centers.

Based on a variety of data centers' specific requirements, Vertiv has developed a customized, ready-made solution: rack systems with integrated thermal management, power supply cooling and monitoring. We also provide optional services such as on-site expertise and support, thereby ensuring that you can easily order, configure, manage and implement your Vertiv Knürr solution.



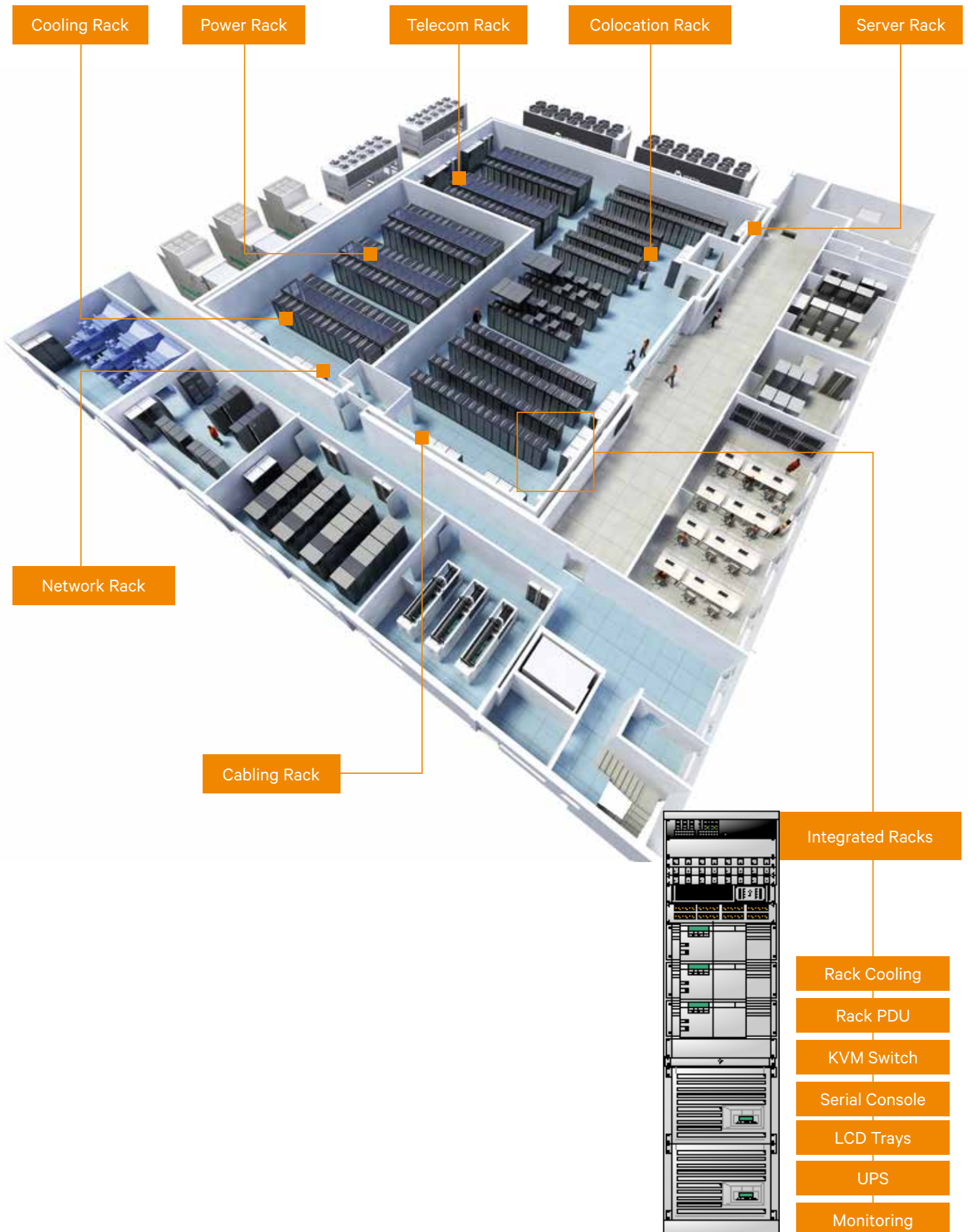



Vertiv™ Knürr® DCM

The Modular Rack Platform for a Future-proof Data Center

- Modular building box: quick, cost-effective and sustainable.
- Maximum space for power-supply and cabling components allowing them to be placed alongside the panels.
- Structural stability with low weight provided by light aluminum structure that can be disassembled.
- More variability with stepless, adjustable-depth air containment with vertical extrusions.

Everything in the data center begins with the Vertiv™ Knürr® DCM!

The Vertiv Knürr DCM is the modular building block for all "in row" applications of Vertiv's products. It's used as server racks, power racks, or storage racks.

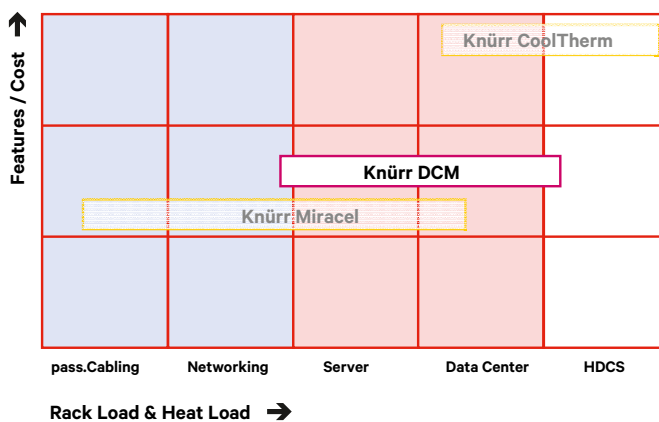
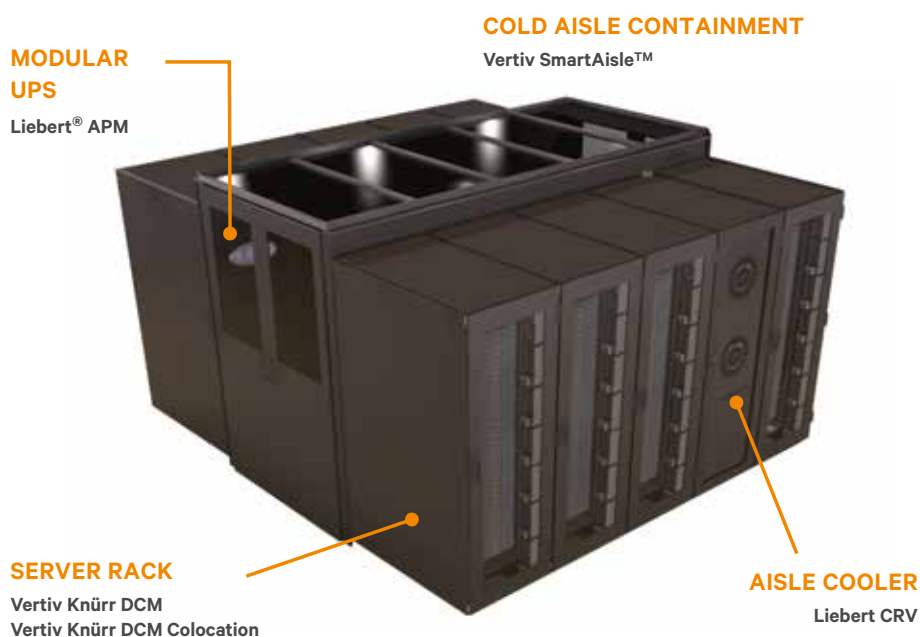

Positioning of rack in area of application



Vertiv™ Knürr® DCM

Application-optimized Server-Rack Solution – The Keystone for your IT Solutions



**The right rack size
for every application**

- **Vertiv™ Knürr® Data Center Module**
The Vertiv Knürr DCM is Vertiv's globally available rack for world-wide, standardized data center planning.
- **Global standard**
The 2000 mm height and 1100 mm depth rack version is the global platform for rack suites at Vertiv. Cooling racks, power racks and server racks based on the Knürr DCM platform guarantee easy integration into the rack suite.
- **Metric measurements**
for global use.
- **Stable and secure**
Vertiv Knürr DCM seismic-tested version available up on request. Static load of up to 1500 kg. Flexible use as a server or active network rack.





1. DCM20059



3. DCM20030

Vertiv™ Knürr® DCM

Features

- **High-load cabinet**
 Static load of 1500 kg featuring a new design, more stable profiles and new high-load corner joints. (1)
- **Screw design**
 Since the rack can easily be dismantled, even to the most restricted areas are accessible. (2)
- **Light aluminum frame**
 Lower weight allows for easier, lighter transportation. (3)
- **Convenient**
 Tool-free door assembly. (4)
- **Low, heavy-duty casters**
 Even fully equipped rack can be moved safely and conveniently. (5)
- **Integrated tilt restraint**
 Quick and easy installation and disassembly.
- **Cable management**
 Guaranteed orderly and space-saving cable management. Adaptable to site installation requirements: cable management can be selected from an extensive range of accessory components. (6)
- **Largest possible perforation**
 For improved airflow. (7)
- **Maximum space**
 PDUs and cable management can also be housed in the space between the 19" level and the side panel.
- **Adjustable-depth air separation**
 Cold/warm air is sealed alongside the panels, permitting adjustment of the depth. The standard air-containment accessory (with 1 U slot) can be used to increase the usable space of your server rack up to 6 U. (8)



2. DCM20008



4. DCM20006



5. DCM20028



6. DCM20027

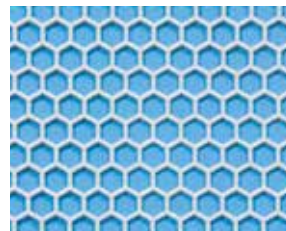

7. MIR20265



8. DCM20000



DCM20066

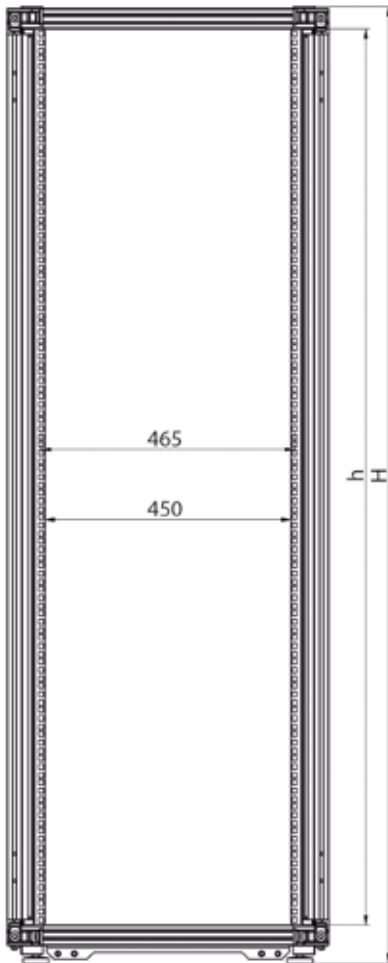

Vertiv™ Knürr® DCM Technical data

- Material**
 - Extruded aluminum.
 - Corner piece, die-cast aluminum.
 - Covers, steel sheet, zinc-passivated.
 - Steel sheet doors.

 - Installation dimensions compliant with IEC 60297-1 and IEC 60297-2**
 - Height: 42 U / 47 U (1 U) = 44.45 mm).
 - Width: 482.6 mm (19" construction).

 - Available space**
 - Jumping space, 80 mm.
 - 130° door opening angle in the rack suite and 180° as individual rack.

 - Configurations**
 - Stationary on leveling feet.
 - Mobile with caster mounting and leveling feet.

 - Finish/Color**
 - Basic rack, polished.
 - Visible surface of covers RAL 7021 dark-grey.

 - Static load rating**
 - 15000 N (stationary model).
 - 10000 N (mobile model).

 - Tests depending on design**
 - IP test compliant with IEC 60529.
 - Earthing and protective conductor test compliant with DIN EN 60950.
- Further standards and tests may be provided upon request.

Further standards and tests may be provided upon request.

Nom. dimension	W	W1	W2	D	D1	D2
W 600 / D 1000	591	535	485	986	856	885
W 600 / D 1100	591	535	485	1086	956	985
W 600 / D 1200	591	535	485	1186	1056	1085
W 800 / D 1000	791	735	685	986	856	885
W 800 / D 1100	791	735	685	1086	956	985
W 800 / D 1200	791	735	685	1186	1056	1085

Nom. height	H	h
H 2000	1983	1872
H 2200	2205	2095

Dimensions in mm:				Conversion:	
W = Width	h = Installation height	U = Standard rack unit	kg = Weight	1 mm = 0.03937 inch	
H = Height	d = Insertion depth	(1 U = 44.45 mm)		1 kg = 2.2046 pounds	
D = Depth	L = Length	UP = Packaging unit			

Vertiv™ Knürr® DCM
Configurator

- Up to 2.5 million different assembly options



Vertiv™ Knürr® DCM – configured by you

Impressive number of variations:

There are now up to 2.5 million options for a configuration with the 'Configurable Article Number' (which replaces the old order numbers).

A system building box that significantly simplifies your combinations.

This 'Configurable Article Number' reproduces all requested properties via multiple choice (see chart below), without requiring detailed rack descriptions.

Definite identification is also possible with a repeat order or upgrade.

The 'Configurable Article Number' makes a significant contribution to simplifying the selection and ordering process.

Product line

Vertiv Knürr DCM

	Dimensions			Doors		19" Extrusions		Covers			Packaging			Color	
	2	3	4	5	6	7	8	9	10	11	12	13	14	15	
	Rack Height	Rack Width	Rack Depth	Front Door	Rear Door	19"-Front Vertical Extrusion	19"-Rear Vertical Extrusion	Cover	Plinth	Side Panel	Packaging	19" vertical extrusion, mounting position front and space between	Free	Color	
1	D= P	B= P	6= P	E= P	A= P	A= P	A= P	S= P	C= P	A= P	B= P	X= P	A= P	X= P	1= P
	Vertiv Knürr DCM Rack	42 U	600 mm	1000 mm	Single glass door	Single glass door	19" vertical server extrusion with air containment and 3x1 U cut-outs*	19" vertical server extrusion	Top cover with cable entry	Fixed plinth, 100 mm	Both sides	Standard packaging	80/740mm		RAL 7035
	D= P	8= P	F= P	B= P	B= P	B= P	X= P	E= P	B= P	L= P		B= P		8= P	
	47 U	800 mm	1100 mm	Single steel sheet door	Single steel sheet door	19" vertical server extrusion with air containment	Without 19" extrusions	Cover with lateral cable entry	Fixed plinth, 200 mm	Left		85/740 mm		RAL 7021	
			G= P	C= P	C= P	C= P		G= P	R= P	R= P		C= P		X= P	
			1200 mm	Perforated single door	Perforated single door	19" Server extrusion with vertical cablemanger*		Cover short	With casters	Right		115/740 mm		without color **	
				G= P	G= P	S= P		X= P	F= P	X= P		D= P			
				Perforated double door	Perforated double door	19" vertical server extrusion		Without cover	Fixed without plinth. Only feet are height-adjustable	Without		123/740 mm			
				X= P	R= P							E= P			
				Without door	Back cover							200/740 mm*			
					X= P							F= P			
					Without door							215/740 mm*			
												G= P			
												150/740 mm			

Configuration example:

Product	Height	Width	Depth	Front Door	Rear Door	19"-Front Vertical Extrusion	19"-Rear Vertical Extrusion	Cover	Plinth	Side Panel	Packaging	19" extrusion insertion depth	Free	Color
D	B	8	F	G	X	A	X	C	B	L	X	X	X	8

Remarks:

* this options might not be possible with each Rack width, depth and 19" mounting position.

** "X" if select no cladding parts.

P = assemble to order (shipped within 5 working days).
Caution: In case of larger orders, delivery times may increase.

Example product number



DCM20003 stationary DCM20022 mobile

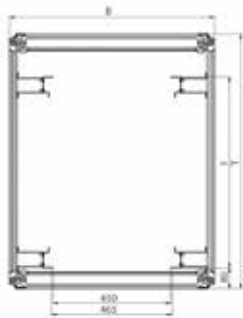

DCM20063 Average width 800 mm, stationary



DCM20062 Average width 600 mm, stationary

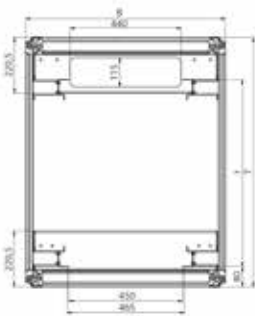

DCM20065 Average width 800 mm, mobile

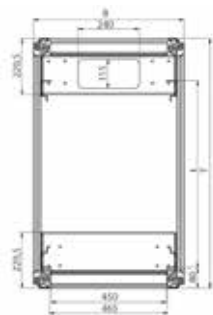

DCM20064 Average width 600 mm, mobile

Vertiv™ Knürr® DCM 19" Heavy Duty Server Rack Width 600 and 800, Stationary and Mobile

- Perforated front door.
- Perforated rear double door.
- Special 19" server extrusions for mounting all off-the-shelf 19" servers.
- Components compliant with IEC 297-3.
- Cable entry via top and bottom cover.
- Cable entry on the top cover can be completely removed at the rear allowing installing and removal of top cover after cabling.
- Mobile design includes heavy-duty casters with ample floor clearance.

■ Jumpering space

- Front 80 mm.

■ Load rating

- 15000 N static.
- 10000 N mobile in data center with load.

■ Protection rating

- IP 20.

■ Tests

- Earth compliant with DIN EN 60950.
- Mobile design: Earthing compliant with VDE 0100 T 540.
- IP test compliant with DIN 40 050 / IEC 529.

■ Airflow circulation

- Perforation: 83%.

■ Material / Finish

- Basic rack, extruded aluminum, polished.
- Corner piece, die-cast aluminum, polished.
- Doors, steel sheet, powder-coated texture.
- Covers, zinc-passivated steel sheet, powder-coated texture.
- 19" extrusions, 2.0 mm zinc-passivated steel sheet.

■ Color

- Visible surfaces and covers coated with RAL 7021, dark-grey.

■ Scope of delivery

- 1 x basic rack.
- 4 x 19" server extrusions, steel sheet inclusive U marking.
- 2 x side panels with quick connectors.
- 1 x top cover with cable entry (three-piece sliding plates can also be opened completely).
- 1 x front door, single, perforated, with handle and mounting for cylinder lock.
- 1 x rear door, double, perforated, steel sheet, with handle and mounting for cylinder lock.
- 4 x leveling feet.
- 1 x complete earthing test (VDE 0100).
- Mobile design: additionally 2 caster mountings with heavy-duty casters and integrated cable entry.

■ How supplied

- Mounted.

■ Note

- Order mounting adapters for 19" server extrusion for mounting Knürr accessories are also available.

W	H	D	U	d	kg	Model	Order No.	UP	
600	2000	1200	42	740	117	Stationary with side panels	DB6GCGSSCFBXXX8	1 unit	
600	2200	1200	47	740	121	Stationary with side panels	DD6GCGSSCFBXXX8	1 unit	
800	2000	1200	42	740	132	Stationary with side panels	DB8GCGSSCFBXXX8	1 unit	
800	2200	1200	47	740	136	Stationary with side panels	DD8GCGSSCFBXXX8	1 unit	
600	2000	1200	42	740	75	Stationary, no side panels	DB6GCGSSCFXXX8	1 unit	
600	2200	1200	47	740	81	Stationary, no side panels	DD6GCGSSCFXXX8	1 unit	
800	2000	1200	42	740	92	Stationary, no side panels	DB8GCGSSCFXXX8	1 unit	
800	2200	1200	47	740	94	Stationary, no side panels	DD8GCGSSCFXXX8	1 unit	
600	2000	1200	42	740	127	Mobile with side panels	DB6GCGSSCRBXXX8	1 unit	
800	2200	1200	47	740	146	Mobile with side panels	DD8GCGSSCRBXXX8	1 unit	
600	2000	1200	42	740	85	Mobile, no side panels	DB6GCGSSCRXXX8	1 unit	
800	2200	1200	47	740	104	Mobile, no side panels	DD8GCGSSCRXXX8	1 unit	

= assemble to order (shipped within 5 working days).
Caution: In case of larger orders, delivery times may increase.



DCM20085



DCM20086



DCM20087



DCM20088

**Vertiv™ Knürr® DCM Colocation Rack
Width 800 mm**

- Perforated front doors with one-point lock.
- Perforated rear doors with one-point lock.
- Special 19" server extrusions for mounting all off-the-shelf 19" servers.
- Components compliant with IEC 297-3.
- Standard cable entry with fixed cable duct on the right.
- Optional cable entry left and right via cover and shelf by reconfiguration of the cable ducts.
- Secure partitioning of the individual bays using securely mounted partition shelves.
- With lateral air containment at the front left and right, each with 1 U opening for mounting different components.
- Doors with handle and mounting for cylinder lock.
- Adjustment of the 19" extrusions in 50 mm increments.

■ Jumping space

- Front 80 mm.

■ Load rating

- 25 kg per rack unit (stationary).
- e.g.: 15 U x 25 kg = 375 kg load for one bay.

■ Protection rating

- IP 20.

■ Tests

- Earthing compliant with VDE 0100 T 450.
- IP test compliant with DIN 40 050 / IEC 529.

■ Airflow circulation

- Perforation: 83%.

■ Material / Finish

- Basic rack, extruded aluminum, polished.
- Corner piece, die-cast aluminum, polished.
- Doors, steel sheet, powder-coated texture.
- Partitioning walls, zinc-passivated steel sheet.
- 19" extrusions, 2.0 mm zinc-passivated steel sheet.
- Shelf supports, zinc-passivated.

■ Color

- Visible cover surface
- Final digit of Order No. 1: RAL 7035 light-grey.
- Final digit of Order No. 8: RAL 7021 dark-grey.

■ Scope of delivery

- 1 x basic rack.
- 4 x 19" server extrusions with regular perforations, steel sheet with rack unit marking for each bay.
- 1 x top cover, including cable-inlet covers on the left and right sides.
- 1 x shelf, including cable-inlet cover on the right; open on the left for cable duct = cable entry.
- 2 x partitioning shelves for 3-way colocation.
- 1 x partitioning shelf for 2-way colocation.
- 3 x perforated front and rear doors for 3-way colocation.
- 2 x perforated front and rear doors for 2-way colocation.
- Air containment at the front with covered 1 U cut-out.

■ How supplied

- Mounted.

■ Note

- Also order mounting adapters for 19" server extrusion for mounting Knürr accessories.
- Side partitioning walls must be ordered separately.
- Cylinder locks must be ordered separately.
- Stationary plinth can be mounted afterwards.

W	H	D	U	d	kg	Model	Order No.	UP
800	2000	1100	13	740	136	3-way colocation without side panels	01.143.000.X-001	1 unit
800	2000	1200	13	740	142	3-way colocation without side panels	01.143.000.X-002	1 unit
800	2200	1100	15	740	145	3-way colocation without side panels	01.143.000.X-003	1 unit
800	2200	1200	15	740	150	3-way colocation without side panels	01.143.000.X-004	1 unit
800	2000	1100	20	740	95	2-way colocation without side panels	01.143.001.X-001	1 unit
800	2000	1200	20	740	122	2-way colocation without side panels	01.143.001.X-002	1 unit
800	2200	1100	23	740	125	2-way colocation without side panels	01.143.001.X-003	1 unit
800	2200	1200	23	740	123	2-way colocation without side panels	01.143.001.X-004	1 unit
800	2000	1100	13	740	175	3-way colocation with side panels	01.143.002.X-001	1 unit
800	2000	1200	13	740	184	3-way colocation with side panels	01.143.002.X-002	1 unit
800	2200	1100	15	740	178	3-way colocation with side panels	01.143.002.X-003	1 unit
800	2200	1200	15	740	194	3-way colocation with side panels	01.143.002.X-004	1 unit
800	2000	1100	20	740	155	2-way colocation with side panels	01.143.003.X-001	1 unit
800	2000	1200	20	740	164	2-way colocation with side panels	01.143.003.X-002	1 unit
800	2200	1100	23	740	165	2-way colocation with side panels	01.143.003.X-003	1 unit
800	2200	1200	23	740	170	2-way colocation with side panels	01.143.003.X-004	1 unit



DCM20110

Partitioning Wall for Retrofitting

- To secure the partitions between the individual bays against unauthorized access.
- Each bay can be closed off separately after initial installation.
- The partitioning wall is inserted above and below on mounting strips provided for this purpose.
- The partitioning wall is screwed into place at the front and covered by the door.

- **Material**
 - Order no.1: Powder-coated RAL 7035, light-grey texture.
 - Order no.8: Powder-coated RAL 7021, dark-grey texture.

- **Finish / Color**
 - Zinc-passivated steel sheet.

- **Scope of delivery**
 - 1 x partitioning wall for retrofitting.
 - 1 x Mounting kit.

- **How supplied**
 - In sets.

- **Note**

Partitioning wall can be installed from every position (top, middle, bottom, left and right).

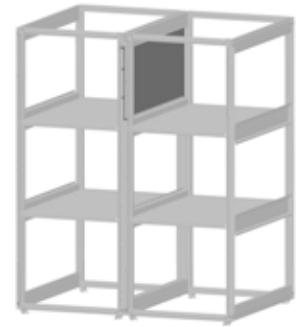

DCM20109

H	D	Model	Order No.	UP
2000	1100	For 3-way colocation	01.143.100.X-001	1 unit
2000	1200	For 3-way colocation	01.143.100.X-002	1 unit
2200	1100	For 3-way colocation	01.143.100.X-003	1 unit
2200	1200	For 3-way colocation	01.143.100.X-004	1 unit
2000	1100	For 2-way colocation	01.143.100.X-005	1 unit
2000	1200	For 2-way colocation	01.143.100.X-006	1 unit
2200	1100	For 2-way colocation	01.143.100.X-007	1 unit
2200	1200	For 2-way colocation	01.143.100.X-008	1 unit



DCM20111

3-point Locking Upgrade Kit

- Upgrade kit for conversion to 3-point locking.
- Additional security.
- Can be upgraded at any time.
- Suitable for heights of 2000 and 2200 mm.

- **Scope of delivery**
 - 1 x Rod for locking unit.
 - 1 x Rod guide.

- **How supplied**
 - In sets.

H	Model	Order No.	UP
2000, 2200	for 3-way colocation	01.143.102.7-001	1 unit
2000, 2200	for 2-way colocation	01.143.102.7-002	1 unit



DCM20099

Cable Duct for Retrofitting

- Secure cabling for data and power-supply lines.
- Subsequent installation in 2- or 3-way colocation.
- Cable duct can be rebuilt at any time.

- **Material**
 - Steel sheet 1.0 mm.

- **Finish / Color**
 - Zinc-passivated steel sheet.

- **Scope of delivery**
 - 1 x cable duct for retrofitting.
 - 1 x Covers.
 - 1 x Mounting kit.

- **How supplied**
 - In sets.



DCM20100

H	Model	Order No.	UP
2000	Short, for 3-way colocation	01.143.101.0-001	1 unit
2000	Long, for 3-way colocation	01.143.101.0-002	1 unit
2200	Short, for 3-way colocation	01.143.101.0-003	1 unit
2200	Long, for 3-way colocation	01.143.101.0-004	1 unit
2000	For 2-way colocation	01.143.101.0-005	1 unit
2200	For 2-way colocation	01.143.101.0-006	1 unit

Dimensions in mm:

W = Width	h = Installation height	U = Standard rack unit	kg = Weight
H = Height	d = Insertion depth	(1 U = 44.45 mm)	
D = Depth	L = Length	UP = Packaging unit	

Conversion:

1 mm = 0.03937 inch
1 kg = 2.2046 pounds



ACCESSORIES

VERTIV™ KNÜRR® MIR2 / VERTIV KNÜRR DCM RACK SPECIFIC ACCESSORIES

Doors

Material

– Steel sheet: 1.0 mm.

Colour

– digit X of order number .1: RAL 7035 light-grey.
– digit X of order number .8: RAL 7021 dark-grey.

Included in delivery







– 1 x door, single, double leaf or rear panel.
– Mounting kit.

Delivered

– Pre-assembled.

Note

Perforated doors (83% free surface) allow for optimum airflow throughout the rack.

Image	Description	Version	Dimensions		Dimensions	
			H 2000 mm		H 2200 mm	
			W 600 mm	W 800 mm	W 600 mm	W 800 mm
	Steel sheet door with perforation, single leaf	160° opening angle, internal hinges	01147803.X	01147805.X	01147806.X	01147808.X
		180° opening angle, external hinges	01157092.X-007	01157092.X-009	01157092.X-010	01157092.X-012
	Steel sheet door with perforation, double leaf	160° opening angle, internal hinges	01147921.X	01147929.X	01147922.X	01147930.X
		180° opening angle, external hinges	01157093.X-007	01157093.X-009	01157093.X-010	01157093.X-012
	Steel sheet door without perforation, single leaf	160° opening angle, internal hinges	01147534.X	01147536.X	01147537.X	01147539.X
		180° opening angle, external hinges	01157094.X-007	01157094.X-009	01157094.X-010	01157094.X-012
	Steel sheet door without perforation, double leaf	160° opening angle, internal hinges	01147570.X-002	01147570.X-010	01147570.X-003	01147570.X-011
		180° opening angle, external hinges	01157095.X-007	01157095.X-009	01157095.X-010	01157095.X-012
	Glass door, single leaf	160° opening angle, internal hinges	01147540.X	01147542.X	01147543.X	01147545.X
		180° opening angle, external hinges	01157090.X-007	01157090.X-009	01157090.X-010	01157090.X-012
	Glass door, double leaf	160° opening angle, internal hinges	01147571.X-002	01147571.X-010	01147571.X-003	01147571.X-011
		180° opening angle, external hinges	01157091.X-007	01157091.X-009	01157091.X-010	01157091.X-012
	Rear panel		01157080.X-003	01157080.X-004	01157080.X-005	01157080.X-006

Top Cover

- With cable entry (sliding plates).
- For orderly cable management in the rack.

Finish / Colour

- digit X of order number .1: RAL 7035 light-grey, powder-coated texture.
- digit X of order number .8: RAL 7021 dark-grey, powder-coated texture.

Included in delivery

- 1 top panel with cable entry.
- Mounting kit.

Material

- Steel, 1.5 mm.

Delivered

- In sets.

Image	Description	Dimensions				
		W 600 mm				
		D 600 mm	D 800 mm	D 1000 mm	D 1100 mm	D 1200 mm
	Top cover with lateral cable inlet		01147570.X	01147572.X	01147573.X	01147574.X
	Top cover with rear cable entry	01157050.X-007	01157050.X-008	01157050.X-001	01157050.X-002	01157050.X-003
	Top cover with cut out for fan units and cable inlet rear. Cut out closed with screwed blanking panel.		01157052.X-001	01157052.X-003	01157052.X-007	01157052.X-008
	Top cover with cable inlet rear and 25 mm raised	01157051.X-001	01157051.X-002	01157051.X-004	01157051.X-011	01157051.X-012
	Top cover, short d 250mm	01147268.X				

Image	Description	Dimensions				
		W 800 mm				
		D 600 mm	D 800 mm	D 1000 mm	D 1100 mm	D 1200 mm
	Top cover with lateral cable inlet		01147575.X	01147577.X	01147578.X	01147579.X
	Top cover with cable inlet rear	01157050.X-011	01157050.X-012	01157050.X-004	01157050.X-005	01157050.X-006
	Top cover with cut out for fan units and cable inlet rear. Cut out closed with screwed blanking panel.		01157052.X-004	01157052.X-006	01157052.X-009	01157052.X-010
	Top cover with cable inlet rear and 25 mm raised	01157051.X-005	01157051.X-006	01157051.X-008	01157051.X-009	01157051.X-010
	Top cover, short d 250mm	01147269.X				

VERTIV™ KNÜRR® MIR2 / VERTIV KNÜRR DCM RACK SPECIFIC ACCESSORIES

Bottom Plates

- For covering the rack underneath.
- With foam rubber seals and brush strips; cable entry at the front and rear.
- For racks with and without castor mounting.

Material / Finish

- Steel sheet, 1,5 mm, galvanized.
- For foam rubber seals (foam rubber, 50x30 mm).

Included in delivery

- Bottom plates.
- 2 x mounting brackets.
- Mounting kit.

Delivered

- In sets.

















Image	Description	Dimensions			
		W 600 mm	D 800 mm	D 1000 mm	D 1100 mm
	Bottom plate closed, used with castor bracket	011570420-001	011478340	011478350	011478400
	Bottom plate for cable entry with foam rubber seal	 011570410-001	 011478460	011478470	 011478520
	Bottom plate, modular	011570400-001	011570400-003	011570400-004	011570400-005
	Bottom plate for cable entry with brush strip	011570450-001	011570450-003	011570450-004	011570450-005
	Perforated bottom plate d 155mm	011570250-001			

Image	Description	Dimensions			
		W 800 mm	D 800 mm	D 1000 mm	D 1100 mm
	Bottom plate closed, used with castor bracket	011570420-003	011478380	011478390	011478440
	Bottom plate for cable entry with foam rubber seal	 011570410-003	 011478500	011478510	 011478560
	Bottom plate, modular	011570400-006	011570400-008	011570400-009	011570400-010
	Bottom plate for cable entry with brush strip	011570450-006	011570450-008	011570450-009	011570450-010
	Bottom plate for cable entry with brush strip	01157043X.001	01157043X.003	01157043X.004	01157043X.005
	Perforated bottom plate d 155mm	011570250-003			

Plinth

- Stationary, including levelling options.
- Cable entry accessible from all sides.
- Removable cover plates.
- Installation option for filter mat.

- **Load rating**
- 10,000 N static.

- **Material**
- Steel sheet.

- **Colour**
- digit X of order number .1: RAL 7035 light-grey.
- digit X of order number .8: RAL 7021 dark-grey.

- **Included in delivery**
- 4 x plinth corners, including levelling feet.
- 8 x cover plates without vents (for a height of 200 mm), 4 x cover plates without vents (for a height of 100 mm).

- 8 x cover plates (for a height of 200 mm, 4 without and 4 with vents), 4 cover plates (for a height of 100 mm, 2 without vents and 2 x with vents).
- Mounting kit.

- **Delivered**
- In sets.

Image	Description	Dimensions				
		D 600 mm	D 800 mm	D 1000 mm	D 1100 mm	D 1200 mm
	Stationary plinth, 100 mm high, without vents	01157.055.X-001.	01157.055.X-002	01147.738.X	01147.739.X	01147.740.X
	Stationary plinth, 100 mm high, with vents	01157.060.X-001	01157.060.X-002	01157.060.X-004	01157.060.X-005	01157.060.X-006
	Stationary plinth, 200 mm high, without vents	01157.056.X-001	01157.056.X-002	01147.788.X	01147.789.X	01147.790.X
	Stationary plinth, 200 mm high, with vents	01157.065.X-001	01157.065.X-002	01157.065.X-004	01157.065.X-005	01157.065.X-006

Image	Description	Dimensions				
		D 600 mm	D 800 mm	D 1000 mm	D 1100 mm	D 1200 mm
	Stationary plinth, 100 mm high, without vents	01157.055.X-007	01157.055.X-008	01147.746.X	01147.747.X	01147.748.X
	Stationary plinth, 100 mm high, with vents	01157.060.X-007	01157.060.X-008	01157.060.X-010	01157.060.X-011	01157.060.X-012
	Stationary plinth, 200 mm high, without vents	01157.056.X-007	01157.056.X-008	01147.796.X	01147.797.X	01147.798.X
	Stationary plinth, 200 mm high, with vents	01157.065.X-007	01157.065.X-008	01157.065.X-010	01157.065.X-011	01157.065.X-012

P - assemble to order (shipped within 5 working days).
Caution: In case of larger orders, delivery times may increase.

Side Panel

– Side panel module for 19" server rack.

Material

– Steel sheet: 1.0 mm.



Finish / Colour

– digit X of order number 1:
RAL 7035 light-grey.
– digit X of order number 8:
RAL 7021 dark-grey.

Included in delivery

– 1 x side panel.
– Mounting kit.

Delivered

– In sets.

H	D	Version	Order No.	Units
2000	600	Side panel	01147.871.X-004	1 unit
2000	800	Side panel	01147.871.X-005	1 unit
2000	1000	Side panel	01147.876.X	1 unit
2000	1100	Side panel	01147.877.X	1 unit
2000	1200	Side panel	01147.878.X	1 unit
2200	600	Side panel	01147.871.X-007	1 unit
2200	800	Side panel	01147.871.X-008	1 unit
2200	1000	Side panel	01147.880.X	1 unit
2200	1100	Side panel	01147.881.X	1 unit
2200	1200	Side panel	01147.882.X	1 unit

Partition Wall

Partition wall for retro-fitting

- For air containment between two fixed adjacent racks.
- The partition wall is fitted between two racks and can be inserted from one side of the linking racks.
- Guided along the upper rear extrusion of one of the linked racks.
- After the partition wall has been inserted, fasteners are bent or welded on one side of the wall and screwed into the vertical T-slot to secure the structure. The rack connectors supplied upon delivery are used on the opposite side.

Material

– Steel sheet: 1.0 mm.

Finish / Colour

– digit X of order number 1: RAL 7035 light-grey, powder-coated texture.
– digit X of order number 8: RAL 7021 dark-grey, powder-coated texture.

Mounted partition wall fixed

- For air containment between two fixed adjacent racks.
- The partition wall is only mounted on one rack and must be mounted before the other racks are installed.
- The partition wall is slotted in at the top of the rear extrusion and attached to the basic rack with quick connectors.
- The rack connectors are then fitted to the top and bottom of the frame extrusions from the inside.
- Plastic cover extrusions are provided to seal the gap between the two racks. These can be clipped into place at the front and back of the gap.

Included in delivery

– 1 x partition wall.
– 1 x set of rack connectors.
– 2 x cover extrusions , earthing set (for fixed partition wall only).
– Mounting kit.

Delivered

– In sets.

Image	Description	Dimensions			Dimensions		
		D 1000 mm	D 1100 mm	D 1200 mm	D 1000 mm	D 1100 mm	D 1200 mm
	Partition wall for retro-fitting	01147644.X	01147645.X	01147646.X	01147647.X	01147648.X	01147649.X
	Mounted, fixed partition wall	01147690.X	01147691.X	01147692.X	01147693.X	01147694.X	01147695.X

Air Containment

- The cold/warm area partition can be quickly and easily retrofitted into the rack.
- Side cover plates with 2 cut-outs each for cables (for 800 mm wide racks).
- 3 x 1 HE cut-outs, covered with cover plates (only in versions with vents).
- Bolted to the sides of the 19" extrusions (in 800 mm wide racks).
- Sealed off from the side panels or from the same level of adjoining racks.
- Foam components allow for infinite adjustability in terms of depth.

Material

- Steel sheet.

Colour

- digit X of order number .1:
RAL 7035 light-grey.
- digit X of order number .8:
RAL 7021 dark-grey.

Included in delivery

- 2 x side cover plates (for 800 mm wide racks).
- 1 x cover plate, bottom.
- 1 x foam block for the top.
- Mounting kit.

Delivered

- In sets.

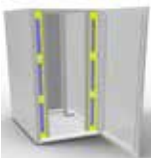
Image	Description	Version	Dimensions		Dimensions	
			H 2000 mm		H 2200 mm	
			W 600 mm	W 800 mm	W 600 mm	W 800 mm
	Air containment without vents	for Racks with castor brackets	01147898.X	01147889.X	01147899.X	01147890.X
		for Racks without castor brackets	01147901.X	01147895.X	01147902.X	01147896.X
	Air containment with 3 x 1 HE cover plates, vertical	for Racks with castor brackets		01147904.X		01147905.X
		for Racks without castor brackets		01147907.X		01147908.X

Dimensions in mm:

W = Width h = Installation height U = Standard rack unit kg = Weight
 H = Height d = Insertion depth (1 U = 44.45 mm)
 D = Depth L = Length UP = Packaging unit

Conversion:

1 mm = 0.03937 inch
 1 kg = 2.2046 pounds

VERTIV™ KNÜRR® MIR2 / VERTIV KNÜRR DCM RACK SPECIFIC ACCESSORIES

19" Vertical Extrusion with Mounting Holes and U Measure Tape

- For mounting 19" rack components.
- For mounting cable management systems and components.
- For mounting slot-in runners, intermediate fixed and pull-out shelves. (no adapter necessary)
- For mounting drawers.

Material / Finish

- Steel sheet: 1.5 mm, galvanized.
- Measure Tape glued.

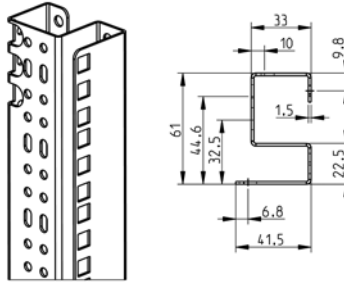

Included in delivery

- Front (2 x 19" vertical extrusions with cross beam and 2 x 19" mountings – for 600 mm wide racks without cross beam and 19" mountings).
- Rear (2 x 19" vertical extrusions with 4 x 19" mountings – for 600 mm wide racks without 19" mountings).

Delivered

- In sets.

W	H	U	Description	Order No.	Units
600	2000	42	19" Vertical extrusion, front	01.157.110.7.003	1 pair
600	2000	42	19" Vertical extrusion, rear	01.157.110.7.003	1 pair
600	2200	47	19" Vertical extrusion, front	01.157.110.7.004	1 pair
600	2200	47	19" Vertical extrusion, rear	01.157.110.7.004	1 pair
800	2000	42	19" Vertical extrusion, front	01.157.113.7.003	1 pair
800	2000	42	19" Vertical extrusion, rear	01.157.114.7.003	1 pair
800	2200	47	19" Vertical extrusion, front	01.157.113.7.004	1 pair
800	2200	47	19" Vertical extrusion, rear	01.157.114.7.004	1 pair

19" vertical extrusion

aluminum with T-slot and increment slide

- For front and rear installation with in the rack.
- Spring nut, variable and adjustable, in U increments (19").

Material

- Extruded aluminum, polished.

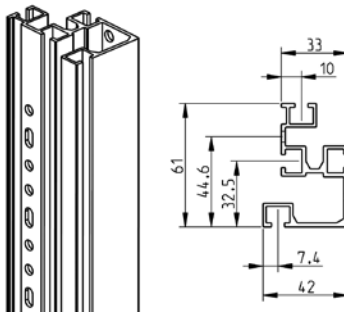

Scope of delivery

- 1 pair 19" LAN T-Slot, with cross beam (depends on order number), with mounting kit.

Note

- Maximal loading per pair 400 kg.

W	H	U	Description	Order No.	Units
800	2000	42	19"-LAN T-Slot, with cross beam, for front side	01.157.105.0.003	1 pair
800	2200	47	19"-LAN T-Slot, with cross beam, for front side	01.157.105.0.004	1 pair
800	2000	42	19"-LAN T-Slot, without cross beam, for back side	01.157.106.0.003	1 pair
800	2200	47	19"-LAN T-Slot, without cross beam, for back side	01.157.106.0.004	1 pair
600	2000	42	19"-LAN T-Slot, without cross beam, for front and back side	01.157.102.0.003	1 pair
600	2200	47	19"-LAN T-Slot, without cross beam, for front and back side	01.157.102.0.004	1 pair

Dimensions in mm:				Conversion:
W = Width	h = Installation height	U = Standard rack unit	kg = Weight	1 mm = 0.03937 inch
H = Height	d = Insertion depth	(1 U = 44.45 mm)		1 kg = 2.2046 pounds
D = Depth	L = Length	UP = Packaging unit		



LUF20337

U tape measure

- For sticking on 19" extrusions.
- Enables fast component positioning at the correct U position.
- Standard length, 48 U; shorten as required.

■ Scope of delivery

- 1 x tape measure.

U	Order No.	UP
48	01.128.400.9	1 unit

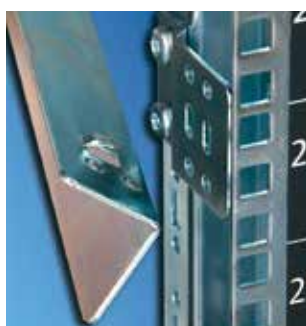

Mounting Adapter for 19" Server Extrusion

- For mounting standard Vertiv™ Knürr®-components (shelves, drawers, slot-in runners, keypad drawers, etc.) inside 19" racks.

■ Material

- Steel sheet: 2 mm, galvanized.

■ Included in delivery

- 4 x adapters.

W	H	U	Order No.	Units
63	44	1	01.147.640.9	1 set

- assemble to order (shipped within 5 working days).
Caution: In case of larger orders, delivery times may increase.

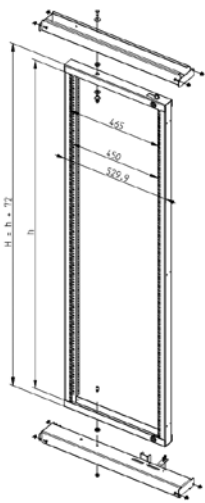

DREH

19"-Swing frame for open angle 135° or 145°

- Caution: The cabinet must be screwed to the floor and wall when using the swing frame!
- 19"-Swing frame**
 - For installation of 19"-components to IEC 297-3.
 - Permits easy access to second mounting level and to components installed in the swing frame.
 - Mountable into Racks with 800 mm widths only.
- Load rating**
 - 200 kg at mounting position A.
 - 300 kg at mounting position B.
- Material**
 - Sheet steel 2 mm.
- Finish**
 - Powder coated, textured.
- Color**
 - Digit X = .1. RAL 7035 light-grey.
 - Digit X = .8. RAL 7021 dark grey.
- Supply schedule**
 - 1 x 19"-Swing frame.
 - 1 x Mounting frames top and bottom.
 - 1 x Square Key.
 - 1 x Mounting hardware.
- Delivered**
 - Assembled.
- Note**

Installation of a swing-frame reduces the nominal installation height of the rack at 4U.

W	H	U	h	Order No.	Units
800	2000	39	1732	01.157.130.X.003	1 unit
800	2200	44	1954	01.157.130.X.004	1 unit



Mounting-Kit, wall

- Material**
 - Sheet steel 3 mm.
- Finish**
 - Powder coated, textured.
- Color**
 - Digit X = .1. RAL 7035 light-grey.
 - Digit X = .8. RAL 7021 dark-grey.
- Supply schedule**
 - 1 unit, with 2 top cover screws.

W	Order No.	Units
800	01.157.140.X.001	1 Stk

Useful depth in the swing frame

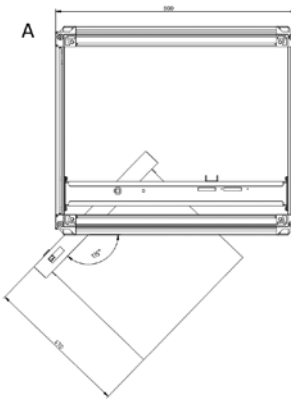

- Mounting position A**
 - Load rating max. 200 kg.
 - Opening angle 135°.
 - Useful depth in swing frame 470 mm.
 - For Racks with 800 mm width only.

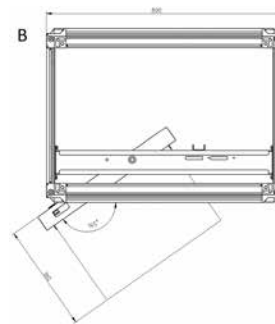

- Mounting position B**
 - Load rating max. 300 kg.
 - Opening angle 145°.
 - Useful depth in swing frame 360 mm.
 - For Racks with 800 mm width only.

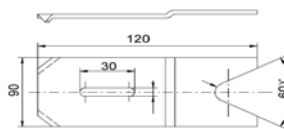

MIR00319

Mounting-Kit, floor mounting

- Material**
 - Sheet steel, 3.0 mm.
- Finish**
 - Zinc passivated.
- Supply schedule**
 - 4 piece.

Order No.	Units
01.130.934.7	1 unit

Dimensions in mm:				Conversion:
W = Width	h = Installation height	U = Standard rack unit	kg = Weight	1 mm = 0.03937 inch
H = Height	d = Insertion depth	(1U = 44.45 mm)		1 kg = 2.2046 pounds
D = Depth	L = Length	UP = Packaging unit		



MIR20093

Brush strip

- Brush strip for all covers with cable entry.
- For dust-protected and flexible cable entry.
- Can be used instead of mounting the sliding covers in the top cover.

Scope of delivery
- 2 x brush strips.

How supplied
- In sets.

B	Version	Order No.	UP
for Rack width 600/800 mm	length 436 mm	01.130.998.9	2 units



MIR00100

Internal Mounting Rack Connector

- For mechanical, stable joining of rack and enclosure suites.

Material / Finish
- Steel sheet: 2 mm, galvanised.

Installation positions
1. On the horizontal extrusions (top & bottom and front & back).
2. Vertically on the vertical extrusion (front & back and top & bottom).

Included in delivery
- 8 x mounting brackets (for connecting 2 racks / frames).
- Mounting kit.

Delivery
- In sets.

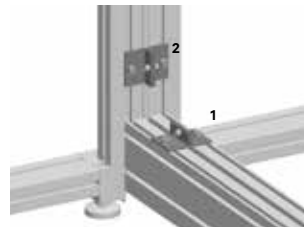

DCM20084

Order No.	Units
01.130.935.7	1 set

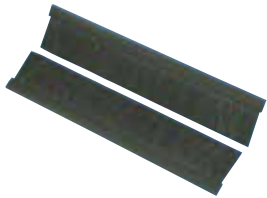

Brush strips for covers

Brush Strips for Covers with Cable Entry on the Side

- Brush strip for all covers with cable entry.
- For dust-protected and flexible cable entry.
- Can be used instead of mounting the sliding covers in the top cover.

Included in delivery
- 4 x brush strips.

Delivered
- In sets.

H	Version	Order No.	Units
800	Brush strip lateral	01.157.016.9-001	1 unit
1000	Brush strip lateral	01.157.016.9-003	1 unit
1100	Brush strip lateral	01.157.016.9-004	1 unit
1200	Brush strip lateral	01.157.016.9-005	1 unit



MIR00161

Filter mat for plinth cover plate for installation in plinth cover plate at the front and rear

Scope of delivery
- 2 x filter mats.

How supplied
- In sets.

W	Version	Order No.	UP
600	MIR2/DCM	01.130.530.9	2 units
700	MIR2/DCM	01.130.531.9	2 units
800	MIR2/DCM	01.130.532.9	2 units



Cross beam

Castor Bracket

- Mobile version: an additional 2 castor mountings with castors including integrated cable entry.
- Set is loadable up to 4000N.

Material / Finish
- Steel sheet: powder-coated texture.

Colour
- RAL 7021 dark-grey.

Included in delivery
- 1 set of castor brackets.
- Mounting kit.

Delivery
- In sets.

W	Version	Order No.	Units
600	MIR 2.0 castor bracket	01.157.073.8 001	1 set
800	MIR 2.0 castor bracket	01.157.073.8 003	1 set

Dimensions in mm:				Conversion:	
W = Width	h = Installation height	U = Standard rack unit	kg = Weight	1 mm = 0.03937 inch	
H = Height	d = Insertion depth	(1 U = 44.45 mm)		1 kg = 2.2046 pounds	
D = Depth	L = Length	UP = Packaging unit			

VERTIV™ KNÜRR® MIR2 / VERTIV KNÜRR DCM RACK SPECIFIC ACCESSORIES

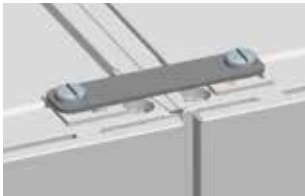

DCM20082

Vertiv™ Knürr® Connector Installed on Top

- For mechanical, stable joining of rack and enclosure suites.
- Can be installed on racks from the top directly into the die-cast corner piece.
- Easy access for installation from the outside.

Material / Finish

- Steel sheet: 3 mm, galvanized.

Included in delivery

- 2 x rack connectors (for connecting 2 racks / frames).
- 4 x knurled screws, M12.

Delivery

- In sets.



DCM20083

Version	Order No.	Units
30 x 140	01.147.642.7	1 set

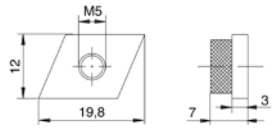
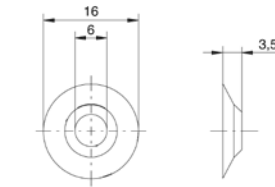

MIR00318

Assembly kit Side panel threaded connection

- Used to screw on the side walls instead of quick connectors.
- Renders rack more sturdy.

Material

- Countersunk washers and mounting nuts, stainless steel.

Scope of delivery (for 2 side panels)

- 16 x countersunk washers.
- 16 x mounting nuts, M5.
- 16 x countersunk screws, M5 x 12.

How supplied

- In sets.

Order No.	UP
01.130.937.9	1 set



MIR00216

Earthing set / doors / top cover / side panel / rear panel

- For safe earthing of doors and panels.

Scope of delivery

- 1 x earthing connection.
- 1 x Mounting kit.

How supplied

- In sets.

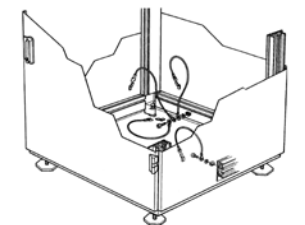

MIR00217

Model	Order No.	UP
for side panel/backside panel	01.157.015.9-001	1 set
for top cover	01.157.015.9-002	1 set
for single doors	01.157.015.9-003	1 set
for split doors	01.157.015.9-004	1 set



MIR20331

Quick connectors For side and rear panels

- Covers can be secured quickly by rotating the locks 90°.
- Easy to turn with wide flat-head screwdriver.

Material / Color

- Final digit of order number 1: Polyamide PA66, RAL 7035, light-grey.
- Final digit of order number 9: Polyamide PA66, RAL 9011, dark-grey.

How supplied

- Sets of 50 units.

Model	Order No.	UP
for side panel RAL 7035	01.133.900.1	1 set
for side panel RAL 9011	01.133.900.9	1 set
for rear panel RAL 7035	01.133.910.1	1 set
for rear panel RAL 9011	01.133.910.9	1 set



MIR20447

Cover screws

Material

- Plastic.

How supplied

- Sets of 4 units.

Order No.	UP
01.131.751.9	4 units

Dimensions in mm:				Conversion:	
W = Width	h = Installation height	U = Standard rack unit	kg = Weight	1 mm = 0.03937 inch	
H = Height	d = Insertion depth	(1 U = 44.45 mm)		1 kg = 2.2046 pounds	
D = Depth	L = Length	UP = Packaging unit			



MEC00074

Crane eyes

- For hanging on crane hooks.
- The crane eyes are screwed into the threads provided on the basic frame.

- **Load rating**
 - Max. 6,800 N.

- **Material**
 - Tool steel, forged.

- **Scope of delivery**
 - 4 x ring bolts.
 - 4 x washers.

- **How supplied**
 - In sets.

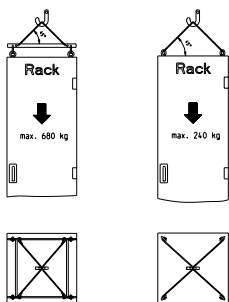

MEC20194

Order No.	UP
01.131.745.9	1 set



MIR20464

Spacer bolt

- M12 bolts.

- **Scope of delivery**
 - Set of 4 units spacer bolt.

Order No.	UP
01.131.752.7	4 units

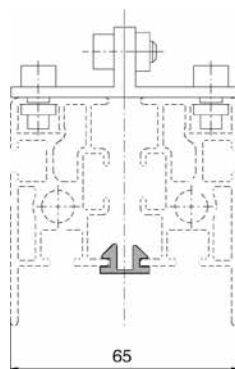

MIR00320

Cover extrusion for rack suites, IP 20

- **Material**
 - PVC extruder cover, black.

- **Scope of delivery**
 - 2 x vertical lengths.
 - 2 x depth lengths.

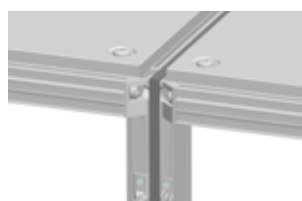

MIR20443

H	D	U	Order No.	UP
1200	600	23	01.131.270.9	1 set
1800	600	37	01.131.273.9	1 set
2000	600	41	01.131.274.9	1 set
2200	600	46	01.131.275.9	1 set
1200	800	23	01.131.276.9	1 set
1800	800	37	01.131.279.9	1 set
2000	800	41	01.131.280.9	1 set
2200	800	46	01.131.281.9	1 set
1200	900	23	01.131.282.9	1 set
1800	900	37	01.131.285.9	1 set
2000	900	41	01.131.286.9	1 set
2200	900	46	01.131.287.9	1 set
2000	1000	41	01.127.760.9	1 set
2200	1000	46	01.127.761.9	1 set
2000	1200	41	01.127.762.9	1 set
2200	1200	46	01.127.763.9	1 set

Dimensions in mm:

W = Width h = Installation height U = Standard rack unit kg = Weight
H = Height d = Insertion depth (1 U = 44.45 mm)
D = Depth L = Length UP = Packaging unit

Conversion:

1 mm = 0.03937 inch
1 kg = 2.2046 pounds



DCM20090

MIR20449

Mounting bracket Fixed

- Sits flush ('airtight').
- Even load distribution on base.
- Also compatible with DCM racks.

■ Load rating

- 15,000 N static.

■ Material

- Sheet steel 3.0 mm.

■ Finish

- Order no. 1: Powder-coated texture, RAL 7035 light-grey.
- Order no. 8: Powder-coated texture, RAL 7021 dark-grey.

■ Scope of delivery

- 2 x mounting brackets for the depth.
- 2 x mounting brackets for the width.
- 1x Mounting kit.

■ How supplied

- In sets.

W	H	D	Order No.	UP
600	27	600	01.147.509.X	1 unit
600	27	700	01.147.510.X	1 unit
600	27	800	01.147.511.X	1 unit
600	27	900	01.147.512.X	1 unit
600	27	1000	01.147.513.X	1 unit
600	27	1100	01.147.514.X	1 unit
600	27	1200	01.147.515.X	1 unit
800	27	600	01.147.525.X	1 unit
800	27	700	01.147.526.X	1 unit
800	27	800	01.147.527.X	1 unit
800	27	900	01.147.528.X	1 unit
800	27	1000	01.147.529.X	1 unit
800	27	1100	01.147.530.X	1 unit
800	27	1200	01.147.531.X	1 unit



MIR20095

Combination lock

- Mechanical solution for a top-quality locking system.
- Access either via a three-digit code that can be individually set on the handle or via a master key for access to the rack independent of the code setting.
- Suitable for Miracel 2/DCM rack single doors with swing handle.
- Subsequent retrofitting also possible without mechanical alteration.

Model	Order No.	UP
Single doors MIR2 / DCM / Smaract Doors, with swing handle	01.137.013.9	1 unit



MIR20460

Door locking set

■ Scope of delivery

- 1 lock set.
- 2 keys (half-cylinder).

Model	Order No.	UP
MIR2 / DCM / Smaract Doors, with swing handle	05.041.299.9	1 set



MIR00069

Complete locking set

■ Scope of delivery

- 2 cylinders with 2 keys each.
- 2 lockable fasteners for side panel with 2 keys each.

Model	Order No.	UP
MIR2 / DCM	01.130.940.9	1 set 



MIR20461

Spare key for door

■ Scope of delivery

- 2 x keys.

Order No.	UP
00.078.467.9	1 unit

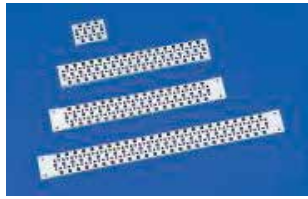

MIR00089

Multifunctional brace

- For routing cables with cable ties.
- For universal mounting option.
- Holes for mounting caged nuts.
- Distance between two multifunctional braces can be selected using T-slot.
- Installation on the extrusions of the rack frame or on the 19° extrusions, diagonal and lateral.

Installation positions

- 1 toward rear of basic frame.
- 2 across width of basic frame.
- 3 across width of 19° extrusions.
- 4 toward rear of 19° extrusions.

Material

- Sheet steel 1.5 mm.

Finish

- Zinc-passivated.

Scope of delivery

- 4 x multifunctional braces.

How supplied

- In sets.

Remark

- Pos. 4 fits only with LAN or T-Nut 19° extrusion.

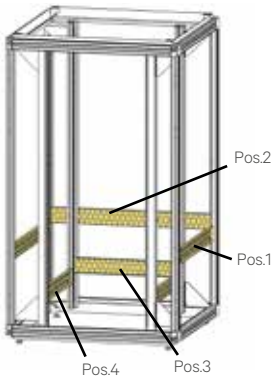

MIR88003

D _{Rack}	d	Installation position	For rack type	Order No.	UP
600	1	1	MIR2/DCM	05.040.160.9	4 units
800	1	1	MIR2/DCM	05.040.161.9	4 units
900	1	1	MIR2/DCM	05.040.162.9	4 units
1000	1	1	MIR2/DCM	05.040.163.9	4 units
1100	1	1	MIR2/DCM	05.040.164.9	4 units
1200	1	1	MIR2/DCM	05.040.165.9	4 units
600	2	2	MIR2/Smaract	05.040.173.9	4 units
800	2	2	MIR2	05.040.174.9	4 units
		3	MIR2/DCM/Smaract/DPR	05.040.175.9	4 units
600	365	4	MIR2/Smaract	05.040.168.9	4 units
800	565	4	MIR2/Smaract	05.040.169.9	4 units
600	440	4	MIR2/Smaract	05.040.170.9	4 units
800	640	4	MIR2/Smaract	05.040.171.9	4 units
900	740	4	MIR2/Smaract	05.040.172.9	4 units
1000	740	4	MIR2/Smaract	05.040.172.9	4 units



MEC20091

Cable routing brace

- Fitted to the Miracel 2/DCM/Smaract basic frame and the 19° extrusion.
- Cables fastened using Velcro and cable ties.
- For organized cable management with in the rack.
- Two-sided installation.
- Provides universal mounting using caged nuts (all dimensions can be accommodated; caged nuts are flexible).

Material

- Sheet steel, 1.5 mm.

Finish

- Zinc-passivated.

Scope of delivery

- 4 x cable routing braces.
- 1 x Mounting kit.

How supplied

- Single items.

Note

- If required, please also order Velcro rolls.



MEC20078

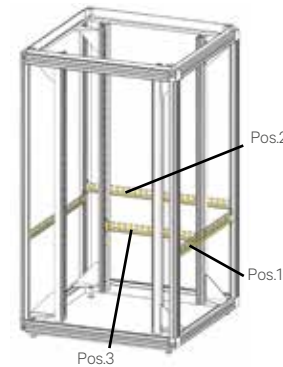

MIR88001

D	L	Model	For rack type	Order No.	UP
600	455	Pos. 1	MIR2 / DCM	05.040.200.9	4 units
800	655	Pos. 1	MIR2 / DCM	05.040.201.9	4 units
900	755	Pos. 1	MIR2 / DCM	05.040.202.9	4 units
1000	855	Pos. 1	MIR2 / DCM	05.040.203.9	4 units
1200		Pos. 1	MIR2 / DCM	05.040.205.9	4 units
	534	Pos. 2	Smaract	05.040.213.9	4 units
	468	Pos. 3	Smaract/DPR	05.040.215.9	4 units

P - assemble to order (shipped within 5 working days).
Caution: In case of larger orders, delivery times may increase.

Dimensions in mm:				Conversion:	
W = Width	h = Installation height	U = Standard rack unit	kg = Weight	1 mm = 0.03937 inch	
H = Height	d = Insertion depth	(1U = 44.45 mm)		1 kg = 2.2046 pounds	
D = Depth	L = Length	UP = Packaging unit			

VERTIV™ KNÜRR® MIR2/ VERTIV KNÜRR DCM RACK SPECIFIC ACCESSORIES



MEC0013

C extrusion rail

- Cables secured with U-clamps or cable clamping bars.
- Space-saving installation between the extrusions on the basic rack.
- Two-sided installation.

- **Material**
 - Sheet steel, 1.5 mm, zinc-passivated.

- **Finish**
 - Zinc-passivated.

- **Scope of delivery**
 - 4 x extrusion rails.
 - 1 x Mounting kit.

- **How supplied**
 - In sets.

- **Note**
 - Please also order U-clamps, cable clamping bars or threaded plates.

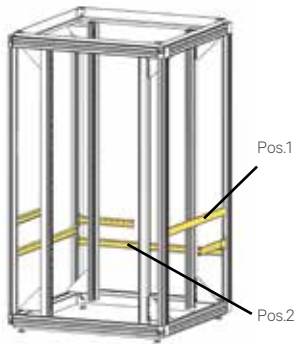

MIR88004

D	W	Installation position	For rack type	Order No.	UP
800		1	MIR2 / DCM	05.040.181.9	4 units
900		1	MIR2 / DCM	05.040.182.9	4 units
1000		1	MIR2 / DCM	05.040.183.9	4 units
1200		1	MIR2 / DCM	05.040.185.9	4 units
	600	2	Smaract	05.040.193.9	4 units
	800	2	MIR2	05.040.194.9	4 units



MIR00096

C extrusion rail

- Cables secured with U-clamps or cable clamping bars.
- Cable clamping close to entry point (type 1).
- Suitable for use with cover panel including cable entry.

- **Material / Finish**
 - Sheet steel, 1.5 mm, zinc passivated.

- **Scope of delivery**
 - 1 x C extrusion rail.
 - 1 x Mounting kit.

- **How supplied**
 - In sets.

- **Note**
 - Please also order U-clamps, cable clamping bars or threaded plates.

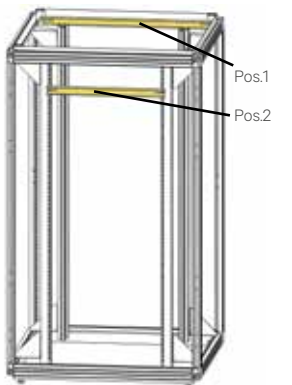

MIR88002

W	L	Model	Order No.	UP
600	482.5	Pos. 1: MIR2 / DCM	05.040.080.0	1 unit
800	682.5	Pos. 1: MIR2 / DCM	05.040.082.0	1 unit
19"	482.5	Pos. 2: MIR2 / DCM / Smaract / DoubleProRack	05.040.080.0	1 unit



DCM20077

Vertiv™ Knürr® MIR2 / Vertiv™ Knürr® DCM PDU Bracket

- For orderly cable management in the rack.
- For hanging in trade-standard PDUs without tools.
- Especially suited to Knürr and Liebert PDUs.

- **Material / Finish**
 - Steel sheet, 1.5 mm, zinc passivated, powder-coated.

- **Color**
 - Final digit of order number .1: RAL 7035 light-grey.
 - Final digit of order number .8: RAL 7021 dark-grey.

- **Scope of delivery**
 - 1 x PDU bracket.
 - 1 x Mounting kit.

- **How supplied**
 - In sets.

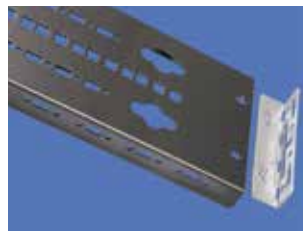

DCM20076

W	H _{Rack}	D	U	Order No.	UP
125	2000	25	42	01.147.816.X	1 unit
125	2200	25	47	01.147.817.X	1 unit

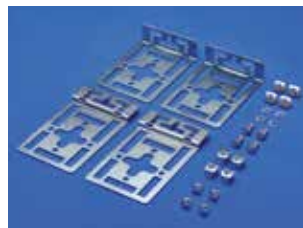

MEC20222

Type 1

PDU mounting kit

- For securing various rack PDUs.
- Suitable for Miracel 2 and DCM racks.
- For installing 1 or 2 PDUs.
- Installation options are described in the "Installation instructions for PDUs" manual.

- **Material / Finish**
 - Sheet steel, 2 mm, zinc passivated.

- **Scope of delivery**
 - 2 x L mounting brackets.
 - 2 x angular mounting brackets.
 - 1 x Mounting kit.

- **How supplied**
 - In sets.



MEC20223

Type 2

Model	For rack type	Order No.	UP
Type 1: short	MIR2 / DCM	01.147.813.9	1 set
Type 2: long	MIR2 / DCM	01.147.814.9	1 set

= assemble to order (shipped within 5 working days).
Caution: In case of larger orders, delivery times may increase.

Dimensions in mm:				Conversion:
W = Width	h = Installation height	U = Standard rack unit	kg = Weight	1 mm = 0.03937 inch
H = Height	d = Insertion depth	(1 U = 44.45 mm)		1 kg = 2.2046 pounds
D = Depth	L = Length	UP = Packaging unit		



MIR20051

Tilt restraint for Vertiv Knürr® MIR2 only 2 Racks, Quick Assembly System

- Quick and easy mounting
- Used as required

■ **Included in delivery**
- 2 x tilt restraints.

■ **Delivery**
- In sets.

Description	Order No.	Units
for MIR2 Rack only	01.127.310.9	2 units



DSC00194

Vertiv™ Knürr® DCM gap sealing depth profil

- Quick and easy retrofitting.
- Gap sealing between the linked rack.

■ **Material**
- Steel sheet, zinc-passivated 1,5 mm.

■ **Scope of delivery**
- 2 gab sealings.
- Mounting kit.

■ **How supplied**
- In Sets.



DSC00202

Description	Order No.	UP
for DCM Rack only	01.147.643.9	1 unit



DCM20107

Vertiv™ Knürr® DCM Seismic Kit

- Retrofitting set for DCM® racks.
- Installed on site.
- Rack with installed seismic kit tested in accordance with Telcordia GR63 Zone 4.
- Maximum total load for seismic application: 500 kg per rack.

■ **Material / Finish**
- Steel sheet, powder-coated.

■ **Color**
- RAL 7021, dark-grey.

■ **Scope of delivery**
- 2 x seismic frames.
- Support for rear EIA-compliant level.
- 1 x Mounting kit.

■ **How supplied**
- In sets.

W	H	Model	Order No.	UP
600	2000	DCM® USA	01.147.909.8	1 set
600	2000	DCM® Standard	01.147.912.8	1 set

for DCM Rack only



DCM Rack

DCM20026

Tilt Restraint for Vertiv™ Knürr® DCM

- Quick and easy mounting and removal.
- Can be integrated in the Vertiv Knürr DCM® rack.
- Use only as required.

■ **Scope of delivery**
- 2 x anti-tilt restrainers.

■ **How supplied**
- In sets.

Description	Order No.	UP
for DCM Rack only	01.147.641.9	2 unit

Dimensions in mm:				Conversion:	
W = Width	h = Installation height	U = Standard rack unit	kg = Weight	1 mm = 0.03937 inch	
H = Height	d = Insertion depth	(1 U = 44.45 mm)		1 kg = 2.2046 pounds	
D = Depth	L = Length	UP = Packaging unit			

Vertiv™ Knürr® System Accessories

Features

BLANKING PANELS

- Design identical to racks
- Tool-less, threaded version available.
- Varying sizes for quick mounting and efficient cooling.

CHASSIS RAILS

- Various designs catering to different requirements.
- Height positioning for different corpus heights of the subracks possible (not defined according to 19" standard).

DRAWERS AND SHELVES

- Various designs catering to different loads.
- Shelves with tool-less mounting available.

Mechanical accessories are fundamental to effective and economical use of server- and network racks.

Blanking panels are an essential feature in operating an energy-efficient data center, as they ensure that cold and warm air in the rack are separated.

When there are no mounting adapters for IT components, chassis rails are required.

Drawers are used to store manuals, spare parts and tools needed on site.





MEC20179

QuickFix 19" blanking panel Tool-less assembly

- For covering free 19" spaces (cold-hot separation).
- Quick and easy tool-less assembly (one click) and disassembly (quarter turn).
- Suitable for 9.5 x 9.5 square holes.

Material

- Sheet steel, 10 mm.

Finish

- Final digit of order number .1: powder-coated texture, RAL 7035, light-grey.
- Final digit of order number .8: powder-coated texture, RAL 7021 dark-grey.

Scope of delivery

- X (see Order Number for quantity) QuickFix 19" blanking panel.
- Mounting kit.

How supplied

- In sets (see Order Number for quantity); fixing clips pre-assembled.

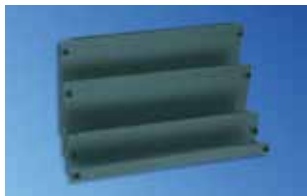

MEC20180



MEC20178

W	H	U	Order No.	UP
482.6	43.6	1	01.103.301.X	6 units
482.6	88.1	2	01.103.302.X	3 units
482.6	132.5	3	01.103.303.X	2 units
482.6	265.9	6	01.103.306.X	1 unit
482.6	399.2	9	01.103.309.X	2 units
482.6	932.6	21	01.103.321.X	1 unit



MEC20181

19" QuickFix blanking panel, tool-less assembly

- For orderly cable management inside the rack.
- Quick and easy tool-less assembly (one click) and disassembly (quarter turn).
- Suitable for 9.5 x 9.5 square holes.

Material

- Sheet steel, 10 mm.

Finish

- Final digit of order number .1: powder-coated texture, RAL 7035, light-grey.
- Final digit of order number .8: powder-coated texture, RAL 7021 dark-grey.

Scope of delivery

- 6 x QuickFix 19" blanking panel cable ports.
- 1 x Mounting kit.

How supplied

- In sets (clips pre-assembled).



MEC20178



MEC20229

W	H	U	Order No.	UP
482.6	43.6	1	01.103.331.X	6 units

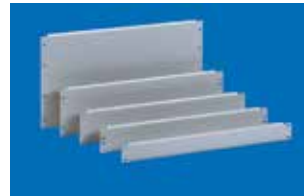

CUD00005

19" blanking plate Screw-on

- For covering free 19" spaces (cold-hot separation).

Material

- Sheet steel, 10 mm.

Finish

- Final digit of order number .1: powder-coated texture, RAL 7035, light-grey.
- Final digit of order number .8: powder-coated texture, RAL 7021 dark-grey.

Scope of delivery

- X (see Order Number for quantity) QuickFix 19" blanking panel.

How supplied

- In sets (see ON for quantity).

Note

- Please also order front panel mounting material.



CUD00004

W	H	U	Order No.	UP
482.6	43.6	1	01.103.201.X	6 units
482.6	88.1	2	01.103.202.1	3 units
482.6	88.1	2	01.103.202.X	3 units
482.6	132.5	3	01.103.203.X	2 units
482.6	265.9	6	01.103.206.X	1 unit
482.6	399.2	9	01.103.209.X	2 units



LUF88006

19" vented front cover plate

- Provides additional ventilation for 19" racks and 19" plinths compliant with IEC 297.

Material / Color

- Final digit of order number .1: ABS (UL 94 V0), light-grey RAL 7035.
- Final digit of order number .9: ABS (UL 94 V0), black RAL 9011.

Scope of delivery

- 1 x vented front cover plate.
- 2 x connectors.

How supplied

- In sets.

Note

- Please also order the appropriate mounting kit for the front plates.

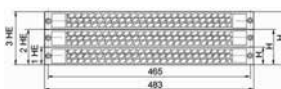

LUF00093

W	H	U	Order No.	UP
483	43.6	1	02.008.111.1	1 unit
483	43.6	1	02.008.111.9	1 unit

= assemble to order (shipped within 5 working days).
Caution: In case of larger orders, delivery times may increase.

Dimensions in mm:				Conversion:
W = Width	h = Installation height	U = Standard rack unit	kg = Weight	1 mm = 0.03937 inch
H = Height	d = Insertion depth	(1U = 44.45 mm)		1 kg = 2.2046 pounds
D = Depth	L = Length	UP = Packaging unit		

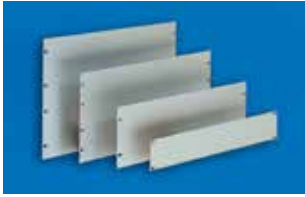

FRO00005

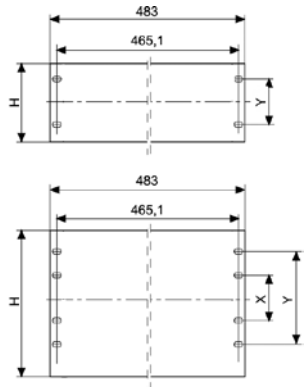

MEC20109

19" front plate Aluminum 3 mm

- **Material / Finish**
 - Final digit of order number .0: AlMg3 - F23 polished with lamination sheet.
 - Final digit of order number .1: AlMg3 - F23, powder-coated, RAL 7035, light-grey.
 - Final digit of order number .6: AlMg3 - F23 EB (anodize-enabled), anodized E6/EV1.
 - Final digit of order number .8: AlMg3 - F23, powder-coated, RAL 7021, dark-grey.

- **Scope of delivery**
 - 1 x 19" front plate.

- **How supplied**
 - Single items.

- **Note**
 - Please also order the appropriate mounting kit for the front plates.

H	X	Y	U	Model	Order No.	UP
436		31.7	1	Polished	02.008.021.0	1 unit
436		31.7	1	Powder-coated, RAL 7035	02.008.021.1	1 unit
881		76.2	2	Powder-coated, RAL 7035	02.008.022.1	1 unit
132.5		57.1	3	Powder-coated, RAL 7035	02.008.023.1	1 unit
1770		101.6	4	Powder-coated, RAL 7035	02.008.024.1	1 unit
265.9	76.2	190.4	6	Powder-coated, RAL 7035	02.008.026.1	1 unit
436		31.7	1	Powder-coated, RAL 7021	02.008.021.8	1 unit
436		31.7	1	Anodized	02.008.071.6	1 unit
881		76.2	2	Anodized	02.008.072.6	1 unit
132.5		57.1	3	Anodized	02.008.073.6	1 unit
1770		101.6	4	Anodized	02.008.074.6	1 unit
265.9	76.2	190.4	6	Anodized	02.008.076.6	1 unit



MEC20144



MEC20149

Cover-plate filter for 19" vented front cover plate

- Used with 19" vented front cover plate.

- **Material / Color**
 - Non-woven and screen cloth.

- **Scope of delivery**
 - 1 x cover-plate filter.
 - 1 x Mounting kit.

- **How supplied**
 - In sets.

- **Note**
 - Appropriate for 02.008.111.X

U	Order No.	UP
1	02.008.131.9	1 unit



LUF00217

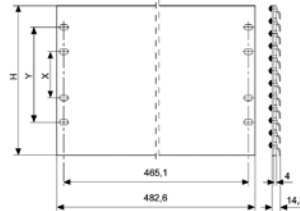

MEC20110

19" ventilation front panel

- Provides additional ventilation for 19" racks and 19" plinths compliant with IEC 297.

- **Material**
 - Aluminum.

- **Finish**
 - Final digit of order number .1: powder-coated, RAL 7035 light-grey.
 - Final digit of order number .6: colorless anodized E6 / EV 1.

- **Scope of delivery**
 - 1 x ventilation front plate.

- **How supplied**
 - Single items.

- **Note**
 - Please also order the appropriate mounting kit for the front plates.

H	Y	U	Model	Order No.	UP
436	31.7	1	Powder-coated, RAL 7035	02.008.101.1	1 unit
436	31.7	1	Anodized	02.008.101.6	1 unit
132.5	57.1	3	Powder-coated, RAL 7035	02.008.103.1	1 unit
132.5	57.1	3	Anodized	02.008.103.6	1 unit



FRO00007

19" front plate hinged

- With 19" adapter and hinge.

- **Material**
 - Aluminum, 3 mm.

- **Finish**
 - Anodized.

- **Scope of delivery**
 - 1 x front plate, hinged.
 - 1 x 19" adapter.
 - 1 x hinge.

- **How supplied**
 - In sets.

- **Note**
 - Please also order the appropriate mounting kit for the front plates.

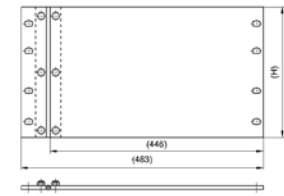

FRO00006

U	Model	Order No.	UP
3	Anodized	01.110.780.6	1 unit
6	Anodized	01.110.781.6	1 unit



MEC20162

Chassis runner

Can be hooked on and screwed on

- For installation in 19" rack and 19" enclosure.
- Can be hooked on for quick and easy mounting.
- Can also be attached with screws to accommodate heavier loads.
- Can be screwed from inside (used in rack suites).
- Adjustable height to suit various main-section heights.

Material / Finish

- Sheet steel, 2.0 mm.
- Zinc-passivated, blue chrome-plated.

Load rating

- 1000 N max. with even load distribution.

Scope of delivery

- 2 x chassis runners.
- 1 x Mounting kit.

How supplied

- In pairs.

Note

When selecting the chassis runner, please take into account the depth "d" of the rack or enclosure. Four 19" extrusions are required for mounting.

- Mounting adapter for 19" server extrusions 01.147.640.9 1 Set.
- Mounting adapter for Smaract 19" server extrusions 01.127.119.9 1 Set.



MEC20167



MEC20167

D _{Rack}	d	L	For rack type	Order No.	UP
600	365	336	MIR2 / DCM / Smaract	01.103.051.0	1 pair P
600	440	411	MIR2 / DCM / Smaract	01.103.052.0	1 pair
800	565	536	MIR2 / DCM / Smaract	01.103.053.0	1 pair P
800	640	611	MIR2 / DCM / Smaract	01.103.054.0	1 pair
900	665	636	MIR2 / DCM / Smaract	01.103.055.0	1 pair
from 900	740	711	MIR2 / DCM / Smaract / CoolTherm	01.103.056.0	1 pair P



MEC20189

Aluminum chasis runner

- Can be screwed on.
- For installation in 19" rack and 19" enclosure.
- Can be screwed from inside (used in rack suites).
- Height can be adjusted to suit various main-section heights.

Material / Finish

- Extruded aluminum, polished.

Load rating

- 700 N max. with even load distribution.

Scope of delivery

- 2 x chassis runners.
- 1 x Mounting kit.

How supplied

- In pairs.

Note

When selecting the chassis runner, please take into account the depth "d" of the rack or enclosure. Four 19" extrusions are required for mounting.

- Mounting adapter for 19" server extrusions 01.147.640.9 1 Set.
- Mounting adapter for Smaract 19" server extrusions 01.127.119.9 1 Set.

D _{Rack}	d	L	For rack type	Order No.	UP
600	365	336	MIR2 / DCM / Smaract	01.103.101.0	1 pair P
600	440	411	MIR2 / DCM / Smaract	01.103.102.0	1 pair
800	565	536	MIR2 / DCM / Smaract	01.103.103.0	1 pair P
800	640	611	MIR2 / DCM / Smaract	01.103.104.0	1 pair P
800	900	636	MIR2 / DCM / Smaract	01.103.105.0	1 pair
from 900	740	711	MIR2 / DCM / Smaract / CoolTherm	01.103.106.0	1 pair P
500	285	254	ConAct	01.103.111.0	1 pair
600	385	354	ConAct	01.103.112.0	1 pair
600	435	403	DoubleProRack with door	01.103.118.0	1 pair
800	635	603	DoubleProRack with door	01.103.119.0	1 pair
500	460	428	DoubleProRack, no door	01.103.122.0	1 pair
600	560	528	DoubleProRack, no door	01.103.123.0	1 pair
700	660	628	DoubleProRack, no door	01.103.124.0	1 pair
800	760	728	DoubleProRack, no door	01.103.125.0	1 pair

P = assemble to order (shipped within 5 working days).
Caution: In case of larger orders, delivery times may increase.

Dimensions in mm:				Conversion:
W = Width	h = Installation height	U = Standard rack unit	kg = Weight	1 mm = 0.03937 inch
H = Height	d = Insertion depth	(1 U = 44.45 mm)		1 kg = 2.2046 pounds
D = Depth	L = Length	UP = Packaging unit		



MEC20163

Chassis runner, adjustable depth

- For installation in 19" rack and 19" enclosure.
- Adjustable depth.
- Can be screwed from inside (used in rack suites).
- Height can be adjusted to suit various main-section heights.

Material / Finish

- Sheet steel, 1.25 mm.
- Zinc-passivated, blue chrome-plated.

Load rating

- 200 N max. with even load distribution.

Scope of delivery

- 2 x basic rails.
- 2 x extension rails.
- 1 x Mounting kit.

How supplied

- In pairs.

Note

- When selecting the chassis runner, please take into account the depth "d" of the rack or enclosure. Four 19" extrusions are required for mounting.
- Mounting adapter for 19" server extrusions 01.147.640.9 1 Set.
 - Mounting adapter for Smaract 19" server extrusions 01.127.119.9 1 Set.



MEC20166

D _{Rack}	d	For rack type	Order No.	UP	
600	355-570	MIR2 / DCM / Smaract	01.103.091.0	1 pair	P
800-1200	565-740	MIR2 / DCM / Smaract	01.103.092.0	1 pair	P
900-1200	740	CoolTherm	01.103.092.0	1 pair	P
600	385	ConAct	01.103.091.0	1 pair	
500-600	435-460	DoubleProRack	01.103.091.0	1 pair	
600-800	560-660	DoubleProRack	01.103.092.0	1 pair	P

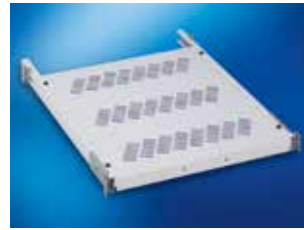

MEC00451

19" shelf Fixed

- Integrated mounting holes; front and rear for handle or hinged cable routing.
- Perforated to optimize air supply.

Material / Finish

- Sheet steel 1.0 mm, electroplated zinc, powder-coated texture.

Color

- Final digit of order number .1: RAL 7035, light grey.
- Final digit of order number .8: RAL 7021 dark-grey.

Load rating

- 500 N static per item.

Scope of delivery

- 2 x mounting rails, incl. mounting bracket.
- 1 x shelf board.
- 1 x extension board (from L = 600).
- 1 x Mounting kit.

How supplied

- In sets.

Note

- Please order requisite mounting adapter when used for DCM or Miracel 2 19" server extrusion.
 - Miracel 2/DCM 1 Set 01.147.640.9
- Please order requisite mounting adapter when used for Smaract 19" server extrusion.
 - Smaract 1 Set 01.127.119.9

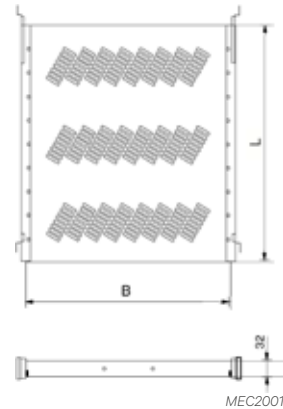

MEC20018

D _{Rack}	WxL	For rack type	Order No.	UP	
365	430x300	MIR2 / DCM / Smaract	01.102.001.1	1 unit	
440	430x300	MIR2 / DCM / Smaract	01.102.002.1	1 unit	
565	430x500	MIR2 / DCM / Smaract	01.102.003.1	1 unit	P
565	430x500	MIR2 / DCM / Smaract	01.102.003.8	1 unit	
640	430x600	MIR2 / DCM / Smaract	01.102.004.1	1 unit	P
640	430x600	MIR2 / DCM / Smaract	01.102.004.8	1 unit	
740	430x600	MIR2 / DCM / Smaract	01.102.005.1	1 unit	P
740	430x600	MIR2 / DCM / Smaract	01.102.005.8	1 unit	
435, 460	430x300	DoubleProRack	01.102.002.1	1 unit	
560	430x500	DoubleProRack	01.102.003.1	1 unit	
635, 660	430x600	DoubleProRack	01.102.004.1	1 unit	
385	430x300	ConAct	01.102.001.1	1 unit	

P = assemble to order (shipped within 5 working days).
Caution: In case of larger orders, delivery times may increase.

Dimensions in mm:				Conversion:
W = Width	h = Installation height	U = Standard rack unit	kg = Weight	1 mm = 0.03937 inch
H = Height	d = Insertion depth	(1 U = 44.45 mm)		1 kg = 2.2046 pounds
D = Depth	L = Length	UP = Packaging unit		

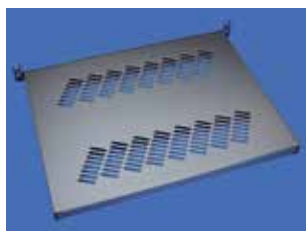

MEC20221

19" QuickFix shelf tool-less assembly

- Quick and easy tool-less mounting. Mounted on 19" cutouts.
- Quick and easy tool-less fitting (one click) and removal (quarter turn).
- Suitable for all racks and enclosures with 19" mounting hole extrusions (9.0 x 9.0 square holes).
- Adjustable depth to accommodate variable recess depths and special dimensions.
- Perforated to optimize air supply.

Material

- Sheet steel, 1.0 mm.

Finish

- Final digit of order number .1: powder-coated texture, RAL 7035, light-grey.
- Final digit of order number .8: powder-coated texture, RAL 7021 dark-grey.

Load rating

- 700 N static with even load distribution.

Scope of delivery

- 1 x 19" QuickFix shelf.
- 1 x Mounting kit.

How supplied

- In sets.

Note

- Cannot be used for 19" t-slot extrusions.
- Nothing may be attached on the first upper U otherwise the shelf can not be mounted in the 19" cutouts.

d _{insertion depth}	WxL	Order No.	UP
365-500	430 x 300	01.102.071.X	1 unit
565-740	430 x 500	01.102.072.1	1 unit
565-740	430 x 500	01.102.072.8	1 unit P

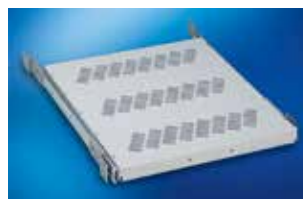

MEC00452

19" shelf partially retractable

- Integrated mounting holes, front and rear for handle or hinged cable routing.
- Perforated to optimize air supply.
- Locks in retracted position (friction lock).
- Quick separator for tool-less removal and decoupling of shelf board.

Material / Finish

- Sheet steel, electroplated zinc, powder-coated texture.

Color

- Final digit of order number .1: RAL 7035, light grey.
- Final digit of order number .8: RAL 7021 dark-grey.

Load rating

- 500 N static per item.

Scope of delivery

- 1 x pair of telescopic slides.
- 1 x shelf board.
- 1 x Mounting kit.

How supplied

- In sets.

Note

- Order requisite mounting adapter when used for DCM or Miracel 2 19" server extrusion.
 - Mounting adapter for 19" server extrusions 01.147.640.9 1 Set.
- Order requisite mounting adapter when used for Smaract 19" server extrusion.
 - Mounting adapter for 19" server extrusions 01.127.119.9 1 Set.

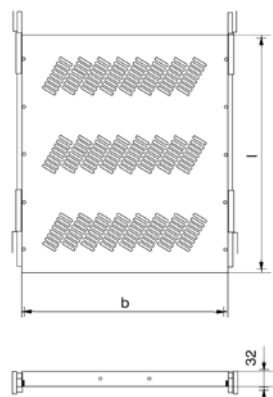

MEC20019

d _{insertion depth}	WxL	Order No.	UP
365-565	430 x 360	01.102.042.X-001	1 unit
565-750	430 x 560	01.102.043.X-001	1 unit

Dimensions in mm:				Conversion:	
W = Width	h = Installation height	U = Standard rack unit	kg = Weight	1 mm = 0.03937 inch	
H = Height	d = Insertion depth	(1 U = 44.45 mm)		1 kg = 2.2046 pounds	
D = Depth	L = Length	UP = Packaging unit			

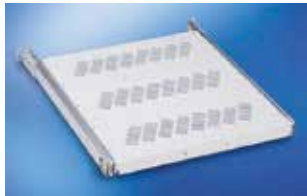

MEC00462

19" shelf fully retractable

- Integrated mounting holes, front and rear for handle or hinged cable routing.
- Perforated to optimize air supply.
- Locks in retracted position (friction lock).
- Quick separator for tool-less removal and decoupling of shelf.

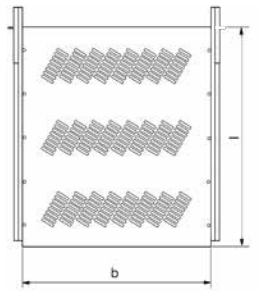

MEC20020

Material / Finish

- Sheet steel, electroplated zinc, powder-coated texture.

Color

- Final digit of order number .1: RAL 7035, light grey.
- Final digit of order number .8: RAL 7021 dark-grey.

Load rating

- 500 N static per item.

Scope of delivery

- 1 x pair of telescopic slides.
- 1 x shelf board.
- 1 x Mounting kit.

How supplied

- In sets.

Note

- Order requisite mounting adapter when used for DCM or Miracel 2 19" server extrusion.
 - Mounting adapter for 19" server extrusions 01147640.9 1 Set.
- Order requisite mounting adapter when used for Smaract 19" server extrusion.
 - Mounting adapter for 19" server extrusions 01127119.9 1 Set.

d _{insertion depth}	WxL	Order No.	UP
365-565	430 x 360	01.102.040.X-001	1 unit
565-750	430 x 560	01.102.041.X-001	1 unit

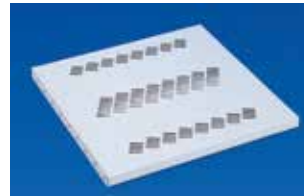

MEC00120

19" heavy-duty shelf fixed

- Perforated utility space.
- Installed as base plate for server or battery.

Material / Finish

- Sheet steel 1.5 mm, electroplated zinc, powder-coated texture.

Color

- Final digit of order number .1: RAL 7035, light grey.
- Final digit of order number .8: RAL 7021 dark-grey.

Load rating

- 1000 N static for CW installation.
- 1500 N static for 19" installation.

Scope of delivery

- 1 x shelf, fixed, threaded connection.
- 2 x mounting braces.
- 1 x Mounting kit.

How supplied

- In sets.

Note

- Please order requisite mounting adapter when used for Miracel 2/DCM 19" server extrusion.
 - Mounting adapter for 19" server extrusions 01147640.9 1 Set.
- Please order requisite mounting adapter when used for Smaract server extrusion.
 - Mounting adapter for 19" server extrusions 01127119.9 1 Set.

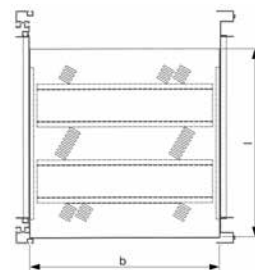

MEC20117

d _{insertion depth}	WxL	For rack type	Order No.	UP
565	467 x 460	MIR2 / DCM / Smaract	01.131.473.X	1 unit
640	467 x 460	MIR2 / DCM / Smaract	01.131.475.X	1 unit
665	467 x 460	MIR2 / DCM / Smaract	01.131.476.X	1 unit
740	467 x 560	MIR2 / DCM / Smaract	01.131.474.X	1 unit



MEC20154

Cable cantilever

- Can be tilted outward from the rear, facilitating easy access to the rear (only 3 piece).
- For easy mounting in side the rack/on the shelf; shelf or rack easily attached or decoupled with spring clip.
- Guarantees defined and kink-free cable management.
- Minimum space requirement at the back of shelves: 40 mm.



MEC88005

Material / Finish

- Sheet steel, 1.5 mm, zinc passivated.

Scope of delivery

- 1 x cable cantilever.
- 1 x Mounting kit.

How supplied

- In sets.

Type	Order No.	UP
2-piece	05.040.096.0	1 unit

= assemble to order (shipped within 5 working days).
Caution: In case of larger orders, delivery times may increase.

Dimensions in mm:				Conversion:	
W = Width	h = Installation height	U = Standard rack unit	kg = Weight	1 mm = 0.03937 inch	
H = Height	d = Insertion depth	(1 U = 44.45 mm)		1 kg = 2.2046 pounds	
D = Depth	L = Length	UP = Packaging unit			



MEC20022

19" heavy-duty shelf fully retractable

- Perforated to optimize air supply.
- Locks in pushed-in and fully retracted position.
- Easy mounting with patented quick-mounting system.
- Installed as base plate for server or battery.

Material / Finish

- Sheet steel, powder-coated texture.

Color

- Final digit of order number .1: RAL 7035, light grey.
- Final digit of order number .8: RAL 7021 dark-grey.

Load rating

- 1200 N static.

Scope of delivery

- 1 x pair of telescopic slides.
- 1 x shelf board.
- 1 x Mounting kit.

How supplied

- In sets.

Note

- Please order requisite mounting adapter when used for Miracel 2/DCM 19" server extrusion.
 - Mounting adapter for 19" server extrusions 011476409 2 Set.
- Please order requisite mounting adapter when used for Smaract server extrusion.
 - Mounting adapter for 19" server extrusions 011271199 2 Set.

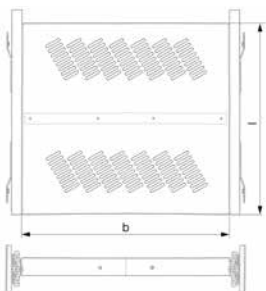

MEC20113

d _{insertion depth}	WxL	For rack type	Order No.	UP
565-750	412 x 560	MIR2 / DCM / Smaract	01102.650.X-001	1 unit



MEC20138

Handle

- Suitable for traditional and heavy-duty shelves.
- With M5 internal thread.

Material

- Die-cast aluminum consoles.
- Extruded aluminum handles.
- Cap made of ABS UL 94 HB.

Finish

- Handle, powder-coated, grey-blue, RAL 5008/ Cap, light-grey, RAL 7035.

Scope of delivery

- 2 x handles.

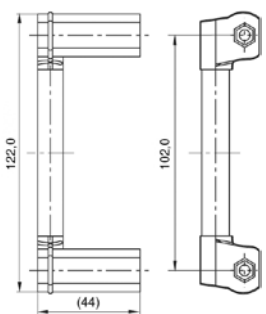

MEC20111

Order No.	UP
00.050.5031	1 set

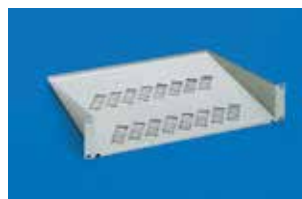

MIR00373

19" shelf, 2 U Fixed

- Installed in racks with fixed 19" components, front.
- Quick and easy mounting on 19" extrusions.
- Also for swing frame in the 19" rack and 19" enclosure.

Color

- Final digit of order number .1: RAL 7035 light-grey.
- Final digit of order number .8: RAL 7021 dark-grey.

Material

- Sheet steel, 1.5 mm.

Load rating

- 200 N static.

Scope of delivery

- 1 x shelf, fixed.
- 1 x Mounting kit.

How supplied

- In sets.

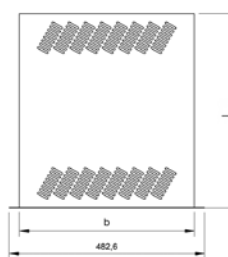
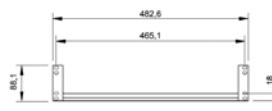

MIR00375

W	H	WxL	Order No.	UP
482.6	88.1	442 x 280	01113.736.X	1 unit
482.6	88.1	442 x 380	01113.737.X	1 unit



MIR00102

19" shelf, 2 U Adjustable

- Installed in racks with adjustable 19" components, front.
- Quick and easy mounting on 19" extrusions.
- Also for swing frame in the 19" rack and 19" enclosure.
- Depth can be adjusted in increments of 25 mm.

Material / Finish

- Sheet steel, 1.5 mm, powder-coated texture.

Color

- Final digit of order number .1: RAL 7035 light-grey.
- Final digit of order number .8: RAL 7021 dark-grey.

Load rating

- 200 N static.

How supplied

- In sets.

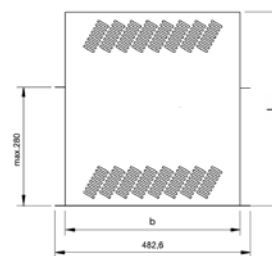
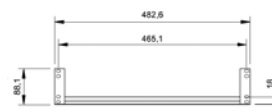

MIR00103

W	H	WxL	Order No.	UP
482.6	88.1	442 x 480	01113.411.X	1 unit

Dimensions in mm:				Conversion:
W = Width	h = Installation height	U = Standard rack unit	kg = Weight	1 mm = 0.03937 inch
H = Height	d = Insertion depth	(1 U = 44.45 mm)		1 kg = 2.2046 pounds
D = Depth	L = Length	UP = Packaging unit		



SCH00058

19" drawer Installed on the front

- Installed on front 19" extrusions.
- For storing service documents.
- Quick and easy mounting.

Material / Finish

- Drawer, sheet steel, powder-coated texture; telescopic slides, Sendzimir zinc-coated.

Color

- Final digit of order number .1: RAL 7035, light grey.
- Final digit of order number .8: RAL 7021 dark-grey.

Load rating

- 150 N static.

Scope of delivery

- 1 x 19" drawer with lock, including key.
- 1 x pair of telescopic slides.
- 1 x Mounting kit.

How supplied

- Pre-assembled.

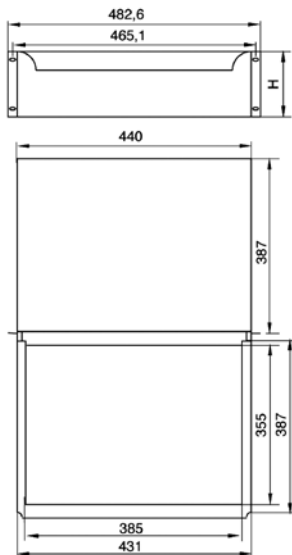

SCH00054

W	H	U	Order No.	UP
482.6	43.6	1	01.102.048.X-001	1 unit
482.6	88.1	2	01.102.048.X-002	1 unit
482.6	132.5	3	01.102.048.X-003	1 unit

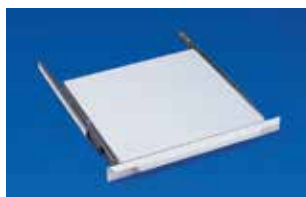

MEC00118

19" writing board 1 U fully retractable

- With handle.
- Can also be used as writing board.
- Locks in retracted position (friction lock).

Material / Finish

- Shelf, sheet steel, 1.0 mm.
- Telescopic slide, cold-rolled steel.

Color

- Final digit of order number .1: RAL 7035 light-grey.
- Final digit of order number .8: RAL 7021 dark-grey.

Load rating

- 500 N static.

Scope of delivery

- 1 x shelf.
- 1 x pair of telescopic slides.
- 1 x Mounting kit.

How supplied

- Pre-assembled.

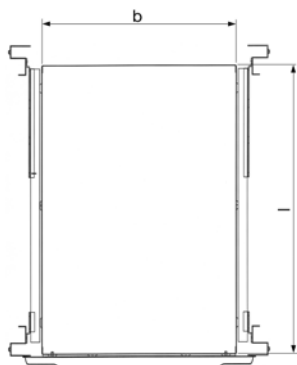

MEC20118

*see Note page 59

d _{insertion depth}	WxL	Order No.	UP
365-565	430 x 360	01.102.045.X-001	1 unit
565-750	430 x 560	01.102.046.X-001	1 unit



SCH00057

19" drawer with lock

- Installed in racks with fixed 19" components on the front and rear.
- Fully retractable.
- With lock.
- Locks in retracted position (friction lock).
- Quick separator for tool-less removal and decoupling of shelf board.

Material / Finish

- Drawer, sheet steel 1.0 mm, powder-coated texture; telescopic slides, cold rolled steel, Sendzimir zinc-coated.

Color

- Final digit of order number .1: RAL 7035 light-grey.
- Final digit of order number .8: RAL 7021 dark-grey.

Load rating

- 500 N static.

Scope of delivery

- 1 x 19" drawer with lock, including key.
- 1 x pair of telescopic slides.
- 1 x Mounting kit.

How supplied

- Pre-assembled.

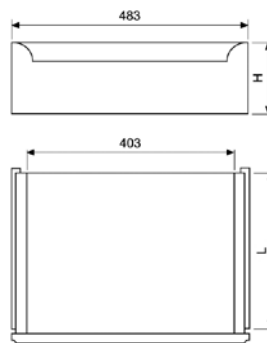

SCH00053

*see Note page 59

D	U	WxL	For rack type	Order No.	UP
565-750	2	412 x 562	MIR2 / DCM / Smaract	01.102.049.X-001	1 unit
565-750	4	412 x 562	MIR2 / DCM / Smaract	01.102.049.X-002	1 unit



SCH00059

19" keyboard drawer, 1 U for 19" keyboard

- With hand support.
- With cable strain relief.
- Locks in retracted position (friction lock).
- Quick separator for tool-less removal and decoupling of drawer.

Material

- Main unit, sheet steel, 1.0 mm.
- Front panel, sheet steel, 1.0 mm.

Color

- Final digit of order number .1: RAL 7035 light-grey.
- Final digit of order number .8: RAL 7021 dark-grey.

Scope of delivery

- 1 x 19" keyboard drawer, 1 U.
- 1 x pair of telescopic slides.
- 1 x Velcro for securing the keyboard.
- 1 x Mounting kit.

How supplied

- Pre-assembled.

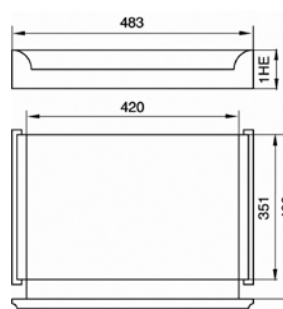

SCH00055

*see Note page 59

d _{insertion depth}	Order No.	UP
565-750	01.102.047.X-001	1 unit



MEC00116

19" keyboard drawer 1 U with extract for pc mouse

- Heel of hand support.
- Mouse area can be extracted right/left.
- Storage compartment for pc mouse.
- Locks in retracted position (friction lock).
- Quick separator for tool-less removal and decoupling of drawer.

■ Dimensions

- Useful shelf space: measurements without heel of hand support 372 x 209 x 32 mm.

■ Color

- Final digit of order number .1: RAL 7035 light-grey.
- Final digit of order number .8: RAL 7021 dark-grey.

■ Scope of delivery

- 1 x 19" keyboard drawer, 1 U.
- 1 x pair of telescopic slides.
- 1 x heel of hand support.
- 1 x Mounting kit.

■ How supplied

- Pre-assembled.

■ Note

Keyboard is not included.
Not compatible with racks, depth 600.

d _{insertion depth}	Order No.	UP
565-750	01.136.379.X	1 unit



MEC20027

Document holder

- Self-adhesive; for higher loads use 6 mm holes.
- For DIN A4 documents.

■ Material

- High-impact Polystyrol.

■ Color

- Grey.

■ Scope of delivery

- 1 x document holder.

W	L	T	Bestell-Nr.	VE
264	236	30	05.016.045.0	1 unit

*Note

- Order requisite mounting adapter when used for DCM or Miracel 2 19" server extrusion.
 - Mounting adapter for 19" server extrusions 01.147.64.0.9 1 Set.
- Order requisite mounting adapter when used for Smaract 19" server extrusion.
 - Mounting adapter for 19" server extrusions 01.127.119.9 1 Set.



Luminestra LED Rack lighting

- Only for rack type Miracel 2 / DCM W 700, W 800.
- Mounted on the basic frame above the vertical extrusions.
- With LED 4000 Kelvin, 7 watt.
- With on/off rocker switch.
- With 1,8 m power supply cable and EURO plug.
- Complete with mounting material.
- Only with 123 mm front clearance space.

■ Color

- White.

■ Scope of delivery

- 1 x Luminestra rack lamp.
- 2 x mounting brackets.
- 1 x Mounting kit.

W	H	D	Order No.	UP
28	38,4	583	01.131.227.9	1 unit



ELM00135

Compact rack lamp

■ Features

- Magnetic mounting.
- Energy-saving lamp.
- Protective contact socket.
- ON/OFF switch.
- Power supply lead 3 m.
- Cover panel.

■ Compliance

- VDE ICE.

■ Protection rating

- IP20.

■ Technical data

- Operating voltage 230 V / 50-60 Hz.
- Lighting: compact fluorescent tube with integrated starter.
- Power consumption: 11 W [^]= 75 W bulb.
- Light intensity: 900 Lm.
- Interference suppression compliant with VDE 0712, IEC 82.
- Socket: 230 VAC / 16A.
- Connections: 3-pole screw clamp, 2,5 mm² with strain relief.

W	H	D	Order No.	UP
65	65	365	01.131.465.9	1 unit



Dimensions in mm:				Conversion:	
W = Width	h = Installation height	U = Standard rack unit	kg = Weight	1 mm = 0.03937 inch	
H = Height	d = Insertion depth	(1 U = 44.45 mm)		1 kg = 2.2046 pounds	
D = Depth	L = Length	UP = Packaging unit			

The right mounting set for every rack type

DCM	MIR2 T-slot	MIR2 Mount. holes	MIR2 Server	MIR2 Swing frame	Smaract T-slot	Smaract Mount. holes	Smaract Server	Double ProRack T-slot	Double ProRack Mount. holes	ConAct	Name	Order No.	UP
	●				●						T-Slot mounting set, M5, wide	05.041.320.9	1 set
		●				●					Mounting set Mount. holes M5/BI 1.5	05.041.321.9	1 set
●			●	●			●				Mounting set Mount. holes M5/BI 2.5	05.041.325.9	1 set 
								●			Mounting set dpr T-slot, M5 narrow	05.041.323.9	1 set
									●		Mounting set dpr mount. holes M5	05.041.322.9	1 set
										●	Mounting Set, ConAct M5	05.041.324.9	1 set

The right mounting set for front panel mounting

Model: Z-form screw

DCM	MIR2 T-slot	MIR2 Mount. holes	MIR2 Server	MIR2 Swing frame	Smaract T-slot	Smaract Mount. holes	Smaract Server	Double ProRack T-slot	Double ProRack Mount. holes	ConAct	Name	Order No.	UP
	●				●						FP mounting set, T-slot M5, wide	05.041.335.9	1 set 
		●				●				●	FP mounting set Mount. holes M5/BI 1.5	05.041.336.9	1 set
●			●	●			●		●		FP mounting set Mount. holes M5/BI 2.5	05.041.337.9	1 set 
								●			FP mounting set, T-slot M5, narrow	05.041.338.9	1 set

The right mounting set for front panel mounting

Model: countersunk screw + rosette

DCM	MIR2 T-slot	MIR2 Mount. holes	MIR2 Server	MIR2 Swing frame	Smaract T-slot	Smaract Mount. holes	Smaract Server	Double ProRack T-slot	Double ProRack Mount. holes	ConAct	Name	Order No.	UP
	●				●						FP mounting set, T-slot M5, wide	05.041.340.9	1 set
		●				●				●	FP mounting set Mount. holes M5/BI 1.5	05.041.341.9	1 set
●			●	●			●		●		FP mounting set Mount. holes M5/BI 2.5	05.041.342.9	1 set
								●			FP mounting set, T-slot M5, narrow	05.041.343.9	1 set

The right accessories for every rack type

DCM	MIR2 T-slot	MIR2 Mount. holes	MIR2 Server	MIR2 Swing frame	Smaract T-slot	Smaract Mount. holes	Smaract Server	Double ProRack T-slot	Double ProRack Mount. holes	ConAct	Name	Order No.	UP
	●				●						Spring nut, M5 wide	01.350.431.9	1 set
								●			Spring nut, M5 narrow	05.041.503.9	1 set
	●				●						Spring nut M6	01.350.405.9	1 set
		●				●				●	Cage nut M5/BI 1.5	05.041.513.7	1 set
●			●	●			●		●		Cage nut M5/BI 2.5	05.041.518.7	1 set
	●				●			●			Oval-head screws, Z-form, M5 x 10	05.041.330.9	1 set
●		●	●	●		●	●		●	●	Oval-head screws, Z-form, M5 x 16	05.041.331.9	1 set
	●				●			●			Countersunk screw M5 x 12 + rosette	05.041.203.9	1 set
●		●	●	●		●	●		●	●	Countersunk screw M5 x 16 + rosette	05.041.290.9	1 set

- assemble to order (shipped within 5 working days).
Caution: In case of larger orders, delivery times may increase.



MIRO0114

Mounting tool for cage nuts

- Allows easy clipping of cage nuts on extrusions.

Material
- Spring steel.

Scope of delivery
- 1 x mounting tool.

Order No. UP

01.130.985.9 1 unit **P**



MEC20125

T-Slot mounting set, M5, wide for MIR2/Smaract®

- For securing 19" front panels and 19" components.

Scope of delivery
- 100 x spring nuts, M5 wide.
- 100 x oval-head screws, Z-form, M5 x 10.
- 20 x cage nuts M5 /plate, 1.5 mm.
- 20 x cylinder screws, M5 x 8.

How supplied
- In sets.

Order No. UP

05.041.320.9 1 set



MEC20126

Mounting set, M5 / plate, 1.5 mm for MIR2/Smaract®

- For securing 19" front panels and 19" components.

Scope of delivery
- 100 x cage nuts M5 /plate, 1.5 mm.
- 100 x oval-head screws, Z-form, M5 x 16.
- 20 x spring nuts, M5 wide.
- 20 x cylinder screws, M5 x 8.

How supplied
- In sets.

Order No. UP

05.041.321.9 1 set



MEC20126

Mounting set; mounting holes server extrusion M5 / plate, 2.5 mm for MIR2/DCM®/Smaract®

- For securing 19" front panels and 19" components.

Scope of delivery
- 100 Käfigmuttern M5 / Blech 2.5 mm.
- 100 Linsenschrauben FormZ M5 x 16.
- 20 Federmuttern M5 breit.
- 20 Zylinderschrauben M5 x 8.

How supplied
- In sets.

Order No. UP

05.041.325.9 1 set **P**



MEC20127

T-slot mounting set, M5, narrow for DoubleProRack®

- For securing 19" front panels and 19" components.

Scope of delivery
- 100 x spring nuts, M5 narrow.
- 20 x oval-head screws, Z-form, M5 x 10.
- 50 x cylinder screws, M5 x 10.
- 30 x oval-head screws, Z-form, M5 x 8.

How supplied
- In sets.

Order No. UP

05.041.323.9 1 set



MEC20126

Mounting set; mounting holes M5 for DoubleProRack®

- For securing 19" front panels and 19" components.

Scope of delivery
- 100 x cage nuts M5 /plate, 2.5 mm.
- 50 x oval-head screws, Z-form, M5 x 16.
- 40 x spring nuts, M5 narrow.
- 40 x cylinder screws, M5 x 10.

How supplied
- In sets.

Order No. UP

05.041.322.9 1 set

P = assemble to order (shipped within 5 working days).
Caution: In case of larger orders, delivery times may increase.

Dimensions in mm:				Conversion:	
W = Width	h = Installation height	U = Standard rack unit	kg = Weight	1 mm = 0.03937 inch	
H = Height	d = Insertion depth	(1 U = 44.45 mm)		1 kg = 2.2046 pounds	
D = Depth	L = Length	UP = Packaging unit			



MEC20096

Mounting holes, mounting set, M5 for ConAct®

- For securing 19" front panels and 19" components.

Scope of delivery

- 50 x cage nuts M5 /plate, 1.5 mm.
- 50 x oval-head screws, Z-form, M5 x 16.
- 50 x cylinder screws, M5 x 8.
- 25 x locking nuts, M5.

How supplied

- In sets.

Order No.	UP
05.041.324.9	1 set



MEC20129

Front panel mounting set, T-slot, M5 wide for MIR2/Smaract®

- For securing 19" front panels and 19" components.

Scope of delivery

- **Type 1:**
50 x spring nuts, M5 wide.
50 x oval-head screws, Z-form, M5 x 10.
- **Type 2:**
50 x spring nuts, M5 wide.
50 x countersunk screws, M5 x 12.
50 x rosettes.

How supplied

- In sets.

Model	Order No.	UP
Type 1: Z-form screw	05.041.335.9	1 set
Type 2: screw + rosette	05.041.340.9	1 set



MEC20098

Front panel mounting set for MIR® 2/Smaract®/ConAct®

- For securing 19" front panels and 19" components.
- Mounting holes.

Scope of delivery

- **Type 1:**
50 x cage nuts M5 /plate, 1.5 mm.
50 x oval-head screws, Z-form, M5 x 16.
- **Type 2:**
50 x cage nuts M5 /plate, 1.5 mm.
50 x countersunk screws, M5 x 16.
50 x rosettes.

How supplied

- In sets.

Model	Order No.	UP
Type 1: Z-form screw	05.041.336.9	1 set
Type 2: screw + rosette	05.041.341.9	1 set



MEC20098

Front panel mounting set; mounting holes, M5/plate, 2.5 mm for MIR2/DCM®/Smaract®/DoubleProRack®

- For securing 19" front panels and 19" components.

Scope of delivery

- **Type 1:**
50 x cage nuts M5 /plate, 2.5 mm.
50 x oval-head screws, Z-form, M5 x 16.
- **Type 2:**
50 x cage nuts M5 /plate, 2.5 mm.
50 x countersunk screws, M5 x 16.
50 x rosettes.

How supplied

- In sets.



MEC20097

Model	Order No.	UP
Type 1: Z-form screw	05.041.337.9	1 set
Type 2: Screw + rosette	05.041.342.9	1 set

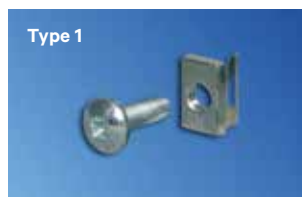

MEC20129

Front panel mounting set, T-slot for DoubleProRack®

- For securing 19" front panels and 19" components.

Scope of delivery

- **Type 1:**
50 x spring nuts, M5 narrow.
50 x oval-head screws, Z-form, M5 x 10.
- **Type 2:**
50 x spring nuts, M5 narrow.
50 x countersunk screws, M5 x 12.
50 x rosettes.

How supplied

- In sets.



MEC20130

Model	Order No.	UP
Type 1: Z-form screw	05.041.338.9	1 set
Type 2: screw + rosette	05.041.343.9	1 set



MEC00060

Spring nut

- To clip on T-slot where required.
- **Type 1:** M5 wide for Miracel 2 / Smaract. T-slot size: 10 x 13 mm.
- **Type 2:** M5 narrow for DoubleProRack. T-slot size: 8 x 13 mm.
- **Type 3:** M6 for Miracel 2 / Smaract. T-slot size: 10 x 13 mm.

■ **Scope of delivery**
- 50 x spring nuts.

■ **How supplied**
- In sets.

Model	Order No.	UP
Type 1: M5 wide	01.350.431.9	1 set
Type 2: M5 narrow	05.041.503.9	1 set
Type 3: M6	01.350.405.9	1 set



MEC20139

Cage nut

- For clipping into extrusions with mounting holes.
- **Type 1:** Plate, 1.5 mm for Miracel 2 / Smaract / ConAct.
- **Type 2:** Plate, 2.5 mm for Miracel 2 Server / Smaract Server / DoubleProRack with 19" mounting holes.

■ **Scope of delivery**
- 50 x cage nuts.

■ **How supplied**
- In sets.

Model	Order No.	UP
M5: Type 1: Plate, 1.5 mm	05.041.513.7	1 set
M5: Type 2: Plate, 2.5 mm	05.041.518.7	1 set
M6: Type 1: Plate, 1.5 mm	05.041.514.7	1 set
M6: Type 2: Plate, 2.5 mm	05.041.519.7	1 set



MEC20140

Oval-head screw

- IEC DIN 967.
- **Scope of delivery**
- 50 x oval-head screws, Z-form.
- **How supplied**
- In sets.

Model	Order No.	UP
M5 x 10	05.041.330.9	1 set
M5 x 16	05.041.331.9	1 set
M6 x 10	05.041.332.9	1 set
M6 x 16	05.041.333.9	1 set



MEC20141

Countersunk screw + rosette

- IEC DIN EN ISO 7047.
- **Scope of delivery**
- 50 x countersunk screws.
- 50 x rosettes.
- **How supplied**
- In sets.

Model	Order No.	UP
M5 x 12	05.041.203.9	1 set
M5 x 16	05.041.290.9	1 set



MEC80020

Oval-head screw self-guiding

- DIN 7500.
- Suitable for system accessories fixed on the inside of the 19" extrusions.
- Suitable for 19" steel and 19" aluminum extrusions.
- Easy screwing.
- **Scope of delivery**
- 50 x oval-head screws, M6x10.
- **How supplied**
- In sets.

Model	Order No.	UP
M6 x 10	05.041.334.9	1 set

assemble to order (shipped within 5 working days).
Caution: In case of larger orders, delivery times may increase.

Dimensions in mm:				Conversion:
W = Width	h = Installation height	U = Standard rack unit	kg = Weight	1 mm = 0.03937 inch
H = Height	d = Insertion depth	(1U = 44.45 mm)		1 kg = 2.2046 pounds
D = Depth	L = Length	UP = Packaging unit		



MEC20227

Oval-head screw With Phillips head

– IEC DIN EN ISO 7045.

■ **Scope of delivery**
– 1 x set of 50 units.



MEC20228

L	Model	Order No.	UP
8	M 5 no washer	05.041.611.8	1 set
12	M 4 no washer	05.041.609.8	1 set
12	M 5 with washer	05.041.613.8	1 set
16	M 5 with washer	05.041.614.8	1 set
16	M 6 with washer	05.041.616.8	1 set



MEC20226

Cylinder screw With hexagon head

– IEC ISO 4762 (modified).

■ **Scope of delivery**
– 1 x set of 50 units.

L	Model	Order No.	UP
8	M 5	05.041.574.8	1 set
8	M 5 microencapsulated	05.041.575.9	1 set



MEC20225

Tensiloc nut

■ **Material**
– Steel nickel-plated.

■ **Scope of delivery**
– 1 x set of 50 units.

Model	Order No.	UP
M 5	05.041.533.8	1 set



HEI00379

Distribution box

- For mounting trade-standard installation technology DIN rail components, such as fuses, clamps, relays, etc.
- When installed, the mounting level can be pulled out at the front and locked in position, significantly simplifying the wiring of the individual components. Not available for “fixed installation” model. Up on request: Delivered assembled and wired. Further versions and models up on request.
- Installation space for up to 22 pieces of equipment with 18 mm width each.
- Mounting of the TS35 DIN rail on several levels with simple plug-in connection.
- Not available for “fixed installation” model.
- “Snap-in” mounting of DIN rail components.
- Easy access to the protective grounding and neutral conductor rails from the front.
- Various positioning options available for N and PE rails. Not available for “fixed installation” model.
- Cable entry at the rear via double brush strip (optionally via bushing sockets).
- Cable strain relief on the inside and therefore accessible from the front.
- Labeling strips on the front, above and below the installation space.
- Installation options available for power distribution with 230 V AC, but also in the low-voltage range (e.g. 48 V DC).
- 19" slot-in, 3 U, depth 150 mm.

■ **Material / Finish**
– Panels powder-coated texture, RAL 7035 light-grey.
– Main unit, sheet steel, zinc-passivated.

■ **Scope of delivery**
– 1 x distribution box.
– Including N and PE rails, cable entry, cable strain relief, empty panel covers and grounding set.

■ **How supplied**
– Fully assembled.

W	H	D	U	19"	Model	Order No.	UP
482.6	134	150	3	•	Pull-out	03.013.385.1	1 unit



HEI20282



ELM00137

Door contact switch

- On/off switch, 4 A, 230 V ~.
- Activated by opening and closing door.

■ **Scope of delivery**

- 1 x door contact switch (not wired).
- 1 x mounting bracket.
- 1 x Mounting kit.

	Order No.	UP
	01.110.722.9	1 unit
For rack type ConAct	01.110.722.9.001	1 unit



ELM00033

Cable junction box

- For 230 V electrical installation on-site.
- As fixed-location exchange point.
- Quick and easy mounting.

■ **Scope of delivery**

- 1 x cable junction box.

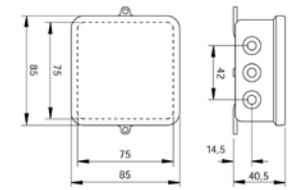

ELM00034

	Order No.	UP
	00.078.720.9	1 unit



ELM00128

Modular terminal box

- For 230V electrical installation on-site.
- With series terminal, 8 x 42.
- Pg 11/16 entry.
- IP 54.

■ **Material**

- High-impact, fire-resistant polystyrene.

■ **Scope of delivery**

- 1 x modular terminal box.
- 4 pg compression glands, pg11.

	Order No.	UP
	01.117.521.9	1 unit

P = assemble to order (shipped within 5 working days).
Caution: In case of larger orders, delivery times may increase.



ELM00114

1 equipotential bonding bar

- For central grounding of all protective conductors.
- With sealable cover.
- Connection options:
1 x round conductor 8 – 10 mm Ø
1 x flat conductor up to 30 mm wide or round conductor 8 – 10 mm Ø.
- 7 x single or multi-wire conductors up to 16 mm² or fine-wire conductors up to 10 mm².

■ **Material**

- Base plate and cover plate, high-impact plastic.
- Brass nickel-plated contact strip.

■ **Scope of delivery**

- 1 x equipotential bonding bar.

	Order No.	UP
	01.117.524.3	1 unit



ELM00068

Grounding bar

- For safe grounding or potential equalization of equipments and components.

■ **Material**

- Electrolyte copper 9 x 9.

■ **Scope of delivery**

- 1 x grounding bar.
- 2 x brackets.
- 1 x Mounting kit.

U	Model	Order No.	UP
24	For DoubleProRack	01.240.546.9	1 unit
21	For DoubleProRack	01.240.545.9	1 unit
18	For DoubleProRack	01.240.544.9	1 unit
15	For DoubleProRack	01.240.543.9	1 unit
45	For Miracel 2 / DCM	01.110.709.9	1 unit
41	For Miracel 2 / DCM	01.110.708.9	1 unit P
12	For Miracel 2 / DCM	01.110.703.9	1 unit



DOP20016

Contact clamp

- Enables safe connection of equipment and components to grounding bar.
- For cables up to 25 mm².

■ **Scope of delivery**

- 20 x contact clamps.

	Order No.	UP
	01.110.715.9	20 units P

Dimensions in mm:				Conversion:
W = Width	h = Installation height	U = Standard rack unit	kg = Weight	1 mm = 0.03937 inch
H = Height	d = Insertion depth	(1U = 44.45 mm)		1 kg = 2.2046 pounds
D = Depth	L = Length	UP = Packaging unit		

Vertiv™ Knürr® Cable Management

Features

- Allows for prescribed cable radii.
- Components are easy to secure and use.
- Components feature addition functions.
- Extensive use of reusable Velcro strips precludes cable strain.
- No blockage of airflow within the rack.

Global networking is continuing to grow, meaning users are in need of an intelligent cable management solution.

To meet this demand, Vertiv Knürr offers a range of products and solutions for server racks, active and passive network racks, as well as special racks.

Our range not only allows you to quickly and easily set up and dismantle racks, it also makes it much simpler to troubleshoot problems in your systems and expand your systems. Our cable management components are all based on a number of key principles: Simple and self-explanatory operation, versatile application options, a clear structure, and a cost-efficient design.

Thanks to the Vertiv Knürr cable management system, your rack will be equipped for the future and will save you time and money for the long term.

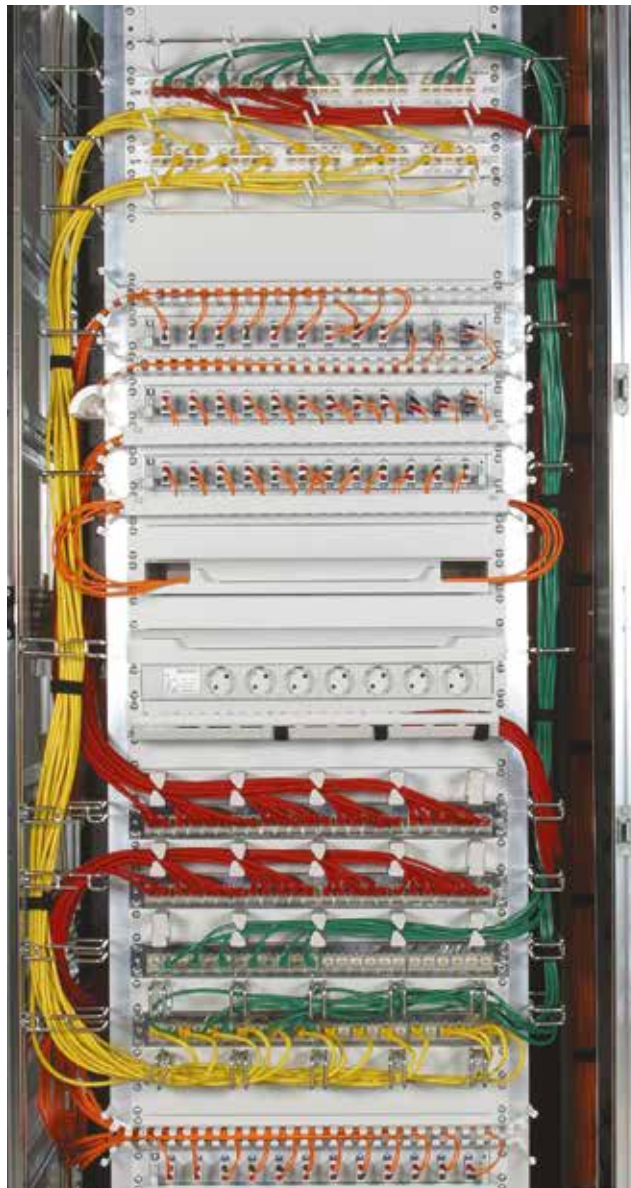



MEC20064

Vertiv™ Knürr® Cable Management Terminology

Laying cables involves ensuring that mechanical stresses are completely avoided.

■ Bending load

The bending radii may never fall below the values provided by the cable manufacturer in the respective data sheets. Where excessive bending occurs, the cables' electrical properties are impaired, and transmission bandwidths and ranges are adversely affected. If manufacturer specifications are not available, then the following rule of thumb applies: loose cabling should be at least 15 times the external cable diameter and fixed cabling at least 10 times the external cable diameter.

■ Buckling load

Extreme bending loads can cause the cable to break.

■ Tensile load

This is determined solely by the copper cross-section of the conductor, as all other materials are too soft. The cable may not be exposed to stress exceeding 50 N/mm² (Cu cross-section) as this causes the conductors to stretch which reduces the cross-section. If higher "pulling" forces are required, cables with additional strain-reduction elements must be used.

■ Compressive stress

Compressive stress is caused by loads bearing down from above, fixed clamping or sharp cable kinking and must always be avoided, as otherwise the "loose" cable structure changes and electrical transmission properties are impaired.

■ Torque strains (twisting)

Cables must never be subjected to torque strains, as they cause cable elements to shift and change their position relative to each other, thereby impairing transmission properties.



MEC20084

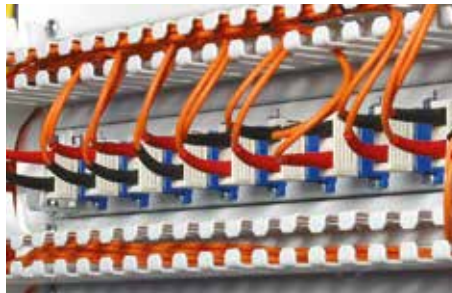

MEC20086

Vertiv™ Knürr® Cable Management Proper Usage

- Various components for fiberglass and copper cables – especially fastening options such as Velcro and cable bundling using different colored strips – guarantee transparent cable management, providing an optimal starting point for both intelligent network expansion and ideal service convenience. (1)
- Special attention has been paid to ensuring that all cable management components can be fastened with Velcro strips which eliminate cable strain and can be reused at any time. Velcro cable ties also aid the installation technician as they are easily manageable, using pinch-free cable bundling. (2)
- Excess cable is stored separately from the patch fields while remaining easily accessible. Copper cable excess can be stored separately from fiber glass excess within the Knürr rack systems: the copper cables are stored on the side while the more sensitive fiberglass cables are stored in a drawer at the front. (3)
- A closer look at the individual products reveals their outstanding versatility. The cable-routing multifunctional brace, for example, not only provides the option of routing cables both horizontally and vertically using Velcro or cable ties, but additionally allows numerous components to be mounted with screws and caged nuts. These caged nuts can also be shifted in a slot with room for play, so that every mounting dimension is accommodated. (4)



1. MEC20082



2. MEC20070



3. MEC20099

Vertiv™ Knürr® Cable Management

Overhead Cabling

Features

- Modular, extremely flexible.
- Robust construction.
- Includes integrated radius for cable entry into rack.
- New cover panel with lateral cable entry.
- Selection of cable throughs and mesh cable trays.
- Suitable for Vertiv Knürr DCM and Vertiv Knürr MIR.
- Includes Vertiv SmartAisle™ enclosure.
- Various combinations possible.

Vertiv's Overhead Cabling Solution

The Vertiv Knürr overhead cable management system is a complete, modular system which offers a variety of cable-tray installment options. The components are very flexible and can be installed on site or modified with ease, to accommodate cable-management requirements that differ from rack to rack. This extremely sturdy and robust system can withstand high stress levels and is suitable for any application. Combined with other items from the Knürr cable-management product range, it provides a comprehensive solution that delivers proper cable bend radii.

Example of Overhead Configuration

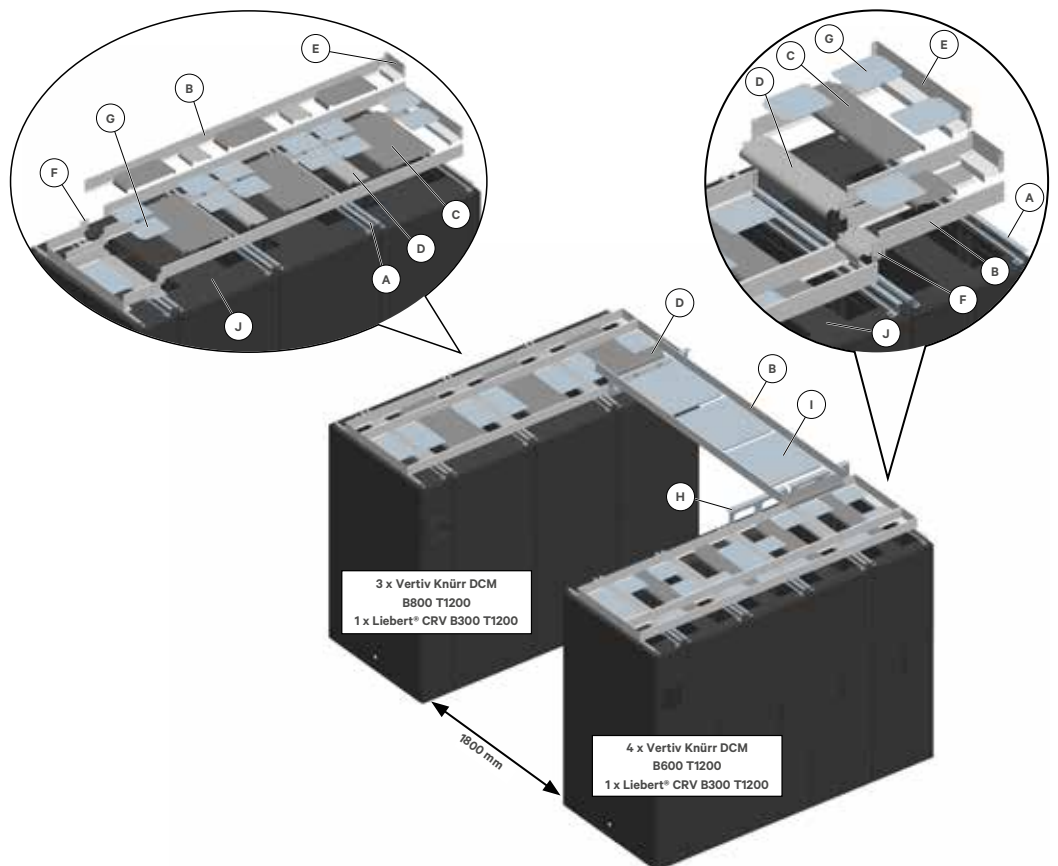

Legend

- A** Support bracket
- B** Mounting bracket
- C** Center panel insert
- D** Transitional cover
- E** End panel insert
- F** Connecting panel insert
- G** Cover plate
- H** Support bracket cross-cabling
- I** Cover cross-cabling
- J** New cover panel with lateral cable entry

Configuration Assistant

Sample Order	Name	Item	
- Left rack suite	Vertiv Knürr DCM B800 T1200	3	01147.722.8
	New cover panel with lateral cable entry (J)	3	01147.579.8
	Liebert® CRV B300 T1200	1	CR0302XXX-XXXXXX
	Support bracket (A)	4	05.045.005.X
	Mounting bracket (B)	2	05.045.011.X
		2	05.045.015.X
	Center panel insert (C)	3	05.045.023.X
		3	05.045.024.X
	Transitional cover (D)	3	05.045.031.X
		3	05.045.032.X
	End panel insert (E)	1	05.045.041.X
		1	05.045.042.X
	Connecting panel insert (F)	1	05.045.045.X
	Cover plate (G)	2	05.045.047.X
- Right rack suite	Vertiv Knürr DCM B800 T1200	4	01147.714.8
	New cover panel with lateral cable entry (J)	4	01147.574.8
	Liebert® CRV B300 T1200	1	CR0302XXX-XXXXXX
	Support bracket (A)	4	05.045.005.X
	Mounting bracket (B)	2	05.045.011.X
		8	05.045.012.X
	Center panel insert (C)	4	05.045.021.X
		4	05.045.022.X
	Transitional cover (D)	4	05.045.031.X
		4	05.045.032.X
	End panel insert (E)	1	05.045.041.X
		1	05.045.042.X
	Connecting panel insert (F)	2	05.045.045.X
	Cover plate (G)	2	05.045.047.X
- Cross-cabling	Support bracket (H)	1	05.045.052.X
		1	05.045.053.X
	Mounting bracket (B)	1	05.045.015.X
	Transitional cover (D)	2	05.045.032.X
	Cover (I)	1	05.045.057.X

Required Data for Overhead Cabling	Example
- Width of racks in the rack suite (300, 600 or 800 mm)	Rack width (W) = 800 mm
- Depth of racks in the rack suite (1000 to 1200 mm)	Rack depth (D) = 1200 mm
- Number of racks in one rack suite	
- Aisle width (Standard dimensions 1200, 1500 and 1800 mm ± 50 mm) – for cross-cabling	Aisle width (AW) = 1800 mm
- Color light-grey RAL 7035 or dark-grey RAL 7021	Dark-grey RAL 7021

Prerequisites for Overhead Cabling

J

Cover panel with lateral cable entry

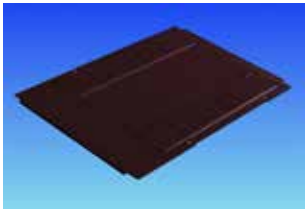

DCM20079

- With lateral cable entry on both sides (sliding plates).
- For orderly cable management with in the rack.
- Optional brush strips.

■ **Material**

- Sheet steel, 1.5 mm.

■ **Finish / Color**

- Final digit of order number .1: powder-coated, RAL 7035.
- Final digit of order number .8: powder-coated, RAL 7021.

■ **Scope of delivery**

- 1 Deckel mit seitlicher Kabeleinführung.
- Montagematerial.

■ **How supplied**

- In sets.

W _{Rack}	D _{Rack}	For rack type	Order No.	UP
600	1000	MIR2 / DCM	01.147.572.X	1 unit
600	1100	MIR2 / DCM	01.147.573.X	1 unit
600	1200	MIR2 / DCM	01.147.574.X	1 unit
800	1000	MIR2 / DCM	01.147.577.X	1 unit
800	1100	MIR2 / DCM	01.147.578.X	1 unit
800	1200	MIR2 / DCM	01.147.579.X	1 unit

K

MIR2 / DCM cover panel short

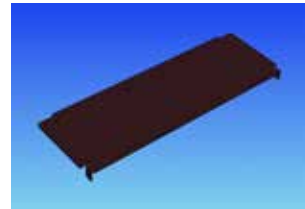

DCM20081

- For covering the front overhead area; the rest remains open.
- Facilitates unobstructed cable entry inside the rack.

■ **Material**

- Sheet steel, 1.5 mm.

■ **Finish / Color**

- Powder-coated texture, RAL 7021, dark-grey.

■ **Scope of delivery**

- 1 x cover panel, short.
- 1 x Mounting kit.

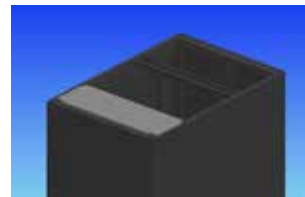

DCM20080

■ **How supplied**

- In sets.

W _{Rack}	L	For rack type	Order No.	UP
600	250	MIR2 / DCM	01.147.268.8	1 unit
800	250	MIR2 / DCM	01.147.269.8	1 unit

Dimensions in mm:				Conversion:	
W = Width	h = Installation height	U = Standard rack unit	kg = Weight	1 mm = 0.03937 inch	
H = Height	d = Insertion depth	(1 U = 44.45 mm)		1 kg = 2.2046 pounds	
D = Depth	L = Length	UP = Packaging unit			

A

Support bracket



MEC20200

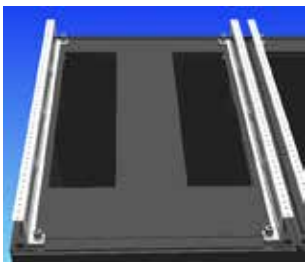

MEC20201

- Secures corner piece at the top of the rack.
- Quick and easy mounting.
- Suitable for both MIR2 and DCM racks.
- Includes screw for securing the mounting brackets, transitional cover and end panel inserts.

- **Material**
 - Sheet steel 2.0 mm.

- **Finish**
 - Final digit of order number .1: powder-coated, RAL 7035 light-grey.
 - Final digit of order number .8: powder-coated, RAL 7021 dark-grey.

- **Scope of delivery**
 - 2 x support brackets.
 - 1 x Mounting kit.

- **How supplied**
 - In sets.

H	D _{Rack}	For rack type	Order No.	UP
44	1000	MIR2 / DCM	05.045.003.X	1 set
44	1100	MIR2 / DCM	05.045.004.X	1 set
44	1200	MIR2 / DCM	05.045.005.X	1 set

B

Mounting brackets

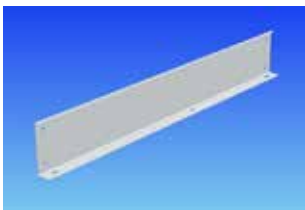

MEC20202

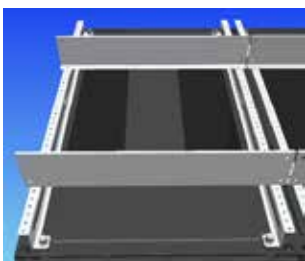

MEC20203

- Secured on support bracket.
- Quick and easy mounting.
- Separate cable trays.

- **Material**
 - Sheet steel 1.0 mm.

- **Finish**
 - Final digit of order number .1: powder-coated, RAL 7035 light-grey.
 - Final digit of order number .8: powder-coated, RAL 7021 dark-grey.

- **Scope of delivery**
 - 2 x mounting brackets.
 - 1 x Mounting kit.

- **How supplied**
 - In sets.

W / L	H	For rack type	Order No.	UP
300	90	MIR2 / DCM	05.045.011.X	1 set
600	90	MIR2 / DCM	05.045.012.X	1 set
800	90	MIR2 / DCM	05.045.013.X	1 set
2400	90	MIR2 / DCM	05.045.015.X	1 set
3000	90	MIR2 / DCM	05.045.016.X	1 set

C

Center panel insert

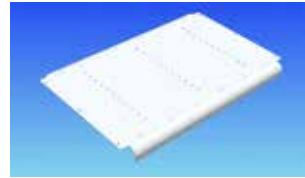

MEC20205

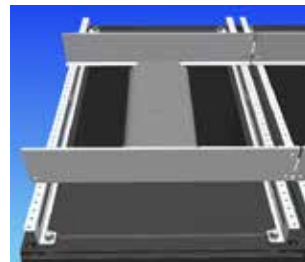

MEC20204

- Secured on mounting bracket.
- Quick and easy mounting.
- With 25 mm radius for bending the cables.

- **Material**
 - Sheet steel, 1.5 mm.

- **Finish**
 - Final digit of order number .1: powder-coated, RAL 7035 light-grey.
 - Final digit of order number .8: powder-coated, RAL 7021 dark-grey.

- **Scope of delivery**
 - 1 x center panel insert.
 - 1 x Mounting kit.

- **How supplied**
 - In sets.

W / L	W _{Rack}	R	For rack type	Order No.	UP
200	600	25	MIR2 / DCM	05.045.021.X	1 set
600	600	25	MIR2 / DCM	05.045.022.X	1 set
200	800	25	MIR2 / DCM	05.045.023.X	1 set
600	800	25	MIR2 / DCM	05.045.024.X	1 set

D

Transitional cover from rack to rack



MEC20206

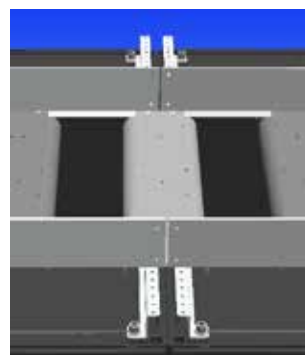

MEC20212

- Secured on support bracket.
- Quick and easy mounting.
- With 25 mm radius for bending the cables.

- **Material**
 - Sheet steel, 1.5 mm.

- **Finish**
 - Final digit of order number .1: powder-coated, RAL 7035 light-grey.
 - Final digit of order number .8: powder-coated, RAL 7021 dark-grey.

- **Scope of delivery**
 - 1 x transitional cover.
 - 1 x Mounting kit.

- **How supplied**
 - In sets.

W / L	R	For rack type	Order No.	UP
200	25	MIR2 / DCM	05.045.031.X	1 set
600	25	MIR2 / DCM	05.045.032.X	1 set

E

End panel insert

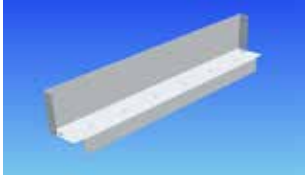

MEC20207

- Secured on support bracket.
- Quick and easy mounting.
- Completes cable trays.

Material

- Sheet steel 1.0 mm.

Finish

- Final digit of order number .1: powder-coated, RAL 7035 light-grey.
- Final digit of order number .8: powder-coated, RAL 7021 dark-grey.

Scope of delivery

- 2 x end panel inserts.
- 1 x Mounting kit.

How supplied

- In sets.

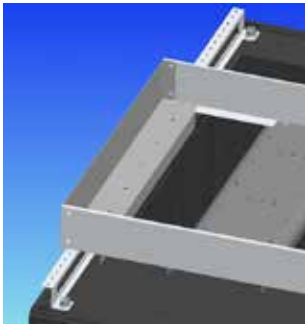

MEC20214

W / L	For rack type	Order No.	UP
200	MIR2 / DCM	05.045.041.X	1 set
600	MIR2 / DCM	05.045.042.X	1 set

F

Connecting panel insert



MEC20208

- For joining mounting brackets.
- Quick and easy mounting.

Material

- Sheet steel, 1.5 mm.

Finish

- Final digit of order number .1: powder-coated, RAL 7035 light-grey.
- Final digit of order number .8: powder-coated, RAL 7021 dark-grey.

Scope of delivery

- 10 x connecting panel inserts.
- 1 x Mounting kit.

How supplied

- In sets.



MEC20213

W	H	For rack type	Order No.	UP
64	86	MIR2 / DCM	05.045.045.X	1 set

G

Cover plate



MEC20209

- For covering the space between the center panel inserts and transitional covers.
- Quick and easy mounting.

Material

- Sheet steel 1.0 mm.

Finish

- Final digit of order number .1: powder-coated, RAL 7035 light-grey.
- Final digit of order number .8: powder-coated, RAL 7021 dark-grey.

Scope of delivery

- 10 x cover plates.
- 1 x Mounting kit.

How supplied

- In sets.

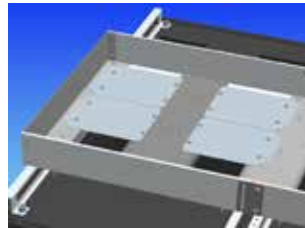

MEC20215

L	W	For rack type	Order No.	UP
229	183	MIR2 / DCM	05.045.047.X	1 set

Option

Mesh cable tray



MEC20218

- Secured on support bracket.
- Quick and easy mounting.

Material

- Round steel, d = 4.5 mm.

Finish

- Zinc-passivated.

Scope of delivery

- 1 x mesh cable tray.
- 1 x Mounting kit.

How supplied

- In sets.

B	L	H	For rack type	Order No.	UP
200	3000	54	MIR2 / DCM	05.045.061.9	1 set
600	3000	54	MIR2 / DCM	05.045.062.9	1 set

Dimensions in mm:

W = Width	h = Installation height	U = Standard rack unit	kg = Weight
H = Height	d = Insertion depth	(1 U = 44.45 mm)	
D = Depth	L = Length	UP = Packaging unit	

Conversion:

1 mm = 0.03937 inch
1 kg = 2.2046 pounds

H

Support bracket Cross-cabling

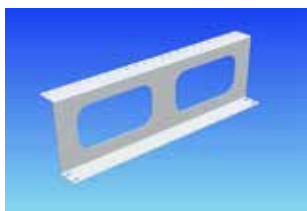

MEC20210

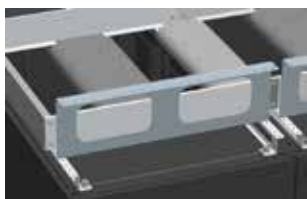

MEC20216

- For cable management at the top between rack suites.
- Quick and easy mounting.
- Includes screw for securing the mounting brackets, transitional covers and cover plates.

Material
- Sheet steel 2.0 mm.

Finish
- Final digit of order number .1:
powder-coated, RAL 7035 light-grey.
- Final digit of order number .8:
powder-coated, RAL 7021 dark-grey.

Scope of delivery
- 2 x support brackets, cross-cabling.
- 1 x Mounting kit.

How supplied
- In sets.

H	W _{Rack}	For rack type	Order No.	UP
166	600	MIR2 / DCM	05.045.052.X	1 set
166	800	MIR2 / DCM	05.045.053.X	1 set

I

Cross-cabling Cover

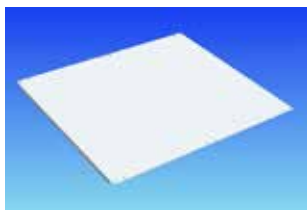

MEC20211

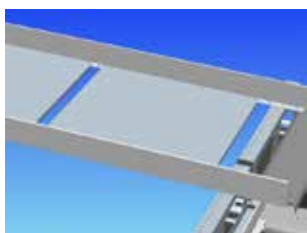

MEC20217

- Provides support for cables and covers the space between the rack suites.
- Secured on mounting bracket.
- Quick and easy mounting.

Material
- Sheet steel 1.0 mm.

Finish
- Final digit of order number .1:
powder-coated, RAL 7035 light-grey.
- Final digit of order number .8:
powder-coated, RAL 7021 dark-grey.

Scope of delivery
- 5 x cover plates.
- 1 x Mounting kit.

How supplied
- In sets.

L	W	For rack type	Order No.	UP
200	200	MIR2 / DCM	05.045.055.X	1 set
200	600	MIR2 / DCM	05.045.056.X	1 set
600	600	MIR2 / DCM	05.045.057.X	1 set

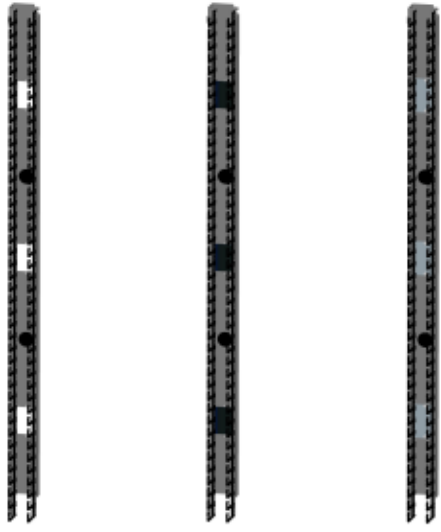

Type 1

Type 2

Type 3

Vertiv™ Knürr® Cable Management

■ Features

- Organized cabling of jumper cables.
- Suitable depends on the model, for 19" Vertiv Knürr, DCM® and MIR2® Racks.
- Also available optionally as cold/warm partitioning.
- Cutouts for cabling from front to back.
- Lightweight plastic construction of the cable fingers ensures durability and simple installation (clip-on).
- Distance between fingers provides sufficient space for all patch cords.
- Rounded edges on the fingers protect cables against damage.

Cable manager models

- **Type 1:** Standard (open cutouts).
- **Type 2:** Version with brush strips in cutouts for cable routing towards the rear.
- **Type 3:** Version with sheet-steel cover plates in cutouts as part of the cold/warm partitioning.

Technical data and required recess depths

Vertiv Knürr DCM

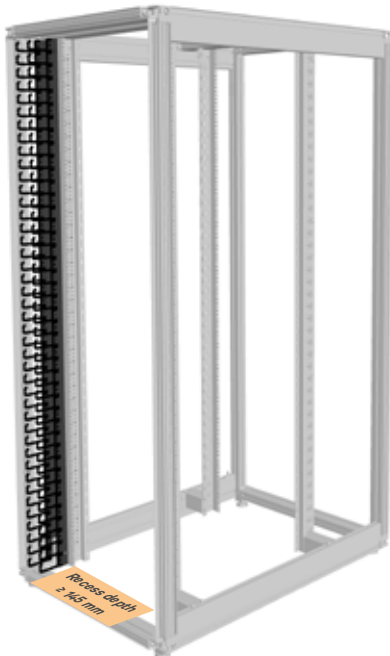

Recess depth
≥ 145 mm

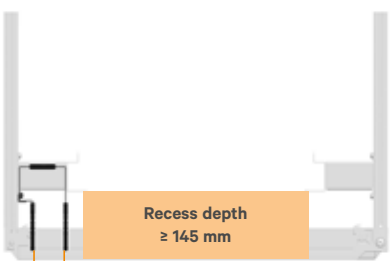

60 mm

Recess depth
≥ 145 mm

Vertiv Knürr DCM



Recess depth
≥ 280 mm



93 mm

On Request

Recess depth
≥ 280 mm

81 mm

Vertiv Knürr MIR2



Recess depth
≥ 145 mm

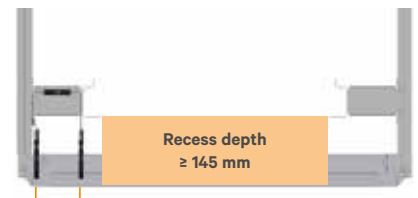

81 mm

Recess depth
≥ 145 mm

Vertiv™ Knürr® DCM cable manager, vertical



DCM2018



DCM2019

Description

- **Left and right models (2 cable managers) included in the delivery.**
- Ideal for organizing cabling of jumper cables (copper and fiber optic cables).
- Retrofitting is possible.
- Prepared for full cold/warm partitioning.
- Cable fingers can be easily installed (clipped on).
- Cabling towards the rear through rubber bushings or cutouts.
- **Can be used for recess depths from 145 mm.**

Material / Finish

- Cable duct: Sheet steel, 2.0 mm.
- Final digit of order number .1: powder-coated, RAL 7035 light-grey.
- Final digit of order number .8: powder-coated, RAL 7021 dark-grey.
- Cable fingers: Polyamide (UL 94 V-0), black.

Scope of delivery

- 1 x cable duct, left.
- 1 x cable duct, right.
- 4 x rows with cable fingers.
- 4 x rubber bushings.
- 1 x Mounting kit.

How supplied

- In pairs (cable fingers unassembled).

Remarks

- Only for DCM Rack.

W _{Rack}	H _{Rack}	U	Recess depth	Cutout size	Order No.	UP
800	2000	42	Starting from 145 mm	66 x 100 mm	05.045.102.X	1 pair
800	2200	47	Starting from 145 mm	66 x 100 mm	05.045.103.X	1 pair



DCM20120



DCM20121

DCM cover panel for vertical cable manager

- **For only 1 cable manager, i. e., 2 kits required for B800 rack.**
- Covers the vertical cable manager.
- Tool-less fastening – clips onto cable finger.
- Can be swiveled on both sides and removed completely.

Material / Finish

- Cover: sheet steel, 2.0 mm.
- Final digit of order number .1: powder-coated, RAL 7035 light-grey.
- Final digit of order number .8: powder-coated, RAL 7021 dark-grey.
- Clip: polyamide (UL 94 V-0), black.

Scope of delivery

- 2 x covers.
- 8 x clips.

How supplied

- In sets (clips pre-assembled).

W	H	U	Order No.	UP
55	927	42	05.045.112.X	1 set
55	1038	47	05.045.113.X	1 set



DCM20117

DCM/MIR2 kit for air partitioning for vertical cable manager

- **Suitable for DCM and MIR2 racks.**
- Separates the cold and hot areas within the rack.
- Prevents hot-spots (air recirculation).

Material / Finish

- Bottom plate, cover plate: sheet steel, 1.0 mm.
- Final digit of order number .1: powder-coated, RAL 7035 light-grey.
- Final digit of order number .8: powder-coated, RAL 7021 dark-grey.
- High-density foam: PUR foam (UL94 HF-1).

Scope of delivery

- 1 x bottom plate.
- 6 x Steel plate cover plates (extension to Type3) for cable routing.
- 1 x Foam element, side.
- 1 x Foam element, top.
- 1 x Mounting kit.

How supplied

- In sets.

Remarks

- For DCM and MIR2 Rack.

W _{Rack}	U	Order No.	UP
800	42 and 47	05.045.132.X	1 set

Vertiv™ Knürr® MIR2 – Cable Manager, Vertical



Left and right models (2 cable managers) included in the delivery.

- Ideal for organizing cabling of jumper cables (copper and fiber optic cables).
- Retrofitting is possible.
- Prepared for full cold/warm partitioning.
- Cable fingers can be easily installed (clipped on).
- Cabling towards the rear through rubber bushings or cutouts.

Can be used for recess depths from 145 mm.

Material / Finish

- Cable duct: Sheet steel, 2.0 mm.
- Final digit of order number .1: powder-coated, RAL 7035 light-grey.
- Final digit of order number .8: powder-coated, RAL 7021 dark-grey.
- Cable fingers: Polyamide (UL 94 V-0), black.

Standard inclusion

- 1 x cable duct, left.
- 1 x cable duct, right.
- 4 x rows with cable fingers.
- 4 x rubber bushings.
- 1 x Mounting kit.

Delivery

- In pairs (cable fingers unassembled).

Note

- For MIR2 only.
- Only front mountable.

W Rac	H Rac	D	U	Recess depth	Cutout size	Order No.	Up
800	2000	42		Starting from 145 mm	81 x 100 mm	05.045.152.x	1 pair
800	2200	47		Starting from 145 mm	81 x 100 mm	05.045.153.x	1 pair

Vertiv Knürr MIR2 – Cover Panel for Vertical Cable Manager



For only 1 cable manager, i. e., 2 kits required for B800 rack.

- Covers the vertical cable manager.
- Tool-less fastening – clips onto cable finger.
- Can be swiveled on both sides and removed completely.

Material / Finish

- Cover: sheet steel, 2.0 mm.
- Final digit of order number .1: powder-coated, RAL 7035 light-grey.
- Final digit of order number .8: powder-coated, RAL 7021 dark-grey.
- Clip: polyamide (UL 94 V-0), black.

Standard inclusion

- 2 x covers.
- 8 x clips.

Delivery

- In sets (clips pre-assembled).

Note

- For MIR2 only.

W	H	D	U	Order No.	Up
55	927	42		05.045.114.x	1 set
55	103	47		05.045.115.x	1 set



DCM2012

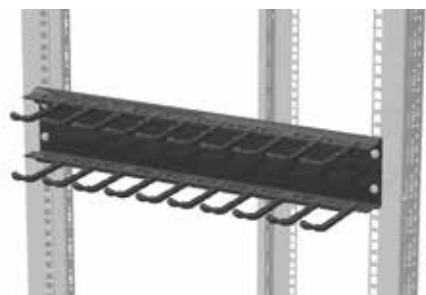

DCM2014

MIR2® / DCM 19" cable manager, horizontal

Description

- 1 U and 2 U models.
- For organized cabling of jumper cables (copper and fiber optic cables).
- Front-mounting on 19" extrusions.
- Cable fingers can be easily installed (clipped on).
- **Can be used for recess depths from 145 mm.**

Scope of delivery

- 1 x cable duct.
- 2 x rows with cable fingers.
- 1 x Mounting kit.

How supplied

- In sets (cable fingers unassembled).

Material / Finish

- Cable duct: sheet steel, 2.0 mm.
- Final digit of order number .1: powder-coated, RAL 7035 light-grey.
- Final digit of order number .8: powder-coated, RAL 7021 dark-grey.
- Cable fingers: polyamide (UL 94 V-0), black.

W	U	Recess depth	Order No.	UP
483	1	Starting from 145 mm	05.045.120.X	1 unit
483	2	Starting from 145 mm	05.045.122.X	1 unit

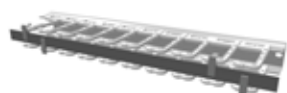

DCM2013

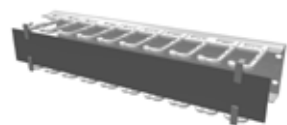

DCM2015

MIR2 / DCM Cover for 19" horizontal cable manager

- Covers the horizontal cable managers.
- Tool-less fastening – clips onto cable finger.
- Can be siveled on both sides and removed completely.

Material / Finish

- Cover: sheet steel, 2.0 mm.
- Final digit of order number .1: powder-coated, RAL 7035 light-grey.
- Final digit of order number .8: powder-coated, RAL 7021 dark-grey.
- Clip: polyamide (UL 94 V-0), black.

Scope of delivery

- 1 x cover.
- 4 x clips.

How supplied

- In sets (clips pre-assembled).

W	H	U	Order No.	UP
483	20	1	05.045.121.X	1 set
483	65	2	05.045.123.X	1 set



MIR20093



DCM2012

MIR2 / DCM Brush strips for vertical cable manager (Typ2)

- Upgrade kit for vertical cable manager for routing cables toward the rear (for extension to Typ 2).
- Inserted in openings in cable duct (1 pair of brushes per opening).

Scope of delivery

- 3 x pairs of brushes (length: 99 mm).

How supplied

- In sets.

L	for cutouts	Order No.	UP
99	66 x100 mm	05.045.130.9	1 set

Dimensions in mm:

W = Width	h = Installation height	U = Standard rack unit	kg = Weight
H = Height	d = Insertion depth	(1 U = 44.45 mm)	
D = Depth	L = Length	UP = Packaging unit	

Conversion:

1 mm	= 0.03937 inch
1 kg	= 2.2046 pounds

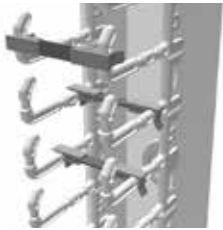

DCM20116

DCM kit for cascading; vertical cable manager

- Separates individual cable groups.
- Tool-less fastening – clips onto cable finger.
- Protects the cables and can be used for labeling.

Material / Finish

- Cascade: sheet steel, 2.0 mm.
- Powder-coated texture, RAL 7021 dark-grey.
- Clip: polyamide (UL 94 V-0), black.

Scope of delivery

- 10 x cascades.
- 20 x clips.

How supplied

- In sets (clips pre-assembled).

W	H	Order No.	UP
55	10	05.045.136.8	1 set

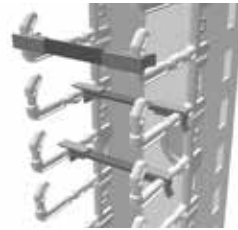

MIR20454

MIR2 kit for cascading; vertical cable manager

- For separating individual cable groups.
- Tool-less fastening – clips onto cable finger.
- Protects the cables and can be used for labeling.

Material / Finish

- Cascade: sheet steel, 2.0 mm. Powder-coated texture, RAL 7021 dark-grey.
- Clip: polyamide (UL 94 V-0), black.

Scope of delivery

- 10 x cascades.
- 20 x clips.

How supplied

- In sets (clips pre-assembled).

W	H	Order No.	UP
76	10	05.045.137.8	1 set



MEC00110

Type 1

19" cable routing board 1 U

- For orderly cable routing.
- Enables safe and secure cable routing of copper and fiberglass cables.

Material / Finish

- Type 1: Front plate, sheet steel, 1.5 mm, powder coated.
- Type 2: Front plate, sheet steel, 1.0 mm, powder coated.

Color

- Final digit of order number .1: RAL 7035, light grey.
- Final digit of order number .8: RAL 7021 dark-grey.

External dimensions

- Cable routing:
- Type 1: 55 x 22 mm, plastic.
- Type 2: 95 x 32 mm, steel.

Scope of delivery

- 1 x 19" front plate.
- 5 x cable routers.

How supplied

- Pre-assembled

Note

Please also order mounting material for front plates.

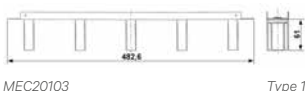

MEC20103

Type 1



MEC20104

Type 2

W	U	Jumpering space	Model	Order No.	UP
483	1	from 80 mm	Type 1	05.040.111.1	1 unit
483	1	from 80 mm	Type 1	05.040.111.X	1 unit
483	1	from 123 mm	Type 2	01.117.144.X	1 unit



MEC20041

19" cable routing board, flexible, 1 U

- For orderly cable routing.
- Enables safe and secure cable routing of copper and fiberglass cables.

Material / Finish

- Front plate, sheet steel, 1.5 mm, powder coated.
- Cable routing bracket, round steel, d = 5 mm, zinc-passivated.

Color

- Final digit of order number .1: RAL 7035, light grey.
- Final digit of order number .8: RAL 7021 dark-grey.

External dimensions

- Cable routers (a x b):
- 1 U: 82 x 43 mm.
- 2 U: 102 x 82 mm.

Scope of delivery

- 1 x front plate.
- 5 x cable routing boards.

How supplied

- Pre-assembled.

Note

Please also order mounting material for front plates.

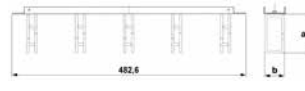

MEC20102



MEC20076

W	U	Jumpering space	Model	Order No.	UP
483	1	from 100 mm	Type 1	05.040.100.X	1 unit
483	2	from 120 mm	Type 2	05.040.101.X	1 unit



MEC20081

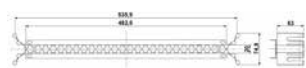

MEC20105



MEC20058

Fiber optic cable routing panel 1 U

- For orderly cable routing.
- Enables safe and secure cable routing of fiber optic cables.
- Optionally with cover plates to protect the cables and can be used for labeling.

Material / Finish

- Fiber optic cable routing panel: Sheet steel 1,5mm, powder-coated texture.
- Cover Accessories: Aluminium 2,5mm, powder-coated texture.

Color

- Final digit of order number .1: RAL 7035, light grey.
- Final digit of order number .8: RAL 7021 dark-grey.

Scope of delivery

- 1 x 19" cable routing board.

How supplied

- Single items.

Note

Please also order mounting material for front plates and cover.
Not suitable for rack widths of 600 mm and 700 mm (asymmetrical).

W	U	Model	Order No.	UP
483	1	Cable routing board	05.040.050.1	1 unit
483	1	Cable routing board	05.040.050.X	1 unit
		Accessories: cover	05.040.051.X	1 unit



MEC20049

19" cable through

- For organized cable management at the 19" front plate.
- Mounting possible on front plates.
- Cables can be fastened with Velcro.

Material / Finish

- Sheet steel, 1,5 mm, powder-coated texture.

Color

- Final digit of order number .1: RAL 7035, light grey.
- Final digit of order number .8: RAL 7021 dark-grey.

Scope of delivery

- 1 x cable through.

How supplied

- Single items.

Note

Please also order mounting material for front plates and Velcro rolls.

W	D	U	Order No.	UP
483	100	1	05.040.055.X	1 unit

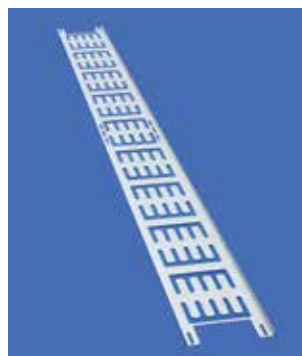

MEC20224

Cable trough

- For orderly cable management in the MIR2 and DCM racks.
- Cables secured with Velcro strips or cable ties.
- 9 mm slit width for securing various parts to caged nuts.

Material / Finish

- Sheet steel, 1,5 mm, zinc passivated, powder-coated.

Color

- Final digit of order number .1: RAL 7035 light grey.
- Final digit of order number .8: RAL 7021, dark-grey.

Scope of delivery

- 1 x cable trough.
- 1 x Mounting kit.

How supplied

- In sets.

Note

If required, please also order Velcro rolls.



MEC20067

H	w	Model	Order No.	UP
2000	100	For MIR2 and DCM racks	05.040.251.X	1 set
2200	100	For MIR2 and DCM racks	05.040.252.X	1 set
2000	150	For MIR2 and DCM racks	05.040.254.X	1 set
2200	150	For MIR2 and DCM racks	05.040.255.X	1 set
2000	200	For MIR2 and DCM racks	05.040.257.X	1 set
2200	200	For MIR2 and DCM racks	05.040.258.X	1 set



MEC00114

Cable clamping bar

- Clips onto the C extrusion rail.

Material

- Polyamide, black.

Scope of delivery

- 1 set of 10 cable clamping bars.

How supplied

- In sets.

Order No.	UP
01.130.869.9	10 units

- assemble to order (shipped within 5 working days).
Caution: In case of larger orders, delivery times may increase.

Dimensions in mm:				Conversion:
W = Width	h = Installation height	U = Standard rack unit	kg = Weight	1 mm = 0.03937 inch
H = Height	d = Insertion depth	(1 U = 44.45 mm)		1 kg = 2.2046 pounds
D = Depth	L = Length	UP = Packaging unit		



MIR00096

U clamp

- Reduces cabling strain and permits individual routing of cables and lines.
- Clamping range, 8–64 mm.

- **Material**
 - Steel / plastic.

- **Scope of delivery**
 - 25 x U clamps.
 - 25 x clamping saddles.

- **How supplied**
 - In sets.

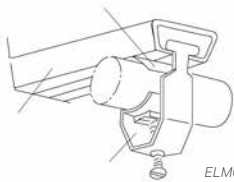

ELM00086

Clamping range	Order No.	UP
8–12 mm	05.040.150.9	1 unit
12–16 mm	05.040.151.9	1 unit
16–22 mm	05.040.152.9	1 unit
22–28 mm	05.040.154.9	1 unit
34–40 mm	05.040.155.9	1 unit
46–52 mm	05.040.157.9	1 unit

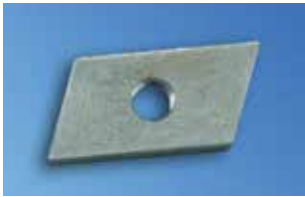

MEC20051

M5 threaded plate

- Used with C extrusion rails.

- **Material / Finish**
 - Flat rolled steel, 4,0 mm, zinc passivated.

- **Scope of delivery**
 - 20 x threaded plates.

- **How supplied**
 - In sets.

Order No.	UP
05.040.077.9	1 set



MEC20136

Type 1

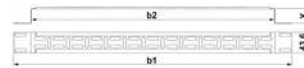

MEC20120

Type 1

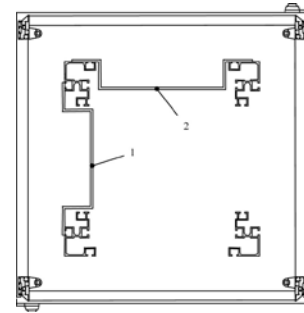

MIR00094

Assembly crossbar

- Cable management with Velcro strips.
- Universal mounting option for installation accessories, socket strips, telecommunication installation units, mounting panels, etc.
- For side and cross installation.

- **Material / Finish**
 - Sheet steel 1,5 mm, powder-coated texture.

- **Color**
 - Final digit of order number .1: RAL 7035 light-grey.
 - Final digit of order number .8: RAL 7021 dark-grey.

- **Scope of delivery**
 - 1 x assembly crossbar.

- **How supplied**
 - Single items.

- **Note**
 - Please also order the appropriate mounting material.

W/d	U	w1	w2	X	Type	Model	Order No.	UP
19"	1	482	442,6	815	1	Pos. 2: MIR2 / DCM / Smaract	05.040.018.X	1 unit



MEC20042

Cable through between the racks

- For orderly cable routing between linked racks, adjacent racks.
- Velcro strips can be used for fastening.

- **Material / Finish**
 - Sheet steel, 1,5 mm.
 - Powder-coated texture, RAL 7035 light-grey.

- **Scope of delivery**
 - 1 x cable through.
 - 1 x Mounting kit.

- **How supplied**
 - In sets.

- **Note**
 - Please also order Velcro rolls.

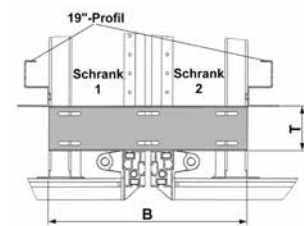

MEC20119

W	D	Order No.	UP
265	60	05.040.058.1	1 unit



MEC20047

FOC 19" excess cable drawer, 1 U

- For storing excess fiber optic cable.
- Pull-out.
- Cables can be fastened with Velcro.

- **Material / Finish**
 - Sheet steel, 15 mm.

- **Color**
 - Final digit of order number .1: RAL 7035 light-grey.
 - Final digit of order number .8: RAL 7021 dark-grey.

- **Scope of delivery**
 - 1 x unit.
 - 1 x drawer.

- **How supplied**
 - In sets.

- **Note**
 - Please also order mounting material for front plates and Velcro rolls.



MEC20099

W	H	D	Order No.	UP
483	44	350	05.040.047.X	1 set



MEC20044

Excess fiber optic cable storage

- For orderly cable routing of Fiber optic cables in Miracel rack (from B 800 mm).
- For storing excess cable.

- **Material / Finish**
 - Base plate: powder-coated texture.
 - Cable routing head: polyamide, black.

- **Color**
 - Final digit of order number .1: RAL 7035 light-grey.
 - Final digit of order number .8: RAL 7021 dark-grey.

- **Scope of delivery**
 - 1 x base plate.
 - 1 x cable routing head.
 - 1 x Mounting kit.

- **How supplied**
 - In sets.



MEC20146

U	Order No.	UP
2	05.040.041.X	1 set



MEC20038

Universal cable routing bracket

- Used for extrusion distance (from front) 123 mm and 73 mm.
- For organized cable management.
- Open version, no threading.
- Mounting on the external side of the 19" extrusion.
- Any installation position selectable.

- **Material**
 - Round steel, d = 6 mm.

- **Finish**
 - Zinc-passivated.

- **Scope of delivery**
 - 4 x cable routing brackets.
 - 1 x Mounting kit.

- **How supplied**
 - In sets.



MEC20072

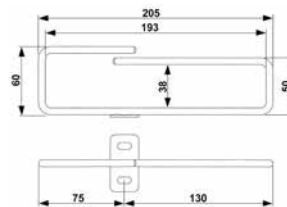

MEC20106

W _{Rack}	For rack type	Order No.	UP
from 800	MIR2 / DCM	05.040.220.9	4 Stk



MEC20039

Square cable routing bracket

- For orderly cable management.
- Open version, no threading.
- Mounted on the external side of the 19" extrusion.
- Any installation position selectable.
- For high cable density.

- **Material**
 - Round steel, d = 6 mm.

- **Finish**
 - Zinc-passivated.

- **Scope of delivery**
 - 4 x square cable routing brackets.
 - 1 x Mounting kit.

- **How supplied**
 - In sets.

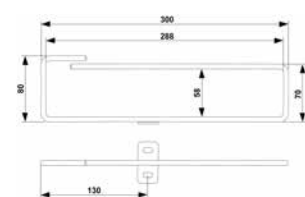

MEC20107

Type 1

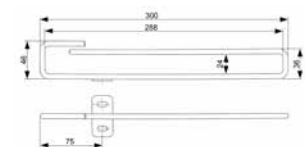

MEC20116

Type 2

W _{Rack}	Type	For rack type	Order No.	UP
from 800	Type 1	MIR2 / DCM	05.040.221.9	4 units
from 700	Type 2	MIR2 / DCM	05.040.222.9	4 units
600	Type 2	Smaract	05.040.222.9	4 units

- assemble to order (shipped within 5 working days).
Caution: In case of larger orders, delivery times may increase.

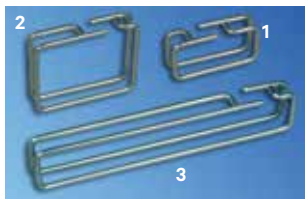

MEC20035

MIR2/DCM Cable routing bracket, flexible

- Enables flexible and organized cable routing.
- Can be easily installed in various positions within the rack.
- Open version, no threading.

Material
- Round steel, d = 5 mm.

Finish
- Zinc-passivated.

Scope of delivery
- 10 x cable routing brackets.
- 1 x Mounting kit.

How supplied
- In sets.



MEC20065

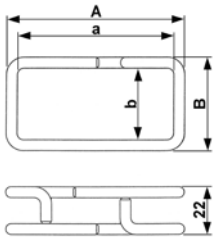

MEC20108

A	a	W	w	Model	Order No.	UP
82	72	43	33	Fig.1	05.040.231.9	10 units
222	212	30	20	Fig.3	05.040.232.9	10 units
102	92	82	72	Fig.2	05.040.233.9	10 units P



ELM00117

Square cable routing bracket

- For organized cable management.
- Open version, no threading.
- Mounted on the external lateral T-slot of the 19" extrusion.
- Any installation position selectable.

Material
- Round steel, d = 5 mm.

Finish
- Zinc-passivated.

Scope of delivery
- 4 x cable routing brackets.
- 1 x Mounting kit.

How supplied
- In sets.

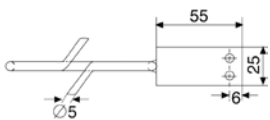
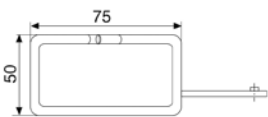

ELM00106

For rack type	Order No.	UP
DoubleProRack	05.040.226.9	4 units



MIR00564

Cable routing bracket

- For organized cable management.
- Open version, no threading.

Material/Oberfläche
- Round steel, d = 5 mm.

Finish
- Zinc-passivated.

Scope of delivery
- 4 x cable routing brackets.
- 1 x Mounting kit.

How supplied
- In sets.

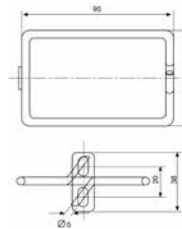

MEC00122

Model	For rack type	Order No.	UP
95 x 60	MIR2 / DCM	05.040.225.9	4 units



ELM00028

Section support bracket

- Ideal for vertical routing and reducing cabling strain.
- Open version, no threading.
- Mounted on the external lateral T-slot of the 19" extrusion.
- Any installation position selectable.
- From rack width 600 mm.

Material / Finish
- Round steel, d = 5 mm, zinc-passivated.

Scope of delivery
- 2 x section support brackets.

How supplied
- In sets.

Note
Please also order the appropriate mounting material.

Z56-1/FH

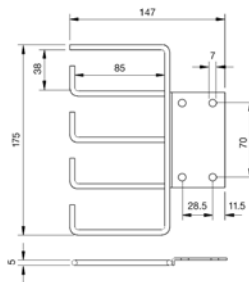

ELM00029

Model	Order No.	UP
MIR2 / DCM / Smaract / DPR	01.117.033.7	2 units P

Dimensions in mm:				Conversion:
W = Width	h = Installation height	U = Standard rack unit	kg = Weight	1 mm = 0.03937 inch
H = Height	d = Insertion depth	(1U = 44.45 mm)		1 kg = 2.2046 pounds
D = Depth	L = Length	UP = Packaging unit		



MIR00183

Cable routing bracket, square

- For organized cable management.
- Open version, no threading.
- Mounted on the external lateral T-slot of the 19" extrusion.
- Any installation position selectable.
- From rack width 800 mm.

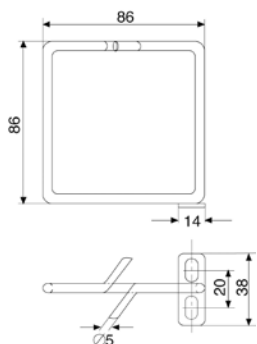

ELM00057

Material

- Zinc-passivated, Zn 10c, white.

Scope of delivery

- 4 x vertical cable routing brackets.
- 1 x Mounting kit.

How supplied

- In sets.

W _{Rack}	Model	For rack type	Order No.	UP
from 800	86 x 86	Miracel 2 / DCM	05.040.224.9	4 units



ELM20008

Cable routing ring

- For organized cable management.
- Open version, no threading.
- Secured on the T-slots of the vertical extrusions.
- Any installation position selectable.

Material / Finish

- PA 6, GF 15, black, UL 94-HB.

Scope of delivery

- 5 x cable routing rings.
- 1 x Mounting kit.

How supplied

- In sets.



ELM20007

Model	For rack type	Order No.	UP
54 x 118 mm	MIR2 / DCM / Smaract	01.312.207.9	5 units



MEC20185

Quick-Strip ties for T-slot Tool-less mounting

- Quick tool-less securing.
- For bundling cables.
- Can be unfastened and reused.
- For organized cable management.
- Can be fitted into T-slots in any position.

Material

- Polyethylene and nylon.
- F.R.T., UL-94 HB.

Color

- Black.

Scope of delivery

- 10 x Quick-Strip Velcro ties.

How supplied

- In sets.



MEC20186

For rack type	Order No.	UP
MIR2 / DCM	00.218.506.0	1 set



MEC20187

Quick-Clamp plastic cable routing bracket for T-slot mounting without tools

- Quick tool-less securing.
- For organized cable management.
- Open version, no threading.
- Secures T-slots in any position.

Material

- Nylon.
- F.R.T., UL-94 HB.

Color

- Black.

Scope of delivery

- 10 x plastic cable routing brackets.

How supplied

- In sets.



MEC20188

For rack type	Order No.	UP
MIR2 / DCM	00.218.505.0	1 set

= assemble to order (shipped within 5 working days).
Caution: In case of larger orders, delivery times may increase.

Dimensions in mm:				Conversion:
W = Width	h = Installation height	U = Standard rack unit	kg = Weight	1 mm = 0.03937 inch
H = Height	d = Insertion depth	(1 U = 44.45 mm)		1 kg = 2.2046 pounds
D = Depth	L = Length	UP = Packaging unit		

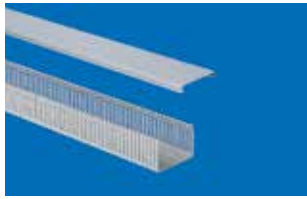

ELM00004

Cable duct

- Ideal for organized and covered cable management of jumper cables.

■ **Material**
- Hard PVC.

■ **Finish**
- Stone-grey RAL 7030.

■ **Scope of delivery**
- 1 x cable duct with cover.
- 1 x Mounting kit.

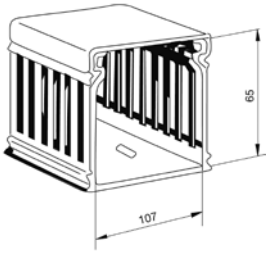

ELM00052

L	Order No.	UP
2000	01.117.098.3	1 unit



MEC20158

Cable routing ring

- For organized cable management.
- Dimensions:
Exterior 61 mm x 42.5 mm.
Interior 52 mm x 23 mm.

■ **Material / Finish**
- Cable support: PPO, similar to RAL 7035 light-grey.
- Soft rubber extrusion: EPDM, similar to RAL 7021 dark-grey.

■ **Scope of delivery**
- 10 x cable routers

■ **How supplied**
- In sets.

■ **Note**
Please also order the appropriate mounting material.

Model	Order No.	UP
Screw-on	05.040.113.9	10 units



MEC20048

Velcro rolls (by the meter)

- For strain-free fastening and bundling of Cu and fiber optic cables.
- Velcro rolls can be cut to any required length.

■ **Material / Color**
- Black, One-Wrap fastener.
- F.R.T., UL 94-V2.
- Blue: One-Wrap fastener.

■ **Scope of delivery**
- 1 meter or 25 meter Velcro rolls.

■ **How supplied**
Sold by the meter.



MEC20147

W	L	Model	Order No.	UP
16	1000	Black	05.040.060.9	1 meter
16	1000	Blue	05.040.061.9	1 meter
16	25000	Black	05.040.065.9	25 meters
16	25000	Blue	05.040.066.9	25 meters



ELM00049

Cable band clip

- For organized cable management.
- For securing harnesses and cables with large cross sections.
- Quick and easy mounting.
- Clips into T-slots in any position.
- Includes releasable clip.

■ **Material**
- PA 6.6, black, UL 94-V0.

■ **Scope of delivery**
- 20 units.

■ **How supplied**
- In sets.

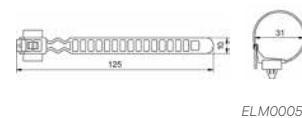

ELM00050

Order No.	UP
01.240.548.9	20 units

Vertiv™ Knürr® Fan Units

Features

CoolBlast®

- Modular construction for varying heat loads; different designs available.
- Top-mounting fan and 19-fan unit available.
- Special protection grid keeps pressure losses to a minimum and reduces noise levels.
- Energy-efficient speed-controlled design also available.

Silent top-mounting fan

- Minimal noise level for use in office environment.
- Provides forced rack cooling.

Filter fan

- Protection class IP54.
- Filter can be replaced quickly and easily.
- Can be used to draw or push air.

The ever-increasing power losses of electronic modules make for high demands on effective cooling. Large air-flow volumes ensure secured heat dissipation. The packing density of the electronic equipment in racks and enclosures is also increasing.

The sharp rise in the price of electricity has resulted in energy efficiency gaining importance and environmental concerns increasingly become a prominent decision-making factor. Consequently, the use of speed-controlled fan units is rising. The additional costs generally prove to be a worthwhile investment.



Vertiv™ Knürr® CoolBlast® Fan Unit for Cover Panel Installation Unregulated and thermostat-controlled

- Provides powerful rack cooling.
 - Suitable for retrofitting in cover panel of MIR2 / DCM rack.
 - DC versions and 115 VAC versions upon request (see Vertiv Knürr CoolBlast® fan inserts).
 - Thermostat-controlled model: Fan function (ON/OFF) thermostat-controlled; setting range from 0° to + 60° C.
- **Scope of delivery**
 - 1 x CoolBlast fan unit.
 - 1 x mains cable, 3 m with safety plug (230 VAC).
 - 1 x Mounting kit.
 - 1 x Operating instructions.
 - **How supplied**
 - Assembled, wired and tested.
 - **Note**
 - Please also order corresponding mains cable.
- **Material**
 - Enclosure: sheet steel, high-grade steel grid.
 - **Finish**
 - Zinc-passivated.
 - **Compliance**
 - CE marking compliant with Low Voltage Directive 73/23/EEC; EMC directive 89/366/EEC

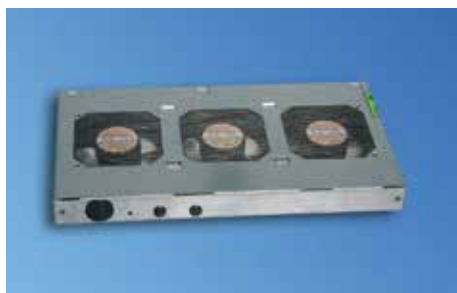

LUF20203



LUF20205



LUF20124

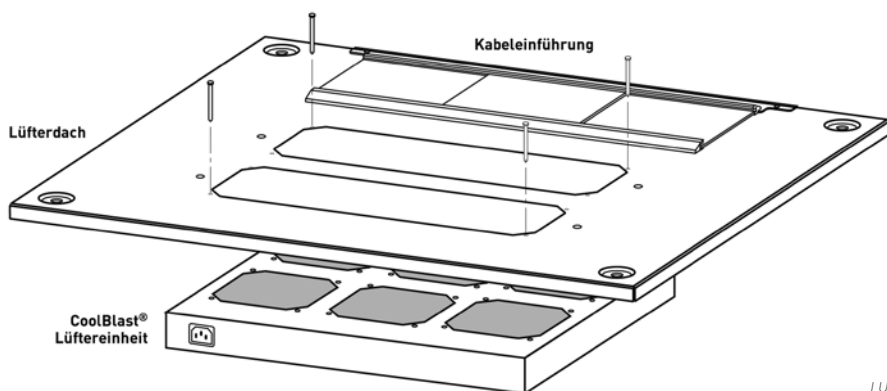

LUF20175

Name	Model	Electrical connection	P(W)	V (m³/h)	ΔP(Pa)	p(dB(A))	Order No.	UP	
CoolBlastT 230V 3-piece		207..253 VAC; 50/60 Hz	45	495	74	45.2	03.027.301.1	1 unit	
CoolBlastT 230V 6-piece		207..253 VAC; 50/60 Hz	90	990	74	48.8	03.027.302.1	1 unit	
CoolBlastT 230V 2-piece	Thermostat	207..253 VAC; 50/60 Hz	30	330	74	43.4	03.027.310.1	1 unit	
CoolBlastT 230V 3-piece	Thermostat	207..253 VAC; 50/60 Hz	45	495	74	45.2	03.027.311.1	1 unit	P
CoolBlastT 230V 6-piece	Thermostat	207..253 VAC; 50/60 Hz	90	990	74	48.8	03.027.312.1	1 unit	

P - assemble to order (shipped within 5 working days).
Caution: In case of larger orders, delivery times may increase.



LUF20160



LUF20161



LUF20124

Vertiv™ Knürr® CoolBlast® Fan Unit for Cover Panel Installation speed-controlled

- Provides powerful rack cooling.
- Suitable for retrofitting in top cover of MIR2 / DCM rack.
- DC version upon request (see CoolBlast fan inserts).
- Settable reference temperature (20° to 55° C).
- Speed control, 30 to 100 %, if sensor fails, 100 % rotation.
- Individual fan monitoring.
- Potential-free common alarm output for excess temperature and fan failure.
- Visual status display for O.K., excess temperature and fan failure.
- Acoustic warning inclusive reset button.

Material

- Enclosure: sheet steel, high-grade steel grid.

Finish

- Zinc-passivated front cover plate, powder-coated, smooth in RAL 7035 light-grey.

Compliance

- CE marking compliant with Low Voltage Directive 73/23/EEC; EMC directive 89/366/EEC.

Scope of delivery

- 1 x CoolBlast fan unit.
- 1 x sensor cable, 2 m (plug-in).
- 1 x signal cable, 2 m (plug-in).
- 1 x mains cable, 3 m with safety plug (230 VAC).
- 1 x Mounting kit.
- 1 x Operating instructions.

How supplied



- Assembled, wired and tested.

Note

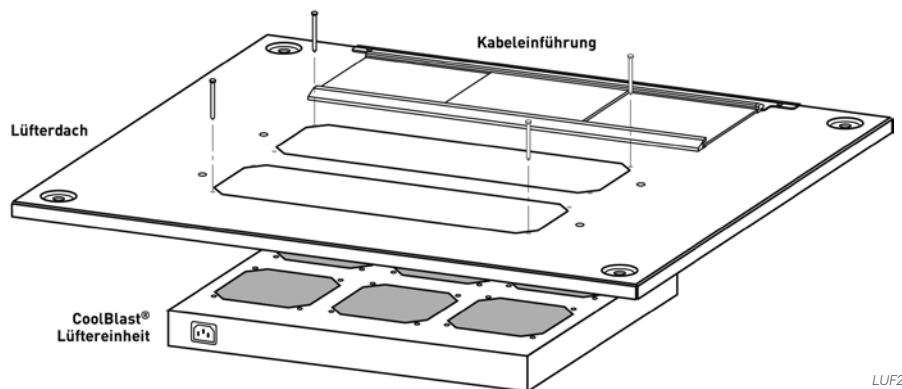
- Please also order specific mains cable.



LUF20175

Name	Model	Electrical connection	P(W)	V (m³/h)	ΔP(Pa)	p(dB(A))	Order No.	UP
CoolBlastT 230V 3-piece	Regulated SP	100..253 VAC; 50/60 Hz	25	553	68	49.6	03.027.321.1	1 unit
CoolBlastT 230V 6-piece	Regulated SP	100..253 VAC; 50/60 Hz	48	1106	68	53.3	03.027.322.1	1 unit
CoolBlastT 230V 3-piece	Regulated HP	100..253 VAC; 50/60 Hz	32	711	173	55.8	03.027.324.1	1 unit 
CoolBlastT 230V 6-piece	Regulated HP	100..253 VAC; 50/60 Hz	62	1422	173	59.1	03.027.325.1	1 unit 

 = assemble to order (shipped within 5 working days).
Caution: In case of larger orders, delivery times may increase.

Dimensions in mm:

W = Width h = Installation height U = Standard rack unit kg = Weight
H = Height d = Usable depth (1 U = 44.45 mm)
D = Depth L = Length UP = Packaging unit

Conversion:

1 mm = 0.03937 inch
1 kg = 2.2046 pounds

SP = Standard Performance V = Air-flow volume (m³/h)
HP = High Performance ΔV = Air-flow volume loss (%)
UP = Ultra High Performance ΔP = Pressure increase (Pa)
n = Number of fans I nom = Nominal current (A)
W = Power consumption I max = Residual current (A)
V = Voltage p = Sound pressure (dB(A))
(400V = 3-phase) distance from the rack 1 m (600 mm x 600 mm; raised cover)



LUF20125



LUF20139

19" Vertiv™ Knürr® CoolBlast® Fan Unit Unregulated and thermostat-controlled

- Fan unit for vertical ventilation of modules in 19" racks.
- Chassis rails are recommended for mounting. Chassis rails are required with 6-piece CoolBlast (use chassis runner, adjustable depth).
- Thermostat-controlled model:
Fan function (ON/OFF) thermostat-controlled; setting range from 0° to + 60° C.

Material

- Sheet steel, high-grade steel grid.

Finish / Color

- Enclosure zinc-passivated.
- Front cover plate, powder-coated, smooth in RAL 7035 light-grey.

How supplied

- Assembled, wired and tested.

Compliance

- CE marking compliant with Low Voltage Directive 73/23/EEC; EMC directive 89/366/EEC.

Scope of delivery

- 1 x CoolBlast fan unit, packed with operating instructions.
- 1 x connection cable, 2 m; Euro power plugs and sockets.

Note

- Please also order specific mains cable.

Name	W	H	D	kg	n	Electrical connection	P(W)	V' (m³/h)	ΔP(Pa)	p(dB(A))	Order No.
CoolBlast 230V 3-piece, thermostat	440	43,6	230	3	3	207 ... 253VAC; 50/60Hz	45	495	74	45,2	03.027.011.1
CoolBlast 230V 6-piece, thermostat	440	43,6	390	6	6	207 ... 253VAC; 50/60Hz	90	990	74	48,8	03.027.012.1
CoolBlast 115V 3-piece, thermostat	440	43,6	230	3	3	103,5 ... 126,5VAC; 50/60Hz	44	576	88	47,3	03.027.014.1
CoolBlast 115V 6-piece, thermostat	440	43,6	390	6	6	103,5 ... 126,5VAC; 50/60Hz	88	1152	88	50,8	03.027.015.1
CoolBlast 24V 3-piece SP	440	43,6	230	2,5	3	12...27 VDC	23	553	68	49,6	03.027.031.1
CoolBlast 24V 6-piece SP	440	43,6	390	5	6	12...27 VDC	46	1106	68	53,3	03.027.032.1

Technical data for Axial Single Fan

	Vertiv Knürr CoolBlast®	Vertiv Knürr CoolBlast	Vertiv Knürr CoolBlast	Vertiv Knürr CoolBlast	Vertiv Knürr CoolBlast
Item number	01914.0709	01914.0759	01914.0509	01914.0519	01914.0519-2
Dim: L x W x H	119 x 119 x 38	119 x 119 x 38	119 x 119 x 38	119 x 119 x 38	119 x 119 x 38
Max. volume flow, free blowing:	184.2 m³/h	237 m³/h	192 m³/h	165 m³/h	120 m³/h
Voltage	24 VDC	24 VDC	115 VAC	230 VAC	230 VAC
Frequency			50 Hz	50 Hz	50 Hz
Power consumption	7.4 W	11 W	14.5 W	15 W	7.5 W
Noise, free blowing	43 dB(A)	59 dB(A)	41 dB(A)	38 dB(A)	32 dB(A)
Bearing system	Ball bearing	Ball bearing	Ball bearing	Ball bearing	Ball bearing
Nominal speed	2950 min-1	4400 min-1	2900 min-1	2600 min-1	2100 min-1
Permitted ambient temp.	-10 °C to + 70 °C	-30 °C to + 55 °C	-40 °C to + 60 °C	-40 °C to + 60 °C	-40 °C to + 70 °C
Service life, L10 at 40°C	75,000 h	70,000 h	43,500 h	43,500 h	43,500 h
Compliance	CE, VDE	CE, VDE	CE, VDE	CE, VDE	CE, VDE
Use in fan unit:	03.027.021.1 03.027.022.1 03.027.051.1 03.027.052.1 03.027.321.1 03.027.322.1	03.027.024.1 P 03.027.025.1 03.027.054.1 03.027.055.1 03.027.324.1 P 03.027.325.1 P	03.027.014.1 03.027.015.1	03.027.011.1 03.027.012.1 03.027.301.1 03.027.302.1 03.027.310.1 03.027.311.1 P 03.027.312.1 02.111.180.9 05.010.306.1 01.24.3428.1 03.028.110.8	02.111.181.9 05.010.307.1



LUF20128



LUF20140



LUF20054

19" Vertiv™ Knürr® CoolBlast® Fan Unit Speed-controlled

- Fan unit for vertical ventilation of modules in 19" racks.
- Reference temperature can be set (20°C to 55°C).
- Speed control, 30 to 100%; if sensor fails, 100% rotation.
- Individual fan monitoring.
- Potential-free alarm output for excess temperature alarm and fan failure.
- Visual status display for O.K., excess temperature and fan failure.
- Acoustic alarm can be switched off with switch.
- Chassis rails are recommended for mounting. Chassis rails are required with 6-piece CoolBlast (use chassis runner, adjustable depth).

Material

- Sheet steel, high-grade steel grid.

Finish / Color

- Enclosure zinc-passivated.
- Front cover plate, powder-coated, smooth in RAL 7035 light-grey.

Compliance

- CE marking compliant with Low Voltage Directive 73/23/EEC; EMC directive 89/366/EEC.

Scope of delivery

- 1 x CoolBlast fan unit, packed with operating instructions.
- 1 x sensor cable, 2 m (plug-in).
- 1 x signal cable, 2 m (plug-in).

Only with DC devices:

- 1 x connection cable, 2 m with connector plug and free ends.

Only with AC devices:

- 1 x connection cable, 2 m; Euro power plugs and sockets.

How supplied

- Assembled, wired and tested.

Note

Further project-specific characteristics can be realized in line with standards.

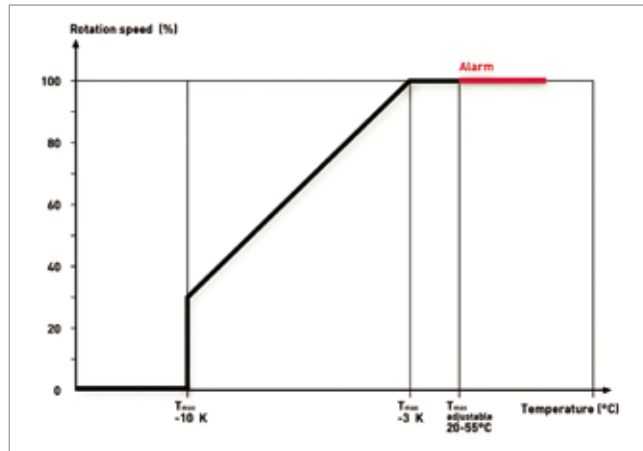

LUF20179

Name	W	H	D	kg	n	Electrical connection	P(W)	V' (m³/h)	ΔP(Pa)	p(dB(A))	Order No.
CoolBlast 115/230V, 3-piece, controlled SP	440	436	230	3.2	3	100 to 253VAC; 50/60Hz	25	553	68	496	03.027.021.1
CoolBlast 115/230V, 6-piece, controlled SP	440	436	390	6.2	6	100 to 253VAC; 50/60Hz	48	1106	68	533	03.027.022.1
CoolBlast 115/230V, 3-piece, controlled HP	440	436	230	3.2	3	100 to 253VAC; 50/60Hz	32	711	173	55.8	03.027.024.1
CoolBlast 115/230V, 6-piece, controlled HP	440	436	390	6.2	6	100 to 253VAC; 50/60Hz	62	1422	173	591	03.027.025.1
CoolBlast 24/48V, 3-piece, controlled SP	440	436	230	3.1	3	20 to 60VDC	25	553	68	496	03.027.051.1
CoolBlast 24/48V, 6-piece, controlled SP	440	436	390	6.1	6	20 to 60VDC	48	1106	68	533	03.027.052.1
CoolBlast 24/48V, 3-piece, controlled HP	440	436	230	3.1	3	20 to 60VDC	32	711	173	55.8	03.027.054.1
CoolBlast 24/48V, 6-piece, controlled HP	440	436	390	6.1	6	20 to 60VDC	62	1422	173	591	03.027.055.1

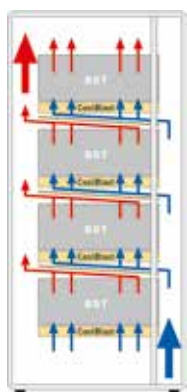

LUF20156

Vertiv™ Knürr® CoolBlast® – Air-flow Routing via Front Intake, 1 U

- The "front-intake unit" for the Vertiv™ Knürr® CoolBlast® fan delivers targeted cooling for module supports arranged on top of each other (heat sources).
- For Knürr CoolBlast slot-in unit 3- and 6 piece for front intake.
- Used as cooling baffle.
- Can be supplemented with front plate and filter mat.

- **Material**
 - Sheet steel.

- **Finish / Color**
 - Powder-coated texture, RAL 7035.
 - Light-grey.

- **Scope of delivery**
 - 1 x air-flow guide.

- **How supplied**
 - Single items.



LUF20131



LUF20142

H	D	Model	Order No.	UP
436	230	For 3-piece	03.027.094.1	1 unit
436	390	For 6-piece	03.027.095.1	1 unit

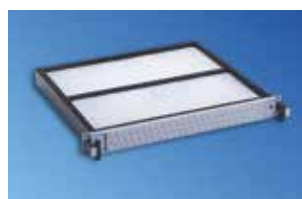

LUF0205

19" Filter Unit, 1 U

- Suitable for use with CoolBlast slot-in unit.
- Adjusted to the respective recess depth.

- **Material**
 - Enclosure: sheet steel.
 - Front cover plate: ABS (UL94 V-0).
 - Handle: extruded aluminum.
 - Filter: Viledon P 15/150.

- **Filter class**
 - G2.

- **Finish / Color**
 - Enclosure: powder-coated texture, RAL 9011 dark-grey.
 - Front cover plate: RAL 7035, light-grey.
 - Handle: powder-coated texture, RAL 5008 grey-blue.

- **Scope of delivery**
 - 1 x filter insert.
 - 1 x filter.

- **How supplied**
 - Single items.

H	D	kg	Order No.	UP
436	282	2.0	03.025.250.1	1 unit
436	660	4.0	03.025.253.1	1 unit



LUF20136

Vertiv Knürr CoolBlast Front Plate

- For use with air-flow guide for front intake.
- Can be retrofitted.

- **Material**
 - Sheet steel.

- **Finish / Color**
 - Powder-coated, RAL 7035.
 - Light-grey, smooth.

- **Scope of delivery**
 - 1 x front plate.

- **How supplied**
 - Single items.

H	Order No.	UP
436	03.027.097.1	1 unit

P = assemble to order (shipped within 5 working days).
Caution: In case of larger orders, delivery times may increase.

Dimensions in mm:				Conversion:	
W = Width	h = Installation height	U = Standard rack unit	kg = Weight	1 mm	= 0.03937 inch
H = Height	d = Usable depth	(1 U = 44.45 mm)		1 kg	= 2.2046 pounds
D = Depth	L = Length	UP = Packaging unit			
SP = Standard Performance	V = Air-flow volume (m ³ /h)				
HP = High Performance	ΔV = Air-flow volume loss (%)				
UP = Ultra High Performance	ΔP = Pressure increase (Pa)				
n = Number of fans	I _{nom} = Nominal current (A)				
W = Power consumption	I _{max} = Residual current (A)				
V = Voltage	p = Sound pressure (dB(A))				
(400V = 3-phase)	distance from the rack 1 m (600 mm x 600 mm; raised cover)				



LUF20121

CoolBlast® Dust/Particle Protection Solution 1: Filter Mat

- Used with CoolBlast® fan top cover.
- Simple filter cover preventing the ingress of dust when the fan stops (regulated or thermostat-controlled version available).
- For all top-cover sizes; filter and adhesive tape can be cut to the required length.

- **Material**
 - Fyledon (filter class G2)
- **Scope of delivery**
 - 1 x filter.
 - 1 x Adhesive tape.
- **How supplied**
 - In sets.



LUF20168

Model	Order No.	UP
For 2, 3 and 6-piece fan unit	01.149.101.9	1 set



LUF20135

Vertiv Knürr CoolBlast Filter for Front Intake

- For use with air-flow routing via front intake.
- Can be retrofitted; filter can also be replaced during operation.

- **Filter class**
 - G2.
- **Material**
 - Viledon K15/150.
- **Scope of delivery**
 - 1 x filter.
- **How supplied**
 - Single items.

W	D	Model	Order No.	UP
400	160	For 3-piece	03.027.098.1	1 unit
400	320	For 6-piece	03.027.099.1	1 unit



LUF00280

Replacement Filter

- For 19" filter insert.
- **Material**
 - Filter: Viledon P 15/150.
- **Filter class**
 - G2.
- **Scope of delivery**
 - 1 x filter.
- **How supplied**
 - Single items.

D	Order No.	UP
282	03.025.246.9	1 unit
660	03.025.249.9	1 unit

Filter Fan

- For specific use where hot spots occur.
- Also suitable for retrofitting, quick and easy.
- The filter mats provide high-level filtration, are easily exchanged and can be cleaned.
- These maintenance-free fans feature a long service life and low noise levels.
- Air-flow routing: blows into the rack (pre-set).
- Can be used to draw in or move air out.

■ **Material**
- Heat-resistant ABS plastic, UL 94 V-0

■ **Color**
- RAL 7035 light-grey.

■ **Compliance**
- CE marking

■ **Protection rating**
- IP 54.



LUF20057



LUF20058

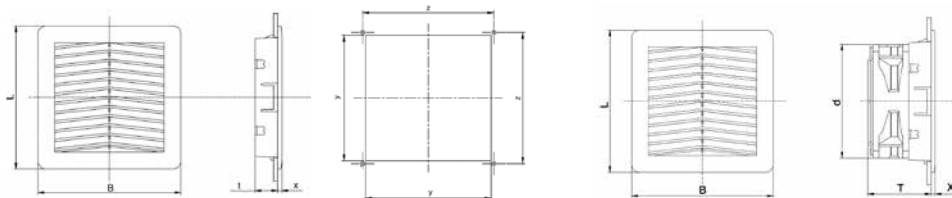

LUF80011

LUF800040

LUF80012

LxW	D/l/x	y/z	kg	Max. AF	El. conn.	L	G	N	Service life/40°	Model	Order No.	UP
150 x 150	71/120/5	125/131	0.812	57 m3/h	230V / 50/60Hz	20 W	43 dB(A)	2650/min	40,000 h	Filter fan	03.026.501.1	1 unit
204 x 204	90/120/5.7	177/185	1	90 m3/h	230V / 50/60Hz	20 W	43 dB(A)	2650/min	40,000 h	Filter fan	03.026.502.1	1 unit
250 x 250	113/172/6	223/230	1.690	240m3/h	230V / 50/60Hz	29 W	50 dB(A)	2800/min	40,000 h	Filter fan	03.026.503.1	1 unit
325 x 325	125/208/7	291/302	3.620	520m3/h	230V / 50/60Hz	67 W	63 dB(A)	2770/min	50,000 h	Filter fan	03.026.504.1	1 unit
150 x 150	24/5	125/131	0.140							Exit filter	03.026.511.1	1 unit
204 x 204	20.5/5.7	177/185	0.275							Exit filter	03.026.512.1	1 unit
250 x 250	25/6	223/230	0.440							Exit filter	03.026.513.1	1 unit
325 x 325	26/7	291/302	0.780							Exit filter	03.026.514.1	1 unit
150 x 150										Replacement filter mat	03.026.521.9	6 unit
204 x 204										Replacement filter mat	03.026.522.9	6 unit
250 x 250										Replacement filter mat	03.026.523.9	6 unit
325 x 325										Replacement filter mat	03.026.524.9	6 unit

Dimensions in mm:				Conversion:	
W = Width	h = Installation height	U = Standard rack unit	kg = Weight	1 mm = 0.03937 inch	
H = Height	d = Usable depth	(1 U = 44.45 mm)		1 kg = 2.2046 pounds	
D = Depth	L = Length	UP = Packaging unit			
SP = Standard Performance	V = Air-flow volume (m ³ /h)				
HP = High Performance	ΔV = Air-flow volume loss (%)				
UP = Ultra High Performance	ΔP = Pressure increase (Pa)				
n = Number of fans	I nom = Nominal current (A)				
W = Power consumption	I max = Residual current (A)				
V = Voltage (400V = 3-phase)	p = Sound pressure (dB(A) distance from the rack 1 m (800 mm x 600 mm; raised cover)				



LUF00237a

Temperature Module

- For monitoring the inside temperature of the rack.
- Temperature display (+ 10°C to + 70°C).
- Alarm temperature set via potentiometer at the front.
- Visual alarm display (LED red).
- Alarm signaling via potential-free switching contact (1 changeover contact 250 VAC / 8 A).
- Power supply 230 V / 50 Hz.

- **Material**
 - Plastic.

- **Compliance**
 - CE marking compliant with Low Voltage Directive 73/23/EEC; EMC directive 89/336/EEC.

- **Scope of delivery**
 - 1 x Temperature module.
 - 1 x Temperature sensor (3 m).

- **How supplied**
 - Assembled, wired and tested.

Order No.	UP
01.117.525.1	1 unit

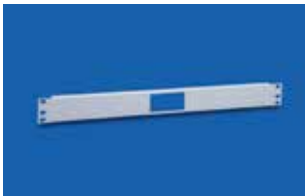

LUF00256

19" Front Plate 1 U for Temperature Module

- For temperature module installation.

- **Material / Finish**
 - Sheet steel, 1.5 mm, powder-coated texture.

- **Color**
 - RAL 7035 light-grey.

- **Scope of delivery**
 - 1 x 19" front plate.

Order No.	UP
01.117.526.1	1 unit



LUF00255

Bracket for Temperature Module

- For non-standard temperature module installation, e.g., on the side of the 19" extrusion.

- **Material / Finish**
 - Aluminum, 2 mm, polished.

- **Scope of delivery**
 - 1 x bracket.
 - 1 x Mounting kit.

- **How supplied**
 - In sets.

Order No.	UP
01.117.527.0	1 unit



LUF20000

Thermostat

- For monitoring the inside temperature of the rack with respect to slot-in units and heating fans.
- Setting range: + 10°C to + 60°C.
- Switching temperature difference (hysteresis) 2 K.
- Contact type: 1 changeover contact.
- Sensor: thermo-bimetal.
- Contact rating: 230 VAC/10 A (heating), 5 A (cooling).
- Interference suppression: compliant with DIN 55014.

- **Material**
 - Plastic.

- **Protection rating**
 - IP 30.

- **Compliance**
 - CE marking compliant with Low Voltage Directive 73/23/EEC; EMC directive 89/336/EEC.

- **Dimensions**
 - 74 x 74 x 23 mm.

- **Scope of delivery**
 - 1 x thermostat.
 - 1 x mounting bracket.
 - 1 x Mounting kit.

Order No.	UP
01.113.384.3	1 unit

Dimensions in mm:				Conversion:	
W = Width	h = Installation height	U = Standard rack unit	kg = Weight	1 mm	= 0.03937 inch
H = Height	d = Usable depth	(1 U = 44.45 mm)		1 kg	= 2.2046 pounds
D = Depth	L = Length	UP = Packaging unit			
SP = Standard Performance	V = Air-flow volume (m³/h)				
HP = High Performance	ΔV = Air-flow volume loss (%)				
UP = Ultra High Performance	ΔP = Pressure increase (Pa)				
n = Number of fans	I _{nom} = Nominal current (A)				
W = Power consumption	I _{max} = Residual current (A)				
V = Voltage (400V = 3-phase)	p = Sound pressure (dB(A) distance from the rack 1 m (600 mm x 600 mm; raised cover)				

Vertiv™ Knürr® Smaract®

Compact Rack

Features

- Ample space for components and cabling provided in an efficient, compact design.
- The innovative frame concept with triangular extrusions ensures low weight while maintaining high stability.
- Modular, stackable construction.
- Easy access from all sides for installation and maintenance – hinged doors and side panels can be quickly removed.
- Secured access: The side panels can only be removed once the front or rear door has been opened.
- The patented mounting hole rails in the 19" extrusion ensure that all components can be positioned quickly and easily.
- Doors and side panels have an 180° opening angle.
- Available as server compact rack: Perforation of front and rear doors > 80%.
- Available as EMC and IP version (also IP-EMC combination).

The Vertiv™ Knürr® Smaract® Compact Rack is an innovative and practical 19" enclosure with extremely low space requirements that is highly flexible and efficient. At the same time, it facilitates integration and modular expansion, delivering a wide range of impressive detailed solutions.

Vertiv Knürr Smaract is an ideal, compact 19" platform available in various models that meet IP and EMC requirements.



Vertiv™ Knürr® Smaract®
Main features

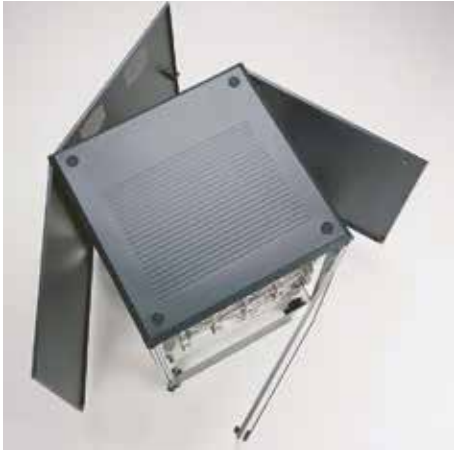

1. SMA20006

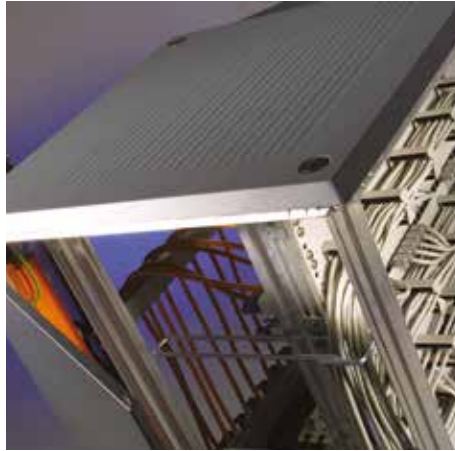

4. SMA20126



2. SMA20005

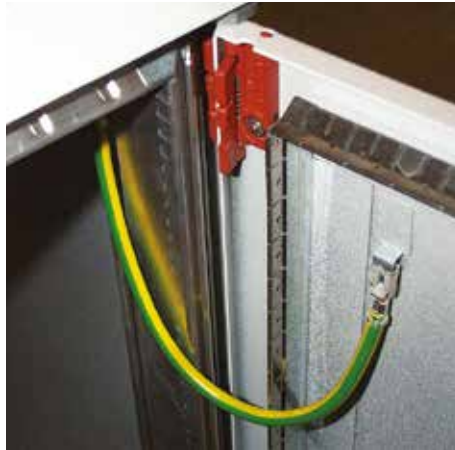

5. SMA20046

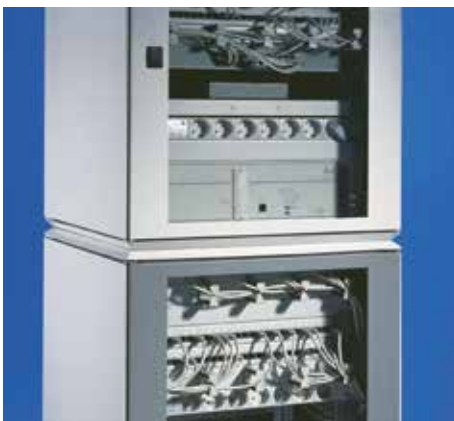

3. SMA20004



6. SMA20017

■ **Access**

Access from all sides is a time-saving factor, e. g. for integration of components and for maintenance. (1)

■ **Intelligent construction**

Innovative frame concept delivers low weight while providing high stability with new triangular extrusions. (2)

■ **Modular concept: simple expansion with stackability**

Provides adequate space on the side for cabling; cable entry on rear door. (3)

■ **Cable management**

Well prepared to have and easy and self-explanatory cabling. (4)

■ **EMC and IP version**

The compact rack can be upgraded to IP or EMC standard at all times. (Also in combined IP/EMC version). (5)

■ **Forward-thinking solutions**

Flexibility due to integration of 19" technology, 6 heights to choose from; 9 U to 24 U. (6)

Vertiv™ Knürr® Smaract® 19" Rack Compliant with IEC 297

Technical data



SMA20067

- **19" components compliant with IEC 297-3**
 - Height: 9 U to 24 U
 - 1 U = 44.45 mm.
 - Width: 482.6 mm (19").
 - Depths: 600, 800, 900 and 1000 mm.
- **Configuration**
 - Fixed, on leveling feet.
 - Mobile, on casters with snib.
- **Tests dependent on design**
 - Safety compliant with EN 50298 and EN 60950.
 - Protective conductor/grounding compliant with DIN VDE 0701-1.
 - Vibration test compliant with MIL-STD 810 E.
 - Vibration and shock test compliant with DIN EN 300019-2-2.
 - IP test compliant with DIN EN 60529.
 - EMC shielding attenuation compliant with IEEE-STD-299 and VG 95 373 part 15 (30 MHz - 1 GHz).
 - Plastic components as per UL94 V-0.
- **Versions**
 - IP 20.
 - IP 54.
 - EMC.
- **Available space**
 - 82% of the basic surface can be used as space for installation and cable routing.

Applications



SMA20166



SMA20109



SMA20122



SMA20181



SMA20009

Vertiv™ Knürr® Smaract® 19" Compact Rack with Glass Door



SMA20024

- For components compliant with IEC 297-3.
- Access from all sides with removable covers.
- Flexible assembly of the components using mounting holes.
- Cable entry via rear panel (optional via top cover/bottom cover).
- Heat loss discharge via own convection or with fan unit on the rear panel (accessory).
- Door opening angle, 180°.
- Front door with safety glass, lockable.

■ Jumpering space

- Front 110 mm.

■ Load rating

- 2000 N static.

■ Protection rating

- IP 20.

■ Material / Finish

- Basic rack, extruded aluminum, polished.
- Corner connector, die-cast, polished.
- Covers, sheet steel, powder-coated texture.
- Glass infill front door, single safety glass panel.

■ Color

- Final digit of order number .1: RAL 7035, light-grey.
- Final digit of order number .8: RAL 7021 dark-grey.

■ Scope of delivery

- 1 x basic rack.
- 2 x side panels, closed; hinged on both sides.
- 1 x top cover, closed.
- 1 x glass front door, lockable.
- 1 x rear door with cable entry, lockable, prepared for ventilation unit.
- 4 x 19" sheet steel vertical extrusions.
- 1 x grounding set.
- 2 x keys.
- 4 x leveling feet.

■ How supplied

- Assembled.

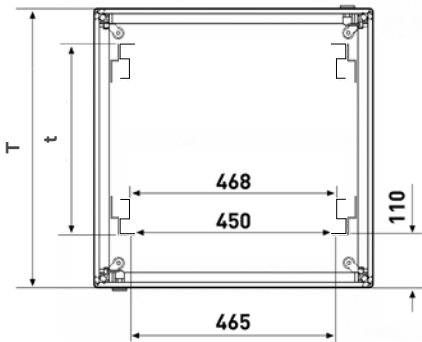
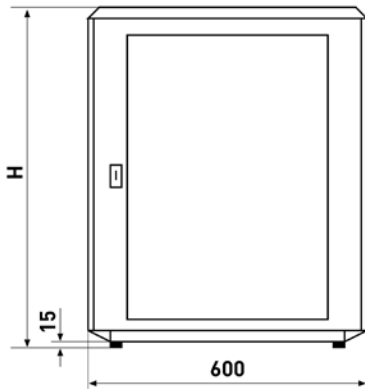

SMA20026

W	H	D	U	d	kg	Model	Order No.	UP
600	478	600	9	365	16	With 19" mount. hole extru.	02.110.057.1	1 unit
600	478	600	9	365	16	With 19" mount. hole extru.	02.110.057.8	1 unit
600	612	600	12	365	20	With 19" mount. hole extru.	02.110.062.1	1 unit
600	612	600	12	365	20	With 19" mount. hole extru.	02.110.062.8	1 unit
600	745	600	15	365	24	With 19" mount. hole extru.	02.110.067.1	1 unit
600	745	600	15	365	24	With 19" mount. hole extru.	02.110.067.8	1 unit
600	879	600	18	365	28	With 19" mount. hole extru.	02.110.072.x	1 unit
600	1012	600	21	365	32	With 19" mount. hole extru.	02.110.077.x	1 unit
600	1145	600	24	365	36	With 19" mount. hole extru.	02.110.082.1	1 unit
600	1145	600	24	365	36	With 19" mount. hole extru.	02.110.082.8	1 unit
600	478	800	9	565	19	With 19" mount. hole extru.	02.110.059.1	1 unit
600	478	800	9	565	19	With 19" mount. hole extru.	02.110.059.8	1 unit
600	612	800	12	565	23	With 19" mount. hole extru.	02.110.064.1	1 unit
600	612	800	12	565	23	With 19" mount. hole extru.	02.110.064.8	1 unit
600	745	800	15	565	27	With 19" mount. hole extru.	02.110.069.1	1 unit
600	745	800	15	565	27	With 19" mount. hole extru.	02.110.069.8	1 unit
600	879	800	18	565	31	With 19" mount. hole extru.	02.110.074.x	1 unit
600	1012	800	21	565	35	With 19" mount. hole extru.	02.110.079.x	1 unit
600	1145	800	24	565	39	With 19" mount. hole extru.	02.110.084.1	1 unit
600	1145	800	24	565	39	With 19" mount. hole extru.	02.110.084.8	1 unit

Vertiv™ Knürr® Smaract® 19" Server Compact Rack with Perforated Door



SMA20067

- For components compliant with IEC 297-3.
- Access from all sides, removable covers.
- With special 19" server extrusions for mounting trade-standard servers.
- With perforated doors on the front and rear (hexagonal holes with large flow cross-section) for optimal airflow.
- Door opening angle, 180°.

■ Jumpering space

- Front 75 mm.

■ Flow cross-section

- 1150 cm² with 9 U.
- 1950 cm² with 15 U.
- 2700 cm² with 21 U.
- 3100 cm² with 24 U.

■ Material / Finish

- Basic rack, extruded aluminum, polished.
- Corner connector, die-cast, polished.
- Covers, sheet steel, powder-coated texture.

■ Color

- Final digit of order number .1: RAL 7035, light-grey.
- Final digit of order number .8: RAL 7021 dark-grey.

■ Scope of delivery

- 1 x basic rack.
- 2 x side panels, closed, hinged on both sides.
- 1 x top cover, closed.
- 1 x front door with perforation, lockable.
- 1 x rear door with perforation, lockable.
- 4 x 19" server sheet-steel extrusions with mounting holes.
- 1 x grounding set.
- 2 x keys.
- 4 x leveling feet.

■ Note

Order mounting adapters for 19" server extrusion for mounting Knürr accessories. Set with 4 adapters order number 01.127.119.9.

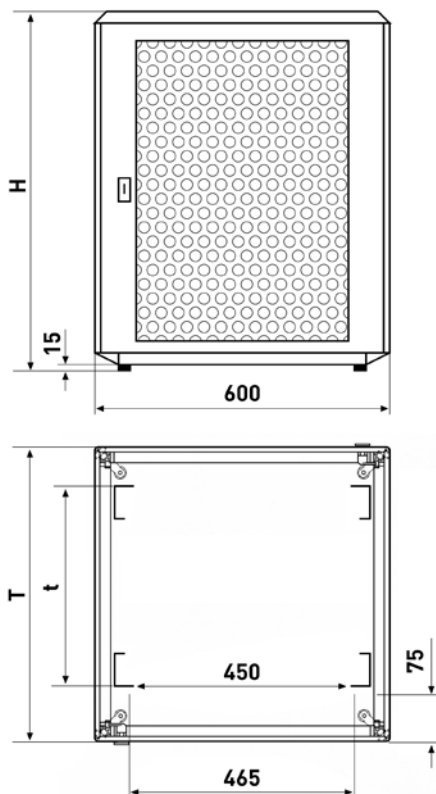

SMA20060

W	H	D	U	d	kg	Model	Order No.	UP	
600	478	900	9	740	21	Door without frame	02.110.010.1	1 unit	
600	478	900	9	740	21	Door without frame	02.110.010.8	1 unit	
600	745	900	15	740	29	Door with frame	02.110.020.1	1 unit	
600	745	900	15	740	29	Door with frame	02.110.020.8	1 unit	
600	1012	900	21	740	37	Door with frame	02.110.030.1	1 unit	
600	1012	900	21	740	37	Door with frame	02.110.030.8	1 unit	
600	1145	900	24	740	41	Door with frame	02.110.035.1	1 unit	
600	1145	900	24	740	41	Door with frame	02.110.035.8	1 unit	
600	1145	1000	24	740	43	Door with frame	02.110.040.1	1 unit	
600	1145	1000	24	740	43	Door with frame	02.110.040.8	1 unit	

= assemble to order (shipped within 5 working days).
Caution: In case of larger orders, delivery times may increase.

Dimensions in mm:				Conversion:
W = Width	h = Installation height	U = Standard rack unit	kg = Weight	1 mm = 0.03937 inch
H = Height	d = Insertion depth	(1 U = 44.45 mm)		1 kg = 2.2046 pounds
D = Depth	L = Length	UP = Packaging unit		

Vertiv™ Knürr® Smaract® 19" Compact Rack
Enclosure without door



SMA20025

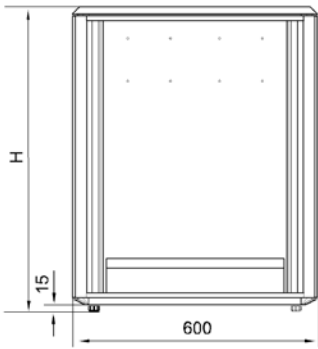

SMA20027

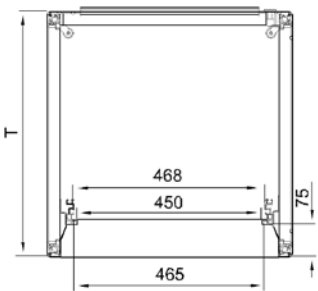

SMA20042

- For components in acc. with IEC 297-3.
- Removable covers.

Load rating

- 2000 N static.

Material/Finish

- Basic rack, extruded aluminum, polished.
- Corner connector, die-cast, polished.
- Covers, sheet steel, powder-coated texture.

Color

- RAL 7035 light-grey.

Supply schedule

- 1 x basic rack.
- 2 x side panels, closed, hinged on both sides.
- 1 x top cover, closed.
- 1 x trim frame, front.
- 1 x rear door with cable entry, lockable, prepared for ventilation unit.
- 2 x 19" aluminum vertical extrusions, front, with T-slot.
- 1 x earthing set.
- 1 x key.
- 4 x leveling feet.

How supplied

- Assembled.

Note

If required, please also order 19" extrusions for rear 19" level.

W	H	D	U	kg	Order no.	UP
600	478	600	9	16	02.110.107.1	1 unit
600	745	600	15	22	02.110.117.1	1 unit
600	1012	600	21	28	02.110.127.1	1 unit
600	478	800	9	19	02.110.109.1	1 unit
600	745	800	15	25	02.110.119.1	1 unit
600	1012	800	21	31	02.110.129.1	1 unit

= assemble to order (shipped within 5 working days).
Caution: In case of larger orders, delivery times may increase.

Dimensions in mm:				Conversion:	
W = Width	h = Installation height	U = Standard rack unit	kg = Weight	1 mm = 0.03937 inch	
H = Height	d = Insertion depth	(1 U = 44.45 mm)		1 kg = 2.2046 pounds	
D = Depth	L = Length	UP = Packaging unit			



SMA20194

Vertiv™ Knürr® Smaract® Glass Door with Swing Handle

- Can be used as front and rear door.
- With swing handle for mounting a profile half-cylinder lock.

Material

- Covers, sheet steel, powder-coated texture.
- Glass infill, single safety glass panel.

Finish

- Powder-coated texture, RAL 7035 light-grey.

Scope of delivery

- 1 x glass door with swing handle.
- 1 x Mounting kit.

How supplied

- In sets.

W	H	U	Model	Order No.	UP
600	478	9	Glass door	02.111.086.1	1 unit
600	612	12	Glass door	02.111.087.1	1 unit
600	745	15	Glass door	02.111.088.1	1 unit
600	879	18	Glass door	02.111.089.1	1 unit
600	1012	21	Glass door	02.111.090.1	1 unit
600	1143	24	Glass door	02.111.091.1	1 unit

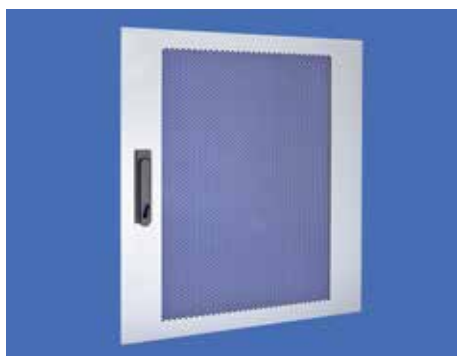

SMA20193

Vertiv Knürr Smaract Door, perforated with Swing Handle

- Can be used as front and rear door.
- With swing handle for mounting a profile half-cylinder lock.
- Hexagonal holes with large flow cross-section.

Material

- Covers, sheet steel, powder-coated texture.

Finish

- Final digit of order number 1: powder-coated texture, RAL 7035, light-grey.
- Final digit of order number .8: powder-coated texture, RAL 7021 dark-grey.

Scope of delivery

- 1 x perforated door with swing handle.
- 1 x Mounting kit.

How supplied

- In sets.

W	H	U	Model	Order No.	UP
600	478	9	Perforated door	02.111.096.x	1 unit
600	612	12	Perforated door	02.111.097.x	1 unit
600	745	15	Perforated door	02.111.098.x	1 unit
600	879	18	Perforated door	02.111.099.x	1 unit
600	1012	21	Perforated door	02.111.100.x	1 unit
600	1143	24	Perforated door	02.111.101.x	1 unit



MIR20460

Door locking set

Scope of delivery

- 1 lock set.
- 2 keys (half-cylinder).

Model	Order No.	UP
MIR2 / DCM / Smaract Doors, with swing handle	01.130.940.9	1 set



SMA20031

**Vertiv™ Knürr® Smaract®
Door Closed**

- Can be used as front and rear door.

■ **Material / Finish**

- Sheet steel, powder-coated texture.

■ **Standard inclusion**

- 1 x rear door, closed.
- 1 x key.
- 1 x Mounting kit.

■ **Delivery**

- In sets.

■ **Color**

- RAL 7035, light-grey.

W	H	D	U	d	kg	Model	Order No.	UP
			9				02.111.076.1	1 unit
			12				02.111.077.1	1 unit
			15				02.111.078.1	1 unit
			18				02.111.079.1	1 unit
			21				02.111.080.1	1 unit
			24				02.111.081.1	1 unit



SMA20195

**Vertiv™ Knürr® Smaract®
Ventilation Unit**

- Easily added onto a rear panel.
- With two axial fans.
- With thermostat.
- Available in two different performance classes.

■ **Technical data for single fan**

- Type 1:
max. volume flow (free blowing): 162 m³/h.
Noise emission (free blowing): 37 dB(A).
- Type 2 (quiet):
max. volume flow (free blowing): 120 m³/h.
Noise emission (free blowing): 32 dB(A).

■ **Technical data for thermostat**

- Setting range: 0 to 60 °C.
- Mains supply: 240 V / 50 Hz.
- Nominal current: 16 A.

■ **Material / Finish**

- Zinc-passivated sheet steel.

■ **Scope of delivery**

- 1 x fan unit wired ready for connection, with thermostat.
- 1 x Mounting kit.

■ **How supplied**

- Pre-assembled.



SMA20180

Model	Order No.	UP
Type 1	02.111.180.9	1 unit
Type 2 (quiet)	02.111.181.9	1 unit

= assemble to order (shipped within 5 working days).
Caution: In case of larger orders, delivery times may increase.

Dimensions in mm:				Conversion:
W = Width	h = Installation height	U = Standard rack unit	kg = Weight	1 mm = 0.03937 inch
H = Height	d = Insertion depth (1 U = 44.45 mm)			1 kg = 2.2046 pounds
D = Depth	L = Length	UP = Packaging unit		



SMA20103

Vertiv Knürr Smaract 19" Aluminum Extrusion with T-slot

- For front and rear installation.

Material / Finish

- 19" extrusions: extruded aluminum polished.
- Mounting bracket: Sheet steel, zinc-passivated.

Scope of delivery

- 2 x 19" extrusions with T-slot incl. increment slides.
- 4 x mounting brackets.
- 1 x Mounting kit.

How supplied

- In sets.

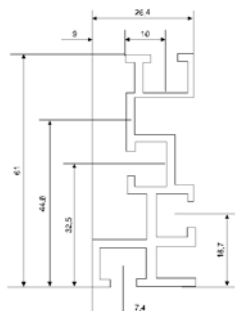

SMA20105

U	Order No.	UP
9	02.111.146.9	1 unit
12	02.111.147.9	1 unit
15	02.111.148.9	1 unit
18	02.111.149.9	1 unit
21	02.111.150.9	1 unit
24	02.111.151.9	1 unit



SMA20104

Vertiv Knürr Smaract 19" Steel Extrusion with Mounting Holes

- For front and rear installation.

Material / Finish

- 19" extrusions: sheet steel, zinc-passivated.
- Mounting bracket: sheet steel, 1.5 mm, zinc-passivated.

Scope of delivery

- 2 x 19" extrusions with mounting holes.
- 4 x mounting brackets.
- 1 x Mounting kit.

How supplied

- In sets.

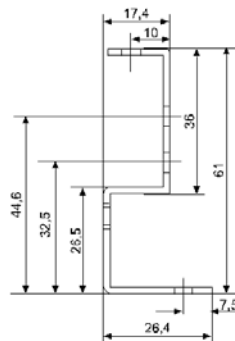

SMA20106

U	Order No.	UP
9	02.111.156.9	1 unit
12	02.111.157.9	1 unit
15	02.111.158.9	1 unit
18	02.111.159.9	1 unit
21	02.111.160.9	1 unit
24	02.111.161.9	1 unit

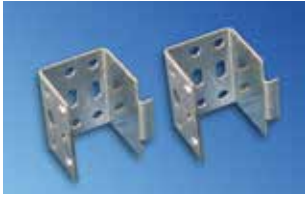

MIR20044

Mounting Adapters for 19" Server Extrusion

- For mounting standard Vertiv Knürr components (storage shelves, drawers, chassis rails, keyboard tray, etc.) in 19" installation space.

- **Material**
 - Zinc-passivated sheet steel.

- **Scope of delivery**
 - 4 x adapters.



MIR20082

U	Order No.	UP
1	01.127.119.9	1 unit



SMA20172

Vertiv™ Knürr® Smaract® Depth Brace

- For additional strengthening of the enclosure.
- For routing cables with cable ties and as universal mounting option.
- With holes for mounting cage nuts.
- Variable positioning with T-slot.
- Installation on the frame extrusions.

- **Material / Finish**
 - Sheet steel, zinc-passivated 1.5 mm.

- **Scope of delivery**
 - 1 x depth brace.
 - 1 x Mounting kit.

- **How supplied**
 - In sets.

- **Note**
 - Not compatible with 19" server extrusions.

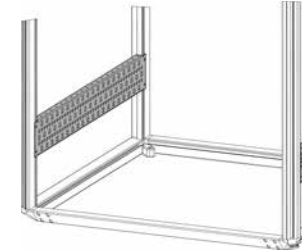

SMA20173

D	Order No.	UP
600	02.111.002.0	1 unit
800	02.111.004.0	1 unit
900	02.111.005.0	1 unit



SMA20028

Vertiv Knürr Smaract Top Cover/Bottom Cover closed

- **Material / Finish**
 - Sheet steel, powder-coated texture.

- **Color**
 - Final digit of order number .1: RAL 7035, light-grey.
 - Final digit of order number .8: RAL 7021 dark-grey.

- **Scope of delivery**
 - 1 x bottom cover, closed.
 - 1 x Mounting kit.

- **How supplied**
 - In sets.

W	D	Order No.	UP
600	600	02.111.052.1	1 unit
600	800	02.111.054.1	1 unit
600	900	02.111.055.1	1 unit
600	900	02.111.055.8	1 unit
600	1000	02.111.056.1	1 unit
600	1000	02.111.056.8	1 unit



SMA20168

Vertiv Knürr Smaract

Top/Bottom Cover with Cable Entry

- With integrated cable clamping.
- With brush strip for cable entry.
- **Material / Finish**
 - Sheet steel, powder-coated texture.
- **Color**
 - Final digit of order number .1: RAL 7035, light-grey.
 - Final digit of order number .8: RAL 7021 dark-grey.
- **Scope of delivery**
 - 1 x bottom cover with cable routing.
 - 1 x brush strip.
 - 1 x Mounting kit.
- **How supplied**
 - In sets.

W	D	Order No.	UP
600	600	02.111.042.1	1 unit
600	800	02.111.044.1	1 unit
600	900	02.111.045.1	1 unit
600	900	02.111.045.8	1 unit
600	1000	02.111.046.1	1 unit
600	1000	02.111.046.8	1 unit

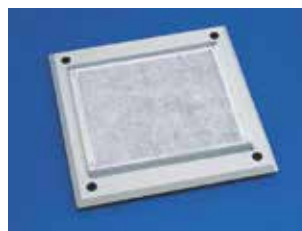

SMA20029

Vertiv Knürr Smaract

Bottom Cover, perforated with Filter Mat

- For cooling with air convection.
- **Material / Finish**
 - Bottom cover: sheet steel, powder-coated texture.
 - Filter mat: Filedon
- **Color**
 - RAL 7035, light-grey.
- **Scope of delivery**
 - 1 x perforated bottom cover with filter mat.
 - 1 x Mounting kit.
- **How supplied**
 - In sets.

W	D	Order No.	UP
600	600	02.111.062.1	1 unit
600	800	02.111.064.1	1 unit

= assemble to order (shipped within 5 working days).
Caution: In case of larger orders, delivery times may increase.

Dimensions in mm:				Conversion:
W = Width	h = Installation height	U = Standard rack unit	kg = Weight	1 mm = 0.03937 inch
H = Height	d = Insertion depth	(1 U = 44.45 mm)		1 kg = 2.2046 pounds
D = Depth	L = Length	UP = Packaging unit		



SMA20058

Vertiv™ Knürr® Smaract®

Replacement Filter Mat for perforated Bottom Cover

- Used with perforated bottom cover.

■ **Material / Finish**

- Fildon.

■ **Scope of delivery**

- 5 x replacement filter mats.

■ **How supplied**

- In sets.

Model	Order No.	UP
for D600	02.111.068.9	5 units
For D800	02.111.069.9	5 units



SMA20177

Vertiv Knürr Smaract Plinth

- Stationary.
- Cable entry possible from all sides.
- Panels front and rear with vent slots and installation option for filter mat.

■ **Material / Finish**

- Sheet steel, powder-coated texture.

■ **Color**

- Final digit of order number .1: RAL 7035, light-grey.
- Final digit of order number .8: RAL 7021 dark-grey.

■ **Scope of delivery**

- 4 x plinth corners.
- 2 x cover plates, closed.
- 2 x cover plates with vent slots.
- 1 x Mounting kit.

■ **How supplied**

- In sets.

■ **Note**

- Can also be mounted in combination with cabinet base.

W	H	D	Order No.	UP
600	100	600	02.111.201.1	1 set P
600	100	800	02.111.203.1	1 set P
600	100	900	02.111.204.1	1 set P
600	100	900	02.111.204.8	1 set



SMA20098

Vertiv Knürr Smaract Plinth Cover Plate with Cable Entry

- Used with plinth.

■ **Material / Finish**

- Sheet steel, powder-coated texture.

■ **Scope of delivery**

- 1 x cover panel with cable entry.
- 1 x brush strip.
- 1 x Mounting kit.

■ **Color**

- Final digit of order number .1: RAL 7035, light-grey.
- Final digit of order number .8: RAL 7021 dark-grey.

■ **How supplied**

- In sets.

W	H	Order No.	UP
600	100	02.111.206.1	1 unit P
600	100	02.111.206.8	1 unit



SMA20034

Vertiv Knürr Smaract Twin Caster

- Height 50 mm.

■ **Color**

- RAL 9011, graphite black.

■ **Load rating**

- 400 N per caster.
- 1200 N max. static total load per rack.

■ **Scope of delivery**

- 2 x twin casters.
- 2 x fixed casters.

■ **Standards**

- Casters compliant with DIN 12530.
- Load compliant with DIN 12527.

■ **How supplied**

- In sets.

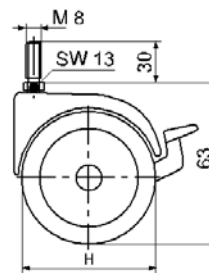

DOP00233

Order No.	UP
02.111.175.9	4 units P

P - assemble to order (shipped within 5 working days).
Caution: In case of larger orders, delivery times may increase.

Dimensions in mm:				Conversion:	
W = Width	h = Installation height	U = Standard rack unit	kg = Weight	1 mm = 0.03937 inch	
H = Height	d = Insertion depth	(1 U = 44.45 mm)		1 kg = 2.2046 pounds	
D = Depth	L = Length	UP = Packaging unit			



SMA20035

Vertiv™ Knürr® Smaract® Stacking Set

- Fixed connection for stacking compact racks.
- **Material / Finish**
 - Steel, cold rolled, zinc-passivated.
- **Scope of delivery**
 - 4 x stacking elements.
 - 1 x Mounting kit.
- **How supplied**
 - In sets.

Order No.	UP
02.111.171.9	4 unit



MEC00074

Vertiv™ Knürr® Smaract® Eyebolt Set

- Mounted/fixed on crane hooks.
- Load rating, 1900 N static per ring screw.
- **Material / Finish**
 - Tool steel, forged.
- **Scope of delivery**
 - 4 x crane eyebolts.
- **How supplied**
 - In sets.

Order No.	UP
01.243.440.9	4 units

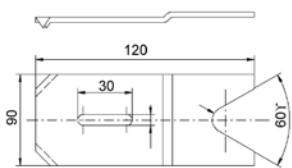

MIR00319

Floor Fixing Kit

- **Material / Finish**
 - Sheet steel, 3.0 mm.
- **Finish**
 - Galvanized.
- **Scope of delivery**
 - 4 x fixing brackets

Order No.	UP
01.130.934.7	1 unit



SMA20094

Vertiv™ Knürr® Smaract® Wall Mounting Bracket

- **Material / Finish**
 - Sheet steel, powder-coated texture.
- **Color**
 - RAL 7035, light-grey.
- **Scope of delivery**
 - 2 x wall mounting brackets.
 - 1 x Drill hole template.
 - 1 x Mounting kit.
- **Load rating**
 - 500 N.
- **How supplied**
 - In sets.



SMA20085

W	Order No.	UP
600	02.111.220.9	1 set



ELM00068

Grounding Bar

- For safe grounding or potential equalization of equipments and components.
- **Material**
 - Electrolyte copper 9 x 9.
- **Scope of delivery**
 - 1 x grounding bar.
 - 2 x brackets.
 - 1 x Mounting kit.

U	Order No.	UP
12	01.110.703.9	1 unit P
15	01.240.543.9	1 unit
18	01.240.544.9	1 unit
21	01.240.545.9	1 unit
24	01.240.546.9	1 unit



DOP20016

Contact Clamp

- Enables safe connection of equipment and components to grounding bar.
- For cables up to 25 mm².
- **Scope of delivery**
 - 20 x contact clamps.

Order No.	UP
01.110.715.9	20 units P



SMA20065

Vertiv™ Knürr® Smaract® 19" Compact Rack EMC with sheet steel door

- For components compliant with IEC 297-3.
- Removable covers.

Load rating

- 2000 N static.

Material

- Basic frame: extruded aluminum.
- Panels: sheet steel.
- EMC spring: high-grade steel.

Finish

- Basic frame: polished.
- Panels: powder-coated texture.

Color

- RAL 7035, light-grey.

Scope of delivery

- 1 x basic rack.
- 2 x side panels, EMC, closed, hinged on both sides.
- 1 x top cover, EMC, closed.
- 1 x bottom cover, EMC, closed.
- 1 x front door, EMC, closed, lockable.
- 1 x rear panel, EMC, closed, screwed.
- 2 x 19" front aluminum vertical extrusions with T-slot incl. increment slide.
- 1 x grounding set.
- 1 x key.
- 4 x leveling feet.

How supplied

- Assembled.

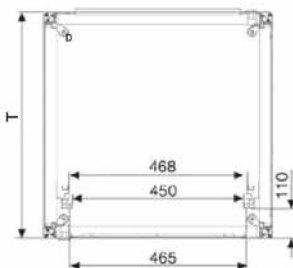
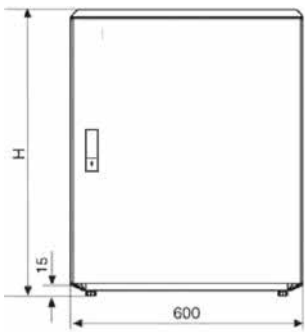

SMA20059

W	H	D	U	kg	Order No.	UP
600	612	600	12	28	02.110.312.1	1 unit
600	879	600	18	36	02.110.322.1	1 unit
600	1146	600	24	44	02.110.332.1	1 unit
600	612	800	12	32	02.110.314.1	1 unit
600	879	800	18	40	02.110.324.1	1 unit
600	1146	800	24	48	02.110.334.1	1 unit

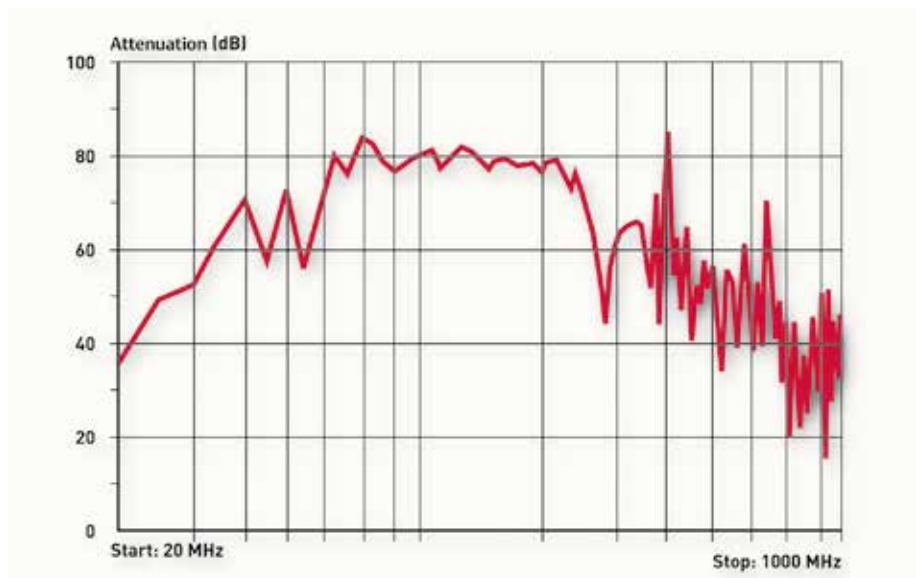

- EMC measurements performed by pkm Electronic GmbH, Frontenhausen.
- Tests were carried out in compliance with the following standard: VG 95373 Part 15.
- Tested rack: width 600, depth 600, height 1150, closed version.



SMA20148

Vertiv™ Knürr® Smaract® Connection Plate, EMC, closed

- EMC shielding.
- Screwed.

- **Material**
 - Panel: sheet steel.
 - EMC spring: high-grade steel.

- **Finish**
 - Powder-coated texture.

- **Color**
 - RAL 7035, light-grey.

- **Scope of delivery**
 - 1 x connection plate closed.
 - 2 x brackets.
 - 1 x Mounting kit.

- **How supplied**
 - In sets.



SMA20137

- **Finish**
 - Powder-coated texture.

- **Color**
 - RAL 7035, light-grey.

- **Scope of delivery**
 - 1 x connection plate closed.
 - 2 x brackets.
 - 1 x Mounting kit.

- **How supplied**
 - In sets.

W	H	U	Order No.	UP
600	131.3	3	02.111.351.1	1 set



SMA20145

Vertiv™ Knürr Smaract Connection Plate, EMC, with Cable Entry

- EMC shielding.
- Screwed.

- **Material**
 - Panel: sheet steel.
 - EMC spring: high-grade steel.
 - EMC seal extrusion: with high-grade steel grid; rubber.

- **Finish**
 - Powder-coated texture.

- **Color**
 - RAL 7035, light-grey.

- **Scope of delivery**
 - 1 x connection plate with cable entry.
 - 2 x brackets.
 - 1 x Mounting kit.

- **How supplied**
 - In sets.

W	H	U	Order No.	UP
600	131.3	3	02.111.361.1	1 set

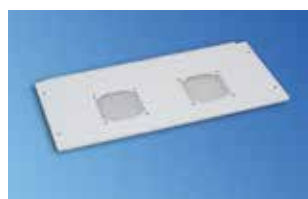

SMA20150

Vertiv™ Knürr Smaract Connection Plate, EMC, for Fan Unit

- EMC shielding.
- Screwed.

- **Material**
 - Panel: sheet steel.
 - EMC spring: high-grade steel.

- **Finish**
 - Powder-coated texture.

- **Color**
 - RAL 7035, light-grey.

- **Scope of delivery**
 - 1 x connection plate for fan unit.
 - 2 x brackets.
 - 1 x Mounting kit.

- **How supplied**
 - In sets.

- **Note**
 - Suitable fan unit: 02.111.180.9.



SMA20135

- **Finish**
 - Powder-coated texture.

- **Color**
 - RAL 7035, light-grey.

- **Scope of delivery**
 - 1 x connection plate for fan unit.
 - 2 x brackets.
 - 1 x Mounting kit.

- **How supplied**
 - In sets.

- **Note**
 - Suitable fan unit: 02.111.180.9.

W	H	U	Order No.	UP
600	264.6	6	02.111.372.1	1 set

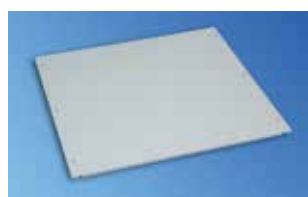

SMA20152

Vertiv™ Knürr Smaract Rear Plate, EMC, closed

- EMC shielding.
- Screwed.

- **Material**
 - Panel: sheet steel.
 - EMC spring: high-grade steel.

- **Finish**
 - Powder-coated texture.

- **Color**
 - RAL 7035, light-grey.

- **Scope of delivery**
 - 1 x rear plate closed.
 - 2 x brackets.
 - 1 x Mounting kit.

- **How supplied**
 - In sets.

W	H	U	Order No.	UP
600	422.9	9	02.111.353.1	1 set
600	556.3	12	02.111.354.1	1 set
600	689.6	15	02.111.355.1	1 set

Dimensions in mm:				Conversion:	
W = Width	h = Installation height	U = Standard rack unit	kg = Weight	1 mm = 0.03937 inch	
H = Height	d = Insertion depth	(1 U = 44.45 mm)		1 kg = 2.2046 pounds	
D = Depth	L = Length	UP = Packaging unit			



SMA20062

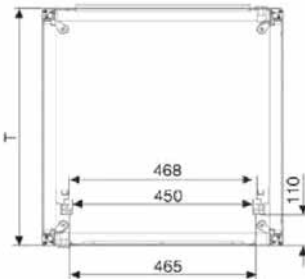
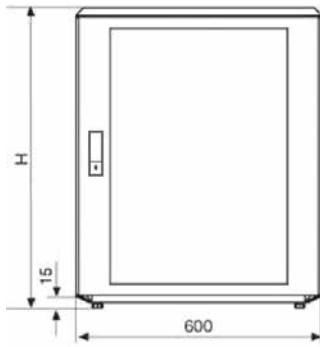

SMA20108

Vertiv™ Knürr® Smaract® 19" Compact Rack IP 54 with glass door

- For components compliant with IEC 297-3.
- Removable covers.

■ **Load rating**

- 2000 N static.

■ **Protection rating**

- IP 54.

■ **Material**

- Basic frame: extruded aluminum.
- Panels: sheet steel.
- Foam seal: polyurethane.

■ **Finish**

- Basic frame: polished.
- Panels: powder-coated texture.

■ **Color**

- RAL 7035, light-grey.

■ **Scope of delivery**

- 1 x basic frame.
- 2 x side panels, IP 54, closed, hinged on both sides.
- 1 x top cover, IP 54, closed.
- 1 x bottom cover, IP 54, closed.
- 1 x glass front door IP 54, lockable.
- 1 x rear panel, IP 54, closed, screwed.
- 2 x 19" aluminum vertical extrusions, front, with T-slot incl. increment slide.
- 1 x grounding set.
- 1 x key.
- 4 x leveling feet.

■ **How supplied**

- Assembled.

W	H	D	U	kg	Order No.	UP
600	612	600	12	28	02.110.212.1	1 unit
600	879	600	18	36	02.110.222.1	1 unit
600	1146	600	24	44	02.110.232.1	1 unit
600	612	800	12	32	02.110.214.1	1 unit
600	879	800	18	40	02.110.224.1	1 unit
600	1146	800	24	48	02.110.234.1	1 unit



SMA20148

Vertiv™ Knürr® Smaract® Connection Plate, IP54, Closed

- Protection rating, IP 54
- Screwed.

- **Material**
 - Panel: sheet steel.
 - Foam seal: polyurethane.

- **Finish**
 - Powder-coated texture.

- **Color**
 - RAL 7035, light-grey.

- **Scope of delivery**
 - 1 x connection plate closed.
 - 2 x brackets.
 - 1 x Mounting kit.

- **How supplied**
 - In sets.



SMA20138

Vertiv Knürr Smaract Connection Plate, IP54, for Fan Unit

- Protection rating, IP 54.
- Screwed.

- **Material**
 - Panels: sheet steel.
 - Foam seal: polyurethane.
 - Exit filter: ABS plastic, UL94 V-0.

- **Finish**
 - Powder-coated texture.

- **Color**
 - RAL 7035, light-grey.

- **Scope of delivery**
 - 1 x connection plate for fan unit.
 - 2 x brackets.
 - 1 x Mounting kit.

- **How supplied**
 - In sets.

- **Note**
 - Suitable fan unit: 02.111.180.9.

W	H	U	Order No.	UP
600	131.3	3	02.111.301.1	1 set



SMA20139

Vertiv Knürr Smaract Connection Plate, IP54, with Cable Entry

- Possible sealing: IP 54.
- Screwed.

- **Material**
 - Panel: sheet steel.
 - Foam seal: polyurethane.
 - Seal extrusion:
 - Type 1: sponge-rubber seal.
 - Type 2: polymeric reinforced with metal.

- **Finish**
 - Powder-coated texture.

- **Color**
 - RAL 7035, light-grey.

- **Scope of delivery**
 - 1 x connection plate with cable entry.
 - 2 x brackets.
 - 1 x Mounting kit.

- **How supplied**
 - In sets.



SMA20169



SMA20138

W	H	U	Model	Order No.	UP
600	131.3	3	Type 1	02.111.311.1	1 set
600	131.3	3	Type 2	02.111.312.1	1 set



SMA20143



SMA20136

W	H	U	Order No.	UP
600	264.6	6	02.111.322.1	1 set

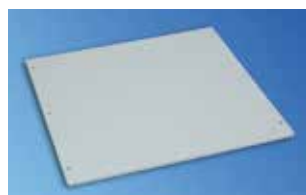

SMA20141

Vertiv Knürr Smaract Rear Panel, IP54, closed

- Protection rating, IP 54.
- Screwed.

- **Material**
 - Panels: sheet steel.
 - Foam seal: polyurethane.

- **Finish**
 - Powder-coated texture.

- **Color**
 - RAL 7035, light-grey.

- **Scope of delivery**
 - 1 x rear panel closed.
 - 2 x brackets.
 - 1 x Mounting kit.

- **How supplied**
 - In sets.

W	H	U	Order No.	UP
600	156.3	3	02.111.308.1	1 set
600	289.6	6	02.111.302.1	1 set
600	422.9	9	02.111.303.1	1 set
600	556.3	12	02.111.304.1	1 set
600	689.6	15	02.111.305.1	1 set
600	823	18	02.111.306.1	1 set
600	956.3	21	02.111.307.1	1 set

Dimensions in mm:				Conversion:
W = Width	h = Installation height	U = Standard rack unit	kg = Weight	1 mm = 0.03937 inch
H = Height	d = Insertion depth	(1 U = 44.45 mm)		1 kg = 2.2046 pounds
D = Depth	L = Length	UP = Packaging unit		

Vertiv™ Knürr® DoubleProRack®

Stand-Alone Enclosure

Features

- Comprehensive 19" enclosure range from the 6 U enclosure to the 24 U compact rack.
- Innovative design.
- Optional with glass door or without front door.
- Integrated carrying handle permits easy handling.
- Version without front door is used for applications, where direct contact to controls is needed.

Das DoubleProRack® is the choice of rack if an innovative design is requested for electronic and networking applications.

The DoubleProRack is commonly used for electronic and networking applications.



Vertiv™ Knürr® DoubleProRack® 19" Enclosure Compliant with IEC 297-3

Technical data

- Die-cast aluminum frame construction connected with depth and vertical extrusions made of aluminum.
- **External dimensions**
 - Width: 554.4 mm.
 - Depths: 500, 600, 700 or 800 mm.
 - Heights: 6 U to 24 U.
- **Installation space compliant with IEC 297-3.**
 - Height 6 – 24 U (1 U = 44.45 mm).
 - Width 19".
- **Tests**
 - Vibration test compliant with MIL-STD 810 D.
 - NEMA 12 test.

Applications



DOP20041



DOP20025



DOP20037



DOP20028



DOP00256

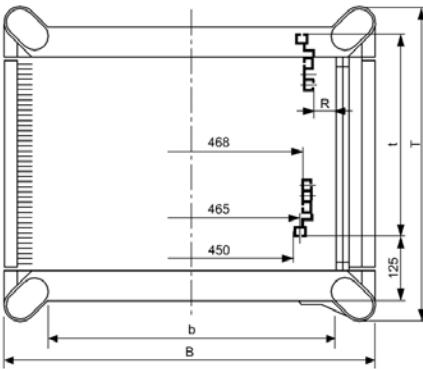
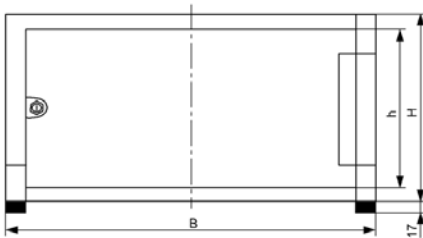

DOP00230

Vertiv™ Knürr® DoubleProRack® 19" Stand-alone Enclosure

Description

- For components compliant with IEC 297-3.
- Side covers and rear panel may be removed.
- Flexible assembly of components using T-slot (also available with mounting holes).
- Cable entry via rear panel.
- Heat loss discharge via convection on the rear panel (optional with fan unit).

Jumpering space

- Front 125 mm.

Load rating

- 1500 N static.

Protection rating

- IP 20.

Material / Finish

- Covers, sheet steel, powder-coated texture.
- Die-cast aluminum frame.
- Extruded aluminum extrusions.
- Front door glass infill, single safety glass panel.

Color

- Panels RAL 7035 light-grey.
- Frame and extrusions, RAL 5008, grey-blue.

Scope of delivery

- 1 x frame rack incl. side covers.
- 1 x full glass door.
- 1 x rear panel with cable entry, 3 parts.
- 1 x panel, above, with vent slots.
- 1 x panel, below, with vent slots.
- 1 x 19" component set (4 vertical extrusions with T-slot).
- 1 x grounding set with M8 grounding bolt.
- 2 x keys.
- 4 x leveling feet.

How supplied

- Assembled.

W	H	D	U	h	d (max.)	Model	Order No.	UP
554.4	311	600	6	265	435	With full glass door	01.246.641.1	1 unit
554.4	444	600	9	399	435	With full glass door	01.246.642.1	1 unit
554.4	577	600	12	532	435	With full glass door	01.246.643.1	1 unit
554.4	711	600	15	666	435	With full glass door	01.246.644.1	1 unit
554.4	844	600	18	799	435	With full glass door	01.246.645.1	1 unit
554.4	978	600	21	932	435	With full glass door	01.246.646.1	1 unit
554.4	1111	600	24	1066	435	With full glass door	01.246.647.1	1 unit
554.4	577	800	12	532	635	With full glass door	01.246.843.1	1 unit
554.4	711	800	15	666	635	With full glass door	01.246.844.1	1 unit
554.4	844	800	18	799	635	With full glass door	01.246.845.1	1 unit
554.4	978	800	21	932	635	With full glass door	01.246.846.1	1 unit
554.4	1111	800	24	1066	635	With full glass door	01.246.847.1	1 unit

Dimensions in mm:

W = Width	h = Installation height	U = Standard rack unit	kg = Weight
H = Height	d = Insertion depth	(1 U = 44.45 mm)	
D = Depth	L = Length	UP = Packaging unit	

Conversion:

1 mm = 0.03937 inch
1 kg = 2.2046 pounds

Vertiv™ Knürr® DoubleProRack® 19" Enclosure without Front Door



DOP00253

Description

- For components compliant with IEC 297-3.
- Side covers and rear panel may be removed.
- Heat loss discharge via convection on the rear panel (optional with fan unit).

Load rating

- 1500 N static.

Protection rating

- IP 20.

Material / Finish

- Covers, sheet steel, powder-coated texture.
- Die-cast aluminum frame.
- Extruded aluminum extrusions.

Color

- Panels RAL 7035 light-grey.
- Frame and extrusions, RAL 5008, grey-blue.

Scope of delivery

- 1 x frame rack incl. side covers.
- 1 x panel, above, with vent slots.
- 1 x panel, below, with vent slots.
- 1 x rear panel (from 12 U enclosure height incl. 3 U vented cover plate).
- 2 x 19" extrusions, front, with mounting holes.
- 2 x 19" extrusions at the rear, T-slot.
- 4 x leveling feet.

How supplied

- Assembled.

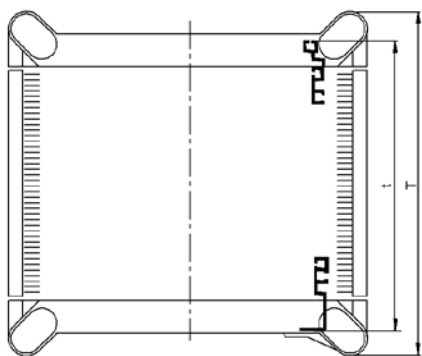
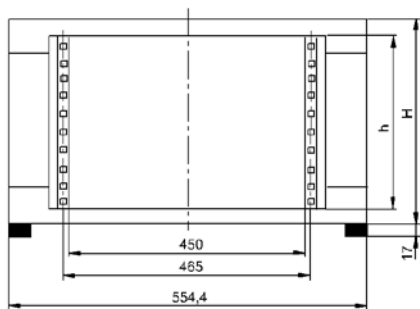

DOP00052

W	H	D	U	h	d (max.)	kg	Model	Order No.	UP
554.4	311	500	6	265	460	12.5	Without door	01.243.506.1	1 unit
554.4	444	500	9	399	460	15.0	Without door	01.243.509.1	1 unit
554.4	577	500	12	532	460	17.0	Without door	01.243.512.1	1 unit
554.4	711	500	15	666	460	19.5	Without door	01.243.515.1	1 unit
554.4	844	500	18	799	460	22.0	Without door	01.243.518.1	1 unit
554.4	978	500	21	932	460	24.0	Without door	01.243.521.1	1 unit
554.4	1111	500	24	1066	460	26.0	Without door	01.243.524.1	1 unit
554.4	311	600	6	265	560	14.0	Without door	01.243.606.1	1 unit
554.4	444	600	9	399	560	16.5	Without door	01.243.609.1	1 unit
554.4	577	600	12	532	560	19.0	Without door	01.243.612.1	1 unit
554.4	711	600	15	666	560	22.0	Without door	01.243.615.1	1 unit
554.4	844	600	18	799	560	24.5	Without door	01.243.618.1	1 unit
554.4	978	600	21	932	560	27.0	Without door	01.243.621.1	1 unit
554.4	1111	600	24	1066	560	29.5	Without door	01.243.624.1	1 unit
554.4	577	700	12	532	660	21.5	Without door	01.243.712.1	1 unit
554.4	711	700	15	666	660	24.0	Without door	01.243.715.1	1 unit
554.4	844	700	18	799	660	27.0	Without door	01.243.718.1	1 unit
554.4	978	700	21	932	660	29.5	Without door	01.243.721.1	1 unit
554.4	1111	700	24	1066	660	32.5	Without door	01.243.724.1	1 unit
554.4	577	800	12	532	760	23.5	Without door	01.243.812.1	1 unit
554.4	711	800	15	666	760	26.5	Without door	01.243.815.1	1 unit
554.4	844	800	18	799	760	29.5	Without door	01.243.818.1	1 unit
554.4	978	800	21	932	760	32.5	Without door	01.243.821.1	1 unit
554.4	1111	800	24	1066	760	35.5	Without door	01.243.824.1	1 unit

Dimensions in mm:

W = Width	h = Installation height	U = Standard rack unit	kg = Weight
H = Height	d = Insertion depth	(1 U = 44.45 mm)	
D = Depth	L = Length	UP = Packaging unit	

Conversion:

1 mm = 0.03937 inch
1 kg = 2.2046 pounds

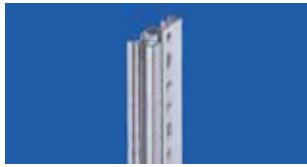

DOP20004

Vertiv™ Knürr® DoubleProRack® 19" Installation, Front with T-slot

- Can also be used as second mounting level.

Material

- Aluminum extrusions.

Finish

- Polished.

Scope of delivery

- 2 x 19" extrusions at the front, T-slot.
- 1 x Mounting kit.

How supplied

- In sets.

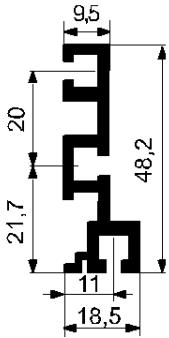

DOP00313

U	Order No.	UP
6	01.240.440.9	1 set
9	01.240.443.9	1 set
12	01.240.445.9	1 set
15	01.240.446.9	1 set
18	01.240.447.9	1 set
21	01.240.448.9	1 set
24	01.240.449.9	1 set



DOP20005

Vertiv™ Knürr® DoubleProRack® 19" Installation, Front with Mounting Holes

- Can also be used as second mounting level.

Material

- Extruded aluminum extrusions.

Finish

- Polished.

Scope of delivery

- 2 x 19" extrusions at the front, mounting holes.

How supplied

- In sets.

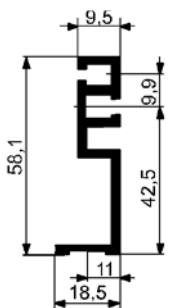

DOP00055

U	Order No.	UP
6	01.240.490.9	1 set
9	01.240.493.9	1 set
12	01.240.495.9	1 set
15	01.240.496.9	1 set
18	01.240.497.9	1 set
21	01.240.498.9	1 set
24	01.240.499.9	1 set



DOP20035

Vertiv™ Knürr® DoubleProRack® Fan Rear Panel 3 U

- With axial fans.
- With thermostat.

Technical data for single fan

- Max. volume flow (free blowing): 162 m³/h.
- Noise emission (free blowing): 37 dB(A).

Technical data for thermostat

- Setting range: 0 to 60°C.
- Mains supply: 240 V / 50 Hz.
- Nominal current: 16 A.

Scope of delivery

- 1 x fan rear panel, wired.
- 1 x Mounting kit.

Finish / Color

- Powder-coated texture, RAL 7035 light-grey.

How supplied

- Assembled.

Note

- Cannot be used in the enclosure's lowest U.



DOP20036

W	H	U	Model	Order No.	UP
554.4	132.5	3	With thermostat	01.243.428.1	1 unit



DOP00275

Vertiv™ Knürr® DoubleProRack® Rear Panel, closed

- For DoubleProRack width 554.4 mm.

Material / Finish

- Sheet steel, 0.8 mm, powder-coated texture.

Color

- RAL 7035, light-grey.

Scope of delivery

- 1 x rear panel, closed.
- 1 x Mounting kit.

How supplied

- In sets.

W	U	Order No.	UP
554.4	6	01.240.454.1	1 unit
554.4	9	01.240.457.1	1 unit
554.4	12	01.240.459.1	1 unit
554.4	15	01.240.460.1	1 unit
554.4	18	01.240.461.1	1 unit
554.4	21	01.240.462.1	1 unit



DOP00278

Knürr DoubleProRack® Multi-functional Handle

- **Material / Finish**
 - Die-cast powder-coated texture.
- **Color**
 - RAL 5008, grey-blue.
- **Standard inclusion**
 - 2 x handles.
 - 1 x Mounting kit.
- **Delivery**
 - In sets.

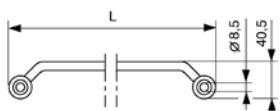

DOP00231

W	H	D	U	Model	Order No.	UP
			500		01.240.641.1	1 unit
			600		01.240.642.1	1 unit
			700		01.240.643.1	1 unit
			800		01.240.644.1	1 unit



DOP00274

Vertiv™ Knürr® DoubleProRack® Connection Panel with Brush Strip

- To cover rear panel along with the corresponding rear panel shortened by 3 U.
- For DoubleProRack width 554.4 mm.
- With brush strip for cable routing and strain relief.

- **Finish / Color**
 - Powder-coated texture, RAL 7035 light-grey.

- **Scope of delivery**
 - 1 x connection plate.
 - 1 x Mounting kit.

- **How supplied**
 - In sets.

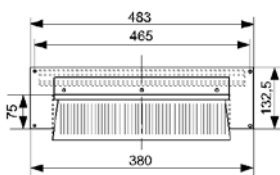

DOP00288

W	H	U	Order No.	UP
554.4	132.5	3	01.243.438.1	1 unit



MEC20122

Vertiv Knürr DoubleProRack Grounding Set for Enclosures

- For grounding top/bottom cover.
- With central grounding bolt.

- **Scope of delivery**
 - 2 x grounding connections, length 250 mm.
 - 4 x spring nuts, M5.
 - 2 x washers.
 - 4 x cylinder screws, M5 x 10.
 - 1 x grounding bolt.

- **How supplied**
 - In sets.



DOP20025

Order No.	UP
01.243.400.9	1 set



MEC20123

Vertiv Knürr DoubleProRack Grounding Set for Doors and Trims

- For grounding doors and/or cover plates.

- **Scope of delivery**
 - 5 x grounding connections, length 250 mm.
 - 1 x grounding connection, 250 mm, two-sided AMP plug.
 - 5 x spring nuts, M5.
 - 5 x cylinder screws, M5 x 10 with tooth-lock washer.
 - 5 x washers.

- **How supplied**
 - In sets.



DOP00286

Order No.	UP
01.245.400.9	1 set

- assemble to order (shipped within 5 working days).
Caution: In case of larger orders, delivery times may increase.

Dimensions in mm:				Conversion:	
W = Width	h = Installation height	U = Standard rack unit	kg = Weight	1 mm = 0.03937 inch	
H = Height	d = Insertion depth	(1U = 44.45 mm)		1 kg = 2.2046 pounds	
D = Depth	L = Length	UP = Packaging unit			



ELM00068

Grounding Bar

- For safe grounding or potential equalization of equipments and components.

■ **Material**
- Electrolyte copper 9 x 9.

■ **Scope of delivery**
- 1 x grounding bar.
- 2 x brackets.
- 1 x Mounting kit.

U	Order No.	UP
12	01.110.703.9	1 unit
15	01.240.543.9	1 unit
18	01.240.544.9	1 unit
21	01.240.545.9	1 unit
24	01.240.546.9	1 unit



DOP20016

Contact Clamp

- Enables safe connection of equipment and components to grounding bar.
- For cables up to 25 mm².

■ **Scope of delivery**
- 20 x contact clamps.

Order No.	UP
01.110.715.9	20 units P



DOP00282

Vertiv™ Knürr® DoubleProRack® Mounting Bracket

- For mounting socket strips and cable duct.

■ **Material / Finish**
- Zinc-passivated sheet steel.

■ **Scope of delivery**
- 2 x mounting brackets.
- 1 x Mounting kit.

■ **How supplied**
- In sets.

Order No.	UP
01.240.533.9	1 set



DOP00267

Vertiv Knürr DoubleProRack Twin Caster 50 mm

- For mobile installation of the DoubleProRack stand-alone enclosure with fixed casters.

■ **Material / Finish**
- Polyamide, RAL 9011 black.

■ **Load rating**
- 400 N per caster.
- 1200 N max. static total load per rack.

■ **Scope of delivery**
- 2 x twin casters.
- 2 x fixed casters.
- 4 x lock washers.

■ **How supplied**
- In sets.

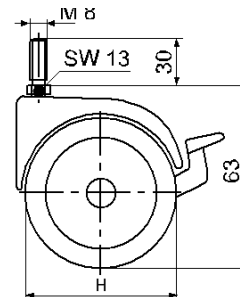

DOP00233

H	Order No.	UP
50	01.240.527.9	1 set
75	01.240.528.9	1 set

Dimensions in mm:				Conversion:	
W = Width	h = Installation height	U = Standard rack unit	kg = Weight	1 mm = 0.03937 inch	
H = Height	d = Insertion depth	(1 U = 44.45 mm)		1 kg = 2.2046 pounds	
D = Depth	L = Length	UP = Packaging unit			

Vertiv™ Knürr® ConAct®

Network wall-mounted housing

Features

- Economical: savings of up to 50% on transport volume and storage space.
- Practical: "one-person" installation as housing is delivered in parts.
- Convenient for laying cables as it can be accessed from all sides; generous lateral clearance space.
- Individual configuration: various modification options available (color, design etc.).

The Vertiv™ Knürr® ConAct® network wall-mounted housing is notable due to its simple and quick "one-person" installation.

The Vertiv Knürr ConAct wall-mounted housing offers ideal conditions for network distribution. It is delivered in flat-pack sets.

Installing the ConAct network housing involves: Unpacking – and then network installation can begin within minutes.





A. ACT00024

■ **Economical**

- Einsparung bis zu 50% des Transportvolumens durch Flat-Pack-Verpackung (siehe Bild A).
- Durch platzsparende Verpackung einfacher Transport bis zur Montage.
- Kleine Verpackung – geringe Lagerfläche.



B. ACT00031

■ **"One-person" installation**

- No unnecessary dismantling of housing as it is delivered in parts.
- Rear panel mounted using drill-hole template.
- Easy assembly:
- Keyhole punching on the rear panel (see figure B).
- Push-in technology for mounting rails and covers.
- Symmetrical housing configuration.



C. ACT00030



D. ACT00033

■ **Cabling made easy**

- Access from all sides guarantees convenient mounting of the components.
- Open construction design permits easy cable management.
- Organized cable management with spacious lateral clearance area and cable clamping rails (see figures C+D).



E. ACT00034



F. ACT00033

■ **Accessories**

- Easy integration of accessories; e.g. socket strips with screw-on points on the vertical extrusion or on the rear panel (see figure E).
- Accessories available for orderly cable management; e.g. cable routing board or cable-routing bracket (see figure F).
- Comprehensive standard range of accessories available; e.g. shelves, drawers, socket strips, etc.

■ **Maintenance-friendly**

- Easy access for servicing is guaranteed when removing the side panels.
- Housing can be locked with security lock.
- Door opening angle: 180°.



ACT00017



ACT00024

1. Unpack



ACT00004

2. Mount rear panel



ACT00005

3. Mount supports and vertical extrusions

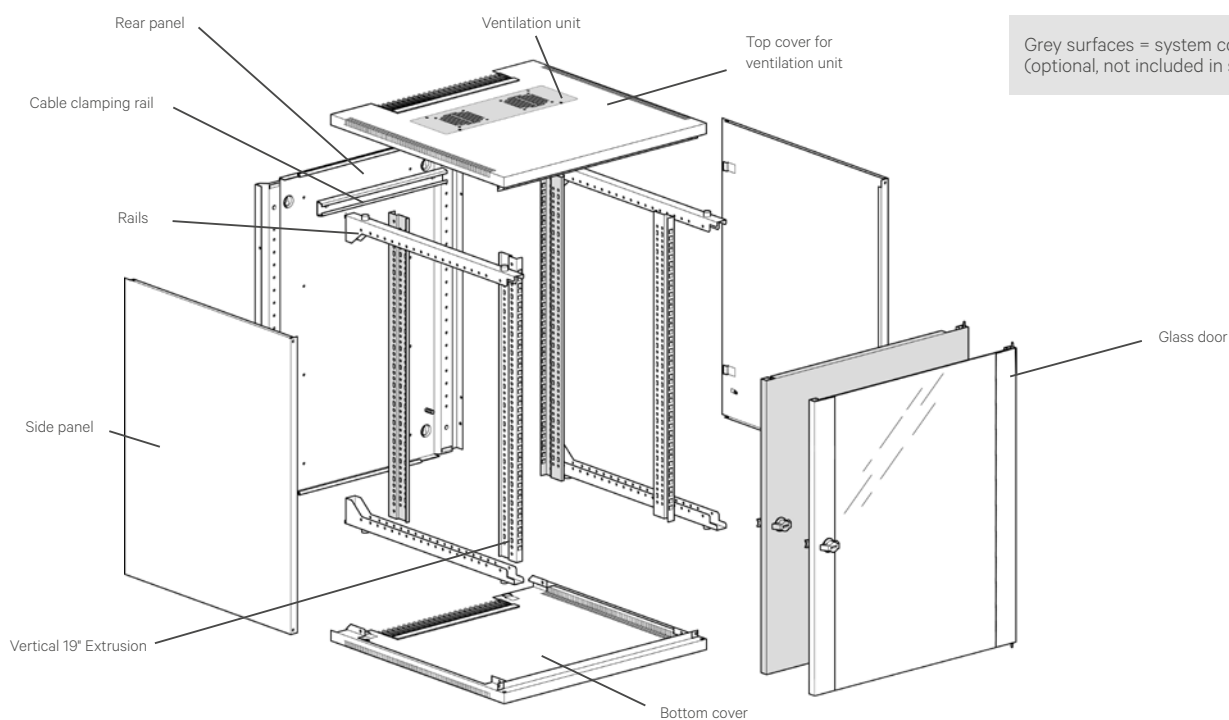

Grey surfaces = system components
(optional, not included in standard delivery)

ACT00038

Vertiv™ Knürr® ConAct® Technical data

■ 19" installation dimensions as per IEC 297-3

- Heights: 6 U / 9 HE / 12 U / 15 U / 18 U / 21 U / 24 U (1 U = 44.45 mm).
- Widths: 482.6 mm (19").

■ External dimensions

- Heights: 352 mm / 486 mm / 619 mm / 752 mm / 886 mm / 1019 mm / 1152 mm.
- Width: 600 mm.
- Depths: 400 mm / 500 mm / 600 mm.

■ Standards

- Grounding VDE 0100 T 540, EN 60950, EN 60529.

■ Configurations

- Stationary, wall mounting.



ACT00006



ACT00007



ACT00008

4. Install cables and components

5. Fit covers into place

6. Installation is now complete.



ACT20053

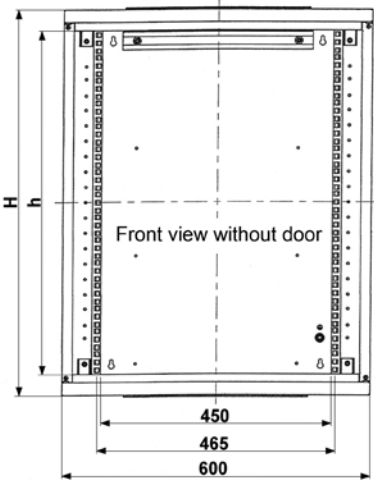
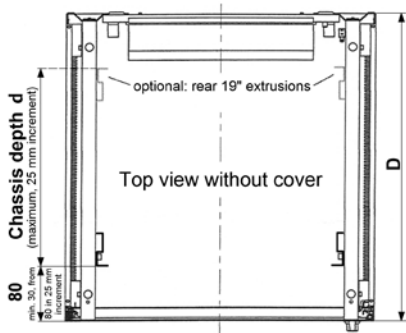

ACT20041

Vertiv™ Knürr® ConAct® 19" Wall-mounted Housing

Description

- For components compliant with IEC 297-3.
- Accessible from all sides; covers can be removed quickly.
- Cable routing via brush strip on top and bottom covers.
- Ventilation unit, optional (can easily be retrofitted).
- Front door with safety glass, lockable.

Jumpering space

- 80 mm (minimum 32, > 80 in 25 mm increments).

Load rating

- 500 N static.

Protection rating

- IP 20.

Material / Finish

- Rear panel and basic frame, sheet steel, zinc-passivated.
- Removable covers, sheet steel, powder-coated texture.
- Front door, single safety glass panel.
- 19" vertical extrusions, zinc-passivated sheet steel.

Color

- RAL 7035, light-grey.

Scope of delivery

- 1 x rear panel.
- 4 x mounting rails.
- 2 x 19" sheet-steel vertical extrusions.
- 1 x top cover, prepared for ventilation unit.
- 1 x bottom cover, closed.
- 2 x side panels.
- 1 x glass door.
- 1 x cable clamping rail.
- 2 x keys.
- 1 x Mounting kit.

How supplied

- In parts.

W	H	D	U	h	d (max.)	kg	Model	Order No.	UP
600	352	400	6	270	235	16	With glass door	05.010.000.1	1 unit
600	486	400	9	404	235	19	With glass door	05.010.001.1	1 unit
600	619	400	12	537	235	22	With glass door	05.010.002.1	1 unit
600	752	400	15	670	235	25	With glass door	05.010.003.1	1 unit
600	886	400	18	804	235	28	With glass door	05.010.004.1	1 unit
600	1019	400	21	937	235	31	With glass door	05.010.005.1	1 unit
600	1152	400	24	1070	235	34	With glass door	05.010.006.1	1 unit
600	352	500	6	270	335	18	With glass door	05.010.007.1	1 unit P
600	486	500	9	404	335	21	With glass door	05.010.008.1	1 unit P
600	619	500	12	537	335	24	With glass door	05.010.009.1	1 unit P
600	752	500	15	670	335	28	With glass door	05.010.010.1	1 unit P
600	886	500	18	804	335	31	With glass door	05.010.011.1	1 unit P
600	1019	500	21	937	335	34	With glass door	05.010.012.1	1 unit
600	1152	500	24	1070	335	37	With glass door	05.010.013.1	1 unit
600	352	600	6	270	435	20	With glass door	05.010.014.1	1 unit P
600	486	600	9	404	435	23	With glass door	05.010.015.1	1 unit P
600	619	600	12	537	435	27	With glass door	05.010.016.1	1 unit P
600	752	600	15	670	435	30	With glass door	05.010.017.1	1 unit P
600	886	600	18	804	435	34	With glass door	05.010.018.1	1 unit P
600	1019	600	21	937	435	37	With glass door	05.010.019.1	1 unit P
600	1152	600	24	1070	435	41	With glass door	05.010.020.1	1 unit P

P - assemble to order (shipped within 5 working days).
Caution: In case of larger orders, delivery times may increase.

Dimensions in mm:				Conversion:	
W = Width	h = Installation height	U = Standard rack unit	kg = Weight	1 mm = 0.03937 inch	
H = Height	d = Insertion depth	(1 U = 44.45 mm)		1 kg = 2.2046 pounds	
D = Depth	L = Length	UP = Packaging unit			



ACT00029

Vertiv™ Knürr® ConAct® 19" Vertical Extrusion

- Install in front and/or rear of housing.

Material / Finish
- Sheet steel, 1.5 mm, zinc passivated.

Scope of delivery
- 2 x vertical extrusions.
- 1 x Mounting kit.

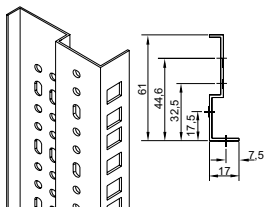

ACT00035

U	Order No.	UP	
6	05.010.321.9	1 set	
9	05.010.322.9	1 set	
12	05.010.323.9	1 set	
15	05.010.324.9	1 set	
18	05.010.325.9	1 set	
21	05.010.326.9	1 set	
24	05.010.327.9	1 set	



ACT20058

Vertiv Knürr ConAct Ventilation Unit with Thermostat

- Easy retrofitting of ventilation unit in top cover.
- With two axial fans.
- With thermostat.
- Available in two performance classes.

Material / Finish
- Zinc-passivated sheet steel.

Technical data for single fan
Type 1:
- Volume flow (free blowing): 162 m³/h per fan.
- Noise emission (free blowing): 37 dB(A).
Type 2 (quiet):
- Volume flow (free blowing): 120 m³/h per fan.
- Noise emission (free blowing): 32 dB(A).

Technical data for thermostat
- Setting range: 0 to 60°C.
- Mains supply: 240 V / 50 Hz.
- Nominal current: 16 A.

Color
- RAL 7035, light-grey.

Scope of delivery
- 1 x ventilation unit ready for connection.
- 1 x Wired with thermostat.

How supplied
- Assembled, wired and tested.



ACT20056



ACT20059

Model	Order No.	UP	
Type 1	05.010.306.1	1 set	
Type 2 (quiet)	05.010.307.1	1 set	



ACT20027

Knürr ConAct® Sheet Steel Door

- Alternative to glass door.

Material / Finish
- Sheet steel, powder-coated texture.

Color
- RAL 7035, light-grey.

Standard inclusion
- 1 x steel door.
- 2 x keys.
- 1 x Mounting kit.

Delivery
- In sets.

Note
If required, we also deliver our ConAct wall-mounted housing with a sheet-steel door. Please contact us at your leisure.



ACT20054

W	H	D	U	h	d	kg	Model	Order No.	UP
			6					05.010.421.1	1 unit
			9					05.010.422.1	1 unit
			12					05.010.423.1	1 unit
			15					05.010.424.1	1 unit
			18					05.010.425.1	1 unit
			21					05.010.426.1	1 unit
			24					05.010.427.1	1 unit



ACT00026

Vertiv Knürr ConAct Grounding Set

- For grounding all covers on housing frame.

Scope of delivery
- 5 x grounding conductors, 6 mm².
- 1 x Mounting kit.

Bestell-Nr.	VE	
05.010.330.9	1 Satz	



MIR00641

Vertiv Knürr ConAct Cable Clamping Rail

- Cables secured with U-clamps, clamping bars or hammer-head threaded plate.
- For mounting on rear panel.

Material / Finish
- Zinc-passivated sheet steel.

Scope of delivery
- 1 x cable clamping rail.
- 1 x Mounting kit.

How supplied
- In sets.



ACT00006_A

Order No.	UP	
05.010.340.9	1 set	



ACT20053

Vertiv Knürr ConAct® Glass Door

- **Material / Finish**

 - Covers, sheet steel, powder-coated texture.
 - Glass infill, single safety glass panel.
- **Color**

 - RAL 7035, light-grey.
- **Standard inclusion**

 - 1 x glass door.
 - 2 x keys.
 - 1 x Mounting kit.
- **Delivery**

 - In sets.

W	H	D	U	h	d	kg	Model	Order No.	UP
			6					05.010.620.1	1 unit
			9					05.010.621.1	1 unit
			12					05.010.622.1	1 unit
			15					05.010.623.1	1 unit
			18					05.010.624.1	1 unit
			21					05.010.625.1	1 unit
			24					05.010.626.1	1 unit

Vertiv™ SmartAisle™

The Comprehensive Solution for Data Centers

Features

- Outstanding fail-safe design.
- Ideal temperature for IT equipment; no hot spots.
- Minimal energy consumption.
- Easy to plan a new data center.

Comprehensive Solution

- Racks.
- Rack PDUs.
- Power distribution.
- UPS.
- Vertiv™ ICOM™-controlled cooling.
- Containment.
- Cable management.
- Rack and aisle monitoring.
- Data center infrastructure.
- DCIM Management.
- Commissioning and maintenance.
- Other services.

All have interfaces at a top-level infrastructure management system (Vertiv *Trellis*™), which facilitates holistic monitoring, management and automation of the physical infrastructure.

The most important trend in IT is the increasing independence of applications from the IT infrastructure. Virtualization and cloud computing are the current buzzwords. Hardware is based on energy-efficient IT components and the dynamic control of these components to meet the applications' current requirements.

Vertiv's SmartAisle™ is the SmartAisle solution encompasses the space, power supply and cooling for servers, storage and the network in the data center. Data centers are highly individual and are constantly subject to change. The physical infrastructure can be adapted to meet any conceivable need by selecting comprehensive portfolio components that harmonize with one another.

The Vertiv SmartAisle™ solution is future-proof and delivers outstanding availability and efficiency.

COLD AISLE CONTAINMENT

COOLING

Liebert® HPM,
HPC, CRV

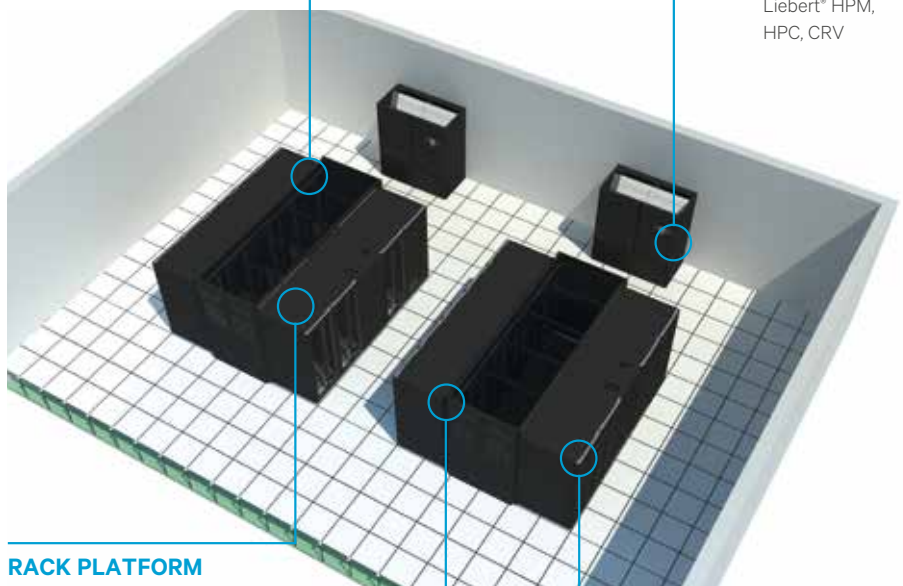

RACK PLATFORM

Vertiv Knürr DCM Schwerlastschrank,
Vertiv Knürr MIR

MONITORING

DCIM, Vertiv ICOM,
Avocent DS View3

POWER SUPPLY

Liebert APM,
Rack PDUs,
Vertiv Knürr PowerTrans®

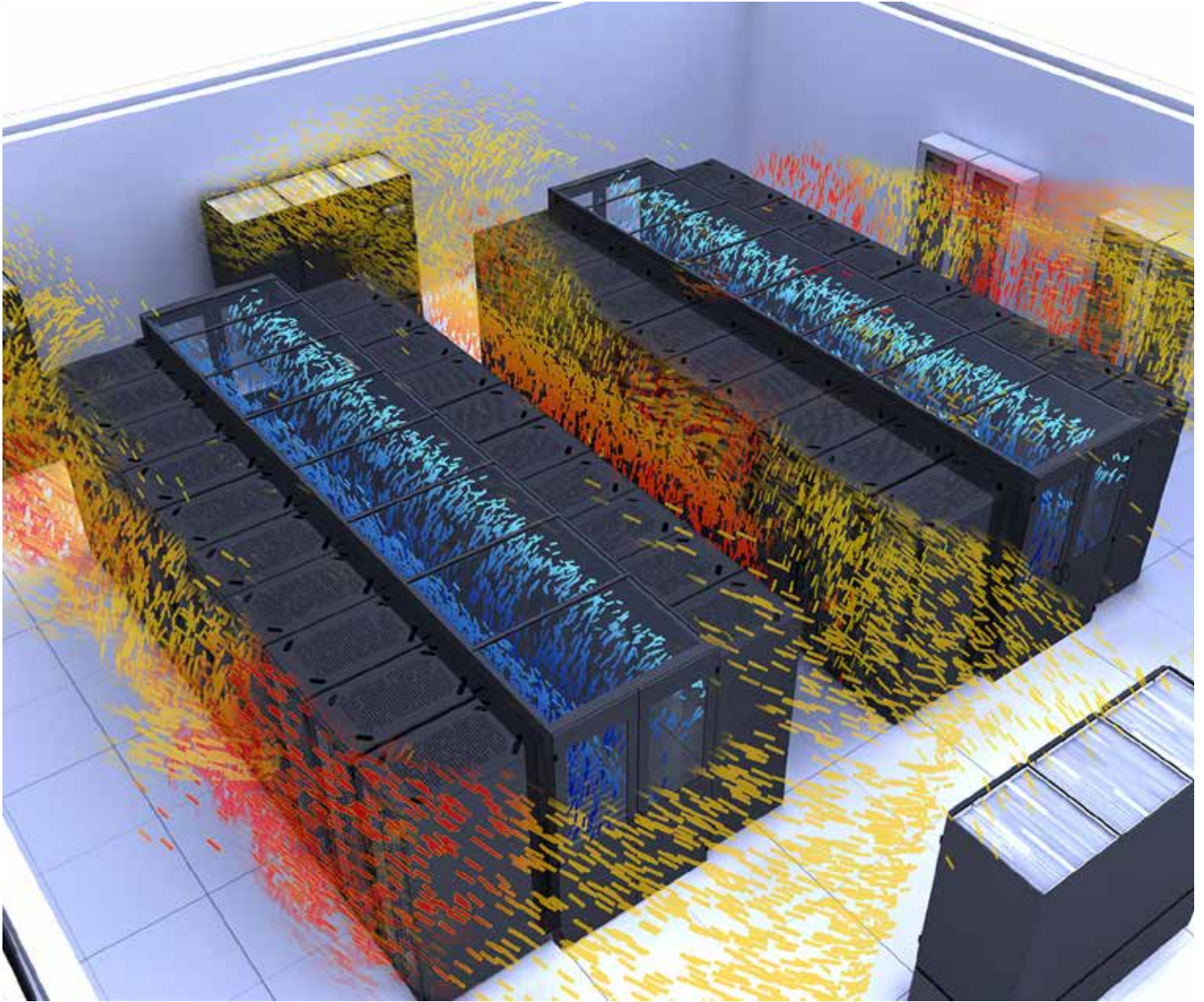

Vertiv™ SmartAisle™ containment – consistent separation of warm and cold air is the cornerstone of an energy-efficient data center.

Vertiv™ SmartAisle™

The Comprehensive Solution Concept for Data Centers

Vertiv Control System



Due to rising power costs and increased environmental awareness, the main objective for most operators is to maximize the energy efficiency of their data centers.

Many have already implemented basic separation of cold air from warm air with blanking panels, bushings for cable entry, cold aisle containment, etc. Air-cooling units are key to energy-efficient data centers and further optimization is achieved by adjusting the fans' speed.

The operator reduces electricity costs significantly by choosing the right type of control system, which in turn increases availability. In the event of one recirculated air cooling device malfunctioning, temperature control is maintained by increasing the speed of the remaining devices.

The two most common control principles are pressure control and control via the cold aisle temperature.

With the Vertiv SmartAisle control principle, the cold aisle temperature, i.e. the temperature of the air supply to the servers is used to control the fans in the room's climate control equipment (see diagram).

This control principle is patented.

The Vertiv SmartAisle Control-System Principle

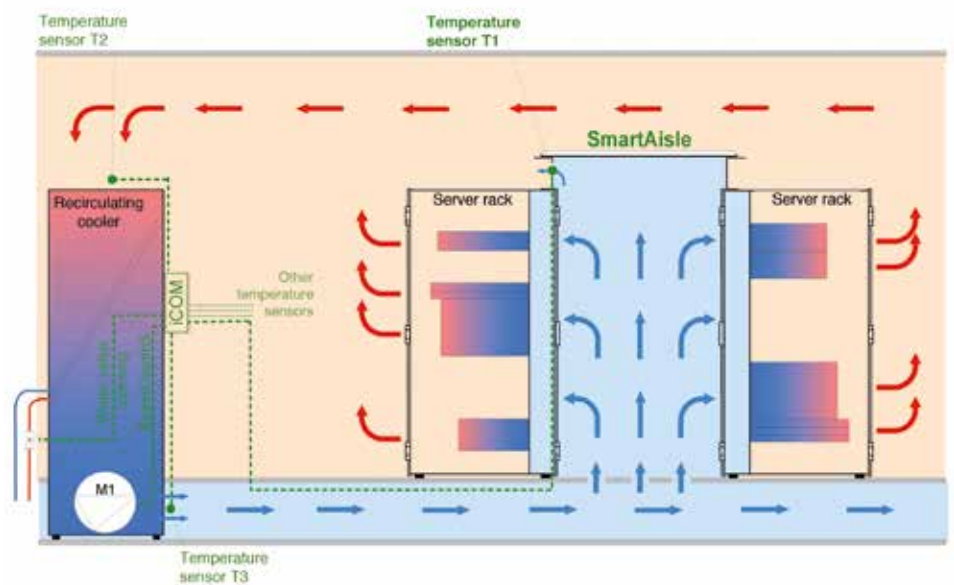



Vertiv™ SmartAisle™

The Comprehensive Solution Concept for Data Centers

Overview of Vertiv™ SmartAisle™ Containment



STANDARD

Standard program:

- Aisle width 1200 / 1500 and 1800 mm.
- Rack height 2000 and 2200 mm.

Features:

- Ideal for new data centers and for retrofitting homogeneous rack aisles.
- Industrial prefabrication makes for a highly economic solution.
- Quick and easy on-site installation.



CUSTOMIZED

Features:

- Precision fit to racks and rows.
- Suitable for retrofitting heterogeneous data centers.
- Compatible with standard Vertiv SmartAisle.



FREE-STANDING

Features:

- Flexible adjustment to racks with non-standard dimensions.
- For racks and applications that are exchanged at intervals.
- Compatible with standard Vertiv SmartAisle.



SWITCH TUBES

Features:

- No hot spots.
- Suitable airflow routing.
- Utilized in energy-efficient data centers.

Standard Vertiv™ SmartAisle™ Containment

Vertiv™ Power Containment Solution

Standard program

- Aisle width: 1200 / 1500 and 1800 mm.
- Rack height: 2000 and 2200 mm.

Features

- Ideal for new data centers and for retro-fitting homogeneous rack aisles.
- Industrial prefabrication makes for a highly economic solution.
- Quick and easy on-site installation.
- The containment can be used for Vertiv racks as well as for the most common racks in the market.
- The racks do not need to be installed in pairs.
- The top panels are transparent so that the available room lighting can be used.

The standard Vertiv SmartAisle product range consists of flexible, adaptable and user-friendly components.

The individual components equalize the tolerances of the racks, which are not usually installed with millimeter precision. The system is compatible with most commercially available racks.

The standard top covers have been prepared for the patented Vertiv SmartAisle control system.

Different door systems are available, including hinged and sliding doors. Hinged or swing doors offer advantages in terms of safety and emergency exits, while sliding doors take up less space.



Vertiv™ SmartAisle™ Containment

■ Configuration assistant

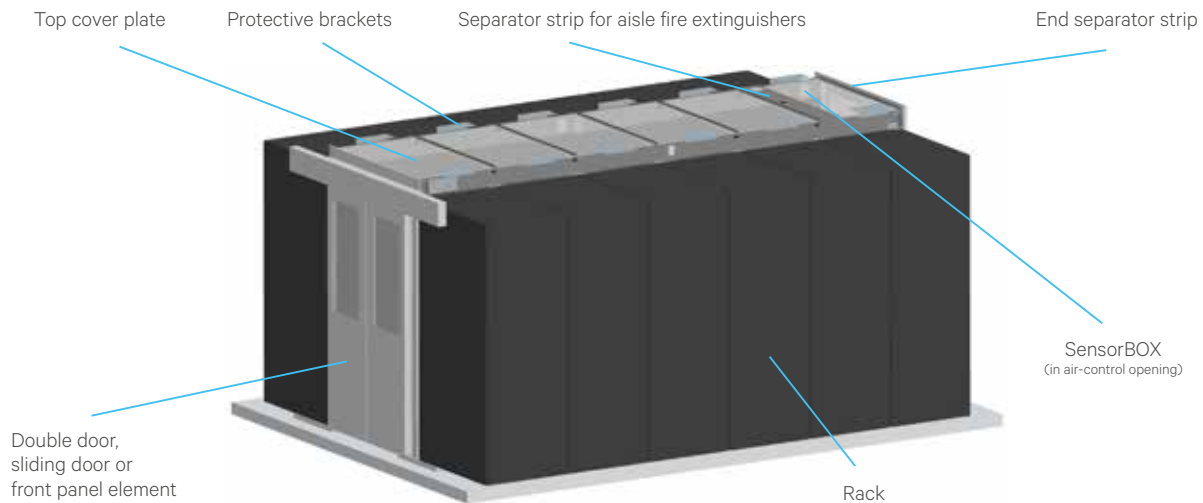

CAC20000

Required data per cold aisle	Example
- Aisle width (standard dimensions 1200, 1500 and 1800 mm ± 50 mm)	Aisle width (AW) = 1200 mm
- Rack height (standard dimensions 2000 and 2200 mm)	Rack height (H) = 2000 mm
- Aisle length	Aisle length (L) = 4800 mm
- Rack type	Vertiv Knürr DCM® B800
- Color (light-grey RAL 7035 or dark-grey RAL 7021)	Dark-grey RAL 7021

Options	Example	Item	
- Front door component (sliding door, double door, front panel)	Sliding door	03.029.026.8	1 unit
- Front door c closer (mechanical, electric)	Electric door closer	03.029.046.8	1 unit
- Rear door component (sliding door, double door, front panel)	Double door	03.029.021.8	1 unit
- Rear door closer (mechanical, electric)	Mechanical door closer	(integrated in double door)	
- Top cover plate	Top cover plate L2400	03.029.129.8	2 sets
- End separator strip	End separator strip GB 1200	03.029.010.8	1 pair
- SensorBOX	Yes	03.029.132.8	2 units
- Protective brackets	Yes	03.029.041.8	6 sets
- DCM® adjustment shim	Yes	03.029.137.8	3 sets
- Filler panel	No		
- Height trims	No		
- Sealing set	Yes	03.029.040.9	2 sets
- Raised-floor air barrier for cable entry	Yes (per rack)	03.029.211.9	22 units
- Open mesh flooring plate	Yes	03.029.090.8	28 units

Dimensions in mm:				Conversion:	
W = Width	h = Installation height	U = Standard rack unit	kg = Weight	1 mm = 0.03937 inch	
H = Height	d = Insertion depth	(1 U = 44.45 mm)		1 kg = 2.2046 pounds	
D = Depth	L = Length	UP = Packaging unit			

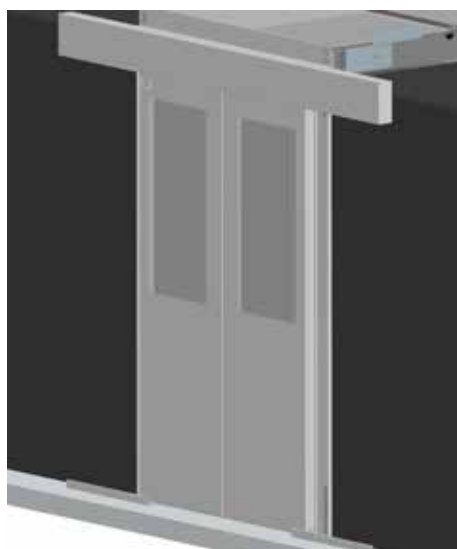

CAC20001

Vertiv™ SmartAisle™ Sliding-door Prepared for Automatic Door Closers

Description

- Used in cold aisle containment for aisle widths: 1200 / 1500 / 1800 mm (± 50 mm).
- Quick and easy mounting.
- Suitable for MIR® and DCM® racks and most other brands.

Clear door opening

- Width: at least 950 mm.
- Height: 2080 mm.

Material

- Door components: sheet steel.
- Observation window: single safety-glass panel.
- Brush strips: polyamide (UL94 HF-1).

Finish

- Final digit of order number .1: powder-coated, RAL 7035 light-grey (e. g. X=1; 03.029.026. X=03.29026.1=light-grey).

- Final digit of order number .8: powder-coated, RAL 7021 dark-grey (e. g. X=8; 03.029.026. X=03.29026.8=dark-grey).

Scope of delivery

- 1 x frame.
- 2 x doors.
- 2 x floor guides.
- 1 x Covers.
- 1 x Sealing material.
- 1 x Mounting kit.

How supplied

- In sets.

Note

Please order the requisite closers (electric or mechanical).

H	AW	Order No.	UP
2000	1200	03.029.026.X	1 set
2200	1200	03.029.027.X	1 set
2000	1500	03.029.061.X	1 set
2200	1500	03.029.062.X	1 set
2000	1800	03.029.066.X	1 set
2200	1800	03.029.067.X	1 set
2400	1200	On request	1 set
2400	1500	On request	1 set
2400	1800	On request	1 set
2600	1200	On request	1 set
2600	1500	On request	1 set
2600	1800	On request	1 set



CAC20004

Electric Sliding-door Closer

Description

- Compatible with SmartAisle™ sliding door.
- Increases energy efficiency as doors closes automatically.
- Opens with "push & go".
- Closes with "push & go" or automatically (0 to 30 seconds).
- Opener/closer contact for control (e.g. fire alarm system).

Material

- Sheet steel.

Finish

- Final digit of order number .1: powder-coated, RAL 7035 light-grey.
- Final digit of order number .8: powder-coated, RAL 7021 dark-grey.

Technical data

- Power supply: 230 V / 50 - 60 Hz.
- Opening speed: 0.4 m/s.
- Closing speed: 0.2 m/s.
- Automatic closing time, adjustable: 0 to 30 s.
- Force: 30 N.

How supplied

- Single items.



CAC20005

Scope of delivery

- 1 x electric drive.
- 1 x cover.
- 1 x Mounting brackets.
- 1 x Mounting kit.

Order No.	UP
03.029.046.X	1 set



CAC20006

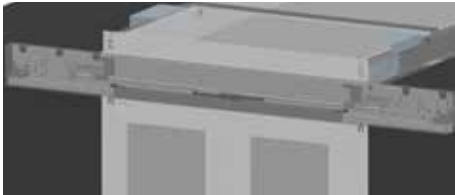

CAC20007

Mechanical Sliding-door Closer

Description

- Suitable for Vertiv™ SmartAisle™ sliding door.
- Increases energy efficiency as doors open and close automatically.
- Stop function when open.

Material

- Sheet steel.

Finish

- Final digit of order number .1: powder-coated, RAL 7035 light-grey (e. g. X=1; 03.029.026. X=03.29026.1=light-grey).

- Final digit of order number .8: powder-coated, RAL 7021 dark-grey (e. g. X=8; 03.029.026. X=03.29026.8=dark-grey).

Scope of delivery

- 2 x sets of gas pressure springs.
- 1 x cover.
- 1 x Mounting brackets.
- 1 x Mounting kit.

Technical data

- Force: 20 N.

How supplied

- Single items.

Order No.	UP
03.029.047.X	1 set

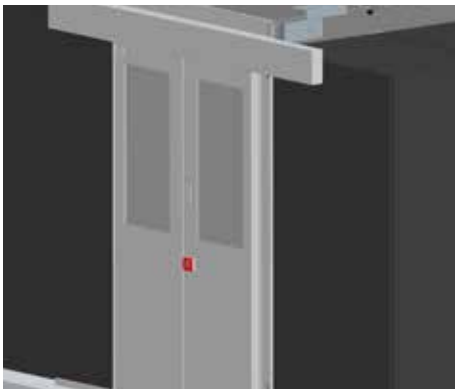

CAC20002



CAC20003

Vertiv™ SmartAisle™ Sliding-door with Access Check

Description

- Used in cold aisle containment for aisle widths: 1200 / 1500 / 1800 mm (± 50 mm).
- Quick and easy mounting.
- Suitable for MIR® and DCM® racks and most other brands.
- Magnets ensure safe closing; in the event of a power failure, the door can easily be opened manually.
- Standard access check with keypad (other systems also available).
- Inside switch for routine exit.
- VdS-compliant emergency switch inside; height of switch < 1 meter.
- VdS-compliant emergency switch outside for rescue purposes.
- Door contact switch for monitoring "door open" - "door closed".

Finish

- Final digit of order number .1: powder-coated, RAL 7035 light-grey.
- Final digit of order number .8: powder-coated, RAL 7021 dark-grey.

Scope of delivery

- 1 x frame.
- 2 x doors.
- 2 x floor guides.
- 1 x rack monitoring system.
- 1 x Electrical closing system.
- 1 x Covers.
- 1 x Sealing material.
- 1 x Mounting kit.

How supplied

- In sets.

Clear door opening

- Width: at least 950 mm.
- Height: 2080 mm.

Material

- Door components: sheet steel.
- Observation window: single safety-glass panel.
- Brush strips: polyamide (UL94 HF-1).

H	AW	Order No.	UP
2000	1200	03.029.029.X	1 set
2200	1200	03.029.029.X	1 set

Dimensions in mm:				Conversion:	
W = Width	h = Installation height	U = Standard rack unit	kg = Weight	1 mm	= 0.03937 inch
H = Height	d = Insertion depth	(1 U = 44.45 mm)		1 kg	= 2.2046 pounds
D = Depth	L = Length	UP = Packaging unit			



CAC20008

Vertiv™ SmartAisle™ Double Door with Automatic Door Closer

Description

- Used in cold aisle containment for aisle widths: 1200 / 1500 / 1800 mm (\pm 50 mm).
- Quick and easy mounting.
- Suitable for MIR® and DCM® racks and most other brands.
- Integrated automatic/mechanical door closer (opening angle 180°, stop angle approx. 120°; door closes automatically from approx. 100°).

Clear door opening

- Width: 1200 mm.
- Height: 2100 mm (for rack height 2000 mm); 2300 (for rack height 2200).

Material

- Door frame: aluminum.
- Door components: sheet steel.
- Observation window: single safety-glass panel.
- Brush strips: polyamide (UL94 HF-1).

Finish

- Final digit of order number .1: powder-coated, RAL 7035 light-grey.
- Final digit of order number .8: powder-coated, RAL 7021 dark-grey.

Scope of delivery

- 1 x door frame.
- 2 x doors.
- 3 x design covers.
- 2 x door closers.
- 1 x Mounting kit.

How supplied

- In sets.

H	AW	Order No.	UP
2000	1200	03.028.021.X	1 set
2200	1200	03.028.022.X	1 set
2000	1500	03.028.041.X	1 set
2200	1500	03.028.042.X	1 set
2000	1800	03.028.046.X	1 set
2200	1800	03.028.047.X	1 set



CAC20009

Vertiv SmartAisle Front Panel

Description

- Used in cold aisle containment for aisle widths: 1200 / 1500 / 1800 mm (\pm 50 mm).
- Alternative to cold aisle door.
- Quick and easy mounting.
- Suitable for MIR® and DCM® racks and most other makes.

Material

- Sheet steel.

Finish

- Final digit of order number .1: powder-coated, RAL 7035 light-grey.

- Final digit of order number .8: powder-coated, RAL 7021 dark-grey.

Scope of delivery

- 1 x bracing bracket.
- 2 to 4 panels.
- 1 x Mounting kit.

How supplied

- In sets.

H	AW	Order No.	UP
2000	1200	03.029.031.X	1 set
2200	1200	03.029.032.X	1 set
2000	1500	03.029.034.X	1 set
2200	1500	03.029.035.X	1 set
2000	1800	03.029.037.X	1 set
2200	1800	03.029.038.X	1 set

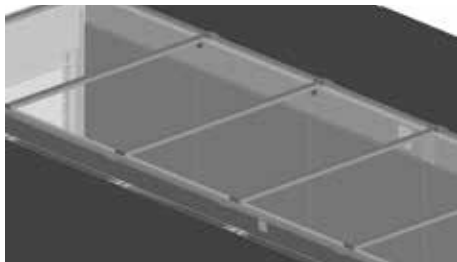

CAC20010

Vertiv™ SmartAisle™ Top Cover Plate

Description

- Used in cold aisle containment for aisle widths: 1200 / 1500 / 1800 mm (± 50 mm).
- Quick and easy mounting.
- Suitable for MIR® and DCM® racks and most other brands.
- With rubber sleeves for cable routing.
- Top cover plate with low fire load and smoke generation (optionally with compound safety glass).
- Top cover plate(s) can be removed quickly and easily.
- Equipped with SensorBOX for energy-efficient operation of the recirculated air cooling devices and for preventing hot spots.

Clear aisle height

- Rack height 2000 mm: 2150 mm.
- Rack height 2200 mm: 2350 mm.

Material

- Angular extrusion, cross brace: sheet steel.
- Top cover plate: polycarbonate, UL94 V-0/DIN 4102 B1.

Finish

- Final digit of order number .1: powder-coated, RAL 7035 light-grey.
- Final digit of order number .8: powder-coated, RAL 7021 dark-grey.

Scope of delivery

- 2 x angular extrusions with air regulation opening.
- 1 x separator strip for L 300/600/800, 3 x separator strips for L 2400.
- 1 x top cover plate for L 300/600/800, 3 x top cover plates for L 2400.
- 2 x angular extrusion plates.
- 1 x Mounting kit.

How supplied

- In sets.

Important Note

When using Vertiv Knürr DCM® racks, please also order corresponding adjustment plates.

Note

Please also order correct number of SensorBOXes for the recirculated air cooling devices' control system.

L	AW	Order No.	UP
300	1200	03.029.120.X	1 set
600	1200	03.029.123.X	1 set
800	1200	03.029.126.X	1 set
2400	1200	03.029.129.X	1 set
300	1500	03.029.121.X	1 set
600	1500	03.029.124.X	1 set
800	1500	03.029.127.X	1 set
2400	1500	03.029.130.X	1 set
300	1800	03.029.122.X	1 set
600	1800	03.029.125.X	1 set
800	1800	03.029.128.X	1 set
2400	1800	03.029.131.X	1 set



CAC20011

Vertiv™ SmartAisle™ End Separator Strip

Description

- Used in cold aisle containment for aisle widths: 1200 / 1500 / 1800 mm (\pm 50 mm).
- Quick and easy mounting.
- For connecting the door component or front panel.

Material

- Sheet steel.

Finish

- Final digit of order number .1: powder-coated, RAL 7035 light-grey.
- Final digit of order number .8: powder-coated, RAL 7021 dark-grey.

Scope of delivery

- 2 x end separator strips.
- 1 x Mounting kit.

How supplied

- Single items.

AW	Order No.	UP
1200	03.029.010.X	1 pair
1500	03.029.011.X	1 pair
1800	03.029.012.X	1 pair

Dimensions in mm:

W = Width	h = Installation height	U = Standard rack unit	kg = Weight
H = Height	d = Insertion depth	(1 U = 44.45 mm)	
D = Depth	L = Length	UP = Packaging unit	

Conversion:

1 mm	= 0.03937 inch
1 kg	= 2.2046 pounds



CAC00NEU

Vertiv™ SmartAisle™ Sliding-door Wall-mount Prepared for Automatic Door Closers

Description

- For a cold aisle containment between rack row and wall.
- For an aisle width of 900 to 1200 mm (± 50 mm).
- Quick and easy mounting.
- Suitable for MIR® and DCM® racks and most other brands.

Clear door opening

- Width: 860 mm (mechanical door closer); 820 mm (electrical door closer).
- Height: 2080 mm.

Material

- Door components: sheet steel.
- Observation window: single safety-glass panel.
- Brush strips: polyamide (UL94 HF-1).

Finish

- Final digit of order number .1: powder-coated, RAL 7035 light-grey.
- Final digit of order number .8: powder-coated, RAL 7021 dark-grey.

Scope of delivery

- 1 x frame.
- 2 x doors.
- 2 x floor guides.
- 1 x Covers.
- 1 x Sealing material.
- 1 x Mounting kit.

How supplied

- In sets.

Note

Please order the requisite closers (electric or mechanical).

H	AW	Order No.	UP
2000-2200	900-1200	03.029.190.X	1 set



CAC00NEU

Electric Sliding-door Closer Wall-mount

Description

- Compatible with Vertiv SmartAisle™ sliding door wall-mount.
- Increases energy efficiency as doors closes automatically.
- Opens with "push & go".
- Closes with "push & go" or automatically (0 to 30 seconds).
- Opener/closer contact for control (e.g. fire alarm system).

Material

- Sheet steel.

Finish

- Final digit of order number .1: powder-coated, RAL 7035 light-grey.
- Final digit of order number .8: powder-coated, RAL 7021 dark-grey.

Scope of delivery

- 1 x electric drive.
- 1 x cover.
- 1 x Mounting brackets.
- 1 x Mounting kit.

Technical data

- Power supply: 230 V / 50 - 60 Hz.
- Opening speed: 0.4 m/s.
- Closing speed: 0.2 m/s.
- Automatic closing time, adjustable: 0 to 30 s.
- Force: 30 N.

How supplied

- Single items.

Order No.	UP
03.029.192.X	1 set

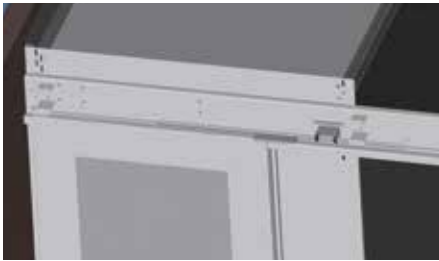

CAC00NEU

Mechanical Sliding-door Closer Wall-mount

- Description**
 - Suitable for Vertiv SmartAisle™ sliding door wall-mount.
 - Increases energy efficiency as doors open and close automatically.
 - Stop function when open.
- Material**
 - Sheet steel.
- Finish**
 - Final digit of order number .1: powder-coated, RAL 7035 light-grey.
 - Final digit of order number .8: powder-coated, RAL 7021 dark-grey.
- Scope of delivery**
 - 2 x sets of gas pressure springs.
 - 1 x cover.
 - 1 x Mounting brackets.
 - 1 x Mounting kit.
- Technical data**
 - Force: 20 N.
- How supplied**
 - Single items.

Order No.	UP
03.029.193.X	1 set

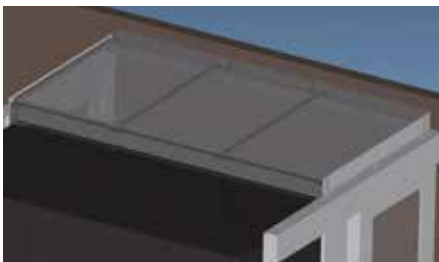

CAC00NEU

Vertiv™ SmartAisle™ Top Cover Plate Wall-mount

- Description**
 - Used in cold aisle containment for aisle width 1200 mm (\pm 50 mm).
 - Quick and easy mounting.
 - Suitable for MIR® and DCM® racks and most other brands.
 - With rubber sleeves for cable routing.
 - Top cover plate with low fire load and smoke generation (optionally with compound safety glass).
 - Top cover plate(s) can be removed quickly and easily.
 - Equipped with SensorBOX for energy-efficient operation of the recirculated air cooling devices and for preventing hot spots.
- Clear aisle height**
 - Rack height 2000 mm: 2150 mm.
 - Rack height 2200 mm: 2350 mm.
- Material**
 - Angular extrusion, cross brace: sheet steel.
 - Top cover plate: polycarbonate, UL94 V-0/DIN 4102 B1.
- Finish**
 - Final digit of order number .1: powder-coated, RAL 7035 light-grey.
 - Final digit of order number .8: powder-coated, RAL 7021 dark-grey.
- Scope of delivery**
 - 2 x angular extrusions with air regulation opening.
 - 1 x separator strip for W 300/600/800, 3 x separator strips for L 2400.
 - 1 x top cover plate for W 300/600/800, 3 x top cover plates for L 2400.
 - 2 x angular extrusion plates.
 - 1 x Mounting kit.
- How supplied**
 - In sets.
- Important Note**

When using Knürr DCM® or MIR® 2 racks, please also order corresponding adjustment plates.
- Note**

Please also order correct number of Sensor-BOXes for the recirculated air cooling devices control system.

L	AW	Order No.	UP
300	1200	03.029.195.X	1 set
600	1200	03.029.196.X	1 set
800	1200	03.029.197.X	1 set
2400	1200	03.029.198.X	1 set



CAC20011

Vertiv™ SmartAisle™ End Separator Strip Wall-mount

Description

- Used in cold aisle containment for aisle widths: 1200 mm (± 50 mm). To the wall.
- Other aisle widths are available on request.
- Quick and easy mounting.
- For connecting the door component or front panel.

Material

- Sheet steel.

Finish

- Final digit of order number .1: powder-coated, RAL 7035 light-grey.
- Final digit of order number .8: powder-coated, RAL 7021 dark-grey.

Scope of delivery

- 2 x end separator strips.
- 1 x Mounting kit.

How supplied

- Single items.

AW	Order No.	UP
1200	03.029.199.X	1 pair



CAC20013

Vertiv™ SmartAisle™ DCM® Adjustment Shim used with Vertiv Knürr DCM® Racks

Description

- Spacer between DCM® rack and cold aisle containment.

Material

- Sheet steel.

Finish

- Final digit of order number .1: powder-coated, RAL 7035 light-grey.
- Final digit of order number .8: powder-coated, RAL 7021 dark-grey.

Scope of delivery

- 1 x adjustment shim.

How supplied

- In sets.



CAC20014

W / L	For rack type	Order No.	UP
300	DCM®	03.029.134.X	1 set
600	DCM®	03.029.135.X	1 set
800	DCM®	03.029.137.X	1 set
1000	DCM®	03.029.139.X	1 set

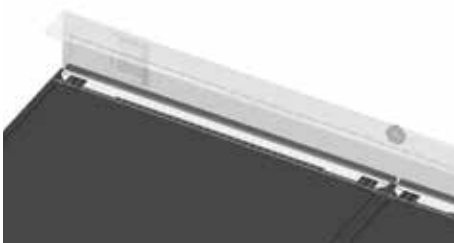

CAC20015



CAC20016

Vertiv SmartAisle SensorBOX for SmartAisle™ Top Cover Plates

Description

- Suitable for air regulation opening of the top cover plates.
- As per patented control-system principle designed for energy-efficient operation of the cooling system.
- Prepared for Liebert® temperature sensor.
- Compatible with a variety of sensors.

Finish

- Final digit of order number .1: powder-coated, RAL 7035 light-grey.
- Final digit of order number .8: powder-coated, RAL 7021 dark-grey.

Scope of delivery

- 1 x SensorBOX.
- 1 x Mounting kit.

How supplied

- In sets.

Material

- Sheet steel.

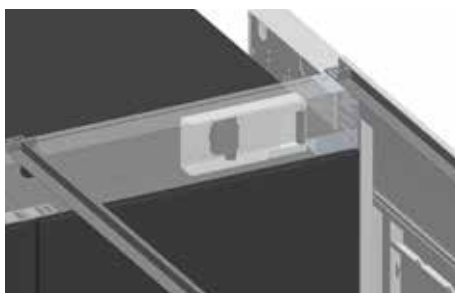

CAC20017

Order No.	UP
03.029.132.X	1 set



CAC20018

Vertiv™ SmartAisle™ Filler Panel

Description

- For sealing off the compartments without racks in the suite.
- Quick and easy mounting.
- Variable height; can be used for total rack heights of 2000 to 2700 mm.
- Several filler panels can be set up in a row.

Finish

- Final digit of order number .1: powder-coated, RAL 7035 light-grey.
- Final digit of order number .8: powder-coated, RAL 7021 dark-grey.

Scope of delivery

- 1 x filler panel (two parts).
- 1 x Mounting kit.

Material

- Sheet steel.

How supplied

- In sets.

Note

Coming soon!

W / L	H	Order No.	UP
300	2000 / 2700	03.029.058.X-001	1 set
600	2000 / 2700	03.029.058.X-004	1 set
800	2000 / 2700	03.029.058.X-006	1 set

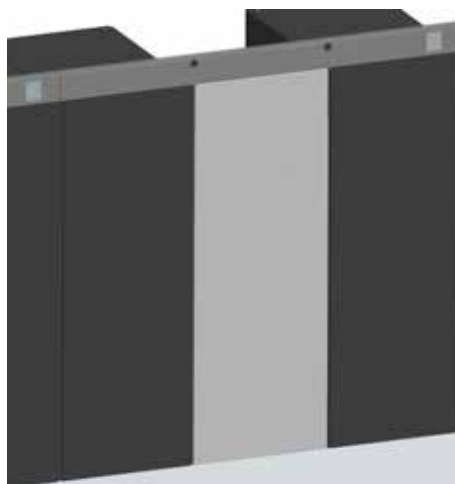

CAC20019

Dimensions in mm:				Conversion:	
W = Width	h = Installation height	U = Standard rack unit	kg = Weight	1 mm = 0.03937 inch	
H = Height	d = Insertion depth	(1 U = 44.45 mm)		1 kg = 2.2046 pounds	
D = Depth	L = Length	UP = Packaging unit			



DCM20057

Vertiv™ SmartAisle™ Height Trim

- For adjusting the separation of the cold and hot areas in smaller racks.

Material

- Sheet steel.

Finish

- Final digit of order number .1: powder-coated, RAL 7035 light-grey.
- Final digit of order number .8: powder-coated, RAL 7021 dark-grey.

Scope of delivery

- 1 x height trim.
- 1 x Mounting kit.

How supplied

- In sets.

Note

Where there are several adjacent height panels, please request the corresponding angular extrusion plates.



LUF20328

W	H	For rack type	Order No.	UP
300	221	DCM®	03.029.140.X	1 set
600	221	DCM®	03.029.141.X	1 set
600	200	MIR®	03.029.051.X	1 set
800	221	DCM®	03.029.143.X	1 set
800	200	MIR®	03.029.052.X	1 set
1000	221	DCM®	03.029.145.X	1 set

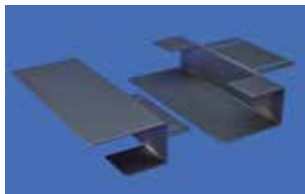

DCM20131

Vertiv SmartAisle Protective Brackets for Top Cover Plate

- Prevents Plexiglas panels from lifting up when there is excess pressure.
- Enables safe pressure equalization in the event of a malfunction or while a fire is being extinguished.

Material

- Sheet steel.

Finish

- Final digit of order number .1: powder-coated, RAL 7035 light-grey.
- Final digit of order number .8: powder-coated, RAL 7021 dark-grey.

Scope of delivery

- 1 x pair of protective brackets.
- 1 x Mounting kit.

How supplied

- In sets.



LUF20383

Order No.	UP
03.029.041.X	1 set



LUF20336

Vertiv SmartAisle Sealing Set for 4.8 meter Aisle Length

- Suitable for installation in MIR® rack.
- For sealing the leveling area between the floor and the rack.
- For sealing MIR® rack suites without side panels.

Material / Color

- Foam element: PUR ether UL94 HF-1, black.
- Cover extrusion: PVC extruder extrusion, black.

Scope of delivery

- 10 meters of foam 40 x 25 mm.
- 31 meters cover extrusion.

How supplied

- In sets.

W	For rack type	Order No.	UP
4800	MIR®	03.029.040.9	1 set

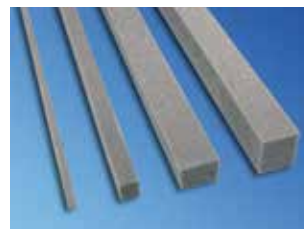

DCM20047

Vertiv SmartAisle Sealing Set for 4.8 meter Aisle Length

- Suitable for sealing gaps (e. g. in the leveling area between floor and rack, between racks, etc.).

Material / Color

- PUR ether (UL94 HF-1), black.

Scope of delivery

- 5 x 2 meters of foam.

How supplied

- In sets.

Size	Order No.	UP
40 x 40 (adhesive surface) mm	03.029.042.9	1 set
20 x 20 (adhesive surface) mm	03.029.043.9	1 set
5 x 10 (adhesive surface) mm	03.029.044.9	1 set
25 x 40 (adhesive surface) mm	03.029.045.9	1 set

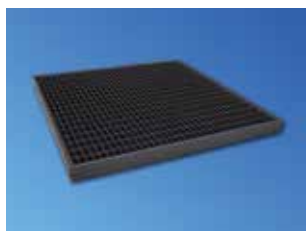

DSC00318

Vertiv™ SmartAisle™ Open Mesh Flooring Plate for Raised Floors

- Used in raised floors.
- Can be used with high heat loads and high cooling-air requirements per rack.
- For energy-efficient operation of the recirculated air cooling devices.
- Stiffener distance 33 x 16 mm.

Material

- Steel, zinc-passivated.

Finish

- Final digit of order number .1: powder-coated, RAL 7035 light-grey.
- Final digit of order number .8: powder-coated, RAL 7021 dark-grey.

Standards

- Produced as per RAL-GZ 638.
- Load capacity as per DIN EN 12825
- On supports: class 1A, deflection under instantaneous working load (2 kN) and 2C (3kN); measured at the center of plate.
- On supports and control-room profiles: deflection under instantaneous working load 2A (3kN).

Scope of delivery

- 1 x open mesh flooring plate for raised floor.

Technical data

- Size 598 x 598 x 40 mm (W x L x H).
- Free cross-section: 77%.
- Max. surface load 50,000 N/m² with even distribution;
- Max. point load (on surface 200 x 200 mm) 4,500 N.

How supplied

- Single items.

Note

- Suitable for raised floors with 40 mm panel heights.

Order No.	UP
03.029.090.X	1 unit

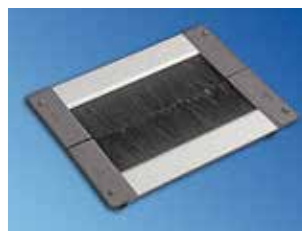

LUF20334

Vertiv SmartAisle Raised Floor Air Barrier for Cable Entry

- For cable entry from the raised floor.
- Lowered into raised floor, or can be mounted on top.
- Two-row tight brushes for pressure-resistant cold-hot separation.
- For new cutouts and as add-on to existing cutouts.
- Two-piece – easy extend and retrofit option.
- The length can easily be shortened on-site (metal saw).
- Also suitable for cabling on the rack wall (U-shape, two pieces).
- Slot-in – and additional threaded connection.

Dimensions

- 03.028.211.9:
 - External dimension (270 mm x 220 mm).
 - Usable cable entry (200 mm x 126 mm).
 - Raised floor cutout (240 mm x 180 mm).
- 03.028.212.9:
 - External dimension (600 mm x 220 mm).
 - Usable cable entry (530 mm x 126 mm).
 - Raised floor cutout (570 mm x 180 mm).

Scope of delivery

- 1 x pair of raised floor air barriers.
- 1 x Mounting kit.

How supplied

- In sets.

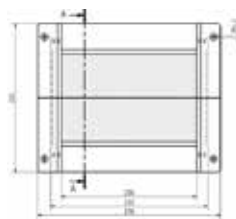

LUF20301

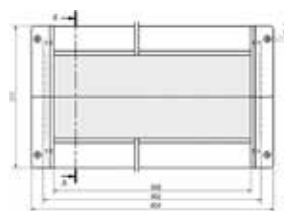

LUF20302

W	H	for type	Order No.	UP
270	220	Length, 270 mm	03.028.211.9	1 set
600	220	Length, 600 mm	03.028.212.9	1 set

Dimensions in mm:

W = Width h = Installation height U = Standard rack unit kg = Weight
 H = Height d = Insertion depth (1U = 44.45 mm)
 D = Depth L = Length UP = Packaging unit

Conversion:

1 mm = 0.03937 inch
 1 kg = 2.2046 pounds

Customized Vertiv™ SmartAisle™ Containment

Customized – Retrofitting Solution from Vertiv™

Features

- Precision fit on racks and rack rows.
- Suitable for retrofitting heterogeneous data centers.
- Combined with standard Vertiv SmartAisle™.

Data center structures are often the result of ongoing changes and modifications spanning a number of years.

The racks have different dimensions and they are not always positioned in a line. Knürr offers this solution based on a profile construction that can be made on site to correspond to the precise dimensions of a given data center.

With the customized solution, the dimensions are measured on site and the profiles and panels for the containment are cut and assembled to meet precise requirements. The panels are normally cut outside the data center in a designated area.

If possible, the customized elements are combined with standard components. As a rule, standard sliding or hinged doors are used. The standard top cover plate is generally used, thus, customized elements are only used to fill the gaps between the racks.



Free-Standing Vertiv™ SmartAisle™ Containment

Free-Standing – Vertiv's Special Solution

Features

- Can be flexibly adjusted to racks with non-standard dimensions.
- For racks and applications that are exchanged at intervals.
- Combined with standard Vertiv SmartAisle™.

Free-Standing System

In many data centers, so-called "free-standing systems" are installed in addition to the server racks. These often non-standard racks are regularly exchanged at defined intervals (usually one to three years).

Free-standing systems may include storage cabinets, cluster applications (e.g. IBM, SUN) or server racks (e.g. IBM, HP, SUN, etc.). There are a number of reasons for delivering a complete package including the racks. For storage applications, one of the main reasons is product liability. Cluster applications are usually leased and with server applications, the reasons are often marketing-related.

The challenge facing the SmartAisle™ for free-standing systems is to construct a flexible cold aisle containment, allowing a modular and fast exchange of these free-standing systems.

The free-standing cold aisle containment solution is based on standard Vertiv SmartAisle™ products and used in combination with these. The panels for the free-standing solution can be customized in both dimensions (height and width) according to the rack dimensions.



Vertiv™ SmartAisle™ Containment SwitchTubes

Switch Tubes – Switch Cooling from Vertiv™

Switches have special requirements.

Cooling/ventilation

- Mostly lateral air flow (from right to left, from left to right, from left and right toward the rear, including many other directions)
 - switches draw in warm air.
- Power requirements for cooling are often high (up to over 10 kW per switch).

Max. permitted input air temperature

- Max. permitted input air temperature is approx. 37° to 40°C
 - Probably higher inlet temperatures in efficient cold/warm separation environment.
 - High energy consumption for cooling.

Cabling

- Large cable volumes.
- Fan units free from cabling; repair work can be performed during operation.
- Air flow should have be free of cables.

Mechanics

- Various heights (1 U to approx. 24 U).
- Various depths, where air can be drawn in from different areas.

Vertiv offers a large range of switch tubes for the most common switch types.

Features

- No hot spots.
- Suitable airflow routing.
- Utilized in energy-efficient data center.

Cooling switches

For cooling purposes, servers draw in cold air from the front and blow heated air out at the rear. By contrast, switches mainly draw the cold air in from the side and blow air out either laterally or at the rear. Since cooling problems arise in racks equipped with consistent hot/cold separation, Special airflow systems are required for switch applications to ensure reliability and energy efficiency.

The Vertiv SmartAisle switch tube is a flexible and safe add-on to the complete SmartAisle program. Various standard products are available for the respective switch types.

SwitchTubes – controlled switch cooling

Servers are usually cooled from the front to the rear, in line with modern and energy-efficient data center requirements. However, cooling direction for switches most often occurs from the side. In this application, the switches draw the cooling air out of the warm area.

The SwitchTube provides air for the switch from the cold aisle, where heated air is directed into the warm aisle..

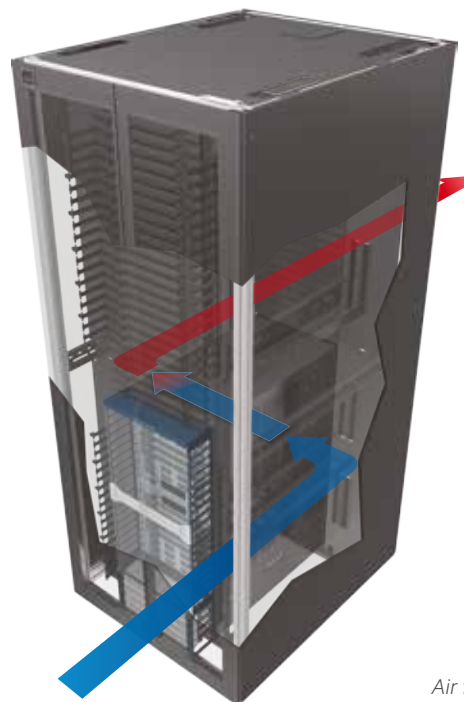

Air flow in switch rack for switches equipped with lateral cooling.

Vertiv™ SmartAisle™ 19" SwitchTube

Description

- For cooling a core switch from the cold aisle.
- Can be used with or without a raised floor.
- Provides energy-efficient cooling for laterally cooled switches.
- Cooling air drawn in from cold aisle (ideally with containment).
- Suitable for both Knürr MIR® and DCM® racks; width of rack 800 mm.
- Space requirement: 3 or 6 U of the 19" installation space.
- Suitable for a number of switch heights.
- Installation height of switches in rack can be adjusted.
- Perforated front panel to the air intake units prevents the exhaust of paper, etc. in the tube.
- Note: cold/warm separation in rack is required.

Material

- Tube: sheet steel.
- High-density foam: PUR ether foam (UL94 HF-1).

Finish

- Final digit of order number .1: powder-coated, RAL 7035 light-grey.
- Final digit of order number .8: powder-coated, RAL 7021 dark-grey.

Scope of delivery

- 2 x air intake units incl. perforated front panel (for 12 – 21 U models)
- 1 x air intake unit incl. perforated front panel (for 7 – 12 U / 4 – 6 U models).
- 1 x adjustable depth lateral air duct.
- 1 x High-density foam.
- 1 x Mounting kit.

How supplied

- In sets.

Important Note

Suitable for cooling max. 2-7 kW thermal load (at $\Delta T = 13 K$) per switch tube (see table on the next page).

Important Note

With many switches, part of the front air-intake perforation is covered (as these are generally located near the front, directly behind the front 19" extrusion).

Important Note

May not be suitable for switches with different cooling directions.

Note

Retrofitting may not be applied due to cables and other accessories.



LUF20360

03.029.217.X



LUF20379

03.029.217.X

W _{Rack}	Application	For rack type	Order No.	UP
800	Core switch 12 - 21 U	MIR®, DCM®	03.029.217.X	1 set
800	Core switch 12 - 21 U	MIR®, DCM®	03.029.218.X	1 set
800	Core switch 7 - 12 U	MIR®, DCM®	03.029.213.X	1 set
800	Core switch 7 - 12 U	MIR®, DCM®	03.029.215.X	1 set
800	Core switch 4 - 6 U	MIR®, DCM®	03.029.214.X	1 set
800	Core switch 7-12U	MIR®, DCM®	03.029.219.X	1 set



LUF20358

03.029.213.X



LUF20377

03.029.215.X



LUF20359

03.029.214.X



LUF20375

03.029.213.X

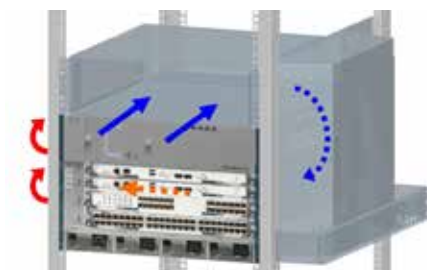

LUF20378

03.029.215.X

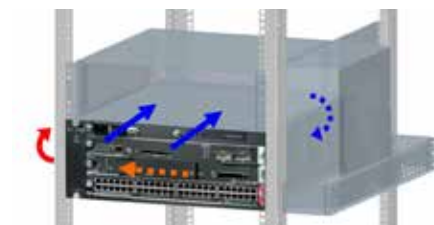

LUF20376

03.029.214.X

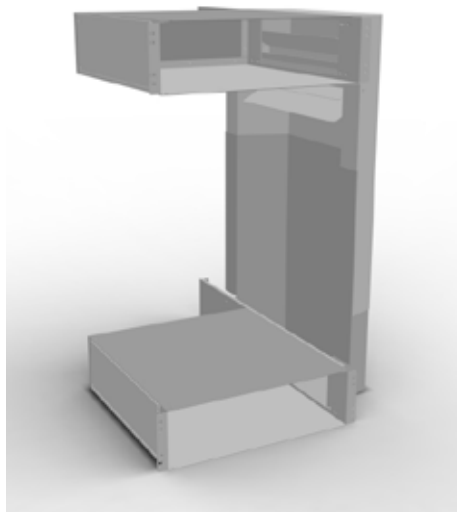

LUF20354



LUF20380

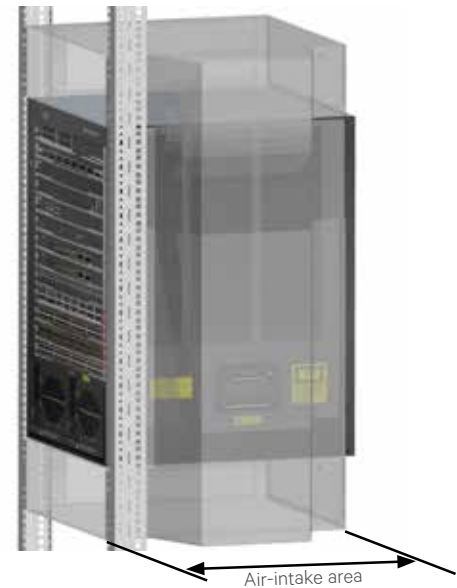

03.029.218.X

Item number	Switch height [U]	Max. cooling	Max. air-intake area depth in mm (Distance to 19" level)	Compatible with
03.029.217.X	12-21	approx. 7 kW ($\Delta T = 13 K$) per switch tube	460	CISCO Catalyst 6506(-E), 6509(-E), 6513, MDS 9509 Director
03.029.218.X	12-21	approx. 7 kW ($\Delta T = 13 K$) per switch tube	600	CISCO NEXUS 7009
03.029.213.X	7-12	approx. 2 kW ($\Delta T = 13 K$) per switch tube	320	CISCO Catalyst 4503, 4506, 4507R, 4510R
03.029.215.X	7-12	approx. 4 kW ($\Delta T = 13 K$) per switch tube	600	CISCO Nexus 7004
03.029.214.X	4-6	approx. 4 kW ($\Delta T = 13 K$) per switch tube	550	CISCO Catalyst 6503(-E), 6504(-E)
03.029.219.X	7-12	approx. 4 kW ($\Delta T = 13K$) per switch tube	460	CISCO CATALYST 6807-XL, Enterasys S4

Dimensions in mm:				Conversion:
W = Width	h = Installation height	U = Standard rack unit	kg = Weight	1 mm = 0.03937 inch
H = Height	d = Insertion depth	(1 U = 44.45 mm)		1 kg = 2.2046 pounds
D = Depth	L = Length	UP = Packaging unit		

Chassis Runner Tube T740

Description

- For supporting switches during installation in rack.
- Supports weight of switches during installation and fitting in rack.
- Can be used with SmartAisle™ 19" switch tubes 12 - 21 U.
- Suitable for insertion depth of 740 mm.
- Suitable for all 19" extrusions.
- Suitable for CISCO Catalyst 6506(-E), MDS 9509 Director.

Material / Finish

- Sheet steel, 2.0 mm, zinc passivated.

Scope of delivery

- 2 x chassis runners.
- 1 x Mounting kit.

How supplied

- In pairs.

w	U	D _{Rack}	For insertion depth	Order No.	UP
130	3	from 900	740	03.029.230.7	1 pair

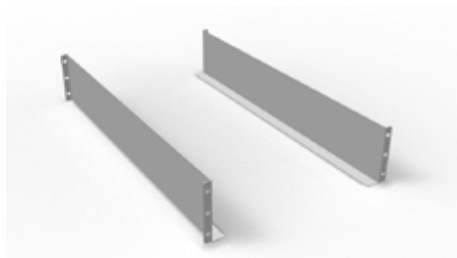

LUF20364



LUF20365



LUF20366

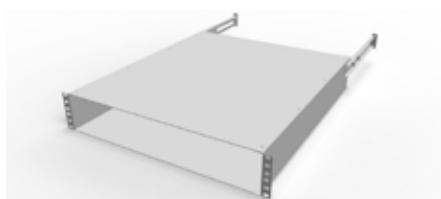

LUF20372

Vertiv™ SmartAisle™ SwitchTube Back-to-front for Switches with back-to-front Cooling

Description

- For 1 U switches with back-to-front cooling.
- Extractable – can be used for different switch depths.
- Suitable for various insertion depths.
- Compatible with both MIR® and DCM® racks.
- Suitable for Enterasys SSA 180.

- Final digit of order number .8: powder-coated, RAL 7021 dark-grey.

Scope of delivery

- 1 x air intake unit.
- 2 x rear support brackets.
- 1 x High-density foam.
- 1 x Edge protector.
- 1 x Mounting kit.

Material

- Tube: sheet steel.
- High-density foam: PUR ether foam (UL94 HF-1).

Finish

- Final digit of order number .1: powder-coated, RAL 7035 light-grey.

How supplied

- In sets.

w	H	U	For insertion depth	Model	Order No.	UP
450	875	2	600-750	for Switches with 1U height	03.029.212.X	1 unit
450	132	3	600-750	for Switches with 2U height	03.029.207.X	1 unit

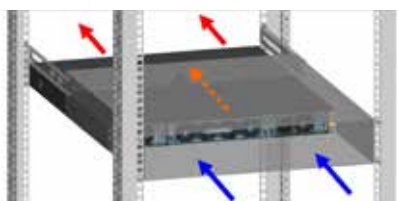

LUF20373

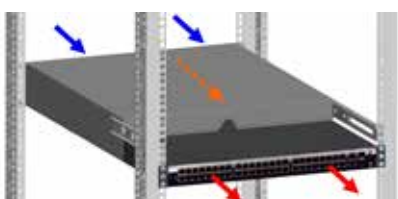

LUF20374

Vertiv™ SmartAisle™ 19" SwitchTube for Switch Heights 1 U / 2 U / 3 U

Description

- For 1 U, 2 U or 3 U switches with lateral cooling.
- Can be used in racks with front-to-back cooling.
- Extractable – can be used for different switch depths.
- Front or rear installation possible.
- Suitable for different cooling directions (from left to right, from right to left or from right and left toward the rear).
- Suitable for different insertion depths from 560 to 755 mm.
- Compatible with both MIR® and DCM® server extrusions.
- Suitable for rack widths of 600, 700, 800 and 1000.
- Suitable for CISCO Catalyst 3750, Juniper EX3200, Juniper EX4200.

Finish

- Final digit of order number .1: powder-coated, RAL 7035 light-grey.
- Final digit of order number .8: powder-coated, RAL 7021 dark-grey.

Scope of delivery

- 1 x air intake unit.
- 2 x lateral air ducts.
- 1 x side cover.
- 1 x High-density foam.
- 1 x Mounting kit.

How supplied

- In sets.

Note

Retrofitting may not be applied due to cables and other accessories.

Material

- Tube: sheet steel.
- High-density foam: PUR ether foam (UL94 HF-1).

W	H	U	For insertion depth	Model	Order No.	UP
440	881	2	560 - 755	for 1 U switch	03.029.210.X	1 unit
440	1325	3	560 - 755	for 2 U switch	03.029.211.X	1 unit
440	177	4	560 - 755	for 3 U switch	03.029.208.X	1 unit

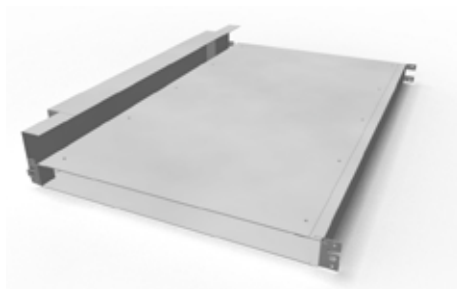

LUF20356

03.029.210.X



LUF20368

03.029.210.X

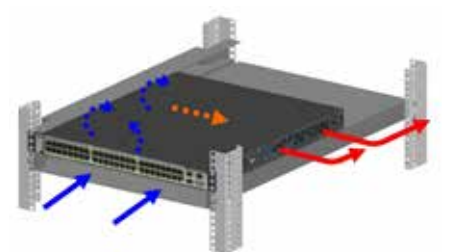

LUF20369

03.029.210.X

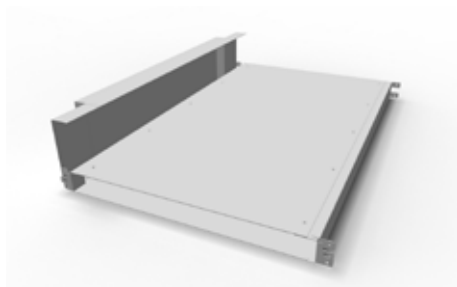

LUF20357

03.029.211.X



LUF20370

03.029.211.X

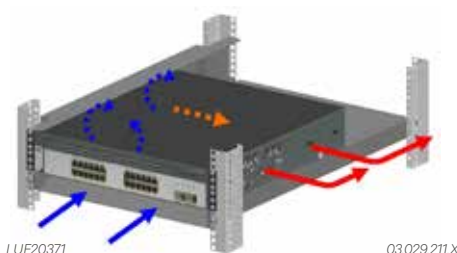

LUF20371

03.029.211.X

Vertiv™ SmartAisle™ SwitchRack for Cisco Nexus 7018

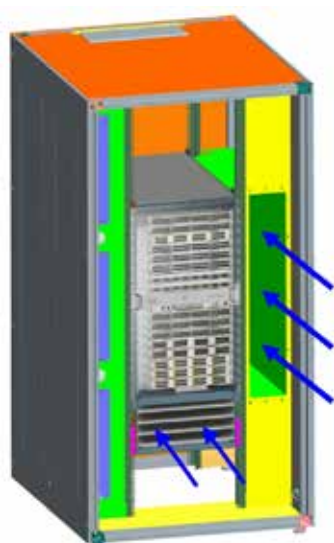

LUF20362

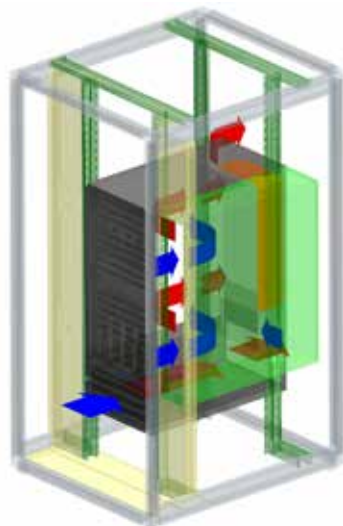

LUF20363

Description

- For installing a CISCO Nexus 7018 at a height of 7 U to 31 U.
- Based on DCM® rack.
- Rack width 1000 mm as per CISCO requirements for adequate cooling air.
- Prevents hot-spots (air recirculation).
- 200 mm clearance space for orderly cabling.
- Includes cold/warm plates for reliable and energy-efficient operation.
- Cold air drawn in from cold aisle.

Material / Finish

- Basic rack, extruded aluminum, polished.
- Corner piece, die-cast aluminum, polished.
- Doors, sheet steel, powder-coated texture.
- Covers, zinc-passivated sheet steel, powder-coated texture.
- PUR ether foam (UL94 HF-1).

Color

- Final digit of order number .1: visible surface of covers RAL 7035 light-grey.
- Final digit of order number .8: visible surfaces of the covers RAL 7021 dark-grey.

Scope of delivery

- 1 x basic frame.
- 4 x 19" server extrusions, sheet steel incl. U marking.
- 2 x side panels with quick connectors.
- 1 x top cover with cable entry (three-piece sliding plates can also be opened completely).
- 1 x front door, double, perforated, with handle and mounting for cylinder lock.
- 1 x rear door, double, perforated, sheet steel, with handle and mounting for cylinder lock.
- 1 x complete air separation unit (left plate with 3 x 2 U 19" cutouts, right plate with air duct).
- 4 x leveling feet.
- 1 x complete grounding set (VDE 0100).

How supplied

- Mounted.

Note

Also order mounting adapter for 19" server extrusion to mount Knürr accessories (01.147.640.9).

W	H	D	U	Recess depth	Insertion depth	Model	Order No.	UP
1000	2000	1200	42	200	740	DCM®	03.029.222.X	1 unit

Dimensions in mm:

W = Width	h = Installation height	U = Standard rack unit	kg = Weight
H = Height	d = Insertion depth	(1 U = 44.45 mm)	
D = Depth	L = Length	UP = Packaging unit	

Conversion:

1 mm	= 0.03937 inch
1 kg	= 2.2046 pounds

Vertiv™ SmartAisle™ Raised Floor SwitchTube

Description

- For cooling a core switch from the raised floor.
- Provides energy-efficient cooling for laterally cooled switches.
- Cold air drawn in from raised floor.
- Compatible with Vertiv Knürr® MIR® rack: width 800 mm (NOT for DCM® rack).
- Suitable for different switch heights.
- Installation height of switches in rack can be adjusted; tool-less blanking plates for covering areas outside of switches.
- Air-duct area: 420 cm².
- Size of cutouts in raised floor (min./max.): 355/410 x 127/162 mm.
- Note: Cold/warm separation in rack is required.
- Note: for max. switch air-intake depth from 460 mm (distance to 19° level).
- Suitable for CISCO Catalyst 6509(-E), Catalyst 6513, Catalyst 6506(-E), MDS 9509 Director, HP ProCurve 8212.

Material

- Tube: sheet steel.
- High-density foam: PUR ether foam (UL94 HF-1).

Finish

- Final digit of order number .1: powder-coated, RAL 7035 light-grey.
- Final digit of order number .8: powder-coated, RAL 7021 dark-grey.

Scope of delivery

- 1 x air duct with blanking plates (1 U, 3 U).
- 1 x bottom plate.
- 1 x Sealing material.
- 1 x Mounting kit.

How supplied

- In sets.

Important Note

- Suitable for cooling max. 4 kW thermal load (at $\Delta T = 13 K$) per switch tube.
- The tube covers part of the front air-intake perforation with many switch types (as these are generally located near the front, directly behind the front 19° extrusion).
- May not be suitable for switches with different cooling directions.
- The uppermost 3 U in the rack cannot be used for cooling.

Note

Retrofitting may not be applied due to cables and other accessories.

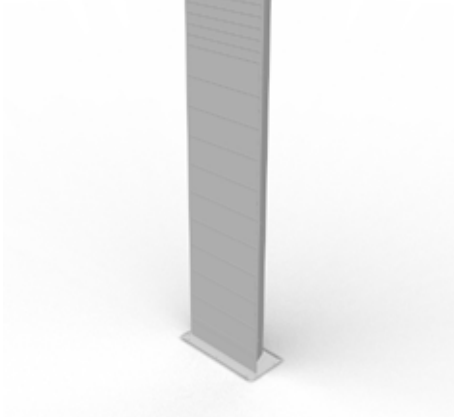

LUF20355



LUF20367

W	H	Item	For rack type	Order No.	UP
800	2000	Tube	MIR [®]	03.029.200.X	1 set
800	2200	Tube	MIR [®]	03.029.202.X	1 set

Dimensions in mm:				Conversion:	
W = Width	h = Installation height	U = Standard rack unit	kg = Weight	1 mm = 0.03937 inch	
H = Height	d = Insertion depth	(1 U = 44.45 mm)		1 kg = 2.2046 pounds	
D = Depth	L = Length	UP = Packaging unit			

Vertiv™

Rack Cooling Solutions

All issues and arguments to date can be summarized under three main criteria for assessing data center infrastructure.

1. Availability

The key issue for all data centers is availability. Maximum computing power, rapid access or lowest costs, are of little use if availability is jeopardized by uncertainties, failures or even lengthy downtimes.

Data center services users, whether it be in-house or a customer that outsources its computing power, will only remunerate the finest computing technology (including cloud computing) if they can rely one hundred percent on the availability of the data they need.

With Vertiv™ data center infrastructure, you are always in a position to achieve the degree of availability that matches your scope of work.

2. Efficiency

A customer who can rely on the availability will still be dissatisfied if this availability is achieved at the expense of efficiency. Efficiency must be seen as a multi-purpose term. Efficiency covers:

The functionality of technical processes, e.g. expressed in the efficiency of the cooling or power supply.

Cost effectiveness in terms of both investment and running costs. When we talk about investment, it is not just the pure equipment investment that matters;

other important factors are:

- Building costs
- Consequential costs for recirculation facilities
- Consequential costs for power supply facilities
- Efficiency of the cooling and power supply facilities
- Consumption values and costs for operating equipment
- Monitoring, service and repair costs.

Timely efficiency in relation to processing speed and the period from data provision to data output.

3. Adaptability

Availability and efficiency are only sufficient if planning, project management and implementation is short term rather than sustainable.

Future-proofing and adaptability for Vertiv are also crucial factors in the development and delivery of data center infrastructure.

Future-proofing redners data center infrastrucutre operational even:

- there is a demand for increased computing capacity
- the heat loads caused by new server types – or changes to the proportions of different server types – are increased or redistributed
- current flow and speed, volume flow or the pressure ratios are changed.

Products from Vertiv are future-proof and provide an appropriate and efficient response.

Adaptability delivers highly efficient results even during planning and project management and is, naturally, also part of future-proofing.



Vertiv™ Knürr® DCD

Cooling Door for Maximum Energy Efficiency

Vertiv™ Knürr® DCD is an air-water heat exchanger that is integrated in the rear door of a server rack. The heat exchanger is designed to absorb heat loads of up to 35 kW from server racks.

- Compact solution for new and existing data centers.
- Highest possible energy efficiency with shortage of fans.
- Supports cold-room concept.
- Permanent water circulation piping can be routed through water-carrying hinges.



Opened Vertiv Knürr DCD



Special water-bearing hinge



Water-connection fitting for the top



Condensation-water discharge fittings



Condensate pan

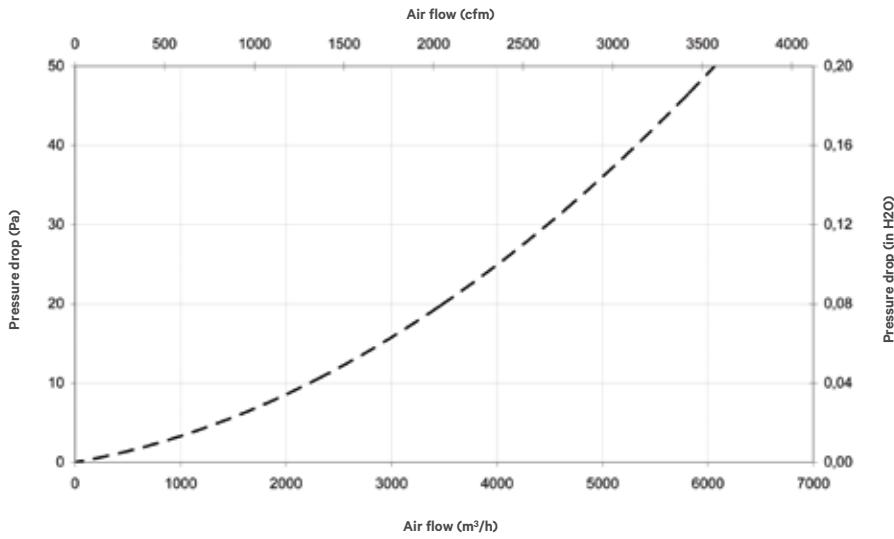

35Pa can be handled in servers with typical fans

Vertiv™ Knürr® DCD Benefits

■ Availability

- No additional fans are required for cooling; fan failure is no longer an issue.
- System is highly reliable.
- Fewer sources of failure.
- No additional fans needed; thus no heat is wasted.
- Guaranteed 35 kW cooling.
- Minimal air pressure drop for cooling air.
- Conduit and collector for condensate water in the event of the temperature dropping below dew point. Condensate water is discharged via a flexible 5/8" hose attached to a male coupling.

■ Efficiency

- Optimal space utilization through ultra compact design and hence very low room costs.
- Lowest possible pressure loss in water cooling circulation: only 54 kPa minimizes energy consumption of pumps.
- Minimal pressure loss in cooling air flow through optimized heat exchanger structure and linear air paths without bends: no energy costs incurred by additional fan for cooling unit.

■ Adaptability

- Standard heights for 2000 and 2200 mm (42 / 47U).
- Standard widths 600, 700 and 800 mm.
- Top or bottom cold-water connection (field can be adjusted).
- Using a special adapter frame, the Vertiv Knürr DCD cooling door is compatible with server racks from other manufacturers.

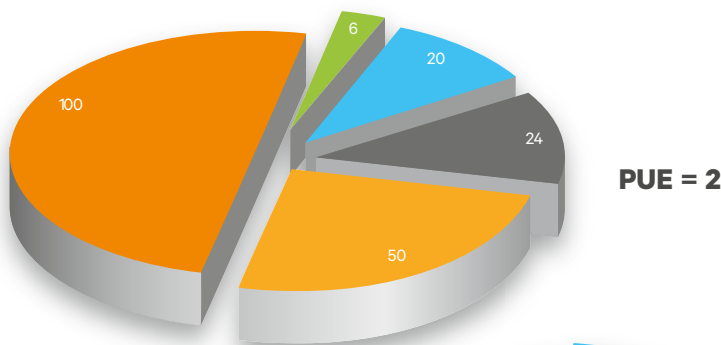

PUE = 1,2

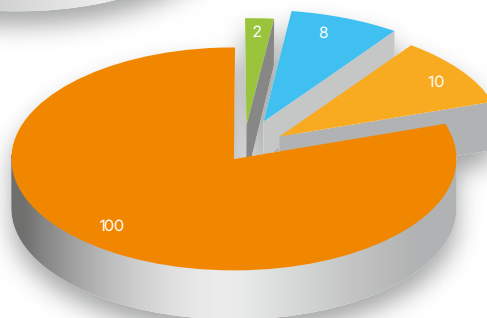

- Lighting
- Electrical losses
- Air circulation
- Cooling
- IT equipment

Vertiv™ Knürr® DCD Configurations



Vertiv™ Knürr® DCD open without trim



Server rack cooling components with Vertiv Knürr DCD cooling door

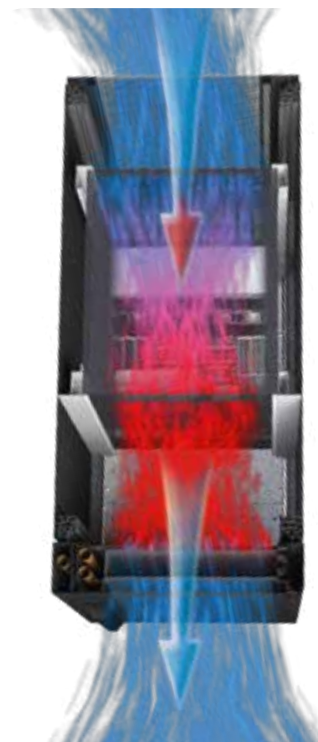

Server rack air flow with Vertiv Knürr DCL (cross-section)

Vertiv™ Knürr® DCD / DCM Basic Specifications

Cooling-air side

Housing material	Sheet steel (powder-coated)
Operating ambient temperature	10 °C ÷ 35 °C (50 °F - 95 °F) (other temperatures available upon on request)
Max. absolute humidity on site	8 g/kg
Air outlet temperature (as per ASHARE)	18 °C ÷ 27 °C (64.4 °F - 80.6 °F)
Air temperature difference - OFF	15 K ÷ 20 K

Cold-water side

Cooling power	35 kW
Cold water inlet temperature	12 °C ÷ 18 °C (53.6 °F - 64.4 °F) (other temperatures available upon on request)
Cold water outlet temperature	18 °C ÷ 24 °C (64.4 °F - 75.2 °F) (other temperatures available upon on request)
Max. operating pressure	10 bar (145 psi)
Pipe connection IN / OUT	1" female (on frame) (DIN ISO 228-1)

Vertiv™ Knürr® DCD Configuration number

Model number – Part 1/2										Detail of model										Part 2/2					
1	2	3	4	5	6	7	8	9	10	11	12	13	14	15	16	17	18	19	20	21	22	23	24	25	
D	C	D	3	5																					

1. – 5. Basic unit
Vertiv Knürr DCD is an air-water exchanger that is integrated into the rear door of a server rack. The heat exchanger serves to absorb heat loads from server racks up to 35kW. Thereby, it can be configured in such way that no thermal loads are released to the installation area.

6. Rack height
A – 2000 mm
B – 2100 mm
C – 2200 mm

7. Rack width
6 – 600 mm
7 – 700 mm
8 – 800 mm

8. Rack type
0 – No rack
3 – 3rd party rack adapter
A – Predisposition for DCM rack

9. CW connection – hinge position
1 – top left
2 – top right
3 – bottom left
4 – bottom right

10. Rack depth
0 – No rack
E – 1000 mm
F – 1100 mm
G – 1200 mm

11. Front Door
0 – No rack
C – One wing perforated right
G – Double wing perforated
L – One wing perforated left
X – Rack without front door

12. 19" rails front
0 – No rack
A – Symmetric with air separation and additional vertical U slots (Width 800 mm)
B – Symmetric with air separation (Width 600 mm)
L – Asymmetric with air separation and additional vertical U slots (Width 700/800 mm)

13. 19" rails back side
0 – No rack
A – Symmetric with air separation and additional vertical U slots (Width 800 mm)
B – Symmetric with air separation (Width 600 mm)
L – Asymmetric with air separation and additional vertical U slots (Width 700/800 mm)
S – Symmetric without air separation (Width 600 mm)
Y – Asymmetric without air separation (Width 700/800 mm)

14. Bottom Plate
0 – No rack
L – Cable entry for levelling feet
R – Cable entry for castors

15. Plinth
0 – No rack
A – Plinth H100 mm
B – Plinth H200 mm
F – Levelling feet
R – with castors (no plinth available)

16. Color
1 – RAL 7035 (light-grey)
G – RAL 7021 (black-grey)

17. Rack side panels
0 – No rack, without side panels
B – With both side panels

18. 19" front side jumpering depth
0 – None
A – 80 mm
D – 123 mm

19. – 20. Free

21. Packaging
P – Short distance (pallet, shrink wrap)
S – Long distance (Wooden box)

22. SFA – special features
A – No SFA
X – SFAs included

23. – 25. Free

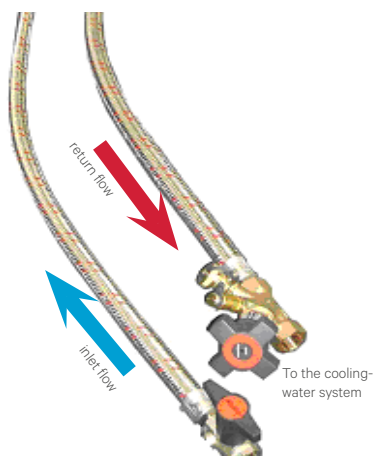

Draining and purging valve with nipple for measurement device connection (3/4", female) (for measuring water flow rate)



Ball valve

Shut-off and control valves (to set the volumetric flow rate)

To DCD - R1" To building chilled water connection - variable



Example of Connecting kit adapter

Vertiv™ Knürr® Chilled Water Connecting Kit

■ Application

– Simple connection to water circulation, simple start-up.

■ Consists of

– Two flexible armored tubes, stainless steel plated, water-resistant and frost-resistant EPDM. Nickel-plated pipe connections.

■ Temperature range

– 0 – 110° C.

■ Operating pressure

– Max. 10 bar.

■ Inner diameter

– 31 mm.

■ Connections

– Threaded connection, 1 1/4" (or 1"), flat sealing.

■ Length

– 1500 mm.

■ Ball valve connections

– 1 1/4" (or 1").

Shut-off and control valves with 3/4" draining and purging connection and a nipple for measuring pressure and temperature.

Connections: 1 1/4" (or 1").

Description	Order No.
Cold-water connection kit 5/4"	080090910
Cold-water connection kit 1"	080090660

Connecting adapter kit

■ Consists of:

– Two flexible pipes respectively for supply and return feed to increase the distance between the chilled water supply and return connection to the building and adapt its interface type.

– 300 mm.

■ Length

Description	Order No.
Pipe DN25 L300 R1" x 1" NPT	400005321
Pipe DN25 L300 R1" x Rp 1"	400005325
Pipe DN25 L300 R1" x Rp 5/4"	400005326

Liebert® DCL up to 35 kW

Modular Rack Cooling

Liebert® DCL, Granting Continuous Availability for Modular Rack Cooling

The Liebert DCL is the Thermal Management unit for lateral attachment to server cabinets offering a wide range of features designed specifically for data center applications.

The unit is available in two different architectures, closed or hybrid loop, and in multiple combinations of up to four server racks to match any customer needs.

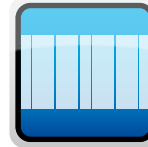

Modularity

- Two cooling architectures for medium to high heat-load density
- Easy to retrofit on site
- Multiple combinations of up to four server racks.



Reliability

- N +1 fan redundancy
- Multi-level “fail-safe” controller
- Comprehensive alarm and monitoring functions
- Automatic emergency door opening.



Energy Efficiency

- Minimized power consumption through EC fans and dynamic fan control
- Long freecooling times thanks to a generously dimensioned heat exchanger.

Liebert® DCL, a New Step Ahead in Energy Savings



Liebert® DCL with Vertiv™ Knürr® DCM Heavy-Duty Rack

Liebert® DCL Closed Loop Cooling Architecture

Modular Combination Possibilities

- Fully contained airflow inside the cabinet or the cabinet row
- No heat load, no airflow in the room, significant noise attenuation
- Complete separation of IT equipment from room, accurately controlled cooling air temperature
- No special requirements for the room - raised floor is not required.

Liebert® DCL with one Vertiv™ Knürr® DCM Heavy-Duty Rack



2-1 combination



High-density Server Rack cooled by two Liebert DCL



4-1 combination



Liebert® DCL Hybrid Cooling Architecture

Modular Combination Possibilities

- “Hybrid” configuration - airflow is contained in the cabinet or cabinet row and room
- Cooling units and cabinets are open at the front and closed at the back
- No heat load in the room, warm air remains inside cabinets
- Distribution of cold air throughout the room, cold air reserve in case of cooling system failure
- Better alternative to hot aisle containment
- No raised floor required

1 Vertiv™ Knürr® DCM rack cooled by 1 Liebert® DCL cooling unit



2-1 combination



1 Vertiv Knürr DCM rack cooled by 2 Liebert DCL cooling units



2-1 combination

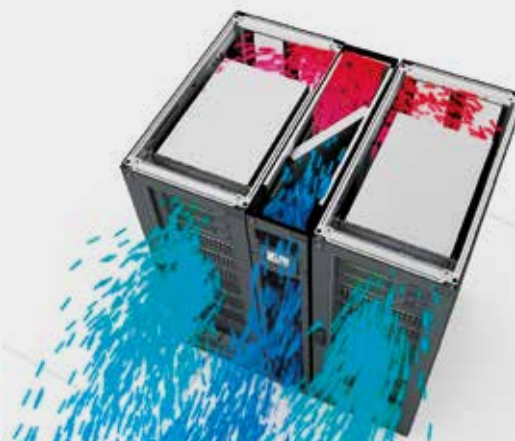

Liebert® DCL, Ensuring Endless Availability Under All Working Conditions

An essential requirement for data center operators which is ensuring uninterrupted availability Liebert DCL guarantees by means of:

- "Fail-safe" functioning ("safe despite faults") in the event of a controller failure, the control valve switches the full volume of the chilled water flow to heat exchangers and the fans to full speed
- With integrated Vertiv™ ICOM™ Control, the Liebert DCL is able to monitor variations in temperature and humidity, instantly adapting its performance to meet variations in heat load
- Access control and data security guaranteed by HTTPS and SNMP V3
- Local and remote (via BMS) alarm management
- Fan speed automatically adjusted in real time to follow changing airflow requirements of IT equipment
- Even air distribution to all internal IT components
- Even temperature profile in the air supply
- n+1 fan redundancy means that the remaining fans support the volume flow required for cooling in the event of a fan failure
- Non return flaps to avoid bypass of cold air through stand-by unit or through a failed fan
- Redundant A/B power supply with automatic operation
- Dual-circuit heat exchanger option ensures redundancy of the water supply if two independent chilled water circuits are installed
- Automatic door opening provides additional overheating protection in case of cooling system failure.



Automatic emergency door opening option for server rack



System with Liebert DCL unit for highest availability

Liebert® DCL, Top-Tier Efficiency and Adaptability

Considering today's competitive market, no data center operator can ignore the issue of costs. Anyone who only thinks about the upfront costs or who wants to cut costs at the expense of reliability will be left dealing with unpleasant surprises later on.

Clever decision-makers will consider Vertiv's experience of ensuring low running costs with maximum availability.

- Greater power density in the data center results in better utilization of space and reduced building costs
- Reduced running costs due to customized operation
- High chilled water supply temperature increases the proportion of freecooling during refrigeration and improves the energy efficiency rating (EER) of the chiller
- The control valve adjusts cold water volume flow for the current operational situation
- Low water-side pressure drop leads to reduced pump power consumption
- Energy cost savings by adjusting the fan speed to the airflow level actually required using the embedded controller
- Low air pressure drop leads to the fans using less power
- EC fans guarantee energy efficient operation with maximum performance over the entire range of fan speeds
- Optional cooling capacity meter to inform the operator about cooling output of the unit (kW)
- Minimum possible investment for cooling components thanks to the option to use up to four server racks for each Liebert® DCL
- Facilitates data center upgrade through its gradual expansion with no need to invest further in different cooling infrastructures
- Can be adapted to different shapes and spaces
 - Heights 2000 mm and 2200 mm
 - Depths 1200 and 1300 mm
- 2 cooling versions - Hybrid or Closed Loop - to meet cooling requirements of various end users
- Simple switchover between 2-way and 3-way valve by means of a ball valve in the bypass line.



Liebert DCL with Vertiv Knürr® DCM Rack



Vertiv™ Knürr® DCM Heavy-Duty Rack server rack for cooling with Liebert DCL, Liebert power distribution modules and integrated cable management

Liebert® DCL Performance Data, Features and Options

STANDARD FEATURES AND OPTIONS

- Field adjustable 2 way / 3 way valve
- 0-10V valve actuator
- Top / Bottom piping connections
- Energy efficient EC Fans
- Vertiv™ ICOM™ Control with large coldfire display "Fail Safe" design
- Unit provided with castors and levelling feet
- Return and supply air temperature sensors
- Rack temperature sensors
- Alarms monitoring.



ADDITIONAL OPTIONS

- Smoke detection
- Leak detection
- Automatic door release in case of cooling failure
- Door status monitoring
- Double CW feed version
- Condensate pump
- Double Power Supply
- BMS monitoring via multiple communication protocols
- Cooling capacity meter

	DC032	DC038
Net Sensible Cooling Capacity (kW)	30.0	34.6
Airflow (m³/h)	4850	6000
Number of Fans	4	6
Vertiv Knürr® DCM Units Height	42 U / 47 U	
Unit Height (mm)	2000 / 2200	
Unit Width (mm)	300	
Unit Depth (mm)	1200 / 1300	

Note: The performances shown above refer to an air inlet temperature of 37°C and chilled water temperature of 10/15°C for a closed loop configuration with racks on both sides



Liebert® CRV from 10 to 60 kW

Efficient Cooling for IT Equipment

Liebert® CRV Row-Based Cooling

The Liebert CRV, row-based cooling unit is optimized to ensure maximum cooling capacity in a minimal footprint. Targeted for small and medium data centers, the unit provides cooling at the server rack level.

The Liebert CRV has been designed to deliver the highest efficiency and availability, by removing heated air from the data center hot aisles, using it to return cooled air to the servers (cold aisle). The Liebert CRV is available in Direct Expansion, as well as Chilled Water versions and in two frame widths - 600 mm and a compact 300 mm. Providing full capacity and airflow modulation to match the servers' load, the unit is able to deliver energy savings via Scroll Compressor with capacity modulation, Electronic Expansion Valve and variable speed EC Fans. The Liebert CRV is a comprehensive row-based solution that includes all of the

main functions fundamental to cooling units, such as cooling, humidification, dehumidification, re-heating, air filtration, condensation management, temperature and humidity control, alarm functions and data communications.

Furthermore, the unit enhances its performances and energy efficiency through the Vertiv™ ICOM™ Control, capable of optimizing unit operations by leveraging on its intelligent management of system components. All components are easily accessible from the front and the rear of the unit, granting simplified service intervention.

The unit also allows ease of installation, through simplified cable and pipes routing from top and bottom of the unit.



Liebert CRV 300 mm DX



Data center cooling infrastructure for small and large applications.

Designed to Optimize IT Performance

The Liebert® CRV, self-contained Thermal Management unit is ideal for the cooling of data center rack rows

The Liebert CRV is a multi-option, precision air conditioner that delivers temperature and humidity control, as well as filtration and notification management, ensuring that data center temperatures are maintained at an optimum level.

The unit is designed to continuously monitor variations in heat loads and instantly deliver the most efficient and effective cooling necessary.

Liebert CRV: Simple, Safe, Adaptable

The Liebert CRV is a plug-and-play unit with the capability of addressing the needs of both open and contained applications.

Cooling is provided at the server rack level rather than the room level. The Liebert CRV removes and filters hot air from the data center aisles, using it to return cooled air to the servers.

The integrated air diffusers accurately direct the airflow towards the necessary direction of the heat load.

Furthermore, Liebert CRV is designed to comply with mission-critical requirements and ensure that servers are maintained at the correct temperature and humidity levels.

The Liebert CRV provides the exact level of cooling required by servers, modulating the airflow and cooling capacity.

The unit is available in two versions to meet various installation demands:

- A stand-alone, direct expansion system with variable capacity up to 36 kW, available in both 300 mm and 600 mm versions, complete with roof or wall-mounted condenser
- A chilled water system with up to 60 kW of capacity available in both 300 mm and 600 mm versions.

FEATURES AND PERFORMANCE

- Units ranging from 10 to 60 kW with chilled water and direct expansion versions
- Industry's highest energy saving levels achieved - increase of up to 50% when the Liebert CRV is combined with Vertiv™ SmartAisle™ cold aisle containment
- Best-in-class Thermal Management unit for row-based applications
- On-site adjustment capability of air diffuser distribution direction maximizes cooling results
- Integrated Vertiv ICOM™ Control for management of capacity and airflow through EC Fans and variable capacity Scroll Compressor
- Ideal for scalable IT infrastructure - increased cooling capacity, reduced noise levels and enhanced efficiency when compared with similar chilled water and direct expansion configurations.

Ensuring Availability Under All Working Conditions

Maintaining IT Infrastructure Availability

With integrated Vertiv™ ICOM™ Control, the Liebert® CRV is able to monitor variations in temperature and humidity, instantly adapting its performance to meet variations in load conditions.

This furthermore ensures increased availability and safety of protected IT equipment.

The Liebert CRV's constant temperature monitoring and control capabilities ensure the availability of servers in all working conditions.

Furthermore, its parallel load sharing functionality enables the management of N+1 configurations.

Meeting Primary IT Requirements

The Liebert CRV's ability to modulate capacity allows for constant, accurate room temperature and humidity levels to be maintained.

The variable capacity capability of the Liebert CRV, contributes to increasing data center availability during both standard operations and in the event of load variations.

A reduction in its start/stop cycling function further contributes to increasing data center availability, as well as lengthening the life of critical components.

The integrated compressors with cooling capacity modulation are designed to avoid peaks in absorbed power, thus reducing the stress placed on components. The Liebert CRV uses a dedicated control that also enables the compressor to operate when the external air temperature increases above standard limits.

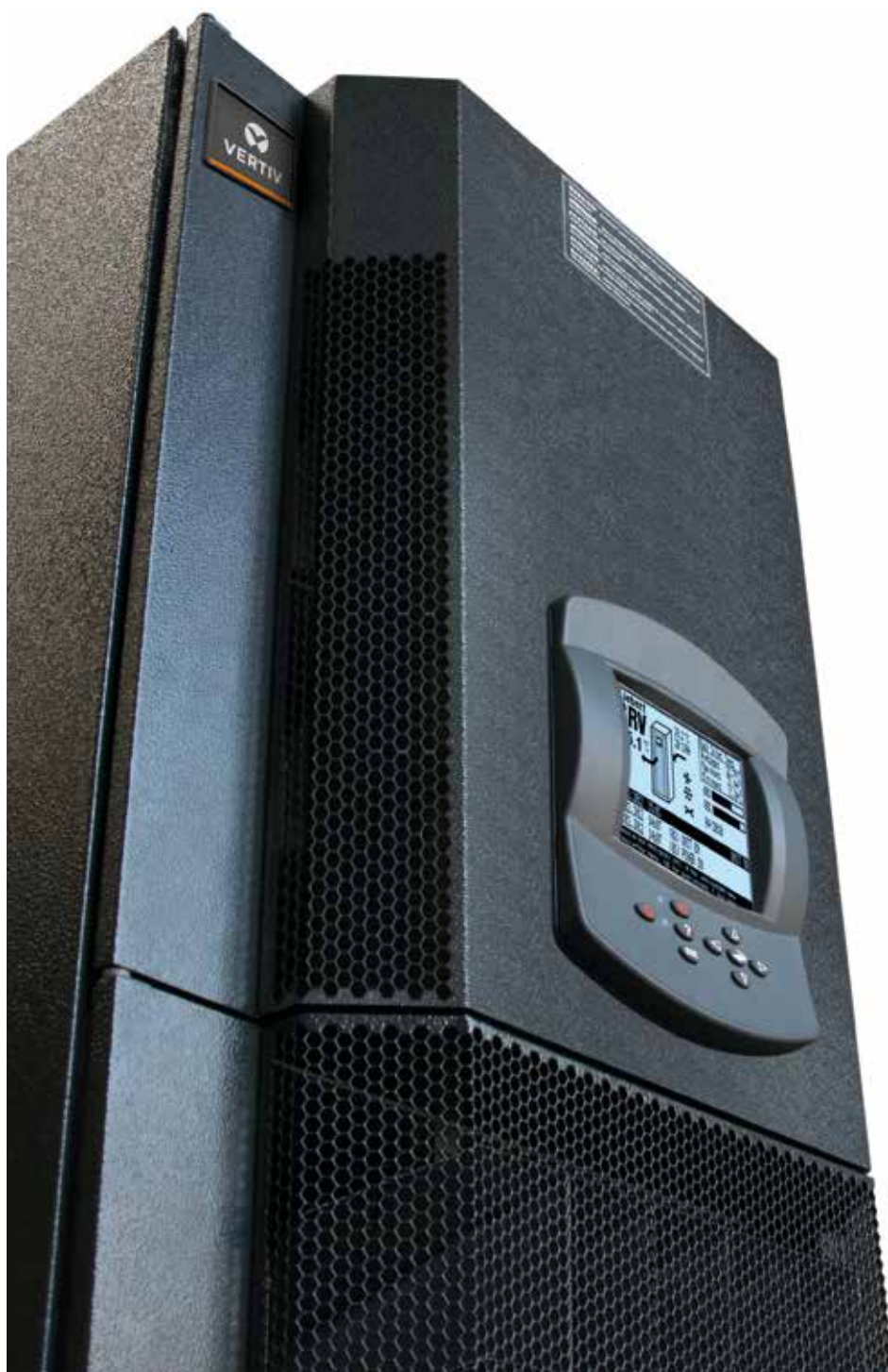

The Liebert CRV 600 mm, self-contained Thermal Management unit is ideal for the cooling of row-based applications.

Extreme Flexibility for Open and Closed Architectures

Suitable For a Wide Range of Installations

The Liebert® CRV addresses the cooling needs of both new and existing data center space, regardless of raised floor availability. It is ideally suited to data centers with up to 50 racks, irrespective of heat load.

Configuration Flexibility

The Liebert CRV can be configured to perform temperature as well as humidity control. The Liebert CRV 300 mm and 600 mm width versions have been designed to specifically meet the requirements of data centers in need of optimizing space occupancy, as well as capital and running costs.



The Ideal Airflow

EC Fans and compressors with variable cooling capacity, managed through integrated Vertiv™ ICOM™ Control, achieve flexible capacity and airflow for the ideal operating conditions of IT equipment.

The Liebert CRV, designed using advanced, computer-aided dynamic fluid technology, delivers optimum air distribution across rack installations. The exceptional levels of air distribution have been proven as a result of wide-scale laboratory and field testing.

Optimizing Total Cost of Ownership

Delivering Optimized Results

Ideally suited for rack-level cooling and specifically designed for high return air temperatures, the Liebert CRV optimizes air distribution and maximizes efficiency, delivering both cost and energy-related savings.

Efficiency is further enhanced through the use of the environmentally friendly R410A refrigerant which ensures constant operation at the highest efficiency levels.

The Liebert CRV is also designed to optimize installation and minimize start up, connection and labor investments. Total cost of ownership advantages are also achieved as a result of the Liebert CRV configuration flexibility. The unit is available for integration with existing racks or as a bundled solution combined with racks, UPS and monitoring capabilities.

Energy Efficient Cooling

The integrated Vertiv ICOM Control, equipped with up to 20 rack temperature sensors, continuously monitors the heat load of the racks and regulates the Liebert CRV, ensuring it provides the most effective level of cooling while at the same time delivering energy savings. Variable capacity compressors modulate the cooling capacity, thus reducing input power with partial loads. EC Fan technology regulates airflow and reduces fan input power.



The integrated Vertiv™ ICOM™ Control monitors variations in temperature and humidity, instantly adapting Liebert® CRV performance to meet changes in load conditions.



Customer Monitoring Interfaces

Basic Web Access

Basic operational information can be made available through the monitoring feature offered by the Vertiv™ ICOM™ Control over Ethernet. A web browser is the only requirement needed for the unit to communicate directly with the local or remote web interface.

Monitoring and Control Through Existing Network Via your Web Browser

The Liebert® CRV system can be fitted with a Vertiv IntelliSlot® Unity Card allowing full advantage to be taken of the Ethernet network and remote monitoring from your computer desktop, network operations center or any network access simply utilizing a standard web browser. A standard web browser, via HTTP protocol or Network Management System software via SNMP protocol, can be used to access the unit information.

Monitoring Integration with Existing Building Management System

If required, by installing the optional Unity card, the Liebert CRV can be monitored and controlled by an existing Building Management System. The Unity card provides Modbus, Bacnet and SNMP protocol support, other than the Web monitoring capability.

Vertiv™ Nform™ Software Centralized Management

As business grows, critical equipment infrastructure expands, thus the need for centralized management of any equipment is key to business success. Connecting to equipment in the distributed critical space is only part of the monitoring challenge.

Vertiv Nform leverages the network connectivity capabilities of Liebert CRV to provide centralized monitoring of the distributed equipment.

Utilizing the SNMP and Web technologies integrated in the Vertiv IntelliSlot communication card, Vertiv Nform centrally manages alarm notifications and provides an intuitive interface to access critical status information. Vertiv Nform allows critical system information to be readily available to support personnel wherever they are, increasing responsiveness to alarm-event conditions, thus allowing IT organizations to maximize their system availability.

Vertiv SiteScan® Web Control, Data Capture, Energy Management and Planning

For customers who require extensive management of critical system equipment spanning multiple locations in an ever-moving global enterprise, Vertiv SiteScan Web will centrally manage critical equipment and give the power to move beyond the event responsive service paradigm.

Vertiv SiteScan Web does it all

- Real-Time Monitoring and Control
- Event Management and Reporting
- Data Analysis and Trending
- Building Management Integration

Vertiv SiteScan Web is a comprehensive critical system management solution dedicated to ensuring reliability through graphics, event management and data export. The standard web interface allows users easy access from anywhere, anytime.

Data Center Application Scenarios

Data Center Rooms with up to 10 Racks

The Liebert® CRV is installed in close proximity to servers for installations relating to network access cabinets and small computer rooms, regardless of the presence of a raised floor. The cooling unit, equipped with ten temperature sensors, modulates the airflow to match the real-time cooling requirements of the server.

Direct Expansion Solution

When a chilled water system and physical building limitations restrict the installation of chillers, a direct expansion solution is the ideal choice.

In the event that internal and external units are installed in close proximity, direct expansion units are able to deliver significant reductions in installation-related time and costs. One of the advantages of

the Liebert CRV with a direct expansion solution is the eco-friendly refrigerant R410A. The unit also offers variable capacity scroll compressor, which has the capability of immediately modulating and adapting its operation according to server cooling requirements. It significantly minimizes start/stop cycling, extending the life cycle of your cooling equipment. The Liebert CRV, operates with a significant return air

temperature, which contributes to maximizing cooling capacity and increasing efficiency without placing additional stress on compressors.

Scenario 1	N° of Racks	1 to 4
	Heat Load	Up to 20 kW
	Space	From 5 m ² and 15 m ²
	Raise Floor	-
	Recommended Solution	Direct Expansion



Scenario 2	N° of Racks	Up to 10
	Heat Load	Up to 100 kW
	Space	Up to 30 m ²
	Raise Floor	-
	Recommended Solution	Direct Expansion



Data Center Rooms with up to 50 Racks

The Liebert® CRV's integration with Vertiv™ SmartAisle™ proves to be the ideal cold aisle containment approach for small data centers requiring heat density increases. This solution has the added advantage of avoiding the installation of raised floors or heightening roof levels.

Chilled Water Solution with Vertiv™ SmartAisle™

The Vertiv SmartAisle separates hot returning air and cold supply air, optimizing the entire cooling solution. By increasing the room temperature, the floor-mounted cooling units can be significantly downsized, reducing the overall level of investment. The higher Energy Efficiency Ratio also improves energy savings and dramatically reduces running costs. The solution delivers the best results when combined with the Liebert HPC - maximizing the freecooling effect and reducing running costs.

Combining the Liebert® CRV with the Liebert HPC Freecooling Chiller for Increased Advantages

Chilled water solutions are optimized to reduce energy consumption:

- With the use of EC Fans and the unit's close proximity to the racks, the Liebert CRV minimizes fan power input and can be regulated based on server load levels.
- As it is specifically designed for high return air temperatures, the Liebert CRV can operate at high chilled water temperatures while maintaining capacity, thus maximizing the chiller freecooling effect.

Scenario 3	N° of Racks	10 to 20
	Heat Load	Up to 200 kW
	Space	Up to 50 m ²
	Raise Floor	-
	Recommended Solution	Chilled Water



Scenario 4	N° of Racks	Up to 50
	Heat Load	Up to 300 kW
	Space	Up to 100 m ²
	Raise Floor	-
	Recommended Solution	Chilled Water



Liebert® CRV Technical Data

		CR011RA	CR021RA	CR020 RA/W	CR035RA/W	CR038RC	CR060RC	CR040	CR050
Net Sensible Cooling Capacity	[kW]	11.7	20.7	24.2	37.7	38.4	57.0	46.6	57.9
Nominal Airflow	m³/h	2700	4050	4170	5540	5420	7758	5650	7410
Weight	[kg]	220	230	335 / 350	365 / 385	220	230	330	365
Humidity Control		Yes	Yes	Yes	Yes	Yes	Yes	Yes	No
Dimensions H x W x D	[mm]	2000x300x1100		2000x600x1175		2000x300x1100 (*)		2000x600x1175	

Note: The performances shown above refer to an air inlet temperature of 38°C, condensing temperature for air and water-glycol cooled units of 45°C and a chilled water temperature of 7/12°C. (*) Unit available also with a 2200 mm height and 1200 mm depth.



STANDARD FEATURES AND OPTIONS

DX Version	CW Version
<ul style="list-style-type: none"> • High efficiency scroll compressor with capacity modulation • Electronic expansion valve • EC plug fans • R410A Refrigerant • Adjustable modular baffle system • Top and bottom connections • Casters and levelling feet • Filters with up to F5 filtration class and clog filter switch • Electrode humidifier • Electric reheat 1-stage • Internal condensate pump • Vertiv™ ICOM™ Control large graphic display • (6) remote rack temperature sensors • Monitoring card for WEB, Modbus and BACnet • 5 port ethernet switch. 	<ul style="list-style-type: none"> • EC plug fans • 3-way or 2-way valve with 0-10 V actuator • Adjustable modular baffle system • Top and bottom connections • Casters and levelling feet • Filters with up to F5 filtration class and clog filter switch • Electrode humidifier • Electric reheat 1-stage • Internal condensate pump • Vertiv ICOM Control large graphic display • (6) remote rack temperature sensors • Monitoring card for WEB, Modbus and BACnet • 5 port ethernet switch.

ADDITIONAL OPTIONS

DX Version	CW Version
<ul style="list-style-type: none"> • Extra Vertiv ICOM Control display • Additional remote rack temperature sensors • Compressor jacket (600 mm models) • Dual power supply with ATS • Vertiv Sitescan® monitoring card. 	<ul style="list-style-type: none"> • Extra Vertiv ICOM Control display • Additional remote rack temperature sensors • Dual power supply with ATS • Sitescan monitoring card • Cooling capacity meter.

Coupling Air Cooled Liebert® CRV Units with Air Cooled Condensers

Model	Ambient Temperature up to 35° C		Ambient Temperature up to 40° C		Ambient Temperature up to 46° C	
	Standard Noise	Low Noise	Standard Noise	Low Noise	Standard Noise	Low Noise
CR011RA	1 x HCR17	1 x HCR33	1 x HCR33	1 x HCR43	1 x HCR43	1 x HCR51
CR021RA	1 x HCR33	1 x HCR43	1 x HCR43	1 x HCR51	1 x HCR51	1 x HCR59
CR020RA	1 x HCR33	1 x HCR43	1 x HCR43	1 x HCR51	1 x HCR51	1 x HCR59
CR035RA	1 x HCR51	1 x HCR59	1 x HCR51	1 x HCR59	1 x HCR76	1 x HCR88

Condensers Dimensions

		Width	Depth	Height	Weight
HCR17	[mm] / [kg]	896	1053	980	49
HCR33	[mm] / [kg]	1112	1340	910	75
HCR43	[mm] / [kg]	1112	2340	910	92
HCR51	[mm] / [kg]	1112	2340	910	93
HCR59	[mm] / [kg]	1112	2340	910	102
HCR76	[mm] / [kg]	1112	3340	910	136
HCR88	[mm] / [kg]	1112	3340	910	165

Coupling Water/Glycol Cooled Liebert CRV Units with Drycoolers

Model	Ambient Temperature up to 30° C		Ambient Temperature up to 35° C		Ambient Temperature up to 40° C	
	Standard Noise	Low Noise	Standard Noise	Low Noise	Standard Noise	Low Noise
CR20RW	1 x ESM018	1 x ELM018	1 x EST028	1 x ELM027	1 x EST050	1 x ELT047
CR35RW	1 x EST028	1 x ELM027	1 x EST050	1 x ELT055	1 x EST070	1 x ELT065

Dry Cooler Dimensions

		Width	Depth	Height	Weight
ESM018	[mm]	2236	820	1030	82
EST028	[mm]	2866	1250	1070	133
EST050	[mm]	2866	1250	1070	193
EST070	[mm]	4066	1250	1070	283
ELM018	[mm]	2236	820	1030	94
ELM027	[mm]	3136	820	1030	139
ELT047	[mm]	4066	1250	1070	225
ELT055	[mm]	4066	1250	1070	254
ELT065	[mm]	5266	1250	1070	302

CHILLED WATER COOLING

Chilled water cooling units may be coupled with Vertiv™ chillers (Liebert HPC or Liebert AFC series). The Liebert HPC chiller series offers a wide range of air cooled or water cooled solutions. Available with various noise thresholds and with freecooling modes, these units significantly enhance the system's energy saving capabilities. Liebert HPC freecooling chillers are available from 40 kW to 1600 kW. The Liebert AFC, Adiabatic Freecooling Chillers, are available from 500 kW to 1450 kW and are designed to maximize data center efficiency and availability.



Vertiv™ Knürr® PowerTrans2®

Power Distribution Rack

Features

- The Vertiv Knürr PowerTrans2 has a modular design with a versatile plug-in units that can be used as required.
- Plug and Play:
Only the main feed must be installed by a qualified electrician.
- The plug-in units can be inserted during operation; there are no downtimes.
- Elementary model:
Power distribution unit without metering.
- Metered version:
Power distribution unit offers extensive metering functions with a high level of accuracy (up to ±1%).
- Highest power density:
up to max. 346 kVA.

The Vertiv Knürr PowerTrans2 forms the interface between the low-voltage power supply and rack PDUs as well as further components for supplying servers and other IT devices.

Rack basics: connecting the Vertiv Knürr DCM rack and the existing PowerTrans2 19" plug-in units simply involves slotting the elements into a free slot and securing them. The rack is then immediately connected to the power supply. The power is distributed via the individual slot-in units, avoiding installation within the building.



PowerTrans2: 19" slot-in



Input Power

- Max. 250 A per phase.
- 1 ph. or 3 ph. feed.
- Max. 2 feeds per rack.



Modularity

- Output distributors can be installed as modules during running operation.



Output Distributor

- 230/400V – 32A via IEC 60309 socket.
- 230/400V – 16A via GST 18 socket.
- 230V – 32A via IEC 60309 socket.
- 230V – 16A via GST18 socket.



Monitoring

- Input level.

Vertiv™ Knürr® PowerTrans2®

Power distribution unit between
Liebert® APM™ UPS system and MPX rack PDUs

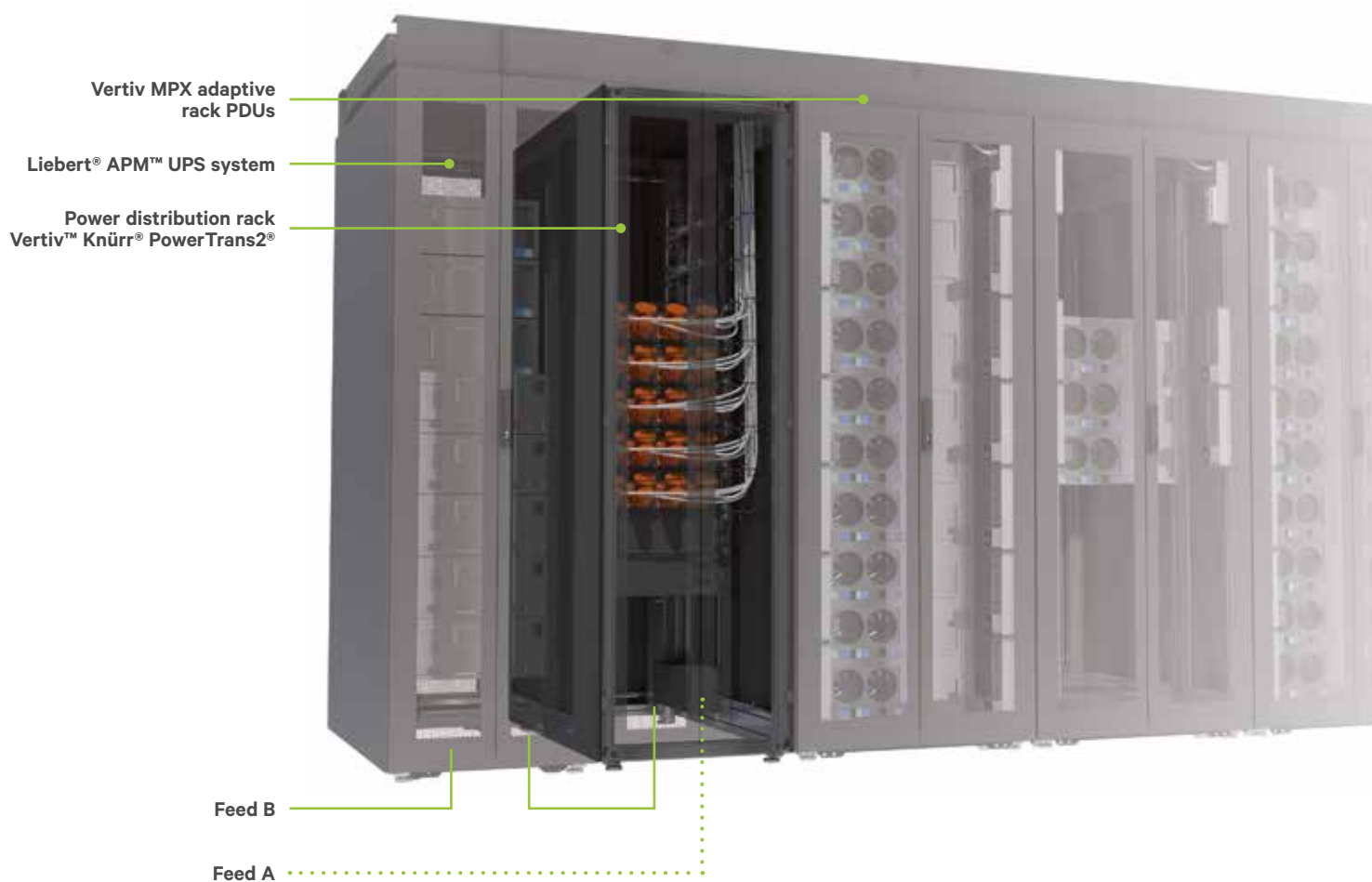

Benefits

- Two feeds (A + B) available for each rack.
- Optimum power distribution from the Liebert APM UPS system to the MPX rack PDUs.
- Each phase input from the Vertiv Knürr PowerTrans2 is monitored and evaluated.
- The Vertiv Knürr PowerTrans2 Basic can be populated with a maximum of 9 plug-in units, while the metered version can be populated with a maximum of 8 plug-in units.
- Minimal footprint due to a rack width of 600 mm.



Vertiv Knürr PowerTrans2

Vertiv™ Knürr® PowerTrans2® 19" Power Distribution Rack

Elementary and Monitored type

- Feed of 2 separate 3-phase 400V mains, L1, L2, L3, N, PE.
- Each with a 250 A circuit breaker in the input.
- Distribution to the individual plugs via busbars and contact-safe plug-in connections.
- Up to 8 (Monitored) / 9 (Elementary) slot-in units where A feed and B feed are possible.

Monitored type

- Provides the following phase-input data: voltage, current, effective power, consumption and frequency.
- Power alarm functions for the individual phases and their operating status are also supported.

Technical data Interfaces

- RJ-45 LAN port (10/100 MBit) – for connecting to local network (LAN) via an Ethernet cable.
- Serial interface: RS485.
- Remote management: Onboard Web Interface, SNMPv1,2,3, SSH and Syslog can be integrated into Vertiv Nform & Vertiv Trellis as well as Nagios or other management software programs.

Material / Finish

- Basic rack, extruded aluminum, polished.
- Corner piece, die-cast aluminum, polished.
- Perforated front door.
- Rear door, double, closed.
- Covers, zinc-passivated sheet steel, powder-coated texture.

Color

- RAL 7021 dark-gray.

Scope of delivery

- 1 x rack with covers, front door, rear door.
- 1 x set of safe-contact busbars, for A feed and B feed.
- 2 x circuit breakers, max. 250 A.
- 16 x (Monitored type) / 18 x (Elementary type) power supply plugs for the slot-in units wired on the busbars.
- 1 x 19" PowerTrans2 metering slot-in unit (Monitored type).
- 2 x 19" T-slot extrusions.
- 18 x chassis runners.
- 1 x complete earthing set.

W	H	D	U	Model	Cable entry	Order No.	UP
600	2000	1000	42	Elementary	Below	03.014.600.8.004	1
600	2000	1100	42	Elementary	Below	03.014.600.8.005	1
600	2000	1200	42	Elementary	Below	03.014.600.8.006	1
600	2200	1000	47	Elementary	Below	03.014.600.8.010	1
600	2200	1100	47	Elementary	Below	03.014.600.8.011	1
600	2200	1200	47	Elementary	Below	03.014.600.8.012	1
600	2000	1000	42	Monitored	Below	03.014.601.8.004	1
600	2000	1100	42	Monitored	Below	03.014.601.8.005	1
600	2000	1200	42	Monitored	Below	03.014.601.8.006	1
600	2200	1000	47	Monitored	Below	03.014.601.8.010	1
600	2200	1100	47	Monitored	Below	03.014.601.8.011	1
600	2200	1200	47	Monitored	Below	03.014.601.8.012	1
600	2000	1000	42	Elementary	Above	03.014.602.8.004	1
600	2000	1100	42	Elementary	Above	03.014.602.8.005	1
600	2000	1200	42	Elementary	Above	03.014.602.8.006	1
600	2200	1000	47	Elementary	Above	03.014.602.8.010	1
600	2200	1100	47	Elementary	Above	03.014.602.8.011	1
600	2200	1200	47	Elementary	Above	03.014.602.8.012	1
600	2000	1000	42	Monitored	Above	03.014.603.8.004	1
600	2000	1100	42	Monitored	Above	03.014.603.8.005	1
600	2000	1200	42	Monitored	Above	03.014.603.8.006	1
600	2200	1000	47	Monitored	Above	03.014.603.8.010	1
600	2200	1100	47	Monitored	Above	03.014.603.8.011	1
600	2200	1200	47	Monitored	Above	03.014.603.8.012	1



PowerTrans2

Vertiv™ Knürr® PowerTrans2® 19" Slot-in Power Distributor

- Power distributor slot-in for PowerTrans2 rack.
- Also functions without PowerTrans2 rack if used with a suitable connection cable.
- 19" slot-in housing.
- Width 19".
- Height: 3 U.
- Depth: 480 mm.
- Color: RAL 7021 dark-gray.
- 2 separate 3-phase inputs with max. 63 A phase current (feed A + feed B).
- Outputs are shown in the table below.
- Backups: 1-pole (for single-phase) or 3-pole (for 3-phase), 2-pole or 4-pole backups available upon request.

Inputs Phase tap per feed	Outputs		Order No.
	Feed A	Feed B	
L1-N, L2-N, L3-N	6 x 230Vac 16 A GST 18i3	6 x 230Vac 16 A GST 18i3	03.014.011.8.002
L1-N, L2-N	2 x 230Vac 32 A IEC60309 1ph/N/PE 6h	2 x 230Vac 32 A IEC60309 1ph/N/PE 6h	03.014.011.8.005
L2-N, L3-N	2 x 230Vac 32 A IEC60309 1ph/N/PE 6h	2 x 230Vac 32 A IEC60309 1ph/N/PE 6h	03.014.011.8.006
L3-N, L1-N	2 x 230Vac 32 A IEC60309 1ph/N/PE 6h	2 x 230Vac 32 A IEC60309 1ph/N/PE 6h	03.014.011.8.007
L1-N, L2-N, L3-N	3 x 230/400Vac 3 x 16 A GST18i5	3 x 230/400Vac 3 x 16 A GST18i5	03.014.012.8.002
L1-N, L2-N, L3-N	2 x 230/400Vac 3 x 32 A IEC60309 3ph/N/PE 6h	2 x 230/400Vac 3 x 32 A IEC60309 3ph/N/PE 6h	03.014.012.8.003

Vertiv Knürr PowerTrans2 Connection Cable

- Connection cable between 19" power distributor slot-in and rack PDUs

Length	Input connector	Output socket	Order No.
5000	230Vac 16 A GST 18i3	230Vac 16 A IEC60320 C19	03.014.013.9.001
5000	230Vac 16 A GST 18i3	230Vac 16 A IEC60309 1ph/N/PE 6h	03.014.013.9.003
5000	230/400Vac 3 x 16 A GST 18i5	230/400Vac 3 x 16 A IEC60309 3ph/N/PE 6h	03.014.014.9.001
5000	230Vac 32 A IEC60309 1ph/N/PE 6h	230Vac 32 A IEC60309 1ph/N/PE 6h	On request
5000	230/400Vac 3 x 32 A IEC60309 3ph/N/PE 6h	230/400Vac 3 x 32 A IEC60309 3ph/N/PE 6h	03.014.014.9.003
10000	230Vac 16 A GST 18i3	230Vac 16 A IEC60320 C19	03.014.013.9.002
10000	230Vac 16 A GST 18i3	230Vac 16 A IEC60309 1ph/N/PE 6h	03.014.013.9.004
10000	230/400Vac 3 x 16 A GST 18i5	230/400Vac 3 x 16 A IEC60309 3ph/N/PE 6h	03.014.014.9.002
10000	230Vac 32 A IEC60309 1ph/N/PE 6h	230Vac 32 A IEC60309 1ph/N/PE 6h	On request
10000	230/400Vac 3 x 32 A IEC60309 3ph/N/PE 6h	230/400Vac 3 x 32 A IEC60309 3ph/N/PE 6h	03.014.014.9.004



Rack PDUs Vertiv™ MPX™, Vertiv MPH2™ and Vertiv MPE

Your product range for the highest data center demands

The key aspects of this product range are:

- High availability for connected electrical loads.
- Optimized energy and capacity management.
- Simplified integration into management tools.
- Simplified physical and electrical installation.

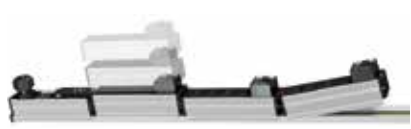
Overview: Vertiv Rack PDUs for Europe

								
Features	Vertiv MPX-Adaptive Rack PDU			Vertiv MPH2-Managed Rack PDU				Vertiv MPE Rack PDU
	MPX-R	MPX-B	MPX-I	MPH2-R	MPH2-M	MPH2-C	MPH2-B	MPE
Modular	■	■	■					
Remote interface	■	■	■*	■	■	■	■	
Measurement per phase	■	■	■*	■	■	■	■	
Measurement per group	■	■		■	■	■	■	
Measurement per output	■			■	■			
Switching per output	■			■		■		
Differential current metering				■	■	■	■	
Measurement parameters	A, V, W, kWh, VA, Hz, power factor, crest factor	A, V, W, kWh, VA, Hz, power factor	A, V, W, kWh, Hz	A, V, W, kWh, VA, Hz, power factor, crest factor	A,V,W,kWh, VA, Hz, power factor, crest factor	A,V,W,kWh, VA, Hz, power factor	A,V,W,kWh, VA, Hz, power factor	
Input	1 ph + 3 ph max. 63 A	1 ph + 3 ph max. 63 A	1 ph + 3 ph max. 63 A	1 ph + 3 ph max. 32 A	1 ph + 3 ph max. 32 A	1 ph + 3 ph max. 32 A	1 ph + 3 ph max. 32 A	1 ph + 3 ph max. 63 A
Outputs	IEC C13 & C19 Schuko	IEC C13 & C19 Schuko	IEC C13 & C19 Schuko Schweiz GST18	IEC C13 & C19	IEC C13 & C19	IEC C13 & C19	IEC C13 & C19	IEC C13 & C19 Schuko
Sensor connections	■	■	■*	■	■	■	■	

The range of Vertiv MPX and Vertiv MPH2 accessories is almost identical, which simplifies administration!

* Only in conjunction with Vertiv MPX-PEM monitored.



Vertiv™ Knürr® DIS Rack PDU® Socket System

Your product range to cover basic requirements in all areas

The key aspects of this product range are:

- Robust design with the highest level of quality.
- Cost effective thanks to flexible and simple assembly.
- Numerous designs for all application areas in IT, network technology, laboratories, and in the home.

Overview: Vertiv™ Knürr® DIS Rack PDU® for Europe

			
Features	Knürr DIS Rack PDU I	Knürr DIS Rack PDU D	Knürr DIS Rack PDU E
Local display	■	■	
Remote interface	■		
Measurement per phase	■	■	
Measurement parameters	A, V, W, kWh, VA, Hz, power factor	A, V, W, kWh, VA, Hz, power factor	
Input	1 ph + 3 ph max. 32 A	1 ph + 3 ph max. 32 A	1 ph + 3 ph max. 32 A
Outputs	IEC C13 & C19 Schuko, Frankreich, Schweiz	IEC C13 & C19 Schuko, Frankreich, Schweiz	IEC C13 & C19 Schuko, Frankreich, Schweiz

Vertiv™ MPX™ – Adaptive Rack PDU

Respond to change and maximize profits

No-one can make definite predictions about the power-supply demands the future will bring. But one thing is certain: the versatile, adaptive Vertiv™ MPX™ rack PDUs equip you with the wherewithal to face all eventualities. They enable you to react quickly to changes in rack equipment and provide dynamic capacities, offering:

- Modular hot-swap-enabled output power
- Modular hot-swap-enabled communication
- Modular input power.



Benefits of Vertiv MPX

- **Adaptive** capacity, distribution, monitoring, control and administration of critical equipment.
- **Flexibility** in reacting to constant changes – modules can be regrouped to accommodate altered requirements.
- **Only purchase what you really need** and utilize existing investments.
- **Reliable communication.**

Flexible, configurable input and output distribution

The scalable design of the MPX rack PDU allows on-site configuration that meets the current requirements of the IT equipment. It is the perfect solution for coping with the ever increasing demands of expanding data centers. You can set up your IT equipment at another location or add new components to extend your environment. All you need to do in this case is simply reconfigure the power supply and the power distribution.

Equipped to face the demands of today and tomorrow

The MPX rack PDU supports a variety of configurations for single-phase and three-phase power inputs enabling changes while retaining the distribution infrastructure.

Developed for critical environments

- **Critical rack operating temperature** – of up to 60° C suitable for high temperatures inside racks.
- **Accurate voltage and current metering** with tolerances of ±1% offer a comprehensive overview.
- **Energy and power metered** with outstanding precision all the way through to output level.
- **Extensive alert function; including notification before failure occurs.**
- **Monitoring of environment conditions** including alerts and alarms.
- **Notification** upon failure or if individual components are removed.

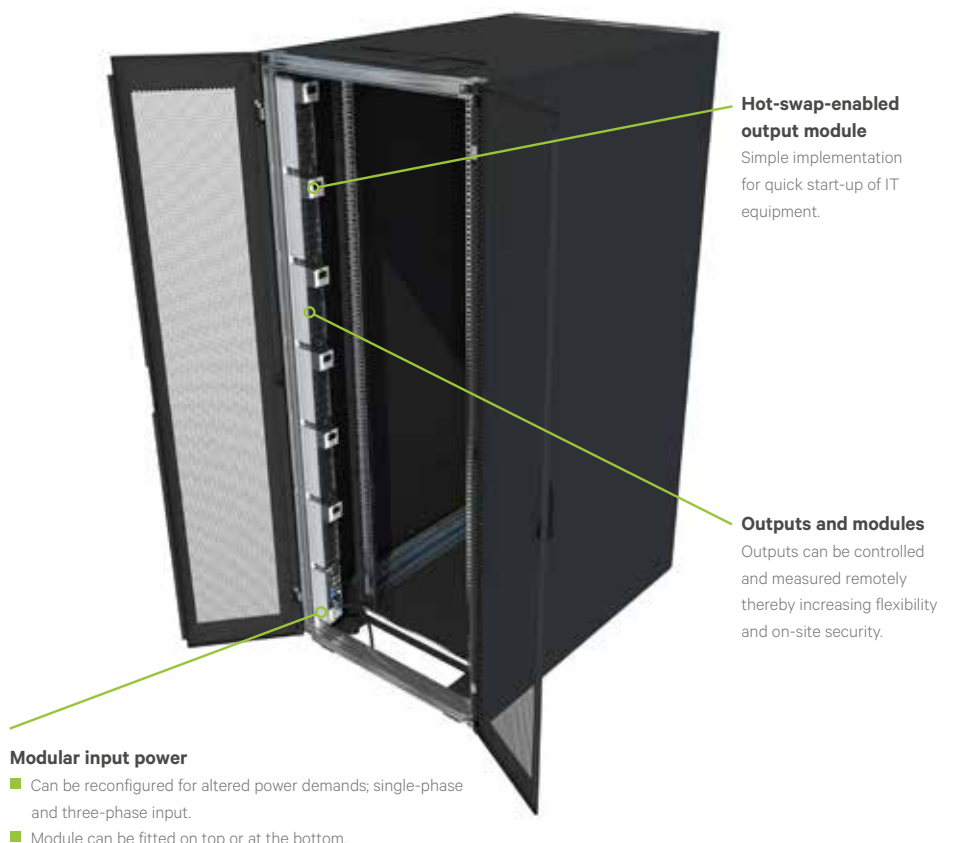

Hot-swap-enabled output module
Simple implementation for quick start-up of IT equipment.

Outputs and modules
Outputs can be controlled and measured remotely thereby increasing flexibility and on-site security.

Modular input power

- Can be reconfigured for altered power demands; single-phase and three-phase input.
- Module can be fitted on top or at the bottom.



Output module (MPX™ BRM):

Provides overload protection by distributing power to individual servers. Available functions: Elementary, Branch Metering and Output Metering with switch function.

The busbar (MPX™ PRC):

Serves as power and communication distribution for all supported modules. Available in two heights to accommodate different rack heights.

Power-rail spacer:

Reserves unused space until needed for an MPX™ module.



BDM™ local display module

Extended diagnostic functionality; customer-convenient display. Features include detailed information about alerts and specific labeling for outputs.



SN sensors:

Consolidates environmental monitoring of temperature, humidity and potential-free input contacts with the power supply at rack level.



Communication module (RPC2):

Installed in the power input module and offers an extendable interface for network communication, sensors and the local display.

Input module (MPX™ PEM):

Routes the input power to the busbar system of the Elementary model (without RPC2™) and the version with input metering (includes pre-installed RPC2™).



Vertiv™ MPX™

Benefits of the modular Vertiv MPX rack PDU

INPUT POWER

- Configurable: 20 to 60 A (USA); 16 to 63 A (EU).
- Single-phase and three-phase.
- Cable routing possible from above and below.

OUTPUT DISTRIBUTOR

- Scalable, combination-compatible and can be replaced during operation
- Single-phase NEMA 5-20R, IEC-C13, IEC-C19, Schuko, Switzerland, GST18.
- Load balance.

MODULARITY

- Input modules.
- Output modules.
- External display.
- External sensors.
- RPC2 communication card.

MONITORING

- Three levels: Input level, module level, output level.
- Temperature and humidity.
- Door contacts and floating break input contacts.

REMOTE CONTROLLED SOCKETS

- Socket level.

Featuring High Availability

- Heat resistant up to 60° C ensuring reliable operation in the warm aisle.
- Modular hot-swap-enabled output module, controller card and sensors; can be exchanged or updated during operation.
- Special switch relay (normally closed); connected servers have an uninterrupted power supply even in the event of failure.
- Redundant power supply for control electronics.
- Fixed databus on the busbar.
- Complete data tapping on the Power Entry Module (PEM) without any additional external monitoring devices.
- Proactive alert by additional metering of the neutral conductor and crest factor (assessment of network quality facilitating early detection of power-supply unit failures).

Maximum Flexibility and Scalability

- All modules configured in line with requirements (patented quick-mount fitting for safe installation).
- One busbar for different networks and power levels – input module can be freely selected. All other components are "hot-swap-enabled" when running operation.
- Mobile display for reading all MPX data on the rack.
- Optical slot-space display (easy server slot-space identification at the push of a button).

Highest Possible Power Levels in all Areas

- Power feed of max. 3 x 63 A; optimal for Blade server applications.
- Only one IP address for up to 4 rails with 24 modules.
- Plug and Play for numerous sensors.
- Extensive monitoring with a metering accuracy of $\pm 1\%$ right through to output level.
- Module and sensor autodetect function with operating software.
- Minimal power loss for MPX systems.

Vertiv™ MPX™

Four equipment models for different requirements

The Vertiv™ MPX™ modular rack PDU consists of various components. The basic element is a busbar, which is responsible for the power and communication distribution to the individual modules. The input power is routed via the MPX Power Entry Module (MPX PEM) to the MPX system. Different output modules (MPX Branch Receptacle Modules, MPX BRM) are available depending on requirements. Four different variants can be set up depending on the component population of the busbars:

1. Vertiv MPX Elementary

Modular basic power distribution without metering and control function. An upgrade to another equipment model is quick and easy.

2. Vertiv MPX Elementary Phase Monitored

Modular power distribution with metering on input. An upgrade to a superordinate line is possible by populating with appropriate output modules.

3. Branch-Monitored Vertiv MPX

Modular power distribution with metering on input and each output module. An upgrade or downgrade to another line is possible if installed with appropriate output modules.

4. Receptacle Managed Vertiv MPX

Modular power distribution with input, metering, each output module and each output. Individual outputs can also be switched on and off remotely. A downgrade to another line is possible if installed with the appropriate output modules.

A combination of the "Elementary Phase Monitored", "Branch-Monitored" and "Receptacle Managed" lines on a shared busbar is also possible and is one of the exceptional features of the MPX. Interfaces for the network communication, sensors and/or local display are provided by the Rack PDU Card (RPC) in the MPX PEM. The RPC Card enables connection to an optional RPC Basic Display Module (RPC BDM) to display local status and alerts.

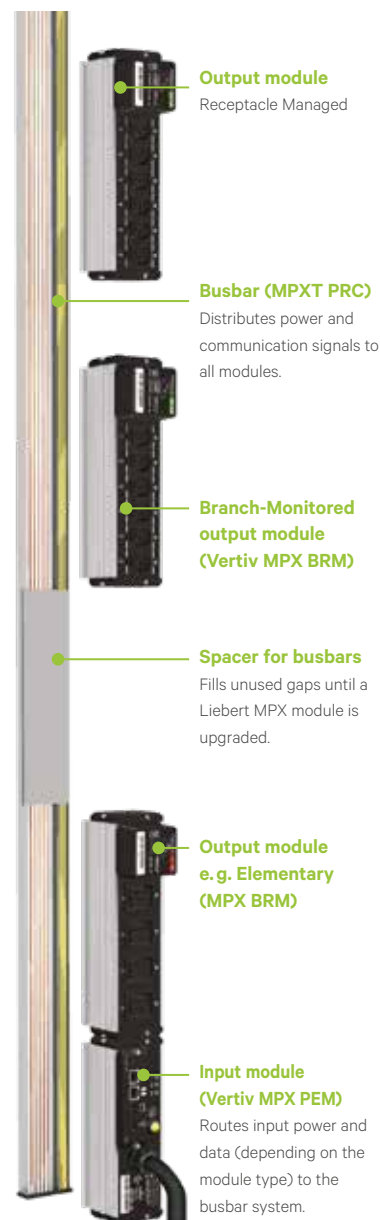

Vertiv™ MPX™ – Configuration models in Europe

		Four equipment models			
	Order number	Vertiv MPX Elementary	Vertiv MPX Elementary Phase monitored	Vertiv MPX Branch-monitored	Vertiv MPX Receptacle Managed
Busbar	Length 1035	MPXPRC-V1035XXX P	■	■	■
	Length 1880	MPXPRC-V1880XXX P	■	■	■
	Length 2144	MPXPRC-V2146XXX	■	■	■
Input Modules	1ph 16A fest	MPXPEM-EHABXS30	■	■	■
	1ph 32A fixed*	MPXPEM-EHAEXQ30	■	■	■
		MPXPEM-EHABXQ30	■	■	■
	3ph 16A fixed	MPXPEM-EHAEXT30	■	■	■
		MPXPEM-EHABXT30 P	■	■	■
	3ph 32A fixed	MPXPEM-EHAEXR30	■	■	■
		MPXPEM-EHABXR30 P	■	■	■
3ph 63A fixed	MPXPEM-EHBEXZ30	■	■	■	
	MPXPEM-EHBBXZ30	■	■	■	
Elementary Output Modules	IEC-C13 L1 (3)	MPXB RM-EEDC3N1N	■	■	■
	IEC-C13 L2 (3)	MPXB RM-EEDC3N2N	■	■	■
	IEC-C13 L3 (3)	MPXB RM-EEDC3N3N	■	■	■
	IEC-C19 L1 (2)	MPXB RM-EEDC2O1N	■	■	■
	IEC-C19 L2 (2)	MPXB RM-EEDC2O2N	■	■	■
	IEC-C19 L3 (2)	MPXB RM-EEDC2O3N	■	■	■
	IEC-C13 L1 (7)	MPXB RM-EEBC7N1N P	■	■	■
	IEC-C13 L2 (7)	MPXB RM-EEBC7N2N P	■	■	■
	IEC-C13 L3 (7)	MPXB RM-EEBC7N3N P	■	■	■
	IEC-C19 L1 (4)	MPXB RM-EEBC4O1N P	■	■	■
	IEC-C19 L2 (4)	MPXB RM-EEBC4O2N P	■	■	■
	IEC-C19 L3 (4)	MPXB RM-EEBC4O3N P	■	■	■
	Schuko L1 (3)	MPXB RM-EEBC3P1N P	■	■	■
	Schuko L2 (3)	MPXB RM-EEBC3P2N P	■	■	■
	Schuko L3 (3)	MPXB RM-EEBC3P3N P	■	■	■
	Switzerland T23 (4)	MPXB RM-EEBC4S1N	■	■	■
	Switzerland T23 (4)	MPXB RM-EEBC4S2N	■	■	■
	Switzerland T23 (4)	MPXB RM-EEBC4S3N	■	■	■
	GST18 (9)	MPXB RM-EEBC9U1N	■	■	■
	GST18 (9)	MPXB RM-EEBC9U2N	■	■	■
	GST18 (9)	MPXB RM-EEBC9U3N	■	■	■
Branch-Monitored Output Modules	IEC-C13 L1 (6)	MPXB RM-EBBC6N1N	↑	■	■
	IEC-C13 L2 (6)	MPXB RM-EBBC6N2N	↑	■	■
	IEC-C13 L3 (6)	MPXB RM-EBBC6N3N	↑	■	■
	IEC-C19 L1 (4)	MPXB RM-EBBC4O1N	↑	■	■
	IEC-C19 L2 (4)	MPXB RM-EBBC4O2N	↑	■	■
	IEC-C19 L3 (4)	MPXB RM-EBBC4O3N	↑	■	■
	Schuko L1 (3)	MPXB RM-EBBC3P1N	↑	■	■
	Schuko L2 (3)	MPXB RM-EBBC3P2N	↑	■	■
	Schuko L3 (3)	MPXB RM-EBBC3P3N	↑	■	■
Receptacle Managed Output Modules	IEC-C13 L1 (6)	MPXB RM-ERBC6N1N P	↓	■	■
	IEC-C13 L2 (6)	MPXB RM-ERBC6N2N P	↓	■	■
	IEC-C13 L3 (6)	MPXB RM-ERBC6N3N P	↓	■	■
	IEC-C19 L1 (4)	MPXB RM-ERBC4O1N P	↓	■	■
	IEC-C19 L2 (4)	MPXB RM-ERBC4O2N P	↓	■	■
	IEC-C19 L3 (4)	MPXB RM-ERBC4O3N P	↓	■	■
	Schuko L1 (3)	MPXB RM-ERBC3P1N	↓	■	■
	Schuko L2 (3)	MPXB RM-ERBC3P2N	↓	■	■
	Schuko L3 (3)	MPXB RM-ERBC3P3N	↓	■	■

Upgrade possible

← Different combinations available →

*Note: One-phase input modules can only be populated with L1 modules.



DOS20153

Vertiv™ MPX™ – Input Module/Power Supply

Elementary and Monitored type

- The MPX PEM is fixed on the MPX PRC and provides the connection to the power supply.
- Fixed-connection cable; 3 m long.
- With IEC60309 plug, 1Ph/N/PE 6h blue, 3Ph/N/PE 6h red.

Monitored type

- The MPX PEM provides connection to the databus for data communication.
- Integrated RPC2 communication card enables remote monitoring and maintenance of the MPX modules.
- Provides the following phase-input data: voltage, current, effective power, consumption and frequency.
- Power alarm functions for individual phases and their operating status are also supported.
- Further important features: Three displays inform the user on the current status of each individual input. An acoustic alarm is activated at certain overload conditions.
- The communication card centralizes the MPXs local and remote administration.
- Serves as the connection point for versatile support options and devices, such as the display module (RPC BDM), various sensors and connection to other MPX™ or MPH2™ systems, for example.
- Has RJ-45 ports for all connections (except USB port) and does not require any special cabling.

■ Technical Data Interfaces:

- RJ-45 LAN port (10/100 MBit) – for local network (LAN) connection via an Ethernet cable.
- Expansion / administration port for local configuration using a computer / laptop, for creating a link-up of several PDUs (MPX or MPH).
- Serial interface RS232.
- Display port for connecting the RPC BDM (display module).
- External sensor port for connecting optional sensors.
- Remote management: Onboard Web interface, CLI, SNMPv1,2,3, SSH, Telnet Syslog, compatible with Avocent ACS, UMG & MPU, Vertiv SiteScan, DSView, Rack Power Manager, Vertiv Nform & Vertiv *Trellis* as well as Nagios or other management software

programs.

- Authentication: local, remote: Active Directory, LDAP, TACACS, Radius, Kerberos.
- Encryption: MD5, AES, DES.

■ Material / Finish

- Enclosure: aluminum.
- Cover: sheet steel.
- Power contacts: silver-plated.
- Databus contacts: gold-plated (only Monitored type)

■ Dimensions

- Width: 75 mm.
- Height: 65 mm.
- Feed cable: 3 m.

■ Color

- Enclosure: aluminum/RAL7021 dark-gray

■ Certification

- CE label in accordance with:
- Low Voltage Directive 2014/35/EU
- EMC Directive 2014/30/EU
- RoHS Directive 2011/65/EG.
- Bureau-Veritas BG - Certificate (Factory Inspection).
- Bureau-Veritas CB - Certificate.

■ Scope of delivery

- 1 x MPX PEM power input module.
- Including connection cable.
- Including RPC2 communication card (only Monitored type).

L	W	H	Feed	Load rating	Type	Order No.	UP
220	75	65	Fixed	230 VAC, max. 32 A	Elementary	MPXPPEM-EHAEXQ30	1 unit
220	75	65	Fixed	230/400 VAC, max. 16 A	Elementary	MPXPPEM-EHAEXT30	1 unit
220	75	65	Fixed	230/400 VAC, max. 32 A	Elementary	MPXPPEM-EHAEXR30	1 unit
266	75	65	Fixed	230/400 VAC, max. 63 A	Elementary	MPXPPEM-EHBEXZ30	1 unit
220	75	65	Fixed	230VAC,max.16A	Monitored	MPXPPEM-EHABXS30	1 unit
220	75	65	Fixed	230 VAC, max. 32 A	Monitored	MPXPPEM-EHABXQ30	1 unit
220	75	65	Fixed	230/400 VAC, max. 16 A	Monitored	MPXPPEM-EHABXT30	1 unit
220	75	65	Fixed	230/400 VAC, max. 32 A	Monitored	MPXPPEM-EHABXR30	1 unit
266	75	65	Fixed	230/400 VAC, max. 63 A	Monitored	MPXPPEM-EHBBXZ30	1 unit

Dimensions in mm:

W = Width h = Installation height U = Standard rack unit kg = Weight
H = Height d = Insertion depth (1 U = 44.45 mm)
D = Depth L = Length UP = Packaging unit

Conversion:

1 mm = 0.03937 inch
1 kg = 2.2046 pounds

Replace x with the number of the color combination you require: 1 = RAL 7035, 6 = RAL 7035/RAL 2003

- assemble to order (shipped within 5 working days).
Caution: In case of larger orders, delivery times may increase.



DOS20153

Vertiv™ MPX™ BRM – Output Module

- The MPX BRM enables the distribution to the individual consumers.
- Each module taps a color-coded phase.
- All modules are protected against overload with a 20 A circuit breaker.
- Modules can be exchanged during operation thereby facilitating user-specific installation without having to shut down the MPX.

Material / Finish

- Enclosure: aluminum.
- Cover: sheet steel.
- Power contacts: silver-plated.
- Databus contacts: gold-plated (only type B and R).

Dimensions

- Width: 75 mm / Height: 65 mm.

Color

- Enclosure: aluminum/RAL7021 dark-gray

Certification

- CE label in accordance with:
- Low Voltage Directive 2014/35/EU
- EMC Directive 2011/65/EG
- RoHS Directive 2011/65/EG.
- Bureau-Veritas BG - Certificate (Factory Inspection).
- Bureau-Veritas CB - Certificate.

Scope of delivery

- 1 x MPX PEM power output module.
- 1 x instruction manual.

Type E – Elementary

- Module for power distribution via respective outputs.

Type B – Branch-Monitored

- Module for power distribution via respective outputs with metering function on module level.
- The MPX BRMs have LED ID indicator which identifies every module with a number.
- Modules are administered in the software.
- Provides the following metered readings: voltage, current, power, apparent power, kWh and power factor.
- Power alarm functions and operating status are supported.

Type R – Receptacle Managed:

- Module for power distribution via respective outputs with metering function on module level and output level.
- The MPX BRMs have LED ID indicator which identifies every module with a number.
- Modules are administered in the software.
- Provides the following metered readings: voltage, current, power, apparent power, kWh, frequency, power factor and crest factor.
- Power alarm functions and operating status are supported.
- Individual outputs can be switched on and off remotely.

L	n	Outputs	Load rating per output	Phase tap	Type	Order No.	UP
266	7	IEC320 C 13	10 A	L1	E	MPXBRM-EEBC7N1N	1 unit
266	7	IEC320 C 13	10 A	L2	E	MPXBRM-EEBC7N2N	1 unit
266	7	IEC320 C 13	10 A	L3	E	MPXBRM-EEBC7N3N	1 unit
266	4	IEC320 C 19	16 A	L1	E	MPXBRM-EEBC4O1N	1 unit
266	4	IEC320 C 19	16 A	L2	E	MPXBRM-EEBC4O2N	1 unit
266	4	IEC320 C 19	16 A	L3	E	MPXBRM-EEBC4O3N	1 unit
266	3	Schuko CEE 7/4	16 A	L1	E	MPXBRM-EEBC3P1N	1 unit
266	3	Schuko CEE 7/4	16 A	L2	E	MPXBRM-EEBC3P2N	1 unit
266	3	Schuko CEE 7/4	16 A	L3	E	MPXBRM-EEBC3P3N	1 unit
266	4	Switzerland T23	16 A	L1	E	MPXBRM-EEBC4S1N	1 unit
266	4	Switzerland T23	16 A	L2	E	MPXBRM-EEBC4S2N	1 unit
266	4	Switzerland T23	16 A	L3	E	MPXBRM-EEBC4S3N	1 unit
266	9	GST18 3-pole	16 A	L1	E	MPXBRM-EEBC9U1N	1 unit
266	9	GST18 3-pole	16 A	L2	E	MPXBRM-EEBC9U2N	1 unit
266	9	GST18 3-pole	16 A	L3	E	MPXBRM-EEBC9U3N	1 unit
133	3	IEC320 C 13	10 A	L1	E	MPXBRM-EEDC3N1N	1 unit
133	3	IEC320 C 13	10 A	L2	E	MPXBRM-EEDC3N2N	1 unit
133	3	IEC320 C 13	10 A	L3	E	MPXBRM-EEDC3N3N	1 unit
133	2	IEC320 C 19	16 A	L1	E	MPXBRM-EEDC2O1N	1 unit
133	2	IEC320 C 19	16 A	L2	E	MPXBRM-EEDC2O2N	1 unit
133	2	IEC320 C 19	16 A	L3	E	MPXBRM-EEDC2O3N	1 unit
266	6	IEC320 C 13	10 A	L1	B	MPXBRM-EBBC6N1N	1 unit
266	6	IEC320 C 13	10 A	L2	B	MPXBRM-EBBC6N2N	1 unit
266	6	IEC320 C 13	10 A	L3	B	MPXBRM-EBBC6N3N	1 unit
266	4	IEC320 C 19	16 A	L1	B	MPXBRM-EBBC4O1N	1 unit
266	4	IEC320 C 19	16 A	L2	B	MPXBRM-EBBC4O2N	1 unit
266	4	IEC320 C 19	16 A	L3	B	MPXBRM-EBBC4O3N	1 unit
266	3	Schuko CEE 7/4	16 A	L1	B	MPXBRM-EBBC3P1N	1 unit
266	3	Schuko CEE 7/4	16 A	L2	B	MPXBRM-EBBC3P2N	1 unit
266	3	Schuko CEE 7/4	16 A	L3	B	MPXBRM-EBBC3P3N	1 unit
266	6	IEC320 C 13	10 A	L1	R	MPXBRM-ERBC6N1N	1 unit
266	6	IEC320 C 13	10 A	L2	R	MPXBRM-ERBC6N2N	1 unit
266	6	IEC320 C 13	10 A	L3	R	MPXBRM-ERBC6N3N	1 unit
266	4	IEC320 C 19	16 A	L1	R	MPXBRM-ERBC4O1N	1 unit
266	4	IEC320 C 19	16 A	L2	R	MPXBRM-ERBC4O2N	1 unit
266	4	IEC320 C 19	16 A	L3	R	MPXBRM-ERBC4O3N	1 unit
266	3	Schuko CEE 7/4	16 A	L1	R	MPXBRM-ERBC3P1N	1 unit
266	3	Schuko CEE 7/4	16 A	L2	R	MPXBRM-ERBC3P2N	1 unit
266	3	Schuko CEE 7/4	16 A	L3	R	MPXBRM-ERBC3P3N	1 unit



DOS20153

Vertiv™ MPX™ PRC – Power Distribution Unit / Communication Bus

- The MPX PRC is the basic element of the MPX power distribution unit.
- Power and data transfer buses are integrated across the entire length of the MP PRC.
- The MPX BRMs (output modules) and the MPX PEM (power input module) are fixed on the MPX PRC and, depending on the type, facilitate the modules' power feed, output, monitoring and management.

Material / Finish

- Busbar housing: aluminum.
- Busbars: copper.
- Databus: gold-plated.

Dimensions

- Width: 68 mm.
- Height: 24 mm.

Color

- Enclosure: aluminum.

Approvals

- CE label in accordance with:
 - Low Voltage Directive 2014/35/EU
 - EMC Directive 2014/30/EU
 - RoHS Directive 2011/65/EG.
- Bureau-Veritas BG – Certificate (Factory Inspection).
- Bureau-Veritas CB – Certificate.

Load rating

- Max. current: 3 x 63 A.
- Nominal voltage (L-N / L-L): 230 / 400 VAC.

Scope of delivery

- 1 x MPX PRC - power distribution unit / communication bus.
- 1 x mounting kit.

L	W	H	U	Model	Order No.	UP
1035	68	24	23	1 PEM (220 mm) + 3 BRM	MPXPRC-V1035XXX	1 unit
1880	68	24	42	1 PEM (220/266 mm) + 6 BRM	MPXPRC-V1880XXX	1 unit
2144	68	24		1 PEM (220/266 mm) +7 BRM	MPXPRC-V2146XXX	1 unit

Vertiv MPX™/MPH™/MPH2™/IMS™ – Sensors

- These sensors are designed for tool-less installation in a Knürr Miracle / DCM rack, and is also compatible with all other rack types.
- "Fixed" type sensors are attached to a cable.
- "Modular" type sensors can be connected to the delivered cable.
- Plugged into the RPC-1000 or RPC2 communication card.
- Several sensors can be connected in rows.
- Automatically displayed in the MPX/MPH/MPH2/IMS software.
- Temperature measurement range: 5 – 60° C.
- Accuracy: ± 0.5° C.
- Humidity measurement range: 10 – 95 %.
- Accuracy: ± 3.5 %.

Note

Sensors are not required for operating the MPX or MPH, MPH2, IMS. However, a communication card is needed.

Scope of delivery

- 1 x sensor with connection cable.
- 1 x instruction manual.

Cable length	Type	Model	Order No.	UP
3660	Fixed	Temperature sensor, single	SN-Z01	1 unit
5180	Fixed	Temperature sensor, triple	SN-Z02	1 unit
5180	Fixed	Temperature sensor, triple + humidity sensor, single	SN-Z03	1 unit
2000	Modular	Temperature sensor, single	SN-T	1 unit
2000	Modular	Temperature sensor, single + humidity sensor, single	SN-TH	1 unit
2000	Modular	2 x door contact - input module*	SN-2D	1 unit
2000	Modular	3 x digital input	SN-3C	1 unit

* Suitable door contact switch; Order no. 06.108.115.9



DOS20153

– assemble to order (shipped within 5 working days).
Caution: In case of larger orders, delivery times may increase.



DOS20153

RPC BDM - 1000 Display Module

- Provides the local display of the monitored data for all connected MPX/MPH/MPH2/IMS systems.
- Operated with a navigation switch.
- Connected via a cable with the RPC, enabling the user to place the displays where they can be easily read in the given local space conditions.
- An individual display can be used for up to four MPX/MPH/MPH2/IMS PDUs, which are all connected in a PDU array.

Note

The display module is not required when operating the MPX or MPH, MPH2, IMS. However, a communication card is needed.

Scope of delivery

- 1 x RPCBDM-1000 display module.
- 1 x connection cable 2 m.
- 1 x mounting kit.

Order No.	UP
RPCBDM-1000	1 unit

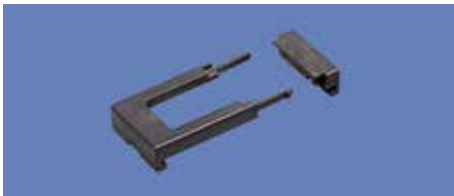

DOS20444

BRM Power-Distribution Cable-Holder Clip Set

- Cable clips provide strain relief for the feed lines of the network equipment.
- Cable clips are suitable for most IEC-C13 socket plugs with a raised edge. (Must be checked for suitability).
- Cable clips are sold in sets of 18 units.

Scope of delivery

- 1 x cable holder set (18 units).

How supplied

- In sets.

Note

- Optimal function only with cable connector 04.000.0519.
- Can only be used with MPXBDM-EBBC6NxN and MPXBDM-ERBC6NxN (x = 1, 2, 3).

Order No.	UP
03.910.216.9	1 unit



395



DOS20493

SafetySleeve™ Cable Protection IEC C19

- SafetySleeves protect the feed lines of the network equipment.
- They can be used on all C19 cables and fit onto all PDUs.

Material / Finish

- PVC, black.

Model	Order No.	UP
C20 plug in C19 socket	03.910.212.9 001	20 unit



DOS20494

SafetySleeve™ Kabelausziehschutz IEC C13

- SafetySleeves protect the feed lines of the network equipment.
- They can be used on all C13 cables and fit onto all PDUs.

Material / Finish

- PVC, black.

Model	Order No.	UP
C14 plug in C13 socket	03.910.213.9 001	50 unit



RPC2-KIT

RPC2 Communication Module for Vertiv™ MPX, MPH2 and IMS

- For retrofitting to existing MPX, MPH and IMS products.
- The communication card can be upgraded during operation.

Technical Data Interfaces

- RJ-45 LAN port (10/100 MBit) – for local network (LAN) connection via an Ethernet cable.
- Expansion / administration port for local configuration using a computer / laptop, for creating a link-up of several PDUs (MPX, MPH2 or IMS).
- Serial interface RS232.
- Display port for connecting the RPC BDM (display module).

- External sensor port for connecting optional sensors.
- Remote management: Onboard Web interface, CLI, SNMPv1,2,3, SSH, Telnet Syslog, compatible with Avocent ACS, UMG & MPU, Vertiv SiteScan, DSView, Rack Power Manager, Vertiv Nform & Vertiv *Trellis* as well as Nagios or other management software programs.
- Authentication: local, remote: Active Directory, LDAP, TACACS, Radius, Kerberos.
- Encryption: MD5, AES, DES.

Order No.	UP
RPC2-KIT	1 unit

Easy Integration into DCIM Systems

The rack PDUs Vertiv™ MPH2™ and MPX™ as well as the in-line metering system MPXIMS™ can be managed both locally and remotely.

- Power data and sensor data are recorded
- Conventional standardized protocols are used to ensure secure data transfer, management, and authentication.

As such, the products can be easily integrated into any existing network and any system architecture.

Flexible Local or Remote Management

Integrated standard displays on the DIS Rack PDU I and MPH2™

show all the key information required at the rack.

The optional local display BDM for the MPH2™ or MPX™ can be mounted in different locations depending on where it can be read most easily.

Remote communication thanks to the modular hot-swappable RPC2™ card ensures seamless expansion options and easy servicing

- **Support for up to four PDUs within a single rack PDU Array™:** Minimizes the number of IP addresses required.
- **Support for up to ten ambient sensors:** Consolidates power and environment monitoring at rack level.
- **Support for Web UI and CLI, with SSL and SSH:** Windows, Linux, and network administrators can use their preferred form of communication with the rack PDU.
- **Support for all conventional remote authentication and encryption protocols:** Products can be seamlessly integrated into an existing security infrastructure.
- **Support for SNMP v1, v2, and v3:** Allows for secure communication via network management systems.
- **Support for IPv4 and IPv6:** Future-proof IP support for rack PDUs.
- **Data logging:** All data is saved automatically, ensuring easy troubleshooting without the need for additional external management software.
- "One-touch" configuration with USB stick directly on the device.

Power management with the following functions:

- Snapshot of all electrical parameters at output, group, phase, and general level.
- Snapshot of the status and the measured values from the ambient sensor.
- Threshold configuration, alerts, and messages.
- Control of individual outputs and groups.
- Status information and configuration of all outputs.
- Network management settings.

To enable **central management** of all rack PDUs within a data center, the following software packages are available:

- **Vertiv Avocent Rack Power Manager**, which includes access and control functions to easily manage and monitor your PDUs.
- Vertiv *Trellis* Express, which provides a comprehensive view of the devices in the data center.
- Vertiv Sitescan.
- Vertiv Nform, which provides an overview of the health status of relatively small to medium data centers.

Rack Power Manager boasts state-of-the-art monitoring functions and allows intelligent server grouping over multiple racks. You also benefit from customized reports and scheduled standard reports, and have the option to define thresholds for real-time alarms. As such, you obtain high-quality information about the power supply infrastructure of your data center, thereby allowing you to make full use of the investment in PDUs.

- Power costs are measured and monitored.
- Historical data is checked in capacity and consumption reports.

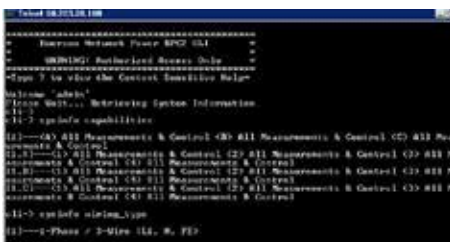

The Vertiv™ *Trellis*™ platform is a pioneering DCIM innovation from Vertiv. It not only reduces IT risks but also increases operational efficiency, meaning it solves current problems and prepares you for the future.

The real-time visualization, monitoring of the power supply, and mobile access provided by the Vertiv *Trellis* platform allow you to:

- reduce inefficiencies without interrupting current processes.
- postpone investments as you make better use of existing resources, thereby improving the operating profit.
- improve Service Level Agreements with complete transparency throughout the infrastructure.
- gain a better insight into the data center and thus improve overall efficiency.

Integration into the **clear, easy-to-install Vertiv Nform™ status monitoring software** ensures the following:

- Rack PDUs are part of a consolidated monitoring solution for data center infrastructure.
- Virtually any component in critical support equipment can be monitored.
- Alerts and automatic actions in the event of a fault.
- Event management.

Integration into the scalable **Vertiv SiteScan® building infrastructure management software** ensures the following:

- Rack PDUs are part of a consolidated monitoring solution for data center infrastructure.
- Virtually any component in critical support equipment can be monitored and controlled.
- Data analysis and trend reports.
- Event management.

Make the Most of Your Rack PDU Investment

The rack PDUs MPX™, MPH2™, and MPXIMS™ can be fully integrated into the industry-leading KVM systems, serial consoles, and infrastructure management systems from Vertiv.

Integration into **Avocent® Advanced Console Server, MergePoint™ Unity KVM Switches and Universal Management Gateway Appliances** offers the following advantages:

- Rack PDUs are integrated into the out-of-band management solution.
- Rack PDUs become part of a consolidated access and control solution.
- The number of IP addresses required for managing the rack PDUs is minimized.

The software provides secure, centralized out-of-band management of all connected IT and network devices in complex and geographically dispersed data centers.

DSView4 and rack PDUs together ensure:

- Consolidated access to server control and the related access control.
- Easy assignment of IT equipment to the relevant rack PDU outputs.

Integration into the management software **Avocent DSView™ 4**, in which all data center management functions are compiled on a consolidated interface, allows for seamless control of the data center for 24/7 operation.

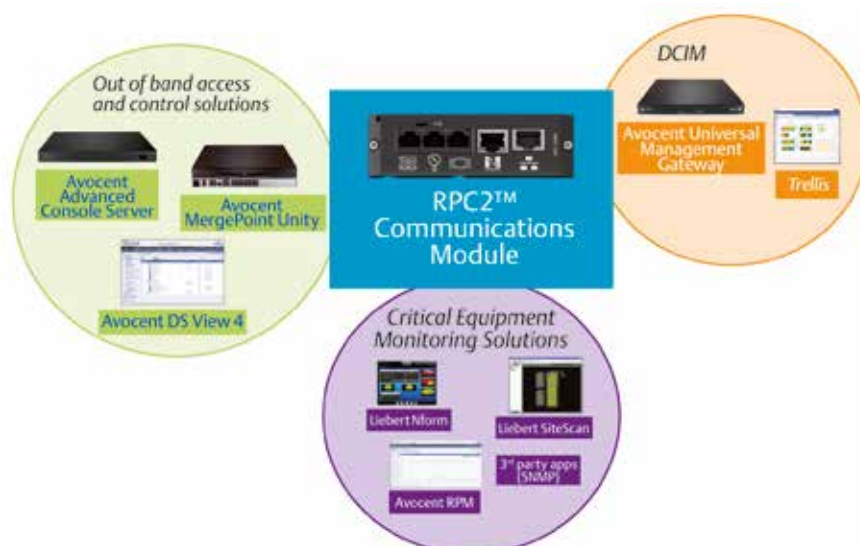

Vertiv™ MPH2™ – Managed Rack PDU

Monitoring and Control

New: All models with differential current metering!

The Vertiv MPH2 Managed Rack PDU is a power supply system with monitoring and control functions. The Vertiv MPH2 offers outstanding features such as easy rack-integration and management architecture as well as optimum availability and energy efficiency.

Four Vertiv MPH2™ versions are available:

Model/functions	Vertiv MPHR	Vertiv MPHM	Vertiv MPH2C	Vertiv MPH2B
Input / Group measurement	■	■	■	■
Output measurement	■	■		
Output switching	■		■	

Benefits of Vertiv MPH2™

- **Monitors several parameters** with defined thresholds and alarm tools.
- **Detects the differential current per phase (all models)** and per output (R and M models). This makes it possible to quickly locate fault current down to server level.
- **Monitors and controls individual outputs** and/or load and appliance groups.
- **A variety of measurements** allow you to predict failing conditions before they occur and proactively manage connected equipment for maximum uptime.
- **Energy and power metering** maximize the data center power and cooling infrastructure.
- **Lowest power consumption** of all switched-rack PDUs lowers power costs and thermal load.
- **Up to four rack Vertiv MPH2 PDUs** can be connected in a Rack PDU Array™ thereby consolidating user-specific IP connections and equipment monitoring.

Developed for critical environments

- **Industry-leading operating temperature** of up to 60° C suitable for high temperatures inside racks.
- **Bistable relays ensure basic power supply** even when shortfalls occur elsewhere.
- **Accurate voltage and current metering up to outlet level** with ±1 % tolerances deliver reliable results.
- **Extensive alarm functions including notification** when an overload occurs in individual groups.
- **Monitoring of environment conditions (temperature, humidity and input contacts)** with alerts and alarms.
- **Notification** upon failure or if loads are removed in individual racks.



reddot award 2015
winner



Vertiv MPH2 savings for a typical data center

	Typical rack PDU with 24 outputs	Vertiv MPH2
Power consumption of PDU (in Watt)	20	5
Annual energy consumption of PDU (kWh)	176	44
Total proportion of the data center's energy consumption (kWh)*	333	83
Energy saving	75%	

Compared with a Switched Rack-PDU model for a typical data center with a 1.9 PUE.

* according to Energy Logic calculations

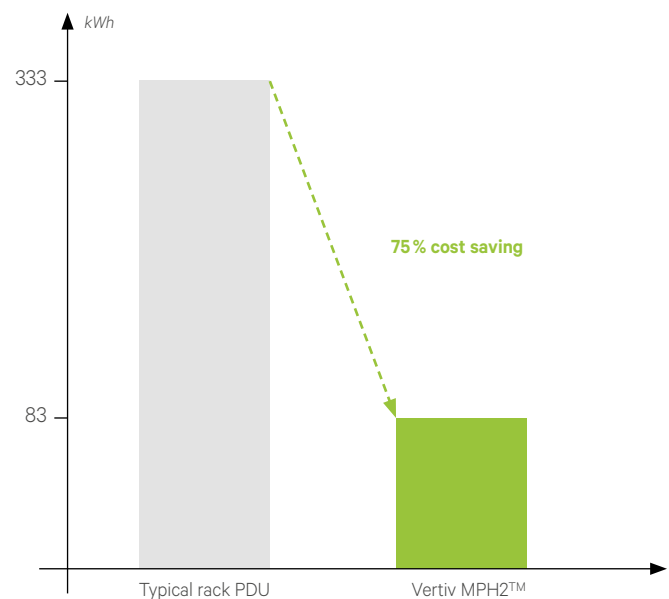



INPUT POWER

- 16 to 32 A (EU).
- Single-phase and three-phase.

OUTPUT DISTRIBUTOR

- IEC C13 and IEC C19.
- Combination systems.

MODULARITY

- Communication card.
- External display.
- External sensors.

MONITORING

- Three various levels: Input level, group level, output level
- Temperature and humidity.
- Door contacts and potential-free input contacts.
- Differential current up to the outlet level.

REMOTE CONTROLLED SOCKETS

- Socket level.

Vertiv™ MPH2™

Benefits

Highest availability levels

- Modular communications card; can be replaced during operation. This simplifies maintenance and increases the level of availability.
- Bistable relays in switchable designs; the server's power supply is ensured even during outages.
- Software-controlled overload protection – affected outputs are switched off before the advance fuse is activated.
- Additional metering of the neutral conductor and of the crest factor; possible faults that cause switch-off are detected in advance.

Leading technology in many areas

- Operating temperatures of up to 60 °C allow secure operation in the warm aisle.
- Metering accuracy of $\pm 1\%$ ensures reliable measurement results.
- Power losses of approx. 5 W, even in switchable models, reducing electricity costs and minimizing the thermal load.
- Differential current metering up to output level supports a quick fault locating.

Metering of differential current with the MPH2

- Display of the TRMS AC+ DC value (AC and DC component), this increases the metering accuracy.
- Differential current detection up to output level. This supports the requirements of DIN EN 50600-2-2, in which a measurement up to granularity level 3 is required.

- Triple alarms (remote, visual and audible) provide immediate alarms in various ways. The MPH2 thus offers alarm redundancy without additional components.
- The measurement is integrated in every MPH2 as standard. This saves you time and money when choosing your solution.
- Together with Vertiv Solutions Commander the measured values are regularly stored, this supports you in the verification obligation of the residual current measurement.

Industry-leading management properties

- An integrated local display and an optional external display facilitates flexible local management.
- Onboard web interface and CLI/SSH interface; suitable for both Windows and Linux administration.
- A variety of authentication options and encrypted protocols ensure integration into Enterprise Security architectures.
- SNMPv3 and IPv6 support so that current requirements, particularly from the public sector, can be satisfied.

Simple integration into ENP solutions

- Can be delivered pre-installed in Knürr racks to save time and costs during installation in the data center.
- Serial integration into Avocent UMG, ACS and MPU guarantees redundant management access to the MPH2.
- Integration into Vertiv software solutions; the MPH2 is an integral part of a comprehensive DCIM solution with monitoring and control functions.



Colored clamps:
Colored labeling of supply.



Communications module (RPC2™):
Offers extendable interfaces for network communication, sensors and local display.



BDM™ local display module
Extended diagnostic functionality; user-friendly display. Features include detailed information about alerts and specific labeling for outputs.



Integrated display:
Provides easy access to important information on the rack.

Ultra-flat circuit breakers:
Compact construction; minimizes space requirements in the rack.



Special tool-less Knürr DCM rack fixture:
Lowers installation costs and extra space in rack for cables and other components.



Connection cable with locking mechanism
Prevents IT cables from being accidentally disconnected.



SN sensors:
Consolidates environmental monitoring of temperature, humidity and potential-free input contacts with the power supply at rack level.



Flexible network cable input:
Simplifies installation in the rack PDU.



Cable and fixed wiring options:
Flexible power distribution; input-cable can be connected locally.

Vertiv™ MPH2™

- The Vertiv MPH2 is a power distribution unit for IT racks which provides metering of electrical values. Depending on the model, individual outputs can also be remote-controlled.
- Data differential current measurement: TRMS AC+DC value (AC and DC component), differential current detection per phase and output (depending on model), measurement accuracy +/- 1 mA, adjustable threshold value from 5 mA to 100 mA, remote, optical and acoustic alarms.
- The integrated RPC2 communications card allows you to connect up to 4 Vertiv MPH2 / MPX™ units as well as monitor and maintain all connected units remotely. Up to 10 sensors (temperature, air humidity, door contacts as well as potential-free input contacts) can be connected.
- The Vertiv MPH2 unit has an integrated display. In addition, the optional external RPCBDM-1000 display module can easily be connected and mounted on the rack.

■ Vertiv MPH2™ models

- **Vertiv MPH2™ B** – Metering per phase and per group (only models with >16 A input power). Differential current detection per phase.
- **Vertiv MPH2™ C** – Metering per phase and per group (only models with >16 A input power). Each output can also be individually switched remotely. Differential current detection per phase.
- **Vertiv MPH2™ M** – Metering per phase and per group (only models with >16 A input power) and per output. Differential current detection per phase and output.
- **Vertiv MPH2™ R** – Metering per phase and per group (only models with >16 A input power) and per output. Each output can also be individually switched remotely. Differential current detection per phase and output.

■ Material / finish / color

- Closed housing, aluminum profile, finely textured powder-coated top (RAL 7021), Vampamid 6 0024 V0 (UL94) recyclable plastic parts, finely textured and colored (RAL 9005).

- Special cables with locking mechanisms can be connected to the outputs.
- Depending on the model, the connecting cable for the MPH2 is attached to the housing (cable length 3 m), also permitting a connecting cable can be connected on site (model with connection unit).
- Remote management: Onboard Web Interface, CLI, SNMPv1,2,3, SSH, Telnet, integratable into Avocent ACS, UMG & MPU, DSView, Vertiv Nform & Vertiv *Trellis* as well as Nagios or other management software programs.
- Authentication: local, remote: active directory, LDAP, TACACS, Radius, Kerberos. Encryption: MD5, AES, DES.
- Measurement parameters: Current (A), voltage (V), real power (W), apparent power (VA), consumption (kWh), power factor, frequency and crest factor (only tapes M and R). Accuracy: ±1 % (V, A).

■ Mechanical dimensions

- Vertical models:
Width x Depth x Length (mm): 56 x 50 x (see table).
- Horizontal models:
1 HU: Width x Depth x Length (mm): 482,6 (440) x 250 x 44.
2 HU: Width x Depth x Length (mm): 482,6 (440) x 250 x 88.

■ Certification

- CE label in accordance with:
- Low Voltage Directive 2014/35/EU
- EMC Directive 2014/30/EU
- RoHS Directive 2011/65/EG.
- Bureau-Veritas BG - Certificate (Factory Inspection).
- Bureau-Veritas CB - Certificate.

■ Scope of delivery

- MPH2™ rack PDU.
- Standard mounting bracket.
- Safety instructions.
- Quickstart guide.

Vertiv™ MPH2™ Types for Europe

Vertical models











Model/functions	Vertiv MPH R	Vertiv MPH M	Vertiv MPH C	Vertiv MPH B
Input / Group measurement	■	■	■	■
Output measurement	■	■		
Output switching	■		■	

Type	Input Values		Input Connector	Outputs		Length (mm)	Order Number
	Voltage	Current		C13	C19		
B	230V	16A	C20 inlet	17	2	916.5	MPHB3241
B	230V	16A	C20 inlet	21		916.5	MPHB3141
B	230V	16A	C20 inlet	30	6	1736.5	MPHB1241
B	230V	16A	IEC 60309 16A 1P+N+G	17	2	916.5	MPHB3242
B	230V	16A	IEC 60309 16A 1P+N+G	21		916.5	MPHB3142
B	230V	16A	IEC 60309 16A 1P+N+G	30	6	1736.5	MPHB1242
B	230V	32A	IEC 60309 32A 1P+N+G	30	6	1736.5	MPHB1243
B	230V	32A	Connection unit	30	6	1736.5	MPHB1260
B	230/400V	3 x 16A	IEC 60309 16A 3P+N+G	30	6	1736.5	MPHB1244
B	230/400V	3 x 32A	IEC 60309 32A 3P+N+G	42		1826.5	MPHB1545
B	230/400V	3 x 32A	IEC 60309 32A 3P+N+G	18	12	1826.5	MPHB1345
B	230/400V	3 x 32A	IEC 60309 32A 3P+N+G	30	6	1826.5	MPHB1245
B	230/400V	3 x 32A	Connection unit	42		1826.5	MPHB1562
B	230/400V	3 x 32A	Connection unit	18	12	1826.5	MPHB1362
B	230/400V	3 x 32A	Connection unit	30	6	1826.5	MPHB1262
C	230V	16A	C20 inlet	8		916.5	MPHC3341
C	230V	16A	C20 inlet	16		1004	MPHC3141
C	230V	16A	C20 inlet	18	6	1736.5	MPHC1141
C	230V	16A	C20 inlet	24		1736.5	MPHC1241
C	230V	16A	IEC 60309 16A 1P+N+G	18	6	1736.5	MPHC1142
C	230V	16A	IEC 60309 16A 1P+N+G	24		1736.5	MPHC1242
C	230V	16A	IEC 60309 16A 1P+N+G	16		1004	MPHC3142
C	230V	32A	IEC 60309 32A 1P+N+G	18	6	1736.5	MPHC1143
C	230V	32A	IEC 60309 32A 1P+N+G	24		1736.5	MPHC1243
C	230V	32A	Connection unit	18	6	1736.5	MPHC1160
C	230V	32A	Connection unit	24		1736.5	MPHC1260
C	230/400V	3 x 16A	IEC 60309 16A 3P+N+G	18	6	1736.5	MPHC1144
C	230/400V	3 x 16A	IEC 60309 16A 3P+N+G	24		1736.5	MPHC1244
C	230/400V	3 x 16A	Connection unit	18	6	1736.5	MPHC1161
C	230/400V	3 x 16A	Connection unit	24		1736.5	MPHC1261
C	230/400V	3 x 32A	IEC 60309 32A 3P+N+G	18	6	1736.5	MPHC1145
C	230/400V	3 x 32A	IEC 60309 32A 3P+N+G	24		1736.5	MPHC1245
C	230/400V	3 x 32A	IEC 60309 32A 3P+N+G	6	12	1736.5	MPHC1345
C	230/400V	3 x 32A	Connection unit	18	6	1736.5	MPHC1162
C	230/400V	3 x 32A	Connection unit	24		1736.5	MPHC1262
C	230/400V	3 x 32A	Connection unit	6	12	1736.5	MPHC1362
M	230V	16A	C20 inlet	8		916.5	MPHM3341
M	230V	16A	IEC 60309 16A 1P+N+G	8		916.5	MPHM3342
M	230V	16A	C20 inlet	16		1004	MPHM3141
M	230V	16A	C20 inlet	18	6	1736.5	MPHM1141
M	230V	16A	C20 inlet	24		1736.5	MPHM1241
M	230V	16A	IEC 60309 16A 1P+N+G	18	6	1736.5	MPHM1142
M	230V	16A	IEC 60309 16A 1P+N+G	24		1736.5	MPHM1242
M	230V	16A	IEC 60309 16A 1P+N+G	16		1004	MPHM3142
M	230V	32A	IEC 60309 32A 1P+N+G	18	6	1736.5	MPHM1143
M	230V	32A	IEC 60309 32A 1P+N+G	24		1736.5	MPHM1243
M	230V	32A	Connection unit	18	6	1736.5	MPHM1160
M	230V	32A	Connection unit	24		1736.5	MPHM1260
M	230/400V	3 x 16A	IEC 60309 16A 3P+N+G	18	6	1736.5	MPHM1144
M	230/400V	3 x 16A	IEC 60309 16A 3P+N+G	24		1736.5	MPHM1244
M	230/400V	3 x 16A	Connection unit	18	6	1736.5	MPHM1161

Vertiv™ MPH2™ Types for Europe

Vertical models

Model/functions	Vertiv MPH _R	Vertiv MPH _M	Vertiv MPH _C	Vertiv MPH _B
Input / Group measurement	■	■	■	■
Output measurement	■	■		
Output switching	■		■	

Type	Input Values		Input Connector	Outputs		Length (mm)	Order Number
	Voltage	Current		C13	C19		
M	230/400V	3 x 16 A	Connection unit	24		1736.5	MPHM1261
M	230/400V	3 x 32 A	IEC 60309 32 A 3P+N+G	18	6	1736.5	MPHM1145 
M	230/400V	3 x 32 A	IEC 60309 32 A 3P+N+G	24		1736.5	MPHM1245
M	230/400V	3 x 32 A	IEC 60309 32 A 3P+N+G	6	12	1736.5	MPHM1345
M	230/400V	3 x 32 A	Connection unit	18	6	1736.5	MPHM1162
M	230/400V	3 x 32 A	Connection unit	24		1736.5	MPHM1262
M	230/400V	3 x 32 A	Connection unit	6	12	1736.5	MPHM1362
R	230V	16 A	C20 inlet	8		916.5	MPHR3341
R	230V	16 A	IEC 60309 16 A 1P+N+G	8		916.5	MPHR3342
R	230V	16 A	C20 inlet	16		1004	MPHR3141
R	230V	16 A	C20 inlet	18	6	1736.5	MPHR1141
R	230V	16 A	C20 inlet	24		1736.5	MPHR1241 
R	230V	16 A	IEC 60309 16 A 1P+N+G	18	6	1736.5	MPHR1142 
R	230V	16 A	IEC 60309 16 A 1P+N+G	24		1736.5	MPHR1242 
R	230V	16 A	IEC 60309 16 A 1P+N+G	16		1004	MPHR3142 
R	230V	32 A	IEC 60309 32 A 1P+N+G	18	6	1736.5	MPHR1143 
R	230V	32 A	IEC 60309 32 A 1P+N+G	24		1736.5	MPHR1243 
R	230V	32 A	Connection unit	18	6	1736.5	MPHR1160
R	230V	32 A	Connection unit	24		1736.5	MPHR1260
R	230/400V	3 x 16 A	IEC 60309 16 A 3P+N+G	18	6	1736.5	MPHR1144 
R	230/400V	3 x 16 A	IEC 60309 16 A 3P+N+G	24		1736.5	MPHR1244
R	230/400V	3 x 16 A	Connection unit	18	6	1736.5	MPHR1161
R	230/400V	3 x 16 A	Connection unit	24		1736.5	MPHR1261
R	230/400V	3 x 32 A	IEC 60309 32 A 3P+N+G	18	6	1736.5	MPHR1145 
R	230/400V	3 x 32 A	IEC 60309 32 A 3P+N+G	24		1736.5	MPHR1245
R	230/400V	3 x 32 A	IEC 60309 32 A 3P+N+G	6	12	1736.5	MPHR1345 
R	230/400V	3 x 32 A	Connection unit	18	6	1736.5	MPHR1162
R	230/400V	3 x 32 A	Connection unit	24		1736.5	MPHR1262
R	230/400V	3 x 32 A	Connection unit	6	12	1736.5	MPHR1362

 - assemble to order (shipped within 5 working days).
Caution: In case of larger orders, delivery times may increase.

Vertiv™ MPH2™ Types for Europe

Horizontal models

Model/functions	Vertiv MPHR	Vertiv MPHM	Vertiv MPH C	Vertiv MPH B
Input / Group measurement	■	■	■	■
Output measurement	■	■		
Output switching	■		■	

Type	Input Values		Input Connector	Outputs		Order Number
	Voltage	Current		C13	C19	
B	230V	16 A	C20 inlet	12		MPHB2141
B	230V	16 A	C20 inlet	8	2	MPHB2341
B	230V	32 A	IEC 60309 32A 1P+N+G	12		MPHB2143
B	230V	32 A	IEC 60309 32A 1P+N+G	8	2	MPHB2343
B	230/400V	3 x 16 A	IEC 60309 16A 3P+N+G	12		MPHB2144
B	230/400V	3 x 16 A	IEC 60309 16A 3P+N+G	2	6	MPHB2244
B	230/400V	3 x 32 A	IEC 60309 32A 3P+N+G	2	6	MPHB2245
M	230V	16 A	C20 inlet	9		MPHM2141
M	230V	16 A	C20 inlet	6	2	MPHM2441
M	230V	32 A	IEC 60309 32A 1P+N+G	9		MPHM2143
M	230V	32 A	IEC 60309 32A 1P+N+G	6	2	MPHM2443
M	230/400V	3 x 16 A	IEC 60309 16A 3P+N+G	9		MPHM2144
M	230/400V	3 x 16 A	IEC 60309 16A 3P+N+G	2	6	MPHM2344
M	230/400V	3 x 32 A	IEC 60309 32A 3P+N+G	2	6	MPHM2345
R	230V	16 A	C20 inlet	9		MPHR2141
R	230V	16 A	C20 inlet	6	2	MPHR2441
R	230V	32 A	IEC 60309 32A 1P+N+G	9		MPHR2143
R	230V	32 A	IEC 60309 32A 1P+N+G	6	2	MPHR2443
R	230/400V	3 x 16 A	IEC 60309 16A 3P+N+G	9		MPHR2144
R	230/400V	3 x 16 A	IEC 60309 16A 3P+N+G	2	6	MPHR2344
R	230/400V	3 x 32 A	IEC 60309 32A 3P+N+G	2	6	MPHR2345
B	230V	16A	C20 inlet	28		MPHB6141
B	230V	16A	C20 inlet	16	4	MPHB6341
B	230V	32A	IEC 60309 32A 1P+N+G	28		MPHB6143
B	230V	32A	IEC 60309 32A 1P+N+G	16	4	MPHB6343
B	230/400V	3 x 16A	IEC 60309 16A 3P+N+G	28		MPHB6144
B	230/400V	3 x 16A	IEC 60309 16A 3P+N+G	17	3	MPHB6644
B	230/400V	3 x 32A	IEC 60309 32A 3P+N+G	28		MPHB6145
B	230/400V	3 x 32A	IEC 60309 32A 3P+N+G	14	6	MPHB6545
B	230/400V	3 x 32A	IEC 60309 32A 3P+N+G	8	12	MPHB6745
M	230V	16A	C20 inlet	18		MPHM6141
M	230V	16A	C20 inlet	12	4	MPHM6441
M	230V	32A	IEC 60309 32A 1P+N+G	18		MPHM6143
M	230V	32A	IEC 60309 32A 1P+N+G	12	4	MPHM6443
M	230/400V	3 x 16A	IEC 60309 16A 3P+N+G	18		MPHM6144
M	230/400V	3 x 16A	IEC 60309 16A 3P+N+G	11	6	MPHM6644
M	230/400V	3 x 32A	IEC 60309 32A 3P+N+G	18		MPHM6145
M	230/400V	3 x 32A	IEC 60309 32A 3P+N+G	11	6	MPHM6645
M	230/400V	3 x 32A	IEC 60309 32A 3P+N+G	4	12	MPHM6345
R	230V	16A	C20 inlet	18		MPHR6141
R	230V	16A	C20 inlet	12	4	MPHR6441
R	230V	32A	IEC 60309 32A 1P+N+G	18		MPHR6143
R	230V	32A	IEC 60309 32A 1P+N+G	12	4	MPHR6443
R	230/400V	3 x 16A	IEC 60309 16A 3P+N+G	18		MPHR6144
R	230/400V	3 x 16A	IEC 60309 16A 3P+N+G	11	6	MPHR6644
R	230/400V	3 x 32A	IEC 60309 32A 3P+N+G	18		MPHR6145
R	230/400V	3 x 32A	IEC 60309 32A 3P+N+G	11	6	MPHR6645
R	230/400V	3 x 32A	IEC 60309 32A 3P+N+G	4	12	MPHR6345



DOS20153

Vertiv™ MPX™/Vertiv MPH™/Vertiv MPH2™/IMS™ – Sensors





- These sensors are designed for tool-less installation in a Knürr Miracle / DCM rack, but is also compatible with all other rack types.
- "Fixed" type sensors are attached to a cable.
- "Modular" type sensors can be connected to the delivered cable.
- Plugged into the RPC-1000 or RPC2 communication card.
- Several sensors can be connected in rows.
- Automatically displayed in the MPX/MPH/MPH2/IMS software.
- Temperature measurement range: 5 – 55° C.
- Accuracy: ± 0.5° C.
- Humidity measurement range: 10 – 95 %.
- Accuracy: ± 3.5 %.

■ Note

The sensors are not required for operating the MPX or MPH, MPH2, IMS. However, a communication card is needed.

■ Scope of delivery

- 1 x sensor with connection cable.
- 1 x instruction manual.

Cable length	Type	Model	Order No.	UP
3660	Fixed	Temperature sensor, single	SN-Z01	1 unit
5180	Fixed	Temperature sensor, triple	SN-Z02	1 unit
5180	Fixed	Temperature sensor, triple + humidity sensor, single	SN-Z03	1 unit 
2000	Modular	Temperature sensor, single	SN-T	1 unit 
2000	Modular	Temperature sensor, single + humidity sensor, single	SN-TH	1 unit 
2000	Modular	2 x door contact - input module*	SN-2D	1 unit 
2000	Modular	3 x digital input	SN-3C	1 unit

* Suitable door contact switch: Order no.: 06.108.115.9



DOS20153

Liebert RPC BDM - 1000 Display Module

- Provides the local display of the monitored data for all connected MPX/MPH/MPH2/IMS systems.
- Operated with a navigation switch.
- Connected via a cable with the RPC, enabling the user to place the displays where needed in the given local space conditions.
- An individual display can be used for up to four MPX/MPH/MPH2/IMS PDUs, which are all connected in a PDU array.

Note

The display module is not required for operating the MPX or MPH, MPH2, IMS. However, a communication card is needed.

Scope of delivery

- 1 x RPCBDM-1000 display module.
- 1 x connection cable 2 m.
- 1 x mounting kit.

Order No.	UP
RPCBDM-1000	1 unit



DOS20495



DOS20496



DOS20497



DOS20498



DOS20499



DOS20500

SafetyLock™ Connection Cable IEC C13 EU

- Connection cables have integrated protection against accidental disconnection.
- For straight locking from C14 to C13.
- Locking cables are sold in sets of 9 units.

■ Technical data

- Standard: IEC 60320.
- Load rating: 250 Vac/10 A.
- Operating temperature: -25° C ~ +70° C.
- Extraction force with locking function: up to 120 N.
- Electric power cable: H05VV-F 3G 1.0 mm².
- Flame retardance: Plug: UL 94V-2 or better; cable: UL VW-1, IEC60332-1. Cat F2.

■ Certification

- ENEC.
- VDE.
- CB scheme.
- RoHS compliant.

■ Color

- Black/white.
- Other colors available upon request.

■ Scope of delivery

- 9 x locking cables.

■ How supplied

- In sets.

L	Model	Order No.	UP
0.5 m	Black	03.951.450.0,001	9 unit
1.0 m	Black	03.951.450.0,002	9 unit
1.5 m	Black	03.951.450.0,003	9 unit
0.5 m	White	03.951.451.0,001	9 unit
1.0 m	White	03.951.451.0,002	9 unit
1.5 m	White	03.951.451.0,003	9 unit

SafetyLock Connection Cable IEC C19 EU

- Connection cables have integrated protection against accidental disconnection.
- For straight locking from C20 to C19.
- Locking cables are sold in sets of 6 units.

■ Technical data

- Standard: IEC 60320.
- Load rating: 250 Vac/16 A.
- Operating temperature: -25° C ~ +70° C.
- Extraction force with locking function: up to 120 N.
- Electric power cable: H05VV-F 3G 1.5 mm².
- Flame retardance: Plug: UL 94V-2 or better; cable: UL VW-1, IEC60332-1. Cat F2.

■ Approvals

- ENEC.
- VDE.
- CB scheme.
- RoHS compliant.

■ Color

- Black/white.
- Other colors available upon request.

■ Scope of delivery

- 6 x locking cables.

■ How supplied

- In sets.

L	Model	Order No.	UP
0.5 m	Black	03.951.455.0,001	6 unit
1.0 m	Black	03.951.455.0,002	6 unit
1.5 m	Black	03.951.455.0,003	6 unit
0.5 m	White	03.951.456.0,001	6 unit
1.0 m	White	03.951.456.0,002	6 unit
1.5 m	White	03.951.456.0,003	6 unit



DSC00236

SpeedMountKit Vertiv™ MPH2™, Vertiv MPE

- Installation of the rack PDUs MPH2 and MPE without tools in Knürr DCM, Miracle 2 and InstaRack.

Rack type	Rack height	Order No.	UP
DCM / Miracle 2	H2000	039514.050001	1 unit
DCM / Miracle 2	H2200	039514.050003	1 unit
InstaRack	H2000	039514.050002	1 unit
InstaRack	H2200	039514.050004	1 unit

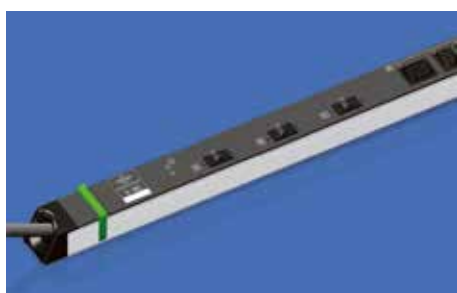

Vertiv MPH2 / Vertiv MPE – Color Coding

Vertiv MPH2 / Vertiv MPE – Color Coding

- Option for color coding power supply A or B.
- Option for color coding the individual phases /groups.
- Installation without tools on MPH2 and MPE.

Design/Color	Order No.	UP
Blue	03.951.476.0.001	20 unit
Red	03.951.476.0.002	20 unit
Yellow	03.951.476.0.003	20 unit
Green	03.951.476.0.004	20 unit
Orange	03.951.476.0.005	20 unit

Vertiv™ MPE – Rack PDU

Reliable power distribution for data centers

The Vertiv MPE Rack PDU is a power distribution unit for data center applications. It provides all the necessary functions of a rack-based power distribution unit and guarantees reliable power distribution. A broad range of IT devices and other sensitive electrical loads can be connected to it.

The MPE offers you the highest level of availability for your critical loads.

- Its high **operating temperature of up to 60°C** makes it suitable for installation in hot aisles (area at the back of the rack).
20 A overload switch for many 32 A models that prevents the overload switch from triggering prematurely at high temperatures and during start-up peaks.
- Output cable with **disconnection protection** to prevent the IEC60320 connection cable from being unintentionally disconnected.
- **Stable aluminum housing** supports the mechanical stability of the housing.
- Extra-large wire cross-sectional area of the input cable; in three-phase models, this makes it possible to subject the neutral wire to greater loads in the event that the loads are unbalanced.

Simple physical and electrical installation helps to keep costs down.

- Vertiv supplies the **PDU's preinstalled in racks** which saves extra work on-site.
- **Flexible cable entry** facilitates installation in the rack.
- **Very low unit profile** – even in the overload switch area – leaves maximum installation space for other components as well as more space for air supply in the rack.
- **Models with fixed connection** facilitate customer-side connection of the input cable for special requirements.
"SpeedMount" function for installation in Vertiv Knürr DCM / InstaRack saves time and money in on-site installation.
- **Great model variety** with power supply from up to three-phase 32 A and a number of different outputs – including country-specific with Schuko plug, UK or Switzerland.



INPUT POWER

- 16 to 63A (EU).
- Single-phase and three-phase.

OUTPUT DISTRIBUTOR

- IEC-C13 and IEC-C19, Schuko, UK.
- Combination systems.

MODULARITY

- Input cable.





Vertiv MPE1345

Vertiv™ MPE – Rack PDU

- The MPE Rack PDU is a power distribution unit for data center applications. It provides all the necessary functions of a rack-based power distribution unit and guarantees reliable power distribution. A broad range of IT devices and other sensitive electrical loads can be connected to it.
- Special cables with a locking function can be connected to the outputs.
- Depending on the model, the connecting cable of the MPH2 is securely attached to the housing (length of input lead: 3 m) or a connection cable can be connected directly on site (models with connection block).
- The PDU can be installed without any tools in Vertiv Knürr racks or other housing systems with the corresponding mountings.
- For 32 A models, the individual groups are protected by a 20 A circuit breaker (hydraulic, magnetic).
- The maximum operating temperature is 60°C (not for MPE-3345-002, this type has 6 x 16A miniature circuit breaker).

Material / Surface / Color

- Closed housing, aluminum profile, upper section powder-coated in RAL 7021 fine structure, plastic parts Vampamid 60024 V0 (UL94) recyclable, dyed fine structure RAL 9005.

Mechanical dimensions

- Width x depth x length (mm) 56 x 50 x (see table).

Standards

- CE label in accordance with:
 - Low Voltage Directive 2014/35/EU
 - RoHS Directive 2011/65/EG
- Bureau-Veritas BG - Certificate (Factory Inspection).
- Bureau-Veritas CB - Certificate.

Input values		Input plug	Outputs			Lengths (mm)	Order No.	
Voltage	Current		C13	C19	Schuko			
100-240V	16A	C20 inlet	18	3		826,5	MPE-3141	
100-240V	16A	C20 inlet	24			826,5	MPE-3241	
230V	16A	IEC 60309 16A 1P+N+G	18	3		826,5	MPE-3142	
230V	16A	IEC 60309 16A 1P+N+G	24			826,5	MPE-3242	
230V	32A	IEC 60309 32 A 1P+N+G	36	6		1736,5	MPE-1243	
230V	32A	IEC 60309 32 A 1P+N+G	24	6	3	1736,5	MPE-1543	
230V	32A	IEC 60309 32 A 1P+N+G			18	1736,5	MPE-1643	
230V	32A	Hardwired	36	6		1736,5	MPE-1260	
230V	32A	Hardwired	24	6	3	1736,5	MPE-1560	
230V	32A	Hardwired			18	1736,5	MPE-1660	
230/400V	3 x 16A	IEC 60309 16 A 3P+N+G	36	12		1736,5	MPE-1144	
230/400V	3 x 16A	IEC 60309 16 A 3P+N+G	36	6	3	1736,5	MPE-1444	
230/400V	3 x 16A	IEC 60309 16 A 3P+N+G			18	1736,5	MPE-1644	
230/400V	3 x 16A	Hardwired	36	12		1736,5	MPE-1161	
230/400V	3 x 16A	Hardwired	36	6	3	1736,5	MPE-1461	
230/400V	3 x 16A	Hardwired			18	1736,5	MPE-1661	
230/400V	3 x 32A	IEC 60309 32A 3P+N+G		6		826,5	MPE-3345-002	
230/400V	3 x 32A	IEC 60309 32A 3P+N+G	36	6		1736,5	MPE-1245	
230/400V	3 x 32A	IEC 60309 32A 3P+N+G	24	12		1736,5	MPE-1345	
230/400V	3 x 32A	IEC 60309 32A 3P+N+G	24	6	3	1736,5	MPE-1545	
230/400V	3 x 32A	IEC 60309 32A 3P+N+G			18	1736,5	MPE-1645	
230/400V	3 x 32A	IEC 60309 32A 3P+N+G	48			1736,5	MPE-1745	
230/400V	3 x 32A	Hardwired	36	6		1736,5	MPE-1262	
230/400V	3 x 32A	Hardwired	24	12		1736,5	MPE-1362	
230/400V	3 x 32A	Hardwired	24	6	3	1736,5	MPE-1562	
230/400V	3 x 32A	Hardwired			18	1736,5	MPE-1662	
230/400V	3 x 32A	Hardwired	48			1736,5	MPE-1762	

- assemble to order (shipped within 5 working days).
Caution: In case of larger orders, delivery times may increase.



DOS20495



DOS20496



DOS20497



DOS20498



DOS20499



DOS20500

SafetyLock™ Connection Cable IEC C13 EU

- Connection cables have integrated protection against accidental disconnection.
- For straight locking from C14 to C13.
- Locking cables are sold in sets of 9 units.

■ Technical data

- Standard: IEC 60320.
- Load rating: 250 Vac/10 A.
- Operating temperature: -25° C ~ +70° C.
- Extraction force with locking function: up to 120 N.
- Electric power cable: H05VV-F 3G 0.75 mm².
- Flame retardance: Plug: UL 94V-2 or better; cable: UL VW-1, IEC60332-1. Cat F2.

■ Certification

- ENEC.
- VDE.
- CB scheme.
- RoHS compliant.

■ Color

- Black/white.
- Other colors available upon request.

■ Scope of delivery

- 9 x locking cables.

■ How supplied

- In sets.

L	Model	Order No.	UP
0.5 m	Black	03.951.450.0,001	9 unit
1.0 m	Black	03.951.450.0,002	9 unit
1.5 m	Black	03.951.450.0,003	9 unit
0.5 m	White	03.951.451.0,001	9 unit
1.0 m	White	03.951.451.0,002	9 unit
1.5 m	White	03.951.451.0,003	9 unit

SafetyLock Connection Cable IEC C19 EU

- Connection cables have integrated protection against accidental disconnection.
- For straight locking from C20 to C19.
- Locking cables are sold in sets of 6 units.

■ Technical data

- Standard: IEC 60320.
- Load rating: 250 Vac/16 A.
- Operating temperature: -25° C ~ +70° C.
- Extraction force with locking function: up to 120 N.
- Electric power cable: H05VV-F 3G 1.5 mm².
- Flame retardance: Plug: UL 94V-2 or better; cable: UL VW-1, IEC60332-1. Cat F2.

■ Approvals

- ENEC.
- VDE.
- CB scheme.
- RoHS compliant.

■ Color

- Black/white.
- Other colors available upon request.

■ Scope of delivery

- 6 x locking cables.

■ How supplied

- In sets.

L	Model	Order No.	UP
0.5 m	Black	03.951.455.0,001	6 unit
1.0 m	Black	03.951.455.0,002	6 unit
1.5 m	Black	03.951.455.0,003	6 unit
0.5 m	White	03.951.456.0,001	6 unit
1.0 m	White	03.951.456.0,002	6 unit
1.5 m	White	03.951.456.0,003	6 unit

Vertiv™ Knürr® DIS Rack PDU® – Basic Rack-PDU

Robust PDUs with useful equipment features

Features

- Closed sheet-steel extrusions and ideal integration into Knürr rack systems deliver high stability and torsional strength.
- Best possible conductivity: Full-length brass busbar provided with many models.
- Double spring contacts for reliable and low contact resistance.

The Vertiv™ Knürr® DIS Rack PDU® product family meets a broad range of data center power distribution requirements for IT applications, computer networking, laboratories and home sector.

Specially configured for the growing number of electronic components in network switching racks or server racks. Available with different accessories, such as circuit breakers, overvoltage protection, mains filter, master-slave function, emergency stop switch, fault-current circuit-breaker, local and remote power metering.



INPUT POWER

- Single-phase or three-phase.
- Up to 22 kVA.
- Simple input supply.



OUTPUT DISTRIBUTOR

- NEMA 5-20R single-phase, IEC C13 and C19, combination systems.
- Schuko, France, Switzerland.



MODULARITY

- More connectivity with expansion unit for Basic Rack PDU GST18.



FORM FACTOR

- Vertical mounting (0 U).
- Rack installation.
- Workstation mounting.

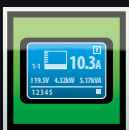

LOCAL MONITORING

- Fixed display.



REMOTE MONITORING

- Secure Web and SNMP interfaces with Vertiv Nform.



OVERLOAD PROTECTION

- SCircuit breakers/fuses per branching cable/output as required.

Benefits

- Optimal phase distribution across the entire rack with color-coded identification of the individual phases.
- Up to 48 different plug options per PDU: shortens the cable distance between the PDU and the consumer.
- One of the most compact PDUs on the market: measures only 44.4 x 45.5 mm, which saves space even on a 600 mm-wide rack.
- Simple and quick installation on the rack extrusion: reduces installation and wiring costs.



Highest possible security and availability with:

- Closed sheet-steel extrusions that deliver high stability and torsional flexibility.
- Extensive certification compliant with the international Standard.
- Double spring contacts for reliable and low contact resistance.
- Unbalanced load monitoring prevents feed-cable overload of 3-phase feed (only DIS Rack PDU® versions M and RM).
- Optimal load monitoring for server installation (only DIS Rack PDU versions D and I).

Maximum flexibility attained due to:

- Internationally compatible configurations and options.
- Power cable lengths of 2.5 m or 4 m for more spatial flexibility.
- Rotating current indicator in 90° steps (only D and I DIS Rack PDU versions).

Extremely low operating costs:

- Installation in the rack is rapid and easy requiring minimal space and reduced installation time.
- Automatic background-light reduction reduces the rack PDU power loss (only with D and I DIS Rack PDU versions).
- Especially flat housing extrusion, providing full accessibility to the 19" level on 600 mm wide server racks.

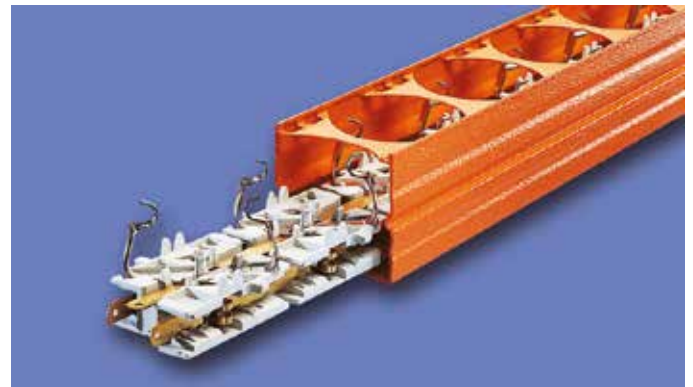

Reliable power distribution at full power delivered by full-length brass busbars.

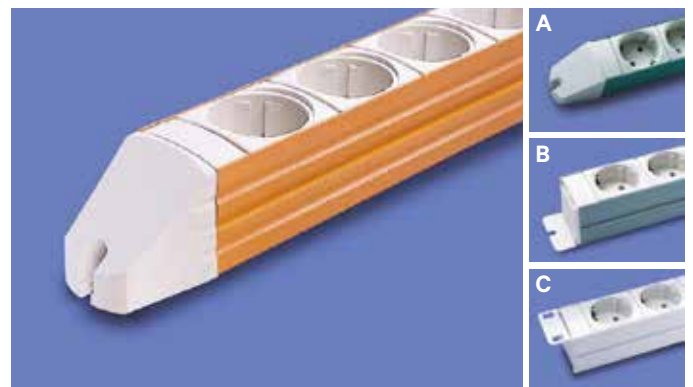

Can be fitted to a rack or workstation.



Highly compact construction; minimizes space requirements in the rack.

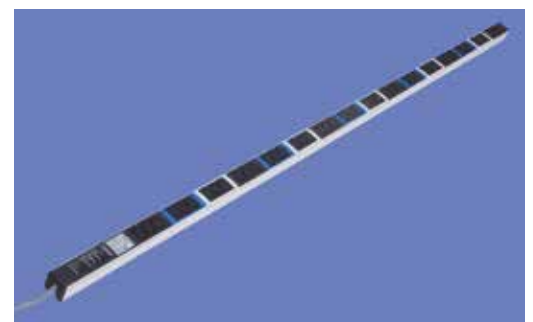

Color-coded phase allocation (L1, L2, L3).

Vertiv™ Knürr® DIS Rack PDU®

European Equipment Models

VERTIV KNÜRR DIS Rack PDU models	Functions	Input power	Outputs
Euro socket system IEC 320	Basic power distribution	16 A - 32 A / 1 ph 3.68 kVA - 7 kVA	IEC60320 C13 & C19
TriplePower	Basic power distribution	16 A - 32 A / 1 ph and 3 ph 3.68 kVA - 22 kVA	IEC60320 C13 & C19 & Schuko
Classic	Basic power distribution/extra large distance between the sockets	1 x 16 A 3.68 kVA	Schuko, France, Switzerland
Compact	Basic power distribution	16 A - 32 A / 1 ph 3.68 kVA - 7 kVA	Schuko, France, Switzerland
Protector FI	Fault-current circuit-breaker FI	1 x 16 A 3.68 kVA	Schuko, France, Switzerland
Protector LS	Circuit breaker (LS) FI	1 x 16 A 3.68 kVA	Schuko, France, Switzerland
Protector FI/LS	Combination FI + LS	1 x 16 A 3.68 kVA	Schuko, France, Switzerland
Protector Emergency Stop	Emergency stop switch	1 x 16 A 3.68 kVA	Schuko, France, Switzerland
Protector Emergency Stop FI/LS	Combination emergency stop + FI + LS	1 x 16 A 3.68 kVA	Schuko, France, Switzerland
Power Cleaner	Mains filter	1 x 16 A 3.68 kVA	Schuko, France
Safety Basic	Overvoltage protection	1 x 16 A 3.68 kVA	Schuko, France, Switzerland
Safety Standard	Mains filter + overvoltage protection	1 x 16 A 3.68 kVA	Schuko, France, Switzerland
Master Slave	Master Slave	1 x 16 A 3.68 kVA	Schuko, France
Combi	Combination Master Slave + overvoltage protection + mains filter	1 x 16 A 3.68 kVA	Schuko, France
D	Input measurement, local	16 A - 32 A / 1 ph and 3 ph 3.68 kVA - 22 kVA	IEC60320 C13 & C19 & Schuko
I	Input measurement, local + remote	16 A - 32 A / 1 ph and 3 ph 3.68 kVA - 22 kVA	IEC60320 C13 & C19 & Schuko



DOS20062



DOS00458



DOS00460



DOS20102

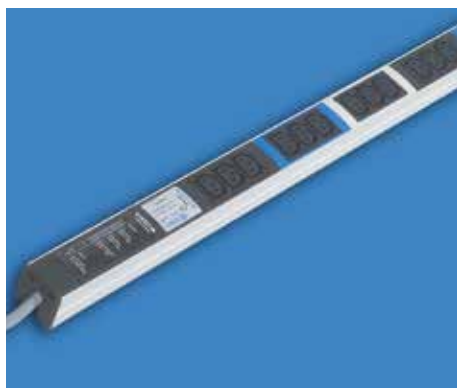

DOS20126

Vertiv™ Knürr® DIS Rack PDU® Euro Socket System, IEC 320

Models on page 230

- Optionally with illuminated switch; 2-pole switching.
- 19" installation option.
- Euro socket combinations of IEC 320 C13 and C19 sockets.
- Feed cable:
 - H05VV-F 3G 1,5 mm² (16 A types)
 - H05VV-F 3G 4 mm² (32 A types).
- Feed cable: 2.5 m / 5 m.

Material / Finish

- Housing: closed sheet steel extrusion, zinc-passivated, powder-coated texture.
- Plastic parts: Vampamid 6 0024 VO (UL94), recyclable.

Abmessungen

- Height: 45.5 mm.
- Width of housing: 44.4 mm (= 1 U).

Approvals/certificates

- CE label in accordance with:
 - Low Voltage Directive 2014/35/EU
 - EMC Directive 2014/30/EU
 - RoHS Directive 2011/65/EG.
- Bureau-Veritas BG - Certificate (Factory Inspection).
- Bureau-Veritas CB - Certificate.
- CSA (only models with IEAC60320 input).

Color

- Enclosure: RAL 7035, light-gray.
- Plastic parts: RAL 7021 dark-gray.

Scope of delivery

- 1 x socket strip.
- 2 x mounting brackets.

Vertiv™ Knürr® DIS Rack PDU TriplePower® Euro Socket System

Models on page 230

- Feed cable:
 - H05VV-F 5G 2,5 mm² (3 x 16 A types)
 - H05VV-F 5G 4 mm² (3 x 32 A types).
- Feed cable: 2.5 m (optional with IEC60309 plug, 3Ph/N/PE 6h).
- Easy mounting on the rack extrusion.
- Standard feed 3 x 16 A.
- Ideal for implementing redundancy (e.g. 96 A with redundant feed).
- Color-coded phase allocation.
- Optimum distribution across the entire rack height (23 U and 41 U).
- Alternative to 3-phase GST18 system.

Material/ Finish

- Housing: closed sheet steel extrusion, zinc-passivated, powder-coated texture.
- Plastic parts: Vampamid 6 0024 VO (UL94), recyclable.

Dimensions

- Height: 45.5 mm.
- Width of housing: 44.4 mm (= 1 U).

Approvals/certificates

- CE label in accordance with:
 - Low Voltage Directive 2014/35/EU
 - EMC Directive 2014/30/EU
 - RoHS Directive 2011/65/EG.
- Bureau-Veritas BG - Certificate (Factory Inspection).
- Bureau-Veritas CB Certificate.

Color

- Enclosure: RAL 7035, light-gray.
- Plastic parts: RAL 7021 dark-gray.

Load rating

- 100-240/173-415 Vac.
- Input: 3 x 16 A.
- Output: 10 A (C13).
- Output: 16 A (C19 / Schuko).

Scope of delivery

- 1 x socket strip.
- 2 x mounting brackets.



DOS00403

Vertiv™ Knürr® DIS Rack PDU® Classic

Models on page 230

- Optionally with illuminated switch; 2-pole switching.
- Socket rotation: 45°.
- Feed cable: H05VV-F 3G 1.5 mm².
- Optionally with Euro plug, IEC320 for UPS application.

■ **Material / Finish**

- Housing: closed sheet steel extrusion, zinc-passivated, powder-coated texture.
- Plastic parts: Vampamid 6 0024 VO (UL94).
- Internal conductor: full-length busbars, brass.

■ **Dimensions**

- Distance between sockets: 100 mm.
- Height: 45.5 mm.
- Width of housing: 44.4 mm (= 1 U).
- Feed cable: 2.5 m.

■ **Approvals/certificates**

- CE label in accordance with:
 - Low Voltage Directive 2014/35/EU
 - EMC Directive 2014/30/EU
 - RoHS Directive 2011/65/EG.
- Bureau-Veritas BG – Certificate (Factory Inspection).
- Bureau-Veritas CB – Certificate.
- VDE-GS – Certificate.

■ **Color**

- RAL 7035, light-gray.

■ **Load rating**

- 100-240 Vac/16 A (output Schuko and UTE).
- 100-240 Vac/10A (outputs Switzerland).

■ **Scope of delivery**

- 1 x socket strip.
- 2 x mounting brackets.



DOS00401

with switch.

Vertiv™ Knürr® DIS Rack PDU Compact

Models on page 231

- Optionally with illuminated switch; 2-pole switching.
- 19" installation option (for length 483 mm).
- 2 versions: standard side panel or design side panel.
- Socket rotation: 45°.
- Feed cable: H05VV-F 3G 1.5 mm².
- Molded right angle plug.
- Optionally with Euro plug, IEC320 for UPS applications.

■ **Material / Finish**

- Housing: closed sheet steel extrusion, zinc-passivated, powder-coated texture.
- Plastic parts: Vampamid 6 0024 VO (UL94), recyclable.
- Internal conductor: full-length busbars, brass.

■ **Dimensions**

- Distance between sockets: 50 mm.
- Height: 45.5 mm.
- Width of housing: 44.4 mm (= 1 U).
- Feed cable: 2.5 m.

■ **Approvals/certificates**

- CE label in accordance with:
 - Low Voltage Directive 2014/35/EU
 - EMC Directive 2014/30/EU
 - RoHS Directive 2011/65/EG.
- Bureau-Veritas BG – Certificate (Factory Inspection).
- Bureau-Veritas CB – Certificate.
- VDE-GS – Certificate.

■ **Color combination**

- Final digit of order number .1: RAL 7035, light-gray.
- Final digit of order number .6: housing RAL 2003 pastel orange.
- Plastic parts: RAL 7035, light-gray.

■ **Load rating**

- 100-240 Vac/16 A (output Schuko and UTE).
- 100-240 Vac/10 A (outputs Switzerland).

■ **Scope of delivery**

- 1 x socket strip.
- 2 x mounting brackets.



DOS20065

with FI circuit breaker

Vertiv™ Knürr® DIS Rack PDU Protector FI

Models on page 231

■ Protector FI

- Fault-current circuit breaker for user protection.
- Protection against indirect contact by disconnection of the circuit when inadmissibly high contact voltage occurs through bodily contact with electrical equipment.
- Additional protection against direct contact.
- Residual operating current $I_g = 10$ mA for alternating and pulsating direct fault currents.
- 19° installation option (for length 483 mm).
- Socket rotation: 45°.
- Feed cable: H05VV-F 3G 1.5 mm².
- Molded right angle plug.

■ Material/ Finish

- Housing: closed sheet steel extrusion, zinc-passivated, powder-coated texture.
- Plastic parts: Vampamid 6 0024 VO (UL94), recyclable.
- Internal conductor: full-length busbars, brass.

■ Dimensions

- Distance between sockets: 50 mm.
- Height: 78 mm.
- Width of housing: 44.4 mm (= 1 U).

- Feed cable: 2.5 m.

■ Approvals/certificates

- CE label in accordance with:
 - Low Voltage Directive 2014/35/EU
 - EMC Directive 2014/30/EU
 - RoHS Directive 2011/65/EG.
- Bureau-Veritas BG – Certificate (Factory Inspection).
- Bureau-Veritas CB – Certificate.

■ Color combination

- Final digit of order number .1: RAL 7035, light-gray.
- Plastic parts: RAL 7035, light gray.

■ Load rating

- 100–240 Vac/16 A.

■ Scope of delivery

- 1 x socket strip.
- 2 x mounting brackets.



DOS00692

with circuit breaker.

Vertiv™ Knürr® DIS Rack PDU Protector LS

Models on page 231

■ Protector LS

- Circuit breaker for overload and short circuit.
- Protects cables and lines by switching off rapidly in the event of a short circuit and defined delayed switch-off when overloads occur.
- Circuit breaker: 16 A.
- Trip characteristics: type B, 2-pole.
- 19° installation option (for length 483 mm).
- Socket rotation: 45°.
- Feed cable: H05VV-F 3G 1.5 mm².
- Molded right angle plug.

■ Material/ Finish

- Housing: closed sheet steel extrusion, zinc-passivated, powder-coated texture.
- Plastic parts: Vampamid 6 0024 VO (UL94), recyclable.
- Internal conductor: full-length busbars, brass.

■ Dimensions

- Distance between sockets: 50 mm.
- Height: 78 mm.
- Width of housing: 44.4 mm (= 1 U).
- Feed cable: 2.5 m.

■ Approvals/certificates

- CE label in accordance with:
 - Low Voltage Directive 2014/35/EU
 - EMC Directive 2014/30/EU
 - RoHS Directive 2011/65/EG.
- Bureau-Veritas BG – Certificate (Factory Inspection).
- Bureau-Veritas CB – Certificate.
- VDE-GS – Certificate.

■ Color combination

- Final digit of order number .1: RAL 7035, light-gray.
- Plastic parts: RAL 7035, light gray.

■ Load rating

- 100–240 Vac/16 A.

■ Scope of delivery

- 1 x socket strip.
- 2 x mounting brackets.



DOS00693

Vertiv™ Knürr® DIS Rack PDU® Protector FI / LS

Models on page 232

■ Protector FI / LS

- Fault current switch and circuit breaker.
- Provides a combination of user, overload and short circuit protection.
- Residual operating current $I_g = 30$ mA for alternating and pulsating direct fault currents.
- Circuit breaker 16 A (Schuko and France) / 10A (Switzerland).
- Trip characteristics, type B, 2-pole.
- 19° installation option (for length 483 mm).
- Socket rotation: 45°.
- Feed cable: H05VV-F 3G 1.5 mm².
- Molded right angle plug.

■ Material / Finish

- Housing: closed sheet steel extrusion, zinc-passivated, powder-coated texture.
- Plastic parts: Vampamid 6 0024 VO (UL94), recyclable.
- Internal conductor: full-length busbars, brass.

■ Dimensions

- Distance between sockets: 50 mm.
- Height: 78 mm.
- Width of housing: 44.4 mm (= 1 U).
- Feed cable: 2.5 m.

■ Approvals/certificates

- CE label in accordance with:
 - Low Voltage Directive 2014/35/EU
 - EMC Directive 2014/30/EU
 - RoHS Directive 2011/65/EG.
- Bureau-Veritas BG – Certificate (Factory Inspection).
- Bureau-Veritas CB – Certificate.

■ Color combination

- Final digit of order number .1: RAL 7035, light-gray.
- Plastic parts: RAL 7035, light-gray.

■ Load rating

- 100–240 Vac/16 A (Schuko and France).
- 100–240 Vac/10 A (Switzerland).

■ Scope of delivery

- 1 x socket strip.
- 2 x mounting brackets.



DOS20059

Vertiv™ Knürr® DIS Rack PDU Protector Emergency Stop

Models on page 232

- With 2-pole emergency stop switch for user protection.
- For manually disconnecting consumers in an emergency.
- Phase and neutral conductors are separated safely.
- Switch must be intentionally unlocked to restart.
- 19° installation option (for length 483 mm).
- Socket rotation: 45°.
- Feed cable: H05VV-F 3G 1.5 mm².
- Molded right angle plug.

■ Material / Finish

- Housing: closed sheet steel extrusion, zinc-passivated, powder-coated texture.
- Plastic parts: Vampamid 6 0024 VO (UL94), recyclable.
- Internal conductor: full-length busbars, brass.

■ Dimensions

- Distance between sockets: Classic: 100 mm, Compact: 50 mm.
- Height: 101 mm.
- Width of housing: 44.4 mm (= 1 U).
- Feed cable: 2.5 m.

■ Approvals/certificates

- CE label in accordance with:
 - Low Voltage Directive 2014/35/EU
 - EMC Directive 2014/30/EU
 - RoHS Directive 2011/65/EG.
- Bureau-Veritas BG – Certificate (Factory Inspection).
- Bureau-Veritas CB – Certificate.

■ Color combinations

- Final digit of order number .1: RAL 7035, light gray.
- Plastic parts: RAL 7035, light gray.

■ Load rating

- 100–240 Vac/16 A.

■ Scope of delivery

- 1 x socket strip.
- 2 x mounting brackets.



DOS00456

Vertiv™ Knürr® DIS Rack PDU® Protector Emergency Stop FI /LS

Models on page 232

- With 2-pole emergency stop switch for user protection.
- For protecting operating personnel.
- For manually disconnecting consumers in an emergency.
- Phase and neutral conductors are separated safely.
- Switch must be intentionally unlocked to restart.
- Socket rotation: 45°.
- Feed cable: H05VV-F 3G 1.5 mm².
- Molded right angle plug.

Material/ Finish

- Housing: closed sheet steel extrusion, zinc-passivated, powder-coated texture.
- plastic parts: Vampamid 6 0024 VO (UL94), recyclable.
- Internal conductor: full-length busbars, brass.

Dimensions

- Distance between sockets: Compact: 50 mm.
- Height: 101 mm.
- Width of housing: 44.4 mm (= 1 U)
- Feed cable: 2.5 m.

Approvals/certificates

- CE label in accordance with:
 - Low Voltage Directive 2014/35/EU
 - EMC Directive 2014/30/EU
 - RoHS Directive 2011/65/EG.
- Bureau-Veritas BG – Certificate (Factory Inspection).
- Bureau-Veritas CB – Certificate.

Color combinations

- Final digit of order number .1: RAL 7035, light-gray.
- Plastic parts: RAL 7035, light-gray.

Additionally:

- With 2-pole fault-current switch and circuit breaker
- Provides a combination of user, overload and short circuit protection.

Load rating

- 100–240 Vac/16 A.

Scope of delivery

- 1 x socket strip.
- 2 x mounting brackets.



DOS20061

Vertiv™ Knürr® DIS Rack PDU Power Cleaner

Models on page 232

- High-frequency glitches generally occur in switching processes ranging from 100 kHz to 5 MHz. This high-frequency rate overloads the mains frequency and affects adjacent electronic equipment. The mains filter attenuates this high-frequency rate.
- The attenuation behavior is harmonized with the typical interference spectrum.
- The mains filter works in both directions: where glitches from the equipment to the socket strip are also filtered from the mains.
- 19" installation option (for length 483 mm).
- Socket rotation: 45°.
- Feed cable: H05VV-F 3G 1.5 mm².
- Molded right angle plug.

Material / Finish

- Housing: closed sheet steel extrusion, zinc-passivated, powder-coated texture.
- Plastic parts: Vampamid 6 0024 VO (UL94), recyclable.
- Internal conductor: full-length busbars, brass.

Dimensions

- Distance between sockets: 50 mm.
- Height: 45.5 mm.
- Width of housing: 44.4 mm (= 1 U).
- Feed cable: 2.5 m.

Approvals/certificates

- CE label in accordance with:
 - Low Voltage Directive 2014/35/EU
 - EMC Directive 2014/30/EU
 - RoHS Directive 2011/65/EG.
- Bureau-Veritas BG – Certificate (Factory Inspection).
- Bureau-Veritas CB – Certificate.

Color combination

- Final digit of order number .1: RAL 7035, light-gray.
- Final digit of order number .6: housing RAL 2003 pastel orange.
- Plastic parts: RAL 7035, light-gray.

Technical data

- Nominal voltage: max. 250 Vac, 50 Hz.
- Nominal current, max. 16 A.
- Filter compliant with VDE 0565-3 (EN 60939-1).

Scope of delivery

- 1 x socket strip.
- 2 x mounting brackets.
- 2 x 19" mounting brackets (additionally with 19" installation option).



DOS20068

with overvoltage protection

Vertiv™ Knürr® DIS Rack PDU® Safety Basic

Models on
page 232

- For protection against transient overvoltage from the mains, which, for example, are caused by switching machines on and off.
 - When critical overvoltages occur, the connection to the mains is cut off.
 - Once the protective conductor has been triggered, the green function display light is not illuminated. Thus, the socket strip can no longer be used.*
 - Basic equipment protection is classified as class 3 (category D).
 - For optimal protection, class 1 and 2 (categories B and C) protective equipment must be installed in the building.
 - 19" installation option (for length 483 mm).
 - Socket rotation: 45°.
 - Feed cable: H05VV-F 3G 1.5 mm².
 - Molded right angle plug.
- **Material / Finish**
 - Housing: closed sheet steel extrusion, zinc-passivated, powder-coated texture.
 - plastic parts: Vampamid 6 0024 VO (UL94), recyclable.
 - Internal conductor: full-length busbars, brass.
- **Dimensions**
 - Distance between sockets: 50 mm.
 - Height: 45.5 mm.
 - Width of housing: 44.4 mm (= 1 U).
- **Approvals/certificates**
 - CE label in accordance with:
 - Low Voltage Directive 2014/35/EU
 - EMC Directive 2014/30/EU
 - RoHS Directive 2011/65/EG.
 - Bureau-Veritas BG – Certificate (Factory Inspection).
 - Bureau-Veritas CB – Certificate.
- **Color combination**
 - Final digit of order number .1: RAL 7035, light-gray.
 - Final digit of order number .6: housing RAL 2003 pastel orange.
 - Plastic parts: RAL 7035, light-gray.
- **Technical data**
 - Appliance class: Type 3 as per DIN EN 61643-11.
 - Requirement class: category D as per VDE 0675-6.
 - Mains voltage: 230 VAC.
 - Nominal current, max. 16 A.
 - Discharge surge current (8/20 μs): 10 kA.
 - Reaction time: < 25 ns.
 - Safety level (at 100 A varistor peak current): L with respect to N: < 800 V, L / N with respect to PE: < 1500V.
- **Scope of delivery**
 - 1 x socket strip.
 - 2 x mounting brackets.

* Send the socket strip to the manufacturer for the safety arrester to be replaced!



DOS20069

Vertiv™ Knürr® DIS Rack PDU® Safety Standard

Models on
page 232

- Standard safety models consist of a combined overvoltage protection/mains filter element.
 - Protects against transient overvoltages from the mains, which, for example, are caused by switching machines on and off.
 - When critical overvoltages occur, connection to the mains is cut off.
 - Once the protective conductor has been triggered, the green function display light is not illuminated. The socket strip can thus no longer be used.*
 - Basic equipment protection is classified as class 3 (category D).
 - For optimal protection, class 1 and 2 (categories B and C) protective equipment must be installed in the building.
 - High-frequency glitches are generally caused by switching processes in an operation from 100 kHz to 5MHz.
 - This high-frequency rate overloads the mains frequency and affects adjacent electronic equipment. The mains filter attenuates this high-frequency rate.
 - The attenuation behavior is harmonized with the typical interference spectrum.
 - 19" installation option (for length 483 mm).
 - Socket rotation: 45°.
 - Feed cable: HO5VV-F 3G 1.5 mm².
 - Molded right angle plug.
- **Material/ Finish**
 - Housing: closed sheet steel extrusion, zinc-passivated, powder-coated texture.
 - Plastic parts: Vampamid 6 0024 VO (UL94), recyclable.
 - Internal conductor: full-length busbars, brass.
- **Dimensions**
 - Distance between sockets: 50 mm.
 - Height: 45.5 mm.
 - Width of housing: 44.4 mm (= 1 U).
 - Feed cable: 2.5 m.
- **Approvals/certificates**
 - CE label in accordance with:
 - Low Voltage Directive 2014/35/EU
 - EMC Directive 2014/30/EU
 - RoHS Directive 2011/65/EG.
 - Bureau-Veritas BG – Certificate (Factory Inspection).
 - Bureau-Veritas CB – Certificate.
- **Color combination**
 - Final digit of order number .1: RAL 7035, light-gray.
 - Final digit of order number .6: housing RAL 2003 pastel orange.
 - Plastic parts: RAL 7035, light-gray.
- **Technical data**
 - Mains voltage: 230 VAC.
 - Nominal current: max. 16 A / 10 A.
 - Discharge surge current (8/20 μs): 10 kA.
 - Reaction time: < 25 ns.
 - Safety level (at 100 A varistor peak current): L with respect to N: < 800 V, L / N with respect to PE: < 1500V.
 - Overvoltage protection
 - Appliance class: Class 3 – as per DIN EN 61643-11.
 - Requirement class: Category D as per VDE 0675-6.
 - Mains filter: as per VDE 0565 (EN 60939).
- **Scope of delivery**
 - 1 x socket strip.
 - 2 x mounting brackets.

* Send the socket strip to the manufacturer for the safety arrester to be replaced!



DOS20070

Vertiv™ Knürr® DIS Rack PDU® Master-Slave

Models on page 232

- Slave plugs will switch on if master switches on.
- Note:
 - The master consumer's power intake must always exceed the switch-on threshold. When switching off the master consumer, the power intake must fall below the switch-off threshold.
 - 19" installation option (for length 483 mm).
 - Socket rotation: 45°.
 - Feed cable: H05VV-F 3G 1.5 mm².
 - Molded right angle plug.

Material / Finish

- Housing: closed sheet steel extrusion, zinc-passivated, powder-coated texture.
- Plastic parts: Vampamid 6 0024 VO (UL94), recyclable.
- Internal conductor: full-length busbars, brass.

Dimensions

- Distance between sockets: 50 mm.
- Height: 45.5 mm.
- Width of housing: 44.4 mm (= 1 U).
- Feed cable: 2.5 m.

Approvals/certificates

- CE label in accordance with:
 - Low Voltage Directive 2014/35/EU
 - EMC Directive 2014/30/EU
 - RoHS Directive 2011/65/EG.
- Bureau-Veritas BG – Certificate (Factory Inspection).
- Bureau-Veritas CB – Certificate.
- VDE GS - Certificate.

Color combination

- Final digit of order number .1: RAL 7035, light-gray.
- Plastic parts: RAL 7035, light-gray.

Load rating

- Max. 250 Vac/16 A.

Technical data

- Switching-threshold setting range
 - On: 20 - 200 mA (approx. 55 mA on delivery).
 - Off: 16 - 160 mA (approx. 44 mA on delivery).
- Switching delay: 550 ms, ± 20 %.
- Electronic module: 2-pole switching.

Scope of delivery

- 1 x socket strip.
- 2 x mounting brackets.



DOS00325 with master-slave overvoltage protection and mains filter.

Vertiv™ Knürr® DIS Rack PDU Combi

Models on page 232

- Master-slave with overvoltage protection and mains filter.
- Automatic consumer switching.
- Combines Master-Slave and Safety Standard functions.
- Socket rotation: 45°.
- Feed cable: H05VV-F 3G 1.5 mm².
- Molded right angle plug.

Material / Finish

- Housing: closed sheet steel extrusion, zinc-passivated, powder-coated texture.
- Plastic parts: Vampamid 6 0024 VO (UL94), recyclable.
- Internal conductor: full-length busbars, brass.

Dimensions

- Distance between sockets: 50 mm.
- Height: 45.5 mm.
- Width of housing: 44.4 mm (= 1 U).
- Feed cable: 2.5 m.

Approvals/certificates

- CE label in accordance with:
 - Low Voltage Directive 2014/35/EU
 - EMC Directive 2014/30/EU
 - RoHS Directive 2011/65/EG.
- Bureau-Veritas BG – Certificate (Factory Inspection).
- Bureau-Veritas CB – Certificate.

Color combination

- Final digit of order number .1: RAL 7035, light-gray.
- Plastic parts: RAL 7035, light-gray.

Technical data

- With overvoltage protection and mains filter.
- Mains voltage: max. 250 VAC.
- Nominal current: 16 A.
- Requirement class: D (protection as per VDE 0675).
- Surge current resistance (8/20 s wave): Max. 10 kA.
- Protection level (1.5/50 µs wave): < 1500 V (L + N against PE).
- Master-slave function:
 - Switching-threshold setting range
 - On: 20 - 200 mA (approx. 55 mA on delivery).
 - Off: 16 - 160 mA (approx. 44 mA on delivery).
 - Switching delay: 550 ms ± 20 %.
- Electronic module: 2-pole switching.

Scope of delivery

- 1 x socket strip.
- 2 x mounting brackets.



DOS80002b

Vertiv™ Knürr® DIS Rack PDU® D

Models on page 233

- Metering electrical values per phase.
- Metering values are clearly displayed on a LCD display.
- LCD display rotation in 90° steps.
- Display contrast can be adjusted.
- Unbalanced-load warning display with 3-phase model.
- Three color LED shows status of PDU.
- Automatic reduction of background light.
- Metering values: Voltage, phase and neutral current, frequency, real power apparent power, energy, power factor.
- Input cable:
 - H05VV -F 5 G 4 mm2 (3 x 32 A types)
 - H05VV -F 3 G 4 mm2 (1 x 32 A types)
 - H05VV -F 5G 2,5 mm2 (3 x 16 A types)
 - H05VV -F 3G 1,5 mm2 (1 x 16 A types)
 - Length: 2,5 m (16 A types); 3 m (32 A types).

Material/ Finish

- Housing: closed sheet steel extrusion, zinc-passivated, powder-coated texture.
- Plastic parts: Vampamid 6 0024 VO (UL94), recyclable.

Approvals/certificates

- CE label in accordance with:
 - Low voltage directive 2014/35/EU
 - EMC-directive 2014/30/EU
 - RoHS-directive 2011/65/EG.
- Bureau-Veritas BG – Certificate (Factory Inspection).
- Bureau-Veritas CB – Certificate.

Color

- Housing: RAL 7035 light gray.
- Plastic parts: RAL 7021 dark-gray.

Scope of delivery

- 1 socket strip.
- 2 mounting brackets.



DOS80002

Vertiv™ Knürr® DIS Rack PDU I

Models on page 233

- Metering electrical values per phase.
- Metering values are clearly displayed on a LCD display.
- LCD display rotation in 90° steps.
- Display contrast can be adjusted.
- Unbalanced-load warning display with 3-phase model.
- Remote interface to get metering values and alarms.
- Automatic reduction of background light.
- Metering values: Voltage, phase and neutral current, frequency, real power apparent power, energy, power factor.
- Input cable:
 - H05VV -F 5 G 4 mm2 (3 x 32 A types)
 - H05VV -F 3 G 4 mm2 (1 x 32 A types)
 - H05VV -F 5G 2,5 mm2 (3 x 16 A types)
 - H05VV -F 3G 1,5 mm2 (1 x 16 A types)
 - Length: 2,5 m (16 A types); 3 m (32 A types).

Data interface:

- RJ45 LAN-Port (10/100) for connection to network (LAN).
- Remote Management: Onboard Web Interface, http/s, CLI, SNMPv1,2,3, SSH, Syslog, IPv4, IPv6, DNS.

Material / Finish

- Housing: closed sheet steel extrusion, zinc-passivated, powder-coated texture.
- Plastic parts: Vampamid 6 0024 VO (UL94), recyclable.

Approvals/certificates

- CE label in accordance with:
 - Low voltage directive 2014/35/EU
 - EMC-directive 2014/30/EU
 - RoHS-directive 2011/65/EG.
- Bureau-Veritas BG – Certificate (Factory Inspection).
- Bureau-Veritas CB – Certificate.

Color

- Housing: RAL 7035 light gray.
- Plastic parts: RAL 7021 dark-gray.

Scope of delivery

- 1 socket strip.
- 2 mounting brackets.

VERTIV KNÜRR DIS Rack PDU Model	Input Values		Input Connector	Outputs						L	S	F1	F2	19"	Safe	Order No.
	Voltage	Current		C13	C19	Schuko	UTE	Type 13	Type 23							
Euro plug IEC320 system																
With feed cable	230V	16 A	Schuko CEE7/7	6						333		■				036000061
	230V	16 A	Schuko CEE7/7	9						483	■	■		■		036020091
	230V	10 A	IEC60320 C13	12						483		■		■		036003121 P
	230V	16 A	IEC60320 C19	15	3					783		■				036004181
	230V	16 A	IEC60320 Sheet I	12						483		■		■		036004121
	230V	16 A	IEC60309 1ph/N/PE 6h	15	3					783		■				036005181
	230V	32 A	IEC60309 1ph/N/PE 6h	20	4					1083		■				036006241
Euro input in plug panel	230V	10 A	IEC60320 C14 inlet	6						383		■				036220061 P
	230V	10 A	IEC60320 C14 inlet	9						483		■		■		036220091 P
Euro input on side panel	230V	10 A	IEC60320 C14 inlet	6						333		■				036227061
	230V	10 A	IEC60320 C14 inlet	9						433		■				036227091
	230V	10 A	IEC60320 C14 inlet	6						383	■	■				036247061 P
230V	10 A	IEC60320 C14 inlet	9						483	■	■					036247091 P
With overload protection 10 A	230V	10 A	Schuko CEE7/7	10						483	■	■		■		036320101
GST18 input in side panel	230V	16 A	GST18	6						383		■				036002061
TriplePower																
230/400V	3 x 16 A	none		24						1033		■				036000241 P
230/400V	3 x 16 A	none		48						1833		■				036000481
230/400V	3 x 16 A	IEC60309 3ph/N/PE 6h		24						1033		■				036008241
230/400V	3 x 16 A	IEC60309 3ph/N/PE 6h		48						1833		■				036008481
230/400V	3 x 16 A	IEC60309 3ph/N/PE 6h		18	6					1133		■				036005241
230/400V	3 x 16 A	IEC60309 3ph/N/PE 6h		36	6					1733		■				036005421
230/400V	3 x 16 A	IEC60309 3ph/N/PE 6h			6					483		■		■		036005061
230/400V	3 x 16 A	IEC60309 3ph/N/PE 6h				12				833		■				033008121
230/400V	3 x 16 A	IEC60309 3ph/N/PE 6h		18	3					833		■				036005211
230/400V	3 x 16 A	IEC60309 3ph/N/PE 6h		18		3				833		■				033005211
230/400V	3 x 16 A	IEC60309 3ph/N/PE 6h		21						833		■				036008211
230/400V	3 x 16 A	IEC60309 3ph/N/PE 6h		45						1733		■				036008451
230/400V	3 x 16 A	IEC60309 3ph/N/PE 6h		36		6				1733		■				033005421
230/400V	3 x 16 A	IEC60309 3ph/N/PE 6h				6				483		■				033005061
230/400V	3 x 32 A	IEC60309 3ph/N/PE/ 6h		30	6					1783		■				036009361
230/400V	3 x 32 A	IEC60309 3ph/N/PE/ 6h		18	12					1783		■				036009301
230/400V	3 x 32 A	IEC60309 3ph/N/PE/ 6h			6					883		■				036009061
230/400V	3 x 32 A	IEC60309 3ph/N/PE/ 6h				18				1483		■				033009181
230/400V	3 x 32 A	IEC60309 3ph/N/PE/ 6h				6				883		■				033009061
Classic																
230V	16 A	Schuko CEE7/7				17				1783		■				03300067X
230V	16 A	Schuko CEE7/7				13				1383		■				03300063X
230V	16 A	Schuko CEE7/7				9				983		■				03300059X
230V	16 A	Schuko CEE7/7				5				583		■				03300055X
230V	16 A	Schuko CEE7/7				16				1733	■	■				03302066X
230V	16 A	Schuko CEE7/7				12				1333	■	■				03302062X
230V	16 A	Schuko CEE7/7				8				933	■	■				03302058X
230V	16 A	Schuko CEE7/7				4				533	■	■				03302054X
230V	16 A	Schuko CEE7/7					13			1383		■		■		03400063X
230V	16 A	Schuko CEE7/7					9			983		■		■		03400059X
230V	16 A	Schuko CEE7/7					5			583		■		■		03400055X
230V	16 A	Schuko CEE7/7					8			933	■	■		■		03402058X
230V	10 A	SEV 1011 T12						13		1383		■				037010631
230V	10 A	SEV 1011 T12						9		983		■				037010591
230V	10 A	SEV 1011 T12						5		583		■				037010551
230V	10 A	SEV 1011 T12						16		1733	■	■				037030661
230V	10 A	SEV 1011 T12						8		933	■	■				037030581

VERTIV KNÜRR DIS Rack PDU Model	Input Values		Input Connector	Outputs					L	S	F1	F2	19"	Safe	Order No.
	Voltage	Current		C13	C19	Schuko	UTE	Type 13							
Compact															
	230V	16 A	Schuko CEE7/7			15			883		■				03.300.015.X
	230V	16 A	Schuko CEE7/7			11			732			■			03.300.111.X
	230V	16 A	Schuko CEE7/7			11			683		■				03.300.011.X P
	230V	16 A	Schuko CEE7/7			11			683		■				03.300.011.X
	230V	16 A	Schuko CEE7/7			7			532			■			03.300.107.X
	230V	16 A	Schuko CEE7/7			7			483		■		■		03.300.007.X P
	230V	16 A	Schuko CEE7/7			8			483		■		■		03.300.008.X P
	230V	16 A	Schuko CEE7/7			4			382			■			03.300.104.X
	230V	16 A	Schuko CEE7/7			4			333		■				03.300.004.1 P
	230V	16 A	Schuko CEE7/7			4			333		■				03.300.004.X
	230V	16 A	Schuko CEE7/7			14			883	■	■				03.302.014.X
	230V	16 A	Schuko CEE7/7			10			732	■		■			03.302.110.X
	230V	16 A	Schuko CEE7/7			10			683	■	■				03.302.010.X
	230V	16 A	Schuko CEE7/7			6			532	■		■		■	03.303.106.X
	230V	16 A	Schuko CEE7/7			6			532	■		■			03.302.106.X
	230V	16 A	Schuko CEE7/7			6			483	■	■		■		03.302.006.X P
	230V	16 A	Schuko CEE7/7			7			483	■	■		■		03.302.007.1
	230V	16 A	Schuko CEE7/7			3			382	■		■			03.302.103.X
	230V	16 A	Schuko CEE7/7			3			333	■	■				03.302.003.X
UPS application	230V	10 A	IEC60320 Sheet E			8			483		■		■		03.300.308.1
	230V	16 A	IEC60320 Sheet I			8			483		■		■		03.300.408.1
	230V	16 A	GST18			6			583	■	■				03.302.206.1
	230V	16 A	GST18			3			433	■	■				03.302.203.1
	230V	16 A	GST18			7			533		■				03.300.207.1
	230V	16 A	GST18			4			383		■				03.300.204.1
	230V	16 A	Schuko CEE7/7				11		683		■			■	03.400.011.X
	230V	16 A	Schuko CEE7/7				7		532			■		■	03.400.107.X
	230V	16 A	Schuko CEE7/7				7		483		■		■	■	03.400.007.1 P
	230V	16 A	Schuko CEE7/7				7		483		■		■	■	03.400.007.X
	230V	16 A	Schuko CEE7/7				4		333		■			■	03.400.004.X
	230V	16 A	Schuko CEE7/7				10		683	■	■			■	03.402.010.X
	230V	16 A	Schuko CEE7/7				6		483	■	■		■	■	03.402.006.X
	230V	16 A	Schuko CEE7/7				3		333	■	■			■	03.402.003.X
	230V	16 A	GST18				7		533		■			■	03.400.207.1
	230V	16 A	GST18				4		383		■			■	03.400.204.1
	230V	10 A	SEV 1011 T12					11	683		■				03.701.011.1
	230V	10 A	SEV 1011 T12					7	483		■		■		03.701.007.1
	230V	10 A	SEV 1011 T12					4	333		■				03.701.004.1
	230V	10 A	SEV 1011 T12					10	732	■		■			03.703.110.1
	230V	10 A	SEV 1011 T12					6	483	■	■		■		03.703.006.1
	230V	10 A	SEV 1011 T12					3	382	■		■			03.703.103.1
	230V	10 A	SEV 1011 T12					3	333	■	■				03.703.003.1
	230V	32 A	IEC60309 1ph/N/PE 6h			18			1183		■				03.300.618.1
Protector FI															
	230V	16 A	Schuko CEE7/7			13			883		■				03.304.013.1
	230V	16 A	Schuko CEE7/7			9			683		■				03.304.009.1
	230V	16 A	Schuko CEE7/7			5			483		■		■		03.304.005.1
	230V	16 A	Schuko CEE7/7				5		483		■		■	■	03.404.005.1
Protector LS															
	230V	16 A	Schuko CEE7/7			13			883		■				03.308.013.1
	230V	16 A	Schuko CEE7/7			9			683		■				03.308.009.1
	230V	16 A	Schuko CEE7/7			5			483		■		■		03.308.005.1
	230V	16 A	Schuko CEE7/7				5		483		■		■	■	03.408.005.1

P = assemble to order (shipped within 5 working days).
Caution: In case of larger orders, delivery times may increase.

VERTIV KNÜRR DIS Rack PDU Model	Input Values		Input Connector	Outputs						L	S	F1	F2	19"	Safe	Order No.
	Voltage	Current		C13	C19	Schuko	UTE	Type 13	Type 23							
Protector FI/LS																
	230V	16 A	Schuko CEE7/7			13				883		■				03.310.013.1
	230V	16 A	Schuko CEE7/7			9				683		■				03.310.009.1
	230V	16 A	Schuko CEE7/7			5				483		■		■		03.310.005.1
	230V	16 A	Schuko CEE7/7				9			683		■			■	03.410.009.1
	230V	16 A	Schuko CEE7/7				5			483		■		■	■	03.410.005.1
	230V	10 A	SEV 1011 T12					5		483		■		■		03.711.005.1
Protector emergency stop switch																
Compact	230V	16 A	Schuko CEE7/7			6				483		■		■		03.326.006.1
	230V	16 A	Schuko CEE7/7				10			683		■			■	03.426.010.1
Protector emergency stop switch FI/LS																
	230V	16 A	Schuko CEE7/7			8				683		■				03.328.008.1
Power Cleaner																
	230V	16 A	Schuko CEE7/7			13				883		■				03.312.013.X
	230V	16 A	Schuko CEE7/7			9				683		■				03.312.009.X
	230V	16 A	Schuko CEE7/7			5				483		■		■		03.312.005.X
	230V	16 A	GST18	6						483		■		■		03.612.206.1
Safety Basic																
	230V	16 A	Schuko CEE7/7			10				732				■		03.316.110.1
	230V	16 A	Schuko CEE7/7			10				683		■				03.316.010.X
	230V	16 A	Schuko CEE7/7			6				483		■		■		03.316.006.1 
	230V	16 A	Schuko CEE7/7			6				483		■		■		03.316.006.X
	230V	16 A	Schuko CEE7/7			4				383		■				03.316.004.1
	230V	16 A	GST18			4				433		■				03.316.204.1
	230V	16 A	GST18	6						483		■		■		03.616.206.1
	230V	16 A	Schuko CEE7/7				6			483		■		■	■	03.416.006.1
Safety Standard																
	230V	16 A	Schuko CEE7/7			13				883	■	■				03.318.013.X
	230V	16 A	Schuko CEE7/7			9				732	■		■			03.318.109.X
	230V	16 A	Schuko CEE7/7			9				683	■	■				03.318.009.X
	230V	16 A	Schuko CEE7/7			5				532	■		■			03.318.105.X
	230V	16 A	Schuko CEE7/7			5				483	■	■		■		03.318.005.X
	230V	16 A	GST18	6						483		■		■		03.618.206.1
	230V	16 A	Schuko CEE7/7				5			483	■	■		■	■	03.418.005.X
	230V	10 A	SEV 1011 T12					5		483	■	■		■		03.719.005.1
Master-Slave																
	230V	16 A	Schuko CEE7/7			9				683		■				03.314.009.1
	230V	16 A	Schuko CEE7/7			5				483		■		■		03.314.005.1
	230V	16 A	Schuko CEE7/7				5			483		■		■	■	03.414.005.1
Combi																
	230V	16 A	Schuko CEE7/7			9				733		■				03.320.009.1
	230V	16 A	Schuko CEE7/7			5				533		■				03.320.005.1

VERTIV KNÜRR DIS Rack PDU Model	Input Values		Input Connector	Outputs						L	S	F1	F2	19"	Safe	Order No.
	Voltage	Current		C13	C19	Schuko	UTE	Type 13	Type 23							

D																
230V	16 A	Schuko CEE7/7				6				483		■		■		03.306.005.1
230V	16 A	IEC60309 1ph/N/PE 6h				6				483		■		■		03.306.805.1
230V	16 A	Schuko CEE7/7				14				933		■				03.306.014.1
230V	16 A	IEC60309 1ph/N/PE 6h				14				933		■				03.306.814.1
230V	16 A	Schuko CEE7/7		9						483		■		■		03.606.008.1
230V	16 A	IEC60309 1ph/N/PE 6h		9						483		■		■		03.606.808.1
230V	16 A	Schuko CEE7/7					6			483		■		■		03.406.006.1
230V	10 A	SEV 1011 T12						5		483		■		■		03.706.005.1
230V	16 A	IEC60309 1ph/N/PE 6h	18	2						933		■				03.606.820.1
230/400V	3 x 16 A	IEC60309 3ph/N/PE 6h				18				1283		■				03.306.518.1
230/400V	3 x 16 A	IEC60309 3ph/N/PE 6h				6				683		■				03.306.506.1
230/400V	3 x 16 A	IEC60309 3ph/N/PE 6h	27	6						1433		■				03.606.533.1
230/400V	3 x 16 A	IEC60309 3ph/N/PE 6h		6						483		■		■		03.606.506.1
230V	32 A	IEC60309 1ph/N/PE 6h				18				1283		■				03.306.618.1
230V	32 A	IEC60309 1ph/N/PE 6h	20	4						1183		■				03.606.624.1
230/400V	3 x 32 A	IEC60309 3ph/N/PE 6h	30	6						1883		■				03.606.936.1
230/400V	3 x 32 A	IEC60309 3ph/N/PE 6h	18	12						1883		■				03.606.930.1
230/400V	3 x 32 A	IEC60309 3ph/N/PE 6h		6						983		■				03.606.906.1
230/400V	3 x 32 A	IEC60309 3ph/N/PE 6h				18				1583		■				03.306.918.1
230/400V	3 x 32 A	IEC60309 3ph/N/PE 6h				6				983		■				03.306.906.1

I																
230V	16 A	IEC60309 1ph/N/PE 6h	18	2						1033		■				03.607.820.1
230V	16 A	Schuko CEE7/7				6				633		■				03.307.006.1
230V	16 A	IEC60309 1ph/N/PE 6h				6				633		■				03.307.806.1
230V	16 A	Schuko CEE7/7				12				933		■				03.307.012.1
230V	16 A	IEC60309 1ph/N/PE 6h				12				933		■				03.307.812.1
230/400V	3 x 16 A	IEC60309 3ph/N/PE 6h				18				1383		■				03.307.518.1
230/400V	3 x 16 A	IEC60309 3ph/N/PE 6h				6				783		■				03.307.506.1
230/400V	3 x 16 A	IEC60309 3ph/N/PE 6h	27	6						1533		■				03.607.533.1
230/400V	3 x 16 A	IEC60309 3ph/N/PE 6h		6						633		■				03.607.506.1
230V	32 A	IEC60309 1ph/N/PE 6h				18				1383		■				03.307.618.1
230V	32 A	IEC60309 1ph/N/PE 6h	20	4						1283		■				03.607.624.1
230/400V	3 x 32 A	IEC60309 3ph/N/PE 6h	30	6						1983		■				03.607.936.1
230/400V	3 x 32 A	IEC60309 3ph/N/PE 6h	18	12						1983		■				03.607.930.1
230/400V	3 x 32 A	IEC60309 3ph/N/PE 6h		6						1083		■				03.607.906.1
230/400V	3 x 32 A	IEC60309 3ph/N/PE 6h				18				1683		■				03.307.918.1
230/400V	3 x 32 A	IEC60309 3ph/N/PE 6h				6				1083		■				03.307.906.1

Outputs:	Type 23 = Switzerland	
C13 = IEC60320 C13	Type 13 = Switzerland	F2 = Design side panel (for installing at workstation)
C19 = IEC60320 C19	L = Length in mm	19" = Suitable for 19" installation
Schuko = Protective contact plug DIN 49440	S = Switch	safe = Child-proof
UTE = France Standard CEE 7-V	F1 = Standard side pane (for rack mounting)	



1. DOS20147

3-Phase in Rack with GST18 Features



2. DOS20132

- **Requirement**
Constant energy increase requirements in the rack caused by high packing densities (e.g. 1 U Pizza servers, blade servers, etc.) (1)
- **Solution**
3-phase distributor with GST18 plug system, e.g. 96 A with redundant feed. (2)
- **Benefits (3, 4)**
 - Modularity.
 - Plug-in capability (no wiring required).
 - Can be expanded.
 - Cascadable.
 - Easy implementation of redundancies/ UPS-secured circuits.
 - Combination of DIN Schuko / IEC320 Euro systems.
 - Any installation position can be selected.
 - Good alternative to 3-phase Vertiv™ Knürr® DIS Rack PDU Triple Power.



3. DOS20142

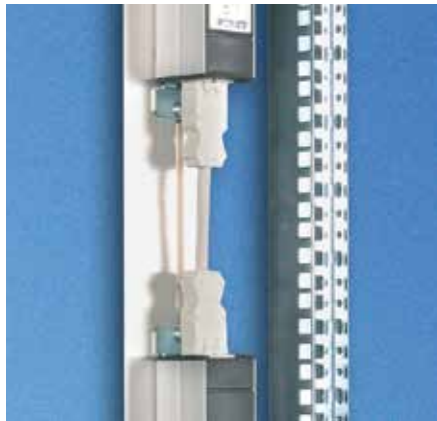

3. DOS20135



DOS20104

Power Supply Cable, 3-Phase Accessories for GST 18 Plug System

- GST 18 socket for connecting GST18i5 distributor block with 3 phases.
 - 5-pole (L1, L2, L3, N, PE) 250/400 V ~.
 - Cable: H05VV-F 5G 2.5 mm².
- **Color**
- Black.

L	Order No.	UP
2000	04.000.048.0	1 unit

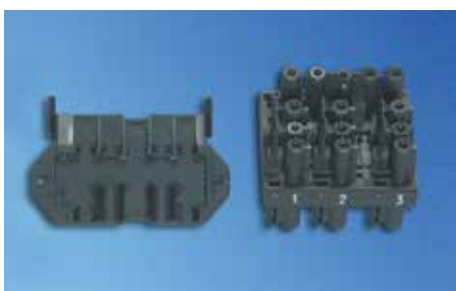

DOS20103

GST18i5 Distributor Block, 3-Phase

- For individual connection at the customer.
 - Modular plug-in connection.
 - 3-phase distribution on various socket strips.
 - Including mounting panel.
- **Color**
- Black.

Order No.	UP
04.000.038.9	1 unit



DOS00467

Power Supply Cable, Single Phase Accessories for GST 18 Plug System

- Mains plug CEE/VII: GST18 socket (Wieland).
- Cable: H05VV-F3G 1.5 mm².

- **Color**
- White.

L	Order No.	UP
2000	04.000.040.0	1 unit
5000	04.000.041.0	1 unit



DOS00469

Connection Cable Accessories for GST 18 Plug System

- GST 18 plug.
- GST 18 socket.
- Cable: H05VV-F3G 1.5 mm².

- **Color**
- For color coding circuits (e.g. UPS).

L	Model	Order No.	UP
200	White	04.000.042.0	1 unit
200	Black	04.000.042.9	1 unit
500	White	04.000.037.0	1 unit
500	Black	04.000.037.9	1 unit
1000	White	04.000.044.0	1 unit
1000	Black	04.000.044.9	1 unit
5000	White	04.000.045.0	1 unit



DOS20105

GST18 Socket

- With threaded connection for cross-section 1.5 – 2.5 mm² with cable strain relief.
- For individual connection.

- **Color**
- White.

Order No.	UP
04.000.046.0	1 unit



DOS00471

GST18 Plug

- With threaded connection for cross-section 1.5 – 2.5 mm² with cable strain relief.
- For individual, further cabling.

- **Color**
- White.

Order No.	UP
04.000.047.0	1 unit



DOS00470



DOS00076

Mains Cable for Euro Socket Strip For DIN 49 440 and French/Belgian Standard

- Mains plug CEE/VII: Euro socket IEC 320.
- Cable: H05VV-F 3G 1 mm².

- **Mains voltage**
- 250 VAC.
- **Nominal current**
- 10 A.

L	Order No.	UP
2000	04.000.054.9	1 unit
6000	04.000.053.9	1 unit

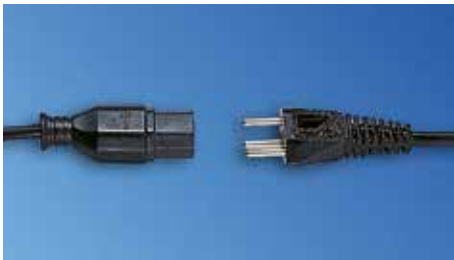

Mains Cable for Euro Socket Strip For Swiss Standard

- Mains plug: Type 12 - Euro socket IEC 320.
- Cable: H05VV-F 3G 1 mm².

- **Mains voltage**
- 250 VAC.
- **Nominal current**
- 10 A.

L	Order No.	UP
2000	04.000.055.9	1 unit



DOS00078

Mains Cable for Euro Socket Strip For British Standard

- Mains plug: Type BS 1363 - IEC320 Euro socket.
- Cable: H05VV-F 3G 1 mm².

- **Mains voltage**
- 250 VAC.
- **Nominal current**
- 10 A.

L	Order No.	UP
2000	04.000.056.9	1 unit



DOS00519

Euro Connection Cable

- Mains plug: IEC 320.
- Euro socket IEC 320.
- Cable: H05VV-F 3G 1 mm².
- USA: SJT AWG18 with USA approval.

- **Mains voltage**
- 250 VAC.
- **Nominal current**
- 10 A.

L	Model	Order No.	UP
900	EU	04.000.051.9	1 unit
900	USA	04.000.052.9	1 unit

Dimensions in mm:

L = Length	n = Number of sockets	U = Standard rack unit
S = Switch	F1 = Standard side panel	UP = Packaging unit
	F2 = Design side panel	Safe = child-proof
	19" = ideal for 19" components	

Conversion:

1 mm	= 0.03937 inch
1 kg	= 2.2046 pounds

Replace .x with the number of your color combination: .1 = RAL 7035, .6 = RAL 7035/RAL 2003



DOS20493

SafetySleeve™ Cable Protection IEC C19

- SafetySleeves protect the feed lines of the network equipment.
- Compatible with all C19 cables and fit onto all PDUs.

- **Material / Finish**
- PVC, black.

Model	Order No.	UP
C20 plug in C19 socket	03.910.212.9 001	20 unit



DOS20494

SafetySleeve™ Cable Protection IEC C13

- SafetySleeves protect the feed lines of the network equipment.
- Compatible with all C13 cables and fit onto all PDUs.

- **Material / Finish**
- PVC, black.

Model	Order No.	UP
C14 plug in C13 socket	03.910.213.9 001	50 unit

Dimensions in mm:

L = Length	n = Number of sockets	U = Standard rack unit
S = Switch	F1 = Standard side panel	UP = Packaging unit
	F2 = Design side panel	Safe = child-proof
	19" = ideal for 19" components	

Conversion:

1 mm	= 0.03937 inch
1 kg	= 2.2046 pounds

Replace .x with the number of your color combination: .1 = RAL 7035, .6 = RAL 7035/RAL 2003

Rack PDU Support and Warranty Options

Vertiv™ offers you various options to ensure that you get the support you need in the event of a fault. You can get in touch with your usual contact person directly or contact us by phone or e-mail.

Technical Support

- Website:
www.VertivCo.eu
- Telephone:
+800 1155 4499
- E-Mail:
eoc@VertivCo.com

Warranty Extension

When you purchase PDUs from us, you also have the option of ordering warranty extensions for certain models. The following overview shows you the various options available for increasing your service level.

Warranty term (months)	Order No.		
	24	36	60
MPH2 B Version (all B models vertical)	free of charge	WE1Y-MPH2VB	WE3Y-MPH2VB
MPH2 R, C, M Versions (all R, C, M models vertical)	free of charge	WE1Y-MPH2VRCM	WE3Y-MPH2VRCM
MPH2 B Version (all B models horizontal)	free of charge	WE1Y-MPH2HB	WE3Y-MPH2HB
MPH2 R, C, M Versions (all R, C, M models horizontal)	free of charge	WE1Y-MPH2HRCM	WE3Y-MPH2HRCM
MPX Components (excluding sensors and display)	free of charge	WE1Y-MPX	WE3Y-MPX

If a warranty case should unfortunately arise for your product, we will decide whether to repair or replace the defective product based on the type of defect in question. Please contact your usual sales contact in such cases.

@Lock – solutions for racks

Access control for data centers and technical rooms

Data centers are broken into on a regular basis. In many cases, the intention is simply to steal high-quality IT equipment. However, breaking in may only be a pretense for stealing data and/or putting in place a man-in-the-middle infrastructure.

On 28 February 2011 for example, an important data center belonging to a global telecommunications service provider was paralyzed by intruders. Only a few weeks previously, a DC service provider working on behalf of a major health care company became the victim of an attempted break-in, which resulted in the entire security concept undergoing a TÜV audit. Generally speaking, attacks of this kind go undetected. Data centers are security areas and therefore need to be secured through various measures. An important part of this is controlling access to and in the data center.

Controlling access to the data center is usually achieved through a combination of organizational measures, e.g., gates and turnstiles, besides a building access control system.

Working with various partners, Vertiv has developed system concepts which not only improve physical security through access controls within the data center but also simplify operative processes, making them less susceptible to errors. These concepts are known as "@Lock".



@lock solution with MLR handles in a co-location datacenter

Option 1: Transponder card system
@Lock "transponder card system" concept

This system concept can be applied throughout – from the DC and cold aisle doors to the individual cabinets. In addition to the card readers and handles, the extensive "Administration Suite" management software is a key part of the system.

Thanks to its modular design and open infrastructure architecture, the new Administration Suite can be expanded as required and can also be implemented for third party providers.

- Encrypted data communication between the hardware, server and client.
- Runs on Windows 2000, Windows XP, Windows Vista, Windows Server 2003, Windows Server 2008, Citrix.
- Allows administration of various users with different types of authorization.
- Client/server capability.
- Web client-capable, SNMP alarming.
- Record changes made to the system by users.
- Straightforward user guidance in spite of extensive tools.
- Wide range of alarm messages.
- Automatic alarm notification via e-mail.
- Centralized locking plans and access management.
- Freely selectable four-eyes-principle.
- Support for the most common transponder types.
- Central management of various systems.
- Records all actions in "Log Events".
- Free replacement of the lock system if the authorizing medium is lost.
- Real-time visualization of the swing handle stations.
- Configuration of special days with different locking regimes.
- Allocation of time profiles for access.
- Able to export "Log Events".
- Multilingual software.

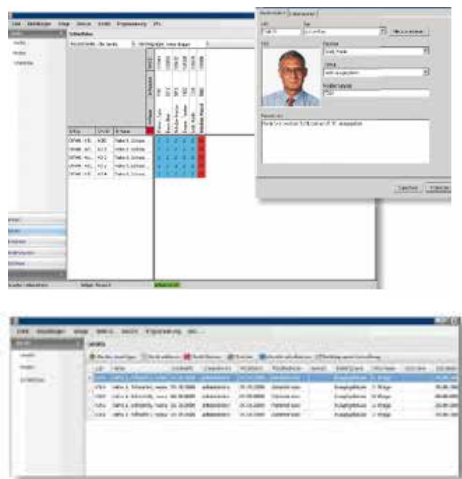

Administration Suite 2.0
 Order number: 01180.049.9

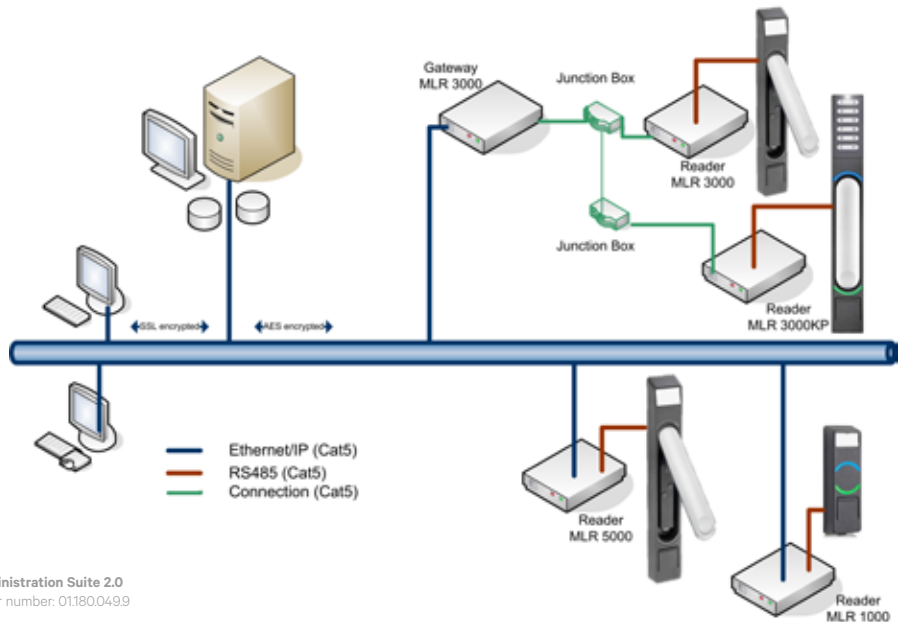

MLR 3000 and MLR 5000 handles are suitable for linking server or network cabinets to the transponder card system. The E-LINE, by Dirak mechatronic swing handles and the Administration Suite software, provide a convenient, reliable way of monitoring access to your data or server cabinet. With the Administration Suite software, security officers can conveniently monitor and manage access directly from a PC.

The integrated LEDs display alarm messages and types of authorization on the handle itself. As a result, technicians on site are given the same information that the Administration Suite software sends to the headquarters. LEDs at the top and bottom of the handle offer permanently high luminosity with low power consumption. As a result, the lock status can be determined quickly, even from a distance of several meters. The top LED can indicate various statuses, such as that the handle is ready to be opened or locked. The bottom LED displays whether the handle is within or

outside the temperature range for the cabinet selected by the customer. As a result, irregularities may be identified quickly, leaving enough time for appropriate action to be taken.

The information display integrated into the handle is backlit and allows customer-specific information, such as the cabinet row, cabinet number etc., to be added for extra clarity.

Handles are also available with integrated Keypad (MLR5000KP). They can be used with either keycard, keypad or both (two-factor-authentication).



@LockMLR3000

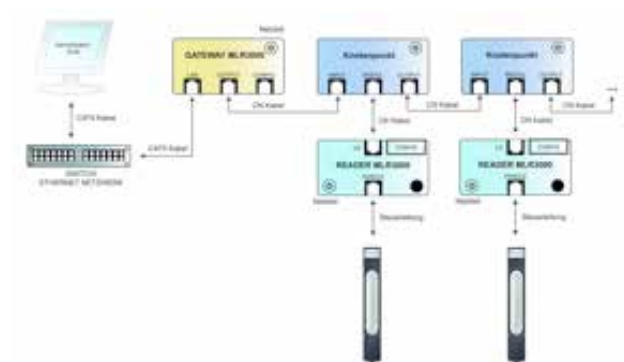

@LockMLR5000

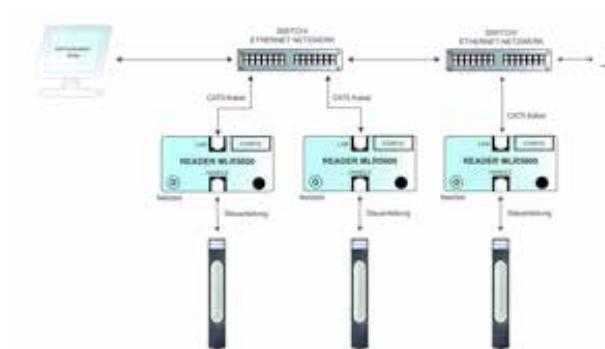

Technical data – @Lock MLR3000/5000

Handle electronics	
Two-part hardware design	Swing handle and reader unit
Visualization	Multicolored status LED
Reader	For 125 kHz transponders (HID 26 bit system), alternatively 13.56 MHz (MIFARE)
Reader	
Housing	Reader unit in plastic housing can be fixed with screws or self-adhesive pad
Power supply	12 V ± 10 % (DC) via low voltage socket
Standby current (system ready)	40 mA (DC)
Max. current consumption (with connector tightening)	440 mA (DC)
RS232 interface for MLR3000	RS232 cable (RXD, TXD, GND, Reader present, PC present), 38,400 baud
Current increase for MLR5000 via Ethernet interface	125 mA (DC)
TCP/IP interface	Ethernet, 10/100 Autosense, up to 100 Mbaud
Connecting cable (reader - handle electronics)	8-pole, 350 cm, UL stranded wire AWG 26, one side with gated RJ45 plug, one side with crimped JST ZH connector ZHR-8
Relay output (via screw clamps)	2.5 mm ² , can be screwed in from plug side, relay contact: 12 V, 3 A, 60 W, 120
Door contact input (via screw clamps)	2.5 mm ² , can be screwed in from plug side, terminals 1 and 2
RS485 interface	RS485 cable to the E-LINE by DIRAK Gateway, (+/A, -/B), 38,400 baud
Memory capacity for transponder cards	2000 + 1 master transponder
Memory capacity for events	500 (ring memory)
Memory capacity for time profiles	30
Integrated real-time clock	With buffering of up to 60 min at 25 °C
Temperature range	-20°C – +70°C

Type	Model	Order No.	UP
@LockMLR3000	for Miracel and DCM front door	01180.226.9	1 unit
@LockMLR3000	for twin door (e.g. DCM rear door)	01180.227.9	1 unit
@LockMLR5000	for Miracel and DCM front door	01180.228.9	1 unit
@LockMLR5000	for twin door (e.g. DCM rear door)	01180.229.9	1 unit
@LockMLR5000 Key Pad	for Miracel and DCM front door	01180.240.9	1 unit
@LockMLR5000 Key Pad	for twin door (e.g. DCM rear door)	01180.241.9	1 unit

Accessories	Bestell-Nr.	UP
Door contact without RJ-45 plug	06.108.115.9	1 unit
HID transponder card	01180.040.9	1 unit
Desktop reader for the initial reading of transponder cards	01180.128.9	1 unit
MLR3000 Gateway	01180.111.9	1 unit
Plug-in power supply (Europe)	01180.035.9	1 unit

Other plug-in power supplies on request



Technical data – MLU3000/5000

MLU card readers can be used to connect a room door with existing electromechanical locking or motorized cold aisle door (Coolfex):

- Three-part hardware design MLU3000 set comprising: external MLU reader, network reader unit and MLU1000 lock.
Visualization on MLU reader: 2 x multicolored status LEDs and 1 x backlit information display.
Antenna for 125 kHz transponders (HID 26 bit system).
- **Optional MLU1000 lock**
 - Die-cast zinc (GDZn), color: matt chrome.
 - 4 m control cable.
 - Power supply 24 V DC +/- 10 % 100 mA.
 - Proximity sensor status contact.
 - Wall/sheeting thickness independent.
 - Electronic opening by interrupting the power supply.
- **MLU3000/MLU5000 network reader**
 - Housing reader unit in plastic housing can be fixed with screws or a self-adhesive pad.
 - Nominal input voltage 12/24/48 V ± 10 % (DC) depending on the electronic lock connected.
 - Standby current (system ready) 40 mA (DC).
 - Max. current consumption RJ12 (LOCK) 1.5 A (DC).
 - Max. current consumption via relay clamp 3.0 A (DC), clamps 10-11.
 - RS232 interface RS 232 cable (RXD, TXD, GND, Reader present, PC present), 38,400 baud.
 - Connecting cable (reader - external MLU antenna) 8-pole, 350 cm, UL stranded wire AWG 26, one side with gated RJ45 plug, one side with

crimped JST ZH connector ZHR-8.

- Relay output (via screw clamps) 2.5 mm, can be screwed on from plug side, relay contact: 12 V, 3 A, 60 W, 120 VA, terminals 3 - 5.
- Door contact input (via screw clamps) 2.5 mm² can be screwed from plug side, terminals 1 and 2.
- RS485 - RS485 interface - cable to the E-LINE by DIRAK Gateway, (+/A, -/B), 38,400 baud (MLU3000).
- TCP/IP Ethernet interface, 10/100 Autosense, up to 100 MBit/s (MLU5000).
- Power off when open/closed: depending on the electronic lock connected, this is configured in the Administration Suite Config Tool.
- Memory capacity for transponder cards 2000: + 1 master transponder.
- Memory capacity for events: 500 (ring memory).
- Memory capacity for time profiles: 30.
- Integrated real-time clock with buffering of up to 60 min at 25 °C.
- Temperature range -20°C – +70°C.

Type	Order No.	UP
MLU 3000	01180.231.9	1 unit
MLU 5000	01180.232.9	1 unit

Option 2: Potential-free contacts

@Lock "potential-free contacts" system concept

Swing handles from the @Lock MLR1000 range are suitable for connecting electromechanical swing handles to existing building management systems or local identification systems, in addition to complementing @LockBlueID or rack monitoring systems.

The handle can be opened as soon as its potential-free contacts are activated or a voltage of 12-24 V DC is supplied. Following activation, the MLR1000 switches to ready-to-open status.

During this period, the user can open the MLR1000 by pressing a button. The LED at the top of the handle offers permanently high luminosity with a low power consumption. As a result, the lock status can be determined quickly, even from a distance of several meters.

The information display integrated into the handle is backlit and allows customer-specific information such as the cabinet row, cabinet number etc., to be added for further clarity.

Technical data – @LockMLR1000

Handle electronics	
Two-part hardware design	MLR1000 and MLR1000 Box
Visualization	Status LED
MLR1000 Box	
Housing	Interface unit, plastic housing can be fixed with screws or self-adhesive pad
Power supply	12 V DC ± 10 % via screw clamps
Standby current (system ready)	40 mA (DC)
Max. current consumption (with connector tightening)	410 mA (DC)
Operating mode	100 % ED
Relay control	12V DC
Operating time	Max. 3 seconds
Contact output	250 V AC, 2 A
Installation position	Vertical
Connection type	Screw clamps, 2.5mm ²
Connecting cable (reader - handle electronics)	8-pole, 350 cm, UL stranded wire AWG 26, one side with gated RJ45 plug, one side with crimped JST ZH connector ZHR-8
Temperature range	-20°C – +70°C

	@Lock MLR5000	@Lock MLR3000	@Lock MLR1000	@Lock BlueID
Software necessary	Admin Suite	Admin Suite	Custom	Web browser, Mobile phone app
E-Line Administration	Yes	Yes	No	No
Suite Software	Yes	Yes	Yes	No
External emergency	Transponder card	Transponder card	Dependent on customer's equipment and software	BlueID
power supply connector	Yes	Gateway	No	Optional
Identification	Yes (in combination w. Administration Suite)	Yes (in combination w. Administration Suite)	Dependent on customer's equipment and software	Optional
IP support	Yes (in combination w. Administration Suite)	Yes (in combination w. Administration Suite)	Dependent on customer's equipment and software	No
Log files	Yes (in combination w. Administration Suite)	Yes (in combination w. Administration Suite)	Dependent on customer's equipment and software	Yes
User profiles	No	No	No	Yes
Four-eyes-principle	Eline by Dirak	Eline by Dirak	Eline by Dirak	BlueID by Baimos Technologies
Off-line mode				
Technology partner				

Type	Model	Order No.	UP
@LockMLR1000	for Miracel and DCM front door	01.180.224.9	1 unit
@LockMLR1000	for twin doors (e.g. DCM rear door)	01.180.225.9	1 unit

Vertiv™ Knürr® RMS Compact II®

Constant Reliability with Remote Monitoring

The advantages of Vertiv Knürr's modern rack monitoring system:

- Guarantees fault-free operation.
- Early disturbance detection.
- Incident logging.
- Automatic monitoring simplifies maintenance.
- Activates countermeasures in the event of a malfunction.
- Central status control of: filters, paper, toner, meter readings, inspection intervals, and much more.
- Up to 12 sensors can be connected in any arrangement.

System Reliability and Availability

System and network management requirements mean the systems' ambient conditions must be monitored. Compliance with the required ambient parameters is extremely important for successful/continuous operation of high-grade components.

Management Software

Inadmissible fluctuations in temperature or humidity often cause hardware defects. Constant automatic monitoring of these parameters is therefore a basic requirement for safeguarding operability. All the relevant data can be recorded and forwarded directly to a higher-level management system, e.g. Nagios or Vertiv Nform™ with the Vertiv Knürr RMS Compact II®.

Alarm Consolidation and Control

Simply recording data does not suffice to ward off damages. When faults occur, short response times are aided by the monitoring system triggering actions automatically (e.g. activating additional fans).

Fast Response

When defined incidents occur, the RMS Compact II can immediately send a message as an "SNMP trap" to the management system or directly as an e-mail to a technician or an SMS gateway.





RMS20047



RMS20048

Vertiv™ Knürr® RMS Compact II®

Description

- **Compact construction** - Zero unit solution (for mounting outside the 19" installation area).
- 19" installation with adapter bracket.
- Safe clamping of all connected cables with integrated cable clamping bracket.
- Cost-effective orderly installation with Plug & Play concept.
- Convenient cabling with RJ45 sensor connections.
- TCP/IP connection via Ethernet (10/100 Base T).
- Configuration via SNMP and Web-Browser.
- Web access is password-protected and optionally encrypted (https).
- 3 different user levels.
- Freely programmable filter system (Boolean logic) for implementing all alarm conditions.
- Compatible with standard network-management and infrastructure-management systems such as Vertiv Nform™ or Open-Source.
- Sensors for monitoring all relevant environmental influences (optional).
- Internal power supply for sensor equipment (no additional power supply necessary).
- Alarms via LEDs, relay, network management or e-mail (SMTP).
- Support from Modbus/TCP.
- System time balancing with NTP servers.

Technical data

- 12 universally usable sensor inputs for temperature and humidity sensors, digital (on/off) or analog sensors (0...10V).

- 3 digital outputs (2 x relay, max. 3 A at 230 VAC, 1 x 750 mA at 48 VDC).
- Power supply: 100 – 240 VAC.
- Operating voltage: 12 VDC.

Compliance

- CE Marking compliant with
 - 2014/35/EU Low Voltage Directive (LVD)
 - 2014/30/EU Electromagnetic Compatibility Directive (EMC)
- 2011/65/EU RoHS2 Directive.

Color

- RAL 7021, dark-grey.

Scope of delivery

- 1 x Knürr RMS Compact II.
- 1 x power supply unit.
- 2 x 19" mounting brackets.
- 1 x support bracket for power supply unit.
- 1 x CD ROM (with manual, MIB file)

How supplied

- In sets.

W	H	D	Model	Order No.	UP
350	42	170	RMS Compact II*	06.108.200.8	1 set



LUF20069

ECO Temperature Sensor RMS II

- **Quick and easy installation**
 - Insensitive to disturbances.
 - No additional power supply required.
 - The sensor must be recalibrated.
- **Technical data**
 - Temperature measurement range: 0..60°C.
 - Accuracy: ± 5 %.
- **Scope of delivery**
 - 1 x sensor.
 - 1 x mounting kit.

Model	Order No.	UP
ECO	06.108.220.9	1 unit

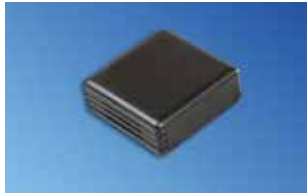

RMS20019

(similar to picture)
RMS compact-specific

Humidity Sensor RMS II

- **Avoids dew**
 - Insensitive to disturbances.
 - Additional power supply required.
 - The sensor does not have to be recalibrated.
- **Technical data**
 - Air measurement range 30 – 90 %.
 - Accuracy: ± 5 %.
- **Scope of delivery**
 - 1 x sensor with RJ45 port.
 - 1 x mounting kit.

Order No.	UP
06.108.212.9	1 unit



RMS20031

Water Sensor RMS II

- **Conductive water spot sensor**
 - Detects presence of water.
- **Technical data**
 - Operating voltage: max. 24 VDC.
- **Scope of delivery**
 - 1 x sensor with 2 m connection cable.
 - 1 x mounting bracket.

Order No.	UP
06.108.217.9	1 unit



RMS20006

Door Contact Sensor RMS II

- **No additional magnet required**
 - Magnet bridge sensor works on all magnetic conductive materials (no special mating part required).
 - Can also be used for monitoring side panels and roof.
 - Standard cable length, 4 m.
- **Technical data**
 - Temperature range: -20° C to +70° C.
 - Switching voltage, max. 200 VDC.
 - Switching current, max. 500 mA.
- **Scope of delivery**
 - 1 x sensor with 4 m connection cable.
 - 1 x mounting kit.
 - With RJ-45 plug

Order No.	UP
06.108.215.9	1 unit



RMS20032

Air Speed Sensor RMS II

- **Fan and filter monitoring**
 - No additional power supply.
 - Automatic detection as analog sensor.
 - Does not have to be recalibrated.
 - Offset and alarm parameters can be set in RMS.
- **Technical data**
 - Measurement range: 0 to 1 m/s.
 - Non-linear measurement,
 - Value table:
 - < 0 m/s < 1 V
 - 0 m/s 1 V
 - 1 m/s 1.7 V
 - 2 m/s 2.9 V
 - 3 m/s 4.1 V
 - 4 m/s 5 V (6 V max.).
- **Scope of delivery**
 - 1 x sensor with 4 m connection cable.
 - 1 x mounting kit.

W	H	D	Order No.	UP
20	39	9	06.108.218.9	1 unit

Dimensions in mm:				Conversion:
W = Width	h = Installation height	U = Standard rack unit	kg = Weight	1 mm = 0.03937 inch
H = Height	d = Insertion depth	(1 U = 44.45 mm)		1 kg = 2.2046 pounds
D = Depth	L = Length	UP = Packaging unit		

Smoke Detector RMS II / RMS III

- **Sends signal to IT Department**
 - Optical smoke detector with VdS approval.
 - For early fire detection with smoke emission.
 - Power supply provided via RMS compact.
 - Standard cable length, 4 m.
- **Technical data**
 - Operates between -20°C and +75°C.
- **Scope of delivery**
 - 1 x sensor with 4 m connection cables.
 - 1 x mounting kit.

W	H	Order No.	UP
Ø 90	75	06.108.211.9	1 unit

Vibration Sensor RMS II / RMS III

- **Protection against vandalism**
 - Detects vibrations.
 - Theft prevention.
- **Scope of delivery**
 - 1 x sensor with 4 m connection cables.

Order No.	UP
06.108.213.9	1 unit

Passive Infrared Movement Sensor RMS II / RMS III

- **Security**
 - Room monitoring with state-of-the-art technology.
- **Technical data**
 - VdS approval: Classes A + B.
 - Range of volumetric lens: 2 – 16 m.
 - Long lens range: 29 – 50 m.
 - Curtain lens range: 17 – 30 m.
 - Manipulation monitoring.
 - Digital fault evaluation.
 - Corner or wall mounting.
- **Scope of delivery**
 - 1 x sensor with 4 m connection cables.
 - 1 x mounting kit.

Order No.	UP
06.108.214.9	1 unit

Sensor Cable RMS II

- **Plug & Play for own sensors**

(Third party and/or any existing analogue/digital sensor)

 - The 4 m long cable is used for connecting further analog/digital sensors or alarm outputs to the sensor input of the Knürr RMS compact II.
 - One end of the cable has an RJ45 connection while other end is open.
 - The RMS automatically recognizes a sensor that is connected to this cable as an analog sensor.
 - A sensor can be supplied with 12 V voltage using the cable.
- **Technical data**
 - Length: 4 m.
- **Scope of delivery**
 - 1 x cable.
 - 1 x layout overview.
- **How supplied**
 - In sets.

Model	L	Order No.	UP
Analog sensor cable	4000	06.108.225.9	1 unit
Digital sensor cable	4000	06.108.224.9	1 unit

Sensor Extension Cable RMS II

- **Flexible positioning of sensors**
 - The cable is used for extending RMS compact II sensors.
 - It consists of a cable with a connected RJ45 plug and an RJ45 connector.
- **Technical data**
 - Length: 3 m and 10 m.
- **Scope of delivery**
 - 1 x cable.
- **How supplied**
 - In sets.

Model	L	Order No.	UP
Sensor extension cable	3000	06.108.223.1	1 unit
Sensor extension cable	10000	06.108.223.5	1 unit

Power over Ethernet (PoE) Update Set RMS II / RMS III

- **Save on cabling**
 - Saves on costly power supply installations (e.g. WLAN access points) or enables centralized UPSs for decentralized equipment (e.g. IP phones).
 - Using the PoE update set, the RMS can therefore support installations with the corresponding UPS concepts and/or non-standard IDF room.
- **Approvals**
 - EMI: FCC Part 15 Class B, CE Class B.
 - Safety: UL, TÜV.
- **Technical data**
 - Input: 48 V DC, 400 mA.
 - Output: 12 V DC (12 W).
 - Operating temperature: 0° to 40° C.
 - Storage temperature: -40° to 70° C.
 - Operating air humidity: 10% to 80% rel. humidity.
- **Scope of delivery**
 - 1 x PoE adapter.
 - 1 x mounting bracket for easy attachment to the RMS (similar to the classic power supply unit mounting bracket).
- **Dimensions**
 - Length: 81 mm.
 - Width: 52 mm.
 - Height: 28 mm.
- **How supplied**
 - In sets.

Model	Order No.	UP
PoE update set	06.108.230.8	1 unit

Carbon Monoxide Alarm Sensor

- **Detects smoke-free gases and triggers an alarm**
 - Used for detecting carbon monoxide emitted by burning fire-retardant cables.
 - Sends signals carbon monoxide to the RMS and triggers an alarm.
 - Standard cable length, 4 m.
 - The RMS automatically recognizes this sensor as a digital sensor.

- **Color**
 - White.

- **Scope of delivery**
 - 1 x sensor.
 - 2 x sensor connection cable.
 - 1 x Mounting kit.
 - 1 x Instructions.

- **How supplied**
 - In sets.

- **Technical data**
 - Operating voltage: 12 VDC ($\pm 20\%$).
 - Power consumption: approx. 190 mA (idle) approx. 280 mA (alarm).
 - Sensitivity: 100 ppm CO.
 - Ambient temperature: -15° C to 40° C.
 - Piezo alarm: approx. 85 dB(A) at 3 m away.
 - Protection rating: IP 20.
 - Switching output 12 V DC: Max. 170 mA.
 - Relay output: Changeover contact, max. 5 A 230 V DC, max. 5 A 30 V DC.
 - Reset: automatic when the gas concentration falls below sensitivity level.

- **Dimensions**
 - Length: 140 mm.
 - Width: 125 mm.
 - Height: 40 mm.

Model	Order No.	UP
Carbon monoxide alarm sensor	06.108.211.8	1 unit

Dimensions in mm:				Conversion:
W = Width	h = Installation height	U = Standard rack unit	kg = Weight	1 mm = 0.03937 inch
H = Height	d = Insertion depth	(1 U = 44.45 mm)		1 kg = 2.2046 pounds
D = Depth	L = Length	UP = Packaging unit		

Vertiv™ Knürr® RMS III®

Constant Reliability with Remote Monitoring

Advantages

- Guarantees fault-free operation.
- Early disturbance detection.
- Incident logging.
- Automatic monitoring simplifies maintenance.
- Activates countermeasures in the event of a malfunction.
- Central status control of: filters, paper, toner, meter readings, inspection intervals, and much more.
- Sensors can be connected in any arrangement.

System Reliability and Availability

System and network management requirements mean the systems' ambient conditions must be monitored. Compliance with the required ambient parameters is extremely important for successful/continuous operation of high-grade components.

Management Software

Inadmissible fluctuations in temperature or humidity often cause hardware defects. Constant automatic monitoring of these parameters is therefore a basic requirement for safeguarding operability. All the relevant data can be recorded and forwarded directly to a higher-level management system, e.g. Nagios Liebert Trellis® with the RMS III®.

Alarm Consolidation and Control

Simply recording data does not suffice to ward off damages. When faults occur, short response times are aided by the monitoring system triggering actions automatically (e.g. activating additional fans).

Fast Response

When defined incidents occur, the RMS III® can immediately send a message as an "SNMP trap" to the management system or directly as an e-mail to a technician or an SMS gateway.





Vertiv™ Knürr® RMS III®

■ Description

- Compact construction - Zero unit solution (for mounting outside the 19" installation area).
- Cost-effective orderly installation with Plug & Play concept.
- Convenient cabling with RJ11 and/or screw terminal sensor connections.
- TCP/IP connection via Ethernet.
- Configuration via SNMP and Web-Browser.
- Web access is password-protected and optionally encrypted (https).
- 3 different user levels.
- Freely programmable filter system (Boolean logic) for implementing all alarm conditions.
- Compatible with standard network-management and infrastructure-management systems such as Liebert Nform™ or Open-Source Software.
- Sensors for monitoring all relevant environmental influences (optional).
- Internal power supply for sensor equipment (no additional power supply necessary).
- Alarms via relay, network management or e-mail (SMTP).
- Support from Modbus/TCP.
- System time balancing with NTP servers.
- Support of MQTT

■ Technical data

- 1x Ethernet connector 10/100 Mbps.
- 6x 1-Wire
- 12x digital on/off connector.
- 1x RS485 connector.
- Up to 40 sensors.
- 4 digital relays outputs (50V).
- Operating voltage: 12 VDC.

■ Compliance

- CE Marking compliant with
- 2014/35/EU Low Voltage Directive (LVD)
- 2014/30/EU Electromagnetic Compatibility Directive (EMC)
- 2011/65/EU RoHS2 Directive.

■ Color

- RAL 7021, dark-grey.

■ Scope of delivery

- 1 x Knürr RMS III®.

■ Optional Items

- 1x Power supply. e.g.: 01:180.035.9000001
- 1x 19" Mounting Shelf for RMSIII 06:108.428.8001

■ How supplied

- Single parts.

W	H	D	Model	Order No.	UP
350	42	170	RMS III*	06:108.401.8	1 pc

Dimensions in mm:

W - Width	h - Installation height	U - Standard rack unit	kg - Weight
H - Height	d - Insertion depth	(1 U = 44.45 mm)	
D - Depth	L - Length	UP - Packaging unit	

Conversion:

1 mm = 0.03937 inch
1 kg = 2.2046 pounds



LUF20069

Combined sensor Temperature Humidity "Eco" (RMS III)

- **Quick and easy installation**
 - Insensitive to disturbances.
 - No additional power supply required.
- **Technical data**
 - Temperature measurement range: 0..60°C.
 - Accuracy : 2%.
 - To be connected to 1-wire port.
- **Scope of delivery**
 - 1 x sensor.

Model	Order No.	UP
ECO	06.108.421.9	1 unit



RMS20019

Temperature Humidity Sensor RMS III

- **Avoids dew**
 - Insensitive to disturbances.
 - Additional power supply required.
- **Technical data**
 - Air measurement range 30 – 90%.
 - Accuracy: 2%.
 - To be connected to 1-wire port.
- **Scope of delivery**
 - 1 x sensor with RJ45 port.

Order No.	UP
06.108.411.9	1 unit



RMS20006

Door Contact Sensor RMS III

- **No additional magnet required**
 - Magnet bridge sensor works on all magnetic conductive materials (no special mating part required).
 - Can also be used for monitoring side panels and roof.
- **Technical data**
 - Temperature range: -20° C to +70° C.
 - Switching voltage, max. 200 VDC.
 - Switching current, max. 500 mA.
 - To be connected to digital IN port.
- **Scope of delivery**
 - 1 x sensor with 4 m connection cable.
 - 1 x mounting kit.

Order No.	UP
06.108.115.9	1 unit



Water Sensor RMS III

- **Conductive water spot sensor**
 - Detects presence of water.
- **Technical data**
 - Operating voltage: max. 24 VDC.
 - To be connected to 1-wire port.
- **Scope of delivery**
 - 1 x sensor with 2 m connection cable.
 - 1 x mounting bracket.

Order No.	UP
06.108.418.9	1 unit

Smoke Detector
RMSII / RMSIII

■ **Sends signal to IT Department**

- Optical smoke detector with VdS approval.
- For early fire detection with smoke emission.
- Power supply provided via RMS compact.
- Standard cable length, 4 m.

■ **Technical data**

- Operates between -20°C and +75°C.

■ **Scope of delivery**

- 1 x sensor with 4 m connection cables.
- 1 x mounting kit.
- To be connected to digital IN port.

W	H	Order No.	UP
Ø 90	75	06.108.211.9	1 unit

Vibration Sensor
RMSII / RMSIII

■ **Protection against vandalism**

- Detects vibrations.
- Theft prevention.
- Reset possible via Viewer software.
- 1 x sensor with 4 m connection cables.
- To be connected to digital IN port.

Order No.	UP
06.108.213.9	1 unit

Passive Infrared Movement Sensor
RMSII / RMSIII

■ **Security**

- Room monitoring with state-of-the-art technology.

- Digital fault evaluation.
- Corner or wall mounting.
- To be connected to digital IN port.

■ **Technical data**

- VdS approval: Classes A + B.
- Range of volumetric lens: 2 – 16 m.
- Long lens range: 29 – 50 m.
- Curtain lens range: 17 – 30 m.
- Manipulation monitoring.

■ **Scope of delivery**

- 1 x sensor with 4 m connection cable.
- 1 x mounting kit.

Order No.	UP
06.108.214.9	1 unit

Power over Ethernet (PoE) Update Set
RMSII / RMSIII

■ **Save on cabling**

- Saves on costly power supply installations (e.g. WLAN access points) or enables centralized UPSs for decentralized equipment (e.g. IP phones).
- Using the PoE update set, the RMS can therefore support installations with the corresponding UPS concepts and/or non-standard IDF room.

■ **Technical data**

- Input: 48 V DC, 400 mA.
- Output: 12 V DC (12 W).
- Operating temperature: 0° to 40° C.
- Storage temperature: -40° to 70° C.
- Operating air humidity: 10% to 80% rel. humidity.

■ **Dimensions**

- Length: 81 mm.
- Width: 52 mm.
- Height: 28 mm.

■ **Approvals**

- EMI: FCC Part 15 Class B, CE Class B.
- Safety: UL, TUV.

■ **Scope of delivery**

- 1 x PoE adapter.
- 1 x mounting bracket for easy attachment to the RMS (similar to the classic power supply unit mounting bracket).

■ **How supplied**

- In sets.

Model	Order No.	UP
PoE update set	06.108.230.8	1 unit

Carbon Monoxide Alarm Sensor
RMSII / RMSIII

■ **Detects smoke-free gases and triggers an alarm**

- Used for detecting carbon monoxide emitted by burning fire-retardant cables.
- Sends signals carbon monoxide to the RMS and triggers an alarm.
- Standard cable length, 4 m.

■ **Dimensions**

- Length: 140 mm.
- Width: 125 mm.
- Height: 40 mm.

■ **Color**

- White.

■ **Scope of delivery**

- 1 x sensor.
- 1 x sensor connection cable.
- 1 x Mounting kit.
- 1 x Instructions

■ **How supplied**

- In sets.

■ **Technical data**

- Operating voltage: 12 VDC (± 20 %).
- Power consumption: approx. 190 mA (idle) approx. 280 mA (alarm).
- Sensitivity: 100 ppm CO.
- Ambient temperature: -15° C to 40° C.
- Piezo alarm: approx. 85 dB(A) at 3 m away.
- Protection rating: IP 20.
- Switching output 12 V DC: Max. 170 mA.
- Relay output: Changeover contact, max. 5 A 230 V DC, max. 5 A 30 V DC.
- Reset: automatic when the gas concentration falls below sensitivity level.
- To be connected to digital IN port.

Model	Order No.	UP
Carbon monoxide alarm sensor	06.108.211.8	1 unit

Dimensions in mm:				Conversion:	
W = Width	h = Installation height	U = Standard rack unit	kg = Weight	1 mm = 0.03937 inch	
H = Height	d = Insertion depth	(1 U = 44.45 mm)		1 kg = 2.2046 pounds	
D = Depth	L = Length	UP = Packaging unit			

RMS III® Technical Data

- **Ethernet:** 100 Mbit
- **HTTP**
- **DHCP**
- **SNMP v1**
- **SNMP v2/3:** future
- **SNMP Trap**
- **Trap destinations:** 5
- **SNTP**
- **SMTP**
- **SMTPv3 TLS**
- **E-mail Destinations:** 5
- **SMS/ netGSM /RS232**
- **SMS Destinations:** 5
- **Logger**
- **Logger records:** 250.000
- **MQTT**
- **IPv6**
- **Certificate Upload**
- **DO Local conditions**
- **1-Wire sensors:** 16
- **1-Wire UNI support**
- **RS-485 support**
- **RS-485 sensors:** 24
- **Modbus /TCP**
- **Email Alarm reminder**
- **Email Periodical Status**
- **Power Input 1:** 9-30V
- **DI (Digital Inputs):** 12
- **DO (Digital Outputs):** 4
- **DO max load:** 50V/1A
- **Operating temperature:** -30-85°C

New in RMS III®

- **Supports broad range of sensors**
 - 1-wire, Digital, RS485 sensors
 - 4 Relays utputs
- **Features**
 - Boolean Logic
 - State- of-the Art secure network protocols
 - Accessfilter (Device Firewall)
 - Cloud Interface already built in (MQTT)
 - Screw Terminal Connectors for Digital Sensors
 - Local Log

VERTIV

- General
- General setup
- Security
- SNMP
- Email
- GSM
- Log & Time
- Portal
- MQTT
- Sensors
- Inputs
- Inputs Logic
- Outputs
- Virtual Outputs
- System

Version: 3.3.6

RMS3 Compact

GENERAL

Sensors

Name	ID	Current Value	Safe Range	Hysteresis	Alarm Alert
Sensor 240	1280	28 %	0.0 .. 100.0	0.0	Disabled
Sensor 242	19200	27.5 °RH	10.0 .. 60.0	0.0	Disabled
Sensor 243	21316	22.0 °C	10.0 .. 60.0	0.0	Disabled

Digital Inputs (DI)

Name	ID	Current Value	Alarm Alert
Binary 1	1	0(Off)	Disabled
Binary 2	2	0(Off)	Disabled
Binary 3	3	0(Off)	Disabled
Binary 4	4	0(Off)	Disabled
Binary 5	5	0(Off)	Disabled
Binary 6	6	0(Off)	Disabled
Binary 7	7	0(Off)	Disabled
Binary 8	8	0(Off)	Disabled
Binary 9	9	0(Off)	Disabled
Binary 10	10	0(Off)	Disabled
Binary 11	11	0(Off)	Disabled
Binary 12	12	0(Off)	Disabled
Binary Logic 13	13	0(Off)	Disabled
Binary Logic 14	14	0(Off)	Disabled
Binary Logic 15	15	0(Off)	Disabled
Binary Logic 16	16	0(Off)	Disabled
Comm Monitor 1	123	0(Off)	Disabled

Digital Outputs (DO)

Name	ID	Current Value	Mode
BinOut 1	151	0(Off)	Manual
BinOut 2	152	0(Off)	Manual
BinOut 3	153	0(Off)	Manual
BinOut 4	154	0(Off)	Manual

Download

SNMP MIB:
 SNMP Object Identifier:
 XML Schema Definition:

Terminal Config (TCP Setup)

Connect with label to:

Inline Metering System (IMS)

Optimum Upgrade Solution for Existing Installations

Vertiv Inline Metering System (IMS) benefits:

- Existing rack PDUs can be retrofitted for optimal savings.
- Almost all consumers can be integrated into the monitoring system, since numerous plug systems are provided (1 ph – 3 ph, max. 63 A per phase).
- Flexible installation inside or outside the rack (e.g. on shelf).

Monitoring is already part of the everyday routine in most data centers when it comes to system availability. Consequently, new systems are equipped with socket strips or **PDUs with integrated monitoring** (Managed PDUs or Adaptive PDUs). Yet, what can be done about existing systems containing socket strips or PDUs that do not provide measuring functions?

Vertiv's solution for this is called IMS (Inline Metering System). These modules allow existing racks with installed basic power distributors to be upgraded accordingly. As almost all server racks are supplied with an A and B-feed, **retrofitting is possible without have to interrupt operation**. The IMS modules can also be installed inside or outside the rack; e.g., on the shelf to save space.

IMS model series overview

VERTIV MPX IMS

Features

- The rack PDU software interface is familiar; communication card is the same as the ones for MPX/MPH.
- Highest possible reliability and availability with an operating temperature of max. 55°C.
- Comprehensive measurement functions (electricity, current, power and energy) with a high measurement accuracy of up to $\pm 1\%$.
- N-conductor overload with 3-phase systems can be prevented as the N-conductor current is monitored.
- Easy connection to the network of up to 4 Liebert MPX IMS / MPH / MPX with only one IP address.
- External sensors and a display can also be connected.





INPUT POWER

- Single-phase or three-phase
- 16 A up to max. 63 A



OUTPUT DISTRIBUTOR

- Single-phase or three-phase
- 16 A up to max. 63 A

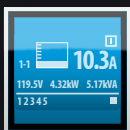

MONITORING

- Input level.

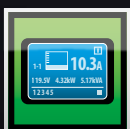

LOCAL MONITORING

- Display for user (MPX™ IMS).



REMOTE MONITORING

- Secure web and SNMP interfaces



RACK PDU ARRAY™

- One IP address; up to 4 rack PDUs (MPX IMS)
- MPX, MPH™ and IMS in the same private network

Vertiv IMS – product series

Features	Vertiv MPX™ IMS
Measurement module	■
Modular	
Display	External
Remote interface	■
Measuring at input level	■
Measurement modules per IP address	4
Max. measurement points per IP address	4
Visualization at PDU level	■
Visualization at rack level	■
Visualization at room level	Only with additional software: Vertiv Nform or Avocent DSView
Measurement parameters	A, V, W, kWh
Phase asymmetry analysis	■
External sensor connection options	■
Input power	1 ph + 3 ph, max 63 A
Connection option	IEC 60309
Protocols	HTTP, HTTPS, SNMP, Telnet
Storage in external database	Only with additional software: Vertiv Nform or Avocent DSView

Order number

1 ph. 16 A	MPXIMS-EHBBXS30
1 ph. 32 A	MPXIMS-EHBBXQ30
3 ph. 16 A	MPXIMS-EHBBXT30
3 ph. 32 A	MPXIMS-EHBBXR30
3 ph. 63 A	MPXIMS-EHBBXZ30

Easy Upgrade from Basic Power Distributor to Measurement-enabled Power Distributor

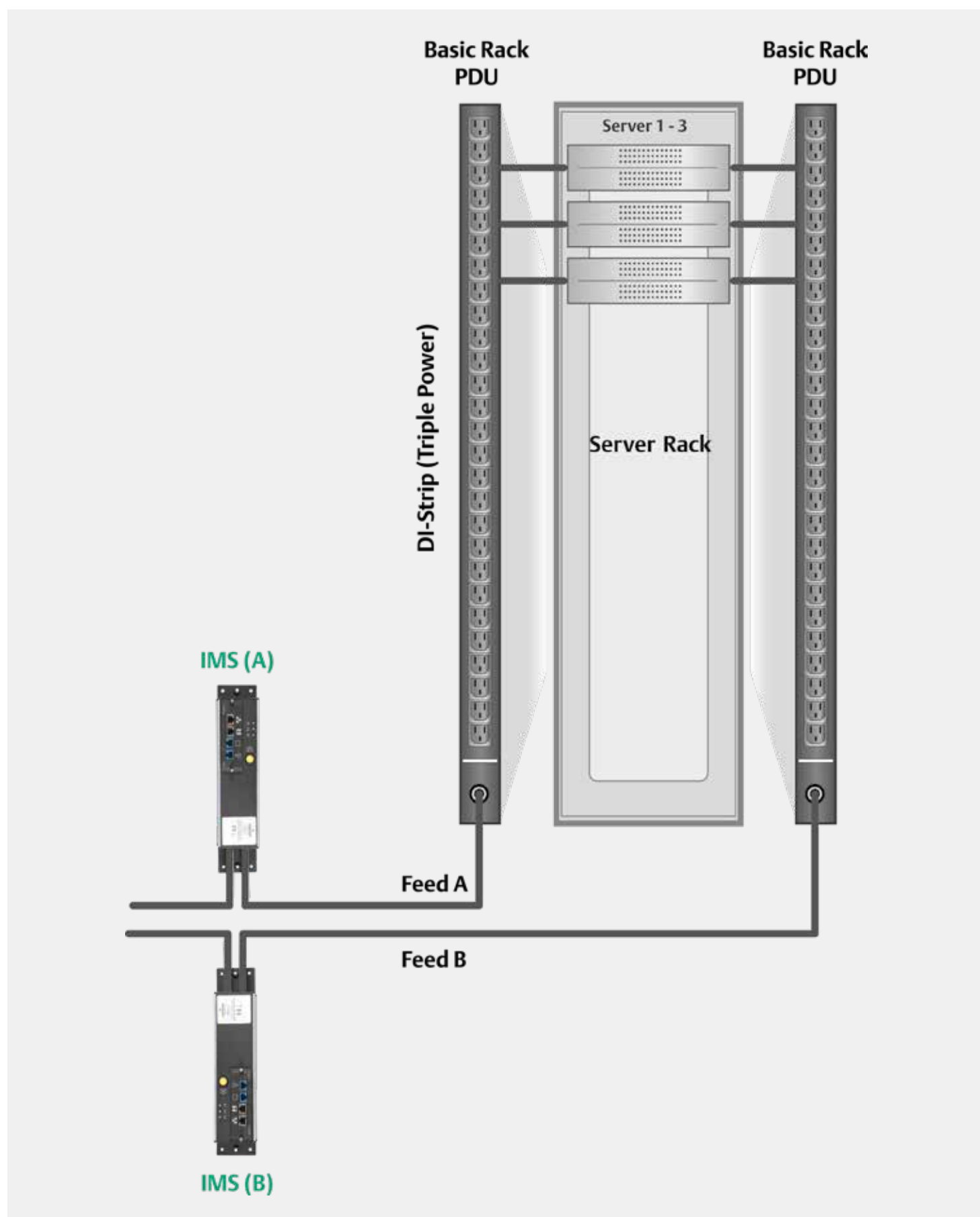



IMS_8141

Vertiv™ MPX™ IMS

- Existing rack PDUs do not have to be replaced as the modules can be retrofitted.
- Almost all consumers can be integrated into the monitoring system, since numerous plug systems are provided (1 ph – 3 ph, max. 63 A per phase).
- Flexible installation inside or outside the rack (e.g. on shelf).
- Liebert® Rack PDU software interface is familiar; communication card is the same as the one for Liebert MPX/MPH.
- Highest possible reliability and availability with an operating temperature of max. 55°C.
- Comprehensive measurement functions (electricity, current, power and energy), with high measurement accuracy of up to ± 1%.
- N-conductor overload with 3-phase systems can be prevented since the N-conductor current is monitored.
- Easy connection to the network of up to 4 Liebert MPX IMS / MPH / MPX with only 1 IP address.
- External sensors and a display can also be connected.

■ Technical data

Interfaces:

- RJ-45 LAN port (10/100 MBit) for connecting to local area network (LAN) via an Ethernet cable.
- Expansion / administration port for local configuration using a computer / laptop, for setting up a link-up of several PDUs (Liebert MPX™ or MPH™).
- Serial interface RS232.
- Display port for connecting the RPC BDM (display module).
- External sensor port for connecting optional sensors.
- Remote management: Onboard web interface, CLI, SNMPv1, 2, 3, SSH, Telnet, integratable into Avocent ACS, UMG & MPU, DSView, Rack Power Manager, Vertiv Nform & Vertiv *Trellis* as well as Nagios or other management software programs.
- Authentication: local, remote; active directory, LDAP, TACACS, Radius, Kerberos.
- Encryption: MD5, AES, DES.

■ Supported technologies:

- Web support provided by Liebert MPX control and management. Authorized users can view status information via their network.
- SNMP support provided by Liebert MPX SNMP management.
- Easy integration into Vertiv Nform, Avocent DSVIEW3 and Nagios.

■ Material / Finish

- Enclosure: aluminum.
- Cover: sheet steel.

■ Dimensions

- Height: 81 mm.
- Width: 75 mm.
- Length: 266 mm.
- Input cable length: 3 m.
- Output cable length: 0.5 m.

■ Certification

- CE label in accordance with Low Voltage Directive 2006/95/EC.
- EMC Directive 2004/108/EC.
- BV GS.

■ Color

- Enclosure: aluminum/RAL 7021 dark-gray.

■ Scope of delivery

- 1 x MPXIMS-Module/power supply.

■ How supplied

- In sets.

Model	L	Input values	Input connector	Output socket	Order No.	UP
Vertiv MPX™ IMS 1 x 16 A	266	230 VAC, 16 A	IEC60309 1ph/N/PE 6h	IEC60309 1ph/N/PE 6h	MPXIMS-EHBXS30	1 unit
Vertiv MPX™ IMS 1 x 32 A	266	230 VAC, 32A	IEC60309 1ph/N/PE 6h	IEC60309 1ph/N/PE 6h	MPXIMS-EHBXQ30	1 unit
Vertiv MPX™ IMS 3 x 16 A	266	230/400 VAC, 16 A	IEC60309 1ph/N/PE 6h	IEC60309 1ph/N/PE 6h	MPXIMS-EHBAXT30	1 unit
Vertiv MPX™ IMS 3 x 32 A	266	230/400 VAC, 32 A	IEC60309 1ph/N/PE 6h	IEC60309 1ph/N/PE 6h	MPXIMS-EHBAXR30	1 unit
Vertiv MPX™ IMS 3x63A	266	230/400 VAC, 62A	IEC60309 3ph/N/PE 6h	IEC60309 3ph/N/PE 6h	MPXIMS-EHBBXZ30	1 unit

Monitoring

Facilities and Monitoring Solutions



SNMP and Web Monitoring

The Vertiv Intellislot SNMP/Web Card provides SNMP and web-based management to your UPS. The card gives you the power to monitor and control your Liebert UPS from a Network Management Station, with Vertiv's Nform or Vertiv MultiLink software, or from any PC running Microsoft® Internet Explorer™. Connecting to your UPS is as simple as launching a web browser.



Vertiv™ MultiLink™ Software

Vertiv MultiLink software enables basic monitoring and graceful shutdown of all your Servers and Workstations in the event of a power failure. Vertiv MultiLink is available for single one-on-one installations or for multiple systems.



Trellis™ Power Insight

The *Trellis*™ Power Insight Application is designed to monitor your Liebert® UPS devices and provides real-time trending for critical UPS performance including voltage and current utilization.



Vertiv Nform™

The Vertiv Nform software allows centralised management and control of SNMP enabled UPSs from Liebert and other vendors. Events and power related data can be tracked and messages sent in the event of a power failure or other power quality event.



Liebert® SiteScan® Web

Liebert SiteScan Web supplies full-scale monitoring and control of critical support systems, first by providing the ability to gather operating information from each piece of equipment and pull it together in one central location, and then by giving you a variety of ways to do it. Liebert SiteScan Web is a powerful hardware + software solution providing:

- Real-Time Monitoring and Control
- Alarm/Event Management
- Data Analysis and Trend Reporting
- Building Management Interoperability.

Data Center Management Solutions

Vertiv™ Avocent® products are a core component of Vertiv's Data Center Infrastructure. These solutions enable small to enterprise sized organisations to reduce costs, increase security and optimise availability and productivity.

This portfolio includes hardware and software solutions. The hardware solutions enable secure, auditable remote access, control and management of critical devices through patented, out-of-band technology. This remote access can be to any distance and can scale to high definition audio and video for specialist verticals.

The software solutions deliver efficiencies to the data center specialist by centralising management of all IT devices. Furthermore, when documenting the data center, managing and planning capacity, we offer organisations a single source of truth tool where they can manage all aspects of this efficiently.

To make it easier, we have divided our products into two sections, as follows:

- **Section 1** - Focuses on customers who want desktop and server room solutions
- **Section 2** - Focuses on customers who require enterprise level solutions to meet the demanding business challenges which require an agile IT infrastructure

SECTION 1

Desktop and Server Room IT Management Solutions

Our range of products enables the end user to:

- Efficiently access control and manage the server room without the need to physically be there.
- Help remove IT assets from unsuitable work areas, like hospitals, factories, warehouses, clean rooms, shops.
- De-clutter work places where users require access to multiple PCs, but do not want to use multiple displays, keyboards and mice.
- Efficiently access server room assets and maximise server room space.

Desktop Solutions

Vertiv™ Avocent® KVM

Having a dedicated display/keyboard/mouse for accessing each PC, can take up a lot of space and also cause unnecessary hardware cost. The whole process can become a costly mess.

This is where the Vertiv Avocent® Keyboard, Video, Mouse (KVM) Appliance comes in: our switch makes access possible to multiple PCs with only one set of peripherals and no software. With the Vertiv Avocent KVM Switch, the end user can immediately shift between multiple devices with high video resolutions and audio and USB sharing, without configuring settings.

Simply plug in our device and benefit from:

- More space
- Less costs (no need to invest in several peripherals)
- Increased efficiency – easier to switch between devices
- A more productive work environment.

Before



After

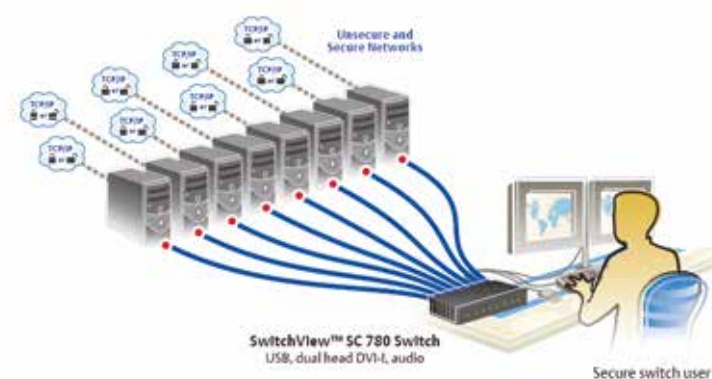

Desktop Solutions

Vertiv™ Avocent® SwitchView™ KVM

Vertiv Avocent SwitchView KVM switches enable you to use a single keyboard, monitor and mouse to access multiple PCs. SwitchView KVM switches can support PS/2 and/or USB PCs, and SwitchView multimedia switches let you share USB devices, speakers and a microphone between PCs.

For more security focussed customers, Vertiv Avocent SwitchView SC KVM switches are field-proven, secure solutions for government agencies and other environments with high security requirements. These solutions allow users to switch safely between computers, operating at different classification levels, from a single switch, providing continuous access to critical data.

Beyond validation by the National Information Assurance Partnership (NIAP) Common Criteria to Evaluation Assurance Level (EAL) 4+ to 2+, the Vertiv Avocent SwitchView SC product line includes a full suite of features to increase security and ensure data protection without limiting the user experience.

Part Number	Description
SV220-xxx	2-Port DVI-I Standard KVM
SV220D-xxx	2-Port DisplayPort Standard KVM
SV220H-xxx	2-Port HDMI Standard KVM
SV240-xxx	4-Port DVI-I Standard KVM
SV240H-xxx	4-Port HDMI Standard KVM
SV240D-xxx	4-Port Display Port Standard KVM
SV340-xxx	4-Port DH DVI-I Standard KVM
SV340H-xxx	4-Port DH HDMI Standard KVM
SV340D-xxx	4-Port DH Display port Standard KVM
SC620-xxx	1 user, 2 systems, SwitchView SC switch, USB, DVI-I (dual link), audio
SC620C-xxx	1 user, 2 systems, SwitchView SC switch, USB, DVI-I (dual link), audio and CAC
SC640-xxx	1 user, 4 systems, SwitchView SC switch, USB, DVI-I (dual link), audio
SC640C-xxx	1 user, 4 systems, SwitchView SC switch, USB, DVI-I (dual link), audio and CAC
SC680-xxx	1 user, 8 systems, SwitchView SC switch, USB, DVI-I (dual link), audio
SC740-xxx	1 user, 4 systems, SwitchView SC switch, USB, DVI-I (dual link, dual head), audio
SC740C-xxx	1 user, 4 systems, SwitchView SC switch, USB, DVI-I (dual link, dual head), audio and CAC
SC780-xxx	1 user, 8 systems, SwitchView SC switch, USB, DVI-I (dual link, dual head), audio
SC840	4 systems, 1 display connection, DVI-I, single-link/dual-link, HDMI and VGA with adapter
SC845	4 systems, 1 port, 1 display connection, DVI-I, single-link/dual-link, HDMI and VGA with adapter
SC840D	4 system connections, 1 display connection, DP 1.2
SC845D	4 system connections, 1 port, 1 display connection, DP 1.2
SC840H	4 system connections, 1 display connection, HDMI 1.4
SC845H	4 system connections, 1 port, 1 display connection, HDMI 1.4
SC885	8 systems, 1 port, 1 display connection, DVI-I, single-link/dual-link, HDMI and VGA with adapter
SC940	4 system connections, 2 display connections, DVI-I, single-link/dual-link HDMI and VGA with adapter
SC945	4 system connections, 1 port, 2 display connections, DVI-I, single-link/dual-link HDMI and VGA with adapter
SC940D	4 system connections, DP 1.2
SC945D	4 system connections, 1 port, DP 1.2
SC940H	4 system connections, 2 display connections, HDMI 1.4
SC945H	4 system connections, 1 port, 2 display connections, HDMI 1.4
SC985	8 systems, 2 port, 2 display connection, DVI-I, single-link/dual-link, HDMI and VGA with adapter
SC240-xxx	1x4 SwitchView SC switch, PS/2, USB, VGA, CAC Reader Support, Intrusion detection
SC320-xxx	1 user, 2 systems, SwitchView SC switch, expanded USB, DVI-I (dual link), audio (4 port model also available)
SC380-xxx	1 user, 4 systems, SwitchView SC switch, expanded USB, DVI-I (dual link, single head), audio
SC620-xxx	1 user, 2 systems, SwitchView SC switch, USB, DVI-I (dual link), audio (4 or 8 port model also available)
SC740-xxx	1 user, 4 systems, SwitchView SC switch, USB, DVI-I (dual link, dual head), audio (8 port model also available)

When ordering products please replace the suffix "-xxx" with the suffix for your region, as follows:

- 001 All Regions Specific to ACS, MPU & LRA products. The -001 part number will now ship with a universal power cable (IEC C13-C14) for direct connection into a PDU
- 201 UK and Ireland
- 202 European region
- 203 Switzerland

Desktop Solutions

Vertiv™ Avocent® Cybex™ KM Switches

The Vertiv family of KM switches delivers the ideal solution for streamlining access to critical information from multiple systems while maintaining high security.

The Vertiv KM switches can support up to four systems with a single keyboard and mouse. In addition, the switches can be easily configured to display content in dual, triple or quad head monitor configurations, allowing the 4-port KM switch to support up to 16 monitors at once.



Choosing a Cybex™ KM Switches allows you to:

- Increase productivity with simultaneous access to all required information via cursor navigation switching
- Reduce cost with access to multiple systems using a single keyboard and mouse
- Support the mobile worker with instant access to mobile and USB device data and a high-speed mobile charging port
- Simplify work with ability to copy and paste data.

Part Number	Description
SVKM120-xxx	2-port desktop KM, Front-panel USB 2.0, audio
SVKM140-xxx	4-Port Standard KM
SCKM120-xxx	2-port Secure KM
SCKM140-xxx	4-port Secure KM
SCKM145-xxx	4-port Secure KM + 1 DPP
CBL0130	Vertiv Avocent Cybex™ SCKM140 cable, USB keyboard, mouse with speakers - 1.8m
CBL0131	Vertiv Avocent Cybex™ SCKM140 cable, USB keyboard, mouse with speakers - 3m
CBL0132	Vertiv Avocent Cybex™ SCKM145 cable, USB keyboard, mouse with speakers & CAC - 1.8m
CBL0133	Vertiv Avocent Cybex™ SCKM145 cable, USB keyboard, mouse with speakers & CAC - 3m

When ordering products please replace the suffix "-xxx" with the suffix for your region, as follows:

- 001 All Regions Specific to ACS, MPU & LRA products. The -001 part number will now ship with a universal power cable (IEC C13-C14) for direct connection into a PDU
- 201 UK and Ireland
- 202 European region
- 203 Switzerland

Desktop and Server Room Solutions

Vertiv™ Avocent® Extension Solutions

If your business involves having expensive hardware in a dangerous environment, you definitely need a solution that allows you to protect your investment.

For example, having a computer in a manufacturing area can easily cause damages to the device, causing you to lose important data and a lot of money. If you're wondering how you can avoid this in the future, the Vertiv Avocent Longview is the solution! Our product is the simple and inexpensive solution that allows you to remove the PC from the harmful environment, without losing any of the functionality.

The Vertiv Avocent Longview is the perfect device for you, if your business involves the following:

- Manufacturing, hospitals or laboratories
- Environments where protection from theft is needed
- Environments where heat, noise and dust are harmful to electronic equipment.

Part Number	Description
LV3010P-xxx	LongView single VGA, USB, audio, CATx 300M
LV3020P-xxx	LongView dual VGA, USB, audio, CATx 300M
LV4010P-xxx	LongView single DVI, USB, audio, CATx 50M
LV4010P-xxx	LongView single DVI, USB, audio, CATx 50M
LV4020P-xxx	LongView dual DVI, USB, audio, CATx 50M
LV5020P-xxx	LongView dual DP, USB, audio, CATx 150M

When ordering products please replace the suffix "-xxx" with the suffix for your region, as follows:

-001 All Regions Specific to ACS, MPU & LRA products. The -001 part number will now ship with a universal power cable (IEC C13-C14) for direct connection into a PDU

-201 UK and Ireland

-202 European region

-203 Switzerland

Server Room IT Management Solutions

Vertiv™ Avocent® "at-the-rack" access Solutions

When managing a server room, individually accessing each rack and device can waste a lot of time.

Vertiv offers you the solution which allows you to manage these devices from one central point. With the Vertiv Avocent Rack Solutions you can access and control the server room without the need to physically be there. Not only do the rack solutions allow you to be in another room as the servers, but they also allow you to manage the servers from another building, country or continent as long as you have an Internet connection, through our digital IP range.

To sum up, by investing in the Vertiv Avocent Rack Solutions, you benefit from:

- More TIME – connect to any device in the server room, wherever you are, and stop wasting the time that takes for you to actually be there
- Proximity – an Internet connection can bring you closer to your server room, anywhere you are on the globe
- Less Costs – by accessing the servers faster, you can decrease the down time, thus allowing your business to save more money
- Simplify work with ability to copy and paste data.

Part Number	Description
4SV1000-xxx	1 local user, 4 systems switch with OSD, USB and PS/2 support
8SV1000-xxx	1 local user, 8 systems switch with OSD, USB and PS/2 support
16SV1000-xxx	1 local user, 16 systems switch with OSD, USB and PS/2 support
AV3108-xxx	1x8 CAT5 digital KVM switch
AV3216-xxx	2x16 CAT5 digital KVM switch
MPUIQ-VMCHS	Server interface module for VGA, USB keyboard, mouse supporting virtual media, CAC and USB2.0.
MPUIQ-VMCHD	Server Interface Module for HDMI video, USB keyboard/mouse supporting virtual media, CAC and USB2.0.
MPUIQ-VMCDV	Server Interface Module for DVI video, USB keyboard/mouse supporting virtual media, CAC and USB2.0.
MPUIQ-VMCDP	Server Interface Module for DisplayPort video, USB keyboard/mouse supporting virtual media, CAC and USB2.0.
PS2IAC-7	7 ft. PS2 CAT-5 integrated access cable
PS2IAC-10	10 ft. PS2 CAT-5 integrated access cable
PS2IAC-15	15 ft. PS2 CAT-5 integrated access cable
USBIAC-7	7 ft. USB CAT-5 integrated access cable
USBIAC-10	10 ft. USB CAT-5 integrated access cable
USBIAC-15	15 ft. USB CAT-5 integrated access cable
AVRIQ-USB2	AV HIGH-RES/VM/CAC/USB2HS IQ MODULE
AVRIQ-VSN	Server Interface module for VGA or 13W3, Sun keyboard, mouse
AVRIQ-SRL	Server Interface module for VT100 Serial Based Devices for extended distance (requires UPD module)
UPD-xxx	Power Supply, Power Cord and 4 output cable to support up to 4 AVRIQ-SRL modules

When ordering products please replace the suffix "-xxx" with the suffix for your region, as follows:

-001 All Regions Specific to ACS, MPU & LRA products. The -001 part number will now ship with a universal power cable (IEC C13-C14) for direct connection into a PDU

-201 UK and Ireland

-202 European region

-203 Switzerland

Server Room IT Management Solutions

LCD Trays

Even though managing your infrastructure remotely gives you many benefits, there will be times when you will need to physically be there to add more hardware, memory, etc.

In order to do that, you need local access devices that get the job done efficiently. So, forget the crash carts, the long cable wires and wasting time by connecting/disconnecting the peripherals! Vertiv introduces you the built-in Vertiv™ Avocent® LCD tray, which allows you to save space and give you efficient access to the rack.

Our products are developed smart, therefore offering you a better solution to managing your IT infrastructure.

The Vertiv Avocent LCD Trays are no different, hence offering you the following benefits:

- More Space – being compact, our LCD trays consume a minimum of space at the rack;
- Simplicity – the product is easy to mount and connect;
- Efficiency – a better working environment equals more productivity;
- Durability – our LCD trays are made to last!

The compact design is well-suited for the small to midsize business environment, data center and server rooms. Vertiv Avocent LCD consoles are available as a standalone or with an 8- or 16-port KVM switch in the same 1U space.

Part Number	Description
LRA185KMM-xxx	1U 19" LCD console w/ USB touchpad and keyboard
LRA185KMM8-xxx	1U 19" LCD console w/ USB touchpad, keyboard and pre-mounted 8-ports AutoView 3108 switch
LRA185KMM16-xxx	1U 19" LCD console w/ USB touchpad, keyboard and pre-mounted 16-ports AutoView 3216 switch

When ordering products please replace the suffix "-xxx" with the suffix for your region, as follows:

-001 All Regions Specific to ACS, MPU & LRA products. The -001 part number will now ship with a universal power cable (IEC C13-C14) for direct connection into a PDU

-201 UK and Ireland

-202 European region

-203 Switzerland

SECTION 2

Enterprise IT Infrastructure Solutions for Data Center

If you want to increase your profit, reduce your IT costs and streamline your data center management, you are certainly looking for:

1. Remote Management

Remotely and securely access and manage data center IT assets.

2. Centralisation

Centralise and standardise IT remote management.

3. Capacity Management and Planning

Get visibility into current data center capacity and the ability to accurately forecast needs.

4. Power Management

Optimise your customers' data center power requirements and ensure maximum availability of their infrastructure.

Enterprise IT Infrastructure Solutions for Data Center Remote Management

With our technology, you can remotely manage any device, any location, any vendor, any time, securely.

This applies to servers and other IT and network devices (routers, switches, firewalls, etc). Administrators can control every connected device from anywhere they like, as if they were actually on site – even when the device itself can no longer communicate over the network. As a result, the response time and outage duration are shortened, thereby improving IT management efficiency and IT availability

Serial Consoles

Secure remote access to devices via their console port. Using ACS console servers, IT professionals and network operations center (NOC) personnel can conduct secure remote data center management including remote control, equipment monitoring or diagnosing and troubleshooting equipment.



Vertiv™ Avocent® ACS 8000

Integrating important new connectivity features such as gigabit fiber, USB and sensors. A dual-core ARM processor architecture with expanded memory capabilities. Optimal performance, security, reliability for a complete out-of-band management solution.



Vertiv Avocent ACS 6000

Advanced Console Server

The ACS 6000 console servers are Vertiv Avocent's next generation console manager. They provide secure, remote access to network devices and UNIX / LINUX-based servers.

Vertiv Avocent ACS v6000

Virtual Advanced Console Server

Advanced console server functionality encapsulated in a virtual machine. Tapping the direct serial connections of the virtual machine on which it resides, this technology delivers higher availability of servers in even the most complex cloud environment.



Vertiv Avocent ACS 800

The Avocent ACS 800 serial console provides serial access, environmental monitoring, IoT integration and remote networking capability to the Edge oriented market sectors of financial institutions, retail chains, education and others.

SECTION 2

Part Number	Description
ACS-V6000-0004	4 Port Virtual ACS v6000 Appliance License
ACS-V6000-0008	8 Port Virtual ACS v6000 Appliance License
ACS-V6000-0016	16 Port Virtual ACS v6000 Appliance License
ACS-V6000-0024	24 Port Virtual ACS v6000 Appliance License
ACS-V6000-0048	48 Port Virtual ACS v6000 Appliance License
ACS6004SAC-G2	ACS 6000 4-port unit single AC power supply
ACS6004DAC-G2	ACS 6000 4-port unit dual AC power supply
ACS6004MDAC-G2	ACS 6000 4-port unit dual AC power supply with built-in modem
ACS6008SAC-G2	ACS 6000 8-port unit single AC power supply
ACS6008DAC-G2	ACS 6000 8-port unit dual AC power supply
ACS6008MDAC-G2	ACS 6000 8-port unit dual AC power supply with built-in modem
ACS6016SAC-G2	ACS 6000 16-port unit single AC power supply
ACS6016DAC-G2	ACS 6000 16-port unit dual AC power supply
ACS6016MDAC-G2	ACS 6000 16-port unit dual AC power supply with built-in modem
ACS6032SAC-G2	ACS 6000 32-port unit single AC power supply
ACS6032DAC-G2	ACS 6000 32-port unit dual AC power supply
ACS6032MDAC-G2	ACS 6000 32-port unit dual AC power supply with built-in modem
ACS6048SAC-G2	ACS 6000 48-port unit single AC power supply
ACS6048DAC-G2	ACS 6000 48-port unit dual AC power supply
ACS6048MDAC-G2	ACS 6000 48-port unit dual AC power supply with built-in modem
ACS8008SAC-400	8-Port ACS8000 Console System with single AC Power Supply
ACS8008SDC-400	8-Port ACS8000 Console System with single DC Power Supply
ACS8008DAC-400	8-Port ACS8000 Console System with dual AC Power Supply
ACS8008MSDC-400	8-Port ACS8000 Console System with single DC Power Supply and Analog Modem
ACS8008MDAC-400	8-Port ACS8000 Console System with dual AC Power Supply and Analog Modem
ACS8016SAC-400	16-Port ACS8000 Console System with single AC Power Supply
ACS8016DAC-400	16-Port ACS8000 Console System with dual AC Power Supply
ACS8016MDAC-400	16-Port ACS8000 Console System with dual AC Power Supply and Analog Modem
ACS8032SAC-400	32-Port ACS8000 Console System with single AC Power Supply
ACS8032DAC-400	32-Port ACS8000 Console System with dual AC Power Supply
ACS8032DDC-400	32-Port ACS8000 Console System with dual DC Power Supply
ACS8032MDAC-400	32-Port ACS8000 Console System with dual AC Power Supply and Analog Modem
ACS8032MDDC-400	32-Port ACS8000 Console System with dual DC Power Supply and Analog Modem
ACS8048SAC-400	48-Port ACS8000 Console System with single AC Power Supply
ACS8048DAC-400	48-Port ACS8000 Console System with dual AC Power Supply
ACS8048DDC-400	48-Port ACS8000 Console System with dual DC Power Supply
ACS8048MDAC-400	48-Port ACS8000 Console System with dual AC Power Supply and Analog Modem
ACS8048MDDC-400	48-Port ACS8000 Console System with dual DC Power Supply and Analog Modem
ACS802EAC-400	ACS800 2-port unit, external AC/DC Power, PDU power cable
ACS802MEAC-400	ACS800 2-port unit w/analog modem, external AC/DC, PDU cable
ACS804EAC-400	ACS800 4-port unit, external AC/DC Power, PDU power cable
ACS804MEAC-400	ACS800 4-port unit w/analog modem, external AC/DC, PDU cable
ACS808EAC-400	ACS800 8-port unit external AC/DC Power, PDU power cable
ACS808MEAC-400	ACS800 8-port unit w/analog modem, external AC/DC, PDU cable

Part Number	Description
ADB0036	RJ45 to DB9F cross converter
ADB0037	RJ45 to DB9M cross converter
ADB0045	SX 550m multi mode SFP fiber transceiver
ADB0047	LX/LH 10km single SFP fiber transceiver
ADB0200	RJ45 to DB9F s/t converter
ADB0210	RJ45 to DB9M s/t converter
CAB0036	RJ45 to DB9F cross cable
CAB0286	Serial Cable - Cable DB-9 female to DB-9 female crossover 6 feet
ADB0017	RJ45 to DB25F cross converter
ADB0025	RJ45 to DB25M cross converter
CAB0017	RJ45 to DB25F cross cable
CAB0025	RJ45 to DB25M s/t cable
CAB0046	RJ45 to DB25M cross cable
CON0091	DB9M to DB9M gender changer
CON0092	DB25F to DB25F gender changer
RMK-88	0U Rack Mount Kit for ACS8000/ACS9000
RMK-89	1U Rack Mount Kit for ACS8000/ACS9000
RMK-91	Rack Mount Kit, 1U tray for ACS800
RMK-92	Rack Mount Kit, DIN-Rail mount for ACS800
RMK-93	Rack Mount Kit, wall mount for ACS800

Enterprise IT Infrastructure Solutions for Data Center

Vertiv™ Avocent® Universal Management Gateway



Key Benefits

- Consolidated Management: Combines the functions of KVM over IP, serial console over IP, rack PDU, SP, and environmental sensor management into a single chassis
- Always-On: Highly reliable, local, remote and out-of-band access to data center infrastructure ensures that monitoring, control, and management can be done at any time, from any place
- Enhanced Security: Shields embedded service processors from unauthorized access; reducing the risk of malicious intrusion
- Streamlined Installation: Leverages pre-built service processor profiles for discovery and management, streamlining discovery and setup for newly installed hardware
- Universal Connectivity: Protects infrastructure investments and eases data center transitions with integrated support for a broad range of IT platforms
- Multi-Tenant Design: Creates a secure environment, improving compliance and auditing tasks for customers considering Colocation and Cloud implementations.
- Includes HTML5 viewer support, no longer the need to exclusively rely on Java for KVM sessions

VERTIV AVOCENT UNIVERSAL MANAGEMENT GATEWAY

Part #	Description
Vertiv Avocent Universal Management Gateway	
UMG4000-400	UMG 4000 40P(AS) 512SP 5000DP
Vertiv Avocent Universal Management Gateway Adapters	
UMIQ-V2	UM KVM MODULE - VGA+SP DUAL RJ45
Vertiv Avocent Universal Management Gateway Accessories	
RMK-50	RACK-MOUNT KIT FOR UM APPLIANCE
WMK-01	WALL-MOUNT KIT FOR UM APPLIANCE
UMIQ-PS	POWER SUPPLY MODULE W/CABLE

Enterprise IT Infrastructure Solutions for Data Center

Vertiv™ Avocent® MergePoint Unity™

The Vertiv Avocent MergePoint Unity switch is the next generation KVM over IP switch.

This industry-leading switch provides IT administrators a complete and secure remote management solution to access and control servers, networking equipment and other devices found in data centers and branch offices.

Key Benefits

- Advanced Remote Management - Provides secure and remote, out-of-band connections directly to the physical KVM, USB and serial ports to complement existing in-band software management tools
- Meet Service Level Agreements and Minimise Downtime - Unified approach enables IT administrators a faster method to diagnose, reconfigure or restore equipment
- Virtual Media - Enables USB media such as CD-ROMs, flash memory and external drives to be virtually attached to a remote server's USB port
- CAC/Smart Card Support - Utilizing the virtual media capabilities remote or local users can map a USB-based smart card reader to the attached servers and authenticate using their smart cards
- Enhanced Serial Adapters - Supports standard, remote SSH connections to the attached serial devices and includes electronic pin-out options for quick and easy connections to the console ports on Cisco network equipment
- Power Device Port - Connect supported rack PDUs for integrated power control, measurement and reporting
- FIPS 140-2 Compliant Cryptography - The FIPS mode of operation uses an embedded FIPS 140-2 certified OpenSSL cryptographic module (Certificate #1051)
- Includes HTML5 viewer support, no longer the need to exclusively rely on Java or ActiveX for KVM sessions

Part Number	Description
DSAVIQ-PS2M	Virtual Media server interface module for VGA video, PS/2 keyboard and mouse, and USB 2.0 virtual media w/ 14 in. PS/2 and USB cables, required for DSR and AutoView™ switches.
UPD-xxx	Power Supply, Power Cord and 4 output cable to support up to 4 DSRIQ-SRL modules
MPU108EDAC-001	8 port, 1 digital KVM path, Dual AC Power Supply
MPU1016DAC-001	16 port, 1 digital KVM path, Dual AC Power Supply
MPU2016DAC-001	16 port, 2 digital KVM paths, Dual AC Power Supply
MPU2032DAC-001	32 port, 2 digital KVM paths, Dual AC Power Supply
MPU4032DAC-001	32 port, 4 digital KVM paths, Dual AC Power Supply
MPU8032DAC-001	32 port, 8 digital KVM paths, Dual AC Power Supply
MPUIQ-VMCHD	Server Interface Module for HDMI video, USB keyboard/mouse supporting virtual media, CAC and USB2.0. Used with MPU appliance.
MPUIQ-VMCHS	HIGH-RES/VM/CAC/USB2HS IQ MODULE
MPUIQ-VMCHS32	HIGH-RES/VM/CAC/USB2HS IQ MODULE 32 PACK
MPUIQ-VMCDV	Server Interface Module for DVI video, USB keyboard/mouse supporting virtual media, CAC and USB2.0. Used with MPU appliance.
MPUIQ-VMCDP	Server Interface Module for DisplayPort video, USB keyboard/mouse supporting virtual media, CAC and USB2.0. Used with MPU appliance.
MPUIQ-SRL	MergePoint Unity switch serial IQ module

IT Infrastructure Solutions for Data Center and Control Rooms

Vertiv™ Avocent® Matrix Digital High Performance KVM System

The next-generation version of Vertiv Avocent High Performance KVM products leverages the experience Vertiv has gained with the Vertiv Avocent AMX™ and HMX product lines to create the best-of-breed platform.

This unified approach enables the Vertiv Avocent Matrix to combine the instantaneous switch time of the Vertiv Avocent AMX system with the digital quality and advanced management features of the Vertiv Avocent HMX system.

Platform Approach

The platform's design creates a future-proof environment where customers can expand functionalities as new technology becomes available, such as alterations in display or peripheral standards.

Video Compression algorithm enables a pixel-accurate, lossless video experience with lag-free, real-time interaction to computing equipment via any USB enabled device.

Unified Management

Compatibility with LDAP and other user authentication frameworks allows the Vertiv Avocent Matrix High Performance KVM to be added easily to existing workflows and setups.

Part Number	Description
MXMGR-R2	Matrix Manager Software
MXR5110-xxx	Matrix Receiver, CATX, USB, single DVI-I, audio
MXS5132-xxx	Matrix 32-port rack mountable CATX switch with flexible ports and redundant power
MXS5120-xxx	Matrix 20-port rack mountable CATX switch with flexible ports
MXT5110-DVI	Matrix Transmitter, Copper, DVI-D with CBL0086 included
MXT5120-VGA	Matrix Transmitter, Copper, VGA with CBL0087 included
DMK-08	Desk Mount Kit for Matrix Receiver
CBL0090	USB keyboard, mouse & DVI-D video cable & audio - 6 ft.
CBL0091	USB keyboard, mouse & DVI-D video cable & audio - 12 ft.
CBL0086	USB keyboard & mouse & DVI-D video cable & audio - 3 ft.
CBL0087	USB keyboard & mouse & VGA video cable & audio - 3 ft.
CBL0088	USB keyboard & mouse & VGA video cable & audio - 6 ft.
CBL0089	USB keyboard & mouse & VGA video cable & audio - 12 ft.
HMX5100T-xxx	HMX TX single DVI-D, USB, audio, SFP- transmitter
HMX5100R-xxx	HMX RX single DVI-D, USB, audio, SFP-receiver
HMX5200R-xxx	HMX RX dual DVI-D, USB, audio, SFP-receiver
HMX5200T-xxx	HMX TX dual DVI-D, USB, audio, SFP- transmitter
HMX6200T-xxx	HMX TX dual DVI-D, QSXGA, USB, audio, SFP- transmitter
HMX6200R-xxx	HMX RX dual DVI-D, QSXGA, USB, audio, SFP-receiver
HMX6210T-xxx	HMX TX dual DVI-D, QSXGA, USB, audio, SFP, VNC- transmitter
RMK-74	Matrix 1U Rack Mount for 3 Transmitters or 2 Receivers
RMK-72	Replacement Rack Mount for MXS5132/MXS5120 Switch

When ordering products please replace the suffix "-xxx" with the suffix for your region, as follows:

-001 All Regions Specific to ACS, MPU & LRA products. The -001 part number will now ship with a universal power cable (IEC C13-C14) for direct connection into a PDU

-201 UK and Ireland

-202 European region

-203 Switzerland

Enterprise IT Infrastructure Solutions for Data Center

**Vertiv™ Avocent®
DSView™**

Management software

Centralisation

IT administrators need to access IT devices from anywhere, carry out diagnoses and implement changes regularly. Regardless of the condition or status of the operating system or network, we offer a software solution which provides a secure, centralised management solution for all connected IT assets – the Vertiv Avocent DSView management software.

When used in conjunction with serial console appliances, rack PDUs, service processor gateways and KVM appliances, the hardware and software combine to allow IT administrators to remotely access, monitor and control target devices on multiple platforms at numerous locations—anywhere, anytime.

When using Vertiv Avocent DSView software you benefit from:

- Easier Administration
- A secure, browser-based user interface for central administration of the entire integrated IT
- Reliable Access
- Hub-and-spoke architecture allows for high availability and decentralised, consolidated and location-independent access
- Easy Expansion
- Easy to incorporate new technologies and provides an integration option for VMware, Citrix and Hyper-V – in addition to an API for own developments and third party tools and systems
- Higher Security
- Supports seamless integration with existing security policies, offers various authentication mechanisms and encrypts the entire data traffic.

Part Number	Description
DSV4-START	DSView software Starter Pack (1 Hub, 1 Spoke, 250 Managed Devices)
DSV4-STND	DSView software Standard Pack (1 Hub, 2 Spokes, 500 Managed Devices)
DSV4-PLUS	DSView software Plus Pack (1 Hub, 4 Spokes, 2,000 Managed Devices)
DSV4-PREM	DSView software Premium Pack (1 Hub, 8 Spokes, 5,000 Managed Devices)
DSV4-MAX	DSView software Max Pack (1 Hub, 15 Spokes, Unlimited Managed Devices)
DSV4-SPOKE	DSView software Spoke Server add-on license
DSV4-ZONE	DSView software single Zone add-on license
DSV4-DEV1	DSView software Managed Device license – 1-pack
DSV4-DEV10	DSView software Managed Device license – 10-pack
DSV4-DEV50	DSView software Managed Device license – 50-pack
DSV4-DEV100	DSView software Managed Device license – 100-pack
DSV4-DEV500	DSView software Managed Device license – 500-pack
DSV4-DEV1000	DSView software Managed Device license – 1,000-pack
DSV4-DEV10000	DSView software Managed Device license – 10,000-pack
DSV4-DCP	DSView software add-on - DCP integration
DSV4-WSK	DSView software Web Services API kit

**Enterprise IT
Infrastructure Solutions
for Data Center
Capacity Management
and Planning:
Vertiv™ Avocent®
Data Center Planner**

If your customer's future plans include business growth with more effective and efficient data center capacity planning and management, then they will need greater IT agility.

Data center managers need a single source of truth of what is currently in their data center, and the impact of future changes, to enable them to be agile in meeting the changing business demands.

Powerfully visualise & document the entire data center

Vertiv Avocent Data Center Planner is a powerful a user-friendly software solution enabling the user to plan, document and visualize the entire data center infrastructure. With end-to-end device connection visualization and power usage information included, Vertiv Avocent Data Center Planner provides the most realistic, current-state view of your physical infrastructure. With Vertiv Avocent Data Center Planner, you will gain real-world insight to enhance planning accuracy and rapidly implement changes.

Part Number	Description
DCP-L1-49-V040	Level 1 Perpetual License for 1-49 Assets
DCP-L2-99-V040	Level 2 Perpetual License for 50-99 Assets
DCP-L3-249-V040	Level 3 Perpetual License for 100-249 Assets
DCP-L4-999-V040	Level 4 Perpetual License for 250-999 Assets
DCP-L5-1249-V040	Level 5 Perpetual License for 1000-1249 Assets
DCP-L6-2499-V040	Level 6 Perpetual License for 1250-2499 Assets
DCP-L7-3749-V040	Level 7 Perpetual License for 2500-3749 Assets
DCP-L8-5999-V040	Level 8 Perpetual License for 3750-5999 Assets
DCP-L9-12499-V040	Level 9 Perpetual License for 6000-12499 Assets
DCP-L10-25000-V040	Level 10 Perpetual License for 12500-25000 Assets

Enterprise IT Infrastructure Solutions for Data Center Power Management

Vertiv™ Avocent® Rack Power Manager You cannot control what you cannot measure.

Most organisations are trying to reduce data center energy consumption where possible. Unless the data center professional understands what is consuming the power, when and why, they are unable to make intelligent decisions on cost reduction strategies.

Vertiv Avocent Rack Power Manager gives the user the capability to monitor and measure the power consumption, the costs and the trends of a single server or of a complete data center in real time.

This enables the user to identify peaks and troughs, stranded capacity and hot spots. With this information they can better utilise and distribute the available power thereby increasing availability and reducing consumption.

Part Number	Description
RPM-BASE50	Rack Power Manager software base pack - 1 hub, 50 Rack PDU's
RPM-BASE100	Rack Power Manager software base pack - 1 hub, 100 Rack PDU's
RPM-BASE250	Rack Power Manager software base pack - 1 hub, 250 Rack PDU's
RPM-BASE500	Rack Power Manager software base pack - 1 hub, 500 Rack PDU's
RPM-BASE1000	Rack Power Manager software base pack - 1 hub, 1 Spoke 1,000 Rack PDU's
RPM-BASE2500	Rack Power Manager software base pack - 1 hub, 4 spokes, 2,500 Rack PDU's
RPM-SPOKE	Rack Power Manager spoke add-on license
RPM-PDU25	Rack Power Manager software 25 PDU add-on license
RPM-PDU50	Rack Power Manager software 50 PDU add-on license
RPM-PDU100	Rack Power Manager software 100 PDU add-on license
RPM-PDU250	Rack Power Manager software 250 PDU add-on license
RPM-PDU500	Rack Power Manager software 500 PDU add-on license
RPM-WSK	Rack Power Manager Web services API Kit w/ 5 hours Tech Support
RPM-DCP	RPM INTEGRATION WITH DCP

Get More Online!

<https://www.vertivco.com/en-emea/login/>



Vertiv™ Partner Program

Join the Vertiv Partner Program. Provide More Solutions. Gain Unparalleled Support. Maximise Your Profits.

<https://www.vertivco.com/en-emea/create-account/>

Channel Product Selector

UPS, Accessories, PDU, Rack, Monitoring: use our tool to determine the best possible solution and share it with selected distributors. Available in 7 languages and as a mobile app.

<https://www.vertivco.com/en-emea/support/tools--applications/interactive-selector/>

Tech Support

Our Commitment to your daily Business, provided by our World Wide Tech support available in 5 Languages (GB, ES, FR, IT, DE).

eoc@vertivco.com

Liebert Technical Support:

Toll-free 00-80011554499 - Toll +39 02 98250222

liebert.upstech@vertivco.com

Vertiv Avocent Customer Care:

support.Avocent@vertivco.com

<https://www.vertivco.com/en-us/support/warranty/it-management-hardware-support-contacts/>

Uninterruptible Power Supplies (UPS)

Single-Phase Offering

Liebert® PSP 500 VA - 650 VA

Liebert® PSA 500 VA - 1500 VA

Liebert® itON 400 VA - 2000 VA

Liebert® PSI 750 VA - 3000 VA

Liebert® PSI-XR 1000 VA - 3000 VA

Liebert® GXT4™ 700 VA - 3000 VA

Liebert® GXT MT+ 1000 VA - 3000 VA

Liebert® GXT4™ 5000 VA - 10000 VA

Liebert® GXT3 10000 VA T MODEL

Liebert® GXT MT+ 6000 VA - 10000 VA TOWER

Liebert® APS 5 kVA - 20 kVA

Liebert® PSP is a full featured UPS that delivers cost-effective power protection in a compact package

The UPS provides battery-backed sockets and a surge protection-only outlet. The UPS battery offers four minutes of backup power at full load - ample time to shut down protected equipment if an outage occurs. Shutdown software and a USB cable are also included, to allow remote alerts and automated graceful shutdown of the connected equipment.

Liebert PSP UPS Supports Your Sensitive Electronics With These Standard Features:

Flexibility

- Three battery-backed UPS sockets, and one surge protection-only sockets differentiated by color
- USB port, Vertiv™ MultiLink™ Software shutdown software, and USB cable
- User replaceable batteries.

Higher Availability

- Up to four minutes of battery backup time at full load. Protects against lightning, spikes and surges
- Full sequenced battery testing to ensure batteries are available when needed
- Advance early warning of UPS shutdown
- RJ-45 port for data line surge protection.

Lowest Total Cost Of Ownership

- Three-Year replacement warranty
- Optional one year warranty extension.

The Liebert PSP Is Ideally Suited For:

- Professional workstations
- Small routers and bridges
- Point-of-sale terminals
- Other sensitive electronics.



Liebert PSP 500-650 VA

Liebert® PSP Specifications

MODEL NUMBER	PSP500MT3-230U	PSP650MT3-230U
Capacity VA/W	500 / 300	650 / 390
Net Weight: kg		3.9
Shipping Weight: kg		4.8
Dimensions: W x D x H, mm		87 x 215 x 251
On-Line Mains Voltage		160-287VAC
On-Line Frequency		50/60Hz ±5Hz
Output Voltage (Mains Normal)		Typical 160-287VAC
Output Voltage (Battery Operation)		230VAC ±5%
On-Battery Wave Form		Stepped Sinewave
Battery Type - VDC x Ah - Quantity		12V x 7.2Ah x 1
Typical Recharge Time		6-8 hours to 90%
Audible and Visual		Audible alarm / LED
Backup Sockets		IEC 320 C13 (3)
Surge Sockets		IEC 320 C13 (1)
Operating Temperature, °C		0 to 40
Storage Temperature, °C		-15 to 40
Operating / Storage Relative Humidity		0%-90%, non-condensing
EMI Classification		Class B
AGENCY		
Safety	IEC/EN/AS 62040-1-1 EN 62040-2:2005 Class B	
EMC	IEC 61000-4-2 Electrostatic discharge	
	IEC 61000-4-3 Radiated E-RFI fields	
	IEC 61000-4-4 Fast E transients	
	IEC 61000-4-5 Surges/Lightning	
	IEC 61000-4-6 Conducted RFI	
Transportation	ISTA Procedure 1A Certification	
Warranty	3 years standard (+ 1 year warranty extension available)	
Packaging	User Manual on CD, Software CD, USB cable, Safety Instruction Sheet, Environment protection sheet	

Load Autonomy

LOAD (WATTS)	PSP500MT3-230U	PSP650MT3-230U
50	55	56
100	18	18
150	11	12
200	8	8
250	5	5
300	3	4
350	0	3

Note: All run times are in minutes, assume fully charged batteries and are typical at 25°C (77°F) with resistive loads.

COMMUNICATIONS/ SHUTDOWN SOFTWARE

Windows built-in power management functions provide monitoring of UPS status and manage the automatic orderly shutdown of the computer if a power outage ever exceeds the battery capacity of the UPS. Vertiv™ MultiLink™ shutdown and monitoring software is also provided.

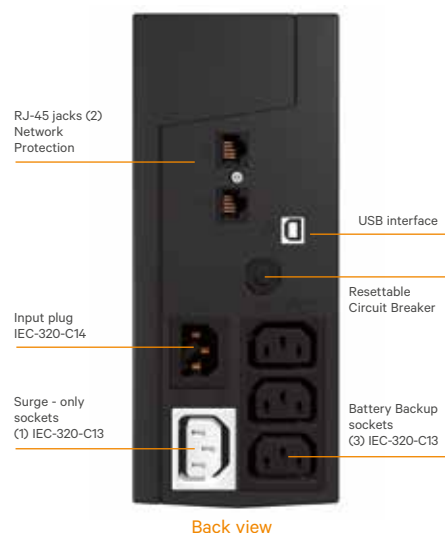

Back view

The Liebert® PSA is a compact line-interactive UPS that offers cost-effective, full-featured power protection for small office computers and electronic equipment

Liebert PSA offers unique features and extraordinary performance.

Designed with simple controls for easy operation, the Liebert PSA provides up to five minutes of back-up time at full load... more than enough time to save work in process and shut down your system.

Shutdown software and a USB cable are also included, to allow remote alerts and automated graceful shutdown of the connected systems.

Liebert PSA UPS supports your sensitive electronics with these standard features:

Flexibility:

- Available in four sizes, including 500, 650, 1000 and 1500VA
- Three to six battery-backed UPS sockets, depending on model size
- One to two surge-only sockets, differentiated by color
- USB communications/shutdown software and cable included
- User replaceable batteries.

Reliability:

- Up to five minutes of battery backup time at full load
- Full sequenced battery testing to ensure batteries are available when needed
- Advance early warning of UPS shutdown
- Lightning and surge protection (TVSS)
- RJ-45 port for data line surge protection.

Low total cost of ownership:

- Three-Years warranty standard.
- Optional one year warranty extension.

The Liebert PSA is ideally suited for:

- Professional Desktop PC's
- Professional Workstations
- Small Routers, Bridges and Hubs
- Point-of-Sale Terminals
- Other Sensitive Electronics.



Liebert PSA 500 VA

Liebert PSA 1000 VA

Liebert® PSA Specifications

MODEL NUMBER	PSA500MT3-230U	PSA650MT3-230U	PSA1000MT3-230U	PSA1500MT3-230U
Capacity VA/W	500/300	650/390	1000/600	1500/900
Net Weight: kg	5.4	5.9	9.5	11.6
Shipping Weight: kg	6.3	6.8	10.7	12.8
Dimensions: W x D x H, mm	95 x 356 x 171		147 x 360 x 234	
On-Line Mains Voltage	160-287VAC			
On-Line Frequency	50/60Hz ±5Hz			
Output Voltage (Mains Normal)	Typical 185-252VAC			
Output Voltage (Battery Operation)	230VAC ±5%			
On-Battery Wave Form	Stepped Sinewave			
Battery Type - VDC x Ah - Quantity	12V x 7.2Ah x 1		12V x 7.2Ah x 2	12V x 9Ah x 2
Typical Recharge Time	6-8 hours to 90%			
Battery Run Time* (Full load)	3-5 minutes			
Battery Run Time* (Half load)	10-13 minutes			
Audible and Visual	Audible alarm / LED			
Backup Sockets	IEC 320 C13 (3)		IEC 320 C13 (6)	
Surge Sockets	IEC 320 C13 (1)		IEC 320 C13 (2)	
Operating Temperature, °C	0 to 40			
Storage Temperature, °C	-15 to 40			
Operating / Storage Relative Humidity	0%-90%, non-condensing			
EMI Classification	Class B			
AGENCY				
Safety	IEC62040-1-1			
Transportation	ISTA Procedure 1A Certification			
Warranty	3 years standard (+ 1 year warranty extension available)			
Packaging	User Manual on CD, Software CD, USB cable, Safety Instruction Sheet, Environment protection sheet, (2) IEC output cables for 500/650VA, (3) IEC output cables for 1000/1500 VA			

*Battery run time may vary depending on load

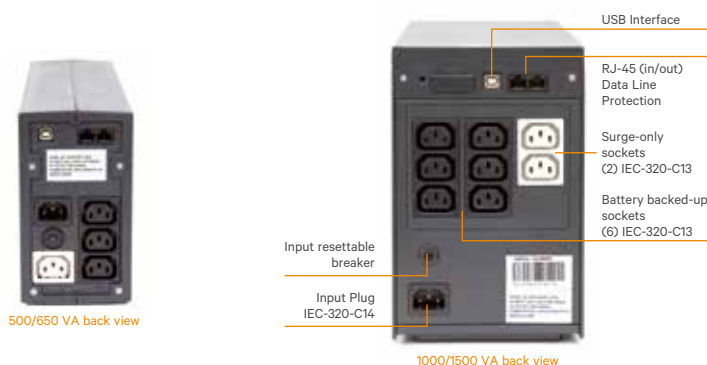

Communications/Shutdown Software:

Windows (98 and later) built-in power management functions provide monitoring of UPS status and manage the automatic orderly shutdown of the computer if a power outage ever exceeds the battery capacity of the UPS. Liebert USB shutdown and monitoring software is provided.

Liebert® itON is a reliable line-interactive UPS designed for the protection of desktop computers and standalone IT equipment

Liebert itON comes complete with an automatic voltage regulator (AVR) allowing flexibility and reliability for PCs and other sensitive electronic equipment. With its compact design and easy to use controls, Liebert itON also provides sufficient back up time, allowing work in progress to be saved safely before proceeding with the system shutdown. Liebert itON also comes complete with automatic restart and cold start functions for increased continuity and availability.

Features

- Automatic voltage regulator (AVR)
- Compact size
- Light weight
- Easy operation.

Higher Availability

- Overload protection and alarm
- Auto re-start with AC recovery
- Fast charging
- Cold start function.

Flexibility

- Available in ratings from 400 VA up to 2000 VA
- USB port (for 1000 VA, 1500 VA, 2000 VA)
- Schuko sockets (for 400 VA, 600 VA, 800 VA)
- Schuko and IEC sockets (for 1000 VA, 1500 VA, 2000 VA).

Ideally Suited for:

- Desktop PCs
- Professional workstations
- Small routers, bridges and hubs
- Point-of-sale terminals
- PBXs
- Other sensitive electronics.



Liebert itON 600 VA

Liebert itON 1000 VA

Liebert itON 2000 VA

Liebert® itON 400 VA Specifications

MODEL NUMBER	Liebert itON 400 VA	Liebert itON 600 VA	Liebert itON 800 VA
Power Rating	400 VA / 240 W	600 VA / 360 W	800 VA / 480 W
DIMENSIONS, W X D X H - MM			
Unit	101 x 279 x 142		
Shipping	143 x 327 x 220		
WEIGHT - KG			
Unit	3.6	4.2	4.9
Shipping	3.9	4.7	5.4
INPUT AC PARAMETERS			
Line Input Nominal Voltage	220 - 240 V AC		
Line Frequency	50 / 60 Hz; Auto Sensing		
Input Socket	Schuko cord		
Output Sockets	(2) Schuko		
Output Voltage	230 V AC		
Waveform (Battery Operation)	Stepped sinewave		
BATTERY PARAMETERS			
Type	Valve-regulated, non-spillable, lead acid		
Quantity x Voltage x Rating	1 x 12V x 4.5 Ahr	1 x 12V x 7 Ahr	1 x 12V x 9 Ahr
Recharge Time	4 hours recovers to 90% capacity (Typical)		
ENVIRONMENTAL			
Operating Temperature	0°C to 40°C		
Relative Humidity	0% to 90% non condensing		
Operating Altitude	<1500 m without derating		
Standards and Certifications			
Safety	EN62040-1:2008		
EMC	EN62040-2:2006 class C2		
Compliance	CE		



Liebert® itON 400 VA
Liebert itON 600 VA
Liebert itON 800 VA

MODEL NUMBER	Liebert itON 1000 VA	Liebert itON 1500 VA	Liebert itON 2000 VA
Power Rating	1000 VA / 600 W	1500 VA / 900 W	2000 VA / 1200 W
Dimensions, W x D x H - mm			
Unit	146 x 341 x 164	146 x 391 x 205	
Shipping	200 x 447 x 264	235 x 495 x 297	
WEIGHT - KG			
Unit	8.0	11.1	11.5
Shipping	9.0	12.1	12.5
INPUT AC PARAMETERS			
Line Input Nominal Voltage	220 - 240 V AC		
Line Frequency	50 / 60 Hz; Auto Sensing		
Input Socket	Schuko cord	IEC 320-C14	
Output Socket	(2) Schuko + (2) IEC 320-C13	(3) Schuko + (3) IEC 320-C13	
Output Voltage	230 V AC		
Waveform (Battery Operation)	Stepped sinewave		
BATTERY PARAMETERS			
Type	Valve-regulated, non-spillable, lead acid		
Quantity x Voltage x Rating	2 x 12V x 7 Ahr	2 x 12V x 9 Ahr	
Recharge Time	4-6 hours recovers to 90% capacity (Typical)		
ENVIRONMENTAL			
Operating Temperature	0°C to 40°C		
Relative Humidity	0% to 90% non condensing		
Operating Altitude	<1500 m without derating		
STANDARDS AND CERTIFICATIONS			
Safety	EN62040-1:2008		
EMC	EN62040-2:2006 class C2		
Compliance	CE		

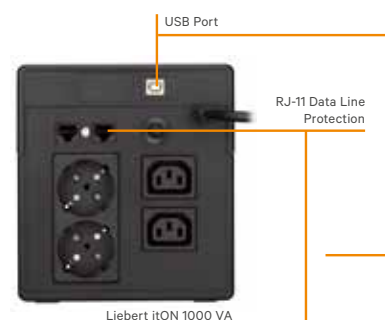

Liebert itON 1000 VA



Liebert itON 1500 VA
Liebert itON 2000 VA

Note: External battery cabinets are not permitted. Internal batteries only.

Liebert® PSI is a compact, line-interactive UPS system designed especially for IT applications such as network closets and small data centers. It provides reliable power protection for servers, critical nodes, network workstations, large network peripherals, network routers, bridges, and other electronic equipment

The flexible design of Liebert PSI allows the UPS to be configured as a self-standing tower or to be rack-mounted within a 2U space.

The UPS features an innovative line-interactive design incorporating buck/boost automatic voltage regulation technology. This protects against utility voltage fluctuation by raising and lowering utility power to the level needed by the connected equipment. It also allows the UPS to prolong battery life by maximizing its time on utility power before going to battery.

Flexibility:

- Eight battery-backed sockets
- Configurable input voltage window
- Rotatable Display Panel
- Automatic Frequency Sensing
- Rack Rail Kit
- Multiple Communications Options (USB, SNMP and Contact Closure).

Higher availability:

- Data line surge protection
- Advance early warning of UPS system status
- Up to five minutes of battery backup time at full load when utility fails
- Full sequenced battery testing
- Surge protection
- Remote emergency power off
- Hot swappable batteries.

Lowest total cost of ownership:

- 0.9 Output Power Factor
- Wider input voltage window
- Reduced installation time and costs
- Three-years warranty standard

Ideally suited for:

- PCs
- Network workstations
- Servers
- Network closets
- Large network peripherals
- VoIP.



Liebert PSI 2U Rack version

Liebert PSI 2U Tower version

Liebert® PSI Specifications

MODEL NUMBER	P5750RT3-230	PS1000RT3-230	PS1500RT3-230	PS2200RT3-230	PS3000RT3-230
Power Rating	750 VA/675 W	1.000 VA/900 W	1.500 VA/1.350 W	2.200 VA/1.980 W	3.000 VA/2.700 W
DIMENSIONS, W X D X H - MM					
Unit	440 x 412 x 88			440 x 657 x 88	
Shipping	560 x 595 x 228			560 x 776 x 228	
WEIGHT - KG					
Unit	15	19,4	20,9	33,8	37,2
Shipping	18,2	22,6	24,1	38,3	41,5
INPUT AC PARAMETERS					
Surge Protection	220J				
Voltage Range Without Battery Operation	165-300, Configurable				
Frequency Range	45-65 Hz, (±0,5 Hz)				
Input Socket	IEC-320-C14			IEC-320-C20	
Output Sockets	(8) IEC-320-C13			(8) IEC-320-C13 - (1) IEC-320-C19	
Voltage, Normal Mode	220/230/240 VAC, Configurable, ±10%				
Voltage, Battery Mode	220/230/240 VAC, Configurable; ±5% Before Low Battery Warning				
Transfer Time	4-6 ms, Typical				
Waveform	Sinewave				
Overload Warning	> 100%				
BATTERY PARAMETERS					
Type	Valve-Regulated, Nonspillable, Lead Acid				
Quantity x Voltage x Ah	2 x 12 x 7,2	3 x 12 x 7,2	3 x 12 x 9	6 x 12 x 7,2	6 x 12 x 9
Backup Time	See Load Autonomy table below				
Recharge Time	5 hours to 90% of rated capacity, after full discharge into resistive load				
ENVIRONMENTAL					
Operating Temperature	0°C to 40°C (32°F to 104°F)				
Storage Temperature	-15°C to 40°C (5°F to 104°F)				
Relative Humidity	0% to 90%, non-condensing				
Operating Altitude	Up to 3000m (10,000 ft.) at 35°C (95°F) without derating				
Audible Noise	<45 dBA				
AGENCY					
Safety	IEC/EN/AS 62040-1-1				
Surge	IEC/EN/AS61000-4-2				
ESD	IEC/EN/AS61000-4-3				
Susceptibility	IEC/EN/AS61000-4-4				
Electrical Fast Transient	IEC/EN/AS 62040-2 2a Ed Class A				
Emissions	IEC/EN/AS61000-4-6				
Conducted Immunity	IEC/EN/AS61000-3-2				
Harmonics	IEC/EN/AS61000-4-6				
Transportation	ISTA Procedure 1A Certification				
Environmental	ROHS compliant				
Warranty	3 years standard (+ 1 year warranty extension available)				
Packaging	Multi-Language User Manual on CD, Liebert MultiLink Software on CD, Contact Closure (ML9P9S) Cable USB Cable, Tower Stand, Mounting Hardware, Rack-Mount Handles, Fixed Mounting Rails, EPO Connector, Input Power Cord, 2200/3000 only: 2 - (1) Schuko to IEC-320-C19 and (1) UK plug to IEC-320- C19 input cord, IEC Output Cable, 750/1000/1500 only: 2 - (2) IEC-320-C13, IEC Output Cable, 2200/3000 only: 3 - (3) IEC-320-C13				

LOAD AUTONOMY - LIEBERT PSI 750VA-3000VA						
	Load %	750 VA	1.000 VA	1.500 VA	2.200 VA	3.000 VA
INTERNAL BATTERY	10	84	93	76	82	76
	20	45	47	32	44	32
	30	25	26	17	19	17
	40	15	15	12	14	12
	50	11	12	9	11	9
	60	9	9	7	9	7
	70	7	7	5	7	5
	80	5	6	4	5	4
	90	4	5	3	4	3
	100	4	4	3	3	3

Note: All run times are in minutes, assume fully charged batteries and are typical at 25°C (77°F) with resistive loads.

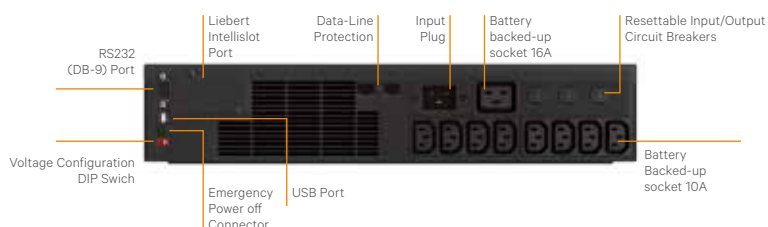

Liebert® PSI-XR is a compact, line-interactive UPS system designed especially for IT applications such as network closets and small data centers

The flexible design of Liebert PSI-XR allows the unit to be configured as a self-standing tower or to be rack-mounted within a 2U space.

The UPS features an innovative line-interactive design incorporating buck/boost automatic voltage regulation technology. This protects against utility voltage fluctuation by raising and lowering utility power to the level needed by the connected equipment. It also allows the UPS to prolong battery life by maximizing its time on utility power before going to battery.

Liebert PSI-XR Standard Features:

Flexibility:

- Six to seven battery-backed sockets
- Configurable input voltage window
- Rotatable Display Panel
- Automatic Frequency Sensing
- Multiple Communications Options (USB, SNMP and Contact Closure).

Higher Availability:

- Data line surge protection
- Advance early warning of UPS system status
- Full sequenced battery testing
- Lightning and surge protection
- Remote emergency power off
- User replaceable hot swappable batteries
- Ample battery backup time at full load when utility fails, for an orderly shutdown of connected equipment.

Lowest Total Cost Of Ownership:

- 0.9 Output Power Factor to provide more power for your protected load, and more energy efficient operation
- Wider input voltage window
- Reduced installation time and costs
- Three-years warranty standard

Ideally suited for:

- PC's
- Network workstations
- Servers
- Network closets
- Large network peripherals
- VoIP.



Liebert PSI XR 2U Rack version



Liebert PSI XR 2U Tower version

Liebert® PSI XR Specifications

MODEL NUMBER	PS1000RT3-230XR	PS1500RT3-230XR	PS2200RT3-230XR	PS3000RT3-230XR
Power Rating, VA/W	1000VA/900W	1500VA/1350W	2200VA/1980W	3000VA/2700W
DIMENSIONS, W X D X H, MM				
Unit	440 x 490.5 x 88	440 x 490.5 x 88	440 x 700.5 x 88	440 x 700.5 x 88
Shipping	560 x 612 x 228	560 x 612 x 228	560 x 821 x 228	560 x 821 x 228
WEIGHT, KG				
Unit / Shipping	25/29	28/32	42/47	46/51
INPUT AC PARAMETERS				
Surge Protection	220J			
Voltage Range Without Battery Operation	165 to 300 VAC (configurable)			
Frequency Range	45-65Hz, (±0.5Hz)			
Input Socket	IEC-320-C14	IEC-320-C14	IEC-320-C20	IEC-320-C20
Output Sockets	(6) IEC-320-C13	(6) IEC-320-C13	(6) IEC-320-C13 (1) IEC-320-C19	(6) IEC-320-C13 (1) IEC-320-C19
Voltage (Normal Mode)	220/230/240 VAC (configurable)			
Voltage (Battery Mode)	220/230/240 VAC (configurable); ±5% before low-battery warning			
Transfer Time	4-6 ms typical			
On-Battery Waveform	Sinewave			
Overload Warning	>100%			
BATTERY PARAMETERS				
Type	Valve-regulated, nonspillable, lead acid			
Quantity x Voltage x Rating	4 x 12 x 7.2	4 x 12 x 9	8 x 12 x 7.2	8 x 12 x 9
Recharge Time	5 hours to 90% of rated capacity, after full discharge into resistive load			
Battery Backup Time				
ENVIRONMENTAL				
Operating / Storage Temperature, °C	0 to 40 / -15 to 40			
Relative Humidity	0% to 90%, non-condensing			
Operating Altitude	Up to 3000m at 35°C without derating			
Audible Noise	<40 dBA, internal fan(s) Off; <45 dBA, internal fan(s) On			
AGENCY				
Safety	IEC62040-1-1			
EMC	IEC/EN/AS 62040-2 2nd Ed Class A			
Transportation	ISTA Procedure 1A Certification			
Warranty	3 years standard (+ 1 year warranty extension available)			
Packaging	User Manual on CD, Software CD, DB9 Serial cable, USB Cable, Tower Stands, Rack Handles w/ mounting hardware, Safety Instruction Sheet, Environment protection sheet, REPO mate socket, (2) IEC output cables for 1000/1500VA and (3) IEC output cables for 2200/3000 VA, for PS2200/3000: (1) "Shucko" CEE 7/7 to IEC-320-C19 input cord and (1) UK plug to IEC-320-C19 input cord.			

Liebert PSI XR Battery Cabinet Specifications

MODEL NUMBER	PSRT3-24VBXR	PSRT3-48VBXR
Used w/UPS Model	PS1000RT3-230XR / PS1500RT3-230XR	PS2200RT3-230XR / PS3000RT3-230XR
DIMENSIONS, W X D X H, MM		
Unit / Shipping	440 x 490.5 x 88 / 560 x 675 x 228	
WEIGHT, KG		
Unit / Shipping	29 / 33	
BATTERIES		
Type	Valve-regulated, nonspillable, lead acid	
Quantity x Voltage x Rating	8 x 12 x 7.2	8 x 12 x 7.2
Battery Manufacturers	CSB, YUASA or Equivalent	
ENVIRONMENTAL		
Operating / Storage Temperature, °C	0 to 40 / -15 to 40	
Relative Humidity	0% to 90%, non-condensing	
Maximum Operating Altitude	3000m at 35°C without derating	
AGENCY		
Safety / Emissions	IEC/EN/AS 62040-1-1 / IEC/EN/AS 62040-2 2nd Ed Class A	
Transportation	ISTA Procedure 1A Certification	

Battery Runtime Chart (Runtimes are in minutes, assuming fully charged batteries at 25°C)

NUMBER OF BATTERIES	PS1000RT3-230XR	PS1500RT3-230XR	PS2200RT3-230XR	PS3000RT3-230XR
Internal Battery (half/full load)	15 / 6	13 / 5	14 / 5	13 / 5
1 Cabinet (half/full load)	73 / 31	55 / 18	45 / 15	31 / 12
2 Cabinet (half/full load)	129 / 65	95 / 46	67 / 29	56 / 18
3 Cabinet (half/full load)	181 / 96	131 / 64	95 / 48	73 / 31
4 Cabinet (half/full load)	233 / 124	167 / 82	143 / 72	95 / 47
5 Cabinet (half/full load)	285 / 151	203 / 106	167 / 84	113 / 56
6 Cabinet (half/full load)	336 / 179	239 / 124	191 / 102	131 / 65

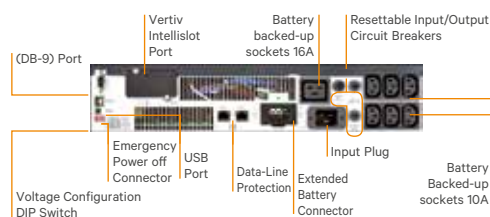

Liebert® GXT4™ is a true on-line UPS that delivers continuous, high-quality AC power to connected equipment with no interruption when transferring to battery

It protects equipment from virtually all power disturbances caused by blackouts, brownouts, sags, surges or noise interference.

For robust UPS protection of up to 3 kVA, the Liebert GXT4 provides industry-leading features in a compact 2U design:

- On-line design means zero transfer time. If utility power fails, your critical load will be supported by a seamless flow of power
- ECO mode option allows improved energy efficiency
- Easy serviceability with replaceable, hot-swappable batteries
- Controllable power to multiple devices via two independently programmable pairs of sockets
- Optional Liebert MicroPOD™ allows for maintenance
- Compatible with Vertiv™ monitoring suite, racks and rack PDUs.

Flexibility:

- Two controllable socket groups
- Rotatable multi-language LCD display
- Automatic frequency sensing
- Rack and tower mounting flexibility
- Multiple communication options (SNMP, Modbus and Relay)
- Frequency conversion capability.

High Availability:

- Advance early warning of UPS system status
- Integrated and extended backup time
- Overload capability
- Periodic battery testing
- Replaceable hot-swappable batteries
- Input power-factor correction
- Internal automatic and manual bypass capability
- Intelligent battery management
- Input circuit breaker
- Lighting and surge protection.

Lower Total Cost of Ownership:

- High output power factor (0.9) to maximize power availability
- ECO mode for increased efficiency
- ENERGY STAR® qualified models
- Wider input voltage minimizes battery use
- Intelligent fan operation
- Two-year standard and extended warranty protection.

Communications for Power Monitoring, Control and Preventive Maintenance:

Liebert GXT4 offers a variety of communication options, providing flexible monitoring, control capabilities and preventive maintenance. These include:

- Optional SNMP/Webcard for UPS monitoring and control
- Optional Modbus and Relay cards
- Vertiv MultiLink™ automated system shutdown software
- Vertiv Nform™ monitoring system.

Ideally suited for:

- Mission critical applications and systems
- Network workstations
- Servers
- Network closets
- Large network peripherals
- VoIP
- PCs.



Liebert GXT4 700 - 3000 VA

Liebert® GXT4™ Specifications

MODEL NUMBER	GXT4-700RT230E	GXT4-1000RT230E	GXT4-1500RT230E	GXT4-2000RT230E	GXT4-3000RT230E
Power Rating	700 VA / 630 W	1000 VA / 900 W	1500 VA / 1350 W	2000 VA / 1800 W	3000 VA / 2700 W
INPUT AC PARAMETERS					
Voltage Range without Battery Operation (V)	230 AC nominal (115 - 280 V AC, variable based on output load)				
Frequency Range (Hz)	40 - 70; Auto sensing				
Input Socket	IEC320-C14	IEC320-C14	IEC320-C14	IEC 320-C20	IEC 320-C20
Output Sockets	(6) IEC320-C13	(6) IEC320-C13	(6) IEC320-C13	(6) IEC320-C13	(6) IEC320-C13 (1) IEC320-C19
Voltage (V)	200 / 208 / 220 / 230 / 240 AC (user configurable); ±3%				
Waveform	Pure Sinewave				
BATTERY PARAMETERS					
Type	Valve-regulated, non-spillable, lead-acid				
Quantity x Voltage x Rating (Ahr)	4 x 12 V x 5.0	4 x 12 V x 5.0	4 x 12 V x 7.2	4 x 12 V x 9.0	6 x 12 V x 9.0
Recharge time	5 hours to 90% capacity after full discharge with 100% load till UPS auto-shutdown (internal batteries only)				
ENVIRONMENTAL					
Operating/Storage Temperature	0° C - to +40°C (+32°F to +104°F) /-15°C to +40°C (5°F to +122°F)				
Relative Humidity (%)	0% RH to 95% RH, non-condensing				
Operating Altitude	Up to 3000 m (10,000 ft) at 25°C (77°F) without derating				
Audible Noise (dBA) at 1 meter (3.2 ft) from the front or sides	<43		<46		<48
AGENCY					
Safety	IEC/EN/AS 62040 -1: 2008; GS Mark				
Safety (UL 1778 Listed)	Yes		-	-	Yes
RFI/EMI	IEC/EN/AS 62040 -2 2 nd Ed (C2)				
Transportation	ISTA Procedure 1A				
Compliance	CE, RoHS				
DIMENSIONS (W X D X H /MM)					
Unit	430 x 408 x 85		430 x 497 x 85		430 x 602 x 85
Shipping	570 x 617 x 262		570 x 617 x 262		570 x 717 x 262
WEIGHT (KG)					
Unit	18.2	18.2	23.2	25.5	32.4
Shipping	20	20	26.0	28.0	35.0
COMPATIBLE EXTERNAL BATTERY CABINET					
	GXT4-48VBATTE			GXT4-72VBATTE	
Type	Valve-regulated, non-spillable, lead acid				
Quantity x Voltage x Rating (Ahr)	2 x 4 x 12 V x 9.0			2 x 6 x 12 V x 9.0	
ENVIRONMENTAL					
Operating/Storage Temperature, °C	0° C - to +40°C (+32°F to +104°F) /-15°C to +50°C (5°F to +122°F)				
Relative Humidity	0% RH to 95% RH, non-condensing				
Maximum Operating Altitude	Up to 3000 m (10,000 ft) at 40°C (77°F) without derating				
AGENCY					
Safety	IEC/EN/AS 62040 -1: 2008; GS Mark				
Transportation	ISTA Procedure 1A				
DIMENSIONS (W X D X H /MM)					
Unit			430 x 497 x 85		430 x 602 x 85
Shipping			570 x 617 x 262		570 x 717 x 262
WEIGHT (KG)					
Unit			32		42
Shipping			35		46

(* Note: check user manual for details.

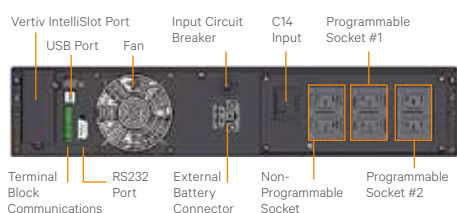

Liebert GXT4 1500 VA

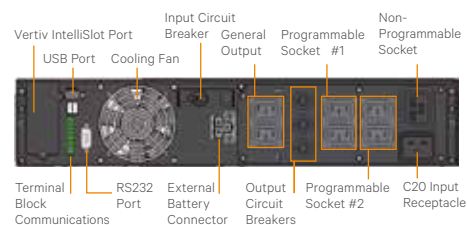

Liebert GXT4 3000 VA



Liebert MicroPOD™



Vertiv™ Intellislot® Communication Card

Liebert® GXT MT+ Gen. 2 features true on-line double conversion technology, delivering best-in-class power protection for critical applications

The new Liebert GXT MT+ Gen. 2 has been designed according to comprehensive technical specifications, allowing it to provide a high level of availability for connected IT equipment. Its ECO mode function is in charge of delivering high levels of efficiency, leading to optimized total cost of ownership (TCO) advantages Liebert GXT MT+ furthermore offers intelligent monitoring and network management functions for improved system shutdown and control. This high performance UPS with proven reliability is available in a compact tower design.

Flexibility:

- Multiple communication options (USB, RS232)
- Network and volt-free contact cards (optional)
- Schuko and IEC output sockets
- Frequency converter operation 50/60 Hz.



Higher Availability:

- Wide input voltage range
- Input circuit breaker
- Automatic frequency detection.

Optimized Total Cost of Ownership:

- ECO mode for high efficiency
- Minimized installation time and costs.

Ideally Suited for:

- VoIP equipment
- Small office networks
- Computer rooms
- Process automation equipment
- Network storage devices.



Liebert GXT MT+ 1 kVA - 3 kVA Gen. 2

Liebert® GXT MT + 1 kVA - 3 kVA Gen. 2 Specifications

MODEL NUMBER	GXT MT+ 1 kVA G2 ES	GXT MT+ 2 kVA G2 ES	GXT MT+ 3 kVA G2 ES
Power Rating	1000 VA / 800 W	2000 VA / 1600 W	3000 VA / 2400 W
DIMENSIONS, W x D x H - mm			
Unit	145 x 282 x 223	145 x 397 x 238	190 x 421 x 336
Shipping	230 x 360 x 325	230 x 472 x 325	320 x 560 x 460
WEIGHT - KG			
Unit	9.7	17.3	27.5
Shipping	10.7	18.7	29.5
INPUT AC PARAMETERS			
Voltage Range Without Battery Operation ⁽¹⁾	From 110 to 300 V AC		
Frequency Range (synchronization)	47 - 53 or 57 - 63 Hz; Autosensing		
Input Socket	1 x IEC 320 - C14	1 x IEC 320 C20	
Output Sockets	3 x IEC320 C13 & 1 x Schuko	3 x IEC 320 C13 & 2 x Schuko & Terminals	
Voltage	220 / 230 / 240 V AC		
Waveform	Sinewave		
BATTERY PARAMETERS			
Type	Valve-regulated, non-spillable, lead acid		
Internal Batteries	Yes		
Quantity x Voltage x Rating	2 x 12 V x 9 Ahr	4 x 12 V x 9 Ahr	6 x 12 V x 9 Ahr
Recharge Time	4 hours recovers to 90% capacity (Typical)		
External Battery Cabinets	Not permitted		
ENVIRONMENTAL			
Operating Temperature	0 °C to 40 °C		
Relative Humidity	20% to 90% non condensing		
Operating Altitude	<1000 m without derating		
Audible Noise	<50 dBA @ 1 meter		
STANDARDS AND CERTIFICATIONS			
Safety	EN62040-1:2008		
EMC	EN62040-2:2006 class C2		
Compliance	CE		

⁽¹⁾ From 110 V to 175 V AC, and 280 V to 300 V AC, derating applies.
Note: External battery cabinets are not permitted. Internal batteries only.

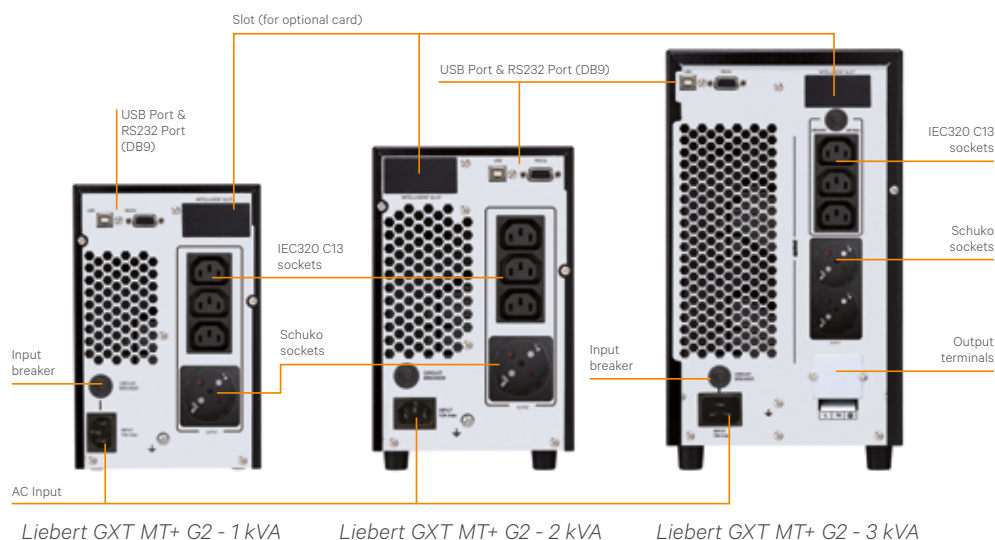

Liebert® GXT4™ UPS meets the need for higher power capacities in small spaces

This true on-line double conversion UPS system is available in larger capacity models of 5 kVA - 10 kVA, featuring integrated maintenance bypass as well as optional extended battery runtime.

The **Liebert GXT4 UPS** is designed for use in either rack or tower configurations. It maintains a compact footprint in all ratings, with 5000 - 6000 VA models with a height of 5 U, and 10000 VA with a height of 6 U, as well as a short depth of <600 mm.

Flexibility:

- Rotatable multi-language LCD display panel
- Compact 5Us or 6Us height and short depth (<600 mm)
- Automatic frequency sensing
- Frequency conversion capability
- Rack & tower mounting flexibility
- User replaceable hot-swappable internal batteries
- Extended backup time with additional battery cabinets
- Vertiv™ IntelliSlot® communication port available
- Includes Windows®-based configuration program
- Built-in USB communication ports for use with Vertiv MultiLink™ automated shutdown software
- Built-in closure signals
- Emergency power-off (EPO).

High Availability:

- Internal automatic and manual bypass
- Self-diagnostics
- Input power-factor correction
- Advance early warning of UPS systems status
- 10 kVA parallel/redundant up to 2+1
- Periodic battery testing
- Intelligent battery management.

Total Cost of Ownership:

- High output power factor
- ECO mode for increased efficiency
- ENERGY STAR® qualified models
- Wider input voltage minimizes battery use
- Battery cutoff voltage to prevent from over discharge of batteries and to prolong battery life.

Communications for Power Monitoring, Control and Preventive Maintenance:

- Liebert GXT4 offers a variety of communication options, providing flexible monitoring, control capabilities and preventive maintenance. These include:
- Optional SNMP/Webcard for UPS monitoring and control
- Optional Modbus and Relay cards
- Vertiv MultiLink automated system shutdown software
- Vertiv Nform™ monitoring system
- Vertiv LIFE™ Services compatibility for UPS preventive maintenance and remote diagnostics.

Ideally Suited for Mission-Critical Applications:

- LAN and WAN servers
- Network equipment
- IP telephony deployments
- Office telecommunication systems
- Test and diagnostic equipment
- Finance applications.



Liebert GXT4 5 - 10 kVA

Liebert® GXT4™ Specifications

MODEL NUMBER	GXT4-5000RT230E	GXT4-6000RT230E	GXT4-10KRT230E
Power Ratings (VA/W)	5000 VA / 4000 W	6000 VA / 4800 W	10000 VA / 9000 W
INPUT AC PARAMETERS			
Voltage Range (VAC)	176 - 280		
Frequency Range (Hz)	40-70; Auto sensing		
Input Socket	Hardwired input on PD2-CE6HDWRMBS standard power distribution box		Hardwired input on PD2-CE10HDWRMBS standard power distributions box
Output Sockets	6 x IEC320-C13 + 2 x IEC320-C19 + hardwired on PD2-CE6HDWRMBS standard power distribution		4 x IEC320-C13 + 4 x IEC320-C19 + hardwired on PD2-CE10HWRDMBS standard power distribution
Voltage (V)	230 factory default		
Waveform	Pure Sinewave		
BATTERY PARAMETERS			
Type	Valve-regulated, non-spillable, lead-acid		
Quantity x Voltage x Rating	20 x 12 V x 5 Ahr		20 x 12 V x 9 Ahr
Recharge time	5 hours to 90% capacity after full discharge with 100% load		
ENVIRONMENTAL			
Operating	0° C - to +40°C (+32°F to +104°F) (no derating)		
Relative Humidity	0% RH to 95% RH, non-condensing		
Operating Altitude	Up to 1000m (3281ft) at 25°C (77°F) without derating		
Audible Noise	<50 dBA, at 1 meter (3.2 ft) from the front or sides		
AGENCY			
Safety	IEC/EN/AS 62040-1: 2008; GS Mark		
EMI/EMC/C-Tick EMC	IEC/EN/AS 62040-2 2nd Ed (C2)		
Transportation	ISTA Procedure 1A		
Compliance	CE, RoHS		
DIMENSIONS (W X D X H / MM)			
Unit / Shipping	430 x 574 x 217 / 516 x 745 x 530		430 x 581 x 261 / 530 x 745 x 563
WEIGHT (KG)			
Unit / Shipping	60 / 71	60 / 71	70 / 92
COMPATIBLE EXTERNAL BATTERY CABINET			
Type	Valve-regulated, non-spillable, lead-acid		
Quantity x Voltage x Rating	1 x 20 x 12 V x 9 Ahr		
ENVIRONMENTAL			
Operating / Storage Temperature	0° C - to +40°C (+32°F to +104°F) / 15° C - to +50°C (5°F to +122°F)		
Relative Humidity	0% RH to 95% RH, non-condensing		
Maximum Operating Altitude	Up to 1000 m (3281 ft) at 25°C (77°F) without derating		
AGENCY			
Safety / Emissions	IEC/EN/AS 62040-1: 2008		
Transportation	ISTA Procedure 1A		
DIMENSIONS (W X D X H / MM)			
Unit / Shipping	430 x 581 x 173 / 530 x 745 x 475		
WEIGHT (KG)			
Unit / Shipping	65 / 76		

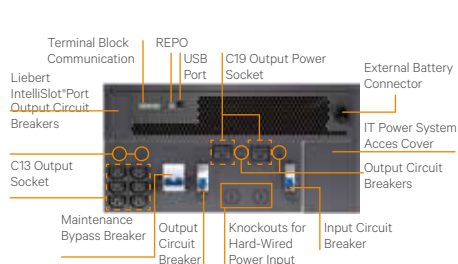

Liebert GXT4 5000/6000 VA

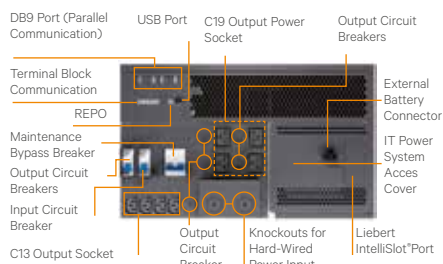

Liebert GXT4 10000 VA



Front view Power Distribution (PD2-CE10HDWRMBS)



Vertiv IntelliSlot Communication Card

Liebert® GXT3 is designed to deliver higher power capacities for applications with limited floor space

This true on-line double conversion UPS system is available in two different 10000 VA versions featuring an integrated maintenance bypass, as well as optional extended battery back up time.

Liebert GXT3 T230 is the standard version free of integrated isolation transformer which can be configured as either 1/1 or 3/1, providing increased flexibility.

The Liebert GXT3 range also offers the possibility of integrated full galvanic isolation with the Liebert GXT3 T220 which houses an output isolation transformer allowing it to be used at 110, 120 phase to neutral or 208, 220 phase to phase voltages, for dual input with phases shifted by 180 degrees.

Communications For Power Monitoring And Control:

Liebert GXT3 offers a variety of communications options providing flexible monitoring and control capabilities.

- Vertiv™ IntelliSlot™ web card providing SNMP and web-based monitoring and control of the UPS
- Vertiv MultiLink™ automated system shutdown software
- Vertiv Nform™ monitoring system
- Third-party monitoring systems.

Ideally suited for Mission-Critical Applications such as:

- LAN & WAN servers
- Network equipment
- IP telephony deployments
- Office telecommunications systems
- ISDN & frame relay applications
- Test and diagnostic equipment
- Micro Processor-controlled equipment
- Finance applications.

Flexibility:

- Automatic frequency detection
- User replaceable hot-swappable internal batteries
- Extended back up time with additional battery cabinets
- Vertiv IntelliSlot communications port
- Includes Windows-based configuration program
- Built-in USB communications for use with Vertiv MultiLink automated shutdown software
- Built-in closure signals
- Emergency power off (EPO)
- Parallelable up to three units (2+1).

Higher Availability:

- Wider input voltage window minimizes battery use
- Internal automatic and manual bypass
- Self-diagnostics.

Reduced Total Cost Of Ownership:

- Standard two-year warranty
- Compact footprint
- Batteries shielded from heat generating electronic components
- Battery cutoff voltage to prevent from overdischarge of batteries.



Liebert GXT3 10000 VA Tower

0.9 PF
More Power
Available!

Liebert® GXT3 Specifications

MODEL NUMBER	GXT3-10000T230	GXT3-10000T220
Power Rating	10000 VA/9000 W	
DIMENSIONS, W x D x H - mm		
Unit / Shipping	300 x 675 x 800 / 426 x 866 x 1062	
WEIGHT - KG		
Unit	105	140
INPUT AC PARAMETERS		
Voltage Range Without Battery Operation	176-280VAC (for 1/1) 304-485VAC (for 3/1)	100 - 185 ±5VAC (for 1/1)
Frequency Range	50 - 60Hz autoselection	
Input Socket	terminal block	
Output Sockets	terminal block	
Voltage	220/230/240VAC	208VAC
Waveform	Sinewave	
BATTERY PARAMETERS		
Type	HR 1234W F12	CSB HR1234R or Panasonic UP-RW1245
Quantity x Voltage	20 x 12V	
Recharge Time	3 hours to 90% capacity after full discharge with 100% load (Internal Batteries Only)	
ENVIRONMENTAL		
Operating Temperature	0 to 30 °C with 0.9 pf 30 to 40 °C with 0.8 pf	
Storage Temperature	- 15 to 50 °C	
Relative Humidity	0%RH to 95%RH, non-condensing	
Operating Altitude	Up to 1000m	
Audible Noise	< 55 dBA, at 1 meter from the rear < 50 dBA, at 1 meter from the front or sides	
Standards and Certifications	CE	UL 1778, c-UL
RFI/EMI	IEC/EN/AS 62040-2 2nd Ed (Cat 2 – Table 6)	FCC Part 15, Subpart B, Class A
Surge Immunity	EN61000-4-5, Level 3, Criteria A	IEC/EN 61000-4-5, ANSI C62.41 (for North America)
Transportation	ISTA Procedure 1A	ISTA Procedure 1B

Liebert GXT3 Battery Cabinet Specifications

MODEL NUMBER	GXT3-240TBATT CE
DIMENSIONS, W x D x H - mm	
Unit / Shipping	300 x 675 x 800 / 426 x 866 x 1062
WEIGHT - KG	
Unit / Shipping	110/140
BATTERIES	
Type	Valve-regulated, non-spillable, lead acid
Quantity x Voltage	2 x 20 x 12V
ENVIRONMENTAL	
Operating / Storage Temperature, °C	0 to 40/-15 to 40
Relative Humidity	0% to 95%, non-condensing
Maximum Operating Altitude	Up to 10000m (40°C)
STANDARDS AND CERTIFICATIONS	
Safety / Emissions	CE
Transportation	ISTA Procedure 1A

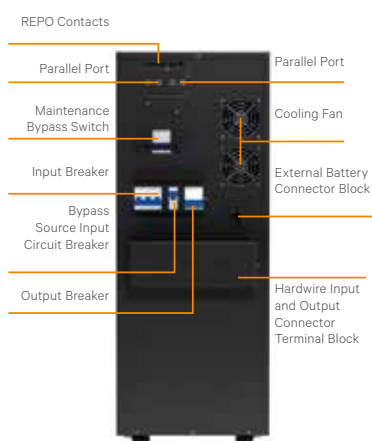

Liebert GXT3-10000T230

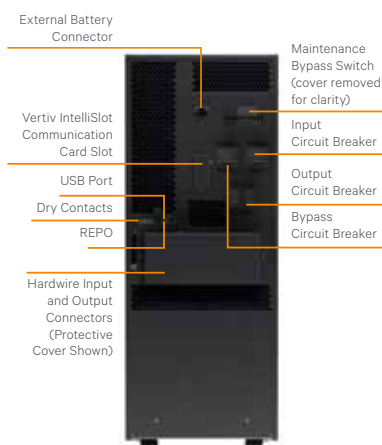

Liebert GXT3-10000T220

Liebert® GXT MT+ features true on-line double conversion technology, delivering best-in-class power protection for critical applications

Liebert GXT MT+ features an attractive design style, together with an LCD display and synoptic scheme in the front panel for easy use. Load protection is ensured with DSP control technology, wide input voltage operation and high output power factor (0.8).

Its small size, the shutdown software included and the maintenance bypass make the Liebert GXT MT+ the perfect and safest choice to protect your critical load.

Flexibility:

- Multiple communication options (USB, RS232)
- Network and volt-free contact cards (optional)
- LCD display and intuitive synoptic in the front panel for easy UPS status.

Higher Availability:

- Wide input voltage range
- Input circuit breaker
- Maintenance bypass
- Automatic frequency detection.

Optimized Total Cost of Ownership:

- Minimized installation time and costs
- Small and compact footprint and size.

Ideally Suited for:

- VoIP equipment
- Small office networks
- Computer rooms
- Process automation equipment
- Network storage devices.



Liebert GXT MT+ 6 kVA - 10 kVA Tower

Liebert® GXT MT + 6 kVA - 10 kVA Tower Specifications

MODEL NUMBER	GXT-MT+ 6 kVA ES	GXT-MT+ 10 kVA ES
Power Rating	6000 VA / 4800 W	10000 VA / 8000 W
DIMENSIONS, W x D x H - mm		
Unit	190 x 369 x 688	190 x 442 x 688
Shipping	290 x 495 x 910	320 x 580 x 910
WEIGHT - KG		
Unit	60	75
Shipping	65	81
INPUT AC PARAMETERS		
Voltage Range Without Battery Operation ⁽¹⁾	From 110 to 300 V AC	
Frequency Range (synchronization)	46 - 54 or 56 - 64 Hz; Autosensing	
Input Socket	Hardwired (L-N-G)	
Output Sockets	Hardwired (L-N-G)	
Voltage	208 / 220 / 230 / 240 V AC	
Waveform	Sinewave	
BATTERY PARAMETERS		
Type	Valve-regulated, non-spillable, lead acid	
Internal Batteries	Yes	
Quantity x Voltage x Rating	16 x 12 V x 9 Ahr	20 x 12 V x 9 Ahr
Recharge Time	9 hours recovers to 90% capacity (Typical)	
External Battery Cabinets	Not permitted	
ENVIRONMENTAL		
Operating Temperature	0 °C to 40 °C	
Relative Humidity	<95% non condensing	
Operating Altitude	<1000 m without derating	
Audible Noise	<55 dBA @ 1 meter	<58 dBA @ 1 meter
STANDARDS AND CERTIFICATIONS		
Safety	EN62040-1:2008	
EMC	EN62040-2:2006 class C3	
Compliance	CE	

⁽¹⁾ From 110 V to 176 V AC derating applies.

Note: External battery cabinets are not permitted. Internal batteries only.



Liebert GXT MT+ 6 kVA - 10 kVA Tower

Modular Power Protection for Immediate and Future Load Demands

The Liebert® APS is a modular, single phase output UPS, with both single and three phase input options, designed for the protection of IT equipment such as workstations, servers and networks, as well as telecommunications-related applications.

The modular, scalable architecture of the Liebert APS is specifically designed to meet immediate load requirements as well as efficiently adapt to future increase needs, allowing expansion in increments of 5 kVA up to a total of 20 kVA with the simple installation of additional power modules. Featured FlexPower technology™ ensures that such power expansions can be carried out without the need for transferring the load to bypass (hot swap) thus extending the load protection and system availability during service and upgrade operations. Maximized system availability can be further achieved in all Liebert APS configurations with redundant power modules reaching the maximum configuration of 20 kVA with an additional 10 kVA of redundancy.

The Liebert APS 5 kVA/4.5 kW power modules deliver an enhanced level of active power when compared to UPS of equal size in both standard and extended autonomy configurations, thus providing customers with more power to support larger loads. Increased active power also contributes to minimizing initial investment costs and optimizing TCO. Optimization of TCO is further extended to batteries which can be housed inside the UPS cabinet together with power modules. The compact battery modules allow significant extension of back up time without increasing the overall cabinet footprint. With a double conversion efficiency of 92% coupled with an output power factor of 0.9, Liebert APS rises to the top of its class delivering both optimized CAPEX and OPEX

Features and Performances:

- 5 kVA / 4.5 kW single phase output power modules
- Site configurable as single or three phase input
- Stand alone or rack mountable
- Hot-Swappable power and battery modules
- Intelligent battery modules
- Double conversion efficiency: 92%
- Integrated autonomy up to 1h @ 4.5 kW
- 1.8 A charging current per module
Optional 10 A charger module
- Terminal block or output socket
- Fully rated @ 40°C.



Liebert APS with matching modular battery cabinet for extended autonomy applications.

Liebert® APS Specifications

RATINGS	
Frame Rating (kVA/kW)	20/18
Power Module rating (kVA/kW)	5/4.5
Maximum number of power module per frame	6
INPUT DATA	
Nominal Input Voltage (V)	220/230/240; Single-Phase - 380/400/415; Three-Phase
Input voltage range without battery discharge at 70% load (V)	140-280 Single-Phase; - 242-485 Three-phase
Nominal Input Frequency (Hz)	50/60
Input Frequency Range (Hz)	40 to 70 auto-sensing
Input Power Factor (kW/kVA)	Single-Phase Input, > 0.99 - Three-phase Input, > 0.95
Input Current Distortion, THDi (%)	< 5
BATTERY MODULE	
Battery Cells Per String	72
Backup Time, Minutes, Full Load (for non-redundant system which has equal number of battery strings and power modules) (min)	5
Maximum Charge Current (Full, Load) (A)	Power module internal charger: 1.8 - Extra Charger module: 10
Voltage temperature compensation	Yes
OUTPUT DATA	
Nominal Output Voltage (V)	220/230/240 Single-Phase
Voltage Regulation (%)	±3
Voltage Stability (100% Step Load) (%)	±7
Voltage Recovery Time (ms)	≤ 60
Output Voltage Distortion, THDv (%)	≤ 3, linear load ≤ 5, non-linear load
Output Frequency (Hz)	50/60
Nominal load power factor (kW/kVA)	0.9
Output Overload Capability (s)	130% for 60s; 150% for 10s - 200% for 1s; > 201% for 0.25s
DIMENSIONS AND WEIGHT	
Unit Weight (empty frame) (kg)	145
Power Module Weight (kg)	8.2
Battery Module Weight (kg)	16.4
Dimensions, W x D x H (mm)	440 x 850 x 970
GENERAL & ENVIRONMENTAL	
Operating Temperature, continuous, without derating (°C)	0 - 40
Double conversion Efficiency (AC-AC) (%)	92
Eco Mode Efficiency (AC-AC) (%)	>98
Environmental	WEEE and ROHS2 (6 by 6), REACH Compliant
Acoustic Noise Level @ 1 meter (dBA)	< 55dB (< 50% load), < 65dB (51-100% load)
UPS Classification According to IEC EN 62040-3	VFI-SS-111
Protection Degree IEC60529	IP 20
Color	RAL 7021

INDEX

Keyword	Product	Page
A		
@lock		239
Access control	Vertiv SmartAisle	136
Air partition	MIR2/DCM	39
Air partition	Cable Manager	77
Air velocity sensor	RMS Compact II	246
Aisle discharge plenum	Vertiv SmartAisle	139
Alarm sensor	RMS Compact II	248, 252
19" aluminum strip	Smaract	105
Anti-tilt system	MIR2/DCM	49
B		
Back plate	Smaract	113
Base	Smaract	105
Base frame	Cable Management	73, 75
Base plate	MIR2/DCM	36
Baying connector	MIR2/DCM	43 - 44
19" blanking plate	System Accessories	51
Bolt clamp	Cable Management	82
19" breadboard profile	MIR2/DCM	40
Brush strip	MIR2/DCM	43, 79
Bulkhead element	Vertiv SmartAisle	137
Busbar	Vertiv MPX	195
C		
C profile rail	Cable Management	48
Cabinet lighting	System Accessories	59
Cable conduit	DCM Colocation	32
Cable joint	System Accessories	56
Cable management		67
Cable management rail	ConAct	125
Cable management strip	Cable Management	81
Cable manager	Cable Management	77, 79
Cable removal protection	MPX	196
Cable removal protection	Knürr DIS Rack PDU	237
Cable retaining clip	Vertiv MPX	196
Cable routing brace	Miracel 2/DCM	47
Cable routing bracket	Cable Management	87
Cable routing panel	Cable Management	80
Cable routing ring	Cable Management	85 - 86
Cable spool	Cable Management	87
Cable trough	Cable Manager	81 - 82
Cage nut	Systemzubehör	64
Cascading	Cable Manager	80
Center section	Cable Management	73

Keyword	Product	Page
Cold device connecting cable	Knürr DIS Rack PDU	236
Colocation rack	DCM	31
Color-coding	Vertiv MPH2	211
Combi Lock	MIR2/DCM	46
ConAct		121
Connecting cable	PowerTrans2	185
Connecting cable	Vertiv MPH2	210
Connecting cable	Vertiv MPE	215
Connecting line	Knürr DIS Rack PDU	235
Connecting piece	Cable Management	74
Connecting plate	Doublepro Rack	139
Connecting plate	Smaract	111, 113
Contact terminal	System Accessories	66
Contact terminal	Smaract	109
Contact terminal	Doublepro Rack	120
CoolBlast	Fan Units	88 - 92
Countersunk screw	System Accessories	64
Cover	Cable Manager	76 - 79
Cover plate	Cable Management	74
Cover screws	MIR2/DCM	44
Cover strip	MIR2/DCM	45
Crossbeam	MIR2/DCM	43
Crosswiring	Cable Management	75
CRV	Liebert® CRV	170
Customized SmartAisle	Vertiv SmartAisle	146
Cylinder screw	System Accessories	65
D		
DCD		157
DCL	Liebert® DCL	162
DCM		20
Depth profile sealing plate	DCM	49
Depth strut	Smaract	106
19" desktop	System Accessories	58
Display module	Vertiv MPX	188
Display module	Vertiv MPH2	209
3-phase distribution block	Knürr DIS Rack PDU	234
Distributor box	System Accessories	65
Knürr DIS Rack PDU		216
Document holder	System Accessories	59
Door contact sensor	RMS Compact II	246
Door contact switch	System Accessories	66
Doors	MIR2/DCM	34
Double base	Switchtube	149
Double base	Vertiv SmartAisle	145

Keyword	Product	Page
Double door	Vertiv SmartAisle	137
Double swivel caster	Smaract	108
Double swivel caster	Doublepro Rack	120
DoublePro Rack		114
19" drawer	System Accessories	58 - 59
Dust cover	CoolBlast	94
E		
Earthquake kit	DCM	49
Electronic lock	Vertiv SmartAisle	135, 140
Enclosure	Vertiv SmartAisle	133
End piece	Cable Management	74
End separator strip	Vertiv SmartAisle	139
Equipotential bonding bar	System Accessories	66
F		
Fan rear panel	Doublepro Rack	118
Fan units		88
Fiber optic cable	Cable Management	81, 83
Filling wall	Vertiv SmartAisle	143
Filter fan	Fan Units	95
Filter mat	MIR2/DCM	43
Filter mat	Smaract	107
19" filter slot	Fan Units	93
Floor mounting	Smaract	109
Free-Standing SmartAisle	Vertiv SmartAisle	147
Front filter intake	CoolBlast	94
Front panel	System Accessories	52
Front panel	CoolBlast	93
Front panel	Fan Units	96
19" front ventilation panel	System Accessories	52
G		
Glass door	Smaract	103
Ground rail	System Accessories	66
Ground rail	Smaract	109
Ground rail	Doublepro Rack	119
Grounding kit	ConAct	125
Grounding kit	MIR2/DCM	44
Grounding kit	Doublepro Rack	119
GXT4	UPS	290, 294
H		
Handle	System Accessories	57
19" heavy duty base	System Accessories	56
Humidity sensor	RMS Compact II	246
I		

Keyword	Product	Page
IMS		254
Infrared motion sensor	RMS Compact II	244
Input module	MPX	188
IT Management Solutions	Desktop and Server Room Solutions	262-267
J		
Junction box	System Accessories	66
K		
Keyboard drawer	System Accessories	58-59
KVM	Desktop Solutions	262, 263
L		
LCD Trays	IT Management Solutions	267
Lifting eyes	MIR2/DCM	45
Lifting eyes	Smaract	109
3 point lock	MIR2/DCM	32
Line Interactive, USP	USP	282-288
Lock kit	MIR2/DCM	46
M		
M5 threaded plate	Cable Management	82
Mains cable	Knürr DIS Rack PDU	236
Maneuvering bar	Cable Management	84
Maneuvering handle	Cable Management	83 - 85
Mechanical lock	Vertiv SmartAisle	136, 141
Mesh cable tray	Cable Management	74
Miracel 2		5
MLR1000		243
MLR3000		241
MLR5000		241
Mounting adapter	MIR2/DCM	41
Mounting adapter	Smaract	106
Mounting aid	System Accessories	62
Mounting bar	Cable Management	82
Mounting bracket	Cable Management	73
Mounting bracket	Doublepro Rack	120
Mounting kit	MIR2/DCM	62 - 63
Mounting kit	Smaract	62 - 63
Mounting kit	ConAct	62 - 63
Vertiv MPE		212
Vertiv MPH2		200
Vertiv MPX		188
Multifunctional strut	MIR2/DCM	47
O		

Keyword	Product	Page
Off-line, UPS	UPS	280
On-line, UPS	UPS	290-300
Output module	Vertiv MPX	194
Oval head screw	System Accessories	64 - 65
P		
Partitioning wall	MIR2/DCM	32, 38
PDU bracket	MIR2/DCM	48
PDU mounting kit	Cable Management	48
Plinth	MIR2/DCM	37
Plinth	Smaract	108
Plinth cover with cable entry	Smaract	108
19" plug-in unit	PowerTrans2	182
Plug connector	Knürr DIS Rack PDU	235
Power cable	Knürr DIS Rack PDU	234, 235
PowerTrans2		182
PSA	UPS	282
Q		
Quick release	MIR2/DCM	44
R		
19" raised floor	System Accessories	54 - 56
Rack cooling	Liebert® DCL	162
Rear panel	Smaract	111
Rear wall	Doublepro Rack	118
Replacement filter	CoolBlast	94
RMS Compact II		244
Roof cabling		70
Roof element	Vertiv SmartAisle	138, 141
Rotating frame	MIR2/DCM	42
RPC2		197
S		
Seal kit	Vertiv SmartAisle	144
Sealing frame	IP55	18
Sensor box	Vertiv SmartAisle	143
Sensor cable	RMS Compact II	247
Sensor extension cable	RMS Compact II	247
Sensors	Vertiv MPX	195
Sensors	Vertiv MPH2	208
Series terminal boxes	System Accessories	66
19" sheet steel profile	Smaract	105
19" shelf	System Accessories	57
Shim	Vertiv SmartAisle	142

Keyword	Product	Page
Side section	MIR2/DCM	38
Side section screw connection	MIR2/DCM	44
Sliding door	Vertiv SmartAisle	135
Slot-in runner	System Accessories	53 - 54
Slot-in runner	Switchtube	151
Smaract		97
SmartAisle		128
Smoke detector	RMS Compact II	247
Socket connector	Knürr DIS Rack PDU	235
Spacer bolts	MIR2/DCM	45
Speedmount kit	Vertiv MPH2	211
Spring nut	System Accessories	64
Stacking kit	Smaract	109
Support bracket, static	MIR2/DCM	46
Switch rack	Vertiv SmartAisle	153
Switch tube	Vertiv SmartAisle	149
T		
Tape measure	MIR2/DCM	41
Temperature module	Fan Units	96
Temperature sensor	RMS Compact II	246
Tensiloc nut	System Accessories	65
Thermostat	Fan Units	96
Top cover	MIR2/DCM	19, 35, 44
Top cover	IP55	19
Top cover	Smaract	106
Top cover	Cable Management	72
Top guard strip	Vertiv SmartAisle	144
Top trim	Vertiv SmartAisle	144
Transition piece	Cable Management	73
U		
UPS	UPS	279
UPS, Off-line	UPS	280
UPS, On-line	UPS	290-300
UPS, Line Interactive	UPS	282-288
V		
Velcro strip	Cable Management	85 - 86
Ventilation unit	Smaract	104
Ventilation unit	ConAct	125
19" vertical strip	ConAct	125
Vibration sensor	RMS Compact II	244
W		
Wall mount	Smaract	109
Wall mounted enclosure	ConAct	124



VertivCo.com | Vertiv Limited, George Curl Way, Southampton, SO18 2RY, VAT Number: GB188146827

© 2018 Vertiv Co. All rights reserved. Vertiv™, the Vertiv logo are trademarks or registered trademarks of Vertiv Co. All other names and logos referred to are trade names, trademarks or registered trademarks of their respective owners. While every precaution has been taken to ensure accuracy and completeness herein, Vertiv Co. assumes no responsibility, and disclaims all liability, for damages resulting from use of this information or for any errors or omissions. Specifications are subject to change without notice.