

Boston[®]

THE ESSENTIAL

GUITAR PARTS

PROGRAM



Fender

Martin & Co.
EST. 1833

GOTOH[®]

Schaller

Wilkinson

Switchcraft

CTS
Electrocomponents

ALPHA

OAK GRIGSBY

GRETSCH

dartfords

Squier
Fender

Boston

Bigsby

Titebond

graphtech
GUITAR LABS
We'll Change The Way You Play!

HOSCO

Shadow

Tube Amp Doctor
EST. SINCE 1992 WORMS, GERMANY

FWF
SYSTEMES



Boston[®]

THE ESSENTIAL

GUITAR PARTS
PROGRAM



1.5.1	bodies, necks and wood	6	1.5.5.4	wood screws.....	85
1.5.1.1	bodies.....	6	1.5.5.4	switch bolts.....	85
1.5.1.2	necks.....	7	1.5.5.4	pickup screws.....	85
1.5.1.7	kerfed lining strips.....	11	1.5.5.4	springs.....	87
1.5.2	tremolos, bridges and tailpieces	12	1.5.5.5	strap buttons and strap locks.....	88
1.5.2.1	tremolos.....	12	1.5.5.6	string retainers and ferrules.....	91
1.5.2.2	tremolo parts.....	16	1.5.5.7	neck plates and neck ferrules.....	93
1.5.2.3	guitar tailpieces.....	20	1.5.5.8	jack plates.....	94
1.5.2.3	bass guitar tailpieces.....	22	1.5.5.9	pickup mounting parts.....	96
1.5.2.3	mandolin tailpieces.....	22	1.5.5.10	truss rods and truss rod parts.....	98
1.5.2.4	tailpiece parts.....	22	1.5.5.11	frets and fret wire.....	99
1.5.2.5	electric guitar bridges.....	22	1.5.5.12	locking/roller nuts.....	100
1.5.2.6	electric guitar bridge parts.....	30	1.5.5.13	miscellaneous hardware.....	100
1.5.2.7	bass guitar bridges and parts.....	35	1.5.6	lacquer and paint	102
1.5.2.8	acoustic guitar bridges.....	39	1.5.7	knobs	104
1.5.2.11	banjo bridges.....	40	1.5.7.1	speed knobs.....	104
1.5.2.11	mandolin bridges.....	41	1.5.7.2	bell knobs.....	104
1.5.2.11	ukulele bridges.....	41	1.5.7.3	dome knobs.....	106
1.5.3	electronics	42	1.5.7.4	switch caps and knobs.....	108
1.5.3.1	electric guitar pickups.....	42	1.5.7.5	miscellaneous knobs.....	109
1.5.3.1	electric bass guitar pickups.....	45	1.5.8	nuts and saddles	111
1.5.3.1	acoustic guitar pickups.....	46	1.5.8.1	nuts.....	111
1.5.3.1	acoustic bass guitar pickups.....	52	1.5.8.2	bridge saddles.....	117
1.5.3.1	pickups for miscellaneous instruments.....	52	1.5.9	pickguards and covers	120
1.5.3.1	pickup parts.....	54	1.5.9.1	pickguards.....	120
1.5.3.2	switches and switch plates.....	58	1.5.9.1	ST vintage SSS.....	123
1.5.3.2	lever switches.....	58	1.5.9.1	ST vintage HSS.....	124
1.5.3.2	toggle switches.....	60	1.5.9.1	ST vintage HH.....	124
1.5.3.2	mini switches.....	61	1.5.9.1	TE vintage.....	125
1.5.3.2	switchplates.....	61	1.5.9.1	LP vintage.....	126
1.5.3.3	potentiometers.....	62	1.5.9.1	PB vintage.....	127
1.5.3.3	25K potentiometers.....	62	1.5.9.1	JB vintage.....	128
1.5.3.3	250K potentiometers.....	63	1.5.9.1	miscellaneous pickguards.....	128
1.5.3.3	500K potentiometers.....	65	1.5.9.2	adhesive back pickguards.....	129
1.5.3.3	1MEG potentiometers.....	67	1.5.9.4	backplates.....	131
1.5.3.3	potentiometer mounting materials.....	68	1.5.9.5	truss rod covers.....	132
1.5.3.4	rectifier tubes.....	69	1.5.10	machine heads	133
1.5.3.4	power tubes.....	69	1.5.10.1	machine heads for classic guitar.....	133
1.5.3.4	preamp tubes.....	70	1.5.10.2	machine heads for acoustic/electric guitar.....	137
1.5.3.5	jack outputs.....	72	1.5.10.3	machine heads for bass guitar.....	147
1.5.3.6	capacitors.....	74	1.5.10.4	machine heads for banjo.....	149
1.5.3.7	wire and cable.....	75	1.5.10.5	machine heads for mandolin.....	149
1.5.3.8	battery clips and holders.....	75	1.5.10.6	machine heads for ukulele.....	150
1.5.3.9	shielding.....	76	1.5.10.7	machine heads for miscellaneous instruments.....	151
1.5.4	binding, trim and inlay	78	1.5.10.8	machine head pegs.....	151
1.5.4.1	binding.....	78	1.5.10.8	machine head bushings.....	153
1.5.4.4	side dots and fingerboard inlay.....	78	1.5.10.8	machine head shafts.....	153
1.5.5	hardware	79	1.5.10.8	miscellaneous machine head parts.....	154
1.5.5.1	bridge pins.....	79	1.5.11	tools	155
1.5.5.1	endpins.....	80	1.5.11.1	allen wrenches and trussrod wrenches.....	155
1.5.5.2	pickguard brackets.....	81	1.5.11.2	work bench tools.....	156
1.5.5.3	control plates.....	81	1.5.11.4	files.....	158
1.5.5.4	screws, bolts and springs.....	83	1.5.11.5	miscellaneous tools.....	160
1.5.5.4	tapping screws.....	83	1.5.11.6	sanding and polishing products.....	161

1.5.1.1 bodies



vintage body, 2 piece alder, made in Japan

31268 **SB-2AL** Stallion model
31271 **TB-2AL** Teaser model



vintage body, 1 piece ash, made in Japan

42737 **JSB-1ASH** Stallion model
42738 **JTB-1ASH** Teaser model



vintage body JM model, 1 piece ash, made in Japan

43855 **JJMB-1ASH**



vintage body JM model, 2 piece alder, made in Japan

42739 **JJMB-2AL**



vintage body Stallion model, 2 piece alder, made in Japan

42740 **JSB-2AL**



vintage body Stallion model, 3 piece alder, made in Japan

42741 **JSB-3AL**



vintage body, Teaser model, 2 piece alder, made in Japan

42742 **JTB-2AL**
42743 **JTB-2ALB** ivoroid binding



vintage body Teaser custom, 1 piece ash, made in Japan

44257 **JTCB-1ASH**



vintage body Teaser custom, 2 piece ash, made in Japan

44258 **JTCB-2ASH**



vintage body Teaser thinline, 2 piece alder, made in Japan

44259 **JTTB-2AL**



vintage body Teaser thinline, 2 piece mahogany, made in Japan

44260 **JTTB-2MAH**

1.5 parts
1.5.1 bodies, necks and wood
1.5.1.1 bodies



Genuine Replacement Part Stratocaster body (vintage bridge), alder

37456 **0998003700** 3-tone sunburst
37457 **0998003706** black
37458 **0998003709** candy apple red



Genuine Replacement Part Telecaster body (vintage bridge), alder

37469 **0998006705** olympic white
37470 **0998006706** black



Genuine Replacement Part Jazz Bass body, alder

37475 **0998008706** black
37476 **0998008732** brown sunburst



Genuine Replacement Part Precision Bass body, alder

37482 **0998010732** brown sunburst
37483 **0998010780** arctic white

1.5 parts
1.5.1 bodies, necks and wood
1.5.1.2 necks



contemporary neck Japan, 9,5" radius, 22 frets medium jumbo, half paddle
41535 **SN22M** all maple



contemporary neck Japan, 9,5" radius, 22 frets medium jumbo, half paddle
41536 **SN22R** maple with rosewood fingerboard

1.5 parts
1.5.1 bodies, necks and wood

1.5.1.2 necks

Boston



contemporary neck Japan, 9,5" radius, 22 frets medium jumbo, half paddle
41537 TN22M all maple



contemporary neck Japan, 9,5" radius, 22 frets medium jumbo, half paddle
41538 TN22R maple with rosewood fingerboard



neck Stallion, 22 frets, paddle head
36993 SN-2022-M all maple



neck Teaser, 22 frets, paddle head
36994 TN-2022-R rosewood fingerboard
36995 TN-2022-M all maple



neck Puncher bass, 21 frets, paddle head
36999 PN-2021-M all maple

1.5 parts
1.5.1 bodies, necks and wood

1.5.1.2 necks

Fender



Genuine Replacement Part Stratocaster neck with medium jumbo frets
37434 0994602921 maple fingerboard



Genuine Replacement Part Telecaster neck with medium jumbo frets
37437 0995102921 maple fingerboard

1.5 parts
1.5.1 bodies, necks and wood
1.5.1.2 necks



Genuine Replacement Part Precision Bass neck with medium jumbo frets
37441 0996102921 maple fingerboard



Genuine Replacement Part Jazz Bass neck with medium jumbo frets
37445 0996202921 maple fingerboard



Genuine Replacement Part 50's Telecaster neck, 21 vintage frets, maple fingerboard, amber lacquered
43195 0990063921 maple fingerboard



Genuine Replacement Part 50's Telecaster neck, 21 vintage frets, C profile, 7,25 radius
43196 0991202921 maple fingerboard



Genuine Replacement Part 50's Stratocaster neck, 21 vintage frets, soft V-shape, amber lacquered
43197 0990061921 maple fingerboard



Genuine Replacement Part 50's Stratocaster neck, 21 medium jumbo frets, soft V-shape
43198 0991102921 maple fingerboard



Genuine Replacement Part 60's Telecaster neck, 21 vintage frets
43199 0991603921 pau ferro fingerboard



Genuine Replacement Part 60's Stratocaster neck, 21 vintage frets
43200 0991003921 pau ferro fingerboard



Genuine Replacement Part 60's Stratocaster neck, 21 medium jumbo frets, pau ferro fingerboard, C-shape
 43201 0991103921
 43202 0992213921 amber lacquered



Genuine Replacement Part 60's Jazzmaster neck, 21 vintage frets, C-shape, amber lacquered
 43203 0991213921 pau ferro fingerboard



Genuine Replacement Part 60's Jaguar neck, 2 vintage frets, C-shape, amber lacquered
 43204 0991233921 pau ferro fingerboard



Genuine Replacement Part American Original '60's Telecaster neck, C profile
 44768 0990140921 round-laminated rosewood fingerboard



Genuine Replacement Part Jazzmaster neck, 21 medium jumbo frets, C-shape
 43205 0991613921 pau ferro fingerboard



Genuine Replacement Part Jaguar neck, 22 medium jumbo frets, C-shape
 43206 0991713921 pau ferro fingerboard



Genuine Replacement Part Standard Series Stratocaster neck, 21 medium jumbo frets
 43209 0994603921 pau ferro fingerboard



Genuine Replacement Part Standard Series Telecaster neck, 21 medium jumbo frets
 43210 0995103921 pau ferro fingerboard

1.5 parts
1.5.1 bodies, necks and wood
1.5.1.2 necks

Fender



Genuine Replacement Part Standard Series Precision Bass neck, 20 medium jumbo frets
43211 0996103921 pau ferro fingerboard



Genuine Replacement Part Standard Series Jazz Bass neck, 20 medium jumbo frets
43212 0996203921 pau ferro fingerboard



Genuine Replacement Part Standard Series Jazz Bass fretless neck
43213 0996283921 pau ferro fingerboard

1.5 parts
1.5.1 bodies, necks and wood
1.5.1.7 kerfed lining strips

Boston



kerfed lining 720x19x5mm, spruce
21768 KLN-72019 10 pcs



1.5 parts

1.5.2 tremolos, bridges and tailpieces

1.5.2.1 tremolos

Bigsby



vibrato tailpiece kit, chrome

- 33894 **B-B5KIT-CH** Telecaster
- 33895 **B-B5-CH** flat top guitars
- 33896 **B-B7-CH** archtop solid body guitars



vibrato tailpiece kit, for archtop solid body guitars

- 37621 **B-B700-CH** chrome

1.5 parts

1.5.2 tremolos, bridges and tailpieces

1.5.2.1 tremolos

Boston



tremolo Stallion, pitch 10,5mm

- 13089 **T-210-C** chrome
- 16947 **T-210-G** gold
- 13090 **T-210-B** black



tremolo Stallion, pitch 10,8mm

- 25192 **T-230-C** chrome
- 25193 **T-230-B** black
- 25194 **T-230-G** gold



tremolo Stallion, pitch 10,8mm, lefthanded

- 25195 **T-230-CLH** chrome
- 25196 **T-230-BLH** black
- 25197 **T-230-GLH** gold

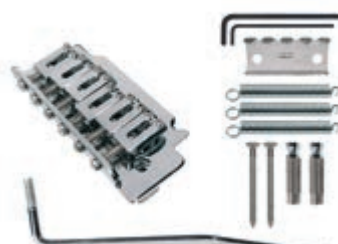

tremolo Stallion, pitch 10,5mm, with 2 studs

- 25201 **T-260-C** chrome
- 25202 **T-260-B** black
- 25203 **T-260-G** gold



tremolo Stallion, pitch 10,5mm, with 2 studs

- 25204 **T-270-C** chrome
- 25205 **T-270-B** black
- 25206 **T-270-G** gold



tremolo Stallion, pitch 10,8mm

- 25207 **T-290-C** chrome
- 25208 **T-290-B** black
- 25209 **T-290-G** gold



tremolo Stallion, pitch 10,8mm, with 2 studs, roller saddles

- 27494 **T-350-C** chrome
- 27495 **T-350-B** black
- 27496 **T-350-G** gold

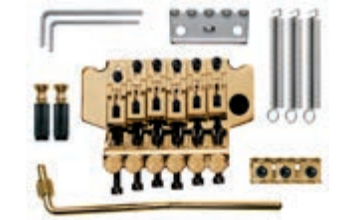

tremolo "Floyd Rose", double lock

- 23388 **TFR-203-C** chrome
- 23389 **TFR-203-B** black
- 23390 **TFR-203-G** goldplated

1.5 parts

1.5.2 tremolos, bridges and tailpieces

1.5.2.1 tremolos

Boston



tremolo "Floyd Rose", double lock
 23391 **TFR-204-C** chrome
 23394 **TFR-204-B** black
 23395 **TFR-204-G** goldplated



tremolo "Floyd Rose", single lock
 23396 **TFR-205-C** chrome
 23397 **TFR-205-B** black
 23398 **TFR-205-G** goldplated

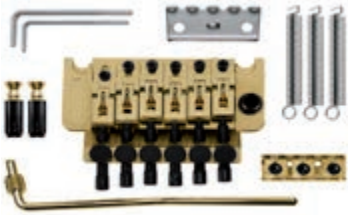

tremolo "Floyd Rose", double lock
 23399 **TFR-220-C** chrome
 23404 **TFR-220-B** black
 23405 **TFR-220-G** goldplated

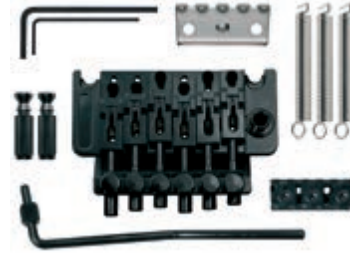

tremolo "Floyd Rose", single lock
 23406 **TFR-225-C** chrome
 23407 **TFR-225-B** black
 23408 **TFR-225-G** goldplated



tremolo "The Point Classic", pitch 10,5mm
 25214 **T-340-B** black
 25215 **T-340-G** gold
 25217 **T-340-MB** black matt finish
 25218 **T-340-MG** gold matt finish



tremolo "The Point Classic", pitch 10,5mm
 25219 **T-330-C** chrome
 25220 **T-330-MC** chrome, matt finish
 25221 **T-330-G** gold



tremolo jag-style, made in Japan, with bridge
 13683 **T-400-C** chrome



tremolo SG-style, made in Japan, saddle and tailpiece included
 31772 **T-480-N** nickel

1.5 parts

1.5.2 tremolos, bridges and tailpieces

1.5.2.1 tremolos

Fender



Genuine Replacement Part tremolo assembly American Vintage Strat
 34154 **0992049000** chrome



Genuine Replacement Part tremolo assembly Standard Series Strat ('06-present)
 36334 **0071014049** chrome

1.5 parts

1.5.2 tremolos, bridges and tailpieces

1.5.2.1 tremolos



Genuine Replacement Part tremolo assembly Pre '06 Standard Series Strat
36336 0059561000 gold



Genuine Replacement Part tremolo assembly Mexico Vintage Strat
36337 0054619000 chrome

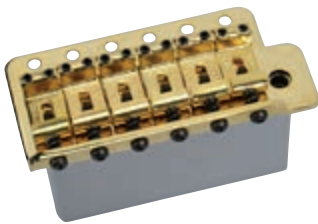

Genuine Replacement Part tremolo assembly Mexico Vintage/Deluxe Player Strat
36338 0053275000 gold



tremolo assembly American Vintage Strat
36342 0992049002 lefthanded, chrome
36343 0992049200 gold
36344 0992049202 lefthanded, gold



Genuine Replacement Part tremolo assembly for American Standard Strat ('08-Present)
43334 0075091000 chrome



Genuine Replacement Part tremolo assembly Import Jaguar/Jazzmaster Models
36345 0264248000 chrome



Genuine Replacement Part tremolo assembly tremolo section Jaguar/Jazzmaster USA
36346 0054466049 chrome

1.5 parts

1.5.2 tremolos, bridges and tailpieces

1.5.2.1 tremolos



tremolo assembly with 6 saddles and studs Jaguar/Jazzmaster USA
36348 0054460000 chrome

1.5 parts

1.5.2 tremolos, bridges and tailpieces

1.5.2.1 tremolos



tremolo, pitch 10,8 mm, steel block, sheet metal saddles, 2 pivot point
42711 510TS-SF1C chrome



tremolo, pitch 10,8 mm, steel block, steel sheet metal saddles, 6 pivot point
42712 510TS-SF2 chrome



tremolo, pitch 11,3 mm, zinc-diecast block, steel sheet metal saddles, 6 pivot points
42713 GE101T chrome



Master Relic Collection tremolo, pitch 11,3 mm, steel block, steel sheet metal saddles with USA thread screws, 6 pivot point
42714 GE101TS-AC



tremolo Wilkinson type, low profile, pitch 10,8 mm, 2 pivot point
42715 VS100N-HC honed chrome

1.5 parts

1.5.2 tremolos, bridges and tailpieces

1.5.2.1 tremolos



Lockmeister tremolo, 37mm block, R2 (41,3mm) nut width
42534 1301023702 chrome



Lockmeister tremolo, 37mm block, R2 (41,3mm) nut width
44125 1301043702 black

1.5 parts

1.5.2 tremolos, bridges and tailpieces

1.5.2.1 tremolos

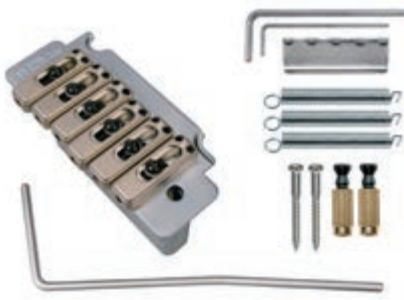

tremolo, Stallion, all adjustable saddles

- 21774 **TWL-108-MC** mat chrome
- 22054 **TWL-128-MB** mat black



tremolo, pitch 10,8mm, with screws, zinc block

- 31121 **T-WVC-C** chrome
- 31122 **T-WVC-G** gold
- 31131 **T-WVC-B** black
- 32140 **T-WVC-N** nickel



tremolo, pitch 10,8mm, with screws, solid steel block

- 31123 **T-WVCS-C** chrome
- 31124 **T-WVCS-G** gold
- 31132 **T-WVCS-B** black
- 32141 **T-WVCS-N** nickel

1.5 parts

1.5.2 tremolos, bridges and tailpieces

1.5.2.2 tremolo parts



tremolo arm, 5mm thread, 5mm arm diameter, white cap

- 1114 **TA-5-FCW** chrome



tremolo arm, 5mm thread, 5mm arm diameter, black cap

- 13687 **TA-5-FCB** chrome
- 16957 **TA-5-FGB** gold
- 5506 **TA-5-FBB** black



tremolo arm, 5mm thread, lefthanded, 5mm arm diameter, white cap

- 7079 **TA-5-FCLW** chrome



tremolo arm, 5mm thread, lefthanded, 5mm arm diameter, black cap

- 13688 **TA-5-FCLB** chrome
- 33011 **TA-5-FGLB** gold
- 33012 **TA-5-FBLB** black



tremolo arm, 6mm thread, 6mm arm diameter, no cap

- 5507 **TA-6-C** chrome
- 5508 **TA-6-B** black
- 16958 **TA-6-G** gold



tremolo arm, 6mm thread, 6mm arm diameter, ribbed tip

- 16960 **TA-6-PG** gold



tremolo arm, 6mm thread, 5mm arm diameter, white cap

- 21784 **TA-6-FCW** chrome



tremolo arm, 6mm thread, 5mm arm diameter, black cap

- 21785 **TA-6-FCB** chrome
- 22225 **TA-6-FGB** gold



tremolo arm, no thread, 5mm arm diameter, fits T-350 and REG-130 tremolo

- 30298 **TA-55-RC** chrome
- 30299 **TA-55-RG** gold



tremolo arm for TFR tremolo, 6mm diameter, M9 inside thread

- 34546 **TA-FR01-C** chrome
- 34549 **TA-FR01-B** black
- 34550 **TA-FR01-G** gold

1.5 parts

1.5.2 tremolos, bridges and tailpieces

1.5.2.2 tremolo parts

Boston



tremolo arm cap

6863 **AW-400-W** white
6864 **AW-400-B** black



tremolo, spring mounting claw, for Stallion tremolo

6889 **SH-44** nickel



tremolo, spring set, for Stallion tremolo, 3 pcs

6890 **SP-50** nickel



tremolo, spring set, extra strong, for Stallion tremolo, 3 pcs

14149 **SP-60** stainless steel



tremolo arm tension spring

24869 **SPR-10** 12 pcs

1.5 parts

1.5.2 tremolos, bridges and tailpieces

1.5.2.2 tremolo parts

Fender

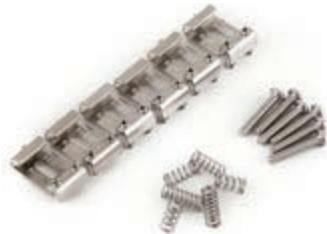

Genuine Replacement Part tremolo saddles Pure Vintage Strat, set of 6

43347 **0992091000** chrome



Genuine Replacement Part tremolo arm, American Standard Strat

33921 **0992054000** chrome
33922 **0992054102** lefthanded



Genuine Replacement Part tremolo arm, USA Vintage Strat

33923 **0992039000** chrome
33924 **0992039102** lefthanded
33925 **0992039200** gold



Genuine Replacement Part tremolo arm, Standard Strat (Mexico)

33926 **0992310100** chrome
33927 **0992310200** gold



Genuine Replacement Part tremolo arm for Classic Player Jaguar/Jazzmaster

36389 **0077422049** chrome with white tip



Genuine Replacement Part tremolo arm for Jaguar/Jazzmaster US, no tip

36398 **0054473049** chrome

1.5 parts

1.5.2 tremolos, bridges and tailpieces

1.5.2.2 tremolo parts



Genuine Replacement Part tremolo arm for Import Jaguar/Jazzmaster
36391 0264261000 chrome with white tip



Genuine Replacement Part tremolo arm for Floyd Rose
36403 0997000300 black
36404 0997000200 gold



Genuine Replacement Part tremolo arm for Floyd Rose LH
36406 1997300200 black



Genuine Replacement Part tremolo arm for Standard Series Strat LH
36400 0060004000 chrome



Genuine Replacement Part tremolo arm Highway One/American Special Stratocaster
43356 0073643000 chrome with white tip



Genuine Replacement Part tremolo arm kit Pure Vintage Stratocaster, chrome
43357 0992092000 '50s Stratocaster
43358 0992093000 '60s Stratocaster



Genuine Replacement Part tremolo spring mounting claw
43352 0010272149 zinc



Genuine Replacement Part tremolo spring mounting claw kit for Pure Vintage Stratocaster
43354 0992084000 nickel



Genuine Replacement Part tremolo arm tips for Strat, set of 2
36393 0994935000 white
36394 0994933000 parchment
36395 0994934000 black



Genuine Replacement Part tremolo springs, set of 6
36408 0018671049 black

1.5 parts
 1.5.2 tremolos, bridges and tailpieces
1.5.2.2 tremolo parts



Genuine Replacement Part tremolo springs Vintage
 36410 0031643049 set of 5



Genuine Replacement Part tremolo springs small
 36411 0994931000
 black, set of 12

1.5 parts
 1.5.2 tremolos, bridges and tailpieces
1.5.2.2 tremolo parts



tremolo arm for American Series/American Standard Strat LH
 36392 0992054202 gold with white tip

1.5 parts
 1.5.2 tremolos, bridges and tailpieces
1.5.2.2 tremolo parts



Genuine Replacement Part tremolo arm for Affinity Series Strat
 36376 0069969000 chrome with white tip



Genuine Replacement Part tremolo arm for Standard Series
 36382 0041359049 chrome with white tip

1.5 parts

1.5.2 tremolos, bridges and tailpieces

1.5.2.2 tremolo parts



tremolo arm vintage, no thread, 5mm arm diameter, white cap

- 31127 TA-WV-CW chrome
- 31129 TA-WV-GW gold



tremolo arm vintage, no thread, 5mm arm diameter, black cap

- 31128 TA-WV-CB chrome
- 31130 TA-WV-GB gold
- 31133 TA-WV-BB black



spare part: set of 6 black metal bolts and spacers for saddle locking of TWL series

- 34696 TWL-001

1.5 parts

1.5.2 tremolos, bridges and tailpieces

1.5.2.3 guitar tailpieces



tailpiece for semi acoustic guitar, 335 model

- 33328 T-2-N nickel
- 6882 T-2-C chrome
- 6883 T-2-G gold



tailpiece for semi acoustic guitar, length 46 + 115mm, with 2 curls

- 8666 T-3-C chrome
- 8668 T-3-G gold



tailpiece for semi acoustic guitar, length 31 + 67mm

- 34843 T-7-G gold

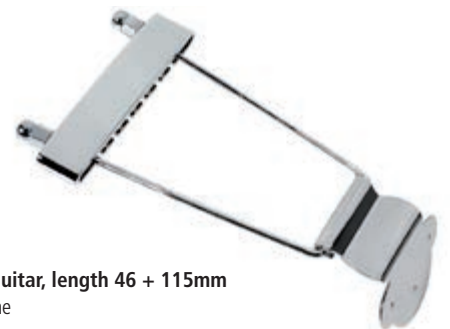

tailpiece for semi acoustic guitar, length 46 + 115mm

- 34844 T-8-C chrome
- 34845 T-8-G gold



tailpiece for semi acoustic guitar with 2 curls

- 35100 T-13-C chrome

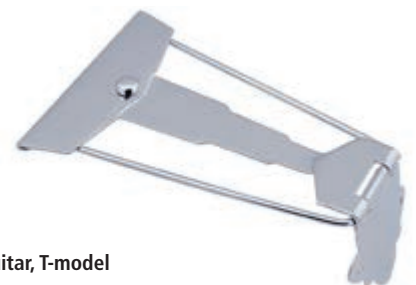

tailpiece for semi acoustic guitar, T-model

- 25278 T-14-C chrome
- 25279 T-14-G gold

1.5 parts

1.5.2 tremolos, bridges and tailpieces

1.5.2.3 guitar tailpieces

Boston



tailpiece for semi acoustic guitar

25280	T-16-C	chrome
25281	T-16-G	gold



tailpiece guitar, LP-model, with studs and anchors

1062	T-70-C	chrome
13101	T-70-B	black
1063	T-70-G	gold



tailpiece guitar, LP-model, aluminum, with studs and anchors

25118	T-70-AN	nickel
25119	T-70-AC	chrome
25120	T-70-AG	gold
25121	T-70-AB	black



tailpiece for electric guitar, V- model

25282	T-100-C	chrome
25283	T-100-G	gold



tailpiece solid body guitar, chrome

8802	SGW-6	6-string
8803	SGW-12	12-string

1.5 parts

1.5.2 tremolos, bridges and tailpieces

1.5.2.3 guitar tailpieces

GOTOH



Master Relic Collection tailpiece guitar, LP-model, with studs and anchors, stud distance 82mm

42725	GE101A-N	aluminium nickel
42726	GE101A-GG	aluminium gold
42728	GE101A-AN	aged nickel

1.5 parts

1.5.2 tremolos, bridges and tailpieces

1.5.2.3 bass guitar tailpieces

Boston



tailpiece for semi acoustic bass guitar, with 2 curls

25276 T-12-C chrome
25277 T-12-G gold

1.5 parts

1.5.2 tremolos, bridges and tailpieces

1.5.2.3 mandolin tailpieces

Boston



Super Packer tailpiece mandolin, open model

42221 TMA-23-C chrome
42222 TMA-23-G gold

1.5 parts

1.5.2 tremolos, bridges and tailpieces

1.5.2.4 tailpiece parts

Boston



tailpiece studs, 2-pack,

17055 SU-100-N nickel
17056 SU-100-C chrome
17057 SU-100-G gold
17058 SU-100-B black



tailpiece studs, 2-pack

17059 SU-110-N nickel
17060 SU-110-C chrome
17061 SU-110-G gold
17062 SU-110-B black

1.5 parts

1.5.2 tremolos, bridges and tailpieces

1.5.2.5 electric guitar bridges

Boston



bridge for guitar with tailpiece, hard wood, plastic saddle

8648 P-221
8837 P-230-H adjustable



bridge for guitar with tailpiece, rosewood

8838 P-230-P adjustable, plastic saddle



bridge for 12-string guitar with tailpiece, rosewood
8650 **P-240** adjustable, fret saddle



bridge for guitar, rosewood, height adjustable
5223 **P-98-P** plastic saddle
8657 **P-102-P** compensated saddles
1036 **P-103-P** adjustable fret saddles
8659 **P-107-P** compensated saddles, thin bottom



bridge for guitar, ebony, height adjustable
8658 **P-102-E** compensated saddles
8843 **P-103-E** adjustable fret saddles
8660 **P-107-E** compensated saddles, thin bottom



bridge for e-guitar, "tune'o matic", stud spacing 73,5mm, stud diam 4,5mm
6875 **B-160-C** chrome
39835 **B-160-N** nickel



bridge for e-guitar, "tune'o matic", stud spacing 74,0mm, stud diam 4,0mm
16738 **B-161-C** chrome
16739 **B-161-N** nickel
16740 **B-161-B** black
16741 **B-161-G** gold



bridge for e-guitar, "tune'o matic", stud spacing 73,0mm, stud diam 6,5mm
30284 **B-162-C** chrome
30285 **B-162-N** nickel
30286 **B-162-B** black
30287 **B-162-G** gold



bridge for e-guitar, "tune'o matic", stud spacing 73,5mm, stud diam 6,0mm
18717 **B-165-C** chrome
18718 **B-165-N** nickel
18719 **B-165-B** black
18720 **B-165-G** gold



bridge for e-guitar, "tune'o matic", stud spacing 74,0mm, stud diam 6,5mm
25287 **B-166-C** chrome
41001 **B-166-N** nickel
25288 **B-166-G** gold

1.5 parts

1.5.2 tremolos, bridges and tailpieces

1.5.2.5 electric guitar bridges

Boston



bridge and tailpiece set, 7-string, with studs

- 25124 **BT-167-C** chrome
- 25125 **BT-167-G** goldplated



bridge and tailpiece set, 12-string, with studs

- 25122 **BT-168-C** chrome
- 25123 **BT-168-G** goldplated



bridge for e-guitar, roller bridge model, with studs

- 25292 **B-200-C** chrome
- 25293 **B-200-G** gold



bridge for e-guitar, roller bridge model, with studs

- 27536 **B-205-C** chrome
- 41000 **B-205-N** nickel
- 27537 **B-205-B** black
- 27538 **B-205-G** gold



bridge for e-guitar, RICK model

- 25294 **B-210-C** chrome
- 31773 **B-210-N** nickel
- 25295 **B-210-G** gold



bridge for e-guitar, chrome

- 13681 **B-400-C** jag/jmast style
- 13682 **B-450-C** mustang style

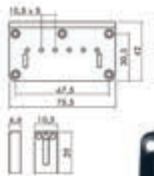

bridge-tailpiece, Stallion, pitch 10,5mm, strings through body

- 16752 **B-1504-C** chrome
- 16753 **B-1504-B** black
- 16754 **B-1504-G** gold

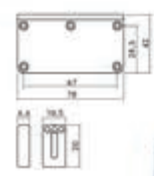

bridge-tailpiece, Stallion, pitch 10,5mm, strings mounted in bridge

- 16755 **B-1506-C** chrome

1.5.2.5 electric guitar bridges



bridge-tailpiece, PRS-model, pitch 10,5mm

- 25245 **B-1600-C** chrome
- 25246 **B-1600-B** black
- 25247 **B-1600-G** gold



bridge-tailpiece, G-model, with studs

- 5569 **B-175-C** chrome
- 5570 **B-175-G** gold



bridge-tailpiece, G-model, with studs, fixed staggered saddles

- 25298 **T-90-C** chrome
- 25299 **T-90-B** black
- 25300 **T-90-G** gold



bridge-tailpiece, Teaser tray style, grooved saddles

- 25248 **T-32-C** chrome
- 25249 **T-32-B** black
- 25250 **T-32-G** gold

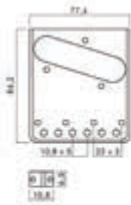

bridge-tailpiece, Teaser tray style, grooved saddles

- 6873 **T-40-C** chrome
- 25251 **T-40-B** black
- 25252 **T-40-G** gold



bridge-tailpiece, Teaser, grooved saddles, flat plate

- 25253 **T-62-C** chrome
- 25254 **T-62-B** black
- 25255 **T-62-G** gold



bridge-tailpiece, Teaser, grooved saddles, flat plate, strings-in-bridge or through-body

- 16765 **T-64-C** chrome
- 16766 **T-64-B** black
- 16767 **T-64-G** gold

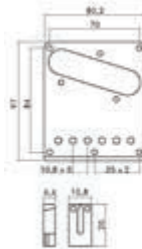

bridge-tailpiece, Teaser, block saddles, flat plate

- 16768 **T-66-C** chrome
- 16769 **T-66-B** black
- 16770 **T-66-G** gold

1.5 parts

1.5.2 tremolos, bridges and tailpieces

1.5.2.5 electric guitar bridges

Boston



bridge-tailpiece, Teaser, block saddles, flat plate /for humbucker

25256 T-68-C chrome
25257 T-68-B black
25258 T-68-G gold

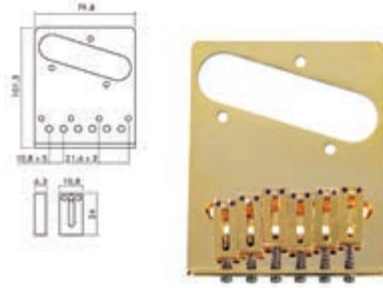

bridge-tailpiece, Teaser, gold, block saddles, flat plate

14114 GTC-301-GG for humbucker
16670 GTC-202-GG

1.5 parts

1.5.2 tremolos, bridges and tailpieces

1.5.2.5 electric guitar bridges

Fender



Genuine Replacement Part guitar bridge for Jazzmaster/Jaguar

43339 0054460049

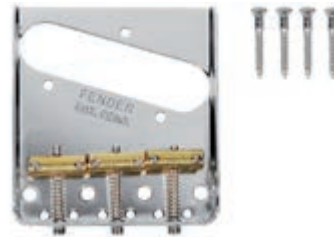

Genuine Replacement Part bridge assembly American Vintage Tele, 3 saddle design

34155 0990806100 chrome

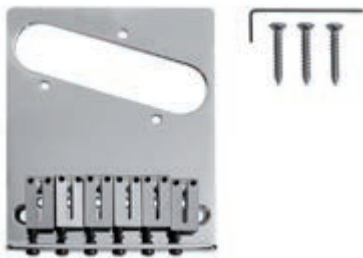

Genuine Replacement Part bridge assembly American Series ('86-'07) Tele

34158 0990807100 chrome



Genuine Replacement Part bridge assembly for American Pro Telecaster

43336 0992005000 chrome

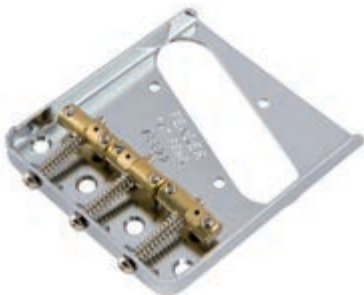

Genuine Replacement Part bridge assembly for American Vintage "Hot Rod" Telecaster

43337 0091114049 nickel



Genuine Replacement Part bridge assembly Standard Series Strat Hardtail

36298 0060068000 chrome

1.5 parts

1.5.2 tremolos, bridges and tailpieces

1.5.2.5 electric guitar bridges

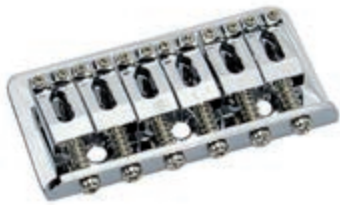

Genuine Replacement Part bridge assembly Strat Hard Tail
36299 0058274000 chrome



Genuine Replacement Part bridge assembly Standard Series Tele
36300 0053354000 chrome



Genuine Replacement Part bridge assembly Standard Series basses
36301 0040798049 chrome



Genuine Replacement Part bridge assembly American Hardtail Strat '86-'07
36307 0032909049 chrome



Genuine Replacement Part bridge assembly Highway One Tele
36319 0060070000 chrome



Genuine Replacement Part bridge assembly Mustang Guitar
36322 0035555000 chrome



Genuine Replacement Part bridge assembly Vintage Hardtail Strat
36325 0037592049 chrome



Genuine Replacement Part bridge assembly Vintage Telecaster®, six saddle
36329 0990810000 chrome



Genuine Replacement Part bridge saddles, American Vintage Telecaster
43338 0012297049 set of 6



Genuine Replacement Part tremolo assembly for Pure Vintage Stratocaster
43335 0094247049 nickel

1.5 parts

1.5.2 tremolos, bridges and tailpieces

1.5.2.5 electric guitar bridges



Master Relic Collection bridge for e-guitar, Teaser, pitch 10,8mm, brass "In-tune" saddles

42716	BS-TC1S	nickel
42718	BS-TC1-AC	aged chrome



bridge for e-guitar, Teaser, pitch 10,8mm, titanium "In-tune" saddles

42717	Ti-TC1S	nickel
-------	---------	--------



bridge for e-guitar, Stallion, strings through body, solid steel saddles, string spacing 10,5 mm

42719	GTC102	chrome
-------	--------	--------



bridge for e-guitar, "tune-o-matic" stud spacing 74,0mm, titanium saddles

42720	Ti-103B-T-N	nickel
42721	Ti-103B-TGG	gold



bridge for e-guitar, "tune-o-matic" thumbwheel spacing 74,0mm, titanium saddles

42722	Ti-103B-N	nickel
42723	Ti-103B-GG	gold



bridge for e-guitar, "tune-o-matic", thumbwheel spacing 74,0mm, hard zinc saddles

42724	GE104B-AN	aged nickel
42727	GE104B-N	nickel

1.5 parts

1.5.2 tremolos, bridges and tailpieces

1.5.2.5 electric guitar bridges



Signum guitar bridge with locking studs, 10,5mm spacing, 12" radius

42522	12350100	nickel
42523	12350200	chrome
42524	12350400	black chrome
42525	12350500	gold



STM guitar roller bridge (for tremolo use), 10,6mm spacing, 14" radius

42526	12080100	nickel
42527	12080200	chrome
42528	12080400	black chrome
42529	12080500	gold



GTM tune-o-matic guitar bridge, 10,5mm spacing, 14" radius

42530	12090100	nickel
42531	12090200	chrome
42532	12090400	black chrome
42533	12090500	gold

1.5 parts

1.5.2 tremolos, bridges and tailpieces

1.5.2.5 electric guitar bridges



bridge-tailpiece Teaser, pitch 10,8mm, staggered brass saddles

31125	B-WTB-C	chrome
32730	B-WTB-N	nickel
34850	B-WTB-G	gold
34851	B-WTB-B	black



bridge-tailpiece, G-model, with studs, adjustable GB saddle

34852	B-GTB-C	chrome
34853	B-GTB-N	nickel
34854	B-GTB-B	black
34855	B-GTB-G	gold



bridge-tailpiece Teaser short version, pitch 10,8mm, staggered brass saddles

39645	B-WTBS-C	chrome
39646	B-WTBS-N	nickel
39647	B-WTBS-B	black
39648	B-WTBS-G	gold

1.5 parts

1.5.2 tremolos, bridges and tailpieces

1.5.2.6 electric guitar bridge parts



bridge saddles, 79-7-2,2mm, 12-pack

6740	407	nylon
------	------------	-------



bridge saddle, bone

5565	BBS-1	82x10x2,5mm
5566	BBS-2	75x8,5x2,5mm
5567	BBS-3	70x8x2,5mm
13648	BBS-4	77x(8-10-7)x2,7mm, folk, arched
13649	BBS-5	83x10x3mm
13650	BBS-6	83x10x3,5mm



bridge saddles, metal, Jocker/ Puncher bass, p=18, with spring and screw, 2-pack

16926	S-215-C	chrome
16927	S-215-G	gold
16928	S-215-B	black



bridge saddles, metal, Jocker/ Puncher bass, p=19, with spring and screw, 4-pack

16917	S-200-C	chrome
16918	S-200-G	gold



bridge saddles, metal, Jocker/ Puncher bass, p=19, with spring and screw, 4-pack

16921	S-205-C	chrome
16922	S-205-G	gold
16930	S-205-B	black



bridge saddles metal, Jocker/ Puncher bass, p=20, with spring and screw, 4-pack

16923	S-210-C	chrome
16924	S-210-G	gold
16925	S-210-B	black



bridge saddles, metal, Stallion roller, p=10,8, with spring and screw, 6-pack

27498	S-146-B	black
27499	S-146-G	gold
27497	S-146-C	chrome



bridge saddle, metal, Stallion, p=10,5, with spring and screw, 6-pack

32300	S-145-N	nickel
16939	S-158-C	chrome
16929	S-158-B	black



bridge saddles, metal, Stallion, p=10,5, with spring and screw, 6-pack

16900	S-140-C	chrome
16901	S-140-G	gold
16902	S-140-B	black



bridge saddles, metal, Stallion, p=10,5, with spring and screw, 6-pack

16903	S-145-C	chrome
16904	S-145-G	gold
16905	S-145-B	black

1.5 parts

1.5.2 tremolos, bridges and tailpieces

1.5.2.6 electric guitar bridge parts

Boston

 <p>bridge saddles, metal, Stallion, p=10,5, with spring and screw, 6-pack 16910 S-158-G gold</p>	 <p>bridge saddles, metal, Stallion, p=10,8, with spring and screw, 6-pack 16906 S-150-C chrome 16907 S-150-G gold 16908 S-150-B black</p>
 <p>bridge saddles, metal, LP-model, with spring and screw, 6-pack 12379 S-160-N nickel</p>	 <p>saddle screws, 12-pack, 1,5 allen key 24888 SAM-6 3,0x6.0 mm 24889 SAM-8 3,0x8.0 mm 24890 SAM-10 3,0x10.0 mm</p>
 <p>saddle screws, 12-pack, 1,27 allen key 24891 SAI-8 2,8x8.0 mm 24892 SAI-10 2,8x10.0 mm</p>	 <p>bridge studs, 2-pack 17063 SU-120-N nickel 17064 SU-120-C chrome 17065 SU-120-G gold 17066 SU-120-B black</p>
 <p>bridge studs, 2-pack 17067 SU-130-N nickel 17068 SU-130-C chrome 17069 SU-130-G gold 17070 SU-130-B black</p>	 <p>bridge studs, 2-pack 17071 SU-140-N nickel 17072 SU-140-C chrome 17073 SU-140-G gold 17074 SU-140-B black</p>

1.5 parts

1.5.2 tremolos, bridges and tailpieces

1.5.2.6 electric guitar bridge parts

Fender

 <p>Genuine Replacement Part bridge saddles, Strat/Tele, American Series '86-'07, set of 6 36549 0990840000 chrome</p>	 <p>Genuine Replacement Part bridge saddles, Vintage 1959 Tele, threaded steel, set of 3 36550 0056038049 chrome</p>
 <p>Genuine Replacement Part bridge saddles, Vintage Tele, threaded, set of 3 36551 0990843000 brass</p>	 <p>Genuine Replacement Part bridge saddle, American Deluxe Strat/Ultra Strat/Tele 36552 0036528000 polished chrome</p>

1.5 parts

1.5.2 tremolos, bridges and tailpieces

1.5.2.6 electric guitar bridge parts



Genuine Replacement Part bridge saddles
American Vintage Tele, threaded, set of 3
43348 0058544049 brass



Genuine Replacement Part bridge saddles
Pure Vintage '58 Telecaster
43349 0992089000 nickel



Genuine Replacement Part bridge saddles
Pure Vintage '64 Telecaster
43350 0992090000 nickel



Genuine Replacement Part bridge posts for
American Vintage Jaguar/Jazzmaster
43353 0054447049 2 pcs



Genuine Replacement Part saddle height
screws, American Deluxe and American
Series guitars '86-'07, 12 pcs
36504 0994927000 black



Genuine Replacement Part saddle height
screws, American Deluxe Tele, short, 4-40 x
3/8, 12 pcs
36505 0018027049 black



Genuine Replacement Part saddle height
screws, American Series Strat '86-'07, 1/4",
12 pcs
36506 0026779049 black



Genuine Replacement Part saddle height
screws, American Vintage Series guitars,
12 pcs
36507 0994928000 nickel



Genuine Replacement Part saddle height
screws, Standard Series basses, 6-32 x 7/16
hex, , 12 pcs
36510 0040800049 nickel



Genuine Replacement Part bridge cover
vintage, chrome
33932 0992270100 Strat
33933 0992271100 Tele



Genuine Replacement Part bridge cover
Vintage Strat
36349 0010223000 gold



Genuine Replacement Part bridge cover
Vintage Jaguar/Jazzmaster
36351 0054465049 chrome

1.5 parts

1.5.2 tremolos, bridges and tailpieces

1.5.2.6 electric guitar bridge parts



Genuine Replacement Part bridge block mounting screws, strat, 12 pcs
36481 0019656049 chrome



Genuine Replacement Part intonation screws, vintage Strat, 4-40 x 5/8, 12 pcs
36492 0015693049 nickel



Genuine Replacement Part intonation screws, American Series Strat/Tele, short 4-40 x 5/8, 12 pcs
36490 0017031049 black



Genuine Replacement Part original Floyd Rose string blocks, 12pcs
43333 1997015049 black



Genuine Replacement Part tremolo saddles, American Vintage Strat, set of 6
36340 0992051000 chrome



Genuine Replacement Part tremolo saddle, American Vintage Strat
36341 0038961049 gold



Genuine Replacement Part bridge block, American Vintage Strat
36533 0019473049

1.5 parts

1.5.2 tremolos, bridges and tailpieces

1.5.2.6 electric guitar bridge parts



bridge block, American Vintage Strat LH
36534 0038962000



String Saver bridge saddle for Fender Stratocaster 10.41mm wide, with spring and screw
42943 PS-8000-00 6-pack



String Saver bridge saddle for Fender Stratocaster Vintage, 11.18mm wide, with spring and screw
42944 PS-8000-F0 6-pack



String Saver bridge saddle for Fender Stratocaster, 10.41mm wide offset intonation, with spring and screw
42946 PS-8001-00 6-pack



String Saver bridge saddle for Jaguar-Jazzmaster-Mustang barrel style, with spring and screw
42947 PS-8108-00 6-pack



String Saver bridge saddle for Fender Telecaster Vintage, with spring and screw,
42948 PS-8166-00 6-pack
42949 PS-8163-00 3-pack



String Saver bridge saddle for Gibson ABR-1
42950 PS-8400-00 6-pack



String Saver bridge saddle for Gibson made in Nashville, 6-pack
42951 PS-8500-00 before 2000
42952 PS-8501-00 after 2000



String Saver bridge saddle for Gotoh
42953 PS-8560-00 6-pack



String Saver bridge saddle for Gotoh 103B
42954 PS-8600-00 6-pack



String Saver bridge saddle for Epiphone/Ibanez
42955 PS-8633-00 6-pack



String Saver bridge saddle for Schaller
42956 PS-8700-00 6-pack

1.5 parts

1.5.2 tremolos, bridges and tailpieces

1.5.2.7 bass guitar bridges and parts

Boston



bridge for Beatle bass, height adjustable, adjustable fret saddles
13361 P-103-EB ebony

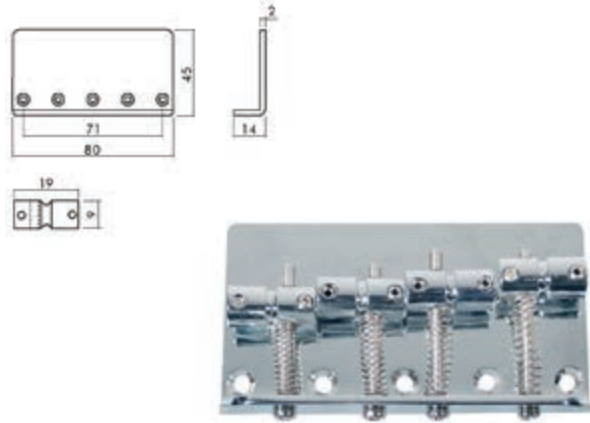

bridge-tailpiece, Jocker/ Puncher bass, pitch 19mm

- 16774 BB-104-C chrome
- 16775 BB-104-B black
- 16776 BB-104-G gold

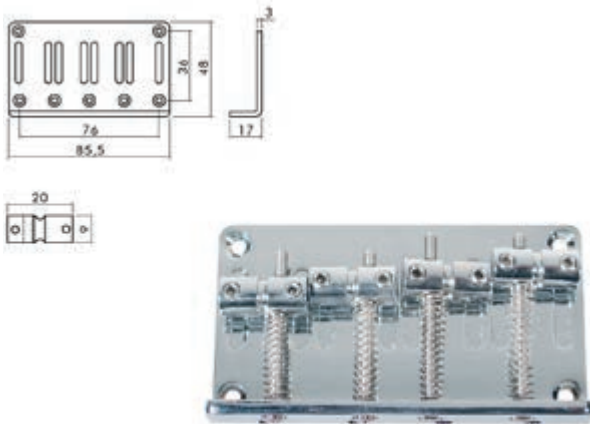

bridge-tailpiece, Jocker/ Puncher bass, pitch 20mm

- 16780 BB-134-C chrome
- 16781 BB-134-B black
- 16782 BB-134-G gold

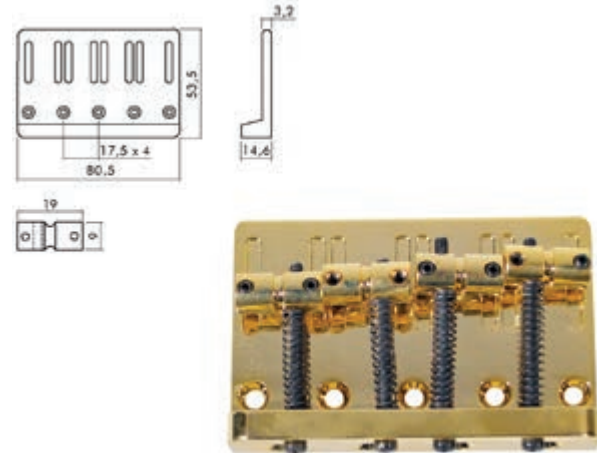

bridge-tailpiece, Jocker/ Puncher bass, pitch 20mm

- 16783 BB-204-C chrome
- 16784 BB-204-B black
- 16785 BB-204-G gold

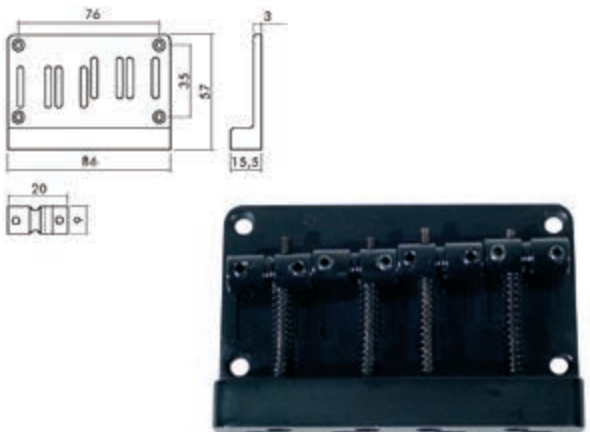

bridge-tailpiece, Jocker/ Puncher bass, pitch 20mm

- 16786 BB-304-C chrome
- 16787 BB-304-B black
- 16788 BB-304-G gold

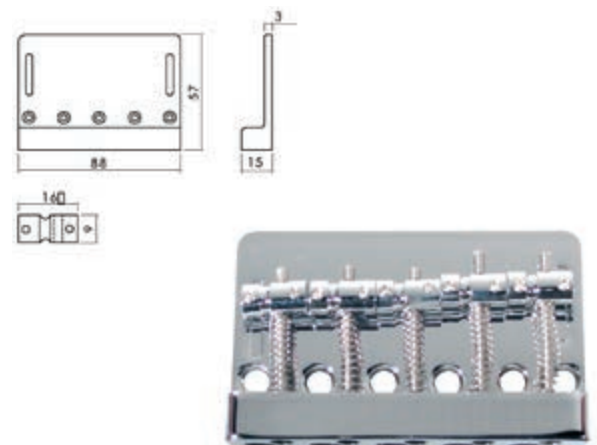

bridge-tailpiece, Jocker/ Puncher bass, 5-string, pitch 16mm

- 16789 BB-405-C chrome
- 16790 BB-405-B black
- 16791 BB-405-G gold

1.5 parts

1.5.2 tremolos, bridges and tailpieces

1.5.2.7 bass guitar bridges and parts

Boston

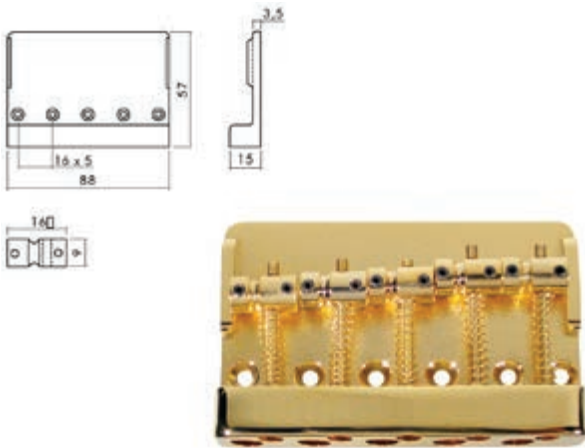

bridge-tailpiece, Jocker/ Puncher bass, 5-string, pitch 16mm
16794 **BB-505-G** gold

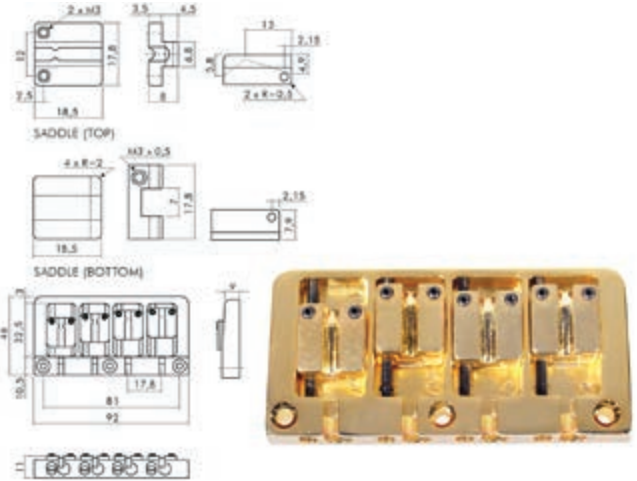

bridge-tailpiece, WMI-model, pitch 20mm
16806 **BB-704-G** gold

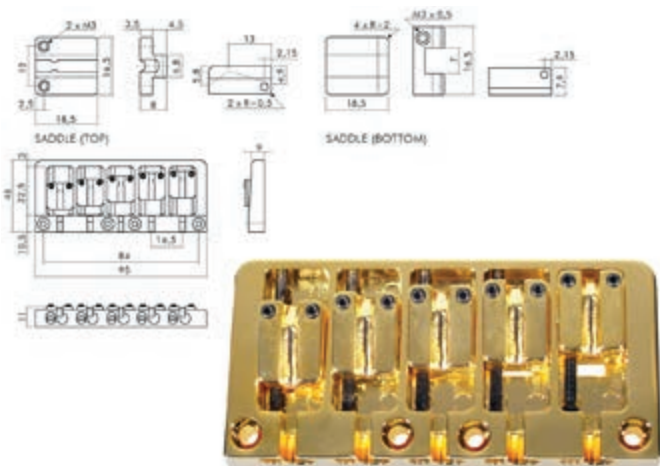

bridge-tailpiece, WMI-model, 5-string, pitch 16,5mm
16809 **BB-705-G** gold

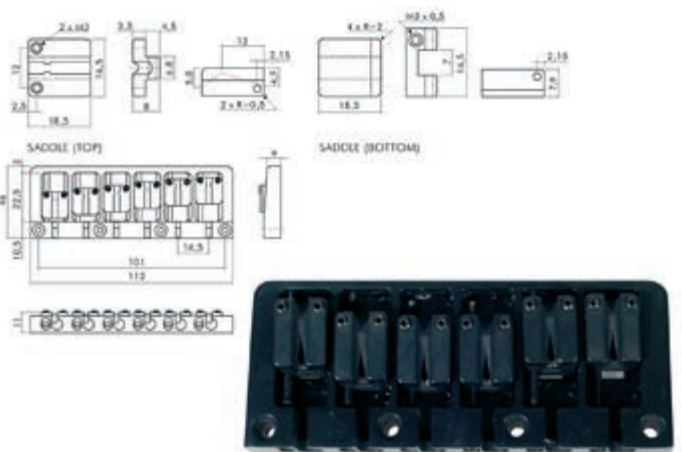

bridge-tailpiece, WMI-model, 6-string, pitch 16,5mm
16811 **BB-706-B** black
16812 **BB-706-G** gold

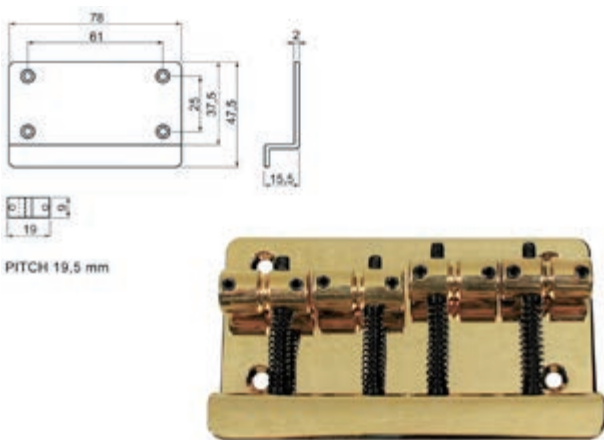

bridge-tailpiece, Jocker/ Puncher bass, pitch 20mm
27241 **BB-123-G** gold



bridge cover metal, chrome
32912 **BMC-90-C** PB model
32911 **BMC-60-C** JB model

1.5 parts

1.5.2 tremolos, bridges and tailpieces

1.5.2.7 bass guitar bridges and parts



Genuine Replacement Part bridge assembly Standard Series 5-string Bass ('06-present)

43341 0053309000 chrome



Genuine Replacement Part bridge assembly Vintage '58 Precision Bass

43342 0095613049 nickel/chrome

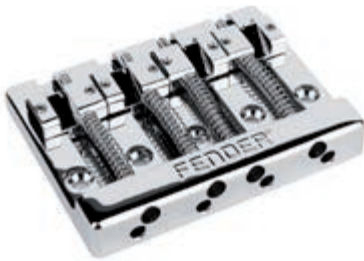

Genuine Replacement Part bridge assembly HiMass 4-string Bass, chrome

43343 0994407000 with zinc saddles
43344 0994408000 with brass saddles

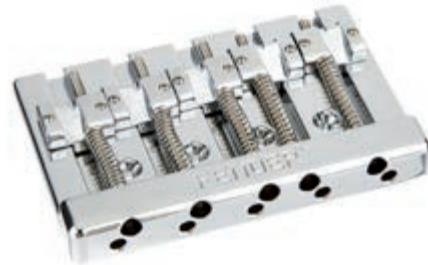

Genuine Replacement Part bridge assembly HiMass 5-string Bass (narrow)

43345 0994410000 chrome with brass saddles



Genuine Replacement Part bridge assembly HiMass 5-string Bass (wide)

43346 0994409000 chrome with zinc saddles

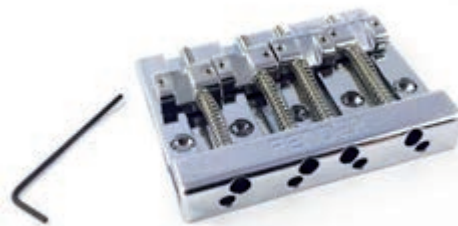

Genuine Replacement Part bridge assembly HiMass DLX Bass

43396 0081460049



Genuine Replacement Part bridge assembly American Deluxe Bass

36311 0058396000 chrome

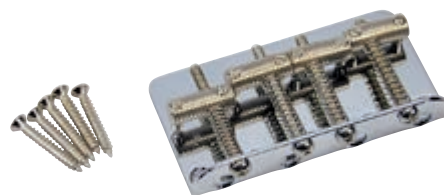

Genuine Replacement Part bridge assembly Vintage Reissue Bases

36328 0990804100 chrome

1.5 parts

1.5.2 tremolos, bridges and tailpieces

1.5.2.7 bass guitar bridges and parts



Genuine Replacement Part bridge assembly American Standard Bass 2007
43397 0075124049 chrome



Genuine Replacement Part bridge saddle, American Standard basses ('08-present)

- 36553 0075127000 1 & 2 strings, chrome
- 36554 0075135000 3 & 4 strings, chrome



Genuine Replacement Part bridge saddle, American Vintage bass
36555 0019469000 nickel



Genuine Replacement Part bridge cover vintage Jazz Bass
33934 0010678000 chrome



Genuine Replacement Part bridge cover vintage Precision Bass
33935 0010108000 chrome



Genuine Replacement Part pickup cover, vintage precision bass
33936 0010116070



Genuine Replacement Part pickup cover, vintage jazz bass
33937 0010660090



Genuine Replacement Part bridge cover '51 Precision Bass®
36352 0032979049 chrome

1.5 parts

1.5.2 tremolos, bridges and tailpieces

1.5.2.7 bass guitar bridges and parts

Wilkinson

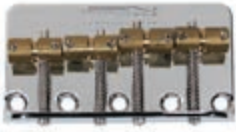

bridge-tailpiece Jocker/ Puncher bass, pitch 19mm, brass saddles

31126	BB-WBBC-C	chrome
34856	BB-WBBC-N	nickel
34857	BB-WBBC-B	black
34858	BB-WBBC-G	gold



bridge saddles for B-WTB bridges, 3-pack

35328	S-202-M	brass
-------	----------------	-------

1.5 parts

1.5.2 tremolos, bridges and tailpieces

1.5.2.8 acoustic guitar bridges

Boston



bridge for acoustic guitar, 155mm

5219	P-132-P	rosewood
5220	P-132-E	ebony



bridge for acoustic guitar, 175mm

5221	P-136-P	rosewood
5222	P-136-E	ebony



bridge for acoustic guitar, 153mm, "Martin" style

6736	P-145-P	rosewood
8653	P-145-E	ebony

1.5 parts

1.5.2 tremolos, bridges and tailpieces

1.5.2.11 banjo bridges

Boston



bridge for banjo, maple, fret saddle, for mandolin banjo
7148 P-005



bridge for banjo, maple, ebony saddle, for tenor banjo
12511 P-9412 height: 1, 2"
1039 P-9458 height: 5, 8"



bridge for banjo, maple, ebony saddle, for 5 string banjo
12510 P-9512 height: 1, 2"
1040 P-9558 height: 5, 8"
14642 P-951116 height: 11, 16"



bridge for banjo, maple, ebony saddle, for 4 string banjo
14643 P-10412 height: 1, 2"
14644 P-10458 height: 5, 8"



bridge for banjo, maple, ebony saddle, for 5 string banjo
14645 P-10512 height: 1, 2"
14646 P-10558 height: 5, 8"



bridge for banjo, maple, ebony+galalith saddle, for tenor banjo
8844 P-1112 height: 1, 2"
14332 P-1158 height: 5, 8"



bridge for banjo, maple, ebony+galalith saddle, for 5 string banjo
8845 P-1212 height: 1, 2"
14647 P-1258 height: 5, 8"



bridge for banjo, rosewood, galalith saddle, for 4+5+6 string banjo
8846 P-014



bridge for banjo, maple, ebony compensated saddles, for 5 string banjo
8847 P-1512 height: 1, 2"
14648 P-1558 height: 5, 8"

1.5 parts

1.5.2 tremolos, bridges and tailpieces

1.5.2.11 mandolin bridges

Boston



bridge for mandolin, no saddle, for flat top

8662 P-110-P rosewood
14650 P-110-E ebony



bridge for mandolin, galalith saddle, for flat top

7147 P-111-P rosewood
8848 P-111-E ebony



bridge for mandolin, compensated saddles, adjust, for arched top

1044 P-118-P rosewood
8663 P-118-E ebony



bridge for mandolin, compensated saddles, adjustable, for arched top

42220 P-120-E ebony

1.5 parts

1.5.2 tremolos, bridges and tailpieces

1.5.2.11 ukulele bridges

Boston



bridge for ukulele, no saddle

14649 P-200-M maple
31011 P-200-R rosewood



bridge for ukulele, plastic saddle

1045 P-201-P rosewood



Vintage single coil, Alnico 5 rods, black fiber bobbin, waxed formvar wire

- 33556 **VSC-57-NWH** 6.0K neck, white
- 33557 **VSC-57-MWH** 6.3K middle RWRP, white
- 33558 **VSC-57-BWH** 6.9K bridge, white



Vintage single coil, Alnico 5 rods, black fiber bobbin, waxed enamel wire

- 33559 **VSC-62-NWH** 6.5K neck, white
- 33560 **VSC-62-MWH** 6.9K middle RWRP, white
- 33561 **VSC-62-BWH** 8.8K bridge, white



Vintage single coil, Alnico 5 rods, black fibre bobbin, waxed formvar wire, 7.5K neck

- 33562 **VTE-52-NCH** chrome
- 33563 **VTE-52-NNI** nickel
- 33564 **VTE-52-NGD** gold



Vintage single coil pickup, Alnico 5 rods, black fibre bobbin, waxed formvar wire, 9.0K bridge

- 33565 **VTE-52-B**



Vintage single coil, Alnico 5 bar, braided shield wiring, waxed enamel wire, 8.0K neck

- 33566 **VSB-46-NIV** ivory
- 33567 **VSB-46-NBK** black



Vintage single coil, Alnico 5 bar, braided shield wiring, waxed enamel wire, 9.5K bridge

- 33568 **VSB-46-BIV** ivory
- 33569 **VSB-46-BBK** black



Vintage single coil, Alnico 5 bar, braided shield wiring, waxed enamel wire, 8.0K neck

- 33570 **VDE-46-NIV** ivory
- 33571 **VDE-46-NBK** black



Vintage single coil, Alnico 5 bar, braided shield wiring, waxed enamel wire, 9.5K bridge

- 33572 **VDE-46-BIV** ivory
- 33573 **VDE-46-BBK** black



Vintage humbucker, Alnico 5 bar, braided shield wiring, waxed enamel wire, 8.0K neck

- 33574 **VHB-57-NCH** chrome
- 33575 **VHB-57-NNI** nickel
- 33576 **VHB-57-NGD** gold



Vintage humbucker, Alnico 5 bar, braided shield wiring, waxed enamel wire, 8.8K bridge

- 33577 **VHB-57-BCH** chrome
- 33578 **VHB-57-BNI** nickel
- 33579 **VHB-57-BGD** gold



Power Rock humbucker, Alnico 5 bar, 4 conductors, waxed formvar wire, 9.6K neck

- 33580 **PHB-90-NZE** zebra
- 33581 **PHB-90-NWH** white
- 33582 **PHB-90-NBK** black
- 33583 **PHB-90-NIV** ivory



Power Rock humbucker, Alnico 5 bar, 4 conductors, waxed formvar wire, 15.0K bridge

- 33584 **PHB-90-BZE** zebra
- 33585 **PHB-90-BWH** white
- 33586 **PHB-90-BBK** black
- 33587 **PHB-90-BIV** ivory

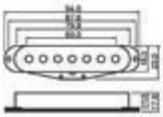

pickup single coil Stallion
7-string, vintage alnico

- 21343 **PU-19-WH** white
- 21344 **PU-19-BK** black



pickup humbucker "standard"

- 12375 **GP-336C-BR** gold, black ring, rear

1.5.3.1 electric guitar pickups



Genuine Replacement Part Eric Clapton Stratocaster® mid boost 25db kit
36556 0057577000



Genuine Replacement Part pickup set Custom Shop White Stratocaster®
35958 0992113000 Fat '50s
35960 0992114000 Custom '69
35961 0992111000 Texas Special™



Genuine Replacement Part pickup set Custom Shop parchment Stratocaster®
35962 0992105000 Hot Noiseless™
35963 0992115000 Vintage Noiseless



Genuine Replacement Part pickup set Original parchment Stratocaster® Original '57/'62
35965 0992117000



Genuine Replacement Part pickup set Original White Stratocaster® Tex-Mex™
35966 0992131000



Genuine Replacement Part pickup set Original Vintage Telecaster®
35984 0992119000



Genuine Replacement Part pickup set Custom Shop Texas Special Telecaster®
35985 0992121000



Genuine Replacement Part pickup set Custom Shop '51 Nocaster®
35986 0992109000



Genuine Replacement Part pickup '62 Jaguar, aged white
35995 0054494049 bridge



Genuine Replacement Part pickup '62 Jazzmaster, aged white
35998 0054444000 neck

1.5 parts
1.5.3 electronics

1.5.3.1 electric guitar pickups



pickup Hot Rod Wide Spacing
Humbucker, US Strat Models
35945 0054036000 aged white



pickup American Series Tele
35982 0050890000 neck

1.5 parts
1.5.3 electronics

1.5.3.1 electric bass guitar pickups



Vintage single coil pickup, Alnico 5 rods, black fiber bobbin, waxed formvar wire, black

33589 VJB-62-NBK 7.5K neck RWRP
33590 VJB-62-BBK 8.0K bridge



Vintage split coil humbucker pickup, Alnico 5 rods, black fiber bobbins, waxed formvar wire, 10.3K

33588 VPB-57-BK

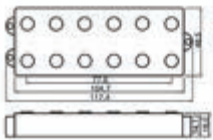

pickup MM-model, ceramic, 4 conductors, 6-string

21380 PU-966-BK black



pickup Jocker Bass model, "Silky Edge", front

13775 PU-611-SEF



pickup Jocker Bass model 5-string, "Silky Edge"

13778 PU-655-SER rear
13779 PU-655-SEF front



pickup bass 6-string, "Silky Edge", rear

13784 PU-766-SER

1.5 parts
1.5.3 electronics

1.5.3.1 electric bass guitar pickups



Genuine Replacement Part pickup American Series Jazz Bass® V
36019 0048736000 bridge



Genuine Replacement Part pickup set Vintage Noiseless Jazz Bass®
36029 0992102000



Genuine Replacement Part pickup set Original Precision Bass®
36040 0992046000

1.5 parts
1.5.3 electronics

1.5.3.1 acoustic guitar pickups



double source pickup system with external pre-amp for steelstring or nylon-string guitar
44330 PHANTASMA

1.5 parts
1.5.3 electronics

1.5.3.1 acoustic guitar pickups



universal passive piezo pickup "Magneton" 5cm with tone control
38371 FWF-MAG



universal powerful passive piezo pickup "Gros Magneton" 7cm with tone control
38372 FWF-GRM



strings instruments triple passive piezo pickup "Ampliphon" with low pass filter
38373 FWF-AMP

1.5 parts
1.5.3 electronics

1.5.3.1 acoustic guitar pickups



Fishman Presys II pickup system with built-in tuner
43516 M/ISY-301



Fishman Presys Blend pickup system with microphone and built-in tuner
43518 M/PSY-301

1.5 parts
1.5.3 electronics

1.5.3.1 acoustic guitar pickups



replacement part Fishman Sonitone preamp with pickup, battery box and jack output
35664 SON-GT1



replacement part Fishman Sonitone preamp with pickup, battery bag
35665 SON-GT2 endpin jack
35666 SON-GT4 gold endpin jack



active 3-band guitar pickup/
preamp/tuner system, with piezo
pickup and endpin jack
41934 EQ-5

1.5 parts
1.5.3 electronics

1.5.3.1 acoustic guitar pickups



ultra slim acoustic pickup for resonator guitars
44169 USA-RESO chrome cover



soundhole pickup, single coil with 4 meter fixed cable, maple housing
19578 SH-330



active soundhole pickup, single coil with 4 meter cable, 2x3v battery
25522 SH-141



active soundhole pickup, with 4 meter cable, 3v battery, volume, soundhole 9-11cm

- 31755 SH-145-B black humbucker
- 25524 SH-145-G grey humbucker



bridge pickup for 2,3mm slot
19596 SH-060 for classic guitar



bridge pickup with fixed saddle, 8mm slot
19590 SH-066



bridge pickup for 2,3mm slot, endpin jack with 2,5mm female jack
19586 SH-1110



bridge pickup with fixed saddle, 2,3mm slot, with 4 meter cable, vol
19592 SH-1900



undersaddle bridge pickup for 2,3mm slot, for acoustic and classic guitar
38464 SH-099



soundhole wireless panorama Nanomag pickup with receiver
38418 SH-APNMG-WL



wireless panorama Nanoflex pickup with receiver
38419 SH-APNFX-WL acoustic guitar
38420 SH-CPNFX-WL classic guitar

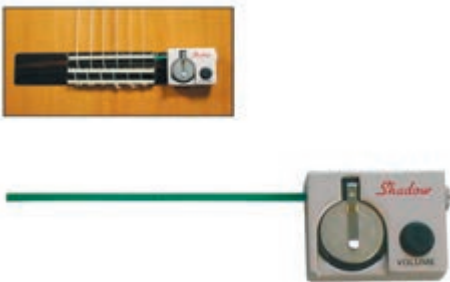

bridge preamp, with fixed NFX pickup, with 4 meter cable, 3v battery, vol
25525 SH-NFX-AC



MicroSonic Nanoflex pickup for acoustic guitar, with endpin preamp
38457 MSA-NFX-V volume
38458 MSA-NFX-VT volume and tone



MicroSonic Nanomag pickup for acoustic guitar, with endpin preamp
38459 MSA-NMG-V volume
38460 MSA-NMG-VT volume and tone



Nanomag pickup, NMG, for use with preamp
34578 SH-NMG-PU



MicroSonic Nanoflex and Nanomag pickup for acoustic guitar, with endpin preamp, 2x volume
38461 MSA-DP-V



MicroSonic Nanoflex pickup for classic guitar, with endpin preamp
38462 MSC-NFX-V volume
38463 MSC-NFX-VT volume and tone

1.5.3.1 acoustic guitar pickups



NANOFLEX
THE NANOFLEX PICKUP WILL BE PLACED IN THE BRIDGE AND FINGERBOARD VIBRATIONS FROM THE SOUNDBOARD... AND... THE STRINGS



soundhole preamp with NFX piezo, endpin jack, 2x3v battery, volume, bass and treble

27399 SH-NFX-2



NANOMAG
THE NANOMAG IS A MAGNETIC PICKUP PLACED AT THE END OF THE FINGERBOARD



soundhole preamp with nmg pickup, endpin jack, 2x3v battery, volume, bass and treble

27400 SH-NMG-2



soundhole preamp with NFX piezo, endpin jack, 3v battery, volume and tone

27401 SH-BASIC-4



endpin preamp with NFX pickup, 9v battery

26581 SH-NFX-EPA acoustic guitar
26582 SH-NFX-EPC classic guitar



endpin preamp with NMG PU, acoustic guitar, 9v battery

32753 SH-NMG-EP



Nanoflex onboard preamp with NFX piezo, endpin jack, 3v battery, volume and tone

35359 SH-JW2-G radius case



Nanoflex onboard preamp/tuner with NFX 6 pickup, each string volume and pan

35304 SH-4020-A acoustic guitar
35305 SH-4020-C classic guitar



Nanoflex flexible polymer transducer, NFX, for bridge mount, 2.3mm wide

33681 SH-NFX-PU23



cable preamp, 6 meter cable, 9v battery, volume, bass, mid and treble

23220 **SH-ECP-2** electric guitar
23221 **SH-BCP-3** bass guitar



preamp, with NFX pickup, 3v battery, volume and tone

38415 **SH-800-NFX** for kanun
38416 **SH-900-NFX** for sitar



transducer, quick mount, with 4 meter cable

19610 **SH-2000**
19613 **SH-2001** volume and tone



transducer, permanent mount, endpin jack

19616 **SH-2500-E**



singleducer, small spot model, 0,3mtr cable, 3,5mm female jack

19620 **SH-710**



0,3mtr cable, 6,3mm female jack

19624 **SH-711** quadducer
19626 **SH-712** singleducer
19628 **SH-713** tripleducer
19630 **SH-714** twinducer



twinducer, small spot model, 0,3mtr cable, 3,5mm female jack

19622 **SH-720**



transducer, multi purpose, in metal case

19618 **SH-020**

1.5 parts
1.5.3 electronics

1.5.3.1 acoustic guitar pickups

Shadow[®]



adhesive for transducers

25272 SH-001 6 pcs

1.5 parts
1.5.3 electronics

1.5.3.1 acoustic bass guitar pickups

Shadow[®]



bridge pickup with fixed saddle, 8mm slot, inclined, 4-string bass

19601 SH-064

1.5 parts
1.5.3 electronics

1.5.3.1 pickups for miscellaneous instruments

FWF
SYSTEMES



universal microphone "MicroMic" with different mounting systems

39996 FWF-MM

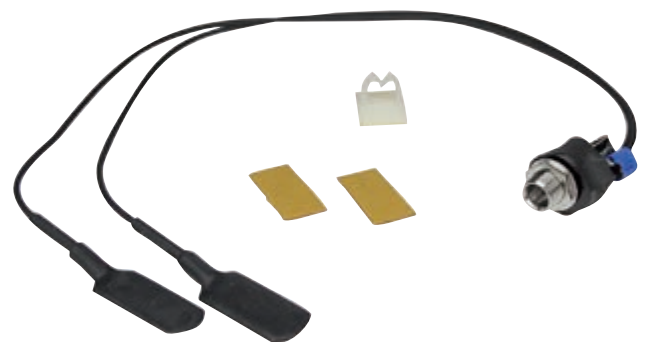

strings instrument double piezo with low pass filter

41927 FWF-MG2 built-in version

1.5 parts
1.5.3 electronics

1.5.3.1 pickups for miscellaneous instruments

Richwood



replacement part Fishman Sonitone Ukulele preamp with pickup,
battery box and jack output
35667 SON-UK1



replacement part Fishman Sonicore Ukulele preamp with pickup,
battery box and jack output
35668 KUL-201

1.5 parts
1.5.3 electronics

1.5.3.1 pickups for miscellaneous instruments

Shadow



mandolin and ukulele bridge pickup with 2 bridges,
with 4 meter cable, volume
19647 SH-920



mandolin arched top bridge pickup, adjustable, with 4 meter cable
19648 SH-925
19649 SH-926 volume and tone



mandolin NMG pu, adjustable, with 4 independent gain pots
31779 SH-927-NMG4 A-type
31780 SH-928-NMG4 F-type



banjo bridge pickup, with 4 meter cable, volume and tone
19652 SH-930 5-string
19654 SH-930-T 4-string
34576 SH-930-G 6-string

1.5 parts
1.5.3 electronics

1.5.3.1 pickups for miscellaneous instruments

Shadow[®]



ukulele bridge pickup for 2,3mm slot, endpin jack with 2,5mm female jack
34577 SH-1110-UK

1.5 parts
1.5.3 electronics

1.5.3.1 pickup parts

Boston



bobbin single coil Jocker bass neck position, vintage alnico
33016 BO-91-FBK black



Master Relic Series Stallion 50's pickup cover 3/set
42756 MRC-STPC50 white relic



Master Relic Series Stallion 60's pickup cover 3/set
42757 MRC-STPC60 parchment relic



Master Relic Series Teaser pickup cover neck position
42758 MRC-TLPCN nickel relic



Master Relic Series LP humbucker pickup cover 2/set
42759 MRC-LP59PC nickel relic



pickup cover single coil, 52mm spacing, 82,0-70,0x18,0mm, 3pcs
34806 SPC-62-WH white
34807 SPC-62-BK black
34808 SPC-62-MG mint green
34809 SPC-62-IV ivory

1.5.3.1 pickup parts

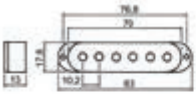

pickup cover, Stallion model single coil, 83,0-70,0x17,8x18,0mm, 3 pcs

- 6096 **SPC-10-WH** white
- 6097 **SPC-10-BK** black



pickup cover metal, chrome

- 32910 **PMC-50-C** Teaser bass model
- 25421 **PMC-60-C** Jocker Bass model



pickup cover, Puncher Bass model split coil, 2 pcs

- 34810 **PPC-15-BK** black
- 34811 **PPC-15-WH** white



pickup cover, Puncher Bass model split coil, no holes, 2 pcs

- 34812 **PPC-25-BK** black

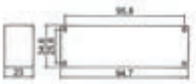

pickup cover, 5-string no holes, 104,0x34,5x23,0mm

- 14092 **BPC-5-BKM** mat black

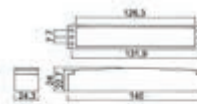

pickup cover, 6-string no holes, 140,0x24,0x24,0mm

- 14093 **BPC-6-BKM** mat black

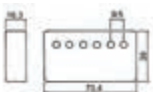

pickup cover, humbucker, pitch= 9,5mm, neck position, metal

- 14094 **HPC-10-CHF** chrome
- 14095 **HPC-10-GGF** gold

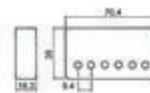

pickup cover, humbucker, pitch=10,0mm, bridge position, metal

- 14096 **HPC-10-CHR** chrome
- 14097 **HPC-10-GGR** gold

1.5.3.1 pickup parts

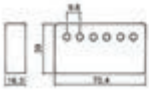

pickup cover, humbucker, pitch= 9,8mm, neck position, metal

- 14098 HPC-20-NIF nickel
- 14100 HPC-20-GGF gold

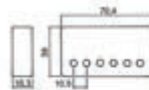

pickup cover, humbucker, pitch=10,5mm, bridge position, metal

- 14101 HPC-20-NIR nickel
- 14103 HPC-20-GGR gold

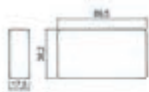

pickup cover, humbucker, 70,0x38,0x17,0mm, no holes

- 8822 HPC-30-GGN metal gold

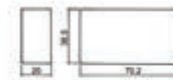

pickup cover, humbucker, 70,2x67,6x20,0mm, no holes

- 14105 HPC-50-BMN plastic mat black



pickup mounting spring, tapered, 12pcs, diam. 8-5mm

- 14370 SPR-08 length 8mm
- 14371 SPR-17 length 17mm

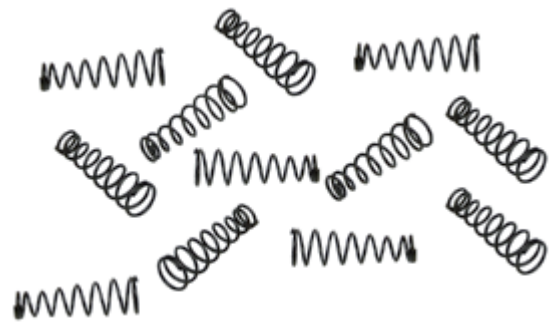

pickup mounting spring, tapered, 12pcs, diam. 6-4mm

- 26130 SPR-22 length 22mm



pickup mounting spring, straight, 12pcs, diam. 5mm

- 14373 SPR-21 length 21mm



pickup mounting spring, straight, 12pcs, diam. 5mm, strong

- 14374 SPR-27 length 27mm
- 14376 SPR-42 length 42mm



pickup mounting spring, straight, 12pcs, diam. 4mm

- 26131 SPR-29 length 30mm

1.5 parts
 1.5.3 electronics
1.5.3.1 pickup parts



Genuine Replacement Part pickup cover, vintage '51 precision bass
 35723 0033167049



Genuine Replacement Part pickup covers Stratocaster®, plastic, set of 3
 36366 0991364000 black
 36367 0992034000 white



Genuine Replacement Part pickup cover Stratocaster, plastic, 3 pcs
 43398 0056251049 parchment



Genuine Replacement Part pickup covers Jazzmaster, plastic, set of 2
 36372 0054442049 parchment



Genuine Replacement Part pickup cover Jaguar, plastic
 36373 0054492049 parchment



Genuine Replacement Part pickup covers P-Bass, plastic, set of 2
 36374 0992037000 black



Genuine Replacement Part pickup covers Jazz Bass®, plastic, set of 2
 36375 0992038000 black



Genuine Replacement Part strat accessory kit, contains pot knobs, switch tip, backplate, pickup covers
 33897 0991363000 black
 33898 0991362000 white
 33899 0991368000 aged white
 33900 0991395000 parchment



Genuine Replacement Part pure vintage 1954 Stratocaster® accessory kit
 44663 0991396000 white

1.5 parts
1.5.3 electronics

1.5.3.1 pickup parts

Boston



Genuine Replacement Part pure vintage '60s Stratocaster®, accessory kit
44664 0992097000 vintage white



Genuine Replacement Part pure vintage '50s Stratocaster®, accessory kit
44665 0992096000 eggshell

1.5 parts
1.5.3 electronics

1.5.3.2 switches and switch plates

Fender



Genuine Replacement Part slide switch, DPDT, Jaguar/Jazzmaster/Mustang
36469 0017079049 black

1.5 parts
1.5.3 electronics

1.5.3.2 lever switches

Boston



lever switch, closed model, 1 5/8 inch spacing, with white cap
13659 SW-43-W 3-way
6265 SW-45-W 5-way



lever switch, open model, 1 5/8 inch spacing, bolts included, with white cap
21443 SW-143-W 3-way
21446 SW-145-W 5-way



lever super switch (10 contact points), open model, vintage, with white cap
41192 SSW-210-W 5-way

1.5 parts
1.5.3 electronics

1.5.3.2 lever switches



Genuine Replacement Part CRL lever switch for strat

43365 0038929049 5-way



Genuine Replacement Part CRL lever switch for strat/tele, bolts included

43366 0038993049 3-way



Genuine Replacement Part lever switch, vintage strat/tele, bolts and caps included

33907 0992041000 3-way



Genuine Replacement Part lever switch, for strat, bolts and cap included

33908 0991367000 5-way



Genuine Replacement Part lever switch, Super Switch, for custom wiring, bolts and cap included

33909 0992251000 5-way



Genuine Replacement Part lever switch, Tele Mod Switch, for custom wiring, bolts and cap included

33910 0992250000 4-way

1.5 parts
1.5.3 electronics

1.5.3.2 lever switches



lever switch, bolts included, no cap

31549 SW-OAK-3 3-way

31550 SW-OAK-5 5-way



lever switch bulk pack, 12 pieces, bolts included, no caps

31737 SW-OAK-3/12 3-way

31738 SW-OAK-5/12 5-way

1.5 parts
1.5.3 electronics

1.5.3.2 lever switches

Schaller

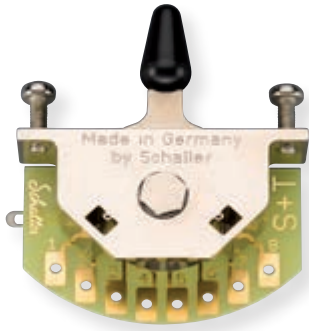

Megaswitch lever switch 5-way, 40,7mm spacing, bolts included, black cap

42535	15310002	E
42536	15310003	S
42537	15310006	M
42538	15310011	T

1.5 parts
1.5.3 electronics

1.5.3.2 toggle switches

Boston



toggle switch 3-way

6267	SW-20-IV	with ivory plate and cap
6266	SW-20-B	with black plate and cap
31551	SW-20-G	with ivory plate and cap



toggle switch 3-way, angled model, chrome

1445	SW-10	with ivory plate and cap
------	-------	--------------------------



toggle switch 3-way, long model, chrome, with black knob

6862	SW-30
------	-------



toggle switch 3-way, block shape

9329	SW-5-CB	black knob, nickel
21464	SW-5-BB	black knob, black
21463	SW-5-GI	ivory knob, gold



toggle switch 3-way, open, black cap

21465	SW-23-NB	nickel
21466	SW-23-BB	black



toggle switch 3-way, open, ivory cap

21467	SW-23-GI	gold lacquer
-------	----------	--------------

1.5 parts
1.5.3 electronics

1.5.3.2 toggle switches

Fender







Genuine Replacement Part 3-way toggle switch, Jazzmaster/'72 Tele

36471	0053694049	chrome with parchment tip
-------	------------	---------------------------

1.5 parts
1.5.3 electronics

1.5.3.2 toggle switches

 <p>toggle switch 3-way, no cap 31485 SW-210-N nickel</p>	 <p>toggle switch 3-way angled, no cap, for thin body guitars (SG, Explorer, Firebird) 31487 SW-230-N nickel</p>	 <p>toggle switch 3-way, long model, no cap, for USA made LP-model guitars 31489 SW-250-N nickel 31490 SW-250-G gold</p>	 <p>switch nut, deep knurled, for thick top guitars 31587 SW-DKN-N nickel 31658 SW-DKN-G brass</p>
--	---	--	--

1.5 parts
1.5.3 electronics

1.5.3.2 mini switches

 <p>mini toggle switch 2-way, on-on 1448 SW-60-N nickel 6833 SW-60-B black 13115 SW-60-G gold lacquer</p>	 <p>mini toggle switch 3-way, on-on-on 6835 SW-65-N nickel 6834 SW-65-B black</p>
 <p>mini toggle switch 3-way, on-off-on 13117 SW-70-N nickel</p>	 <p>mini toggle switch 2-way, on-on, 1-pole 21453 SW-158-N nickel 21455 SW-158-G gold lacquer</p>
 <p>mini toggle switch 2-way, on-on, 2-pole 21456 SW-160-N nickel</p>	 <p>mini toggle switch 3-way, on-off-on 21459 SW-170-N nickel 21461 SW-170-G gold lacquer</p>

1.5 parts
1.5.3 electronics

1.5.3.2 switchplates

	<p>toggle switch plate 1115 EP-508-I ivory with gold imprint 1116 EP-508-B black with gold imprint 1117 EP-508-W white with gold imprint</p>
---	--

1.5 parts
1.5.3 electronics

1.5.3.3 potentiometers



Genuine Replacement Part 100K potentiometer, mid boost for Deluxe Series basses
36289 0049443049



Genuine Replacement Part dual 500K/250K potentiometer, split shaft
43360 0990847000



Genuine Replacement Part TBX Tone potentiometer, standard length bushing .375", 3/8" diameter, with .022mf capacitor
33911 0992052000

1.5 parts
1.5.3 electronics

1.5.3.3 25K potentiometers



small 25K audio potentiometer, 16mm. 10mm. bushing, M7x0, 75 thread
42007 ALPS25-A55

1.5 parts
1.5.3 electronics

1.5.3.3 25K potentiometers







kill pot potentiometer, machine gun effect, 25K, long bushing, M7x0,75 thread
32947 SH-124-25

1.5 parts
1.5.3 electronics

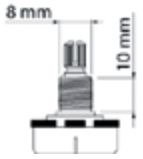
1.5.3.3 250K potentiometers

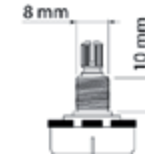

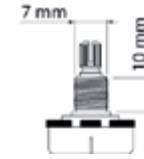



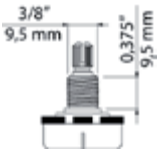

ALPS[®]

  <p>250K potentiometer, 10mm. bushing, M8x0,75 thread, made in Japan</p> <p>1441 PM-250-B linear (tone) 1442 PM-250-A audio (volume)</p>	  <p>small 250K potentiometer, 16mm., 10mm. bushing, M8x0,75 thread, made in Japan</p> <p>23287 PM-250-BS linear (tone) 23288 PM-250-AS audio (volume)</p>	  <p>2x250K blender potentiometer, 10mm. bushing, M7x0,75 thread, blends 2 sources, made in Japan</p> <p>14110 PM-250-Z</p>
---	--	--

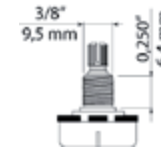
1.5 parts
1.5.3 electronics

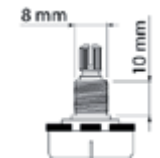
1.5.3.3 250K potentiometers

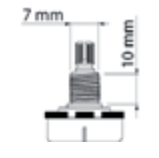

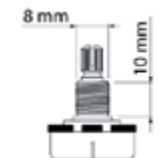

a
ALPHA

  <p>250K potentiometer, standard length bushing .375", 3/8" diameter, made in Taiwan</p> <p>31825 ALP250-A31 audio 31826 ALP250-B32 linear</p>	  <p>250K potentiometer, solid shaft, short bushing .250", 3/8" diameter, for pickguard</p> <p>31829 ALP250-A35 audio 31830 ALP250-B36 linear</p>	  <p>250K potentiometer, 10mm. bushing, M8x0,75 thread, made in Taiwan</p> <p>31834 ALP250-A41 audio 31835 ALP250-B42 linear</p>
  <p>small 250K potentiometer, 16mm., 10mm. bushing, M7x0,75 thread, made in Taiwan</p> <p>31838 ALPS250-A46 audio 31839 ALPS250-B47 linear</p>	  <p>push-pull 250K potentiometer, standard length bushing .375", 3/8" diameter, made in Taiwan</p> <p>35371 ALPP250-A50 audio 35372 ALPP250-B51 linear</p>	

1.5 parts
1.5.3 electronics

1.5.3.3 250K potentiometers

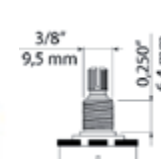

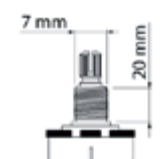

CTS
Electrocomponents[®]

  <p>250K potentiometer, standard length bushing .375", 3/8" diameter</p> <p>31714 CTS250-A51 audio 31713 CTS250-B50 linear</p>	  <p>250K potentiometer, short bushing .250", 3/8" diam., USA style dished back, pickguard mount</p> <p>31719 CTS250-A56 audio 31718 CTS250-B55 linear</p>	  <p>250K potentiometer, long bushing .750", 3/8" diameter, for thick/ carved tops, LP USA</p> <p>35141 CTS250-A63 audio 35142 CTS250-B64 linear</p>
--	---	--

1.5 parts
1.5.3 electronics

1.5.3.3 250K potentiometers



 <p>250K audio potentiometer, solid shaft, short bushing .250", 3/8" diameter, pickguard mount 31720 CTS250-A57</p>	 <p>potentiometer 20 pcs bulk pack, 250K 31726 CTS-A51/20 audio 31727 CTS-B50/20 linear</p>	 <p>potentiometer 20 pcs bulk pack, 250K short 31730 CTS-A56/20 audio 31731 CTS-B55/20 linear</p>
 <p>potentiometer 20 pcs bulk pack, 250K long 35345 CTS-A63/20 audio 35346 CTS-B64/20 linear</p>	 <p>potentiometer 20 pcs bulk pack, 250K solid shaft 35348 CTS-A57/20 short audio</p>	

1.5 parts
1.5.3 electronics

1.5.3.3 250K potentiometers





 <p>custom low friction potentiometer 250K 37553 0220831000</p>
--

1.5 parts
1.5.3 electronics

1.5.3.3 250K potentiometers



 <p>Genuine Replacement Part 250K potentiometer, .375" length bushing 33912 0990830000 33913 0990831000 solid shaft</p>	 <p>Genuine Replacement Part 250K No Load potentiometer, .375" length bushing, with .022mf capacitor 33914 0990832000 33915 0990833000 solid shaft</p>	
 <p>Genuine Replacement Part 250K potentiometer, concentric stacked for Vintage '62 Jazz Bass® 36287 0019268049</p>	 <p>Genuine Replacement Part 250K Push/Pull potentiometer, .375" length bushing, with .022mf capacitor 33916 0992257000</p>	 <p>Genuine Replacement Part 250K potentiometer, pickup pan for Deluxe Series basses 36288 0049441000</p>

1.5 parts
1.5.3 electronics

1.5.3.3 250K potentiometers

Shadow[®]

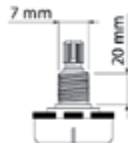

kill pot potentiometer, machine gun effect, 250K,
long bushing, M7x0,75 thread
32946 SH-124-250

1.5 parts
1.5.3 electronics

1.5.3.3 250K potentiometers

Ultra

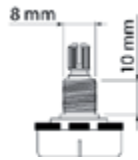

250K push-pull potentiometer, 10mm. bushing,
M8x0,75 thread, made in Korea
16217 PP-250-B linear (tone)
16218 PP-250-A audio (volume)

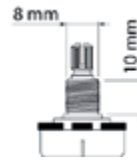

250K potentiometers, 6 pcs, 10mm. bushing,
M8x0,75 thread, made in Korea
21468 PM-1250-B linear (tone)
21469 PM-1250-A audio (volume)

1.5 parts
1.5.3 electronics

1.5.3.3 500K potentiometers

ALPS[®]

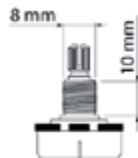

500K potentiometer, 10mm. bushing,
M8x0,75 thread, made in Japan
1443 PM-500-B linear (tone)
1444 PM-500-A audio (volume)



small 500K potentiometer, 16mm., 10mm. bushing,
M8x0,75 thread, made in Japan
23289 PM-500-BS linear (tone)
23290 PM-500-AS audio (volume)

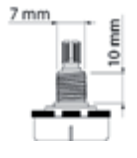

2x500K blender potentiometer, 10mm. bushing,
M7x0,75 thread, blends 2 sources, made in Japan
14111 PM-500-Z

1.5 parts
1.5.3 electronics

1.5.3.3 500K potentiometers

ALPHA

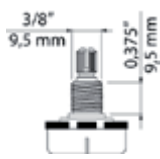

500K potentiometer, standard length bushing
.375", 3/8" diameter, made in Taiwan
31827 ALP500-A33 audio
31828 ALP500-B34 linear

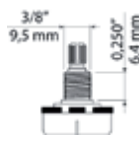

500K potentiometer, solid shaft, short bushing
.250", 3/8" diameter, for pickguard
31831 ALP500-A37 audio
31832 ALP500-B38 linear

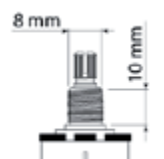

500K potentiometer, 10mm. bushing,
M8x0,75 thread, made in Taiwan
31836 ALP500-A43 audio
31837 ALP500-B44 linear

1.5 parts
1.5.3 electronics

1.5.3.3 500K potentiometers



small 500K potentiometer, 16mm., 10mm. bushing, M7x0,75 thread, made in Taiwan
31840 ALPS500-A48 audio
31841 ALPS500-B49 linear



push-pull 500K potentiometer, standard length bushing .375", 3/8" diameter, made in Taiwan
35373 ALPP500-A52 audio
35374 ALPP500-B53 linear

1.5 parts
1.5.3 electronics

1.5.3.3 500K potentiometers



500K potentiometer, standard length bushing .375", 3/8" diameter
31716 CTS500-A53 audio
31715 CTS500-B52 linear



500K potentiometer, short bushing .250", 3/8" diam., USA style dished back, pickguard mount
35138 CTS500-A61 audio
35139 CTS500-B62 linear



500K potentiometer, long bushing .750", 3/8" diameter, for thick/ carved tops, LP USA
31717 CTS500-A54 audio
35140 CTS500-B60 linear



potentiometer 20 pcs bulk pack, 500K
31728 CTS-A53/20 audio
31729 CTS-B52/20 linear



potentiometer 20 pcs bulk pack, 500K short
35343 CTS-A61/20 audio
35344 CTS-B62/20 linear



potentiometer 20 pcs bulk pack, 500K long
31732 CTS-A54/20 audio
35347 CTS-B60/20 linear

1.5 parts
1.5.3 electronics

1.5.3.3 500K potentiometers



custom low friction potentiometer 500K
37554 0220835000



1.5 parts
1.5.3 electronics

1.5.3.3 500K potentiometers



Genuine Replacement Part 500K potentiometer,
.375" length bushing, with .022mf capacitor
33917 0990834000
33918 0990835000 solid shaft

1.5 parts
1.5.3 electronics

1.5.3.3 500K potentiometers

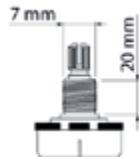

kill pot potentiometer, machine gun effect, 500K long bushing, M7x0,75 thread
31783 SH-124-500

1.5 parts
1.5.3 electronics

1.5.3.3 500K potentiometers

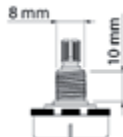

500K push-pull potentiometer, 10mm. bushing,
M8x0,75 thread, made in Korea

6260 PP-500-A audio (volume)
21472 PP-500-B linear (tone)

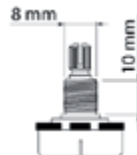

500K potentiometers, 6 pcs, 10mm. bushing,
M8x0,75 thread, made in Korea

21470 PM-1500-B linear (tone)
21471 PM-1500-A audio (volume)

1.5 parts
1.5.3 electronics

1.5.3.3 1MEG potentiometers

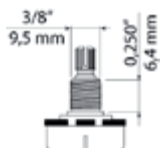

1MEG audio potentiometer, solid shaft, short
bushing .250", 3/8" diameter, for pickguard mount
31833 ALP1MG-A39

1.5 parts
1.5.3 electronics

1.5.3.3 1MEG potentiometers



1000K audio potentiometer, solid shaft, short bushing .250", 3/8" diameter, pickguard mount
31721 CTS1MEG-A58



potentiometer 20 pcs bulk pack, 1000K short audio potentiometers solid shaft
35349 CTS-A58/20

1.5 parts
1.5.3 electronics

1.5.3.3 1MEG potentiometers



Genuine Replacement Part 1MEG potentiometer, .375" length bushing
33920 0019066049 solid shaft
36290 0054032049 split shaft



Genuine Replacement Part 1MEG potentiometer, .375" length bushing, solid shaft
43361 0095704049



Genuine Replacement Part 1MEG mini potentiometer, .375" length bushing, solid shaft
43362 0054457049



Genuine Replacement Part 1MEG linear potentiometer, master volume Jazzmaster, split shaft
36291 0054453049

1.5 parts
1.5.3 electronics

1.5.3.3 potentiometer mounting materials



mounting nuts for small pots, M7, for PM-250-BS/AS and PM-500-BS/AS
25086 PM-HN-S 12 pcs



mounting nuts for standard pots, M8, for PM-250-B/A and PM-500-B/A
25087 PM-HN-L 12 pcs



mounting nuts for 3/8" pots
31725 PM-HN-3832 12 pcs



Master Relic Series LP knob position indicator 4/set
42768 MRC-LP59PI nickel relic



pointer washers, 6-pack, 30 degrees angled point, 9.5mm hole for inch pots
14807 DP-3095-N nickel
14808 DP-3095-G gold



pointer washers, 6-pack, 90 degrees angled point, 9.5 mm hole for inch pots, gold
14811 DP-9095-N nickel
14812 DP-9095-G gold

1.5 parts
1.5.3 electronics

1.5.3.3 potentiometer mounting materials



Genuine Replacement Part potentiometer locking washers, 12 pcs
43363 0016436049 nickel



Genuine Replacement Part mounting nuts for 3/8" pots, 12 pcs
43364 0016352049

1.5 parts
1.5.3 electronics

1.5.3.4 rectifier tubes



selected rectifier tube

- 43717 GZ34STR RT501
- 43718 GZ34CZ RT521
- 43719 5Y3GT RT503
- 43720 5Y3WGTB RT513
- 43721 5U4GB RT504
- 43722 5U4G RT512
- 43723 EZ81/6CA4 RT506



solid state rectifier (RT515)
43724 SSR1

1.5 parts
1.5.3 electronics

1.5.3.4 power tubes



selected power tubes

- 43661 6L6GCSTR/2 pair RT212
- 43662 6L6GCSTR/4 quartet RT214
- 43663 6L6GCSTR/6 sextet RT216



selected power tubes

- 43664 6L6WGCSTR/2 pair RT812
- 43665 6L6WGCSTR/4 quartet RT814
- 43666 6L6WGCSTR/6 sextet RT816



selected power tubes

- 43667 KT66/2 pair RT822
- 43668 KT66/4 quartet RT824



selected power tubes

- 43669 5881WXT/2 pair RT312
- 43670 5881WXT/4 quartet RT314



selected power tubes

- 43671 6V6GTSTR/2 pair RT832
- 43672 6V6GTSTR/4 quartet RT834



selected power tubes

- 43673 EL34BSTR/2 pair RT162
- 43674 EL34BSTR/4 quartet RT164
- 43675 EL34BSTR/6 sextet RT166



selected power tubes

- 43676 E34LCZ/2 pair RT152
- 43677 E34LCZ/4 quartet RT154
- 43678 E34LCZ/6 sextet RT156



selected power tubes

- 43679 EL34SVT/2 pair RT252
- 43680 EL34SVT/4 quartet RT254

1.5.3.4 power tubes



selected power tubes,
43681 **EL84STR/2** pair RT872
43682 **EL84STR/4** quartet RT874



selected power tubes
43683 **EL84CZ/2** pair RT272
43684 **EL84CZ/4** quartet RT274



selected power tubes
43685 **EL84M/2** pair RT372
43686 **EL84M/4** quartet RT374



selected power tubes
43687 **7027A/2** pair RT242
43688 **7027A/4** quartet RT244



selected power tubes
43689 **6550ASTR/2** pair RT882
43690 **6550ASTR/4** quartet RT884
43691 **6550ASTR/6** sextet RT886



selected power tubes
43692 **KT88STR/2** pair RT892
43693 **KT88STR/4** quartet RT894
43694 **KT88STR/6** sextet RT896

1.5.3.4 preamp tubes



selected preamp tube (RT080)
43695 **7025WA**



selected preamp tube (RT008)
43696 **ECC83WA**



selected preamp tube (RT010)
43697 **7025**



selected preamp tube (RT001)
43698 **12AX7AC**



selected preamp tube (RT011)
43699 **7025S**



selected preamp tube **7025 / E83CC**
(RT030)
43700 **7025/E83CC**



selected preamp tube (RT003)
43701 **ECC83Cz**



selected preamp tube (RT033)
43702 **ECC803S**

1.5.3.4 preamp tubes

			
selected preamp tube (RT006) 43703 12AX7WAR	selected preamp tube 12AY7 / 6072a (RT007) 43704 12AY7	selected preamp tube 12AY7 / 6072a high grade (RT070) 43705 12AY7HG	selected preamp tube (RT009) 43706 5751
			
selected preamp tube (RT090) 43707 5751HG	selected preamp tube 12AT7 / ECC81 (RT002) 43708 12AT7	selected preamp tube 12AU7 / ECC82 (RT005) 43709 12AU7	selected preamp tube 12AU7WA / E82CC (RT065) 43710 12AU7WA
			
selected preamp tube (RT043) 43711 12BH7ASTR	selected preamp tube 12DW7 / 7247 (RT044) 43712 12DW7	selected preamp tube EF86 / 6267 (RT-EF86) 43713 EF86	selected preamp tube 6922 / E88CC (RT-6922) 43714 6922
			
selected preamp tube (RT980) 43715 6SN7GT	selected preamp tube (RT-6SL7) 43716 6SL7GT		



strap button nut, for EPJ models M8 thread, with nut and washer

34538 EPJ-SB-GD gold
40633 EPJ-SB-NI nickel



endpin jack, solder 6,3mm fem jack

34273 EPJ-48-C chrome
34274 EPJ-48-N nickel
34275 EPJ-48-BK black
34276 EPJ-48-GD gold



endpin jack, solder 6,3mm fem jack, fixed jack plate

21441 EPJ-67-C chrome
21442 EPJ-67-G gold



endpin jack, 2.5mm female jack - 6.3mm female jack

29689 EPJ-5525-N nickel



endpin jack, 3.5mm female jack - 6.3mm female jack

29690 EPJ-5535-N nickel



chassis connector jack, 6,3mm, 2-pole, M9

6919 SJ-1 chrome



chassis connector jack, 6,3mm, 2-pole, M9, 6 pcs

21451 SJ-2 chrome
31525 SJ-2-BK black
31526 SJ-2-GD gold



chassis connector jack, 6,3mm, 3-pole, M9

8992 SJ-3 chrome



nut for chassis connector, 12 pcs

13635 SJN-N nickel
13640 SJN-B black
13641 SJN-G gold



rivet for chassis connector, 12 pcs

13638 SJWA-N nickel
13639 SJWA-B black
13642 SJWA-G gold

1.5 parts
1.5.3 electronics
1.5.3.5 jack outputs



Genuine Replacement Part 2-pole chassis connector jacks, 6,3mm, .276 bushing depth, 3/8 32" thread, 2 pcs
36479 0021956049 nickel

1.5 parts
1.5.3 electronics
1.5.3.5 jack outputs



Fishman endpin jack
44457 18A0061

1.5 parts
1.5.3 electronics
1.5.3.5 jack outputs



thick panel jack, for 6,3mm, 2-pole, made in USA
32292 SC-151 nickel



thick panel jack, for 6,3mm, 3-pole, made in USA
32293 SC-152B nickel
32294 SC-152 brass
32296 SC-155 black



endpin jack, solder 6,3mm fem jack, made in USA
34557 SC-6J1216 nickel



chassis connector jack, 2-pole, 6,3mm, .276 bushing depth, 3/8" 32 thread
32766 SC-11 nickel

1.5.3.5 jack outputs



chassis connector jack, 2-pole, nickel, 6,3mm, .276 bushing depth, 3/8" 32 thread , bulk pack 50 pcs
32767 SC-11/50



chassis connector jack, 2-pole, 6,3mm, .375 XL bushing depth, 3/8" 32 thread
31482 SC-FAL11 nickel



chassis connector jack, 3-pole, 6,3mm, .276 bushing depth, 3/8" 32 thread
31481 SC-12B nickel



nuts for model 11, 12B and FAL11, 12 pcs, with 3/8" 32 thread
32768 SC-P10001 nickel



rivets for model 11, 12B and FAL11, 12 pcs
32769 SC-S10221 nickel

1.5.3.6 capacitors



capacitor, microfarad, 10 pcs, tone control
21447 CDR-333 0,033



capacitor, microfarad, 10 pcs, tone control, for bass
21448 CDR-104 0,100
21450 CDR-683 0,068



capacitor, microfarad, 10 pcs, tone control, for bass, Teaser, LP-model
21449 CDR-473 0,047

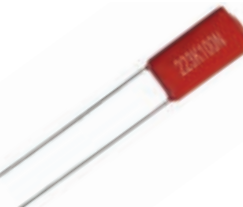

capacitor, microfarad, 10 pcs, tone control, for Stallion model
26119 CDR-223 0,022

1.5.3.7 wire and cable



4-conductor shielded cable, 1 meter, for inner guitar electronics
31312 GIC-41



cloth covered wire, vintage style, 15 meter, 18 gauge (1mm²), tinned stranded copper
31817 VCC-18R-BK black
31818 VCC-18R-WH white
31819 VCC-18R-RD red
31824 VCC-18R-YE yellow



cloth covered wire, vintage style, 1 meter, 18 gauge (1mm²), tinned stranded copper
31820 VCC-181-BK black
31821 VCC-181-WH white
31822 VCC-181-RD red
31823 VCC-181-YE yellow



braided shield wire, vintage style, 1 meter, 18 gauge (1mm²)
34458 VCC-201 copper



braided shield wire, vintage style, 15 meter, 18 gauge (1mm²)
34459 VCC-20R copper



USA made (Gavitt) waxed cotton braided push back wire, 1 foot
41979 PBW1/BK black
41980 PBW1/WH white



USA made (Gavitt) waxed cotton braided push back wire, 50 feet
41981 PBW50/BK black
41982 PBW50/WH white



USA made (Gavitt) waxed cotton braided push back wire, 10 feet
41983 PBW10/BK black
41984 PBW10/WH white



USA made (Gavitt) shielded waxed cotton braided push back wire
41985 PBWS1 1 foot
41986 PBWS10 10 feet
41987 PBWS50 50 feet

1.5.3.8 battery clips and holders



battery holder bag with velcro flap and double sided mounting tape
43537 BH-1200



battery holder, vertical type, without screws and connector. For 9 Volt block battery
9338 BH-2000

1.5 parts
1.5.3 electronics

1.5.3.8 battery clips and holders

Boston



battery holder, horizontal type,
without screws and connector.
Fits 9V block battery PP3
24708 BH-2100



battery clamp metal, with screws
24709 BH-1500

1.5 parts
1.5.3 electronics

1.5.3.9 shielding

Boston



copper shielding tape, 1 inch wide
31789 CST-100X5 5 feet long
37027 CST-100X100 100 feet long



copper shielding tape, 2 inch wide
31790 CST-200X5 5 feet long
33367 CST-200X100 100 feet long



height adjuster, Stallion model single coil, with shielding
14154 HAJ-ST

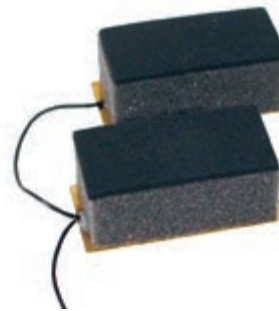

height adjuster, Puncher Bass model, with shielding, 2 pcs
14155 HAJ-PB



height adjuster, Jockey Bass model, with shielding
14156 HAJ-JB

1.5 parts
1.5.3 electronics
1.5.3.9 shielding



electrically conductive coating GRAPHIT 33
41859 GRP33-200 200ml spray can

1.5 parts
1.5.3 electronics
1.5.3.9 shielding



Genuine Replacement Part pick-guard shield, '60s Strat, 11 holes
36524 0019699049



Genuine Replacement Part pickup grounding shield, Jazzmaster
36519 0054439049



1.5 parts
 1.5.4 binding, trim and inlay
1.5.4.1 binding

Boston

 <p>binding, abalone, 2 pcs 33363 BND-1515A 800x1,5x1,5mm 33364 BND-2015A 800x2,0x1,5mm</p>	 <p>cab binding, 1700x5x1,0mm 15431 BND-0510W white 15432 BND-0510C cream 15430 BND-0510B black</p>	 <p>cab binding, 1700x8x1,5mm 15409 BND-0815W white 15410 BND-0815C cream 15411 BND-0815B black</p>
 <p>cab binding, 1700x8x1,0mm 15407 BND-0810W white 15406 BND-0810C cream 15408 BND-0810B black</p>	 <p>cab binding, 1400x8x1,5mm 15412 BND-0815CT tortoise</p>	 <p>cab binding, 1400x14x1,5mm 15433 BND-1415C cream</p>
 <p>cab binding, cream grained 15442 BND-0515CG 1400x5x1,5mm 15443 BND-1015CG 1400x10x1,5mm</p>		

1.5 parts
 1.5.4 binding, trim and inlay
1.5.4.4 side dots and fingerboard inlay

Boston

 <p>pearl eyes, makassar, white pearl, 10-pack 11327 MAK-095 diameter: 9,5 mm.</p>	 <p>pearl eyes, iris, abalone pearl, 10-pack 11354 IRS-095 diameter: 9,5 mm. 11356 IRS-105 diameter: 10,5 mm. 11357 IRS-110 diameter: 11,0 mm. 11358 IRS-115 diameter: 11,5 mm. 11360 IRS-125 diameter: 12,5 mm. 11361 IRS-130 diameter: 13,0 mm.</p>	 <p>pearl eyes, goldfish, gold pearl, 10-pack 11369 GFS-035 diameter: 3,5 mm. 11378 GFS-075 diameter: 7,5 mm. 11379 GFS-080 diameter: 8,0 mm. 11380 GFS-085 diameter: 8,5 mm. 11382 GFS-095 diameter: 9,5 mm. 11383 GFS-100 diameter: 10,0 mm. 11384 GFS-105 diameter: 10,5 mm. 11385 GFS-110 diameter: 11,0 mm. 11386 GFS-115 diameter: 11,5 mm. 11387 GFS-120 diameter: 12,0 mm. 11388 GFS-125 diameter: 12,5 mm. 11389 GFS-130 diameter: 13,0 mm.</p>
--	---	--

1.5 parts
1.5.5 hardware

1.5.5.1 bridge pins

Boston

 <p>bridge pins, plastic, 12-pack 6424 2089 black 1085 2086 with white dot 24898 2014 3mm pearloid dot 24901 2026 5mm pearloid dot</p>	 <p>bridge pins, plastic, 12-pack 1086 2087 white 1084 2084 with black dot 24896 2012 3mm pearloid dot 24899 2024 5mm pearloid dot</p>
 <p>bridge pins, plastic, 12-pack 6744 2088 ivory 6743 2085 with black dot 24897 2013 3mm pearloid dot 24900 2025 5mm pearloid dot</p>	  <p>bridge pins, plastic, 6-pack 34838 2110 black with pearloid dot 34839 2120 white with pearloid dot 34840 2130 ivory with pearloid dot</p>
 <p>bridge pins, 6-pack 8852 337-E ebony 8853 337-P rosewood</p>	 <p>bridge pins, 6-pack, pearloid dot 8854 338-E ebony 8855 338-P rosewood</p>

1.5 parts
1.5.5 hardware

1.5.5.1 bridge pins





Fender

	<p>Genuine Replacement Part bridge pins for acoustic guitar, set of 6 36450 0990402000 white with black dot 36452 0990402006 black with white dot</p>
--	--

1.5 parts
1.5.5 hardware

1.5.5.1 bridge pins

graphtech
GUITAR LABS
We're changing the way you play!

 <p>TUSQ Traditional style bridge pins, set of 6 42563 PP-1100-01 white 42565 PP-2100-01 black</p>	 <p>TUSQ Traditional style bridge pins, set of 6 42567 PP-1122-00 white with 2mm black inlay 42569 PP-2122-00 black with 2mm white inlay</p>
 <p>TUSQ Traditional style bridge pins, set of 6 42571 PP-1142-00 white with 2mm mother of pearl inlay 42573 PP-2142-00 black with 2mm mother of pearl inlay</p>	 <p>TUSQ Traditional style bridge pins, set of 6 42575 PP-1182-00 white with 2mm paua shell inlay 42577 PP-2182-00 black with 2mm paua shell inlay</p>

1.5 parts
1.5.5 hardware

1.5.5.1 bridge pins



TUSQ Presentation style bridge pins, set of 6
42579 **PP-4000-00** white
42581 **PP-3000-00** black



TUSQ Presentation style bridge pins, set of 6
42583 **PP-1044-00** white with 4mm mother of pearl inlay
42585 **PP-2044-00** black with 4mm mother of pearl inlay



TUSQ Presentation style bridge pins, set of 6
42587 **PP-1000-00** white with 4mm paua shell inlay
42589 **PP-2000-00** black with 4mm paua shell inlay

1.5 parts
1.5.5 hardware

1.5.5.1 bridge pins



pin set (7 bridge pins plus 1 end pin)
44545 **18APP17** plain ebony wood
44546 **18APP18** black plastic plain
44547 **18APP21** black plastic with white inlay
44548 **18APP28** white plastic with black inlay
44549 **18APP60** white plastic with tortoise inlay



bass pin set (5 bridge pins plus 1 end pin)
44550 **18APPBI** white plastic with black inlay

1.5 parts
1.5.5 hardware

1.5.5.1 bridge pins



bridge pins, with extractor, 6-pack
25827 **BP-150** brass
25829 **BP-150-BN** bone
25830 **BP-150-W** ebony
25831 **BP-150-HN** horn

1.5 parts
1.5.5 hardware

1.5.5.1 endpins



endpin, plastic, with screw, 12-pack
1019 **EP-W** white
1020 **EP-B** black



endpin, plastic, folk model (violin shape), 12-pack
1022 **2091** black
6747 **2091-WD** black with white dot
1023 **2092** white
6748 **2092-BD** white with black dot
6746 **2093** ivory
6749 **2093-BD** ivory with black dot



endpin, ebony, 1-pack
1024 **331-E** without eye
8850 **333-E** with pearloid eye
8851 **334-E** with parisian eye

1.5 parts
1.5.5 hardware

1.5.5.2 pickguard brackets

Boston



Master Relic Series pickguard bracket, with mounting material, for LP-model

42752 MRC-LP59BRC chrome relic



pickguard bracket, with mounting material, for LP-model

16897 PH-59-C chrome
16899 PH-59-B black
16898 PH-59-G gold



pickguard bracket, with mounting material, for jazz model

8805 PH-L55-N chrome

1.5 parts
1.5.5 hardware

1.5.5.3 control plates

Boston



control plate, 32x160mm, Teaser, 9,5mm holes for inch pots

13102 CP-TE-AC chrome
31305 CP-TE-AN nickel
13103 CP-TE-AG gold
13120 CP-TE-AB black gloss



control plate, 32x160mm, Teaser, 8,5mm holes for metric pots

6076 CP-TE-C chrome
6077 CP-TE-G gold
6078 CP-TE-B black gloss



control plate, Jocker bass, 9,5mm holes for inch pots

7959 CP-JB-AC chrome
32093 CP-JB-AN nickel
13104 CP-JB-AG gold
13123 CP-JB-AB black gloss



control plate, Jocker bass, 8,5mm holes for metric pots

7958 CP-JB-C chrome
35350 CP-JB-N nickel
13121 CP-JB-G gold
13122 CP-JB-B black gloss



control plate, Puncher bass, 8,5mm holes for metric pots

17013 CP-PB-C chrome
17014 CP-PB-G gold
17015 CP-PB-B black



control plate, switch plate, jag-model

25301 CP-JG1-C chrome

1.5 parts
1.5.5 hardware

1.5.5.3 control plates

Boston



control plate, rotary volume wheels, jag-jmast model
25302 CP-JG2-C chrome



control plate, pots and output jack, jag-model, 8,5mm holes for metric pots
25303 CP-JG3-C chrome

1.5 parts
1.5.5 hardware

1.5.5.3 control plates

Fender



control plate Tele
36354 0992058000 chrome
36355 0992058200 gold



Genuine Replacement Part control plate '51 Precision Bass®
36362 0035332000 chrome



Genuine Replacement Part control plate, '62 Jazz Bass®, 3 hole
36363 0992055000 chrome



Genuine Replacement Part control plate, Jazz Bass®, standard 4 hole
36364 0992057100 chrome

1.5 parts
1.5.5 hardware

1.5.5.3 control plates



Master Relic Collection control plate, TE-model
42729 CP-10-AC aged chrome

1.5 parts
1.5.5 hardware

1.5.5.4 screws, bolts and springs



Genuine Replacement Part control knob set screws, 8-32 x 3/16, 24 pcs
36488 0994922000 nickel



Genuine Replacement Part slide switch mounting screws - Jaguar/Jazzmaster, (4-40 X 1/4" Philips), 12pcs
43374 0015719049 nickel

1.5 parts
1.5.5 hardware

1.5.5.4 tapping screws



Master Relic Series screw, 3x12mm, 12pcs, oval countersunk, tapping, for pickguard
42760 TS-01-N/REL nickel relic



Master Relic Series screw set complete, relic
42761 MRC-STSCW Stallion
42762 MRC-TLSCW Teaser

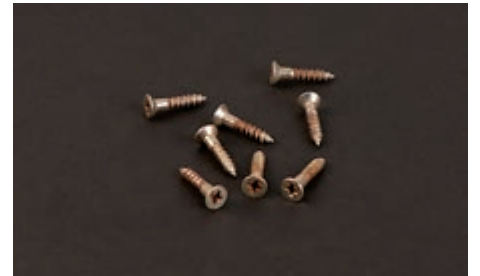

Master Relic Series mounting ring screws, flat head 2.4mmx13mm, 8/pack for two pickups
42770 MRC-MRSCWNL nickel relic

screw, 3x12mm, 12pcs, oval countersunk, tapping, for pickguard
13900 TS-01-N nickel
13901 TS-01-C chrome
13902 TS-01-B black
13903 TS-01-G gold



screw, 4x45mm, 12pcs, oval countersunk, tapping, for neck mount
13908 TS-03-N nickel
13909 TS-03-C chrome
13910 TS-03-B black
13911 TS-03-G gold



screw, 4,5x45mm, 12pcs, oval countersunk, tapping, for neck mount
22798 TS-04-N nickel
9280 TS-04-C chrome
9281 TS-04-B black
9282 TS-04-G gold



screw, 3,5x25mm, 12pcs, flat countersunk, tapping
13912 TS-05-C chrome
13913 TS-05-B black
13914 TS-05-G gold



screw, 3x12mm, 12pcs, flat countersunk, tapping
13917 TS-06-G gold



screw, 4x25mm, 12pcs, flat countersunk, tapping
13919 TS-08-B black



screw, 2,2x6,5mm, 12pcs, dome head, tapping, for trussrod cover and tuners short
14317 TS-14-N nickel
14318 TS-14-B black
14319 TS-14-M brass



screw, 2,2x9,5mm, 12pcs, dome head, tapping, for tuners
14320 TS-15-N nickel
14321 TS-15-B black
14322 TS-15-M brass



1.5 parts
1.5.5 hardware
1.5.5.4 tapping screws



Genuine Replacement Part pickguard screws 24pcs
36147 0994923000 chrome
36148 0994924000 gold



Genuine Replacement Part pickguard screws 12pcs
43377 0015578049 nickel



Genuine Replacement Part bridge mounting screws, 5 x 1", 12 pcs
36482 0021422049 chrome



Genuine Replacement Part bridge mounting screws, vintage '52 Tele, 6 x 1 slotted, 12 pcs
36483 0018371049 nickel



Genuine Replacement Part bridge mounting screws, vintage Strat, 6 x 1-1/4", 12 pcs
36484 0016170049 nickel



Genuine Replacement Part bass bridge mounting screws, 5 x 1", 12 pcs
36486 0015610049 chrome



Genuine Replacement Part neck mounting screws, 4 pcs
36498 0994948000 chrome



Genuine Replacement Part pickguard/control plate mounting screws, '50s era Tele, 4 x 1/2 slotted, 12 pcs
36501 0018368049 nickel



Genuine Replacement Part strap button mounting screws, 6 x 1, oval head, 12 pcs
36511 0016188049 chrome



Genuine Replacement Part tuner mounting screws, Classic/Vintage series guitars, #3 x 3/8", 12 pcs
36512 0011357049 nickel



Genuine Replacement Part tuner/string tree mounting screws, vintage Strat, 12 pcs
36514 0018823049 gold

1.5 parts
1.5.5 hardware

1.5.5.4 wood screws



Boston

 <p>screw, 2,1x10mm, 12pcs, dome head 13865 WS-02-N nickel 13866 WS-02-C chrome 13867 WS-02-B black 13868 WS-02-G gold</p>	 <p>screw, 3,5x25mm, 12pcs, oval countersunk 13877 WS-04-N nickel 13878 WS-04-C chrome 13879 WS-04-B black 13880 WS-04-G gold</p>
 <p>screw, 3,5x25mm, 12pcs, dome head 30957 WS-05-BC black chrome</p>	 <p>screw, 3,5x32mm, 12pcs, dome head, for tremolo mount on body 24880 WS-06-C chrome 24881 WS-06-B black</p>
 <p>screw, 3,8x25mm, 12pcs, flat countersunk 13889 WS-09-G gold</p>	 <p>screw, 2,4x10mm, 12pcs, flat countersunk, for HB pu ring short 24884 WS-10-G gold</p>
 <p>screw, 2,4x16mm, 12pcs, oval countersunk, for HB pu ring long 40999 WS-14-N nickel 24885 WS-14-C chrome 24886 WS-14-B black 24887 WS-14-G gold</p>	 <p>screw, 2,4x17mm, 12pcs, oval countersunk, for HB pu ring long 34540 WS-15-G gold</p>

1.5 parts
1.5.5 hardware

1.5.5.4 switch bolts



Boston

 <p>switch bolt, 3,0x 5mm, 12pcs, dome head, metric M3 8810 SS-18-N nickel 8811 SS-18-B black 8812 SS-18-G gold</p>	 <p>switch bolt, 3,4x12mm, 12pcs, dome head, 6-32 thread for USA lever switches 26124 SS-20-N nickel 31642 SS-20-B black 31643 SS-20-G gold</p>
---	--

1.5 parts
1.5.5 hardware

1.5.5.4 pickup screws

Boston

 <p>pickup bolt, 3x20mm, 12pcs, dome head, metric, also lever switch modern 39629 PS-18-N nickel</p>	 <p>pickup bolt, 2,4x26mm, 12pcs, dome head, for Boston humbuckers 26127 PS-17-N nickel 26128 PS-17-BK black 26129 PS-17-GD gold</p>
--	---

1.5.5.4 pickup screws



pickup bolt, 2,6x12mm, 12pcs, flat countersunk

22525 **PS-01-C** chrome
22526 **PS-01-GD** gold
22527 **PS-01-BK** black



pickup bolt, 2,6x30mm, 12pcs, dome head, for HB mount

13849 **PS-11-N** nickel
13850 **PS-11-B** black



pickup bolt, 3x20mm, 12pcs, flat countersunk, metric, also for lever switch vintage

24964 **PS-16-C** chrome



pickup bolt, 3x20mm, 12pcs, dome head, metric, also lever switch modern

24965 **PS-18-C** chrome



pickup bolt, nickel, 3,4x18mm, 12pcs

26125 **PS-20-N** oval countersunk
26126 **PS-22-N** dome head



pickup screw, 2,6x25mm, 12pcs, dome head, tapping

13846 **PS-10-N** nickel
13847 **PS-10-B** black



pickup screw, 2,6x35mm, 12pcs, dome head, tapping

13852 **PS-12-N** nickel
13853 **PS-12-B** black



pickup screw, 2,6x40mm, 12pcs, flat countersunk, tapping

13855 **PS-13-N** nickel
13857 **PS-13-G** gold



pickup screw, 3x20mm, 12pcs, dome head, tapping

13860 **PS-14-G** gold

1.5 parts
1.5.5 hardware

1.5.5.4 pickup screws



Genuine Replacement Part pickup/selector switch mounting screws, Philips roundhead, 12 pcs
43373 0994926000 gold
43399 0994925000 chrome



Genuine Replacement Part neck pickup mounting screws, vintage Tele, 3 x 1 slotted 12 pcs
36499 0018373049 nickel



Genuine Replacement Part pickup mounting screws, slotted machine, vintage '50s Tele, 6-32 x 5/8, round head, 12 pcs
36502 0018376049



Genuine Replacement Part pickup mounting screws, vintage basses, 4 x 1-1/4 philips, 12 pcs
36503 0027035049 nickel



Genuine Replacement Part pickup mounting screws, #3-48 x 13/16", 12 pcs
43378 0050166049



Genuine Replacement Part Jazzmaster/Telecaster pickup mounting screws, 12pcs
43379 0016295049 nickel

1.5 parts
1.5.5 hardware

1.5.5.4 springs



Genuine Replacement Part intonation springs, 12 pcs
36545 0019281049



Genuine Replacement Part intonation springs, American Deluxe guitars, tall 3/8, 12 pcs
36547 0019394049 black

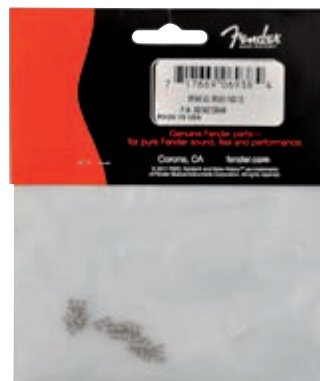

Genuine Replacement Part intonation springs, American Vintage Strat, 12 pcs
36548 0019273049 nickel



Genuine Replacement Part pickup mounting tubes, 12 pcs
36478 0994916000

1.5.5.5 strap buttons and strap locks

	<p>strap buttons, metal, with screw, v-model, diameter 13mm, 2-pack</p> <p>16685 EP-K-C chrome 16686 EP-K-G gold 16687 EP-K-B black 16684 EP-K-N nickel</p>		<p>strap buttons, metal, with screw, v-model, diameter 14mm, 2-pack</p> <p>6900 EP-F-N nickel 12627 EP-F-C chrome 6902 EP-F-G gold 6901 EP-F-B black</p>
	<p>strap buttons, metal, with screw, v-model, diameter 14mm, 2-pack</p> <p>16688 EP-L-N nickel 16689 EP-L-C chrome 16690 EP-L-G gold 16691 EP-L-B black</p>		<p>strap buttons, metal, with screw, spherical model, diameter 14mm, 2-pack</p> <p>16692 EP-R-N nickel 16693 EP-R-C chrome 16694 EP-R-G gold 16695 EP-R-B black</p>
	<p>strap buttons, metal, with screw, v-model, diameter 15mm, 2-pack</p> <p>16696 EP-S-N nickel 16697 EP-S-C chrome 16698 EP-S-G gold 16699 EP-S-B black</p>		<p>strap buttons, metal, with screw, spherical model, diameter 17mm, 2-pack</p> <p>8796 EP-HN-C chrome 8798 EP-HN-G gold 8797 EP-HN-B black</p>
	<p>strap buttons, metal, with screw, v-model, diameter 17mm, 2-pack</p> <p>16700 EP-PP-N nickel 16701 EP-PP-C chrome 16702 EP-PP-G gold 16703 EP-PP-B black</p>		<p>strap buttons, metal, with screw, spherical model, diameter 17mm, 2-pack</p> <p>16704 EP-RR-N nickel 16705 EP-RR-C chrome 16706 EP-RR-G gold 16707 EP-RR-B black</p>
	<p>Lock & Rock strap buttons, no screws, 6-pack</p> <p>25308 BEP-BUT-CH chrome 25309 BEP-BUT-BK black</p>		<p>straplock system, with screws</p> <p>33235 BSL-20-CH chrome 33236 BSL-20-BK black 33237 BSL-20-GD gold 33238 BSL-20-NI nickel 33427 BSL-20-BC black chrome</p>

1.5 parts
1.5.5 hardware

1.5.5.5 strap buttons and strap locks

Boston



Lock & Rock strap locks, 6-pack in box

- 24294 **BEP-10-CH** chrome
- 24295 **BEP-10-BK** black
- 24296 **BEP-10-GD** gold
- 25449 **BEP-10-BC** black chrome



- acoustic strap secure, made in the USA, brass**
- 43081 **ASSI-BR** inch threaded endpin jacks
 - 43082 **ASSM-BR** metric threaded endpin jacks



- felt ring for endpin, 12x3mm, 12-pack**
- 13643 **EP-FEW** black

1.5 parts
1.5.5 hardware

1.5.5.5 strap buttons and strap locks

Fender



Genuine Replacement Part strap buttons, 2 pcs

- 36462 **0063267049** chrome
- 36463 **0018916049** gold



strap buttons for strap locks, 2 pcs

- 36468 **0994914000** chrome



strap buttons, 2 pcs

- 36464 **0994915000** nickel



strap locks, 2 pcs

- 36467 **0990690000** chrome



strap locks, 2 pcs

- 43166 **0990818300** chrome
- 43167 **0990818301** black
- 43168 **0990818302** gold



Genuine Replacement Part strap button felt washers, 12 pcs

- 36465 **0994929000** black
- 36466 **0994930000** white

1.5 parts
1.5.5 hardware

1.5.5.5 strap buttons and strap locks

GOTOH[®]



Master Relic Collection strap buttons with screws, 2 pcs, aged aluminium

42733 **EP-A1** spherical model
42734 **EP-B2** v-model

1.5 parts
1.5.5 hardware

1.5.5.5 strap buttons and strap locks

Martin & Co.[®]
EST. 1833



Goto strap button with screw

44551 **13SBBPG** gold
44552 **G13SB0007** chrome

1.5 parts
1.5.5 hardware

1.5.5.5 strap buttons and strap locks

MARVEL



strap lock, screws included

25740 **MVS-501-CR** chrome
25741 **MVS-501-NI** nickel
25742 **MVS-501-BK** black
25743 **MVS-501-GD** gold

1.5 parts
1.5.5 hardware

1.5.5.5 strap buttons and strap locks

Schaller



S-locks strap locks

42510 **14010101** nickel
42511 **14010201** chrome
42512 **14010401** black
42513 **14010501** gold
42927 **14010301** satin chrome
42928 **14010601** ruthenium
42929 **14010701** satin pearl
42930 **14010801** vintage copper

1.5.5.6 string retainers and ferrules

 <p>string retainer, Stallion, with nylon spacer and screw 1125 SH-2-N nickel 6311 SH-2-B black 6312 SH-2-G gold</p>	 <p>string retainer, button model, with screw, diameter 10mm, height 5mm 32279 SH-3-N nickel 16840 SH-3-C chrome 16841 SH-3-G gold 16842 SH-3-B black</p>
 <p>string retainer, button model, with screw, diameter 10mm, height 5mm 6313 SH-4-B black 6314 SH-4-G gold</p>	 <p>string retainer, button model, with screw, diameter 10mm, height 7mm 16844 SH-5-G gold 16845 SH-5-B black</p>
 <p>string retainer for bass guitar, button model, with screw, 19mm, height 6,5mm 26551 SH-6-N nickel</p>	 <p>string retainer for bass guitar, button model, with screw, 19mm, height 7mm 32281 SH-15-N nickel 32282 SH-15-C chrome 32284 SH-15-G gold 32283 SH-15-B black</p>
 <p>string retainer for bass guitar, button model, with screw, 19mm, height 10mm 16847 SH-14-G gold</p>	 <p>string retainer for bass guitar, button model, with screw, 19mm, height 7mm 16850 SH-16-G gold</p>
 <p>string retainer, cilinder model, height 6.5mm, with spacer and screw 14131 SH-8-N nickel 14132 SH-8-C chrome 14133 SH-8-B black 14134 SH-8-G gold</p>	 <p>string retainer, cilinder model, height 9.0mm, with spacer and screw 14135 SH-10-N nickel 14136 SH-10-C chrome</p>
 <p>string retainer, bar model, for 6 strings, with screws 16852 SH-11-C chrome 16853 SH-11-G gold 16854 SH-11-B black</p>	 <p>string retainer, bar model, for 6 strings, with screws 14141 SH-12-G gold</p>
 <p>string retainer, bar model, for 6 strings, with screws 16855 SH-13-C chrome 16856 SH-13-G gold 16857 SH-13-B black</p>	 <p>string ferrules, Teaser, 9.5mm diameter x 10mm, 6-pack 12387 TB-20-N nickel</p>
 <p>string ferrules, Teaser, 8,3mm diameter x 9mm, 6-pack 14119 TB-10-N nickel 14120 TB-10-C chrome 14121 TB-10-B black 14122 TB-10-G gold</p>	 <p>string ferrules, for bass guitar, 9.6mm diameter x 11,5mm, 4-pack 14164 TB-30-N nickel 14165 TB-30-C chrome 14167 TB-30-B black</p>

1.5 parts
1.5.5 hardware

1.5.5.6 string retainers and ferrules

Boston



string ferrules, Teaser, 6,5mm diameter x 11mm, 6-pack

16858 **TB-05-N** nickel
16859 **TB-05-C** chrome
16860 **TB-05-G** gold
16861 **TB-05-B** black



string ferrules, Teaser, 8,2mm diameter x 9,5mm, 6-pack

16862 **TB-07-N** nickel
16863 **TB-07-C** chrome
16864 **TB-07-G** gold
16865 **TB-07-B** black

1.5 parts
1.5.5 hardware

1.5.5.6 string retainers and ferrules

Fender



Genuine Replacement Part string guides for American Standard, 2pcs

40494 **0994911000** chrome
40495 **0039475049** gold



Genuine Replacement Part string guide for American Standard

43389 **0021537010** black



Genuine Replacement Part string guide for Vintage Stratocaster

43388 **0018803049** gold
43390 **0994910000** chrome



Genuine Replacement Part string guide for Vintage Telecaster

40496 **0994912000** nickel



Genuine Replacement Part string ferrules American Standard Telecaster, 6pcs

43355 **0994917000** chrome



Genuine Replacement Part string ferrules Tele, 6pcs

36528 **0994918000** chrome
36529 **0018876049** gold



Genuine Replacement Part string ferrules bass, 4pcs

36530 **0048604049** chrome

1.5 parts
1.5.5 hardware

1.5.5.6 string retainers and ferrules



Master Relic Collection string ferrules,
6pcs
42732 TLB-1-AN aged nickel



Master Relic Collection string retainer,
Stallion, nickel spacer and screw, 2pcs
42736 RG105&RG130 aged nickel

1.5 parts
1.5.5 hardware

1.5.5.7 neck plates and neck ferrules



neck mounting plate, 64,2x51mm, rectangular
6093 NP-64-C chrome
31546 NP-64-N nickel
6095 NP-64-G gold
6094 NP-64-B black



neck plate cushion, 64,2x51mm, for NP-64
neck mounting plates
6865 NC-2 black



neck mounting plate, 64,5x51,4mm, for
contoured body heel
16989 NP-76-C chrome
16990 NP-76-G gold
16991 NP-76-B black



neck mounting plates, 50,5x15,1mm, 2 pcs
16992 NP-82-C chrome
16993 NP-82-G gold
16994 NP-82-B black



neck mounting ferrules, 13,0mm, 4 pcs
17009 W-760-C chrome
17010 W-760-G gold
17011 W-760-B black



neck mounting ferrules, 14,0mm, 4 pcs
17001 W-730-C chrome
17002 W-730-G gold
17012 W-730-B black



neck mounting ferrules, 14,0mm, 4 pcs
17003 W-740-C chrome
17004 W-740-G gold
17005 W-740-B black



neck mounting ferrules, 14,0mm, 4 pcs
17006 W-750-C chrome
17007 W-750-G gold
17008 W-750-B black



neck mounting ferrules, 15,0mm, 4 pcs
16995 W-710-C chrome
16996 W-710-G gold
16997 W-710-B black



neck mounting ferrules, 15,0mm, 4 pcs
16998 W-720-C chrome
16999 W-720-G gold
17000 W-720-B black

1.5 parts
1.5.5 hardware

1.5.5.7 neck plates and neck ferrules



Genuine Replacement Part neck plate
American Vintage/Mexico, for guitar and
bass, no logo
33938 0991447100 chrome
36164 0991447200 gold



Genuine Replacement Part neck plate American Vintage '70s for guitar and
bass, 'F-logo'
33939 0991448100 chrome



Genuine Replacement Part neck plate
American Vintage '70s, for guitar, 'F-logo',
3 bolt
33940 0054525049 chrome



Genuine Replacement Part neck plate Ame-
rican Series, Fender Corona logo, chrome
36162 0991445100 guitar
36163 0991446100 bass



Genuine Replacement Part neck plate
Deluxe Strat', 4 bolt
43400 0059209049 chrome



Genuine Replacement Part 3-bolt machine
neck bolt for guitar or bass, 1/4-28x1-9/16 N
43375 0012156049

1.5 parts
1.5.5 hardware

1.5.5.7 neck plates and neck ferrules



Master Relic Collection neck plate for guitar, including 4 screws
42730 NBS-3-AC aged chrome

1.5 parts
1.5.5 hardware

1.5.5.8 jack plates



Master Relic Series LP jack
plate
42767 MRC-LP59JC
cream relic











Master Relic Series TE-model
input cup, with retainer clip,
metal
42766 MRC-TLJCC
chrome relic

1.5 parts
1.5.5 hardware

1.5.5.8 jack plates

Boston

 <p>recessed jack plate, Stallion, metal 1122 JP-2-C chrome 31306 JP-2-N nickel 1123 JP-2-B black 7146 JP-2-MB black mat 6893 JP-2-G gold</p>	 <p>jack plate, football shape, slanted metal 6079 JP-3-C chrome 6080 JP-3-B black 13614 JP-3-G gold</p>
 <p>jack plate, square, plastic 34x34mm, flat 6429 JP-100-B black 6430 JP-100-W white 6431 JP-100-IV ivory</p>	 <p>jack plate, rectangular, recessed hole, slanted metal 6891 JP-1-C chrome 6892 JP-1-G gold 17022 JP-1-B black</p>
 <p>jack plate, square, flat metal 6911 JP-5-C chrome 6912 JP-5-B black 24149 JP-5-G gold</p>	 <p>jack plate, diamond shape, slanted metal 17016 JP-6-C chrome 17017 JP-6-G gold 17018 JP-6-B black</p>
 <p>jack plate, football shape, recessed hole, slanted metal 17019 JP-7-C chrome 17020 JP-7-G gold 17021 JP-7-B black</p>	 <p>TE-model input cup, with retainer clip, metal 6894 JP-4-C chrome 6895 JP-4-B black 6896 JP-4-G gold</p>
 <p>TE-model input cup, with angled screwholes, M9 thread, metal 31118 JP-8-C chrome 31119 JP-8-B black 31120 JP-8-G gold</p>	 <p>TE-model input cup, press-in model, inside diameter 9,6mm (3/8\" data-bbox="695 515 945 565"/></p>
 <p>TE-model input cup, with angled screwholes, 3/8\" data-bbox="235 595 490 680"/></p>	

1.5 parts
1.5.5 hardware

1.5.5.8 jack plates

Fender

 <p>Genuine Replacement Part Stratocaster® recessed jack ferrule plate 36158 0991940100 chrome 36159 0991940200 gold</p>	 <p>Genuine Replacement Part Stratocaster recessed jack ferrule plate 43381 0033023049 chrome</p>
---	--

1.5 parts
1.5.5 hardware
1.5.5.8 jack plates



Genuine Replacement Part Telecaster®
jack ferrule cup
36160 0991941000 chrome



Genuine Replacement Part recessed
football shaped jack plate
43382 0050100049 chrome

1.5 parts
1.5.5 hardware
1.5.5.8 jack plates



Master Relic Collection jack plate,
including screws
42731 JCS-1-AC aged chrome

1.5 parts
1.5.5 hardware
1.5.5.9 pickup mounting parts



humbucker frame, flat, 3x3mm
34818 HF3030BK black
34828 HF3030IV ivory



humbucker frame, flat, 5x5mm
34819 HF5050BK black
34829 HF5050IV ivory



humbucker frame, flat bottom slanted top, 3x5mm
34820 HFS3050BK black
34830 HFS3050IV ivory



humbucker frame, flat bottom slanted top, 5x7mm
34821 HFS5070BK black
34831 HFS5070IV ivory



humbucker frame, flat bottom slanted top, 7x9mm
34822 HFS7090BK black
34832 HFS7090IV ivory



**humbucker frame, flat bottom slanted top,
11x120mm**
34823 HFS110120BK black
34833 HFS110120IV ivory



humbucker frame, curved bottom slanted top, 3x5mm

34824 **HCS3050BK** black
34834 **HCS3050IV** ivory



humbucker frame, curved bottom slanted top, 5x7mm

34826 **HCS5070BK** black
34835 **HCS5070IV** ivory



humbucker frame, curved bottom slanted top, 7x9mm

34825 **HCS7090BK** black
34836 **HCS7090IV** ivory



humbucker frame, curved bottom slanted top, 10x11mm

34827 **HCS100110BK** black
34837 **HCS100110IV** ivory

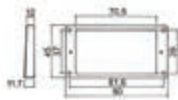

pickup ring, humbucker, flat, black, plastic

6103 **HPF-02-SBK** height: 4,5- 6,0mm, low
6104 **HPF-02-TBK** height: 10,0-11,7mm, high

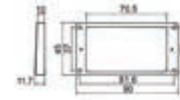

pickup ring, humbucker, flat, ivory, plastic

9408 **HPF-02-SCR** height: 4,5- 6,0mm, low
9409 **HPF-02-TCR** height: 10,0-11,7mm, high

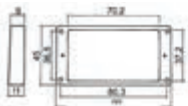

pickup ring, humbucker, flat, black, plastic

14106 **HPF-04-SBK** height: 4,2- 6,0mm, low
14107 **HPF-04-TBK** height: 9,0-11,0mm, high, flat

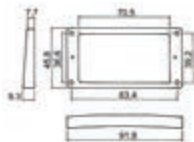

pickup ring, humbucker, plastic, black

34231 **HPF-08-TBK** height: 10,0-12,0mm, high, flat
6105 **HPR-08-SBK** height: 2,5x 5,2mm, low, slanted
6106 **HPR-08-TBK** height: 7,7x 9,3mm, high, slanted

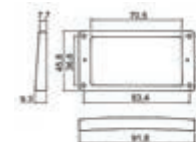

pickup ring, humbucker, plastic, ivory, slanted

6825 **HPR-08-SCR** height: 2,5x 5,2mm, low
6826 **HPR-08-TCR** height: 7,7x 9,3mm, high

1.5 parts
1.5.5 hardware

1.5.5.10 truss rods and truss rod parts

Boston



double action truss rod, 6x9mm bar model, 4mm allen nut

42251 **TRD-362-4** 440mm length, for G-style guitar
42245 **TRD-420-4** 460mm length, for electric/acoustic guitar
42250 **TRDG-440-7** 362mm length, for acoustic guitar
42246 **TRD-460-4** 420mm length, for classical guitar



double action truss rod, 6x9mm bar model, 4mm allen nut, for bass guitar

42247 **TRD-590-4** 590mm length
42248 **TRD-610-4** 610mm length
42249 **TRD-630-4** 630mm length



truss rod, bar model 6mm, 4mm allen nut, UNF-10-32 thread

27483 **TRO-425-K** 425mm.
17023 **TRO-460-K** 460mm.
17024 **TRO-600-K** 600mm.
17025 **TRO-630-K** 630mm.



truss rod, bar model 6mm, 7mm hexanut "G-style", UNF-10-32 thread

27484 **TRO-425-L** 425mm.
17026 **TRO-460-L** 460mm.
18320 **TRO-600-L** 600mm.



truss rod nut, allen nut, allen key size 4mm, UNF 10-32 thread

30283 **TRN-20**



truss rod nut, crosshead, vintage

24846 **TRN-25**



truss rod nut, hexagonal, brass, "G-style"

24847 **TRN-30**



truss rod nut, bullet style, allen key size 4mm

24848 **TRN-40**

1.5 parts
1.5.5 hardware

1.5.5.10 truss rods and truss rod parts

Fender



Genuine Replacement Part truss rod nut, 1/8"

36557 **0994945000** "Bullet" style
36558 **0994943000** American Series guitars



Genuine Replacement Part truss rod nut, 3/16", Mexico guitars/basses, 2pcs

36559 **0038454049**



Genuine Replacement Part truss rod nut, Vintage Series guitars

36561 **0994944000**

1.5 parts
1.5.5 hardware

1.5.5.10 truss rods and truss rod parts



2-way adjustable truss rod

44521	G13NR0009	14-fret
44522	G13NR0013	12-fret

1.5 parts
1.5.5 hardware

1.5.5.11 frets and fret wire



fretwire, 5 m., 18% nickel silver

14523	FW-1530068	h=1,5 w=3,0 g=0,6mm, alternative for 6000
30058	FW-1427058	h=1,4 w=2,7 g=0,5mm, alternative for 6100, jumbo
30059	FW-1424058	h=1,4 w=2,4 g=0,5mm, alternative for 6105, narrow jumbo
14524	FW-1329058	h=1,3 w=2,9 g=0,5mm, alternative for 6110, wide jumbo
14525	FW-1329068	h=1,3 w=2,9 g=0,6mm, alternative for 6120, wide jumbo large tan
14522	FW-0927058	h=0,9 w=2,7 g=0,5mm, alternative for 6130, med. jumbo, vintage L
14521	FW-1125068	h=1,1 w=2,5 g=0,6mm, alternative for 6170, modern ST and TE
14519	FW-1120058	h=1,1 w=2,0 g=0,5mm, alternative for 6200, vintage ST and TE



fretwire, 5 m., 12% nickel silver

14517	FW-0716062	h=0,7 w=1,6 g=0,6mm
14518	FW-1120052	h=1,1 w=2,0 g=0,5mm
14520	FW-0920062	h=0,9 w=2,0 g=0,6mm

1.5 parts
1.5.5 hardware

1.5.5.11 frets and fret wire



Genuine Replacement Part fret wire, Strat/Tele/other electrics, 24 pcs

36540	0991998000	standard size (medium jumbo)
36541	0992014000	vintage size
36542	0991999000	jumbo size



Genuine Replacement Part fret wire, Jazzbass/Precision Bass@/other basses, 24 pcs

36543	0991997000	standard size
36544	0992015000	vintage size

1.5 parts
1.5.5 hardware

1.5.5.12 locking/roller nuts

Boston



top nut, metal, roller nut

16876	TNM-5-CH	chrome
16877	TNM-5-GD	gold
16878	TNM-5-BK	black



toplock, top nut with string lock, Floyd Rose style, length: 4,26 cm

23584	LTN-2-CH	chrome
23585	LTN-2-BK	black
23586	LTN-2-GD	gold

1.5 parts
1.5.5 hardware

1.5.5.12 locking/roller nuts

Fender



Genuine Replacement Part LSR roller nut, shims, bezel adapter (for retrofitting to Wilkinson) and mounting screws

37516 0990812000

1.5 parts
1.5.5 hardware

1.5.5.13 miscellaneous hardware

Boston



thumb rest, for bass guitar

9330 TR-6-BK black

1.5 parts

1.5.5 hardware

1.5.5.13 miscellaneous hardware



Genuine Replacement Part thumb rest for Vintage Precision/Jazz Bass®

36426 0992036000 black

**nitrocellulose primer aerosol 500ml**

34898	NC-340-WH	white (for light finishes)
34899	NC-340-GY	grey (for dark finishes)
41846	NC-340-TP	transparent (for see-through finishes)

**nitrocellulose lacquer aerosol 500ml**

34439	NC-510-AM	tinted clear coat (neck amber)
41534	NC-510-SHY	sunburst heart yellow (perfect for sunburst)
38177	NC-510-TBR	tobacco brown (perfect for honeyburst)
41847	NC-510-SRT	sunburst red (perfect for 3 tone transition)
34438	NC-510-NT	clear coat high gloss (final layer)

**nitrocellulose lacquer aerosol 500ml**

34440	NC-520-BK	black
34897	NC-520-VW	vintage white
41530	NC-520-OWH	olympic white
41531	NC-520-FRD	old fiesta red
41843	NC-530-DBU	daphne blue
41532	NC-530-SBU	sonic blue
41844	NC-520-LPB	lake placid blue metallic
41845	NC-520-SGR	sherwood green metallic

**lacquer spray can nozzle, set of 5**

41897	NOZNC-M	standard spraying volume
41898	NOZNC-L	large spraying volume
41899	NOZNC-XL	extra large spraying volume

**freezer relic spray FREEZE 75, spray can**

41858	FRZ75-400	HFO gas, 400ml
41857	FRZ75-200	200ml

Cellulose Sanding Sealer cellulose paint, 400ml aerosol

43943	FS5109	Aged Olympic White
43944	FS5267	Arctic White
43945	FS5638	British Racing Green
43946	FS5327	Capri Orange
43947	FS5258	Dakota Red
43948	FS5387	Daphne Blue
43949	FS7167	Desert Tan
43950	FS5437	Fiesta Red
43951	FS5366	Graffiti Yellow
43952	FS7163	Horizon Blue
43953	FS5222	Jet Black
43954	FS5320	New Olympic White
43955	FS6221	Olive Drab Green
43956	FS5224	Seafoam Green
43957	FS6059	Shell Pink
43958	FS5424	Sky Blue
43959	FS5379	Sonic Blue
43960	FS6076	Surf Blue
43961	FS5383	Surf Green
43962	FS7159	Surf Orange
43963	FS7255	Torino Red
43964	FS5367	Tv Yellow
43965	FS5269	Union Blue
43966	FS5268	Union Red
43967	FS5390	Vintage Cream
43968	FS5007	Clear
43969	FS5251	Grey
43970	FS5008	White

Metallic Cellulose Paint, 400ml aerosol

43971	FS5981	Aztec Gold
43972	FS5395	Burgundy Mist
43973	FS5391	Charcoal Frost
43974	FS7262	Copper
43975	FS5907	Dark Cola
43976	FS6345	Daytona Blue
43977	FS7238	Ice Blue
43978	FS5431	Inca Silver
43979	RF1628	Kingfisher Blue
43980	FS5228	Lake Placid Blue
43981	FS7171	Midnight Wine
43982	FS5659	Modern Gold Top
43983	FS5404	Ocean Turquoise
43984	FS5257	Pelham Dark Blue
43985	FS6976	Pelham Light Blue
43986	FS7194	Royal Purple
43987	FS6552	Sherwood Green
43988	FS5723	Shoreline Gold
43989	FS5264	Vintage Gold Top

Nitrocellulose Lacquer, 400ml aerosol

43990	FS5074	Amber
43991	FS5115	British Racing Green
43992	FS5073	Dark Brown
43993	FS5282	Dark Cobalt Blue
43994	RF0803	Dark Oak
43995	FS5075	Dark Orange
43996	FS6210	Dark Rich Mahogany
43997	FS5043	Dark Yellow
43998	FS5403	Emerald Green
43999	FS5000	Gloss Clear
44000	FS5134	Heritage Cherry Red
44001	FS5116	Light Blue
44002	FS5012	Light Brown
44003	FS5325	Light Orange
44004	FS5042	Light Red
44005	FS5227	Light Yellow
44006	FS6563	Lightest Brown
44007	FS6206	Lime Green
44008	FS5293	Matt Clear
44009	FS5232	Purple
44010	FS5001	Satin Clear
44011	FS6102	Strong Amber
44012	FS7979	Teal Green
44013	FS5044	Tint Black
44014	FS5727	Tinted Walnut
44015	FS5323	Tomato Red
44016	FS5457	Weak Amber
44017	FS6202	Weakest Amber
44018	FS5372	Wine Red

Nitrocellulose Neck Lacquer, 400ml aerosol

44019	FS7094	Amber
44020	FS7100	Clear
44021	FS7253	Dark Tobacco
44022	FS7141	Honey
44023	FS7097	Tobacco

Pigmented Nitrocellulose Lacquer, 400ml aerosol

44024	FS5046	Blonde White
44025	RF0855	Olive Green
44026	FS5291	Oxblood
44027	RF0859	Paisley Pink
44028	FS5423	Pale Yellow
44029	FS5326	Smoky Cherry Red
44030	FS5265	Solid Walnut
44031	FS5045	Strong Black
44032	FS5061	Strong Cherry Red
44033	FS7022	Super Trans Blonde White
44034	FS6214	Toffee Butterscotch
44035	FS5446	Toffee Light Butterscotch
44036	FS5419	Turquoise
44037	FS5058	Vintage Butterscotch

Nitrocellulose Lacquer Gloss Clear - 1000ml can

44053	FS5113	
-------	---------------	--

1.5 parts
1.5.7 knobs

1.5.7.1 speed knobs



Boston

 <p>speed knob (hatbox), transparent 1134 KG-110 gold 1135 KB-110 black 1136 KW-110 white 13711 KA-110 amber</p>	 <p>speed knob (hatbox), for inch type pot shaft, transparent 13713 KG-114 gold 13714 KB-114 black 13715 KW-114 white 13716 KA-114 amber</p>
 <p>speed knob (hatbox), inch size for USA pots, relic 42777 KB-110I-R black 42778 KG-110I-R gold</p>	 <p>speed knob (notched edge), transparent 33036 KG-112 gold 33037 KB-112 black</p>
 <p>speed knob (notched edge), for inch type pot shaft, transparent 33039 KG-116 gold 33040 KB-116 black</p>	

1.5 parts
1.5.7 knobs

1.5.7.2 bell knobs

Boston

 <p>Master Relic Series bell knob Stallion set VTT 42753 MRC-ST50KN white relic 42754 MRC-ST60KN parchment relic</p>	 <p>bell knob, Stallion, white, fits both 24 fine (CTS) and 18 coarse knurl (Alpha), m.i. Japan 35407 KW-1726-V volume 35408 KW-1726-T tone</p>
 <p>bell knob, Stallion, black, fits both 24 fine (CTS) and 18 coarse knurl (Alpha), m.i. Japan 35409 KB-1726-V volume 35410 KB-1726-T tone</p>	 <p>bell knob, Stallion, ivory, fits both 24 fine (CTS) and 18 coarse knurl (Alpha), m.i. Japan 35417 KI-1726-V volume 35418 KI-1726-T tone</p>
 <p>bell knob, Stallion, white 1137 KW-240-T tone 1138 KW-240-V volume</p>	 <p>bell knob, Stallion, for inch type pot shaft, white 13712 KW-244-T tone 13736 KW-244-V volume</p>
 <p>bell knob, Stallion, black 1139 KB-240-T tone 1140 KB-240-V volume</p>	 <p>bell knob, Stallion, for inch type pot shaft, black 13737 KB-244-T tone 13738 KB-244-V volume</p>
 <p>bell knob, Stallion, ivory 6294 KI-240-T tone 6295 KI-240-V volume</p>	 <p>bell knob, Stallion, mint 13717 KC-240-TG tone 13718 KC-240-VG volume</p>





1.5.7.2 bell knobs

 <p>bell knob, Stallion, for inch type pot shaft, mint 25902 KC-244-TG tone 25903 KC-244-VG volume</p>	 <p>bell knob, Stallion, mint 13719 KC-240-TB tone 13720 KC-240-VB volume</p>
 <p>bell knob, wood, Stallion, 25x13mm 30911 KWM-310 maple 30919 KWZ-310 zebra</p>	 <p>bell knob, wood, Stallion, with pointer, 25x14mm 30920 KWB-320 bubingga 30921 KWE-320 ebony 30922 KWM-320 maple</p>
 <p>bell knob, transparant 1141 KG-160 gold 1143 KB-160 black 1142 KW-160 white 24444 KA-160 amber</p>	 <p>bell knob, lefty, transparent 34800 KG-160L gold 34798 KB-160L black 34799 KA-160L amber</p>
 <p>witch hat knob, with gold cap, black 6290 KG-260-T tone 6291 KG-260-V volume</p>	 <p>witch hat knob, with chrome cap, black 6292 KS-260-T tone 6293 KS-260-V volume</p>
 <p>bell knob, wood, hat model, 25x19mm 30929 KWZ-340 zebra 30930 KWM-340 maple 30931 KWB-340 bubingga</p>	 <p>bell knob SG model, black with chrome cap 14495 KB-130-T tone 14496 KB-130-V volume</p>
 <p>bell knob SG model, for inch type pot shaft, black with chrome cap 14501 KB-134-T tone 14502 KB-134-V volume</p>	 <p>bell knob SG model, black with gold cap 38705 KB-132-T tone 38706 KB-132-V volume</p>
 <p>bell knob SG model, for inch type pot shaft, black with gold cap 38707 KB-136-T tone 38708 KB-136-V volume</p>	 <p>bell knob SG model, gold with gold cap 14497 KG-130-T tone 14498 KG-130-V volume</p>
 <p>bell knob SG model, for inch type pot shaft, gold with gold cap 14503 KG-134-T tone 14504 KG-134-V volume</p>	 <p>bell knob SG model, lefty, gold with gold cap 34795 KG-130L-T tone 34796 KG-130L-V volume</p>
 <p>bell knob, LP, embossed numbers, inch size for USA pots, relic 42775 KB-160I-R black 42776 KG-160I-R gold</p>	 <p>hat knob LP/SG style, gold with silver cap, relic, Volume 42771 KG-130-VSR metric size for import/ Japan pots 42772 KG-130-VSIR inch size for USA pots</p>

1.5 parts
1.5.7 knobs

1.5.7.2 bell knobs

Boston

	<p>hat knob LP/SG style, gold with silver cap, relic, Tone</p> <p>42773 KG-130-TSR metric size for import/ Japan pots</p> <p>42774 KG-130-TSIR inch size for USA pots</p>		<p>bell knob with pearloid inlay</p> <p>41790 KN-261 nickel</p> <p>41791 KCH-261 chrome</p> <p>41792 KB-261 black</p> <p>41793 KBN-261 black nickel</p> <p>41794 KG-261 gold</p>
	<p>bell knob with abalone inlay</p> <p>41795 KN-262 nickel</p> <p>41796 KCH-262 chrome</p> <p>41797 KB-262 black</p> <p>41798 KBN-262 black nickel</p> <p>41799 KG-262 gold</p>		<p>bell knob with black pearl inlay</p> <p>41800 KN-263 nickel</p> <p>41801 KCH-263 chrome</p> <p>41802 KB-263 black</p> <p>41803 KBN-263 black nickel</p> <p>41804 KG-263 gold</p>
	<p>mini bell knob, black & grey</p> <p>34804 KB-148-T tone</p> <p>34805 KB-148-V volume</p>		

1.5 parts
1.5.7 knobs

1.5.7.2 bell knobs

Fender

	<p>Genuine Replacement Part strat knobs for CTS shaft size, 1V + 2T</p> <p>33901 0992035000 white</p> <p>33902 0991365000 black</p> <p>33903 0991369000 aged</p>		<p>Original Replacement Part strat knobs for CTS shaft size, 1V + 2T</p> <p>34888 0056254049 parchment</p>
	<p>Genuine Replacement Part volume and tone knob set for '72 Tele Custom</p> <p>36416 0054521049 black</p>		<p>Genuine Replacement Part 1965 Jazzmaster Witch Hat knobs, 2pcs</p> <p>43371 0992086000 vintage white</p>

1.5 parts
1.5.7 knobs

1.5.7.3 dome knobs











Boston

	<p>dome knob, metal, diam 19,0mmx19,0mm, with set screw, shaft size 6,1mm, fits CTS</p> <p>16708 KCH-205 chrome</p> <p>16709 KB-205 black</p> <p>16710 KG-205 gold</p>		<p>dome knob, metal, diam 19,0mmx19,0mm, with set screw, shaft size 6,1mm</p> <p>16711 KCH-210 chrome</p> <p>16712 KB-210 black</p> <p>16713 KG-210 gold</p>
	<p>dome knob, metal, diam 18,0mmx18,5mm, with set screw, shaft size 6,1mm</p> <p>16717 KCH-220 chrome</p> <p>16718 KB-220 black</p> <p>16719 KG-220 gold</p>		<p>dome knob, metal, diam 15,0mmx15,0mm, with set screw allen type, shaft size 6,1mm</p> <p>16720 KCH-225 chrome</p> <p>16721 KB-225 black</p> <p>16722 KG-225 gold</p>

1.5 parts
1.5.7 knobs

1.5.7.3 dome knobs

Boston

	<p>dome knob, metal, diam 19,0mmx19,0mm, push on, shaft size 6,0mm</p> <p>16723 KCH-230 chrome</p> <p>16724 KB-230 black</p> <p>16725 KG-230 gold</p>		<p>dome knob, metal, diam 19,0mmx19,0mm, push on, shaft size 6,0mm</p> <p>16726 KCH-235 chrome</p> <p>16727 KB-235 black</p> <p>16728 KG-235 gold</p>
	<p>double dome knob, metal, 14x11 + 19x10mm, with set screws allen type, shaft size 6,0 + 6,1</p> <p>16735 KCH-270 chrome</p> <p>16736 KB-270 black</p> <p>16737 KG-270 gold</p>		<p>double dome knob, metal, 15x14 + 19x12mm, with set screws allen type, shaft size 6,0 + 6,1</p> <p>25386 KCH-280 chrome</p> <p>25387 KB-280 black</p> <p>25388 KG-280 gold</p>
	<p>dome knob, wood, 2 rings, 19x18mm</p> <p>30935 KWM-350 maple</p> <p>30934 KWZ-350 zebra</p> <p>30936 KWB-350 bubingga</p> <p>30938 KWE-350 ebony</p>		<p>dome knob, wood, 2 rings, 15x18mm</p> <p>30939 KWW-360 walnut</p> <p>30940 KWM-360 maple</p> <p>30942 KWE-360 ebony</p>
	<p>dome knob, wood, 18x18mm</p> <p>30943 KWW-370 walnut</p> <p>30944 KWM-370 maple</p>		<p>dome knob with pearloid inlay, 18x18mm with set screw</p> <p>41805 KN-236 nickel</p> <p>41806 KCH-236 chrome</p> <p>41807 KB-236 black</p> <p>41808 KBN-236 black nickel</p> <p>41809 KG-236 gold</p>
	<p>dome knob with abalone inlay, 18x18mm with set screw</p> <p>41810 KN-237 nickel</p> <p>41811 KCH-237 chrome</p> <p>41812 KB-237 black</p> <p>41813 KBN-237 black nickel</p> <p>41814 KG-237 gold</p>		<p>dome knob with black pearl inlay, 18x18mm with set screw</p> <p>41815 KN-239 nickel</p> <p>41816 KCH-239 chrome</p> <p>41817 KB-239 black</p> <p>41818 KBN-239 black nickel</p> <p>41819 KG-239 gold</p>

1.5 parts
1.5.7 knobs

1.5.7.3 dome knobs

Fender

	<p>Genuine Replacement Part tele/pbass knobs for CTS shaft size, 2pcs</p> <p>33904 0991366000 chrome</p>		<p>Genuine Replacement Part tele vintage knobs for CTS shaft size, 2pcs domes</p> <p>33905 0992056000 chrome</p>
	<p>Genuine Replacement Part knob vintage dome style for Tele, 2pcs</p> <p>36413 0992056200 gold</p>		<p>Genuine Replacement Part knob set for Jaguar/Mustang Bass, large, 2 pcs</p> <p>39609 0019455049 black</p>

1.5 parts
1.5.7 knobs

1.5.7.3 dome knobs



Genuine Replacement Part knob for '62 Jazz Bass®, chrome

36420 0019502049 upper knob
36421 0019503049 lower knob



Genuine Replacement Part lower knob for Deluxe Jazz Bass®

36423 0049412049 black



Genuine Replacement Part lower knob for Deluxe Precision Bass®

36425 0049457049 chrome



Genuine Replacement Part knob kit '60s Jazz Bass, 3pcs

43370 0992085000 black

1.5 parts
1.5.7 knobs

1.5.7.3 dome knobs



Master Relic Collection round dome knob

42735 VK1-19 aged chrome

1.5 parts
1.5.7 knobs

1.5.7.4 switch caps and knobs



Master Relic Series switch tip and arm knob set

42755 MRC-STAS parchment relic



Master Relic Series switch cap Stallion, metric size, 3,5mm, fits import switch

42764 LW-390/RE white Relic



Master Relic Series switch cap Stallion, inch size, 4,8mm, fits USA switch,

42765 LW-390IN/RE white Relic



switch cap Stallion, fits CRL 4,8mm blade

14381 LW-390-IN white
14382 LC-390-IN california
14380 LI-390-IN ivory
14379 LB-390-IN black



switch cap Teaser barrel model, fits CRL 4,8mm blade

14387 LB-360-IN black



switch cap Stallion, fits 3,5mm blade

6268 LW-390 white
13734 LC-390 california
6330 LI-390 ivory
1450 LB-390 black



switch cap Teaser hihat model, fits 3,5mm blade

6269 LB-330 black
6270 LW-330 white
34785 LI-330 ivory



switch cap Teaser barrel model, fits 3,5mm blade

14377 LB-360 black
14378 LW-360 white
34786 LI-360 ivory

1.5 parts
1.5.7 knobs

1.5.7.4 switch caps and knobs

Boston

	switch cap LP-style, inch, fits Switchcraft				switch cap LP-style, metric		
	14385	TI-340-IN	ivory		6331	TI-340	ivory
	14383	TB-340-IN	black		1451	TB-340	black
	14386	TA-340-IN	amber		13735	TA-340	amber
	14384	TW-340-IN	white		1452	TW-340	white
	33042	TCH-340-IN	chrome plated		14526	TCH-340	brass, chrome
33043	TBS-340-IN	gold plated	1449	TBS-340	gold plated		

	switch cap LP-style, metric small M3		
	34787	TI-350	ivory
	34788	TB-350	black
	34789	TO-350	orange
	34790	TW-350	white

1.5 parts
1.5.7 knobs

1.5.7.4 switch caps and knobs

Fender

		
Genuine Replacement Part switch tips Tele, barrel model, 2 pcs 36473 0994936000 black	Genuine Replacement Part switch tips Tele, 'top hat' model, 2 pcs 36474 0994937000 black	Genuine Replacement Part switch tips Strat, 2 pcs 36475 0994940000 white 36476 0994938000 parchment 36477 0994939000 black

1.5 parts
1.5.7 knobs

1.5.7.5 miscellaneous knobs

Boston

	knob, Jocker bass, black 1145 KB-140-L large 1146 KB-140-S small		knob, Jocker bass, black, with set screw 26137 KB-145-L large 26138 KB-145-S small
	beveled top knob 34801 KB-146 with white indicator		pointer knob, chicken head model 1148 KB-150 black
	tea cup knob, Hofner violin bass 1963 model with set screw allen type 31768 KGI-160 gold and ivory		

1.5 parts
1.5.7 knobs

1.5.7.5 miscellaneous knobs



Genuine Replacement Part j bass/mustang knobs for CTS shaft size, 2+1
33906 0091370000 black



Genuine Replacement Part rotary wheel
Preset Control 1"x.25 with allen bolt, for
Jazzmaster/Jaguar
36418 0054455049 black





Genuine Replacement Part 1952 Telecaster knurled
knobs, 2 pcs
43367 0094040049 chrome



Genuine Replacement Part 1958 Telecaster knurled
knobs, 2 pcs
43368 0094057049 chrome









Genuine Replacement Part 60's Telecaster knurled
knobs, 2 pcs
43369 0095799049 chrome

 <p>top nut, bone 5557 BN-4 53x10x6x4,5mm. 5558 BN-5 53x10x5mm. 5559 BN-6 43x8x6mm. 5561 BN-8 43x5,7x3,5mm</p>	 <p>top nut, bone, extra large 13652 BN-13 55x10x7mm</p>
 <p>top nut, bone, shaped 5560 BN-7 43x8x6mm. 13647 BN-7A 46(43,5)x9x6mm.</p>	 <p>top nut for electric guitar, Stallion model, bone, shaped 5562 BN-9 44x6x3,2mm. 13644 BN-9A 42,5x6,5x3,1mm.</p>
 <p>top nut for electric guitar, for LP-model, bone, shaped 13645 BN-11 43,5x8,5x5mm</p>	 <p>top nut for arched top guitar, bone 5563 BN-10 43x5,7x3,5mm</p>
 <p>top nut for bass guitar, Puncher bass model, bone, shaped 13646 BN-12 42x9x5mm</p>	 <p>top nut assortment kit, plastic, 126-pack 20728 ASK-010</p>
 <p>top nuts for classic guitar, plastic, 12-pack 7867 900-C 52x6x10mm</p>	
 <p>top nuts for steel string concert guitar, plastic, 12-pack 7868 900-CS 47x6x8mm</p>	
 <p>top nuts for acoustic guitar, plastic, 12-pack, folk-western 7869 900-FW 42x6x8mm</p>	 <p>top nuts, plastic, 12-pack, folk-western 18873 900-W</p>
 <p>top nuts for electric guitar, plastic, 12-pack 7870 900-E 41,5x6x7mm</p>	 <p>top nuts for electric guitar, Stallion model, plastic, shaped, 12-pack 13721 900-STU 51x6mm. 13722 900-STF 41,5x6mm, slotted</p>
 <p>top nuts for electric guitar, LP-model, plastic, shaped, 12-pack 18874 900-LP</p>	 <p>top nuts for bass guitar, plastic, 12-pack 7871 900-B 42,5x6x8,5mm</p>

1.5 parts
1.5.8 nuts and saddles
1.5.8.1 nuts

Boston

 <p>top nuts for 12-string guitar, plastic, 6-pack 7872 900-12 48x6x8mm</p>	<p>top nut, carbon</p> <table border="0"> <tr><td>7875</td><td>NTC-1</td><td>51,5x4,5x3,5mm</td></tr> <tr><td>7876</td><td>NTC-2</td><td>44,5x5,2x3,5mm</td></tr> <tr><td>7877</td><td>NTC-3</td><td>41,5x6,2x3,5mm</td></tr> <tr><td>7878</td><td>NTC-4</td><td>44x8x6mm</td></tr> <tr><td>7879</td><td>NTC-5</td><td>41,5x5,2x3,5mm</td></tr> <tr><td>7880</td><td>NTC-6</td><td>52x8,5x5mm</td></tr> <tr><td>7881</td><td>NTC-7</td><td>43x8,8x6,3mm</td></tr> <tr><td>7882</td><td>NTC-8</td><td>43x8x5mm</td></tr> <tr><td>7883</td><td>NTC-9</td><td>41,5x8,2x5mm</td></tr> <tr><td>7884</td><td>NTC-10</td><td>40x8x4mm</td></tr> <tr><td>7885</td><td>NTC-11</td><td>43,5x7,3x5.3mm</td></tr> <tr><td>7886</td><td>NTC-12</td><td>43x8x4,3mm</td></tr> <tr><td>7887</td><td>NTC-13</td><td>43x8,5x6,2mm</td></tr> <tr><td>7888</td><td>NTC-14</td><td>41,5x9 x5mm</td></tr> <tr><td>7889</td><td>NTC-15</td><td>43,5x7,5x5mm</td></tr> </table>	7875	NTC-1	51,5x4,5x3,5mm	7876	NTC-2	44,5x5,2x3,5mm	7877	NTC-3	41,5x6,2x3,5mm	7878	NTC-4	44x8x6mm	7879	NTC-5	41,5x5,2x3,5mm	7880	NTC-6	52x8,5x5mm	7881	NTC-7	43x8,8x6,3mm	7882	NTC-8	43x8x5mm	7883	NTC-9	41,5x8,2x5mm	7884	NTC-10	40x8x4mm	7885	NTC-11	43,5x7,3x5.3mm	7886	NTC-12	43x8x4,3mm	7887	NTC-13	43x8,5x6,2mm	7888	NTC-14	41,5x9 x5mm	7889	NTC-15	43,5x7,5x5mm
7875	NTC-1	51,5x4,5x3,5mm																																												
7876	NTC-2	44,5x5,2x3,5mm																																												
7877	NTC-3	41,5x6,2x3,5mm																																												
7878	NTC-4	44x8x6mm																																												
7879	NTC-5	41,5x5,2x3,5mm																																												
7880	NTC-6	52x8,5x5mm																																												
7881	NTC-7	43x8,8x6,3mm																																												
7882	NTC-8	43x8x5mm																																												
7883	NTC-9	41,5x8,2x5mm																																												
7884	NTC-10	40x8x4mm																																												
7885	NTC-11	43,5x7,3x5.3mm																																												
7886	NTC-12	43x8x4,3mm																																												
7887	NTC-13	43x8,5x6,2mm																																												
7888	NTC-14	41,5x9 x5mm																																												
7889	NTC-15	43,5x7,5x5mm																																												
 <p>top nuts for mandolin, plastic, 6-pack 7873 900-M 31x4x7mm</p>																																														
 <p>top nuts for banjo, plastic, 6-pack 7874 900-BJ 30x5x8,5mm</p>																																														
 <p>top nut, carbon, blank 22153 NTC-19 41,5-3,1-6,5</p>	 <p>top nut, graphite, shaped 22156 GRTN-425 42,5-6,5-3,1</p>																																													
 <p>metal nut raiser, to convert from standard to slide guitar 42746 NR-01</p>																																														



1.5 parts
1.5.8 nuts and saddles
1.5.8.1 nuts

Fender

	<p>Genuine Replacement Part fingerboard nut</p> <table border="0"> <tr><td>37517</td><td>0038487049</td><td>5-string Precision/Jazz Bass, blank</td></tr> <tr><td>37518</td><td>0048649049</td><td>Jazz Bass, precut, 2 pieces</td></tr> <tr><td>37519</td><td>0994920000</td><td>most USA/Mexico guitars, blank, 2 pieces</td></tr> <tr><td>37520</td><td>0994921000</td><td>Precision Bass, precut</td></tr> <tr><td>37521</td><td>0048650000</td><td>American Deluxe Precision Bass</td></tr> <tr><td>37522</td><td>0073916049</td><td>Malmsteen Strat, brass</td></tr> </table>	37517	0038487049	5-string Precision/Jazz Bass, blank	37518	0048649049	Jazz Bass, precut, 2 pieces	37519	0994920000	most USA/Mexico guitars, blank, 2 pieces	37520	0994921000	Precision Bass, precut	37521	0048650000	American Deluxe Precision Bass	37522	0073916049	Malmsteen Strat, brass
37517	0038487049	5-string Precision/Jazz Bass, blank																	
37518	0048649049	Jazz Bass, precut, 2 pieces																	
37519	0994920000	most USA/Mexico guitars, blank, 2 pieces																	
37520	0994921000	Precision Bass, precut																	
37521	0048650000	American Deluxe Precision Bass																	
37522	0073916049	Malmsteen Strat, brass																	

1.5 parts
1.5.8 nuts and saddles
1.5.8.1 nuts

graph tech
SUNAM LABS
We're changing the way you play!

 <p>NuBone master luthier kit: 9 type nuts + 3 type saddles 42591 MC-1000-00 50 pcs</p>	 <p>NuBone 10-pack electric guitar nuts (Fender)</p> <table border="0"> <tr><td>42592</td><td>LC-5000-10</td><td>flat & curved bottom, slotted</td></tr> <tr><td>42593</td><td>LC-5010-10</td><td>flat bottom, slotted</td></tr> <tr><td>42594</td><td>LC-1000-10</td><td>curved bottom, blank</td></tr> </table>	42592	LC-5000-10	flat & curved bottom, slotted	42593	LC-5010-10	flat bottom, slotted	42594	LC-1000-10	curved bottom, blank
42592	LC-5000-10	flat & curved bottom, slotted								
42593	LC-5010-10	flat bottom, slotted								
42594	LC-1000-10	curved bottom, blank								

1.5 parts
1.5.8 nuts and saddles
1.5.8.1 nuts



NuBone 10-pack electric/acoustic guitar nuts, slotted
42596 LC-6060-10 Epiphone



NuBone 10-pack acoustic/electric guitar nuts, slotted
42595 LC-6010-10 Gibson



NuBone 10-pack electric bass nuts, curved bottom, slotted
42597 LC-1214-10 Fender Jazz Bass
42598 LC-1204-10 Fender Precision Bass



NuBone 10-pack electric bass nuts, curved bottom, slotted
42597 LC-1214-10 Fender Jazz Bass
42598 LC-1204-10 Fender Precision Bass



NuBone 10-pack acoustic guitar nuts, angled bottom, slotted
42599 LC-M644-10 Martin



NuBone 10-pack acoustic guitar nuts, angled bottom, slotted
42600 LC-M600-10 Martin



NuBone 10-pack acoustic guitar nuts
42601 LC-6116-10 slotted



NuBone 10-pack acoustic guitar nuts
42602 LC-6134-10 slotted



NuBone 10-pack 12-string acoustic guitar nuts
42603 LC-1568-10 slotted



NuBone 10-pack 12-string acoustic guitar nuts
42604 LC-1578-10 slotted



NuBone 10-pack classical guitar nuts
42605 LC-6200-10 slotted



NuBone 10-pack blank nuts 44.45 x 3.17 x 6.20mm
42606 LC-2200-10



NuBone 10-pack blank nuts 48.39 x 4.88 x 9.52mm
42607 LC-4000-10



TUSQ electric guitar nut (Fender)
42613 PQ-5000-00 flat & curved bottom, slotted
42615 PQ-5010-00 flat bottom, slotted
42617 PQ-1000-00 curved d bottom, blank



TUSQ 10-pack electric guitar nuts, flat & curved bottom, slotted
42614 LQ-5000-10 Fender

1.5 parts
1.5.8 nuts and saddles
1.5.8.1 nuts

 <p>TUSQ 10-pack electric guitar nuts, flat bottom, slotted 42616 LQ-5010-10 Fender</p>	 <p>TUSQ 10-pack electric guitar nuts, curved bottom, blank 42618 LQ-1000-10 Fender</p>
 <p>TUSQ acoustic/electric guitar nut, slotted 42619 PQ-6010-00 Gibson</p>	 <p>TUSQ 10-pack acoustic/electric guitar nuts, slotted 42620 LQ-6010-10 Gibson</p>
 <p>TUSQ electric/acoustic guitar nut, slotted 42621 PQ-6060-00 Epiphone 42623 PQ-6060-L0 Epiphone, lefthanded</p>	 <p>TUSQ 10-pack electric/acoustic guitar nuts, slotted 42622 LQ-6060-10 Epiphone</p>
 <p>TUSQ electric bass nut, curved bottom, slotted 42624 PQ-1214-00 Fender Jazz Bass</p>	 <p>TUSQ 10-pack electric bass nuts, curved bottom, slotted 42625 LQ-1214-10 Fender Jazz Bass 42627 LQ-1204-10 Fender Precision Bass</p>
 <p>TUSQ electric bass nut, curved bottom, slotted 42626 PQ-1204-00 Fender Precision Bass</p>	 <p>TUSQ acoustic guitar nut, angled bottom, slotted 42628 PQ-M644-00 Martin</p>
 <p>TUSQ 10-pack acoustic guitar nuts, angled bottom, slotted 42629 LQ-M644-10 Martin</p>	 <p>TUSQ acoustic guitar nut, angled bottom, slotted 42630 PQ-M600-00 Martin</p>

1.5 parts
1.5.8 nuts and saddles
1.5.8.1 nuts



TUSQ 10-pack acoustic guitar nuts, angled bottom, slotted
42631 LQ-M600-10 Martin



TUSQ acoustic guitar nut, angled bottom, slotted, lefthanded
42632 PQ-M600-L0 Martin



TUSQ blank nut, angled bottom
42633 PQ-M100-00 Martin



TUSQ 10-pack blank nuts, angled bottom
42634 LQ-M100-10 Martin



TUSQ acoustic guitar nut, slotted
42635 PQ-6116-00
42637 PQ-6116-L0 lefthanded



TUSQ 10-pack acoustic guitar nuts, slotted
42636 LQ-6116-10



TUSQ acoustic guitar nut, slotted
42638 PQ-6134-00
42640 PQ-6134-L0 lefthanded



TUSQ 10-pack acoustic guitar nuts, slotted
42639 LQ-6134-10



TUSQ acoustic guitar nut, slotted
42641 PQ-1720-00 Fender Guild



TUSQ 10-pack acoustic guitar nuts, slotted
42642 LQ-1720-10 Fender Guild





TUSQ acoustic guitar nut, slotted
42643 PQ-1728-00
42644 PQ-1728-L0 lefthanded



TUSQ acoustic guitar nut, slotted
42645 PQ-1801-00

1.5 parts
1.5.8 nuts and saddles
1.5.8.1 nuts



 <p>TUSQ 12-string acoustic guitar nut, slotted 42646 PQ-1568-00</p>	 <p>TUSQ 12-string acoustic guitar nut, slotted 42647 PQ-1578-00</p>
 <p>TUSQ 10-pack 12-string acoustic guitar nuts, slotted 42648 LQ-1578-10</p>	 <p>TUSQ 12-string acoustic guitar nut, slotted 42649 PQ-1500-00 42650 PQ-1500-LO lefthanded</p>
 <p>TUSQ classical guitar nut, slotted 42651 PQ-6250-00 Yamaha</p>	 <p>TUSQ classical guitar nut, slotted 42652 PQ-6200-00 42654 PQ-6200-LO lefthanded</p>
 <p>TUSQ 10-pack classical guitar nuts, slotted 42653 LQ-6200-10</p>	 <p>TUSQ blank nut 42655 PQ-2200-00 44.45 x 3.17 x 6.20mm 42657 PQ-4000-00 48.39 x 4.88 x 9.52mm 42659 PQ-3000-00 43.21 x 4.65 x 8.43mm 42661 PQ-4025-00 63.50 x 6.35 x 11.10mm 42663 PQ-4125-00 63.50 x 3.17 x 8,1mm</p>
 <p>TUSQ 10-pack blank nuts 42656 LQ-2200-10 44.45 x 3.17 x 6.20mm 42658 LQ-4000-10 48.39 x 4.88 x 9.52mm 42660 LQ-3000-10 43.21 x 4.65 x 8.43mm 42662 LQ-4025-10 63.50 x 6.35 x 11.10mm 42664 LQ-4125-10 63.50 x 3.17 x 11.10mm</p>	 <p>TUSQ blank nut 42665 PQ-4187-00 48.84 x 4.90 x 7.78mm 42666 PQ-4201-00 45.75 x 4.93 x 7.92mm 42667 PQ-4202-00 63.50 x 4.75 x 11.10mm</p>

1.5 parts
1.5.8 nuts and saddles
1.5.8.1 nuts



	<p>Performer Series genuine replacement part, bone nut for ukulele, 6 pieces 38997 UKS-001 soprano/concert, 36x3,5mm 38998 UKT-001 tenor, 38x3,5mm 38999 UKB-001 baritone, 38x3,5mm 39000 UKBB-001 bass, 45x5mm</p>
---	--

1.5 parts
1.5.8 nuts and saddles
1.5.8.1 nuts



bone nut blank
44530 13NB



corian 12-string nut blank
44531 13NL

1.5 parts
1.5.8 nuts and saddles
1.5.8.1 nuts



genuine replacement part, bone topnut
33183 TN-52-BN 52mm x 9,3mm x 4,5mm

1.5 parts
1.5.8 nuts and saddles
1.5.8.2 bridge saddles



bridge saddles, plastic, 12-pack
12381 915-1 82x9,8-8,8-2mm
12382 915-2 82x8,8-7,7-2mm
12383 915-3 82x7,7-6,6-2mm
12384 915-4 82x6,6-5,5-2mm
12385 915-5 82x5,5-4,8-2mm

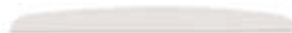

bridge saddles, plastic, 12-pack, arched
12386 915-6 69-7,0-4,4-2mm

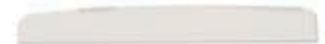

bridge saddles, plastic, 6-pack, compensated, arched
22149 915-7 72x7-8-6-2,5mm
22150 915-8 72x8-9-7-2,5mm
22151 915-9 72x9-10-8-2,5mm

1.5 parts

1.5.8 nuts and saddles

1.5.8.2 bridge saddles



NuBone 10-pack compensated acoustic guitar saddles

- 42608 **LC-9110-00** 2.6mm thickness
- 42609 **LC-9200-C0** 3.1mm thickness
- 42610 **LC-9280-C0** 3.25mm thickness
- 42611 **LC-9400-00** 3.30mm thickness



NuBone 10-pack classical guitar saddles

- 42612 **LC-9210-10** compensated



TUSQ compensated acoustic guitar saddle, 2.6mm thickness

- 42668 **PQ-9110-00**
- 42669 **LQ-9110-10** 10-pack



TUSQ compensated acoustic guitar saddles, 3.1mm

- 42670 **PQ-9200-C0**
- 42671 **LQ-9200-10** 10-pack
- 42672 **PQ-9200-L0** lefthanded
- 42673 **PQ-9216-C0** 16" radius
- 42674 **PQ-9216-L0** 16" radius, lefthanded



TUSQ compensated acoustic guitar saddle, 3.25mm thickness

- 42675 **PQ-9280-C0**
- 42676 **LQ-9280-10** 10-pack
- 42677 **PQ-9280-L0** lefthanded



TUSQ compensated acoustic guitar saddle

- 42678 **PQ-9400-00** 3.30mm thickness



TUSQ compensated acoustic guitar saddles

- 42679 **LQ-9400-10** 3.30mm thickness



TUSQ compensated classical guitar saddle

- 42680 **PQ-9210-00**



TUSQ compensated classical guitar saddle

- 42681 **LQ-9210-10**



TUSQ blank saddle 76.71 x 3.15 x 11.43mm

- 42682 **PQ-9000-00**
- 42683 **LQ-9000-10** 10-pack



TUSQ blank slab 101.60 x 3.17 x 12.70mm

- 42684 **PQ-9125-00**
- 42685 **LQ-9125-10** 10-pack



TUSQ blank saddle

- 42686 **PQ-9332-00**

1.5 parts
1.5.8 nuts and saddles

1.5.8.2 bridge saddles



TUSQ 10-pack blank slabs 101.60 x 2.39 x 12.70mm
42687 LQ-9332-10

1.5 parts
1.5.8 nuts and saddles

1.5.8.2 bridge saddles



Performer Series genuine replacement part, bone bridge saddle for ukulele, 6 pieces

- 39001 UKS-002 soprano/concert, 52x2,5mm
- 39002 UKT-002 tenor, 56x2,5mm
- 39003 UKB-002 baritone, 60x3mm

1.5 parts
1.5.8 nuts and saddles

1.5.8.2 bridge saddles



corian pre-shaped nut flat bottom
44529 13NP



Tusq saddle blank

- 44523 13STUSQB blank
- 44524 G13SL0376 compensated medium
- 44525 13STUSQH compensated high



bone saddle

- 44526 13SRB blank
- 44527 13SRBC compensated high
- 44528 13SRBM pre-shaped medium

1.5 parts
1.5.8 nuts and saddles

1.5.8.2 bridge saddles



genuine replacement part bone bridge saddle
33184 BS-80-BN 80mm

1.5 parts
1.5.9 pickguards and covers
1.5.9.1 pickguards

Boston

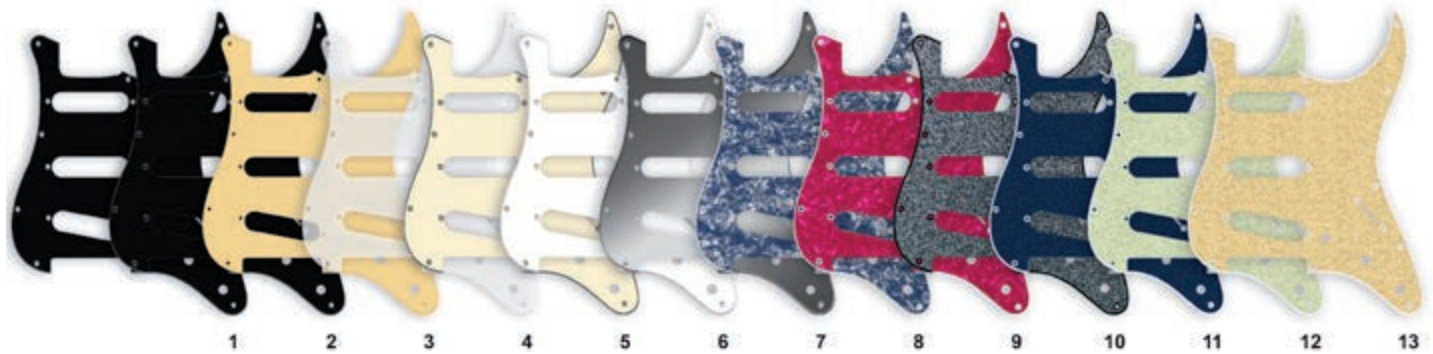

1-PLY	ST VINTAGE NO HOLES	ST VINTAGE SSS	ST VINTAGE SSS LH	ST VINTAGE HSS	ST VINTAGE HSS 2P	ST VINTAGE HH
1 black	ST-100-B	ST-113-B	SL-113-B	ST-123-B	ST-122-B	ST-133-B
2 black mat	ST-100-BM	ST-113-BM	SL-113-BM	ST-123-BM	ST-122-BM	ST-133-BM
3 cream	ST-100-C	ST-113-C	SL-113-C	ST-123-C	ST-122-C	ST-133-C
4 transparent	ST-100-TR	ST-113-TR	SL-113-TR	ST-123-TR	ST-122-TR	ST-133-TR
5 vintage white	-	ST-113-VW	-	-	-	-
6 white	ST-100-W	ST-113-W	SL-113-W	ST-123-W	ST-122-W	ST-133-W
2-PLY						
7 mirror chrome	ST-200-MC	ST-213-MC	SL-213-MC	ST-223-MC	ST-222-MC	ST-233-MC
8 pearl ocean blue	-	ST-213-POB	SL-213-POB	ST-223-POB	ST-222-POB	ST-233-POB
9 pearl pink	ST-200-PP	ST-213-PP	SL-213-PP	ST-223-PP	ST-222-PP	-
10 sparkling black	ST-200-SBK	ST-213-SBK	SL-213-SBK	ST-223-SBK	ST-222-SBK	ST-233-SBK
11 sparkling blue	ST-200-SBU	ST-213-SBU	SL-213-SBU	ST-223-SBU	ST-222-SBU	ST-233-SBU
12 sparkling champagne	-	ST-213-SCH	SL-213-SCH	ST-223-SCH	ST-222-SCH	ST-233-SCH
13 sparkling gold	ST-200-SGD	ST-213-SGD	SL-213-SGD	ST-223-SGD	ST-222-SGD	ST-233-SGD
14 sparkling red	ST-200-SRD	ST-213-SRD	SL-213-SRD	ST-223-SRD	ST-222-SRD	ST-233-SRD
15 sparkling silver	-	ST-213-SSV	SL-213-SSV	ST-223-SSV	ST-222-SSV	ST-233-SSV
16 tiger brown pearl	ST-200-RBP	ST-213-RBP	SL-213-RBP	ST-223-RBP	ST-222-RBP	ST-233-RBP
3-PLY						
17 black	ST-300-B	ST-313-B	SL-313-B	ST-323-B	ST-322-B	ST-333-B
18 black and cream	ST-300-BC	ST-313-BC	SL-313-BC	ST-323-BC	ST-322-BC	ST-333-BC
19 marble orange	ST-300-MO	ST-313-MO	SL-313-MO	ST-323-MO	ST-322-MO	ST-333-MO
20 marble yellow	ST-300-MY	ST-313-MY	SL-313-MY	ST-323-MY	ST-322-MY	ST-333-MY
21 mint green	ST-300-M	ST-313-M	SL-313-M	ST-323-M	ST-322-M	ST-333-M
22 pearl blue	ST-300-PBU	ST-313-PBU	SL-313-PBU	ST-323-PBU	ST-322-PBU	ST-333-PBU
23 pearl cream	ST-300-PC	ST-313-PC	SL-313-PC	ST-323-PC	ST-322-PC	ST-333-PC
24 pearl red	ST-300-PR	ST-313-PR	SL-313-PR	ST-323-PR	-	ST-333-PR
25 pearl violet	ST-300-PV	ST-313-PV	SL-313-PV	ST-323-PV	ST-322-PV	ST-333-PV
26 pearl yellow	ST-300-PY	ST-313-PY	SL-313-PY	ST-323-PY	ST-322-PY	ST-333-PY
27 tiger pearl	-	ST-313-RP	SL-313-RP	ST-323-RP	ST-322-RP	ST-333-RP
28 tiger red	ST-300-RR	ST-313-RR	SL-313-RR	ST-323-RR	ST-322-RR	-
29 tiger yellow	ST-300-RY	ST-313-RY	SL-313-RY	ST-323-RY	ST-322-RY	ST-333-RY
30 vintage white	ST-300-VW	ST-313-VW	SL-313-VW	ST-323-VW	ST-322-VW	ST-333-VW
31 white	ST-300-W	ST-313-W	SL-313-W	ST-323-W	ST-322-W	ST-333-W
32 wild cat orange	ST-300-WCO	ST-313-WCO	SL-313-WCO	ST-323-WCO	ST-322-WCO	-
33 wild cat yellow	ST-300-WCY	ST-313-WCY	SL-313-WCY	ST-323-WCY	ST-322-WCY	-
4-PLY						
34 black	ST-400-B	ST-413-B	SL-413-B	ST-423-B	ST-422-B	ST-433-B
35 pearl black	ST-400-PB	ST-413-PB	SL-413-PB	ST-423-PB	ST-422-PB	ST-433-PB
36 pearl white	ST-400-PW	ST-413-PW	SL-413-PW	ST-423-PW	ST-422-PW	ST-433-PW
37 pearl white webbing	ST-400-PWW	ST-413-PWW	SL-413-PWW	ST-423-PWW	ST-422-PWW	ST-433-PWW
38 tortoise	ST-400-T	ST-413-T	SL-413-T	ST-423-T	ST-422-T	ST-433-T
39 tortoise brown pearl	-	ST-413-TBP	SL-413-TBP	ST-423-TBP	ST-422-TBP	ST-433-TBP
40 tortoise intense	ST-400-TI	ST-413-TI	SL-413-TI	ST-423-TI	ST-422-TI	ST-433-TI

1.5 parts
1.5.9 pickguards and covers
1.5.9.1 pickguards

Boston

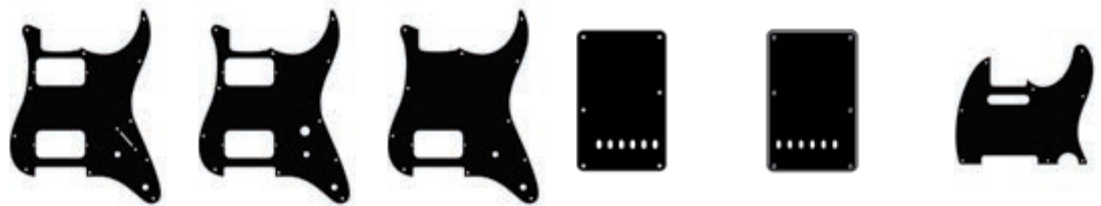
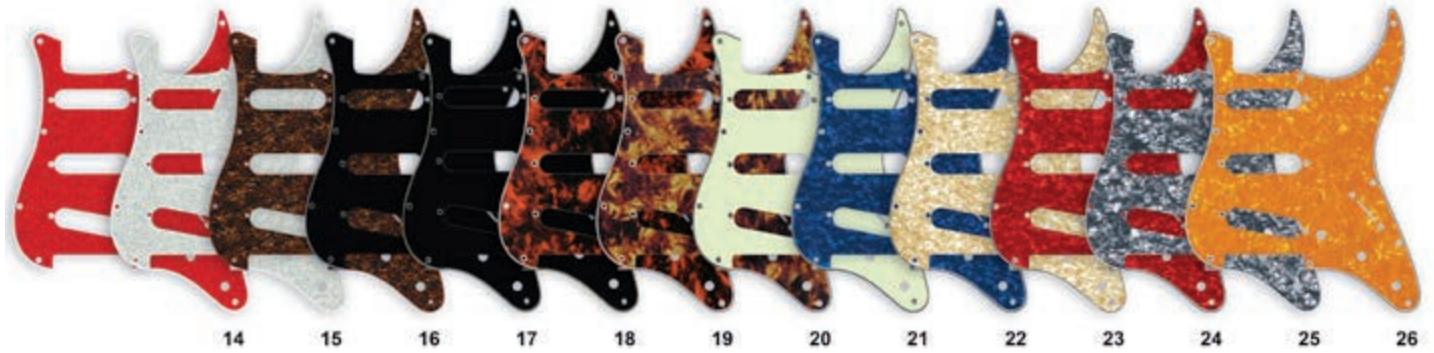

1-PLY	ST VINTAGE HH 2P	ST VINTAGE HH 2P TS	ST VINTAGE H 2P	BACKPLATE	BACKPLATE L	TE VINTAGE	
1 black	ST-132-B	ST-131-B	ST-144-B	BP-113-B	-	TE-110-B	
2 black mat	ST-132-BM	ST-131-BM	ST-144-BM	BP-113-BM	-	TE-110-BM	
3 cream	ST-132-C	ST-131-C	ST-144-C	BP-113-C	-	TE-110-C	
4 transparent	ST-132-TR	ST-131-TR	ST-144-TR	BP-113-TR	-	TE-110-TR	
5 vintage white	-	-	-	BP-113-VW	-	TE-113-VW	
6 white	ST-132-W	-	ST-144-W	BP-113-W	BPL113-W	TE-110-W	
2-PLY	7 mirror chrome	ST-232-MC	ST-231-MC	ST-244-MC	BP-213-MC	BPL213-MC	TE-210-MC
8 pearl ocean blue	ST-232-POB	ST-231-POB	ST-244-POB	BP-213-POB	-	TE-210-POB	
9 pearl pink	ST-232-PP	ST-231-PP	ST-244-PP	BP-213-PP	-	TE-210-PP	
10 sparkling black	ST-232-SBK	ST-231-SBK	ST-244-SBK	BP-213-SBK	-	TE-210-SBK	
11 sparkling blue	ST-232-SBU	ST-231-SBU	ST-244-SBU	BP-213-SBU	-	TE-210-SBU	
12 sparkling champagne	ST-232-SCH	ST-231-SCH	ST-244-SCH	BP-213-SCH	-	-	
13 sparkling gold	ST-232-SGD	ST-231-SGD	ST-244-SGD	BP-213-SGD	-	TE-210-SGD	
14 sparkling red	ST-232-SRD	ST-231-SRD	ST-244-SRD	BP-213-SRD	-	TE-210-SRD	
15 sparkling silver	ST-232-SSV	ST-231-SSV	ST-244-SSV	BP-213-SSV	-	TE-210-SSV	
16 tiger brown pearl	ST-232-RBP	ST-231-RBP	ST-244-RBP	BP-213-RBP	-	TE-210-RBP	
3-PLY	17 black	ST-332-B	ST-331-B	ST-344-B	BP-313-B	BPL313-B	TE-310-B
18 black and cream	ST-332-BC	ST-331-BC	-	BP-313-BC	-	TE-310-BC	
19 marble orange	ST-332-MO	ST-331-MO	ST-344-MO	BP-313-MO	-	TE-310-MO	
20 marble yellow	ST-332-MY	ST-331-MY	ST-344-MY	BP-313-MY	-	TE-310-MY	
21 mint green	ST-332-M	ST-331-M	ST-344-M	BP-313-M	BPL313-M	TE-310-M	
22 pearl blue	ST-332-PBU	ST-331-PBU	ST-344-PBU	BP-313-PBU	-	TE-310-PBU	
23 pearl cream	ST-332-PC	ST-331-PC	ST-344-PC	BP-313-PC	-	TE-310-PC	
24 pearl red	ST-332-PR	ST-331-PR	ST-344-PR	BP-313-PR	-	TE-310-PR	
25 pearl violet	ST-332-PV	ST-331-PV	ST-344-PV	BP-313-PV	-	-	
26 pearl yellow	ST-332-PY	ST-331-PY	ST-344-PY	BP-313-PY	-	TE-310-PY	
27 tiger pearl	ST-332-RP	ST-331-RP	-	BP-313-RP	-	-	
28 tiger red	ST-332-RR	ST-331-RR	ST-344-RR	BP-313-RR	-	TE-310-RR	
29 tiger yellow	ST-332-RY	ST-331-RY	-	BP-313-RY	-	TE-310-RY	
30 vintage white	ST-332-VW	ST-331-VW	ST-344-VW	BP-313-VW	BPL313-VW	TE-310-VW	
31 white	ST-332-W	ST-331-W	ST-344-W	BP-313-W	BPL313-W	TE-310-W	
32 wild cat orange	ST-332-WCO	ST-331-WCO	ST-344-WCO	BP-313-WCO	-	TE-310-WCO	
33 wild cat yellow	ST-332-WCY	-	ST-344-WCY	BP-313-WCY	-	TE-310-WCY	
4-PLY	34 black	ST-432-B	ST-431-B	ST-444-B	BP-413-B	-	TE-410-B
35 pearl black	-	ST-431-PB	ST-444-PB	-	-	TE-410-PB	
36 pearl white	ST-432-PW	ST-431-PW	ST-444-PW	BP-413-PW	BPL413-PW	TE-410-PW	
37 pearl white webbing	ST-432-PWW	-	ST-444-PWW	BP-413-PWW	-	TE-410-PWW	
38 tortoise	ST-432-T	ST-431-T	ST-444-T	-	BPL413-T	TE-410-T	
39 tortoise brown pearl	ST-432-TBP	ST-431-TBP	ST-444-TBP	-	-	TE-410-TBP	
40 tortoise intense	ST-432-TI	ST-431-TI	ST-444-TI	BP-413-TI	BPL413-TI	TE-410-TI	

1.5 parts
1.5.9 pickguards and covers
1.5.9.1 pickguards

Boston

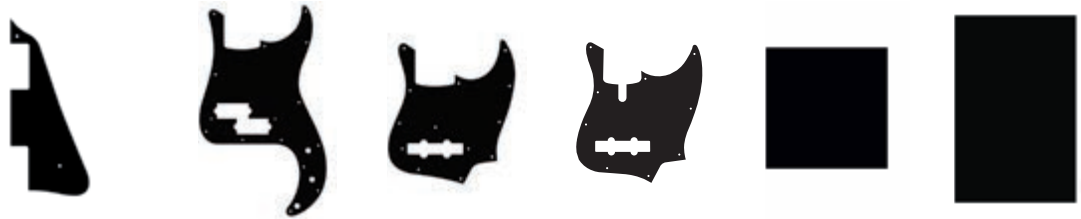

1-PLY	LP VINTAGE	PB VINTAGE	JB VINTAGE	SIRE MARCUS MILLER V-SERIES	SHEET 30X29	SHEET 29X45
1 black	LP-113-B	PB-115-B	JB-110-B	MMV-110-B	PG-133-B	PG-134-B
2 black mat	LP-113-BM	PB-115-BM	JB-110-BM	MMV-110-BM	PG-133-BM	PG-134-BM
3 cream	LP-113-C	PB-115-C	JB-110-C	MMV-110-C	PG-133-C	PG-134-C
4 transparent	LP-113-TR	PB-115-TR	JB-110-TR	MMV-110-TR	PG-133-TR	PG-134-TR
5 vintage white	-	-	-	MMV-110-VW	-	-
6 white	LP-113-W	PB-115-W	JB-110-W	MMV-110-W	PG-133-W	PG-134-W
2-PLY						
7 mirror chrome	LP-213-MC	PB-215-MC	JB-210-MC	MMV-210-MC	PG-233-MC	PG-234-MC
8 pearl ocean blue	LP-213-POB	PB-215-POB	JB-210-POB	MMV-210-POB	PG-233-POB	PG-234-POB
9 pearl pink	LP-213-PP	PB-215-PP	JB-210-PP	MMV-210-PP	PG-233-PP	PG-234-PP
10 sparkling black	LP-213-SBK	PB-215-SBK	JB-210-SBK	MMV-210-SBK	PG-233-SBK	PG-234-SBK
11 sparkling blue	LP-213-SBU	PB-215-SBU	JB-210-SBU	MMV-210-SBU	PG-233-SBU	PG-234-SBU
12 sparkling champagne	LP-213-SCH	-	-	-	PG-233-SCH	PG-234-SCH
13 sparkling gold	LP-213-SGD	PB-215-SGD	-	-	PG-233-SGD	PG-234-SGD
14 sparkling red	LP-213-SRD	PB-215-SRD	JB-210-SRD	MMV-210-SRD	PG-233-SRD	PG-234-SRD
15 sparkling silver	LP-213-SSV	PB-215-SSV	-	-	PG-233-SSV	PG-234-SSV
16 tiger brown pearl	LP-213-RBP	PB-215-RBP	JB-210-RBP	MMV-210-RBP	PG-233-RBP	PG-234-RBP
3-PLY						
17 black	LP-313-B	PB-315-B	JB-310-B	MMV-310-B	PG-333-B	PG-334-B
18 black and cream	LP-313-BC	PB-315-BC	JB-310-BC	MMV-310-BC	PG-333-BC	PG-334-BC
19 marble orange	LP-313-MO	PB-315-MO	JB-310-MO	MMV-310-MO	PG-333-MO	PG-334-MO
20 marble yellow	LP-313-MY	PB-315-MY	-	MMV-310-MY	PG-333-MY	PG-334-MY
21 mint green	LP-313-M	PB-315-M	JB-310-M	MMV-310-M	PG-333-M	PG-334-M
22 pearl blue	LP-313-PBU	PB-315-PBU	JB-310-PBU	MMV-310-PBU	PG-333-PBU	PG-334-PBU
23 pearl cream	LP-313-PC	PB-315-PC	JB-310-PC	MMV-310-PC	PG-333-PC	PG-334-PC
24 pearl red	LP-313-PR	PB-315-PR	JB-310-PR	MMV-310-PR	PG-333-PR	PG-334-PR
25 pearl violet	LP-313-PV	PB-315-PV	JB-310-PV	MMV-310-PV	PG-333-PV	PG-334-PV
26 pearl yellow	LP-313-PY	PB-315-PY	JB-310-PY	MMV-310-PY	PG-333-PY	PG-334-PY
27 tiger pearl	LP-313-RP	-	JB-310-RP	MMV-310-RP	PG-333-RP	PG-334-RP
28 tiger red	LP-313-RR	PB-315-RR	JB-310-RR	MMV-310-RR	PG-333-RR	PG-334-RR
29 tiger yellow	LP-313-RY	PB-315-RY	-	MMV-310-RY	PG-333-RY	PG-334-RY
30 vintage white	LP-313-VW	PB-315-VW	JB-310-VW	MMV-310-VW	PG-333-VW	PG-334-VW
31 white	LP-313-W	PB-315-W	JB-310-W	MMV-310-W	PG-333-W	PG-334-W
32 wild cat orange	LP-313-WCO	PB-315-WCO	JB-310-WCO	MMV-310-WCO	PG-333-WCO	PG-334-WCO
33 wild cat yellow	LP-313-WCY	PB-315-WCY	JB-310-WCY	MMV-310-WCY	PG-333-WCY	PG-334-WCY
4-PLY						
34 black	LP-413-B	PB-415-B	JB-410-B	MMV-410-B	PG-433-B	PG-434-B
35 pearl black	LP-413-PB	PB-415-PB	JB-410-PB	MMV-410-PB	PG-433-PB	PG-434-PB
36 pearl white	LP-413-PW	PB-415-PW	JB-410-PW	MMV-410-PW	PG-433-PW	PG-434-PW
37 pearl white webbing	LP-413-PWW	PB-415-PWW	JB-410-PWW	MMV-410-PWW	PG-433-PWW	PG-434-PWW
38 tortoise	LP-413-T	PB-415-T	JB-410-T	MMV-410-T	PG-433-T	PG-434-T
39 tortoise brown pearl	LP-413-TBP	PB-415-TBP	JB-410-TBP	MMV-410-TBP	PG-433-TBP	PG-434-TBP
40 tortoise intense	LP-413-TI	PB-415-TI	JB-410-TI	MMV-410-TI	PG-433-TI	PG-434-TI

1.5 parts
 1.5.9 pickguards and covers
1.5.9.1 pickguards

Boston



pickguard Standard Strat, HSS, 11 screw holes LH, 4-ply
 36071 0055321000 tortoise shell



pickguard Strat Contemporary, HSH, 11 screw holes, 4-ply
 36075 0992230000 white pearl

1.5 parts
 1.5.9 pickguards and covers
1.5.9.1 ST vintage SSS

Boston



Master Relic Series pickguard Stallion SSS
 42747 MRC-ST75W1 1 ply vintage white relic
 42748 MRC-ST63MI3 3 ply mint ivory relic

1.5 parts
 1.5.9 pickguards and covers
1.5.9.1 ST vintage SSS

Fender



Genuine Replacement Part pickguard Strat®, SSS, 11 screw holes

- 36061 0992139000 1-ply gold anodized
- 36049 0991360000 3-ply white
- 36050 0991359000 3-ply black
- 36051 0992144000 3-ply mint green
- 36052 0991374000 3-ply parchment
- 36057 0992141000 4-ply black pearl
- 36059 0992142000 4-ply black tortoise shell
- 36060 0992140000 4-ply black white pearl



Genuine Replacement Part pickguard '57 Vintage Strat, SSS, 8 screw holes

- 36076 0992017000 1-ply white
- 36077 0992143000 1-ply gold anodized
- 36078 0991358000 3-ply black
- 36079 0991346000 3-ply black pearl
- 36080 0991349000 4-ply tortoise shell



Genuine Replacement Part pickguard '62 Vintage Strat, SSS, 11 screw holes, 3-ply

- 36082 0992018000 white
- 36084 0991343000 mint green

1.5 parts

1.5.9 pickguards and covers

1.5.9.1 ST vintage SSS



pickguard Strat®, SSS, 11 screw holes, 1-ply

36047 0991360100 polished chrome
36048 0991360200 polished gold

1.5 parts

1.5.9 pickguards and covers

1.5.9.1 ST vintage HSS



pickguard, Stallion, SSH

20766 ST1SSH-C 1 ply, cream
20801 ST3SSH-PG 3 ply, pearl grey
20808 ST3SSH-SG 3 ply, sparkling gold
20809 ST3SSH-SBU 3 ply, sparkling blue
20810 ST3SSH-SR 3 ply, sparkling red
20811 ST3SSH-SS 3 ply, sparkling silver
20812 ST3SSH-SCH 3 ply, sparkling champagne



pickguard Standard Strat, HSS, 11 screw holes

36062 0050671049 3-ply, white
36063 0055267000 3-ply, black
36064 0991337000 4-ply, tortoise shell
36067 0992146000 4-ply, black pearl
36068 0064009000 4-ply, black pearl

1.5 parts

1.5.9 pickguards and covers

1.5.9.1 ST vintage HSS



pickguard Standard Strat, HSS, 11 screw holes

36070 0064010000 gold metallic

1.5 parts

1.5.9 pickguards and covers

1.5.9.1 ST vintage HH



pickguard, Stallion, 3 ply, HH

20815 ST3HH-M mint

1.5 parts

1.5.9 pickguards and covers

1.5.9.1 ST vintage HH



Genuine Replacement Part pickguard Standard Strat, HH, 11 screw holes, 4-ply
36074 0991372000 tortoise shell

1.5 parts

1.5.9 pickguards and covers

1.5.9.1 ST vintage HH



pickguard Standard Strat, HH, 11 screw holes, 3-ply
36073 0055268000 black

1.5 parts

1.5.9 pickguards and covers

1.5.9.1 TE vintage



Master Relic Series pickguard Teaser 1 ply

42749 MRC-TL50W1 vintage white relic
42750 MRC-TLBL black bakelite relic



pickguard, Teaser custom, 3 ply
22135 TM3-B black



pickguard, Teaser deluxe, 3 ply
22136 TD3-B black

1.5 parts
 1.5.9 pickguards and covers
1.5.9.1 TE vintage



pickguard Standard Tele®, 8 screw holes
 36090 **0991355200** 1-ply, gold
 36088 **0992151000** 1-ply, black pearl
 36092 **0991375000** 3-ply, parchment
 36093 **0991356000** 3-ply, black
 36094 **0992154000** 3-ply, mint green
 36095 **0992174000** 4-ply, parchment moto
 36097 **0992150000** 4-ply, white pearl
 36096 **0992152000** 4-ply, tortoise shell

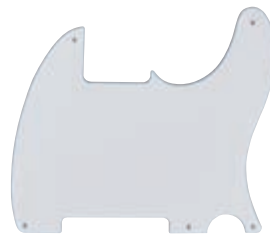

Genuine Replacement Part pickguard '50s Esquire, 5 screw holes, 1-ply
 36100 **0068214049** white



Genuine Replacement Part pickguard '52 Telecaster®, 5 screw holes, 1-ply
 36101 **0992019000** black (bakelite)



Genuine Replacement Part pickguard '69 Telecaster® Thinline, 3-ply
 36106 **0058678002** white pearl



Genuine Replacement Part pickguard '72 Tele Custom, 16 screw holes, 3-ply
 36107 **0054523049** black



Genuine Replacement Part pickguard '72 Tele Thinline, 12 screw holes, 3-ply
 36109 **0054571002** white pearl

1.5 parts
 1.5.9 pickguards and covers
1.5.9.1 LP vintage



Master Relic Series pickguard LP 59
 42751 **MRC-LP59IV** 1 ply cream relic

1.5 parts
 1.5.9 pickguards and covers
1.5.9.1 PB vintage

Boston



pickguard, Puncher bass, 3 ply
 20908 **PB3-SCH** sparkling champagne

1.5 parts
 1.5.9 pickguards and covers
1.5.9.1 PB vintage

Fender



Genuine Replacement Part pickguard
Standard Precision Bass®, 13 screw holes,
3-ply, with truss rod notch
 36130 **0991352000** 3 -ply, black
 36131 **0991376000** 3 -ply, parchment
 36134 **0992160000** 4 -ply, white moto
 36136 **0992175000** 4-ply, tortoiseshell



Genuine Replacement Part pickguard
American Deluxe Precision Bass®, 10 screw
holes, 4-ply
 36139 **0049456000** aged white moto



Genuine Replacement Part pickguard '57
Precision Bass®, 10 screw holes, 1-ply
 36142 **0992020000** gold anodized



Genuine Replacement Part pickguard '62
Precision Bass®, 13 screw holes, 4-ply, with
truss rod notch
 36144 **0992021000** tortoise shell

1.5 parts
 1.5.9 pickguards and covers
1.5.9.1 PB vintage

Fender
 OUTLET



pickguard Standard Precision Bass® V®, 13 screw holes
 36129 **0058261000** 3-ply, white
 36138 **0075346000** 4-ply, tortoise shell

1.5 parts
 1.5.9 pickguards and covers
1.5.9.1 PB vintage



pickguard '62 Precision Bass®, 13 screw holes, 3-ply, with truss rod notch
 36143 0991361000 white

1.5 parts
 1.5.9 pickguards and covers
1.5.9.1 JB vintage



Genuine Replacement Part pickguard Standard Jazz Bass®, 10 screw holes, with truss rod notch
 36117 0991351000 3-ply, black
 36119 0992157000 3-ply, tortoise shell
 36120 0992170000 4-ply, white pearl
 39643 0074131000 4-ply, tortoise shell



Genuine Replacement Part pickguard '62 Jazz Bass®, 11 screw holes with truss rod notch
 36125 0054081000 3-ply, mint green
 36126 0992022000 4-ply, tortoise shell



Genuine Replacement Part pickguard '75 Jazz Bass®, 11 screw holes, 3-ply
 36127 0055252049 black

1.5 parts
 1.5.9 pickguards and covers
1.5.9.1 miscellaneous pickguards



pickguard, SG-model, 3 ply
 20921 SG3-B black



pickguard, SG-model custom, 3 ply
 22131 SM3-B black



pickguard, 335-model, black
 20922 JZ3-B 3 ply
 22133 E-3-4B 4 ply

1.5 parts

1.5.9 pickguards and covers

1.5.9.1 miscellaneous pickguards

Boston



pickguard, electric mandolin, 3 ply
20924 **MDE3-B** black



pickguard, mandolin, 3 pl
24893 **MD3-B2** black
24895 **MD3-BT** brown tortoise

1.5 parts

1.5.9 pickguards and covers

1.5.9.1 miscellaneous pickguards

Fender



Genuine Replacement Part pickguard
'62 Jazzmaster®, 13 screw holes,
4-ply
36114 **0991354000** tortoise shell



Genuine Replacement Part pickguard
shield
43380 **0054452149** Jazzmaster

1.5 parts

1.5.9 pickguards and covers

1.5.9.2 adhesive back pickguards

Boston



Boston pickguard, acoustic, teardrop
model, self adhesive

- 32026 **AG-100-W** white
- 32027 **AG-100-B** black
- 32028 **AG-100-TR** transparent
- 32029 **AG-100-VW** vintage white
- 32030 **AG-100-M** mint



Boston pickguard, acoustic, teardrop
model, self adhesive, pearl

- 32032 **AG-100-PWW** white webbing
- 32034 **AG-100-PV** violet
- 32035 **AG-100-POB** ocean blue
- 32036 **AG-100-PC** cream
- 32037 **AG-100-PR** red
- 32038 **AG-100-PBU** blue
- 32039 **AG-100-PP** pink
- 32040 **AG-100-PY** yellow



Boston pickguard, acoustic, teardrop
model, self adhesive, tortoise

- 40532 **AG-100-T**
- 40546 **AG-100-TI** intense
- 32043 **AG-100-TBP** brown pearl



Boston pickguard, acoustic, teardrop
model, self adhesive, tiger

- 32044 **AG-100-RBP** brown pearl
- 32045 **AG-100-RP** pearl
- 32046 **AG-100-RR** red
- 32047 **AG-100-RY** yellow

1.5 parts

1.5.9 pickguards and covers

1.5.9.2 adhesive back pickguards

Boston



pickguard, acoustic, self adhesive hummingbird model
13690 PG-6-HM



pickguard, acoustic, self adhesive dove model
13691 PG-11-DV



pickguard, flamenco, self adhesive, transparent
23291 PG-3-CL



pickguard adhesive material, 20x25cm
6373 GG-BK black
22125 GG-WH white
6372 GG-TS tortoise
6857 GG-CL transparent



pickguard adhesive material, 25,5x30,5cm
22126 GG-BK-2 black
22127 GG-WH-2 white
22128 GG-TS-2 tortoise
22129 GG-CL-2 transparent

1.5 parts

1.5.9 pickguards and covers

1.5.9.2 adhesive back pickguards

Martin & Co
EST. 1833



self-adhesive pickguard black
44517 13PG
44519 13PGBO oversized



self-adhesive pickguard faux tortoise
44518 13PGT
44520 13PGTO oversized

1.5 parts
 1.5.9 pickguards and covers
1.5.9.4 backplates

Boston



back plate, switch cavity, 55,6mm, 1 ply, LP-model
 6426 **P-101-B** black
 6427 **P-101-W** white
 6428 **P-101-IV** ivory



back plate, potmeters cavity, 1 ply, LP-model
 5546 **P-102-B** black
 5547 **P-102-W** white
 6425 **P-102-IV** ivory

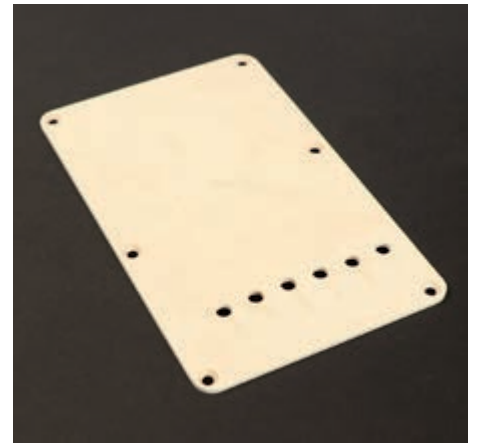

Master Relic Series back plate, string spacing 11,2mm, 1 ply
 42763 **BP-105RE** white relic



back plate, no holes, 1 ply, for Stallion, 87x138mm
 6861 **P-103-MW** white mat

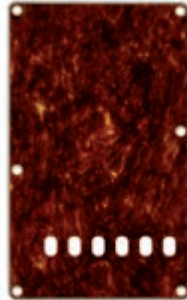

back plate, string spacing 11,2mm, 4 ply, standard Stallion, 86x138mm
 40519 **BP-413-T** tortoise

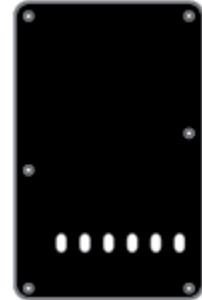

back plate, string spacing 11,2mm, 4 ply, standard Stallion, 86x138mm
 32654 **BP-413-PB** pearl black

1.5 parts
 1.5.9 pickguards and covers
1.5.9.4 backplates

Fender



Genuine Replacement Part Stratocaster® back plate, 1-ply
 36149 **0991320000** white



Genuine Replacement Part Stratocaster® back plate, 3-ply
 36150 **0991321000** white
 36151 **0991322000** black



Genuine Replacement Part Stratocaster® back plate, 4-ply
 36153 **0991323000** white moto

1.5 parts

1.5.9 pickguards and covers

1.5.9.5 truss rod covers

Boston



truss rod cover
13625 **LRC-22-B**
black, 2 ply, black - white



truss rod cover
13626 **LRC-24-B**
black, 2 ply, black - white



truss rod cover
13627 **LRC-26-B**
black, 2 ply, black - white



truss rod cover
13629 **LRC-30-B**
black, 2 ply, black - white



truss rod cover
13631 **LRC-34-B**
black, 2 ply, black - white



truss rod cover
13632 **LRC-36-B**
black, 2 ply, black - white

1.5 parts
1.5.10 machine heads

1.5.10.1 machine heads for classic guitar

Boston



machine heads for classic guitar, metal shaft, 3x left+3x right, 70mm
11044 028



machine heads for classic guitar, double drilled metal shaft, 3x left+3x right, 70mm
11993 028-2M metal buttons
9410 028-2



machine heads for classic guitar, nylon shaft, 3x left+3x right, 70mm
34848 126-P pearloid buttons



machine heads for classic guitar, nylon shaft, 3x left+3x right, 70mm, gold,
34849 127-PG pearloid buttons



machine heads for classic guitar, nylon shaft, 3x left+3x right, 70mm
982 128 plastic buttons
11048 128-P pearloid buttons



machine heads for classic guitar, nylon shaft, 3x left+3x right, 70mm, nickel
983 129 pearloid buttons
984 129-P pearloid buttons
14631 129-B butterfly buttons



machine heads for classic guitar, nylon shaft, 3x left+3x right, 70mm, gold
11054 129-G pearloid buttons
14630 129-PG pearloid buttons
11053 129-BG butterfly buttons



machine heads for classic guitar, nylon shaft, 3x left+3x right, 70mm, solid brass
11994 130-SB wood buttons

1.5 parts
1.5.10 machine heads

1.5.10.1 machine heads for classic guitar

Boston

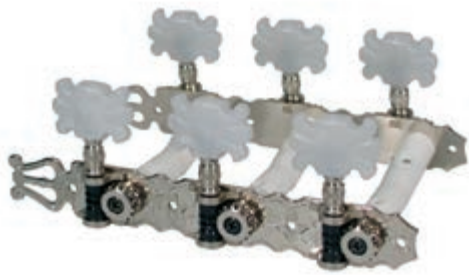

machine heads for classic guitar, nylon shaft, 3x left+3x right, 70mm, nickel

14639	131	pearloid buttons
14632	131-P	pearloid buttons
14634	131-B	butterfly buttons



machine heads for classic guitar, nylon shaft, 3x left+3x right, 70mm, gold

11995	131-G	pearloid buttons
14633	131-PG	pearloid buttons
14635	131-BG	butterfly buttons

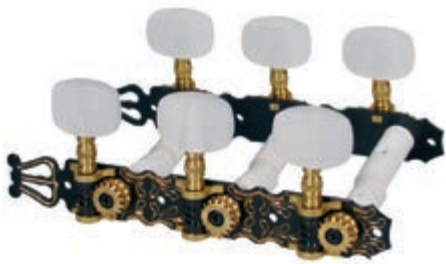

machine heads for classic guitar, nylon shaft, 3x left+3x right, 70mm, black engraved

986	132-PBE	pearloid buttons
-----	----------------	------------------



machine heads for classic guitar, nylon shaft, 3x left+3x right, 70mm, brass

31743	133-IM	ivory colored buttons
-------	---------------	-----------------------



machine heads for classic guitar, nylon shaft, 3x left+3x right

988	155-LR	plastic buttons
-----	---------------	-----------------

1.5 parts

1.5.10 machine heads

1.5.10.1 machine heads for classic guitar

GOTOH[®]



machine heads for classic guitar, nylon shaft, 3x left+ 3x right, 70 mm

42689 35G-1800-BB black button

42690 35G-620-2M ivoroid button

1.5 parts

1.5.10 machine heads

1.5.10.1 machine heads for classic guitar

MARTINEZ
玛丁尼



machine heads for MC20 models

43511 MC1B gold



machine heads for MC40/MC50 models

43512 M1GK-A2B S3 gold



machine heads for MC88/MC98 models

43513 M1GK-AS S3 gold



machine heads for MC118/MC128 models

43514 M1GK-P12 S4 gold



machine heads for Professional models

43515 M1GK-E2 S4 gold

1.5 parts
1.5.10 machine heads

1.5.10.1 machine heads for classic guitar

Salvador Cortez
— ARTESANIA AL —
ESTILO DE ESPAÑA



genuine replacement part set of machine heads 3L3R, gold

33176	MH102G-A1R	with amber pegs, for model 10, 22, 25, 32
33177	MH102G-P1R	with salmon pegs, for model 50
33178	MH093GK-A1B	with black pegs, for model 55, 60, 65
33179	MH093GK-A1W	with pearloid pegs, for model 70
33180	MH097GK-A1B	with black pegs, for model 80, 90, 110, 13

1.5 parts
1.5.10 machine heads

1.5.10.1 machine heads for classic guitar

Schaller



machine heads Lyra model, acrylic white pegs, white string rollers
43331 1034056331 gold



machine heads Hauser model, acrylic white pegs, white string rollers
43332 1033056331 gold

1.5 parts
1.5.10 machine heads

1.5.10.1 machine heads for classic guitar

Wittner



finetuner peg for flamenco guitar diam. 9,5, taper 1:30, 1piece
39803 275114M-FG

1.5.10.2 machine heads for acoustic/electric guitar



machine heads for guitar, metal shaft, metal buttons

6750 **056-LR** 3x left+3x right
14636 **056-L** 6x left
14637 **056-R** 6x right



machine heads for guitar, metal shaft, metal buttons, with cover

990 **057-LR** 3x left+3x right
991 **057-L** 6x left
14638 **057-R** 6x right



machine heads for guitar, 3x left+3x right, plastic buttons

989 **055-LR** metal shaft
11045 **055-2LR** double drilled metal shaft



machine heads for guitar, 3x left+3x right, vintage style

16448 **60-NLR** nickel
16449 **60-GLR** gold



machine heads for guitar, 3x left+3x right, vintage style, metal buttons

21545 **62-NLR** nickel
21546 **62-CLR** chrome
21547 **62-GLR** gold



machine heads for guitar, metal shaft, 3x left+3x right, metal buttons, with cover

16436 **058-CLR** chrome
16437 **058-GLR** gold
16438 **058-BLR** black



machine heads for guitar, metal shaft, 3x left+3x right, metal buttons, with cover

16439 **059-CLR** chrome
16440 **059-GLR** gold
16441 **059-BLR** black



machine heads for guitar, die cast, 3x left+3x right

992 **70-CLR** chrome
993 **70-GLR** gold
8436 **70-BLR** black

1.5.10.2 machine heads for acoustic/electric guitar



machine heads for guitar, die cast, 3x left+3x right, deluxe buttons

23571 **79-CLR** chrome
23572 **79-GLR** gold
23573 **79-BLR** black



machine heads for guitar, die cast, 3x left+3x right

26051 **78-CLR** chrome
26052 **78-GLR** gold
26053 **78-BLR** black



machine heads for guitar, die cast, 3x left+3x right, amber pearloid buttons

16450 **74-CLR** chrome



machine heads for guitar, die cast, 3x left+3x right, deluxe buttons

16451 **74-GLR** gold
16452 **74-BLR** black



machine heads for guitar, die cast, 3x left+3x right

21583 **73-CLR** chrome
21584 **73-GLR** gold
21585 **73-BLR** black



machine heads for guitar, die cast, 3x left+3x right, deluxe buttons

21586 **75-CLR** chrome
21587 **75-GLR** gold
21588 **75-BLR** black



machine heads for guitar, die cast, 3x left+3x right, deluxe buttons

21589 **76-CLR** chrome
21590 **76-GLR** gold
21591 **76-BLR** black



machine heads for guitar, die cast, 3x left+3x right, small buttons

26060 **77-CLR** chrome
26061 **77-GLR** gold
26062 **77-BLR** black



machine heads for guitar, metal shaft, 6x left, metal buttons, with cover

16442	059-CL	chrome
16443	059-GL	gold
16444	059-BL	black



machine heads for guitar, die cast, 6x left, small

994	72-CL	chrome
8437	72-BL	black
8501	72-GL	gold



machine heads for guitar, die cast, 6x left, deluxe buttons

21592	76-CL	chrome
21593	76-GL	gold
21594	76-BL	black



machine heads for guitar, die cast, 6x left, small buttons

26054	77-CL	chrome
26055	77-GL	gold
26056	77-BL	black



machine heads for guitar, die cast, 6x right, small

14323	72-CR	chrome
14324	72-BR	black
14325	72-GR	gold



machine heads for guitar, die cast, 6x right, small buttons

26057	77-CR	chrome
26058	77-GR	gold
26059	77-BR	black



machine heads for guitar, metal shaft, 6x right, metal buttons, with cover

16445	059-CR	chrome
16446	059-GR	gold



machine heads for guitar, 6x left, vintage style, metal buttons

21265	62-NL	nickel
21266	62-CL	chrome
21267	62-GL	gold

1.5 parts
1.5.10 machine heads

1.5.10.2 machine heads for acoustic/electric guitar

Boston



locking machine heads guitar, die cast 6L, low gearing 19:1

- 32454 **194-CL** chrome
- 32455 **194-GL** gold
- 32456 **194-BL** black



locking machine heads guitar die cast 3L3R, low gearing 19:1

- 32457 **194-CLR** chrome
- 32458 **194-GLR** gold
- 32459 **194-BLR** black



machine heads for 10-string guitar, nylon shaft, 100mm

- 11050 **142-10** plastic buttons



machine heads for 12-string guitar, metal shaft, 116,6mm

- 1002 **047-116** plastic buttons
- 1003 **047-116M** metal buttons



machine heads for 12-string guitar, double drilled metal shaft, 125,0mm

- 1004 **047-125** plastic buttons



machine heads for 12-string guitar, die cast

- 1005 **272-CLR** chrome
- 8505 **272-BLR** black



machine heads for 12-string guitar, die cast

- 26063 **277-CLR** chrome
- 26064 **277-GLR** gold
- 26065 **277-BLR** black

1.5 parts
1.5.10 machine heads

1.5.10.2 machine heads for acoustic/electric guitar



Genuine Replacement Part machine heads, vintage Kluson style strat/tele, mounting materials included

33928 099204000



Genuine Replacement Part machine heads, vintage 70s F-style strat/tele, mounting materials included

33929 0990822100



Genuine Replacement Part machine heads, Schaller locking strat/tele, mounting materials included

33930 0990818000 brushed

33931 0990818100 chrome



Genuine Replacement Part machine head, Standard Mexico, 2 guide pins

36430 0037429049 chrome



Genuine Replacement Part machine heads, vintage Kluson style strat/tele LH, mounting materials included, set of 6

36432 0992040002 chrome



Genuine Replacement Part machine heads, vintage Kluson style strat/tele, mounting materials included, set of 6

36433 0992040200 gold



Genuine Replacement Part machine heads, American Standard, 2 guide pins, set of 6

36435 0990820100 chrome

36436 0990820200 gold

1.5 parts

1.5.10 machine heads

1.5.10.2 machine heads for acoustic/electric guitar

GOTOH®



machine heads for guitar, 3xL+3xR, ratio 1:18

42691 **SGS-510 Z-G** gold button, gold
42692 **SGS-510 Z-C** chrome button, chrome



machine heads for guitar, 3xL+3xR, ratio 1:18, chrome button

44283 **SGL-510-L5C** chrome



machine heads for guitar, 3xL+3xR, ratio 1:18, gold button

44284 **SGL-510-L5G** gold



machine heads for guitar, 3xL+3xR, ratio 1:18

44285 **SG-301-20-C** chrome button, chrome
44286 **SG-301-20-G** gold button, gold



locking machine heads for guitar, 3xL+3xR, ratio 1:18, chrome button,

44287 **SG-301MGT-C** chrome



machine heads for guitar, 3xL+3xR, ratio 1:15, height adjustable post, magnum lock, chrome button

42695 **SGS-510-C**



machine heads for guitar, 3x left+3x right, ratio 1:15, keystone button

42696 **SD-90-SL-N** nickel
42697 **SD-90-SL-GG** gold



Master Relic Collection machine heads for guitar, 3x left+3x right, ratio 1:15, aged keystone button

42698 **SD-90-SL-AN** aged nickel

1.5 parts

1.5.10 machine heads

1.5.10.2 machine heads for acoustic/electric guitar



locking machine heads for guitar, 3x left+3x right, ratio 1:15, bean button
44292 SD-90MGTSLN nickel



machine heads for guitar, 3x left+3x right, ratio 1:16, gold oval button
44290 SG-381-05-G gold



machine heads for guitar, 3x left+3x right, ratio 1:21
42693 SGL-510 Z-G black button, gold
42694 SGL-510 Z-C black button, chrome



machine heads for guitar, 3x left+3x right, black wooden button
44289 SG-381EN07G gold body



machine heads for guitar, 6x left, ratio 1:15
42699 SD-91-05M-N nickel button, nickel
42700 SD-91-05M-G gold button, gold



machine heads for guitar, 6x left, ratio 1:15, height adjustable posts,
magnum lock
42702 SD-91-NHAPM nickel button



Master Relic Collection machine heads for guitar, 6x left, ratio 1:15,
aged nickel button
42701 SD-91-05MAN aged nickel

1.5 parts
1.5.10 machine heads

1.5.10.2 machine heads for acoustic/electric guitar



Gotoh butter bean machine heads set

44535 **18T0000** nickel
44536 **18T0001** gold



Grover 102-CV machine heads set

44537 **G13TM5085** chrome



Gotoh side mount machine heads set

44538 **18TG81C** chrome
44539 **18TG81G** gold



Gotoh bottom mount machine heads set

44540 **18TG01C** chrome
44541 **18TG01G** gold



Gotoh mini machine heads set

44542 **18TG65C** chrome
44543 **18TG65B** black
44544 **18TG65G** gold

1.5 parts
1.5.10 machine heads

1.5.10.2 machine heads for acoustic/electric guitar

Schaller



GrandTune Single machine heads 3L3R Butterbean, 21,7x6mm solid shaft
42514 5101234130 nickel
42515 5105234130 gold



Original G-Series machine heads 3L3R Deluxe KeyStone. 21,7x6mm solid shaft
43078 10140123163 nickel
43079 10140523163 gold



GrandTune Classic Hauser machine heads pearloid white pegs, white string rollers
42516 6101636011 nickel
42517 6105636011 gold



M6 135° machine heads 6L with small metal pegs, staggered locking shaft
42518 0202200150 chrome



M6 Mini machine heads 6L with small metal pegs, solid shaft
42520 0402200136 chrome



M4 90° Light machine heads 2L2R with M4 light pegs, splitted shaft
42521 5404032270 black chrome



Original F-Series machine heads 6L with small metal pegs, staggered locking shaft
42519 5602200150 chrome



Original F-Series machine heads 70's 6L with small metal pegs, splitted solid shaft
43080 10580220156 chrome

1.5.10.2 machine heads for acoustic/electric guitar



machine heads for guitar, die cast, 3x left+3x right, low gearing 19:1

- 30951 **191-CLR** chrome
- 30953 **191-GLR** gold
- 30954 **191-BLR** black



machine heads for guitar, G-style, 3x left+3x right, tombstone buttons

- 32754 **160-CLR** chrome
- 32755 **160-NLR** nickel
- 32757 **160-GLR** gold



machine heads for guitar, open frame, 3x left+3x right

- 40732 **WJ-28N/CR** chrome
- 40733 **WJ-28N/BK** black
- 40734 **WJ-28N/GD** gold



machine heads for guitar, die cast, 6x left, low gearing 19:1

- 30958 **191-CL** chrome
- 30959 **191-GL** gold
- 30960 **191-BL** black



machine heads for guitar, vintage F-style, 6x left, split shaft

- 32758 **162-NL** nickel
- 32759 **162-CL** chrome
- 32760 **162-BL** black
- 32765 **162-GL** gold

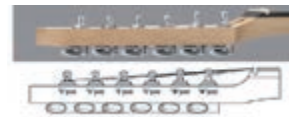

machine heads for guitar with EZ LOK and staggered post height, 6x left

- 33682 **162-NL-4S2M** nickel



machine heads for guitar with EZ LOK and staggered post height, 6x left,

- 33683 **162-NL-4M2L** nickel

1.5 parts
1.5.10 machine heads

1.5.10.3 machine heads for bass guitar

Boston



machine heads for bass guitar, 4x left

16453 **86-CL** chrome
16454 **86-BL** black



machine heads for bass guitar, 4x left

16458 **88-CL** chrome
16459 **88-GL** gold
16460 **88-BL** black



machine heads for bass guitar, 4x left

21598 **87-GL** gold



machine heads for bass guitar, 2x left+2x right

16455 **88-CLR** chrome
16457 **88-BLR** black



machine heads for bass guitar, die cast, 2x left+2x right

5486 **92-CLR** chrome
14355 **92-GLR** gold
14357 **92-BLR** black



machine heads for bass guitar, die cast, 4x left

5487 **92-CL** chrome
14358 **92-BL** black

1.5 parts
1.5.10 machine heads

1.5.10.3 machine heads for bass guitar

Fender



Genuine Replacement Part bass machine heads, Standard Series, set of 4
36441 0036400049 chrome

1.5 parts

1.5.10 machine heads

1.5.10.3 machine heads for bass guitar

GOTOH[®]



machine heads for bass guitar, 2x left+2x right, lightweight resolite
42703 GB-350- C chrome



machine heads for bass guitar, 5-string, 4x left+1x right, lightweight resolite
42704 GB-350-5-C chrome



machine heads for bass guitar, 4 x left, lightweight resolite
42705 GB-640-N nickel

1.5 parts

1.5.10 machine heads

1.5.10.3 machine heads for bass guitar

Wilkinson[®]



machine heads for bass guitar, F-style, 4x left

- 32761 189-NL nickel
- 32762 189-CL chrome
- 32763 189-BL black
- 32764 189-GL gold

1.5 parts

1.5.10 machine heads

1.5.10.4 machine heads for banjo

Boston



machine heads for 4-string banjo, professional

18715 **BJ-1004-C** chrome
18716 **BJ-1004-G** gold



machine heads for 5-string banjo, professional

16461 **BJ-1005-C** chrome

1.5 parts

1.5.10 machine heads

1.5.10.5 machine heads for mandolin

Boston



machine heads for mandolin, metal shaft, 2 holes, 70mm

1000 **043-2** plastic buttons
1001 **043-2M** metal buttons



machine heads for mandolin, metal shaft, 69mm, plastic buttons

16463 **044-N** nickel
16464 **044-G** gold



machine heads for mandolin, metal shaft, 69mm, plastic buttons

16465 **045-N** nickel
16466 **045-G** gold

1.5 parts
1.5.10 machine heads

1.5.10.5 machine heads for mandolin

GOTOH[®]



machine heads for A-style mandolin, metal shaft, 69 mm

42707 **MA-40-MM-N** ivory button, nickel
42708 **MA-40-MB-GG** black button, gold



machine heads for F-style mandolin, metal shaft, 69 mm

42709 **MF-40-MM-N** ivory button, nickel
42710 **MF-40-MB-GG** black button, gold

1.5 parts
1.5.10 machine heads

1.5.10.6 machine heads for ukulele

Boston



machine heads for ukulele, guitar model, double drilled metal shaft, set of 4

998 **056-U** plastic buttons



machine heads for ukulele, nickel plated, set of 4 pcs

23574 **UMH-200-WH** white buttons
23575 **UMH-200-IV** ivory buttons
23576 **UMH-200-AM** amber buttons
23577 **UMH-200-PW** pearloid white buttons

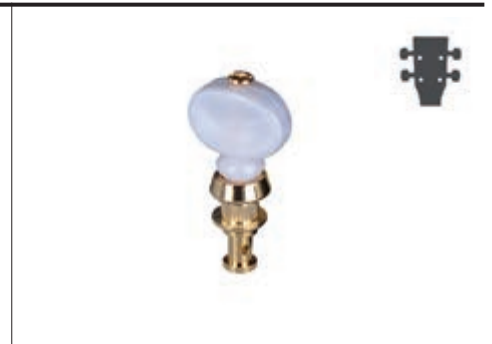

machine heads for ukulele, gold plated, set of 4 pcs

23581 **UMH-210-PW** pearloid white buttons

1.5 parts
1.5.10 machine heads

1.5.10.6 machine heads for ukulele

GOTOH[®]



machine heads for ukulele, ultra light, 1:14 ratio, nickel

42706 **UK-12-05MAN** black button

1.5 parts
1.5.10 machine heads

1.5.10.6 machine heads for ukulele



machine heads for soprano ukulele guitar model, 2x left+2x right
26805 UMH100GD/BK gold with black knob

1.5 parts
1.5.10 machine heads

1.5.10.7 machine heads for miscellaneous instruments



finetuner peg for saz, diam. 8,1
32731 2704M-SAZ

1.5 parts
1.5.10 machine heads

1.5.10.8 machine head pegs



machine head pegs, metal, push-on model,
18x13mm, 12-pack
1008 BUT-04 nickel



machine head pegs, push-on
model, 19x13mm, 12-pack
1009 BUT-05
pearloid



machine head pegs, grinded push-on model,
22x15mm, 12-pack
1011 BUT-07 pearloid



machine head pegs, push-on model,
21x13mm, 12-pack
1012 BUT-08 black plastic















machine head pegs, push-on model,
22x13mm, 12-pack
1013 BUT-09 pearloid



machine head pegs, push-on model,
21x13mm, 12-pack
1014 BUT-10 ivory plastic

1.5.10.8 machine head pegs

 <p>machine head pegs, butterfly model, push-on model, 24x16mm, 12-pack 1015 BUT-11 pearloid</p>	 <p>machine head pegs, bolt-on model, 23x17mm, 6-pack 21180 BUT-13 pearloid white</p>
 <p>machine head pegs, pearloid, bolt-on model, 23x16mm, 6-pack 21183 BUT-18-PW white 21184 BUT-18-AM amber</p>	 <p>machine head pegs, metal, bolt-on model, 23x16mm, 6-pack 21187 BUT-25-C chrome 21188 BUT-25-G gold 21189 BUT-25-B black</p>
 <p>machine head pegs, metal, bolt-on model, 24x17mm, 6-pack 21190 BUT-27-C chrome 21191 BUT-27-G gold 21192 BUT-27-B black</p>	 <p>machine head pegs, metal, bolt-on model, 19x20mm, 6-pack 21193 BUT-29-C chrome 21194 BUT-29-G gold 21195 BUT-29-B black</p>
 <p>machine head pegs, metal, bolt-on model, 19x14mm, 6-pack 21196 BUT-31-C chrome 21197 BUT-31-G gold</p>	 <p>machine head pegs, metal, bolt-on model, 18x14mm, 6-pack 21198 BUT-33-C chrome 21199 BUT-33-G gold 21200 BUT-33-B black</p>
 <p>machine head pegs, metal, bolt-on model, 18x14mm, 6-pack 21201 BUT-35-C chrome 21202 BUT-35-G gold</p>	 <p>machine head pegs, metal, bolt-on model, 19x14mm, 6-pack 21203 BUT-37-C chrome 21204 BUT-37-G gold 21205 BUT-37-B black</p>
 <p>machine head pegs, metal, bolt-on model, 23x16mm, 6-pack 21206 BUT-39-C chrome 21207 BUT-39-G gold</p>	 <p>machine head pegs, metal, bolt-on model, 34x23mm, 4-pack 21208 BUT-62-C chrome 21209 BUT-62-G gold</p>

1.5.10.8 machine head pegs

 <p>genuine replacement part set of machine head pegs 33185 MHP-A1R amber, for model 22, 25, 32 33186 MHP-P1R salmon, for model 50 33187 MHP-A1B black, for model 55, 60, 65, 80, 90, 110, 130 33188 MHP-A1W pearloid, for model 60, 70, 120, 140 33189 MHP-P6I grained ivory, for model 220, 240</p>	
--	--

1.5 parts
1.5.10 machine heads

1.5.10.8 machine head bushings

Boston



machine head bushings, 6-10mm diameter,
12-pack
1018 **MHP-16-N** nickel



machine head bushings, 6,3mm diameter,
6-pack
16869 **MHP-18-C** chrome
16870 **MHP-18-G** gold
16871 **MHP-18-B** black



machine head bushings, 6,3mm diameter,
6-pack
16872 **MHP-19-N** nickel
16873 **MHP-19-C** chrome
16874 **MHP-19-G** gold
16875 **MHP-19-B** black

1.5 parts
1.5.10 machine heads

1.5.10.8 machine head bushings

Fender



Genuine Replacement Part machine
head bushings for American and
locking machine heads, set of 6
36456 **0058820049** chrome



Genuine Replacement Part machine
head bushings for American Vintage
Guitar, set of 6
36458 **0994946000** chrome



Genuine Replacement Part machine
head bushings for Standard Bass,
set of 4
36459 **0051532049** chrome



Genuine Replacement Part machine
head bushings for Vintage Bass, set
of 4
36460 **0019509049** chrome

1.5 parts
1.5.10 machine heads

1.5.10.8 machine head shafts

Boston



machine head shafts, metal, 2 holes, nickel,
12-pack
8110 **MHP-08D** 6x26mm



machine head shafts, metal, 1 middle hole,
nickel, 12-pack
11042 **MHP-09E** 6x26mm



machine head shafts, metal, 2 holes, nickel,
12-pack
11043 **MHP-11D** 6x22mm



machine head shafts, nylon, 12-pack
8111 **MHP-0109K** 9x28mm
8112 **MHP-0109L** 9x31mm



machine head shafts, nylon, 12-pack
8113 **MHP-0110K** 10x29mm
8114 **MHP-0110L** 10x31mm

1.5 parts
1.5.10 machine heads

Boston

1.5.10.8 miscellaneous machine head parts



machine head worm gear, diam.11mm,
12-pack
8134 MHP-2511 brass



bolts for machine head shafts, 2,5x5mm,
12-pack
8115 MHP-20BK black

1.5 parts
1.5.11 tools

1.5.11.1 allen wrenches and trussrod wrenches



allen wrench
13723 **WR-15** 1.5mm
13724 **WR-20** 2.0mm
13725 **WR-25** 2.5mm
13726 **WR-30** 3.0mm



allen wrench, 30.0mm long
13728 **WR-430** 4.0mm
31930 **WR-530** 5.0mm



truss rod wrench
13732 **PSL-07** for 9/32" nut
13733 **PSL-08** for 5/16" Gibson nut



allen wrench set with holder and screws
14148 **WRH-10-BK** 4 sizes, 1.5/2.0/2.5/3.0mm



allen wrench
24870 **WR-127** 1.27mm, .050"

1.5 parts
1.5.11 tools

1.5.11.1 allen wrenches and trussrod wrenches

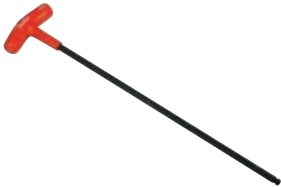

Genuine Replacement Part truss rod wrench
36563 **0023811049** 1/8 hex, set of 12
36564 **0048693049** American Series
bass, long handle,
3/16"



Genuine Replacement Part allen wrench kit for American Standard Bass
43359 **0995504002** black

1.5 parts
1.5.11 tools

1.5.11.1 allen wrenches and trussrod wrenches



long allen wrench for trussrod adjustment
44532 **18TOOL12** 5mm
44533 **18TOOL15** 4mm

1.5 parts
1.5.11 tools

1.5.11.1 allen wrenches and trussrod wrenches



spare part, trussrod adjustment key
37274 **TRK-1**

1.5 parts
1.5.11 tools

1.5.11.2 work bench tools

Boston



battery holder, horizontal type, clamp model (36x56mm)
25304 BH-2200



guitar neck support, wood, short model
26278 BNS-100

1.5 parts
1.5.11 tools

1.5.11.2 work bench tools

Fender



Custom Shop Series CruzTools tool kit
37351 0990519000



The Arch Work Station
43165 0990527000

1.5 parts
1.5.11 tools

1.5.11.2 work bench tools



<p>step gauge guitar, measuring string height, fret crown height, nut slot height 42779 H-SG-G</p>	<p>Groobar, aid to determine nut slot height, 4/set 42780 H-GB4</p>	<p>fret setter for resetting frets without loosening the strings for small, medium and wide frets 42813 H-FS10</p>
<p>fret hammer two heads, plastic/steel, weight: 225gr, head diameter: 25mm x 75mm, length: 330mm 42814 H-FH-L</p>	<p>fret slot saw, carbon steel, universal cutting teeth, tooth spacing 1.25mm 42815 H-FSW050 thickness: 0,50mm 42816 H-FSW060 thickness: 0,60mm</p>	<p>fret slot cleaning saw, thickness 0,50mm (Ryoba style), pull cut and push cut 42817 H-FSCW050</p>
<p>fret puller, carbon steel, blade width 10,0mm, flat blade thickness 0,40mm 42818 H-TC10</p>	<p>fret cutter, high carbon steel, blade width 26mm, not suitable for stainless steel frets 42819 H-FC190</p>	<p>fret cutter for stainless steel frets 42820 H-FC28SS</p>
<p>set of 5 scrapers small scraper set 42840 H-SCR-5</p>	<p>set of two wide scrapers, size: 120 x 44mm, thickness: 0,40mm 42841 H-SCR-2</p>	<p>wide straight scraper, size: 150 x 55mm, thickness 1,0mm 42842 H-SCR1S</p>
<p>stainless steel fingerboard radius gauge + string height check, for 7,25" - 9,5" - 10" - 12" - 14" - 16" 42843 H-RG2</p>	<p>hex screwdriver for comfortably adjusting bridge saddle 42844 H-HEXCD15 thickness: 1,5mm 42845 H-HEXSD127 thickness: 1,27mm / 0,05"</p>	<p>guitar tech padded mat, with magnetised storing area for small parts 42846 GTPM-30</p>

1.5 parts
1.5.11 tools

1.5.11.2 work bench tools



guitar neck support
44478 18A0076



workbench mat with logo
44479 18A0099

1.5 parts
1.5.11 tools

1.5.11.4 files



fret end file, extra fine (15cm length, 3mm width, 2mm thickness)
33339 FEF-10



fret crowning file for narrow frets (19,5cm length, 16mm width, 4mm thickness)
33349 FCF-101



fret crowning file, for standard frets (19,5cm length, 16mm width, 4mm thickness)
33341 FCF-102



fret crowning file, for wide frets (19,5cm length, 16mm width, 4mm thickness)
33350 FCF-103



fret finishing file, for narrow frets (19,5cm length, 16mm width, 4mm thickness)
35542 FFF-201



nut slotting files, with tapered ends, set of 3 pcs (19cm length, 14mm width, 2mm thickness)
33340 NFS-103



thin nut file, (15cm length, 12mm width)

33353	TNF-017	.017
33354	TNF-024	.024
33359	TNF-028	.028
33355	TNF-032	.032
33356	TNF-036	.036
33360	TNF-046	.046
33358	TNF-050	.050
33361	TNF-056	.056



set of 10 thin nut files

42781 **H-NF10**

Files: 010", 013", 016", 024", 028", 032", 036", 042", 046", 056"



set of 11 thin nut files

42782 **H-NF11**

Files: 010", 013", 016", 024", 028", 032", 036", 042", 046", 050", 056"



nut file 15 cm length

- | | | |
|-------|-----------------|------------------------------------|
| 42783 | H-NF-010 | teeth per inch: 73, 010" / 0,25 mm |
| 42784 | H-NF-013 | teeth per inch: 80, 013" / 0,33 mm |
| 42785 | H-NF-016 | teeth per inch: 80, 016" / 0,41 mm |
| 42786 | H-NF-024 | teeth per inch: 76, 024" / 0,61 mm |
| 42787 | H-NF-028 | teeth per inch: 76, 028" / 0,71 mm |
| 42788 | H-NF-032 | teeth per inch: 78, 032" / 0,81 mm |
| 42789 | H-NF-036 | teeth per inch: 78, 036" / 0,91 mm |
| 42790 | H-NF-042 | teeth per inch: 78, 042" / 1,07 mm |
| 42791 | H-NF-046 | teeth per inch: 78, 046" / 1,17 mm |
| 42792 | H-NF-050 | teeth per inch: 78, 050" / 1,27 mm |
| 42793 | H-NF-056 | teeth per inch: 66, 056" / 1,42 mm |



fret levelling file, 160 mm (L) x 28mm (W) x 5 mm (D), single cut teeth per inch: 20 cut

44261 **H-FL160S**



dual grit mini diamond plates, for honing sharp fret ends and sharpening knives

- | | | |
|-------|------------------|---------------|
| 42806 | H-IDP-156 | 150/600 grit |
| 42807 | H-IDP-410 | 400/1000 grit |



3 in 1 diamond fret crown file for small (R=1mm), medium (R=2mm) or wide frets (R=3mm)

42808 **H-FCF600**



fret end file (pencil like shape) for precise filing

- | | | |
|-------|--------------|----------------------|
| 42809 | H-FE1 | small frets (R=1mm) |
| 42810 | H-FE2 | medium frets (R=2mm) |
| 42811 | H-FE3 | wide frets (R=3mm) |

1.5 parts
1.5.11 tools

1.5.11.5 miscellaneous tools

Boston



"Punch-a-Pick" pick cutter, max thickness 2mm
39402 PAP-351

1.5 parts
1.5.11 tools

1.5.11.5 miscellaneous tools



cleaner spray KONTAKT 60
41860 KTK60-100 100ml spray can
41861 KTK60-200 200ml spray can

1.5 parts
1.5.11 tools

1.5.11.5 miscellaneous tools

LOCTITE



soldering wire 1.0mm 500gr on reel
42282 IDH288365

1.5 parts
1.5.11 tools

1.5.11.6 sanding and polishing products



radius double function sanding block for shaping fingerboard 7,25" and 9,5" radius
42795 **H-SB-1**



radius sanding block for shaping fingerboard
42796 **H-SB-2** 10" and 12" radius
42797 **H-SB-3** 14" and 16" radius
42798 **H-SB-4** 15" and 20" radius



fret polishing rubbers 4/set
42812 **H-FPR-SET**
150-180- 400-1000 grit, polishes small scratches and dirty frets

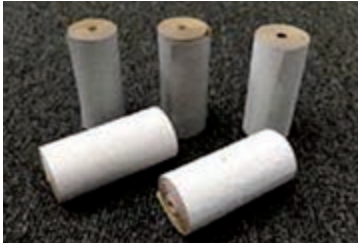

self-adhesive sandpaper suitable to use with H-SB sanding blocks
42799 **KCR100** 100 grit, 1,4m
42800 **KCR120** 120 grit, 1,8m
42801 **KCR150** 150 grit, 2,2m
42802 **KCR240** 240 grit, 2,6m
42803 **KCR320** 320 grit, 3,2m
42804 **KCR400** 400 grit, 3,2m
42805 **KCR600** 600 grit, 3,2m

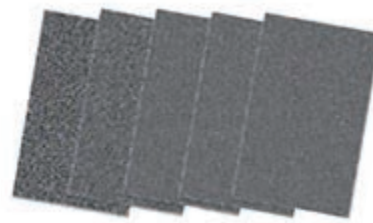

standard water proof sanding paper, pack of 10
42830 **KSC180** 180 grit
42831 **KSC240** 240 grit
42832 **KSC320** 320 grit
42833 **KSC400** 400 grit
42834 **KSC600** 600 grit
42835 **KSC800** 800 grit
42836 **KSC1000** 1000 grit
42837 **KSC1200** 1200 grit
42838 **KSC1500** 1500 grit
42839 **KSC2000** 2000 grit

1.5 parts
1.5.11 tools

1.5.11.6 sanding and polishing products



sanding sheets, 16 sheets, 8 grits:
80, 120, 240, 400, 600, 800, 1500
and 3000 grit
42821 **SSS-SET**



sanding sheet (not paper),
perfect for curved surfaces
42822 **SSS-80** 80 grit
42823 **SSS-120** 120 grit
42824 **SSS-240** 240 grit
42825 **SSS-400** 400 grit
42826 **SSS-600** 600 grit
42827 **SSS-800** 800 grit
42828 **SSS-1500** 1500 grit
42829 **SSS-3000** 3000 grit

