

PRODUCT CATALOG

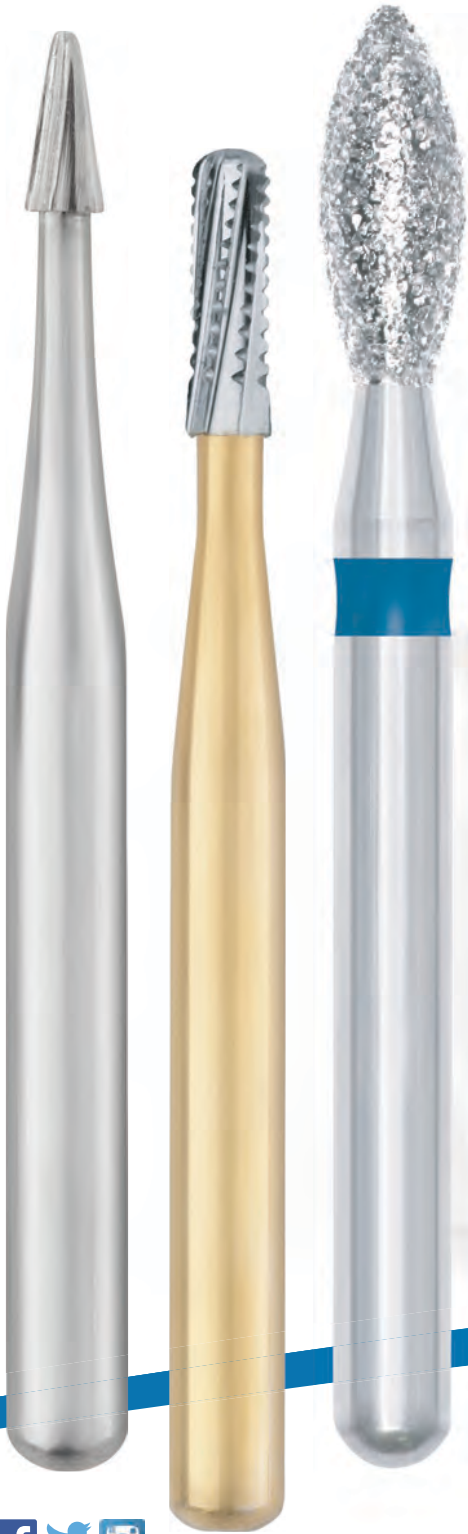

simply better dentistry™

SS WHITE®



#SSWHITE

Table of Contents

Introduction

Table of Contents	2
SS White® History/About Us	3

Carbide Burs

Operative Burs	4
Great White® Burs	8
Great White® Ultra Burs	9
Trimming and Finishing Burs	10
Safe End Finishing Burs	12
Oral Surgery Burs	13

Minimally Invasive Products

Fissurotomy® Burs	15
SmartBurs®II	16

Polishers

Jazz® Polishers	17
---------------------------	----

Laboratory Burs

CAD/CAM Burs	21
Great White® Lab Series	22
Express Line Lab Burs	27
Express Line Diamond Discs	28
Jazz Lab Polishers	29

Diamond Instruments

Great White® Z Diamonds	31
Piranha® Diamonds	32
Piranha® 2X Diamonds	38
Revelation® Diamonds	39

Endodontic Carbide Burs

Endoguide® Burs	44
Endo Safe End Burs	45

Kits

Procedural Kits	46
---------------------------	----

Instrument Organization

Bur Blocks	51
Shanks and Measurements	52

Instrument Usage Guidelines

Storage and Sterilization	53
-------------------------------------	----

Information For Use

SmartBurs®II	54
Jazz® Polishers	56
Endoguide®	57
Notes	59



A Proud Heritage of Innovation, Collaboration and Achievement

The name SS White® is synonymous with dentistry in the United States. The glorious history of SS White Burs began in 1844 when Samuel Stockton White opened up his business in Philadelphia, PA.

The growth of SS White is directly related to Dr. White's determination to improve his chosen profession. He encouraged doctors to communicate ideas freely with him, resulting in many innovations and a business philosophy that is the foundation of the company, even today.



Samuel Stockton White

SS White Founder
1822-1879

Celebrating Our 175th Year and Our Philosophy Remains...

SS White Dental continues the founder's tradition of identifying and developing ideas that will improve the quality of dental care and make it more efficient. We believe that innovation and the creation of unique products are the cornerstone of our company and make SS White one of the most well recognized and trusted names in dentistry.

Our mission is to provide dental clinicians with the highest quality products, to enable practitioners to work more accurately to conserve healthy tissue, to help them be more efficient to save chair-time, and to maximize comfort and quality to create better patient outcomes and grow their practice through patient referrals.

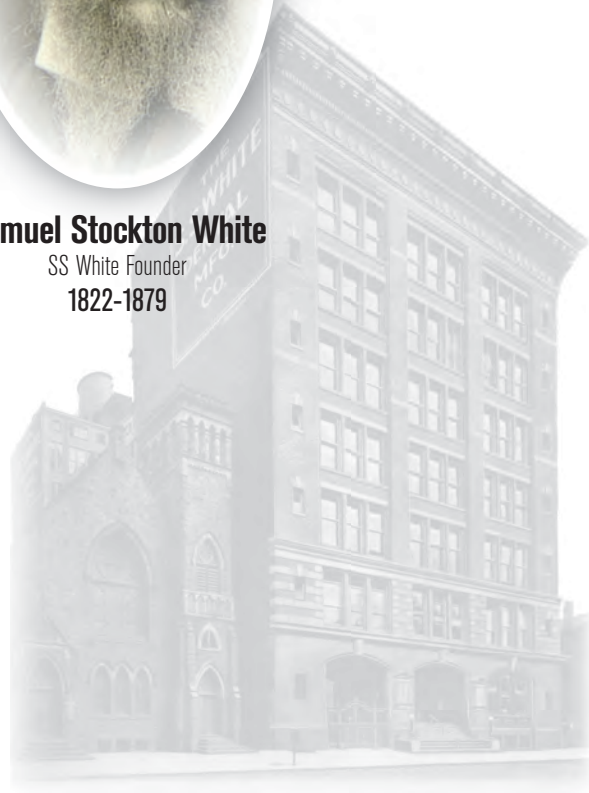

Force Resistant Solid Carbide Burs



Our burs are engineered to deliver superior consistency, strength and cutting rate with minimal vibration for maximized performance and procedural comfort for you and your patient.



STERILE R AVAILABLE IN ROLLS OF 25

"SS White offers strength, consistency and predictability in each carbide bur they manufacture. This gives me confidence that for each patient; I can maximize the quality of the restoration and create better, more beautiful smiles."

- Dr. Lou Graham

ROUND

	1/4	1/2	1	2	3	4	5	6	7	8	10
FG	17839	14961	14964	14967	14968	14970	14971	14973	14974	17706	
STERILE FG	10670	10145	10146	10147		10148		10149		10158	
FG (BULK)	13014	13012	13001	13002	13030	13004	13005	13006	13007	13008	
SS		14962	14965	15039	14969	17654		17657			
STERILE SS		10845									
SS (BULK)		13013	13010	13022	13031	13041		13066			
RA		14717	14718	14721	14724	14727	14730	14733	14736	14739	
STERILE RA		10139		10140		10141	10823	10142		10143	
RA (BULK)				13802		13804		13806		13808	
HP	14820	14821	14823	14826	14829	14832	14835	14838	14841	14844	14846
STERILE HP		10849		10837		10836		10835		10824	
HP (BULK)		12012	12001	12002		12004		12006		12008	

PEAR

	1/2 P	1P	2P	4P	329	330	300M	331	332	330L	331L	332L
FG	17731	17732	17733	17734	14999	15001	15010	15004	15005	15008	15037	15038
STERILE FG						10152	10857	10671	10853	10819	10917	
FG (BULK)	13015	13011	13003	13040	13291	13330	13335	13331	13332	13300	13333	13334
SS		17840				15002	15070					
STERILE SS						10843						
SS (BULK)		13009				13290	13292					
RA						14764		14765			14768	

STRAIGHT/FLAT
END PLAIN



	56	57	57L	58	59
FG	14991	14994	15028	14996	
STERILE FG	10678	10679	10798		
FG (BULK)	13056	13057	13074	13058	
SS	16893	14995		14993	
SS (BULK)	13065	13075		13085	
RA		14761			14763
HP		14867			14868

STRAIGHT/FLAT
END CROSS CUT



	556	557	558	559	560	556L	557L	558L
FG	15003	15006	15009	15034	15035	15059	15032	15033
STERILE FG	10153	10154	10806	10858	10922		10825	
FG (BULK)	13556	13557	13558	13509	13560	13507	13577	13551
SS	15058	15045	15048					
SS (BULK)	13506	13500	13550					
RA		14766	14769	14772	14775			
STERILE RA		10144						
HP		14871	14874	14877	14800			14907

STRAIGHT/ROUND
END PLAIN



	1156	1157	1158
FG	17707	17708	17709
STERILE FG		10748	10802
FG (BULK)	13156	13157	13158
SS	17710	17711	17705
SS (BULK)	13155	13154	13153

STRAIGHT/ROUND END
CROSSCUT FISSURE



	1556	1557	1558
FG	15020	15021	15024
STERILE FG		10826	10254
FG (BULK)	13516	13559	13580
SS	15019	15022	15025
SS (BULK)	13515	13517	13581
RA	14792	14793	14796
HP	14897	14898	14901
HP (BULK)		12057	12058

INVERTED
CONE



	33 1/2	34	35	36	37	37L	38	39
FG	14979	14982	14985	14986	14988	15027	14989	14990
STERILE FG	10676	10805	10150	10151	10677	10916	10817	10818
FG (BULK)	13033	13034	13035	13036	13037	13070	13038	13039
SS	14980	14983	15042		15026			
SS (BULK)	13032	13043	13053		13073			
RA	14744	14745	14748	14751	14754	14799	14757	14760
STERILE RA	10931	10827	10828	10829	10930			
HP	14849	14850	14853	14856	14859	14904	14862	14865
STERILE HP	10803							

TAPER/FLAT
END PLAIN



	169	170	171	169L	170L	171L
FG	16884	14997	15000	16887	15030	15031
STERILE FG	10801	10673	10816	10157	10674	
FG (BULK)	13169	13170	13171	13168	13172	13174
SS			17660			
SS (BULK)			13173			

TAPER/ FLAT
END CROSS CUT



	699	700	701	702	703	699L	700L	701L	702L
FG	16890	15012	15015	17608	15017	16892	16894	15036	
STERILE FG	10923		10913	10847	10927				
FG (BULK)	13699	13707	13701	13702	13703	13697	13709	13710	
SS	16891	15051	15016						
SS (BULK)	13698	13708	13700						
RA		14778	14781	14784	14787			14805	
STERILE RA			10830						
HP	14882	14883	14886	14889	14892			14910	14890
HP (BULK)			12701	12702	12703				
STERILE HP			10834	10833	10832				10848

TAPER/ ROUND
END PLAIN



	1170	1171	1170L	1171L
FG	17712	17714	17716	17717
FG (BULK)	13117	13114	13119	13113
SS	17713	17715		
SS (BULK)		13112		
RA	14789	14791		

END CUT



	956	957
FG	15007	15018
FG (BULK)	13956	13957
STERILE FG		10155
RA		14790
HP		14895

WHEEL



	14
FG	14976
FG (BULK)	13140
RA	14742
HP	14847

AMALGAM PREP



	244	245	246	256	257	271
FG	15060	15052	15053	17654	15055	15056
STERILE FG		10675		10156		10196
FG (BULK)	13244	13245	13246	13256	13257	1327
SS		15057				
SS (BULK)		13243				

SURGICAL & ENDODONTIC LENGTH



	1	2	4	6	8	557	558	1557	1558	700	701
FGSL	14001-5	14002-5	14004-5	14006-5	14008-5	14057-5	14058-5	14059-5	14060-5	14070-5	14071-5
STERILE FGSL	10687	10159	10160	10161	10162	10195	10683	10685	10680	10903	10681
RASL		14112-5	14114-5	14116-5	14118-5	14157-5	14158-5	14159-5			
STERILE RASL		10164	10165	10166	10167						

SURGICAL & ENDODONTIC LENGTH



	702	703	1702	1703
FGSL	14072-5	14073-5	14074-5	14075-5
STERILE FGSL	10682		10842	10797
RASL	14172-5	14173-5	14174-5	14175-5
STERILE RASL	10855			

Save 12 Hours of Chair Time Annually with Faster, Longer Lasting Metal Cutting

Designed with technically advanced blade geometry and force resistant solid carbide, SS White® Great White® Burs are more durable, enabling one bur to remove up to three PFMs.

GREAT WHITE® GOLD SERIES

METAL CUTTING - CAVITY PREPARATION CARBIDE BURS

STERILE R AVAILABLE IN ROLLS OF 25



ROUND

10 PK
100 PK
STERILE FG



GW2R
18202
13086
10693

GW2L2R
18202-5
5 PACK
10928

GW4R
18204
13087
10701

GWSL4R
18205-5
5 PACK
10709

GW6R
18206
13088
10705

GWSL6R
18207-5
5 PACK
10708

GW8R
18208
10706

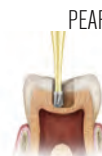

PEAR

10 PK
100 PK
STERILE FG



GW2P
18209
10692

GW245
18212
10839

GW330
18210
13090
10838

GW330S
18211



INVERTED
CONE

10 PK
STERILE FG



GW34
18214
10694

GW35
18215
10700

GW37
18216



STRAIGHT
FISSURE

10 PK
100 PK
STERILE FG



GWH340
14918
10796

GWH342
14919
5 PACK

GWH342L
14920

GW1557
18221
13092
10691

GWSL1557
18225-5
5 PACK



STRAIGHT FLAT
END FISSURE

10 PK
100 PK
STERILE FG



GW556
18217
10702

GW557
18218
13091
10703

GW557S
18219

GWSL557
18220-5
5 PACK
10707

GW558
18222
10704

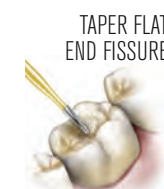

TAPER FLAT
END FISSURE

10 PK
STERILE FG



GW701
18223

GW702
18224
10918



RESTORATION
REMOVAL

10 PK
100 PK
STERILE FG



GW1 (331)
15061
13093
10929

GW2 (1558)
15062
13095
10690

GW1S
15063
13094

GW2S
15064
13096

"I have yet to experience anything that cuts as fast, accurate and smooth as a Great White® Bur, saving my practice time and money while reducing stress. A single Great White® Bur replaces my use of two to three carbide burs for PFM crown removal, a time savings of about 12 hours per year and over \$4,000 in productivity."

- Howard S. Glazer, DDS





Faster Bulk Reductions and Crown Preps With a Single Instrument

Cut up to 40% faster with significantly less effort than diamonds. Great White® Ultra provides high-speed performance and cuts restorative materials faster, enabling transition between different substrates with minimal clogging and no drag.

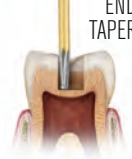

"The Great White® Ultra is a versatile bur designed for crown and bridge. It cuts smoothly and efficiently through dentin, enamel, amalgam, composite and cast metal restorations. The unique blade geometry ensures smooth cutting action even when moving from dentin to amalgam or cast metal restorations." – Steven Abrams, DDS

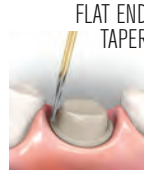
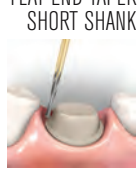
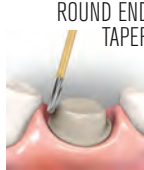
STERILE R AVAILABLE IN ROLLS OF 25

<p>FOOTBALL</p>  <p>5 PK STERILE FG HEAD LENGTH (mm) MAX HEAD DIAMETER (mm)</p>	<p>GWU 379-023 18193-5 10909 4.2 2.3</p>	<p>SHORT FLAT END TAPER</p>  <p>5 PK HEAD LENGTH (mm) MAX HEAD DIAMETER (mm)</p>	<p>GWU 845KR-016 18195-5 4.0 1.6</p> <p>GWU 845KR-018 18196-5 4.0 1.8</p> <p>GWU 845KR-025 18197-5 4.0 2.5</p>	<p>DEPTH CUTTER</p>  <p>10 PK STERILE FG</p>	<p>GWDC1 15040 10933</p> <p>GWDC2 15041 10138</p>
<p>FLAT END TAPER</p>  <p>5 PK STERILE FG HEAD LENGTH (mm) MAX HEAD DIAMETER (mm)</p>	<p>GWU 847-016 18200-5 8.0 1.6</p> <p>GWU 847-018 18191-5 10840 8.0 1.8</p> <p>GWU 847-020 18192-5 8.0 2.0</p>	<p>FLAT END TAPER SHORT SHANK</p>  <p>5 PK HEAD LENGTH (mm) MAX HEAD DIAMETER (mm)</p>	<p>GWU 847-016S 18186-5 8.0 1.6</p> <p>GWU 847-018S 18187-5 8.0 1.8</p> <p>GWU 847-020S 18185-5 8.0 2.0</p>		
<p>ROUND END TAPER</p>  <p>5 PK STERILE FG HEAD LENGTH (mm) MAX HEAD DIAMETER (mm)</p>	<p>GWU 855-025 18194-5 7.0 2.5</p> <p>GWU 856-016 18198-5 8.0 1.6</p> <p>GWU 856-018 18188-5 10715 8.0 1.8</p> <p>GWU 856-020 18189-5 10716 8.0 2.0</p> <p>GWU856-023 18190-5 8.0 2.5</p>	<p>ROUND END TAPER SHORT SHANK</p>  <p>5 PK STERILE FG HEAD LENGTH (mm) MAX HEAD DIAMETER (mm)</p>	<p>GWU 856-016S 18182-5 10137 8.0 1.6</p> <p>GWU 856-018S 18196-5 4.0 1.8</p> <p>GWU 856-020S 18184-5 8.0 2.0</p>		

Crown and Bridge Preparation Kit



All-In-One Kit
Designed for the efficient atraumatic removal of failed amalgams, composites, zirconia and PFM Crowns.
Kit Reorder No. 18150

- Kit Contents:**
- 2 Great White® Ultra #856-016
 - 2 Great White® Ultra #856-018
 - 2 Great White® Ultra #856-020
 - 1 Great White® Ultra #379-023
 - 2 Great White® Ultra #847-016
 - 2 Great White® Ultra #847-018
 - 1 Autoclavable Bur Block

The Great White® Ultra:

- Cuts quickly and smoothly through enamel
- Negotiates amalgam and other restorative materials with minimal clogging and no "drag or stalling"
- Allows completion of the bulk reduction task in the crown preparation with a single instrument
- More efficient –less chair time
- Helps provide precise margins

Powerful Cutting Performance for Faster, More Beautiful Finishes and Polishes

- 10 blade Safe End or 12 blade finishing burs efficiently trim and contour composites
- 20 blade Safe End or 20 blade Finishing burs create an ultra-smooth, pre-polish on composites



STERILE R AVAILABLE IN ROLLS OF 25

ROUND



12 BLADE
STERILE 12 BLADE

7002 15102-5 10809
7003 15103-5
7004 15086-5 10133
7006 15088-5 10168
7008 15090-5 10720
7009 15109-5 10846

20 BLADE
STERILE 20 BLADE

14081-5
10134

30 BLADE
STERILE 30 BLADE

14304-5 14306-5 14308-5
10904 10905

EGG



12 BLADE
STERILE 12 BLADE

7377 15377-5
7378 15370-5 10804
7379 15379-5 10725
8377
8378
8379
9406

20 BLADE
STERILE 20 BLADE

15378-5 15371-5 15380-5
10808 10911

30 BLADE

14316-5

BULK 100

13626

BEVEL



12 BLADE

7878 15875-5 8878

20 BLADE
STERILE 20 BLADE

15879-5 10935

NEEDLE



12 BLADE
STERILE 12 BLADE

7901 15121-5 10170
7902 15093-5 10731
7903 15903-5 10732
7904 14080-5
8901
8902
8903
8904
9904

20 BLADE
STERILE 20 BLADE

14083-5 14084-5 14085-5 14086-5
10907

30 BLADE
STERILE 30 BLADE

14314-5 10820

BULK 100

13620 13621 13622



FOOTBALL



12 BLADE
STERILE 12 BLADE

7404 15106-5
7406 15095-5
7408 15408-5
8404 10169
8406 10728
8408 10171

20 BLADE
STERILE 20 BLADE

15404-5 15406-5 15409-5
10699 10934 10925

BULK 100

13623 13624 13625



FOA 1



12 BLADE

FOA1
16004-5



BULLET



12 BLADE
12 BLADE STERILE

7801 15801-5
7802 15802-5
7803 15092-5
9803 14333-5



FLAME



12 BLADE
STERILE FG

7104 15091-5
7106 15094-5
7108 15108-5
7274 15274-5
8274 10924

20 BLADE

15275-5



INVERTED TAPER



12 BLADE

7303 15303-5
7304 15304-5



STRAIGHT



30 BLADE

7572 15572-5
7583 15096-5
9561 14361-5
9572 14372-5

ROUND END
TAPER



12 BLADE
12 BLADE STERILE

7675 15675-5
7676 15677-5
8675 10136
8676 15676-5
9642 15678-5

20 BLADE
20 BLADE STERILE

15676-5 15678-5
10910

30 BLADE
30 BLADE STERILE

14342-5
10851



TAPER



12 BLADE
12 BLADE STERILE

7702 15705-5
7713 15713-5
7642 15642-5
7664 15664-5
8642 10729

20 BLADE

14082-5

FLAT END
TAPER



12 BLADE
12 BLADE STERILE

7204 15204-5
7205 15205-5
7206 15206-5
7375 15375-5
7376 15381-5
8375 15376-5
8376 15382-5

20 BLADE

15376-5 15382-5



CFT



FG
STERILE FG

CFT1 16001-5
CFT2 16002-5
CFT3 16003-5
10733 10821 10822

SURGICAL LENGTH
FINISHING



12 BLADE

7902SL 16902-5
7104SL 16900-5
7106SL 14087-5
7108SL 16901-5



SAFE END
SERIES



10 BLADE
10 BLADE STERILE

SE3 16006-5
SE4 16007-5
SE6 16008-5
SE8 16009-5
SE9 16010-5
10697 10194 10192 10135 10193

20 BLADE
20 BLADE STERILE

16030-5 16031-5 16032-5 16033-5 16034-5
10926 10831 10813 10814 10815

Carbide Multi-Bladed Finishing Instruments for Composite Restorations

Ideal for contouring and finishing subgingival and interproximal composite margins. Non-cutting rounded tip prevents "pink composites" due to damage to hard and soft tissue.

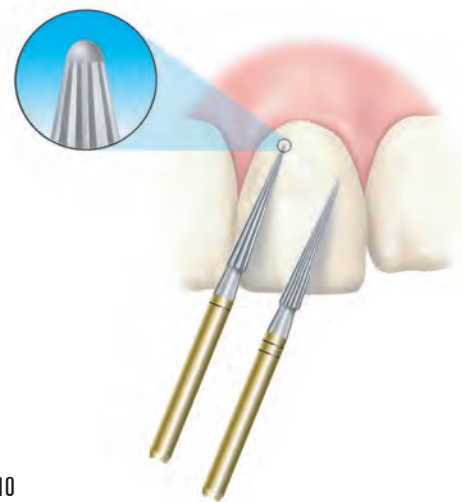

SE3-10
10 Blade 16006-5

SE3-20
20 Blade 16030-5



SE4-10
10 Blade 16007-5

SE4-20
20 Blade 16031-5



SE6-10
10 Blade 16008-5

SE6-20
20 Blade 16032-5



SE8-10
10 Blade 16009-5

SE8-20
20 Blade 16033-5



SE9-10
10 Blade 16010-5

SE9-20
20 Blade 16034-5

Safe End Series Finishing Bur Kit

#16051

Each kit contains one of the following Safe End Series Burs in an autoclavable bur block

- SE3-10 SE3-20
- SE4-10 SE4-20
- SE6-10 SE6-20
- SE8-10 SE8-20
- SE9-10 SE9-20



Order # 16051

Advanced Finishing System
Efficient Procedures
Aesthetic Finishing Procedures

Packaged Sterile for Convenience and Safety

- Unique blade geometry eliminates clogging and delivers faster cutting with more effective bone and tooth removal discharge
- Compatible with all popular hand pieces



STERILE **R** ALL ORAL SURGERY BURS AVAILABLE IN PACKS OF 10

ORAL SURGERY BUR SHAPE SELECTION



Round		Shank #1		Shank #2	Shank #3	Shank #4		Shank #5		Shank #6	
Size	Head Dia.	SSW#	Sterile Package*	SSW#	SSW#	SSW#	STRYKER#	SSW#	STRYKER#	SSW#	STRYKER#
1	1.0	14823									
2	1.2	14826									
4	1.4	14832									
6	1.8	14838	34838	30020	30035	30050	2296-100-418	30060	2296-101-418	30000	277-10-418
8	2.3	14844	34844	30021	30036	30051	2296-100-423	30031	2296-101-423	30001	277-10-423
10	2.7	14846	64846								







Cross Cut Fissure

Cross Cut Fissure		Shank #1		Shank #2	Shank #3	Shank #4		Shank #5		Shank #6	
Size	Head Dia.	SSW#	Sterile Package*	SSW#	SSW#	SSW#	STRYKER#	SSW#	STRYKER#	SSW#	STRYKER#
557	1.0	14871									
558	1.2	14874									
560	1.6	14880				30052				30002	
1557	1.0	14898									
1558	1.2	14901									
700	1.2	14883									
701	1.2	14886	34916	30022		30053	2296-100-212	30062			
701L	1.2	14910									
702	1.6	14889	34889	30023	30037	30054	2296-100-216	30063	2296-101-216	30003	277-10-216
702L	1.6	14890		30024		30055	2296-100-316	30064	2296-101-316	30004	
1702	1.6	14916		30029		30048		30069			
1702L	1.6	14917		30030		30049		30070			
703	2.1	14892	34892	30025	30038	30056	2296-100-221	30065	2296-101-221	30005	277-10-221
703L	2.1	14893		30026	30039	30057	2296-100-321	30066	2296-101-321	30006	
1703	2.1	14914	34914	30027	30040	30058		30067		30007	
1703L	2.1	14915	34915	30028		30059	2296-100-421	30068	2296-101-421	30008	





Surgical Length Non-Sterile Burs

(SOLD IN 5 PACKS)





Surgical Bur (SL) Shank Length - Round

	SIZE	HEAD DIA.	SLRA	SLFG
	1	1.0		14001-5
	2	1.2	14112-5	14002-5
	4	1.4	14114-5	14004-5
	6	1.8	14116-5	14006-5
	8	2.3	14118-5	14008-5

Surgical Bur (SL) Shank Length - Cross Cut

	SIZE	HEAD DIA.	SLRA	SLFG
	557	1.0	14157-5	14057-5
	558	1.2	14158-5	14058-5
	1557	1.0	14159-5	14059-5
	1558	1.2		14060-5
	700	1.0		14070-5

Surgical Bur (SL) Shank Length - Cross Cut

	SIZE	HEAD DIA.	SLRA	SLFG
	701	1.2		14071-5
	702	1.6	14172-5	14072-5
	703	2.1	14173-5	14073-5
	1702	1.6	14174-5	14074-5
	1703	2.1	14175-5	14075-5

Hall® is a registered trademark of Zimmer, Inc. • Stryker® is a registered trademark of Stryker Corporation • MicroAire® is a registered trademark of MicroAire Surgical Instruments, Inc.

Third Molar Extractions

Reduced Clogging

SS White®'s unique blade geometry allows for more effective bone and tooth removal discharge creating a more efficient instrument

More Efficient Cutting

Faster cutting by design, SS White® Oral Surgery Burs save time for all surgical procedures

Reduced Bur Breakage

Internal testing shows that SS White® burs consistently outperform all competitive burs in neck strength, significantly reducing bur breakage

Packaged Sterile

For your convenience and safety, SS White® Oral Surgery burs shank #1-6* come in a single sterile package

Surgical Bur (SL) Shank Length

Friction Grip Surgical Length



Right Angle Surgical Length



Oral Surgery Bur Shank Length #1-6

Shank #1 - 44.5mm

Fits Hall® & Most Standard Hand Pieces for Medium Bur Guard



Shank #2 - 51mm

Fits Hall® & MicroAire® Hand Pieces with Medium Bur Guard



Shank #3 - 65mm

Fits Hall® & MicroAire® Hand Pieces with Long Bur Guard



Shank #4 - 44.5mm

Fits Stryker® 100K & Impaction Handpiece



Shank #5 - 59mm

Fits Stryker® 100K & Impaction Handpiece



Shank #6 - 44.5mm

Fits Stryker® 50K & Osteotome Drill J-Notch







Early Diagnosis and Conservative Treatment of Hidden Fissure Caries

The Fissurotomy® bur head shape allows conservative exploration of fissures with a patient-friendly technique, often without the use of anesthesia. The funnel-shaped design enables you to explore enamel fissures and restore in 3 to 5 minutes.

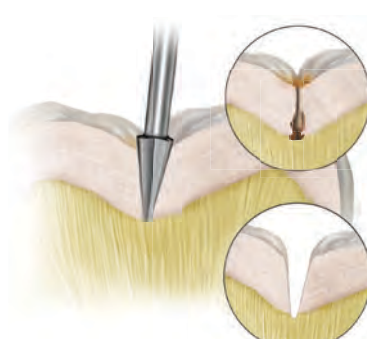
FISSUROTOMY®
CONSERVATIVE PREPARATION & EXPLORATION BURS

STERILE R AVAILABLE IN ROLLS OF 25

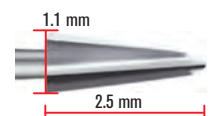
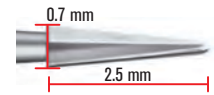
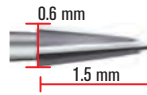

ORIGINAL	NARROW TAPER FISSURE	SHALLOW TAPER FISSURE
		
<p>Fissurotomy® Original ITEM # FG18010 FG STERILE 10914 FGSS 18011 BULK 13097 BULK SS 13098 10 PK Head Length (mm) 2.5 Max Head Diameter (mm) 1.1</p> 	<p>Fissurotomy® NTF ITEM # FG18014 FG STERILE 10915 FGSS 18016 BULK 13100 10 PK Head Length (mm) 2.5 Max Head Diameter (mm) 0.7</p> 	<p>Fissurotomy® STF ITEM # FG18013 FG STERILE 10932 FGSS 18015 BULK 13099 10 PK Head Length (mm) 1.5 Max Head Diameter (mm) 0.8</p> 

Diagnostic & Finishing Bur Kit



All-In-One Kit
Designed for the efficient diagnosis of suspect fissures and the finishing of the cavity preparation.
Kit Reorder No. 18007

Kit Contents:
3-Original Fissurotomy® Burs
3-Fissurotomy® Micro NTF Burs
3-Fissurotomy® Micro STF Burs
1-Finishing Bur® #7901
1-Finishing Bur® #7406
1-Autoclavable Bur Block

The Fissurotomy Bur:

- Tip of bur is smaller and more conservative than 1/4 round.
- Fine carbide tip will not strip quickly like thin diamonds.
- Virtually pain free to the DEJ and in most cases no anesthesia is needed.
- Ideal cavity preparation form for a flowable composite.
- Cleaner, more controlled and less costly than air abrasion.

CRA Product Review:

- 100% of CRA Evaluators rated Fissurotomy® Bur excellent or good and worthy of trial by colleagues¹
- Bur design produces very conservative occlusal preps¹
- Anesthetic often not required¹

Source: 1. CRA Newsletter, Volume 25, Issue 7, July 2001, Page 4

Fissurotomy Instruments are essential when removing decay in deep lesions because they preserve the healthy dentin. This reduces post-operative sensitivity and avoids unnecessary root canal procedures."

- Howard S. Glazer, DDS

The Only Rotary Cutting Instruments That Discriminate Between Healthy and Carious Zones of Dentin

A clinical study conducted at NYU College of Dentistry showed that 84% of patients preferred use of a SmartBurs® II instrument compared to use of a carbide bur with no local anesthetic for future dental treatment.*



STERILE R AVAILABLE IN ROLLS OF 25

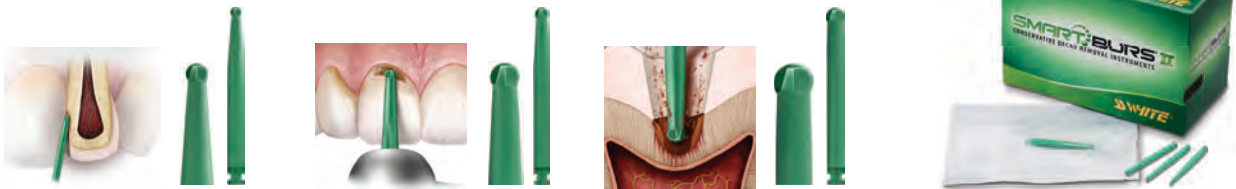

SmartBurs® II
RA # 4
ITEM # 52000
10 PK
RA STERILE 52004
Head Diameter (mm) 1.4

SmartBurs® II
RA # 6
ITEM # 52001
10 PK
RA STERILE 52006
Head Diameter (mm) 1.8

SmartBurs® II
RA # 8
ITEM # 52002
10 PK
RA STERILE 52008
Head Diameter (mm) 2.3

SmartBurs® II Combo
5 each of RA #4; 10 each of RA #6, RA #8)
ITEM # 52003
25 PK
STERILE 52010
SmartBurs® II Instruments are made for use at standard slow handpiece speeds of 5,000 to 10,000 rpm.

You and Your Patients Will Appreciate The SmartBurs® II Difference

The NYU patient study showed that there was no postoperative hypersensitivity in either Class I or V procedures conducted on 40 patients.*



SmartBurs® II Instruments conserve remaining healthy dentin to avoid inadvertent pulp exposure.



SmartBurs® II Instruments do not traumatize healthy dentinal tubules, thereby reducing post operative sensitivity.



SmartBurs® II Instruments do no harm to healthy dentinal tubules so patients may experience a more comfortable caries removal procedure without anesthesia.

"SmartBurs® II provides a conservative endpoint during excavation of infected carious dentin. Underlying and potentially protective caries affected dentin is thus preserved. SmartBurs® II relies on dentin hardness to provide a scientifically-based endpoint, and not staining, which can be variable or absent, and not a true indicator of remaining carious dentin."

-- Daniel W. Boston, DMD

Associate Dean for Clinical Comprehensive Care, Temple University Kornberg School of Dentistry

Create Faster, More Beautiful, Polishes with Jazz® Polishers



Eliminate Up To 3 Steps When Finishing and Polishing Composite Restorations:

- 10-blade Safe End or 12-blade finishing burs: Efficiently trim and contour composites
- 20-blade Safe End or 20-blade finishing burs: Place anatomical features, reduce high points and pre-polish
- Jazz® Supreme One-Step Polishers: Eliminate 3 step polisher system and still get beautiful, high shine



STERILE R AVAILABLE IN ROLLS OF 25 IN RIGHT ANGLE

SUPREME - COMPOSITE 1-STEP UNIVERSAL POLISHING SYSTEM



C2S - COMPOSITE 2-STEP POLISHING SYSTEM



C1S - COMPOSITE 1-STEP SINGLE-PATIENT POLISHING SYSTEM



C2S - COMPOSITE 2-STEP POLISHING SYSTEM



P2S - PORCELAIN & METAL 2-STEP SINGLE-PATIENT POLISHING SYSTEM



P3S - PORCELAIN & METAL 3-STEP POLISHING SYSTEM



P3S - PORCELAIN & METAL 3-STEP POLISHING SYSTEM



P3S - PORCELAIN & METAL 3-STEP POLISHING SYSTEM



FOR ZIRCONIA

When you need one polishing system for Zirconia:



A specially formulated polisher for full contour zirconia restorations.

High diamond grit for more efficiency and durability.

Achieve a high gloss and eliminate the need for glazing.

3 PK

STERILE

1. Use the medium grit polisher for reducing and smoothing



Medium Flame FG
Item #89110
#89110-S3

Medium Small Flame RA
Item #89111
#89111-S3

Medium Flame RA
Item #89112
#89112-S3

Medium Cup RA
Item #89113
#89113-S3

Medium Knife Edge RA
Item #89114

2. Finish with the fine grit polisher to achieve a high luster



Fine Flame FG
Item #89115
#89115-S3

Fine Small Flame RA
Item #89116
#89116-S3

Fine Flame RA
Item #89117
#89117-S3

Fine Cup RA
Item #89118
#89118-S3

Fine Knife Edge RA
Item #89119

STERILE

FOR POLISHING

When you need one polishing system for all CAD/CAM, porcelain, metal and composite materials:



Impregnated brushes for polishing CAD/CAM, porcelain, composites and metals.

Produces glossy surfaces after minimal processing time.

Low heat generation with minimal polishing paste required.

3 PK - RA Latch Type

STERILE

Diamond Impregnated



Brush Polisher PMC2S
Medium Large Cup/Brush
Item #89120

Brush Polisher PMC2S
Medium Small Cup/Brush
Item #89121
#89121-S3

Brush Polisher PMC2S
Medium Flame/Brush
Item #89122
#89122-S3

Silicon Carbide Impregnated



Brush Polisher PMC2S
Fine Large Cup/Brush
Item #89123
#89123-S3

Brush Polisher PMC2S
Fine Small Cup / Brush
Item #89124
#89124-S3

Brush Polisher PMC2S
Fine Flame / Brush
Item #89125
#89125-S3

STERILE



FOR GENERAL FINISHING

3 Step perforated finishing strips



Flexible silicon carbide coated metal strips for manual surface adjustments.

Perforation removes the cut material cleanly.

Strips are specially designed for easier interproximal application.

3 PK

- Coarse
- Medium
- Fine

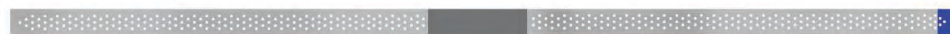

Jazz Pro Finishing Strip PMCE3S Coarse - Item #89127

Dimensions (mm): 4 x 150



Jazz Pro Finishing Strip PMCE3S Coarse - Item #89130

Dimensions (mm): 2.5 x 150



Jazz Pro Finishing Strip PMCE3S Medium - Item #89128

Dimensions (mm): 4 x 150



Jazz Pro Finishing Strip PMCE3S Medium - Item #89131

Dimensions (mm): 2.5 x 150



Jazz Pro Finishing Strip PMCE3S Fine - Item #89129

Dimensions (mm): 4 x 150



Jazz Pro Finishing Strip PMCE3S Fine - Item #89132

Dimensions (mm): 2.5 x 150

FOR DENTURE & ORTHO ACRYLICS

3 Steps to adjust, smooth and polish dentures and acrylics:



Chairside denture adjustments and polishing.

Silicon carbide abrasive polishers with various grits for different areas of application.

Achieve brilliant results for smoothing, pre-polishing and polishing.

HP Shanks

6 PK



Jazz Denture A3S
Coarse Large Flame
Item #89165



Jazz Denture A3S
Medium Large Flame
Item #89166



Jazz Denture A3S
Fine Large Flame
Item #89167



KITS AND ASSORTMENT PACKS



Jazz® Polishes Supreme Composite 1-Step Universal Polishing System

4 Pc. Kit in Autoclavable Bur Block

Kit Includes (1 of each):

- #89031 Universal Flame
 - #89032 Universal Knife Edge
 - #89033 Universal Cup
 - #89034 Universal Small Flame
- Item #89035**



Jazz® Polishes C2S Composite 2-Step Polishing System

8 Pc. Kit in Autoclavable Bur Block

Kit Includes (1 of each):

- #89022 Medium Flame
 - #89023 Medium Knife Edge
 - #89024 Medium Cup
 - #89025 Medium Small Flame
 - #89026 Fine Flame
 - #89027 Fine Knife Edge
 - #89028 Fine Cup
 - #89029 Fine Small Cup
- Item #89030**



Jazz® Polishes C1S Composite 1-Step Single-Patient Polishing System

12 Pc. Assortment Pack

Assortment Pack Includes (4 of each):

- #89037 Universal Cup
 - #89038 Universal Knife Edge
 - #89036 Universal Flame
- Item #89039**



Jazz® Polishes P2S Porcelain & Metal 2-Step Single-Patient Polishing System

12 Pc. Assortment Pack

Assortment Pack Includes (3 of each):

- #89018 Medium Cup
 - #89017 Medium Flame
 - #89020 Fine Cup
 - #89019 Fine Flame
- Item #89021**



Jazz® Polishes P3S Porcelain & Metal 3-Step Polishing System

12 Pc. Kit in Autoclavable Bur Block

Kit Includes (1 of each):

- #89004 Coarse Flame
 - #89005 Coarse Cup
 - #89006 Coarse Knife Edge
 - #89007 Coarse Small Flame
 - #89008 Medium Flame
 - #89009 Medium Cup
 - #89010 Medium Knife Edge
 - #89011 Medium Small Flame
 - #89012 Fine Flame
 - #89013 Fine Cup
 - #89014 Fine Knife Edge
 - #89015 Fine Small Edge
- Item #89016**



Complete Composite Finishing & Polishing Kit

Kit Includes (1 of each):

- 1-SE3-10 - #16006-5
 - 1-SE3-20 - #16030-5
 - 1-SE6-10 - #16008-5
 - 1-SE6-20 - #16032-5
 - 1-SE9-10 - #16010-5
 - 1-SE9-20 - #16034-5
 - 1-FG 7379 - #15379-5
 - 1-FG 8379 - #15380-5
 - 1-FG 7274 - #15274-5
 - 1-FG 8274 - #15275-5
 - 1-Jazz™ Supreme Cup - #89033
 - 1-Jazz™ Supreme Large Flame - #89031
- Item #18220**

Drive Down Material Cost Using Enhanced Performance CAD/CAM Milling Burs with Proven Durability

SS White carbide CAD/CAM burs for Roland® milling machines are built to last against abrasive materials such as zirconium, as well as soft materials like PMMA and wax blanks. The superior design of these burs leads to an extraordinarily long-life advantage compared to competitive burs.

- Diamond coated design increases life of the bur and reduces cost per use
- Reduces remakes by lowering excessive heat and cutting force, often required with lesser quality milling burs
- Sharper cutting efficiency produces superior surface quality
- Ample chip space guarantees efficient chip removal and polished flutes provide bur-free, clean milling results



SSWROL-034050-20-02

Head Diameter: .3mm
Shank Diameter: 4mm
Overall Length: 50mm
Cutter Design: 2 Flute Ball End
Milling Machines:
DWX-4, DWX-50, 51D, 52DC
Material Use:
PMMA, Wax, Zirconia, Composite



SSWROL-064050-20-02

Head Diameter: .6mm
Shank Diameter: 4mm
Overall Length: 50mm
Cutter Design: 2 Flute Ball End
Milling Machines:
DWX-4, DWX-50, 51D, 52DC
Material Use:
PMMA, Wax, Zirconia, Composite



SSWROL-084050-20-02

Head Diameter: .8mm
Shank Diameter: 4mm
Overall Length: 50mm
Cutter Design: 2 Flute Ball End
Milling Machines:
DWX-4, DWX-50, 51D, 52DC
Material Use:
PMMA, Wax, Zirconia, Composite



SSWROL-104050-20-02

Head Diameter: 1mm
Shank Diameter: 4mm
Overall Length: 50mm
Cutter Design: 2 Flute Ball End
Milling Machines:
DWX-4, DWX-50, 51D, 52DC
Material Use:
PMMA, Wax, Zirconia, Composite



SSWROL-204050-20-02

Head Diameter: 2mm
Shank Diameter: 4mm
Overall Length: 50mm
Cutter Design: 2 Flute Ball End
Milling Machines:
DWX-4, DWX-50, 51D, 52DC
Material Use:
PMMA, Wax, Zirconia, Composite



SSWROL-034050-20-01

Head Diameter: .3mm
Shank Diameter: 4mm
Overall Length: 50mm
Cutter Design: 2 Flute Ball End
Milling Machines:
DWX-4, DWX-50, 51D, 52DC
Material Use:
PMMA, Wax, Zirconia



SSWROL-064050-20-01

Head Diameter: .6mm
Shank Diameter: 4mm
Overall Length: 50mm
Cutter Design: 2 Flute Ball End
Milling Machines:
DWX-4, DWX-50, 51D, 52DC
Material Use:
PMMA, Wax, Zirconia



SSWROL-084050-20-01

Head Diameter: .8mm
Shank Diameter: 4mm
Overall Length: 50mm
Cutter Design: 2 Flute Ball End
Milling Machines:
DWX-4, DWX-50, 51D, 52DC
Material Use:
PMMA, Wax, Zirconia



SSWROL-104050-20-01

Head Diameter: 1mm
Shank Diameter: 4mm
Overall Length: 50mm
Cutter Design: 2 Flute Ball End
Milling Machines:
DWX-4, DWX-50, 51D, 52DC
Material Use:
PMMA, Wax, Zirconia



SSWROL-204050-20-01

Head Diameter: 2mm
Shank Diameter: 4mm
Overall Length: 50mm
Cutter Design: 2 Flute Ball End
Milling Machines:
DWX-4, DWX-50, 51D, 52DC
Material Use:
PMMA, Wax, Zirconia



Increased Performance and Durability with Zirconium Nitride Coated Lab Cutters

- 10X increased durability and longevity with extremely hard cutting surface of 2,800 Vickers
- Abrasion resistance reduces surface heat and vibration for a cooler, more consistent surface finish
- Comprehensive selection of shapes, sizes and grits, manufactured with tungsten carbide heads and stainless steel shanks

GREAT WHITE™ LAB SERIES CARBIDE BURS

SGE SERIES™ Model Plaster - BULK REDUCTION ON WET PLASTER Soft Reline - REMOVAL

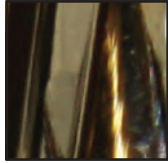

Shank	ISO Shape	200	201
SSW Item Number		GW79-050SGE-4	GW79-070SGE-4
ISO Grit		223	223
Head Dia		050	070
Head Length mm		13	14
Color Band			
Max Speed		30K	20K
Brasseler Number		H79SGE.11.050	H79SGE.11.070
Edenta Number		-	-

GE SERIES™ Model Plaster - BULK MATERIAL REDUCTION OF WET OR DRY PLASTE Acrylic - BULK REDUCTION Non-Precious Alloy - BULK REDUCTION

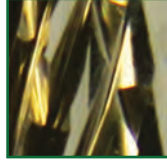

Shank	ISO Shape	143	200	200	200	200	201
SSW Item Number		GW72-060GE-4	GW79-045GE-4	GW79-050GE-4	GW351-060GE-4	GW351-070GE-4	GW79-060GE-4
ISO Grit		220	220	220	220	220	220
Head Dia		060	045	050	060	070	060
Head Length mm		13	13	13	13	13	14
Color Band							
Max Speed		20K	30K	30K	20K	20K	20K
Brasseler Number		-	-	H79GE.11.050	H351GE.11.060	H351GE.11.070	-
Edenta Number		5850.060HP	5650.045HP	-	5250.060HP	6050.070HP	5550.060HP

E SERIES™ Chrome Cobalt - TRIMMING PARTIAL DENTURE FRAMEWORK Hard Acrylic - TRIMMING DENTURES, TRAYS, TEMPORARY RESTORATIONS Metal Alloy - TRIMMING CROWN AND BRIDGE METAL SUBSTRUCTURES Composite - TRIMMING TEMPORARY APPLIANCE AND RESTORATIONS Plaster & Stone - TRIMMING MODELS & DIES

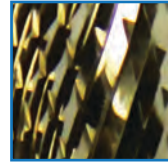

Shank	ISO Shape	201	237	257	275
SSW Item Number		GW79-070GE-4	GW77-060GE-4	GW78-060GE-4	GW251-060GE-4
ISO Grit		220	220	220	220
Head Dia		070	060	060	060
Head Length mm		14	11	12	14
Color Band					
Max Speed		20K	20K	20K	20K
Brasseler Number		H79GE.11.070	-	-	H251GE.11.060
Edenta Number		-	5150.060HP	5350.060HP	5450.060HP

Shank	ISO Shape	001	001	001	001	001
SSW Item Number		GW71-014E-4	GW71-023E-4	GW71-027E-4	GW71-031E-4	GW71-040E-4
ISO Grit		190	190	190	190	190
Head Dia		014	023	027	031	040
L mm		1.25	2.1	2.5	2.6	3.5
Color Band						
Max Speed		40K	40K	40K	30K	30K
Brasseler Number		H71E.11.014	H71E.11.023	H71E.11.027	H71E.11.031	H71E.11.040
Edenta Number		-	7110.023HP	7110.027HP	7110.031HP	7110.040HP

Shank	ISO Shape	001	001	001	110	123	139	141	143	144	144	187
SSW Item Number		GW71-050E-4	GW71-060E-4	GW71-070E-4	GW296-040E-4	GW364-023E-4	GW129-014E-4	GW141-023E-4	GW72-060E-4	GW364-023RE-4	GW293-023E-4	GW257-023E-4
ISO Grit		190	190	190	190	190	190	190	190	190	190	190
Head Dia		050	060	070	040	023	014	023	060	023	023	023
L mm		4.5	5.5	6.5	6	15	4	8	13	15	15	15
Color Band												
Max Speed		30K	20K	20K	30K	40K	40K	40K	20K	40K	40K	40K
Brasseler Number		H71E.11.050	H71E.11.060	H71E.11.070	H296E.11.040	H364E.11.023	H129E.11.014	H141E.11.023	H72E.11.060	H364RE.10.023	H293E.11.023	-
Edenta Number		7110.050HP	7110.060HP	-	-	0310.023HP	-	-	5810.060HP	0210.023HP	-	0610.023HP

Shank	ISO Shape	198	198	199	199	200	200	200	200	200	201
SSW Item Number		GW138-023E-4	GW351-040E-4	GW261-023E-4	GW79-031E-4	GW79-040E-4	GW79-045E-4	GW79-050E-4	GW351-060E-4	GW351-070E-4	GW257-060RE-4
ISO Grit		190	190	190	190	190	190	190	190	190	190
Head Dia		023	040	023	031	040	045	050	060	070	060
Head Length mm		8	8	11.5	11.5	13	13	13	13	13	14
Color Band											
Max Speed		440K	30K	40K	30K	30K	30K	30K	20K	20K	20K
Brasseler Number		H138E.11.023	H351E.11.040	H261E.11.023	-	H79E.11.040	-	H79E.11.050	H351E.11.060	H351E.11.070	H257RE.11.060
Edenta Number		0710.023HP	6210.040HP	0110.023HP	6410.031HP	5710.040HP	5610.045HP	-	5210.060HP	-	5910.060HP

Shank	ISO Shape	201	225	225	225	237	237	237	237	257	257
SSW Item Number		GW79-060E-4	GW137-016E-4	GW137-023E-4	GW137-060E-4	GW77-023E-4	GW77-029E-4	GW77-040E-4	GW77-060E-4	GW78-023E-4	GW78-040E-4
ISO Grit		190	190	190	190	190	190	190	190	190	190
Head Dia		060	016	023	060	023	029	040	060	023	040
Head Length mm		14	4	5.5	8	5.5	5.5	9	11	6	9
Color Band											
Max Speed		20K	40K	40K	20K	40K	40K	30K	20K	40K	30K
Brasseler Number		-	H137E.11.016	-	H137E.11.060	H77E.11.023	H77E.11.029	H77E.11.040	H77E.11.060	H78E.11.023	-
Edenta Number		5510.060HP	0910.023HP	0910.023HP	-	7710.023HP	7710.029HP	-	7010.060HP	-	6110.040HP

Shank	ISO Shape	257	273	275	275	275	277	277	277	289	292
SSW Item Number		GW78-060E-4	GW251-040E-4	GW250-040E-4	GW251-060E-4	GW251-070E-4	GW73-023E-4	GW73-040E-4	GW73-060E-4	GW139-023E-4	GW295-023E-4
ISO Grit		190	190	190	190	190	190	190	190	190	190
Head Dia		060	040	040	060	070	023	040	060	023	023
Head Length mm		12	9	13	14	14	3.8	6	10	8	15
Color Band											
Max Speed		20K	30K	30K	20K	20K	40K	30K	20K	40K	40K
Brasseler Number		H78E.11.060	H251E.11.040	H250E.11.040	H251E.11.060	H251E.11.070	H73E.11.023	H73E.11.040	H73E.11.060	H139E.11.023	H295E.11.023
Edenta Number		5310.060HP	7210.040HP	-	5410.060HP	-	1810.023HP	-	6310.060HP	0810.023HP	0410.023HP

EF SERIES

Cross Cut

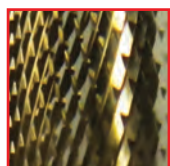

Chrome Cobalt - TRIMMING DENTURE FRAMEWORK
Hard Acrylic - TRIMMING DENTURES, TRAYS, TEMPORARY RESTORATIONS
Metal Alloy - TRIMMING CROWN AND BRIDGE METAL SUBSTRUCTURES
Composite - TRIMMING TEMPORARY APPLIANCE AND RESTORATIONS **Plaster & Stone** - TRIMMING MODELS & DIES

Shank	ISO Shape	141	144	187	187	198	199	199	200	200	200
SSW Item Number		GW129-023EF-4	GW364-023REF-4	GW257-023EF-4	GW257-060EF-4	GW138-023EF-4	GW261-023EF-4	GW79-031EF-4	GW79-040EF-4	GW79-045EF-4	GW351-060EF-4
ISO Grit		140	140	140	140	140	140	140	140	140	140
Head Dia		023	023	023	060	023	023	031	040	045	060
Head Length mm		8	15	15	14	8	11.5	11.5	13	13	13
Color Band											
Max Speed		40K	40K	40K	20K	40K	40K	30K	30K	30K	20K
Brasseler Number		H129EF.11.023	H364R.11.023	H257EF.11.023	H257EF.11.060	H138EF.11.023	H261EF.11.023	-	H79EF.11.040	-	H351EF.11.060
Edenta Number		1720.023HP	0220.023HP	0620.023HP	-	0720.023HP	0120.023HP	6420.031HP	5720.040HP	5620.045HP	5220.060HP



Shank	ISO Shape	201	237	237	257	275	277	289	292
SSW Item Number		GW79-060EF-4	GW77-023EF-4	GW77-029EF-4	GW78-060EF-4	GW251-060EF-4	GW73-023EF-4	GW139-023EF-4	GW295-023EF-4
ISO Grit		140	140	140	140	140	140	140	140
Head Dia		060	023	029	060	060	023	023	023
Head Length mm		14	5.5	5.5	12	14	3.8	8	15
Color Band									
Max Speed		20K	40K	40K	20K	20K	40K	40K	40K
Brasseler Number		-	H77EF.11.023	H77EF.11.029	H78EF.11.060	H251EF.11.060	H73EF.11.023	H139EF.11.023	H295EF.11.023
Edenta Number		5520.060HP	7720.023HP	7720.029HP	5320.060HP	5420.060HP	1820.023HP	0820.023HP	0420.023HP

Left Handed
EFL SERIES™
Cross Cut

Left Handed
EL SERIES™
Cross Cut

EUF SERIES™ High Noble Alloys - TRIMS
WITHOUT FOLDING
Gold Cast Restorations - TRIM
AND ADJUST

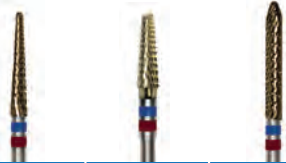
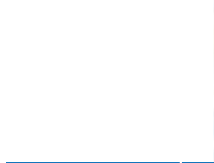
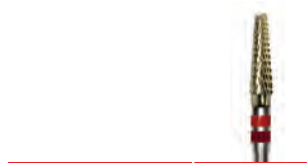
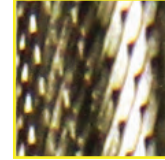

Shank	ISO Shape	200
SSW Item Number		GW79-040EFL-4
ISO Grit		142
Head Dia		040
Head Length mm		13
Color Band		
Max Speed		30K
Brasseler Number		H79EFL.11.040
Edenta Number		-

Shank	ISO Shape	199	200	292
SSW Item Number		GW261-023EL-4	GW79-040EL-4	GW295-023EL-4
ISO Grit		192	192	192
Head Dia		023	040	023
L mm		11.5	13	15
Color Band				
Max Speed		40K	30K	40K
Brasseler Number		H261EL.11.023	H79EL.11.040	H295EL.11.023
Edenta Number		-	-	-

Shank	ISO Shape	277	289
SSW Item Number		GW73-014EUF-4	GW139-023EUF-4
ISO Grit		110	110
Head Dia		014	023
L mm		2.9	8
Color Band			
Max Speed		40K	40K
Brasseler Number		H73EUF.11.014	H139EUF.11.023
Edenta Number		-	-

DF SERIES™ Precision Metal- Crowns and Bridged - FINISHING PRIOR TO VENEERING
Non-Precious Metal - Crowns and Bridged - FINISHING PRIOR TO VENEERING
Porcelain to Metal Margins - FINE ADJUSTMENTS

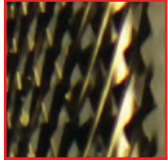

Shank	ISO Shape	141	198	199	200	219	289	292
SSW Item Number		GW129-023DF-4	GW138-023DF-4	GW261-023DF-4	GW79-040DF-4	GW136-016DF-4	GW139-023DF-4	GW295-023DF-4
ISO Grit		141	141	141	141	141	141	141
Head Dia		023	023	023	040	016	023	023
L mm		8	8	11.5	13	8	8	15
Color Band								
Max Speed		40K	40K	40K	30K	40K	40K	40K
Brasseler Number		H129DF.11.023	H138DF.11.023	H261DF.11.023	H79DF.11.040	H136DF.11.016	H139DF.11.023	H295DF.11.02
Edenta Number		-	-	-	-	-	-	-

UM SERIES™ Precious Metal Castings - TRIM, CONTOUR AND FINISH
Chrome Cobalt - ADJUST AND FINISH
Non-Precious Metal Casting - TRIM, CONTOUR AND FINISH
Partial Denture Framework - TRIM AND CONTOUR



Shank	ISO Shape	141	198	200	200	237	273	275	275	277	289
SSW Item Number		GW129-023UM-4	GW138-023UM-4	GW79-040UM-4	GW351-060UM-4	GW77-023UM-4	GW251-040UM-4	GW250-040UM-4	GW251-060UM-4	GW73-014UM-4	GW139-023UM-4
ISO Grit		145	145	145	145	145	145	145	145	145	145
Head Dia		023	023	040	060	023	040	040	060	014	023
Head Length mm		8	8	13	13	5.5	9	13	14	2.9	8
Color Band											
Max Speed		40K	40K	30K	20K	40K	30K	30K	20K	40K	40K
Brasseler Number		H129UM.11.023	H138UM.11.023	H79UM.11.040	H351UM.11.060	H77UM.11.023	H251UM.11.040	H250UM.11.040	H251UM.11.060	H73UM.11.014	H139UM.11.023
Edenta Number		-	-	-	-	-	-	-	-	-	-

UK SERIES™

Cross Cut

Ceramic Restorations - TRIM AND FINISH
Composite Restorations - TRIM AND FINISH
Acrylic Appliances - TRIM AND CONTOUR



Shank	ISO Shape	198	289
SSW Item Number		GW138-023UK-4	GW139-023UK-4
ISO Grit		144	144
Head Dia		023	023
Head Length mm		8	8
Color Band			
Max Speed		40K	40K
Brasseler Number		H138UK.11.023	H139UK.11.023
Edenta Number		-	-

Q SERIES™

Cross Cut

Acrylic - ADJUST AND CONTOUR
Titanium - LIGHT TRIMMING
Plaster - TRIM

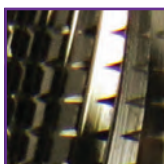

Shank	ISO Shape	200	200	272	275
SSW Item Number		GW79-040Q-4	GW351-060Q-4	GW390-016Q-4	GW251-060Q-4
ISO Grit		176	176	176	176
Head Dia		040	060	016	060
Head Length mm		13	13	3.5	14
Color Band					
Max Speed		30K	20K	40K	20K
Brasseler Number		H79Q.11.040	H351Q.11.060	H390Q.11.016	H251Q.11.060
Edenta Number		-	-	-	-

FSQ SERIES™

Cross Cut

Titanium Implant Abutments - TRIM AND CONTOUR
Soft Acrylic Denture Reline - TRIM
Acrylic Appliances - TRIM



Shank	ISO Shape	141	200	201	275	289
SSW Item Number		GW129-023FSQ-4	GW79-040FSQ-4	GW79-070FSQ-4	GW251-060FSQ-4	GW139-023FSQ-4
ISO Grit		132	132	132	132	132
Head Dia		023	040	070	060	023
Head Length mm		8	13	14	14	8
Color Band						
Max Speed		40K	30K	30K	20K	40K
Brasseler Number		H129FSQ.11.023	H79FSQ.11.040	H79FSQ.11.070	H251FSQ.11.060	H139FSQ.11.023
Edenta Number		1727.023HP	6927.040HP	-	7227.060HP	0827.023HP

GSQ SERIES™

Cross Cut

Soft Acrylic or Silicone Denture Reline - TRIM
Non-Precious Alloy - BULK REDUCTION

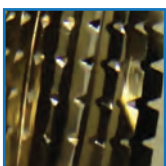

Shank	ISO Shape	199	200	200	200	201	275
SSW Item Number		GW261-023GSQ-4	GW79-040GSQ-4	GW351-060GSQ-4	GW351-070GSQ-4	GW79-070GSQ-4	GW251-060GSQ-4
ISO Grit		172	172	172	172	172	172
Head Dia		023	040	060	070	070	060
Head Length mm		11.5	13	13	13	14	14
Color Band							
Max Speed		40K	30K	20K	20K	20K	20K
Brasseler Number		H261GSQ.11.023	H79GSQ.11.040	H351GSQ.11.060	-	H79GSQ.11.070	H251GSQ.11.060
Edenta Number		0175.023HP	-	5275.060HP	6075.070HP	-	7275.060HP

G SERIES™ Plaster and Stone - TRIM Acrylic - TRIM

Spiral Fluted

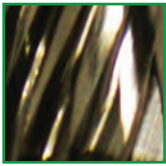

Shank	ISO Shape	143	143	200	200	200	200	201	201	237	257
SSW Item Number		GW72-060G-4	GW72-070G-4	GW79-045G-4	GW79-050G-4	GW351-060G-4	GW351-070G-4	GW79-060G-4	GW79-070G-4	GW77-060G-4	GW78-060G-4
ISO Grit		215	215	215	215	215	215	215	215	215	215
Head Dia		060	070	045	050	060	070	060	070	060	060
Head Length mm		13	13	13	13	13	13	14	14	11	12
Color Band											
Max Speed		20K	20K	30K	30K	20K	20K	20K	20K	20K	20K
Brasseler Number		H72G.11.060	H72G.11.070	-	H79G.11.050	H351G.11.060	H351G.11.070	-	H79G.11.070	H77G.11.060	-
Edenta Number		5880.060HP	-	5680.045HP	-	5280.060HP	-	5580.060HP	-	-	5380.060HP

M SERIES™ Plaster & Stone - TRIM Acrylic - BULK REDUCTION

Spiral Fluted

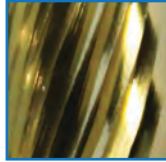

Shank	ISO Shape	275	Shank	ISO Shape	001	001	001	143	187	199	199	200
SSW Item Number		GW251-060G-4	SSW Item Number		GW71-016M-4	GW71-040M-4	GW71-050M-4	GW72-060M-4	GW257-023M-4	GW261-023M-4	GW79-031M-4	GW79-040M-4
ISO Grit		215	ISO Grit		175	175	175	175	175	175	175	175
Head Dia		060	Head Dia		016	040	050	060	023	023	031	040
Head Length mm		14	Head Length mm		1.4	3.5	4.5	13	15	11.5	11.5	13
Color Band			Color Band									
Max Speed		20K	Max Speed		40K	30K	30K	20K	40K	40K	30K	30K
Brasseler Number		-	Brasseler Number		H71.11.016	H71.11.040	H71.11.050	H72.11.060	H257.11.023	H261.11.023	-	H79.11.040
Edenta Number		5480.060HP	Edenta Number		-	7170.040HP	7170.050HP	5870.060HP	-	-	6470.031HP	5770.040HP



Shank	ISO Shape	200	200	200	200	201	201	201	237	257	257
SSW Item Number		GW79-045M-4	GW79-050M-4	GW351-060M-4	GW351-070M-4	GW257-060RM-4	GW79-060M-4	GW79-070M-4	GW77-060M-4	GW78-023M-4	GW78-060M-4
ISO Grit		175	175	175	175	175	175	175	175	175	175
Head Dia		045	050	060	070	060	060	070	060	023	060
Head Length mm		13	13	13	13	14	14	14	11	6	12
Color Band											
Max Speed		30K	30K	20K	20K	20K	20K	20K	20K	40K	20K
Brasseler Number		-	H79.11.050	H351.11.060	H351.11.070	H257R.11.060	-	H79.11.070	H77.11.060	H78.11.023	H78.11.060
Edenta Number		5670.045HP	-	5270.060HP	-	5970.060HP	5570.060HP	-	5170.060HP	-	5370.060HP



Shank	ISO Shape	275	275	277
SSW Item Number		GW251-060M-4	GW251-070M-4	GW73-060M-4
ISO Grit		175	175	175
Head Dia		060	070	060
Head Length mm		14	14	10
Color Band				
Max Speed		20K	20K	20K
Brasseler Number		251.11.060	H251.11.070	H73.11.060
Edenta Number		5470.060HP	-	6370.060HP

Laboratory Metal Burs

The SS White® Express Line Lab Metal Finishing Bur's unique blade geometry cuts easily through metal with minimal heat and hand strain, resulting in less vibration and requiring only a soft touch when cutting:

- Reduced hand fatigue and increased productivity
- Designed to decrease metal finishing time substantially
- Ideal for shaping and gross reduction

EXPRESS LINE LAB METAL FINISHING BURS



FG (25mm) EL-1 16101 EL-2 16102 EL-3 16103 EL-4 16104 EL-5 16105

EXPRESS LINE® Lab Metal Finishing Bur Kit #16100

Kit Contains: One each of the following
Express Line Lab Metal Finishing Burs
EL1, EL2, EL 3, EL4, EL5, FG7006

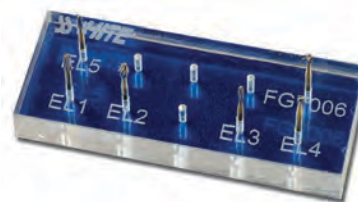

EXPRESS LINE LAB DIAMONDS - STRAIGHT HANDPIECE INSTRUMENTS

- Excellent abrasive capacity & life
- Ideal for shaping and gross reduction
- Works great on PFM, chrome & ceramic materials
- HP Diamonds on 44.5mm shanks



ROUND

Item # 801-020 16200 801-030 16201



INVERTED
CONE

805-020 16202 805-030 16203 805-040 16204 806-030 16205



CONE FLAT
END

Item # 845-020 16206 848-030 16207 854-040 16208



CONE ROUND
END

854R-040 16209 859-030 16210



FLAME

863-030 16211

Diamond Discs

Increase lab efficiency by eliminating wheel changes and cutting with dull wheels. SS White® Diamond Discs provide a smoother finish than comparable coarse wheels and cut faster. Ideal for temporary crown and bridge material and orthodontic stripping. Uniform spacing between the diamond aggregates helps ensure immediate removal of debris and less clogging:

- Designed to last longer than conventional wheels
- Ideal to use on ceramics, acrylics, and plaster
- Reduces black marks on porcelain

EXPRESS LINE DIAMOND DISCS

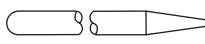
Standard Straight Handpiece .0925" 
 .118" 

FLEX Mounted Diamond Discs

 LT

927F
Double Sided

Order #	927F200M	927F220M
Head Size (1/10mm)	200	220
Thickness (mm)	0.24	0.24
Grit	Medium	Medium

 LT

916F
Single Sided

Order #	916F200M	916F220M
Head Size (1/10mm)	200	220
Thickness (mm)	0.17	0.17
Grit	Medium	Medium

 LT

917F
Single Sided

Order #	917F200M	917F220M
Head Size (1/10mm)	200	220
Thickness (mm)	0.17	0.17
Grit	Coarse	Coarse

SUPERFLEX Mounted Diamond Discs

 LT

910S
Double Sided

Order #	910S200M	910S220M
Head Size (1/10mm)	200	220
Thickness (mm)	0.19	0.19
Grit	Fine	Fine

 LT

927S
Double Sided

Order #	277S220M
Head Size (1/10mm)	220
Thickness (mm)	0.19
Grit	Fine

 LT

917S
Single Sided

Order #	917S220M
Head Size (1/10mm)	220
Thickness (mm)	0.12
Grit	Fine

Jazz Lab Polishers

FOR PORCELAIN & METAL



NEW PRODUCT

- Ceramic bonded grinder with diamond grit for more efficiency and durability.
- Maintains shape during application.
- Heat resistant.
- HP shanks.



Lab Grinder PM2S
Coarse Large Disc
Item #89133
1 PK



Lab Grinder PM2S
Coarse Taper Cylinder
Item #89134
3 PK



Lab Grinder PM2S
Coarse Straight Cylinder
Item #89135
3 PK



Lab Grinder PM2S
Coarse Small Disc
Item #89136
1 PK



Lab Grinder PM2S
Medium Large Disc
Item #89137
1 PK



Lab Grinder PM2S
Medium Taper Cylinder
Item #89138
3 PK



Lab Grinder PM2S
Medium Straight Cylinder
Item #89139
3 PK



Lab Grinder PM2S
Medium Small Disc
Item #89140
1 PK

FOR ZIRCONIA & LITHIUM DISILICATE - POLISHING



NEW PRODUCT

- Specially designed polisher for full contour zirconia restorations.
- Produces glossy surfaces with high diamond concentration for more efficiency.
- Eliminates the need for glazing.
- HP shanks.



Lab Polisher ZL3S
Coarse Large Disc
Item #89141
1 PK



Lab Polisher ZL3S
Coarse Flame
Item #89142
3 PK



Lab Polisher ZL3S
Coarse Wheel
Item #89143
3 PK

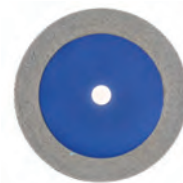

Lab Polisher ZL3S
Coarse Wheel
Unmounted
Item #89144
1 PK



Jazz Lab Polisher ZL3S
Medium Large Disc
Item #89145
1 PK



Jazz Lab Polisher ZL3S
Medium Flame
Item #89146
3 PK



Lab Polisher ZL3S
Medium Wheel
Item #89147
3 PK



Lab Polisher ZL3S
Medium Wheel
Unmounted
Item #89148
1PK



Jazz Lab Polisher ZL3S
Fine Large Disc
Item #89149
1 PK



Lab Polisher ZL3S
Fine Flame
Item #89150
3 PK



Lab Polisher ZL3S
Fine Wheel
Item #89151
3 PK



Lab Polisher ZL3S
Fine Wheel
Unmounted
Item #89152
1 PK

FOR PORCELAIN POLISHING



- Flexible polishing discs for all porcelain materials.
- Diamond grit for highest efficiency.
- Surface corrections without additional glazing.
- HP shank.



Lab Polisher P3S
Coarse Large Disc
Item #89153
1 PK

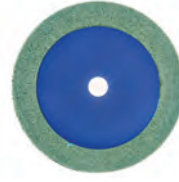

Lab Polisher P3S
Coarse Wheel
Unmounted
Item #89154
1 PK



Lab Polisher P3S
Coarse Flame
Item #89155
3 PK



Lab Polisher P3S
Coarse Small Wheel
Item #89156
3 PK



Lab Polisher P3S
Medium Large Disc
Item #89157
1 PK



Lab Polisher P3S
Medium Wheel
Unmounted
Item #89158
1 PK



Lab Polisher P3S
Medium Flame
Item #89159
3 PK



Lab Polisher P3S
Medium Small Wheel
Item #89160
3 PK



Lab Polisher P3S
Fine Large Disc
Item #89161
1 PK



Lab Polisher P3S
Fine Wheel
Unmounted
Item #89162
1 PK



Lab Polisher P3S
Fine Flame
Item #89163
3 PK



Lab Polisher P3S
Fine Small Wheel
Item #89164
3 PK



Jazz Precision Mandrel
#89168
HP Shank 303-050 Screw Top Mandrel
5mm Head Size
5 PK

Over 35% of All Crowns Placed Have Zirconia Copings

Gain Access or Remove a Crown in less than 1 minute with Great White[®] Z. The proprietary bonding process with fine grit synthetic diamond particles creates more consistent particle coverage, durability and cutting efficiency, enabling faster completion of more efficient procedures, providing significant material cost savings, chair time savings and patient satisfaction.

Images Not Shown to Scale



STERILE R AVAILABLE IN ROLLS OF 25



ROUND END TAPER
 GWZ 856-018
 ITEM# 18161
 5 PK
FG STERILE 10900
 Head Length (mm) 8.0
 Max Head Diameter (mm) 1.8
 LOA - Overall Length (mm) 22.0



ROUND
 GWZ 801-014
 ITEM# 18162
 5 PK
 Head Length (mm) 1.3
 Max Head Diameter (mm) 1.4
 LOA - Overall Length (mm) 19.0



GWZ 801-018
 ITEM# 18163
 5 PK
FG STERILE 10902
 Head Length (mm) 1.7
 Max Head Diameter (mm) 1.8
 LOA - Overall Length (mm) 19.0

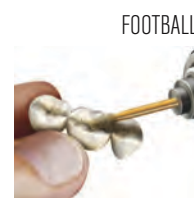

FOOTBALL
 GWZ 379-023
 ITEM# 18164
 5 PK
FG STERILE 10901
 Head Length (mm) 4.2
 Max Head Diameter (mm) 2.3
 LOA - Overall Length (mm) 19.0

Great White[®]Z Introductory Kit



All-In-One Kit
 Designed for the efficient atraumatic removal of failed zirconia and PFM Crowns.
Kit Reorder No. 18160

Kit Contents:
 Great White[®]Z #GWZ 856-018
 Great White[®]Z #GWZ 801-014
 Great White[®]Z #GWZ 801-018
 Great White[®]Z #GWZ 379-023

Great White[®]Z Cuts Zirconia Much More Efficiently
 Great White[®]Z Diamonds are manufactured with fine diamond particles and a proprietary diamond bonding technique which has been shown to reduce micro-fractures, vibrations and have increased patient satisfaction.

"I highly recommend Great White[®]Z Diamonds, they will cut significant time from zirconia crown removal procedures while reducing stress, usually with just one diamond."

- Howard Strassler, DDS

Love How a New Diamond Cuts?

Save Up to 50% With Single-Patient-Use Diamonds

- **Quality & Consistency:** Significantly increase preparation quality with the use of a new diamond for each patient.
- **Broad Selection:** With over 550 diamonds to choose from, Piranha® meets all of your clinical needs.
- **Simplicity:** Eliminate the expense of sterilization and worry of cross contamination.
- **Control:** Clinicians prefer the feel of a “fresh” diamond for each patient.



ALL SINGLE-USE PIRANHAS AVAILABLE IN PRE-STERILE PACKS OF 25

POINTED FOOTBALL



	368-016	368-020	368-021	368-023
DIAMETER (mm)	1.6	2.0	2.1	2.3
HEAD LENGTH (mm)	3.4	4.5	4.5	5.0
● Super Coarse				368-023SC
● Coarse	368-016C	368-020C	368-021C	368-023C
● Medium	368-016M		368-021M	368-023M
● Fine	368-016F	368-020F	368-021F	368-023F
● Very Fine	368-016VF			368-023VF

FOOTBALL



	379-018	379-023	390-014
DIAMETER (mm)	1.8	2.3	1.4
HEAD LENGTH (mm)	3.4	4.2	2.9
● Super Coarse			379-023SC
● Coarse	379-018C	379-023C	
● Medium	379-018M	379-023M	
● Fine	379-018F	379-023F	390-014F
● Very Fine	379-023VF		390-014VF
● S (Short Shank)	379-018C-S		

MOSQUITO NOSE

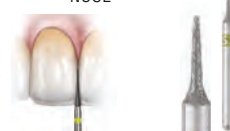

	392-016
DIAMETER (mm)	1.6
HEAD LENGTH (mm)	4.5
● Medium	392-016M
● Fine	392-016F
● Very Fine	392-016VF

ROUND



	801-010	801-012	801-013	801-014	801-015	801-016	801-018	801-021	801-023
DIAMETER (mm)	1.0	1.2	1.3	1.4	1.5	1.6	1.8	2.1	2.3
HEAD LENGTH (mm)	0.9	1.1	1.2	1.3	1.4	1.5	1.7	2.0	2.2
● Super Coarse									801-023SC
● Coarse	801-012C		801-014C		801-016C		801-018C	801-021C	801-023C
● Medium	801-010M	801-012M	801-013M	801-014M	801-015M	801-016M	801-018M	801-021M	801-023M
● Fine			801-013F	801-014F	801-016F		801-018F	801-021F	801-023F
● Very Fine	801-014VF				801-018VF			801-023VF	
○ Ultra Fine							801-018UF	801-023UF	

BARREL

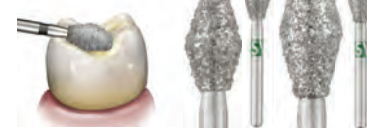

	811-033	811-037
DIAMETER (mm)	3.3	3.7
HEAD LENGTH (mm)	5.0	7.0
TIP DIAMETER (mm)	1.8	2.0
● Super Coarse	811-033SC	811-037SC
● Coarse	811-033C	811-037C

INVERTED CONE



	805-010	805-012	805-014	805-016	807-016	807-018
DIAMETER (mm)	1.0	1.2	1.4	1.6	1.6	1.8
HEAD LENGTH (mm)	1.1	1.2	1.4	1.6	4.0	5.0
TIP DIAMETER (mm)	1.0	1.2	1.4	1.6	1.6	1.8
● Coarse	805-010C	805-012C	805-014C	805-016C	807-016C	807-018C
● Medium	805-010M	805-012M	805-014M	805-016M		

DOUBLE INVERTED CONE



	813-014
DIAMETER (mm)	x.x
HEAD LENGTH (mm)	x.x
TIP DIAMETER (mm)	x.x
● Medium	813-014M

DEPTH CUTTER



DIAMETER (mm)	2.2	2.6
HEAD LENGTH (mm)	0.9	0.9
DEPTH (mm)	0.3	0.5
Medium	828-022M	828-026M

PEAR



DIAMETER (mm)	0.8	1.0	1.2
HEAD LENGTH (mm)	2.5	3.0	3.0
TIP DIAMETER (mm)	0.8	1.0	1.2
Coarse	830-008C	830-010C	830-012C
Medium	8030-008M	830-010M	830-012M
S (Short Shank)	830-008M-S	830-010M-S	830-012M-S

TRI-WHEEL DEPTH CUTTER

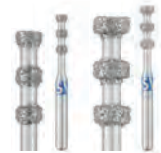

DIAMETER (mm)	1.6	2.1
HEAD LENGTH (mm)	6.0	6.0
DEPTH (mm)	0.3	0.5
Medium	834-016M	834-021M

FLAT END CYLINDER



DIAMETER (mm)	0.8	0.9	1.0	1.2	1.4	1.2	1.4	1.2	1.4	1.6
HEAD LENGTH (mm)	3.0	3.0	3.0	4.0	4.0	6.0	6.0	8.0	8.0	8.0
TIP DIAMETER (mm)	0.8	0.9	1.0	1.2	1.4	12	1.4	1.2	1.4	1.6
Super Coarse									837-014SC	
Coarse			835-010C	835-012C	835-014C	836-012C	836-014C	837-012C	837-014C	837-016C
Medium	835-008M	835-009M	835-010M	835-012M	835-014M	836-012M	836-014M	837-012M	837-014M	837-016M
S (Short Shank)			835-010C-S							
S (Short Shank)				835-012M-S	835-014M-S					

MODIFIED FLAT END CYLINDER



DIAMETER (mm)	1.4
HEAD LENGTH (mm)	8.0
TIP DIAMETER (mm)	1.4
Coarse	837KR-014C
Fine	837KR-014F

ROUND END CYLINDER



DIAMETER (mm)	1.0	1.2
HEAD LENGTH (mm)	4.0	4.0
TIP DIAMETER (mm)	1.0	1.2
Super Coarse		838-012SC
Coarse	838-010C	

FLAT END TAPER



DIAMETER (mm)	1.0	1.2	1.4	1.4	1.6	1.8	1.2	1.4	1.6	1.8
HEAD LENGTH (mm)	4.0	4.0	4.0	6.0	6.0	6.0	8.0	8.0	8.0	8.0
TIP DIAMETER (mm)	0.7	0.8	0.95	0.7	0.9	1.1	0.8	0.8	1.0	1.2
Super Coarse								847-014SC	847-016SC	847-018SC
Coarse	845-010C	845-012C	845-014C	846-014C	846-016C			847-014C	847-016C	847-018C
Medium				846-014M	846-016M	846-018M		847-014M	847-016M	847-018M
Fine								847-014F	847-016F	847-018F
SS (Short Shank)							847-012C-S	847-014C-S	847-016C-S	847-018C-S
SS (Shorter Than Short Shank)								847-014C-SS	847-016C-SS	847-018C-SS



	847L-014	847L-016	848-016	848-018
DIAMETER (mm)	1.4	1.6	1.6	1.8
HEAD LENGTH (mm)	9.0	9.0	10.0	10.0
TIP DIAMETER (mm)	1.0	1.0	1.0	1.0
● Super Coarse			848-016SC	848-018SC
● Coarse			848-016C	848-018C
● Medium	847L-014M	847L-016M	848-016M	848-018M
● Fine	847L-014F		848-016F	848-018F
● S (Short Shank)			848-016C-S	
● S (Short Shank)				848-018M-S



	845KR-016	845KR-018	845KR-025	846KR-014	846KR-016	846KR-018
DIAMETER (mm)	1.6	1.8	2.5	1.4	1.6	x.x
HEAD LENGTH (mm)	4.0	4.0	4.0	6.0	6.0	x.x
TIP DIAMETER (mm)	1.2	1.2	1.4	0.9	1.1	x.x
● Coarse	845KR-016C	845KR-018C	845KR-025C	846KR-014C	846KR-016C	846KR-018C
● Medium		845KR-018M	845KR-025M	846KR-016M	846KR-016M	846KR-018M
● S (Short Shank)		845KR-018C-S			846KR-016C-S	
● SS (Shorter Than Short Shank)					846KR-016C-SS	
● SS (Shorter Than Short Shank)						846KR-016M-SS



	847KR-016	847KR-018
DIAMETER (mm)	1.6	1.8
HEAD LENGTH (mm)	8.0	8.0
TIP DIAMETER (mm)	1.0	1.2
● Super Coarse	847KR-016SC	847KR-018SC
● Coarse		847KR-018C
● Medium		847KR-018M
● Fine	847KR-016F	847KR-018F
● S (Short Shank)	847KR-016SC-S	
● S (Short Shank)	847KR-016C-S	
● SS (Shorter Than Short Shank)	847KR-016SC-SS	
● SS (Shorter Than Short Shank)	847KR-016C-SS	



	849-011	850-012	850-014	850-016	850-018	850-021	855-014	855-016
DIAMETER (mm)	1.1	1.2	1.4	1.6	1.8	2.1	1.4	1.6
HEAD LENGTH (mm)	4.0	10.0	10.0	10.0	10.0	10.0	6.0	6.0
TIP DIAMETER (mm)	0.4	0.7	0.8	1.0	1.1	1.5	0.8	0.8
● Super Coarse		850-012SC	850-014SC	850-016SC	850-018SC		855-014SC	855-016SC
● Coarse		850-012C	850-014C	850-016C	850-018C	850-021C	855-014C	855-016C
● Medium		850-012M	850-014M	850-016M	850-18M	850-021M	855-014M	855-016M
● Fine	849-011F	850-012F	850-014F	850-016F	850-018F	850-021F	855-014F	855-016F
● S (Short Shank)							855-014C-S	
● S (Short Shank)			850-014M-S	850-016M-S	850-016M-S			855-016M-S
● SS (Shorter Than Short Shank)							855-014C-SS	855-016C-SS
● SS (Shorter Than Short Shank)								855-016M-SS



	855-018	855-025	856-012	856-014	856-016	856-018	856-020	856-021	856-024	856-025
DIAMETER (mm)	1.8	2.5	1.2	1.4	1.6	1.8	2.0	2.1	2.4	2.5
HEAD LENGTH (mm)	6.0	7.0	8.0	8.0	8.0	8.0	8.0	8.0	8.0	8.0
TIP DIAMETER (mm)	1.2	1.6	0.6	0.8	1.0	1.2	1.4	1.5	1.8	1.9
● Super Coarse	855-018SC		856-012SC	856-014SC	856-016SC	856-016SC		856-021SC		856-025SC
● Coarse	855-018C		856-012C	856-014C	856-016C	856-018C	856-020C	856-021C	856-024C	856-025C
● Medium	855-018M	855-025M	856-012M	856-014M	856-016M	856-018M		856-021M		856-025M
● Fine			856-012F	856-014F	856-016F	856-018F		856-021F		
● Very Fine					856-016VF					
● S (Short Shank)			856-012SC-S	856-014SC-S	856-016SC-S					
● S (Short Shank)	855-018M-S	855-025M-S			856-016C-S	856-018C-S		856-021C-S		
● SS (Shorter Than Short Shank)					856-016SC-SS					
● SS (Shorter Than Short Shank)					856-016C-SS			856-024C-SS		

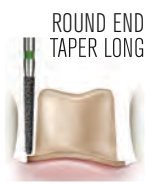

ROUND END
TAPER LONG



	856L-014	856L-016	856L-018
DIAMETER (mm)	1.4	1.6	1.8
HEAD LENGTH (mm)	9.0	9.0	9.0
TIP DIAMETER (mm)	0.8	1.0	1.2
● Super Coarse	856L-014SC	856L-016SC	856L-018SC
● Coarse			856L-018C
● Medium	856L-014M	856L-016M	856L-018M
● Fine		856L-016F	856L-018F
● S (Short Shank)	856L-014C-S	856L-016C-S	

SAFE END
TAPER



	851-012	851-014	851-016
DIAMETER (mm)	1.2	X.X	1.6
HEAD LENGTH (mm)	8.0	X.X	8.0
TIP DIAMETER (mm)	0.9	X.X	1.3
● Fine	851-012F	851-014F	851-016F

CHRISTMAS
TREE



	852-010	852-012
DIAMETER (mm)	1.0	1.2
HEAD LENGTH (mm)	6.0	6.0
TIP DIAMETER (mm)	0.5	0.5
● Coarse	852-010C	
● Medium	852-010M	852-012M
● Fine		852-012F
● Very Fine		852-012VF

NEEDLE



	858-008	858-013	858-014	858-016	859-010	859-014	859-016	859-018
DIAMETER (mm)	0.8	1.3	1.4	1.6	1.0	1.4	1.6	1.8
HEAD LENGTH (mm)	8.0	8.0	8.0	8.0	10.0	10.0	10.0	12.0
TIP DIAMETER (mm)	0.3	0.4	0.5	0.6	0.25	0.4	0.6	0.8
● Super Coarse			858-014SC					
● Coarse			858-014C	858-016C	859-010C	859-014C		859-018C
● Medium	858-008M	858-013M	858-014M	858-016M	859-010M	859-014M	859-016M	859-018M
● Fine	858-008F	858-013F	858-014F	858-016F	859-010F	859-014F	859-016F	859-018F
● Very Fine	858-008VF		858-014VF			859-014VF	859-016VF	859-018VF
● S (Short Shank)			858-014C-S			859-014C-S		859-018C-S

FLAME

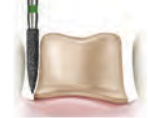

	860-010	860-012	860-014	860-016	862-010	862-012	862-014	862-016	862-017	862L-018	863-012
DIAMETER (mm)	1.0	1.4	1.4	1.6	1.4	1.2	1.4	1.6	1.7	1.8	1.2
HEAD LENGTH (mm)	3.0	4.0	5.0	5.0	8.0	8.0	8.0	8.0	8.0	9.0	10.0
TIP DIAMETER (mm)	0.35	0.45	0.45	0.45	0.35	0.35	0.45	0.45	0.5	0.5	0.45
● Super Coarse						862-012SC	862-014SC				
● Coarse		860-012C	860-014C	860-016C	862-010C	862-012C	862-014C	862-016C		862L-018C	863-012C
● Medium	860-010M	860-012M	860-014M	860-016M	862-010M	862-012M	862-014M	862-016M	862-017M	862L-018M	863-012M
● Fine		860-012F			862-010F	862-012F	862-014F	862-016F	862-017F	862L-018F	863-012F
● Very Fine		860-012VF				862-012VF	862-014VF	862-016VF			863-012VF
● S (Short Shank)						862-012C-S	862-014C-S	862-016C-S			863-012C-S
● SS (Shorter Than Short Shank)						862-014C-SS					
● SS (Shorter Than Short Shank)						862-014M-SS					

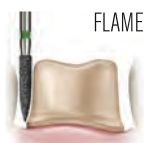

DIAMETER (mm)
HEAD LENGTH (mm)
TIP DIAMETER (mm)



863-014	863-016	863-018	868-018	868-021	868-022	868-023	868-024	888-012	889-009
1.4	1.6	1.8	1.8	2.1	2.2	2.3	2.4	1.2	0.9
10.0	10.0	10.0	5.0	5.0	5.0	5.0	5.0	7.0	4.0
0.45	0.45	0.4	0.45	0.2	0.2	0.2	0.2	0.3	0.4

● Super Coarse

888-012SC

● Coarse

863-014C 863-016C 863-018C 868-018C

● Medium

863-014M 863-016M 863-018M 868-018M 868-024M 888-012M

● Fine

863-014F 863-016F 863-018F 868-022F 868-023F 888-012F 889-009F

● Very Fine

868-021VF 888-012VF

● S (Short Shank)

863-016C-S



DIAMETER (mm)
HEAD LENGTH (mm)
TIP DIAMETER (mm)



877-010	877-012	878-012	878-014	878-016	879-012	879-014	879-016
1.0	1.2	1.2	1.4	1.6	1.2	1.4	1.6
6.0	6.0	8.0	8.0	8.0	10.0	10.0	10.0
1.0	1.2	1.2	1.4	1.6	1.2	1.4	1.6

● Coarse

877-012C 878-012C 878-014C 878-016C 879-012C 879-014C 879-016C

● Medium

877-010M 877-012M 878-012M 878-014M 878-016M 879-012M 879-014M 879-016M

● Fine

877-010F 877-012F 878-012F 878-014F 878-016F 879-012F 879-014F 879-016F



DIAMETER (mm)
HEAD LENGTH (mm)
TIP DIAMETER (mm)



877K-016	878K-012	878K-014	878K-016	878K-018	878K-021	879K-012	879K-014	879K-016	879K-017	879K-018	879K-021
1.6	1.2	1.4	1.6	1.8	2.1	1.2	1.4	1.6	1.7	1.8	2.1
6.0	8.0	8.0	8.0	8.0	8.0	10.0	10.0	10.0	10.0	10.0	10.0
1.2	0.9	1.1	1.5	1.5	1.7	0.9	1.1	1.2	1.3	1.5	1.7

● Super Coarse

878K-014SC 878K-016SC

● Coarse

877L-016C 878K-012C 878K-014C 878K-016C 878K-018C 878K-021C 879K-014C 879K-016C 879K-018C

● Medium

877K-016M 878K-012M 878K-014M 878K-016M 878K-018M 878K-021M 879K-012M 879K-014M 879K-016M 879K-017M 879K-018M 879K-021M

● Fine

877K-016F 878K-012F 878K-014F 878K-016F 878K-018F 878K-021F 879K-012F 879K-014F 879K-016F 879K-017F 879K-018F 879K-021F

● SS (Shorter Than Short Shank)

877K-016C-SS

● SS (Shorter Than Short Shank)

877K-016M-SS



DIAMETER (mm)
HEAD LENGTH (mm)
TIP DIAMETER (mm)



880-010	880-012	880-014	881-009	881-010	881-012	881-014	881-016	881-018	882-010
1.0	1.2	1.4	x.x	1.0	1.2	1.4	1.6	1.8	x.x
6.0	6.0	6.0	x.x	8.0	8.0	8.0	8.0	8.0	x.x
1.0	1.2	1.4	x.x	1.0	1.2	1.4	1.6	1.8	x.x

● Coarse

880-012C 880-014C 881-009C 881-012C 881-014C 881-018C

● Medium

880-010M 880-012M 880-014M 881-010M 881-012M 881-014M 881-018M 882-010M

● Fine

880-010F 880-012F 880-014F 881-010F 881-012F 881-014F 881-016F

● Very Fine

881-016VF



BEVELED CYLINDER



	885-012	885-014	885-016	886-012	886-014	886-016
DIAMETER (mm)	1.2	1.4	1.6	1.2	1.4	1.6
HEAD LENGTH (mm)	8.0	8.0	8.0	10.0	10.0	10.0
TIP DIAMETER (mm)	0.45	0.45	0.45	0.45	0.45	0.45
● Coarse	885-012C	885-014C	885-016C	886-012C	886-014C	886-016C
● Medium	885-012M	885-014M	885-016M	886-012M	886-014M	886-016M
● Fine	885-012F	885-014F	885-016F	886-012F	886-014F	886-016F



ACORN



	905-023	905-027	905-031
DIAMETER (mm)	2.3	2.7	3.1
HEAD LENGTH (mm)	2.5	2.9	2.9
TIP DIAMETER (mm)	0.3	0.3	0.3
● Medium	905-023M	905-027M	905-031M
● Fine	905-023F	905-027F	



WHEEL



	909-033	909-035	909-040	909-042
DIAMETER (mm)	x.x	3.5	4.0	4.2
HEAD LENGTH (mm)	x.x	1.5	1.2	1.2
● Super Coarse			909-040SC	
● Coarse		909-035C	909-040C	909-042C
● Medium			909-040M	
● Fine	909-033F		909-040F	



FLAT END CYLINDER



	6051-017
DIAMETER (mm)	1.7
HEAD LENGTH (mm)	9.0
TIP DIAMETER (mm)	1.7
● Coarse	6051-017C



FLAT END TAPER



	6055-018
Diameter (mm)	1.8
Head Length (mm)	9.0
Tip Diameter (mm)	1.4
● Coarse	6055-018C



KS



	KS03	KS13	KS23	KS33	KS35
DIAMETER (mm)	1.3	1.3	2.3	3.3	3.5
HEAD LENGTH (mm)	7.0	7.0	8.0	8.0	8.0
TIP DIAMETER (mm)	1.3	1.3	2.3	3.3	3.5
● Super Coarse	KS03-SC	KS13-SC	KS23-SC	KS33-SC	KS35-SC



FINISHING



	SE3	SE4	SE6	SE8	SE9
DIAMETER (mm)	1.0	1.2	1.6	1.6	1.6
HEAD LENGTH (mm)	3.0	4.0	5.7	7.7	8.7
TIP DIAMETER (mm)	0.5	0.5	0.6	0.6	0.6
● Medium	SE3M				
● Fine	SE3F	SE4F	SE6F	SE8F	SE9F
● Very Fine	SE3VF	SE4VF	SE6VF	SE8VF	SE9VF



TISSUE PROTECTIVE END



	10839-012	10839-U14	10839-U16
DIAMETER (mm)	1.2	1.4	1.6
● Medium	10839-012M	10839-014M	10839-016M

"Piranha Single Use Diamonds make crown preparations predictable and efficient. Too many clinicians use diamonds way past their prime. This can cause heat and postoperative sensitivity. With Piranha, you never have to worry about that and you get the same great cut time and time again."

- Dr. Louis Malcmacher

Turbo Double Action Diamond Instruments









- Deep, blade-like channel edges help to increase cutting speed
- Aggressive cutting reduces chair time
- Proven to cut cooler than competitive diamonds
- Great for bulk reduction with little or no finishing required because of medium grit diamonds



Cross Channels...
Flush debris and reduce clogging for a faster, cooler cut.



ALL SINGLE-USE PIRANHA 2XS AVAILABLE IN PACKS OF 5

<p>FOOTBALL</p>  <p>368-023</p> <p>Diameter (mm) 2.3 Head Length (mm) 5.0 Tip Diameter (mm) 0.2</p> <p>368-023-2X</p>	<p>FLAT END TAPER</p>  <p>847-018 847-020 847-024 848-020</p> <p>Diameter (mm) 1.8 2.0 2.4 2.0 Head Length (mm) 8.0 8.0 8.0 10.0 Tip Diameter (mm) 1.2 1.4 1.8 1.2</p> <p>847-018-2X 847-020-2X 847-024-2X 848-020-2X</p>	<p>ROUND END TAPER</p>  <p>849-012 849-018 849-022 850-016</p> <p>Diameter (mm) 1.2 1.8 2.2 1.6 Head Length (mm) 4.0 4.0 4.0 10.0 Tip Diameter (mm) 0.5 1.1 1.5 1</p> <p>849-012-2X 849-018-2X 849-022-2X 850-016-2X</p>
<p>ROUND END TAPER</p>  <p>854-018 855-014 855-018 855-023 856-014 856-016 856-018 856L-018 856-020 856-024</p> <p>Diameter (mm) 1.8 1.4 1.8 2.3 1.4 1.6 1.8 1.8 2.0 2.4 Head Length (mm) 10.0 6.0 6.0 6.0 8.0 8.0 8.0 9.0 8.0 8.0 Tip Diameter (mm) 1.4 0.8 1.2 1.8 0.8 1.0 1.2 1.0 1.4 1.8</p> <p>854-018-2X 855-014-2X 855-018-2X 855-023-2X 856-014-2X 856-016-2X 856-018-2X 856L-018-2X 856-020-2X 856-024-2X</p>	<p>FLAME</p>  <p>868-018</p> <p>Diameter (mm) .45 Head Length (mm) 5.0</p> <p>868-018-2X</p>	
<p>MODIFIED BEVELED CYLINDER</p>  <p>877-014 878-016 879-018</p> <p>Diameter (mm) 1.4 1.6 1.8 Head Length (mm) 6.0 8.0 10.0 Tip Diameter (mm) 1.4 1.6 1.8</p> <p>877-014-2X 878-016-2X 879-018-2X</p>	<p>CURETTAGE</p>  <p>878K-020 885K-020 886K-023</p> <p>Diameter (mm) 2.0 2.0 2.3 Head Length (mm) 8.0 8.0 10.0 Tip Diameter (mm) 1.6 1.6 1.9</p> <p>878-020-2X 885-020-2X 886-023-2X</p>	<p>ROUND END CYLINDER</p>  <p>880-014 881-016 882-018</p> <p>Diameter (mm) 1.4 1.6 1.8 Head Length (mm) 6.0 8.0 10.0 Tip Diameter (mm) 1.4 1.6 1.8</p> <p>880-014-2X 881-016-2X 882-018-2X</p>

Revelation® Diamond
368-016M

Revelation® Diamond
852-012M

A Premium Diamond Instrument That Cuts 11% Faster and Costs 25% Less

A 3-layer dense, uniform diamond matrix which keeps a greater number of diamond particles in direct contact with the tooth surface translates to a smooth feel and consistently fast cutting time after time.

REVELATION® DIAMOND INSTRUMENTS

Premium Quality Diamonds

KS



	KS-0	KS-1	KS-2	KS-3	KS-4	KS-5	KS-6
Diameter (mm)	1.0	1.2	1.4	1.6	2.4	3.1	2.5
Head Length (mm)	7.0	7.0	8.0	8.0	4.2	6.2	8.0
Tip Diameter (mm)	1.0	1.2	1.4	1.6	-	-	1.9
● Super Coarse		91418-5	91420-5	91421-5	91422-5	91423-5	91417-5
● Medium	91416-5						
● Short Shank		91419-5					

END CUTTING SAFE SIDE



	10839-012	10839-014	10839-016
Diameter (mm)	1.2	1.4	1.6
Head Length (mm)	0.1	0.1	0.1
● Medium	91145-5	91146-5	91147-5

POINTED FOOTBALL



	368-016	368-020	368-023
Diameter (mm)	1.6	2.0	2.3
Head Length (mm)	3.2	4.6	5.0
● Super Coarse	91161-5		91168-5
● Coarse	91158-5	91162-5	91165-5
● Medium	91160-5	91164-5	91167-5
● Fine	91159-5	91163-5	91166-5
● Very Fine			91169-5

FOOTBALL



	379-014	379-018	379-023
Diameter (mm)	1.4	1.8	2.3
Head Length (mm)	2.8	3.4	4.3
● Super Coarse		91176-5	91180-5
● Coarse	91172-5	91173-5	91177-5
● Medium	91171-5	91175-5	91179-5
● Fine	91170-5	91174-5	91178-5
● Very Fine			91182-5
○ Ultra Fine			91169-5

MOSQUITO NOSE



	392-016
Diameter (mm)	1.6
Head Length (mm)	5.0
● Fine	91183-5
● Very Fine	91184-5

ROUND



	801-010	801-012	801-014	801-016	801-018	801-021	801-023	801-029	801-033
Diameter (mm)	1.0	1.2	1.4	1.6	1.8	2.1	2.3	2.9	3.3
Head Length (mm)	1.0	1.2	1.4	1.6	1.8	2.1	2.3	2.9	3.3
● Super Coarse				91192-5	91193-5		91197-5	91200-5	
● Coarse	91185-5	91186-5	91188-5	91190-5	91004-5	91006-5	91194-5	91198-5	91201-5
● Medium	91001-5	91187-5	91189-5	91191-5	91003-5	91005-5	91196-5	91199-5	
● Fine							91195-5		



INVERTED CONE

	805-010	805-012	805-014	805-016
Diameter (mm)	1.0	1.2	1.4	1.6
Head Length (mm)	1.0	1.5	1.5	1.5
Tip Diameter (mm)	1.0	1.2	1.4	1.6
● Coarse	91009-5	91010-5	91011-5	91012-5
● Medium	91202-5	91203-5	91204-5	91205-5



BARREL

	811-033	811-037
Diameter (mm)	3.3	3.7
Head Length (mm)	5.5	7.0
Tip Diameter (mm)	1.8	2.0
● Super Coarse	91207-5	91210-5
● Coarse	91206-5	91208-5
● Medium		91209-5



DOUBLE INVERTED CONE

	813-014	813-016
Diameter (mm)	1.4	1.6
Head Length (mm)	1.5	1.5
● Coarse	91211-5	91213-5
● Medium	91212-5	



PEAR

	830-008	830-010	830-012
Diameter (mm)	0.8	1.0	1.2
Head Length (mm)	2.5	3.0	3.0
Tip Diameter (mm)	0.8	1.0	1.2
● Coarse	91214-5	91020-5	91021-5
● Medium		91215-5	91216-5

TRI-WHEEL DEPTH CUTTER



	834-016	834-021
Diameter (mm)	1.6	2.1
Head Length (mm)	6.0	6.0
Depth (mm)	0.3	0.5
● Medium	91217-5	91218-5

FLAT END CYLINDER

SHOULDER (STRAIGHT CYLINDER)



	835-010	835-014	836-010	836-012	836-014	837-012	837-014	837-016	837KR-014
Diameter (mm)	1.0	1.4	1.0	1.2	1.4	1.2	1.4	1.6	1.4
Head Length (mm)	3.0	4.0	6.0	6.0	6.0	8.0	8.0	8.0	8.0
Tip Diameter (mm)	1.0	1.4	1.4	1.2	1.4	1.2	1.4	1.6	1.4
● Super Coarse	91220-5						91224-5		91225-5
● Coarse	91031-5	91221-5	91223-5	91033-5	91034-5	91035-5	91036-5	91037-5	
● Medium	91219-5	91222-5							

CYLINDER



	845KR-018	845KR-026	846KR-016
Diameter (mm)	1.8	2.6	1.6
Head Length (mm)	4.0	4.0	6.0
Tip Diameter (mm)	1.2	1.2	1.1
● Super Coarse			91232-5
● Coarse	91226-5		
● Medium	91227-5		91231-5
● S (Short Shank)		91229-5	
● S (Short Shank)		91230-5	
● SS (Shorter Than Short Shank)	91228-5		

FLAT END CONE



	847-012	847-014	847-016	847-018
Diameter (mm)	1.2	1.4	1.6	1.8
Head Length (mm)	8.0	8.0	8.0	8.5
Tip Diameter (mm)	0.8	0.8	1.0	1.2
● Super Coarse	91234-5	91235-5	91237-5	91240-5
● Coarse	91233-5	91055-5	91056-5	91057-5
● Medium			91236-5	91239-5
● Fine		91112-5	91113-5	
● S (Short Shank)				91238-5



MODIFIED SHOULDER

	847KR-016	847KR-018
Diameter (mm)	1.6	1.8
Head Length (mm)	8.5	8.5
Tip Diameter (mm)	1.0	1.2
● Super Coarse	91244-5	91246-5
● Coarse	91241-5	91245-5
● Medium	91243-5	
● Fine	91242-5	

FLAT END TAPER

	848-016	848-018
Diameter (mm)	1.6	1.8
Head Length (mm)	10.0	10.0
Tip Diameter (mm)	1.0	1.0
● Super Coarse	91247-5	91249-5
● Coarse	91058-5	91059-5
● Medium		91248-5

ROUND END TAPER

	850-012	850-014	850-016	850-018	850L-016	850L-022	850L-024
Diameter (mm)	1.2	1.4	1.6	1.8	1.6	2.2	2.4
Head Length (mm)	10.0	10.0	10.0	10.0	11.5	11.5	11.5
Tip Diameter (mm)	0.7	0.8	1.0	1.1	1.0	1.1	1.1
● Super Coarse	91251-5	91255-5	91259-5	91263-5			
● Coarse	91250-5	91252-5	91256-5	91260-5	91264-5	91265-5	91266-5
● Medium		91254-5	91258-5	91262-5			
● Fine		91253-5	91257-5	91261-5			

CHRISTMAS TREE

	852-012
Diameter (mm)	1.2
Head Length (mm)	6.0
Tip Diameter (mm)	1.0
● Super Coarse	91270-5
● Coarse	91267-5
● Medium	91269-5
● Fine	91268-5

ROUND END TAPER

	855-012	855-014	855-016	855-018	855-025	856-012	856-014	856-016	856-018	856-021	856-025
Diameter (mm)	1.2	1.4	1.6	1.8	2.5	1.2	1.4	1.6	1.8	2.1	2.5
Head Length (mm)	6.0	6.0	6.0	6.0	7.0	8.0	8.0	8.0	8.0	8.0	8.0
Tip Diameter (mm)	0.6	0.8	0.8	1.2	1.6	0.6	0.8	1.0	1.2	1.5	1.9
● Super Coarse	91273-5	91274-5	91276-5		91280-5	91282-5	91287-5	91290-5	91294-5	91298-5	91302-5
● Coarse	91271-5		91275-5		91279-5	91281-5	91283-5	91069-5	91070-5	91296-5	91299-5
● Medium							91286-5	91068-5	91293-5		91301-5
● Fine							91285-5	91116-5	91117-5	91297-5	
● Short Shank				91278-5			91288-5	91291-5	91295-5		
● Short Shank	91272-5			91277-5			91284-5	91289-5	91292-5		91300-5

ROUND END TAPER - LONG

	856L-014	856L-016	856L-018	856L-020
Diameter (mm)	1.4	1.6	1.8	2.0
Head Length (mm)	9.0	9.0	9.0	9.0
Tip Diameter (mm)	0.8	1.0	1.2	1.5
● Super Coarse	91304-5	91306-5	91308-5	
● Coarse	91303-5	91305-5	91307-5	91309-5

"Efficiency translates to a savings in energy expended, time and money (time = money). However, efficiency by any definition should never be at the expense of providing a quality service and/or product to your patient. Revelation® Diamonds offer both quality and efficiency."
 - Dr. Howard Glazer

NEEDLE



	858-008	858-012	858-014	858-016	859-010	859-014	859-016	859-018
Diameter (mm)	0.8	1.2	1.4	1.6	1.0	1.4	1.6	1.8
Head Length (mm)	8.0	8.0	8.0	8.0	10.0	10.0	10.0	10.0
Tip Diameter (mm)	0.3	0.3	0.5	0.6	0.25	0.4	0.6	0.8
● Super Coarse			91317-5					
● Coarse			91072-5	91319-5	91074-5	91322-5	91075-5	91077-5
● Medium	91311-5	91314-5	91071-5		91321-5	91324-5	91326-5	91076-5
● Fine	91310-5	91313-5	91118-5		91320-5	91323-5	91119-5	91327-5
● Very Fine	91312-5					91325-5		
● Short Shank			91315-5					
● Short Shank			91316-5					
● Short Shank			91318-5					

FLAME



	860-012	862-010	862-012	862-014	862-016	863-012	863-016	868-018	868-021	868-022
Diameter (mm)	1.2	1.0	1.2	1.4	1.6	1.2	1.6	1.8	2.1	2.2
Head Length (mm)	4.0	8.0	8.0	8.0	8.0	10.0	10.0	5.0	5.0	5.0
Tip Diameter (mm)	0.45	0.35	0.35	0.35	0.45	0.45	0.45	0.45	0.2	0.2
● Super Coarse	91329-5		91335-5	91340-5	91341-5	91346-5	91348-5			
● Coarse	91328-5	91330-5	91083-5	91084-5	91085-5	91086-5		91091-5		
● Medium		91332-5	91334-5	91339-5	91343-5	91345-5		91349-5		91351-5
● Fine	91120-5	91331-5	91121-5	91338-5	91342-5	91344-5				91350-5
● Very Fine			91128-5			91347-5		91129-5		
○ Ultra Fine			91137-5							
● Short Shank			91336-5							
● Short Shank			91333-5	91337-5						

CURTAGE



	877K-016
Diameter (mm)	1.6
Head Length (mm)	6.0
Tip Diameter (mm)	1.2
● Super Coarse	91353-5
● Medium	91352-5

MODIFIED BEVELED CYLINDER



	878-012	878-014	878-016
Diameter (mm)	1.2	1.4	1.6
Head Length (mm)	8.0	8.0	8.0
Tip Diameter (mm)	1.2	1.4	1.6
● Super Coarse	91355-5		
● Coarse	91354-5	91356-5	91357-5
● Medium			91358-5

CURETTAGE



	878K-012	878K-014	878K-016	878K-018	878K-021	879K-016	879K-018
Diameter (mm)	1.2	1.4	1.6	1.8	2.1	1.6	1.8
Head Length (mm)	8.0	8.0	8.0	8.0	8.0	9.5	9.5
Tip Diameter (mm)	0.9	1.1	1.5	1.5	1.7	1.2	1.3
● Super Coarse	91361-5	91363-5	91365-5	91368-5	91371-5	91372-5	91373-5
● Coarse	91359-5	91362-5	91364-5	91367-5	91370-5		
● Medium	91360-5	91097-5	91098-5				
● Short Shank			91366-5	91369-5			

ROUND END CYLINDER

	880-014	881-012	881-014	881-016
Diameter (mm)	1.4	1.2	1.4	1.6
Head Length (mm)	6.0	8.0	8.0	8.0
Tip Diameter (mm)	1.4	1.2	1.4	1.6
● Super Coarse				91376-5
● Coarse	91041-5	91375-5	91043-5	
● Medium	91374-5			

BEVEL CYLINDER

	885-012	885-014	885-016	886-012	886-014	886-016
Diameter (mm)	1.2	1.4	1.6	1.2	1.4	1.6
Head Length (mm)	8.0	8.0	8.0	10.0	10.0	10.0
Tip Diameter (mm)	0.45	0.45	0.45	0.45	0.45	0.45
● Super Coarse	91379-5	91383-5	91385-5		91392-5	
● Coarse	91105-5	91381-5	91384-5	91387-5	91390-5	91106-5
● Medium	91378-5	91382-5	91386-5	91388-5	91391-5	
● Fine	91377-5			91389-5		
● Short Shank	91380-5					

FLAME

	888-012	889-008	889-010
Diameter (mm)	1.2	0.8	1.0
Head Length (mm)	8.0	4.0	4.0
Tip Diameter (mm)	0.3	0.3	0.3
● Coarse			91395-5
● Medium	91394-5	91397-5	
● Fine	91393-5	91396-5	

ACORN

	905-018	905-023	905-027	905-031
Diameter (mm)	1.8	2.3	2.7	3.1
Head Length (mm)	2.3	2.8	2.9	3.2
Tip Diameter (mm)	0.3	0.3	0.3	0.3
● Short Shank	91399-5	91401-5	91403-5	91405-5
● Short Shank	91398-5	91400-5	91402-5	91404-5

WHEEL

	909-035	909-036
Diameter (mm)	3.5	3.6
Head Length (mm)	1.2	1.2
● Coarse	91025-5	91406-5

WHEEL

	909-040	909-042
Diameter (mm)	4.0	4.2
Head Length (mm)	1.3	1.7
● Super Coarse		91410-5
● Coarse		91026-5
● Short Shank	91409-5	
● Short Shank	91407-5	
● Short Shank	91408-5	

MICRO PREP

	Fiss Original	Fiss NTF	Fiss STF
Diameter (mm)	1.1	0.7	0.7
Head Length (mm)	2.5	2.5	1.5
Tip Diameter (mm)	0.4	0.4	0.4
● Medium	91411-5		
● Fine	91412-5	91414-5	91415-5
● Short Shank	91413-5		

FINISHING

	7901-009	7404-014
Diameter (mm)	0.9	1.4
Head Length (mm)	3.7	2.6
● Fine	91154-5	91156-5
● Very Fine	91155-5	91157-5

SAFE END

	SE3	SE6	SE9
Diameter (mm)	1.0	1.6	1.6
Head Length (mm)	3.0	5.7	8.7
Tip Diameter (mm)	0.5	0.6	0.6
● Fine	91148-5	91150-5	91152-5
● Very Fine	91149-5	91151-5	91153-5

SLOW SPEED ROUND

	801-018-RA	801-023-RA
Diameter (mm)	1.8	2.3
Head Length (mm)	1.7	2.2
● Coarse		91428-5
● Medium	91426-5	91427-5
● Fine		91429-5

SLOW SPEED ROUND END TAPER

	850-014-RA	850-016-RA
Diameter (mm)	1.4	1.6
Head Length (mm)	0.8	1.0
● Medium	91424-5	91425-5

Precision Micro Endodontic Burs

Endodontic Access and Exploration

EndoGuide® was co-developed with leading endodontists to be “three tools in one,” eliminating 2-3 Gates Glidden and 1 Ultrasonic tip. It and has been proven to be more efficient and more precise in troughing to remove pins, posts or broken files, finding canals in both molars and anteriors, and accessing calcified canals.

- Conical shape acts as a self-centering guide
- Facilitates increased tactile sense of dentin and calcified canals
- Conserves healthy peri-cervical dentin



STERILE R AVAILABLE IN ROLLS OF 25



SLFG 27 mm
EG1A # 15066
5 PK
FG STERILE 20100

Head Length (mm) 2.5
Tip Diameter (mm) 0.33
Back Diameter (mm) 1.07

Initial access in non-restored anterior and bicuspid teeth



SLRA 27 mm
EG1 # 14780
5 PK
RA STERILE 20101

Head Length (mm) 3.5
Tip Diameter (mm) 0.28
Back Diameter (mm) 0.71

Deep troughing; deeper orifice enlargement; calcified canals



SLRA 27 mm
EG2 # 14779
5 PK
RA STERILE 20102

Head Length (mm) 2.5
Tip Diameter (mm) 0.33
Back Diameter (mm) 1.07

De-roofing pulp chamber; deep orifice enlargement; calcified canals



SLFG 27 mm
EG3 # 15023
5 PK
FG STERILE 20103

Head Length (mm) 1.5
Tip Diameter (mm) 0.28
Back Diameter (mm) 0.71

Initial access for small incisors; troughing and navigating calcified canals



SLFG 29 mm
EG4 # 15029
5 PK
FG STERILE 20104

Head Length (mm) 3.5
Tip Diameter (mm) 0.28
Back Diameter (mm) 0.71

Deep troughing; navigating super ovoid; calcified canals



XLRA 39 mm
EG5 # 14794
5 PK
RA STERILE 20104

Head Length (mm) 1.5
Tip Diameter (mm) 0.28
Back Diameter (mm) 0.71

Deep troughing; retrieving separated instruments; navigating super ovoid; calcified canals



XLRA 34 mm
EG6 # 14795
5 PK
RA STERILE 20106

Head Length (mm) 2.5
Tip Diameter (mm) 0.28
Back Diameter (mm) 0.71

Deep troughing; retrieving separated instruments; navigating super ovoid; calcified canals



XLRA 34 mm
EG7 # 14786
5 PK
RA STERILE 20107

Head Length (mm) 1.5
Tip Diameter (mm) 0.33
Back Diameter (mm) 1.07

Deep troughing; retrieving separated instruments; navigating super ovoid; calcified canals



EndoGuide Molar Kit #18051

For Endodontic Exploration Contains seven EndoGuide Burs designed to increase visibility and control during endodontic exploration in molars when locating hidden canals, navigating deeply calcified canals and troughing between canals.



EndoGuide Anterior/Bicuspid Kit #18052

For Endodontic Access & Exploration Contains all instrumentation to create endodontic access through metal, porcelain and zirconia, featuring SS White Great White #2 metal cutting bur, Great White Z Diamonds along with four EndoGuide Burs ideally suited for locating and accessing single root canals in anterior/bicuspid teeth.

“EndoGuide Burs have eliminated my dependence on round burs and the ultrasonic tips. EndoGuide Burs offer greater precision and efficiency in creating straight-line access and identifying canals in molar teeth.”

- John A. Khademi, DDS, MS

For Endodontic Access Lateral Extension

The Endo Safe End Instruments are available in 2 sizes (1.4mm and 1.8mm) and are designed for lateral endodontic access enlargement without the risk of penetrating the pulp chamber floor. The safe end tip will prohibit the access from getting deeper, yet still allows for lateral expansion.

ENDO SAFE END

ENDODONTIC ACCESS BURS

STERILE R AVAILABLE IN ROLLS OF 25



ESE-014
 ITEM # 16040-5
 5 PK
 FG STERILE 10695
 Head Length (mm) 9.0
 Max Head Diameter (mm) 1.4
 LOA (Overall Length mm) 24.0



ESE-018
 ITEM # 16042-5
 5 PK
 FG STERILE 10696
 Head Length (mm) 9.0
 Max Head Diameter (mm) 1.8
 LOA (Overall Length mm) 24.0

Enlargement of Endo Access to Gain Straight Line Access to all canals

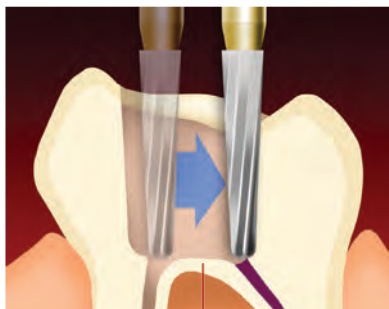

FURCATION AREA

- This must be accomplished without penetrating the floor of the pulp chamber.
- The Endo Safe End instrument will cut only laterally and not apically to prevent perforation of the furcation area.
- The ideal bur for this procedure is a side-cutting only with a safe end (non-cutting) tip designed to prevent ledging... the SS White® Endo Safe End burs.



COMPETITIVE BUR



ENDO SAFE END BUR

SS White® Procedural Kits



Kits provide a systematic approach to the rational selection of rotary instruments for each given procedure. Kits provide greater organization and efficiency within the dental office and ensure that the proper instrument to task is always available, allowing clinicians the ability to achieve optimal restorative results.

Comfortable Cavity Prep™ Kit A Comfortable Experience for Your Patients



Kit Contents:

- | | |
|--|--|
| 2 Fissurotomy® Bur-Original #18010 | 1 #8406 - 20 Blade Finishing Bur #15406-5 |
| 2 Fissurotomy® Bur-NTF #18014 | 1 #8901- 20 Blade Finishing Bur #14083-5 |
| 2 Fissurotomy® Bur-STF #18013 | 1 #329 #14999 |
| 2 Smartburs® II #4 #52000 | 1 #330 #15001 |
| 2 Smartburs® II #6 #52001 | 1 #169L #16887 |
| 2 Smartburs® II #8 #52002 | 1 #245 #15052 |
| 1 Great White® #2 #15062 | 1 Jazz® Supreme One-Step Polisher Flame #89031 |
| 1 #7901- 12 Blade Finishing Bur #15121-5 | 1 Jazz® Supreme One-Step Polisher Cup #89033 |
| 1 #7406- 12 Blade Finishing Bur #15095-5 | |

The SS White® Comfortable Cavity Preparation Kit features patented rotary instruments exclusively designed to provide a less invasive and more comfortable caries preparation experiences. It also supplies task specific SS White® rotary instruments to optimize clinical efficiency.
Kit Reorder No. 16384

Minimally Invasive Preparation – Finishing & Polishing Kit



Kit Contents:

- | | |
|-------------------|------------------------------------|
| 1 SE3-10 #16006-5 | 1 FG 7379 #15379-5 |
| 1 SE3-20 #16030-5 | 1 FG 8379 #15380-5 |
| 1 SE6-10 #16008-5 | 1 FG 7274 #15274-5 |
| 1 SE6-20 #16032-5 | 1 FG 8274 #15275-5 |
| 1 SE9-10 #16010-5 | 1 Jazz™ Supreme Cup #89033 |
| 1 SE9-20 #16034-5 | 1 Jazz™ Supreme Large Flame #89031 |

When conservative procedures matter, this kit contains rotary instruments suited for minimally invasive preparation, finishing and polishing. Three different Fissurotomy Burs aid in the identification and treatment of hidden caries. Also included is an excellent selection of 12 and 20 blade Finishing Burs, including the new anatomically designed FOA1 and Jazz™ Supreme One-Step Composite Polishers.
Kit Reorder No. 18130

Fissurotomy® Kit

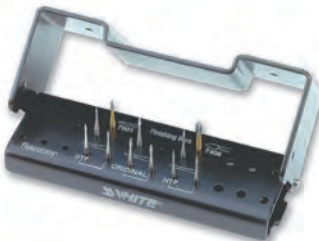

Kit Contents:

- 3 Original Fissurotomy® Burs #18010
- 3 Fissurotomy® Micro NTF Burs #18014
- 3 Fissurotomy® Micro STF Burs #18013
- 1 Finishing Bur #7901 #15121-5
- 1 Finishing Bur #7406 #15095-5
- 1 Autoclavable Bur Block

Fissurotomy® instruments allow early diagnosis, conservative preparation and treatment of hidden fissure caries, often without the use of anesthesia. Developed in collaboration with Temple University, the Fissurotomy® bur head shape allows conservative exploration of fissures with a patient-friendly technique that is virtually pain-free and creates an ideal cavity form. **Kit Reorder No. 18007**

Complete Restoration Removal Kit



Kit Contents:

- 1 Great White® #1 **#15061**
- 1 Great White® #2 **#15062**
- 1 Revelation® Diamond 801-014C **#91188-5**
- 1 Revelation® Diamond 801-018C **#91004-5**
- 1 Revelation® Diamond 856-016C **#91069-5**
- 1 Great White® Z 801-018 **#18163**
- 1 Great White® Z 856-018 **#18161**

Doctors who previously used 2 or 3 carbides to remove crowns reported using one GW to remove 2-3 crowns. The faster cutting rate is experienced in amalgam, PFM and all non-precious metals which doctors indicated saves them 12 hours a year.

Kit Reorder No. 18180

Great White® Z Introductory Kit



Kit Contents:

- 1 Great White® Z #GWZ 856-018 **#18161**
- 1 Great White® Z #GWZ 801-014 **#18162**
- 1 Great White® Z #GWZ 801-018 **#18163**
- 1 Great White® Z #GWZ 379-023 **#18164**

Clinicians reported Great White® Z Diamonds create endodontic access in 1 minute through zirconia. On average, clinicians who access 300 crowns that contain zirconia copings will save 45 hours of chairtime.

Kit Reorder No. 18160

Great White® Ultra Crown and Bridge Preparation Kit

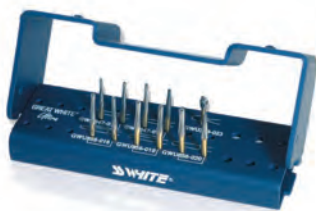

Kit Contents:

- 2 Great White® Ultra #856-016 **#18198-5**
- 2 Great White® Ultra #856-018 **#18188-5**
- 2 Great White® Ultra #856-020 **#18189-5**
- 1 Great White® Ultra #379-023 **#18193-5**
- 2 Great White® Ultra #847-016 **#18200-5**
- 2 Great White® Ultra #847-018 **#18191-5**

Great White® Ultra Burs cut 11.5% to 35.3% faster than all major diamond competitors, saving a dentist between 1.15 minute to 3.53 minutes when cutting a 10 minute crown preparation.

Kit Reorder No. 18150

CAD/CAM Preparation & Finishing Kit



Kit Contents:

- 1 Great White Depth Cutter 1 **#15040**
- 1 Great White Depth Cutter 2 **#15041**
- 1 FG #169 **#16884**
- 1 Finishing Bur #7675 **#15675-5**
- 1 Great White® Ultra #379-023 **#18193-5**
- 1 Great White® Ultra #856-016S **#18182-5**
- 1 Piranha Diamond #881-016 **#881-016VF**
- 1 Jazz® Polisher Fine Flame P3S **#89012**
- 1 Jazz® Polisher Med Flame P3S **#89008**
- 1 Jazz® Polisher Coarse Flame P3S **#89004**

Add efficiency and organization to CAD/CAM preparations with a streamlined selection of rotary instruments for milled ceramic crowns, inlays and partial coverage restorations. Featuring the innovative SS White® Great White® 1.5mm & 2mm depth cutter along with selected carbide burs, diamond instruments and Jazz® Polishers, organized in an autoclavable metal bur block.

Kit Reorder No. 64502

Inlay/Onlay Kit



Kit Contents:

- 1 Piranha® Diamond 852-012VF **#852-012VF**
- 1 Piranha® Diamond 859-014VF **#859-014VF**
- 1 Piranha® Diamond 10839-012 **#10839-012M**
- 1 Safe End 20 Blade SE6-20 **#16032-5**
- 1 Piranha® Diamond 379-018F **#379-018F**
- 1 Trimming and Finishing #7404 **#15106-5**
- 1 Taper Round End Plain #1170L **#17716**
- 1 Great White® Ultra 845KR-016 **#18195-5**
- 1 Great White® Ultra 845KR-018 **#18196-5**
- 1 Great White® Ultra 845KR-025 **#18197-5**

The SS White Inlay/Onlay Kit provide you with: Four preparation instruments, two occlusal adjustment / finishing burs and four margin/interproximal shaping instruments. The kit contains a selection of ten preparation diamonds and carbide burs housed within an autoclavable bur block.

Kit Reorder No. 18049

Complete Composite Finishing and Polishing Kit



Kit Contents:

- 1 SE3-10 #16006-5
- 1 SE3-20 #16030-5
- 1 SE6-10 #16008-5
- 1 SE6-20 #16032-5
- 1 SE9-10 #16010-5
- 1 SE9-20 #16034-5
- 1 FG 7379 #15379-5
- 1 FG 8379 #15380-5
- 1 FG 7274 #15274-5
- 1 FG 8274 #15275-5
- 1 Jazz™ Supreme Cup #89033
- 1 Jazz™ Supreme Large Flame #89031

A convenient selection of SS White® trimming and finishing burs and one-step polishers specifically designed to trim, contour and pre-polish anterior and posterior composite resin materials using SS White® Safe End and regular Trimming and Finishing Burs. Final polishing is accomplished with Jazz® Supreme single-step polishers. **Kit Reorder No. 18220**

Reliant™ Orthodontic Finishing Kit



Kit Contents:

- 1 118L-18 Blade Carbide Finishing Bur #15123-5
- 1 118S-18 Blade Carbide Finishing Bur #15122-5
- 1 218-18 Blade Carbide Finishing Bur #15124-5
- 1 815SL-18 Blade Finishing Bur #15125-5
- 1 129- Diamond (868-018EF) #91129-5
- 1 Jazz Polisher Universal Flame #89031

The Reliant™ Orthodontic Finishing Kit adds precision and organization to orthodontic adhesive removal (debonding) and finishing procedures with a streamlined selection of rotary instruments including the exclusive 18 blade 118S, 118L and 218 carbide burs. **Kit Reorder No. 15084**

Jazz® Polishers Supreme Composite 1-Step Universal Polishing System



Kit Includes:

- 1 Universal Flame #89031
- 1 Universal Knife Edge #89032
- 1 Universal Cup #89033
- 1 Universal Small Flame #89034

Single-step composite polishing system saves time. Features breakthrough technology to produce the highest shine possible. Jazz® Supreme eliminates the need for multiple polishing systems. Compatible with all direct esthetic restorative materials. Jazz® Supreme Polishers are re-usable and autoclavable for multi-patient use. **Kit Reorder No. 89035**

Jazz® Polishers C2S Composite 2-Step Polishing System



Kit Contents:

- 1 Medium Flame #89022
- 1 Medium Knife Edge #89023
- 1 Medium Cup #89024
- 1 Medium Small Flame #89025
- 1 Fine Flame #89026
- 1 Fine Knife Edge #89027
- 1 Fine Cup #89028
- 1 Fine Small Cup #89029

When you need one polishing system compatible with all direct esthetic restorative materials, Jazz 2-Step polishers eliminate the need for multiple polishing systems. Polisher shapes are available in two grits to sequentially reduce, smooth and create a high luster. Re-usable and autoclavable for multi-patient-use. **Kit Reorder No. 89030**

Jazz® P3S Porcelain & Metal Polishing Kit



Kit Contents:

- 1 Coarse Flame #89004
- 1 Coarse Cup #89005
- 1 Coarse Knife Edge #89006
- 1 Coarse Small Flame #89007
- 1 Medium Flame #89008
- 1 Medium Cup #89009
- 1 Medium Knife Edge #89010
- 1 Medium Small Flame #89011
- 1 Fine Flame #89012
- 1 Fine Cup #89013
- 1 Fine Knife Edge #89014
- 1 Fine Small Flame #89015

Use the Jazz 3-step porcelain and metal polishing system to adjust, smooth and polish your indirect porcelain and metal restorations to restore or enhance original luster. Diamond impregnated polishers achieve brilliant results on porcelain and metal restorations. Specially formulated rubber matrix allows for an excellent polish with minimal pressure. **Kit Reorder No. 89016**

EndoGuide® Anterior Bicuspid Kit For Endodontic Access and Exploration



Kit Contents:

- 1 EndoGuide® EG1A #15066
- 1 EndoGuide® EG1 #14780
- 1 EndoGuide® EG2 #14779
- 1 EndoGuide® EG3 #15023
- 1 Great White® #2 #15062
- 1 Great White® Z #18161
- 1 Great White® Z #18163

To locate and access single root canals in anterior and bicuspid teeth, the EndoGuide® Anterior/Bicuspid Kit features an autoclavable bur block and contains all instrumentation to create endodontic access through metal, porcelain, zirconia and tooth structure. **Kit Reorder No. 18052**

EndoGuide® Molar Kit For Endodontic Exploration in Molars



Kit Contents:

- 1 EndoGuide® EG1 #14780
- 1 EndoGuide® EG2 #14779
- 1 EndoGuide® EG3 #15023
- 1 EndoGuide® EG4 #15029
- 1 EndoGuide® EG5 #14794
- 1 EndoGuide® EG6 #14795
- 1 EndoGuide® EG6 #14786

To increase visibility, control and efficiency during endodontic exploration in molars, the EndoGuide® Molar Kit features an autoclavable bur block with seven EndoGuide® instruments for de-roofing, locating hidden canals, enlarging deep orifices, navigating deeply calcified canals and troughing between canals. **Kit Reorder No. 18051**

Express Line Metal Lab Kit

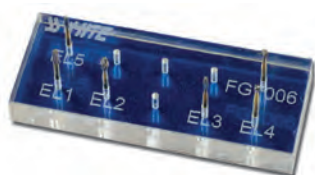

Kit Contents:

- 1 EL1 #16101
- 1 EL2 #16102
- 1 EL3 #16103
- 1 EL4 #16104
- 1 EL5 #16105
- 1 FG7006 #15088-5

The Express Line High Speed Metal Finishing Burs are designed to substantially decrease metal finishing time and help reduce the physical stress in the process. The kit features six Express Line Metal Finishing Burs. **Kit Reorder No. 16100**



Safe End Finishing Bur Kit



Kit Contents:

- 1 SE3-10 #16006-5
- 1 SE4-10 #16007-5
- 1 SE6-10 #16008-5
- 1 SE8-10 #16009-5
- 1 SE9-10 #16010-5
- 1 SE3-20 #16030-5
- 1 SE4-20 #16031-5
- 1 SE6-20 #16032-5
- 1 SE8-20 #16033-5
- 1 SE9-20 #16034-5

The SS White® Safe End Series of carbide multi-bladed finishing instruments is one of the most advanced and complete aesthetic finishing systems available, featuring an efficient two-step approach to finishing in one convenient kit. The Safe End on each instrument is non-cutting, to help deter inadvertent damage to gingival tissue, epithelial attachments, and tooth structure.

Kit Reorder No. 16051

Surgical Procedure Kit



Kit Contents:

- 1 557 #13557
- 1 Round 6 #14973
- 1 Round 8 #17706
- 1 1701 #14074-5
- 1 1702 #14075-5

This special set of SS White® surgical length carbide burs includes the most popular surgical length carbides and simplifies common surgical procedures including sectioning teeth for extractions, cutting bone and creating proper endodontic access.

Kit Reorder No. 18170

Jazz P2S Polisher 12 Pc. Kit



Kit Contents:

- 3 Medium Cup #89018
- 3 Medium Flame #89017
- 3 Fine Flame #89019

Single-patient-use system saves sterilization cost and time. Shanks are made of high performance polymer. Silicone carbide particles embedded in a specially formulated silicone matrix enable a high gloss finish. Compatible with all porcelain and metal restorations, which eliminates the need for multiple polishing systems. 2-step system to smooth and polish quickly. Convenient selection of Jazz porcelain and metal polishers for single-patient use in a 12-piece assortment pack.

Kit Reorder No. 89021

Jazz C1S Polisher Composite 12 Pc. Kit



Kit Contents:

- 4 Universal Cup #89018
- 4 Universal Knife Edge #89038
- 4 Universal Flame #89036

Convenient selection of Jazz composite polishers for single-patient use in a 12-piece assortment pack. When you need efficient composite polishing in a disposable product without compromising quality, Jazz C1S polishers deliver results.

Kit Reorder No. 89039

Universal Bur Blocks

Efficient and Organized

Each Universal Block can be autoclaved and can accommodate a full range of shank lengths including surgical length and short shank instruments. SS White® has teamed up with dental clinicians like yourself to organize the tools that inspire dental masterpieces everyday.

Our innovative rotary instrument cabinets and universal bur blocks help improve chair side efficiency and inventory control. With the right rotary instruments at your fingertips you can focus your talent on the dental masterpiece at hand.



Item #16410
Blue



Item #16411
Bordeaux

- 3 Popular Color Selections
- Autoclavable
- Use with Diamonds, Carbides & Polishers
- Minimizes Damage to Instruments
- Ideal Organization



Item #16415
Black

Bur Accessories

Bur Blocks & Brushes



Wire
Cleaning Brush
(Autoclavable)
#26040



FG
Thermo Block
(Autoclavable)
#16392



HP/RA
Thermo Block
(Autoclavable)
#16407

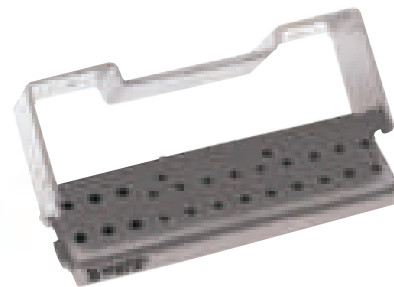

Universal
Aluminum Block
(Autoclavable)
#16391

Shank Types

FG (Friction Grip)

Shank Diameter
.0630" 1.60mm
Overall Length
.748" 19.0mm



Friction grip burs are used in high speed hand pieces. In most offices, they are the main operative burs.

RA (Right Angle)

Shank Diameter
.0925" 2.35mm
Overall Length
.886" 22.5mm



Right angle burs, used in slow speed hand pieces, allow for greater control and feel when cutting enamel or dentin.

SS (FG Short Shank)

Shank Diameter
.0630" 1.60mm
Overall Length
.670" 17.0mm



Short shanks are used for greater access in the posterior region - particularly when patients do not have the ability to open their mouths wide enough.

RA SL (Right Angle Surgical Length)

Shank Diameter
.0925" 2.35mm
Overall Length
1.024" 26.0mm



FG SL (FG Surgical Length)

Shank Diameter
.0630" 1.60mm
Overall Length
.984" 25.0mm



Surgical length burs are used when greater length and visibility are required. They are ideal for extraction and root canal procedures.

HP (Hand Piece)

Shank Diameter
.0925" 2.35mm
Overall Length
1.752" 44.5mm



Hand piece burs are used in dental laboratories as well as in extraction procedures where greater access is required.

Carbide Burs - Maximum Head Diameters in Millimeters & Inches

Bur #	MM	Inch	Bur #	MM	Inch	Bur #	MM	Inch	Bur #	MM	Inch	Bur#	MM	Inch
1/4	.51	.20	1P	.79	.031	34	.9	0.31	59	1.40	.055	1558	1.19	.047
1/2	.61	.024	2P	.99	.039	35	.99	.039	556	.79	.031	558L	1.19	.047
1	.79	.03	4P	1.40	.0551	36	1.19	0.47	1156	.79	.031	559	1.40	.055
2	.99	.039	329	.61	.024	37	1.40	.055	1556	.79	.031	560	1.60	.063
3	1.19	.047	330	.79	.031	37L	1.40	.055	556L	.79	.031	956	.79	.031
4	1.40	.055	331	.99	.039	38	1.60	.063	557	.99	.039	957	.99	.039
5	1.60	.063	331L	.99	.039	39	.071	1.80	1157	.99	.039	244	.69	.027
6	1.80	.071	332	1.19	.047	56	.79	.031	1557	.99	.039	245	.89	.035
7	2.11	.083	332L	1.19	.047	57	.99	.039	557L	.99	.039	246	1.09	.043
8	2.1	.091	14	1.19	.047	57L	.99	.39	558	1.19	.047	256	.81	.032
1/2P	.61	.024	33 1/2	.61	.024	58	1.19	.047	1158	1.19	.047	257	1.09	.043
												271	1.40	.055

Taper Fissure Carbide Burs - Tip Maximum Head Diameters in Millimeters & Inches

Bur #	Tip Diameter		Max Diameter		Bur #	Tip Diameter		Max Diameter		Bur #	Tip Diameter		Max Diameter	
	MM	Inch	MM	Inch		MM	Inch	MM	Inch		MM	Inch	MM	Inch
169	.46	.018	.89	.035	699	.46	.018	.89	.035	702	1.12	.044	1.60	.063
169L	.46	.018	.89	.035	700	.56	.022	.99	.039	703	1.55	.061	2.06	.081
170	.56	.022	.99	.039	700L	.56	.022	.99	0.39	1170	.64	.025	.99	.039
170L	.56	.022	.99	.039	701	.76	.030	1.19	.047	1171	.81	.032	1.19	.047
171	.76	.030	1.19	.047	701L	.76	.030	1.19	.047					

Storage and Sterilization



Instructions for Use

Storage and Shelf Life of Pre-Sterilized Products

50°C (122°F Max). See package for expiration.

Cleaning and Sterilizing SS White Dental, Inc. Rotary Dental Instruments

The intention of these instructions is to provide guidelines for the sterilization of rotary dental instruments.

Unless otherwise indicated, all instruments are supplied clean but not sterile. It is the user's responsibility to sterilize instruments before the first use and if applicable, before each additional use. Instruments indicated as non-sterile single use should be processed following these guidelines before the initial use only and then properly discarded.

Warnings:

Used rotary instruments should be considered contaminated and shall be handled following appropriate precautions and guidelines. Personal protective equipment (PPE) including gloves, mask, and eye protection should be worn. Further controls may be required if specific patient risks are present.

Cleaning:

Automatic Cleaning is the recommended method for pre-sterilization cleaning. Follow the machine manufacturer's recommended method while utilizing approved agents for the cleaning of rotary dental instruments. If there is an excessive delay between use and cleaning, manual cleaning may be required. In the case that automatic cleaning is not available, rotary dental instruments may be cleaned manually. Manually brush debris from instruments under running water with a wire brush and approved cleaning agent. PPE should be worn and care taken to avoid spreading contaminants during the brushing process. After cleaning, dry instruments with paper towel or dry heat not exceeding 140°C. Inspect and properly discard any instruments with signs of excessive wear, damage or corrosion.

Sterilization:

Saturated steam under pressure (autoclave) is the recommended method of sterilization for rotary dental instruments. The recommended cycle is 20 to 30 minutes at 121°C (250°F) at 15 to 30 psi. For faster processing a rapid cycle of 3 to 10 minutes at 135°C (275°F) at 25 to 30 psi is also acceptable. Operation of the autoclave should follow the manufacturer's recommended methods and materials.

Storage:

After sterilization, store instruments in a dry, clean, and ambient temperature environment.

Validation:

These processes have been validated on SS White Dental rotary dental instruments. Following these instructions along with the instructions of the equipment utilized remains the responsibility of the user. Proper steps should be taken to ensure all equipment is operating safely and properly in accordance with manufacturer's guidelines. Any deviation from these guidelines may require subsequent validation and monitoring for effectiveness and potential risks. Results are maintained by SS White Dental, Inc.



Instructions for Use

Risk if re-used - If product is used properly, after initial use, cutting ability will be compromised.

Please remember that the single-use SS White Smartburs[®] Instrument is especially designed to remove only decayed material after you have created access using another instrument. The patented SS White Smartburs[®] II Instrument is designed not to cut or remove enamel, composite, amalgam or healthy dentin. The instrument dulls when it comes in contact with these harder substances. As a result it is designed to conserve healthy tooth structure and protect against unintentional pulp exposures.

Important Steps When Using Smartburs[®] II Instruments

- 1) Create direct access to decay using appropriate carbide burs; then switch to a SS White Smartburs[®] II Instrument to excavate carious dentin.
- 2) Use your SS White Smartburs[®] II Instrument with your existing latch slow-speed handpiece. Use your slow-speed handpiece at 5,000 to 10,000 RPM to remove decayed dentin. Note: Using the Smartburs[®] II at the lower end of this range (5,000) will extend the service life of the instrument
- 3) Begin decay removal with a circular, light brush stroke. Start in the center and top of the carious lesion, working your way to the periphery. Return to the center and proceed down into the decay after top layers are removed, taking care to reduce contact with the axial walls.
- 4) When the SS White Smartburs[®] II Instrument contacts healthy dentin, you will tactilely sense a vibration, as the instrument is unable to cut healthy tissue.
Note: Prolonged contact with enamel or restorations will rapidly degrade the SS White Smartburs[®] II Instrument's working end.
- 5) After repeated contact with healthy tissue, the polymer edges of the SS White Smartburs[®] II Instrument will roll and become deformed. You will feel tactile smoothness when the instrument is spent.
- 6) Verify caries removal with an explorer and/or caries dye*. If needed, use a fresh SS White Smartburs[®] II Instrument to remove any remaining decay and verify caries removal again.
- 7) When decay is completely removed, fill the cavity with a restorative of your choice. Dispose of the used SS White SmartBurs[®] II Instrument.

*Caries dyes may be useful in assessing dentin decay removal. In general, brightly red stained dentin is highly softened and highly infected, and indicated for removal. Lighter pink staining dentin may be affected or healthy tissue and should be inspected with an explorer to assess the need for removal.

Assessing Caries Removal

Natural dentin staining within a carious lesion (tan, brown, black) may be healthy or caries affected dentin that does not need to be removed. Using your explorer in dentin is a generally accepted method to verify caries removal. When working in deep carious lesions it is often difficult to detect the amount of remaining healthy dentin adjacent to the pulp and the risk of pulp exposure becomes a concern. SS White Smartburs®II instruments can help you protect against unintentional pulp exposure.

Reorder Information

Description	Size	Order No.	Unit of Sale
SmartBurs®II	RA #4	52000	Pkg. of 10
SmartBurs®II	RA #6	52001	Pkg. of 10
SmartBurs®II	RA #8	52002	Pkg. of 10
SmartBurs®II Combo Pack	RA #4	52003	Pkg. of 25
	RA #6		5 Each RA #4
	RA #8		5 Each RA #6
			5 Each RA #8

Warnings

SS White Smartburs®II Instruments may not be appropriate for all patients under all circumstances, so professional judgment and discretion should be exercised at all times. SS White Smartburs®II Instruments should be used only by licensed dental professionals with appropriate levels of clinical experience and training. Caution and care should be utilized at all times. Treatment options and techniques outlined in this insert are suggestions may experience discomfort if anesthesia is not administered prior to treatment or if only and may not be appropriate for all patients. Some patients excess levels of force are applied during treatment. Vibration and other side effects may be reported by some patients and treatment results may vary. Dentists must apply appropriate levels of force when using SS White Smartburs®II Excessive force can cause premature wear and tear to the instruments. Use your professional judgment.

Disclaimer of Warranties

SS White Smartburs®II Instruments are provided without warranties of any kind, as-is and with all faults, SS White Burs, Inc., its agents, affiliates and representatives ("SS White"), hereby disclaim all warranties, express or implied, regarding SS White Smartburs®II Instruments, including, without limitation, warranties of merchantability, non-infringement and fitness for a particular purpose.

Limitation of Liability

SS White disclaims all liability and damages of any kind resulting from intentional or negligent conduct or otherwise that arise out of the use or misuse of any SS White instruments or these instructions. 1. U.S. Patent Nos. 6,106,291 and 6,347,941



Instructions for Use

Use your SS White Jazz Instrument with your latch slow-speed handpiece at the recommended RPM below.



1-step diamond polishing system for smoothing and polishing dental composites to the ultimate shine.

Indications: Ultimate single-step polishing of all composite restorations.

Directions for use: Trim and smooth restoration with diamond or carbide finishing bur to maximum smoothness.

- 1) Polish with Jazz Supreme beginning with firm pressure and higher speed. Maximum rpm: 15,000. Wipe restoration with cotton. Continue polishing with reduced pressure and speed with light touch to create desired shine.
- 2) For best results, polish wet.

Composition: All Supreme polishers contain a synthetic rubber matrix infused with diamond particles in various sizes and pigments (mainly Titanium Dioxide). The shanks are made of stainless steel and are surface refined with gold flashing.



2-step diamond polishing system for smoothing and polishing dental composites to a high-luster.

Indications: High-luster polishing of all composite restorations.

Directions for use:

- 1) Reduce and smooth with medium grit (pink) polisher.
- 2) Finish to high-luster with fine grit (white) polisher.

IMPORTANT: Clean restoration surface with gauze between polishing steps to remove polish residues. Polish wet at 8,000 rpm. Maximum rpm: 15,000.

Composition: All C2S polishers contain a synthetic rubber matrix infused with diamond particles in various sizes and pigments (mainly Titanium Dioxide). The shanks are made of stainless steel.



1-step diamond polishing system for smoothing and polishing dental composites to a high-gloss.

Indications: High-gloss single-step polishing of all composite restorations.

Directions for use:

- 1) Polish finished restoration until desired shine is achieved. Polish wet at 8,000 rpm. Maximum rpm: 15,000.

Disposable tool NOT for Reuse.

Composition: All C1S polishers contain a synthetic rubber matrix infused with diamond particles in various sizes and pigments (mainly Titanium Dioxide). The shanks are made of high performance polymer.



3-step polishing system for smoothing and polishing dental porcelain and metals to a high-luster.

Indications: High-luster polishing of all porcelain & metal restorations.

Directions for use:

- 1) Reduce and trim with coarse grit (green) polisher.
- 2) Smooth with medium grit (pink) polisher.
- 3) Finish to high-luster with fine grit (white) polisher. Polish wet or dry at 8,000 rpm. Maximum rpm: 15,000.

Composition: All P3S polishers contain synthetic rubber, diamond grain in various sizes and pigments (mainly Titanium Dioxide). The shanks are made of stainless steel.



2-step polishing system for smoothing and polishing dental porcelain and metals to a high-gloss.

Indications: High-gloss polishing of all porcelain & metal restorations.

Directions for use:

- 1) Reduce and smooth with medium grit (pink) polisher.
- 2) Finish to final gloss with fine grit (yellow) polisher. Polish wet or dry at 8,000 rpm. Maximum rpm: 15,000.

Disposable tool NOT for Reuse.

Composition: All P2S polishers contain a silicone matrix infused with silicon carbide particles in various sizes and pigments (mainly Titanium Dioxide). The shanks are made of high quality polymer.

Warnings: The product should not be used if a patient is known to be allergic to any of the ingredients of the polishing instruments. Avoid inhaling grinding dust. Do not exceed maximum rotary speed.

Storage: Storage temperature 2-28°C/36-82°F. Do not expose to direct sunlight. Keep out of the reach of children! For use in dentistry only!

Cleaning Instructions:

- 1) Clean burs of visible debris. Automatic washing is preferable.
- 2) Autoclave on a short cycle at a temperature of less than 130°C.



Instructions for Use

EndoGuide® Burs are a unique series of eight burs for non-surgical root canal treatment. Specifically designed to maximize efficiency during endodontic exploration and access while conserving healthy tooth structure. The patented¹, conical shaped micro-diameter tip of the EndoGuide® Burs acts as a self-centering guide to permit straight-line access to canals. EndoGuide® Burs blade design functions to effectively polish the dentin surface as it cuts, making visual dentin mapping easier and canal identification more precise. Two EndoGuide® kits address the specific endodontic needs of Anterior/Bicuspid teeth and Molar teeth. Individual EndoGuide® Burs are also available (See Table A).



EndoGuide® Anterior/Bicuspid Kit
(For Endodontic Access and Exploration) #18052
Contains all instrumentation to create endodontic access through metal, porcelain and zirconia



EndoGuide® Molar Kit
(For Endodontic Exploration) #18051
Contains seven EndoGuide® Burs designed to increase visibility and control during endodontic exploration in molars.

NOTE: Initial access and de-roofing in molars should be performed with the Great White® #2 bur or Great White® Z Diamonds supplied in the EndoGuide® Anterior/Bicuspid Kit for Endodontic Access and Exploration, order #18052.

Operational Instructions

1. EndoGuide® Burs are task specific; each bur is designed for a particular area of use during endodontic access and canal exploration.
2. While EndoGuide® Burs are diminutive in size, they are very efficient cutters in both the vertical and lateral directions. To maximize cutting efficiency and avoid bur breakage, it is recommended that the clinician applies only enough pressure to guide the bur while allowing the instrument to progress through the substrate. When used for troughing procedures, a light sweeping motion is suggested.
3. Excessive force to the instrument, especially in a lateral direction, can lead to bur damage.

Initial Access Through Restorations/Tooth Surfaces

1. Identify the material makeup of any existing restorations that must be removed or penetrated to gain access.
2. Once identified, select the appropriate instrument for the task. (See Table A)

NOTE: SS White® Complete Restoration Removal Kit (Order #18180) contains instrumentation specifically designed for efficient, non-traumatic removal of failed amalgams, composites, PFM crowns, and all-ceramic crowns, including zirconia and lithium disilicate ceramics.

Endodontic Access and Exploration

EndoGuide® Burs are ideal for use when performing micro-endodontics using magnification-enhanced vision via a dental operating microscope or loops. For best product performance, always match the EndoGuide® Bur to the task to be performed (See Table A). Slow-speed EndoGuide® Burs are those with SLRA (Surgical Length Right Angle) and XLRA (Extra-Long Right Angle) shanks for use in standard slow-speed right-angle latch handpieces at slow-speed rpm ranges appropriate for endodontic procedures. High-speed EndoGuide® Burs are those with SLRA (Surgical Length Friction Grip) shanks for use in standard high-speed friction grip handpieces at high-speed rpm ranges appropriate for endodontic procedures.

Precautions

1. Before each use, inspect the bur for damaged blades or signs of excessive wear. Discard worn burs.
2. Maintain handpieces in accordance with the manufacturer's instructions.
3. Fully seat the bur into the chuck mechanism to eliminate non-concentric operation.
4. Do not exceed manufacturer's suggested speed recommendations.
5. Clean and sterilize burs in accordance with the instructions provided by the manufacturer of your sterilization unit. Do not immerse carbide burs in cold sterilizing solutions or other strong oxidizing agents.











Warnings

SS White® EndoGuide® Burs may not be appropriate for all patients under all circumstances, so professional judgment and discretion should be exercised at all times. SS White® EndoGuide® Burs should be used only by licensed dental professionals with appropriate levels of clinical experience and training. Caution and care should be used at all times. Treatment options and techniques outlined in this insert are suggestions only and may not be appropriate for all patients. Dentists must apply appropriate levels of force when using SS White® EndoGuide® Burs. Excessive force can cause premature wear to the instruments. Use your professional judgment.

Limitation of Liability

SS White® disclaims all liability and damages of any kind resulting from intentional or negligent conduct or otherwise that arise out of the use or misuse of any SS White® instruments or these instructions. 1. U.S Patent No. 6,257,889 B1

Use the following reference guide (Table A.) when matching EndoGuide® Burs to the task to be performed

Kit and Bur Reference Guide: SS White® EndoGuide® Precision Micro Endodontic Burs							
Bur #	Bur Photograph (Actual Size)	Head Length (mm)	Reorder Pkg. Size	SS White Order #	Included in: Anterior/Bicuspid Kit #18052	Included in: Molar Kit #18051	Recommended Applications
EG1A	 SLFG* Length = 27mm	2.5	5-pk	15066	YES	NO	• Initial access in non-restored anterior and bicuspid teeth
EG1	 SLRA* Length = 27mm	3.5	5-pk	14780	YES	YES	• Deep troughing • Deeper orifice enlargement and calcified canals
EG2	 SLRA* Length = 27mm	2.5	5-pk	14779	YES	YES	• De-roofing pulp chamber • Deep orifice enlargement and calcified canals
EG3	 SLFG* Length = 27mm	1.5	5-pk	15023	YES	YES	• Initial access for small incisors • Troughing and navigating calcified canals
EG4	 SLFG* Length = 29mm	3.5	5-pk	15029	NO	YES	• Deep troughing • Navigating super ovoid and calcified canals
EG5	 XLRA* Length = 34mm	1.5	5-pk	14794	NO	YES	• Deep troughing • Retrieving separated instruments • Navigating deeply calcified canals
EG6	 XLRA* Length = 34mm	2.5	5-pk	14795	NO	YES	
EG7	 XLRA* Length = 34mm	1.5	5-pk	14786	NO	YES	
SS White Great White® Carbides and Diamonds							
GW2	 FG Length = 19mm	4.0	10-pk 100-pk	15062 13095	YES	NO	• Metal crown access or removal • Amalgam restoration and decay removal • Molar initial access and de-roofing
GWZ 856-018 (Round End Cone)	 FG Length = 22mm	8.0	5-pk	18161	YES	NO	• Ceramic/zirconia crown removal • Molar initial access and de-roofing
GWZ 801-018 (Round)	 FG Length = 19mm	1.8	5-pk	18163	YES	NO	• Initial access through ceramic/zirconia crowns • Molar initial access and de-roofing

*NOTE: SLRA (Surgical Length Right Angle) and XLRA (Extra-Long Right Angle) shanks are for use in right angle latch slow-speed handpieces; SLFG (Surgical Length Friction Grip) shanks are for use in friction grip high-speed handpieces.



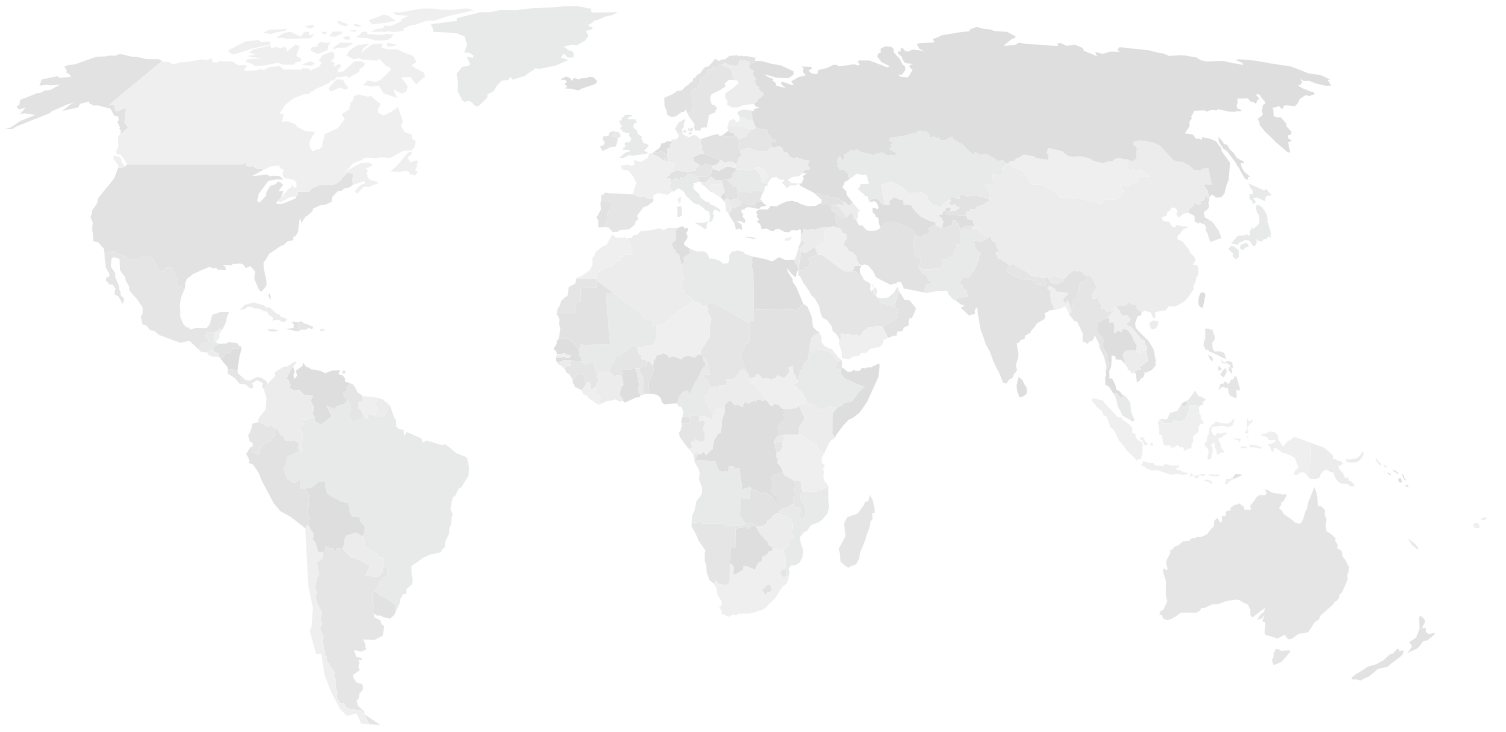

Simply Better Dentistry Worldwide

