

VX Solo II

Instructions for installation and use

Instructions for installation and use VX Solo II substations



VX Solo II (T°C)
- 1 HE circuit



VX Solo II H (ECL 210/A230)
- 1 HE circuit



VX Solo II H2 (ECL 210/A260)
- 2 HE circuits



VX Solo II HWP (ECL 210/A237)
- 1 HE circuit, primary connection for DHW cylinder

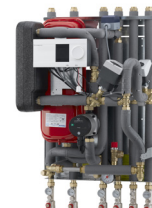

VX Solo II HWP (ECL 210/A247)
- 1 HE circuit, primary connection for DHW cylinder



VX Solo II H2WP (ECL 210/A260)
- 2 HE circuits, primary connection for DHW cylinder



VX Solo II H2WP (ECL 310/A377)
- 2 HE circuits, primary connection for DHW cylinder



VX Solo II HWS (ECL 210/A237)
- 1 HE circuit, secondary connection for DHW cylinder



VX Solo II HWS (ECL 210/A247)
- 1 HE circuit, mixing loop, secondary connection for DHW cylinder

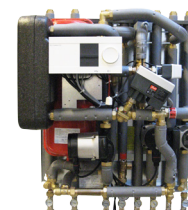

VX Solo II H2WS (ECL 210/A267)
- 2 HE circuits, secondary connection for DHW cylinder

1. Contents

| | | |
|------|--|----|
| 1.0 | Contents | 2 |
| 2.0 | Product introduction..... | 3 |
| 2.1 | VX Solo II (T°C) - 1 HE circuit + prim. connection for DHW cylinder | 3 |
| 2.2 | VX Solo II H (ECL 210/A230) - 1 HE circuit | 4 |
| 2.3 | VX Solo II H2 (ECL 210/A260) - 2 HE circuits..... | 5 |
| 2.4 | VX Solo II HWP (ECL 210/A237) - 1 HE circuit + prim. connection for DHW cylinder | 6 |
| 2.5 | VX Solo II HWP (ECL 210/A247) - 1 HE circuit + prim. connection for DHW cylinder | 7 |
| 2.6 | VX Solo II H2WP (ECL 210/A260) - 2 HE circuits + prim. connection for DHW cylinder..... | 8 |
| 2.7 | VX Solo II H2WP (ECL 310/A377) - 2 HE circuits + prim. connection for DHW cylinder..... | 9 |
| 2.8 | VX Solo II HWS (ECL 210/A237) - 1 HE circuit + sec. connection for DHW cylinder | 10 |
| 2.9 | VX Solo II HWS (ECL 210/A247) - 1 HE circuit + mixing loop, sec. connection for DHW cylinder | 11 |
| 2.10 | VX Solo II H2WS (ECL 210/A267) - 2 HE circuits + sec. connection for DHW cylinder | 12 |
| 3.0 | Dimensional sketch / connections..... | 13 |
| 4.0 | Enduser instructions, General..... | 14 |
| 5.0 | Enduser instructions, Adjustment and Setting | 15 |
| 6.0 | Installation instructions, Safety and Handling..... | 16 |
| 7.0 | Installation instructions - Getting started | 17 |
| 8.0 | Description of VX Solo variants | 18 |
| 9.0 | Installation instructions, general | 19 |
| 10.0 | Adjustment and commissioning, filling the system and differential pressure controller | 22 |
| 11.0 | Adjustment and commissioning, Heating circuit | 24 |
| 12.0 | Circulation pump, Heating circuit..... | 30 |
| 13.0 | Adjustment and commissioning, DHW cylinder circuit..... | 31 |
| 14.0 | Pump, DHW cylinder circuit..... | 32 |
| 15.0 | Maintenance..... | 33 |
| 15.1 | Maintenance schedule (recommendations)..... | 34 |
| 16.0 | Troubleshooting..... | 35 |
| 16.1 | Troubleshooting - Heating | 35 |
| 16.2 | Troubleshooting - Domestic hot water..... | 37 |
| 17.0 | EU Declaration of Conformity | 39 |
| 18.0 | Commissioning Certificate..... | 41 |

Instructions for installation and use VX Solo II substations

2.0 Product introduction

2.1 VX Solo II (T°C) - 1 HE circuit + prim. connection for DHW cylinder

- | | |
|------------------------------------|--|
| 1 Plate heat exchanger HE | 15 Manometer |
| 4 Diff. pressure controller | 16 Expansion vessel |
| 5 Strainer | 17 Air valve |
| 7 Ball valve | 23 Sensor pocket for heat meter |
| 8 Circulation pump HE | 24 Flexible fitting piece for heat meter |
| 11 Safety valve HE | 30 Thermostatic valve T°C200/VS2 |
| 13 Thermometer | |
| 14 Pockets for pressure gauge 1/2" | |

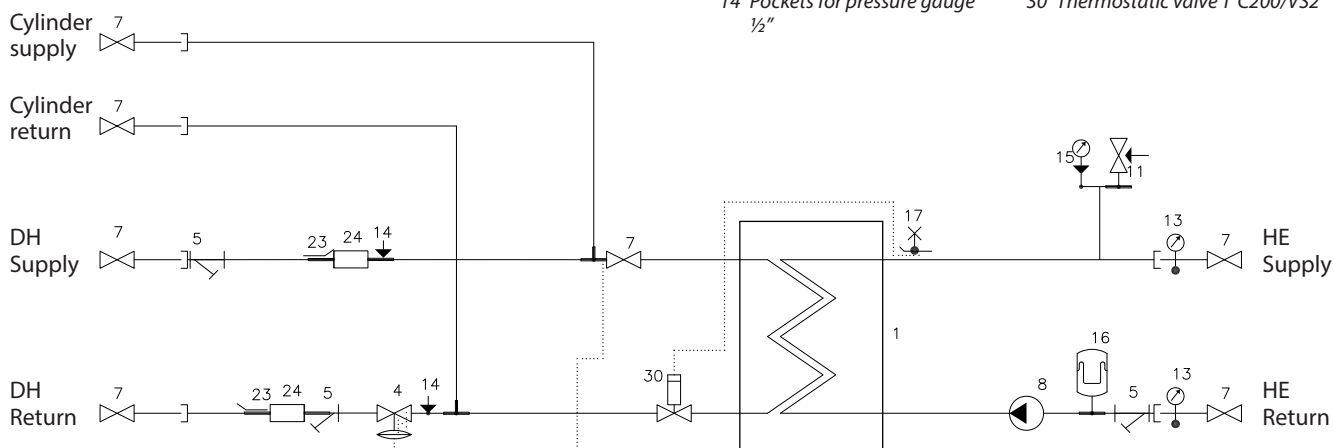

Principal components

- 1 Plate heat exchanger
- 4 Differential pressure controller
- 8 Circulation pump, HE
- 16 Expansion vessel
- 17 Air valve
- 24 Fitting piece for heat meter
- 30 Thermostat T°C 200

The substation offers variable connection possibilities, as connection of pipes can be established both in the top or in the bottom of the substation. Please note that the ball valves are supplied loose with the substation, - for mounting on site.

Accessories available as extra equipment (mounting on site)
RAVK 25-65/VMA thermostatic valve for DHW - Code No. 144B2021

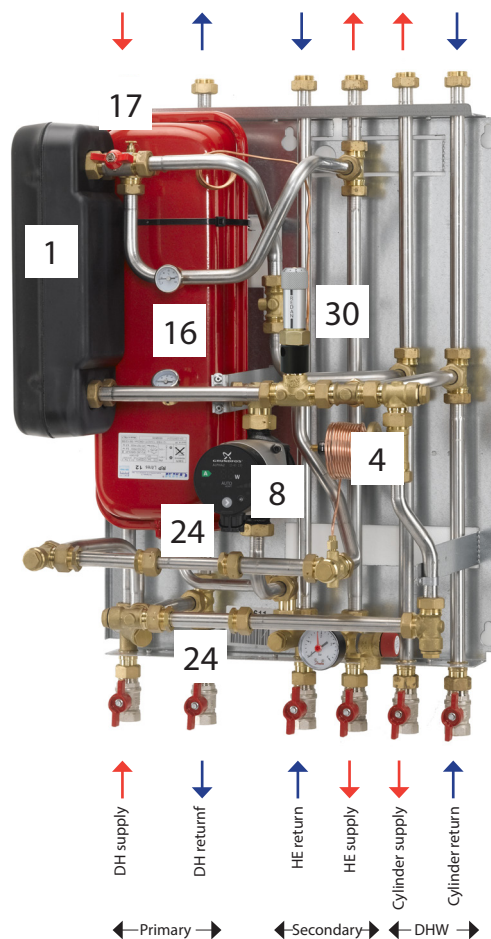

Instructions for installation and use VX Solo II substations

2.2 VX Solo II H (ECL 210/A230) - 1 HE circuit

- | | |
|------------------------------------|--|
| 1 Plate heat exchanger HE | 24 Fitting piece for heat meter ¾" x 110 mm |
| 5 Strainer | 25 Controller Danfoss ECL210/ A230 |
| 7 Ball valve | 26 Outdoor sensor, ESMT |
| 8 Circulation pump HE | 27 Sensor, ESMC |
| 11 Safety valve HE | 29 Actuator AMV 150 |
| 13 Thermometer | 30 Flow controller with integrated control valve AHQM |
| 14 Pockets for pressure gauge | |
| 15 Manometer | |
| 16 Expansion vessel | |
| 23 Sensor pocket for heat meter | |
- Options:
57 Safety thermostat

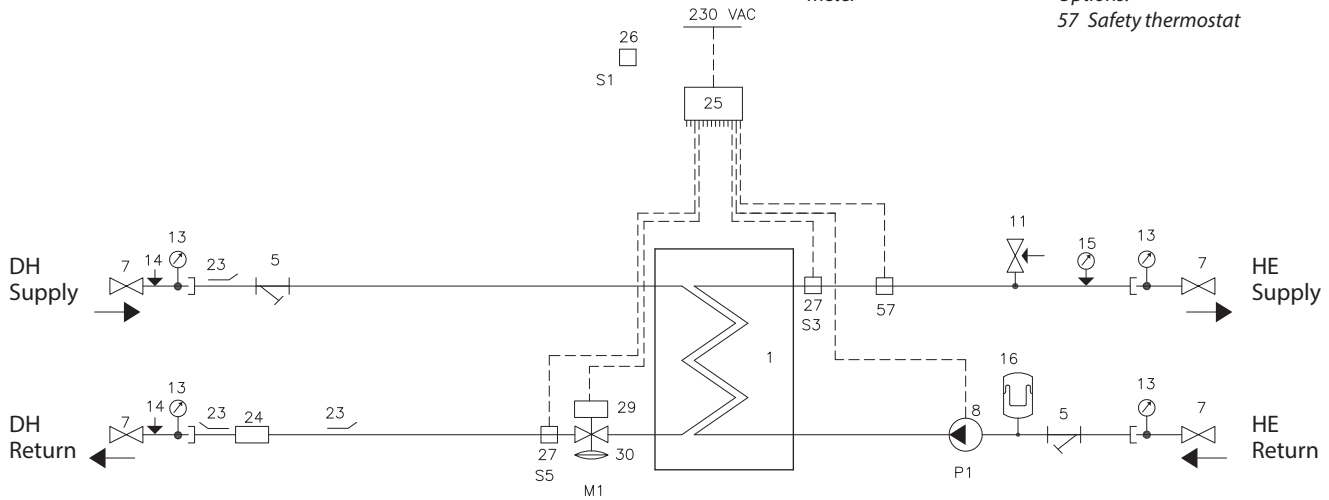

Principal components

- 1 Plate heat exchanger
- 8 Circulation pump, HE
- 11 Safety valve, HE
- 16 Expansion vessel
- 24 Fitting piece for heat meter
- 25 Electronic controller
- 29 Actuator AMV 150
- 30 Flow controller with integrated control valve AHQM

The substation offers variable connection possibilities, as connection of pipes can be established both in the top or in the bottom of the substation. Please note that the ball valves are supplied loose with the substation, - for mounting on site.

Variants available with safety function for HE circuit.

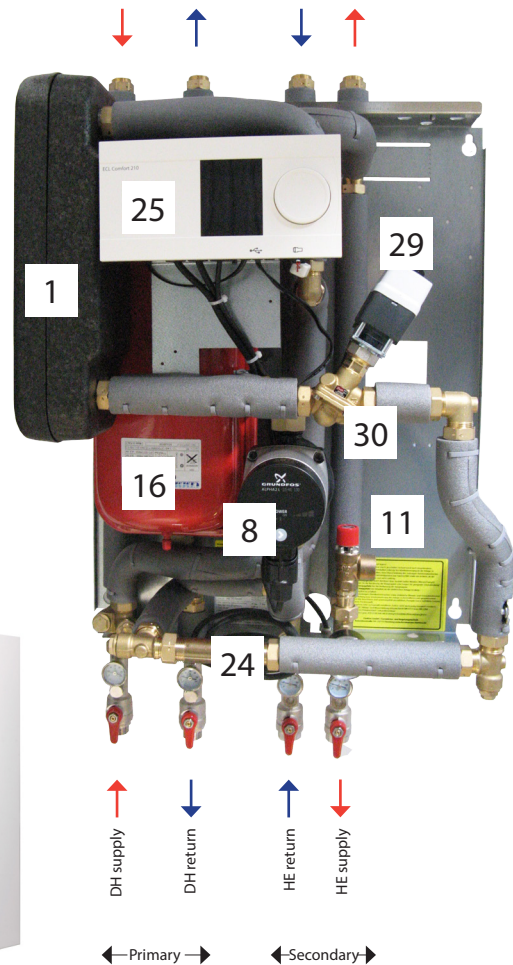

Instructions for installation and use VX Solo II substations

2.3 VX Solo II H2 (ECL 210/A260) - 2 HE circuits

- 1 Plate heat exchanger, HE, with insulation
- 5 Strainer
- 6 Non-return valve
- 7 Ball valve
- 8 Circulation pump HE
- 10 Circulation pump FH
- 11 Safety valve HE
- 13 Thermometer
- 14 Pocket for pressure gauge
- 15 Manometer
- 16 Expansion vessel
- 23 Sensor pocket for heat meter
- 24 Fitting piece for heat meter 3/4" x 110 mm
- 25 Controller Danfoss ECL 210/A260
- 26 Outdoor sensor, ESMT

- 27 Sensor Danfoss, ESMC
- 29 Danfoss actuator AMV 13, HE
- 30 Danfoss flow controller with integrated control valve AHQM
- 33 Danfoss actuator AMV 150, FH
- 34 3-way valve VMV
- 57 Safety thermostat

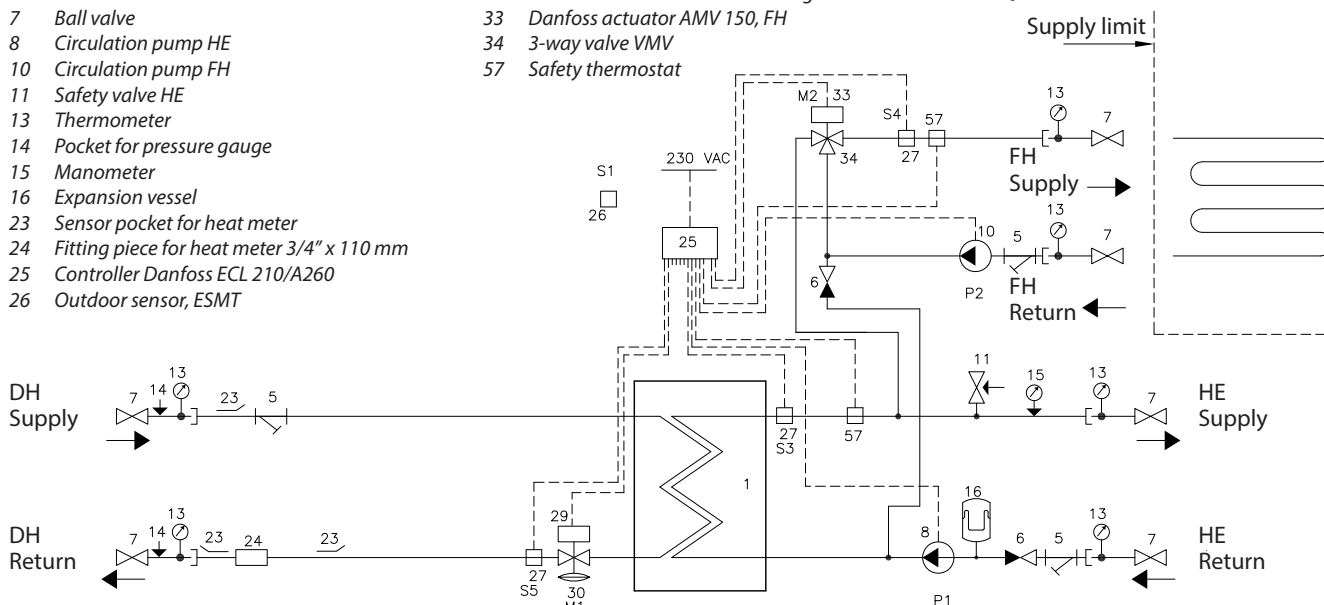

Principal components

- 1 Plate heat exchanger
- 8 Circulation pump, HE
- 10 Circulation pump, FH
- 11 Safety valve, HE
- 16 Expansion vessel
- 24 Fitting piece for heat meter
- 25 Electronic controller
- 29 Actuator AMV 13
- 30 Flow controller with integrated control valve AHQM
- 33 Actuator AMV150
- 34 3-way valve VMV 30/15
- 57 Safety temperature monitor

The substation offers variable connection possibilities, as connection of pipes can be established both in the top or in the bottom of the substation. Please note that the ball valves are supplied loose with the substation, - for mounting on site.

Variants available with safety function for two HE circuits.

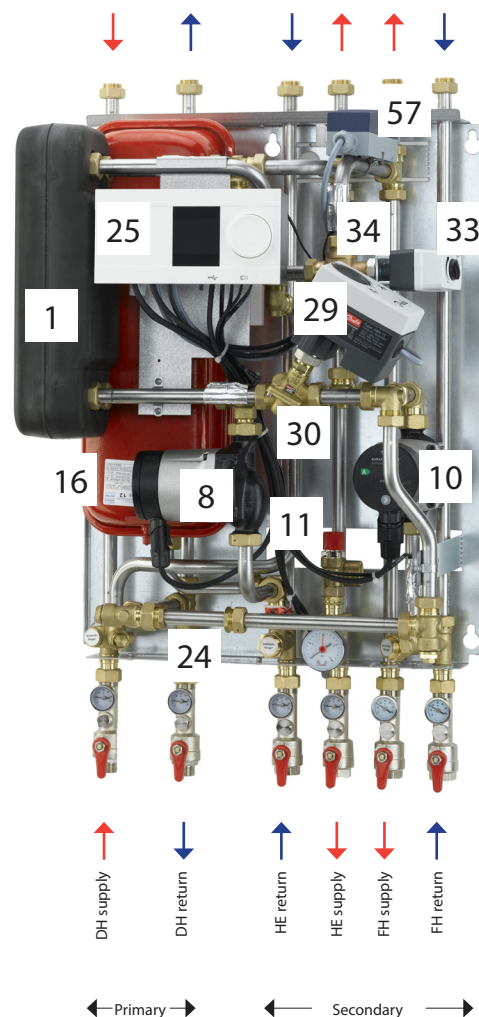

Instructions for installation and use VX Solo II substations

2.4 VX Solo II HWP (ECL 210/A237) - 1 HE circuit + prim. connection for DHW cylinder

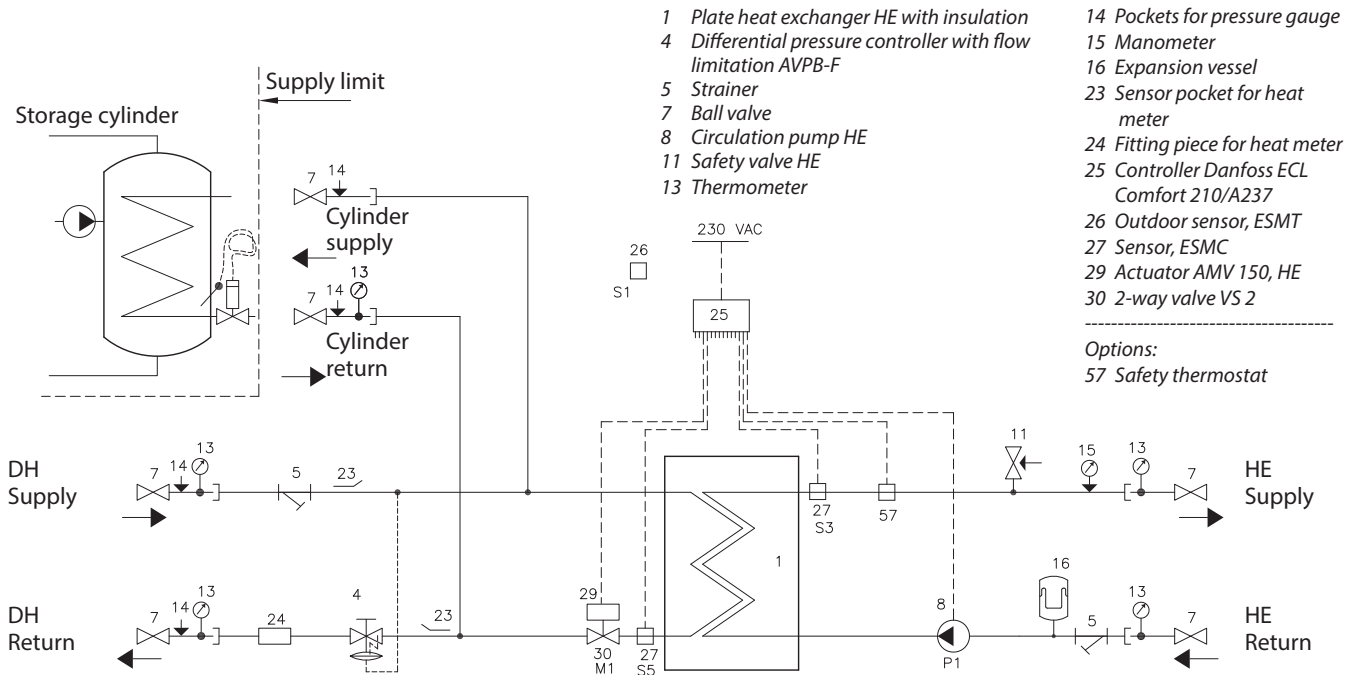

Principal components

- 1 Plate heat exchanger HE
- 4 Differential pressure controller
- 8 Circulation pump, HE
- 11 Safety valve, HE
- 16 Expansion vessel
- 24 Fitting piece for heat meter
- 25 Electronic controller
- 29 Actuator AMV 150
- 30 2-way valve VS2

The substation offers variable connection possibilities, as connection of pipes can be established both in the top or in the bottom of the substation. Please note that the ball valves are supplied loose with the substation, - for mounting on site.

Accessories available as extra equipment (mounting on site)
 RAVK 25-65/VMA thermostatic valve for DHW - Code No. 144B2021
 AVTB 15 kvs=1.9 thermostatic valve for DHW - Code No. 144B2022

Variants available with safety function for HE circuit.

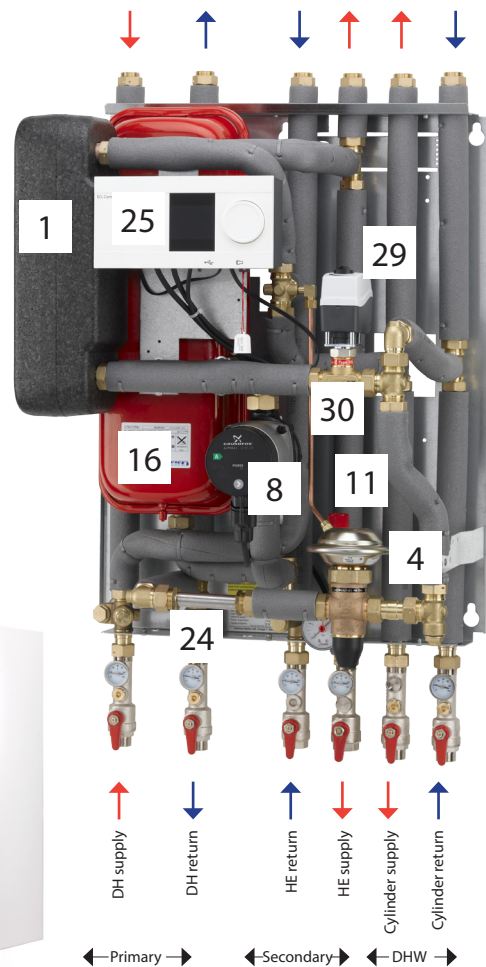

Instructions for installation and use VX Solo II substations

2.5 VX Solo II HWP (ECL 210/A247) - 1 HE circuit + prim. connection for DHW cylinder

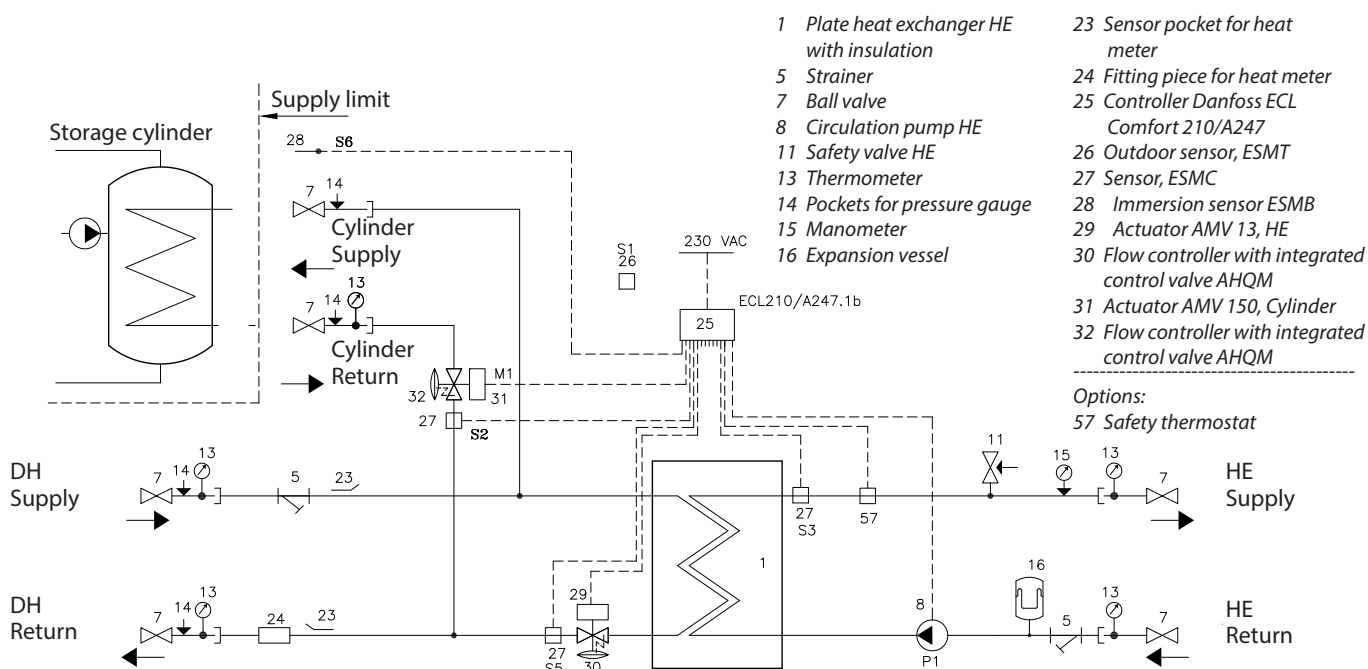

Principal components

- 1 Plate heat exchanger HE
- 8 Circulation pump, HE
- 11 Safety valve, HE
- 16 Expansion vessel
- 24 Fitting piece for heat meter
- 25 Electronic controller ECL 210/A247
- 29 Actuator AMV 13
- 30 Flow controller with integrated control valve AHQM
- 31 Actuator AMV 150
- 32 Flow controller with integrated control valve AHQM
- 57 Safety temperature monitor

The substation offers variable connection possibilities, as connection of pipes can be established both in the top or in the bottom of the substation. Please note that the ball valves are supplied loose with the substation, - for mounting on site.

Variants available with safety function for HE circuit.

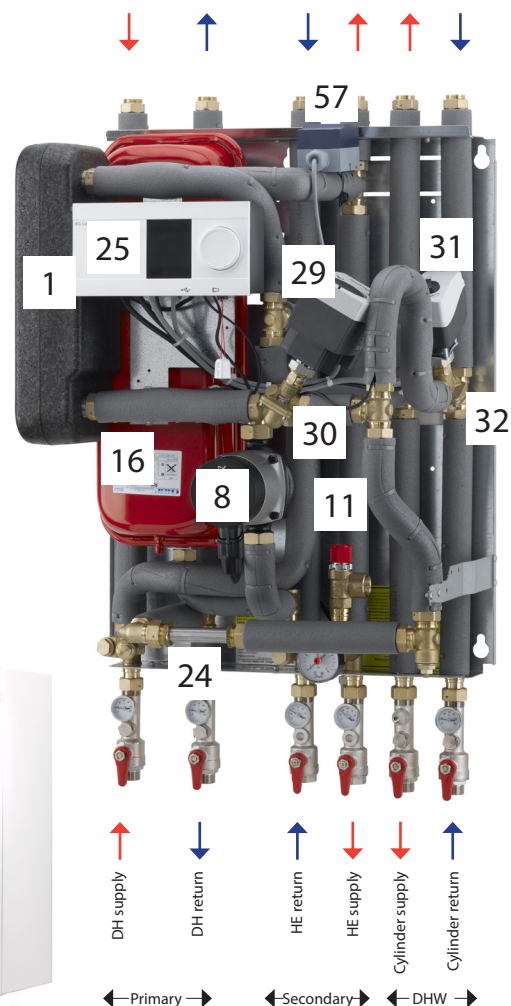

Instructions for installation and use VX Solo II substations

2.6 VX Solo II H2WP (ECL 210/A260) - 2 HE circuit + prim. connection for DHW cylinder

- | | | | |
|--|---------------------------------|--|----------------------------------|
| 1 Plate heat exchanger HE | 7 Ball valve | 24 Fitting piece for heat meter | 33 Actuator AMV 150, FH |
| 4 Differential pressure controller with flow limitation AVPB-F | 8 Circulation pump HE | 25 Controller Danfoss ECL Comfort 210/A260 | 34 Three way valve VMV |
| 5 Strainer | 10 Circulation pump FH | 26 Outdoor sensor ESMT | 57 Safety thermostat, FH circuit |
| 6 Non-return valve | 11 Safety valve HE | 27 Sensor, ESMC | |
| | 13 Thermometer | 29 Actuator AMV 13, HE | Options: |
| | 14 Pockets for pressure gauge | 30 2-way valve VS2 | 57 Safety thermostat, HE circuit |
| | 15 Manometer | | |
| | 16 Expansion vessel | | |
| | 23 Sensor pocket for heat meter | | |

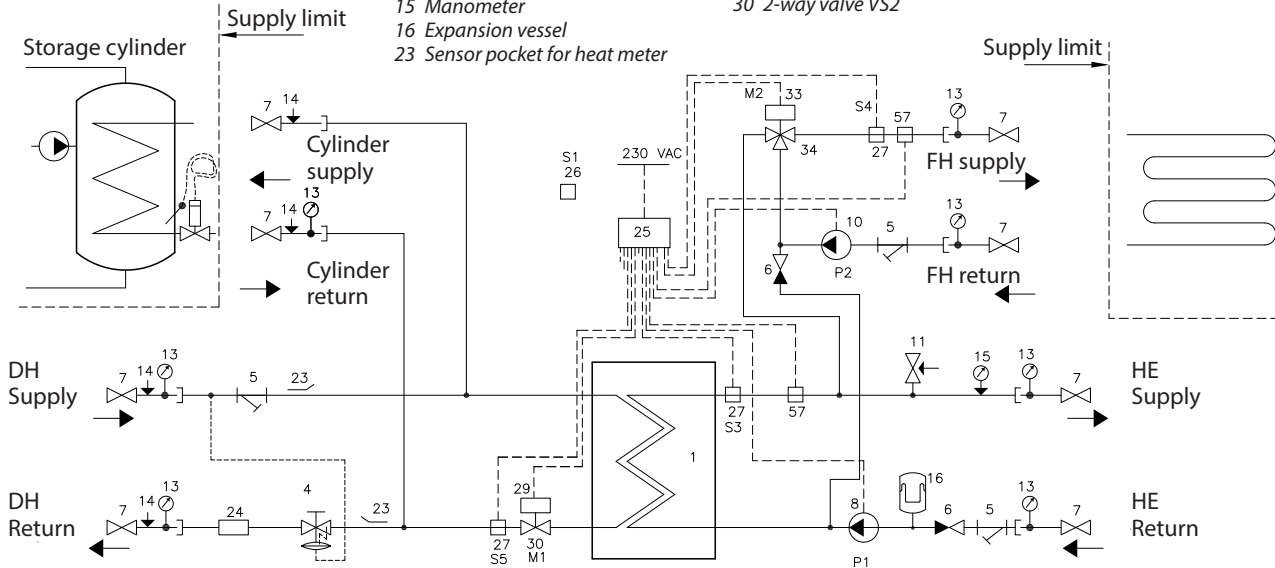

Principal components

- 1 Plate heat exchanger
- 4 Differential pressure controller
- 8 Circulation pump, HE
- 10 Circulation pump, FH
- 11 Safety valve, HE
- 16 Expansion vessel
- 24 Fitting piece for heat meter
- 25 Electronic controller
- 29 Actuator AMV 13
- 30 Flow controller with integrated control valve AHQM
- 33 Actuator AMV 150
- 34 3-way valve VMV 30/15
- 57 Safety temperature monitor

The substation offers variable connection possibilities, as connection of pipes can be established both in the top or in the bottom of the substation. Please note that the ball valves are supplied loose with the substation, - for mounting on site.

Accessories available as extra equipment (mounting on site)
 RAVK 25-65/VMA thermostatic valve for DHW - Code No. 144B2021
 AVTB 15 kvs=1.9 thermostatic valve for DHW - Code No. 144B2022

Variants available with safety function for two HE circuits.

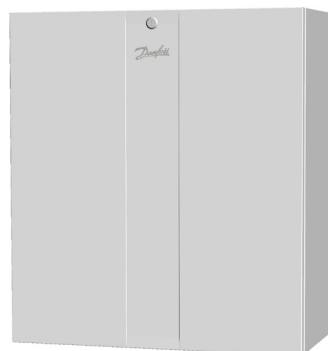
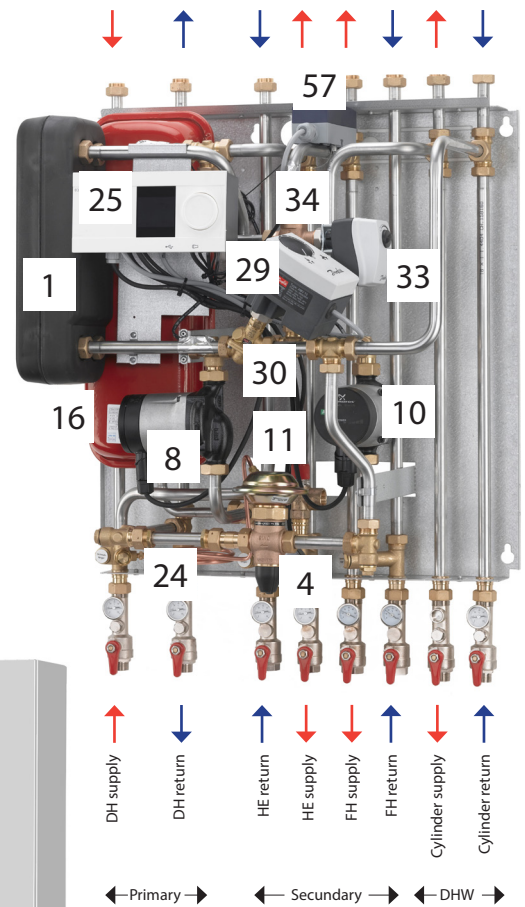

Instructions for installation and use VX Solo II substations

2.7 VX Solo II H2WP (ECL 310/A377) - 2 HE circuit + prim. connection for DHW cylinder

- | | | | |
|---------------------------|---|---|----------------------------------|
| 1 Plate heat exchanger HE | 13 Thermometer | 26 Outdoor sensor ESMT | 33 Actuator AMV 150, FH |
| 5 Strainer | 14 Pockets for pressure gauge | 27 Sensor, ESMC | 34 Three way valve VMV |
| 6 Non-return valve | 15 Manometer | 28 Immersion sensor ESMB | 57 Safety thermostat, FH circuit |
| 7 Ball valve | 16 Expansion vessel | 29 Actuator AMV 13, HE | |
| 8 Circulation pump HE | 23 Sensor pocket for heat meter | 30 Flow controller with integrated control valve AHQM | Options: |
| 10 Circulation pump FH | 24 Fitting piece for heat meter | 31 Actuator AMV 150, Cylinder | 57 Safety thermostat, HE circuit |
| 11 Safety valve FH | 25 Controller Danfoss ECL Comfort 310/377 | 32 Flow controller with integrated control valve AHQM | |

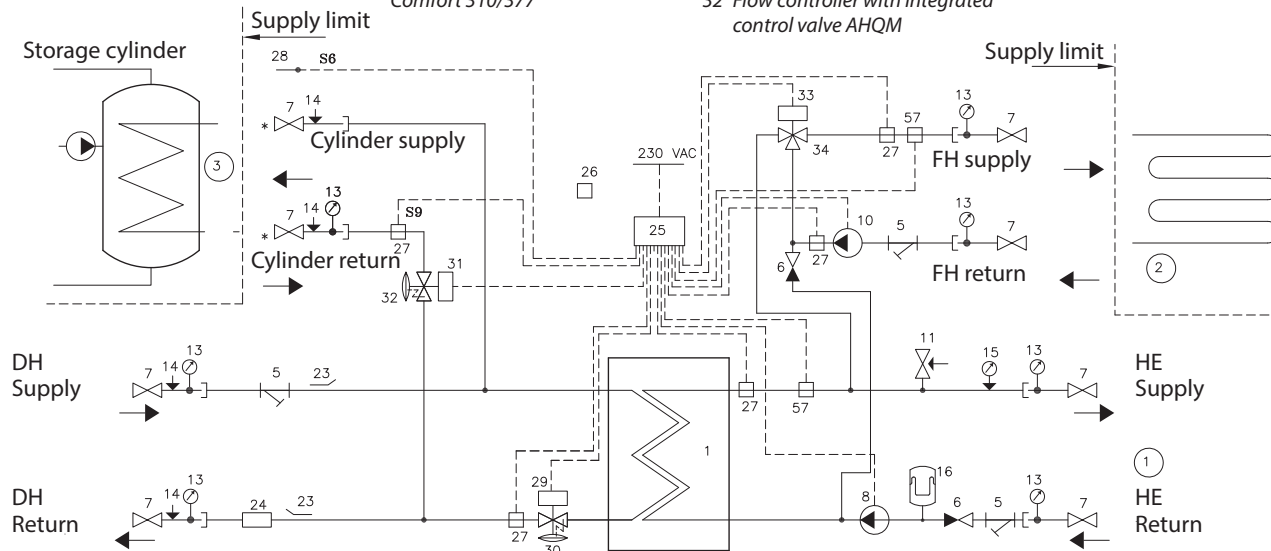

Principal components

- 1 Plate heat exchanger
- 4 Differential pressure controller
- 8 Circulation pump, HE
- 10 Circulation pump, FH
- 11 Safety valve, HE
- 16 Expansion vessel
- 24 Fitting piece for heat meter
- 25 Electronic controller
- 29 Actuator AMV 13
- 30 Flow controller with integrated control valve AHQM
- 31 Actuator AMV 150
- 32 Flow controller with integrated control valve AHQM
- 33 Actuator AMV 150
- 34 3-way valve VMV 30/15
- 57 Safety temperature monitor

The substation offers variable connection possibilities, as connection of pipes can be established both in the top or in the bottom of the substation. Please note that the ball valves are supplied loose with the substation, - for mounting on site.

Variants available with safety function for two HE circuits.

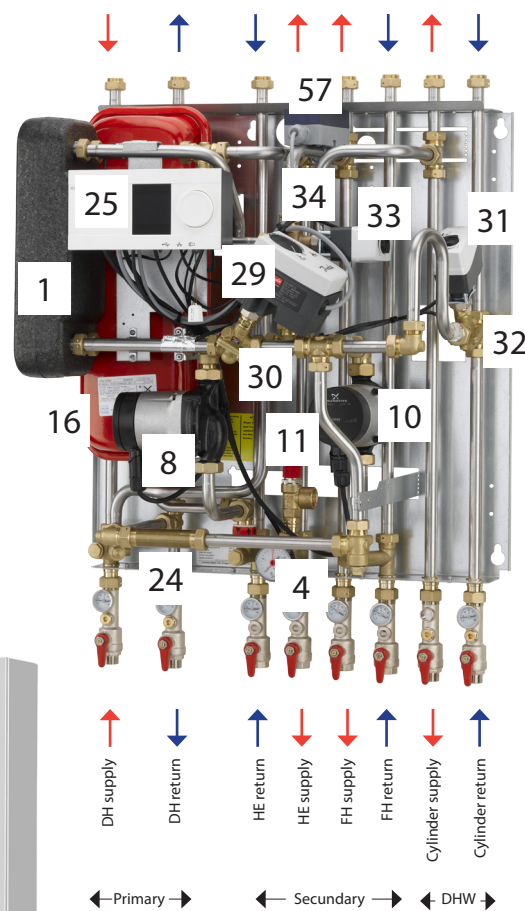
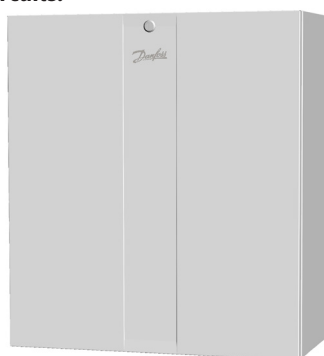

Instructions for installation and use VX Solo II substations

2.8 VX Solo II HWS (ECL 210/A237) - 1 HE circuit + sec. connection for DHW cylinder

- 1 Plate heat exchanger HE
 - 5 Strainer
 - 6 Non-return valve
 - 7 Ball valve
 - 8 Circulation pump HE
 - 8A Circulation pump DHW
 - 11 Safety valve HE
 - 13 Thermometer
 - 14 Air valve
 - 15 Manometer
 - 16 Expansion vessel
 - 23 Sensor pocket for heat meter
 - 24 Fitting piece for heat meter
 - 25 Controller Danfoss ECL Comfort 210/A237
 - 26 Outdoor sensor, ESMT
 - 27 Sensor, ESMC
 - 28 Immersion sensor ESMB
 - 29 Actuator AMV 150, HE
 - 30 Flow controller with integrated control valve AHQM
- Options:
57 Safety thermostat

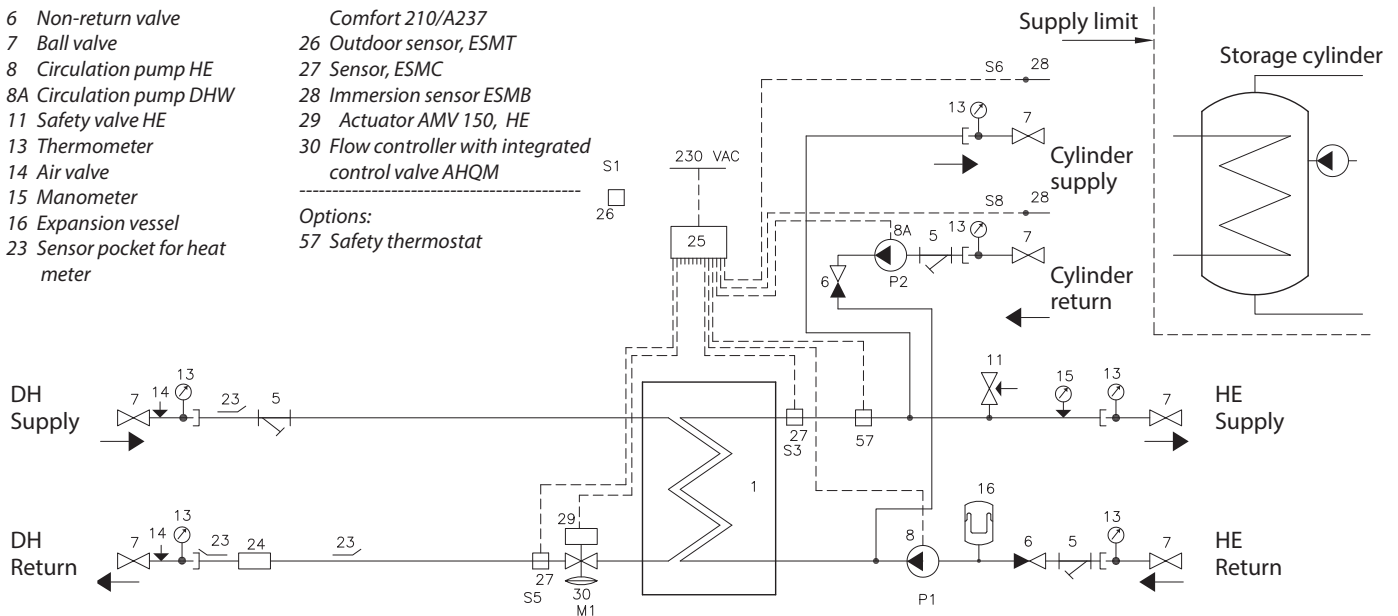

Principal components

- 1 Plate heat exchanger
- 8 Circulation pump, HE
- 8A Circulation pump, Cylinder
- 11 Safety valve, HE
- 16 Expansion vessel
- 24 Fitting piece for heat meter
- 25 Electronic controller
- 29 Actuator AMV 150
- 30 Flow controller with integrated control valve AHQM

The substation offers variable connection possibilities, as connection of pipes can be established both in the top or in the bottom of the substation. Please note that the ball valves are supplied loose with the substation, - for mounting on site.

Variants available with safety function for HE circuit.

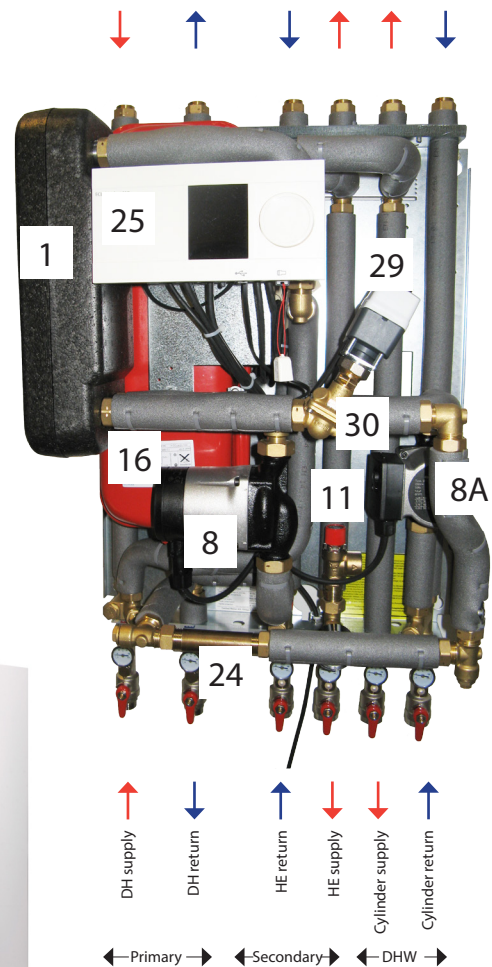

Instructions for installation and use VX Solo II substations

2.9 VX Solo II HWS (ECL 210/A247) - 1 HE circuit + mixing loop, sec. connection for DHW cylinder

- 1 Plate heat exchanger HE
- 5 Strainer
- 6 Non-return valve
- 7 Ball valve
- 8A Circulation pump DHW
- 10 Circulation pump HE
- 11 Safety valve HE
- 13 Thermometer
- 14 Pockets for pressure gauge
- 15 Manometer
- 16 Expansion vessel
- 23 Sensor pocket for heat meter
- 24 Fitting piece for heat meter
- 25 Controller Danfoss ECL Comfort 210/A247
- 26 Outdoor sensor ESMT
- 27 Sensor, ESMC
- 28 Immersion sensor ESMB
- 29 Actuator AMV 150
- 30 Flow controller with integrated control valve AHQM
- 33 Actuator AMV 150
- 34 Three-way valve VMV

Options:
57 Safety thermostat, HE circuit

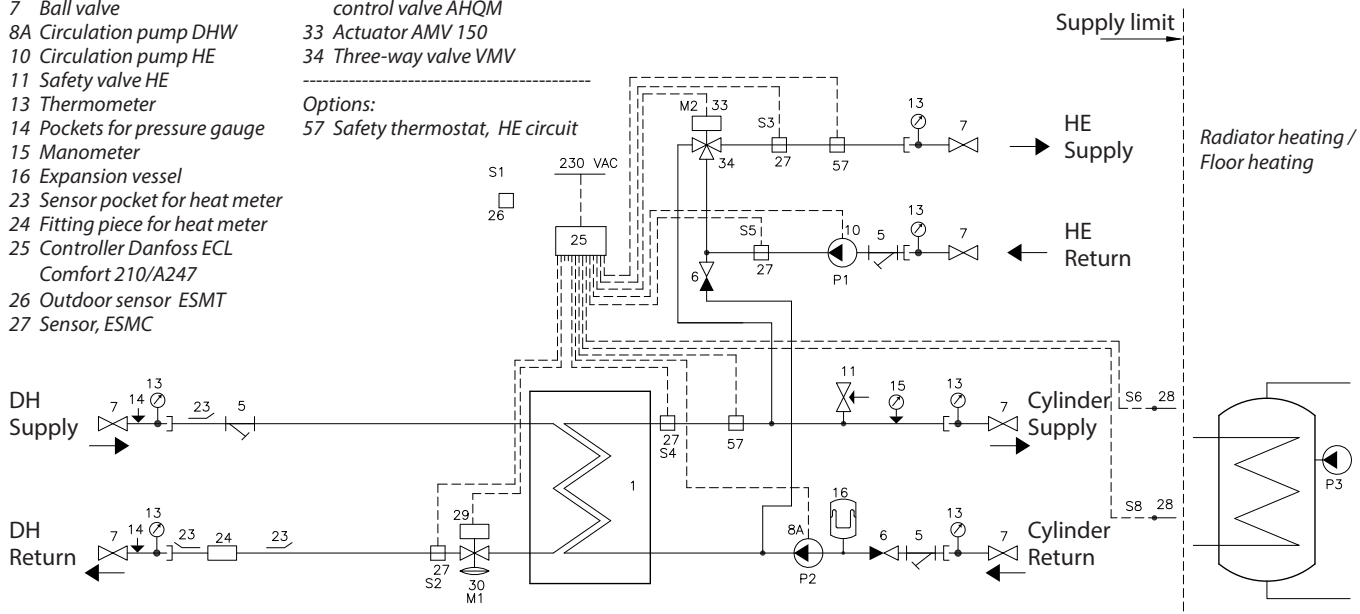

Principal components

- 1 Plate heat exchanger
- 8A Circulation pump, Cylinder
- 10 Circulation pump, HE
- 11 Safety valve, HE
- 16 Expansion vessel
- 24 Fitting piece for heat meter
- 25 Electronic controller
- 29 Actuator AMV 150
- 30 Flow controller with integrated control valve AHQM
- 33 Actuator AMV150
- 34 3-way valve VMV 30/15

The substation offers variable connection possibilities, as connection of pipes can be established both in the top or in the bottom of the substation. Please note that the ball valves are supplied loose with the substation, - for mounting on site.

Variants available with safety function for two circuits.

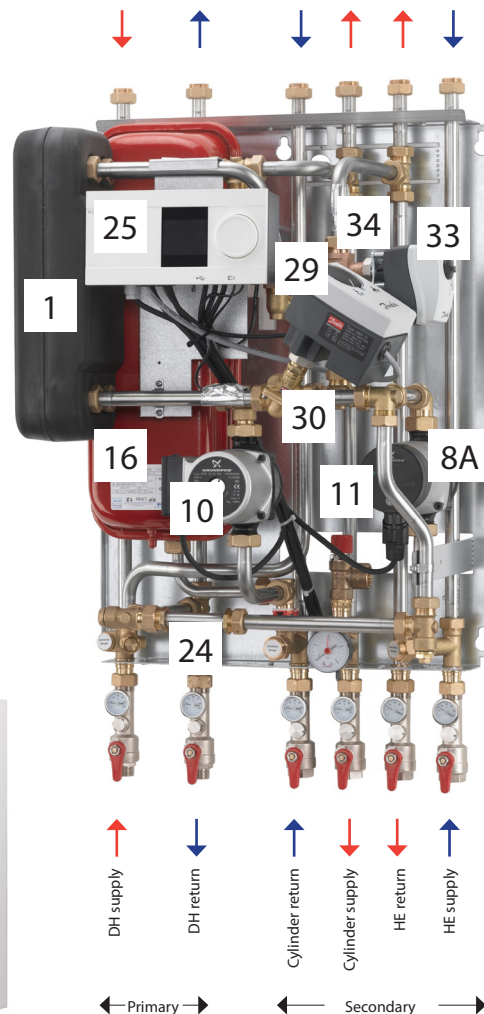

Instructions for installation and use VX Solo II substations

2.10 VX Solo II H2WS (ECL 210/A267) - 2 HE circuits + sec. connection for DHW cylinder

- 1 Plate heat exchanger HE
 - 5 Strainer
 - 6 Non-return valve
 - 7 Ball valve
 - 8 Circulation pump HE
 - 8A Circulation pump DHW
 - 10 Circulation pump FH
 - 11 Safety valve HE
 - 13 Thermometer
 - 15 Manometer
 - 16 Expansion vessel
 - 23 Sensor pocket for heat meter
 - 24 Fitting piece for heat meter
 - 25 Controller Danfoss ECL Comfort 210/A267
 - 26 Outdoor sensor ESMT
 - 27 Sensor, ESMC
 - 28 Immersion sensor ESMB
 - 29 Actuator AMV 13, HE
 - 30 Flow controller with integrated control valve AHQM
 - 33 Actuator AMV 150
 - 34 Three way valve VMV
 - 57 Safety thermostat, FH circuit
- Options:
57 Safety thermostat, HE circuit

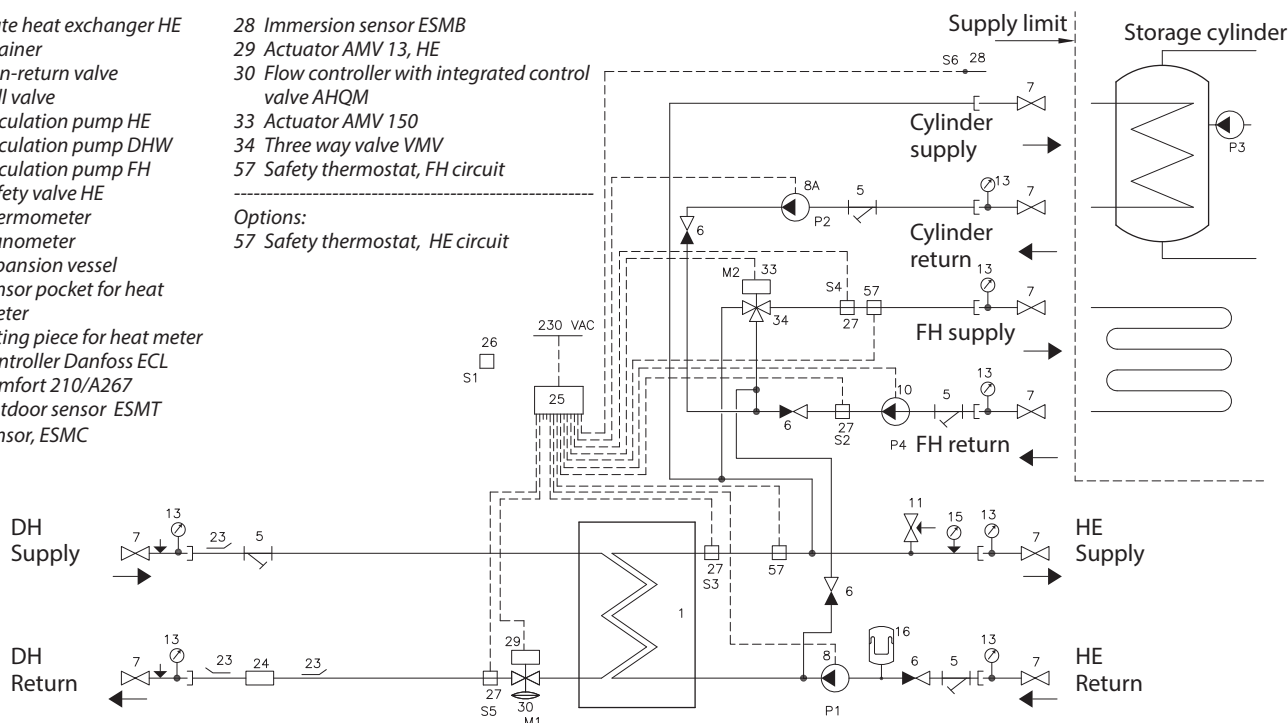

Principal components

- 1 Plate heat exchanger
- 8 Circulation pump, HE
- 8A Circulation pump, Cylinder
- 10 Circulation pump, FH
- 11 Safety valve, HE
- 16 Expansion vessel
- 24 Fitting piece for heat meter
- 25 Electronic controller
- 29 Actuator AMV 13
- 30 Flow controller with integrated control valve AHQM
- 33 Actuator AMV 150
- 34 3-way valve VMV 30/15
- 57 Safety temperature monitor

The substation offers variable connection possibilities, as connection of pipes can be established both in the top or in the bottom of the substation. Please note that the ball valves are supplied loose with the substation, - for mounting on site.

Variants available with safety function for two HE circuits.

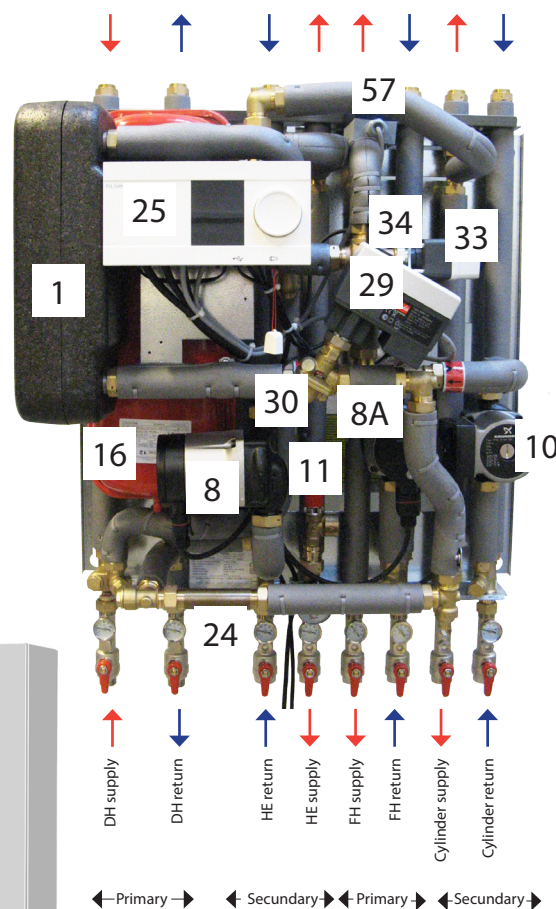
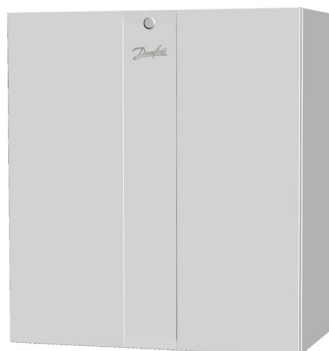

4

Instructions for installation and use VX Solo II substations

3.0 Dimensional sketch / connections

VX Solo II HWP / HWS

Dimensions:

Dimensions without cover
H 861 x W max. 525 x D 345 mm

Dimensions with cover
H 861 x W 550 x D 381 mm

Note dimensions for VX Solo II T°C:

Dimensions without cover
H 801 x W max. 525 x D 345 mm

Dimensions with cover
H 801 x W 550 x D 380 mm

Connections:

Order:

- 1 District heating (DH) supply
- 2 District heating (DH) return
- 3 Heating (HE) / Cylinder return
- 4 Heating (HE) / Cylinder supply
- 5 Cylinder / HE supply
- 6 Cylinder / HE return

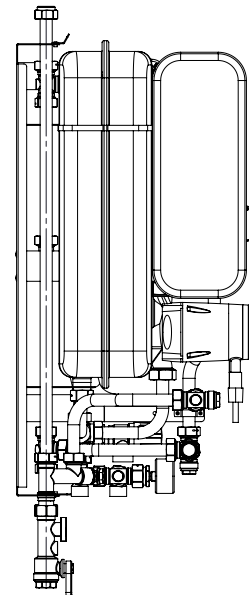
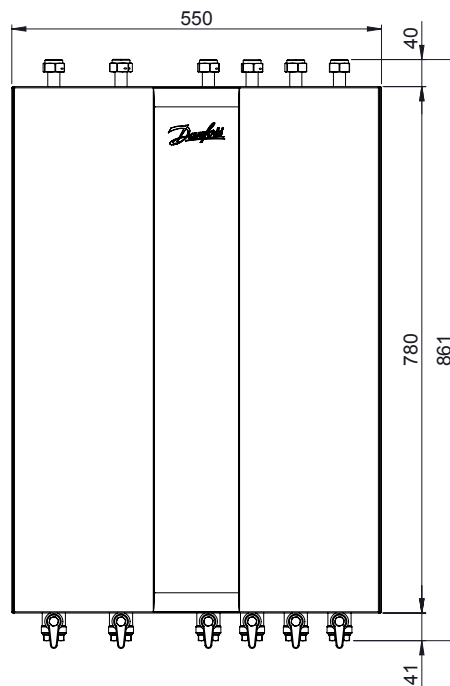

Connections size:

DH: G $\frac{3}{4}$ " (ET)
DCW, DHW, HE: G $\frac{3}{4}$ " (IT)

VX Solo II H2WP / H2WS

Dimensions:

Dimensions without cover
H861 x W650 x D365 mm

Dimensions with cover
H861 x W700 x D381 mm

Connections:

Order:

- 1 District heating (DH) supply
- 2 District heating (DH) return
- 3 Heating (HE) return
- 4 Heating (HE) supply
- 5 Floor heating supply
- 6 Floor heating return
- 7 Cylinder supply
- 8 Cylinder return

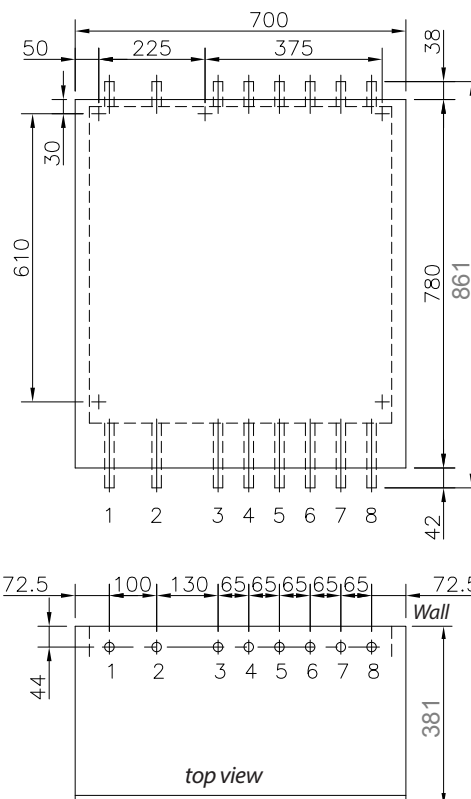

Connections size:

DH: G $\frac{3}{4}$ " (ET)
DCW, DHW, HE: G $\frac{3}{4}$ " (IT)

Instructions for installation and use VX Solo II substations

4.0 Enduser instructions, General

Instructions

Please read these instructions carefully before installing and commissioning this substation. The manufacturer accepts no liability for loss or damage resulting from failure to comply with these instructions for use. Read and follow these instructions carefully to prevent the risk of physical injury and/or damage to property. Exceeding the recommended operating parameters appreciably increases the risk of personal injury and/or damage to property.

Installation, commissioning and maintenance must be carried out by qualified and authorised personnel (both plumbing and electrical work).

Once the station has been installed and is operating, there is *normally* no need to alter the settings or other functions. The district heating substation is very reliable and easy to operate.

For more detailed information about the substation, see the sections concerning installation and commissioning.

Description

These instructions apply to substation types VX Solo II, which are district heating substations for indirect heating for single-family houses, semi-detached and terraced houses as well as flats. With one or two heating circuits for radiator and/or floor heating and with connection pipes for domestic hot water cylinder on primary or secondary side. For wall-mounting and with variable connection possibilities.

The HE supply temperature is controlled either by a self-acting thermostat 20°C or by a Danfoss ECL controller in combination with an electronic actuator. The ECL controller acts as the brain of the heating system. It lets you easily control and optimise system performance and operation.

We recommend regular inspections of the substation - ideally in connection with readings of the district heating meter.

Pay special attention to any leaks and an excessively high return temperature in the district heating circuit (poor cooling of the district heating water). Cooling - i.e. the difference between the supply and return temperature of the district heating water - has a significant effect on the overall energy economy. Therefore, it is important to focus on the supply and return temperature in the heating system.

The difference should typically be 30–35°C in systems that operate with radiators. In systems that feature floor heating, the difference is typically 5–10°C. In these systems, it is important that the supply temperature does not exceed 35°C.

Irregularities

When reading the meters, check all joints and connections for leaks.

If you identify any irregularities/leaks, contact your professional provider for assistance.

Check the troubleshooting section before contacting your professional provider.



Warning! Hot surfaces

Parts of the substation may be very hot and can cause burn injuries. Be very careful when you are in the immediate vicinity of the unit.

Warnings about high pressure and high temperature

The maximum supply temperature in the district heating network can be up to 120°C and the operating pressure can be up to 16 bar. This may result in a risk of scalding from touching the substation and from outflow of the medium (water/steam). Exceeding the substation design data and operating parameters for pressure and temperature carries an appreciable risk of personal injury and/or damage to property.

Emergencies

In the event of fire, leaks or other hazards, immediately shut off all sources of energy to the substation, if possible, and call for appropriate assistance.

If the domestic hot water is discoloured or malodorous, shut off all ball valves on the substation and the storage cylinder, notify all users and call for professional assistance without delay.

Instructions for installation and use VX Solo II substations

5.0 Enduser instructions, Adjustment and Setting

Heating circuit, Differential Pressure Controller

The differential pressure controller (Fig. 1) reduces the high, fluctuating pressure in the district heating network to a constant operating pressure.

The **AVPL** differential pressure controller is initially set by the plumber in connection with the commissioning of the substation. If disruptions to the operation occur: noise in the radiator thermostats or poor regulation capacity, it may be necessary to reset the differential pressure controller to a lower or higher operating pressure. We suggest that you contact your local plumber for assistance.

The **TD200** differential pressure controller is preset from factory and should not be adjusted afterwards.

The **AVPB-F** differential pressure controller is preset from factory and should not be adjusted afterwards. The controller has a control valve with adjustable flow restrictor and flow setting is being done by the adjustment of the flow restrictor position. We suggest that you contact your local plumber for assistance.

Fig. 1

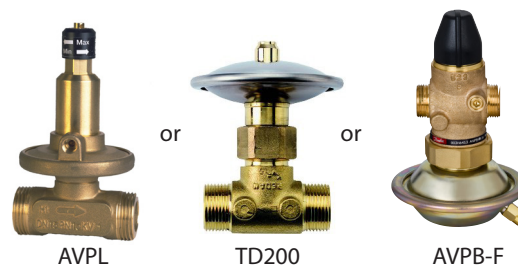

Heating circuit, Temperature control

Thermostatic control

The supply temperature to the substation can be set by adjusting the thermostat TC (Fig. 2), which controls the temperature for the heating circuit.

The thermostat will be set by the installer in connection with the commissioning, but it may be necessary to adjust it subsequently depending on the outdoor temperature.

Approximate thermostat scale setting:

- Pos. 1 = 20°C
- 2 = 30°C
- 3 = 40°C
- 4 = 50°C
- 5 = 60°C
- 6 = 70°C

Please note that a label on the TC thermostat will indicate the temperature range.

NB! For houses that are heated exclusively with floor heating.

The supply temperature should typically be set to approx. 30–35°C. ALWAYS refer to the instructions from the floor supplier.

Other variations with other types of thermostatic valves for control of the heating circuit may occur.

Electronic control

The temperature for the heating circuit can be controlled electronically by either a Danfoss ECL 210 or a Danfoss ECL 310 controller (Fig. 3). The supply temperature is calculated by the controller on basis of the outdoor temperature.

See the enclosed documentation for same.

Fig. 2



Fig. 3



ECL 210 / ECL 310

Pump.

VX Solo II substations are factory fitted with pump(s) (Fig. 4). The pump setting is established in connection with the commissioning. Generally speaking, this setting is not to be altered. If it should nevertheless be necessary to change the pump setting, see the section concerning pumps in the installation and commissioning sections regarding the individual products.

In the summer, you can switch off the power to the pump at the mains if you want to save electricity by not heating your home.

Start-up and venting – see the installation and commissioning sections, if necessary.

Fig. 4



Instructions for installation and use VX Solo II substations

6.0 Installation instructions, Safety and Handling

Instructions

Please read these instructions carefully before installing and commissioning this substation. The manufacturer accepts no liability for loss or damage resulting from failure to comply with these instructions for use. Read and follow these instructions carefully to prevent the risk of physical injury and/or damage to persons and property. Exceeding the recommended operating parameters considerably increases the risk of personal injury and/or damage to property. Installation, commissioning and maintenance must be carried out by qualified and authorized personnel in compliance with the local safety regulations.

Once the station has been installed and is operating, there is *normally* no need to alter the settings or other functions. The district heating substation is very reliable and easy to operate.

Energy source

The substation is primarily designed for connection to district heating. Alternative energy sources can be used if the operating conditions are equivalent to district heating at all times.

Application

The substation is designed only to heat water and other heating media may not be used. The substation is to be connected to the household piping in a frost-free room, where the temperature does not exceed 50 °C and the relative humidity is not higher than 80%. The substation must not be covered, bricked in or otherwise cut off from access.

Choice of materials

Only use materials, that comply with local regulations.

Corrosion

The maximum chloride compounds of the medium must not be higher than 300 mg/l. The risk of corrosion increases considerably if the recommended chloride content is exceeded.

Safety valve(s)

Installation of safety valve(s) must always be in compliance with local regulations.

Noise level.

≤ 55 dB.

Storage

Before installation, the units must be stored in a dry, heated (i.e. frost-free) room. (Relative humidity max. 80% and storage temperature 5-70 °C).

The units must not be stacked higher than the limit at the factory (max. 8 layers) Units supplied in cardboard packaging must be lifted using the handles incorporated in the packaging. Units must be placed on pallets for transport/moving across large distances.

As far as possible, do not lift the substation by the pipes. Lifting by the pipes may cause leaks. REMEMBER to retighten.

Disposal

Dispose of the packaging in accordance with the local regulations for disposal of used packaging materials.

The substation is made of materials that cannot be disposed of together with household waste.

Close all energy sources and disconnect all connection pipes. Disconnect and dismantle the product for disposal in accordance with the applicable local regulations for the disposal of the individual components.



Connection

It must be possible to cut off all energy sources to the unit - including electrical connections - at all times.

Potential equalization/grounding

Potential equalization is an electrical equalizer connection to secure against user contact with dangerous voltage, which may occur for example between two piping systems. Potential equalization reduces corrosion in heat exchangers, water heaters, district heating units and plumbing installations. Equalization of potentials should be effected according to local regulations.

Warning! Hot surfaces

Parts of the substation may be very hot and can cause burn injuries. Be very careful when you are in the immediate vicinity of the substation.

Warning of high pressure and high temperature

The maximum supply temperature in the district heating network can be up to 120°C and the operating pressure can be up to 16 bar. This may result in a risk of scalding from touching the substation and from outflow of the medium (water/steam). Exceeding the substation design data and operating parameters for pressure and temperature carries an appreciable risk of personal injury and/or damage to property.

Emergencies

In the event of fire, leaks or other hazards, immediately shut off all sources of energy to the substation, if possible and call for appropriate assistance.

If the domestic hot water is discoloured or malodorous, shut off all ball valves on the substation, notify all users and call for professional assistance immediately.

Warning of damage during transport

On reception of the substation, and before installing it, check for any evidence of damage during transport. The substation must be handled and moved with the greatest care and attention.

NB! - Tightening of connections

Before mounting of the substation, ALL pipe connections MUST be retightened, as vibrations during transport may have caused leaks. Once the substation has been put into operation ALL pipe connections MUST be pressure tested for leaks and retightened once more if necessary.

DO NOT OVERTIGHTEN THE PIPE CONNECTIONS – see page 19, “Test & connections” for more information.



Handling

We recommend that you wear suitable safety footwear and suitable safety working gloves while handling and installing the substation.



7.0 Installation instructions - Getting started

Connect the substation to the household piping in accordance with the labelling at the bottom and/or in accordance with the instructions in this manual.

Please also refer to page 19, Installation instructions, General.

GETTING STARTED is a quick guide and some details in connection with installation and commissioning may require additional information, which can be found elsewhere in this instruction manual.

1. The ball valves, which are supplied loose with the substation, can be mounted either on the top connections or bottom connections. For connection in top, demount the plugs from the top connections and mount them on the bottom connections.
2. The substation is prepared for wall mounting. Mount the substation on a solid wall using two sturdy bolts, screws, expansion bolts or similar.
3. When the unit has been securely mounted, close all shut-off valves on the substation before connecting the unit to the household piping.
4. Mount the district heating meter (see page 20).
5. **IMPORTANT! Tighten all pipe connections, as they may have loosened during transport and handling (do NOT overtighten).**
6. On systems that feature a safety valve, establish a drain connection in compliance with the applicable legislation.
7. Fill the heat exchanger / the system with water according to the instructions on page 22 until the manometer shows a working pressure, which corresponds to the system height + approx. 5 m (approx. 1.2 - 1.5 bar).
8. Check the substation and the household piping thoroughly for leaks.
9. Pressure test the entire system for leaks in accordance with the applicable regulations.
10. Connect pump and automatic components, if any, to the electricity supply, **but do not** switch on the power.
11. Heat the system and vent the radiator circuit/heating side thoroughly on the radiators and the air valve, if any.
12. For substations, which include zone valve, remember to remove the red split on the position indicator of the zone valve.
13. Now switch on the pump and automatic components, if any.
14. Finish by adjusting the substation in accordance with this instruction manual, and remember to fill-in the commissioning certificate on page 41.

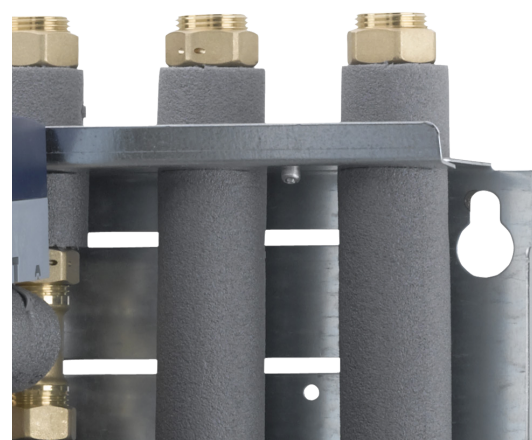

IMPORTANT! Heating and cooling the substation may cause leaks. Therefore it may be necessary to retighten the connections in the period after commissioning.

Instructions for installation and use VX Solo II substations

8.0 Description of VX Solo II

VX Solo II are district heating substations for indirect heating for single-family houses, semi-detached and terraced houses as well as flats. With one or two heating circuits for radiator and/or floor heating and with connection pipes for domestic hot water cylinder on primary or secondary side.

As standard the substations are supplied with fitting piece(s) for mounting of heat meter(s).

The VX Solo II substations are available in various variants, - please see photos to the right.

The supply temperature to the heating circuit can be regulated by a self-acting thermostatic valve (type VX Solo II (T°C)). In rooms with floor heating, the temperature is regulated using the floor heating thermostat for the room in question. In rooms with radiators, the temperature is regulated using the radiator thermostats.

Alternatively, the heating circuits can be regulated using fully automatic Danfoss ECL weather compensation equipment, - a Danfoss ECL controller in combination with electronic actuator(s). The ECL controller acts as the brain of the heating system. It lets you easily control and optimise system performance and operation.

VX Solo II substations are also fitted with pump(s).

As an option the VX Solo II substations can be equipped with a thermostat with safety monitor.

The VX Solo II variants are designed for wall mounting and offer variable connection possibilities as connection of pipes can be made both in top or bottom of the substation.

General information

PLEASE NOTE! Some models may have a slightly different appearance, as variants with other components may be supplied.

Supplier instructions for the fitted components will always be supplied together with the substation.



VX Solo II (T°C)



VX Solo II H (ECL 210/A230)



VX Solo II H2 (ECL 210/A260)



VX Solo II HWP (ECL 210/A237)



VX Solo II HWP (ECL210/A247)

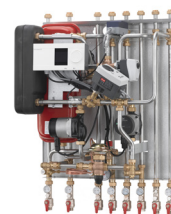

VX Solo II H2WP (ECL 210/A260)

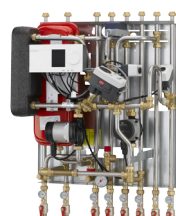

VX Solo II H2WP (ECL 310/A377)



VX Solo II HWS (ECL 210/A237)



VX Solo II HWS (ECL 210/A247)

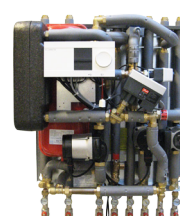

VX Solo II H2WS (ECL 210/A267)

Instructions for installation and use VX Solo II substations

9.0 Installation instructions, general

The installation, connection and maintenance of the substation must be performed by qualified and authorised personnel.

Installation must always be performed in accordance with the applicable legislation and in compliance with these instructions.

The substation must be installed so that it is freely accessible and can be maintained without unnecessary disruption. Lift the substation by its mounting plate and secure it to a solid wall using 2 expansion bolts or the like positioned in the two keyholes in the mounting plate.

We recommend positioning of rubber spacers between the wall and the unit to prevent the transfer of resonance noise from the pump into the wall.

Before commissioning, rinse all the pipes in the household piping system thoroughly to remove any impurities, and check and clean the dirt strainers in the substation.

Connect the substation to the household piping in accordance with the labelling at the bottom and/or in accordance with the instructions in this manual.



Test and connections

Before filling the system with water, retighten all the pipe connections because vibrations and shocks during transport and handling may have caused leaks. Once the system has been filled with water, tighten all the pipe connections once more before performing pressure test for leaks. After heating of the system, check all the connections and retighten if necessary.

Please note that the connections feature EPDM rubber gaskets!

Therefore, it is important that you DO NOT OVERTIGHTEN the union nuts. Over-tightening may result in leaks. Leaks caused by over-tightening or failure to retighten connections are not covered by the warranty.



Variable connections possibilities

The substations offer variable connection possibilities, as connection of pipes can be established in the top or in the bottom of the substation. Upon delivery the substation is prepared for connection in bottom of the substation.

For change of connection from bottom to top, demount plugs on connection pipes in top of substation and ball valves on connection pipes in bottom of substation, and mount plugs in connection pipes in bottom of substation and ball valves on connection pipes in top of substation.

Please note that the air screw, which originally is mounted on the heating supply pipe in top of substation must be relocated to the highest point of the substation.

PLEASE NOTE that the variable connection possibilities makes it possible to establish some of the connections in the top and others in the bottom of the substation. This may be desirable in some cases.

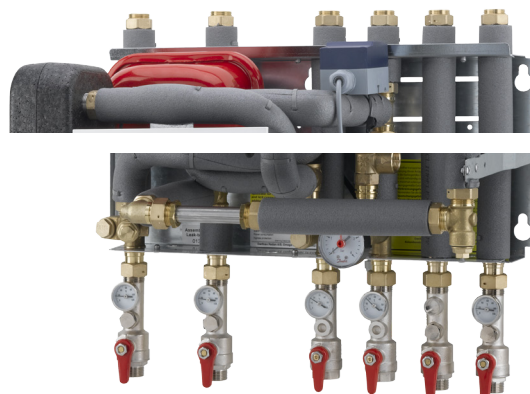

Safety valve

Always lead the blow-off pipes from the safety valves to a drain in accordance with applicable legislation.

Expansion vessel

The VX Solo II substations are equipped with an expansion vessel, which is factory set to 0,5 bar.

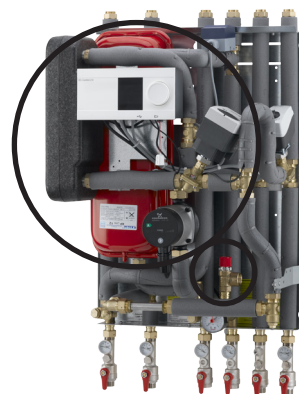

Instructions for installation and use VX Solo II substations

Fitting piece for heat meter(s)

The VX Solo II substations are equipped with fixed fitting piece(s) size 3/4" x 110 mm for fitting of heat meter in DH supply and return (leak detection) or only in DH return.

Fitting of heat meter (*not part of the delivery*)

- Close the ball valves on the district heating line
- Loosen the union nuts at both ends of the fitting piece and remove it
- Fit/fasten the heat meter - remember gaskets
- Mount temperature sensors in sensor pockets (according to meter regulations)
- Remember to check and tighten all pipe connections before commissioning the heat meter.

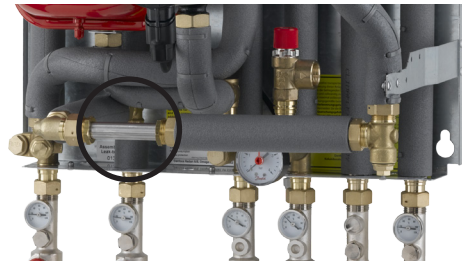
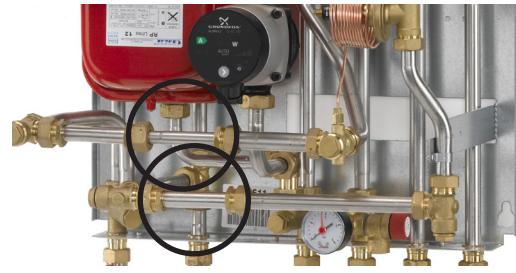

Mounting of temperature sensor

The heat meter (*not part of the delivery*) is supplied with temperature sensors for measuring the supply and return flow temperatures.

The VX Solo II substations are prepared for mounting of temperature sensors with M10x1 connection (see photo to the right).

The supply flow sensor is mounted in the sensor pocket on DH supply (pos. A)

- *dismount M10 plug (pos. A)*
- *insert one temperature sensor in the sensor pocket*
- *tighten temperature sensor union nut*

Mount the return flow sensor in the heat meter housing (pos. C) or in the sensor pocket on DH return (pos. B).

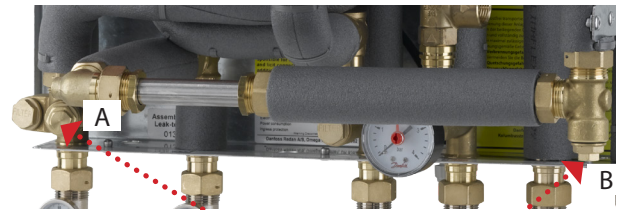

Pipe bushing 1/2"/M10x1 incl. plug M10

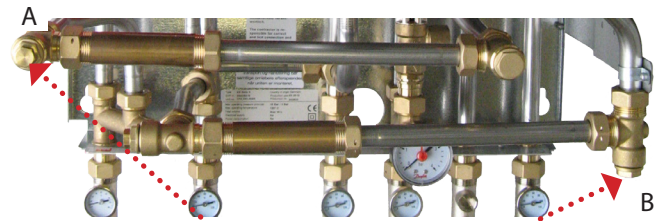

Pipe bushing 1/2"/M10x1 incl. plug M10



*Please note:
Some variants are supplied with 1/2" plug.*



Instructions for installation and use VX Solo II substations

Electrical connection

The electrical connection of the unit must be performed by authorised personnel. The unit is to be connected to a 230 V AC mains supply.

The power supply/connection must be carried out in accordance with the applicable regulations and instructions.

The unit must be connected to an external switch so that it can be disconnected in connection with maintenance, cleaning and repairs or in the event of an emergency.

For VX Solo II substations supplied with Danfoss ECL electronic controller the control equipment includes actuator(s) and sensors installed in the unit and the controller. The controller is electrically wired to sensors, pump and actuator(s).

Connection of outdoor sensor and immersion sensor, if any, is carried out in accordance with below instructions.

Installation of outdoor sensor (ESMT)

The outdoor temperature sensor is supplied loose with the unit. It is to be mounted on site as shown in the drawings to the right. Always mount the sensor on the coldest side of the building (normally the north side).

It must not be exposed to morning sunlight, and must not be positioned above windows, doors, ventilation ducts, balconies under overhanging roof sections, or close to any other heat source.

Installation height: approx. 2.5 m above ground level.

Temperature range: -50 to 50° C.

Electrical connections

The cables can be connected to the sensor in any order.

Connection cable: 2 x 0.4 - 1.5 mm².

Connect the cable ends to ECL controller in clamps 29 and 30.

Mounting of immersion sensor (ESMB-12)

The immersion sensor for accurate temperature measurement and control in the cylinder is supplied separately and must be mounted and connected to the controller on site.

Temperature range immersion sensor: 0 to 100 °C

Temperature range immersion pocket: 0 to 180 °C

2-wire cable (2 x 0.34 mm² spliced) is preassembled in the controller.

- 1) Mount sensor pocket (supplied loose) in top or bottom of cylinder.
- 2) Lay immersion sensor and cable from substation to cylinder and mount immersion sensor in immersion pocket.

In case the length of the sensor cable is not long enough for your property, it is recommendable to change the whole cable. The minimum area for the cable is 0,4 mm² and max. length is 125 m.

Access to ECL base part

Access to the base part for connection of outdoor sensor or the like is obtained by pulling the lock (pin) down with a screwdriver until a yellow line is visible on the lock. Then, the front piece can easily be removed. Lock by pressing the lock (pin) up.

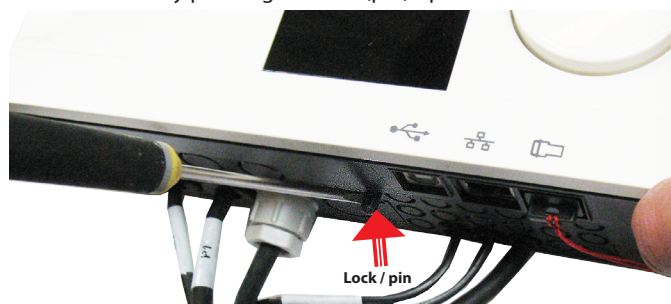

Controller ECL 210/310

| | |
|------------------------|-------------------------------|
| Supply voltage: | 230 V a.c. - 50 Hz |
| Voltage range: | 207 to 244 V a.c. (IEC 60038) |
| Power consumption: | 5 VA |
| Load on relay outputs: | 4(2) A - 230 V a.c. |
| Load on triac outputs: | 0,2 A - 230 V a.c. |

Actuator AMV13 / AMV 150

| | |
|-------------------|--------------------|
| Supply voltage | 230 V a.c. - 50 Hz |
| Power consumption | 2 / 7 VA |

For further information please refer to the enclosed instructions.

Pumps (Alpha2 L & Alpha2)

| | |
|--------------------|--------------------|
| Supply voltage: | 230 V a.c. - 50 Hz |
| Protection class: | IP42 |
| Power consumption: | Max. 25 Watt |

For further information please refer to the enclosed instructions for the circulation pumps.

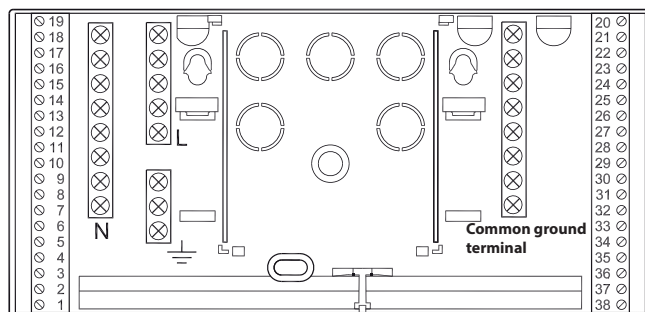
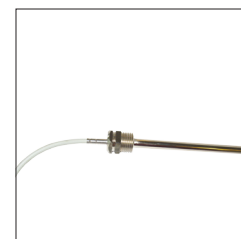
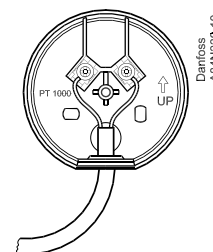
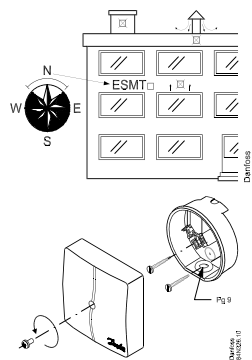

ECL Comfort 210/310 base part

Danfoss 5/11105.11

Instructions for installation and use VX Solo II substations

10.0 Adjustment and commissioning, filling the system and differential pressure controller

General information

PLEASE NOTE! Some models may have a slightly different appearance, but the control function is in principle the same as described below.

Commissioning

Commission the unit in accordance with the instructions on pages 17-21.

Filling the system

Filling of water to the heating system must be done through connection to an exterior cold water supply. Check and tighten all connections before adding water to the system, as vibrations during transport may have caused leaks. After having added water to the system, tighten all the connections before performing leak test. Then heat up the system, check the connections and tighten once again if necessary.

Before adding water to the system and first start-up, check if:

- pipes are connected according to the circuit diagram,
- expansion vessel is connected,
- heat meter is mounted,
- shut-off valves are closed,
- threaded and flanged connections are tightened.

Filling - (Note, by means of exterior cold water supply):

If the pressure drops below 1 bar, water must be added to the system. The operating pressure should never exceed 1.5 bar.

(The safety valve opens at 3 bar)

1. Pump must be switched off when water is added to the system.
2. Fill heat exchanger and system with water until the manometer shows a working pressure, which corresponds to the system height + 5 m (approx. 1.5 - 2.0 bar)
3. Vent the system completely.
4. Start the pump.
5. For substations, which include zone valve, remember to remove the red split on the position indicator of the zone valve.

If system pressure drops dramatically within a short time, heating system should be examined for leakage, - this includes checking the factory set pressure of the expansion vessel.

Differential pressure controller

(Standard on systems with self-acting thermostatic valve). The differential pressure controller reduces the fluctuating pressure in the district heating network to a small and invariable operating pressure in the substation. The required room temperature is controlled on your radiator thermostats.

Differential pressure controller AVPL

AVPL is a self-acting differential pressure controller for PN 16 with adjustable differential pressure setting and the differential pressure controller can be set at any differential pressure between 5 kPa and 25 kPa (0.05 bar and 0.25 bar).

The preset factory setting of the controller is 10 kPa (0.1 bar). The differential pressure can be set by means of an Allen key NV 3. 1 turn corresponds with 1 kPa (0.01 bar).

The controller settings can be changed in accordance with the enclosed producer instructions:

Differential pressure controller (PN 16) AVPL
Return mounting, adjustable setting

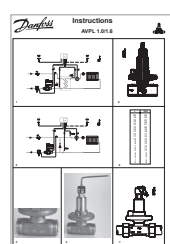
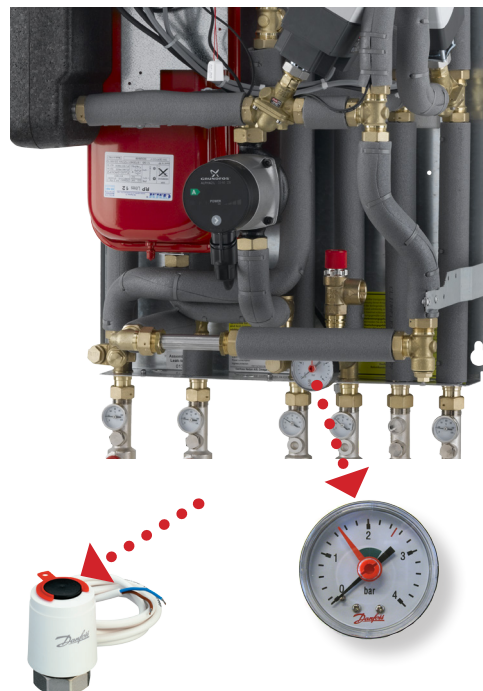

AVPL

Instructions for installation and use VX Solo II substations

Differential pressure controller TD200

This type of differential pressure controller is preset from factory and should not be adjusted afterwards.



Differential pressure controller AVPB-F

The self-acting differential pressure controller AVPB-F with flow limitation reduces the fluctuating pressure in the district heating network to a small and invariable operating pressure in the substation and thereby ensures the best possible operating conditions.

The control valve opens on falling differential pressure to maintain constant differential pressure, and closes on rising differential pressure or when set max. flow is exceeded.

The differential pressure controller is preset from factory and **should not** be adjusted afterwards.

The controller has a control valve with adjustable flow restrictor and flow setting is being done by the adjustment of the flow restrictor position.

The controller is equipped with excess pressure safety valve, which protects the actuator from too high differential pressure.

Please see enclosed instructions, AVPB-F

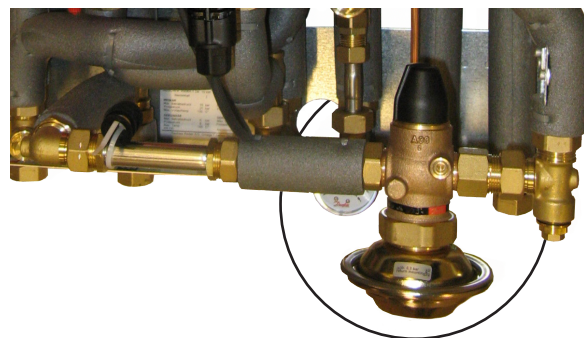
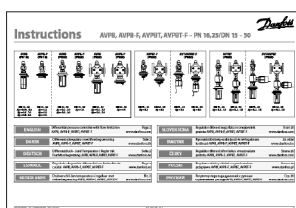

Flow setting

Flow setting is being done by the adjustment of the flow restrictor position.

Instructions for installation and use VX Solo II substations

11.0 Adjustment and commissioning, heating circuit

The temperature for the heating circuit can be controlled by a thermostatic valve T°C 200.

Approximate thermostat scale setting:

- Pos. 1 = 20°C
- 2 = 30°C
- 3 = 40°C
- 4 = 50°C
- 5 = 60°C
- 6 = 70°C

Please note that the values are intended as a guide and may vary according to the district heating operating conditions.

Approximate supply temperatures at:

- 10 °C outdoor temperature approx. 40°C
- 0 °C outdoor temperature approx. 55°C
- 10 °C outdoor temperature approx. 65°C

It is important to keep the supply temperature to the radiators as low as possible (the temperature is indicated by thermometer mounted in HE return). The room temperature is controlled by radiator thermostats.

Floor heating (substation with heat exchanger for floor heating). It is important to keep the supply temperature to the floor heating system as low as possible, approx. 30-35° (the temperature is indicated by thermometer mounted in HE supply),

The T°C is typically set in pos. 2-2.5 (intended as a guide). The supply temperature should not exceed 40°C (ALWAYS refer to the instructions of the floor supplier).

Please note that a label on the TC thermostat will indicate the temperature range.



Zone valve / thermal actuator TWA-A (option)

The thermostatically controlled VX Solo II can as option be equipped with zone valve/thermal actuator TWA-V, which enables connection to an **electronic programmable room thermostat**.

The thermal actuator of the zone valve is switched on by an external contact from the room thermostat, and starts to open or close the valve. The actuating movement is achieved by means of an electrically heated expansion element. When the heating current is switched off, the actuator shuts or opens the valve.

The actuator is equipped with a visual position indicator to show the open or closed position of the valve. Heating operation is then activated by the programmable room thermostat in connection with a zone valve /thermal actuator TWA-A.

Electronic programmable room thermostat (option)

If the substation is connected to a room thermostat the temperature is controlled by the room thermostat and radiator thermostats. Please note that the room thermostat keeps the temperature at a constant level in the whole apartment according to the set room parameters.

Consult additional maintenance instructions for room thermostat for further information. It is recommended to avoid fully opened thermostats on some radiators and fully shut-off on others. Higher temperature at the top and lower temperature at the bottom part of radiators means that the system operation is correct.



Zone valve / Thermal actuator TWA-A

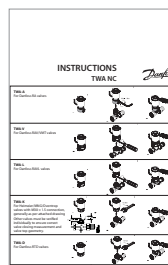

Instructions for installation and use VX Solo II substations

Danfoss ECL Comfort 210 or 310

The temperature for the heating circuits can be controlled electronically by a Danfoss ECL 210 or 310 controller. The ECL controller is supplied with an ECL Application Key, which contains information about application, language and factory settings, adapted to the type of system, for which it is ordered.

Note! Various applications can be loaded.

The controller is factory-set for local language and the running time for the actuator (heating circuit) is preset for the actual application. General controller settings such as "Time and Date" must be entered during commissioning of the controller. And also the desired supply flow temperature must be set.

Please refer to the enclosed manufacturer instructions for the ECL 210/310 controller in order to **set the required temperature for the heating circuit:**

ECL Application Key Box with ECL Comfort 210/310 user guide and mounting guide, for further information.



We recommend that your order commissioning of the controller with your local Danfoss representative.

Note, in systems that feature only floor heating it is important that the supply temperature does not exceed 35°C, and ALWAYS check the instructions from the floor supplier (typically for wooden floors).

Actuator(s) + valve(s)

For substations fitted with a Danfoss ECL controller, electronic actuator(s) and control valve(s) will in combination with the ECL controller control the secondary side of the substation.

Below schedule states the controller application as well as the actuator/valve combination for control of the heating circuit(s):

| Type | Radiator Circuit | Floor Heating Circuit |
|--|------------------|-----------------------|
| VX Solo II H (ECL 210/A230), page 4 | AHQM / AMV 150 | |
| VX Solo II H2 (ECL 210/A260), page 5 | AHQM / AMV 13 | VMV / AMV 150 |
| VX Solo II HWP (ECL 210/A237), page 6 | VS2 / AMV 150 | |
| VX Solo II HWP (ECL 210/A247), page 7 | AHQM / AMV 150 | |
| VX Solo II H2WP (ECL 210/A260), page 8 | VS2/AMV13 | VMV / AMV 150 |
| VX Solo II H2WP (ECL 310/A377), page 9 | AHQM / AMV 13 | VMV / AMV 150 |
| VX Solo II HWS (ECL 210/A237), page 10 | AHQM / AMV 13 * | |
| VX Solo II HWS (ECL 210/A247), page 11 | AHQM / AMV 150 * | VMV / AMV 150 |
| VX Solo II H2WS (ECL 210/A267), page 12 | AHQM / AMV 13 * | VMV / AMV 150 |

* will also control the inlet temperature for the DHW cylinder circuit. Please see page 31.

In the following pages you will find more information about the actuators and valves.

Instructions for installation and use VX Solo II substations

AHQM / AMV 150

The VX Solo II substations can be supplied with a self-acting flow controller with integrated control valve Danfoss AHQM and an electrical actuator AMV 150

The controller closes when set max. flow is exceeded. The flow-controller is equipped with excess pressure safety valve, which protects the actuator from too high differential pressure.

The electrical actuator has undergone a functional test from factory. In case of operating disturbances the actuator can be closed manually turning the manual override knob on top of actuator counter-clockwise.

Please see enclosed instructions, Electrical actuator AMV 150 Flow-controller with integrated control valve AHQM

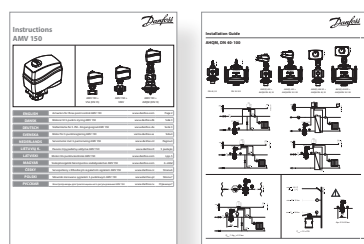

Manual override (AMV 150)



AHQM



Press and hold the button (on the bottom side of the actuator) during manual override.

AHQM / AMV 13

VX Solo II substations can be supplied with a self-acting flow controller with integrated control valve Danfoss AHQM and an electrical actuator AMV 13.

The controller closes when set max. flow is exceeded.

The flow-controller is equipped with excess pressure safety valve, which protects the actuator from too high differential pressure.

The electrical actuator has undergone a functional test from factory.

Please see enclosed instructions, Electrical actuator AMV 13 Flow-controller with integrated control valve AHQM

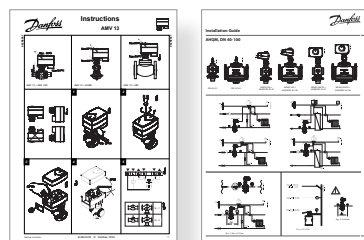

AHQM



AMV 13

The AMV 13 is typically used on units for floor heating in combination with a safety thermostat (Jumo) to protect from overheating.

Instructions for installation and use VX Solo II substations

VMV / AMV 150

VX Solo II substations can be supplied with a 3-way valve VMV and an electrical actuator AMV 150, which in combination with the ECL controller controls the floor heating circuit.

The electrical actuator has undergone a functional test from factory. In case of operating disturbances the actuator can be closed manually turning the manual override knob on top of actuator counter-clockwise.

Please see enclosed instructions, Electrical actuator AMV 150 3-way seated mixing valve VMV

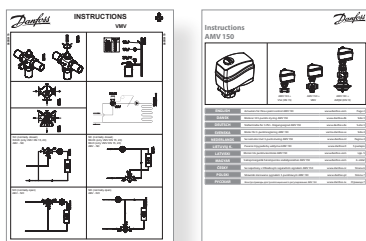

Manual override (AMV)



VMV



Press and hold the button (on the bottom side of the actuator) during manual override.

VS2 / AMV 150

VX Solo II substations can be supplied with a 2-way valve VS 2 and an electrical actuator AMV 150, which in combination with the ECL controller controls the heating circuit.

The electrical actuator has undergone a functional test from factory. In case of operating disturbances the actuator can be closed manually turning the manual override knob on top of actuator counter-clockwise.

Please see enclosed instructions, Electrical actuator AMV 150 2-way valve VS 2

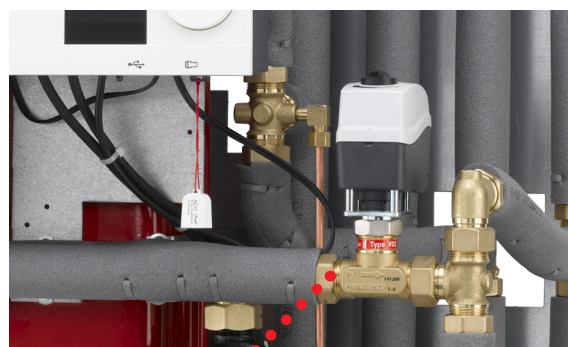
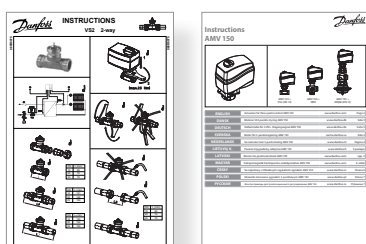

Manual override (AMV)



VS 2



Press and hold the button (on the bottom side of the actuator) during manual override.

Instructions for installation and use VX Solo II substations

VS2 / AMV 13

VX Solo II substations can be supplied with a 2-way valve VS 2 and an electrical actuator AMV 13, which in combination with the ECL controller controls the heating circuit.

The electrical actuator has undergone a functional test from factory

*Please see enclosed instructions,
Electrical actuator AMV 13
2-way valve VS 2*

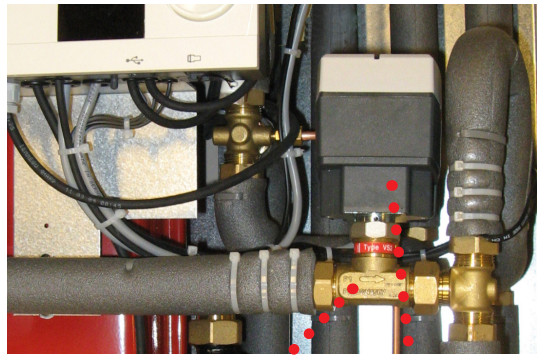
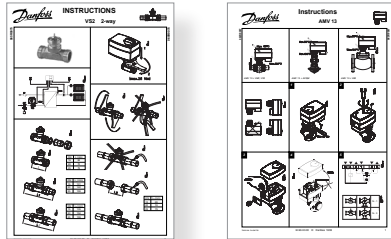

VS2



AMV 13

Safety function(option)

For VX Solo II substations with electronic control Danfoss ECL 210 or ECL 310, the heating circuit(s) can be supplied with safety function (safety thermostat type Jumo AT + actuator AMV 13) for protection against overheating.

From factory the Jumo AT safety thermostat is pre-wired to the Danfoss ECL controller with a 2 m cable, enabling the thermostat housing to be mounted in any mounting position on the household piping (HE supply) on site.

*Please see enclosed operating instructions
Jumo heatTHERM-AT*

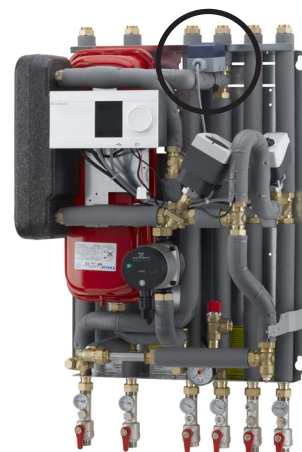

Wiring diagrams

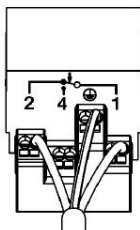

TR, TW, STW

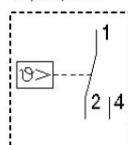

STB

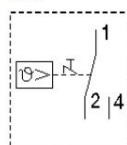

Instructions for installation and use VX Solo II substations

12.0 Circulation pump(s) - Heating Circuit

Grundfos Pumpe ALPHA2 L

Substation start-up /pump

Do not start up the pump until the system has been filled with the flow media and vented. See Grundfos instructions for the pump.

The pump is self-venting. It need not be vented before start-up. Air in the pump may cause noise. This noise ceases after a few minutes running.

Please note, that the system cannot be vented through the pump
Please note, that the pump must not run dry.

Pump settings

GRUNDFOS ALPHA2 L has seven optional settings which can be selected with the push-button.

Enclosed photo shows the recommended and alternative pump settings for system types.

The pump is set at the factory to the "Highest proportional-pressure curve" (PP2). In this control mode, the pump performance and consequently the power consumption are adjusted according to the heat demand in the system.

If the recommended pump setting does not give the desired distribution of heat in the rooms of the house, change the pump setting to the shown alternative.

For further information about pump settings please refer to the enclosed Grundfos instructions.

ALPHA2 L,

Installation and operating instructions



Summer operation

Substations with Danfoss T°C Thermostat

In the summer, you can stop the pump by switching it off at the mains. However, remember to start the pump (briefly) at least once a month during the summer.

Systems with Danfoss ECL

Outside the heating period, the pump will be disconnected automatically from the heating system. During the summer period, the controller will start the pump for a minute at least once every three days to prevent the pump from blocking.

Start-up after summer operation - venting

Please note that it may be necessary to vent the system again. To vent the system, use the air vent, if any, in the substation, or the radiators or, if appropriate, the air valve at the highest point of the system.

For further information about venting of pump etc. please refer to the enclosed Grundfos instructions.

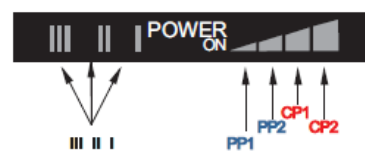
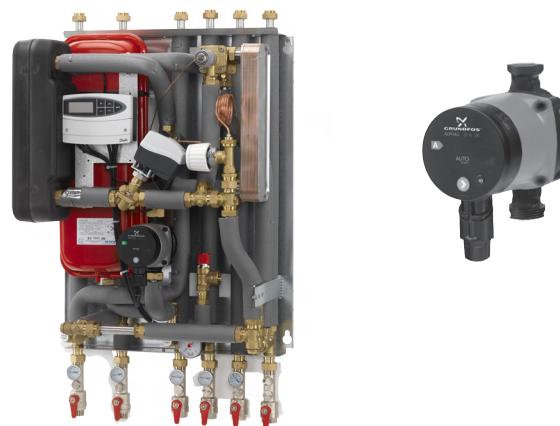
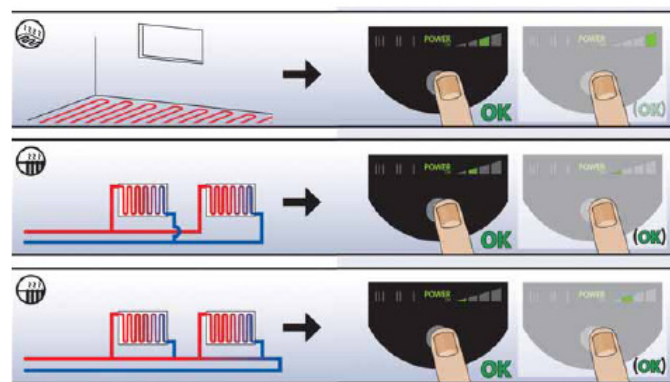

Fig. 8 Seven light fields

| Button presses | Light field | Description |
|----------------|-----------------------|-------------------------------------|
| 0 | PP2 (factory setting) | Highest proportional-pressure curve |
| 1 | CP1 | Lowest constant-pressure curve |
| 2 | CP2 | Highest constant-pressure curve |
| 3 | III | Constant curve, speed III |
| 4 | II | Constant curve, speed II |
| 5 | I | Constant curve, speed I |
| 6 | PP1 | Lowest proportional-pressure curve |
| 7 | PP2 | Highest proportional-pressure curve |



Recommended and alternative pump settings according to system type.

| Pos. | System type | Pump setting | |
|------|--------------------|--|--|
| | | Recommended | Alternative |
| A | Underfloor heating | Lowest constant-pressure curve (CP1)* | Highest constant-pressure curve (CP2)* |
| B | Two-pipe systems | Highest proportional-pressure curve (PP2)* | Lowest proportional-pressure curve (PP1)* |
| C | One-pipe systems | Lowest proportional-pressure curve (PP1)* | Highest proportional-pressure curve (PP2)* |

Instructions for installation and use VX Solo II substations

Grundfos Pump ALPHA2

Substation start-up / pump

Do not start up the pump until the system has been filled with the flow media and vented. It is recommended to set the pump at highest speed of rotation before start-up. Then set the pump at lowest possible speed of rotation, in due consideration of the electricity consumption and the heating comfort.

Factory-setting of the pump is *AUTOADAPT*. *AUTOADAPT* is suitable for most systems. In this pump setting the pump performance will continuously be adjusted to the actual system requirements. For floor heating *AUTOADAPT* is recommended.

Pump settings:

Floor heating and two-pipe systems:

Choose *AUTOADAPT*-function (adjusts the pump performance to the actual system requirements).

One-pipe systems:

Setting of pump according to the enclosed instructions.

ALPHA2 GRUNDFOS INSTRUCTIONS

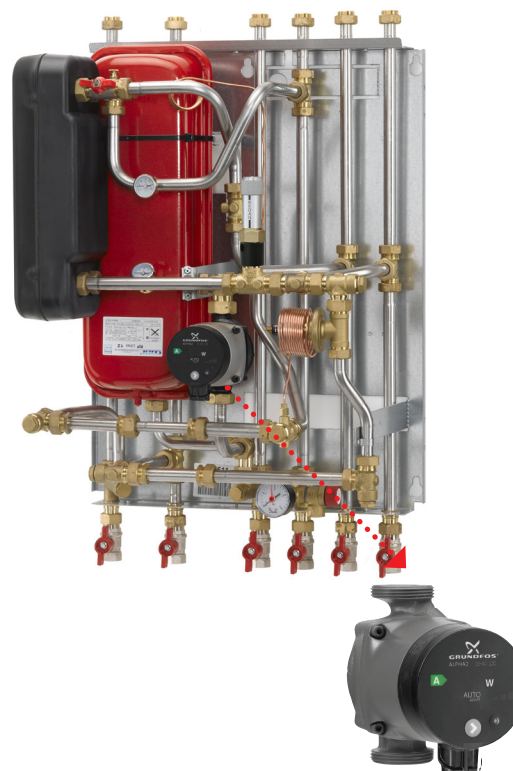

Summer operation

Substation with T°C thermostat:

In periods without heating demand the pump can be switched off on the switch and the shut-off valve/"summer valve" **S** in top of the station can be closed during this period. Switch on the pump (for a short period) at least once per month.

For start-up follow the above start-up instructions. It is recommended to vent the system after the summer period again.

Substation with Danfoss ECL:

The circulation pump for heating is automatically switched off in periods without heat demand. To prevent the pump from blocking in periods without heat demand, the controller automatically switches on the pump for some minutes every third day. In this period the circulation pump should be set at the highest speed of rotation.

If the heating requirement increases the pump setting can be changed by means of the selector switch.

For more information about venting of pumps ect. please refer to the enclosed Grundfos instructions.



Instructions for installation and use VX Solo II substations

13.0 Adjustment and commissioning, DHW Cylinder circuit

Domestic hot water

The VX Solo II substations types HWP and HWS are supplied with connection pipes for domestic hot water cylinder on the primary or secondary side.

The temperature in the DHW cylinder can be controlled by the Danfoss ECL controller in combination with an actuator + valve.

Danfoss ECL Comfort 210/310

The application Key contains information about application, language and factory settings, adapted to the type of system, for which it is ordered.

Note! Various applications can be loaded.

The controller is factory-set for local language and the running time for the actuator (DHW circuit) is preset for the actual application.

General controller settings such as "Time and Date" must be entered during commissioning of the controller. And also the desired DHW temperature must be set.

(Make sure that the immersion sensor is placed correctly before making adjustment of the temperature).

Please refer to the enclosed manufacturer instructions for the ECL 210/310 controller in order to **set the required domestic hot water temperature in the DHW cylinder circuit:**

ECL Application Key Box with ECL Comfort 210/310 user guide and mounting guide, for further information.

We recommend that your order commissioning of the controller with your local Danfoss Sales Company.

Below schedule states whether the VX Solo II is supplied with connection pipes for DHW cylinder on the primary side or the secondary side, and whether the DHW temperature in the cylinder is controlled by the electronic controller and also states the controller application and the actuator/valve combination.

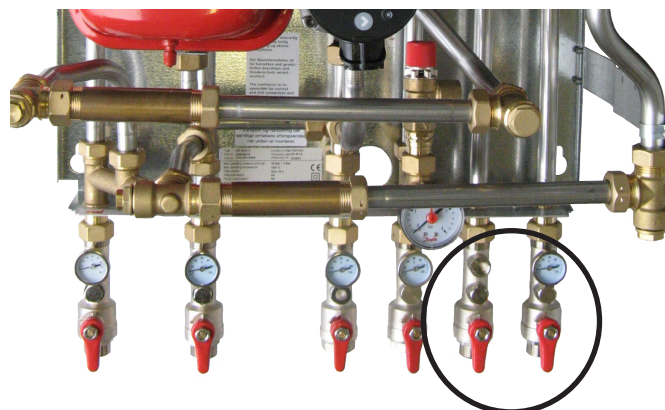

| Type | Primary Connection for Cylinder | Secondary Connection for Cylinder | Pump for Cylinder Circuit |
|---|--|--|---------------------------|
| VX Solo II HWP (ECL 210/A237), page 6 | Control not part of delivery | | |
| VX Solo II HWP (ECL 210/A247), page 7 | Danfoss ECL 210, Application A247 + AHQM / AMV 150 | | |
| VX Solo II H2WP (ECL 210/A260), page 8 | Control not part of delivery | | |
| VX Solo II H2WP (ECL 310/A377), page 9 | Danfoss ECL 310, Application A377 + AHQM / AMV 150 | | |
| VX Solo II HWS (ECL 210/A237), page 10 | | Danfoss ECL 210, Application A237 (AHQM / AMV 13) | Grundfos UPS 15-40 |
| VX Solo II HWS (ECL 210/A247), page 11 | | Danfoss ECL 210, Application A247 (AHQM / AMV 150) | Grundfos UPS 15-40 |
| VX Solo II H2WS (ECL 210/A267), page 12 | | Danfoss ECL 210, Application A267 (AHQM / AMV 13) | Grundfos UPS 15-40 |

Please note:

Circulation pump for the domestic hot water on the secondary side of the cylinder is not part of the delivery and must be mounted on site.

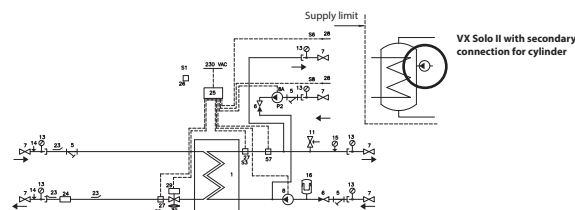
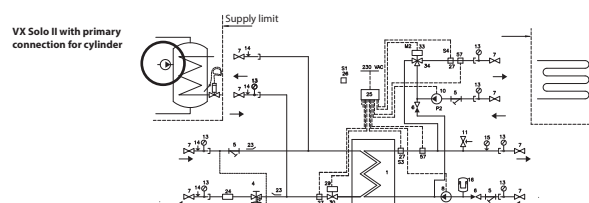

Instructions for installation and use VX Solo II substations

Actuator + valve, unit with electronic control of the heating and DHW cylinder circuits

For controlling the domestic hot water circuit the VX Solo II HWP (ELC 210/A247) and the VX Solo II H2WP (ECL 310/A377) are supplied with electrical actuator type Danfoss AMV 150 with Danfoss valve housing type AHQM placed on the primary return flow pipe. The AMV actuator is electrically wired to the controller from the plant.

The electrical actuator has undergone a functional test and is preset from factory.

In the event of operating disturbances the actuator can be shut off manually in accordance with enclosed instructions, by turning the manual override knob on top of the actuator clockwise.

**Please see enclosed instructions,
Electrical actuator AMV 13
Flow-controller with integrated control valve AHQM**

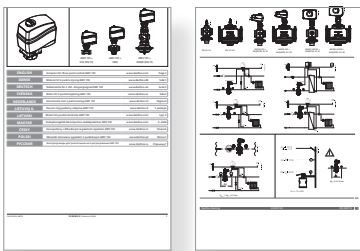

AHQM

Manual override (AMV 150)



Press and hold the button (on the bottom side of the actuator) during manual override.

14.0 Pump, DHW Cylinder circuit

Domestic hot water circulation pump

VX Solo II with connection pipes for domestic hot water cylinder on the secondary side (types HWS and H2WS) are fitted with a circulation pump from factory.

It is recommended to set the pump at highest speed of rotation (setting 3) before start-up. Then set the pump at lowest possible speed of rotation (setting 1), in due consideration of the electricity consumption and the heating comfort. Factory setting of the selector switch is centre position (default). Select setting 2 and 3 only if the pump setting does not meet actual system requirements.

**Please see enclosed instructions,
GRUNDFOS UPS**

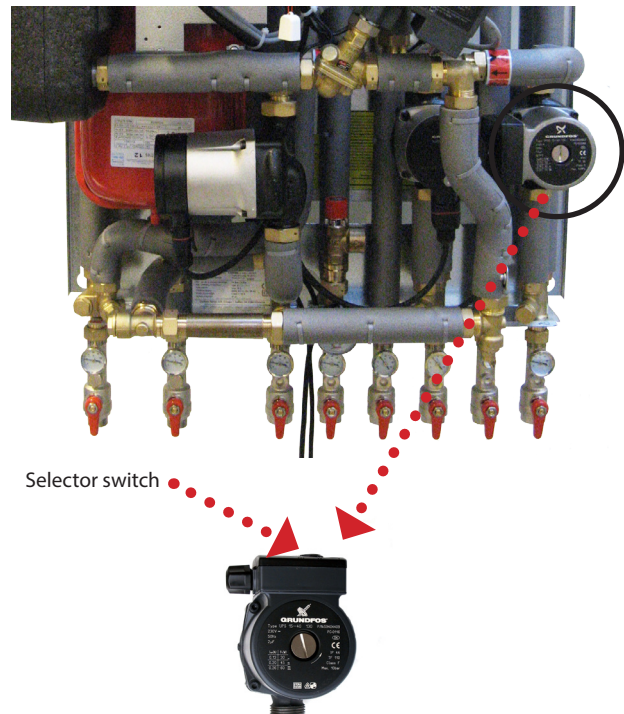
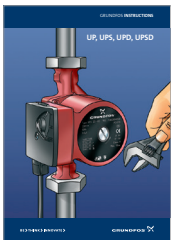

Selector switch

Instructions for installation and use VX Solo II substations

15.0 Maintenance

Maintenance work

Is only to be carried out by qualified and authorised personnel.

Inspection

The substation should be checked regularly by authorised personnel. Any necessary maintenance must be performed in accordance with the instructions in this manual and other sets of instructions.

During service the dirt strainers are to be cleaned – including the filter on the controller, all pipe connections must be tightened and the safety valve must be function tested by turning the lever.



Rinsing/cleaning of plate heat exchanger

To clean the plate heat exchanger, rinse it by running clean water through the exchanger at high speed and in the opposite direction to the normal flow. This will remove any dirt deposits that may have built up in the exchanger. If rinsing with clean water is not sufficient, the exchanger can also be cleaned by circulating a cleaning agent approved by Danfoss (e.g. Kaloxi or Radiner FI cleaning fluid) through the exchanger. Both these cleaning fluids are environmentally friendly and can be disposed off through the standard sewer system. After use of a cleaning fluid, the plate heat exchanger must be rinsed thoroughly with clean water.

Acid cleaning of plate heat exchanger

Deposits of limescale may build up in plate heat exchangers for domestic hot water on account of the large temperature fluctuations, and because aerated water is used on the secondary side. If it becomes necessary to clean the exchanger with acid, this can be done as shown on the drawing to the right. Brazen plate heat exchangers can withstand rinsing with a dilute acid solution - e.g. 5% formic, acetic or phosphoric acid).

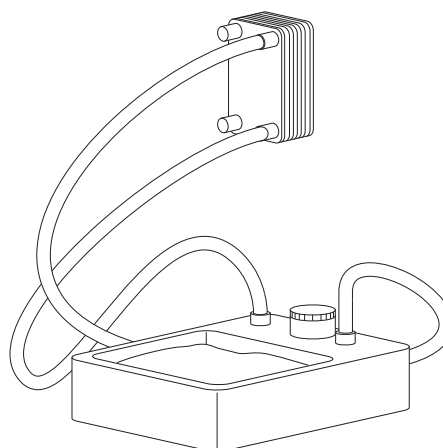

Measures after maintenance work

After maintenance work and before commissioning:

- Check that all screwed connections are tight.
- Check that all safety features, covers, that were removed, have been replaced properly.
- Clean the working area and remove any spilled materials.
- Clear all tools, materials and other equipment from the working area.
- Connect to energy supply and check for leaks.
- Vent the system.
- Carry out any necessary adjustment again.
- Make sure that all safety features on the device and the system work properly.

Meter reading

The caretaker/owner must perform visual checking and reading of the district heating meter at short, regular intervals. (The meter is not a part of the delivery from Danfoss).

Service procedures must only be performed by trained, authorised personnel.

NB! Excessive consumption for whatever reason is not covered by the Danfoss warranty.

Cooling / Return temperature reading

Cooling – i.e. the difference between the supply and return temperature of the district heating water – has a significant effect on overall energy economy. Therefore, it is important to focus on the supply and return temperature in the heating system. The difference should typically be 30–35°C. Please note that a low district heating return temperature is directly related to the return temperature from the heating circuit and the return temperature of the circulation water.

It is therefore important to focus on these return temperatures.

Instructions for installation and use VX Solo II substations

15.1 Maintenance schedule (recommendations)

| Interval | Maintenance work | Comments |
|----------------------|---|---|
| At least once a year | Check all connections for leaks | If you identify a leak, replace the gaskets and retighten the pipe connections |
| | Check that the safety valve on the cold water supply is functioning correctly. | Check the functionality by turning the lever on the safety valves |
| | Check that all components are intact and functioning as intended | In the event of irregularities, lack of functionality or visible faults and defects in a component, replace the component in question |
| | Clean all dirt filters/strainers in the substation | Replace any filters that are not intact |
| | Check that any electrical cables are in serviceable condition and that it is possible to disconnect the electrical power supply to the substation | Visual check. Check whether it is possible to disconnect the current to the substation. |
| | Check the pipes and exchanger for signs of corrosion | Visual check |
| | Check that the temperature regulators are set in accordance with the instructions in this manual | Follow the instructions in the present manual |
| | Check the functions of all shut-off valves | Check that the ball valves open and close as they should |

Service and maintenance procedures must only be performed by trained, authorised personnel.

Please note that after dismantling, the gaskets **MUST** be replaced. Once the system has been filled with water, retighten all the pipe connections once more before performing pressure test for leaks. After heating of the system, check all the connections and retighten if necessary.

Please note that the connections may feature EPDM gaskets! Therefore, it is important that you **DO NOT OVERTIGHTEN** the pipe connections. Over-tightening may result in leaks. Leaks caused by over-tightening or failure to retighten connections are not covered by the warranty.

Instructions for installation and use VX Solo II substations

16.0 Troubleshooting

If operating disturbances occur, the following basic features should be checked before carrying out actual troubleshooting:

- the substation is connected correctly,
- the district heating supply temperature is at the normal level (summer at least 60 °C, winter at least 70 °C),
- the differential pressure is higher than or equal to the normal (local) differential pressure in the district heating network. - If in doubt, ask the district heating plant,
- the substation is connected to electricity (pump and automatic components),
- the dirt strainer in the district heating supply pipe is clean,
- air pockets in the system.

16.1 Troubleshooting - Heating

| Problem | Possible cause | Solution |
|-----------------------------|---|---|
| No heat | Strainer clogged on DH og HE side (radiator circuit). | Clean strainer. |
| | Filter in district heating meter clogged. | Clean the filter (after consulting the district heating plant). |
| | Defective differential pressure controller. | Check the functions of the differential pressure controller - clean valve seat if required. |
| | Defective sensor | Replace sensor |
| | Defektive aktuator. | Check the functioning of the actuator. |
| | Defective motor valve - or possibly dirt in the valve housing. | Check the functions of the motor valve - clean valve housing if required. |
| | Automatic controls wrongly set or defective - possibly power failure. | Check if the setting of the controller is correct - see separate instructions. Check the power supply. Temporary setting of actuator to "manual" control - see instruction on heating circuit, manual control. |
| | Pump out of operation. | Check that the pump is receiving power and that it runs. Control that there is no air in the pump housing - see pump manual. |
| Uneven heat distribution | The pump is set at too low speed of rotation. | Set the pump at higher speed of rotation - see instructions on heating circuit. |
| | Air pockets in the system. | Vent the installation thoroughly. |
| Supply temperature too high | Air pockets in the system. | Vent the installation thoroughly. |
| | Wrong setting of automatic controls. | Adjust automatic controls, see instructions for automatic controls. |
| | Defective sensor. | Replace sensor. |
| | Defective controller. The controller does not react as it should in accordance with the instructions. | Call in automatic controls manufacturer or replace controller. |

Instructions for installation and use **VX Solo II substations**

| Problem | Possible cause | Solution |
|----------------------------|---|---|
| Supply temperature too low | Wrong setting of automatic controls. | Adjust automatic controls, see instructions for automatic controls. |
| | Defective controller. The controller does not react as it should in accordance with the instructions. | Call in automatic controls manufacturer or replace controller. |
| Poor cooling | Outdoor sensor mounted or placed incorrectly. | Mount/place outdoor sensor correctly. |
| | Strainer clogged. | Clean strainer. |
| | Too small heating surface/ too small radiators compared to the total heating requirement of the building. | Increase total heating surface. |
| | Poor utilization of existing heating surface. | Make sure that the heat is distributed evenly across the full heating surface - open all radiators and keep the radiator in the system from heating up at the bottom. Higher temperature at the top and lower temperature at the bottom part of the radiators means that the system operation is correct. |
| | The system is single-pipe. | It is extremely important to keep the supply temperature to the radiators as low as ever possible, while maintaining a reasonable level of comfort. |

Instructions for installation and use **VX Solo II substations**

16.2 Troubleshooting - Domestic hot water

| Problem | Possible cause | Solution |
|---------------------------|--|--|
| No domestic hot water | Defective or wrongly set differential pressure controller. | Check the functions of the differential pressure controller - clean valve seat and capillary tubes if required, - air and rinse capillary tubes. |
| | Strainer on DH supply clogged. | Clean strainer. |
| | Defective actuator - or possibly dirt in the valve housing. | Check the functions of the actuator - clean valve seat if required. |
| | Automatic controls wrongly set or defective - possibly power failure. | Check if the setting of the controller is correct, - see separate instructions. Check the power supply; Temporary setting of actuator to "manual" control - see instructions on heating circuit, manual control. |
| | Calified heating element. | Clean DHW cylinder with acid solution or replace heating element. |
| Long waiting time | Inadequate cylinder capacity. | Wait for heating / loading of the cylinder. You may check the specifications of the manufacturer conc. cylinder capacity. |
| | Circulation pump out of operation. | Check whether the pump is running - whether the pump is receiving power. control that there is no air in the pump housing - see pump manual. |
| Temperature too low | See "No domestic hot water". | See "No domestic hot water". |
| | Non-return valve on the circulation line defective (leads to mixing - and the circulation water pipes become cold during tapping). | Replace non-return valve. |
| Temperature too high | Defective actuator - possibly dirt in the valve housing. | Check the functions of the actuator - clean valve seat if required. |
| | Automatic controls wrongly set or defective. | Check if the setting of the controller is correct, - see separate instructions. |
| | Defective immersion sensor. | Replace immersion sensor. |
| Variations in temperature | Non-return valve on the circulation line defective (leads to mixing - and the circulation water pipes become cold during tapping). | Replace non-return valve. |

Instructions for installation and use VX Solo II substations

| Problem | Possible cause | Solution |
|--------------------------------------|--|--|
| Declining temperature during tapping | Defective or wrongly set differential pressure controller (set too low). | Check the functions of the differential pressure controller - clean valve seat and capillary tubes if required, - air and rinse capillary tubes. |
| | Automatic controls wrongly set. | Check that the controller has been correctly set - see separate instructions. |
| | Immersion sensor placed incorrectly. | Place immersion sensor correctly in accordance with the manufacturer instructions for the cylinder. You may contact Danfoss Redan A/S for further information. |
| | Calified heating element. | Clean DHW cylinder with acid solution or replace heating element. |
| Poor cooling | Calified heating element. | Clean DHW cylinder with acid solution or replace heating element. You may check the specifications of the manufacturer conc. cylinder capacity. |

17.0 EU Declaration of Conformity

Danfoss Redan A/S
District Energy
Omega 7, Søften
DK-8382 Hinnerup
Telephone +45 87 43 89 43

EC-DECLARATION OF CONFORMITY

For CE marking in EU (European Union)

Danfoss Redan A/S District Energy

DK-8382 Hinnerup

Declares under our sole responsibility that below products including all available power and control options:

VX Solo II

Main components: See instruction manual.

Covered by this declaration is in conformity with the following directive(s), standard(s) or other normative document(s), provided that the products are used in accordance with our instructions.

EU Directives:

EMC Directive 2004/108/EEC

EN 61000-6-1 2007 Electromagnetic compatibility- Generic standard: Immunity for residential, commercial and light industry.

EN 61000-6-2 2007 Electromagnetic compatibility- Generic standard: Immunity industry.

EN 61000-6-3 2007 Electromagnetic compatibility- Generic standard: Emission for residential, commercial and light industry.

EN 61000-6-4 2007 Electromagnetic compatibility- Generic standard: Emission industry.

Machinery Directive 2006/42/EEC

EN ISO 14121-1 Safety of machinery -- Risk assessment

EN 60204-1-Safety of machinery - Electrical equipment of machines — Part 1: General requirements

PED Directive 97/23/EEC

Conformity assessment procedure followed: Module A - Internal control of production

All substations that falls under Article 3 §3 and category 1 shall not be CE-marked according to this directive

CE marked affixed year 2010

Approved by:



Place and date of issue: Hinnerup, Aug. 22nd, 2013

Name: Katja Brødegaard

Title: Quality & HSE Manager

Instructions for installation and use VX Solo II substations

18.0 Commissioning Certificate

Commissioning certificate

The substation is the direct link between the district heating supply network and the household piping system. All supply pipes and the pipes in the household piping system must be checked and rinsed before commissioning. Once the system has been filled with water, all pipe connections must be retightened before performing pressure test for leaks. The dirt strainers must be cleaned and the substation must be adjusted in accordance with the instructions in this manual.

It is important to comply with all technical regulations and the applicable legislation in every respect.

Installation and commissioning must only be performed by trained, authorised personnel.

The substation is checked in the factory for leaks before delivery. Leaks are however possible due to vibrations caused by transport, handling and heating of the system and therefore it is important to check all connections and to retighten if necessary before commissioning. Please note that the connections may feature EPDM gaskets! **Therefore it is important that you DO NOT OVER-TIGHTEN the connections.** Over-tightening may result in leaks. Leaks caused by over-tightening or failure to retighten connections are not covered by the warranty.

To be filled-out by the installer.

This substation has been retightened, adjusted and commissioned

on the:

Date/Year

by installer:

Company name (stamp)

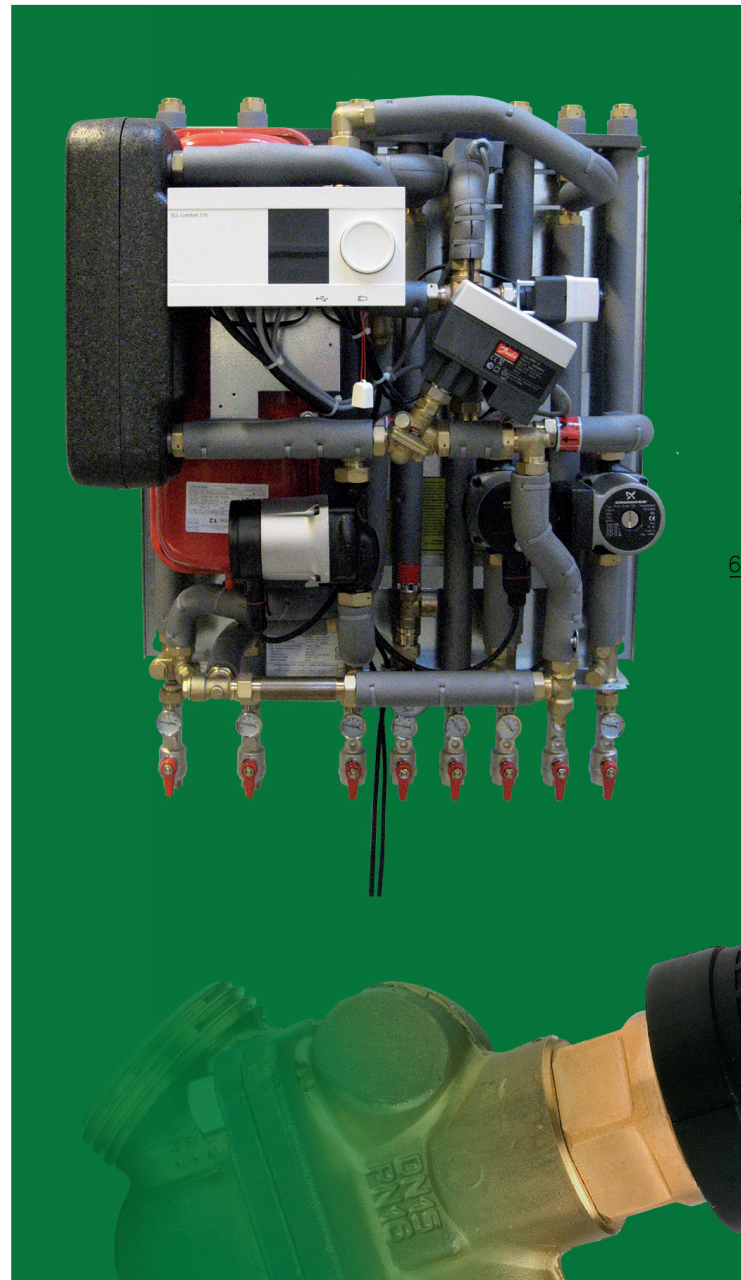

Danfoss Redan A/S · District Energy · Omega 7, Søften · DK-8382 Hinnerup
Tel. +45 87 43 89 43 · Fax: +45 87 43 89 44 · redan@danfoss.com · www.redan.danfoss.dk

Danfoss can accept no responsibility for possible errors in catalogues, brochures and other printed material. Danfoss reserves the right to alter its products without notice. This also applies to products already on order provided that such alterations can be made without subsequential changes being necessary in specifications already agreed. All trademarks in this material are property of the respective companies. Danfoss and the Danfoss logotype are trademarks of Danfoss A/S. All rights reserved.