

MCON

MCON-C/CG Controller

Instruction Manual Second Edition



IAI America, Inc.

Please Read Before Use

Thank you for purchasing our product.

This Instruction Manual describes all necessary information items to operate this product safely such as the operation procedure, structure and maintenance procedure.

To ensure the safe operation of this product, please read and fully understand this manual. The enclosed DVD in this product package includes the Instruction Manual for this product. For the operation of this product, print out the necessary sections in the Instruction Manual or display them using the personal computer.

After reading through this manual, keep this Instruction Manual at hand so that the operator of this product can read it whenever necessary.

[Important]

- This Instruction Manual is original.
- The product cannot be operated in any way unless expressly specified in this Instruction Manual. IAI shall assume no responsibility for the outcome of any operation not specified herein.
- Information contained in this Instruction Manual is subject to change without notice for the purpose of product improvement.
- If you have any question or comment regarding the content of this manual, please contact the IAI sales office near you.
- Using or copying all or part of this Instruction Manual without permission is prohibited.
- The company names, names of products and trademarks of each company shown in the sentences are registered trademarks.
- DeviceNet is a registered mark of ODVA.
- CC-Link and SSCNET is a registered mark of Mitsubishi Electric Corporation.
- PROFIBUS is a registered mark of Siemens.
- CompoNet is the registered trademark of OMRON Corporation.
- EtherCAT® is a registered mark of Beckhoff Automation GmbH.
- EtherNet/IP is a trademark used under the license of ODVA.
- PROFINET is a trademark used under the license of PROFIBUS Association.
- MECHATROLINK is a registered mark of MECHATROLINK Association.

Construction of Instruction Manual for Each Controller Model and This Manual

MCON-C/CG

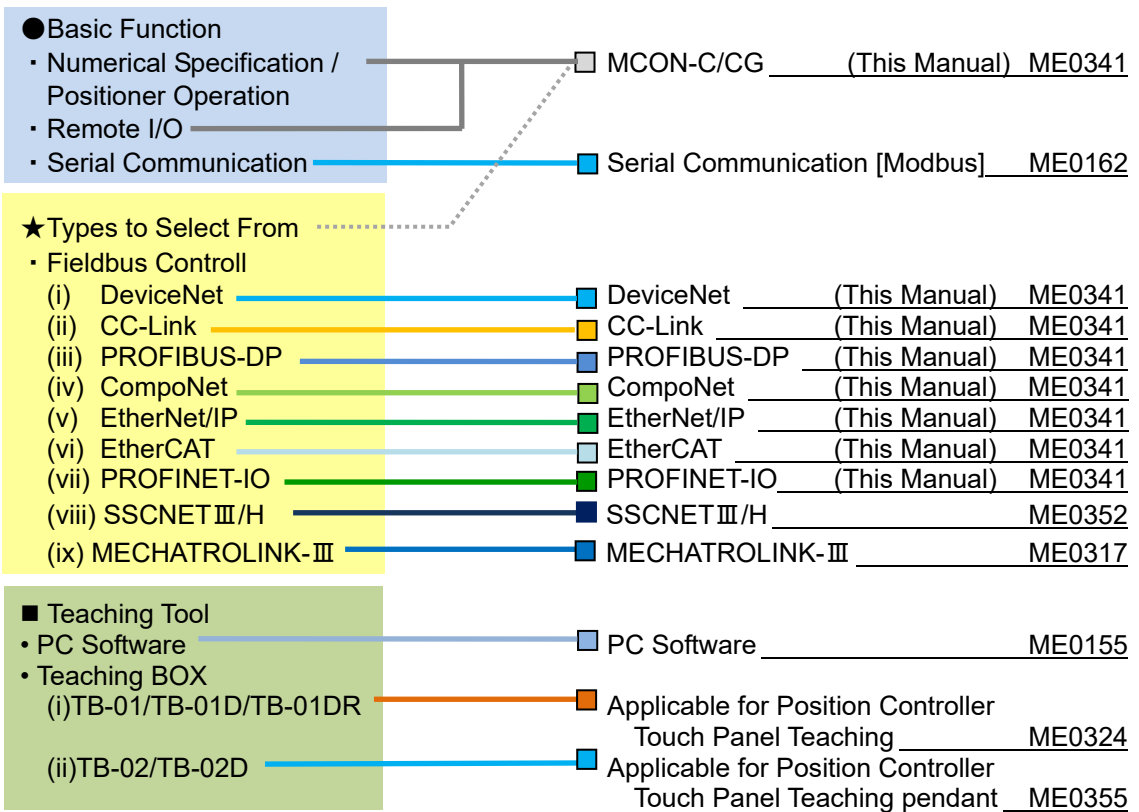
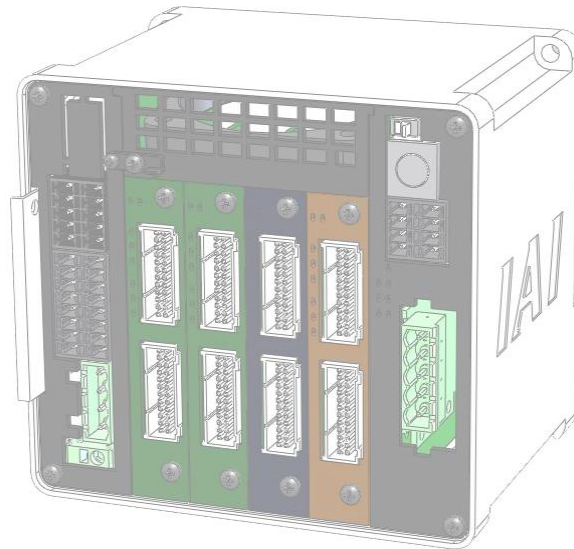

Table of Overall Contents

Name for Each Parts and Their Functions	In this section, explains the functions and conditions of the connectors and LED lamps located on the front of the controller.	13
Chapter 1 Specifications Check	In this chapter, explains about the specifications, current amperage, model codes and so on for the products.	19
Chapter 2 Wiring	In this chapter, explains about the connections to actuators and external devices.	37
Chapter 3 Operation	In this chapter, explains the details of each operation such as the initial settings, how to set up in the position data or parameter data, control signals in each mode and how to make operation.	61
Chapter 4 Vibration Suppress Control Function	In this chapter, explains about the vibration suppress control function to reduce vibration caused by the actuator.	255
Chapter 5 Collision Detection Feature	In this chapter, explains the setup and tuning for collision detection feature.	261
Chapter 6 Power-Saving Function (Automatic Servo-off and Full Servo Function)	In this chapter, explains the feature to reduce the power consumption while the actuator is stopped.	265
Chapter 7 Absolute Reset and Absolute Battery	In this chapter, explains the procedures for absolute reset and replacement of battery.	269
Chapter 8 Parameter	In this chapter, explains how to set up or fine-tune the controller settings.	275
Chapter 9 Troubleshooting	In this chapter, explains how to act in errors and contents of them.	317
Chapter 10 Appendix	In this chapter, explains compliance with safety categories, model codes of connectable actuators, etc.	341
Chapter 11 Warranty	In this chapter, explains about the Warranty.	425

Table of Contents

Starting Procedures	
Safety Guide	1
Precautions in Operation	8
International Standards Compliances	12
CE Marking	12
UL	12
Name for Each Parts and Their Functions	13
Actuator Axes	17
Chapter 1 Specifications Check	19
1.1 Product Check	19
1.1.1 Parts	19
1.1.2 Teaching Tool	21
1.1.3 Instruction manuals related to this product, which are contained in the instruction manual (DVD)	21
1.1.4 How to Read the Model Nameplate	22
1.1.5 How to read the model	23
1.2 List of Basic Specifications	24
1.3 Calculation for Power Capacity	26
1.4 Specifications for each Fieldbus	27
1.4.1 Specifications of DeviceNet Interface	27
1.4.2 Specifications of CC-Link Interface	27
1.4.3 Specifications of PROFIBUS-DP Interface	28
1.4.4 Specifications of CompoNet Interface	28
1.4.5 Specifications of EtherNet/IP Interface	28
1.4.6 Specifications of EtherCAT Interface	29
1.4.7 Specifications of PROFINET-IO Interface	29
1.4.8 Specifications of SSCNET III/H Interface	29
1.4.9 Specifications of MECHATROLINK-III Interface	29
1.5 External Dimensions	30
1.5.1 Controller Main Unit	30
1.5.2 Absolute Battery Box	31
1.6 Option	32
1.6.1 Absolute Battery Box	32
1.6.2 Regenerative Resistor Unit (RER-1)	33
1.7 Installation and Storage Environment	34
1.8 Noise Elimination and Mounting Method	35
Chapter 2 Wiring	37
2.1 Wiring Diagram (Connection of construction devices)	37
2.2 Circuit Diagram	38
2.3 Wiring Method	46
2.3.1 Connection to Power Input Connector	46
2.3.2 Wiring Layout of System I/O Connector	47
2.3.3 Connection of Drive Cutoff/Emergency Stop Input Connector	48
2.3.4 Connecting with Actuator	49
2.3.5 Connection of Absolute Battery Connector	52
2.3.6 Connection of External Brake Connector	53
2.3.7 Connection of SIO Connector	54
2.3.8 Wiring Layout of Fieldbus Connector	55
Chapter 3 Operation	61
3.1 Basic Operation	61
3.1.1 Basic Operation Methods	61
3.1.2 Parameter Settings	65

3.2	Initial Setting	66
3.2.1	Operation Mode Setting (Setting in gateway parameter setting tool).....	66
3.2.2	Parameter Settings (Setting on RC PC Software).....	72
3.3	Setting of Position Data	74
3.4	Fieldbus Type Address Map	82
3.4.1	PLC Address Construction by each Operation Mode	82
3.4.2	Example for each Fieldbus Address Map	85
3.4.3	Gateway Control Signals (Common for all operation modes)	102
3.4.4	Control Signals for Simple Direct Mode.....	105
3.4.5	Control Signals for Positioner 1 Mode	110
3.4.6	Control Signals for Direct Indication Mode	115
3.4.7	Control Signals for Positioner 2 Mode	122
3.4.8	Control Signals for Positioner 3 Mode	126
3.4.9	Control Signals for Positioner 5 Mode	129
3.4.10	Control Signals for Remote I/O Mode.....	133
3.4.11	About Commands (Position Data Read/Write and Alarm Axis Read).....	137
3.5	Input and Output Signal Process for Fieldbus.....	156
3.6	Power Supply	158
3.7	Control and Functions of Input and Output Signals of Modes Other than Remote I/O Mode	160
3.7.1	Input and Output Signal Functions	160
3.7.2	Operation for Positioner 1/Simple Direct Modes	177
3.7.3	Operation for Direct Indication Mode	179
3.7.4	Operation for Positioner 2, Positioner 3 and Positioner 5 Modes.....	181
3.8	Control and functions of Input and output signals of Remote I/O Mode	183
3.8.1	Operation Supportive Signal = Patterns 0 to 2, 4 and 5 in common	183
3.8.2	Operation with the Position No. Input = Operations of PIO Patterns 0 to 2	192
3.8.3	Direct Position Specification (Solenoid Valve Mode 1) = Operation of PIO Pattern 4	212
3.8.4	Direct Position Specification (Solenoid Valve Mode 2) = Operation of IO Pattern 5.....	224
3.9	About Gateway Parameter Setting Tool	234
3.9.1	Startup of Tool.....	234
3.9.2	Explanation of each Menu	235
3.9.3	Description of Functions	237
3.9.4	Operation Mode Setting.....	244
3.10	Fieldbus Status LEDs	245
3.10.1	DeviceNet	245
3.10.2	CC-Link	246
3.10.3	PROFIBUS-DP	247
3.10.4	CompoNet.....	248
3.10.5	EtherNet/IP	249
3.10.6	EtherCAT	250
3.10.7	PROFINET-IO	252
3.10.8	SSCENTⅢ/H Interface	253
3.10.9	MECHATROLINK-Ⅲ Interface.....	253
Chapter 4	Vibration Suppress Control Function	255
4.1	Setting Procedure.....	257
4.2	Settings of Parameters for Vibration Suppress Control	258
4.3	Setting of Position Data	259
Chapter 5	Collision Detection Feature	261
5.1	Collision Detection Judgement.....	261
5.2	Settings.....	262
5.3	Adjustment.....	263

Chapter 6	Power-saving Function (Automatic Servo-off and Full Servo Functions).....	265
Chapter 7	Absolute Reset and Absolute Battery	269
7.1	Absolute Reset	269
7.2	Absolute Battery (for Simple Absolute Type).....	272
7.2.1	Absolute encoder backup specifications	273
7.2.2	Absolute Battery Charge.....	273
7.2.3	Absolute Battery Voltage Drop Detection	274
Chapter 8	Parameter	275
8.1	Parameter List	276
8.2	Detail Explanation of Parameters	281
8.3	Servo Adjustment	313
8.3.1	Adjustment of Pulse Motor and Servo Motor	313
8.3.2	Adjustment of Brushless DC Electric Motor.....	315
Chapter 9	Troubleshooting	317
9.1	Action to Be Taken upon Occurrence of Problem	317
9.2	Fault Diagnosis.....	319
9.2.1	Impossible operation of controller.....	319
9.2.2	Positioning and speed of poor precision (incorrect operation)	320
9.2.3	Generation of noise and/or vibration.....	321
9.2.4	Impossible Communication.....	321
9.3	Gateway Alarm	322
9.3.1	Gateway Alarm Codes	322
9.4	Driver Alarm.....	325
9.4.1	Alarm Level	325
9.4.2	Simple Alarm Code	325
9.4.3	Alarm Codes for Driver Board (Each Axis)	327
Chapter 10	Appendix	341
10.1	Conformity to Safety Category	341
10.2	When Connecting Power Supply with + Grounding	352
10.3	Maintenance	353
10.3.1	Consumed Parts	353
10.3.2	Maintenance Information	353
10.3.3	Replacement of Fan	354
10.4	List of Specifications of Connectable Actuators	355
10.4.1	Specifications for Servo Motor Type Actuator	355
10.4.2	Specifications for Brushless DC Electric Motor Actuator	369
10.4.3	Specifications for Pulse Motor Type Actuator	370
Chapter 11	Warranty.....	425
11.1	Warranty Period.....	425
11.2	Scope of the Warranty.....	425
11.3	Honoring the Warranty	425
11.4	Limited Liability	425
11.5	Conditions of Conformance with Applicable Standards/Regulations, Etc., and Applications	426
11.6	Other Items Excluded from Warranty	426
Change History	427

Starting Procedures (‘PC’ stated in this section means ‘RC PC software’.)

When using this product for the first time, make sure to avoid mistakes and incorrect wiring by referring to the procedure below.

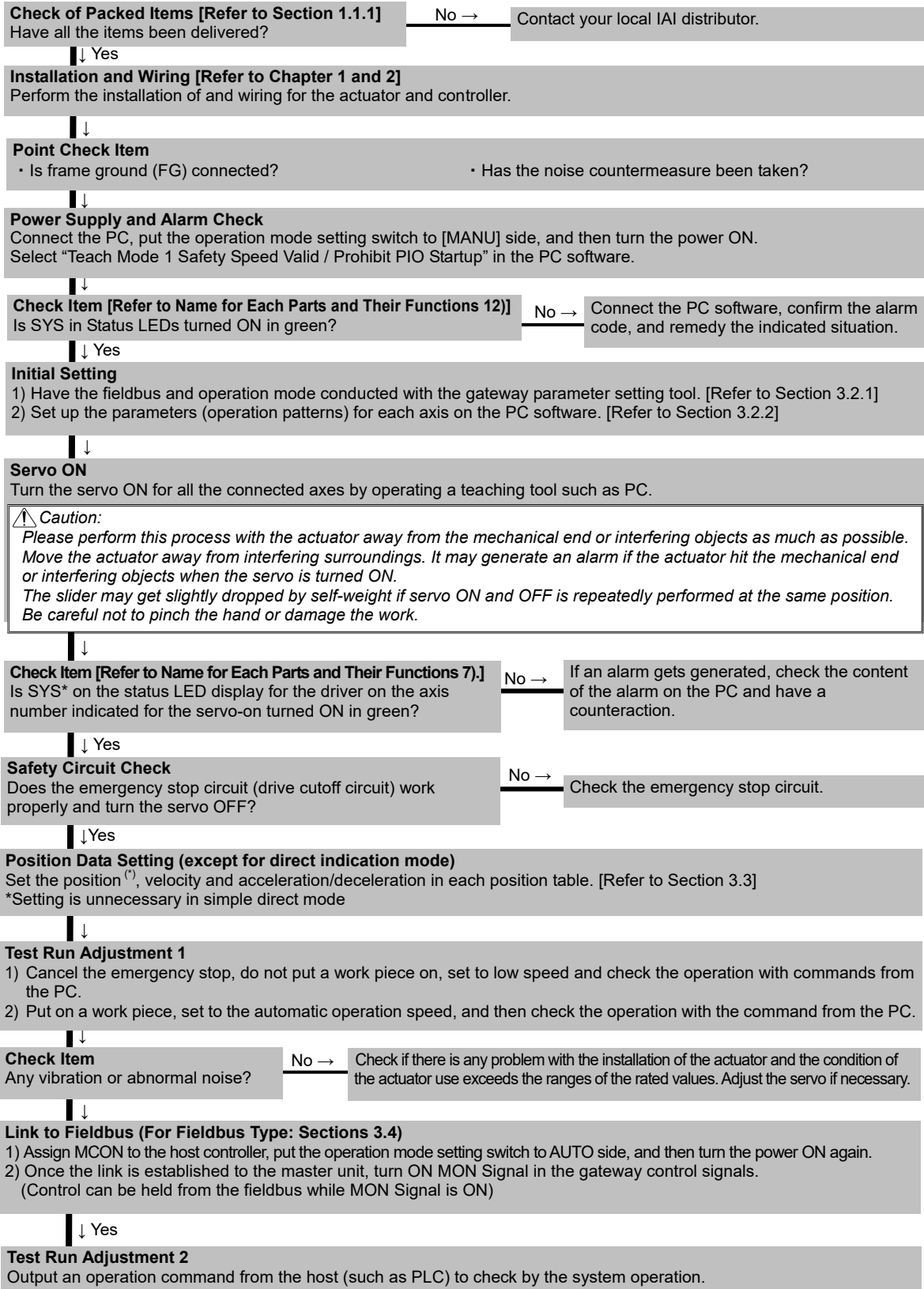

MCON

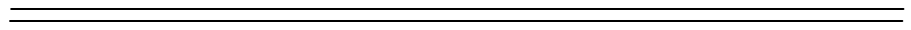

Safety Guide

“Safety Guide” has been written to use the machine safely and so prevent personal injury or property damage beforehand. Make sure to read it before the operation of this product.

Safety Precautions for Our Products

The common safety precautions for the use of any of our robots in each operation.

No.	Operation Description	Description
1	Model Selection	<ul style="list-style-type: none"> ● This product has not been planned and designed for the application where high level of safety is required, so the guarantee of the protection of human life is impossible. Accordingly, do not use it in any of the following applications. <ol style="list-style-type: none"> 1) Medical equipment used to maintain, control or otherwise affect human life or physical health. 2) Mechanisms and machinery designed for the purpose of moving or transporting people (For vehicle, railway facility or air navigation facility) 3) Important safety parts of machinery (Safety device, etc.) ● Do not use the product outside the specifications. Failure to do so may considerably shorten the life of the product. ● Do not use it in any of the following environments. <ol style="list-style-type: none"> 1) Location where there is any inflammable gas, inflammable object or explosive 2) Place with potential exposure to radiation 3) Location with the ambient temperature or relative humidity exceeding the specification range 4) Location where radiant heat is added from direct sunlight or other large heat source 5) Location where condensation occurs due to abrupt temperature changes 6) Location where there is any corrosive gas (sulfuric acid or hydrochloric acid) 7) Location exposed to significant amount of dust, salt or iron powder 8) Location subject to direct vibration or impact ● For an actuator used in vertical orientation, select a model which is equipped with a brake. If selecting a model with no brake, the moving part may drop when the power is turned OFF and may cause an accident such as an injury or damage on the work piece.

No.	Operation Description	Description
2	Transportation	<ul style="list-style-type: none"> ● When carrying a heavy object, do the work with two or more persons or utilize equipment such as crane. ● When the work is carried out with 2 or more persons, make it clear who is to be the leader and who to be the follower(s) and communicate well with each other to ensure the safety of the workers. ● When in transportation, consider well about the positions to hold, weight and weight balance and pay special attention to the carried object so it would not get hit or dropped. ● Transport it using an appropriate transportation measure. The actuators available for transportation with a crane have eyebolts attached or there are tapped holes to attach bolts. Follow the instructions in the instruction manual for each model. ● Do not step or sit on the package. ● Do not put any heavy thing that can deform the package, on it. ● When using a crane capable of 1t or more of weight, have an operator who has qualifications for crane operation and sling work. ● When using a crane or equivalent equipments, make sure not to hang a load that weighs more than the equipment's capability limit. ● Use a hook that is suitable for the load. Consider the safety factor of the hook in such factors as shear strength. ● Do not get on the load that is hung on a crane. ● Do not leave a load hung up with a crane. ● Do not stand under the load that is hung up with a crane.
3	Storage and Preservation	<ul style="list-style-type: none"> ● The storage and preservation environment conforms to the installation environment. However, especially give consideration to the prevention of condensation. ● Store the products with a consideration not to fall them over or drop due to an act of God such as earthquake.
4	Installation and Start	<p>(1) Installation of Robot Main Body and Controller, etc.</p> <ul style="list-style-type: none"> ● Make sure to securely hold and fix the product (including the work part). A fall, drop or abnormal motion of the product may cause a damage or injury. Also, be equipped for a fall-over or drop due to an act of God such as earthquake. ● Do not get on or put anything on the product. Failure to do so may cause an accidental fall, injury or damage to the product due to a drop of anything, malfunction of the product, performance degradation, or shortening of its life. ● When using the product in any of the places specified below, provide a sufficient shield. <ol style="list-style-type: none"> 1) Location where electric noise is generated 2) Location where high electrical or magnetic field is present 3) Location with the mains or power lines passing nearby 4) Location where the product may come in contact with water, oil or chemical droplets

No.	Operation Description	Description
4	Installation and Start	<p>(2) Cable Wiring</p> <ul style="list-style-type: none"> ● Use our company's genuine cables for connecting between the actuator and controller, and for the teaching tool. ● Do not scratch on the cable. Do not bend it forcibly. Do not pull it. Do not coil it around. Do not insert it. Do not put any heavy thing on it. Failure to do so may cause a fire, electric shock or malfunction due to leakage or continuity error. ● Perform the wiring for the product, after turning OFF the power to the unit, so that there is no wiring error. ● When the direct current power (+24V) is connected, take the great care of the directions of positive and negative poles. If the connection direction is not correct, it might cause a fire, product breakdown or malfunction. ● Connect the cable connector securely so that there is no disconnection or looseness. Failure to do so may cause a fire, electric shock or malfunction of the product. ● Never cut and/or reconnect the cables supplied with the product for the purpose of extending or shortening the cable length. Failure to do so may cause the product to malfunction or cause fire. <p>(3) Grounding</p> <ul style="list-style-type: none"> ● The grounding operation should be performed to prevent an electric shock or electrostatic charge, enhance the noise-resistance ability and control the unnecessary electromagnetic radiation. ● For the ground terminal on the AC power cable of the controller and the grounding plate in the control panel, make sure to use a twisted pair cable with wire thickness 0.5mm² (AWG20 or equivalent) or more for grounding work. For security grounding, it is necessary to select an appropriate wire thickness suitable for the load. Perform wiring that satisfies the specifications (electrical equipment technical standards). ● Perform Class D Grounding (former Class 3 Grounding with ground resistance 100Ω or below).





No.	Operation Description	Description
4	Installation and Start	<p>(4) Safety Measures</p> <ul style="list-style-type: none"> ● When the work is carried out with 2 or more persons, make it clear who is to be the leader and who to be the follower(s) and communicate well with each other to ensure the safety of the workers. ● When the product is under operation or in the ready mode, take the safety measures (such as the installation of safety and protection fence) so that nobody can enter the area within the robot's movable range. When the robot under operation is touched, it may result in death or serious injury. ● Make sure to install the emergency stop circuit so that the unit can be stopped immediately in an emergency during the unit operation. ● Take the safety measure not to start up the unit only with the power turning ON. Failure to do so may start up the machine suddenly and cause an injury or damage to the product. ● Take the safety measure not to start up the machine only with the emergency stop cancellation or recovery after the power failure. Failure to do so may result in an electric shock or injury due to unexpected power input. ● When the installation or adjustment operation is to be performed, give clear warnings such as "Under Operation; Do not turn ON the power!" etc. Sudden power input may cause an electric shock or injury. ● Take the measure so that the work part is not dropped in power failure or emergency stop. ● Wear protection gloves, goggle or safety shoes, as necessary, to secure safety. ● Do not insert a finger or object in the openings in the product. Failure to do so may cause an injury, electric shock, damage to the product or fire. ● When releasing the brake on a vertically oriented actuator, exercise precaution not to pinch your hand or damage the work parts with the actuator dropped by gravity.
5	Teaching	<ul style="list-style-type: none"> ● When the work is carried out with 2 or more persons, make it clear who is to be the leader and who to be the follower(s) and communicate well with each other to ensure the safety of the workers. ● Perform the teaching operation from outside the safety protection fence, if possible. In the case that the operation is to be performed unavoidably inside the safety protection fence, prepare the "Stipulations for the Operation" and make sure that all the workers acknowledge and understand them well. ● When the operation is to be performed inside the safety protection fence, the worker should have an emergency stop switch at hand with him so that the unit can be stopped any time in an emergency. ● When the operation is to be performed inside the safety protection fence, in addition to the workers, arrange a watchman so that the machine can be stopped any time in an emergency. Also, keep watch on the operation so that any third person can not operate the switches carelessly. ● Place a sign "Under Operation" at the position easy to see. ● When releasing the brake on a vertically oriented actuator, exercise precaution not to pinch your hand or damage the work parts with the actuator dropped by gravity. <p>* Safety protection Fence : In the case that there is no safety protection fence, the movable range should be indicated.</p>

No.	Operation Description	Description
6	Trial Operation	<ul style="list-style-type: none">• When the work is carried out with 2 or more persons, make it clear who is to be the leader and who to be the follower(s) and communicate well with each other to ensure the safety of the workers.• After the teaching or programming operation, perform the check operation one step by one step and then shift to the automatic operation.• When the check operation is to be performed inside the safety protection fence, perform the check operation using the previously specified work procedure like the teaching operation.• Make sure to perform the programmed operation check at the safety speed. Failure to do so may result in an accident due to unexpected motion caused by a program error, etc.• Do not touch the terminal block or any of the various setting switches in the power ON mode. Failure to do so may result in an electric shock or malfunction.
7	Automatic Operation	<ul style="list-style-type: none">• Check before starting the automatic operation or rebooting after operation stop that there is nobody in the safety protection fence.• Before starting automatic operation, make sure that all peripheral equipment is in an automatic-operation-ready state and there is no alarm indication.• Make sure to operate automatic operation start from outside of the safety protection fence.• In the case that there is any abnormal heating, smoke, offensive smell, or abnormal noise in the product, immediately stop the machine and turn OFF the power switch. Failure to do so may result in a fire or damage to the product.• When a power failure occurs, turn OFF the power switch. Failure to do so may cause an injury or damage to the product, due to a sudden motion of the product in the recovery operation from the power failure.

No.	Operation Description	Description
8	Maintenance and Inspection	<ul style="list-style-type: none"> ● When the work is carried out with 2 or more persons, make it clear who is to be the leader and who to be the follower(s) and communicate well with each other to ensure the safety of the workers. ● Perform the work out of the safety protection fence, if possible. In the case that the operation is to be performed unavoidably inside the safety protection fence, prepare the “Stipulations for the Operation” and make sure that all the workers acknowledge and understand them well. ● When the work is to be performed inside the safety protection fence, basically turn OFF the power switch. ● When the operation is to be performed inside the safety protection fence, the worker should have an emergency stop switch at hand with him so that the unit can be stopped any time in an emergency. ● When the operation is to be performed inside the safety protection fence, in addition to the workers, arrange a watchman so that the machine can be stopped any time in an emergency. Also, keep watch on the operation so that any third person can not operate the switches carelessly. ● Place a sign “Under Operation” at the position easy to see. ● For the grease for the guide or ball screw, use appropriate grease according to the Instruction Manual for each model. ● Do not perform the dielectric strength test. Failure to do so may result in a damage to the product. ● When releasing the brake on a vertically oriented actuator, exercise precaution not to pinch your hand or damage the work parts with the actuator dropped by gravity. ● The slider or rod may get misaligned OFF the stop position if the servo is turned OFF. Be careful not to get injured or damaged due to an unnecessary operation. ● Pay attention not to lose the cover or untightened screws, and make sure to put the product back to the original condition after maintenance and inspection works. Use in incomplete condition may cause damage to the product or an injury. <p>* Safety protection Fence : In the case that there is no safety protection fence, the movable range should be indicated.</p>
9	Modification and Dismantle	<ul style="list-style-type: none"> ● Do not modify, disassemble, assemble or use of maintenance parts not specified based at your own discretion.
10	Disposal	<ul style="list-style-type: none"> ● When the product becomes no longer usable or necessary, dispose of it properly as an industrial waste. ● When removing the actuator for disposal, pay attention to drop of components when detaching screws. ● Do not put the product in a fire when disposing of it. The product may burst or generate toxic gases.
11	Other	<ul style="list-style-type: none"> ● Do not come close to the product or the harnesses if you are a person who requires a support of medical devices such as a pacemaker. Doing so may affect the performance of your medical device. ● See Overseas Specifications Compliance Manual to check whether complies if necessary. ● For the handling of actuators and controllers, follow the dedicated instruction manual of each unit to ensure the safety.

Alert Indication

The safety precautions are divided into “*Danger*”, “*Warning*”, “*Caution*” and “*Notice*” according to the warning level, as follows, and described in the Instruction Manual for each model.

Level	Degree of Danger and Damage	Symbol
Danger	This indicates an imminently hazardous situation which, if the product is not handled correctly, will result in death or serious injury.	 <i>Danger</i>
Warning	This indicates a potentially hazardous situation which, if the product is not handled correctly, could result in death or serious injury.	 <i>Warning</i>
Caution	This indicates a potentially hazardous situation which, if the product is not handled correctly, may result in minor injury or property damage.	 <i>Caution</i>
Notice	This indicates lower possibility for the injury, but should be kept to use this product properly.	 <i>Notice</i>

Precautions in Operation

1. Make sure to follow the usage condition, environment and specification range of the product.
Not doing so may cause a drop of performance or malfunction of the product.

2. Use an appropriate teaching tool.
Use the PC Software or an appropriate teaching pendant to interface with this controller.
[Refer to 1.1.2 Teaching Tool]

3. Create a secure data backup for use in case of a breakdown.
A non-volatile memory is used as the backup memory for this controller. All the registered position data and parameters are written into this memory and backed-up at the same time. Therefore, you will not usually lose the data even if the power is shut down. However, make sure to save the latest data so a quick recovery action can be taken in case the controller is broken and needs to be replaced with another one.

How to Save Data

- (1) Save the data to external memory or hard disk using the PC software
- (2) Hard-copy the information of position tables and parameters on paper

4. Initial Setting the operation

To make this controller flexibly applied in various situations, it is made applicable for seven types of communication standards, possesses seven types of fieldbus operation modes for control method, and is equipped with five types of operation patterns in the remote I/O mode. The setup can be performed in the initial setting. [Refer to Chapter 3.2 Initial Setting and Chapter 8 Parameter]

Set the operation mode and operation pattern setting to the logic that suits your use after the power is turned ON.



Warning: Please note it is very risky when the control sequence, operation mode of fieldbus and operation pattern of remote I/O mode setting do not match each other. The normal operation might not occur. There may be no movement, or there may be unexpected movement.

5. Actuator would not operate without servo-on and pause signals.

- (1) Servo ON Signal (SON)

The servo-on signal (SON) is available to select whether to enable or disable in the Parameter No.21. [Refer to 8.2 [13] Servo ON input disable]

If it is set to "Enable", the actuator would not operate unless turning this signal ON.

If parameter is set to "1", SON is made disable. If it is set to "Disable", the servo becomes on and the actuator operation becomes enabled as soon as the power supply to the controller is turned ON and the emergency stop signal is cancelled. It is set to "0" (Effective) at delivery.

Have the setting that suits to the desirable control logic.

- (2) Pause Signal (*STP)

Considering safety, the pause signal (*STP) is an input signal which is always ON.

Therefore, the actuator will not operate when this signal is not ON in the ordinary use.

This signal is available to choose valid/invalid in Parameter No.15. [Refer to 8.2 [11] Selecting Pause Input Invalid]

Set the parameter to "1" to make it invalid. When it is set invalid, the actuator will become available to operate without making this signal ON. It is set to "0" (Valid) at the delivery.

6. Clock Setting in Calendar Function

There may be a case in the first time to supply the power after delivery that Gateway Alarm Code 84A "Real Time Clock Vibration Stop Detected" is generated. In the case this happens, set the current time with a teaching tool.

If the battery is fully charged, the clock data is retained for approximately 10 days after the power is turned OFF.

Even though the time setting is conducted before the product is shipped, the battery is not fully charged. Therefore, there may be a case that the clock data is lost even if the days described above have not passed.

7. Note that there are some frictions and/or torsions in through-hole of rotary actuator when it is used

When using rotary actuator with a through hole in the center of the revolution and using the hole to put cables through, have a treatment to prevent wear from rubbing or wire break due to the cables getting twisted.

Take particular note on actuators of 360-degree specification because they can be rotated infinitely in a single direction.

8. Limitations on operation of rotary actuator in index mode

Rotary actuators of 360° specification can select the normal mode for finite rotations or the index mode enabling multi-rotation control by using parameter No.79 "Rotational axis mode selection".

[Refer to Chapter 8 Parameter.]

The following limitations are applied to the index mode:

- 1) In the JOG or Inching Operation using a teaching tool such as PC software or using PIO signal, the range of 1 time of command is 360° at maximum for JOG while 1° at maximum for Inching.
- 2) Pressing is unavailable. The pressing torque can only be set to 0.
- 3) Do not issue positioning command around 0° repeatedly during movement near 0°. Failure to follow this may cause the actuator to rotate in the direction reverse to the specified rotation direction or operate indefinitely.
- 4) Software stroke limit is invalid in the index mode.

9. According to Sequence Program Creation

Please note the following things when creating a sequence program.

When data transfer is necessary between two devices that have a different scan time from each other, duration more than the longer scan time is required to certainly read the signal. (It is recommended to have a timer setting of at least twice as long as the scan time in order for the PLC to adequately perform the reading process.)

● Operation Image

PLC

(e.g. scan time is 20msec)

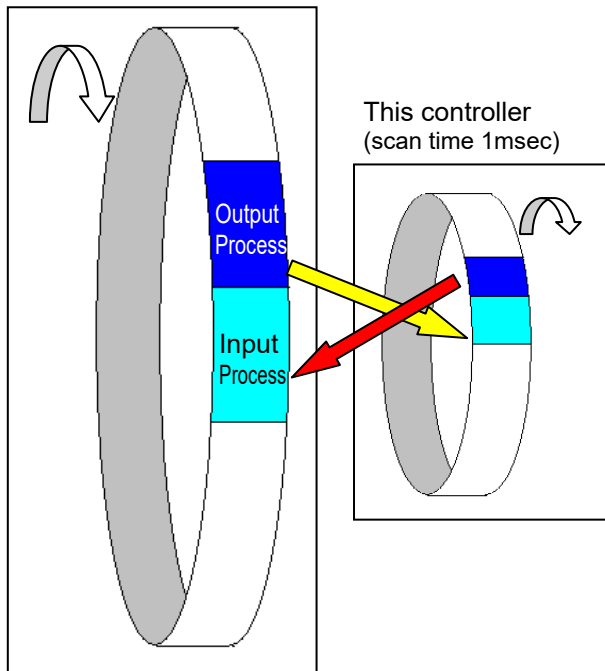

As shown in the diagram, the input and output timings of two devices that have different scan time do not match, when transferring a signal. There is no guarantee that PLC would read the signal as soon as this controller signal turns ON. In such a case, make the setting to read the signal after a certain time that is longer than the longer scan time to ensure the reading process succeeds on the PLC side.

It is the same in the case this controller side reads the signal.

In such a case, it is recommended to ensure 2 to 4 times of the scan time for the timer setting margin.

It is risky to have the setting below the scan time since the timer is also processed in the scan process.

In the diagram, PLC can only read the input once in 20msec even though this controller output once in 1msec.

Because PLC only conducts output process once in 20msec, this controller identifies the same output status for that entire time period.

Also, if one tries to read the signal that is being re-written by the other, the signal may be read wrong. Make sure to read the signal after the rewriting is complete. (It is recommended to have more than 2 scan periods to wait.) Make sure not to have the output side to change the output until the other side completes the reading. Also, a setting is made on the input area not to receive the signal less than a certain time to prevent a wrong reading of noise. This duration also needs to be considered.

10. PLC Timer Setting

Do not have the PLC timer setting to be done with the minimum setting.

Setting to "1" for 100msec timer turns ON at the timing from 0 to 100msec while 10msec timer from 0 to 10msec for some PLC.

Therefore, the same process as when the timer is not set is held and may cause a failure such as the actuator cannot get positioned to the indicated position number in Positioner Mode.

Set "2" as the minimum value for the setting of 10msec timer and when setting to 100msec, use 10msec timer and set to "10".

11. Regarding Battery-less Absolute Type Actuator

- 1) For the pulse motor type, the setting switched over between the absolute type and incremental type with the parameters.
 - Parameter No.83 Absorber unit
0 : not used = (Incremental Type), 1 : Use = (Absolute Type)
- 2) For actuator of RCP5 series, for the first time to turn the servo on after turning on the power, it will have slight position adjustment due to the characteristics of the stepping motor.
The maximum movement amount at position adjustment operation is the distance of $0.025 \times$ lead length [mm].
Also, the current position displayed on the teaching tool before turning the servo on is the coordinates before adjustment operation.
- 3) After the first time the servo is tuned on after the power has been supplied, the home-return complete signal [HEND] and the limit switch output signal (LS) are output.
- 4) When the first servo-on is conducted out of the soft limit range, an error would not be output.
Soft limit monitoring starts after it is moved into the range.
- 5) Make sure to have a home-return operation (absolute reset) after detaching the motor unit from the actuator for motor replacement purpose and so on.

12. Motor Features in AUTO Mode

Status (condition) display and servomotor are available in AUTO Mode.
However, they are not available when the connection is established with SSCNET III/H or MECHATROLINK-III.

International Standards Compliances

MCON with the following overseas standard.

RoHS Directive	CE Marking	UL
<input type="radio"/>	<input type="radio"/>	<input type="radio"/>

Name for Each Parts and Their Functions

●MCON-C/CG Type

6) Absolute Battery Connector
(for the simple absolute type)

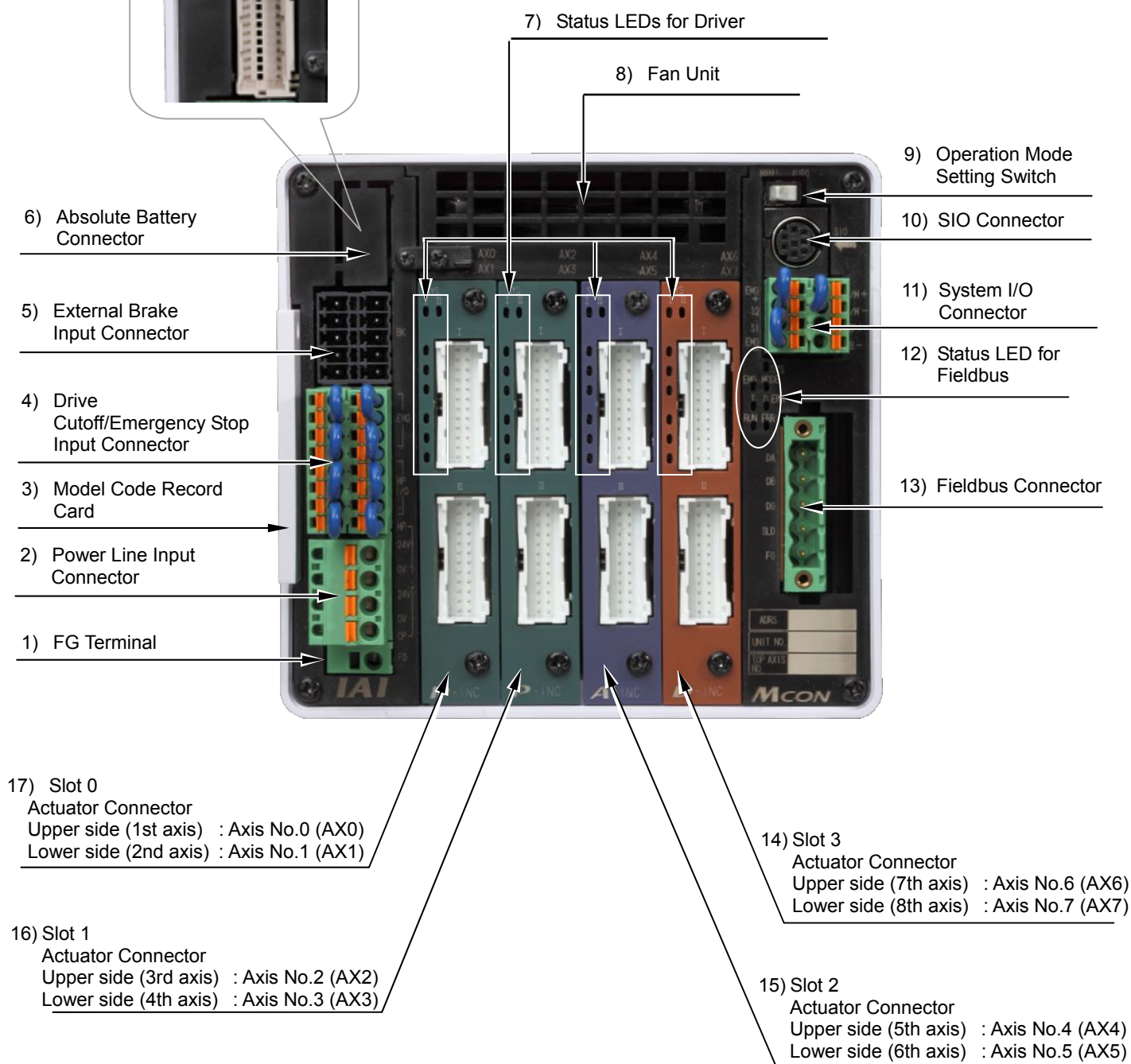

- 1) **FG Terminal**
This is the terminal block for frame grounding. Since this controller is made of plastic, it is necessary to ground from this terminal block. Have the grounding resistance kept at 100Ω or less (Class D for grounding class (Grounding No. 3 in old standard)).
- 2) **Power Line Input Connector**
This is the connector to supply 24V DC power supply to the controller. The control power supply and the motor power supply are to be input separately. This enables external drive cutoff that cuts only the motor power supply. [Refer to 2.3.1]
- 3) **Model Code Record Card**
This is a card with information of the connected axes recorded on for eight axes at the maximum. It is available to pull out from the controller and check the information. The serial number of the controller is also recorded.
- 4) **Drive Cutoff/Emergency Stop Input Connector**
External drive cutoff and emergency stop can be performed individually for each slot (2 axes). [Refer to 2.3.3]
- 5) **External Brake Input Connector**
An external compulsory brake release can be performed on each axis. The brake is ordinarily released with the servo ON and activated with the servo OFF. In the tuning at the startup or in the maintenance work, have a brake release switch for each axis connected to this connector to make a compulsory brake release available, and the actuator can be moved manually while the servo is OFF. [Refer to 2.3.6]
- 6) **Absolute Battery Connector**
This connector is mounted on the simple absolute type. An external absolute battery box for eight axes can be connected with one cable. This is not mounted on the incremental type.
- 7) **Status LEDs for Driver**
These lamps indicate the status of the driver and that for absolute type for each slot (in 2 axes unit). There is no absolute status display for the incremental type.

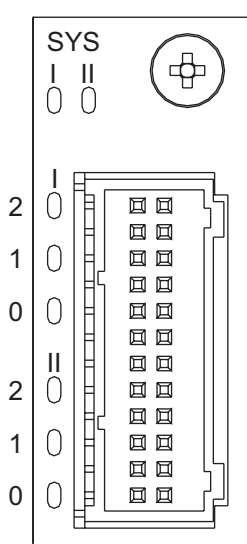

Part Name	Description
SYS I	System status of driver for axis connected to upper connector (Servo ON: Green, Servo OFF: OFF, Alarm generated, Emergency stop condition: Red)
SYS II	System status of driver for axis connected to lower connector (Servo ON: Green, Servo OFF: OFF, Alarm generated, Emergency stop condition: Red)
I-0	Absolute status of driver for axis connected to upper connector 0 ^(Note 1)
I-1	Absolute status of driver for axis connected to upper connector 1 ^(Note 1)
I-2	Absolute status of driver for axis connected to upper connector 2 ^(Note 1)
II-0	Absolute status of driver for axis connected to lower connector 0 ^(Note 1)
II-1	Absolute status of driver for axis connected to lower connector 1 ^(Note 1)
II-2	Absolute status of driver for axis connected to lower connector 2 ^(Note 1)

Note 1: Refer to "7.1 [1] Status LEDs for Driver" for details.

- 8) Fan Unit
This is the fan unit to cool down the controller. This unit can be detached from the controller for maintenance by removing the screw on the hook in the front of the controller.
- 9) Operation Mode Setting Switch
This is a switch to change the operation mode between Automatic Operation (AUTO) and Manual Operation (MANU). The operation modes are provided to avoid the duplication of the SIO (Serial) communication operation using PC software or a teaching pendant (described as teaching tool from now on) and the operation with Fieldbus or PIO (Parallel I/O). For the details of the mode selection, refer to 11) System I/O Connector.
- 10) SIO Connector
This is a connector dedicated for the teaching tool connection. [Refer to 2.3.7]
- 11) System I/O Connector
This is a connector for additional devices for the input of all-axes external emergency stop, AUTO/MANU switchover and external regenerative resistor. [Refer to 2.3.2]
It is connected in a series with the operation mode setting switch (AUTO/MANU) on the front panel. The controller can be in the following modes by the mode selection on each switch and teaching tool.

MCON status	Condition		
	Switch on Front Panel	Teaching Tool ^{Note 1}	Operation Mode Switchover Input ^{Note 2}
AUTO	AUTO	Prohibit PIO Startup	OFF (Input 0V)
	AUTO	Accept PIO Startup	OFF (Input 0V)
	AUTO	Accept PIO Startup	ON (Release)
	MANU	Accept PIO Startup	ON (Release)
	MANU	Accept PIO Startup	OFF (Input 0V)
MANU	AUTO	Prohibit PIO Startup	ON (Release)
	MANU	Prohibit PIO Startup	ON (Release)
	MANU	Prohibit PIO Startup	OFF (Input 0V)

Note 1 : "Accept PIO Startup" and "Prohibit PIO Startup" are the functions to select the operation mode of when the teaching tool is connected.

Note 2 : Refer to "2.2 [4] Layout for Mode Switchover Circuit" for the details.

⚠ Caution : (1) If "Accept PIO Startup" is selected on the teaching tool, the AUTO operation becomes available no matter the condition of the front panel or external switchover signal input, thus attention may have to be paid. In such a condition, the actuator may get activated by following the signal from the host.
(2) The information of "Accept PIO Startup" or "Prohibit PIO Startup" is remained when the teaching tool is removed from the controller. Do not fail to select "Prohibit PIO Startup" when removing the teaching tool after finishing the teaching operation or debugging.

12) Status LED for Fieldbus

They are the LED lamps to show the status of the controller and Fieldbus.
 The layout and the content of LED display differ depending on each Fieldbus.
 Refer to the operation of each mode for the details.
 [Refer to 3.10]

13) Fieldbus Connector

A connector for Fieldbus connection is mounted for the Fieldbus. [Refer to 2.3.8]

14) to 17) Slot 0 to 3 Actuator Connector

Insert one driver board to one slot each. (Four driver boards are available to insert at the maximum.)

A driver board of the high output setting type is able to control one axis per piece. For others, two axes can be controlled by one piece of driver board.

⚠ Caution :

- (1) *The driver board differs depending on the actuator to be connected.*
- (2) *Do not attempt to insert the driver board to a slot other than the one that the board was originally inserted to.*
The parameter dedicated for the indicated actuator is already written to the driver board at the purchase order. Inserting the driver board to another slot may lead to a wrong wiring.
- (3) *On the slot without a driver board inserted, there is a face plate attached.*



Driver Board of Slot 0 : Drive Uint 0
Driver Board of Slot 1 : Drive Uint 1
Driver Board of Slot 2 : Drive Uint 2
Driver Board of Slot 3 : Drive Uint 3

Driver Board (Drive Uint)
 Select either one of for pulse motor, for 24V servo motor or for brushless DC electric motor
 (to be indicated at the purchase order considering the connected actuator type)

⚠ Caution : *Cutoff/boot of driving source is to be done on each driver board (2 axes) (control by one axis to another cannot be performed). Therefore, when Cold Start Level (Drive Cutoff) Alarm is generated on one axis out of two, the other axis with the alarm not being generated will also stop. Consider this when constructing the system.*

Actuator Axes

Refer to the pictures below for the actuator axes that can be controlled by MCON.
0 defines the home position, and items in () are for the home-reversed type (option).

⚠ Caution: *There are some actuators that are not applicable to the origin reversed type. Check further on the catalog or the Instruction Manual of the actuator.*

(1) Rod Type

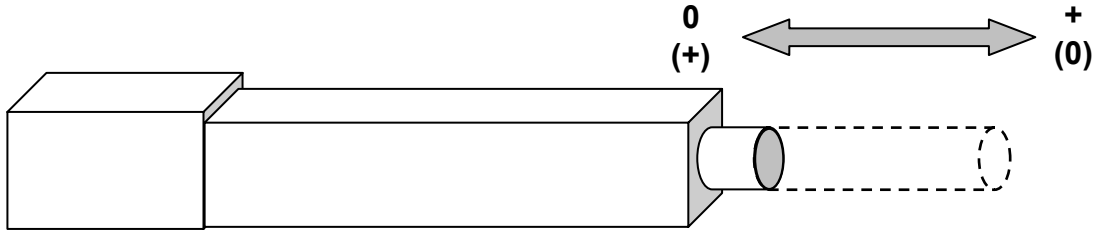

(2) Slider Type

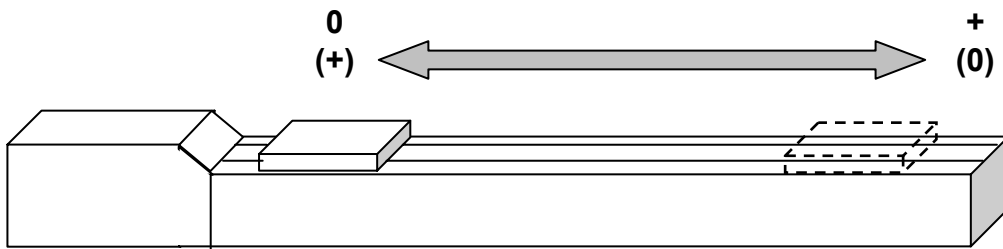

(3) Table Type

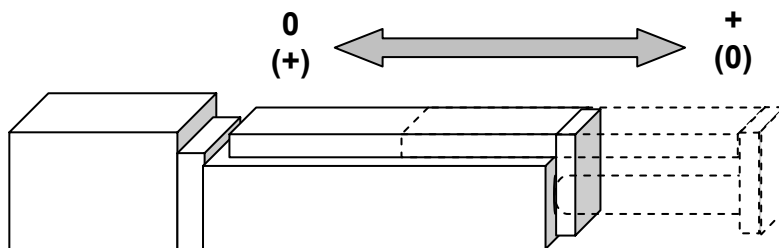

(4) Arm Type

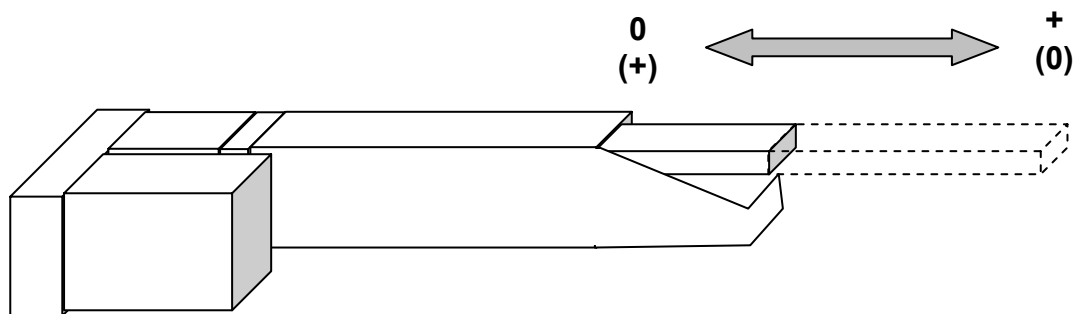

(5) Gripper Type

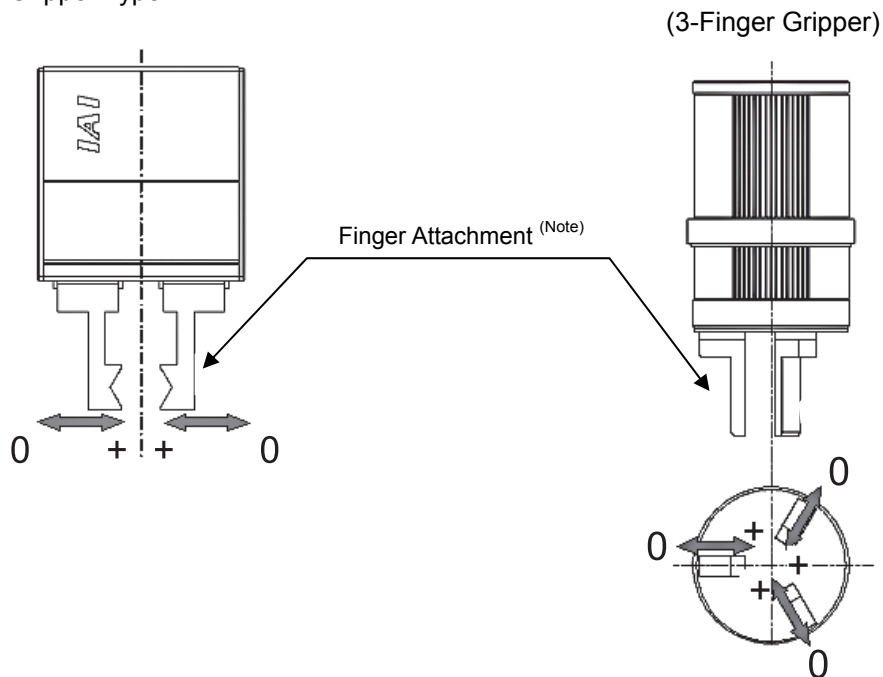

Note Finger attachment is not included in the actuator package. Please prepare separately.

(6) Rotary Type

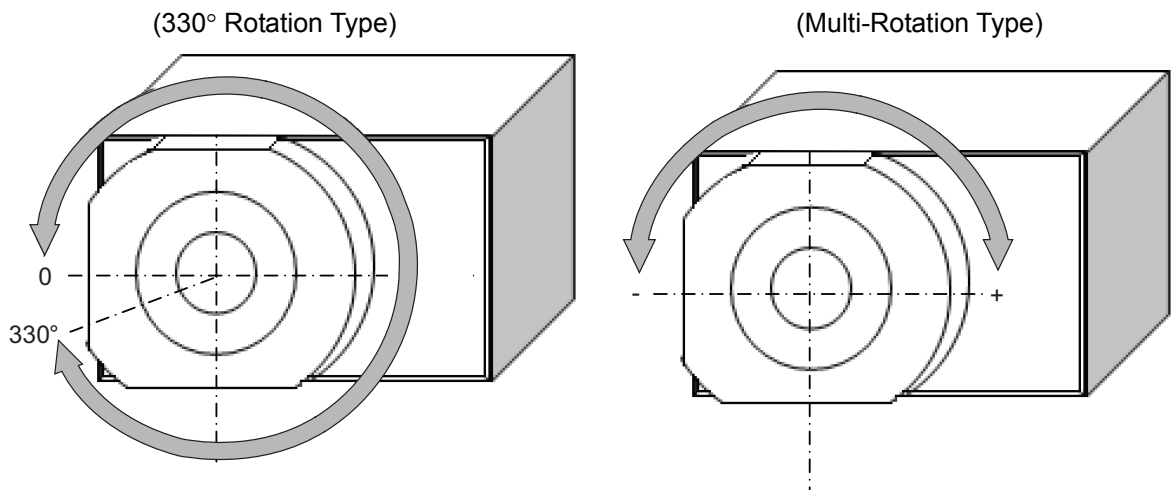





For Multi-Rotation Type with the origin reversed type, the directions of + and - are the other way around.





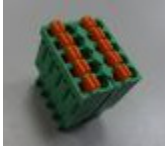

Chapter 1 Specifications Check

1.1 Product Check

1.1.1 Parts

The standard configuration of this product is comprised of the following parts.
If you find any faulty or missing parts, contact your local IAI distributor.

No.	Part Name	Model and Picture	Number	Remarks
1	Controller Main Body	Refer to "1.1.4 How to read the model plate", "1.1.5 How to read the model".	1	
Accessories				
2	Power Connector	FKC2.5HC/4-ST-5.08 (Supplier : PHOENIX CONTACT) 	1	Recommended Cable Size <ul style="list-style-type: none"> Control Power Supply 0.5 to 0.3mm² (AWG20 to 22) Motor Driving Power Supply 3.5 to 0.5mm² (AWG12 to 20) Choose a size that withstands the current. [Refer to 2.3.1 Connection to Power Input Connector]
3	External Brake Input Connector	FMCD1.5/5-ST-3.5 (Supplier : PHOENIX CONTACT) 	1	Recommended cable size 0.5 to 0.2mm ² (AWG20 to 24)
4	Drive Cutoff/Emergency Stop Input Connector	FMCD1.5/8-ST-3.5 (Supplier : PHOENIX CONTACT) 	1	Recommended Cable Size <ul style="list-style-type: none"> Emergency Stop 0.5 to 0.2mm² (AWG20 to 24) Motor Power External Input 1.25 to 0.5mm² (AWG16 to 20)
5	System I/O Connector	FMCD1.5/4-ST-3.5 (Supplier : PHOENIX CONTACT) 	1	Recommended cable size 0.5 to 0.2mm ² (AWG20 to 24)
6	Dummy Plug (For Safety Category Complied Type)	DP-5 	1	

No.	Part Name	Model and Picture	Number	Remarks
7	DeviceNet Connector (For DeviceNet Type)	MSTB2.5/5-STF-5.08 AU M (Supplier : PHOENIX CONTACT) 	1	Prepare a terminal resistance separately if this controller is to be allocated at the terminal.
8	CC-Link Connector (For CC-Link Type)	MSTB2.5/5-STF-5.08 AU (Supplier : PHOENIX CONTACT) 	1	Terminal Resistance (130Ω/1/2W, 110Ω/1/2W) enclosed one unit each
9	Absolute Battery Box (Option)	For Simple Absolute Type MSEP-ABB 	1	(Battery AB-7 Please purchase separately) 
10	Safety Guide		1	The picture shows an image.
11	First Step Guide	ME0344 	1	The picture shows an image.
12	Instruction Manual (DVD)		1	The picture shows an image.

1.1.2 Teaching Tool

A teaching tool such as PC software is necessary when performing the setup for position setting, parameter setting, etc. that can only be done on the teaching tool. Please prepare either of the following teaching tools.

No.	Part Name	Model
1	PC Software (Includes RS232C Exchange Adapter + Peripheral Communication Cable)	RCM-101-MW
2	PC Software (Includes USB Exchange Adapter + USB Cable + Peripheral Communication Cable)	RCM-101-USB
3	Teaching Pendant (Touch Panel Teaching)	TB-01
4	Teaching Pendant (Touch Panel Teaching with deadman's switch)	TB-01D
5	Teaching Pendant (Dead man's switch right mounted touch panel teaching)	TB-01DR
6	Touch panel teaching (with no deadman's switch / dead man's switch)	TB-02/TB-02D

1.1.3 Instruction manuals related to this product, which are contained in the instruction manual (DVD).

No.	Name	Manual No.
1	MCON Controller Instruction Manual	ME0341
2	PC Software RCM-101-MW/RCM-101-USB Instruction Manual	ME0155
3	Touch Panel Teaching TB-01, TB-01D, TB-01DR Applicable for Position Controller Instruction Manual	ME0324
4	Touch panel teaching TB-02/TB-02D Applicable for Position Controller Instruction Manual	ME0355
5	SSCNET III/H Applicable Controller Instruction Manual	ME0352
6	MECHATROLINK-III Applicable Controller Instruction Manual	ME0317

1.1.4 How to Read the Model Nameplate

[1] Main Body Case Side Surface

Model →	MODEL	MCON-C-5-20PWAI-PWAI-20WAI-20WAI-3DI-N-DV-2-0-ABB
Manufactured date →	PRODUCT DATE	2015/09/01
Manual No. →	MANUAL No.	ME0341
Input power supply →	CP INPUT	DC24V 2.0A
	MP INPUT	DC24V 7.6A
Information of the connected axes (Axis No. 0 to 7) →	AXIS No. /OUTPUT	
	0	DC24V 1.2A
	1	
	2	DC24V 1.6A
	3	DC24V 1.6A
	4	DC24V 0.4A
	5	
	6	
	7	
 CAUTION : Connect the wiring correctly and properly. Use IAI Corporation specified cables.		
Made In Japan		

[2] Model Code Card

Equipment Name	
----------------	--

Model →	Model	MCON-C-5-20PWAI-PWAI-20WAI-20WAI-3DI-N-DV-2-0-ABB	
Version →	Version	0-0-A0-A0-NN-NN-BOA-NN	
		Serial No. *****	
Information of the connected axes /Serial number → (Axis No. 0 to 7)	AXIS No. / Model / Serial No.		
	0	RCP5-SA4C-WA-35P-16-200-P3-S	*****
	1		
	2	RCA2-TCA4NA-I-20-4-50-A1-S	*****
	3	RCA2-TCA4NA-I-20-4-50-A1-S	*****
	4	RCD-RA1DA-I-3-2-30-D5-S	*****
	5		
	6		
	7		
IAI			

1.1.5 How to read the model

(Example) Consists of 5 axes:

Axis No.0	:	Pulse motor type	
Axis No.1	:	Pulse motor type	Inactive Axis
Axes No.2, 3	:	Servo motor type	
Axes No.4	:	Brushless DC motor type	
Axis No.5	:	Not connected	

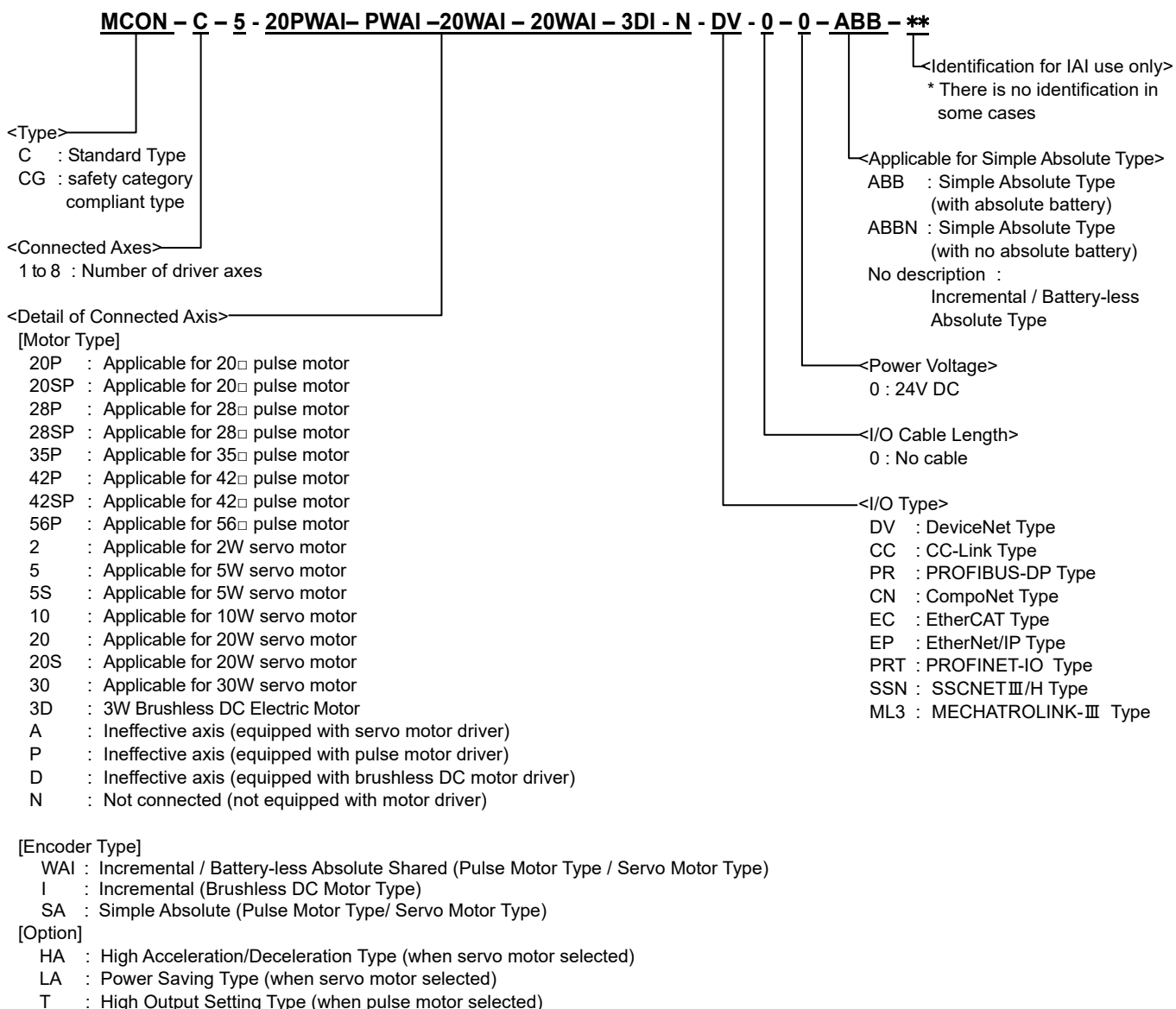

1.2 List of Basic Specifications

Specification Item	Details of Specifications	
Number of Controlled Axes	Max.8 axis	
Control/Motor Power Supply Voltage	24V DC \pm 10%	
Current Consumption of Brake Release Power	0.15A \times Number of axes	
Control Power Current Consumption	1.0A	
Control Power In-Rush Current	MAX. 5A 30ms or less	
Motor Current Consumption	Refer to Section < Motor Current Consumption >	
Motor Power In-Rush Current	Number of slots \times MAX. 10A 5ms or less	
Controller Heat Generation	MAX. 26W	
Control System	Driver for Pulse Motor : Weak field-magnet vector control Driver for Servo Motor : Vector control Driver for Brushless DC Motor : Square wave drive	
Encoder Resolution	Refer to Section <Encoder Resolution>	
Actuator Cable Length	MAX. 20m (Note) It is 10m at maximum for Simple Absolute Type.	
Serial Communication (SIO Port: Only for teaching)	RS485 1CH (complying with Modbus Protocol) Speed 9.6 to 230.4kbps	
External Interface	DeviceNet, CC-Link, PROFIBUS-DP, CompoNet, EtherNet/IP, EtherCAT, PROFINET-IO, MECHATROLINK-III, SSCNET III/H [Refer to 1.4 Specifications for each Fieldbus.]	
Data Setting and Input	PC software, Touch panel teaching, Gateway parameter setting tool	
Data Retention Memory	Position data and parameters are saved in the nonvolatile memory (FeRAM). (Note) There is no limitation in number of writing.	
Positioning Points	256 points (There is no limit for simple direct and direct indication modes) (Note) The number of positioning points differs depending on the operation mode select by the parameter setting.	
LED Display (mounted on Front Panel)	Status LED for Driver : 8 points (for each driver board) Status LED for Fieldbus : 7 points	
Forcibly Releasing of Electromagnetic Brake	Can be released with the forcibly releasing signal input (24V DC input) to each axis	
Protective Functions (Note 1)	Overcurrent Protection (Equipped with a built-in cutoff circuit using a semiconductor for each slot)	
Protection Function against Electric Shock	Class I basic insulation	
Insulation Resistance	500V DC 10M Ω	
Mass	Incremental type : 620g Max., Absolute type : 690g Max., Absolute battery box : 1950g (for 8-axis type) Max.	
Cooling Method	Forced air-cooling	
External Dimensions	123W \times 115H \times 95D	
Environ-ment	Ambient Temperature	0 to 40°C
	Ambient Humidity	85%RH or less (non-condensing)
	Ambient Environment	Refer to 1.7 [1] Installation Environment
	Ambient Storage Temperature	-20 to 70°C 0 to 40°C for absolute battery
	Ambient Storage Humidity	85%RH or less (non-condensing)
	Usable Altitude	1000m or lower above sea level
	Vibration Durability	Frequency 10 to 57Hz / Swing width: 0.075mm Frequency 57 to 150Hz / Acceleration: 9.8m/s ² XYZ Each direction Sweep time: 10 min. Number of sweep: 10 times
	Shock Resistance	Dropping height 800mm, 1 corner, 3 edges and 6 surfaces
	Protection Class	IP20

Note 1 For servo motor, the over-current protection is triggered at 1.4 times the maximum load current.

<Motor Current Consumption>

See below for the motor current consumption (rated current, peak current) of the connectable actuators.

Actuator Type				Rated Current [A]	Peak Current [A]	
					Power Saving Type	Standard Type
Pulse Motor <small>(Note 2)</small>	RCP2 RCP3	20P to 28P		/	/	2.0
		28SP to 56P		/	/	2.0
	RCP4 RCP5 RCP6	28SP to 56P	High Output Invalid	/	/	2.0
			High-Output Type <small>(Note 3)</small>	3.5	/	4.2
Servo Motor <small>(Note 4)</small>	2W		0.8	/	/	4.6
	5W		1.0	/	/	6.4
	10W (RCL)		1.3	/	/	6.4
	10W (RCA, RCA2)		1.3	2.5	/	4.4
	20W		1.3	2.5	/	4.4
	20W (20S Type)		1.7	3.4	/	5.1
	30W		1.3	2.2	/	4.4
Brushless DC Motor	3W		0.7	/	/	1.5

Note 2 The current is maximized at the excitation phase detection conducted in the first servo-on process after the power is supplied (ordinary 100ms).

Note 3 High-output type driver board can control one axis per board.

Note 4 Maximum current draw is realized during the excitation phase following the initial servo power ON. (Normal: Approx. 1 to 2 sec, MAX: 10 sec).

<Encoder Resolution>

See below for the resolution of encoders mounted on the connectable actuators.

Actuator Type			Encoder Resolution
Pulse Motor	RCP2 to 5	All types	800 pulse/rev
	RCP6	All types	8192 pulse/rev
Servo Motor	RCA	Incremental Encoder	800 pulse/rev
		Battery-less Absolute Encoder	16384 pulse/rev
	RCA2	RCA2-□□□N (A)	1048 pulse/rev
		Other than RCA2-□□□N (A)	800 pulse/rev
	RCL	RA1L · SA1L · SA4L · SM4L	715 pulse/30.03mm
		RA2L · SA2L · SA5L · SM5L	855 pulse/35.91mm
RA3L · SA3L · SA6L · SM6L		1145 pulse/48.09mm	
Brushless DC Motor	RCD	RA1D · GRSM	400 pulse/rev
		RA1DA · GRSMA	480 pulse/rev

1.3 Calculation for Power Capacity

For the calculation of 24V DC power capacity, figure out the numbers for (1) to (6) below, and then follow Step (7).

- (1) Control Power Current Consumption : 1.0A.....1)
- (2) Motor Power Current Consumption :
Add the total motor current consumption of all connected actuators.....2)
- (3) Current Consumption at Excitation Phase Detection :
Add the inrush current for all connected axes.3)
- (4) Add the Control Power Inrush Current : 5A4)
- (5) Add the Motor Power Inrush Current : Number of slots × 10A each.5)
- (6) Current Consumption of Brake Release Power: Number of actuators with brake × 0.15A.....6)
- (7) Selection of Power Supply :

Usually, the rated current is to be approximately 1.3 times higher than the total of Control Power 1) + 2) + 6) above considering approximately 30% of margin to the load current. However, considering the inrush currents [excitation 3), control 4) and motor power 5)], even though it is a short time, select a power supply with “sufficient peak load capacity. Avoid current of 3) to 5) from occurring at the same time by having the timing of emergency stop release (turning the motor power on) and timing to turn the servo on shifted^(Note 1) from each other and so on. Huge current flow of the same time may cause a transient voltage drop. Be careful especially when selecting a power source equipped with remote sensing.

Note1 The timing to turn the servo on can be shifted in Driver Shutdown Release Delay Time [refer to 3.9.9 3) GW Parameter 3] in the gateway parameter setting tool.

(Note) Ensure motor and control power supplies reference the same potential when using multiple power supplies.

(Reference) Selection of Power Supply Protection Circuit Breaker

It is recommended that the power supply protection is conducted on the primary side (AC power side) of the 24V DC power supply unit.

When selecting the protection breaker, consider the rated cutoff current of the circuit breaker so a cutoff is surely performed even in the case of inrush current of 24V DC power supply unit or a short-circuit of the power supply.

- Rated Breaking Current > Short-circuit Current = Primary Power Supply Capacity / Power Voltage
- (Reference) In-rush Current of IAI Power Supply Unit PS241 = 50 to 60A, 3msec

1.4 Specifications for each Fieldbus

1.4.1 Specifications of DeviceNet Interface

Item	Specification			
Communication Protocol	DeviceNet2.0			
	Group 2 Dedicated Server			
	Network-Powered Insulation Node			
Baud Rate	Automatically follows the master			
Communication System	Master-Slave System (Polling)			
Number of Occupied Channels	Refer to 3.4.1 PLC Address Construction by each Operation Mode			
Number of Occupied Nodes	1 Node			
Communication Cable Length ^(Note 1)	Baud Rate	Max. Network Length	Total Branch Line Length	Max. Branch Line Length
	500kbps	100m	39m	6m
	250kbps	250m	78m	
	125kbps	500m	156m	
Communications Cable	Use the dedicated cable.			
Connector ^(Note 2)	MSTB2.5/5-GF-5.08 AU (Manufactured by PHOENIX CONTACT or equivalent)			
Consumption Current of Communication Power Supply	60mA			
Communication Power Supply	24V DC (Supplied from DeviceNet)			

Note 1 For T branch communication, refer to the Instruction Manuals for the master unit and programmable logic controller (PLC) to be mounted.

Note 2 The cable-side connector is a standard accessory. [Refer to 1.1.1 Parts]

1.4.2 Specifications of CC-Link Interface

Item	Specification					
Communication Protocol	CC-Link ver1.10 or ver2.00					
Station Type	Remote Device Station (MAX. four stations occupied)					
Baud Rate	10M/5M/2.5M/625k/156kbps					
Communication System	Broadcast Polling System					
Number of occupied stations	Refer to 3.4.1 PLC Address Construction by each Operation Mode					
Communication Cable Length ^(Note 1)	Baud Rate (bps)	10M	5M	2.5M	625k	156k
	Total Cable Length (m)	100	160	400	900	1200
Communications Cable	Apply the dedicated cable					
Connector ^(Note 2)	MSTB2.5/5-GF-5.08 AU (Manufactured by PHOENIX CONTACT or equivalent)					

Note 1 For T branch communication, refer to the Instruction Manuals for the master unit and PLC to be mounted.

Note 2 The cable-side connector is a standard accessory. [Refer to 1.1.1 Parts]

1.4.3 Specifications of PROFIBUS-DP Interface

Item	Specification		
Communication Protocol	PROFIBUS-DP		
Baud Rate	Automatically follows the master		
Communication System	Hybrid System (Master-Slave System or Token Passing System)		
Number of occupied stations	Refer to 3.4.1 PLC Address Construction by each Operation Mode		
Communication Cable Length	MAX. Total Network	Baud Rate	Cable Type
	100m	3,000/6,000/12,000kbps	Type A Cable
	200m	1,500kbps	
	400m	500kbps	
	1000m	187.5kbps	
1200m	9.6/19.2/93.75kbps		
Communications Cable	STP cable AWG18		
Connector ^(Note 1)	9-pin female D-sub Connector		
Transmission Path Format	Bus/Tree/Star		

Note 1 Please prepare a 9-pin male D-sub connector for the cable-end connector.

1.4.4 Specifications of CompoNet Interface

Item	Specification
Communication System	CompoNet dedicated protocol
Communication Type	Remote I/O communication
Baud Rate	Automatically follows the master
Communication Cable Length	Follows CompoNet specifications
Slave Type	Word-Mixed Slave
Available Node Addresses for Setting	0 to 63 (Setting conducted on controller parameter)
Number of occupied channels	Refer to 3.4.1 PLC Address Construction by each Operation Mode
Communications Cable ^(Note 1)	Round Cable (JIS C3306, VCTF2-core) Flat cable I (with no sheathed) Flat cable II (sheathed)
Connector (Controller Side)	XW7D-PB4-R (Manufactured by OMRON or equivalent)

Note 1 Prepare separately for the communication cable.

1.4.5 Specifications of EtherNet/IP Interface

Item	Specification
Communication Protocol	IEC61158 (IEEE802.3)
Baud Rate	10BASE-T/100BASE-T (Autonegotiation setting is recommended)
Communication Cable Length	Follows EtherNet/IP specifications (Distance between hub and each node: 100m max.)
Number of Connection	Master Unit
Available Node Addresses for Setting	0.0.0.0 to 255.255.255.255
Communications Cable ^(Note 1)	Category 5 or more (Double shielded cable braided with aluminum foil recommended)
Connector	RJ45 Connector × 1pc

Note 1 Prepare separately for the communication cable.

1.4.6 Specifications of EtherCAT Interface

Item	Specification
Communication Protocol	IEC61158 type 12
Physical Layer	100Base-TX (IEEE802.3)
Baud Rate	Automatically follows the master
Communication Cable Length	Follows EtherCAT® specifications (Distance between each node: 100m max.)
Slave Type	I/O slave
Available Node Addresses for Setting	0 to 127 (17 to 80 : When connected to the master (CJ1W-NC*82) manufactured by OMRON)
Communications Cable ^(Note 1)	Category 5e or more (Double shielded cable braided with aluminum foil recommended)
Connector	RJ45 Connector × 2pcs (Input × 1, Output × 1)
Connect	Daisy chain only

Note 1 Prepare separately for the communication cable.

1.4.7 Specifications of PROFINET-IO Interface

Item	Specification
Communication Protocol	IEC61158 (IEEE802.3), IEC61784
Baud Rate	100Mbps
Communication Cable Length	Distance between each segment: 100m Max.
Number of Connection	Master Unit
Available Node Addresses for Setting	0.0.0.0 to 255.255.255.255
Communications Cable ^(Note 1)	Category 5 or more (Double shielded cable braided with aluminum foil recommended)
Connector	RJ45 Connector × 1pc
GSDML File Version	Ver 2.3

Note 1 Prepare separately for the communication cable.

1.4.8 Specifications of SSCNET III/H Interface

Refer to SSCNET III/H interface, SSCNET III/H Applicable Controller Instruction Manual (ME0352).

1.4.9 Specifications of MECHATROLINK-III Interface

Refer to MECHATROLINK-III interface, MECHATROLINK-III Applicable Controller Instruction Manual (ME0317).

1.5 External Dimensions

1.5.1 Controller Main Unit

Front View

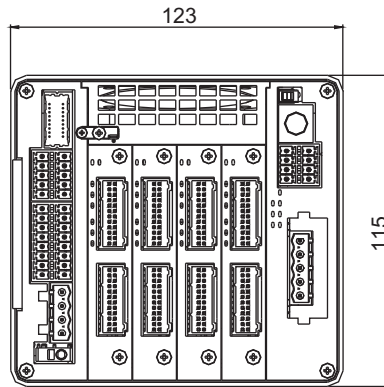

Rear View

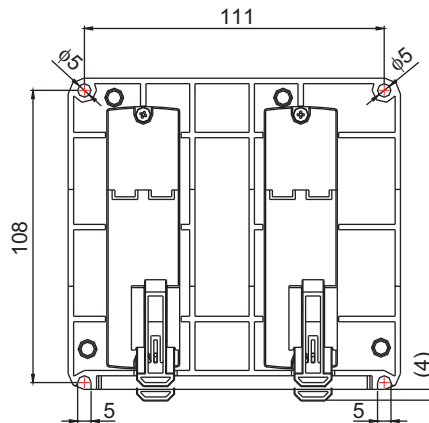

Side View

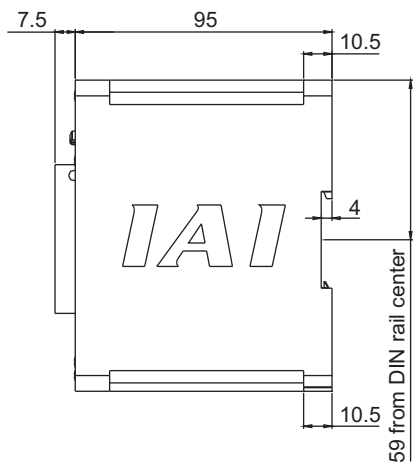

1.5.2 Absolute Battery Box

Front View

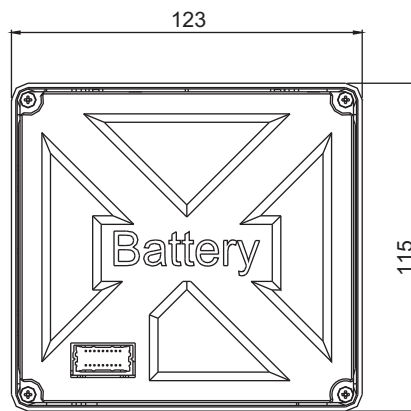

Rear View

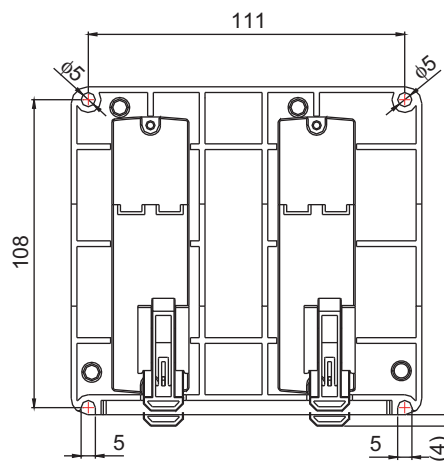

Side View

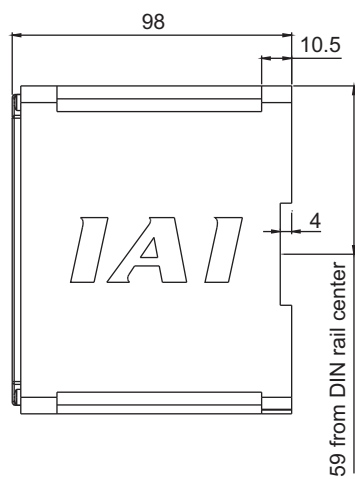

1.6 Option

1.6.1 Absolute Battery Box

For Simple Absolute type, an absolute battery box capable for the batteries for 8 axes is used. The battery is to be attached only to the axes for Simple Absolute Type. The connection to MCON controller is to be made with the dedicated cable (CB-MSEP-AB005).
 (Note) Cable length: 0.5m

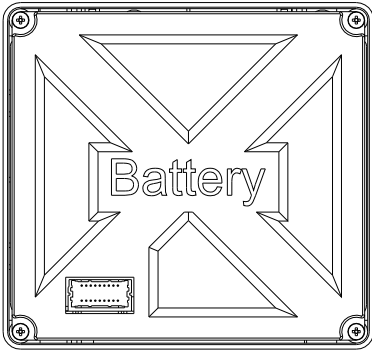

Front View when Cover ON

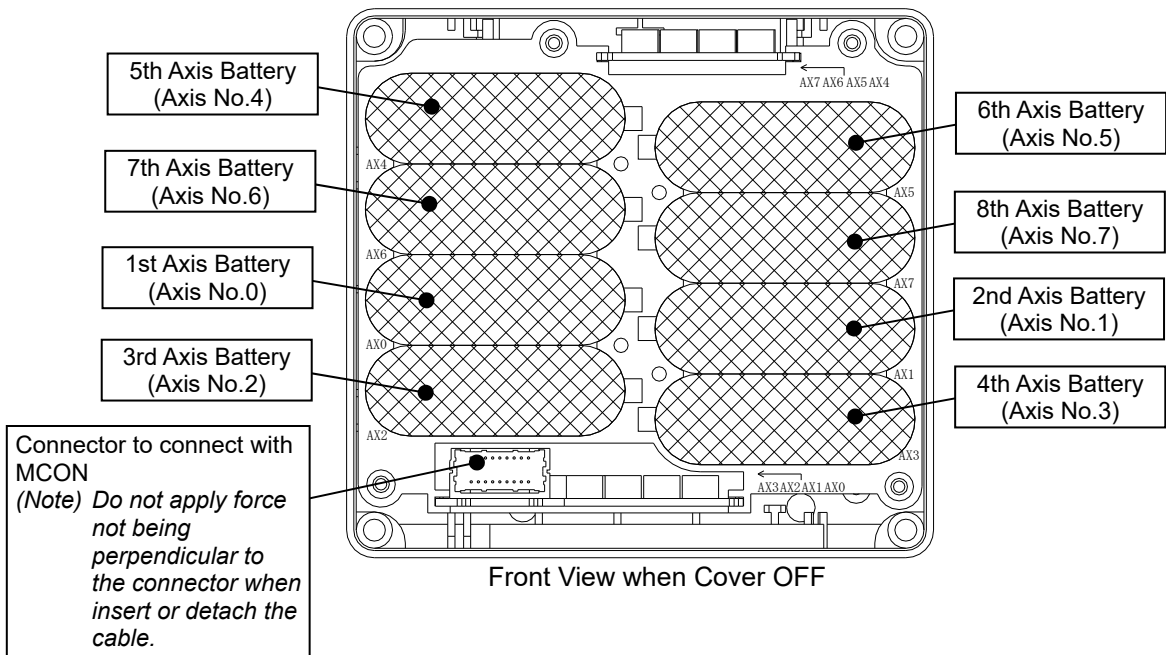

1.6.2 Regenerative Resistor Unit (RER-1)

This unit is necessary to be connected in the case that the regenerative energy cannot be consumed by the regenerative resistor built into the MCON controller.

It is necessary to connect the unit in the following case:

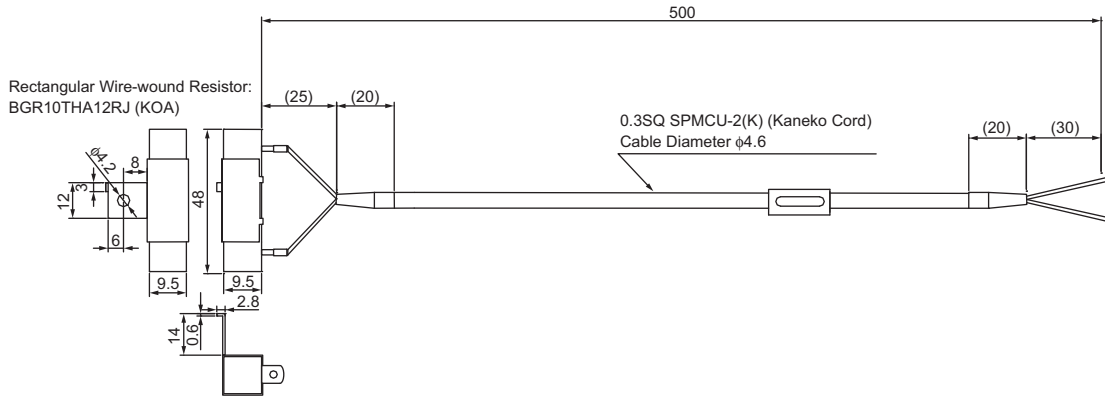

Condition to Require Regenerative Units

Number of Connected Actuator	3 to 8 units of high acceleration/deceleration type actuators
Number of Regenerative Resistor Unit	1



Caution: The regenerative resistor consumes regenerative current and converts it to heat. Therefore, the temperature may get high in some operational conditions. Attach on the metal part of the device with a screw to radiate the heat.

1.7 Installation and Storage Environment

This product is capable for use in the environment of pollution degree 2^{*1} or equivalent.

*1 Pollution Degree 2 : Environment that may cause non-conductive pollution or transient conductive pollution by frost (IEC60664-1)

[1] Installation Environment

Do not use this product in the following environment.

- Location where the surrounding air temperature exceeds the range of 0 to 40°C
- Location where condensation occurs due to abrupt temperature changes
- Location where relative humidity exceeds 85%RH
- Location exposed to corrosive gases or combustible gases
- Location exposed to significant amount of dust, salt or iron powder
- Location subject to direct vibration or impact
- Location exposed to direct sunlight
- Location where the product may come in contact with water, oil or chemical droplets
- Environment that blocks the air vent [Refer to 1.8 Noise Elimination and Mounting Method]

When using the product in any of the locations specified below, provide a sufficient shield.

- Location subject to electrostatic noise
- Location where high electrical or magnetic field is present
- Location with the mains or power lines passing nearby

[2] Storage and Preservation Environment

- Storage and preservation environment follows the installation environment. Especially, when the product is to be left for a long time, pay special attention to condensed water.
Unless specially specified, moisture absorbency protection is not included in the package when the machine is delivered. In the case that the machine is to be stored in an environment where dew condensation is anticipated, take the condensation preventive measures from outside of the entire package, or directly after opening the package.

1.8 Noise Elimination and Mounting Method

(1) Noise Elimination Grounding (Frame Ground)

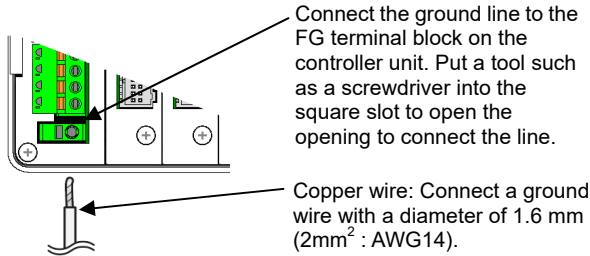

Earth Terminal
Grounding resistance at 100Ω or less
(Formerly Class-III grounding)

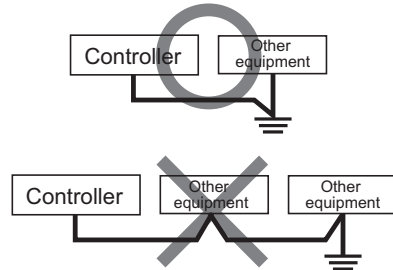

Do not share the ground wire with or connect to other equipment. Ground each controller.

(2) Precautions regarding wiring method

- 1) Wire is to be twisted for the power supply.
- 2) Separate the signal and encoder lines from the power supply and power lines.

(3) Noise Sources and Elimination

Carry out noise elimination measures for electrical devices on the same power path and in the same equipment. The following are examples of measures to eliminate noise sources.

- 1) AC solenoid valves, magnet switches and relays
[Measure] Install a Surge absorber parallel with the coil.
- 2) DC solenoid valves, magnet switches and relays
[Measure] Mount the windings and diodes in parallel.
Select a diode built-in type for the DC relay.

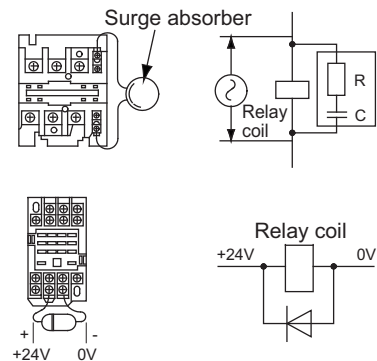

(4) Cooling Factors and Installation

Design and Build the system considering the size of the controller box, location of the controller and cooling factors to keep the ambient temperature around the controller below 40°C. Pay a special attention to the battery unit since the performance of it would drop both in the low and high temperatures. Keep it in a room temperature environment as much as possible. (Approximately 20°C is the recommended temperature.)

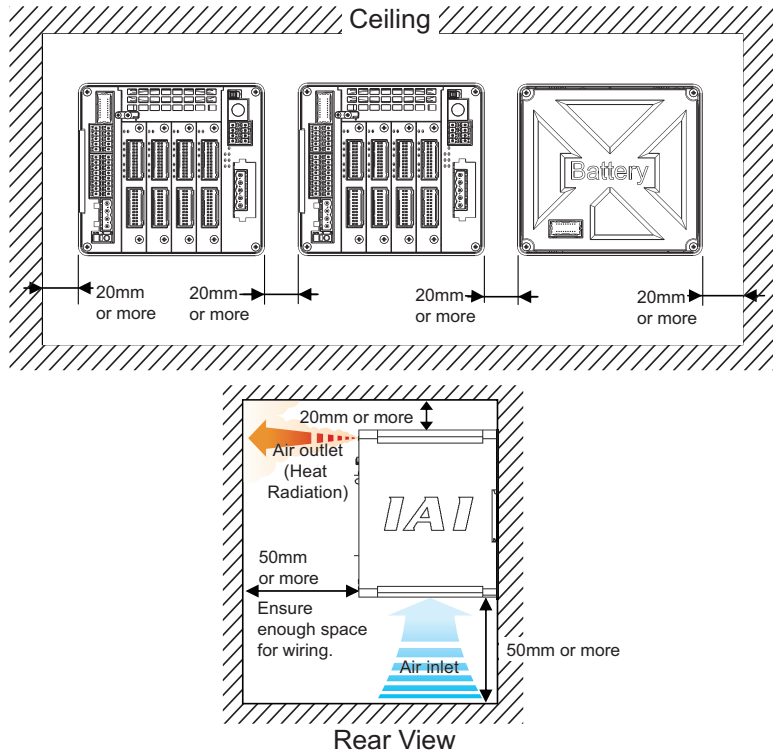

For the attachment of the unit, use the fixture holes on the four corners or attach on the DIN rail. (Attachment should be the same for the absolute battery box.)

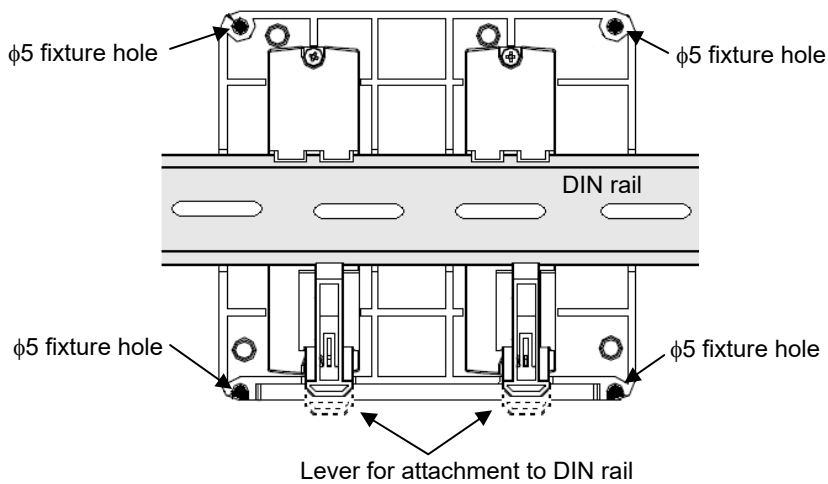

Chapter 2 Wiring

2.1 Wiring Diagram (Connection of construction devices)

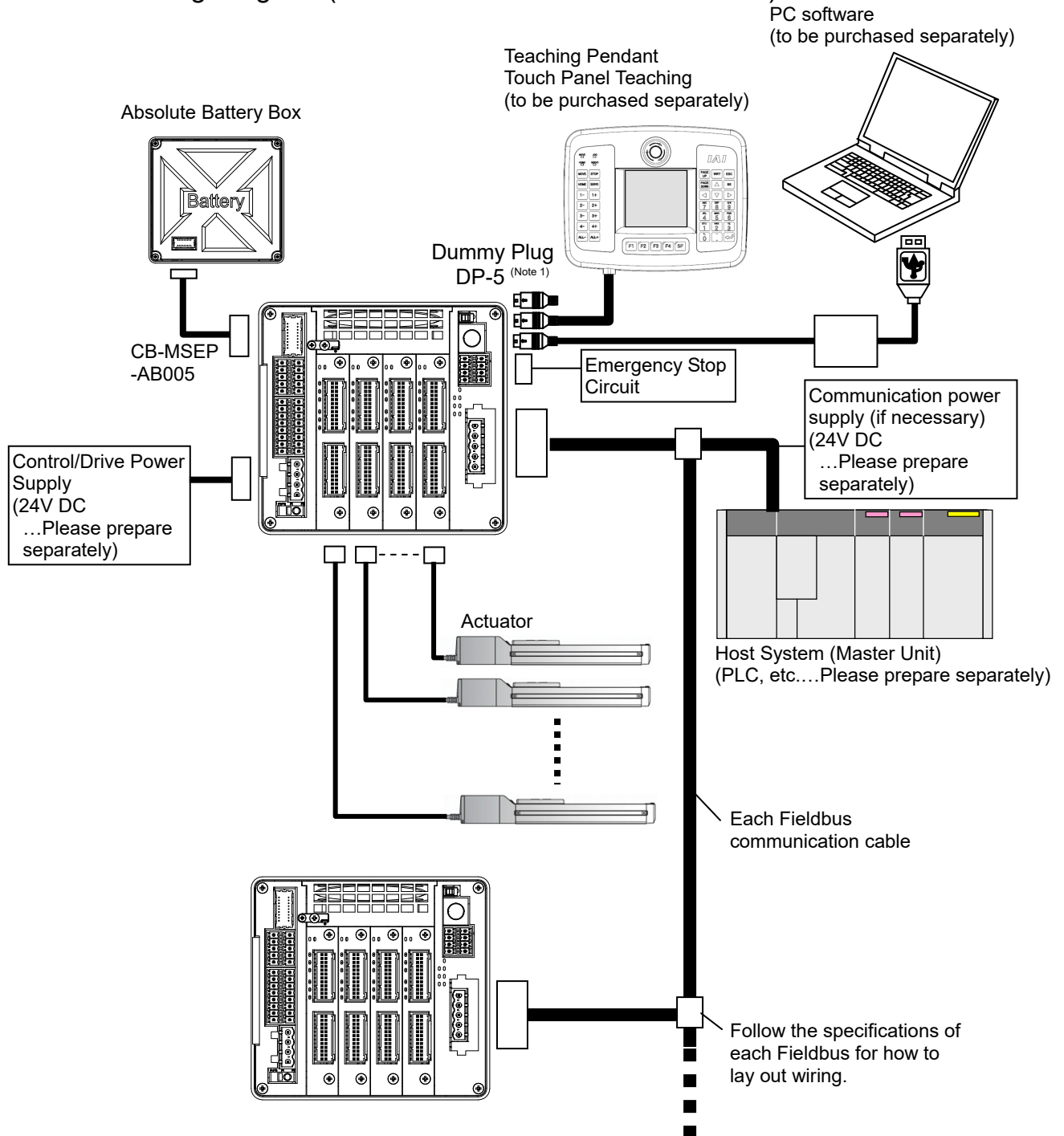

Caution: Make sure to turn the power to the controller OFF when inserting or removing the connector that connects the PC software or teaching pendant to the controller. Inserting or removing the connector while the power is turned ON causes a controller failure.

Note 1 For MCON-CG, in case a teaching tool is not connected to SIO connector, have the enclosed dummy plug plugged (DP-5) in the connector.

2.2 Circuit Diagram

Sample circuit diagrams are shown below.

[1] Power Supply and Emergency Stop

The diagram shown below is an example of a circuit for when reflecting the emergency stop switch on a teaching pendant to the emergency stop circuit of the system.

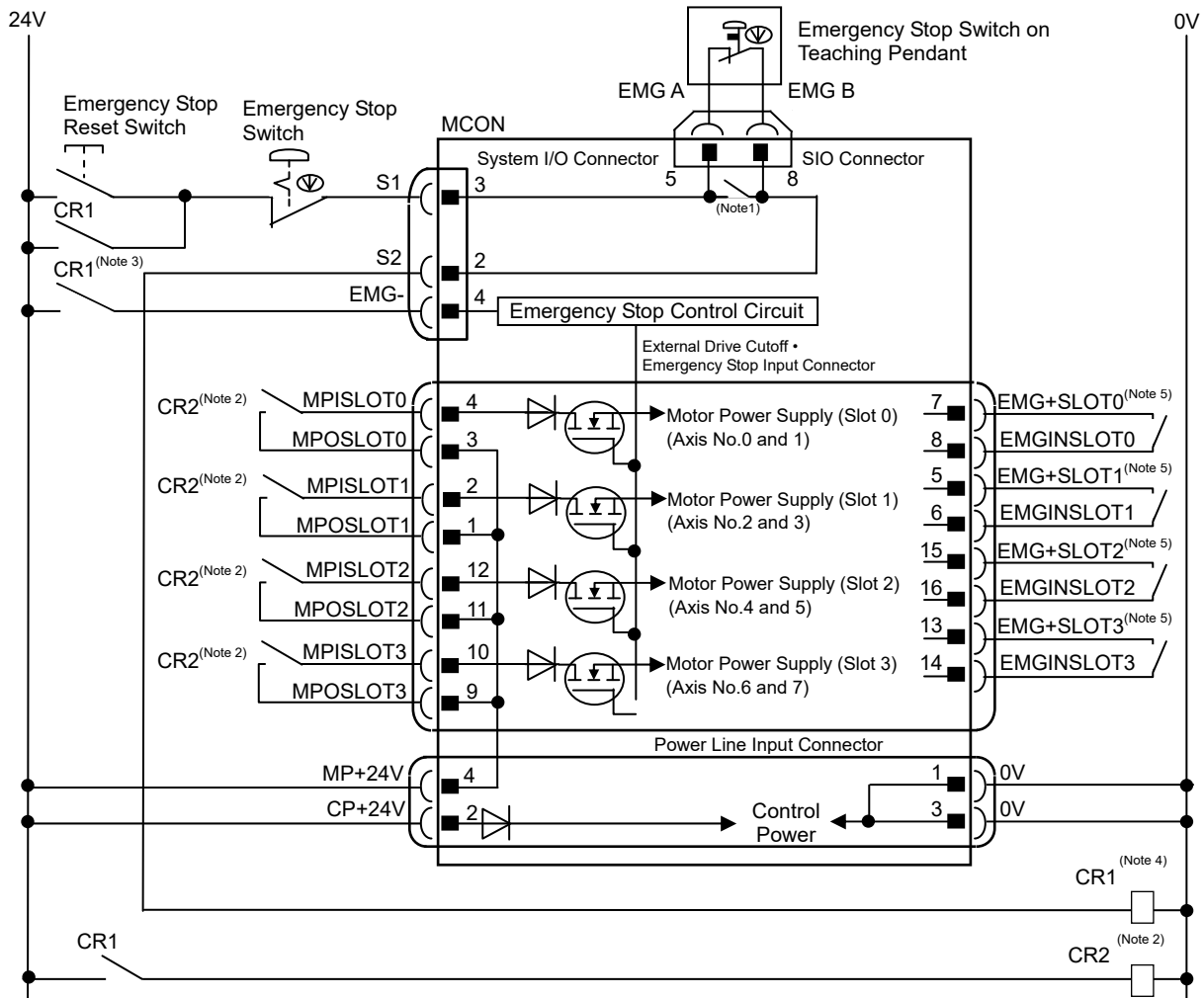

Note 1 MCON-C : When there is nothing plugged in the SIO connector, S1 and S2 are short-circuited inside the controller.

MCON-CG : When there is nothing plugged in the SIO connector, S1 and S2 are not short-circuited. To make them short-circuited, have the enclosed dummy plug DP-5 plugged in the SIO connector. [Refer to 2.3.7]

Note 2 When the motor power must be disconnected externally for safety category compliance, apply a safety rated relay between MPISLOT* and MPOSLOT*. Choose one that is capable to open and close with the motor current consumption of the connected actuator [Refer to 1.2 List of Basic Specifications].

Note 3 The rating for the emergency stop signal (EMG-) to turn ON/OFF at contact CR1 is 24V DC and 10mA.

Note 4 For CR1, select the one with coil current 0.1A or less.

Note 5 By cutting out the connection between EMG+SLOT* and EMGINSLOT*, only the disconnected slot number can be made in the condition of an emergency stop. (*: Slot Number)



Caution: When supplying the power by turning ON/OFF the 24V DC, keep the 0V being connected and have the +24V supplied/disconnected (cut one side only).

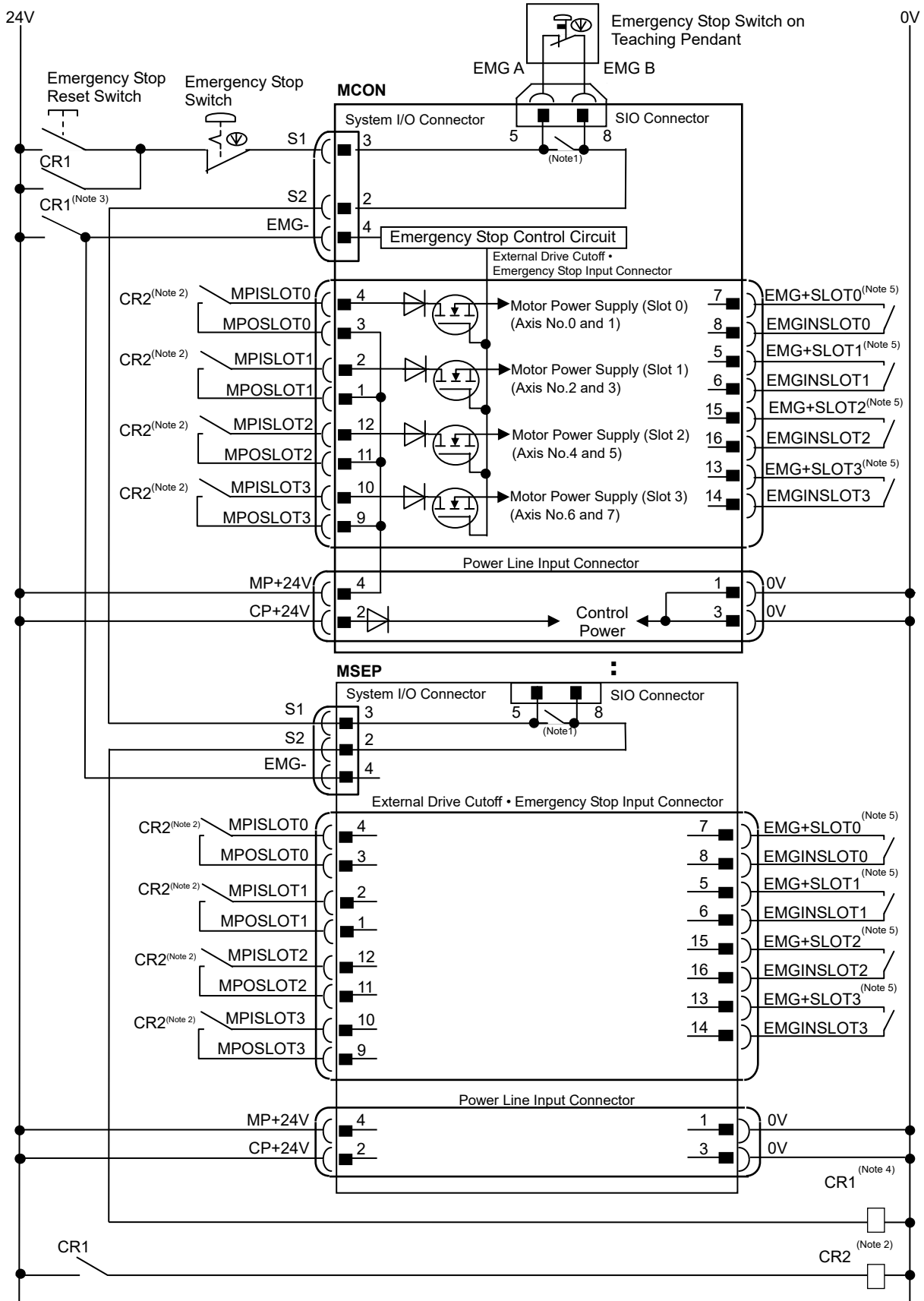

Note Check the previous page for Notes 1 to 5.

[2] Motor • Encoder Circuit

⚠ Caution: There is an axis number (AX0 to AX7) shown on the actuator cables. Refer to the figure below to plug the actuators correctly. Wrong connection will issue an error such as the encoder wire breakage. Check in the instruction manual of each actuator for the details (connection layout diagram) of each cable.

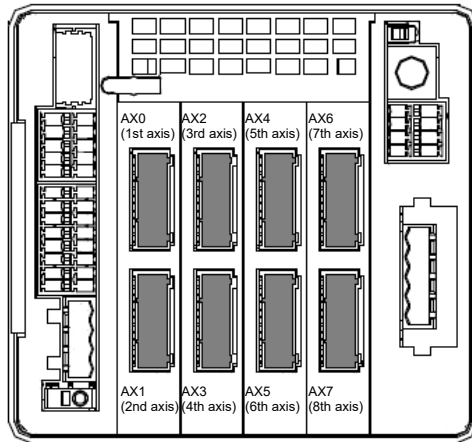

1) Connection to RCP2 Series

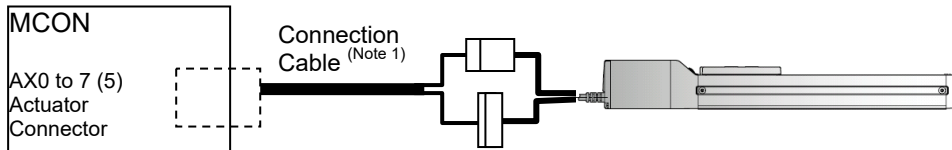

2) Connection to RCP6, RCP5, RCP4, RCP3, RCA2, RCD and RCL Series

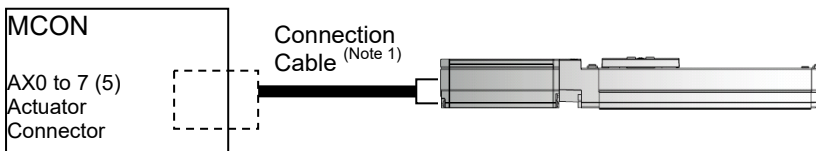

3) Connection to RCP2 Small Rotary Series

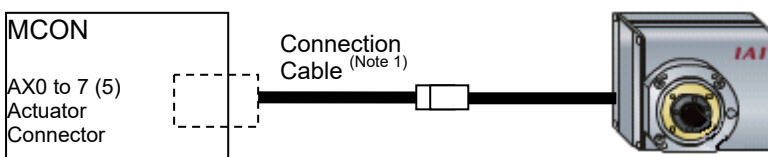

4) Connection to RCA Series

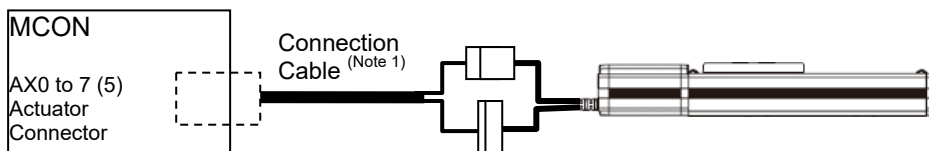

Note 1 Applicable Connection Cable Model Codes □□□: Cable length Example) 030 = 3m

Model	Cable Model	Remarks
RCP2 (Other than Rotary small type)	CB-PSEP-MPA□□□	Robot cable from 0.5 to 20m
RCP2 Rotary small type (RTBS/RTCS/RTBSL/RTCSL)	CB-RPSEP-MPA□□□	Robot cable from 0.5 to 20m
RCA	CB-ASEP2-MPA□□□	Robot cable from 0.5 to 20m
RCP3, RCA2, RCL	CB-APSEP-MPA□□□	Robot cable from 0.5 to 20m
	CB-APSEP-MPA□□□-LC	Standard cable from 0.5 to 20m
RCP4 (Other than SA3/RA3), RCD-RA1DA(-D3) ^(Note 2)	CB-CA-MPA□□□-RB	Robot cable from 0.5 to 20m ^(Note 3)
	CB-CA-MPA□□□	Standard cable from 0.5 to 20m ^(Note 3)
RCP6, RCP5, RCP4(SA3/RA3), RCD-RA1DA(-D5) ^(Note 2) , GRSNA Gripper/Rotary of RCP2CR, RCP2W	CB-CAN-MPA□□□-RB	Robot cable from 0.5 to 20m ^(Note 3)
	CB-CAN-MPA□□□	Standard cable from 0.5 to 20m ^(Note 3)

Note 2 -D3/-D5 in brackets () for RCD show the symbols for the applicable controllers.

Note 3 The maximum cable length for RCD is 10m for both the standard cable and robot cable.

[3] Connection to Absolute Battery Unit (for Simple Absolute Type Only)

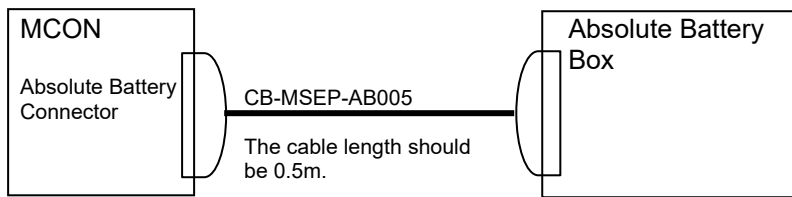

(Note) Do not apply force not being perpendicular to the connector when insert or detach the cable.

[4] Layout for Mode Switchover Circuit

When a switchover of the operation modes (AUTO/MANU) is required with an external input, connect a device such as a switch between AUTO/MANU + terminal and AUTO/MANU – terminal.

If not switching externally, apply a jumper on AUTO/MANU + terminal and AUTO/MANU – terminal.

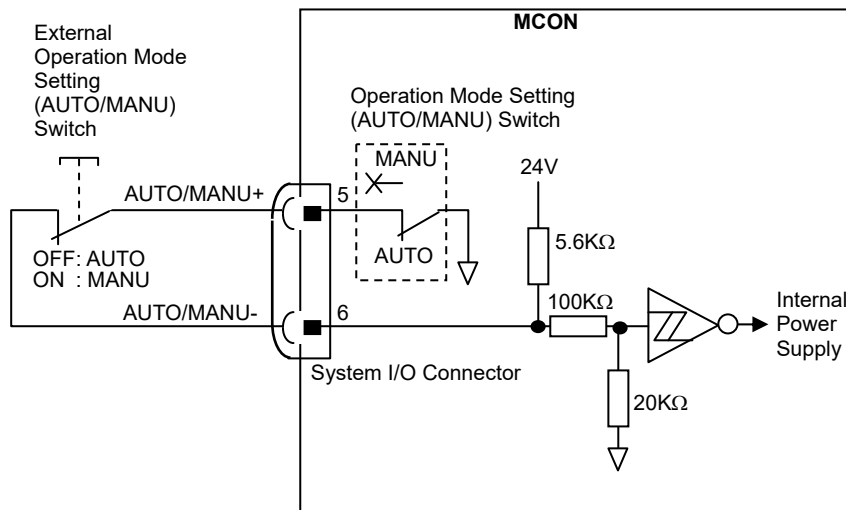

[5] Layout for External Brake Input Circuit

Lay out the circuit when an external compulsory brake release with using an actuator equipped with a brake is desired. It is not necessary if an external release is not required. It is possible to release the brake as long as the control power is supplied to MCON even without the main power being supplied to the controller.

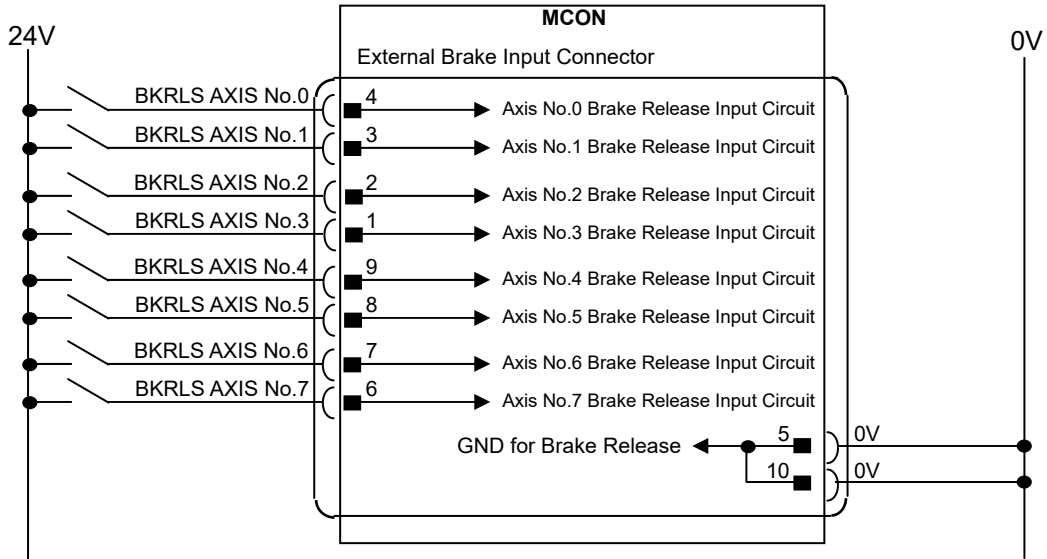

[6] Layout of Regenerative Resistor (Option)

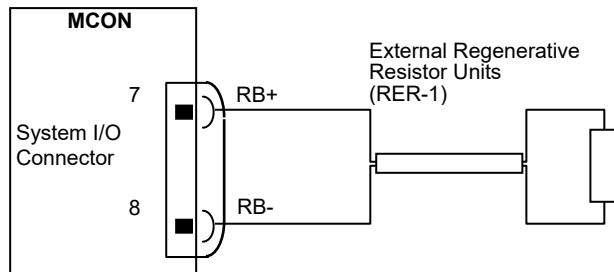

Condition to Require Regenerative Units

Number of Connected Actuator	3 to 8 units of high acceleration/deceleration type actuators
Number of Regenerative Resistor Unit	1

Caution: The regenerative resistor consumes regenerative current and converts it to heat. Therefore, the temperature may get high in some operational conditions. Attach on the metal part of the device with a screw the heat.

[7] Wiring Layout for Fieldbus

Follow the instruction manual of the master unit for each Fieldbus and the constructing PLC for the details of how to connect the cables.

1) DeviceNet Type

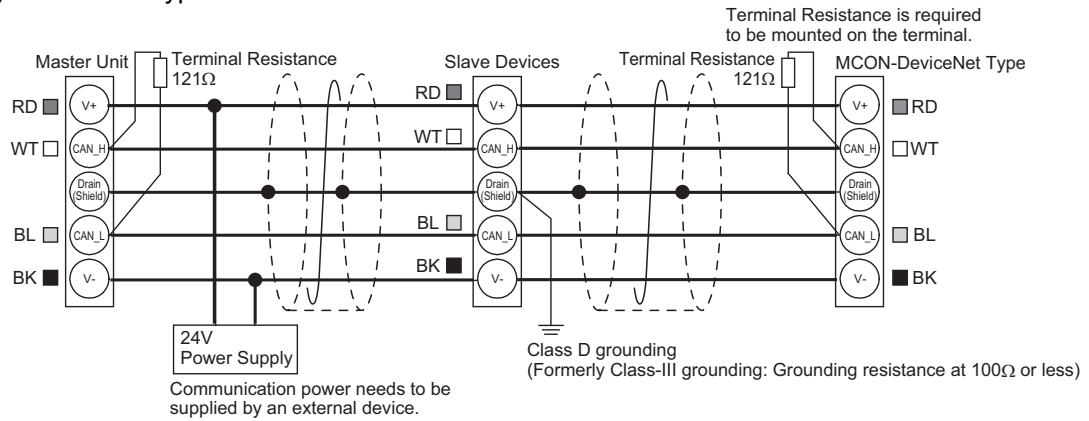

2) CC-Link Type

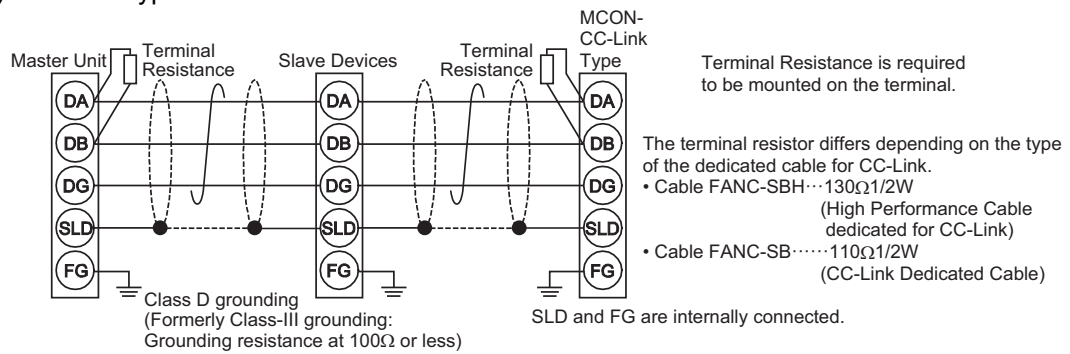

3) PROFIBUS-DP Type

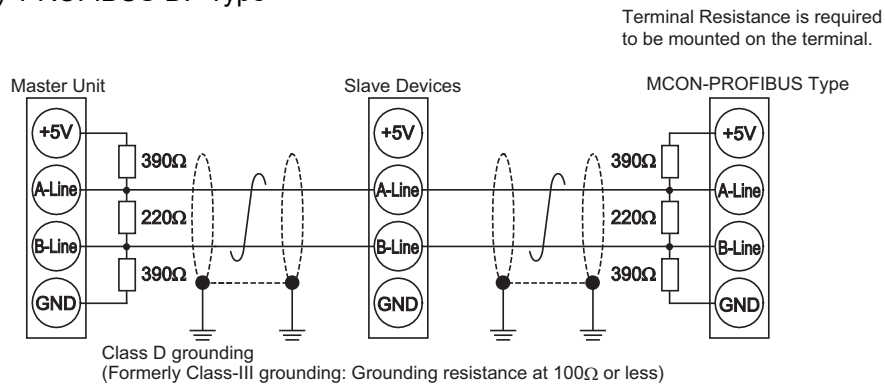

4) CompoNet Type

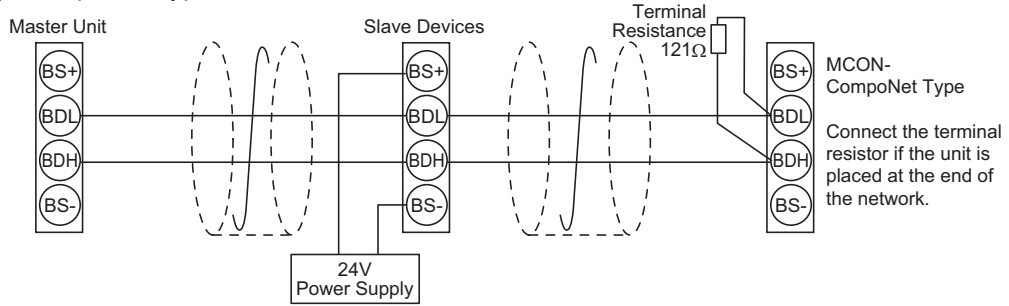

Supply power separately to the slave devices that requires the communication power supply. It is not necessary to supply communication power to MCON Unit, however, there is no problem even if communication power is supplied.

5) EtherNet/IP Type

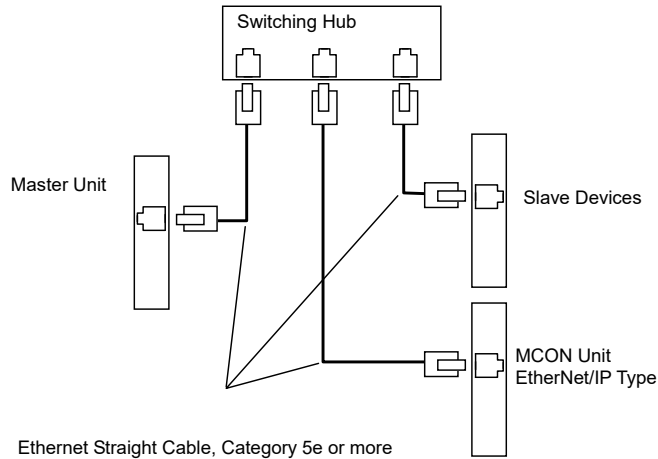

Ethernet Straight Cable, Category 5e or more
Double shielded cable braided with aluminum foil recommended

6) EtherCAT Type

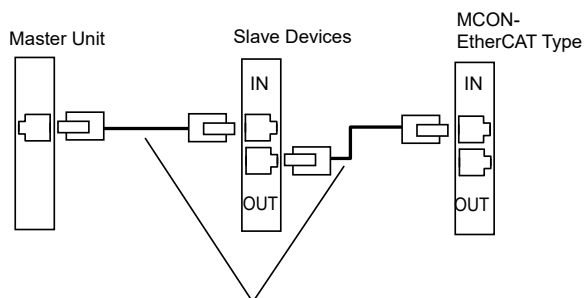

Ethernet Straight Cable
 Category 5e or more
 Double shielded cable braided with aluminum foil
 recommended
 (Note) Terminal resistance is not required

7) PROFINET-IO Type

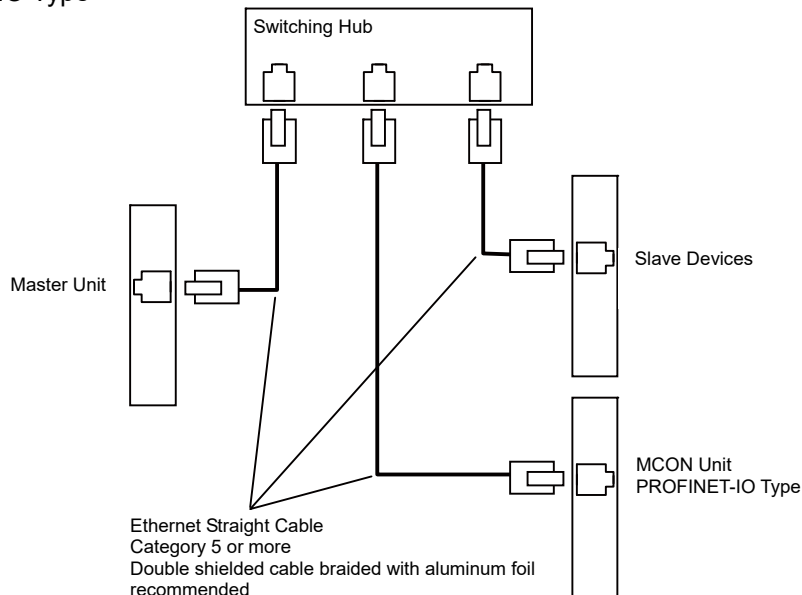

Ethernet Straight Cable
 Category 5 or more
 Double shielded cable braided with aluminum foil
 recommended

8) SSCNET III/H Type

Refer to wiring of SSCNET III/H, SSCNET III/H Applicable Controller Instruction Manual (ME0352).

9) MEHCATROLINK-III Type

Refer to wiring of MEHCATROLINK-III, MEHCATROLINK-III Applicable Controller Instruction Manual (ME0317).

2.3 Wiring Method

2.3.1 Connection to Power Input Connector

The wire of the power supply is to be connected to the enclosed connector (plug). Strip the sheath of the applicable wires for 10mm and insert them to the connector. Push a protrusion beside the cable inlet with a small slotted screwdriver to open the inlet. Once the cable is inserted, take the slotted screwdriver OFF the protrusion to fix the cable to the terminal.

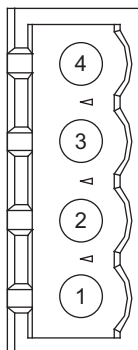
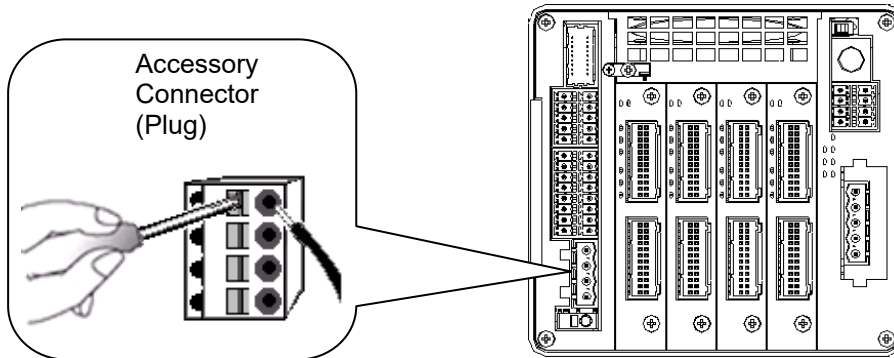

Front view of connector on controller side

Connector Name	Power Line Input Connector		
Cable Side	FKC2.5HC/4-ST-5.08	Enclosed in standard package Manufactured by PHOENIX CONTACT	
Controller Side	MSTBA2.5HC/4-G-5.08		
Pin No.	Signal Name	Description	Applicable cable diameter
1	0V	Power Input for Control (24V DC \pm 10%)	KIV0.5 to 0.3mm ² (AWG20 to 22)
2	CP+24V	Power Input for Motor Drive (24V DC \pm 10%)	KIV3.5 to 0.5mm ² (AWG12 to 20) Select the cable thickness allowable for the current figured out in "1.3 Calculation for Power Capacity" (*). * It is no problem to calculate the current consumption using the rated value.
3	0V		
4	MP+24V		

(Note) If supplying power with using a 24V DC, having it turned ON/OFF, keep the 0V connected and have the +24V supplied/cut (cut one side only).

2.3.2 Wiring Layout of System I/O Connector

The connector consists of the emergency stop input for the whole controller, changeover of the operation modes (AUTO/MANU) externally and the external regenerative resistor connection terminals.

Insert the wires to the enclosed connector (plug). Strip the sheath of the applicable wires for 10mm and insert them to the connector. Push a protrusion beside the cable inlet with a small slotted screwdriver to open the inlet. Once the cable is inserted, take the slotted screwdriver OFF the protrusion to fix the cable to the terminal.

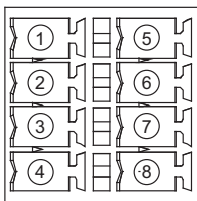

Front view of connector on controller side

Connector Name	System I/O Connector	
Cable Side	FMCD1.5/4-ST-3.5	Enclosed in standard package Manufactured by PHOENIX CONTACT
Controller Side	MCDN1.5/4-G1-3.5P26THR	

Pin No.	Signal Name	Description	Applicable cable diameter
1	EMG+24V	+24V power output for emergency stop	KIV0.5 to 0.2mm ² (AWG20 to 24)
2	S2	For external emergency stop signal input	
3	S1	For external emergency stop signal output	
4	EMG-	Emergency Stop Input (available for all the slots)	
5	AUTO/MANU+	For operation mode (AUTO/MANU) switchover	
6	AUTO/MANU-	Operation mode (AUTO/MANU) switchover signal input	
7	RB+	Regenerative resistor connection +	Dedicated regenerative resistor connection
8	RB-	Regenerative resistor connection -	

2.3.3 Connection of Drive Cutoff/Emergency Stop Input Connector

Insert wires if an emergency stop input is desired individually for each slot or drive cutoff for each slot. Unless it is desired, the controller can be used in the condition that the enclosed short-circuit line is connected.

Insert the wires to the enclosed connector (plug). Strip the sheath of the applicable wires for 10mm and insert them to the connector. Push a protrusion beside the cable inlet with a small slotted screwdriver to open the inlet. Once the cable is inserted, take the slotted screwdriver OFF the protrusion to fix the cable to the terminal.

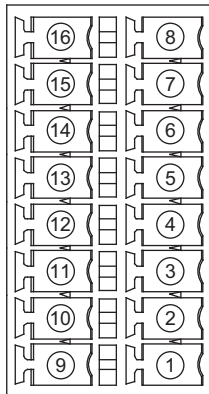

Front view of connector on controller side

Connector Name	Drive Cutoff/Emergency Stop Input Connector	
Cable Side	FMCD1.5/8-ST-3.5	Enclosed in standard package Manufactured by PHOENIX CONTACT
Controller Side	MCDN1.5/8-G1-3.5P26THR	

Pin No.	Signal Name	Description	Applicable cable diameter
1	MPOSLOT1	For motor power output slot 1 (Axis No. 2 and 3)	KIV1.25 to 0.5mm ² (AWG16 to 20) Select the cable thickness allowable for the current figured out in the power capacity.
2	MPISLOT1	For motor power input slot 1 (Axis No. 2 and 3)	
3	MPOSLOT0	For motor power output slot 0 (Axis No. 0 and 1)	
4	MPISLOT0	For motor power input slot 0 (Axis No. 0 and 1)	
5	EMG+24VSLOT1	For emergency stop power output slot 1 (Axis No. 2 and 3)	KIV0.5 to 0.2mm ² (AWG20 to 24)
6	EMGINSLOT1	For emergency stop power input slot 1 (Axis No. 2 and 3)	
7	EMG+24VSLOT0	For emergency stop power output slot 0 (Axis No. 0 and 1)	
8	EMGINSLOT0	For emergency stop power input slot 0 (Axis No. 0 and 1)	
9	MPOSLOT3	For motor power output slot 3 (Axis No. 6 and 7)	KIV1.25 to 0.5mm ² (AWG16 to 20) Select the cable thickness allowable for the current figured out in the power capacity.
10	MPISLOT3	For motor power input slot 3 (Axis No. 6 and 7)	
11	MPOSLOT2	For motor power output slot 2 (Axis No. 4 and 5)	
12	MPISLOT2	For motor power input slot 2 (Axis No. 4 and 5)	
13	EMG+24VSLOT3	For emergency stop power output slot 3 (Axis No. 6 and 7)	KIV0.5 to 0.2mm ² (AWG20 to 24)
14	EMGINSLOT3	For emergency stop power input slot 3 (Axis No. 6 and 7)	
15	EMG+24VSLOT2	For emergency stop power output slot 2 (Axis No. 4 and 5)	
16	EMGINSLOT2	For emergency stop power input slot 2 (Axis No. 4 and 5)	

2.3.4 Connecting with Actuator

Connect the relay cables to the actuator connectors.
Check in the instruction manual of each actuator for the details of the relay cables.

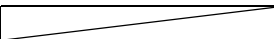
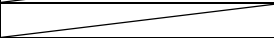
Connector Name	Actuator Connector	
Cable Side	PADP-24V-1-S	
Controller Side	S24B-PADSS-1	

(1) Pulse Motor Type

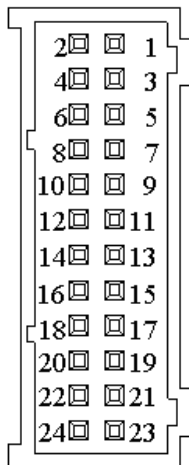

Front view of connector on controller side

Pin No.	Signal Name	Description	Applicable cable diameter
1	ϕ A	Motor Driving A-phase	Cable dedicated for IAI products
2	VMM	Motor Power	
3	ϕ B	Motor Driving B-phase	
4	VMM	Motor Power	
5	ϕ /A	Motor Driving /A-phase	
6	ϕ /B	Motor Driving /B-phase	
7	LS+	Limit Switch Positive Side	
8	LS-	Limit Switch Negative Side	
9	BK+	Brake Release Positive Side	
10	BK-	Brake Release Negative Side	
11	NC	Not to be used	
12	NC	Not to be used	
13	A+	Encoder A-phase differential + input	
14	A-	Encoder A-phase differential - input	
15	B+	Encoder B-phase differential + input	
16	B-	Encoder B-phase differential - input	
17	5V	Encoder Power Supply	
18	/PS	Encoder Line Driver Enable Output	
19	GND	Ground	
20	LSGND	Ground for Limit Switch	
21	NC	Disconnected	
22	NC	Disconnected	
23	NC	Disconnected	
24	FG	Grounding	

(2) Servo Motor Type

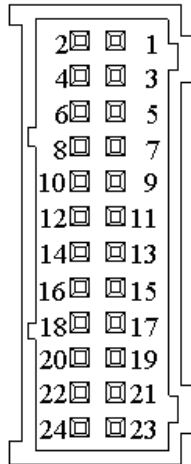

Front view of connector on controller side

Pin No.	Signal Name	Description	Applicable cable diameter
1	U	Motor Driving U-phase	Cable dedicated for IAI products
2	V	Motor Driving V-phase	
3	NC	Disconnected	
4	NC	Disconnected	
5	W	Motor Driving W-phase	
6	NC	Disconnected	
7	BK+	Brake Release Positive Side	
8	BK-	Brake Release Negative Side	
9	LS+	Limit Switch Positive Side	
10	LS-	Limit Switch Negative Side	
11	A+	Encoder A-phase differential + input	
12	A-	Encoder A-phase differential - input	
13	B+	Encoder B-phase differential + input	
14	B-	Encoder B-phase differential - input	
15	Z+	Encoder Z-phase differential + input	
16	Z-	Encoder Z-phase differential - input	
17	5V	Encoder Power Supply	
18	/PS	Encoder Line Driver Enable Output	
19	GND	Ground	
20	LSGND	Ground for Limit Switch	
21	NC	Disconnected	
22	NC	Disconnected	
23	NC	Disconnected	
24	FG	Grounding	

(3) Brushless DC Motor Type

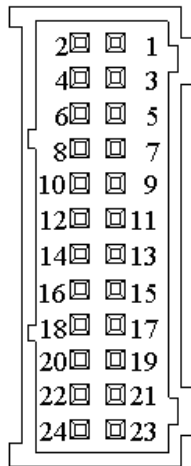

Front view of connector on controller side

Pin No.	Signal Name	Description	Applicable cable diameter
1	U	Motor Driving U-phase	Cable dedicated for IAI products
2	V	Motor Driving V-phase	
3	NC	Disconnected	
4	NC	Disconnected	
5	W	Motor Driving W-phase	
6	NC	Disconnected	
7	NC	Disconnected	
8	NC	Disconnected	
9	NC	Disconnected	
10	NC	Disconnected	
11	A+	Encoder A-phase differential + input	
12	A-	Encoder A-phase differential - input	
13	B+	Encoder B-phase differential + input	
14	B-	Encoder B-phase differential - input	
15	HS1	Hall IC Input 1	
16	HS2	Hall IC Input 2	
17	5V	Encoder Power Supply	
18	NC	Disconnected	
19	GND	Ground	
20	HS3	Hall IC Input 3	
21	NC	Disconnected	
22	NC	Disconnected	
23	NC	Disconnected	
24	FG	Grounding	

2.3.5 Connection of Absolute Battery Connector

Connect the absolute battery unit to the controller for Simple Absolute Type.

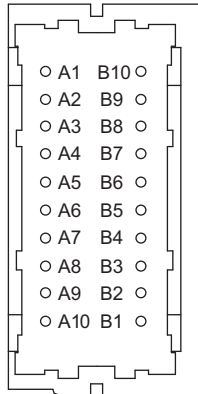

Front view of connector on controller side

Connector Name	Absolute Battery Connector	
Cable Side	CZHR-20V-S	
Controller Side	S20B-CZWHS-B-1	

Pin No.	Signal Name	Description	Applicable cable diameter
A1	GND	0V	Cable dedicated for IAI products
A2	BATTMP AXIS No.0	Axis No.0 Absolute Battery Temperature Sensor	
A3	BATTMP AXIS No.1	Axis No.1 Absolute Battery Temperature Sensor	
A4	BATTMP AXIS No.2	Axis No.2 Absolute Battery Temperature Sensor	
A5	BATTMP AXIS No.3	Axis No.3 Absolute Battery Temperature Sensor	
A6	GND	0V	
A7	BATTMP AXIS No.4	Axis No.4 Absolute Battery Temperature Sensor	
A8	BATTMP AXIS No.5	Axis No.5 Absolute Battery Temperature Sensor	
A9	BATTMP AXIS No.6	Axis No.6 Absolute Battery Temperature Sensor	
A10	BATTMP AXIS No.7	Axis No.7 Absolute Battery Temperature Sensor	
B10	GND	0V	
B9	BAT AXIS No.0	Axis No.0 Absolute Battery	
B8	BAT AXIS No.1	Axis No.1 Absolute Battery	
B7	BAT AXIS No.2	Axis No.2 Absolute Battery	
B6	BAT AXIS No.3	Axis No.3 Absolute Battery	
B5	GND	0V	
B4	BAT AXIS No.4	Axis No.4 Absolute Battery	
B3	BAT AXIS No.5	Axis No.5 Absolute Battery	
B2	BAT AXIS No.6	Axis No.6 Absolute Battery	
B1	BAT AXIS No.7	Axis No.7 Absolute Battery	

2.3.6 Connection of External Brake Connector

Connection needs to be established when an external brake release is required for the actuator. The brake can be released if the power (24V DC 150mA/axis) is supplied to this connector even without the main power supplied to the controller.

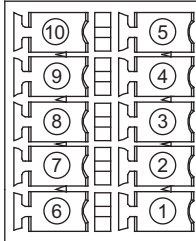

Front view of connector on controller side

Connector Name	External Brake Connector	
Cable Side	FMCD1.5/5-ST-3.5	Enclosed in standard package Manufactured by PHOENIX CONTACT
Controller Side	MCDN1.5/5-G1-3.5P26THR	

Pin No.	Signal Name	Description	Applicable cable diameter
1	BKRLS AXIS No.3	Axis No.3 Brake Release Input	KIV0.5 to 0.2mm ² (AWG20 to 24)
2	BKRLS AXIS No.2	Axis No.2 Brake Release Input	
3	BKRLS AXIS No.1	Axis No.1 Brake Release Input	
4	BKRLS AXIS No.0	Axis No.0 Brake Release Input	
5	GND	0V	
6	BKRLS AXIS No.7	Axis No.7 Brake Release Input	
7	BKRLS AXIS No.6	Axis No.6 Brake Release Input	
8	BKRLS AXIS No.5	Axis No.5 Brake Release Input	
9	BKRLS AXIS No.4	Axis No.4 Brake Release Input	
10	GND	0V	

2.3.7 Connection of SIO Connector

Connect an teaching tool such as the PC software.

(Note) Do not attempt connect the device to the same SIO network as the SEP related controllers such as PSEP.

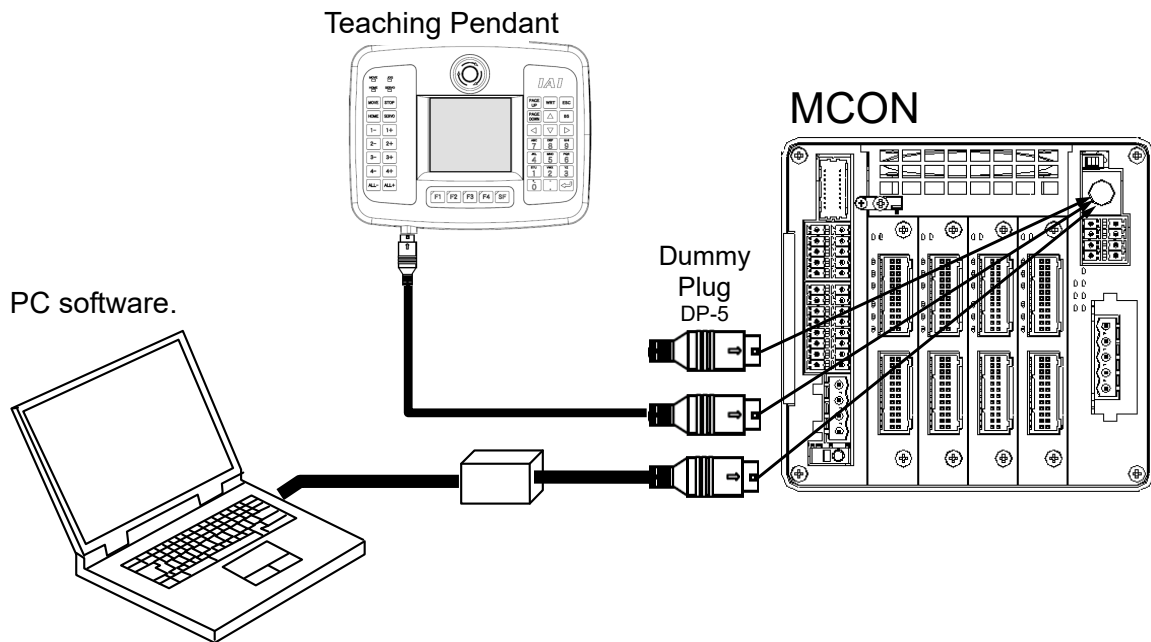

Connector Name	SIO Connector	
Cable Side	miniDIN 8-pin	
Controller Side	TCS7587-0121077	

Pin No.	Signal Name	Description	Applicable cable diameter
1	SGA	Teaching Tool Signal +	Cable dedicated for IAI products
2	SGB	Teaching Tool Signal -	
3	5V	Power supply for teaching tool	
4	ENB	Enable signal input	
5	EMGA	Emergency Stop Signal A	
6	24V	Power supply for teaching tool	
7	0V	0V	
8	EMGB	Emergency Stop Signal B	
Shell	0V	0V	

⚠ Caution: For MCON-CG, it is not available to operate the machine with nothing plugged in the SIO connector.
In such a case, plug in the dummy plug DP-5.

2.3.8 Wiring Layout of Fieldbus Connector

Check the instruction manuals for each Fieldbus master unit and mounted PLC for the details.

1) DeviceNet Type

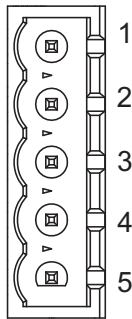
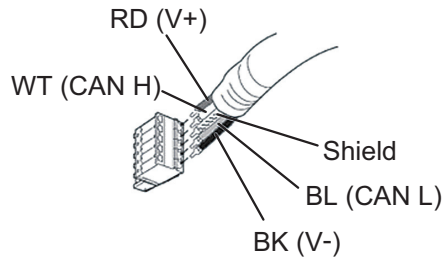

Front view of connector on controller side

Connector Name	DeviceNet Connector	
Cable Side	MSTB2.5/5-STF-5.08 AU M	Enclosed in standard package Manufactured by PHOENIX CONTACT
Controller Side	MSTB2.5/5-GF-5.08 AU	

Pin No.	Signal Name (Color)	Description	Applicable cable diameter
1	V- (BK)	Power Supply Cable Negative Side	Dedicated cable for DeviceNet
2	CAN L (BL)	Communication Data Low Side	
3	Shield (None)	Shield	
4	CAN H (WT)	Communication Data High Side	
5	V+ (RD)	Power Supply Cable Positive Side	

(Note) Connect a terminal resistor (121Ω) between CAN L and CAN H if the unit comes to the end of the network. [Refer to 2.2 [7] Wiring Layout for Fieldbus.]

2) CC-Link Type

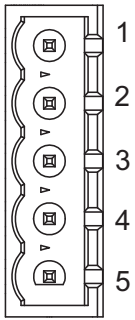
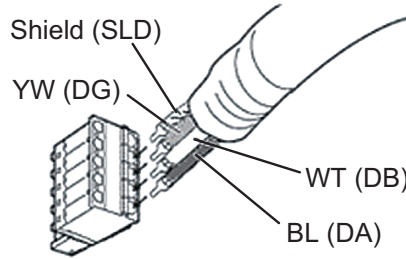

Front view of connector on controller side

Connector Name	CC-Link Connector	
Cable Side	MSTB2.5/5-STF-5.08 AU	Enclosed in standard package Manufactured by PHOENIX CONTACT
Controller Side	MSTB2.5/5-GF-5.08 AU	

Pin No.	Signal Name (Color)	Description	Applicable cable diameter
1	DA (BL)	Communication Line A	Dedicated cable for CC-Link
2	DB (WT)	Communication Line B	
3	DG (YW)	Digital GND	
4	SLD	Connect the shield of the shielded cable (Connect the FG of the 5 pins and controller FG internally)	
5	FG	Frame Ground (Connect the SLD of the 4 pins and controller FG internally)	

(Note) Connect a terminal resistor between DA and DB if the unit comes to the end of the network. [Refer to 2.2 [7] Wiring Layout for Fieldbus.]

3) PROFIBUS-DP Type

Use the type A cable for PROFIBUS-DP (EN5017).

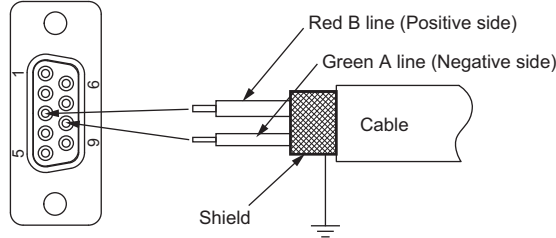

Connector Name	PROFIBUS-DP Connector	
Cable Side	9-pin D-sub Connector (Male)	Please prepare separately
Controller Side	9-pin D-sub Connector (Female)	

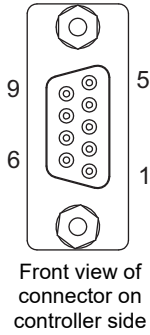

Pin No.	Signal Name	Description	Applicable cable diameter
1	NC	Disconnected	PROFIBUS-DP Dedicated Cable
2	NC	Disconnected	
3	B-Line	Communication Line B (RS485)	
4	RTS	Request for Sending	
5	GND	Signal GND (Insulation)	
6	+5V	+5V Output (Insulation)	
7	NC	Disconnected	
8	A-Line	Communication Line A (RS485)	
9	NC	Disconnected	

(Note) Connect a terminal resistor between A-line and B-line if the unit comes to the end of the network. [Refer to 2.2 [7] Wiring Layout for Fieldbus.]

4) CompoNet Type

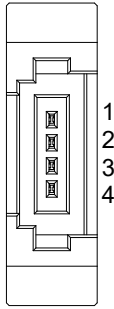
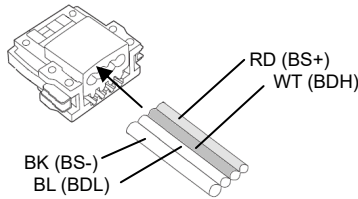

Front view of connector on controller side

Connector Name	CompoNet Connector	
Cable Side	Prepare a connector complied with CompoNet standards.	
Controller Side	XW7D-PB4-R	Produced by OMRON

Pin No.	Signal Name (Color)	Description	Applicable cable diameter
1	BS+ (RD)	Communication Power Supply + ^(Note 1)	CompoNet Dedicated Cable
2	BDH (WT)	Signal line H side	
3	BDL (BL)	Signal line L side	
4	BS- (BK)	Communication Power Supply - ^(Note 1)	

Note 1 It is not necessary to supply the communication power. (Internal power source is used.)

If conducting multi power supply to other slave devices via communication cables, there is no problem with connecting the power supply to BS+ and BS- terminals.

(Note) Connect a terminal resistor (121Ω) between BDH and BDL if the unit comes to the end of the network. [Refer to 2.2 [7] Wiring Layout for Fieldbus.]

5) EtherNet/IP Type

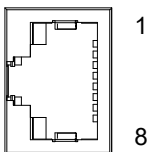
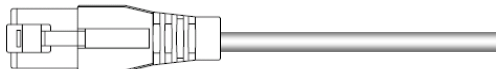

Front view of connector on controller side

Connector Name	EtherNet/IP Connector	
Cable Side	8P8C Modular Plug	Please prepare separately
Controller Side	8P8C Modular Jack	

Pin No.	Signal Name	Description	Applicable cable diameter
1	TD+	Data sending +	For Ethernet cable, use a straight STP cable that possesses the performance of Category 5e or more.
2	TD-	Data sending -	
3	RD+	Data receiving +	
4	-	Disconnected	
5	-	Disconnected	
6	RD-	Data receiving -	
7	-	Disconnected	
8	-	Disconnected	

6) EtherCAT Type

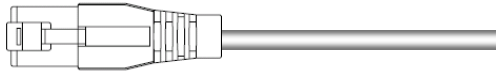

Connector Name	EtherCAT Connector	
Cable Side	8P8C Modular Plug	Please prepare separately
Controller Side	8P8C Modular Jack	

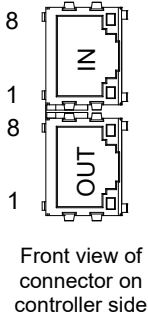

Front view of connector on controller side

Pin No.	Signal Name	Description	Applicable cable diameter
1	TD+	Data sending +	For EtherCAT cable, use a straight STP cable that possesses the performance of Category 5e or more.
2	TD-	Data sending -	
3	RD+	Data receiving +	
4	-	Disconnected	
5	-	Disconnected	
6	RD-	Data receiving -	
7	-	Disconnected	
8	-	Disconnected	

There are IN and OUT designated for the communication port. Be careful not to plug in the communication cable in the wrong way.

7) PROFINET-IO Type

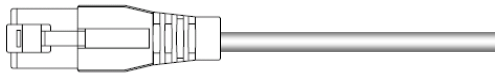

Connector Name	PROFINET Connector	
Cable Side	8P8C Modular Plug	Please prepare separately
Controller Side	8P8C Modular Jack	

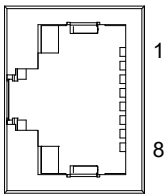

Front view of connector on controller side

Pin No.	Signal Name	Description	Applicable cable diameter
1	TD+	Data sending +	For Ethernet cable, use a straight STP cable that possesses the performance of Category 5 or more.
2	TD-	Data sending -	
3	RD+	Data receiving +	
4	-	Disconnected	
5	-	Disconnected	
6	RD-	Data receiving -	
7	-	Disconnected	
8	-	Disconnected	

8) SSCNET III/H Type

Refer to wiring of connector for SSCNET III/H, SSCNET III/H Applicable Controller Instruction Manual (ME0352).

9) MECHATROLINK-III Type

Refer to wiring of connector for MECHATROLINK-III, MECHATROLINK-III Applicable Controller Instruction Manual (ME0317).

Chapter 3 Operation

3.1 Basic Operation

3.1.1 Basic Operation Methods

This controller is to be controlled with fieldbus. Even though there are several types for an actuator, such as slider type, rod type, rotary type, gripper type, etc., the method to control the operation is the same unless otherwise specified in this manual.

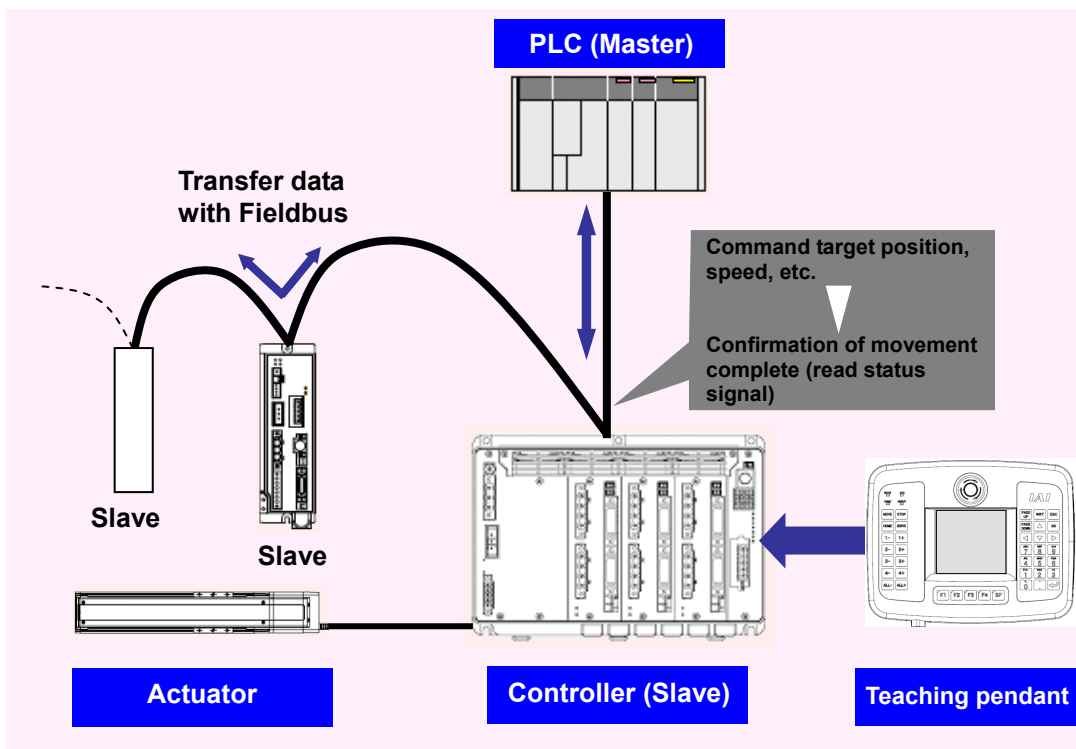

[1] Operation Mode Setting [Refer to Sections 3.2.1 and 3.9]
 Establish the settings for those such as the slave addresses in the Fieldbus using Gateway Parameter Setting Tool. Establish the settings of the operation mode for all the axes.

- 1) Establish the setting following the procedure described in Section 3.2.1
- 2) Set the gateway parameters to suit the system to be used.
 Establish such settings as the calendar function (clock setting) use or the speed unit change in Direct Indication Mode.



[2] Parameter Settings [Refer to Sections 3.2.2]
 Establish the parameter settings on all the connected axes by using a teaching tool such as the PC software.

- 1) When using an operation mode in those described in the next page except for Remote I/O Mode, set the Parameter No. 25 PIO Pattern to 6. When using Remote I/O Mode^(Note 1), establish the setting in Parameter No. 25 PIO Pattern considering the suitable operation pattern to be used.
 [Refer to 3.4.10 Control Signals in Remote I/O Mode.]
Note 1: It is necessary to set all the axes of MCON to Remote I/O Mode.
- 2) Set the zone (Parameters No.1 and 2) and soft limit (Parameter No.3 and 4) that suit to the system.
 [Refer to Chapter 8 Parameter]



[3] Setting of Position Data [Refer to Sections 3.3]
(Note) Setting of Direct Indication Mode is not necessary.
 Set the data for those to be used such as target position, speed, etc. to the position data.



[4] Fieldbus Settings [Refer to Sections 3.4.1 and 3.4.2]
 Assign MCON to PLC (master unit).
 [Refer to the instruction manuals for the master unit and PLC]



[5] Link to Network

- 1) Put the operation mode setting switch on the front panel of MCON to AUTO side and reboot the power. (By putting to AUTO, Fieldbus line activates.)
- 2) Once the link to PLC (master unit) is established^(Note 2), turn ON MON Signal of the gateway control signals^(Note 3). While MON Signal is ON, control from fieldbus is available.
Note 2: By referring to 3.10 Fieldbus status LEDs display, confirm that the communication is established in the normal condition.
Note 3: Refer to 3.4.3 Control Signals of Gateway.



[6] Operation Control in Each Operation Mode [Refer to Sections 3.4.4 to 3.4.10]

- 1) Send the information of the target position, speed, acceleration/deceleration, etc. from PLC (master unit) to the MCON.
- 2) The actuator follows the received information of the target position, speed, acceleration/deceleration, etc. to perform a positioning at the specific coordinates.
- 3) Confirm the status of positioning complete.

• Operation Mode Available

7 types of operation modes are available to select from. The settings are to be established with Gateway Parameter Setting Tool. Shown below are the outline.

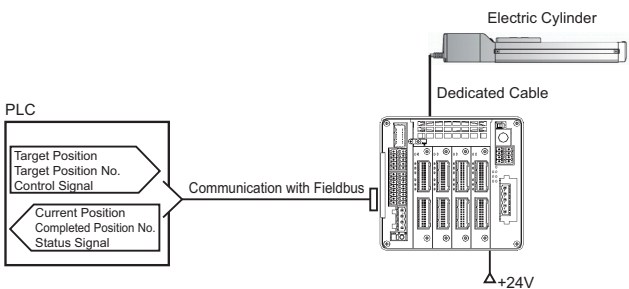
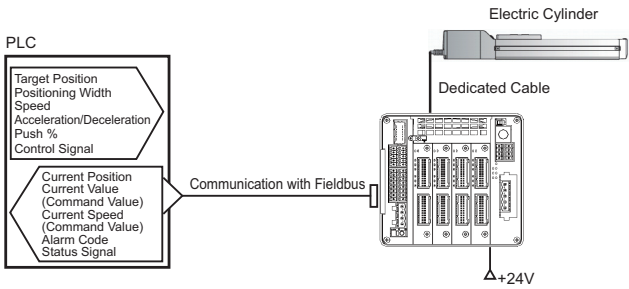
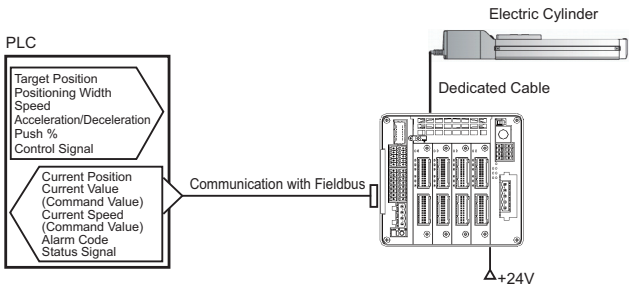
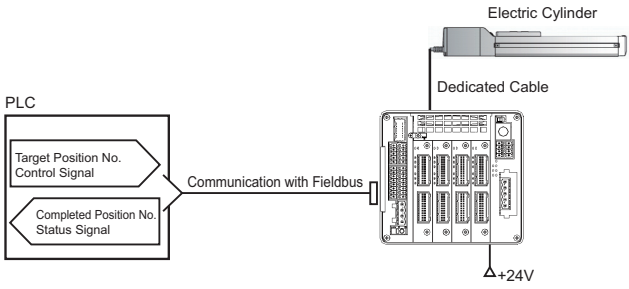
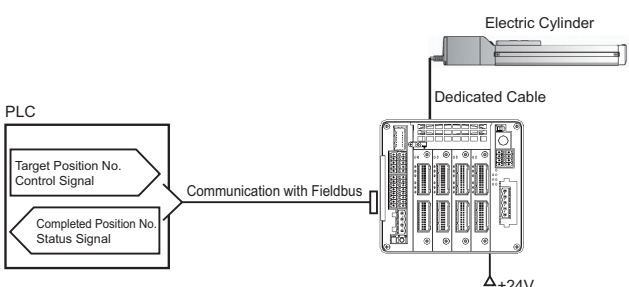
Operation Mode	Contents	Overview
Simple Direct Mode	<p>The target position can be indicated directly by inputting a value. Also, monitoring of the current position is available in 0.01mm unit.</p> <p>Those other than the target position are to be indicated in the position table, and the setting can be done for 256 points at maximum.</p>	
Positioner 1 Mode	<p>The 256 points of position data can be registered at the maximum and is able to stop at the registered positions. Also, monitoring of the current position is available in 0.01mm unit.</p>	
Direct Indication Mode	<p>The target position, speed acceleration/deceleration and pressing current limit can be indicated with inputting a number.</p> <p>As well as monitoring of the current position in 0.01mm unit, monitoring of current speed and command current is also available.</p>	
Positioner 2 Mode	<p>This is the operation mode of the position data of 256 points at maximum set in the position table. The monitoring of the current position is not available</p> <p>This mode is that the transferred data is reduced from Positioner 1 Mode.</p>	
Positioner 3 Mode	<p>This is the operation mode of the position data of 256 points at maximum set in the position table. The monitoring of the current position is not available</p> <p>This is the mode to control with the minimized number of signals to perform the positioning operation by reducing the amount of sent and received data from Positioner 2 Mode.</p>	

Operation Mode	Contents	Overview
Positioner 5 Mode	<p>This is the operation mode of the position data of 16 points at maximum set in the position table.</p> <p>It is a mode that enabled to monitor the current position in 0.1mm unit by reducing the volume and number of position table from Positioner 2 Mode.</p>	
Remote I/O Mode	<p>It is the operation mode to control with ON/OFF of bits like PIO (24V input and output). Five types ^(Note 1) of control are available.</p> <p><i>Note : It is to be switched with PIO patterns (driver board parameters)</i></p>	

Note 1: Five types of control (PIO Pattern) [Refer to the 3.4.10 Control Signal for Remote I/O Mode for details.]

PIO Pattern	Operation Mode	I/O Specification
0	Positioning mode	Position number specification 64 points Zone signal output 1 point Position zone signal output ^(Note 2) 1 point
1	Teaching mode	Positioning points 64 points Position zone signal output ^(Note 2) 1 point Jog operation is available The current position can be written to a specified position.
2	256-point mode	Positioning points 256 points Position zone signal output ^(Note 2) 1 point
4	Solenoid valve mode 1	Positioning points 7 points Zone signal output 1 point ^(Note 1) Position zone signal output ^(Note 2) 1 point Operation command available only with position number indication
5	Solenoid valve mode 2	Positioning points 3 points Zone signal output 1 point ^(Note 1) Position zone signal output ^(Note 2) 1 point The actuator is operated by specifying forward, backward and intermediate position commands. Complete signal is able to output a signal equivalent to the limit switch

Note 2: The position zone signal is able to switch to the zone signal in the setting of Parameter No. 149.

3.1.2 Parameter Settings

Parameter data should be set appropriately according to the application requirements. Parameters are variables to be set to meet the use of the controller in the similar way as settings of the ringtone and silent mode of a cell phone and settings of clocks and calendars.

(Example)

Software Stroke Limit : Set a proper operation range for definition of the stroke end, prevention of interferences with peripherals and safety.

Zone Output : Set to require signal outputs in an arbitrary position zone within the operation zone.

Parameters should be set to meet the use of the controller prior to operation. Once set, they may not set every operation.

Refer to Chapter 8 Parameter for the parameter types and the details.

3.2 Initial Setting

The operation mode is to be set using Gateway Parameter Setting Tool (Ver. 2.1.0.0 or later). Setting of the parameters including the operation pattern are to be conducted on RC PC Software (Ver. 10.0.0.0 or later).

Shown below is the process for the setup. Follow the instruction to conduct the setting properly.

(Preparation) Install RC PC Software and Gateway Parameter Setting. For Gateway Parameter Setting Tool, install the file stored in the CD-ROM for PC software, or download from our website, intelligentactuator.com. [Refer to the instruction manual of the PC software for the details of the PC software.]

Make sure the system I/O connector wires and operation mode setting switch are in MANU condition when having the setting done. [Refer to “Name and Function of Each Part 9), 11)”]

3.2.1 Operation Mode Setting (Setting in gateway parameter setting tool)

[Step 1] Connect between the PC and SIO connector on MCON with the cable enclosed in the RC PC Software, and start the gateway parameter setting tool. The following window appears. Select “MCON” and click “OK” button.

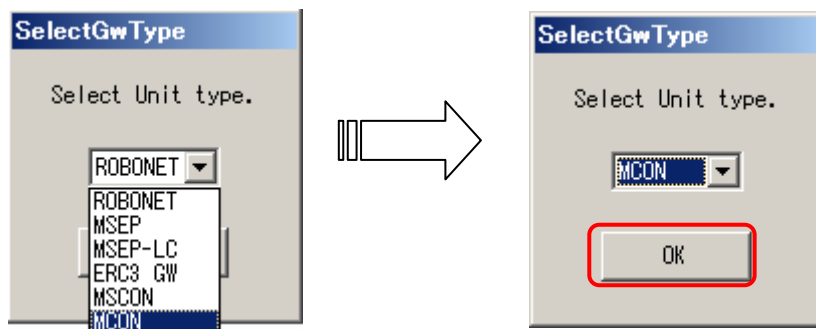

[Step 2] Once MCON is detected the detected unit numbers become available to select. Select the unit number to be connected and click the “OK” button.

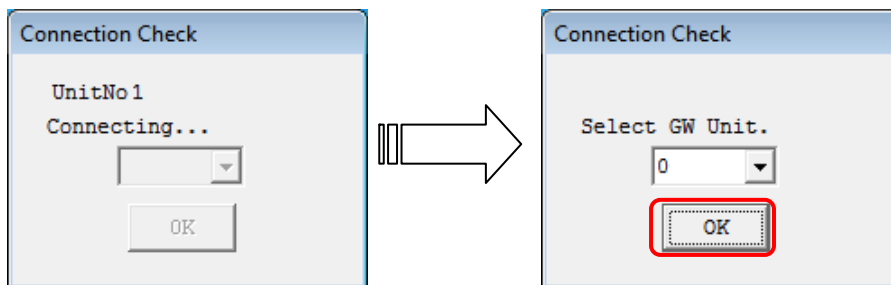

MCON being detected

Select the unit number to be connected

[Step 3] The main window opens. The main window opens even when MCON could not be detected.

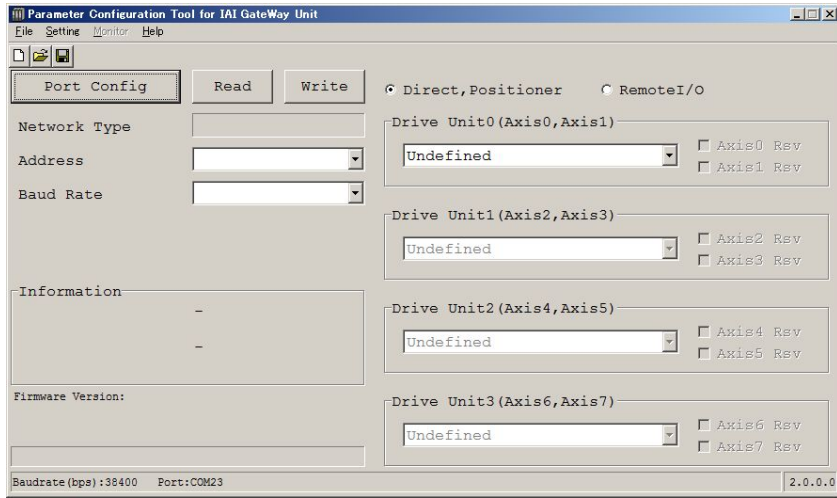

Main windows (Initial condition)

[Step 4] Reading is started from MCON to PC. Click on the “Read” button and a confirmation window appears. Click on the “Yes” button. If the writing is finished in normal condition, writing complete window appears. Click “OK” button.

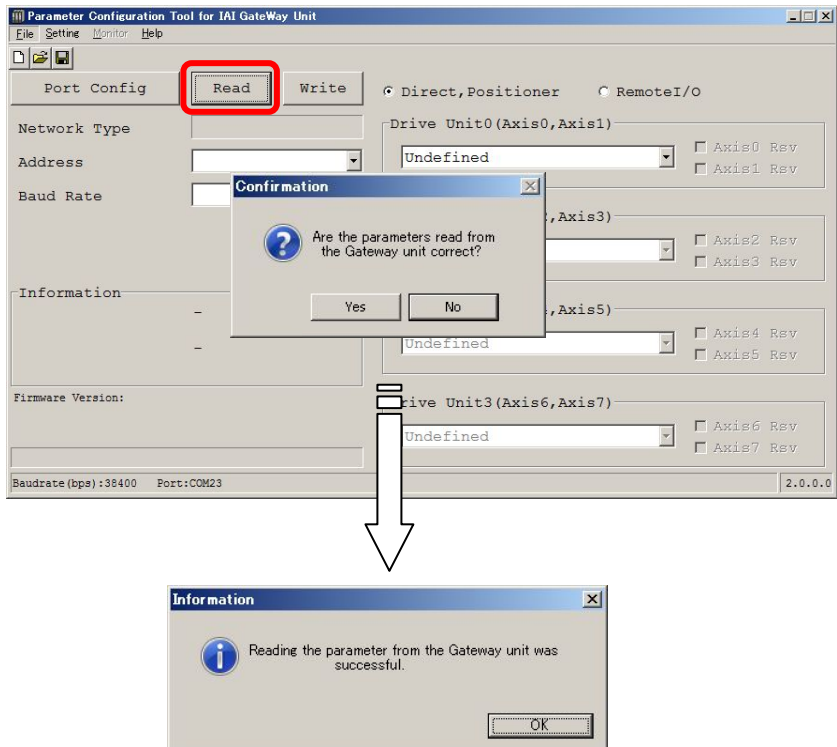

[Step 5] The parameters input to MCON are listed as shown below. Indicate the Fieldbus node addresses in Address.

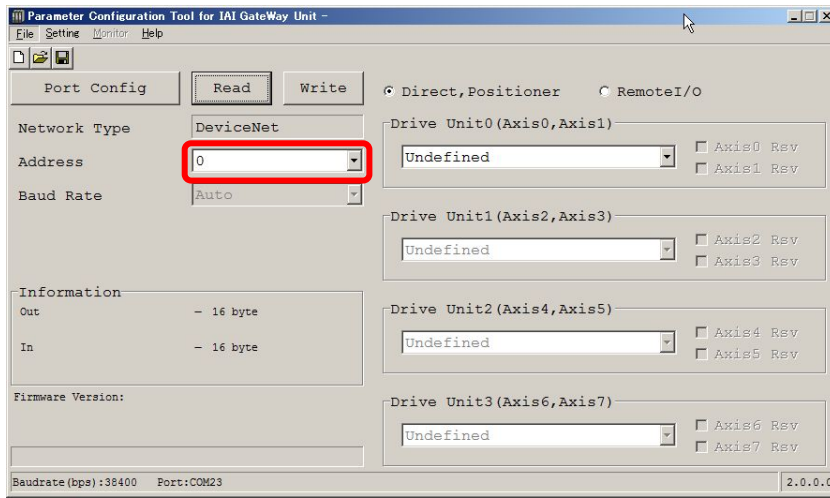

Caution:
In the following slave, set the value the number of occupied station is added to the current station number.

Network Type	CC-Link
Address	1
Baud Rate	10Mbps
Information	
Mode	- Ver.2 mode Remote net
Extend Cyclic setting	- octuple
Station Qnt	- 2 station

[Step 6] Select whether to use Remote I/O Mode or any other mode (Direct Value/Positioner Mode). When Remote I/O Mode is selected, any other mode except for Remote I/O Mode cannot be selected for all the axes on MCON.

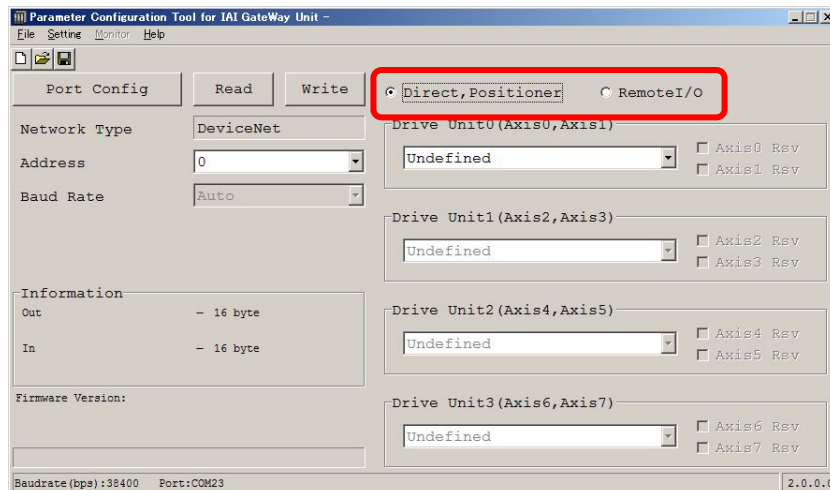

- [Step 7] Select an operation mode for each drive unit (in 2 axes unit).
 Select an operation mode for Drive Unit 0 (AX0: 1st axis, AX1: 2nd axis) first. (Only Remote I/O Mode can be selected if Remote I/O Mode was selected in Step 6.)

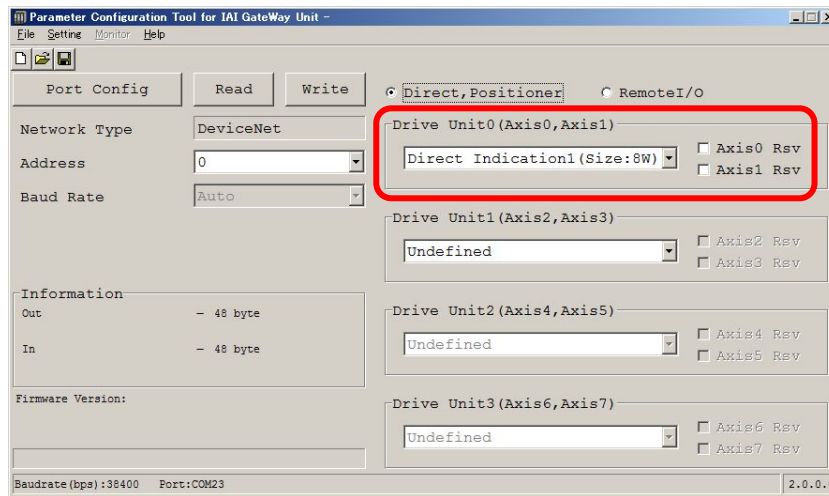

- [Step 8] For the number of driver axes 3 or more, select the operation mode of Drive Unit 1 (AX2: 3rd axis, AX3: 4th axis).
 (Note) By selecting the operation mode for Drive Unit 0 [Refer to Step 7], the operation mode for Drive Unit 1 becomes available to be selected.

- [Step 9] For the number of driver axes 5 or more, select the operation mode of Drive Unit 2 (AX4: 5th axis, AX5: 6th axis).
 (Note) By selecting the operation mode for Drive Unit 1 [Refer to Step 8], the operation mode for Drive Unit 2 becomes available to be selected.

- [Step 10] Select Operation Mode on Drive Unit 3 (AX6: 7th axis, AX7: 8th axis) when the number of the driver axes is seven or more.
 (Note) By selecting Operation Mode in Drive Unit 2 [Refer to Step 9], Operation Mode is Drive Unit 3 becomes available to select.

- [Step 11] In case there is an actuator that is connected but not to be activated (reserved axis), tick on "Axis n Reserved" beside the operation mode setting box for each drive unit. (n indicate the axis number)
 (Note) An error will be issued if an actuator is not connected.

 **Caution:** Even if the total number of the used axes is an odd number, make the last axis in reservation to get an even number. It is necessary to secure as much area as when not set as reserved even if set as the reserved axis.

- [Step 12] Conduct only for EtherNet/IP Type (move onto Step 13 if not applied)
Click on Setting in the menu and select EtherNet/IP Setting, and the setting window for the IP address, subnet mask and default gateway opens. Establish the settings to suit your system.

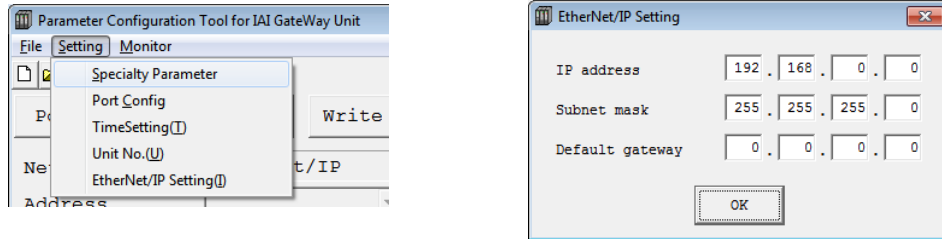

- [Step 13] Write the edited operation mode setting parameters to MCON. Click on the "Transfer" button shown below and a confirmation window pops up. Click on the "Yes" button.
If the writing is finished in normal condition, writing complete window appears. Click "OK" button.

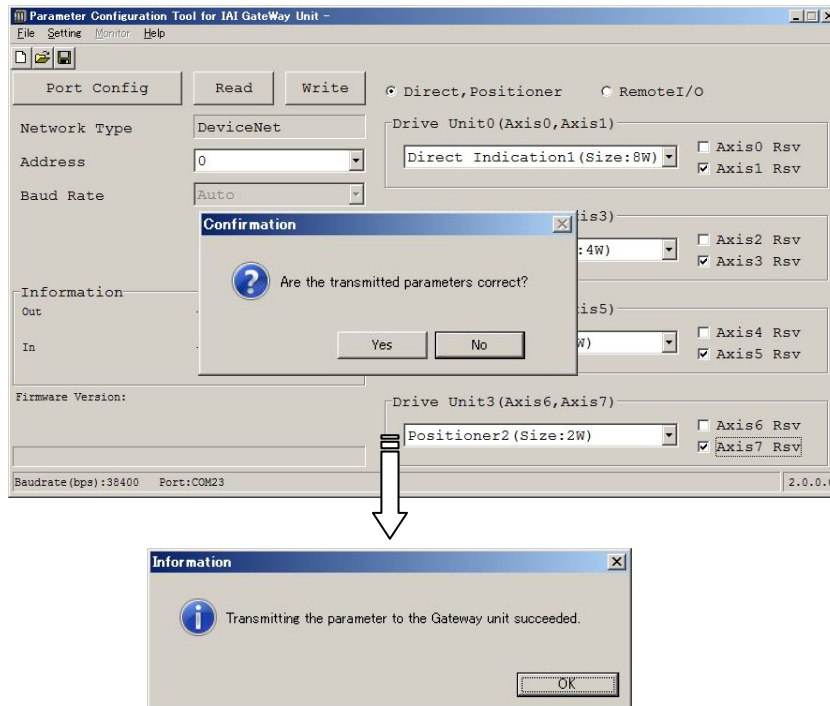

- [Step 14] A confirmation window for Gateway Unit reboot opens. Click "Yes" button to accept the reboot.

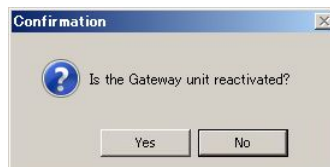

- [Step 15] After rebooting, a confirmation window for parameter reading appears for confirmation of the written contents. Click “Yes” button to accept the reading. Once the reading process is complete, confirm that the written contents are reflected.
If not written properly, do the process again from Step 1.

Reference: The settings are conducted in the special parameters for the process of communication error, change in pressing method for Fieldbus Type and speed unit change for Direct Indication Mode. Refer to 3.9 About Gateway Parameter Setting Tool for the details.

3.2.2 Parameter Settings (Setting on RC PC Software)

- [Step 1] Close the gateway parameter setting tool and start RC PC Software. Select “Teach Mode 1 (Safety Velocity Effective / PIO Startup Prohibited)” in MANU Operation Mode Select.

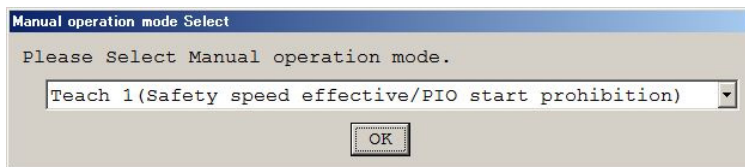

- [Step 2] Show the axis select window in “Parameter” – “Edit”, and select the axis to make setup.

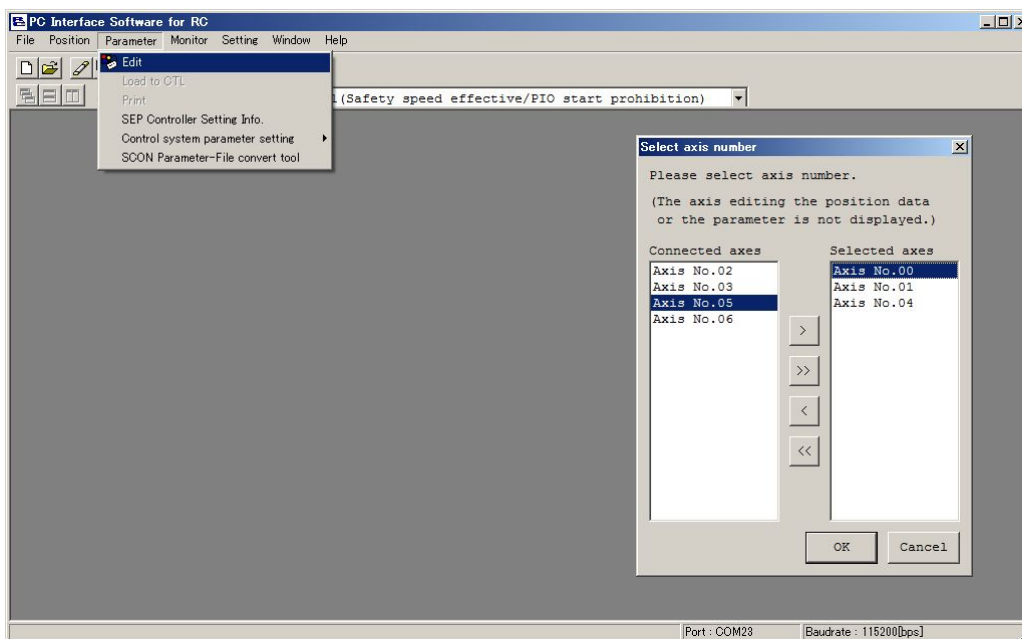

- [Step 3] Check if the setting of Parameter No. 158 Selection of Valid/Invalid Axis matches with the content set in Step 11 of 3.2.1 Gateway parameter Setting Tool for all the axes.

Parameter No.158 Selection of Valid/Invalid Axis

Actuator Connection Status	Parameter Setting Value
Actuator connection	0 (Enable)
Actuator Not Connected (Disabled Axis)	1 (Invalid)

- [Step 4] Set Parameter No. 25 PIO Pattern to the axes set valid in Step 3 by following the contents set in Step 6 of 3.2.1 Operation Mode Setting.

[Refer to the table of Operation Mode Available in 3.1.1 Basic Operation Methods]
Parameter No.25 PIO pattern select

Operation Patterns	PIO Pattern Setting Value
Types other than Remote I/O Mode	6
Remote I/O Mode	0, 1, 2, 4, 5 (select number referring to Section 3.4.10)

[Step 5] Set the zone (Parameters No.1 and 2) and soft limit (Parameter No.3 and 4) that suit to the system.

[Step 6] Write the edited parameters to MCON. Writing is to be conducted in unit of the drive units (two axes unit).
Once "Transfer" button is pressed, the confirmation message window appears. Click on "Yes" button.



[Step 7] A confirmation window for Gateway Unit reboot opens. Click "Yes" button to accept the reboot. Rebooting is also to be conducted in unit of the driving units (two axes unit).



[Step 8] Reboot all ^(Note 1) the axes and the setup is complete.

Note 1 It is not necessary to have a transfer and reboot o the drive units with no parameter change made.

3.3 Setting of Position Data

The values in the position table can be set as shown below. In the case that only positioning is necessary, all you have to do is to input the position data, and nothing else is required as long as the indication of acceleration and deceleration is needed. For the speed and acceleration/deceleration, the data set to the parameters is automatically reflected to the setting. Therefore, the work can be simple if you put the speed and acceleration/deceleration data to the parameter setting.

1)	2)	3)	4)	5)	6)	7)	8)	9)	10)	11)	12)	13)	14)	15)	
No.	Position [mm]	Velocity [mm/s]	Acceleration [G]	Deceleration [G]	Pressing [%]	Threshold [%]	Positioning width [mm]	Zone+ [mm]	Zone- [mm]	Acceleration/Deceleration mode	Incremental	Gain set	Stop mode	Vibration suppress No.	Comment
0	0.00	100.00	0.30	0.30	0.00	0.00	0.10	0.00	0.00	0	0	0	0	0	
1	100.00	100.00	0.30	0.30	0.00	0.00	0.10	0.00	0.00	0	0	0	0	0	
2	150.00	200.00	0.30	0.30	50.00	0.00	30.00	0.00	0.00	0	0	0	0	0	
3	200.00	400.00	1.00	1.00	0.00	0.00	0.10	0.00	0.00	0	0	0	0	0	1
4	200.00	200.00	0.30	0.30	0.00	0.00	0.10	250.00	230.00	0	0	0	0	0	2
5	500.00	50.00	0.10	0.10	0.00	0.00	0.10	0.00	0.00	0	0	0	0	0	
6															
7															

⚠ Caution: The input value is treated as the angle for the rotary actuator. Therefore;
 [mm]→[deg] 1.2=1.2deg
 [mm/s]→[deg/s]..... 100=100deg/s
 They are treated as above.
 Please note that the display on the screen of a teaching tool such as the PC software is in [mm].

- 1) Position No. It is the number commanded by PLC in operation command.

⚠ Caution: Do not use position No.0 if available positions remains enough. At the first servo ON after power ON, the completed position No. output is 0 even if the actuator is not located at position No.0. The actuator enters into the same state as that at positioning to position No.0. The completed position No. output is 0 during movement of the actuator. To use position No.0, get the command history by using the sequence program to check completed position No.0 based on the history.

- 2) Position [mm] Positioning coordinate value. Enter it as the distance from the home position.
 For pitch feed (relative movement = incremental feed), enter the pitch width.
 A value with – indicates that the actuator moves toward the home position. A value without – indicates that the actuator moves to be away from the home position.

⚠ Caution: (1) In the case of a Gripper Type:
 Set the coordinate value on the single finger basis. Set the value for the movement of one finger from the home position. Stroke information in the specification is shown in the total value of movement distance of the two fingers.
 Therefore, the stroke is 1/2 of what is described in the specifications.
 (2) In the case of a Rotary Type
 Set the coordinate value by an angle from the home.

- 3) Velocity [mm/s]···· Set the velocity in the operation.
Do not attempt to input a value more than the maximum velocity or less than the minimum velocity^{*1}.
*1 Minimum velocity [mm/s] =
Lead length [mm] / Number of encoder pulse / 0.001 [sec]
- 4) Acceleration [G] ·· Set the acceleration at start.
- 5) Deceleration [G] ·· Set the deceleration at stop.

(Reference) How to set the acceleration is described below The same idea can be applied to the deceleration.

1G=9800mm/s² : Acceleration capable to accelerate up to 9800mm/s per second

0.3G : Acceleration capable to accelerate up to 9800mm/s × 0.3 = 2940mm/s per second

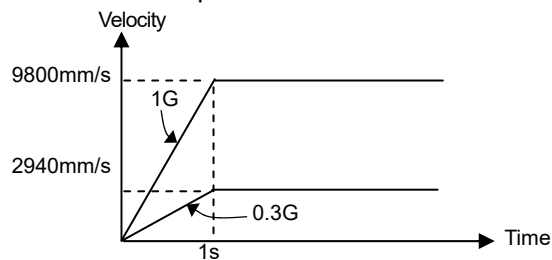

⚠ Caution: (1) Set the velocity, acceleration and deceleration so that they do not exceed the rating values described in the brochure or the catalog or instruction manual of the actuator. The setting that exceeds the rated acceleration/deceleration speed may shorten the actuator life remarkably.

(2) Consider to lower the acceleration/deceleration speed when a shock or vibration is applied to the actuator or work. In such cases, do not continue the use of the actuator, otherwise the product life may be shortened extremely fast.

(3) If the payload is extremely lighter than the rated payload, increase acceleration/deceleration to larger than their rated values to shorten the tact time. Contact our company. Inform us of the weight, shape and mounting method of the work and the installation conditions of the actuator.

(4) For the gripper type, have the setting done for the speed and acceleration/deceleration in the basis of one finger. Therefore, note that the relative speed and acceleration/deceleration speed become twice as it is set for the two fingers.

- 6) Pressing [%] ····· Set a value other than 0 here and the pressing operation is available. Set a pressing torque (limit current value) in %. If the value is set to 0, the normal positioning operation is performed. The speed for the pressing operation is set in Parameter No.34. If the setting done in 3) is less than the pressing speed setting value, the pressing operation is performed at this setting value.

⚠ Caution: If the pressing speed is changed, the pressing force may differ from that specified in 10.4 List of Specifications of Connectable Actuators. When the pressing speed is changed, make sure to measure the actual pressing force before start using.

7) Threshold [%] ·····

Pulse Motor Type
Limited Feature

Set the threshold value of the pressing torque in %. If the torque (load current) becomes larger than this setting value during pressing, the detection signal is output. This feature is used to monitor the load current and judge whether the operation is good or not in such an operation as press fitting in pressing. This feature is limited only to the pulse motor type actuators. Set to 0 for the servo motor type and brushless DC motor type actuators.

8) Positioning width [mm] ··· In Positioner * Mode, Simple Direct Mode and PIO patterns^(Note 1)

0 to 2 and 4 in Remote I/O Mode, the positioning complete signal is output if the remaining moving distance is entered within the zone set here when positioning is performed. For pressing, the actuator is moved at the setup velocity and acceleration/deceleration in the same way as normal positioning to the position of the coordinate value set in 2) and then performs pressing movement by the data set here. For PIO pattern 5, the positioning band is not the complete signal output range against positioning command. Despite the specified position number, the relevant output signal (LS*) is turned ON when the actuator reaches the setting range. The operation is accomplished as if a sensor were installed to detect the actuator. PIO pattern 5 does not correspond to the pressing operation.

Set the positioning band more than the minimum unit of the movement amount (movement amount for one pulse of an encoder) of the used actuator.

Note 1 PIO pattern: This is the operation pattern of Remote I/O Mode.

[Refer to 3.8 Control and functions of Input and output signals of Remote I/O Mode]

[Example of PIO pattern 5]

The figure below shows the position table and the position at which each of the LS signals is turned ON. If the actuator passes any of the positioning bands in the operation by another position number or manual operation in the servo-off state, the relevant LS signal is always turned ON.

No.	Position [mm]	Velocity [mm/s]	Acceleration [G]	Deceleration [G]	Pressing [%]	Threshold [%]	Positioning width [mm]	Zone+ [mm]	Zone- [mm]	Acceleration/Deceleration mode	Incremental	Gain set	Stop mode
0	0.00	250.00	0.20	0.20	0	0	5.00	0.00	0.00	0	0	0	0
1	70.00	250.00	0.20	0.20	0	0	10.00	0.00	0.00	0	0	0	0
2	150.00	250.00	0.20	0.20	0	0	5.00	0.00	0.00	0	0	0	0

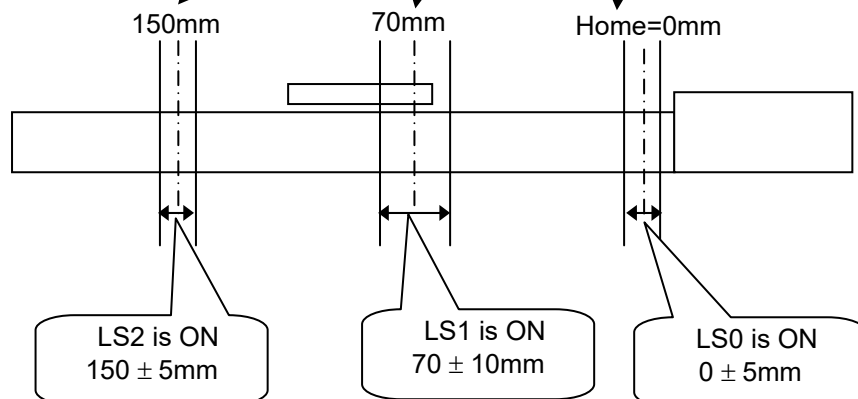

- 9) Zone + [mm] ^(Note 2)Set the coordinate value on the positive side at which position zone output signal PZONE is turned ON. PZONE is set to ON in the zone between this value and the coordinate value on the negative side set in 10).
The feature follows the specified position number. It is valid only when the position is specified but invalid in another position operation.
- 10)Zone - [mm] ^(Note 2)Set the coordinate value on the negative side at which position zone output signal PZONE is turned ON.

Note 2 If set to Zone + < Zone -, PZONE Signal turns ON out of the ranges of Zone + and Zone -.

11) Acceleration/deceleration mode Select a proper acceleration/deceleration pattern depending on the load.

Set value	Acceleration/Deceleration Pattern	Operation
0	Trapezoid	
1	S-shaped Motion (Refer to Caution at S-shaped Motion)	<p>Set the S-motion rate with parameter No.56.</p>
2	First-Order Delay Filter (Refer to Caution at First-order Delay Filter)	<p>Set the first-order filter constant with parameter No.55.</p>

Caution at S-shaped Motion



- 1) Since it requires a speed change during the operation, even if having the position command or direct command that S-shaped motion is set while the actuator is moving, S-shaped motion control cannot be performed and will be the trapezoid control. Make sure to make a command while the actuator is stopped.
- 2) S-shaped motion control is invalid in the index mode of the rotary actuator. It will be the trapezoid control even if S-shaped acceleration/deceleration control is indicated.
- 3) Do not use S-shaped acceleration/deceleration control if the setting of the acceleration time or the deceleration time exceeds 2 seconds. It will be the trapezoid control.
- 4) Do not pause on the move during acceleration or deceleration. It will change the speed (acceleration) and may cause a danger.



Caution at First-order Delay Filter:

- 1) Since it requires a speed change during the operation, even if having the position command or direct command that first-order delay filter is set while the actuator is moving, first-order delay filter control cannot be performed and will be the trapezoid control. Make sure to make a command while the actuator is stopped.
- 2) First-order delay filter control is invalid in the index mode of the rotary actuator. It will be the trapezoid control even if first-order delay filter control is indicated

12) Incremental Set to 1 for pitch feed (relative movement = incremental feed).
The value set for the position in 1) indicates the pitch feed distance.
With the value set to 0, positioning is defined to the position in 1) based on the absolute coordinate system.



Caution: In the pitch feed, do not perform a command with a pitch smaller than the minimum encoder resolution (lead/encoder pulse number) or that less than positioning accuracy repeatability.
There would be no deviation to occur even with the command because it is an operation command to the same position as the positioning complete condition, but the positioning control cannot be performed properly.
When solenoid valve mode 2 is selected, set this to 0. Setting this to 1 causes the position data error to occur.

13) Transported Load/Gain Set In this section, the features differ for each motor type.

Motor Type	Symbol	Function
Pulse Motor Type	13)-1	Transported Load
Servo Motor Type	13)-2	Gain Set

13)-1 Transported Load ... Register 4 types of load weights with using the smart tuning, and choose the number from the registered numbers (0 to 3) that is to be used.

Pulse Motor Type
Limited Feature

From the numbers (load weights) registered in this section, the shortest tact time function calculates the optimum speed and acceleration/deceleration.

[Refer to the instruction manual of smart tuning tool for how to register the load weights and shortest tact time.]

Setting	Name
0	Transported Load Pattern No.0
1	Transported Load Pattern No.1
2	Transported Load Pattern No.2
3	Transported Load Pattern No.3

13)-2 Gain Set Six parameters required for servo gain adjustment are collected to be a single set. 4 types of settings are able to be registered and the servo gains can be switched over for each positioning operation. By utilizing Smart Tuning Function ^(Note 1) in the PC software, the setting close to the optimum can be obtained.

Servo Motor Type
Limited Feature

Note 1 Refer to Chapter 10.4 List of Specifications of Connectable Actuators for the applicable models. It may require the setting of the gain set dedicated for the home-return operation in the case this function is used to have the high-speed setting or the setting to apply a transported weight more than the ratings. For how to set up and the caution items, refer to the instruction manual for RC PC Software.

[Parameters constructed in 1 set]

- Servo Gain Number (Position Gain)
- Position Feed Forward Gain
- Speed Loop Proportional Gain
- Speed Loop Integral Gain
- Torque Filter Time Constant
- Current Control Band Number

It is able to establish the gain set that corresponds to the position number to be operated to the indicated gain set.

[Refer to "Servo Adjustment" in Section 8.3 for each gain parameter details.]

Setting	Parameter Set Select	Parameter No.
0	Gain Set 0	7, 71, 31 to 33, 54
1	Gain Set 1	120 to 125
2	Gain Set 2	126 to 131
3	Gain Set 3	132 to 137

- 14) Stop mode Automatic servo OFF is enabled after a certain period from the completion of positioning for power saving.
 Time setting is to be conducted in Parameter No. 36 to 38
 Automatic Servo-off Delay Time 1 to 3, and three types of time are available to select.
 Selection is available from 0 to 3 for the servo motor type and brushless DC motor type.
 Selection is available from 0 to 7 for the pulse motor type.

Setting	Operation after Positioning Complete	Selectable Type
0	Keep the servo ON	All types
1	Automatic servo-off in a certain time (Parameter No. 36 set values)	All types
2	Automatic servo-off in a certain time (Parameter No. 37 set values)	All types
3	Automatic servo-off in a certain time (Parameter No. 38 set values)	All types
4	Full servo control	Pulse motor type
5	Full-servo control for a certain time (Parameter No. 36 set values) and then automatically turning servo OFF	Pulse motor type
6	Full-servo control for a certain time (Parameter No. 37 set values) and then automatically turning servo OFF	Pulse motor type
7	Full-servo control for a certain time (Parameter No. 38 set values) and then automatically turning servo OFF	Pulse motor type

⚠ Caution:

- No retaining torque is provided in automatic servo OFF. Pay sufficient attention to the setting because the actuator may be moved by external force applied to it.
- Do not use the automatic servo OFF if the next moving command is relative distance specification (pitch feed). Failure to follow it may cause position shift to occur.
- Do not use the automatic servo OFF in pressing. If used, the pressing force is lost.
- Automatic Servo OFF would not function in the operation with teaching mode of PC software.

15)Vibration suppress No.

Suppresses vibration (sympathetic vibration) of the load installed on the actuator.
 It possesses a capacity to deal with 3 types of vibration. There are 4 parameters corresponds to 1 type of vibration and they are compiled in 1 set.
 Set the parameter set corresponds to the position number necessary for the vibration control in the position table.
 [Refer to Chapter 4 Vibration Suppress Control Function.]

Servo Motor Type Limited Feature

Cannot be used in direct indication mode

Setting	Vibration Control Frequency (Specific Frequency)	Parameter No.
0	Vibration suppress frequency (Natural frequency)	—
1	Vibration Control Parameter Set 1	97 to 100
2	Vibration Control Parameter Set 2	101 to 104
3	Vibration Control Parameter Set 3	105 to 108

 **Caution:** (1) The vibration frequency that can be controlled (applicable specific frequency) is from 0.5 to 30Hz.
 (2) The vibration control is applicable only for the vibration generated by the load of the actuator connected to this controller. Other vibrations cannot be controlled.
 (3) The vibration control is applicable only for the vibration in the direction of the actuator operation. Vibration in other directions cannot be controlled.
 (4) The vibration control is not applicable for home-return and pressing operations.
 (5) If the vibration frequency setting is low, the takt time may become long. The value below approximately 6Hz makes the positioning finishing to take more than 150ms.

This feature is limited only to the servo motor type actuators.
 Set to 0 for the pulse motor type and brushless DC motor type actuators.

3.4 Fieldbus Type Address Map

3.4.1 PLC Address Construction by each Operation Mode

The address domain to be occupied differs depending on the operation mode.
Refer to the example in Section 3.4.2 for the assignment.

- PLC Output → MCON Input (n is PLC output top word address to MCON) ^(Note 1)

PLC output Area	Simple Direct Mode	Positioner 1 Mode	Direct Indication Mode	Positioner 2 Mode	Positioner 3 Mode	Positioner 5 Mode	Remote I/O Mode	Details	
MCON Gateway Control Area	n	Gateway Control 0							3.4.3
	n+1	Gateway Control 1							
	n+2	Demand Command							3.4.11
	n+3	Data 0							
	n+4	Data 1							
	n+5	Data 2							
	n+6	Data 3							
	n+7	Occupied Area ^(Note 2)							
Connected Axes Control Area	n+8	Target Position (Axis No.0)	Occupied Area ^(Note 2)	Target Position (Axis No.0)	Specified Position No. (Axis No.0)	Control Signal/ Position No. (Axis No.0)	Specified Position No. (Axis No.0)	Assignment Area for Axis No.0	3.4.4 to 3.4.10
	n+9				Control Signal (Axis No.0)	Assignment Area for Axis No.1	Control Signal (Axis No.0)	Assignment Area for Axis No.1	
	n+10	Specified Position No. (Axis No.0)	Specified Position No. (Axis No.0)	Positioning Width (Axis No.0)	Assignment Area for Axis No.1	Assignment Area for Axis No.2	Assignment Area for Axis No.1	Assignment Area for Axis No.2	
	n+11	Control Signal (Axis No.0)	Control Signal (Axis No.0)			Assignment Area for Axis No.3		Assignment Area for Axis No.3	
	n+12	Assignment Area for Axis No.1	Occupied Area ^(Note 2)	Velocity (Axis No.0)	Assignment Area for Axis No.2 and later	Assignment Area for Axis No.4	Assignment Area for Axis No.2 and later	Assignment Area for Axis No.4	
	n+13			Acceleration/Deceleration (Axis No.0)		Assignment Area for Axis No.5		Assignment Area for Axis No.5	
	n+14		Assignment Area for Axis No.1	Current Limitation Value (Axis No.0)		Assignment Area for Axis No.6		Assignment Area for Axis No.6	
	n+15		Assignment Area for Axis No.1	Control Signal (Axis No.0)		Assignment Area for Axis No.7		Assignment Area for Axis No.7	
	n+16 to n+23	Assignment Area for Axis No.2 and later	Assignment Area for Axis No.2 and later	Assignment Area for Axis No.1					
	n+24 to n+71			Assignment Area for Axis No.2 and later					

Note 1 For CC-Link, n and n+1 are for input and output bit addresses, and n+8 is for the top address of data register.

Note 2 This is the domain occupied unconditionally. Therefore, this domain cannot be used for any other purpose.

 **Caution:**

- Remote I/O Mode cannot be used together with other modes.
- Only Positioner 3 Mode and Remote I/O Mode are available to be selected in CompoNet. (CompoNet occupies 32 bytes no matter of the number of axes.)

© In the case of CC-Link
Station Type: Ver.2.00 Remote device station
Extended Cyclic Setting/Occupied Station Number Setting:
Register the information of the occupations displayed on Gateway Parameter Setting Tool to the master unit. Connection cannot be established if information other than occupation is set. [Refer to 3.2.1 Operation Mode Setting]

• MCON Output → PLC Input (n is PLC input top word address from MCON) (Note 1)

PLC Input Area	Simple Direct Mode	Positioner 1 Mode	Direct Indication Mode	Positioner 2 Mode	Positioner 3 Mode	Positioner 5 Mode	Remote I/O Mode	Details
MCON Gateway Response Area	n	Gateway Status 0						3.4.3
	n+1	Gateway Status 1						
	n+2	Response Command						3.4.11
	n+3	Data 0						
	n+4	Data 1						
	n+5	Data 2						
	n+6	Data 3						
	n+7	Occupied Area (Note 2)						
Connected Axes Response Area	n+8	Current Position (Axis No.0)	Current Position (Axis No.0)	Completed Position No./ Simple Alarm ID (Axis No.0)	Status Signal/ Completed Position (Axis No.0)	Completed Position No./ Simple Alarm ID (Axis No.0)	Assignment Area for Axis No.0	3.4.4 to 3.4.10
	n+9			Status Signal (Axis No.0)	Assignment Area for Axis No.1	Status Signal (Axis No.0)	Assignment Area for Axis No.1	
	n+10	Completed Position No./ Simple Alarm ID (Axis No.0)	Command Current (Axis No.0)	Assignment Area for Axis No.1	Assignment Area for Axis No.2	Assignment Area for Axis No.1	Assignment Area for Axis No.2	
	n+11	Status Signal (Axis No.0)			Assignment Area for Axis No.3		Assignment Area for Axis No.3	
	n+12	Assignment Area for Axis No.1	Current Speed (Axis No.0)	Assignment Area for Axis No.2 and later	Assignment Area for Axis No.4	Assignment Area for Axis No.2 and later	Assignment Area for Axis No.4	
	n+13		Occupied Area (axis No.0)		Assignment Area for Axis No.5		Assignment Area for Axis No.5	
	n+14		Alarm Code (Axis No.0)		Assignment Area for Axis No.6		Assignment Area for Axis No.6	
	n+15		Status Signal (Axis No.0)		Assignment Area for Axis No.7		Assignment Area for Axis No.7	
	n+16 to n+23		Assignment Area for Axis No.2		Assignment Area for Axis No.1			
	n+24 to n+71	Assignment Area for Axis No.2 and later						

Note 1 For CC-Link, n and n+1 are for input and output bit addresses, and n+8 is for the top address of data register.

Note 2 This is the domain occupied unconditionally. Therefore, this domain cannot be used for any other purpose.

⚠ Caution:

- Remote I/O Mode cannot be used together with other modes.
- Only Positioner 3 Mode and Remote I/O Mode are available to be selected in CompoNet. (CompoNet occupies 32 bytes no matter of the number of axes.)

© In the case of CC-Link
 Station Type: Ver.2.00 Remote device station
 Extended Cyclic Setting/Occupied Station Number Setting:
 Register the information of the occupations displayed on Gateway Parameter Setting Tool to the master unit. Connection cannot be established if information other than occupation is set. [3.2.1 Operation Mode Setting]

3.4.2 Example for each Fieldbus Address Map

Shown below is an example for the address map by the combination of operation modes for each Fieldbus.

Refer to it for the address assignment.

The examples for the address map constructions shown below are provided for each Fieldbus, however is described together ^(Note 1) for the networks of the same address assignment.

Note 1 Order of address maps for each Fieldbus

- 1) DeviceNet and CompoNet ^(Note 2)
- 2) CC-Link
- 3) PROFIBUS-DP, EtherNet/IP, EtherCAT
- 4) PROFNET-IO

Note 2 For CompoNet, only Positioner 3 Mode and Remote are available for selection.

Ⓢ For CC-Link
Station Type and Extended Cyclic Setting/Occupied Station Number Settings:
Register the setting displayed on Gateway Parameter Setting Tool to the host. [Refer to 3.2.1 Operation Mode Setting]
(Connection cannot be established with other ways)



Caution:

- If Remote I/O Mode is selected, all the axes connected to MCON are involved in Remote I/O Mode.
- This controller is able to control 2 axes with one driver board (1 slot), however, different operation mode cannot be selected in the same driver board.
Example Set the 1st axis in Slot 1 to Positioner 1 Mode and 2nd to Simple Direct Mode
- Even if only one axis is used in the two axes on the same slot, it requires the address space for 2 axes.

[1] Address Map with Combination of Simple Direct Mode/Positioner 1 Mode and Direct Indication Mode

In the table below, shows the address map when eight axes of MCON are operated with a combination of Simple Direct Mode/Positioner 1 Mode and Direct Indication Mode in four types of construction for each Fieldbus as an example.

Combination Example	Number of Simple Direct Mode Axes	Number of Direct Indication Mode Axes
1	8	0
2	6	2
3	2	6
4	0	8

1) DeviceNet (CompoNet is not applicable for this mode)

[Combination Example 1] When number of Simple Direct Mode/Positioner 1 Mode axes is 8 and number of Direct Indication Mode 0
(n is the top channel number for each PLC input and output between MCON and PLC)

PLC → MCON		MCON → PLC	
CH No.	Description	CH No.	Description
n to n+1	Gateway Control	n to n+1	Gateway Status
n+2 to n+7	Demand Command	n+2 to n+7	Response Command
n+8 to n+11	Axis No.0 Control Information	n+8 to n+11	Axis No.0 Status Information
n+12 to n+15	Axis No.1 Control Information	n+12 to n+15	Axis No.1 Status Information
n+16 to n+19	Axis No.2 Control Information	n+16 to n+19	Axis No.2 Status Information
n+20 to n+23	Axis No.3 Control Information	n+20 to n+23	Axis No.3 Status Information
n+24 to n+27	Axis No.4 Control Information	n+24 to n+27	Axis No.4 Status Information
n+28 to n+31	Axis No.5 Control Information	n+28 to n+31	Axis No.5 Status Information
n+32 to n+35	Axis No.6 Control Information	n+32 to n+35	Axis No.6 Status Information
n+36 to n+39	Axis No.7 Control Information	n+36 to n+39	Axis No.7 Status Information

[Combination Example 2] When number of Simple Direct Mode/Positioner 1 Mode e axes is 6 and number of Direct Indication Mode 2

(n is the top channel number for each PLC input and output between MCOM and PLC)

PLC → MCON		MCON → PLC	
CH No.	Description	CH No.	Description
n to n+1	Gateway Control	n to n+1	Gateway Status
n+2 to n+7	Demand Command	n+2 to n+7	Response Command
n+8 to n+11	Axis No.0 Control Information	n+8 to n+11	Axis No.0 Status Information
n+12 to n+15	Axis No.1 Control Information	n+12 to n+15	Axis No.1 Status Information
n+16 to n+19	Axis No.2 Control Information	n+16 to n+19	Axis No.2 Status Information
n+20 to n+23	Axis No.3 Control Information	n+20 to n+23	Axis No.3 Status Information
n+24 to n+27	Axis No.4 Control Information	n+24 to n+27	Axis No.4 Status Information
n+28 to n+31	Axis No.5 Control Information	n+28 to n+31	Axis No.5 Status Information
n+32 to n+35	Axis No.6 Control Information	n+32 to n+35	Axis No.6 Status Information
n+36 to n+39		n+36 to n+39	
n+40 to n+43	Axis No.7 Control Information	n+40 to n+43	Axis No.7 Status Information
n+44 to n+47		n+44 to n+47	

[Combination Example 3] When number of Simple Direct Mode/Positioner 1 Mode axes is 2 and number of Direct Indication Mode 6

(n is the top channel number for each PLC input and output between MCON and PLC)

PLC → MCON		MCON → PLC	
CH No.	Description	CH No.	Description
n to n+1	Gateway Control	n to n+1	Gateway Status
n+2 to n+7	Demand Command	n+2 to n+7	Response Command
n+8 to n+11	Axis No.0 Control Information	n+8 to n+11	Axis No.0 Status Information
n+12 to n+15	Axis No.1 Control Information	n+12 to n+15	Axis No.1 Status Information
n+16 to n+19	Axis No.2 Control Information	n+16 to n+19	Axis No.2 Status Information
n+20 to n+23		n+20 to n+23	
n+24 to n+27	Axis No.3 Control Information	n+24 to n+27	Axis No.3 Status Information
n+28 to n+31		n+28 to n+31	
n+32 to n+35	Axis No.4 Control Information	n+32 to n+35	Axis No.4 Status Information
n+36 to n+39		n+36 to n+39	
n+40 to n+43	Axis No.5 Control Information	n+40 to n+43	Axis No.5 Status Information
n+44 to n+47		n+44 to n+47	
n+48 to n+51	Axis No.6 Control Information	n+48 to n+51	Axis No.6 Status Information
n+52 to n+55		n+52 to n+55	
n+56 to n+59	Axis No.7 Control Information	n+56 to n+59	Axis No.7 Status Information
n+60 to n+63		n+60 to n+63	

[Combination Example 4] When number of Simple Direct Mode/Positioner 1 Mode axes is 0 and number of Direct Indication Mode 8
(n is the top channel number for each PLC input and output between MCON and PLC)

PLC → MCON		MCON → PLC	
CH No.	Description	CH No.	Description
n to n+1	Gateway Control	n to n+1	Gateway Status
n+2 to n+7	Demand Command	n+2 to n+7	Response Command
n+8 to n+11	Axis No.0 Control Information	n+8 to n+11	Axis No.0 Status Information
n+12 to n+15		n+12 to n+15	
n+16 to n+19	Axis No.1 Control Information	n+16 to n+19	Axis No.1 Status Information
n+20 to n+23		n+20 to n+23	
n+24 to n+27	Axis No.2 Control Information	n+24 to n+27	Axis No.2 Status Information
n+28 to n+31		n+28 to n+31	
n+32 to n+35	Axis No.3 Control Information	n+32 to n+35	Axis No.3 Status Information
n+36 to n+39		n+36 to n+39	
n+40 to n+43	Axis No.4 Control Information	n+40 to n+43	Axis No.4 Status Information
n+44 to n+47		n+44 to n+47	
n+48 to n+51	Axis No.5 Control Information	n+48 to n+51	Axis No.5 Status Information
n+52 to n+55		n+52 to n+55	
n+56 to n+59	Axis No.6 Control Information	n+56 to n+59	Axis No.6 Status Information
n+60 to n+63		n+60 to n+63	
n+64 to n+67	Axis No.7 Control Information	n+64 to n+67	Axis No.7 Status Information
n+68 to n+71		n+68 to n+71	

2) CC-Link

[Combination Example 1] When number of Simple Direct Mode/Positioner 1 Mode axes is 8 and number of Direct Indication Mode 0
(Extended Cyclic Setting/Number of Occupied Stations:
4 times/2 stations)

PLC → MCON		MCON → PLC	
Address	Description	Address	Description
RY 00 to 1F	Gateway Control	RX 00 to 1F	Gateway Status
RY 20 to 6F	Demand Command	RX 20 to 6F	Response Command
RY 70 to 7F	Cannot be used.	RX 70 to 7F	Cannot be used.
RY 80 to BF	Cannot be used.	RX 80 to BF	Cannot be used.
RWw 00 to 03	Axis No.0 Control Information	RWr 00 to 03	Axis No.0 Status Information
RWw 04 to 07	Axis No.1 Control Information	RWr 04 to 07	Axis No.1 Status Information
RWw 08 to 0B	Axis No.2 Control Information	RWr 08 to 0B	Axis No.2 Status Information
RWw 0C to 0F	Axis No.3 Control Information	RWr 0C to 0F	Axis No.3 Status Information
RWw 10 to 13	Axis No.4 Control Information	RWr 10 to 13	Axis No.4 Status Information
RWw 14 to 17	Axis No.5 Control Information	RWr 14 to 17	Axis No.5 Status Information
RWw 18 to 1B	Axis No.6 Control Information	RWr 18 to 1B	Axis No.6 Status Information
RWw 1C to 1F	Axis No.7 Control Information	RWr 1C to 1F	Axis No.7 Status Information

[Combination Example 2] When number of Simple Direct Mode/Positioner 1 Mode axes is 6 and number of Direct Indication Mode 2 (Extended Cyclic Setting/Number of Occupied Stations: 8 times/2 stations)

PLC → MCON		MCON → PLC	
Address	Description	Address	Description
RY 000 to 01F	Gateway Control	RX 000 to 01F	Gateway Status
RY 020 to 06F	Demand Command	RX 020 to 06F	Response Command
RY 070 to 07F	Cannot be used.	RX 070 to 07F	Cannot be used.
RY 080 to 17F	Cannot be used.	RX 080 to 17F	Cannot be used.
RWw 00 to 03	Axis No.0 Control Information	RWr 00 to 03	Axis No.0 Status Information
RWw 04 to 07	Axis No.1 Control Information	RWr 04 to 07	Axis No.1 Status Information
RWw 08 to 0B	Axis No.2 Control Information	RWr 08 to 0B	Axis No.2 Status Information
RWw 0C to 0F	Axis No.3 Control Information	RWr 0C to 0F	Axis No.3 Status Information
RWw 10 to 13	Axis No.4 Control Information	RWr 10 to 13	Axis No.4 Status Information
RWw 14 to 17	Axis No.5 Control Information	RWr 14 to 17	Axis No.5 Status Information
RWw 18 to 1B	Axis No.6 Control Information	RWr 18 to 1B	Axis No.6 Status Information
RWw 1C to 1F		RWr 1C to 1F	
RWw 20 to 23	Axis No.7 Control Information	RWr 20 to 23	Axis No.7 Status Information
RWw 24 to 27		RWr 24 to 27	
RWw 28 to 2B	Cannot be used.	RWr 28 to 2B	Cannot be used.
RWw 2C to 2F	Cannot be used.	RWr 2C to 2F	Cannot be used.
RWw 30 to 33	Cannot be used.	RWr 30 to 33	Cannot be used.
RWw 34 to 37	Cannot be used.	RWr 34 to 37	Cannot be used.
RWw 38 to 3B	Cannot be used.	RWr 38 to 3B	Cannot be used.
RWw 3C to 3F	Cannot be used.	RWr 3C to 3F	Cannot be used.

[Combination Example 3] When number of Simple Direct Mode/Positioner 1 Mode axes is 2 and number of Direct Indication Mode 6
(Extended Cyclic Setting/Number of Occupied Stations: 8 times/2 stations)

PLC → MCON		MCON → PLC	
Address	Description	Address	Description
RY 000 to 01F	Gateway Control	RX 000 to 01F	Gateway Status
RY 020 to 06F	Demand Command	RX 020 to 06F	Response Command
RY 070 to 07F	Cannot be used.	RX 070 to 07F	Cannot be used.
RY 080 to 17F	Cannot be used.	RX 080 to 17F	Cannot be used.
RWw 00 to 03	Axis No.0 Control Information	RWr 00 to 03	Axis No.0 Status Information
RWw 04 to 07	Axis No.1 Control Information	RWr 04 to 07	Axis No.1 Status Information
RWw 08 to 0B	Axis No.2 Control Information	RWr 08 to 0B	Axis No.2 Status Information
RWw 0C to 0F		RWr 0C to 0F	
RWw 10 to 13	Axis No.3 Control Information	RWr 10 to 13	Axis No.3 Status Information
RWw 14 to 17		RWr 14 to 17	
RWw 18 to 1B	Axis No.4 Control Information	RWr 18 to 1B	Axis No.4 Status Information
RWw 1C to 1F		RWr 1C to 1F	
RWw 20 to 23	Axis No.5 Control Information	RWr 20 to 23	Axis No.5 Status Information
RWw 24 to 27		RWr 24 to 27	
RWw 28 to 2B	Axis No.6 Control Information	RWr 28 to 2B	Axis No.6 Status Information
RWw 2C to 2F		RWr 2C to 2F	
RWw 30 to 33	Axis No.7 Control Information	RWr 30 to 33	Axis No.7 Status Information
RWw 34 to 37		RWr 34 to 37	
RWw 38 to 3B	Cannot be used.	RWr 38 to 3B	Cannot be used.
RWw 3C to 3F	Cannot be used.	RWr 3C to 3F	Cannot be used.

[Combination Example 4] When number of Simple Direct Mode/Positioner 1 Mode axes is 0 and number of Direct Indication Mode 8
(Extended Cyclic Setting/Number of Occupied Stations: 8 times/2 stations)

PLC → MCON		MCON → PLC	
Address	Description	Address	Description
RY 000 to 01F	Gateway Control	RX 000 to 01F	Gateway Status
RY 020 to 06F	Demand Command	RX 020 to 06F	Response Command
RY 070 to 07F	Cannot be used.	RX 070 to 07F	Cannot be used.
RY 080 to 17F	Cannot be used.	RX 080 to 17F	Cannot be used.
RWw 00 to 03	Axis No.0 Control Information	RWr 00 to 03	Axis No.0 Status Information
RWw 04 to 07		RWr 04 to 07	
RWw 08 to 0B	Axis No.1 Control Information	RWr 08 to 0B	Axis No.1 Status Information
RWw 0C to 0F		RWr 0C to 0F	
RWw 10 to 13	Axis No.2 Control Information	RWr 10 to 13	Axis No.2 Status Information
RWw 14 to 17		RWr 14 to 17	
RWw 18 to 1B	Axis No.3 Control Information	RWr 18 to 1B	Axis No.3 Status Information
RWw 1C to 1F		RWr 1C to 1F	
RWw 20 to 23	Axis No.4 Control Information	RWr 20 to 23	Axis No.4 Status Information
RWw 24 to 27		RWr 24 to 27	
RWw 28 to 2B	Axis No.5 Control Information	RWr 28 to 2B	Axis No.5 Status Information
RWw 2C to 2F		RWr 2C to 2F	
RWw 30 to 33	Axis No.6 Control Information	RWr 30 to 33	Axis No.6 Status Information
RWw 34 to 37		RWr 34 to 37	
RWw 38 to 3B	Axis No.7 Control Information	RWr 38 to 3B	Axis No.7 Status Information
RWw 3C to 3F		RWr 3C to 3F	

3) PROFIBUS-DP, EtherNet/IP, EtherCAT

[Combination Example 1] When number of Simple Direct Mode/Positioner 1 Mode axes is 8 and number of Direct Indication Mode 0
(n is the top node address for each PLC input and output between MCON and PLC)

PLC → MCON		MCON → PLC	
Node Address (Byte Address)	Description	Node Address (Byte Address)	Description
n to n+3	Gateway Control	n to n+3	Gateway Status
n+4 to n+15	Demand Command	n+4 to n+15	Response Command
n+16 to n+23	Axis No.0 Control Information	n+16 to n+23	Axis No.0 Status Information
n+24 to n+31	Axis No.1 Control Information	n+24 to n+31	Axis No.1 Status Information
n+32 to n+39	Axis No.2 Control Information	n+32 to n+39	Axis No.2 Status Information
n+40 to n+47	Axis No.3 Control Information	n+40 to n+47	Axis No.3 Status Information
n+48 to n+55	Axis No.4 Control Information	n+48 to n+55	Axis No.4 Status Information
n+56 to n+63	Axis No.5 Control Information	n+56 to n+63	Axis No.5 Status Information
n+64 to n+71	Axis No.6 Control Information	n+64 to n+71	Axis No.6 Status Information
n+72 to n+79	Axis No.7 Control Information	n+72 to n+79	Axis No.7 Status Information

[Combination Example 2] When number of Simple Direct Mode/Positioner 1 Mode axes is 6 and number of Direct Indication Mode 2
(n is the top node address for each PLC input and output between MCON and PLC)

PLC → MCON		MCON → PLC	
Node Address (Byte Address)	Description	Node Address (Byte Address)	Description
n to n+3	Gateway Control	n to n+3	Gateway Status
n+4 to n+15	Demand Command	n+4 to n+15	Response Command
n+16 to n+23	Axis No.0 Control Information	n+16 to n+23	Axis No.0 Status Information
n+24 to n+31	Axis No.1 Control Information	n+24 to n+31	Axis No.1 Status Information
n+32 to n+39	Axis No.2 Control Information	n+32 to n+39	Axis No.2 Status Information
n+40 to n+47	Axis No.3 Control Information	n+40 to n+47	Axis No.3 Status Information
n+48 to n+55	Axis No.4 Control Information	n+48 to n+55	Axis No.4 Status Information
n+56 to n+63	Axis No.5 Control Information	n+56 to n+63	Axis No.5 Status Information
n+64 to n+71	Axis No.6 Control Information	n+64 to n+71	Axis No.6 Status Information
n+72 to n+79		n+72 to n+79	
n+80 to n+87	Axis No.7 Control Information	n+80 to n+87	Axis No.7 Status Information
n+88 to n+95		n+88 to n+95	

[Combination Example 3] When number of Simple Direct Mode/Positioner 1 Mode axes is 2 and number of Direct Indication Mode 6
(n is the top node address for each PLC input and output between MCON and PLC)

PLC → MCON		MCON → PLC	
Node Address (Byte Address)	Description	Node Address (Byte Address)	Description
n to n+3	Gateway Control	n to n+3	Gateway Status
n+4 to n+15	Demand Command	n+4 to n+15	Response Command
n+16 to n+23	Axis No.0 Control Information	n+16 to n+23	Axis No.0 Status Information
n+24 to n+31	Axis No.1 Control Information	n+24 to n+31	Axis No.1 Status Information
n+32 to n+39	Axis No.2 Control Information	n+32 to n+39	Axis No.2 Status Information
n+40 to n+47		n+40 to n+47	
n+48 to n+55	Axis No.3 Control Information	n+48 to n+55	Axis No.3 Status Information
n+56 to n+63		n+56 to n+63	
n+64 to n+71	Axis No.4 Control Information	n+64 to n+71	Axis No.4 Status Information
n+72 to n+79		n+72 to n+79	
n+80 to n+87	Axis No.5 Control Information	n+80 to n+87	Axis No.5 Status Information
n+88 to n+95		n+88 to n+95	
n+96 to n+103	Axis No.6 Control Information	n+96 to n+103	Axis No.6 Status Information
n+104 to n+111		n+104 to n+111	
n+112 to n+119	Axis No.7 Control Information	n+112 to n+119	Axis No.7 Status Information
n+120 to n+127		n+120 to n+127	

[Combination Example 4] When number of Simple Direct Mode/Positioner 1 Mode axes is 0 and number of Direct Indication Mode 8
(n is the top node address for each PLC input and output between MCON and PLC)

PLC → MCON		MCON → PLC	
Node Address (Byte Address)	Description	Node Address (Byte Address)	Description
n to n+3	Gateway Control	n to n+3	Gateway Status
n+4 to n+15	Demand Command	n+4 to n+15	Response Command
n+16 to n+23	Axis No.0 Control Information	n+16 to n+23	Axis No.0 Status Information
n+24 to n+31		n+24 to n+31	
n+32 to n+39	Axis No.1 Control Information	n+32 to n+39	Axis No.1 Status Information
n+40 to n+47		n+40 to n+47	
n+48 to n+55	Axis No.2 Control Information	n+48 to n+55	Axis No.2 Status Information
n+56 to n+63		n+56 to n+63	
n+64 to n+71	Axis No.3 Control Information	n+64 to n+71	Axis No.3 Status Information
n+72 to n+79		n+72 to n+79	
n+80 to n+87	Axis No.4 Control Information	n+80 to n+87	Axis No.4 Status Information
n+88 to n+95		n+88 to n+95	
n+96 to n+103	Axis No.5 Control Information	n+96 to n+103	Axis No.5 Status Information
n+104 to n+111		n+104 to n+111	
n+112 to n+119	Axis No.6 Control Information	n+112 to n+119	Axis No.6 Status Information
n+120 to n+127		n+120 to n+127	
n+128 to n+135	Axis No.7 Control Information	n+128 to n+135	Axis No.7 Status Information
n+136 to n+143		n+136 to n+143	

4) PROFINET-IO

[Combination Example 1] When number of Simple Direct Mode/Positioner 1 Mode axes is 8 and number of Direct Indication Mode 0

PLC → MCON		MCON → PLC	
4-word Number of Module	Description	4-word Number of Module	Description
1	Gateway Control, Demand Command, Data 0	1	Gateway Status, Response Command, Data 0
2	Data 1 to 3	2	Data 1 to 3
3	Axis No.0 Control Information	3	Axis No.0 Status Information
4	Axis No.1 Control Information	4	Axis No.1 Status Information
5	Axis No.2 Control Information	5	Axis No.2 Status Information
6	Axis No.3 Control Information	6	Axis No.3 Status Information
7	Axis No.4 Control Information	7	Axis No.4 Status Information
8	Axis No.5 Control Information	8	Axis No.5 Status Information
9	Axis No.6 Control Information	9	Axis No.6 Status Information
10	Axis No.7 Control Information	10	Axis No.7 Status Information

[Combination Example 2] When number of Simple Direct Mode/Positioner 1 Mode axes is 6 and number of Direct Indication Mode 2

PLC → MCON		MCON → PLC	
4-word Number of Module	Description	4-word Number of Module	Description
1	Gateway Control, Demand Command, Data 0	1	Gateway Status, Response Command, Data 0
2	Data 1 to 3	2	Data 1 to 3
3	Axis No.0 Control Information	3	Axis No.0 Status Information
4	Axis No.1 Control Information	4	Axis No.1 Status Information
5	Axis No.2 Control Information	5	Axis No.2 Status Information
6	Axis No.3 Control Information	6	Axis No.3 Status Information
7	Axis No.4 Control Information	7	Axis No.4 Status Information
8	Axis No.5 Control Information	8	Axis No.5 Status Information
9	Axis No.6 Control Information	9	Axis No.6 Status Information
10		10	
11		11	
12	Axis No.7 Control Information	12	Axis No.7 Status Information

[Combination Example 3] When number of Simple Direct Mode/Positioner 1 Mode axes is 2 and number of Direct Indication Mode 6

PLC → MCON		MCON → PLC	
4-word Number of Module	Description	4-word Number of Module	Description
1	Gateway Control, Demand Command, Data 0	1	Gateway Status, Response Command, Data 0
2	Data 1 to 3	2	Data 1 to 3
3	Axis No.0 Control Information	3	Axis No.0 Status Information
4	Axis No.1 Control Information	4	Axis No.1 Status Information
5	Axis No.2 Control Information	5	Axis No.2 Status Information
6		6	
7	Axis No.3 Control Information	7	Axis No.3 Status Information
8		8	
9	Axis No.4 Control Information	9	Axis No.4 Status Information
10		10	
11	Axis No.5 Control Information	11	Axis No.5 Status Information
12		12	
13	Axis No.6 Control Information	13	Axis No.6 Status Information
14		14	
15	Axis No.7 Control Information	15	Axis No.7 Status Information
16		16	

[Combination Example 4] When number of Simple Direct Mode/Positioner 1 Mode axes is 0 and number of Direct Indication Mode 8

PLC → MCON		MCON → PLC	
4-word Number of Module	Description	4-word Number of Module	Description
1	Gateway Control, Demand Command, Data 0	1	Gateway Status, Response Command, Data 0
2	Data 1 to 3	2	Data 1 to 3
3	Axis No.0 Control Information	3	Axis No.0 Status Information
4		4	
5	Axis No.1 Control Information	5	Axis No.1 Status Information
6		6	
7	Axis No.2 Control Information	7	Axis No.2 Status Information
8		8	
9	Axis No.3 Control Information	9	Axis No.3 Status Information
10		10	
11	Axis No.4 Control Information	11	Axis No.4 Status Information
12		12	
13	Axis No.5 Control Information	13	Axis No.5 Status Information
14		14	
15	Axis No.6 Control Information	15	Axis No.6 Status Information
16		16	
17	Axis No.7 Control Information	17	Axis No.7 Status Information
18		18	

[2] Address Map for Positioner 2 and Positioner 5 Mode

Shown below is the address map for each Fieldbus when eight axes of MCON are operated in Positioner 2 or Positioner 5 Mode.

1) DeviceNet (CompoNet is not applicable for this mode)

(n is the top channel number for each PLC input and output between MCON and PLC)

PLC → MCON		MCON → PLC	
CH No.	Description	CH No.	Description
n to n+1	Gateway Control	n to n+1	Gateway Status
n+2 to n+7	Demand Command	n+2 to n+7	Response Command
n+8 to n+9	Axis No.0 Control Information	n+8 to n+9	Axis No.0 Status Information
n+10 to n+11	Axis No.1 Control Information	n+10 to n+11	Axis No.1 Status Information
n+12 to n+13	Axis No.2 Control Information	n+12 to n+13	Axis No.2 Status Information
n+14 to n+15	Axis No.3 Control Information	n+14 to n+15	Axis No.3 Status Information
n+16 to n+17	Axis No.4 Control Information	n+16 to n+17	Axis No.4 Status Information
n+18 to n+19	Axis No.5 Control Information	n+18 to n+19	Axis No.5 Status Information
n+20 to n+21	Axis No.6 Control Information	n+20 to n+21	Axis No.6 Status Information
n+22 to n+23	Axis No.7 Control Information	n+22 to n+23	Axis No.7 Status Information

2) CC-Link

(Extended Cyclic Setting/Number of Occupied Stations: 1 times/4 stations)

PLC → MCON		MCON → PLC	
Address	Description	Address	Description
RY 00 to 1F	Gateway Control	RX 00 to 1F	Gateway Status
RY 20 to 6F	Demand Command	RX 20 to 6F	Response Command
RY 70 to 7F	Cannot be used.	RX 70 to 7F	Cannot be used.
RWw 00 to 01	Axis No.0 Control Information	RWr 00 to 01	Axis No.0 Status Information
RWw 02 to 03	Axis No.1 Control Information	RWr 02 to 03	Axis No.1 Status Information
RWw 04 to 05	Axis No.2 Control Information	RWr 04 to 05	Axis No.2 Status Information
RWw 06 to 07	Axis No.3 Control Information	RWr 06 to 07	Axis No.3 Status Information
RWw 08 to 09	Axis No.4 Control Information	RWr 08 to 09	Axis No.4 Status Information
RWw 0A to 0B	Axis No.5 Control Information	RWr 0A to 0B	Axis No.5 Status Information
RWw 0C to 0D	Axis No.6 Control Information	RWr 0C to 0D	Axis No.6 Status Information
RWw 0E to 0F	Axis No.7 Control Information	RWr 0E to 0F	Axis No.7 Status Information

3) PROFIBUS-DP, EtherNet/IP, EtherCAT

(n is the top node address for each PLC input and output between MCON and PLC)

PLC → MCON		MCON → PLC	
Node Address (Byte Address)	Description	Node Address (Byte Address)	Description
n to n+3	Gateway Control	n to n+3	Gateway Status
n+4 to n+15	Demand Command	n+4 to n+15	Response Command
n+16 to n+19	Axis No.0 Control Information	n+16 to n+19	Axis No.0 Status Information
n+20 to n+23	Axis No.1 Control Information	n+20 to n+23	Axis No.1 Status Information
n+24 to n+27	Axis No.2 Control Information	n+24 to n+27	Axis No.2 Status Information
n+28 to n+31	Axis No.3 Control Information	n+28 to n+31	Axis No.3 Status Information
n+32 to n+35	Axis No.4 Control Information	n+32 to n+35	Axis No.4 Status Information
n+36 to n+39	Axis No.5 Control Information	n+36 to n+39	Axis No.5 Status Information
n+40 to n+43	Axis No.6 Control Information	n+40 to n+43	Axis No.6 Status Information
n+44 to n+47	Axis No.7 Control Information	n+44 to n+47	Axis No.7 Status Information

4) PROFINET-IO

PLC → MCON		MCON → PLC	
4-word Number of Module	Description	4-word Number of Module	Description
1	Gateway Control, Demand Command, Data 0	1	Gateway Status, Response Command, Data 0
2	Data 1 to 3	2	Data 1 to 3
3	Axis No.0 Control Information	3	Axis No.0 Status Information
	Axis No.1 Control Information		Axis No.1 Status Information
4	Axis No.2 Control Information	4	Axis No.2 Status Information
	Axis No.3 Control Information		Axis No.3 Status Information
5	Axis No.4 Control Information	5	Axis No.4 Status Information
	Axis No.5 Control Information		Axis No.5 Status Information
6	Axis No.6 Control Information	6	Axis No.6 Status Information
	Axis No.7 Control Information		Axis No.7 Status Information

[3] Address Map for Positioner 3 Mode

Shown below is the address map for each Fieldbus when eight axes of MCON are operated in Positioner 3 Mode.

1) DeviceNet, CompoNet

(n is the top channel number for each PLC input and output between MCON and PLC)

PLC → MCON		MCON → PLC	
CH No.	Description	CH No.	Description
n to n+1	Gateway Control	n to n+1	Gateway Status
n+2 to n+7	Demand Command	n+2 to n+7	Response Command
n+8	Axis No.0 Control Information	n+8	Axis No.0 Status Information
n+9	Axis No.1 Control Information	n+9	Axis No.1 Status Information
n+10	Axis No.2 Control Information	n+10	Axis No.2 Status Information
n+11	Axis No.3 Control Information	n+11	Axis No.3 Status Information
n+12	Axis No.4 Control Information	n+12	Axis No.4 Status Information
n+13	Axis No.5 Control Information	n+13	Axis No.5 Status Information
n+14	Axis No.6 Control Information	n+14	Axis No.6 Status Information
n+15	Axis No.7 Control Information	n+15	Axis No.7 Status Information

2) CC-Link

(Extended Cyclic Setting/Number of Occupied Stations: 1 times/4 stations)

PLC → MCON		MCON → PLC	
Address	Description	Address	Description
RY 00 to 1F	Gateway Control	RX 00 to 1F	Gateway Status
RY 20 to 6F	Demand Command	RX 20 to 6F	Response Command
RY 70 to 7F	Cannot be used.	RX 70 to 7F	Cannot be used.
RWw 0	Axis No.0 Control Information	RWr 00	Axis No.0 Status Information
RWw 01	Axis No.1 Control Information	RWr 01	Axis No.1 Status Information
RWw 02	Axis No.2 Control Information	RWr 02	Axis No.2 Status Information
RWw 03	Axis No.3 Control Information	RW 03	Axis No.3 Status Information
RWw 04	Axis No.4 Control Information	RWr 04	Axis No.4 Status Information
RWw 05	Axis No.5 Control Information	RWr 05	Axis No.5 Status Information
RWw 06	Axis No.6 Control Information	RWr 06	Axis No.6 Status Information
RWw 07	Axis No.7 Control Information	RW 07	Axis No.7 Status Information
RWw 08 to 0F	Cannot be used.	RWr 08 to 0F	Cannot be used.

3) PROFIBUS-DP, EtherNet/IP, EtherCAT

(n is the top node address for each PLC input and output between MCON and PLC)

PLC → MCON		MCON → PLC	
Node Address (Byte Address)	Description	Node Address (Byte Address)	Description
n to n+3	Gateway Control	n to n+3	Gateway Status
n+4 to n+15	Demand Command	n+4 to n+15	Response Command
n+16, n+17	Axis No.0 Control Information	n+16, n+17	Axis No.0 Status Information
n+18, n+19	Axis No.1 Control Information	n+18, n+19	Axis No.1 Status Information
n+20, n+21	Axis No.2 Control Information	n+20, n+21	Axis No.2 Status Information
n+22, n+23	Axis No.3 Control Information	n+22, n+23	Axis No.3 Status Information
n+24, n+25	Axis No.4 Control Information	n+24, n+25	Axis No.4 Status Information
n+26, n+27	Axis No.5 Control Information	n+26, n+27	Axis No.5 Status Information
n+28, n+29	Axis No.6 Control Information	n+28, n+29	Axis No.6 Status Information
n+30, n+31	Axis No.7 Control Information	n+30, n+31	Axis No.7 Status Information

4) PROFINET-IO

PLC → MCON		MCON → PLC	
4-word Number of Module	Description	4-word Number of Module	Description
1	Gateway Control, Demand Command, Data 0	1	Gateway Status, Response Command, Data 0
2	Data 1 to 3	2	Data 1 to 3
3	Axis No.0 Control Information	3	Axis No.0 Status Information
	Axis No.1 Control Information		Axis No.1 Status Information
	Axis No.2 Control Information		Axis No.2 Status Information
	Axis No.3 Control Information		Axis No.3 Status Information
4	Axis No.4 Control Information	4	Axis No.4 Status Information
	Axis No.5 Control Information		Axis No.5 Status Information
	Axis No.6 Control Information		Axis No.6 Status Information
	Axis No.7 Control Information		Axis No.7 Status Information

[4] Address Map for Remote I/O Mode

Shown below is the address map for each Fieldbus when eight axes of MCON are operated in Remote I/O Mode.

1) DeviceNet, CompoNet

(n is the top channel number for each PLC input and output between MCON and PLC)

PLC → MCON		MCON → PLC	
CH No.	Description	CH No.	Description
n to n+1	Gateway Control	n to n+1	Gateway Status
n+2 to n+7	Demand Command	n+2 to n+7	Response Command
n+8	Axis No.0 Control Information	n+8	Axis No.0 Status Information
n+9	Axis No.1 Control Information	n+9	Axis No.1 Status Information
n+10	Axis No.2 Control Information	n+10	Axis No.2 Status Information
n+11	Axis No.3 Control Information	n+11	Axis No.3 Status Information
n+12	Axis No.4 Control Information	n+12	Axis No.4 Status Information
n+13	Axis No.5 Control Information	n+13	Axis No.5 Status Information
n+14	Axis No.6 Control Information	n+14	Axis No.6 Status Information
n+15	Axis No.7 Control Information	n+15	Axis No.7 Status Information

2) CC-Link

(Extended Cyclic Setting/Number of Occupied Stations: 1 times/4 stations)

PLC → MCON		MCON → PLC	
Address	Description	Address	Description
RY 00 to 1F	Gateway Control	RX 00 to 1F	Gateway Status
RY 20 to 6F	Demand Command	RX 20 to 6F	Response Command
RY 70 to 7F	Cannot be used.	RX 70 to 7F	Cannot be used.
RWw 00	Axis No.0 Control Information	RWr 00	Axis No.0 Status Information
RWw 01	Axis No.1 Control Information	RWr 01	Axis No.1 Status Information
RWw 02	Axis No.2 Control Information	RWr 02	Axis No.2 Status Information
RWw 03	Axis No.3 Control Information	RWr 03	Axis No.3 Status Information
RWw 04	Axis No.4 Control Information	RWr 04	Axis No.4 Status Information
RWw 05	Axis No.5 Control Information	RWr 05	Axis No.5 Status Information
RWw 06	Axis No.6 Control Information	RWr 06	Axis No.6 Status Information
RWw 07	Axis No.7 Control Information	RWr 07	Axis No.7 Status Information
RWw 08 to 0F	Cannot be used.	RWr 08 to 0F	Cannot be used.

3) PROFIBUS-DP, EtherNet/IP, EtherCAT
(n is the top node address for each PLC input and output between MCON and PLC)

PLC → MCON		MCON → PLC	
Node Address (Byte Address)	Description	Node Address (Byte Address)	Description
n to n+3	Gateway Control	n to n+3	Gateway Status
n+4 to n+15	Demand Command	n+4 to n+15	Response Command
n+16, n+17	Axis No.0 Control Information	n+16, n+17	Axis No.0 Status Information
n+18, n+19	Axis No.1 Control Information	n+18, n+19	Axis No.1 Status Information
n+20, n+21	Axis No.2 Control Information	n+20, n+21	Axis No.2 Status Information
n+22, n+23	Axis No.3 Control Information	n+22, n+23	Axis No.3 Status Information
n+24, n+25	Axis No.4 Control Information	n+24, n+25	Axis No.4 Status Information
n+26, n+27	Axis No.5 Control Information	n+26, n+27	Axis No.5 Status Information
n+28, n+29	Axis No.6 Control Information	n+28, n+29	Axis No.6 Status Information
n+30, n+31	Axis No.7 Control Information	n+30, n+31	Axis No.7 Status Information

4) PROFINET-IO

PLC → MCON		MCON → PLC	
4-word Number of Module	Description	4-word Number of Module	Description
1	Gateway Control, Demand Command, Data 0	1	Gateway Status, Response Command, Data 0
2	Data 1 to 3	2	Data 1 to 3
3	Axis No.0 Control Information	3	Axis No.0 Status Information
	Axis No.1 Control Information		Axis No.1 Status Information
	Axis No.2 Control Information		Axis No.2 Status Information
	Axis No.3 Control Information		Axis No.3 Status Information
4	Axis No.4 Control Information	4	Axis No.4 Status Information
	Axis No.5 Control Information		Axis No.5 Status Information
	Axis No.6 Control Information		Axis No.6 Status Information
	Axis No.7 Control Information		Axis No.7 Status Information

3.4.3 Gateway Control Signals (Common for all operation modes)

When operating the system with Fieldbus, the axes are controlled via Gateway of MCON. The top 2 words of input and output in each operation mode are the signals Gateway control and status monitoring.

(n is the top word address for each PLC input and output between MCON and PLC)

PLC → MCON (PLC Output)		MCON → PLC (PLC Input)	
Control Signal 0	n	Status Signal 0	n
Control Signal 1	n+1	Status Signal 1	n+1

(1) PLC I/O Signal

PLC Output

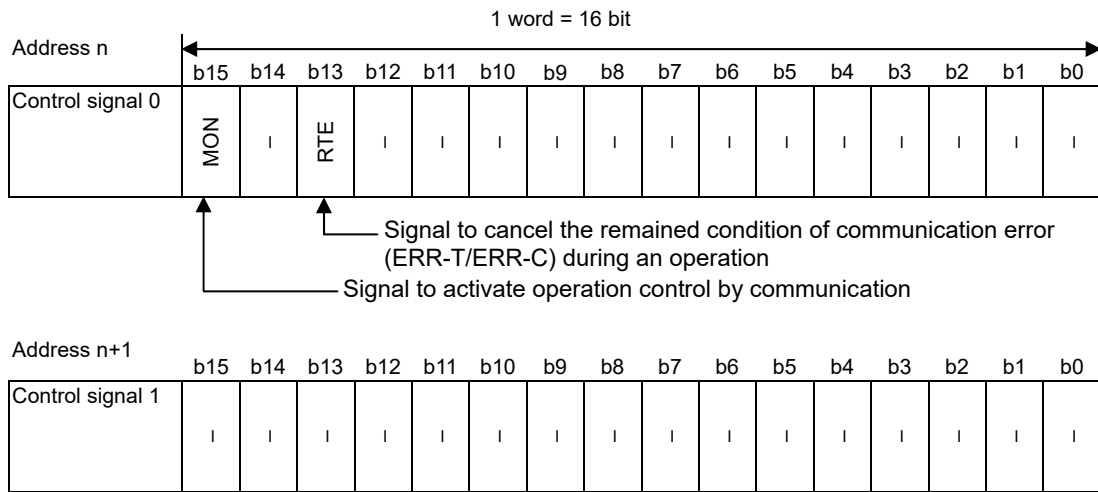

PLC Input

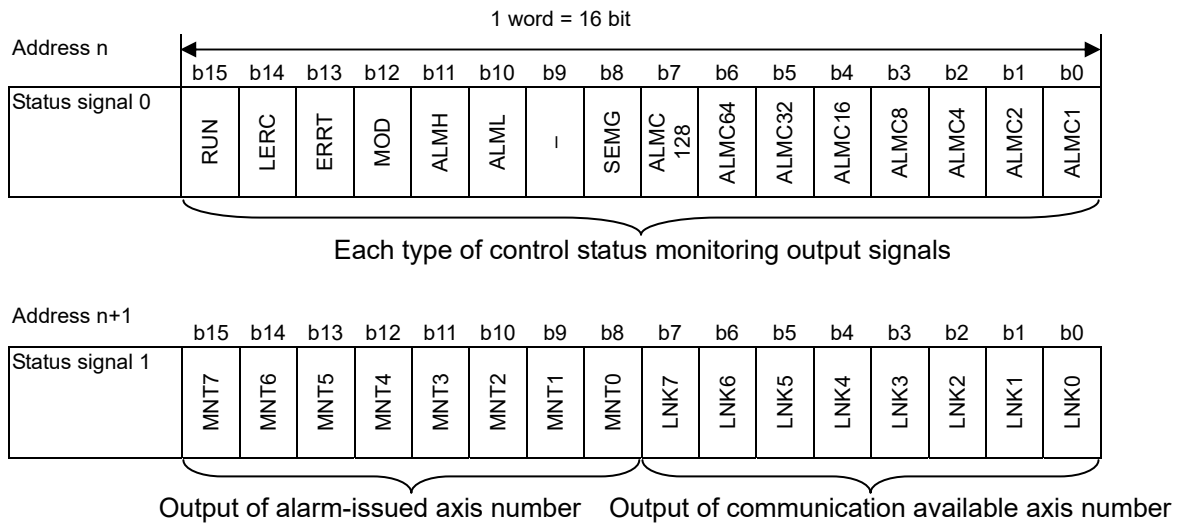

(2) List for Input and Output Signal

(ON = Applicable bit is "1", OFF = Applicable bit is "0")

Signal Type	Bit	Symbol	Description	Details	
PLC Output	b15	MON	Operation control with communication is available while it is ON	-	
	b14	-	Cannot be used.	-	
	b13	RTE	Retained condition of ERR-T or ERR-C during an operation is cancelled if it is ON It is the cancel signal when ERR-T or ERR-C occurrence is set to latch in Gateway Parameter Setting Tool	-	
	b12	-	Cannot be used.	-	
	b11				
	b10				
	b9				
	b8				
	b7				
	b6				
	b5				
	b4				
	b3				
	b2				
	b1				
	b0				
	Status signal 0				b15
		b14			
		b13			
		b12			
		b11			
		b10			
		b9			
		b8			
		b7			
		b6			
		b5			
b4					
b3					
b2					
b1					
b0					
Status signal 1	b15	-	Cannot be used.	-	
	b14				
	b13				
	b12				
	b11				
	b10				
	b9				
	b8				
	b7				
	b6				
	b5				
	b4				
	b3				
	b2				
b1					
b0					

(ON = Applicable bit is "1", OFF = Applicable bit is "0")

Signal Type	Bit	Symbol	Description	Details	
PLC Input	Control signal 0	b15	RUN	This signal turns ON when Gateway is in normal operation.	-
		b14	LERC	This signal turns ON if the ERR-T or ERR-C occurred during an operation is retained and turns OFF if cancel signal RTE is turn ON. It is effective when ERR-T or ERR-C occurrence is set to latch in Gateway Parameter Setting Tool.	-
		b13	ERRT	This signal turns ON when a communication error is detected between the Gateway and each axis.	-
		b12	MOD	This signal turns ON if the operation mode switch on the front of the unit is selected to be on MANU side, and turns OFF if on AUTO side.	-
		b11	ALMH	This signal turns ON when an error caused by the Gateway that requires a reboot is occurred. (A wrong setting in the parameters can be considered. Check the parameters settings.)	-
		b10	ALML	This signal turns ON when a light error caused by the Gateway is occurred. (It is considered that there shall be a loss of the calendar data. Check the parameters settings.)	-
		b9	-	Cannot be used.	-
		b8	SEMG	This signal turns ON when EMGIN input of the system I/O connector is OFF (emergency stop). When this bit is turned ON, all the connected axes get in the emergency stop.	-
		b7	ALMC1 to 128	It is an output of an alarm code caused by the Gateway. [Refer to Gateway alarm codes in Chapter 9 Troubleshooting for details.]	-
		b6			
		b5			
		b4			
		b3			
		b2			
	b1				
	b0				
	Control signal 1	b15	MNT7	The bit of an axis number that a light error alarm is generated turns ON. Axis No.0 = MNT0 to Axis No.7 = MNT7	-
		b14	MNT6		
		b13	MNT5		
		b12	MNT4		
		b11	MNT3		
		b10	MNT2		
b9		MNT1			
b8		MNT0	[Refer to 8.2 [64] Light Malfunction Alarm Output Select]	-	
b7		LNK7			
b6		LNK6			
b5		LNK5			
b4		LNK4			
b3		LNK3			
b2		LNK2			
b1	LNK1	The bit of the axis number identified as effective by the Gateway turns ON. Axis No.0 = LNK0 to Axis No.7 = LNK7	-		
b0	LNK0				

3.4.4 Control Signals for Simple Direct Mode

 **Caution:** This mode is not applicable for CompoNet.

This is a mode to operate with inputting the target position for positioning directly. Except for the target position, the operation follows the position data set in the indicated position number.

The settable No. of position data items is max 256 points.
The main functions of ROBO Cylinder capable to control in this mode are as described in the following table.

ROBO cylinder function	○: Direct control △: Indirect control ×: Disabled	Remarks
Home-return operation	○	
Positioning operation	○	For those other than the target position, it is necessary to set the position data.
Speed and acceleration/ deceleration setting	△	These items must be set in the position data table.
Separate settings for acceleration and deceleration	△	
Pitch feed (incremental)	△	
Pressing operation	△	
Speed change during movement	△	
Pause	○	
Zone signal output	△	These items must be set in the parameters.
Position zone signal	△	These items must be set in the position data table.
Vibration control	△	This feature is limited only to the servo motor type actuators.
PIO pattern selection	×	

(1) PLC Address Composition
(m is PLC input and output top word address for each axis number)

PLC → MCON (PLC Output)		MCON → PLC (PLC Input)	
Target Position	m to m+1	Current Position	m to m+1
Specified Position No.	m+2	Completed Position No. (Simple Alarm Code)	m+2
Control Signal	m+3	Status Signal	m+3

[Refer to Section 3.4.2 for the address maps for each Fieldbus.]

(2) Input and Output Signal Assignment for each Axis

The I/O signals for each axis consists of 4-word for each I/O bit register.

- The control signals and status signals are ON/OFF signals in units of bit.
- For the target position and current position, 2-word (32-bit) binary data is available and values from -999999 to +999999 (unit: 0.01mm) can be used. Negative numbers are to be dealt with two's complement.

Caution:
 • Set the position data in the range of the soft stroke (0 to effective stroke length) of the actuator.

- For the indicated position number and complete position number, 1-word (16-bit) binary data is available and values from 0 to 255 can be used.

Caution:
 Set the operational condition in advance with using a teaching tool such as PC software in the position number to be used. Selecting a position number with no setting conducted will generate the alarm code 0A2 "Position Data Error".

PLC Output (m is PLC output top word address for each axis number)

1 word = 16 bit

Address m	b15	b14	b13	b12	b11	b10	b9	b8	b7	b6	b5	b4	b3	b2	b1	b0
Target Position (Lower word)																

Address m+1	b15	b14	b13	b12	b11	b10	b9	b8	b7	b6	b5	b4	b3	b2	b1	b0
Target Position (Upper word)																

(Note) If the target position is a negative value, it is indicated by a two's complement.

Address m+2	b15	b14	b13	b12	b11	b10	b9	b8	b7	b6	b5	b4	b3	b2	b1	b0
Specified Position No.									PC128	PC64	PC32	PC16	PC8	PC4	PC2	PC1

Address m+3	b15	b14	b13	b12	b11	b10	b9	b8	b7	b6	b5	b4	b3	b2	b1	b0
Control Signal	BKRL							JOG+	JOG-	JVEL	JISL	SON	RES	STP	HOME	CSTR

PLC Input (m is PLC input top word address for each axis number)

1 word = 16 bit

Address m	b15	b14	b13	b12	b11	b10	b9	b8	b7	b6	b5	b4	b3	b2	b1	b0
Current Position (Lower word)																

Address m+1	b15	b14	b13	b12	b11	b10	b9	b8	b7	b6	b5	b4	b3	b2	b1	b0
Current Position (Upper word)																

(Note) If the target position is a negative value, it is indicated by a two's complement.

Address m+2	b15	b14	b13	b12	b11	b10	b9	b8	b7	b6	b5	b4	b3	b2	b1	b0
Completed Position No.	-	-	-	-	-	-	-	-	PM128	PM64	PM32	PM16	PM8	PM4	PM2	PM1

Address m+3	b15	b14	b13	b12	b11	b10	b9	b8	b7	b6	b5	b4	b3	b2	b1	b0
Status Signal	EMGS	CRDY	ZONE2	ZONE1	PZONE	-	-	MEND	ALML	-	PSFL	SV	ALM	MOVE	HEND	PEND

(3) I/O signal assignment

(ON = Applicable bit is "1", OFF = Applicable bit is "0")

Signal Type	Bit	Symbol	Description	Details	
PLC Output	Target Position	32 bits	–	32-bit signed integer indicating the current position Unit: 0.01mm Available range for Setting: -999999 to 999999 Set the target position with the value from the home position. (Example) If +25.40mm, input 000009EC _H (2540 in decimal system). (Note) Input the negative value using a compliment of 2.	3.7.2
	Specified Position No.	16 bits	PC1 to PC128	16-bit integer Available range for Setting: 0 to 255 To operate, it is necessary to have the position data that the operation conditions are already set in advance with a teaching tool such as the PC software. In this register, indicate the position number the data is input with a binary number. Indicating a value out of the range or operating with a position number with no setting conducted will generate the alarm code 0A2 "Position Data Error".	3.7.2
	Control Signal	b15	BKRL	Brake release ON: Brake release, OFF: Brake activated	3.7.1 [15]
		b14	–	Cannot be used.	–
		b13			
		b12			
		b11			
		b10			
		b9			
		b8	JOG+	+Jog ON: Movement against home position, OFF: Stop	3.7.1 [10]
		b7	JOG-	-Jog ON: Movement toward home position, OFF: Stop	
		b6	JVEL	Jog-speed/inch-distance switching OFF : Use the setting values of Parameter No.26 JOG Speed and No.48 Inching Distance in MCON ON : Use the setting values of Parameter No.47 JOG Speed 2 and No.49 Inching Distance in MCON	3.7.1 [11]
		b5	JISL	Jog/inching switching ON: Inching, OFF: Jog	3.7.1 [12]
		b4	SON	Servo ON command ON: Servo ON, OFF: Servo OFF	3.7.1 [5]
b3		RES	Reset A reset is performed when this signal turns ON.	3.7.1 [4]	
b2	STP	Pause ON: Pause, OFF: Pause release	3.7.1 [8]		
b1	HOME	Home return Home-return command with this signal ON, command carried on till complete even if the signal is turned OFF on the way	3.7.1 [6]		
b0	CSTR	Positioning start Movement command executed with this signal ON, command carried on till complete even if the signal is turned OFF on the way	3.7.1 [7]		

(ON = Applicable bit is "1", OFF = Applicable bit is "0")

Signal Type	Bit	Symbol	Description	Details	
PLC Input	Current Position	32 bits	–	32-bit signed integer indicating the current position Unit: 0.01mm (Example) If +10.23mm, input 000003FF _H (1023 in decimal system). <i>(Note) Negative numbers are two's implement.</i>	3.7.2
	Completed Position No. (Simple Alarm Code)	16 bits	PM1 to PM128	16-bit integer The positioning complete position number is output in a binary number once getting into the positioning width after moving to the target position. In the case that the position movement has not been performed at all, or during the movement, "0" is output. Read it by turning PEND Signal ON after movement. The simple alarm code (refer to Chapter 9 Troubleshooting) is output while an alarm is issued (ALM of Status Signal is ON).	3.7.2
	Status Signal	b15	EMGS	This signal turns ON during an emergency stop	3.7.1 [2]
		b14	CRDY	This signal turns ON when the controller is standing by.	3.7.1 [1]
		b13	ZONE2	"ON" for the current position within the zone 2 set range The zone range setting is necessary for the parameter.	3.7.1 [9]
		b12	ZONE1	"ON" for the current position within the zone 1 set range The zone range setting is necessary for the parameter.	
		b11	PZONE	Position zone This signal turns ON when the current position is inside the specified position zone.	3.7.1 [9]
		b10	–	Cannot be used.	–
		b9			
		b8	MEND	This signal turns ON at either of positioning complete of after movement, home return complete or pressing complete or pressing failure, and turns OFF at movement start. It is OFF when the servo is OFF.	3.7.1 [19]
		b7	ALML	Light error alarm output It turns ON when an overload warning or message level error is issued.	3.7.1 [21]
		b6	–	Cannot be used.	–
		b5	PSFL	"ON" for pressing and a miss	3.7.1 [18]
		b4	SV	This signal turns ON when operation standby is complete (Servo is ON).	3.7.1 [5]
		b3	ALM	This signal is ON while an alarm is generated.	3.7.1 [3]
b2	MOVE	This signal is ON while in movement.	3.7.1 [7]		
b1	HEND	This signal turns ON at home return complete and is kept unless the home position is lost due to a fact such as an alarm.	3.7.1 [6]		
b0	PEND	This signal turns ON at positioning complete and is kept ON during a stop with the servo ON, but does not turn ON when pressing operation is failed.	3.7.1 [7]		

3.4.5 Control Signals for Positioner 1 Mode

⚠ Caution: This mode is not applicable for CompoNet.

Operation is performed by indicating a position number from the operation modes of the position data set in the position table.

The settable No. of position data items is max 256 points.

The main functions of ROBO Cylinder capable to control in this mode are as described in the following table.

ROBO cylinder function	○: Direct control △: Indirect control ×: Disabled	Remarks
Home-return operation	○	
Positioning operation	△	These items must be set in the position data table.
Speed and acceleration/ deceleration setting	△	
Separate settings for acceleration and deceleration	△	
Pitch feed (incremental)	△	
Pressing operation	△	
Speed change during movement	△	
Pause	○	
Zone signal output	△	These items must be set in the parameters.
Position zone signal	△	These items must be set in the position data table.
Vibration control	△	This feature is limited only to the servo motor type actuators.
PIO pattern selection	×	

(1) PLC Address Composition

(m is PLC input and output top word address for each axis number)

PLC → MCON (PLC Output)		MCON → PLC (PLC Input)	
Cannot be used.	m to m+1	Current Position	m to m+1
Specified Position No.	m+2	Completed Position No. (Simple Alarm Code)	m+2
Control Signal	m+3	Status Signal	m+3

[Refer to Section 3.4.2 for the address maps for each Fieldbus.]

(2) Input and Output Signal Assignment for each Axis

The I/O signals for each axis consists of 4-word for each I/O bit register.

- The control signals and status signals are ON/OFF signals in units of bit.
- For the current position, 2-word (32-bit) binary data is available and values from -999999 to +999999 (unit: 0.01mm) can be used. Negative numbers are to be dealt with two's complement.
- For the indicated position number and complete position number, 1-word (16-bit) binary data is available and values from 0 to 255 can be used.



Caution:

Set the operational condition in advance with using a teaching tool such as PC software in the position number to be used. Selecting a position number with no setting conducted will generate the alarm code 0A2 "Position Data Error".

PLC Output (m is PLC output top word address for each axis number)

Address m		1 word = 16 bit															
		b15	b14	b13	b12	b11	b10	b9	b8	b7	b6	b5	b4	b3	b2	b1	b0
Cannot be used.																	
Address m+1		b15	b14	b13	b12	b11	b10	b9	b8	b7	b6	b5	b4	b3	b2	b1	b0
Cannot be used.																	
Address m+2		b15	b14	b13	b12	b11	b10	b9	b8	b7	b6	b5	b4	b3	b2	b1	b0
Specified Position No.		-	-	-	-	-	-	-	-	PC128	PC64	PC32	PC16	PC8	PC4	PC2	PC1
Address m+3		b15	b14	b13	b12	b11	b10	b9	b8	b7	b6	b5	b4	b3	b2	b1	b0
Control Signal		BKRL	-	-	-	-	MODE	PWRT	JOG+	JOG-	JVEL	JISL	SON	RES	STP	HOME	CSTR

PLC Input (m is PLC input top word address for each axis number)

1 word = 16 bit

Address m	b15	b14	b13	b12	b11	b10	b9	b8	b7	b6	b5	b4	b3	b2	b1	b0
Current Position (Lower word)																

Address m+1	b15	b14	b13	b12	b11	b10	b9	b8	b7	b6	b5	b4	b3	b2	b1	b0
Current Position (Upper word)																

(Note) If the target position is a negative value, it is indicated by a two's complement.

Address m+2	b15	b14	b13	b12	b11	b10	b9	b8	b7	b6	b5	b4	b3	b2	b1	b0
Completed Position No.	-	-	-	-	-	-	-	-	PM128	PM64	PM32	PM16	PM8	PM4	PM2	PM1

Address m+3	b15	b14	b13	b12	b11	b10	b9	b8	b7	b6	b5	b4	b3	b2	b1	b0
Status Signal	EMGS	CRDY	ZONE2	ZONE1	PZONE	MODES	WEND	MEND	ALML	-	PSFL	SV	ALM	MOVE	HEND	PEND

(3) I/O signal assignment

(ON = Applicable bit is "1", OFF = Applicable bit is "0")

Signal Type	Bit	Symbol	Description	Details	
PLC Output	Specified Position No.	16 bits	PC1 to PC128	16-bit integer Available range for Setting: 0 to 255 To operate, it is necessary to have the position data that the operation conditions are already set in advance with a teaching tool such as the PC software. In this register, indicate the position number the data is input with a binary number. Indicating a value out of the range or operating with a position number with no setting conducted will generate the alarm code 0A2 "Position Data Error".	3.7.2
	Control Signal	b15	BKRL	Brake release ON: Brake release, OFF: Brake activated	3.7.1 [15]
		b14	-	Cannot be used.	-
		b13			
		b12			
		b11			
		b10	MODE	Teaching mode command OFF: Standard mode, ON : Teaching mode	3.7.1 [13]
		b9	PWRT	Position import command ON: Position Data Import	3.7.1 [14]
		b8	JOG+	+Jog ON: Movement against home position, OFF: Stop	3.7.1 [10]
		b7	JOG-	-Jog ON: Movement toward home position, OFF: Stop	
		b6	JVEL	Jog-speed/inch-distance switching OFF : Use the setting values of Parameter No.26 JOG Speed and No.48 Inching Distance in MCON ON : Use the setting values of Parameter No.47 JOG Speed 2 and No.49 Inching Distance in MCON	3.7.1 [11]
		b5	JISL	Jog/inching switching ON: Inching, OFF: Jog	3.7.1 [12]
		b4	SON	Servo ON command ON: Servo ON, OFF: Servo OFF	3.7.1 [5]
		b3	RES	Reset A reset is performed when this signal turns ON.	3.7.1 [4]
		b2	STP	Pause ON: Pause, OFF: Pause release	3.7.1 [8]
b1	HOME	Home return Home-return command with this signal ON, command carried on till complete even if the signal is turned OFF on the way	3.7.1 [6]		
b0	CSTR	Positioning start Movement command executed with this signal ON, command carried on till complete even if the signal is turned OFF on the way	3.7.1 [7]		

(ON = Applicable bit is "1", OFF = Applicable bit is "0")

Signal Type	Bit	Symbol	Description	Details
PLC Input	Current Position	32 bits	– 32-bit signed integer indicating the current position Unit: 0.01mm (Example) If +10.23mm, input 000003FF _H (1023 in decimal system). <i>(Note) Negative numbers are two's implement.</i>	3.7.2
	Completed Position No. (Simple Alarm Code)	16 bits	PM1 to PM128 16-bit integer The positioning complete position number is output in a binary number once getting into the positioning width after moving to the target position. In the case that the position movement has not been performed at all, or during the movement, "0" is output. Read it by turning PEND Signal ON after movement. The simple alarm code (refer to Chapter 9 Troubleshooting) is output while an alarm is issued (ALM of Status Signal is ON).	3.7.2
Status Signal	b15	EMGS	This signal turns ON during an emergency stop	3.7.1 [2]
	b14	CRDY	This signal turns ON when the controller is standing by.	3.7.1 [1]
	b13	ZONE2	"ON" for the current position within the zone 2 set range The zone range setting is necessary for the parameter.	3.7.1 [9]
	b12	ZONE1	"ON" for the current position within the zone 1 set range The zone range setting is necessary for the parameter.	
	b11	PZONE	Position zone This signal turns ON when the current position is inside the specified position zone.	3.7.1 [9]
	b10	MODES	This signal is ON while the teaching mode is selected.	3.7.1 [13]
	b9	WEND	This signal turns ON when reading is complete.	3.7.1 [14]
	b8	MEND	This signal turns ON at either of positioning complete of after movement, home return complete or pressing complete or pressing failure, and turns OFF at movement start. It is OFF when the servo is OFF.	3.7.1 [19]
	b7	ALML	Light error alarm output It turns ON when an overload warning or message level error is issued.	3.7.1 [21]
	b6	–	Cannot be used.	–
	b5	PSFL	"ON" for pressing and a miss	3.7.1 [18]
	b4	SV	This signal turns ON when operation standby is complete (Servo is ON).	3.7.1 [5]
	b3	ALM	This signal is ON while an alarm is generated.	3.7.1 [3]
	b2	MOVE	This signal is ON while in movement.	3.7.1 [7]
	b1	HEND	This signal turns ON at home return complete and is kept unless the home position is lost due to a fact such as an alarm.	3.7.1 [6]
b0	PEND	This signal turns ON at positioning complete and is kept ON during a stop with the servo ON, but does not turn ON when pressing operation is failed.	3.7.1 [7]	

3.4.6 Control Signals for Direct Indication Mode

⚠ Caution: This mode is not applicable for CompoNet.

This is an operation mode to indicate directly with values for the target position, positioning width, speed, acceleration/deceleration and pressing current.

Set a value to each input and output data register. Set to the parameters when using the zone signals.

The main functions of ROBO Cylinder capable to control in this mode are as described in the following table.

ROBO cylinder function	O: Direct control Δ: Indirect control ×: Disabled	Remarks
Home-return operation	○	
Positioning operation	○	
Speed and acceleration/ deceleration setting	○	
Separate settings for acceleration and deceleration	×	Values for acceleration and deceleration should be the same.
Pitch feed (Incremental)	○	
Pressing operation	○	Selection can be made from the pressing method same as CON type such as PCON and that same as SEP type such as PSEP.
Speed change during movement	○	
Pause	○	
Zone signal output	Δ	Parameters must be set.
Position zone signal	×	
Vibration control	×	
PIO pattern selection	×	

(1) PLC Address Composition

(m is PLC input and output top word address for each axis number)

PLC → MCON (PLC Output)		MCON → PLC (PLC Input)	
Target Position	m to m+1	Current Position	m to m+1
Positioning Width	m+2 to m+3	Command Current	m+2 to m+3
Command Speed	m+4	Current Speed	m+4
Acceleration/ Deceleration	m+5	Cannot be used.	m+5
Pressing Current Limit	m+6	Alarm Code	m+6
Control Signal	m+7	Status Signal	m+7

[Refer to Section 3.4.2 for the address maps for each Fieldbus.]

(2) Input and Output Signal Assignment for each Axis

The I/O signals for each axis consists of 8-word for each I/O bit register.

- The control signals and status signals are ON/OFF signals in units of bit.
- For the target position and current position, 2-word (32-bit) binary data is available and values from -999999 to +999999 (unit: 0.01mm) can be used. Negative numbers are to be dealt with two's complement.



Caution:

- Set the position data in the range of the soft stroke (0 to effective stroke length) of the actuator.

- Set the positioning width. The positioning width is expressed using 2-word (32 bits) binary data. The figures from 0 to +999999 (Unit: 0.01mm) can be set in PLC.
- The command speed is expressed using 1-word (16 bits) binary data. The figures from 1 to +65535 (Unit: 1.0mm/s or 0.1mm/s) can be set in PLC. A change of the unit is to be conducted on Gateway Parameter Setting Tool.
- The Acceleration/Deceleration is expressed using 1-word (16 bits) binary data. The figures from 1 to 300 (Unit: 0.01G) can be set in PLC.
- The pressing current limit value is expressed using 1-word (16 bits) binary data. The figures from 0 to 100% (0 to FF_H) can be set in PLC.

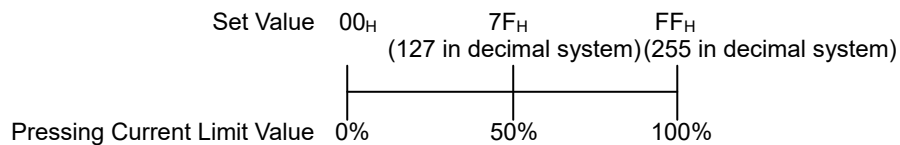

Caution:

Have the setting with values available in the range of for speed, acceleration/deceleration and pressing current of the actuator. (Refer to the catalog or instruction manual of the actuator.) Otherwise, it may cause an abnormal condition of the servo or a malfunction of the actuator such as the alarm codes 0A3 "Position Command Information Data Error", 0C0 "Excess Actual Speed", 0C8 "Overcurrent", 0CA "Overheated" or 0E0 "Overloaded".

- The command current is expressed using 2-word (32 bits) binary data (Unit: 1mA).
- The current speed is expressed using 1-word (16 bits) binary data (Unit: 1.0mm/s or 0.1mm/s).
The unit is the one set in the command speed. A positive number is output when the revolution of the driving motor is in CCW, while a negative number when CW. Negative numbers are output with two's complement.
For Slider and Rod Types of actuators, a negative number is output when a movement is made towards the motor side, while a positive number when against the motor side. For Reversed Motor Type, it is the other way around. For Gripper Type, a positive number is output when fingers are closed. For Rotary Type, a positive number is output when rotating clockwise.
- The alarm code is expressed using 1-word (16 bits) binary data.

PLC Output (m is PLC output top word address for each axis number)

1 word = 16 bit

Address m	b15	b14	b13	b12	b11	b10	b9	b8	b7	b6	b5	b4	b3	b2	b1	b0
Target Position (Lower word)																

Address m+1	b15	b14	b13	b12	b11	b10	b9	b8	b7	b6	b5	b4	b3	b2	b1	b0
Target Position (Upper word)																

(Note) If the target position is a negative value, it is input by a two's complement.

Address m+2	b15	b14	b13	b12	b11	b10	b9	b8	b7	b6	b5	b4	b3	b2	b1	b0
Positioning Width (Lower word)	32,768	16,384	8,192	4,096	2,048	1,024	512	256	128	64	32	16	8	4	2	1

Address m+3	b15	b14	b13	b12	b11	b10	b9	b8	b7	b6	b5	b4	b3	b2	b1	b0
Positioning Width (Upper word)	-	-	-	-	-	-	-	-	-	-	-	-	524,288	262,144	131,072	65,536

Address m+4	b15	b14	b13	b12	b11	b10	b9	b8	b7	b6	b5	b4	b3	b2	b1	b0
Command Speed	32,768	16,384	8,192	4,096	2,048	1,024	512	256	128	64	32	16	8	4	2	1

Address m+5	b15	b14	b13	b12	b11	b10	b9	b8	b7	b6	b5	b4	b3	b2	b1	b0
Acceleration/Deceleration	-	-	-	-	-	-	-	256	128	64	32	16	8	4	2	1

Address m+6	b15	b14	b13	b12	b11	b10	b9	b8	b7	b6	b5	b4	b3	b2	b1	b0
Pressing Current Limit Value	-	-	-	-	-	-	-	256	128	64	32	16	8	4	2	1

Address m+7	b15	b14	b13	b12	b11	b10	b9	b8	b7	b6	b5	b4	b3	b2	b1	b0
Control Signal	BKRL	INC	DIR	PUSH	-	-	-	JOG+	JOG-	JVEL	JISL	SON	RES	STP	HOME	CSTR

PLC Input (m is PLC input top word address for each axis number)

1 word = 16 bit

Address m	b15	b14	b13	b12	b11	b10	b9	b8	b7	b6	b5	b4	b3	b2	b1	b0
Current Position (Lower word)																

Address m+1	b15	b14	b13	b12	b11	b10	b9	b8	b7	b6	b5	b4	b3	b2	b1	b0
Current Position (Upper word)																

(Note) If the target position is a negative value, it is output by a two's complement.

Address m+2	b15	b14	b13	b12	b11	b10	b9	b8	b7	b6	b5	b4	b3	b2	b1	b0
Command Current (Lower word)	32,768	16,384	8,192	4,096	2,048	1,024	512	256	128	64	32	16	8	4	2	1

Address m+3	b15	b14	b13	b12	b11	b10	b9	b8	b7	b6	b5	b4	b3	b2	b1	b0
Command Current (Upper word)	-	-	-	-	-	-	-	-	-	-	-	-	524,288	262,144	131,072	65,536

Address m+4	b15	b14	b13	b12	b11	b10	b9	b8	b7	b6	b5	b4	b3	b2	b1	b0
Current Speed																

(Note) If the negative value, it is indicated by a two's complement.

Address m+5	b15	b14	b13	b12	b11	b10	b9	b8	b7	b6	b5	b4	b3	b2	b1	b0
Cannot be used.																

Address m+6	b15	b14	b13	b12	b11	b10	b9	b8	b7	b6	b5	b4	b3	b2	b1	b0
Alarm Code																

Address m+7	b15	b14	b13	b12	b11	b10	b9	b8	b7	b6	b5	b4	b3	b2	b1	b0
Status Signal	EMGS	CRDY	ZONE2	ZONE1	-	-	-	MEND	ALML	-	PSFL	SV	ALM	MOVE	HEND	PEND

(3) I/O signal assignment

(ON = Applicable bit is "1", OFF = Applicable bit is "0")

Signal Type	Bit	Symbol	Description	Details	
PLC Output	Target Position	32 bits	-	32-bit signed integer indicating the current position Unit: 0.01mm Available range for Setting: -999999 to 999999 Set the target position with the value from the home position. (Example) If +25.40mm, input 000009EC _H (2540 in decimal system). (Note) Input the negative value using a compliment of 2.	3.7.3
	Positioning Width	32 bits	-	32-bit integer Unit: 0.01mm Available range for Setting: 0 to 999999 (Example) If 25.40mm, input 000009EC _H (2540 in decimal system). This register value has two meanings depending on the operation type. 1) Positioning operation ⇒ Range for positioning complete against the target position 2) Pressing operation ⇒ Pressing width (Pressing operation distance) A pressing operation is performed when PUSH Signal in the control signals is ON.	3.7.3
	Command Speed	16 bits	-	16-bit integer Unit: 1.0mm/s or 0.1mm/s (It is set to 1.0mm/s in the initial setting.) A change of the unit is to be conducted on Gateway Parameter Setting Tool. Available range for Setting: 1 to 65535 Specify the speed at which to move the actuator. (Example) If 254.0mm/s, input 09EC _H (2540 in decimal system). It may cause an alarm or a malfunction if executing a movement command with 0 or a value more than the maximum speed of the actuator.	3.7.3
	Acceleration/Deceleration	16 bits	-	16-bit integer Unit: 0.01G Available range for Setting: 1 to 300 Specify the acceleration/deceleration at which to move the actuator. The acceleration and deceleration will be the same value. (Example) If 0.30G, input 001E _H (30 in decimal system). It may cause an alarm or a malfunction if executing a movement command with 0 or a value exceeding the maximum acceleration/deceleration of the actuator.	3.7.3
	Pressing Current Limit Value	16 bits	-	16-bit integer Unit: % Available range for Setting: 0 to FF _H 7F _H =50%, FF _H =100% Indicate the current value for pressing operation. (Example) When setting to 50%, indicate FF _H * 50% = 255 * 50% = 127 (Decimal Number) = 007F _H . The pressing range available for indication differs depending on the actuator (Refer to the catalogue or instruction manual for the actuator). It may cause an alarm or a malfunction if executing a movement command with a value more than the maximum pressing current.	3.7.3

Signal Type	Bit	Symbol	Description	Details	
PLC Output	Control Signal	b15	BKRL	Brake release ON: Brake release, OFF: Brake activated	3.7.1 [15]
		b14	INC	Absolute position commands are issued when this signal is OFF, and incremental position commands are issued when the signal is ON.	3.7.1 [20]
		b13	DIR	Push direction specification ON: Movement against home position, OFF: Movement toward home position <i>(Note) This signal is effective when the pressing method of CON type is selected.</i>	3.7.1 [17]
		b12	PUSH	Push-motion specification ON: Pressing operation, OFF: Positioning operation	3.7.1 [16]
		b11	-	Cannot be used.	-
		b10			
		b9			
		b8	JOG+	+Jog ON: Movement against home position, OFF: Stop	3.7.1 [10]
		b7	JOG-	-Jog ON: Movement toward home position, OFF: Stop	
		b6	JVEL	Jog-speed/inch-distance switching OFF : Use the setting values of Parameter No.26 JOG Speed and No.48 Inching Distance in MCON ON : Use the setting values of Parameter No. 47 JOG Speed 2 or Command Speed ^(Note 1) , and No. 49 Inching Distance 2 in MCON	3.7.1 [11]
		b5	JISL	Jog/inching switching ON: Inching, OFF: Jog	3.7.1 [12]
		b4	SON	Servo ON command ON: Servo ON, OFF: Servo OFF	3.7.1 [5]
		b3	RES	Reset A reset is performed when this signal turns ON.	3.7.1 [4]
		b2	STP	Pause ON: Pause, OFF: Pause release	3.7.1 [8]
b1	HOME	Home return Home-return command with this signal ON, command carried on till complete even if the signal is turned OFF on the way	3.7.1 [6]		
b0	CSTR	Positioning start Movement command executed with this signal ON, command carried on till complete even if the signal is turned OFF on the way	3.7.1 [7]		

Note 1 When Command Speed Setting = 0 : Operation will be made with a value in Parameter No. 47 "PIO JOG Speed 2" in MCON.

When Command Speed Setting ≠ 0 : Operation will be made with the setting value in Command Speed.

(ON = Applicable bit is "1", OFF = Applicable bit is "0")

Signal Type	Bit	Symbol	Description	Details	
PLC Input	Current Position	32 bits	–	32-bit signed integer indicating the current position Unit: 0.01mm (Example) If 10.23mm, input 000003FF _H (1023 in decimal system). <i>(Note) Negative numbers are two's implement.</i>	3.7.3
	Command Current	32 bits	–	32-bit integer The electrical current presently specified by a command is indicated. The setting unit is mA. This resistor makes an output in hexadecimal numbers. (Example) Reading: 000003FF _H = 1023 (Decimal number) = 1023mA	3.7.3
	Current Speed	16 bits	–	16-bit integer The current speed is indicated. Unit: 1.0mm/s or 0.1mm/s. A change of the unit is to be conducted on Gateway Parameter Setting Tool. (Example) Reading: 03FF _H = 1023 (Decimal number) = 1023mm/s <i>(Note) Negative numbers are two's implement.</i>	3.7.3
	Alarm Code	16 bits	–	16-bit integer The alarm code (refer to Chapter 9 Troubleshooting) is output while an alarm is issued (ALM of Status Signal is ON).	3.7.3
	Status Signal	b15	EMGS	This signal turns ON during an emergency stop	3.7.1 [2]
		b14	CRDY	This signal turns ON when the controller is standing by.	3.7.1 [1]
		b13	ZONE2	"ON" for the current position within the zone 2 set range The zone range setting is necessary for the parameter.	3.7.1 [9]
		b12	ZONE1	"ON" for the current position within the zone 1 set range The zone range setting is necessary for the parameter.	
		b11	–	Cannot be used.	–
		b10			
		b9			
		b8	MEND	This signal turns ON at either of positioning complete of after movement, home return complete or pressing complete or pressing failure, and turns OFF at movement start. It is OFF when the servo is OFF.	3.7.1 [19]
		b7	ALML	Light error alarm output It turns ON when an overload warning or message level error is issued.	3.7.1[21]
		b6	–	Cannot be used.	–
b5	PSFL	This signal turns ON when the actuator missed the load in push-motion operation.	3.7.1 [18]		
b4	SV	This signal turns ON when operation standby is complete (Servo is ON).	3.7.1 [5]		
b3	ALM	This signal is ON while an alarm is generated.	3.7.1 [3]		
b2	MOVE	This signal is ON while in movement.	3.7.1 [7]		
b1	HEND	This signal turns ON at home return complete and is kept unless the home position is lost due to a fact such as an alarm.	3.7.1 [6]		
b0	PEND	This signal turns ON at positioning complete and is kept ON during a stop with the servo ON, but does not turn ON when pressing operation is failed.	3.7.1 [7]		

3.4.7 Control Signals for Positioner 2 Mode

⚠ Caution: This mode is not applicable for CompoNet.

It is an operation mode to operate with indicating a position number.
 The operation is to be made by using the position data set in the position table.
 This is a mode that the indication of the target position and the monitoring of the current value are removed from Positioner 1 Mode.
 The settable No. of position data items is max 256 points.
 The main functions of ROBO Cylinder capable to control in this mode are as described in the following table.

ROBO cylinder function	○: Direct control △: Indirect control ×: Disabled	Remarks
Home-return operation	○	
Positioning operation	△	
Speed and acceleration/ deceleration setting	△	These items must be set in the position data table.
Separate settings for acceleration and deceleration	△	
Pitch feed (incremental)	△	
Pressing operation	△	
Speed change during movement	△	
Pause	○	
Zone signal output	△	These items must be set in the parameters.
Position zone signal	△	These items must be set in the position data table.
Vibration control	△	This feature is limited only to the servo motor type actuators.
PIO pattern selection	×	

(1) PLC Address Composition

(m is PLC input and output top word address for each axis number)

PLC → MCON (PLC Output)		MCON → PLC (PLC Input)	
Specified Position No.	m	Completion Position No. (Simple Alarm Code)	m
Control Signal	m+1	Status Signal	m+1

[Refer to Section 3.4.2 for the address maps for each Fieldbus.]

(2) Input and Output Signal Assignment for each Axis

The I/O signals for each axis consists of 2-word for each I/O bit register.

- The control signals and status signals are ON/OFF signals in units of bit.
- For the indicated position number and complete position number, 1-word (16-bit) binary data is available and values from 0 to 255 can be used.



Caution:

Set the operational condition in advance with using a teaching tool such as PC software in the position number to be used. Selecting a position number with no setting conducted will generate the alarm code 0A2 "Position Data Error".

PLC Output (m is PLC output top word address for each axis number)

1 word = 16 bit

Address m	b15	b14	b13	b12	b11	b10	b9	b8	b7	b6	b5	b4	b3	b2	b1	b0
Specified Position No.	-	-	-	-	-	-	-	-	PC128	PC64	PC32	PC16	PC8	PC4	PC2	PC1

Address m+1	b15	b14	b13	b12	b11	b10	b9	b8	b7	b6	b5	b4	b3	b2	b1	b0
Control Signal	BKRL	-	-	-	-	MODE	PWRT	JOG+	JOG-	JVEL	JISL	SON	RES	STP	HOME	CSTR

PLC Input (m is PLC input top word address for each axis number)

1 word = 16 bit

Address m	b15	b14	b13	b12	b11	b10	b9	b8	b7	b6	b5	b4	b3	b2	b1	b0
Completed Position No.	-	-	-	-	-	-	-	-	PM128	PM64	PM32	PM16	PM8	PM4	PM2	PM1

Address m+1	b15	b14	b13	b12	b11	b10	b9	b8	b7	b6	b5	b4	b3	b2	b1	b0
Status Signal	EMGS	CRDY	ZONE2	ZONE1	PZONE	MODES	WEND	MEND	ALML	-	PSFL	SV	ALM	MOVE	HEND	PEND

(3) I/O signal assignment

(ON = Applicable bit is "1", OFF = Applicable bit is "0")

Signal Type	Bit	Symbol	Description	Details	
PLC Output	Specified Position No.	16 bits	PC1 to PC128 16-bit integer Available range for Setting: 0 to 255 To operate, it is necessary to have the position data that the operation conditions are already set in advance with a teaching tool such as the PC software. In this register, indicate the position number the data is input with a binary number. Indicating a value out of the range or operating with a position number with no setting conducted will generate the alarm code 0A2 "Position Data Error".	3.7.4	
	Control Signal	b15	BKRL	Brake release ON: Brake release, OFF: Brake activated	3.7.1 [15]
		b14	-	Cannot be used.	-
		b13			
		b12			
		b11			
		b10	MODE	Teaching mode command OFF: Standard mode, ON : Teaching mode	3.7.1 [13]
		b9	PWRT	Position import command ON: Position Data Import	3.7.1 [14]
		b8	JOG+	+Jog ON: Movement against home position, OFF: Stop	3.8.1 [10]
		b7	JOG-	-Jog ON: Movement toward home position, OFF: Stop	
		b6	JVEL	Jog-speed/inch-distance switching OFF : Use the setting values of Parameter No.26 JOG Speed and No.48 Inching Distance in MCON ON : Use the setting values of Parameter No.47 JOG Speed 2 and No.49 Inching Distance in MCON	3.7.1 [11]
		b5	JISL	Jog/inching switching ON: Inching, OFF: Jog	3.7.1 [12]
		b4	SON	Servo ON command ON: Servo ON, OFF: Servo OFF	3.7.1 [5]
		b3	RES	Reset A reset is performed when this signal turns ON.	3.7.1 [4]
		b2	STP	Pause ON: Pause, OFF: Pause release	3.7.1 [8]
		b1	HOME	Home return Home-return command with this signal ON, command carried on till complete even if the signal is turned OFF on the way	3.7.1 [6]
		b0	CSTR	Positioning start Movement command executed with this signal ON, command carried on till complete even if the signal is turned OFF on the way	3.7.1 [7]

(ON = Applicable bit is "1", OFF = Applicable bit is "0")

Signal Type	Bit	Symbol	Description	Details	
PLC Input	Completed Position No. (Simple Alarm Code)	16 bits	PM1 to PM128	16-bit integer The positioning complete position number is output in a binary number once getting into the positioning width after moving to the target position. In the case that the position movement has not been performed at all, or during the movement, "0" is output. Read it by turning PEND Signal on after movement. The simple alarm code (refer to Chapter 9 Troubleshooting) is output while an alarm is issued (ALM of Status Signal is ON).	3.7.4
	Status Signal	b15	EMGS	This signal turns ON during an emergency stop	3.7.1 [2]
		b14	CRDY	This signal turns ON when the controller is standing by.	3.7.1 [1]
		b13	ZONE2	"ON" for the current position within the zone 2 set range The zone range setting is necessary for the parameter.	3.7.1 [9]
		b12	ZONE1	"ON" for the current position within the zone 1 set range The zone range setting is necessary for the parameter.	
		b11	PZONE	Position zone This signal turns ON when the current position is inside the specified position zone.	3.7.1 [9]
		b10	MODES	This signal is ON while the teaching mode is selected.	3.7.1 [13]
		b9	WEND	This signal turns ON when reading is complete.	3.7.1 [14]
		b8	MEND	This signal turns ON at either of positioning complete or after movement, home return complete or pressing complete or pressing failure, and turns OFF at movement start. It is OFF when the servo is OFF.	3.7.1 [19]
		b7	ALML	Light error alarm output It turns ON when an overload warning or message level error is issued.	3.7.1 [21]
		b6	-	Cannot be used.	-
		b5	PSFL	This signal turns ON when the actuator missed the load in push-motion operation.	3.7.1 [18]
		b4	SV	This signal turns ON when operation standby is complete (Servo is ON).	3.7.1 [5]
		b3	ALM	This signal is ON while an alarm is generated.	3.7.1 [3]
		b2	MOVE	This signal is ON while in movement.	3.7.1 [7]
b1	HEND	This signal turns ON at home return complete and is kept unless the home position is lost due to a fact such as an alarm.	3.7.1 [6]		
b0	PEND	This signal turns ON at positioning complete and is kept ON during a stop with the servo ON, but does not turn ON when pressing operation is failed.	3.7.1 [7]		

3.4.8 Control Signals for Positioner 3 Mode

This is the operation mode with the position No. set up.

The operation is to be made by using the position data set in the position table.

This is the mode with the minimum amount of input and output signals and the sent and received data in 1-word.

The settable No. of position data items is max 256 points.

The main functions of ROBO Cylinder capable to control in this mode are as described in the following table.

ROBO cylinder function	○: Direct control △: Indirect control ×: Disabled	Remarks
Home-return operation	○	
Positioning operation	△	
Speed and acceleration/ deceleration setting	△	These items must be set in the position data table.
Separate settings for acceleration and deceleration	△	
Pitch feed (Incremental)	×	
Pressing operation	△	These items must be set in the position data table.
Speed change during movement	△	
Pause	○	
Zone signal output	△	These items must be set in the parameters.
Position zone signal	×	
Vibration control	△	This feature is limited only to the servo motor type actuators.
PIO pattern selection	×	

(1) PLC Address Composition

(m is PLC input and output top word address for each axis number)

PLC → MCON (PLC Output)		MCON → PLC (PLC Input)	
Control Signal/ Specified Position No.	m	Status Signal/ Completion Position No.	m

[Refer to Section 3.4.2 for the address maps for each Fieldbus.]

(2) Input and Output Signal Assignment for each Axis

The I/O signals for each axis consists of 1-word for each I/O bit register.

- The control signals and status signals are ON/OFF signals in units of bit.
- Binary data of 8 bits for the specified position number and complete position number and values from 0 to 255 can be used.



Caution:

Set the operational condition in advance with using a teaching tool such as PC software in the position number to be used. Selecting a position number with no setting conducted will generate the alarm code 0A2 "Position Data Error".

PLC Output (m is PLC output top word address for each axis number)

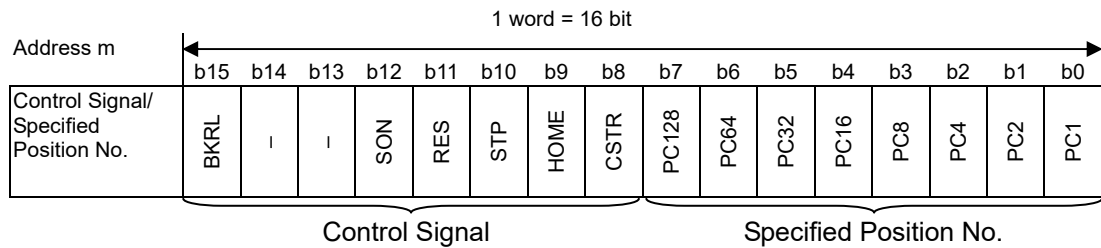

PLC Input (m is PLC input top word address for each axis number)

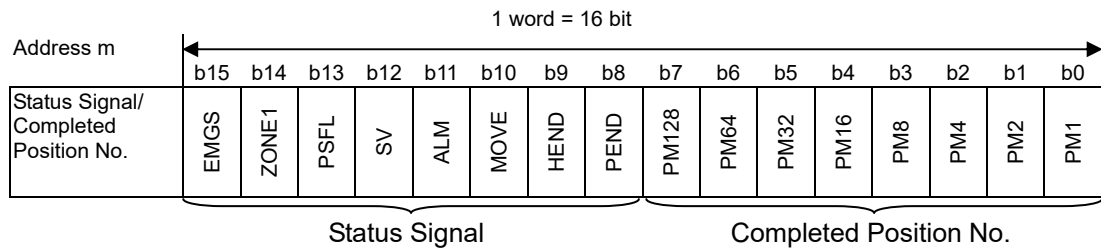

(3) I/O signal assignment

(ON = Applicable bit is "1", OFF = Applicable bit is "0")

Signal Type	Bit	Symbol	Description	Details	
PLC Output	Control Signal/ Specified Position No.	b15	BKRL	Brake release ON: Brake release, OFF: Brake activated	3.7.1 [15]
		b14	-	Cannot be used.	-
		b13			
		b12	SON	Servo ON command ON: Servo ON, OFF: Servo OFF	3.7.1 [5]
		b11	RES	Reset A reset is performed when this signal turns ON.	3.7.1 [4]
		b10	STP	Pause ON: Pause, OFF: Pause release	3.7.1 [8]
		b9	HOME	Home return Home-return command with this signal ON, command carried on till complete even if the signal is turned OFF on the way	3.7.1 [6]
		b8	CSTR	Positioning start Movement command executed with this signal ON, command carried on till complete even if the signal is turned OFF on the way	3.7.1 [7]
		b7	PC1 to PC128	Command position No. (8 bits binary data) Available range for Setting: 0 to 255 To operate, it is necessary to have the position data that the operation conditions are already set in advance with a teaching tool such as the PC software. In this register, indicate the position number the data is input with a binary number. Indicating a value out of the range or operating with a position number with no setting conducted will generate the alarm code 0A2 "Position Data Error".	3.7.4
		b6			
		b5			
		b4			
		b3			
b2					
b1					
b0					
PLC Input	Status Signal/ Completed Position No.	b15	EMGS	This signal turns ON during an emergency stop	3.7.1 [2]
		b14	ZONE1	"ON" for the current position within the zone 1 set range The zone range setting is necessary for the parameter.	3.7.1 [9]
		b13	PSFL	This signal turns ON when the actuator missed the load in push-motion operation.	3.7.1 [18]
		b12	SV	This signal turns ON when operation standby is complete (Servo is ON).	3.7.1 [5]
		b11	ALM	This signal is ON while an alarm is generated.	3.7.1 [3]
		b10	MOVE	This signal is ON while in movement.	3.7.1 [7]
		b9	HEND	This signal turns ON at home return complete and is kept ON unless the home position is lost due to a fact such as an alarm.	3.7.1 [6]
		b8	PEND	This signal turns ON at positioning complete and is kept ON during a stop with the servo ON, but does not turn ON when pressing operation is failed.	3.7.1 [7]
		b7	PM1 to PM128	Completed position No. (8 bits binary data) The positioning complete position number is output in a binary number once getting into the positioning width after moving to the target position. In the case that the position movement has not been performed at all, or during the movement, "0" is output. Read it by turning PEND Signal ON after movement.	3.7.4
		b6			
		b5			
		b4			
		b3			
b2					
b1					
b0					

3.4.9 Control Signals for Positioner 5 Mode

⚠ Caution: This mode is not applicable for CompoNet.

It is an operation mode to operate with indicating a position number.
 The operation is to be made by using the position data set in the position table.
 It is a mode that enabled to monitor the current position in 0.1mm unit by reducing the number of position table from Positioner 2 Mode.
 The settable No. of position data items is max 16 points.
 The main functions of ROBO Cylinder capable to control in this mode are as described in the following table.

ROBO cylinder function	○: Direct control △: Indirect control ×: Disabled	Remarks
Home-return operation	○	
Positioning operation	△	These items must be set in the position data table.
Speed and acceleration/ deceleration setting	△	
Separate settings for acceleration and deceleration	△	
Pitch feed (incremental)	△	
Pressing operation	△	
Speed change during movement	△	
Pause	○	
Zone signal output	△	These items must be set in the parameters.
Position zone signal	×	
Vibration control	△	This feature is limited only to the servo motor type actuators.
PIO pattern selection	×	

(1) PLC Address Composition

(m is PLC input and output top word address for each axis number)

PLC → MCON (PLC Output)		MCON → PLC (PLC Input)	
Specified Position No.	m	Completion Position No. (0.1mm unit)	m
Control Signal	m+1	Status Signal	m+1

[Refer to Section 3.4.2 for the address maps for each Fieldbus.]

(2) Input and Output Signal Assignment for each Axis

The I/O signals for each axis consists of 2-word for each I/O bit register.

- The control signals and status signals are ON/OFF signals in units of bit.
- For the indicated position number and complete position number, 1-word (16-bit) binary data is available and values from 0 to 15 can be used.
- The current position is the binary data in 1 word (16 bits), and can deal with numbers from -32768 to +32767 (unit: 0.1mm) in PLC. Negative numbers are to be dealt with two's complement.



Caution:

Set the operational condition in advance with using a teaching tool such as PC software in the position number to be used. Selecting a position number with no setting conducted will generate the alarm code 0A2 "Position Data Error".

PLC Output (m is PLC output top word address for each axis number)

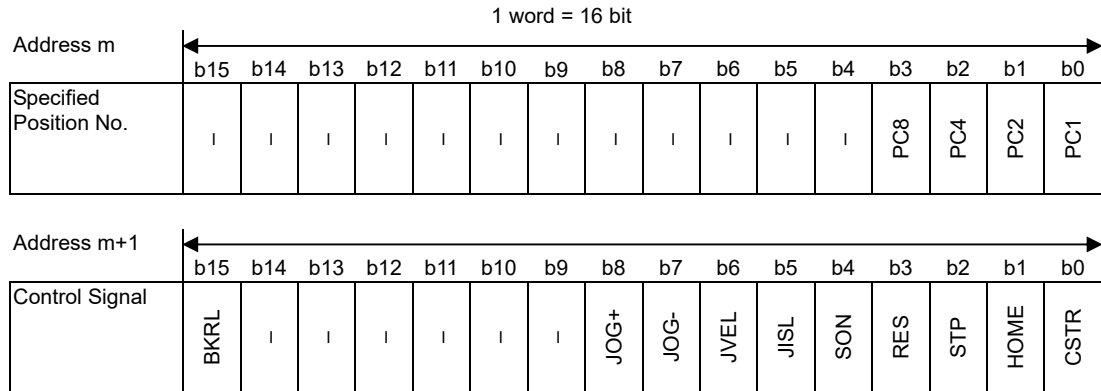

PLC Input (m is PLC input top word address for each axis number)

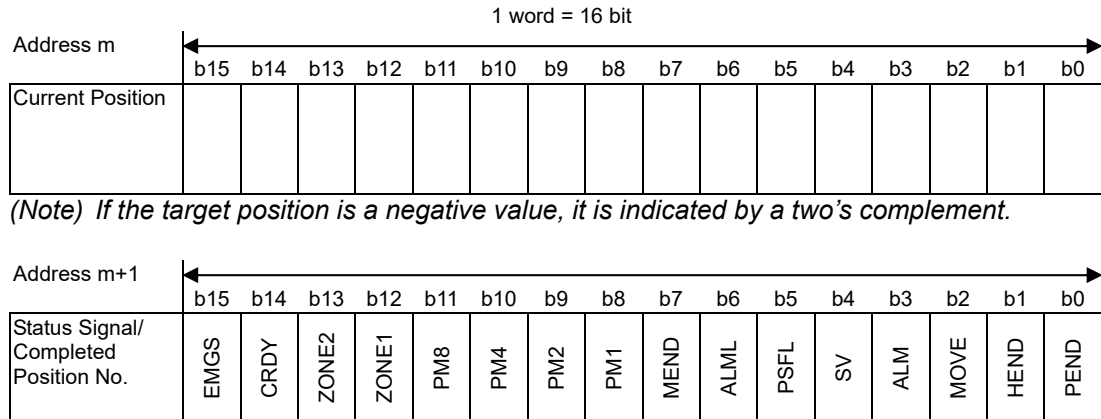

(3) I/O signal assignment

(ON = Applicable bit is "1", OFF = Applicable bit is "0")

Signal Type	Bit	Symbol	Description	Details	
PLC Output	Specified Position No.	16 bits	PC1 to PC8 16-bit integer (4-bit use) Available range for Setting: 0 to 15 To operate, it is necessary to have the position data that the operation conditions are already set in advance with a teaching tool such as the PC software. In this register, indicate the position number the data is input with a binary number. Indicating a value out of the range or operating with a position number with no setting conducted will generate the alarm code 0A2 "Position Data Error".	3.7.4	
	Control Signal	b15	BKRL	Brake release ON: Brake release, OFF: Brake activated	3.7.1 [15]
		b14	-	Cannot be used.	-
		b13			
		b12			
		b11			
		b10			
		b9			
		b8	JOG+	+Jog ON: Movement against home position, OFF: Stop	3.7.1 [10]
		b7	JOG-	-Jog ON: Movement toward home position, OFF: Stop	
		b6	JVEL	Jog-speed/inch-distance switching OFF : Use the setting values of Parameter No.26 JOG Speed and No.48 Inching Distance in MCON ON : Use the setting values of Parameter No.47 JOG Speed 2 and No.49 Inching Distance in MCON	3.7.1 [11]
		b5	JISL	Jog/inching switching ON: Inching, OFF: Jog	3.7.1 [12]
		b4	SON	Servo ON command ON: Servo ON, OFF: Servo OFF	3.7.1 [5]
		b3	RES	Reset A reset is performed when this signal turns ON.	3.7.1 [4]
b2	STP	Pause ON: Pause, OFF: Pause release	3.7.1 [8]		
b1	HOME	Home return Home-return command with this signal ON, command carried on till complete even if the signal is turned OFF on the way	3.7.1 [6]		
b0	CSTR	Positioning start Movement command executed with this signal ON, command carried on till complete even if the signal is turned OFF on the way	3.7.1 [7]		

(ON = Applicable bit is "1", OFF = Applicable bit is "0")

Signal Type	Bit	Symbol	Description	Details	
PLC Input	Current Position	16 bits	–	16-bit signed integer indicating the current position Unit: 0.01mm (Example) If +102.3mm, input 000003FF _H (1023 in decimal system). <i>(Note) Negative numbers are two's implement.</i>	3.7.4
	Status Signal /Completed Position No.	b15	EMGS	This signal turns ON during an emergency stop	3.7.1 [2]
		b14	CRDY	This signal turns ON when the controller is standing by.	3.7.1 [1]
		b13	ZONE2	"ON" for the current position within the zone 2 set range The zone range setting is necessary for the parameter.	3.7.1 [9]
		b12	ZONE1	"ON" for the current position within the zone 1 set range The zone range setting is necessary for the parameter.	
		b11	PM1 to PM8	16-bit integer, Available range for output: 0 to 15 The positioning complete position number is output in a binary number once getting into the positioning width after moving to the target position. In the case that the position movement has not been performed at all, or during the movement, "0" is output. Read it by turning PEND Signal on after movement. The simple alarm code (refer to Chapter 9 Troubleshooting) is output while an alarm is issued (ALM of Status Signal is ON).	3.7.4
		b10			
		b9			
		b8			
		b7	MEND	This signal turns ON at either of positioning complete of after movement, home return complete or pressing complete or pressing failure, and turns OFF at movement start. It is OFF when the servo is OFF.	3.7.1 [19]
		b6	ALML	Light error alarm output It turns ON when an overload warning or message level error is issued.	3.7.1 [21]
		b5	PSFL	"ON" for pressing and a miss	3.7.1 [18]
		b4	SV	This signal turns ON when operation standby is complete (Servo is ON).	3.7.1 [5]
		b3	ALM	This signal is ON while an alarm is generated.	3.7.1 [3]
		b2	MOVE	This signal is ON while in movement.	3.7.1 [7]
b1	HEND	This signal turns ON at home return complete and is kept unless the home position is lost due to a fact such as an alarm.	3.7.1 [6]		
b0	PEND	This signal turns ON at positioning complete and is kept ON during a stop with the servo ON, but does not turn ON when pressing operation is failed.	3.7.1 [7]		

3.4.10 Control Signals for Remote I/O Mode

It is an operation mode to control with ON/OFF of bits as it is done in PIO (24V I/O).
 Set the position data from a teaching tool such as the RC PC software.
 The number of positioning points depends on the operation pattern (PIO pattern) set in the parameters of MCON unit.
 The I/O specifications for the operation pattern are described as follows.

PIO Pattern	Operation Mode	I/O Specification
0	Positioning mode	Position number specification 64 points Zone signal output 1 point ^(Note 1) Position zone signal output ^(Note 2) 1 point
1	Teaching mode	Positioning points 64 points Position zone signal output ^(Note 2) 1 point Jog operation is available The current position can be written to a specified position.
2	256-point mode	Positioning points 256 points Position zone signal output ^(Note 2) 1 point
3	-	Unavailable. Parameter data error would be generated if setting is made.
4	Solenoid valve mode 1	Positioning points 7 points Zone signal output 1 point ^(Note 1) Position zone signal output ^(Note 2) 1 point Operation command available only with position number indication
5	Solenoid valve mode 2	Positioning points 3 points Zone signal output 1 point ^(Note 1) Position zone signal output ^(Note 2) 1 point The actuator is operated by specifying forward, backward and intermediate position commands. Complete signal is able to output a signal equivalent to the limit switch

Note 1 Set the range of the zone in parameter. It becomes constantly valid once the home-return operation is complete.

Note 2 The range of the zone is to be set in the position table, and is activated only when that position number is indicated. It is invalid in other position number commands. The position zone signal can be switched over to the zone signal with the setting of Parameter No. 149.

The functions capable to control in this mode are as described in the table below.

○: Operation available ×: Operation not available

ROBO cylinder function	Operation Pattern (PIO Pattern)				
	0 Positioning Mode	1 Teaching Mode	2 256 points Mode	4 Solenoid Valve Mode 1	5 Solenoid Valve Mode 2
Home-return operation	○	○	○	○	○ ^(Note 3)
Positioning operation	○	○	○	○	○
Speed and acceleration/deceleration setting	○	○	○	○	○
Separate settings for acceleration and deceleration	○	○	○	○	○
Pitch feed (Incremental)	○	○	○	○	×
Pressing operation	○	○	○	○	○
Speed change during movement	○	○	○	×	○
Pause	○	○	○	○	○ ^(Note 4)
Zone signal output	○	○ ^(Note 5)	○ ^(Note 5)	○	○
Position zone signal	○ ^(Note 5)	○ ^(Note 5)	○ ^(Note 5)	○ ^(Note 5)	○ ^(Note 5)
Vibration control (For servo motor type only)	○	○	○	○	○

Note 3 Home-return operation is performed in the first movement command.

Note 4 It is available when the parameter No.27 of "Movement Command Type" is set to "0".

Note 5 Select either of the zone signal output or position zone signal output in Parameter No. 149.

(1) PLC Address Composition

(m is PLC input and output top word address for each axis number)

PLC→MCON (PLC Output)				MCON→PLC (PLC Input)			
Port No.0 to 15		m		Port No.0 to 15		m	

[Refer to Section 3.4.2 for the address maps for each Fieldbus.]

(2) Input and Output Signal Assignment for each Axis

The I/O signals for each axis consists of 1 word for each I/O bit register.

- The I/O bit register is controlled using the ON/OFF signal in units of bit.
(ON = Applicable bit is "1", OFF = Applicable bit is "0")
- The content of the signal for each bit changes depending what is selected in the PIO patterns.

[Refer to next section I/O signal assignment]

PLC Output (m is PLC input and output top word address for each axis number)

Address m	← 1 word=16 bit →															
	b15	b14	b13	b12	b11	b10	b9	b8	b7	b6	b5	b4	b3	b2	b1	b0
Controller Input port No.	15	14	13	12	11	10	9	8	7	6	5	4	3	2	1	0

PLC Input (m is PLC input and output top word address for each axis number)

Address m	← 1 word=16 bit →															
	b15	b14	b13	b12	b11	b10	b9	b8	b7	b6	b5	b4	b3	b2	b1	b0
Controller Output Port No.	15	14	13	12	11	10	9	8	7	6	5	4	3	2	1	0

(3) I/O signal assignment

The controller's I/O port signal varies depending on the parameter No.25 setting.
 [Refer to 3.8 Remote I/O Mode]

		Set the parameter No.25 of MCON					
		Positioning mode		Teaching mode		256-point mode	
		0		1		2	
Category	Port No.	Symbol	Signal Name	Symbol	Signal Name	Symbol	Signal Name
PLC output→ MCON input	0	PC1	Specified position No.	PC1	Specified position No.	PC1	Specified position No.
	1	PC2		PC2		PC2	
	2	PC4		PC4		PC4	
	3	PC8		PC8		PC8	
	4	PC16		PC16		PC16	
	5	PC32		PC32		PC32	
	6	–	Unavailable	MODE	Teaching mode command	PC64	
	7	–		JISL	Jog/inching switching	PC128	
	8	–		JOG+	+Jog	–	
	9	BKRL	Brake release	JOG-	-Jog	BKRL	Brake release
	10	–	Unavailable	–	Unavailable	–	Unavailable
	11	HOME	Home return	HOME	Home return	HOME	Home return
	12	*STP	Pause	*STP	Pause	*STP	Pause
	13	CSTR	Positioning start	CSTR/ PWRT	Positioning start/ Position data import command	CSTR	Positioning start
	14	RES	Reset	RES	Reset	RES	Reset
15	SON	Servo ON command	SON	Servo ON command	SON	Servo ON command	
MCON output →PLC input	0	PM1	Completed position No.	PM1	Completed position No.	PM1	Completed position No.
	1	PM2		PM2		PM2	
	2	PM4		PM4		PM4	
	3	PM8		PM8		PM8	
	4	PM16		PM16		PM16	
	5	PM32		PM32		PM32	
	6	MOVE	Moving signal	MOVE	Moving signal	PM64	
	7	ZONE1	ZONE1	MODES	Teaching mode signal	PM128	
	8 (Note 1)	PZONE/ ZONE2	Position zone/ Zone 2	PZONE/ ZONE1	Position zone/ Zone 1	PZONE/ ZONE1	Position zone/ Zone 1
	9	–	Unavailable	–	Unavailable	–	Unavailable
	10	HEND	Home return completion	HEND	Home return completion	HEND	Home return completion
	11	PEND	Positioning completion signal	PEND/ WEND	Positioning completion signal/ Position data import complete	PEND	Positioning completion signal
	12	SV	Operation preparation end	SV	Operation preparation completion	SV	Operation preparation end
	13	*EMGS	Emergency stop	*EMGS	Emergency stop	*EMGS	Emergency stop
	14	*ALM	Alarm	*ALM	Alarm	*ALM	Alarm
15	LOAD /TRQS *ALML	Torque check (Note 2)/ Light malfunction output	*ALML	Light malfunction output	LOAD /TRQS *ALML	Torque check (Note 2)/ Light malfunction output	

Note 1 It is available to change in Parameter No. 149 Zone Output Switchover.

Note 2 It is available to change in Parameter No. 156 Torque Inspection / Light Malfunction Output Select for the pulse motor driver.

It is the light malfunction output for the servo motor driver / brushless DC motor driver.

(Note) “*” in codes above shows the signal of the active low. (A signal of active low is a signal that the input signal is processed when it is turned OFF, output signal is ordinarily on while the power is ON, and turns OFF when the signal is output.)

		Set the parameter No.25 of MCON			
		Solenoid valve mode 1		Solenoid valve mode 2	
		4		5	
Category	Port No.	Symbol	Signal Name	Symbol	Signal Name
PLC output→ MCON input	0	ST0	Start position 0	ST0	Start position 0
	1	ST1	Start position 1	ST1 (JOG+)	Start position 1
	2	ST2	Start position 2	ST2 (No function)	Start position 2
	3	ST3	Start position 3	–	Unavailable
	4	ST4	Start position 4	–	
	5	ST5	Start position 5	–	
	6	ST6	Start position 6	–	
	7	–	Unavailable	–	
	8	–		–	
	9	BKRL	Brake release	BKRL	Brake release
	10	–	Unavailable	–	Unavailable
	11	HOME	Home return	–	Unavailable
	12	*STP	Pause	–	
	13	–	Unavailable	–	
	14	RES	Reset	RES	Reset
15	SON	Servo ON command	SON	Servo ON Command	
MCON output →PLC input	0	PE0	Position 0 complete	LS0	Retrieval to the Edge Commands 0
	1	PE1	Position 1 complete	LS1 (TRQS)	Retrieval to the Edge Commands 1
	2	PE2	Position 2 complete	LS2 (No function)	Retrieval to the Edge Commands 2
	3	PE3	Position 3 complete	–	Unavailable
	4	PE4	Position 4 complete	–	
	5	PE5	Position 5 complete	–	
	6	PE6	Position 6 complete	–	
	7	ZONE1	Zone 1	ZONE1	Zone 1
	8 (Note 1)	PZONE/ ZONE2	Position zone/ Zone 2	PZONE/ ZONE2	Position zone/ Zone 2
	9	–	Unavailable	–	Unavailable
	10	HEND	Home return completion	HEND	Home return completion
	11	PEND	Positioning completion signal	–	Unavailable
	12	SV	Operation preparation end	SV	Operation preparation end
	13	*EMGS	Emergency stop	*EMGS	Emergency stop
	14	*ALM	Alarm	*ALM	Alarm
15	LOAD/TR QS *ALML	Torque check (Note 2)/ Light malfunction output	*ALML	Light malfunction output	

Note 1 It is available to change in Parameter No. 149 Zone Output Switchover.

Note 2 It is available to change in Parameter No. 156 Torque Inspection / Light Malfunction Output Select for the pulse motor driver.

It is the light malfunction output for the servo motor driver / brushless DC motor driver.

(Note) Brackets in the symbol names shown above are the functions before home-return operation.

(Note) "*" in codes above shows the signal of the active low. (A signal of active low is a signal that the input signal is processed when it is turned OFF, output signal is ordinarily on while the power is ON, and turns OFF when the signal is output.)

3.4.11 About Commands (Position Data Read/Write and Alarm Axis Read)

By sending a specific code to a specific address, the position data reading and writing, and the reading of the axis number that an alarm was issued and the alarm code can be performed.

 **Caution:** It is not necessary to use commands in Simple Direct Mode because no position data is to be used in it.

Shown below is the table to indicate the assignment of each signal.

(1) PLC Address Composition

(n is PLC input and output top address.)

PLC → MCON (PLC Output)		MCON → PLC (PLC Input)	
Demand Command	n+2	Response Command	n+2
Data 0	n+3	Data 0	n+3
Data 1	n+4	Data 1	n+4
Data 2	n+5	Data 2	n+5
Data 3	n+6	Data 3	n+6

[Refer to Section 3.4.2 for the address maps for each Fieldbus.]

(2) Demand Command List

Class	Code	Description
Handshaking	0000 _H	Demand command cleared
Write Position Data	1000 _H	Writing of target position
	1001 _H	Writing of positioning width
	1002 _H	Writing of speed
	1003 _H	Writing of individual zone boundary on positive side
	1004 _H	Writing of individual zone boundary on negative side
	1005 _H	Writing of acceleration
	1006 _H	Writing of deceleration
	1007 _H	Writing current limit at pressing
	1008 _H	Writing of load current threshold
Read Position Data	1040 _H	Reading of target position
	1041 _H	Reading of positioning width
	1042 _H	Reading of speed
	1043 _H	Reading of individual zone boundary on positive side
	1044 _H	Reading of individual zone boundary on negative side
	1045 _H	Reading of acceleration
	1046 _H	Reading of deceleration
	1047 _H	Reading of current limit at pressing
	1048 _H	Reading of load current threshold
Error Information Monitoring	4000 _H	Reading of alarm-issued axis pattern
	4001 _H	Reading of alarm code

(3) Details of Commands

The input and output signals are consist of 5-word for each input and output data register.

- The target position and current position are expressed using 2-word (32 bits) binary data. The figures from -999999 to +999999 (Unit: 0.01mm) can be set in PLC. Negative numbers are to be dealt with two's complement.
- Binary data of 2-word (32 bits) for the pressing band and values from -999999 to +999999 (unit: 0.01mm) in PLC can be used. Negative numbers are to be dealt with two's complement.



Caution:

- *Set the position data of the actuator, such as the target position and pressing band, in the range of the soft stroke (0 to effective stroke length).*

- Binary data of 2-word (32 bits) for the speed and values from 1 to +999999 (unit: 1.0mm/s or 0.1mm/s) in PLC can be used. A change of the unit is to be conducted on Gateway Parameter Setting Tool.
- The Acceleration and Deceleration are expressed using 1-word (16 bits) binary data. The figures from 1 to 300 (Unit: 0.01G) can be set in PLC.
- The pressing current limit value is expressed using 1-word (16 bits) binary data. The figures from 0 (0%) to 255 (100%) can be set in PLC.
- Binary data of 1-word (16 bits) for the axis numbers and values from 0 (No.0) to 7 (No.7) in PLC can be used.
- Binary data of 1-word (16 bits) for the position numbers and values from 0 (No.0) to 255 (No.255) in PLC can be used.
- The alarm code is expressed using 1-word (16 bits) binary data.



Caution:

Have the setting with values available in the range of for speed, acceleration/deceleration and pressing current of the actuator. (Refer to the catalog or instruction manual of the actuator.) Otherwise, it may cause an abnormal condition of the servo or a malfunction of the actuator such as the alarm codes 0A3 "Position Command Information Data Error", 0C0 "Excess Actual Speed", 0C8 "Overcurrent", 0CA "Overheated" or 0E0 "Overloaded".

1) Demand command cleared [0000h]

PLC Output (Address n is the input and output top address for MCON Gateway Unit.)

Note Response command does not return.

1 word=16 bit

		← 1 word=16 bit →																
		Bit		b15	b14	b13	b12	b11	b10	b9	b8	b7	b6	b5	b4	b3	b2	b1
Demand Command Cleared	Address	n+2	0	0	0	0	0	0	0	0	0	0	0	0	0	0	0	0
	Demand Command [0000h]																	
	n+3	0	0	0	0	0	0	0	0	0	0	0	0	0	0	0	0	0
	Data 0 [0]																	
	n+4	0	0	0	0	0	0	0	0	0	0	0	0	0	0	0	0	0
Data 1 [0]																		
n+5	0	0	0	0	0	0	0	0	0	0	0	0	0	0	0	0	0	
Data 2 [0]																		
n+6	0	0	0	0	0	0	0	0	0	0	0	0	0	0	0	0	0	
Data 3 [0]																		

2) Writing of Target Position [1000h]

PLC Output (Address n is the input and output top address for MCON Gateway Unit.)

Note If the writing is finished in normal condition, the same content as the demand command is returned to the response command.

If an error is generated, an error response is returned. [Refer to this Section 22].]

1 word=16 bit

		← 1 word=16 bit →																
		Bit		b15	b14	b13	b12	b11	b10	b9	b8	b7	b6	b5	b4	b3	b2	b1
Writing of Target Position	Address	n+2	0	0	0	1	0	0	0	0	0	0	0	0	0	0	0	0
	Demand Command [1000h]																	
	n+3									128	64	32	16	8	4	2	1	
	Data 0 [Position No.]																	
	n+4																	
Data 1 [Target Position (Lower word)]																		
n+5																		
Data 2 [Target Position (Upper word)]																		
n+6														4	2	1		
Data 3 [Axis No.]																		

3) Writing of Positioning Width [1001h]

PLC Output (Address n is the input and output top address for MCON Gateway Unit.)

Note If the writing is finished in normal condition, the same content as the demand command is returned to the response command. If an error is generated, an error response is returned. [Refer to this Section 22].]

1 word=16 bit

Address	Bit															
	b15	b14	b13	b12	b11	b10	b9	b8	b7	b6	b5	b4	b3	b2	b1	b0
n+2 Demand Command [1001h]	0	0	0	1	0	0	0	0	0	0	0	0	0	0	0	1
n+3 Data 0 [Position No.]	-	-	-	-	-	-	-	-	128	64	32	16	8	4	2	1
n+4 Data 1 [Pressing Width (Lower word)]																
n+5 Data 2 [Pressing Width (Upper word)]																
n+6 Data 3 [Axis No.]	-	-	-	-	-	-	-	-	-	-	-	-	-	4	2	1

4) Writing of Speed [1002h]

PLC Output (Address n is the input and output top address for MCON Gateway Unit.)

Note If the writing is finished in normal condition, the same content as the demand command is returned to the response command. If an error is generated, an error response is returned. [Refer to this Section 22].]

1 word=16 bit

Address	Bit															
	b15	b14	b13	b12	b11	b10	b9	b8	b7	b6	b5	b4	b3	b2	b1	b0
n+2 Demand Command [1002h]	0	0	0	1	0	0	0	0	0	0	0	0	0	0	1	0
n+3 Data 0 [Position No.]	-	-	-	-	-	-	-	-	128	64	32	16	8	4	2	1
n+4 Data 1 [Speed (Lower word)]	32768	16384	8192	4096	2048	1024	512	256	128	64	32	16	8	4	2	1
n+5 Data 2 [Speed (Upper word)]	-	-	-	-	-	-	-	-	-	-	-	-	524288	262144	131072	65536
n+6 Data 3 [Axis No.]	-	-	-	-	-	-	-	-	-	-	-	-	-	4	2	1

- 5) Writing of individual zone boundary on positive side [1003h]
 PLC Output (Address n is the input and output top address for MCON Gateway Unit.)
Note If the writing is finished in normal condition, the same content as the demand command is returned to the response command. If an error is generated, an error response is returned. [Refer to this Section 22].]

1 word=16 bit

Address	Bit															
	b15	b14	b13	b12	b11	b10	b9	b8	b7	b6	b5	b4	b3	b2	b1	b0
n+2 Deand [1003h]	0	0	0	1	0	0	0	0	0	0	0	0	0	1	0	1
n+3 Data 0 [Position No.]									128	64	32	16	8	4	2	1
n+4 Data 1 [Individual zone boundary on positive side (Lower word)]																
n+5 Data 2 [Individual zone boundary on positive side (Upper word)]																
n+6 Data 3 [Axis No.]														4	2	1

- 6) Writing of individual zone boundary on negative side [1004h]
 PLC Output (Address n is the input and output top address for MCON Gateway Unit.)
Note If the writing is finished in normal condition, the same content as the demand command is returned to the response command. If an error is generated, an error response is returned. [Refer to this Section 22].]

1 word=16 bit

Address	Bit															
	b15	b14	b13	b12	b11	b10	b9	b8	b7	b6	b5	b4	b3	b2	b1	b0
n+2 Demand Command [1004h]	0	0	0	1	0	0	0	0	0	0	0	0	0	1	1	0
n+3 Data 0 [Position No.]									128	64	32	16	8	4	2	1
n+4 Data 1 [Individual zone boundary on negative side (Lower word)]																
n+5 Data 2 [Individual zone boundary on negative side (Upper word)]																
n+6 Data 3 [Axis No.]														4	2	1

7) Writing of Acceleration [1005h]

PLC Output (Address n is the input and output top address for MCON Gateway Unit.)

Note If the writing is finished in normal condition, the same content as the demand command is returned to the response command. If an error is generated, an error response is returned. [Refer to this Section 22).]

1 word=16 bit

Address	Bit															
	b15	b14	b13	b12	b11	b10	b9	b8	b7	b6	b5	b4	b3	b2	b1	b0
n+2 Demand Command [1005h]	0	0	0	1	0	0	0	0	0	0	0	0	0	1	0	1
n+3 Data 0 [Position No.]									128	64	32	16	8	4	2	1
n+4 Data 1 [Acceleration]								256	128	64	32	16	8	4	2	1
n+5 Data 2 [0]	0	0	0	0	0	0	0	0	0	0	0	0	0	0	0	0
n+6 Data 3 [Axis No.]														4	2	1

8) Writing of Deceleration [1006h]

PLC Output (Address n is the input and output top address for MCON Gateway Unit.)

Note If the writing is finished in normal condition, the same content as the demand command is returned to the response command. If an error is generated, an error response is returned. [Refer to this Section 22).]

1 word=16 bit

Address	Bit															
	b15	b14	b13	b12	b11	b10	b9	b8	b7	b6	b5	b4	b3	b2	b1	b0
n+2 Demand Command [1006h]	0	0	0	1	0	0	0	0	0	0	0	0	0	1	1	0
n+3 Data 0 [Position No.]									128	64	32	16	8	4	2	1
n+4 Data 1 [Deceleration]								256	128	64	32	16	8	4	2	1
n+5 Data 2 [0]	0	0	0	0	0	0	0	0	0	0	0	0	0	0	0	0
n+6 Data 3 [Axis No.]														4	2	1

9) Writing of Current Limit at Pressing [1007h]

PLC Output (Address n is the input and output top address for MCON Gateway Unit.)

Note If the writing is finished in normal condition, the same content as the demand command is returned to the response command. If an error is generated, an error response is returned. [Refer to this Section 22].]

← 1 word=16 bit →

	Address	Bit															
		b15	b14	b13	b12	b11	b10	b9	b8	b7	b6	b5	b4	b3	b2	b1	b0
Writing of Current Limit at Pressing	n+2 Demand Command [1007h]	0	0	0	1	0	0	0	0	0	0	0	0	0	1	1	1
	n+3 Data 0 [Position No.]									128	64	32	16	8	4	2	1
	n+4 Data 1 [Pressing Current Limit]									128	64	32	16	8	4	2	1
	n+5 Data 2 [0]	0	0	0	0	0	0	0	0	0	0	0	0	0	0	0	0
	n+6 Data 3 [Axis No.]														4	2	1

10) Writing of load current threshold [1008h]

PLC Output (Address n is the input and output top address for MCON Gateway Unit.)

Note If the writing is finished in normal condition, the same content as the demand command is returned to the response command. If an error is generated, an error response is returned. [Refer to this Section 22].]

← 1 word=16 bit →

	Address	Bit															
		b15	b14	b13	b12	b11	b10	b9	b8	b7	b6	b5	b4	b3	b2	b1	b0
Writing of load current threshold	n+2 Demand Command [1008h]	0	0	0	1	0	0	0	0	0	0	0	0	0	1	1	1
	n+3 Data 0 [Position No.]									128	64	32	16	8	4	2	1
	n+4 Data 1 [Load current threshold]									128	64	32	16	8	4	2	1
	n+5 Data 2 [0]	0	0	0	0	0	0	0	0	0	0	0	0	0	0	0	0
	n+6 Data 3 [Axis No.]														4	2	1

11) Reading of Target Position [1040h]
 PLC Output (Address n is the input and output top address for MCON Gateway Unit.)

← 1 word=16 bit →

Address	Bit															
	b15	b14	b13	b12	b11	b10	b9	b8	b7	b6	b5	b4	b3	b2	b1	b0
n+2 Demand Command [1040h]	0	0	0	1	0	0	0	0	0	1	0	0	0	0	0	0
n+3 Data 0 [Position No.]									128	64	32	16	8	4	2	1
n+4 Data 1 [0]	0	0	0	0	0	0	0	0	0	0	0	0	0	0	0	0
n+5 Data 2 [0]	0	0	0	0	0	0	0	0	0	0	0	0	0	0	0	0
n+6 Data 3 [Axis No.]														4	2	1

PLC Input (Address n is the input and output top address for MCON Gateway Unit.)

← 1 word=16 bit →

Address	Bit															
	b15	b14	b13	b12	b11	b10	b9	b8	b7	b6	b5	b4	b3	b2	b1	b0
n+2 Response Command [1040h]	0	0	0	1	0	0	0	0	0	1	0	0	0	0	0	0
n+3 Data 0 [Position No.]									128	64	32	16	8	4	2	1
n+4 Data 1 [Target Position (Lower word)]																
n+5 Data 2 [Target Position (Upper word)]																
n+6 Data 3 [Axis No.]														4	2	1

12) Reading of Positioning Width [1041h]

PLC Output (Address n is the input and output top address for MCON Gateway Unit.)

1 word=16 bit

Address	Bit															
	b15	b14	b13	b12	b11	b10	b9	b8	b7	b6	b5	b4	b3	b2	b1	b0
n+2 Demand Command [1041h]	0	0	0	1	0	0	0	0	0	1	0	0	0	0	0	1
n+3 Data 0 [Position No.]									128	64	32	16	8	4	2	1
n+4 Data 1 [0]	0	0	0	0	0	0	0	0	0	0	0	0	0	0	0	0
n+5 Data 2 [0]	0	0	0	0	0	0	0	0	0	0	0	0	0	0	0	0
n+6 Data 3 [Axis No.]														4	2	1

PLC Input (Address n is the input and output top address for MCON Gateway Unit.)

1 word=16 bit

Address	Bit															
	b15	b14	b13	b12	b11	b10	b9	b8	b7	b6	b5	b4	b3	b2	b1	b0
n+2 Response Command [1041h]	0	0	0	1	0	0	0	0	0	1	0	0	0	0	0	1
n+3 Data 0 [Position No.]									128	64	32	16	8	4	2	1
n+4 Data 1 [Pressing Width (Lower word)]																
n+5 Data 2 [Pressing Width (Upper word)]																
n+6 Data 3 [Axis No.]														4	2	1

13) Reading of Speed [1042h]

PLC Output (Address n is the input and output top address for MCON Gateway Unit.)

1 word=16 bit

Address	Bit															
	b15	b14	b13	b12	b11	b10	b9	b8	b7	b6	b5	b4	b3	b2	b1	b0
n+2 Demand Command [1042h]	0	0	0	1	0	0	0	0	0	1	0	0	0	0	1	0
n+3 Data 0 [Position No.]	-	-	-	-	-	-	-	-	128	64	32	16	8	4	2	1
n+4 Data 1 [0]	0	0	0	0	0	0	0	0	0	0	0	0	0	0	0	0
n+5 Data 2 [0]	0	0	0	0	0	0	0	0	0	0	0	0	0	0	0	0
n+6 Data 3 [Axis No.]	-	-	-	-	-	-	-	-	-	-	-	-	-	4	2	1

PLC Input (Address n is the input and output top address for MCON Gateway Unit.)

1 word=16 bit

Address	Bit															
	b15	b14	b13	b12	b11	b10	b9	b8	b7	b6	b5	b4	b3	b2	b1	b0
n+2 Response Command [1042h]	0	0	0	1	0	0	0	0	0	1	0	0	0	0	1	0
n+3 Data 0 [Position No.]	-	-	-	-	-	-	-	-	128	64	32	16	8	4	2	1
n+4 Data 1 [Speed (Lower word)]	32768	16384	8192	4096	2048	1024	512	256	128	64	32	16	8	4	2	1
n+5 Data 2 [Speed (Upper word)]	-	-	-	-	-	-	-	-	-	-	-	-	524288	262144	131072	65536
n+6 Data 3 [Axis No.]	-	-	-	-	-	-	-	-	-	-	-	-	-	4	2	1

- 14) Reading of individual zone boundary on positive side [1043h]
 PLC Output (Address n is the input and output top address for MCON Gateway Unit.)
Note If the writing is finished in normal condition, the same content as the demand command is returned to the response command. If an error is generated, an error response is returned. [Refer to this Section 22].

1 word=16 bit

Address	Bit															
	b15	b14	b13	b12	b11	b10	b9	b8	b7	b6	b5	b4	b3	b2	b1	b0
n+2 Demand Command [1043h]	0	0	0	1	0	0	0	0	0	1	0	0	0	1	0	1
n+3 Data 0 [Position No.]									128	64	32	16	8	4	2	1
n+4 Data 1 [0]	0	0	0	0	0	0	0	0	0	0	0	0	0	0	0	0
n+5 Data 2 [0]	0	0	0	0	0	0	0	0	0	0	0	0	0	0	0	0
n+6 Data 3 [Axis No.]														4	2	1

PLC Input (Address n is the input and output top address for MCON Gateway Unit.)

1 word=16 bit

Address	Bit															
	b15	b14	b13	b12	b11	b10	b9	b8	b7	b6	b5	b4	b3	b2	b1	b0
n+2 Response Command [1043h]	0	0	0	1	0	0	0	0	0	1	0	0	0	0	1	0
n+3 Data 0 [Position No.]									128	64	32	16	8	4	2	1
n+4 Data 1 [Individual zone boundary on positive side (Lower word)]																
n+5 Data 2 [Individual zone boundary on positive side (Upper word)]																
n+6 Data 3 [Axis No.]														4	2	1

- 15) Reading of individual zone boundary on negative side [1044h]
 PLC Output (Address n is the input and output top address for MCON Gateway Unit.)
Note If the writing is finished in normal condition, the same content as the demand command is returned to the response command. If an error is generated, an error response is returned. [Refer to this Section 22].]

1 word=16 bit

Address	Bit															
	b15	b14	b13	b12	b11	b10	b9	b8	b7	b6	b5	b4	b3	b2	b1	b0
n+2 Demand Command [1044h]	0	0	0	1	0	0	0	0	0	1	0	0	0	1	1	0
n+3 Data 0 [Position No.]									128	64	32	16	8	4	2	1
n+4 Data 1 [0]	0	0	0	0	0	0	0	0	0	0	0	0	0	0	0	0
n+5 Data 2 [0]	0	0	0	0	0	0	0	0	0	0	0	0	0	0	0	0
n+6 Data 3 [Axis No.]														4	2	1

PLC Input (Address n is the input and output top address for MCON Gateway Unit.)

1 word=16 bit

Address	Bit															
	b15	b14	b13	b12	b11	b10	b9	b8	b7	b6	b5	b4	b3	b2	b1	b0
n+2 Response Command [1044h]	0	0	0	1	0	0	0	0	0	1	0	0	0	0	1	0
n+3 Data 0 [Position No.]									128	64	32	16	8	4	2	1
n+4 Data 1 [Individual zone boundary on negative side (Lower word)]																
n+5 Data 2 [Individual zone boundary on negative side (Upper word)]																
n+6 Data 3 [Axis No.]														4	2	1

16) Reading of Acceleration [1045h]
 PLC Output (Address n is the input and output top address for MCON Gateway Unit.)

← 1 word=16 bit →

Address	Bit															
	b15	b14	b13	b12	b11	b10	b9	b8	b7	b6	b5	b4	b3	b2	b1	b0
n+2 Demand Command [1045h]	0	0	0	1	0	0	0	0	0	1	0	0	0	1	0	1
n+3 Data 0 [Position No.]									128	64	32	16	8	4	2	1
n+4 Data 1 [0]	0	0	0	0	0	0	0	0	0	0	0	0	0	0	0	0
n+5 Data 2 [0]	0	0	0	0	0	0	0	0	0	0	0	0	0	0	0	0
n+6 Data 3 [Axis No.]														4	2	1

PLC Input (Address n is the input and output top address for MCON Gateway Unit.)

← 1 word=16 bit →

Address	Bit															
	b15	b14	b13	b12	b11	b10	b9	b8	b7	b6	b5	b4	b3	b2	b1	b0
n+2 Response Command [1045h]	0	0	0	1	0	0	0	0	0	1	0	0	0	1	0	1
n+3 Data 0 [Position No.]									128	64	32	16	8	4	2	1
n+4 Data 1 [Acceleration]								256	128	64	32	16	8	4	2	1
n+5 Data 2 [0]	0	0	0	0	0	0	0	0	0	0	0	0	0	0	0	0
n+6 Data 3 [Axis No.]														4	2	1

17) Reading of Deceleration [1046h]
 PLC Output (Address n is the input and output top address for MCON Gateway Unit.)

1 word=16 bit

Address	Bit															
	b15	b14	b13	b12	b11	b10	b9	b8	b7	b6	b5	b4	b3	b2	b1	b0
n+2 Demand Command [1046h]	0	0	0	1	0	0	0	0	0	1	0	0	0	1	1	0
n+3 Data 0 [Position No.]									128	64	32	16	8	4	2	1
n+4 Data 1 [0]	0	0	0	0	0	0	0	0	0	0	0	0	0	0	0	0
n+5 Data 2 [0]	0	0	0	0	0	0	0	0	0	0	0	0	0	0	0	0
n+6 Data 3 [Axis No.]														4	2	1

PLC Input (Address n is the input and output top address for MCON Gateway Unit.)

1 word=16 bit

Address	Bit															
	b15	b14	b13	b12	b11	b10	b9	b8	b7	b6	b5	b4	b3	b2	b1	b0
n+2 Response Command [1046h]	0	0	0	1	0	0	0	0	0	1	0	0	0	1	1	0
n+3 Data 0 [Position No.]									128	64	32	16	8	4	2	1
n+4 Data 1 [Deceleration]								256	128	64	32	16	8	4	2	1
n+5 Data 2 [0]	0	0	0	0	0	0	0	0	0	0	0	0	0	0	0	0
n+6 Data 3 [Axis No.]														4	2	1

18) Reading of Current Limit at Pressing [1047h]
 PLC Output (Address n is the input and output top address for MCON Gateway Unit.)

← 1 word=16 bit →

Address	Bit															
	b15	b14	b13	b12	b11	b10	b9	b8	b7	b6	b5	b4	b3	b2	b1	b0
n+2 Demand Command [1047h]	0	0	0	1	0	0	0	0	0	1	0	0	0	1	1	1
n+3 Data 0 [Position No.]									128	64	32	16	8	4	2	1
n+4 Data 1 [0]	0	0	0	0	0	0	0	0	0	0	0	0	0	0	0	0
n+5 Data 2 [0]	0	0	0	0	0	0	0	0	0	0	0	0	0	0	0	0
n+6 Data 3 [Axis No.]														4	2	1

PLC Input (Address n is the input and output top address for MCON Gateway Unit.)

← 1 word=16 bit →

Address	Bit															
	b15	b14	b13	b12	b11	b10	b9	b8	b7	b6	b5	b4	b3	b2	b1	b0
n+2 Response Command [1047h]	0	0	0	1	0	0	0	0	0	1	0	0	0	1	1	1
n+3 Data 0 [Position No.]									128	64	32	16	8	4	2	1
n+4 Data 1 [Current Limit at Pressing]									128	64	32	16	8	4	2	1
n+5 Data 2 [0]	0	0	0	0	0	0	0	0	0	0	0	0	0	0	0	0
n+6 Data 3 [Axis No.]														4	2	1

19) Reading of load current threshold [1048h]

PLC Output (Address n is the input and output top address for MCON Gateway Unit.)

Note If the writing is finished in normal condition, the same content as the demand command is returned to the response command. If an error is generated, an error response is returned. [Refer to this Section 22].]

1 word=16 bit

Address	Bit															
	b15	b14	b13	b12	b11	b10	b9	b8	b7	b6	b5	b4	b3	b2	b1	b0
n+2 Demand Command [1048h]	0	0	0	1	0	0	0	0	0	0	0	0	0	1	1	1
n+3 Data 0 [Position No.]	1	1	1	1	1	1	1	1	128	64	32	16	8	4	2	1
n+4 Data 1 [0]	0	0	0	0	0	0	0	0	0	0	0	0	0	0	0	0
n+5 Data 2 [0]	0	0	0	0	0	0	0	0	0	0	0	0	0	0	0	0
n+6 Data 3 [Axis No.]	1	1	1	1	1	1	1	1	1	1	1	1	1	4	2	1

PLC Input (Address n is the input and output top address for MCON Gateway Unit.)

1 word=16 bit

Address	Bit															
	b15	b14	b13	b12	b11	b10	b9	b8	b7	b6	b5	b4	b3	b2	b1	b0
n+2 Response Command [1048h]	0	0	0	1	0	0	0	0	0	1	0	0	0	1	1	1
n+3 Data 0 [Position No.]	1	1	1	1	1	1	1	1	128	64	32	16	8	4	2	1
n+4 Data 1 [Load current threshold]	1	1	1	1	1	1	1	1	128	64	32	16	8	4	2	1
n+5 Data 2 [0]	0	0	0	0	0	0	0	0	0	0	0	0	0	0	0	0
n+6 Data 3 [Axis No.]	1	1	1	1	1	1	1	1	1	1	1	1	1	4	2	1

20) Reading of Alarm-issued Axis Pattern [4000h]

PLC Output (Address n is the input and output top address for MCON Gateway Unit.)

Note If this command is sent, the response command updates with the latest information until the demand command clear is sent.

1 word=16 bit

Address	Bit															
	b15	b14	b13	b12	b11	b10	b9	b8	b7	b6	b5	b4	b3	b2	b1	b0
n+2 Demand Command [4000h]	0	1	0	0	0	0	0	0	0	0	0	0	0	0	0	0
n+3 Data 0 [0]	0	0	0	0	0	0	0	0	0	0	0	0	0	0	0	0
n+4 Data 1 [0]	0	0	0	0	0	0	0	0	0	0	0	0	0	0	0	0
n+5 Data 2 [0]	0	0	0	0	0	0	0	0	0	0	0	0	0	0	0	0
n+6 Data 3 [0]	0	0	0	0	0	0	0	0	0	0	0	0	0	0	0	0

PLC Input (Address n is the input and output top address for MCON Gateway Unit.)

1 word=16 bit

Address	Bit															
	b15	b14	b13	b12	b11	b10	b9	b8	b7	b6	b5	b4	b3	b2	b1	b0
n+2 Response Command [4000h]	0	1	0	0	0	0	0	0	0	0	0	0	0	0	0	0
n+3 Data 0 [0]	0	0	0	0	0	0	0	0	0	0	0	0	0	0	0	0
n+4 Data 1 [Alarm-issued Axis Pattern] 1: Alarm 2: Normal									Status of 8th Axis	Status of 7th Axis	Status of 6th Axis	Status of 5th Axis	Status of 4th Axis	Status of 3rd Axis	Status of 2nd Axis	Status of 1st Axis
n+5 Data 2 [0]	0	0	0	0	0	0	0	0	0	0	0	0	0	0	0	0
n+6 Data 3 [0]	0	0	0	0	0	0	0	0	0	0	0	0	0	0	0	0

21) Reading of Alarm Code [4001h]

PLC Output (Address n is the input and output top address for MCON Gateway Unit.)

Note If this command is sent, the response command updates with the latest information until the demand command clear is sent.

1 word=16 bit

Address	Bit															
	b15	b14	b13	b12	b11	b10	b9	b8	b7	b6	b5	b4	b3	b2	b1	b0
n+2 Demand Command [4001h]	0	1	0	0	0	0	0	0	0	0	0	0	0	0	0	1
n+3 Data 0 [0]	0	0	0	0	0	0	0	0	0	0	0	0	0	0	0	0
n+4 Data 1 [0]	0	0	0	0	0	0	0	0	0	0	0	0	0	0	0	0
n+5 Data 2 [0]	0	0	0	0	0	0	0	0	0	0	0	0	0	0	0	0
n+6 Data 3 [Axis No.]														4	2	1

PLC Input (Address n is the input and output top address for MCON Gateway Unit.)

1 word=16 bit

Address	Bit															
	b15	b14	b13	b12	b11	b10	b9	b8	b7	b6	b5	b4	b3	b2	b1	b0
n+2 Response Command [4001h]	0	1	0	0	0	0	0	0	0	0	0	0	0	0	0	1
n+3 Data 0 [0]	0	0	0	0	0	0	0	0	0	0	0	0	0	0	0	0
n+4 Data 1 [Alarm Code]																
n+5 Data 2 [0]	0	0	0	0	0	0	0	0	0	0	0	0	0	0	0	0
n+6 Data 3 [Axis No.]														4	2	1

22) Error Response Command

PLC Output (Address n is the input and output top address for MCON Gateway Unit.)

In the case that the command did not complete in normal condition, this error response command is returned.

1 word=16 bit

Bit		b15	b14	b13	b12	b11	b10	b9	b8	b7	b6	b5	b4	b3	b2	b1	b0
Error Response Command	n+2 Demand Command	1	The values are those with the bit 15 of the demand command code being 1.														
	n+3 Data 0 [Undefined]																
	n+4 Data 1 [Error Detail]	0101 _H : Incorrect Axis Number 0102 _H : Incorrect Position Number 0103 _H : Incorrect Command 0201 _H : Communication Error 0202 _H : Controller Execution Impossible															
	n+5 Data 2 [Undefined]																
	n+6 Data 3 [Undefined]																

3.5 Input and Output Signal Process for Fieldbus

(1) I/O Signal Timings

When any of the control signal is turned ON to perform the operation of the robot cylinder using the PLC's sequence program, the response (status) is returned to the PLC. The maximum response time is expressed using the following formula. The value is constant regardless the number of composition axes.

Max. response time (msec.) = $Yt + Xt + (3 \times Mt) + \text{Response process time (operation time, etc.)}$

Yt : Master Station → Slave Transmission Delay Time } Fieldbus Transmission Delay Time
 Xt : Slave → Master Station Transmission Delay Time }

Mt = MCON internal communication sending time (Ttx) + MCON internal communication receiving time (Trx)

Refer to the instruction manual of the mounted PLC for the master station → slave transfer delay time (Yt) and the slave → master station transfer delay time (Xt).

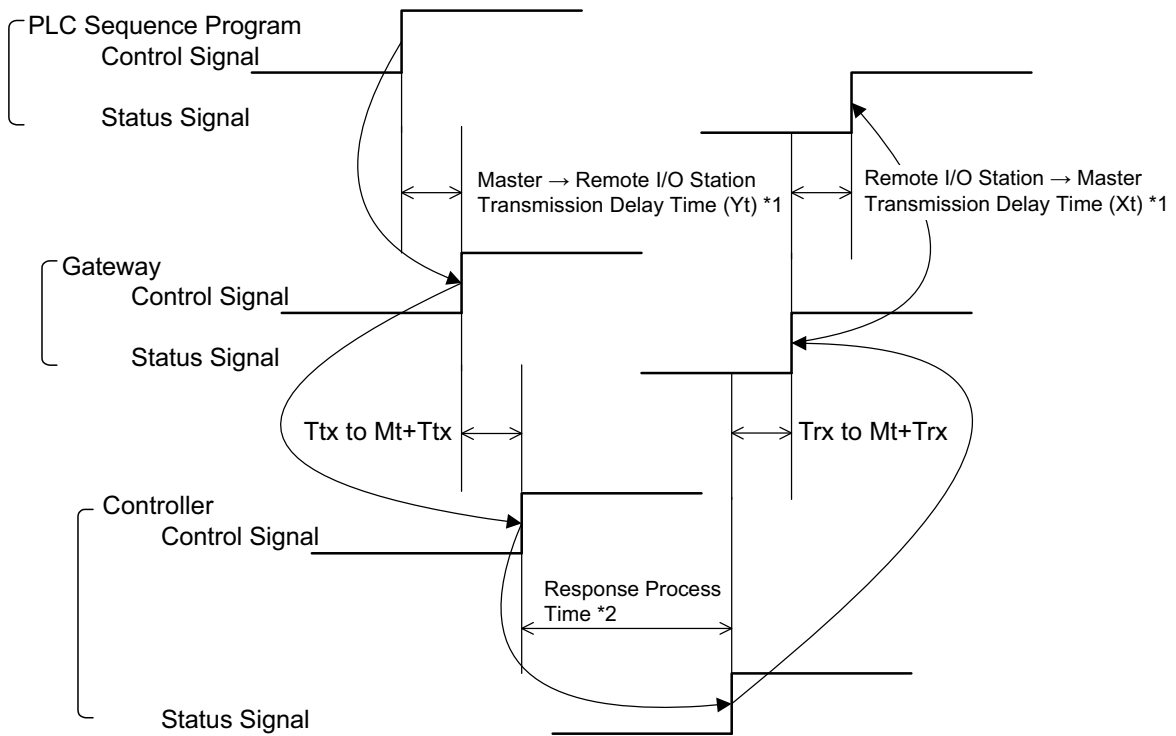

*1 Refer to PLC Manual

*2 Varies depending on the content of control

Mt = max.6ms
 (data being processed at once for eight axes)

* When monitoring not conducted in AUTO

(2) Command Sending and Receiving Timing (Reading and Writing of Position Data and Reading of Alarm Axis)

By writing and reading the specified commands to the area of 5-word next to Gateway control/status area, reading and writing of the position data and reading of alarm axis can be conducted.

Gateway executes the demand command ever time the control/status data exchange finishes for all the axes. [Refer to Section 3.4.11 About Command.]

- Step

- 1) PLC confirms the area of response command is 0.
- 2) PLC sets the necessary demand commands and data to the indicated area and send them.
- 3) Gateway detects that the area of the demand command has become other than 0, and rewrites the appropriate axis data if it is the writing command, and reads the requirement data from the appropriate axis if reading command.
- 4) Gateway output the response result to PLC once the command is executed.
- 5) Once PLC has confirmed the response result, clear the area for the demand command to 0.
- 6) Gateway clears the response command area to 0 and waits for the next command after it detects the demand command is cleared.

The procedures from 1) to 6) are repeated when continuously used.

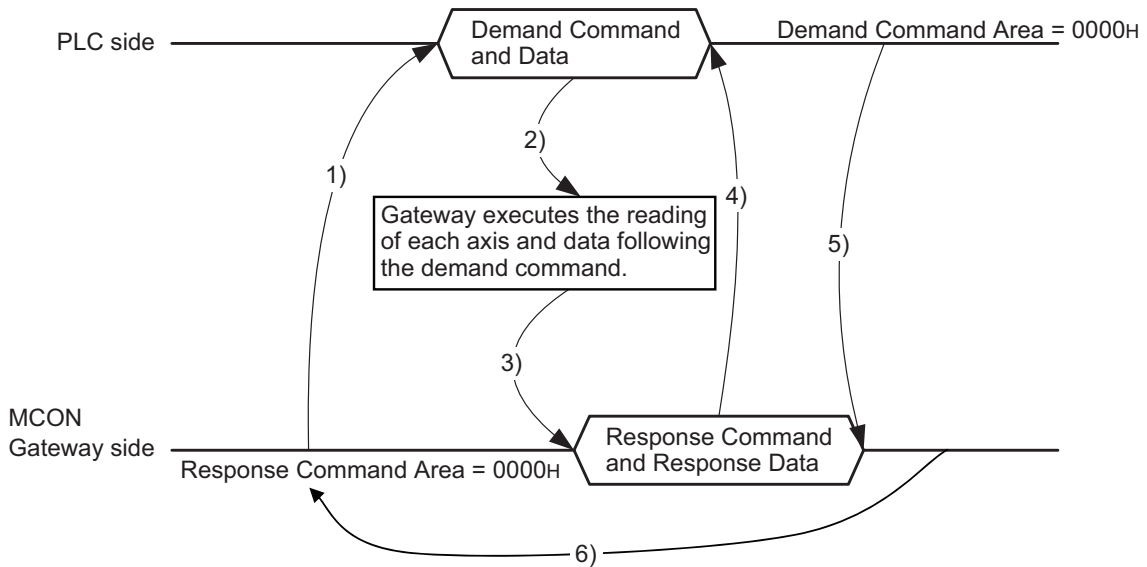

3.6 Power Supply

Follow the steps below to turn ON the power to the controller.

- 1) Control power and the drive (24V DC).
- 2) Cancel the emergency stop condition or make the motor drive power supply available to turn ON.
- 3) If using the servo-on signal, input the signal from the host side.
(Utilize such feature as Driver Shutdown Release Delay Time [refer to 3.9.3 3) GW Parameter 3] to shift the timing to turn the servo on so the occurrence of in-rush current can be dispersed.)
- 4) Input the home return signal (HOME) from the host side.

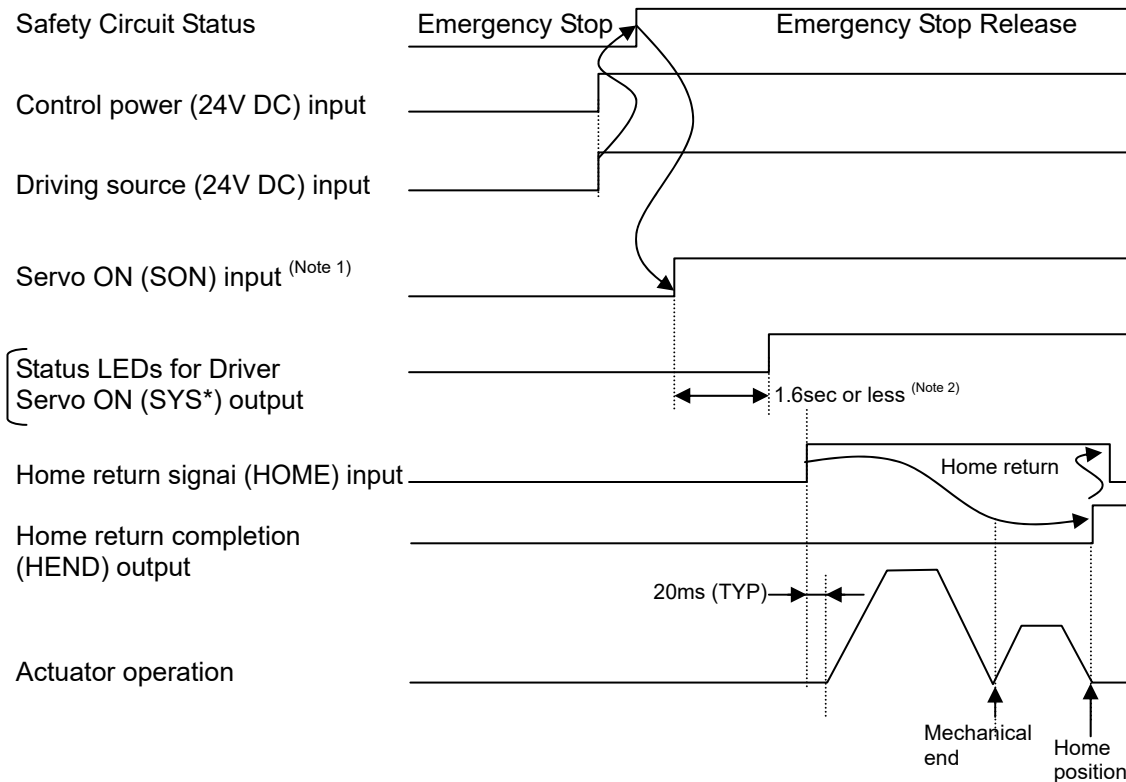

Note 1 The servo turns on when SON Signal gets input if Parameter No. 21 Servo-on Input is turned "Valid".

Note 2 Input the movement (Home return) command after having a delay time of 1.6sec or more for the magnetic pole phase detection of the motor at the first servo-on input after the power is turned ON. In the second time or later, make the delay time of 60ms or more.



Warning: Executing a servo ON when the actuator is position very close to a mechanical end may cause the magnetic pole phase detection operation to malfunction and reporting of the magnetic pole unconfirmed or excitation detection errors. Always move the actuator physical position away from the mechanical end before executing the servo ON command.

The timing to turn the servo on can be shifted in Driver Shutdown Release Delay Time [Refer to 3.9.3 3) GW Parameter 3] in the gateway parameter setting tool.

- Driver Shutdown Release Delay Time

It is used in purpose to scatter the in-rush current when the power is supplied to multiple controllers from one power source.

Utilize Driver Shutdown Release Delay Time [refer to 3.9.3 3) GW Parameter 3] in the gateway parameter setting tool to shift the timing to turn the servo on so the occurrence of in-rush current can be dispersed.

Utilize Driver Shutdown Release Delay Time [refer to 3.9.3 3) GW Parameter 3] to shift the timing to turn the servo ON so the occurrence of in-rush current can be dispersed.

3.7 Control and Functions of Input and Output Signals of Modes Other than Remote I/O Mode

3.7.1 Input and Output Signal Functions

Input and output signals are prepared for each axis number.
The applicable bit is "1" when the signal is ON and "0" when it is OFF.

(1) Controller ready (CRDY) PLC Input Signal

Operation Mode	Positioner 1	Simple Direct	Direct numeric specification	Positioner 2	Positioner 3	Positioner 5
○ : Equipped × : Not equipped	○	○	○	○	×	○

Regardless of the alarm or servo conditions, when the controller initialization is completed normally after the power injection and the controller can control the system, it is turned ON. Even in the alarm condition, when the controller can control the system, it is turned ON.

(2) Emergency stop (EMGS) PLC Input Signal

Operation Mode	Positioner 1	Simple Direct	Direct numeric specification	Positioner 2	Positioner 3	Positioner 5
○ : Equipped × : Not equipped	○	○	○	○	○	○

When the controller is stopped in an emergency (motor driving power is cut off), it is turned ON. When the emergency stop status is cleared, it is turned OFF.

Also, ALM* in the driver status LEDs flashes. [Refer to Name and Function of Each Part 7]
Have an appropriate safety treatment such as interlock with this signal for the host controller.

(Note) It is not an emergency stop output due to an alarm generation of the controller.

(3) Alarm (ALM) PLC Input Signal

Operation Mode	Positioner 1	Simple Direct	Direct numeric specification	Positioner 2	Positioner 3	Positioner 5
○ : Equipped × : Not equipped	○	○	○	○	○	○

This is a signal that is OFF in normal condition and turns ON when an alarm of operation cancelled level ^(Note 1) or higher is generated. This signal turns OFF once the reset (RES) signal is turned ON while an alarm of operation cancelled level is being generated. (In the case of the alarm with the cold start level, re-injection of the power is required.)

Also, ALM* in the driver status LEDs flashes. [Refer to Name and Function of Each Part 7]

Note 1 Check the 9.3 Gateway Alarm and 9.4 Driver Alarm for details of alarms.

(4) Reset (RES) PLC Output Signal

Operation Mode	Positioner 1	Simple Direct	Direct numeric specification	Positioner 2	Positioner 3	Positioner 5
○ : Equipped × : Not equipped	○	○	○	○	○	○

The reset signal RES possesses two functions, one is an alarm reset while an alarm is being generated, and the other is to cancel the operation while in a pause.

- 1) Once this signal is turned ON while an alarm of operation cancelled level is being generated, the alarm is cancelled. (In the case of the alarm with the cold start level, re-injection of the power is required.) Confirm the cause of the alarm and remove it before conducting a reset of the alarm. Having the alarm reset repeatedly without removing the cause of the alarm to restart the operation may cause a critical malfunction such as motor burn-down.
- 2) When this signal is turned ON from OFF condition during the pause condition, the remainder of the planned movement left can be cancelled and the remained operation can be deleted.

(5) Servo ON command (SON) PLC Output Signal

Servo ON status (SV) PLC Input Signal

Positioning complete (PEND) PLC Input Signal

Operation Mode	Positioner 1	Simple Direct	Direct numeric specification	Positioner 2	Positioner 3	Positioner 5
○ : Equipped × : Not equipped	○	○	○	○	○	○

- 1) Servo ON command SON is the signal making the servo motor of the actuator operable.
- 2) Once the Servo ON is executed and the operation comes available, Servo ON status signal SV starts turned ON. The positioning complete signal PEND turns ON at the same time. Also, the axis driver status LEDs (SYS*) on the front panel corresponding for the axis No. turns ON in green. [Refer to Name and Function of Each Part 7) driver status LEDs]
- 3) With the power being supplied, then controller cannot be operated while the SV signal remains OFF. If SON Signal is turned OFF during the actuator operation, the actuator decelerates and stops with the emergency stop torque, servo turns OFF, and the motor goes into the free-run condition.
For the actuators equipped with a brake, the brake gets activated.

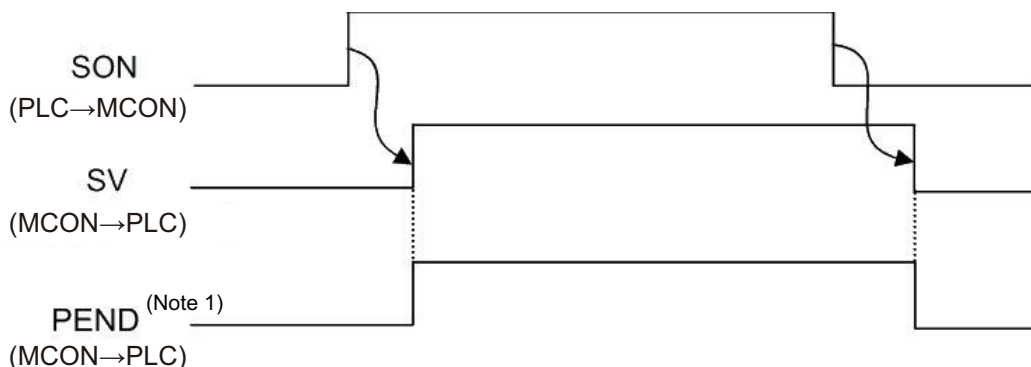

Note 1 PEND would not turn ON in the pause condition.

- (6) Home return (HOME) PLC Output Signal
- Home return completion (HEND) PLC Input Signal
- Moving (MOVE) PLC Input Signal
- Positioning complete (PEND) PLC Input Signal

Operation Mode	Positioner 1	Simple Direct	Direct numeric specification	Positioner 2	Positioner 3	Positioner 5
○ : Equipped × : Not equipped	○	○	○	○	○	○

HOME Signal is a signal to conduct an automatic home-return operation. Once HOME Signal is turned ON, this signal is processed as a rise (ON-edge), and the actuator starts home-return operation. Once the home-return operation is completed, the home-return operation complete signal HEND turns ON. The home return complete signal HEND is kept ON unless the home position is lost. The positioning complete signal PEND turns OFF and the moving signal MOVE turns ON during a home-return operation.

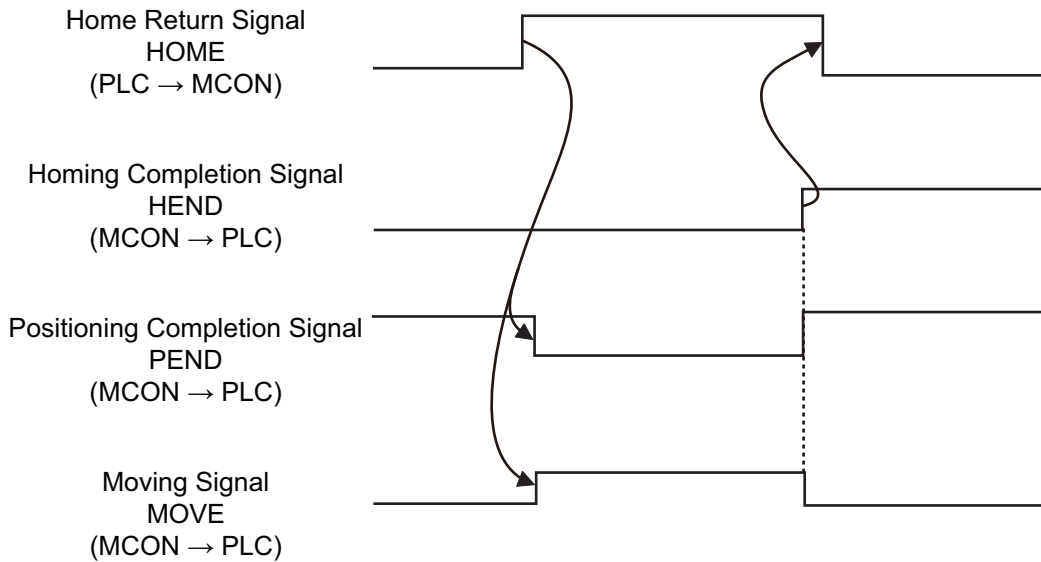

⚠ Caution: *If an actuator of Incremental Type is connected, and in Position * Mode and Simple Direct Mode, when the positioning command is issued without performing the home-return operation after the power is turned ON, the positioning can be performed once only after the automatic home-return operation is executed. Exercise caution that in the direct indication mode, issuing a positioning command to a given position following the power ON, without performing a home return first, will generate an alarm "Error Code 83: ALARM HOME ABS (absolute position move command when home return is not yet completed)" (operation-reset alarm).*

[Operation of Slider Type/Rod Type Actuator]

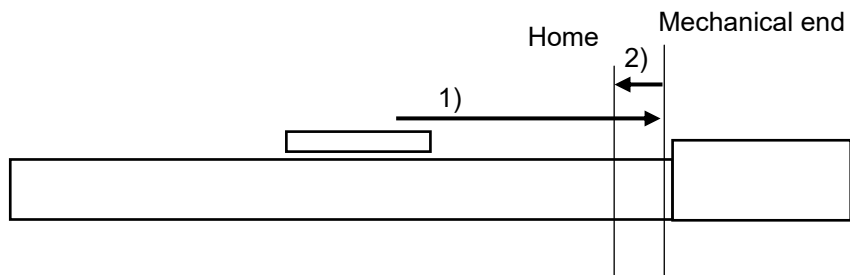

- 1) With the HOME signal being ON, the actuator moves toward the home return speed.
The speed for most of the actuators is 20mm/s, however, for some actuators it is less than 20mm/s.
- 2) The actuator is turned at the mechanical end and stopped at the home position. The movement amount in this process follows the setting in Parameter No. 22 "Home return offset level".

⚠ Caution: *In the home reverse specification, the actuator moves in the reverse direction.
Make sure to refer to Section 8.2 [14] when a change to Parameter No.22 "Home Return Offset Level" is required.*

[Operation of Rotary Actuator]

- (1) 330° Rotation Specification

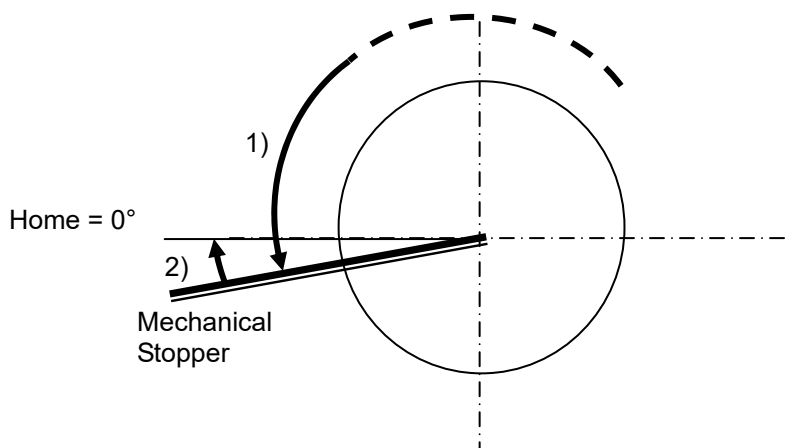

- 1) By HOME Signal being ON, the rotary part turns in CCW (counterclockwise) from the view of load side. The velocity is either 20deg/s.
- 2) The actuator is turned at the mechanical stopper and stopped at the home position. The amount of movement at this time is that set in Parameter No.22 "Home Return Offset Level".

⚠ Caution: *Make sure to refer to Section 8.2 [14] when a change to Parameter No.22 "Home Return Offset Level" is required.*

(2) Multi-Rotation Type

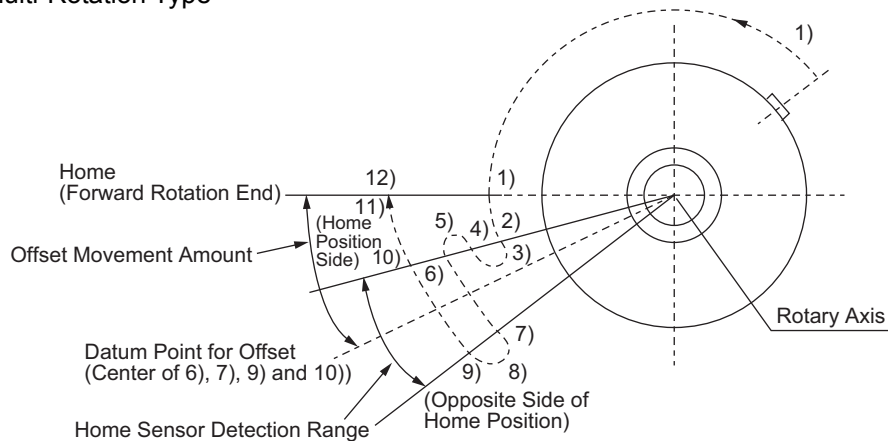

- 1) Once the home-return operation is started, the rotary part turns in CCW (counterclockwise) from the view of the load side. The speed is either 20deg/s.
- 2) Home sensor turns ON.
- 3) Starts reversed rotation.
- 4) Goes back to a point exceeded the home sensor detection range, and confirms the home sensor is turned OFF.
- 5) Starts reversed rotation.
- 6) Confirms the home sensor gets turned on again.
- 7) Goes to a point exceeded the home sensor detection range on the opposite side of the home position, and confirms the home sensor is turned OFF.
- 8) Starts reversed rotation.
- 9) Confirms the home sensor turns ON.
- 10) Goes to a point exceeded the home sensor detection range on the home position side, and confirms the home sensor is turned OFF.
- 11) Based on the result gained from 6), 7), 9) and 10), the center of the home sensor detection range is calculated.
- 12) The actuator moves in a certain amount for each actuator from the position of 11) and stops at the home position.

⚠ Caution: *The direction to rotate is the other way for the reversed rotation type. Make sure to refer to Section 8.2 [14] when a change to Parameter No.22 "Home Return Offset Level" is required.*

[For Gripper]

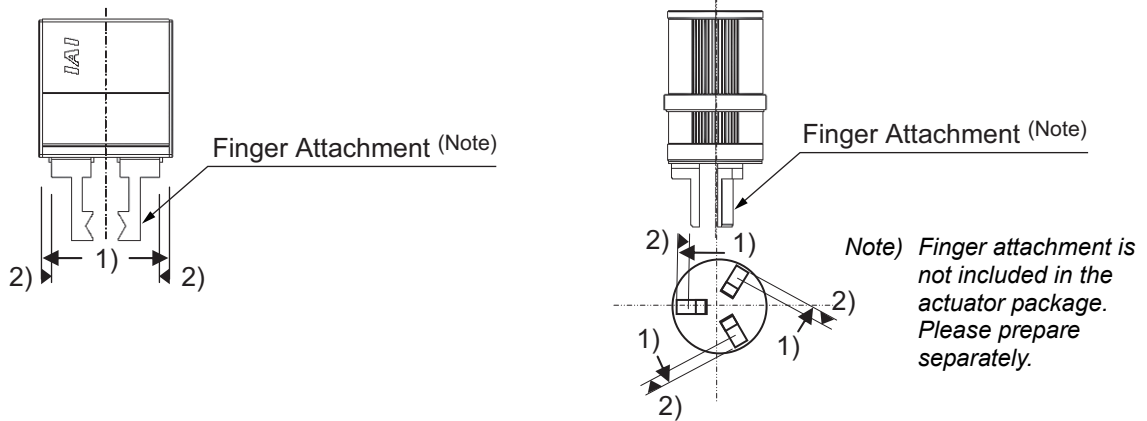

- 1) The actuator moves toward the mechanical end (to end side) at the home return speed (20mm/s).
- 2) The actuator is turned at the mechanical end and stopped at the home position. The amount of movement at this time is that set in Parameter No.22 "Home Return Offset Level" after Z-phase is detected.

⚠ Caution: *Make sure to refer to Section 8.2 [14] when a change to Parameter No.22 "Home Return Offset Level" is required.*

- (7) Positioning start (CSTR) PLC Output Signal
- Moving (MOVE) PLC Input Signal
- Positioning complete (PEND) PLC Input Signal

Operation Mode	Positioner 1	Simple Direct	Direct numeric specification	Positioner 2	Positioner 3	Positioner 5
○ : Equipped	○	○	○	○	○	○
× : Not equipped						

This signal is processed at the startup (ON edge) and the positioning is performed to the target position with the specified position No. or set using the PLC's target position register.

- 1) Once the start signal CSTR is turned ON, the actuator starts to accelerate following the data in the specified position table to perform positioning at the target position.
- 2) Once the operation starts, the positioning complete signal PEND turns OFF. Turn OFF CSTR Signal. If CSTR Signal is not turned OFF, output of complete position number cannot be performed and the positioning complete signal would not turn ON when the positioning is complete.
- 3) Once the positioning is complete, the number of positioning complete position is output in the binary data by Complete Position No. PM1 to PM**, and the positioning complete signal PEND is turned ON at the same time.
- 4) The moving signal MOVE turns ON at the same time as the operation starts, and turns OFF once the positioning complete signal PEND turns ON or the movement command output completes.
- 5) The positioning complete signal PEND turns ON once the remaining movement gets into the range of the positioning band. PEND Signal will be kept ON once it is turned ON unless the start signal CSTR is turned back ON, servo is turned OFF ^(Note 1) or the actuator is out of the positioning band width range ^(Note 1).

Note 1 It can be switched over with Parameter No. 39 [Positioning complete signal output system].

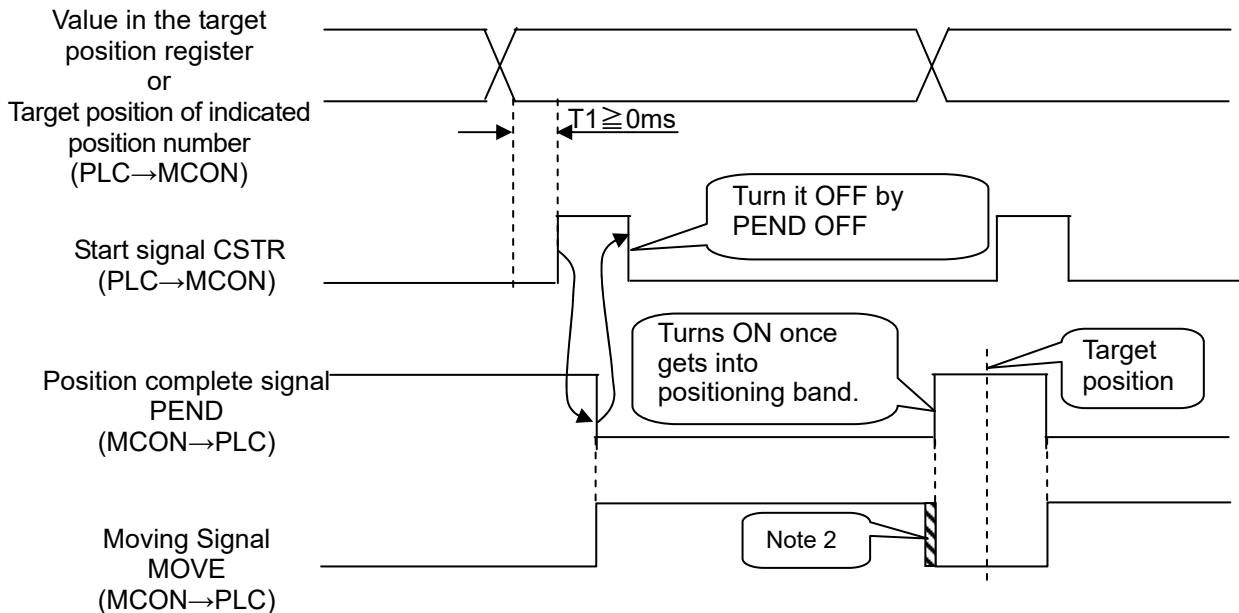

Note 2 MOVE turns ON at the same time as PEND turns OFF, and turns OFF once the command from a controller to the motor is finished. Therefore, when the positioning band setting is wide, the signal may turn OFF even in the actuator operation, and may turn OFF prior to PEND if the positioning band setting is narrow.

 **Caution:** *When the servo-motor is turned OFF or stopped in an emergency while the actuator is stopped at the target position, the PEND signal is turned OFF temporarily.
Then, when the servo-motor is turned ON and the actuator is within the positioning width, the PEND signal is turned ON again.
When the positioning is completed with the CSTR signal turned ON, the PEND signal is not turned ON.*

(8) Pause (STP) PLC Output Signal

Operation Mode	Positioner 1	Simple Direct	Direct numeric specification	Positioner 2	Positioner 3	Positioner 5
○ : Equipped × : Not equipped	○	○	○	○	○	○

When this signal is turned ON, the actuator movement is decelerated and stopped. When it is turned OFF, the actuator movement is restarted.

The acceleration in the operation restart or the deceleration in stopping operation, is expressed as the value for the acceleration/deceleration for the position No. set using the specified position No. resistor in the Position* Mode and Simplified Direct Value Mode, and as the value set in the acceleration/deceleration register in the Direct indication mode.

(9) Zone 1 (ZONE1) PLC Input Signal Zone 2 (ZONE2) PLC Input Signal Position Zone (PZONE) PLC Input Signal

Operation Mode	Positioner 1	Simple Direct	Direct numeric specification	Positioner 2	Positioner 3	Positioner 5
○ : Equipped × : Not equipped	○	○	△ (No PZONE)	○	△ (Only for PZONE1)	△ (No PZONE)

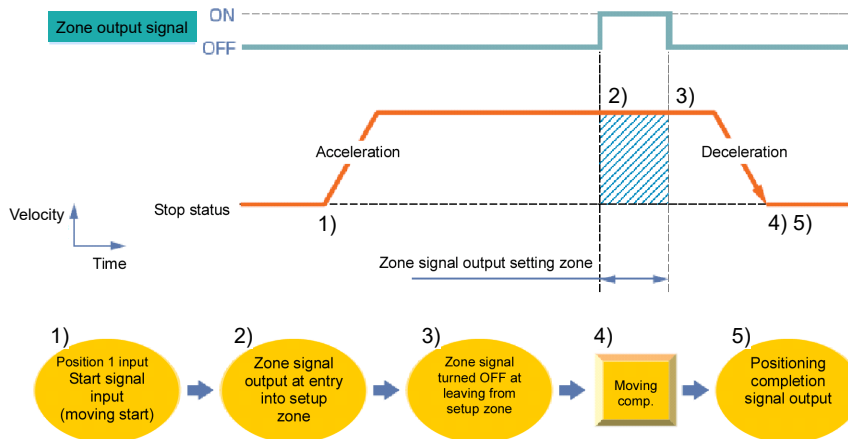

This is a function enables to turn a signal on while the actuator is passing a certain position (in the zone range) or during a stop, in which there are two types.

- 1) Zone signal (ZONE1, ZONE2) ··· Turn the output on at a position set in the parameter.
- 2) Position zone signal (PZONE) ··· Turn the output on at a position set in the position table.

The roles of a sensor, such as the judgment of complete position at pressing complete, continuous operation range setting for the pitch feed or operation interlock of other devices in the setting range, can be made available.

(1) Zone signal (ZONE1, ZONE2)

Set the zone range to the parameter.

- 1) ZONE1: Parameter No.1 (Zone boundary 1+), Parameter No.2 (Zone boundary 1-)
- 2) ZONE2: Parameter No.23 (Zone boundary 2+), Parameter No.24 (Zone boundary 2-)

The zone signal is kept effective also during the emergency stop unless the memory of the origin is lost due to alarm.

(2) Position zone signal (PZONE)

No.	Position [mm]	Velocity [mm/s]	Acceleration [G]	Deceleration [G]	Pressing [%]	Threshold [%]	Positioning width [mm]	Zone+ [mm]	Zone- [mm]	Acceleration/Deceleration mode	Incremental	Gain set	Stop mode
0													
1	0.00	250.00	0.20	0.20	0	0	0.10	50.00	30.00	0	0	0	0
2	100.00	250.00	0.20	0.20	0	0	0.10	70.00	60.00	0	0	0	0
3	50.00	250.00	0.20	0.20	50	0	20.00	60.00	65.00	0	0	0	0

Setting of zone range

Set the zone range to the position table.

This set value becomes valid while the position number set in the zone range is executed. It is kept effective also during the emergency stop unless the actuator is operated or the memory of the origin is lost due to alarm.

(3) Output Ranges of Set Values and Signals

The zone output range differs depending on the difference of the values set in the zone positive side and negative side.

- 1) Value set for positive side > value set for negative side:
Output signal turn ON in the range from the value on negative side to that on positive side, and turns OFF out of the range
- 2) Value set for positive side < value set for negative side:
Output signal turn OFF in the range from the value on positive side to that on negative side, and turns ON out of the range

[Example of Line Axis]

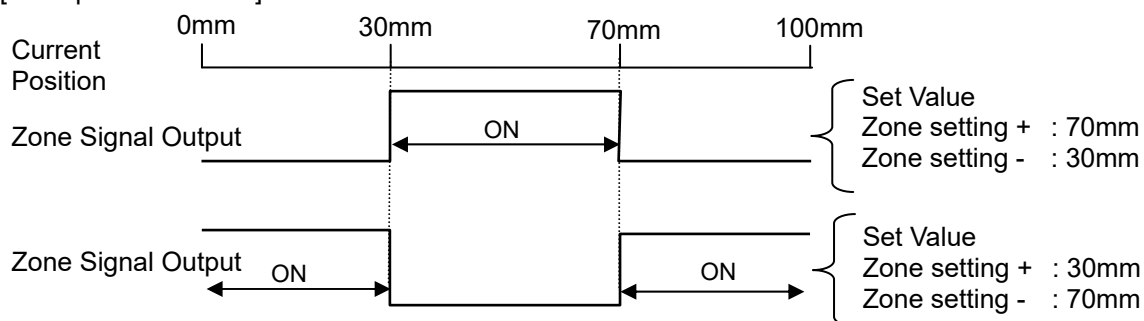

[Example of rotary actuator of multi-rotation specification in index mode]

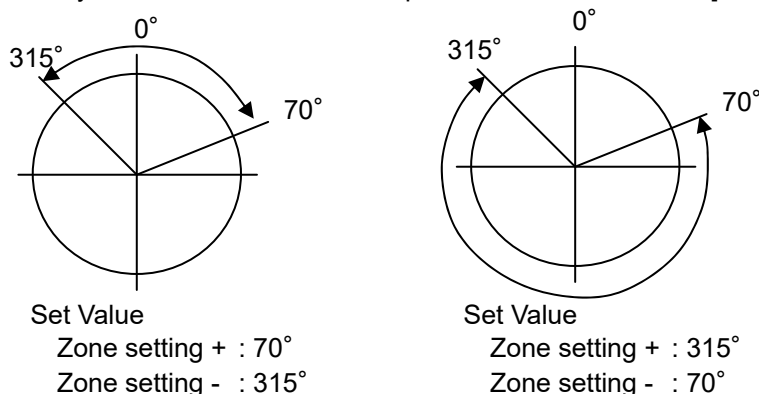

⚠ Caution: Since this signal becomes effective after the coordinate system is established after the home return is completed, it would not be output just with the power turned ON.

(10) + Jog (JOG+) PLC Output Signal
 - Jog (JOG-) PLC Output Signal

Operation Mode	Positioner 1	Simple Direct	Direct numeric specification	Positioner 2	Positioner 3	Positioner 5
○ : Equipped × : Not equipped	○	○	○	○	×	○

This signal is the command for the jog operation startup or inching operation startup. If a + command is issued, the actuator will operate in the direction opposite home. When a - command is issued, the actuator will operate in the direction of home.

1) Jog operation

Jog operation can be performed when the jog/inch switching (JISL) signal is OFF. While the "JOG+" is turned ON, the movement direction is to the opposite of the home and when it is turned OFF, the actuator is decelerated and stopped. While the "JOG-" is ON, the actuator will operate in the direction of home and when it is turned OFF, it is decelerated to a stop.

The operation is performed based on the set values of the following parameters.

- The speed is based on the parameter value ON/OFF specified using the Jog Speed/Inching Distance Change-Over (JVEL) signal.
 - If the JVEL signal is OFF, the actuator operates according to parameter No.26, "PIO jog speed".
 - If the JVEL signal is ON, the actuator operates according to parameter No.47, "PIO jog speed 2".
 However, it will operate in the speed described below in the direct indication mode when JVEL Signal is on.
 - When Command Speed Setting = 0 : Operation will be made with a value in Parameter No. 47 "PIO JOG Speed 2" in MCON.
 - When Command Speed Setting ≠ 0 : Operation will be made with the setting value in Command Speed.
- The acceleration/deceleration conforms to the rate acceleration/deceleration (the specific value varies depending on the actuator).
- When both the JOG+ and JOG- signals are turned ON, the actuator is decelerated and stopped.

2) Inching (incremental) operation

The inching operation is available while the JISL signal is turned ON. One time of ON input gives the actuator a constant amount of movement of the inching distance set in the parameter.

When the JOG+ is turned ON, the movement is to the opposite of the home and when the JOG- is turned ON, the movement is to the home.

The operation is performed based on the set values.

- The speed conforms to the value of the parameter ON/OFF specified by the JVEL signal.
 - If the JVEL signal is OFF, the actuator operates according to parameter No.26, "PIO jog speed".
 - If the JVEL signal is ON, the actuator operates according to parameter No.47, "PIO jog speed 2".
- The travel conforms to the value of the parameter ON/OFF specified by the JVEL signal.
 - If the JVEL signal is OFF, the actuator operates according to parameter No.48, "PIO inch distance".
 - If the JVEL signal is ON, the actuator operates according to parameter No.49, "PIO inch distance 2".
- The acceleration/deceleration conforms to the rate acceleration/deceleration (the specific value varies depending on the actuator).

During the normal operation, even when the "+" Jog Signal or "-" Jog Signal is turned ON, the normal operation is continued. (The Jog signal is ignored.)

In the pause condition, even when the "+" Jog Signal or "-" Jog Signal is turned ON, the actuator is not moved.

(Note) Because the software stroke limit is disabled before the homing operation, the actuator might run against the mechanism end. Take the greatest care.

(11) Jog-speed/inch-distance switching (JVEL) PLC Output Signal

Operation Mode	Positioner 1	Simple Direct	Direct numeric specification	Positioner 2	Positioner 3	Positioner 5
○ : Equipped × : Not equipped	○	○	○	○	×	○

It is a signal to switch the parameters to indicate the speed or inching (incremental) distance when in JOG operation and inching operation. Table below shows the relations.

JVEL signal	Jog operation : JISL=OFF	Inch operation : JISL=ON
OFF	Parameter No.26, "Jog speed"	Parameter No.26, "Jog speed" Parameter No.48, "Inch distance"
ON	Parameter No.47, "Jog speed 2" (Note 1)	Parameter No.47, "Jog speed 2" Parameter No.49, "Inch distance 2"

Note 1 It will operate in the indicated following speed in the direct indication mode.
When Command Speed Setting = 0 : Operation will be made with a value in Parameter No. 47 "PIO JOG Speed 2" in MCON.

When Command Speed Setting ≠ 0 : Operation will be made with the setting value in Command Speed.

(12) Jog/inching switching (JISL) PLC Output Signal

Operation Mode	Positioner 1	Simple Direct	Direct numeric specification	Positioner 2	Positioner 3	Positioner 5
○ : Equipped × : Not equipped	○	○	○	○	×	○

This signal changes over the jog operation and the inching (incremental) operation.

JISL = OFF : Jog operation

JISL = ON : Inching operation

When the JISL signal is turned ON (for inching operation) during the jog operation, the actuator is decelerated and performs the inching operation.

When the JISL signal is turned OFF (jog) while the actuator is moving by inching, the actuator will complete the movement and then switch to the jog function.

		Jog operation	Inching operation
JISL		OFF	ON
JVEL = OFF	Speed	Parameter No.26, "Jog speed"	Parameter No.26, "Jog speed"
	Movement distance	-	Parameter No.48, "Inch distance"
	Acceleration/ deceleration	Rated value (The specific value varies depending on the actuator.)	Rated value (The specific value varies depending on the actuator.)
JVEL = ON	Speed	Parameter No.47, "Jog speed 2" (Note 2)	Parameter No.47, "Jog speed 2"
	Movement distance	-	Parameter No.49, "Inch distance 2"
	Acceleration/ deceleration	Rated value (The specific value varies depending on the actuator.)	Rated value (The specific value varies depending on the actuator.)
Operation		When the JOG +/JOG - signal is ON.	Upon detection of the leading (ON edge) of the JOG +/JOG - signal.

Note 1 It will operate in the indicated following speed in the direct indication mode.
When Command Speed Setting = 0 : Operation will be made with a value in Parameter No. 47 "PIO JOG Speed 2" in MCON.

When Command Speed Setting ≠ 0 : Operation will be made with the setting value in Command Speed.

(13) Teaching mode command (MODE) PLC Output Signal

Teaching mode signal (MODES) PLC Input Signal

Operation Mode	Positioner 1	Simple Direct	Direct numeric specification	Positioner 2	Positioner 3	Positioner 5
○ : Equipped × : Not equipped	○	×	×	○	×	×

When the MODE signal is turned ON, the normal operation mode is changed to the teaching mode.

When the mode is changed to the teaching mode, the MODES Signal is turned ON.

After confirming that the MODES signal is turned ON on the PLC side, start the teaching operation.

(Note) In order to change the normal operation mode to the teaching mode, the following conditions are required.

- The actuator operation (motor) is stopped.
- The + JOG (JOG+) signal and – JOG (JOG-) signal are turned OFF.
- The Position Data Import Command (PWRT) Signal and Positioning Start (CSTR) Signal are turned OFF.

(Note) When the PWRT signal is not turned OFF, the mode is not returned to the normal operation mode.

(14) Position data import command (PWRT) PLC Output Signal

Position data import complete (WEND) PLC Input Signal

Operation Mode	Positioner 1	Simple Direct	Direct numeric specification	Positioner 2	Positioner 3	Positioner 5
○ : Equipped × : Not equipped	○	×	×	○	×	×

The PWRT signal is available when the teaching mode signal (MODES) is turned ON.

Turn ON the PWRT signal ^(Note1), Then, the current position data will be written in the position data box for the position No. set using the PLC's specified Position No. channel. ^(Note2)

When the data writing is completed, the WEND signal is turned ON.

After the WEND signal is turned ON, turn OFF the PWRT signal in the host machine.

When the PWRT signal is turned OFF before the WEND signal is turned ON, the WEND signal is not turned ON.

When the PWRT signal is turned OFF the WEND signal is also turned OFF.

Note1 Turn it ON for 20msec or more. If the time is shorter than 20msec, the writing is not completed.

Note2 When the data items except for the position have not been defined, the parameter initial values are written. [Refer to Chapter 8 Parameter]

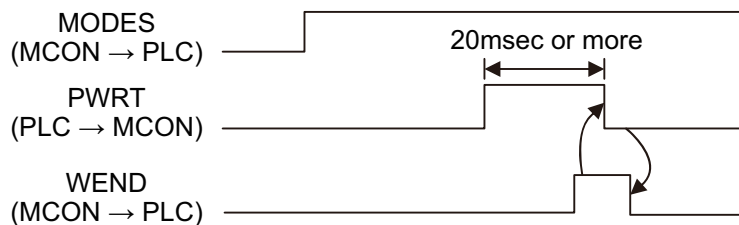

(15) Brake release (BKRL) **PLC Output Signal**

Operation Mode	Positioner 1	Simple Direct	Direct numeric specification	Positioner 2	Positioner 3	Positioner 5
○ : Equipped x : Not equipped	○	○	○	○	○	○

The brake can be released while BKRL signal is turned ON. For an actuator equipped with a brake, the brake can be controlled automatically with the ON/OFF of the servo, however, it may require to release the brake in such cases as when installing to the system or conducting Direct Teach^{*1}, when the slider or rod needs to be moved manually with hand. This operation also can be performed with the brake release switch on the controller front panel, or by supplying 24V to the brake power terminal on the control power connector.

*1 Direct Teaching: It is an operation to move the slider or rod manually with hand to read the coordinate to the position table.

 **Warning:** (1) *Release the brake with a special care. Doing so carelessly may cause an injury or a malfunction of actuator, work piece or other devices due to a drop of the slider or rod.*

(2) *Make sure to put the setting back to activate the brake after releasing it. It is extremely dangerous to perform operation with the brake open. Drop of the slider or rod may cause injury or malfunction of actuator body, work piece or system.*

(16) Push-motion specification (PUSH) PLC Output Signal

Operation Mode	Positioner 1	Simple Direct	Direct numeric specification	Positioner 2	Positioner 3	Positioner 5
○ : Equipped × : Not equipped	×	×	○	×	×	×

When the movement command signal is output after this signal is turned ON, the pressing operation is performed.

When this signal is set to "OFF", the normal positioning operation is performed.

The same pressing type as CON related models such as PCON Controller or the same pressing type as SEP related models such as PSEP can be selected for the pressing type in Parameter No.181. Refer to 8.2 [73] for how to make selection.

[Pressing Operation CON Method]

After reaching the target position ^(Note 1) from the current position, the actuator moves with the pressing speed for the distance set as the pressing band width.

The positioning complete signal (PEND) turns ON if the work piece hits and pressing is judged as completed while in the pressing operation.

Note 1 In Direct Indication Mode, it is the value input in the target position register.

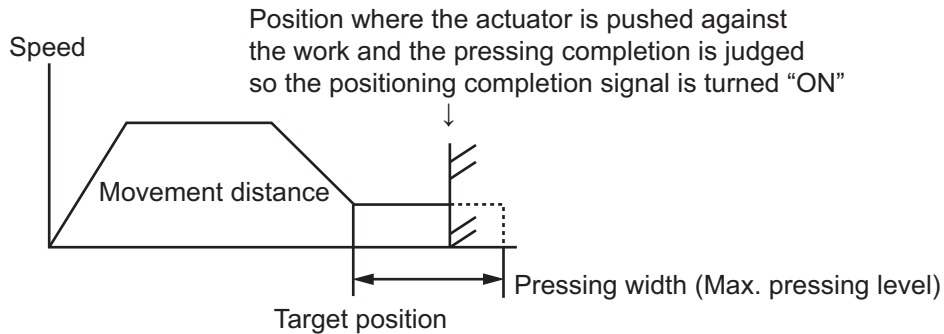

[Pressing Operation SEP Method]

The pressing operation is performed with the start position set at the point in front of the target position ^(Note 1) for the width of the positioning width (for Direct Indication Mode).

The positioning complete signal (PEND) turns ON if the work piece hits and pressing is judged as completed while in the pressing operation.

Note 1 In Direct Indication Mode, it is the value input in the target position register.

(Note) Pulling operation cannot be performed.

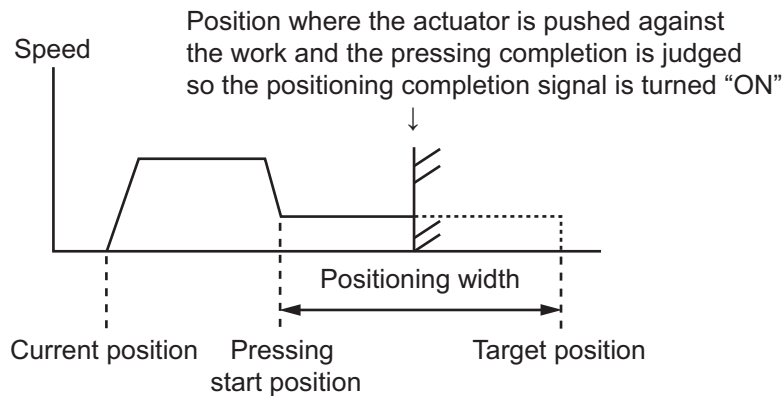

(17) Push direction specification (DIR) **PLC Output Signal**

Operation Mode	Positioner 1	Simple Direct	Direct numeric specification	Positioner 2	Positioner 3	Positioner 5
○ : Equipped × : Not equipped	×	×	○	×	×	×

This signal specifies the pressing direction.
 When this signal is turned OFF, the pressing operation is performed to the direction of the value determined by adding the positioning width to the target position.
 Pressing operation starts towards the position where the positioning width is added to the target position if this signal is turned ON.
 When the normal positioning operation, this signal is ineffective.

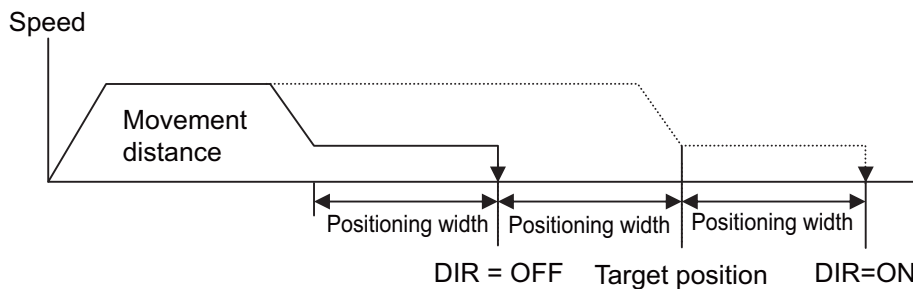

(18) Pressing and a miss (PSFL) **PLC Input Signal**

Operation Mode	Positioner 1	Simple Direct	Direct numeric specification	Positioner 2	Positioner 3	Positioner 5
○ : Equipped × : Not equipped	○	○	○	○	○	○

In the case that the pressing operation was performed, and the actuator moved the travel distance set in the controller position table positioning width or set using the PLC's positioning width register, but it was not pushed against the work, this signal is turned ON.

(19) Command complete signal (MEND) **PLC Input Signal**

Operation Mode	Positioner 1	Simple Direct	Direct numeric specification	Positioner 2	Positioner 3	Positioner 5
○ : Equipped × : Not equipped	○	○	○	○	×	○

This signal turns ON when the movement to the target position indicated by the host system is complete.
 Even though the control is about the same as PEND, this signal turns ON even if pressing is missed.
 It is OFF when servo is OFF or emergency stop is OFF. Also, if CSTR Signal is ON, this signal would not turn ON.

(20) Incremental command (INC) **PLC Output Signal**

Operation Mode	Positioner 1	Simple Direct	Direct numeric specification	Positioner 2	Positioner 3	Positioner 5
○ : Equipped x : Not equipped	x	x	○	x	x	x

When the movement command is issued while this signal is turned ON, the actuator is moved to the position expressed as the value input in the PLC's target position register based on the current position. (relative movement)

When this signal is turned OFF, the actuator is moved to the position expressed as the value set in the PLC's target position register.

(21) Light error alarm (ALML) **PLC Input Signal**

This signal turns ON when an overload warning or message level alarm is generated. [Refer to 8.2 [64] Light Malfunction Alarm Output Select]

For the message level alarm, refer to the section for the Chapter 9 Troubleshooting.

3.7.2 Operation for Positioner 1/Simple Direct Modes

If the position data is written to the target position register (for Simple Direct Mode) or the target position is set in the position data of MCON (for Positioner 1 Mode), the operation shall be made with other information, such as the speed, acceleration/deceleration, positioning width, pressing force, etc., set to the position data.

- Example of operation (Normal Positioning Operation with Simple Direct Mode)
(Preparation) Set the axis numbers to be used in Simple Direct Mode with Gateway Parameter Setting Tool. [Refer to 3.2.1 Operation Mode Setting.]
Set the position data items (speed, acceleration/deceleration, pressing width, etc) except for the target position item, in the position table.
- 1) Set the target position data in the target position register.
 - 2) Set the position No. where the speed and acceleration/deceleration, etc., have been set, in the setup position No. register.
 - 3) In the condition where the positioning completion (PEND) signal is turned ON or under movement signal (MOVE) is turned OFF, turn ON the positioning command (CSTR) signal.
The data items set in Steps 1) and 2) are read in the controller at the startup (ON edge) of the CSTR signal.
 - 4) After the CSTR signal is turned ON, the PEND signal is turned OFF after tpdf.
 - 5) After confirming that the PEND signal is turned OFF or MOVE signal is turned ON, turn OFF the CSTR signal. Do not change the value in the target position register until the CSTR signal is turned OFF.
 - 6) At the same time when the PEND signal is turned OFF, the MOVE signal is turned ON.
 - 7) The current position data is continuously updated. When the remaining travel distance becomes within the range of the positioning width set in the position data, and the CSTR signal is turned OFF, the PEND signal is turned ON. Then, the completed position No. is output to the completed position No. register.
Accordingly, for the read of the completed position No. register when the positioning is completed, confirm it some time (Remaining Travel Distance Movement Time) after the PEND signal is turned ON.
The current position data might be changed slightly even when the system is stopped.
 - 8) MOVE signal turns OFF at the same time as or within 10ms after PEND signal turns ON.
 - 9) The target position data can be changed during the actuator movement.
In order to change the target position, change the target position data and turn ON the CSTR signal after the time longer than the PLC scanning time has passed.
Change the value for the CSTR signal after the time longer than the PLC scanning time has passed.

- Example of operation (Pressing operation)
For the pressing operation, set the current limit to the pressing force box and pressing width to the pressing width box in the position data at the stage of (preparation). By conducting a positioning operation towards the set position number, the actuator performs a pressing operation.

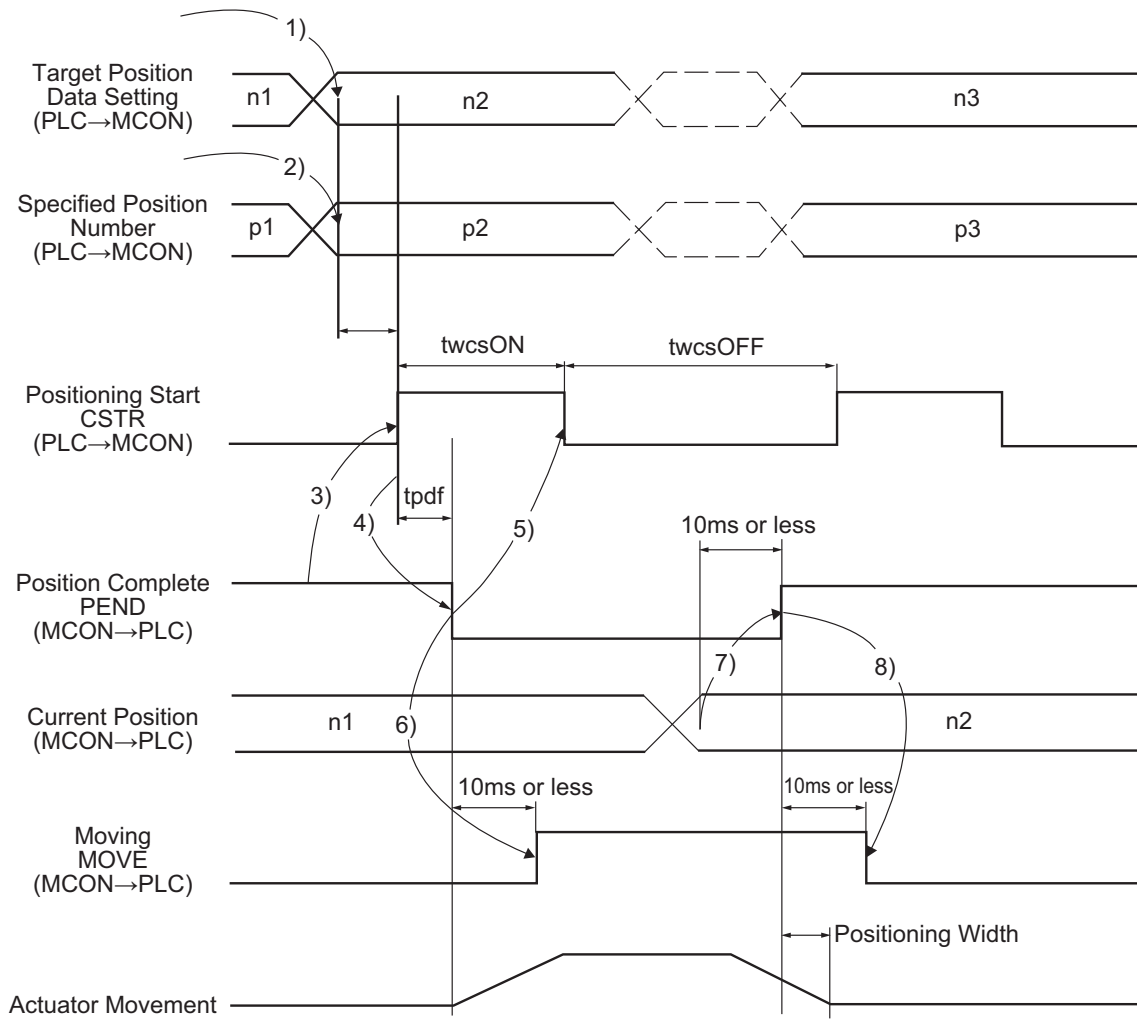

To turn ON $TwcsON$, have an interval of time more than 10ms.
 To turn OFF $TwcsOFF$, have an interval of time more than 10ms.
 $Tpdf = Yt+6+Xt$ (minimum value) to $Yt+6+Xt+12$ (maximum value)

3.7.3 Operation for Direct Indication Mode

It is operated with the data set in the PLC's target position register, positioning width register, setup speed register, acceleration/deceleration register and pressing current limit setup register.

- Example of operation (Pressing operation)

(Preparation) Set the axis numbers to be used in Direct Indication Mode with Gateway Parameter Setting Tool. [Refer to 3.2.1 Operation Mode Setting.]

- 1) Set the target position data in the target position register.
- 2) Set the positioning width (pressing width) data in the positioning width register.
- 3) Set the speed data to the speed register.
- 4) Set the acceleration/deceleration data to the acceleration/deceleration register.
- 5) Set the pressing current limit data in the pressing current limit value register.
- 6) Turn ON the pressing setup (PUSH) signal.
- 7) Specify the pressing direction using the pressing direction setup (DIR) signal.
- 8) In the condition where the positioning completion (PEND) signal is turned ON or under movement signal (MOVE) is turned OFF, turn ON the positioning start (CSTR) signal. The data items set in Steps 1) through 5) are read in the controller at the startup (ON edge) of the CSTR signal.
- 9) After the CSTR signal is turned ON, the PEND signal is turned OFF after tpdf.
- 10) After confirming that the PEND signal is turned OFF or MOVE signal is turned ON, turn OFF the CSTR signal. Do not change any value in each register until the CSTR signal has been turned OFF.
- 11) The current position data is continuously updated.
- 12) When the CSTR signal is turned OFF and the motor current reaches the current limit value set in Step 5), the PEND signal is turned ON. (Pressing complete)
Even when the positioning width (pressing width) set in Step 2) is reached, in the case that the current does not reach the motor current limit value set in Step 5), the pressing and a miss (PSFL) signal is turned ON. In this case, the PEND signal is not turned ON. (Pressing and a miss)
- 13) After the PEND signal or PSFL signal is turned ON, turn OFF the PUSH signal.
- 14) MOVE signal turns OFF at the same time as or within 10ms after PEND signal turns ON.

- Example of operation (Normal positioning operation)

For the general positioning operation, set the signal in Step 6) to OFF.

When the remaining travel distance becomes within the range of the positioning width set in the position data, and the CSTR signal is turned OFF, the PEND signal is turned ON.

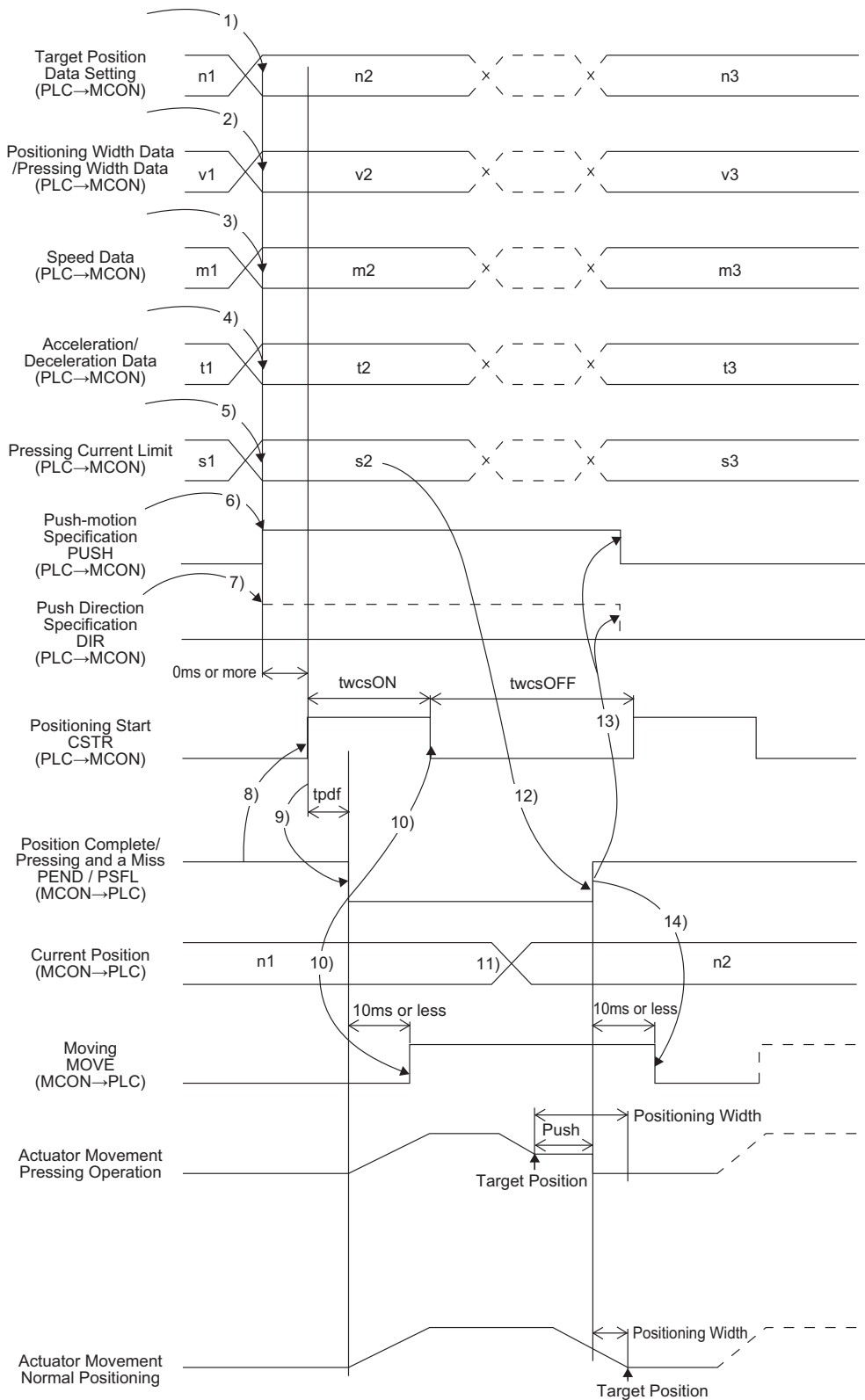

To turn ON TwcsON, have an interval of time more than 10ms.
 To turn OFF TwcsOFF, have an interval of time more than 10ms.
 $Tdpf = Yt+6+Xt$ (minimum value) to $Yt+6+Xt+12$ (maximum value)

3.7.4 Operation for Positioner 2, Positioner 3 and Positioner 5 Modes

The operation is to be made with the target position, speed, acceleration/deceleration, positioning width and pressing force set in the position data of MCON.

- Example of operation (Positioning operation)

(Preparation) Set the axis numbers to be used in Positioner 2, Positioner 3 or Positioner 5 Mode with Gateway Parameter Setting Tool. [Refer to 3.2.1 Operation Mode Setting.]

Set the position data (target position, speed, acceleration/deceleration, etc.) to the position table.

- 1) Set the position No. where the speed and acceleration/deceleration, etc., have been set, in the setup position No. register.
- 2) In the condition where the positioning completion (PEND) signal is turned ON or under moving signal (MOVE) is turned OFF, turn ON the positioning start (CSTR) signal. The data items set in Step 1) is read in the controller at the startup (ON edge) of the CSTR signal.
- 3) After the CSTR signal is turned ON, the PEND signal is turned OFF after tpdf.
- 4) After confirming that the PEND signal is turned OFF or MOVE signal is turned ON, turn OFF the CSTR signal. Do not change the value in the target position register until the CSTR signal is turned OFF.
- 5) The current position data is continuously updated for Positioner 5 Modes.
- 6) At the same time when the PEND signal is turned OFF, the MOVE signal is turned ON.
- 7) Once the remaining movement amount of the actuator gets into the range of the positioning width set in the parameter, PEND signal turns ON if CSTR signal is OFF, and the complete position number is output to the complete position number register. Accordingly, for the read of the completed position No. register when the positioning is completed, confirm it some time (Remaining Travel Distance Movement Time) after the PEND signal is turned ON. MOVE signal turns OFF at the same time as or within 10ms after PEND signal turns ON.

- Example of operation (Pressing operation)

For the pressing operation, set the current limit to the pressing box and pressing width to the positioning width box in the position data at the stage of (preparation). By conducting a positioning operation towards the set position number, the actuator performs a pressing operation.

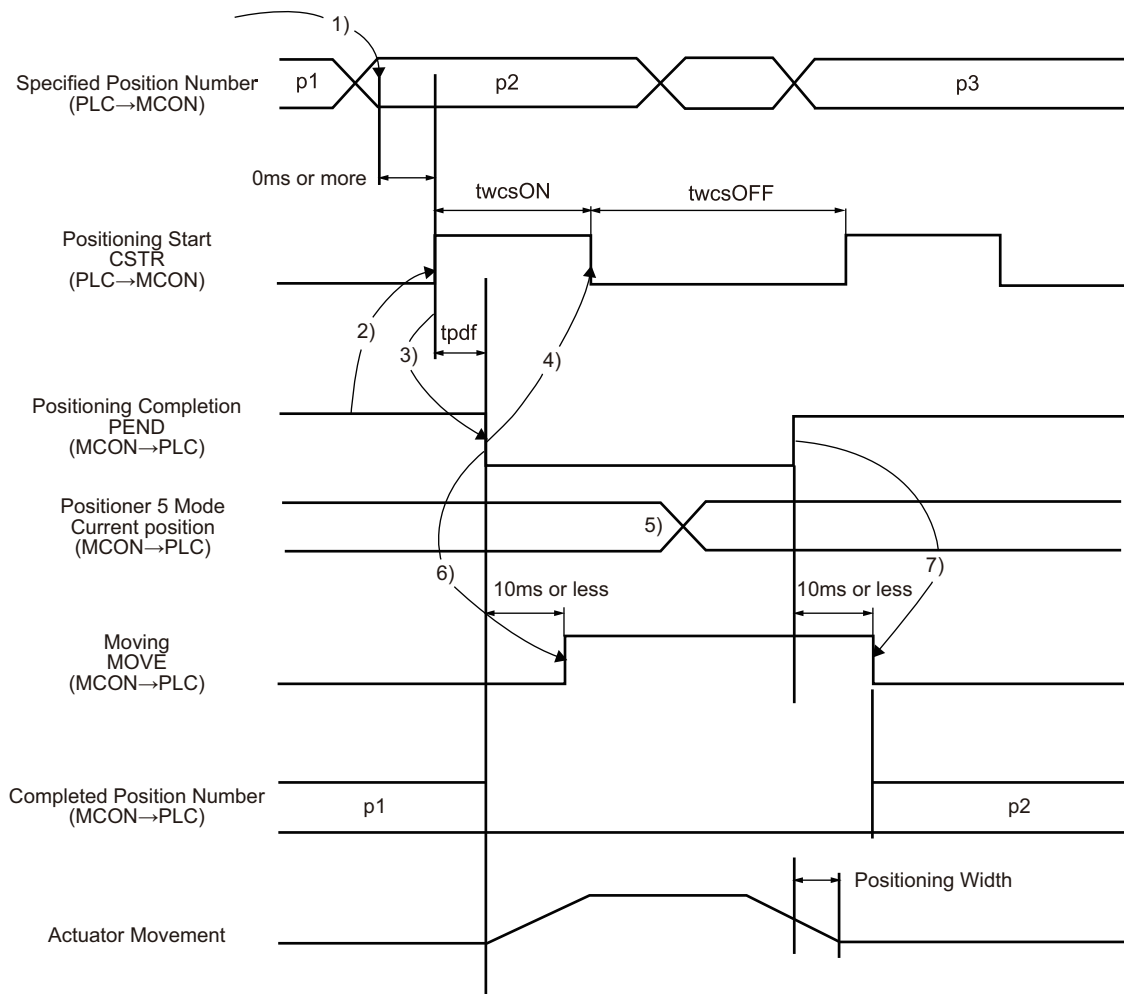

To turn ON TwcsON, have an interval of time more than 10ms.
 To turn OFF TwcsOFF, have an interval of time more than 10ms.
 $Tpdf = Yt+6+Xt$ (minimum value) to $Yt+6+Xt+12$ (maximum value)

3.8 Control and functions of Input and output signals of Remote I/O Mode

3.8.1 Operation Supportive Signal = Patterns 0 to 2, 4 and 5 in common

[1] Emergency stop status (EMGS)

PIO Signal	Output
	*EMGS
In common for all PIO patterns	○

○: Available, ×: Unavailable

1) The emergency stop status EMGS is turned ON when in normal condition and turned OFF when it opens between EMG+ and EMG- (emergency stop condition or disconnected) for "Emergency Stop Circuit".

2) The signal turns on once the emergency stop condition is cancelled and it closes between EMG+ and EMG-.

Have an appropriate safety treatment such as interlock with this signal for the host controller (PLC, etc.).

(Note) It is not an emergency stop output due to an alarm generation of the controller.

[2] Servo ON (SON, SV, PEND)

PIO Signal	Input	Output	
	SON	SV	PEND
Other than pattern 5	○	○	○
Pattern 5	○	○	×

○: Available, ×: Unavailable

1) Servo ON command SON is the signal making the servo motor of the actuator operable.

2) If the servo-on is performed to enable operation, the servo ON status signal SV output signal is turned ON.

Also, the status LEDs for driver (SV) on the front panel corresponding for the axis number turns on in green. [Refer to Name for Each Parts and Their Functions 7) Status LEDs for Driver]

3) With the power being supplied, then controller cannot be operated while the SV signal remains OFF. If the SON signal is turned OFF under operation of the actuator, the actuator is decelerated and stopped with the emergency stop torque, the servo is turned OFF and the motor gets into the free-run condition.

For the actuators equipped with a brake, the brake gets activated.

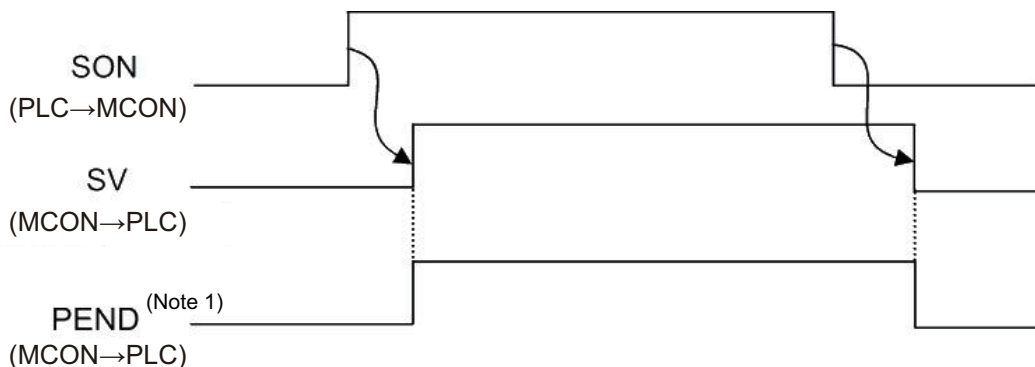

Note1 PEND would not turn ON in the pause condition.

[3] Home return (HOME, HEND, PEND, MOVE)

PIO Signal	Input	Output		
	HOME	HEND	PEND	MOVE
Patterns 0 and 1	○	○	○	○
Patterns 2 and 4	○	○	○	×
Pattern 5	× ^(Note1)	○	×	×

○ : Available, ×: Unavailable

Note1 Pattern 5 cannot make a home return with HOME signal. Refer to 3.8.4 [1] Home Return (ST0, HEND) for how to perform a home-return operation.

The HOME signal is intended for automatic home return. The HOME signal is caught at the rising edge (ON edge) to start the home return. At completion of the home return, home return completion signal HEND is turned ON. The home-return complete signal HEND is kept ON unless the memory of origin point is lost for a reason. The positioning complete signal PEND turns OFF and the moving signal MOVE turns ON during a home-return operation.

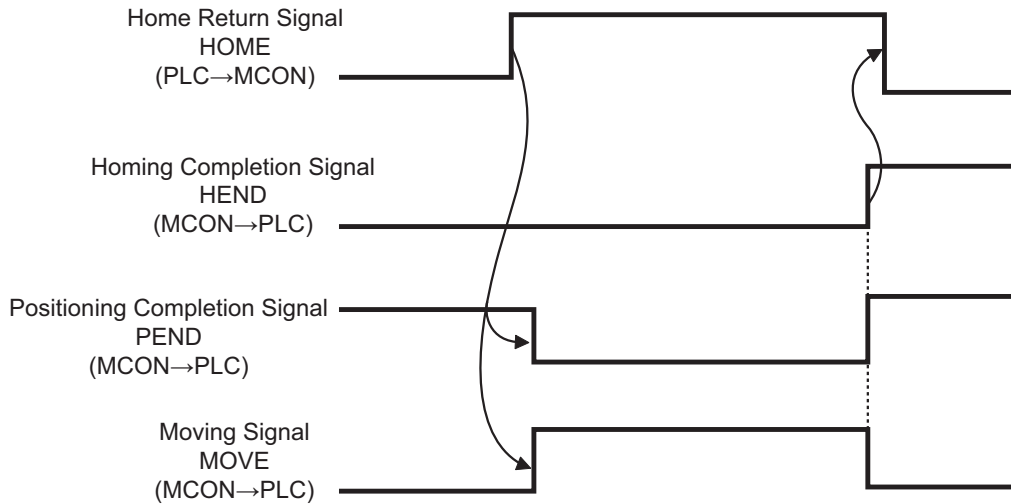

[Operation of Slider Type/Rod Type Actuator]

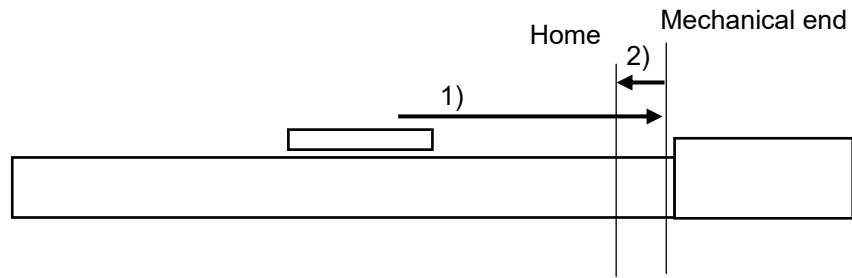

- 1) With the HOME signal being ON, the actuator moves toward the mechanical end at the home return speed.
The speed for most of the actuators is 20mm/s, however, for some actuators it is less than 20mm/s.
- 2) The actuator is turned at the mechanical end and stopped at the home position. The movement amount in this process follows the setting in Parameter No. 22 "Home return offset level".

⚠ Caution: *In the home reverse specification, the actuator moves in the reverse direction.
Make sure to refer to Section 8.2 [14] when a change to Parameter No.22 "Home Return Offset Level" is required.*

[Operation of Rotary Actuator]

- (1) 330° Rotation Specification

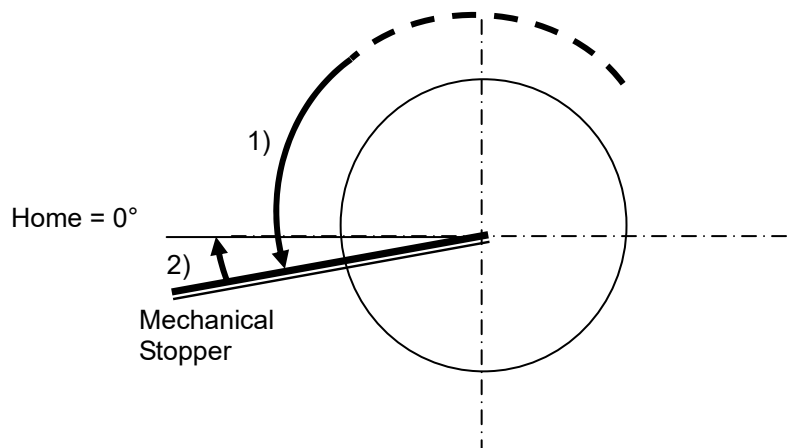

- 1) By HOME Signal being ON, the rotary part turns in CCW (counterclockwise) from the view of load side. The velocity is either 20deg/s.
- 2) The actuator is turned at the mechanical stopper and stopped at the home position. The amount of movement at this time is that set in Parameter No.22 "Home Return Offset Level".

⚠ Caution: *Make sure to refer to Section 8.2 [14] when a change to Parameter No.22 "Home Return Offset Level" is required.*

(2) Multi-Rotation Type

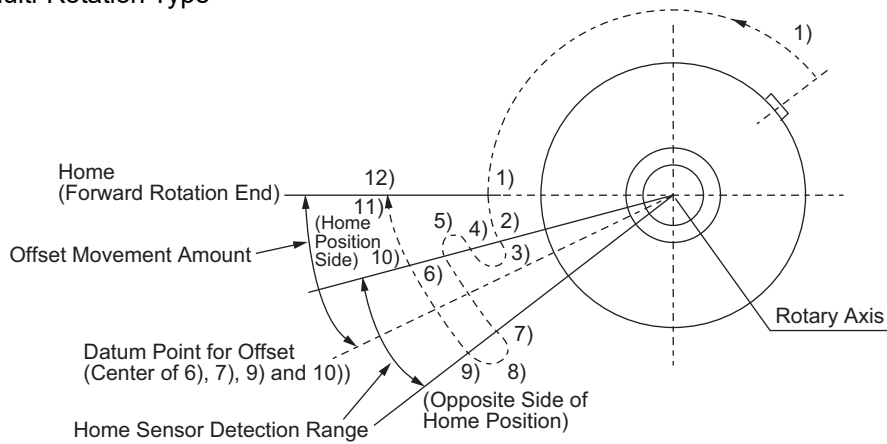

- 1) Once the home-return operation is started, the rotary part turns in CCW (counterclockwise) from the view of the load side. The speed is either 20deg/s.
- 2) Home sensor turns ON.
- 3) Starts reversed rotation.
- 4) Goes back to a point exceeded the home sensor detection range, and confirms the home sensor is turned OFF.
- 5) Starts reversed rotation.
- 6) Confirms the home sensor gets turned on again.
- 7) Goes to a point exceeded the home sensor detection range on the opposite side of the home position, and confirms the home sensor is turned OFF.
- 8) Starts reversed rotation.
- 9) Confirms the home sensor turns ON.
- 10) Goes to a point exceeded the home sensor detection range on the home position side, and confirms the home sensor is turned OFF.
- 11) Based on the result gained from 6), 7), 9) and 10), the center of the home sensor detection range is calculated.
- 12) The actuator moves in a certain amount for each actuator from the position of 11) and stops at the home position.

Caution: *The direction to rotate is the other way for the reversed rotation type. Make sure to refer to Section 8.2 [14] when a change to Parameter No.22 "Home Return Offset Level" is required.*

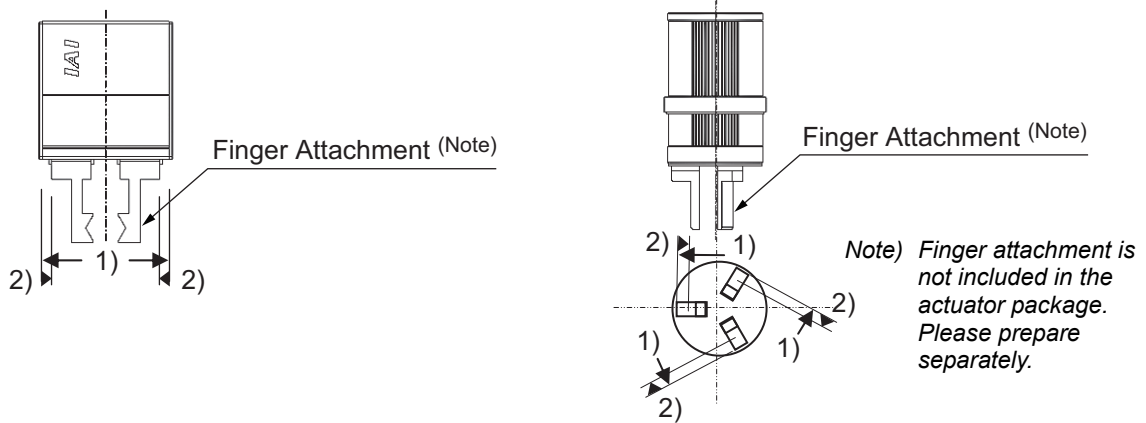

- 1) The actuator moves toward the mechanical end (to end side) at the home return speed (20mm/s).
- 2) The actuator is turned at the mechanical end and stopped at the home position. The amount of movement at this time is that set in Parameter No.22 "Home Return Offset Level" after Z-phase is detected.

⚠ Caution: Make sure to refer to Section 8.2 [14] when a change to Parameter No.22 "Home Return Offset Level" is required.

[4] Zone signal and position zone signal (ZONE1, PZONE)

PIO Signal	Output	
	ZONE1	PZONE
Pattern 0	○	○(Note2)
Pattern 1	×	○(Note1)
Pattern 2	×	○(Note1)
Pattern 4	○	○(Note2)
Pattern 5	○	○(Note2)

○ : Available, ×: Unavailable

Note1 PZONE Signal can be changed to ZONE1 Signals by the setting in Parameter No.149.

Note2 PZONE Signal can be changed to ZONE2 Signals by the setting in Parameter No.149.

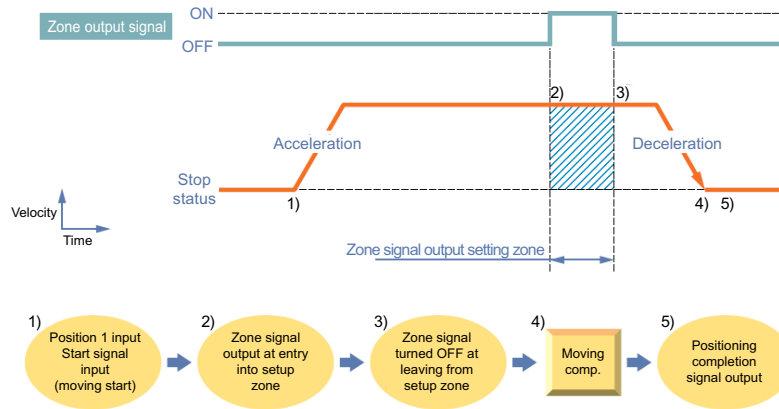

This is a function enables to turn a signal on while the actuator is passing a certain position (in the zone range) or during a stop, in which there are two types.

- 1) Zone signal (ZONE1) The output signal is turned ON at the position set by the proper parameter.
- 2) Position zone signal (PZONE) The output signal is turned ON at the position set in the position table.

The feature can play a role as the sensor for judging whether the completion position is good or not at completion of pressing, setting the continuous operation zone in pitch feed or interlocking operations of other units in the setting zone.

(1) Zone signal (ZONE)

Set the zone range to the relevant parameter.

- 1) parameter No. 1 : "Zone Boarder 1 "+" Side"
- 2) parameter No. 2 : "Zone Boarder 1 "-" Side"

The zone signal ZONE is kept effective also during the emergency stop unless the memory of the origin is lost due to alarm.

(2) Position zone signal (PZONE)

No.	Position [mm]	Velocity [mm/s]	Acceleration [G]	Deceleration [G]	Pressing [%]	Threshold [%]	Positioning width [mm]	Zone+ [mm]	Zone- [mm]	Acceleration/Deceleration mode	Incremental	Gain set	Stop mode
0													
1	0.00	250.00	0.20	0.20	0	0	0.10	50.00	30.00	0	0	0	0
2	100.00	250.00	0.20	0.20	0	0	0.10	70.00	60.00	0	0	0	0
3	50.00	250.00	0.20	0.20	50	0	20.00	60.00	65.00	0	0	0	0

Setting of zone range

Zone ranges should be set in the position table.

While the operation corresponding to a position number is executed, the zone range set for the position number is valid. It is kept effective also during the emergency stop unless the actuator is operated or the memory of the origin is lost due to alarm.

(3) Setting values and signal output range

The zone output range varies depending on the difference between the value set for the positive side of the zone and that for the negative side.

- 1) Value set for positive side > value set for negative side: Output signal turn ON in the range from the value on negative side to that on positive side, and turns OFF out of the range
- 2) Value set for positive side < value set for negative side: Output signal turn OFF in the range from the value on positive side to that on negative side, and turns ON out of the range

[Example of Line Axis]

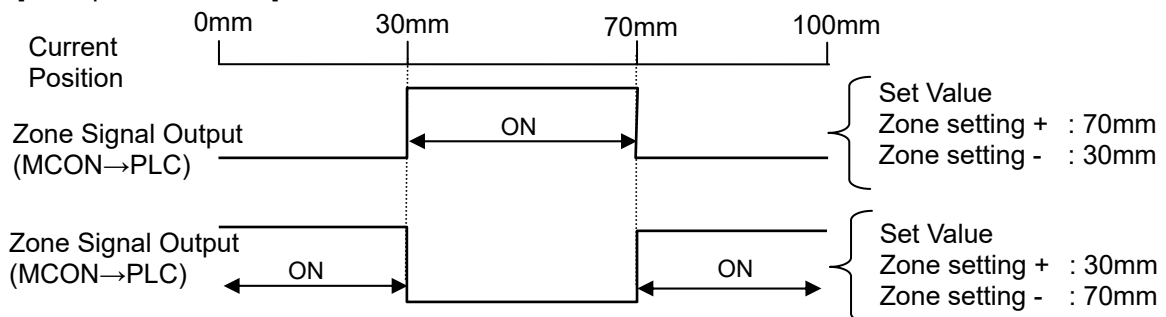

[Example of rotary actuator of multi-rotation specification in index mode]

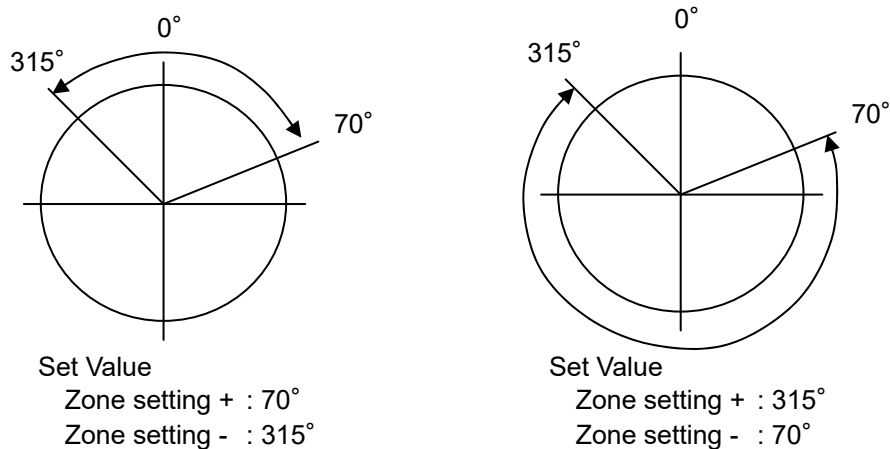

⚠ Caution: Since this signal becomes effective after the coordinate system is established after the home return is completed, it would not be output just with the power turned ON.

[5] Alarm, alarm reset (*ALM, RES)

PIO signal	Input	Output
	RES	*ALM
In common for all PIO patterns	○	○

○ : Available, ×: Unavailable

- 1) Alarm signal *ALM is set to ON in the normal status but turned OFF at the occurrence of an alarm at a level equal to or higher than the operation release level.
- 2) Turning reset signal RES ON under occurrence of an alarm at the operation release level allows the alarm^(Note 1) to be released. The action is taken at the rising edge (ON edge).
- 3) The alarm reset should be done after the cause of the alarm is confirmed and removed. If alarm reset and restart are repeated many times without removal of the cause, a severe failure such as motor burnout may occur.

Note 1 Check the 9.3 Gateway Alarm and 9.4 Driver Alarm for details of alarms.

 **Caution:** Reset signal RES has two features, or alarm reset under occurrence of an alarm and operation interruption (cancellation of remaining moving distance) under temporary stop. For the operation interruption under temporary stop, refer to the description of the operation in each pattern.

[6] Binary output of alarm Information (*ALM, PM1 to 8)

PIO signal	Output	
	*ALM	PM1 to 8
Common to Patterns 0 to 2	○	○
Pattern 4 ^(Note 1)	○	×
Pattern 5 ^(Note 1)	○	×

○: Available, ×: Unavailable

Note1 Patterns 4 and 5 do not have this function.

- 1) If an alarm at a level equal to or higher than the operation release level occurs, completed position number output signals PM1 to PM8 output the alarm information in the binary code format.
- 2) The PLC can read the binary code of alarm signal *ALM as the strobe signal to refer to alarm information.

[Refer to 9.4.2 Simple Alarm Codes]

[7] Brake release (BKRL)

PIO signal	Input
	BKRL
Pattern 0	○
Pattern 1 ^(Note 1)	×
Pattern 2, 4, 5	○

○ : Available, ×: Unavailable

Note1 Pattern 1 does not have this feature

The brake can be released while BKRL signal is set to ON. If a brake is installed in the actuator, the brake is automatically controlled by servo ON/OFF. Releasing the brake may be required to move the slider and/or the rod by hand in case of installation of the actuator in the machine or direct teach^{*1}. This operation can be done by break release signal BKRL as well as the brake release switch ON the front panel of the controller.

^{*1} Direct teaching: This operation is intended to get coordinate values to the position by moving the slider and/or the rod by hand.

 **Warning:** (1) *Take sufficient care to release the brake. Doing so carelessly may cause an injury or a malfunction of actuator, work piece or other devices due to a drop of the slider or rod.*

(2) *After the brake is released, always make the brake applied again. Any operation with the brake remaining released is extremely dangerous. The slider or rod may drop to cause people to be injured and/or the actuator, the work and/or the machine to be damaged.*

3.8.2 Operation with the Position No. Input = Operations of PIO Patterns 0 to 2

It is the operation methods for PIO Patterns 0 to 2. These patterns provide normal controller operation methods in which the controller is operated by turning the start signal ON after a position No. is entered.

[1] Positioning [Basic] (PC1 to PC**, CSTR, PM1 to PM**, PEND, MOVE)

PIO signal	Input		Output		
	PC1 to PC**	CSTR	PM1 to PM**	PEND	MOVE
PIO pattern 0	PC1 to 32	○	PM1 to 32	○	○
PIO pattern 1	PC1 to 32	○	PM1 to 32	○	○
PIO pattern 2	PC1 to 128	○	PM1 to 128	○	×

○ : Available, ×: Unavailable

(Note) Operation without home return leads the operation based on the data of the specified position No. after automatic home return. If one or more problems are found, interlock by home return complete signal HEND is required.

Sample use

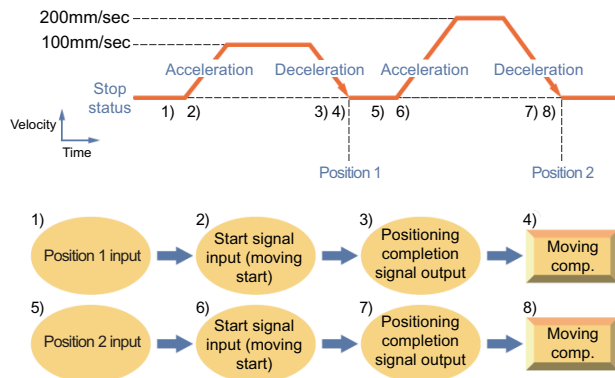
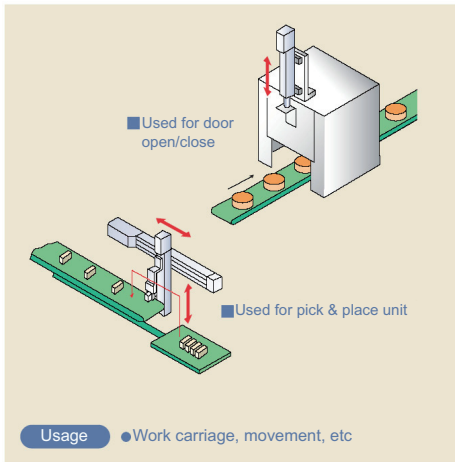

No.	Position [mm]	Velocity [mm/s]	Acceleration [G]	Deceleration [G]	Pressing [%]	Threshold [%]	Positioning width [mm]	Zone+ [mm]	Zone- [mm]	Acceleration/Deceleration mode	Incremental	Gain set	Stop mode
0													
1	70.00	100.00	0.20	0.20	0	0	0.10	0.00	0.00	0	0	0	0
2	150.00	200.00	0.20	0.20	0	0	0.10	0.00	0.00	0	0	0	0

Control method

- 1) First enter command position No. PC1 to PC** with binary data. Next turn start signal CSTR ON. Then the actuator starts acceleration depending on the data in the specified position table for positioning to the target position.
- 2) At operation start, positioning complete signal PEND is turned OFF. Always turn the CSTR signal OFF. Without it, the completed position number is not output and the positioning complete signal is not turned ON at the completion of positioning.
- 3) When the positioning is completed, the positioning complete position numbers are output from complete position No.PM1 to PM** with binary data and also positioning complete signal PEND is turned ON.
- 4) The moving signal MOVE turns ON at the same time as the operation starts, and turns OFF once the positioning complete signal PEND turns ON or the movement command output completes.
- 5) Positioning complete signal PEND is turned ON if the remaining moving distance enters into the positioning width. PEND Signal will be kept ON once it is turned ON unless the start signal CSTR is turned back ON, servo is turned OFF ^(Note 1) or the actuator is out of the positioning band width range ^(Note 1).

Note 1 It can be switched over with Parameter No.39.

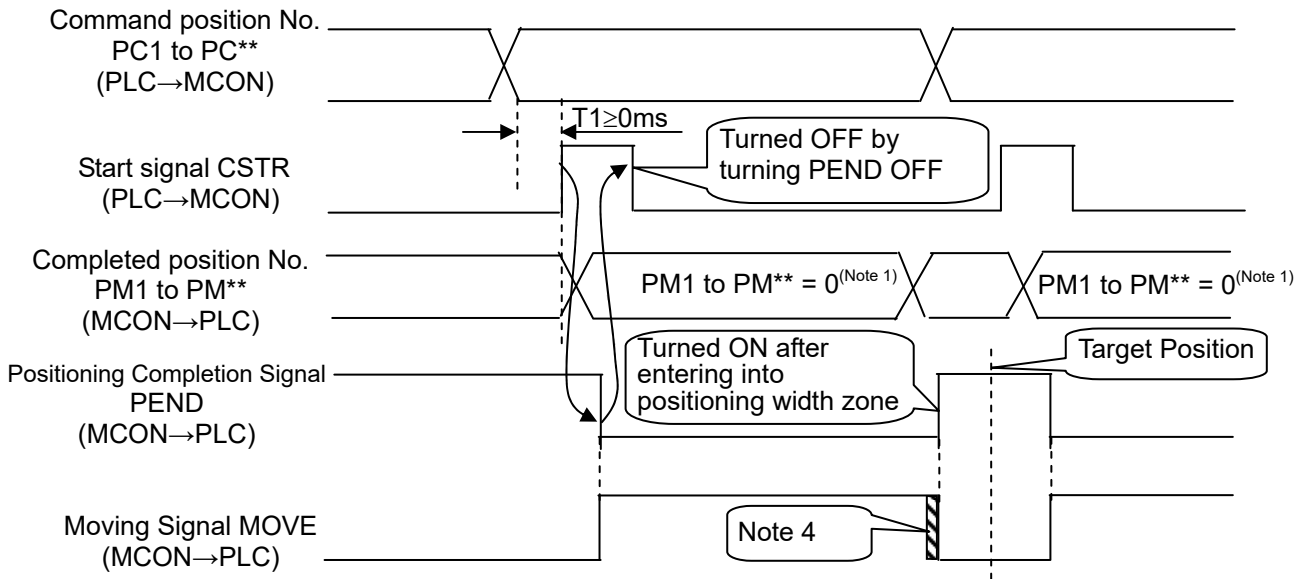

Note 1 The completion position No. output is set to 0 during movement of the actuator.

⚠ Caution:

- (1) At the completion of positioning, positioning complete signal PENDING is not turned ON if start signal SCTR remains ON. If this occurs, turn CSTR OFF then PENDING is turned ON immediately. Therefore, create the sequence program so that turning PENDING OFF makes CSTR turned OFF and the PLC waits for the state in which PENDING is turned ON.
- (2) At the positioning to the position same as that specified in the stop (complete) position number, PENDING is turned OFF once but moving signal MOVE is not turned ON. Therefore, use PENDING to turn CSTR OFF. However, since the duration of being off is short, the signal of being off may not be read depending on the PLC scanning time. In such a case, turn CSTR off with using the timer.
- (3) MOVE turns ON at the same time as PENDING turns OFF, and turns OFF once the command from a controller to the motor is finished. Therefore, it may turn off while the actuator is moving if the setting of positioning width is large, and may turn OFF earlier than PENDING OFF the positioning width setting is small.

■ Binary data

○ : ON ● : OFF

Command position No.	PC128	PC64	PC32	PC16	PC8	PC4	PC2	PC1
Completed position No.	PM128	PM64	PM32	PM16	PM8	PM4	PM2	PM1
0	●	●	●	●	●	●	●	●
1	●	●	●	●	●	●	●	○
2	●	●	●	●	●	●	○	●
3	●	●	●	●	●	●	○	○
4	●	●	●	●	●	○	●	●
5	●	●	●	●	●	○	●	○
6	●	●	●	●	●	○	○	●
7	●	●	●	●	●	○	○	○
8	●	●	●	●	○	●	●	●
9	●	●	●	●	○	●	●	○
10	●	●	●	●	○	●	○	●
⋮	⋮	⋮	⋮	⋮	⋮	⋮	⋮	⋮
253	○	○	○	○	○	○	●	○
254	○	○	○	○	○	○	○	●
255	○	○	○	○	○	○	○	○

[Shortcut control of rotary actuator of multi-rotation specification]

(1) Set of shortcut selection

The shortcut selection can be made valid/invalid by Parameter No.80 "rotation axis shortcut selection". If the shortcut selection is made valid, the actuator can be moved only in a single direction.

[Operation Examples]

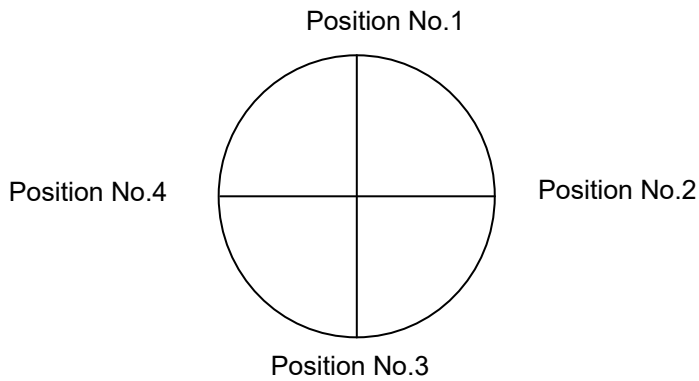

Position No.	Position
1	0
2	90
3	180
4	270

Enter position data assuming $1^\circ = 1\text{mm}$.

(Example) 1.2 is assumed as 1.2° .

For operation in the order of positions $1 \rightarrow 2 \rightarrow 3 \rightarrow 4 \rightarrow 1$, the actuator is moved differently whether the shortcut selection is valid or invalid.

• When shortcut selection is invalid:

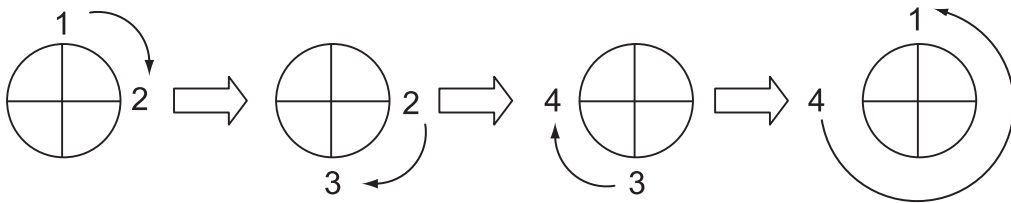

• When shortcut selection is valid:

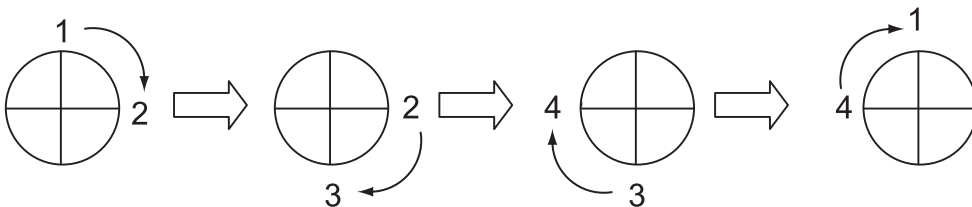

(2) Infinite Rotation Control

Making the shortcut selection valid and moving the actuator in a specific direction continuously allows the actuator to be rotated continuously as a motor. The continuous operation can be done as described below.

[Operation Examples]

This example rotates the actuator by 2 turns and finally stops it at position No.4.

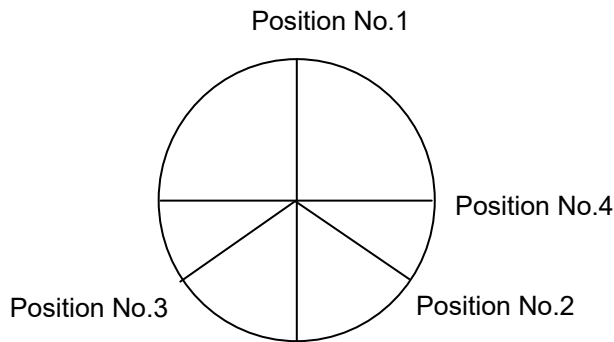

Position No.	Position
1	0
2	120
3	240
4	90

Enter position data assuming $1^\circ = 1\text{mm}$.

(Example) 1.2 is assumed as 1.2° .

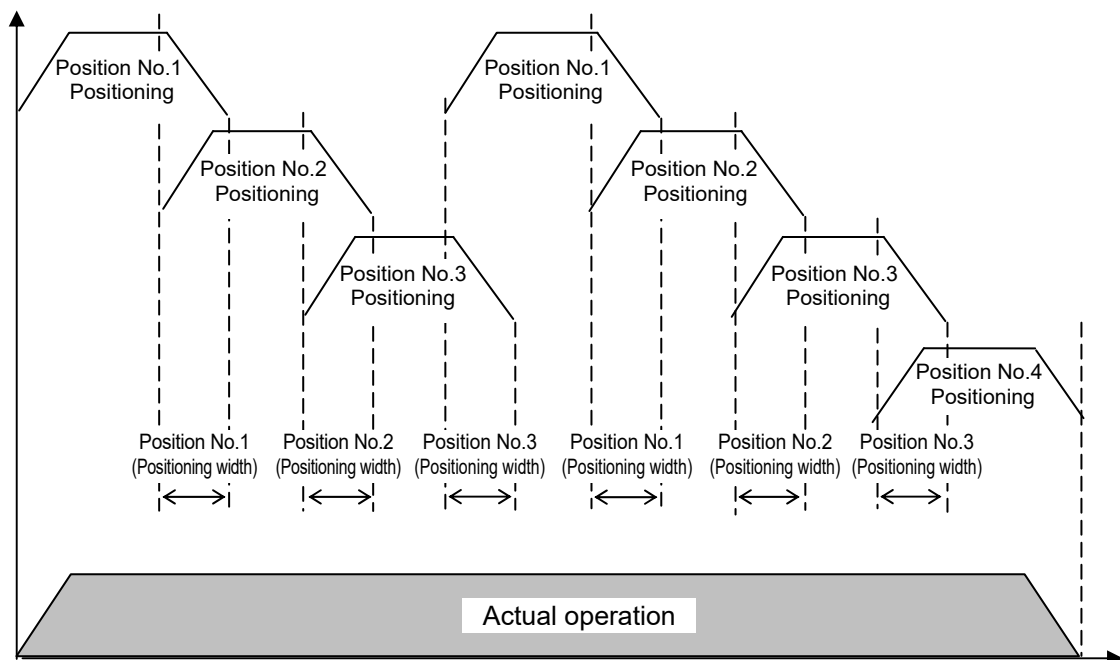

- 1) Widen the positioning widths of position No.1 to 3 so that they are located before the position at which deceleration is started.
- 2) Positioning of position No.1 makes positioning complete signal (PEND) turned ON before deceleration is started.
If PEND is turned ON, positioning of position No.2 is executed. Similarly, positioning is repeated in the order of position No.3 → 1 → 2 → 3 → 4. Because the normal positioning always gives position data specified last the highest priority, the actuator can be rotated continuously.
- 3) If the speeds in position No.1 to 4 are set to be the same, the actuator can be rotated at the same speed. Then the actuator is stopped at the positioning set in position No.4. The number of rotations is defined by the number of repeats of position No.1 to 3.

[2] Speed change during the movement

■ Sample use

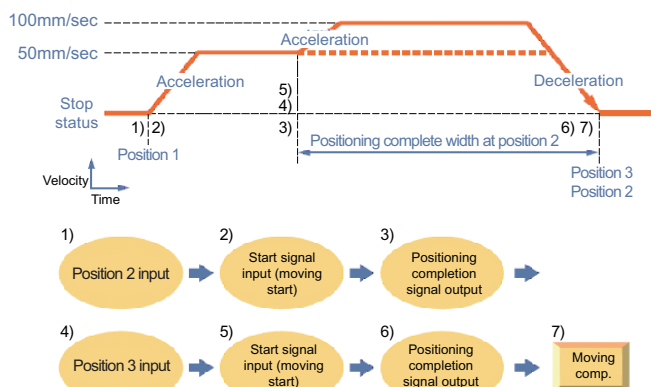
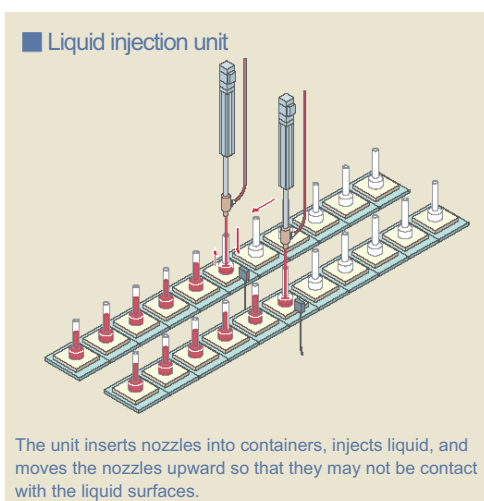

No.	Position [mm]	Velocity [mm/s]	Acceleration [G]	Deceleration [G]	Pressing [%]	Threshold [%]	Positioning width [mm]	Zone+ [mm]	Zone- [mm]	Acceleration/Deceleration mode	Incremental	Gain set	Stop mode
0													
1	150.00	250.00	0.20	0.20	0	0	0.10	0.00	0.00	0	0	0	0
2	0.00	50.00	0.20	0.20	0	0	100.00	0.00	0.00	0	0	0	0
3	0.00	100.00	0.20	0.20	0	0	0.10	0.00	5.00	0	0	0	0

■ Control method

The speed of the actuator can be changed while it moves. Positions are used by the number of speeds. The method of controlling the operation to each position is the same as that described in [1] Positioning.

The example below describes the case of 2 speeds:

- 1) In this example, the speed is changed while the actuator moves from the position of 150mm to the position of 0mm. At first, set the positioning to the target position at the first speed in position No.2. In the positioning width, set the distance from the speed change position to the target position. The value is set to 100mm in the example. Thus, for position No.2, positioning complete signal PEND is turned ON at the position before the target position by 100mm.
- 2) Set the positioning to the target position at the second speed in position No.3.
- 3) Start position No.2. Then start position No.3 successively when PEND in position No.2 is turned ON. In normal positioning, position data specified later has always a priority over position data specified earlier. Thus, the operation in position No.3 is started on the way of the operation in position No.2.

In this example, the target positions No.2 and 3 are equal with each other. They may not be the same. However, setting the target positions to be equal with each other allows the distance from the speed change position to the target position to be known easily.

To increase in the number of speed change steps, add a position number and operation sequence, set the speed change position in the positioning width and operate the actuator continuously.

[3] Pitch feeding (relative movement = incremental feed)

■ Sample use

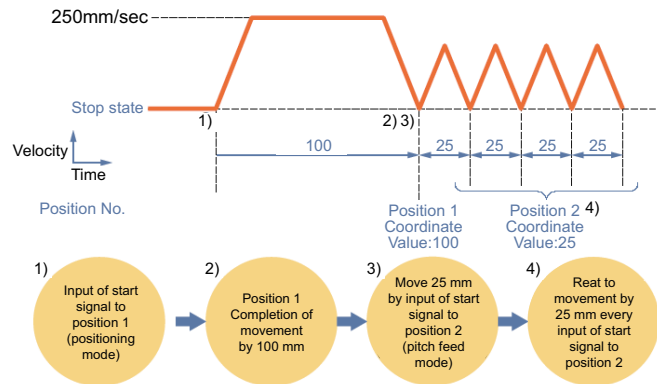
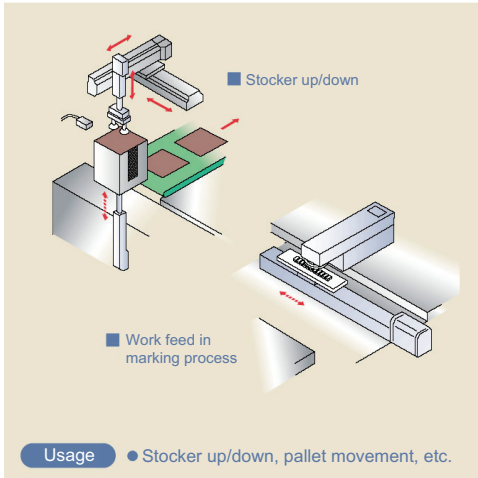

No.	Position [mm]	Velocity [mm/s]	Acceleration [G]	Deceleration [G]	Pressing [%]	Threshold [%]	Positioning width [mm]	Zone+ [mm]	Zone- [mm]	Acceleration/Deceleration mode	Incremental	Gain set	Stop mode
0													
1	100.00	250.00	0.20	0.20	0	0	0.10	0.00	0.00	0	0	0	0
2	25.00	250.00	0.20	0.20	0	0	0.10	0.00	0.00	0	1	0	0

(Position No.2 sets pitch feed.)

■ Control method

- 1) The method of controlling pitch feed is the same as that described in [1] Positioning except the setting of the position table. Repeat the positioning of a specific position No.
- 2) For pitch feed, the position set in the position table indicates the pitch. Set the pitch (relative moving distance = incremental moving distance) in column "Position".
- 3) If the operation command is issued, the actuator moves from the current stop position by "Position" in the position table. To perform continuous movement, repeat the operation. The relative movement amount is calculated in "mm". Therefore, there will be no cumulative tolerable error in repeated operations.

⚠ Caution: In the pitch feed, do not perform a command with a pitch smaller than the minimum encoder resolution (lead/encoder pulse number) or that less than positioning accuracy repeatability. There would be no deviation to occur even with the command because it is an operation command to the same position as the positioning complete condition, but the positioning control cannot be performed properly.

- ⚠ **Caution:** (1) If the actuator reaches the software limit corresponding to the stroke end in the pitch feed operation, the actuator stops at the position and positioning complete signal PEND is turned ON.
- (2) Note that, in pitch feed just after pressing operation (to be in the pressing state), the start position is not the stop position at the completion of pressing but the coordinate value entered in "Position" of the pressing position data. The movement to the base point is added to the first pitch feed.

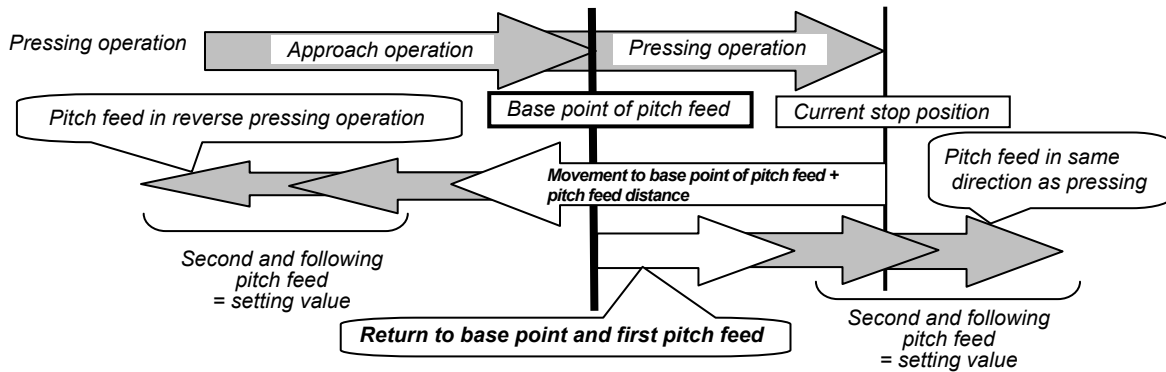

- (3) If the position number for pitch feed is started (CSTR ON) during normal positioning, the actuator moves to the position of the coordinate resulting from adding the pitch feed distance to the target coordinate of the positioning. Repeating the start of pitch feed several times allows the pitch feed distance to be added to the target position by the number of repeats. Do not use the pitch feed function in such a way, because the PLC cannot confirm the complete position.
- (4) Note that, if pitch feed is started (CSTR ON) repeatedly during pause, the actuator moves continuously by the distance based on the number of starts. In such a case, cancel the remaining moving distance by turning reset signal RES to ON in the pause state or take interlock so that the start signal is not turned ON during pause.
- (5) At software limit (stroke end) in pitch feed, the actuator is decelerated to be stopped and positioning complete output PEND is output.
- (6) MOVE turns ON at the same time as PEND turns OFF, and turns OFF once PEND turns ON or the movement command output completes. Accordingly, with a large positioning width being set, MOVE may be turned OFF while the actuator is moved.
- (7) Pressing is enabled by using the pitch feed function. However, do not make control of changing to pitch feed on the way of normal positioning (before PEND turning ON). Pressing is interrupted by using the pitch feed function as soon as start signal CSTR is turned ON. The PLC cannot manage the position of the actuator any more.

[4] Pressing operation

■ Sample use

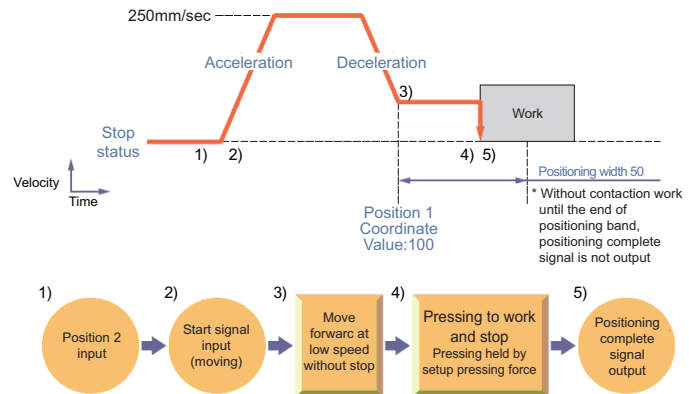
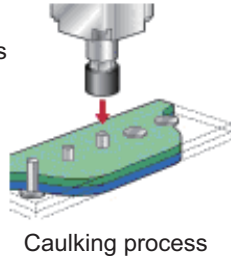
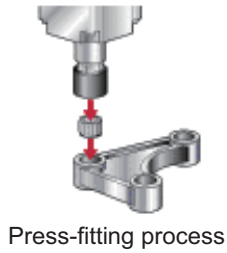

No.	Position [mm]	Velocity [mm/s]	Acceleration [G]	Deceleration [G]	Pressing [%]	Threshold [%]	Positioning width [mm]	Zone+ [mm]	Zone- [mm]	Acceleration/Deceleration mode	Incremental	Gain set	Stop mode
0													
1	0.00	250.00	0.20	0.20	0	0	0.10	0.00	0.00	0	0	0	0
2	100.00	250.00	0.20	0.20	50	0	50.00	0.00	0.00	0	0	0	0

(Position No.2 sets pressing operation.)

■ Control method

- 1) The method of controlling the pressing operation is the same as that described in [1] Positioning except the setting of the position table. Any setting of "Pressing" in the position table allows the pressing operation to be done. "Positioning width" is assumed as pressing operation distance.
- 2) The actuator moves at the setting speed and rating torque to the position of the coordinate set in "Position" in the similar way as normal positioning. Then the operation changes to pressing. The moving distance in pressing is the value set in "Positioning width". The pressing is performed with the torque (current limit value) set in percent in "Pressing" of PIO patterns 1 to 2 being the upper limit.
- 3) The control method is the same as that in [1] Positioning. However, the processing of positioning complete signal PEND is different from that in [1] Positioning. PEND is output when the shaft is stopped by pressing (pressing complete). If the work is not subject to pressing (miss-pressing), the actuator moves by the value set in "Positioning width" to stop but PEND is not turned ON.

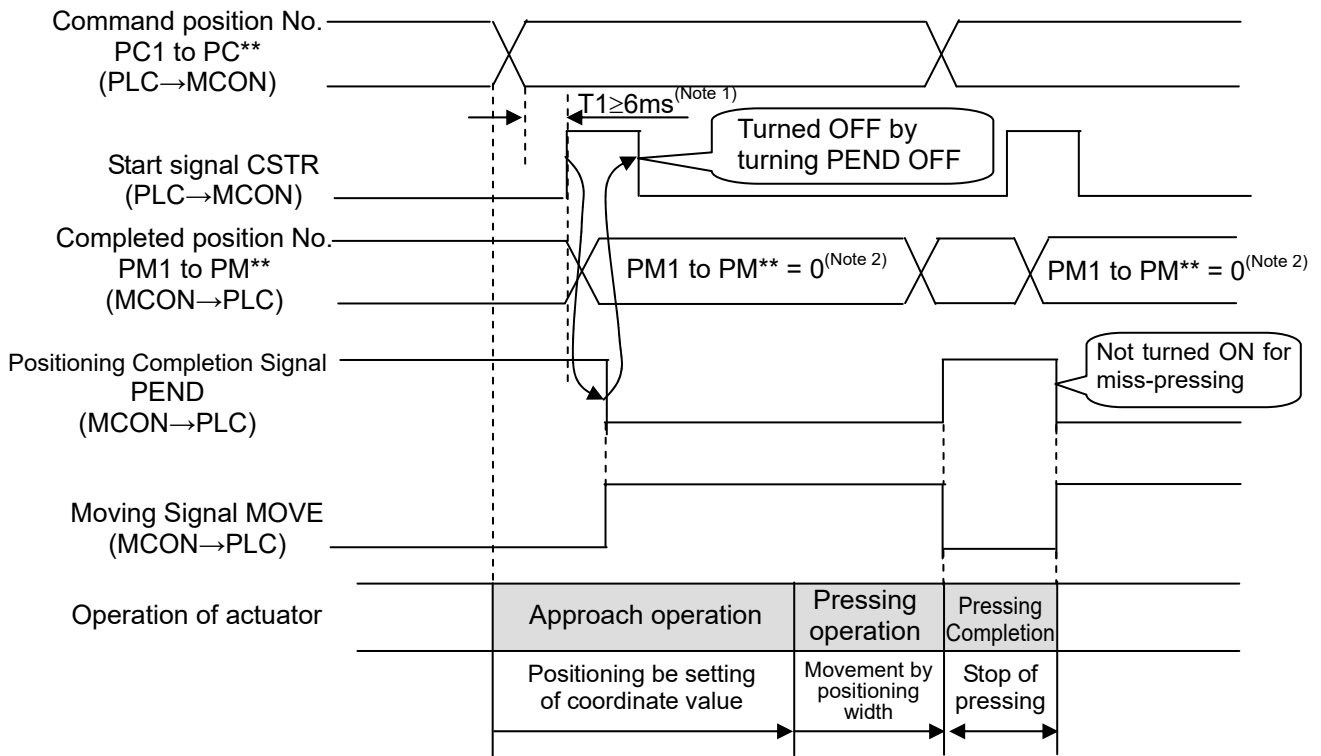

Note 1 Set the period taken from entering the position number to turning CSTR ON to 6ms or longer. Because 6ms timer process on the PLC is also entered to the controller, positioning at another position may occur. Take the PLC scan time into account.

Note 2 The completion position No. output is set to 0 during movement of the actuator.

⚠ Caution: (1) The speed during pressing operation is set in Parameter No.34. Check the 10.4 List of Specifications of Connectable Actuators for the pressing operation speed.

Do not set any value larger than the value in the list. If the speed set in the position table is equal to or less than the pressing speed, the pressing is performed at the setup speed.

(2) The approach start position of pressing should be located at or before the pressing start position (coordinate 100mm or less in the above example) If not, the moving direction varies depending on the start position to be dangerous.

For example, pressing at coordinate larger than the pressing end position (larger than 150mm) is performed in the direction from the current position to the pressing end position. Note that pressing after positioning to the position of coordinate 100mm does not take place.

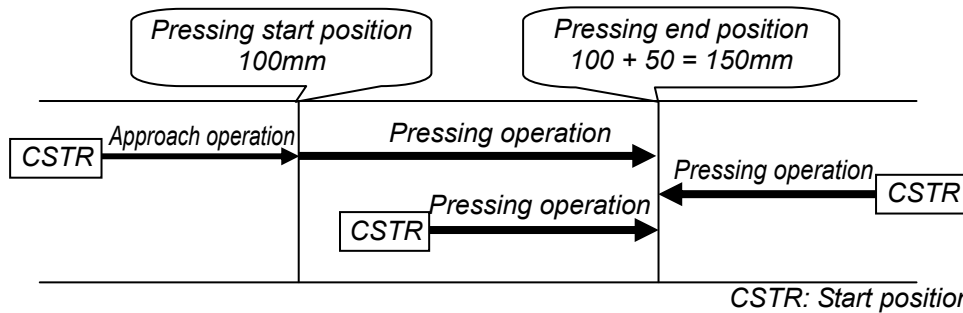

(3) The work is pressed after the pressing is completed. The work may moves backward or forward. If the actuator is moved backward before the approach position, alarm code 0DC "Pressing Motion Range Over Error" occurs to stop the actuator. In movement of the work in the pressing direction, PENDING is turned OFF if the load current becomes lower than the current limit (pressing [%]). Miss-pressing occurs when the actuator moves by the pressing moving distance set in "Positioning width".

(4) Do not make control of changing to pressing on the way of normal positioning (before PENDING turning ON). Depending on the position at which start signal CSTR is turned ON, the pressing is performed improperly. Then the PLC cannot manage the position of the actuator.

(5) Pressing control cannot be performed with the rotary actuator. If the index mode is selected for the rotary actuator of multi-rotation specification, pressing operation cannot be set. The positioning complete signal PENDING is turned ON when the actuator reaches the positioning width.

(6) If the actuator gets pressed to the work during the approach operation, 0DC "Pressing Motion Range Over Error" would be issued.

Judging completion of pressing operation

The operation monitors the torque (current limit value) in percent in “Pressing” of the position table and turns pressing complete signal PENDING ON when the load current satisfies the condition shown below during pressing. PENDING is turned ON at satisfaction of the condition if the work is not stopped.

(Accumulated time in which current reaches pressing value [%]) – (accumulated time in which current is less than pressing value [%]) \geq 255ms (Parameter No.6)

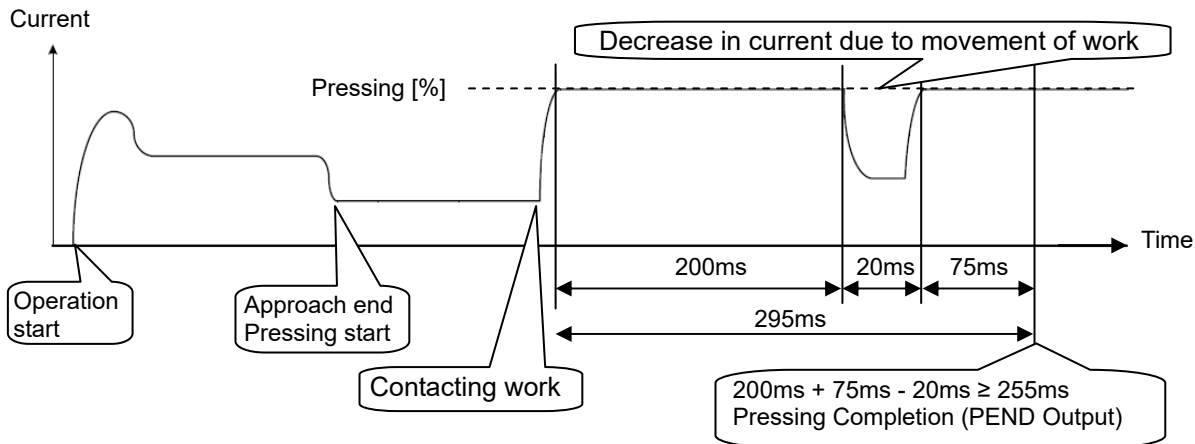

[5] Tension Operation

■ Image diagram

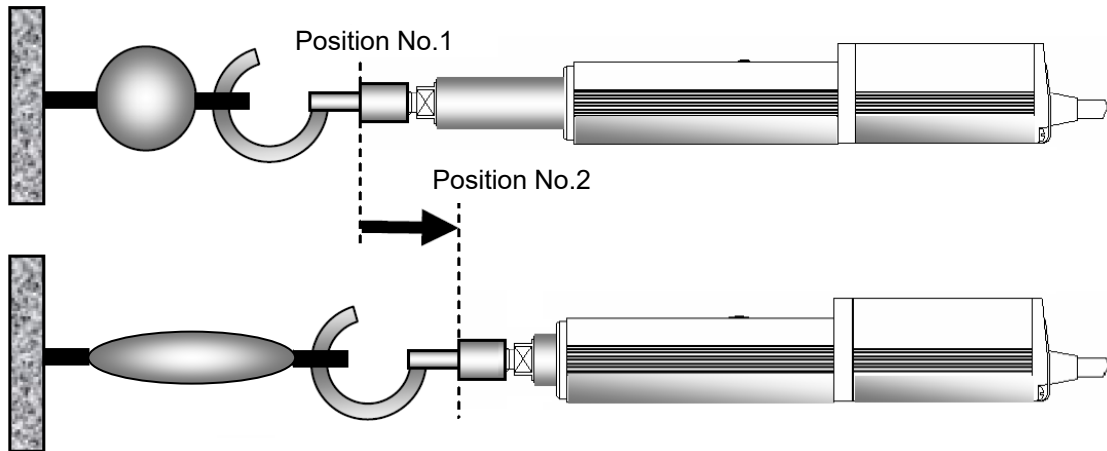

No.	Position [mm]	Velocity [mm/s]	Acceleration [G]	Deceleration [G]	Pressing [%]	Threshold [%]	Positioning width [mm]	Zone+ [mm]	Zone- [mm]	Acceleration/Deceleration mode	Incremental	Gain set	Stop mode
0													
1	100.00	250.00	0.20	0.20	0	0	0.10	0.00	0.00	0	0	0	0
2	80.00	250.00	0.20	0.20	50	0	-50.00	0.00	0.00	0	0	0	0
3													

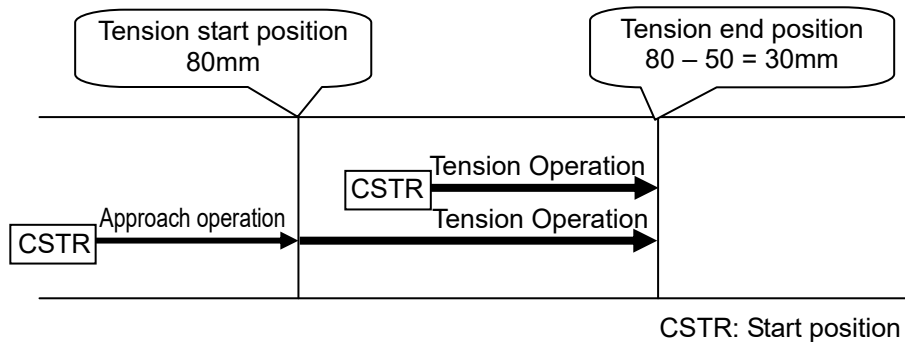

■ Control method

The method of controlling the tension operation is the same as that described in [4] Pressing operation. The control method is explained below by using the sample position table shown above.

- 1) Position No.2 indicates the settings of tension operation. The settings of "Position" and "Positioning width" show the tension start position and the tension quantity, respectively. Attach - (minus sign) to the tension quantity. Specify the upper limit of the torque required for tension in percent (limited current value) in "Pressing". The speed, acceleration, and deceleration are the conditions of positioning to the coordinate value (80mm) set in "Position".
- 2) Position No.1 indicates the tension start preparation position. Specify a value larger than the coordinate value at which the tension provided by position No.2 ends ($80 - 50 = 30\text{mm}$) in "Position".
- 3) First define the positioning in position No.1. Next, the operation in position No.2 moves the actuator to the position of 80mm at the setting speed and rating torque and change to the tension operation. The actuator moves by 50mm in the negative direction in the tension operation. The upper limit of the tensile force is the torque set in percent.
- 4) In the similar way as pressing, the positioning complete signal is output when the shaft is stopped by tension (pressing complete). If the actuator cannot be stopped during movement within the setting positioning width (miss-pressing), it moves by the setting distance to stop but PEND is not turned ON.

- ⚠ Caution:** (1) The speed during tension operation is set in Parameter No.34. Check the 10.4 List of Specifications of Connectable Actuators for the pressing speed. The speed for pulling operation is same as that for pressing operation. Do not set any value larger than the value in the list. If the speed set in the position table is equal to or less than the tension speed, the tension operation is performed at the setup speed.
- (2) The tension ready position should be the tension start position or forward. If not, the moving direction varies depending on the start position to be dangerous. The tension operation from a coordinate (less than 30mm = 80 – 50 in the above example) located before the end position (30mm or less) changes to the pressing operation from the current position to the tension end position. Note that the tension operation after positioning to the position of 80mm does not take place.

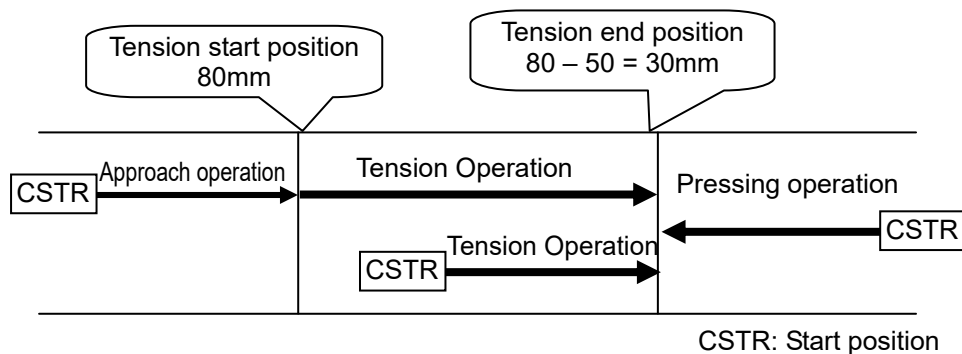

- (3) The work is pulled also after completion of the tension. The work is drawn back or pulled further if the work is moved. When the work is drawn back before the approach position, alarm code 0DC “pressing operation range error” occurs to stop the work. When the work is moved in the tension direction and the load current becomes less than the current limit value (pressing in [%]), PEND is turned OFF. Naturally, the work reaches the tension moving distance set in “Positioning width” to cause miss-pressing.
- (4) Do not make control of changing to tension operation on the way of normal positioning (before PEND turning ON). Depending on the position at which start signal is turned ON, the tension operation is performed improperly. Then the PLC cannot manage the position of the actuator.
- (5) Tension operation cannot be performed with the rotary actuator.

[6] Multi-step pressing

■ Image diagram

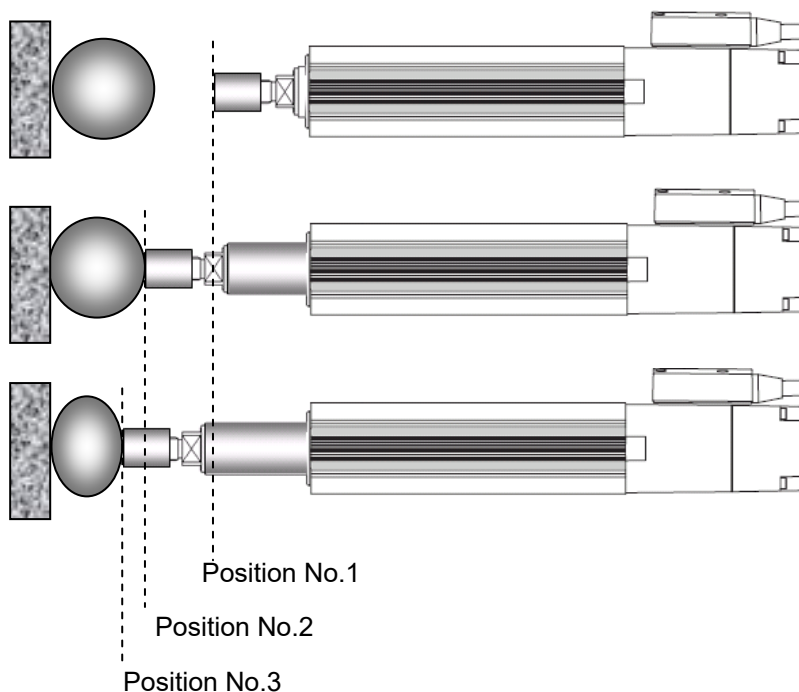

No.	Position [mm]	Velocity [mm/s]	Acceleration [G]	Deceleration [G]	Pressing [%]	Threshold [%]	Positioning width [mm]	Zone+ [mm]	Zone- [mm]	Acceleration/Deceleration mode	Incremental	Gain set	Stop mode
0													
1	0.00	250.00	0.20	0.20	0	0	0.10	0.00	0.00	0	0	0	0
2	50.00	250.00	0.20	0.20	30	0	20.00	0.00	0.00	0	0	0	0
3	50.00	250.00	0.20	0.20	50	0	20.00	0.00	0.00	0	0	0	0
4													

■ Control method

After pressing, the pressing pressure can only be changed in the pressing state. The method of controlling multi-step pressing is the same as that described in [4] Pressing operation. Shown below is the explanation with the position table above as an example.

- 1) Set the weak pressing (30%) in position No.2 and perform the pressing operation.
- 2) If pressing complete signal PEND is turned ON, start the pressing operation with pressing pressure (50%) greater than the first pressure set in position No.3.
The position data in position No.3 should be the same as that in position No.2 except the setting in "Pressing".
- 3) To add a pressing step with another pressing pressure, add a sequence consisting of a position number and a pressing operation.

[7] Teaching by PIO (MODE, MODES, PWRT, WEND, JISL, JOG+, JOG-)

PIO signal	Input					Output	
	MODE	JISL	JOG+	JOG-	PWRT	MODES	WEND
Other than pattern 1	×	×	×	×	×	×	×
Pattern 1	○	○	○	○	○	○	○

○: Existence of signal, ×: No signal

(Note) The feature is available only in pattern 1.

Teaching by PIO is enabled.

It is possible to select the teaching mode, move the actuator to the target position with jog or inching operation, and write the coordinate value into any position number.

(1) Teaching Mode Selecting

- 1) To select the teaching mode, set teaching mode signal MODE to ON. If the teaching mode is selected, mode status signal MODES is turned ON.
 - While the actuator is operating, MODE signal input is invalid. Therefore, after the operation is completed, the MODES signal is turned ON.
 - With the MODES signal being ON, the CSTR signal is changed to teaching signal PWRT. Therefore, it is not possible to operate the actuator by specifying a position No.
- 2) To cancel the teaching mode to return to the normal operation mode, set the MODE signal to OFF. If the MODE signal is turned OFF, the MODES signal is turned OFF to return to the normal operation mode.

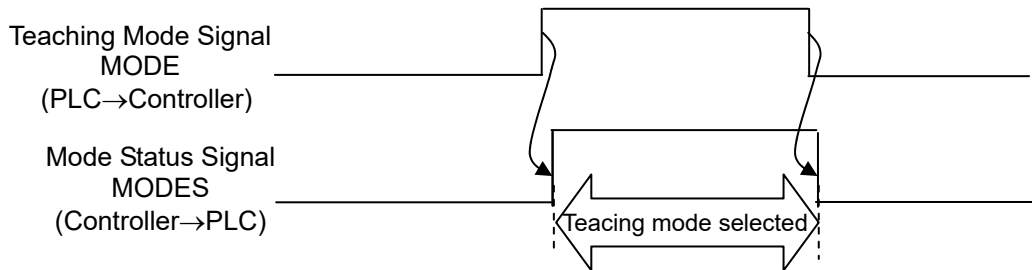

(2) Jog/inching switch and jog input

- 1) Jog/inching switching signal JISL indicates whether the jog operation^{*1} or inching operation^{*2} is performed by the jog input signal.
 - JISL signal OFF Jog operation
 - JISL signal ON Inching operation
- 2) There are two jog input signals, or JOG+ for operation in the positive direction and JOG- for operation in the negative direction.

*1 Jog operation: The actuator is moved while the jog input signal is set to ON.

- JOG+ While JOG+ is set to ON, the actuator is moved in the positive direction. If JOG+ is turned OFF, the actuator is decelerated and then stopped.
- JOG- While JOG- is set to ON, the actuator is moved in the negative direction. If JOG- is turned OFF, the actuator is decelerated and then stopped.
- Velocity Value set in Parameter No.26 "PIO jog speed".
- Acceleration/Deceleration Rating acceleration/deceleration of actuator
- Pause Signal *STP Enabled

*2 Inching operation : Once the jog input signal is turned ON, the actuator is moved by a certain distance.

- JOG+ Once JOG+ is turned ON, the actuator is moved by a certain distance in the positive direction.
- JOG- Once JOG- is turned ON, the actuator is moved by a certain distance in the negative direction.
- Moving distance Value set in Parameter No.48 "PIO inching distance".
- Velocity Value set in Parameter No.26 "PIO jog speed".
- Acceleration/Deceleration Rating acceleration/deceleration of actuator
- Pause Signal *STP Enabled

Warning: (1) In home return incomplete state, software limit cannot stop the actuator.

Take interlock and prohibit the operation or perform the operation carefully.
 (2) If the JISL signal is changed during inching operation, the inching being operated is continued. If JISL is changed during job operation, the jog is stopped.

(3) Writing current data to position table

- 1) The feature is valid only when the teaching mode is selected (with the MODES signal being ON).
- 2) Specify the position number to which the current data is written in the binary data format in command position No.PC1 to PC32. Turn current value writing signal PWRT ON.
- 3) The coordinate value of the current position is written into the position table for the controller.
 If position data is written previously, only the coordinate value in "Position" is only rewritten.
 If nothing is written, the values set in the parameters below are written as the speed, acceleration/deceleration, positioning width, acceleration/deceleration mode, stop mode and vibration control No.. Other data is set to "0".
 - Velocity Parameter No.8 "Default speed"
 - Acceleration Parameter No.9 "Default acceleration/deceleration"
 - Deceleration Parameter No.9 "Default acceleration/deceleration"
 - Positioning width Parameter No.10 "Default positioning width (in-position)"
 - Acceleration/deceleration mode Parameter No.52 "Default acceleration/deceleration mode"
 - Stop mode Parameter No.53 "Default stop mode"
 - Vibration control No. Parameter No.109 "Default vibration control No."
- 4) At the completion of writing, controller write complete signal WEND is output. Then turn the PWRT signal OFF.
- 5) When the PWRT signal is turned OFF the WEND signal is also turned OFF.
 Turn OFF PWRT after confirming WEND is turned ON.Turning it OFF before turning ON disturbs the proper data writing.

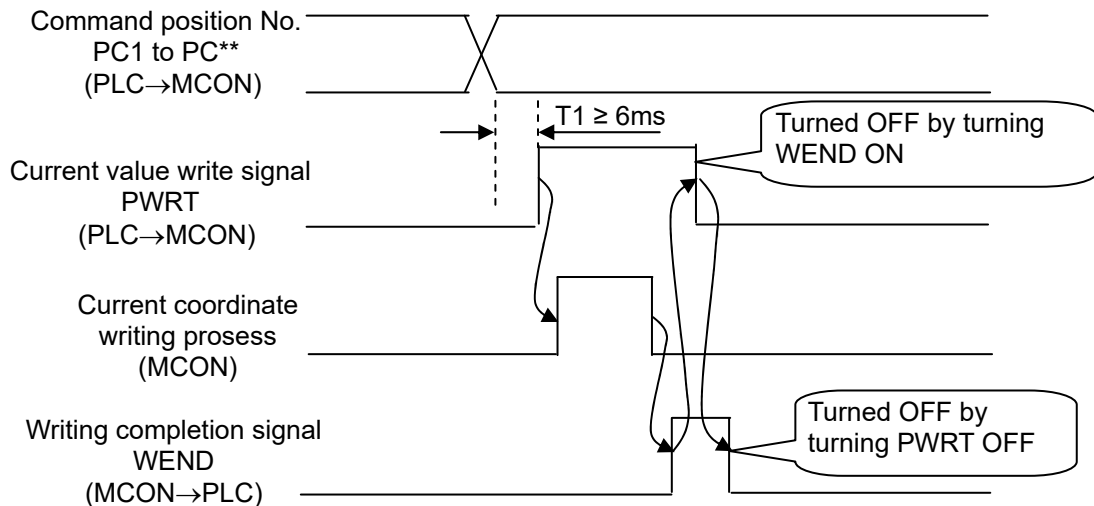

Caution:

- (1) Set the period taken from entering position No. to turning the PWRT ON to 6ms or longer. In spite of 6ms timer process in the PLC, commands may be input to the controller concurrently to cause writing to another position. Take the scanning time in the PLC into account, set a period as 2 to 4 times as the scanning time.
 - (2) Turning the PWRT signal ON in the state in which home return is not completed (the HEND signal is set to ON) causes alarm 093 "PWRT signal detected before completion of home return" to occur.
 - (3) Turning PWRT signal OFF before turning WEND signal ON disturbs the proper data writing.
 - (4) Writing processing with position table screen remaining open on a teaching tool such as PC cannot lead the data on the screen to be updated. To update and confirm writing data, take the following actions:
 - 1) PC software Left-click the  button.
 - 2) Teaching Pendant or Touch Panel Teaching .. Change to user adjustment screen, input "4" in adjustment No. and return to the position table screen after software reset.
- Check the relevant Instruction Manual for details of operation.

[8] Pause and operation interruption (*STP, RES, PEND, MOVE)

PIO signal	Input		Output	
	*STP	RES	PEND	MOVE
Pattern 0 to 1	○	○	○	○
Pattern 2	○	○	○	×

○: Existence of signal, ×: No signal

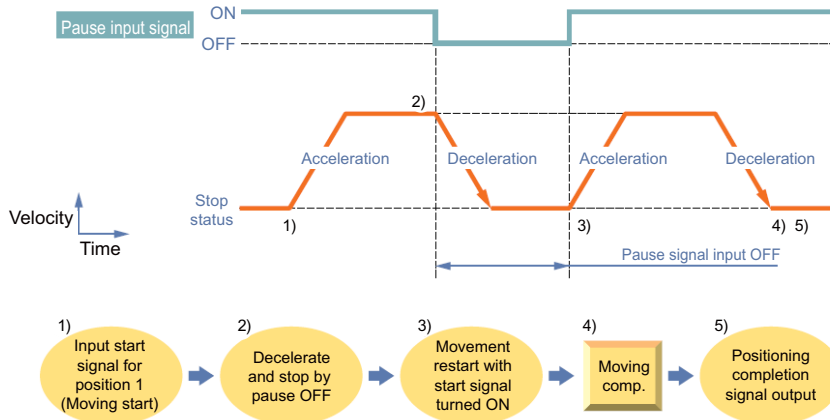

■ Control method

Pause is possible during movement. In addition, the remaining moving distance can be cancelled to interrupt the operation.

The pause signal is an input signal always set to ON. So, it is normally used to remain ON. Use this function for interlock in case where an object is invaded into the moving direction of the actuator being moved.

- 1) If pause signal *STP is turned OFF during operation of the actuator, the actuator is decelerated to a stop. The deceleration is defined by the value set in the position table.
- 2) During pause, moving signal MOVE is set to OFF but positioning complete signal PEND is not turned ON.
- 3) If pause signal *STP is returned to ON, the actuator continues the remaining movement. The acceleration is the value set in the position table.
- 4) Turning reset signal RES ON during pause (*STP being ON) allows the remaining movement to be canceled to interrupt the operation.

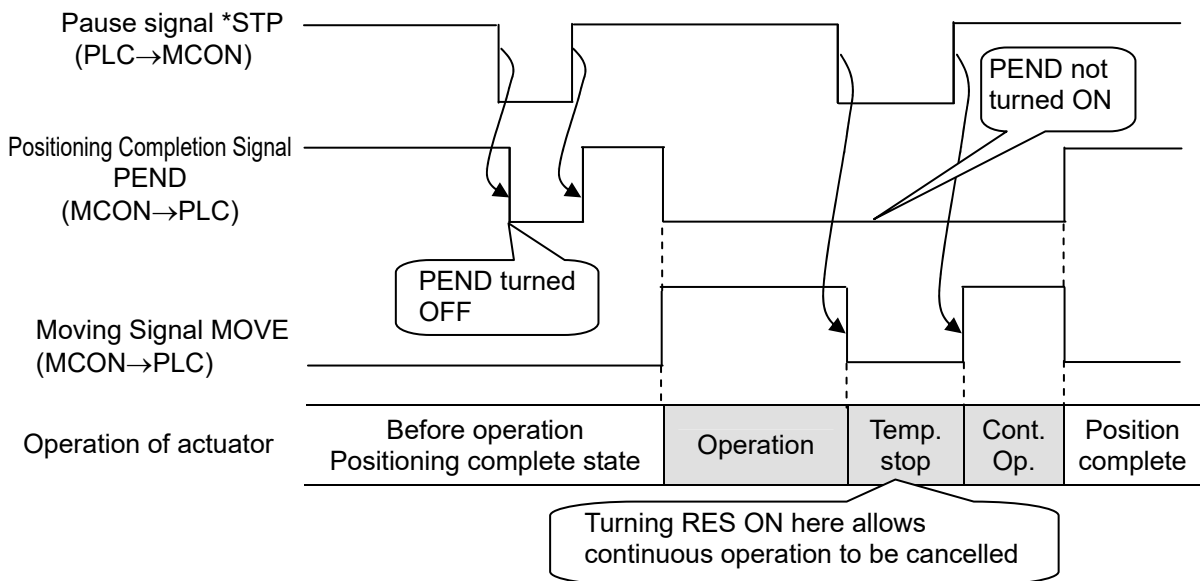

⚠ Caution: (1) At occurrence of an alarm in the release level ^(Note 1), RES can reset the alarm. Cancel the remaining moving distance after confirmation that alarm signal *ALM (being ON in normal state and OFF at occurrence of an alarm) is set to ON.
 Note 1 Check the 9.3 Gateway Alarm and 9.4 Driver Alarm for details of alarms.

(2) Turning *STP OFF with the actuator being in the positioning complete state causes PEND to be turned OFF. Note that this situation may not occur when a sequence program is created.

(3) If *STP is turned ON during pressing operation, the actuator is stopped with the pressing force remaining unchanged. If *STP is turned OFF, the pressing operation is restarted.

3.8.3 Direct Position Specification (Solenoid Valve Mode 1) = Operation of PIO Pattern 4

The start signal is provided for every position number. Only turning ON the relevant input signal according to the table shown below allows the operation based on the data in the target position number to be performed. The operation mode is called the solenoid valve mode because solenoid valves can directly drive air cylinders.

At the completion of positioning, every completed position number is output as well as the positioning complete signal.

[1] Positioning [Basic] (ST1 to ST6, PE1 to PE6, PEND)

Position No.	Input	Output	
0	ST0	PE0	PEND
1	ST1	PE1	PEND
2	ST2	PE2	PEND
3	ST3	PE3	PEND
4	ST4	PE4	PEND
5	ST5	PE5	PEND
6	ST6	PE6	PEND

- (Note)
- Speed change is not allowed during movement.
 - If start signal ST* is issued without home return, the home return operation is automatically done before the operation based on the data of the specified position number. When this specification is not desired, interlock by home return complete signal HEND is required.

■ Sample use

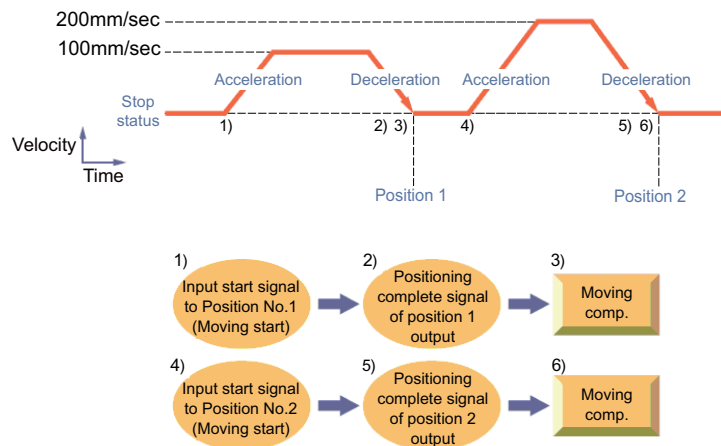
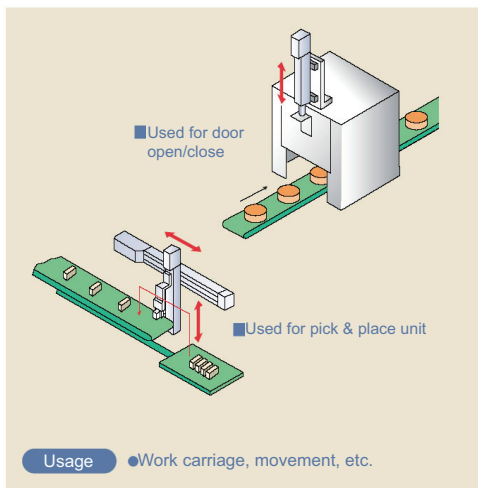

No.	Position [mm]	Velocity [mm/s]	Acceleration [G]	Deceleration [G]	Pressing [%]	Threshold [%]	Positioning width [mm]	Zone+ [mm]	Zone- [mm]	Acceleration/Deceleration mode	Incremental	Gain set	Stop mode
0	0.00	100.00	0.20	0.20	0	0	0.10	0.00	0.00	0	0	0	0
1	70.00	100.00	0.20	0.20	0	0	0.10	0.00	0.00	0	0	0	0
2	150.00	200.00	0.20	0.20	0	0	0.10	0.00	0.00	0	0	0	0

■ Control method

- 1) When start signal ST* is turned ON, the actuator starts acceleration based on the data in the specified position table for positioning to the target position.
- 2) At the completion of positioning, positioning complete signal PENDING is turned ON as well as current position No. PE* of the specified position.
- 3) After PENDING is turned ON, turn the ST* signal OFF.
- 4) Current position No. PE* and positioning completion signal PENDING are turned ON if the remaining moving distance is entered into the positioning width zone. PE* and PENDING turned ON once remain ON unless start signal ST* is turned ON again or the servo is turned OFF. They are also turned OFF when pause signal *STP is turned OFF.

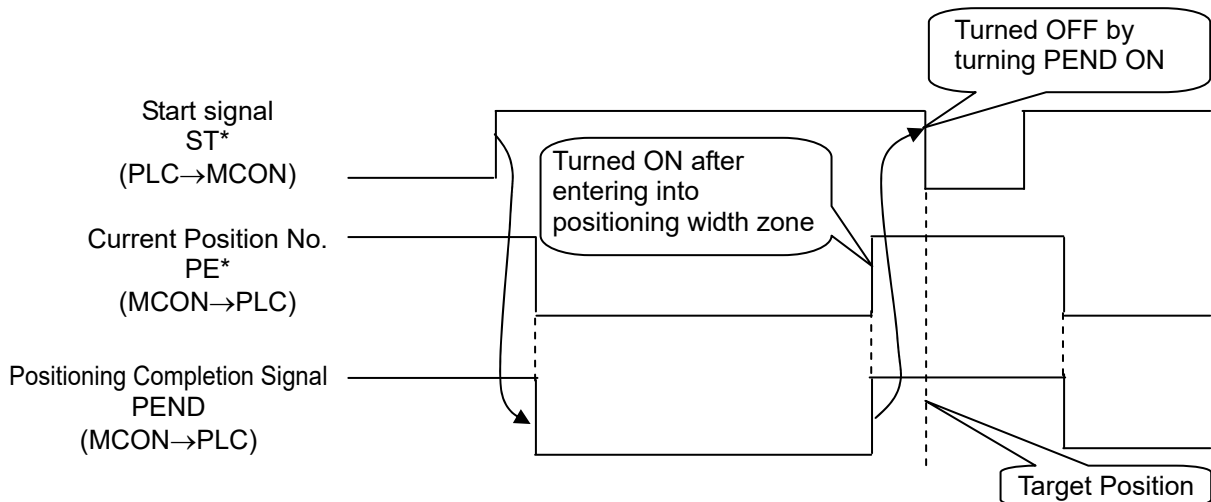

⚠ Caution:

- (1) If the ST* signal is turned ON for the position after completion of positioning, both the PE* and PENDING signals remain ON (except the pitch feed operation).
- (2) Both the PE* and PENDING signals are set to ON in the positioning width zone. Accordingly, they may be turned ON under operation of the actuator if a large positioning width is set.
- (3) Interlock should be taken so that two or more ST* signals are set to ON simultaneously.
 - 1) Entering the ST* signal of another position during positioning is invalid. If the ST* signal of another position is turned ON during positioning, the operation is terminated after the completion of the positioning being operated.
 - 2) Entering the ST* signal of another position with the ST* signal of the current position remaining ON after the completion of positioning allows the positioning to the other position to be executed.
- (4) If Parameter No.27 "Move command type" is set to "0" (factory setting), turning ST* OFF during positioning caused the operation to be interrupted.

[2] Pitch feeding (relative movement = incremental feed)

■ Sample use

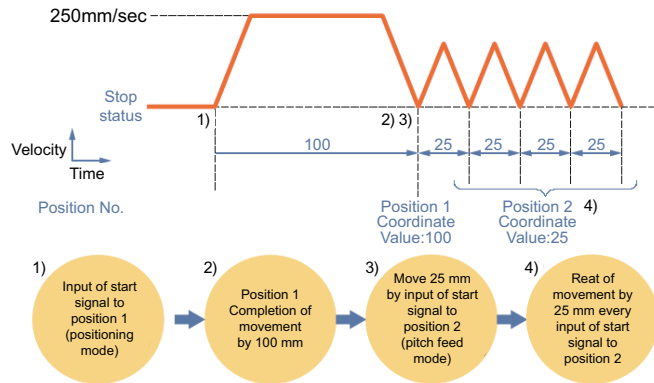
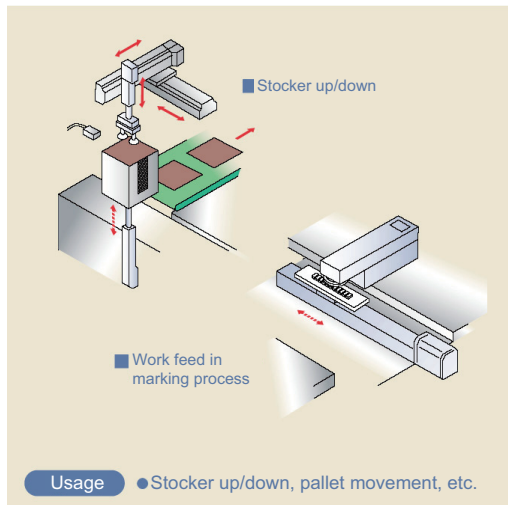

No.	Position [mm]	Velocity [mm/s]	Acceleration [G]	Deceleration [G]	Pressing [%]	Threshold [%]	Positioning width [mm]	Zone+ [mm]	Zone- [mm]	Acceleration/Deceleration mode	Incremental	Gain set	Stop mode
0													
1	100.00	250.00	0.20	0.20	0	0	0.10	0.00	0.00	0	0	0	0
2	25.00	250.00	0.20	0.20	0	0	0.10	0.00	0.00	0	1	0	0

(Position No.2 sets pitch feed.)

■ Control method

- 1) The method of controlling pitch feed is the same as that described in [1] Positioning except the setting of the position table. Repeat the positioning of a specific position No.
- 2) For pitch feed, the position set in the position table indicates the pitch. Set the pitch (relative moving distance = incremental moving distance) in column "Position".
- 3) If the operation command is issued, the actuator moves from the current stop position by "Position" in the position table. To perform continuous movement, repeat the operation. Any accumulation error does not occur because the home position (coordinate value 0) is specified as the base point.

⚠ Caution:
 (1) Because pitch feed is repeated, turning ON the ST* signal of the same position after

- completion of positioning causes both the PE* and PEND signals to be turned OFF at operation start and turned ON again at completion of positioning in the same way as [1] Positioning.
- (2) If the actuator reaches the software limit (stroke end) in pitch feed, the actuator is decelerated to be stopped and current position No. PE* and positioning complete signal PEND are turned ON at the stop position.
 - (3) Both the PE* and PEND signals are set to ON in the positioning width zone. Accordingly, they may be turned ON under operation of the actuator if a large positioning width is set.
 - (4) Interlock should be taken so that two or more ST* signals are set to ON simultaneously.
 - 1) Entering the ST* signal of another position during positioning is invalid. If the ST* signal of another position is turned ON during positioning, the operation is terminated after the completion of the positioning being operated.
 - 2) Entering the ST* signal of another position with the ST* signal of the current position remaining ON after the completion of positioning allows the positioning to the other position to be executed.
 - (5) If Parameter No.27 "Move command type" is set to "0" (factory setting), turning ST* OFF during positioning caused the operation to be interrupted.
 - (6) Note that, when Parameter No.27 "Move command type" is set to "1", starting (ST* ON) pitch feed repeatedly during pause causes the actuator to be moved successively by the number of starts. If this situation is supposed, cancel the remaining moving distance by turning reset signal RES ON in the pause state or take interlock so that start signals are not turned ON during pause.
 - (7) The pressing operation is enabled by using the pitch feed function.
 - (8) In the pitch feed, do not perform a command with a pitch smaller than the minimum encoder resolution (lead/encoder pulse number) or that less than positioning accuracy repeatability.
There would be no deviation to occur even with the command because it is an operation command to the same position as the positioning complete condition, but the positioning control cannot be performed properly.

[3] Pressing operation

■ Sample use

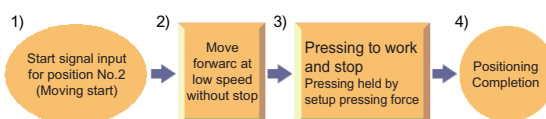
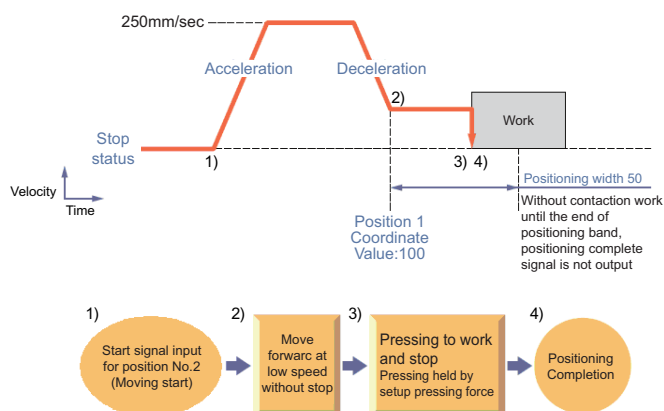
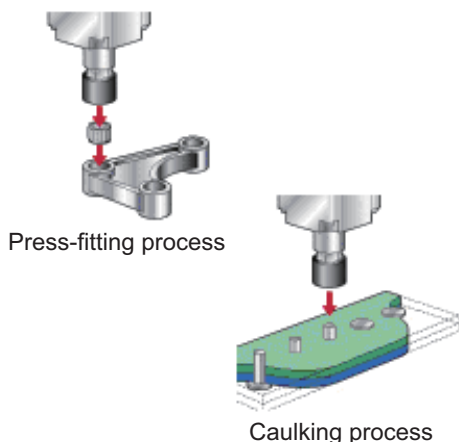

No.	Position [mm]	Velocity [mm/s]	Acceleration [G]	Deceleration [G]	Pressing [%]	Threshold [%]	Positioning width [mm]	Zone+ [mm]	Zone- [mm]	Acceleration/Deceleration mode	Incremental	Gain set	Stop mode
0													
1	0.00	250.00	0.20	0.20	0	0	0.10	0.00	0.00	0	0	0	0
2	100.00	250.00	0.20	0.20	50	0	50.00	0.00	0.00	0	0	0	0

(Position No.2 sets pressing operation.)

■ Control method

- 1) The method of controlling the pressing operation is the same as that described in [1] Positioning except the setting of the position table. Any setting of "Pressing" in the position table allows the pressing operation to be done. "Positioning width" is assumed as pressing operation distance.
- 2) The actuator moves at the setting speed and rating torque to the position of the coordinate set in "Position" in the similar way as normal positioning. Then the operation changes to pressing. The moving distance in pressing is the value set in "Positioning width". The pressing is performed with the torque (current limit value) set in percent in "Pressing" of PIO patterns 4 being the upper limit.
Pressing operation using force sensor of PIO pattern 7 performs pressing by the pressing force set in percent of the base thrust in pressing operation using force sensor*1.
- 3) The control method is the same as that in [1] Positioning. However, the processing of positioning complete signal PEND is different from that in [1] Positioning. PEND is output when the shaft is stopped by pressing (pressing complete). If the work is not subject to pressing (miss-pressing), the actuator moves by the value set in "Positioning width" to stop but PEND is not turned ON. The current position No. PE* is turned ON at the completion of pressing and even in miss-pressing.

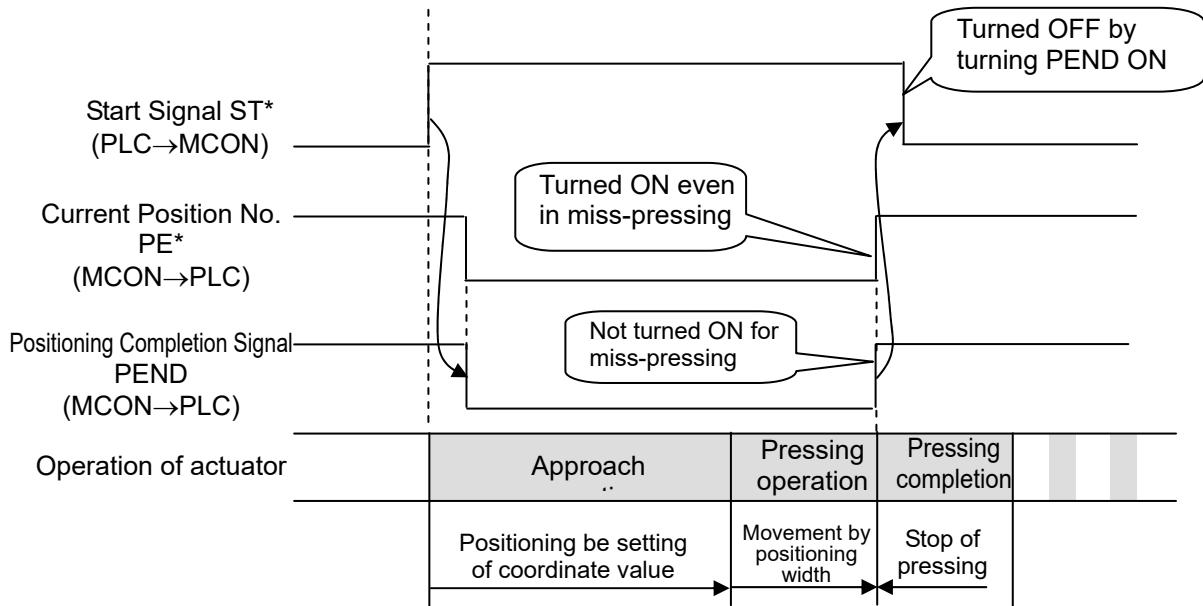

- ⚠ Caution:** (1) The speed during pressing operation is set in Parameter No.34. Check the 10.4 List of Specifications of Connectable Actuators for the pressing operation speed. Do not set any value larger than the value in the list. If the speed set in the position table is equal to or less than the pressing speed, the pressing is performed at the setup speed.
- (2) The approach start position of pressing should be located at or before the pressing start position (coordinate 100mm or less in the above example) If not, the moving direction varies depending on the start position to be dangerous. For example, pressing at coordinate larger than the pressing end position (larger than 150mm) is performed in the direction from the current position to the pressing end position. It would not proceed to the pressing operation at 150mm point after positioning at 100mm point.

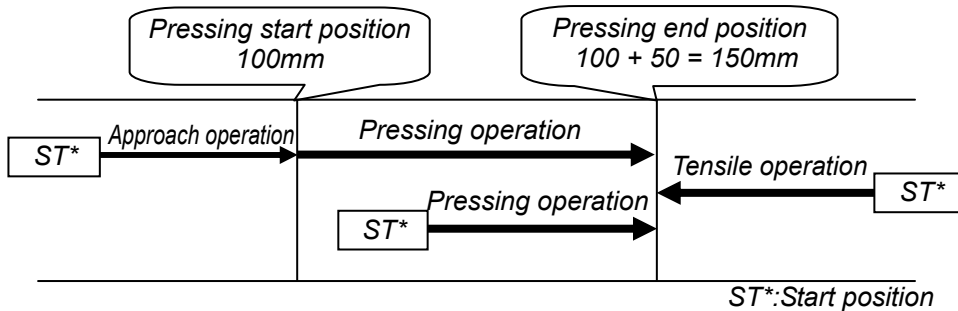

- (3) The work is pressed after the pressing is completed. The work may moves backward or forward. If the actuator is moved backward before the approach position, alarm code 0DC "pressing operation range error" occurs to stop the actuator. In movement of the work in the pressing direction, PEND is turned OFF if the load current becomes lower than the current limit (pressing [%]). Miss-pressing occurs when the actuator moves by the pressing moving distance set in "Positioning width".
- (4) Pressing control cannot be performed with the rotary actuator.

Judging completion of pressing operation

The operation monitors the torque (current limit value) in percent in "Pressing" of the position table and turns pressing complete signal PENDING ON when the load current satisfies the condition shown below during pressing. PENDING is turned ON at satisfaction of the condition if the work is not stopped.

(Accumulated time in which current reaches pressing value [%]) – (accumulated time in which current is less than pressing value [%]) ≥ 255ms (Parameter No.6)

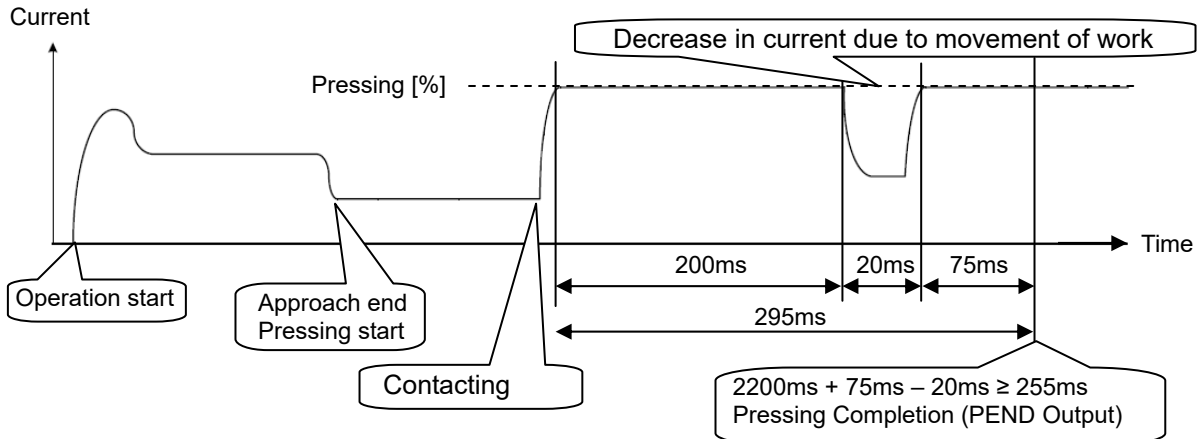

[4] Tension Operation

■ Image diagram

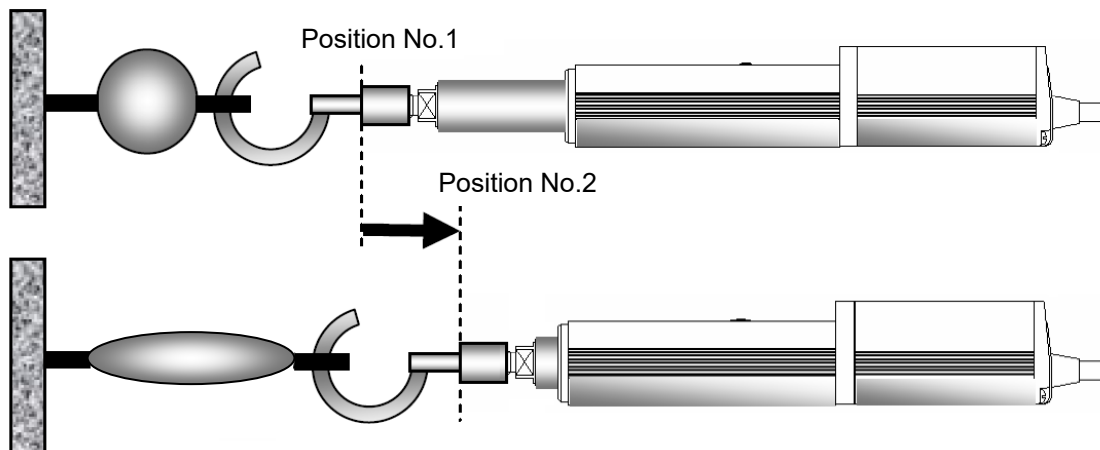

No.	Position [mm]	Velocity [mm/s]	Acceleration [G]	Deceleration [G]	Pressing [%]	Threshold [%]	Positioning width [mm]	Zone+ [mm]	Zone- [mm]	Acceleration/Deceleration mode	Incremental	Gain set	Stop mode
0													
1	100.00	250.00	0.20	0.20	0	0	0.10	0.00	0.00	0	0	0	0
2	80.00	250.00	0.20	0.20	50	0	-50.00	0.00	0.00	0	0	0	0
3													

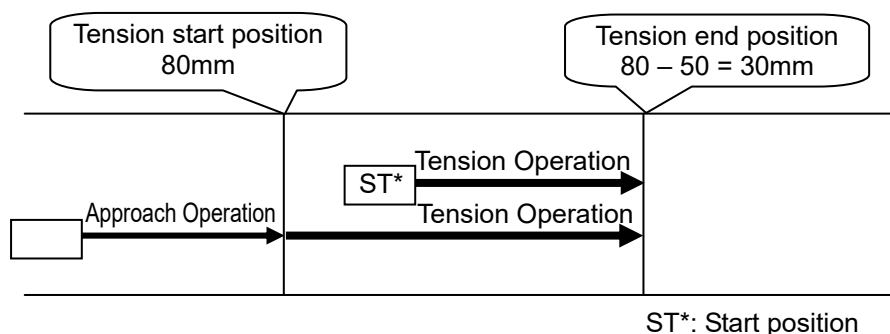

■ Control method

The method of controlling the tension operation is the same as that described in [3] Pressing operation. The control method is explained below by using the sample position table shown above.

- 1) Position No.2 indicates the settings of tension operation. The settings of "Position" and "Positioning width" show the tension start position and the tension quantity, respectively. Attach - (negative sign) to the tension quantity. Specify the upper limit of the torque required for tension in percent (limited current value) in "Pressing". The speed, acceleration, and deceleration are the conditions of positioning to the coordinate value (80mm) set in "Position".
- 2) Position No.1 indicates the tension start preparation position. Specify a value larger than the coordinate value at which the tension provided by position No.2 ends ($80 - 50 = 30\text{mm}$) in "Position".
- 3) First define the positioning in position No.1. Next, the operation in position No.2 moves the actuator to the position of 80mm at the setting speed and rating torque and change to the tension operation. The actuator moves by 50mm in the negative direction in the tension operation. The upper limit of the tensile force is the torque set in percent.
- 4) In the similar way as pressing, the positioning complete signal is output when the shaft is stopped by tension (pressing complete). If the actuator cannot be stopped during movement within the setting positioning width (miss-pressing), it moves by the setting distance to stop but PEND is not turned ON. The current position No. PE* is turned ON at the completion of pressing and even in miss-pressing.

- ⚠ Caution:** (1) The speed during tension operation is set in Parameter No.34. [Refer to 10.4 List of Specifications of Connectable Actuators for the pressing speed.]
Do not set any value larger than the value in the list. If the speed set in the position table is equal to or less than the tension speed, the tension operation is performed at the setup speed.
- (2) The tension ready position should be the tension start position or forward. If not, the moving direction varies depending on the start position to be dangerous.
The tension operation from a coordinate (less than 30mm = 80 – 50 in the above example) located before the end position (30mm or less) changes to the pressing operation from the current position to the tension end position. Note that the tension operation after positioning to the position of 80mm does not take place.

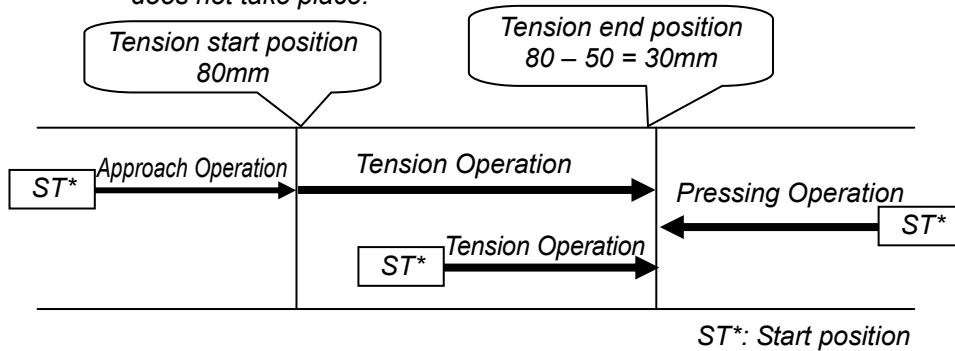

- (3) The work is pulled also after completion of the tension. The work is drawn back or pulled further if the work is moved. When the work is drawn back before the approach position, alarm code 0DC "pressing operation range error" occurs to stop the work. When the work is moved in the tension direction and the load current becomes less than the current limit value (pressing in [%]), PEND is turned OFF. Naturally, the work reaches the tension moving distance set in "Positioning width" to cause miss-pressing.
- (4) Tension operation cannot be performed with the rotary actuator.

[5] Multi-step pressing

■ Image diagram

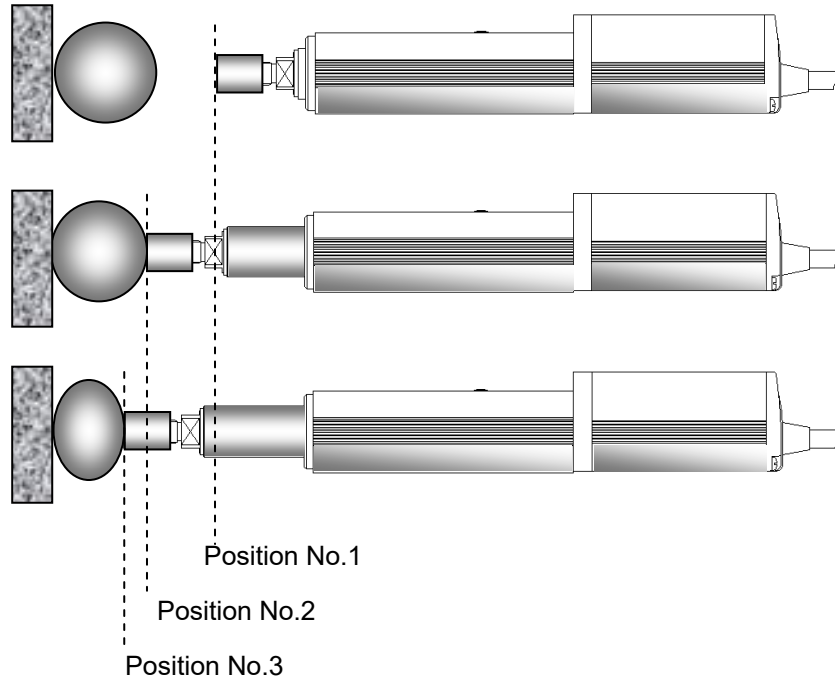

No.	Position [mm]	Velocity [mm/s]	Acceleration [G]	Deceleration [G]	Pressing [%]	Threshold [%]	Positioning width [mm]	Zone+ [mm]	Zone- [mm]	Acceleration/Deceleration mode	Incremental	Gain set	Stop mode
0													
1	0.00	250.00	0.20	0.20	0	0	0.10	0.00	0.00	0	0	0	0
2	50.00	250.00	0.20	0.20	30	0	20.00	0.00	0.00	0	0	0	0
3	50.00	250.00	0.20	0.20	50	0	20.00	0.00	0.00	0	0	0	0
4													

■ Control method

After pressing, the pressing pressure can only be changed in the pressing state. The method of controlling multi-step pressing is the same as that described in [3] Pressing operation. Shown below is the explanation with the position table above as an example.

- 1) Set the weak pressing (30%) in position No.2 and perform the pressing operation.
- 2) If pressing complete signal PEND is turned ON, start the pressing operation with pressing pressure (50%) greater than the first pressure set in position No.3. In this particular operation, turn ON ST3 after completion of ST2, and turn OFF ST2 when PEND is turned OFF. In usual case, do not turn ON two or more ST* signals simultaneously. The position data in position No.3 should be the same as that in position No.2 except the setting in "Pressing".
- 3) To add a pressing step with another pressing pressure, add a sequence consisting of a position number and a pressing operation.

[6] Pause and operation interruption (ST*, *STP, RES, PE*, PEND)

Pause is possible during movement. In this mode, the following two methods are possible for pause.

1) Use of pause signal *STP

Turning reset signal RES ON during the pause allows the remaining moving distance to be cancelled to interrupt the operation.

2) Use of start signal ST*

This method is valid when Parameter No.27 "Move command type" is set to "0" (factory setting). The actuator can only be moved while the ST* signal is set to ON and stopped if ST* is turned OFF. Since setting the ST* signal to OFF is assumed as interrupt of operation, the remaining moving distance may not be cancelled.

(1) Use of pause signal *STP

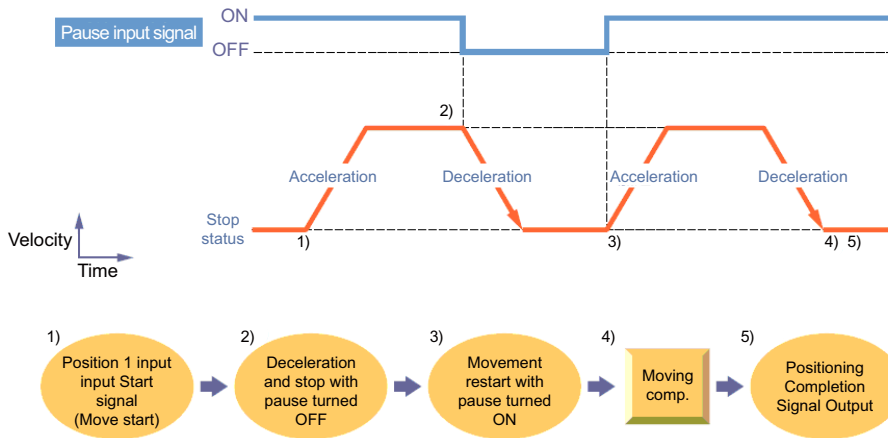

■ Control method

The pause signal is an input signal always set to ON. So, it is normally used to remain ON. Use this function for interlock in case where an object is invaded into the moving direction of the actuator being moved.

- 1) If pause signal *STP is turned OFF during operation of the actuator, the actuator is decelerated to a stop. The deceleration is defined by the value set in the position table.
- 2) During pause, current position No. PE* and positioning complete signal PEND are not turned ON.
- 3) If pause signal *STP is returned to ON, the actuator continues the remaining movement. The acceleration is the value set in the position table.
- 4) Turning reset signal RES ON during pause (*STP being ON) allows the remaining movement to be canceled to interrupt the operation.

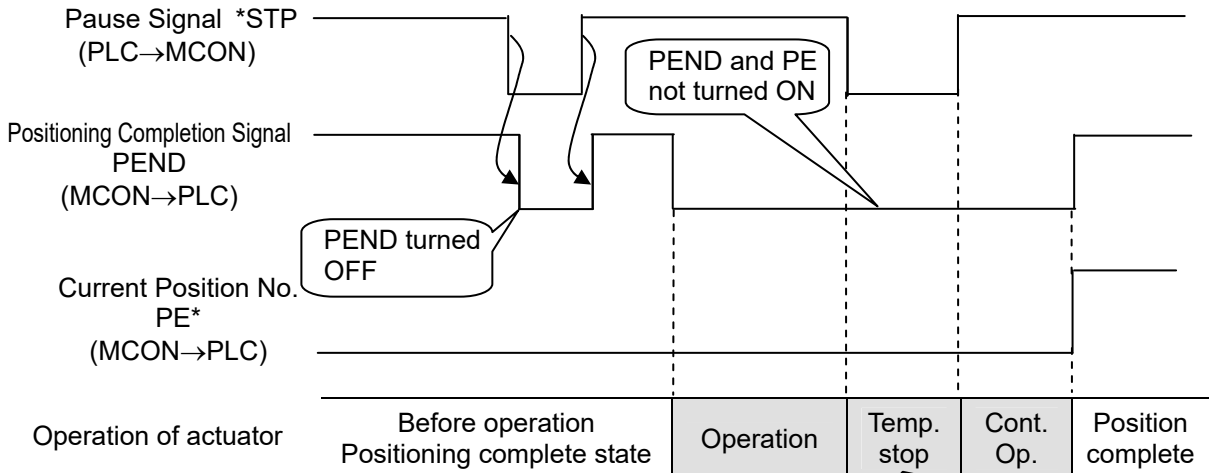

Caution: (1) At occurrence of an alarm in ... Turning RES ON here allows continuous operation to be cancelled

alarm. Cancel the remaining moving distance after confirmation that alarm signal *ALM (being ON in normal state and OFF at occurrence of an alarm) is set to ON.

Note 1 [Refer to 9.3 Gateway Alarm and 9.4 Driver Alarm for details of alarms.]

(2) Turning *STP OFF with the actuator being in the positioning complete state causes PEND to be turned OFF. Note that this situation may not occur when a sequence program is created.

(2) Use of start signal ST*

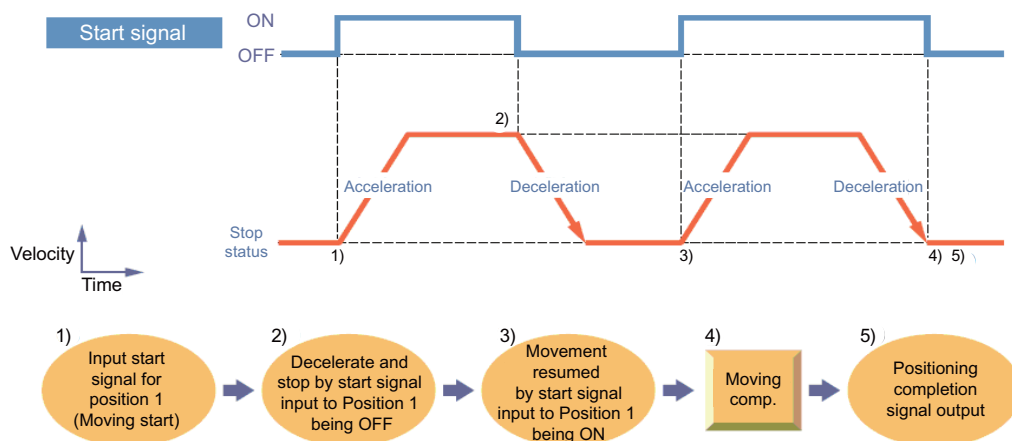

■ Control method

If start signal ST* is turned OFF during movement, the actuator can be paused. Use the control method for interlock in case where an object is invaded into the moving direction of the actuator being moved.

- 1) If the ST* signal is turned OFF during movement, the actuator is paused. The deceleration is the value set in the position table.
- 2) Turning the ST* signal OFF causes the positioning to be interrupted and deemed complete signal PEND to be turned ON.
- 3) If the ST* signal is turned ON again, the remaining movement is continued. The acceleration is the value set in the position table.

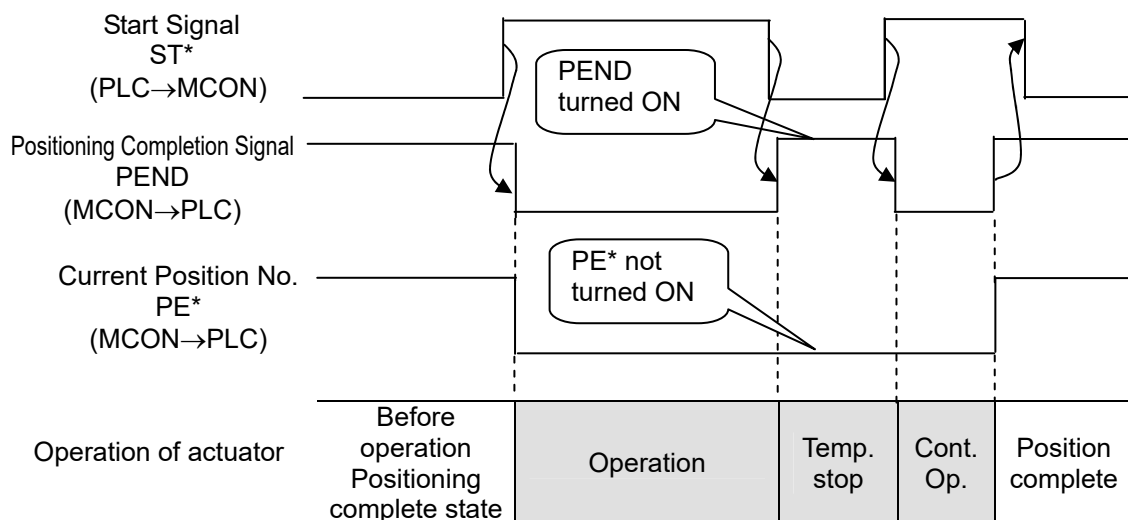

3.8.4 Direct Position Specification (Solenoid Valve Mode 2) = Operation of PIO Pattern 5

The start signal is provided for every position number. Only turning ON the relevant input signal according to the table shown below allows the operation based on the data in the target position number to be performed. The operation mode is called the solenoid valve mode because solenoid valves can directly drive air cylinders. At invasion of the actuator into the positioning width set for each position, the output signal is turned ON in the operation of any position number or manual operation of the actuator in servo OFF status as if a sensor were installed.

Positioning and speed change during operation are possible. Their control methods are the same as those of other patterns.

⚠ Caution: This pattern does not allow pressing and pitch feed.

[1] Home return (ST0, HEND)

The I/O of PIO varies as shown in the table below depending on the position number before home return.

Position No.	Input	Output
0	ST0	LS0
1	ST1 ⇒ JOG+	LS1
2	ST2 ⇒ Invalid	LS2 ⇒ Invalid

Before home return, start signal ST0 works as JOG- moving to the home return direction while it is set to ON and ST1 works as JOG+ while it is set to ON. By using this function, move the actuator to a position at which home return can be done safely. The speed of ST1 is the home return speed.

After the home return is fully prepared, turn the ST0 signal ON to start the home return. At the completion of the home return, home return complete signal HEND is turned ON. Turn the ST0 signal OFF if HEND is turned ON. HEND remains ON unless the home is lose due to occurrence.

If a certain home positioning precision is required, Set "Position" of position No.0 to 0 mm and the ST0 signal is not changed by the HEND signal to remain ON. After the home return is completed, positioning is provided for position No.0. [Refer to [3] Positioning in this chapter]

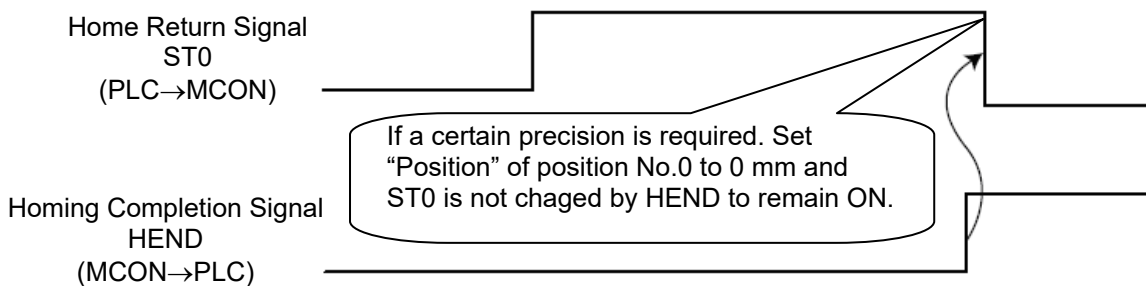

⚠ Warning: (1) Use this pattern with Parameter No.27 "Move command type" set to "0" (factory setting). When Parameter No.27 is set to "1", the home return is started as soon as the ST0 signal is turned ON and the operation cannot be stopped even if ST0 is turned OFF.
 (2) If "Position" in position No.0 is set to other than 0mm, the operation is continued without change to provide positioning after home return.

[Operation of Slider Type/Rod Type Actuator]

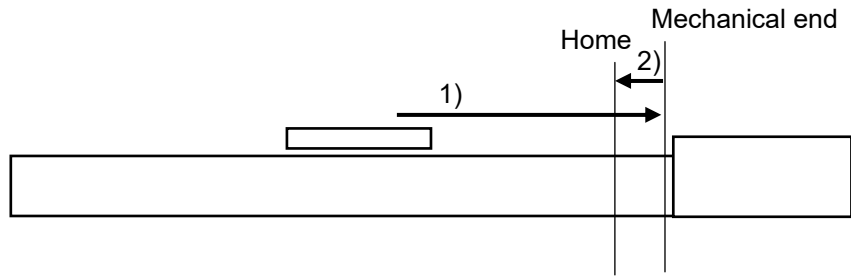

- 1) With the ST0 signal being ON, the actuator moves toward the mechanical end at the home return speed. The moving speed is 20mm/s for most actuators but less than 20mm/s for some actuators.
- 2) The actuator is turned at the mechanical end and stopped at the home position. The movement amount is the value set by Parameter No.22 "Home return offset level".

⚠ Caution: *In the home reverse specification, the actuator moves in the reverse direction. Make sure to refer to Section 8.2 [14] when a change to Parameter No.22 "Home Return Offset Level" is required.*

[Operation of Rotary Actuator]

- (1) 330° Rotation Specification

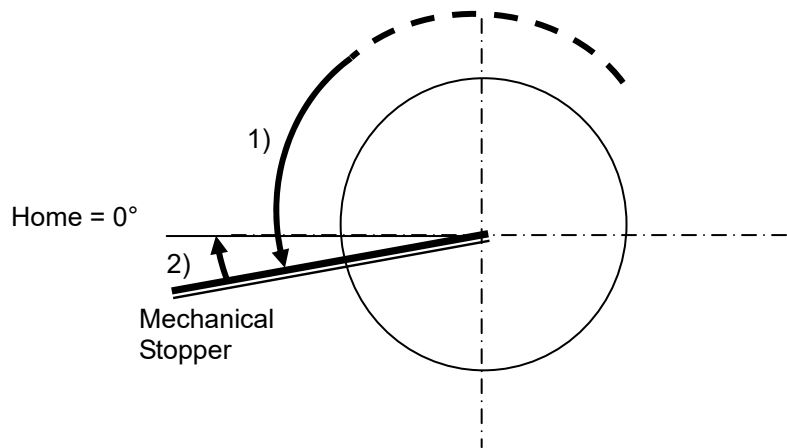

- 1) By HOME Signal being on, the rotary part turns in CCW (counterclockwise) from the view of load side. The velocity is either 20deg/s.
- 2) The actuator is turned at the mechanical stopper and stopped at the home position. The amount of movement at this time is that set in Parameter No.22 "Home Return Offset Level".

⚠ Caution: *Make sure to refer to Section 8.2 [14] when a change to Parameter No.22 "Home Return Offset Level" is required.*

(2) Multi-Rotation Type

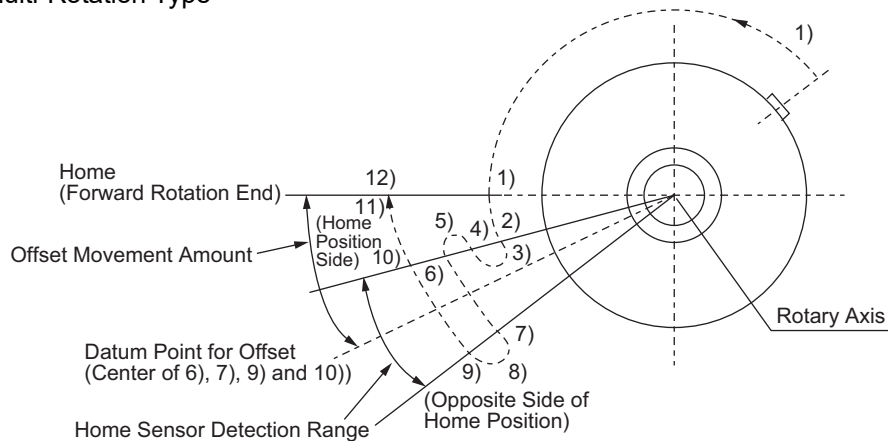

- 1) Once the home-return operation is started, the rotary part turns in CCW (counterclockwise) from the view of the load side. The speed is either 20deg/s.
- 2) Home sensor turns ON.
- 3) Starts reversed rotation.
- 4) Goes back to a point exceeded the home sensor detection range, and confirms the home sensor is turned OFF.
- 5) Starts reversed rotation.
- 6) Confirms the home sensor gets turned on again.
- 7) Goes to a point exceeded the home sensor detection range on the opposite side of the home position, and confirms the home sensor is turned OFF.
- 8) Starts reversed rotation.
- 9) Confirms the home sensor turns ON.
- 10) Goes to a point exceeded the home sensor detection range on the home position side, and confirms the home sensor is turned OFF.
- 11) Based on the result gained from 6), 7), 9) and 10), the center of the home sensor detection range is calculated.
- 12) The actuator moves in a certain amount for each actuator from the position of 11) and stops at the home position.

Caution: *The direction to rotate is the other way for the reversed rotation type. Make sure to refer to Section 8.2 [14] when a change to Parameter No.22 "Home Return Offset Level" is required.*

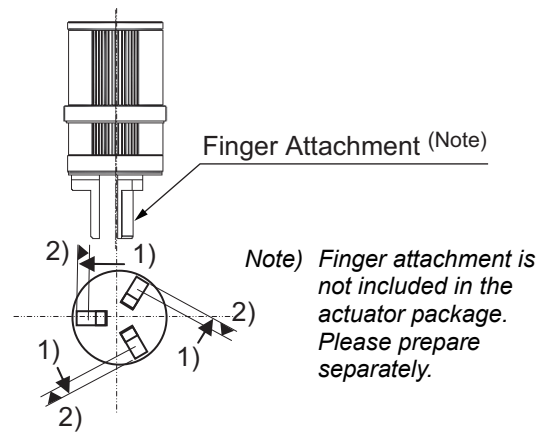
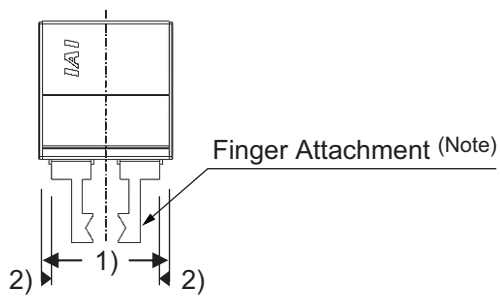

- 1) The actuator moves toward the mechanical end (to end side) at the home return speed (20mm/s).
- 2) The actuator is turned at the mechanical end and stopped at the home position. The movement amount at this time is determined for each actuator and cannot be changed.

⚠ Caution: Make sure to refer to Section 8.2 [14] when a change to Parameter No.22 "Home Return Offset Level" is required.

[2] Features of LS signals (LS0 to 2)

The LS* signals are not complete signals for positioning commands such as those for other PIO patterns. Despite the specified position No., the corresponding LS* signal is turned ON when the actuator is entered into the setup value range as if the actuator were detected by a sensor installed.

(Example) The figure below shows the position table and the position at which each of the LS signals is turned ON. If the actuator passes any of the positioning widths in the operation by another position number or manual operation in the servo OFF state, the relevant LS signal is always turned ON.

No.	Position [mm]	Velocity [mm/s]	Acceleration [G]	Deceleration [G]	Pressing [%]	Threshold [%]	Positioning width [mm]	Zone+ [mm]	Zone- [mm]	Acceleration/Deceleration mode	Incremental	Gain set	Stop mode
0	0.00	250.00	0.20	0.20	0	0	5.00	0.00	0.00	0	0	0	0
1	70.00	250.00	0.20	0.20	0	0	10.00	0.00	0.00	0	0	0	0
2	150.00	250.00	0.20	0.20	0	0	5.00	0.00	0.00	0	0	0	0

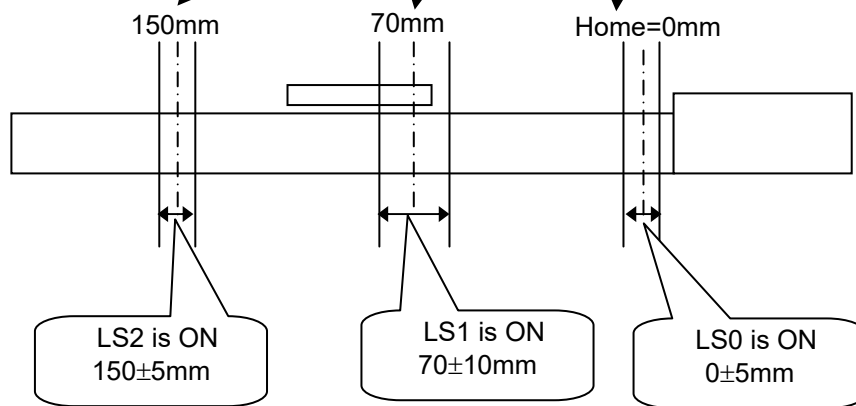

⚠ Caution: Even though a cold start error is generated, LS Signal would not turn OFF.

[3] Positioning [Basic] (ST0 to ST2, LS0 to LS1)

Position No.	Input	Output
0	ST0	LS0
1	ST1	LS1
2	ST2	LS2

(Note) Pressing and pitch feed are unavailable.

■ Sample use

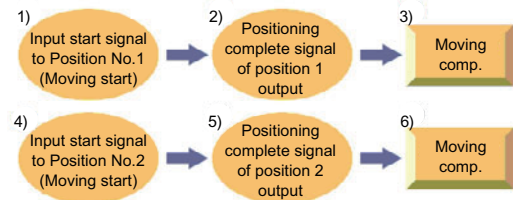
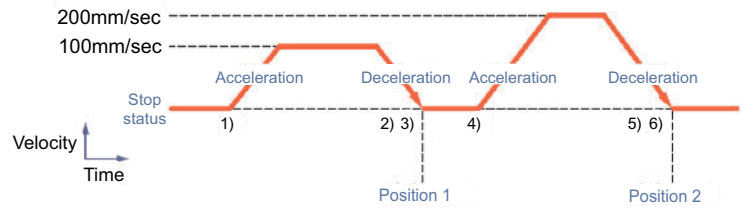
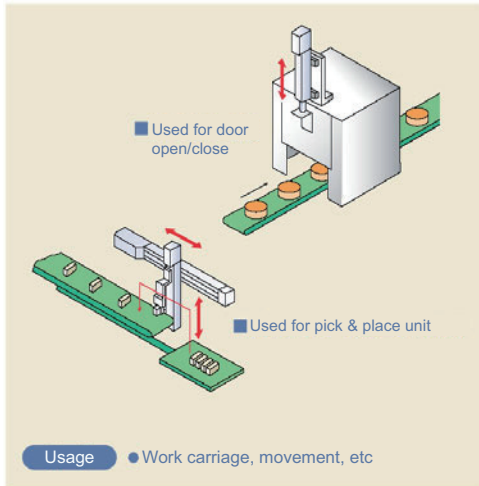

No.	Position [mm]	Velocity [mm/s]	Acceleration [G]	Deceleration [G]	Pressing [%]	Threshold [%]	Positioning width [mm]	Zone+ [mm]	Zone- [mm]	Acceleration/Deceleration mode	Incremental	Gain set	Stop mode
0	0.00	100.00	0.20	0.20	0	0	0.10	0.00	0.00	0	0	0	0
1	70.00	100.00	0.20	0.20	0	0	0.10	0.00	0.00	0	0	0	0
2	150.00	200.00	0.20	0.20	0	0	0.10	0.00	0.00	0	0	0	0

■ Control method

- 1) When start signal ST* is turned ON, the actuator starts acceleration based on the data in the specified position table for positioning to the target position. Turning the ST* signal OFF on the way causes the actuator to be decelerated and stopped. So, make the ST* signal remain ON until the actuator reaches the target position.
- 2) At the completion of positioning, position detection output LS* of the specified position is turned ON.
- 3) Position detection output LS* is turned ON if the remaining moving distance enters into the positioning width. LS* is set to ON if the current position is located within the positioning width zone or OFF if the current position is located out of the positioning width zone (the same situation occurs in the servo OFF status).
- 4) Leave the ST* signal to be ON until the actuator is moved to another position and turn OFF it at the next ST* signal. If the ST* signal is turned OFF at the LS* signal, the actuator is decelerated to a stop in the positioning width and thus the actuator may not reach the target position. In continuous operation, turn ON the next ST* signal by setting the positioning width within the required precision range or setting the period taken from detection of the LS* signal to reaching the target position.

(Example) Repetition of ST1 → ST2 → ST1 →
 Insert timer Δt if necessary.

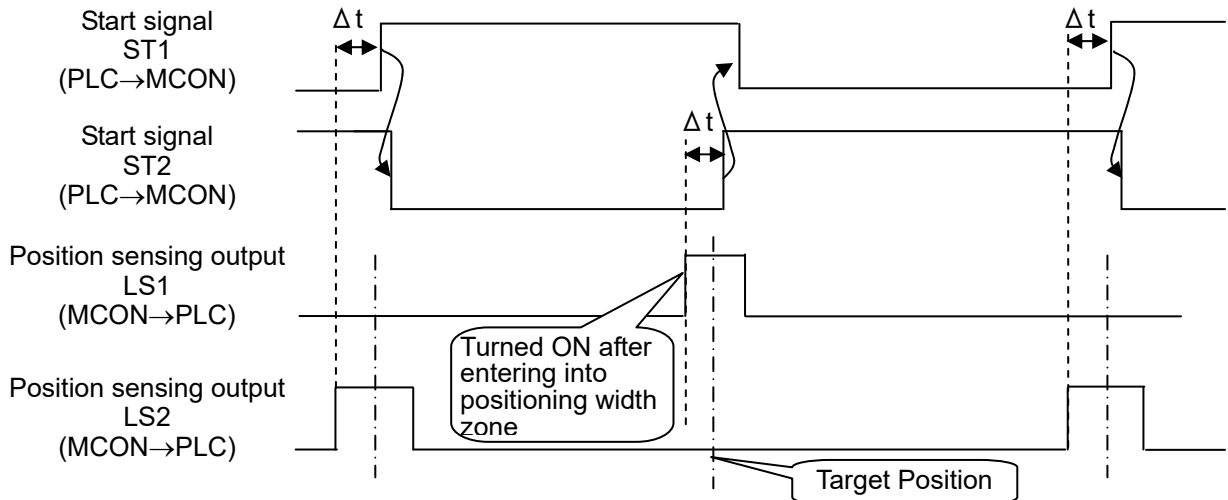

Δt : Time required to certainly reach the target position after the position sensing output LS1 or 2 is turned ON.

[Example of stop position when the ST* signal is turned OFF by the LS* signal]
 If the positioning width is set at a position before the original deceleration start position, the actuator cannot reach the target position.

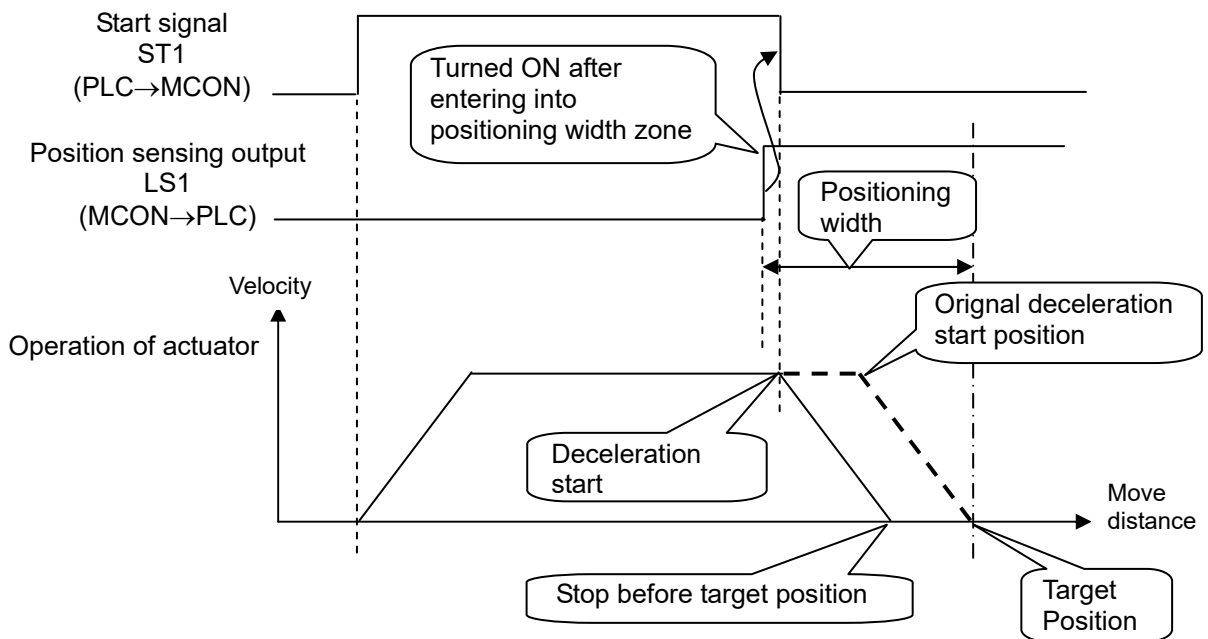

⚠ Caution: (1) If the ST* signal for the position is turned ON after the completion of positioning, the LS* signal remains ON.
 (2) Both the LS* and PEND signals are set to ON in the positioning width zone. Accordingly, they may be turned ON under operation of the actuator if a large positioning width is set.
 (3) Interlock should be taken so that two or more ST* signals are set to ON simultaneously. If two or more ST* signals are input simultaneously, they will be executed according to the following priorities: ST0→ST1→ST2

[4] Speed change during the movement

■ Sample use

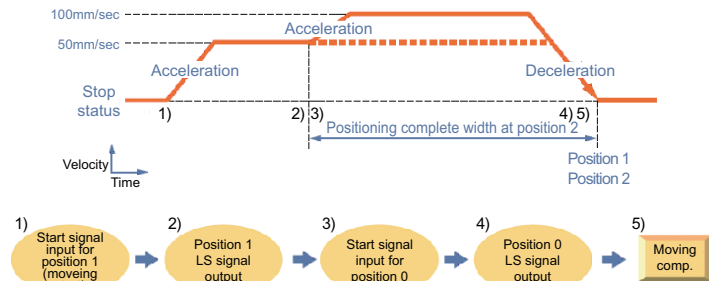
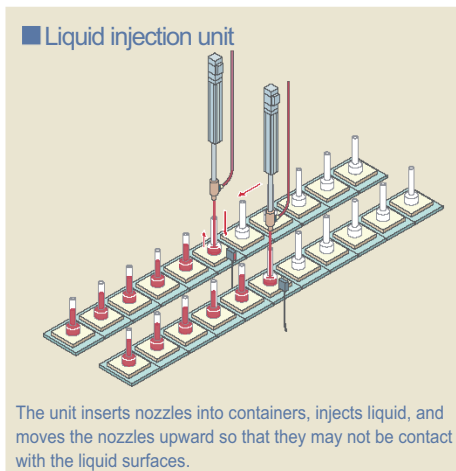

No.	Position [mm]	Velocity [mm/s]	Acceleration [G]	Deceleration [G]	Pressing [%]	Threshold [%]	Positioning width [mm]	Zone+ [mm]	Zone- [mm]	Acceleration/Deceleration mode	Incremental	Gain set	Stop mode
0	0.00	100.00	0.20	0.20	0	0	0.10	0.00	0.00	0	0	0	0
1	0.00	50.00	0.20	0.20	0	0	100.00	0.00	0.00	0	0	0	0
2	150.00	200.00	0.20	0.20	0	0	0.10	0.00	0.00	0	0	0	0

■ Control method

The speed of the actuator can be changed while it moves. The operation control method is the same as that in [3] Positioning. This pattern prioritizes the start signal specified later over the previous signal. Accordingly if another position No. is started during operation, then the new operation begins. This can be used to change the speed.

- 1) In this example, the speed is changed while the actuator moves from the position of 150mm to the position of 0mm. At first, set the positioning to the target position at the first speed in position No.1. In the positioning width, set the distance from the speed change position to the target position. The value is set to 100mm in the example. Thus, for position No.1, position sensing signal LS1 is turned ON at the position before the target position by 100mm.
- 2) Set the positioning to the target position at the second speed in position No.0.
- 3) Then start position No.1 (ST1 signal) and use position sensing output signal LS1 of position No.1 to start position No.0 (ST0 signal). Since this pattern prioritizes the signal specified later over the previous signal, the operation of No.1 is changed to the operation of No.0 during the operation of No.1.
(Note) If there is a signal commanded afterwards, the commanded signal will start activating once the previously commanded signal is turned OFF.
- 4) Use position sensing signal LS0 of position No.0 to turn the ST1 signal OFF.

In this example, the target positions No.0 and 1 are equal with each other. They may not be the same. However, setting the target positions to be equal with each other allows the distance from the speed change position to the target position to be known easily. Depending on the timing when the actuator accepts the input signal, the speed change may be delayed a little. Changing the positioning width can adjust the timing.

The timing chart shown below indicates that the actuator changes its speed while it moves to position No.1 after the completion of positioning at position No.2 and moves to position No.0.

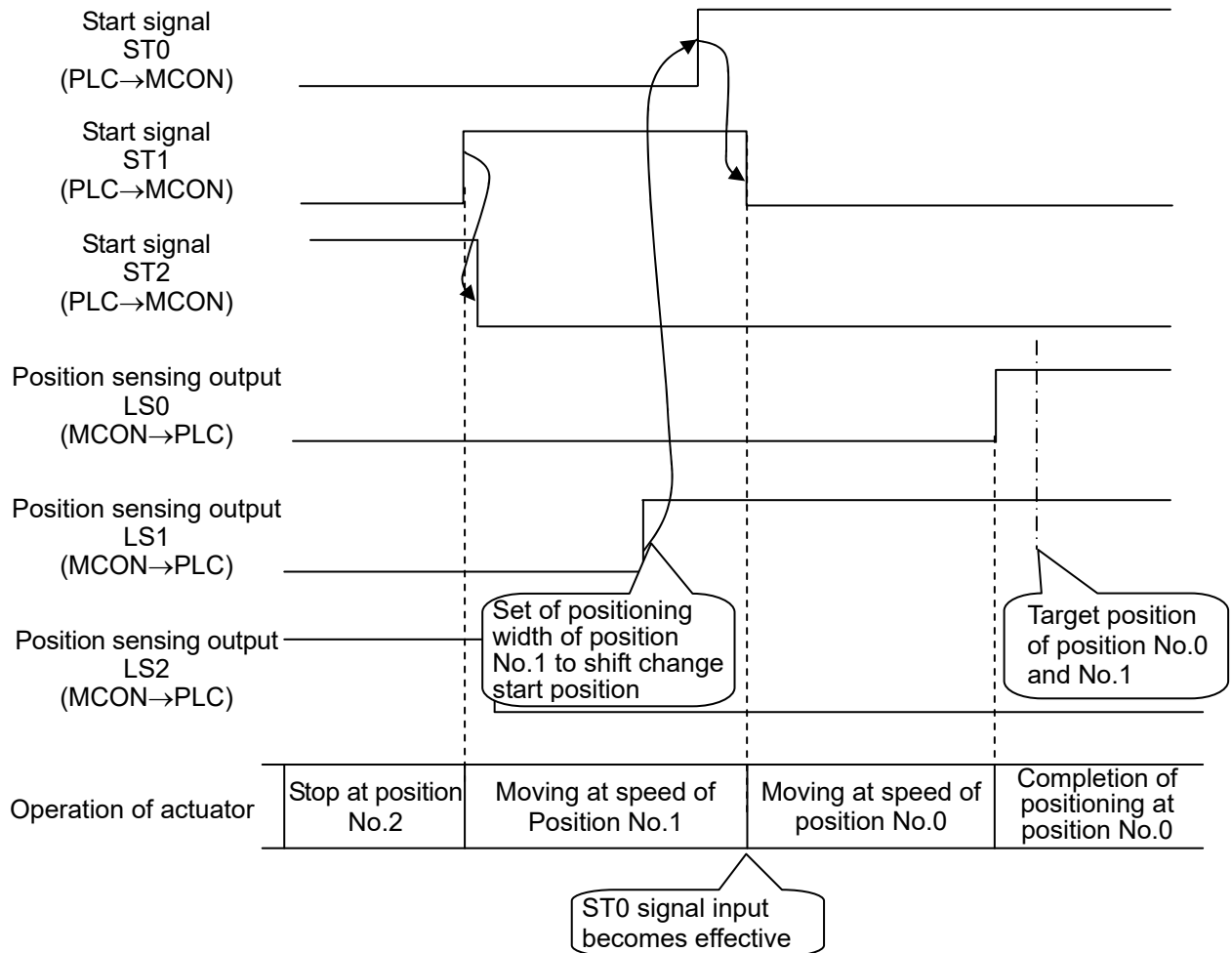

[5] Pause and Operation Interruption (ST*, *STP, RES, PE*, PEND)

Turning start signal ST* OFF allows the actuator to be paused while it is moved. To restart it, turn the same ST* signal ON.

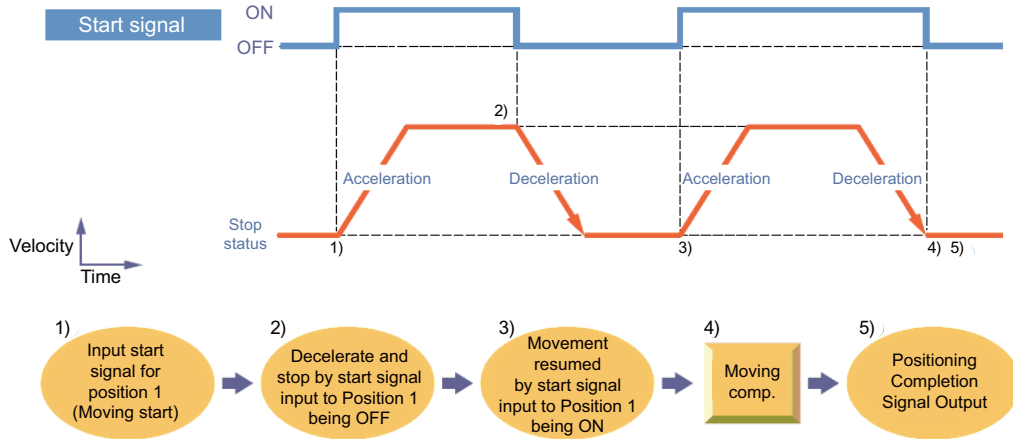

■ Control method

If start signal ST* is turned OFF during movement, the actuator can be paused.

Use the control method for interlock in case where an object is invaded into the moving direction of the actuator being moved.

- 1) If the ST* signal is turned OFF during movement, the actuator is decelerated to a stop. The deceleration is the value set in the position table.
- 2) If the ST* signal is turned ON again, the remaining movement is continued. The acceleration is the value set in the position table.

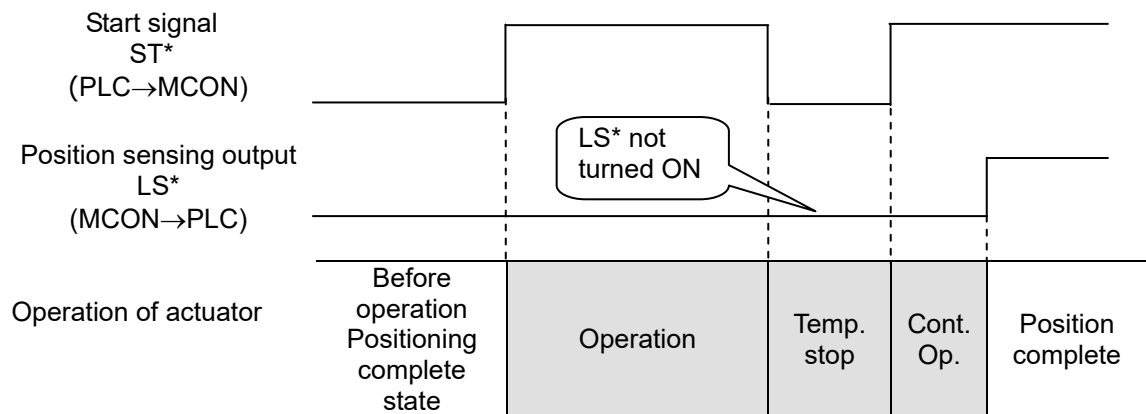

3.9 About Gateway Parameter Setting Tool

This tool is necessary for the process such as MCON operation mode select.

Shown below is how to use the tool.

(Note) The design of the screen may differ depending on the operation system of your PC.

3.9.1 Startup of Tool

- 1) Boot the Gateway Parameter Setting Tool after the power to MCON is turned ON, and the window shown below appears.
Select "MCON" and click on the "OK" button.

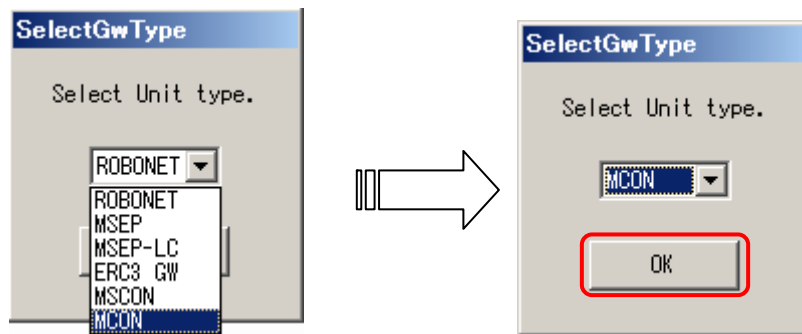

- 2) Once MCON is detected the detected unit numbers become available to select. Select the unit number to be connected and click the "OK" button.

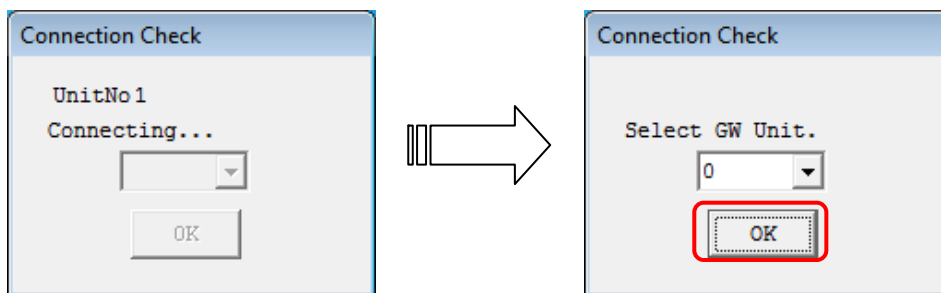

MCON being detected

Select the unit number to be connected

- 3) The main window opens. The main window opens even when MCON could not be detected. Click on the “Read” button in this window and the parameters start to be read from MCON. Parameter transfer starts if the “Write” button is clicked. However, note that the transfer cannot be made if there is a blank like Address and Communication Speed in the figure below.

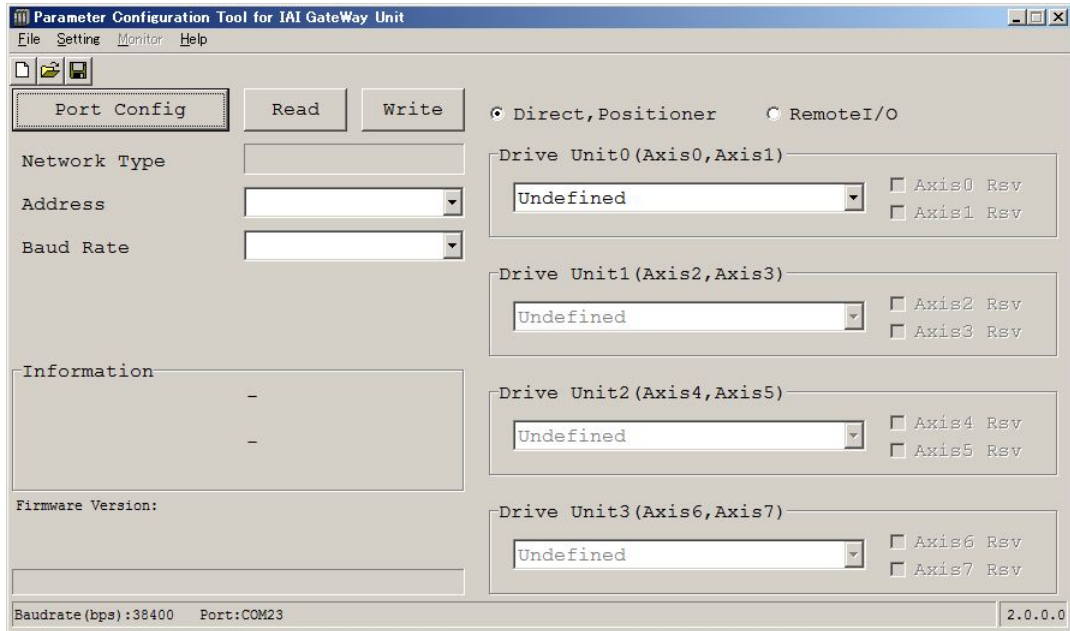

Main windows (Initial condition)

3.9.2 Explanation of each Menu

(Note) If MCOM is not detected, there will be some items that cannot be displayed or selected.

1) File Menu

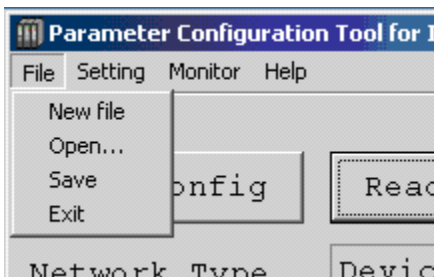

In the main window, click on the file menu on the top left corner and the menu list pops up as shown in the figure above.

- New file : Create new network parameters and operation mode parameters.
- Open : Open the saved parameter files to show on the main window.
- Save : Save the parameter remained in the tool as a file.
- Exit : Close the tool.

2) Setting Menu

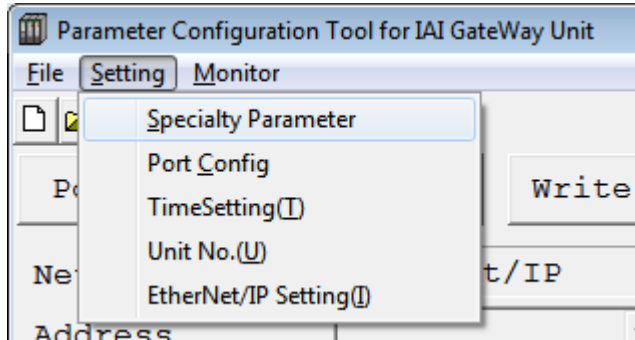

Click on the “Setting” menu on the top left corner in the main window and the setting menu list pops up.

- Specialty Parameter : Set the parameters related to the process of Gateway area in MCON.
[Refer to 3.9.3 1) to 3) GW Parameter 1/2/3, 4) GW Mode Select.]
- Port Config : Set the communication speed between the tool and PC and COM port number.
- Time Setting (T) : Set the clock retained in MCON.
[Refer to 3.9.3 5) Clock Setting.]
- Unit No. (U) : Set the unit number setting of MCON and top axis number in that unit.
[Refer to 3.9.3 6) Unit Number.]
- EtherNet/IP Setting (I) : For EtherNet/IP type, this menu is displayed.
Set IP address etc.
[Refer to 3.9.3 7) EtherNet/IP Setting]

3) Monitor menu

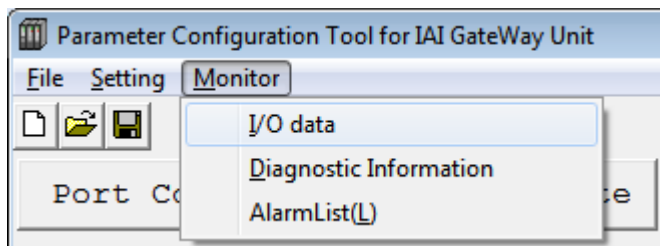

Click on the [Monitor] menu on the top left corner in the main window and the monitor menu list pops up.

(Note) “Monitor” cannot be selected before reading a parameter.

- I/O data : Show the details of the host PLC and MCON data.
[Refer to 3.9.3 8) I/O data.]
- Diagnosis Information : Show the number of ERRT and ERRC occurrence, emergency stops and scan time.
[Refer to 3.9.3 9) Diagnosis information.]
- Alarm List (L) : Read and show the alarm list retained in MCON.
[Refer to 3.9.3 10) Alarm list.]

3.9.3 Description of Functions

1) GW-Param

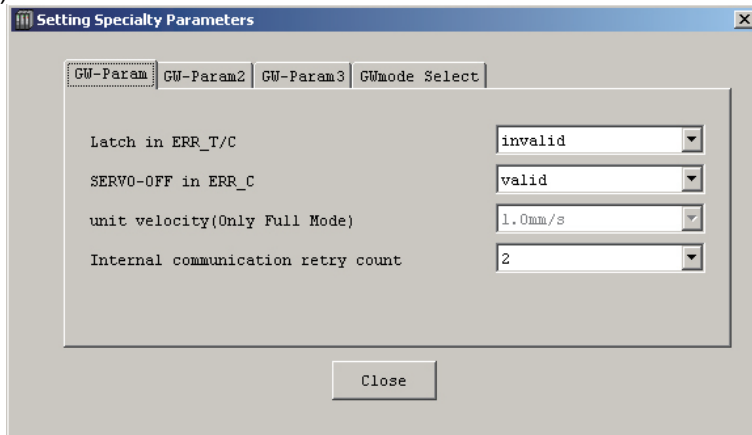

- Latch in ERR_T/C : Select whether to continue the error even in recoverable condition after ERRT and ERRC are issued.
- SERVO-OFF in ERR_C : Select whether to turn the servo OFF on the connected axes when ERRC is occurred.
- unit velocity (Only Direct Indication Mode): Select the unit for speed from 1.0mm/s and 0.1mm/s.
- Internal communication retry count : Set the number of communication retries with the connected axes in AUTO mode.

2) GW-Param 2

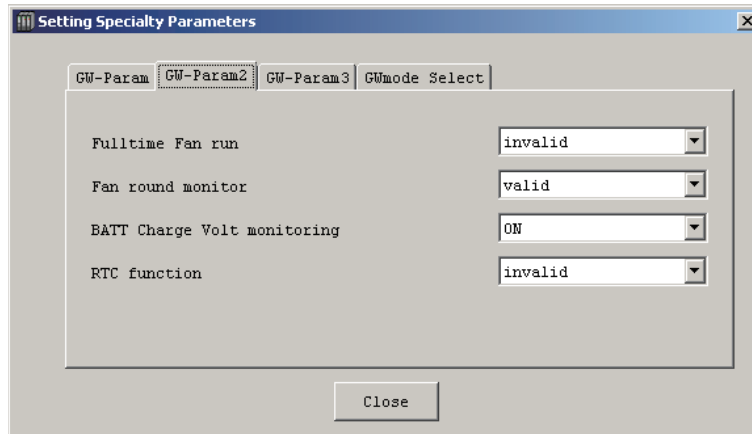

- Fulltime Fan run : Select whether to always drive the fan even in AUTO mode.
- Fan round monitor : Select whether to/not to monitor the fan rotation speed with the monitor function.
- BATT Charge Volt monitoring : Select whether to/not to monitor the absolute battery charge voltage.
- RTC function : Select whether to use the calendar function.

3) GW-Param 3

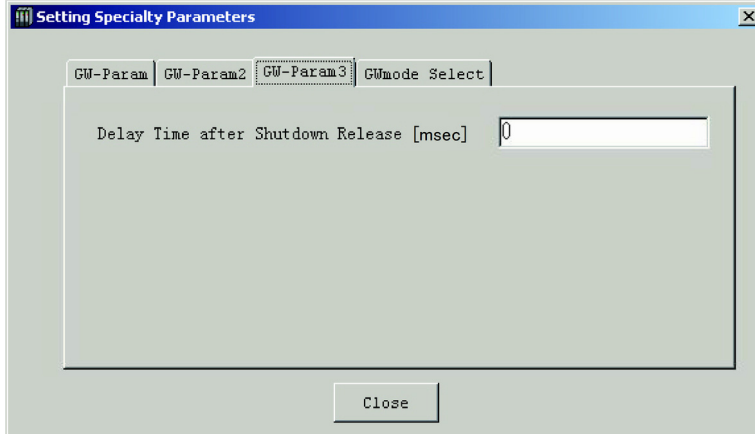

- Driver Time after Shutdown Release : Set the latency (interval) for when supplying the power to the driver boards on Slot 0 to 3 in turns. It is used in purpose to reduce the in-rush current by making the timing different for power supply to the driver boards when two or more driver boards are mounted. Do not attempt to turn on and off the MP individually by using the drive cutoff connectors when this time is to be set as it can be a cause of alarm generation.

4) GW mode Select

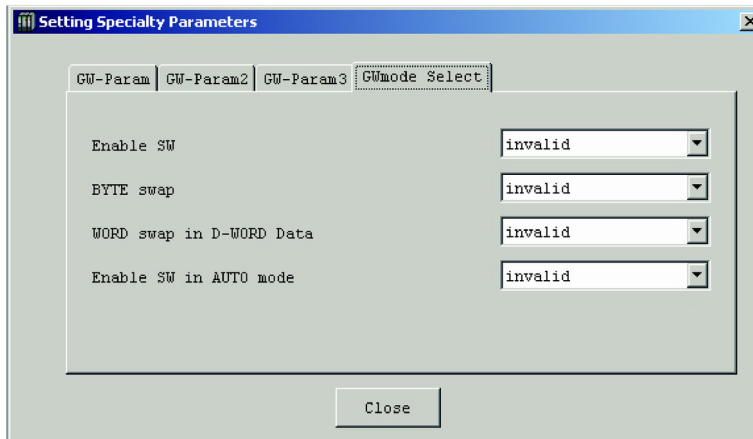

- Enable SW : Select whether to activate/inactivate the enable switch in TP.
- BYTE swap : Set the byte swap. [Refer to 4)-1 in this section.]
- WORD swap in D-WORD Data : Set whether to swap the W-word sized data with word size. [Refer to 4)-2 in this section.]
- Enable SW in AUTO mode : Select whether to activate/inactivate the enable switch in AUTO mode.

4)-1 BYTE swap: Swap the upper and lower in the sent and received data in byte unit. Set this considering the connected host system if necessary.

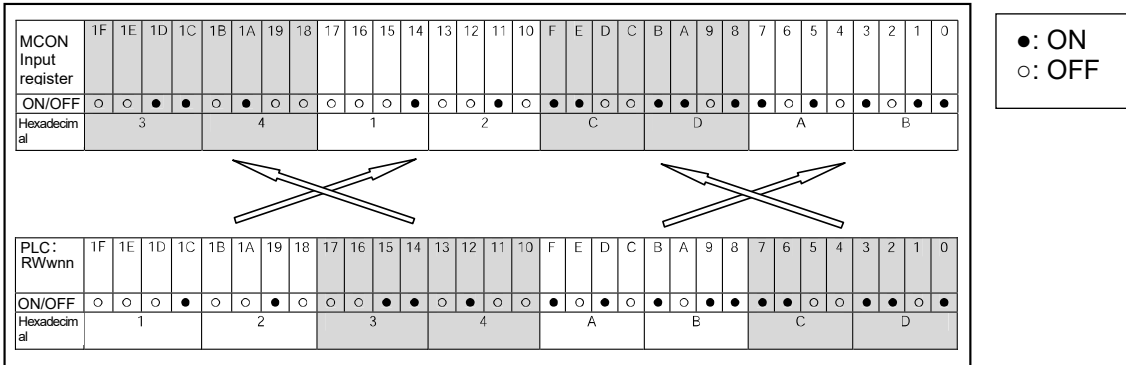

●: ON
○: OFF

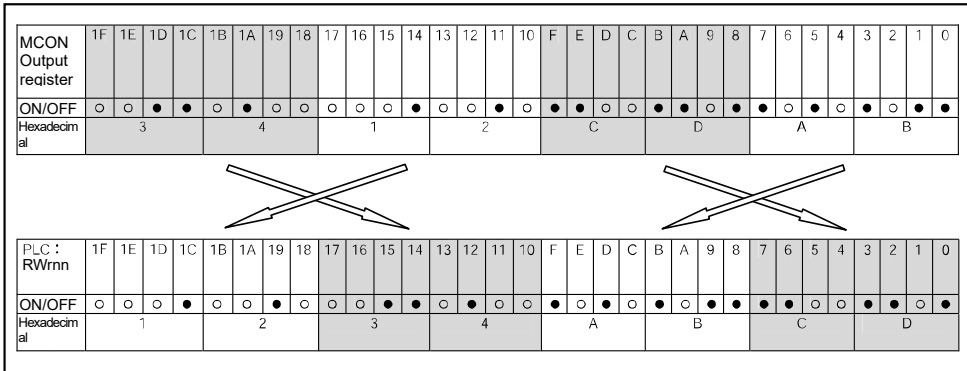

4)-2 WORD Swap in D-WORD Data: Swap the upper and lower in the W-word sized sent and received data in word unit.
Set this considering the connected host system if necessary.

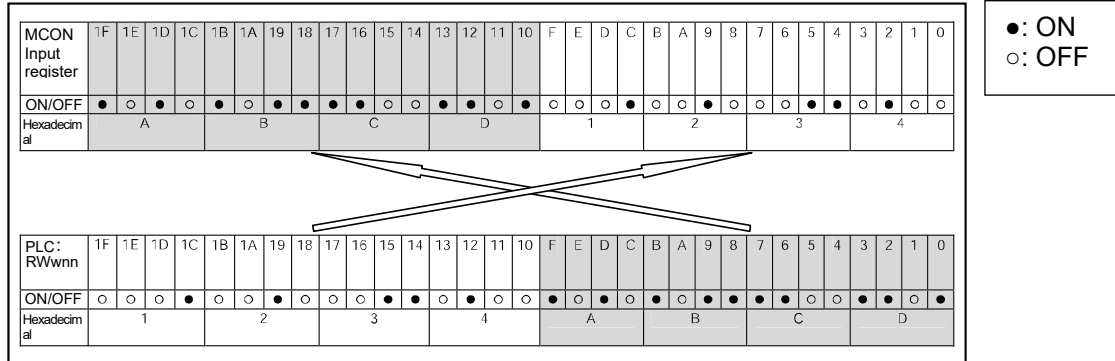

●: ON
○: OFF

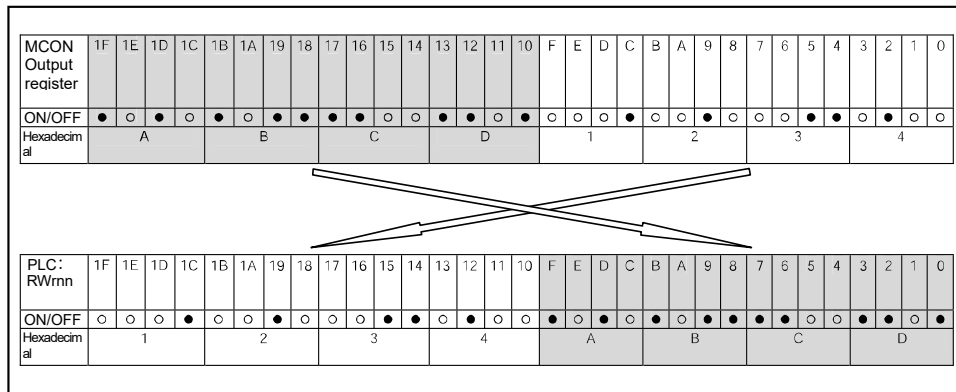

5) Time Setting

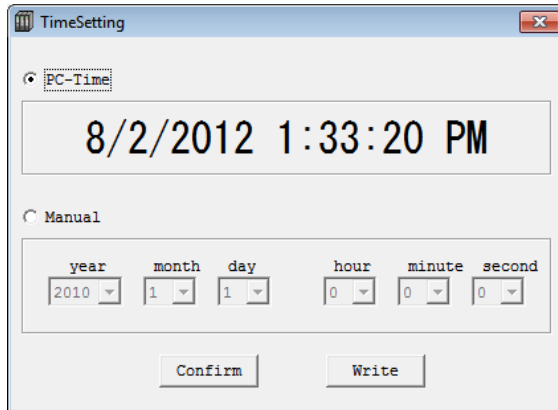

By selecting Time on PC, the current time on the PC is acquired and set to MCON. If Set Manually is selected, desired time set in the clock edit in the window can be set in MCON. Click "Write", and the time setting is transferred to MCON and the data is written in. Clicking on the Confirm button and the clock data currently retained in MCON can be read and displayed.

Caution: The clock (calendar) function in MCON can be retained for approximately 10 days (reference) after the power to MCON is turned OFF. Once the clock data is lost, the time passed since the power is turned back on as 2000/1/1 0:00:00 is displayed as the current time.

6) Unit No. Setting

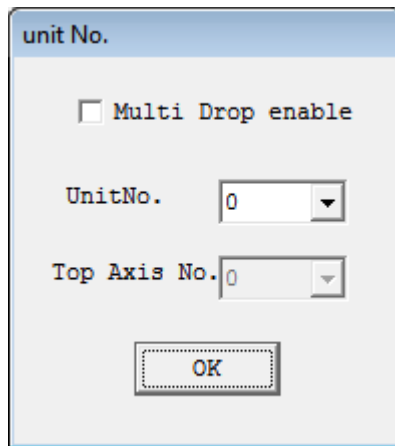

This setting is to be conducted when 2 units of MCON are to be connected to the PC software at the same time.

(It is not necessary to have this setting done for 1 unit of MCON.)

- Multi Drop enable : Tick in the box if the setting in this window is to be activated.
- Unit No. : Set the unit number of MCON.
- Top Axis No. : Set the top axis number of MCON composition axes.

7) EtherNet/IP Setting (Setting to be established for EtherNet/IP type)

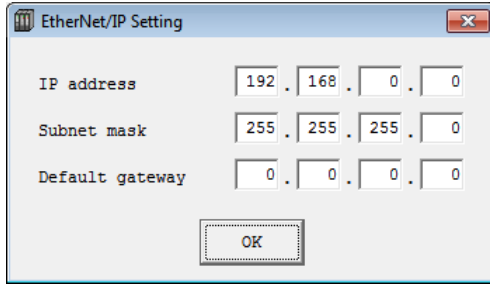

- IP address : Set IP address for MCON.
- Subnet mask : Set subnet mask.
- Default gateway : Set default gateway.

8) I/O Data (Register Monitor)

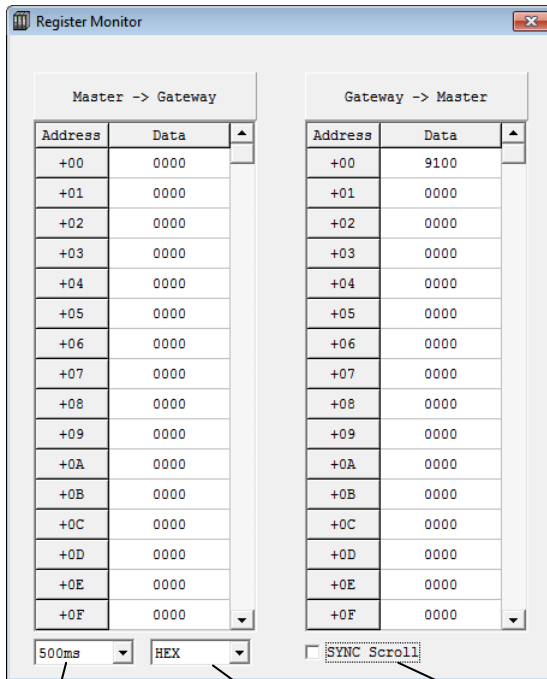

Data Reading Frequency Display Switchover SYNC Scroll

In this register monitor window, shows the data that Gateway Unit has received from the host (master) and the data sent back to the host (master).

- Data Reading Frequency : Select the frequency of displayed data update from 100 to 500ms.
- Display Switchover : Select from binary and hexadecimal for the display.
- SYNC Scroll : Tick in the box to make the list of the sent and received data scrolled together.

9) Diagnosis Information

Diagnostic Information		
scan time[msec]	0	
ERR_T counter	0	Clear
ERR_C counter	0	Clear
EMG counter	1	Clear

The number of the communication error (ERRC and ERRT) occurrence and number of the emergency stop (EMG) detection can be counted.

10) Alarm List

Record	Code	Content	Detail	Address	OccTime
0	843	ABS charge circuit err.	----	----	2015/08/04 22:08:39
1	86A	DB Parameter type mismatch.	0008	----	2015/08/04 22:08:39
2	843	ABS charge circuit err.	----	----	2015/08/04 22:08:39
3	FFF	Power up (not error)	----	----	2015/08/04 22:08:36
4	----	----	----	----	----
5	----	----	----	----	----
6	----	----	----	----	----
7	----	----	----	----	----
8	----	----	----	----	----
9	----	----	----	----	----
10	----	----	----	----	----
11	----	----	----	----	----
12	----	----	----	----	----
13	----	----	----	----	----
14	----	----	----	----	----
15	----	----	----	----	----

Click on the "Update" button and the alarm list is read again from MCON.
 Click on the "Clear" button and the alarm list retained in MCON are all deleted.
 Press "Save" button and the alarm list retained in MCON will be saved in CSV format.

Refer to Chapter 9 Troubleshooting for the details of the alarms.

3.9.4 Operation Mode Setting

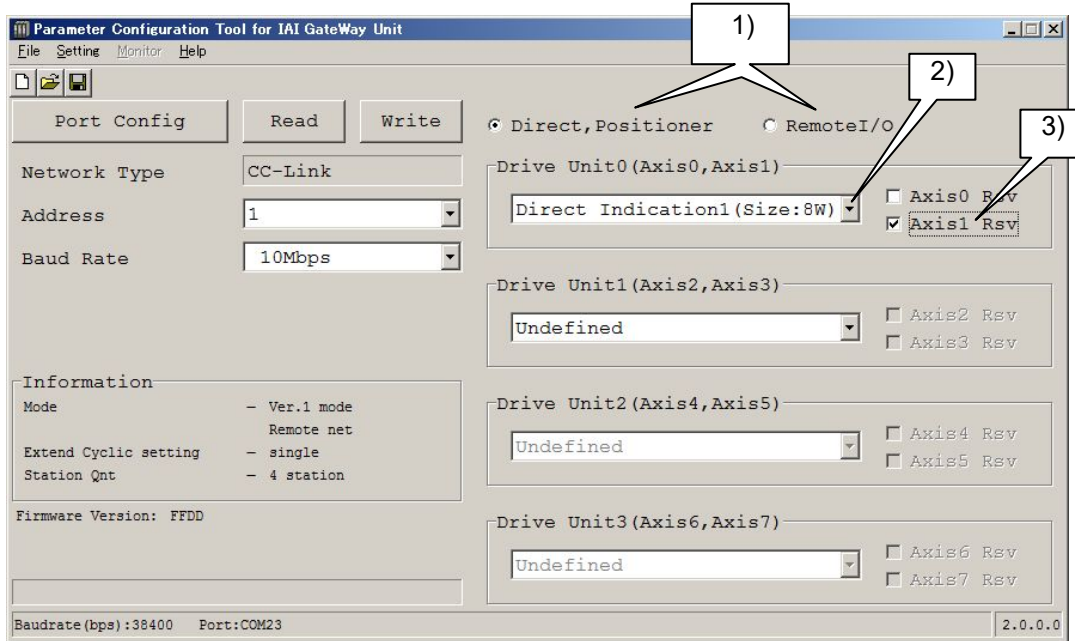

Operation mode setting is to be conducted in the following procedures.

- 1) Select ^(Note1) which mode you will use from Direct, Positioner Mode (those other than Remote I/O Mode) and Remote I/O Mode.
- 2) Select ^(Note2) an operation mode for Drive Unit 0 (AX0: 1st axis, AX1: 2nd axis).
- 3) If making one of the axes for Drive Unit 0 the reserved axis (unused axis), tick on "Axis 0 Rsv" or "Axis 1 Rsv" ^(Note3) beside the operation mode setting box.
- 4) Once the operation mode for Drive Unit 0 is selected, selection of an operation mode for Drive Unit 1 (AX2: 3rd axis, AX3: 4th axis) becomes available. Select a desired operation mode. Also, if there is a reserved axis, tick on "Axis 2 Rsv" or "Axis 3 Rsv" beside the operation mode setting box.
- 5) Once the operation mode for Drive Unit 1 is selected, selection of an operation mode for Drive Unit 2 (AX4: 5th axis, AX5: 6th axis) becomes available. Select a desired operation mode. Also, if there is a reserved axis, tick on "Axis 4 Rsv" or "Axis 5 Rsv" beside the operation mode setting box.
- 6) Once the operation mode of Drive Unit 2 is selected, selection of an operation mode for Drive Unit 3 (AX6: 7th axis, AX7: 8th axis) becomes available. Select a desired operation mode. Also, if there is a reserved axis, tick on "Axis 6 Rsv" or "Axis 7 Rsv" beside the operation mode setting box.

Note 1 Remote I/O Mode and other modes cannot be set at the same time. When Remote I/O Mode is selected, the operation mode for all the actuator will become Remote I/O Mode.

Note 2 For MCON, setting of drive units in individual is the basic concept.

Note 3 If set as the reserved axis, but an actuator not to be connected, set as the invalid axis in Parameter No.158 Effective/Invalid Axis Setting.

Even when the number of the used axes is an odd number, have one more axis at the end input as a reserved axis to make an even number. It is necessary to secure as much area as when not set as reserved even if set as the reserved axis.

3.10 Fieldbus Status LEDs

The communication status of the fieldbus can be checked.

3.10.1 DeviceNet

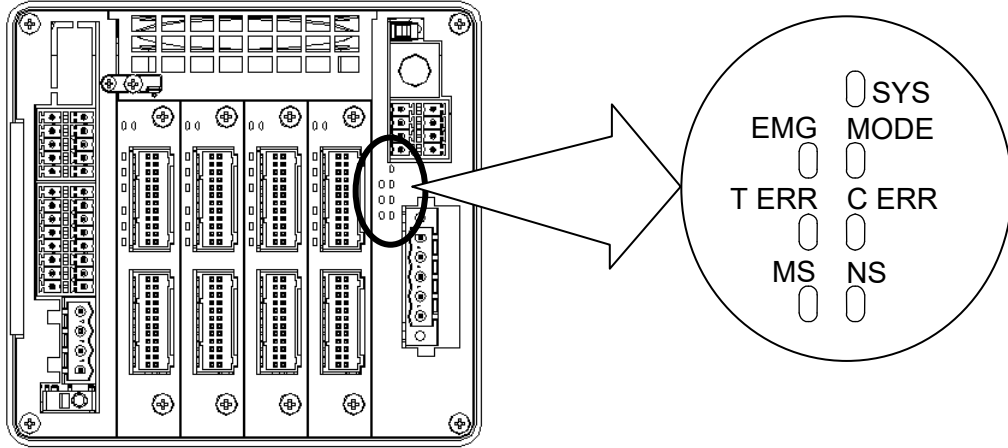

○: Illuminating, ×: OFF, ☆: Flashing

Symbol	Lamp Condition	Color	Description	
SYS (System status)	●	Green	Ready	
	●	Orange	Alarm generated	
	×	—	Power is OFF or in initializing	
EMG (Emergency stop status)	●	Red	Emergency stop	
	×	—	Normal	
MODE (AUTO/MANU status)	●	Green	AUTO Mode	
	×	—	MANU Mode	
T ERR (Controller internal communication status)	●	Orange	Controller internal communication error	
	×	—	Normal	
C ERR (Fieldbus communication status)	●	Orange	Fieldbus communication error	
	×	—	Normal	
Fieldbus status	NS	●	Green	Online (Normal)
		☆	Green	Online (Even though the network is established normally, the master does not identify as MCON)
		●	Orange	An error occurs.
		☆	Orange	No response returned from another slave device
		☆ ☆	Green/Orange (Blink by turn)	In self-checking process.
	MS	●	Green	Communication in normal condition
		☆	Green	Parameter setting error
		●	Orange	It is caused by the hardware breakdown.
		☆	Orange	Light malfunction
		☆ ☆	Green/Orange (Blink by turn)	In self-checking process.

3.10.2 CC-Link

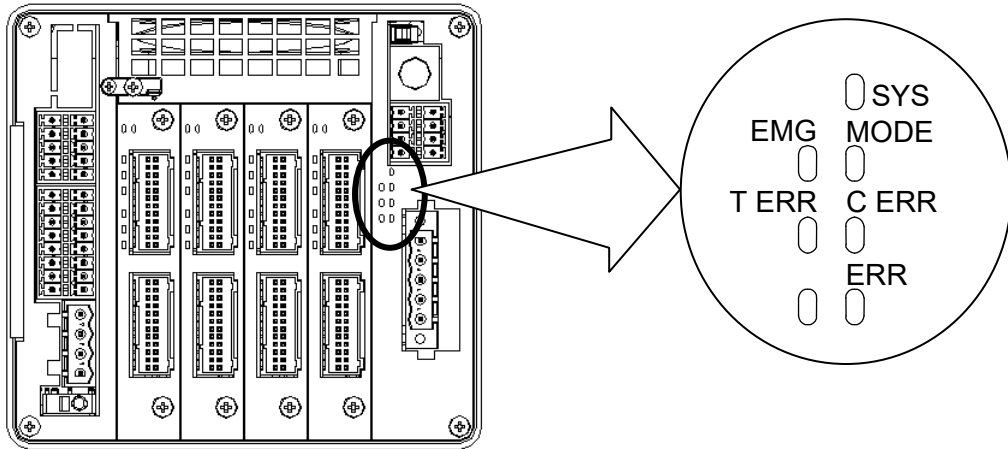

○: Illuminating, ×: OFF, ☆: Flashing

Symbol	Lamp Condition	Color	Description
SYS (System status)	●	Green	Ready
	●	Orange	Alarm generated
	×	—	Power is OFF or in initializing
EMG (Emergency stop status)	●	Red	Emergency stop
	×	—	Normal
MODE (AUTO/MANU status)	●	Green	AUTO Mode
	×	—	MANU Mode
T ERR (Controller internal communication status)	●	Orange	Controller internal communication error
	×	—	Normal
C ERR (Fieldbus communication status)	●	Orange	Fieldbus communication error
	×	—	Normal
Fieldbus status	ERR	●	An error occurs. (CRC error, station No. setting error or baud rate setting error)
		☆	Station number or baud rate changed after the power-on
		×	Normal
	RUN	●	Green

3.10.3 PROFIBUS-DP

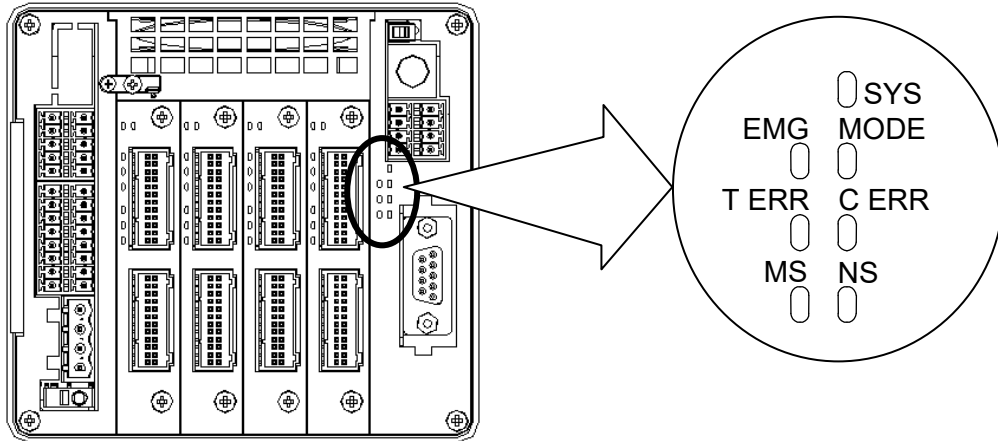

○: Illuminating, ×: OFF, ☆: Flashing

Symbol	Lamp Condition	Color	Description
SYS (System status)	●	Green	Ready
	●	Orange	Alarm generated
	×	—	Power is OFF or in initializing
EMG (Emergency stop status)	●	Red	Emergency stop
	×	—	Normal
MODE (AUTO/MANU status)	●	Green	AUTO Mode
	×	—	MANU Mode
T ERR (Controller internal communication status)	●	Orange	Controller internal communication error
	×	—	Normal
C ERR (Fieldbus communication status)	●	Orange	Fieldbus communication error
	×	—	Normal
Fieldbus status	NS	●	Online (Normal)
		☆	Online (Even though the network is established normally, the master does not identify as MCON)
		●	An error occurs. (Parameter error or initializing error)
	MS	●	Initializing is completed.
		☆	Initializing completed and in self-checking process
		●	An error occurs. (Exceptional error)

3.10.4 CompoNet

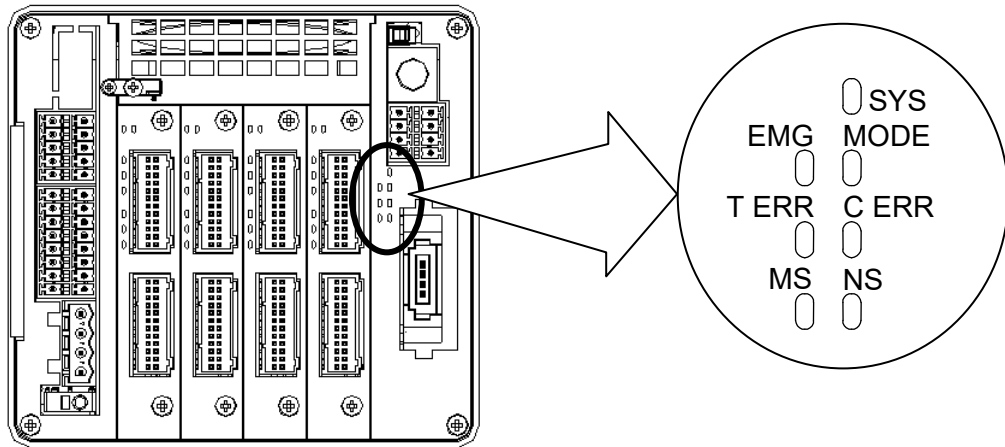

○: Illuminating, ×: OFF, ☆: Flashing

Symbol	Lamp Condition	Color	Description	
SYS (System status)	●	Green	Ready	
	●	Orange	Alarm generated	
	×	—	Power is OFF or in initializing	
EMG (Emergency stop status)	●	Red	Emergency stop	
	×	—	Normal	
MODE (AUTO/MANU status)	●	Green	AUTO Mode	
	×	—	MANU Mode	
T ERR (Controller internal communication status)	●	Orange	Controller internal communication error	
	×	—	Normal	
C ERR (Fieldbus communication status)	●	Orange	Fieldbus communication error	
	×	—	Normal	
Fieldbus status	NS	●	Green	Online (Normal)
		☆	Green	Online (Even though the network is established normally, awaiting for being identified as MCON by master)
		●	Orange	Node address duplication error, slave address wrongly established
		☆	Orange	No response returned from another slave device
		×	—	Power is OFF, under reset operation, under initializing process
	MS	●	Green	Communication in normal condition
		●	Orange	Malfunction of hardware
		☆	Orange	EEPROM reading failed in initializing process
	×	—	Power is not ON, under reset operation	

3.10.5 EtherNet/IP

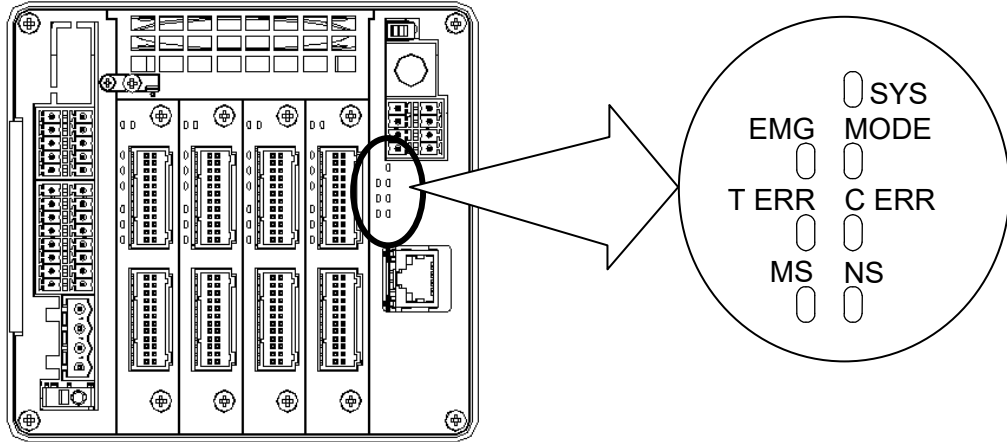

○: Illuminating, ×: OFF, ☆: Flashing

Symbol	Lamp Condition	Color	Description
SYS (System status)	●	Green	Ready
	●	Orange	Alarm generated
	×	–	Power is OFF or in initializing
EMG (Emergency stop status)	●	Red	Emergency stop
	×	–	Normal
MODE (AUTO/MANU status)	●	Green	AUTO Mode
	×	–	MANU Mode
T ERR (Controller internal communication status)	●	Orange	Controller internal communication error
	×	–	Normal
C ERR (Fieldbus communication status)	●	Orange	Fieldbus communication error
	×	–	Normal
Fieldbus status	NS	●	Online (Communication in normal condition)
		☆	Online (Even though the network is established normally, the master does not identify as MCON)
		●	Communication error (such as IP address duplication)
		☆	Communication error (Communication timeout has been detected)
		×	Power is OFF or IP address not established
	MS	●	Communication in normal condition
		☆	Construction information setting is incomplete, or scanner (master) is in idling condition
		●	Malfunction of hardware (board replacement required)
		☆	Initializing error, light error such as setting violation, recoverable with rebooting
		×	Power is OFF

3.10.6 EtherCAT

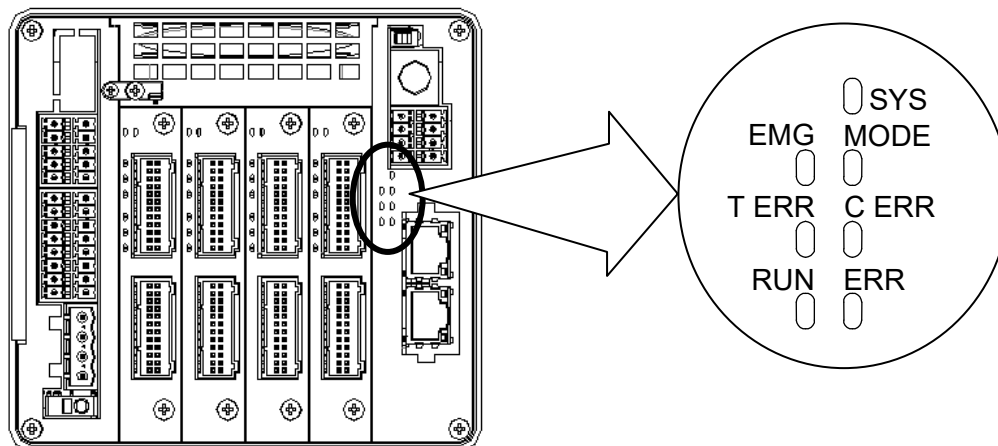

○: Illuminating, ×: OFF, ☆: Flashing

Symbol	Lamp Condition	Color	Description	
SYS (System status)	●	Green	Ready	
	●	Orange	Alarm generated	
	×	—	Power is OFF or in initializing	
EMG (Emergency stop status)	●	Red	Emergency stop	
	×	—	Normal	
MODE (AUTO/MANU status)	●	Green	AUTO Mode	
	×	—	MANU Mode	
T ERR (Controller internal communication status)	●	Orange	Controller internal communication error	
	×	—	Normal	
C ERR (Fieldbus communication status)	●	Orange	Fieldbus communication error	
	×	—	Normal	
Fieldbus status	ERR	●	Orange	Communication component (module) error
		☆	Orange ^(Note 1)	Construction information (settings) error (Information received from the master cannot be set)
		☆	Orange ^(Note 3)	Communication section circuit error (Watchdog timer timeout)
		×	—	No abnormality or the power is OFF
	RUN	●	Green	Normal communication (OPERATION) condition
		☆	Green ^(Note 1)	PRE-OPERATION condition
		☆	Green ^(Note 2)	SAFE-OPERATION condition
		●	Orange	Communication component (module) error
	×	—	Initializing (INIT) condition or Power is OFF	

Note 1 ON: 200ms, OFF: 200ms

Note 2 ON: 200ms, OFF: 1000ms

Note 3 ON: 200ms, OFF: 200ms, ON: 200ms, OFF: 1000ms

• Timing of LED flashing

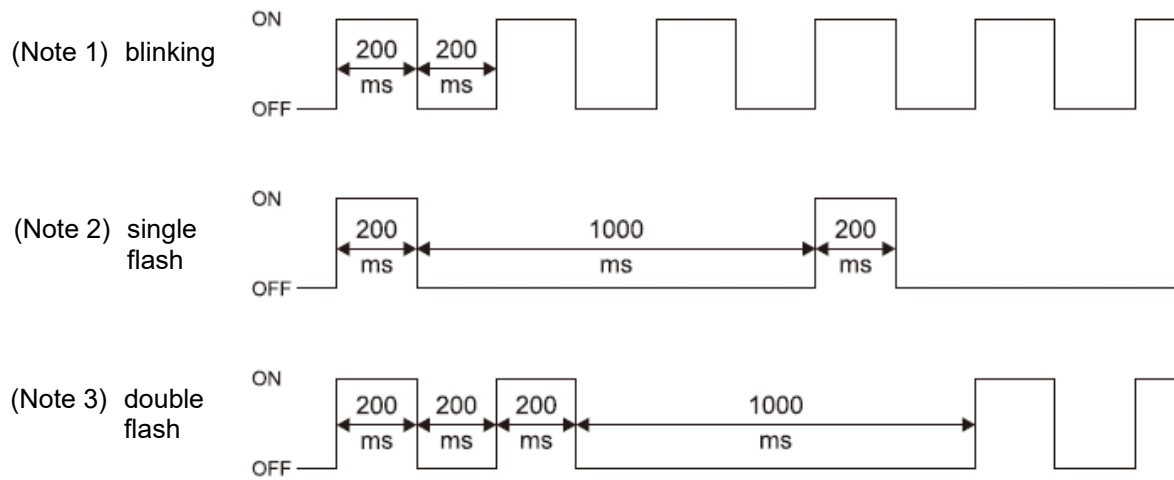

3.10.7 PROFINET-IO

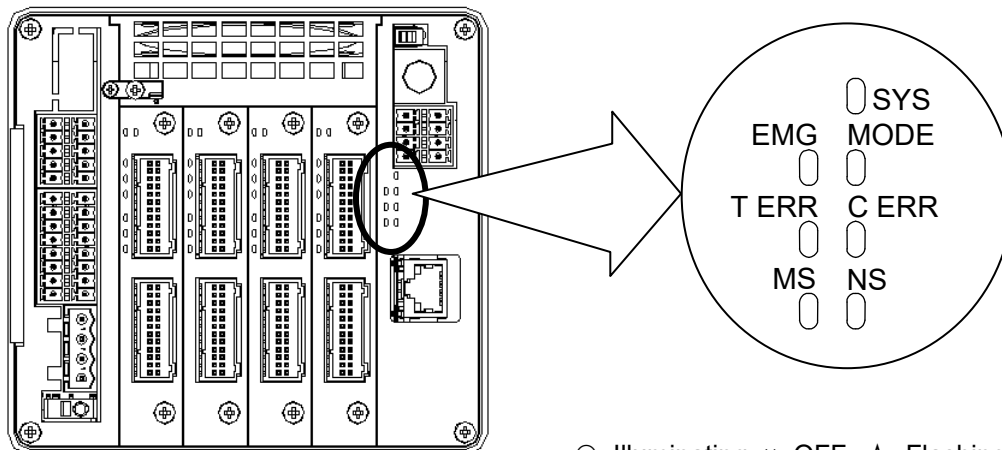

○: Illuminating, ×: OFF, ☆: Flashing

Symbol	Lamp Condition	Color	Description	
SYS (System status)	●	Green	Ready	
	●	Orange	Alarm generated	
	×	—	Power is OFF or in initializing	
EMG (Emergency stop status)	●	Red	Emergency stop	
	×	—	Normal	
MODE (AUTO/MANU status)	●	Green	AUTO Mode	
	×	—	MANU Mode	
T ERR (Controller internal communication status)	●	Orange	Controller internal communication error	
	×	—	Normal	
C ERR (Fieldbus communication status)	●	Orange	Fieldbus communication error	
	×	—	Normal	
Fieldbus status	NS	●	Online (Communication in normal condition : RUN status)	
		☆	Online (Not identified by master : STOP status)	
		×	The power is OFF or there is no connectable MCON.	
	MS ^(Note 1)	●	Green	In the normal operation
		☆1	Green	Network under diagnosis
		☆2	Green	Engineering tool identifying nodes
		●	Red	Exception error generated (Hardware malfunction)
		☆1	Red	Settings and actual network construction do not match
		☆2	Red	IP address not established
		☆3	Red	Station name not established
		☆4	Red	Internal error occurred
×	—	Power is OFF or in initialization		

Note 1 The continues to flash for number of times stated beside the star mark (☆) in every 0.25sec.

3.10.8 SSCENT III/H

Refer to status LED of SSCNET III/H, SSCNET III/H Applicable Controller Instruction Manual (ME0352).

3.10.9 MECHATROLINK-III

Refer to status LED of MECHATROLINK-III, MECHATROLINK-III Applicable Controller Instruction Manual (ME0317).

Chapter 4 Vibration Suppress Control Function

The vibration suppress control function suppresses vibrations of loads induced by our actuators.

The function can suppress vibrations in the same direction as the movement of the actuator in the frequency range from 0.5Hz to 30Hz.

Measure the frequency of the generated vibration and set it to the parameter. Three frequencies can be defined as parameters. Specify the parameters in the position table to reflect them on suppression of vibrations generated by the operation. For a single moving command (position data), only a single parameter can be set.

(Note) This feature is limited only to the servo motor type actuators.

Cannot be used in direct indication mode

Before this function can be used, you must read the cautions described on the next page.

[Functional Operation Image]

The figure below shows an example in which two actuators are subject to 2-axis combination. Actuator A is moved to cause actuator B corresponding to a joint to be vibrated. Measure the vibrations of B in the direction in which A is moved and make proper vibration suppress control in the direction to suppress the vibrations of B. Vibrations of Actuator B caused by the movement of B cannot be suppressed by Actuator A.

★No setting of vibration suppress control

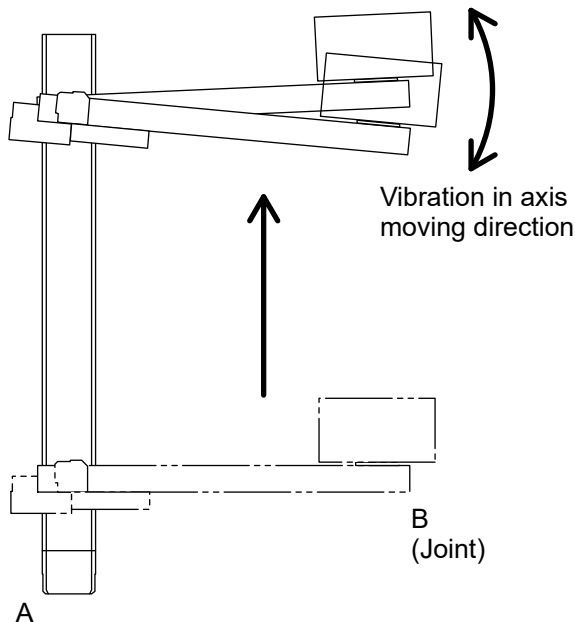

☆Setting of vibration suppress control

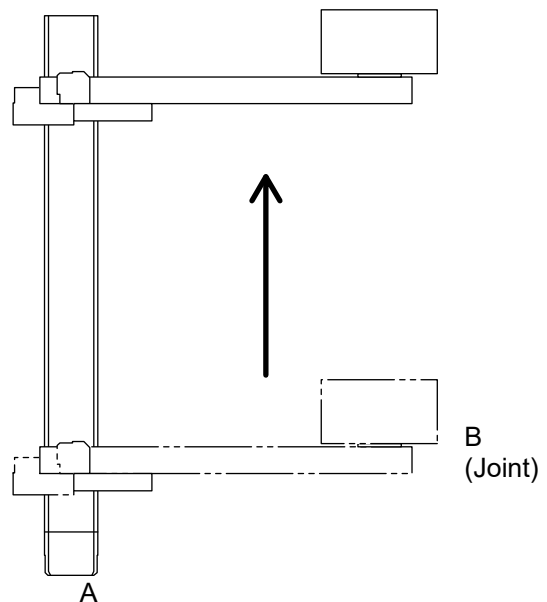

⚠ Caution:

• Use of Frequency Analysis Tool for Anti-Vibration Control

If using the frequency analysis tool for anti-vibration control installed in the PC software, it is necessary to get the key file (Fam.dll), copy and store it in the same folder as the executable file (RcPc.exe) of the PC software.

Please contact IAI for the key file.

Refer to "Chapter 14 Frequency Analysis Feature for Anti-Vibration Control" in the RC PC Software Instruction Manual for how to operate.

• Vibrations subject to vibration suppress control

It is the vibration of the load generated by IAI actuator, and is in the same directions as the actuator movement.

• Vibrations not subject to vibration suppress control

- 1) Vibration whose source is not the operation of the actuator
- 2) Vibration in a direction different from the direction in which the actuator, or the vibration source, is moved.
- 3) Vibration of vibrating object itself (This function moves objects easily vibrated without vibrations and cannot suppress vibrations already generated.)

• Conditions in which vibration suppress effect can hardly be obtained

- 1) When the frequency to control is the same value as the mechanical angle of the motor (motor rotation) or the electrical angle of the motor

Frequency of motor's mechanical angle (motor revolution):

operation speed [mm/s]/lead length [mm]

Frequency of motor's electric angle:

4 times of frequency of mechanical angle for servo motor installation axis

Example 1: Servo motor installation axis

For lead length 20mm and operation speed 100mm/s:

Frequency of mechanical angle (motor revolution) : 5Hz

Frequency of electric angle (four times of frequency of mechanical angle) : 20Hz

- 2) When a higher speed response is required for the vibration control than the set speed control response, the speed response is not able to catch up with the vibration control.

- 3) In case of a system shown in the figure on the right, the vibration cannot be controlled directly by the actuator, thus the effect may be only small or even nothing.

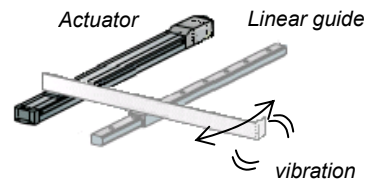

• Vibration suppress control unavailable in home return and pressing operations

Home return and pressing operations cannot suppress vibrations. Operating the vibration suppress control function in pressing causes 0A2 "position data error" to occur.

• Prohibition of simultaneous use of vibration suppress control with feed forward gain

The vibration suppress control function cannot be used with feed forward gain simultaneously.

• Prohibition of switch to use vibration suppress control during moving operation.

Switching between vibration suppress control and normal positioning is disabled during movement of the actuator. Any switching command causes 0C5 "Illegal control system transition command error" to occur.

• Response of vibration suppress control

Vibration suppress control has time lag from speed command in the operation plan. This makes cycle time longer.

Lower the setting frequency is, longer the time lag is.

• Consideration of servo gain

If the servo gain setting is not conducted properly, the effect of the anti-vibration control may get dropped. First adjust the servo gain prior to setting of vibration suppress control.

4.1 Setting Procedure

To use the vibration suppress control function, make proper measurements and settings depending on the procedure described below.

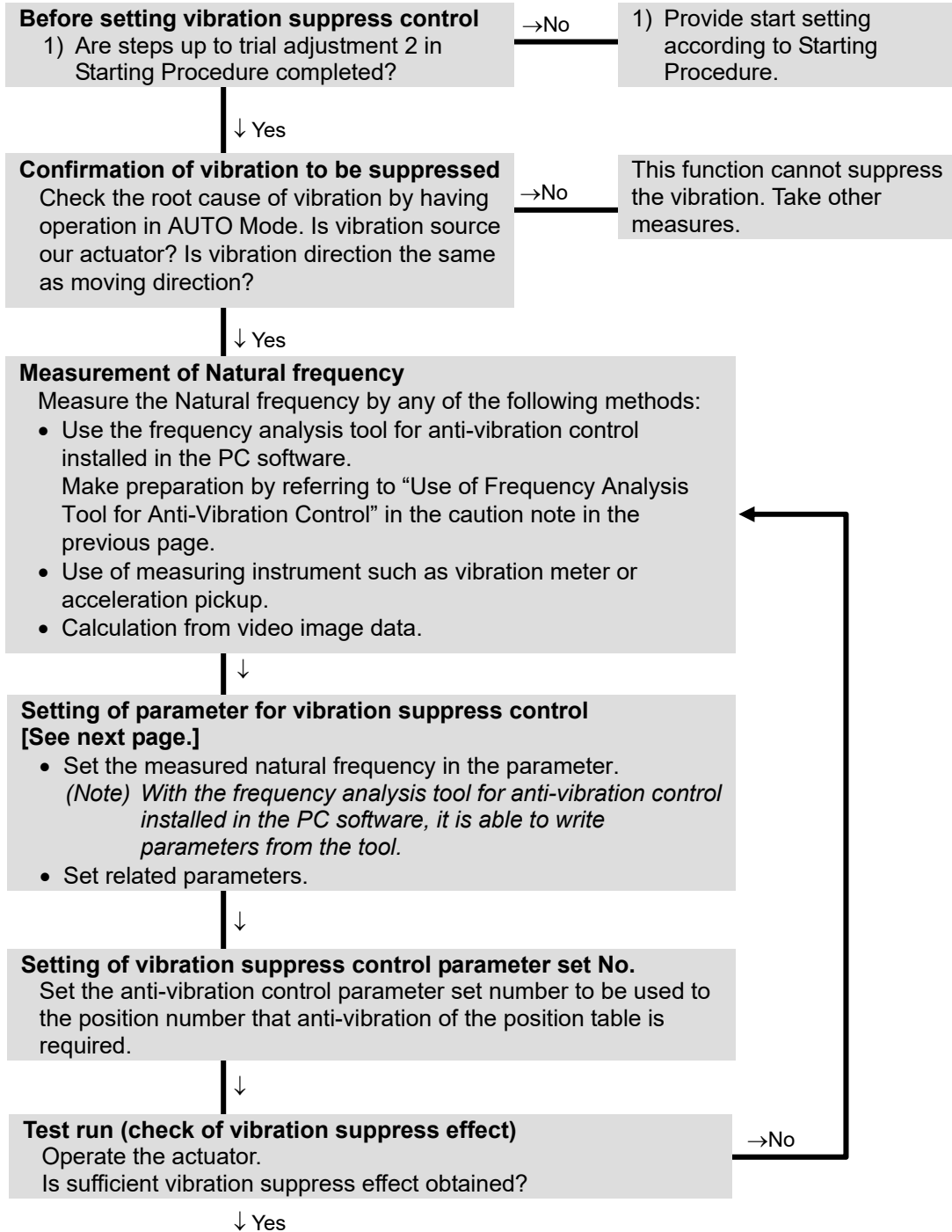

Now the settings are completed.

4.2 Settings of Parameters for Vibration Suppress Control

Set the parameters associated with vibration suppress control, which are listed in the table below.

Parameter No.	Parameter Set No.	Parameter Name	Unit	Default	Input Range
97	1	Damping characteristic coefficient 1	Rate	10	0 to 1000
98		Damping characteristic coefficient 2	Rate	1000	0 to 1000
99		Natural frequency	1/1000Hz	10000	500 to 30000
100		Notch filter gain	Rate	9990	1 to 20000
101	2	Damping characteristic coefficient 1	Rate	10	0 to 1000
102		Damping characteristic coefficient 2	Rate	1000	0 to 1000
103		Natural frequency	1/1000Hz	10000	500 to 30000
104		Notch filter gain	Rate	9990	1 to 20000
105	3	Damping characteristic coefficient 1	Rate	10	0 to 1000
106		Damping characteristic coefficient 2	Rate	1000	0 to 1000
107		Natural frequency	1/1000Hz	10000	500 to 30000
108		Notch filter gain	Rate	9990	1 to 20000
109		Default vibration suppress No.		0	0 to 3
110		Stop method at servo OFF		0	0, 1

[1] Damping characteristic coefficient 1, 2 (Parameter No.97, 98, 101, 102, 105, and 106)
In this section, do not change.

[2] Natural frequency [1/1000Hz] (Parameter No.99, 103 and 107)

Set the natural frequency of the load measured. It can be input directly to the parameter from the frequency analysis tool for anti-vibration control included in the PC software if the tool is already used. [Refer to the Instruction Manual of the RC PC software.]

Set the specific frequency of the loaded object close to the setting so a higher anti-vibration performance can be obtained.

[Reference] Other vibration measuring methods

- Use of measuring instrument such as vibration meter and acceleration pickup
- Calculation from video image data

[3] Notch filter gain (Parameter No.100, 104 and 108)

Set the notch filter gain following the table below in response to the measured specific frequency of the loaded object. See the table below for reference. Provide fine adjustment if overshooting occurs.

If the notch filter gain setting is too high, overshooting would occur during the settling time.

If the notch filter gain setting is too low, undershooting would occur during the settling time.

Measured Natural Frequency [Hz]	Setting Value of Notch Filter Gain
0.5	9900
1	9980
2 to 30	9990

[4] Default vibration suppress No. (Parameter No.109)

When a position is written into a position table not registered yet, the initial value set to this parameter is automatically entered in the "Vibration suppress No." field. To change the setting, edit the position table later.

- 0: Normal positioning control (default)
- 1: Use Anti-Vibration Control Parameter Set 1
- 2: Use Anti-Vibration Control Parameter Set 2
- 3: Use Anti-Vibration Control Parameter Set 3

[5] Stop method at servo OFF (Parameter No.110)

The table below shows the relationship between the values of Parameter No.110 and stop commands.

Stop Command	Stop Method at Servo OFF Setting Value			
	0 : Sudden Stop		1 : Deceleration and stop	
	Vibration suppress control	Normal positioning control	Vibration suppress control	Normal positioning control
Pause	Anti-vibration deceleration stop	Normal deceleration and stop	Anti-vibration deceleration stop	Normal deceleration and stop
Servo OFF	Sudden stop by emergency stop torque			
Emergency Stop				
Error (Operation-cancellation level alarms)				
Error (Cold start)	Sudden stop by emergency stop torque			

4.3 Setting of Position Data

To make the anti-vibration control effective, set the parameter set number to be used in Anti-Vibration Number Column in Position Data.

(Note) The vibration suppress control function cannot be used in pressing operation.

No.	Position [mm]	Velocity [mm/s]	Acceleration [G]	Deceleration [G]	Pressing [%]	Threshold [%]	Positioning width [mm]	Zone+ [mm]	Zone- [mm]	Acceleration/Deceleration mode	Incremental	Gain set	Stop mode	Vibration suppress No.
0														
1	0.00	50.00	0.01	0.01	0	0	0.10	0.00	0.00	0	0	0	0	0
2	50.00	50.00	0.01	0.01	0	0	0.10	0.00	0.00	0	0	0	0	1
3	50.00	50.00	0.01	0.01	50	0	0.10	0.00	0.00	0	0	0	0	3
4														

Set natural frequency 1 (enabled)
 Set natural frequency 3 (Alarm: It cannot be in common with Error. 0A2 Position Data Error Pressing Operation.)

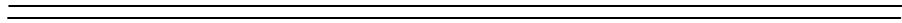

Chapter 5 Collision Detection Feature

This controller is equipped with a feature to stop immediately when the actuator is hit on an object during operation.

Understand this chapter well to avoid any trouble in operation and safety.

Collision detection feature is a feature that stops the operation by generating an alarm and turning OFF the servo when the command current exceeds the set value. The range for detection also can be set.

Warning: This feature is a supportive feature to reduce the damage to a work piece in case of an emergency. It does not mean to compensate in any unexpected damage. The setup of this feature is necessary to be adjusted to an expected collision, and the optimum value differs depending on the system. Well confirm the status before use.

5.1 Collision Detection Judgement

Judgment is made as a collision when the current position is in the range of the position zone, for longer than the time set in the parameter *1 and the current has exceeded the threshold *2, and it turns ON PIO Load output judgment (LOAD) signal and turns the servo OFF after generating the collision detection alarm.

*1 Parameter No.50 Load output judgment time

*2 "Threshold" in the positioner table.

◎Example of judgement (when judgment time is 255ms)

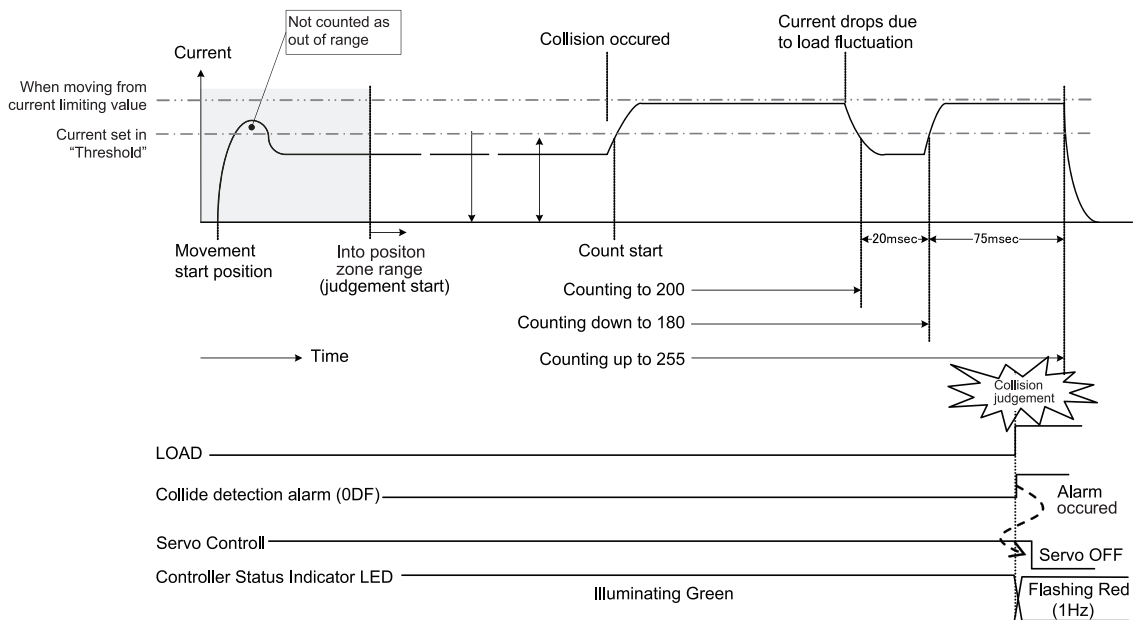

5.2 Settings

Have the following settings established when using following function.

1) Select to use feature

Setting can be established in the parameters. Setting of parameter “No.168 Collision Detection Feature”

Setting value	Operation status	Alarm level
0	Detection not to be conducted (same when set to 2, 4 or 6)	—
1	Detection is conducted in position zone setting range.	Operation cancel level
3 ^(Note1)	Detection is conducted in position zone setting range, but is not conducted in the following conditions. <ul style="list-style-type: none"> • The first movement after releasing from a pause • Movement from a stop in the position zone range 	
5	Detection is conducted in position zone setting range.	Message level
7 ^(Note1)	Detection is conducted in position zone setting range, but is not conducted in the following conditions. <ul style="list-style-type: none"> • The first movement after releasing from a pause • Movement from a stop in the position zone range 	

Note 1 In this setting, it can avoid a mistake to detect the current during acceleration.

2) Setting of Detection Current Value

Setting is made by inputting 0 (0%) to 100 (100%) in “Threshold” cell in the position table. Detection is not conducted if set to 0.

3) Setting of Adjustment time

Setting can be established in the parameters. Setting of parameter “No.50 Load Output Judgment Time”

Position zone : 0 to 9999 [ms] (Initial Value 255ms)

4) Setting of Adjustment Range (position zone)

Set the range in “Zone +” and “Zone -” in the position table. Set a small value in “Zone +” and “Zone -”.

Position zone : 0.00 to Actuator Stroke Length [mm]

5.3 Adjustment

Refer to the following when performing an adjustment.

- 1) Adjustment Range : Avoid the acceleration range, which requires high current", and set the range with possibility that collision can occur.
- 2) Detection Current Value : Considering the movement velocity and weight of a work piece, set a low value in the range that detection mistake would not occur. (Set it slightly higher than the current necessary for constant velocity movement, and tune little by little.)

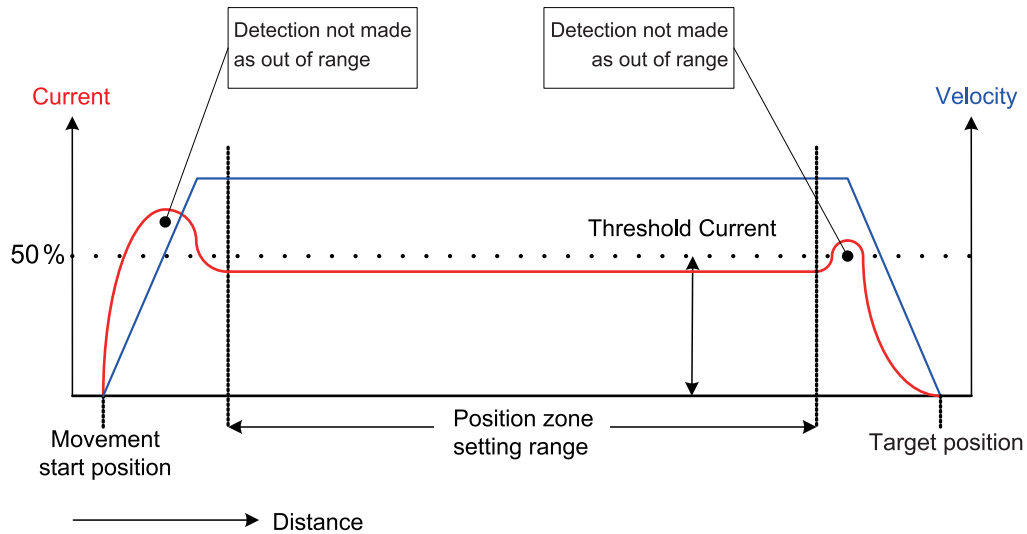

Chapter 6 Power-saving Function (Automatic Servo-off and Full Servo Functions)

This controller possesses Automatic Servo OFF (setting available on all motor types) and Full Servo functions (for pulse motor type only) to reduce the power consumption while the actuator is stopped. Read the description in this chapter carefully to save power so that the controller can be operated safely.

Automatic Servo-off function automatically turns the servo OFF in certain time after positioning process is finished. The next positioning command is issued to turn the servo ON automatically and achieve the positioning. No holding current flows in the stop state to allow the power consumption to be saved.

3 types of patterns can be set for the time since positioning complete until servo turned OFF, and either one can be selected.

In the Full Servo Function ^(Note 1), it is able to reduce the power consumption (Note) by controlling the pulse motor which consumes comparatively high current during a stop.

For the power saving function, which of Parameter No.53 or "Stop Mode" in the position table is to be used is determined by the actuator condition. The details are shown below.

Note 1 Certain amount of stop current is applied to restrain small vibration during a stop to stop completely. Also, return to the target position will not be performed for the misalignment in the range of ± 2 counts from the target position for the encoder value.

(Return operation will be performed even for misalignment of 1 count when the full servo feature is activated.)

Setting	PIO Pattern 0 to 2, 4	PIO Pattern 5
Standby after home return is complete (Positioning to the target point is not done)	Power saving function executed with the values set in Parameter No.53 (Stop Mode of the position number is invalid)	
Standby with the servo turned ON after the power is supplied (Positioning to the target point is not done)		Power saving function executed with the values set in Parameter No.53 (Stop Mode of the position number is invalid)
Standby after the positioning is complete to the target position set in the position table	Power saving function executed with the values set in "Stop Mode" in each position number (Setting of Parameter No.53 is invalid)	

Warning: Do not use this function if the automatic servo OFF is followed by pitch feed (relative movement). Servo ON/OFF may cause slight position shift to occur. If position shift occurs due to external force during servo OFF, positioning to the correct position is disabled. It is because pitch feed is operated based on the position at start used as the base point.

Caution: Automatic Servo-off Function is not effective while in pressing operation. Do not use. It becomes effective at completion of positioning. In pressing, the function becomes effective only when miss-pressing occurs (the status at the completion of operation without pressing is the same as that at the completion of positioning). No retaining torque is provided in automatic servo-off. The actuator can move with an external force. Pay attention to the interference to the peripherals and the safety in the installation.

⚠ Caution: *When an operation is made with jog or inching while in operation with the full servo function, the full servo function will be inactivated. If a movement is made again on the position number that the full servo function is set valid, the full servo function will be activated.*

- (1) Setting of periods taken until automatic servo OFF
 Three periods from completion of positioning to automatic servo OFF can be set in the following parameters in seconds [sec].

Parameter No.	Name	Unit	Input range	Initial value
36	Automatic servo-off delay time 1	sec	0 to 9999	0
37	Automatic servo-off delay time 2	sec	0 to 9999	0
38	Automatic servo-off delay time 3	sec	0 to 9999	0

- (2) Set of power-saving mode
 Select a proper power-saving mode from the conditions below. Set the corresponding value in the stop mode or parameter No.53 of the position table.
 Selection is available from 0 to 3 for the servo motor type and brushless DC motor type.
 Selection is available from 0 to 7 for the pulse motor type.
 [Refer to 14) Stop mode in 3.3 Set of Position Table.]

Set value	Operation after completion of positioning	Selectable type
0	Servo ON not changed	All type
1	Automatic servo off in a certain time (set in Parameter No.36)	All type
2	Automatic servo off in a certain time (set in Parameter No.37)	All type
3	Automatic servo off in a certain time (set in Parameter No.38)	All type
4	Full Servo Control	Pulse motor type
5	Full-servo control for a certain time (value set in Parameter No.36) and then automatically turning servo OFF	Pulse motor type
6	Full-servo control for a certain time (value set in Parameter No.37) and then automatically turning servo OFF	Pulse motor type
7	Full-servo control for a certain time (value set in Parameter No.38) and then automatically turning servo OFF	Pulse motor type

⚠ Caution:

- No retaining torque is provided in automatic servo OFF. Pay sufficient attention to the setting because the actuator may be moved by external force applied to it.
- Do not use the automatic servo OFF if the next moving command is relative distance specification (pitch feed). Failure to follow it may cause position shift to occur.
- Do not use the automatic servo OFF in pressing. If used, the pressing force is lost.
- Automatic Servo OFF would not function in the operation with teaching mode of PC software.

- (3) Status of positioning complete signal in selection of automatic servo OFF
 Automatic servo OFF causes the actuator to be in other than the positioning complete state due to the servo OFF. Positioning complete signal (PEND) is turned OFF. Changing the PEND signal to the in-position signal judging whether the actuator is stopped within the positioning width zone instead of the positioning complete signal allows PEND not to be turned OFF during servo OFF.
 This setting is reflected on complete position numbers PM1 to PM** in PIO patterns 0 to 2 confirming the positioning complete position No. or current position numbers PE* in PIO patterns 4.
 Define the setting in Parameter No.39.

Value set in Parameter No.39	Content of PEND signal	Signal outputs during automatic servo OFF		
		PEND	PM1 to PM**	PE**
0	Positioning Completion Signal	OFF	OFF	OFF
1	In-position Signal	ON	ON	ON

(Note) SYS in the driver status LED lamps on the front panel blinks in green during the automatic servo OFF.

[For Parameter No.39 = 0]

Operation of actuator	Positioning operation	Automatic servo OFF standby	Servo OFF	Positioning operation
Servo Condition	ON	ON	OFF	ON
Completed Position No. Output (Current position number output)	PM1 to ** = 0 (PE** = OFF)	PM1 to ** = Output (PE** = ON)	PM1 to ** = 0 (PE** = OFF)	PM1 to ** = 0 (PE** = OFF)
Positioning Completion Signal PEND	OFF	ON	OFF	OFF

[For Parameter No.39 = 1]

Operation of actuator	Positioning operation	Automatic servo OFF standby	Servo OFF	Positioning operation
Servo Condition	ON	ON	OFF	ON
Completed Position No. Output (Current position number output)	PM1 to ** = 0 (PE** = OFF)	PM1 to ** = Output (PE** = ON)	PM1 to ** = 0 Output (PE** = ON)	PM1 to ** = 0 (PE** = OFF)
Positioning Completion Signal PEND	OFF	ON	ON	OFF

Chapter 7 Absolute Reset and Absolute Battery

7.1 Absolute Reset

The controller for Simple Absolute Type retains the encoder position information with the battery backup. Also, connecting the battery-less absolute type controller to an actuator enables to retain the encoder position information without any battery. For those types, it is not necessary to have a home-return operation in every startup.

To retain the encoder position information, it is necessary to register (absolute reset) the home position.

It can be checked on the status LEDs for the driver whether the absolute reset is necessary. Have an absolute reset completed if the status LEDs for the driver shows the absolute reset is incomplete.

(Note) For battery-less absolute type, conduct an absolute reset after motor replacement.

(Note) There is no battery-less absolute type and simple absolute type in the DC brushless motor type.

[1] Status LEDs for Driver

Driver status (condition) and absolute status can be displayed for each axis to be connected. There is no absolute status display for the incremental type and battery-less absolute type.

LED Display for Upper Connector Axis Numbers (0th, 2nd, 4th and 6th axes)

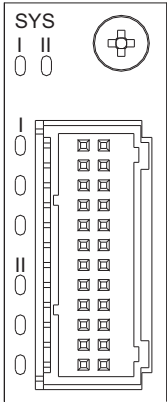

Name	Description		
SYS I	Driver for upper connector connection axes numbers (0 th , 2 nd , 4 th and 6 th axes) System status Green Light is turned ON. : Servo ON Red Light is turned ON. : Alarm generated, Emergency stop condition OFF : Servo OFF		
I-2	Absolute Status 1, 2 for driver for upper connector connection axes numbers (0, 2, 4 and 6 Axis) The current absolute status is expressed of the patterns of the light in I-2 and I-1.		
I-1			
		I-1	
		I-2	
	Green Light is turned ON.	Absolute reset complete	Absolute reset incomplete
	Red Light is turned ON.	Alarm generated	
I-0	Absolute Status 0 for driver for upper connector connection axes numbers (0 th , 2 nd , 4 th and 6 th axes) Green Light is turned ON. : Battery fully charged Orange Light is turned ON. : Battery charging operation Red Light is turned ON. : Battery disconnected		

LED Display for Upper Connector Axis Numbers (1st, 3rd, 5th and 7th axes)

	SYS II	Driver for lower connector connection axes numbers (1 st , 3 rd , 5 th and 7 th axes) Green Light is turned ON. : Servo ON Red Light is turned ON. : Alarm generated, Emergency stop condition OFF : Servo OFF											
	II-2 II-1	Absolute Status 1 for driver for lower connector connection axes numbers (1, 3, 5 and 7 Axis) The current absolute status is expressed of the patterns of the light in II-2 and II-1.											
		<table border="1"> <tr> <td></td> <td colspan="2">II-1</td> </tr> <tr> <td></td> <td>Green Light is turned ON.</td> <td>Red Light is turned ON.</td> </tr> <tr> <td>Green Light is turned ON.</td> <td>Absolute reset complete</td> <td>Absolute reset incomplete</td> </tr> <tr> <td>Red Light is turned ON.</td> <td colspan="2">Alarm generated</td> </tr> </table>		II-1			Green Light is turned ON.	Red Light is turned ON.	Green Light is turned ON.	Absolute reset complete	Absolute reset incomplete	Red Light is turned ON.	Alarm generated
	II-1												
	Green Light is turned ON.	Red Light is turned ON.											
Green Light is turned ON.	Absolute reset complete	Absolute reset incomplete											
Red Light is turned ON.	Alarm generated												
II-0	Absolute Status 2 for driver for lower connector connection axes numbers (1 st , 3 rd , 5 th and 7 th axes) Green Light is turned ON. : Battery fully charged Orange Light is turned ON. : Battery charging operation Red Light is turned ON. : Battery disconnected												

The absolute reset is to be done with using a teaching tool such as the PC software. Shown below are the steps.

[2] Absolute reset procedure from teaching tool

- 1) Connect the controller with the actuator. [Refer to Chapters 1 and 2.]
- 2) For Simple Absolute Type, connect the absolute battery box and the controller with the dedicated cable. [Refer to 2.2 [3] Connection of Absolute Battery]
- 3) Connect the teaching tool, set the operation mode setting switch on the front face of the panel on the controller to MANU side, and then turn the power on.
- 4) The absolute encoder error appears on the teaching tool. Perform alarm reset.
- 5) Perform home-return operation at servo-ON condition. Once the home return is complete, the point of origin is memorized at the same time the origin point is established.

In below explains the procedure using each teaching tool:

(1) For PC software

- 1) Open the position data edit window from IN window, and click on **Alarm** button to reset the alarm.

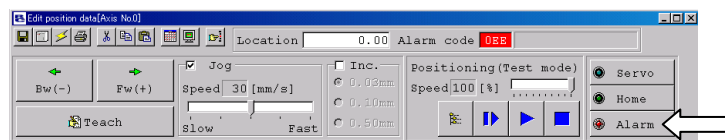

- 2) Click on **Home** button in the servo-on status.

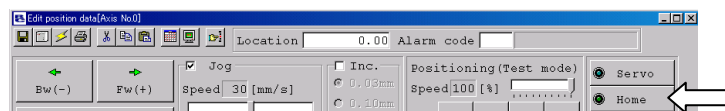

(2) For TB-01

1)

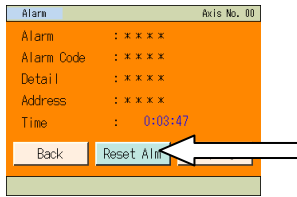

Touch **Reset Alm** to reset the alarm.

2)

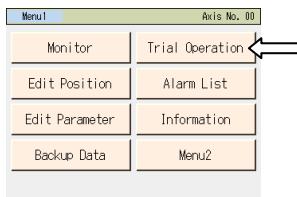

Press **Trial Operation** on the Menu 1 screen.

3)

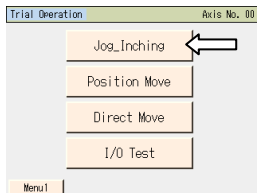

Press **Jog_Inching** on Trial screen.

4)

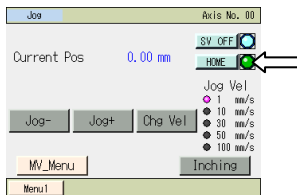

Press **Home** on Job/Inching screen.
(Conduct it in the servo-on status)

Adjustment for Repeatability of Home Position
 In case the home position has changed from where it was previously in an absolute reset after the absolute data has lost, it can be adjusted in Parameter No. 22 Home Return Offset. Mark the home position on the mechanical side at the first startup. From the position where it has changed from the original home position after the absolute reset, move the actuator to the marked position with such an operation as JOG operation. Read the coordinates and add (if the number is positive, and subtract if negative) them to the values in Parameter No. 22.
 (Note) At this time, note the values in Parameter No. 22 before the adjustment so the setting can be put back in any occasions.

7.2 Absolute Battery (for Simple Absolute Type)

Absolute battery and absolute battery box are enclosed in the simple absolute type controllers. The absolute battery is used to back up the absolute data.

The absolute battery has a specified position for each axis number. Refer to the figure below to insert the batteries to the absolute battery box. There is also an instruction for the connector inserting positions for the absolute battery cable. Connect it properly following the figure shown below.

- Front View of Absolute Battery Unit with Cover Removed

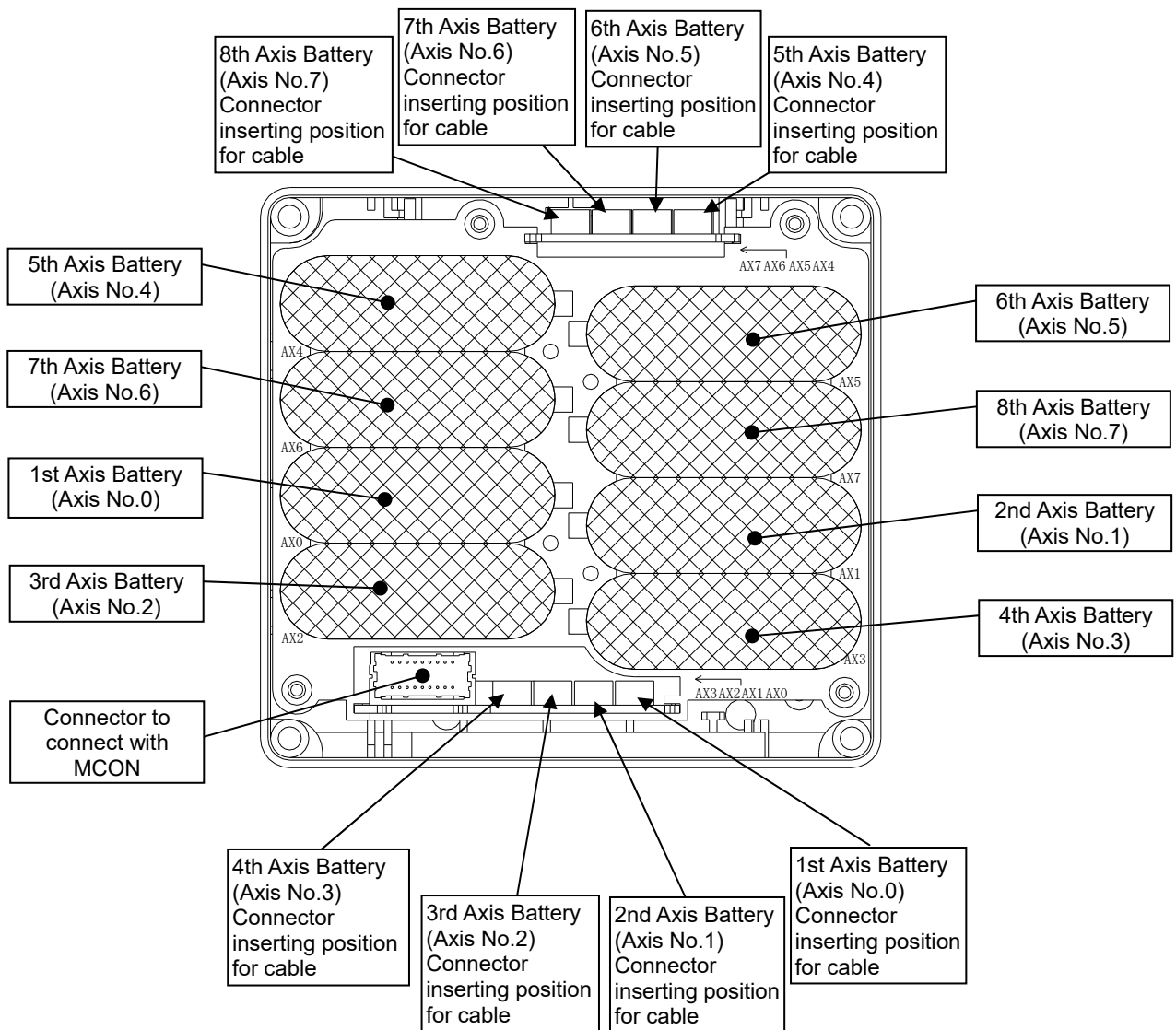

7.2.1 Absolute encoder backup specifications

Item	Specifications
Battery model	AB-7
Quantity	1 pc/axis (8 units max. / 8 axes)
Battery voltage	3.6V
Current capacity	3300mAH
Nominal	3.6V 3700mAH
Reference for battery replacing timing ^(Note 1)	Approx. 3 years (It varies significantly by the effects of the usage condition)

Note 1 Replace the battery regularly.

7.2.2 Absolute Battery Charge

Please have the battery charged for more than 72 hours before using for the first time or after replacing with a new one. The battery gets charged while the controller is supplied with 24V power.

Data holding time (Reference time when battery is new)

Parameter No.155 setting	Upper limit of encoder revolution at power-off [rpm]		Reference for battery retaining time [days]	Holding time per hour of battery charge time (reference) [H]
	When the connected actuator is a model other than RCA2-***NA;	When the connected actuator is RCA2-***NA;		
0	100	75	20	6.6
1	200	150	15	5.0
2	400	300	10	3.3
3	800	600	5	1.6

Leaving the controller power OFF for more than the data holding time will lead to a loss of the data. Have the battery charged as early as possible.

There is life to the battery and the duration for data holding will decrease. Replace the battery with a new one if the retaining time is remarkably dropped even with enough charging time.

(Example) From Monday to Friday : charge for 8 hours per day, discharge for 16 hours,
 Saturday and Sunday : When using with discharge
 Connected axis : Any model except for RCA2-***NA

1) If parameter No.155 = 3 setting;

Total charge amount : Operation hours per day 8 [H] × Retaining time per charge for 1 hour 1.6 [H] × Weekday 5 [days] = 64 [H]

Total discharge amount : Stopped time during night 16 [H] × Weekday 5 [days] + Stopped time on Saturday and Sunday 48 [H] = 128 [H]

Total discharge amount : 16 [h] × 5 [day] + 48 [h] = 128 [h]

→ If starting on Monday with a full-charge, the total amount of the discharge in a week exceeds total amount of battery charge in 64 [H], thus the fully charged storage decreases by 64 [H]. Therefore, it is necessary to have the battery fully charged in every 10-day period.

2) If parameter No.155 = 2 setting;

Total charge amount : Operation hours per day 8 [H] × Retaining time per charge for 1 hour 3.3 [H] × Weekday 5 [days] = 132 [H]

Total discharge amount : Stopped time during night 16 [H] × Weekday 5 [days] + Stopped time on Saturday and Sunday 48 [H] = 128 [H]

→ If starting on Monday, because the total amount of charge has exceeded the total amount of discharge, it is not necessary to have a continuous full charge. 4-hour charge is stored every week.

7.2.3 Absolute Battery Voltage Drop Detection

If the voltage of the absolute battery is dropped, the error detection responding to the voltage is held.

Voltage	PIO Signals	Alarm
2.5V ±8% or less	Alarm signal *ALM ^(Note 1) OFF	0EE Absolute Encoder Error Detection 2 or 0EF Absolute Encoder Error Detection 3

Note 1 *ALM are the signals of active low.

After the power is supplied to the controller, they are usually ON and turned OFF when an error is detected. If the alarm is generated, it will be necessary to absolute reset after the battery replacement. (The controller checks the battery voltage at the time the power is supplied. The controller would not detect it even if the battery voltage is decreased to the alarm level while it is on.)

(Note) *It is necessary to have the absolute reset to cancel the alarm.*

Chapter 8 Parameter

Parameter data should be set appropriately according to the applicaiton requirements.

When a change is required to the parameters, make sure to back up the data before the change so the settings can be returned anytime.

With using PC software, it is able to store the backup to the PC. With using a teaching pendant, it is able to store the backup to the memory card. Write down on a memo when data backup is not available.

Also, for the purpose of rapid recovery after the investigation of failure unit or replacing the controller, keep data backup or memo also after the parameter change.

The change to the parameters will be activated after they are edited, written to the non-volatile controller built-in memory (FeRAM), then either software reset or reboot of the power. It will not become active only with setting on the teaching tool.



- Warning:** (1) *Parameter setting has great influences on operations of the controller. Incorrect parameter setting may not only cause malfunction or failure of the controller to occur but also people and assets to be exposed to risk. The controller is configured to be applicable to normal operation at shipment. Before providing certain change or setting for the controller to be fit to your system, understand the control methods of the controller sufficiently. Please contact us if you have anything unclear.*
- (2) *Do not turn OFF the power to the controller during the parameter writing. Parameter cannot be written properly, which may cause an unexpected operation, and is extremely dangerous.*

8.1 Parameter List

Each axis number has the following parameter table. Have the setting and checking on each axis number.

The categories in the table below indicate whether parameters should be set or not. There are five categories as follows:

- A : Check the settings before use.
- B : Use parameters of this category depending on their uses.
- C : Use parameters of this category with the settings at shipments leaving unchanged as a rule. Normally they may not be set.
- D : Parameters of the category are set at shipment in accordance with the specification of the actuator. Normally they may not be set.
- E : Parameters of the category are exclusively used by us for convenience of production. Changing their settings may not only cause the actuator to operate improperly but also to be damaged. So, never change the setting of the parameters.

Category do not appear on the teaching tool.

Also, the unused parameter numbers are not mentioned in the list.

Parameter List

(1/5)

No.	Category	Name	Symbol	Unit ^(Note 1)	Input Range	Default factory setting	Applicable Motor Type ^(Note 3)			Relevant sections
							A	P	D	
1	B	Zone 1 Positive Side	ZONM	mm [deg]	-9999.99 to 9999.99	Actual stroke on positive side ^(Note 2)	○	○	○	8.2 [1] 8.2 [83]
2	B	Zone 1 Negative Side	ZONL	mm [deg]	-9999.99 to 9999.99	Actual stroke on negative side ^(Note 2)	○	○	○	
3	A	Soft Limit Positive Side	LIMM	mm [deg]	-9999.99 to 9999.99	Actual stroke on positive side ^(Note 2)	○	○	○	8.2 [2]
4	A	Soft Limit Negative Side	LIML	mm [deg]	-9999.99 to 9999.99	Actual stroke on negative side ^(Note 2)	○	○	○	
5	D	Home Return Direction	ORG	-	0: Reverse 1: Normal	In accordance with actuator ^(Note 2)	○	○	○	8.2 [3]
6	C	Push & Hold Stop Judgment Period	PSWT	msec	0 to 9999	255	○	○	○	8.2 [4]
7	C	Servo Gain Number	PLGO	-	0 to 31	In accordance with actuator ^(Note 2)	○	○	○	8.2 [5] 8.3
8	B	Default Velocity	VCMD	mm/s [deg/s]	1 to Actuator's max. speed	Rated actuator speed ^(Note 2)	○	○	○	8.2 [6]
9	B	Default Acceleration/Deceleration	ACMD	G	0.01 to Actuator's max. acceleration/ deceleration	Rated actuator's acceleration/ Deceleration ^(Note 2)	○	○	○	8.2 [7]
10	B	Default Positioning Width	INP	mm [deg]	Actuator's min. resolution to 999.99	In accordance with actuator ^(Note 2)	○	○	○	8.2 [8]
12	B	Current limitation at positioning stop	SPOW	%	0 to 70	In accordance with actuator ^(Note 2)	-	○	-	8.2 [9]
13	C	Current-Limiting Value During Home Return	ODPW	%	0 to 100 0 to 300	In accordance with actuator ^(Note 2)	-	○	-	8.2 [10]
15	B	Pause Input Disable Selection	STP	-	0: Enabled 1: Disabled	0	○	○	○	8.2 [11]
18	E	Home Position Check Sensor Input Polarity	LS	-	0 to 2	In accordance with actuator ^(Note 2)	○	○	-	8.2 [12]
21	B	Servo ON Input Disable Selection	SON	-	0: Enabled 1: Disabled	0	○	○	○	8.2 [13]
22	C	Home Return Offset Level	OFST	mm [deg]	0.00 to 9999.99	In accordance with actuator ^(Note 2)	○	○	○	8.2 [14]
23	B	Zone 2 Positive Side	ZNM2	mm [deg]	-9999.99 to 9999.99	Actual stroke on positive side ^(Note 2)	○	○	○	8.2 [15] 8.2 [1]
24	B	Zone 2 Negative Side	ZNL2	mm [deg]	-9999.99 to 9999.99	Actual stroke on negative side ^(Note 2)	○	○	○	

Note 1 The unit [deg] is for rotary actuator and lever type gripper. It is displayed in [mm] in the teaching tools.

Note 2 The setting values vary in accordance with the specification of the actuator. At shipment, the parameters are set in accordance with the specification.

Note 3 A: Servo motor type, P: Pulse motor type, D: Brushless DC Motor

Parameter List

(2/5)

No.	Category	Name	Symbol	Unit ^(Note 1)	Input Range	Default factory setting	Applicable Motor Type ^(Note 3)			Relevant sections
							A	P	D	
25	A	PIO Pattern Selection	IOPN	-	0 to 2, 4 to 6	6	○	○	○	8.2 [16] 3.4.10
26	B	PIO Jog Velocity	JOGV	mm/s [deg/s]	1 to 250 (maximum speed for the actuators with 250 or less)	In accordance with actuator ^(Note 2)	○	○	○	8.2 [17]
27	B	Movement Command Type	MCT	-	0 : Level 1 : Edge	0	○	○	○	8.2 [18]
28	B	Default movement direction for excitation-phase signal detecting movement	PHSP	-	0: Reverse 1: Forward	In accordance with actuator ^(Note 2)	○	○	-	8.2 [19]
29	B	Excitation-phase signal detection time	PHSP	msec	1 to 999	10	-	○	-	8.2 [20]
					50 to 999	128	○	-		
30	B	Excitation detection type	PHSP	-	0: Conventional method 1: New method 1 2: New method 2	1	-	○	-	8.2 [21]
	B	Pole Sensing Type	PHSP	-	0: Current Control 1: Distance Control 1 2: Distance Control 2	1	○	-	-	8.2 [22]
31	B	Velocity Loop Proportional Gain	VLPG	-	1 to 27661	In accordance with actuator ^(Note 2)	○	○	○	8.2 [23] 8.3
32	B	Velocity Loop Integral Gain	VLPT	-	1 to 217270	In accordance with actuator ^(Note 2)	○	○	○	8.2 [24] 8.3
33	C	Torque Filter Time Constant	TRQF	-	0 to 2500	In accordance with actuator ^(Note 2)	○	○	○	8.2 [25] 8.3
34	C	Push Velocity	PSHV	mm/s [deg/s]	1 to actuator's max. pressing speed	In accordance with actuator ^(Note 2)	○	○	○	8.2 [26]
35	C	Safety Velocity	SAFV	mm/s [deg/s]	1 to 250 (maximum speed for the actuators with 250 or less)	100	○	○	○	8.2 [27]
36	C	Auto Servo-motor OFF Delay Time 1	ASO1	sec	0 to 9999	0	○	○	○	8.2 [28] Section 6 (1)
37	C	Auto Servo-motor OFF Delay Time 2	ASO2	sec	0 to 9999	0	○	○	○	
38	B	Auto Servo-motor OFF Delay Time 3	ASO3	sec	0 to 9999	0	○	○	-	
39	B	Position Complete Signal Output Method ^(Note 3)	PEND	-	0: PEND 1: INP	0	○	○	○	8.2 [29] Section 6 (3)
40	C	Home-return Input Disable	HOME	-	0: Enabled 1: Disabled	0	○	○	○	8.2 [30]
43	B	Home position check sensor input polarity	HMC	-	0: Sensor not used 1: a contact 2: b contact	In accordance with actuator ^(Note 2)	○	○	-	8.2 [31]
46	B	Velocity override	OVRD	%	0 to 100	100	○	○	○	8.2 [32]
47	B	PIO Jog Velocity 2	IOV2	mm/s [deg/s]	1 to 250 (maximum speed for the actuators with 250 or less)	In accordance with actuator ^(Note 2)	○	○	○	8.2 [33]
48	B	PIO Inching Distance	IOID	mm [deg/s]	0.01 to 1.00	1.00	○	○	○	8.2 [34]
49	B	PIO Inching Distance 2	IOD2	mm [deg/s]	0.01 to 1.00	0.10	○	○	○	
50	C	Load Output Judgment Time Period	LDWT	msec	0 to 9999	255	-	○	-	8.2 [35]
51	B	Torque inspected range	TRQZ	-	0: Enabling 1: Disabling	0	-	○	-	8.2 [36]

Note 1 The unit [deg] is for rotary actuator and lever type gripper. It is displayed in [mm] in the teaching tools.

Note 2 The setting values vary in accordance with the specification of the actuator. At shipment, the parameters are set in accordance with the specification.

Note 3 A: Servo motor type, P: Pulse motor type, D: Brushless DC Motor

Parameter List

(3/5)

No.	Category	Name	Symbol	Unit ^(Note 1)	Input Range	Default factory setting	Applicable Motor Type ^(Note 3)			Relevant sections	
							A	P	D		
52	B	Default Acceleration/Deceleration Mode	MOD	-	0: Trapezoid pattern 1: S-motion 2: Primary delay filter	0	<input type="radio"/>	<input type="radio"/>	<input type="radio"/>	8.2 [37]	
53	B	Default Stop Mode	HSTP	-	0 to 3	0 (Not applicable)	<input type="radio"/>	-	<input type="radio"/>	8.2 [38] Section 6 (2)	
					0 to 7		-	<input type="radio"/>			
54	C	Current Control Width Number	CTLF	-	0 to 15	In accordance with actuator ^(Note 2)	<input type="radio"/>	-	<input type="radio"/>	8.2 [39]	
55	B	Position Command Primary Filter Time Constant	PLPF	msec	0.0 to 100.0	0.0	<input type="radio"/>	<input type="radio"/>	<input type="radio"/>	8.2 [40] 8.3	
56	B	S-motion Rate	SCRV	%	0 to 100	0	<input type="radio"/>	<input type="radio"/>	<input type="radio"/>	8.2 [41]	
71	B	Position Feed Forward Gain	PLFG	-	0 to 100	0	<input type="radio"/>	<input type="radio"/>	-	8.2 [42] 8.3	
						50	-	-	<input type="radio"/>		
77	D	Ball Screw Lead Length	LEAD	mm [deg]	0.01 to 999.99	In accordance with actuator ^(Note 2)	<input type="radio"/>	<input type="radio"/>	<input type="radio"/>	8.2 [43]	
78	D	Axis Operation Type	ATYP	-	0: Linear axis 1: Rotary axis	In accordance with actuator ^(Note 2)	<input type="radio"/>	<input type="radio"/>	<input type="radio"/>	8.2 [44]	
79	B	Rotary Axis Mode Selection	ATYP	-	0: Normal mode 1: Index mode	In accordance with actuator ^(Note 2)	<input type="radio"/>	<input type="radio"/>	<input type="radio"/>	8.2 [45]	
80	B	Rotational Axis Shortcut Selection	ATYP	-	0: Disabled 1: Enabled	In accordance with actuator ^(Note 2)	<input type="radio"/>	<input type="radio"/>	<input type="radio"/>	8.2 [46]	
83	B	Absolute unit	ETYP	-	0: Not used 1: Used	In accordance with specification at order accepted	<input type="radio"/>	<input type="radio"/>	-	8.2 [47]	
88	D	Software Limit Margin	SLMA	mm	0 to 9999.99	0	<input type="radio"/>	<input type="radio"/>	<input type="radio"/>	8.2 [48]	
91	C	Current Limit Value at Stopping Due to Miss-pressing	FSTP	-	0: Current limiting value at stop 1: Current limit value during pressing	0	<input type="radio"/>	<input type="radio"/>	<input type="radio"/>	8.2 [49]	
97	C	Vibration suppress parameter set 1	Damping Characteristic Coefficient 1	DC11	-	0 to 1000	10	<input type="radio"/>	-	-	8.2 [50] 4.2
98	C		Damping Characteristic Coefficient 2	DC21	-	0 to 1000	1000	<input type="radio"/>	-	-	
99	B		Natural Frequency	NP01	1/1000Hz	500 to 30000	10000	<input type="radio"/>	-	-	
100	C		Notch Filter Gain	NFG1	-	1 to 20000	9990	<input type="radio"/>	-	-	
101	C	Vibration suppress parameter set 2	Damping Characteristic Coefficient 1	DC12	-	0 to 1000	10	<input type="radio"/>	-	-	
102	C		Damping Characteristic Coefficient 2	DC22	-	0 to 1000	1000	<input type="radio"/>	-	-	
103	B	Natural Frequency	NP02	1/1000Hz	500 to 30000	10000	<input type="radio"/>	-	-		
104	C	Notch Filter Gain	NFG2	-	1 to 20000	9990	<input type="radio"/>	-	-		
105	C	Vibration suppress parameter set 3	Damping Characteristic Coefficient 1	DC11	-	0 to 1000	10	<input type="radio"/>	-	-	
106	C		Damping Characteristic Coefficient 2	DC21	-	0 to 1000	1000	<input type="radio"/>	-	-	
107	B	Natural Frequency	NP03	1/1000Hz	500 to 30000	10000	<input type="radio"/>	-	-		
108	C	Notch Filter Gain	NFG3	-	1 to 20000	9990	<input type="radio"/>	-	-		
109	B	Default Vibration Suppress No.	CTLF	-	0 to 3	0	<input type="radio"/>	-	-	-	

Note 1 The unit [deg] is for rotary actuator and lever type gripper. It is displayed in [mm] in the teaching tools.

Note 2 The setting values vary in accordance with the specification of the actuator. At shipment, the parameters are set in accordance with the specification.

Note 3 A: Servo motor type, P: Pulse motor type, D: Brushless DC Motor

Parameter List

(4/5)

No.	Category	Name	Symbol	Unit ^(Note 1)	Input Range	Default factory setting	Applicable Motor Type ^(Note 3)			Relevant sections
							A	P	D	
110	B	Stop Method at Servo OFF	PSOF	-	0: Rapid stop 1: Deceleration to stop	0	○	○	○	8.2 [52]
112	B	Monitoring Mode Selection Monitoring Period	FMNT	-	0: Unused 1: Monitor Function 1 2: Monitor Function 2 3: Monitor Function 3	1	○	○	○	8.2 [53]
113	B	Monitoring Period	FMNT	msec	1 to 60000	1	○	○	○	8.2 [54]
120	C	Servo Gain Number 1	PLG1	-	0 to 31	In accordance with actuator ^(Note 2)	○	-	-	8.2 [55] 8.2 [5]
121	C	Feed Forward Gain 1	PLF1	-	0 to 100	In accordance with actuator ^(Note 2)	○	-	-	8.2 [55] 8.2 [47]
122	C	Velocity Loop Proportional Gain 1	VLG1	-	1 to 27661	In accordance with actuator ^(Note 2)	○	-	-	8.2 [55] 8.2 [23]
123	C	Velocity Loop Integral Gain 1	VLT1	-	1 to 217270	In accordance with actuator ^(Note 2)	○	-	-	8.2 [55] 8.2 [24]
124	C	Torque Filter Time Constant 1	TRF1	-	0 to 2500	In accordance with actuator ^(Note 2)	○	-	-	8.2 [55] 8.2 [25]
125	C	Current Control Width Number 1	CLP1	-	0 to 15	In accordance with actuator ^(Note 2)	○	-	-	8.2 [55] 8.2 [39]
126	C	Servo Gain Number 2	PLG2	-	0 to 31	In accordance with actuator ^(Note 2)	○	-	-	8.2 [55] 8.2 [5]
127	C	Feed Forward Gain 2	PLF2	-	0 to 100	In accordance with actuator ^(Note 2)	○	-	-	8.2 [55] 8.2 [47]
128	C	Speed Loop Proportional Gain 2	VLG2	-	1 to 27661	In accordance with actuator ^(Note 2)	○	-	-	8.2 [55] 8.2 [23]
129	C	Speed Loop Integral Gain 2	VLT2	-	1 to 217270	In accordance with actuator ^(Note 2)	○	-	-	8.2 [55] 8.2 [24]
130	C	Torque Filter Time Constant 2	TRF2	-	0 to 2500	In accordance with actuator ^(Note 2)	○	-	-	8.2 [55] 8.2 [25]
131	C	Current Control Width Number 2	CLP2	-	0 to 15	In accordance with actuator ^(Note 2)	○	-	-	8.2 [55] 8.2 [39]
132	C	Servo Gain Number 3	PLG3	-	0 to 31	In accordance with actuator ^(Note 2)	○	-	-	8.2 [55] 8.2 [5]
133	C	Feed Forward Gain 3	PLF3	-	0 to 100	In accordance with actuator ^(Note 2)	○	-	-	8.2 [55] 8.2 [47]
134	C	Speed Loop Proportional Gain 3	VLG3	-	1 to 27661	In accordance with actuator ^(Note 2)	○	-	-	8.2 [55] 8.2 [23]
135	C	Speed Loop Integral Gain 3	VLT3	-	1 to 217270	In accordance with actuator ^(Note 2)	○	-	-	8.2 [55] 8.2 [24]
136	C	Torque Filter Time Constant 3	TRF3	-	0 to 2500	In accordance with actuator ^(Note 2)	○	-	-	8.2 [55] 8.2 [25]
137	C	Current Control Width Number 3	CLP3	-	0 to 15	In accordance with actuator ^(Note 2)	○	-	-	8.2 [55] 8.2 [39]
138	C	Servo Gain Switchover Time Constant	GCFT	ms	10 to 2000	10	○	-	-	8.2 [56]
143	B	Overload Level Ratio	OLWL	%	50 to 100	-	○	-	○	8.2 [57]

Note 1 The unit [deg] is for rotary actuator and lever type gripper. It is displayed in [mm] in the teaching tools.

Note 2 The setting values vary in accordance with the specification of the actuator. At shipment, the parameters are set in accordance with the specification.

Note 3 A: Servo motor type, P: Pulse motor type, D: Brushless DC Motor

Parameter List

(5/5)

No.	Category	Name	Symbol	Unit ^(Note 1)	Input Range	Default factory setting	Applicable Motor Type ^(Note 3)			Relevant sections
							A	P	D	
144	B	Gain Scheduling Upper Limit Multiplying Ratio	GSUL	%	0 to 1023	0 (Disabling)	-	○	-	8.2 [58]
145	C	GS Velocity Loop Proportional Gain	GSPC	-	1 to 30000	In accordance with actuator ^(Note 2)	-	○	-	8.2 [59] 8.2 [23]
146	C	GS Velocity Loop Integral Gain	GSIC	-	1 to 500000	In accordance with actuator ^(Note 2)	-	○	-	8.2 [60] 8.2 [24]
147	B	Total Movement Count Threshold	TMCT	Times	0 to 999999999	0 (Disabling)	○	○	○	8.2 [61]
148	B	Total Operated Distance Threshold	ODOT	m	0 to 999999999	0 (Disabling)	○	○	○	8.2 [62]
149	B	Zone Output Changeover	ZONE	-	0: Not to change 1: To change	0	○	○	○	8.2 [63]
151	B	Light Malfunction Alarm Output Select	FSTP	-	0: Overload warning output 1: Message label alarm output	1	○	○	○	8.2 [64]
152	B	High Output Setting	BUEN	-	0: Disabling 1: Enabling	In accordance with actuator ^(Note 2)	-	○	-	8.2 [65]
153	B	BU Velocity Loop Proportional Gain	BUPC	-	1 to 10000	In accordance with actuator ^(Note 2)	-	○	-	8.2 [66] 8.2 [23]
154	B	BU Velocity Loop Integral Gain	BUIC	-	1 to 100000	In accordance with actuator ^(Note 2)	-	○	-	8.2 [67] 8.2 [24]
155	A	Absolute Battery Retention Time	AIP	-	0: 20 days 1: 15 days 2: 10 days 3: 5 days	0	○	○	-	8.2 [68] 6.2.2
156	B	Torque Check/Light Malfunction Output Select	SLAL	-	0: Torque check effective 1: Light malfunction effective	0	-	○	-	8.2 [69]
158	B	Enable/Disable Axis Select	EFCT	-	0: Enabled 1: Disabled	0	○	○	○	8.2 [70]
166	B	Startup Current Limit Extension Feature	DCET	-	0: Disabling 1: Enabling	In accordance with actuator ^(Note 2)	-	○	-	8.2 [71]
168	B	Collision Detection Feature	CODT	-	0 to 7	0	-	○	-	8.2 [72] 5.2
181	B	Pressing Method	SPOS	-	0: CON type 1: SEP type	0	○	○	○	8.2 [73]

Note 1 The unit [deg] is for rotary actuator and lever type gripper. It is displayed in [mm] in the teaching tools.

Note 2 The setting values vary in accordance with the specification of the actuator. At shipment, the parameters are set in accordance with the specification.

Note 3 A: Servo motor type, P: Pulse motor type, D: Brushless DC Motor

8.2 Detail Explanation of Parameters

Establish settings for each axis number.

⚠ Caution: • If parameters are changed (writing), provide software reset or reconnect the power to reflect the setting values.
 • The unit [deg] is for rotary actuator and lever type gripper. Pay attention that it is displayed in mm in the teaching tools.

- [1] Zone 1 positive side, zone 1 negative side (Parameter No.1, No.2)
 Zone 2 positive side, zone 2 negative side (Parameter No.23, No.24)

No.	Name	Symbol	Unit	Input Range	Default factory setting
1	Zone 1 Positive Side	ZONM	mm [deg]	-9999.99 to 9999.99	Actual stroke on positive side
2	Zone 1 Negative Side	ZONL	mm [deg]	-9999.99 to 9999.99	Actual stroke on negative side
23	Zone 2 Positive Side	ZNM2	mm [deg]	-9999.99 to 9999.99	Actual stroke on positive side
24	Zone 2 Negative Side	ZNL2	mm [deg]	-9999.99 to 9999.99	Actual stroke on negative side

These parameters are used to set the zone in which zone signal (ZONE1 or ZONE2) turns ON. The minimum setting unit is 0.01 mm [deg].

If a specific value is set to both zone setting positive side and zone setting negative side, the zone signal is not output.

A setting sample is shown below.

[Example of when line axis]

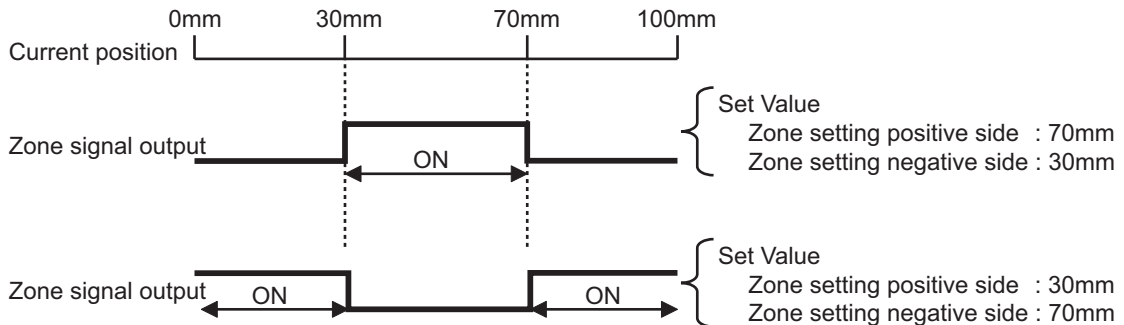

[Example of Rotary Actuator Index Mode]

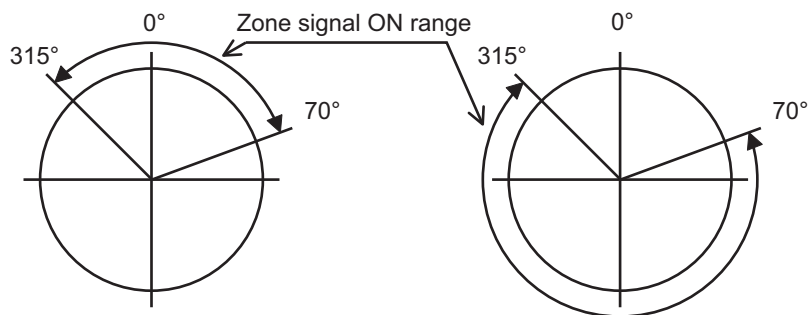

⚠ Caution: The zone detection range would not output unless the value exceeds that of the minimum resolution (actuator lead length / No. of Encoder Pulses).

[2] Soft limit positive side, Soft limit negative side (Parameter No.3, No.4)

No.	Name	Symbol	Unit	Input Range	Default factory setting
3	Soft Limit Positive Side	LIMM	mm [deg]	-9999.99 to 9999.99	Actual stroke on positive side
4	Soft Limit Negative Side	LIML	mm [deg]	-9999.99 to 9999.99	Actual stroke on negative side

0.3mm [deg] is added to the outside of the effective actuator stroke for the setting at the delivery (since there would be an error at the end of effective stroke if set to 0). Change the setting if required for the cases such as when there is interference or to prevent a crash, or when using the actuator with slightly exceeding effective stroke in the operational range. An incorrect soft limit setting will cause the actuator to collide into the mechanical end, so exercise sufficient caution.

The minimum setting unit is 0.01mm.

Note: To change a soft limit, set a value corresponding to 0.3mm outside of the effective stroke.

Example) Set the effective stroke to between 0mm to 80mm

Parameter No.3 (positive side) 80.3

Parameter No.4 (negative side) -0.3

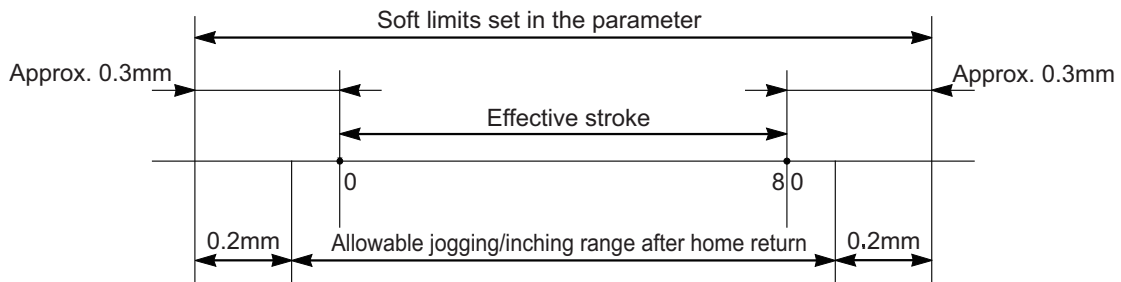

The operational range for jog and inching after the home return is 0.2mm [deg] less than the set value.

Alarm Code 0D9 "Soft Limit Over Error" will be generated when the set value exceeded the value (0 when shipped out) set in Parameter No.88 "Software Limit Margin". If the setting is not done in Parameter No.88, the value set in this parameter become the detection value for Alarm Code 0D9 "Soft Limit Over Error".

[3] Home return direction (Parameter No.5)

No.	Name	Symbol	Unit	Input Range	Default factory setting
5	Home Return Direction	ORG	-	0: Reverse 1: Forward	In accordance with actuator

Unless there is a request of Home Reversed Type (option), the home-return direction is on the motor side for the line axis, counterclockwise side for the rotary axis and outer (open) side for the gripper. [Refer to the coordinate system of the actuator.]

If it becomes necessary to reverse the home direction after the actuator is installed on the machine, change the setting.

⚠ Caution: For the actuator of rod or rotary type, the home direction cannot be changed.

[4] Press & hold stop judgment period (Parameter No.6)

No.	Name	Symbol	Unit	Input Range	Default factory setting
6	Push & Hold Stop Judgment Period	PSWT	msec	0 to 9999	255

Judging completion of pressing operation

(1) For Standard type (PIO pattern 0 to 2)

The operation monitors the torque (current limit value) in percent in "Pressing" of the position table and turns pressing complete signal PEND ON when the load current satisfies the condition shown below during pressing. PEND is turned ON at satisfaction of the condition if the work is not stopped.

(Accumulated time in which current reaches pressing value [%])

– (accumulated time in which current is less than pressing value [%])

≥ 255 ms (Parameter No.6)

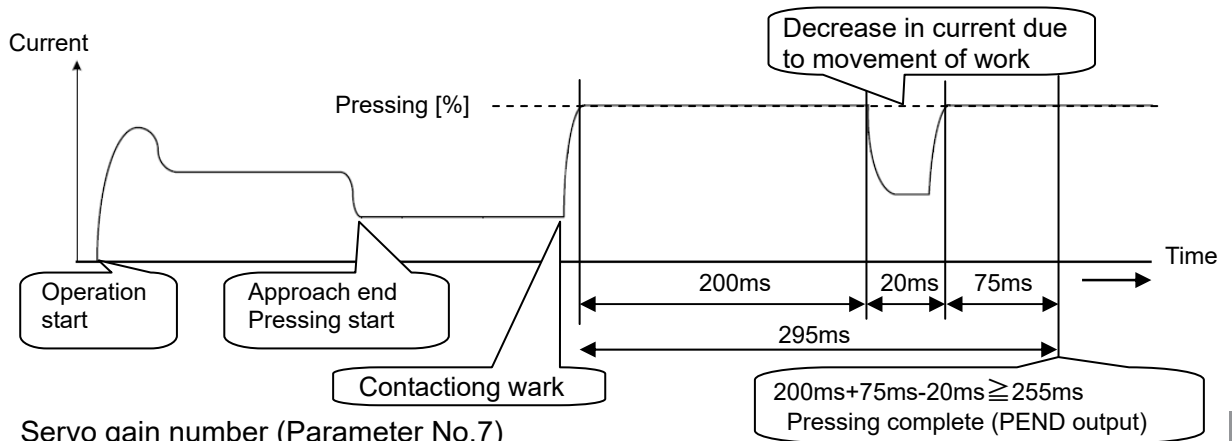

[5] Servo gain number (Parameter No.7)

No.	Name	Symbol	Unit	Input Range	Default factory setting
7	Servo Gain Number	PLGO	-	0 to 31	In accordance with actuator

The servo gain is also called position loop gain or position control system proportion gain.

The parameter defines the response when a position control loop is used. Increasing the set value improves the tracking performance with respect to the position command. However, increasing the parameter value excessively increases the changes of overshooting.

When the set value is too low, the follow-up ability to the position command is degraded and it takes longer time to complete the positioning.

For a system of low mechanical rigidity or low natural frequency (every object has its own natural frequency), setting a large servo gain number may generate mechanical resonance, which then cause not only vibrations and/or noises but also overload error to occur.

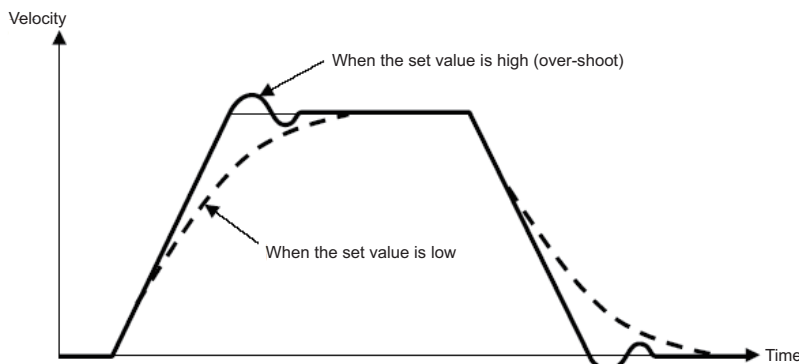

[6] Default velocity (Parameter No.8)

No.	Name	Symbol	Unit	Input Range	Default factory setting
8	Default Velocity	VCMD	mm/s [deg/s]	1 to Actuator's max. speed	Rated actuator speed

The factory setting is the rated velocity of the actuator.
 When a target position is set in an unregistered position table, the setting in this parameter is automatically written in the applicable position number.
 It is convenient to set the velocity often used.

[7] Default acceleration/deceleration (Parameter No.9)

No.	Name	Symbol	Unit	Input Range	Default factory setting
9	Default Acceleration/Deceleration	ACMD	G	0.01 to Actuator's max. acceleration/ deceleration	Rated actuator's acceleration/ deceleration

The factory setting is the rated acceleration/deceleration of the actuator.
 When a target position is set in an unregistered position table, the setting in this parameter is automatically written in the applicable position number.
 It is convenient to set the acceleration/deceleration often used.

[8] Default positioning width (in-position) (Parameter No.10)

No.	Name	Symbol	Unit	Input Range	Default factory setting
10	Default Positioning Width	INP	mm [deg]	Actuator's min. resolution to 999.99	In accordance with actuator

When a target position is set in an unregistered position table, the setting in this parameter is automatically written in the applicable position number. When the remaining moving distance enters into this width, the positioning complete signal PEND/INP is output.
 It is convenient to set the positioning width often used.

For pulse motor type only

[9] Current-limiting value at standstill during positioning (Parameter No.12)

No.	Name	Symbol	Unit	Input Range	Default factory setting
12	Current-limiting value at standstill during positioning	SPOW	%	0 to 70	In accordance with actuator

When the value is increased, the stop holding torque is increased.
 Even though it is generally unnecessary to change this setting, setting the value larger is necessary in the case a large external force is applied during stop. Please contact IAI.

[10] Current-limiting value during home return (Parameter No.13)

No.	Name	Symbol	Unit	Input Range	Default factory setting	Type
13	Current-Limiting Value During Home Return	ODPW	%	0 to 100	In accordance with actuator	Pulse Motor Type
				0 to 300		Servo Motor Type Brushless DC Motor Type

The setting is established for the current to suit for the standard type actuator at the delivery. Increasing this setting will increase the home return torque. Normally this parameter need not be changed. If the home return should be completed before the correct position depending on the affixing method, load condition or other factors when the actuator is used in a vertical application, the setting value must be increased. Please contact IAI.

[11] Pause input disable selection (Parameter No.15)

No.	Name	Symbol	Unit	Input Range	Default factory setting
15	Pause Input Disable Selection	STP	-	0: Enabled 1: Disabled	0

This parameter defines whether the pause input signal is disabled or enabled. If a pause operation is not needed, set the parameter to "1" and an operation becomes available without controlling the pause signal.

Set Value	Description
0	Enabled (Use)
1	Disabled (Does not use)

[12] Home position check sensor input polarity (Parameter No.18)

For servo motor type and pulse motor type only

No.	Name	Symbol	Unit	Input Range	Default factory setting
18	Home Position Check Sensor Input Polarity	LS	-	0 to 2	In accordance with actuator

The home sensor is an option.

Set Value	Description
0	Standard specification (sensor not used)
1	Input is a contact
2	Input is b contact

[13] Servo ON input disable (Parameter No.21)

No.	Name	Symbol	Unit	Input Range	Default factory setting
21	Servo ON Input Disable Selection	SON	-	0: Enabled 1: Disabled	0

This parameter defines whether the servo ON input signal is disabled or enabled. When the servo ON input signal is disabled, the servo is turned ON as soon as the controller power is turned ON.

Set this parameter to "1" if servo ON/OFF is not provided.

Set Value	Description
0	Enabled (Use)
1	Disabled (Does not use)

[14] Home return offset level (Parameter No.22)

No.	Name	Symbol	Unit	Input Range	Default factory setting
22	Home Return Offset Level	OFST	mm [deg]	0.00 to 9999.99	In accordance with actuator

In this setting can set the distance from the mechanical end to the home position.

An adjustment is available for the following cases.

- 1) Want to match the actuator home position and the mechanical origin of the system.
- 2) Want to set a new home after reversing the factory-set home direction.
- 3) Want to eliminate a slight deviation from the previous home position generated after replacing the actuator.

[Adjustment Process]

- 1) Homing execution
- 2) Offset check
- 3) Parameter setting change
- 4) If setting a number close to a multiple of the lead length (including home-return offset value = 0) to the home offset value, there is a possibility to servo lock on Z-phase at absolute reset, thus the coordinates may get shifted for the lead length.

For Absolute Type, do not attempt to set a value near a number that the lead length is multiplied by an integral number.

Have enough margin.

After the setting, repeat home return several times to confirm that the actuator always returns to the same home position.

 **Caution:** *If the home return offset has been changed, the soft limit parameters must also be adjusted accordingly.
In case there is a necessity of setting a value more than the initial setting, contact IAI.*

[15] Zone 2 positive side, zone 2 negative side (Parameter No.23, No.24)

[Refer to 8.2 [1].]

[17] PIO jog velocity (Parameter No.26)

No.	Name	Symbol	Unit	Input Range	Default factory setting
26	PIO Jog Velocity	JOGV	mm/s [deg/s]	1 to 250 (250 or less of actuator maximum speed)	In accordance with actuator

The setting of JOG operation velocity when the set in the JOG velocity / inching distance switchover signal JVEL is set to OFF.

Set an appropriate value in Parameter No.26 in accordance with the purpose of use.

[18] Movement command type (Parameter No.27)

No.	Name	Symbol	Unit	Input Range	Default factory setting
27	Movement Command Type	MCT	-	0 : Level 1 : Edge	0

Set the input methods for the start signal (ST0 to ST6, or ST0 to ST2 if PIO Pattern = 5) when PIO Pattern 4 = Solenoid Valve Mode 1 (7-point type) and PIO Pattern 5 = Solenoid Valve Mode 2 (3-point type).

Set Value	Input Method	Description
0	Level	The actuator starts moving when the input signal turns ON. When the signal turns OFF during movement, the actuator will decelerate to a stop and complete its operation.
1	Edge	The actuator starts moving when the rising edge of the input signal is detected. The actuator will not stop when the signal turns OFF during the movement, until the target position is reached.

[Level System]

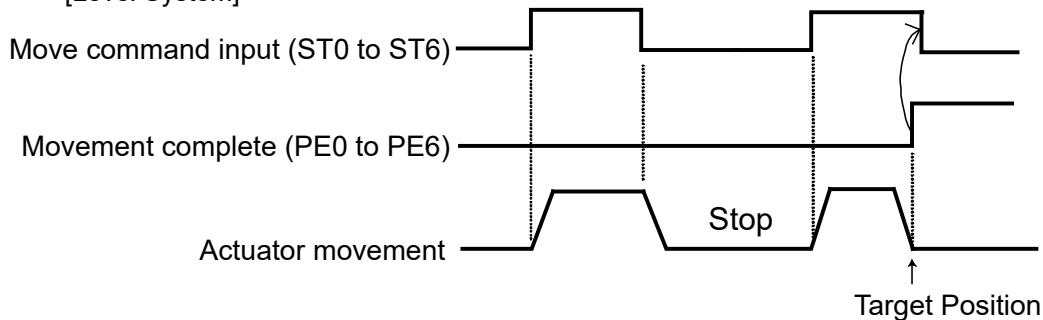

[Edge System]

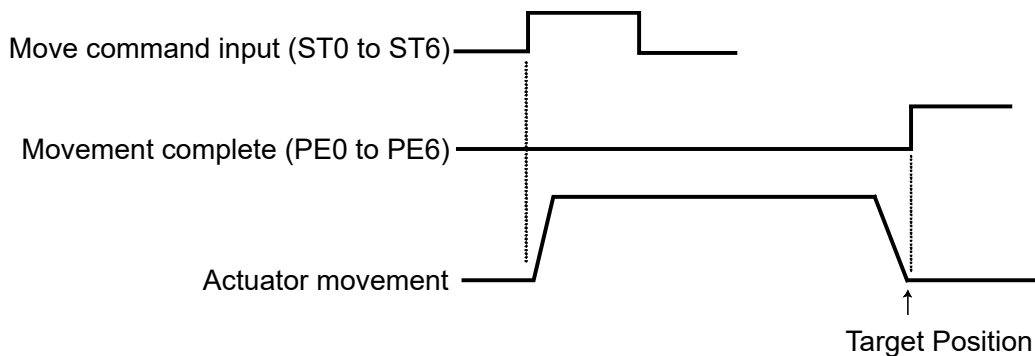

[19] Default movement direction for excitation-phase signal detecting movement (Parameter No.28)

For servo motor type and pulse motor type only

No.	Name	Symbol	Unit	Input Range	Default factory setting
28	Default Movement Direction for Excitation-phase Signal Detection	PHSP	–	0 : Reversed direction 1 : Forward direction	In accordance with actuator

Excitation detection^(Note) starts when the servo is turned ON for the first time after the power is supplied. Define the detection direction at this time.

Even though it is generally unnecessary to change this setting, set this to the direction which the motor is easy to move when the actuator interferes with the mechanical end or peripheral object at the time the power is supplied.

If the direction not interfering is the same direction as the home return direction, set the same values as set to Parameter No.5 Home Return Direction. If the direction is opposite, set the other values from Parameter No.5. (If No.5 is 0, set 1. If No.5 is 1, set 0.)

Note 1 For Simple Absolute Type, the excitation detection is performed at the end of home return operation.

[20] Excitation-phase signal detection time (Parameter No.29)

For servo motor type and pulse motor type only

No.	Name	Symbol	Unit	Input Range	Default factory setting	Specifications
29	Excitation-phase Signal Detection Time	PHSP	msec	1 to 999	10	Pulse motor type
				50 to 999	128	Servo motor type

Excitation detection^(Note) starts when the servo is turned ON for the first time after the power is supplied. Define the detection direction at this time.

Even though it is generally unnecessary to change this setting, changing the setting of this parameter may be effective when excitation error is generated or abnormal operation is confirmed.

Please contact us in the case a change is necessary to this parameter.

Note 1 For Simple Absolute Type, the excitation detection is performed at the end of home return operation.

[21] Excitation detection type (Parameter No.30)

For pulse motor type only

No.	Name	Symbol	Unit	Input Range	Default factory setting
30	Excitation Detection Type	PHSP	-	0 : Conventional method 1 : New method 1 (For vertical mount installation) 2 : New method 2 (For horizontal mount installation)	1

Excitation detection^(Note 1) starts when the servo is turned ON for the first time after the power is supplied. In the new method, this operation was made smoother, thus quieter than ever (if compared with our existing products).

In the case the new method 2 (horizontal mount installation) is set and the actuator is mounted vertically, the slider or the rod may drop at the excitation operation. Follow the instructed orientation to install. If the slide or rod drops with the mentioned way of installation, set with the current setting.

Note 1 For Simple Absolute Type, the excitation detection is performed at the end of home return operation.

[22] Pole sensing type (Parameter No.30)

For servo motor type only

No.	Name	Symbol	Unit	Input Range	Default Factory Setting
30	Pole Sensing Type	PHSP	-	0 : Current Control 1 : Distance Control 1 2 : Distance Control 2	1

At the time the magnetic pole detection is performed at the serve-on after the power is turned on, the operation system is defined at the same time. It is not necessary to make a change in normal use.

[23] Velocity loop proportional gain (Parameter No.31)

No.	Name	Symbol	Unit	Input Range	Default factory setting
31	Velocity Loop Proportional Gain	VLPG	-	1 to 27661	In accordance with actuator

This parameter determines the response of the speed control loop. When the set value is increased, the follow-up ability to the velocity command becomes better (the servo-motor rigidity is enhanced). The higher the load inertia becomes, the larger the value should be set. However, excessively increasing the setting will cause overshooting or oscillation, which facilitates producing the vibrations of the mechanical system.

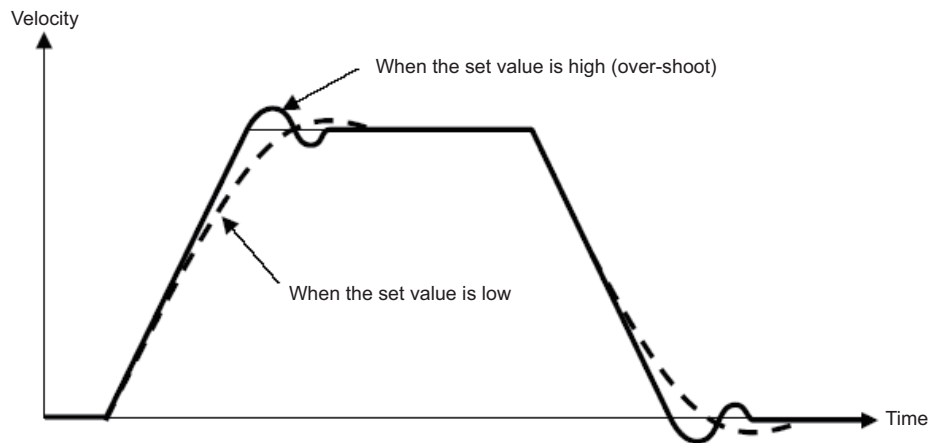

Also, for the conditions to use this item in the pulse motor type, refer to “Selecting to Use Velocity Loop Proportional Gain and Velocity Loop Integrated Gain” in the bottom of the next page.

[24] Velocity loop integral gain (Parameter No.32)

No.	Name	Symbol	Unit	Input Range	Default factory setting
32	Velocity Loop Integral Gain	VLPT	-	1 to 217270	In accordance with actuator

Any machine produces frictions. This parameter is intended to cope with deviation generated by external causes including frictions. Increasing the setting value improves the reactive force

against load change. That is, the servo rigidity increases. However, increasing the parameter value excessively may make the gain too high, which then cause the machine system to be vibrated due to overshoot or shaking.

Tune it to obtain the optimum setting by watching the velocity response.

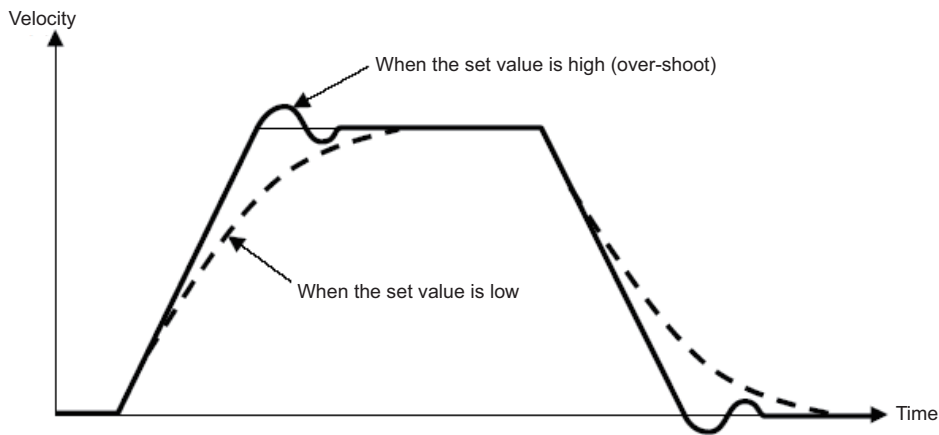

Also, for the conditions to use this item in the pulse motor type, refer to “Selecting to Use Velocity Loop Proportional Gain and Velocity Loop Integrated Gain” in the bottom of the next page.

【Selecting the Use of velocity loop proportional gain and velocity loop integrated gain】

Even though Velocity Loop Proportional Gain of pulse motor specification can be set to Parameter No.31, 145 and 153, and Velocity Loop Integrated Gain to Parameter No.32, 146 and 154, the values to be effective during an operation is just one of them. The following table shows which parameter number becomes effective in each condition.

Effective Parameter Number

		High Output Setting (Parameter No.152)	
		0 (Disable)	1 (Enable)
Gain Scheduling (Parameter No.144)	to 100 (Disable)	Parameter No.31, 32	Parameter No.153, 154
	101 to (Enable)	Parameter No.145, 146	Parameter No.145, 146

[25] Torque filter time constant (Parameter No.33)

No.	Name	Symbol	Unit	Input Range	Default factory setting
33	Torque Filter Time Constant	TRQF	-	0 to 2500	In accordance with actuator

This parameter decides the filter time constant for the torque command. When vibrations and/or noises occur due to mechanical resonance during operation, this parameter may be able to suppress the mechanical resonance. This function is effective for torsion resonance of ball screws (several hundreds Hz).

[26] Pressing velocity (Parameter No.34)

No.	Name	Symbol	Unit	Input Range	Default factory setting
34	Pressing velocity	PSHV	mm/s [deg/s]	1 to actuator's max. pressing speed	In accordance with actuator

This is the parameter to set the velocity in pressing operation.

The setting is done considering the actuator type when the product is delivered. [Refer Appendix to 10.4 List of Specifications of Connectable Actuators]

If a change to the setting is required, make sure to have the setting below the maximum pressing velocity of the actuator. Setting it fast may disable to obtain the specified pressing force. Also when setting at a low velocity, take 5mm/s as the minimum. Specified pressing force may not be obtained also when a low speed setting is set.

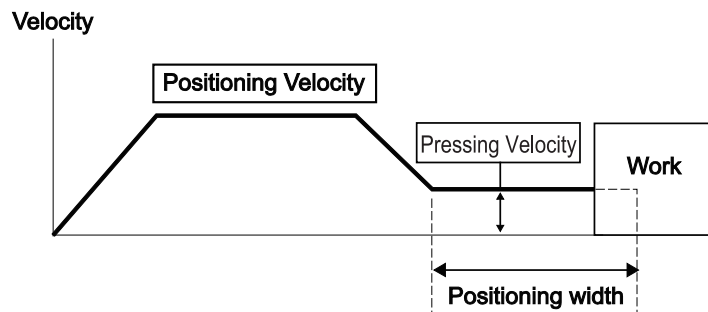

⚠ Caution: If the velocity of the positioning of the position table is set below this parameter, the pressing velocity will become the same as the positioning speed.

[27] Safety velocity (Parameter No.35)

No.	Name	Symbol	Unit	Input Range	Default factory setting
35	Safety Velocity	SAFV	mm/s [deg/s]	1 to 250 (maximum speed for the actuators with 250 or less)	100

This is the parameter to set the maximum speed of manual operation while the safety velocity selected in the teaching tool. Do not have the setting more than necessary.

[28] Auto servo motor OFF delay time 1, 2, 3 (Parameter No.36, No.37, No.38)

No.	Name	Symbol	Unit	Input Range	Default factory setting
36	Auto Servo-motor OFF Delay Time 1	ASO1	sec	0 to 9999	0
37	Auto Servo-motor OFF Delay Time 2	ASO2	sec	0 to 9999	0
38	Auto Servo-motor OFF Delay Time 3	ASO3	sec	0 to 9999	0

Set the duration before the servo turns OFF after positioning process is complete when the power saving function is used.

[Refer to Chapter 6 Power-saving Function.]

[29] Position complete signal output method (Parameter No.39)

No.	Name	Symbol	Unit	Input Range	Default factory setting
39	Position Complete Signal Output Method	PEND	-	0: PEND 1: INP	0

This is the parameter to select the type of the positioning complete signals to be used. It is available except for when PIO Pattern = 5 (Solenoid Valve Type 2 [3-point type]) is selected.

There are 2 types of positioning complete signals and the output condition would differ depending on whether the servo is ON after the positioning is complete or the servo is OFF.

Set Value	Signal Type	During Servo ON (positioning complete)	During Servo OFF
0	PEND	It will not turn OFF even if the current position is out of the range of the positioning width.	Turns OFF in any case
1	INP	Turns ON when the current position is in the positioning width, and OFF when out of it.	

Complete position No. outputs PM1 to PM** and current position No. outputs PE0 to PE6 are issued in the similar way.

[30] Home-return Input Disable (Parameter No.40)

No.	Name	Symbol	Unit	Input Range	Default factory setting
40	Home-return Input Disable	HOME	-	0: Enabled 1: Disabled	0

This parameter defines whether the home return input signal is disabled or enabled. Normally this parameter need not be changed.

Set Value	Description
0	Enabled (Use)
1	Disable (Does not use)

[31] Home position check sensor input polarit
(Parameter No.43)

For servo motor type and pulse motor type only

No.	Name	Symbol	Unit	Input Range	Default factory setting
43	Home Position Check Sensor Input Polarity	HMC	-	0: Sensor not used 1: a contact 2: b contact	In accordance with actuator

Set the input signal polarity of the home position check sensor (option).

Since the home position check sensor is installed just below the mechanical end, if the actuator reverses without reaching the mechanical end because of a reason such as interference, an alarm will be generated because it will be identified as off the position and causes home position sensor non-detected error.

It is generally unnecessary to change the setting.

Set Value	Description
0	Home position check sensor not used
1	Sensor polarity: Contact a
2	Sensor polarity: Contact b

[32] Velocity override (Parameter No.46)

No.	Name	Symbol	Unit	Input Range	Default factory setting
46	Velocity Override	OVRD	%	1 to 100	100

When move commands are issued from the PLC, the moving speed set in the "Velocity" field of the position table can be overridden by the value set by this parameter.

Actual movement velocity = [Velocity set in the position table] × [setting value in Parameter No.46]

Example) Value in the "Velocity" field of the position table: 500mm/s
Setting in Parameter No.46 20%

In this case, the actual movement speed becomes 100mm/s.

The minimum setting unit is 1% and the input range is 1 to 100%.

(Note) This parameter is ignored for move commands from a teaching tool such as PC software.

[33] PIO jog velocity 2 (Parameter No.47)

No.	Name	Symbol	Unit	Input Range	Default factory setting
47	PIO Jog Velocity 2	IOV2	mm/s (deg/s)	1 to 250 (250 or less of actuator maximum speed)	In accordance with actuator

The setting of JOG operation velocity when the set in the JOG velocity / inching distance switchover signal JVEL is set to ON.

Set the appropriate value considering how the system is to be used.

However, it will operate at the value in this parameter only when JVEL Signal is on and Command Speed Setting = 0 at the same time in the direct indication mode.
(Operation will be made at the Command Speed setting value when JVEL Signal is on and Command Speed Setting ≠ 0.)

[34] PIO inch distance, PIO inch distance 2 (Parameter No.48, No.49)

No.	Name	Symbol	Unit	Input Range	Default factory setting
48	PIO Inching Distance	IOID	mm [deg/s]	0.01 to 1.00	1.00
49	PIO Inching Distance 2	IOD2	mm [deg/s]	0.01 to 1.00	0.10

When the selected PIO pattern is "1" (teaching mode), this parameter defines the inching distance to be applied when inching input commands are received from the PLC.

Parameter No.49 defines the inching distance when 1 is set in the JOG speed / inching distance switchover signal JVEL for field network type.

The maximum allowable value is 1mm.

For pulse motor type only

[35] Load output judgment time period (Parameter No.50)

No.	Name	Symbol	Unit	Input Range	Default factory setting
50	Load Output Judgment Time Period	LDWT	msec	0 to 9999	255

This parameter defines the time taken to judging whether torque level status signal (TRQS) is ON.

If the command torque exceeds the value set in "Threshold" of position data for the time set by this parameter during pressing operation, torque level status signal (TRQS) is turned ON.

Refer to 3.8.2 [4] or 3.8.3 [3] Pressing Operation for the details of the pressing operation.

For pulse motor type only

[36] Torque inspected range (Parameter No.51)

No.	Name	Symbol	Unit	Input Range	Default factory setting
51	Torque Inspected Range	TRQZ	-	0 : Enabled 1 : Disabled	0

The load output (LOAD) turns ON when it exceeds the current [%] set as the position table threshold in the range (check range) set with Zone +/Zone - in the position table during the pressing operation.

[37] Default acceleration/deceleration mode (Parameter No.52)

No.	Name	Symbol	Unit	Input Range	Default factory setting
52	Default Acceleration/Deceleration Mode	MOD	-	0 to 2	0 (Trapezoid)

When a target position is written to an unregistered position table, this value is automatically set as the "Acceleration/deceleration mode" of the applicable position number. Refer to [3.3 Position Data Setting 11) Acceleration/Deceleration Mode] for Acceleration/Deceleration Mode

Set Value	Description
0	Trapezoid
1	S-motion
2	Primary delay filter

[38] Default stop mode (Parameter No.53)

No.	Name	Symbol	Unit	Input Range	Default factory setting
53	Default Stop Mode	HSTP	-	0 to 3 (Other than pulse motor specification) 0 to 7 (Pulse motor specification)	0 (Not applicable)

This parameter defines the power-saving function. [Refer to Chapter 6 Power-saving Function.]

For servo motor type and brushless DC motor type only

[39] Current control width number (Parameter No.54)

No.	Name	Symbol	Unit	Input Range	Default factory setting
54	Current Control Width Number	CLPF	-	0 to 15	In accordance with actuator

This parameter is for the manufacturer's use only to determine the response capability of the current loop control. Therefore, do not change the settings in this parameter. If the parameter is changed carelessly, control safety may be adversely affected and a very dangerous situation may result.

[40] Position command primary filter time constant (Parameter No.55)

No.	Name	Symbol	Unit	Input Range	Default factory setting
55	Position Command Primary Filter Time Constant	PLPF	msec	0.0 to 100.0	0.0

This is to be used when setting the value in "Acceleration/Deceleration Mode" box in the position table to 2 "Primary Delay Filter".

The primary delay filter is disabled if "0" is set.

The greater the setting value is, the longer the delay is and the slower the acceleration/deceleration is. The impact at the acceleration and deceleration will be eased, but the cycle time will become longer.

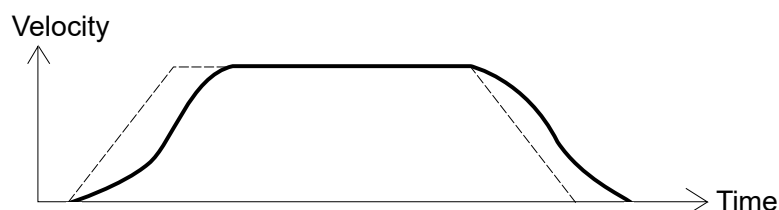

[41] S-motion rate (Parameter No.56)

No.	Name	Symbol	Unit	Input Range	Default factory setting
56	S-motion Rate	SCRV	%	0 to 100	0

This parameter is used when the value in the “Acceleration/deceleration mode” field of the position table is set to “1 (S-motion)”.

This enables to ease the impact at acceleration and deceleration without making the cycle time longer.

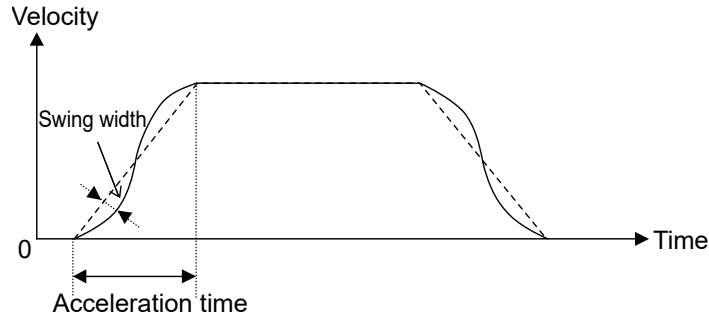

The S-motion is a sine curve that has the acceleration time as 1 cycle. The level of its swing width can be set by this parameter.

Setting [%]	Level of swing width
0	No S-motion (Dotted line shown in the image below)
100	Sine curve swing width $\times 1$ (Double-dashed line shown in the image below)
50	Sine curve swing width $\times 0.5$ (Dashed line shown in the image below)
10	Sine curve swing width $\times 0.1$ (Solid line shown in the image below)

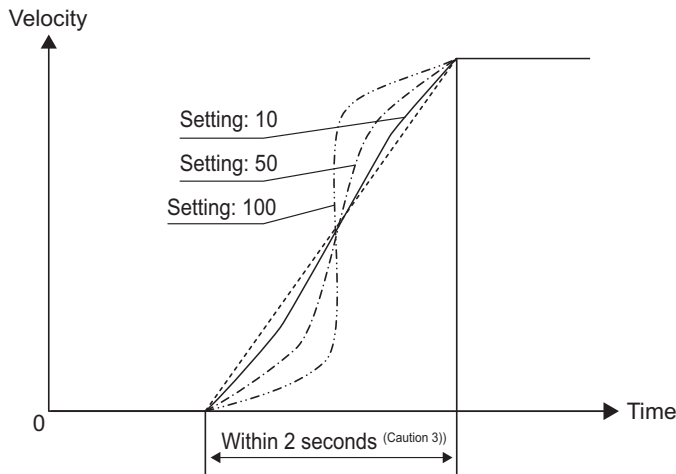

- ⚠ Caution:**
- 1) If the S-motion is specified in acceleration/deceleration mode, executing position command or direct value command while the actuator is moving causes an actuator to move along the trapezoid pattern.
To change a speed during operation, be sure to specify such a position command while the actuator is in pause state.
 - 2) In the index mode of rotary actuator, the S-motion control is disabled. If S-motion acceleration/deceleration is specified, the trapezoid pattern is used in acceleration/deceleration mode.
 - 3) If acceleration time or deceleration time exceeds 2 seconds, do not specify S-motion control. The actuator will be the trapezoid operation.
 - 4) Do not perform temporary stop during acceleration or deceleration. The speed change (acceleration) may cause the dangerous situation.

[42] Position Feed forward gain (Parameter No.71)

No.	Name	Symbol	Unit	Input Range	Default factory setting	Type
71	Position Feed Forward Gain	PLFG	-	0 to 100	0	Pulse Motor Type Servo Motor Type
					50	Brushless DC Motor Type

This parameter defines the level of feed forward gain to be applied to position control. Setting this parameter allows the servo gain to be increased and the response of the position control loop to be improved. This is the parameter to improve the takt time and traceability even more after fine-tuning the settings for “Servo Gain Number (Parameter No.7)”, “Velocity Loop Proportional Gain (Parameter No.31)”, etc.

This can result in shorter positioning time.

The gain adjustment of position, speed and current loop in feedback control can directly change the response of the servo control system. Thus, improper adjustment may cause the control system to be unstable and further vibrations and/or noises to occur. On the other hand, since this parameter only changes the speed command value and does not relate with the servo loop, it neither makes the control system unstable nor generate continuous vibrations and/or noises. However, excessive setting may generate vibrations and/or noises until the machine can follow command values in every operation.

In the trapezoidal pattern, adding the value resulting from multiplying the speed command by the feed forward gain to the speed command can reduce the delay of speed follow-up and the position deviation.

The feedback control providing control in accordance with the result causes control delay to occur. This conducts the supportive control independent from the control delay.

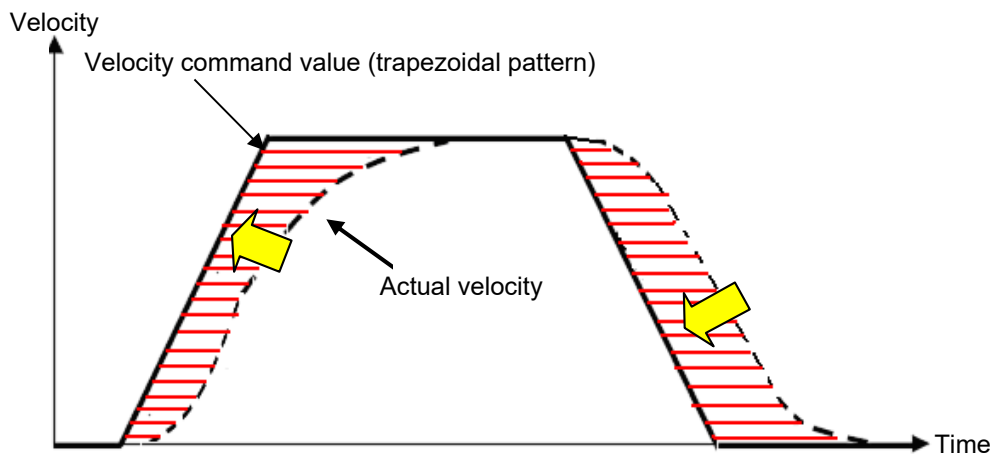

⚠ Caution: Anti-vibration control function is unavailable when the feed-forward gain is used (with the settings except for 0).

[43] Ball screw lead length (Parameter No.77)

No.	Name	Symbol	Unit	Input Range	Default factory setting
77	Ball Screw Lead Length	LEAD	mm	0.01 to 999.99	In accordance with actuator

This parameter set the ball screw lead length.
The factory setting is the value in accordance with the actuator characteristics.

⚠ Caution: *If the setting is changed, not only the normal operation with indicated speed, acceleration or amount to move is disabled, but also it may cause a generation of alarm, or malfunction of the unit.*

[44] Axis operation type (Parameter No.78)

No.	Name	Symbol	Unit	Input Range	Default factory setting
78	Axis Operation Type	ATYP	-	0: Linear axis 1: Rotary axis	In accordance with actuator

This parameter defines the type of the actuator used.

Connected Actuator	Set Value	Reference
Linear Axis	0	Actuator other than rotary type
Rotary Axis	1	Actuator of rotary type

(Note) Refer to 10.4 List of Specifications of Connectable Actuators for the rotary type actuators.

⚠ Caution: *Do not change the setting of this parameter. Failure to follow this may cause an alarm or fault to occur.*

[45] Rotary axis mode selection (Parameter No.79)

No.	Name	Symbol	Unit	Input Range	Default factory setting
79	Rotary Axis Mode Selection	ATYP	-	0: Normal mode 1: Index mode	In accordance with actuator

This parameter defines the mode of the rotational axis.

When the Parameter No.78 (Axis Operation Type) is set to "1: Rotary Axis" and the index mode is selected, the current value indication is fixed to "0 to 359.99". When the index mode is selected, the short course control is enabled.

Set Value	Description
0	Normal Mode
1	Index Mode

- The index mode cannot be specified for actuators of absolute specification.

⚠ Caution: · When it is set to "Index Mode", the push & hold operation is not available. Even when data is entered in the "Push & Hold" data box in the Position Data, it becomes invalid and normal operation is performed. The positioning width becomes the parameter's default value for the positioning width.

· Change the value in the soft limit at the same time when changing the setting of Index Mode to Normal Mode. Parameter data error would be generated if the value in the soft limit is set to 0. Set a value that is -0.3mm out of the effective stroke.

[46] Rotational axis shortcut selection (Parameter No.80)

No.	Name	Symbol	Unit	Input Range	Default factory setting
80	Rotational Axis Shortcut Selection	ATYP	-	0: Disabled 1: Enabled	In accordance with actuator

Select whether valid/invalid the shortcut when positioning is performed except for when having the relative position movement in the multiple rotation type rotary actuator. The shortcut means that the actuator is rotated to the next position in the rotational direction of the smaller travel distance.

Set Value	Description
0	Shortcut Invalid
1	Shortcut Valid

Refer to [Nearer Direction Control of Multi-Rotation Type Rotary Actuator] in 3.8.2 Position Number Input Operation.

[47] Absolute unit (Parameter No.83)

For servo motor type and pulse motor type only

No.	Name	Symbol	Unit	Input Range	Default factory setting
83	Absolute Unit	ETYP	-	0: Not used 1: Used	In accordance with specification at order accepted

[For pulse motor type]

Set to 1 if simple absolute type or battery-less absolute type and 0 if others.
Set to 0 when using the battery-less absolute in incremental.

[For servo motor type]

Set to 1 for Simple Absolute, and set to 0 for other types.
The battery-less absolute cannot be used in incremental.

[48] Software limit margin (Parameter No.88)

No.	Name	Symbol	Unit	Input Range	Default factory setting
88	Software Limit Margin	SLMA	mm (deg)	0 to 9999.99	0

This is the parameter to set the position of over error detection against the soft limit errors set in Parameters No.3 and No.4.

It is not necessary to change the setting in normal use.

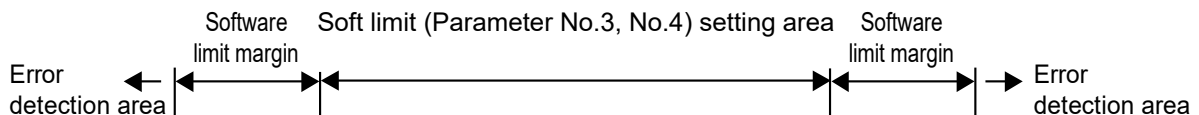

[49] Current limit value at stopping due to miss-pressing (Parameter No.91)

No.	Name	Symbol	Unit	Input Range	Default factory setting
91	Current Limit Value at Stopping Due to Miss-pressing	FSTP	-	0: Current limiting value at stop 1: Current limit value during pressing	0

This parameter select the restricted current value at stopping due to miss-pressing. This restricted current value locks the servo till the next moving command.

Set Value	Description
0	Use the current limit value (Parameter No. 12) at positioning stop.
1	Use the current limit value at pressing set in the position table.

For servo motor type only

[50] Damping characteristic coefficient 1, 2 / Natural frequency / Notch filter gain (Parameter No.97 to No.108)

	No.	Name	Symbol	Unit	Input range	Default factory setting
Parameter set 1	97	Damping characteristic coefficient 1	DC11	-	0 to 1000	10
	98	Damping characteristic coefficient 2	DC21	-	0 to 1000	1000
	99	Natural frequency	NP01	1/1000Hz	500 to 30000	10000
	100	Notch filter gain	NFG1	-	1 to 20000	9990
Parameter set 2	101	Damping characteristic coefficient 1	DC12	-	0 to 1000	10
	102	Damping characteristic coefficient 2	DC22	-	0 to 1000	1000
	103	Natural frequency	NP02	1/1000Hz	500 to 30000	10000
	104	Notch filter gain	NFG2	-	1 to 20000	9990
Parameter set 3	105	Damping characteristic coefficient 1	DC13	-	0 to 1000	10
	106	Damping characteristic coefficient 2	DC23	-	0 to 1000	1000
	107	Natural frequency	NP03	1/1000Hz	500 to 30000	10000
	108	Notch filter gain	NFG3	-	1 to 20000	9990

This parameter is exclusively used for vibration suppress control. [Refer to Chapter 4 Vibration Suppress Control Function for details.]

[51] Default vibration suppress No. (Parameter No.109)

For servo motor type only

No.	Name	Symbol	Unit	Input Range	Default factory setting
109	Default Vibration Suppress No.	CTLS	-	0 to 3	0

This parameter is exclusively used for vibration suppress control.
 [Refer to Chapter 4 Vibration Suppress Control Function for details.]

[52] Stop method at servo OFF (Parameter No.110)

No.	Name	Symbol	Unit	Input Range	Default factory setting
110	Stop Method at Servo OFF	PSOF	-	0: Sudden Stop 1: Deceleration to stop	0

This parameter select how to stop the actuator at issue of servo OFF command, emergency stop or occurrence of an error (operation release level).

Stop Command	Set Value			
	0 : Sudden Stop		1 : Deceleration to stop	
	In Anti-Vibration Control Process	In Normal Positioning Control Process	In Anti-Vibration Control Process	In Normal Positioning Control Process
Pause	Vibration Control Deceleration and Stop	Normal Deceleration and Stop	Vibration Control Deceleration and Stop	Normal Deceleration and Stop
Servo OFF	Sudden stop due to emergency stop torque			
Emergency Stop				
Error (Operation Cancellation Level)				
Error (Cold Start)	Sudden stop due to emergency stop torque			

[53] Monitoring mode selection (Parameter No.112)

No.	Name	Symbol	Unit	Input Range	Default factory setting
112	Monitoring Mode Selection	FMNT	-	0: Unused 1: Monitor Function 1 2: Monitor Function 2 3: Monitor Function 3	1

The controller can be connected with PC software to monitor the servo.
 This parameter allows you to select a monitoring mode function (number of channels in the servomotor).

Check the Instruction Manual of the RC PC software for details.

Set Value	Description
0	Unused
1	Sets the 4CH record mode.
2	Sets the 8CH record mode.
3	Sets the 2CH record mode.

[54] Monitoring period (Parameter No.113)

No.	Name	Symbol	Unit	Input Range	Default factory setting
113	Monitoring Period	FMNT	msec	1 to 60000	1

This is the parameter to set up the frequency to the initial setting^(Note 1) of time to obtain data (Sampling Frequency) when the monitoring mode is selected.

By setting the value in this parameter bigger, the frequency of data obtaining can be made longer.

It is set to 1msec in the initial setting. Up to 60000msec can be set.

1msec frequency setting	60000msec frequency setting
Up to 2.048 seconds in 4CH record mode	Up to 34 hours 8 minutes in 4CH record mode
Up to 1.024 seconds in 8CH record mode	Up to 17 hours 4 minutes in 8CH record mode
Up to 4.096 seconds in 2CH record mode	Up to 68 hours 16 minutes in 2CH record mode

Note 1 The sampling period can be changed in the RC PC software.

For servo motor type only

[55] Servo gain number / Position Feed forward gain / Velocity loop proportional gain / Velocity loop integral gain / Torque filter time constant / Current control width number (Parameter No.120 to 137)

	No.	Name	Symb ol	Unit	Input Range	Default factory setting
Gain set 1	120	Servo gain number 1	PLG1	-	0 to 31	In accordance with actuator
	121	Position Feed forward gain 1	PLF1	-	0 to 100	
	122	Velocity loop proportional gain 1	VLG1	-	1 to 27661	
	123	Velocity loop integral gain 1	VLT1	-	1 to 217270	
	124	Torque filter time constant 1	TRF1	-	0 to 2500	
	125	Current control width number 1	CLP1	-	0 to 15	
Gain set 2	126	Servo gain number 2	PLG2	-	0 to 31	In accordance with actuator
	127	Position Feed forward gain 2	PLF2	-	0 to 100	
	128	Velocity loop proportional gain 2	VLG2	-	1 to 27661	
	129	Velocity loop integral gain 2	VLT2	-	1 to 217270	
	130	Torque filter time constant 2	TRF2	-	0 to 2500	
Gain set 3	131	Current control width number 2	CLP2	-	0 to 15	In accordance with actuator
	132	Servo gain number 3	PLG3	-	0 to 31	
	133	Position Feed forward gain 3	PLF3	-	0 to 100	
	134	Velocity loop proportional gain 3	VLG3	-	1 to 27661	
	135	Velocity loop integral gain 3	VLT3	-	1 to 217270	
	136	Torque filter time constant 3	TRF3	-	0 to 2500	
	137	Current control width number 3	CLP3	-	0 to 15	

- Servo gain number 1/2/3 (Parameter No. 120, 126, 132)
This parameter determines the response of the position control loop.
[Refer to 8.2 [5] Servo gain number.]
- Position Feed forward gain 1/2/3 (Parameter No. 121, 127, 133)
This parameter defines the feed forward gain of the position control system.
[Refer to 8.2 [47] Position Feed forward gain.]
- Velocity loop proportional gain 1/2/3 (Parameter No. 122, 128, 134)
This parameter determines the response of the speed control loop.
[Refer to 8.2 [23] Velocity loop proportional gain.]
- Velocity loop integral gain 1/2/3 (Parameter No. 123, 129, 135)
This parameter determines the response of the speed control loop.
[Refer to 8.2 [24] Velocity loop integral gain.]
- Torque filter time constant 1/2/3 (Parameter No. 124, 130, 136)
This parameter decides the filter time constant for the torque command.
[Refer to 8.2 [25] Torque filter time constant.]
- Current control width number 1/2/3 (Parameter No. 125, 131, 137)
This parameter defines the control width of the current control system.
[Refer to 8.2 [39] Current control width number.]

[Reference Item] 3.3 Position Data Setting 13)-2 Gain Set

[56] Servo gain switchover time constant (Parameter No.138)

For servo motor type only

No.	Name	Symbol	Unit	Input Range	Default factory setting
138	Servo Gain Switchover Time Constant	GCFT	msec	10 to 2000	10

When a switchover of the servo gain set is commanded in the position table, the switchover process is completed after time more than 3 times of the time spent in the setting of this parameter is passed since the operation of the commanded position number has started.

⚠ Caution: A time constant being rather short may cause the servo gain to change rapidly to have the operation of the actuator unstable.

[57] Overload level ratio (Parameter No. 143)

For servo motor type and brushless DC motor type only

No.	Name	Symbol	Unit	Input Range	Default factory setting
143	Overload Level Ratio	OLWL	%	50 to 100	100

With the motor temperature of when an operation is held at the rating being set as 100%, the 048 overload warning (message level) is output when the motor temperature exceeds the rate set in this parameter. [Refer to 8.2 [64].]

The judgment would not be made if the value is set to 100%.

Do not attempt to change the setting for this feature from the initial setting in the pulse motor type as the feature is not applicable in this type.

For pulse motor type only

[58] Gain scheduling upper limit multiplying ratio (Parameter No.144)

No.	Name	Symbol	Unit	Input Range	Default factory setting
144	Gain Scheduling Upper Limit Multiplying Ratio	GSUL	%	0 to 1023	0 (Disabled)

Gain scheduling is the function to change the gain in accordance with the operation speed. This parameter shows the multiplying rate of the upper limit of the changeable gain.

With the set multiplying rate, the values for GS Velocity Loop Proportional Gain (Parameter No.145) and GS Velocity Loop Integrated Gain (Parameter No.146) are changed.

Set Value	Description
100 or less	Gain scheduling disabled
101 to 1023	Gain scheduling enabled (Recommended value 300)

[59] GS velocity loop proportional gain (Parameter No.145)

For pulse motor type only

No.	Name	Symbol	Unit	Input Range	Default factory setting
145	GS Velocity Loop Proportional gain	GSPC	-	1 to 30000	In accordance with actuator

When the gain scheduling upper multiplying rate (Parameter No.144) is set to 101 or more, this parameter setting becomes effective for Velocity Loop Proportional Gain.

[Refer to the 8.2 [23] Velocity loop proportional gain for the details]

Also, for the conditions to use this item, refer to "Selecting to Use Velocity Loop Proportional Gain and Velocity Loop Integrated Gain" in the bottom of 8.2 [24].

[60] GS velocity loop integral gain (Parameter No.146)

For pulse motor type only

No.	Name	Symbol	Unit	Input Range	Default factory setting
146	GS Velocity Loop Integral Gain	GSIC	-	1 to 500000	In accordance with actuator

When the gain scheduling upper multiplying rate (Parameter No.144) is set to 101 or more, this parameter setting becomes effective for Velocity Loop Integrated Gain.

[Refer to the 8.2 [24] Velocity loop integral gain for the details]

Also, for the conditions to use this item, refer to “Selecting to Use Velocity Loop Proportional Gain and Velocity Loop Integrated Gain” in the bottom of 8.2 [24].

[61] Total movement count target value (Parameter No.147)

No.	Name	Symbol	Unit	Input Range	Default factory setting
147	Total movement count target value	TMCT	Times	0 to 999999999	0 (Disabled)

An alarm is generated when the total movement count exceeds the value set to this parameter. The judgment would not be made if the value is set to 0.

[62] Total operated distance target value (Parameter No.148)

No.	Name	Symbol	Unit	Input Range	Default factory setting
148	Total operated distance target value	ODOT	m	0 to 999999999	0 (Disabled)

An alarm is generated when the total operation distance exceeds the value set to this parameter.

The judgment would not be made if the value is set to 0.

[63] Zone output changeover (Parameter No.149)

No.	Name	Symbol	Unit	Input Range	Default factory setting
149	Zone Output Changeover	ZONE	-	0: Not to change 1: To change	0

When there is PZONE signal to the current PIO pattern or the Fieldbus Operation Mode and no ZONE1 or ZONE2 signal, it is available to change the PZONE signal to either ZONE1 or ZONE2 signal.

(Note) ZONE1 signal is assigned prior to ZONE2 signal.

The correlation between the setting of Parameter No. 25 “PIO Pattern Select” and the zone signal output is as shown in the table below.

Operation Mode	Parameter No.25 PIO pattern selection	Parameter No.149 Zone Output Changeover Set Value	
		0	1
Remote I/O Mode	0	PZONE	ZONE2
	1	PZONE	ZONE1
	2	PZONE	ZONE1
	4 5	PZONE	ZONE2

[64] Light Malfunction Alarm Output Select (Parameter No.151)

No.	Name	Symbol	Unit	Input Range	Default factory setting
151	Light Malfunction Alarm Output Select	FSTP	-	0: Overload warning output 1: Message level alarm output	1

If set to 0, *ALML will be generated when overload level ratio (Parameter No. 143) has been exceeded.

If set to 1, *ALML will be generated when a message level alarm has been generated.

[65] High output setting (Parameter No.152)

For pulse motor type only

No.	Name	Symbol	Unit	Input Range	Default factory setting
152	High Output Setting	BUEN	-	0: Disabled 1: Enabled	0 (Disabling)

Set whether use the high output function. Note that it is necessary to indicate the high-output setting type (option) and have an actuator applicable for high-output ^(Note 1) connected.

(Note 1) High-output applicable actuator : RCP4, RCP5 Series

[66] BU velocity loop proportional gain (Parameter No.153)

For pulse motor type only

No.	Name	Symbol	Unit	Input Range	Default factory setting
153	BU Velocity Loop Proportional Gain	BUPC	-	1 to 10000	In accordance with actuator

The setting in this parameter gets effective for Velocity Loop Proportional Gain when Parameter No. 152 “High-Output Setting” is valid and No. 144 “Gain Scheduling Upper Magnification” is set to 100 or lower.

[Refer to the 8.2 [23] Velocity loop proportional gain for the details]

Also, for the conditions to use this item, refer to “Selecting to Use Velocity Loop Proportional Gain and Velocity Loop Integrated Gain” in the bottom of 8.2 [24].

[67] BU velocity loop integral gain (Parameter No.154)

For pulse motor type only

No.	Name	Symbol	Unit	Input Range	Default factory setting
154	BU Velocity Loop Integral Gain	BUIC	-	1 to 100000	In accordance with actuator

The setting in this parameter gets effective for Velocity Loop Proportional Gain when Parameter No. 152 “High-Output Setting” is valid and No. 144 “Gain Scheduling Upper Magnification” is set to 100 or lower.

[Refer to the 8.2 [24] Velocity loop integral gain for the details]

Also, for the conditions to use this item, refer to “Selecting to Use Velocity Loop Proportional Gain and Velocity Loop Integrated Gain” in the bottom of 8.2 [24].

[68] Absolute battery retention time (Parameter No.155)

For servo motor type and pulse motor type only

No.	Name	Symbol	Unit	Input Range	Default factory setting
155	Absolute Battery Retention Ttime	AIP	-	0: 20 days 1: 15 days 2: 10 days 3: 5 days	0

For simple absolute type, set how long the encoder position information is to be retained after the power to the controller is turned OFF. The setting can be selected from 4 phases and as the motor rotation speed gets slower, the time to retain the position information gets longer. In the case that there is a possibility that the slide or the rod of the actuator that transports the work may be moved by an external force, follow the table below and calculate ^(Note 1) the number of rotation from the moved speed and set this parameter to the value faster than this value. If the motor rotation setting value exceeds the set value, the position information will be lost. [Refer to the 7.2.2 Absolute Battery Charge]

Note 1 Motor rotation [rpm] = Moved speed [mm/s] / Lead length [mm] × 60

Setting	Upper Limit of Motor Rotation Speed at Power being OFF [rpm]		Position information retaining time (reference)
	Other than RCA2-***NA	RCA2-***NA	
0	100	75	20 days
1	200	150	15 days
2	400	300	10 days
3	800	600	5 days

For pulse motor type only

[69] Torque check/Light malfunction output select (Parameter No.156)

No.	Name	Symbol	Unit	Input Range	Default factory setting
156	Torque Check/Light Malfunction Output Select	SLAL	-	0: Outputs load output judgment status signal or torque level status signal 1: Message of light malfunction alarm output	0

Output of the load judgment output status signal (LOAD) or the torque level status signal (TRQS) can be changed to the output of the light malfunction alarm (ALML). Selection of whether to make the light malfunction alarm output the overload warning output or message level alarm output can be conducted in Parameter No. 151. [Refer to the 8.2 [64].]

[70] Active/Inactive axis select (Parameter No.158)

No.	Name	Symbol	Unit	Input Range	Default factory setting
158	Active/Inactive Axis Select	EFCT	-	0: Enabled 1: Disabled	0

In the case an operation is desired to be made with less axes than what were purchased, by setting this parameter to ineffective, an alarm would not be generated. It is useful when connecting specific axes for operation at the startup or can be reserved for an extension in the future.

For pulse motor type only

[71] Startup Current Limit Extension Feature (Parameter No.166)

No.	Name	Symbol	Unit	Input Range	Default factory setting
166	Startup Current Limit Extension Feature	DCET	-	0: Disabled 1: Enabled	0 (Disabled)

Drive control is made to the operation that causes an impact force at the start of movement when moving to the target position from the stop state. Effect is expected on an actuator used in large equipment with static friction of load (such as gripper).

This feature would not work even if this parameter is activated in the following cases.

- 1) Home return
- 2) The first escape operation after pressing is finished
- 3) First movement after pause is released
- 4) When movement command is issued during operation

[72] Collision Detection Feature (Parameter No.168)

For pulse motor type only

No.	Name	Symbol	Unit	Input Range	Default factory setting
168	Collision Detection Feature	CODT	-	0 to 7	0

It is a feature to generate a collision detection alarm and stop the operation (turn the servo OFF) when the actuator is crashed.

Detection is conducted in the range set that the position zone is set. [Refer to the Chapter 5 Collision Detection Feature]

Setting value	Operation status	Alarm level
0	Detection not to be conducted (same when set to 2, 4 or 6)	-
1	Detection is conducted in position zone setting range.	Operation cancellation level
3 (Note 1)	Detection is conducted in position zone setting range, but is not conducted in the following conditions. In this setting, it can avoid a mistake to detect the current during acceleration. <ul style="list-style-type: none"> • The first movement after releasing from a pause • Movement from a stop in the position zone range 	
5	Detection is conducted in position zone setting range.	Message level
7 (Note 1)	Detection is conducted in position zone setting range, but is not conducted in the following conditions. In this setting, it can avoid a mistake to detect the current during acceleration. <ul style="list-style-type: none"> • The first movement after releasing from a pause • Movement from a stop in the position zone range 	

Note 1 In this setting, it can avoid a mistake to detect the current during acceleration.

[73] Pressing Type (Parameter No.181)

No.	Name	Symbol	Unit	Input Range	Default factory setting
181	Pressing type	SPOS	-	0: Type CON 1: Type SEP	0

The pressing method can be selected from CON type and SEP type.

[Pressing Operation CON Method]

After reaching the target position ^(Note 1) from the current position, the actuator moves with the pressing speed for the distance set as the pressing band width.

The positioning complete signal (PEND) turns ON if the work piece hits and pressing is judged as completed while in the pressing operation.

Note 1 In Direct Indication Mode, it is the value input in the target position register.

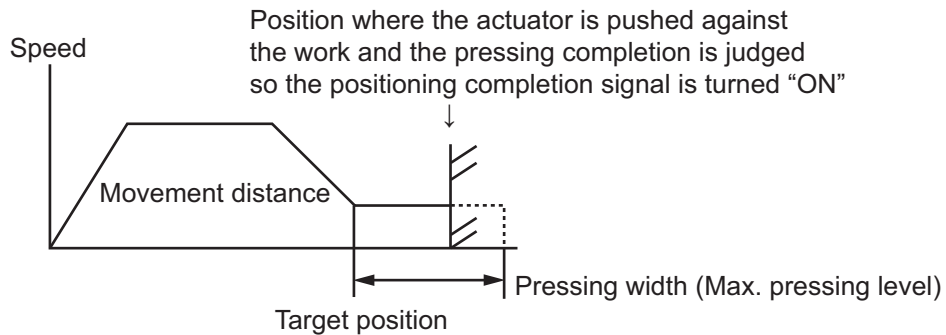

[Pressing Operation SEP Method]

The pressing operation is performed with the start position set at the point in front of the target position ^(Note 1) for the width of the positioning width (for Direct Indication Mode).

The positioning complete signal (PEND) turns ON if the work piece hits and pressing is judged as completed while in the pressing operation.

Note 1 In Direct Indication Mode, it is the value input in the target position register.

(Note) Pulling operation cannot be performed.

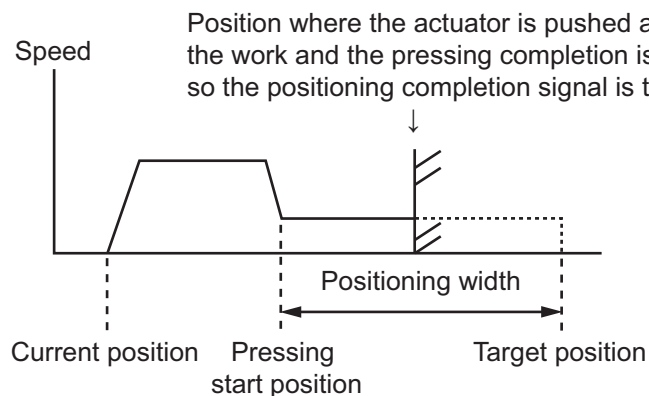

8.3 Servo Adjustment

The parameters are preset at the factory before shipment so that the actuator operates stably within the rated (maximum) transportable weight. However, the preset setting cannot always be the optimum load condition in the actual use. In such cases, servo adjustment may be required. This section describes the basic servo adjustment method.

⚠ Caution: *Rapid and excessive settings are dangerous. They may damage devices including the actuator or injure people. Take sufficient note on the setting. Record settings during servo adjustment so that prior settings can always be recovered. When a problem arises and the solution cannot be found, please contact IAI.*

8.3.1 Adjustment of Pulse Motor and Servo Motor

No.	Situation that requires adjustment	How to Adjust
1	<p>Takes time to finish positioning</p> <p>Positioning accuracy is not appropriate</p> <p>Shorter takt time is desired</p>	<ul style="list-style-type: none"> Set Parameter No.55 "Position command primary filter time constant" to "0" if it is set. Increase the value of Parameter No.7 "Servo gain number". By setting a larger value, the follow-up ability to the position command becomes better. Set the value to any of 3 to 10 roughly or up to 15 at the maximum. If the value is too large, an overshoot is caused easily and may cause noise or vibration. <u>If the value of Parameter No.7 "Servo gain number" is increased, also adjust the Parameter No.31 "Speed loop proportional gain" in increasing direction to ensure the stability in the control system.</u> To increase the value of Parameter No.31 "Speed loop proportional gain" <u>by about 20% of the default.</u> Prior to the setting, adjust Parameter No.7 "Servo gain number".
2	Vibration is generated at acceleration/deceleration	<ul style="list-style-type: none"> The cause of the problem is excessive "acceleration/deceleration setting" or vulnerable structure of the unit on which the actuator is installed. If possible, reinforce the unit itself, first. Decrease the values of "acceleration/deceleration setting". Decrease the number of Parameter No.7 "Servo gain number". If the Parameter No.7 "Servo gain number" is too low, it takes long time to finish the positioning.
3	<p>Speed is uneven during the movement</p> <p>Speed accuracy is not appropriate</p>	<ul style="list-style-type: none"> Increase the value of Parameter No.31 "Speed loop proportional gain". By setting a larger value, the follow-up ability to the speed command becomes better. Setting too large value makes the mechanical components easy to vibrate. As a reference for the setting, increase the value little <u>by little by 20% from the initial setting.</u>

No.	Situation that requires adjustment	How to Adjust
4	<p>Abnormal noise is generated. Especially, when stopped state and operation in low speed (less than 50mm/sec), comparatively high noise is generated.</p>	<ul style="list-style-type: none"> Input the Parameter No.33 "Torque Filter Time Constant". Try to increase by 50 as a reference for the setting. If the setting is too large, it may cause a loss of control system stability and lead the generation of vibration. <p>[Important] Prior to Adjustment: This phenomenon is likely to occur when the stiffness of the mechanical components is not sufficient. The actuator itself may also resonate if its stroke is over 600mm or it is belt-driven type. Before having an adjustment, check if:</p> <ol style="list-style-type: none"> The value for Parameter No.7 "Servo gain number", Parameter No.31 "Speed loop proportional gain", or Parameter No.32 "Speed loop integral gain" are excessive. The stiffness of the load is sufficient as much as possible, or the attachments are not loosened. The actuator unit is mounted securely with a proper torque. There is no waviness on the actuator mounting surface.
5	<p>Trace precision is desired to be improved. Equi-speed performance is desired to be improved. Response is desired to be improved.</p>	<ul style="list-style-type: none"> Make the condition optimized with Parameter No.7 "Servo gain number" and Parameter No.31 "Velocity loop proportional gain" adjusted by referring to the way to adjust stated in No.1 to 3 in the previous page. <p>[Reference] The most important factor is to select the actuator (motor). The servo is extremely sensitive to the inertia of the load. If the inertia moment of the load is too large in comparison with the inertia moment of the servo motor itself, the motor is highly affected by the load. This may cause the actuator to be controlled unstably. Therefore, to improve the precisions of the trace, position, speed and response of the actuator, the load inertia ratio must be made small. For high trace precision, equi-speed performance, and response of the actuator in such a use as application, it is better to use ball screws with small leads in the actuator as much as possible and an actuator of motor capacity higher by at least one level. The best method is to calculate the load inertia to select the proper actuator.</p>
6	<p>Large static friction of load makes actuator start slowly. Large load inertia makes response of actuator low at start and stop. Cycle time is desired to be shortened.</p>	<ul style="list-style-type: none"> Set parameter No.71 "Feed forward gain". Select a value in the range from 10 to 50 roughly. The larger the setting value is, the smaller the deviation is. Then the response is improved. Setting a large value may cause vibrations and/or noises to occur. Set the feed forward gain in order to improve the response of the actuator further after adjusting Parameter No.7 "Servo gain number" and Parameter No.31 "Speed loop proportional gain".
7	<p>There is an impact at the start or stop.</p>	<ul style="list-style-type: none"> Change the setting in Parameter No.55 "Position command primary filter time constant" to approximately 50ms. If there is no improvement in situation, try to increase the setting gradually. If there is an improvement, try to decrease the setting gradually to the boundary. Making a change to this setting will make the settling time longer thus the takt time also becomes longer. The accuracy for the positioning also becomes worse. It is recommended, to solve the problem from the root cause, to replace the host positioning unit with one that is equipped with acceleration/deceleration function.

8.3.2 Adjustment of Brushless DC Electric Motor













No.	Situation that requires adjustment	How to Adjust																																																												
1	Hunching occurs at positioning stop	Set the parameter in the following steps, and check the operation. If an improvement is confirmed in operation, finish the adjustment. It is not necessary to proceed to the next step.																																																												
2	Fluctuation in speed occur during operation Speed is inaccurate																																																													
			<p>Procedure 1 : Change Parameter No. 32 "Velocity Loop Integrated Gain" Set the five types of values below in order, and check the operation.</p> <table border="1" data-bbox="719 636 1329 869"> <thead> <tr> <th>Setting Order</th> <th>Velocity Loop Integrated Gain Setting</th> </tr> </thead> <tbody> <tr><td>1</td><td>411</td></tr> <tr><td>2</td><td>592</td></tr> <tr><td>3</td><td>925</td></tr> <tr><td>4</td><td>1645</td></tr> <tr><td>5</td><td>3700</td></tr> </tbody> </table> <p>Go onto Procedure 2 if there is no improvement in operation.</p> <p>Procedure 2 : Change Parameter No. 31 "Velocity Loop Proportional Gain" and Parameter No. 32 "Velocity Loop Integrated Gain" Set the six types of values below in order, and check the operation.</p> <table border="1" data-bbox="719 1061 1329 1391"> <thead> <tr> <th colspan="3">●Load of 0.2kg or less</th> </tr> <tr> <th>Setting Order</th> <th>Velocity Loop Proportional Gain Setting</th> <th>Velocity Loop Integrated Gain Setting</th> </tr> </thead> <tbody> <tr><td>1</td><td>42</td><td>382</td></tr> <tr><td>2</td><td>42</td><td>520</td></tr> <tr><td>3</td><td>42</td><td>749</td></tr> <tr><td>4</td><td>42</td><td>1171</td></tr> <tr><td>5</td><td>42</td><td>2081</td></tr> <tr><td>6</td><td>42</td><td>4683</td></tr> </tbody> </table> <table border="1" data-bbox="719 1413 1305 1742"> <thead> <tr> <th colspan="3">●Load over 0.2kg</th> </tr> <tr> <th>Setting Order</th> <th>Velocity Loop Proportional Gain Setting</th> <th>Velocity Loop Integrated Gain Setting</th> </tr> </thead> <tbody> <tr><td>1</td><td>32</td><td>231</td></tr> <tr><td>2</td><td>32</td><td>315</td></tr> <tr><td>3</td><td>32</td><td>453</td></tr> <tr><td>4</td><td>32</td><td>708</td></tr> <tr><td>5</td><td>32</td><td>1259</td></tr> <tr><td>6</td><td>32</td><td>2833</td></tr> </tbody> </table> <p>Contact IAI if there is no improvement in operation.</p>	Setting Order	Velocity Loop Integrated Gain Setting	1	411	2	592	3	925	4	1645	5	3700	●Load of 0.2kg or less			Setting Order	Velocity Loop Proportional Gain Setting	Velocity Loop Integrated Gain Setting	1	42	382	2	42	520	3	42	749	4	42	1171	5	42	2081	6	42	4683	●Load over 0.2kg			Setting Order	Velocity Loop Proportional Gain Setting	Velocity Loop Integrated Gain Setting	1	32	231	2	32	315	3	32	453	4	32	708	5	32	1259	6	32
Setting Order	Velocity Loop Integrated Gain Setting																																																													
1	411																																																													
2	592																																																													
3	925																																																													
4	1645																																																													
5	3700																																																													
●Load of 0.2kg or less																																																														
Setting Order	Velocity Loop Proportional Gain Setting	Velocity Loop Integrated Gain Setting																																																												
1	42	382																																																												
2	42	520																																																												
3	42	749																																																												
4	42	1171																																																												
5	42	2081																																																												
6	42	4683																																																												
●Load over 0.2kg																																																														
Setting Order	Velocity Loop Proportional Gain Setting	Velocity Loop Integrated Gain Setting																																																												
1	32	231																																																												
2	32	315																																																												
3	32	453																																																												
4	32	708																																																												
5	32	1259																																																												
6	32	2833																																																												
3	Abnormal noise is generated / Especially, when stop or operation in low speed (less than 20mm/sec), comparatively high noise is generated.	Change the values for Parameter No. 31 "Velocity Loop Proportional Gain" and Parameter No. 32 "Velocity Loop Integrated Gain" to the following. Speed loop proportional gain : 32 Speed loop integral gain : 231																																																												

Chapter 9 Troubleshooting

9.1 Action to Be Taken upon Occurrence of Problem

Upon occurrence of a problem, take an appropriate action according to the procedure below in order to ensure quick recovery and prevent recurrence of the problem.

1) Status LEDs Check on Controller

LED			Operation status	Status of PIO Output Signal
SYS	SYS I	SYS II		*ALM output ^(Note 1)
 (Orange Light is turned ON.)	 (Green Light is turned ON.)	 (Green Light is turned ON.)	Alarm generated due to Gateway (Fieldbus error, etc.)	ON
 (Green Light is turned ON.)	 (Red Light is turned ON.)	 (Green Light is turned ON.)	Alarm generated on either Axis No.0, 2, 4 or 6 (depending on slot the driver board is inserted)	ON
 (Green Light is turned ON.)	 (Green Light is turned ON.)	 (Red Light is turned ON.)	Alarm generated on either Axis No.1, 3, 5 or 7 (depending on slot the driver board is inserted)	ON
 (Orange Light is turned ON.)	 (Red and green by turn)	 (Red and green by turn)	In initializing at startup	OFF

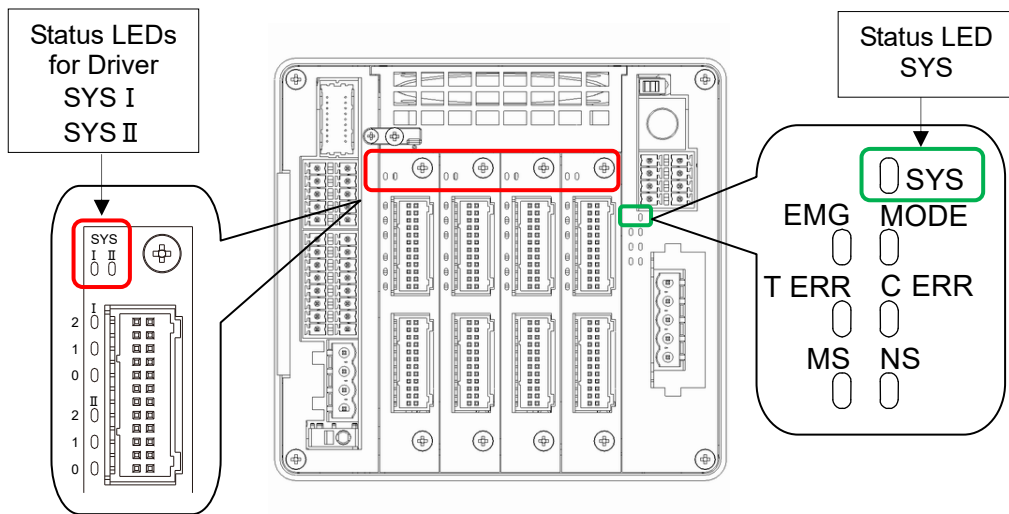

Refer to [7.1 [1] Driver Status LED] for the driver status LED display.
 Refer to [3.10 Fieldbus Status LED] for the status LED display.

- 2) Check whether an alarm occurs on the host controller (PLC, etc.).
- 3) Check the voltage of the main power supply (24V DC).
- 4) Voltage check of Fieldbus power supply
- 5) Check the voltage (24V DC) of the power supply for brake (for the actuator with the brake).
- 6) Alarm Check ^(Note1)
 Check the alarm code on the teaching tool such as PC software.
- 7) Check the connectors for disconnection or connection error.
- 8) Check the cables for connection error, disconnection or pinching.
 Cut off the main power of the system which this controller is installed in and remove the cables around the measurement point (to avoid conductivity through the surrounding circuit) before checking the conductivity.

- 9) Check the I/O signals.
Using the host controller (PLC, etc.) or a teaching tool such as PC software, check the presence of inconsistency in I/O signal conditions.
- 10) Check the noise elimination measures (grounding, installation of power line filter, etc.).
- 11) Check the events leading to the occurrence of problem ^(Note 2), as well as the operating condition at the time of occurrence.
- 12) Analyze the cause.
- 13) Treatment

Note 1 Alarms subject to this function include those in 9.3 Gateway Alarm and 9.4 Driver Alarm but do not include errors in the teaching tool such as PC software.

Note 2 The time of alarm generated can be recorded if the clock is set to the current time on Gateway Parameter Setting Tool. Refer to [3.9.3 (5) Clock Setting] for how to set up the date and time.

If the current time is set, the data is remained for approximately 10 days under the condition that the power to the controller is OFF. If the setting is not conducted or the time data is lost, it will be the time passed since 2000/1/1, 00:00:00 when the power is turned ON. Even if the date and time data is lost, the generated error code is retained.

! *Notice: In troubleshooting, exclude normal portions from suspicious targets to narrow down the causes. Check 1) to 11) described above before contacting us.*

9.2 Fault Diagnosis

This section describes faults largely divided into four types as follows:

- (1) Impossible operation of controller
- (2) Positioning and speed of poor precision (incorrect operation)
- (3) Generation of noise and/or vibration
- (4) Communication not established

9.2.1 Impossible operation of controller

Situation	Possible cause	Check/Treatment
SYS LED or SYS I/SYS II LEDs on driver board turn ON in red when power is supplied.	<ol style="list-style-type: none"> (1) Occurrence of alarm. (2) During emergency-stop. <ol style="list-style-type: none"> 1) Was the emergency-stop switch released? 2) EMG- on the system I/O connector is not connected. 	<ol style="list-style-type: none"> (1) Check the error code with the teaching tool being connected and remove the cause by referring the alarm list. [Refer to [9.3 Gateway Alarm and 9.4 Driver Alarm] (2) <ol style="list-style-type: none"> 1) Release the emergency stop switch. 2) Check the connection of the system I/O connector (EMG-). [Refer to 2.2 [1] Power Supply and Emergency Stop]
Both position No. and start signal are input to the controller, but the actuator does not move.	<ol style="list-style-type: none"> 1) Servo OFF condition. 2) The pause signal is OFF. 3) Positioning command is issued to a stop position. 4) There is no positioning data set to the commanded position number. 5) Writing the information in a wrong area for Direct Indication Mode. 	<ol style="list-style-type: none"> 1) Are SYS I/SYS II LEDs on the driver board that the operated axes are connected turned ON in green? [Refer to Name for Each Parts and Their Functions] Turn ON the servo-on signal SON. 2) Operation is available when pause signal *STP is ON and pause when it is OFF. Turn it ON. 3) Check the sequence or the settings of the position table. 4) It will generate Alarm Code 0A2 "Position Data Error". Conduct the position table setting.
Connected the teaching tool and supplied the motor and control power to controller, but operation would not start. (the emergency stop switch is released on the teaching tool)	Cable treatment or mode selection. <ol style="list-style-type: none"> 1) Emergency stop condition 2) Servo OFF condition 3) In pause 	<ol style="list-style-type: none"> 1) Supply 24V DC to EMG- terminal of the system I/O connector. <div style="border: 1px solid black; padding: 5px; margin: 5px 0;"> <p> Warning <i>If the process of 1) is conducted, put back the setting as soon as the adjustment work is finished. Starting the operation without putting it back may cause a serious accident since the emergency stop is set invalid.</i></p> </div> <ol style="list-style-type: none"> 2) 3) Put the operation mode switch on the front panel of the controller to "MANU" side, and select the teach mode on the teaching tool.

9.2.2 Positioning and speed of poor precision (incorrect operation)

Situation	Possible cause	Check/Treatment
Completion of operation on the way to home return.	In the home return of our standard specification, the actuator is first pressed to the mechanical end, moved oppositely, and subject to positioning stop at the home position. Therefore, the product may judge as the mechanical end even though it is still on the way when the load is large and interfere with surrounding object. 1) A load exceeding its rating weight is installed on the actuator. 2) It is touched to interference in the way of the run. 3) Torsion stress is applied to guide due to improper fixing method of the actuator or uneven fastening of bolts. 4) The sliding resistance of the actuator itself is large.	1) Reduce the load. 2) Remove the interference. 3) Loosen the fixing bolts once and check whether the slider can move smoothly. If the slider can move smoothly, check if there is a deformation on the attached surface, and install the actuator again following the instructions stated in Instruction Manual. 4) Please contact IAI.
Shocks at start and/or stop.	Acceleration/deceleration is set too high.	Decrease the settings of acceleration/deceleration.
Overshoot during deceleration to stop.	The load inertia is large.	Decrease the setting of deceleration.
Positioning of poor precision. ----- Uneven speed during movement. ----- Acceleration/deceleration not smooth (bad speed response).	[Refer to 8.3 Servo Adjustment.]	
Positioning at a position different from that of commanded position No.	For remote I/O mode, the start signal CSTR after the position number command is too early, or input at the same timing. <i>Note Inputting at the same timing is available for Fieldbus Type. (Excluding remote I/O mode)</i>	The stop position may be set for another purpose. Make sure to complete the reading of the position numbers to this controller before inputting the start signal.
Complete signal PEND is not output even though positioning process is completed.	Start signal CSTR is not turned OFF.	Make the start signal CSTR turned OFF before completing the positioning process by the turn-off of positioning complete signal PEND after starting operation, and so on.

9.2.3 Generation of noise and/or vibration

Situation	Possible cause	Check/Treatment
Generation of noise and/or vibration from actuator itself.	Noise and vibration are generated by many causes including the status of load, the installation of the actuator, and the rigidity of the unit on which the actuator is installed.	Servo adjustment may improve the situation. [Refer to 8.3 Servo Adjustment.]
Vibrations of load.	<ol style="list-style-type: none"> 1) Acceleration/deceleration is set too high. 2) The installation structure and/or the installed load are easily affected by acceleration/deceleration. 	<ol style="list-style-type: none"> 1) Decrease the settings of acceleration/deceleration. 2) Revise the installation structure and load.

9.2.4 Impossible Communication

Situation	Possible cause	Check/Treatment
Not connectable with host machine.	<ol style="list-style-type: none"> 1) Communication rates do not match. 2) The machine number (station number) is set to be duplicate with that of another unit or out of the range. 3) Poor wiring or disconnection of communication cable. 	<ol style="list-style-type: none"> 1) Set the communication rate to match that of the host machine. [Refer to the Instruction Manual of the host unit.] 2) Correct the unit number (station number) setting. Machine numbers (station numbers) vary depending on communication modes. Refer to 3.4 Fieldbus Type Address Map and the instruction manuals for the host devices for the details. 3) Review the wiring again. Check if termination resistances are connected to network terminals with correct values. Check if the communication power supply is established properly for DeviceNet Type. [Refer to the Instruction Manual of the host unit.]

9.3 Gateway Alarm

9.3.1 Gateway Alarm Codes

The alarm codes are read into ALMC1 to128 (b7 to b0) in Gateway Status Signal 0.

[Refer to 3.4.3 Gateway Control Signals (Common for all operation modes).]

(Note) The alarm code shown on Gateway Parameter Setting Tool is applied with "8" on the top of the alarm codes listed below. (Example) If the alarm code is 43, it will be shown as 843.

Alarm Code	Alarm Name	Cause/Treatment
43 (843)	Absolute Battery Charge Voltage Drop	Cause : The voltage of the absolute battery charger has dropped. Treatment : Check the voltage of the 24V DC power supply. Check the wire layout between the absolute battery box and MCON controller.
48 (848)	Decrease in Fan Revolution	Cause : The fan rotation speed has decreased for the cooling fan on the main unit. Treatment : It is considered that it is the end of the product life of the fan (approximately 3 years). Replace the fan.
49 (849)	Time Notification Error	Cause : It is an internal communication error of MCON. The clock data transfer from Gateway board to the driver board has failed. Treatment : Turn the power OFF and reboot. If the same error occurs again, please contact IAI.
4A (84A)	Real Time Clock Operation Stop Detection	Cause : Clock data has lost. The clock data can be remained for approximately 10 days after the power to the controller is turned OFF. Treatment : Have the clock setting done from the Gateway Parameter Setting Tool again.
4B (84B)	Real Time Clock Access Error	Cause : It is an internal error of MCON. The clock data failed to be acquired internally. Treatment : Turn the power OFF and reboot. If the same error occurs again, please contact IAI.
50 (850)	Fieldbus Communication Error (ERR-C)	Cause : It is a Fieldbus link error. If the flip-flop is set in Gateway Parameter Setting Tool during this error, the actuator is stopped in the condition of the error and any command is ignored until it receives a release signal. Treatment : Check the settings for Fieldbus (node addresses, communication speed, etc.) and wiring layout.
60 (860)	Master-Slave Axes Communication Error (ERR-T)	Cause : It is an internal error of MCON. The communication with the driver board to connect each axis of the actuators was not able to be established. Treatment : It is considered that the driver board is not inserted or there is a failure in the connection (connector is not inserted deep enough).
6A (86A)	Driver Board Operation Pattern Error	Cause : Operation modes which cannot be used together are indicated. Treatment : Set the operation modes again on Gateway Parameter Setting Tool.
80 (880)	GW Parameter Error	Cause : There is an error in Gateway parameters. Treatment : Check the settings such as the number of connected axes and operation mode on Gateway Parameter Setting Tool.
81 (881)	Parameter Check Sum Error	Cause : There is a possibility that the memory data inside MCON has destroyed. Treatment : Establish all the settings again on Gateway Parameter Setting Tool or write the backup data if it exists.

Alarm Code	Alarm Name	Cause/Treatment
90 (890)	Driver Board Mount Error	<p>Cause : The number of axes (number of driver boards) set in Gateway Parameter Setting Tool does not match with the number of the actually connected axes.</p> <p>Treatment : Match the numbers of the axes.</p>
93 (893)	Driver Board Operation Pattern Error	<p>Cause : It is an internal communication error of MCON. Data communication failure has occurred for information such as operation mode setting switch status, fieldbus operation mode and I/O mode operation pattern.</p> <p>Treatment : Turn the power OFF and reboot. If the same error occurs again, please contact IAI.</p>
95 (895)	Motor Voltage Monitoring Timeout	<p>Cause : An error occurred to the motor voltage on the monitored driver board during the shutdown control.</p> <ol style="list-style-type: none"> 1) Motor voltage readout not conducted in normal condition 2) Motor voltage not risen up 3) Malfunction of communication board <p>Treatment : Shutdown control process cannot be used together with controls using the EMG/MP connectors. Check the connection of the EMG/MP connectors. Contact IAI if an error occurs even after having the treatment.</p>
9C (89C)	Fieldbus Module Not Detected	<p>Cause : Communication board for Fieldbus was not detected.</p> <ol style="list-style-type: none"> 1) Communication board is not inserted. 2) Malfunction of communication board <p>Treatment : Turn the power OFF and reboot. If the same error occurs again, please contact IAI.</p>
9D (89D)	Fieldbus Module Initialization Timeout	<p>Cause : Initialization of the fieldbus module did not finish even after a certain while has passed.</p> <p>Treatment : Turn the power OFF and reboot. If the same error occurs again, please contact IAI.</p>
9E (89E)	Fan Error	<p>Cause : A Fan error was detected.</p> <p>Treatment : It is considered that it is the end of the product life of the fan (approximately 3 years). Replace the fan.</p>
A0 (8A0)	Control Power Overvoltage	<p>Cause : Control power voltage reached beyond the overvoltage threshold (120% of 24V DC = 28.8V).</p> <ol style="list-style-type: none"> 1) The voltage of 24V DC power supply is high. 2) A faulty part inside the controller 3) Turning the servo ON at acceleration/deceleration spends a huge current consumption transiently. Using the remote sensing function with a power supply with no enough current capacity may cause overvoltage responding to the current change. <p>Treatment : 1) 2) Check the voltage of the input power supply. 3) Think to use a power supply with enough current capacity or not to use the remote sensing function. If the voltage is normal, please contact IAI.</p>
A1 (8A1)	Control Power Voltage Drop	<p>Cause : The control power voltage dropped less than the voltage drop threshold (70% of 24V DC = 16.8V).</p> <ol style="list-style-type: none"> 1) The voltage of 24V DC power is low 2) A faulty part inside the controller <p>Treatment : Check the power voltage. If the voltage is normal, please contact IAI.</p>

Alarm Code	Alarm Name	Cause/Treatment
A2 (8A2)	Overvoltage on motor power	<p>Cause : 1) Motor power input voltage (input to MPI terminal) is too large (38V or more) Turning the servo ON at acceleration/deceleration spends a huge current consumption transiently. Using the remote sensing function with a power supply with not enough current capacity may cause overvoltage responding to the current change.</p> <p>2) Overcurrent is generated on the motor power supply line</p> <p>Treatment : 1) Check the power voltage input to MPI terminal. Think to use a power supply with enough current capacity or not to use the remote sensing function.</p> <p>2) Check the wire layout between the actuator and controller.</p>
A6 (8A6)	Encoder Voltage Drop	<p>Cause : The power voltage for the encoder has dropped below the allowable range.</p> <p>Treatment : Check the connection between the actuator and MCON.</p>
AA (8AA)	Regenerative Electric Discharge Circuit Error	<p>Cause : There is an error in the regenerative discharge circuit inside the controller.</p> <p>Treatment : Turn the power OFF and reboot. If the same error occurs again, please contact IAI.</p>
AB (8AB)	Assumed Regenerative Discharge Excessive Power	<p>Cause : The regenerative electric power exceeded what can be dealt with the regenerative resistor.</p> <p>Treatment : Decrease the acceleration/deceleration speed, revise the operation interval or connect an external optional regenerative resistor (RER-1).</p>
AC (8AC)	Continuous Regenerative Excessive Discharge	<p>Cause : The regenerative electric power exceeded what can be dealt with the regenerative resistor.</p> <p>Treatment : Decrease the acceleration/deceleration speed, revise the operation interval or connect an external optional regenerative resistor (RER-1).</p>
FFF	Power-on Log	It is the log at the power being on (it is not an error).

9.4 Driver Alarm

9.4.1 Alarm Level

The alarms are classified to 3 types of levels by the content of the error.

Alarm level	SYS I / II LED	*ALM signal	Status when an error occurred	Cancellation method
Message	Green Light is turned ON.	No output	No stop	Alarm of maintenance output such as battery voltage drop or the teaching tool such as PC software [Refer to Instruction Manual of each tool for details.]
Operation release	Red Light is turned ON.	Output	Servo OFF after deceleration to stop	Reset the alarm by the PIO or teaching tool.
Cold start	Red Light is turned ON.	Output	Servo OFF after deceleration to stop	Software reset or power reconnection by teaching tool. Home return is required for any actuators of other than simple absolute specification.

⚠ Caution: Reset each alarm after identifying and removing the cause.
 If the cause of the alarm cannot be removed or when the alarm cannot be reset after removing the cause, please contact IAI.
 If the same error occurs again after resetting the alarm, it means that the cause of the alarm has not been removed.

9.4.2 Simple Alarm Code

Simple alarm codes are read into the complete position register (PM8 to PC1) in Simplified Direct Value, Positioner 1, Positioner 2, Positioner 5 and each mode of remote I/O when an alarm is generated.

○: ON ●: OFF

*ALM	ALM8 (PM8)	ALM4 (PM4)	ALM2 (PM2)	ALM1 (PM1)	Binary Code	Description: Alarm code is shown in ().
○	●	●	●	●	–	Normal
●	●	●	●	○	1	Collision Detection (0DF)
●	●	●	○	●	2	Software reset during servo ON (090) Position number error during teaching (091) PWRT signal detected during movement (092) PWRT signal detected before completion of home return (093)
●	●	●	○	○	3	Move command during servo OFF (080) Position command in incomplete home return (082) Absolute position move command when home return is not yet completed (083) Movement command during home return operation (084) Position No. error during movement (085) Position command information data error (0A3) Command deceleration error (0A7)
●	●	○	●	●	4	Mismatched PCB (0F4)
●	●	○	○	●	6	Parameter data error (0A0) Parameter data error (0A1) Position data error (0A2) Unsupported motor/encoder type (0A8)

(Note) *ALM Signal is an active low signal. It is ON when the power is applied to the controller, and turns OFF when the signal is output.

○: ON ●: OFF

*ALM	ALM8 (PM8)	ALM4 (PM4)	ALM2 (PM2)	ALM1 (PM1)	Binary Code	Description: Alarm code is shown in ().
●	●	○	○	○	7	Z-phase position error (0B5) Z-phase detection time out (0B6) Magnetic pole indeterminacy (0B7) Excitement detection error (0B8) Home sensor non-detection (0BA) Home return timeout (0BE)
●	○	●	●	●	8	Actual speed excessive (0C0)
●	○	●	●	○	9	Overcurrent (0C8) Overvoltage (0C9) Overheat (0CA) Current Sensor Offset Adjustment Error (0CB) Drive source error (0D4)
●	○	●	○	○	11	Command counter overflow in Incomplete home return (0D5) Deviation overflow (0D8) Software stroke limit exceeded (0D9) Pressing motion range over error (0DC)
●	○	○	●	●	12	Electric angling mismatching (0B4) Servo error (0C1) Illegal control system transition command (0C5) Motor power source voltage excessive (0D2) Overload (0E0) Driver logic error (0F0)
●	○	○	●	○	13	Encoder send error (0E4) Encoder receipt error (0E5) Encoder Counter Error (0E6) A-, B- and Z-phase wire breaking (0E7) A and B-phase wire breaking (0E8) BLA encoder error detection (0EB) PS-phase wire breaking (0EC) Absolute encoder error detection 1 (0ED) Absolute encoder error detection 2 (0EE) Absolute encoder error detection 3 (0EF)
●	○	○	○	●	14	CPU error (0FA) Logic error (0FC)
●	○	○	○	○	15	Nonvolatile memory write verify error (0F5) Nonvolatile memory write timeout (0F6) Nonvolatile memory data destroyed (0F8)

(Note) *ALM Signal is an active low signal. It is ON when the power is applied to the controller, and turns OFF when the signal is output.

9.4.3 Alarm Codes for Driver Board (Each Axis)

(Note) In the shaded alarm code columns in the table below, the applicable driver board type is shown with symbols. The alarm codes not shaded are in common for all the driver board.

- P : Pulse Motor · · RCP2, RCP3, RCP4 and RCP5 Series
- A : Servo motort · · RCA, RCA2 and RCL Series
- D : Pulse/brushless DC electric motor · · RCD Series

Alarm Code	Alarm Level	Alarm Name	Cause/Treatment
048	Message	Driver overload alarm	Cause : The load current exceeded the value set in Parameter No.143 "Overload Level Ratio". This alarm is kept alarm condition until reset is made. This alarm turns ON when the load current exceeds the setting from a value below the setting. Treatment : Lower the setting of acceleration/deceleration. Also, increase the frequency of pause.
049			Cause : Motor current has reached the detection current set in the collision detection feature. Treatment : Remove the cause of collision. If it is an unexpected detection, re-adjust the collision detection feature. [Refer to Chapter 5 Collision Detection Feature]
04E		Exceeded movement count threshold	Cause : The total number of the operation times exceeded the value set in Parameter No.147 "Total Movement Count Threshold".
04F		Exceeded operated distance threshold	Cause : The total number of the operation distance exceeded the value set in Parameter No.148 "Total Operated Distance Threshold".
06B		Maintenance information data error	Cause : The maintenance information (total movement count, total operated distance) is lost. Treatment : Please contact IAI.
080	Operation release	Move command in servo OFF	Cause : A move command was issued when the servo is OFF. Treatment : Issue a movement command after confirming the servo is ON (servo ON signal (SV) or position complete signal (PEND) is ON).
082		Position command in incomplete home return	Cause : A position move command was issued before home return was completed. Treatment : Issue a command after confirming that home return has been completed (HEND) is ON.
083		Numerical command in incomplete home return	Cause : An absolute position command was issued by numerical specification before home return was completed (direct command from Field Network). Treatment : Issue a numeric specification after performing home return operation and confirming the complete signal (HEND).
084		Absolute position move command when home return is not yet completed	Cause : A move command was issued when home return was still in progress. Treatment : Issue a movement command after performing home return operation and confirming the complete signal (HEND).
085		Position No. error during movement	Cause : A non-existing (invalid) position number was specified in the positioner mode. Treatment : Check the position table again and indicate an effective position number.
090		Software reset command in servo-ON condition	Cause : A software reset command was issued when the servo was ON. Treatment : Issue a software reset command after confirming that the servo is OFF (SV signal is 0).

Alarm Code	Alarm Level	Alarm Name	Cause/Treatment
091	Operation release	Position No. error in teaching	<p>Cause : The position number out of the available range was selected in the teaching.</p> <p>Treatment : Set the indication position number to 255 or less in Positioner 1 or Positioner 2 Mode, or to 64 or less in Remote I/O Teaching Mode.</p>
092		PWRT signal detection during movement	<p>Cause : The current position write signal PWRT was input in the teaching mode of PIO pattern 1 while the actuator was jogging.</p> <p>Treatment : Check that JOG+/- signal is not on and stopped (MOVE output signal is off) before inputting.</p>
093		PWRT signal detection in incomplete home return	<p>Cause : The current position write signal PWRT was input in the teaching mode of PIO pattern 1 when home return was not yet completed.</p> <p>Treatment : Input the HOME signal first to perform home return, and then input the PWRT signal after confirming that the home return has completed (HEND output signal is ON).</p>
0A0	Cold start	PIO function assignment error	<p>Cause : Data input in Parameter No. 25 PIO Pattern Select is not appropriate.</p> <p>Treatment : Select either of PIO Patterns 0, 1, 2, 4 or 5. Select 6 when in a mode other than Remote I/O Mode.</p>
0A1		Parameter data error	<p>Cause : The data input range in the parameter area is not appropriate.</p> <p>Example 1) This error occurs when the magnitude relationship is apparently inappropriate such as when 300mm was incorrectly input as the value of the soft limit negative side while the value of the soft limit positive side was 200.3mm.</p> <p>Example 2) In rotary axis, when the index mode is changed to the normal mode and the soft limit negative side is 0, this error is issued. Set the soft limit negative side to a value -0.3mm is added to the outer side of the effective stroke. [Refer to 8.2 [2] Soft limit +, Soft limit -]</p> <p>Treatment : Change the value to the appropriate one.</p>
0A2	Operation release	Position data error	<p>Cause : 1) A move command was input when no target position was set in the "Position" field of a position No. in the position table. 2) The value of the target value in the "Position" field exceeded the Parameter No.3 and 4 "Soft limit set value". 3) A 1 was set to "Incremental" column in the solenoid valve mode 2 of PIO pattern 5. 4) Pressing operation was specified while the vibration suppress control function remained effective.</p> <p>Treatment : 1) Set the target position. 2) Change the target position value to the one within the soft limit set value. 3) The target position cannot be set by relative coordinate (incremental feed). 4) The vibration suppress control function and pressing operation cannot be used concurrently. Provide setting so that either of the functions is effective.</p>

Alarm Code	Alarm Level	Alarm Name	Cause/Treatment																
0A3	Operation release	Position command data error	<p>Cause : 1) The command value during direct numeric specification exceeded the maximum set value. 2) Pressing operation was specified in the field bus specification while the vibration suppress function remained effective.</p> <p>Treatment : 1) Exceeded command item code is displayed in the detailed code. Input an appropriate value by referring to these values.</p> <table border="1"> <thead> <tr> <th>Detailed Code (Command Item Code)</th> <th>Command Item</th> </tr> </thead> <tbody> <tr> <td>0</td> <td>Target Position</td> </tr> <tr> <td>2</td> <td>Command Speed</td> </tr> <tr> <td>4</td> <td>Acceleration</td> </tr> <tr> <td>6</td> <td>Deceleration</td> </tr> <tr> <td>8</td> <td>Positioning Width</td> </tr> <tr> <td>C</td> <td>Pressing Current Limit Value</td> </tr> <tr> <td>D</td> <td>Control Signal</td> </tr> </tbody> </table> <p>2) The vibration suppress control function and pressing operation cannot be used concurrently. Provide setting so that either of the functions is effective.</p>	Detailed Code (Command Item Code)	Command Item	0	Target Position	2	Command Speed	4	Acceleration	6	Deceleration	8	Positioning Width	C	Pressing Current Limit Value	D	Control Signal
Detailed Code (Command Item Code)		Command Item																	
0	Target Position																		
2	Command Speed																		
4	Acceleration																		
6	Deceleration																		
8	Positioning Width																		
C	Pressing Current Limit Value																		
D	Control Signal																		
0A7	Command deceleration error	<p>Cause : Because there is not enough deceleration distance when the deceleration is changed to a lower setting during the operation, the actuator exceeded the soft limit when deceleration was made from the current position with the deceleration after the change.</p> <p>The cause is that the timing to make the next movement command when the speed was changed during the operation was late.</p> <p>Treatment : Make the timing earlier for the movement command for the deceleration speed change.</p>																	
0A8	Cold start	Unsupported motor/encoder types	<p>Cause : A motor or encoder not applicable for this controller is connected, and the motor or encoder cannot be classified.</p> <p>Treatment : Contact us in case this alarm is issued with the applicable actuator or occurs again even after the power is rebooted.</p>																
0B4		Electric angling mismatching	<p>Cause : The position deviation counter is over-flown.</p> <p>Treatment : This error occurs when an actuator cannot operate. Confirm about the load conditions, that the work does not interfere with any object nearby or the brake has been released, etc. If the error occurs even when the servo is ON, the cable breakage or disconnection is considered. Check the cable connection. Please contact IAI if there is no failure in the cable and connector connections.</p>																
0B5		Z-phase position error	<p>Cause : The point where Z-phase was detected in home-return operation was out of the specified area. Encoder error</p> <p>Treatment : Please contact IAI.</p>																
	Only for A drivers																		
	Only for A drivers																		

Alarm Code	Alarm Level	Alarm Name	Cause/Treatment
0B6 Only for A drivers	Operation release	Z-phase detection time out	<p>Cause : This indicates the Z-phase could not be detected at the first servo-on or home-return operation after the power is turned ON in Simple Absolute type.</p> <ol style="list-style-type: none"> 1) Connector connection error or wire breakage on an actuator cable. 2) Brake cannot be released on a controller equipped with a brake. 3) Detection of the motor is not performed properly because an external force is applied. 4) The slide resistance of the actuator itself is large. <p>Treatment :</p> <ol style="list-style-type: none"> 1) Check for the actuator cable wiring condition. 2) Check the wiring condition of the brake cable, and also turn on/off the brake release switch to see if the brake makes a “clicking” sound. If the brake is not making any noise, check if the power is supplied to the brake properly. 3) Check if there is any abnormality in the parts assembly condition. 4) If the transportation weight is in the acceptable range, cut off the power to check the slide resistance manually by moving with hand. <p>If the actuator itself is suspected to be the cause, please contact IAI.</p>
0B7 Only for A drivers	Cold start	Magnetic pole indeterminacy	<p>Cause : It shows the magnetic pole phase could not be detected after a certain time being passed even though the process for the magnetic pole phase detection was executed at the first servo-on after the power is turned ON.</p> <ol style="list-style-type: none"> 1) Connector connection error or wire breakage on an actuator cable. 2) Brake cannot be released on a controller equipped with a brake. 3) Detection of the motor is not performed properly because an external force is applied. 4) The slide resistance of the actuator itself is large. <p>Treatment :</p> <ol style="list-style-type: none"> 1) Check for the actuator cable wiring condition. 2) Check the wiring condition of the brake cable, and also turn on/off the brake release switch to see if the brake makes a “clicking” sound. If the brake is not making any noise, check if the power is supplied to the brake properly. 3) Check if there is any abnormality in the parts assembly condition. 4) If the transportation weight is in the acceptable range, cut off the power to check the slide resistance manually by moving with hand. <p>If the actuator itself is suspected to be the cause, please contact IAI.</p>

Alarm Code	Alarm Level	Alarm Name	Cause/Treatment
0B8 Only for P drivers	Cold start	Excitement detection error	<p>Cause : The magnetic pole phase detection is not completed after a certain time being passed even though the detection process was executed at the first servo-on after the power is turned ON.</p> <ol style="list-style-type: none"> 1) Connection error or wire breakage on an actuator cable. 2) Brake is not released (when equipped with a brake). 3) Load to the motor is high due to external force. 4) Power was turned ON while touching to the mechanical end. 5) The resistance in the actuator sliding operation is large. <p>Treatment : 1) Check the wiring condition of the actuator cables. 2) If an improvement can be confirmed when 24V DC, 150mA is supplied to BKRLS terminal in the external brake input connector, a malfunction of the controller can be considered. Please contact IAI. 3) Confirm that there is no error in the mechanical part assembly condition. 4) Move the slider or the rod to a point where it would not hit the mechanical end and reboot the system. 5) If the loaded weight is within the allowable range, turn the power OFF and check the resistance in sliding operation by moving the slider with hand.</p>
0BA	Operation release	Home sensor non-detection	<p>Cause : This indicates that the home-return operation of the actuator equipped with origin sensor (option for those except for rotary actuator) is not completed in normal condition.</p> <ol style="list-style-type: none"> 1) The work piece has interfered with the peripherals during the home-return operation. 2) The resistance in the actuator sliding operation is large. 3) Attachment error, malfunction or wire breakage of origin sensor. <p>Treatment : If there is no interference of the work piece confirmed with the peripherals, 2) or 3) can be considered as a cause. Please contact IAI.</p>
0BE		Home return timeout	<p>Cause : Home return does not complete after elapse of a certain period after the start of home return.</p> <p>Treatment : This error does not occur in normal operation. The combination of the controller and actuator may be incorrect. Please contact IAI.</p>
0C0		Actual speed excessive	<p>Cause : This indicates the number of motor rotation exceeded the number of allowable rotation.</p> <ol style="list-style-type: none"> 1) The slide resistance of the actuator is locally high. 2) The load is increased too much due to a external force. <p>With the reasons above, it can be considered a sudden speed increase has occurred before detecting the servo error.</p> <p>Treatment : Even though this would not occur in normal operation, check if there is any abnormality in the parts assembly condition. Also check if there is a possibility that an external force may be applied in the direction of the actuator movement.</p>

Alarm Code	Alarm Level	Alarm Name	Cause/Treatment
0C1 Only for P drivers	Operation release	Servo error	<p>Cause : It indicates 2 seconds has passed without making a move since a move command was received.</p> <ol style="list-style-type: none"> 1) Connection error or wire breakage on an actuator cable 2) Brake is not released (when equipped with a brake). 3) Load to the motor is high due to external force. 4) The resistance in the actuator sliding operation is large. <p>Treatment : 1) Check the wiring condition of the actuator cables.</p> <ol style="list-style-type: none"> 2) If an improvement can be confirmed when 24V DC, 150mA is supplied to BKRLS terminal in the external brake input connector, a malfunction of the controller can be considered. Please contact IAI. 3) Confirm that there is no error in the mechanical part assembly condition. 4) Move the slider or the rod to a point where it would not hit the mechanical end and reboot the system.
0C5 Only for A drivers		Illegal transition command in control system	<p>Cause : 1) Change the operation from the vibration suppress control operation to the normal position control operation.</p> <ol style="list-style-type: none"> 2) Change the operation from the normal position control operation to the vibration suppress control operation. <p>Treatment : Change the sequence so the next action is conducted after confirming the positioning complete signal (PEND) is turned ON for both cases 1) and 2).</p>
0C8	Cold start	Overcurrent	<p>Cause : The output current in the power circuit section is increased abnormally.</p> <p>Treatment : This alarm will not be generated in normal operation. It can be considered as the insulation degradation of the motor winding or malfunction of the controller. Please contact IAI.</p>
0C9 Only for P drivers		Overvoltage	<p>Cause : The voltage on the power regenerative circuit exceeded the threshold.</p> <p>Treatment : Malfunction of the controller can be concerned. Please contact IAI.</p>

Alarm Code	Alarm Level	Alarm Name	Cause/Treatment
0CA	Cold start	Overheat	<p>Cause : Temperature on the components inside the controller has exceeded the temperature defined for each actuator.</p> <ol style="list-style-type: none"> 1) Operation is performed with the load condition exceeding the specified range. 2) High temperature around the controller. 3) Load to the motor is high due to external force. 4) A faulty part inside the controller. <p>Treatment : 1) Revise the operation condition such as decreasing the acceleration/deceleration speed. 2) Lower the ambient temperature of the controller. 3) Confirm that there is no error in the mechanical part assembly condition.</p> <p><i>Note This error would not normally occur. If it occurs, confirm there is not (1) to (3) above. If the same problem occurs again even with the process above, malfunction of controller can be considered. Please contact IAI.</i></p>
0CB		Current sensor offset adjustment error	<p>Cause : An error was found to the sensor in the status check of the current detection sensor conducted at the initializing process in the startup.</p> <ol style="list-style-type: none"> 1) A breakdown of the current detection sensor or peripheral component is supposed. 2) An error in the offset adjustment is supposed. 3) The actuator has moved by an external force at the time the power was turned on. <p>Treatment : In case the same error occurs even after rebooting the power in a condition that the actuator does not move, it is necessary to replace the PC board or adjust the offset. Please contact IAI.</p>
0D2 Only for A and D drivers	Operation cancellation	Motor power source voltage excessive	<p>Cause : A malfunction of a component inside the controller can be considered.</p> <p>Treatment : If this error occurs often, there is a concern of a controller malfunction. Please contact IAI.</p>

Alarm Code	Alarm Level	Alarm Name	Cause/Treatment
0D4	Cold start	Drive source error	<p>Cause : 1) Motor power input voltage (input to MPI terminal) is too large During acceleration/deceleration and servo-on, the current consumption rises transiently. Using the remote sensing function with a power supply with no enough current capacity may cause overvoltage responding to the current change. 2) Overcurrent is generated on the motor power supply line.</p> <p>Treatment : 1) Check the power voltage input to MPI terminal. Think to use a power supply with enough current capacity or not to use the remote sensing function. 2) Check the wire layout between the actuator and controller. Please report the environment of use and condition of operation in case this error occurs often.</p>
0D5 Only for P drivers		Differential Counter Overflow with Home Return Incomplete	<p>Cause : This alarm indicates that the position deviation counter has overflowed. 1) The speed dropped or stopped during JOG move due to an impact of external force, hit to the mechanical end or overload. 2) The excited-phase detection operation following the power-on is unstable.</p> <p>Treatment : 1) This error occurs when the actuator cannot be operated as it is commanded. Check the load conditions such as if the work is touching to the surrounding object, or brake is properly released, and remove the cause. 2) Overload is concerned. Revise the transportable weight.</p>
0D8	Operation cancellation	Deviation overflow	<p>Cause : This alarm indicates that the position deviation counter has overflowed. 1) The speed dropped or the actuator stopped due to the effect of external force or overload. 2) The excited-phase detection operation following the power-on is unstable. 3) The power supply voltage dropped. 4) Servo gain number is too small</p> <p>Treatment : 1) This error occurs when the actuator cannot be operated as it is commanded. Check the load conditions such as if the work is touching to the surrounding object, or brake is properly released, and remove the cause. 2) Overload can be concerned. Revise the transportable weight and redo the home-return operation. 3) Check for the source voltage. 4) Tune the servo-motor gain number.</p>
0D9		Software stroke limit exceeded	<p>Cause : The current position of the actuator exceeds the software stroke limit.</p> <p>Treatment : Return the actuator to be within the range of the software stroke limit.</p>

Alarm Code	Alarm Level	Alarm Name	Cause/Treatment
0DC	Operation cancellation	Pressing motion range over error	<p>Cause : 1) After the pressing operation has complete, the force to push back is too large and the pushed back to the pressing start setting position. 2) The actuator touched the work during the approach movement before the pressing movement.</p> <p>Treatment : 1) Revise the setting and adjust it so the force to push back gets smaller. 2) Correct the pressing start setting position to the front to have the approach distance shorter.</p>
0DF Only for P drivers		Collision detection	<p>Cause : Collision of actuator was detected.</p> <p>Treatment : Remove the cause of collision. If it is an unexpected detection, re-adjust the collision detection feature. [Refer to Chapter 5 Collision Detection Feature]</p>
0E0	Cold start	Overload	<p>Cause : 1) The work weight exceeds the rated weight, or an external force is applied and the load increased. 2) If the actuator is equipped with a brake, the brake is not released. 3) The slide resistance of the actuator is locally high.</p> <p>Treatment : 1) Check the work and its surrounding area to remove the cause. 2) If an improvement can be confirmed when 24V DC, 150mA is supplied to BKRLS terminal in the external brake input connector, a malfunction of the controller can be considered. Please contact IAI. If the error cannot be cancelled, malfunction of brake, cable breakage or controller malfunction can be considered. Please contact IAI. 3) In the case that the work can be moved by hand, move it. Then, check that there is no location where a sliding resistant is too large. Check if the installation face is distorted. When the error occurs in operation of the actuator only, Please contact IAI.</p> <div style="border: 1px solid black; padding: 5px; margin-top: 10px;"> <p> Caution Restart the operation after making sure to remove the cause. If you cannot determine that the cause is removed completely, wait for at least 30 minutes before turning ON the power to prevent the motor coil from burning.</p> </div>

Alarm Code	Alarm Level	Alarm Name	Cause/Treatment
0E4 Only for A drivers	Cold start	Encoder send error	<p>Cause : The data sending and receiving between the controller and encoder is conducted by the serial communication. This error indicates that the data sent from the controller was not received properly at the encoder side.</p> <ol style="list-style-type: none"> 1) Encoder cable is about to break or connector is not plugged properly 2) Effect of noise 3) One or more communication ICs installed on the encoder board are faulty. 4) One or more communication ICs installed on the controller board are faulty. <p>Treatment : 1) Check on the cables and the connector joints to see if any abnormality. 2) Interrupt the power to the peripheral equipment and activate only the actuator. If any error does not occur, it might be caused by noise. Take proper measures against noise. If 3) or 4) is the case, the encoder or controller must be replaced. If the cause cannot be specified, please contact IAI.</p>
0E5 Only for P and A drivers		Encoder receipt error	<p>Cause : This indicates that the data was not received to the controller in the normal condition from the simple absolute area.</p> <ol style="list-style-type: none"> 1) Connector connection error (If the detail code in the error list of the teaching tool is 0002H.) 2) Effect of noise (If the detail code in the error list of the teaching tool is 0001H.) 3) Malfunction of component (communication part) inside the controller. 4) Initialization of battery-less absolute encoder is incomplete <p>Treatment : 1) Check if any wire breakage on a connector and the condition of wire connections. 2) Interrupt the power to the peripheral equipment and activate only the this actuator and actuator. If any error does not occur, it might be caused by noise. Take proper measures against noise. 3) It is necessary to replace the actuator (motor part) or controller. If the cause cannot be specified, please contact IAI.</p>
0E6 Only for P and A drivers		Encoder Counter Error	<p>Cause : It is in a condition the encoder cannot detect the position information properly.</p> <ol style="list-style-type: none"> 1) Breakage on encoder relay cable, actuator enclosed cable or improper connector connection 2) Malfunction of encoder itself 3) Error status was received in initial communication with battery-less absolute encoder <p>Treatment : 1) Check if any breakage of cable at connectors and the condition of connections. Malfunction of the encoder can be concerned if there is no suspected point on the cables. Please contact IAI.</p>

Alarm Code	Alarm Level	Alarm Name	Cause/Treatment
0E7 Only for A drivers	Cold start	A-, B- and Z-phase wire breaking	<p>Cause : Encoder signals cannot be detected correctly.</p> <p>1) Wire breakage or connector connection error on an actuator cable or cable enclosed in an actuator.</p> <p>2) Malfunction of encoder itself.</p> <p>Treatment : 1) Check if any wire breakage on a connector and the condition of wire connections.</p> <p>If the cables are in the normal condition, the malfunction of the encoder can be considered. Please contact IAI.</p>
0E8		A- and B-phase wire breaking	<p>Cause : Encoder signals cannot be detected correctly.</p> <p>1) Wire breakage or connector connection error on an actuator cable or cable enclosed in an actuator.</p> <p>2) Malfunction of encoder itself.</p> <p>Treatment : 1) Check if any wire breakage on a connector and the condition of wire connections.</p> <p>If the cables are in the normal condition, the malfunction of the encoder can be considered. Please contact IAI.</p>
0EB Only for P and A drivers		Battery-less absolute encoder error detection	<p>Cause : It is a condition that the battery-less absolute encoder cannot detect the position information correctly.</p> <p>Treatment : Check if any wire breakage on a connector and the condition of wire connections.</p> <p>If the cables are normal, faulty encoder is suspected. Please contact IAI.</p>
0EC Only for D drivers		PS-phase wire breaking	<p>Cause : Encoder signals cannot be detected correctly.</p> <p>1) Wire breakage or connector connection error on an actuator cable or cable enclosed in an actuator.</p> <p>2) Malfunction of encoder itself.</p> <p>Treatment : 1) Check if any wire breakage on a connector and the condition of wire connections.</p> <p>If the cables are in the normal condition, the malfunction of the encoder can be considered. Please contact IAI.</p>

Alarm Code	Alarm Level	Alarm Name	Cause/Treatment
0ED Only for P and A drivers	Operation release	Absolute encoder error detection 1	Cause : The current position has changed while controller was reading the absolute data or saving files. Treatment : Avoid a condition that gives vibration to the actuator.
0EE Only for P and A drivers		Absolute encoder error detection 2	Cause : The position data cannot be detected properly in the Battery-less absolute type or Simple absolute type encoder. 1) When the power is supplied for the first time to after the motor replacement of Battery-less absolute type or Simple absolute type (before executing absolute reset) 2) Voltage drop of absolute battery. (simple absolute type) (If the detail code in the error list of the teaching tool is 0001 _H .) 3) Wire breakage or connector connection error on an actuator cable or cable enclosed in an actuator or connector being removed and inserted. (If the detail code in the error list of the teaching tool is 0002 _H .) 4) Changed the parameters of controller. Treatment : 3) Supply the power for 72 hours or more and after charging the battery enough, perform the absolute reset operation. If the same failure occurs often even with enough battery charge, it is considered the end of the battery life. Replace the battery. Conduct an absolute reset for 1), 3) and 4). [Refer to Chapter 7. Absolute Reset and Absolute Battery]
0EF Only for P and A drivers	Operation release	Absolute encoder error detection 3	Cause : The encoder for the Simple absolute type cannot detect the position information properly. (Encoder over speed error) The current position changed with a speed more than the rotation speed setting by an external cause during the power shutoff. Treatment : Set the rotation speed to a higher speed than what currently is. If the same failure occurs again, it is necessary to have an absolute reset. [Refer to Chapter 7. Absolute Reset and Absolute Battery]
0F0 Only for A and D drivers	Cold start	Driver logic error	Cause : Exceeded load, parameter (motor type) mismatched, noise, malfunction of controller, etc. Treatment : Please contact IAI.
0F4		Mismatched PCB	Cause : The PCB is not applicable for the connected motor in the startup check. There is a possibility of mismatch between the actuator and controller. Check the model codes. Treatment : Should this error occur, please contact IAI.
0F5	Operation release	Nonvolatile memory write verify error	Cause : It is verified at the data writing process to the non-volatile memory that the data inside the memory and the data to be written are matched. There was a mismatch detected in this process. (Faulty nonvolatile memory.) Treatment : When the error is caused even when the power is re-input, please contact IAI.
0F6	Cold start	Nonvolatile memory write timeout	Cause : There is no response in the specified time duration during the data writing to the non-volatile memory. (Faulty nonvolatile memory.) Treatment : When the error is caused even when the power is re-input, please contact IAI.

Alarm Code	Alarm Level	Alarm Name	Cause/Treatment
0F8		Nonvolatile memory data destroyed	<p>Cause : Abnormal data was detected during the nonvolatile memory check after starting. (Faulty nonvolatile memory.)</p> <p>Treatment : When the error is caused even when the power is re-input, please contact IAI.</p>
0FA		CPU error	<p>Cause : The CPU operation is not normal.</p> <p>1) Faulty CPU.</p> <p>2) Malfunction due to noise.</p> <p>Treatment : When the error is caused even when the power is re-input, please contact IAI.</p>
0FC		Logic error (Component error in controller)	<p>Cause : The controller is not operating properly.</p> <p>1) Malfunction due to the effect of noise, etc.</p> <p>2) Malfunction of peripheral circuit components.</p> <p>Treatment : Turn the power OFF and reboot.</p> <p>If the error occurs again, check for presence of noise.</p> <p>Also, if you have another controller, replace it and try. A recurring error with the spare controller suggests presence of noise.</p> <p>If the cause cannot be identified, please contact IAI.</p>
100 to 1FF	Message	Alarm on teaching tool	[Refer to the Instruction Manual of teaching tool.]
200 to 2FF	Operation release	Alarm on teaching tool	[Refer to the Instruction Manual of teaching tool.]
300 to 3FF	Cold start	Alarm on teaching tool	[Refer to the Instruction Manual of teaching tool.]

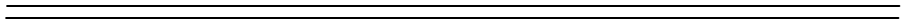

Chapter 10 Appendix

10.1 Conformity to Safety Category

In this section shows an example of a circuit using the dedicated teaching pendant. However, it is not possible for us to check the conformity of our product to the condition of your system.

Therefore, it is necessary that the user construct the circuit considering the condition of use and the categories to be applied.

[1] System Configuration

When it is necessary to construct a system that complies with Safety Category (ISO12100-1/ISO13849-1), use a MCON-CG contactor and teaching pendant (Model codes: TB-01D/DR or TB-02D).

Also, TP adapter (Model : RCB-LB-TGS) is required.

The system can conform to up to safety category B to 4 (ISO12100-1/ISO13849-1) by changing connections of system I/O connectors.

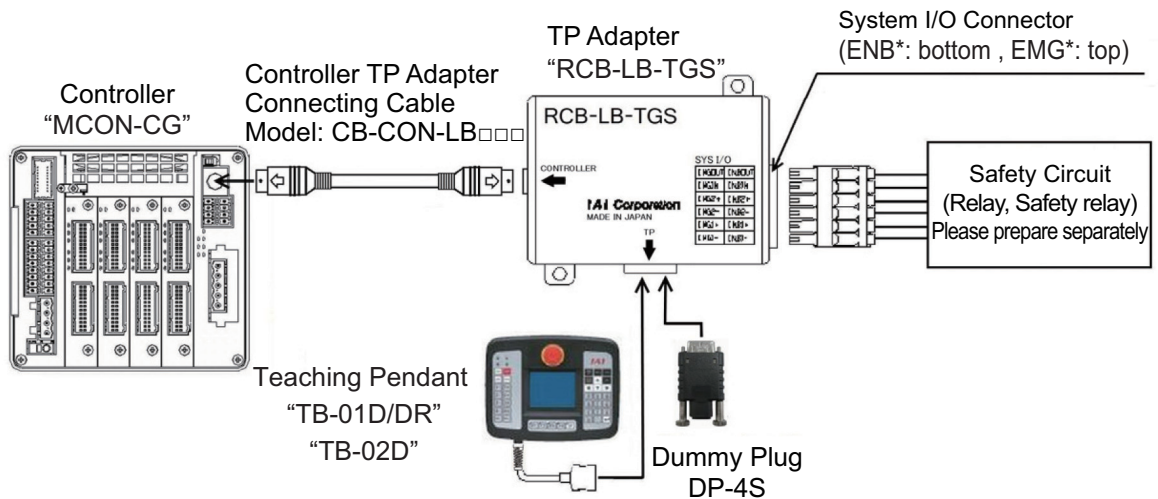

[2] Wiring and setting of safety circuit

(1) Power supply

To use safety relays and/or contactors of 24V DC specification in the safety circuit, the control power supply should be used only for the circuit as much as possible. (Do not use the same power source as the driving power supply for this controller.)

It is the risk prevention treatment preparing for the cases such as the operation error of the safety circuit caused by not enough power capacity.

(2) Specification of system I/O connector for TP adapter

Connector Name		System I/O Connector	Applicable Wire
Upper side (EMG side)	Cable side	FMC1.5/6-ST-3.5 ^(Note 1)	Phoenix Contact AWG24 to 16 (0.2 to 1.25m ²)
	TP adapter side	MCDN1.5/6-G1-3.5P26T HR	
Lower side (ENB side)	Cable side	FMC1.5/6-ST-3.5 ^(Note 1)	
	TP adapter side	MCDN1.5/6-G1-3.5P26T HR	

	Pin No.	Signal name	Description
Upper side (EMG side)	1	EMG1-	Emergency stop contact 1 (30V DC or less, 100mA or less)
	2	EMG1+	
	3	EMG2-	Emergency stop contact 2 (30V DC or less, 100mA or less)
	4	EMG2+	
	5	EMGIN	Emergency stop detection input
	6	EMGOUT	24V power supply output for emergency stop detection input
Lower side (ENB side)	7	ENB1-	Enable contact 1 (30V DC or less, 100mA or less)
	8	ENB1+	
	9	ENB2-	Enable contact 2 (30V DC or less, 100mA or less)
	10	ENB2+	
	11	ENBIN	Enable detection input
	12	ENBOUT	24V power supply output for enable detection input

Note 1 Connectors on the cable side are attached under conditions where initial wiring has been conducted.

In order to support each category, remove the initial wiring and wire your safety circuit.

• Upper side (EMG) connector

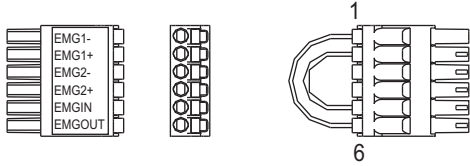

• Lower side (ENB) connector

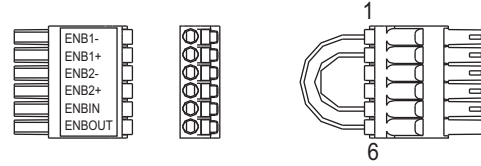

Wiring	Color	Signal	No.
AWG24	YW	EMG1-	1
	YW	EMG1+	2
	—	EMG2-	3
	—	EMG2+	4
	YW	EMGIN	5
	YW	EMGOUT	6

Wiring	Color	Signal	No.
AWG24	YW	ENB1-	1
	YW	ENB1+	2
	—	ENB2-	3
	—	ENB2+	4
	YW	ENBIN	5
	YW	ENBOUT	6

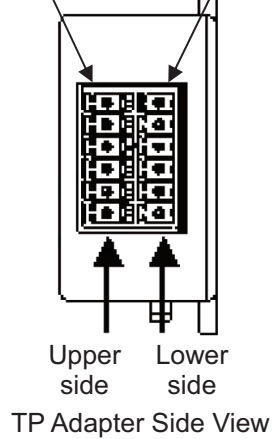

(3) Connection of dummy plug of TP adapter

When operating the controller with AUTO Mode, make sure to connect the enclosed dummy plug (DP-4S).

[3] Examples of safety circuits

1) In case of category 1

TB-01D/TB-01DR or TB-02D

(or Dummy plug : DP-4S)

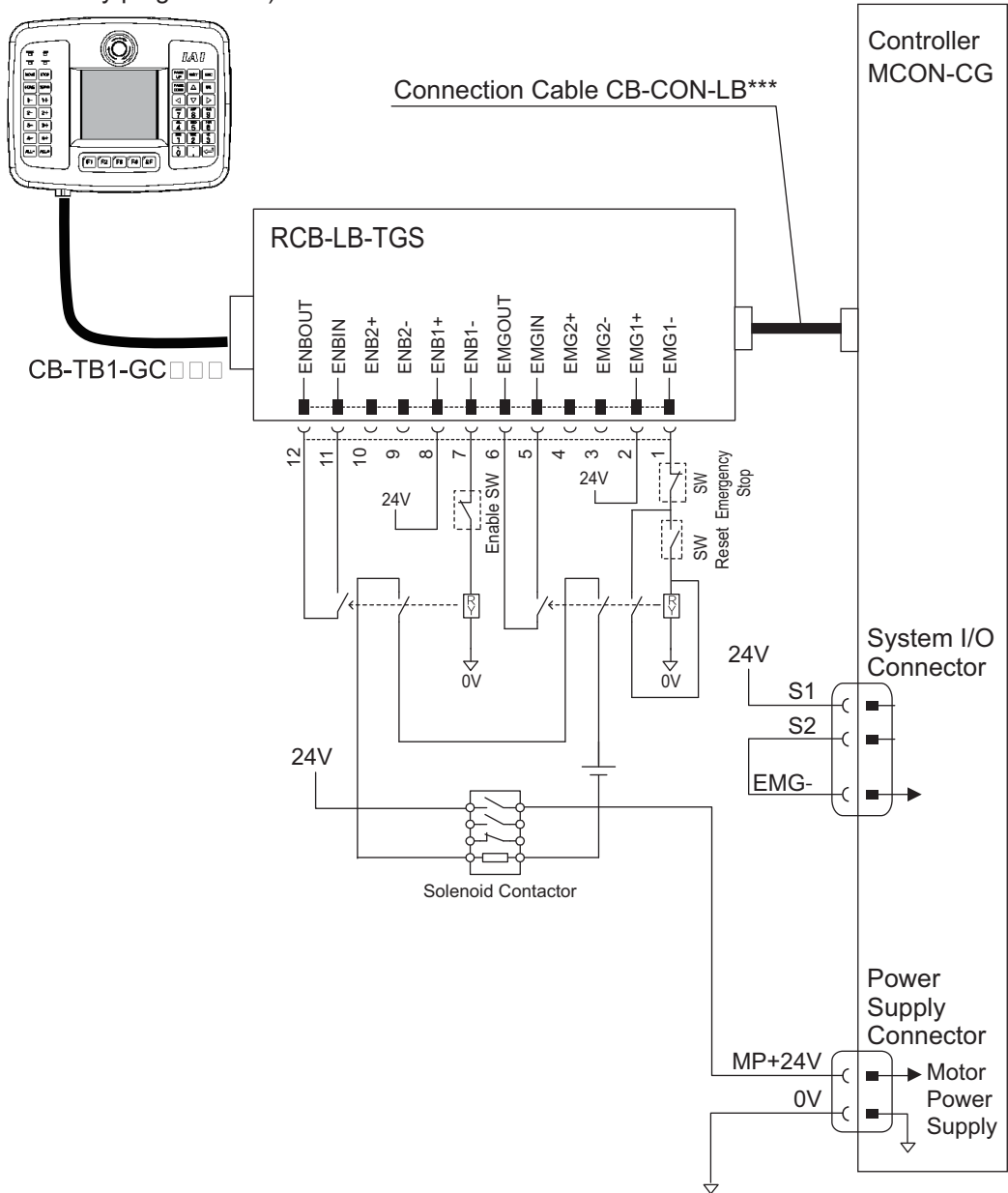

- Detailed category 1 circuit example

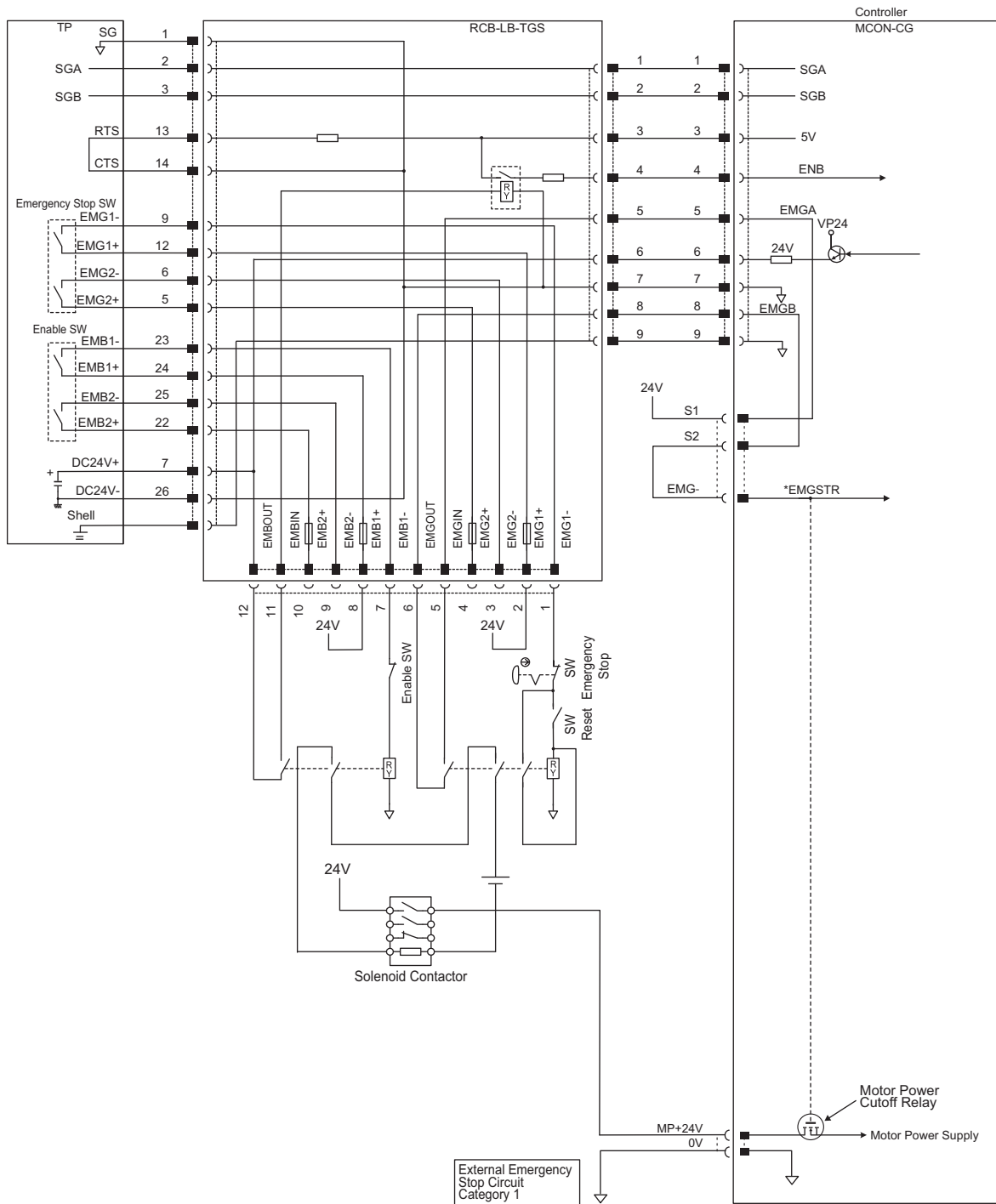

2) In case of category 2

TB-01D/TB-01DR or TB-02D
(or Dummy plug : DP-4S)

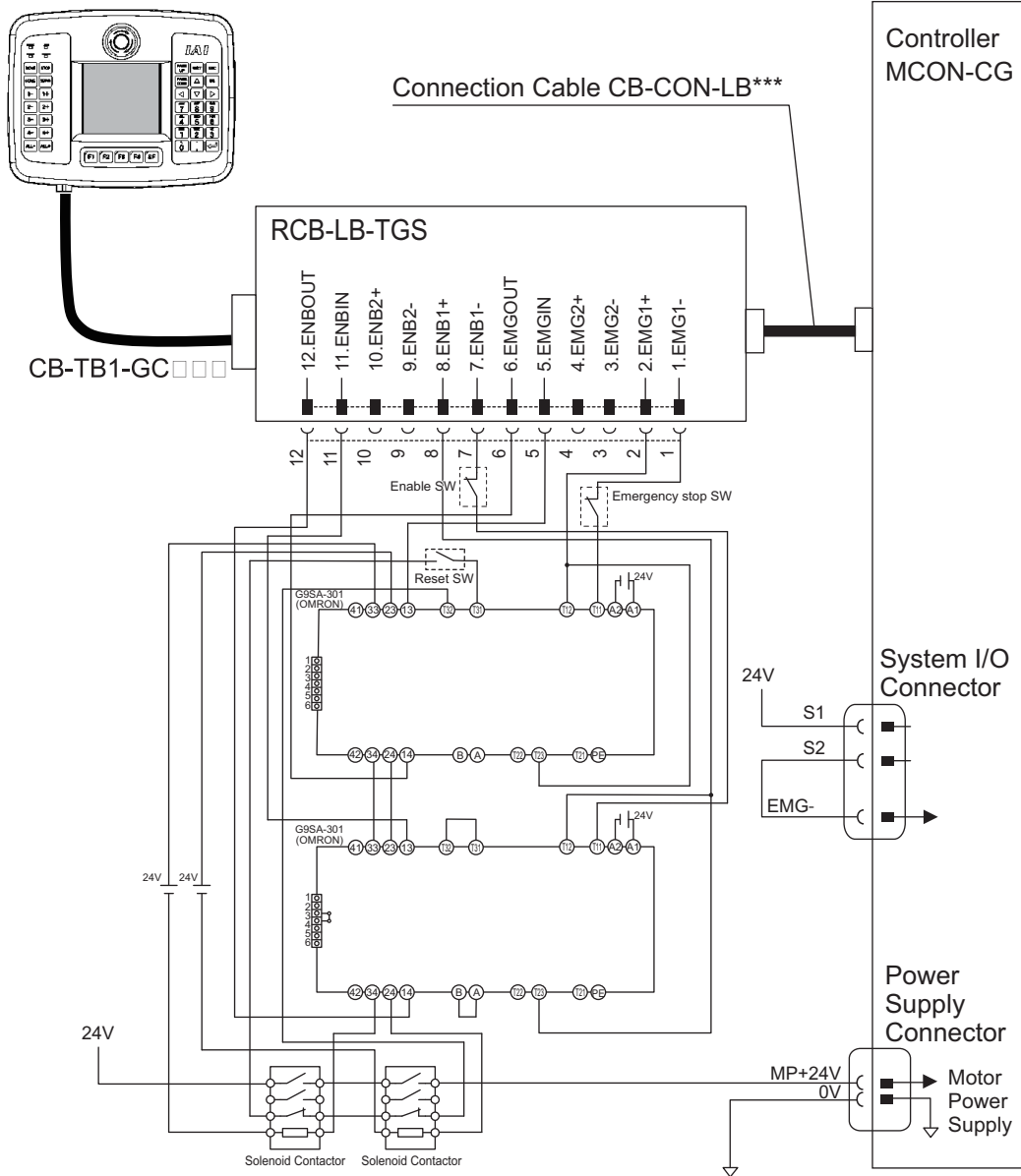

- Detailed category 2 circuit example

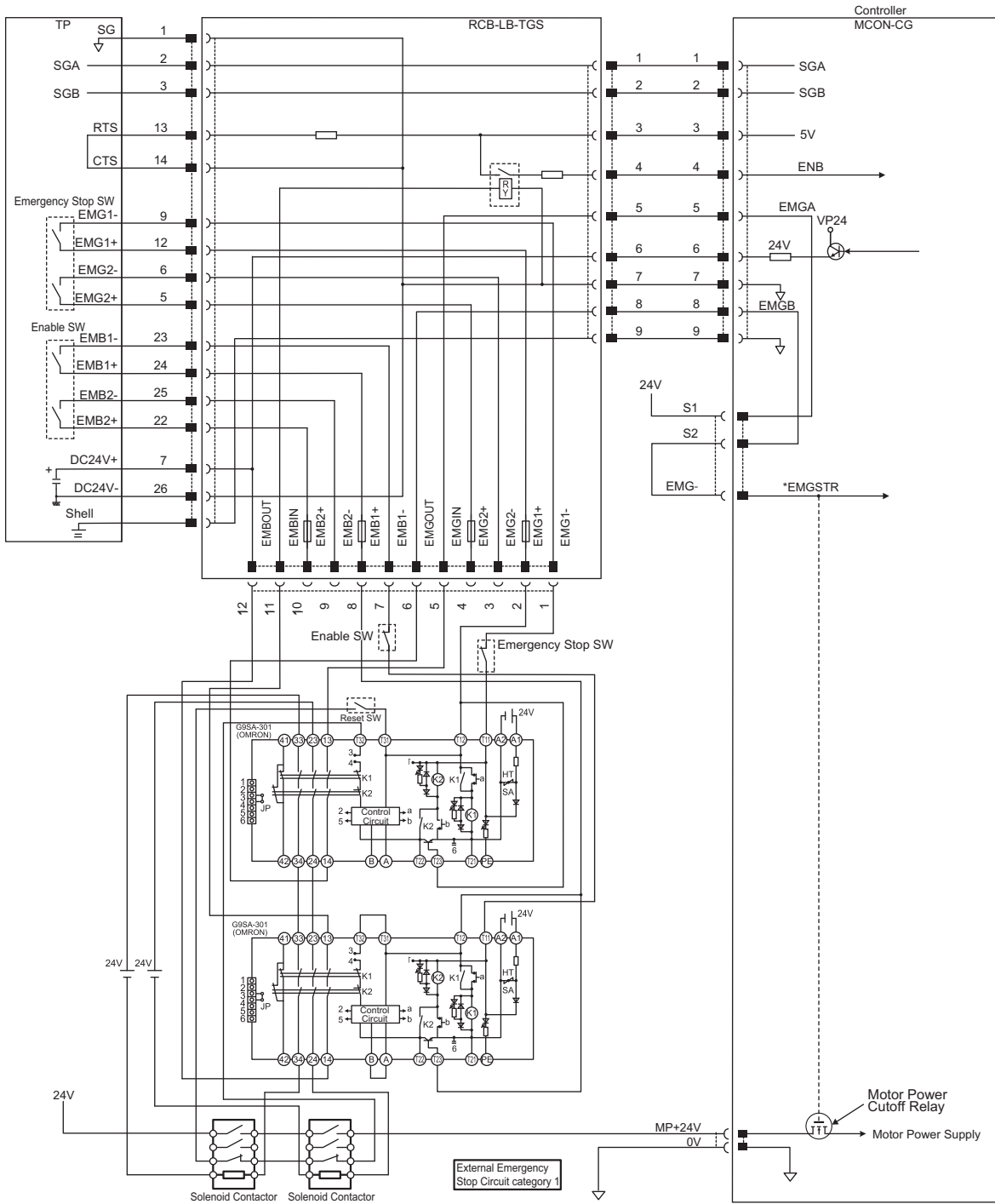

3) In case of category 3 or 4

TB-01D/TB-01DR or TB-02D
(or Dummy plug : DP-4S)

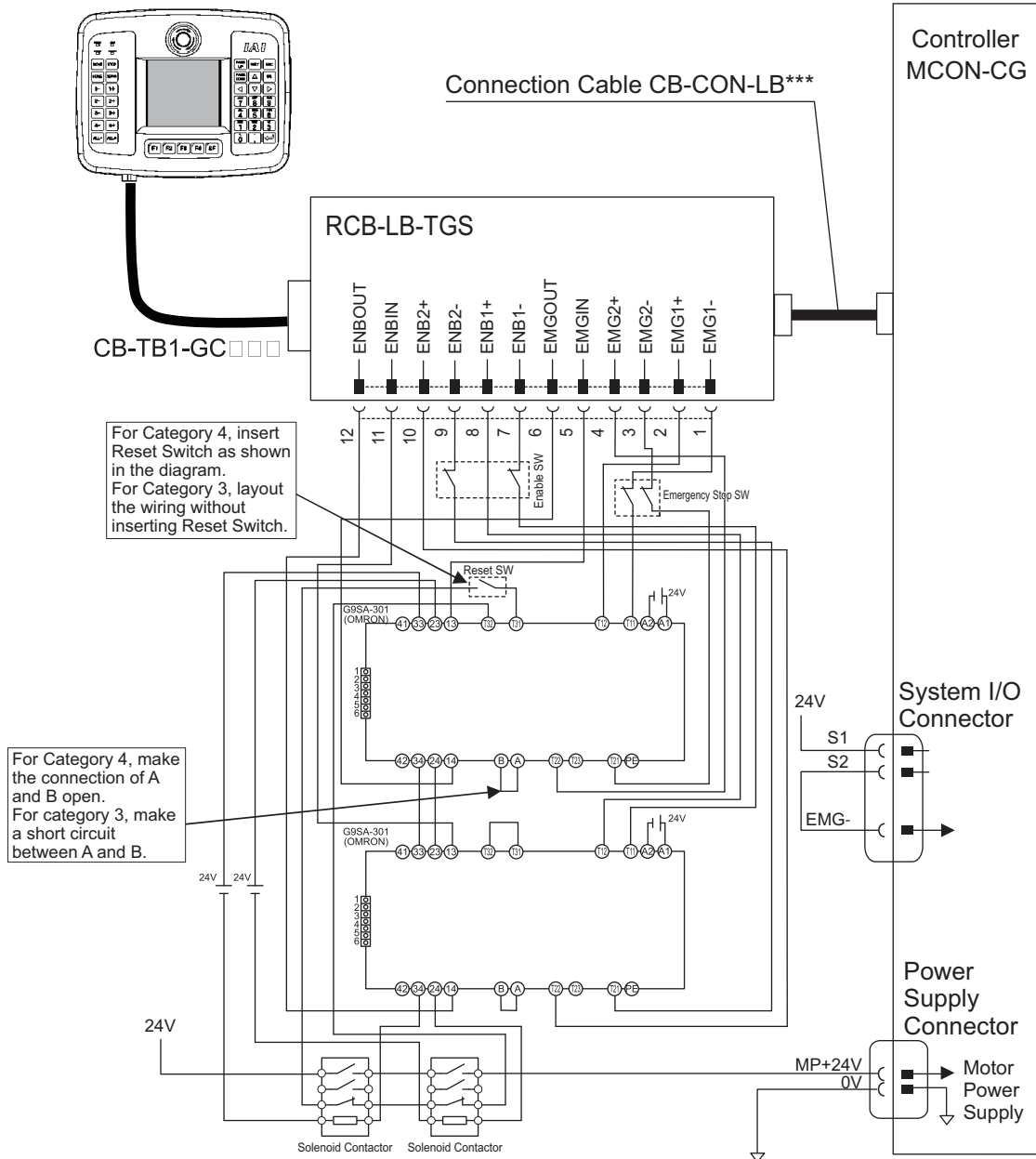

- Detailed category 3 or 4 circuit example

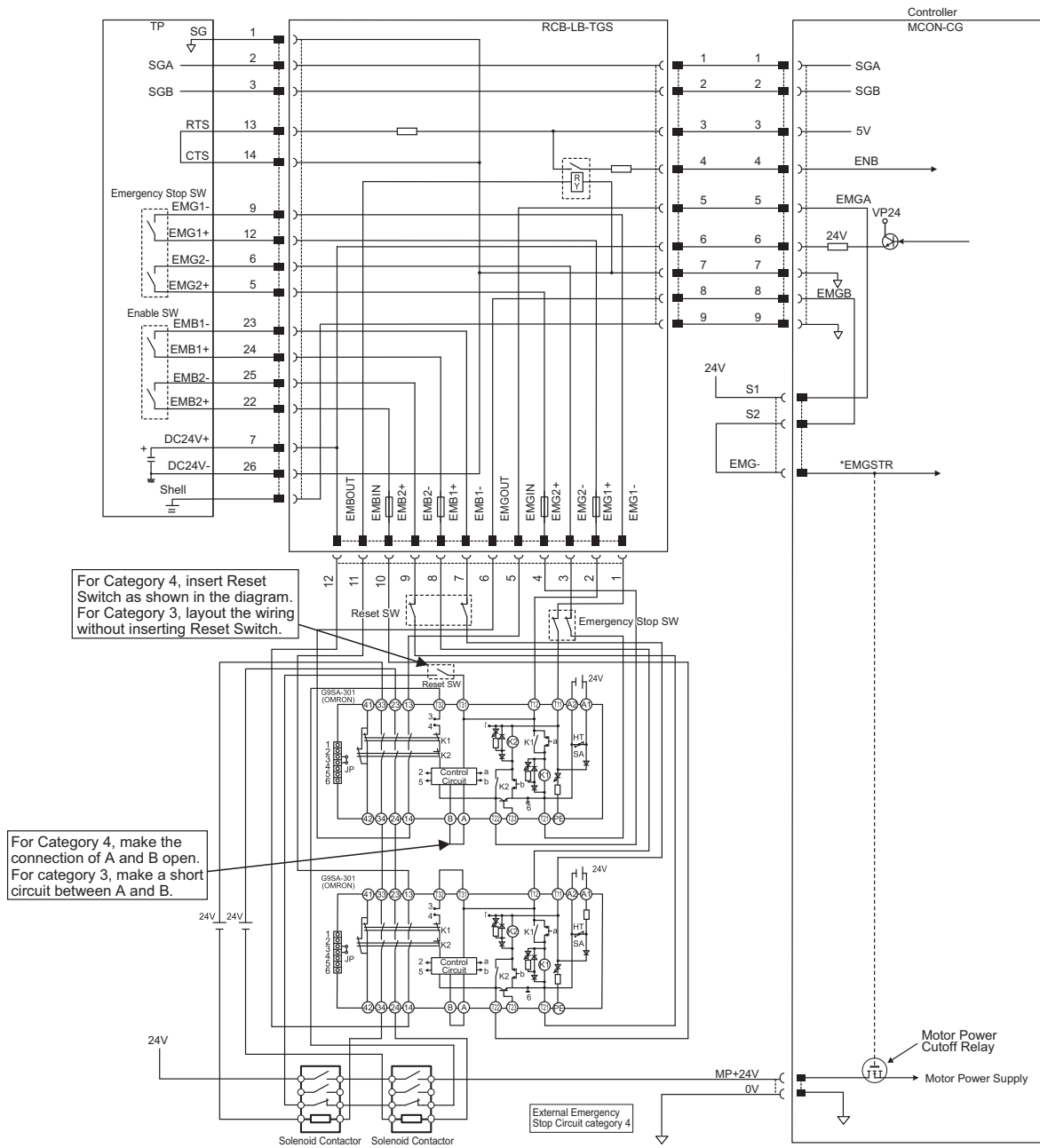

[4] TP adapter and accessories
 1) TP adapter external dimensions

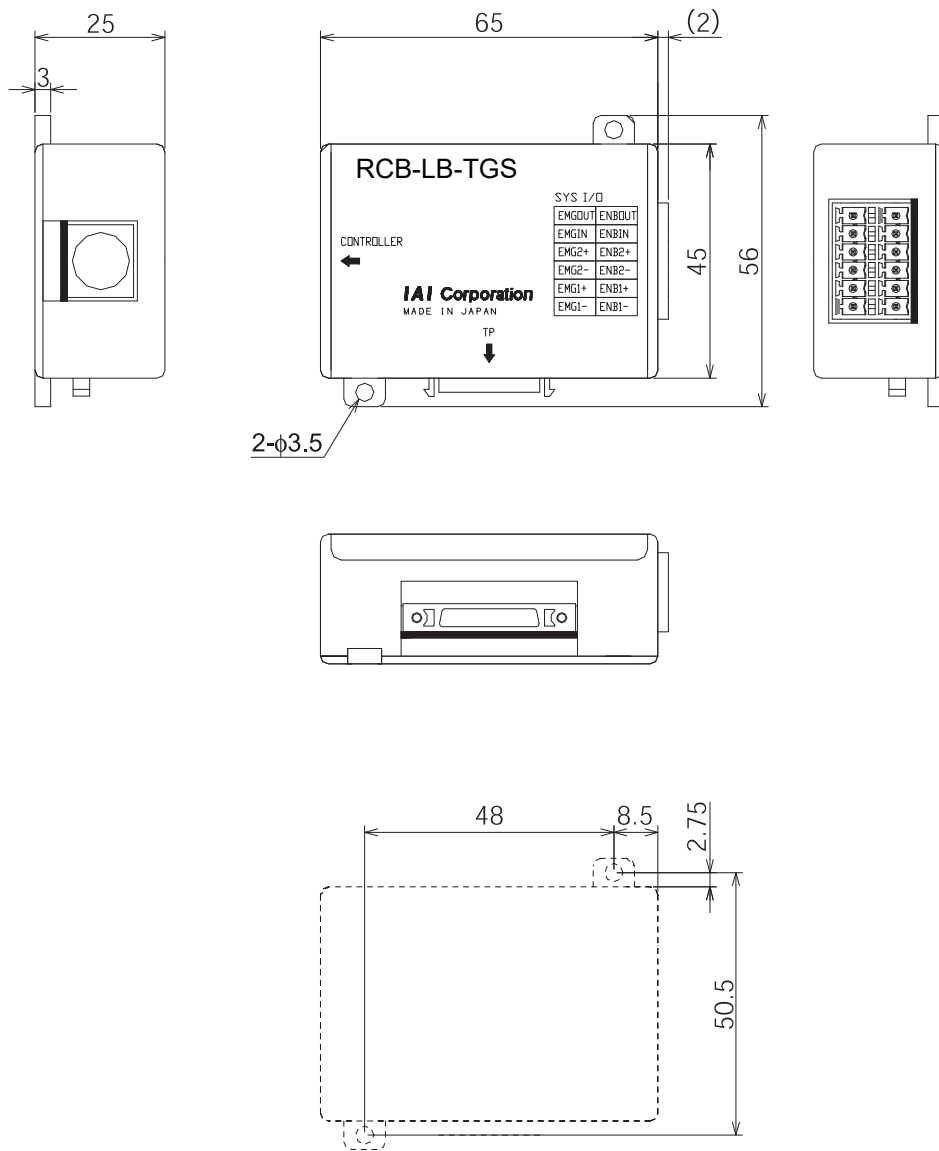

3) Dummy plug

Connect a dummy plug to the teaching pendant connecting connector.

Make sure to connect a dummy plug if the AUTO mode is specified.

Without the connection, it will be the emergency stop condition.

Model : DP-4S

Signal	No.
GND	1
EMGS	2
VCC	3
DTR	4
EMGOUT2	5
EMGIN2	6
NC	7
RSVCC	8
EMGIN1	9
NC	10
NC	11
EMGOUT1	12
RTS	13
CTS (GND)	14
TXD	15
RXD	16
DSR	17
NC	18
NC	19
RSVTBX1	20
RSVTBX2	21
ENBVCC2	22
ENBTBX1	23
ENBVCC1	24
ENBTBX2	25
GND	26

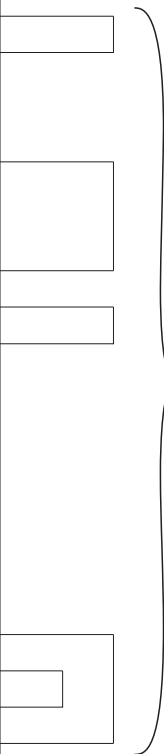

DP-4S



Plug : HDR-E26MSG1

Short-circuit processing.

10.2 When Connecting Power Supply with + Grounding

When using with + grounding, there is a risk of short-circuit of 24V DC power supply if connected to the PC. This is because many PCs have the communication ground (GND) and the frame ground (FG) connected inside and short-circuit occurs through the frame ground. Also, if controllers with different 24V DC power supplies are connected with serial communication, the communication line may become the route of controller power supply in some cases depending on the timing to turn on the power, resulting in the malfunction of the communication line.

Troubleshooting is summarized separately in [ME0271 Caution for + Grounding 24V Power Controller]. Please refer to it.

10.3 Maintenance

10.3.1 Consumed Parts

These parts below have production life. Shown below is the reference.

Item	Life	Specification
Electrolytic capacitor	5 years	0 to 40°C
Backup capacitor for calendar feature	5 years	When repeated to conduct for 12H in 40°C environment and cut for 12H in 20°C environment
Forced air-cooling FAN	Approx. 3 years	When repeated to conduct for 24H in 40°C

10.3.2 Maintenance Information

The times of actuator run and distance of operation can be summed up and recorded ^(Note 1) in the controller.

Also, an alarm is output ^(Note 3) and signal can be output ^(Note 4) externally when the times and distance ^(Note 2) exceed the threshold. By this signal, notice can be available for the timing of grease supply or regular inspection.

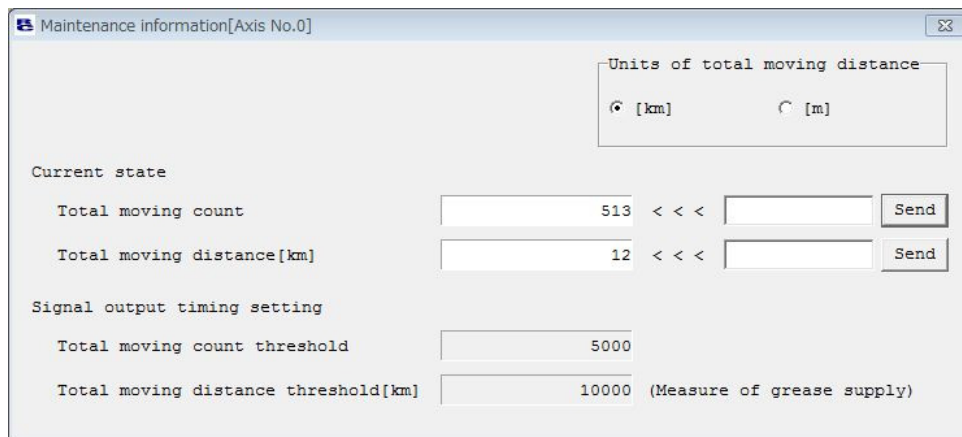

Note 1 The contents recorded in the teaching tool and Modbus communication can be checked. To check in the teaching tool [Refer in each instruction manual for details]

- TB-01/TB-02 [Monitor] → [Maintenance]
- TB-02 [Information] → [Maintenance Information]

· RC PC software [Monitor (M)] → [Maintenance Information (I)] → Select axis

Note 2 Set in Parameter No. 147 "Total Times of Movement Target" and No. 148 "Total Drive Distance Target".

Note 3 The message level alarms "04E Times of Movement Target Exceeded" and "04F Drive Distance Target Exceeded" are output. [Refer to 9.4.3 Alarm Codes on Driver Board (Each Axis)]

Note 4 A light malfunction alarm (ALML) is output. [Refer to 3.7.1 [21]]

10.3.3 Replacement of Fan

SYS LED lamp (Note 1) turns on in red when an error on the fan has been detected. Start up the gateway parameter setting tool and check the alarm code.

If the alarm code is either "848" (Fan Rotation Drop) or "89E" (Fan Error), replace the fan unit by referring to the following steps.

Also, once a fan error has been detected, the gateway status signal gets output and detection can be monitored here.

Note 1 [Refer to 3.10 Fieldbus Status LED]

	Alarm Code	Alarm Name
Parameter Configuration tool	848	Decrease in Fan Revolution
	89E	Fun error
B0 to b7 in Gateway Status Signal 0 (ALMC1 to ALMC128)	48	Decrease in Fan Revolution
	9E	Fun error

[Step 1] Prepare a new fan.

[Step 2] Turn the power off and detach the fan unit fixing screw (screw on the right in the two aligned ones).

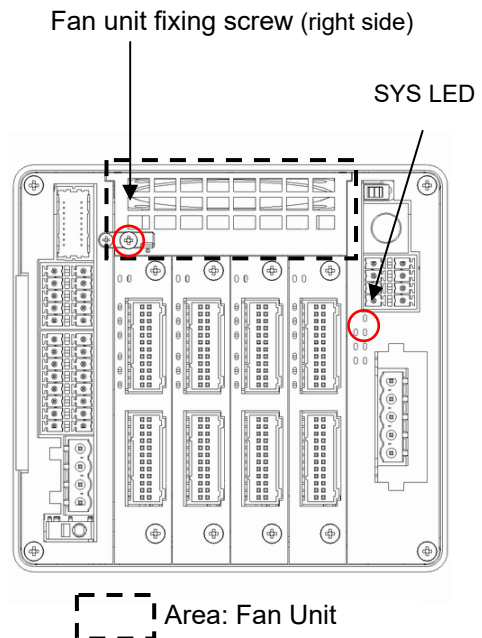
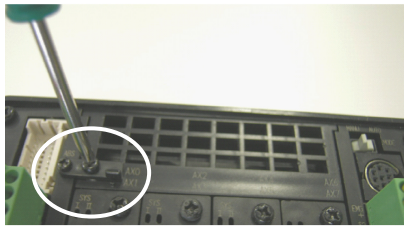

[Step 3] Rotate the fan unit holder till it goes out of the fan unit interference.

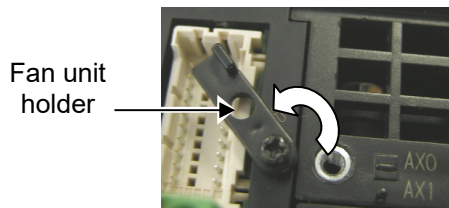

[Step 4] Grab the lattice* on the fan unit with a tool such as needle-nose plier, and pull out the fan unit.

*The lattice on the fan unit is disposable.

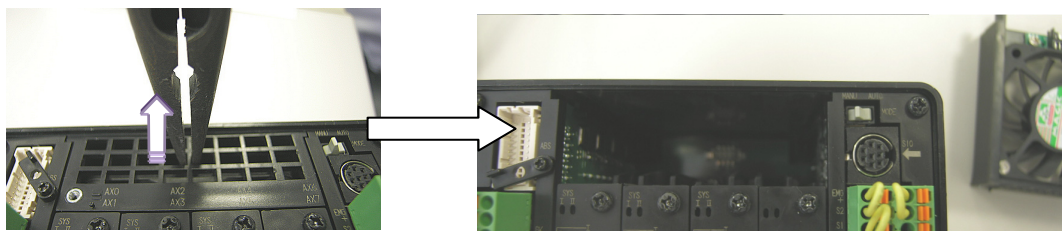

[Step 5] The new fan unit is to be pushed in to be settled. At this time, make sure the fan unit is pushed in down to become flush with the peripheral.

[Step 6] Rotate the fan unit holder so the fan unit fixing screw can be tightened.

10.4 List of Specifications of Connectable Actuators

The specifications included in this list are limited to those needed to set operating conditions and parameters. For other detailed specifications, refer to the catalog or operation manual for your actuator.

⚠ Caution :

- The push force is based on the rated push speed (factory setting) indicated in the list, and provides only a guideline.
- Make sure the actual push force is equal to or greater than the minimum push force. If not, the push force will not stabilize.
- Do not change the setting of push speed (parameter No.34). If you must change the push speed, consult IAI.
- If, among the operating conditions, the positioning speed is set to a value equal to or smaller than the push speed, the push speed will become the set speed and the specified push force will not generate.

(Note) RCP2-SA7C/SA7R and RCP2CR-SA7C/SA7R is not connected.

10.4.1 Specifications for Servo Motor Type Actuator

Actuator series	Type	Feed screw	Motor output [W]	No. of encoder pulses	Lead [mm]	Mounting direction	Minimum speed [mm/s]	Maximum speed [mm/s]	Maximum acceleration/ deceleration [G]	Minimum push force [N]	Maximum push force [N]	Rated push speed [mm/s]
RCA (rod type)	RA3C	Ball screw	20	800	10	Horizontal	12.5	500	Energy-saving spec.: 0.3	—	—	—
						/vertical	—	—	—			
					5	Horizontal	6.25	250	Energy-saving spec.: 0.3	—	—	—
						/vertical	—	—	—			
					2.5	Horizontal	3.12	125	Energy-saving spec.: 0.2	—	—	—
						/vertical	—	—	—			
	RGS3C	Ball screw	20	800	10	Horizontal	12.5	500	Energy-saving spec.: 0.3	—	—	—
						/vertical	—	—	—			
					5	Horizontal	6.25	250	Energy-saving spec.: 0.3	—	—	—
						/vertical	—	—	—			
					2.5	Horizontal	3.12	125	Energy-saving spec.: 0.2	—	—	—
						/vertical	—	—	—			
	RGD3C	Ball screw	20	800	10	Horizontal	12.5	500	Energy-saving spec.: 0.3	—	—	—
						/vertical	—	—	—			
					5	Horizontal	6.25	250	Energy-saving spec.: 0.3	—	—	—
						/vertical	—	—	—			
					2.5	Horizontal	3.12	125	Energy-saving spec.: 0.2	—	—	—
						/vertical	—	—	—			
	RA3D	Ball screw	20	800	10	Horizontal	12.5	500	0.3	—	—	—
						/vertical	—	—	—			
					5	Horizontal	6.25	250	0.3	—	—	—
						/vertical	—	—	—			
					2.5	Horizontal	3.12	125	0.2	—	—	—
						/vertical	—	—	—			
RGS3D	Ball screw	20	800	10	Horizontal	12.5	500	0.3	—	—	—	
					/vertical	—	—	—				
				5	Horizontal	6.25	250	0.3	—	—	—	
					/vertical	—	—	—				
				2.5	Horizontal	3.12	125	0.2	—	—	—	
					/vertical	—	—	—				
RGD3D	Ball screw	20	800	10	Horizontal	12.5	500	0.3	—	—	—	
					/vertical	—	—	—				
				5	Horizontal	6.25	250	0.3	—	—	—	
					/vertical	—	—	—				
				2.5	Horizontal	3.12	125	0.2	—	—	—	
					/vertical	—	—	—				

Actuator series	Type	Feed screw	Motor output [W]	No. of encoder pulses	Lead [mm]	Mounting direction	Minimum speed [mm/s]	Maximum speed [mm/s]	Maximum acceleration/deceleration [G]	Minimum push force [N]	Maximum push force [N]	Rated push speed [mm/s]
RCA (rod type)	RA3R	Ball screw	20	800	10	Horizontal /vertical	12.5	500	0.3	—	—	—
					5	Horizontal /vertical	6.25	250	0.3	—	—	—
					2.5	Horizontal /vertical	3.12	125	0.2	—	—	—
	RGD3R	Ball screw	20	800	10	Horizontal /vertical	12.5	500	0.3	—	—	—
					5	Horizontal /vertical	6.25	250	0.3	—	—	—
					2.5	Horizontal /vertical	3.12	125	0.2	—	—	—
	RA4C	Ball screw	20	800	12	Horizontal /vertical	15	600	Energy-saving spec.: 0.3 High acc/dec spec.: 1.0	—	—	—
					6	Horizontal /vertical	7.5	300	Energy-saving spec.: 0.3 High acc/dec spec.: 1.0	—	—	—
					3	Horizontal /vertical	3.75	150	Energy-saving spec.: 0.2 High acc/dec spec.: 0.2	—	—	—
			30		12	Horizontal /vertical	15	600	Energy-saving spec.: 0.3 High acc/dec spec.: 1.0	—	—	—
					6	Horizontal /vertical	7.5	300	Energy-saving spec.: 0.3 High acc/dec spec.: 1.0	—	—	—
					3	Horizontal /vertical	3.75	150	Energy-saving spec.: 0.2 High acc/dec spec.: 0.2	—	—	—
	RGS4C	Ball screw	20	800	12	Horizontal /vertical	15	600	Energy-saving spec.: 0.3 High acc/dec spec.: 1.0	—	—	—
					6	Horizontal /vertical	7.5	300	Energy-saving spec.: 0.3 High acc/dec spec.: 1.0	—	—	—
					3	Horizontal /vertical	3.75	150	Energy-saving spec.: 0.2 High acc/dec spec.: 0.2	—	—	—
			30		12	Horizontal /vertical	15	600	Energy-saving spec.: 0.3 High acc/dec spec.: 1.0	—	—	—
					6	Horizontal /vertical	7.5	300	Energy-saving spec.: 0.3 High acc/dec spec.: 1.0	—	—	—
					3	Horizontal /vertical	3.75	150	Energy-saving spec.: 0.2 High acc/dec spec.: 0.2	—	—	—
	RGD4C	Ball screw	20	800	12	Horizontal /vertical	15	600	Energy-saving spec.: 0.3 High acc/dec spec.: 1.0	—	—	—
					6	Horizontal /vertical	7.5	300	Energy-saving spec.: 0.3 High acc/dec spec.: 1.0	—	—	—
					3	Horizontal /vertical	3.75	150	Energy-saving spec.: 0.2 High acc/dec spec.: 0.2	—	—	—
			30		12	Horizontal /vertical	15	600	Energy-saving spec.: 0.3 High acc/dec spec.: 1.0	—	—	—
					6	Horizontal /vertical	7.5	300	Energy-saving spec.: 0.3 High acc/dec spec.: 1.0	—	—	—
					3	Horizontal /vertical	3.75	150	Energy-saving spec.: 0.2 High acc/dec spec.: 0.2	—	—	—

Actuator series	Type	Feed screw	Motor output [W]	No. of encoder pulses	Lead [mm]	Mounting direction	Minimum speed [mm/s]	Maximum speed [mm/s]	Maximum acceleration/deceleration [G]	Minimum push force [N]	Maximum push force [N]	Rated push speed [mm/s]
RCA (rod type)	RA4D	Ball screw	20	800	12	Horizontal /vertical	15	600	0.3	-	-	-
					6	Horizontal /vertical	7.5	300	0.3	-	-	-
					3	Horizontal /vertical	3.75	150	0.2	-	-	-
			12		Horizontal /vertical	15	600	0.3	-	-	-	
			6		Horizontal /vertical	7.5	300	0.3	-	-	-	
			3		Horizontal /vertical	3.75	150	0.2	-	-	-	
	30	12	Horizontal /vertical	15	600	0.3	-	-	-			
	6	Horizontal /vertical	7.5	300	0.3	-	-	-				
	3	Horizontal /vertical	3.75	150	0.2	-	-	-				
	RGS4D	Ball screw	20	800	12	Horizontal /vertical	15	600	0.3	-	-	-
					6	Horizontal /vertical	7.5	300	0.3	-	-	-
					3	Horizontal /vertical	3.75	150	0.2	-	-	-
			12		Horizontal /vertical	15	600	0.3	-	-	-	
			6		Horizontal /vertical	7.5	300	0.3	-	-	-	
			3		Horizontal /vertical	3.75	150	0.2	-	-	-	
	30	12	Horizontal /vertical	15	600	0.3	-	-	-			
	6	Horizontal /vertical	7.5	300	0.3	-	-	-				
	3	Horizontal /vertical	3.75	150	0.2	-	-	-				
	RGD4D	Ball screw	20	800	12	Horizontal /vertical	15	600	0.3	-	-	-
					6	Horizontal /vertical	7.5	300	0.3	-	-	-
					3	Horizontal /vertical	3.75	150	0.2	-	-	-
			12		Horizontal /vertical	15	600	0.3	-	-	-	
			6		Horizontal /vertical	7.5	300	0.3	-	-	-	
			3		Horizontal /vertical	3.75	150	0.2	-	-	-	
30	12	Horizontal /vertical	15	600	0.3	-	-	-				
6	Horizontal /vertical	7.5	300	0.3	-	-	-					
3	Horizontal /vertical	3.75	150	0.2	-	-	-					
RA4R	Ball screw	20	800	12	Horizontal /vertical	15	600	0.3	-	-	-	
				6	Horizontal /vertical	7.5	300	0.3	-	-	-	
				3	Horizontal /vertical	3.75	150	0.2	-	-	-	
		12		Horizontal /vertical	15	600	0.3	-	-	-		
		6		Horizontal /vertical	7.5	300	0.3	-	-	-		
		3		Horizontal /vertical	3.75	150	0.2	-	-	-		
30	12	Horizontal /vertical	15	600	0.3	-	-	-				
6	Horizontal /vertical	7.5	300	0.3	-	-	-					
3	Horizontal /vertical	3.75	150	0.2	-	-	-					

Actuator series	Type	Feed screw	Motor output [W]	No. of encoder pulses	Lead [mm]	Mounting direction	Minimum speed [mm/s]	Maximum speed [mm/s]	Maximum acceleration/deceleration [G]	Minimum push force [N]	Maximum push force [N]	Rated push speed [mm/s]				
RCA (rod type)	RGD4R	Ball screw	20	800	12	Horizontal /vertical	15	600	0.3	-	-	-				
					6	Horizontal /vertical	7.5	300	0.3	-	-	-				
					3	Horizontal /vertical	3.75	150	0.2	-	-	-				
					12	Horizontal /vertical	15	600	0.3	-	-	-				
					6	Horizontal /vertical	7.5	300	0.3	-	-	-				
					3	Horizontal /vertical	3.75	150	0.2	-	-	-				
	SRA4R	Ball screw	20	800	5	Horizontal /vertical	6.25	250	0.3	-	-	-				
					2.5	Horizontal /vertical	3.12	125	0.2	-	-	-				
					5	Horizontal /vertical	6.25	250	0.3	-	-	-				
					2.5	Horizontal /vertical	3.12	125	0.2	-	-	-				
					5	Horizontal /vertical	6.25	250	0.3	-	-	-				
					2.5	Horizontal /vertical	3.12	125	0.2	-	-	-				
	SRGS4R	Ball screw	20	800	5	Horizontal /vertical	6.25	250	0.3	-	-	-				
					2.5	Horizontal /vertical	3.12	125	0.2	-	-	-				
					5	Horizontal /vertical	6.25	250	0.3	-	-	-				
					2.5	Horizontal /vertical	3.12	125	0.2	-	-	-				
5					Horizontal /vertical	6.25	250	0.3	-	-	-					
2.5					Horizontal /vertical	3.12	125	0.2	-	-	-					
SRGD4R	Ball screw	20	800	5	Horizontal /vertical	6.25	250	0.3	-	-	-					
				2.5	Horizontal /vertical	3.12	125	0.2	-	-	-					
				5	Horizontal /vertical	6.25	250	0.3	-	-	-					
				2.5	Horizontal /vertical	3.12	125	0.2	-	-	-					
				5	Horizontal /vertical	6.25	250	0.3	-	-	-					
				2.5	Horizontal /vertical	3.12	125	0.2	-	-	-					
RCA (slider type)	SA4C	Ball screw	20	Incremental 800	10	Horizontal /vertical	12.5 (Note 1)	665	Energy-saving spec.: 0.3 High acc/dec spec.: 1.0	-	-	-				
				Battery-less Absolute 16384	5	Horizontal /vertical	6.25 (Note 1)	330	Energy-saving spec.: 0.3 High acc/dec spec.: 1.0	-	-	-				
					2.5	Horizontal /vertical	3.12 (Note 1)	165	Energy-saving spec.: 0.2 High acc/dec spec.: 0.2	-	-	-				
	SA4D	Ball screw	20	800	10	Horizontal /vertical	12.5	665	0.3	-	-	-				
					5	Horizontal /vertical	6.25	330	0.3	-	-	-				
					2.5	Horizontal /vertical	3.12	165	0.2	-	-	-				
	SA4R	Ball screw	20	Incremental 800	10	Horizontal /vertical	12.5 (Note 1)	665	0.3	-	-	-				
				Battery-less Absolute 16384	5	Horizontal /vertical	6.25 (Note 1)	330	0.3	-	-	-				
					2.5	Horizontal /vertical	3.12 (Note 1)	165	0.2	-	-	-				
	SA5C	Ball screw	20	Incremental 800	20	Horizontal /vertical	25 (Note 1)	1300 800	Energy-saving spec.: 0.3 High acc/dec spec.: 0.8	-	-	-				
					12	Horizontal /vertical	15 (Note 1)	800 (at 50 to 450st) 760 (at 500st)	Energy-saving spec.: 0.3 High acc/dec spec.: 0.8	-	-	-				
					6	Horizontal /vertical	7.5 (Note 1)	400 (at 50 to 450st) 380 (at 500st)	Energy-saving spec.: 0.3 High acc/dec spec.: 0.8	-	-	-				
					3	Horizontal /vertical	3.75 (Note 1)	200 (at 50 to 450st) 190 (at 500st)	Energy-saving spec.: 0.2 High acc/dec spec.: 0.2	-	-	-				
					SA5D	Ball screw	20	800	12	Horizontal /vertical	15	800 (at 50 to 450st) 760 (at 500st)	0.3	-	-	-
									6	Horizontal /vertical	7.5	400 (at 50 to 450st) 380 (at 500st)	0.3	-	-	-
	3	Horizontal /vertical	3.75	200 (at 50 to 450st) 190 (at 500st)					0.2	-	-	-				
	SA5R	Ball screw	20	Incremental 800	12	Horizontal /vertical	15 (Note 1)	800 (at 50 to 450st) 760 (at 500st)	0.3	-	-	-				
				Battery-less Absolute 16384	6	Horizontal /vertical	7.5 (Note 1)	400 (at 50 to 450st) 380 (at 500st)	0.3	-	-	-				
3					Horizontal /vertical	3.75 (Note 1)	200 (at 50 to 450st) 190 (at 500st)	0.2	-	-	-					

Note 1 Speed with the incremental encoder

Actuator series	Type	Feed screw	Motor output [W]	No. of encoder pulses	Lead [mm]	Mounting direction	Minimum speed [mm/s]	Maximum speed [mm/s]	Maximum acceleration/ deceleration [G]	Minimum push force [N]	Maximum push force [N]	Rated push speed [mm/s]			
RCA (slider type)	SA6C	Ball screw	30	Incremental 800 Battery-less Absolute 16384	20	Horizontal	25 (Note 1)	1300 (at 50 to 500st) 1160 (at 550st) 990 (at 600st)	Energy-saving spec.: 0.3	-	-	-			
						Vertical		800	High acc/dec spec.: 0.8	-	-	-			
					12	Horizontal /vertical	15 (Note 1)	800 (at 50 to 450st) 760 (at 500st) 640 (at 550st) 540 (at 600st)	Energy-saving spec.: 0.3	-	-	-			
								High acc/dec spec.: 1.0	-	-	-				
	6	Horizontal /vertical	7.5 (Note 1)	400 (at 50 to 450st) 380 (at 500st) 320 (at 550st) 270 (at 600st)	Energy-saving spec.: 0.3	-	-	-							
				High acc/dec spec.: 1.0	-	-	-								
	3	Horizontal /vertical	3.75 (Note 1)	200 (at 50 to 450st) 190 (at 500st) 160 (at 550st) 135 (at 600st)	Energy-saving spec.: 0.2	-	-	-							
				High acc/dec spec.: 0.2	-	-	-								
	SA6D	Ball screw	30	800	12	Horizontal /vertical	15	800 (at 50 to 450st) 760 (at 500st) 640 (at 550st) 540 (at 600st)	0.3	-	-	-			
								6	Horizontal /vertical	7.5	400 (at 50 to 450st) 380 (at 500st) 320 (at 550st) 270 (at 600st)	0.3	-	-	-
											3	Horizontal /vertical	3.75	200 (at 50 to 450st) 190 (at 500st) 160 (at 550st) 135 (at 600st)	0.2
	SA6R	Ball screw	30	Incremental 800 Battery-less Absolute 16384	12	Horizontal /vertical	15 (Note 1)	800 (at 50 to 450st) 760 (at 500st) 640 (at 550st) 540 (at 600st)	0.3	-				-	-
								6	Horizontal /vertical	7.5 (Note 1)	400 (at 50 to 450st) 380 (at 500st) 320 (at 550st) 270 (at 600st)	0.3	-	-	-
											3	Horizontal /vertical	3.75 (Note 1)	200 (at 50 to 450st) 190 (at 500st) 160 (at 550st) 135 (at 600st)	0.2
	SS4D	Ball screw	20	800	10	Horizontal /vertical	12.5	665	0.3	-				-	-
								5	Horizontal /vertical	6.25	330	0.3	-	-	-
											2.5	Horizontal /vertical	3.12	165	0.2
	SS5D	Ball screw	20	800	12	Horizontal /vertical	15	800 (at 50 to 450st) 760 (at 500st)	0.3	-				-	-
6								Horizontal /vertical	7.5	400 (at 50 to 450st) 380 (at 500st)	0.3	-	-	-	
										3	Horizontal /vertical	3.25	200 (at 50 to 450st) 190 (at 500st)	0.2	-

Note 1 Speed with the incremental encoder

Actuator series	Type	Feed screw	Motor output [W]	No. of encoder pulses	Lead [mm]	Mounting direction	Minimum speed [mm/s]	Maximum speed [mm/s]	Maximum acceleration/deceleration [G]	Minimum push force [N]	Maximum push force [N]	Rated push speed [mm/s]
RCA (slider type)	SS6D	Ball screw	30	800	12	Horizontal /vertical	15	800 (at 50 to 450st) 760 (at 500st) 640 (at 550st) 540 (at 600st)	0.3	-	-	-
					6	Horizontal /vertical	7.5	400 (at 50 to 450st) 380 (at 500st) 320 (at 550st) 270 (at 600st)	0.3	-	-	-
					3	Horizontal /vertical	3.25	200 (at 50 to 450st) 190 (at 500st) 160 (at 550st) 135 (at 600st)	0.2	-	-	-
RCA (arm type)	A4R	Ball screw	20	800	10	Horizontal /vertical	12.5	330	0.2	-	-	-
					5	Horizontal /vertical	6.25	165	0.2	-	-	-
	A5R	Ball screw	20	800	12	Horizontal /vertical	15	400	0.2	-	-	-
					6	Horizontal /vertical	7.5	200	0.2	-	-	-
	A6R	Ball screw	30	800	12	Horizontal /vertical	15	400	0.2	-	-	-
					6	Horizontal /vertical	7.5	200	0.2	-	-	-
RCA2 (rod type)	RA2AC	Ball screw	5	800	4	Horizontal /vertical	5	180 (at 25st) 200 (at 50 to 100st)	0.3	-	-	-
					2	Horizontal /vertical	2.5	100	0.3	-	-	-
					1	Horizontal /vertical	1.25	50	0.3	-	-	-
	RA2AR	Ball screw	5	800	4	Horizontal /vertical	5	180 (at 25st) 200 (at 50 to 100st)	0.3	-	-	-
					2	Horizontal /vertical	2.5	100	0.3	-	-	-
					1	Horizontal /vertical	1.25	50	0.3	-	-	-
	RN3N RN3NA	Ball screw	10	1048	4	Horizontal /vertical	3.81	200	0.3	-	-	-
					2	Horizontal /vertical	1.90	100	0.2	-	-	-
					1	Horizontal /vertical	0.95	50	0.2	-	-	-
		Lead screw	10	1048	4	Horizontal /vertical	3.81	200	0.2	-	-	-
					2	Horizontal /vertical	1.90	100	0.2	-	-	-
					1	Horizontal /vertical	0.95	50	0.2	-	-	-
	RP3N RP3NA	Ball screw	10	1048	4	Horizontal /vertical	3.81	200	0.3	-	-	-
					2	Horizontal /vertical	1.90	100	0.3	-	-	-
					1	Horizontal /vertical	0.95	50	0.2	-	-	-
		Lead screw	10	1048	4	Horizontal /vertical	3.81	200	0.2	-	-	-
					2	Horizontal /vertical	1.90	100	0.2	-	-	-
					1	Horizontal /vertical	0.95	50	0.2	-	-	-
	GS3N GS3NA	Ball screw	10	1048	4	Horizontal /vertical	3.81	200	0.3	-	-	-
					2	Horizontal /vertical	1.90	100	0.3	-	-	-
					1	Horizontal /vertical	0.95	50	0.2	-	-	-
		Lead screw	10	1048	4	Horizontal /vertical	3.81	200	0.2	-	-	-
					2	Horizontal /vertical	1.90	100	0.2	-	-	-
					1	Horizontal /vertical	0.95	50	0.2	-	-	-
	GD3N GD3NA	Ball screw	10	1048	4	Horizontal /vertical	3.81	200	0.3	-	-	-
					2	Horizontal /vertical	1.90	100	0.3	-	-	-
					1	Horizontal /vertical	0.95	50	0.2	-	-	-
		Lead screw	10	1048	4	Horizontal /vertical	3.81	200	0.2	-	-	-
					2	Horizontal /vertical	1.90	100	0.2	-	-	-
					1	Horizontal /vertical	0.95	50	0.2	-	-	-

Actuator series	Type	Feed screw	Motor output [W]	No. of encoder pulses	Lead [mm]	Mounting direction	Minimum speed [mm/s]	Maximum speed [mm/s]	Maximum acceleration/deceleration [G]	Minimum push force [N]	Maximum push force [N]	Rated push speed [mm/s]
RCA2 (rod type)	SD3N SD3NA	Ball screw	10	1048	4	Horizontal	3.81	200	0.3	-	-	-
						Vertical			0.2			
					2	Horizontal	1.90	100	0.3			
						Vertical			0.2			
		1			Horizontal	0.95	50	0.2				
					Vertical			0.2				
	Lead screw	10	1048	4	Horizontal/vertical	3.81	200	0.2				
					1			Horizontal/vertical	1.90	100	0.2	
	1			Horizontal/vertical	0.95	50	0.2					
				1			Horizontal/vertical	0.95	50	0.2		
	RN4N	Ball screw	20	1048	6	Horizontal	5.72			270	0.3	-
						Vertical		220	0.2	-	-	-
					4	Horizontal	3.81	200	0.3	-	-	-
						Vertical			0.2	-	-	-
					2	Horizontal	1.90	100	0.2	-	-	-
						Vertical			0.2	-	-	-
		Lead screw			6	Horizontal	5.72	220	0.2	-	-	-
						Vertical			0.2	-	-	-
					4	Horizontal	3.81	200	0.2	-	-	-
						Vertical			0.2	-	-	-
					2	Horizontal	1.90	100	0.2	-	-	-
						Vertical			0.2	-	-	-
	RP4N	Ball screw	20	1048	6	Horizontal	5.72	270	0.3	-	-	-
						Vertical		220	0.2	-	-	-
					4	Horizontal	3.81	200	0.3	-	-	-
						Vertical			0.2	-	-	-
					2	Horizontal	1.90	100	0.2	-	-	-
						Vertical			0.2	-	-	-
		Lead screw			6	Horizontal	5.72	220	0.2	-	-	-
						Vertical			0.2	-	-	-
					4	Horizontal	3.81	200	0.2	-	-	-
						Vertical			0.2	-	-	-
					2	Horizontal	1.90	100	0.2	-	-	-
						Vertical			0.2	-	-	-
	GS4N	Ball screw	20	1048	6	Horizontal	5.72	270	0.3	-	-	-
						Vertical		220	0.2	-	-	-
					4	Horizontal	3.81	200	0.3	-	-	-
						Vertical			0.2	-	-	-
					2	Horizontal	1.90	100	0.2	-	-	-
						Vertical			0.2	-	-	-
		Lead screw			6	Horizontal	5.72	220	0.2	-	-	-
						Vertical			0.2	-	-	-
					4	Horizontal	3.81	200	0.2	-	-	-
						Vertical			0.2	-	-	-
					2	Horizontal	1.90	100	0.2	-	-	-
						Vertical			0.2	-	-	-
	GD4N	Ball screw	20	1048	6	Horizontal	5.72	270	0.3	-	-	-
						Vertical		220	0.2	-	-	-
4					Horizontal	3.81	200	0.3	-	-	-	
					Vertical			0.2	-	-	-	
2					Horizontal	1.90	100	0.2	-	-	-	
					Vertical			0.2	-	-	-	
Lead screw		6			Horizontal	5.72	220	0.2	-	-	-	
					Vertical			0.2	-	-	-	
		4			Horizontal	3.81	200	0.2	-	-	-	
					Vertical			0.2	-	-	-	
		2			Horizontal	1.90	100	0.2	-	-	-	
					Vertical			0.2	-	-	-	

Actuat or series	Type	Feed screw	Motor output [W]	No. of encoder pulses	Lead [mm]	Mounting direction	Minimum speed [mm/s]	Maximum speed [mm/s]	Maximum acceleration/ deceleration [G]	Minimum push force [N]	Maximum push force [N]	Rated push speed [mm/s]
RCA2 (rod type)	SD4N	Ball screw	20	1048	6	Horizontal	5.72	240 (at 25st) 300 (at 50 to 75st)	0.3	-	-	-
						Vertical		200 (at 25st) 300 (at 50 to 75st)				
					4	Horizontal	3.81	200	0.3	-	-	-
						Vertical						
					2	Horizontal	1.90	100	0.2	-	-	-
						Vertical						
		Lead screw	6	Horizontal	5.72	200 (at 25st) 300 (at 50 to 75st)	0.2	-	-	-		
				Vertical							0.2	-
			4	Horizontal	3.81	200	0.2	-	-	-		
				Vertical							0.2	-
			2	Horizontal	1.90	100	0.2	-	-	-		
				Vertical							0.2	-

Actuator series	Type	Feed screw	Motor output [W]	No. of encoder pulses	Lead [mm]	Mounting direction	Minimum speed [mm/s]	Maximum speed [mm/s]	Maximum acceleration/deceleration [G]	Minimum push force [N]	Maximum push force [N]	Rated push speed [mm/s]
RCA2 (slider type)	SA2AC	Ball screw	5	800	4	Horizontal	5	180 (at 25st) 200 (at 50 to 75st)	0.3	-	-	-
						Vertical			0.3	-	-	-
					2	Horizontal	2.5	100	0.3	-	-	-
						Vertical			0.3	-	-	-
					1	Horizontal	1.25	50	0.3	-	-	-
						Vertical			0.3	-	-	-
	SA2AR	Ball screw	5	800	4	Horizontal	5	180 (at 25st) 200 (at 50 to 100st)	0.3	-	-	-
						Vertical			0.3	-	-	-
					2	Horizontal	2.5	100	0.3	-	-	-
						Vertical			0.3	-	-	-
					1	Horizontal	1.25	50	0.3	-	-	-
						Vertical			0.3	-	-	-
	SA3C	Ball screw	10	800	6	Horizontal	7.5	300	0.3	-	-	-
						Vertical			0.2	-	-	-
					4	Horizontal	5	200	0.3	-	-	-
						Vertical			0.2	-	-	-
					2	Horizontal	2.5	100	0.2	-	-	-
						Vertical			0.2	-	-	-
	SA3R	Ball screw	10	800	6	Horizontal	7.5	300	0.3	-	-	-
						Vertical			0.2	-	-	-
					4	Horizontal	5	200	0.3	-	-	-
						Vertical			0.2	-	-	-
					2	Horizontal	2.5	100	0.2	-	-	-
						Vertical			0.2	-	-	-
SA4C	Ball screw	20	800	10	Horizontal	12.5	380 (at 50st) 500 (at 100 to 500st)	0.3	-	-	-	
					Vertical			0.2	-	-	-	
				5	Horizontal	6.25	250	0.3	-	-	-	
					Vertical			0.2	-	-	-	
				2.5	Horizontal	3.12	125	0.2	-	-	-	
					Vertical			0.2	-	-	-	
SA4R	Ball screw	20	800	10	Horizontal	12.5	380 (at 50st) 500 (at 100 to 500st)	0.3	-	-	-	
					Vertical			0.2	-	-	-	
				5	Horizontal	6.25	250	0.3	-	-	-	
					Vertical			0.2	-	-	-	
				2.5	Horizontal	3.12	125	0.2	-	-	-	
					Vertical			0.2	-	-	-	

Actual or series	Type	Feed screw	Motor output [W]	No. of encoder pulses	Lead [mm]	Mounting direction	Minimum speed [mm/s]	Maximum speed [mm/s]	Maximum acceleration/ deceleration [G]	Minimum push force [N]	Maximum push force [N]	Rated push speed [mm/s]
RCA2 (slider type)	SA5C	Ball screw	20	800	20	Horizontal	25	380 (at 50st) 540 (at 100st) 660 (at 150st) 770 (at 200st) 860 (at 250st) 940 (at 300st) 1000 (at 350 to 600st) 910 (at 650st) 790 (at 700st) 690 (at 750st) 610 (at 800st)	0.3	-	-	-
						Vertical		380 (at 50st) 540 (at 100st) 660 (at 150st) 770 (at 200st) 800 (at 250 to 650st) 790 (at 700st) 690 (at 750st) 610 (at 800st)				
					12	Horizontal	15	380 (at 50st) 540 (at 100st) 600 (at 150 to 550st) 570 (at 600st) 490 (at 650st) 425 (at 700st) 370 (at 750st) 330 (at 800st)	0.3	-	-	-
						Vertical		380 (at 50st) 540 (at 100st) 600 (at 150 to 550st) 570 (at 600st) 490 (at 650st) 425 (at 700st) 370 (at 750st) 330 (at 800st)	0.2	-	-	-
					6	Horizontal	7.5	300 (at 50 to 550st) 285 (at 600st) 245 (at 650st) 210 (at 700st) 185 (at 750st) 165 (at 800st)	0.3	-	-	-
						Vertical		300 (at 50 to 550st) 285 (at 600st) 245 (at 650st) 210 (at 700st) 185 (at 750st) 165 (at 800st)	0.2	-	-	-
	3	Horizontal	3.75	150 (at 50 to 550st) 140 (at 600st) 120 (at 650st) 105 (at 700st) 90 (at 750st) 80 (at 800st)	0.2	-	-	-				
		Vertical		150 (at 50 to 550st) 140 (at 600st) 120 (at 650st) 105 (at 700st) 90 (at 750st) 80 (at 800st)	0.2	-	-	-				
	SA5R	Ball screw	20	800	12	Horizontal	15	380 (at 50st) 540 (at 100st) 600 (at 150 to 550st) 570 (at 600st) 490 (at 650st) 425 (at 700st) 370 (at 750st) 330 (at 800st)	0.3	-	-	-
						Vertical		380 (at 50st) 540 (at 100st) 600 (at 150 to 550st) 570 (at 600st) 490 (at 650st) 425 (at 700st) 370 (at 750st) 330 (at 800st)	0.2	-	-	-
					6	Horizontal	7.5	300 (at 50 to 550st) 285 (at 600st) 245 (at 650st) 210 (at 700st) 185 (at 750st) 165 (at 800st)	0.3	-	-	-
						Vertical		300 (at 50 to 550st) 285 (at 600st) 245 (at 650st) 210 (at 700st) 185 (at 750st) 165 (at 800st)	0.2	-	-	-
3					Horizontal	3.75	150 (at 50 to 550st) 140 (at 600st) 120 (at 650st) 105 (at 700st) 90 (at 750st) 80 (at 800st)	0.2	-	-	-	
					Vertical		150 (at 50 to 550st) 140 (at 600st) 120 (at 650st) 105 (at 700st) 90 (at 750st) 80 (at 800st)	0.2	-	-	-	

Actuator series	Type	Feed screw	Motor output [W]	No. of encoder pulses	Lead [mm]	Mounting direction	Minimum speed [mm/s]	Maximum speed [mm/s]	Maximum acceleration/deceleration [G]	Minimum push force [N]	Maximum push force [N]	Rated push speed [mm/s]
RCA2 (slider type)	SA6C	Ball screw	30	800	20	Horizontal	25	380 (at 50st) 540 (at 100st) 660 (at 150st) 770 (at 200st) 860 (at 250st) 940 (at 300st) 1000 (at 350 to 600st) 910 (at 650st) 790 (at 700st) 690 (at 750st) 610 (at 800st)	0.3	-	-	-
						Vertical		380 (at 50st) 540 (at 100st) 660 (at 150st) 770 (at 200st) 800 (at 250 to 650st) 790 (at 700st) 690 (at 750st) 610 (at 800st)				
					12	Horizontal	15	380 (at 50st) 540 (at 100st) 600 (at 150 to 550st) 570 (at 600st) 490 (at 650st) 425 (at 700st) 370 (at 750st) 330 (at 800st)	0.3	-	-	-
						Vertical		380 (at 50st) 540 (at 100st) 600 (at 150 to 550st) 570 (at 600st) 490 (at 650st) 425 (at 700st) 370 (at 750st) 330 (at 800st)	0.2	-	-	-
					6	Horizontal	7.5	300 (at 50 to 550st) 285 (at 600st) 245 (at 650st) 210 (at 700st) 185 (at 750st) 165 (at 800st)	0.3	-	-	-
						Vertical		300 (at 50 to 550st) 285 (at 600st) 245 (at 650st) 210 (at 700st) 185 (at 750st) 165 (at 800st)	0.2	-	-	-
	3	Horizontal	3.75	150 (at 50 to 550st) 140 (at 600st) 120 (at 650st) 105 (at 700st) 90 (at 750st) 80 (at 800st)	0.2	-	-	-				
		Vertical		150 (at 50 to 550st) 140 (at 600st) 120 (at 650st) 105 (at 700st) 90 (at 750st) 80 (at 800st)	0.2	-	-	-				
	SA6R	Ball screw	30	800	12	Horizontal	15	380 (at 50st) 540 (at 100st) 600 (at 150 to 550st) 570 (at 600st) 490 (at 650st) 425 (at 700st) 370 (at 750st) 330 (at 800st)	0.3	-	-	-
						Vertical		380 (at 50st) 540 (at 100st) 600 (at 150 to 550st) 570 (at 600st) 490 (at 650st) 425 (at 700st) 370 (at 750st) 330 (at 800st)	0.2	-	-	-
					6	Horizontal	7.5	300 (at 50 to 550st) 285 (at 600st) 245 (at 650st) 210 (at 700st) 185 (at 750st) 165 (at 800st)	0.3	-	-	-
						Vertical		300 (at 50 to 550st) 285 (at 600st) 245 (at 650st) 210 (at 700st) 185 (at 750st) 165 (at 800st)	0.2	-	-	-
3					Horizontal	3.75	150 (at 50 to 550st) 140 (at 600st) 120 (at 650st) 105 (at 700st) 90 (at 750st) 80 (at 800st)	0.2	-	-	-	
					Vertical		150 (at 50 to 550st) 140 (at 600st) 120 (at 650st) 105 (at 700st) 90 (at 750st) 80 (at 800st)	0.2	-	-	-	

Actuator series	Type	Feed screw	Motor output [W]	No. of encoder pulses	Lead [mm]	Mounting direction	Minimum speed [mm/s]	Maximum speed [mm/s]	Maximum acceleration/ deceleration [G]	Minimum push force [N]	Maximum push force [N]	Rated push speed [mm/s]
RCA2 (table type)	TCA3NA TCA3N TC3N	Ball screw	10	1048	4	Horizontal	3.81	200	0.3	-	-	-
						Vertical			0.2			
					2	Horizontal	1.90	100	0.3	-	-	-
		Vertical				0.2						
		1			Horizontal	0.95	50	0.2	-	-	-	
					Vertical			0.2				
	Lead screw	10	1048	4	Horizontal /vertical	3.81	200	0.2	-	-	-	
						1.90		100				0.2
				1	0.95	50	0.2	-	-	-		
	TWA3NA TWA3N TW3N	Ball screw	10	1048	4	Horizontal	3.81	200	0.3	-	-	-
						Vertical			0.2			
					2	Horizontal	1.90	100	0.3	-	-	-
		Vertical				0.2						
		1			Horizontal	0.95	50	0.2	-	-	-	
					Vertical			0.2				
	Lead screw	10	1048	4	Horizontal /vertical	3.81	200	0.2	-	-	-	
						1.90		100				0.2
				1	0.95	50	0.2	-	-	-		
	TFA3NA TFA3N TF3N	Ball screw	10	1048	4	Horizontal	3.81	200	0.3	-	-	-
						Vertical			0.2			
					2	Horizontal	1.90	100	0.3	-	-	-
		Vertical				0.2						
		1			Horizontal	0.95	50	0.2	-	-	-	
					Vertical			0.2				
	Lead screw	10	1048	4	Horizontal /vertical	3.81	200	0.2	-	-	-	
						1.90		100				0.2
				1	0.95	50	0.2	-	-	-		
	TCA4NA	Ball screw	20	1048	6	Horizontal	5.72	270 (at 30st) 300 (at 50st)	0.3	-	-	-
						Vertical		220 (at 30st) 300 (at 50st)				
					4	Horizontal	3.81	200	0.3	-	-	-
						Vertical			0.2			
					2	Horizontal	1.90	100	0.2	-	-	-
						Vertical			0.2			
		Lead screw	20	1048	6	Horizontal /vertical	3.81	200	0.2	-	-	-
							1.90		100			
					4	Horizontal /vertical	0.95	50	0.2	-	-	-
							3.81		200			
					2	Horizontal /vertical	1.90	100	0.2	-	-	-
							0.95		50			
	TCA4N TC4N	Ball screw	20	1048	6	Horizontal	5.72	270 (at 30st) 300 (at 50st)	0.3	-	-	-
						Vertical		220 (at 30st) 300 (at 50st)				
					4	Horizontal	3.81	200	0.3	-	-	-
						Vertical			0.2			
					2	Horizontal	1.90	100	0.2	-	-	-
						Vertical			0.2			
		Lead screw	20	1048	6	Horizontal /vertical	5.72	220	0.2	-	-	-
							0.95		50			
					4	Horizontal /vertical	3.81	200	0.2	-	-	-
1.90							100		0.2			
2					Horizontal /vertical	1.90	100	0.2	-	-	-	
						0.95		50				0.2
TWA4NA	Ball screw	20	1048	6	Horizontal	5.72	270 (at 30st) 300 (at 50st)	0.3	-	-	-	
					Vertical		220 (at 30st) 300 (at 50st)					0.2
				4	Horizontal	3.81	200	0.3	-	-	-	
					Vertical			0.2				
				2	Horizontal	1.90	100	0.2	-	-	-	
					Vertical			0.2				
	Lead screw	20	1048	6	Horizontal /vertical	3.81	220	0.2	-	-	-	
						1.90		100				0.2
				4	Horizontal /vertical	0.95	50	0.2	-	-	-	
						3.81		200				0.2
				2	Horizontal /vertical	1.90	100	0.2	-	-	-	
						0.95		50				0.2

Actuator series	Type	Feed screw	Motor output [W]	No. of encoder pulses	Lead [mm]	Mounting direction	Minimum speed [mm/s]	Maximum speed [mm/s]	Maximum acceleration/ deceleration [G]	Minimum push force [N]	Maximum push force [N]	Rated push speed [mm/s]
RCA2 (table type)	TWA4N TW4N	Ball screw	20	1048	6	Horizontal	5.72	270	0.3	-	-	-
						Vertical		220				
					4	Horizontal	3.81	200	0.3	-	-	-
						Vertical						
					2	Horizontal	1.90	100	0.2	-	-	-
						Vertical						
		Lead screw			6	Horizontal	5.72	220	0.2	-	-	-
						Vertical						
					4	Horizontal	3.81	200	0.2	-	-	-
						Vertical						
					2	Horizontal	1.90	100	0.2	-	-	-
						Vertical						
	TFA4NA	Ball screw	20	1048	6	Horizontal	5.72	270 (at 30st) 300 (at 50st)	0.3	-	-	-
						Vertical		220 (at 30st) 300 (at 50st)				
					4	Horizontal	3.81	200	0.3	-	-	-
						Vertical						
					2	Horizontal	1.90	100	0.2	-	-	-
						Vertical						
		Lead screw			6	Horizontal	3.81	220	0.2	-	-	-
						Vertical						
					4	Horizontal	1.90	100	0.2	-	-	-
						Vertical						
					2	Horizontal	0.95	50	0.2	-	-	-
						Vertical						
	TFA4N TF4N	Ball screw	20	1048	6	Horizontal	5.72	270	0.3	-	-	-
						Vertical		220				
					4	Horizontal	3.81	200	0.3	-	-	-
						Vertical						
					2	Horizontal	1.90	100	0.2	-	-	-
						Vertical						
		Lead screw			6	Horizontal	5.72	220	0.2	-	-	-
						Vertical						
					4	Horizontal	3.81	200	0.2	-	-	-
						Vertical						
					2	Horizontal	1.90	100	0.2	-	-	-
						Vertical						
TA4C	Ball screw	10	800	6	Horizontal	7.5	300	0.3	-	-	-	
					Vertical		0.2					
				4	Horizontal	5	200	0.3	-	-	-	
					Vertical							0.2
				2	Horizontal	2.5	100	0.2	-	-	-	
					Vertical							0.2

Actuator series	Type	Feed screw	Motor output [W]	No. of encoder pulses	Lead [mm]	Mounting direction	Minimum speed	Maximum speed	Maximum acceleration/ deceleration	Minimum push force	Maximum push force	Rated push speed
							[mm/s]	[mm/s]	[G]	[N]	[N]	[mm/s]
RCA2 (table type)	TA4R	Ball screw	10	800	6	Horizontal	7.5	300	0.3	-	-	-
						Vertical			0.2	-	-	-
					4	Horizontal	5	200	0.3	-	-	-
						Vertical			0.2	-	-	-
					2	Horizontal	2.5	100	0.2	-	-	-
						Vertical			0.2	-	-	-
	TA5C	Ball screw	20	800	10	Horizontal	12.5	465	0.3	-	-	-
						Vertical		400	0.2	-	-	-
					5	Horizontal	6.25	250	0.3	-	-	-
						Vertical			0.2	-	-	-
					2.5	Horizontal	3.12	125	0.2	-	-	-
						Vertical			0.2	-	-	-
	TA5R	Ball screw	20	800	10	Horizontal	12.5	465	0.3	-	-	-
						Vertical		400	0.2	-	-	-
					5	Horizontal	6.25	250	0.3	-	-	-
						Vertical			0.2	-	-	-
					2.5	Horizontal	3.12	125	0.2	-	-	-
						Vertical			0.2	-	-	-
	TA6C	Ball screw	20	800	12	Horizontal	15	560	0.3	-	-	-
						Vertical		500	0.2	-	-	-
					6	Horizontal	7.5	300	0.3	-	-	-
						Vertical			0.2	-	-	-
					3	Horizontal	3.75	150	0.2	-	-	-
						Vertical			0.2	-	-	-
TA6R	Ball screw	20	800	12	Horizontal	15	560	0.3	-	-	-	
					Vertical		500	0.2	-	-	-	
				6	Horizontal	7.5	300	0.3	-	-	-	
					Vertical			0.2	-	-	-	
				3	Horizontal	3.75	150	0.2	-	-	-	
					Vertical			0.2	-	-	-	
TA7C	Ball screw	30	800	12	Horizontal	15	600	0.3	-	-	-	
					Vertical		580	0.2	-	-	-	
				6	Horizontal	7.5	300	0.3	-	-	-	
					Vertical			0.2	-	-	-	
				3	Horizontal	3.75	150	0.2	-	-	-	
					Vertical			0.2	-	-	-	
TA7R	Ball screw	30	800	12	Horizontal	15	600	0.3	-	-	-	
					Vertical		580	0.2	-	-	-	
				6	Horizontal	7.5	300	0.3	-	-	-	
					Vertical			0.2	-	-	-	
				3	Horizontal	3.75	150	0.2	-	-	-	
					Vertical			0.2	-	-	-	
RCL	RA1L	Linear	-	715	-	Horizontal /vertical	42	300	2	0.75	2	2
	RA2L			855		Horizontal /vertical	42	340	2	1.5	4	4
	RA3L			1145		Horizontal /vertical	42	450	2	3	8	8
	SA1L			715		Horizontal	42	420	2	-	-	-
	SA2L			855		Horizontal	42	460	2	-	-	-
	SA3L			1145		Horizontal	42	600	2	-	-	-
	SA4L			715		Horizontal	42	1200	2	-	-	-
	SM4L			715		Horizontal	42	1200	2	-	-	-
	SA5L			855		Horizontal	42	1400	2	-	-	-
	SM5L			855		Horizontal	42	1400	2	-	-	-
	SA6L			1145		Horizontal	42	1600	2	-	-	-
	SM6L			1145		Horizontal	42	1600	2	-	-	-

10.4.2 Specifications for Brushless DC Electric Motor Actuator

Actuator series	Type	Feed screw	Motor output [W]	No. of encoder pulses	Lead [mm]	Mounting direction	Minimum speed [mm/s]	Maximum speed [mm/s]	Maximum acceleration/ deceleration [G]	Minimum push force [N]	Maximum push force [N]	Rated push speed [mm/s]
RCD	RA1D	Lead screw	3	400	2	Horizontal /vertical	2.5	300	1	0.41	5.98	5
	RA1DA			480								
	GRSN	Lead screw	3	400	2	Horizontal /vertical	2.5	67	1	2.1	10.0	5
	GRSNA			480								

10.4.3 Specifications for Pulse Motor Type Actuator

Actuator series	Type	Feed screw	No. of encoder pulses	Lead [mm]	Mounting direction	Minimum speed [mm/s]	Maximum speed [mm/s]	Maximum acceleration/ deceleration [G]	Minimum push force [N]	Maximum push force [N]	Rated push speed [mm/s]
RCP2 (rod type)	RA2C	Ball screw	800	1	Horizontal /vertical	1.25	25	0.05	50	100	3
	RA3C	Ball screw	800	5	Horizontal /vertical	6.25	187	0.2	21	73.5	20
				2.5	Horizontal /vertical	3.12	114		50	156.8	
	RGD3C	Ball screw	800	5	Horizontal /vertical	6.25	187	0.2	21	73.5	20
				2.5	Horizontal /vertical	3.12	114 93		50	156.8	
	RA4C	Ball screw	800	10	Horizontal /vertical	12.5	458 (at to 250st) 350 (at 300st)	0.2	30	150	20
				5	Horizontal /vertical	6.25	250 (at 50 to 200st) 237 (at 250st) 175 (at 300st)		75	284	
				2.5	Horizontal	3.12	125 (at 50 to 200st) 118 (at 250st) 87 (at 300st)		150	358	
					Vertical		114				
	RGS4C	Ball screw	800	10	Horizontal /vertical	12.5	458 (at to 250st) 350 (at 300st)	0.2	30	150	20
				5	Horizontal /vertical	6.25	250 (at 50 to 200st) 237 (at 250st) 175 (at 300st)		75	284	
				2.5	Horizontal	3.12	125 (at 50 to 200st) 118 (at 250st) 87 (at 300st)		150	358	
					Vertical		114				

Actuator series	Type	Feed screw	No. of encoder pulses	Lead	Mounting direction	Minimum speed	Maximum speed	Maximum acceleration/ deceleration [G]	Minimum push force [N]	Maximum push force [N]	Rated push speed [mm/s]
				[mm]		[mm/s]	[mm/s]				
RCP2 (rod type)	RGD4C	Ball screw	800	10	Horizontal/vertical	12.5	458 (at 250st) 350 (at 300st)	0.2	30	150	20
				5	Horizontal/vertical	6.25	250 (at 50 to 200st) 237 (at 250st) 175 (at 300st)				
				2.5	Horizontal	3.12	125 (at 50 to 200st) 118 (at 250st) 87 (at 300st)				
	Vertical	114									
	RA6C	Ball screw	800	16	Horizontal/Vertical	20	450 400	0.2	75	240	20
				8	Horizontal/vertical	10	210				
				4	Horizontal/vertical	5	130				
	RGS6C	Ball screw	800	16	Horizontal/Vertical	20	450 400	0.2	75	240	20
				8	Horizontal/vertical	10	210				
				4	Horizontal/vertical	5	130				
	RGD6C	Ball screw	800	16	Horizontal/Vertical	20	450 400	0.2	75	240	20
				8	Horizontal/vertical	10	210				
				4	Horizontal/vertical	5	130				
	RA8C/RA8R	Ball screw	800	10	Horizontal/vertical	12.5	RA8C: 300 RA8R: 200	0.2	286	1000	10
				5	Horizontal/vertical	6.25	RA8C: 150 RA8R: 100	0.1	571	2000	
	RA10C	Ball screw	800	10	Horizontal/Vertical	12.5	250 167	0.04	500	1500	10
				5	Horizontal/vertical	6.25	125	0.02	1000	3000	
				2.5	Horizontal/vertical	3.12	63	0.01	3100	6000	
	SRA4R	Ball screw	800	5	Horizontal/vertical	6.25	250	0.3	26	90	20
				2.5	Horizontal/Vertical	3.12	125	0.2	50	170	
SRGS4R	Ball screw	800	5	Horizontal/vertical	6.25	250	0.3	26	90	20	
			2.5	Horizontal/Vertical	3.12	125	0.2	50	170		
SRGD4R	Ball screw	800	5	Horizontal/vertical	6.25	250	0.3	26	90	20	
			2.5	Horizontal/Vertical	3.12	125	0.2	50	170		
RCP2W (rod type)	RA4C	Ball screw	800	10	Horizontal/Vertical	12.5	450 (at 50 to 250st) 350 (at 300st) 250	0.2	30	150	20
				5	Horizontal/vertical	6.25	190 (at 50 to 250st) 175 (at 300st)				
				2.5	Horizontal	3.12	125 (at 50 to 200st) 115 (at 250st) 85 (at 300st)				
					Vertical		115 (at 50 to 250st) 85 (at 300st)				
	RA6C	Ball screw	800	16	Horizontal/Vertical	20	320 265	0.2	75	240	20
				8	Horizontal/vertical	10	200				
				4	Horizontal/vertical	5	100				

Actuator series	Type	Feed screw	No. of encoder pulses	Lead [mm]	Mounting direction	Minimum speed [mm/s]	Maximum speed [mm/s]	Maximum acceleration/ deceleration [G]	Minimum push force [N]	Maximum push force [N]	Rated push speed [mm/s]						
RCP2 (slider type)	SA5C	Ball screw	800	20	Horizontal	25	380 (at 50st) 540 (at 100st) 660 (at 150st) 770 (at 200st) 860 (at 250st) 940 (at 300st) 1000 (at 350 to 550st) 980 (at 600st) 850 (at 650st) 740 (at 700st) 650 (at 750st) 580 (at 800st)	0.7	11	39	20						
					Vertical		380 (at 50st) 540 (at 100st) 660 (at 150st) 770 (at 200st) 800 (at 250 to 600st) 740 (at 700st) 650 (at 750st) 580 (at 800st)					0.2					
					12		Horizontal						15	300 (at 50st) 460 (at 100st) 600 (at 150 to 550st) 540 (at 600st) 460 (at 650st) 400 (at 700st) 360 (at 750st) 300 (at 800st)	0.7	40	115
							Vertical							300 (at 50st) 460 (at 100st) 600 (at 150 to 550st) 540 (at 600st) 460 (at 650st) 400 (at 700st) 360 (at 750st) 300 (at 800st)	0.3		
				6	Horizontal	7.5	295 (at 50st) 300 (at 100 to 550st) 270 (at 600st) 230 (at 650st) 200 (at 700st) 180 (at 750st) 150 (at 800st)	0.7	70	210							
					Vertical		295 (at 50st) 300 (at 100 to 550st) 270 (at 600st) 230 (at 650st) 200 (at 700st) 180 (at 750st) 150 (at 800st)	0.3									
				3	Horizontal	3.75	150 (at to 550st) 135 (at 600st) 115 (at 650st) 100 (at 700st) 90 (at 750st) 75 (at 800st)	0.7	140	330							
					Vertical		150 (at to 550st) 135 (at 600st) 115 (at 650st) 100 (at 700st) 90 (at 750st) 75 (at 800st)	0.3									
	SA5R	Ball screw	800	12	Horizontal	15	300 (at 50st) 460 (at 100st) 600 (at 150 to 550st) 540 (at 600st) 460 (at 650st) 400 (at 700st) 360 (at 750st) 300 (at 800st)	0.3	-	-	-						
					Vertical		300 (at 50st) 460 (at 100st) 600 (at 150 to 550st) 540 (at 600st) 460 (at 650st) 400 (at 700st) 360 (at 750st) 300 (at 800st)	0.2									
				6	Horizontal	7.5	295 (at 50st) 300 (at 100 to 550st) 270 (at 600st) 230 (at 650st) 200 (at 700st) 180 (at 750st) 150 (at 800st)	0.3	-	-	-						
					Vertical		295 (at 50st) 300 (at 100 to 550st) 270 (at 600st) 230 (at 650st) 200 (at 700st) 180 (at 750st) 150 (at 800st)	0.2									
3				Horizontal	3.75	150 (at to 550st) 135 (at 600st) 115 (at 650st) 100 (at 700st) 90 (at 750st) 75 (at 800st)	0.2	-	-	-							
				Vertical		150 (at to 550st) 135 (at 600st) 115 (at 650st) 100 (at 700st) 90 (at 750st) 75 (at 800st)	0.2										

Actuator series	Type	Feed screw	No. of encoder pulses	Lead [mm]	Mounting direction	Minimum speed [mm/s]	Maximum speed [mm/s]	Maximum acceleration/ deceleration [G]	Minimum push force [N]	Maximum push force [N]	Rated push speed [mm/s]
RCP2 (slider type)	SA6C	Ball screw	800	20	Horizontal	25	380 (at 50st) 540 (at 100st) 660 (at 150st) 770 (at 200st) 860 (at 250st) 940 (at 300st) 1000 (at 350 to 550st) 980 (at 600st) 850 (at 650st) 740 (at 700st) 650 (at 750st) 580 (at 800st)	0.7	11	39	20
					Vertical		380 (at 50st) 540 (at 100st) 660 (at 150st) 770 (at 200st) 800 (at 250 to 600st) 740 (at 700st) 650 (at 750st) 580 (at 800st)				
				12	Horizontal	15	300 (at 50st) 460 (at 100st) 600 (at 150 to 550st) 540 (at 600st) 460 (at 650st) 400 (at 700st) 360 (at 750st) 300 (at 800st)	0.7	40	115	
					Vertical		300 (at 50st) 460 (at 100st) 600 (at 150 to 550st) 540 (at 600st) 460 (at 650st) 400 (at 700st) 360 (at 750st) 300 (at 800st)	0.3			
				6	Horizontal	7.5	295 (at 50st) 300 (at 100 to 550st) 270 (at 600st) 230 (at 650st) 200 (at 700st) 180 (at 750st) 150 (at 800st)	0.7	70	210	
					Vertical		295 (at 50st) 300 (at 100 to 550st) 270 (at 600st) 230 (at 650st) 200 (at 700st) 180 (at 750st) 150 (at 800st)	0.3			
	3	Horizontal	3.75	150 (at to 550st) 135 (at 600st) 115 (at 650st) 100 (at 700st) 90 (at 750st) 75 (at 800st)	0.7	140	330				
		Vertical		150 (at to 550st) 135 (at 600st) 115 (at 650st) 100 (at 700st) 90 (at 750st) 75 (at 800st)	0.3						
	SA6R	Ball screw	800	12	Horizontal	15	300 (at 50st) 460 (at 100st) 600 (at 150 to 550st) 540 (at 600st) 460 (at 650st) 400 (at 700st) 360 (at 750st) 300 (at 800st)	0.3	-	-	-
					Vertical		300 (at 50st) 460 (at 100st) 600 (at 150 to 550st) 540 (at 600st) 460 (at 650st) 400 (at 700st) 360 (at 750st) 300 (at 800st)	0.2			
				6	Horizontal	7.5	295 (at 50st) 300 (at 100 to 550st) 270 (at 600st) 230 (at 650st) 200 (at 700st) 180 (at 750st) 150 (at 800st)	0.3	-	-	
					Vertical		295 (at 50st) 300 (at 100 to 550st) 270 (at 600st) 230 (at 650st) 200 (at 700st) 180 (at 750st) 150 (at 800st)	0.2			
3				Horizontal	3.75	150 (at to 550st) 135 (at 600st) 115 (at 650st) 100 (at 700st) 90 (at 750st) 75 (at 800st)	0.2	-	-		
				Vertical		150 (at to 550st) 135 (at 600st) 115 (at 650st) 100 (at 700st) 90 (at 750st) 75 (at 800st)	0.2				

Actuator series	Type	Feed screw	No. of encoder pulses	Lead [mm]	Mounting direction	Minimum speed	Maximum speed	Maximum acceleration/ deceleration	Minimum push force [N]	Maximum push force [N]	Rated push speed [mm/s]
						[mm/s]	[mm/s]	[G]			
RCP2 (slider type)	SS7C	Ball screw	800	12	Horizontal	15	600 (at 50 to 500st) 470 (at 600st)	0.3	40	120	20
					Vertical			0.2			
				6	Horizontal	7.5	300 (at 50 to 500st) 230 (at 600st)	0.3	75	220	
					Vertical			0.2			
				3	Horizontal	3.75	150 (at 50 to 500st) 115 (at 600st)	0.2	140	350	
					Vertical			0.2			
	SS7R	Ball screw	800	12	Horizontal	15	600 (at 50 to 500st) 470 (at 600st) 440 (at 600st)	0.3	-	-	-
					Vertical			0.2			
				6	Horizontal	7.5	250 (at 50 to 500st) 230 (at 600st)	0.3	-	-	
					Vertical			0.2			
				3	Horizontal	3.75	105 (at 50 to 500st) 105 (at 600st)	0.2	-	-	
					Vertical			0.2			
	SS8C	Ball screw	800	20	Horizontal	25	666 (at 50 to 800st) 625 (at to 900st) 515 (at to 1000st) 600 (at 50 to 800st) 600 (at to 900st) 515 (at to 1000st)	0.3	50	180	20
					Vertical			0.2			
				10	Horizontal	12.5	333 (at 50 to 800st) 310 (at to 900st) 255 (at to 1000st) 300 (at 50 to 800st) 300 (at to 900st) 255 (at to 1000st)	0.3	95	320	
					Vertical			0.2			
				5	Horizontal	6.25	165 (at 50 to 800st) 155 (at to 900st) 125 (at to 1000st)	0.2	180	630	
					Vertical			0.2			
						150 (at 50 to 800st) 150 (at to 900st) 125 (at to 1000st)	0.2				
							Vertical				0.2

Actuator series	Type	Feed screw	No. of encoder pulses	Lead [mm]	Mounting direction	Minimum speed [mm/s]	Maximum speed [mm/s]	Maximum acceleration/ deceleration [G]	Minimum push force [N]	Maximum push force [N]	Rated push speed [mm/s]	
RCP2 (slider type)	SS8R	Ball screw	800	20	Horizontal	25	600 (at 50 to 800st) 600 (at 900st) 515 (at 1000st)	0.3	-	-	-	
					Vertical		333 (at 50 to 800st) 333 (at 900st) 333 (at 1000st)	0.2				
				10	Horizontal	12.5	300 (at 50 to 800st) 300 (at 900st) 255 (at 1000st)	0.3	-	-	-	
					Vertical		250 (at 50 to 800st) 250 (at 900st) 250 (at 1000st)	0.2				
				5	Horizontal	6.25	160 (at 50 to 800st) 155 (at 900st) 125 (at 1000st)	0.2	-	-	-	
					Vertical		140 (at 50 to 800st) 140 (at 900st) 140 (at 1000st)	0.2				
	HS8C	Ball screw	800	30	Horizontal	37.5	1200 (at 50 to 800st) 1000 (at 900st) 800 (at 1000st)	0.3	-	-	-	
					Vertical		750(at 50 to 800st) 750(at 900st) 750(at 1000st)	0.2				
		Ball screw	800	30	Horizontal	37.5	1200(at 50 to 800st) 1000(at 900st) 800(at 1000st)	0.3	-	-	-	
					Vertical		750(at 50 to 800st) 750(at 900st) 750(at 1000st)	0.2				
	RCP2 (belt type)	BA6/BA6U	Belt	800	Equivalent to 54	Horizontal	67.5	1000	0.5	-	-	-
		BA7/BA7U	Belt	800	Equivalent to 54	Horizontal	67.5	1500	0.5	-	-	-
RCP2 (gripper type)	GRSS	-	800	1.57	-	1.96	78	-	4	14	5	
	GRLS	-	800	12	-	15 (deg/s)	600 (deg/s)	-	1.8	6.4	5 (deg/s)	
	GRS	-	800	1	-	1.25	33	-	9	21	5	
	GRM	-	800	1.1	-	1.37	36	-	23	80	5	
	GRST	-	800	1.05	-	1.31	34	-	15	40	5	
		-	800	2.27	-	2.83	75	-	7.5	20	5	
	GR3LS	-	800	12	-	15 (deg/s)	200 (deg/s)	-	5	18	5 (deg/s)	
	GR3LM	-	800	12	-	15 (deg/s)	200 (deg/s)	-	15	51	5 (deg/s)	
	GR3SS	-	800	2.5	-	3.12	40	-	7	22	5	
	GR3SM	-	800	3	-	3.75	50	-	30	102	5	
RCP2W (gripper type)	GRHM	-	800	2	-	2.5	100	-	25	125	5	
	GRHB	-	800	2	-	2.5	100	-	60	200	5	
	GRSS	-	800	1.57	-	1.96	78	-	4	14	5	
	GRLS	-	800	12	-	15 (deg/s)	600 (deg/s)	-	1.8	6.4	5 (deg/s)	
	GRS	-	800	1	-	1.25	33	-	9	21	5	
GRM	-	800	1.1	-	1.37	36	-	23	80	5		
GR3SS	-	800	2.5	-	3.12	40	-	7	22	5		
GR3SM	-	800	3	-	3.75	50	-	30	102	5		

Actuator series	Type	Feed screw	No. of encoder pulses	Lead	Mounting direction	Minimum speed	Maximum speed	Maximum acceleration/ deceleration	Minimum push force	Maximum push force	Rated push speed
				[mm]		[mm/s]	[mm/s]	[G]			
RCP2 (rotary type)	RTBS	-	800	Gear ratio: 1/30	-	15 (deg/s)	400 (deg/s)	-	-	-	-
		-		Gear ratio: 1/45	-	10 (deg/s)	266 (deg/s)	-	-	-	-
	RTBSL	-	800	Gear ratio: 1/30	-	15 (deg/s)	400 (deg/s)	-	-	-	-
		-		Gear ratio: 1/45	-	10 (deg/s)	266 (deg/s)	-	-	-	-
	RTCS	-	800	Gear ratio: 1/30	-	15 (deg/s)	400 (deg/s)	-	-	-	-
		-		Gear ratio: 1/45	-	10 (deg/s)	266 (deg/s)	-	-	-	-
	RTCSL	-	800	Gear ratio: 1/30	-	15 (deg/s)	400 (deg/s)	-	-	-	-
		-		Gear ratio: 1/45	-	10 (deg/s)	266 (deg/s)	-	-	-	-
	RTB	-	800	Gear ratio: 1/20	-	22.5 (deg/s)	600 (deg/s)	-	-	-	-
		-		Gear ratio: 1/30	-	15 (deg/s)	400 (deg/s)	-	-	-	-
	RTBL	-	800	Gear ratio: 1/20	-	22.5 (deg/s)	600 (deg/s)	-	-	-	-
		-		Gear ratio: 1/30	-	15 (deg/s)	400 (deg/s)	-	-	-	-
	RTC	-	800	Gear ratio: 1/20	-	22.5 (deg/s)	600 (deg/s)	-	-	-	-
		-		Gear ratio: 1/30	-	15 (deg/s)	400 (deg/s)	-	-	-	-
	RTCL	-	800	Gear ratio: 1/20	-	22.5 (deg/s)	600 (deg/s)	-	-	-	-
		-		Gear ratio: 1/30	-	15 (deg/s)	400 (deg/s)	-	-	-	-
	RTBB	-	800	Gear ratio: 1/20	-	22.5 (deg/s)	600 (deg/s)	-	-	-	-
		-		Gear ratio: 1/30	-	15 (deg/s)	400 (deg/s)	-	-	-	-
	RTBBL	-	800	Gear ratio: 1/20	-	22.5 (deg/s)	600 (deg/s)	-	-	-	-
		-		Gear ratio: 1/30	-	15 (deg/s)	400 (deg/s)	-	-	-	-
RTCB	-	800	Gear ratio: 1/20	-	22.5 (deg/s)	600 (deg/s)	-	-	-	-	
	-		Gear ratio: 1/30	-	15 (deg/s)	400 (deg/s)	-	-	-	-	
RTCBL	-	800	Gear ratio: 1/20	-	22.5 (deg/s)	600 (deg/s)	-	-	-	-	
	-		Gear ratio: 1/30	-	15 (deg/s)	400 (deg/s)	-	-	-	-	

Actuator series	Type	Feed screw	No. of encoder pulses	Lead	Mounting direction	Minimum speed	Maximum speed	Maximum acceleration/ deceleration [G]	Minimum push force [N]	Maximum push force [N]	Rated push speed [mm/s]	
				[mm]		[mm/s]	[mm/s]					
RCP3 (rod type)	RA2AC	Lead screw	800	4	Horizontal /vertical	5	180 (at 25st) 200 (at 50 to 100st)	0.2	0.9	16.1	5	
				2		2.5	100		1.9	28.3		
				1		1.25	50		3.8	39.5		
		Ball screw Standard type	800	4	Horizontal /vertical	5	180 (at 25st) 200 (at 50 to 100st)	0.3	3.6	20.9	5	
						0.2						
				2	Horizontal /vertical	2.5	100	0.3	7.2	42.0		
						0.2						
				1	Horizontal /vertical	1.25	50	0.3	14.4	82.8		
						0.2						
	Ball screw High thrust type	800	4	Horizontal /vertical	5	180 (at 25st) 200 (at 50 to 100st)	0.3	6.6	35.7			
					0.2							
			2	Horizontal /vertical	2.5	100	0.3	13.2	70.6			
	0.2											
	1	Horizontal /vertical	1.25	50	0.3	26.4	142.9					
	0.2											
	RA2BC	Lead screw	800	6	Horizontal /vertical	7.5	180 (at 25st) 280 (at 50st) 300 (at 75 to 150st)	0.2	0.6	11.9	5	
						4	5		180 (at 25st) 200 (at 50 to 150st)	0.9		16.1
						2	2.5		100	1.9		28.3
		Ball screw Standard type	800	6	Horizontal /vertical	7.5	180 (at 25st) 280 (at 50st) 300 (at 75 to 150st)	0.3	1.8	14.3		
						0.2						
				4	Horizontal /vertical	5	180 (at 25st) 200 (at 50 to 150st)	0.3	3.6	20.9		
						0.2						
				2	Horizontal /vertical	2.5	100	0.3	7.2	42.0		
						0.2						
		1	Horizontal /vertical	1.25	50	0.3	14.4	82.8				
				0.2								
		Ball screw High thrust type	800	6	Horizontal /vertical	7.5	180 (at 25st) 280 (at 50st) 300 (at 75 to 150st)	0.3	4.4	24.1		
						0.2						
				4	Horizontal /vertical	5	180 (at 25st) 200 (at 50 to 150st)	0.3	6.6	35.7		
						0.2						
				2	Horizontal /vertical	2.5	100	0.3	13.2	70.6		
						0.2						
		1	Horizontal /vertical	1.25	50	0.3	26.4	142.9				
	0.2											
	RA2AR	Lead screw	800	4	Horizontal /vertical	5	180 (at 25st) 200 (at 50 to 150st)	0.2	0.9	16.1	5	
						2	2.5		100	1.9		28.3
1						1.25	50		3.8	39.5		
RA2BR	Lead screw	800	6	Horizontal /vertical	7.5	180 (at 25st) 280 (at 50st) 300 (at 75 to 150st)	0.2	0.6	11.9	5		
					4	5		180 (at 25st) 200 (at 50 to 150st)	0.9		16.1	
					2	2.5		100	1.9		28.3	

Actuator series	Type	Feed screw	No. of encoder pulses	Lead	Mounting direction	Minimum speed	Maximum speed	Maximum acceleration/ deceleration [G]	Minimum push force [N]	Maximum push force [N]	Rated push speed [mm/s]
				[mm]		[mm/s]	[mm/s]				
RCP3 (slider type)	SA2AC	Lead screw	800	4	Horizontal	5	180 (at 25st) 200 (at 50 to 100st)	0.2	-	-	-
				2		2.5	100				
				1		1.25	50				
	SA2BC	Lead screw	800	6	Horizontal	7.5	180 (at 25st) 280 (at 50st) 300 (at 75 to 150st)	0.2	-	-	-
				4		5	180 (at 25st) 200 (at 50 to 150st)				
				2		2.5	100				
	SA2AR	Lead screw	800	4	Horizontal	5	180 (at 25st) 200 (at 50 to 100st)	0.2	-	-	-
				2		2.5	100				
				1		1.25	50				
	SA2BR	Lead screw	800	6	Horizontal	7.5	180 (at 25st) 280 (at 50st) 300 (at 75 to 150st)	0.2	-	-	-
				4		5	180 (at 25st) 200 (at 50 to 150st)				
				2		2.5	100				
	SA3C	Ball screw	800	6	Horizontal	7.5	300	0.3	9	15	20
					Vertical			0.2			
				4	Horizontal	5	200	0.3	14	22	
					Vertical			0.2			
				2	Horizontal	2.5	100	0.2	27	44	
					Vertical			0.2			
	SA3R	Ball screw	800	6	Horizontal	7.5	300	0.3	9	15	-
					Vertical			0.2			
				4	Horizontal	5	200	0.3	14	22	
					Vertical			0.2			
				2	Horizontal	2.5	100	0.2	27	44	
					Vertical			0.2			
SA4C	Ball screw	800	10	Horizontal	12.5	380 (at 50st) 500 (at 100st to 500st)	0.7	20	34	20	
				Vertical			0.3				
			5	Horizontal	6.25	250	0.7	40	68		
				Vertical			0.3				
			2.5	Horizontal	3.12	125	0.7	82	136		
				Vertical			0.3				
SA4R	Ball screw	800	10	Horizontal	12.5	380 (at 50st) 500 (at 100st to 500st)	0.3	20	34	-	
				Vertical			0.2				
			5	Horizontal	6.25	250	0.3	40	68		
				Vertical			0.2				
			2.5	Horizontal	3.12	125	0.2	82	136		
				Vertical			0.2				

Actuator series	Type	Feed screw	No. of encoder pulses	Lead [mm]	Mounting direction	Minimum speed [mm/s]	Maximum speed [mm/s]	Maximum acceleration/ deceleration [G]	Minimum push force [N]	Maximum push force [N]	Rated push speed [mm/s]				
RCP3 (slider type)	SA5C	Ball screw	800	20	Horizontal	25	380 (at 50st) 540 (at 100st) 660 (at 150st) 770 (at 200st) 860 (at 250st) 940 (at 300st) 1000 (at 350 to 600st) 910 (at 650st) 790 (at 700st) 690 (at 750st) 610 (at 800st)	0.7	17	28	20				
					Vertical		380 (at 50st) 540 (at 100st) 660 (at 150st) 770 (at 200st) 800 (at 250 to 650st) 790 (at 700st) 690 (at 750st) 610 (at 800st)	0.2							
					12		Horizontal	15				380 (at 50st) 540 (at 100st) 600 (at 150st to 550st) 570 (at 600st) 490 (at 650st) 425 (at 700st) 370 (at 750st) 330 (at 800st)	0.7	28	47
							Vertical					380 (at 50st) 540 (at 100st) 600 (at 150st to 550st) 570 (at 600st) 490 (at 650st) 425 (at 700st) 370 (at 750st) 330 (at 800st)	0.3		
				6	Horizontal	7.5	300 (at 50st to 550st) 285 (at 600st) 245 (at 650st) 210 (at 700st) 185 (at 750st) 165 (at 800st)	0.7	57	95					
					Vertical		300 (at 50st to 550st) 285 (at 600st) 245 (at 650st) 210 (at 700st) 185 (at 750st) 165 (at 800st)	0.3							
				3	Horizontal	3.75	150 (at 50st to 550st) 140 (at 600st) 120 (at 650st) 105 (at 700st) 90 (at 750st) 80 (at 800st)	0.7	113	189					
					Vertical		150 (at 50st to 550st) 140 (at 600st) 120 (at 650st) 105 (at 700st) 90 (at 750st) 80 (at 800st)	0.3							
	SA5R	Ball screw	800	12	Horizontal	15	380 (at 50st) 540 (at 100st) 600 (at 150st to 550st) 570 (at 600st) 490 (at 650st) 425 (at 700st) 370 (at 750st) 330 (at 800st)	0.3	30	47	20				
					Vertical		380 (at 50st) 540 (at 100st) 600 (at 150st to 550st) 570 (at 600st) 490 (at 650st) 425 (at 700st) 370 (at 750st) 330 (at 800st)	0.2							
				6	Horizontal	7.5	300 (at 50st to 550st) 285 (at 600st) 245 (at 650st) 210 (at 700st) 185 (at 750st) 165 (at 800st)	0.3	58	95					
					Vertical		300 (at 50st to 550st) 285 (at 600st) 245 (at 650st) 210 (at 700st) 185 (at 750st) 165 (at 800st)	0.2							
3				Horizontal	3.75	150 (at 50st to 550st) 140 (at 600st) 120 (at 650st) 105 (at 700st) 90 (at 750st) 80 (at 800st)	0.2	112	189						
				Vertical		150 (at 50st to 550st) 140 (at 600st) 120 (at 650st) 105 (at 700st) 90 (at 750st) 80 (at 800st)	0.2								

Actuator series	Type	Feed screw	No. of encoder pulses	Lead [mm]	Mounting direction	Minimum speed [mm/s]	Maximum speed [mm/s]	Maximum acceleration/ deceleration [G]	Minimum push force [N]	Maximum push force [N]	Rated push speed [mm/s]				
RCP3 (slider type)	SA6C	Ball screw	800	20	Horizontal	25	380 (at 50st) 540 (at 100st) 660 (at 150st) 770 (at 200st) 860 (at 250st) 940 (at 300st) 1000 (at 350 to 600st) 910 (at 650st) 790 (at 700st) 690 (at 750st) 610 (at 800st)	0.7	17	28	20				
					Vertical		380 (at 50st) 540 (at 100st) 660 (at 150st) 770 (at 200st) 800 (at 250 to 650st) 790 (at 700st) 690 (at 750st) 610 (at 800st)	0.2							
					12		Horizontal	15				380 (at 50st) 540 (at 100st) 600 (at 150st to 550st) 570 (at 600st) 490 (at 650st) 425 (at 700st) 370 (at 750st) 330 (at 800st)	0.7	28	47
							Vertical					380 (at 50st) 540 (at 100st) 600 (at 150st to 550st) 570 (at 600st) 490 (at 650st) 425 (at 700st) 370 (at 750st) 330 (at 800st)	0.3		
				6	Horizontal	7.5	300 (at 50st to 550st) 285 (at 600st) 245 (at 650st) 210 (at 700st) 185 (at 750st) 165 (at 800st)	0.7	57	95					
					Vertical		300 (at 50st to 550st) 285 (at 600st) 245 (at 650st) 210 (at 700st) 185 (at 750st) 165 (at 800st)	0.3							
				3	Horizontal	3.75	150 (at 50st to 550st) 140 (at 600st) 120 (at 650st) 105 (at 700st) 90 (at 750st) 80 (at 800st)	0.7	113	189					
					Vertical		150 (at 50st to 550st) 140 (at 600st) 120 (at 650st) 105 (at 700st) 90 (at 750st) 80 (at 800st)	0.3							
	SA6R	Ball screw	800	12	Horizontal	15	380 (at 50st) 540 (at 100st) 600 (at 150st to 550st) 570 (at 600st) 490 (at 650st) 425 (at 700st) 370 (at 750st) 330 (at 800st)	0.3	30	47	20				
					Vertical		380 (at 50st) 540 (at 100st) 600 (at 150st to 550st) 570 (at 600st) 490 (at 650st) 425 (at 700st) 370 (at 750st) 330 (at 800st)	0.2							
					6		Horizontal	7.5				300 (at 50st to 550st) 285 (at 600st) 245 (at 650st) 210 (at 700st) 185 (at 750st) 165 (at 800st)	0.3	58	95
							Vertical					300 (at 50st to 550st) 285 (at 600st) 245 (at 650st) 210 (at 700st) 185 (at 750st) 165 (at 800st)	0.2		
3				Horizontal	3.75	150 (at 50st to 550st) 140 (at 600st) 120 (at 650st) 105 (at 700st) 90 (at 750st) 80 (at 800st)	0.2	112	189						
				Vertical		150 (at 50st to 550st) 140 (at 600st) 120 (at 650st) 105 (at 700st) 90 (at 750st) 80 (at 800st)	0.2								

Actuator series	Type	Feed screw	No. of encoder pulses	Lead [mm]	Mounting direction	Minimum speed [mm/s]	Maximum speed [mm/s]	Maximum acceleration/ deceleration [G]	Minimum push force [N]	Maximum push force [N]	Rated push speed [mm/s]
RCP3 (table type)	TA3C	Ball screw	800	6	Horizontal	7.5	300	0.3	5.4	9	20
					Vertical		200	0.2			
				4	Horizontal	5	200	0.3	8.4	14	
					Vertical		133	0.2			
				2	Horizontal	2.5	100	0.2	16.8	28	
					Vertical		67	0.2			
	TA3R	Ball screw	800	6	Horizontal	7.5	300	0.3	5.4	9	20
					Vertical		200	0.2			
				4	Horizontal	5	200	0.3	8.4	14	
					Vertical		133	0.2			
				2	Horizontal	2.5	100	0.2	16.8	28	
					Vertical		67	0.2			
	TA4C	Ball screw	800	6	Horizontal	7.5	300	0.3	9	15	20
					Vertical		200	0.2			
				4	Horizontal	5	200	0.3	13.2	22	
					Vertical		133	0.2			
				2	Horizontal	2.5	100	0.2	26.4	44	
					Vertical		67	0.2			
	TA4R	Ball screw	800	6	Horizontal	7.5	300	0.3	9	15	20
					Vertical		200	0.2			
				4	Horizontal	5	200	0.3	13.2	22	
					Vertical		133	0.2			
				2	Horizontal	2.5	100	0.2	26.4	44	
					Vertical		67	0.2			
TA5C	Ball screw	800	10	Horizontal	12.5	465	0.3	20	34	20	
				Vertical		400	0.2				
			5	Horizontal	6.25	250	0.3	40	68		
				Vertical		125	0.2				
			2.5	Horizontal	3.12	125	0.2	82	136		
				Vertical		67	0.2				
TA5R	Ball screw	800	10	Horizontal	12.5	465	0.3	20	34	20	
				Vertical		400	0.2				
			5	Horizontal	6.25	250	0.3	40	68		
				Vertical		125	0.2				
			2.5	Horizontal	3.12	125	0.2	82	136		
				Vertical		67	0.2				
TA6C	Ball screw	800	12	Horizontal	15	560	0.3	30	47	20	
				Vertical		500	0.2				
			6	Horizontal	7.5	300	0.3	58	95		
				Vertical		150	0.2				
			3	Horizontal	3.75	150	0.2	112	189		
				Vertical		67	0.2				
TA6R	Ball screw	800	12	Horizontal	15	560	0.3	30	47	20	
				Vertical		500	0.2				
			6	Horizontal	7.5	300	0.3	58	95		
				Vertical		150	0.2				
			3	Horizontal	3.75	150	0.2	112	189		
				Vertical		67	0.2				

Actuator series	Type	Feed screw	No. of encoder pulses	Lead [mm]	Mounting direction	Minimum speed [mm/s]	Maximum speed [mm/s]	Maximum acceleration/ deceleration [G]	Minimum push force [N]	Maximum push force [N]	Rated push speed [mm/s]
RCP3 (table type)	TA7C	Ball screw	800	12	Horizontal	15	600	0.3	30	47	20
					Vertical		580	0.2			
				6	Horizontal	7.5	300	0.3	58	95	
					Vertical			0.2			
				3	Horizontal	3.75	150	0.2	112	189	
					Vertical			0.2			
	TA7R	Ball screw	800	12	Horizontal	15	600	0.3	30	47	20
					Vertical		580	0.2			
				6	Horizontal	7.5	300	0.3	58	95	
					Vertical			0.2			
				3	Horizontal	3.75	150	0.2	112	189	
					Vertical			0.2			

Actuator series	Type	Feed screw	No. of encoder pulses	Lead [mm]	Mounting direction	Minimum speed [mm/s]	Maximum speed [mm/s]	Maximum acceleration/ deceleration [G]	Minimum push force [N]	Maximum push force [N]	Rated push speed [mm/s]
RCP4 (slider type)	SA3C/ SA3R	Ball screw	800	6	Horizontal	7.5	(Note) It is the value when high-thrust function is effective. 420	1.0	16	58	20
					Vertical			0.5			
				4	Horizontal	5	(Note) It is the value when high-thrust function is effective. 280	1.0	25	86	
					Vertical			0.5			
				2	Horizontal	2.5	(Note) It is the value when high-thrust function is effective. 140	1.0	49	173	
					Vertical			0.5			
	SA5C	Ball screw	800	20	Horizontal	25	(Note) It is the value when high-thrust function is effective. 1440 (at 50 to 500st) 1225 (at 550st) 1045 (at 600st) 900 (at 650st) 785 (at 700st) 690 (at 750st) 610 (at 800st)	1.0	16	56	
					Vertical			(Note) It is the value when high-thrust function is effective. 1280 (at 50 to 500st) 1225 (at 550st) 1045 (at 600st) 900 (at 650st) 785 (at 700st) 690 (at 750st) 610 (at 800st)			0.5
				12	Horizontal	15	(Note) It is the value when high-thrust function is effective. 900 (at 50 to 450st) 795 (at 500st) 665 (at 550st) 570 (at 600st) 490 (at 650st) 425 (at 700st) 375 (at 750st) 330 (at 800st)	1.0	26	93	
					Vertical			(Note) It is the value when high-thrust function is effective. 450 (at 50 to 450st) 395 (at 500st) 335 (at 550st) 285 (at 600st) 245 (at 650st) 215 (at 700st) 185 (at 750st) 165 (at 800st)			0.5
				6	Horizontal	7.5	(Note) It is the value when high-thrust function is effective. 450 (at 50 to 450st) 395 (at 500st) 335 (at 550st) 285 (at 600st) 245 (at 650st) 215 (at 700st) 185 (at 750st) 165 (at 800st)	0.1	53	185	
					Vertical			(Note) It is the value when high-thrust function is effective. 225 (at 50 to 450st) 195 (at 500st) 165 (at 550st) 140 (at 600st) 120 (at 650st) 105 (at 700st) 90 (at 750st) 80 (at 800st)			0.5
				3	Horizontal	3.75	(Note) It is the value when high-thrust function is effective. 225 (at 50 to 450st) 195 (at 500st) 165 (at 550st) 140 (at 600st) 120 (at 650st) 105 (at 700st) 90 (at 750st) 80 (at 800st)	1.0	106	370	
					Vertical			(Note) It is the value when high-thrust function is effective. 225 (at 50 to 450st) 195 (at 500st) 165 (at 550st) 140 (at 600st) 120 (at 650st) 105 (at 700st) 90 (at 750st) 80 (at 800st)			0.5

Actuator series	Type	Feed screw	No. of encoder pulses	Lead [mm]	Mounting direction	Minimum speed [mm/s]	Maximum speed [mm/s]	Maximum acceleration/ deceleration [G]	Minimum push force [N]	Maximum push force [N]	Rated push speed [mm/s]	
RCP4 (slider type)	SA5R	Ball screw	800	20	Horizontal	25	(Note) It is the value when high-thrust function is effective. 1440 (at 50 to 500st) 1225 (at 550st) 1045 (at 600st) 900 (at 650st) 785 (at 700st) 690 (at 750st) 610 (at 800st)	1.0	16	56	20	
					Vertical		(Note) It is the value when high-thrust function is effective. 1120 (at 50 to 550st) 1045 (at 600st) 900 (at 650st) 785 (at 700st) 690 (at 750st) 610 (at 800st)					0.5
					12	Horizontal	15	(Note) It is the value when high-thrust function is effective. 900 (at 50 to 450st) 785 (at 500st) 665 (at 550st) 570 (at 600st). 490 (at 650st). 425 (at 700st). 375 (at 750st) 330 (at 800st)				
						Vertical		(Note) It is the value when high-thrust function is effective. 800 (at 50 to 550st) 785 (at 500st) 665 (at 550st) 570 (at 600st) 490 (at 650st) 425 (at 700st) 375 (at 750st) 330 (at 800st)				0.5
				6	Horizontal	7.5	(Note) It is the value when high-thrust function is effective. 450 (at 50 to 450st) 395 (at 500st) 335 (at 550st) 285 (at 600st) 245 (at 650st) 215 (at 700st) 185 (at 750st) 168 (at 800st)	1.0	53	185		
					Vertical		(Note) It is the value when high-thrust function is effective. 450 (at 50 to 450st) 395 (at 500st) 335 (at 550st) 285 (at 600st) 245 (at 650st) 215 (at 700st) 185 (at 750st) 168 (at 800st)					0.5
				3	Horizontal	3.75	(Note) It is the value when high-thrust function is effective. 225 (at 50 to 450st) 195 (at 500st) 165 (at 550st) 140 (at 600st) 120 (at 650st) 105 (at 700st) 90 (at 750st) 80 (at 800st)	1.0	106	370		
					Vertical		(Note) It is the value when high-thrust function is effective. 225 (at 50 to 450st) 195 (at 500st) 165 (at 550st) 140 (at 600st) 120 (at 650st) 105 (at 700st) 90 (at 750st) 80 (at 800st)					0.5

Actuator series	Type	Feed screw	No. of encoder pulses	Lead [mm]	Mounting direction	Minimum speed [mm/s]	Maximum speed [mm/s]	Maximum acceleration/ deceleration [G]	Minimum push force [N]	Maximum push force [N]	Rated push speed [mm/s]
RCP4 (slider type)	SA6C	Ball screw	800	20	Horizontal	25	(Note) It is the value when high-thrust function is effective. 1440 (at 50 to 500st) 1230 (at 550st) 1045 (at 600st) 905 (at 650st) 785 (at 700st) 690 (at 750st) 615 (at 800st)	1.0	16	56	20
					Vertical		(Note) It is the value when high-thrust function is effective. 1280 (at 50 to 500st) 1230 (at 550st) 1045 (at 600st) 905 (at 650st) 785 (at 700st) 690 (at 750st) 615 (at 800st)				
				12	Horizontal	15	(Note) It is the value when high-thrust function is effective. 900 (at 50 to 450st) 795 (at 500st) 670 (at 550st) 570 (at 600st) 490 (at 650st) 430 (at 700st) 375 (at 750st) 335 (at 800st)	1.0	26	93	
					Vertical		(Note) It is the value when high-thrust function is effective. 450 (at 50 to 450st) 395 (at 500st) 335 (at 550st) 285 (at 600st) 245 (at 650st) 215 (at 700st) 185 (at 750st) 165 (at 800st)				
				6	Horizontal	7.5	(Note) It is the value when high-thrust function is effective. 450 (at 50 to 450st) 395 (at 500st) 335 (at 550st) 285 (at 600st) 245 (at 650st) 215 (at 700st) 185 (at 750st) 165 (at 800st)	1.0	53	185	
					Vertical		(Note) It is the value when high-thrust function is effective. 225 (at 50 to 450st) 195 (at 500st) 165 (at 550st) 140 (at 600st) 120 (at 650st) 105 (at 700st) 90 (at 750st) 80 (at 800st)				
				3	Horizontal	3.75	(Note) It is the value when high-thrust function is effective. 225 (at 50 to 450st) 195 (at 500st) 165 (at 550st) 140 (at 600st) 120 (at 650st) 105 (at 700st) 90 (at 750st) 80 (at 800st)	1.0	106	370	
					Vertical		(Note) It is the value when high-thrust function is effective. 225 (at 50 to 450st) 195 (at 500st) 165 (at 550st) 140 (at 600st) 120 (at 650st) 105 (at 700st) 90 (at 750st) 80 (at 800st)				

Actuator series	Type	Feed screw	No. of encoder pulses	Lead [mm]	Mounting direction	Minimum speed [mm/s]	Maximum speed [mm/s]	Maximum acceleration/ deceleration [G]	Minimum push force [N]	Maximum push force [N]	Rated push speed [mm/s]			
RCP4 (slider type)	SA6R	Ball screw	800	20	Horizontal	25	(Note) It is the value when high-thrust function is effective. 128 (at 50 to 500st) 1230 (at 550st) 1045 (at 600st) 905 (at 650st) 785 (at 700st) 690 (at 750st) 615 (at 800st)	1.0	16	56	20			
					Vertical			0.5						
				12	Horizontal	15		(Note) It is the value when high-thrust function is effective. 900 (at 50 to 450st) 795 (at 500st) 670 (at 550st) 570 (at 600st) 490 (at 650st) 430 (at 700st) 375 (at 750st) 335 (at 800st)	1.0	26		93		
					Vertical				0.5					
				6	Horizontal	7.5			(Note) It is the value when high-thrust function is effective. 450 (at 50 to 450st) 395 (at 500st) 335 (at 550st) 285 (at 600st) 245 (at 650st) 215 (at 700st) 185 (at 750st) 165 (at 800st)	1.0		53	185	
					Vertical					0.5				
				3	Horizontal	3.75				(Note) It is the value when high-thrust function is effective. 225 (at 50 to 450st) 195 (at 500st) 165 (at 550st) 140 (at 600st) 120 (at 650st) 105 (at 700st) 90 (at 750st) 80 (at 800st)		1.0	106	370
					Vertical							0.5		

Actuator series	Type	Feed screw	No. of encoder pulses	Lead [mm]	Mounting direction	Minimum speed [mm/s]	Maximum speed [mm/s]	Maximum acceleration/ deceleration [G]	Minimum push force [N]	Maximum push force [N]	Rated push speed [mm/s]
RCP4 (slider type)	SA7C	Ball screw	800	24	Horizontal	30	(Note) It is the value when high-thrust function is effective. 1200 (at 50 to 600st) 1155 (at 650st) 1010 (at 700st) 890 (at 750st) 790 (at 800st)	1.0	32	112	20
					Vertical			0.5			
				16	Horizontal	20	(Note) It is the value when high-thrust function is effective. 980 (at 50 to 550st) 865 (at 600st) 750 (at 650st) 655 (at 700st) 580 (at 750st) 515 (at 800st)	1.0	48	168	
					Vertical			0.5			
				8	Horizontal	10	(Note) It is the value when high-thrust function is effective. 490 (at 50 to 550st) 430 (at 600st) 375 (at 650st) 325 (at 700st) 290 (at 750st) 255 (at 800st)	1.0	96	336	
					Vertical			0.5			
				4	Horizontal	5	(Note) It is the value when high-thrust function is effective. 245 (at 50 to 550st) 185 (at 650st) 160 (at 700st) 145 (at 750st) 125 (at 800st)	1.0	192	673	
					Vertical			0.5			
	SA7R	Ball screw	800	24	Horizontal	30	(Note) It is the value when high-thrust function is effective. 1000 (at 50 to 700st) 890 (at 750st) 790 (at 800st)	1.0	32	112	20
					Vertical			0.5			
				16	Horizontal	20	(Note) It is the value when high-thrust function is effective. 840 (at 50 to 600st) 750 (at 750st) 655 (at 700st) 580 (at 750st) 515 (at 800st)	1.0	48	168	
					Vertical			0.5			
700	(Note) It is the value when high-thrust function is effective. 700 (at 50 to 650st) 655 (at 700st) 580 (at 750st) 515 (at 800st)	0.5									

Actuator series	Type	Feed screw	No. of encoder pulses	Lead [mm]	Mounting direction	Minimum speed [mm/s]	Maximum speed [mm/s]	Maximum acceleration/ deceleration [G]	Minimum push force [N]	Maximum push force [N]	Rated push speed [mm/s]	
RCP4 (slider type)	SA7R	Ball screw	800	8	Horizontal	10	(Note) It is the value when high-thrust function is effective. 490 (at 50 to 550st) 430 (at 600st) 375 (at 650st) 325 (at 700st) 290 (at 750st) 255 (at 800st)	1.0	96	336	20	
					Vertical			0.5				
				4	Horizontal	5		(Note) It is the value when high-thrust function is effective. 210 (at 50 to 600st) 185 (at 700st) 160 (at 700st) 145 (at 750st) 125 (at 800st)	1.0	192		673
					Vertical				0.5			

Actuator series	Type	Feed screw	No. of encoder pulses	Lead [mm]	Mounting direction	Minimum speed [mm/s]	Maximum speed [mm/s]	Maximum acceleration/ deceleration [G]	Minimum push force [N]	Maximum push force [N]	Rated push speed [mm/s]			
RCP4 (rod type)	RA3C/ RA3R	Ball screw	800	16	Horizontal	20	(Note) It is the value when high-thrust function is effective. 1120	1.0	15	36	20			
					Vertical			0.5						
				10	Horizontal	12.5	(Note) It is the value when high-thrust function is effective. 700	1.0	16	57				
					Vertical			0.5						
				5	Horizontal	6.25	(Note) It is the value when high-thrust function is effective. 350	1.0	33	114				
					Vertical			0.5						
				2.5	Horizontal	3.12	(Note) It is the value when high-thrust function is effective. 175	1.0	65	229				
					Vertical			0.5						
				RA5C	Ball screw	800	20	Horizontal	25	(Note) It is the value when high-thrust function is effective. 800		1.0	16	56
								Vertical				0.5		
							12	Horizontal	15	(Note) It is the value when high-thrust function is effective. 700		1.0	26	93
								Vertical				0.5		
	6	Horizontal	7.5				(Note) It is the value when high-thrust function is effective. 450	1.0	53	185				
		Vertical						0.5						
	3	Horizontal	3.75				(Note) It is the value when high-thrust function is effective. 225	1.0	106	370				
		Vertical						0.5						
	RA5R	Ball screw	800				20	Horizontal	25	(Note) It is the value when high-thrust function is effective. 800	1.0	16	56	
								Vertical			0.5			
							12	Horizontal	15	(Note) It is the value when high-thrust function is effective. 700	1.0	26	93	
								Vertical			0.5			
				6	Horizontal	7.5	(Note) It is the value when high-thrust function is effective. 450	1.0	53	185				
					Vertical			0.5						
				3	Horizontal	3.75	(Note) It is the value when high-thrust function is effective. 225	1.0	106 370 When motor type is 42SP	370 750 When motor type is 42SP				
					Vertical			0.5						
RA6C				Ball screw	800	24	Horizontal	30	(Note) It is the value when high-thrust function is effective. 800	1.0	52	182		
							Vertical			0.5				
						16	Horizontal	20	(Note) It is the value when high-thrust function is effective. 700	1.0	78	273		
							Vertical			0.5				
	8	Horizontal	10			(Note) It is the value when high-thrust function is effective. 420	1.0	156	547					
		Vertical					0.5							
	4	Horizontal	5			(Note) It is the value when high-thrust function is effective. 210	1.0	312	1094					
		Vertical					0.5							

Actuator series	Type	Feed screw	No. of encoder pulses	Lead [mm]	Mounting direction	Minimum speed [mm/s]	Maximum speed [mm/s]	Maximum acceleration/ deceleration [G]	Minimum push force [N]	Maximum push force [N]	Rated push speed [mm/s]					
RCP4 (rod type)	RA6R	Ball screw	800	24	Horizontal	30	(Note) It is the value when high-thrust function is effective. 800	1.0	52	182	20					
					Vertical		(Note) It is the value when high-thrust function is effective. 600	0.5								
				16	Horizontal	20	(Note) It is the value when high-thrust function is effective. 700	1.0	78	273						
					Vertical		(Note) It is the value when high-thrust function is effective. 560	0.5								
				8	Horizontal	10	(Note) It is the value when high-thrust function is effective. 420	1.0	156	547						
					Vertical		(Note) It is the value when high-thrust function is effective. 210	0.5								
				4	Horizontal	5	(Note) It is the value when high-thrust function is effective. 210	1.0	312	1094						
					Vertical		(Note) It is the value when high-thrust function is ineffective. 94	0.3								
				RCP4 (gripper type)	GRSML	-	800	1.88	-	2.35		(Note) It is the value when high-thrust function is ineffective. 94	0.3	25	87	5
					GRSLL	-	800	2.52	-	3.15		(Note) It is the value when high-thrust function is ineffective. 125	0.3	40	140	5
					GRSWL	-	800	3.14	-	3.93		(Note) It is the value when high-thrust function is ineffective. 157	0.3	50	220	5
					GRLM	-	800	12	-	15 (deg/s)		(Note) It is the value when high-thrust function is ineffective. 600 (deg/s)	0.3	10	35	5
GRLM	-	800	12		-	15 (deg/s)	(Note) It is the value when high-thrust function is ineffective. 600 (deg/s)	0.3	10	60	5					
GRLW	-	800	12.86		-	16.08 (deg/s)	(Note) It is the value when high-thrust function is ineffective. 643 (deg/s)	0.3	23	90	5					

Actuator series	Type	Feed screw	No. of encoder pulses	Lead [mm]	Mounting direction	Minimum speed [mm/s]	Maximum speed [mm/s]	Maximum acceleration/ deceleration [G]	Minimum push force [N]	Maximum push force [N]	Rated push speed [mm/s]
RCP4W (slider type)	SA5C	Ball screw	800	10	Horizontal	12.5	(Note) It is the value when high-thrust function is effective. 330	0.6	38.2	66.9	20
				5	Horizontal	6.25	(Note) It is the value when high-thrust function is effective. 165	0.6	42.3	147.9	
	SA6C	Ball screw	800	12	Horizontal	15	(Note) It is the value when high-thrust function is effective. 400	0.6	35.5	82.8	20
				6	Horizontal	7.5	(Note) It is the value when high-thrust function is effective. 200	0.6	51.3	179.5	
	SA7C	Ball screw	800	16	Horizontal	20	(Note) It is the value when high-thrust function is effective. 530	0.6	46.3	161.9	20
				8	Horizontal	10	(Note) It is the value when high-thrust function is effective. 265	0.6	96.5	337.9	
RCP4W (rod type)	RA6C	Ball screw	800	12	Horizontal	15	(Note) It is the value when high-thrust function is effective. (Note) It could differ depending on ambient temperature. 500 (at 50st) 560 (at 100 to 400st)	1.0	40	107	20
					Vertical		(Note) It is the value when high-thrust function is effective. (Note) It could differ depending on ambient temperature. 500	0.5			
				6	Horizontal	7.5	(Note) It is the value when high-thrust function is effective. ((Note) It could differ depending on ambient temperature. 360	1.0	79	227	
					Vertical		(Note) It is the value when high-thrust function is effective. (Note) It could differ depending on ambient temperature. 360	0.5			
				3	Horizontal	3.75	(Note) It is the value when high-thrust function is effective. (Note) It could differ depending on ambient temperature. 180	1.0	159	478	
					Vertical		(Note) It is the value when high-thrust function is effective. (Note) It could differ depending on ambient temperature. 180	0.5			
	RA6C (42SP motor)	Ball screw	800	3	Vertical	3.75	(Note) It is the value when high-thrust function is effective. 70	0.5	354	768	20

Actuator series	Type	Feed screw	No. of encoder pulses	Lead [mm]	Mounting direction	Minimum speed [mm/s]	Maximum speed [mm/s]	Maximum acceleration/ deceleration [G]	Minimum push force [N]	Maximum push force [N]	Rated push speed [mm/s]				
RCP4W (rod type)	RA7C	Ball screw	800	16	Horizontal	20	(Note) It is the value when high-thrust function is effective. (Note) It could differ depending on ambient temperature. 500 (at 50st) 560 (at 100 to 500st)	1.0	94	330	20				
					Vertical		(Note) It is the value when high-thrust function is effective. (Note) It could differ depending on ambient temperature. 400	0.5							
				8	Horizontal	10	(Note) It is the value when high-thrust function is effective. (Note) It could differ depending on ambient temperature. 340	1.0	187	670					
					Vertical		(Note) It is the value when high-thrust function is effective. (Note) It could differ depending on ambient temperature. 280	0.5							
				4	Horizontal	5	(Note) It is the value when high-thrust function is effective. (Note) It could differ depending on ambient temperature. 170	1.0	375	1326					
					Vertical		(Note) It is the value when high-thrust function is effective. (Note) It could differ depending on ambient temperature. 140	0.5							
				RA7C (56SP motor)	Ball screw	800	4	Vertical	5	(Note) It is the value when high-thrust function is effective. 80		0.5	515	1358	20

Actuator series	Type	Feed screw	No. of encoder pulses	Lead [mm]	Mounting direction	Minimum speed [mm/s]	Maximum speed [mm/s]	Maximum acceleration/ deceleration [G]	Minimum push force [N]	Maximum push force [N]	Rated push speed [mm/s]
RCP5 (slider type)	SA4C/ SA4R	Ball screw	800	16	Horizontal	20	(Note) It is the value when high-thrust function is effective. 1260 (at 50 to 400st) 1060 (at 450st) 875 (at 500st)	1.0	21	48	20
					Vertical			0.5			
				10	Horizontal	12.5	(Note) It is the value when high-thrust function is effective. 785 (at 50 to 400st) 675 (at 450st) 555 (at 500st)	1.0	22	77	
					Vertical			0.5			
				5	Horizontal	6.25	(Note) It is the value when high-thrust function is effective. 390 (at 50 to 400st) 330 (at 450st) 275 (at 500st)	1.0	44	155	
					Vertical			0.5			
				2.5	Horizontal	3.12	(Note) It is the value when high-thrust function is effective. 195 (at 50 to 400st) 165 (at 450st) 135 (at 500st)	1.0	88	310	
					Vertical			0.5			
	SA6C/ SA6R	Ball screw	800	20	Horizontal	25	(Note) It is the value when high-thrust function is effective. SA6C: 1440 (at 50 to 450st) SA6C: 1335 (at 500st) SA6R: 1280 (at 50 to 500st) 1130 (at 550st) 970 (at 600st) 840 (at 650st) 735 (at 700st) 650 (at 750st) 575 (at 800st)	1.0	16	56	20
					Vertical			(Note) It is the value when high-thrust function is effective. 1280 (at 50 to 500st) 1130 (at 550st) 970 (at 600st) 840 (at 650st) 735 (at 700st) 650 (at 750st) 575 (at 800st)			
				12	Horizontal	15	(Note) It is the value when high-thrust function is effective. 900 (at 50 to 400st) 885 (at 450st) 735 (at 500st) 620 (at 550st) 535 (at 600st) 460 (at 650st) 405 (at 700st) 335 (at 750st) 315 (at 800st)	1.0	26	93	
					Vertical			(Note) It is the value when high-thrust function is effective. SA6C: 900 (at 50 to 400st) SA6C: 885 (at 450st) SA6R: 800 (at 50 to 450st) 735 (at 500st) 620 (at 550st) 535 (at 600st) 460 (at 650st) 405 (at 700st) 335 (at 750st) 315 (at 800st)			

Actuator series	Type	Feed screw	No. of encoder pulses	Lead [mm]	Mounting direction	Minimum speed [mm/s]	Maximum speed [mm/s]	Maximum acceleration/deceleration [G]	Minimum push force [N]	Maximum push force [N]	Rated push speed [mm/s]
RCP5 (slider type)	SA6C/SA6R	Ball screw	800	6	Horizontal	7.5	(Note) It is the value when high-thrust function is effective. 450 (at 50 to 400st) 435 (at 450st) 365 (at 500st) 305 (at 550st) 265 (at 600st) 230 (at 650st) 200 (at 700st) 175 (at 750st) 155 (at 800st)	1.0	53	185	20
					3						
				Vertical		0.5					
				SA7C/SA7R	Ball screw	800	24	Horizontal	30	(Note) It is the value when high-thrust function is effective. 1220 (at 50 to 600st) 1145 (at 650st) 1000 (at 700st) 885 (at 750st) 785 (at 800st)	
	Vertical	0.5									
	16	Horizontal	20				(Note) It is the value when high-thrust function is effective. 980 (at 50 to 550st) 875 (at 600st) 755 (at 650st) 660 (at 700st) 585 (at 750st) 520 (at 800st)	1.0	48	168	
		Vertical					(Note) It is the value when high-thrust function is effective. 840 (at 50 to 600st) 755 (at 650st) 660 (at 700st) 585 (at 750st) 520 (at 800st)	0.5			
	8	Horizontal	10				(Note) It is the value when high-thrust function is effective. 490 (at 50 to 550st) 430 (at 600st) 375 (at 650st) 325 (at 700st) 290 (at 750st) 255 (at 800st)	1.0	96	336	
		Vertical						0.5			
	4	Horizontal	5				(Note) It is the value when high-thrust function is effective. SA7C: 245 (at 50 to 550st) SA7C: 215 (at 600st) SA7R: 210 (at 50 to 600st) 185 (at 650st) 160 (at 700st) 140 (at 750st) 125 (at 800st)	1.0	192	673	
		Vertical						(Note) It is the value when high-thrust function is effective. 215 (at 50 to 600st) 185 (at 650st) 160 (at 700st) 140 (at 750st) 125 (at 800st)			0.5

Actuator series	Type	Feed screw	No. of encoder pulses	Lead [mm]	Mounting direction	Minimum speed [mm/s]	Maximum speed [mm/s]	Maximum acceleration/ deceleration [G]	Minimum push force [N]	Maximum push force [N]	Rated push speed [mm/s]				
RCP5 (rod type)	RA4C/ RA4R	Ball screw	800	16	Horizontal	20	(Note) It is the value when high-thrust function is effective. RA4C: 1120 (at 50 to 360st) RA4C: 1080 (at 410st) RA4R: (at 50 to 410st)	1.0	21	48	20				
					Vertical			0.5							
				10	Horizontal	12.5		(Note) It is the value when high-thrust function is effective. RA4C: 700 (at 50 to 360st) RA4C: 685 (at 410st) RA4R: 610 (at 50 to 410st)	1.0	22		77			
					Vertical				0.5						
				5	Horizontal	6.25	(Note) It is the value when high-thrust function is effective. 350 (at 50 to 360st) 340 (at 410st)		1.0	44		155			
					Vertical				0.5						
				2.5	Horizontal	3.12		(Note) It is the value when high-thrust function is effective. 175 (at 50 to 360st) 170 (at 410st)	1.0	88		310			
					Vertical				0.5						
				RA6C/ RA6R	Ball screw	800	20		Horizontal	25		(Note) It is the value when high-thrust function is effective. 800	1.0	16	56
									Vertical				0.5		
							12	Horizontal	15	(Note) It is the value when high-thrust function is effective. 700			1.0	26	93
								Vertical					0.5		
	6	Horizontal	7.5				(Note) It is the value when high-thrust function is effective. 450	1.0	53		186				
		Vertical						0.5							
	3	Horizontal	3.75					(Note) It is the value when high-thrust function is effective. 225 (at 65 to 365st) 220 (at 415st)	1.0	106	370				
		Vertical							0.5						
	RA7C/ RA7R	Ball screw	800				24		Horizontal	30	(Note) It is the value when high-thrust function is effective. 800	1.0	52	182	
									Vertical			0.5			
							16	Horizontal	20	(Note) It is the value when high-thrust function is effective. RA7C: 700 RA7R: 560		1.0	78	273	
								Vertical				0.5			
				8	Horizontal	10	(Note) It is the value when high-thrust function is effective. 420	1.0	156		547				
					Vertical			0.5							
				4	Horizontal	5		(Note) It is the value when high-thrust function is effective. RA7C: 210 RA7R: 175	1.0	312	1094				
					Vertical				0.5						

Actuator series	Type	Feed screw	No. of encoder pulses	Lead [mm]	Mounting direction	Minimum speed [mm/s]	Maximum speed [mm/s]	Maximum acceleration/ deceleration [G]	Minimum push force [N]	Maximum push force [N]	Rated push speed [mm/s]
RCP5 (rod type)	RA8C	Ball screw	800	20	Horizontal	25	280 (at 50) 405 (at 100st) 505 (at 150st) 585 (at 200st) 600(at 250 to 350st) 520 (at 400st) 440 (at 450st) 360 (at 500st) 320 (at 550st) 280 (at 600st) 240 (at 650st) 220 (at 700st)	0.2	167	500	10
					Vertical		280 (at 50) 405 (at 100st) 450 (at 150 to 400st) 440 (at 450st) 360 (at 500st) 320 (at 550st) 280 (at 600st) 240 (at 650st) 220 (at 700st)				
				10	Horizontal	12.5	280 (at 50) 300 (at 100 to 350st) 260 (at 400st) 220 (at 450st) 180 (at 500st) 160 (at 550st) 140 (at 600st) 120 (at 650st) 110 (at 700st)	0.2	333	1000	
					Vertical		250 (at 50 to 400st) 220 (at 450st) 180 (at 500st) 160 (at 550st) 140 (at 600st) 120 (at 650st) 110 (at 700st)				
				5	Horizontal	6.25	150 (at 50 to 350st) 130 (at 400st) 110 (at 450st) 90 (at 500st) 80 (at 550st) 70 (at 600st) 60 (at 650st) 55 (at 700st)	0.1	667	2000	
					Vertical						
	RA8R	Ball screw	800	20	Horizontal	25	280 (at 50) 400 (at 100 to 450st) 360 (at 500st) 320 (at 550st) 280 (at 600st) 240 (at 650st) 220 (at 700st)	0.2	167	500	10
					Vertical		280 (at 50) 400 (at 100 to 450st) 360 (at 500st) 320 (at 550st) 280 (at 600st) 240 (at 650st) 220 (at 700st)				
				10	Horizontal	12.5	200 (at 50 to 450st) 180 (at 500st) 160 (at 550st) 140 (at 600st) 120 (at 650st) 110 (at 700st)	0.2	333	1000	
					Vertical		200 (at 50 to 450st) 180 (at 500st) 160 (at 550st) 140 (at 600st) 120 (at 650st) 110 (at 700st)				
				5	Horizontal	6.25	100 (at 50 to 450st) 90 (at 500st) 80 (at 550st) 70 (at 600st) 60 (at 650st) 55 (at 700st)	0.1	667	2000	
					Vertical						

Actuator series	Type	Feed screw	No. of encoder pulses	Lead [mm]	Mounting direction	Minimum speed [mm/s]	Maximum speed [mm/s]	Maximum acceleration/ deceleration [G]	Minimum push force [N]	Maximum push force [N]	Rated push speed [mm/s]
RCP5 (rod type)	RA10C	Ball screw	800	10	Horizontal	12.5	117 (at 50st) 167 (at 100st) 200 (at 150st) 250 (at 200 to 500st) 220 (at 550st) 200 (at 600st) 180 (at 650st) 160 (at 700st) 140 (at 750st) 120 (at 800st)	0.4	429	1500	10
					Vertical		117 (at 50st) 167 (at 100 to 650st) 160 (at 700st) 140 (at 750st) 120 (at 800st)				
				5	Horizontal	6.25	83 (at 50st) 125 (at 100 to 400st) 110 (at 450st) 90 (at 500st) 80 (at 550st) 70 (at 600st) 60 (at 650st) 55 (at 700st) 50 (at 750st) 45 (at 800st)	0.02	857	3000 (at to 550st) 2900 (at 600st) 2500 (at 650st) 2200 (at 700st) 2000 (at 750st) 1800 (at 800st)	
					Vertical		63 (at 50 to 500st) 55 (at 550st) 50 (at 600st) 45 (at 650st) 40 (at 700st) 35 (at 750st) 30 (at 800st)			6000(at to 700st) 5900 (at 750st) 5400 (at 800st)	
				2.5	Horizontal	3.12	63 (at 50 to 500st) 55 (at 550st) 50 (at 600st) 45 (at 650st) 40 (at 700st) 35 (at 750st) 30 (at 800st)	0.01	1714	6000(at to 700st) 5900 (at 750st) 5400 (at 800st)	
					Vertical		63 (at 50 to 500st) 55 (at 550st) 50 (at 600st) 45 (at 650st) 40 (at 700st) 35 (at 750st) 30 (at 800st)			6000(at to 700st) 5900 (at 750st) 5400 (at 800st)	
	RA10R	Ball screw	800	10	Horizontal	12.5	117 (at 50st) 167 (at 100st) 200 (at 150 to 600st) 180 (at 650st) 160 (at 700st) 140 (at 750st) 120 (at 800st)	0.04	429	1500	10
					Vertical		117 (at 50st) 140(at 100 to 750st) 120 (at 800st)				
				5	Horizontal	6.25	83 (at 50st) 100 (at 100 to 450st) 90 (at 500st) 80 (at 550st) 70 (at 600st) 60 (at 650st) 55 (at 700st) 50 (at 750st) 45 (at 800st)	0.02	857	3000 (at to 550st) 2900 (at 600st) 2500 (at 650st) 2200 (at 700st) 2000 (at 750st) 1800 (at 800st)	
					Vertical		83 (at 50st) 100 (at 100 to 450st) 90 (at 500st) 80 (at 550st) 70 (at 600st) 60 (at 650st) 55 (at 700st) 50 (at 750st) 45 (at 800st)			3000 (at to 550st) 2900 (at 600st) 2500 (at 650st) 2200 (at 700st) 2000 (at 750st) 1800 (at 800st)	
				2.5	Horizontal	3.12	50 (at 50 to 600st) 45 (at 650st) 40 (at 700st) 35 (at 750st) 30 (at 800st)	0.01	1714	6000(at to 700st) 5900 (at 750st) 5400 (at 800st)	
					Vertical		50 (at 50 to 600st) 45 (at 650st) 40 (at 700st) 35 (at 750st) 30 (at 800st)			6000(at to 700st) 5900 (at 750st) 5400 (at 800st)	



Actuator series	Type	Feed screw	No. of encoder pulses	Lead [mm]	Mounting direction	Minimum speed [mm/s]	Maximum speed [mm/s]	Maximum acceleration/ deceleration [G]	Minimum push force [N]	Maximum push force [N]	Rated push speed [mm/s]
RCP5 (belt type)	BA4/BA4U	Belt	800	Equivalent to 48	Horizontal	60	890 (at 300st) 1040 (at 400st) 1120 (at 500st) 1160 (at 600st) 1200 (at 700 to 1200st)	0.5	–	–	–
	BA6/BA6U	Belt	800	Equivalent to 48	Horizontal	60	890 (at 300st) 1070 (at 400st) 1220 (at 500st) 1340 (at 600st) 1400 (at 700st) 1440 (at 800st) 1500 (at 900 to 2200st)	0.5	–	–	–
	BA7/BA7U	Belt	800	Equivalent to 48	Horizontal	60	890 (at 300st) 1070 (at 400st) 1220 (at 500st) 1340 (at 600st) 1450 (at 700st) 1520 (at 800st) 1550 (at 900st) 1600 (at 1000 to 2600st)	0.5	–	–	–

Correlation diagram of speed and loading capacity for the RCP2 slider type

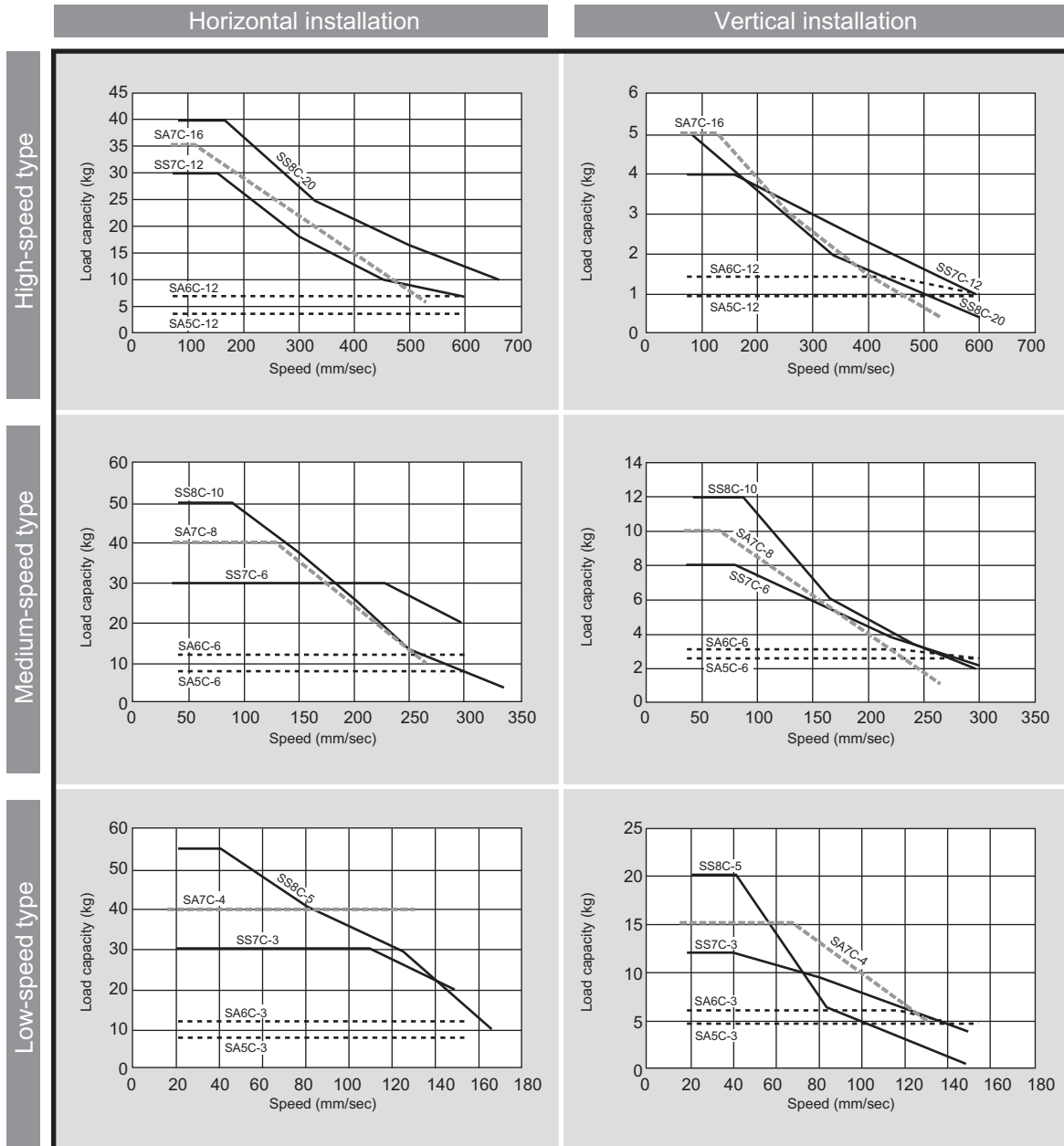

(Note) In the above graphs, the number after the type code indicates the lead.

(Note) RCP2-SA7C/SA7R and RCP2CR-SA7C/SA7R is not connected.

Correlation diagram of speed and loading capacity for the RCP2 slider type (motor-reversing type)

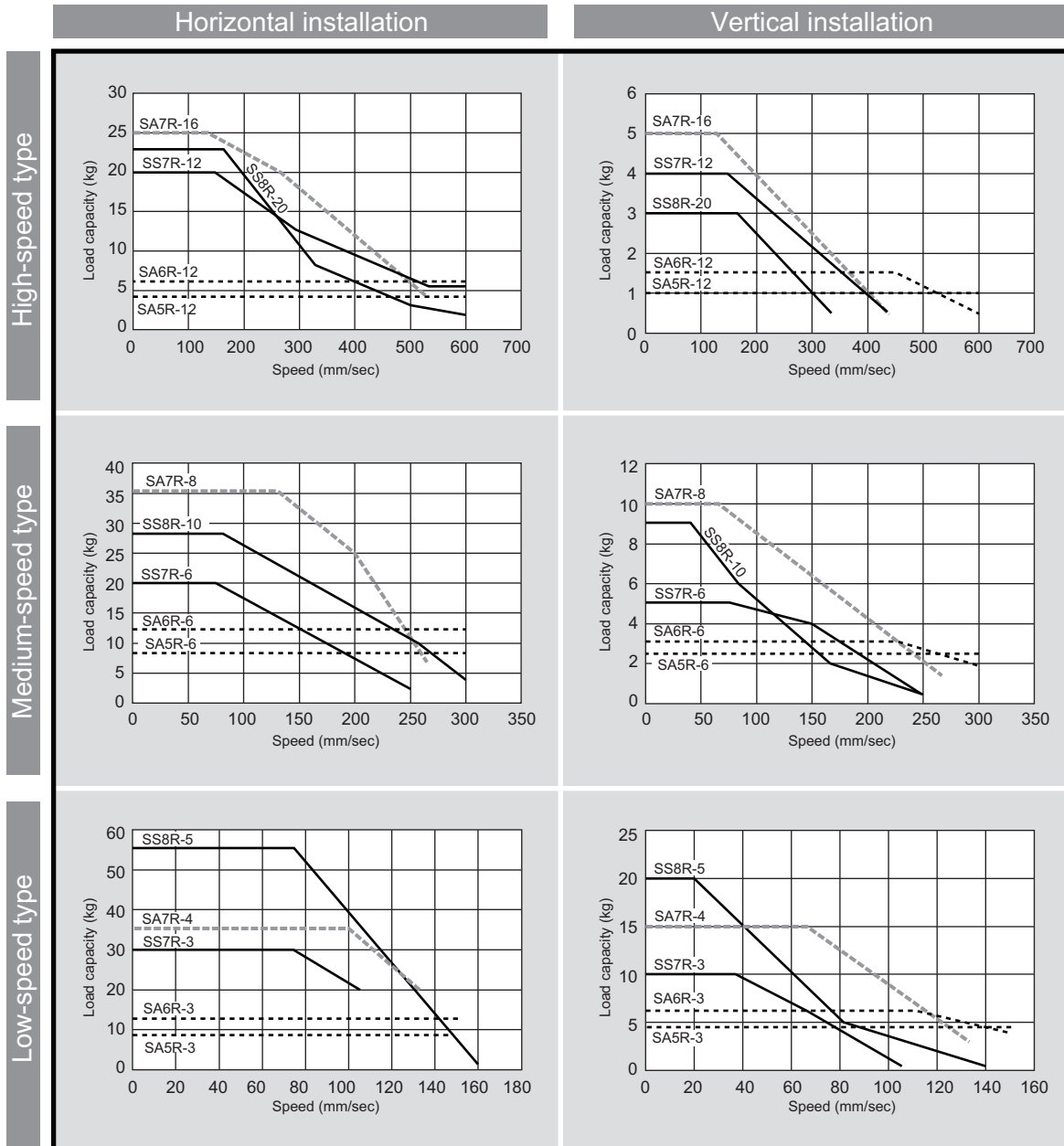

(Note) In the above graphs, the number after the type code indicates the lead.

(Note) RCP2-SA7C/SA7R and RCP2CR-SA7C/SA7R is not connected.

Correlation diagram of speed and loading capacity for the standard RCP2 rod type

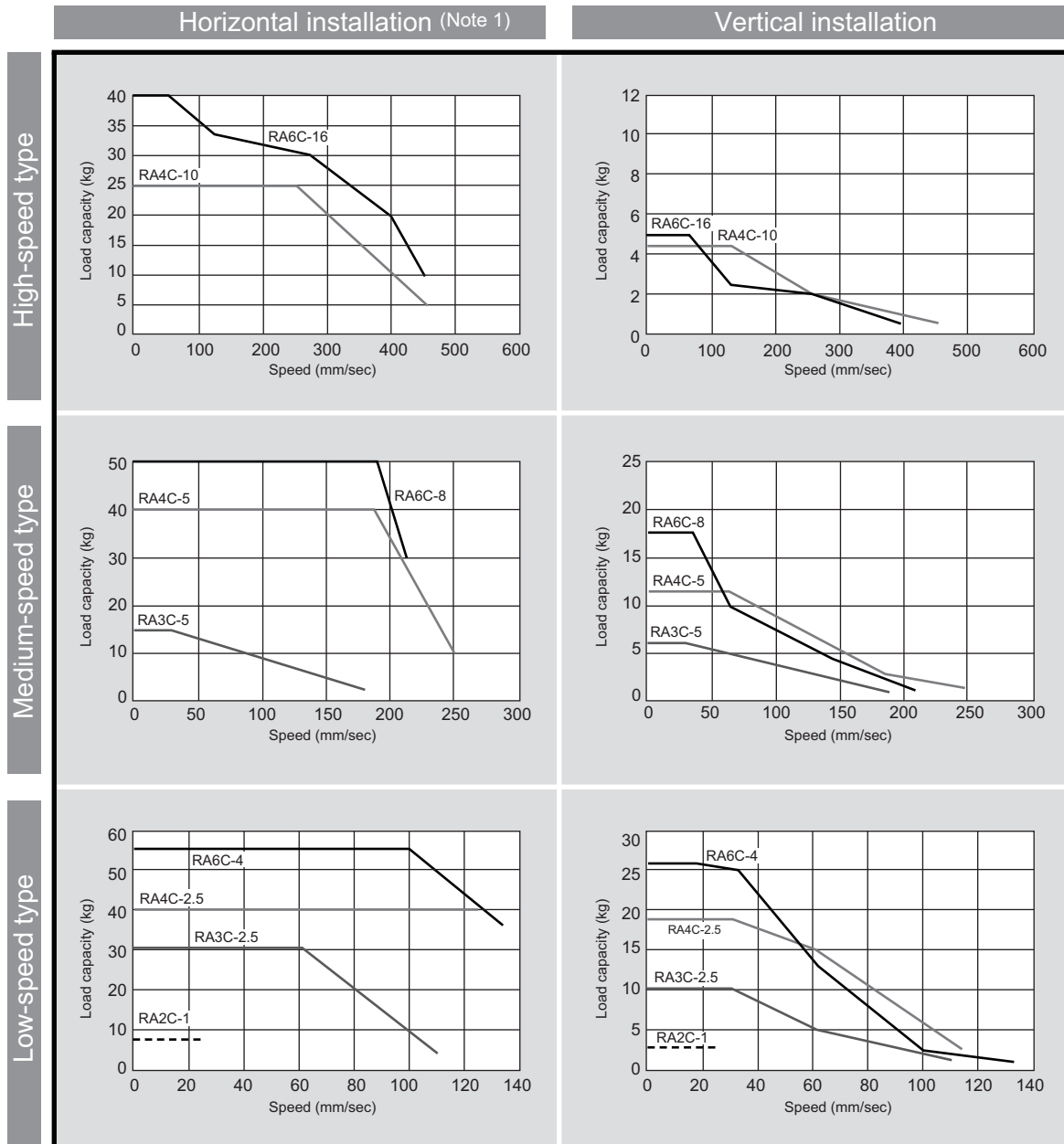

(Note) In the above graphs, the number after the type code indicates the lead.
 (Note 1) The figures for horizontal installation assume use of an external guide.

Correlation diagram of speed and loading capacity for RCP2 single-guide type

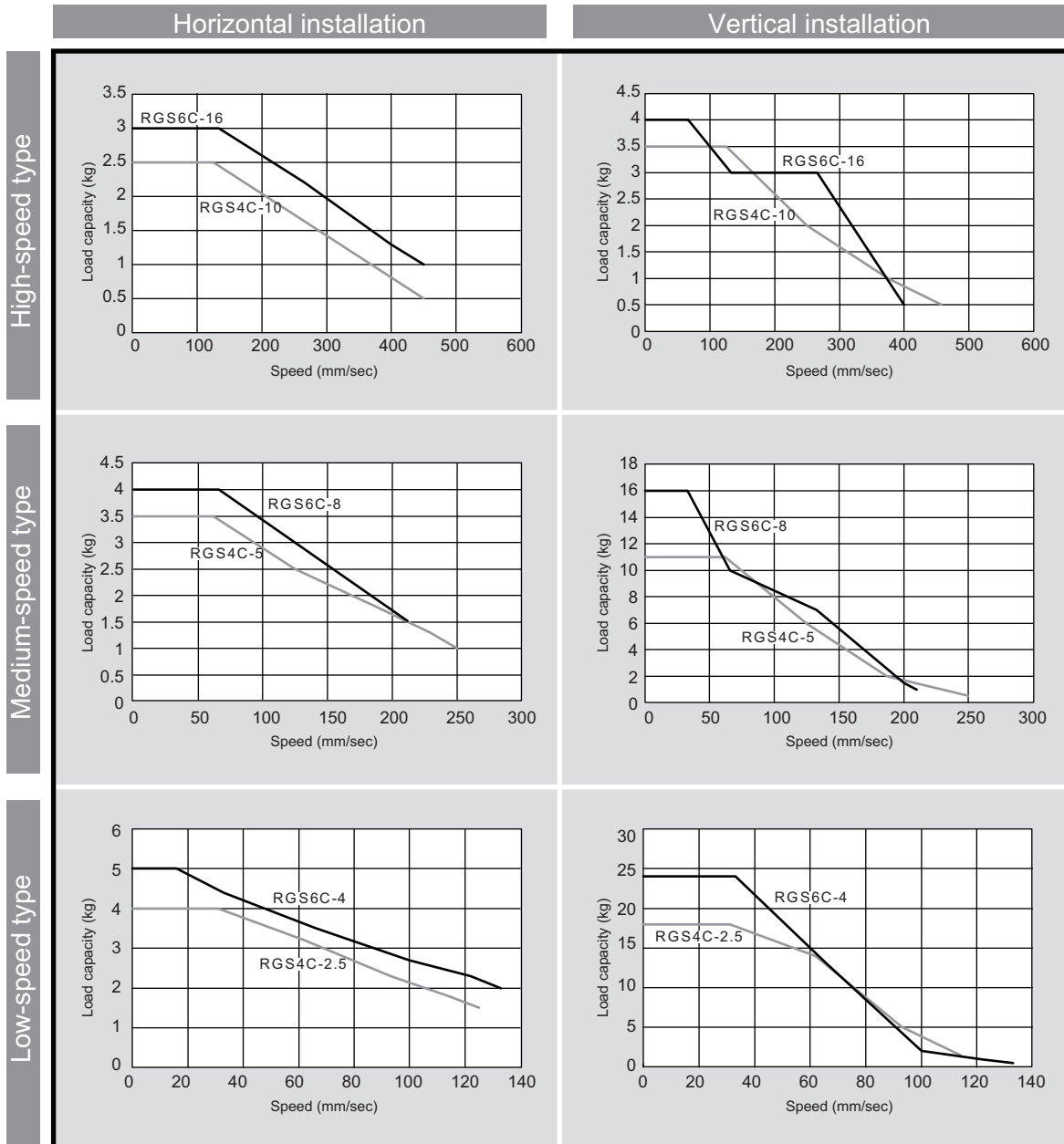

(Note) In the above graphs, the number after the type code indicates the lead.

Correlation diagram of speed and loading capacity for the RCP2 double-guide type

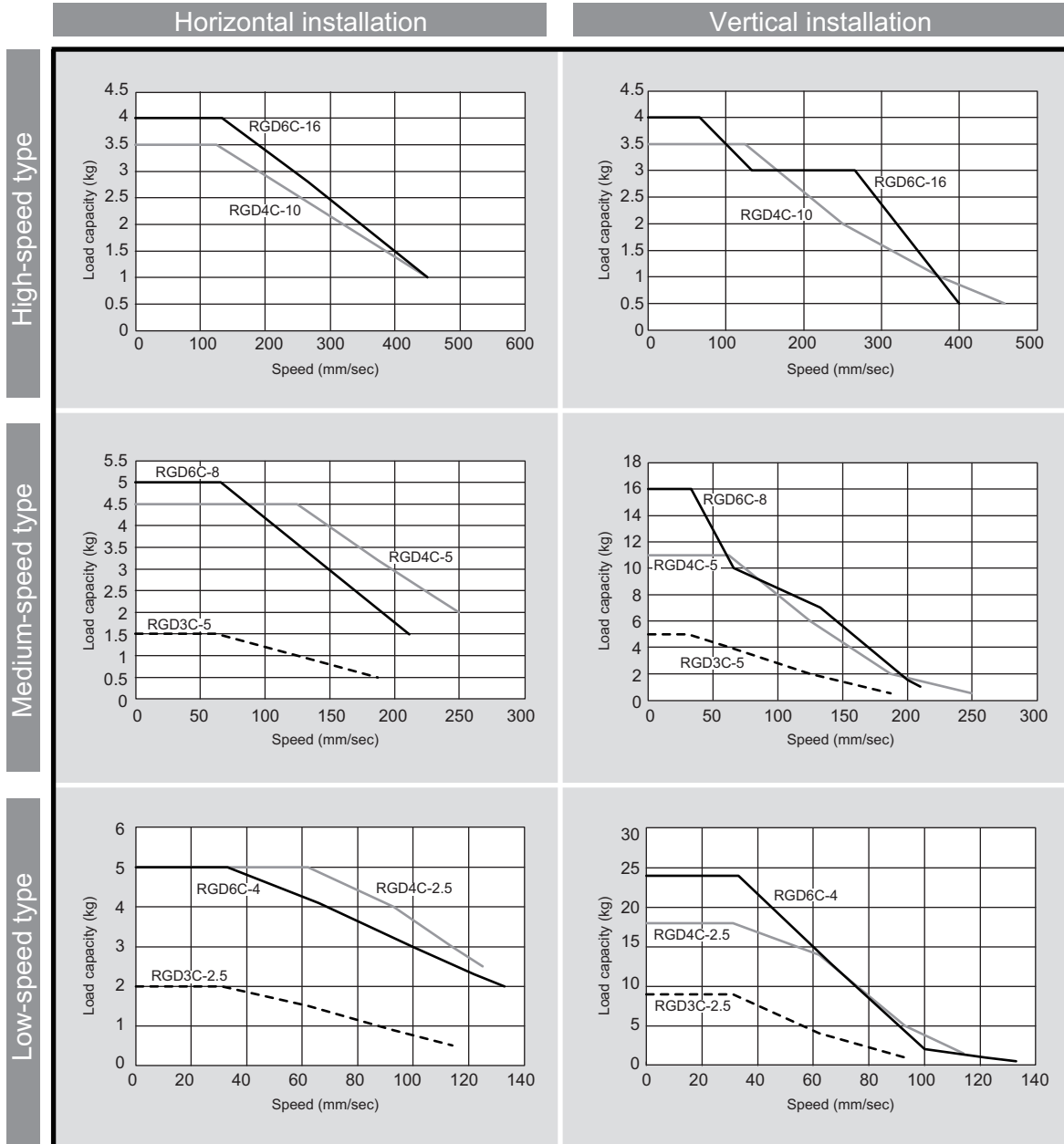

(Note) In the above graphs, the number after the type code indicates the lead.

Correlation diagram of speed and loading capacity for the RCP2 dustproof/splash-proof type

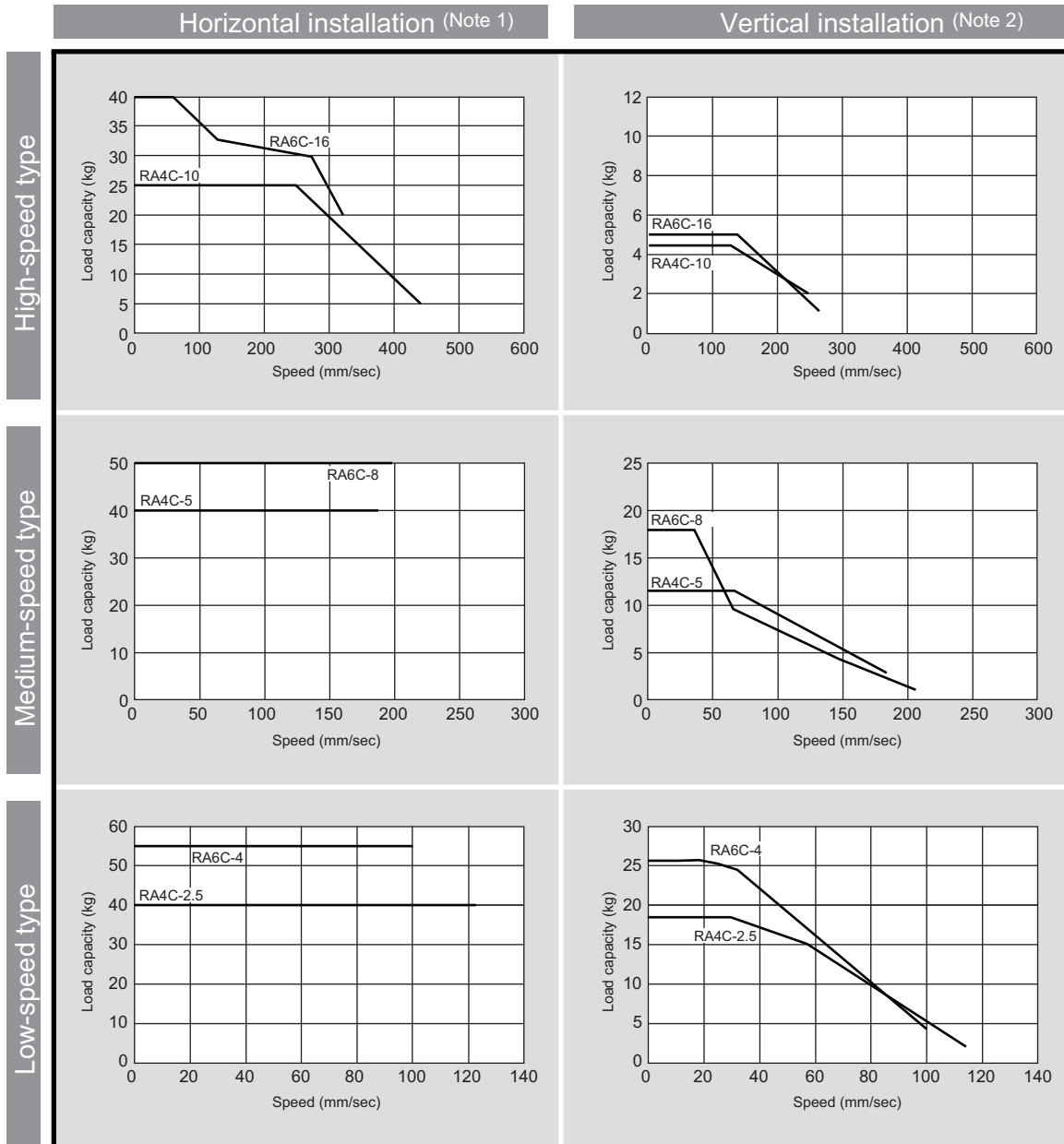

(Note) In the above graphs, the number after the type code indicates the lead.

(Note 1) The figures for horizontal installation assume use of an external guide.

(Note 2) Use of the actuator at the maximum loading capacity corresponding to the applicable speed may cause vibration/overshooting. Select an appropriate model that provides an allowance of approx. 70%.

Correlation diagram of speed and loading capacity for the RCP3 slider type

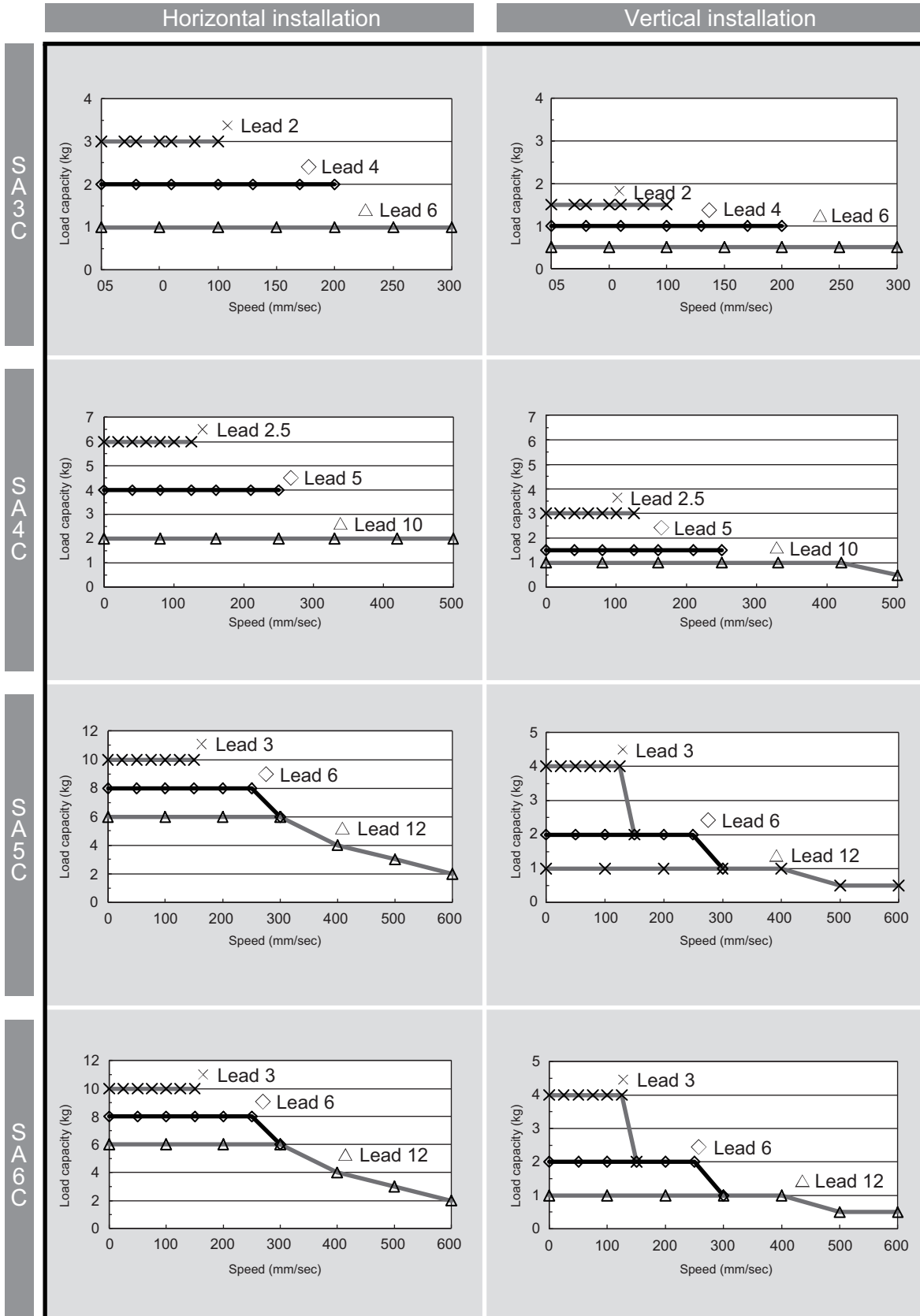

Correlation diagram of speed and loading capacity for the RCP3 table type

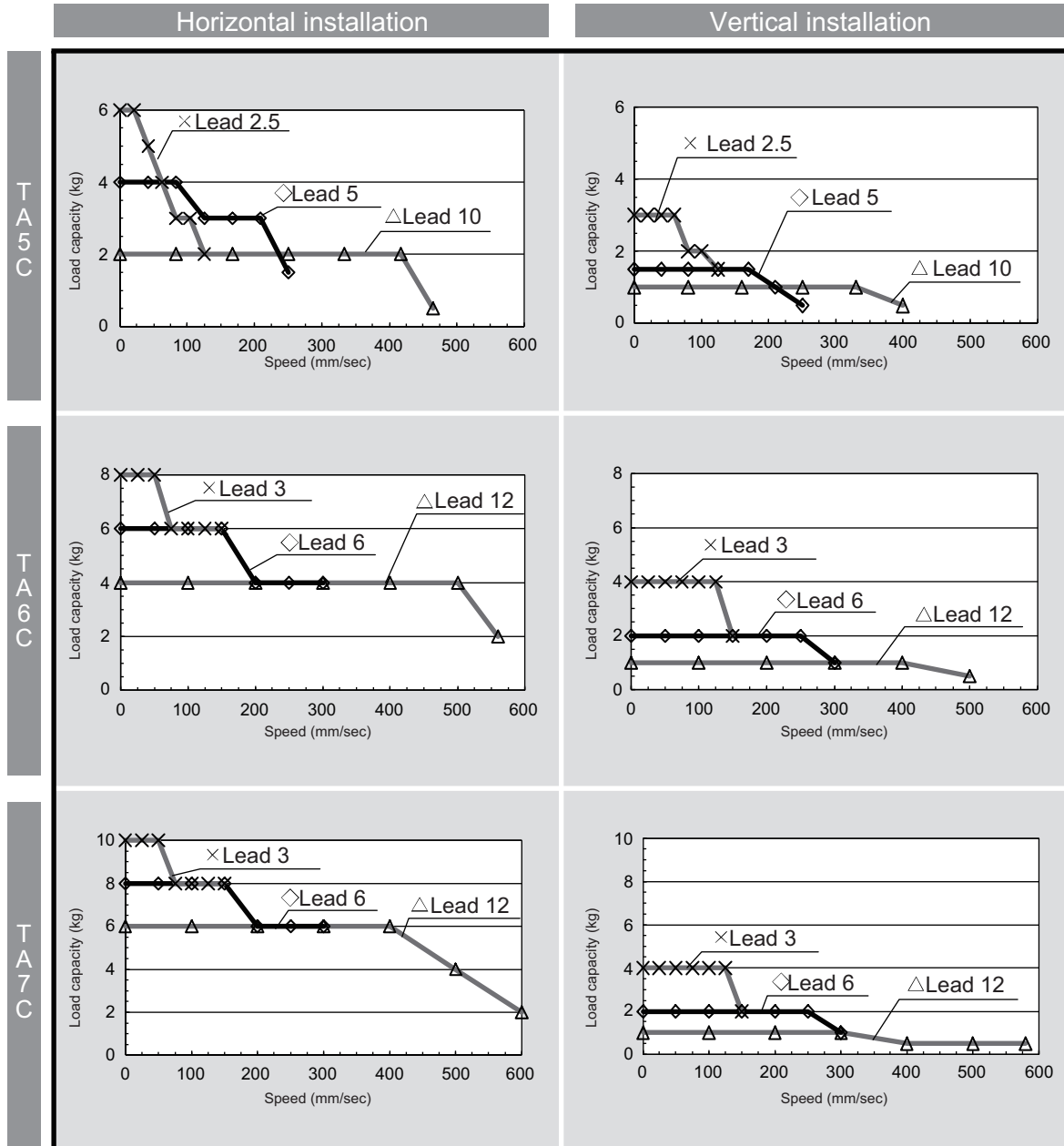

Correlation diagram of speed and loading capacity for the RCP4 slider type
(High output effective)

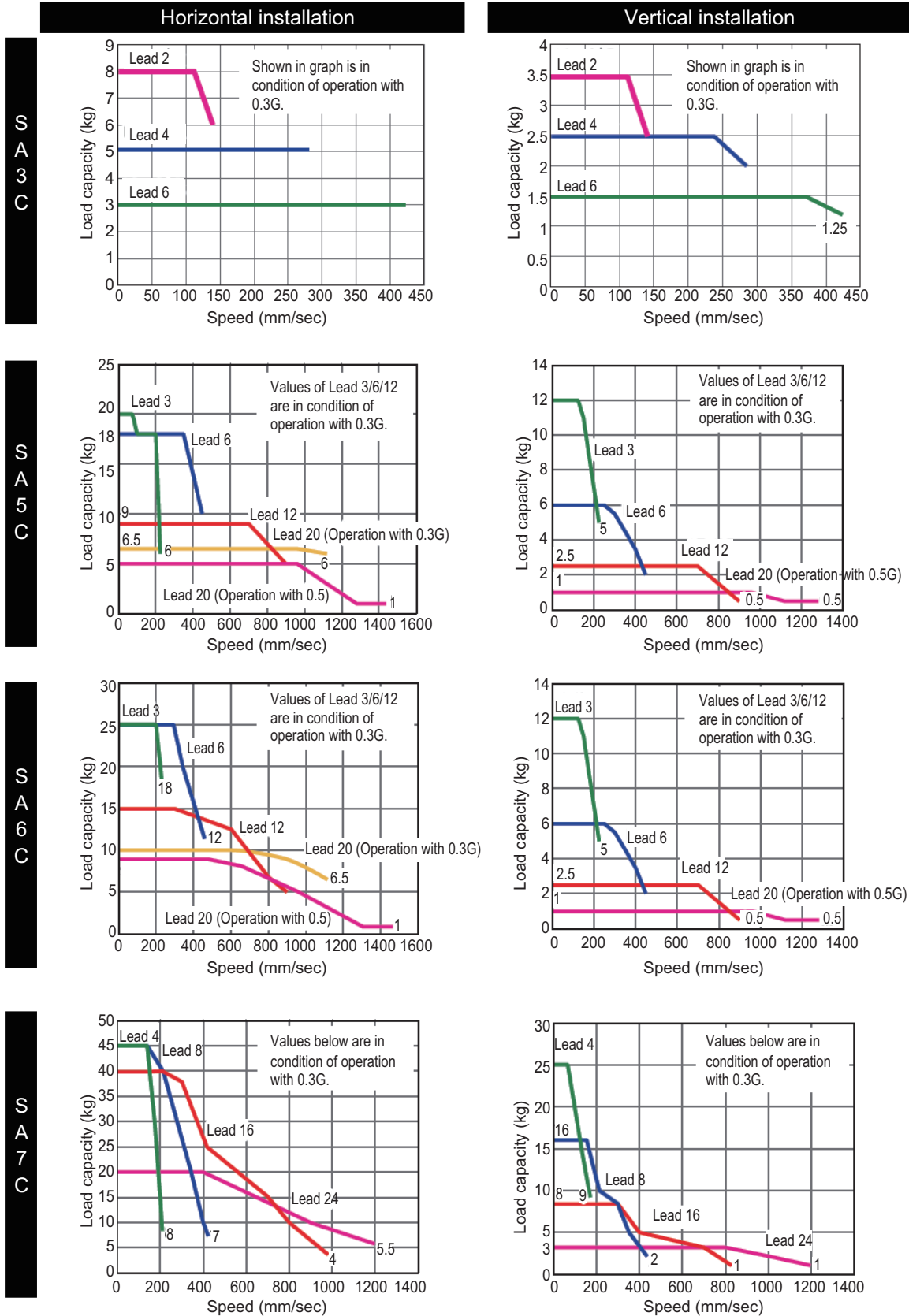

Correlation diagram of speed and loading capacity for the RCP4 slider type
(High output effective)

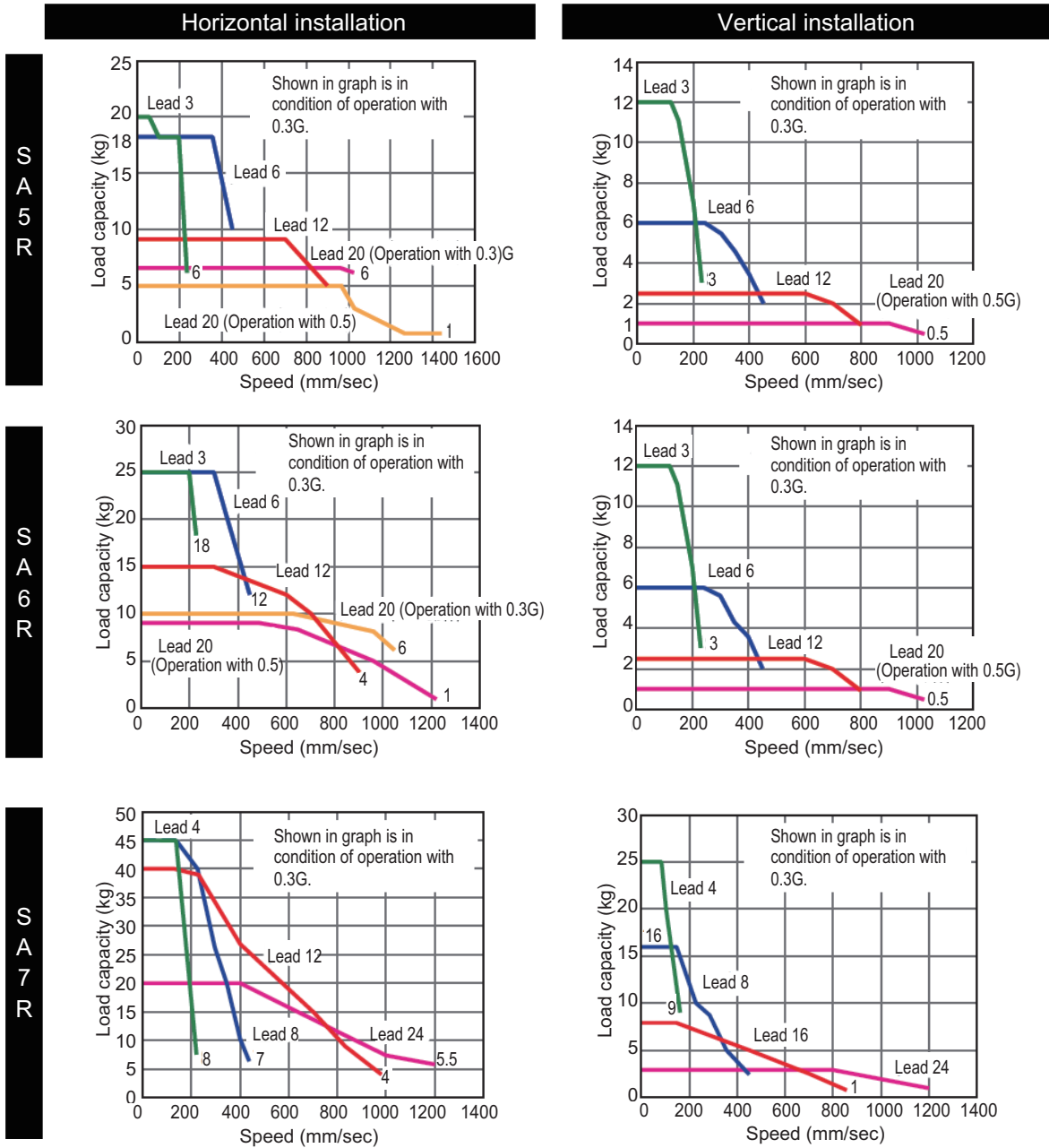

Correlation diagram of speed and loading capacity for the RCP4 rod type
(High output effective)

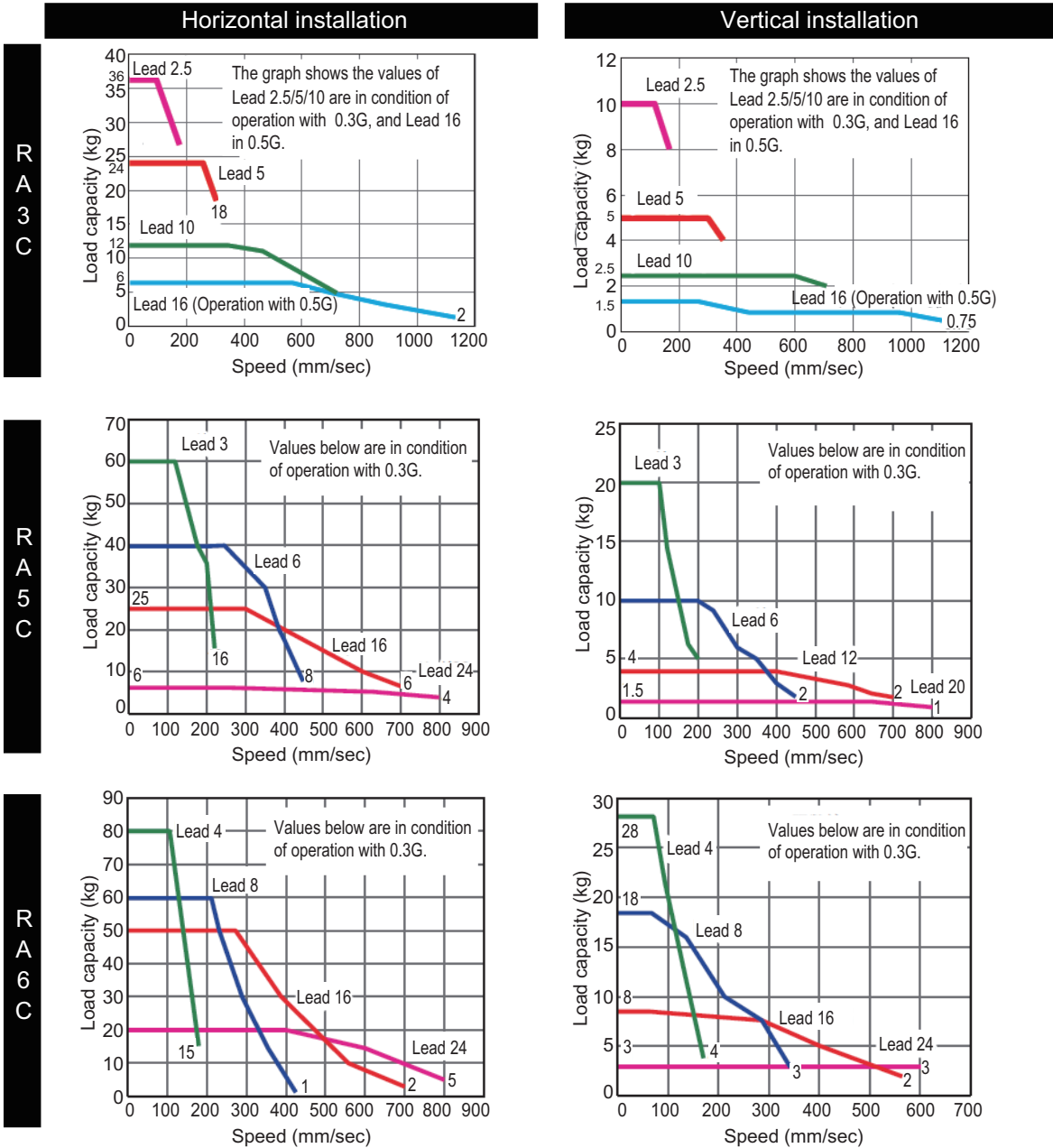

Correlation diagram of speed and loading capacity for the RCP4 rod type
(High output effective)

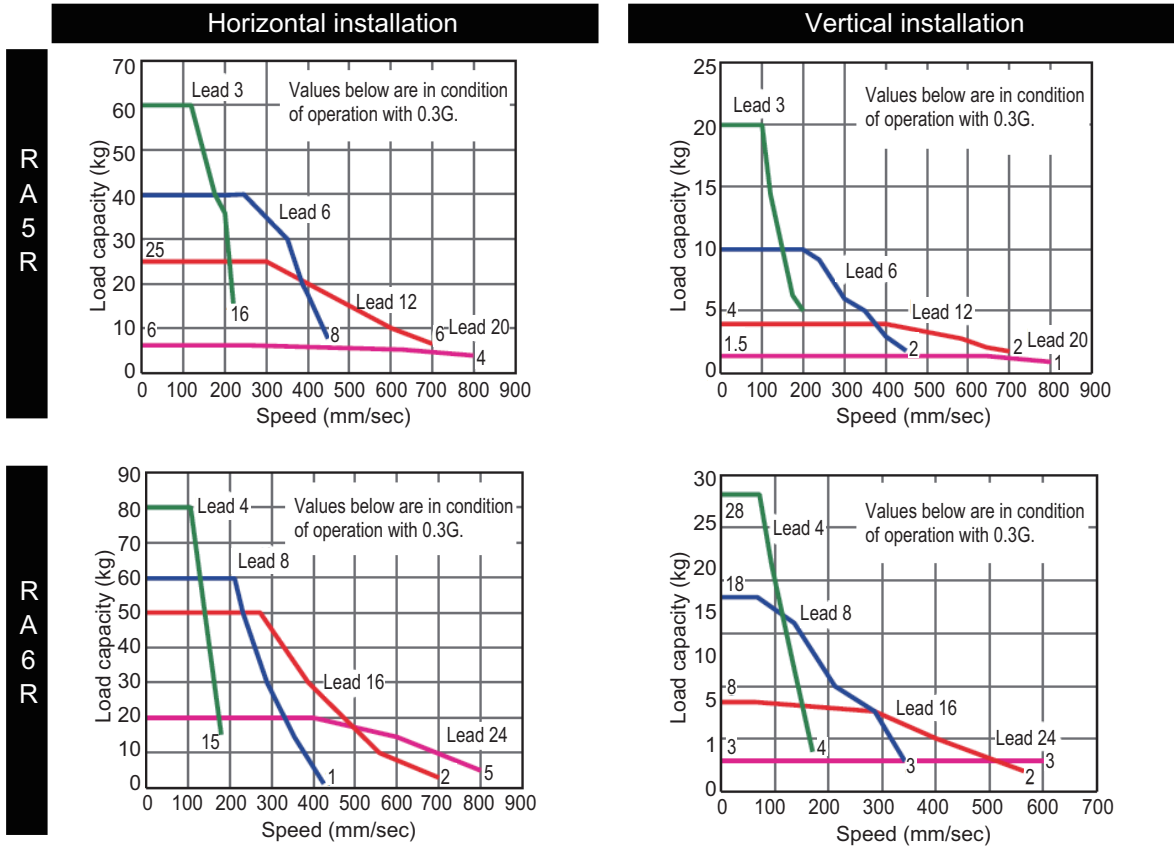

Correlation diagram of speed and loading capacity for the RCP4W rod type (High output effective)

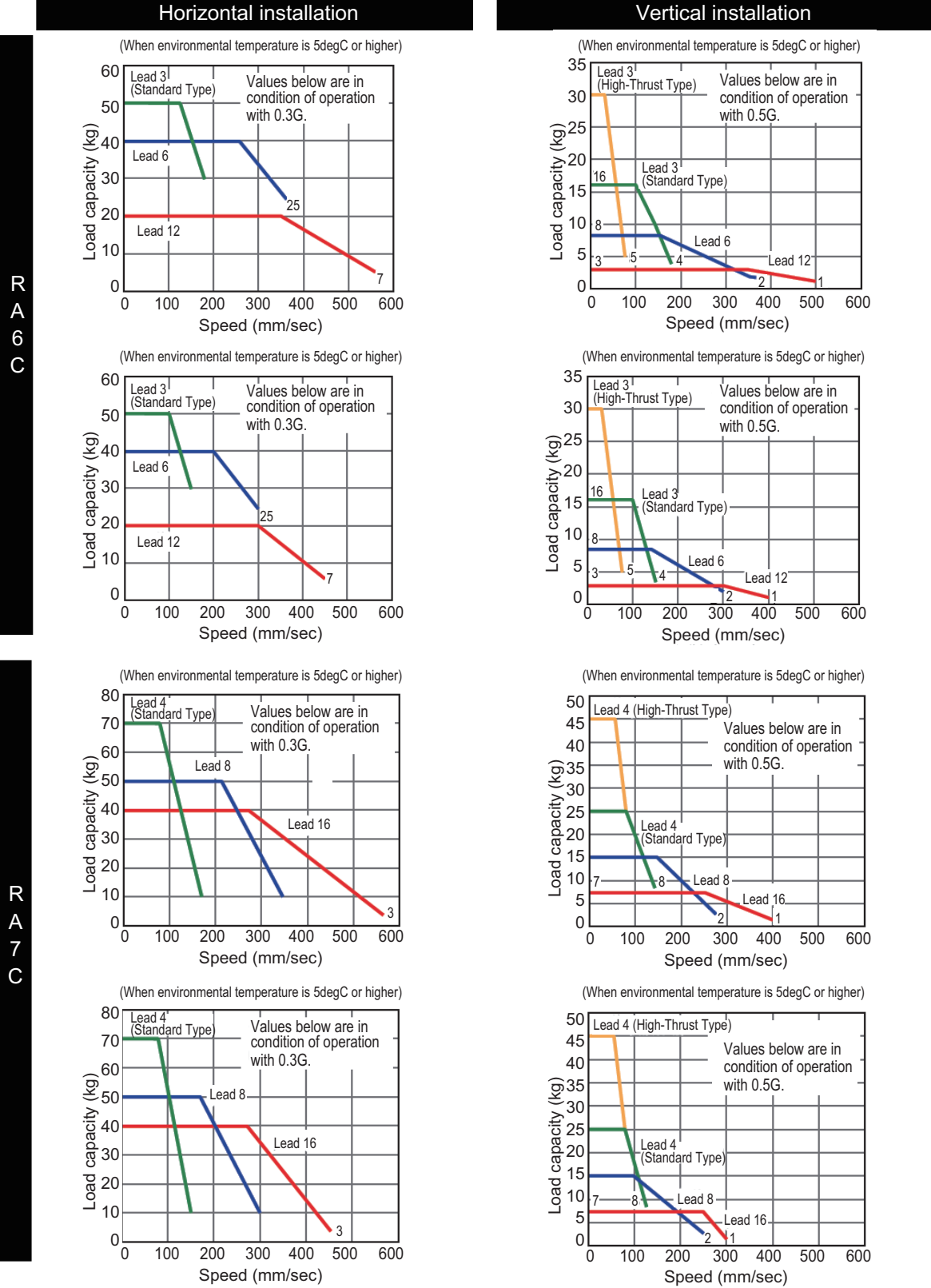

Correlation diagram of speed and loading capacity for the RCP5 slider type
(High output effective)

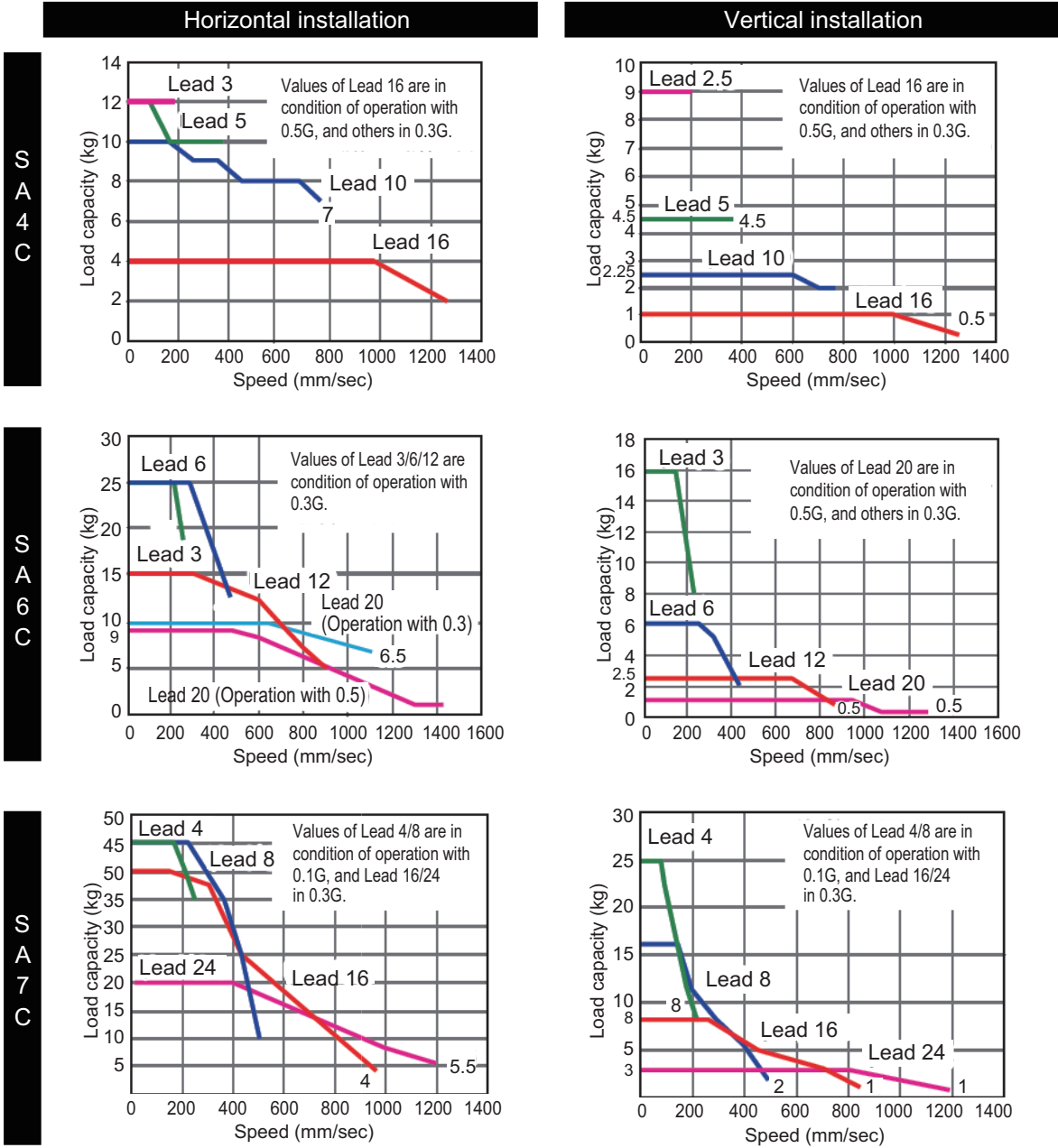

Correlation diagram of speed and loading capacity for the RCP5 rod type
(High output effective)

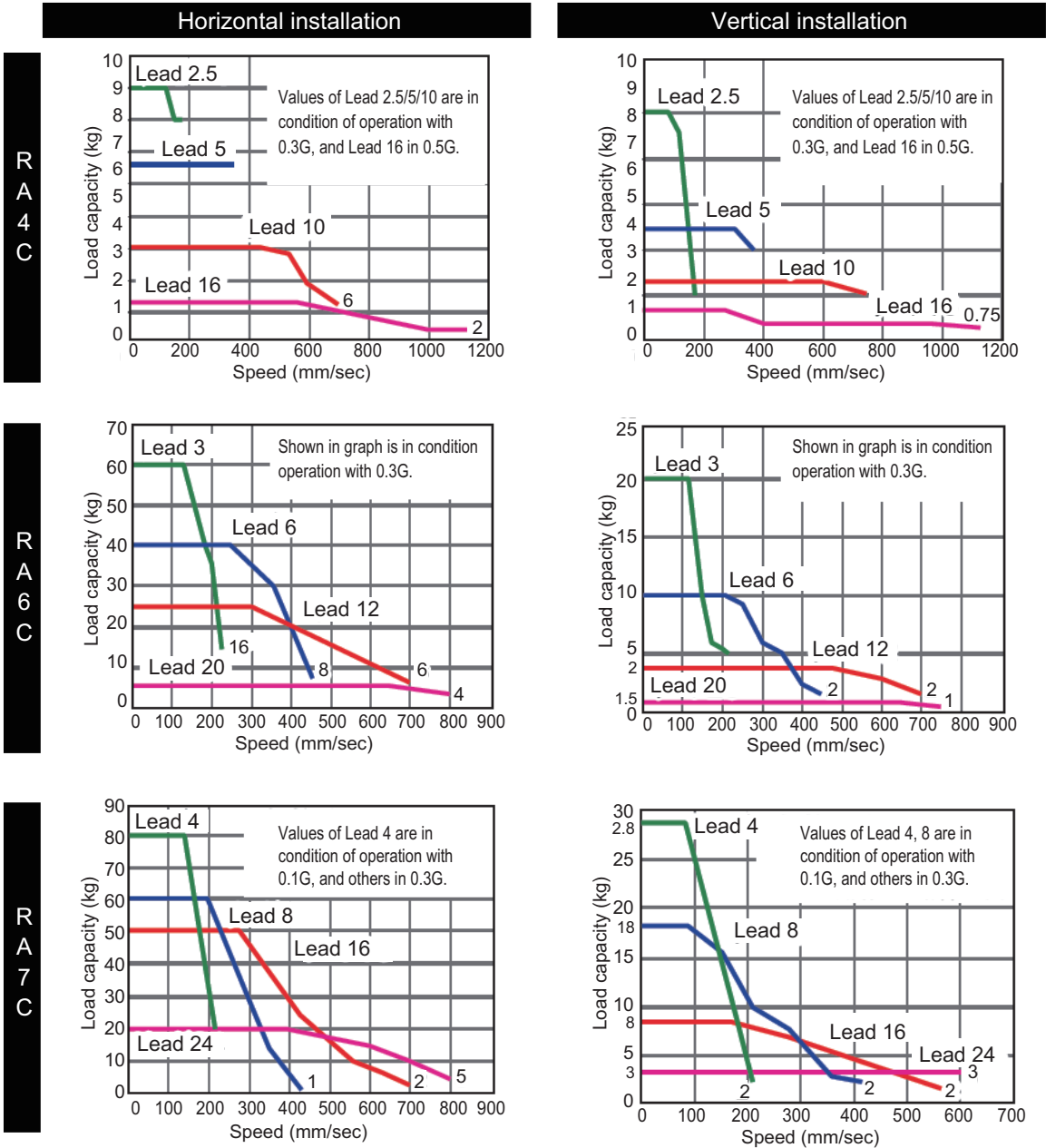

Pressing Force and Current Limit Value

⚠ Caution

- The correlation of the pressing force and the current limit value is the rated pressing speed (in the setting at the delivery) and is a reference value.
- Use the actuator with the setting above the minimum pressing force value. The pressing force will be unstable if it is below the minimum pressing force value.
- If the positioning speed setting in the operation condition is made lower than the pressing speed, the pressing speed will follow that speed, thus cannot perform the expected pressing force.

RCP2 Series

Rod Type

RA2C Type

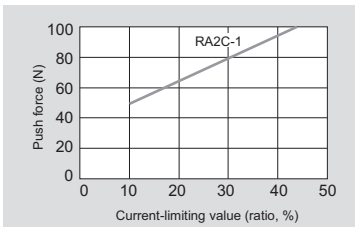

RA3C/RGD3C

RA4C/RGS4C/RGD4C

RA6C/RGS6C/RGD6C

High-speed type

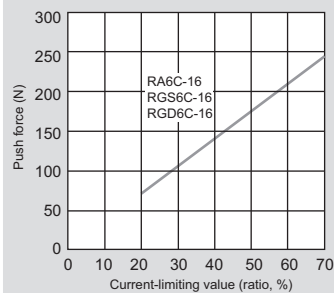
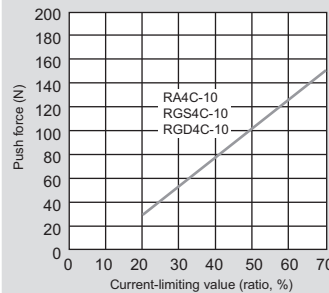

Medium-speed type

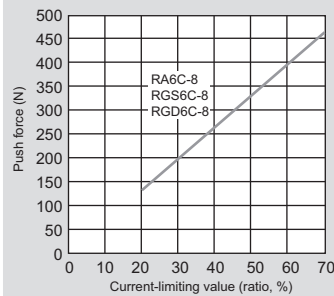
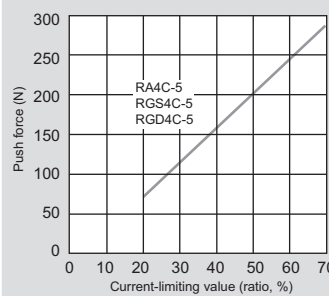
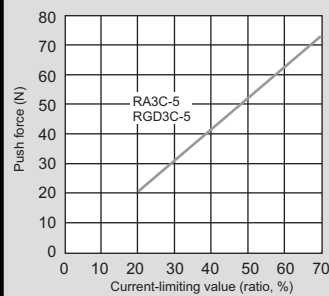

Low-speed type

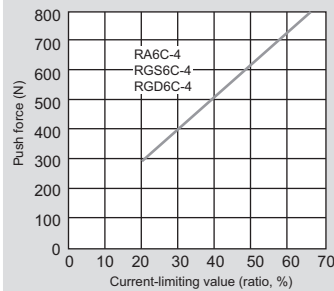
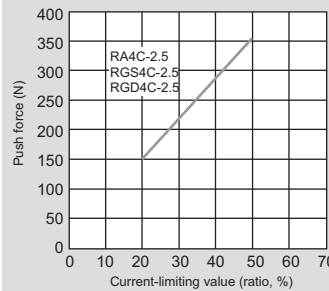
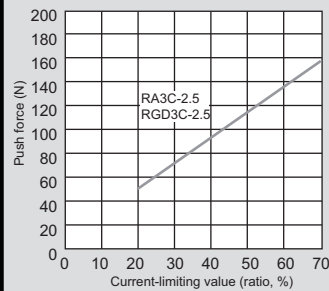

RCP2 Series

Short Type

SRA4R/SRGS4R/SRGD4R

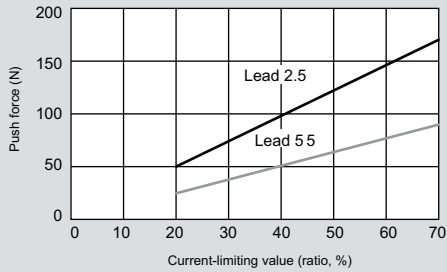

RCP2 Series

Slider Type

SA5C/SA6C/SA7C Type

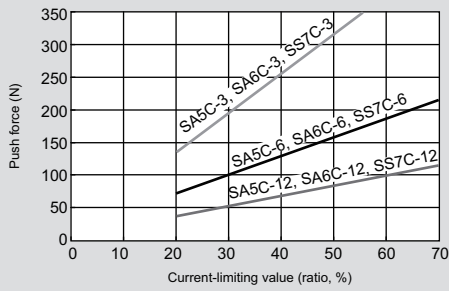

SA7C Type

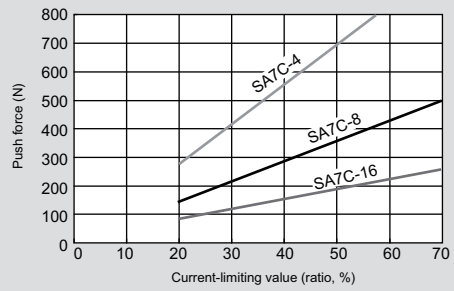

SS8C Type

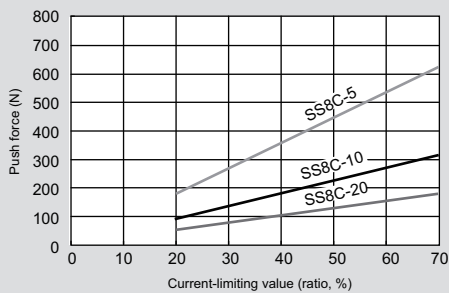

RCP2 Series

Gripper

GRSS

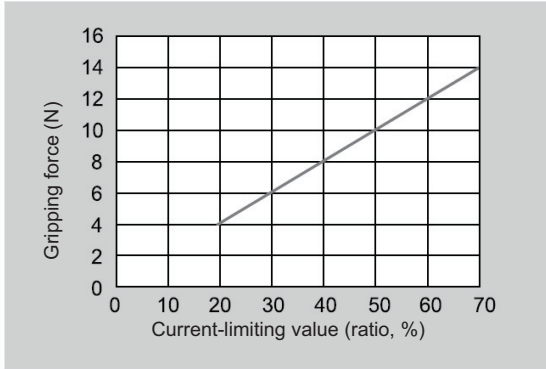

GRLS

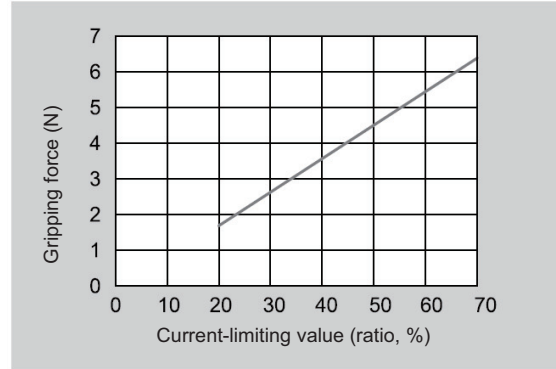

GRS

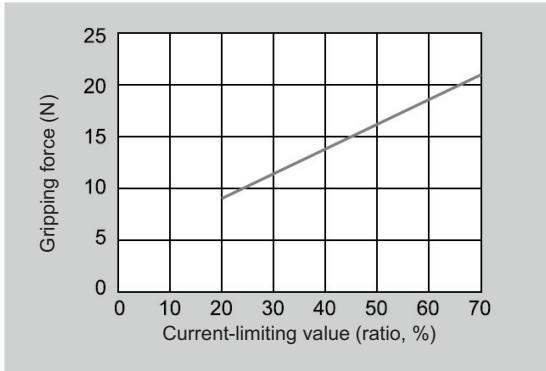

GRM

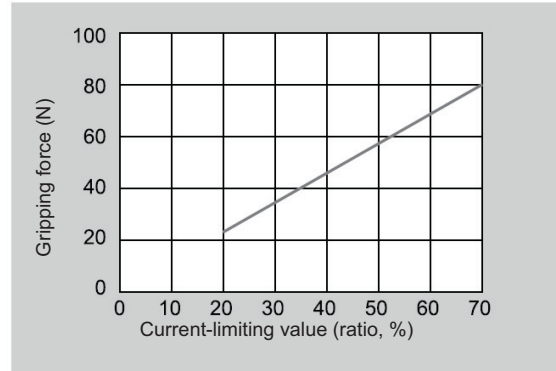

GRST

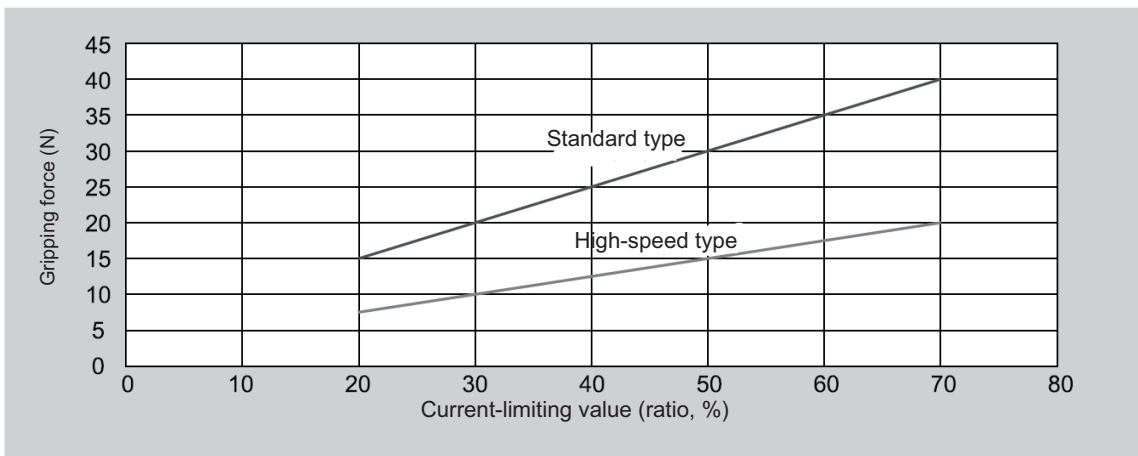

GR3LS

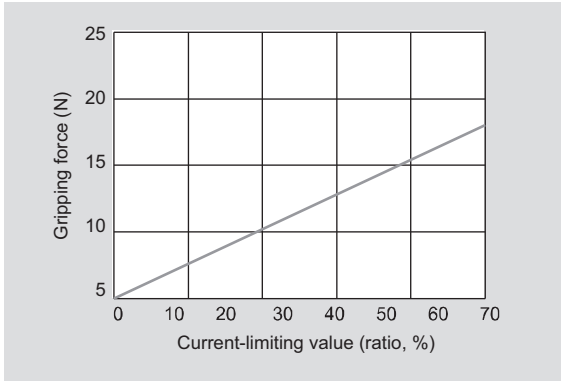

GR3LM

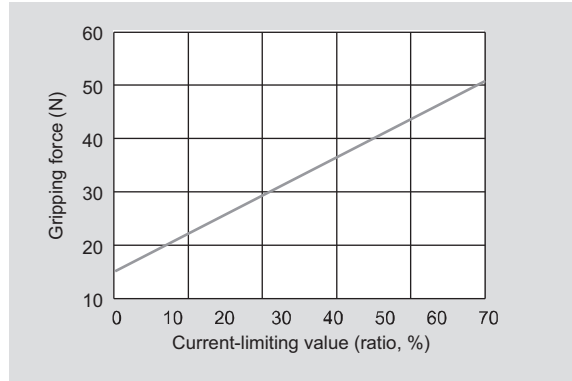

GR3SS

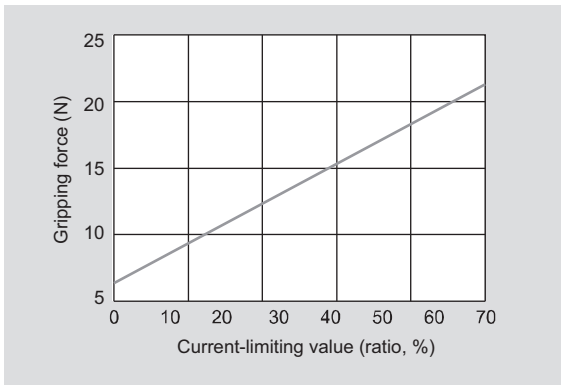

GR3SM

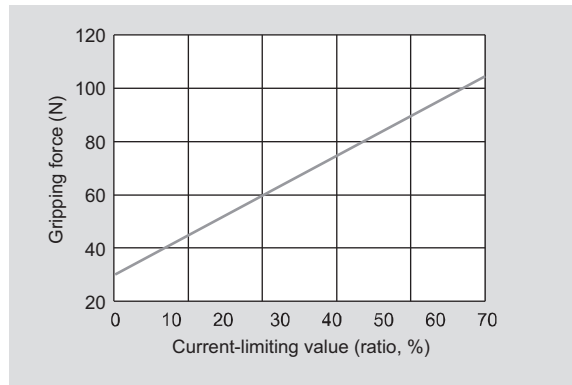

RA2AC/RA2AR Lead 1

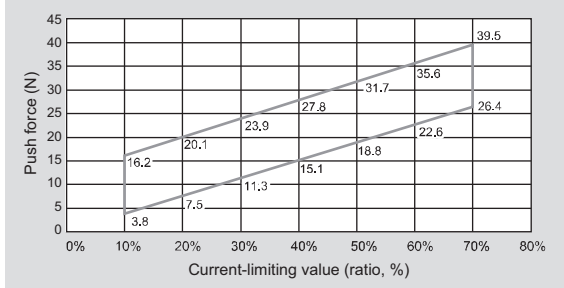

RA2BC/RA2BR Lead 2

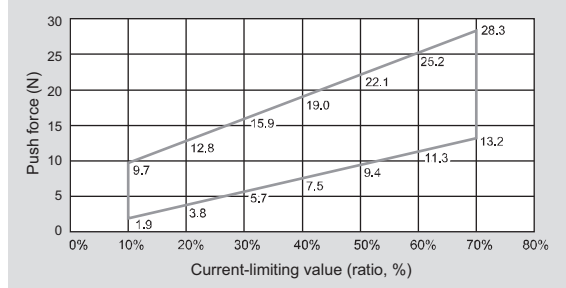

RA2AC/RA2AR Lead 2

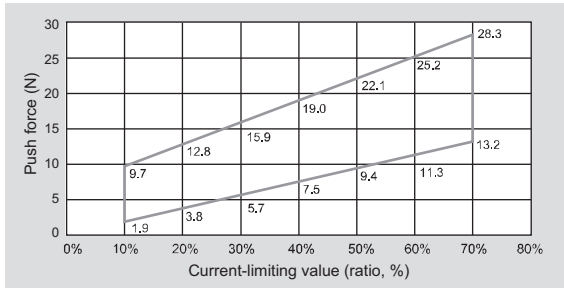

RA2BC/RA2BR Lead 4

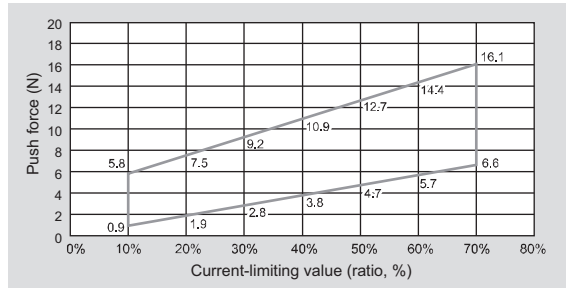

RA2AC/RA2AR Lead 4

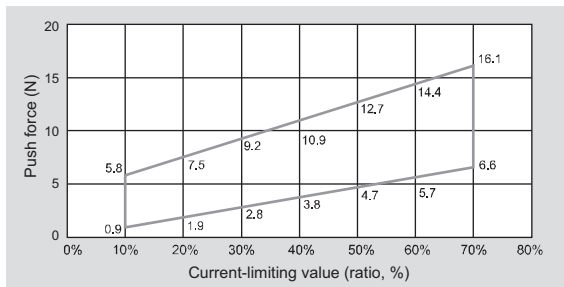

RA2BC/RA2BR Lead 6

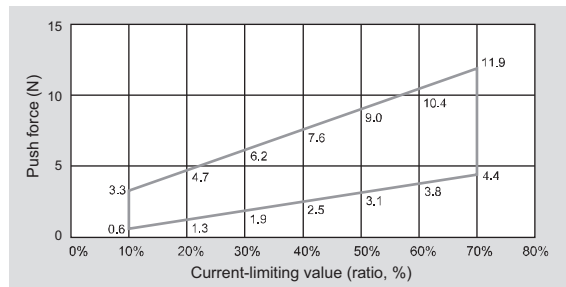

RCP3 Series Slider Type

SA3C Type

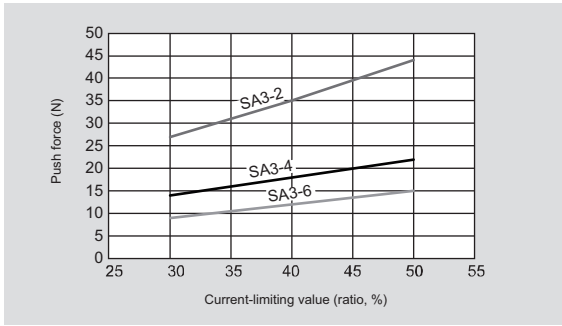

SA4C Type

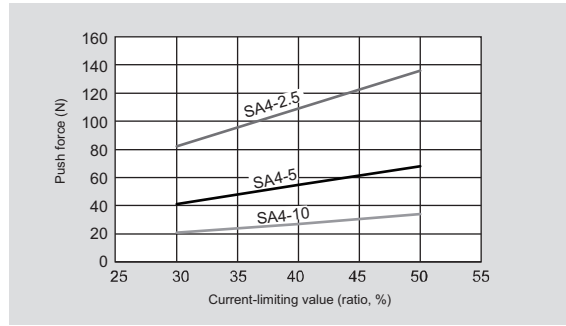

SA5C/SA6C Type

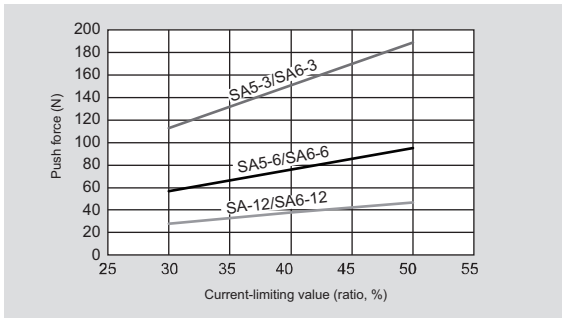

RCP3 Series Slim, Compact Table Type

TA3C/TA3R Type

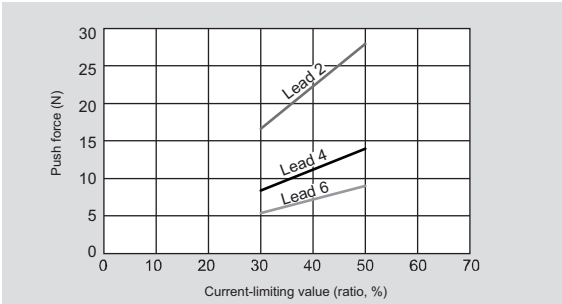

TA4C/TA4R Type

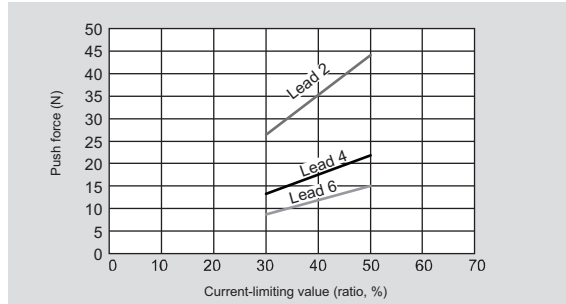

RCP3 Series Table Type

TA5C Type

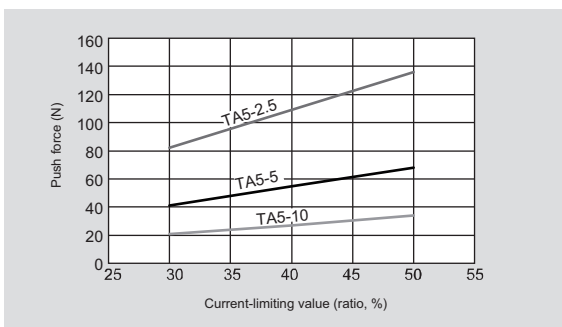

TA6C/TA7C Type

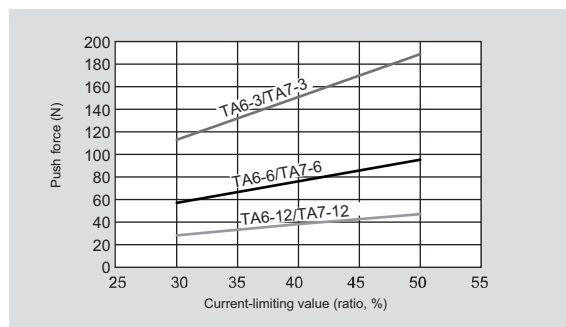

RCP4 Series

Slider Type

SA3C Type

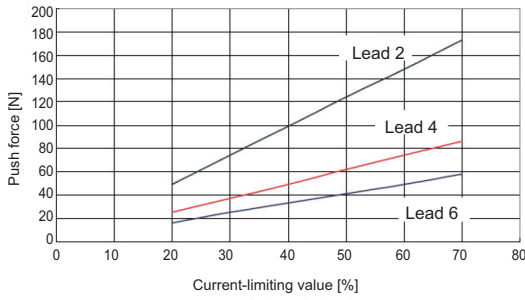

SA5C/SA6C/SA5R/SA6R Type

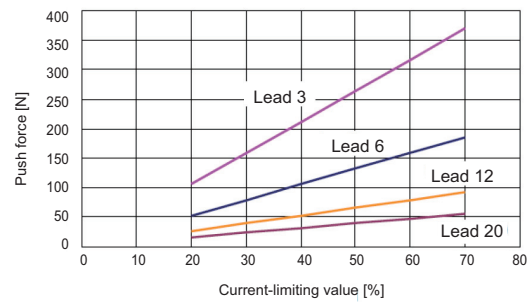

SA7C/SA7R Type

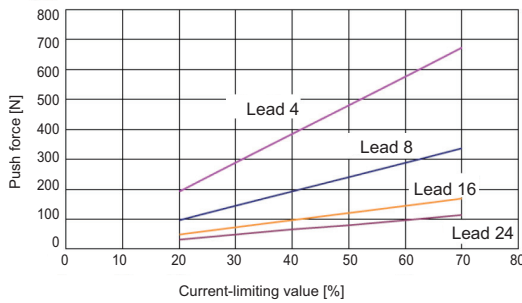

RCP4 Series

Rod Type

RA3C Type

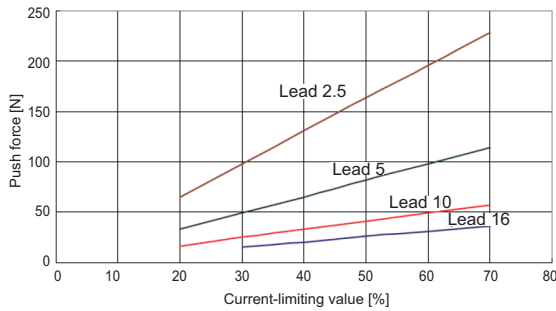

SA5C/RA5R Type

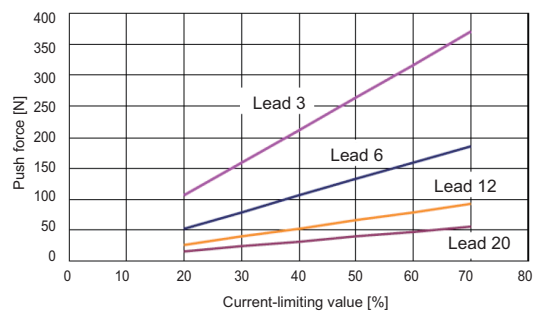

SA6C/SA6R Type

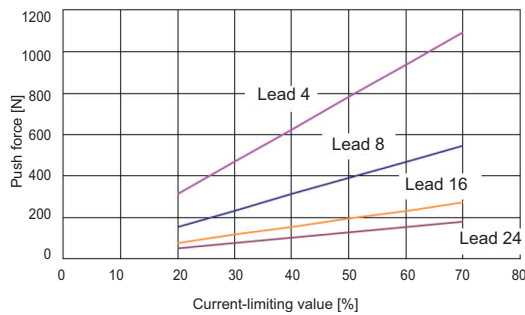

SA5C Type (42SP Motor)

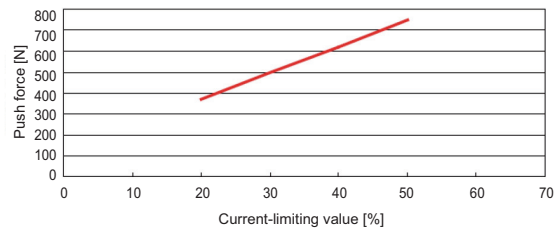

RCP4 Series Gripper Type

GRSML Type

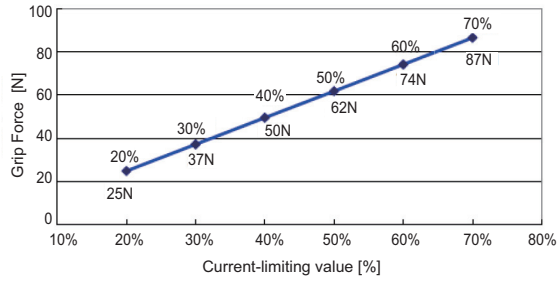

GRSLL Type

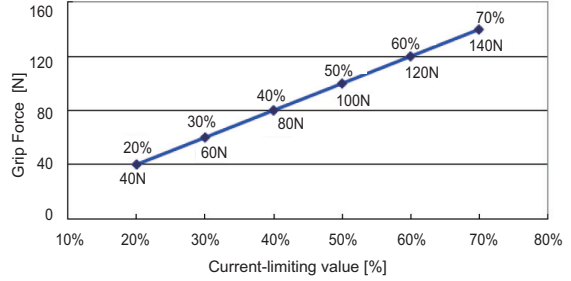

GRSWL Type

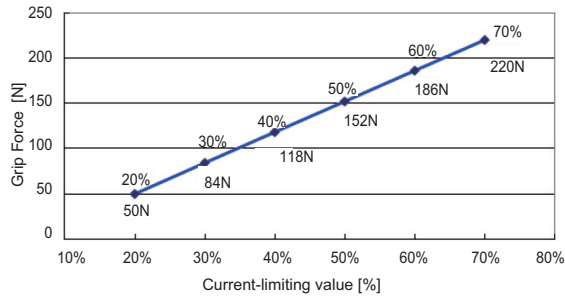

GRLM Type

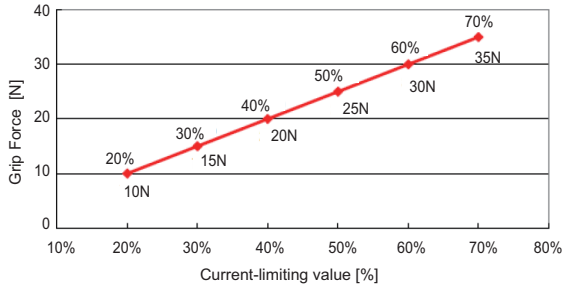

GRL Type

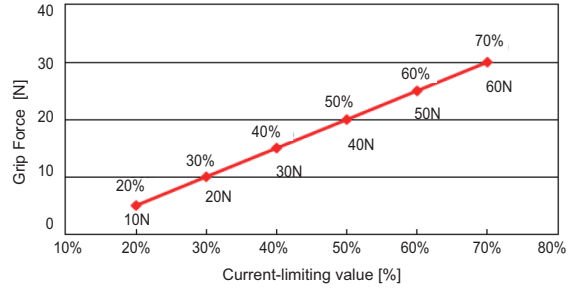

GRLW Type

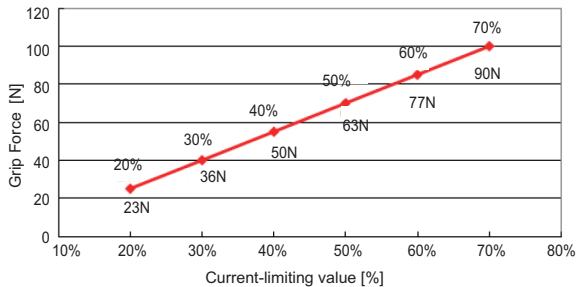

RCP4W Series

Slider Type

SA5C Type

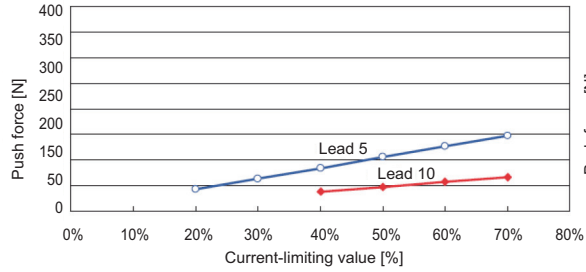

SA6C Type

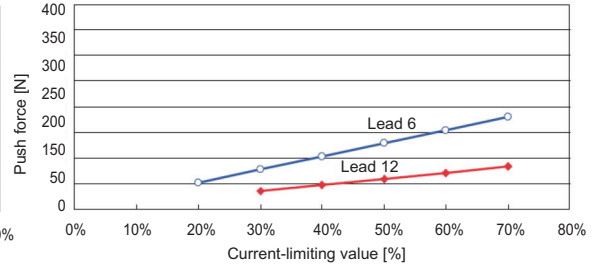

SA7C Type

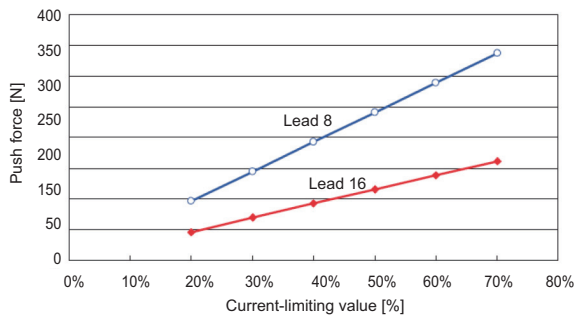

RCP4W Series

Rod Type

RA6C Lead 3

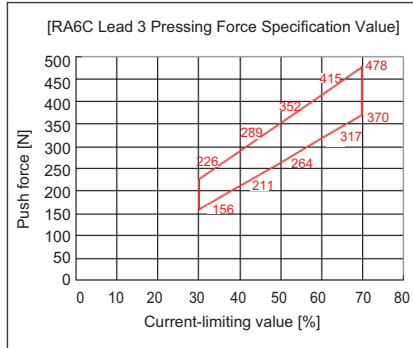

RA7C Lead 4

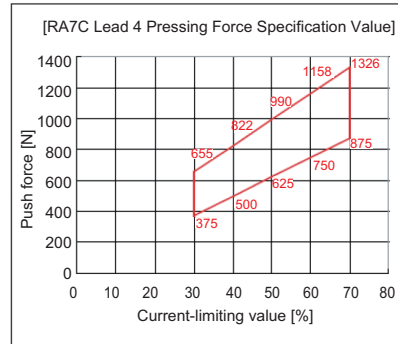

RA6C Lead 6

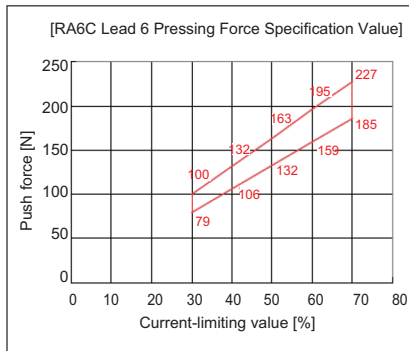

RA7C Lead 8

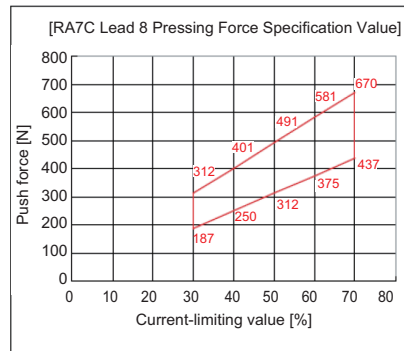

RA6C Lead 12

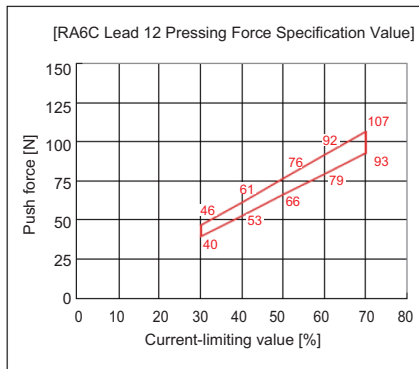

RA7C Lead 12

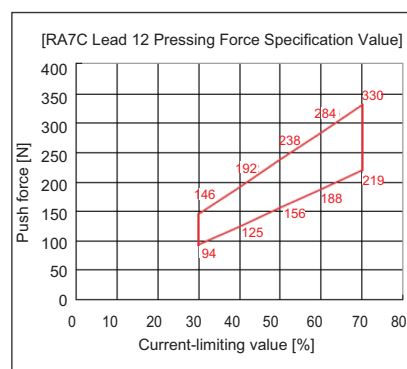

RA6C Lead 3 (High-Thrust Type : 42SP)

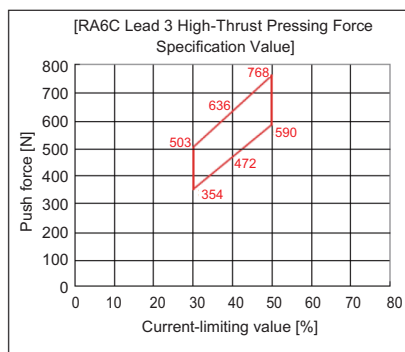

RCP5 Series

Slider Type

SA4C Type

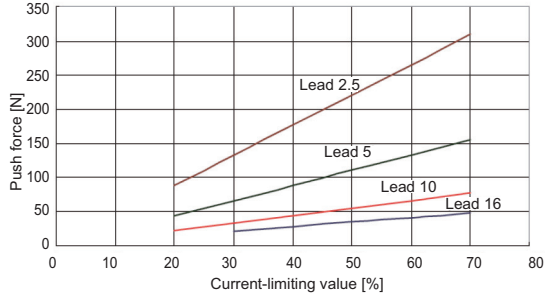

SA6C Type

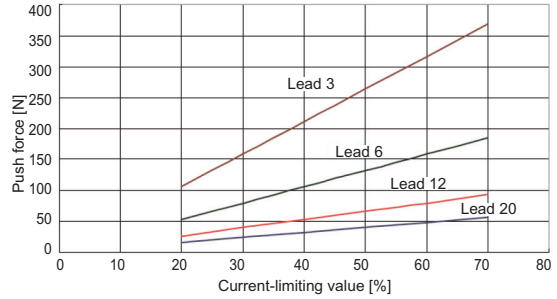

SA7C Type

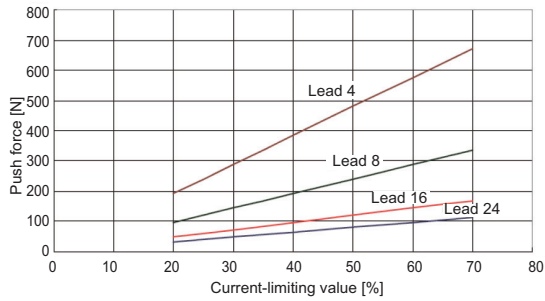

RCP5 Series

Rod Type

RA4C Type

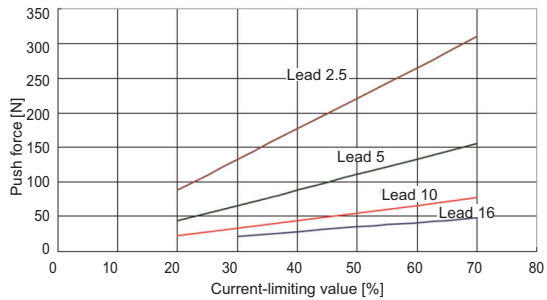

RA6C Type

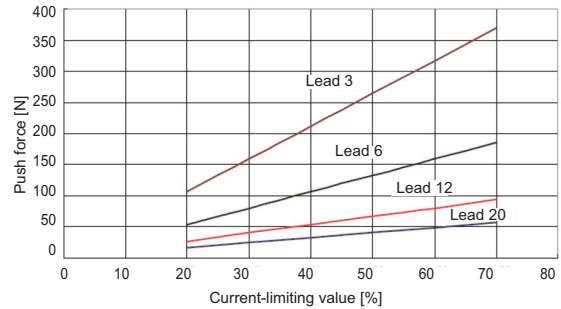

RA7C Type

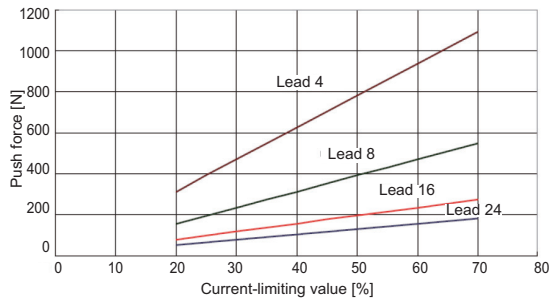

Chapter 11 Warranty

11.1 Warranty Period

One of the following periods, whichever is shorter:

- 18 months after shipment from our company
- 12 months after delivery to the specified location

11.2 Scope of the Warranty

Our products are covered by warranty when all of the following conditions are met. Faulty products covered by warranty will be replaced or repaired free of charge:

- (1) The breakdown or problem in question pertains to our product as delivered by us or our authorized dealer.
- (2) The breakdown or problem in question occurred during the warranty period.
- (3) The breakdown or problem in question occurred while the product was in use for an appropriate purpose under the conditions and environment of use specified in the operation manual and catalog.
- (4) The breakdown of problem in question was caused by a specification defect or problem, or by a quality issue with our product.

Note that breakdowns due to any of the following reasons are excluded from the scope of warranty:

- [1] Anything other than our product
- [2] Modification or repair performed by a party other than us (unless we have approved such modification or repair)
- [3] Anything that could not be easily predicted with the level of science and technology available at the time of shipment from our company
- [4] A natural disaster, man-made disaster, incident or accident for which we are not liable
- [5] Natural fading of paint or other symptoms of aging
- [6] Wear, depletion or other expected result of use
- [7] Operation noise, vibration or other subjective sensation not affecting function or maintenance

Note that the warranty only covers our product as delivered and that any secondary loss arising from a breakdown of our product is excluded from the scope of warranty.

11.3 Honoring the Warranty

As a rule, the product must be brought to us for repair under warranty.

11.4 Limited Liability

- (1) We shall assume no liability for any special damage, consequential loss or passive loss such as a loss of expected profit arising from or in connection with our product.
- (2) We shall not be liable for any program or control method created by the customer to operate our product or for the result of such program or control method.

11.5 Conditions of Conformance with Applicable Standards/Regulations, Etc., and Applications

- (1) If our product is combined with another product or any system, device, etc., used by the customer, the customer must first check the applicable standards, regulations and/or rules. The customer is also responsible for confirming that such combination with our product conforms to the applicable standards, etc. In such a case we will not be liable for the conformance of our product with the applicable standards, etc.
- (2) Our product is for general industrial use. It is not intended or designed for the applications specified below, which require a high level of safety. Accordingly, as a rule our product cannot be used in these applications. Contact us if you must use our product for any of these applications:
 - [1] Medical equipment pertaining to maintenance or management of human life or health
 - [2] A mechanism or mechanical equipment intended to move or transport people (such as a vehicle, railway facility or aviation facility)
 - [3] Important safety parts of mechanical equipment (such as safety devices)
 - [4] Equipment used to handle cultural assets, art or other irreplaceable items
- (3) Contact us at the earliest opportunity if our product is to be used in any condition or environment that differs from what is specified in the catalog or operation manual.

11.6 Other Items Excluded from Warranty

The price of the product delivered to you does not include expenses associated with programming, the dispatch of engineers, etc. Accordingly, a separate fee will be charged in the following cases even during the warranty period:

- [1] Guidance for installation/adjustment and witnessing of test operation
- [2] Maintenance and inspection
- [3] Technical guidance and education on operating/wiring methods, etc.
- [4] Technical guidance and education on programming and other items related to programs

Change History

Revision Date	Revision Description
2015.09	First Edition
2016.01	1B Edition <ul style="list-style-type: none"> • Revising of applicable teaching tools • Revising of cable lengths • Change made to selection method for pressing CON/SEP system • Correction made to writing error
2016.04	1C Edition <ul style="list-style-type: none"> • Applicable for RCP6 and TB-02/TB02D (except for 10.4) • Applicable connection cable model codes revised in 2.2 [2] • Correction made to explanation for JOG speed in direct indication mode in 3.4.6, 3.7.1 and 8.2 • Parameter initial value revised in 8.1 and 8.2 • Correction made to explanation for Parameter No. 143 (Overload Level Ratio) in 8.2 [57] • Correction made to writing error
2016.05	Second Edition <ul style="list-style-type: none"> • Applicable for SSCNET
2016.06	2B Edition <ul style="list-style-type: none"> • Applicable for CE mark/UL standards • Applicable for MECHATROLINK-III • “12. Motor Features in AUTO Mode” added in caution notes • 1.1.1 Volume column added in 1.1.1 Components • 10.4 Correction made to note regarding connection to RCP2-SA7C/SA7R (connection not available) • Correction made to writing error



IAI Corporation

Head Office: 577-1 Obane Shimizu-KU Shizuoka City Shizuoka 424-0103, Japan
TEL +81-54-364-5105 FAX +81-54-364-2589
website: www.iai-robot.co.jp/

Technical Support available in USA, Europe and China

IAI America, Inc.

Head Office: 2690 W. 237th Street, Torrance, CA 90505
TEL (310) 891-6015 FAX (310) 891-0815
Chicago Office: 110 East State Parkway, Schaumburg, IL 60173
TEL(847) 908-1400 FAX (847) 908-1399
Atlanta Office: 1220 Kennestone Circle, Suite 108, Marietta, GA 30066
TEL (678) 354-9470 FAX (678) 354-9471
website: www.intelligentactuator.com

IAI Industrieroboter GmbH

Ober der Röth 4, D-65824 Schwalbach am Taunus, Germany
TEL 06196-88950 FAX 06196-889524

IAI (Shanghai) Co., Ltd.

SHANGHAI JIAHUA BUSINESS CENTER A8-303, 808, Hongqiao Rd. Shanghai 200030, China
TEL 021-6448-4753 FAX 021-6448-3992
website: www.iai-robot.com

IAI Robot (Thailand) Co., Ltd.

825, PhairojKijja Tower 12th Floor, Bangna-Trad RD., Bangna, Bangna, Bangkok 10260, Thailand
TEL +66-2-361-4458 FAX +66-2-361-4456