

THE DENTAL  
SOLUTIONS  
COMPANY™



# See more with certainty

Dentsply Sirona Imaging Solutions for Orthodontics

[dentsplysirona.com](https://dentsplysirona.com)



# Changing the face of Orthodontics

Digital integration, ever decreasing radiation levels, and increasingly enlightened patients are all factors that influence how you practice each and every day. With imaging systems from Dentsply Sirona you can rely on experience that provides you with peace of mind and provides your patients with safe, high-quality care. Dentsply Sirona has been a pioneer in the field of dental X-rays for more than 125 years, establishing new methods and innovations in imaging - ones that will allow you to face your daily challenges efficiently and in an improved way.

## The right system for today's orthodontic practice. More than X-rays

Pure imaging is no longer enough. Of course, image quality is key when it comes to modern X-ray systems, because the quality of the clinical X-ray data is the basis for the following diagnosis and treatment. CBCTs are essential for support in a number of orthodontic treatments, providing relevant diagnostic information for indications such as: avoiding periodontal problems by checking the available space in the alveolar ridge, evaluation of palatal suture maturation for decisions on palatal expansion, and position of impacted teeth, to name just a few amongst a vast number of other treatment offerings and benefits. If you can't see it, you can't diagnose and treat it, which is why Dentsply Sirona extraoral imaging devices provide high-quality X-rays at the lowest reasonable dose to give both you and your patient the support you need and deserve.

## The advantages at a glance

- Informed treatment planning based on CBCT image information, helping to foresee and avoid clinical complications during treatment.
- 3D images in the dose of a 2D X-ray. A broader overview of the clinical situation without additional radiation exposure.
- Excellent image quality to support treatment analysis
- Optimized workflows: Valuable time saved by reducing the need to switch between different X-ray softwares.

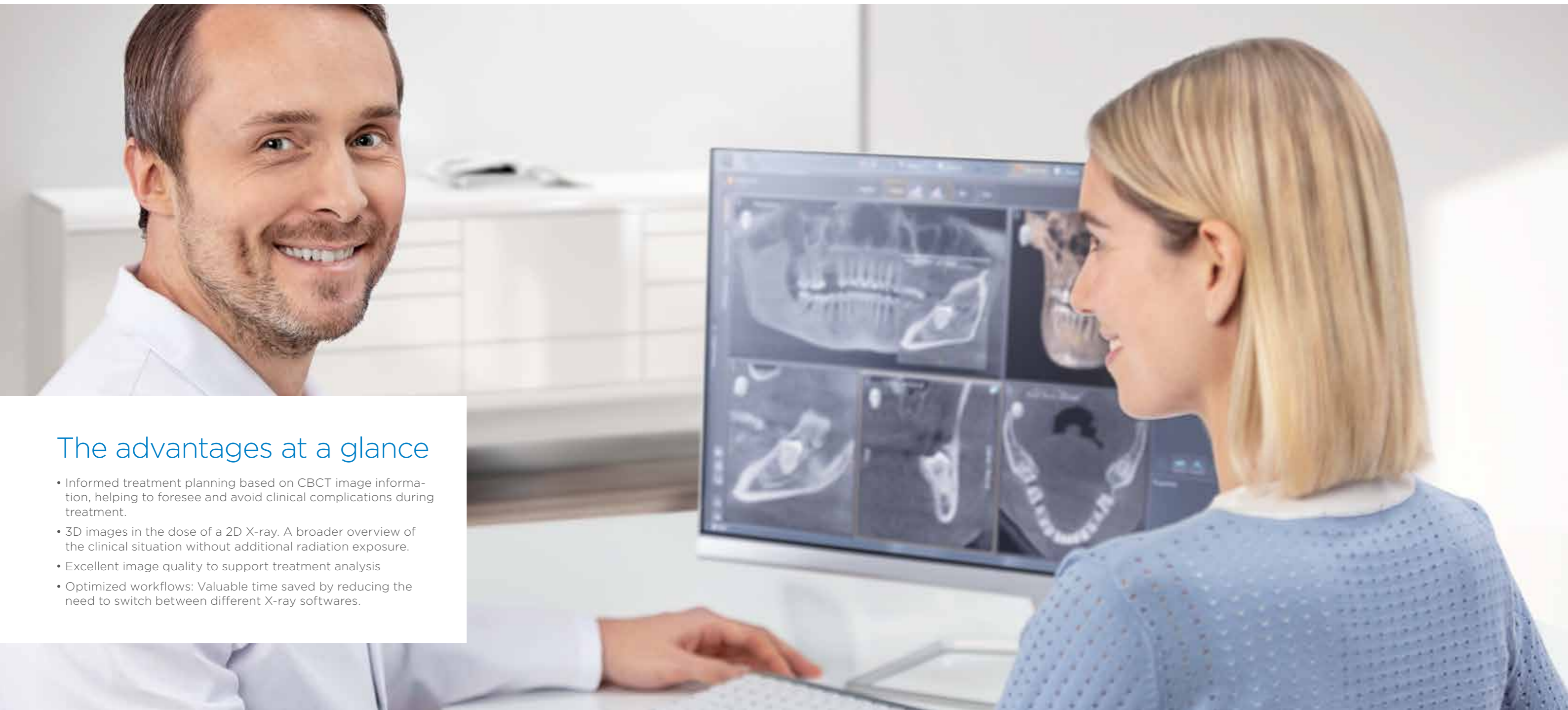

## The third dimension makes the difference – with Low Dose CBCT images in the dose range of a 2D X-ray

Diagnostic information based on CBCT images in the dose range of a 2D X-ray – this is made possible by the Low Dose mode. Its optimized pre-filtering enables the imaging of dense structures, such as bones, at a greatly reduced dose and can therefore, be used easily and efficiently for many clinical situations.

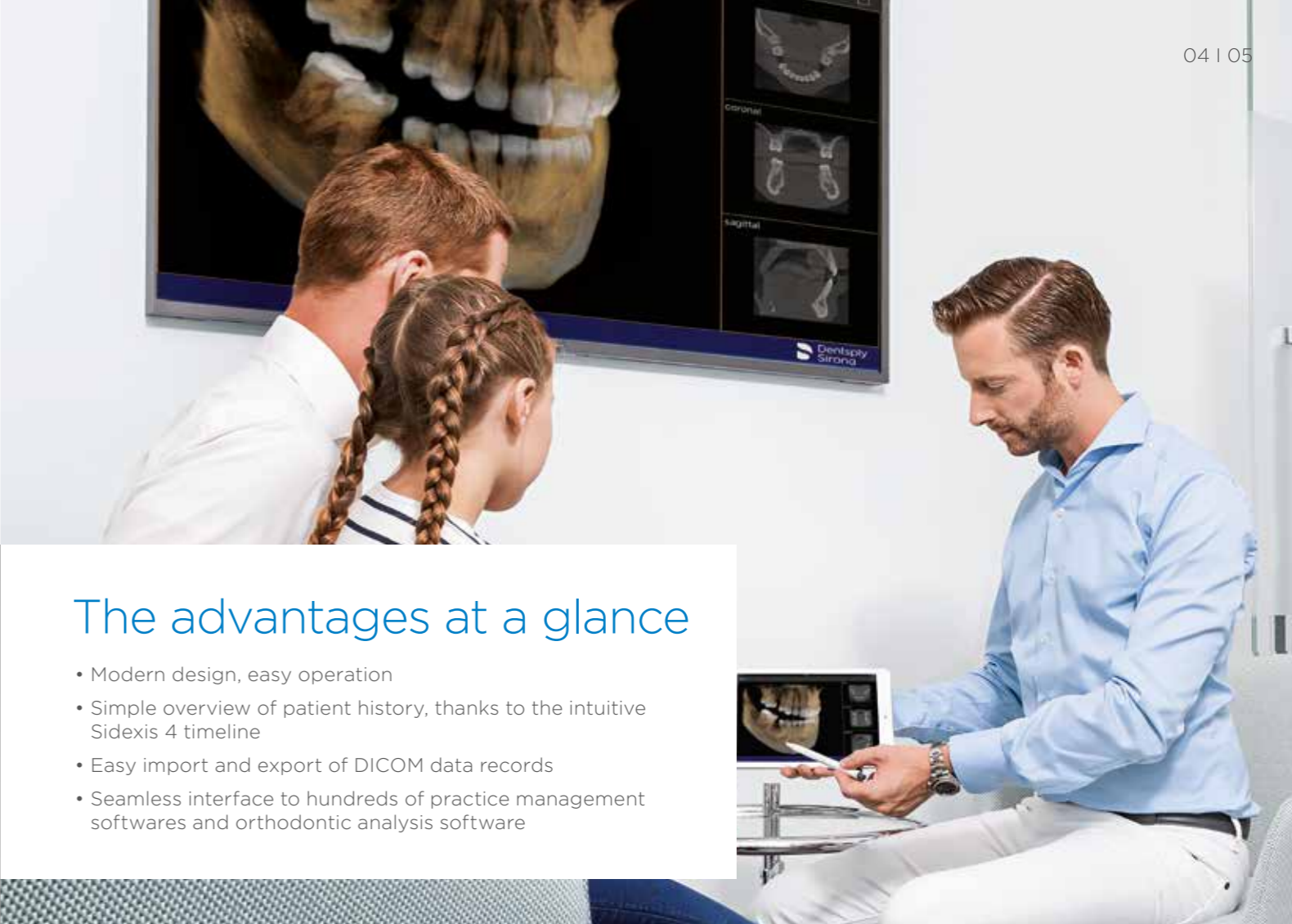

### The advantages at a glance

- Modern design, easy operation
- Simple overview of patient history, thanks to the intuitive Sidexis 4 timeline
- Easy import and export of DICOM data records
- Seamless interface to hundreds of practice management softwares and orthodontic analysis software

### Sidexis 4 – Optimum Workflow with a clear structure

Whether 2D or 3D – brilliant images only become optimally visible in the corresponding software. The intelligent imaging software, Sidexis 4, provides support during diagnosis. With its award-winning user interface, it is easy to use and saves valuable time. All the while, your patients feel safe and well-informed; a strong basis for trust.

#### More possibilities with security

Once you have completed your diagnosis, Sidexis 4 offers you the opportunity to choose from a variety of treatment planning solutions, which can be directly integrated within the software. In addition, Sidexis 4 communicates via the open and free SLIDA interface with all common practice management programs, so that the manual duplication of entries is no longer necessary.

Of course, the further use of your images in analysis and planning software is also quick, easy and comfortable, thanks to the ability to forward images automatically or with a single click to specific programs.

#### Application examples for Low Dose

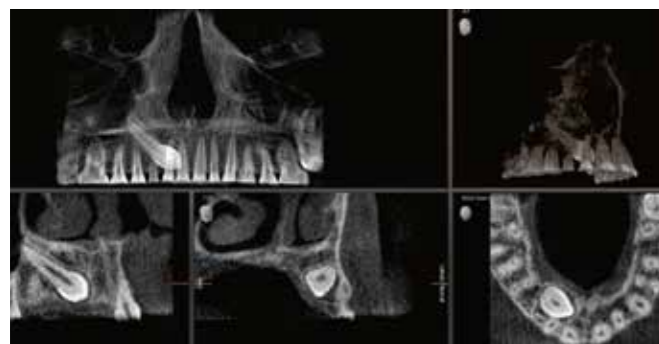

Localization of displaced incisor Ø 5 cm x 5.5 cm at 3 µSv.

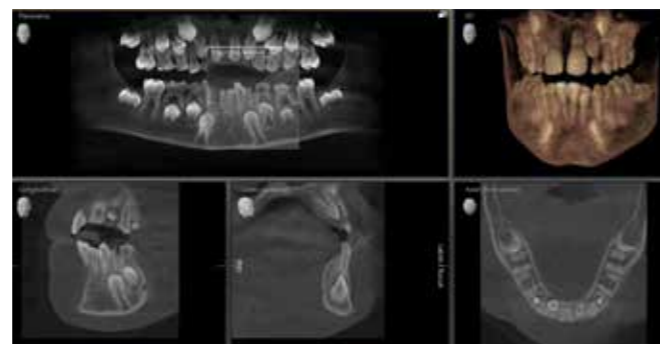

Tooth position determination Ø 8 cm x 8 cm at 8 µSv.

## Because dose matters

There is a fundamental conflict of interest in dental X-ray imaging. On the one hand, it is important to achieve the best possible image quality to ensure reliable diagnostic findings, on the other hand the radiation exposure should be as minimal as possible for the patient. At Dentsply Sirona we have made it our business to achieve the best image quality at the lowest reasonable dose at all times. The Dentsply Sirona extraoral imaging family of products are based on the ALARA principle (As Low As Reasonably Achievable) and offers numerous possibilities for dose reduction.

### QuickShot

It reduces the exposure time and dose of panoramic and cephalometric programs. This facilitates, for example, working with children in panoramic and cephalometric images.



### 3D Low Dose

The optimized Low Dose mode with a dedicated copper filter allows for the imaging of dense structures, e.g. bone, in the dose range of a 2D X-ray. With the 3D modes in the Axeos and Orthophos family, you decide on a case-by-case basis whether you use high-resolution volumes to display fine structures (HD) or a low-dose image with a minimal dose.

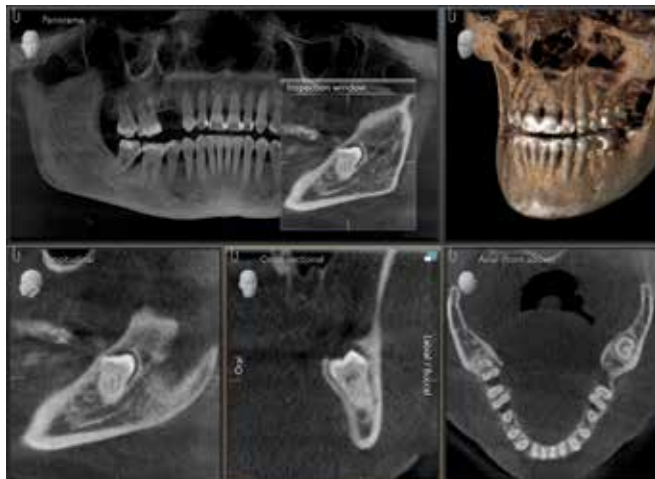

### Extraoral Bitewing

With Axeos and Orthophos models, you can use the bitewing function to create extraoral bitewing images with a lower dose and X-ray beam angulation for the posterior tooth region. With this program selection you can focus on the area of interest.

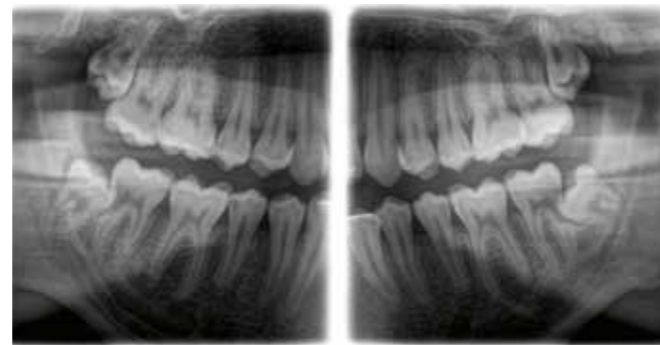

### Dedicated programs for young patients

This panoramic program is adapted to the anatomy of young patients. For dose reduction, it is reduced horizontally and vertically and provides a high degree of image sharpness.



## See more: Better images, better diagnostic accuracy.

Dentsply Sirona imaging devices score points in practices around the world with their innovative technological features and precise images. All programs and recording parameters are adapted to the specific diagnostic tasks and offer you more possibilities.

### DCS - Sharpness for fine details

The Direct Conversion Sensor (DCS)\* has redefined the standard of panoramic imaging. X-rays are converted directly into electrical signals - unlike conventional systems, there is no signal loss due to light conversion. This means an improved image information output for you. The result is images with a high level of sharpness - even at a low dose.

### Autofocus

To achieve a sharp and undistorted panoramic image, the jaw must be correctly positioned in the sharp image layer of the device. Which is why the Orthophos creates several thousand individual images in one rotation and automatically recognizes the areas in which the jaw is optimally positioned. These selected areas are then displayed in an overall sharp image - without any manual intermediate steps.



Panoramic image with conventional sensor technology. Axeos and Orthophos SL with DCS sensor technology.

### MARS -Metal Artifact Reduction Software

Metal artifacts can often provide challenges in 3D X-ray imaging. MARS helps to minimize this by automatically reducing metal artifacts. At Dentsply Sirona, MARS is automatically included in all 3D solutions.

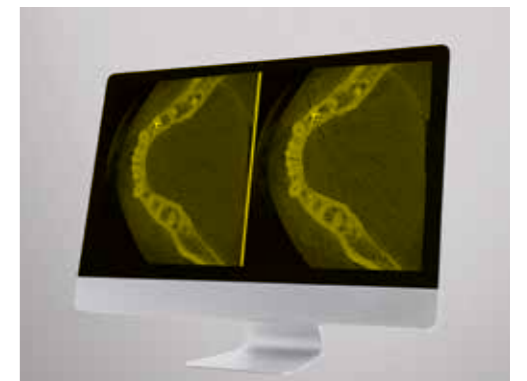

\* Only with Axeos and Orthophos SL.

## Axeos

### The specialist system: 2D/3D hybrid device

Axeos – the 2D/3D specialist system with a large volume and high image quality for practices with a broad treatment offering. Developed together with both specialized and general practitioners, Axeos provides the fullest range of functions out of all of the Dentsply Sirona extraoral X-ray systems. In addition to excellent image quality and tailor-made 3D volume sizes, the design was also heavily focused on the optimization of patient comfort. Axeos not only provides quality in performance and comfort, but also design, thanks to its integrated biteblock accessory cabinet and ambient light.

### The advantages at a glance

- Orthodontic indications and planning of orthognatic surgeries are covered by the FoVs from 5x5,5 to 17x13
- Low Dose enables 3D images in the dose range of 2D X-rays
- DCS sensor with autofocus function for outstanding HD images with high sharpness in the panorama area
- Comprehensive panoramic and cephalometric programs for bitewing, sinus or ceph images, and an optional left or right cephalometric arm which can be retrofitted at any time
- Auto-positioning and automatic height adjustment for reproducible positioned images and an efficient workflow
- Integrated organization system with Ambient-Light for bite block accessories. Illuminated from the inside and within reach of the operator
- Work with SureSmile Aligner and SureSmile Ortho software



## Orthophos SL

### The high-end system: 2D or 2D/3D hybrid device

Orthophos SL – the high-end 2D / 3D system with high image quality for practices wanting the latest technologies and those who simply want more. The third dimension provides important information for the Orthodontic treatment planning and expansive treatment options. The integrated Direct Conversion Sensor (DCS) completely redefines the standard of panoramic imaging and delivers high sharpness. Its namesake, 'Sharp Layer' technology, ensures autofocused panoramic images even in anatomically difficult cases. The device features high ease of use thanks to auto-positioning, intuitive touchpad operation, and an individually adjustable ambient light for an exclusive look and feel.

### The advantages at a glance

- Medium FoV orthodontic CBCT indications such as: the evaluation of the alveolar ridge, palatal suture maturation and impacted canines are covered by the FoVs from 5x5,5 to 11x10
- Low Dose enables 3D images in the dose range of 2D X-rays
- DCS sensor with autofocus function for images in HD quality
- Sharp layer technology for reliably sharp images
- Auto-positioning with patented occlusal bite block and touch-pad for optimally positioned images and simple reproducibility
- Comprehensive panoramic and cephalometric programs for bitewing, sinus or ceph images, and an optional left or right cephalometric arm which can be retrofitted at any time
- Certified to work with SureSmile Aligner and SureSmile Ortho software



## Orthophos S

The all-round system: 2D/3D hybrid device

Orthophos S - the high-quality 2D / 3D all-round system with a comprehensive range of services for every practice. Whether used as a pure 2D device or including a 3D module - the Orthophos S is a reliable partner and optimized for the daily tasks in the practice. Its Csl-Plus sensor with Autofocus function allows for sharp images even in anatomically difficult cases. The patented occlusal bite block positions patients quickly and automatically. For use in orthodontics the device is optionally available with a cephalometric arm. And because future-proofing is important to Dentsply Sirona, the system is 3D ready and the cephalometric arm can be retrofitted at any time.

### The advantages at a glance

- Medium FoV orthodontic CBCT indications such as: the evaluation of the alveolar ridge, palatal suture maturation and impacted canines are covered by the FoVs from 5x5,5 to 11x10
- 2D-Csl-Plus sensor with autofocus function for sharp details and autofocused images, even in anatomically difficult cases
- Comprehensive 2D programs for bitewing, sinus or temporomandibular joint images
- Patented occlusal bite block for automatic patient positioning with high consistency and reproducibility
- Left or right cephalometric arm for ceph images, which can be ordered optionally or retrofitted at any time



## Orthophos E

The right choice for a smooth entrance into 2D digital imaging

The preferred entry-level 2D X-ray unit facilitates a smooth entrance into the world of digital imaging. Its Csl sensor technology ensures reliable image quality with simple operation. The various programs provide you with a wide range of diagnostic options, including the P10 program with height collimation specifically for pediatric images. From the motorized temple and forehead supports, automatic temple width measurement with light localizers and stable handles to facilitate safe and proven patient positioning, you are ensured a great image and positive patient experience.

### The advantages at a glance

- Csl sensor for reliable image quality
- Convenient operation with the MultiPad
- Reliable and accurate positioning with automatic temple width measurement, in addition to motor temple and forehead supports
- P10 for child panoramic images, equipped with height collimation for horizontal exposure reduction and a reduced dose





## Even more support – the ceph arm for orthodontics

The choice is yours: all of our extraoral imaging systems can be equipped with a cephalometric arm and thus, provide you with all of the relevant cephalometric images needed to support your diagnosis. Facilitated by the QuickShot function, low dose images are provided quickly and in high quality. The image width is selectable: 28 cm or 18 cm. In addition to the usual programs for lateral, symmetrical (p. a. or a. p.) and carpus images, there is also a large number of special options to select from.

### Program:

- (C1) Symmetrical p.a.
- (C2) Symmetrical a.p.
- (C3) Asymmetrical, image size adjustable: 23 cm H x 18 cm W or 23 cm H x 28 cm W.
- (C4) Carpus image
- Special options, e.g. semi-axial

### Orientation of the cephalometric arm:

- Orthophos E: left
- Orthophos S: left or right
- Orthophos SL: left or right
- Axeos: left or right



## SureSmile® Aligner

Your Clear Aligner Solution by Dentsply Sirona

At Dentsply Sirona we don't just design individual units, but seamless solutions to support the entire treatment workflow. Which is why you can now use the images captured with your Orthophos S, Orthophos SL and Axeos devices to plan your treatment with SureSmile aligners. In conjunction with an optical scan, they are validated for use in the SureSmile Aligner and SureSmile Ortho software, providing the ultimate treatment offering.

Even with the most simple cases you may encounter obstacles, so it is important to have sufficient diagnostic information to help minimize risks and to support a successful treatment outcome.

### Benefits of using CBCT:

- Radiographic localization helps to supplement the findings of inspection and palpation. If deeply impacted canine palpation is inconclusive, very often radiography is the only means of localization.
- Identify obstacles prior to treatment (e.g. localization of impacted teeth)
- Assess periodontal structures to evaluate available bone
- Take actual root position into account and ensure optimal root axis for final treatment plan
- CBCT provides accurate measurements



### Brimming with clinical excellence, yet almost invisible

The aligners are made by experts using the latest technology and proven materials. Precise processing of the data and a thorough quality control system ensure outstanding fit, excellent durability, and a virtually invisible treatment. With SureSmile Aligner you can choose different trim line designs, individualize attachments, conceal gaps with automated pontics and even treat mild to moderate class II or III cases.

### Superior treatment planning

SureSmile Aligners are created in a sophisticated process. Our Digital Lab will propose a treatment plan that will match each patient's natural anatomy. Facial photos are superimposed with the 3D model in order to plan the final tooth position to be in line with the natural facial features of your patient. X-ray data will be registered with the 3D model, smile photo and the patient's natural head position. A sophisticated quality management system ensures that all our plans meet the highest standards. The result? Outstanding initial proposals that keep modifications to a minimum.

### Customer focused workflow

The workflow with SureSmile can be smoothly integrated into any practice. The software is browser-based and does not require local installation. Furthermore, the SureSmile Digital Lab accepts data from all common intraoral scanners. On our award-winning eLearning platform SureSmileU you can find all sorts of step-by-step guides, videos, and job aids. For you and your staff that means ongoing support during the practice integration. The flexible pricing of the aligner packages is designed to meet your practice and patient's needs.

# Technical Features

Performance features	Orthophos E 2D	Orthophos S 2D	Orthophos S 3D	Orthophos SL 2D	Orthophos SL 3D	Axeos
X-ray generator	60-90 kV, 3-16mA	60-90 kV, 3-16mA	60-90 kV, 3-16 mA	60-90 kV, 3-16mA	60-90 kV, 3-16 mA	60-90 kV, 3-16 mA
Panoramic exposure time	P1 14.2 s max.	P1: max 14.2 s P1 Quickshot: max. 9.1 s	P1: max 14.2 s P1 Quickshot: max. 9.1 s	P1: max 14.2 s P1 Quickshot: max. 9.1 s	P1: max 14.2 s P1 Quickshot: max. 9.1 s	P1: max 14.2 s P1 Quickshot: max. 9.1 s
Radiation time Ceph	Standard 9.4 s	Standard 9.4 s Quickshot 4.7 s	Standard 9.4 s Quickshot 4.7 s	Standard 9.4 s Quickshot 4.7 s	Standard 9.4 s Quickshot 4.7 s	Standard 9.4 s Quickshot 4.7 s
User interface	MultiPad	EasyPad	EasyPad	EasyPad	EasyPad	EasyPad
Patient positioning	manual	automatic (occlusal bite block)	automatic (occlusal bite block)	automatic (occlusal bite block)	automatic (occlusal bite block)	automatic (occlusal bite block)
Panorama technology	Csl	Csl Plus	Csl Plus	DCS	DCS	DCS
Autofocus	-	yes	yes	yes	yes	yes
Ceph arm (optional)	left	left or right	left or right	left or right	left or right	left or right
Ceph unit with 2 sensors	optional	yes	yes	yes	yes	yes
Quickshot	-	yes	yes	yes	yes	yes
Fields of View (dxh)	-	upgradeable	5 x 5.5 to 11 x 10	upgradeable*	5 x 5.5 to 11 x 10	5 x 5.5 to 17 x 13
3D Low Dose	-	upgradeable	yes	upgradeable*	yes	yes
HD mode	-	upgradeable	yes	upgradeable*	yes	yes
Base	optional	optional	optional	optional	optional	optional
Wheelchair accessible	yes	yes	yes	yes	yes	yes
Remote control	optional	optional	optional	optional	optional	optional
Ambient Light	-	-	-	yes (background lighting)	yes (background lighting)	yes (cabinet and background lighting)

\* available soon

## Technical dimensions

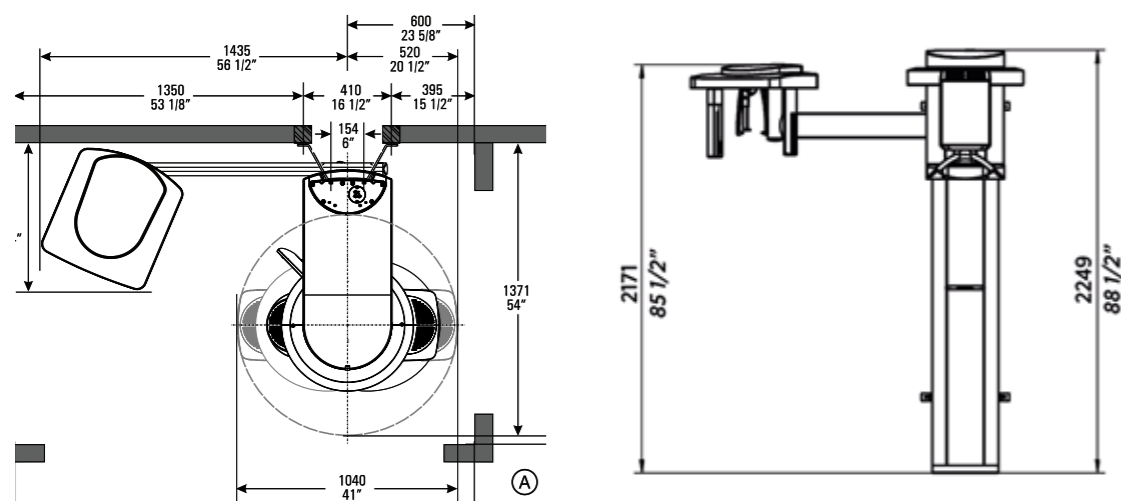

### Recommended room dimensions:

- Axeos and Orthophos: space required 1,280 x 1,411 mm
- Axeos and Orthophos with ceph side arm: space required 2,155 x 1,411 mm

### Minimum room dimensions:

- Axeos and Orthophos: space required 1,040 x 1,371 mm
- Axeos and Orthophos with ceph side arm: space required 1,955 x 1,371 mm

You will find all additional measurements in the according installation requirements.

# PC Requirements

## Requirements for Sidexis 4

Specification for one server and an unlimited number of workstations.

	Sidexis 4 Server	Min. for 2D Workstation	Min. for 3D Workstation
Operating system*	Windows Server 2008 R2 Windows Server 2012 R2 Windows Server 2016 Windows Server 2019	Windows 8.1 Pro (64 bit) Windows 10 Pro (64 bit)	Windows 8.1 Pro (64 bit) Windows 10 Pro (64 bit)
CPU	≥ 2.3 GHz QuadCore Processor with 64 bit (x64)	≥ 2 GHz DualCore	≥ 2.3 GHz QuadCore Processor with 64 bit (x64)
RAM	≥ 8 GB	≥ 4 GB	≥ 8 GB
Graphic card**	≥ 1 GB	≥ 512 MB	≥ 1 GB
DirectX	DirectX 10 with WDDM 1.0 or higher driver	DirectX 9.0c	DirectX 10 with WDDM 1.0 or higher driver

\* For 64-bit operating systems, installation under Boot Camp is also approved.

\*\* To ensure that the interaction with the volume rendered in 3D is reliably "jerk-free", graphic cards with at least the following passmarks are required. GPU benchmark values recommended: NVIDIA: Passmark > 1000; AMD: Passmark > 1500; Onboard: > 540.

## Requirements for one image acquisition computer

Specification for only one computer needed to allow device integration in your practice.

	Axeos	Orthophos S 3D / Orthophos SL 3D	Orthophos S 2D / Orthophos SL 2D	Orthophos E
Operating system	Windows 10 (64 bit)	Windows 8.1 Professional (64 bit) Windows 10 (64 bit)	Windows 8.1 Professional (64 bit) Windows 10 (64 bit)	See requirements for Sidexis 4 2D workstation
RAM	16 GB	16 GB	16 GB	
CPU	≥ 2.3 GHz QuadCore Processor 64 bit with SSE3 support (Intel i73xx or comparable)	≥ 2.3 GHz QuadCore Processor 64 bit with SSE3 support (Intel i73xx or comparable)	SL*: ≥ 2.3 GHz QuadCore Processor 64 bit with SSE3 support (Intel i73xx or comparable)  S: ≥ Intel i3 3rd Generation or comparable RAM 16 GB	
Hard drive	≥ 2 TB	≥ 1 TB	≥ 1 TB	
Graphic	DirectX 11-graphics adapter (min. 4 GB RAM)	DirectX 11-graphics adapter (2 GB RAM dedicated) with latest graphic card driver	SL*: DirectX 10-graphics card (1 GB RAM dedicated) or Intel Onboard Graphics with latest graphic card driver  S: DirectX 9.0 graphics card (512 MB RAM dedicated) or Intel Onboard Graphics with the latest graphic card driver	
Screen resolution	Minimum 1280 x 1024 pixels Recommended 1600 x 1200 pixels			

\* Panorama editor.

Further information at [www.sidexis.com/systemrequirements](http://www.sidexis.com/systemrequirements)  
System requirements for the hardware used may vary.



## Dentsply Sirona

Sirona Dental Systems GmbH  
Fabrikstraße 31, 64625 Bensheim, Deutschland  
dentsplysirona.com

## Procedural Solutions

Preventive  
Restorative  
Orthodontics  
Endodontics  
Implants  
Prosthetics

## Enabling Technologies

CAD/CAM  
Imaging  
Treatment Centers  
Instruments