



Experience, Trust, Service

MST[®] RESPIRATORY PROTECTOR



PART NUMBERS AND SCHEMATICS GUIDE

Company Profile

Since 1944, Marco has developed a strong tradition of providing innovative and reliable products and services to the surface preparation and protective coatings industries. We are the world's premier provider of Abrasives, Blasting Equipment, Coating Equipment, Engineered Systems, Rental Equipment, Safety Equipment, Service, and Repair.

Through innovative designs and a total commitment to quality, Marco manufactures products that increase production rates, create a safer workplace, and reduce maintenance costs. Marco's industry experience, manufacturing capabilities, legendary customer service, product availability, logistics services, and technology leadership is your assurance that we deliver high quality products and services, providing the best value to you, our customer.

The Marco Difference

- **Industry Experience** – With Marco on your team, you have access to expertise which can only come from over 65 years of industry leadership. We have organized our engineering department, production specialists, customer operations, and safety support into a "Center of Competence." As a Marco customer, you have access to hundreds of years of cumulative experience related to your operations.
- **Manufacturing Excellence** – Marco is a U.S. based, ISO 9001:2008 certified manufacturer of equipment for the Surface Preparation and Protective Coatings industries. Marco's engineers benchmark the industry to ensure that we design and manufacture superior products that set the "Gold Standard" for performance, safety, and quality.
- **Legendary Customer Service** – Marco's legendary customer service team is staffed by friendly, highly-trained individuals who are focused on providing the highest level of product support, order accuracy, and customer satisfaction.
- **Product Availability** – We stock over 10,000 SKU's and have over 45 shipping locations to serve North American and International markets for all major brands of blasting and painting equipment. As the largest provider of surface preparation and protective coatings equipment in the world, our inventory levels and product availability are unmatched.
- **Logistics Services** – Marco's in-house logistics team is dedicated to moving your shipment anywhere in the world. We move over 14,000 truckloads every year, allowing you to save on freight costs by leveraging our buying power. Lower your process costs with a single invoice, which includes product and freight.
- **Technology Leadership** – Our website provides: Operator's Manuals, Part Numbers and Schematics Guides, MSDS information, and Features and Specifications Guides, providing access to information 24/7. Our Extranet application allows you to receive quotes and place orders online. Our Intranet maintains a complete record of your purchase history to assist with ongoing support of your existing equipment and future purchasing decisions.

Vision Statement

Marco is the world's premier provider of Abrasives, Blasting Equipment, Coating Equipment, Engineered Systems, Rental Equipment, Safety Equipment, Service, and Repair.

Mission Statement

Marco provides strong leadership and innovation to the surface preparation and protective coatings industries. We dedicate our efforts to the continuous improvement of our products, services, processes, people, and most importantly, the quality of our customer's experience.

Quality Policy

Marco is committed to providing superior quality in the design, manufacturing, distribution, rental, service, and repair of our products. Our ISO 9001:2008 certification extends throughout all operations in all locations. Continuous improvement of our processes and supply chain Integration comprise the core of our business strategy for delivering exceptional quality and value in all Marco products and services.

Management Philosophy

We are a company dedicated to the success of every customer and associate. We discuss, debate, challenge, measure, and test our ideas. We will be boundless and limitless in our passion to improve. Through sound leadership and dedicated associates, we will ensure a long term, profitable future for Marco, our associates, customers, and suppliers.



TABLE OF CONTENTS

Company Profile	2
Table of Contents	3
MST® Respiratory Protector	4-5
Part Numbers	4
Power Sources	4
Calibration Parts	5
Part Numbers & Schematics	6-7
Optional Accessories	8
Maintenance Notes	9-11







PART NUMBERS & SCHEMATICS GUIDE

Part Numbers	MST RESPIRATORY PROTECTOR				
	CO Monitor	Pelican® Case	Outlet Fittings	Inlet Fittings	9-Volt Batteries
10COC50	X	X	X	X	X



	Part Numbers	MST RESPIRATORY PROTECTOR POWER SOURCES
		Description
	10RP80123	12-Volt DC Battery Adapter
	10RP80247	120-Volt AC Adapter
	10103346	9-Volt Battery <i>(Two Required)</i>

PART NUMBERS & SCHEMATICS GUIDE

	Part Numbers	MST RESPIRATORY PROTECTOR CALIBRATION PARTS
		Description
	1050136	Calibration Kit Complete <i>(Includes: 1050105, 1050106, 1050114, 1050129, 1050120 , 1050122)</i>
	1050105	Span Gas – 95 ppm Calibration Gas
	1050106	Zero Calibration Gas
	1050120	Potentiometer Tool For Calibration
	1050122	Calibration Gas Regulator Valve
	1050129	3 Ft. Hose For Calibration

PART NUMBERS & SCHEMATICS GUIDE

MST® Respiratory Protector







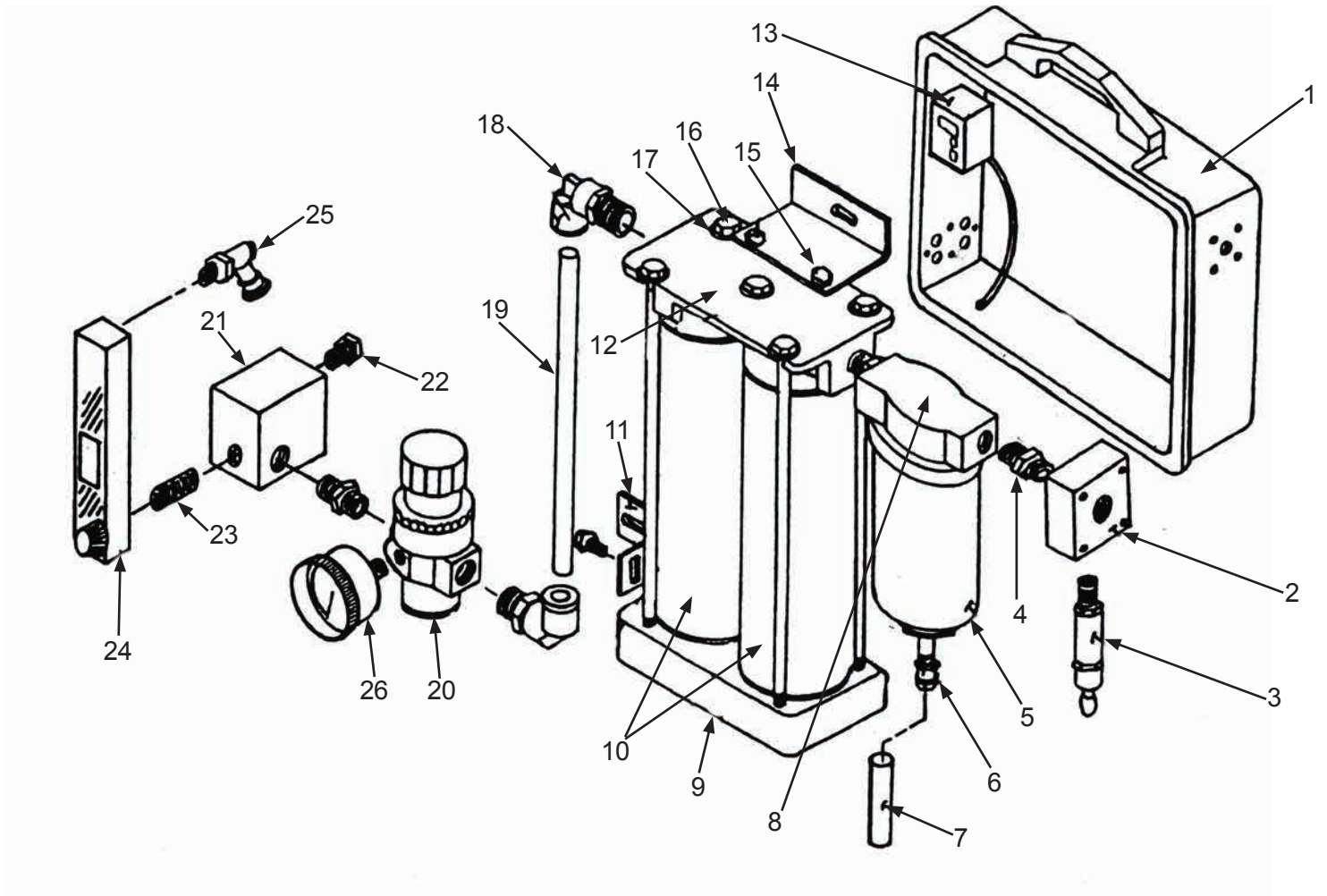

Item #	Part #	Description
Fig. 1		
—	10COC50	MST Respiratory Protector <i>Includes: 9V Batteries (Quantity of Two), 1/4" Female Quick-Disconnects (Quantity of Four), Inlet Fitting And Potentiometer Tool</i>
1	10RP80143	Orange Exterior Case With Holes
2	10RP80008	Black Porting Block
3	10RP80014	Pressure Relief Valve
4	10RPS608005	3/8" Hex Nipple <i>(Three Required)</i>
5	10RP80090	3/8" Pre-Filter, 50 CFM
6	10RP80051	Tube Fitting
7	10RPS710005	Drain Tube
8	10RP80095	Water And Oil Separator Manifold
9	10RP80001	Black Filter Base
10	10RP80005	Aluminum Tube – Third and Fourth Stage Filters
11	10RP80114	Base Bracket
12	10RP80078	Black Filter Manifold
13	10RP80127	Internal Carbon Monoxide Monitor With Sensor
14	10RP80009	Manifold Filter Bracket
15	10RPS006148	Bracket Bolts <i>(Three Required)</i>
16	10RPS011040	Manifold Filter Bolts <i>(Five Required)</i>
17	10RP12021	Manifold Filter Washers <i>(Five Required)</i>
18	10RP80116	3/8" Tubing Street Elbow <i>(Two Required)</i>
19	10RP80117B	Connecting Tube
20	10RP80080	Air Regulator
21	10RP80047	Black Outlet Porting Block
22	10RPS687001	1/8" Hex Pipe Plug <i>(Three Required)</i>
23	10RPS603001	1/8" Close Nipple
24	10RP80213	Sampling Flow Meter
25	10RP80261	90° Tube Lock Collar
26	10RP80076	Pressure Gauge, 1 – 160 PSI
—	105M326	Features and Specifications Guide – MST Respiratory Protector
—	106M326	Part Numbers and Schematics Guide – MST Respiratory Protector
—	109V326	Operator's Manual – MST Respiratory Protector

PART NUMBERS & SCHEMATICS GUIDE

Figure 1: MST® Respiratory Protector



OPTIONAL ACCESSORIES

	Part Numbers	MST RESPIRATORY PROTECTOR ACCESSORIES	
		Description	
	10COC50FILX	Replacement Filters with 3 Filter Elements	
	10RP80006	End Caps for Stage Three and Four Filters	
	10ME38	3/8" Male Coupling, 2-Lug for Air Inlet	
	10BV17	1/4" Male Quick-Disconnect for Breathing Line	
	10BV15	1/4" Female Quick-Disconnect Coupling, Shut-Off with 3/8" Male Pipe Thread	
	10RP806691	Remote Strobe and Alarm with 20 Ft. of Cord	
	10RP80326	Y Adapter for Alarm and Strobe	
	10RP80459	50 Ft. Extension Cord for Alarm and Strobe	

MAINTENANCE NOTES

DATE	TYPE OF SERVICE	PART NUMBER

MAINTENANCE NOTES

DATE	TYPE OF SERVICE	PART NUMBER

GLOBAL HEADQUARTERS

- 3425 East Locust Street
Davenport, IA 52803

ph: 800.BLAST.IT (800.252.7848)

ph: 563.324.2519

fax: 563.324.6258

GULF STATES HEADQUARTERS

- 701 East Boulevard
Deer Park, TX 77536

ph: 800.BLAST.IT (800.252.7848)

ph: 281.930.0905

fax: 281.542.0736

REGIONAL BRANCH OFFICES

- **Iowa**
Davenport
- **Louisiana**
Harvey
Lafayette
- **Ohio**
Youngstown
- **Texas**
Beaumont
Corpus Christi
Deer Park



Experience, Trust, Service

ABRASIVES

BLASTING

COATING

ENGINEERED SYSTEMS

RENTAL

SAFETY

SERVICE & REPAIR

40+ NATIONWIDE SHIPPING LOCATIONS

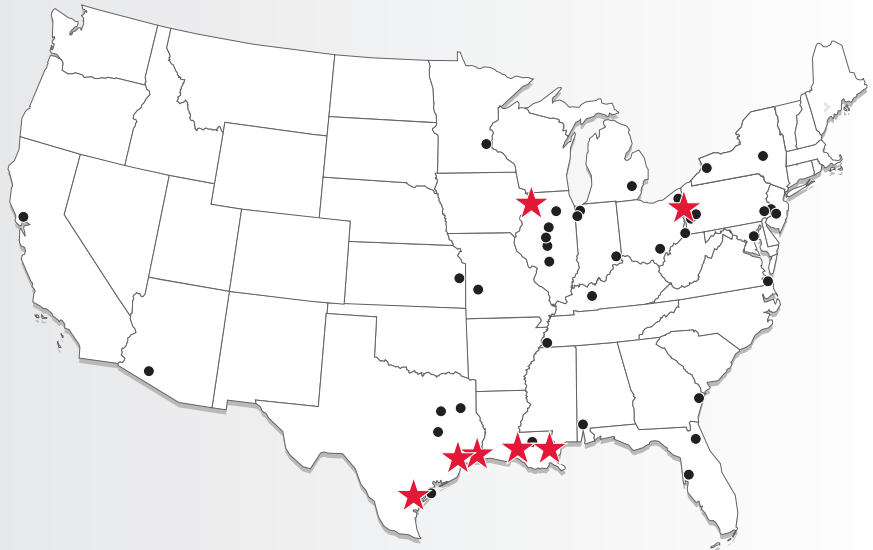

★ Marco Regional Branch Offices
and Shipping Locations

● Direct Shipping Locations

CONTACT MARCO

800.BLAST.IT
(800.252.7848)

563.324.2519

FAX: 563.324.6258

WWW.MARCO.US

SALES@MARCO.US