

Fluid Handling Sourcebook

Unique Solutions from Lab to Process

See page 19

Why pour it?
Pump it!

- Easier
- Faster
- More accurate

See page 42

See page 35

Expert product assistance

Polo, Application Specialist

800-323-4340
ColeParmer.com

Cole-Parmer: Your Fluid Handling Experts

Get expert
technical
assistance when
you need it...

99.7% satisfaction when our expert
specialists select products based on your needs.

Your trusted partner for equipment & supplies

1 Source for pumps, tubing,
fittings, and more!

85 Years of collective
applications knowledge

99.7 Percent satisfaction when
our specialists help you
choose your product

3615 Items guaranteed in stock
—you need it, we've got it!

10,000+ Application solutions provided
monthly. We can help you too.

100,000 Products. We have what you need.

Contact us today!

 800-323-4340

 ColeParmer.com

 sales@coleparmer.com

 847-247-2929

Go to www.coleparmer.com/terms for a full list of terms and conditions. For full information on returns, go to www.coleparmer.com/returns.

©2015 Cole-Parmer Instrument Company. All rights reserved. Printed in the United States of America. For a listing of Cole-Parmer owned trademarks, go to ColeParmer.com/trademarks. All other trademarks, servicemarks, tradenames, or other logos of third parties are and remain the property of such third parties.

Ensure Your Accuracy. Get Calibrated.

- ✓ Precalibration
- ✓ Recalibration
- ✓ On-Site
- ✓ Repair



Conformity*

ANSI/ISO/IEC 17025:2005 accredited
 NIST Handbook 150, 2000 Edition
 ANSI/NCCL Z540-2-1997
 NIST Technical Note 1297 ISO 9000:2000

*Please check our scope of accreditation for any limitations.

INNOCAL®

INNOVATIVE CALIBRATION SOLUTIONS

866-INNOCAL (866-466-6225)

InnoCalSolutions.com info@innocalsolutions.com

Look Inside for...



Masterflex® L/S®
Digital Pump System



Customer Approved

Fluid Handling

Masterflex® Pumps & Tubing	2-32
Pumps	33-47
Tubing	48-55
Fittings	56-61
Filtration	62-65
Flowmeters	66-70
Pressure	71-74
Valves	75-76

Oakton®
EcoTestr™ pH 2
Pocket Tester



Customer Approved



Electrochemistry

Conductivity	78-81
pH/Ion	82-88



StableTemp™
Stirring Hot Plate



Customer Approved

Equipment & Instrumentation

Balances	90
Baths & Circulators	91
Mixers	92-95
Stirrers & Hot Plates	96
Viscometers	97

Lab Supplies

Bags	99
Beakers	100
Bottles	101-103
Carboys	104
Cleaning Solutions	105
Gloves	106
Pipettes	107-109
Supports & Clamps	110
Syringes	111
Tweezers & Forceps	112

PP Graduated
Beaker with
Handle



Customer Approved

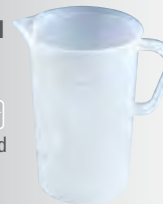

MORE at ColeParmer.com

1 resource...

100,000 products

Plus...tools to help you
select, purchase, use:



Research
specs and
technical articles



Live Chat
expert answers
immediately



Watch
videos to
do it right



Check order status

NOW on
ColeParmer.com

- Track order
- Convert quotes
- Reprint invoice

**You Need It.
We've
Got It!
Guaranteed.**



Look for items with a GIS icon and catalog numbers highlighted in orange. If any of these items are not in stock when you order, we will pay the shipping costs!*

*GIS items in this catalog are guaranteed in stock through 12/31/15 when you use the two-letter alpha code prefix with the product catalog number. Program valid only in the US and Canada. Cole-Parmer reserves the right to extend or remove GIS items at any time.

Why MASTERflex® Peristaltic Pumps?

1 Easy

- Quick installation
- Low maintenance
- Easy tubing changeover

2 Durable

- Trusted for over 45 years
- Broad chemical compatibility

3 Versatile

- From research to process
- Handles just about any fluid
- Multichannel capabilities

4 Customizable

- Configurable systems
- Many tubing options
- Easy scale-up

5 Accurate

- Flow ranges from 0.0006 mL/min to 42 L/min
- Rigorous design and testing standards
- Tubing is custom manufactured to precise tolerances



Selecting a Masterflex® Pump: As Easy As

A Application Requirements

- What is my required flow rate?
- What chemical am I pumping?
- Do conditions such as viscosity or back pressure play an important role in my decision?

B Base a Pump Series on Your Flow Rate

- Use the table below to find the pump series that best fits your flow rate needs

C Complete Your System

- L/S and I/P pump series are divided into three components—pump head, tubing, and drive
- Select the three components from the same series or choose a complete preconfigured system

Masterflex pump series	Features	Flow range	Speed		Remote control capability	Multichannel capabilities	Page(s)
			Fixed	Variable			
C/L®	Compact, low-flow pump that easily fits on benchtop or mounts within a panel	0.002 to 43 mL/min		✓	Yes	Yes	4
L/S®	High-accuracy drives for precise flow control and dispensing	0.0006 to 3400 mL/min	✓	✓	Yes	Yes	5–20
I/P®	Powerful systems that provide better protection from possible hazards such as dust and water	0.012 to 19 LPM	✓	✓	Yes	Yes	22–29
B/T®	Highest flow rates—ideal for large batch fluid transfer with excellent hazard protection	0.3 to 42 LPM	✓	✓	Yes	Yes	30–31

10,000+ Combinations

Masterflex pumps allow you to choose each component for your unique demands—change out components as your needs change

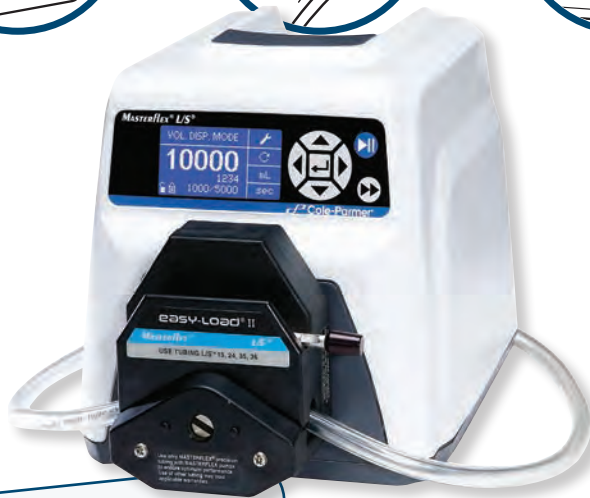

Or choose a Complete System

Convenient preconfigured systems include everything you need to get started

PUMP HEAD + TUBING + DRIVE

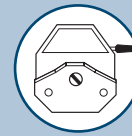

WHAT TO CONSIDER:

- Flow rate—Different pump heads have different flow rate capabilities.
- Tubing change frequency—Some pump heads enable rapid tubing changes.
- Desired number of channels—Pump heads are stackable in most cases.
- Chemical compatibility—If chemicals spill, pump head materials become important.
- Accuracy—Standard pump heads offer the most accurate, repeatable flow rates.

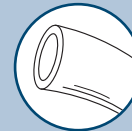

WHAT TO CONSIDER:

- Flow rate—Tubing size directly affects flow rate.
- Chemical compatibility
- Tubing life
- Fluid viscosity, presence of solids, back pressure, or suction lift—High-performance tubing is best for these conditions.
- Fluid temperature



WHAT TO CONSIDER:

- Flow rate—The rpm of the drive directly correlates to flow rate.
- Fixed- or variable-speed—Variable-speed drives enable flow rate adjustment.
- Accuracy of flow rate or dispense volume—Many drives have digital speed control circuitry for highly accurate and repeatable flow rates.
- Remote control or computer interface—Some drives can connect to your process controller or can be operated by a foot switch.
- Environmental protection against hazards—Many drives are sealed against dust and water exposure.

Custom OEM Pump Systems

When an off-the-shelf pump just won't cut it, you need a solution custom-built for your requirements

With more than 100 years of combined experience, our design engineers will partner with you to create the exact pump you need. Contact our Application Specialists to get started!



Still not sure what to choose?

Let our expert Application Specialists find the right pump for your application.

800-323-4340 ColeParmer.com/tapps

C/L® Variable-Speed Compact Pumps Pump in even the tightest spaces!

- Pump fluids in either direction—easily switchable reversing motor
- Stop/start remotely via contact closure
- MAX button quickly primes or purges tubing
- Both pumps include 5 ft (1.5 m) of 0.89-mm ID Tygon® E-LFL tubing.

A. C/L Single-Channel Pumps

- Quick and easy tubing changes—open cover and release occlusion bed in one motion
- Pump from 0.002 to 43 mL/min
- Pump head made from polyphenylene sulfide, acetal, and copolyester; stainless steel rollers

B. C/L Dual-Channel Pumps

- Pump from 0.002 to 12.3 mL/min per channel, depending on drive and tubing
- Pump head made of polyphenylene sulfide and stainless steel; rollers made of acetal co-polymer



FEATURES

- ✓ Flow range: 0.002 to 43 mL/min
- ✓ ¼-DIN housing is perfect for panel mounting
- ✓ Reversible pumping
- ✓ Stop/start remote control capabilities

Power supplies are:



rpm	Speed control (repeatability)	Number of channels	Number of rollers	Reversible motor	IP rating	Dimensions—¼ DIN (L x W x H)	Power		Catalog number	Price
							VAC, Hz	Amps		
A. C/L single-channel compact pumps										
1.7 to 10	±5%	1	4	Yes	IP22	7" x 3¼" x 3½" (17.8 x 9.5 x 8.9 cm)	90 to 260, 50/60	110 mA at 115 VAC	JL-77122-04	
							12 VDC†	—	JL-77122-06	
13 to 80							90 to 260, 50/60	175 mA at 115 VAC	JL-77122-14	
50 to 300							12 VDC†	—	JL-77122-16	
							90 to 260, 50/60	400 mA at 115 VAC	JL-77122-24	
							12 VDC†	—	JL-77122-26	
B. C/L dual-channel compact pumps										
1 to 6	±5%	2	6	Yes	IP22	7½" x 3¾" x 3½" (19 x 9.5 x 8.9 cm)	90 to 260, 50/60	110 mA at 115 VAC	JL-77120-32	
							12 VDC†	—	JL-77120-52	
10 to 60							90 to 260, 50/60	175 mA at 115 VAC	JL-77120-42	
							12 VDC†	—	JL-77120-62	

†Power supply not included with 12 VDC models.

[JL-77120-03](#) Brackets for panel mounting.
Set of 2

[JL-77200-07](#) Replacement power supply,
100 to 240 VAC, for pump 77122-24

[JL-77120-11](#) Replacement power supply,
100 to 240 VAC, for pumps 77122-04, -14;
77120-32 and -42









Microbore Pump Tubing Ordering Information

Tube ID (mm)	Tygon® E-Lab	Silicone (platinum-cured)	Silicone (peroxide-cured)	PharMed® BPT	Tygon E-LFL (long flex life)	Viton®	Puri-Flex™	C-Flex®	Solvent/hydrocarbon
0.19	NEW JL-06460-10	—	—	—	—	—	JL-96418-10	JL-95718-10	JL-95712-10
0.25	JL-06460-12	—	—	JL-95809-12	—	—	JL-96418-12	JL-95718-12	JL-95712-12
0.51	JL-06460-18	JL-95590-18	—	JL-95809-18	JL-06449-18	—	JL-96418-18	JL-95718-18	JL-95712-18
0.89	JL-06460-26	JL-95590-26	JL-07625-26	JL-95809-26	JL-06449-26	JL-97632-26	JL-96418-26	JL-95718-26	JL-95712-26
1.14	JL-06460-30	JL-95590-30	JL-07625-30	JL-95809-30	JL-06449-30	JL-97632-30	JL-96418-30	JL-95718-30	JL-95712-30
1.42	JL-06460-34	JL-95590-34	JL-07625-34	JL-95809-34	JL-06449-34	JL-97632-34	JL-96418-34	JL-95718-34	JL-95712-34
2.06	JL-06460-42	JL-95590-42	JL-07625-42	JL-95809-42	JL-06449-42	JL-97632-42	JL-96418-42	JL-95718-42	JL-95712-42
2.79	JL-06460-48	JL-95590-48	JL-07625-48	JL-95809-48	JL-06449-48	JL-97632-48	JL-96418-48	JL-95718-48	JL-95712-48
Quantity/pack	100 ft (30.4 m)	50 ft (15.2 m)	50 ft (15.2 m)	100 ft (30.4 m)	100 ft (30.4 m)	50 ft (15.2 m)	50 ft (15.2 m)	50 ft (15.2 m)	50 ft (15.2 m)
Price/pk									

Flow Rates in mL/min

rpm	Microbore pump tubing size (ID)								
	0.19 mm	0.25 mm	0.51 mm	0.89 mm	1.14 mm	1.42 mm	2.06 mm	2.79 mm	
1 to 6	0.002 to 0.013	0.0028 to 0.017	0.012 to 0.07	0.036 to 0.20	0.057 to 0.34	0.08 to 0.49	0.15 to 0.88	0.22 to 1.3	
1.7 to 10	0.002 to 0.013	0.004 to 0.022	0.015 to 0.087	0.041 to 0.25	0.064 to 0.39	0.09 to 0.57	0.18 to 1.05	0.28 to 1.65	
10 to 60	0.02 to 0.13	0.03 to 0.18	0.12 to 0.70	0.36 to 2.1	0.55 to 3.3	0.8 to 4.9	1.5 to 8.9	2.1 to 12.3	
13 to 80	0.017 to 0.10	0.03 to 0.18	0.12 to 0.70	0.33 to 2.0	0.52 to 3.1	0.75 to 4.5	1.4 to 8.5	1.8 to 11.0	
50 to 300	0.06 to 0.38	0.11 to 0.67	0.43 to 2.6	1.2 to 7.4	1.9 to 11.5	2.8 to 17.0	5.3 to 32	7.2 to 43	

L/S® Pump Heads Selection Guide

Description	Flow rates (mL/min)	Multichannel or stackable	Special features	Page number
Standard				
	0.001 to 2900 mL/min	Yes, stack up to 4 heads	<ul style="list-style-type: none"> ✓ Highest precision, yet economical ✓ Accurate, repeatable fluid transfer ✓ Each head dedicated to one tubing size 	5
Easy-Load® II				
	0.001 to 2900 mL/min	Yes, stack up to 4 heads	<ul style="list-style-type: none"> ✓ Easy tubing changes ✓ Automatic retention ✓ Adjustable occlusion 	6
Easy-Load® 3				
	0.001 to 2900 mL/min	Yes, stack up to 4 heads	<ul style="list-style-type: none"> ✓ Easy tubing changes ✓ Automatic retention ✓ Same side tubing entry/exit ✓ Install and stack without tools or hardware 	7
Easy-Load®				
	0.001 to 2300 mL/min	Yes, stack up to 4 heads	<ul style="list-style-type: none"> ✓ Load or change multiple tubing sizes quickly and easily ✓ Low maintenance ✓ Models available for ATEX Zone 2 applications 	7
High-Performance				
	0.006 to 3400 mL/min	No	<ul style="list-style-type: none"> ✓ Highest flow rate of any L/S pump head ✓ Up to 100 psi with L/S HP (High-Pressure) pump tubing ✓ ATEX Zone 2 applications model available 	8
PTFE-Tubing				
	0.001 to 65 mL/min	No	<ul style="list-style-type: none"> ✓ Uses rigid PTFE-tubing ✓ Pressures up to 150 psi ✓ Transfer aggressive solvents ✓ High purity 	ColeParmer.com
Multichannel				
	0.00005 to 2300 mL/min (per channel)	Yes, stack up to 32 channels	<ul style="list-style-type: none"> ✓ Synchronous flow from up to 32 channels without cartridges ✓ Two-stop tubing sets are easy to load with no adjustment needed 	9
Multichannel Cartridge				
	0.00001 to 1700 mL/min (per channel)	Yes, 1 to 12 channels	<ul style="list-style-type: none"> ✓ Synchronous flow rates ✓ Run up to 12 channels on a single pump head ✓ Easy tubing changes ✓ Holds tubing securely in place 	ColeParmer.com
PTFE-Diaphragm				
	10.0 to 800 mL/min	No	<ul style="list-style-type: none"> ✓ PTFE and borosilicate glass are the only wetted parts ✓ Up to 100 psi (6.9 bar) ✓ Accurate metering ✓ Handles aggressive fluids 	ColeParmer.com

L/S® Standard Pump Heads

Ideal for accurate and repeatable fluid transfer applications

- Available with PC housing with CRS or SS rotor, or PPS housing with SS rotor
- PC housing allows you to see pump in operation; PPS housing and SS rotors have excellent chemical resistance

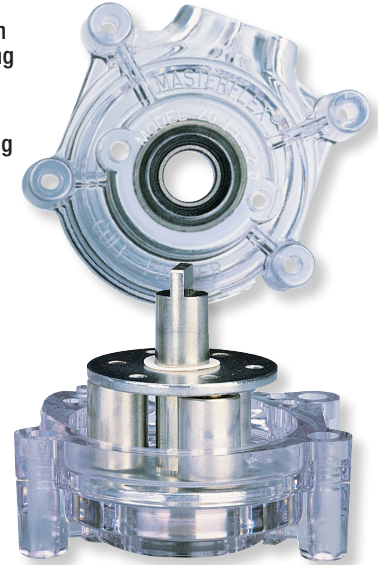

FEATURES

- ✓ Best overall pump head performance
- ✓ Designed and optimized for one tubing size
- ✓ Stack up to four heads

A. Standard Pump Heads for Precision Tubing

- Flow rates: 0.001 to 2300 mL/min
- Perfect for common fluid transfer applications
- Select a pump head for one of the following precision tubing sizes: L/S 13, L/S 14, L/S 16, L/S 17, L/S 18

B. Standard Pump Heads for High-Performance Precision Tubing

- Flow rates: 0.033 to 2900 mL/min
- Accepts our high-performance precision tubing—choose these pump heads for better pressure generation, suction lift, viscous fluid transfer, and longer tubing life
- Select a pump head for one of the following high-performance tubing sizes: L/S 15, L/S 24, L/S 35, L/S 36



Pump tubing size	mL per rev	Flow rates in mL/min		Catalog number††		
		0.02 to 100 rpm	6 to 600 rpm	PC housing		PPS housing
				CRS rotor	SS rotor	SS rotor
A. Standard pump heads for precision pump tubing						
L/S 13	0.06	0.001 to 6	0.36 to 36	JL-07013-20	JL-07013-21	JL-07013-52
L/S 14	0.21	0.004 to 21	1.3 to 130	JL-07014-20	JL-07014-21	JL-07014-52
L/S 16	0.8	0.016 to 80	4.8 to 480	JL-07016-20	JL-07016-21	JL-07016-52
L/S 17	2.8	0.059 to 280	17 to 1700	JL-07017-20	JL-07017-21	JL-07017-52
L/S 18	3.8	0.077 to 380	23 to 2300	JL-07018-20	JL-07018-21	JL-07018-52
Price						
B. Standard pump heads for high-performance precision pump tubing						
L/S 15	1.7	0.033 to 170	10 to 1000	JL-07015-20	JL-07015-21	JL-07015-52
L/S 24	2.8	0.057 to 280	17 to 1700	JL-07024-20	JL-07024-21	JL-07024-52
L/S 35	3.8	0.077 to 380	23 to 2300	JL-07035-20	JL-07035-21	—
Price						
L/S 36	4.8	0.096 to 480	29 to 2900	JL-07036-30	JL-07036-31	—
Price						

†PC = polycarbonate PPS = polyphenylene sulfide
CRS = cold-rolled steel SS = stainless steel

††Maximum system pressure = L/S 13, L/S 14, L/S 15, L/S 16, L/S 24: 40 psi (2.7 bar); L/S 17, L/S 36: 20 psi (1.4 bar); L/S 18: 15 psi (1.0 bar); L/S 35: 35 psi (2.4 bar)

Mounting Hardware

Stack up to four L/S Standard pump heads on one drive (see drive specifications for recommended number of heads). Hardware is stainless steel.

Heads to be mounted	Catalog number	Price/st
Hardware for Standard Heads L/S 13 to 35		
One	JL-07013-04	
Two	JL-07013-05	
Three	JL-07013-08	
Four	JL-07013-09	
Hardware for Standard Heads L/S 36		
One	JL-07036-01	
Two	JL-07036-02	

L/S® Easy-Load® II Pump Heads

No more slipping of tubing—automatic retention holds it securely in place

- Reduced pulsation and improved pressure performance and mechanical stability with standard four-roller rotor
- Pump heads made of durable PPS housing
- Choice of rotors—economical CRS rotors or SS rotors for better chemical resistance and durability
- Don't let pressure get to you. Choose models with adjustable occlusion—tighten for higher pressure, loosen for longer tubing life

A. Pump Heads for Precision Pump Tubing (not shown)

- Wide flow range for wider range of applications from 0.06 to 2300 mL/min

B. Pump Heads for High-Performance Precision Pump Tubing

- Pump viscous liquids and get better pressure generation and suction lift

C. Two-Channel Pump Heads for Precision Pump Tubing

- No need to stack heads, get two channels in one head!

What's included: single-channel mounting hardware and a 15" (38-cm) length of silicone pump tubing. Pump head comes ready to mount to drive. Hardware for mounting two or more heads is available below.



C



B

FEATURES

- ✓ Load tubing easily
- ✓ Accepts several tubing sizes for a wide flow range
- ✓ Stack up to four heads

ISO 9001:2008
CERTIFIED SUPPLIER



Pump tubing size accepted	mL per rev	Flow rates in mL/min		Maximum system pressure† psi (bar)	Catalog number‡					
		1 to 100 rpm	6 to 600 rpm		Fixed occlusion		Adjustable occlusion			
					CRS rotor	SS rotor	SS rotor			
Cat. no.	Price	Cat. no.	Price	Cat. no.	Price					
A. Easy-Load II pump heads for precision pump tubing (not shown)										
L/S 13	0.06	0.06 to 6	0.36 to 36	40 (2.7)						
L/S 14	0.21	0.21 to 21	1.3 to 130	40 (2.7)						
L/S 16	0.8	0.8 to 80	4.8 to 480	40 (2.7)	JL-77200-50		JL-77200-60		JL-77201-60	
L/S 25	1.7	1.7 to 170	10 to 1000	35 (2.4)						
L/S 17	2.8	2.8 to 280	17 to 1700	20 (1.4)						
L/S 18	3.8	3.8 to 380	23 to 2300	15 (1.0)						
B. Easy-Load II pump heads for high-performance precision pump tubing										
L/S 15	1.7	1.7 to 170	10 to 1000	40 (2.7)						
L/S 24	2.8	2.8 to 280	17 to 1700	40 (2.7)	JL-77200-52		JL-77200-62		JL-77201-62	
L/S 35	3.8	3.8 to 380	23 to 2300	35 (2.4)						
L/S 36	4.8	4.8 to 480	29 to 2900	20 (1.4)						
C. Two-channel Easy-Load II pump heads for precision pump tubing										
L/S 13	0.06	0.06 to 6	0.36 to 36	40 (2.7)						
L/S 14	0.21	0.21 to 21	1.3 to 130	40 (2.7)	JL-77202-50		JL-77202-60		—	—
L/S 16	0.8	0.8 to 80	4.8 to 480	40 (2.7)						
L/S 25	1.7	1.7 to 170	10 to 1000	35 (2.4)						

†Actual performance varies depending on pump tubing formulation—values shown are for firm pump tubing.

‡CRS = cold-rolled steel SS = stainless steel

Teky's Tips



How Masterflex Pump Heads Work

1

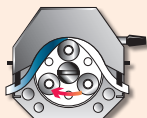

Tubing is placed in the tubing bed—between the rotor and housing—where it is occluded (squeezed).

2

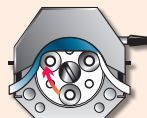

The rollers on the rotor move across the tubing, pushing the fluid. The tubing behind the rollers recovers its shape, creates a vacuum, and draws fluid in behind it.

3

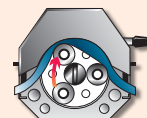

A "pillow" of fluid is formed between the rollers. This is specific to the ID of the tubing and the geometry of the rotor. Flow rate is determined by multiplying speed by the size of the pillow. This pillow stays fairly constant except with extremely viscous fluids.

Mounting Hardware for Easy-Load II Heads

Mount up to four L/S Easy-Load II pump heads on a single drive; see individual drive specifications for maximum number of heads to be mounted. Mounting hardware is stainless steel.

Heads to be mounted	Catalog number	Price/st
One	JL-77200-01	
Two	JL-77200-02	
Three	JL-77200-03	
Four	JL-77200-04	

L/S® Easy-Load® 3 Pump Heads

No tools or hardware needed

- Mount and stack heads in seconds with twist-lock mounting feature
- CRS rotor is more economical while SS offers greater durability and chemical resistance
- Mount up to four pump heads without tools or hardware when using mounting plate
- Included mounting plate adapts Easy-Load 3 pump heads to L/S drives

FEATURES

- ✓ Same side tubing entry/exit for space-limited applications
- ✓ Automatic tubing retention
- ✓ Stack up to four heads



ISO9001:2008 CERTIFIED SUPPLIER

Pump tubing sizes accepted	mL per rev	Flow rates in mL/min		Maximum system pressure† psi (bar)	Catalog number‡	
		1 to 100 rpm	6 to 600 rpm		CRS rotor	SS rotor
Easy-Load 3 pump heads for precision pump tubing						
L/S 13	0.06	0.06 to 6	0.36 to 36	40 (2.7)	JL-77800-50	JL-77800-60
L/S 14	0.22	0.22 to 22	1.3 to 130	40 (2.7)		
L/S 16	0.8	0.8 to 80	4.8 to 480	40 (2.7)		
L/S 25	1.7	1.7 to 170	10 to 1000	35 (2.4)		
L/S 17	2.8	2.8 to 280	17 to 1700	20 (1.4)		
L/S 18	3.8	3.8 to 380	23 to 2300	15 (1.0)		
Easy-Load 3 pump heads for high-performance precision pump tubing						
L/S 15	1.7	1.7 to 170	10 to 1000	30 (2.0)	JL-77800-52	JL-77800-62
L/S 24	2.8	2.8 to 280	17 to 1700	30 (2.0)		
L/S 35	3.8	3.8 to 380	23 to 2300	25 (1.7)		
L/S 36	4.8	4.8 to 480	29 to 2900	20 (1.4)		
				Price		

†Actual performance varies depending on pump tubing formulation—values shown are for firm pump tubing.
‡CRS = cold-rolled steel SS = stainless steel

JL-77800-00 Replacement mounting kit, for mounting Easy-Load 3 pump head to Masterflex L/S pump drives. Includes mounting plate and four screws

Wait!

There's More at ColeParmer.com

Find all the product specs you need!

L/S® Easy-Load® Pump Heads

Save time with fast tubing changes and reduced maintenance

- No need to remove head to change tubing
- PPS housing offers improved chemical resistance; SS rotor offers increased durability and chemical resistance
- Get four separate pumping channels by mounting up to four heads on one drive
- ATEX Zone 2 approved models rated to EEx II 3 G c II C T6
- Ready to use—include single-channel mounting hardware and 15" (38 cm) of silicone tubing

FEATURES

- ✓ Fixed occlusion averaged for several tubing sizes
- ✓ Stack up to four heads
- ✓ ATEX Zone 2 rated models available



ISO9001:2008 CERTIFIED SUPPLIER Zone 2 07516-40, -42

Pump tubing sizes accepted	mL per rev	Flow rates in mL/min		Maximum system pressure psi (bar)	Catalog number‡			
		1 to 100 rpm	6 to 600 rpm		White PPS housing		Black PPS housing	ATEX-approved PPS housing
					CRS rotor	SS rotor	SS rotor	SS rotor
Easy-Load pump heads for precision pump tubing								
L/S 13	0.06	0.06 to 6	0.36 to 36	40 (2.7)	JL-07516-00	JL-07516-10	JL-07518-60	JL-07516-40
L/S 14	0.21	0.21 to 21	1.3 to 130	40 (2.7)				
L/S 16	0.8	0.8 to 80	4.8 to 480	40 (2.7)				
L/S 25	1.7	1.7 to 170	10 to 1000	35 (2.4)				
L/S 17	2.8	2.8 to 280	17 to 1700	20 (1.4)				
L/S 18	3.8	3.8 to 380	23 to 2300	15 (1.0)				
Easy-Load pump heads for high-performance precision pump tubing								
L/S 15	1.7	1.7 to 170	10 to 1000	40 (2.7)	JL-07516-02	JL-07516-12	JL-07518-62	JL-07516-42
L/S 24	2.8	2.8 to 280	17 to 1700	40 (2.7)				
				Price				

†PSF = polysulfone PPS = polyphenylene sulfide CRS = cold-rolled steel SS = stainless steel

Mounting Hardware for Easy-Load Heads

Stack up to four L/S Easy-Load pump heads on one drive. Order mounting hardware based on number of mounted pump heads. Hardware is stainless steel.

Heads to be mounted	Catalog number	Price/st
One	JL-07013-04	
Two	JL-07013-05	
Three	JL-07013-08	
Four	JL-07013-09	

L/S® High-Performance Pump Heads

Highest flow rate and pressure generation of any L/S pump head

- Offers better suction lift, viscous fluid transfer, and long tubing life—at pressures up to 150 psi (10.2 bar)
- Mount pump head upright or on its side—design allows tubing to enter/exit the same side of the pump head
- Rollers, bearings, rotor plates, and rotor shaft are made of stainless steel (SS); occlusion bed is made from polyphenylene sulfide (PPS) for excellent chemical resistance
- Compatible with all L/S drives listed in this catalog that accept two or more pump heads
- Accepts high-performance precision pump tubing sizes: L/S 15, L/S 24, L/S 35, L/S 36, and our high-pressure pump tubing: L/S 14HP, L/S 15HP, L/S 16HP and L/S 24HP
- Tubing enters/exits the same side of high-performance pump head 77250-62 for easy connection to tubing inlet and outlet
- ATEX Zone 2 approved model 77250-82; rated to EEx II 3 G c II C T6

What's included: mounting hardware and a 15" (38-cm) length of L/S 35 pump tubing.



FEATURES

- ✓ Load high-performance precision tubing easily
- ✓ Pressures up to 150 psi with L/S HP tubing
- ✓ Not stackable
- ✓ ATEX Zone 2 rated models available

ISO 9001:2008
CERTIFIED SUPPLIER



ATEX
Zone 2
77250-82



Pump tubing size	mL per rev	Flow rates in mL/min		Maximum system pressure psi (bar)	High-Performance pump head		ATEX-approved High-Performance pump head	
		0.02 to 100 rpm	6 to 600 rpm		Catalog number	Price	Catalog number	Price
L/S 14HP†	0.3	0.006 to 30	Not recommended	150 (10.2)	JL-77250-62		JL-77250-82	
L/S 16HP†	0.9	0.018 to 90	Not recommended	125 (8.5)				
L/S 15HP†	1.7	0.033 to 170	Not recommended	100 (6.8)				
L/S 24HP†	2.4	0.048 to 240	Not recommended	80 (5.5)				
L/S 15	1.8	0.036 to 180	11 to 1100	40 (2.7)				
L/S 24	3.0	0.060 to 300	18 to 1800	40 (2.7)				
L/S 35	4.3	0.086 to 430	26 to 2600	35 (2.4)				
L/S 36	5.8	0.116 to 580	34 to 3400	20 (1.4)				

†L/S 14HP, L/S 15HP, L/S 16HP and L/S 24HP pump tubing is for use only with the L/S High-Performance pump head mounted on any L/S 100 rpm drive capable of running two or more pump heads. **Note:** High-Performance pump heads are not stackable.

L/S High-Pressure Pump Tubing Ordering Information

Pump tubing formulation	L/S 14HP	L/S 16HP	L/S 15HP	L/S 24HP
PharMed® BPT 	JL-95664-14 /25 ft (7.6 m)	JL-95664-16 /25 ft (7.6 m)	JL-95664-15 /25 ft (7.6 m)	JL-95664-24 /25 ft (7.6 m)
Norprene® 	—	JL-06504-16 /25 ft (7.6 m)	JL-06504-15 /25 ft (7.6 m)	—

Teky's Tips



Loading the High-Performance Pump Head

Rotate tubing retainer knob counterclockwise to release retainer, then lift latch to open.



Insert tubing into occlusion bed so that the tubing ends extend out of the tubing entrance as shown.



Snap the latch closed. Pull the tubing snug around the rotor, close the cover, and rotate the tubing retainer knob clockwise to secure tubing.



Mounted upright

L/S® Multichannel Pump Heads

Get low-pulsation synchronous flow in multiple channels without cartridges

- Load the tubing, latch the occlusion bed, and run the pump—two-stop tubing gives you optimal tension with no adjustment
- Stackable two-, four-, or eight-channel heads for up to 24 channels
- Six roller heads deliver low-pulsation flow; three-roller heads offer higher flow rates
- Machined stainless steel (SS) and anodized aluminum with SS rotor, bearings, and rollers for reliable, continuous-duty operation
- Flow range: 0.045 to 2300 mL/min per channel depending on drive rpm and tubing size
- Heads for L/S precision pump tubing accept two-stop tubing set sizes L/S 13, L/S 14, and L/S 16; heads for L/S high-performance precision pump tubing accept two-stop tubing set sizes L/S 15, L/S 24, and L/S 35
- Compatible with L/S drives that accept two or more pump heads; 1/10 hp min



FEATURES

- ✓ Stackable for up to 24 synchronous flow channels
- ✓ Models for L/S two-stop tubing sets available
- ✓ Durable stainless steel and anodized aluminum construction



Stack heads for even more channels!

What's included: mounting hardware and hex key tool

ISO9001:2008
CERTIFIED SUPPLIER



Number of channels	Number of rollers	Max channels with stacked heads†		Catalog number	Price
		100 rpm drive	600 rpm drive		
A. L/S Multichannel pump heads for precision pump tubing, sizes L/S 13, L/S 14, L/S 16					
4	6	24	12	JL-07535-04	
8				JL-07535-08	
B. L/S Multichannel pump heads for high-performance precision pump tubing, sizes L/S 15, L/S 24, L/S 35					
2	3	12	6	JL-07536-02	
4				JL-07536-04	

†Maximum channel capacity depends on drive torque capability and tubing formulation used.

L/S Two-Stop Precision Tubing Sets Ordering Information for 07535- and 07536-series pump heads

Pump tubing formulation	L/S Precision pump tubing			L/S High-performance precision pump tubing		
	L/S 13	L/S 14	L/S 16	L/S 15	L/S 24	L/S 35
Tygon® E-LFL	JL-06447-13 /pk of 8	JL-06447-14 /pk of 8	JL-06447-16 /pk of 8	JL-06447-15 /pk of 4	JL-06447-24 /pk of 4	JL-06447-35 /pk of 4
Silicone (platinum-cured)	JL-06421-13 /pk of 8	JL-06421-14 /pk of 8	JL-06421-16 /pk of 8	JL-06421-15 /pk of 4	JL-06421-24 /pk of 4	JL-06421-35 /pk of 4
BioPharm Plus Silicone (platinum-cured)	JL-96116-13 /pk of 8	JL-96116-14 /pk of 8	JL-96116-16 /pk of 8	JL-96116-15 /pk of 4	JL-96116-24 /pk of 4	JL-96116-35 /pk of 4
PharMed® BPT	JL-96114-13 /pk of 8	JL-96114-14 /pk of 8	JL-96114-16 /pk of 8	JL-96114-15 /pk of 4	JL-96114-24 /pk of 4	JL-96114-35 /pk of 4
Chem-Durance® Bio	JL-96117-13 /pk of 8	JL-96117-14 /pk of 8	JL-96117-16 /pk of 8	JL-96117-15 /pk of 4	JL-96117-24 /pk of 4	JL-96117-35 /pk of 4
Viton®	JL-96428-13 /pk of 8	JL-96428-14 /pk of 8	JL-96428-16 /pk of 8	JL-96428-15 /pk of 4	JL-96428-24 /pk of 4	JL-96428-35 /pk of 4















Flow Rates per Channel in mL/min with L/S Two-Stop Precision Pump Tubing Sets above

Drive rpm	Precision pump tubing			High-performance precision pump tubing		
	L/S 13	L/S 14	L/S 16	L/S 15	L/S 24	L/S 35
1 to 100	0.045 to 4.5	0.16 to 16	0.47 to 47	1.6 to 160	2.8 to 280	3.8 to 380
6 to 600	0.27 to 27	0.96 to 96	2.8 to 280	10 to 1000	17 to 1700	23 to 2300

L/S® Precision Pump Tubing

Ensure optimal performance from your Masterflex pump

- Custom extruded to fit Masterflex pumps
- Engineered for long life in peristaltic pump applications

		Flow range (approximate)†	L/S 13	L/S 14	L/S 16	L/S 25	L/S 17	L/S 18
		0.06 to 36 mL/min	0.06 to 36 mL/min	0.21 to 130 mL/min	0.8 to 480 mL/min	1.7 to 1000 mL/min	2.8 to 1700 mL/min	3.8 to 2300 mL/min
Pump tubing formulation	Description	Compatible pump head						
Silicone (platinum-cured)	<ul style="list-style-type: none"> - Complies with USP Class V, EP, FDA, REACH, RoHS, ADFC - Low protein binding, fungus resistant, phthalate and latex-free - Accommodates a wide temperature range 	<ul style="list-style-type: none"> ✓ Standard ✓ Easy-Load® ✓ Easy-Load II ✓ Easy-Load 3 ✓ Multichannel cartridge 	JL-96410-13	JL-96410-14	JL-96410-16	JL-96410-25	JL-96410-17	JL-96410-18
			7.6 m (25 ft)/pk	7.6 m (25 ft)/pk	7.6 m (25 ft)/pk	7.6 m (25 ft)/pk	7.6 m (25 ft)/pk	7.6 m (25 ft)/pk
Silicone (peroxide-cured)	<ul style="list-style-type: none"> - Complies with USP Class VI, EP, FDA, 3A, REACH, RoHS, ADFC - Greater physical compression capability - Economical, longer tubing life 	<ul style="list-style-type: none"> ✓ Standard ✓ Easy-Load ✓ Easy-Load II ✓ Easy-Load 3 ✓ Multichannel cartridge 	JL-96400-13	JL-96400-14	JL-96400-16	JL-96400-25	JL-96400-17	JL-96400-18
			7.6 m (25 ft)/pk	7.6 m (25 ft)/pk	7.6 m (25 ft)/pk	7.6 m (25 ft)/pk	7.6 m (25 ft)/pk	7.6 m (25 ft)/pk
BioPharm Silicone (platinum-cured)	<ul style="list-style-type: none"> - Complies with USP Class VI, EP, FDA, 3A, REACH, RoHS, ADFC - Low absorption; excellent biocompatibility - Very low extractable; weather, ozone, corona, radiation resistant 	<ul style="list-style-type: none"> ✓ Standard ✓ Easy-Load ✓ Easy-Load II ✓ Easy-Load 3 ✓ Multichannel cartridge 	JL-96420-13	JL-96420-14	JL-96420-16	JL-96420-25	JL-96420-17	JL-96420-18
			7.6 m (25 ft)/pk	7.6 m (25 ft)/pk	7.6 m (25 ft)/pk	7.6 m (25 ft)/pk	7.6 m (25 ft)/pk	7.6 m (25 ft)/pk
BioPharm Plus Silicone (platinum-cured)	<ul style="list-style-type: none"> - Complies with USP Class VI, EP, FDA, REACH, RoHS, ADFC - Ultra-smooth—minimizes particle entrapment - Very low extractable—ideal for lab, biotech, and pharmaceutical applications 	<ul style="list-style-type: none"> ✓ Standard ✓ Easy-Load ✓ Easy-Load II ✓ Easy-Load 3 ✓ Multichannel cartridge 	JL-96440-13	JL-96440-14	JL-96440-16	JL-96440-25	JL-96440-17	JL-96440-18
			7.6 m (25 ft)/pk	7.6 m (25 ft)/pk	7.6 m (25 ft)/pk	7.6 m (25 ft)/pk	7.6 m (25 ft)/pk	7.6 m (25 ft)/pk
Puri-Flex™	<ul style="list-style-type: none"> - Complies with USP Class VI, FDA, 3A, REACH, RoHS, ADFC - Heat sealable, weldable, and economical - Long pump life when compared to silicone or many other TPE tubings 	<ul style="list-style-type: none"> ✓ Standard ✓ Easy-Load ✓ Easy-Load II ✓ Easy-Load 3 ✓ Multichannel cartridge 	JL-96419-13	JL-96419-14	JL-96419-16	JL-96419-25	JL-96419-17	JL-96419-18
			7.6 m (25 ft)/pk	7.6 m (25 ft)/pk	7.6 m (25 ft)/pk	7.6 m (25 ft)/pk	7.6 m (25 ft)/pk	7.6 m (25 ft)/pk
C-Flex®	<ul style="list-style-type: none"> - Complies with USP Class VI, EP, REACH, RoHS, ADFC - Heat sealable, weldable, economical - Better resistance to pH fluctuations 	<ul style="list-style-type: none"> ✓ Standard ✓ Easy-Load ✓ Easy-Load II ✓ Easy-Load 3 ✓ Multichannel cartridge 	JL-06424-13	JL-06424-14	JL-06424-16	JL-06424-25	JL-06424-17	JL-06424-18
			7.6 m (25 ft)/pk	7.6 m (25 ft)/pk	7.6 m (25 ft)/pk	7.6 m (25 ft)/pk	7.6 m (25 ft)/pk	7.6 m (25 ft)/pk
C-Flex® ULTRA	<ul style="list-style-type: none"> - Complies with USP Class VI, EP, REACH, RoHS, ADFC - Longest life of any C-Flex formulation - Lowest spallation and reduced residue 	<ul style="list-style-type: none"> ✓ Standard ✓ Easy-Load ✓ Easy-Load II ✓ Easy-Load 3 ✓ Multichannel cartridge 	—	JL-06434-14	JL-06434-16	JL-06434-25	JL-06434-17	JL-06434-18
			—	7.6 m (25 ft)/pk	7.6 m (25 ft)/pk	7.6 m (25 ft)/pk	7.6 m (25 ft)/pk	7.6 m (25 ft)/pk
PharMed® BPT	<ul style="list-style-type: none"> - Complies with USP Class VI, EP, FDA, NSF, REACH, RoHS - >10,000 hours of tubing life; sealable, weldable - Ideal for tissue and cell culture work 	<ul style="list-style-type: none"> ✓ Standard ✓ Easy-Load ✓ Easy-Load II ✓ Easy-Load 3 ✓ Multichannel cartridge 	JL-06508-13	JL-06508-14	JL-06508-16	JL-06508-25	JL-06508-17	JL-06508-18
			7.6 m (25 ft)/pk	7.6 m (25 ft)/pk	7.6 m (25 ft)/pk	7.6 m (25 ft)/pk	7.6 m (25 ft)/pk	7.6 m (25 ft)/pk
PharmaPure®	<ul style="list-style-type: none"> - Complies with USP Class VI, EP, FDA, REACH, RoHS - Nontoxic and nonhemolytic biocompatible - Long life even under pressure with VERY low spallation 	<ul style="list-style-type: none"> ✓ Easy-Load ✓ Easy-Load II 	JL-06435-13	JL-06435-14	JL-06435-16	JL-06435-25	JL-06435-17	JL-06435-18
			7.6 m (25 ft)/pk	7.6 m (25 ft)/pk	7.6 m (25 ft)/pk	7.6 m (25 ft)/pk	7.6 m (25 ft)/pk	7.6 m (25 ft)/pk

†Determined under the following conditions: Using a 1 to 600 rpm drive; 0 psi at inlet, 0.5 psi at outlet; water temperature at 22°C (72°F).

Benchtop Tubing Cutter

Steel blade makes right-angle cuts in several sizes of Masterflex tubing:

C/L® 2.06 mm, 2.79 mm OD
L/S® sizes 13, 14, 15, 16, 17, 18, 24, 25, 35, 36
I/P® sizes 26, 73

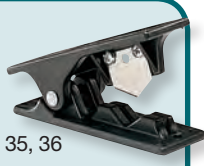

[JL-06438-10](#) Benchtop tubing cutter

Tubing size	L/S 13	L/S 14	L/S 16	L/S 25	L/S 17	L/S 18
Inner diameter	0.8 mm (0.03")	1.6 mm (0.06")	3.1 mm (0.12")	4.8 mm (0.19")	6.4 mm (0.25")	7.9 mm (0.31")
Hose barb size	1.6 mm (1/16")	1.6 mm (1/16")	3.2 mm (3/16")	4.8 mm (3/16")	6.4 mm (1/4")	9.5 mm (3/8")
Flow range (approximate)†	0.06 to 36 mL/min	0.21 to 130 mL/min	0.8 to 480 mL/min	1.7 to 1000 mL/min	2.8 to 1700 mL/min	3.8 to 2300 mL/min













Pump tubing formulation	Description	Compatible pump head	L/S 13	L/S 14	L/S 16	L/S 25	L/S 17	L/S 18
Chem-Durance® Bio 	<ul style="list-style-type: none"> Complies: USP Class VI, FDA, REACH, RoHS Excellent chemical compatibility and biocompatibility Excellent pump life and durability under pressure 	<ul style="list-style-type: none"> ✓ Easy-Load ✓ Easy-Load II 	JL-06442-13	JL-06442-14	JL-06442-16	JL-06442-25	JL-06442-17	JL-06442-18
			15.2 m (50 ft)/pk	15.2 m (50 ft)/pk	15.2 m (50 ft)/pk	15.2 m (50 ft)/pk	15.2 m (50 ft)/pk	15.2 m (50 ft)/pk
Solve-Flex® 	<ul style="list-style-type: none"> Complies with USP Class VI Excellent chemical resistance, especially with solvents Low spallation Fluoropolymer lined tubing 	<ul style="list-style-type: none"> ✓ Easy-Load ✓ Easy-Load II 	—	—	—	—	JL-96446-17	—
							3.6 m (12 ft)/pk	
Tygon® E-LFL 	<ul style="list-style-type: none"> Complies with USP Class VI, EP, FDA, EU Food, REACH, RoHS, ADFC Longest life of all Tygon formulations Broad chemical resistance 	<ul style="list-style-type: none"> ✓ Standard ✓ Easy-Load ✓ Easy-Load II ✓ Easy-Load 3 ✓ Multichannel cartridge 	JL-06440-13	JL-06440-14	JL-06440-16	JL-06440-25	JL-06440-17	JL-06440-18
			7.6 m (25 ft)/pk	7.6 m (25 ft)/pk	7.6 m (25 ft)/pk	7.6 m (25 ft)/pk	7.6 m (25 ft)/pk	7.6 m (25 ft)/pk
Tygon E-Food (B-44-4X) 	<ul style="list-style-type: none"> Complies with FDA, EU Food, NSF, 3A, REACH, RoHS, ADFC Smooth inner surface unaffected by commercial sanitizers Nontoxic; will not affect taste or odor 	<ul style="list-style-type: none"> ✓ Standard ✓ Easy-Load ✓ Easy-Load II ✓ Easy-Load 3 ✓ Multichannel cartridge 	JL-06418-13	JL-06418-14	JL-06418-16	JL-06418-25	JL-06418-17	JL-06418-18
			15.2 m (50 ft)/pk	15.2 m (50 ft)/pk	15.2 m (50 ft)/pk	15.2 m (50 ft)/pk	15.2 m (50 ft)/pk	15.2 m (50 ft)/pk
Tygon E-Lab (E-3603) 	<ul style="list-style-type: none"> Complies with USP Class VI, FDA, EU Food, NSF, REACH, RoHS, ADFC Ideal for general transfer applications Nonaging, nonoxidizing, low gas permeability 	<ul style="list-style-type: none"> ✓ Standard ✓ Easy-Load ✓ Easy-Load II ✓ Easy-Load 3 ✓ Multichannel cartridge 	JL-06509-13	JL-06509-14	JL-06509-16	JL-06509-25	JL-06509-17	JL-06509-18
			15.2 m (50 ft)/pk	15.2 m (50 ft)/pk	15.2 m (50 ft)/pk	15.2 m (50 ft)/pk	15.2 m (50 ft)/pk	15.2 m (50 ft)/pk
Tygon Fuel & Lubricant (F-4040-A) 	<ul style="list-style-type: none"> Complies with REACH, RoHS, ADFC Specially formulated to transport hydrocarbons, petroleum products, and distillates Low gas permeability 	<ul style="list-style-type: none"> ✓ Standard ✓ Easy-Load ✓ Easy-Load II ✓ Easy-Load 3 ✓ Multichannel cartridge 	JL-06401-13	JL-06401-14	JL-06401-16	JL-06401-25	JL-06401-17	JL-06401-18
			15.2 m (50 ft)/pk	15.2 m (50 ft)/pk	15.2 m (50 ft)/pk	15.2 m (50 ft)/pk	15.2 m (50 ft)/pk	15.2 m (50 ft)/pk
Tygon Chemical (2001) 	<ul style="list-style-type: none"> Complies with FDA 21 CFR 175.300, REACH, RoHS, ADFC Best chemical resistance of Tygon formulations Plasticizer-free with low gas permeability 	<ul style="list-style-type: none"> ✓ Easy-Load ✓ Easy-Load II 	JL-06475-13	JL-06475-14	JL-06475-16	JL-06475-25	JL-06475-17	JL-06475-18
			15.2 m (50 ft)/pk	15.2 m (50 ft)/pk	15.2 m (50 ft)/pk	15.2 m (50 ft)/pk	15.2 m (50 ft)/pk	15.2 m (50 ft)/pk
Norprene® (A-60 G) 	<ul style="list-style-type: none"> Complies with NSF, REACH, RoHS Up to 10,000 hours of tubing life Excellent choice for pressure/vacuum applications 	<ul style="list-style-type: none"> ✓ Standard ✓ Easy-Load ✓ Easy-Load II ✓ Easy-Load 3 ✓ Multichannel cartridge 	JL-06404-13	JL-06404-14	JL-06404-16	JL-06404-25	JL-06404-17	JL-06404-18
			15.2 m (50 ft)/pk	15.2 m (50 ft)/pk	15.2 m (50 ft)/pk	15.2 m (50 ft)/pk	15.2 m (50 ft)/pk	15.2 m (50 ft)/pk
Norprene Food (A 60 F) 	<ul style="list-style-type: none"> Complies with FDA, 3A, NSF, REACH, RoHS Ideal for high-temperature food applications Resists heat, ozone, acids, and alkalis 	<ul style="list-style-type: none"> ✓ Standard ✓ Easy-Load ✓ Easy-Load II ✓ Easy-Load 3 ✓ Multichannel cartridge 	JL-06402-13	JL-06402-14	JL-06402-16	JL-06402-25	JL-06402-17	JL-06402-18
			15.2 m (50 ft)/pk	15.2 m (50 ft)/pk	15.2 m (50 ft)/pk	15.2 m (50 ft)/pk	15.2 m (50 ft)/pk	15.2 m (50 ft)/pk
Viton® 	<ul style="list-style-type: none"> Complies with FDA, ADFC Perfect for applications where FDA and chemical compatibility is needed Resists corrosives, solvents, and oils at elevated temperatures 	<ul style="list-style-type: none"> ✓ Standard ✓ Easy-Load ✓ Easy-Load II ✓ Easy-Load 3 ✓ Multichannel cartridge 	JL-96412-13	JL-96412-14	JL-96412-16	JL-96412-25	JL-96412-17	JL-96412-18
			7.6 m (25 ft)/pk	7.6 m (25 ft)/pk	7.6 m (25 ft)/pk	7.6 m (25 ft)/pk	7.6 m (25 ft)/pk	7.6 m (25 ft)/pk

L/S® High-Performance Precision Pump Tubing

Thicker wall compared to our Precision pump tubing

- Best choice for applications involving pressure, suction lift, viscous fluids, or long tubing life

Tubing size	L/S 15	L/S 24	L/S 35	L/S 36
Inner diameter	4.8 mm (0.19")	6.4 mm (0.25")	7.9 mm (0.31")	9.7 mm (0.38")
Hose barb size	4.8 mm (3/16")	6.4 mm (1/4")	9.5 mm (3/8")	9.5 mm (3/8")
Flow range (approximate)†	1.7 to 1000 mL/min (1.8 to 1100 mL/min)	2.8 to 1700 mL/min (3.0 to 1800 mL/min)	3.8 to 2300 mL/min (4.3 to 2600 mL/min)	4.8 to 2900 mL/min (5.8 to 3400 mL/min)

Pump tubing formulation	Description	Compatible pump head				
Silicone (platinum-cured) 	<ul style="list-style-type: none"> – Complies with USP Class V, EP, FDA, REACH, RoHS, ADFC – Low protein binding, fungus resistant, phthalate and latex-free – Accommodates a wide temperature range 	<ul style="list-style-type: none"> ✓ Standard ✓ Easy-Load ✓ Easy-Load II ✓ Easy-Load 3 ✓ High-Performance 	JL-96410-15	JL-96410-24	JL-96410-35	JL-96410-36
			7.6 m (25 ft)/pk	7.6 m (25 ft)/pk	7.6 m (25 ft)/pk	7.6 m (25 ft)/pk
Silicone (peroxide-cured) 	<ul style="list-style-type: none"> – Complies with USP Class VI, EP, FDA, 3A, REACH, RoHS, ADFC – Greater physical compression capability – Economical, longer tubing life 	<ul style="list-style-type: none"> ✓ Standard ✓ Easy-Load ✓ Easy-Load II ✓ Easy-Load 3 ✓ High-Performance 	JL-96400-15	JL-96400-24	JL-96400-35	JL-96400-36
			7.6 m (25 ft)/pk	7.6 m (25 ft)/pk	7.6 m (25 ft)/pk	7.6 m (25 ft)/pk
BioPharm Silicone (platinum-cured) 	<ul style="list-style-type: none"> – Complies with USP Class VI, EP, FDA, 3A, REACH, RoHS, ADFC – Low absorption; excellent biocompatibility – Very low extractable; weather, ozone, corona, radiation resistant 	<ul style="list-style-type: none"> ✓ Standard ✓ Easy-Load ✓ Easy-Load II ✓ Easy-Load 3 ✓ High-Performance 	JL-96420-15	JL-96420-24	JL-96420-35	JL-96420-36
			7.6 m (25 ft)/pk	7.6 m (25 ft)/pk	7.6 m (25 ft)/pk	7.6 m (25 ft)/pk
BioPharm Plus Silicone (platinum-cured) 	<ul style="list-style-type: none"> – Complies with USP Class VI, EP, FDA, REACH, RoHS, ADFC – Ultra-smooth—minimizes particle entrapment – Very low extractable—ideal for lab, biotech, and pharmaceutical applications 	<ul style="list-style-type: none"> ✓ Standard ✓ Easy-Load ✓ Easy-Load II ✓ Easy-Load 3 ✓ High-Performance 	JL-96440-15	JL-96440-24	JL-96440-35	JL-96440-36
			7.6 m (25 ft)/pk	7.6 m (25 ft)/pk	7.6 m (25 ft)/pk	7.6 m (25 ft)/pk
Puri-Flex™ 	<ul style="list-style-type: none"> – Complies with USP Class VI, FDA, 3A, REACH, RoHS, ADFC – Heat sealable, weldable, and economical – Long pump life when compared to silicone or many other TPE tubings 	<ul style="list-style-type: none"> ✓ Standard ✓ Easy-Load ✓ Easy-Load II ✓ Easy-Load 3 ✓ High-Performance 	JL-96419-15	JL-96419-24	JL-96419-35	JL-96419-36
			7.6 m (25 ft)/pk	7.6 m (25 ft)/pk	7.6 m (25 ft)/pk	7.6 m (25 ft)/pk
C-Flex® 	<ul style="list-style-type: none"> – Complies with USP Class VI, EP, REACH, RoHS, ADFC – Heat sealable, weldable, economical – Better resistance to pH fluctuations 	<ul style="list-style-type: none"> ✓ Standard ✓ Easy-Load ✓ Easy-Load II ✓ Easy-Load 3 ✓ High-Performance 	JL-06424-15	JL-06424-24	JL-06424-35	JL-06424-36
			7.6 m (25 ft)/pk	7.6 m (25 ft)/pk	7.6 m (25 ft)/pk	7.6 m (25 ft)/pk
C-Flex® ULTRA 	<ul style="list-style-type: none"> – Complies with USP Class VI, EP, REACH, RoHS, ADFC – Longest life of any C-Flex formulation – Lowest spallation and reduced residue 	<ul style="list-style-type: none"> ✓ Standard ✓ Easy-Load ✓ Easy-Load II ✓ Easy-Load 3 ✓ High-Performance 	JL-06434-15	JL-06434-24	JL-06434-35	JL-06434-36
			7.6 m (25 ft)/pk	7.6 m (25 ft)/pk	7.6 m (25 ft)/pk	7.6 m (25 ft)/pk
PharMed® BPT 	<ul style="list-style-type: none"> – Complies with USP Class VI, EP, FDA, NSF, REACH, RoHS – >10,000 hours of tubing life; sealable, weldable – Ideal for tissue and cell culture work 	<ul style="list-style-type: none"> ✓ Standard ✓ Easy-Load ✓ Easy-Load II ✓ Easy-Load 3 ✓ High-Performance 	JL-06508-15	JL-06508-24	JL-06508-35	JL-06508-36
			7.6 m (25 ft)/pk	7.6 m (25 ft)/pk	7.6 m (25 ft)/pk	7.6 m (25 ft)/pk
PharmaPure® 	<ul style="list-style-type: none"> – Complies with USP Class VI, EP, FDA, REACH, RoHS – Nontoxic and nonhemolytic biocompatible – Long life even under pressure with VERY low spallation 	<ul style="list-style-type: none"> ✓ Easy-Load ✓ Easy-Load II 	JL-06435-15	JL-06435-24	—	—
			7.6 m (25 ft)/pk	7.6 m (25 ft)/pk	—	—

†Value in () obtained by High-Performance pump head. Flow range determined under the following conditions: Using a 1 to 600 rpm drive; 0 psi at inlet, 0.5 psi at outlet; water temperature at 22°C (72°F).

DON'T RISK IT!









Our chemical compatibility database provides important information on chemical resistance—check it out at ColeParmer.com/ChemChart

Tubing size	L/S 15	L/S 24	L/S 35	L/S 36
Inner diameter	4.8 mm (0.19")	6.4 mm (0.25")	7.9 mm (0.31")	9.7 mm (0.38")
Hose barb size	4.8 mm (3/16")	6.4 mm (1/4")	9.5 mm (3/8")	9.5 mm (3/8")
Flow range (approximate)†	1.7 to 1000 mL/min (1.8 to 1100 mL/min)	2.8 to 1700 mL/min (3.0 to 1800 mL/min)	3.8 to 2300 mL/min (4.3 to 2600 mL/min)	4.8 to 2900 mL/min (5.8 to 3400 mL/min)

Pump tubing formulation	Description	Compatible pump head				
Chem-Durance® Bio 	<ul style="list-style-type: none"> Complies: USP Class VI, FDA, REACH, RoHS Excellent chemical compatibility and biocompatibility Excellent pump life and durability under pressure 	<ul style="list-style-type: none"> ✓ Easy-Load ✓ Easy-Load II 	JL-06442-15	JL-06442-24	JL-06442-35	JL-06442-36
			15.2 m (50 ft)/pk	15.2 m (50 ft)/pk	15.2 m (50 ft)/pk	15.2 m (50 ft)/pk
Solve-Flex® 	<ul style="list-style-type: none"> Complies with USP Class VI Excellent chemical resistance, especially with solvents Low spallation Fluoropolymer lined tubing 	<ul style="list-style-type: none"> ✓ Easy-Load ✓ Easy-Load II 	—	JL-96446-24	—	—
			—	3.6 m (12 ft)/pk	—	—
Tygon® E-LFL 	<ul style="list-style-type: none"> Complies with USP Class VI, EP, FDA, REACH, RoHS, ADCF Longest life of all Tygon formulations Broad chemical resistance 	<ul style="list-style-type: none"> ✓ Standard ✓ Easy-Load ✓ Easy-Load II ✓ Easy-Load 3 ✓ High-Performance 	JL-06440-15	JL-06440-24	JL-06440-35	JL-06440-36
			7.6 m (25 ft)/pk	7.6 m (25 ft)/pk	7.6 m (25 ft)/pk	7.6 m (25 ft)/pk
Tygon E-Food (B-44-4X) 	<ul style="list-style-type: none"> Complies with FDA, NSF, 3A, and EU Food regulations (10/2011) Smooth inner surface unaffected by common commercial sanitizers Nontoxic 	<ul style="list-style-type: none"> ✓ Standard ✓ Easy-Load ✓ Easy-Load II ✓ Easy-Load 3 ✓ High-Performance 	JL-06418-15	JL-06418-24	JL-06418-35	JL-06418-36
			15.2 m (50 ft)/pk	15.2 m (50 ft)/pk	15.2 m (50 ft)/pk	15.2 m (50 ft)/pk
Tygon E-Lab (E-3603) 	<ul style="list-style-type: none"> Complies with USP Class V, EP, FDA, REACH, RoHS, ADCF Ideal for general transfer applications Clear for easy monitoring Nontoxic, nonaging, nonoxidizing 	<ul style="list-style-type: none"> ✓ Standard ✓ Easy-Load ✓ Easy-Load II ✓ Easy-Load 3 ✓ High-Performance 	JL-06509-15	JL-06509-24	JL-06509-35	JL-06509-36
			15.2 m (50 ft)/pk	15.2 m (50 ft)/pk	15.2 m (50 ft)/pk	15.2 m (50 ft)/pk
Tygon Fuel & Lubricant (F-4040-A) 	<ul style="list-style-type: none"> Complies with USP Class V, EP, FDA, REACH, RoHS, ADCF Ideal for transferring hydrocarbons, gasoline, kerosene, and heating oil Very low gas permeability 	<ul style="list-style-type: none"> ✓ Standard ✓ Easy-Load ✓ Easy-Load II ✓ Easy-Load 3 ✓ High-Performance 	JL-06401-15	JL-06401-24	JL-06401-35	JL-06401-36
			15.2 m (50 ft)/pk	15.2 m (50 ft)/pk	15.2 m (50 ft)/pk	15.2 m (50 ft)/pk
Tygon Chemical (2001) 	<ul style="list-style-type: none"> Complies with USP Class V, EP, FDA, REACH, RoHS, ADCF Best chemical resistance of Tygon formulations Plasticizer-free with low gas permeability 	<ul style="list-style-type: none"> ✓ Easy-Load ✓ Easy-Load II 	JL-06475-15	JL-06475-24	—	—
			15.2 m (50 ft)/pk	15.2 m (50 ft)/pk	—	—
Norprene® (A-60 G) 	<ul style="list-style-type: none"> Complies with NSF, REACH, RoHS Up to 10,000 hours of tubing life Excellent choice for pressure/vacuum applications 	<ul style="list-style-type: none"> ✓ Standard ✓ Easy-Load ✓ Easy-Load II ✓ Easy-Load 3 ✓ High-Performance 	JL-06404-15	JL-06404-24	JL-06404-35	JL-06404-36
			15.2 m (50 ft)/pk	15.2 m (50 ft)/pk	15.2 m (50 ft)/pk	15.2 m (50 ft)/pk
Norprene Food (A 60 F) 	<ul style="list-style-type: none"> Complies with FDA, 3A, NSF, REACH, RoHS Ideal for high-temperature food applications Resists heat, ozone, acids, and alkalis 	<ul style="list-style-type: none"> ✓ Standard ✓ Easy-Load ✓ Easy-Load II ✓ Easy-Load 3 ✓ High-Performance 	JL-06402-15	JL-06402-24	JL-06402-35	JL-06402-36
			15.2 m (50 ft)/pk	15.2 m (50 ft)/pk	15.2 m (50 ft)/pk	15.2 m (50 ft)/pk
Viton® 	<ul style="list-style-type: none"> Complies with FDA, ADCF Perfect for applications where FDA and chemical compatibility is needed Resists corrosives, solvents, and oils at elevated temperatures 	<ul style="list-style-type: none"> ✓ Standard ✓ Easy-Load ✓ Easy-Load II ✓ Easy-Load 3 ✓ High-Performance 	JL-96412-15	JL-96412-24	JL-96412-35	JL-96412-36
			7.6 m (25 ft)/pk	7.6 m (25 ft)/pk	7.6 m (25 ft)/pk	7.6 m (25 ft)/pk

L/S® Drives Selection Guide

Description	Flow rates (mL/min)	Special features	Page number
Fixed-Speed			
	Lowest: 0.06 Highest: 290	<ul style="list-style-type: none"> ✓ Consistent repeatable flow rates ✓ Economical and compact ✓ UL, cUL, and CE listed models 	ColeParmer.com
Variable-Speed Economy Console			
	Lowest: 0.42 Highest: 2900	<ul style="list-style-type: none"> ✓ Economical variable flow ✓ Simple speed control ✓ UL, cUL, and CE listed models ✓ Accept stacked pump heads for multiple channels 	ColeParmer.com
Precision Modular			
	Lowest: 0.06 Highest: 3400	<ul style="list-style-type: none"> ✓ Separate motor and controller up to 15 ft (4.6 m) ✓ Models available with IP66-rated wall-mount controllers ✓ Pump heads can be stacked 	15
Precision Variable-Speed Console			
	Lowest: 0.06 Highest: 3400	<ul style="list-style-type: none"> ✓ Economical variable flow ✓ Simple speed control ✓ ETL and CE listed ✓ Accept stacked pump heads for multiple channels ✓ Drives are stackable 	16
Variable-Speed Digital and Computer Compatible			
	Lowest: 0.001 Highest: 3400	<ul style="list-style-type: none"> ✓ Four-line graphical LCD with menu-driven programming ✓ Maintenance-free brushless motor ✓ PWM speed control with 6000:1 turndown ✓ Tachometer feedback for $\pm 0.1\%$ speed control ✓ Calibration capability 	17-18
Digital Process			
	Lowest: 0.001 Highest: 3400	<ul style="list-style-type: none"> ✓ Four-line graphical LCD with menu-driven programming ✓ Sealed housing; IP66 and NEMA 4X rated for washdown ✓ Maintenance-free brushless motor; PWM speed control ✓ Dispensing features include delay interval and cumulative volume ✓ Remote control capability 	19
Digital Modular Dispensers			
	Lowest: 0.001 Highest: 3400	<ul style="list-style-type: none"> ✓ Maintenance-free brushless motor ✓ Precise repetitive dispensing with antidrip ✓ Precise PWM speed control ✓ Quiet operation ✓ Tachometer feedback for $\pm 0.1\%$ speed control ✓ Available with washdown wall-mount controller ✓ Calibration capability 	20

L/S® Compact Variable-Speed Pumps

Make low-flow pumping easy!



- No confusing menus—easy-to-use speed controller and reversing switch get you pumping quicker
- No stress loading of tubing—new easy-loading Miniflex™ pump head with automatic tubing retention keeps tubing in place
- Easier on the budget—complete system accepts continuous tubing, no need to buy two-stop tubing
- Dual-channel model delivers synchronous flow from two separate channels

FEATURES

- ✓ Flow rates: 1.8 to 220 mL/min
- ✓ Remote start/stop via contact closure on back of pump
- ✓ Stack for smaller overall footprint

These easy-to-use complete pumps offer a wide occlusion angle, which prevents fluid backflow up to the rated pressure of the tubing. Prime or flush tubing quickly by depressing the MAX button. Self-lubricating thermoplastic polyester rollers are low friction and long wearing for smooth operation and long life.

What's included: L/S Miniflex pump head and dual-voltage (115/230 VAC) benchtop power supply.

Flow Rates in mL/min

rpm	Precision pump tubing			
	L/S 13	L/S 14	L/S 16	L/S 25†
Single-channel pump 77240-20				
35 to 200	1.8 to 10	6.3 to 36	21 to 118	40 to 220
Dual-channel pump 77240-30				
35 to 200	1.8 to 10	6.3 to 36	21 to 118	—

†Recommended for use with silicone or C-Flex® formulations only.



Specifications

Speed control (repeatability): $\pm 5\%$	Dimensions (L x W x H): 8 5/8" x 5 1/4" x 4 1/2" (22 x 13.3 x 11.4 cm)
Reversible motor: yes	Power: 90 to 260 VAC, 50/60 Hz

Number of channels	rpm	IP rating	Catalog number	Price
1	35 to 200	IP22	JL-77240-20	
2			JL-77240-30	

Accessories

[JL-77200-07](#) Replacement power supply, dual-voltage 115/230 VAC
[JL-17050-01](#) NIST-traceable calibration with data for peristaltic pump drive

L/S® Precision Variable-Speed Modular Drives

Place where convenient—ideal for limited spaces, hoods, or isolation chambers

- Three-digit LED display shows motor rpm—confirm speed setting at a glance
- Remote control capabilities: speed, direction, and start/stop
- ±0.25% speed control for precise flow regulation—ideal for metering applications

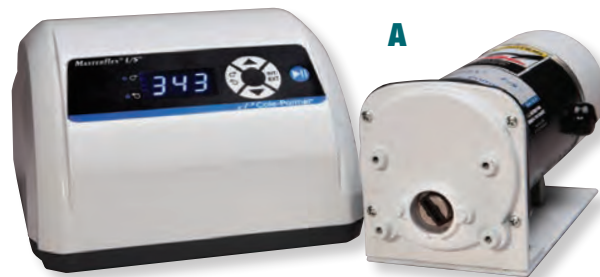

A. Modular Drives with Benchtop Controller

- Splash-resistant ABS plastic controller housing is IP33 rated; drive housing is epoxy finished steel, IP33 rated
- Remote control capabilities via a DB9 female connector on back of controller

B. Washdown Modular Drives with Wall-Mount Controller

- Wall-mount controller housing is powder-coated aluminum, IP66 / NEMA 4X rated for washdown; powder-coated steel drive housing is IP66 / NEMA 4X rated for washdown
- Remote control capabilities via weather-resistant connection on controller

FEATURES

- ✓ Flow rates: 0.06 to 3400 mL/min
- ✓ Easy up-front control of speed, direction, and start/stop
- ✓ Reversible motor—purge tubing before or after pumping; pump fluid in either direction



B
Models 07557-60 and -70 include wall-mount controller



rpm	Speed control (resolution)	Pump heads accepted	Motor size	IP rating	Dimensions (L x W x H)	Power (50/60 Hz)		Catalog number	Price
						VAC	Amps		
A. Precision modular drives with benchtop controller									
6 to 600	±0.25% (1 rpm at 600 rpm; 0.1 rpm at 100 rpm)	2	1/10 hp (75 W)	IP33	Controller: 10 1/2" x 8 1/4" x 5" Drive: 10 3/4" x 4 3/8" x 4 1/2"	90 to 260	2.2 at 115 VAC, 1.1 at 230 VAC	JL-07557-00	
1 to 100		4						JL-07557-10	
B. Precision washdown modular drives with washdown wall-mount controller									
6 to 600	±0.25% (1 rpm at 600 rpm; 0.1 rpm at 100 rpm)	2	1/10 hp (75 W)	IP66	Controller: 9" x 11 1/4" x 4 1/2" Drive: 15 1/16" x 7" x 6"	90 to 260	2.2 at 115 VAC, 1.1 at 230 VAC	JL-07557-60	
1 to 100		4						JL-07557-70	

[JL-07557-51](#) Extension cable, 9 ft (2.7 m); extend distance between motor and controller

[JL-07595-47](#) Cable assembly, for benchtop modular drives; DB9 male connector and 25 ft (7.9 m) cable with stripped wire terminal ends. Use for remote control

[JL-77300-32](#) Cable assembly, for washdown modular drives; 18-pin round connector and 25 ft (7.9 m) cable with stripped wire terminal ends. Use for remote control

[JL-17050-01](#) NIST-traceable calibration with data for peristaltic pump drive

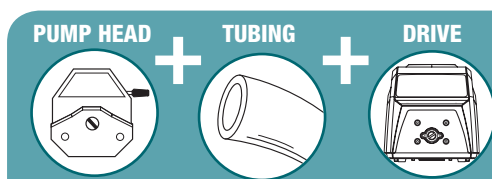

Choose a Complete System

One catalog number includes all 3!

System	Flow range	What's included			Power	Catalog number	Price
		Pump head	Tubing	Drive			
	4.8 to 480 mL/min	Easy-Load® 3 77800-60	C-Flex® ULTRA L/S 16 tubing 06434-16 10 ft (3 m)	Modular drive 07557-00 6 to 600 rpm	90 to 260, 50/60	JL-77913-60	
	17 to 1700 mL/min	Easy-Load II 77200-62	C-Flex ULTRA L/S 24 tubing 06434-24 10 ft (3 m)	Modular drive 07557-00 6 to 600 rpm	90 to 260, 50/60	JL-77913-70	
	17 to 1700 mL/min	Easy-Load II 77200-62	C-Flex ULTRA L/S 24 tubing 06434-24 10 ft (3 m)	Modular drive 07557-60 6 to 600 rpm	90 to 260, 50/60	JL-77913-80	

L/S® Precision Variable-Speed Console Drives

Don't lose control of your metering applications—digital display gives you precise control

- Accurate and repeatable settings with 3-digit LED display of rpm
- Pump fluid in either direction with reversible motor—perfect for purging tubing
- Save space and increase productivity by stacking 2 or 4 pump heads on the same drive to create a multichannel pump system
- Maximize processes in a minimal footprint by stacking splash-resistant, IP33-rated drives
- Two ways to control speed, direction, and start/stop—use either the membrane keypad or remote control capabilities
- Customize for your application—drives accept nine pump head types: Standard, Easy-Load®, Easy-Load® II, Easy-Load® 3, Multichannel, High-Performance, Cartridge, PTFE-Tubing, and PTFE-Diaphragm

FEATURES

- ✓ Flow rates: 0.06 to 3400 mL/min
- ✓ Variable speed from 1 to 600 rpm
- ✓ Reversible motor accepts up to four pump heads



Stack up to 4 heads to maximize productivity in less space

Flow Rates in mL/min (flow rates in parentheses can only be obtained with the High-Performance pump head—at ColeParmer.com)

rpm	Precision pump tubing						High-performance precision pump tubing			
	L/S 13	L/S 14	L/S 16	L/S 25	L/S 17	L/S 18	L/S 15	L/S 24	L/S 35	L/S 36
	Standard†, Easy-Load, Easy-Load II, Easy-Load 3						Multichannel†, Standard†, Easy-Load II, Easy-Load 3, High-Performance			
6 to 600	Cartridge, Multichannel			Cartridge			Easy-Load			
6 to 600	0.36 to 36	1.3 to 130	4.8 to 480	10 to 1000	17 to 1700	23 to 2300	10 to 1000 (11 to 1100)	17 to 1700 (18 to 1800)	23 to 2300 (26 to 2600)	29 to 2900 (34 to 3400)
1 to 100	0.06 to 6	0.21 to 21	0.8 to 80	1.7 to 170	2.8 to 280	3.8 to 380	1.7 to 170 (1.8 to 180)	2.8 to 280 (3.0 to 300)	3.8 to 380 (4.3 to 430)	4.8 to 480 (5.8 to 580)

†The Standard pump head is not available for L/S 25. ‡Multichannel head is not available for L/S 36. Multichannel and Cartridge heads are available for microbore tubing.

ISO 9001:2008
CERTIFIED SUPPLIER



rpm	Speed control (resolution)	Pump heads accepted	Motor size	IP rating	Dimensions (L x W x H)	Power (50/60 Hz)		Catalog number	Price
						VAC	Amps		
6 to 600	±0.25% (1 rpm at 600 rpm; 0.1 rpm at 100 rpm)	2	1/10 hp (75 W)	IP33	10" x 8.5" x 8.5" (25.4 x 21.6 x 21.6 cm)	90 to 260	1.8 at 115 VAC, 1.2 at 230 VAC	JL-07528-10	
3 to 300		2						JL-07528-20	
1 to 100		4						JL-07528-30	

Accessories

- [JL-07595-45 Connector](#), DB9 male. Use for 4 to 20 mA remote control
- [JL-07595-47 Cable assembly](#), DB9 male connector and 25-ft (7.9-m) cable with stripped wire terminal ends. Use for remote control
- [JL-77595-35 Foot switch](#), DB9 male

- [JL-07528-80 Handheld remote controller](#); for remote control of start/stop, route tubing through handle for dispensing into containers
- [JL-17050-01 NIST-traceable calibration](#) with data for peristaltic pump drive

Choose a Complete System
One catalog number includes all 3!

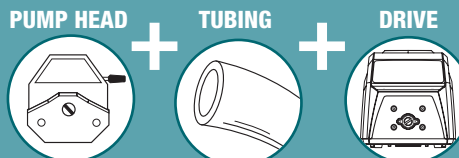

System	Flow range	What's included			Power	Catalog number	Price
		Pump head	Tubing	Drive			
	4.8 to 480 mL/min	Easy-Load® 3 77800-60	C-Flex® ULTRA L/S 16 tubing 06434-16 10 ft (3 m)	Precision console drive 07528-10 6 to 600 rpm	90 to 260 VAC, 50/60 Hz	JL-77916-10	
	17 to 1700 mL/min	Easy-Load II 77200-62	C-Flex® ULTRA L/S 24 tubing 06434-24 10 ft (3 m)				JL-77916-20

L/S® Variable-Speed Digital Drives

Versatile, worry-free operation

- Brushless, maintenance-free motor provides $\pm 0.1\%$ speed control accuracy with 6000:1 turndown ratio
- Bright graphical LCD offers easy programming, four operating modes, and seven languages
- Get more accurate dispensing with preprogrammed calibration
- Change based on your needs—drives accept all L/S pump heads for more pumping versatility
- Choose how you want to dispense: volume, copy cycles, or time
- Operate remotely via DB25 female connector

FEATURES

- ✓ Flow rates: 0.001 to 3400 mL/min
- ✓ Variable speed from 0.02 to 600 rpm
- ✓ Programmable, reversible motor accepts up to four pump heads
- ✓ Ensure dispensing accuracy with antidrip function
- ✓ Hands-free dispensing via time interval dispense cycles

Four operating modes for more functionality: continuous run, time dispense, copy dispense, and volume dispense



Flow Rates in mL/min (flow rates in parentheses can only be obtained with the High-Performance pump head—at ColeParmer.com)

rpm	Precision pump tubing						High-performance precision pump tubing			
	L/S 13	L/S 14	L/S 16	L/S 25	L/S 17	L/S 18	L/S 15	L/S 24	L/S 35	L/S 36
	Standard†, Easy-Load, Easy-Load II, Easy-Load 3						Multichannel‡, Standard, Easy-Load II, Easy-Load 3, High-Performance			
	Cartridge, Multichannel			Cartridge			Easy-Load			
0.1 to 600	0.006 to 36	0.021 to 130	0.08 to 480	0.17 to 1000	0.28 to 1700	0.38 to 2300	0.17 to 1000 (0.18 to 1100)	0.28 to 1700 (0.30 to 1800)	0.38 to 2300 (0.43 to 2600)	0.48 to 2900 (0.57 to 3400)
0.02 to 100	0.001 to 6	0.004 to 21	0.016 to 80	0.033 to 170	0.057 to 280	0.077 to 380	0.033 to 170 (0.036 to 183)	0.057 to 280 (0.057 to 300)	0.077 to 380 (0.086 to 433)	0.096 to 480 (0.113 to 566)

†The Standard pump head is not available for L/S® 25.

‡Multichannel head is not available for L/S 36. Multichannel and Cartridge heads are available for microbore tubing.

ISO9001:2008
CERTIFIED SUPPLIER



rpm	Speed control (resolution)	Pump heads accepted	Motor size	IP rating	Dimensions (L x W x H)	Power (50/60 Hz)		Catalog number	Price
						VAC	Amps		
0.1 to 600	$\pm 0.1\%$ (0.1 rpm at 600 rpm; 0.01 rpm at 100 rpm)	2	1/10 hp (75 W)	IP33	10" x 8.5" x 8.5" (25.4 x 21.6 x 21.6 cm)	90 to 260	2.2 at 115 VAC, 1.1 at 230 VAC	JL-07522-20	
0.02 to 100		4						JL-07522-30	

Accessories

- [JL-07523-92](#) Foot switch, momentary start/stop; 6-ft (1.8-m) cable
- [JL-07523-94](#) DB25 male connector. Use to create your own cable
- [JL-07523-95](#) Cable assembly, DB25 male connector and 25 ft (7.9 m) cable with stripped wire ends for remote control

- [JL-07523-97](#) Handheld remote controller; route tubing through handle for dispensing into containers
- [JL-17050-01](#) NIST-traceable calibration with data for peristaltic pump drive

PUMP HEAD + TUBING + DRIVE

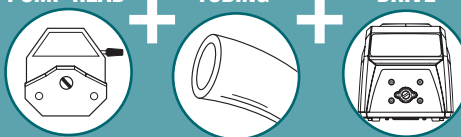

Choose a Complete System
One catalog number includes all 3!

System	Flow range	What's included			Power	Catalog number	Price
		Pump head	Tubing	Drive			
	0.08 to 480 mL/min	Easy-Load® 3 77800-60	C-Flex® ULTRA L/S 16 tubing 06434-16 10 ft (3 m)	Digital drive 07522-20 0.1 to 600 rpm	90 to 260 VAC, 50/60 Hz	JL-77921-65	
	0.28 to 1700 mL/min	Easy-Load II 77200-62	C-Flex ULTRA L/S 24 tubing 06434-24 10 ft (3 m)			JL-77921-75	

L/S® Computer-Compatible Digital Drives

Automate your process by interfacing drives with a computer

- Flow rate: 0.001 to 3400 mL/min with L/S tubing
- Interface drive to your PC via DB9 serial or USB connector
- Graphical LCD shows four operating modes: continuous run, time dispense, copy dispense, and volume dispense. View pump performance continually
- Antidrip function ensures dispensing accuracy
- Remote control capabilities via DB25 female connector on drive
- Menu driven interface—select one of seven languages for programming and operation

Drives offer analog remote control options and simple programming—ideal for automated process applications. Precise PWM speed control ($\pm 0.1\%$) maximizes accuracy and efficiency while the brushless motor gives you quiet, maintenance-free reliability.

What's included: 6-ft (1.8-m) line cord with IEC 320/EE22 socket. Shipped with country-specific plug/cord set; please specify ultimate destination when ordering.

FEATURES

- ✓ Flow rates: 0.001 to 3400 mL/min
- ✓ Variable speed from 0.02 to 600 rpm
- ✓ Programmable, reversible motor accepts up to four pump heads
- ✓ Remote functionality



Drive 07551-20 shown with L/S High-Performance pump head 77250-62

ISO9001:2008
CERTIFIED SUPPLIER



rpm	Speed control (resolution)	Pump heads accepted	Motor size	IP rating	Dimensions (L x W x H)	Power (50/60 Hz)		Catalog number	Price
						VAC	Amps		
0.1 to 600	$\pm 0.1\%$ (0.1 rpm at 600 rpm; 0.01 rpm at 100 rpm)	2	1/40 hp (75 W)	IP33	10" x 8 1/2" x 8 1/2" (25.4 x 21.6 x 21.6 cm)	90 to 260 VAC	2.2 at 115 VAC, 1.1 at 230 VAC	JL-07551-20	
0.02 to 100		4						JL-07551-30	

[JL-07523-92](#) Foot switch, momentary start/stop; 6-ft (1.8-m) cable

[JL-07523-94](#) DB25 male connector. Use to create your own cable

[JL-07523-95](#) Cable assembly, DB25 male connector and 25-ft (7.9-m) cable with stripped wire ends for remote control

[JL-07523-98](#) Tilt bail, use to securely elevate front of drive

[JL-07523-97](#) Handheld remote controller, DB9; for on/off control; route tubing through handle for filling and dispensing applications

[JL-17050-01](#) NIST-traceable calibration with data for peristaltic pump drive

Choose a Complete System
One catalog number includes all 3!

PUMP HEAD + TUBING + DRIVE



System	Flow range	What's included			Power	Catalog number	Price
		Pump head	Tubing	Drive			
	0.08 to 480 mL/min	Easy-Load® 3 77800-60	C-Flex® ULTRA L/S 16 tubing 06434-16 10 ft (3 m)	Computer-compatible drive 07551-20 0.1 to 600 rpm	115/230 VAC, 50/60 Hz	JL-77924-55	
	0.28 to 1700 mL/min	Easy-Load II 77200-62	C-Flex® ULTRA L/S 24 tubing 06434-24 10 ft (3 m)			JL-77924-65	

L/S® Digital Console Process Drives Transfer, dispense, and meter in lab, process and washdown environments

- IP66 and NEMA 4X rated. Sealed housing and sealed keypad are protected from dust, water, and chemicals in the wash-down environment—simply hose down to clean.
- Available with either a 316 SS or a powder-coat steel housing
- Flow rate: 0.001 to 3400 mL/min with L/S tubing depending on drive rpm and tubing size
- Graphical LCD shows six different parameters: motor rpm, flow rate, dispense volume, cumulative volume, dispense interval time, and copy number.
- Brushless, maintenance-free motor with $\pm 0.1\%$ speed control accuracy and a 6000 to 1 turndown ratio
- Dispense by: volume—in milliliters (0.001 to 99,999), liters, and gallons; copy—1 to 99,999 dispense cycles. Set time interval of on/off cycles; 1 sec to 99 hr, 59 min, 59 sec.
- Remote control capabilities via 31-pin circular waterproof connection

FEATURES

- ✓ Flow rates: 0.001 to 3400 mL/min
- ✓ Variable speed
- ✓ IP66 and NEMA 4X rated
- ✓ Programmable, reversible motor accepts two or four pump heads and offers remote functionality



Drive 07575-30 shown with L/S High-Performance pump head 77250-62

What's included: 6-ft (1.8-m) line cord—features IEC 320/CEE 22 connector coupler; watertight cord connection. Please specify destination country when ordering; drive is shipped with country-specific plug/cord set.

ISO 9001:2008
CERTIFIED SUPPLIER



rpm	Speed control (resolution)	Pump heads accepted	Motor size	IP rating	Dimensions (L x W x H)	Power (50/60 Hz)		Catalog number	Price
						VAC	Amps		
Digital process drive with 316 stainless steel housing									
0.1 to 600	$\pm 0.1\%$	2	1/10 hp (75 W)	IP66	12" x 9" x 9 9/16" (30.5 x 22.9 x 23.6 cm)	90 to 260	2.2 at 115 VAC, 1.1 at 230 VAC	JL-07575-30	
0.02 to 100		4							
Digital process drive with powder-coat steel housing									
0.1 to 600	$\pm 0.1\%$	2	1/10 hp (75 W)	IP66	12" x 9" x 9 9/16" (30.5 x 22.9 x 23.6 cm)	90 to 260	2.2 at 115 VAC, 1.1 at 230 VAC	JL-07575-40	
0.02 to 100		4							

[JL-07575-84](#) Washdown foot switch, momentary start/stop; 6-ft (1.8-m) cable

[JL-17050-01](#) NIST-traceable calibration with data for peristaltic pump drive

[JL-07575-80](#) Cable assembly, 31-pin round connector and 25-ft (7.9-m) cable with stripped wire ends for remote control

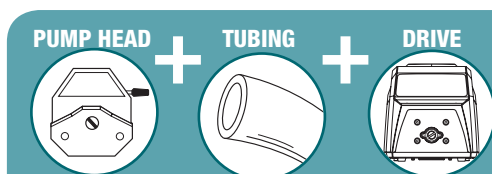

Choose a Complete System
One catalog number includes all 3!

System	Flow range	What's included			Power	Catalog number	Price
		Pump head	Tubing	Drive			
	0.28 to 1700 mL/min	Easy-Load® II 77200-62	C-Flex® ULTRA L/S 24 tubing 06434-24 10 ft (3 m)	Digital console process drive with 316 SS housing 07575-30 0.1 to 600 rpm	90 to 260 VAC, 50/60 Hz	JL-77975-25	
	0.28 to 1800 mL/min	Hgh-Performance 77250-62	C-Flex ULTRA L/S 24 tubing 06434-24 10 ft (3 m)				
	0.28 to 1700 mL/min	Easy-Load II 77200-62	C-Flex ULTRA L/S 24 tubing 06434-24 10 ft (3 m)	Digital console process drive with powder-coat steel housing 07575-40 0.1 to 600 rpm	90 to 260 VAC, 50/60 Hz	JL-77975-45	

L/S® Digital Modular Dispensing Drives

Three dispensing modes and precision low-maintenance motor

- Graphical LCD shows four operating modes: continuous run, timed dispense, copy dispense, volume dispense
- Dispense by mL—volume in mL of each dispense, 0.001 to 9999 mL; Copy—1 to 9,999 dispense cycles; or SEC—time interval between each dispense cycle (1 to 9,999 secs)
- Antidrip function ensures dispense accuracy
- Brushless, maintenance-free motor offers $\pm 0.1\%$ speed control accuracy and a 6000 to 1 turndown ratio
- Remote control capabilities: speed, direction, start/stop/prime, and tach output

What's included: 6-ft (1.8-m) cable to connect drive and controller and 6-ft (1.8-m) line cord with IEC 320/CEE22 socket. Shipped with country-specific plug/cord set; please specify destination when ordering.

A. Modular Drive with Benchtop Controller

- Stackable, splash-resistant ABS plastic controller housing is IP33 rated; drive housing is epoxy finished steel, IP33 rated
- Remote control via a DB25 female connector on back of controller

B. Washdown Modular Drive with Wall-Mount Controller

- Wall-mount controller housing is powder-coated aluminum, IP66 / NEMA4X rated for washdown; powder-coated steel drive housing is IP66 / NEMA4X rated for washdown
- Remote control via weather-resistant connection on controller



A

FEATURES

- ✓ Flow rates: 0.001 to 3400 mL/min depending on drive rpm and tubing size
- ✓ Variable speed
- ✓ Programmable, reversible motor accepts up to two pump heads and offers remote functionality

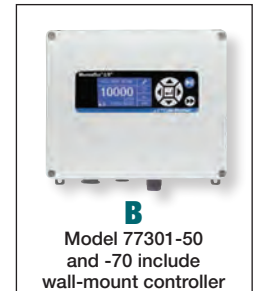

B

Model 77301-50 and -70 include wall-mount controller



rpm	Speed control	Pump heads accepted	Motor size	IP rating	Dimensions (L x W x H)	Power (50/60 Hz)		Catalog number	Price
						VAC	Amps		
A. Digital modular drive with benchtop controller									
0.1 to 600	$\pm 0.1\%$	2	1/10 hp (75 W)	IP33	Controller: 10½" x 8¼" x 5" (26.7 x 21 x 12.7 cm) Drive: 10½" x 3½" x 4½" (26.7 x 9.7 x 11.7 cm)	90 to 260	2.2 at 115 VAC, 1.1 at 230 VAC	JL-77301-40	
0.02 to 100		4						JL-77301-60	
B. Digital washdown modular drive with washdown, wall-mount controller									
0.1 to 600	$\pm 0.1\%$	2	1/10 hp (75 W)	IP66	Controller: 9" x 11¾" x 4½" (23 x 30 x 11.4 cm) Drive: 15½" x 7" x 6" (39.5 x 17.8 x 15.2 cm)	90 to 260	2.2 at 115 VAC, 1.1 at 230 VAC	JL-77301-50	
0.02 to 100		4						JL-77301-70	

[JL-07523-95 Cable assembly](#), for benchtop modular drives 77301-40 and -60; DB25 male connector and 25-ft (7.9-m) cable with stripped wire ends for remote control

[JL-77301-82 Extension cable](#), 9 ft (2.7 m) extends distance between motor and controller

[JL-07575-80 Remote control cable](#) for washdown modular drives 77301-50 and -70; wire to controller/PLC; 25-ft (8.3-m) length

[JL-17050-01 NIST-traceable calibration](#) for peristaltic pump drive

Choose a Complete System
One catalog number includes all 3!

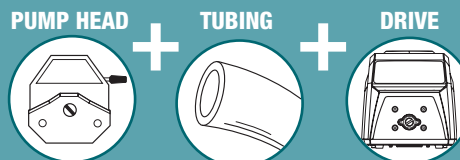

System	Flow range	What's included			Power	Catalog number	Price
		Pump head	Tubing	Drive			
	0.28 to 1700 mL/min	Easy-Load® II 77200-62	C-Flex® ULTRA L/S 24 tubing 06434-24 10 ft (3 m)	Digital modular drive 77301-40 0.1 to 600 rpm	90 to 260 VAC, 50/60 Hz	JL-77923-80	
	0.28 to 1700 mL/min	Easy-Load II 77200-62	C-Flex ULTRA L/S 24 tubing 06434-24 10 ft (3 m)	Digital modular drive 77301-50 0.1 to 600 rpm	90 to 260 VAC, 50/60 Hz	JL-77923-90	

Modular Touch-Screen Dispensing Pumps

Intuitive touch-screen interface
for easy programming and control

 Cole-Parmer®



07582-00



"Run" screen displays all operational parameters so you can confirm activity and program settings at a glance.

- Flow range: 0.001 to 1500 mL/min with Masterflex® L/S® pump tubing
- Program options include constant flow rate, stepped flow, ramped flow, and pulsed flow
- Pump or dispense by volume or time
- Advanced options include program linkage, step repeat, go-to step statements, and program alarms
- Store and transfer programs to a PC or from pump to pump
- Controller is preprogrammed with flow ranges for all accepted tubing sizes

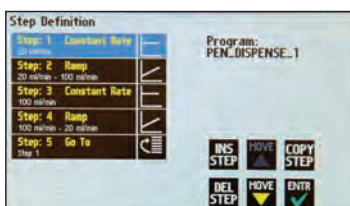

Set up single- or multi-step programs using the intuitive touch screen.

Quickly set up single- or multiple-step programs depending on the requirements of your application. The controller will store up to 50 programs with up to 20 steps each; programs are easily recalled for later use. When pumps are daisy-chained, programs can be transferred from pump to pump to ensure process or experimental consistency.

The included Masterflex Easy-Load® II pump head with automatic tubing retention makes tubing changes quick and easy. Controller is preprogrammed with maximum and minimum flow rates for all accepted tubing sizes. Tubing calibration function ensures flow accuracy and allows user to select calibration volume based on volume being dispensed.

Additional features include screen lockout to prevent inadvertent program changes, forward and reverse prime to rapidly fill or purge tubing, and user selectable restart function in the event of power outage. Controller and drive are housed in durable painted steel.

What's included: Easy-Load II pump head, power adapter with 6-ft (1.8-m) line cord with IEC 320/CEE22 socket. These models are shipped with country-specific plug/cord set; please specify ultimate destination when ordering.



The current step is highlighted during program operation.



Specifications

Accuracy: ±1%
Input/output: RS-485, USB Type B, DB15, mini phono jack
Motor: 1.8° stepper
Motor input power: 30 V, 1.67 A

Dimensions (W x H x D)
 Drive: 4 3/8" x 6" x 10"
 (11.1 x 15.2 x 25.4 cm)
 Controller: 9" x 3" x 7 3/4"
 (22.9 x 7.6 x 19.7 cm)

Flow range (mL/min)	Pump head(s) included	Tubing sizes accepted	Drive speed rating (rpm)	IP rating	Power	Catalog number	Price
0.001 to 1500	One L/S Easy-Load II 77200-60	L/S 13, L/S 14, L/S 16, L/S 25, L/S 17, L/S 18	0.02 to 375	IP33	100 to 240 VAC	JL-07582-00	
0.001 to 1250 per channel	Two L/S Easy-Load II 77200-60	L/S 13, L/S 14, L/S 16, L/S 25, L/S 17, L/S 18				JL-07582-10	
0.001 to 500 per channel	One L/S Easy-Load II dual-channel 77202-60	L/S 13, L/S 14, L/S 16, L/S 25				JL-07582-20	

[JL-74906-92](#) Foot switch for remote start/stop control

I/P® Easy-Load® Pump Heads

Minimize downtime with faster tubing changes

- Optimize pressure capabilities and tubing life with adjustable occlusion
- Less maintenance and quieter operation with included tang boot
- No more loose pump heads—five-screw mounting for more secure attachment
- Adjust flow rate to your needs—can pump from 0.6 to 13 LPM
- PSF housing with CRS or SS rotor, or PPS housing with SS rotor available. PPS has better chemical resistance than PSF. CRS rotors have sealed bearings; SS rotors have PTFE-sealed bearings



Pump tubing sizes accepted	mL per rev	Flow rates (LPM) at indicated rpm			Maximum system psi (bar)	Catalog number†			
		100	540	20 to 650		PSF housing, CRS rotor	PSF housing, SS rotor	PPS housing, SS rotor	ATEX-approved; PSF housing, SS rotor
I/P 26	6.15	0.6	3.2	0.12 to 4	40 (2.7)	JL-77602-00	JL-77602-10	JL-77601-60	JL-77602-80
I/P 73	12.3	1.2	6.8	0.2 to 8					
I/P 82	20.0	2.0	11.0	0.4 to 13					
Price									

†PSF = polysulfone PPS = polyphenylene sulfide CRS = cold-rolled steel SS = stainless steel

[JL-77601-96](#) Dual-channel mounting hardware for two pump heads, stainless steel

FEATURES

- ✓ Load tubing without removing pump head from drive
- ✓ Automatic tubing retention
- ✓ Stack up to two pump heads
- ✓ ATEX Zone 2 rated model available

I/P® High-Performance Pump Heads

Get higher flow rates and pressure ratings

- Easily transfer viscous fluids
- Pump up to 19 LPM for higher volume processing
- Durable design for longer life—made of stainless steel rollers, bearings, rotor plates, and rotor shaft. Occlusion bed is made of thermoset polyester
- Compatible with I/P drives that accept two or more pump heads; pump head is not stackable

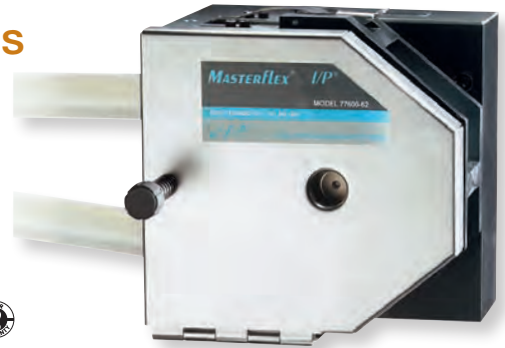

Pump tubing sizes accepted	mL per rev	Flow rates (LPM) at 20 to 650 rpm	Maximum system psi (bar)	Catalog number†	
				Polyester and SS housing, SS rotor	ATEX-approved; polyester and SS housing, SS rotor
I/P 70	12.3	0.26 to 8	40 (2.7)	JL-77600-62	JL-77600-82
I/P 88	26.2	0.4 to 17	35 (2.4)		
I/P 89	29.2	0.52 to 19	20 (1.4)		
Price					

†SS = stainless steel

FEATURES

- ✓ Easy to load tubing
- ✓ Adjustable tubing retention
- ✓ “C”-shaped design—tubing enters/exits the same side
- ✓ ATEX Zone 2 rated model available

Wait!

There's More at ColeParmer.com













Browse **100,000+** products plus find **Technical Resources** to help you choose

I/P® Precision Pump Tubing

Engineered for long life in peristaltic pumps

- Ensure optimal Masterflex® pump performance
- Custom extruded to fit Masterflex pumps
- Lot-to-lot consistency for superior accuracy and repeatability











Tubing size	I/P 26	I/P 73	I/P 82
Inner diameter	6.4 mm (0.25")	9.5 mm (0.37")	12.7 mm (0.5")
Hose barb size	6.4 mm (¼")	9.5 mm (¾")	12.7 mm (½")
Flow range (approximate)†	0.01 to 4 LPM 0.002 to 1.1 GPM	0.01 to 8 LPM 0.002 to 2.1 GPM	0.02 to 13 LPM 0.005 to 3.5 GPM

Pump tubing formulation	Description	Compatible pump head			
Silicone (platinum-cured) 	<ul style="list-style-type: none"> – Complies with USP Class V, EP, FDA, REACH, RoHS, ADCF – Fungus-resistant; phthalate- and latex-free – Accommodates a wide temperature range 	<ul style="list-style-type: none"> ✓ Standard ✓ Easy-Load® 	JL-96410-26	JL-96410-73	JL-96410-82
			7.6 m (25 ft)/pk	7.6 m (25 ft)/pk	7.6 m (25 ft)/pk
Silicone (peroxide-cured) 	<ul style="list-style-type: none"> – Complies with USP Class VI, EP, FDA, 3A, REACH, RoHS, ADCF – Greater physical compression capability – Economical, longer tubing life 	<ul style="list-style-type: none"> ✓ Standard ✓ Easy-Load 	JL-96400-26	JL-96400-73	JL-96400-82
			7.6 m (25 ft)/pk	7.6 m (25 ft)/pk	7.6 m (25 ft)/pk
BioPharm Silicone (platinum-cured) 	<ul style="list-style-type: none"> – Complies with USP Class VI, EP, FDA, 3A, REACH, RoHS, ADCF – Lower absorption; excellent biocompatibility – Very low extractable and weather, ozone, corona, radiation resistant 	<ul style="list-style-type: none"> ✓ Standard ✓ Easy-Load 	JL-96420-26	JL-96420-73	JL-96420-82
			7.6 m (25 ft)/pk	7.6 m (25 ft)/pk	7.6 m (25 ft)/pk
BioPharm Plus Silicone (platinum-cured) 	<ul style="list-style-type: none"> – Complies with USP Class VI, EP, FDA, 3A, REACH, RoHS, ADCF – Ultra-smooth—minimizes particle entrapment – Very low extractable—ideal for lab, biotech pharma applications 	<ul style="list-style-type: none"> ✓ Standard ✓ Easy-Load 	JL-96440-26	JL-96440-73	JL-96440-82
			7.6 m (25 ft)/pk	7.6 m (25 ft)/pk	7.6 m (25 ft)/pk
Puri-Flex™ 	<ul style="list-style-type: none"> – Complies with USP Class VI, EP, REACH, RoHS, ADCF – Heat sealable, weldable, and economical – Long pump life when compared to silicone or many other TPE tubings 	<ul style="list-style-type: none"> ✓ Standard ✓ Easy-Load 	JL-96419-26	JL-96419-73	JL-96419-82
			7.6 m (25 ft)/pk	7.6 m (25 ft)/pk	7.6 m (25 ft)/pk
C-Flex® 	<ul style="list-style-type: none"> – Complies with USP Class VI, EP, REACH, RoHS, ADCF – Heat sealable, weldable, economical – Better resistance to pH fluctuations 	<ul style="list-style-type: none"> ✓ Standard ✓ Easy-Load 	JL-06424-26	JL-06424-73	JL-06424-82
			7.6 m (25 ft)/pk	7.6 m (25 ft)/pk	7.6 m (25 ft)/pk
C-Flex® ULTRA 	<ul style="list-style-type: none"> – Complies with USP Class VI, EP, REACH, RoHS, ADCF – Longest life of any C-Flex formulation – Lowest spallation and reduced residue 	<ul style="list-style-type: none"> ✓ Standard ✓ Easy-Load 	JL-06434-26	JL-06434-73	JL-06434-82
			7.6 m (25 ft)/pk	7.6 m (25 ft)/pk	7.6 m (25 ft)/pk
PharMed® BPT 	<ul style="list-style-type: none"> – Complies: USP Class VI, EP, FDA, NSF, REACH, RoHS – Over 10,000 hours of tubing life, sealable, weldable – Ideal for tissue and cell culture work 	<ul style="list-style-type: none"> ✓ Standard ✓ Easy-Load 	JL-06508-26	JL-06508-73	JL-06508-82
			7.6 m (25 ft)/pk	7.6 m (25 ft)/pk	7.6 m (25 ft)/pk
PharmaPure® 	<ul style="list-style-type: none"> – Complies with USP Class VI, EP, FDA, REACH, RoHS – Nontoxic and nonhemolytic biocompatible – Long life even under pressure with VERY low spallation 	<ul style="list-style-type: none"> ✓ Easy-Load 	JL-06435-26	JL-06435-73	JL-06435-82
			7.6 m (25 ft)/pk	7.6 m (25 ft)/pk	7.6 m (25 ft)/pk
Chem-Durance® Bio 	<ul style="list-style-type: none"> – Complies: USP Class VI, FDA, REACH, RoHS – Excellent chemical compatibility and biocompatibility – Excellent pump life, durable under pressure 	<ul style="list-style-type: none"> ✓ Easy-Load 	JL-06442-26	JL-06442-73	JL-06442-82
			15.2 m (50 ft)/pk	15.2 m (50 ft)/pk	15.2 m (50 ft)/pk

I/P® Precision Pump Tubing (continued)

Engineered for long life in peristaltic pumps

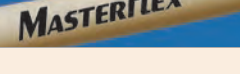
- Ensure optimal Masterflex® pump performance
- Custom extruded to fit Masterflex pumps
- Lot-to-lot consistency for superior accuracy and repeatability

		Tubing size	I/P 26	I/P 73	I/P 82
		Inner diameter	6.4 mm (0.25")	9.5 mm (0.37")	12.7 mm (0.5")
		Hose barb size	6.4 mm (¼")	9.5 mm (⅜")	12.7 mm (½")
		Flow range (approximate)†	0.01 to 4 LPM 0.002 to 1.1 GPM	0.01 to 8 LPM 0.002 to 2.1 GPM	0.02 to 13 LPM 0.005 to 3.5 GPM
Pump tubing formulation	Description	Compatible pump head			
Tygon® E-LFL 	<ul style="list-style-type: none"> – Complies with USP Class VI, EP, FDA, EU Food, REACH, RoHS, ABCF – Longest life of all Tygon formulations – Broad chemical resistance 	<ul style="list-style-type: none"> ✓ Standard ✓ Easy-Load® 	JL-06440-26	JL-06440-73	JL-06440-82
			7.6 m (25 ft)/pk	7.6 m (25 ft)/pk	7.6 m (25 ft)/pk
Tygon E-Food (B-44-4X) 	<ul style="list-style-type: none"> – Complies with FDA, EU Food, NSF, 3A, REACH, RoHS, ABCF – Smooth inner surface unaffected by commercial sanitizers – Nontoxic, will not affect taste or odor 	<ul style="list-style-type: none"> ✓ Easy-Load 	JL-06418-26	JL-06418-73	JL-06418-82
			15.2 m (50 ft)/pk	15.2 m (50 ft)/pk	15.2 m (50 ft)/pk
Tygon E-Lab (E-3603) 	<ul style="list-style-type: none"> – Complies with USP Class VI, FDA, EU Food, NSF, REACH, RoHS, ABCF – Ideal for general transfer applications – Nonaging, nonoxidizing, low gas permeability 	<ul style="list-style-type: none"> ✓ Standard ✓ Easy-Load 	JL-06509-26	JL-06509-73	JL-06509-82
			15.2 m (50 ft)/pk	15.2 m (50 ft)/pk	15.2 m (50 ft)/pk
Tygon Fuel & Lubricant (F-4040-A) 	<ul style="list-style-type: none"> – Complies with REACH, RoHS, ABCF – Specially formulated to transport hydrocarbons, petroleum products, distillates – Very low gas permeability 	<ul style="list-style-type: none"> ✓ Easy-Load 	—	JL-06401-73	JL-06401-82
			—	15.2 m (50 ft)/pk	15.2 m (50 ft)/pk
Tygon Chemical (2001) 	<ul style="list-style-type: none"> – Complies with FDA 21 CFR 175.300, REACH, RoHS, ABCF – Best chemical resistance of any Tygon formulation – Plasticizer-free and low gas permeability 	<ul style="list-style-type: none"> ✓ Easy-Load 	JL-06475-26	JL-06475-73	JL-06475-82
			15.2 m (50 ft)/pk	15.2 m (50 ft)/pk	15.2 m (50 ft)/pk
Norprene® (A-60 G) 	<ul style="list-style-type: none"> – Complies with NSF, REACH, RoHS – Up to 10,000 hours of tubing life – Best choice for pressure/vacuum applications 	<ul style="list-style-type: none"> ✓ Standard ✓ Easy-Load 	JL-06404-26	JL-06404-73	JL-06404-82
			15.2 m (50 ft)/pk	15.2 m (50 ft)/pk	15.2 m (50 ft)/pk
Norprene Food (A 60 F) 	<ul style="list-style-type: none"> – Complies with FDA, 3A, NSF, REACH, RoHS – Ideal for high-temperature food applications – Resists heat, ozone, acids, and alkalis 	<ul style="list-style-type: none"> ✓ Standard ✓ Easy-Load 	JL-06402-26	JL-06402-73	JL-06402-82
			15.2 m (50 ft)/pk	15.2 m (50 ft)/pk	15.2 m (50 ft)/pk
Viton® 	<ul style="list-style-type: none"> – Complies with FDA, ABCF – Perfect where FDA and chemical compatibility are needed – Resists corrosives, solvents, and oils at elevated temperatures 	<ul style="list-style-type: none"> ✓ Standard ✓ Easy-Load 	JL-96412-26	JL-96412-73	—
			7.6 m (25 ft)/pk	7.6 m (25 ft)/pk	—

†Determined under the following conditions: Using a 1 to 650 rpm drive; 0 psi at inlet, 0.5 psi at outlet; water temperature at 22°C (72°F).

Overlook Filler/Dispensing Nozzles

- Maximize the speed, precision, and accuracy of dispensing and filling applications
- Minimize splashing and dripping when dispensing into narrow- or wide-mouth containers
- Dimensional tolerances of ±0.05% for assured repeatability

Tubing ID	Catalog number	Price
1/32"	JL-30619-06	
1/16"	JL-30619-01	
1/8"	JL-30619-07	
3/16"	JL-30619-02	
1/4"	JL-30619-08	
5/16"	JL-30619-03	
3/8"	JL-30619-09	
1/2"	JL-30619-04	
5/8"	JL-30619-10	
3/4"	JL-30619-05	















I/P® High-Performance Precision Pump Tubing

Thicker wall compared to our Precision pump tubing

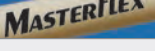
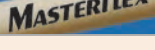

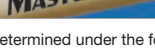

- Best choice for applications involving pressure, suction lift, viscous fluids, or long tubing life

Tubing size	I/P 70	I/P 88	I/P 89
Inner diameter	9.5 mm (0.37")	12.7 mm (0.5")	15.88 mm (0.62")
Hose barb size	9.5 mm (3/8")	12.7 mm (1/2")	15.88 mm (5/8")
Flow range (approximate)†	0.01 to 8 LPM 0.002 to 2.1 GPM	0.02 to 17 LPM 0.005 to 4.5 GPM	0.03 to 19 LPM 0.007 to 5.0 GPM

Pump tubing formulation	Description	Compatible pump head			
Silicone (platinum-cured) 	<ul style="list-style-type: none"> – Complies: USP Class V, EP, FDA, REACH, RoHS, ADFC – Fungus-resistant; phthalate- and latex-free – Accommodates a wide temperature range 	✓ High-Performance	JL-96510-70	JL-96510-88	JL-96510-89
			3 m (10 ft)/pk	3 m (10 ft)/pk	3 m (10 ft)/pk
BioPharm Silicone (platinum-cured) 	<ul style="list-style-type: none"> – Complies with USP Class VI, EP, FDA, 3A, REACH, RoHS, ADFC – Lower absorption; excellent biocompatibility 	✓ High-Performance	JL-96421-70	JL-96421-88	JL-96421-89
			3 m (10 ft)/pk	3 m (10 ft)/pk	3 m (10 ft)/pk
BioPharm Plus Silicone (platinum-cured) 	<ul style="list-style-type: none"> – Complies: USP Class VI, EP, FDA, 3A, REACH, RoHS, ADFC – Ultra-smooth—minimizes particle entrapment 	✓ High-Performance	JL-96441-70	JL-96441-88	JL-96441-89
			3 m (10 ft)/pk	3 m (10 ft)/pk	3 m (10 ft)/pk
Puri-Flex™ 	<ul style="list-style-type: none"> – Complies: USP Class VI, FDA, REACH, RoHS, ADFC – Heat sealable, weldable, and economical – Long pump life when compared to silicone 	✓ High-Performance	JL-96419-70	JL-96419-88	JL-96419-89
			3 m (10 ft)/pk	3 m (10 ft)/pk	3 m (10 ft)/pk
C-Flex® 	<ul style="list-style-type: none"> – Complies: USP Class VI, EP, REACH, RoHS, ADFC – Heat sealable, weldable, economical – Better resistance to pH fluctuations 	✓ High-Performance	JL-06424-70	JL-06424-88	JL-06424-89
			3 m (10 ft)/pk	3 m (10 ft)/pk	3 m (10 ft)/pk
PharMed® BPT 	<ul style="list-style-type: none"> – Complies: USP Class VI, EP, FDA, NSF, REACH, RoHS – >10,000 hours of tubing life, sealable, weldable – Ideal for tissue and cell culture work 	✓ High-Performance	JL-06508-70	JL-06508-88	—
			7.6 m (25 ft)/pk	7.6 m (25 ft)/pk	—
Chem-Durance® Bio 	<ul style="list-style-type: none"> – Complies: USP Class VI, FDA, REACH, RoHS – Excellent biocompatibility, chemical compatibility – Excellent pump life, durable under pressure 	✓ High-Performance	JL-06442-70	JL-06442-88	JL-06442-89
			15.2 m (50 ft)/pk	7.6 m (25 ft)/pk	7.6 m (25 ft)/pk
Tygon® E-LFL 	<ul style="list-style-type: none"> – Complies with USP Class VI, EP, FDA, EU Food, REACH, RoHS, ABCF – Longest life of all Tygon formulations 	✓ High-Performance	JL-06440-70	JL-06440-88	JL-06440-89
			7.6 m (25 ft)/pk	7.6 m (25 ft)/pk	7.6 m (25 ft)/pk
Tygon® E-Food (B-44-4X) 	<ul style="list-style-type: none"> – Complies: FDA, EU Food, NSF, 3A, REACH, RoHS, ABCF – Smooth inner surface unaffected by commercial sanitizers; will not affect taste or odor 	✓ High-Performance	JL-06418-70	JL-06418-88	JL-06418-89
			15.2 m (50 ft)/pk	15.2 m (50 ft)/pk	15.2 m (50 ft)/pk
Tygon® E-Lab (E-3603) 	<ul style="list-style-type: none"> – Complies with USP Class VI, FDA, EU Food, NSF, REACH, RoHS, ABCF – Ideal for general transfer applications; nonaging, nonoxidizing, low gas permeability 	✓ High-Performance	JL-06509-70	JL-06509-88	JL-06509-89
			15.2 m (50 ft)/pk	15.2 m (50 ft)/pk	15.2 m (50 ft)/pk
Norprene® (A-60 G) 	<ul style="list-style-type: none"> – Complies with NSF, REACH, RoHS – Up to 10,000 hours of tubing life – Best choice for pressure/vacuum applications 	✓ High-Performance	JL-06404-70	JL-06404-88	JL-06404-89
			7.6 m (25 ft)/pk	7.6 m (25 ft)/pk	7.6 m (25 ft)/pk
Norprene Food (A-60 F) 	<ul style="list-style-type: none"> – Complies with FDA, 3A, NSF, REACH, RoHS – Ideal for high-temperature food applications – Resists heat, ozone, acids, and alkalis 	✓ High-Performance	—	JL-06402-88	JL-06402-89
			—	7.6 m (25 ft)/pk	7.6 m (25 ft)/pk

†Determined under the following conditions: Using a 1 to 650 rpm drive; 0 psi at inlet, 0.5 psi at outlet; water temperature at 22°C (72°F).

I/P® Drives Selection Guide

Description	Special features	Page number
Brushless Process		
	<ul style="list-style-type: none"> ✓ Compact and powerful ✓ Maintenance-free brushless motor ✓ IP55 rated 	26
Precision Variable-Speed Modular		
	<ul style="list-style-type: none"> ✓ Separate motor and controller for convenient setup ✓ Model available with wall-mount controller and IP66 protection 	27
Variable-Speed Modular Digital Dispensing		
	<ul style="list-style-type: none"> ✓ Digital dispensing with calibration ✓ Separate motor and controller for convenient setup ✓ Model available with wall-mount controller and IP66 protection 	28
Digital Brushless Process		
	<ul style="list-style-type: none"> ✓ Digital dispensing with calibration ✓ Sealed housing; IP66 and NEMA 4X rated for washdown ✓ Maintenance-free brushless motor 	29

I/P® Brushless Process Drives

Powerful, low-maintenance drives keep you pumping

- Don't worry about moisture, chemicals, or dust—IP55-rated nonchip epoxy-coated steel housing
- Goes where you need it—compact and light enough to carry with one hand, powerful enough to drive two pump heads
- Get up to speed quickly—easy to adjust speed knob and LED display for improved repeatability



FEATURES

- ✓ Flow rates: 0.2 to 19 LPM
- ✓ Accuracy of ±0.25% speed control
- ✓ LED display
- ✓ Reversible motor and remote control capabilities
- ✓ Accept up to 2 pump heads

ISO 9001:2008
CERTIFIED SUPPLIER



Motor speed (rpm)	Speed control (repeatability)	Pump heads accepted	Motor size	Power (50/60 Hz)		Catalog number	Price
				VAC	Amps		
Variable-speed brushless process drive; 14"L x 10"W x 9"H (35.6 x 25.4 x 22.9 cm)							
33 to 650	±0.25% (2% of max rpm)	2	1/8 hp (0.25 kW)	90 to 260	4.5 at 115 VAC, 2.6 at 230 VAC	JL-77410-10	
Variable-speed brushless process drive with remote input/output; 14"L x 10"W x 9"H (35.6 x 25.4 x 22.9 cm)							
33 to 650	±0.25% (2% of max rpm)	2	1/8 hp (0.25 kW)	90 to 260	4.5 at 115 VAC, 2.6 at 230 VAC	JL-77411-00	



[JL-07595-43](#) Washdown foot switch for model 77411-00

[JL-77300-32](#) Remote cable kit. Required for model 77411-00 to operate the remote inputs and outputs

PUMP HEAD + TUBING + DRIVE



Choose a Complete System
One catalog number includes all 3!

System	Flow range	What's included			Power	Catalog number	Price
		Pump head	Tubing	Drive			
	0.4 to 8 LPM	Easy-Load® 77602-10	C-Flex® ULTRA I/P 73 tubing 06434-73 10 ft (3 m)	Brushless process drive 77410-10 33 to 650 rpm	90 to 260 VAC, 50/60 Hz	JL-77963-10	
	0.7 to 17 LPM	High-Performance 77600-62	Tygon® E-LFL I/P 88 tubing 06440-88 3 ft (1 m)	Brushless process drive 77410-10 33 to 650 rpm	90 to 260 VAC, 50/60 Hz	JL-77963-20	

I/P® Precision Variable-Speed Modular Drives

Place motor and controller where convenient with modular design

- Easy control of speed, direction, and start/stop with membrane keypad
- Ideal for metering and critical transfer applications

A. Modular Drive with Benchtop Controller

- Splash-resistant ABS plastic controller housing is IP33 rated; drive housing is epoxy finished steel, IP33 rated
- 6-ft (1.8-m) cable connects drive and controller; optional extension cable is available
- Remote control via DB9 female connector on controller

B. Washdown Modular Drive with Wall-Mount Controller

- Wall-mount controller housing is powder-coated aluminum, IP66 / NEMA 4X rated for washdown; powder-coated steel drive housing is IP66 / NEMA 4X rated for washdown
- 6-ft (1.8-m) cable connects drive and controller; optional extension cable is available
- Remote control via weather-resistant connection on controller



A.
07591-20

FEATURES

- ✓ Flow rates: 0.036 to 19 LPM
- ✓ Accuracy of ±0.25% speed control
- ✓ LED display
- ✓ Reversible motor
- ✓ Remote control capabilities
- ✓ Accept up to 2 pump heads

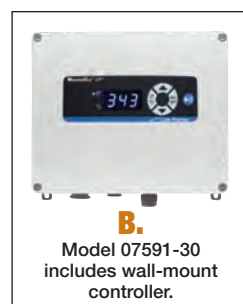

B.
Model 07591-30 includes wall-mount controller.

What's included: 6-ft (1.8-m) line cord with IEC 320/CEE22 socket. These models are shipped with country-specific plug/cord set; please specify ultimate destination when ordering.

ISO9001:2008
CERTIFIED SUPPLIER



07591-30



rpm	Speed control (resolution)	Pump heads accepted	Motor size	IP rating	Dimensions (L x W x H)	Power (50/60 Hz)		Catalog number	Price
						VAC	Amps		
A. Precision modular drive with benchtop controller									
6 to 650	±0.25% (1 rpm at 650 rpm)	2†	1/2 hp (149 W)	IP33	Controller: 10 3/8" x 8 3/8" x 5 1/2" Drive: 13 7/8" x 5 1/2" x 6 1/8"	90 to 260	4.4 at 115 VAC, 2.2 at 230 VAC	JL-07591-20	
B. Precision washdown modular drive with wall-mount controller									
6 to 650	±0.25% (1 rpm at 650 rpm)	2†	1/2 hp (149 W)	IP66	Controller: 10 1/8" x 11" x 4 3/4" Drive: 14 1/4" x 7" x 6 1/2"	90 to 260	4.4 at 115 VAC, 2.2 at 230 VAC	JL-07591-30	

†Drive accepts two pump heads when loaded with silicone or C-Flex® tubing.

[JL-07557-51](#) Extension cable, 9 ft (2.7 m); extend distance between motor and controller

[JL-07595-47](#) Cable assembly for benchtop drive 07591-20; DB9 male connector and 25-ft (7.9-m) cable with stripped wire terminal ends. Use for remote control

[JL-77300-32](#) Cable assembly for washdown drive 07591-30; 18-pin round connector and 25-ft (7.9-m) cable with stripped wire terminal ends. Use for remote control

[JL-17050-01](#) NIST-traceable calibration for peristaltic pump drive

Choose a Complete System
One catalog number includes all 3!

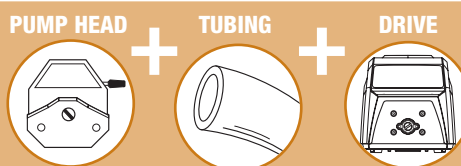

System	Flow range	What's included			Power	Catalog number	Price
		Pump head	Tubing	Drive			
	0.06 to 8 LPM	Easy-Load® 77602-10	C-Flex® ULTRA I/P 73 tubing 06434-73 10 ft (3 m)	Modular drive 07591-20 6 to 650 rpm	90 to 260 VAC, 50/60 Hz	JL-77962-20	
	0.06 to 8 LPM	Easy-Load 77601-10	C-Flex ULTRA I/P 73 tubing 06434-73 10 ft (3 m)	Modular drive 07591-30 6 to 650 rpm	90 to 260 VAC, 50/60 Hz	JL-77962-30	

I/P® Variable-Speed Modular Digital Dispensing Drives

Get precise digital dispensing with virtually no maintenance

- Graphical LCD shows four operating modes: continuous run, timed dispense, copy dispense, and volume dispense
- Programmable dispense interval lets you set the delay between dispense cycles for convenient, automated dispensing by time or by volume
- Brushless motor gives you quiet, maintenance-free reliability

A. Modular Drive with Benchtop Controller

- Splash-resistant ABS plastic controller housing is IP33 rated; drive housing is epoxy finished steel, IP33 rated
- 6-ft (1.8-m) cable connects drive and controller; optional extension cable is available
- Remote control capabilities via a DB25 female connector on controller

B. Washdown Modular Drive with Wall-Mount Controller

- Wall-mount controller housing is powder-coated aluminum, IP66 / NEMA 4X rated for washdown; powder-coated steel drive housing is IP66 / NEMA 4X rated for washdown
- 6-ft (1.8-m) cable connects drive and controller; optional extension cable is available
- Remote control capabilities via weather-resistant 31-pin round connection on controller

A.
07594-00



FEATURES

- ✓ Flow rates: 0.0006 to 19 LPM
- ✓ Accuracy of ±0.1% speed control
- ✓ Four-line graphical display
- ✓ Antidrip, reversible motor
- ✓ Remote control capabilities
- ✓ Accept up to 2 pump heads



B.
Model 07594-10 includes wall-mount controller

What's included: 6-ft (1.8-m) line cord with IEC 320/CEE22 socket. These models are shipped with country-specific plug/cord set; please specify ultimate destination when ordering.

ISO9001:2008
CERTIFIED SUPPLIER



rpm	Speed control (resolution)	Pump heads accepted	Motor size	IP rating	Dimensions (L x W x H)	Power (50/60 Hz)		Catalog number	Price
						VAC	Amps		
A. Digital modular dispensing drive with benchtop controller									
0.1 to 650	±0.1% (0.1 rpm at 650 rpm)	2	3/8 hp (280 W)	IP33	Controller: 10½" x 8¼" x 5" Drive: 15½" x 7" x 6"	90 to 260	4.5 at 115 VAC, 2.5 at 230 VAC	JL-07594-00	
B. Digital washdown modular dispensing drive with wall-mount controller									
0.1 to 650	±0.1% (0.1 rpm at 650 rpm)	2	3/8 hp (280 W)	IP66	Controller: 9" x 11¼" x 4½" Drive: 15½" x 7" x 6"	90 to 260	4.5 at 115 VAC, 2.5 at 230 VAC	JL-07594-10	

[JL-77301-82](#) Extension cable, 9 ft (2.7 m); extend distance between motor and controller

[JL-07523-95](#) Cable assembly for benchtop drive 07594-00; DB25 male connector and 25-ft (7.9-m) cable with stripped wire ends for remote control

[JL-07575-80](#) Cable assembly for washdown drive 07594-10; 31-pin round connector and 25-ft (7.9-m) cable with stripped wire ends for remote control

[JL-17050-01](#) NIST-traceable calibration for peristaltic pump drive

PUMP HEAD + TUBING + DRIVE

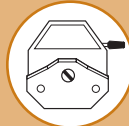

Choose a Complete System
One catalog number includes all 3!

System	Flow range	What's included			Power	Catalog number	Price
		Pump head	Tubing	Drive			
	0.001 to 8 LPM	Easy-Load® 77602-10	C-Flex® ULTRA I/P 73 tubing 06434-73 10 ft (3 m)	Digital dispensing drive 07594-00 0.1 to 650 rpm	90 to 260 VAC, 50/60 Hz	JL-77970-40	
	0.001 to 8 LPM	Easy-Load 77602-10	C-Flex ULTRA I/P 73 tubing 06434-73 10 ft (3 m)	Digital dispensing drive 07594-10 0.1 to 650 rpm	90 to 260 VAC, 50/60 Hz	JL-77970-50	

I/P® Digital Console Process Drives

Maintenance-free drives built for process applications

- Graphical LCD shows four operating modes: continuous run, timed dispense, copy dispense, volume dispense
- Dispense by mL—volume in mL of each dispense, 0.001 to 9999 mL; Copy—1 to 9,999 dispense cycles; or SEC—time interval of on/off cycles (1 sec to 99 hr, 59 min, 59 sec per cycle)

Model 77420-10 features a 316 stainless steel housing with an anodized aluminum base. Ideal for pharmaceutical, dairy, biotech, and food and beverage applications.

Model 77420-20 features a powder-coated steel housing with anodized aluminum base. Use in process, manufacturing, and water-treatment applications where stainless steel is not a critical requirement.

What's included: 6-ft (1.8-m) line cord with IEC 320/CEE22 socket. These models are shipped with country-specific plug/cord set; please specify ultimate destination when ordering.



FEATURES

- ✓ Flow rates: 0.0006 to 19 LPM
- ✓ Accuracy of ±0.1% speed control
- ✓ Four-line graphical display
- ✓ Antidrip, reversible motor
- ✓ IP66-rated for easy washdown
- ✓ Accept up to 2 pump heads

77420-10 shown with I/P High-Performance pump head 77600-62



rpm	Speed control (resolution)	Pump heads accepted	Motor size	IP rating	Dimensions (L x W x H)	Power (50/60 Hz)		Catalog number	Price
						VAC	Amps		
Digital process drive with 316 stainless steel housing									
0.1 to 650	±0.1%	2	3/8 hp (280 W)	IP66	16 1/16" x 11 1/8" x 12 7/8"	90 to 260	4.5 at 115 VAC, 2.5 at 230 VAC	JL-77420-10	
Digital process drive with powder-coat steel housing									
0.1 to 650	±0.1%	2	3/8 hp (280 W)	IP66	16 1/16" x 11 1/8" x 12 7/8"	90 to 260	4.5 at 115 VAC, 2.5 at 230 VAC	JL-77420-20	

Accessories

- [JL-07575-84](#) Washdown foot switch, momentary start/stop; 6-ft (1.8-m) cable
- [JL-07575-80](#) Cable assembly, 31-pin round connector and 25-ft (7.9-m) cable with stripped wire ends for remote control
- [JL-17050-01](#) NIST-traceable calibration for peristaltic pump drive

Wait!

There's More at ColeParmer.com

Find all the product specs you need!

PUMP HEAD + TUBING + DRIVE



Choose a Complete System
One catalog number includes all 3!

System	Flow range	What's included			Power	Catalog number	Price
		Pump head	Tubing	Drive			
	0.001 to 8.0 LPM	Easy-Load® 77602-10	C-Flex® ULTRA I/P 73 tubing 06434-73 10 ft (3 m)	Digital process drive 77420-10 0.1 to 650 rpm	90 to 260 VAC, 50/60 Hz	JL-77964-20	
	0.001 to 8.0 LPM	Easy-Load 77602-10	C-Flex® ULTRA I/P 73 tubing 06434-73 10 ft (3 m)	Digital process drive 77420-20 0.1 to 650 rpm	90 to 260 VAC, 50/60 Hz	JL-77964-30	

B/T® Fixed- and Variable-Speed Pumps

Achieve the highest flow rates of any Masterflex pump—up to 42 LPM (11.1 GPM)

Fixed-Speed Pumps

- Economical and easy to operate
- Reversible motor: purge before or after pumping, pump fluid in either direction
- IP55-rated motor—wash off dirt and debris

Air-Powered Pump

- Use in locations where electricity is unsafe or impractical
- Includes pressure regulator—control your compressor air to match pump requirements
- 24 cfm (0.68 m³), 100 psi (6.9 bar) minimum air required, supply your own compressor to power pump
- IP56-rated motor protects against dust and strong water jets
- Rated for ATEX Zone 2 EEx II 3 G c IIC T6; NEC Class 1, Division 2, Groups A, B, C, D, T6

Variable-Speed Modular Pump

- Place washdown controller wherever it's convenient
- Controller with 16-ft (4.9-m) cord mounts on pump or wall
- IP56-rated motor protects against dust and strong water jets
- Reversible motor: purge before or after pumping, pump fluid in either direction

Variable-Speed Modular Digital Pump

- High-volume, high-accuracy dispensing
- Dispense by volume or time, or pump continuously
- Separate motor and controller by up to 6 feet (1.8 m) for convenient operation
- IP56-rated controller and motor protect against dust and water

What's included: a Rapid-Load® pump head, 3 ft (1 m) of Tygon® E-LFL B/T 91 pump tubing, and a 6-ft (1.8-m) power cord (115 VAC: US standard plug; 230 VAC: European plug).



Fixed-speed pump
77111-60

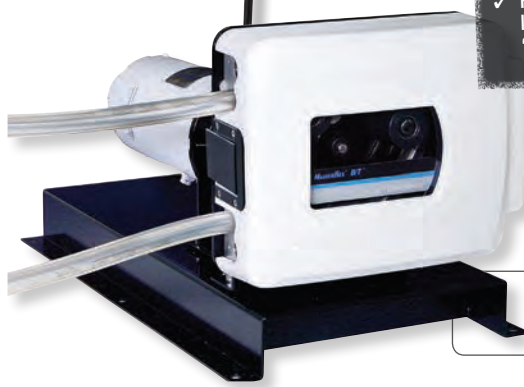

Variable-speed modular digital pump
77111-40

FEATURES

- ✓ Flow rates up to 42 LPM
- ✓ Interlock switch shuts off power when pump head is opened
- ✓ Washdown pumps handle the toughest process and production applications, then clean up with ease
- ✓ Gentle peristaltic action is ideal for pumping shear-sensitive or viscous fluids (up to 10,000 cps)
- ✓ Rotor and occlusion bed design allow easier tube loading and prevent "tubing roll" during operation

Flow Rates in LPM (GPM)

rpm	PerfectPosition™ pump tubing	
	B/T 87	B/T 91
321	18.9 (5.0)	42 (11.1)
271	16.0 (4.2)	35 (9.4)
35 to 321	1.9 to 17.7 (0.5 to 4.7)	4.0 to 37 (1.06 to 9.8)
12 to 321	0.71 to 18.9 (0.19 to 5.0)	1.4 to 42 (0.4 to 11.1)

Motor type	Motor size	rpm	IP rating	Mounting type	Dimensions (L x W x H)	Power		Catalog number	Price
						VAC (Hz)	Amps		
Fixed-speed	1 hp (0.75 kW)	321	IP55	Direct-drive	27" x 15.8" x 15.1" (68.6 x 40 x 38.4 cm)	115 (60)	12.6	JL-77111-30	
		271				220 (50)	6.3	JL-77111-37	
Variable-speed, air powered	¾ hp (0.56 kW)	35 to 321	IP56	Direct-drive	27" x 15.8" x 15.1" (68.6 x 40 x 38.4 cm)	Requires 24 cfm (0.68 m ³) 100 psi (6.9 bar) minimum		JL-77111-80	
Variable-speed (±5%)	½ hp (0.37 kW)	12 to 321	Controller: IP56	Direct-drive	27" x 15.8" x 17.4" (68.6 x 40 x 44.2 cm)	115 (50/60)	6.5	JL-77111-60	
						230 (50/60)	3.3	JL-77111-67	
Variable-speed (±0.3%)	½ hp (0.37 kW)	12 to 321	Drive: IP56	Direct-drive	Controller: 9" x 11" x 4½" (22.9 x 27.9 x 11.4 cm) Drive: 27" x 15¾" x 15" (68.6 x 40.0 x 38.4 cm)	90 to 130 (50/60)	6.5	JL-77111-40	
						190 to 260 (50/60)	3.3	JL-77111-47	

[JL-77300-32](#) Remote cable, required for remote control operation of models 77111-40 and -47; 25 ft (7.6 m)













[JL-77111-90](#) Bracket for digital controller on models 77111-40 and -47

B/T® PerfectPosition™ Pump Tubing

Easily place tubing with printed retention marks

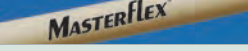
– Optimized for use in B/T pumps to provide the performance you expect

Tubing size	B/T 87	B/T 91
Inner diameter	12.7 mm (0.5")	19.0 mm (0.75")
Hose barb size	12.7 mm (½")	19.0 mm (¾")

Pump tubing formulation	Description		
Silicone (platinum-cured) 	<ul style="list-style-type: none"> – Smooth surface; low protein binding levels – Fungus-resistant; phthalate- and latex-free – Accommodates a wide temperature range 	JL-96510-87 3 m (10 ft)/pk	JL-96510-91 3 m (10 ft)/pk
Silicone (peroxide-cured) 	<ul style="list-style-type: none"> – Smooth surface for minimal particle entrapment – Very low extractables, with documented biocompatibility for sensitive applications 	JL-96400-87 3 m (10 ft)/pk	JL-96400-91 3 m (10 ft)/pk
BioPharm Plus Silicone (platinum-cured) 	<ul style="list-style-type: none"> – Very low extractable; biocompatible for sensitive applications – Longest tubing life of any silicone pump tubing – Lower spallation than regular silicone 	JL-96445-87 3 m (10 ft)/pk	JL-96445-91 3 m (10 ft)/pk
Puri-Flex™ 	<ul style="list-style-type: none"> – Heat sealable, weldable, and economical – Long pump life when compared to silicone or many other TPE tubings 	JL-96419-87 3 m (10 ft)/pk	JL-96419-91 3 m (10 ft)/pk
C-Flex® 	<ul style="list-style-type: none"> – Heat sealable, weldable, economical – Longest life of any C-Flex formulation – Better resistance to pH fluctuations 	JL-06424-87 3 m (10 ft)/pk	JL-06424-91 3 m (10 ft)/pk
PharMed® BPT 	<ul style="list-style-type: none"> – Over 10,000 hours of tubing life – Resists ozone and UV radiation – Ideal for tissue and cell culture work 	JL-06507-87 3 m (10 ft)/pk	JL-06507-91 3 m (10 ft)/pk
PharmaPure® 	<ul style="list-style-type: none"> – Nontoxic and nonhemolytic – Great for tissue and cell work – Low extractables and gas permeability 	JL-06437-87 3 m (10 ft)/pk	JL-06437-91 3 m (10 ft)/pk
Chem-Durance® Bio 	<ul style="list-style-type: none"> – Excellent chemical resistance – Plasticizer-free inner liner – Excellent biocompatibility 	JL-06443-87 3 m (10 ft)/pk	JL-06443-91 3 m (10 ft)/pk
Tygon® E-LFL 	<ul style="list-style-type: none"> – Longest life of all Tygon formulations – USP Class VI, EU Pharmacopoeia 3.2.9, FDA 21 	JL-06440-87 3 m (10 ft)/pk	JL-06440-91 3 m (10 ft)/pk
Tygon® E-Food (B-44-4X) 	<ul style="list-style-type: none"> – Complies with FDA, NSF, 3A, and EU food regulations – Smooth inner surface unaffected by common commercial sanitizers 	JL-06418-87 3 m (10 ft)/pk	JL-06418-91 3 m (10 ft)/pk
Norprene® Food (A-60-F) 	<ul style="list-style-type: none"> – Ideal for high-temperature food applications – Resists heat, ozone, acids, and alkalis – Complies with FDA and NSF food regulations 	JL-06399-87 3 m (10 ft)/pk	JL-06399-91 3 m (10 ft)/pk

Find even more online!
Go to ColeParmer.com to see full product details.

Masterflex® Barbed Fittings

Designed to tight tolerances and made from virgin materials

Size	Use with Masterflex® tubing sizes			HDPE		Polypropylene		Kynar® PVDF	
	L/S®	I/P®	B/T®	Catalog number	Price/pk of 10	Catalog number	Price/pk of 10	Catalog number	Price/pk of 10
A. Straight barsbs									
1/16"	13, 14	—	—	JL-30612-01		JL-30612-43		JL-30612-04	
1/8"	16	—	—	JL-30612-05		JL-30612-47		JL-30612-08	
3/16"	15, 25	—	—	JL-30612-09		JL-30612-51		JL-30612-12	
1/4"	17, 24	26	—	JL-30612-13		JL-30612-55		JL-30612-16	
3/8"	18, 35, 36	70, 73	86	JL-30612-17		JL-30612-59		JL-30612-20	
1/2"	—	82, 88	87	JL-30612-21		JL-30612-63		JL-30612-24	
5/8"	—	89	—	JL-30612-25		JL-30612-67		JL-30612-28	
3/4"	—	—	91	JL-30612-29		JL-30612-71		JL-30612-32	
1"	—	—	92	JL-30612-33		JL-30612-75		JL-30612-36	
B. Tee connectors (equal leg)									
1/16"	13, 14	—	—	JL-30613-01		JL-30613-43		JL-30613-04	
1/8"	16	—	—	JL-30613-05		JL-30613-47		JL-30613-08	
3/16"	15, 25	—	—	JL-30613-09		JL-30613-51		JL-30613-12	
1/4"	17, 24	26	—	JL-30613-13		JL-30613-55		JL-30613-16	
3/8"	18, 35, 36	70, 73	86	JL-30613-17		JL-30613-59		JL-30613-20	
1/2"	—	82, 88	87	JL-30613-21		JL-30613-63		JL-30613-24	
5/8"	—	89	—	JL-30613-25		JL-30613-67		JL-30613-28	
3/4"	—	—	91	JL-30613-29		JL-30613-71		JL-30613-32	
1"	—	—	92	JL-30613-33		JL-30613-75		JL-30613-36	
C. Y-connectors (equal leg)									
1/16"	13, 14	—	—	JL-30614-01		JL-30614-43		JL-30614-04	
1/8"	16	—	—	JL-30614-05		JL-30614-47		JL-30614-08	
3/16"	15, 25	—	—	JL-30614-09		JL-30614-51		JL-30614-12	
1/4"	17, 24	26	—	JL-30614-13		JL-30614-55		JL-30614-16	
3/8"	18, 35, 36	70, 73	86	JL-30614-17		JL-30614-59		JL-30614-20	
1/2"	—	82, 88	87	JL-30614-21		JL-30614-63		JL-30614-24	



A
Straight barb



B
Tee connector



C
"Y" connector

Overlook Filler/Dispensing Nozzles

No more messy dispensing



- Maximize the speed, precision, and accuracy of dispensing and filling applications
- Minimize splashing and dripping
- Dimensional tolerances of $\pm 0.05\%$ for assured repeatability

These nozzles combine the ease of plastic components with the accuracy and reliability of stainless steel filler needles. Nozzles feature a 316L stainless steel needle and a polycarbonate base with hose barb adapter. Materials meet FDA, USDA and USP Class VI requirements. Sterilize by ethylene oxide, autoclaving, or gamma irradiation.



Tubing ID	Catalog number	Price/ea
1/32"	JL-30619-06	
1/16"	JL-30619-01	
1/8"	JL-30619-07	
3/16"	JL-30619-02	
1/4"	JL-30619-08	
5/16"	JL-30619-03	
3/8"	JL-30619-09	
1/2"	JL-30619-04	
5/8"	JL-30619-10	
3/4"	JL-30619-05	

Pure-Fit® TC Tubing Clamps

Install easily over existing tubing lines

- Eliminate risk of puncture or rupture with smooth contours
- Fully sterilizable
- Meet USP Class IV criteria



The Pure-Fit TC clamp has a press-down locking mechanism that provides complete fluid stoppage. Its side-release mechanism ensures against unwanted opening.

Sterilize PP by gamma irradiation only; PVDF may be sterilized by gamma irradiation or autoclaving. Sold in pack of 10.

Fits Masterflex® tubing sizes	Material	Catalog number	Price/pk
L/S® 13, 14, 15, 16, 17, 25	Polypropylene	JL-06822-01	
	PVDF	JL-06822-03	
L/S 18, 24, 35, 36; I/P® 26, 70, 73, 82	Polypropylene	JL-06822-11	
	PVDF	JL-06822-13	

Tubing Weights

Keep tubing in place during dispense cycles



Flow-through PTFE weights fit Masterflex L/S® tubing sizes noted.

Description	Catalog number	Price
Weight for L/S 16, 15, and 25	JL-78226-81	
Weight for L/S 17, 18, 24, 35, 36	JL-78226-82	
Set of two; one each of 78226-81 and 78226-82	JL-77310-03	

Why Choose Ismatec® Peristaltic Pumps?

1

Precise

Flow rates as low as 0.0004 mL/min for delivering accurate volumes.

2

Reduced Pulsation

Better reproducibility and longer tubing life with planetary gear drive construction.

3

Gentle Handling

Select pumps with convex rollers to extend tubing life and use with fragile samples such as live cells.

4

Customizable

Mix and match drives, pump heads, and tubing for a system tailored to your needs.

5

Quality & Durability

Swiss-engineered design manufactured to strict ISO 9001:2008 standards with two-year warranty in most models.



Selecting the Right Ismatec Pump

Pump Series	Features	Flow range	Find it on...
Low-Flow High-Accuracy	High-precision multichannel dispensing and delivery pumps for analytical applications. Planetary drive. RS-232 or analog interface. 4, 8, 12, 16, or 24 channels.	0.0004 to 44	34
Compact Multichannel	Compact cassette dispensing pumps. Some models with calibrating functions. RS-232 or analog interface. 2 or 4 channels.	0.003 to 59	34
Reglo Quick Pump	Compact cassette dispensing pump. Simple tubing changeout. Analog interface only. 1 channel.	2.1 to 230	ColeParmer.com
Fixed-Speed Rack-Mount	Rack mounted, fixed speed pumps. Use these pumps almost anywhere. Easy tubing changes even while pump is running. 2 or 4 channels.	0.014 to 22	35
Flowmaster™	Powerful pump for heavy-duty processes. Stainless steel housing, IP65 rated; dust-tight and waterproof. Analog interface. 1 channel.	35 to 13,000	35
ecoline	Economical and powerful. Stackable stainless steel housing. Simple set up and operation. Models with analog interface. 1 to 8 channels.	0.0075 to 5400	36
Quick-Couple Drives	Variety of pump heads and drives offer a wide range of pumping solutions. Pump heads are easy to install, drives come in both basic and programmable versions. RS-232 and/or analog interface. 1, 2, 3, 4, 8, 12, 16, or 24 channels.	0.003 to 3600	36
Washdown Process	Programmable, with calibrating functions. IP65-rated; dust-tight and waterproof. RS-232 and/or analog interface. 1 channel.	0.45 to 3400	ColeParmer.com
Reglo Independent Channel Control	Independently controlled channels with different speed capabilities. Bidirectional flow in each channel. 3 or 4 channels.	—	35

How to splice microbore tubing

- Bring together one end of a length of color-coded tubing (A) and one end of a length of extension tubing (B). Both lengths of tubing should have the same ID and OD.
- Center a 1 to 2" piece of larger tubing (C) over the ends of the two pieces to be joined (A and B). The short tubing piece should be of similar material and with an ID approximately equal to the OD of the tubing to be joined.
- With the short piece (C) centered over the joint, apply solvent or sealant to the outside of tubing (B) and slide tubing (C) onto (B). Repeat the process for tubing (A) to join tubing permanently. If future tubing changes are necessary, then apply solvent or sealant only to tubing (B) and (C). Use a ketone-type solvent to splice Tygon® or Viton® tubing; an RTV adhesive for silicone tubing; and a tetrahydrofuran with PharMed® BPT tubing.

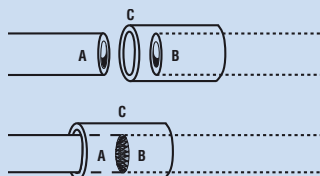

Ismatec® Low-Flow High-Accuracy Pumps Fewer tubing changes

- Planetary drive for less pulsation and longer tubing life
- Smooth rotation and accurate liquid flow provided by eight SS rotors
- Easy repeatability with four-digit LED
- Simple to use—automatic occlusion cartridges provide reproducible results
- Five modes for pumping or dispensing including flow rate, time, batches, drip-free, and volume
- Control via keypad, computer, or remote control



See page 38.

Specifications

Accuracy: better than $\pm 1\%$ **Pressure:** up to 22 psi (1.5 bar) **Power:** 115/230 VAC, 50/60 Hz (selectable)



Flow range per channel	Channels	Speed	Rollers	Tubing	Catalog number	Price
Low-speed planetary gear-driven pumps						
0.0004 to 11 mL/min	4	0.11 to 11.25 rpm	8	Two-stop (page 38)	JL-78001-00	
	8				JL-78001-10	
	12				JL-78001-20	
	16				JL-78001-30	
	24				JL-78001-40	
Standard-speed planetary gear-driven pumps						
0.002 to 44 mL/min	4	0.4 to 45 rpm	8	Two-stop (page 38)	JL-78001-02	
	8				JL-78001-12	
	12				JL-78001-22	
	16				JL-78001-32	
	24				JL-78001-42	

Replacement Cartridges

Order extra cartridges and adapters when fast tubing changes are crucial.

[JL-78001-95](#) Replacement Click'n'go™ cartridge

[JL-78001-90](#) Replacement adjustable occlusion cartridge

[JL-07618-71](#) Replacement adapters hold two-stop color-coded tubing in cartridge. Two adapters required per cartridge. Pack of 12

Ismatec® Compact Multichannel Pumps No more inconsistent results

- Consistent flow and reduced tubing wear for improved results
- Get more productivity in a compact unit—up to four channels provide more fluid transfer simultaneously
- No maintenance—rollers are self-lubricating
- Easy channel changes—Click'n'go™ minicartridges snap in place
- Get smoother flow with 12-roller pumps

A. Variable-Speed Pumps

Speed is adjustable in 1% steps (0 to 99%). Control speed remotely. Start/stop pump or change direction via contact closure; monitor speed through frequency output.

B. Programmable Variable-Speed Digital Pumps

Continuously pump or dispense in any of four modes—flow rate, time, batches, or drip-free. Pumps feature analog input and output controls, as well as an RS-232 interface for control by a computer. Remote control capable.

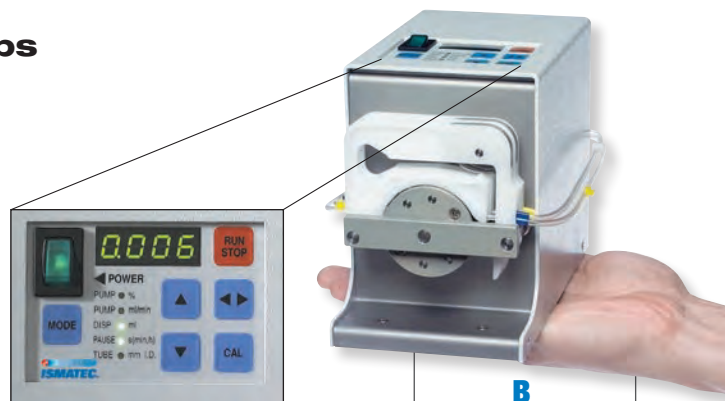

B Digital pump 78017-00 is fully programmable.



Specifications

Pressure: up to 22 psi **Power:** 115/230 VAC, 50/60 Hz (selectable)



See page 38.

Channels	Rollers	Tubing	A. Standard variable-speed pumps				B. Programmable variable-speed digital pumps			
			Flow range per channel (mL/min)	Speed	Catalog number	Price	Flow range per channel (mL/min)	Speed	Catalog number	Price
2	6	Three-stop (page 38)	0.009 to 59	3.2 to 160 rpm	JL-78016-00		0.005 to 59	1.6 to 160 rpm	JL-78016-40	
	8		0.008 to 50		JL-78016-10		0.004 to 50		JL-78017-00	
	12		0.007 to 34		JL-78017-25		0.004 to 34		JL-78016-45	
4	6	Three-stop (page 38)	0.006 to 37	2.0 to 100 rpm	JL-78017-30		0.003 to 37	1.0 to 100 rpm	—	—
	8		0.005 to 31		JL-78016-30		0.003 to 31		JL-78017-10	
	12		0.005 to 21		JL-78017-35		0.003 to 21		JL-78017-20	

Minicartridges

Optional minicartridges with adjustable occlusion manually vary pressure on each channel.

[JL-07624-64](#) Optional adjustable occlusion minicartridge

[JL-78016-98](#) Replacement Click'n'go™ minicartridge

Ismatec® Reglo Independent Channel Control Peristaltic Pumps

Pump each channel at different speeds and directions!

- Flexibility of bidirectional flow in each channel
- USB interface for quick connections
- Don't waste time—easy-to-use tubing cassettes for fast changeovers

These two-, three- and four-channel peristaltic pumps let you individually control the flow and direction of each channel from the intuitive keypad or via your computer—expanding your benchtop pumping capabilities with a single compact unit! Pump delivers continuous pumping or precision dispensing up to 35 mL/min with the capability of bidirectional flow in each channel. Plus, independent channel calibration minimizes tube-to-tube differences, resulting in high calibration accuracy.



Independently control each channel—direction and speed



See page 38

Specifications

Speed: 1 to 100 rpm **Pressure:** up to 14.5 psi (1.0 bar)
Accuracy: ±1%



Flow range per channel	Channels	Rollers	Tubing	Power (VAC, Hz)	Catalog number	Price
0.001 to 35 mL/min	2	8	Three-stop (pg. 38)	100 to 240, 50/60	JL-78001-60	
	3				JL-78001-70	
	4				JL-78001-80	

Ismatec® Flowmaster™ Pump

Stainless steel construction—ideal for sanitary fluid transfer

- Easy cleaning—housing is IP65 rated for washdown
- Change tubing in just seconds!
- Easy to disassemble for cleaning
- Meets requirements of the biotech, food and beverage, and pharmaceutical industries



The three-roller pump head with interchangeable rotors handles tubing with inside diameters of 6.4 to 16.0 mm and wall thicknesses of 1.6 and 3.2 mm. Accepts a 0 to 5 VDC, 0 to 10 VDC, 1 to 20 mA, or 4 to 20 mA input signal for remote speed control. Features multiple overload protection and an extensive analog interface with status information for process control systems.

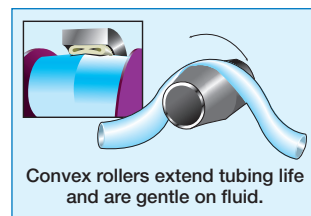

Convex rollers extend tubing life and are gentle on fluid.



See page 39



Flow range	Speed	Rollers	Tubing	Power	Catalog number	Price
37 mL/min to 13 L/min	5 to 500 rpm	3	Pump (see page 39)	120/240 VAC, 50/60 Hz	JL-78025-00	

[JL-17050-01](#) NIST-traceable calibration for peristaltic pump drive

Ismatec® Fixed-Speed Rack-Mount Pumps

No need to stop pump to change tubing!

- Use these pumps almost anywhere with compact size mounting rod
- A constant-speed, synchronous motor ensures a steady, repeatable flow rate

Mincartridge design offers the easiest and most convenient tubing changes of all—even replace tubing while your pump is running! Order extra minicartridges (below). Have extra tubing on hand when fast tubing changes are crucial.

What's included: a 5½" L x ½" dia (14 x 0.5 cm) mounting rod, a 6-ft (1.8-m) cord with plug, and two or four minicartridges.



See page 38

Mincartridge design—fast tubing changes even when pump is running.



Flow range (mL/min)	Channels	Speed	Rollers	Tubing	115 VAC, 60 Hz		230 VAC, 50 Hz	
					Catalog number	Price	Catalog number	Price
0.047 to 6.2	2	20 rpm	8	Three-stop (page 38)	JL-78012-00		JL-78012-05	
0.14 to 19.0		60 rpm	8		JL-78012-20		JL-78012-25	
0.17 to 22.0		60 rpm	6		JL-78012-80		JL-78012-85	
0.056 to 7.4	4	20 rpm	6	Three-stop (page 38)	JL-78012-90		JL-78012-95	
0.047 to 6.2		20 rpm	8		JL-78012-30		JL-78012-35	
0.093 to 12.0		40 rpm	8		JL-78012-40		JL-78012-45	
0.056 to 7.4		20 rpm	6		JL-78012-50		JL-78012-55	
0.11 to 15.0		40 rpm	6		JL-78012-60		JL-78012-65	

Specifications

Pressure: 14 to 22 psi

Minicartridges

- [JL-78016-98](#) Replacement Click'n'go™ minicartridge
- [JL-07624-64](#) Adjustable occlusion minicartridge

Ismatec® ecoline Pumps

Save space—pumps stack easily

- Durable stainless steel housing and four stabilizing feet for easier stacking
- Simple setup and operation—start, stop, and reverse flow with a single switch
- Rotors accommodate 1.6 or 2.4 mm wall tubing

Pumps A, B, C, and E are controllable remotely via an analog input signal (0 to 5 VDC, 0 to 10 VDC, 0 to 20 mA, or 4 to 20 mA); start/stop drive or reverse direction via contact closure (eight-pin DIN). Input signals from your existing instruments actuate drive functions.

A–C. Single-Channel Pumps

- Minimize tubing wear and ensure automatic centering with convex roller

D. Masterflex® Easy-Load® Pump

- Change tubing quickly with easily accessible head
- Polysulfone housing and stainless steel rotor
- Order tubing on pages 10–13

E. Minicartridge Pumps

- No adjustments needed—spring-loaded cassettes for optimal occlusion at all times
- Get consistent, low-pulse flow with 6 or 12 rollers



Key	Flow range per channel	Channels	Speed	Rollers	Tubing	Power (50/60 Hz)	Catalog number	Price
Single-channel pumps								
A	1.7 to 5400 mL/min	1	3.5 to 350 rpm	2	Pump (page 39)	115/230 VAC	JL-78022-10	
B	1.6 to 5000 mL/min			3			JL-78022-20	
C	0.25 to 1300 mL/min			3			JL-78022-30	
Easy-Load pump								
D	0.23 to 1600 mL/min	1	3.5 to 350 rpm	3	Masterflex® (page 10–13)	115/230 VAC	JL-78022-50	
Minicartridge pumps								
E	0.01 to 130 mL/min	8	3.5 to 350 rpm	6	Three-stop (page 38)	115/230 VAC	JL-78022-40	
	0.0075 to 75 mL/min	4		12			JL-78022-60	

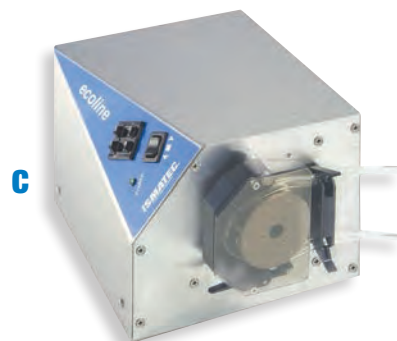

Accessories

- [JL-07624-64](#) Adjustable occlusion minicartridge
- [JL-78016-98](#) Replacement Click'n'go™ minicartridge
- [JL-07610-25](#) Foot switch, momentary contact
- [JL-17050-01](#) NIST-traceable calibration for peristaltic pump drive

Ismatec® Quick-Couple Drives

No more difficult pump head mounting

- Mount pump heads quickly with turn-and-lock mounting system
- Flow rates from 0.003 to 3700 mL/min

Control speed remotely via analog signal (0 to 5 VDC, 0 to 10 VDC, 0 to 20 mA, or 4 to 20 mA). Start/stop pump or change flow direction remotely via DB15 female contact enclosure.

A. Digital Drive with Analog Input

- Speed adjustment in 0.1% steps via potentiometer
- Prime, flush, or prevent overflow with Max/Slow toggle switch

B. Programmable Digital Drive

- Save time—recall and store up to four programs
- Preprogrammed with tubing sizes and heads for faster setup

Dispense by volume, time, flow rate, batches with variable pause time, stored programs, roller back steps, or number of dispensing cycles. Digital display shows speed, flow rate, dispensing volume, dispensing time, and pause time.

Use the RS-232 interface (DB-9 female) to automate your lab.



REQUIRED System Components

- 1) Quick-couple drive
- 2) Pump head 37
- 3) Tubing 10–13, 38–39



Key	Programmable	Flow range per channel	Speed	Power	Catalog number	Price
A	No	0.003 to 3700 mL/min	2.4 to 240 rpm	115 VAC, 60 Hz or 230 VAC, 50 Hz	JL-78002-10	
B	Yes	0.001 to 3700 mL/min	1 to 240 rpm		JL-78002-00	

[JL-17050-01](#) NIST-traceable calibration for peristaltic pump drive



Find even more online! Go to [ColeParmer.com](#) to search more than 100,000 products.

Ismatec® Pump Heads for Quick-Couple Drives

A. Minicartridge Pump Heads

Minimize pulsation with more rollers. Get up to 24 channels with 78002-50 and 07623-00 below. Get up to 16 channels of the smoothest flow with 78002-90 and 07623-30 below.

Flow range (mL/min)	Channels	Rollers	Tubing	Max pressure	Catalog number	Price
0.003 to 89	8 (up to 24)	6	Three-stop (page 38)	22 psi	JL-78002-50	
0.003 to 52	4 (up to 16)	12			JL-78002-90	

JL-07623-00 Eight-channel extension pump head. Use up to two with 78002-50 to get 24 channels

JL-07623-30 Four-channel extension pump head. Use up to three with 78002-90 to get 16 channels

B. Standard Cartridge Pump Heads

Ideal pump-head for multichannel applications at higher flow rates. Click 'n' go cartridges allow quick and easy tubing changes.

Flow range (mL/min)	Channels	Rollers	Tubing	Max pressure	Catalog number	Price
0.004 to 180	8	8	Two-stop (page 38)	22 psi	JL-78002-34	
	12				JL-78002-36	

C. Tubing Bed Pump Heads

Ideal for delicate substances which require gentle occlusion setting. Spring-loaded tubing bed adjusts occlusion for optimum pressure and tubing.

Flow range (mL/min)	Channels	Rollers	Tubing	Max pressure	Catalog number	Price
2.6 to 1110	2	6	Pump (page 39)	22 psi	JL-07611-10	
0.22 to 530	3				JL-07611-15	

D. Quick-Change Pump Head

Hinged tube-bed allows rapid tube change-over. Easily accessible pump head. Self-centering tube-track results in longer tubing-life. Stainless steel rollers.

Flow range (mL/min)	Channels	Rollers	Tubing	Max pressure	Catalog number	Price
0.072 to 880	1	3	Pump (page 39)	36 psi	JL-78002-22	
0.44 to 2800					JL-78002-20	

E. High-Viscosity Pump Head

Ideal for media with high viscosity or with a certain level of solid content. Accepts tubing with 1.6-mm and 2.4-mm wall thickness (for elevated differential pressures). Stainless steel rollers. Pressure on tubing adjustable via rollers.

Flow range (mL/min)	Channels	Rollers	Tubing	Max pressure	Catalog number	Price
0.41 to 3600	1	3	Pump (page 39)	36 psi	JL-78002-60	

F. Masterflex® Easy-Load® Pump Heads

Allows for fast and easy tubing changes. Accepts Masterflex pump tubing. Requires mounting plate below. Masterflex L/S® tubing is located on pages 10–13.

Flow range (mL/min)	Channels	Rollers	Tubing	Max pressure	Catalog number	Price
3.4 to 672	1 (up to 2)	3	L/S® 15, L/S 24	20 psi	JL-07516-12	
0.12 to 912			L/S 13, L/S 14, L/S 16, L/S 17, L/S 18, L/S 25		JL-07516-10	

JL-78020-90 Mounting plate for Masterflex Easy-Load pump head

JL-07013-05 Mounting hardware to connect two Easy-Load pump heads

G. PTFE-Diaphragm Pump Heads

Pump almost any fluid with these chemically inert PTFE-diaphragm pump heads. Pump heads withstand temperatures up to 150°F (66°C). Use adapter 78002-70 to mount to Quick-Couple drives.

Flow range (mL/min)	Ball check	Rollers	Tubing	Max pressure	Catalog number	Price
0.5 to 60	Glass	1/8" NPT(M)	Pump (page 39)	75 psi	JL-07090-62	
4 to 480	PTFE	1/4" NPT(M)		50 psi	JL-07090-42	

JL-78002-70 Adapter for mounting PTFE Diaphragm pump heads onto 78002-series drives

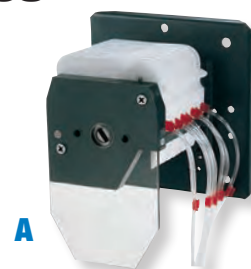

A



B



C

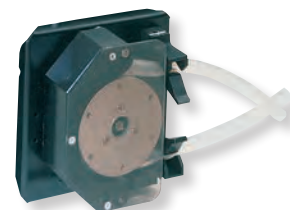

D



E



F



G

2- and 3-Stop Color-Coded Tubing for Ismatec® Pumps

Don't confuse your tubing—
color-coded stops for easy identification

STEP 1: Choose a tubing material & select the catalog number prefix.

Make sure to choose 2-stop or 3-stop tubing based on what your pump uses!

STEP 3: Complete your system with extension tubing.

Connect stopped and extension tubing with barbed fittings or splicing.

Material	Description	Suffixes for the available sizes	Tubes/pk (length)	2-Stop Tubing		3-Stop Tubing		Extension Tubing		
				Catalog number prefix	Price/pk*	Catalog number prefix	Price/pk*	Catalog number prefix	Length/pk	Price/pk*
Tygon® E-LFL	<ul style="list-style-type: none"> Complies with USP Class VI, EP, FDA, EU food, REACH, RoHS, ADF Longest life of all Tygon formulations Broad chemical resistance 	10, 12, 18, 26, 30, 34, 42, 48	12 (16")	JL-96449-XX		JL-96450-XX		JL-06449-XX	100 ft	
Tygon® E-Food	<ul style="list-style-type: none"> Complies with FDA, EU Food, NSF, 2A, REACH, RoHS, ADF Smooth inner surface; nontoxic 	10, 12, 18, 26, 30, 34, 42, 48	12 (16")	JL-96457-XX		JL-96458-XX		JL-06457-XX	100 ft	
Tygon® E-Lab	<ul style="list-style-type: none"> Complies with USP Class VI, FDA, EU Food, NSF, REACH, RoHS, ADF Ideal for general transfer applications Nonaging, nonoxidizing, low gas permeability 	10, 12, 18, 26, 30, 34, 42, 48	12 (16")	JL-96460-XX		JL-96461-XX		JL-06460-XX	100 ft	
Silicone (peroxide cured)	<ul style="list-style-type: none"> Complies with USP Class VI, EP, FDA, 3A, REACH, RoHS, ADF Greater physical compression capability Economical, long tubing life 	22, 24, 26, 28, 30, 32, 34, 36, 38, 40, 42, 44, 46, 48	6 (16")	JL-07616-XX		JL-07624-XX		JL-07625-XX	50 ft	
Silicone (platinum cured)	<ul style="list-style-type: none"> Complies with USP Class V, EP, FDA, REACH, RoHS, ADF Low protein binding, fungus-resistant, phthalate and latex free 	22, 24, 26, 28, 30, 32, 34, 36, 38, 40, 42, 44, 46, 48	6 (16")	JL-95602-XX		JL-95603-XX		JL-95612-XX	50 ft	
Viton®	<ul style="list-style-type: none"> Complies with FDA, ADF Resists corrosives, solvents, and oils at elevated temperatures 	26, 30, 34, 38, 42, 46, 48	12 (12")	JL-97628-XX		JL-97629-XX		JL-97632-XX	50 ft	
PharMed® BPT	<ul style="list-style-type: none"> Complies with USP Class VI, EP, FDA, NSF, REACH, RoHS Over 10,000 hours of tubing life, sealable, weldable Ideal for tissue and cell culture work 	12, 18, 26, 32, 36, 40, 42, 44, 48	12 (16")	JL-95713-XX		JL-95714-XX		JL-95809-XX	100 ft	
Autoclavable PharMed® BPT	<ul style="list-style-type: none"> Ideal for tissue and cell culture work 	12, 32, 48	6 (16")	JL-95692-XX		JL-95693-XX				
PVC Solvent/hydrocarbon	<ul style="list-style-type: none"> Resistant to ozone and UV light Resists to cracking, swelling, hardening Ideal for fuels, distillates, lubricants, and glycol-based coolants 	10, 12, 14, 18, 26, 30, 32, 34, 36, 40, 42, 48	12 (16")	JL-95606-XX		JL-95605-XX		JL-95712-XX	50 ft	
MHLL	<ul style="list-style-type: none"> Suitable for acetone, MEK, and other highly aggressive chemicals Long life and outstanding fatigue resistance 	24, 30, 36, 42, 48	6 (16")	JL-96427-XX		JL-96425-XX		None (PharMed BPT recommended for extension tubing; see 95809-XX above)		

STEP 2:

Find your desired flow rate and select the catalog number suffix (see page 39 for more).

Flow rate [†] (mL/min) with Fixed-Speed Pumps (page 35)										Catalog number suffix	ID (mm)	Color-coded stops
78012-00	78012-20	78012-30	78012-40	78012-45	78012-50	78012-55	78012-60	78012-80	78012-90			
0.047	0.14	0.047	0.093	0.093	0.056	0.056	0.11	0.17	0.056	-10	0.19	O/R
0.081	0.24	0.08	0.16	0.16	0.1	0.1	0.19	0.29	0.1	-12	0.25	O/B
0.19	0.56	0.19	0.37	0.37	0.22	0.22	0.43	0.65	0.22	-14	0.38	O/G
0.25	0.75	0.25	0.5	0.5	0.29	0.29	0.58	0.86	0.29	-16	0.44	G/Y
0.34	1	0.34	0.67	0.67	0.38	0.38	0.77	1.2	0.38	-18	0.51	O/Y
0.52	1.6	0.52	1	1	0.6	0.6	1.2	1.8	0.6	-22	0.64	O/W
0.73	2.2	0.73	1.5	1.5	0.84	0.84	1.7	2.5	0.84	-24	0.76	Bk/Bk
1	2.9	1	2	2	1.1	1.1	2.3	3.4	1.1	-26	0.89	O/O
1.3	3.8	1.3	2.5	2.5	1.5	1.5	2.9	4.4	1.5	-28	1.02	W/W
1.6	4.7	1.6	3.1	3.1	1.8	1.8	3.6	5.4	1.8	-30	1.14	R/R
2	5.9	2	3.9	3.9	2.3	2.3	4.6	6.9	2.3	-32	1.3	GR/GR
2.3	6.8	2.3	4.6	4.6	2.7	2.7	5.4	8	2.7	-34	1.42	Y/Y
2.6	7.7	2.6	5.1	5.1	3	3	6	9.1	3	-36	1.52	Y/B
2.9	8.8	2.9	5.8	5.8	3.5	3.5	6.9	10	3.5	-38	1.65	B/B
3.5	10	3.5	7	7	4.2	4.2	8.4	13	4.2	-40	1.85	G/G
4.1	12	4.1	8.2	8.2	5	5	10	15	5	-42	2.06	P/P
4.8	14	4.8	9.5	9.5	5.8	5.8	12	17	5.8	-44	2.29	P/Bk
5.5	16	5.5	11	11	6.6	6.6	13	20	6.6	-46	2.54	P/O
6.2	19	6.2	12	12	7.4	7.4	15	22	7.4	-48	2.79	P/W

[†]Flow ranges (mL/min) are nominal. Actual flow depends on factors such as occlusion, fluid viscosity, temperature, and pressure

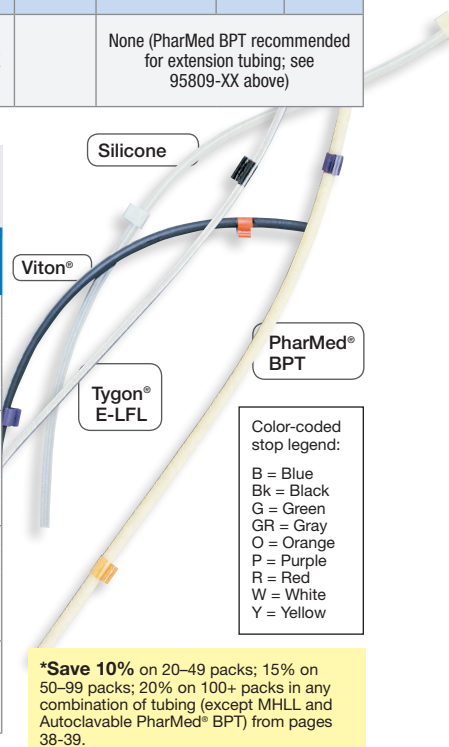

STEP 2 (continued): Find your desired flow rate and select the catalog number suffix.

Flow ranges [†] (mL/min) with indicated pump system (pages 34 and 36)													Catalog number suffix	ID (mm)	Color-coded stops
78016-00	78016-10	78016-30	78016-40	78017-00	78017-10	78017-20	78017-25	78017-30	78017-35	78017-45	78022-40	78022-60			
0.009-0.45	0.008-0.37	0.005-0.23	0.005-0.45	0.004-0.37	0.003-0.23	0.003-0.21	0.007-0.34	0.006-0.28	0.005-0.21	0.004-0.34	0.01-0.98	0.0075-0.75	-10	0.19	O/R
0.015-0.76	0.013-0.65	0.009-0.41	0.008-0.76	0.007-0.65	0.005-0.41	0.004-0.38	0.012-0.61	0.01-0.48	0.008-0.38	0.007-0.61	0.017-1.7	0.013-1.3	-12	0.25	O/B
0.035-1.7	0.03-1.5	0.019-0.94	0.017-1.7	0.015-1.5	0.01-0.94	0.009-0.88	0.028-1.4	0.022-1.1	0.018-0.88	0.014-1.4	0.038-3.8	0.031-3.1	-14	0.38	O/G
0.046-2.3	0.04-2	0.025-1.3	0.023-2.3	0.02-2	0.013-1.3	0.012-1.2	0.038-1.9	0.029-1.4	0.024-1.2	0.019-1.9	0.05-5	0.041-4.1	-16	0.44	G/Y
0.061-3.1	0.054-2.7	0.034-1.7	0.031-3.1	0.027-2.7	0.017-1.7	0.016-1.6	0.05-2.5	0.038-1.9	0.031-1.6	0.025-2.5	0.067-6.7	0.055-5.5	-18	0.51	O/Y
0.096-4.8	0.084-4.2	0.052-2.6	0.048-4.8	0.042-4.2	0.026-2.6	0.024-2.4	0.077-3.9	0.06-3	0.048-2.4	0.039-3.9	0.1-10	0.085-8.5	-22	0.64	O/W
0.13-6.7	0.12-5.8	0.073-3.6	0.067-6.7	0.058-5.8	0.036-3.6	0.33-3.3	0.11-5.3	0.084-4.2	0.067-3.3	0.053-5.3	0.15-15	0.12-12	-24	0.76	Bk/Bk
0.18-9	0.16-7.9	0.098-4.9	0.09-9	0.079-7.9	0.049-4.9	0.044-4.4	0.14-7.1	0.11-5.7	0.088-4.4	0.071-7.1	0.2-20	0.15-15	-26	0.89	O/O
0.23-12	0.2-10	0.13-6.3	0.12-12	0.1-10	0.063-6.3	0.056-5.6	0.18-9	0.15-7.3	0.11-5.6	0.09-9	0.26-26	0.2-20	-28	1.02	W/W
0.29-14	0.25-12	0.16-7.8	0.14-14	0.12-12	0.078-7.8	0.067-6.7	0.22-11	0.18-9	0.13-6.7	0.11-11	0.32-32	0.24-24	-30	1.14	R/R
0.37-18	0.31-16	0.2-10	0.18-18	0.16-16	0.1-10	0.083-8.3	0.26-13	0.23-11	0.17-8.3	0.13-13	0.4-40	0.29-29	-32	1.3	GR/GR
0.43-21	0.37-18	0.23-11	0.21-21	0.18-18	0.11-11	0.094-9.4	0.3-15	0.27-13	0.19-9.4	0.15-15	0.47-47	0.33-33	-34	1.42	Y/Y
0.48-24	0.41-20	0.26-13	0.24-24	0.2-20	0.13-13	0.1-10	0.33-17	0.3-15	0.21-10	0.17-17	0.53-53	0.36-36	-36	1.52	Y/B
0.56-28	0.47-23	0.29-15	0.28-28	0.23-23	0.15-15	0.12-12	0.37-19	0.35-17	0.23-12	0.19-19	0.61-61	0.41-41	-38	1.65	B/B
0.67-34	0.56-28	0.35-17	0.34-34	0.28-28	0.17-17	0.13-13	0.43-21	0.42-21	0.27-13	0.21-21	0.73-73	0.47-47	-40	1.85	G/G
0.79-40	0.66-33	0.41-20	0.4-40	0.33-33	0.2-20	0.15-15	0.49-24	0.5-25	0.3-15	0.24-24	0.87-87	0.53-53	-42	2.06	P/P
0.92-46	0.76-38	0.48-24	0.46-46	0.38-38	0.24-24	0.17-17	0.55-27	0.58-29	0.34-17	0.27-27	1-100	0.6-60	-44	2.29	P/Bk
1.1-53	0.88-44	0.55-27	0.53-53	0.44-44	0.27-27	0.19-19	0.62-31	0.66-33	0.39-19	0.31-31	1.2-120	0.68-68	-46	2.54	P/O
1.2-59	0.99-50	0.62-31	0.59-59	0.5-50	0.31-31	0.21-21	0.69-34	0.74-37	0.43-21	0.34-34	1.3-130	0.75-75	-48	2.79	P/W

Flow ranges [†] (mL/min) with indicated pump system (pages 34 and 37)								Catalog number suffix	ID (mm)	Color-coded stops
78001-00, 78001-10, 78001-20, 78001-30, 78001-40	78001-02, 78001-12, 78001-22, 78001-32, 78001-42	78002-34	78002-36	78002-50	78002-90					
0.0007-0.066	0.003-0.26	0.004-0.94	0.004-0.94	0.003-0.67	0.003-0.51	-10	0.19	O/R		
0.001-0.1	0.005-0.41	0.008-1.8	0.008-1.8	0.005-1.1	0.004-0.91	-12	0.25	O/B		
0.003-0.22	0.009-0.86	0.019-4.5	0.019-4.5	0.011-2.6	0.009-2.1	-14	0.38	O/G		
0.003-0.28	0.011-1.1	0.025-6.1	0.025-6.1	0.014-3.5	0.012-2.8	-16	0.44	G/Y		
0.004-0.38	0.015-1.5	0.034-8.2	0.034-8.2	0.019-4.6	0.016-3.8	-18	0.51	O/Y		
0.006-0.58	0.023-2.3	0.053-13	0.053-13	0.03-7.2	0.024-5.8	-22	0.64	O/W		
0.009-0.81	0.032-3.2	0.074-18	0.074-18	0.042-10	0.033-8	-24	0.76	Bk/Bk		
0.011-1.1	0.044-4.4	0.1-24	0.1-24	0.057-14	0.044-11	-26	0.89	O/O		
0.014-1.4	0.057-5.7	0.13-31	0.13-31	0.073-18	0.056-13	-28	1.02	W/W		
0.017-1.7	0.07-7	0.16-38	0.16-38	0.09-22	0.067-16	-30	1.14	R/R		
0.022-2.2	0.089-8.9	0.2-47	0.2-47	0.11-27	0.083-20	-32	1.3	GR/GR		
0.026-2.6	0.11-11	0.23-55	0.23-55	0.13-32	0.094-23	-34	1.42	Y/Y		
0.03-3	0.12-12	0.26-62	0.26-62	0.15-36	0.1-25	-36	1.52	Y/B		
0.035-3.5	0.14-14	0.3-71	0.3-71	0.17-42	0.12-28	-38	1.65	B/B		
0.43-4.3	0.17-17	0.36-86	0.36-86	0.21-50	0.13-32	-40	1.85	G/G		
0.52-5.2	0.21-21	0.43-100	0.43-100	0.25-59	0.15-37	-42	2.06	P/P		
0.062-6.2	0.25-25	0.51-120	0.51-120	0.29-69	0.17-41	-44	2.29	P/Bk		
0.075-7.5	0.3-30	0.63-150	0.62-150	0.33-79	0.19-46	-46	2.54	P/O		
0.088-8.8	0.35-35	0.74-180	0.74-180	0.37-89	0.21-52	-48	2.79	P/W		

Teky's Tips



How to order 2- and 3-stop tubing

Step 1: Choose a tubing material and select the corresponding catalog number prefix from the table on page 38. Make sure to choose 2-stop or 3-stop tubing based on what your pump uses!

Step 2: Find your pump system and desired flow rate and select the catalog number suffix from the tables on pages 38 and 39.

Step 3: Complete your system with extension tubing from page 38. You can connect stopped tubing and extension tubing with hose barb fittings or by splicing together.

Pump Tubing for Ismatec® Pumps

ID (mm)	OD (mm)	Wall (mm)	Tygon® E-Lab			Silicone (peroxide cured)			Silicone (platinum cured)			Norprene®			Viton®		
			Cat.no.	Ft/pk	Price/pk*	Cat.no.	Ft/pk	Price/pk*	Cat.no.	Ft/pk	Price/pk*	Cat.no.	Ft/pk	Price/pk*	Cat.no.	Ft/pk	Price/pk*
0.8	4.0	1.6	JL-06509-13	50		JL-96400-13	25		JL-95802-01	25		JL-06404-13	50		JL-96412-13	25	
1.6	4.8	1.6	JL-06407-72	50		JL-96400-14	25		JL-96410-14	25		JL-06410-01	50		JL-96412-14	25	
3.2	6.4	1.6	JL-06407-76	50		JL-06411-67	25		JL-95802-05	25		JL-06410-02	50		—	—	—
4.8	8.0	1.6	JL-06407-78	50		JL-06411-03	25		JL-95802-09	25		JL-06410-04	50		JL-96412-25	25	
6.4	9.5	1.6	JL-06407-80	50		JL-06411-71	25		JL-95802-12	25		JL-06410-05	50		JL-96412-18	25	
6.4	11.1	2.4	JL-06509-24	50		JL-06411-72	25		JL-95802-13	25		JL-06410-06	50		JL-96412-24	25	
8.0	11.2	1.6	JL-06407-83	50		JL-06411-75	25		JL-95802-15	25		JL-06410-08	50		JL-06434-05	25	
9.5	12.7	1.6	JL-06407-86	50		JL-06411-12	25		JL-95802-18	25		JL-06410-10	50		JL-06434-06	25	
11.1	14.3	1.6	JL-06407-87	50		—	—	—	—	—	—	JL-06410-13	50		—	—	—
12.8	16.0	1.6	JL-06407-90	25		JL-06411-80	25		JL-95802-21	25		JL-06410-14	50		JL-06434-07	25	
16.0	22.4	3.2	—	—	—	JL-06411-58	25		JL-95802-25	25		JL-06410-17	50		JL-06434-08	25	

ID (mm)	Flow ranges (mL/min) with indicated pump system ^{††}									
	Page 660		Page 661				Page 664			
	78025-00	78022-10	78022-20	78022-30	07611-10 [†]	07611-15 [†]	78002-20 [†]	78002-22 [†]	78002-60 [†]	
0.8	—	—	—	0.25 to 25	—	0.22 to 22	—	0.072 to 17	—	
1.6	—	1.7 to 170	1.6 to 160	0.9 to 90	—	0.63 to 63	—	0.026 to 62	0.41 to 99	
3.2	—	6.6 to 660	5.9 to 590	3.5 to 350	2.6 to 260	2.4 to 240	1.7 to 400	1.0 to 240	1.5 to 370	
4.8	—	15.0 to 1500	13.0 to 1300	7.7 to 770	5.5 to 550	5.3 to 530	3.6 to 860	2.2 to 530	3.4 to 830	
6.4	37 to 3700	25.0 to 2500	23.0 to 2300	13.0 to 1300	8.9 to 890	—	6.0 to 1400	3.7 to 880	6.2 to 1500	
8.0	—	37.0 to 3700	34.0 to 3400	—	11.1 to 1110	—	8.8 to 2100	—	9.5 to 2300	
9.5	80 to 8000	48.0 to 4800	44.0 to 4400	—	—	—	12 to 2800	—	13 to 3000	
11.1	—	54.0 to 5400	50.0 to 5000	—	—	—	—	—	15 to 3600	
12.8	100 to 10000	—	—	—	—	—	—	—	—	
16.0	130 to 13000	—	—	—	—	—	—	—	—	

^{††}Note: Lower flow rates achievable with digital drives. [†]Flow rate with Digital Drive 78002-10; lower flow rate achievable with Programmable Drive 78002-00.

Cole-Parmer® Digital Gear Drive with Remote Control

Easier setup and operation

NEW

- Graphical LCD shows four operating modes: continuous run, timed dispense, copy dispense, volume dispense
- Get pulse-free flow in combination with Micropump® A-mount head
- Maximize bench space by stacking up to three drives
- Control speed, direction, and more remotely via DB25 female connector on drive

Analog remote control options and simple programming make this drive ideal for automated process applications. Drive features set time interval between dispense cycles for hands-free dispensing. Batch count function counts down and displays batches completed. Cumulative volume function enables you to track total volume dispensed over multiple cycles.

What's included: 6-ft (1.8-m) line cord with IEC 320/CEE22 socket. These models are shipped with country specific plug/cord set; please specify ultimate destination when ordering.



Cole-Parmer®

JL-07523-92 Foot switch for momentary start/stop; 6-ft (1.8-m) cable
JL-07523-94 Male connector, DB25.
Use to create your own cable

Motor rpm	Motor hp	Motor type	Power VAC	Power Hz	Catalog number	Price
36 to 3600	1/10	PMDC	90 to 260	50/60	JL-75211-70	



Cole-Parmer® Gear Pump Systems

Order one part number, get a complete system—drive and pump head

Benchtop Analog Drives provide continuous-duty operation with Micropump® A-mount pump heads. Gradual, one-second acceleration offers smooth control of drive speed and flow rate. The permanent-magnet, direct-current (PMDC) drive is built to last—excellent for long-term applications.

Benchtop Digital Drives. Graphical LCD shows four operating modes: continuous run, timed dispense, copy dispense, and volume dispense. View pump performance continually. Systems deliver pulse-free flow in combination with Micropump® A-mount head. Retrieve displacement and flow values by pump head size. IP33-rated enclosure ensures splash and dust resistance. Drive has a DB25F connection to the optional foot switch for hands-free on/off control (order foot switch separately).



Benchtop analog system 74013-45



Benchtop digital system 74014-32

Cole-Parmer®



Specifications

Viscosity: 0.2 to 1500 cp
Suction lift: 0.6 m of H₂O (at 1750 rpm)
Duty cycle: continuous
Port size: 1/8" NPT(F)

Remote control:
Analog drives: none
Digital drives: (input) on/off by contact closure
0 to 10 VDC, 0 to 20 mA,
4 to 20 mA, and remote output

Max operating temperature:
60°C (104°F)
Speed:
Analog drives: 50 to 5000 rpm
Digital drives: 36 to 3600 rpm

Flow rates (mL/min) [†]			Max pressure		Wetted parts			Benchtop analog systems			Benchtop digital systems			Service kits	
mL/rev	at 50 rpm	at 3600 rpm	Diff (bar)	System (bar)	Body	Gears	Seals	Catalog number	Power (VAC)	Price	Catalog number	Power (VAC)	Price	Catalog number	Price
0.017	0.85	85	1.38	20.68											
0.092	4.60	331.2	5.17	20.68	316 SS	PPS	PTFE	JL-74013-75	220		JL-74014-02	90 to 260		—	—
							PTFE	JL-74013-00	115						
0.092	4.60	331.2	5.17	20.68	316 SS	PPS	PPS	JL-74013-05	220		JL-74014-62	90 to 260		—	—
							PTFE	JL-74013-60	115						
0.261	13.05	939.6	8.61	20.68	316 SS	PEEK	Viton®	JL-74013-65	220		JL-74014-52	90 to 260		JL-74012-52	
							PTFE	JL-74013-50	115						
0.316	15.8	1137.6	5.17	20.68	316 SS	PPS	PTFE	JL-74013-10	115		JL-74014-12	90 to 260		—	—
							PTFE	JL-74013-15	220						
0.64	32.0	2304	5.17	20.68	316 SS	PPS	PTFE	JL-74013-20	115		JL-74014-22	90 to 260		JL-74012-22	
							PTFE	JL-74013-25	220						
0.91	45.5	3276	5.17	20.68	316 SS	PPS	PTFE	JL-74013-30	115		JL-74014-32	90 to 260		—	—
							PTFE	JL-74013-35	220						
1.17	58.5	4212	4.14	20.68	316 SS	PPS	Viton	JL-74013-40	115		JL-74014-42	90 to 260		—	—
							PTFE	JL-74013-45	220						

[†]Flow rates in mL/min are based on water at room temperature and no back pressure.

[JL-07523-92](#) Foot switch, momentary start/stop, 1.8-m cable

[JL-06385-10](#) Male pipe adapter (straight);
PP, 1/4" OD x 1/8" NPT(M). Pack of 10

[JL-30621-31](#) Male pipe adapter; HDPE, 1/8" NPT(M) x 1/4" ID. Pack of 10

[JL-40610-36](#) Male pipe adapter; natural PP,
1/8" NPT(M) x 1/4" ID. Pack of 10

Catalyst™ FH10, FH15, and FH30 Peristaltic Pumps

Get quick setup and repeatable low flow rates

NEW

- Compact, stackable pumps feature a durable steel housing with chip-resistant epoxy-based paint
- Max button runs pump at 100% speed—use to prime or flush tubing
- Remote control connections on back of pump; start/stop pump with a contact closure
- Separate single-turn speed control and cw/off/ccw switch with green LED power indicator—maintain speed setting when you turn pump on/off or reverse direction

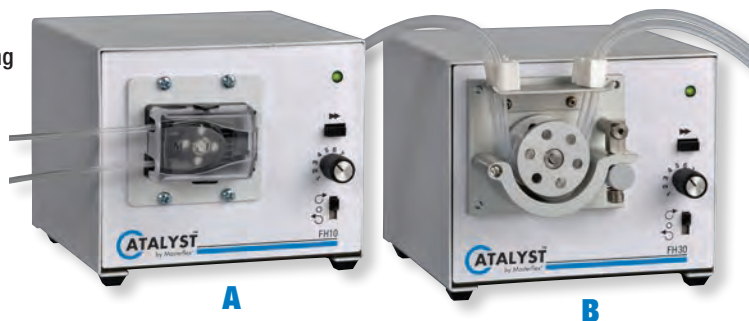

Fluid Handling

Pumps

A. Catalyst FH10 Single-Channel Pumps

- Flow: 0.002 to 50 mL/min depending on tubing size and drive rpm
- Pumps accept continuous lengths of tubing for a clean, uninterrupted flow path with no fittings
- A single motion opens pump head cover and releases occlusion bed for quick and easy tubing changes
- Polyphenylene sulfide (PPS), acetal, and copolyester pump head with four stainless steel (SS) rollers

B. Catalyst FH15 Single-Channel and FH30 Dual-Channel Pumps

- Flow: 0.8 to 105 mL/min depending on tubing size and drive rpm
- Dual-channel model delivers synchronous flow from two separate channels
- Pump head has average fixed occlusion for tubing; no need to adjust occlusion
- Two-stop tubing sets are easy to load
- Self-lubricating thermoplastic polyester (Ertalyle® TX) rollers are low friction and long wearing for smooth operation and long life



Specifications

Remote control input: start/stop via contact closure

Reversible motor: yes IP rating: IP22

Flow range (mL/min)	Tubing sizes accepted (mm ID)	Speed range	Dimensions (L x W x H)	Power (50/60 Hz)		Catalog number	Price
				VAC	Amps		
A. Catalyst FH10 single-channel pumps							
0.002 to 1.65	0.19, 0.25, 0.89, 1.42, 2.06, 2.79	1.7 to 10	7" x 5¼" x 4½" (17.8 x 13.4 x 11.4 cm)	90 to 260	0.4 at 115 VAC, 0.25 at 230 VAC	JL-77720-00	
0.017 to 11		13 to 80				JL-77720-02	
0.07 to 50		50 to 300				JL-77720-04	
B. Catalyst FH15 single-channel pump							
0.8 to 105	0.8, 1.6, 3.2, 4.8	20 to 100	7" x 5¼" x 4½" (17.8 x 13.4 x 11.4 cm)	90 to 260	0.5 at 115 VAC, 0.3 at 230 VAC	JL-77720-20	
B. Catalyst FH30 dual-channel pump							
0.8 to 14	0.8, 1.6	20 to 100	7" x 5¼" x 4½" (17.8 x 13.4 x 11.4 cm)	90 to 260	0.5 at 115 VAC, 0.3 at 230 VAC	JL-77720-30	

Tubing Coils for Catalyst FH10 Pumps

Tubing ID	0.19 mm ID	0.25 mm ID	0.89 mm ID	1.42 mm ID	2.06 mm ID	2.79 mm ID
Flow (mL/min) at 1.7 to 10 rpm	0.002 to 0.013	0.004 to 0.022	0.041 to 0.25	0.09 to 0.57	0.18 to 1.05	0.25 to 1.65
Flow (mL/min) at 13 to 80 rpm	0.017 to 0.10	0.03 to 0.18	0.33 to 2.0	0.75 to 4.5	1.4 to 8.5	1.8 to 11.0
Flow (mL/min) at 50 to 300 rpm	0.07 to 0.43	0.12 to 0.73	1.4 to 8.3	3.2 to 19	5.9 to 35.2	8.3 to 50
Silicone, platinum-cured (15 m/49.2 ft)	—	—	JL-97200-14	JL-97200-16	JL-97200-17	JL-97200-18
PharMed® BPT (30 m/98.4 ft)	—	JL-97200-33	JL-97200-34	JL-97200-36	JL-97200-37	JL-97200-38
Tygon® E-Food (30 m/98.4 ft)	JL-97200-72	JL-97200-73	JL-97200-74	JL-97200-76	JL-97200-77	JL-97200-78

Two-Stop Tubing Sets for Catalyst FH15 and FH30 Pumps

Tubing ID	0.8 mm ID	1.6 mm ID	3.2 mm ID	4.8 mm ID
Flow (mL/min) with FH15	0.8 to 4.0	2.8 to 14	11 to 54	21 to 105
Flow (mL/min) with FH30	0.8 to 4.0	2.8 to 14	Not recommended	
Silicone, platinum-cured (6/pk)	JL-97100-12	JL-97100-13	JL-97100-16	JL-97100-17
PharMed® BPT (12/pk)	JL-97100-22	JL-97100-23	JL-97100-26	JL-97100-27
Norprene® Food (12/pk)	JL-97100-42	JL-97100-43	JL-97100-46	JL-97100-47
Tygon® E-Food (12/pk)	JL-97100-62	JL-97100-63	JL-97100-66	JL-97100-67

Catalyst™ FH100 and FH100D Peristaltic Pumps

You'll be up to speed and pumping in no time at all

NEW

- Integrated pump and drive systems are provided fully assembled, reducing setup time
- Pump head accepts multiple tubing sizes for a broad flow range
- Integral pump head allows tubing change in less than 30 seconds—tubing occlusion is automatic when pump head is closed
- Interlock switch powers unit down when pump head is opened for tubing change
- Contamination-free pumping—the fluid contacts only the tubing

A. Catalyst FH100 Precision Peristaltic Pumps

- Intuitive keypad is easy to use—quickly increase or decrease flow
- Digital display of speed (rpm) for accurate control and repeatability
- Reversible motor permits purging of tubing before and after use
- Remote control capability is ideal for automated process applications

B. Catalyst FH100D Digital Peristaltic Dispensing Pumps

- Accurate dispensing from a simple, ready-to-use pump
- Clear multiline LCD displays all operational parameters
- Control capabilities include programmable dispensing in volume, time, or copy modes
- Programmed delay between cycles for convenient automated dispensing
- Programmable in seven languages—provides easy intuitive setup
- Optimize system accuracy by calibrating the pump system under application conditions—the calibration is stored in memory—one calibration value per tubing size



A

CATALYST™
by Masterflex®



B

ISO9001:2008 CERTIFIED SUPPLIER

Flow range (mL/min)	Tubing sizes accepted (mm ID)	Speed range	Speed control (repeatability)	Remote control input	Reversible motor	Power (50/60 Hz)		Catalog number	Price
		VAC	Amps						
A. Catalyst FH100 pump accepts 1.6 mm (thin-wall) tubing									
0.5 to 3000	0.8, 1.6, 3.2, 4.8, 6.4, 8.0	4 to 400 rpm	±0.25%	4 to 20 mA, 0 to 10 V	Yes	90 to 260	1.6 at 115 VAC, 1.9 at 230 VAC	JL-77722-00	
A. Catalyst FH100X pump accepts 2.4 mm (thick-wall) tubing									
14 to 4000	4.8, 6.4, 8.0, 9.5	4 to 400 rpm	±0.25%	4 to 20 mA, 0 to 10 V	Yes	90 to 260	1.6 at 115 VAC, 1.9 at 230 VAC	JL-77722-02	
B. Catalyst FH100D pump accepts 1.6 mm (thin-wall) tubing									
0.5 to 3000	0.8, 1.6, 3.2, 4.8, 6.4, 8.0	4 to 400 rpm	±0.25%	0 to 20 mA, 4 to 20 mA, 0 to 10 V scalable	Yes	90 to 260	1.6 at 115 VAC, 1.9 at 230 VAC	JL-77722-10	
B. Catalyst FH100DX pump accepts 2.4 mm (thick-wall) tubing									
14 to 4000	4.8, 6.4, 8.0, 9.5	4 to 400 rpm	±0.25%	0 to 20 mA, 4 to 20 mA, 0 to 10 V scalable	Yes	90 to 260	1.6 at 115 VAC, 1.9 at 230 VAC	JL-77722-12	

Accessories

[JL-77722-80](#) Handheld remote controller for models FH100 and FH100X.

DB9; for on/off control; route tubing through handle for filling applications

[JL-77722-90](#) Handheld remote controller for models FH100D and FH100DX.

DB25; for on/off control; route tubing through handle for dispensing applications

[JL-17050-01](#) NIST-traceable calibration with data for peristaltic pumps

Tubing Coils

Description	1.6 mm (thin-wall) tubing for FH100 and FH100D pumps						2.4 mm (thick-wall) tubing for FH100X and FH100DX pumps				
	0.8 mm	1.6 mm	3.2 mm	4.8 mm	6.4 mm	8.0 mm	4.8 mm	6.4 mm	8 mm	9.5 mm	
Inner diameter	0.8 mm	1.6 mm	3.2 mm	4.8 mm	6.4 mm	8.0 mm	4.8 mm	6.4 mm	8 mm	9.5 mm	
Hose barb size	1/32"	1/16"	1/8"	3/16"	1/4"	5/16"	3/16"	1/4"	5/16"	3/8"	
Flow (mL/min)	0.5 to 40	2.0 to 150	6.5 to 550	16 to 1200	24 to 2000	36 to 3000	14 to 1200	24 to 2000	36 to 3000	48 to 4000	
Length/pk	15 m (49.2 ft)	15 m (49.2 ft)	15 m (49.2 ft)	15 m (49.2 ft)	15 m (49.2 ft)	15 m (49.2 ft)	15 m (49.2 ft)	15 m (49.2 ft)	15 m (49.2 ft)	15 m (49.2 ft)	
Silicone, platinum-cured	—	JL-97000-71	JL-97000-72	JL-97000-73	JL-97000-74	JL-97000-75	JL-97000-76	JL-97000-77	JL-97000-78	JL-97000-79	
PharMed® BPT	JL-97000-20	JL-97000-21	JL-97000-22	JL-97000-23	JL-97000-24	JL-97000-25	—	—	—	—	
Norprene® Food	—	JL-97000-41	JL-97000-42	JL-97000-43	JL-97000-44	JL-97000-45	—	—	—	—	
Tygon® E-Food	—	JL-97000-61	JL-97000-62	JL-97000-63	JL-97000-64	JL-97000-65	—	JL-97000-67	JL-97000-68	JL-97000-69	

Catalyst™ FH100M Multichannel Peristaltic Pumps

Multiple flow channels from a single pump



- Flow ranges from 2 µL/min to 530 mL/min per channel
- Cartridge design provides fast tubing changes, and eliminates hardware in other multichannel designs
- Clear multiline LCD displays all operational parameters
- Control capabilities include programmable dispensing in volume, time, or copy modes
- Programmed delay between cycles for convenient automated dispensing
- Contamination-free pumping—the fluid contacts only the tubing material
- Programmable in seven languages—provides easy intuitive setup
- High repeatability on all channels
- Available in 4, 8, or 12 channel models (2, 4, and 6 channels when using the large cassettes)



Fluid Handling

Flow Rates in mL/min with two-stop microbore tubing—for use with small cartridges

Pump model	Number of rollers	Tubing ID					
		0.19 mm ID	0.25 mm ID	0.89 mm ID	1.42 mm ID	2.06 mm ID	2.79 mm ID
FH100M 4/8	8	0.013 to 0.60	0.018 to 0.91	0.18 to 9.1	0.04 to 20.0	0.88 to 44.0	1.38 to 67.0
FH100M 8/4	4	0.02 to 0.85	0.03 to 1.0	0.26 to 13.0	0.53 to 26.0	1.14 to 57.0	2.06 to 100.0
FH100M 12/8	8	0.002 to 0.11	0.004 to 0.20	0.03 to 1.9	0.07 to 4.3	0.14 to 8.6	0.25 to 14.0

Flow Rates in mL/min with two-stop precision tubing—for use with large cartridges

Pump model	Number of rollers	Tubing ID				
		0.8 mm ID	1.6 mm ID	3.2 mm ID	4.8 mm ID	6.4 mm ID
FH100M 4/6	6	0.21 to 10.0	0.6 to 30.0	2.2 to 110	4.0 to 200	5.6 to 280
FH100M 8/3	3	0.22 to 11.0	0.84 to 42.0	3.2 to 160	6.8 to 340	10.6 to 530
FH100M 12/6	6	0.033 to 1.9	0.012 to 6.6	0.35 to 20.0	0.70 to 40.0	0.98 to 56.0

Questions?

Trust our **expert** Application Specialists to help you find the right product.

Bob, 7 years of experience

Call: 800-323-4340 E-mail: sales@coleparmer.com

Pumps

Specifications

- | | |
|---|---|
| Speed range: 4 to 400 rpm | Reversible motor: yes |
| Speed control (repeatability): ±0.25% | IP rating: IP31 |
| Remote control input: 0 to 20 mA, 4 to 20 mA, 0 to 10 V scalable | Power: 90 to 260 VAC, 50/60 Hz; 1.6 A at 115 VAC, 1.9 A at 230 VAC |



Model	Max no. of channels	No. of rollers	Cartridges included	Flow range per channel (mL/min)	Catalog number	Price
FH100M 4/6	4	6	2 large	0.21 to 280	JL-77724-00	
FH100M 4/8	4	8	4 small	0.013 to 67	JL-77724-02	
FH100M 8/3	8	3	4 large	0.22 to 530	JL-77724-04	
FH100M 8/4	8	4	8 small	0.02 to 100	JL-77724-06	
FH100M 12/6	12	6	6 large	0.033 to 56	JL-77724-08	
FH100M 12/8	12	8	12 small	0.002 to 14	JL-77724-10	

Accessories

- [JL-77724-60](#) Replacement cartridge, small; for FH100M 8/3 and 8/4
- [JL-77724-65](#) Replacement cartridge, large; for FH100M 8/3 and 8/4
- [JL-77724-70](#) Replacement cartridge, small; for FH100M 4/6, 4/8, 12/6 and 12/8
- [JL-77724-75](#) Replacement cartridge, large; for FH100M 4/6, 4/8, 12/6 and 12/8
- [JL-17050-01](#) NIST-traceable calibration with data for peristaltic pump drive

Two-Stop Microbore Tubing Sets—for small cartridges

Formulation	Silicone, platinum-cured (6/pk)	PharMed® BPT (12/pk)	Tygon® E-Food (12/pk)
0.19 mm ID	JL-97200-02	JL-97200-22	JL-97200-62
0.25 mm ID	JL-97200-03	JL-97200-23	JL-97200-63
0.89 mm ID	JL-97200-04	JL-97200-24	JL-97200-64
1.42 mm ID	JL-97200-06	JL-97200-26	JL-97200-66
2.06 mm ID	JL-97200-07	JL-97200-27	JL-97200-67
2.79 mm ID	JL-97200-08	JL-97200-28	JL-97200-68

Two-Stop Precision Tubing Sets—for large cartridges

Formulation	Silicone, platinum-cured (6/pk)	PharMed® BPT (12/pk)	Norprene® Food (12/pk)	Tygon® E-Food (12/pk)
0.8 mm ID	JL-97100-12	JL-97100-22	JL-97100-42	JL-97100-62
1.6 mm ID	JL-97100-13	JL-97100-23	JL-97100-43	JL-97100-63
3.2 mm ID	JL-97100-16	JL-97100-26	JL-97100-46	JL-97100-66
4.8 mm ID	JL-97100-17	JL-97100-27	JL-97100-47	JL-97100-67
6.4 mm ID	JL-97100-18	JL-97100-28	JL-97100-48	JL-97100-68

Cole-Parmer® Syringe Pumps

Ideal for low-flow, low-pressure applications

- Backlit alphanumeric LCD guides you through setup and operating procedures
- Don't lose your settings—nonvolatile memory retains settings even after pump is turned off

A. Single-Syringe Infusion Pump automatically selects display units based on syringe used, obtaining precise flow rates down to 0.2 µL/hr. A wide dynamic range (6000:1) provides excellent flexibility.

B. Multi-Syringe Pumps achieve flow rates down to 0.001 µL/hr. Easy programming via keypad—infusion/withdrawal pumps sequence operations. Control from a computer with RS-232 interface.†

C. Multi-Step Multi-Syringe Pumps allow flow rates to vary from a slow trickle to a steady stream down to 0.001 µL/hr. Program up to 8 commands and repeat up to 10 times. Pumps allow you to program flow rate hold, pause, and change of direction; each program can be run up to 12 hours. Pumps can also sequence operations. Operate your pump from a computer—great for daisy-chaining pumps!



Pump continuously and automatically delivers exact quantities of liquid.



Specifications

Accuracy: ±<1%
Reproducibility: ±0.1%

Description	Number of syringes accepted	Flow rate per syringe	Syringe size accepted	Linear force	Power (VAC, Hz)	Catalog number	Price
A. Single-syringe pump							
Infusion	1	0.2 µL/hr to 500 mL/hr	10 µL to 60 mL	20 lb (9.1 kg)	115, 50/60 230, 50/60	JL-74900-00 JL-74900-05	
B. Multi-syringe pumps							
Infusion	2	0.001 µL/hr to 147 mL/min	10 µL to 140 mL	40 lb (18.1 kg)	115, 50/60	JL-74900-10	
	10				230, 50/60	JL-74900-15	
Infusion/withdrawal	2	0.001 µL/hr to 147 mL/min	10 µL to 140 mL	40 lb (18.1 kg)	115, 50/60	JL-74900-30	
	10				230, 50/60	JL-74900-35	
Infusion/withdrawal	2	0.001 µL/hr to 147 mL/min	10 µL to 140 mL	40 lb (18.1 kg)	115, 50/60	JL-74900-20	
	10				230, 50/60	JL-74900-25	
C. Multi-step multi-syringe pumps							
Infusion	2	0.001 µL/hr to 147 mL/min	10 µL to 140 mL	40 lb (18.1 kg)	115, 50/60	JL-74900-60	
	10				230, 50/60	JL-74900-65	
Infusion/withdrawal	2	0.001 µL/hr to 147 mL/min	10 µL to 140 mL	40 lb (18.1 kg)	115, 50/60	JL-74900-80	
	10				230, 50/60	JL-74900-85	
Infusion/withdrawal	2	0.001 µL/hr to 147 mL/min	10 µL to 140 mL	40 lb (18.1 kg)	115, 50/60	JL-74901-00	
	10				230, 50/60	JL-74901-05	
Infusion/withdrawal	2	0.001 µL/hr to 147 mL/min	10 µL to 140 mL	40 lb (18.1 kg)	115, 50/60	JL-74901-10	
	10				230, 50/60	JL-74901-15	

†Order RS-232 cables separately online or call our Application Specialists.

Low-Flow Piston Pump Systems

Remote flow rate control via analog signal or RS-232

- Flow down to 0.002 mL/min; pressure up to 6000 psi (414 bar)
- Smooth fluid delivery from intra RPM stepper motor control
- Integrated piston wash to rinse away crystallized chemicals

Software control of refill rates and compressibility compensation add to the versatility of the pumps and enhance pump performance. Precise metering is attained by a positive-displacement reciprocating piston assembly. The high-resolution stepper motor is used to maximize flow output and minimize pulsation.

Choose pumps with an integrated pulse damper to further reduce pulsation. Pumps also feature the ability to monitor pressure and set high and low limits.

Specifications

Viscosity: 500 cp max
Repeatability: typically ±0.3%
Duty cycle: continuous
Maximum fluid temperature: 248°F (120°C)
Power: 110 to 220 VAC, 50/60 Hz



Flow rate (mL/min)		Max pressure psi (bar)	Wetted parts		Connection		Standard		Integrated pulse damper	
Min	Max		Body	Piston	Inlet	Outlet	Catalog number	Price	Catalog number	Price
0.002	2.5	6000 (413)	316 SS	PE	¼" fitting for ⅛" tubing	Ferrule for ⅛" tubing	JL-73150-00		JL-73150-02	
0.003	5	6000 (413)			⅛" Swagelok®	⅛" Swagelok	JL-73150-20		JL-73150-12	
0.01	20	3000 (206)	316 SS	PE	¼" fitting for ⅛" tubing	Ferrule for ⅛" tubing	JL-73150-30		JL-73150-32	
0.003	5	6000 (413)			⅛" Swagelok	⅛" Swagelok	JL-73150-40		JL-73150-42	
0.01	10	6000 (413)	316 SS	PE	¼" fitting for ⅛" tubing	Ferrule for ⅛" tubing	JL-73150-50			
0.02	40	1500 (103)			⅛" Swagelok	⅛" Swagelok	JL-73150-60			
0.01	10	3000 (206)	316 SS	PE	¼" fitting for ⅛" tubing	Ferrule for ⅛" tubing	JL-73150-70			
0.01	20	1500 (103)			⅛" Swagelok	⅛" Swagelok	JL-73150-80			
0.04	80	750 (52)								



Cole-Parmer® Touch-Screen Syringe Pumps

Intuitive programming and control

- Control flow rates from 5 pL/min to 220 mL/min via touch-screen display
- Save space by positioning pump on side—display rotates automatically
- Daisy chain up to 99 pumps with built-in RS-485 connectivity
- Accepts any type of syringe

Model 74905-50 is an infuse only syringe pump. It accommodates up to two syringes. Flow rates are defined by the user and operation is based on a selectable target volume or time values to control the total infusion volume.

Model 74905-52 is an infuse/withdraw syringe pump. The pump accommodates up to two syringes. The unit will operate in the following modes: infuse only, withdraw only, infuse then withdraw, withdraw then infuse, and continuous. One program can be stored.

Model 74905-54 is a programmable version of the 74905-52 pump. It is programmed to accept up to 800 user-defined steps—up to 40 programs with 20 steps each can be stored in memory.

Model 74905-56 is a push/pull syringe pump. The pump accommodates up to two syringes for infusion and two syringes for withdrawal. This pump is designed to support infusion and



withdrawal simultaneously at the user-defined flow rates. The unit operates in the following modes: infuse only, withdraw only, infuse then withdraw, withdraw then infuse, and continuous.

Model 74905-58 is a programmable version of the 74905-56 pump. It is programmed to accept up to 800 user-defined steps—up to 40 programs with 20 steps each can be stored into memory.



Specifications

Accuracy: ±0.355%
Reproducibility: ±0.05%

Syringe sizes accepted: 0.5 µL to 140 mL
Linear force: 75 lb (34 kg)

Output: RS-232, RS-485, USB,
15 pin D-sub connector

Description	Flow rate per syringe	Power (VAC, Hz)	Catalog number	Price
Infusion	5 pL/min to 220.97 mL/min	100 to 240, 50/60	JL-74905-50	
Infusion/withdrawal			JL-74905-52	
Infusion/withdrawal programmable			JL-74905-54	
Push/pull			JL-74905-56	
Push/pull programmable			JL-74905-58	

Cole-Parmer® Entry-Level Touch-Screen Syringe Pumps

Get more done simultaneously

- Accommodate two syringes for infusion and two syringes for withdrawal at the same time
- Control flow rates from 0.58 pL/min to 88.28 mL/min via full-color touch screen
- Daisy chain up to 99 pumps together with the built-in RS-485 connectivity
- Accept syringes from 0.5 µL to 60 mL

These pumps feature a continuous push and pull (infusion/withdrawal) pump. When used with check valves, the pump will draw fluid from a reservoir while opposite side is dispensing fluid. After dispensing the user-settable volume, the pump automatically switches direction and dispenses from the other side while the just-consumed side is being refilled.

Pump can be placed on its side to provide a smaller footprint with the display automatically rotating.



Specifications

Accuracy: ±0.5%
Reproducibility: ±0.05%
Linear force: 75 lb (34 kg)

Output: RS-232, RS-485, USB,
15 pin D-sub connector
Power: 100 to 240 VAC, 50/60 Hz



Number of syringes	Syringe sizes accepted	Flow rate per syringe	Catalog number	Price
Infusion only pumps				
1	0.5 µL to 60 mL	1.28 pL/min to 88.28 mL/min	JL-74905-02	
2	0.5 µL to 10 mL		JL-74905-06	
Infusion/withdrawal programmable pumps				
1	0.5 µL to 60 mL	1.28 pL/min to 88.28 mL/min	JL-74905-04	
2	0.5 µL to 10 mL	1.28 pL/min to 88.28 mL/min	JL-74905-08	
2	0.5 µL to 10 mL	0.58 pL/min to 11.70 mL/min	JL-74905-12	
1	0.5 µL to 1000 µL	3.66 pL/min 363 µL/min	JL-74905-34	

Standard-Duty Dry Vacuum Piston Pumps

Great for filtering, aspirating, degassing, and desiccating

- Oil free for life science applications
- Water trap prevents liquid from being drawn into the pump
- Muffler provides quiet operation

Use the convenient gauge and control knob to adjust vacuum level. Single-head models also provide pressure. Avoid using pump with organic, acidic, or basic vapors.

What's included: gauge, control knob, water trap, carrying handle, suction cup feet, on/off switch, two 1/4" barbed fittings, and a 6-ft (1.8-m) cord (115 VAC models come with a standard US plug; 230 VAC models come with a European (Schuko) plug).

Service kits include all components commonly required for refurbishment.



CE
230 VAC models only
RUNS DRY

Free-air capacity cfm (L/min)	Ultimate [†] vacuum	Maximum pressure	Wetted parts	Motor hp	Noise rating	Port size (tube ID)	Power (VAC, Hz)	Catalog number	Price	Service kits	
										Catalog number	Price
Single-head pumps											
0.76 (22)	26.0" Hg (100 Torr)	100 psig (6.89 bar)	Aluminum (treated for corrosion resistance), SS, and PTFE	1/8	62 dB(A)	1/4"	115, 60	JL-79204-00		JL-79204-01	
0.67 (19)							230, 50	JL-79204-05			
1.20 (34)	27.2" Hg (70 Torr)	50 psig (3.45 bar)		1/8		1/4"	115, 60	JL-79204-10	JL-79204-11		
0.99 (28)							230, 50	JL-79204-15	JL-79204-21		
1.60 (45)	27.6" Hg (60 Torr)	100 psig (6.89 bar)		1/4		1/4"	115, 60	JL-79204-20	JL-79204-21		
1.34 (38)							230, 50	JL-79204-25			
Dual-head pumps											
2.1 (60)	29.8" Hg (5 Torr)	—	Aluminum (treated for corrosion resistance), SS, and PTFE	1/3	58 dB(A)	3/8"	115, 60	JL-79204-30		JL-79204-31	
1.8 (50)							230, 50	JL-79204-35		JL-79204-51	
7.1 (201)	27.6" Hg (60 Torr)	—		1/3		3/8"	115, 60	JL-79204-70	JL-79204-51		
5.9 (168)							230, 50	JL-79204-75			

[†]Ultimate total vacuum

[JL-06414-20](#) Tygon® non-DEHP vacuum tubing, 1/4" ID x 5/8" OD. Pack of 10 ft (3.0 m)

High-Capacity Vacuum/Pressure Pumps

Won't get overloaded

- Shaded-pole fan-cooled motor has thermal overload switch to protect your pump system
- Heads on pumps 07061-60 and -05 are connected in parallel for higher capacity; heads on 07061-11 and -13 are connected in series for greater vacuum
- Select pumps with or without gauges, regulators, and valves
- Free-air capacities up to 2.2 cfm (62.3 L/min)

What's included: 6-ft (1.8-m), three-wire cord (US standard plug on 115 VAC models). Models 07061-11 and -13 include a filter/muffler.



07061-40

ISO9001:2008
CERTIFIED SUPPLIER

UL
RUNS DRY

Pump head configuration	Free-air capacity cfm (L/min)	Max vacuum	Max pressure	Wetted parts	Motor hp	Port size	Noise rating	Power (VAC, Hz)	Catalog number	Price
Pump without gauges or regulators (order regulators separately below; order gauges with 1/4" NPT(M) connections online)										
Single	1.1 (31.2)	25.5" Hg	60 psi (4.14 bar)	Aluminum, stainless steel, Nordel®, and Nomex®	1/8	1/4" NPT(F), 3/8" hose barb on gauges	68 dB(A)	115, 60	JL-07061-21	
	1.0 (28.3)	24.0" Hg						220/240, 50	JL-07061-22	
Pumps with gauges, regulators, and adjustable relief valve										
Single	1.1 (31.2)	25.5" Hg	60 psi (4.14 bar)	Aluminum, stainless steel, Nordel, and Nomex	1/8	1/4" NPT(F), 3/8" hose barb on gauges	68 dB(A)	115, 60	JL-07061-40	
	1.0 (28.3)	24.0" Hg						220/240, 50	JL-07061-42	
Dual/parallel	2.2 (62.3)	25.5" Hg	60 psi (4.14 bar)		1/4			115, 60	JL-07061-60	
	1.8 (51.0)	24.0" Hg						220, 50	JL-07061-05	
Pump with vacuum gauge only										
Dual/series	1.15 (32.5)	29.0" Hg	—	Aluminum, stainless steel, Nordel, and Nomex	1/4	1/4" NPT(F), 3/8" hose barb on gauges	68 dB(A)	115, 60	JL-07061-11	
	0.85 (24.0)	28.0" Hg						220, 50	JL-07061-13	

[JL-07061-32](#) Pressure regulator assembly for pumps 07061-21 and -22

[JL-07061-30](#) Vacuum regulator assembly for pumps 07061-21 and -22

[JL-07061-01](#) Service kit for all pumps

[JL-07061-03](#) Service kit for dual-head pumps. Pumps 07061-60, -05, -11, and -13 also require kit 07061-01 above

[JL-07061-06](#) Diaphragm for all models, neoprene/nylon

[JL-07061-04](#) Replacement diaphragm for all models, Nordel/Nomex

Cole-Parmer® Air Cadet® Vacuum/Pressure Pumps

Get better results with minimal dead space

- Minimizes dead space and air entrapment with unique cavity configuration
- No maintenance needed—AC motors are brushless with sealed ball bearings
- Worry-free pumping with reduced stress, wear, and heat buildup

Air Cadet®



UL US CE S 115 VAC model only

Convenient on/off power switch

CE

A–B. Single- and Dual-Head Pumps

- Handle tough applications easily
- Increase your capacity with dual-head models independently pumping or connected in series
- Easy shut-off with power switch on all models except 07532-65

What's included: PTFE thread tape and polyethylene 3/8" NPT(M) x 3/8" hose barb adapters.

C. Vacuum/Pressure Stations

- Increase productivity—evacuate or pressurize two systems simultaneously with auxiliary port
- Get control with built-in bronze and brass gauge and stainless steel regulator

What's included: PTFE thread tape, two polyethylene 3/8" NPT(M) x 3/8" hose barb adapters, and one polyethylene 1/4" NPT(M) x 3/8" hose barb adapter (for auxiliary port).

D. OEM Vacuum/Pressure Pumps

- Get long, reliable operation—continuous operation up to 18 psi for 4000 service hours
- Provides pumping with minimal stress and heat buildup

ISO9001:2008 CERTIFIED SUPPLIER



Free-air capacity cfm (LPM)	Max vacuum " Hg (Torr)	Max pressure psi (bar)	Wetted parts	Noise rating	Port size	Power	Catalog number	Price
A. Single-head pumps								
0.54 (15.5) 0.45 (13)	20 (508)	18 (1.24)	Noryl® pump head, FKM diaphragm, PTFE valves, and polyethylene (PE) adapters	72 dB(A)	3/8" hose barb	115 VAC, 60 Hz 230 VAC, 50 Hz	JL-07532-40 JL-07532-45	
B. Dual-head pumps								
1.1 (31)† 0.91 (26)†	20 (508)	18 (1.24)	Noryl pump head, FKM diaphragm, PTFE valves, and PE adapters	76 dB(A)	3/8" hose barb	115 VAC, 60 Hz 230 VAC, 50 Hz	JL-07532-60 JL-07532-65‡	
C. Vacuum/pressure stations								
0.5 (14.1) 0.4 (11.3)	20 (508)	18 (1.24)	FKM diaphragm, SS regulator, bronze/brass gauge, and PE adapters	73 dB(A)	3/8" hose barb	115 VAC, 60 Hz 230 VAC, 50 Hz	JL-07532-80 JL-07532-85	
D. OEM vacuum/pressure pumps								
0.6 (17)	20 (508)	18 (1.24)	Noryl pump head, FKM diaphragm, PTFE valves	72 dB(A)	3/8" NPT(F)	115 VAC	JL-07530-85	
	18 (457.2)	15 (1.03)	Noryl pump head, FKM diaphragm, PTFE valves, and PE adapters			12 VDC	JL-07532-25	

† Total free-air capacity. Single-channel capacity is half this value. ‡ Power switch not available on 230 VAC models. **Note:** Do not use metal fittings with any Air Cadet pump.

Accessories

[JL-07395-20](#) Vacuum/pressure gauge connector kit, brass. Contains two PE adapters and one each of bushing, pipe tee, and adapter for pipe mount

Service Kits contain a nitrile diaphragm, Noryl pump head with two valves of PTFE resin, and two Noryl retainers. Nitrile diaphragm ensures long diaphragm life.

[JL-07530-06](#) Service kit with nitrile diaphragm

Replacement Parts

[JL-07530-77](#) Pump head assembly, Valox®. Includes valves and retainers. For continuous pressures greater than 14 psi

[JL-07530-71](#) Diaphragm clamp assembly; includes diaphragm clamp and shaft, and eccentric assembly

[JL-07530-79](#) Diaphragm shaft

[JL-07530-75](#) Eccentric assembly

[JL-08270-33](#) Thread sealer tape of PTFE resin. Each roll measures 260"L x 1/2"W. Pack of 10 rolls

Your Complete Source for **Fluid Handling** Products



Get Pumping:

>2300 Pumps



See it Through:

>170 Tubing
Formulations plus
Custom Cut Sizes

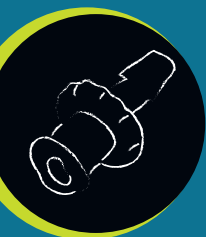

The Right Fit:

4500+ Fitting Options

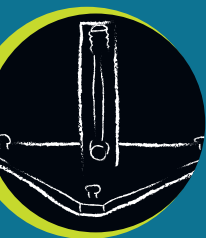

In the Flow:

More than 3200
Flowmeter Options



Pressure Relief:

Select from 3000+
Pressure Gauges

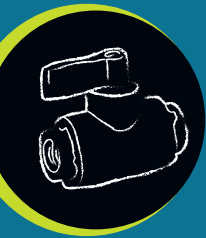

Control your Flow:

More than 1000 Valves

Masterflex® L/S® Pump page 16

Flowmeter page 67

MORE ONLINE ► ColeParmer.com

Use only MASTERFLEX® precision tubing with MASTERFLEX pumps to ensure optimum performance. Use of other tubing may void applicable warranties.

Product Selection | Troubleshooting | And More...

Not sure what to choose?

Our expert Application Specialists can help you find the right product for your application.

800-323-4340

— or Ch@t Live —





Cole-Parmer® Silicone Tubing

No need to worry about the heat—
use for applications up to 460°F

Peroxide Silicone



Applications: Pharmaceutical, biotechnology, food and beverage, aerospace, and general lab applications.

Characteristics: Peroxide-cured, excellent heat resistance, low compression set, odorless, nontoxic, translucent.

Certifications: Elastomer is FDA-compliant (21 CFR 177.2600) and meets USP Class VI requirements. Tubing is manufactured according to GMP.

Temperature range: -60 to 460°F (-51 to 238°C)

Sterilize: Autoclave or gamma irradiation.

Platinum Silicone



Applications: Pharmaceutical, biotechnology, aerospace, food and beverage, and general lab applications.

Characteristics: Platinum-cured, excellent heat resistance, low compression set, odorless, nontoxic, translucent.

Certifications: Elastomer is FDA-compliant (21 CFR 177.2600) and meets USP Class VI. Tubing is manufactured according to GMP.

Temperature range: -58 to 446°F (-50 to 230°C)

Sterilize: Autoclave or gamma irradiation.

Buy More...Save More!

20% off on 20+
15% off on 10 to 19
10% off on 4 to 9 packs



Dimensions: in. (mm)			Max psi at 70°F (21°C)	Peroxide silicone		Platinum silicone	
ID	OD	Wall		Catalog number	Price/25-ft pk	Catalog number	Price/25-ft pk
1/50 (0.5)	1/12 (2.1)	1/32 (0.8)	30	JL-06411-59		JL-95802-00	
1/32 (0.8)	3/32 (2.4)	1/32 (0.8)	30	JL-06411-60		JL-95802-01	
1/16 (1.6)	1/8 (3.2)	1/32 (0.8)	15	JL-06411-62		JL-95802-02	
3/32 (2.4)	5/32 (4.0)	1/32 (0.8)	15	JL-06411-63		JL-95802-03	
1/8 (3.2)	3/16 (4.8)	1/32 (0.8)	10	JL-06411-64		JL-95802-04	
1/8 (3.2)	1/4 (6.4)	1/16 (1.6)	20	JL-06411-67		JL-95802-05	
1/8 (3.2)	3/8 (9.6)	1/8 (3.2)	25	JL-06411-68		JL-95802-06	
5/32 (4.0)	5/32 (4.0)	1/32 (0.8)	10	JL-06411-65		JL-95802-07	
3/16 (4.8)	1/4 (6.4)	1/32 (0.8)	9	JL-06411-66		JL-95802-08	
3/16 (4.8)	5/16 (8.0)	1/16 (1.6)	13	JL-06411-03		JL-95802-09	
3/16 (4.8)	7/16 (11.2)	1/8 (3.2)	22	JL-06411-69		JL-95802-10	
1/4 (6.4)	5/16 (8.0)	1/32 (0.8)	9	JL-06411-70		JL-95802-11	
1/4 (6.4)	3/8 (9.6)	1/16 (1.6)	10	JL-06411-71		JL-95802-12	
1/4 (6.4)	7/16 (11.2)	3/32 (2.4)	17	JL-06411-72		JL-95802-13	
1/4 (6.4)	1/2 (12.8)	1/8 (3.2)	17	JL-06411-74		JL-95802-14	
5/16 (8.0)	7/16 (11.2)	1/16 (1.6)	10	JL-06411-75		JL-95802-15	
5/16 (8.0)	1/2 (12.8)	3/32 (2.4)	16	JL-06411-76		JL-95802-16	
5/16 (8.0)	9/16 (14.4)	1/8 (3.2)	20	JL-06411-77		JL-95802-17	
3/8 (9.6)	1/2 (12.8)	1/16 (1.6)	10	JL-06411-12		JL-95802-18	
3/8 (9.6)	9/16 (14.4)	3/32 (2.4)	12	JL-06411-78		JL-95802-19	
3/8 (9.6)	5/8 (16.0)	1/8 (3.2)	15	JL-06411-79		JL-95802-20	
1/2 (12.8)	5/8 (16.0)	1/16 (1.6)	9	JL-06411-80		JL-95802-21	
1/2 (12.8)	11/16 (17.6)	3/32 (2.4)	10	JL-06411-19		JL-95802-22	
1/2 (12.8)	3/4 (19.2)	1/8 (3.2)	12	JL-06411-55		JL-95802-23	
5/8 (16.0)	13/16 (20.8)	3/32 (2.4)	10	JL-06411-82		JL-95802-24	
5/8 (16.0)	7/8 (22.4)	1/8 (3.2)	12	JL-06411-58		JL-95802-25	
3/4 (19.2)	1 (25.4)	1/8 (3.2)	9	JL-06411-83		JL-95802-26	

Benchtop Tubing Cutter

Steel blade makes right-angle cuts in plastic tubing 1/16" to 3/8" OD.

JL-06438-10 Benchtop cutter

JL-06438-11 Replacement blade



Tygon® BioPharm Silicone Tubing

Reduce particle entrapment with
ultra-smooth inner surface



Formulation: Tygon® 3350 silicone, platinum cured.

Applications: Pharmaceutical, cosmetic, industrial, and auto-analysis applications.

Characteristics: Ultra-smooth inner surface reduces particle entrapment and minimizes bacterial growth. Good for mild to medium concentration bases, salts, and alcohols; is odorless, tasteless, and nontoxic. Transparent.

Certifications: Elastomer is FDA-compliant (21 CFR 177.2600) and meets USP Class VI requirements, NSF criteria and EP 3.2.9 requirements. Tubing is manufactured according to GMP.

Temperature range: -112 to 392°F (-80 to 200°C)

Sterilize: Ethylene oxide, gamma irradiation, or autoclave for 30 min, 15 psi (1.0 bar).

Buy More...Save More!

20% off on 20+
15% off on 10 to 19
10% off on 4 to 9 packs

Dimensions: in. (mm)			Max psi at 73°F (bar at 23°C)	Catalog number	Price/50-ft pk
ID	OD	Wall			
1/32 (0.8)	3/32 (2.4)	1/32 (0.8)	16 (1.1)	JL-95702-00	
1/16 (1.6)	1/8 (3.2)	1/32 (0.8)	10 (0.7)	JL-95702-01	
1/16 (1.6)	3/16 (4.8)	1/16 (1.6)	15 (1.0)	JL-95702-02	
3/32 (2.4)	5/32 (4.0)	1/32 (0.8)	7 (0.5)	JL-95702-03	
3/32 (2.4)	7/32 (5.6)	1/16 (1.6)	12 (0.8)	JL-95702-04	
1/8 (3.2)	3/16 (4.8)	1/32 (0.8)	7 (0.5)	JL-95702-05	
1/8 (3.2)	1/4 (6.4)	1/16 (1.6)	9 (0.6)	JL-95702-06	
3/16 (4.8)	1/4 (6.4)	1/32 (0.8)	5 (0.3)	JL-95702-08	
3/16 (4.8)	5/16 (8.0)	1/16 (1.6)	7 (0.5)	JL-95702-09	
3/16 (4.8)	3/8 (9.6)	3/32 (2.4)	9 (0.6)	JL-95702-10	
1/4 (6.4)	3/8 (9.6)	1/16 (1.6)	5 (0.3)	JL-95702-13	
1/4 (6.4)	7/16 (11.2)	3/32 (2.4)	7 (0.5)	JL-95702-14	
5/16 (8.0)	7/16 (11.2)	1/16 (1.6)	5 (0.3)	JL-95702-16	
5/16 (8.0)	1/2 (12.8)	3/32 (2.4)	6 (0.4)	JL-95702-17	
3/8 (9.6)	1/2 (12.8)	1/16 (1.6)	4 (0.3)	JL-95702-18	
3/8 (9.6)	9/16 (14.4)	3/32 (2.4)	5 (0.3)	JL-95702-19	
3/8 (9.6)	5/8 (16.0)	1/8 (3.2)	7 (0.5)	JL-95702-20	

Free Certificate of Compliance

Cole-Parmer will provide a certificate of resin or elastomer compliance FREE at your request with each order of fittings or tubing. Certificates list your company's PO number, order reference number, catalog number, formulation, compound number, lot number (where applicable), and the regulations and agencies the tubing or fitting complies with, including FDA, USP, USDA, National Formulary, NSF International, GMP, and 3A. Look for the blue "check" icon throughout this catalog to identify when a certificate of compliance is available.



DON'T RISK IT!

Our chemical compatibility database provides important information on chemical resistance—check it out at ColeParmer.com/ChemChart



Cole-Parmer® Platinum-Cured Reinforced Silicone Tubing

Won't crack under pressure—
withstands pressures to 312 psi



Formulation: Tygon® 3370 I. B., silicone, platinum cured.

Applications: Demanding sanitary high-pressure pharmaceutical, biotechnology, food and beverage, and cosmetic applications.

Characteristics: Excellent heat resistance, low compression set, odorless, and nontoxic, translucent.

Certifications: Elastomer is FDA-compliant (21 CFR 177.2600) and USP Class V extractables; exceeds Class VI implant; exceeds 3A Sanitary Standards; produced to Bulk Pharmaceutical cGMPs (FDA 21 CFR 210, 211). Tubing is manufactured according to GMP.

Temperature range: -60 to 320°F (-51 to 160°C)

Sterilize: Autoclave, ethylene oxide, or gamma irradiation.

Buy More...Save More!

20% off on 20+
15% off on 10 to 19
10% off on 4 to 9 packs



Dimensions: in. (mm)			Max psi at 70°F (bar at 21°C)	Catalog number	Price/pk
ID	OD	Wall			
3/16 (4.8)	7/16 (11.2)	1/8 (3.2)	312 (21.5)	JL-95703-00	
1/4 (6.4)	1/2 (12.8)	1/8 (3.2)	248 (17.1)	JL-95703-01	
3/8 (9.6)	5/8 (16.0)	1/8 (3.2)	180 (12.4)	JL-95703-02	
1/2 (12.8)	13/16 (20.8)	5/32 (4.0)	168 (11.6)	JL-95703-03	
5/8 (16.0)	15/16 (24.0)	5/32 (4.0)	144 (9.9)	JL-95703-04	
3/4 (19.1)	1 1/8 (28.6)	3/16 (4.8)	144 (9.9)	JL-95703-05	
1 1/4 (31.8)	1 5/8 (41.4)	3/16 (4.8)	96 (6.6)	JL-95703-07	

Dow Corning® Pharma-50 Tubing

No organic additives and low extractables

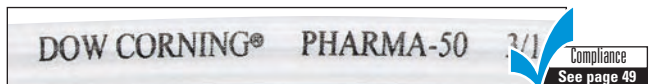

Applications: Pharmaceutical, biotechnology, and ultrapure fluid processing.

Characteristics: 50 durometer, translucent platinum-cured silicone tubing with a very low extractable profile. Pharma tubing remains flexible and resilient for long service life. Dow Corning maintains complete traceability from silica to silicone tubing.

Certifications: Elastomer exceeds test guidelines for USP Class VI Plastics and the tubing itself meets or exceeds FDA (21 CFR 177.2600), 3A Sanitary Standards and European Pharmacopoeia (EP) requirements. Produced under Bulk Pharmaceutical (BP) and current GMP principles.

Temperature range: -60 to 460°F (-51 to 232°C)

Sterilize: Autoclave, ethylene oxide, or gamma irradiation.

Buy More...Save More!

20% off on 20+
15% off on 10 to 19
10% off on 4 to 9 packs

Dimensions: in. (mm)			Max psi at 70°F (bar at 21°C)	Catalog number	Price/ 50-ft pk
ID	OD	Wall			
1/8 (3.2)	1/4 (6.4)	1/16 (1.6)	21 (1.4)	JL-96105-00	
3/16 (4.8)	3/8 (9.6)	3/32 (2.4)	16 (1.1)	JL-96105-02	
1/4 (6.4)	3/8 (9.6)	1/16 (1.6)	12 (0.8)	JL-96105-03	
1/4 (6.4)	7/16 (11.1)	3/32 (2.4)	17 (1.2)	JL-96105-04	
1/4 (6.4)	1/2 (12.8)	1/8 (3.2)	17 (1.2)	JL-96105-05	
5/16 (8.0)	1/2 (14.0)	1/8 (3.0)	16 (1.1)	JL-96105-06	
3/8 (9.6)	9/16 (14.3)	3/32 (2.4)	13 (0.9)	JL-96105-08	
3/8 (9.6)	5/8 (16.0)	1/8 (3.2)	14 (1.0)	JL-96105-09	
1/2 (12.8)	3/4 (19.1)	1/8 (3.2)	10 (0.7)	JL-96105-11	
5/8 (16.0)	7/8 (22.2)	1/8 (3.2)	9 (0.6)	JL-96105-12	

Silastic® Laboratory Tubing

Resists bacteria and fungus growth



Applications: Pharmaceutical, biotech, filtration, and environmental analysis.

Characteristics: Platinum-cured silicone, nonpyrogenic, bacteria and fungus-resistant, extremely low extractables, and does not impart a taste or odor.

Certifications: Exceeds USP Class VI Plastics Test requirements, elastomer and tubing are manufactured under Bulk Pharmaceutical cGMPs in an FDA-registered, ISO-9002-certified facility.

Temperature range: -65 to 480°F (-54 to 249°C)

Sterilize: Autoclave or radiation.

Buy More...Save More!

20% off on 20+
15% off on 10 to 19
10% off on 4 to 9 packs

Dimensions: in. (mm)			Catalog number	Price/ 50-ft pk
ID	OD	Wall		
0.012 (0.3)	0.025 (0.6)	0.0065 (0.2)	JL-96115-00	
0.02 (0.5)	0.037 (0.9)	0.0085 (0.22)	JL-96115-02	
0.025 (0.6)	0.047 (1.2)	0.011 (0.3)	JL-96115-04	
0.03 (0.8)	0.065 (1.7)	0.0175 (0.4)	JL-96115-06	
0.04 (1)	0.085 (2.2)	0.0225 (0.6)	JL-96115-08	
0.058 (1.5)	0.077 (2.0)	0.0095 (0.2)	JL-96115-10	
0.062 (1.6)	0.095 (2.4)	0.0165 (0.4)	JL-96115-12	
0.062 (1.6)	0.125 (3.2)	0.0315 (0.8)	JL-96115-14	
0.078 (2)	0.125 (3.2)	0.0235 (0.6)	JL-96115-16	
0.104 (2.6)	0.192 (4.9)	0.044 (1.1)	JL-96115-18	
0.132 (3.4)	0.183 (4.6)	0.0255 (0.6)	JL-96115-20	
1/8 (3.2)	1/4 (6.4)	1/16 (1.6)	JL-96115-22	
3/16 (4.8)	5/16 (8.0)	1/16 (1.6)	JL-96115-24	
3/16 (4.8)	3/8 (9.5)	3/32 (2.4)	JL-96115-26	
1/4 (6.4)	3/8 (9.5)	1/16 (1.6)	JL-96115-28	
1/4 (6.4)	9/16 (11.1)	3/32 (2.4)	JL-96115-30	
1/4 (6.4)	1/2 (12.8)	1/8 (3.2)	JL-96115-32	
5/16 (8.0)	1/2 (12.8)	3/32 (2.4)	JL-96115-34	
3/8 (9.5)	1/2 (12.8)	1/16 (1.6)	JL-96115-36	
3/8 (9.5)	9/16 (14.3)	3/32 (2.4)	JL-96115-38	
3/8 (9.5)	5/8 (15.9)	1/8 (3.2)	JL-96115-40	
1/2 (12.8)	1 1/16 (17.5)	3/32 (2.4)	JL-96115-42	
1/2 (12.8)	3/4 (19.1)	1/8 (3.2)	JL-96115-44	
5/8 (15.9)	7/8 (22.2)	1/8 (3.2)	JL-96115-46	

Platinum-Cured Silicone Tubing Spools

Cut tubing to your needs

Reduce unpacking time, save money on shipping, and ensure that you always have enough tubing on hand with bulk tubing.



Dimensions in. (mm)		Length per spool	Catalog number	Price
ID	OD			
1/32 (0.8)	3/32 (2.4)	500 ft (152 m)	JL-98906-00	
1/16 (1.6)	1/8 (3.2)		JL-98906-02	
1/8 (3.2)	1/4 (6.4)	300 ft (91 m)	JL-98906-04	
3/16 (4.8)	5/16 (8.0)		JL-98906-06	
1/4 (6.4)	3/8 (9.6)		JL-98906-08	
3/8 (9.6)	5/8 (16.0)		JL-98906-10	
5/8 (16.0)	7/8 (22.4)		JL-98906-12	

Ratchet Tubing Clamps

Durable Celcon® plastic tubing clamps are autoclavable; won't rust, corrode, or distort. Twelve-position ratchet control adjusts from full flow to complete closure. Mini-clamp is suitable for up to 1/8" (2.1 mm) OD tubing. Standard clamp accepts flexible tubing to 1/2" (12.7 mm) OD.



06833-00

JL-06833-01 Mini tubing clamp. Pack of 25

JL-06833-00 Tubing clamp. Pack of 25



Dow Corning® Pharma-65 Tubing

Resilient for extended service life



Applications: High-pressure, pharmaceutical, biotechnology, and ultra-pure fluid processing.

Characteristics: 65 durometer, platinum-cured silicone tubing with a very low extractable profile; it contains no phthalates, plasticizers, latex, or other organic additives. Remains flexible and resilient for long service life. Dow Corning maintains complete traceability from silica to silicone tubing.

Certifications: Elastomer is FDA-compliant (21 CFR 177.2600) and meets USP Class VI requirements. Meets 3A Sanitary Standards and European Pharmacopoeia (EP) requirements. Tubing is manufactured according to Bulk Pharmaceutical (BP) and current GMP.

Temperature range: -60 to 460°F (-51 to 232°C)

Sterilize: Autoclave, ethylene oxide, or gamma irradiation.

Buy More...Save More!
20% off on 20+ 15% off on 10 to 19 10% off on 4 to 9 packs

Dimensions: in. (mm)			Max psi at 70°F (bar at 21°C)	Catalog number	Price/50-ft pk
ID	OD	Wall			
1/8 (3.2)	1/4 (6.4)	1/16 (1.6)	19 (1.3)	JL-96107-00	
3/16 (4.8)	5/16 (8.0)	1/16 (1.6)	13 (0.9)	JL-96107-01	
3/16 (4.8)	3/8 (9.6)	3/32 (2.4)	15 (1.0)	JL-96107-02	
1/4 (6.4)	7/16 (11.2)	3/32 (2.4)	20 (1.4)	JL-96107-04	
1/4 (6.4)	1/2 (12.8)	1/8 (3.2)	19 (1.3)	JL-96107-05	
5/16 (8.0)	1/2 (12.8)	3/32 (2.4)	12 (0.8)	JL-96107-06	
3/8 (9.6)	1/2 (12.8)	1/16 (1.6)	11 (0.8)	JL-96107-07	
3/8 (9.6)	9/16 (14.4)	3/32 (2.4)	13 (0.9)	JL-96107-08	
3/8 (9.6)	5/8 (16.0)	1/8 (3.2)	13 (0.9)	JL-96107-09	
1/2 (12.8)	11/16 (17.6)	3/32 (2.4)	12 (0.8)	JL-96107-10	
1/2 (12.8)	3/4 (19.1)	1/8 (3.2)	11 (0.8)	JL-96107-11	
5/8 (16.0)	7/8 (22.4)	1/8 (3.2)	8 (0.6)	JL-96107-12	
3/4 (19.1)	1 (25.4)	1/8 (3.2)	7 (0.5)	JL-96107-13	

Find even more online! Go to ColeParmer.com to search more than 100,000 products.

PharMed® BPT Tubing

Protect your light-sensitive samples



Applications: Cell and tissue culture work and pharmaceutical uses. Also good for light-sensitive samples.

Characteristics: Nontoxic; nonhemolytic; extremely low permeability; resists acids, alkalies, oxidizing agents, and animal and vegetable oils; heat-sealable, bondable, and formable. Opaque beige.

Certifications: Elastomer is FDA-compliant (21 CFR 177.2600) and meets USP Class VI and NSF (Standard 51) requirements. Meets EP requirements. Tubing is manufactured according to GMP.

Temperature range: -60 to 275°F (-51 to 135°C)

Sterilize: Autoclave, ethylene oxide, or gamma irradiation.

Buy More...Save More!
20% off on 20+ 15% off on 10 to 19 10% off on 4 to 9 packs

Dimensions: in. (mm)			Max psi at 70°F (bar at 21°C)	Catalog number	Price/25-ft pk
ID	OD	Wall			
1/50 (0.5)	9/64 (3.7)	1/16 (1.6)	50 (3.4)	JL-96880-00	
1/32 (0.8)	5/32 (4.0)	1/16 (1.6)	40 (2.8)	JL-96880-02	
1/16 (1.6)	3/16 (4.8)	1/16 (1.6)	34 (2.3)	JL-96880-04	
1/8 (3.2)	1/4 (6.4)	1/16 (1.6)	19 (1.3)	JL-96880-06	
3/16 (4.8)	5/16 (8.0)	1/16 (1.6)	13 (0.9)	JL-96880-08	
1/4 (6.4)	3/8 (9.6)	1/16 (1.6)	10 (0.7)	JL-96880-10	
1/4 (6.4)	1/2 (12.8)	1/8 (3.2)	19 (1.3)	JL-96880-12	
5/16 (8.0)	7/16 (11.2)	1/16 (1.6)	8 (0.6)	JL-96880-14	
3/8 (9.6)	5/8 (16.0)	1/8 (3.2)	13 (0.9)	JL-96880-16	
1/2 (12.8)	3/4 (19.1)	1/8 (3.2)	11 (0.8)	JL-96880-18	
5/8 (16.0)	7/8 (22.4)	1/8 (3.2)	8 (0.6)	JL-96880-20	
3/4 (19.1)	1 (25.4)	1/8 (3.2)	7 (0.5)	JL-96880-22	

Microbore PharMed BPT Tubing

Dimensions: in. (mm)			Fits needle gauge	Catalog number	Price/100-ft pk
ID	OD	Wall			
0.010 (0.25)	0.082 (2.08)	0.036 (0.91)	30	JL-95809-12	
0.020 (0.51)	0.096 (2.44)	0.038 (0.97)	24	JL-95809-18	
0.035 (0.89)	0.111 (2.82)	0.038 (0.97)	20	JL-95809-26	
0.045 (1.14)	0.121 (3.07)	0.038 (0.97)	18	JL-95809-30	
0.051 (1.30)	0.127 (3.23)	0.038 (0.97)	18	JL-95809-32	
0.056 (1.42)	0.132 (3.35)	0.038 (0.97)	17	JL-95809-34	
0.060 (1.52)	0.136 (3.45)	0.038 (0.97)	16	JL-95809-36	
0.073 (1.85)	0.149 (3.78)	0.038 (0.97)	15	JL-95809-40	

C-Flex® Tubing

Meets the demands of various industries

– Available in three formulations—standard, clear, and animal-derived component-free (ADCF)

Applications: General-purpose lab uses requiring high performance and long life.

Characteristics: Exceptional tensile and tear strength, good biocompatibility, excellent chemical resistance, low gas permeability, and a smooth surface. Standard C-Flex is opaque white; C-Flex Clear and C-Flex ADCF are clear.

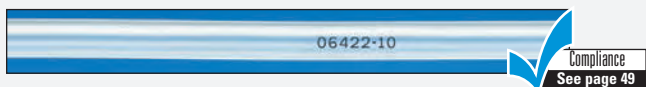

Certifications: Meets USP Class VI. Tubing is manufactured according to GMP.

Temperature range: -50 to 275°F (-45 to 135°C)

Sterilize: Autoclave, ethylene oxide, or gamma irradiation.

Buy More...Save More!
20% off on 20+ 15% off on 10 to 19 10% off on 4 to 9 packs

Dimensions in. (mm)			C-Flex			C-Flex Clear			C-Flex ADCF		
ID	OD	Wall	Catalog number	Max psi at 70°F (21°C)	Price/25-ft pk	Catalog number	Max psi at 70°F (21°C)	Price/25-ft pk	Catalog number	Max psi at 70°F (21°C)	Price/50-ft pk
1/50 (0.5)	1/12 (2.1)	1/32 (0.8)	JL-06424-59	30		JL-06422-00	50		—	—	—
1/32 (0.8)	3/32 (2.4)	1/32 (0.8)	JL-06424-60	31		JL-06422-01	51		—	—	—
1/16 (1.6)	1/8 (3.2)	1/32 (0.8)	JL-06424-62	15		JL-06422-02	25		—	—	—
3/32 (2.4)	5/32 (4.0)	1/32 (0.8)	JL-06424-63	14		JL-06422-03	23		—	—	—
1/8 (3.2)	3/16 (4.8)	1/32 (0.8)	JL-06424-64	10		JL-06422-04	17		—	—	—
1/8 (3.2)	1/4 (6.4)	1/16 (1.6)	JL-06424-67	21		JL-06422-05	35		JL-06432-50	35	—
5/32 (4.0)	7/32 (5.6)	1/32 (0.8)	JL-06424-65	10		JL-06422-06	17		—	—	—
3/16 (4.8)	1/4 (6.4)	1/32 (0.8)	JL-06424-66	9		JL-06422-07	15		—	—	—
3/16 (4.8)	5/16 (8.0)	1/16 (1.6)	JL-06424-03	13		JL-06422-08	22		JL-06432-51	22	—
3/16 (4.8)	7/16 (11.2)	1/8 (3.2)	JL-06424-69	22		JL-06422-09	36		—	—	—
1/4 (6.4)	3/8 (9.6)	1/16 (1.6)	JL-06424-71	12		JL-06422-10	20		JL-06432-53	20	—
1/4 (6.4)	7/16 (11.2)	3/32 (2.4)	JL-06424-72	17		JL-06422-11	28		JL-06432-54	28	—
1/4 (6.4)	1/2 (12.8)	1/8 (3.2)	JL-06424-74	17		JL-06422-12	28		JL-06432-55	28	—
5/16 (8.0)	7/16 (11.2)	1/16 (1.6)	JL-06424-75	10		JL-06422-13	17		—	—	—
5/16 (8.0)	1/2 (12.7)	3/32 (2.4)	JL-06424-76	16		JL-06422-14	27		JL-06432-56	27	—
3/8 (9.6)	1/2 (12.7)	1/16 (1.6)	JL-06424-12	10		JL-06422-15	17		JL-06432-57	17	—
3/8 (9.6)	5/8 (16.0)	1/8 (3.2)	JL-06424-79	14		JL-06422-16	23		JL-06432-59	23	—
1/2 (12.7)	11/16 (17.6)	3/32 (2.4)	JL-06424-19	10		JL-06422-17	17		JL-06432-60	17	—
1/2 (12.7)	3/4 (19.1)	1/8 (3.2)	JL-06424-81	10		JL-06422-18	17		JL-06432-61	17	—

Cole-Parmer® Flexible PVC Reinforced Tubing

More durable than standard PVC



Applications: For high-pressure applications, food processing, and beverage handling.

Characteristics: Good acid/alkali resistance and aging characteristics. White polyester yarn with orange tracer yarn embedded in a transparent PVC wall.

Certifications: Resin is FDA-compliant (21 CFR 170.199) and meets USDA requirements. NSF-listed (standard 51) with 3A Sanitary Standards for dairy.

Temperature range: -5 to 180°F (-21 to 82°C)

Sterilize: Ethylene oxide.



Buy More...Save More!
 20% off on 20+
 15% off on 10 to 19
 10% off on 4 to 9 packs

Dimensions: in. (mm)			Max psi at 70°F	Catalog number	Price/50-ft pk
ID	OD	Wall			
3/16 (4.8)	3/8 (9.6)	3/32 (2.4)	250	JL-06602-00	
1/4 (6.4)	7/16 (11.2)	3/32 (2.4)	250	JL-06602-01	
3/8 (9.6)	9/16 (14.3)	3/32 (2.4)	225	JL-06602-02	
1/2 (12.8)	3/4 (19.1)	1/8 (3.2)	200	JL-06602-03	
5/8 (16.0)	29/32 (23.2)	9/64 (3.6)	200	JL-06602-04	
3/4 (19.1)	1 1/32 (26.2)	1/8 (3.2)	150	JL-06602-05	
1 (25.4)	1 5/16 (33.4)	5/32 (3.8)	125	JL-06602-06	
1 1/2 (38.1)	1 15/16 (49.2)	3/16 (4.8)	100	JL-06602-08	
2 (50.8)	2 1/2 (63.6)	1/4 (6.4)	75	JL-06602-09	

Cole-Parmer® Vinyl Tubing

Ideal for general-purpose applications



Applications: General-purpose lab use.

Characteristics: Fair chemical and abrasion resistance, odorless, nontoxic and transparent.

Certifications: Tubing is manufactured according to GMP.

Temperature range: -45 to 180°F (-43 to 82°C)

Sterilize: Ethylene oxide.



Buy More...Save More!
 20% off on 20+
 15% off on 10 to 19
 10% off on 4 to 9 packs

Dimensions: in. (mm)			Max psi at 70°F (bar at 21°C)	Catalog number	Price/pk
ID	OD	Wall			
1/16 (1.6)	1/8 (3.2)	1/32 (0.8)	40 (2.8)	JL-06405-01	/50-ft
1/8 (3.2)	1/4 (6.4)	1/16 (1.6)	59 (4.0)	JL-06405-02	/50-ft
3/16 (4.8)	5/16 (8.0)	1/16 (1.6)	51 (3.5)	JL-06405-03	/50-ft
3/16 (4.8)	7/16 (11.2)	1/8 (3.2)	46 (3.2)	JL-06405-04	/100-ft
1/4 (6.4)	3/8 (9.6)	1/16 (1.6)	51 (3.5)	JL-06405-06	/50-ft
1/4 (6.4)	7/16 (11.2)	3/32 (2.4)	55 (3.8)	JL-06405-07	/100-ft
1/4 (6.4)	1/2 (12.8)	1/8 (3.2)	64 (4.4)	JL-06405-08	/50-ft
5/16 (8.0)	7/16 (11.2)	1/16 (1.6)	46 (3.2)	JL-06405-09	/50-ft
5/16 (8.0)	1/2 (12.8)	3/32 (2.4)	55 (3.8)	JL-06405-10	/100-ft
3/8 (9.6)	1/2 (12.8)	1/16 (1.6)	41 (2.8)	JL-06405-12	/50-ft
3/8 (9.6)	9/16 (14.4)	3/32 (2.4)	46 (3.2)	JL-06405-15	/100-ft
3/8 (9.6)	5/8 (16.0)	1/8 (3.2)	55 (3.8)	JL-06405-16	/100-ft
1/2 (12.8)	5/8 (16.0)	1/16 (1.6)	28 (1.9)	JL-06405-18	/50-ft
1/2 (12.8)	1 1/16 (17.6)	3/32 (2.4)	36 (2.5)	JL-06405-19	/100-ft
1/2 (12.8)	3/4 (19.1)	1/8 (3.2)	41 (2.8)	JL-06405-20	/50-ft
5/8 (16.0)	13/16 (20.8)	3/32 (2.4)	32 (2.2)	JL-06405-25	/100-ft
5/8 (16.0)	7/8 (22.4)	1/8 (3.2)	36 (2.5)	JL-06405-27	/50-ft
3/4 (19.1)	1 (25.4)	1/8 (3.2)	32 (2.2)	JL-06405-31	/50-ft
1 (25.4)	1 1/4 (31.8)	1/8 (3.2)	23 (1.6)	JL-06405-36	/50-ft
1 1/4 (31.8)	1 3/4 (44.5)	1/4 (6.4)	41 (2.8)	JL-06405-46	/50-ft

Tygon® Non-DEHP Lab Tubing

Pliable formulation for sharp radius bending



Formulation: Tygon E-3603

Applications: General lab, food & beverage, biopharm, analytical instruments.

Characteristics: Non-DEHP, phthalate free. Long-life, chemical resistant, nonoxidizing; able to bend to sharp radius curves and easily works with fittings. Transparent.

Certifications: FDA-compliant (21 CFR 175.300); meets USP Class VI and NSF 51 requirements.

Temperature range: -51 to 165°F (-46 to 74°C)

Sterilize: Autoclave or ethylene oxide.

Buy More...Save More!
 20% off on 20+
 15% off on 10 to 19
 10% off on 4 to 9 packs

Dimensions: in. (mm)			Max psi at 70°F (bar at 21°C)	Catalog number	Price/50-ft pk
ID	OD	Wall			
1/32 (0.8)	3/32 (2.4)	1/32 (0.8)	69 (4.8)	JL-06407-70	
1/16 (1.6)	1/8 (3.2)	1/32 (0.8)	36 (2.5)	JL-06407-71	
1/16 (1.6)	3/16 (4.8)	1/16 (1.6)	69 (4.8)	JL-06407-72	
3/32 (2.4)	5/32 (4.0)	1/32 (0.8)	25 (1.7)	JL-06407-73	
1/8 (3.2)	3/16 (4.8)	1/32 (0.8)	20 (1.4)	JL-06407-75	
1/8 (3.2)	1/4 (6.4)	1/16 (1.6)	36 (2.5)	JL-06407-76	
3/16 (4.0)	7/32 (5.6)	1/32 (0.8)	17 (1.2)	JL-06407-77	
3/16 (4.8)	5/16 (8.0)	1/16 (1.6)	25 (1.7)	JL-06407-78	
3/16 (4.8)	3/8 (9.6)	3/32 (2.4)	36 (2.5)	JL-06407-79	
1/4 (6.4)	3/8 (9.6)	1/16 (1.6)	20 (1.4)	JL-06407-80	
1/4 (6.4)	7/16 (11.2)	3/32 (2.4)	28 (1.9)	JL-06407-81	
1/4 (6.4)	1/2 (12.8)	1/8 (3.2)	35 (2.5)	JL-06407-82	
3/16 (8.0)	7/16 (11.2)	1/16 (1.6)	17 (1.2)	JL-06407-83	
3/16 (8.0)	1/2 (12.8)	3/32 (2.4)	23 (1.6)	JL-06407-84	
3/16 (8.0)	9/16 (14.4)	1/8 (3.2)	30 (2.1)	JL-06407-85	
3/16 (9.6)	1/2 (12.8)	1/16 (1.6)	14 (1.0)	JL-06407-86	
3/8 (9.6)	9/16 (14.4)	3/32 (2.4)	20 (1.4)	JL-06407-87	
3/8 (9.6)	5/8 (16.0)	1/8 (3.2)	25 (1.7)	JL-06407-88	
7/16 (11.2)	9/16 (14.4)	1/16 (1.6)	13 (0.9)	JL-06407-89	
1/2 (12.8)	5/8 (16.0)	1/16 (1.6)	12 (1.8)	JL-06407-90	
1/2 (12.8)	1 1/16 (1.6)	3/32 (2.4)	15 (1.0)	JL-06407-91	
1/2 (12.8)	3/4 (19.1)	1/8 (3.2)	20 (1.4)	JL-06407-92	
1/2 (12.8)	13/16 (20.8)	5/32 (4.0)	24 (1.7)	JL-06407-93	
5/8 (16.0)	13/16 (20.8)	3/32 (2.4)	13 (0.9)	JL-06407-94	
5/8 (16.0)	7/16 (11.2)	1/8 (3.2)	17 (1.2)	JL-06407-95	
3/4 (19.1)	1 (25.4)	1/8 (3.2)	14 (1.0)	JL-06407-96	
3/4 (19.1)	1 1/8 (28.6)	3/16 (4.8)	20 (1.4)	JL-06407-97	
1 (25.4)	1 1/4 (31.8)	1/8 (3.2)	12 (0.8)	JL-06407-98	
1 (25.4)	1 1/2 (66.8)	1/4 (6.4)	20 (1.4)	JL-06407-99	

Microbore/Autoanalysis Tubing

Dimensions: in. (mm)			Fits needle gauge	Catalog number	Price/100-ft pk
ID	OD	Wall			
0.008 (0.19)	0.080 (2.03)	0.036 (0.91)	33	JL-06460-10	
0.010 (0.25)	0.082 (2.08)	0.036 (0.91)	30	JL-06460-12	
0.017 (0.44)	0.093 (2.36)	0.036 (0.91)	26	JL-06460-16	
0.020 (0.51)	0.096 (2.44)	0.036 (0.91)	24	JL-06460-18	
0.025 (0.64)	0.101 (2.57)	0.036 (0.91)	23	JL-06460-22	
0.035 (0.89)	0.111 (2.82)	0.036 (0.91)	20	JL-06460-26	
0.040 (1.02)	0.116 (2.95)	0.036 (0.91)	19	JL-06460-28	
0.045 (1.14)	0.121 (3.07)	0.036 (0.91)	18	JL-06460-30	
0.056 (1.42)	0.132 (3.35)	0.036 (0.91)	17	JL-06460-34	
0.081 (2.06)	0.157 (3.99)	0.036 (0.91)	14	JL-06460-42	
0.110 (2.79)	0.186 (4.72)	0.036 (0.91)	12	JL-06460-48	

Handheld Tubing Cutter

Steel blade coated with PTFE resin produces clean, straight cuts through tubing up to 1 1/4" OD (cuts polyethylene tubing up to 1 1/2" OD). Order carrying pouch and replacement blade separately below.



- JL-06438-90 Handheld tubing cutter
- JL-06438-81 Tubing cutter pouch
- JL-06438-92 Replacement blade for handheld tubing cutter 06438-90



Cole-Parmer® PTFE Tubing

Won't crack under heat or pressure



Applications: Demanding lab, chemical, electrical, mechanical, pharmaceutical, and automotive applications. Good for high-purity work. PTFE tubing withstands extreme temperatures.

Characteristics: Chemically inert, nontoxic, and virtually nonporous. Excellent crack- and stress-resistance. Low coefficient of friction. Translucent.

Certifications: Resin is FDA-compliant (21 CFR 177.1550).

Temperature range: -400 to 500°F (-240 to 260°C)

Sterilize: Autoclave, ethylene oxide, or dry heat.

Buy More...Save More!



20% off on 20+
15% off on 10 to 19
10% off on 4 to 9 packs

Dimensions: in. (mm)			Max psi at 70°F (bar at 21°C)	Catalog number	Price/25-ft pk
ID	OD	Wall			
1/32 (0.8)	1/16 (1.6)	1/64 (0.4)	370 (25.5)	JL-06407-41	
1/16 (1.6)	1/8 (3.2)	1/32 (0.8)	370 (25.5)	JL-06605-27	
3/32 (2.4)	5/32 (4.0)	1/32 (0.8)	294 (20.3)	JL-06605-28	
1/8 (3.2)	3/16 (4.8)	1/32 (0.8)	240 (16.5)	JL-06605-29	
3/16 (3.2)	1/4 (6.4)	1/16 (1.6)	375 (25.9)	JL-06605-30	
5/32 (4.0)	1/4 (6.4)	3/64 (1.2)	274 (18.9)	JL-06605-31	
3/16 (4.8)	1/4 (6.4)	1/32 (0.8)	175 (12.1)	JL-06605-32	
3/16 (4.8)	5/16 (8.0)	1/16 (1.6)	294 (20.3)	JL-06605-33	
1/4 (6.4)	5/16 (8.0)	1/32 (0.8)	137 (9.4)	JL-06605-34	
1/4 (6.4)	3/8 (9.6)	1/16 (1.6)	240 (16.5)	JL-06605-35	
19/64 (7.5)	3/8 (9.6)	1/25 (1.0)	143 (9.9)	JL-06605-36	
5/16 (8.0)	3/8 (9.6)	1/32 (0.8)	113 (7.8)	JL-06605-37	
3/8 (9.6)	7/16 (11.2)	1/32 (0.8)	96 (6.6)	JL-06605-39	
3/8 (9.6)	1/2 (12.8)	1/16 (1.6)	175 (12.1)	JL-06605-40	
2/5 (10.2)	1/2 (12.8)	1/20 (1.4)	137 (9.4)	JL-06605-41	
7/16 (11.2)	1/2 (12.8)	1/32 (0.8)	83 (5.7)	JL-06605-42	
1/2 (12.8)	9/16 (14.3)	1/32 (0.8)	73 (5.0)	JL-06605-44	
1/2 (12.8)	5/8 (16.0)	1/16 (1.6)	137 (9.4)	JL-06605-45	
5/16 (14.3)	5/8 (16.0)	1/32 (0.8)	66 (4.6)	JL-06605-46	
5/8 (16.0)	1 1/16 (17.5)	1/32 (0.8)	59 (4.1)	JL-06605-48	
5/8 (16.0)	3/4 (19.2)	1/16 (1.6)	113 (7.8)	JL-06605-49	
3/4 (19.2)	7/8 (22.2)	1/16 (1.6)	96 (6.6)	JL-06605-51	

Cole-Parmer® PFA Tubing

Stands up to highly corrosive materials



Applications: Demanding lab, chemical, electrical, mechanical, pharmaceutical, and automotive applications. For the transfer of high-temperature or highly corrosive materials. Also good for high-purity work.

Characteristics: Chemically inert, nontoxic, and virtually nonporous. Excellent crack- and stress-resistance. Low coefficient of friction. Translucent.

Certifications: Resin is FDA-compliant (21 CFR 177.1550). Tubing is manufactured in ISO 9001-2008 approved facility.

Temperature range: -320 to 500°F (-195 to 260°C)

Sterilize: Autoclave, ethylene oxide, or dry heat.

Buy More...Save More!



20% off on 20+
15% off on 10 to 19
10% off on 4 to 9 packs

Dimensions: in. (mm)			Max psi at 70°F (bar at 21°C)	Catalog number	Price/25-ft pk
ID	OD	Wall			
1/32 (0.8)	1/16 (1.6)	1/64 (0.4)	600 (41.4)	JL-06371-00	
1/16 (1.6)	1/8 (3.2)	1/32 (0.8)	592 (40.8)	JL-06375-01	
3/32 (2.4)	5/32 (4.0)	1/32 (0.8)	471 (32.5)	JL-06371-01	
1/8 (3.2)	3/16 (4.8)	1/32 (0.8)	385 (26.5)	JL-06371-02	
1/8 (3.2)	1/4 (6.4)	1/16 (1.6)	600 (41.4)	JL-06371-21	
5/32 (4.0)	1/4 (6.4)	3/64 (1.2)	421 (29.0)	JL-06375-02	
3/16 (4.8)	1/4 (6.4)	1/32 (0.8)	280 (19.3)	JL-06371-03	
3/16 (4.8)	5/16 (8.0)	1/16 (1.6)	471 (32.5)	JL-06371-22	
1/4 (6.4)	5/16 (8.0)	1/32 (0.8)	220 (15.2)	JL-06371-04	
1/4 (6.4)	3/8 (9.6)	1/16 (1.6)	388 (26.8)	JL-06375-05	
19/64 (7.5)	3/8 (9.6)	5/128 (1.0)	229 (15.8)	JL-06371-23	
5/16 (8.0)	3/8 (9.6)	1/32 (0.8)	180 (12.4)	JL-06371-05	
5/16 (8.0)	7/16 (11/2)	1/16 (1.6)	324 (22.3)	JL-06371-24	
3/8 (9.6)	1/2 (12.8)	1/16 (1.6)	283 (19.5)	JL-06375-07	
2/5 (10.2)	1/2 (12.8)	1/20 (1.2)	220 (9.5)	JL-06371-25	
7/16 (11/2)	1/2 (12.8)	1/32 (0.8)	133 (9.2)	JL-06371-07	
1/2 (12.8)	5/8 (16.0)	1/16 (1.6)	220 (15.2)	JL-06371-26	
5/8 (16.0)	3/4 (19.0)	1/16 (1.6)	150 (10.3)	JL-06375-08	
1 1/16 (17.5)	3/4 (19.0)	1/32 (0.8)	87 (6.0)	JL-06371-28	
3/4 (19.0)	7/8 (22.2)	1/16 (1.6)	153 (10.5)	JL-06371-29	

Cole-Parmer® PTFE Microbore Tubing

Minimize friction, maximize chemical resistance

Use this translucent tubing in extreme temperatures and in harsh chemical environments. It's chemically inert, has low permeability, and has the lowest friction coefficient of any tubing. Temperature range is -400 to 500°F (-240 to 260°C); melts at 620°F (327°C). Tensile strength is 2500 to 4000 psi. PTFE tubing resin is UL-recognized and complies with FDA (21 CFR 177.1550) and USP Class VI requirements.



Buy More...Save More!



20% off on 20+
15% off on 10 to 19
10% off on 4 to 9 packs

Dimensions			Fits needle gauge	Catalog number	Price/100 ft
ID	OD	Wall			
Ultramicrobore PTFE tubing (finer than a human hair)					
0.002"	0.014"	0.006"	44	JL-06417-70	
0.004"	0.016"	0.006"	38	JL-06417-72	
0.006"	0.016"	0.005"	34	JL-06417-74	
0.008"	0.016"	0.004"	33	JL-06417-76	
Microbore PTFE tubing					
0.012"	0.030"	0.009"	30	JL-06417-11	
0.022"	0.042"	0.010"	24	JL-06417-21	
0.032"	0.056"	0.012"	21	JL-06417-31	
0.042"	0.066"	0.012"	18	JL-06417-41	
0.052"	0.076"	0.012"	16	JL-06417-51	

JL-06417-60 Microbore tubing assortment pack. One 100-ft (30.4-m) roll each of 06417-11, -21, -31, -41, and -51 (500-ft [152.4-m] total)

Viton® Tubing

Worry-free acid transfer

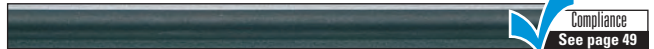

Applications: Acid and solvent transfer; high-temperature work.

Characteristics: Opaque black.

Certifications: Tubing is manufactured according to GMP.

Temperature range: 8 to 400°F (-13 to 204°C)

Sterilize: Not recommended.

Buy More...Save More!

20% off on 20+ 15% off on 10 to 19 10% off on 4 to 9 packs



Dimensions: in. (mm)			Max psi at 70°F (bar at 21°C)	Catalog number	Price/25-ft pk
ID	OD	Wall			
1/16 (1.6)	1/8 (3.2)	1/32 (0.8)	23 (1.6)	JL-06434-01	
1/8 (3.2)	3/16 (4.8)	1/32 (0.8)	21 (1.4)	JL-06434-02	
3/16 (4.8)	1/4 (6.4)	1/32 (0.8)	19 (1.3)	JL-06434-03	
1/4 (6.4)	5/16 (8.0)	1/32 (0.8)	17 (1.2)	JL-06434-04	
5/16 (8.0)	7/16 (11.2)	1/16 (1.6)	20 (1.4)	JL-06434-05	
3/8 (9.6)	1/2 (12.8)	1/16 (1.6)	18 (1.2)	JL-06434-06	
1/2 (12.8)	5/8 (16.0)	1/16 (1.6)	16 (1.1)	JL-06434-07	
5/8 (16.0)	7/8 (22.4)	1/8 (3.2)	17 (1.8)	JL-06434-08	
3/4 (19.1)	1 (25.4)	1/8 (3.2)	15 (1.0)	JL-06434-09	

DON'T RISK IT!

Our chemical compatibility database provides important information on chemical resistance—check it out at ColeParmer.com/ChemChart



Cole-Parmer® FEP Tubing

Does not deteriorate with age



Compliance
See page 49



Applications: Demanding lab, chemical, electrical, mechanical, pharmaceutical, and automotive applications. Excellent for the transfer of extreme temperature or highly corrosive materials. Also good for high-purity work.

Characteristics: Chemically inert, nontoxic, heat resistant, with a low coefficient of friction. Doesn't deteriorate with age. Tough, but bends even at -454°F (-270°C). Translucent.

Certifications: Resin is FDA-compliant (21 CFR 177.1550). Tubing is manufactured in ISO 9001-2008 approved facility.

Temperature range: -454 to 400°F (-270 to 205°C)

Sterilize: With autoclave, ethylene oxide, or dry heat.

Buy More...Save More!
20% off on 20+ 15% off on 10 to 19 10% off on 4 to 9 packs

Dimensions: in. (mm)			Max psi at 70°F (bar at 21°C)	Catalog number	Price/ 25-ft pk
ID	OD	Wall			
1/32 (0.8)	1/16 (1.6)	1/64 (0.4)	500 (34.5)	JL-06406-60	
1/16 (1.6)	1/8 (3.2)	1/32 (0.8)	444 (30.6)	JL-06406-62	
3/32 (2.4)	5/32 (4.0)	1/32 (0.8)	353 (24.3)	JL-06406-63	
1/8 (3.2)	3/16 (4.8)	1/32 (0.8)	289 (19.9)	JL-06406-64	
1/8 (3.2)	1/4 (6.4)	1/16 (1.6)	450 (31.0)	JL-06450-05	
5/32 (4.0)	1/4 (6.4)	3/64 (1.2)	329 (22.7)	JL-06450-04	
3/16 (4.8)	1/4 (6.4)	1/32 (0.8)	209 (14.4)	JL-06406-66	
3/16 (4.8)	5/16 (8.0)	1/16 (1.6)	353 (24.3)	JL-06450-06	
1/4 (6.4)	5/16 (8.0)	1/32 (0.8)	150 (10.3)	JL-06406-72	
1/4 (6.4)	3/8 (9.6)	1/16 (1.6)	288 (19.9)	JL-06450-07	
19/64 (7.5)	3/8 (9.6)	5/128 (1.0)	172 (11.9)	JL-06450-02	
5/16 (8.0)	3/8 (9.6)	1/32 (0.8)	140 (9.7)	JL-06406-74	
5/16 (8.0)	7/16 (11.2)	1/16 (1.6)	243 (16.8)	JL-06450-08	
3/8 (9.6)	7/16 (11.2)	1/32 (0.8)	110 (7.6)	JL-06406-12	
3/8 (9.6)	1/2 (12.8)	1/16 (1.6)	210 (14.5)	JL-06450-09	
7/16 (11.1)	1/2 (12.8)	1/32 (0.8)	102 (7.0)	JL-06406-76	
7/16 (11.1)	9/16 (14.3)	1/16 (1.6)	185 (12.8)	JL-06450-14	
1/2 (12.8)	9/16 (14.3)	1/32 (0.8)	88 (6.1)	JL-06406-18	
1/2 (12.8)	5/8 (16.0)	1/16 (1.6)	165 (11.4)	JL-06450-15	
5/8 (16.0)	11/16 (17.5)	1/32 (0.8)	71 (4.9)	JL-06450-00	
5/8 (16.0)	3/4 (19.2)	1/16 (1.6)	135 (9.3)	JL-06450-17	
11/16 (17.5)	3/4 (19.1)	1/32 (0.8)	65 (4.5)	JL-06450-01	
3/4 (19.2)	7/8 (22.2)	1/16 (1.6)	115 (7.9)	JL-06450-19	

Cole-Parmer® Corrugated FEP Tubing

No kinks or distortion

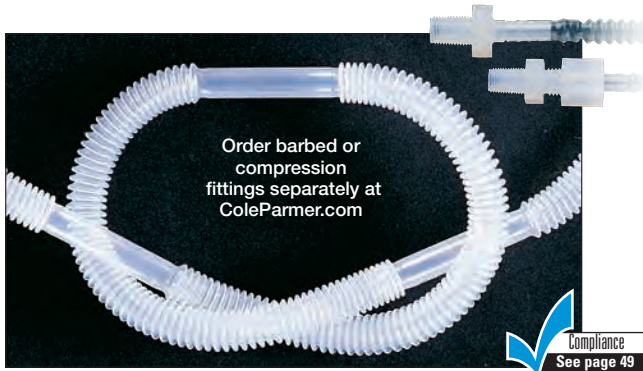

Order barbed or compression fittings separately at ColeParmer.com

Compliance
See page 49

High flexibility and excellent chemical resistance. Corrugations prevent kinking and help tubing retain its shape without limiting pressure or vacuum abilities. Simply cut this custom-extruded tubing to desired length. Sold in 5-ft lengths; each length has alternating sections of corrugated (10" L) and noncorrugated (2" L) tubing, with noncorrugated 1" L sections at both ends. Temperature range: -300 to 400°F (-184 to 205°C). Withstands 27" Hg vacuum.



Cuff ID	Cuff OD	Wall	Max psi at 70°F (bar at 21°C)	Catalog number	Price/ 5-ft length*
Tubing compatible with barbed fittings					
1/4"	9/32"	1/64"	250 (17.2)	JL-06407-50	
3/8"	13/32"	1/32"	200 (13.8)	JL-06407-52	
Tubing compatible with compression fittings					
7/32"	1/4"	1/64"	250 (17.2)	JL-06407-60	
21/64"	3/8"	1/32"	200 (13.8)	JL-06407-62	
29/64"	1/2"	1/32"	170 (11.7)	JL-06407-64	
11/16"	3/4"	1/32"	120 (8.3)	JL-06407-66	

*Discounts: Save 10% on 10 to 49, 15% on 50 to 99, and 20% on 100 5-ft lengths or more.

Rigid Fluorinated Ethylene Propylene (FEP) Tubing Spools

Maximize tubing on hand

Reduce unpacking time, save money on shipping, and ensure that you always have enough tubing on hand with bulk tubing. Spools also available in PTFE and PFA.



Applications: Transfer of abrasive fluids, pharmaceutical processes.
Characteristics: Good chemical resistance at a low cost, temperature-resistant, and low coefficient of friction, semi-flexible. Transparent.
Certifications: FDA compliant (21 CFR 177.1550). Meets USP Class VI.
Temperature range: -454 to 400°F (-270 to 205°C)
Sterilize: Autoclave, ethylene oxide, or dry heat.

Dimensions in. (mm)			Catalog number	Ft/spool	Price
ID	OD	Wall			
1/16 (1.6)	1/8 (3.2)	1/32 (0.8)	JL-95230-00	250	
1/8 (3.2)	1/4 (6.4)	1/16 (1.6)	JL-95230-02		
5/32 (4.0)	1/4 (6.4)	3/64 (1.19)	JL-95230-04		
3/16 (4.8)	1/4 (6.4)	1/32 (0.8)	JL-95230-06		
1/4 (6.4)	5/16 (8.0)	1/32 (0.8)	JL-95230-08		
1/4 (6.4)	3/8 (9.6)	1/16 (1.6)	JL-95230-10	100	
5/16 (8.0)	3/8 (9.6)	1/32 (0.8)	JL-95230-12		
3/8 (9.6)	1/2 (12.8)	1/16 (1.6)	JL-95230-14		
7/16 (11.2)	1 1/2 (12.8)	1/32 (0.8)	JL-95230-16		
1/2 (12.8)	5/8 (16.0)	1/16 (1.6)	JL-95230-18		

Tubing Accessories

Handheld Tubing Cutter

Steel blade coated with PTFE resin produces clean, straight cuts through tubing up to 1 1/4" OD (cuts polyethylene tubing up to 1 1/2" OD). Order carrying pouch and replacement blade separately below.



JL-06438-90 Handheld tubing cutter

JL-06438-81 Tubing cutter pouch

JL-06438-92 Replacement blade for handheld tubing cutter 06438-90

Benchtop Tubing Cutter

Steel blade makes right-angle cuts in plastic tubing 1/16" to 5/8" OD.



JL-06438-10 Benchtop cutter

JL-06438-11 Replacement blade

Plastic Clamp Ties



Perfect for flexible fuel line, water line, and vacuum line applications. Special curved clamp tie head ensures a tight seal. Ties measure 8"L x 0.18"W; maximum diameter of 1 3/4". Black resin resists UV degradation.

JL-95615-00 Clamp ties, white. 100/pk

JL-95615-10 Clamp ties, black. 100/pk

Stainless Steel Hose Clamps

SS strap and screw housing with a steel screw. Band-type worm drive.



Clamp diameter		Catalog number	Price/pk of 10*
Min	Max		
7/32"	5/8"	JL-06403-11	
1 1/16"	1 1/4"	JL-06403-12	
1 3/16"	1 3/4"	JL-06403-13	
1 1/16"	2"	JL-06403-14	
1 5/16"	2 1/4"	JL-06403-15	
2"	2 3/4"	JL-06403-16	
2 3/4"	3 1/2"	JL-06403-21	
3 1/2"	4 3/8"	JL-06403-22	
4 3/8"	5 1/8"	JL-06403-23	
5 1/8"	5 7/8"	JL-06403-24	
5 1/2"	6 1/4"	JL-06403-25	

*Discounts: Save 10% on 5-24 pks, 15% on 25-99 pks, and 20% on 100+ pks.

Cole-Parmer® Plastic Hose Clamps and Kits

Reusable white acetal copolymer or white or black nylon clamps will not rust or corrode. Recommended for continuous use from ambient temperature for the acetal copolymer to 200°F (93°C); ambient temperature for nylon clamps is 180°F (82°C). Clamps are nonconducting and stable in a wide variety of chemicals; black clamps resist UV degradation.

Once set, clamps stay put. To use, just position clamp on hose or tubing bundle and press the jaws together with a pair of pliers. Order clamps individually or in kits. Kits include 170 assorted clamps from 0.228" to 1.405" ID.

JL-06832-99 White acetal copolymer hose-clamp kit

JL-06420-99 White nylon hose-clamp kit

JL-06430-49 Black nylon hose-clamp kit



Cole-Parmer®

White Acetal Hose Clamps

Inside diameter				Catalog number	Qty/pk	Price/pk**
Decimal inches		Millimeters				
Min	Max	Min	Max			
0.228	0.256	5.8	6.5	JL-06832-01	100	
0.269	0.291	6.8	7.4	JL-95614-00	100	
0.307	0.342	7.8	8.7	JL-06832-03	100	
0.351	0.394	8.9	10.0	JL-06832-02	100	
0.387	0.440	9.8	11.2	JL-95614-01	100	
0.404	0.452	10.3	11.5	JL-06832-04	100	
0.449	0.511	11.4	13.0	JL-06832-06	100	
0.513	0.586	13.0	14.9	JL-06832-08	100	
0.569	0.650	14.5	16.5	JL-06832-10	100	
0.616	0.707	15.7	18.0	JL-06832-12	100	
0.702	0.801	17.8	20.4	JL-06832-14	100	
0.759	0.848	19.3	21.5	JL-06832-16	100	
0.779	0.899	19.8	22.8	JL-06832-18	100	
0.859	0.989	21.8	25.1	JL-06832-20	100	
0.928	1.072	23.6	27.2	JL-06832-22	100	
0.985	1.135	25.0	28.8	JL-06832-24	100	
1.123	1.296	28.5	32.9	JL-06832-28	50	
1.218	1.405	30.9	35.7	JL-06832-32	50	
1.338	1.566	34.0	39.8	JL-06832-34	50	
1.472	1.724	37.4	43.8	JL-06832-36	50	

**Discounts: Save 10% on 4-19 pks, 15% on 20-79 pks, and 20% on 80+ pks.

Nylon Hose Clamps

Inside diameter				Qty/pk	White		Black	
Decimal inches		Millimeters			Catalog number	Price/pk**	Catalog number	Price/pk**
Min	Max	Min	Max					
0.246	0.290	5.95	7.5	100	JL-06420-50		JL-06430-07	
0.283	0.312	7.1	7.9	100	JL-06420-52		JL-06430-02	
0.350	0.395	9.1	9.9	100	JL-06420-56		JL-06430-06	
0.360	0.410	9.3	10.5	100	JL-06420-58		JL-06430-08	
0.430	0.480	11.11	12.3	100	JL-06420-60		JL-06430-10	
0.500	0.545	12.7	13.8	100	JL-06420-62		JL-06430-12	
0.525	0.605	13.3	15.4	100	JL-06420-64		JL-06430-14	
0.580	0.660	15.0	16.9	100	JL-06420-66		JL-06430-46	
0.650	0.750	16.6	19.0	100	JL-06420-68		JL-06430-18	
0.750	0.875	19.05	22.2	100	JL-06420-70		JL-06430-20	
0.779	0.899	19.7	22.6	100	JL-06420-72		JL-06430-22	
0.859	0.989	21.8	25.0	100	JL-06420-74		JL-06430-44	
0.900	0.989	23.0	25.0	100	JL-06420-76		JL-06430-26	
0.990	1.135	25.0	28.5	100	JL-06420-78		JL-06430-28	
1.123	1.296	28.5	32.9	50	JL-06420-80		JL-06430-30	
1.250	1.425	31.7	35.9	50	JL-06420-82		JL-06430-32	
1.406	1.610	35.7	40.8	50	JL-06420-84		JL-06430-34	
1.593	1.812	40.4	46.0	50	JL-06420-86		JL-06430-36	
1.790	2.110	45.6	53.5	50	JL-06420-88		JL-06430-38	
1.870	2.125	47.0	52.0	50	JL-06420-90		JL-06430-40	
2.119	2.390	53.5	60.7	25	JL-06420-92		JL-06430-42	

**Discounts: Save 10% on 4-19 pks, 15% on 20-79 pks, and 20% on 80+ pks.

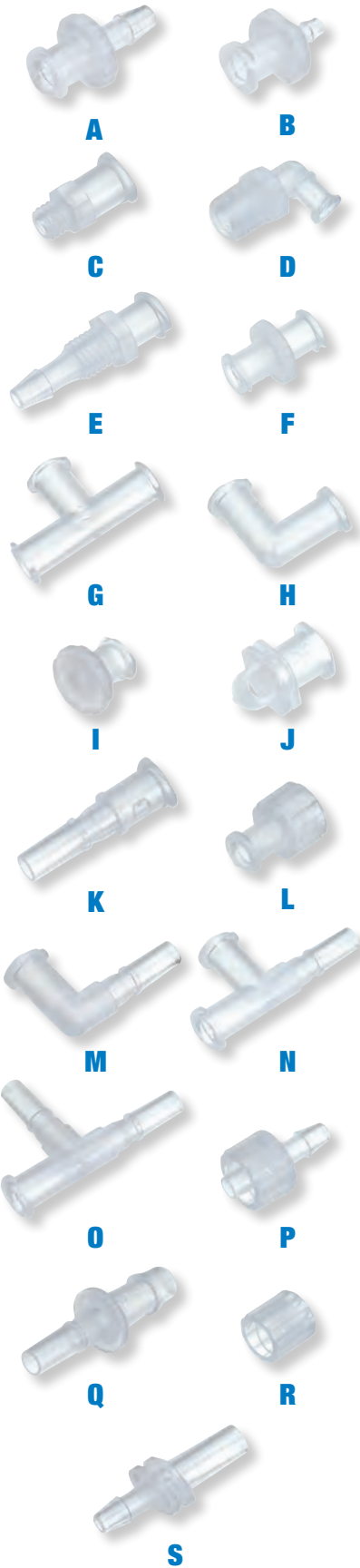

Cole-Parmer® Premium Luer Fittings

Premium luer fittings for critical applications

- Manufactured from 100% virgin raw materials in a Class 100,000 environment
- Full material traceability on all items

These luer fittings are ideal for a variety of applications, including syringes or small tubing. Manufactured in compliance with ISO 594-1 standards, these fittings are inspected to be free from contaminants, and are fully traceable. All parts meet tight dimensional tolerances for increased reliability and process purity. Choose from a range of sizes, 1/16" to 1/4", with a variety of connection options. **Pack of 25.**

Search

For our complete line of luer fittings, go to...
ColeParmer.com/Luer



Buy More...Save More!

20% off on 100+
15% off on 50 to 99
10% off on 10 to 49 packs



Key	Description	Polypropylene		Polycarbonate		Nylon	
		Cat. no.	Price/pk	Cat. no.	Price/pk	Cat. no.	Price/pk
Female luer x hose barb adapters							
A	Female luer x 1/16" hose barb	JL-45508-00		JL-45501-00		JL-45502-00	
	Female luer x 3/32" hose barb	JL-45508-02		JL-45501-02		JL-45502-02	
	Female luer x 1/8" hose barb	JL-30800-08		JL-45501-04		JL-45502-04	
	Female luer x 5/32" hose barb	JL-45508-06		JL-45501-06		JL-45502-06	
	Female luer x 3/16" hose barb	JL-45508-08		JL-45501-08		JL-45502-08	
	Female luer x 1/4" hose barb	JL-30800-06		JL-45501-20		JL-45502-20	
Female luer x hose barb adapters (smooth bore)							
B	Female luer x 1/16" hose barb (smooth bore)	JL-45508-50		JL-45501-50		JL-45502-50	
	Female luer x 3/32" hose barb (smooth bore)	JL-45508-52		JL-45501-52		JL-45502-52	
	Female luer x 1/8" hose barb (smooth bore)	JL-45508-54		JL-45501-54		JL-45502-54	
Female luer x thread adapters							
C	Female luer x 10-32 special tapered thread	JL-45508-70		JL-45501-70		JL-45502-70	
	Female luer x 10-32 UNF thread	JL-45508-60		JL-45501-60		JL-45502-60	
	Female luer x 1/4-28 UNF thread	JL-45508-66		JL-45501-66		JL-45502-66	
	Female luer x 1/4-28 UNF bottom sealing thread	JL-45508-76		—	—	JL-45505-76	
	Female luer x 1/8-27 NPT thread	JL-30800-00		—	—	JL-45505-78	
D	Female luer x 1/8-27 NPT thread elbow	JL-45518-80		—	—	JL-45505-80	
Female luer bulkhead x hose barb adapters							
E	Female luer x 1/4-28 UNF thread to 1/16" hose barb	JL-45508-30		JL-45501-30		JL-45502-30	
	Female luer x 1/4-28 UNF thread to 3/32" hose barb	JL-45508-32		JL-45501-32		JL-45502-32	
	Female luer x 1/4-28 UNF thread to 1/8" hose barb	JL-45508-34		JL-45501-34		JL-45502-34	
Female adapters							
F	Female luer x female luer	JL-45508-22		JL-45501-22		JL-45502-22	
G	Female tee	JL-45508-56		JL-45501-56		JL-45502-56	
H	Female elbow	JL-45508-26		JL-45501-26		JL-45502-26	
I	Female luer x cap	JL-30800-12		JL-45501-28		JL-45502-28	
J	Female luer x cap with tether loop	JL-45508-64		JL-45501-64		JL-45502-64	
Male x female adapters							
K	Male luer x female luer coupler	JL-45508-82		JL-45501-82		JL-45502-82	
L	Male luer x female luer coupler with lock ring	JL-45508-80		JL-45501-80		JL-45502-80	
M	Male luer x female luer elbow	JL-45508-84		JL-45501-84		JL-45502-84	
N	Male x female x female tee	JL-45508-85		JL-45501-85		JL-45502-85	
O	Male x male x female tee	JL-45508-75		JL-45501-75		JL-45502-75	
Male luer lock x hose barb adapters							
P	Male luer lock x 1/16" hose barb	JL-45518-00		JL-45504-00		JL-45505-00	
	Male luer lock x 3/32" hose barb	JL-45518-02		JL-45504-02		JL-45505-02	
	Male luer lock x 1/8" hose barb	JL-30800-24		JL-45504-04		JL-45505-04	
	Male luer lock x 5/32" hose barb	JL-45518-06		JL-45504-06		JL-45505-06	
	Male luer lock x 3/16" hose barb	JL-45518-08		JL-45504-08		JL-45505-08	
	Male luer lock x 1/4" hose barb	JL-30800-22		JL-45504-19		JL-45505-19	
Male luer x hose barb adapters (for use with separate rotating lock ring "R")							
Q	Male luer x 1/16" hose barb	JL-45518-40		JL-45504-40		JL-45505-40	
	Male luer x 3/32" hose barb	JL-45518-42		JL-45504-42		JL-45505-42	
	Male luer x 1/8" hose barb	JL-45518-44		JL-45504-44		JL-45505-44	
	Male luer x 5/32" hose barb	JL-45518-46		JL-45504-46		JL-45505-46	
	Male luer x 3/16" hose barb	JL-45518-48		JL-45504-48		JL-45505-48	
	Male luer x 1/4" hose barb	JL-45518-50		JL-45504-50		JL-45505-50	
R	Snap luer lock ring	JL-45518-74		JL-45504-74		JL-45505-74	
Male slip luer x hose barb adapters (no lock ring)							
S	Male luer x 1/16" hose barb	JL-45518-22		JL-45504-22		JL-45505-22	
	Male luer x 3/32" hose barb	JL-45518-24		JL-45504-24		JL-45505-24	
	Male luer x 1/8" hose barb	JL-45518-26		JL-45504-26		JL-45505-26	
	Male luer x 5/32" hose barb	JL-45518-28		JL-45504-28		JL-45505-28	
	Male luer x 3/16" hose barb	JL-45518-52		JL-45504-52		JL-45505-52	
	Male luer x 1/4" hose barb	JL-45518-54		JL-45504-54		JL-45505-54	



Cole-Parmer® Barbed Fittings

No tools needed for assembly

Combine these fittings with our flexible tubing for use in your low-pressure applications (less than 30 psi).

High-Density Polyethylene (HDPE). Very good chemical resistance. Temp range: -65 to 150°F (-53 to 65°C). Sterilize by ethylene oxide.

Nylon. Good chemical resistance. Temp range: -50 to 250°F (-46 to 121°C). Sterilize by ethylene oxide.

Polypropylene (PP). Very good chemical resistance. Temp range: 9 to 180°F (-13 to 66°C). Sterilize by ethylene oxide or gamma irradiation.

PVDF. Excellent chemical resistance. Temp range: -80 to 265°F (-62 to 129°C). Sterilize by ethylene oxide or autoclave.

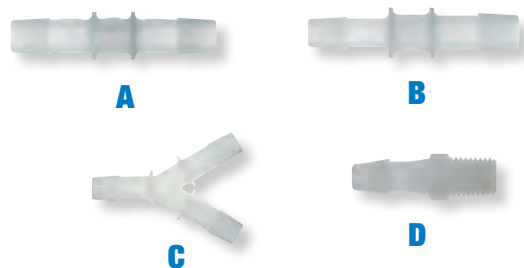

Buy More...Save More!

20% off on 100+
15% off on 50 to 99
10% off on 10 to 49 packs



Fluid Handling

Fittings

Tubing ID	HDPE			Nylon			Polypropylene			PVDF		
	Catalog number	Qty/pk	Price/pk	Catalog number	Qty/pk	Price/pk	Catalog number	Qty/pk	Price/pk	Catalog number	Qty/pk	Price/pk
A. Straight connectors												
1/16"	JL-30622-47	10		JL-30622-48	10		JL-40622-49	10		JL-30703-00	10	
3/32"	JL-30622-44	10		JL-30622-45	10		JL-40622-46	10		JL-30703-01	10	
1/8"	JL-30622-53	10		JL-30622-54	10		JL-41518-05	10		JL-30703-02	10	
3/16"	JL-30622-55	10		JL-30622-56	10		JL-40622-57	10		JL-30703-04	10	
1/4"	JL-30621-85	10		JL-30621-86	10		JL-40610-00	10		JL-30703-05	10	
3/8"	JL-30621-89	10		JL-30621-90	10		JL-40610-02	10		JL-30703-07	10	
1/2"	JL-30621-92	10		JL-30621-93	10		JL-40610-03	10		JL-30703-08	10	
5/8"	JL-30621-79	10		JL-30621-80	10		JL-40610-04	10		JL-30703-09	10	
3/4"	JL-30621-81	10		JL-30621-82	10		JL-40610-05	5		JL-30703-10	5	
1"	JL-30621-83	10		JL-30621-84	10		JL-40610-06	5		JL-30703-11	5	
B. Reducing connectors												
1/8" x 1/16"	JL-31518-29	10		JL-30622-22	25		JL-40622-23	25		JL-30703-41	10	
1/4" x 1/8"	JL-30622-27	10		JL-30622-28	10		JL-41518-36	10		JL-30703-50	10	
1/4" x 3/16"	JL-30622-29	10		JL-30622-30	10		JL-40622-32	10		JL-30703-52	10	
3/8" x 1/4"	JL-30622-35	10		JL-30703-99	10		JL-40610-08	10		JL-30703-54	10	
1/2" x 1/4"	JL-30622-38	10		JL-30622-39	10		JL-40610-10	10		JL-30703-56	10	
1/2" x 3/8"	JL-30622-42	10		JL-30622-43	10		JL-40610-12	10		JL-30703-58	10	
5/8" x 1/4"	JL-30621-96	10		JL-30621-97	10		JL-40610-13	10		JL-30703-59	10	
5/8" x 1/2"	JL-30622-03	10		JL-30622-04	10		JL-40610-16	10		JL-30703-62	10	
3/4" x 1/2"	JL-30622-09	5		JL-30622-10	5		JL-40610-18	5		JL-30703-64	5	
1" x 1/2"	JL-30622-15	5		JL-30622-16	5		JL-40610-20	5		JL-30703-66	5	
1" x 3/4"	JL-30622-13	5		JL-30622-14	5		JL-40610-22	5		JL-30703-68	5	
C. Y connectors												
1/16"	JL-30726-01	10		JL-30726-21	10		JL-40726-41	10		JL-30703-90	10	
3/32"	JL-30726-02	10		JL-30726-22	10		JL-40726-42	10		JL-30703-91	10	
1/8"	JL-30726-03	10		JL-30726-23	10		JL-40726-43	10		JL-30703-92	10	
3/16"	JL-30726-04	10		JL-30726-24	10		JL-40726-44	10		JL-30726-64	10	
1/4"	JL-30726-05	10		JL-30726-25	10		JL-40726-45	10		JL-30726-65	10	
3/8"	JL-30726-06	10		JL-30726-26	10		JL-40726-46	10		JL-30703-93	10	
1/2"	JL-30726-07	10		JL-30726-27	10		JL-40726-47	10		JL-30703-94	10	
5/8"	JL-30726-08	10		JL-30726-28	10		JL-40726-48	10		JL-30726-68	10	
D. NPT male threaded adapters, NPT(M) x tubing ID												
1/8" x 1/8"	JL-30621-26	10		JL-30621-27	10		JL-40621-28	25		JL-30704-07	10	
1/8" x 1/4"	JL-30621-31	10		JL-30621-32	10		JL-40610-36	10		JL-30704-09	10	
1/4" x 1/8"	JL-30621-42	10		JL-30621-44	10		JL-40621-45	10		JL-30621-43	10	
1/4" x 1/4"	JL-30621-46	10		JL-30621-47	10		JL-40610-38	10		JL-30704-11	10	
3/8" x 1/4"	JL-30621-56	10		JL-30621-57	10		JL-40610-41	10		JL-30704-14	10	
3/8" x 3/8"	JL-30621-62	10		JL-30621-63	10		JL-40610-42	10		JL-30704-15	10	
1/2" x 1/4"	JL-30621-73	10		JL-30621-74	10		JL-40610-44	10		JL-30704-17	10	
1/2" x 3/8"	JL-30621-75	10		JL-30621-76	10		JL-40610-45	10		JL-30704-18	10	
1/2" x 1/2"	JL-30621-77	10		JL-30621-78	10		JL-40610-46	10		JL-30704-19	10	
3/4" x 1/2"	JL-30621-20	10		JL-30621-21	10		JL-40610-50	5		JL-30704-23	5	
3/4" x 3/4"	JL-30621-12	10		JL-30621-13	10		JL-40610-51	5		JL-30704-24	5	
1" x 1"	JL-31517-18	10		JL-30401-34	10		JL-40610-53	5		JL-30704-26	5	



Free Certificate of Compliance

Cole-Parmer will provide a certificate of resin or elastomer compliance FREE at your request with each order of fittings, gaskets, or tubing. Certificates list your company's PO number, order reference number, catalog number, formulation, compound number, lot number (where applicable), and the regulations and agencies the fitting, tubing, or gasket complies with, including FDA, USP, USDA, National Formulary, NSF International, GMP, and 3A. Look for the blue "check" icon throughout this catalog to identify when a certificate of compliance is available.

CPC™ Plastic Quick-Disconnect Fittings

Fittings connect in a snap

- Acetal fittings are ideal for use with corrosive fluids
- Polycarbonate and polysulfone materials meet USP Class VI requirements

Simply press the thumb latch to disconnect coupling halves. Polycarbonate and polysulfone materials meet USP Class VI requirements and pass all physicochemical, cytotoxicity, leachables, and extractables tests. Order complete couplings or separate bodies and inserts from the tables below.

Note: Standard bodies and inserts fit together; won't work with large bodies and inserts and vice versa.



Buy More...Save More!
 \$ 20% off on 100+
 15% off on 50 to 99
 10% off on 10 to 49 packs

Specifications

Body material	Acetal	Polycarbonate (PC)	Polysulfone (PSF)
Temperature range	-40 to 180°F (-40 to 82°C)	-40 to 250°F (-40 to 121°C)	-40 to 300°F (-40 to 148°C)
Max pressure	120 psi	125 psi†	120 psi
Max vacuum	28" Hg	25" Hg	25" Hg
Sterilization	Autoclave or ETO	Autoclave, ETO, or gamma irradiation	Autoclave, ETO, or gamma irradiation

†Max pressure for 1/2" polycarbonate fittings is 60 psi.

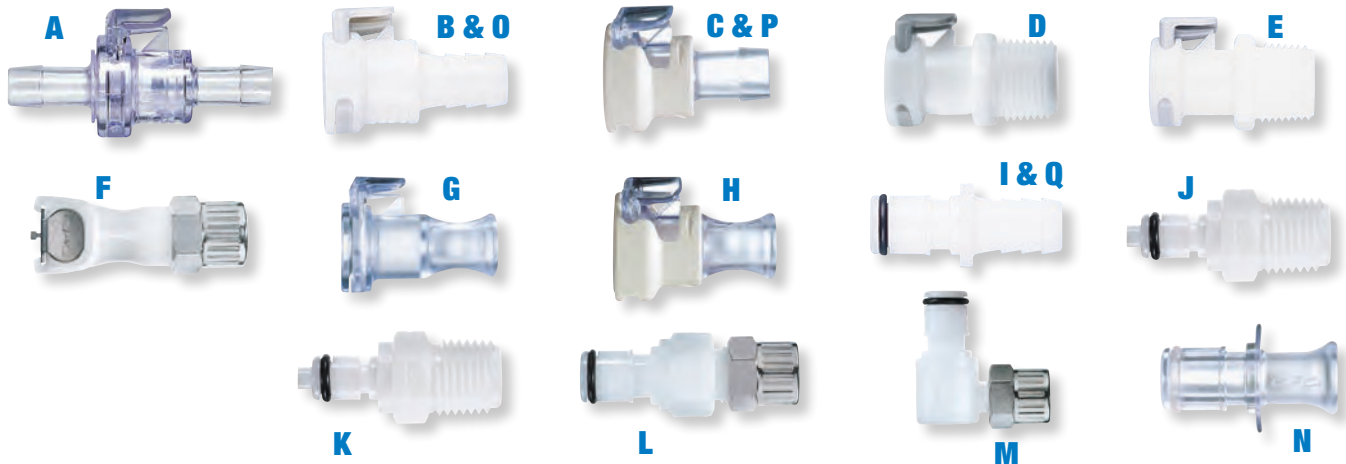

Complete Couplings

Key	Catalog number	Size	Material	Length	Qty/pk	Price/pk
A	JL-06360-90	1/4" tubing ID	Acetal	—	10	
	JL-31305-00		PC	—	10	
	JL-06360-91		Acetal	—	10	
	JL-31305-05	3/8" tubing ID	PC	—	10	
	JL-31306-05		PSF	—	10	

Standard Bodies and Caps

Key	Catalog number	Size	Material	Length	Qty/pk	Price/pk
Barbed bodies						
B	JL-06360-94	1/4" tubing ID	Acetal	1.31" (33.3 mm)	10	
	JL-31311-11		PC		5	
	JL-31311-21		PSF		5	
	JL-06360-95	3/8" tubing ID	Acetal	1.31" (33.3 mm)	10	
	JL-31311-12		PC		5	
	JL-31311-22		PSF		5	
Hose barb coupling bodies with lock						
C	JL-31311-16	1/4" tubing ID	PC	1.31" (33.3 mm)	5	
	JL-31311-26		PSF		5	
	JL-31311-17	3/8" tubing ID	PC	1.31" (33.3 mm)	5	
	JL-31311-27		PSF		5	
BSP straight-through bodies						
D	JL-06360-01	1/4" BSP	Acetal	1.31" (33.3 mm)	10	
	JL-06360-02	3/8" BSP			10	
NPT(M) bodies						
E	JL-06360-00	1/4" NPT	Acetal	1.31" (33.3 mm)	10	
	JL-06360-96	3/8" NPT			10	
Compression coupling bodies						
F	JL-06360-06	1/4" OD	Acetal	1.31" (33.3 mm)	10	
	JL-06360-08	3/8" OD			10	
Sealing caps						
G	JL-31311-64	1/4"	PC	1.31" (33.3 mm)	5	
	JL-31311-74	1/4"	PSF		5	
Sealing caps with lock						
H	JL-31311-67	1/4"	PC	1.31" (33.3 mm)	5	
	JL-31311-77	1/4"	PSF		5	

Standard Inserts and Plugs

Key	Catalog number	Size	Material	Length	Qty/pk	Price/pk
Barbed inserts						
I	JL-06360-92	1/4" tubing ID	Acetal	1.28" (32.5 mm)	10	
	JL-31311-61		PC		5	
	JL-31311-71		PSF		5	
	JL-06360-93	3/8" tubing ID	Acetal	1.28" (32.5 mm)	10	
	JL-31311-62		PC		5	
	JL-31311-72		PSF		5	
BSP straight-through inserts						
J	JL-06360-27	1/4" BSP	Acetal	1.28" (32.5 mm)	10	
	JL-06360-97	3/8" BSP			10	
NPT(M) inserts						
K	JL-06360-16	1/4" NPT	Acetal	1.28" (32.5 mm)	10	
	JL-06360-18	3/8" NPT			10	
Compression coupling inserts						
L	JL-06360-21	1/4" OD	Acetal	1.28" (32.5 mm)	10	
	JL-06360-24	3/8" OD			10	
Sealing caps						
M	JL-06360-31	1/4" OD	Acetal	1.28" (32.5 mm)	10	
	JL-06360-34	3/8" OD			10	
Plugs with lock						
N	JL-31311-68	1/4"	PC	1.20" (30.5 mm)	5	
	JL-31311-78	1/4"	PSF		5	

Large Bodies and Inserts (use these bodies and inserts together)

Key	Catalog number	Size	Material	Length	Qty/pk	Price/pk
Barbed bodies						
O	JL-31311-13	1/2" tubing ID	PC	1.96" (49.8 mm)	5	
	JL-31311-23		PSF		5	
Hose barb coupling bodies with lock						
P	JL-31311-18	3/8" tubing ID	PC	1.96" (49.8 mm)	5	
	JL-31311-28		PSF		5	
Barbed inserts						
Q	JL-31311-63	1/2" tubing ID	PC	1.90" (48.3 mm)	5	
	JL-31311-73		PSF		1.40" (35.6 mm)	5



CPC™ High-Flow Quick-Disconnect Couplings

No more leaks—valved couplings automatically shut off flow

A complete quick-disconnect fitting consists of a body and an insert (order fitting halves separately). Plug insert into coupling body to connect—fitting halves lock into place immediately. To disconnect, simply press the button on the coupling body.

Valved models have a spring-operated 316 SS valve that seals the flow path when fitting halves are disengaged. All fitting bodies have 316 SS latch springs and EPDM seals.

Specifications

	Polypropylene	Polysulfone
Body material	Polypropylene	Polysulfone
Temperature range	32 to 160°F (0 to 71°C)	-40 to 280°F (-40 to 137°C)
Max pressure	60 psi	125 psi
Max vacuum	27.5" Hg	27.5" Hg
Sterilization	ETO or gamma	Autoclave, ETO, or gamma

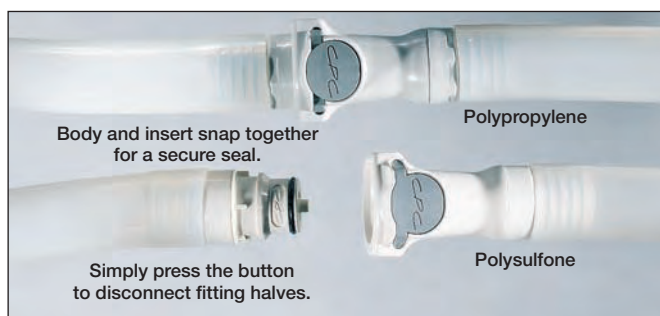

Buy More...Save More!

20% off on 100+
15% off on 50 to 99
10% off on 10 to 49 packs



A. 31303-00



D. 31303-30



B. 31303-10



E. 31303-40



C. 31303-20



F. 31303-50

Quick-Disconnect Bodies (Female Coupling Halves)

A. Threaded Adapter Bodies

Flow size	NPT(M)	Polypropylene		Polysulfone	
		Catalog number	Price/pk of 1	Catalog number	Price/pk of 1
Valved fittings					
3/8"	3/8"	JL-31303-00		JL-31307-00	
3/8"	1/2"	JL-31303-01		JL-31307-01	
3/8"	3/4"	JL-31303-02		JL-31307-02	
Straight-through fittings					
3/8"	3/8"	JL-31303-05		JL-31307-05	
3/8"	1/2"	JL-31303-06		JL-31307-06	
3/8"	3/4"	JL-31303-07		JL-31307-07	

B. Hose Barb Bodies

Flow size	Tube ID	Polypropylene		Polysulfone	
		Catalog number	Price/pk of 1	Catalog number	Price/pk of 1
Valved fittings					
3/8"	3/8"	JL-31303-10		JL-31307-10	
3/8"	1/2"	JL-31303-11		JL-31307-11	
3/8"	5/8"	JL-31303-12		JL-31307-12	
3/8"	3/4"	JL-31303-13		JL-31307-13	
Straight-through fittings					
3/8"	3/8"	JL-31303-15		JL-31307-15	
3/8"	1/2"	JL-31303-16		JL-31307-16	
3/8"	5/8"	JL-31303-17		JL-31307-17	
3/8"	3/4"	JL-31303-18		JL-31307-18	

C. Bulkhead Panel Mount Hose Barb Bodies

Flow size	Tube ID	Polypropylene		Polysulfone	
		Catalog number	Price/pk of 1	Catalog number	Price/pk of 1
Valved fittings					
3/8"	3/8"	JL-31303-20		JL-31307-20	
3/8"	1/2"	JL-31303-21		JL-31307-21	
3/8"	5/8"	JL-31303-22		JL-31307-22	
3/8"	3/4"	JL-31303-23		JL-31307-23	
Straight-through fittings					
3/8"	3/8"	JL-31303-25		JL-31307-25	
3/8"	1/2"	JL-31303-26		JL-31307-26	
3/8"	5/8"	JL-31303-27		JL-31307-27	
3/8"	3/4"	JL-31303-28		JL-31307-28	

Quick-Disconnect Inserts (Male Coupling Halves)

D. Male Threaded Inserts

Flow size	NPT(M)	Polypropylene		Polysulfone	
		Catalog number	Price/pk of 1	Catalog number	Price/pk of 1
Valved fittings					
3/8"	3/8"	JL-31303-35		JL-31307-35	
3/8"	1/2"	JL-31303-36		JL-31307-36	
3/8"	3/4"	JL-31303-37		JL-31307-37	
Straight-through fittings					
3/8"	3/8"	JL-31303-30		JL-31307-30	
3/8"	1/2"	JL-31303-31		JL-31307-31	
3/8"	3/4"	JL-31303-32		JL-31307-32	

E. Hose Barb Inserts

Flow size	Tube ID	Polypropylene		Polysulfone	
		Catalog number	Price/pk of 1	Catalog number	Price/pk of 1
Valved fittings					
3/8"	3/8"	JL-31303-45		JL-31307-45	
3/8"	1/2"	JL-31303-46		JL-31307-46	
3/8"	5/8"	JL-31303-47		JL-31307-47	
3/8"	3/4"	JL-31303-48		JL-31307-48	
Straight-through fittings					
3/8"	3/8"	JL-31303-40		JL-31307-40	
3/8"	1/2"	JL-31303-41		JL-31307-41	
3/8"	5/8"	JL-31303-42		JL-31307-42	
3/8"	3/4"	JL-31303-43		JL-31307-43	

F. Elbow Hose Barb Inserts

Flow size	Tube ID	Polypropylene		Polysulfone	
		Catalog number	Price/pk of 1	Catalog number	Price/pk of 1
Valved fittings					
3/8"	3/8"	JL-31303-55		JL-31307-55	
3/8"	1/2"	JL-31303-56		JL-31307-56	
Straight-through fittings					
3/8"	3/8"	JL-31303-50		JL-31307-50	
3/8"	1/2"	JL-31303-51		JL-31307-51	

Find even more online! Go to ColeParmer.com to search more than 100,000 products.

Fluid Handling

Fittings

Cole-Parmer® Polypropylene (PP) and PVDF Sanitary Clamp Fittings

Maintain sanitary conditions in your processes

- Meet USP Class VI for pharmaceutical use and FDA, USDA, and 3A standards for food contact
- All fittings are compatible with Tri-Clamp® fittings
- Excellent chemical resistance; low leachable characteristics

Note: Though both materials may be autoclaved, PVDF tolerates high temperatures better than PP does and will perform more consistently after repeated autoclaving.



Clamp size	PP		PVDF	
	Cat. no.	Price	Cat. no.	Price
A. Eccentric reducers				
1 1/2" x 3/4" mini	JL-31805-01		JL-31808-01	
B. Concentric reducers				
1" ladish x 3/4" mini	JL-31805-05		JL-31808-05	
1 1/2" x 3/4" mini	JL-31805-06		JL-31808-06	
1 1/2" x 1" ladish	JL-31805-10		JL-31808-10	
2" x 1" ladish	JL-31805-11		JL-31808-11	
2" x 1 1/2"	JL-31805-14		JL-31808-14	
C. Barbed adapters, clamp x tubing ID				
3/4" mini x 1/8"	JL-31805-24		JL-31808-24	
3/4" mini x 1/4"	JL-31805-25		JL-31808-25	
3/4" mini x 3/8"	JL-31805-26		JL-31808-26	
3/4" mini x 1/2"	JL-31805-27		JL-31808-27	
3/4" mini x 5/8"	JL-31805-28		JL-31808-28	
3/4" mini x 3/4"	JL-31805-29		JL-31808-29	
1" ladish x 1/8"	JL-31805-30		JL-31808-30	
1" ladish x 1/4"	JL-31805-31		JL-31808-31	
1" ladish x 3/8"	JL-31805-32		JL-31808-32	
1" ladish x 1/2"	JL-31805-33		JL-31808-33	
1" ladish x 3/4"	JL-31805-34		JL-31808-34	
1" ladish x 1"	JL-31805-35		JL-31808-35	
1 1/2" x 1"	JL-31805-41		JL-31808-41	
2" x 1"	JL-31805-47		JL-31808-47	
D. Pipe thread adapters, clamp x NPT(M)				
1" ladish x 1/8"	JL-31805-56		JL-31808-56	
1" ladish x 1/4"	JL-31805-57		JL-31808-57	
1" ladish x 3/8"	JL-31805-58		JL-31808-58	
1" ladish x 1/2"	JL-31805-59		JL-31808-59	
1" ladish x 3/4"	JL-31805-60		JL-31808-60	
1" ladish x 1"	JL-31805-61		JL-31808-61	
1" ladish x 1 1/4"	JL-31805-62		JL-31808-62	
1" ladish x 1 1/2"	JL-31805-63		JL-31808-63	
1 1/2" x 3/4"	JL-31805-68		JL-31808-68	
1 1/2" x 1"	JL-31805-69		JL-31808-69	
1 1/2" x 1 1/4"	JL-31805-70		JL-31808-70	
1 1/2" x 1 1/2"	JL-31805-71		JL-31808-71	
2" x 1"	JL-31805-77		JL-31808-77	
2" x 1 1/4"	JL-31805-78		JL-31808-78	
2" x 1 1/2"	JL-31805-79		JL-31808-79	
2" x 2"	JL-31805-80		JL-31808-80	
E. Pipe thread adapters, clamp x NPT(F)				
1" ladish x 3/4"	JL-31806-04		JL-31809-04	
1" ladish x 1"	JL-31806-05		JL-31809-05	
1 1/2" x 1 1/2"	JL-31806-15		JL-31809-15	
F. 90° elbows				
3/4" mini	JL-31806-41		JL-31809-41	
1" ladish	JL-31806-42		JL-31809-42	
1 1/2"	JL-31806-43		JL-31809-43	
2"	JL-31806-44		JL-31809-44	
G. 45° elbows				
3/4" mini	JL-31806-51		JL-31809-51	
1" ladish	JL-31806-52		JL-31809-52	
1 1/2"	JL-31806-53		JL-31809-53	
2"	JL-31806-54		JL-31809-54	
H. Standard tees				
3/4" mini	JL-31806-61		JL-31809-61	
1" ladish	JL-31806-62		JL-31809-62	
1 1/2"	JL-31806-63		JL-31809-63	
2"	JL-31806-64		JL-31809-64	
I. Clamps				
3/4" mini	—	—	JL-31811-00	
1" and 1 1/2"	—	—	JL-31811-01	
2"	—	—	JL-31811-02	
2 1/2"	—	—	JL-31811-03	



Specifications

Clamp size	Inner dimension (based on SS tube ID)
3/4" mini	9/16"
1" maxi	7/8"
1" ladish†	7/8"
1 1/2"	1 3/8"
2"	1 7/8"
2 1/2"	2 3/8"
3"	2 7/8"

†Choose 1" ladish fittings for a direct match with 1" stainless steel sanitary connections.

Chemical resistance

PP: very good PVDF: excellent

Temperature range

PP: 15 to 180°F (-9 to 82°C)
PVDF: -40 to 280°F (-40 to 138°C)

Max pressure

In ambient conditions, using plastic true union style clamp
PP: 125 psi PVDF: 150 psi

Sterilization: ETO or autoclave

J. Nylon Clamps

Clamp size	Catalog number	Price
1/2" to 3/4"	JL-30508-21	
1" to 1 1/2"	JL-30508-23	
2"	JL-30508-25	
3"	JL-30508-27	
4"	JL-30508-29	

Gaskets (not shown)

Gasket size	Catalog number	Price
Platinum-cured silicone		
3/4" mini	JL-30548-00	
1" ladish	JL-30548-02	
1 1/2"	JL-30548-04	
2"	JL-30548-06	
2 1/2"	JL-30548-08	
Viton®		
3/4" mini	JL-30548-20	
1" ladish	JL-30548-22	
1 1/2"	JL-30548-24	
2"	JL-30548-26	
2 1/2"	JL-30548-28	
Buna N		
3/4" mini	JL-30548-40	
1" ladish	JL-30548-42	
1 1/2"	JL-30548-44	
2"	JL-30548-46	
2 1/2"	JL-30548-48	
EPDM		
3/4" mini	JL-30548-60	
1" ladish	JL-30548-62	
1 1/2"	JL-30548-64	
2"	JL-30548-66	
2 1/2"	JL-30548-68	
PTFE		
3/4" mini	JL-30548-80	
1" ladish	JL-30548-82	
1 1/2"	JL-30548-84	
2"	JL-30548-86	
2 1/2"	JL-30548-88	

Cole-Parmer® 316L and 304 Stainless Steel Sanitary Clamp Couplings

Meet FDA requirements and 3A Sanitary Standards



All couplings are compatible with standard 304L fittings clamps.

316L Stainless Steel Couplings are ideal for the pharmaceutical industry; they offer great chemical compatibility for use with corrosive acids and bases.

304 Stainless Steel Couplings are ideal for the food, beverage, and dairy industries; they offer good chemical compatibility and are cost effective.



Key	Clamp size	316L stainless steel		304 stainless steel	
		Catalog number	Price	Catalog number	Price
Concentric reducers					
A	1" x ¾"	JL-30700-50	—	—	—
	1½" x 1"	JL-30700-51	—	JL-30700-95	—
	2" x 1"	JL-30700-52	—	JL-30700-96	—
	2" x 1½"	JL-30700-53	—	JL-30700-97	—
Eccentric reducers					
B	1" x ¾"	JL-30700-54	—	—	—
	1½" x 1"	JL-30700-55	—	JL-30700-98	—
	2" x 1"	JL-30700-56	—	JL-30700-99	—
	2" x 1½"	JL-30700-57	—	JL-30701-00	—
Barbed adapters					
C	¾" x ⅛"	JL-30700-58	—	—	—
	¾" x ¼"	JL-30700-59	—	—	—
	¾" x ⅜"	JL-30700-60	—	—	—
	¾" x ½"	JL-30700-61	—	—	—
	¾" x ¾"	JL-30700-62	—	—	—
	1" x 1"	JL-30700-63	—	JL-30800-50	—
	1½" x 1½"	JL-30700-64	—	JL-30800-51	—
	2" x 2"	JL-30700-65	—	JL-30800-52	—
Threaded adapters, clamp x NPT(M)					
D	¾" x ⅛"	JL-30700-66	—	—	—
	¾" x ¼"	JL-30700-67	—	—	—
	¾" x ⅜"	JL-30700-68	—	—	—
	¾" x ½"	JL-30700-69	—	—	—
	¾" x ¾"	JL-30700-70	—	—	—
	1" x ¾"	JL-30700-71	—	JL-30800-53	—
	1" x 1"	JL-30700-72	—	JL-30800-54	—
	1" x 1½"	JL-30700-74	—	JL-30800-55	—
	1" x 2"	JL-30700-75	—	JL-30800-56	—
	1½" x ¾"	JL-30700-76	—	JL-30800-57	—
	1½" x 1"	JL-30700-77	—	JL-30800-58	—
	1½" x 1¼"	JL-30700-78	—	JL-30800-59	—
	1½" x 1½"	JL-30700-79	—	JL-30800-60	—
	1½" x 2"	—	—	JL-30800-61	—
90° elbows					
E	¾"	JL-30700-80	—	—	—
	1"	JL-30700-81	—	JL-30800-62	—
	1½"	JL-30700-82	—	JL-30800-63	—
	2"	JL-30700-83	—	JL-30800-64	—
45° elbows					
F	¾"	JL-30700-84	—	—	—
	1"	JL-30700-85	—	JL-30800-65	—
	1½"	JL-30700-86	—	JL-30800-66	—
	2"	JL-30700-87	—	JL-30800-67	—
Tees					
G	¾"	JL-30700-88	—	—	—
	1"	JL-30700-89	—	JL-30800-68	—
	1½"	JL-30700-90	—	JL-30800-69	—
	2"	JL-30700-91	—	JL-30800-70	—
Crosses					
H	1"	JL-30700-92	—	JL-30800-71	—
	1½"	JL-30700-93	—	JL-30800-72	—
	2"	JL-30700-94	—	JL-30800-73	—
Clamps					
I	½" to ¾"	—	—	JL-30800-74	—
	1" to 1½"	—	—	JL-30800-75	—
	2"	—	—	JL-30800-76	—
	2½"	—	—	JL-30800-77	—
	3"	—	—	JL-30800-78	—
	4"	—	—	JL-30800-80	—



A



B



C

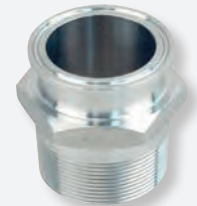

D

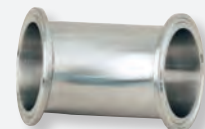

F



E

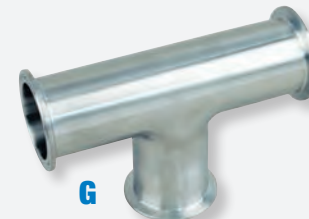

G



H



I

Fluid Handling

Fittings

Advantec® Glass and Quartz Fiber Filters

Ideal for analytical or gravimetric studies

Borosilicate Glass Fiber Filters create a biologically inert filter matrix that is resistant to both chemicals and pH extremes. Use as prefilters to extend membrane life, for water/air pollution analysis, or liquid clarification. Filters without binder withstand up to 932°F (500°C); filters with binder withstand up to 250°F (120°C). Grades GC90, GS25, and DP70 with binder offer higher wet strength and lower fiber release.

Quartz Fiber Filters have very low trace metal content and can withstand temperatures up to 1832°F (1000°C). Use to sample acidic gases at high temperatures or for air pollution analysis.



Specifications

Grade	Characteristics/applications
Borosilicate glass fiber filters	
GA55	General purpose; air pollution monitoring
GB140	Low absorption; slower filtration speed for industrial waste analysis
GC50	Membrane prefilter (<0.45 µm), for industrial and wastewater analysis and scintillation counting
GD120	Membrane prefilter (<1.2 µm), high wet strength and high loading capacity
GF75	Highest retention; filtering very fine protein precipitates and clarifying chemically aggressive solutions
GA100	General purpose; filtering cells and precipitated proteins; air pollution monitoring
GA200	Thick filter; filtering viscous fluids such as liquid sugars and gels
GB100R	Low trace metal content; sampling high and low volume aerosols for airborne dust and metal contaminants
GC90	High wet strength
GS25	Membrane prefilter (<0.65 µm), high wet strength
DP70	High wet strength and very high loading capacity; dust and fine particulate sampling
Quartz fiber filters	
QR200	Low adsorption; high-temperature filtration and monitoring airborne particulates
QR100	Superior chemical resistance, will not absorb acidic gases



Filter 06646-35 shown with stainless steel filtration holder 29900-05 (holder sold separately on page 64)

Grade	Retention	Thickness	Water flow rate†	Binder	25-mm dia	47-mm dia	90-mm dia	125-mm dia	142-mm dia	293-mm dia
					Cat. no. / Price	Cat. no. / Price	Cat. no. / Price	Cat. no. / Price	Cat. no. / Price	Cat. no. / Price
Borosilicate glass fiber filters										
GA55	0.6 µm	0.21 mm	23	None	JL-06657-00 /bx of 100	JL-06646-02 /bx of 100	JL-06646-04 /bx of 100	JL-06646-05 /bx of 100	JL-06657-07 /bx of 100	—
GB140	0.4 µm	0.56 mm	58	None	JL-06646-84 /bx of 100	JL-06646-12 /bx of 100	JL-06646-14 /bx of 100	JL-06646-15 /bx of 100	JL-06657-17 /bx of 100	JL-06657-18 /bx of 50
GC50	0.5 µm	0.19 mm	28	None	JL-06647-95 /bx of 100	JL-06646-22 /bx of 100	JL-06646-24 /bx of 100	JL-06646-25 /bx of 100	JL-06657-27 /bx of 100	JL-06657-28 /bx of 50
GD120	0.9 µm	0.51 mm	14	None	JL-06657-30 /bx of 50	JL-06646-32 /bx of 50	JL-06646-34 /bx of 50	JL-06646-35 /bx of 50	JL-06657-37 /bx of 50	JL-06656-13 /bx of 50
GF75	0.3 µm	0.35 mm	84	None	JL-06656-24 /bx of 100	JL-06646-42 /bx of 100	JL-06646-44 /bx of 100	JL-06646-45 /bx of 100	JL-06656-23 /bx of 100	JL-06656-25 /bx of 50
GA100	1.0 µm	0.44 mm	11	None	JL-06657-50 /bx of 100	JL-06646-54 /bx of 100	JL-06657-54 /bx of 100	JL-06657-56 /bx of 100	JL-06657-57 /bx of 100	JL-06657-58 /bx of 50
GA200	0.8 µm	0.74 mm	15	None	JL-06646-63 /bx of 50	JL-06657-62 /bx of 50	JL-06657-64 /bx of 50	JL-06657-66 /bx of 50	JL-06657-67 /bx of 50	JL-06657-68 /bx of 50
GB100R	0.6 µm	0.40 mm	15	None	JL-06657-70 /bx of 100	JL-06646-75 /bx of 100	JL-06646-83 /bx of 100	JL-06657-76 /bx of 100	JL-06657-77 /bx of 100	JL-06657-78 /bx of 50
GC90	0.5 µm	0.30 mm	20	Organic	JL-06657-80 /bx of 100	JL-06657-82 /bx of 100	JL-06656-12 /bx of 100	JL-06657-86 /bx of 100	JL-06657-87 /bx of 100	JL-06656-05 /bx of 50
GS25	0.6 µm	0.21 mm	15	Organic	JL-06657-90 /bx of 100	JL-06657-92 /bx of 100	JL-06657-94 /bx of 100	JL-06657-96 /bx of 100	JL-06657-97 /bx of 100	JL-06656-33 /bx of 50
DP70	0.6 µm	0.52 mm	20	Organic	JL-06658-00 /bx of 50	JL-06646-53 /bx of 50	JL-06658-04 /bx of 50	JL-06658-06 /bx of 50	JL-06658-07 /bx of 50	JL-06658-08 /bx of 50
Quartz fiber filters										
QR200	—	1.0 mm	—	Inorganic	JL-06658-08 /bx of 100	JL-06658-12 /bx of 50	JL-06658-14 /bx of 50	JL-06658-16 /bx of 50	—	—
QR100	—	0.38 mm	—	None	JL-06658-20 /bx of 100	JL-06649-52 /bx of 100	JL-06658-24 /bx of 100	JL-06658-26 /bx of 100	—	—

†Time (in seconds) required to filter one liter of deionized water at 68°F (20°C) through 9.6 cm² using a 300 mm Hg vacuum.



Cole-Parmer® Syringe Filters



Get easy, reliable filtration—just slip on and twist

- Easy identification—membrane type and pore size printed on each filter
- Filter more confidently—filters are 100% integrity tested and manufactured in accordance with ISO 9002 standards
- Get a secure fit—bidirectional membrane support and luer lock inlet/outlet
- Sterile filters are sterilized by gamma irradiation and certified nonpyrogenic, noncytotoxic, and blister packed

Glass Prefilters with Final Filter

- Save time—borosilicate glass fiber prefilter and cellulose filter in one
- Prefilter extends life of final filter by removing particulates from sample
- Reduces retention volume and sample loss



Membrane Type	Membrane Dia	Pore size	Housing	Retention volume	Qty/ bx	Catalog number	Price/ bx
Nonsterile filters							
Cellulose acetate	26 mm	0.20 µm	Acrylic	0.23 mL	100	JL-02915-90	
		0.45 µm				JL-02915-92	
		0.80 µm				JL-02915-94	
Sterile filter							
Cellulose acetate	26 mm	0.20 µm	Acrylic	0.23 mL	50	JL-02915-40	

Cellulose Acetate Filters

- Low protein binding—ideal for biological solutions
- Use for sterilization and clarification of aqueous solutions



Pore size	Membrane dia	Housing	Color	Qty/bx	Catalog number	Price/bx
Nonsterile filters						
0.22 µm	26 mm	Acrylic	Blue	100	JL-02915-60	
0.45 µm			Clear		JL-02915-58	
0.80 µm			Green		JL-02915-62	
Sterile filters						
0.22 µm	26 mm	Acrylic	Blue	50	JL-02915-12	
0.45 µm			Clear		JL-02915-00	
0.80 µm			Green		JL-02915-10	

Nylon Filters

- Low levels of extractables with no wetting agents
- Hydrophilic nylon for good chemical resistance—ideal for aqueous and most organics



Pore size	Membrane dia	Housing	Color	Qty/bx	Catalog number	Price/bx
Nonsterile filters						
0.22 µm	25 mm	PP	Natural	100	JL-02915-16	
0.45 µm					JL-02915-14	
Sterile filters						
0.20 µm	25 mm	PP	Red	50	JL-02915-04	
0.45 µm			Natural		JL-02915-02	

Teky's Tips



Choose the Right Filter!

Membrane type	Applications
Glass prefilter	One-step prefiltration and filtration. Choose the final membrane to meet your application needs. High particle loading capacity.
Cellulose acetate	Sterilization and clarification of aqueous solutions. Low protein binding.
Nylon	Filtration of organic and aqueous solutions. Low extractables.
PTFE	Sterilization of gases and alcohols; cleaning acids, alkalies, and organic solvents; venting purposes. For aggressive chemicals.
Nitrocellulose	High protein retention; microbiological analysis, waste water treatment; sterilization of aqueous solutions.

Specifications

Membrane dia	Housing type	Sample volume	Retention volume†	Pressure limit at 25°C	Max temp	Effective filtration area
15 mm	PP	≤5 mL	10 µL	87 psi	127°C	1.7 cm²
25 mm	PP	≤100 mL	0.1 mL	87 psi	127°C	4.8 cm²
26 mm	Acrylic	≤100 mL	0.1 mL	87 psi	50°C	5.3 cm²
50 mm	PP	≤2 L	0.5 mL	60 psi	134°C	20 cm²

†Varies for glass prefilters; see glass prefilter table below.

PTFE Filters

- Ideal for aggressive chemicals—organic solvents, concentrated acids and bases, propellants and more
- Use for gas/air filtration
- 50-mm membranes have stepped hose barb connectors for ¼" to ½" ID tubing



Pore size	Membrane dia	Housing	Color	Qty/bx	Cat. no.	Price/bx
Nonsterile filters						
0.20 µm	15 mm	PP	Natural	100	JL-29550-08	
0.45 µm					JL-29550-10	
0.20 µm	25 mm	PP	Natural	100	JL-02915-20	
0.45 µm					JL-02915-22	
0.20 µm	50 mm	PP	Natural	20	JL-02915-28	
0.45 µm					JL-02915-30	
Sterile filters						
0.20 µm	25 mm	PP	Natural	50	JL-02915-08	
0.50 µm					JL-02915-06	

Nitrocellulose Filters

- Good for macromolecules—highest protein retention
- Get fast flow rates with aqueous solutions
- Ideal for microbiological analysis, waste water treatment, and sterilization of aqueous solutions



Pore size	Membrane dia	Housing	Color	Qty/bx	Cat. no.	Price/bx
Nonsterile filter						
0.20 µm	26 mm	Acrylic	Blue	100	JL-02915-56	
Sterile filters						
0.20 µm	26 mm	Acrylic	Blue	50	JL-02915-52	
0.45 µm					JL-02915-53	



Sanitary holders feature connections that completely disassemble for easy cleaning.



90-mm pressure holder with reservoir 02926-54



Advantec® Pressure Filtration Holders

Stainless steel type 304 or 316 minimizes resistance and maximizes flow rate

– Model 02933-00 meets EPA specifications for EPA Hazardous Waste Toxicity Test

Pressure filtration holders maximize flow rates by applying positive pressure to the fluid over a broad membrane surface. Holders are autoclavable with one filter membrane that is sealed with removable wing nuts. All holders vent to release pressure.

Holders have PTFE gaskets, silicone O-rings, and PTFE-coated photoetched stainless steel support screens† to prevent nitrocellulose membranes from sticking. Holders process samples from an in-line system or pressure vessel. Available in stainless steel, stainless steel with a reservoir, and sanitary stainless steel.

Stainless Steel Holders are available in the following sizes: 90, 142, and 293 mm.

Stainless Steel Holders with Reservoir let you filter samples without a separate pressure-dispensing vessel. The 47-mm holder has a 200-mL capacity, the 90-mm holder has a 750-mL capacity, and the 142-mm holders have a 1500-mL capacity.

Sanitary Stainless Steel Holders are best used in-line to filter-sterilize liquids or gases. Sanitary inlet and outlet connections can be completely disassembled for thorough cleaning. Filter from 20 to 100 liters with our model 29900-00 pressure holder. Top plate has knobs for easy positioning over membrane.

Holder material	Filter dia	Prefilter dia	Filtration area	Max pressure psi (bar)	Included adapter size (mm ID)	Dimensions (H x dia)	Catalog number	Price
Stainless steel holders								
304 SS	90 mm	75 mm	45.3 cm ²	100 (7)	3/4" NPT†† to 11	13 1/2" x 5 1/4" (34.3 x 13.3 cm)	JL-02926-50†	
316 SS	90 mm	75 mm	45.3 cm ²	100 (7)	3/4" NPT†† to 11	13 1/2" x 5 1/4" (34.3 x 13.3 cm)	JL-29902-06	
304 SS	142 mm	124 mm	113.0 cm ²	100 (7)	3/4" NPT†† to 11	16 3/4" x 7 1/4" (42.5 x 18.4 cm)	JL-02927-50	
316 SS	142 mm	124 mm	113.0 cm ²	100 (7)	3/4" NPT†† to 11	16 3/4" x 7 1/4" (42.5 x 18.4 cm)	JL-29900-02	
304 SS	293 mm	257 mm	530.0 cm ²	100 (7)	3/4" NPT†† to 16	16" x 14" (40.6 x 35.6 cm)	JL-29900-04	
316 SS	293 mm	257 mm	530.0 cm ²	100 (7)	3/4" NPT†† to 16	16" x 14" (40.6 x 35.6 cm)	JL-02930-00	
Stainless steel holders with reservoir								
304 SS	47 mm	35 mm	12.5 cm ²	71 (4.9)	1/4" NPT(F) to 10	14 1/4" x 2 3/4" (36.2 x 7 cm)	JL-02926-32	
304 SS	90 mm	75 mm	45.0 cm ²	71 (4.9)	Inlet: 1/4" NPT(F) to 7-13 Outlet: 3/4" NPT(F) to 11	17 3/8" x 5 1/4" (44 x 13.3 cm)	JL-02926-54	
316 SS	90 mm	75 mm	45.0 cm ²	71 (4.9)	Inlet: 1/4" NPT(F) to 7-13 Outlet: 3/4" NPT(F) to 11	17 3/8" x 5 1/4" (44 x 13.3 cm)	JL-29902-68	
304 SS	142 mm	124 mm	113.0 cm ²	71 (4.9)	Inlet: 1/4" NPT(F) to 7-13 Outlet: 3/4" NPT(F) to 11	23" x 7 1/4" (58.4 x 18.4 cm)	JL-02927-00†	
316 SS	142 mm	124 mm	113.0 cm ²	71 (4.9)	Inlet: 1/4" NPT(F) to 7-13 Outlet: 3/4" NPT(F) to 11	23" x 7 1/4" (58.4 x 18.4 cm)	JL-02933-00†	
Sanitary stainless steel holders								
316 SS	90 mm	75 mm	45.0 cm ²	100 (7)	1 1/2" sanitary to 11	14" x 5 1/4" (35.6 x 13.3 cm)	JL-29900-00	
304 SS	142 mm	124 mm	113.0 cm ²	100 (7)	1 1/2" sanitary to 11	16 3/4" x 7 1/4" (42.5 x 18.4 cm)	JL-29900-06	
316 SS	142 mm	124 mm	113.0 cm ²	100 (7)	1 1/2" sanitary to 11	16 3/4" x 7 1/4" (42.5 x 18.4 cm)	JL-29900-05	
304 SS	293 mm	257 mm	530.0 cm ²	100 (7)	1 1/2" sanitary to 11	16" x 14" (40.6 x 35.6 cm)	JL-29900-08	
316 SS	293 mm	257 mm	530.0 cm ²	100 (7)	1 1/2" sanitary to 11	16" x 14" (40.6 x 35.6 cm)	JL-29900-10	

†Model 02926-50 has a 304 SS support screen. ††Meets specifications for EPA Hazardous Waste Toxicity Test.
††Includes one NPT(M) adapter and one NPT(F) adapter.

Pressure Vessels

Use these electropolished stainless steel pressure vessels to propel filtration fluids through pressure holders by applying external pressure from compressed gases. Increasing pressure increases the efficiency of the EPR (ethylene propylene rubber) O-ring seal.

Vessels feature 5 7/8" x 4 7/8" (14.9 x 12.3 cm) wide-mouth opening for easy cleaning, SS dip tube, and molded neoprene rubber base for stability. Intake for the dip tube, located at the deepest point in the vessel, minimizes fluid loss to 6.0 mL. Sterilize vessels at 250°F (121°C) for 30 minutes. Make connections to four 1/4" NPT(F) ports. Pressure vessels are ASME certified.

Material	304 SS	316 SS	304 SS	316 SS	304 SS	316 SS	304 SS	316 SS
Capacity	1 gal. (3.78 L)		3 gal. (11.3 L)		5 gal. (18.9 L)		8 gal. (30.2 L)	
Height	8 1/2" (21.6 cm)		15 1/2" (39.4 cm)		22 1/2" (57.2 cm)		21 1/8" (53.5 cm)	
Inside diameter	9" (22.9 cm)		9" (22.9 cm)		9" (22.9 cm)		12" (30.5 cm)	
Max temperature	300°F (149°C)		300°F (149°C)		300°F (149°C)		300°F (149°C)	
Max pressure	125 psi (8.5 bar)		125 psi (8.5 bar)		125 psi (8.5 bar)		110 psi (7.5 bar)	
Price								



Double-Open-End Liquid Filter Cartridges

A. Bonded Gradient-Density Cartridges. Ideal for removing a broad range of deformable and nondeformable particles. Rigid designs ideal for filtering high-solids, higher-viscosity fluids that require higher differential pressures. Polypropylene fiber medium is thermally bonded to a rigid core for added durability. Cartridges impart no taste, odor or color; suitable to 175°F (79°C).

µm rating, nominal	Flow rate†	Length	Catalog number	Price
1	2 GPM at <2 psid	10" (25.4 cm)	JL-01512-00	
5			JL-01512-08	
10			JL-01512-18	
25			JL-01512-28	
50			JL-01512-38	
1	5 GPM at <2 psid	20" (50.8 cm)	JL-01512-02	
5			JL-01512-12	
10			JL-01512-22	
25			JL-01512-32	
50			JL-01512-42	

B. String-Wound Gradient-Density Cartridges. Ideal for removing a broad range of deformable and non-deformable particles such as sand, silt, sludge, rust, and scale. String-wind pattern has lower pressure drop for higher flow. Polypropylene string is resistant to chemical and bacterial attack; suitable to 150°F (66°C).

µm rating, nominal	Flow rate†	Length	Catalog number	Price
5	10 GPM at <1 psid	10" (25.4 cm)	JL-01513-00	
30			JL-01513-02	
50			JL-01513-04	

C. Spun Gradient-Density Cartridges. Ideal for removing a broad range of deformable and non-deformable particles such as sand, silt, sludge, rust, and scale. Polypropylene construction is resistant to chemical and bacterial attack. One-micron and five-micron cartridges are certified to NSF Standard 42 for materials and impart no taste, odor, or color. Suitable to 145°F (63°C).

µm rating, nominal	Flow rate†	Length	Cat. no.	Price
1	5 GPM at 0.6 psid	10" (25.4 cm)	JL-01509-14	/ea
5	5 GPM at 0.2 psid		JL-01509-15	/pk of 2
1	10 GPM at 0.6 psid	20" (50.8 cm)	JL-01509-37	/ea
5	10 GPM at 0.6 psid		JL-01509-40	/ea
25	10 GPM at 0.2 psid		JL-01509-41	/ea

D. High-Efficiency Pleated Filter Cartridges. The pleated polypropylene (PP) design offers flow rates and dirt-loading capacities higher than spun or wound depth cartridges. Biologically safe and designed to meet FDA requirements for regulated industries. All-PP construction provides broad chemical compatibility. The gradient density microfiber media provides removal of a broader range of particle sizes than typical pleated filters. Suitable to 122°F (50°C).

µm rating, nominal	Flow rate†	Length	Catalog number	Price
0.2	2 GPM at 1 psid	10" (25.4 cm)	JL-29830-00	
	2 GPM at <1 psid	20" (50.8 cm)	JL-29830-01	

†psid refers to pounds per square inch pressure drop through the filter system. For optimal performance, change cartridges at 25 psid.

‡To use with aqueous solutions, prewet with methanol, then rinse with water before use.

†††Pore sizes for polypropylene cartridges are nominal.

††††Filtration efficiency and chlorine reduction efficiency are reduced at higher flow rates; chlorine capacity based on 75% reduction using 2 ppm free chlorine feed concentration at 68°F (20°C).

E. Extra-Strength Pleated Cellulose Cartridges. This cellulose cartridge is blended with polyester for better wet strength. The polyester material allows more pleats to improve flow and dirt loading. Suitable to 165°F (74°C).

µm rating, nominal	Flow rate†	Length	Catalog number	Price
1	15 GPM at <1 psid	10" (25.4 cm)	JL-01509-11	
5			JL-01509-09	

F. Filter Cartridges for Ultrapure Applications. These cartridges are autoclavable to 250°F (121°C) and in-line sterilizable to 257°F (125°C) for up to 30-minute cycles. They are tolerant to an accumulated exposure of 10 hours. The filters may also be sanitized with compatible chemical agents. All cartridges are suitable to 180°F (82°C) at 10 psid.

The cartridges comply with U.S. CFR Title 21 guidelines for repeated food contact, comply with USP Class VI, 121°C Plastics guidelines, and pass the MEM Elution Cytotoxicity Test. Aqueous extracts contain less than 0.25 EU/mL.

Multi-Layer Nylon Cartridges. These consist of two pleated nylon membranes with the top acting as a prefilter to increase cartridge life and efficiency.

Glass Microfiber Cartridges. Made of resin-bonded borosilicate glass microfibers that do not leach flavor-altering substances. Meet NSF Standard 53 for the reduction of cysts. Ideal as prefilters to protect membrane filter/RO systems.

Polypropylene (PP) Cartridges. Thermally bonded high-purity PP fiber. Economical for a chemically inert media with high dirt-loading capacity. Suitable for air/gas filtration; FDA-acceptable. Hydrophobic; prewet before liquid filtration.†

Pleated PTFE Cartridges. Clean room-constructed using thermal welding instead of adhesives or additives. Ideal for the more aggressive liquid or air/gas filtration applications. Hydrophobic; prewet before liquid filtration.†

Semiconductor Cartridges. Single-layer PES membrane over PP core. Each is flushed with high-purity water to leach less than 5 ppb TOC and less than 5 ppb trace metals. Ideal for any high-purity chemical or DI water application.

Cartridge type	µm rating††	Length	Catalog number	Price
Serial nylon	0.2	10" (25.4 cm)	JL-06479-16	
	0.45		JL-06479-20	
Glass fiber	3.0	10" (25.4 cm)	JL-06479-24	
	1.0		JL-06479-32	
Polypropylene	3.0	10" (25.4 cm)	JL-06479-36	
	1.0		JL-06479-40	
Polypropylene	5	10" (25.4 cm)	JL-06479-44	
	10		JL-06479-48	
PTFE	0.1	10" (25.4 cm)	JL-06479-48	
	0.2		JL-06479-52	
Semiconductor	0.2	10" (25.4 cm)	JL-06479-60	

G. Economical Carbon-Impregnated Cartridges. These cellulose cartridges remove organic tastes/odors and chlorine, plus reduce sediment. Best suited for chemically neutral waters with lower chlorine concentrations. The 10" cartridge can treat approximately 2500 gallons at 1 GPM for chlorine†††. The 10" cartridge meets NSF Standard 42 for materials. Suitable to 125°F (52°C).

µm rating, nominal	Flow rate††	Length	Catalog number	Price
5	5 GPM at 4.0 psid	10" (25.4 cm)	JL-01509-25	
	5 GPM at 1.0 psid	20" (50.8 cm)	JL-01509-27	

Cole-Parmer® Acrylic Variable-Area Flowmeters for Bench or Panel Mount

Don't sacrifice durability for precision

- Easily and precisely control flow of your application via manual valve
- Durable acrylic bodies with integral metering tubes for accurate readings
- Stand up to even aggressive plant environments
- Versatile—easy panel installation or move from bench to bench with optional tripod base 32462-50 (order separately at ColeParmer.com)



Specifications

Accuracy:

2" and 50-mm models: ±5% FS
4" and 100-mm models: ±3% FS
5" and 127-mm models: ±2% FS

Max operating temp: 150°F (65°C)

Connections:

2", 4", 50-mm, and 100-mm models: 1/8" NPT(F)[†]
5" and 127-mm models: 1" NPT(F)

Media type: liquids or gases

Max pressure: 100 psi (6.9 bar)

Materials of construction

Part	2" and 50 mm	4" and 100 mm	5" and 127 mm
Body	Acrylic		
Fittings	Brass		PVC
O-rings	Buna N		
Float	Black glass (BG), Aluminum (AL)	316 Stainless steel (SS)	



32461-60 flowmeter shown on tripod base 32462-50

Flowmeters with Valves; English-Unit Scale

Float [‡]	For liquid applications			For air applications		
	Flow range	Cat. no.	Price	Flow range	Cat. no.	Price
Flowmeters with 2" scale						
BG	0.2–2 GPH	JL-32460-00	—	0.1–1 scfh	JL-32460-10	—
SS	0.4–5 GPH	JL-32460-02	—	0.2–2 scfh	JL-32460-12	—
BG	1–10 GPH	JL-32460-04	—	0.4–5 scfh	JL-32460-14	—
SS	2–20 GPH	JL-32460-06	—	0.5–10 scfh	JL-32460-16	—
SS	4–40 GPH	JL-32460-08	—	2–20 scfh	JL-32460-18	—
SS	—	—	—	3–30 scfh	JL-32460-20	—
BG	—	—	—	4–50 scfh	JL-32460-22	—
SS	—	—	—	10–100 scfh	JL-32460-24	—
SS	—	—	—	20–200 scfh	JL-32460-26	—
Flowmeters with 4" scale						
SS	1–10 GPH	JL-32461-00	—	0.4–5 scfh	JL-32461-10	—
SS	2–25 GPH	JL-32461-02	—	1–10 scfh	JL-32461-12	—
SS	4–50 GPH	JL-32461-04	—	2–20 scfh	JL-32461-14	—
SS	6–60 GPH	JL-32461-06	—	4–40 scfh	JL-32461-16	—
SS	0.2–2.5 GPM	JL-32461-07[†]	—	10–100 scfh	JL-32461-18	—
SS	0.4–5 GPM	JL-32461-08[†]	—	14–150 scfh	JL-32461-20	—
SS	—	—	—	20–200 scfh	JL-32461-22	—
AL	—	—	—	0.5–5 scfm	JL-32461-24[†]	—
SS	—	—	—	1–10 scfm	JL-32461-26[†]	—
Flowmeters with 5" scale						
SS	1–10 GPM	JL-32466-50	—	3–25 scfm	JL-32466-60	—
SS	2–20 GPM	JL-32466-52	—	4–50 scfm	JL-32466-62	—

[†]These models have dual scale: GPM/GPH, scfm/scfh, LPM/LPH; they also have 1/4" NPT(F) connections and use optional tripod base 32462-60 sold separately online.
[‡]Float material key: BG = black glass, SS = stainless steel, AL = aluminum.

Flowmeters without Valves; English-Unit Scales

Float [‡]	For liquid applications			For air applications		
	Flow range	Cat. no.	Price	Flow range	Cat. no.	Price
Flowmeters with 4" scale						
SS	1–10 GPH	JL-32458-00	—	0.4–5 scfh	JL-32458-10	—
SS	—	—	—	0.5–5 scfm	JL-32458-24[†]	—
SS	—	—	—	1–10 scfm	JL-32458-26[†]	—
Flowmeters with 5" scale						
SS	0.4–5 GPM	JL-32462-00	—	3–25 scfm	JL-32458-10	—
SS	2–20 GPM	JL-32462-04	—	10–100 scfm	JL-32458-14	—

Flowmeters with Valves; Metric-Unit Scales

Float [‡]	For liquid applications			For air applications		
	Flow range (mL/min)	Catalog number	Price	Flow range (LPM)	Catalog number	Price
Flowmeters with 50-mm scale						
BG	5 to 50	JL-32460-30	—	0.04 to 0.5	JL-32460-40	—
SS	10 to 100	JL-32460-32	—	0.1 to 1	JL-32460-42	—
SS	20 to 240	JL-32460-34	—	0.4 to 5	JL-32460-44	—
SS	—	—	—	1 to 10	JL-32460-46	—
AL	—	—	—	2 to 25	JL-32460-48	—
SS	—	—	—	4 to 50	JL-32460-50	—
SS	—	—	—	10 to 100	JL-32460-52	—
Flowmeters with 100-mm scale						
SS	4 to 50	JL-32461-30	—	0.4 to 5	JL-32461-50	—
SS	10 to 120	JL-32461-32	—	1 to 10	JL-32461-52	—
BG	25 to 225	JL-32461-34	—	2 to 20	JL-32461-54	—
SS	40 to 400	JL-32461-36	—	3 to 30	JL-32461-56	—
SS	40 to 660	JL-32461-38	—	4 to 50	JL-32461-58	—
SS	100 to 1500	JL-32461-40	—	10 to 100	JL-32461-60	—
SS	200 to 3000	JL-32461-42	—	14 to 140	JL-32461-62[†]	—
SS	0.8 to 9 LPM	JL-32461-44[†]	—	30 to 280	JL-32461-64[†]	—
SS	1.5 to 20 LPM	JL-32461-46[†]	—	—	—	—
Flowmeters with 127-mm scale						
SS	4 to 36 LPM	JL-32466-54	—	100 to 700	JL-32466-66	—
SS	—	—	—	400 to 3400	JL-32466-70	—

Flowmeters without Valves; Metric-Unit Scales

Float [‡]	For liquid applications			For air applications		
	Flow range (mL/min)	Catalog number	Price	Flow range (LPM)	Catalog number	Price
Flowmeters with 50-mm scale						
BG	5 to 50	JL-32457-30	—	0.04 to 0.5	JL-32457-40	—
BG	10 to 100	JL-32457-32	—	0.1 to 1	JL-32457-42	—
SS	20 to 240	JL-32457-34	—	0.4 to 5	JL-32457-44	—
SS	—	—	—	1 to 10	JL-32457-46	—
Flowmeters with 100-mm scale						
BG	4 to 50	JL-32458-30	—	0.4 to 5	JL-32458-50	—
SS	10 to 120	JL-32458-32	—	1 to 10	JL-32458-52	—
BG	25 to 225	JL-32458-34	—	2 to 20	JL-32458-54	—
SS	40 to 400	JL-32458-36	—	3 to 30	JL-32458-56	—
SS	40 to 660	JL-32458-38	—	4 to 50	JL-32458-58	—
SS	100 to 1500	JL-32458-40	—	10 to 100	JL-32458-60	—
SS	200 to 3000	JL-32458-42	—	14 to 140	JL-32458-62[†]	—
SS	0.8 to 9 LPM	JL-32458-44[†]	—	30 to 280	JL-32458-64[†]	—
SS	1.5 to 20 LPM	JL-32458-46[†]	—	80 to 560	JL-32458-65[†]	—
Flowmeters with 127-mm scale						
SS	1 to 15 LPM	JL-32462-20	—	100 to 700	JL-32462-30	—
SS	4 to 36 LPM	JL-32462-22	—	100 to 1400	JL-32462-32	—
SS	5 to 75 LPM	JL-32462-24	—	400 to 3000	JL-32462-34	—



Cole-Parmer® Panel-Mount Flowmeters

No more eye strain—front shield magnifies scale 16% for easier readings

- Scale will not wear off—made of fused ceramic for durability
- More accurate readings—vertical tangential locator with hairline accuracies
- Aluminum is economical and good for general use with noncorrosive gases and liquids
- 316 Stainless steel (SS) withstands higher temperatures and pressures, and features excellent chemical compatibility
- A 150-mesh inlet screen is included



150-mm flowmeter 32005-14 with valve

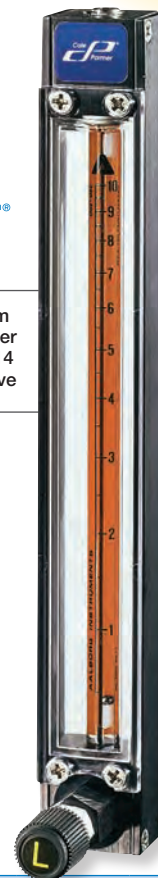

Fluid Handling

Flowmeters

ISO9001:2008
CERTIFIED SUPPLIER

Specifications

Accuracy: ±5% full-scale
Min flow rate: approximately 10% of max flow rate
Max pressure: 200 psi
Operating temperature: -15 to 250°F (-26 to 121°C)
Connections: 1/8" NPT(F)

Materials of Construction			
Part	Aluminum	Brass	316 SS
Flowtube	Borosilicate glass		
Fittings, valves	Aluminum	Chrome-plated brass	316 SS
O-rings	Buna N		Viton®
Float	Glass, 316 SS, carboloy, or sapphire		
Frame	Aluminum, acrylic, polycarbonate		

Search

For our complete selection of flowmeters, go to...

ColeParmer.com/Flowmeters

65-mm Direct-Reading Flowmeters

Max flow	Float†	Flowmeters without valve						Flowmeters with valve					
		Aluminum fittings		Brass fittings		316 SS fittings		Aluminum fittings		Brass fittings		316 SS fittings	
		Cat. no.	Price	Cat. no.	Price	Cat. no.	Price	Cat. no.	Price	Cat. no.	Price	Cat. no.	Price
For air													
7 mL/min	G	JL-32010-15		—	—	JL-32012-15		JL-32013-15		JL-32014-15		JL-32015-15	
50 mL/min	SS	JL-32010-01		JL-32011-01		JL-32012-01		JL-32013-01		JL-32014-01		JL-32015-01	
100 mL/min	G	JL-32010-03		JL-32011-03		JL-32012-03		JL-32013-03		JL-32014-03		JL-32015-03	
250 mL/min	C	JL-32010-05		—	—	JL-32012-05		JL-32013-05		JL-32014-05		JL-32015-05	
500 mL/min	C	JL-32010-07		JL-32011-07		JL-32012-07		JL-32013-07		JL-32014-07		JL-32015-07	
1.0 LPM	G	JL-32010-09		JL-32011-09		JL-32012-09		JL-32013-09		JL-32014-09		JL-32015-09	
2.0 LPM	SS	JL-32010-11		JL-32011-11		JL-32012-11		JL-32013-11		JL-32014-11		JL-32015-11	
5.0 LPM	G	JL-32010-13		JL-32011-13		JL-32012-13		JL-32013-13		JL-32014-13		JL-32015-13	
10.0 LPM	SS	JL-32010-17		JL-32011-17		JL-32012-17		JL-32013-17		JL-32014-17		JL-32015-17	
16.0 LPM	SS	JL-32010-16		JL-32011-16		JL-32012-16		JL-32013-16		JL-32014-16		JL-32015-16	

150-mm Direct-Reading Flowmeters

Max flow	Float†	Flowmeters without valve						Flowmeters with valve					
		Aluminum fittings		Brass fittings		316 SS fittings		Aluminum fittings		Brass fittings		316 SS fittings	
		Cat. no.	Price	Cat. no.	Price	Cat. no.	Price	Cat. no.	Price	Cat. no.	Price	Cat. no.	Price
For air													
25 mL/min	Sa	JL-32030-00		JL-32031-00		JL-32032-00		JL-32033-00		JL-32034-00		JL-32035-00	
50 mL/min	Sa	JL-32000-00		JL-32001-00		JL-32002-00		JL-32003-00		JL-32004-00		JL-32005-00	
100 mL/min	C	JL-32000-04		JL-32001-04		JL-32002-04		JL-32003-04		JL-32004-04		JL-32005-04	
200 mL/min	SS	JL-32000-06		JL-32001-06		JL-32002-06		JL-32003-06		JL-32004-06		JL-32005-06	
300 mL/min	C	JL-32000-08		JL-32001-08		JL-32002-08		JL-32003-08		JL-32004-08		JL-32005-08	
500 mL/min	Sa	JL-32030-08		JL-32031-08		JL-32032-08		JL-32033-08		JL-32034-08		JL-32035-08	
800 mL/min	G	JL-32030-09		JL-32031-09		JL-32032-09		JL-32033-09		JL-32034-09		JL-32035-09	
1.25 LPM	C	JL-32030-10		JL-32031-10		JL-32032-10		JL-32033-10		JL-32034-10		JL-32035-10	
2.5 LPM	G	JL-32000-10		JL-32001-10		JL-32002-10		JL-32003-10		JL-32004-10		JL-32005-10	
5.0 LPM	Sa	JL-32000-12		JL-32001-12		JL-32002-12		JL-32003-12		JL-32004-12		JL-32005-12	
10.0 LPM	G	JL-32000-14		JL-32001-14		JL-32002-14		JL-32003-14		JL-32004-14		JL-32005-14	
42 LPM	SS	JL-32030-15		JL-32031-15		JL-32032-15		JL-32033-15		JL-32034-15		JL-32035-15	
For water													
20 mL/min	SS	—		JL-32001-30		JL-32002-30		JL-32003-30		JL-32004-30		JL-32005-30	
100 mL/min	G	JL-32000-34		JL-32001-34		JL-32002-34		JL-32003-34		JL-32004-34		JL-32005-34	
200 mL/min	C	—		JL-32001-36		JL-32002-36		JL-32003-36		JL-32004-36		JL-32005-36	
500 mL/min	SS	JL-32000-38		JL-32001-38		JL-32002-38		JL-32003-38		JL-32004-38		JL-32005-38	
1.2 LPM	SS	JL-32030-40		—	—	JL-32032-40		JL-32033-40		—	—	JL-32035-40	

†Float material: Sa = sapphire, C = carboloy, SS = 316 stainless steel, and G = glass.

Cole-Parmer® Flowmeters and Proportional Controllers for Gases

Measure 130 standard gases—user selectable from display

- Accuracy of $\pm 0.8\%$ of reading +0.2% full-scale; repeatability of $\pm 0.2\%$
- 100 to 1 turndown with ranges of 1 SCCM full-scale up to 1000 SLPM
- Models with 4 to 20 mA output or totalizer are available

These meters measure flow via pressure drop across a laminar flow element (LFE). Because the flow element makes the flow stream laminar, placement in the process does not require straight pipe runs upstream or downstream of the meter, greatly simplifying installation. As compared to thermal mass technologies, the LFE design provides an ultrafast response within 10 milliseconds and offers “instant on” with no warm-up time.

An integrated keypad around the display is all that is required to program the unit for service. The 0 to 5 VDC output allows transmission of the flow value to a remote display, recorder, or controller regulating a valve or pump.

Flow controllers feature an integrated PID to direct the unit's response to process changes. Flow set point is established with keypad, the optional set point control module, a 0 to 5 V signal, or an RS-232 input signal. Order set point control modules separately from the table. For portable flow metering applications, order the battery pack listed below table.

What's included: 120/230 VAC power adapter with communications cable 32929-89 and NIST-traceable calibration report supplied by the manufacturer.



Mass flowmeter 32908-59 shown with optional battery pack 32929-50



Flow controller 32907-51

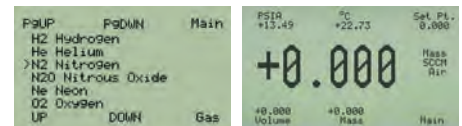

Meters and controllers feature a dynamic display that simultaneously shows flow rate, line pressure, fluid temperature, and (for controllers) the set point. For the units shown, both power and input/output signals are transmitted through a single multi-pin connector.



Specifications

Max particulate size:

Up to 1 LPM: 20 μm
>1 LPM to 1000 LPM: 50 μm

Accuracy: $\pm 0.8\%$ of reading, +0.2% full-scale

Repeatability: $\pm 0.2\%$

Response time:

Flowmeters: 10 msec
Flow controllers: 50 msec

Operating temperature:

14 to 122°F (–10 to 50°C)

Max pressure: 145 psig (9.9 bar)

Pressure drop: 0.8 to 3.2 psig (flowmeter)

Output signal: 0 to 5 VDC, RS-232

Input signal: 0 to 5 VDC and RS-232

Wetted materials:

Flowmeters: 302 and 303 SS, Viton®, silicone RTV, and glass-reinforced nylon, aluminum

Flow controllers: 302, 303; Viton, silicone RTV, glass-reinforced nylon, aluminum, brass, 410 SS, silicon, glass

Power:

Flowmeters: 7 to 30 VDC at 30 mA
Flow controllers
Models ≤ 10 LPM: 12 to 30 VDC at 250 mA
Models ≤ 50 LPM: 24 to 30 VDC at 750 mA

Display type: four-digit, seven-line LCD; 1/4"H flow display

Connections:

≤ 10 mL/min: 10-32 UNF
50 mL/min to 10 LPM: 1/8" NPT(F)
50 to 100 LPM: 1/4" NPT(F)
100 and 250 LPM: 1/2" NPT(F)
500 and 1000 LPM: 3/4" NPT(F)

Flow range	Mass flowmeters		Mass flow controllers		Set point modules [†]	
	Catalog number	Price	Catalog number	Price	Catalog number	Price
0.01 to 1 mL/min	JL-32908-51		JL-32907-51		JL-32907-83	
0.05 to 5 mL/min	JL-32908-53		JL-32907-53		JL-32907-85	
0.1 to 10 mL/min	JL-32908-55		JL-32907-55		JL-32907-87	
0.5 to 50 mL/min	JL-32908-57		JL-32907-57		JL-32907-89	
1 to 100 mL/min	JL-32908-59		JL-32907-59		JL-32907-91	
2 to 200 mL/min	JL-32908-61		JL-32907-61		JL-32907-93	
5 to 500 mL/min	JL-32908-63		JL-32907-63		JL-32907-97	
0.01 to 1 LPM	JL-32908-67		JL-32907-67		JL-32907-83	
0.05 to 5 LPM	JL-32908-69		JL-32907-69		JL-32907-85	
0.1 to 10 LPM	JL-32908-71		JL-32907-71		JL-32907-87	
0.5 to 50 LPM	JL-32908-73		JL-32907-73		JL-32907-89	
1 to 100 LPM	JL-32908-75		JL-32907-75		JL-32907-91	
2.5 to 250 LPM	JL-32908-77		JL-32907-77		JL-32907-95	
5 to 500 LPM	JL-32908-79		JL-32907-79		JL-32907-97	
10 to 1000 LPM	JL-32908-81		JL-32907-81		JL-32907-99	

[†]May be ordered as an option.

[JL-17080-10](#) NIST-traceable recalibration

[JL-32929-50](#) Battery pack, for portable operation of mass or volumetric flowmeter only

[JL-32929-89](#) Replacement communication cable, 8-DIN to stripped ends

Cole-Parmer® Low Pressure Drop Gas Mass Flowmeters and Controllers

Achieve high accuracy and low pressure drop

- Full-scale pressure drops as low as 0.1 psid to 0.69 psid
- Measure 30 standard gases with a 200:1 turndown ratio
- Set up and control from an easy-to-use keypad

NEW

Using a newer laminar differential pressure flow technology, these mass flow meters and controllers have a much lower pressure drop across the instrument. Meters and controllers require no warm-up time, and offer a 10 ms response time for meters and 100 ms for controllers. Typical applications include air sampling, natural gas metering and calibration, and gas analysis and totalizing.

Select from 130 different gases in real time with the gas and gas mix calibrations already programmed into the meter or controller. An integrated keypad around the display is all that is required to program the unit for service. The 0 to 5 VDC output permits transmission of the flow value to a remote display, recorder, or controller regulating a valve or pump.

Battery-Powered Meters allow you to take the meter from site to site for flow rate establishment and on-site calibration. They have a monochrome display and rechargeable integrated battery packs.

Voltage-Powered Meters and Controllers are designed for single-area use and feature a dynamic, color thin-film transistor (TFT) display with backlight. The TFT display simultaneously shows flow rate, line pressure, fluid temperature, and (for controllers) the set point. Easily see when the unit is at max range or out of range—each numeric reading of the four parameters changes to yellow at 100% of range or red at 128% of range. Both power and input/output signals are transmitted through a single multipin connector.

What's included: 120/230 VAC power adapter with communications cable and NIST-traceable calibration report supplied by the manufacturer.



Cole-Parmer®

Fluid Handling

Flowmeters

Specifications

Maximum particulate size:

Up to 1 L/min: 20 µm
>1 L/min: 50 µm

Accuracy: ±0.8% of reading
+ 0.2% of full-scale

Repeatability: ±0.2% full-scale

Response time:

Meters: 10 msec
Controllers: 100 msec

Operating temperature:

14 to 122°F (-10 to 50°C)

Maximum pressure: 50 psi

Wetted materials:

Meters: 303 and 302 stainless steel, Viton PPS, silicone RTV, glass-reinforced nylon, aluminum

Controllers: 303 and 302 stainless steel, Viton PPS, silicone RTV, glass-reinforced nylon, aluminum, 416 stainless steel, nickel, silicon, glass

Electrical connection:

8-pin mini-DIN

Output signal:

0 to 5 VDC, RS-232

Input signal:

12 to 30 VDC, RS-232

Display: 4-digit, seven-line LCD;

1¼" H flow display



Flow range	Connections
<=20 mL/min	10-32 UNF
50 mL/min to 2 L/min	1/8" NPT(F)
5 to 20 L/min	1/4" NPT(F)
40 L/min	1/2" NPT(F)
50 L/min to 250 L/min	3/4" NPT(F)
500 L/min	3/4" NPT(F)

Flow range	Battery-powered mass meters with monochrome display			DC-powered (7 to 30 VDC) mass meters with TFT display			DC-powered (12 to 30 VDC) mass controllers with TFT display		
	Catalog number	Pressure drop	Price	Catalog number	Pressure drop	Price	Catalog number	Pressure drop	Price
0 to 0.5 mL/min	JL-32935-00	0.06 psi		JL-32935-20	0.06 psi		JL-32935-40	0.06 psi	
0 to 1 mL/min	JL-32935-01	0.06 psi		JL-32935-21	0.06 psi		JL-32935-41	0.06 psi	
0 to 2 mL/min	JL-32935-02	0.06 psi		JL-32935-22	0.06 psi		JL-32935-42	0.06 psi	
0 to 5 mL/min	JL-32935-03	0.07 psi		JL-32935-23	0.07 psi		JL-32935-43	0.08 psi	
0 to 10 mL/min	JL-32935-04	0.07 psi		JL-32935-24	0.07 psi		JL-32935-44	0.08 psi	
0 to 20 mL/min	JL-32935-05	0.07 psi		JL-32935-25	0.07 psi		JL-32935-45	0.07 psi	
0 to 50 mL/min	JL-32935-06	0.07 psi		JL-32935-26	0.07 psi		JL-32935-46	0.07 psi	
0 to 100 mL/min	JL-32935-07	0.06 psi		JL-32935-27	0.06 psi		JL-32935-47	0.07 psi	
0 to 200 mL/min	JL-32935-08	0.06 psi		JL-32935-28	0.06 psi		JL-32935-48	0.07 psi	
0 to 500 mL/min	JL-32935-09	0.06 psi		JL-32935-29	0.06 psi		JL-32935-49	0.08 psi	
0 to 1 L/min	JL-32935-10	0.07 psi		JL-32935-30	0.07 psi		JL-32935-50	0.10 psi	
0 to 2 L/min	JL-32935-11	0.07 psi		JL-32935-31	0.07 psi		JL-32935-51	0.18 psi	
0 to 5 L/min	JL-32935-12	0.07 psi		JL-32935-32	0.07 psi		JL-32935-52	0.10 psi	
0 to 10 L/min	JL-32935-13	0.08 psi		JL-32935-33	0.08 psi		JL-32935-53	0.12 psi	
0 to 20 L/min	JL-32935-14	0.25 psi		JL-32935-34	0.25 psi		JL-32935-54	0.26 psi	
0 to 40 L/min	JL-32935-15	0.12 psi		JL-32935-35	0.12 psi		JL-32935-55	0.14 psi	
0 to 50 L/min	JL-32935-16	0.14 psi		JL-32935-36	0.14 psi		JL-32935-56	0.17 psi	
0 to 100 L/min	JL-32935-17	0.24 psi		JL-32935-37	0.24 psi		JL-32935-57	0.30 psi	
0 to 250 L/min	JL-32935-18	0.60 psi		JL-32935-38	0.60 psi		JL-32935-58	0.69 psi	
0 to 500 L/min	JL-32935-19	0.39 psi		JL-32935-39	0.39 psi		JL-32935-59	0.69 psi	

[JL-32929-89](#) Replacement communication cable, 8-DIN to stripped ends

[JL-17080-10](#) NIST-traceable recalibration with data

Heavy-Duty Flowmeters/Totalizers

Eliminate the need for expensive wiring with battery power

- Two totalizers allow for process or period-specific volume monitoring
- FM-approved for Class I, Division I environments

These heavy-duty in-line flowmeters/totalizers display flow rate and accumulated flow in gallons or liters. The compact, yet robust design makes them ideal for use in manufacturing, pilot-plant, or quality control areas.

All flowmeters measure linearly across a range and record a cumulative volume plus a resettable volume. Meters are factory-calibrated using water but can store two application-specific K-factors determined in process. To conserve power, the six-digit display automatically turns on with flow and then turns off four minutes after flow ceases. The internal parts are simple to replace for easy maintenance—contact our Application Specialists for details.

Meters operate on two lithium batteries (included). Remote installation of the flowmeter body is possible using the optional remote installation kit 05609-93 (order separately below). Calibration container and replacement battery kits can be ordered below.



Flowmeter 05609-17
with sanitary Tri-Clamp® connection



Flowmeter 05609-23
with NPT(F) connection

Specifications

Repeatability: ±0.1% of reading

Maximum pressure:

- Aluminum: 300 psig (21 bar);
- NPT SS: 1500 psig (105 bar);
- Tri-Clamp SS: 450 psig (31 bar);
- Flanged SS: 285 psig (19 bar)

Operating temp: 14 to 140°F (-10 to 60°C)

Wetted materials: 316 SS or aluminum housing, PVDF rotor and supports, tungsten carbide shaft, 316 SS retainers, and ceramic bearings

Maximum particulate size:

- Models with ≤50 GPM (190 LPM)
max flow rate: 125 µm
- Models with >50 GPM (190 LPM)
max flow rate: 500 µm

Display: 6-digit LCD, 1/2"H (with floating decimal)

Input power: two 3 V lithium batteries (included)

Battery life: 9000 hours nominal

Approvals: EEx II 3 G IIC T4



Flow range	Connections	Body material	Accuracy	Catalog number	Price
1 to 10 GPM (3.8 to 37.9 LPM)	1/2" NPT(F)	Aluminum	±2% of rdg	JL-05609-01	
	1/2" NPT(F)	316 SS		JL-05609-03	
	3/4" Tri-Clamp†	316 SS		JL-05609-05	
2 to 20 GPM (7.6 to 75.7 LPM)	3/4" NPT(F)	Aluminum	±2.0% of rdg	JL-05609-07	
	3/4" NPT(F)	316 SS		JL-05609-09	
	1" Tri-Clamp†	316 SS		JL-05609-11	
5 to 50 GPM (18.9 to 190 LPM)	1" NPT(F)	Aluminum	±1.5% of rdg	JL-05609-13	
	1" NPT(F)	316 SS		JL-05609-15	
	1 1/2" Tri-Clamp†	316 SS		JL-05609-17	
10 to 100 GPM (38 to 380 LPM)	1 1/2" NPT(F)	Aluminum	±1% of rdg	JL-05609-21	
	1 1/2" NPT(F)	316 SS		JL-05609-23	
	2" Tri-Clamp†	316 SS		JL-05609-25	
20 to 200 GPM (6 to 760 LPM)	1 1/2" ANSI‡	316 SS	±1% of rdg	JL-05609-27	
	2" NPT(F)	Aluminum		JL-05609-29	
	2" NPT(F)	316 SS		JL-05609-31	
	2 1/2" Tri-Clamp†	316 SS		JL-05609-33	
	2" ANSI‡	316 SS		JL-05609-35	

†Sanitary flange

‡150# ANSI flange

Accessories

[JL-05610-70](#) Calibration container; HDPE, 5-gal. (19 L) capacity

[JL-05610-96](#) Replacement battery kit

[JL-05609-93](#) Remote installation kit. Mount display up to 100 feet (30 m) from sensor—ideal for measuring flow in hot pipes (up to 250°F/121°C) or in inaccessible areas. Kit includes a sensor cover with 10-ft (3-m) cable, remote display housing, and installation hardware. FM-approved

[JL-05609-91](#) Output module, pulse output. Module provides a digital open collector output for interfacing with compatible instrumentation

[JL-05609-92](#) Output module, 4 to 20 mA or 5 to 20 volts. Module provides an output for interfacing with compatible instrumentation

[JL-17080-12](#) NIST-traceable calibration



Order your Product with
NIST-Traceable Calibration
866-466-6225 InnoCalSolutions.com

INNOCAL®
INNOVATIVE CALIBRATION SOLUTIONS



WIKA® 3A Sanitary Gauges

Get better readings

- Glycerin fill reduces fluctuations
- Manufactured for clean-in-place (CIP) applications
- All-welded gauge assembly contains an external flush diaphragm
- Assembly meets the criteria set forth by 3A standards



Specifications

Accuracy: ±3-2-3% of span	Wetted materials: 316L SS	Process connection: 3/4" Tri-Clamp®
Operating temp: 50 to 257°F (10 to 125°C)	Lens: polycarbonate	Casing: 304 SS
		Dial size: 2 1/2" (64 mm)

Range	Resolution	Catalog number	Price
30 psi	0.5 psi	JL-68056-72	
60 psi	1 psi	JL-68056-74	
100 psi	2 psi	JL-68056-76	
160 psi	2 psi	JL-68056-78	

[JL-17040-10](#) NIST-traceable calibration with data

Cole-Parmer® Low-Pressure Mechanical Gauges

Perfect for accurately measuring pressures below 10 psi

- Manufactured with a chrome-plated case, use these gauges to measure low pressure in filter systems, cleanrooms, or fluidic systems



Specifications

Accuracy: ±1 1/2% full scale	Wetted materials: brass
Dial size: 2 1/2" (64 mm)	Lens: polycarbonate
Operating temp: 0 to 150°F (0 to 66°C)	Process connection: 1/4" NPT(M)
	Casing: black steel

Range	Catalog number	Price
0 to 10" H ₂ O	JL-68357-00	
0 to 15" H ₂ O	JL-68357-02	
0 to 30" H ₂ O	JL-68357-04	
0 to 60" H ₂ O	JL-68357-06	
0 to 100" H ₂ O	JL-68357-08	
0 to 3 psi	JL-68357-14	
0 to 5 psi	JL-68357-16	
0 to 10 psi	JL-68357-18	

[JL-17040-10](#) NIST-traceable calibration with data

Ashcroft® Digital Pressure Gauges with Backlight

Simple three-button programming

- Easy-to-read, 5-digit display with backlight and 20-segment bar graph
- Stainless steel sensor; IP67-rated case
- Features tare, min/max memory, and nine engineering plus one custom engineering units



Specifications

Accuracy: ±0.5% full-scale	Wetted materials: 17-4 ph and 316L stainless steel
Dial size: 2 1/2" (64 mm)	Lens: polycarbonate
Operating temp: -4 to 140°F (-20 to 60°C)	Process connection: 1/4" NPT(M)
Units of measure: psi, " Hg, cm Hg, mm Hg, kPa, mPa, bar, kg/cm ² , ft H ₂ O, and user-defined unit	Power: two AA batteries (included)

Range	Resolution	Catalog number	Price
0 to 30" Hg	0.01" Hg	JL-68334-01	
30" Hg to 30 psi	0.01" Hg	JL-68334-03	
30" Hg to 100 psi	0.01" Hg	JL-68334-07	
0 to 15 psi	0.001 psi	JL-68334-09	
0 to 30 psi	0.001 psi	JL-68334-11	
0 to 60 psi	0.001 psi	JL-68334-13	
0 to 100 psi	0.01 psi	JL-68334-15	
0 to 200 psi	0.01 psi	JL-68334-17	
0 to 300 psi	0.01 psi	JL-68334-19	
0 to 500 psi	0.01 psi	JL-68334-21	
0 to 1000 psi	0.1 psi	JL-68334-25	
0 to 5000 psi	0.1 psi	JL-68334-27	
0 to 10,000 psi	1 psi	JL-68334-31	

[JL-09376-01](#) Batteries, AA. Pk of 4

[JL-17040-12](#) NIST-traceable calibration with data

Handheld Differential Pressure Meters

Intrinsically safe models for hazardous use

- Select one of nine units
- Feature zero, hold, maximum, minimum, and out-of-range, functions
- Smooth fluctuating pressure readings with filter function
- Displays average of last sixteen pressure readings



Specifications

Accuracy: ±0.2% full scale	Process connections: 1/8" BSP
Operating temperature: 32 to 122°F (0 to 50°C)	Units of measure: psi, " H ₂ O, cm H ₂ O, " Hg, mm Hg, mbar, torr, kPa, and kg/cm ²
Temperature range (compensated): 68 to 86°F (20 to 30°C)	Power: one 9 V battery (included)
Media compatibility: clean, noncorrosive, inert gases	Approval (intrinsically safe models): EEx Ia IIC T4

Range	Resolution	Catalog number	Price
Intrinsically safe differential pressure gauges			
-5 to 5 psid	0.001 psi	JL-68600-06	
-30 to 30 psid	0.01 psi	JL-68600-02	
-100 to 100 psid	0.1 psi	JL-68600-04	
Non-intrinsically safe differential pressure gauges			
-5 to 5 psid	0.001 psi	JL-68600-10	
-30 to 30 psid	0.01 psi	JL-68600-12	
-100 to 100 psid	0.1 psi	JL-68600-14	

[JL-95616-00](#) PVC tubing, 4 mm ID x 6 mm OD. Pack of 25 ft.

[JL-09376-04](#) Replacement batteries, 9 V. Pack of 4

[JL-17090-31](#) NIST-traceable calibration with data

Cole-Parmer® Rugged Digital Pressure Gauges

No more waiting for a response

- Fast response time—3 readings per second
- ±0.25% test gauge accuracy
- 316 stainless steel wetted parts
- Temperature-compensated piezoresistive sensor



Specifications

Accuracy: ±0.25% full-scale ±1 least significant digit

Operating temp:
-4 to 185°F (-20 to 85°C)

Wetted materials: 316 SS

Process connection: 1/4" NPT male

Power:

Battery powered:
two AA batteries (included)
Loop powered: 8 to 32 VDC

Display:
Ranges up to 1000 psi: 3.5-digit LCD, 0.5"H
Ranges of 3000 and 5000 psi:
4-digit LCD, 0.5"H, lower display for units
Min/max models: 4-digit LCD, 0.5"H, lower display for units

A. Battery-Powered Gauges

Standard Models feature a rugged, epoxy-coated extruded aluminum case and rear cover with ABS/polycarbonate front bezel. Battery life up to 2000 hours; low-battery indication.

NEMA 4X Models feature a red backlight for low-light readability, polycarbonate display window, UV-stabilized ABS/polycarbonate case, front on/off pushbutton, 5-minute auto shutoff, front-accessible calibration adjustments (3000 and 5000 psi models have internal calibration pushbuttons). Battery life is from 150 to 1500 hours; low-battery indication.



Range	Resolution	Standard		NEMA 4X	
		Cat. no.	Price	Cat. no.	Price
760 to 0 Torr absolute	1 Torr	JL-68935-00		JL-68935-34	
-30.0" Hg to 15.0 psi	0.1" Hg/0.1 psi	JL-68935-08		JL-68935-42	
-15.0 to 15.0 psi	0.1 psi	JL-68935-10		JL-68935-44	
0 to 15.00 psi	0.01 psi	JL-68935-12		JL-68935-46	
0 to 30.0 psi	0.1 psi	JL-68935-14		JL-68935-48	
-30.0" Hg to 100.0 psi	0.1" Hg/0.1 psi	JL-68935-16		JL-68935-50	
0 to 100.0 psi	0.1 psi	JL-68935-18		JL-68935-52	
-30.0" Hg to 199.9 psi	0.1" Hg/0.1 psi	JL-68935-20		JL-68935-54	
0 to 1000 psi	1 psi	JL-68935-28		JL-68935-62	
0 to 3000 psi	1 psi	JL-68935-30		JL-68935-64	
0 to 5000 psi	1 psi	JL-68935-32		JL-68935-66	

B. Battery-Powered Gauges with Min/Max/Zero

Gauges capture maximum and minimum readings. Display can be zeroed when gauge is turned on. Gauges feature a rugged, epoxy-coated extruded aluminum case, rear cover with ABS/polycarbonate front bezel, front on/off push button, 5-minute auto shutoff, and internal calibration pushbuttons. The 4-digit display provides added resolution in most ranges. Battery life up to 2000 hours; low-battery indication.



Range	Resolution	Catalog number	Price
760.0 to 0 Torr absolute	0.1 Torr	JL-68936-00	
0 to 30.00" Hg	0.01" Hg	JL-68936-02	
-30.0" Hg to 100.0 psi	0.1" Hg/0.01 psi	JL-68936-16	
0 to 100.0 psi	0.1 psi	JL-68936-18	
-30.0" Hg to 200.0 psi	0.1" Hg/0.01 psi	JL-68936-20	
0 to 200.0 psi	0.1 psi	JL-68936-22	
0 to 300.0 psi	0.1 psi	JL-68936-24	
0 to 500.0 psi	0.1 psi	JL-68936-26	
0 to 1000 psi	1 psi	JL-68936-28	
0 to 3000 psi	1 psi	JL-68936-30	
0 to 5000 psi	1 psi	JL-68936-32	

C. Loop-Powered Gauges

Gauges can be powered by any 8 to 32 VDC source for low-voltage operation or use as a transmitter with an analog 4 to 20 mA output. Units feature a rugged, epoxy-coated extruded aluminum case, rear cover with ABS/polycarbonate front bezel, and front-accessible calibration adjustments. Test level adjustment and push button allow output to be checked. Include a 3-ft (1-m) L, two-conductor 22 AWG cable with stripped ends.



Range	Resolution	Catalog number	Price
760 to 0 Torr absolute	1 Torr	JL-68936-34	
0 to 30.0" Hg	0.1" Hg	JL-68936-36	
0 to 3.00 psi	0.01 psi	JL-68936-38	
0 to 5.00 psi	0.01 psi	JL-68936-40	
-15.0 to 15.0 psi	0.1 psi	JL-68936-42	
0 to 15.00 psi	0.01 psi	JL-68936-44	
0 to 30.0 psi	0.1 psi	JL-68936-46	
0 to 100.0 psi	0.1 psi	JL-68936-48	
0 to 199.9 psi	0.1 psi	JL-68936-50	

Accessories

[JL-68936-95](#) Protective rubber boot, fits all gauges except the NEMA 4X models

[JL-09376-01](#) Replacement batteries, AA. Pack of 4

[JL-17040-12](#) NIST-traceable calibration with data



Boot 68936-95

Cole-Parmer® Gas Regulators

Deliver gas at constant pressure and volume, from full cylinder inlet pressure to end point working pressure

General-Purpose Regulators

These regulators are designed for economy and longevity in applications involving inert and noncorrosive gases. Include 10 µm sintered SS filter, rubber valve seat, nylon-reinforced rubber diaphragm, aluminum-alloy body and bonnet, and brass gauges.

A. Single-Stage Regulators

are designed for long-life performance where precise pressure control is not desired. Overload protected.

B. Two-Stage Regulators

reduce cylinder pressure in two stages. Use first stage to approach working pressure; use second stage for precise adjustment of working pressure. Second stage is overload protected.

High-Purity Regulators

Ideal for corrosive or noncorrosive gas applications. Designed and constructed for diffusion resistance and easy cleanup. Only brass, stainless steel (SS), PTFE, and Kel-F® contact the operating media. Metal diaphragm, packless valves, and high-purity seals minimize or eliminate outgoing and inboard diffusion. Supplied with SS screen filter (25 µm); and brass body, bonnet, and gauges.

C. Single-Stage High-Purity Regulators

are recommended for analytical work where precise pressure control is not critical.

D. Two-Stage High-Purity Regulators let you precisely regulate working pressure.

Special-Service Regulators

E. Model 03274-10 is a single-stage unit specially designed for gases that attack brass or copper-bearing alloys. When used with low-vapor-pressure liquefied gases, no inlet gauge is needed. Rubber-supported PTFE diaphragm, Kel-F® seat, aluminum-alloy body and bonnet, SS delivery gauge, and 10 µm sintered SS filter.

F. Model 03274-15 is for regulating corrosive halogen gases. Monei® filter, body, gauges, and diaphragm; chrome-plated brass bonnet; and Kel-F® valve seat.

G. Model 03274-20 is a two-stage 316 SS regulator with packless diaphragm valve—handles electronic and corrosive gases. Only SS and PTFE contact operating media. Excellent diffusion resistance; effective for trace analysis. Metal-to-metal diaphragm seal minimizes leak rate to reduce vacuum purging time and residual contaminant levels. Bubble-tight shutoff.

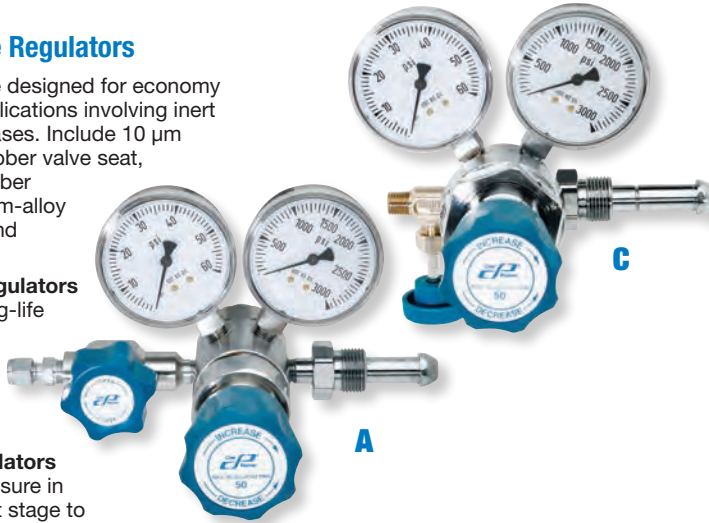

Gas/Regulator Selection Table

Gas	Quality grade	Key letter	CGA fitting
Air	Compressor	A-B	346
	Ultrapur, Zero grade	C-D	590
Ar	Ultra high-purity	A-B	580
	Research, Ultrapur	C-D	580
	Zero grade	C-D	580
BF ₃	All	F	330
C ₂ H ₄	All	A-B	350
C ₂ H ₆	All	A-B	350
		A	580
CH ₄	Chemically pure, Technical	A-B	350
	Commercial	A-B	350
	Instrument	C-D	350
CO	All	A-B	350
CO ₂	Coleman, Chemically pure	A-B	320
	Research, Anaerobe grade	C-D	320
D ₂	Chemically pure	A-B	350
	Research	C-D	350
H ₂	Ultra high-purity	A-B	350
	Research, Ultrapur	C-D	350
	Zero grade	C-D	350
HCl	Electronic, Technical	F	330
He	High-purity	A-B	580
	Research, Ultrapur	C-D	580
	Zero grade	C-D	580
Kr	Research	C-D	580
N ₂	Ultra high-purity	A-B	580
	Research, Ultrapur	C-D	580
	Zero grade	C-D	580
Ne	Chemically pure	A-B	580
	Research	C-D	580
NF ₃	All	F	330
NH ₃	Electronic	E	660
O ₂	Research, Ultrapur	C-D	540
	Zero grade	C-D	540
	Extra-dry	C	540
SF ₆	All	A-B	590
SiH ₄	Semiconductor	G	350
Xe	All	C-D	580

Specifications

Maximum delivery pressure:

Low psig series—
Model G (03274-20): 25 psi
All other low psig models: 50 psi
High psig series—
Model F (03274-15): 200 psi
All other high psi models: 100 psi

Maximum inlet pressure:

Model E (03274-10): 400 psi
All other models: 3000 psi

Delivery gauge graduations:

Low psig series
Model G (03274-20): 1 psi
All other models: 2 psi
High psig series: 5 psi

Inlet gauge graduations:

Models F and G: 50 psi
All other models: 100 psi

Outlet connection:

Models A, B, E, and F: 1/4" NPT(M)
Models C, D, and G: 1/4" NPT(F);
compression fitting for 6-mm
OD tubing included

Key	Type	CGA fitting	Low psig regulators			High psig regulators		
			Catalog number	Capacity	Price	Catalog number	Capacity	Price
A	Single-stage	320	JL-98202-00	850 scfh		JL-98202-10	1500 scfh	
		346	JL-98202-01	850 scfh		JL-98202-11	1500 scfh	
		350	JL-98202-02	850 scfh		JL-98202-12	1500 scfh	
		580	JL-98202-03	850 scfh		JL-98202-13	1500 scfh	
		590	JL-98202-04	850 scfh		JL-98202-14	1500 scfh	
B	Two-stage	320	JL-98202-20	600 scfh		JL-98202-30	1200 scfh	
		346	JL-98202-21	600 scfh		JL-98202-31	1200 scfh	
		540	JL-98202-22	600 scfh		JL-98202-32	1200 scfh	
		580	JL-98202-23	600 scfh		JL-98202-33	1200 scfh	
		590	JL-98202-24	600 scfh		JL-98202-34	1200 scfh	
C	High-purity single-stage	320	JL-98210-20	500 scfh		JL-98210-30	1000 scfh	
		350	JL-98210-22	500 scfh		JL-98210-32	1000 scfh	
		540	JL-98210-24	500 scfh		JL-98210-34	1000 scfh	
		580	JL-98210-26	500 scfh		JL-98210-36	1000 scfh	
		590	JL-98210-28	500 scfh		JL-98210-38	1000 scfh	
D	High-purity two-stage	320	JL-98210-00	450 scfh		JL-98210-10	900 scfh	
		350	JL-98210-02	450 scfh		JL-98210-12	900 scfh	
		540	JL-98210-04	450 scfh		JL-98210-14	900 scfh	
		580	JL-98210-06	450 scfh		JL-98210-16	900 scfh	
		590	JL-98210-08	450 scfh		JL-98210-18	900 scfh	
E	Specialty	660	JL-03274-10	2200 scfh		—	—	
F		330	—	—		JL-03274-15	780 scfh	
G		350	JL-03274-20	240 scfh		—	—	

Cole-Parmer® High-Accuracy Industrial Pressure Transducers

Withstand high shock and vibration

- Welded stainless steel (SS) housing rated to NEMA 4 (IP65) standards
- SS capacitive sensor handles your more demanding systems
- Feature adjustable zero and span potentiometers



Specifications

Accuracy: ±0.13% full-scale
Operating temp: -40 to 260°F (-40 to 126°C)
Process connection: ¼" NPT(M)
Power: 12 to 28 VDC (unregulated)

Electrical connection: 2-ft (0.6-m) L cable
Wetted materials: PH 17-4 SS
Dimensions (L x dia): 5" x 2" (12.7 x 5.1 cm)

Range	4 to 20 mA output		0.1 to 5.1 V output	
	Catalog number	Price	Catalog number	Price
Compound transducers				
-14.7 to 15 psi	JL-68073-00		JL-68074-00	
-14.7 to 30 psi	JL-68073-02		JL-68074-02	
-14.7 to 60 psi	JL-68073-04		JL-68074-04	
-14.7 to 100 psi	JL-68073-06		JL-68074-06	
Gauge pressure transducers				
0 to 25 psig	JL-68073-08		JL-68074-08	
0 to 50 psig	JL-68073-10		JL-68074-10	
0 to 100 psig	JL-68073-12		JL-68074-12	
0 to 500 psig	JL-68073-14		JL-68074-14	
0 to 1000 psig	JL-68073-16		JL-68074-16	
0 to 3000 psig	JL-68073-18		JL-68074-18	
0 to 5000 psig	JL-68073-20		JL-68074-20	
0 to 10,000 psig	JL-68073-22		JL-68074-22	

Cole-Parmer® High-Accuracy Pressure Transducers

Be more accurate, affordably

- SS sensor attached to SS electrode forms a variable capacitor



Specifications

Accuracy: ±0.25% full-scale
Temp range (compensated): -4 to 176°F (-20 to 80°C)
Process connection: ¼" NPT(M)

Power: 9 to 30 VDC
Wetted materials: PH 17-4 SS
Dimensions (L x dia): 2¾" x 1½" (7 x 3.8 cm)

Range	4 to 20 mA output		0.5 to 5.5 V output	
	Catalog number	Price	Catalog number	Price
Compound transmitters				
-14.7 to 0 psi	JL-68075-00		JL-68075-30	
-14.7 to 15 psi	JL-68075-02		JL-68075-32	
Gauge pressure transmitters				
0 to 5 psi	JL-68075-10		JL-68075-40	
0 to 10 psi	JL-68075-12		JL-68075-42	
0 to 25 psi	JL-68075-14		JL-68075-44	
0 to 50 psi	JL-68075-16		JL-68075-46	
0 to 100 psi	JL-68075-18		JL-68075-48	
0 to 250 psi	JL-68075-20		JL-68075-50	

Cole-Parmer® Economical Pressure Transducers

Accuracy in a compact, durable package

- High-performance ASIC married to a very stable polysilicon thin-film pressure sensor
- Sensor is electron-beam welded to a SS pressure fitting for high overpressure capability and outstanding durability against shock and vibration
- Circuitry is held securely within an internal cage and housed in a reinforced nylon enclosure



Specifications

Accuracy: ±1% span
Temp range (compensated): -40 to 257°F (-40 to 125°C)
Process connection: ¼" NPT (M)

Power: 9 to 36 VDC
Wetted materials: PH 17-4 SS
Dimensions (dia x L): 1" x 2½" (2.5 x 6.4 cm)

Range	4 to 20 mA output		1 to 5 VDC output	
	Catalog number	Price	Catalog number	Price
30" Hg to 30 psi	JL-68900-48		JL-68900-62	
0 to 30 psi	JL-68900-50		JL-68900-64	
0 to 100 psi	JL-68900-52		JL-68900-66	
0 to 200 psi	JL-68900-54		JL-68900-68	
0 to 500 psi	JL-68900-56		JL-68900-70	
0 to 1000 psi	JL-68900-58		JL-68900-72	
0 to 3000 psi	JL-68900-60		JL-68900-74	

Cole-Parmer® Sealed SS Pressure Transducers

No epoxies to cause signal instability or drift

- Stainless steel (SS) diaphragm and polysilicon strain gauge are bonded by vapor deposition



Specifications

Temp range (compensated): -4 to 176°F (-20 to 80°C)
Process connection: ¼" NPT(M)
Power: 9 to 30 VDC
Output: 4 to 20 mA (call for models with 1 to 5 V output)
Wetted materials: PH 17-4 SS
Dimensions (L x dia): 2¾" x 1½" (7 x 3.8 cm)

Range	Catalog number	Price
Vacuum and compound transducers; ±0.4% accuracy (BFSL)		
30" Hg to 0 psi	JL-07356-10	
30" Hg to 30 psi	JL-07356-11	
Pressure transducers; ±0.4% accuracy (BFSL)		
0 to 30 psi	JL-07356-51	
0 to 60 psi	JL-07356-52	
0 to 100 psi	JL-07356-53	
0 to 300 psi	JL-07356-54	
0 to 750 psi	JL-07356-55	
0 to 1000 psi	JL-07356-56	
Pressure transducers; ±0.25% accuracy (BFSL); with NIST-traceable calibration report		
0 to 100 psi	JL-68001-04	
0 to 200 psi	JL-68001-05	



Cole-Parmer® Two- and Three-Way Direct Lift Solenoid Valves

Ideal with high-purity or corrosive fluids—made of inert PTFE

- Minimize trapped liquids with minimal dead volume
- Mount almost anywhere—lightweight and compact

Models with a 1/16" orifice have mounting holes at the bottom only and models with a 3/32" or 5/32" orifice have mounting holes at the top and bottom. Optional mounting clip 01540-50 can be used to mount valves with a 1/16" orifice in any position.

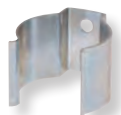

Mounting clip
01540-50



Mounting flange
01540-55



Specifications

Vacuum rating: 26" Hg **Lead wire length:** 15" (38 cm)

Maximum fluid temperature: 158°F (70°C)

Ports NPT(F)	Orifice	Max psi	Response time	Watts	12 VDC		24 VDC	
					Catalog number	Price	Catalog number	Price
Two-way solenoid valves; normally closed								
1/4-28	1/16"	30	20 ms	4.0	JL-01540-01		JL-01540-02	
1/4-28	1/16"	60	25 ms	8.0	JL-01540-03		JL-01540-04	
1/4-28	3/32"	20	20 ms	5.1	JL-01540-05		JL-01540-06	
1/8	5/32"	18	30 ms	8.0	JL-01540-07		JL-01540-08	
Two-way solenoid valves; normally open								
1/4-28	1/16"	30	20 ms	4.0	JL-01540-09		JL-01540-10	
Three-way solenoid valves								
1/4-28	1/16"	30	20 ms	4.0	JL-01540-11		JL-01540-12	
1/4-28	1/16"	60	25 ms	8.0	JL-01540-13		JL-01540-14	
1/8	5/32"	18	30 ms	8.0	JL-01540-17		JL-01540-18	

JL-01540-50 Mounting clip for two- and three-way valves

JL-01540-55 Mounting flange for two- and three-way valves

Can't choose?

Trust our **expert** Application Specialists to help you find the right product.

Jeevan, 25+ years of experience

Call: 800-323-4340 E-mail: sales@coleparmer.com

Fluid Handling

Valves

Miniature Check Valves

Install in any position—use with liquids and gases



Breaking pressure is 0.18 psi, closing pressure is 0.014 psi. Maximum temperature (at maximum psi) is 250°F (121°C) for "A" and "C"; 200°F (93°C) for "B."

Note: Valves require 1 psi back pressure for a tight seal.

Tube ID	C _v	Working pressure	Catalog number	Price
A. Nylon body and fluorosilicone diaphragm				
1/8"	0.12	3 to 5 psi (0.2 to 0.3 bar)	JL-98553-00	
3/16"	0.13		JL-98553-01	
1/4"	0.13		JL-98553-02	
B. PP body and Viton® diaphragm				
1/8"	0.11	3 to 5 psi (0.2 to 0.3 bar)	JL-98553-10	
3/16"	0.12		JL-98553-11	
1/4"	0.12		JL-98553-12	
5/16"	0.13		JL-98553-13	
C. PVDF body and Viton diaphragm				
3/16"	0.12	3 to 5 psi (0.2 to 0.3 bar)	JL-98553-21	
1/4"	0.12		JL-98553-22	
3/8"	0.12		JL-98553-34	

Two- and Three-Way Stopcocks with Hose Barb Connections

Easily adjust flow

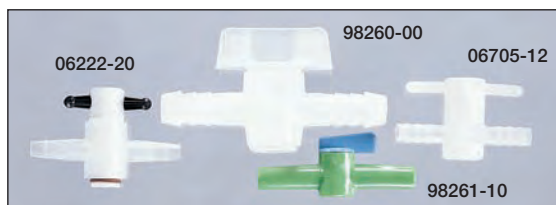

PP stopcocks have plugs made of PTFE and are autoclavable. Maximum temperature is 275°F (135°C); maximum pressure is 2 psi. **LDPE stopcocks** are rated for 167°F (75°C); maximum pressure is 7 psi. **HDPE stopcocks** are rated for 203°F (95°C); maximum pressure is 7 psi. **PVDF stopcocks** are rated for 464°F (240°C); maximum pressure is 5 psi.

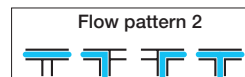

Tube ID	Orifice	Material	Catalog number	Price
Two-way stopcocks				
1/4" to 5/16"	2 mm	PP	JL-06222-20	
1/4" to 5/16"	4 mm		JL-06222-40	
3/8"	1/4"	LDPE	JL-98260-00	
1/2"	3/8"		JL-98260-10	
10 mm	6.8 mm	HDPE	JL-98261-10	
14 mm	10.7 mm		JL-98261-20	
16 mm	12.7 mm		JL-98261-30	
Three-way stopcocks; follow flow pattern 2				
1/4" to 5/16"	2 mm	PP	JL-06225-20	
1/4" to 5/16"	4 mm		JL-06225-40	
6 mm	4 mm	PVDF	JL-06705-10	
8 mm	6 mm		JL-06705-12	
10 mm	8 mm		JL-06705-14	

Cole-Parmer® Solenoid-Operated 2- and 3-Way Pinch Valves

No contamination of valve

- Control flow in your tubing without direct contact between the fluid and the valve
- Fast response time
- Low-power consumption and high-cycle life
- Excellent for sanitary and pharmaceutical applications

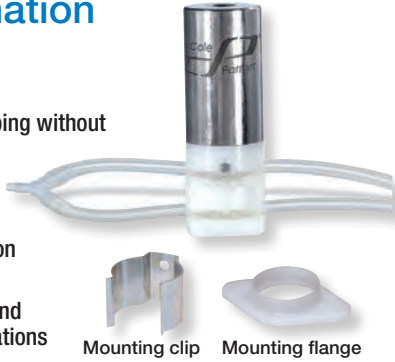

Mounting clip Mounting flange

What's included: 15" 26-gauge PTFE lead wires. Two-way valves include a 12" length of silicone tubing; three-way valves include two 6" (15.2 cm) lengths of tubing with a "Y" connector. See pages 605-653 for additional tubing.



Tubing size (ID x OD)	Max pressure	Watts	12 VDC		24 VDC	
			Cat. no.	Price	Cat. no.	Price
Two-way pinch valves; normally closed						
1/32" x 3/32"	15 psi (1 bar)	2.6	JL-98302-00		JL-98302-10	
1/16" x 1/8"	15 psi (1 bar)	2.6	JL-98302-02		JL-98302-12	
1/8" x 1/4"	20 psi (1.4 bar)	4.0	JL-98302-06		JL-98302-16	
Two-way pinch valves; normally open						
1/32" x 3/32"	15 psi (1 bar)	2.6	JL-98302-20		JL-98302-30	
1/16" x 1/8"	15 psi (1 bar)	2.6	JL-98302-22		JL-98302-32	
1/8" x 1/4"	20 psi (1.4 bar)	4.0	JL-98302-26		JL-98302-36	
Three-way pinch valves; one normally open, one normally closed						
1/32" x 3/32"	15 psi (1 bar)	2.6	JL-98302-40		JL-98302-48	
1/16" x 1/8"	15 psi (1 bar)	2.6	JL-98302-42		JL-98302-50	
1/8" x 1/4"	20 psi (1.4 bar)	4.0	JL-98302-46		JL-98302-54	

[JL-01540-50](#) Mounting clip for 2- and 3-way valves

[JL-01540-55](#) Mounting flange for 2- and 3-way valves

Cole-Parmer® PTFE Multi-Turn Needle Valves

Maintain flow control to 75 psi

- PTFE body and O-ring; CTFE valve spindle
- Max temperature of 200°F (93°C)
- Orifice is 0.125"



06393-60



06393-61



06393-94



Max flow rate (mL/min)		Body type	Catalog number	Price
Air	H ₂ O			
Multi-turn needle valves; 1/8" NPT(F) connectors				
2400	130	Aluminum	JL-06393-70	
55,000	2800			
2400	130	316 SS	JL-06393-80	
55,000	2800			
Multi-turn needle valves; 3/8" nipple connectors				
2400	130	Aluminum	JL-06393-61	
55,000	2800			
2400	130	316 SS	JL-06393-90	
55,000	2800			
Multi-turn needle valves; connectors for 1/4" OD				
2400	130	Aluminum	JL-06393-66	
55,000	2800			
2400	130	316 SS	JL-06393-94	
55,000	2800			

Parker® High-Pressure Metal Ball Valves

Don't worry about leaks

Connections	Material (body, seals)	C _v	Orifice	Max pressure†	Max temperature	Dimensions (L x H)	Catalog number	Price
A. Two-way valves (straight)								
1/8" compression	SS, PFA	0.2	0.093"		300°F (149°C)	2" x 1 5/8" (51 x 41 mm)	JL-30527-30	
1/8" compression	Brass, PFA	0.2	0.093"	2500 psi (172 bar)	300°F (149°C)	2" x 1 5/8" (51 x 41 mm)	JL-30527-64	
1/8" NPT(F)	SS, PFA	0.44	0.125"		300°F (149°C)	1 7/8" x 1 5/8" (48 x 41 mm)	JL-30527-32	
1/8" NPT(F)	Brass, PFA	0.44	0.125"		300°F (149°C)	1 7/8" x 1 5/8" (48 x 41 mm)	JL-30527-66	
1/4" compression	SS, PFA	0.44	0.125"	2500 psi (172 bar)	300°F (149°C)	2 1/4" x 1 5/8" (57 x 41 mm)	JL-30527-34	
1/4" compression	Brass, PFA	0.44	0.125"		300°F (149°C)	2 1/4" x 1 5/8" (57 x 41 mm)	JL-30527-68	
1/4" NPT(F)	SS, PFA	1.02	0.187"		300°F (149°C)	2" x 2" (51 x 51 mm)	JL-30527-36	
1/4" NPT(F)	Brass, PFA	1.02	0.187"	3000 psi (207 bar)	300°F (149°C)	2" x 2" (51 x 51 mm)	JL-30527-70	
1/4" NPT(M)	SS, PFA	1.02	0.187"		300°F (149°C)	2" x 2" (51 x 51 mm)	JL-30527-38	
B. Three-way valves								
1/8" compression	SS, PFA	0.18	0.093"		300°F (149°C)	2" x 2 1/4" (51 x 57 mm)	JL-30527-54	
1/8" compression	Brass, PFA	0.18	0.093"	2500 psi (172 bar)	300°F (149°C)	2" x 2 1/4" (51 x 57 mm)	JL-30527-80	
1/8" NPT(F)	SS, PFA	0.34	0.125"		300°F (149°C)	1 5/8" x 2 1/4" (41 x 57 mm)	JL-30527-56	
1/8" NPT(F)	Brass, PFA	0.34	0.125"		300°F (149°C)	1 5/8" x 2 1/4" (41 x 57 mm)	JL-30527-82	
1/4" compression	SS, PFA	0.34	0.125"	2500 psi (172 bar)	300°F (149°C)	2 1/4" x 2 1/2" (57 x 64 mm)	JL-30527-58	
1/4" compression	Brass, PFA	0.34	0.125"		300°F (149°C)	2 1/4" x 2 1/2" (57 x 64 mm)	JL-30527-84	
1/4" NPT(F)	SS, PFA	0.7	0.187"	3000 psi (207 bar)	300°F (149°C)	2" x 2 1/2" (51 x 64 mm)	JL-30527-60	
1/4" NPT(F)	Brass, PFA	0.7	0.187"		300°F (149°C)	2" x 2 1/2" (51 x 64 mm)	JL-30527-86	
3/8" compression	SS, PFA	0.7	0.187"	3000 psi (207 bar)	300°F (149°C)	2 5/8" x 2 3/4" (67 x 70 mm)	JL-30527-62	
3/8" compression	Brass, PFA	0.7	0.187"		300°F (149°C)	2 5/8" x 2 3/4" (67 x 70 mm)	JL-30527-88	

†Preset from factory to 1000 psig. Packing nut must be tightened to achieve higher pressures.



30527-38



30527-34

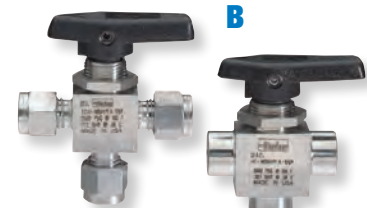

30527-58



30527-60



Oakton® Meters for Any Application



Testers—
simply dip and read

Conductivity 78
pH 82

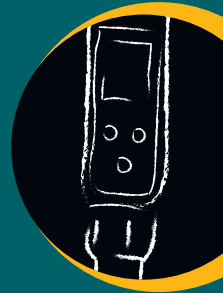

Handheld Meters—
take it where you need it

Conductivity 79–80
pH 83
Dissolved Oxygen Online
Multiparameter Online



Benchtop Meters—
higher precision for
more accurate results

Conductivity Online
pH/Ion 84
Dissolved Oxygen Online
Multiparameter Online



MORE ONLINE ▶ ColeParmer.com/Oakton

Product Selection | Troubleshooting | And More...

800-323-4340
— or Ch@t Live —

Not sure what to choose?
Our expert Application Specialists can help you find the
right product for your application.





Oakton® Waterproof EcoTestr™ TDS and EC Pocket Meters

Stop replacing sensors

- Price allows you to just replace meter
- Rugged, chemical-resistant stainless steel sensors
- Easy push-button electronic single-point calibration
- Read measurements easily—ergonomic display for easy viewing at a glance
- Waterproof, floating meter—ideal for damp or dirty conditions
- Save money—ideal for education or field use

Choose from four models depending on your parameter. TDS models include a self-adjusting TDS factor from 0.40 to 1.0.

OAKTON®

ISO9001:2008
CERTIFIED SUPPLIER

IP 67

Description		EcoTestr TDS Low	EcoTestr TDS High	EcoTestr EC Low	EcoTestr EC High
Catalog number		JL-35462-10	JL-35462-15	JL-35462-30	JL-35462-35
Range	Conductivity	—	—	0 to 1990 µS	0 to 19.90 mS
	TDS	0 to 1990 ppm	0 to 10.0 ppt	—	—
Resolution	Conductivity	—	—	10 µS	0.1 mS
	TDS	10 ppm	0.1 ppt	—	—
Accuracy	Conductivity	—	—	±1% FS	±2% FS
	TDS	±1% FS	±2% FS	—	—
Temperature compensation		Automatic, 0 to 50°C, 2% per °C			
Calibration		One-point digital calibration			
Power		Four 1.5 V batteries (included), >200 hours life			
Price					

[JL-09377-16](#) Replacement batteries, 1.5 V button cell. Pack of 6



Oakton® Dual-Range Waterproof TDS Testr® 11 and EC Testr® 11 Meters

Get longer life with replaceable sensor

- Don't worry about losing your meter—floats if dropped in water and included lanyard keeps it close
- Get more out of your meter—dual range measurements for a wider application range
- Easy calibration—up to one point per range
- Stands up to whatever you throw at it—Valox® housing and stainless steel electrodes for good chemical compatibility

OAKTON®

ISO9001:2008
CERTIFIED SUPPLIER

CE

IP 67

Description		TDS Testr 11 Dual Range	EC Testr 11 Dual Range
Catalog number		JL-35662-10	JL-35662-30
Range	Conductivity	0 to 2000 ppm; 0 to 10.0 ppt	0 to 2000 µS; 0 to 20.00 mS
	Temperature	32 to 122°F (0 to 50°C)	32 to 122°F (0 to 50°C)
Resolution	Conductivity	10 ppm; 0.10 ppt	10 µS; 0.10 mS
	Temperature	0.1°F (0.1°C)	0.1°F (0.1°C)
Accuracy	Conductivity	±1% full scale	±1% full scale
	Temperature	±0.9°F (±0.5°C)	±0.9°F (±0.5°C)
Temperature compensation		Automatic, 0 to 50°C; 2% per °C	
Calibration		One or two points	
Power		Four 1.5 V alkaline batteries (included), approximately 150 hours continuous use	
Price			

Accessories

[JL-35661-17](#) Replacement sensor for pin-style testers

[JL-09377-16](#) Replacement batteries, 1.5 V button cell. Pack of 6

[JL-35661-70](#) Calibration kit, includes two each of TDS calibration solution pouches (447, 1413, 2764, and 15,000 µS), two rinse water pouches, sample jar, and foam-lined carrying case. Use with any Oakton TDS/EC Testr meter

[JL-17090-30](#) NIST-traceable calibration for conductivity meter



Replaceable sensor

Oakton® Waterproof CON 150 Meter

Get more for your money

- Best value for an IP67-rated waterproof meter
- Know the status of your probe—intuitive, user-friendly icon displays cell constant
- Get quick and easy electrode attachment to a beaker or container with Grip-Clip™ holder
- Recall more data with expanded data logging for up to 150 data sets
- Use as a benchtop meter as well—built-in stand and wall-mount option
- Versatile power supply—battery or AC

Rugged, waterproof housing is ideal for use in any environment. View more data simultaneously with large, three-line LCD providing conductivity or TDS measurement with temperature. Get faster calibration with auto-ranging and auto-cal functions for one calibration point per measurement range. Select a probe with a 0.1, 1.0, or 10 cell constant and automatic temperature compensation (ATC). Get more accuracy even in fluctuating temperatures with ATC.

Meter features include adjustable conductivity-to-TDS factor, selectable temperature coefficient, ready (stability) indicator, smart averaging, hold function, calibration alarm (visible), battery life indicator, and probe status.

Meter includes: conductivity cell (K = 1.0), Grip-Clip holder, and two AA batteries.

Kit adds: two calibration standards and hard carrying case.

NEW



Electrochemistry

Conductivity



Built-in meter stand for steady benchtop use.



Description	CON 150 meter with probe	CON 150 meter kit
Catalog number	JL-35607-32	JL-35607-90
Precalibrated catalog number	JL-35607-34	JL-35607-91
Range	Conductivity	0 to 200 mS
	TDS	0 to 200 ppt
	Temperature	-17.0 to 230.0°F (-10.0 to 110.0°C)
Resolution	Conductivity	0.01 µS to 0.1 mS
	TDS	0.01 ppm to 0.1 ppt
	Temperature	0.1°F/°C
Accuracy	Conductivity	±1% full-scale
	TDS	±1% full-scale
	Temperature	±0.9°F (±0.5°C)
Calibration	Conductivity	Auto/manual; 1 point/range
	TDS	Auto/manual; 1 point/range
	Temperature	Offset 0.1 increments
Temperature compensation	Automatic or manual from -10 to 110°C	
Conductivity-to-TDS factor	0.4 to 1.0	
Data logging	Stores up to 150 data sets	
Power	Two AA batteries (included); universal power adapter (optional)	
Price		
Precalibrated price		

Accessories

- [JL-35608-55](#) Conductivity cell, K = 0.1
- [JL-35608-50](#) Replacement conductivity cell, K = 1.0
- [JL-35608-51](#) Conductivity cell, K = 10
- [JL-35614-50](#) Replacement Grip-Clip holder easily attaches probe to side of container for hands-free measurement
- [JL-35614-51](#) Hard carrying case
- [JL-35420-72](#) Optional power adapter, 110/220 VAC
- [JL-09376-01](#) Replacement batteries, AA. Pack of 4
- [JL-17090-30](#) NIST-traceable calibration with data for conductivity meter

Save time, save money!

Choose Precalibrated
Includes a data-rich, ISO 17025 certificate—no additional charge!

Precalibrated by **INNOCAL**
INNOVATIVE CALIBRATION SOLUTIONS

Oakton® Waterproof CON 450 Meter

Easy to read in any environment

- Use it in any environment with backlit display and rugged design
- Know the status of your probe—intuitive, user-friendly icon displays cell constant
- Get quick and easy electrode attachment to a beaker or container with Grip-Clip™ holder
- Download and analyze up to 500 data sets with USB or RS-232 output
- Use as a benchtop meter as well—built-in stand and wall-mount option
- Versatile power supply—battery or AC

Waterproof, IP67-rated meter is ideal for even the harshest environments. View the main measurement simultaneously with temperature on backlit display. Get faster calibration with auto-cal function, which permits one calibration point per measurement range. Select a probe with a 0.1, 1.0, or 10 cell constant and automatic temperature compensation (ATC). Get more accuracy even in fluctuating temperatures with ATC.

Meter features include adjustable conductivity-to-TDS factor, selectable temperature coefficient, ready (stability) indicator, smart averaging, user-selectable °F/°C units, hold function, calibration alarm, battery life-indicator, and electrode status.

Meter includes: conductivity cell (model 35608-50, K = 1.0), Grip-Clip holder, and batteries.

Kit adds: calibration standards and hard carrying case.



Description	CON 450 meter with probe	CON 450 meter kit
Catalog number	JL-35608-32	JL-35608-80
Precalibrated catalog number	JL-35608-34	JL-35608-81
Range	Conductivity	0 to 200 mS
	TDS	0 to 200 ppt
	Salinity	0 to 50 ppt
	Temperature	-17.0 to 230.0°F (-10.0 to 110.0°C)
Resolution	Conductivity	0.01 µS to 0.1 mS
	TDS	0.01 ppm to 0.1 ppt
	Salinity	0.01
	Temperature	0.1°F/°C
Accuracy	Conductivity	±1% full-scale
	TDS	±1% full-scale
	Salinity	±1% full-scale
	Temperature	±0.9°F (±0.5°C)
Calibration	Conductivity	Auto/manual; 1 point/range
	TDS	Auto/manual; 1 point/range
	Salinity	Auto/manual; 1 point/range
	Temperature	±5.0° offset
Temperature compensation	Automatic or manual from -10 to 110°C	
Data logging	Stores up to 500 data sets	
Output	USB or RS-232	
Power	Two AA batteries (included); 500 hours (without backlight); AC adapter (optional)	
Price		
Precalibrated price		

Accessories

[JL-35608-55](#) Conductivity cell, K = 0.1

[JL-35608-50](#) Replacement conductivity cell, K = 1.0

[JL-35608-51](#) Conductivity cell, K = 10

[JL-35614-50](#) Replacement Grip-Clip electrode holder

[JL-35614-51](#) Hard carrying case

[JL-35630-53](#) Data cable for USB connectivity

[JL-35420-01](#) Data cable for RS-232 connectivity

[JL-35420-72](#) Optional AC adapter, 110/220 VAC

[JL-09376-01](#) Replacement batteries, AA. Pack of 4



NEW

Easy one-button data logging

Save time, save money!

Choose Precalibrated

Includes a data-rich, ISO 17025 certificate—no additional charge!

Precalibrated by **INNOCAL**
INNOVATIVE CALIBRATION SOLUTIONS



Convenient kit saves you money!



Cole-Parmer® Conductivity Solutions, NIST-Traceable Reference Materials

Trust your standards—high accuracy

– Up to ±0.25% accuracy verified by an ISO Guide 34 and ISO 17025 accredited lab

A. Batch-Tested Bottles, 16-oz

– Easy calibration with included instructions and temperature compensation chart

– Includes NIST-traceable certificate and batch testing information



B. Individually Tested Bottles, 16-oz

– Each bottle individually calibrated—NIST-traceable certificate included with serial number and testing information

– Easy calibration with step-by-step instructions and included temperature compensation chart

C. One-Shot® Vials, pack of six 3.4-oz vials

– Fresh solution each time you calibrate—single-use vials eliminate contamination

– Grab it and go—convenient for field use; calibrate right in vial

– Includes NIST-traceable calibration report and temperature compensation chart



Conductivity (µS)	Resistivity (MΩ)	TDS (ppm)	Catalog number	Price
A. Batch tested, one 16-oz (473-mL) glass bottle				
1	1	0.66	JL-00652-20	
5	0.2	3.3	JL-00652-22	
10	0.1	6.6	JL-00652-24	
100	0.01	66	JL-00652-26	
1000	0.001	666	JL-00652-28	
1413	0.00071	933	JL-00652-30	
10,000	0.0001	6666	JL-00652-32	
100,000	0.00001	66,666	JL-00652-34	
150,000	0.0000066	100,000	JL-00652-53	
200,000	0.000005	133,333	JL-00652-55	
B. Individually tested, one 16-oz (473-mL) glass bottle				
1	1	0.66	JL-00652-40	
5	0.2	3.3	JL-00652-42	
10	0.1	6.6	JL-00652-44	
100	0.01	66	JL-00652-46	
1000	0.001	666	JL-00652-48	
1413	0.00071	933	JL-00652-50	
10,000	0.0001	6666	JL-00652-52	
100,000	0.00001	66,666	JL-00652-54	
150,000	0.0000066	100,000	JL-00652-56	
200,000	0.000005	133,333	JL-00652-58	
C. One-Shot®, pack of six 3.4-oz (100-mL) vials				
5	0.2	3.3	JL-00652-60	
10	0.1	6.6	JL-00652-62	
100	0.01	66	JL-00652-64	
1000	0.001	666	JL-00652-66	
1413	0.00071	933	JL-00652-68	
10,000	0.0001	6666	JL-00652-70	
100,000	0.00001	66,666	JL-00652-72	
150,000	0.0000066	100,000	JL-00652-76	
200,000	0.000005	133,333	JL-00652-78	
Assortment†	—	—	JL-00652-74	

†Assortment has one 100-mL vial each of 10, 100, 1000, 1413, 10,000, and 100,000 µS.

Oakton® Calibration Solutions

Save money while calibrating

- KCl, NaCl, and 442 conversions printed right on the bottle
- Temperature corrections at hand—printed right on the bottle

Include NIST-traceable calibration report supplied by the manufacturer. One 17-oz (500-mL) bottle.



Conductivity (µS)	Conductivity-to-TDS calibration values			Catalog number	Price
	ppm KCl	ppm NaCl	ppm 442		
23	11.6	10.7	14.74	JL-00653-23	
84	40.38	38.04	50.5	JL-00653-16	
447	226	215	300	JL-00653-47	
1413	745	702	1000	JL-00653-18	
1500	757	737	1050	JL-00653-15	
2070	1045	1041	1500	JL-00653-27	
2764	1382	1414	2062	JL-00653-20	
8974	5101	4487	7608	JL-00653-89	
12,880	7447	7230	11,367	JL-00606-10	
15,000	8759	8532	13,455	JL-00653-50	
80,000	52,168	48,384	79,688	JL-00653-32	

MYRON L Calibration Solutions

Be more accurate

- Get reliable readings with ±1% accuracy
- Include conversions for quick reference

Include NIST-traceable calibration report supplied by the manufacturer. One 32-oz (946-mL) bottle.



Conductivity (µS)	Conductivity-to-TDS calibration values			Catalog number	Price
	ppm KCl	ppm NaCl	ppm 442		
23.8	—	11.08	15	JL-01489-90	
46.7	—	21.8	30	JL-01489-91	
70	—	32.8	45	JL-01489-92	
445	—	214	300	JL-01489-93	
700	—	340	478	JL-01489-94	
2060	—	1036	1500	JL-01489-95	
3900	—	2027	3000	JL-01489-96	
7000	—	3740	5687	JL-01489-97	
16,630	—	9462	15,000	JL-01489-98	
30,100	—	18,235	30,000	JL-01489-99	

Electrochemistry

Conductivity



Oakton® Waterproof EcoTestr™ pH 2 Pocket Meter

No more replacing electrodes

- Easy to use—simply dip and read results on the easy-to-read display
- Waterproof housing is ideal for dirty or damp conditions—even floats if dropped in water
- Transparent protective cap also holds calibration solutions

Single-junction electrode is recessed to protect against breakage. Meter offers up to three-point calibration with autobuffer recognition for quick calibrations. Automatic temperature compensation ensures accurate readings, even under changing conditions. Hold function allows you to lock a measured value.



Model	EcoTestr pH 2
Catalog number	JL-35423-10
Range	0 to 14.0 pH
Resolution	0.1 pH
Accuracy	±0.1 pH
Temperature compensation	Automatic
Calibration	Up to 3 points
Buffer recognition	4.0, 7.0, or 10.0
Power	Four 1.5 V button cell batteries (included)
Price	

Accessories

[JL-09377-16](#) Replacement batteries, 1.5 V. Pack of 6

[JL-17101-45](#) NIST-traceable calibration for pH pocket meters (non-BNC)

Wait!

There's More at ColeParmer.com

Find all the product specs you need!

Oakton® Waterproof pHTestr® 10, 20, and 30 Pocket Meters

Save money—replace electrode instead of meter

- IP67-rated housing floats in water and won't roll off table
- Resistant to most chemicals with Valox® sensor housing
- Automatic buffer recognition for calibration up to three points
- Don't let temperature interfere—automatic temperature compensation minimizes impact

Double-junction electrode sensors handle wastewater and solutions containing sulfides, heavy metals, and Tris. Electrode sensors offer a clog-resistant Kynar® PVDF junction and a recessed, glass pH bulb to protect against breakage.

pHTestr 10 offers the most economical option.

pHTestr 20 features ±0.01 pH accuracy—suitable for most ASTM and EPA test procedures.

pHTestr 30 includes all of the features of the pHTestr 20 along with dual pH and 0.1-resolution temperature display. Temperature display units in selectable °F or °C.

What's included: protective plastic storage case, lanyard, and batteries.

pHTestr 10

pHTestr 20

pHTestr 30



Description	pHTestr 10	pHTestr 20	pHTestr 30 with temperature readout
Catalog number	JL-35634-10	JL-35634-20	JL-35634-30
Range	-1.0 to 15.0 pH	-1.00 to 15.00 pH	-1.00 to 15.00 pH
Resolution	0.1 pH	0.01 pH	0.01 pH
Accuracy	±0.1 pH	±0.01 pH	±0.01 pH
Temperature compensation	Automatic, 32 to 122°F (0 to 50°C)		
Calibration	Up to three pH points		
Buffer recognition	4.0, 7.0, 10.0 USA 4.0, 6.9, 9.2 NIST	4.01, 7.00, 10.01 USA 4.01, 6.86, 9.18 NIST	
Power	Four 1.5 V button cell batteries (included)		
Price			

Accessories

[JL-35624-38](#) Replacement pH sensor

[JL-09377-16](#) Replacement batteries, 1.5 V button cell. Pack of 6

[JL-17101-45](#) NIST-traceable calibration for pH pocket meters (non-BNC)

Oakton® Waterproof pH 450 Meter

No more difficulty reading measurements

- Use it in any environment with backlit display and rugged design
- Intuitive, user-friendly icons show electrode status as pH slope
- Get quick and easy electrode attachment to a beaker or container with Grip-Clip™ holder
- Download and analyze up to 500 data sets with USB or RS-232 output
- Use as a benchtop meter as well—built-in stand and wall-mount option

NEW



Waterproof, IP67-rated meter is ideal for even the harshest environments. View the main measurement simultaneously with temperature and calibration data with % slope on the large, backlit LCD. Be more accurate with up to six calibration points from USA, NIST, DIN, and custom pH buffers. Automatic temperature compensation (ATC) ensures measurement accuracy even in fluctuating temperatures.

Additional features include ready (stability) indicator, smart averaging, hold function, calibration alarm (visible), battery-life indicator, and electrode status.

Meter only includes: Grip-Clip holder and two AA batteries.

Meter with probe adds: "All-in-one" pH/temperature electrode (model 35808-71).

Meter kit further adds: pH buffer solutions, storage solution, rinse solution, and hard carrying case.

ISO9001:2008
CERTIFIED SUPPLIER



Meter only

Description	Meter only	Meter with probe	Meter kit
Model	pH 450		
Catalog number	JL-35618-32	JL-35618-30	JL-35618-90
Precalibrated cat. no.	JL-35618-34	JL-35618-33	JL-35618-91
Range	pH	-2.00 to 16.00	
	mV	±2000 mV	
	Ion	0.0 to 19,999	
	Temperature	-17.0 to 230.0°F (-10.0 to 110.0°C)	
Resolution	pH	0.01	
	mV	0.1 mV ±999.9 mV; 1 mV beyond	
	Ion	0.01	
	Temperature	0.1°F/°C	
Accuracy	pH	±0.01	
	mV	±0.2 mV ±2 LSD or ±0.5% of reading; whichever is greater	
	Ion	±0.5% full-scale (monovalent); ±1% full-scale (divalent)	
	Temperature	±0.9°F (±0.5°C)	
Calibration	pH	Up to 6 points: USA, NIST, DIN	
	mV	±200 mV	
	Ion	Up to 6 points	
	Temperature	Offset 0.1 increments	
Temperature compensation	Automatic or manual from -10 to 110°C		
Output	USB or RS-232		
Data logging	500 data sets		
Power	Two AA batteries (included); universal power adapter (optional)		
Price			
Precalibrated price			

OAKTON®

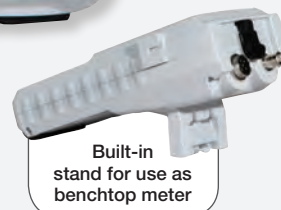

Built-in stand for use as benchtop meter

Accessories

- [JL-35808-71](#) Replacement "All-in-One" pH electrode with built-in ATC; single-junction, epoxy body, BNC connector
- [JL-35808-72](#) "All-in-One" pH electrode with built-in ATC; double-junction, epoxy body, BNC connector
- [JL-35618-05](#) ATC probe. Use with any standard pH electrode for temperature compensation
- [JL-35614-50](#) Replacement Grip-Clip electrode holder
- [JL-35614-51](#) Hard carrying case, for 150/450 meters
- [JL-35630-53](#) Data cable for USB connectivity
- [JL-35420-01](#) Data cable for RS-232 connectivity
- [JL-35420-72](#) Optional adapter, 110/220 VAC
- [JL-09376-01](#) Replacement batteries, AA. Pack of 4
- [JL-17106-20](#) NIST-traceable calibration with data for pH meter

Electrochemistry

pH / Ion



Kim, 12 years of experience

Need Help Selecting?

Trust our **expert** Application Specialists to help you find the right product.

800-323-4340 sales@coleparmer.com ColeParmer.com

Oakton® Benchtop pH 700 and Ion 700 Meters

No more lost data—store and recall up to 100 data sets

- Takes up less bench space—40% smaller than comparable models
- Super-large dual-line display is easy to read
- Simple calibrations with 5-point automatic pH buffer recognition for USA and NIST buffers
- More accurate measurements with up to 5-point calibration for ion concentration on Ion 700 model
- Versatile—use with any pH, ORP, or ISE electrodes with BNC connector

pH 700 meter measures pH, mV, relative mV, and temperature. Ion 700 meter adds ion concentration measurement and reads directly in ppm for easy use. Automatic temperature compensation (ATC) maintains reading accuracy even with fluctuating temperatures.

Meters feature Auto-Hold, selectable °F or °C measurement, and easy recall of electrode slope or offset.

Save time, save money!

Choose Precalibrated

Includes a data-rich, ISO 17025 certificate—no additional charge!

Precalibrated by **INNOCAL**
INNOVATIVE CALIBRATION SOLUTIONS



Keep procedures handy with quick-reference pull out

Search

For our complete selection of pH/ion meters, go to...
ColeParmer.com/PHMeters

Electrochemistry

pH / Ion

Specifications

OAKTON®

ISO9001:2008
CERTIFIED SUPPLIER

CE Meter only



Model		pH 700	Ion 700
Range	pH	-2.00 to 16.00	-2.00 to 16.00
	mV/rel mV	±2000	±2000
	ISE	—	0.01 to 2000 ppm
	Temperature	32 to 100°F (0.0 to 100.0°C)	32 to 100°F (0.0 to 100.0°C)
Resolution	pH	0.01 pH	0.01 pH
	mV/rel mV	0.1 within ±199.9 mV, 1 beyond ±199.9 mV	0.1 within ±199.9 mV, 1 beyond ±199.9 mV
	ISE	—	0.01 to 2000 ppm
	Temperature	0.1°F or °C	0.1°F or °C
Accuracy	pH	±0.01 pH	±0.01 pH
	mV/rel mV	±0.2 within ±199.9 mV, ±2 beyond 199.9 mV	±0.2 within ±199.9 mV, ±2 beyond 199.9 mV
	ISE	—	±0.5% of reading (monovalent); ±1% of reading (divalent)
	Temperature	±0.9°F (±0.5°C)	±0.9°F (±0.5°C)
Calibration	pH	Up to 5 points with autobuffer recognition	Up to 5 points with autobuffer recognition
	mV	Up to ±150 mV offset adjustment	Up to ±150 mV offset adjustment
	ISE	—	From 2 to 5 consecutive points (0.1, 1.0, 10.0, 100.0, 1000 ppm)
	Temperature compensation	Automatic or manual from 32 to 100°F (0 to 100°C)	Automatic or manual from 32 to 100°F (0 to 100°C)
Buffer recognition		USA or NIST buffer sets	USA or NIST buffer sets
Data logging		100 data sets	100 data sets
Power		100/240 VAC, 50/60 Hz	100/240 VAC, 50/60 Hz

Model	Description	Meter		Precalibrated meter	
		Catalog number	Price	Catalog number	Price
pH 700	Meter only	JL-35419-00		JL-35419-01	
pH 700	Meter with "all-in-one" pH/ATC electrode	JL-35419-03		JL-35419-05	
Ion 700		JL-35419-23		JL-35419-27	
pH 700	Meter with double-junction pH electrode, ATC probe, and removable electrode holder	JL-35419-10		JL-35419-11	
Ion 700		JL-35419-20		JL-35419-24	
pH 700	Meter with removable electrode holder	JL-35419-12		JL-35419-15	
Ion 700		JL-35419-22		JL-35419-26	

[JL-59001-65](#) Combination pH electrode; single junction, gel-filled, epoxy body

[JL-59001-70](#) Combination pH electrode; double junction, gel-filled, epoxy body

[JL-35811-71](#) "All-in-one" combination pH electrode; single junction, gel-filled, epoxy body

[JL-35805-04](#) Replacement combination pH electrode; double junction, refillable, glass body

[JL-35613-13](#) Replacement ATC probe, SS

[JL-35420-54](#) Replacement electrode arm

[JL-17106-20](#) NIST-traceable calibration with data for pH/ion meter

Cole-Parmer® Epoxy-Body Combination pH and ORP Electrodes

Get fast, stable readings

- Impact resistant—epoxy-body housing for added strength
- Ideal for your general-purpose applications in the lab or field
- Compatible with most brands of pH meter

These electrodes are ideal for prolonged pH or ORP readings. Electrodes with sealed, gel-filled design require virtually no maintenance. Electrodes with PTFE reference-junction offer extended electrode life. All listed electrodes have Ag/AgCl reference cells.

What's included: 3.3-ft (1-m) cable with BNC connector.

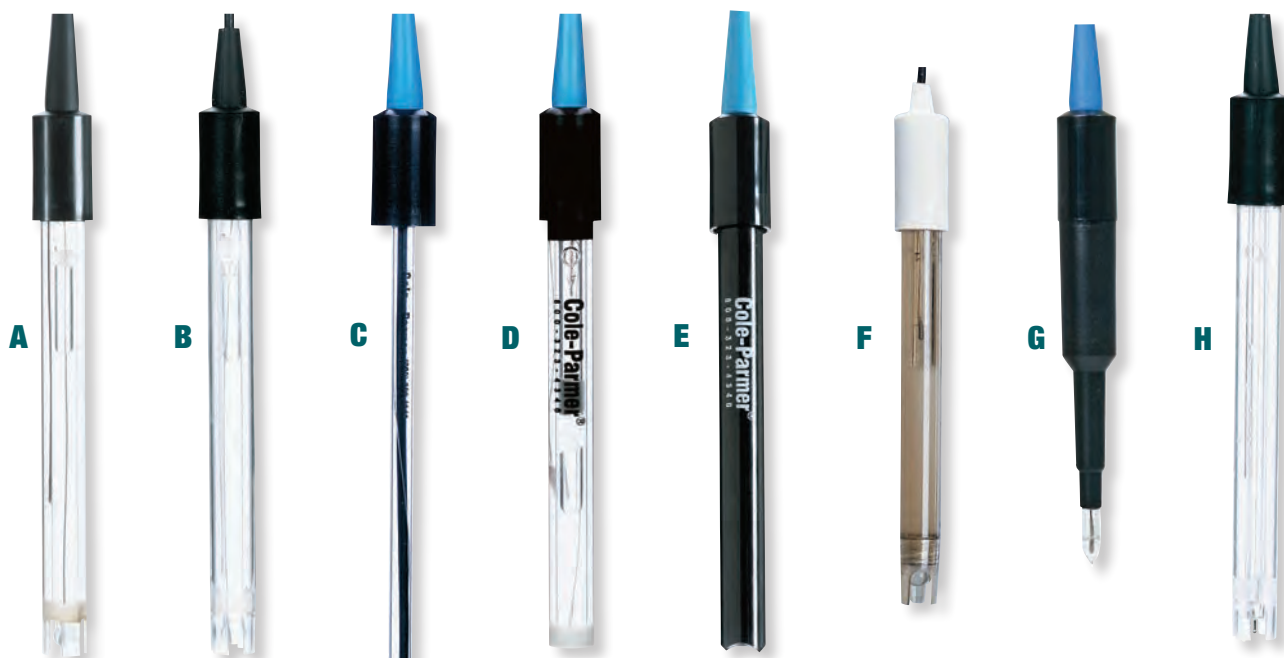

Key	Description	Reference junction	Type	Maximum temperature	Length x dia (mm)	Catalog number	Price
General-purpose pH electrodes							
A	General purpose	Single	Sealed	176°F (80°C)	127 x 12	JL-59001-65	
	For dirty samples	Double				JL-59001-70	
B	General purpose, refillable	Single	Refillable†	176°F (80°C)	148 x 12	JL-05992-30	
	For dirty samples, refillable	Double				JL-05991-12	
C	Extra-long neck for test tube sampling	Single	Sealed	176°F (80°C)	220 x 6	JL-05990-45	
D	Flat tip for surface or low-volume sampling	Single	Sealed	176°F (80°C)	127 x 12	JL-05990-65	
PTFE reference-junction pH electrodes (clog resistant)							
E	General purpose	Single	Sealed	212°F (100°C)	110 x 12	JL-05992-00	
	For dirty samples	Double				JL-05992-02	
Special-purpose pH electrodes							
F	Coiled-cable for dirty samples	Double	Sealed	176°F (80°C)	140 x 12	JL-05993-28	
G	Spear-tip for dirty samples				110 x 10	JL-59002-24	
ORP electrodes							
A	General purpose	Single	Sealed	176°F (80°C)	127 x 12	JL-59001-75	
	For dirty samples	Double				JL-59001-77	
H	General purpose, refillable	Single	Refillable††	176°F (80°C)	155 x 12	JL-05990-55	

†Use fill solution 05992-48 ††Use fill solution 05992-47

Accessories

JL-05992-48 Reference fill solution, 4 M KCl. Two 125-mL bottles

JL-05992-47 Reference fill solution, 3.8 M KCl with AgCl. Two 125-mL bottles

JL-05983-25 Adapter, BNC to US standard plug meter

Cole-Parmer® Glass-Body Combination pH and ORP Electrodes

Faster response and increased stability across 0 to 14 pH range

- More durable—dome bulb for better protection from breakage
- Withstand higher temperatures and chemical attack
- Get more stability in low-ionic strength solutions
- Resistant to Na⁺ ion interferences
- Compatible with most brands of pH meters

Available as refillable or sealed design for single, double, and annular Ag/AgCl junctions. Single-junction is ideal for clean samples; double junction is compatible with sulfates, Tris, and proteins; and annular junction is ideal for dirty samples.

What's included: 3.3-ft (1-m) cable and BNC connector.

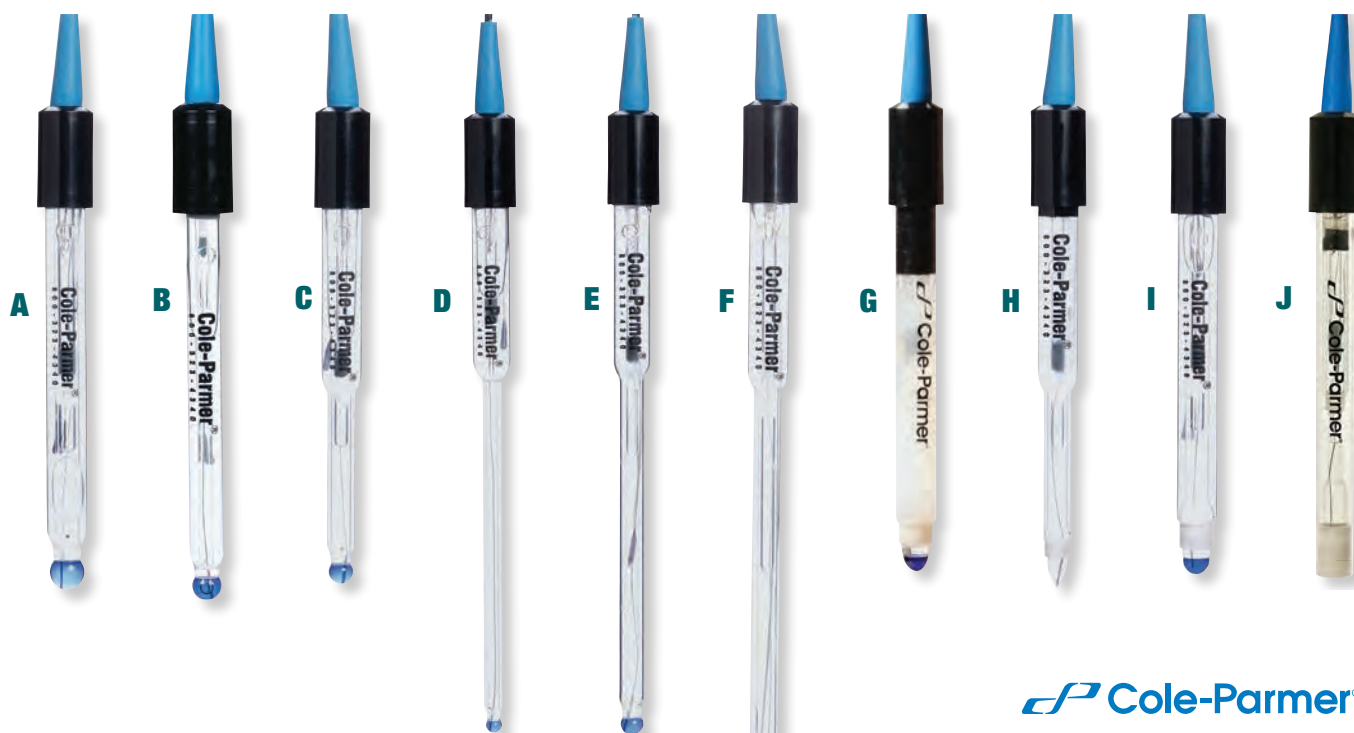

 Cole-Parmer®

Key	Description	Reference junction	Type	Maximum temperature	Length x dia (mm)	Catalog number	Price
General-purpose pH electrodes							
A	General-purpose, laboratory	Single	Refillable	212°F (100°C)	154 x 12	JL-05991-22	
	General-purpose for TRIS, sulfates, proteins	Double			154 x 12	JL-59001-34	
B	Rugged, low maintenance	Single	Sealed	212°F (100°C)	123 x 9.5	JL-05991-81	
	Rugged for TRIS, sulfates, proteins	Double			124 x 9.5	JL-59001-36	
C	General-purpose, thin neck	Single	Refillable†	212°F (100°C)	154 x 8	JL-05991-42	
D	Long neck for small test tubes				210 x 6	JL-05991-61	
E	Long neck for large test tubes				210 x 8	JL-05991-51	
F	Extra-long neck for flasks and bottles				326 x 8	JL-05990-40	
Special-purpose pH electrodes							
G	High temperature, KNO ₃ gel	Double	Sealed	248°F (120°C)	130 x 12	JL-05998-30	
H	Spear tip for piercing semisolids and foods	Single	Sealed	212°F (100°C)	159 x 8	JL-05998-20	
I	Soil electrode, eliminates "suspension effect"	Annular	Refillable†	212°F (100°C)	145 x 12	JL-05992-62	
J	Flat-tip for surface or low volume sampling	Double	Refillable†	212°F (100°C)	130 x 12	JL-05991-44	
ORP electrodes							
A	General purpose	Single	Sealed	212°F (100°C)	110 x 12	JL-05991-08	
	For dirty samples	Double				JL-05991-18	

†Use fill solution 05992-47.

Accessories

[JL-05992-47](#) Reference fill solution for refillable electrodes, 3.8 M KCl with AgCl. Two 125-mL bottles

[JL-05983-25](#) Adapter, BNC to US standard plug meter



Oakton® pH Buffer Solutions

Keep your readings accurate with these quality buffers

– Standardized against NIST-traceable pH references for meters with 0.01 resolution



pH	500-mL bottles			1-L bottles			4-L bottles			
	Catalog number	Price/ea	Catalog number	Price/cs of 12	Catalog number	Price/ea	Catalog number	Price/ea	Catalog number	Price/cs of 4
1.68	JL-00654-01		—	—	—	—	—	—	—	—
4.01	JL-00654-00		JL-05942-21	—	JL-05942-22	—	JL-05942-24	—	JL-05942-25	—
6.86	JL-00654-03		—	—	—	—	—	—	—	—
7.00	JL-00654-04		JL-05942-41	—	JL-05942-42	—	JL-05942-44	—	JL-05942-45	—
9.18	JL-00654-07		—	—	—	—	—	—	—	—
10.00	JL-00654-08		JL-05942-61	—	JL-05942-62	—	JL-05942-64	—	JL-05942-65	—
12.45	JL-00654-12		—	—	—	—	—	—	—	—



Save by ordering larger sizes or by the case!

Oakton® pH Buffer and pH Solution Packs

Maintain accuracy and your budget

– Save money by purchasing buffer pack—includes 500 mL bottle of pH 4, 7, and 10 NIST-traceable buffers

– Keep electrodes clean and stored correctly—purchase solution pack which adds 500-mL bottles of cleaning and storage solutions



Description	Qty/pk	Catalog number	Price/pk
pH buffer pack	3 bottles	JL-05942-10	
pH solution pack	5 bottles	JL-05942-15	

Oakton® pH Buffer Pouches

Keep your accuracy even on the go!

- Single-use pouch—just tear, dip, calibrate
- Standardized to NIST-traceable pH references
- Sold in pack of 20 pouches



pH	Catalog number	Price/pk
4.01	JL-35653-01	
7.00	JL-35653-02	
10.00	JL-35653-03	
Rinse solution	JL-35653-00	

[JL-35653-04](#) Buffer pouch assortment pack; contains five pouches each of pH 4, 7, and 10 buffers and rinse solution

Thermo Scientific™ Orion™ pH Buffers

Color-coded for ease of use

– Standardized against NIST-traceable pH references for superior accuracy



Available in a 475-mL (pint) bottle and portable 5 x 60-mL convenience packs. The All-in-One™ pH buffer kits include a pint each of 4, 7, and 10 buffer; either ROSS™ or standard electrode storage solution; and electrode storage bottle.

pH	5 x 60-mL bottles		475-mL bottles	
	Catalog number	Price	Catalog number	Price
1.68	JL-55350-26		JL-55350-28	
4.01	JL-55350-40		JL-55350-42	
5.00	—	—	JL-55350-38	
6.86	JL-55350-54		JL-55350-56	
7.00	JL-55350-44		JL-55350-46	
9.18	JL-55350-58		JL-55350-60	
10.01	JL-55350-48		JL-55350-52	
12.46	JL-55350-62		JL-55350-64	

[JL-55350-66](#) ROSS All-in-One pH buffer kit

[JL-55350-68](#) Standard All-in-One pH buffer kit

Cole-Parmer® pH Buffers, NIST-Traceable Reference Materials

Feel more confident about accuracies

NEW

- Calibrated by ISO Guide 34 and ISO 17025 accredited laboratory—includes NIST-traceable certificate supplied by manufacturer
- Easy calibrations—include instructions and temperature compensation chart



pH	500-mL bottles		1-L bottles		4-L bottles	
	Cat. no.	Price	Cat. no.	Price	Cat. no.	Price
Colorless buffers						
4.01	JL-00651-00		JL-00651-30		JL-00651-70	
7.00	JL-00651-02		JL-00651-32		JL-00651-72	
10.00	JL-00651-04		JL-00651-34		JL-00651-74	
Color-coded buffers						
4.01 (red)	JL-00651-06		JL-00651-36		JL-00651-76	
7.00 (yellow)	JL-00651-08		JL-00651-38		JL-00651-78	
10.00 (blue)	JL-00651-10		JL-00651-40		JL-00651-80	

Oakton® Electrode Cleaning and Storage Solutions

Clean electrodes make clean measurements

- Easily remove grease, protein, and other deposits with cleaning solution
- Make electrode last longer—store in our storage solution
- Choose 500-mL bottle or case of 24 500-mL bottles



OAKTON®

Solution type	Catalog number	Price/ea	Catalog number	Price/cs
Cleaning	JL-00653-06		JL-35655-06	
Storage	JL-00653-04		JL-35655-04	

Find even more online! Go to ColeParmer.com to search more than 100,000 products.

Thermo Scientific™ Orion™ PerpHect™ pH Buffer Packs

Fast, simple calibration

- Tear, dip, calibrate
- Individual use packs are sealed against light, air, and other contaminants



pH	Cat. no.	Qty/pk	Price/pk	Cat. no.	Qty/pk	Price/pk
4.01	JL-55350-00	10		JL-55350-02	25	
7.00	JL-55350-10	10		JL-55350-12	25	
10.01	JL-55350-20	10		JL-55350-22	25	
Rinse solution	JL-55350-30	10		JL-55350-32	25	

pH Buffer Capsules

No more wasted buffer

- Make only the buffer you need—empty one capsule into 100 mL of water and stir
- Accurate to ±0.02 pH
- Ten capsules per vial



pH	Color	Catalog number	Price/vial
4.0	Orange	JL-05977-12	
7.0	Green	JL-05977-14	
9.0	Yellow	JL-05977-16	
10.0	Blue	JL-05977-18	

Thermo Scientific™ Orion™ pH Electrode Cleaning Kit

Get longer electrode life

NEW

- Restores performance of your electrode
- Remove protein, bacteria, oil, and grease with ease
- Includes one bottle each of cleaning solution, beaker, and pipette



Description	Catalog number	Price
pH electrode cleaning kit	JL-05730-70	

Accessories

JL-05730-71 Replacement solution A for removal of proteins. Four 30-mL bottles, beaker, and pipette

JL-05730-72 Replacement solution B for removal of bacteria. Four 60-mL bottles, beaker, and pipette

JL-05730-73 Replacement solution C for general-purpose cleaning. Four 30-mL bottles, beaker, and pipette

JL-05730-74 Replacement solution D for removal of oil and grease. Four 60-mL bottles, beaker, and pipette

Thermo Scientific™ Orion™ ORP Standards

No hazardous chemicals or organics

- No more mixing—stable and ready to use
- Use as relative mV standard and calibrate offset of sample
- Redox potential values are 215 mV for Ag/AgCl reference electrodes and 420 mV for standard hydrogen reference electrodes



Description/packaging	Catalog number	Price
One-pint (475-mL) bottle	JL-05730-55	
Five 2-oz (60-mL) bottles	JL-05730-57	

Electrode Saver Bottles

Keeps electrodes in working order

- Protect against bumps, spills, and drying out
- Accepts electrodes up to 13 mm diameter



Capacity (mL)	Dimensions (H x dia)	Catalog number	Price
50	4" x 1½" (10 x 3.8 cm)	JL-05990-99	
5	1¾" x 7/8" (4.4 x 2.2 cm)	JL-35805-50	

05990-99

35805-50

Don't Get Burned—Gain More Confidence in Your Readings

Digi-Sense® Precalibrated Thermocouple Thermometers

- Compact, affordable units provide accurate and dependable readings
- No need to worry about reading measurements—large, backlit LCD makes readings easy

General-Purpose Thermocouple Thermometers

Meters accept both type K or J thermocouple probes with miniconnector. The two- and four-channel models provide data logging of up to 18,000 readings; USB interface lets you easily download data to a PC for analysis with included software.

Professional Thermocouple Thermometers with IR Input

These durable meters deliver accurate readings in an ergonomic design. Models accept type K probes and an optional infrared (IR) wand for noncontact measurements from a distance. Two- and four-channel models continually scan each channel for real-time measurements. Data logging models allow you to download and analyze data fully.



What's included: type K bead wire temperature probe (one for each input), batteries, and NIST-traceable calibration report with data supplied by InnoCal. Data logging models also include USB cable and software.



20250-01

20250-17



Description	General-purpose thermometers			Professional thermocouple thermometers with IR input			
	JL-20250-01	JL-20250-02	JL-20250-03	JL-20250-18	JL-20250-17	JL-20250-19	JL-20250-20
Thermocouple (T/C) inputs	1 (type K or J)	2 (type K or J)	4 (type K or J)	1 (type K)	2 (type K)	2 (type K)	4 (type K)
Infrared (IR) input	No			Yes, with optional IR wand 20250-24 (order below)			
T/C range	K: -328 to 2501°F (-200 to 1372°C) J: -346 to 2012°F (-210 to 1100°C)			K: -328 to 2501°F (-200 to 1372°C)			
IR range	—			-31 to 1022°F (-35 to 550°C)			
Resolution	0.1°F/C below 1000°, 1°F/C above 1000°			0.1°F/C below 1000°, 1°F/C above 1000°			
T/C accuracy	Above -148°F (-100°C): ±[0.5% rdg + 1.8°F (1°C)] Below -148°F (-100°C): ±[0.5% rdg + 3.6°F (2°C)] Differentials: ±[0.5% rdg + 3.6°F (2°C)]			Above -148°F (-100°C): ±[0.15% rdg + 1.8°F (1°C)] Below -148°F (-100°C): ±[0.5% rdg + 3.6°F (2°C)] Differentials: ±[0.5% rdg + 1.8°F (1°C)]			
	—			Above 14°F (-10°C): ±[2.0% rdg + 3.6°F (2°C)]; Below 14°F (-10°C): ±9°F (5°C); T/C-IR differentials: ±[2.0% rdg + 5.4°F (3°C)] above 14°F (-10°C); ±11°F (6°C) below 14°F (-10°C)			
IR accuracy	—			—			
Data logging	No	18,000 points		No	18,000 points		10,000 points
USB interface	No	Yes		No	Yes		Yes
Temp differential	No	Yes		Yes		—	
Scan function	No			No	Yes		
Dimensions	6½" x 2½" x 1½" (16.5 x 6.4 x 2.9 cm)			8" x 3" x 2" (20.1 x 7.5 x 5 cm)			
Price	—			—			

JL-20250-24 Optional infrared wand for professional thermocouple thermometers only. Features 8:1 distance-to-spot ratio. Measures 6½" x 2" x 1½" (16.4 x 5 x 4 cm). Includes one 9 V battery

JL-09376-00 Replacement batteries, AAA. Pack of 12

JL-09376-04 Replacement batteries, 9 V. Pack of 4

✓ **Save time and money—** precalibrated to NIST-traceable standards before you receive it

✓ **Don't let** probe errors interfere with readings— electronic offset compensates for errors

✓ **Choose your readout—** measures in °F, °C, or Kelvin (K) with 0.1 resolution

✓ **Features for your convenience:**
 - Min/Max/Avg
 - Hold
 - Relative time stamp
 - Auto-off to save battery life

✓ **Take measurements from a distance with optional infrared wand on Professional series**

Precalibration provided by

INNOCAL®

Precalibration | Recalibration | Onsite

866-InnoCal (866-466-6225)
 InnoCalSolutions.com

Optional IR wand



Cole-Parmer® Symmetry® PT Toploading Balances

Large weighing surface allows placement of a variety of samples

NEW



Symmetry®

- Weighing modes include parts counting, percent weighing, checkweighing, animal/dynamic weighing and density determination
- USB and RS-232 interfaces offer connection to a computer or printer for GLP/GMP-compliant outputs
- Sealed keypad, splashproof design, and removable stainless steel weighing pan
- An oversized backlit LCD provides clear visibility of weighing results
- Digital filters compensate for vibration, drafts or temperature changes
- Fast stabilization and response time

What's included: AC power adapter. The 210-g and 410-g models also include a draft shield.



Specifications

Calibration: Internal or external with calibration mass

Weighing units: g, ct, oz, dwt, mg, grains, oz, ozt, dwt, custom

Power: 115/220 VAC power adapter and built-in rechargeable battery pack (battery function not available on models 10001-06, -07, -13)

Capacity	Readability	Repeatability	Linearity	Pan size	Cat. no.	Price
Internal calibration						
210 g	0.001 g	±0.002 g	±0.002 g	5 1/8" x 5 1/8" (13.0 x 13.0 cm)	JL-10001-10	
410 g	0.001 g	±0.002 g	±0.002 g	5 1/8" x 5 1/8" (13.0 x 13.0 cm)	JL-10001-11	
2200 g	0.01 g	±0.02 g	±0.02 g	7 1/2" x 6 1/4" (19.0 x 16.0 cm)	JL-10001-12	
4200 g	0.01 g	±0.02 g	±0.02 g	7 1/2" x 6 1/4" (19.0 x 16.0 cm)	JL-10001-13	
External calibration						
210 g	0.001 g	±0.002 g	±0.002 g	5 1/8" x 5 1/8" (13.0 x 13.0 cm)	JL-10001-02	
410 g	0.001 g	±0.002 g	±0.002 g	5 1/8" x 5 1/8" (13.0 x 13.0 cm)	JL-10001-03	
2200 g	0.01 g	±0.02 g	±0.02 g	7 1/2" x 6 1/4" (19.0 x 16.0 cm)	JL-10001-04	
4200 g	0.01 g	±0.02 g	±0.02 g	7 1/2" x 6 1/4" (19.0 x 16.0 cm)	JL-10001-05	
5000 g	0.1 g	±0.2 g	±0.4 g	7 1/2" x 6 1/4" (19.0 x 16.0 cm)	JL-10001-06	
15000 g	0.1 g	±0.2 g	±0.4 g	7 1/2" x 6 1/4" (19.0 x 16.0 cm)	JL-10001-07	

Accessories

[JL-11120-78](#) Compact thermal printer

[JL-10000-47](#) Kensington™ type security lock and cable

[JL-17101-52](#) NIST-traceable calibration with data for balances

Cole-Parmer® Symmetry® PA Analytical Balances

Discover Symmetry—affordable, advanced, accurate

NEW



Symmetry®

- Three-door glass draft shield provides easy access inside the weighing chamber
- Oversized backlit LCD provides clear visibility of weighing results
- Sealed keypad, splashproof design, and removable stainless steel weighing pan offer safeguards in a messy lab environment
- Weighing modes include parts counting, percent weighing and checkweighing
- USB and RS-232 interfaces offer connection to a computer or printer for GLP/GMP-compliant output
- Digital filters compensate for vibration, drafts or temperature changes
- Selectable multi-language display and output
- Fast stabilization and response time



Specifications

Calibration: Internal or external with calibration mass

Weighing units: g, ct, oz, dwt, mg, grains, oz, ozt, dwt, custom

Power: 115/220 VAC power adapter

What's included: AC power adapter and draft shield.

Capacity	Readability	Repeatability	Linearity	Pan size	Catalog number	Price
Internal calibration						
120 g	0.0001 g	±0.0002 g	±0.0002 g	3 1/2" dia (9.0 cm)	JL-10001-08	
220 g	0.0001 g	±0.0002 g	±0.0002 g	3 1/2" dia (9.0 cm)	JL-10001-09	
External calibration						
120 g	0.0001 g	±0.0002 g	±0.0002 g	3 1/2" dia (9.0 cm)	JL-10001-00	
220 g	0.0001 g	±0.0002 g	±0.0002 g	3 1/2" dia (9.0 cm)	JL-10001-01	

Accessories

[JL-11120-78](#) Compact thermal printer

[JL-10000-47](#) Kensington™ type security lock and cable

[JL-17101-52](#) NIST-traceable calibration with data for balances

Bath Fluids

Get more out of your bath!

Use these bath fluids to maintain desired bath temperatures. Refer to the table below to select the appropriate bath fluid for your application. For operator safety, set the overtemperature cutoff of your bath/circulator below the flash point of the bath fluid you use.

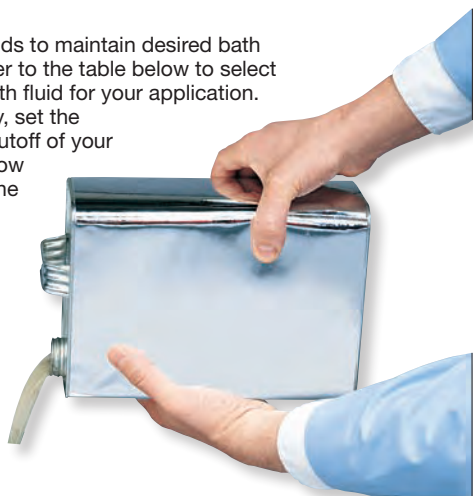

Fluid type	Silicone 210	Dynalene® HK-50	Silicone 200 20 (hot)	Silicone 710 (hot)
Catalog number	JL-01294-60	JL-01297-00	JL-01294-40	JL-01294-00
Specific gravity	0.98	0.85	0.95	1.11
Temperature range	-65 to 280°C	-50 to 58°C	10 to 149°C	150 to 250°C
Freezing point	—	-60°C	-84°C	-22°C
Flash point	288°C	65°C	246°C	302°C
Viscosity	98 cp at 26°C	2.35 cp at 25°C	18.98 cp at 25°C	33 cp at 99°C
Quantity	1 gal. (3.8 L)	1 gal. (3.8 L)	1 gal. (3.8 L)	1 gal. (3.8 L)
Price				

Note: Do not use automotive antifreeze with circulating baths—additives can be harmful to the circulating pump. Silicone fluids are not compatible with silicone tubing.

Cole-Parmer® StableTemp® Digital Utility Water Baths

Get digital accuracy at an analog price

NEW

- Recall settings at the touch of a button
- Know when process is complete with built-in timer

Dual thermostat baths provide ±0.1°C precision and overtemperature safety feature prevents overheating. Seamless tank eliminates rusting and is easy to clean.



StableTemp

ISO9001:2008
CERTIFIED SUPPLIER



Specifications

Temperature range: 5°C above ambient to 100°C

Temperature uniformity: ±0.2°C

Temperature stability: ±0.1°C

Wetted materials: 304 SS

High-temperature cutoff: yes

Bath capacity	Opening (L x W)	Working depth	120 VAC, 60 Hz		240 VAC, 50 Hz	
			Cat. no.	Price	Cat. no.	Price
2 L	3 7/8" x 4 5/16"	5 1/2"	JL-14576-00		JL-14576-02	
5 L	5" x 10 13/16"	5 1/2"	JL-14576-04		JL-14576-06	
10 L	10 9/16" x 11 5/8"	5 1/2"	JL-14576-08		JL-14576-10	
20 L	9 1/2" x 17 1/2"	5"	JL-14576-12		JL-14576-14	
28 L	9 1/2" x 17 1/2"	7"	JL-14576-16		JL-14576-18	

Cole-Parmer® Polystat® Cooling/Heating Circulating Baths

Get excellent cooling across range of temperatures

- Two-speed pump with up to 21 L/min flow
- Maximize bench space with compact size
- Protect samples and bath with high-temperature and low-level cut offs

Standard Digital Controller Baths feature five programmable set points, adjustable high-temperature cutoff, user-settable Min/Max temperature limits, and an adjustable pump nozzle. **Advanced Digital Controller Baths** offer all the features of the Standard Digital models (except adjustable pump nozzle) plus five programmable set points, a two-stage (force/suction) pump for greater circulation capacity, and a USB port.

What's included: lid, 6-ft (1.8-m) power cord with plug, M16 x 1 pump connection and 8- and 12-mm hose barb fittings with clamps for external circulation.

Specifications

Wetted materials: stainless steel, polymers

Low-level cutoff: yes

polystat®

ISO9001:2008
CERTIFIED SUPPLIER



Bath capacity	Temperature range	Stability	Cooling capacity at 20°C	Pump type	Max pump pressure psi (mbar)	Max pump flow (L/min)	Working area (W x L x D)	Power (VAC, Hz)	Catalog number	Price
Standard digital controller baths										
6.5 L	-20 to 100°C	±0.05°C	250 W	Force	4.4 (310)	17	5 9/16" x 4 13/16" x 5 7/8" (13.5 x 12.2 x 15 cm)	115, 60 230, 50	JL-12122-02 JL-12122-04	
8.6 L	-28 to 100°C	±0.05°C	500 W	Force	4.4 (310)	17	6 13/16" x 7 3/16" x 5 7/8" (17.3 x 18.3 x 15 cm)	115, 60 230, 50	JL-12122-32 JL-12122-34	
8.6 L	-28 to 150°C	±0.05°C	500 W	Force	4.4 (310)	17	6 13/16" x 7 3/16" x 5 7/8" (17.3 x 18.3 x 15 cm)	115, 60 230, 50	JL-12122-36 JL-12122-38	
Advanced digital controller baths										
6.5 L	-20 to 100°C	±0.025°C	250 W	Force/suction	11.7 (750)	21	5 9/16" x 4 13/16" x 5 7/8" (13.5 x 12.2 x 15 cm)	115, 60 230, 50	JL-12122-12 JL-12122-14	
6.5 L	-20 to 100°C	±0.025°C	250 W	Force/suction	11.7 (750)	21	5 9/16" x 4 13/16" x 5 7/8" (13.5 x 12.2 x 15 cm)	115, 60 230, 50	JL-12122-26 JL-12122-28	
8.6 L	-28 to 200°C	±0.025°C	500 W	Force/suction	11.7 (750)	21	6 13/16" x 7 3/16" x 5 7/8" (17.3 x 18.3 x 15 cm)	115, 60 230, 50	JL-12122-42 JL-12122-44	
8.6 L	-35 to 200°C	±0.025°C	800 W	Force/suction	11.7 (750)	21	6 13/16" x 7 3/16" x 5 7/8" (17.3 x 18.3 x 15 cm)	115, 60† 230, 50†	JL-12122-56 JL-12122-58	

†Requires 20 amp current.

Stir-Pak® Heavy-Duty Mixer Systems

Easily customize to your needs

1. Speed Controller

- Simple controls—speed adjustment knob and separate “forward/off/reverse” switch
- Reduce gear failure with torque limiting protection

2. Mixer Heads

- Don't limit your mixing angle—adjustable tilt from 0 to 30° for proper propeller placement
- Maintenance-free, rugged motor
- For more viscous or larger samples, choose a high-torque, low-speed mixer head with keyless chuck
- For lower viscosity samples, use a high-speed low-torque mixer head with through shaft for easy shaft positioning



REQUIRED System Components

- 1) Speed controller
 - 2) Mixer head
- or choose complete system



Complete systems include: speed controller, mixer head, shaft, propeller, clamp and stand.

1. Speed controller			2. Mixer heads							Complete systems	
Power (VAC, Hz)	Catalog number	Price	Description	Speed (rpm)	hp	Max torque (in-oz)	Power (VAC, Hz)	Catalog number	Price	Catalog number	Price
115, 50/60	JL-50007-00		High torque, low speed; with keyless chuck	2 to 180	1/15	340	115, 50/60	JL-50007-10		JL-50007-12	
230, 50/60	JL-50007-05						230, 50/60	JL-50007-15		JL-50007-17	
115, 50/60	JL-50007-00			High speed, low torque; with adjustable through-shaft collet	9 to 900	1/15	70	115, 50/60	JL-50007-20		JL-50007-22
230, 50/60	JL-50007-05		230, 50/60					JL-50007-25		JL-50007-27	
115, 50/60	JL-50007-00		23 to 2300		1/10	45	115, 50/60	JL-50007-30		JL-50007-32	
230, 50/60	JL-50007-05						230, 50/60	JL-50007-35		JL-50007-37	
115, 50/60	JL-50007-00						60 to 6000	1/10	17	115, 50/60	JL-50007-40
230, 50/60	JL-50007-05		230, 50/60	JL-50007-45		JL-50007-47					

ServoDyne™ Electronic Mixers

Get more precise mixing

- Monitor and control speed, torque, and batch time through digital controller or a computer interface

1. Controller

Provide precise control of mixing speed within ±0.2% despite changes in viscosity, temperature, or line voltage. Monitor torque, set torque limits, or measure and control differential torque with mixer head in use and sets the appropriate rpm and torque limits for that motor. Operates on 115 VAC, 50/60 Hz.

High-Torque, Low-Speed Models have a keyless chuck that accepts mixing shafts up to 3/8" (10 mm) in diameter.

High-Speed, Low-Torque Models have an adjustable, through-shaft precision hand-tightened collet that accepts 3/8" (10 mm) dia mixing shafts. Through-shaft design allows positioning the mixing propeller at any depth without moving the mixer head.

Complete systems include: speed controller, mixer head, shaft, propeller, clamp and stand.

Optional software program lets you control up to 16 ServoDyne mixers and Masterflex® L/S® computer-compatible pump drives. (See ColeParmer.com/Mixers for more information.)

2. Mixer Heads

- Maintenance-free—permanent-magnet DC motor with permanently lubricated ball-bearing construction
- Rotate mixer head from 0° to 30° for proper positioning of shaft and propeller
- Optical shaft encoder relays the exact motor rotation speed data to the electronic mixer controller



1. Controller		2. Mixer heads					Complete systems			
Catalog number	Price	Description	Speed (rpm)	hp	Max torque (in-oz)		Catalog number	Price	Catalog number	Price
					Continuous	Intermittent				
JL-50008-00		High torque, low speed; with keyless chuck	3 to 180	1/15	340	510	JL-50008-10		JL-50008-12	
			20 to 900	1/15	70	105	JL-50008-20		JL-50008-22	
		High speed, low torque; with adjustable through-shaft collet	60 to 2300	1/10	45	65	JL-50008-30		JL-50008-32	
			150 to 6000	1/10	17	25	JL-50008-40		JL-50008-42	



Cole-Parmer® Digital Reversing Mixer

Time your cycles for more efficient mixing

- Won't lose speed—brushless, 142 in-oz torque motor maintains speed
- Minimize aeration and vortexing—reversing feature alters mixing pattern for better mixing
- No more moving mixer head to change impeller depth—through-shaft housing for easier positioning
- No more motor burn out—overload protection if torque exceeds ratings
- See what you're mixing—integrated sample light illuminates sample area

Mix samples up to 20,000 cps or up to 6.6 gallons (25 liters) easily and effectively. Repeat mixing conditions accurately with LED display, with control to ±1 rpm or 3% of reading. Set timer from 1 to 2000 minutes, with audible alert when complete.

Mixer includes: mixer head, adjustable chuck (accepts rod up to 3/8" [9.5 mm] dia), chuck key, mounting support rod, external power supply, and grounded power cord with plug assembly.

Complete system adds: propeller/shaft, support stand, and clamp.



Description	Speed (rpm)	hp	Max torque (in-oz)	Power (VAC, Hz)	Catalog number	Price
Mixer only	40 to 2010	1/10	142	100 to 230, 50/60	JL-50004-00	
Complete system					JL-50004-10	

[JL-17050-03](#) NIST-traceable calibration for mixers



Complete system 50004-10 includes mixer, support stand, clamp, and mixer propeller.

Equipment & Instrumentation

Mixers

Real-Torque Digital™ Brushless Mixers

Won't let speed change even as viscosity changes

- Chuck guard encloses spinning chuck for added safety
- Set torque reading at zero via torque tare function

Mixers feature a sparkless, brushless DC motor that provides a long, maintenance-free service life. The totally enclosed nonventilated motor is rated for continuous duty. Overload protection automatically shuts off the mixer if maximum torque is exceeded—an LED light signals overload conditions. The through-shaft design lets you easily alter shaft length and propeller depth.

What's included: calibration certificate, stainless steel chuck and key (accepts up to 3/8" [9.5 mm] dia shafts), chuck guard, 5"L x 1/2" dia (127 mm L x 13 mm dia) mounting rod, and 6-ft (1.8-m) cord with three-prong plug.



Speed range (torque)		Motor	Power (50/60 Hz)	Catalog number	Price
Low speed	High speed				
12 to 360 rpm (800 in-oz)	360 to 1800 rpm (160 in-oz)	1/2 hp	115 VAC	JL-50800-00	
			230 VAC	JL-50800-05	
20 to 600 rpm (480 in-oz)	600 to 3000 rpm (96 in-oz)		115 VAC	JL-50800-10	
			230 VAC	JL-50800-15	
40 to 1200 rpm (240 in-oz)	1200 to 6000 rpm (48 in-oz)		115 VAC	JL-50800-20	
		230 VAC	JL-50800-25		

[JL-04561-24](#) Heavy-duty clamp, holds rods up to 1 1/8" (30 mm) dia.

Made of 304 SS with chemical-resistant epoxy coating

[JL-50001-93](#) Mixer safety stand. Cast zinc-aluminum base has chemical-resistant epoxy coating.

The 304 SS rod measures 28"H x 1" dia (711 mm H x 25 mm dia)

[JL-04552-88](#) Replacement mixer chuck with key



Chuck guard for added protection

U-Shaped Paddle Assemblies of electropolished 304 SS. Ideal for your large-volume or high-viscosity mixing. Shafts measure 3/8" dia x 36"L (9.5 mm dia x 914 mm L).

Paddle dia, in. (mm)	Cat. no.	Price
4 (102)	JL-50801-64	
5 (127)	JL-50801-66	
10 (254)	JL-50801-68	

IKA® RW 20 Digital Dual-Range Mixer

No separate components to purchase—complete system is ready to go!

- No downtime—maintenance-free motor for continuous duty
- Fulfill all your lab mixing needs—two speed ranges for a variety of applications
- No need to move mixer head to reposition propeller—through-shaft design for easy movement
- No difficult controls—easy-to-use knob and LED display for accurate setting

Use this versatile, affordable mixer for liquid volumes up to 5 gallons (18.9 liters) and viscosities up to 10,000 cps (approximately the viscosity of honey). Select speed from 60 to 2000 rpm in two ranges for a variety of applications.

What's included: chuck (accepts up to 3/8" [10 mm] dia shafts), 6 1/4" L x 1/2" dia (159 mm L x 10 mm dia) mounting rod, four-blade propeller mixer stand, and clamp.



Complete system includes propeller, clamp, and stand



Four-Blade Propeller
Yours free!

Boss Head Clamp
Yours free!

Plate Stand
Yours free!



Speed (rpm)	hp	Max torque (in-oz)	Power (VAC, Hz)	Catalog number	Price
60 to 500/ 240 to 2000	1/25	259	115, 50/60	JL-50705-00	
			230, 50/60	JL-50705-10	

Equipment & Instrumentation

Mixers

IKA® EUROSTAR Digital Mixers

Mix viscous samples up to 30,000 cps

- Speed won't change even as viscosity changes
- Won't overheat—thermal overload shut-off for safety
- Maintenance-free design for continuous duty

EUROSTAR 20 Digital Mixer handles volumes up to 4 gallons (15 liters) and viscosities up to 10,000 cps.

EUROSTAR 40 Digital Mixer will mix volumes up to 6.6 gallons (25 liters) and viscosities up to 30,000 cps.

What's included: chuck (accepts up to 3/8" [10 mm] dia shaft) and 6 1/4" L x 1/2" dia (159 mm x 13 mm) mounting rod.



Speed (rpm)	hp	Max torque (in-oz)	Power (VAC, Hz)	Catalog number	Price
Eurostar 20 digital mixer					
30 to 2000	1/16	28.3	115, 50/60	JL-50702-30	
			230, 50/60	JL-50702-35	
Eurostar 40 digital mixer					
30 to 2000	1/8	56.6	115, 50/60	JL-50702-40	
			230, 50/60	JL-50702-45	

IKA® EUROSTAR Digital Constant-Speed Mixers

Speed won't change even as viscosity does

- Automatic adjustment to desired speed with unique continuous speed comparison
- No need to move mixer head to remove samples—through-shaft design for impeller adjustments
- Worry-free operation—maintenance-free motor with overload protection
- Handle even large samples—up to 26.4 gallons (100 liters)

EUROSTAR 60 Digital Mixer (50704-20 and -25) handles volumes up to 10.6 gallons (40 liters) and viscosities up to 50,000 cps.

EUROSTAR 100 Digital Mixer (50704-30 and -35) will mix volumes up to 26.4 gallons (100 liters) and viscosities up to 70,000 cps.

What's included: chuck (accepts up to 3/8" [10 mm] dia shaft) and 6 1/4" L x 1/2" dia (159 mm x 13 mm) mounting rod.



Speed (rpm)	hp	Max torque (in-oz)	Power (VAC, Hz)	Catalog number	Price
Eurostar 60 digital mixer					
30 to 2000	3/16	85	115, 50/60	JL-50704-20	
			230, 50/60	JL-50704-25	
Eurostar 100 digital mixer					
30 to 1300	1/5	142	115, 50/60	JL-50704-30	
			230, 50/60	JL-50704-35	

Accessories for Laboratory Mixers

A. Shafts. All 3/8" (10 mm) dia shafts are machined on one end to accept a 5/16" (8 mm) bore dia propeller.

Key	Shaft dimensions, dia x L, in. (mm)	Catalog number	Price
A	5/16 x 12 (8 x 305)	JL-04552-20	
	5/16 x 18 (8 x 457)	JL-04552-30	
	3/8 x 12 (10 x 305)	JL-04552-25	
	3/8 x 18 (10 x 457)	JL-04552-35	
	3/8 x 24 (10 x 610)	JL-04552-00	
	3/8 x 30 (10 x 762)	JL-04552-05	

B. Turbine Propellers are for airless mixing in deep containers.

C. Marine-Style Propellers are for general-purpose mixing. Use alone or mount several on a single shaft for thorough agitation.

D. Folding Propeller is for use in narrow-mouth vessels. Folded diameter is 1 1/16" (18 mm).

Key	Description	Bore dia in. (mm)	Overall dia in. (mm)	Catalog number	Price
B	Turbine style	3/8 (9.5)	2 (51)	JL-04552-15	
		5/16 (8)	2 (51)	JL-04552-10	
C	Marine style	5/16 (8)	1 (25)	JL-04552-40	
		5/16 (8)	1 1/2 (38)	JL-04552-45	
		5/16 (8)	2 (51)	JL-04552-50	
		3/8 (9.5)	2 (51)	JL-04552-55	
		5/16 (8)	3 (76)	JL-04552-60	
D	Folding style	5/16 (8)	2 (51) open	JL-04543-00	

E-G. Clamps ensure a sturdy connection between mixer and stands.

Key	Catalog number	Price
E	JL-08041-22	
F	JL-04340-50	
G	JL-04560-24	

H. Stand. Corrosion resistant, electropolished cast steel base; 303 SS support rod. Both legs accept an extra support rod.

I. Mixer Stand has a cast-iron base and a stainless steel rod.

J. 316 SS Mixer Stand accepts extra screw-in support rods in both legs.

Key	Dimensions H x dia, in. (mm)	Stand		Extra support rod	
		Cat. no.	Price	Cat. no.	Price
H	29 x 5/8 (737 x 16)	JL-04552-80		JL-04552-85	
I	24 x 3/8 (610 x 16)	JL-04546-00		—	—
J	29 x 5/8 (737 x 16)	JL-04344-00		JL-04344-10	

K-P. Plastic Mixing Paddle Assemblies

Use these plastic paddle assemblies for mixing most acids and corrosive solutions. Plastic-coated steel assemblies provide better chemical resistance than stainless steel alone.

Material	Shaft, dia x L, in. (mm)	Max paddle dia, in. (mm)	Catalog number	Price
K. Fixed, dual-blade paddle assembly —for mixing medium-viscosity liquids				
Polypropylene	5/16 x 13 1/16 (8 x 350)	1 1/8 (41)	JL-06367-10	
L. A-shaped, blade paddle assembly —for mixing highly viscous liquids				
Polypropylene	5/16 x 13 1/16 (8 x 350)	2 3/8 (67)	JL-06367-20	
M. Swing-out, dual-blade paddle assembly —for use in narrow-necked vessels				
Polypropylene	5/16 x 13 1/16 (8 x 350)	2 3/8 (60)	JL-06367-40	
	5/16 x 13 1/16 (8 x 350)	4 (102)	JL-06367-60	
N. Three-blade paddle assembly —for general-purpose mixing				
PTFE	5/16 x 12 (8 x 305)	2 (51)	JL-04449-06	
PTFE	5/16 x 18 (8 x 457)	2 (51)	JL-04449-10	
O. Anchor-style paddle assembly —for mixing medium- to high-viscosity liquids				
PTFE	3/8 x 22 (10 x 559)	4 (102)	JL-06367-70	
P. Four-blade paddle assembly —for mixing low- to medium-viscosity liquids				
PTFE	3/8 x 22 1/2 (10 x 562)	2 3/8 (60)	JL-06367-80	

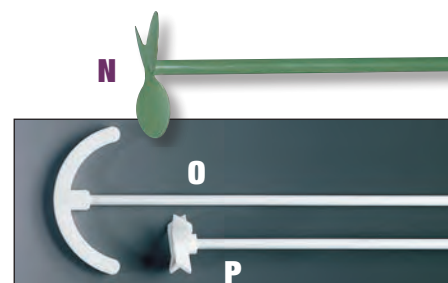
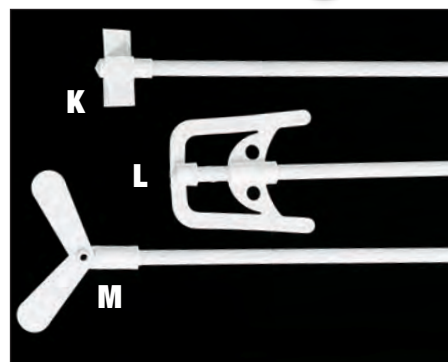
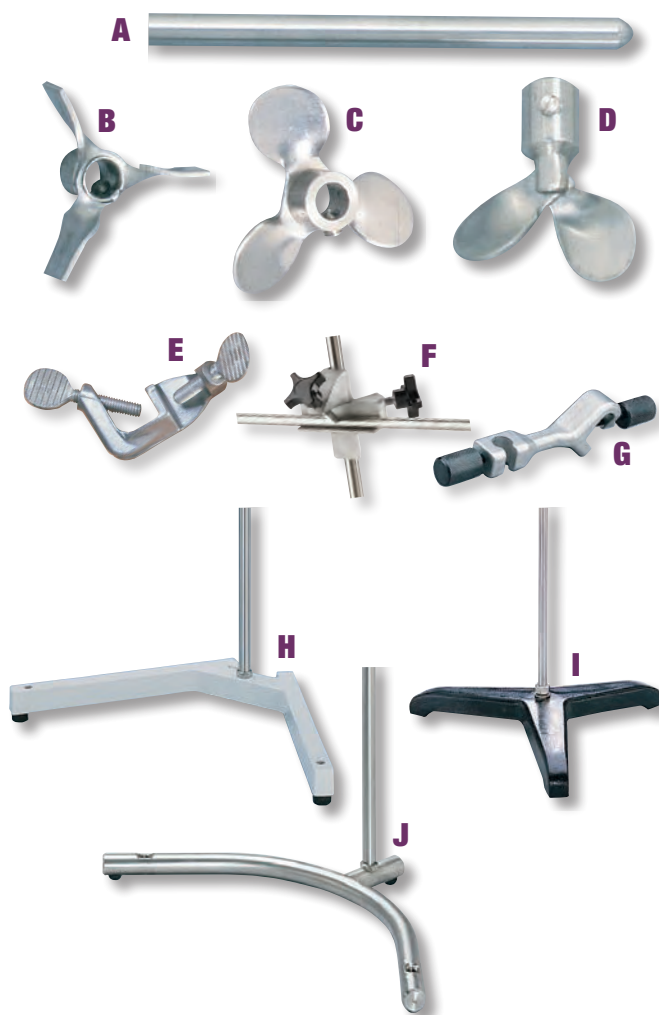

Cole-Parmer® StableTemp™ Stirrers and Stirring Hot Plates

Get precise speed and temperature control across range

- Stay safe—hot surface warning until plate cools below 50°C
- Don't worry about spills—liquids diverted away from internal components for longer life
- Improved accuracy with LED display
- Corrosion-resistant ceramic top

Advanced Stirring Hot Plate

- More accurate results with separate heat and stirring displays
- Protect you and your sample with overtemperature protection
- Includes temperature probe, rod, and clamp

Models with aluminum top plate also available at ColeParmer.com



StableTemp

CE
230 VAC models

Top plate		Heating		Stirring		Power		Catalog number	Price
Dimensions	Material	Temp range	Max load	Speed range	Max capacity	VAC	Hz		
StableTemp stirrers									
4" x 4" (10.2 x 10.2 cm)	Ceramic	—	—	30 to 1200 rpm	1 L	120	50/60	JL-03406-00	
						230	50/60	JL-03406-05	
7" x 7" (17.8 x 17.8 cm)	Ceramic	—	—	30 to 1200 rpm	4 L	120	50/60	JL-03406-10	
						230	50/60	JL-03406-15	
10" x 10" (25.4 x 25.4 cm)	Ceramic	—	—	30 to 1200 rpm	6 L	120	50/60	JL-03406-30	
						230	50/60	JL-03406-35	
StableTemp stirring hot plates									
4" x 4" (10.2 x 10.2 cm)	Ceramic	86 to 1004°F (30 to 540°C)	15 lb (6.8 kg)	30 to 1200 rpm	1 L	120	50/60	JL-03407-00	
						230	50/60	JL-03407-05	
7" x 7" (17.8 x 17.8 cm)	Ceramic	86 to 1004°F (30 to 540°C)	25 lb (11.4 kg)	30 to 1200 rpm	4 L	120	50/60	JL-03407-10	
						230	50/60	JL-03407-15	
10" x 10" (25.4 x 25.4 cm)	Ceramic	86 to 752°F (30 to 400°C)	35 lb (15.9 kg)	30 to 1200 rpm	6 L	120	50/60	JL-03407-30	
						230	50/60	JL-03407-35	
StableTemp advanced stirring hot plate									
7" x 7" (17.8 x 17.8 cm)	Ceramic	86 to 1004°F (30 to 540°C)	25 lb (11.4 kg)	30 to 1200 rpm	4 L	120	50/60	JL-03407-40	
						230	50/60	JL-03407-45	

Equipment & Instrumentation

Stirrers & Hot Plates

Corning® Digital Stirrers and Stirring Hot Plates

Maintain constant speed and temperature

- Conserve lab space—fits inside a hood or cabinet
- Get uniform heating, easy cleaning, and scratch-resistance
- Temperature display is adjustable in 5° increments and indicates when set temperature is reached
- Glass ceramic top holds up to 25 lbs



CE
230 VAC models only

Top plate dimensions	Temp range	Stirring speed range	Power		Catalog number	Price
			VAC	Hz		
Stirrers						
5" x 7" (12.7 x 17.8 cm)	—	60 to 1150 rpm	120	60	JL-84302-40	
			220	50	JL-84302-45	
10" x 10" (25.4 x 25.4 cm)	—	60 to 1150 rpm	120	60	JL-84302-50	
			220	50	JL-84302-55	
Stirring hot plates						
5" x 7" (12.7 x 17.8 cm)	41 to 1022°F (5 to 550°C)	60 to 1150 rpm	120	60	JL-84303-40	
			220	50	JL-84303-45	
10" x 10" (25.4 x 25.4 cm)	41 to 1022°F (5 to 550°C)	60 to 1150 rpm	120	60	JL-84303-50	
			220	50	JL-84303-55	

JL-17002-27 NIST-traceable calibration with data for stirrers and hot plates

Cole-Parmer® Mono-Mold® Stir Bars

Resist spin out at high speeds

- Super-strong alnico V magnets remain coupled to drive magnets even at high speeds
- Chemically inert, low-friction, leakproof PTFE coating provides smooth spinning and maximum energy transfer

Cole-Parmer®

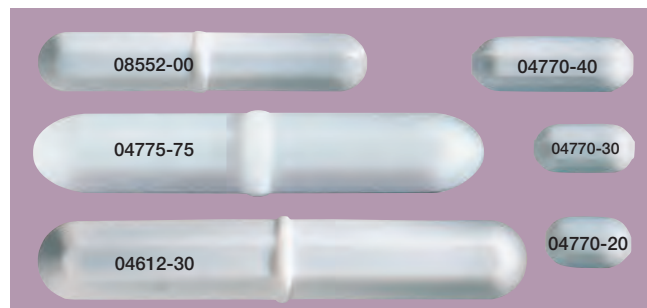

Size		With spinning ring		Without spinning ring	
Length	Diameter†	Cat. no.	Price	Cat. no.	Price
7/16" (11.1 mm)	3/16" (4.8 mm)	—	—	JL-04775-10	
1/2" (12.7 mm)	5/16" (7.9 mm)	JL-08548-00		JL-04770-20	
5/8" (15.9 mm)	5/16" (7.9 mm)	JL-08549-00		JL-04770-30	
1" (25.4 mm)	3/8" (9.5 mm)	JL-08550-00		JL-04770-40	
1 1/2" (38.1 mm)	3/8" (9.5 mm)	JL-08551-00		JL-04770-50	
2" (50.8 mm)	3/8" (9.5 mm)	JL-08552-00		JL-04770-60	
2 1/2" (63.5 mm)	3/8" (9.5 mm)	JL-04775-75		—	—
2 1/2" (63.5 mm)	1/2" (12.7 mm)	—	—	JL-04770-70	
3" (76.2 mm)	1/2" (12.7 mm)	JL-04612-30		JL-04612-40	

†Diameter given does not include the diameter of the spinning ring.

Cole-Parmer® Rotational Viscometers

Included 316 stainless steel spindles are ideal for food applications!

- Select from 10 language options
- Ensure accurate readings by calibrating your viscometer to a known standard

Determine the dynamic viscosity of samples in applications such as food (sauces, juices, and syrups), adhesives, petroleum products, biofuels, paints, pharmaceuticals, chemicals, and more! Over/under range alarm sounds when your sample is too high/low for the spindle selected. All models feature 10 language options (English, French, German, Italian, Japanese, Spanish, Portuguese, Dutch, Polish, and Catalan), push-button control with easy-to-use menu system, motor self-test, user calibration to a known standard, and universal power supply.

Basic Viscometers are an economical choice for fast, accurate viscosity readings. Feature a 4-line display that shows selected speed, selected spindle, viscosity, and % of full scale.

Basic Viscometers with USB Output include software to download data through the USB output to your PC for analysis. Store up to 10 user programs for repeated tests. Display selected speed, selected spindle, viscosity, % torque, shear rate, and shear stress on the 5-line display. Enter the sample density, and the unit calculates and displays kinematic viscosity (cSt) as well.

Advanced Viscometers with Temperature Probe have three times the speed selections and double the speed range of the basic models. Monitor and display temperature with the included RTD temperature probe. Program features include time to torque, time to stop, ramp, and multistep.

Programmable Viscometers feature 2600 speed selections and the highest speed range, up to 250 rpm. Monitor and display temperature with the included RTD temperature probe. Control the viscometer through a PC using the included software; also includes curves, graphs, and database references.

Optional low viscosity adapters allow measurement down to 1 cp when used with low range viscometers and 3.2 cp when used with medium range viscometers. Model 98965-54 includes a water jacket for attachments to an external circulating bath (not included; go to www.coleparmer.com for our full selection).

What's included: 316 stainless steel spindles (four spindles for the low range and six for the other ranges), spindle protector, stand, carrying case, and universal power supply. Models 98965-43 through -48 also include data logging software; USB cable. Models 98965-49 through -51 also include control software, data logging software, and USB cable.



Cole-Parmer®



Viscosity range	Rotational speed range	Number of selectable speeds	Output	Catalog number	Price
Basic viscometers					
20 to 2,000,000 cp (low)	0.3 to 100 rpm	18	None	JL-98965-40	
100 to 13,000,000 cp (medium)				JL-98965-41	
200 to 106,000,000 cp (high)				JL-98965-42	
Basic viscometers with data logging software and USB cable					
20 to 2,000,000 cp (low)	0.3 to 100 rpm	18	USB	JL-98965-43	
100 to 13,000,000 cp (medium)				JL-98965-44	
200 to 106,000,000 cp (high)				JL-98965-45	
Advanced viscometers with temperature probe, data logging software, and USB cable					
20 to 6,000,000 cp (low)	0.01 to 200 rpm	54	USB	JL-98965-46	
100 to 40,000,000 cp (medium)				JL-98965-47	
200 to 106,000,000 cp (high)				JL-98965-48	
Programmable viscometers with temperature probe, control software, data logging software, and USB cable					
20 to 6,000,000 cp (low)	0.01 to 250 rpm	2600	USB	JL-98965-49	
100 to 40,000,000 cp (medium)				JL-98965-50	
200 to 106,000,000 cp (high)				JL-98965-51	

Specifications

Accuracy: ±1% full-scale

Resolution

<10,000 cp: 0.1 cp
 ≥10,000 cp: 1 cp

Reproducibility: ±0.2%

Temperature probe (indicated models):
 100 Ω Pt RTD; 32 to 212°F (0 to 100°C)

Power: 100 to 240 VAC, 50/60 Hz

Search

For our full selection of viscometer accessories, go to...

ColeParmer.com/Viscometers

Equipment & Instrumentation

Viscometers

Sample Prep and Storage Made Easy



Guaranteed in Stock

You need it, we've got it! Thousands of items guaranteed in stock

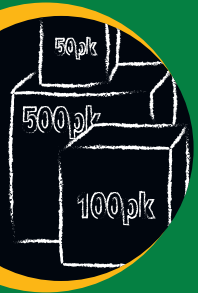

Stock up and Save

Save up to 20% on labware and supplies



Chemical Compatibility

Check material compatibility before you buy

ColeParmer.com/Chemchart



Stirring Hot Plate page 96

MORE ONLINE ▶ ColeParmer.com



Product Selection | Troubleshooting | And More...

Not sure what to choose?

Our expert Application Specialists can help you find the right product for your application.

800-323-4340

— or Ch@t Live —



WHIRL-PAK® Sterile Sampling Bags, LDPE

Keep samples safe—easy-seal bags hold solids and liquids

- Quick and easy sealing—flip bag around wire/tape and bend to seal
- No more poking—puncture-proof tabs keep wire intact even after extensive use

Sampling Bags are available with or without a white labeling area.

"Speci-Sponge" Bags are designed to sample surfaces and equipment for *Listeria*, *Salmonella*, and other food-borne pathogens; contain a 1½" x 3" (3.8 x 7.6 cm) sponge that is free of bactericides and noninhibitory; with white labeling area.

Sodium Thiosulfate Bags are EPA-compliant for potable water collection; contain a nontoxic, nonnutritive 10-mg active ingredient tablet of sodium thiosulfate to neutralize the chlorine at the point of collection; with white labeling area.

High-Temperature Bag is for hot fill samples with a temperature up to 215°F (102°C). The FDA-compliant film is a blend of low-density polyethylene and nylon that will hold liquids, solids, sauces, gravies, and other samples having a high temperature. Bag is self standing and does not need a rack or special holder to keep it upright, making sample collection safe and easy. With white labeling area. **Caution:** Do not put bag in boiling water.

Buy More...Save More!
 20% off on 120+ 15% off on 30 to 119 10% off on 6 to 29 packs or cases



Capacity oz (mL)	Size (W x L)	Thickness (mil)	Catalog number	Qty/pk	Price/pk
Sampling bags without white labeling area					
4 (118)	3" x 7¼" (7.6 x 18.4 cm)	2.25	JL-06499-10	500	
18 (532)	4½" x 9" (11.4 x 22.9 cm)	2.5	JL-06499-20	500	
24 (710)	6" x 9" (15.2 x 22.9 cm)	3.0	JL-06499-30	500	
36 (1065)	5" x 15" (12.7 x 38.1 cm)	3.0	JL-06499-40	500	
42 (1242)	6" x 15" (15.2 x 38.1 cm)	3.0	JL-06499-50	500	
69 (2041)	7½" x 15" (19.1 x 38.1 cm)	3.0	JL-06499-54	500	
Standup sampling bags with white labeling area					
4 (118)	3" x 7¼" (7.6 x 18.4 cm)	2.5	JL-06499-16	500	
18 (532)	4½" x 9" (11.4 x 22.9 cm)	3.0	JL-06499-21	500	
24 (710)	6" x 9" (15.2 x 22.9 cm)	3.0	JL-06499-31	500	
27 (798)	5" x 12" (12.7 x 30.5 cm)	3.0	JL-06499-32	250	
36 (1065)	5" x 15" (12.7 x 38.1 cm)	4.0	JL-06499-33	250	
42 (1242)	6" x 15" (15.2 x 38.1 cm)	4.0	JL-06499-34	250	
69 (2041)	7½" x 15" (19.1 x 38.1 cm)	4.0	JL-06499-35	250	
Sampling bags with white labeling area					
2 (58)	3" x 5" (7.6 x 12.7 cm)	2.5	JL-06499-60	500	
4 (118)	3" x 7¼" (7.6 x 18.4 cm)	2.25	JL-06499-70	500	
7 (207)	3¾" x 7" (9.5 x 17.8 cm)	2.5	JL-06499-72	500	
13 (384)	5¼" x 7½" (13.3 x 19.1 cm)	2.5	JL-06499-74	500	
18 (532)	4½" x 9" (11.4 x 22.9 cm)	2.5	JL-06499-80	500	
24 (710)	6" x 9" (15.2 x 22.9 cm)	3.0	JL-06499-85	500	
27 (798)	5" x 12" (12.7 x 30.5 cm)	3.0	JL-06499-87	500	
69 (2041)	7½" x 15" (19.1 x 38.1 cm)	3.0	JL-06499-89	500	
92 (2721)	10" x 15" (25.4 x 38.1 cm)	4.0	JL-06499-94	250	
123 (3637)	10" x 20" (25.4 x 50.8 cm)	4.0	JL-06499-98	250	
184 (5441)	15" x 20" (38.1 x 50.8 cm)	4.0	JL-06499-99	100	
"Speci-Sponge" bags for surface sampling with sponge					
18 (532)	4½" x 9" (11.4 x 22.9 cm)	2.5	JL-06499-13	100	
55 (1627)	7½" x 11¾" (19.1 x 29.8 cm)	4.0	JL-06499-14	100	
18 (532)	4" x 9" (10.2 x 22.9 cm)	2.5	JL-06499-52†	100	
Sodium thiosulfate bags for water sampling with tablet					
3% (100)	3" x 7¼" (7.6 x 18.4 cm)	2.5	JL-06499-90	100	
10% (300)	4½" x 9" (11.4 x 22.9 cm)	2.5	JL-06499-95	100	
High-temperature bag					
18 (532)	4½" x 9" (11.4 x 22.9 cm)	3.0	JL-06498-16	500	

†Model 06499-52 has a sterile glove.

Accessories

JL-66203-10 Carrying rack for 2- and 4-oz bags. Double-grid design keeps bags upright and has 15 compartments. Vinyl coated, autoclavable

JL-66203-00 Carrying rack for 18-oz bags. Double-grid design keeps bags upright. Rack has 20 compartments. Vinyl coated, autoclavable

JL-06498-12 Water scoop, 18" (45.7 cm) L coated handle. Two alligator clips hold a variety of bag sizes

JL-06498-14 Mailing tube for 3%-oz (100 mL) sodium thiosulfate bag. Polyethylene, 5"L x 2" dia (12.7 x 5.1 cm)

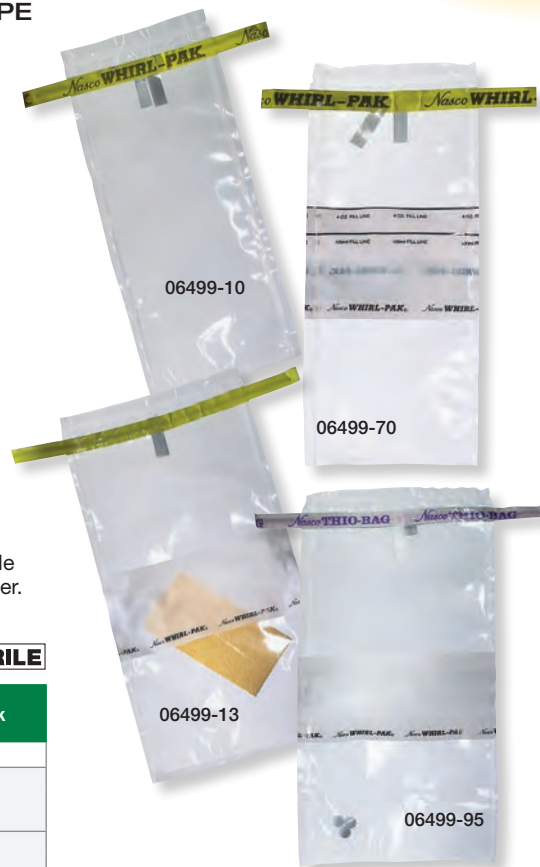

Standup bags stay upright



Water scoop holds bag open for easy filling



Mailing tube



Rack

Bags

Lab Supplies

Cole-Parmer® Class A Griffin Low-Form Graduated Glass Beakers

Easy readings and exceptional durability

- Double-scale graduations for easy measuring while pouring in or out
- Meet ASTM E960 specifications for Class A borosilicate glass beakers
- Stand up to temperatures of 445°F (230°C) for long-term, or 752°F (400°C) for short-term
- Autoclavable

NEW

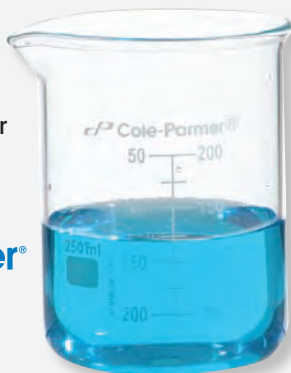

Cole-Parmer®

Buy More...Save More!

20% off on 120+
15% off on 30 to 119
10% off on 6 to 29 packs or cases

Capacity mL (oz)	Graduation interval (mL)	Catalog number	Qty/pk	Price/pk
10 (1/8)	—	JL-34503-42†	12	
25 (7/8)	5	JL-34503-44	12	
50 (1 3/4)	10	JL-34503-46	12	
100 (3)	10	JL-34503-48	12	
150 (5)	20	JL-34503-50	12	
250 (8)	25	JL-34503-52	12	
400 (13)	25	JL-34503-54	12	
600 (20)	50	JL-34503-56	6	
1000 (32)	50	JL-34503-58	6	
2000 (64)	100	JL-34503-60	4	
3000 (96)	125	JL-34503-62	1	
5000 (160)	250	JL-34503-64	1	

†The 10-mL beaker does not have graduations

Cole-Parmer® Tri-Corner Beakers, PP

Easy pouring from three sides

- Easily mix on stirrer—flat bottom keeps stir bars centered
- Accurate to ±5% with molded graduations
- Withstand temperatures to 250°F (121°C)
- Autoclavable



Cole-Parmer®

Buy More...Save More!

20% off on 120+ 15% off on 30 to 119 10% off on 6 to 29 packs or cases

Capacity mL (oz)	Graduations (mL)	Catalog number	Qty/pk	Price/pk
50 (1.5)	10	JL-06020-01		
100 (3.5)	10	JL-06020-03	100	
250 (8)	20	JL-06020-05		
400 (13)	40	JL-06020-07		
800 (26)	50	JL-06020-09	100	
1000 (32)	50	JL-06020-11		
Five of each above	—	JL-06010-07	30	

Disposable Griffin Low-Form Beakers, PP

Molded-in graduations won't wear off

- No need to convert volumes—graduated in mL and oz
- Won't stick together—stacking rib for easier separation
- Autoclavable



Buy More...Save More!

20% off on 120+ 15% off on 30 to 119 10% off on 6 to 29 packs or cases

Capacity mL (oz)	Graduations (mL)	Catalog number	Qty/pk	Price/pk
15 (0.5)	5	JL-06006-12	100	
15 (0.5)	5	JL-06006-15	1000	
30 (1)	5	JL-06006-22	100	
30 (1)	5	JL-06006-25	1000	
50 (1.7)	5	JL-06006-32	100	
50 (1.7)	5	JL-06006-35	1000	
100 (3.5)	5	JL-06006-42	100	
100 (3.5)	5	JL-06006-45	1000	
150 (5)	5	JL-06006-52	100	
150 (5)	5	JL-06006-55	1000	
250 (8)	10	JL-06006-63	50	
250 (8)	10	JL-06006-65	500	
400 (13)	25	JL-06006-72	50	
400 (13)	25	JL-06006-75	500	
600 (20)	25	JL-06006-83	25	
600 (20)	25	JL-06006-85	500	

DON'T RISK IT!

Our chemical compatibility database provides important information on chemical resistance—check it out at ColeParmer.com/ChemChart



PYREX® Brand 1003 Heavy-Duty Griffin Beakers

Get the best strength even under harsh conditions

- Measure initial quantity and how much is used—double metric scale on 250- to 4000-mL sizes
- Know your solution—extra-large marking spot for easier identification
- Reference: ASTM E-960



Buy More...Save More!

15% off on 10+ packs or cases 10% off on 5 to 9 packs or cases

Capacity mL (oz)	Graduation range (mL)	Graduation interval (mL)	Catalog number	Qty	Price
150 (5)	20 to 140	20	JL-34512-06	12/pk	
150 (5)	20 to 140	20	JL-34512-26	48/cs	
250 (8)	25 to 200	25	JL-34512-07	12/pk	
250 (8)	25 to 200	25	JL-34512-27	48/cs	
400 (13)	25 to 325	25	JL-34512-08	12/pk	
400 (13)	25 to 325	25	JL-34512-28	48/cs	
600 (20)	50 to 500	50	JL-34512-09	6/pk	
600 (20)	50 to 500	50	JL-34512-29	36/cs	
1000 (32)	50 to 1000	50	JL-34512-11	6/pk	
1000 (32)	50 to 1000	50	JL-34512-31	24/cs	
2000 (64)	200 to 1800	200	JL-34512-13	4/pk	
2000 (64)	200 to 1800	200	JL-34512-33	8/pk	
4000 (128)	500 to 3500	250	JL-34512-15	1/pk	
4000 (128)	500 to 3500	250	JL-34512-35	4/pk	



Thermo Scientific™ Nalgene™ Heavy-Duty Bottles, PP

Withstand repeated full vacuum applications

- Use under repeated full vacuum for 24 hours at 68°F (20°C)
- PP closure with thermoplastic elastomer (TPE) gasket
- Autoclavable



Buy More...Save More!

- 20% off on 120+
- 15% off on 30 to 119
- 10% off on 6 to 29 packs or cases

Capacity, mL (oz)	Cap size	Catalog number	Qty/pk	Price/pk
250 (8)	53B	JL-06257-05	6	
1000 (32)		JL-06257-10	6	
2000 (64)		JL-06257-20	2	
4000 (128)	83B	JL-06257-00	1	
5000 (160)		JL-06257-30		

Cole-Parmer® Class A Glass Media Bottles

NEW

Easy pouring, wide-mouth opening

- Ideal of mixing, storing, and sampling
- Get quick identification—large marking spot and gradations
- Autoclavable PP cap and bottle



Capacity mL (oz)	Graduation range (mL)	Graduation interval (mL)	Thread size	Catalog number	Qty/cs	Price/cs
100 (3)	20 to 80	25	GL45	JL-34505-72	10	
250 (8)	50 to 200	50		JL-34505-74	10	
500 (16)	100 to 400	100		JL-34505-76	10	
1000 (32)	100 to 900	100	GL45	JL-34505-78	10	
2000 (64)	400 to 1800	100		JL-34505-80	4	

Thermo Scientific™ Nalgene™ Filling/Venting Caps, PP

Quick and easy aseptic liquid transfer

Filling/Venting Caps have thermoplastic elastomer (TPE) gaskets to allow aseptic liquid transfer. Include 6" (15 cm) and 30" (76 cm) lengths of platinum-cured silicone tubing. Autoclavable.

Fitting Kits include two PP fittings, two acetal nuts, two silicone gaskets, thermoplastic elastomer (TPE) port cap, instructions, and template. Autoclavable.

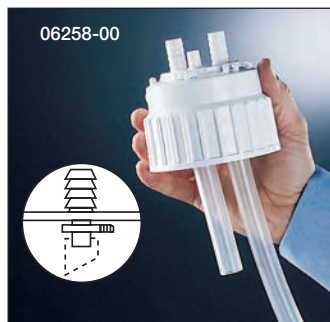

Buy More...Save More!

- 20% off on 120+
- 15% off on 30 to 119
- 10% off on 6 to 29 packs or cases

Tubing ID	Ports	Cap size	Catalog number	Qty/pk	Price/pk
Filling/venting caps					
1/2"	2 tubing, 1 venting	83B	JL-06258-00	1	
1/4"		53B	JL-06258-10	1	
1/4"		83B	JL-06258-20	1	
Barbed bulkhead fitting kits					
1/4"	—	—	JL-06259-10	2	
1/2"	—	—	JL-06259-00	2	

PYREX® Brand 1395 Media Bottles

Permanent white graduations won't wear off

- Use for mixing or storing of your solutions—full capacity indicated by bead line on 100-mL to 2-L sizes
- Linerless, autoclavable polypropylene screw cap included on each bottle
- Color code your samples with optional color-coded PP caps

Caution: Bottles larger than 2 liters should not be used under vacuum pressure, as breakage may occur. Do not tighten caps immediately after autoclaving.



Buy More...Save More!

- 15% off on 10+ packs or cases
- 10% off on 5 to 9 packs or cases

Capacity mL (oz)	Graduation range (mL)	Thread size	Neck ID	Catalog number	Qty/cs	Price/cs
25 (¾)	10 to 25	GL25	14.5 mm	JL-34514-20	10	
50 (1¾)	20 to 50	GL32	16.5 mm	JL-34514-21	10	
100 (3)	40 to 80	GL45	29 mm	JL-34514-22	10	
250 (8)	50 to 200	GL45	29 mm	JL-34514-23	10	
500 (16)	100 to 400	GL45	29 mm	JL-34514-24	10	
1000 (32)	100 to 900	GL45	29 mm	JL-34514-25	10	
2000 (64)	400 to 1800	GL45	29 mm	JL-34514-26	4	
5000 (160)	500 to 4500	GL45	29 mm	JL-34514-28	1	
10,000 (320)	2000 to 9000	GL45	29 mm	JL-34514-30	1	

JL-34514-50 Polypropylene cap, orange, GL45. Cs of 20

JL-34514-53 Polypropylene cap, green, GL45. Cs of 20

JL-34514-54 Polypropylene cap, gray membrane, GL45. Cs of 10

JL-34514-55 Polypropylene cap, red high-temp. GL45. Cs of 10

JL-34514-60 Pouring ring, clear, low temperature. Cs of 50

JL-34514-65 Pouring ring, red, high temperature. Cs of 50

Cole-Parmer® Precleaned EPA Sample Containers

No contaminants—precleaned and ready to use

- Include certificate of conformance to EPA specifications
- Identify samples easier with included labels (unattached)

A-D. Glass Bottles, Jars, and Jugs are processed and certified to meet the requirements of the current US EPA “Specifications and Guidance for Contaminant-Free Sample Containers” document for semi-volatile organics, pesticides, PCBs, metals, cyanide, fluoride, nitrate and nitrite analyses. Include PTFE-lined caps.

E. Glass Septa Jars are processed and certified to meet the requirements of the current US EPA “Specifications and Guidance for Contaminant-Free Sample Containers” document for purgeable volatile organic analysis. Include PTFE-lined silicone septa bonded to open-top caps.



Capacity mL (oz)	Neck size	Qty/ cs	Catalog number	Price/ cs
A. Clear wide-mouth glass jars				
60 (2)	53 mm	24	JL-99540-40	
125 (4)	58 mm	24	JL-99540-41	
250 (8)	70 mm	12	JL-99540-42	
500 (16)	89 mm	12	JL-99540-43	
950 (32)	89 mm	12	JL-99540-44	
B. Amber narrow-mouth glass bottles				
125 (4)	22 mm	24	JL-99540-30	
250 (8)	24-414	12	JL-99540-31	
500 (16)	28 mm	12	JL-99540-32	
1000 (34)	33-430	12	JL-99540-33	
C. Amber wide-mouth glass bottles				
125 (4)	38 mm	12	JL-99540-51	
250 (8)	45 mm	12	JL-99540-53	
500 (16)	53 mm	12	JL-99540-55	
950 (32)	53 mm	12	JL-99540-57	
D. Amber narrow-mouth glass jugs				
2500 (80)	38-430	6	JL-99540-34	
4000 (135)	38-430	4	JL-99540-35	
E. Clear wide-mouth glass septa jars				
60 (2)	53 mm	24	JL-99540-20	
125 (4)	58 mm	24	JL-99540-21	

DON'T RISK IT!

Our chemical compatibility database provides important information on chemical resistance—check it out at ColeParmer.com/ChemChart



Graduated Sample Containers, PP

No more leaks—leakproof for better sampling

- Easier sampling—graduated for measuring directly
- Durable design—translucent, unbreakable, and chemical resistant
- Sterile containers are individually wrapped



Buy More...Save More!

20% off on 120+ 15% off on 30 to 119 10% off on 6 to 29 packs or cases

Capacity mL (oz)	Description	Qty/ pk	Catalog number	Price/ pk
118 (4)	Sterile, no tab	100	JL-06049-40	
118 (4)	Nonsterile with white tab	500	JL-06049-50	

Sample Bottles, HDPE

Store samples without breaking your budget

- Provide good chemical resistance for a wide range of uses
- Bottles are made of HDPE; included cap is made of polypropylene and lined with polyethylene foam
- Easy mailing with optional mailing tube (sold separately)



Buy More...Save More!

20% off on 120+ 15% off on 30 to 119 10% off on 6 to 29 packs or cases

Capacity mL (oz)	Qty/ pk	Catalog number	Price/ pk
180 (6)	300	JL-06043-01	
250 (8)	329	JL-06049-01	
500 (16)	198	JL-06050-05	

[JL-06049-30](#) Mailing tubes for bottle 06049-01. Carton of 240

Thermo Scientific™ Nalgene™ Wide-Mouth Bottles, LDPE

Get better sample visibility

- Translucent material provides flexibility and impact resistance
- Ideal for shipping liquids—include leakproof polypropylene (PP) screw caps



Buy More...Save More!

20% off on 120+ 15% off on 30 to 119 10% off on 6 to 29 packs or cases

Capacity mL (oz)	Cap size	Catalog number	Qty/ pk	Price/ pk
30 (1)	28 mm	JL-06043-10		
60 (2)	28 mm	JL-06043-20	12	
125 (4)	38 mm	JL-06043-30		
250 (8)	43 mm	JL-06043-40	12	
500 (16)	53 mm	JL-06043-50		
1000 (32)	63 mm	JL-06043-60	6	

Cole-Parmer® Wide-Mouth Bottles, LDPE, HDPE, PP

Wide-mouth opening provides easier filling and sampling

- Offered in pack quantities or bulk pack quantities to meet your specific requirements
- Reliable and sturdy
- Choose from three materials; all include a leakproof PP closure

HDPE Bottles are manufactured with FDA-compliant resin for noncontaminating storage of chemicals and food-grade products.

LDPE Bottles are translucent and ideal for food and general-use laboratory applications.

PP Bottles are rigid and offer superior chemical resistance; perfect for storage and sampling of liquids and solids. **Autoclavable.**



Buy More...Save More!

- 20% off on 120+
- 15% off on 30 to 119
- 10% off on 6 to 29 packs or cases



Capacity mL (oz)	Cap size	Catalog number	Qty/pk	Price/pk	Catalog number	Qty/cs	Price/cs
HDPE							
60 (2)	22 mm	JL-06045-18	12		JL-06045-23	72	
125 (4)	28 mm	JL-06045-24	12		JL-06045-25	72	
250 (8)	28 mm	JL-06045-26	12		JL-06045-27	72	
500 (16)	28 mm	JL-06045-28	12		JL-06045-29	48	
1000 (32)	28 mm	JL-06045-44	6		JL-06045-31	24	
2000 (64)	45 mm	JL-06045-46	1		JL-06045-33	6	
LDPE							
60 (2)	22 mm	JL-06045-02	12		JL-06045-03	72	
125 (4)	28 mm	JL-06045-04	12		JL-06045-05	72	
250 (8)	28 mm	JL-06045-06	12		JL-06045-07	72	
500 (16)	28 mm	JL-06045-08	12		JL-06045-09	48	
1000 (32)	28 mm	JL-06045-14	6		JL-06045-11	6	
PP							
30 (1)	22 mm	JL-06045-48	12		JL-06045-41	72	
60 (2)	22 mm	JL-06045-56	12		JL-06045-43	72	
125 (4)	28 mm	JL-06045-58	12		JL-06045-45	72	
250 (8)	28 mm	JL-06045-62	12		JL-06045-47	72	
500 (16)	28 mm	JL-06045-66	12		JL-06045-49	48	
1000 (32)	28 mm	JL-06045-68	6		JL-06045-51	24	
2000 (64)	45 mm	JL-06045-74	1		JL-06045-53	6	

Collapsible Containers, LDPE

Won't take up extra space—easily expand when filled

- Stack neatly when empty, just unscrew cap and fill to expand
- Include polypropylene caps

Buy More...Save More!

- 20% off on 120+
- 15% off on 30 to 119
- 10% off on 6 to 29 packs or cases

Capacity L (gallon)	Cap size	Qty/pk	Catalog number	Price/pk
1 (1/4)	38 mm	12	JL-06100-10	
4 (1)			JL-06100-20	
10 (2 1/2)	38 mm	10	JL-06100-30	
19 (5)			JL-06100-40	



Thermo Scientific™ Nalgene™ Economy Wide-Mouth Bottles, HDPE

Rugged design fits all your needs

- Leakproof, PP enclosure

Buy More...Save More!

- 20% off on 120+
- 15% off on 30 to 119
- 10% off on 6 to 29 packs or cases

Capacity mL (oz)	Cap size	Catalog number	Qty/pk	Price/pk	Catalog number	Qty/cs	Price/cs
30 (1)	28 mm	JL-06035-31	12		JL-06035-33	72	
60 (2)	28 mm	JL-06035-35			JL-06035-37		
125 (4)	38 mm	JL-06035-39			JL-06035-41		
250 (8)	43 mm	JL-06035-43	12		JL-06035-45	72	
500 (16)	53 mm	JL-06035-47	6		JL-06035-49	48	
1000 (32)	63 mm	JL-06035-51	6		JL-06035-53	24	



Teky's Tips



Caring for Your Plasticware

Washing Plastics with a Mild Detergent is sufficient for most general applications. Be sure to rinse with tap water, then rinse again with distilled water. Most plastics, particularly the polyolefins (PPCO, PP, PMP, LDPE, and HDPE), have nonwetting surfaces that resist attack and are easy to clean. Do not use abrasive cleaners or scouring pads on plastic labware. Do not use strong alkaline cleaning agents with polycarbonate (PC).

Ultrasonic Cleaners can be used as long as labware does not rest on the bottom of the tank. Use a cleaning basket for best results.

Bottles

Lab Supplies

Cole-Parmer® Economical Heavy-Duty Carboys with Shoulder Handle, PP

Sturdy, octagonal design for added rigidity

- Easier filling and pouring with offset neck
- Leakproof spigot models have tube fitting for easier filling of containers
- Polypropylene closure reduces evaporation
- Autoclavable



Buy More...Save More!
20% off on 120+ 15% off on 30 to 119 10% off on 6 to 29 packs or cases

Liters (gallons)	Cap size	Catalog number	Qty/pk	Price/pk
Heavy-duty carboys with shoulder handle				
5 (1¼)	45 mm	JL-62507-00	1	
10 (2½)	90 mm	JL-62507-10	1	
20 (5¼)	90 mm	JL-62507-20	1	
Heavy-duty carboys with shoulder handle and spigot				
5 (1¼)	45 mm	JL-62507-05	1	
10 (2½)	90 mm	JL-62507-15	1	
20 (5¼)	90 mm	JL-62507-25	1	

Carboys

Thermo Scientific™ Nalgene™ FDA-Compliant Carboys, PP

Get a better grip with two-handle construction

- Dispense solutions more quickly with optional spigot models—accept ¼", ½", or ⅝" ID tubing
- Leakproof polypropylene (PP) cap
- Autoclavable



Buy More...Save More!
20% off on 120+ 15% off on 30 to 119 10% off on 6 to 29 packs or cases

Liters (gallons)	Cap size	Catalog number	Qty/pk	Price/pk
FDA-compliant carboys, USP Class VI				
10 (2½)	83B	JL-06063-12	1	
20 (5)	83B	JL-06063-22		
50 (13)	83B	JL-06063-32		
FDA-compliant carboys with spigot, USP Class VI				
10 (2½)	83B	JL-06064-50	1	
20 (5)	83B	JL-06064-60		
50 (13)	83B	JL-06064-70		

Lab Supplies

Thermo Scientific™ Nalgene™ Round Carboys, LDPE

No more leaks

- Leakproof, polypropylene cap for no worry transport
- Make transport easy with easy-grip handles
- Withstand corrosive materials
- Maintain adequate levels of solution—larger than 10-L carboys indicate 1-gallon and 5-liter increments
- Dispense easily with spigot models



Buy More...Save More!
20% off on 120+ 15% off on 30 to 119 10% off on 6 to 29 packs or cases

Liters (gallons)	Cap size	Catalog number	Qty/pk	Price/pk
Carboys with shoulder handles				
10 (2½)	83B	JL-06031-32	1	
15 (4)	83B	JL-06031-42		
20 (5)	83B	JL-06031-52		
25 (6½)	83B	JL-06031-62		
50 (13)	83B	JL-06031-72		
Wide-mouth carboys with shoulder handles				
10 (2½)	100 mm	JL-06056-22	1	
15 (4)	100 mm	JL-06056-32		
20 (5)	100 mm	JL-06056-52		
Carboy with spigot and shoulder handles				
4 (1)	38-430	JL-06065-10	1	
10 (2½)	83B	JL-06065-22		
20 (5)	83B	JL-06065-32		
25 (6½)	83B	JL-06065-52		
50 (13)	83B	JL-06065-62		
Carboys with ½" OD tubulation and shoulder handles				
10 (2½)	83B	JL-06080-42	1	
20 (5¼)	83B	JL-06080-52		

Accessories

- [JL-06258-30](#) Replacement cap, PP, 83B. Pack of 2
- [JL-63000-16](#) Replacement cap, PP, 100 mm. Pack of 12
- [JL-63000-18](#) Replacement cap, PP, 38-430. Pack of 12
- [JL-06070-22](#) Replacement spigot, PP



Cole-Parmer® Cleaning Products

Easily clean glass, metal, plastic, rubber, and other hard materials



- Safe and effective cleaning products
- Highly concentrated, aqueous solutions are free-rinsing
- Meet USDA guidelines for incidental contact with food processing systems
- Do not contain CFCs, phosphates, silicates, halogens, or phenols



Cleaner	Type	Cleaning applications	Dilution	pH	Packaging	Cat. no.	Price/ea	Cat. no.	Qty/cs	Price/cs
Micro-90®	Ionic, nonionic, USDA authorized	Manual or ultrasonic; removes most biological materials; cleans glass, most metals, plastic, and rubber†	1:100 to 2:100	9.5	0.26 gal. (1 L)	JL-18100-05	—	JL-18100-04	12	—
					1 gal. (4 L)	—	—	JL-18100-11	4	—
					5 gal. (18.9 L)	—	—	JL-18100-20	1	—
					55-gal. drum (208 L)	JL-18100-30	—	—	—	—
Zymit®	Enzymatic, USDA authorized	Machine, manual, or ultrasonic; dissolves protein and starch-based soils; may use for delicate materials	1:100	7.5	0.26 gal. (1 L)	JL-18101-30	—	JL-18101-20	12	—
LF2100™	Low-sudsing, anionic, nonionic, amphoteric, USDA authorized	Automatic washers, high-pressure and high agitation applications†	1:100	9.7	0.26 gal. (1 L)	JL-18102-00	—	JL-18102-10	12	—
					5.3 gal. (20 L)	JL-18102-30	—	—	—	—
Surface-Cleanse/930®	Nonionic, USDA authorized	Cleans grease, petroleum, oils from glass, aluminum, lead, zinc, and plastic without surface damage	1:200	7.0	0.26 gal. (1 L)	JL-18103-00	—	JL-18103-10	12	—
					5.3 gal. (20 L)	JL-18103-30	—	—	—	—
Micro-A07®	Citric acid, nonionic, USDA authorized	Removes millstone, hard water scale, rust, mineral deposits, and other inorganic soils from filter membranes, labware, and industrial equipment	1:100 to 2:100	2.5	0.26 gal. (1 L)	JL-18104-00	—	JL-18104-01	12	—
					5.3 gal. (20 L)	JL-18104-30	—	—	—	—

†Do not use on zinc, magnesium, or aluminum.

Kimberly-Clark® Critical Task Wipes

Low-lint, absorbent, soft, and nonabrasive

- Won't scratch delicate surfaces
- Single- and two-ply delicate task wipes are made of a finely textured tissue
- Solvent-resistant KimTech CL4 wipes are made of a single-ply, nonwoven fabric specially bonded to eliminate surface fibers and trap particles



Description	Compliance	Wipe size	Qty/bx	Box/cs	Cat. no.	Price/cs*
Delicate task wipes						
Kimwipes® EX-L, 1 ply	—	4 1/2" x 8 1/2"	280	60	JL-33670-04	—
		15" x 16 3/4"	140	15	JL-33670-06	—
Kaydry® EX-L, 2 ply	—	15" x 16 3/4"	90	15	JL-33670-10	—
Cleanroom wipes						
Kimtech CL4 cleanroom	ISO Class 4	12" x 12"	100	5	JL-33670-20	—

*Discounts: Save 10% on 10 to 49 cases and 15% on 50 or more cases.

Bacdown® Hand Soap

Won't dry your skin

- Formulated specifically for those washing frequently to minimize dry, chapped skin
- Protects against gram-negative and gram-positive bacteria as well as yeast and fungi



Packaging	Catalog number	Price/ea	Catalog number	Qty/cs	Price/cs
16 oz (500 mL)	JL-86115-02	—	JL-86115-00	12	—
0.26 gal. (1 L)	JL-86115-06	—	JL-86115-04	12	—
1.32 gal. (5 L)	JL-86115-10	—	—	—	—

CONFLIKT® Detergent Disinfectant

No need to dilute—ready to use

- Don't worry about contaminants—easily and effectively decontaminates surfaces
- Ammonium-based detergent disinfects and cleans hard surfaces



This prediluted detergent is effective against a wide range of viruses, bacteria, pathogenic fungi, mold, and mildew. USDA approved and EPA registered. Comes in a 32-oz spray bottle and a 1-gal. refill.

Packaging	Catalog number	Price/ea	Catalog number	Qty/cs	Price/cs
32 oz (946 mL)	JL-86115-40	—	JL-86115-38	6	—
1 gal. (3.7 L)	JL-86115-44	—	JL-86115-42	4	—

Ansell Touch N Tuff™ Nitrile Gloves

Keep dexterity without sacrificing safety

- Thin formulation, yet resists punctures and tears
- No fillers—gloves are 100% nitrile
- Ambidextrous



Compliance: FDA regulations for food contact



Size	Length	Thickness	Qty/ bx	Catalog number	Price per box	
					1 bx	10 bx
Powdered gloves						
Small	9½" (24 cm)	4 mil	100	JL-81602-40		
Medium				JL-81602-50		
Large				JL-81602-60		
X-large				JL-81602-70		
Powder-free gloves						
Small	9½" (24 cm)	4 mil	100	JL-81602-45		
Medium				JL-81602-55		
Large				JL-81602-65		
X-large				JL-81602-75		

ANSELL TNT™ Blue Disposable Nitrile Gloves

Durable and comfortable

- Static dissipative to eliminate static electricity
- Textured fingertips for better gripping
- Powder-free
- Ambidextrous



Compliance: FDA regulations for food contact.

Size	Length	Thickness	Qty/ bx	Catalog number	Price per box	
					1 bx	10 bx
Small	9½" (24 cm)	5 mil	100	JL-81601-04		
Medium				JL-81601-05		
Large				JL-81601-06		
X-large				JL-81601-07		

Gloves

Microflex® FreeForm™ SE Nitrile Gloves

Minimize stress, maximize motion

- Soft feel with textured surface for better grip
- Conform to your hand for better comfort and full range of motion
- Powder-free, ambidextrous

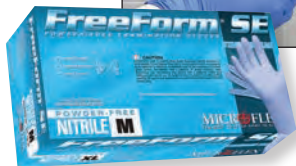

Size	Length	Thickness	Qty/ case	Catalog number	Price per case	
FreeForm SE gloves						
Small	9½" (24 cm)	5.1 mil	1000	JL-86445-20		
Medium				JL-86445-21		
Large				JL-86445-22		
X-large				JL-86445-23		
FreeForm SE extended-cuff gloves						
Small	11½" (29 cm)	6.3 mil	500	JL-86445-24		
Medium				JL-86445-25		
Large				JL-86445-26		
X-large				JL-86445-27		

Cryo-Glove® Cryogenic Gloves

Keep hands from freezing

- Protect as low as –256°F (–160°C)
- Maximum protection while remaining flexible

Water-Resistant Gloves provide protection in closed systems. A stay-dry lining keeps you warm and comfortable. **Waterproof Gloves** have a nylon exterior and a seamless waterproof lining. Gloves keep you dry and wick moisture away from your hands. **Cryo-Industrial® Gloves** feature a rugged, abrasion-resistant outer shell that protects the glove and provides an excellent grip for heavy-duty applications. Waterproof liner protects against cryogenic splashes while the inner lining wicks moisture from your hands for enhanced comfort.



Note: Do not immerse gloves in liquid nitrogen.



Description	Size	Length	Catalog number	Price per pair
Water-resistant Cryo-Glove gloves				
Wrist	Medium	12" (30 cm)	JL-09113-02	
	Large		JL-09113-04	
Mid-arm	Medium	15" (38 cm)	JL-09113-12	
	Large		JL-09113-14	
	X-large		JL-09113-16	
Elbow	Medium	19" (48 cm)	JL-09113-22	
	Large		JL-09113-24	
	X-large		JL-09113-26	
Waterproof Cryo-Glove gloves				
Mid-arm	Medium	15" (38 cm)	JL-09113-30	
	Large		JL-09113-32	
	X-large		JL-09113-34	
Elbow	Medium	19" (48 cm)	JL-09113-35	
	Large		JL-09113-37	
	X-large		JL-09113-39	
Cryo-Industrial heavy-duty gloves				
Mid-arm	Medium	15" (38 cm)	JL-09113-62	
	Large		JL-09113-64	
	X-large		JL-09113-66	

Lab Supplies

Glove Dispenser

Glove box dispenser holds one box of disposable gloves. Dispenser can be placed on benchtop or wall-mounted using hardware included. Measures (W x H x D) 10" x 5½" x 4" (25.2 x 14 x 10.2 cm).



[JL-63535-13](#) Glove box dispenser

Cole-Parmer® Serological Pipettes, PS

Fits just about any pipettor

These serological pipettes are made from transparent polystyrene (PS), sterilized by gamma irradiation, and designed for quick and accurate fluid dispensing. The highly legible permanent graduations prevent ambiguity and guarantee precise dispensing to ±2%. Graduations show volume removed or remaining on all pipettes larger than 1 mL. Generous negative graduations provide additional pipetting volume.

Unique filter plug eliminates lint fibers and ensures plug stays in place to prevent overfilling. The uniform mouth piece fits all major pipettors and has color-coded TD rings for easy identification. Each lot is tested for endotoxins and cytotoxicity, and guaranteed nonhemolytic—ideal for your tissue culture applications.

The individually wrapped pipettes are supplied in a fiber-free paper/plastic combination that is easy to open. The dispenser box allows you to remove pipettes without opening the top. Universal stacking design requires less laboratory space and each box is color coded for quick recognition.

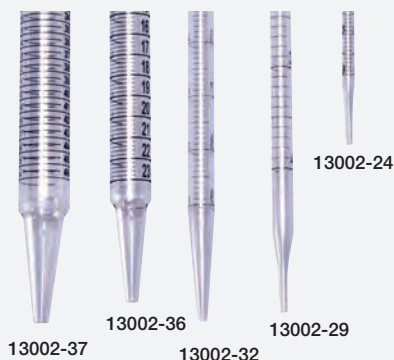

STERILE

Capacity (mL)	Graduation interval (mL)	Tip style	Color ring	Qty/bag	Qty/cs	Catalog number	Price/cs
Individually wrapped							
1	0.01	Standard	Yellow	—	500	JL-13002-12	
1	0.1	Standard	Red	—	500	JL-13002-14	
2	0.01	Standard	White	—	500	JL-13002-15	
5	0.1	Standard	Blue	—	200	JL-13002-16	
10	0.1	Standard	Orange	—	200	JL-13002-17	
25	0.2	Standard	Green	—	150	JL-13002-19	
50	0.5	Standard	Purple	—	100	JL-13002-20	
Bulk wrapped							
1	0.01	Standard	Yellow	25	1000	JL-13002-24	
1	0.1	Standard	Red	25	1000	JL-13002-26	
2	0.01	Standard	White	25	1000	JL-13002-28	
5	0.1	Standard	Blue	25	500	JL-13002-29	
10	0.1	Standard	Orange	25	400	JL-13002-30	
10	0.1	Wide	Orange	25	400	JL-13002-32	
25	0.2	Standard	Green	10	150	JL-13002-36	
50	0.5	Standard	Purple	10	100	JL-13002-37	

Disposable Transfer Pipettes

Easily draw and deliver solutions

- Deliver repeatable, uniform drops
- Eliminate cross-contamination with these low-cost, disposable LDPE pipettes



Key	Description	Graduations		Bulb draw	Total capacity	Drops per mL	Length in. (mm)	Qty/pk	Catalog number	Price/pk
		Increments	Maximum							
A	Small bulb, graduated	0.1 mL	0.3 mL	0.8 mL	1.5 mL	21	4 ⁵ / ₈ (117)	500	JL-06226-37	
B	Small bulb, graduated	0.25 mL	1 mL	2.2 mL	3.9 mL	25	5 ¹ / ₂ (140)	500	JL-06226-41	
C	Large capacity, thin stem	—	—	3.3 mL	4.6 mL	25	6 ¹ / ₈ (156)	500	JL-06226-65	
D	Large capacity, fine tip	—	—	3.5 mL	5.8 mL	50	6 ¹ / ₄ (159)	500	JL-06226-67	
E	Large capacity, graduated	0.25 mL	1 mL	3.4 mL	5.8 mL	25	6 ¹ / ₈ (156)	500	JL-06226-61	
F	Large capacity, extra-long stem	—	—	2.3 mL	6.0 mL	25	9 (229)	400	JL-06226-69	
G	Large capacity, graduated	0.5 mL	3.0 mL	3.2 mL	7.5 mL	20	6 ¹ / ₈ (156)	500	JL-06226-63	
H	Jumbo bulb, long stem	—	—	8.0 mL	15.0 mL	19	6 ¹ / ₈ (156)	250	JL-06226-51	

Pipette Pump™ Controllers

Dispense more quickly

- Attach pipette and easily dispense via plunger or wheel
- Made of HDPE



For pipettor volume	Color	Catalog number	Price
Pipette pumps			
0.2 mL	Yellow	JL-06221-01	
2.0 mL	Blue	JL-06221-02	
10.0 mL	Green	JL-06221-03	
25.0 mL	Red	JL-06221-04	
Pipette pumps with rapid-release lever			
2.0 mL	Blue	JL-06221-32	
10.0 mL	Green	JL-06221-33	
25.0 mL	Red	JL-06221-34	

Cole-Parmer® Single-Channel Pipettors

Don't sacrifice performance for price

– Ergonomic, lightweight design with soft plunger movement minimizes hand fatigue

Pipettors feature streamlined, low-pressure tip ejector for easy access to narrow containers. They facilitate last drop dispensing and reverse pipetting technique with two-stage plunger operation for blow-out. Easy to calibrate and disassemble for routine servicing or autoclaving. Adjustable-volume pipettors feature quick, easy click-stop, digital volume settings. Individually calibrated in accordance with DIN 12650 Standards and supplied with a computer-generated calibration document supplied by the manufacturer and calibration tool.



Specifications

Tip ejector: tip ejector with blow-out step

Autoclavable: autoclavable tip cone and lower section assembly

Volume	Increments	Accuracy	Reproducibility	Catalog number	Price
Fixed-volume pipettors					
100 µL	—	±0.3%	±0.2%	JL-21600-00	
200 µL	—			JL-21600-02	
500 µL	—			JL-21600-04	
1000 µL	—			JL-21600-06	
5000 µL	—			JL-21600-08	
Adjustable-volume pipettors					
0.1 to 10 µL	0.1 µL	±2.5%	1.33%	JL-21600-10	
5 to 50 µL	1.0 µL	±1.3%	0.7%	JL-21600-12	
20 to 100 µL	1.0 µL	±1.1%	0.4%	JL-21600-14	
40 to 200 µL	1.0 µL	±0.9%	0.3%	JL-21600-16	
200 to 1000 µL	10.0 µL	±0.8%	0.2%	JL-21600-18	
1 to 5 mL	100.0 µL	±0.6%	0.2%	JL-21600-20	



Tips

Volume (µL)	Qty/pk	Catalog number	Price/pk
0.2 to 10	1000	JL-25711-06	
0 to 200	1000	JL-25711-12	
	960	JL-25711-14	
200 to 1300	1000	JL-25711-70	
	1000	JL-18889-08	
1000 to 5000	500	JL-25711-71	
	250	JL-25711-72	

Omega™ Pipette Controllers

Don't be surprised by dead batteries again

- LED display indicates battery charge status
- Contoured buttons ensure comfort during pipetting
- Quick and quiet pump fills a 10-mL pipette in 1.3 seconds
- Accepts glass or plastic serological pipettes, from 1 to 100 mL
- Continue pipetting while connected to the charger or adapter

These compact pipette controllers feature an ergonomic rounded design for comfortable hand fit and light-action button springs for minimal activation pressure. The UV-resistant plastic housing is lightly textured to ensure a slip-resistant grip. Five-bar LED battery charge indicator lights up during use; each bar represents 20% of the rechargeable lithium batteries charge capacity.

What's included: one 0.45 µm sterile filter, pipette wall mount, spare I.D. labels, rechargeable lithium ion battery, AC adapter, and pocket knife.



Specifications

Pipetting rate: 7.7 mL/sec

Autoclavability: nosepiece, filter, adapter, wall mount

No. of speeds: adjustable via thumb dial

Power: rechargeable lithium battery with 115 VAC, 60 Hz adapter

Memory: no

Housing color	Catalog number	Price
Blue	JL-25200-91	
Clear	JL-25200-92	
Purple	JL-25200-93	
Gray	JL-25200-94	
Green	JL-25200-95	
Red	JL-25200-96	



Battery charge LED indicator

Accessories

[JL-25200-66](#) Replacement filters; sterile, 0.45 µm. Pack of 10

[JL-25200-67](#) Replacement filters; nonsterile, 0.45 µm. Pack of 10

[JL-25200-68](#) Silicone pipettor mount for pipette sizes 0.1 to 50 mL

[JL-25200-69](#) Rubber filter interface

[JL-25200-97](#) Battery charger

[JL-25200-98](#) Replacement nose-piece, red

[JL-25200-99](#) Replacement nose-piece, gray

BioPette™ Plus Autoclavable Adjustable-Volume Pipettors

Autoclavable, comfortable, and accurate

- Superior accuracy and reproducibility
- Convenient thumbwheel and push-button volume selection
- Universal shaft accepts most pipette tips

This line of pipettes is ergonomically designed for comfort and engineered to be lightweight and well balanced—use in either your right or left hand. Large digital display provides enhanced visibility. Chemical-resistant, maintenance-free seals and finely polished pistons provide unsurpassed accuracy sample after sample. Adjustable digital micrometer is slightly recessed to prevent unintentional changes and is protected from the effects of thermal expansion by the insulated pipettor body. The tip ejector is ergonomically positioned to reduce fatigue during prolonged use, is adjustable to accommodate various styles of tips, and is removable for pipetting into narrow tubes. Tip ejector's stainless steel construction resists corrosion, rust, and breakage. Pipettors are fully autoclavable.



Specifications

Tip ejector: yes Autoclavable: yes

Volume (mL)	Increments (mL)	Accuracy	Reproducibility	Catalog number	Price
Single-channel pipettors					
0.1 to 2.0	0.02	±0.8%	±0.5%	JL-24601-00	
0.5 to 10	0.02	±0.8%	±0.5%	JL-24601-02	
2 to 20	0.02	±0.8%	±0.6%	JL-24601-04	
10 to 100	0.2	±0.8%	±1%	JL-24601-06	
20 to 200	0.2	±0.8%	±1%	JL-24601-08	
100 to 1000	2	±0.8%	±1%	JL-24601-10	
1000 to 5000	10	±0.8%	±1%	JL-24601-12	
1000 to 10,000	20	±0.8%	±1%	JL-24601-14	
Eight-channel pipettors					
1 to 10	0.02	±0.8%	±0.5%	JL-24601-16	
5 to 50	0.2	±0.8%	±0.5%	JL-24601-18	
20 to 200	0.2	±0.8%	±0.6%	JL-24601-20	
50 to 300	0.5	±0.8%	±1%	JL-24601-22	
Twelve-channel pipettors					
1 to 10	0.02	±0.8%	±0.5%	JL-24601-24	
5 to 50	0.2	±0.8%	±0.5%	JL-24601-26	
20 to 200	0.2	±0.8%	±0.6%	JL-24601-28	
50 to 300	0.5	±0.8%	±1%	JL-24601-30	

Eppendorf® Research® plus Adjustable-Volume Pipettors

Minimize stress and fatigue

- Requires up to 50% less pipetting force
- Designed to fit comfortably in your hand

Spring-loaded tip cone achieves optimal tightness and minimal attachment forces—doing most of the work for you! Make your volume adjustments with just one hand, only a few turns will get you to your desired volume. Four-digit volume display is easy to view. Multichannel pipettors offer channel indicators, in addition to flexibility of removing any of the independent channels—use as many as you need.

Secondary adjustment gives you greater accuracy for specific liquid types. Pipettors are made from Fortron® PPS, which is resistant to acids, alkalis, mildew, bleaches, aging, sunlight, heat, and abrasion. Fully autoclavable for simple decontamination.



Specifications

Calibration: user Tip ejector: yes Autoclavable: yes, fully

Volume	Increments	Accuracy†	Precision†	Control button color	Catalog number	Price
Single-channel pipettors						
0.1 to 2.5 µL	0.002 µL	±1.4%	±0.7%	Dark gray	JL-24505-01	
0.5 to 10 µL	0.01 µL	±1%	±0.4%	Gray	JL-24505-02	
2 to 20 µL	0.02 µL	±1%	±0.3%	Light gray	JL-24505-03	
2 to 20 µL	0.02 µL	±1%	±0.3%	Yellow	JL-24505-04	
10 to 100 µL	0.1 µL	±0.8%	±0.2%	Yellow	JL-24505-05	
20 to 200 µL	0.2 µL	±0.6%	±0.2%	Turquoise	JL-24505-06	
30 to 300 µL	0.2 µL	±0.6%	±0.2%	Orange	JL-24505-07	
100 to 1000 µL	1 µL	±0.6%	±0.2%	Blue	JL-24505-08	
0.5 to 5 mL	5 µL	±0.6%	±0.15%	Violet	JL-24505-09	
1 to 10 mL	10 µL	±0.6%	±0.15%	Turquoise	JL-24505-11	
Eight-channel pipettors						
0.5 to 10 µL	0.01 µL	±2%	±1%	Gray	JL-24505-12	
10 to 100 µL	0.1 µL	±0.6%	±0.3%	Yellow	JL-24505-13	
30 to 300 µL	0.2 µL	±0.8%	±0.3%	Orange	JL-24505-14	
Twelve-channel pipettors (not shown)						
0.5 to 10 µL	0.01 µL	±2%	±1%	Gray	JL-24505-15	
10 to 100 µL	0.1 µL	±0.6%	±0.3%	Yellow	JL-24505-16	
30 to 300 µL	0.2 µL	±0.8%	±0.3%	Orange	JL-24505-17	

†Accuracy and precision values given at maximum volume of pipettor.

Find even more online! Go to ColeParmer.com to search more than 100,000 products.

Pipettes

Lab Supplies

Cole-Parmer® Jiffy-Jack® Lab Jacks

Safely position sample or equipment



- Easily position equipment or sample with a twist of the knob
- Rugged construction stands up to heavy loads
- Add optional support rod for probes, clamps, or other items



Model 08057-20 supports up to 132 lb (60 kg).

Top plate dimensions	Open height	Closed height	Max support static load	Catalog number	Price
Plastic lab jack					
8" x 8" (20.3 x 20.3 cm)	12" (30.5 cm)	3" (7.6 cm)	15 lb (6 kg)	JL-08055-50	
Aluminum lab jacks					
4" x 4" (10.2 x 10.2 cm)	5" (12.7 cm)	2½" (6.4 cm)	66 lb (30 kg)	JL-08057-10	
6" x 6" (15.2 x 15.2 cm)	9¾" (24.8 cm)	3" (7.6 cm)	132 lb (60 kg)	JL-08057-20	
8" x 8" (20.3 x 20.3 cm)	13" (33.0 cm)	3½" (8.9 cm)	176 lb (80 kg)	JL-08057-30	
10" x 10" (25.4 x 25.4 cm)	13" (33.0 cm)	3½" (8.9 cm)	198 lb (90 kg)	JL-08057-40	
Stainless steel heavy-duty lab jacks					
3" x 3" (7.6 x 7.6 cm)	5" (12.7 cm)	2½" (6.4 cm)	20 lb (9.0 kg)	JL-08057-12	
4" x 4" (10.2 x 10.2 cm)	5" (12.7 cm)	2½" (6.4 cm)	30 lb (13.6 kg)	JL-08057-14	
6" x 6" (15.2 x 15.2 cm)	9¾" (24.8 cm)	3" (7.6 cm)	35 lb (15.8 kg)	JL-08057-16	
8" x 8" (20.3 x 20.3 cm)	13" (33.0 cm)	3½" (8.9 cm)	55 lb (25.0 kg)	JL-08057-18	
10" x 10" (25.4 x 25.4 cm)	13" (33.0 cm)	3½" (8.9 cm)	80 lb (36.3 kg)	JL-08057-22	
12" x 12" (30.5 x 30.5 cm)	19½" (49.5 cm)	4" (10.2 cm)	150 lb (68.0 kg)	JL-08057-24	
16" x 16" (40.6 x 40.6 cm)	19½" (49.5 cm)	4" (10.2 cm)	180 lb (81.6 kg)	JL-08057-26	

[JL-08057-50](#) Ratchet tool adds extra leverage to models 08057-24 and -26

[JL-08057-52](#) Support rod kit allows you to mount a 17" (43.2 cm) L vertical support rod to models 08057-16, -18, -22, -24, and -26

Supports & Clamps

Keck® Connectors, Clamps, and Clips

Keep connections together

A. Keck Original Standard Taper Clips

Economical standard taper clips securely hold conical joints under pressure without damaging glass. The polyoxymethylene (POM) acetal resin clips are safe to 302°F (150°C). Resistant to concentrated alkalis and dilute acids (not resistant to halogen gases and concentrated acids).



Plastic taper clips are easy to attach and remove.

Joint size no.	Color	Qty/pk	Catalog number	Price/pk
10	Green	12	JL-06839-90	
12	Violet		JL-06839-95	
14	Yellow		JL-06840-05	
19	Blue	12	JL-06840-10	
24	Green		JL-06840-15	
29	Red		JL-06840-20	
34	Orange	12	JL-06840-25	
40	Yellow		JL-06840-30	
45	Brown		JL-06840-35	

[JL-06840-00](#) Standard taper clip assortment pack. Six each of sizes 14, 19, 24, and 29 (24 total)

[JL-06840-50](#) Standard taper clip assortment pack. Three each of all nine sizes in table above (27 total)

B. Keck Metal Standard Taper Clips

Durable nickel-plated steel taper clips securely hold conical joints under pressure. Clips offer superior chemical and temperature resistance—withstanding temperatures to 932°F (500°C).



Joint size no.	Qty/pk	Cat. no.	Price/pk
14	6	JL-06836-05	
19		JL-06836-10	
24		JL-06836-15	
29		JL-06836-20	

C. Keck Ball-Joint Clips

Secure ball and socket joints—no locking screw required. Polyoxymethylene (POM) acetal resin clips are safe to 302°F (150°C). Resistant to concentrated alkalis and dilute acids (not resistant to halogen gases or concentrated acids).



Joint size no.	Color	Qty/pk	Catalog number	Price/pk
13	Violet	12	JL-06838-10	
19	Blue		JL-06838-15	
29	Red		JL-06838-20	
35	Orange		JL-06838-25	

Lab Supplies



Hamilton Standard Microliter® Syringes

Provide precise liquid delivery—from 10 to 500 µL

Syringes with Cemented and Removable needles include a 304 stainless steel needle with a noncoring beveled tip—ideal for septum penetration in all chromatographic techniques. If you use large numbers of syringes, choose one of our convenient “economy packs” containing six 10-µL syringes with cemented or removable needles. Each pack is in a protective storage container and includes a set of adhesive-backed numbers for syringe identification.

Syringes with Luer Tip Connections do not include a needle; order needles separately; see ColeParmer.com.



Syringes		Needles		Catalog number	Price/ea	Economy packs	
Capacity	Type	Gauge‡	Tip type			Catalog number	Price/pk of 6
10 µL	Cemented needle	26s	Noncoring beveled	JL-07938-00		JL-07938-30	
	Removable needle			JL-07938-10		JL-07938-40	
25 µL	Cemented needle	22s	Noncoring beveled	JL-07938-01		—	—
	Removable needle			JL-07938-11		—	
	Luer tip†			JL-07938-21		—	
50 µL	Cemented needle	22s	Noncoring beveled	JL-07938-02		—	—
	Removable needle			JL-07938-12		—	
	Luer tip†			JL-07938-22		—	
100 µL	Cemented needle	22s	Noncoring beveled	JL-07938-03		—	—
	Removable needle			JL-07938-13		—	
	Luer tip†			JL-07938-23		—	
250 µL	Cemented needle	22s	Noncoring beveled	JL-07938-04		—	—
	Removable needle			JL-07938-14		—	
	Luer tip†			JL-07938-24		—	
500 µL	Cemented needle	22s	Noncoring beveled	JL-07938-05		—	—
	Removable needle			JL-07938-15		—	
	Luer tip†			JL-07938-25		—	

†Luer tip syringes do not include a needle; order separately.

‡An “s” denotes “small bore”—reduces dead volume and provides impedance to improve transfer accuracy.

Syringes

BD™ Disposable Syringes

Luer-Lok™ tips allow for easy connection of syringe filters

Use these latex-free, disposable polycarbonate syringes for your general-purpose applications. Available in either Luer-Lok or slip-tip versions. Autoclavable.



Capacity	Graduations	Type	Qty	Catalog number	Price
Sterilized syringes, individually wrapped					
1 mL	1/100 mL	Luer-Lok	100/bx	JL-07940-00	
3 mL	1/10 mL	Luer-Lok	200/bx	JL-07940-02	
		Slip tip		JL-07940-04	
5 mL	1/5 mL	Luer-Lok	100/bx	JL-07940-06	
		Slip tip	125/bx	JL-07940-08	
10 mL	1/5 mL	Luer-Lok	100/bx	JL-07940-12	
		Slip tip		JL-07940-14	
60 mL	1 mL, 2 oz in 1/4 oz	Luer-Lok	40/bx	JL-07940-30	
		Slip tip		JL-07940-28	
Nonsterilized syringes					
1 mL	1/100 mL	Slip tip	100/pk	JL-07944-00	
3 mL	1/10 mL	Luer-Lok	100/pk	JL-07944-02	
		Slip tip		JL-07944-04	
5 mL	1/5 mL	Luer-Lok	100/pk	JL-07944-06	
		Slip tip		JL-07944-08	
10 mL	1/5 mL	Luer-Lok	50/pk	JL-07944-12	
		Slip tip		JL-07944-14	
20 mL	1 mL, 3/4 oz in 1/2 oz	Luer-Lok	25/pk	JL-07944-16	
		Slip tip		JL-07944-18	

Capacity	Graduations	Type	Qty	Catalog number	Price
Nonsterilized syringes (cont.)					
30 mL	1 mL, 1 oz in 1/2 oz	Luer-Lok	25/pk	JL-07944-24	
		Slip tip		JL-07944-22	
60 mL	1 mL, 2 oz in 1/4 oz	Luer-Lok	25/pk	JL-07944-28	
		Slip tip		JL-07944-30	
Nonsterilized syringes, bulk pack					
1 mL	1/100 mL	Slip tip	3000/cs	JL-07945-00	
3 mL	1/10 mL	Luer-Lok	1600/cs	JL-07945-02	
		Slip tip		JL-07945-04	
5 mL	1/5 mL	Luer-Lok	1400/cs	JL-07945-06	
		Slip tip		JL-07945-08	
10 mL	1/5 mL	Luer-Lok	850/cs	JL-07945-12	
		Slip tip		JL-07945-14	
20 mL	1 mL, 3/4 oz in 1/2 oz	Luer-Lok	325/cs	JL-07945-16	
		Slip tip		JL-07945-18	
30 mL	1 mL, 1 oz in 1/2 oz	Luer-Lok	225/cs	JL-07945-24	
		Slip tip		JL-07945-22	
60 mL	1 mL, 2 oz in 1/4 oz	Luer-Lok	125/cs	JL-07945-28	
		Slip tip		JL-07945-30	

Warning—These products are not approved or intended for, and should not be used for, medical, clinical, surgical or other patient oriented applications.

Lab Supplies

General-Purpose Tweezers and Forceps, Stainless Steel (SS) and Plastic

Get a more precise grip

Buy More...Save More!

20% off on 120+
15% off on 30 to 119
10% off on 6 to 29 packs or cases

SS Tweezers,
straight tips and finger serrations.



Length	Catalog number	Qty/ pk	Price/pk
7"	JL-07288-04	12	\$

SS Straight: Thick, Flat Strong Tips,
serrated tips and grips. Style OOD.

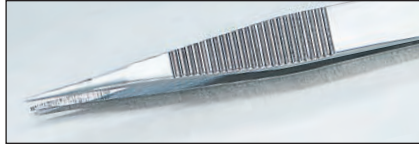

Length	Catalog number	Qty/ pk	Price/pk
4 1/4"	JL-07287-03	1	\$

SS Self-Locking Tweezers,
straight narrow tips.



Length	Catalog number	Qty/ pk	Price/pk
4 1/4"	JL-07288-01	12	\$

SS Tweezers,
smooth spade tips.

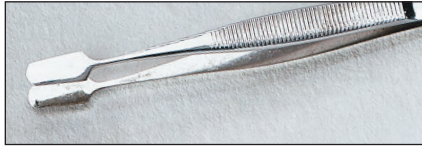

Length	Catalog number	Qty/ pk	Price/pk
4 1/4"	JL-07288-07	12	\$

SS Solder Utility Tweezers,
curved tips and finger serrations.



Length	Catalog number	Qty/ pk	Price/pk
7"	JL-07288-03	12	\$

SS Tweezers,
curved serrated tips.

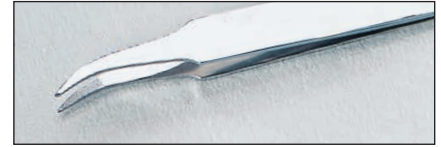

Length	Catalog number	Qty/ pk	Price/pk
4 1/4"	JL-07288-05	12	\$

SS Forceps,
straight serrated tips.



Length	Catalog number	Qty/ pk	Price/pk
6"	JL-07288-12	1	\$
12"	JL-07288-14	1	\$

SS Forceps,
plastic-coated rounded tips.



Length	Catalog number	Qty/ pk	Price/pk
12"	JL-07288-10	1	\$

PTFE-Covered Nickel-Plated Forged Steel Forceps are heat and chemical resistant. **Autoclavable.**



Length	Catalog number	Qty/ pk	Price/pk*
4 1/4"	JL-06440-00	2	\$

*Quantity discount does not apply.

Reinforced Nylon Forceps have corrugated handles, serrated blades, and rounded tips. **Autoclavable.** Sterile—individually wrapped.

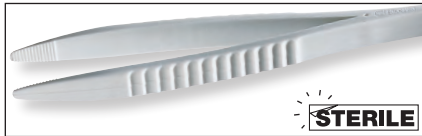

Sterile	Length	Catalog number	Qty/ pk	Price/pk
No	4 7/8"	JL-06443-15	100	\$
Yes	4 3/8"	JL-06443-26	100	\$

Nylon Forceps feature corrugated handles and serrated blades. **Autoclavable.** Sterile—individually wrapped.

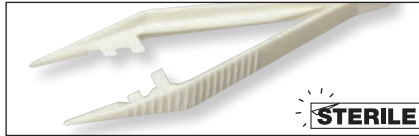

Sterile	Length	Catalog number	Qty/ pk	Price/pk
No	4 1/4"	JL-06443-25	100	\$
Yes	4 1/4"	JL-06443-27	70	\$

PA (Polyamide) Tweezers,
rounded tips.

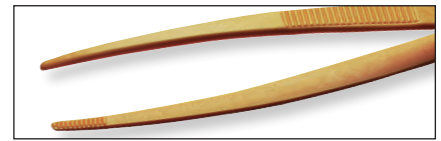

Length	Catalog number	Qty/ pk	Price/pk
7"	JL-06446-20	1	\$

Polystyrene Disposable Sterile Forceps feature corrugated handles and rounded serrated tips. Sterile—come individually wrapped.

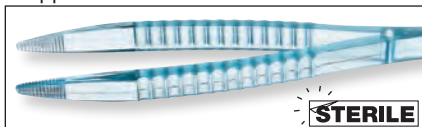

Length	Catalog number	Qty/ pk	Price/pk*
4 7/8"	JL-06443-20	100	\$

*Quantity discount does not apply.

Plastic Curved: Smooth Rounded Tips 2AB



Length	Catalog number	Qty/ pk	Price/pk
4 1/2"	JL-07290-06	12	\$

Plastic Curved: Very Fine and Smooth Tips 7-STD



Length	Catalog number	Qty/ pk	Price/pk
4 1/2"	JL-07290-08	12	\$

Get excellent chemical compatibility—even with harsh chemicals

MASTERFLEX[®] **Solve-Flex[®] Pump Tubing**

- One formulation for all chemicals—reduces the number of tubings you keep on hand
- Get longer life with flexible outer jacket
- Fluoropolymer liner for low spallation and assured purity of fluid
- Smooth-bore fluoropolymer liner is plasticizer-free, hydrophobic, and resists the absorption/adsorption of aqueous fluids
- Meets USP Class VI requirements

Plasticizer-free fluoropolymer inner layer

Thermoplastic-elastomer outer layer

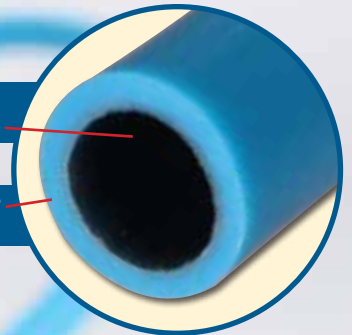

Find out more!
See pages 11, 13

BioConnect[®]
Single-Use Custom Assemblies

Your Source for Custom Bioprocess Solutions

- ◆ **Save valuable time**—get custom assemblies crafted to your exact specifications
- ◆ **Choose your components**—select from your trusted brands
- ◆ **Ensure quality and regulatory compliance** with complete validation

866-802-0579 ColeParmer.com/BioConnect



625 East Bunker Court
Vernon Hills, IL 60061-1844

Phone: 800-323-4340
Fax: 847-247-2929
E-mail: info@coleparmer.com
www.coleparmer.com

CHANGE SERVICE REQUESTED



- ✓ Correct this address
- ✓ Unsubscribe from future mailings
- ✓ Remove name gone from organization

Simply go to www.wastefreemail.com and enter code from green box below left or fax this cover to 571-970-6072

Presorted Standard
U.S. Postage
PAID
Cole-Parmer
Instrument Company

Printed in U.S.A.

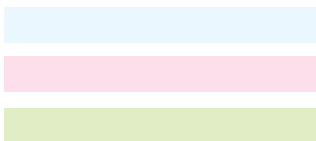

99999-16

4009

You Need It.
We've Got It! Guaranteed.



See inside for details

GET PUMPING!

**Transfer, dispense,
and meter accurately**

Masterflex® L/S® Process
Stainless Steel Pump
See page 19

**Get up to speed and
pumping in no time!**

Catalyst™ FH100D
Peristaltic Dispensing Pump
See page 42

**Control all channels
independently**

Ismatec® ICC Peristaltic Pump
See page 35

Need a custom solution?

Our design engineers will partner with you to create the exact pump you need. **Contact us today to get started!**

800-323-4340 ColeParmer.com/tapps